

Valves and Components
Ventil-Komponente
Valvole e Componenti
Soupapes et Composants
Válvulas y Componentes
Zawory i elementy zaworowe
Клапана и детали ГРМ
صمامات والمكونات

CATAE1901



2019-2021

ENGINE EXPERTISE BY  **FEDERAL-MOGUL
MOTORPARTS**



EXPERTISE INSIDE OUT TOP TO BOTTOM



 **Payen**[®]

 **GOETZE**[®]

Niral[®]



 **GLYCO**[®]



WHY WOULD YOU RELY ON OUR 5 ENGINE BRANDS?

- Market-leading coverage with high-quality materials and components
- Comprehensive range
- Take full benefit of the latest engine technologies:
Coriuseal[™], Coriusim[™], LKZ-Ring[®], Carboglide[®], IROX[®] and Durabowl[®]
- OE quality solutions for the Aftermarket
- Dedicated technical support and training for distributors and repair specialists

ENGINE EXPERTISE
BY  **FEDERAL-MOGUL**
MOTORPARTS





AE[®] INTRODUCES SODIUM-FILLED HOLLOW VALVES

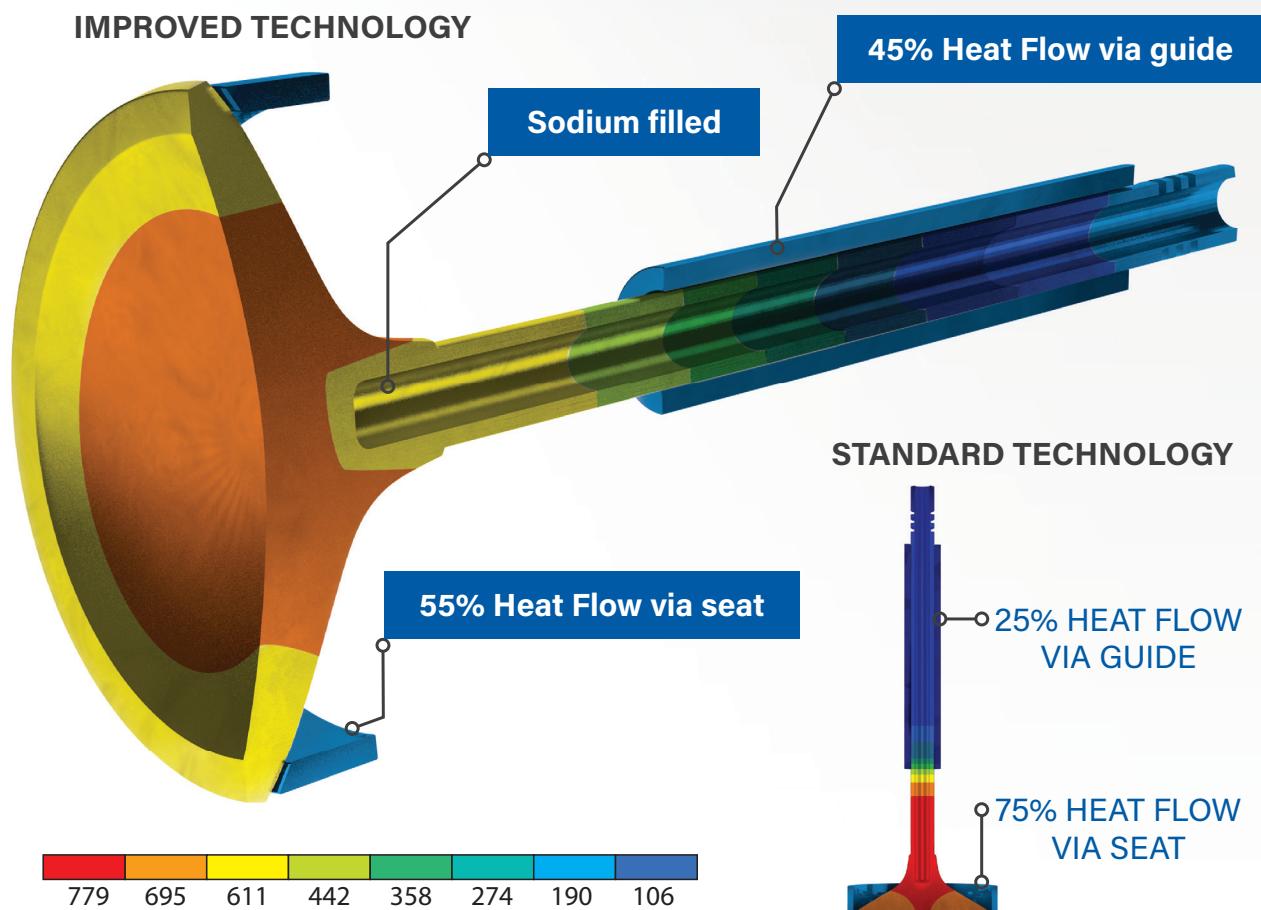

The heat dissipation via the valve guide is greater with sodium-filled valves, which prevents the engine from overheating and increases performance & durability. Its hollow structure makes the valve lighter and helps reduce automotive emissions.

TECHNOLOGY HIGHLIGHTS

- Temperature reduction in the underhead region between 80°C to 150°C
- Heat dissipation reduced from the seat and transferred through to the guide by 20%
- Weight reduction by up to 16%



ENGINE EXPERTISE

BY **FEDERAL-MOGUL
MOTORPARTS**



All trademarks shown are owned by Federal-Mogul LLC or one or more of its subsidiaries in one or more countries.

CONTENTS



| | |
|-----------------------------------|------|
| Contents | II |
| BER certificate | IV |
| Manufacturers list | V |
| F-M MP Anti-Counterfeit programme | VI |
| Terms of business | VIII |
| How to use this catalogue | X |
| New Parts List | 2 |
| Application | 21 |
| Numerical parts list | 938 |
| Valve guides | 975 |
| Valve seats semi finished | 978 |
| Valve seats fully finished | 979 |
| OE interchange | 980 |
| Technical notes | 992 |
| AE Valves trouble tracer | 996 |



| | |
|--------------------------------|------|
| Inhaltsverzeichnis | II |
| GVO-Zertifikat | IV |
| Herstellerliste | V |
| F-M MP Anti-Fälschungsprogramm | VI |
| Geschäftsbedingungen | VIII |
| So benutzen Sie diesen Katalog | XI |
| Neuaufnahmen | 2 |
| Anwendungen | 21 |
| Numerische Teileliste | 938 |
| Ventilführungen | 975 |
| Halbfertige Ventilsitze | 978 |
| Einbaufertige Ventilsitze | 979 |
| OE-Umschlüsselungsliste | 980 |
| Technische Hinweise | 992 |
| Symptome und Ausfallursachen | 996 |





| | |
|--|------|
| Contenuti | II |
| Certificazione BER | IV |
| Elenco costruttori | V |
| Programma di anti-contraffazione di F-M MP | VI |
| Condizioni generali | VIII |
| Come si utilizza il catalogo | XII |
| Elenco nuovi componenti | 2 |
| Applicazioni | 21 |
| Elenco riferimenti | 938 |
| Guidavalvole | 975 |
| Sedi valvole semilavorate | 978 |
| Sedi valvole finite | 979 |
| Intercambi con OE | 980 |
| Note Tecniche | 992 |
| Analisi danni valvole AE | 996 |



| | |
|---|------|
| Contenu | II |
| Certificat BER | IV |
| Liste des constructeurs | V |
| Le programme anti-contrefaçon de F-M MP | VI |
| Conditions générales de vente | VIII |
| Comment utiliser ce catalogue | XIII |
| Liste des nouveautés | 2 |
| Applications | 21 |
| Liste des références | 938 |
| Guides de soupape | 975 |
| Sièges de soupape semi-finis | 978 |
| Sièges de soupape finis | 979 |
| Cross-list OE | 980 |
| Notes techniques | 992 |
| Tableau des défauts | 996 |

| | |
|---|---|
|  |  |
| Índice..... III | Zawartość..... III |
| Certificación BER..... IV | Certyfikat BER..... IV |
| Lista de constructores..... V | Lista producentów..... V |
| Programa antifalsificación de F-M MP..... VI | Program przeciwdziałania podrabianiu części F-M MP..... VI |
| Condiciones de venta..... IX | Warunki prowadzenia działalności..... IX |
| Cómo utilizar este catálogo..... XIV | Jak korzystać z tego katalogu..... XV |
| Lista de referencias nuevas..... 2 | Lista nowych produktów..... 2 |
| Aplicaciones..... 21 | Zastosowania..... 21 |
| Lista de referencias numéricas..... 938 | Lista numeryczna części..... 938 |
| Guías de válvula..... 975 | Prowadnice zaworowe..... 975 |
| Asientos de válvula semiacabados..... 978 | Gniazda zaworowe wstępnie wykończone..... 978 |
| Asientos de válvula totalmente acabados..... 979 | Gniazda zaworowe całkowicie wykończone..... 979 |
| Lista de cruce de referencias de equipo original..... 980 | Lista zamienników OE..... 980 |
| Notas técnicas..... 992 | Uwagi techniczne..... 992 |
| Apartado de resolución de problemas Válvulas AE..... 996 | Zawory - najczęściej występujące problemy..... 996 |

| | |
|---|---|
|  |  |
| Содержание..... III | المحتويات..... III |
| Сертификация BER..... IV | شهادة BER..... IV |
| Список производителей..... V | قائمة جهات التصنيع..... V |
| Программа защиты от подделок F-M MP..... VI | برنامج جديد لمكافحة إنتاج قطع الغيار المقلدة F-M MP..... VI |
| Условия сотрудничества..... IX | شروط العمل التجاري..... IX |
| Как пользоваться каталогом..... XVI | كيفية استخدام هذا الكتالوج..... XVI |
| Список новинок ассортимента деталей..... 2 | قائمة قطع الغيار الجديدة..... 2 |
| Применимость с сортировкой по производителям..... 21 | تطبيقات جهة التصنيع..... 21 |
| Нумерованный список деталей..... 938 | قائمة القطع المرقمة..... 938 |
| Направляющие клапанов..... 975 | موجهات الصمامات..... 975 |
| Седла клапанов, полуобработанные..... 978 | مقاعد الصمامات تشطيب شبه نهائي..... 978 |
| Седла клапанов, полностью обработанные..... 979 | مقاعد الصمامات تشطيب تام..... 979 |
| Взаимозаменяемость с оригинальными деталями..... 980 | قائمة تبديل المعدات الأصلية..... 980 |
| Технические примечания..... 992 | الملاحظات التقنيّة..... 992 |
| Диагностика неисправностей клапанов AE и методы их устранения..... 996 | كاشف المشاكل لصمامات AE..... 996 |



Certificate for the use of Federal-Mogul Motorparts products in the European Aftermarket according to MV BER EC 461/ 2010 and respective Guidelines

According to the paragraph 19 and 20 of the supplementary guidelines for the new EU regulation N° 461/2010 on vertical restraints in agreements for the sale and repair of motor vehicles and the sales of automotive replacement parts from 05/27/2010.

Our original parts match the quality of the components used for the assembly of the motor vehicle in question as designated and have been manufactured according to the specifications and production standards of the motor vehicle according to Recital (19), our 'matching quality parts' match the quality according to Recital (20) of the guidelines.

We hereby confirm, that the Federal-Mogul Motorparts products using the brand names AE®, ABEX®, BERAL®, BERU®, CHAMPION®, DURON®, FERODO®, FP DIESEL®, GLYCO®, GOETZE®, JURID®, MOOG®, NECTO®, NÜRAL®, PAYEN®, QUICK STEER®, STOP®, WAGNER™ sold in the European Aftermarket, fulfill the quality requirements applicable to the use of spare parts for repair or maintenance of motor vehicles by authorised repairers.

Date: 01/01/2018



Andrew Sexton
President EMEA Aftermarket
Federal-Mogul Motorparts



Beru® is a registered trademark of BorgWarner. All other trademarks shown are owned by Federal-Mogul LLC or one or more of its subsidiaries in one or more countries.

MANUFACTURERS LIST

| | | | |
|---------------|-------------------|---------------|-------------|
| ABARTH | see FIAT | LEXUS | 373 |
| ALFA ROMEO | 21 | LOTUS | 374 |
| AUDI | 39 | MAN | 375 |
| AUSTIN | see AUSTIN MORRIS | MAZDA | 405 |
| AUSTIN MORRIS | 81 | MERCEDES-BENZ | 411 |
| AUTOBIANCHI | 83 | MG | 544 |
| BEDFORD | 86 | MINI | 547 |
| BMW | 89 | MITSUBISHI | 551 |
| CHEVROLET | 116 | MWM | 558 |
| CHRYSLER | 126 | NISSAN | 565 |
| CITROËN | 130 | OPEL | 580 |
| DACIA | 157 | PERKINS | 610 |
| DAEWOO | 161 | PEUGEOT | 616 |
| DAF | 167 | PORSCHE | 646 |
| DAIHATSU | 173 | PROTON | 652 |
| DAIMLER | see JAGUAR | RENAULT | 654 |
| DEUTZ / KHD | 174 | ROVER | 718 |
| DS | see CITROËN | SAAB | 725 |
| FIAT | 189 | SAVIEM | see RENAULT |
| FORD | 227 | SCANIA | 730 |
| FSO | see FIAT | SEAT | 744 |
| HONDA | 272 | SKODA | 768 |
| HYUNDAI | 279 | SMART | 783 |
| INNOCENTI | see FIAT | SSANGYONG | 786 |
| ISUZU | 289 | SUBARU | 789 |
| IVECO | 292 | SUZUKI | 793 |
| JAGUAR | 331 | TOYOTA | 801 |
| JEEP | 335 | VAUXHALL | 815 |
| KIA | 337 | VOLVO | 843 |
| LADA | 343 | VW | 874 |
| LANCIA | 347 | ZASTAVA | 934 |
| LAND ROVER | 366 | | |





**KEEP IT REAL
KEEP OUT COUNTERFEIT**

The authenticity of all our engine and sealing products is protected by the MAPP Code (Manufacturers Against Product Piracy) and the PrioSpot® Authentication device, featured on a special Anti-Counterfeit label on the packaging. In this way you can be sure of our trusted Federal-Mogul Motorparts quality!

HOW TO CHECK THE AUTHENTICITY OF YOUR PRODUCTS

1 Check if the packaging is closed and the label is intact

2 Verify the unique alphanumeric code and data matrix code

→ Type in the alphanumeric code at www.fmecat.eu

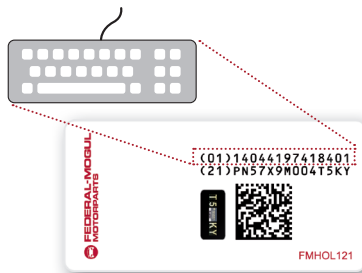

→ Read the Data Matrix Code with a 2-D scanner

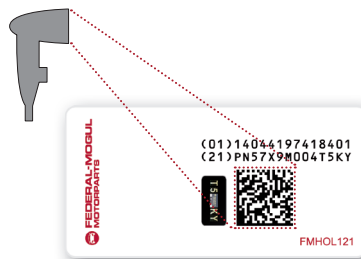

→ Read the Data Matrix Code on your smartphone with NeoReader™ App



3 Verify the unique security code on the PrioSpot® Label

→ Different code on each packaging



→ Code contains the last 4 digits of the alphanumeric code

→ The code and the Federal-Mogul Motorparts logo shimmer in rainbow colours only in direct light

→ Only in direct light a digit, repeating the last digit of the security code, is visible. This digit will move up and down when you change the angle of the PrioSpot®

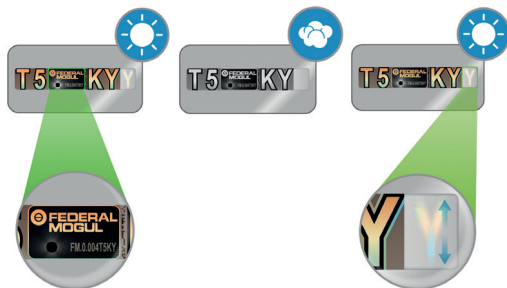

ENGINE EXPERTISE
BY **FEDERAL-MOGUL**
MOTORPARTS



NOTES



TERMS OF BUSINESS

IMPORTANT

Reproduction of this catalogue or parts thereof is only allowed with our explicit permission in writing. Pictorial representations and design are copyrighted. Claims for damages, of any form whatsoever, resulting from details made in this catalogue or from incorrect use, application, storage or handling, are explicitly excluded. Contractual rights and any resulting or related claims based thereon, irrespective of form, initially come into being on the basis of a separate written agreement, in particular on the basis of our general terms of sale and delivery.

All former statements lose their validity with the publication of this catalogue.

The catalogue is not an operating manual for the use and installation of the valves and components. It does not contain any advice in a legal sense. The catalogue neither replaces the constantly applicable technical regulations - particularly for tolerances - nor the installation and maintenance stipulations of the individual engine manufacturer.

Also, it is not possible to forego the expertise of those carrying out the installation and application. The individual references made in this catalogue for the installation and the application of the valves and components are instructions solely for the technically qualified specialist and are to be checked and verified by them for their suitability in each case. Federal-Mogul accepts no responsibility for application decisions.

The contents of the catalogue are not intended to create or substitute any contractual agreement which has to be reserved exclusively to a separate agreement between 2 identified parties, whereby seller can be only one of our Federal-Mogul entities as mentioned on the back cover page.

The right is retained to correct errors and alterations, particularly with regard to amendments in the engine manufacturers details and stipulations.

GESCHÄFTSBEDINGUNGEN – WICHTIGE HINWEISE

Nachdruck, auch auszugsweise, ist nur mit unserer ausdrücklichen schriftlichen Zustimmung gestattet. Die bildlichen Darstellungen und Ausstattungen sind geschützt. Ersatzansprüche, gleich welcher Art, aufgrund der Angaben in diesem Katalog oder auf Grund unsachgemäßem Umgang, unsachgemäßer Verwendung, Lagerung oder Handhabung der angebotenen Produkte, sind ausdrücklich ausgeschlossen. Vertragliche Ansprüche und daraus abgeleitete oder darauf beruhende Ansprüche, gleich welcher Art, kommen erst auf Grund einer besonderen schriftlichen Vereinbarung, insbesondere auf der Grundlage unserer allgemeinen Verkaufs- und Lieferbedingungen, zustande.

Der Katalog ist keine Einbauanleitung für Ventile und Komponenten.

Er enthält keine Beratung im Rechtssinne. Der Katalog ersetzt weder die immer vorrangigen technischen Vorschriften, insbesondere für Toleranzen, sowie die Einbau- und Wartungsvorschriften des jeweiligen Motorenherstellers, noch kann auf das notwendige Fachwissen des die Montage und die Verwendung Durchführenden verzichtet werden. Die in diesem Katalog jeweils gegebenen Hinweise für Einbau und Verwendung der Ventile und Komponenten sind Hinweise ausschließlich für den technisch ausgebildeten und versierten Fachmann, die von ihm im jeweiligen Anwendungsfall auf ihre Eignung geprüft und entschieden werden müssen. Eine Haftung wird von Federal-Mogul für Anwendungsentscheidungen nicht übernommen. Die Inhalte dieses Katalogs sind nicht dazu bestimmt eine vertragliche Verpflichtung zu begründen oder zu ersetzen, was ausschliesslich einer gesonderten Vereinbarung zwischen 2 konkret bezeichneten Parteien vorbehalten bleibt, wobei der Verkäufer eine unserer Federal-Mogul Gesellschaften sein wird, wie auf der Rückseite des Kataloges.

Die Korrektur von Irrtümern und Änderungen, in besondere auf Grund von geänderten Angaben und Vorschriften der Motorenhersteller, bleibt vorbehalten.

CONDIZIONI GENERALI - IMPORTANTE

La riproduzione di questo catalogo, anche parziale, è permessa soltanto in seguito ad una autorizzazione scritta. I grafici ed i disegni sono marchio depositato. Reclami per difetti, di qualsiasi natura essi siano, relativi al contenuto di questo catalogo, o all'uso improprio di esso, verranno respinti. Le pretese avanzate od i reclami dovranno essere in conformità con le nostre condizioni generali di vendita.

Il presente catalogo annulla e sostituisce tutte le edizioni precedenti.

Il catalogo non è un manuale per l'utilizzo ed il montaggio delle valvole e componenti. Non contiene indicazioni in questo senso. Esso non sostituisce le descrizioni tecniche, sempre prioritarie, in particolare per le tolleranze, né le istruzioni relative al montaggio ed alla manutenzione date dai costruttori dei rispettivi motori. Non può in nessun caso essere paragonato alla conoscenza professionale necessaria per il montaggio e l'utilizzo. Le considerazioni sul montaggio delle valvole e componenti, fatte su questo catalogo, sono destinate esclusivamente a professionisti con formazione tecnica i quali verificheranno l'esattezza della informazioni, in ogni caso.

Le responsabilità derivanti dall'utilizzo improprio dello stesso non potranno essere addebitate alla Federal-Mogul.

I contenuti del catalogo non sostituiscono in alcun modo gli accordi contrattuali che sono riservati esclusivamente a due contraenti definiti; come venditore si intende una delle società Federal Mogul menzionate sul retro del catalogo.

Ci riserviamo di apportare correzioni e modifiche, relative, in particolare, a dati o istruzioni ricevute dal costruttore del motore.

CONDITIONS GÉNÉRALES DE VENTE - IMPORTANT

La reproduction de ce catalogue, même partielle, n'est autorisée qu'avec notre accord préalable et par écrit. Les illustrations graphiques et la présentation font l'objet d'un copyright. Nous excluons toutes réclamations ayant pour objet ce catalogue ou pouvant résulter de son incompréhension, portant sur de mauvaises utilisations, manipulations, manutentions ou mauvais stockage. Des droits contractuels et des droits dérivés, de quelque nature qu'ils soient, ne peuvent résulter que d'un accord écrit, particulièrement sur la base de nos conditions générales de ventes et de livraisons.

Ce catalogue annule et remplace toute édition antérieure.

Le catalogue n'est pas une notice d'utilisation et de montage des soupapes et composants. Il ne contient pas de directives en tant que telles. Le catalogue ne remplace ni les prescriptions techniques, toujours prioritaires, particulièrement pour les tolérances, ni les prescriptions de montage et d'entretien des constructeurs des moteurs figurant dans ce catalogue. Il ne peut en aucun cas remplacer les connaissances professionnelles nécessaires pour le montage et l'utilisation. Les remarques données pour le montage et l'utilisation des soupapes et composants sont exclusivement destinées au professionnel averti et de formation technique, à qui il appartiendra de vérifier la conformité des indications pour chaque cas. La responsabilité des décisions d'utilisation ne peut être prise en charge par Federal-Mogul.

Le contenu de ce catalogue ne peut constituer ou remplacer un contrat qui doit faire l'objet d'un document séparé établi entre 2 parties, dont l'une doit être une entité légale de Federal-Mogul dont la liste figure sur la couverture arrière.

Nous nous réservons le droit d'apporter toutes corrections d'erreurs et modifications, suite notamment à de nouvelles données fournies par les constructeurs.

TERMS OF BUSINESS

CONDICIONES DE VENTA - IMPORTANTE

Queda totalmente prohibida la reproducción, total o parcial, del contenido de este catálogo, salvo previa autorización nuestra, realizada por escrito. Están, asimismo, reservados todos los derechos sobre el diseño y presentación del catálogo. No se aceptará ningún tipo de reclamación que esté basada en la interpretación de los datos contenidos en este catálogo, así como en el incorrecto uso, manipulación o almacenaje de nuestras piezas. Únicamente se aceptarán reclamaciones que estén basadas en derechos contractuales o en los motivos arriba indicados, siempre que exista un acuerdo especial y por escrito basado en nuestras condiciones generales de venta y suministro.

Con la edición de este catálogo queda anulada toda la información contenida en catálogos anteriores.

El catálogo no es un manual para el uso e instalación de los válvulas y componentes, y no representa una asesoría técnica, en el sentido legal. Los datos del catálogo no sustituyen, en ningún caso, a las especificaciones técnicas, tanto en lo que se refiere a tolerancias como a las instrucciones de instalación y mantenimiento, indicadas por los fabricantes de los motores, especificaciones que serán siempre prioritarias. Se entiende que el uso y montaje de estas piezas está encomendado a personal debidamente cualificado. Las indicaciones sobre uso y montaje de las válvulas y componentes contenidas en este catálogo, están exclusivamente dirigidas a profesionales con la debida capacitación y formación técnica, que deben decidir en cada caso sobre la exactitud de las mismas. La responsabilidad de estas decisiones no puede ser, en ningún caso, achacada a Federal-Mogul.

La información facilitada en el catálogo no representa o sustituye ningún tipo de acuerdo, quedando a tal efecto, el acuerdo por separado entre dos partes donde sólo entidades de Federal-Mogul, pueden ser identificadas como la parte vendedora como se menciona en la contraportada.

Los datos e instrucciones contenidos en este catálogo podrán ser corregidos o modificados sin previo aviso.

WARUNKI PROWADZENIA DZIAŁALNOŚCI - WAŻNE

Reprodukcja tego katalogu lub jego części jest możliwa tylko za wyraźną zgodą na piśmie. Ilustracje i grafika są chronione prawem autorskim. Roszczenia dotyczące szkód, niezależnie od formy, wynikających z przedstawionych w tym katalogu treści lub z nieprawidłowego użycia, zastosowania, przechowywania lub obsługi są w sposób wyraźny wyłączone. Prawa umowne i inne wynikające lub związane z roszczeniami na nimi opartymi, niezależnie od formy, są tworzone na podstawie oddzielnej umowy pisemnej, w szczególności na podstawie naszych ogólnych warunków sprzedaży i dostawy. Wszystkie wcześniejsze oświadczenia tracą ważność wraz z opublikowaniem tego katalogu.

Katalog nie jest instrukcją obsługi i instalacji śrub głowicowych zaworów i komponentów. Nie zawiera porad w sensie prawnym. Katalog nie zastępuje obowiązujących uregulowań technicznych – zwłaszcza w zakresie tolerancji – ani opisów montażu i konserwacji poszczególnych producentów silników. Nie jest również możliwe pominięcie doświadczenia osob dokonujących doboru i przeprowadzających montaż części. Poszczególne odniesienia zawarte w tym katalogu, a dotyczące doboru, montażu i stosowania śrub głowicowych zaworów i komponentów, są instrukcjami wyłącznie dla wykwalifikowanego technicznie specjalisty, który w każdym przypadku musi je sprawdzić i zweryfikować ich przydatność. Federal-Mogul nie przyjmuje odpowiedzialności za decyzje dotyczące zastosowania.

Zawartość tego katalogu nie stanowi ani nie zastępuje umowy, która może być zawarta jedynie jako oddzielny dokument podpisany przez dwie strony, przy czym sprzedawcą może być tylko jedna z jednostek koncernu Federal-Mogul, zgodnie z opisem na wewnętrznej stronie tylnej okładki.

Zachowane zostaje prawo korygowania błędów i wprowadzania zmian, zwłaszcza odnośnie zmian dotyczących parametrów i warunków pracy określonych przez producentów silników.

УСЛОВИЯ СОТРУДНИЧЕСТВА - ВАЖНЫЕ

Копирование данного каталога или его частей допускается исключительно при получении нашего разрешения в письменной форме. Иллюстрации и дизайн защищены авторским правом. Требования о возмещении ущерба любой формы, исходя из содержания каталога или из-за неправильного использования, хранения или обращения, абсолютно исключены. Договорные права и любые результирующие или связанные с этим требования, независимо от их формы, должны являться частью отдельного письменного соглашения и основываться на наших общих условиях продаж и поставок.

Все прежние утверждения теряют свою юридическую силу с момента публикации данного каталога.

Каталог не является руководством пользователя и инструкцией по установке клапанов и деталей газораспределительного механизма. Он не содержит советов в юридическом понимании этого слова. Каталог не является заменой для издаваемых производителями двигателей технических инструкций по ремонту, в особенности для допусков технических величин, а также инструкций по монтажу и регламентному обслуживанию. Отдельные ссылки для установки и замены клапанов и деталей газораспределительного механизма, приведенные в этом каталоге, являются инструкциями исключительно для технически компетентного специалиста и в каждом случае должны быть проверены им на предмет их пригодности. Federal-Mogul не несет ответственность за ремонтные работы.

Содержимое каталога не предназначено для создания или замены любого контрактного соглашения, которое может быть оформлено только в виде отдельного соглашения между двумя установленными сторонами, где продавцом может являться только одно из юридических лиц Federal-Mogul, как упомянуто на внутренней стороне обложки каталога. Federal-Mogul оставляет за собой право вносить исправления и изменения в частности в отношении поправок по деталям изготовителей двигателей и их условиям.

هام

لا يُسمح بنسخ هذا الدليل أو أي جزء منه إلا بتصريح كتابي صريح. جميع التمثيلات التصويرية والتصميمات محفوظة بموجب حقوق الطبع والنشر، ولا تتحمل الشركة صراحة أي مطالبات بخسائر، أيًا كانت صورتها، تنشأ عن التفاصيل الواردة في هذا الدليل أو نتيجة لسوء الاستخدام أو التطبيق أو التخزين أو النقل. أي حقوق تعاقدية أو أي مطالبات لها علاقة بتلك الحقوق أو تنشأ تأسيساً عليها، بغض النظر عن صورتها، تنشأ تأسيساً على اتفاق كتابي منفصل، وبخاصة تأسيساً على شروط البيع والتسليم الخاصة بنا. تفقد كل البيانات السابقة صلاحيتها بمجرد نشر هذا الدليل.

هذا الدليل ليس دليلاً للتشغيل لتوضيح استخدام وتركيب المكابس أو البطانة أو التجميع. كما لا يحتوي على أي نصيحة بالمعنى القانوني، ولا يحل هذا الدليل محل القواعد الفنية المطبقة باستمرار خاصة فيما يتعلق بالتحميل، كما لا يحل محل شروط التركيب والصيانة الخاصة بمصنعي المحركات الفردية. كذلك لا يمكن الاستغناء عن خبرة الفنيين الذين يقومون بالتركيب أو التطبيق. وجميع الإشارات الواردة في هذا الدليل والتي تتعلق بتركيب وتطبيق المكابس والبطانة وعمليات التجميع هي إرشادات للمتخصصين الفنيين المؤهلين فحسب ويتم مراجعتها والتأكد من ملاءمتها في كل حالة على حده. ولا تتحمل شركة Federal-Mogul أي مسؤولية تتعلق بقرارات التطبيق.

ليس المقصود بمحتوى هذا الدليل أن يخلق أو يستبدل أي اتفاقات تعاقدية يتم الاحتفاظ بها حصرياً في اتفاقية منفصلة بين طرفين محددتين، والتي يمكن أن يكون بموجبها أحد الكيانات التابعة لشركة Federal-Mogul هو الطرف البائع كما هو موضح في الوجه الداخلي للغلاف الخارجي. وتحتفظ الشركة بحقوقها في تصحيح أي أخطاء وإجراء أي تعديلات وبخاصة فيما يتعلق بتعديل تفاصيل مصنع المحرك والأحكام المنصوص عليها.

©2018 Federal-Mogul Global Aftermarket EMEA, BVBA.
The contents of this publication are the copyright of Federal-Mogul Global Aftermarket EMEA, BVBA. Unauthorised reproduction in whole or in part is expressly forbidden.



is owned by Federal-Mogul LLC or one or more of its subsidiaries in one or more countries.



HOW TO USE

VOLVO



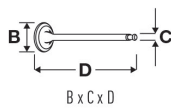

B x C x D

OE



MAT.



13



14



15

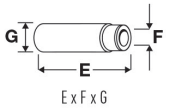

E x F x G

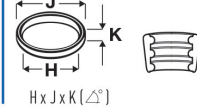

H x J x K (Δ°)

| 1 | 85 | | 130.17 | 2 | | | | | | | | | | | |
|---|------------------------|---------|--------|-----------|---------------------|--------|------------------------|--------|----|-----------------------|----|----|----------------------------|----|----|
| 3 | TD121F | 11980cc | 6 Cyl. | 12 Valves | 272-283kW/370-385PS | Diesel | Turbo Intercooled, OHV | TD9179 | 21 | | | | | | |
| | TD121G | 11980cc | 6 Cyl. | 12 Valves | 235-243kW/320-330PS | Diesel | Turbo, OHV | TD9183 | | | | | | | |
| | TD121GD | 11980cc | 6 Cyl. | 12 Valves | 243kW/330PS | Diesel | Turbo, OHV | TD9143 | | | | | | | |
| | TD122FS | 11980cc | 6 Cyl. | 12 Valves | 287-291kW/395-396PS | Diesel | Turbo Intercooled, OHV | TD9194 | | | | | | | |
| 4 | F 12 | | | | 08/1977 → 12/1994 | | | | | | | | | | |
| 5 | V34949 | 6 | 8 | 468302-5 | 11 | 12 | 30° | H | 16 | VAG50965 | 17 | 19 | VS6337 | 22 | 20 |
| | 54.10 x 11.00 x 167.49 | | | | MB cr | | | | | 82.00 x 11.06 x 18.00 | | | 44.95 x 56.60 x 9.45 (45°) | | |
| 7 | V34950 | | 9 | 468303-3 | 10 | | 45° | H | 18 | VAG50964 | | | | | |
| | 50.10 x 10.98 x 167.40 | | | | ME + MB | | | | | 66.00 x 11.06 x 18.04 | | | | | |

[4] Fully finished
[4] Fertigtgeschliffene
[4] Entièrement finis
[4] Totalmente acabada
[4] Finite

- | | | |
|--|---|---|
| <ul style="list-style-type: none"> 1 Panel Number 2 Bore Size 3 Engine Detail 4 Model Detail 5 Valve Reference 6 Fitting Position 7 Valve Dimension 8 Valve OE Reference | <ul style="list-style-type: none"> 9 Bi-Metal Valve Icon 10 Material Specification 11 Valve Stem Coating 12 Cotter Design 13 Seat Angle 14 Seat Treatment 15 Tip Treatment 16 Valve Guide Reference | <ul style="list-style-type: none"> 17 Valve Guide Shape 18 Valve Guide Dimension 19 Valve Seat Reference 20 Valve Seat Dimension 21 TecDoc Engine Number 22 Foot Note |
|--|---|---|

| MATERIAL | TYPE | MATERIAL CODE | HEAD | STEM |
|----------|--------------|---------------|--|---|
| MB | Monometallic | EN52 | Martensitic chrome-silicon alloy steel (MB) | n/a |
| MD | Monometallic | 21-4N | Austenitic chrome-manganese-nickel steel (MD) | n/a |
| MD+MB | Bimetallic | 21-4N + EN52 | Austenitic chrome-manganese-nickel steel (MD) | Martensitic chrome-silicon alloy steel (MB) |
| ME+MB | Bimetallic | VA63 + EN52 | Austenitic chrome-manganese-nickel steel with added niobium, tungsten and nitrogen (ME) | Martensitic chrome-silicon alloy steel (MB) |
| MF+MB | Bimetallic | Nim80 + EN52 | Nimonic™, nickel based super alloy with added chromium, cobalt and titanium (MF) | Martensitic chrome-silicon alloy steel (MB) |
| MH+MB | Bimetallic | Ni30 + EN52 | Iron based hybrid austenitic superalloy with added nickel, chrome, titanium and aluminium (MH) | Martensitic chrome-silicon alloy steel (MB) |

| FEATURE CODE | DESCRIPTION |
|--------------|----------------------------|
| cr | Chrome plated stem |
| tu | Tuftrided / Nitrided valve |
| ss | Stellite welded seat |
| Y | Hardened valve seat |
| st | Stellite welded tip |
| H | Hardened valve tip |

VOLVO



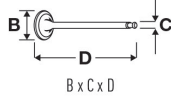



B x C x D

OE





13



14





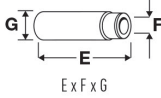

15

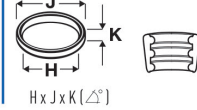

E x F x G



H x J x K (Δ°)

| | | | | | | | | | | | | | | | | |
|----------|--|-------------------|----------|-----------|---------------------|-----------|------------------------|------------------|-----------|--|-----------|-----------|--|-----------|----------------------------|-----------|
| 1 | 85 | | 2 | | | | | | | | | | | | | |
| 3 | TD121F | 11980cc | 6 Cyl. | 12 Valves | 272-283kW/370-385PS | Diesel | Turbo Intercooled, OHV | TD9179 21 | | | | | | | | |
| | TD121G | 11980cc | 6 Cyl. | 12 Valves | 235-243kW/320-330PS | Diesel | Turbo, OHV | TD9183 | | | | | | | | |
| | TD121GD | 11980cc | 6 Cyl. | 12 Valves | 243kW/330PS | Diesel | Turbo, OHV | TD9143 | | | | | | | | |
| | TD122FS | 11980cc | 6 Cyl. | 12 Valves | 287-291kW/395-396PS | Diesel | Turbo Intercooled, OHV | TD9194 | | | | | | | | |
| 4 | F 12 | 08/1977 → 12/1994 | | | | | | | | | | | | | | |
| 5 | V34949  | 6 | 8 | 468302-5 | 11 | 12 | 30° | H | 16 | VAG50965  | 17 | 19 | VS6337  [4] | 22 | 44.95 x 56.60 x 9.45 (45°) | 20 |
| | 54.10 x 11.00 x 167.49 | | | | MB cr | | | | | 82.00 x 11.06 x 18.00 | | | | | | |
| 7 | V34950  | | 9 | 468303-3 | 10 | | 45° | H | 18 | VAG50964  | | | | | | |
| | 50.10 x 10.98 x 167.40 | | | | ME + MB | | | | | 66.00 x 11.06 x 18.04 | | | | | | |

[4] Fully finished
[4] Fertiggeschliffene
[4] Entièrement finis
[4] Totalmente acabada
[4] Finite

- | | | |
|--|---|---|
| <ul style="list-style-type: none"> 1 Tafel Nr. 2 Bohrung 3 Motorangaben 4 Modellangaben 5 Artikelnummer Ventil 6 Einbauposition 7 Ventilabmessungen 8 Ventil OE Referenznummer | <ul style="list-style-type: none"> 9 Bimetall Ventil 10 Materialspezifikation 11 Ventilschaftbeschichtung 12 Ventilkegelstückkonstruktion 13 Sitzwinkel 14 Sitzbehandlung 15 Materialbehandlung Ventilspitze 16 Artikelnummer Ventilführung | <ul style="list-style-type: none"> 17 Ventilführungsform 18 Ventilführungsabmessungen 19 Artikelnummer Ventilsitzring 20 Ventilsitzringabmessungen 21 TecDoc Motornummer 22 Fußnote |
|--|---|---|

| MATERIAL | TYP | MATERIALCODE | VENTILKOPF | VENTILSCHAFT |
|--------------|------------|--------------|--|---|
| MB | Monometall | EN52 | Martensitischer Chrom-Silizium-Legierungsstahl (MB) | n/a |
| MD | Monometall | 21-4N | Austenitischer Chrom-Mangan-Nickel-Stahl (MD) | n/a |
| MD+MB | Bimetall | 21-4N + EN52 | Austenitischer Chrom-Mangan-Nickel-Stahl (MD) | Martensitischer Chrom-Silizium-Legierungsstahl (MB) |
| ME+MB | Bimetall | VA63 + EN52 | Austenitischer Chrom-Mangan-Nickel-Stahl mit Zusatz von Niobium, Wolfram und Stickstoff (ME) | Martensitischer Chrom-Silizium-Legierungsstahl (MB) |
| MF+MB | Bimetall | Nim80 + EN52 | Nimonic™, nickelbasierte Superlegierung mit Zusatz von Chrom, Cobalt und Titan (MF) | Martensitischer Chrom-Silizium-Legierungsstahl (MB) |
| MH+MB | Bimetall | Ni30 + EN52 | Eisenbasierte Mischform austenitischer Superlegierung mit Zusatz von Nickel, Chrom, Titan und Aluminium (MH) | Martensitischer Chrom-Silizium-Legierungsstahl (MB) |

| KURZZEICHEN AUSSTATTUNG | BESCHREIBUNG |
|-------------------------|--|
| cr | Chrombeschichteter Ventilschaft |
| tu | Tuftride-behandelter/nitrierter Schaft |
| ss | Geschweißter Stelliteventilsitz |
| Y | Gehärteter Ventilsitz |
| st | Geschweißte Stellitspitze |
| H | Gehärtete Ventilspitze |



COME SI UTILIZZA IL CATALOGO

VOLVO



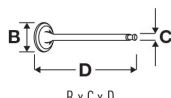

B x C x D

OE



MAT.



13



14





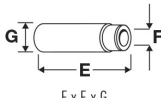

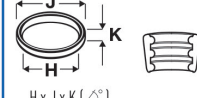

15



E x F x G



H x J x K (Δ°)

| | | | | | | | | | | | | | | |
|----------|------------------------|---|---|-----------------|---|--------|------------------------|------------------|-----------------------|---|-----------|----------------------------|-----------|-----------|
| 1 | 85 |  | 130.17 | 2 | | | | | | | | | | |
| 3 | TD121F | 11980cc | 6 Cyl. | 12 Valves | 272-283kW/370-385PS | Diesel | Turbo Intercooled, OHV | TD9179 21 | | | | | | |
| | TD121G | 11980cc | 6 Cyl. | 12 Valves | 235-243kW/320-330PS | Diesel | Turbo, OHV | TD9183 | | | | | | |
| | TD121GD | 11980cc | 6 Cyl. | 12 Valves | 243kW/330PS | Diesel | Turbo, OHV | TD9143 | | | | | | |
| | TD122FS | 11980cc | 6 Cyl. | 12 Valves | 287-291kW/395-396PS | Diesel | Turbo Intercooled, OHV | TD9194 | | | | | | |
| 4 | F 12 08/1977→12/1994 | | | | | | | | | | | | | |
| 5 | V34949 | 6 | 8 | 468302-5 | 12 | 30° | H | 16 | VAG50965 | 17 | 19 | VS6337 | 22 | 20 |
| | 54.10 x 11.00 x 167.49 | | | |  | | | | 82.00 x 11.06 x 18.00 |  | | 44.95 x 56.60 x 9.45 (45°) | | |
| 7 | V34950 | | 9 | 468303-3 | 11 | 45° | H | 18 | VAG50964 | 17 | | | | |
| | 50.10 x 10.98 x 167.40 | |  | |  | | | | 66.00 x 11.06 x 18.04 |  | | | | |

[4] Fully finished
[4] Fertigtgeschliffene
[4] Entièrement finis
[4] Totalmente acabada
[4] Finite

- | | | |
|---|--|---|
| <ul style="list-style-type: none"> 1 Numero Pannello 2 Alesaggio 3 Dettaglio Motore 4 Dettaglio Modello 5 Riferimento Valvola 6 Posizione Montaggio 7 Dimensione Valvola 8 Riferimento OE valvola | <ul style="list-style-type: none"> 9 Valvola Bi-Metallica 10 Specifica Materiale 11 Rivestimento Stelo Valvola 12 Disegno Semiconi 13 Angolo Sede 14 Trattamento Sede 15 Trattamento Punteria 16 Riferimento Guida Valvola | <ul style="list-style-type: none"> 17 Forma Guida Valvola 18 Dimensioni Guida valvola 19 Riferimento Sede Valvola 20 Dimensioni Sede Valvola 21 Numero Motore DecDoc 22 Nota a piè pagina |
|---|--|---|

| MATERIALE | TIPO | CODICE MATERIALE | TESTA | STELO |
|--------------|----------------|------------------|---|--|
| MB | Mono-Metallica | EN52 | Lega acciaio martensitico cromo-silicio (MB) | n/a |
| MD | Mono-Metallica | 21-4N | Acciaio austenitico cromo-manganese-nichel (MD) | n/a |
| MD+MB | Bi-metallica | 21-4N + EN52 | Acciaio austenitico cromo-manganese-nichel (MD) | Lega acciaio martensitico cromo-silicio (MB) |
| ME+MB | Bi-metallica | VA63 + EN52 | Acciaio austenitico cromo-manganese-nichel con aggiunta di niobio ,tungsteno ed azoto (ME) | Lega acciaio martensitico cromo-silicio (MB) |
| MF+MB | Bi-metallica | Nim80 + EN52 | Nimonic™, super lega a base di nichel con aggiunta di cromo cobalto e titanio , (MF) | Lega acciaio martensitico cromo-silicio (MB) |
| MH+MB | Bi-metallica | Ni30 + EN52 | "Superlega austenitica ibrida a base di ferro con aggiunta di nichel , cromo,titanio, ed alluminio "(MH)" | Lega acciaio martensitico cromo-silicio (MB) |

| CODICE CARATTERISTICHE | DESCRIZIONE |
|------------------------|--|
| cr | Strato di cromo sullo stelo di valvola |
| tu | Valvola Carbotritura |
| ss | Sede saldata in stellite |
| Y | Sede valvola rinforzata |
| st | Puntale saldato in Stellite |
| H | Puntale valvola rinforzato |

INSTRUCTIONS POUR L'UTILISATION DU CATALOGUE

VOLVO



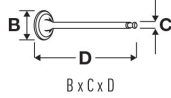

B x C x D

OE



MAT.



13



14





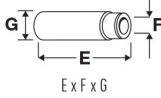

15

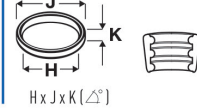

E x F x G



H x J x K [22°]

| | | | | | | | | | | | | | | | |
|----------|--|-------------------|----------|-----------|---------------------|-----------|------------------------|------------------|-----------|--|-----------|-----------|--|-----------|-----------|
| 1 | 85 | | 2 | | | | | | | | | | | | |
| 3 | TD121F | 11980cc | 6 Cyl. | 12 Valves | 272-283kW/370-385PS | Diesel | Turbo Intercooled, OHV | TD9179 21 | | | | | | | |
| | TD121G | 11980cc | 6 Cyl. | 12 Valves | 235-243kW/320-330PS | Diesel | Turbo, OHV | TD9183 | | | | | | | |
| | TD121GD | 11980cc | 6 Cyl. | 12 Valves | 243kW/330PS | Diesel | Turbo, OHV | TD9143 | | | | | | | |
| | TD122FS | 11980cc | 6 Cyl. | 12 Valves | 287-291kW/395-396PS | Diesel | Turbo Intercooled, OHV | TD9194 | | | | | | | |
| 4 | F 12 | 08/1977 → 12/1994 | | | | | | | | | | | | | |
| 5 | V34949  | 6 | 8 | 468302-5 | 9 | 11 | 12 | 30° | 16 | VAG50965  | 17 | 19 | VS6337  | 22 | 20 |
| | 54.10 x 11.00 x 167.49 | | | | 10 | MB cr | | H | | 82.00 x 11.06 x 18.00 | | | 44.95 x 56.60 x 9.45 (45°) | | |
| 7 | V34950  | | 9 | 468303-3 | 10 | ME + MB | | 45° | 18 | VAG50964  | | | | | |
| | 50.10 x 10.98 x 167.40 | | | | | | | H | | 66.00 x 11.06 x 18.04 | | | | | |

[4] Fully finished
[4] Fertiggeschliffene
[4] Entierement finis
[4] Totalmente acabada
[4] Finite

- | | | |
|--|---|--|
| <p>1 Numéro de panneau</p> <p>2 Alésage</p> <p>3 Détail du moteur</p> <p>4 Détail du modèle</p> <p>5 Référence soupape</p> <p>6 Position de montage</p> <p>7 Dimension de la soupape</p> <p>8 Référence OE</p> | <p>9 Soupapes bi-Métallique</p> <p>10 Spécification du matériel</p> <p>11 Revêtement</p> <p>12 Type de clavettes</p> <p>13 Angle du siège</p> <p>14 Sièges</p> <p>15 Traitement de pointe</p> <p>16 Référence du guide de soupape</p> | <p>17 Forme de guide de valve</p> <p>18 Dimension du guide de soupape</p> <p>19 Référence siège de soupape</p> <p>20 Dimension du siège de soupape</p> <p>21 Numéro de moteur TecDoc</p> <p>22 Notes</p> |
|--|---|--|

| MATIÈRES | TYPE | CODE MATIÈRE | TÊTE DE SOUPAPE | TIGE DE SOUPAPE |
|--------------|-----------------|--------------|---|--|
| MB | mono-métallique | EN52 | Alliage acier martensitique Chrome-silicone (MB) | Idem |
| MD | mono-métallique | 21-4N | Alliage acier austenitique chrome-manganese-nickel (MD) | Idem |
| MD+MB | Bi-métallique | 21-4N + EN52 | Alliage acier austenitique chrome-manganese-nickel (MD) | Alliage acier martensitique Chrome-silicone (MB) |
| ME+MB | Bi-métallique | VA63 + EN52 | Alliage acier austenitique chrome-manganese-nickel au niobium, tungstène et azote(MD) | Alliage acier martensitique Chrome-silicone (MB) |
| MF+MB | Bi-métallique | Nim80 + EN52 | Nimonic™, super alliage base nickel - chrome - cobalt - titanium (MF) | Alliage acier martensitique Chrome-silicone (MB) |
| MH+MB | Bi-métallique | Ni30 + EN52 | Base fonte avec alliage austenitique avec nickel, chrome, titanium et aluminium (MH) | Alliage acier martensitique Chrome-silicone (MB) |

| CODE CARACTÉRISTIQUE | DESCRIPTION |
|----------------------|--------------------------------------|
| cr | Couche de chrome sur tige de soupape |
| tu | Soupape Nitrurée |
| ss | Siège soudé Stellite |
| Y | Siège de soupape durci |
| st | Pointe soudée Stellite |
| H | Pointe de soupape durcie |



🇪🇸 CÓMO UTILIZAR ESTE CATÁLOGO

VOLVO

B x C x D

OE

MAT.

13

14

15

E x F x G

H x J x K (Δ°)

| | | | | | | | | |
|----------|-----------|---------|----------|-----------|---------------------|--------|------------------------|-----------|
| 1 | 85 | | 2 | | | | | |
| 3 | TD121F | 11980cc | 6 Cyl. | 12 Valves | 272-283kW/370-385PS | Diesel | Turbo Intercooled, OHV | 21 |
| | TD121G | 11980cc | 6 Cyl. | 12 Valves | 235-243kW/320-330PS | Diesel | Turbo, OHV | TD9183 |
| | TD121GD | 11980cc | 6 Cyl. | 12 Valves | 243kW/330PS | Diesel | Turbo, OHV | TD9143 |
| | TD122FS | 11980cc | 6 Cyl. | 12 Valves | 287-291kW/395-396PS | Diesel | Turbo Intercooled, OHV | TD9194 |

4 F 12

5 V34949 **6**

54.10 x 11.00 x 167.49

7 V34950

50.10 x 10.98 x 167.40

8 468302-5

08/1977 → 12/1994

468303-3

9 30° H

10 45° H

11 MB cr

12 30° H

13 30° H

14 45° H

16 VAG50965 **17**

82.00 x 11.06 x 18.00

18

VAG50964 **19**

66.00 x 11.06 x 18.04

20

19 VS6337 **22**

44.95 x 56.60 x 9.45 (45°)

21

[4] Fully finished
[4] Fertigeschiffene
[4] Entièrement finis
[4] Totalmente acabada
[4] Finite

- | | | |
|---|---|---|
| <p>1 Número de Panel</p> <p>2 Diámetro</p> <p>3 Datos del motor</p> <p>4 Modelo</p> <p>5 Referencia de válvula</p> <p>6 Posición de montaje</p> <p>7 Dimensión de la válvula</p> <p>8 Referencia de equipo original</p> | <p>9 Válvula Bimetálica</p> <p>10 Especificación de material</p> <p>11 Revestimiento del vástago de la válvula</p> <p>12 Diseño de la chaveta</p> <p>13 Ángulo del asiento</p> <p>14 Tratamiento del asiento</p> <p>15 Tratamiento de la punta</p> <p>16 Referencia de la guía de válvula</p> | <p>17 Forma de la guía de válvula</p> <p>18 Dimensión de la guía de válvula</p> <p>19 Referencia del asiento de válvula</p> <p>20 Dimension del asiento de válvula</p> <p>21 Número de motor TecDoc</p> <p>22 Nota al pie</p> |
|---|---|---|

| MATERIAL | TIPO | CÓDIGO MATERIAL | CABEZA | VÁSTAGO |
|----------|--------------|-----------------|---|--|
| MB | Monometálico | EN52 | Acero martensítico de aleación de cromo y silicio (MB) | n/a |
| MD | Monometálico | 21-4N | Acero austenítico de cromo-manganeso-níquel (MD) | n/a |
| MD+MB | Bimetálico | 21-4N + EN52 | Acero austenítico de cromo-manganeso-níquel (MD) | Acero martensítico de aleación de cromo y silicio (MB) |
| ME+MB | Bimetálico | VA63 + EN52 | Acero austenítico de cromo-manganeso-níquel con adición de niobio, tungsteno y nitrógeno (ME) | Acero martensítico de aleación de cromo y silicio (MB) |
| MF+MB | Bimetálico | Nim80 + EN52 | Nimonic™, súper aleación a base de níquel con cromo, cobalto y titanio añadidos (MF) | Acero martensítico de aleación de cromo y silicio (MB) |
| MH+MB | Bimetálico | Ni30 + EN52 | Superaleación híbrida austenítica a base de hierro con níquel añadido, cromo, titanio y aluminio (MH) | Acero martensítico de aleación de cromo y silicio (MB) |

| CÓDIGO DE CARACTERÍSTICA | DESCRIPCIÓN |
|--------------------------|---|
| cr | Capa de cromo en el vástago de la válvula |
| tu | Válvula nitrurada / nitrocarbuzada |
| ss | Asiento Stellite soldado |
| Y | Asiento de válvula endurecido |
| st | Punta Stellite soldada |
| H | Punta de válvula endurecida |

JAK UŻYWAĆ TEGO KATALOGU

VOLVO



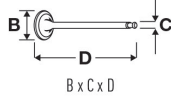

B x C x D

OE



MAT.



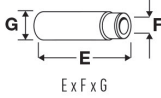



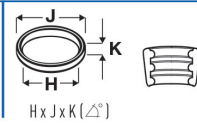

E x F x G



H x J x K (Δ°)

| | | | | | | | | |
|----------|---|---|-------------------|-----------|---------------------|-----------|------------------------|---|
| 1 | 85 |  | 130.17 | 2 | | | | |
| 3 | TD121F | 11980cc | 6 Cyl. | 12 Valves | 272-283kW/370-385PS | Diesel | Turbo Intercooled, OHV | TD9179 21 |
| | TD121G | 11980cc | 6 Cyl. | 12 Valves | 235-243kW/320-330PS | Diesel | Turbo, OHV | TD9183 |
| | TD121GD | 11980cc | 6 Cyl. | 12 Valves | 243kW/330PS | Diesel | Turbo, OHV | TD9143 |
| | TD122FS | 11980cc | 6 Cyl. | 12 Valves | 287-291kW/395-396PS | Diesel | Turbo Intercooled, OHV | TD9194 |
| 4 | F 12 08/1977 → 12/1994 | | | | | | | |
| 5 | V34949  | 6 | 8 468302-5 | 9 | 10 | 11 | 12 30° | 13 H |
| | 54.10 x 11.00 x 167.49 | | | | | MB cr | | |
| 7 | V34950  | | 468303-3 | 9 | 10 | 11 | 12 45° | 13 H |
| | 50.10 x 10.98 x 167.40 | | | | | ME + MB | | |
| | | | | | | | | 16 VAG50965  |
| | | | | | | | | 82.00 x 11.06 x 18.00 |
| | | | | | | | | 17 |
| | | | | | | | | 19 VS6337  |
| | | | | | | | | 44.95 x 56.60 x 9.45 (45°) 22 |
| | | | | | | | | 20 |

[4] Fully finished
[4] Fertigeschiffene
[4] Entièrement finis
[4] Totalmente acabada
[4] Finite

- | | | |
|---|--|--|
| <ul style="list-style-type: none"> 1 Numer panelu 2 Średnica cylindra 3 Informacje o silniku 4 Model 5 Referencja zaworu 6 Pozycja montażu 7 Wymiary zaworu 8 Odpowiednik OE zaworu | <ul style="list-style-type: none"> 9 Zawór bimetalowy 10 Specyfikacja materiału 11 Powłoka trzonka zaworu 12 Typ zamka 13 Kąt przylgni 14 Wykończenie gniazda 15 Wykończenie końcówki 16 Ref przewodnicy zaworowej | <ul style="list-style-type: none"> 17 Kształt przewodnicy zaworowej 18 Wymiary przewodnicy zaworowej 19 Ref gniazda zaworowego 20 Wymiary gniazda zaworowego 21 Numer silnika TecDoc 22 Stopka |
|---|--|--|

| MATERIAŁ | TYP | KOD MATERIAŁU | GŁÓWKA | TRZONEK |
|----------|------------|---------------|---|--|
| MB | Mono-Metal | EN52 | Martenzytyczny chromowo-krzemowy stop stali (MB) | n/a |
| MD | Mono-Metal | 21-4N | Austenityczna stal chromowo-manganowo-niklowa (MD) | n/a |
| MD+MB | Bi-metal | 21-4N + EN52 | Austenityczna stal chromowo-manganowo-niklowa (MD) | Martenzytyczny chromowo-krzemowy stop stali (MB) |
| ME+MB | Bi-metal | VA63 + EN52 | Austenityczna stal chromowo-manganowo-niklowa z dodatkiem niobu, wolframu i azotu (ME) | Martenzytyczny chromowo-krzemowy stop stali (MB) |
| MF+MB | Bi-metal | Nim80 + EN52 | Nimonic™, stop oparty o nikiel z dodatkiem chromu, kobaltu i tytanu (MF) | Martenzytyczny chromowo-krzemowy stop stali (MB) |
| MH+MB | Bi-metal | Ni30 + EN52 | Żelazo w oparciu o hybrydowy austenityczny stop z dodatkiem nitylu, chromu, tytanu i aluminium (MH) | Martenzytyczny chromowo-krzemowy stop stali (MB) |

| KOD CECHY | OPIS |
|-----------|---|
| cr | Warstwa chromu na trzpieniu zaworu |
| tu | Zawór węgloazotowany (w procesie Tufftride)/azotowany |
| ss | Spawane stellite gniazdo |
| Y | Utwardzone gniazdo zaworu |
| st | Spawana końcówka stellite |
| H | Hartowana końcówka zaworu |



КАК ПОЛЬЗОВАТЬСЯ КАТАЛОГОМ

VOLVO

B x C x D

OE

E x F x G

H x J x K (Δ°)

| | | | | | | | | |
|----------|------------------------|----------|-------------------|-----------|---------------------|-----------|----------------------------|------------------|
| 1 | 85 | | 130.17 | 2 | | | | |
| 3 | TD121F | 11980cc | 6 Cyl. | 12 Valves | 272-283kW/370-385PS | Diesel | Turbo Intercooled, OHV | TD9179 21 |
| | TD121G | 11980cc | 6 Cyl. | 12 Valves | 235-243kW/320-330PS | Diesel | Turbo, OHV | TD9183 |
| | TD121GD | 11980cc | 6 Cyl. | 12 Valves | 243kW/330PS | Diesel | Turbo, OHV | TD9143 |
| | TD122FS | 11980cc | 6 Cyl. | 12 Valves | 287-291kW/395-396PS | Diesel | Turbo Intercooled, OHV | TD9194 |
| 4 | F 12 | | 08/1977 → 12/1994 | | | | | |
| 5 | V34949 | 6 | 8 | 468302-5 | 11 | 12 | 30° | H |
| | 54.10 x 11.00 x 167.49 | | | | 10 | 16 | VAG50965 | 17 |
| | | | | | 9 | 18 | 82.00 x 11.06 x 18.00 | 19 |
| 7 | V34950 | | 9 | 468303-3 | 10 | 16 | VAG50964 | 20 |
| | 50.10 x 10.98 x 167.40 | | | | 10 | 18 | 66.00 x 11.06 x 18.04 | 22 |
| | | | | | | 18 | 44.95 x 56.60 x 9.45 (45°) | 20 |

[4] Fully finished
[4] Fertigtgeschliffene
[4] Entièrement finis
[4] Totalmente acabada
[4] Finite

- | | | |
|--|---|--|
| <ul style="list-style-type: none"> 1 Номер панели 2 Размер отверстия цилиндра 3 Информация о двигателе 4 Информация о модели 5 Артикул клапана 6 Положение установки 7 Размеры клапана 8 Оригинальный номер клапана 9 Биметаллический клапан | <ul style="list-style-type: none"> 10 Характеристики материала 11 Покрытие штока клапана 12 Конструкция сухаря клапана 13 Угол седла 14 Обработка седла 15 Обработка конца штока клапана 16 Артикул направляющей втулки клапана | <ul style="list-style-type: none"> 17 Форма направляющей втулки клапана 18 Размеры направляющей втулки клапана 19 Артикул седла клапана 20 Размеры седла клапана 21 Номер двигателя в TecDoc 22 Примечание |
|--|---|--|

| КОД КАТАЛОГА | ТИП | КОД МАТЕРИАЛА | МАТЕРИАЛ ГОЛОВКИ КЛАПАНА | МАТЕРИАЛ ШТОКА КЛАПАНА |
|--------------|-------------------|---------------|---|---|
| MB | Монометаллический | EN52 | Мартенситная хромо-кремниевая легированная сталь (MB) | |
| MD | Монометаллический | 21-4N | Аустенитная хромо-марганцево-никелевая сталь (MD) | |
| MD+MB | Биметаллический | 21-4N + EN52 | Аустенитная хромо-марганцево-никелевая сталь (MD) | Мартенситная хромо-кремниевая легированная сталь (MB) |
| ME+MB | Биметаллический | VA63 + EN52 | Аустенитная хромо-марганцево-никелевая сталь с добавлением ниобия, вольфрама и азота (ME) | Мартенситная хромо-кремниевая легированная сталь (MB) |
| MF+MB | Биметаллический | Nim80 + EN52 | Nimonic™, жароустойчивый сплав на основе никеля с добавлением хрома, кобальта и титана (MF) | Мартенситная хромо-кремниевая легированная сталь (MB) |
| MH+MB | Биметаллический | Ni30 + EN52 | Гибридный аустенитный жароустойчивый сплав на основе железа с добавлением никеля, хрома, титана и алюминия (MH) | Мартенситная хромо-кремниевая легированная сталь (MB) |

| ИДЕНТИФИЦИРУЮЩИЙ КОД | ОПИСАНИЕ |
|----------------------|--|
| cr | "Хромовое покрытие штока клапана" |
| tu | "Клапан, обработанный газовым нитрированием / азотированием" |
| ss | Стеллитовое седло |
| Y | Закаленное седло клапана |
| st | Стеллитовый наконечник |
| H | Закаленный наконечник клапана |

كيفية استخدام هذا الكتالوج

VOLVO

FEDERAL-MOGUL MOTORPARTS

| | | | | | | | | | | | | | | |
|----------|------------------------|-------------------|---------------|-----------|---------------------|-----------|------------------------|------------------|-----------------------|-----------|-----------|----------------------------|-----------|-----------|
| 1 | 85 | | 130.17 | 2 | | | | | | | | | | |
| 3 | TD121F | 11980cc | 6 Cyl. | 12 Valves | 272-283kW/370-385PS | Diesel | Turbo Intercooled, OHV | 21 TD9179 | | | | | | |
| | TD121G | 11980cc | 6 Cyl. | 12 Valves | 235-243kW/320-330PS | Diesel | Turbo, OHV | TD9183 | | | | | | |
| | TD121GD | 11980cc | 6 Cyl. | 12 Valves | 243kW/330PS | Diesel | Turbo, OHV | TD9143 | | | | | | |
| | TD122FS | 11980cc | 6 Cyl. | 12 Valves | 287-291kW/395-396PS | Diesel | Turbo Intercooled, OHV | TD9194 | | | | | | |
| 4 | F 12 | 08/1977 → 12/1994 | | | | | | | | | | | | |
| 5 | V34949 | 6 | 468302-5 | 8 | 11 | 12 | 30° | 16 | VAG50965 | 17 | 19 | VS6337 | 22 | 20 |
| | 54.10 x 11.00 x 167.49 | | | | MB cr | | H | | 82.00 x 11.06 x 18.00 | | | 44.95 x 56.60 x 9.45 (45°) | | |
| 7 | V34950 | | 468303-3 | 9 | 10 | 11 | 45° | 16 | VAG50964 | 17 | 19 | VS6337 | 22 | 20 |
| | 50.10 x 10.98 x 167.40 | | | | ME + MB | | H | | 66.00 x 11.06 x 18.04 | | | 44.95 x 56.60 x 9.45 (45°) | | |

[4] Fully finished [4] Fertiggeschliffene [4] Entièrement finis [4] Totalmente acabada [4] Finite

- | | | |
|--|--|---|
| <p>1 رقم اللوحة</p> <p>2 حجم القطر</p> <p>3 تفاصيل المحرك</p> <p>4 تفاصيل الطراز</p> <p>5 الرقم المرجعي للوصف</p> <p>6 وضعيّة التركيب</p> <p>7 أبعاد الصّمام</p> <p>8 الرقم المرجعي للصّمام من المصنّع الأصليّ</p> | <p>9 صمّام ثنائيّ المعدن</p> <p>10 مواصفات المواد</p> <p>11 طلاء الصّمام بالبخار</p> <p>12 تصميم مايبك الصّمام</p> <p>13 زاوية مقعد الصّمام</p> <p>14 معالجة مقعد الصّمام</p> <p>15 معالجة طرف الصّمام</p> <p>16 الرقم المرجعي لدليل الصّمام</p> | <p>17 شكل دليل الصّمام</p> <p>18 أبعاد دليل الصّمام</p> <p>19 الرقم المرجعي لمقعد الصّمام</p> <p>20 أبعاد مقعد الصّمام</p> <p>21 رقم المحرك وفق TecDoc</p> <p>22 ملحوظة هامشيّة</p> |
|--|--|---|





| ساق الصّمام | رأس الصّمام | رمز المادة | النوع | المادة |
|--|--|--------------|---------------|--------|
| غير متوفّر | سببكية فولاذية مارتنسيتية مصنوعة من مزيج الكروم والسيليكون (MB) | EN52 | أحاديّ المعدن | MB |
| غير متوفّر | (MD) فولاذ أوستنيتي مصنوع من الكروم والمنغنيز والنيكل | 21-4N | أحاديّ المعدن | MD |
| سببكية فولاذية مارتنسيتية مصنوعة من مزيج الكروم والسيليكون | (MD) فولاذ أوستنيتي مصنوع من الكروم والمنغنيز والنيكل | 21-4N + EN52 | ثنائيّ المعدن | MD+MB |
| سببكية فولاذية مارتنسيتية مصنوعة من مزيج الكروم والسيليكون | فولاذ أوستنيتي مصنوع من الكروم والمنغنيز والنيكل ومُضاف إليه النيوبيوم، والتنجستين، والنيتروجين (ME) | VA63 + EN52 | ثنائيّ المعدن | ME+MB |
| سببكية فولاذية مارتنسيتية مصنوعة من مزيج الكروم والسيليكون | الفائقة القائمة على النيكل Nimonic™ سببكية "نيمونيك" (MF) ومُضاف إليها الكروم، والكوبالت والتيتانيوم | Nim80 + EN52 | ثنائيّ المعدن | MF+MB |
| سببكية فولاذية مارتنسيتية مصنوعة من مزيج الكروم والسيليكون | سببكية أوستنيتية فائقة هجينة قائمة على الحديد ومُضاف إليها (MH) النيكل، والكروم، والتيتانيوم والألومنيوم | Ni30 + EN52 | ثنائيّ المعدن | MH+MB |





| الوصف | كود الخاصية |
|---------------------------------|-------------|
| طبقة الكروم في ساق الصمام | cr |
| صمامات التروجين / الطف البركاني | tu |
| مقعد ملحوم بالإستيليت | ss |
| مقعد صمام مقوى | Y |
| رأس ملحوم بالإستيليت | st |
| رأس صمام مقوى | H |



NEW PARTS LIST

Liste der Neuaufnahmen • Elenco nuovi riferimenti
Liste des nouvelles références

| | | |      9 | |
|--------|---------------|---|---|-----|
| V80000 | BMW | N43 B16 A | 95 | 12 |
| V80001 | BMW | N43 B16 A | 95 | 12 |
| V80002 | BMW | N63 B44 A, N63 B44 B | 113 | 60 |
| V80003 | BMW | N63 B44 A, N63 B44 B | 113 | 60 |
| V80004 | MERCEDES-BENZ | M 271.820, M 271.860, M 271.861 | 446 | 15 |
| V80005 | MERCEDES-BENZ | M 271.820, M 271.860, M 271.861 | 446 | 15 |
| V80006 | MERCEDES-BENZ | M 276.950, M 276.952, M 276.955, M 276.956, M 276.957, M 276.958 | 483 | 97 |
| | | M 278.920, M 278.922, M 278.927, M 278.929, M 278.932 | 484 | 99 |
| | | M 278.928 | 484 | 100 |
| V80007 | MERCEDES-BENZ | M 276.950, M 276.952, M 276.955, M 276.956, M 276.957, M 276.958 | 483 | 97 |
| | | M 278.928 | 484 | 100 |
| V80008 | MERCEDES-BENZ | M 270.910, M 274.910 | 449 | 25 |
| | | M 270.920, M 274.920 | 450 | 28 |
| V80009 | MERCEDES-BENZ | M 270.910, M 274.910 | 449 | 25 |
| | | M 270.920, M 274.920 | 450 | 28 |
| V80010 | SEAT | CNKA | 755 | 29 |
| | VW | CDGA, CKMA, CMAA | 892 | 30 |
| | | CGGB | 893 | 31 |
| | | CNKA | 897 | 49 |
| V80011 | SEAT | CNKA | 755 | 29 |
| | VW | CDGA, CKMA, CMAA | 892 | 30 |
| | | CGGB | 893 | 31 |
| | | CNKA | 897 | 49 |
| V80012 | AUDI | CJZA, CJZB, CYVA, CYVB | 46 | 2 |
| | SEAT | CJZA, CJZB, CYVA, CYVB | 749 | 8 |
| | SKODA | CJZA, CJZB, CYVA, CYVB | 771 | 2 |
| | VW | CJZA, CJZB, CYVA, CYVB | 884 | 4 |
| V80013 | AUDI | CJZA, CJZB, CYVA, CYVB | 46 | 2 |
| | SEAT | CJZA, CJZB, CYVA, CYVB | 749 | 8 |
| | SKODA | CJZA, CJZB, CYVA, CYVB | 771 | 2 |
| | VW | CJZA, CJZB, CYVA, CYVB | 884 | 4 |
| V80016 | CHEVROLET | Z 18 XER | 123 | 30 |
| | OPEL | A 18 XER, Z 18 XER | 596 | 42 |
| | VAUXHALL | A 18 XER, Z 18 XER | 831 | 43 |
| V80017 | CHEVROLET | Z 18 XER | 123 | 30 |
| | OPEL | A 18 XER, Z 18 XER | 596 | 42 |
| | VAUXHALL | A 18 XER, Z 18 XER | 831 | 43 |
| V80018 | LOTUS | 1ZZ-FE | 374 | 1 |
| | TOYOTA | 1ZZ-FE | 806 | 15 |
| V80019 | LOTUS | 1ZZ-FE | 374 | 1 |
| | TOYOTA | 1ZZ-FE | 806 | 15 |
| V80020 | CITROËN | EB2DTS (HNY) | 136 | 9 |
| | OPEL | B 12 XHT (EB2DTS) | 587 | 14 |
| | PEUGEOT | EB2DTS (HNY), EB2DTS (HNX), EB2DTS (HNW) | 622 | 9 |
| | VAUXHALL | B 12 XHT (EB2DTS) | 823 | 16 |
| V80021 | CITROËN | EB2DTS (HNY) | 136 | 9 |
| | OPEL | B 12 XHT (EB2DTS) | 587 | 14 |
| | PEUGEOT | EB2DTS (HNY), EB2DTS (HNX), EB2DTS (HNW) | 622 | 9 |
| | VAUXHALL | B 12 XHT (EB2DTS) | 823 | 16 |
| V80022 | VW | AGK, ATA, AUH, BCQ | 933 | 152 |
| V80023 | VW | AGK, ATA, AUH, BCQ | 933 | 152 |
| V80024 | AUDI | CEUC, CTGE | 78 | 102 |
| | VW | CGEA | 930 | 143 |
| | | CJTA | 930 | 144 |
| V80025 | BMW | N54 B30 B | 106 | 39 |
| | | N54 B30 A | 109 | 45 |
| V80028 | AUDI | BHZ, BUL, BZC, CAEB, CAED, CDLA, CDLB, CDLC, CDLH, CDMA, CDNC, CESA, CETA, CHJA, CPMA, CPMB, CPSA | 70 | 78 |
| | | CEPA, CEPB | 71 | 81 |





| | | |  |  |  |  | 9 | | |
|----------|---------------|--|---|---|---|---|----------|--|--|
| V80028 | AUDI | CCDA, CCEA | 77 | 96 | | | | | |
| | | CCAA | 77 | 97 | | | | | |
| | | CAJA, CAKA, CCBA, CGWC, CGXC, CMUA, CTUB | 77 | 98 | | | | | |
| | | AUK, BKH | 77 | 99 | | | | | |
| | | CEUA, CGTA, CRDB, CTGA | 78 | 101 | | | | | |
| | | BAR, BVJ, BYH | 78 | 103 | | | | | |
| | | BUJ, BXA | 79 | 106 | | | | | |
| | | VW | 927 | 134 | | | | | |
| | | V90312 | DEUTZ/KHD | F 1L 712 | 177 | 8 | | | |
| | | | | F 2L 712 | 177 | 10 | | | |
| F 3L 712 | 177 | | | 12 | | | | | |
| F 4L 712 | 178 | | | 14 | | | | | |
| F 6L 712 | 178 | | | 16 | | | | | |
| V91466 | TOYOTA | 1C | 808 | 23 | | | | | |
| | | 2C | 809 | 25 | | | | | |
| V94135 | SUBARU | 1NZ-FE | 791 | 8 | | | | | |
| | | 2NZ-FE | 804 | 10 | | | | | |
| | TOYOTA | 1NZ-FE, 1NZ-FXE | 805 | 11 | | | | | |
| | | 1NZ-FNE | 805 | 12 | | | | | |
| V94194 | NISSAN | SR20DE | 576 | 35 | | | | | |
| V94195 | NISSAN | SR20DE | 576 | 35 | | | | | |
| V94266 | PORSCHE | 911.01, 911.02, 911.04 | 647 | 2 | | | | | |
| V94267 | PORSCHE | 911.01, 911.02, 911.04 | 647 | 2 | | | | | |
| V94376 | MERCEDES-BENZ | M 102.983 | 486 | 104 | | | | | |
| | | M 102.990, M 102.991, M 102.992 | 486 | 105 | | | | | |
| V94414 | AUDI | 1Y | 50 | 20 | | | | | |
| | | AAZ | 51 | 22 | | | | | |
| | SEAT | 1Y | 756 | 35 | | | | | |
| | | AAZ | 757 | 37 | | | | | |
| | | AEF | 757 | 38 | | | | | |
| | SKODA | AEF | 776 | 19 | | | | | |
| | VW | 1Y | 903 | 68 | | | | | |
| | | AAZ | 904 | 70 | | | | | |
| | | AEF | 904 | 72 | | | | | |
| | | BGG | 907 | 80 | | | | | |
| QR20DE | | 577 | 39 | | | | | | |
| V95024 | DEUTZ/KHD | BF 4M 1013, BF 4M 1013 C, BF 4M 1013 E, BF 4M 1013 EC | 183 | 35 | | | | | |
| | | BF 6M 1013, BF 6M 1013 C, BF 6M 1013 CP, BF 6M 1013 E, BF 6M 1013 EC, BF 6M 1013 ECP | 183 | 37 | | | | | |
| V95051 | TOYOTA | 1ZR-FE | 806 | 16 | | | | | |
| V95052 | TOYOTA | 1ZR-FE | 806 | 16 | | | | | |
| V95053 | LEXUS | 2AD-FHV, 2AD-FTV | 373 | 1 | | | | | |
| | | TOYOTA | 1AD-FTV | 809 | 27 | | | | |
| | | | 2AD-FHV, 2AD-FTV | 811 | 32 | | | | |
| V95054 | LEXUS | 2AD-FHV, 2AD-FTV | 373 | 1 | | | | | |
| | | TOYOTA | 1AD-FTV | 809 | 27 | | | | |
| | | | 2AD-FHV, 2AD-FTV | 811 | 32 | | | | |
| V95055 | TOYOTA | 3S-GE, 3S-GTE | 811 | 30 | | | | | |
| V95056 | TOYOTA | 3S-GE, 3S-GTE | 811 | 30 | | | | | |
| V95057 | TOYOTA | 1KD-FTV | 814 | 39 | | | | | |
| V95058 | TOYOTA | 1KD-FTV | 814 | 39 | | | | | |
| V95059 | BMW | M60 B30 | 109 | 46 | | | | | |
| | | M62 B35 (358S1), M62 B35 (358S2), M62 B35 TU | 110 | 48 | | | | | |
| V95060 | BMW | M60 B30 | 109 | 46 | | | | | |
| | | M60 B30 (308S1) | 109 | 47 | | | | | |
| | | M62 B35 (358S1), M62 B35 (358S2), M62 B35 TU | 110 | 48 | | | | | |
| V95065 | HONDA | N22A1, N22A2 | 278 | 25 | | | | | |
| V95066 | HONDA | N22A1, N22A2 | 278 | 25 | | | | | |
| V95067 | DAF | GR 165 S1, GR 184 S1, GR 210 S1 | 169 | 5 | | | | | |
| | IVECO | F4AE0481A, F4AE0481C, F4AE0481D, F4AE3481A, F4AE3481B, F4AE3481C, F4AE3481D | 312 | 26 | | | | | |



NEW PARTS LIST

Liste der Neuaufnahmen • Elenco nuovi riferimenti
Liste des nouvelles références

| | | | 9 | |
|-------------------|-----------------|--|--------------|-----|
| V95067 | IVECO | F4AE0681A, F4AE0681B, F4AE0681C, F4AE0681D, F4AE0681E, F4AE3681B, F4AE3681D, F4AE3681E | 313 | 28 |
| V95068 | DAF | GR 165 S1, GR 184 S1, GR 210 S1 | 169 | 5 |
| | IVECO | F4AE0481A, F4AE0481C, F4AE0481D, F4AE3481A, F4AE3481B, F4AE3481C, F4AE3481D | 312 | 26 |
| | | F4AE0681A, F4AE0681B, F4AE0681C, F4AE0681D, F4AE0681E, F4AE3681B, F4AE3681D, F4AE3681E | 313 | 28 |
| V95069 | HYUNDAI | G4HG | 280 | 2 |
| | KIA | G4HE | 338 | 1 |
| | | G4HG | 338 | 2 |
| V95070 | HYUNDAI | G4HG | 280 | 2 |
| | KIA | G4HE | 338 | 1 |
| | | G4HG | 338 | 2 |
| V95073 | MERCEDES-BENZ | M 272.911, M 272.920, M 272.921, M 272.922 | 464 | 54 |
| | | M 272.940, M 272.941, M 272.942, M 272.943, M 272.944, M 272.945, M 272.946, M 272.947, M 272.948, M 272.949, M 272.952 | 466 | 58 |
| V95074 | MERCEDES-BENZ | M 272.911, M 272.920, M 272.921, M 272.922 | 464 | 54 |
| | | M 272.940, M 272.941, M 272.942, M 272.943, M 272.944, M 272.945, M 272.946, M 272.947, M 272.948, M 272.949, M 272.952 | 466 | 58 |
| V95077 | HYUNDAI | D4BF | 286 | 28 |
| | | D4BH | 287 | 29 |
| | | 4D56T, D4BA, D4BX | 287 | 30 |
| | | D4BB | 287 | 31 |
| | KIA | D4BH | 342 | 19 |
| | | MITSUBISHI | D4BF | 556 |
| | D4BH | | 556 | 20 |
| | 4D56 T, 4D56 TD | | 557 | 22 |
| | | | | |
| | V95078 | HYUNDAI | D4BF | 286 |
| D4BH | | | 287 | 29 |
| 4D56T, D4BA, D4BX | | | 287 | 30 |
| D4BB | | | 287 | 31 |
| KIA | | D4BH | 342 | 19 |
| | | MITSUBISHI | D4BF | 556 |
| D4BH | | | 556 | 20 |
| 4D56 T, 4D56 TD | | | 557 | 22 |
| | | | | |
| V95094 | | HONDA | D14Z4, D14Z5 | 274 |
| | R18A1, R18A2 | | 276 | 18 |
| | K24A4 | | 278 | 26 |
| V95102 | DEUTZ/KHD | BF 4M 1013, BF 4M 1013 C, BF 4M 1013 E, BF 4M 1013 EC | 183 | 35 |
| | | BF 4M 1013 FC | 183 | 36 |
| | | BF 6M 1013, BF 6M 1013 C, BF 6M 1013 CP, BF 6M 1013 E, BF 6M 1013 EC, BF 6M 1013 ECP | 183 | 37 |
| | | BF 6M 1013 FC | 184 | 38 |
| V95103 | DEUTZ/KHD | BF 4M 1013, BF 4M 1013 C, BF 4M 1013 E, BF 4M 1013 EC | 183 | 35 |
| | | BF 4M 1013 FC | 183 | 36 |
| | | BF 6M 1013, BF 6M 1013 C, BF 6M 1013 CP, BF 6M 1013 E, BF 6M 1013 EC, BF 6M 1013 ECP | 183 | 37 |
| | | BF 6M 1013 FC | 184 | 38 |
| V95112 | SCANIA | DC 9.22, DC 9.29, DC 9.30, DC 9.32, DC 9.35, DC 9.36 | 742 | 20 |
| | | DC 13.05, DC 13.06, DC 13.07, DC 13.10 | 742 | 21 |
| V95113 | SCANIA | DC 9.22, DC 9.29, DC 9.30, DC 9.32, DC 9.35, DC 9.36 | 742 | 20 |
| | | DC 13.05, DC 13.06, DC 13.07, DC 13.10 | 742 | 21 |
| V95114 | AUDI | CAGA, CAGB, CAGC, CAHA, CAHB, CBAA, CBAB, CBBB, CFFA, CFFB, CFGB, CFGC, CFGD, CFHB, CFHD, CGLA, CGLB, CGLC, CGLD, CGLE, CJCA, CJCB, CJCC, CJCD, CLJA, CLLB, CMEA, CMFA, CMFB, CMGA, CMGB, CNHA, CNHC, CRBC, CRBD, CRFA, CRFC, CRLB, CRLC, CRUA, CSUA, CSUB, CUNA, CUPA, CUVC, CUWA, DFGA | 60 | 48 |
| | | CDTA, CDTB, CDUC, CDUD, CGQB, CJGA, CJGC, CJGD, CJMA, CKVB, CKVC, CLAA, CLAB, CLZB, CMHA, CNRB, CPNA, CPNB, CRCA, CTBA | 75 | 90 |
| | SEAT | CAGA, CAGC, CAHA, CBDB, CEGA, CFFA, CFFB, CFFE, CFGB, CFGC, CFHC, CFHD, CFJA, CGLB, CJCA, CJCC, CKFC, CLCB, CRBC, CRLB, CRMB, CRVA, CRVC, CUNA, CUPA, CUVA, CUVC, CUWA | 764 | 57 |
| | SKODA | CBBB, CBDB, CEGA, CFFB, CFGB, CFHA, CFHC, CFHF, CFJA, CKFB, CKFC, CLCA, CLCB, CLJA, CRLB, CRMB, CRVC, CUNA, CUPA, CUUB, DFEA, DFGA | 780 | 32 |





| | |  | |  | |  | |  | | 9 | |
|--------|---------------|--|-----|---|--|---|--|---|--|----------|--|
| V95114 | VW | CAAA, CAAB, CAAC, CAAD, CAAE, CBAA, CBAB, CBAC, CBBA, CBBB, CBDA, CBDB, CBDC, CBEA, CCHA, CCHB, CDDB, CDCA, CEGA, CFCA, CFFA, CFFB, CFFD, CFFE, CFGB, CFGC, CFHB, CFHC, CFHE, CFHF, CFJA, CFJB, CJAA, CKFC, CKRA, CKTB, CKTC, CKUB, CKUC, CLCA, CLCB, CLJA, CLLA, CNEA, CNFA, CNFB, CRBB, CRBC, CRFC, CRLB, CRMB, CRUA, CRVA, CRVC, CSHA, CUNA, CUPA, CUUB, CUVA, CUVB, CUWA, CYKB, DFEA, DFEF, DFGA, DFGB, DFHA | 917 | 109 | | | | | | | |
| | | CFEA | 927 | 135 | | | | | | | |
| | | CJGD, CJMA, CNRB, CRCA | 929 | 140 | | | | | | | |
| V95119 | NISSAN | MR20DE | 574 | 30 | | | | | | | |
| V95120 | NISSAN | MR20DE | 574 | 30 | | | | | | | |
| V95121 | MERCEDES-BENZ | OM 470.903, OM 470.906, OM 470.908 | 512 | 135 | | | | | | | |
| V95122 | MERCEDES-BENZ | OM 470.903, OM 470.906, OM 470.908 | 512 | 135 | | | | | | | |
| V95123 | MERCEDES-BENZ | OM 471.900, OM 471.901, OM 471.902, OM 471.903, OM 471.905, OM 471.906, OM 471.909, OM 471.910, OM 471.911, OM 471.913, OM 471.914, OM 471.915, OM 471.917, OM 471.927, OM 471.932, OM 471.933, OM 471.934, OM 471.935 | 543 | 184 | | | | | | | |
| V95124 | MERCEDES-BENZ | OM 471.900, OM 471.901, OM 471.902, OM 471.903, OM 471.905, OM 471.906, OM 471.909, OM 471.910, OM 471.911, OM 471.913, OM 471.914, OM 471.915, OM 471.917, OM 471.927, OM 471.932, OM 471.933, OM 471.934, OM 471.935 | 543 | 184 | | | | | | | |
| V95125 | AUDI | CAYB, CAYC, CLHA, CRKB, CXMA | 50 | 19 | | | | | | | |
| | SEAT | CFWA | 755 | 30 | | | | | | | |
| | | CAYA, CAYB, CAYC, CLHA, CLHB, CLNA, CRKB | 756 | 33 | | | | | | | |
| | SKODA | CFWA | 774 | 15 | | | | | | | |
| | | CAYA, CAYB, CAYC, CLHA, CLHB, CLNA, CRKB | 775 | 18 | | | | | | | |
| | VW | CFWA | 900 | 61 | | | | | | | |
| | | CAYA, CAYB, CAYC, CAYD, CAYE, CLHA, CLHB, CLNA, CRKA, CRKB, CXXA, CXXB, DCXA, DGDB | 901 | 64 | | | | | | | |
| V95126 | AUDI | CAYB, CAYC, CLHA, CRKB, CXMA | 50 | 19 | | | | | | | |
| | SEAT | CFWA | 755 | 30 | | | | | | | |
| | | CAYA, CAYB, CAYC, CLHA, CLHB, CLNA, CRKB | 756 | 33 | | | | | | | |
| | SKODA | CFWA | 774 | 15 | | | | | | | |
| | | CAYA, CAYB, CAYC, CLHA, CLHB, CLNA, CRKB | 775 | 18 | | | | | | | |
| | VW | CFWA | 900 | 61 | | | | | | | |
| | | CAYA, CAYB, CAYC, CAYD, CAYE, CLHA, CLHB, CLNA, CRKA, CRKB, CXXA, CXXB, DCXA, DGDB | 901 | 64 | | | | | | | |
| V95127 | AUDI | BDB, BHE, BMJ, BUB | 76 | 93 | | | | | | | |
| | | BPF | 76 | 94 | | | | | | | |
| | | BHK | 80 | 108 | | | | | | | |
| | PORSCHE | M02.2Y | 647 | 3 | | | | | | | |
| | SKODA | CDVA | 782 | 39 | | | | | | | |
| | VW | AYT, AZZ, BAA, BDL, BFH, BKJ, BKK, BKL, BML, BMV, BMX, BPF, BRJ, BRK, BUB, CBRA, CFLA | 930 | 142 | | | | | | | |
| | | AXZ | 931 | 147 | | | | | | | |
| | | BHK, BLV, BWS, CDVA, CHNA | 932 | 148 | | | | | | | |
| V95128 | AUDI | BDB, BHE, BMJ, BUB | 76 | 93 | | | | | | | |
| | | BPF | 76 | 94 | | | | | | | |
| | | BHK | 80 | 108 | | | | | | | |
| | PORSCHE | M02.2Y | 647 | 3 | | | | | | | |
| | SKODA | CDVA | 782 | 39 | | | | | | | |
| | VW | AYT, AZZ, BAA, BDL, BFH, BKJ, BKK, BKL, BML, BMV, BMX, BPF, BRJ, BRK, BUB, CBRA, CFLA | 930 | 142 | | | | | | | |
| | | AXZ | 931 | 147 | | | | | | | |
| | | BHK, BLV, BWS, CDVA, CHNA | 932 | 148 | | | | | | | |
| V95129 | NISSAN | YD22DDT, YD22DDTi, YD22ETI | 577 | 36 | | | | | | | |
| | | YD25DDTi | 578 | 41 | | | | | | | |
| V95130 | NISSAN | YD22DDT, YD22DDTi, YD22ETI | 577 | 36 | | | | | | | |
| | | YD25DDTi | 578 | 41 | | | | | | | |
| V95131 | NISSAN | QG18DE | 573 | 24 | | | | | | | |
| V95132 | NISSAN | QG18DE | 573 | 24 | | | | | | | |
| V95133 | HYUNDAI | D3EA | 284 | 19 | | | | | | | |
| | | D4EA, D4EA-F, D4EA-V | 285 | 21 | | | | | | | |
| | | D4EB | 286 | 25 | | | | | | | |
| | KIA | D4EA, D4EA-F | 341 | 14 | | | | | | | |
| V95134 | HYUNDAI | D3EA | 284 | 19 | | | | | | | |
| | | D4EA, D4EA-F, D4EA-V | 285 | 21 | | | | | | | |
| | | D4EB | 286 | 25 | | | | | | | |
| | KIA | D4EA, D4EA-F | 341 | 14 | | | | | | | |
| V95135 | CITROËN | DT17BTED4 (UHZ), DT17ED4, DT17TED4 (UHZ) | 144 | 29 | | | | | | | |



NEW PARTS LIST

Liste der Neuaufnahmen • Elenco nuovi riferimenti
Liste des nouvelles références





| | | | 9 | | |
|---------|------------|---|---|-------|----|
| V95135 | CITROËN | DT20C | 148 | 42 | |
| | | JAGUAR | AJD | 332 1 | |
| | | | 306DT, AJV6D | 332 2 | |
| | LAND ROVER | 276DT | 367 | 4 | |
| | | 368DT | 367 | 5 | |
| | | 306DT, 30DDTX | 368 | 8 | |
| | | 448DT | 368 | 9 | |
| | PEUGEOT | DT17 (UHZ), DT17BTED4 (UHZ), DT17TED4 | 630 | 28 | |
| | | DT20C | 635 | 42 | |
| | V95136 | CITROËN | DT17BTED4 (UHZ), DT17ED4, DT17TED4 (UHZ) | 144 | 29 |
| DT20C | | | 148 | 42 | |
| JAGUAR | | AJD | 332 | 1 | |
| | | | 306DT, AJV6D | 332 2 | |
| | | LAND ROVER | 276DT | 367 | 4 |
| | | 368DT | 367 | 5 | |
| | | 306DT, 30DDTX | 368 | 8 | |
| | | 448DT | 368 | 9 | |
| PEUGEOT | | DT17 (UHZ), DT17BTED4 (UHZ), DT17TED4 | 630 | 28 | |
| | | DT20C | 635 | 42 | |
| V95137 | CITROËN | DV4C (8HR) | 135 | 5 | |
| | | DV6C (9HD), DV6C (9HL), DV6C (9HR), DV6DBM (9HE), DV6DTED (9HP), DV6DTEDM (9HJ), DV6DUM (9HH), DV6ETED (9HN), DV6ETED (9HW), DV6ETEDM (9HK), DV6FC (BHZ), DV6UC (9HM) | 140 | 18 | |
| | FIAT | 9HM (DV6UC) | 201 | 28 | |
| | FORD | KVJA | 239 | 13 | |
| | | | T1BA, T1BB, T1BC, T1DA, T1DB, T1WB, T3DA, T3DB, T3JA, TZJA, TZJB | 243 | 23 |
| | PEUGEOT | DV4C (8HR) | 621 | 7 | |
| | | DV6C (9HD), DV6C (9HL), DV6C (9HR), DV6CTED (9HD), DV6DTED (9HP), DV6DTEDM (9HJ), DV6DUM (9HH), DV6ETED (9HN), DV6ETEDM (9HK), DV6FC (BHZ), DV6UC (9HM) | 626 | 16 | |
| | VOLVO | D 4162 T | 849 | 2 | |
| | V95138 | CITROËN | DV4C (8HR) | 135 | 5 |
| | | | DV6C (9HD), DV6C (9HL), DV6C (9HR), DV6DBM (9HE), DV6DTED (9HP), DV6DTEDM (9HJ), DV6DUM (9HH), DV6ETED (9HN), DV6ETED (9HW), DV6ETEDM (9HK), DV6FC (BHZ), DV6UC (9HM) | 140 | 18 |
| FIAT | | 9HM (DV6UC) | 201 | 28 | |
| FORD | | KVJA | 239 | 13 | |
| | | | T1BA, T1BB, T1BC, T1DA, T1DB, T1WB, T3DA, T3DB, T3JA, TZJA, TZJB | 243 | 23 |
| PEUGEOT | | DV4C (8HR) | 621 | 7 | |
| | | DV6C (9HD), DV6C (9HL), DV6C (9HR), DV6CTED (9HD), DV6DTED (9HP), DV6DTEDM (9HJ), DV6DUM (9HH), DV6ETED (9HN), DV6ETEDM (9HK), DV6FC (BHZ), DV6UC (9HM) | 626 | 16 | |
| VOLVO | | D 4162 T | 849 | 2 | |
| V95140 | | FORD | CVRA, CVRB, CVRC, CYFA, CYFB, CYFC, CYFD, CYRA, CYRB, CYRC, DRF5, DRFA, DRFB, DRFC, DRFD, DRFE, DRFF, DRFG, DRR5, DRRR, DRRB, DRRC, GBVAJPF, GBVAJQJ, GBVAJQW, P8FA, P8FB, PGFA, PGFB, QJBA, QJBB, QJBC, QJBD, QVFA, QWFA, SRFA, SRFB, SRFC, SRFD, SRFE, UHFA, UHFB, UHFC, USR6, USRA, USRB | 262 | 76 |
| | | | H9FB, H9FD, JXFA, JXFC, PHFA, PHFC | 266 | 85 |
| | SAFA, SAFB | | 266 | 86 | |
| | LAND ROVER | ZSD-422 | 369 | 14 | |
| | | ZSD-424 | 370 | 17 | |
| | V95141 | CHEVROLET | M13A | 120 | 17 |
| | | FIAT | M16A | 203 | 38 |
| SUBARU | | M13A | 791 | 9 | |
| SUZUKI | | M13A | 797 | 17 | |
| | | M16A | 798 | 18 | |
| V95142 | CHEVROLET | M13A | 120 | 17 | |
| | FIAT | M16A | 203 | 38 | |
| | SUBARU | M13A | 791 | 9 | |
| | SUZUKI | M13A | 797 | 17 | |
| | | M16A | 798 | 18 | |
| V95143 | DAIHATSU | 1NR-FE | 173 | 3 | |
| | SUBARU | 1NR-FE | 790 | 3 | |
| | TOYOTA | 1NR-FE | 803 | 5 | |
| V95144 | DAIHATSU | 1NR-FE | 173 | 3 | |
| | SUBARU | 1NR-FE | 790 | 3 | |





|    | | |  9 | |
|---|-----------|--|---|-----|
| V95144 | TOYOTA | 1NR-FE | 803 | 5 |
| V95145 | TOYOTA | 2KD-FTV | 813 | 36 |
| V95146 | TOYOTA | 2KD-FTV | 813 | 36 |
| V95147 | TOYOTA | 1KZ-T | 814 | 40 |
| | | 1KZ-TE | 814 | 41 |
| V95148 | TOYOTA | 1KZ-T | 814 | 40 |
| | | 1KZ-TE | 814 | 41 |
| V95149 | AUDI | CBZA, CBZB | 46 | 1 |
| | SEAT | CBZA, CBZB | 749 | 7 |
| | SKODA | CBZA, CBZB | 771 | 1 |
| | VW | CBZA, CBZB, CBZC | 884 | 3 |
| V95150 | AUDI | CBZA, CBZB | 46 | 1 |
| | SEAT | CBZA, CBZB | 749 | 7 |
| | SKODA | CBZA, CBZB | 771 | 1 |
| | VW | CBZA, CBZB, CBZC | 884 | 3 |
| V95152 | AUDI | BDW | 65 | 64 |
| | | BYT | 66 | 68 |
| | | BZB, CABA, CABB, CABD, CDA, CDHA, CDHB | 66 | 69 |
| | | AWA, AXW, BLR, BLX, BLY, BMB, BVY, BVZ, BYK | 68 | 75 |
| | | AXX, BGB, BPG, BPJ, BPY, BWA, BWE, BWT, CAEA, CAWB, CBFA, CCTA, CCZA, CCZC, CDNA, CDNB, CFKA | 69 | 77 |
| | | CTSA | 71 | 82 |
| | | BDX, CJBA | 76 | 95 |
| | | BPK, BYU | 78 | 100 |
| | | CALA, CALB | 79 | 107 |
| | SEAT | BYT, BZB, CDA, CDHA, CDHB | 765 | 59 |
| | | BLR, BLY, BVY, BVZ | 766 | 63 |
| | | BWA, BWE, CCZA | 766 | 64 |
| | SKODA | BZB, CDA, CDAB | 780 | 33 |
| | | BLR, BLX, BLY, BVX, BVY, BVZ | 781 | 36 |
| | | BWA, CCZA | 782 | 37 |
| | VW | BZB, CDA, CDAB, CGYA | 923 | 124 |
| | | AXW, BLR, BLX, BLY, BVX, BVY, BVZ | 926 | 132 |
| | | AXX, BPY, BWA, CAWA, CAWB, CBFA, CCTA, CCTB, CCZA, CCZC, CCZD, CFPA, CJKB | 926 | 133 |
| | | BGP, BGQ, BPR, BPS, BTK, CBTA, CBUA, CCA | 928 | 137 |
| V95153 | BMW | N13 B16 A | 92 | 1 |
| | CITROËN | EP6 CB (5FK), EP6CDTX (5FY), EP6DTX (5FU) | 141 | 22 |
| | MINI | N18 B16 A, N18 B16 B, N18 B16 C | 549 | 6 |
| | PEUGEOT | EP6CDTX, EP6CDTX (5FU) | 628 | 21 |
| V95154 | BMW | N47 D16 A | 92 | 2 |
| | MINI | N47 C16 A | 549 | 8 |
| V95155 | BMW | N20 B20 A, N20 B20 B | 102 | 29 |
| | | N55 B30 A | 106 | 40 |
| | | N52 B30, N52 B30 A, N52 B30 B, N52N B30 B, N53 B30, N53 B30 A | 112 | 55 |
| V95156 | FORD | M1CA, M1CB, M1DA, M1JA, M1JC, M1JE, YYJA, YYJB | 237 | 7 |
| | | M2DA, M2GA, M2GB, P4JA, P4JB, P4JC, P4JD, SFCA, SFCB, SFCC, SFCD, SFDA, SFJA, SFJB, SFJC, SFJD, XMJA, XMJB | 238 | 8 |
| V95157 | CHEVROLET | A 17 DTE | 122 | 24 |
| | OPEL | A 17 DT, A 17 DTC, A 17 DTE, A 17 DTJ, A 17 DTL, A 17 DTN, A 17 DTR, A 17 DTS, Z 17 DTJ, Z 17 DTR | 594 | 34 |
| | VAUXHALL | A 17 DT, A 17 DTC, A 17 DTE, A 17 DTJ, A 17 DTL, A 17 DTR, A 17 DTS, Z 17 DTJ, Z 17 DTR | 829 | 35 |
| V95159 | CITROËN | EB2D (HMT), EB2DT (HNZ), EB2F (HMZ) | 136 | 8 |
| | PEUGEOT | EB2D (HMT), EB2DT (HNZ), EB2F (HMZ) | 621 | 8 |
| V95160 | RENAULT | DXi 13, DXi 13 440, DXi 13 460, DXi 13 480, DXi 13 500, DXi 13 520 | 716 | 100 |
| | VOLVO | D13A360, D13A400, D13A440, D13A480, D13A520, D13B360, D13B400, D13B440, D13B500, D13C380, D13C420, D13C460, D13C500, D13C540 | 872 | 69 |
| V95161 | RENAULT | DXi 13, DXi 13 440, DXi 13 460, DXi 13 480, DXi 13 500, DXi 13 520 | 716 | 100 |
| | VOLVO | D13A360, D13A400, D13A440, D13A480, D13A520, D13B360, D13B400, D13B440, D13B500, D13C380, D13C420, D13C460, D13C500, D13C540 | 872 | 69 |
| V95162 | BMW | N47 D16 A | 92 | 2 |
| | MINI | N47 C16 A | 549 | 8 |
| V95163 | CITROËN | EB2D (HMT), EB2DT (HNZ), EB2F (HMZ) | 136 | 8 |



NEW PARTS LIST

Liste der Neuaufnahmen • Elenco nuovi riferimenti
Liste des nouvelles références

| | | |      9 | | | |
|--|---------------|--|---|--|-----|-----|
| V95163 | PEUGEOT | EB2D (HMT), EB2DT (HNZ), EB2F (HMZ) | 621 | 8 | | |
| V95164 | DEUTZ/KHD | TCD 2013 L06 4V, TCD 2013 L6 4V | 184 | 39 | | |
| | RENAULT | DXi 5 | 713 | 87 | | |
| | | DXi 7 | 713 | 88 | | |
| | VOLVO | D7E240, D7E280, D7E290, D7E320 | 867 | 61 | | |
| V95165 | DEUTZ/KHD | TCD 2013 L06 4V, TCD 2013 L6 4V | 184 | 39 | | |
| | RENAULT | DXi 5 | 713 | 87 | | |
| | | DXi 7 | 713 | 88 | | |
| | VOLVO | D7E240, D7E280, D7E290, D7E320 | 867 | 61 | | |
| V95166 | VOLVO | D16C550, D16C610 | 873 | 70 | | |
| V95167 | VOLVO | D16C550, D16C610 | 873 | 70 | | |
| V95168 | SCANIA | DC 9.01, DC 9.02, DC 9.03, DC 9.04, DC 9.05, DC 9.06, DSC 9.11, DSC 9.12, DSC 9.13, DSC 9.15 | 733 | 1 | | |
| | | DC 9.11, DC 9.12, DC 9.13, DC 9.16, DC 9.17, DC 9.18 | 733 | 2 | | |
| V95169 | SCANIA | DC 9.01, DC 9.02, DC 9.03, DC 9.04, DC 9.05, DC 9.06, DSC 9.11, DSC 9.12, DSC 9.13, DSC 9.15 | 733 | 1 | | |
| | | DC 9.11, DC 9.12, DC 9.13, DC 9.16, DC 9.17, DC 9.18 | 733 | 2 | | |
| V95170 | RENAULT | DXi 11 | 715 | 94 | | |
| V95171 | RENAULT | DXi 11 | 715 | 94 | | |
| V95174 | MERCEDES-BENZ | OM 457.958, OM 457.962, OM 457.966 | 526 | 159 | | |
| | | OM 457.974, OM 457.976, OM 457.977, OM 457.980, OM 458.990, OM 458.991 | 527 | 160 | | |
| | | OM 460.900, OM 460.901, OM 460.902, OM 460.903, OM 460.904, OM 460.905, OM 460.906, OM 460.907, OM 460.908, OM 460.909, OM 460.910, OM 460.911, OM 460.912, OM 460.913, OM 460.914, OM 460.915, OM 460.916, OM 460.917, OM 460.918, OM 460.919, OM 460.920, OM 460.921, OM 460.922, OM 460.923, OM 460.925, OM 460.929, OM 460.931, OM 460.951, OM 460.970, OM 460.971, OM 460.975, OM 460.976, OM 460.977, OM 460.978, OM 460.979, OM 460.980, OM 460.981 | 528 | 161 | | |
| | | OM 460.939, OM 460.940, OM 460.941, OM 460.942, OM 460.943, OM 460.944, OM 460.945, OM 460.946, OM 460.947, OM 460.948, OM 460.949, OM 460.961 | 529 | 162 | | |
| | | OM 521.940, OM 521.950, OM 541.920, OM 541.921, OM 541.922, OM 541.923, OM 541.924, OM 541.925, OM 541.926, OM 541.927, OM 541.928, OM 541.940, OM 541.941, OM 541.942, OM 541.943, OM 541.944, OM 541.945, OM 541.946, OM 541.947, OM 541.948, OM 541.949, OM 541.950, OM 541.951, OM 541.952, OM 541.970, OM 541.971, OM 541.972, OM 541.973, OM 541.974, OM 541.975, OM 541.976, OM 541.977, OM 541.978, OM 541.980, OM 541.981, OM 941.910, OM 941.920, OM 941.921, OM 941.929, OM 941.930, OM 941.940, OM 941.960, OM 941.970, OM 941.980, OM 941.981, OM 941.990 | 536 | 176 | | |
| | | OM 541.953, OM 541.959, OM 541.990, OM 541.991, OM 541.992, OM 541.993, OM 541.994, OM 541.996, OM 541.997, OM 541.998, OM 541.999, OM 941.991 | 537 | 177 | | |
| | | OM 522.940, OM 522.941, OM 522.942, OM 522.943, OM 522.950, OM 542.920, OM 542.921, OM 542.922, OM 542.923, OM 542.924, OM 542.925, OM 542.926, OM 542.940, OM 542.941, OM 542.942, OM 542.943, OM 542.944, OM 542.945, OM 542.947, OM 542.948, OM 542.956, OM 542.957, OM 542.958, OM 542.960, OM 542.961, OM 542.962, OM 542.963, OM 542.964, OM 942.900, OM 942.910, OM 942.911, OM 942.912, OM 942.925, OM 942.930, OM 942.960, OM 942.967, OM 942.970, OM 942.980, OM 942.990 | 541 | 181 | | |
| | | OM 542.972 | 542 | 182 | | |
| | | V95175 | MERCEDES-BENZ | OM 457.958, OM 457.962, OM 457.966 | 526 | 159 |
| | | | | OM 457.974, OM 457.976, OM 457.977, OM 457.980, OM 458.990, OM 458.991 | 527 | 160 |
| OM 460.900, OM 460.901, OM 460.902, OM 460.903, OM 460.904, OM 460.905, OM 460.906, OM 460.907, OM 460.908, OM 460.909, OM 460.910, OM 460.911, OM 460.912, OM 460.913, OM 460.914, OM 460.915, OM 460.916, OM 460.917, OM 460.918, OM 460.919, OM 460.920, OM 460.921, OM 460.922, OM 460.923, OM 460.925, OM 460.929, OM 460.931, OM 460.951, OM 460.970, OM 460.971, OM 460.975, OM 460.976, OM 460.977, OM 460.978, OM 460.979, OM 460.980, OM 460.981 | 528 | | | 161 | | |
| OM 460.939, OM 460.940, OM 460.941, OM 460.942, OM 460.943, OM 460.944, OM 460.945, OM 460.946, OM 460.947, OM 460.948, OM 460.949, OM 460.961 | 529 | | | 162 | | |
| OM 521.940, OM 521.950, OM 541.920, OM 541.921, OM 541.922, OM 541.923, OM 541.924, OM 541.925, OM 541.926, OM 541.927, OM 541.928, OM 541.940, OM 541.941, OM 541.942, OM 541.943, OM 541.944, OM 541.945, OM 541.946, OM 541.947, OM 541.948, OM 541.949, OM 541.950, OM 541.951, OM 541.952, OM 541.970, OM 541.971, OM 541.972, OM 541.973, OM 541.974, OM 541.975, OM 541.976, OM 541.977, OM 541.978, OM 541.980, OM 541.981, OM 941.910, OM 941.920, OM 941.921, OM 941.929, OM 941.930, OM 941.940, OM 941.960, OM 941.970, OM 941.980, OM 941.981, OM 941.990 | 536 | | | 176 | | |
| OM 541.953, OM 541.959, OM 541.990, OM 541.991, OM 541.992, OM 541.993, OM 541.994, OM 541.996, OM 541.997, OM 541.998, OM 541.999, OM 941.991 | 537 | | | 177 | | |
| OM 522.940, OM 522.941, OM 522.942, OM 522.943, OM 522.950, OM 542.920, OM 542.921, OM 542.922, OM 542.923, OM 542.924, OM 542.925, OM 542.926, OM 542.940, OM 542.941, OM 542.942, OM 542.943, OM 542.944, OM 542.945, OM 542.947, OM 542.948, OM 542.956, OM 542.957, OM 542.958, OM 542.960, OM 542.961, OM 542.962, OM 542.963, OM 542.964, OM 942.900, OM 942.910, OM 942.911, OM 942.912, OM 942.925, OM 942.930, OM 942.960, OM 942.967, OM 942.970, OM 942.980, OM 942.990 | 541 | | | 181 | | |
| OM 542.972 | 542 | | | 182 | | |
| V95176 | MERCEDES-BENZ | | | M 272.960, M 272.961, M 272.963, M 272.964, M 272.965, M 272.966, M 272.967, M 272.970, M 272.971, M 272.972, M 272.975, M 272.978 | 482 | 96 |
| | | | | M 273.922, M 273.923, M 273.924 | 483 | 98 |
| | | | | | | |
| V95177 | MERCEDES-BENZ | M 272.960, M 272.961, M 272.963, M 272.964, M 272.965, M 272.966, M 272.967, M 272.970, M 272.971, M 272.972, M 272.975, M 272.978 | 482 | 96 | | |
| | | M 273.922, M 273.923, M 273.924 | 483 | 98 | | |

| | |     9 | |
|-----------|---------------|---|------------------------------------|
| V95178 | FORD | M2DA, M2GA, M2GB, P4JA, P4JB, P4JC, P4JD, SFCA, SFCA, SFCC, SFCD, SFDA, SFJA, SFJB, SFJC, SFJD, XMJA, XMJB | 238 8 |
| V95179 | FORD | M1CA, M1CB, M1DA, M1JA, M1JC, M1JE, YYJA, YYJB | 237 7 |
| V95181 | FORD | T1BA, T1BB, T1BC, T1DA, T1DB, T1WB, T3DA, T3DB, T3JA, TZJA, TZJB | 243 23 |
| V95182 | ALFA ROMEO | 199 A3.000, 199 B1.000, 199 B4.000 | 24 1 |
| | CHEVROLET | LDV, LSF | 117 3 |
| | CHRYSLER | 199 B1.000 | 127 1 |
| | FIAT | 199 A3.000, 199 A9.000, 199 B1.000, 199 B2.000, 199 B4.000, 199 B8.000, 223 A9.000 | 196 10 |
| | FORD | F6JD | 239 12 |
| | LANCIA | 199 A3.000, 199 B1.000 | 350 4 |
| | OPEL | A 13 DTC, A 13 DTE, A 13 DTR, A 13 FD, D13A, Z 13 DTE | 584 1 |
| | PEUGEOT | 199 A9.000 | 620 1 |
| | SUZUKI | D13A | 794 4 |
| | VAUXHALL | A 13 DTC, A 13 DTE, A 13 DTR, A 13 FD, Z 13 DTE | 819 2 |
| | V95183 | ALFA ROMEO | 199 A3.000, 199 B1.000, 199 B4.000 |
| CHEVROLET | | LDV, LSF | 117 3 |
| CHRYSLER | | 199 B1.000 | 127 1 |
| FIAT | | 199 A3.000, 199 A9.000, 199 B1.000, 199 B2.000, 199 B4.000, 199 B8.000, 223 A9.000 | 196 10 |
| FORD | | F6JD | 239 12 |
| LANCIA | | 199 A3.000, 199 B1.000 | 350 4 |
| OPEL | | A 13 DTC, A 13 DTE, A 13 DTR, A 13 FD, D13A, Z 13 DTE | 584 1 |
| PEUGEOT | | 199 A9.000 | 620 1 |
| SUZUKI | | D13A | 794 4 |
| VAUXHALL | | A 13 DTC, A 13 DTE, A 13 DTR, A 13 FD, Z 13 DTE | 819 2 |
| V95186 | | CHEVROLET | A 17 DTE |
| | OPEL | A 17 DT, A 17 DTC, A 17 DTE, A 17 DTJ, A 17 DTL, A 17 DTN, A 17 DTR, A 17 DTS, Z 17 DTJ, Z 17 DTR | 594 34 |
| | VAUXHALL | A 17 DT, A 17 DTC, A 17 DTE, A 17 DTJ, A 17 DTL, A 17 DTR, A 17 DTS, Z 17 DTJ, Z 17 DTR | 829 35 |
| V95187 | CHEVROLET | Z 20 DM, Z 20 DMH | 124 33 |
| | DAEWOO | Z 20 DMH | 164 11 |
| | OPEL | Z 20 DM, Z 20 DMH | 599 52 |
| | VAUXHALL | Z 20 DM, Z 20 DMH | 834 53 |
| V95188 | CHEVROLET | Z 20 DM, Z 20 DMH | 124 33 |
| | DAEWOO | Z 20 DMH | 164 11 |
| | OPEL | Z 20 DM, Z 20 DMH | 599 52 |
| | VAUXHALL | Z 20 DM, Z 20 DMH | 834 53 |
| V95189 | CHEVROLET | F 18D3 | 122 28 |
| V95190 | CHEVROLET | F 18D3 | 122 28 |
| V95191 | BMW | N20 B20 A, N20 B20 B | 102 29 |
| | | N55 B30 A | 106 40 |
| | | N52 B30, N52 B30 A, N52 B30 B, N52N B30 B, N53 B30, N53 B30 A | 112 55 |
| V95192 | AUDI | CHPB, CMBA, CPTA, CPWA, CUKB, CXSA, CXSB, CZCA, CZDA, CZEA | 46 4 |
| | SEAT | CHPA, CMBA, CPTA, CPWA, CXSA, CZCA, CZDA, CZEA | 750 11 |
| | SKODA | CHPA, CHPB, CPWA, CZCA, CZDA, CZEA | 771 4 |
| | VW | CHPA, CHPB, CMBA, CNLA, CPTA, CPVA, CPWA, CRJA, CUKA, CUKB, CXSA, CXSB, CZCA, CZDA, CZEA | 885 7 |
| V95193 | AUDI | CHPB, CMBA, CPTA, CPWA, CUKB, CXSA, CXSB, CZCA, CZDA, CZEA | 46 4 |
| | SEAT | CHPA, CMBA, CPTA, CPWA, CXSA, CZCA, CZDA, CZEA | 750 11 |
| | SKODA | CHPA, CHPB, CPWA, CZCA, CZDA, CZEA | 771 4 |
| | VW | CHPA, CHPB, CMBA, CNLA, CPTA, CPVA, CPWA, CRJA, CUKA, CUKB, CXSA, CXSB, CZCA, CZDA, CZEA | 885 7 |
| V95194 | JEEP | OM 651.925 | 336 1 |
| | MERCEDES-BENZ | OM 651.901 OM 651.911, OM 651.912, OM 651.913, OM 651.916, OM 651.921, OM 651.924, OM 651.925, OM 651.930, OM 651.940, OM 651.950, OM 651.955, OM 651.956, OM 651.957, OM 651.960, OM 651.961, OM 651.980 | 450 27 451 31 |
| V95195 | JEEP | OM 651.925 | 336 1 |
| | MERCEDES-BENZ | OM 651.901 OM 651.911, OM 651.912, OM 651.913, OM 651.916, OM 651.921, OM 651.924, OM 651.925, OM 651.930, OM 651.940, OM 651.950, OM 651.955, OM 651.956, OM 651.957, OM 651.960, OM 651.961, OM 651.980 | 450 27 451 31 |
| V95196 | SMART | M 132.910, M 132.930 | 784 3 |
| V95197 | SMART | M 132.910, M 132.930 | 784 3 |
| V95198 | HYUNDAI | G4FA | 282 12 |
| | | G4FC, G4FD | 283 13 |



NEW PARTS LIST

Liste der Neuaufnahmen • Elenco nuovi riferimenti
Liste des nouvelles références

| | | | 9 | |
|--------|------------|--|-----|-----|
| V95198 | KIA | G4FA | 339 | 9 |
| | | G4FC, G4FD | 340 | 10 |
| V95199 | HYUNDAI | G4FA | 282 | 12 |
| | | G4FC, G4FD | 283 | 13 |
| | KIA | G4FA | 339 | 9 |
| | | G4FC, G4FD | 340 | 10 |
| V95200 | HONDA | R18A1, R18A2 | 276 | 18 |
| | | K24A4 | 278 | 26 |
| V95201 | HYUNDAI | G4GC, G4GC-G | 284 | 17 |
| | | G6BA | 285 | 23 |
| | | G6BA-G | 285 | 24 |
| | KIA | G4GC | 341 | 13 |
| | | G6BA | 341 | 16 |
| V95202 | HYUNDAI | G4GC, G4GC-G | 284 | 17 |
| | | G6BA | 285 | 23 |
| | | G6BA-G | 285 | 24 |
| | KIA | G4GC | 341 | 13 |
| | | G6BA | 341 | 16 |
| V95203 | HYUNDAI | G4LA | 280 | 3 |
| | KIA | G4LA | 338 | 3 |
| V95204 | HYUNDAI | G4LA | 280 | 3 |
| | KIA | G4LA | 338 | 3 |
| V95205 | IVECO | F3BE0681A, F3BE0681B, F3BE0681E, F3BE0681G, F3BE3681B | 326 | 64 |
| | | F3B3681B | 326 | 65 |
| V95206 | IVECO | F3BE0681A, F3BE0681B, F3BE0681E, F3BE0681G, F3BE3681B | 326 | 64 |
| | | F3B3681B | 326 | 65 |
| V95207 | RENAULT | MIDR 06.35.40 G, MIDR 06.35.40 H, MIDR 06.35.40 J/3, MIDR 06.35.40 J1, MIDR 06.35.40 L1, MIDR 06.35.40 N/3 | 717 | 103 |
| V95208 | RENAULT | MIDR 06.35.40 G, MIDR 06.35.40 H, MIDR 06.35.40 J/3, MIDR 06.35.40 J1, MIDR 06.35.40 L1, MIDR 06.35.40 N/3 | 717 | 103 |
| V95209 | DAF | MX 265, MX 300, MX 340, MX 375 | 172 | 14 |
| V95210 | DAF | MX 265, MX 300, MX 340, MX 375 | 172 | 14 |
| V95211 | DAF | PE 228 C, PE 265 C, PE 310 C, PE 360 C, PR 228 S, PR 265 S | 169 | 7 |
| V95212 | DAF | PE 228 C, PE 265 C, PE 310 C, PE 360 C, PR 228 S, PR 265 S | 169 | 7 |
| V95213 | DAF | XE 390 C, XE 390 C1, XF 280 M, XF 315 M, XF 355 M | 171 | 12 |
| V95214 | VOLVO | D9A260, D9A300, D9A340, D9A380 | 867 | 62 |
| V95215 | MITSUBISHI | 3A91 | 553 | 5 |
| | | 4A90 | 553 | 6 |
| | | 4A91 | 553 | 7 |
| V95216 | MITSUBISHI | 3A91 | 553 | 5 |
| | | 4A90 | 553 | 6 |
| | | 4A91 | 553 | 7 |
| V95218 | CHRYSLER | ECC | 128 | 7 |
| | | EDV, EDZ | 128 | 8 |
| V95219 | CHRYSLER | ECC | 128 | 7 |
| | | EDV, EDZ | 128 | 8 |
| V95220 | ALFA ROMEO | 198 A1.000, 199 A8.000, 940 A2.000, 940 B1.000, 955 A2.000, 955 A7.000, 955 A8.000 | 24 | 3 |
| | FIAT | 198 A1.000, 198 A4.000, 199 A8.000, 312 A1.000, 955 A2.000, 955 A8.000 | 200 | 23 |
| | LANCIA | 198 A1.000, 198 A4.000 | 353 | 14 |
| V95223 | ALFA ROMEO | 198 A2.000, 940 A3.000, 955 A3.000, 955 A4.000 | 25 | 9 |
| | CHRYSLER | 198 A2.000 | 127 | 4 |
| | FIAT | 198 A2.000, 198 A6.000, 199 B5.000, 263 A4.000, 350 A2.000, 350 A3.000, 955 A3.000, 955 A4.000 | 204 | 40 |
| | LANCIA | 198 A2.000, 350 A2.000, 350 A3.000, 955 A4.000 | 354 | 19 |
| V95224 | NISSAN | K10 B | 569 | 11 |
| | OPEL | K10B | 586 | 8 |
| | SUZUKI | K10B | 795 | 6 |
| | VAUXHALL | K10B | 821 | 10 |
| V95225 | NISSAN | K10 B | 569 | 11 |
| | OPEL | K10B | 586 | 8 |
| | SUZUKI | K10B | 795 | 6 |
| | VAUXHALL | K10B | 821 | 10 |

| | | | 9 | |
|--------|-----------|---|-----|----|
| V95226 | DEUTZ/KHD | BF 6M 1015 C, BF 6M 1015 CP | 188 | 59 |
| | | BF 8M 1015 C, BF 8M 1015 CP, TCD 2015 V8 | 188 | 61 |
| V95227 | DEUTZ/KHD | BF 6M 1015, BF 6M 1015 CU, TCD 2015 V6 | 188 | 58 |
| | | BF 6M 1015 C, BF 6M 1015 CP | 188 | 59 |
| | | BF 8M 1015 | 188 | 60 |
| | | BF 8M 1015 C, BF 8M 1015 CP, TCD 2015 V8 | 188 | 61 |
| V95228 | HYUNDAI | D3FA | 281 | 6 |
| | | D4FC | 281 | 7 |
| | | D4FA | 281 | 8 |
| | | D4FB | 283 | 14 |
| | | D4FD | 283 | 15 |
| | KIA | D3FA | 338 | 4 |
| | | D4FC | 338 | 5 |
| | | D4FA | 339 | 6 |
| | | D4FB, D4FB-L | 340 | 11 |
| | | | | |
| V95229 | HYUNDAI | D3FA | 281 | 6 |
| | | D4FC | 281 | 7 |
| | | D4FA | 281 | 8 |
| | | D4FB | 283 | 14 |
| | | D4FD | 283 | 15 |
| | KIA | D3FA | 338 | 4 |
| | | D4FC | 338 | 5 |
| | | D4FA | 339 | 6 |
| | | D4FB, D4FB-L | 340 | 11 |
| | | | | |
| V95234 | CITROËN | DW10 C HYBRID (RHC), DW10BTED4 (RHF), DW10CB (RHD), DW10CTED4 (RHD), DW10CTED4 (RHE), DW10CTED4 (RHH), DW10DTE4 (RHB), DW10FC (AHT), DW10FD (AHU) | 149 | 43 |
| | | | | |
| | FIAT | RH02 | 219 | 80 |
| | | RHH | 219 | 81 |
| | FORD | KLWA, TXBA, TXDA, TXDB, TXWA, TYDA, TYWA, UFDA, UFDB, UKDA, UKDB | 260 | 68 |
| | | LPBA | 261 | 69 |
| | PEUGEOT | DW10 C HYBRID (RHC), DW10BTED4 (RHF), DW10CTED4 (RHE), DW10CTED4 (RHH) | 636 | 43 |
| V95235 | HYUNDAI | G4KE | 286 | 26 |
| | KIA | G4KE | 342 | 17 |
| V95236 | HYUNDAI | G4KE | 286 | 26 |
| | KIA | G4KE | 342 | 17 |
| V95237 | AUDI | CHZJ | 46 | 3 |
| | SEAT | CHYA, CHYB | 750 | 10 |
| | SKODA | CHYA, CHYB | 771 | 3 |
| | VW | CHYA, CHYB | 885 | 6 |
| V95238 | AUDI | CHZJ | 46 | 3 |
| | SEAT | CHYA, CHYB | 750 | 10 |
| | SKODA | CHYA, CHYB | 771 | 3 |
| | VW | CHYA, CHYB | 885 | 6 |
| V95239 | DACIA | H4B 400, H4B 410 | 158 | 2 |
| | RENAULT | H4B 400, H4B 401, H4B 408 | 673 | 8 |
| V95240 | DACIA | H4B 400, H4B 410 | 158 | 2 |
| | RENAULT | H4B 400, H4B 401, H4B 408 | 673 | 8 |



NEW PARTS LIST

Liste der Neuaufnahmen • Elenco nuovi riferimenti
Liste des nouvelles références

| VAG96115 | MAN | D 2066 LF01, D 2066 LF02, D 2066 LF03, D 2066 LF04, D 2066 LF06, D 2066 LF07, D 2066 LF11, D 2066 LF12, D 2066 LF13, D 2066 LF14, D 2066 LF17, D 2066 LF18, D 2066 LF19, D 2066 LF20, D 2066 LF21, D 2066 LF22, D 2066 LF23, D 2066 LF24, D 2066 LF25, D 2066 LF26, D 2066 LF27, D 2066 LF28, D 2066 LF29, D 2066 LF30, D 2066 LF31, D 2066 LF32, D 2066 LF33, D 2066 LF35, D 2066 LF36, D 2066 LF37, D 2066 LF38, D 2066 LF39, D 2066 LF40, D 2066 LF41, D 2066 LF42, D 2066 LF43, D 2066 LOH01, D 2066 LOH02, D 2066 LOH03, D 2066 LOH04, D 2066 LOH05, D 2066 LOH06, D 2066 LOH07, D 2066 LOH08, D 2066 LOH10, D 2066 LOH11, D 2066 LOH12, D 2066 LUH07, D 2066 LUH08, D 2066 LUH09, D 2066 LUH11, D 2066 LUH12, D 2066 LUH13, D 2066 LUH14, D 2066 LUH15, D 2066 LUH21, D 2066 LUH22, D 2066 LUH23, D 2066 LUH24 | 391 | 9 |
|-----------|---------------|--|-----|-----|
| | | D 2676 LF01, D 2676 LF02, D 2676 LF03, D 2676 LF04, D 2676 LF05, D 2676 LF06, D 2676 LF07, D 2676 LF11, D 2676 LF12, D 2676 LF13, D 2676 LF14, D 2676 LF21, D 2676 LOH01, D 2676 LOH02, D 2676 LOH03, D 2676 LOH04, D 2676 LOH10, D 2676 LOH26, D 2676 LOH27, D 2676 LOH28 | 396 | 20 |
| | | D 2866 LF/290, D 2866 LF23, D 2866 LF24, D 2866 LF25, D 2866 LF26, D 2866 LF27, D 2866 LF28, D 2866 LF31, D 2866 LF32, D 2866 LF36, D 2866 LF37, D 2866 LF40, D 2866 LF41, D 2866 LF43, D 2866 LOH27, D 2866 LOH28, D 2866 LOH29, D 2866 LOH32, D 2866 LOH33, D 2866 LOH34, D 2866 LUH23, D 2866 LUH24, D 2866 LUH25, D 2866 LUH29, D 2866 LUH30, D 2866 LUH51 | 400 | 23 |
| | | D 2876 LF03, D 2876 LF04, D 2876 LF05, D 2876 LF06, D 2876 LF07, D 2876 LF11, D 2876 LF20, D 2876 LOH02, D 2876 LOH03 | 401 | 26 |
| | | D 2876 LF12, D 2876 LF13, D 2876 LF25, D 2876 LOH20, D 2876 LOH21 | 402 | 27 |
| | | D 2840 LF25 | 403 | 31 |
| VAG96293B | RENAULT | K4J 715, K4J D 740 | 680 | 19 |
| VAG96320 | MERCEDES-BENZ | OM 900.910, OM 900.911, OM 900.912, OM 900.913, OM 900.915, OM 900.916, OM 900.917, OM 900.918, OM 900.919, OM 900.920, OM 900.921, OM 900.922, OM 904.904, OM 904.905, OM 904.906, OM 904.907, OM 904.908, OM 904.909, OM 904.910, OM 904.911, OM 904.912, OM 904.914, OM 904.915, OM 904.916, OM 904.917, OM 904.918, OM 904.919, OM 904.920, OM 904.921, OM 904.922, OM 904.923, OM 904.924, OM 904.925, OM 904.926, OM 904.927, OM 904.928, OM 904.929, OM 904.930, OM 904.931, OM 904.932, OM 904.933, OM 904.934, OM 904.935, OM 904.936, OM 904.937, OM 904.938, OM 904.939, OM 904.940, OM 904.941, OM 904.942, OM 904.943, OM 904.944, OM 904.945, OM 904.946, OM 904.947, OM 904.948, OM 904.949, OM 904.950, OM 904.951, OM 904.952, OM 904.953, OM 904.954, OM 904.955, OM 904.956, OM 904.957, OM 904.959, OM 904.961, OM 904.962, OM 904.964, OM 904.965, OM 904.966, OM 904.967, OM 904.968, OM 904.970, OM 904.972, OM 904.973, OM 904.976, OM 904.979, OM 907.910, OM 907.920, OM 907.930, OM 907.940, OM 907.941, OM 907.960, OM 907.970, OM 907.980, OM 907.990 | 503 | 126 |
| | | OM 902.910, OM 902.911, OM 902.912, OM 902.913, OM 902.914, OM 902.915, OM 902.916, OM 902.917, OM 902.918, OM 902.919, OM 902.920, OM 902.921, OM 902.922, OM 902.923, OM 902.924, OM 902.925, OM 902.926, OM 902.927, OM 902.930, OM 902.931, OM 902.932, OM 902.933, OM 902.934, OM 902.935, OM 902.936, OM 906.910, OM 906.911, OM 906.912, OM 906.913, OM 906.914, OM 906.915, OM 906.916, OM 906.917, OM 906.918, OM 906.919, OM 906.920, OM 906.921, OM 906.922, OM 906.923, OM 906.924, OM 906.925, OM 906.926, OM 906.927, OM 906.928, OM 906.929, OM 906.930, OM 906.931, OM 906.932, OM 906.933, OM 906.934, OM 906.935, OM 906.936, OM 906.937, OM 906.938, OM 906.939, OM 906.940, OM 906.941, OM 906.944, OM 906.945, OM 906.946, OM 906.947, OM 906.948, OM 906.949, OM 906.950, OM 906.951, OM 906.952, OM 906.953, OM 906.954, OM 906.955, OM 906.956, OM 906.957, OM 906.958, OM 906.959, OM 906.960, OM 906.961, OM 906.962, OM 906.963, OM 906.964, OM 906.965, OM 906.966, OM 906.967, OM 906.968, OM 906.970, OM 906.971, OM 906.974, OM 906.975, OM 906.976, OM 906.977, OM 906.978, OM 906.979, OM 906.980, OM 906.981, OM 906.982, OM 906.983, OM 906.985, OM 906.986, OM 906.988, OM 906.990, OM 906.991, OM 906.995, OM 906.998, OM 909.900, OM 909.901, OM 909.910, OM 909.911, OM 909.920, OM 909.921, OM 909.960, OM 909.970, OM 909.971 | 505 | 127 |
| | | OM 924.910, OM 924.911, OM 924.912, OM 924.914, OM 924.915, OM 924.916, OM 924.917, OM 924.919, OM 924.920, OM 924.922, OM 924.923, OM 924.924, OM 924.925, OM 924.928, OM 924.929, OM 924.930, OM 924.931, OM 924.932, OM 924.933 | 508 | 128 |
| | | M 906.900 | 509 | 129 |
| | | OM 925.920, OM 926.949 | 509 | 130 |
| | | OM 926.910, OM 926.911, OM 926.912, OM 926.913, OM 926.914, OM 926.915, OM 926.916, OM 926.917, OM 926.918, OM 926.919, OM 926.920, OM 926.921, OM 926.924, OM 926.925, OM 926.926, OM 926.927, OM 926.928, OM 926.929, OM 926.930, OM 926.932, OM 926.934, OM 926.935, OM 926.937, OM 926.938, OM 926.939, OM 926.940, OM 926.941, OM 926.942, OM 926.945, OM 926.947, OM 926.948, OM 926.950 | 510 | 131 |
| | | BF 4M 1013, BF 4M 1013 C, BF 4M 1013 E, BF 4M 1013 EC | 183 | 35 |
| | | BF 4M 1013 FC | 183 | 36 |
| | | BF 6M 1013, BF 6M 1013 C, BF 6M 1013 CP, BF 6M 1013 E, BF 6M 1013 EC, BF 6M 1013 ECP | 183 | 37 |
| | | BF 6M 1013 FC | 184 | 38 |
| VAG96331 | MAN | D 0834 LFL40, D 0834 LFL41, D 0834 LFL42, D 0834 LFL50, D 0834 LFL51, D 0834 LFL52, D 0834 LFL53, D 0834 LFL54, D 0834 LFL55, D 0834 LFL60, D 0834 LFL61, D 0834 LFL62, D 0834 LFL63, D 0834 LFL64, D 0834 LFL65, D 0834 LOH40, D 0834 LOH50, D 0834 LOH51, D 0834 LOH52, D 0834 LOH53, D 0834 LOH60, D 0834 LOH61 | 386 | 4 |
| | | D 0836 LF41, D 0836 LF44, D 0836 LFG50, D 0836 LFL40, D 0836 LFL41, D 0836 LFL44, D 0836 LFL50, D 0836 LFL51, D 0836 LFL52, D 0836 LFL53, D 0836 LFL54, D 0836 LFL55, D 0836 LFL60, D 0836 LFL61, D 0836 LFL62, D 0836 LFL63, D 0836 LFL64, D 0836 LFL65, D 0836 LOH40, D 0836 LOH41, D 0836 LOH51, D 0836 LOH52, D 0836 LOH55, D 0836 LOH56, D 0836 LOH60, D 0836 LOH61, D 0836 LOH62, D 0836 LOH63, D 0836 LOH64, D 0836 LOH65, D 0836 LUH40, D 0836 LUH41, D 0836 LUH50 | 390 | 8 |
| VAG96335 | IVECO | F3A3681A, F3A3681B, F3AE0681B, F3AE0681D, F3AE0681E, F3AE0681H, F3AE3681D | 325 | 60 |
| VAG96337 | IVECO | F3A3681A, F3A3681B, F3AE0681B, F3AE0681D, F3AE0681E, F3AE0681H, F3AE3681D | 325 | 60 |
| VAG96338 | MERCEDES-BENZ | M 271.921, M 271.940, M 271.941, M 271.942, M 271.944, M 271.946, M 271.948, M 271.956 | 446 | 16 |
| | | M 271.950, M 271.952, M 271.954, M 271.955 | 447 | 17 |
| VAG96341 | DEUTZ/KHD | F 2L 1011 F | 176 | 1 |
| | | F 2M 1011 | 176 | 2 |
| | | F 3L 1011 F | 176 | 3 |
| | | F 3M 1011 F | 176 | 4 |
| | | BF 4L 1011 F | 176 | 5 |
| | | BF 4L 1011 FT, F 4M 1011 F | 176 | 6 |

| VAG96341 | DEUTZ/KHD | F 4L 1011 F | 176 | 7 |
|----------------------------|---------------|--|-----|-----|
| VAG96342B | CITROËN | EW7A (6FY), EW7J4 (6FZ) | 144 | 31 |
| | | XU7JP4 (LFY) | 146 | 35 |
| | | EW10A (RFJ), EW10J4 (RFN), EW10J4S (RFK) | 151 | 49 |
| | | EW10D (RLZ) | 151 | 50 |
| | | XU10J4R (RFV) | 153 | 58 |
| | | XU10J4RS (RFS) | 153 | 59 |
| | | EW12J4 (3FY), EW12J4 (3FZ) | 154 | 63 |
| | FIAT | RFN (EW10J4) | 218 | 79 |
| | | XU10 (RFV) | 220 | 88 |
| | LANCIA | RFN, RFN (EW10J4) | 362 | 45 |
| | | RFV (XU10J4R) | 363 | 52 |
| | PEUGEOT | EW7A (6FY), EW7J4 (6FZ) | 630 | 30 |
| | | XU7JP4 (LFY) | 632 | 35 |
| | | EW10A (RFJ), EW10J4 (RFN), EW10J4 (RFR), EW10J4S (RFK) | 638 | 49 |
| EW10D (RLZ) | | 638 | 50 | |
| XU10J4R (RFV) | | 640 | 58 | |
| XU10J4RS (RFS) | | 640 | 59 | |
| EW12J4 (3FY), EW12J4 (3FZ) | | 641 | 63 | |
| VAG96343 | CITROËN | EW7A (6FY), EW7J4 (6FZ) | 144 | 31 |
| | | XU7JP4 (LFY) | 146 | 35 |
| | | EW10A (RFJ), EW10J4 (RFN), EW10J4S (RFK) | 151 | 49 |
| | | EW10D (RLZ) | 151 | 50 |
| | | XU10J4R (RFV) | 153 | 58 |
| | | XU10J4RS (RFS) | 153 | 59 |
| | | EW12J4 (3FY), EW12J4 (3FZ) | 154 | 63 |
| | FIAT | RFN (EW10J4) | 218 | 79 |
| | | XU10 (RFV) | 220 | 88 |
| | LANCIA | RFN, RFN (EW10J4) | 362 | 45 |
| | | RFV (XU10J4R) | 363 | 52 |
| | PEUGEOT | EW7A (6FY), EW7J4 (6FZ) | 630 | 30 |
| | | XU7JP4 (LFY) | 632 | 35 |
| | | EW10A (RFJ), EW10J4 (RFN), EW10J4 (RFR), EW10J4S (RFK) | 638 | 49 |
| EW10D (RLZ) | | 638 | 50 | |
| XU10J4R (RFV) | | 640 | 58 | |
| XU10J4RS (RFS) | | 640 | 59 | |
| EW12J4 (3FY), EW12J4 (3FZ) | | 641 | 63 | |
| VAG96345 | MERCEDES-BENZ | OM 900.910, OM 900.911, OM 900.912, OM 900.913, OM 900.915, OM 900.916, OM 900.917, OM 900.918, OM 900.919, OM 900.920, OM 900.921, OM 900.922, OM 904.904, OM 904.905, OM 904.906, OM 904.907, OM 904.908, OM 904.909, OM 904.910, OM 904.911, OM 904.912, OM 904.914, OM 904.915, OM 904.916, OM 904.917, OM 904.918, OM 904.919, OM 904.920, OM 904.921, OM 904.922, OM 904.923, OM 904.924, OM 904.925, OM 904.926, OM 904.927, OM 904.928, OM 904.929, OM 904.930, OM 904.931, OM 904.932, OM 904.933, OM 904.934, OM 904.935, OM 904.936, OM 904.937, OM 904.938, OM 904.939, OM 904.940, OM 904.941, OM 904.942, OM 904.943, OM 904.944, OM 904.945, OM 904.946, OM 904.947, OM 904.948, OM 904.949, OM 904.950, OM 904.951, OM 904.952, OM 904.953, OM 904.954, OM 904.955, OM 904.956, OM 904.957, OM 904.959, OM 904.961, OM 904.962, OM 904.964, OM 904.965, OM 904.966, OM 904.967, OM 904.968, OM 904.970, OM 904.972, OM 904.973, OM 904.976, OM 904.979, OM 907.910, OM 907.920, OM 907.930, OM 907.940, OM 907.941, OM 907.960, OM 907.970, OM 907.980, OM 907.990 | 503 | 126 |



NEW PARTS LIST

Liste der Neuaufnahmen • Elenco nuovi riferimenti
Liste des nouvelles références





| VAG96345 | MERCEDES-BENZ | OM 902.910, OM 902.911, OM 902.912, OM 902.913, OM 902.914, OM 902.915, OM 902.916, OM 902.917, OM 902.918, OM 902.919, OM 902.920, OM 902.921, OM 902.922, OM 902.923, OM 902.924, OM 902.925, OM 902.926, OM 902.927, OM 902.930, OM 902.931, OM 902.932, OM 902.933, OM 902.934, OM 902.935, OM 902.936, OM 906.910, OM 906.911, OM 906.912, OM 906.913, OM 906.914, OM 906.915, OM 906.916, OM 906.917, OM 906.918, OM 906.919, OM 906.920, OM 906.921, OM 906.922, OM 906.923, OM 906.924, OM 906.925, OM 906.926, OM 906.927, OM 906.928, OM 906.929, OM 906.930, OM 906.931, OM 906.932, OM 906.933, OM 906.934, OM 906.935, OM 906.936, OM 906.937, OM 906.938, OM 906.939, OM 906.940, OM 906.941, OM 906.944, OM 906.945, OM 906.946, OM 906.947, OM 906.948, OM 906.949, OM 906.950, OM 906.951, OM 906.952, OM 906.953, OM 906.954, OM 906.955, OM 906.956, OM 906.957, OM 906.958, OM 906.959, OM 906.960, OM 906.961, OM 906.962, OM 906.963, OM 906.964, OM 906.965, OM 906.966, OM 906.967, OM 906.968, OM 906.970, OM 906.971, OM 906.974, OM 906.975, OM 906.976, OM 906.977, OM 906.978, OM 906.979, OM 906.980, OM 906.981, OM 906.982, OM 906.983, OM 906.985, OM 906.986, OM 906.988, OM 906.990, OM 906.991, OM 906.995, OM 906.998, OM 909.900, OM 909.901, OM 909.910, OM 909.911, OM 909.920, OM 909.921, OM 909.960, OM 909.970, OM 909.971 | 505 | 127 | |
|-----------|---------------|--|--|--|-----|
| | | OM 924.910, OM 924.911, OM 924.912, OM 924.914, OM 924.915, OM 924.916, OM 924.917, OM 924.919, OM 924.920, OM 924.922, OM 924.923, OM 924.924, OM 924.925, OM 924.928, OM 924.929, OM 924.930, OM 924.931, OM 924.932, OM 924.933 | 508 | 128 | |
| | | M 906.900 | 509 | 129 | |
| | | OM 925.920, OM 926.949 | 509 | 130 | |
| | | OM 926.910, OM 926.911, OM 926.912, OM 926.913, OM 926.914, OM 926.915, OM 926.916, OM 926.917, OM 926.918, OM 926.919, OM 926.920, OM 926.921, OM 926.924, OM 926.925, OM 926.926, OM 926.927, OM 926.928, OM 926.929, OM 926.930, OM 926.932, OM 926.934, OM 926.935, OM 926.937, OM 926.938, OM 926.939, OM 926.940, OM 926.941, OM 926.942, OM 926.945, OM 926.947, OM 926.948, OM 926.949, OM 926.950, OM 926.951, OM 926.952, OM 926.953, OM 926.954 | 510 | 131 | |
| VAG96346 | ALFA ROMEO | 939 A4.000 | 27 | 15 | |
| | CHEVROLET | L95 | 120 | 16 | |
| | | F 16D3, F 16D4, LDE | 121 | 21 | |
| | | Z 18 XER | 123 | 30 | |
| | DAEWOO | F16D3 | 163 | 10 | |
| | FIAT | 192 B3.000 | 204 | 39 | |
| | | 939 A4.000 | 206 | 45 | |
| | OPEL | A 16 LET, A 16 XER | 591 | 26 | |
| | | Z 16 LEL, Z 16 LER, Z 16 LET | 593 | 30 | |
| | | Z 16 XE1, Z 16 XEP, Z 16 XER | 593 | 31 | |
| | | A 18 XEL, Z 18 XEP | 596 | 41 | |
| | | A 18 XER, Z 18 XER | 596 | 42 | |
| | SAAB | A16 LET | 726 | 1 | |
| | VAUXHALL | A 16 LET, A 16 XER | 826 | 27 | |
| | | Z 16 LEL, Z 16 LER, Z 16 LET | 827 | 31 | |
| | | Z 16 XE1, Z 16 XEP, Z 16 XER | 828 | 32 | |
| | | A 18 XEL, Z 18 XEP | 831 | 42 | |
| | | A 18 XER, Z 18 XER | 831 | 43 | |
| VAG96347B | CITROËN | TU5JP (NFV) | 143 | 25 | |
| | | TU5JP (NFZ) | 143 | 26 | |
| | NISSAN | K7J 700 | 570 | 15 | |
| | | PEUGEOT | TU2J2 (MFZ) | 622 | 10 |
| | | | TU3J2 (KFZ) | 624 | 14 |
| | | | TU5J2 (NFW), TU5J2 (NFW/NFY), TU5JP (NFZ) | 628 | 23 |
| | | | RENAULT | E5F 710, E5F 716, E7F 700, E7F 704, E7F 706, E7F 708, E7F 730, E7F 750 | 674 |
| | | E6J 700, E6J 701, E6J 706, E6J 712, E6J 713, E6J 718, E6J 734, E6J 738, E6J 760, E7J 601, E7J 624, E7J 626, E7J 634, E7J 635, E7J 700, E7J 706, E7J 707, E7J 710, E7J 711, E7J 718, E7J 719, E7J 720, E7J 724, E7J 726, E7J 728, E7J 742, E7J 745, E7J 754, E7J 756, E7J 757, E7J 764, E7J 770, E7J 771, E7J 773, E7J 780, K7J 700, K7J 701 | 675 | 12 | |
| VAG96348 | IVECO | F2BE0681A, F2BE0681B, F2BE0681C, F2BE0681D, F2BE0681DA, F2BE0681DB, F2BE0681E, F2BE0681F | 322 | 52 | |
| VAG96349 | IVECO | F2BE0681A, F2BE0681B, F2BE0681C, F2BE0681D, F2BE0681DA, F2BE0681DB, F2BE0681E, F2BE0681F | 322 | 52 | |
| VAG96350 | VOLVO | D16C550, D16C610 | 873 | 70 | |
| VAG96353B | AUDI | ALZ, AVU, BFQ, BGU, BSE, BSF, CCSA, CMXA | 55 | 34 | |
| | | SEAT | ALZ, BFQ, BGU, BSE, BSF, CCSA, CHGA, CMXA | 760 | 47 |
| | | SKODA | AVU, BFQ, BGU, BSE, BSF, CCSA, CHGA, CMXA | 778 | 27 |
| | | VW | ALZ, AVU, AYD, BFQ, BFS, BGU, BSE, BSF, CCSA, CHGA, CMXA | 910 | 87 |
| | | VAG96354B | DACIA | K9K 612, K9K 790, K9K 792, K9K 794, K9K 796, K9K 830, K9K 856, K9K 858, K9K 892, K9K 894, K9K 896, K9K 898 | 159 |
| | MERCEDES-BENZ | OM 607.951 | 443 | 3 | |
| | NISSAN | K9K, K9K 270, K9K 276, K9K 282, K9K 292, K9K 410, K9K 430, K9K 608, K9K 636, K9K 700, K9K 702, K9K 704, K9K 708, K9K 710, K9K 714, K9K 716, K9K 722, K9K 728, K9K 732, K9K 764, K9K 772, K9K 892, K9K 896 | 570 | 16 | |

| VAG96354B | RENAULT | K9K 608, K9K 612, K9K 636, K9K 700, K9K 702, K9K 704, K9K 706, K9K 708, K9K 710, K9K 712, K9K 714, K9K 716, K9K 718, K9K 722, K9K 724, K9K 728, K9K 729, K9K 732, K9K 734, K9K 740, K9K 750, K9K 752, K9K 760, K9K 762, K9K 764, K9K 766, K9K 768, K9K 770, K9K 772, K9K 780, K9K 790, K9K 792, K9K 794, K9K 796, K9K 800, K9K 802, K9K 804, K9K 806, K9K 808, K9K 812, K9K 820, K9K 830, K9K 832, K9K 834, K9K 836, K9K 837, K9K 856, K9K 896, K9K 898, K9K P 732 | 677 16 | |
|--|------------|--|--|--------|
| | SUZUKI | K9K 266, K9K 700 | 797 15 | |
| VAG96357 | LEXUS | 2AD-FHV, 2AD-FTV | 373 1 | |
| | MINI | 1ND, 1ND-TV | 548 1 | |
| | SUBARU | 1ND-TV | 790 4 | |
| | TOYOTA | 1ND-TV | 803 7 | |
| | | 1AD-FTV | 809 27 | |
| | | 2AD-FHV, 2AD-FTV | 811 32 | |
| | | 2KD-FTV | 813 36 | |
| 1KD-FTV | 814 39 | | | |
| VAG96359 | ALFA ROMEO | 199 A3.000, 199 B1.000, 199 B4.000 | 24 1 | |
| | | 199 B8.000 | 24 2 | |
| | CHEVROLET | LDV, LSF | 117 3 | |
| | | Z 13 DT, Z 13 DTJ | 117 4 | |
| | CHRYSLER | 199 B1.000 | 127 1 | |
| | FIAT | 169 A1.000, 188 A8.000, 188 A9.000, 199 A2.000 | 195 9 | |
| | | 199 A3.000, 199 A9.000, 199 B1.000, 199 B2.000, 199 B4.000, 199 B8.000, 223 A9.000 | 196 10 | |
| | FORD | FD4 | 236 5 | |
| | | F6JD | 239 12 | |
| | LANCIA | 188 A9.000, 199 A2.000 | 350 3 | |
| | | 199 A3.000, 199 B1.000 | 350 4 | |
| | OPEL | A 13 DTC, A 13 DTE, A 13 DTR, A 13 FD, D13A, Z 13 DTE | 584 1 | |
| | | Y 13 DT, Z 13 DT, Z 13 DTH, Z 13 DTJ, Z 13 DTR | 584 2 | |
| | PEUGEOT | 199 A9.000 | 620 1 | |
| | SUBARU | Z 13 DT | 790 1 | |
| | SUZUKI | D13A | 794 4 | |
| | | Z 13 DT, Z 13 DTJ | 794 5 | |
| | VAUXHALL | A 13 DTC, A 13 DTE, A 13 DTR, A 13 FD, Z 13 DTE | 819 2 | |
| | | Y 13 DT, Z 13 DT, Z 13 DTH, Z 13 DTJ, Z 13 DTR | 819 3 | |
| | VAG96360 | ALFA ROMEO | 198 A2.000, 940 A3.000, 955 A3.000, 955 A4.000 | 25 9 |
| | | | 937 A5.000, 939 A2.000 | 29 24 |
| | | | 937 A8.000 | 30 26 |
| | | | 939 A1.000 | 30 27 |
| 939 A3.000, 939 A9.000 | | | 32 31 | |
| 198 A5.000, 844 A2.000, 939 B3.000, 939 B5.000, 940 A5.000 | | | 33 34 | |
| CHRYSLER | | 198 A2.000 | 127 4 | |
| | | 198 A5.000 | 127 5 | |
| FIAT | | 198 A2.000, 198 A6.000, 199 B5.000, 263 A4.000, 350 A2.000, 350 A3.000, 955 A3.000, 955 A4.000 | 204 40 | |
| | | 192 A5.000, 192 B1.000, 939 A2.000 | 210 52 | |
| | | 937 A5.000 | 210 54 | |
| | | 939 A3.000 | 212 59 | |
| | | 198 A5.000, 844 A2.000, 939 B5.000, 940 A5.000 | 215 67 | |
| | | 198 A2.000, 350 A2.000, 350 A3.000, 955 A4.000 | 354 19 | |
| LANCIA | | 844 A1.000 | 355 25 | |
| | | 937 A5.000 | 356 27 | |
| | | 198 A5.000, 844 A2.000 | 359 36 | |
| OPEL | | Z 19 DTH, Z 19 DTJ | 598 47 | |
| | | A 20 DTC, A 20 DTH, A 20 DTJ | 599 51 | |
| SAAB | | Z19 DTJ | 726 4 | |
| | | Z19DTH | 727 7 | |
| | | A20 DTH | 727 8 | |
| VAUXHALL | | Z 19 DTH, Z 19 DTJ | 833 48 | |
| | | A 20 DTC, A 20 DTH, A 20 DTJ | 834 52 | |
| VAG96361B | | NISSAN | G9T 722, G9T 750 | 577 37 |
| | | | G9U 135, G9U 630, G9U 632, G9U 650, G9U 720, G9U 724, G9U 730, G9U 754 | 578 40 |
| | | OPEL | G9T 720, G9T 722, G9T 750 | 606 73 |



NEW PARTS LIST

Liste der Neuaufnahmen • Elenco nuovi riferimenti
Liste des nouvelles références

| | |  |  |  |  |  | 9 |
|------------------|-----------------|---|---|---|---|---|----------|
| VAG96361B | OPEL | G9U 630, G9U 632, G9U 650, G9U 720, G9U 724, G9U 730, G9U 750, G9U 754 | | | 607 | 78 | |
| | RENAULT | G9T 600, G9T 605, G9T 606, G9T 607, G9T 642, G9T 645, G9T 700, G9T 702, G9T 703, G9T 704, G9T 706, G9T 707, G9T 710, G9T 712, G9T 720, G9T 722, G9T 742, G9T 743, G9T 750 | | | 700 | 50 | |
| | | G9U 630, G9U 632, G9U 650, G9U 720, G9U 724, G9U 730, G9U 750, G9U 754 | | | 704 | 58 | |
| | VAUXHALL | G9T 720, G9T 722, G9T 750 | | | 840 | 73 | |
| | | G9U 630, G9U 632, G9U 650, G9U 720, G9U 724, G9U 730, G9U 750, G9U 754 | | | 841 | 78 | |
| VAG96364 | CITROËN | DV4C (8HR) | | | 135 | 5 | |
| | | DV4D, DV4TD (8HT), DV4TD (8HX), DV4TD (8HZ) | | | 135 | 6 | |
| | | DV4TED4 (8HY) | | | 135 | 7 | |
| | | DV6ATED4 (9HX), DV6AUTED4 (9HX), DV6B, DV6BTED4 (9HT), DV6BTED4 (9HW), DV6BUTED4 (9HT), DV6TED4 (9HY), DV6TED4 (9HZ), DV6TED4BU (9HS), DV6UTED4 (9HU) | | | 139 | 17 | |
| | | DV6C (9HD), DV6C (9HL), DV6C (9HR), DV6DBM (9HE), DV6DTE (9HP), DV6DTE (9HJ), DV6DUM (9HH), DV6ETED (9HN), DV6ETED (9HW), DV6ETEDM (9HK), DV6FC (BHZ), DV6UC (9HM) | | | 140 | 18 | |
| | FIAT | 9HM (DV6UC) | | | 201 | 28 | |
| | | 9HU | | | 201 | 29 | |
| | FORD | F6JA (DV4TD), F6JB (DV4TD), F6JC | | | 239 | 11 | |
| | | KVJA | | | 239 | 13 | |
| | | G8DA, G8DB, G8DC, GPDA, GPDC, HHDA, HHDB, HHJA, HHJB, HHJC, HHJD, HHJE, HHJF, MTD, UBJA | | | 242 | 22 | |
| | | T1BA, T1BB, T1BC, T1DA, T1DB, T1WB, T3DA, T3DB, T3JA, TZJA, TZJB | | | 243 | 23 | |
| | MAZDA | F6J8, F6JA, F6JB | | | 406 | 4 | |
| | | Y601 | | | 407 | 6 | |
| | MINI | 9HZ (DV6TED4) | | | 548 | 2 | |
| | PEUGEOT | DV4C (8HP), DV4TD (8HT), DV4TD (8HX), DV4TD (8HZ) | | | 621 | 6 | |
| | | DV4C (8HR) | | | 621 | 7 | |
| | | DV6ATED4 (9HV), DV6ATED4 (9HX), DV6AUTED4 (9HX), DV6BTED4 (9HT), DV6BTED4 (9HW), DV6TED4 (9HV), DV6TED4 (9HY), DV6TED4 (9HZ), DV6TED4BU (9HS), DV6UTED4 (9HU) | | | 625 | 15 | |
| | | DV6C (9HD), DV6C (9HL), DV6C (9HR), DV6CTED (9HD), DV6DTE (9HP), DV6DTE (9HJ), DV6DUM (9HH), DV6ETED (9HN), DV6ETEDM (9HK), DV6FC (BHZ), DV6UC (9HM) | | | 626 | 16 | |
| | SUZUKI | 8HY | | | 795 | 9 | |
| | | 9HX | | | 796 | 13 | |
| | TOYOTA | 2WZ-TV | | | 804 | 8 | |
| | VOLVO | D 4162 T | | | 849 | 2 | |
| D 4164 T | | | 849 | 3 | | | |
| VAG96365B | CITROËN | ET3J4 (KFU) | | | 136 | 10 | |
| | PEUGEOT | ET3J4 (KFU) | | | 622 | 11 | |
| VAG96366 | FIAT | 126 A.000 | | | 201 | 26 | |
| | | 126 A1.000, 126 A1.048 | | | 203 | 35 | |
| | | 126 A2.000, 126 A2.048 | | | 204 | 41 | |
| VAG96367 | FORD | CFBA, CGBA, CGBB, CHBA, CHBB, CSDA, CSDB, Q7DA, QQDA, QQDB, QQDC, QQDD | | | 258 | 62 | |
| | | AOBA, AOBC, AODA, AODB, AODE, AOWA, AOWB, SYDA, TBBA, TBBB | | | 264 | 79 | |
| | | CJBA, CJBB, N4JB | | | 265 | 80 | |
| | | GZ, SEBA | | | 265 | 81 | |
| | MAZDA | ZJ-VE | | | 407 | 5 | |
| | | B6ZE | | | 407 | 9 | |
| | | L813, L823 | | | 409 | 14 | |
| | | LF17, LF18, LFF7 | | | 410 | 19 | |
| | | L3, L3C1 | | | 410 | 20 | |
| | VOLVO | B 4184 S11 | | | 857 | 30 | |
| | | B 4204 S3 | | | 861 | 40 | |
| | VAG96368 | CITROËN | P22DTE (4HU), P22DTE (4HV) | | | 154 | 62 |
| | | FIAT | 4HU (P22 DTE PUMA), 4HV (P22 DTE PUMA) | | | 221 | 91 |
| FORD | | ABFA, D3FA, D5BA, D6BA, F3FA, FIFA, FMBA, HJBA, HJBB, HJBC, N7BA | | | 261 | 72 | |
| | | CVRA, CVRB, CVRC, CYFA, CYFB, CYFC, CYFD, CYRA, CYRB, CYRC, DRF5, DRFA, DRFB, DRFC, DRFD, DRFE, DRFF, DRFG, DRR5, DRRB, DRRC, GBVAJPF, GBVAJQJ, GBVAJQW, P8FA, P8FB, PGFA, PGFB, QJBA, QJBB, QJBC, QJBD, QVFA, QWFA, SRFA, SRFB, SRFC, SRFD, SRFE, UHFA, UHFB, UHFC, USR6, USRA, USRB | | | 262 | 76 | |
| | | D2FA, D2FB, D2FE, D4FA, DOFA (DT24), F4FA, FXFA, H9FA | | | 266 | 84 | |
| | | H9FB, H9FD, JXFA, JXFC, PHFA, PHFC | | | 266 | 85 | |
| | | SAFA, SAFB | | | 266 | 86 | |
| JAGUAR | | FMBA, FMBB | | | 332 | 4 | |
| | | QJBA | | | 332 | 5 | |
| LAND ROVER | | ZSD-422 | | | 369 | 14 | |

| | | | 9 | | |
|------------|--|--|------------------------|-----|----|
| VAG96368 | LAND ROVER | ZSD-424 | 370 | 17 | |
| | PEUGEOT | P22DTE (4HU), P22DTE (4HV) | 641 | 62 | |
| VAG96369 | MAZDA | HR16DE | 408 | 10 | |
| | MITSUBISHI | HR16DE | 554 | 11 | |
| | NISSAN | HR12DE | 572 | 20 | |
| | | HR16DE | 572 | 21 | |
| VAG96370 | MAZDA | HR16DE | 408 | 10 | |
| | MITSUBISHI | HR16DE | 554 | 11 | |
| | NISSAN | HR12DE | 572 | 20 | |
| | | HR16DE | 572 | 21 | |
| VAG96371 | MERCEDES-BENZ | OM 639.939 | 448 | 23 | |
| | | OM 640.940, OM 640.941, OM 640.942 | 451 | 29 | |
| | | OM 642.820, OM 642.822, OM 642.826, OM 642.830, OM 642.832, OM 642.834, OM 642.835, OM 642.836, OM 642.838, OM 642.850, OM 642.852, OM 642.853, OM 642.854, OM 642.856, OM 642.858, OM 642.861, OM 642.862, OM 642.867, OM 642.868, OM 642.870, OM 642.872, OM 642.884, OM 642.887, OM 642.890, OM 642.896, OM 642.898, OM 642.910, OM 642.920, OM 642.921, OM 642.930, OM 642.932, OM 642.940, OM 642.950, OM 642.960, OM 642.961, OM 642.970, OM 642.975, OM 642.990, OM 642.992, OM 642.993 | 453 | 32 | |
| | MITSUBISHI | OM 639.939 | 555 | 17 | |
| | SMART | OM 639.939 | 785 | 7 | |
| VAG96372 | VOLVO | D 5244 T, D 5244 T2, D 5244 T4, D 5244 T5, D 5244 T8 | 854 | 20 | |
| VAG96375 | NISSAN | YD22DDT, YD22DDTi, YD22ETI | 577 | 36 | |
| | | YD25DDTi | 578 | 41 | |
| VAG96376 | NISSAN | YD22DDT, YD22DDTi, YD22ETI | 577 | 36 | |
| | | YD25DDTi | 578 | 41 | |
| VAG96381 | DAIHATSU | 1NR-FE | 173 | 3 | |
| | SUBARU | 1NR-FE | 790 | 3 | |
| | TOYOTA | 1NR-FE | 803 | 5 | |
| VAG96382 | DEUTZ/KHD | TCD 2013 L06 4V, TCD 2013 L6 4V | 184 | 39 | |
| | | RENAULT | DXi 5 | 713 | 87 |
| | | | DXi 7 | 713 | 88 |
| | VOLVO | D7E240, D7E280, D7E290, D7E320 | 867 | 61 | |
| VAG96383B | NISSAN | M1D | 574 | 28 | |
| | | M9R, M9R 630, M9R 760, M9R 780, M9R 782 | 574 | 29 | |
| | OPEL | M9R 630, M9R 692, M9R 780, M9R 782, M9R 784, M9R 786, M9R 788 | 600 | 54 | |
| | | M9T 670, M9T 672, M9T 676, M9T 678, M9T 680, M9T 686, M9T 690, M9T 692, M9T 694, M9T 696, M9T 698, M9T 880, M9T 896, M9T 898 | 602 | 62 | |
| RENAULT | M9R 610, M9R 615, M9R 630, M9R 692, M9R 700, M9R 721, M9R 722, M9R 724, M9R 740, M9R 742, M9R 744, M9R 746, M9R 748, M9R 750, M9R 760, M9R 761, M9R 762, M9R 763, M9R 780, M9R 782, M9R 784, M9R 786, M9R 788, M9R 800, M9R 802, M9R 804, M9R 805, M9R 809, M9R 814, M9R 815, M9R 816, M9R 817, M9R 820, M9R 824, M9R 830, M9R 832, M9R 833, M9R 844, M9R 845, M9R 849, M9R 855, M9R 856, M9R 862, M9R 864, M9R 865, M9R 866 | 695 | 44 | | |
| | M9R A 700, M9R B 610, M9R B 721, M9R C 613, M9R C 615, M9R C 830, M9R G 832, M9Ra 742, M9Rk 800, M9Rk 802, M9Rk 805, M9Rk 806, M9Rk 816 | 696 | 45 | | |
| VAUXHALL | M9R 630, M9R 780, M9R 782, M9R 784, M9R 786, M9R 788 | 834 | 55 | | |
| | M9T 670, M9T 672, M9T 676, M9T 678, M9T 680, M9T 686, M9T 690, M9T 692, M9T 694, M9T 696, M9T 698, M9T 880, M9T 898 | 837 | 62 | | |
| VAG96384 | CHRYSLER | 169 A4.000 | 127 | 2 | |
| | | FIAT | 169 A4.000, 199 A4.000 | 198 | 16 |
| | | | 199 A7.000, 350 A1.000 | 201 | 25 |
| | FORD | FP4 | 237 | 6 | |
| | LANCIA | 169 A4.000 | 351 | 8 | |
| 350 A1.000 | | 353 | 15 | | |
| VAG96385 | NISSAN | K10 B | 569 | 11 | |
| | OPEL | K10B | 586 | 8 | |
| | SUZUKI | K10B | 795 | 6 | |
| | VAUXHALL | K10B | 821 | 10 | |
| VAG96386B | BMW | N43 B16 A | 95 | 12 | |
| | | N40 B16 A, N45 B16, N45 B16 A | 96 | 18 | |
| | | N42 B18 A, N46 B18 A | 97 | 22 | |
| | | N42 B20, N42 B20 A, N42 B20 B, N46 B20 A, N46 B20 B | 100 | 26 | |
| | | N46 B20 C | 101 | 28 | |
| | | S63 B44 A | 114 | 61 | |
| | | N62 B44, N62 B44 A | 114 | 64 | |















NEW PARTS LIST







Liste der Neuaufnahmen • Elenco nuovi riferimenti
Liste des nouvelles références

| VAG96386B | BMW | N62 B48 B | 115 | 66 | | |
|---|--|---|-----------|---|-----|----|
| VAG96387B | BMW | N47 D16 A | 92 | 2 | | |
| | | B37 C15 A, B37 D15 A | 95 | 14 | | |
| | | B47 C20 A, B47 D20 A, N47 D20 A, N47 D20 B, N47 D20 C, N47 D20 D, N47S D20 D | 99 | 24 | | |
| | | B57 D30 A, B57 D30 B, B57 D30 C, N57 D30 A, N57 D30 B, N57 D30 C | 107 | 41 | | |
| | | MINI | N47 C16 A | 549 | 8 | |
| | | B37 C15 A | 550 | 9 | | |
| VAG96388B | AUDI | B47 C20 A, N47 C20 A | 550 | 10 | | |
| | | CAYB, CAYC, CLHA, CRKB, CXMA | 50 | 19 | | |
| | SEAT | CFWA | 755 | 30 | | |
| | SKODA | CAYA, CAYB, CAYC, CLHA, CLHB, CLNA, CRKB | 756 | 33 | | |
| | | CFWA | 774 | 15 | | |
| | VW | CAYA, CAYB, CAYC, CLHA, CLHB, CLNA, CRKB | 775 | 18 | | |
| VAG96389B | AUDI | CFWA | 900 | 61 | | |
| | | CAYA, CAYB, CAYC, CAYD, CAYE, CLHA, CLHB, CLNA, CRKA, CRKB, CXXA, CXXB, DCXA, DGDB | 901 | 64 | | |
| | VW | BDB, BHE, BMJ, BUB | 76 | 93 | | |
| | | BHK | 80 | 108 | | |
| | | AYT, AZZ, BAA, BDL, BFH, BKJ, BKK, BKL, BML, BMV, BMX, BPF, BRJ, BRK, BUB, CBRA, CFLA | 930 | 142 | | |
| | | AXZ | 931 | 147 | | |
| VAG96390B | AUDI | BHK, BLV, BWS, CDVA, CHNA | 932 | 148 | | |
| | | BDB, BHE, BMJ, BUB | 76 | 93 | | |
| | VW | BHK | 80 | 108 | | |
| | | AYT, AZZ, BAA, BDL, BFH, BKJ, BKK, BKL, BML, BMV, BMX, BPF, BRJ, BRK, BUB, CBRA, CFLA | 930 | 142 | | |
| | | AXZ | 931 | 147 | | |
| | | BHK, BLV, BWS, CDVA, CHNA | 932 | 148 | | |
| VAG96391 | CHEVROLET | M13A | 120 | 17 | | |
| | FIAT | M16A | 203 | 38 | | |
| | SUZUKI | M13A | 797 | 17 | | |
| | | M16A | 798 | 18 | | |
| VAG96392B | BMW | N13 B16 A | 92 | 1 | | |
| | CITROËN | EP3 (8FP), EP3 (8FS) | 140 | 19 | | |
| | | EP6 (5FW), EP6C (5FS) | 141 | 21 | | |
| | | EP6 CB (5FK), EP6CDTX (5FY), EP6DTX (5FU) | 141 | 22 | | |
| | | EP6CDT (5FN), EP6CDT (5FV), EP6CDTX (5FU), EP6DT (5FR), EP6DT (5FX), EP6DTS (5FD), EP6DTS (5FY), EP6FDT (5GZ) | 142 | 23 | | |
| | | MINI | N12 B14 A | 548 | 3 | |
| | | N12 B16 A, N14 B16 A, N14 B16 C | 548 | 4 | | |
| | PEUGEOT | N16 B16 A | 549 | 5 | | |
| | | N18 B16 A, N18 B16 B, N18 B16 C | 549 | 6 | | |
| | | EB2D (HMT), EB2DT (HNZ), EB2F (HMZ) | 621 | 8 | | |
| | | EB2DTS (HNY), EB2DTS (HNX), EB2DTS (HNW) | 622 | 9 | | |
| | | EP3, EP3 (8FS), EP3C | 626 | 17 | | |
| | | EP6 | 627 | 19 | | |
| | | EP6 (5FW), EP6C (5FS) | 627 | 20 | | |
| | | EP6CDTX, EP6CDTX (5FU) | 628 | 21 | | |
| | | EP6DT (5FR), EP6DT (5FX), EP6DTS (5FY), EP6FDT (5GZ) | 628 | 22 | | |
| | | VAG96393B | BMW | N13 B16 A | 92 | 1 |
| | | | CITROËN | EP3 (8FP), EP3 (8FS) | 140 | 19 |
| | | | | EP6 (5FW), EP6C (5FS) | 141 | 21 |
| | | | | EP6 CB (5FK), EP6CDTX (5FY), EP6DTX (5FU) | 141 | 22 |
| EP6CDT (5FN), EP6CDT (5FV), EP6CDTX (5FU), EP6DT (5FR), EP6DT (5FX), EP6DTS (5FD), EP6DTS (5FY), EP6FDT (5GZ) | | | | 142 | 23 | |
| MINI | N12 B14 A | | | 548 | 3 | |
| N12 B16 A, N14 B16 A, N14 B16 C | 548 | | | 4 | | |
| PEUGEOT | N16 B16 A | | 549 | 5 | | |
| | N18 B16 A, N18 B16 B, N18 B16 C | | 549 | 6 | | |
| | EB2D (HMT), EB2DT (HNZ), EB2F (HMZ) | | 621 | 8 | | |
| | EB2DTS (HNY), EB2DTS (HNX), EB2DTS (HNW) | | 622 | 9 | | |
| | EP3, EP3 (8FS), EP3C | | 626 | 17 | | |
| | EP6 | | 627 | 19 | | |

| | |  |  |  |  | 9 |
|---|---------|---|---|---|---|----------|
| VAG96393B | PEUGEOT | EP6 (5FW), EP6C (5FS) | | | 627 | 20 |
| | | EP6CDTX, EP6CDTX (5FU) | | | 628 | 21 |
| | | EP6DT (5FR), EP6DT (5FX), EP6DTS (5FY), EP6FDT (5GZ) | | | 628 | 22 |
| VAG96394 | HYUNDAI | G4HC | | | 280 | 1 |
| | | G4HG | | | 280 | 2 |
| | | G4LA | | | 280 | 3 |
| | KIA | G4HE | | | 338 | 1 |
| | | G4HG | | | 338 | 2 |
| | | G4LA | | | 338 | 3 |
| | | A5D | | | 339 | 7 |
| VAG96395 | HYUNDAI | D3FA | | | 281 | 6 |
| | | D4FC | | | 281 | 7 |
| | | D4FA | | | 281 | 8 |
| | | D4FB | | | 283 | 14 |
| | | D4FD | | | 283 | 15 |
| | KIA | D3FA | | | 338 | 4 |
| | | D4FC | | | 338 | 5 |
| | | D4FA | | | 339 | 6 |
| VAG96396 | HYUNDAI | D4FB, D4FB-L | | | 340 | 11 |
| | | G4EA, G4EH | | | 281 | 5 |
| VAG96397 | HYUNDAI | G4EB, G4EK | | | 282 | 10 |
| | | G4EA, G4EH | | | 281 | 5 |
| VAG96398 | HYUNDAI | G4EB, G4EK | | | 282 | 10 |
| | | G4FA | | | 282 | 12 |
| VAG96399 | HYUNDAI | G4FC, G4FD | | | 283 | 13 |
| | | G4GB | | | 339 | 9 |
| | | G4GC, G4GC-G | | | 340 | 10 |
| | | G6BA | | | 283 | 16 |
| | | G6BA | | | 284 | 17 |
| VAG96400 | HYUNDAI | G6BA | | | 285 | 23 |
| | | G4GC | | | 341 | 13 |
| | | G6BA | | | 341 | 16 |
| | | G4GB | | | 283 | 16 |
| VAG96401 | HYUNDAI | G4GC, G4GC-G | | | 284 | 17 |
| | | G6BA | | | 285 | 23 |
| | | G4GC | | | 341 | 13 |
| | | G6BA | | | 341 | 16 |
| | | D3EA | | | 284 | 19 |
| VAG96402B | BMW | D4EA, D4EA-F, D4EA-V | | | 285 | 21 |
| | | D4EB | | | 286 | 25 |
| | | D4EA, D4EA-F | | | 341 | 14 |
| | | N52 B25, N52 B25 A, N52 B25 C, N53 B25 A | | | 95 | 13 |
| VAG96403B | BMW | N20 B20 A, N20 B20 B | | | 102 | 29 |
| | | N54 B30 B | | | 106 | 39 |
| | | N55 B30 A | | | 106 | 40 |
| | | N54 B30 A | | | 109 | 45 |
| | | N52 B30, N52 B30 A, N52 B30 B, N52N B30 B, N53 B30, N53 B30 A | | | 112 | 55 |
| | | N52 B25, N52 B25 A, N52 B25 C, N53 B25 A | | | 95 | 13 |
| | | N20 B20 A, N20 B20 B | | | 102 | 29 |
| | | N54 B30 B | | | 106 | 39 |
| N55 B30 A | | | 106 | 40 | | |
| N54 B30 A | | | 109 | 45 | | |
| N52 B30, N52 B30 A, N52 B30 B, N52N B30 B, N53 B30, N53 B30 A | | | 112 | 55 | | |

|  |  | ccm |  |  |  |  |
|---|---|------|---|---|---|---|
| 160 D100 | 82.60 | 1929 | 4 | 8 | Diesel | 32 |
| 182 B9.000 | 82.00 | 1910 | 4 | 8 | Diesel | 20 |
| 192 A5.000 | 82.00 | 1910 | 4 | 16 | Diesel | 21 |
| 192 B1.000 | 82.00 | 1910 | 4 | 16 | Diesel | 21 |
| 198 A1.000 | 72.00 | 1368 | 4 | 16 | Petrol | 3 |
| 198 A2.000 | 79.50 | 1598 | 4 | 16 | Diesel | 9 |
| 198 A5.000 | 83.00 | 1956 | 4 | 16 | Diesel | 34 |
| 199 A3.000 | 69.60 | 1248 | 4 | 16 | Diesel | 1 |
| 199 A6.000 | 72.00 | 1368 | 4 | 16 | Petrol | 4 |
| 199 A8.000 | 72.00 | 1368 | 4 | 16 | Petrol | 3 |
| 199 B1.000 | 69.60 | 1248 | 4 | 16 | Diesel | 1 |
| 199 B4.000 | 69.60 | 1248 | 4 | 16 | Diesel | 1 |
| 199 B8.000 | 69.60 | 1248 | 4 | 16 | Diesel | 2 |
| 350 A1.000 | 72.00 | 1368 | 4 | 8 | Petrol | 5 |
| 4.108 | 79.37 | 1760 | 4 | 8 | Diesel | 8 |
| 8140.21.200 D.I. | 93.00 | 2445 | 4 | 8 | Diesel | 55 |
| 8140.61.200 | 93.00 | 2445 | 4 | 8 | Diesel | 55 |
| 8144.21.220 | 93.00 | 2445 | 4 | 8 | Diesel | 55 |
| 8144.61.200 | 93.00 | 2445 | 4 | 8 | Diesel | 55 |
| 8144.67.220 | 93.00 | 2500 | 4 | 8 | Diesel | 56 |
| 839 A6.000 | 82.00 | 2387 | 5 | 10 | Diesel | 29 |
| 841 C.000 | 82.00 | 2387 | 5 | 10 | Diesel | 29 |
| 841 G.000 | 82.00 | 2387 | 5 | 20 | Diesel | 30 |
| 844 A2.000 | 83.00 | 1956 | 4 | 16 | Diesel | 34 |
| 932 A2.000 | 83.00 | 1970 | 4 | 16 | Petrol | 35 |
| 937 A1.000 | 83.00 | 1970 | 4 | 16 | Petrol | 35 |
| 937 A2.000 | 82.00 | 1910 | 4 | 8 | Diesel | 22 |
| 937 A3.000 | 82.00 | 1910 | 4 | 8 | Diesel | 23 |
| 937 A4.000 | 82.00 | 1910 | 4 | 16 | Diesel | 21 |
| 937 A5.000 | 82.00 | 1910 | 4 | 16 | Diesel | 24 |
| 937 A7.000 | 82.00 | 1910 | 4 | 8 | Diesel | 25 |
| 937 A8.000 | 82.00 | 1910 | 4 | 16 | Diesel | 26 |
| 939 A.000 | 87.30 | 3196 | 6 | 24 | Petrol | 48 |
| 939 A1.000 | 82.00 | 1910 | 4 | 8 | Diesel | 27 |
| 939 A2.000 | 82.00 | 1910 | 4 | 16 | Diesel | 24 |
| 939 A3.000 | 82.00 | 2387 | 5 | 20 | Diesel | 31 |
| 939 A4.000 | 80.50 | 1796 | 4 | 16 | Petrol | 15 |
| 939 A5.000 | 86.00 | 2198 | 4 | 16 | Petrol | 46 |
| 939 A6.000 | 86.00 | 1859 | 4 | 16 | Petrol | 45 |
| 939 A9.000 | 82.00 | 2387 | 5 | 20 | Diesel | 31 |
| 939 B3.000 | 83.00 | 1956 | 4 | 16 | Diesel | 34 |
| 939 B5.000 | 83.00 | 1956 | 4 | 16 | Diesel | 34 |
| 940 A2.000 | 72.00 | 1368 | 4 | 16 | Petrol | 3 |
| 940 A3.000 | 79.50 | 1598 | 4 | 16 | Diesel | 9 |
| 940 A5.000 | 83.00 | 1956 | 4 | 16 | Diesel | 34 |
| 940 B1.000 | 72.00 | 1368 | 4 | 16 | Petrol | 3 |
| 955 A2.000 | 72.00 | 1368 | 4 | 16 | Petrol | 3 |
| 955 A3.000 | 79.50 | 1598 | 4 | 16 | Diesel | 9 |
| 955 A4.000 | 79.50 | 1598 | 4 | 16 | Diesel | 9 |
| 955 A7.000 | 72.00 | 1368 | 4 | 16 | Petrol | 3 |
| 955 A8.000 | 72.00 | 1368 | 4 | 16 | Petrol | 3 |
| AR 00526 | 78.00 | 1570 | 4 | 8 | Petrol | 7 |
| AR 00536 | 78.00 | 1570 | 4 | 8 | Petrol | 7 |
| AR 00548 | 80.00 | 1779 | 4 | 8 | Petrol | 14 |
| AR 01600 | 78.00 | 1567 | 4 | 8 | Petrol | 6 |
| AR 01608 | 80.00 | 1779 | 4 | 8 | Petrol | 14 |
| AR 01608 X | 80.00 | 1779 | 4 | 8 | Petrol | 14 |
| AR 01644 | 80.00 | 1357 | 4 | 8 | Petrol | 13 |
| AR 01678 | 80.00 | 1779 | 4 | 8 | Petrol | 14 |
| AR 06100 | 78.00 | 1567 | 4 | 8 | Petrol | 6 |
| AR 06166 | 84.00 | 1962 | 4 | 8 | Petrol | 41 |
| AR 06168 | 80.00 | 1779 | 4 | 8 | Petrol | 14 |
| AR 06202 | 80.00 | 1779 | 4 | 8 | Petrol | 14 |
| AR 06224 | 84.00 | 1962 | 4 | 8 | Petrol | 41 |
| AR 06416 | 84.00 | 1962 | 4 | 8 | Petrol | 41 |
| AR 06420 | 84.00 | 1962 | 4 | 8 | Petrol | 41 |

|  |  | ccm |  |  |  |  |
|---|---|------|--|---|---|---|
| AR 06476 | 84.00 | 1995 | 4 | 8 | Petrol | 42 |
| AR 16201 | 83.00 | 1970 | 4 | 16 | Petrol | 35 |
| AR 30124 | 84.00 | 1490 | 4 | 8 | Petrol | 37 |
| AR 30128 | 84.00 | 1490 | 4 | 8 | Petrol | 37 |
| AR 30184 | 80.00 | 1286 | 4 | 8 | Petrol | 11 |
| AR 30514 | 84.00 | 1490 | 4 | 8 | Petrol | 37 |
| AR 30520 | 84.00 | 1490 | 4 | 8 | Petrol | 37 |
| AR 30550 | 87.00 | 1712 | 4 | 8 | Petrol | 47 |
| AR 30558 | 87.00 | 1712 | 4 | 8 | Petrol | 47 |
| AR 30585 | 80.00 | 1186 | 4 | 8 | Petrol | 10 |
| AR 30734 | 84.00 | 1490 | 4 | 8 | Petrol | 37 |
| AR 30736 | 87.00 | 1712 | 4 | 8 | Petrol | 47 |
| AR 30737 | 87.00 | 1712 | 4 | 8 | Petrol | 47 |
| AR 30737 A | 87.00 | 1712 | 4 | 8 | Petrol | 47 |
| AR 30750 | 84.00 | 1490 | 4 | 8 | Petrol | 37 |
| AR 30751 | 84.00 | 1490 | 4 | 8 | Petrol | 37 |
| AR 30753 | 80.00 | 1351 | 4 | 8 | Petrol | 12 |
| AR 30755 | 80.00 | 1351 | 4 | 8 | Petrol | 12 |
| AR 32102 | 82.00 | 1598 | 4 | 16 | Petrol | 17 |
| AR 32103 | 82.00 | 1598 | 4 | 16 | Petrol | 17 |
| AR 32104 | 82.00 | 1598 | 4 | 16 | Petrol | 17 |
| AR 32201 | 82.00 | 1747 | 4 | 16 | Petrol | 19 |
| AR 32205 | 82.00 | 1747 | 4 | 16 | Petrol | 19 |
| AR 32301 | 83.00 | 1970 | 4 | 16 | Petrol | 35 |
| AR 32302 | 82.00 | 1910 | 4 | 8 | Diesel | 28 |
| AR 32310 | 83.00 | 1970 | 4 | 16 | Petrol | 35 |
| AR 32401 | 88.00 | 2492 | 6 | 24 | Petrol | 50 |
| AR 32405 | 88.00 | 2492 | 6 | 24 | Petrol | 50 |
| AR 32501 | 82.00 | 2387 | 5 | 10 | Diesel | 29 |
| AR 33201 | 84.00 | 1596 | 4 | 8 | Petrol | 38 |
| AR 33501 | 80.00 | 1351 | 4 | 8 | Petrol | 12 |
| AR 33503 | 82.00 | 1370 | 4 | 16 | Petrol | 16 |
| AR 33601 | 82.60 | 1929 | 4 | 8 | Diesel | 33 |
| AR 34103 | 83.00 | 1970 | 4 | 16 | Petrol | 35 |
| AR 34201 | 88.00 | 2492 | 6 | 24 | Petrol | 50 |
| AR 34202 | 82.00 | 2387 | 5 | 10 | Diesel | 29 |
| AR 36201 | 88.00 | 2492 | 6 | 24 | Petrol | 50 |
| AR 36202 | 82.00 | 2387 | 5 | 10 | Diesel | 29 |
| AR 36301 | 83.00 | 1970 | 4 | 16 | Petrol | 35 |
| AR 37101 | 82.00 | 1910 | 4 | 8 | Diesel | 20 |
| AR 37203 | 82.00 | 1598 | 4 | 16 | Petrol | 18 |
| AR 38201 | 82.00 | 1598 | 4 | 16 | Petrol | 17 |
| AR 38401 | 82.00 | 1747 | 4 | 16 | Petrol | 19 |
| AR 38501 | 82.00 | 1370 | 4 | 16 | Petrol | 16 |
| AR 61101 | 78.00 | 1567 | 4 | 8 | Petrol | 6 |
| AR 61102 | 80.00 | 1779 | 4 | 8 | Petrol | 14 |
| AR 64103 | 84.00 | 1995 | 4 | 8 | Petrol | 43 |
| AR 67101 | 84.00 | 1773 | 4 | 8 | Petrol | 40 |
| AR 67102 | 84.00 | 1773 | 4 | 8 | Petrol | 40 |
| AR 67103 | 83.40 | 1748 | 4 | 8 | Petrol | 36 |
| AR 67105 | 83.40 | 1748 | 4 | 8 | Petrol | 36 |
| AR 67106 | 82.00 | 1747 | 4 | 16 | Petrol | 19 |
| AR 67201 | 84.00 | 1995 | 4 | 8 | Petrol | 43 |
| AR 67202 | 84.00 | 1995 | 4 | 8 | Petrol | 43 |
| AR 67203 | 84.00 | 1995 | 4 | 16 | Petrol | 44 |
| AR 67204 | 83.00 | 1970 | 4 | 16 | Petrol | 35 |
| AR 67402 | 84.00 | 1756 | 4 | 8 | Petrol | 39 |
| AR 67501 | 82.60 | 1929 | 4 | 8 | Diesel | 33 |
| AR 67502 | 82.60 | 1929 | 4 | 8 | Diesel | 33 |
| AR 67601 | 82.00 | 1598 | 4 | 16 | Petrol | 17 |
| VM 07 B | 92.00 | 2499 | 4 | 8 | Diesel | 54 |
| VM 08 B | 92.00 | 2499 | 4 | 8 | Diesel | 54 |
| VM 31 B | 92.00 | 2499 | 4 | 8 | Diesel | 54 |
| VM 32 B | 92.00 | 2499 | 4 | 8 | Diesel | 54 |
| VM 4HT 2.4 | 92.00 | 2393 | 4 | 8 | Diesel | 53 |
| VM 4HT/2 | 88.00 | 1995 | 4 | 8 | Diesel | 49 |

|  |  | ccm |  |  |  |  |
|---|---|------|---|---|---|---|
| VM 80 A | 88.00 | 1995 | 4 | 8 | Diesel | 49 |
| VM 81 A | 92.00 | 2393 | 4 | 8 | Diesel | 53 |
| VM 82 A | 92.00 | 1779 | 3 | 6 | Diesel | 52 |
| VM 84 A | 92.00 | 2499 | 4 | 8 | Diesel | 54 |
| VM 96 A | 92.00 | 1779 | 3 | 6 | Diesel | 52 |
| VM HR 588 HT | 88.00 | 2493 | 5 | 10 | Diesel | 51 |

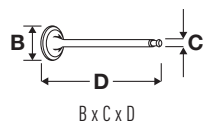

OE

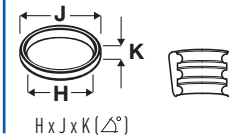
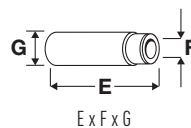
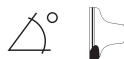

1 69.60

| | | | | | | | |
|------------|--------|--------|-----------|-----------|--------|-------------|---------|
| 199 A3.000 | 1248cc | 4 Cyl. | 16 Valves | 66kW/90PS | Diesel | Turbo, DOHC | TD23450 |
| 199 B1.000 | 1248cc | 4 Cyl. | 16 Valves | 70kW/95PS | Diesel | Turbo, DOHC | TD24590 |
| 199 B4.000 | 1248cc | 4 Cyl. | 16 Valves | 62kW/84PS | Diesel | Turbo, DOHC | TD24938 |

MITO 1.3 MultiJet 09/2008→

V95182 ■
21.85 x 5.98 x 109.25

55204574

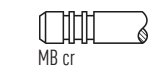

45°

H

VAG96359 ■ ■
43.28 x 6.00 x 10.25



V95183 ■
22.50 x 5.99 x 109.20

55223836



45°

SS

H

2 69.60

| | | | | | | | |
|------------|--------|--------|-----------|-----------|--------|------|---------|
| 199 B8.000 | 1248cc | 4 Cyl. | 16 Valves | 59kW/80PS | Diesel | DOHC | TD29692 |
|------------|--------|--------|-----------|-----------|--------|------|---------|

MITO 1.3 MultiJet 12/2013→

V95015 ■
21.85 x 6.00 x 109.20

55 195 680



45°

Y

H

VAG96359 ■ ■
43.28 x 6.00 x 10.25

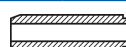

V95016 ■
21.80 x 6.00 x 109.20

55 208 213



45°

H

3 72.00

| | | | | | | | |
|------------|--------|--------|-----------|---------------------|--------|-------------|---------|
| 198 A1.000 | 1368cc | 4 Cyl. | 16 Valves | 110kW/150PS | Petrol | Turbo, DOHC | TD23452 |
| 199 A8.000 | 1368cc | 4 Cyl. | 16 Valves | 114kW/155PS | Petrol | Turbo, DOHC | TD21700 |
| 940 A2.000 | 1368cc | 4 Cyl. | 16 Valves | 110-125kW/150-170PS | Petrol | Turbo, DOHC | TD23920 |
| 940 B1.000 | 1368cc | 4 Cyl. | 16 Valves | 77kW/105PS | Petrol | DOHC | TD26994 |
| 955 A2.000 | 1368cc | 4 Cyl. | 16 Valves | 99kW/135PS | Petrol | DOHC | TD24588 |
| 955 A7.000 | 1368cc | 4 Cyl. | 16 Valves | 99kW/135PS | Petrol | Turbo, DOHC | TD24940 |
| 955 A8.000 | 1368cc | 4 Cyl. | 16 Valves | 120kW/163PS | Petrol | Turbo, DOHC | TD24589 |

GIULIETTA 1.4 TB 04/2010→

MITO 1.4 MultiAir

09/2009→

MITO 1.4 TJet 08/2008→

MITO 1.4 Turbo MultiAir

10/2009→

V98026 ■
26.80 x 6.00 x 95.20

55 185 028



45°

V95220 ■
22.40 x 5.99 x 94.65

55206233

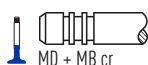

45°

H

4 72.00

| | | | | | | | |
|------------|--------|--------|-----------|-----------|--------|------|---------|
| 199 A6.000 | 1368cc | 4 Cyl. | 16 Valves | 70kW/95PS | Petrol | DOHC | TD23447 |
|------------|--------|--------|-----------|-----------|--------|------|---------|

MITO 1.4 09/2008→

V98026 ■
26.80 x 6.00 x 95.20

55 185 028



45°

V98027 ■
22.45 x 5.97 x 94.70

55 185 080

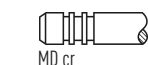

45°

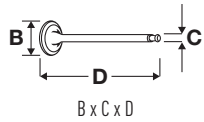

OE

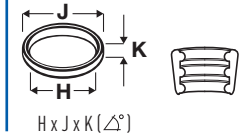
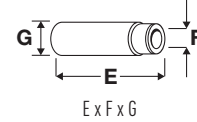
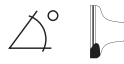

5  **72.00**

| | | | | | | | |
|-------------------|--------|----------|-----------------|-----------|--------|-------------|----------------|
| 350 A1.000 | 1368cc | 4 Cyl. | 8 Valves | 57kW/78PS | Petrol | SOHC | TD26416 |
| MITO 1.4 | | 03/2011→ | | | | | |

| | | | | | | | |
|-----------------------|------------|---|-----|--|--|--|--|
| V98022 ■ | 55 194 219 |  | 45° | | | | |
| 33.30 x 5.00 x 99.90 | | MB cr | | | | | |
| V98023 ■ | 55 200 422 |  | 45° | | | | |
| 28.10 x 5.00 x 100.50 | | MD + MB cr | | | | | |

6  **78.00**

| | | | | | | | |
|-----------------|--------|--------|-----------------|-------------------|--------|--|--------------|
| AR 01600 | 1567cc | 4 Cyl. | 8 Valves | 78-80kW/106-109PS | Petrol | | TD32 |
| AR 06100 | 1567cc | 4 Cyl. | 8 Valves | 81kW/110PS | Petrol | | TD47 |
| AR 61101 | 1567cc | 4 Cyl. | 8 Valves | 76-81kW/103-110PS | Petrol | | TD102 |

| | | | |
|---------------|-----------------|----------------|-----------------|
| 75 1.6 | 05/1985→09/1989 | 75 1.6 Cat | 05/1989→02/1992 |
| ALFETTA 1.6 | 01/1975→12/1984 | ALFETTA GT 1.6 | 01/1976→09/1982 |
| GIULIETTA 1.6 | 10/1977→05/1985 | SPIDER 1600 | 03/1966→12/1968 |

| | | | | | |
|-----------------------|------------|--|-----|----------------------|--|
| V90388 ■ | 605 21 575 |  | 30° | VAG92168B ■ |  |
| 37.10 x 8.96 x 106.10 | | MD | | 51.00 x 9.00 x 14.05 | |

7  **78.00**

| | | | | | | | |
|-----------------|--------|--------|-----------------|------------------|--------|-------------|-------------|
| AR 00526 | 1570cc | 4 Cyl. | 8 Valves | 71-81kW/97-110PS | Petrol | DOHC | TD22 |
| AR 00536 | 1570cc | 4 Cyl. | 8 Valves | 80kW/109PS | Petrol | DOHC | TD24 |

| | | | |
|-------------------|-----------------|---------|-----------------|
| GIULIA 1600 Super | 06/1964→12/1978 | GT 1600 | 01/1966→12/1977 |
| SPIDER 1600 | 03/1966→12/1990 | | |

| | | | | | |
|-----------------------|------------|---|-----|----------------------|---|
| V90388 ■ | 605 21 575 |  | 30° | VAG92168B ■ |  |
| 37.10 x 8.96 x 106.10 | | MD | | 51.00 x 9.00 x 14.05 | |

8  **79.37**

| | | | | | | | |
|--------------|--------|-----------------|-----------------|-----------|--------|----------------|--------------|
| 4.108 | 1760cc | 4 Cyl. | 8 Valves | 38kW/52PS | Diesel | Perkins | TD141 |
| GIULIA 1.8 D | | 06/1976→12/1978 | | | | | |

| | | | | | | |
|-----------------------|--------------|---|-----|---|----------------------|---|
| V3251 ■ | 140600330000 |  | 45° | H | VAG701 ■ |  |
| 35.99 x 7.95 x 117.04 | | MB | | | 54.00 x 8.03 x 12.77 | |
| | | | | | VAG586 ■ |  |
| | | | | | 62.00 x 8.01 x 12.76 | |

9  **79.50**

| | | | | | | | |
|-------------------|--------|--------|------------------|------------|--------|--------------------|----------------|
| 198 A2.000 | 1598cc | 4 Cyl. | 16 Valves | 88kW/120PS | Diesel | Turbo, DOHC | TD21698 |
| 940 A3.000 | 1598cc | 4 Cyl. | 16 Valves | 77kW/105PS | Diesel | Turbo, DOHC | TD23923 |
| 955 A3.000 | 1598cc | 4 Cyl. | 16 Valves | 88kW/120PS | Diesel | Turbo, DOHC | TD24591 |
| 955 A4.000 | 1598cc | 4 Cyl. | 16 Valves | 85kW/115PS | Diesel | Turbo, DOHC | TD23451 |

| | | | |
|--------------------|----------|---------------|----------|
| GIULIETTA 1.6 JTDM | 04/2010→ | MITO 1.6 JTDM | 08/2008→ |
|--------------------|----------|---------------|----------|

| | | | | | | | |
|-----------------------|----------|---|-----|---|---|-----------------------|---|
| V95223 ■ | 55205125 |  | 45° | Y | H | VAG96360 ■ ■ ■ |  |
| 26.55 x 5.00 x 114.40 | | MB | | | | 46.70 x 5.00 x 10.03 | |
| V98006 ■ | 55207955 |  | 45° | | | | |
| 24.50 x 5.00 x 114.40 | | MD + MB cr | | | | | |

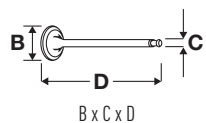

OE

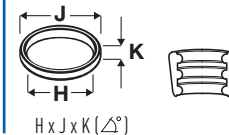
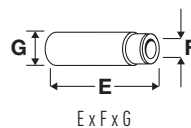

10 80.00

| | | | | | | | |
|----------------------|-----------------|--------|----------|-----------|--------|------|---------|
| AR 30585 | 1186cc | 4 Cyl. | 8 Valves | 50kW/68PS | Petrol | SOHC | TD10129 |
| 33 1.2 | 06/1983→12/1989 | | | | | | |
| V91630 | 605 40 325 | | 45° | | | | |
| 33.10 x 8.00 x 92.10 | | MD cr | | | | | |

11 80.00

| | | | | | | | |
|----------------------|-----------------|--------|----------|----------------|--------|-----------------|------|
| AR 30184 | 1286cc | 4 Cyl. | 8 Valves | 55kW/75PS | Petrol | SOHC | TD85 |
| ALFASUD 1.3 | 09/1976→12/1981 | | | ALFASUD 1.3 ti | | 09/1977→09/1984 | |
| V91630 | 605 40 325 | | 45° | | | | |
| 33.10 x 8.00 x 92.10 | | MD cr | | | | | |

12 80.00

| | | | | | | | |
|----------------------|-----------------|--------|----------|-----------------|--------|-----------------|-------|
| AR 30753 | 1351cc | 4 Cyl. | 8 Valves | 65-66kW/88-90PS | Petrol | SOHC | TD119 |
| AR 30755 | 1351cc | 4 Cyl. | 8 Valves | 65-66kW/88-90PS | Petrol | SOHC | TD120 |
| AR 33501 | 1351cc | 4 Cyl. | 8 Valves | 66kW/90PS | Petrol | SOHC | TD123 |
| 33 1.4 i.e. | 07/1990→09/1994 | | | 145 1.4 i.e. | | 07/1994→12/1996 | |
| 146 1.4 i.e. | 12/1994→12/1996 | | | | | | |
| V91630 | 605 40 325 | | 45° | | | | |
| 33.10 x 8.00 x 92.10 | | MD cr | | | | | |

13 80.00

| | | | | | | | |
|-----------------------|-----------------|--------|----------|----------------------|--------|--|------|
| AR 01644 | 1357cc | 4 Cyl. | 8 Valves | 66-70kW/90-95PS | Petrol | | TD35 |
| GIULIETTA 1.3 | 10/1977→06/1983 | | | | | | |
| V90388 | 605 21 575 | | 30° | VAG92168B | | | |
| 37.10 x 8.96 x 106.10 | | MD | | 51.00 x 9.00 x 14.05 | | | |
| | | | | VAG96216B | | | |
| | | | | 54.00 x 9.01 x 14.05 | | | |

14 80.00

| | | | | | | | |
|----------------|-----------------|--------|----------|-------------------|--------|-----------------|---------|
| AR 00548 | 1779cc | 4 Cyl. | 8 Valves | 83-97kW/113-132PS | Petrol | | TD18 |
| AR 01608 | 1779cc | 4 Cyl. | 8 Valves | 87-89kW/118-121PS | Petrol | | TD5340 |
| AR 01608 X | 1779cc | 4 Cyl. | 8 Valves | 85kW/115PS | Petrol | | TD33 |
| AR 01678 | 1779cc | 4 Cyl. | 8 Valves | 88-90kW/120-122PS | Petrol | | TD38 |
| AR 06168 | 1779cc | 4 Cyl. | 8 Valves | 88kW/120PS | Petrol | | TD54 |
| AR 06202 | 1779cc | 4 Cyl. | 8 Valves | 85-89kW/116-121PS | Petrol | | TD55 |
| AR 61102 | 1779cc | 4 Cyl. | 8 Valves | 88kW/120PS | Petrol | | TD10149 |
| 75 1.8 | 09/1985→02/1992 | | | 90 1.8 | | 10/1984→07/1987 | |
| 1750-2000 1750 | 03/1968→10/1972 | | | ALFETTA 1.8 | | 07/1974→12/1984 | |
| ALFETTA GT 1.8 | 01/1974→12/1976 | | | BERLINA 1.8 | | 09/1968→12/1972 | |
| GIULIETTA 1.8 | 04/1979→07/1985 | | | GT V 1750 | | 01/1967→12/1972 | |
| SPIDER 1750 | 01/1967→12/1971 | | | | | | |

| | | | | | | | |
|-----------------------|------------|----|-----|----------------------|--|--|--|
| V90388 | 605 21 575 | | 30° | VAG92168B | | | |
| 37.10 x 8.96 x 106.10 | | MD | | 51.00 x 9.00 x 14.05 | | | |
| | | | | VAG96216B | | | |
| | | | | 54.00 x 9.01 x 14.05 | | | |

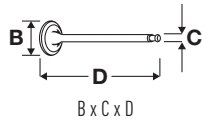

OE

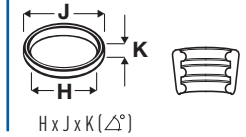
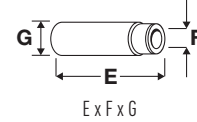
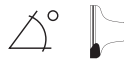





15  **80.50**

| | | | | | | | |
|------------|-----------------|--------|-----------|--------------------|--------|------|---------|
| 939 A4.000 | 179cc | 4 Cyl. | 16 Valves | 96-103kW/131-140PS | Petrol | DOHC | TD20270 |
| 159 1.8 | 03/2007→11/2011 | | | | | | |

| | | | | | |
|---|------------|---|-----|---|---|
| V98024  | 55557741 |  | 45° | VAG96346  |  |
| 31.00 x 5.00 x 114.00 | | MB cr | | 37.00 x 4.99 x 10.04 | |
| V98025  | 71 744 388 |  | 45° | | |
| 27.50 x 5.00 x 113.20 | | MD + MB cr | | | |



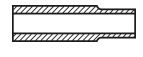



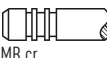

16  **82.00**

| | | | | | | | |
|----------|--------|--------|-----------|------------|--------|------|--------|
| AR 33503 | 1370cc | 4 Cyl. | 16 Valves | 76kW/103PS | Petrol | DOHC | TD9752 |
| AR 38501 | 1370cc | 4 Cyl. | 16 Valves | 76kW/103PS | Petrol | DOHC | TD9753 |

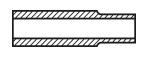
| | | | | | | |
|---|-----------------|---|-----------------|---|---|---|
| 145 1.4 i.e. 16V T.S. | 12/1996→01/2001 | 146 1.4 i.e. 16V T.S. | 11/1996→01/2001 | | | |
| V91931  | 608 12 982 |  | 45° | H | VAG96230  |  |
| 30.00 x 7.00 x 113.00 | | MB cr | | | 46.00 x 7.02 x 13.06 | |
| V91932  | 608 12 981 |  | 45° | H | | |
| 26.00 x 7.00 x 108.50 | | MD + MB cr | | | | |



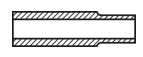

17  **82.00**

| | | | | | | | |
|----------|--------|--------|-----------|-------------------|--------|------|---------|
| AR 32102 | 1598cc | 4 Cyl. | 16 Valves | 82-88kW/112-120PS | Petrol | DOHC | TD14369 |
| AR 32103 | 1598cc | 4 Cyl. | 16 Valves | 81-88kW/110-120PS | Petrol | DOHC | TD15389 |
| AR 32104 | 1598cc | 4 Cyl. | 16 Valves | 88kW/120PS | Petrol | DOHC | TD15388 |
| AR 38201 | 1598cc | 4 Cyl. | 16 Valves | 88kW/120PS | Petrol | DOHC | TD9754 |
| AR 67601 | 1598cc | 4 Cyl. | 16 Valves | 88kW/120PS | Petrol | DOHC | TD19 |

| | | | | | | |
|---|-----------------|---|-----------------|----|---|---|
| 145 1.6 16V T.S. | 09/1997→12/2000 | 145 1.6 i.e. 16V T.S. | 12/1996→01/2001 | | | |
| 146 1.6 16V T.S. | 09/1997→12/2000 | 146 1.6 i.e. 16V T.S. | 11/1996→01/2001 | | | |
| 147 1.6 16V T.SPARK | 01/2001→03/2010 | 155 1.6 16V T.S. | 05/1996→12/1997 | | | |
| 156 1.6 16V T.SPARK | 09/1997→09/2005 | 156 1.6 16V T.SPARK. | 05/2000→05/2006 | | | |
| V91933  | 608 11 153 |  | 45° | H | VAG96146  |  |
| 33.40 x 7.00 x 113.10 | | MB cr | | | 42.50 x 7.04 x 13.05 | |
| V91934  | 608 11 154 |  | 45° | SS | VAG96230  |  |
| 28.00 x 7.00 x 108.60 | | MD cr | | | 46.00 x 7.02 x 13.06 | |
| V94591  | 606 74 496 |  | 45° | SS | H | |
| 28.00 x 7.00 x 108.80 | | MD + MB cr | | | | |

18  **82.00**

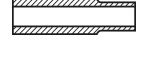
| | | | | | | | |
|-------------------------|-----------------|--------|-----------|------------|--------|------|---------|
| AR 37203 | 1598cc | 4 Cyl. | 16 Valves | 76kW/103PS | Petrol | DOHC | TD15508 |
| 147 1.6 16V T.SPARK ECO | 01/2001→03/2010 | | | | | | |

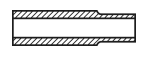
| | | | | | | |
|---|------------|---|-----|---|---|---|
| V91931  | 608 12 982 |  | 45° | H | VAG96146  |  |
| 30.00 x 7.00 x 113.00 | | MB cr | | | 42.50 x 7.04 x 13.05 | |
| V91932  | 608 12 981 |  | 45° | H | VAG96230  |  |
| 26.00 x 7.00 x 108.50 | | MD + MB cr | | | 46.00 x 7.02 x 13.06 | |

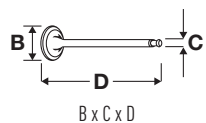

OE

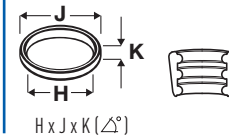
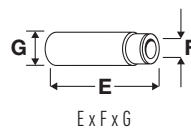

19 82.00

| | | | | | | | |
|-----------------------|-----------------|--------|-----------|-----------------------|--------|------|-----------------|
| AR 32201 | 1747cc | 4 Cyl. | 16 Valves | 106kW/144PS | Petrol | DOHC | TD9462 |
| AR 32205 | 1747cc | 4 Cyl. | 16 Valves | 103kW/140PS | Petrol | DOHC | TD15390 |
| AR 38401 | 1747cc | 4 Cyl. | 16 Valves | 103kW/140PS | Petrol | DOHC | TD9755 |
| AR 67106 | 1747cc | 4 Cyl. | 16 Valves | 103kW/140PS | Petrol | DOHC | TD5070 |
| 145 1.8 i.e. 16V | 03/1998→01/2001 | | | 145 1.8 i.e. 16V T.S. | | | 12/1996→12/1998 |
| 146 1.8 i.e. 16V T.S. | 11/1996→01/2001 | | | 155 1.7 T.S. 16V | | | 05/1996→12/1997 |
| 156 1.8 16V T.SPARK | 09/1997→05/2006 | | | GT 1.8 TS | | | 11/2003→09/2010 |
| GTV 1.8 16V | 05/1998→10/2005 | | | SPIDER 1.8 16V | | | 05/1998→04/2005 |

V91933 ■
33.40 x 7.00 x 113.10

608 11 153

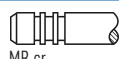

45°

H

VAG96146 ■
42.50 x 7.04 x 13.05



V91934 ■
28.00 x 7.00 x 108.60

608 11 154



45°

SS

VAG50895 ■
46.00 x 7.04 x 13.03

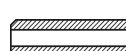

V94591 ■
28.00 x 7.00 x 108.80
01/02→

606 74 496

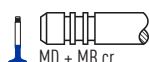

45°

SS

H

VAG96230 ■
46.00 x 7.02 x 13.06

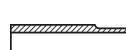

20 82.00

| | | | | | | | |
|-------------|-----------------|--------|----------|-------------------|--------|-------------|-----------------|
| 182 B9.000 | 1910cc | 4 Cyl. | 8 Valves | 74-77kW/101-105PS | Diesel | Turbo, SOHC | TD18312 |
| AR 37101 | 1910cc | 4 Cyl. | 8 Valves | 81kW/110PS | Diesel | SOHC | TD15510 |
| 147 1.9 JTD | 06/2003→03/2010 | | | 156 1.9 JTD | | | 10/2000→05/2001 |

V94470 ■
35.30 x 8.00 x 115.00

46 750 859

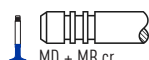

45°

H

VAG96124 ■ ■
42.90 x 8.02 x 14.06



V94471 ■
34.50 x 8.00 x 115.00

46 783 962

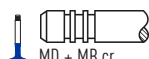

45°

H

VAG96203 ■ ■
43.00 x 8.03 x 14.08

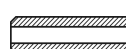

V94590 ■
34.45 x 8.00 x 115.00

55202630

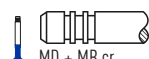

45°

SS

H

VAG96210 ■ ■
43.00 x 8.04 x 14.04



21 82.00

| | | | | | | | |
|-----------------|-----------------|--------|-----------|--------------------|--------|-------------|-----------------|
| 192 A5.000 | 1910cc | 4 Cyl. | 16 Valves | 103kW/140PS | Diesel | Turbo, DOHC | TD17981 |
| 192 B1.000 | 1910cc | 4 Cyl. | 16 Valves | 100kW/136PS | Diesel | Turbo, DOHC | TD19061 |
| 937 A4.000 | 1910cc | 4 Cyl. | 16 Valves | 93-103kW/126-140PS | Diesel | Turbo, DOHC | TD18844 |
| 147 1.9 JTD 16V | 11/2002→03/2010 | | | 156 1.9 JTD | | | 11/2002→05/2006 |
| 156 1.9 JTD 16V | 11/2002→05/2006 | | | | | | |

V94588 ■
27.90 x 6.00 x 114.00

46 802 049

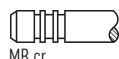

45°

Y

H

V94589 ■
25.80 x 6.00 x 114.30

46 787 902

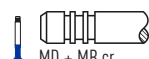

45°

H

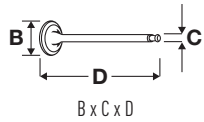

OE

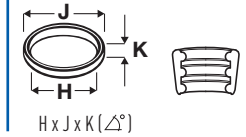
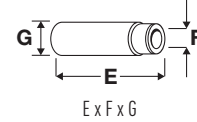

22 **82.00**

| | | | | | | | |
|-------------------|--------|-----------------|-----------------|-------------------|--------|--------------------|----------------|
| 937 A2.000 | 1910cc | 4 Cyl. | 8 Valves | 85-88kW/115-120PS | Diesel | Turbo, SOHC | TD16382 |
| 147 1.9 JTD | | 04/2001→03/2010 | | 147 1.9 JTDM 8V | | 07/2005→03/2010 | |
| 156 1.9 JTD | | 05/2001→05/2006 | | | | | |

| | | | | | | |
|---------------------------------|------------|------------|-----|------|----------------------|--|
| V94064 | 608 14 605 | | 45° | H | VAG96124 | |
| 35.50 x 8.00 x 115.00 →12/00 | | MB cr | | | 42.90 x 8.02 x 14.06 | |
| V94470 | 46 750 859 | | 45° | H | VAG96203 | |
| 35.30 x 8.00 x 115.00 01/01→ | | MD + MB cr | | | 43.00 x 8.03 x 14.08 | |
| V94065 | 608 14 604 | | 45° | | VAG96210 | |
| 34.50 x 8.00 x 115.00 | | MD cr | | | 43.00 x 8.04 x 14.04 | |
| V94471 | 46 783 962 | | 45° | H | | |
| 34.50 x 8.00 x 115.00 | | MD + MB cr | | | | |
| V94590 | 55202630 | | 45° | SS H | | |
| 34.45 x 8.00 x 115.00 | | MD + MB cr | | | | |

23 **82.00**

| | | | | | | | |
|-------------------|--------|-----------------|-----------------|------------|--------|--------------------|----------------|
| 937 A3.000 | 1910cc | 4 Cyl. | 8 Valves | 88kW/120PS | Diesel | Turbo, SOHC | TD20727 |
| 147 1.9 JTDM 8V | | 07/2005→03/2010 | | | | | |

| | | | | | | |
|-----------------------|------------|------------|-----|---|----------------------|--|
| V94470 | 46 750 859 | | 45° | H | VAG96124 | |
| 35.30 x 8.00 x 115.00 | | MD + MB cr | | | 42.90 x 8.02 x 14.06 | |
| V94065 | 608 14 604 | | 45° | | VAG96203 | |
| 34.50 x 8.00 x 115.00 | | MD cr | | | 43.00 x 8.03 x 14.08 | |
| V94471 | 46 783 962 | | 45° | H | VAG96210 | |
| 34.50 x 8.00 x 115.00 | | MD + MB cr | | | 43.00 x 8.04 x 14.04 | |

24 **82.00**

| | | | | | | | |
|--------------------|--------|-----------------|------------------|------------------|--------|--------------------|----------------|
| 937 A5.000 | 1910cc | 4 Cyl. | 16 Valves | 110kW/150PS | Diesel | Turbo, DOHC | TD18078 |
| 939 A2.000 | 1910cc | 4 Cyl. | 16 Valves | 110kW/150PS | Diesel | Turbo, DOHC | TD18473 |
| 147 1.9 JTDM 16V | | 09/2004→03/2010 | | 156 1.9 JTD | | 07/2004→05/2006 | |
| 156 1.9 JTD 16V Q4 | | 07/2004→05/2006 | | 159 1.9 JTDM 16V | | 09/2005→11/2011 | |
| GT 1.9 JTD | | 11/2003→09/2010 | | | | | |

| | | | | | | |
|---------------------------------|------------|------------|-----|-----|--------------------------------|--|
| V94588 | 46 802 049 | | 45° | Y H | VAG96360 | |
| 27.90 x 6.00 x 114.00 →06/06 | | MB cr | | | 46.70 x 5.00 x 10.03 07/06→ | |
| V98005 | 55207517 | | 45° | | | |
| 28.00 x 5.00 x 114.40 07/06→ | | MB cr | | | | |
| V94589 | 46 787 902 | | 45° | H | | |
| 25.80 x 6.00 x 114.30 →06/06 | | MD + MB cr | | | | |
| V98006 | 55207955 | | 45° | | | |
| 24.50 x 5.00 x 114.40 07/06→ | | MD + MB cr | | | | |

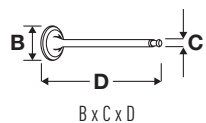

OE



MAT.

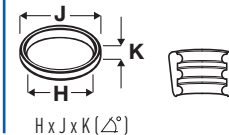
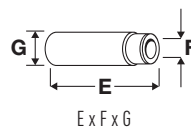

25 82.00

| | | | | | | | |
|-------------------|--------|-----------------|-----------------|------------|--------|--------------------|----------------|
| 937 A7.000 | 1910cc | 4 Cyl. | 8 Valves | 85kW/115PS | Diesel | Turbo, SOHC | TD20933 |
| 159 1.9 JTDM 8V | | 09/2005→11/2011 | | | | | |

| | | | | | | |
|--|------------|----------------|-----|---|---|--|
| V94470 ■ 35.30 x 8.00 x 115.00 | 46 750 859 | MD + MB cr | 45° | H | VAG96124 ■ ■ ■ 42.90 x 8.02 x 14.06 | |
| V94471 ■ 34.50 x 8.00 x 115.00 | 46 783 962 | MD + MB cr | 45° | H | VAG96203 ■ ■ ■ 43.00 x 8.03 x 14.08 | |
| | | | | | VAG96210 ■ ■ ■ 43.00 x 8.04 x 14.04 | |

26 82.00

| | | | | | | | |
|-------------------|--------|-----------------|------------------|---------------------|--------|--------------------|----------------|
| 937 A8.000 | 1910cc | 4 Cyl. | 16 Valves | 100-100kW/136-136PS | Diesel | Turbo, DOHC | TD20271 |
| 159 1.9 JTDM 16V | | 09/2005→11/2011 | | | | | |

| | | | | | | | |
|--|------------|----------------|-----|---|---|---|--|
| V94588 ■ 27.90 x 6.00 x 114.00 Eng.→5553217 | 46 802 049 | MB cr | 45° | Y | H | VAG96360 ■ ■ ■ 46.70 x 5.00 x 10.03 Eng.5553218→ | |
| V98005 ■ 28.00 x 5.00 x 114.40 Eng.5553218→ | 55207517 | MB cr | 45° | | | | |
| V94589 ■ 25.80 x 6.00 x 114.30 Eng.→5553217 | 46 787 902 | MD + MB cr | 45° | | H | | |
| V98006 ■ 24.50 x 5.00 x 114.40 Eng.5553218→ | 55207955 | MD + MB cr | 45° | | | | |

27 82.00

| | | | | | | | |
|-------------------|--------|-----------------|-----------------|------------|--------|--------------------|----------------|
| 939 A1.000 | 1910cc | 4 Cyl. | 8 Valves | 88kW/120PS | Diesel | Turbo, SOHC | TD18915 |
| 159 1.9 JTDM 8V | | 09/2005→11/2011 | | | | | |

| | | | | | | | |
|--|------------|----------------|-----|--|---|---|--|
| V94470 ■ 35.30 x 8.00 x 115.00 | 46 750 859 | MD + MB cr | 45° | | H | VAG96124 ■ ■ ■ 42.90 x 8.02 x 14.06 | |
| V98005 ■ 28.00 x 5.00 x 114.40 | 55207517 | MB cr | 45° | | | VAG96203 ■ ■ ■ 43.00 x 8.03 x 14.08 | |
| V94065 ■ 34.50 x 8.00 x 115.00 | 608 14 604 | MD cr | 45° | | | VAG96210 ■ ■ ■ 43.00 x 8.04 x 14.04 | |
| V94471 ■ 34.50 x 8.00 x 115.00 | 46 783 962 | MD + MB cr | 45° | | H | VAG96360 ■ ■ ■ 46.70 x 5.00 x 10.03 | |
| V98006 ■ 24.50 x 5.00 x 114.40 | 55207955 | MD + MB cr | 45° | | | | |



OE

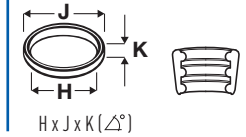

28



82.00

| AR 32302 | 1910cc | 4 Cyl. | 8 Valves | 77kW/105PS | Diesel | Turbo, SOHC | TD9769 |
|---------------------------------|------------|------------|----------|-----------------|----------------------|-------------|-----------------|
| 145 1.9 JTD | | | | 02/1999→01/2001 | | | 146 1.9 JTD |
| 156 1.9 JTD | | | | 09/1997→10/2000 | | | 02/1999→01/2001 |
| V94064 | 608 14 605 | | 45° | H | VAG96124 | | |
| 35.50 x 8.00 x 115.00 →12/00 | | MB cr | | | 42.90 x 8.02 x 14.06 | | |
| V94470 | 46 750 859 | | 45° | H | VAG96203 | | |
| 35.30 x 8.00 x 115.00 01/01→ | | MD + MB cr | | | 43.00 x 8.03 x 14.08 | | |
| V94065 | 608 14 604 | | 45° | | VAG96210 | | |
| 34.50 x 8.00 x 115.00 | | MD cr | | | 43.00 x 8.04 x 14.04 | | |
| V94471 | 46 783 962 | | 45° | H | | | |
| 34.50 x 8.00 x 115.00 | | MD + MB cr | | | | | |

29



82.00

| 839 A6.000 | 2387cc | 5 Cyl. | 10 Valves | 103kW/140PS | Diesel | Turbo, SOHC | TD18819 |
|---------------------------------|------------|------------|-----------|--------------------|----------------------|-------------|-----------------|
| 841 C.000 | 2387cc | 5 Cyl. | 10 Valves | 110kW/150PS | Diesel | Turbo, SOHC | TD16383 |
| AR 32501 | 2387cc | 5 Cyl. | 10 Valves | 99-100kW/135-136PS | Diesel | Turbo, SOHC | TD9770 |
| AR 34202 | 2387cc | 5 Cyl. | 10 Valves | 100kW/136PS | Diesel | Turbo, SOHC | TD11604 |
| AR 36202 | 2387cc | 5 Cyl. | 10 Valves | 103kW/140PS | Diesel | SOHC | TD15636 |
| 156 2.4 JTD | | | | 09/1997→05/2006 | | | 166 2.4 JTD |
| | | | | | | | 09/1998→06/2007 |
| V94064 | 608 14 605 | | 45° | H | VAG96124 | | |
| 35.50 x 8.00 x 115.00 →12/00 | | MB cr | | | 42.90 x 8.02 x 14.06 | | |
| V94470 | 46 750 859 | | 45° | H | VAG96203 | | |
| 35.30 x 8.00 x 115.00 01/01→ | | MD + MB cr | | | 43.00 x 8.03 x 14.08 | | |
| V94065 | 608 14 604 | | 45° | | VAG96210 | | |
| 34.50 x 8.00 x 115.00 | | MD cr | | | 43.00 x 8.04 x 14.04 | | |
| V94471 | 46 783 962 | | 45° | H | | | |
| 34.50 x 8.00 x 115.00 | | MD + MB cr | | | | | |
| V94590 | 55202630 | | 45° | ss | H | | |
| 34.45 x 8.00 x 115.00 | | MD + MB cr | | | | | |

30



82.00

| 841 G.000 | 2387cc | 5 Cyl. | 20 Valves | 129kW/175PS | Diesel | Turbo, DOHC | TD18292 |
|-----------------------|------------|------------|-----------|-----------------|--------|-------------|-----------------|
| 156 2.4 JTD | | | | 10/2003→05/2006 | | | 166 2.4 JTD |
| | | | | | | | 10/2003→06/2007 |
| V94588 | 46 802 049 | | 45° | Y | H | | |
| 27.90 x 6.00 x 114.00 | | MB cr | | | | | |
| V94589 | 46 787 902 | | 45° | | H | | |
| 25.80 x 6.00 x 114.30 | | MD + MB cr | | | | | |



OE

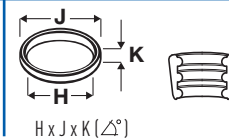
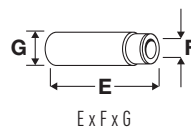

31 82.00

| | | | | | | | |
|--------------------|-----------------|--------|------------------|---------------------|--------|--------------------|----------------|
| 939 A3.000 | 2387cc | 5 Cyl. | 20 Valves | 147-154kW/200-209PS | Diesel | Turbo, DOHC | TD18474 |
| 939 A9.000 | 2387cc | 5 Cyl. | 20 Valves | 154kW/210PS | Diesel | Turbo, DOHC | TD20935 |
| 159 2.4 JTDM | 09/2005→12/2012 | | | 159 2.4 JTDM Q4 | | 05/2007→11/2011 | |
| BRERA 2.4 JTDM 20V | 01/2006→06/2010 | | | SPIDER 2.4 JTDM | | 04/2007→06/2010 | |

V94588 ■
27.90 x 6.00 x 114.00
Eng.→5553217

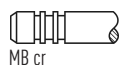

45° Y H

VAG96360 ■ ■
46.70 x 5.00 x 10.03
Eng.5553218→

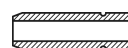

V98005 ■
28.00 x 5.00 x 114.40
Eng.5553218→

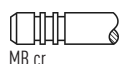

45°

V94589 ■
25.80 x 6.00 x 114.30
Eng.→5553217

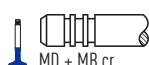

45° H

V98006 ■
24.50 x 5.00 x 114.40
Eng.5553218→

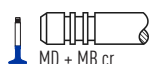

45°

32 82.60

| | | | | | | | |
|-----------------|-----------------|--------|-----------------|-----------|--------|-------------|----------------|
| 160 D100 | 1929cc | 4 Cyl. | 8 Valves | 51kW/69PS | Diesel | SOHC | TD10307 |
| AR 6 1.9 D | 04/1985→12/1989 | | | | | | |

V91291 ■
37.50 x 8.00 x 116.50

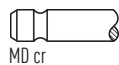

45°

VAG92366 ■ ■
46.50 x 8.00 x 14.10



V91321 ■
33.50 x 8.00 x 116.45

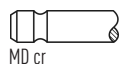

45°

33 82.60

| | | | | | | | |
|-----------------|-----------------|--------|-----------------|-----------------|--------|--------------------|----------------|
| AR 33601 | 1929cc | 4 Cyl. | 8 Valves | 66-68kW/90-92PS | Diesel | Turbo, SOHC | TD5069 |
| AR 67501 | 1929cc | 4 Cyl. | 8 Valves | 66-68kW/90-92PS | Diesel | Turbo, SOHC | TD140 |
| AR 67502 | 1929cc | 4 Cyl. | 8 Valves | 66-68kW/90-92PS | Diesel | Turbo, SOHC | TD21140 |
| 145 1.9 D | 07/1994→02/1999 | | | 145 1.9 TD | | 10/1994→02/1999 | |
| 146 1.9 D | 05/1995→09/1996 | | | 146 1.9 TD | | 12/1994→02/1999 | |
| 155 1.9 TD | 04/1993→12/1997 | | | | | | |

V91291 ■
37.50 x 8.00 x 116.50

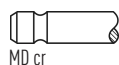

45°

VAG96124 ■ ■
42.90 x 8.02 x 14.06



V91321 ■
33.50 x 8.00 x 116.45

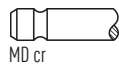

45°

VAG96203 ■ ■
43.00 x 8.03 x 14.08



VAG96210 ■ ■
43.00 x 8.04 x 14.04





OE

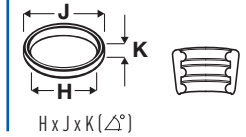
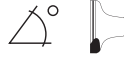

34 **83.00**

| | | | | | | | |
|------------|--------|--------|-----------|-------------|--------|-------------|---------|
| 198 A5.000 | 1956cc | 4 Cyl. | 16 Valves | 121kW/165PS | Diesel | Turbo, DOHC | TD24647 |
| 844 A2.000 | 1956cc | 4 Cyl. | 16 Valves | 120kW/163PS | Diesel | Turbo, DOHC | TD24594 |
| 939 B3.000 | 1956cc | 4 Cyl. | 16 Valves | 125kW/170PS | Diesel | Turbo, DOHC | TD23107 |
| 939 B5.000 | 1956cc | 4 Cyl. | 16 Valves | 125kW/170PS | Diesel | Turbo, DOHC | TD24645 |
| 940 A5.000 | 1956cc | 4 Cyl. | 16 Valves | 103kW/140PS | Diesel | Turbo, DOHC | TD24578 |

| | | | |
|--------------------|-----------------|-----------------|-----------------|
| 159 2.0 JTDM | 05/2009→11/2011 | BRERA 2.0 JTDM | 03/2008→06/2010 |
| GIULIETTA 2.0 JTDM | 04/2010→ | SPIDER 2.0 JTDM | 04/2009→06/2010 |

V98005
28.00 x 5.00 x 114.40

55207517

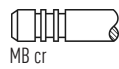

45°

VAG96360
46.70 x 5.00 x 10.03

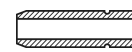

V98006
24.50 x 5.00 x 114.40

55207955



45°

35 **83.00**

| | | | | | | | |
|------------|--------|--------|-----------|---------------------|--------|-----------------|---------|
| 932 A2.000 | 1970cc | 4 Cyl. | 16 Valves | 119-121kW/162-165PS | Petrol | DOHC, Injection | TD18076 |
| 937 A1.000 | 1970cc | 4 Cyl. | 16 Valves | 119-122kW/162-166PS | Petrol | DOHC, Injection | TD16381 |
| AR 16201 | 1970cc | 4 Cyl. | 16 Valves | 110kW/150PS | Petrol | DOHC | TD4188 |
| AR 32301 | 1970cc | 4 Cyl. | 16 Valves | 114kW/155PS | Petrol | DOHC | TD9463 |
| AR 32310 | 1970cc | 4 Cyl. | 16 Valves | 110-114kW/150-155PS | Petrol | DOHC | TD15391 |
| AR 34103 | 1970cc | 4 Cyl. | 16 Valves | 114kW/155PS | Petrol | DOHC | TD11599 |
| AR 36301 | 1970cc | 4 Cyl. | 16 Valves | 110kW/150PS | Petrol | DOHC | TD15392 |
| AR 67204 | 1970cc | 4 Cyl. | 16 Valves | 110kW/150PS | Petrol | DOHC | TD4190 |

| | | | |
|------------------------|-----------------|---------------------|-----------------|
| 145 2.0 16V | 03/1998→01/2001 | 145 2.0 16V T.S. | 10/1995→01/2001 |
| 146 2.0 16V | 03/1998→01/2001 | 146 2.0 16V T.S. | 10/1995→01/2001 |
| 147 2.0 | 07/2002→05/2005 | 147 2.0 16V T.SPARK | 01/2001→03/2010 |
| 155 2.0 T.S. 16V | 03/1995→12/1997 | 156 2.0 16V T.SPARK | 09/1997→06/2002 |
| 156 2.0 JTS | 01/2002→05/2006 | 166 2.0 T.SPARK | 09/1998→06/2007 |
| GT 2.0 JTS | 11/2003→09/2010 | GTV 2.0 JTS | 04/2003→10/2005 |
| GTV 2.0 T.SPARK 16V | 06/1995→10/2005 | SPIDER 2.0 JTS | 04/2003→04/2005 |
| SPIDER 2.0 T.SPARK 16V | 06/1995→04/2005 | | |

V91933
33.40 x 7.00 x 113.10

608 11 153

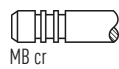

45°

H

VAG96123
42.25 x 7.02 x 13.05



V91934
28.00 x 7.00 x 108.60

608 11 154

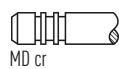

45°

SS

VAG96230
46.00 x 7.02 x 13.06

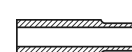

V94591
28.00 x 7.00 x 108.80

606 74 496



45°

SS

H

36 **83.40**

| | | | | | | | |
|----------|--------|--------|----------|-------------------|--------|------|-------|
| AR 67103 | 1748cc | 4 Cyl. | 8 Valves | 83kW/113PS | Petrol | DOHC | TD134 |
| AR 67105 | 1748cc | 4 Cyl. | 8 Valves | 83-85kW/113-115PS | Petrol | DOHC | TD135 |

| | | | |
|--------------|-----------------|--|--|
| 155 1.7 T.S. | 04/1993→04/1996 | | |
|--------------|-----------------|--|--|

V91308
44.00 x 8.00 x 116.00

605 64 098

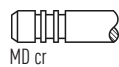

45°



OE

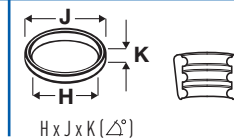
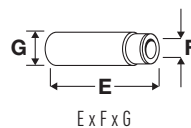
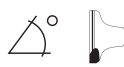

37 84.00

| | | | | | | | |
|----------|--------|--------|----------|-----------------|--------|-----------------|--------|
| AR 30124 | 1490cc | 4 Cyl. | 8 Valves | 61-64kW/83-87PS | Petrol | SOHC | TD78 |
| AR 30128 | 1490cc | 4 Cyl. | 8 Valves | 70kW/95PS | Petrol | SOHC | TD79 |
| AR 30514 | 1490cc | 4 Cyl. | 8 Valves | 70kW/95PS | Petrol | SOHC | TD6373 |
| AR 30520 | 1490cc | 4 Cyl. | 8 Valves | 66kW/90PS | Petrol | SOHC | TD91 |
| AR 30734 | 1490cc | 4 Cyl. | 8 Valves | 77kW/105PS | Petrol | SOHC | TD108 |
| AR 30750 | 1490cc | 4 Cyl. | 8 Valves | 74kW/101PS | Petrol | SOHC, Injection | TD116 |
| AR 30751 | 1490cc | 4 Cyl. | 8 Valves | 71-72kW/97-98PS | Petrol | SOHC | TD117 |

| | | | |
|----------------|-----------------|-------------|-----------------|
| 33 1.5 | 06/1983→04/1993 | 33 1.5 i.e. | 01/1990→09/1994 |
| 33 1.5 i.e. | 07/1990→08/1991 | ALFASUD 1.5 | 05/1978→01/1987 |
| ALFASUD 1.5 ti | 01/1979→12/1984 | | |

V91630 605 40 325 45°
33.10 x 8.00 x 92.10 MD cr

38 84.00

| | | | | | | | |
|----------|--------|--------|----------|------------|--------|------|-------|
| AR 33201 | 1596cc | 4 Cyl. | 8 Valves | 76kW/103PS | Petrol | SOHC | TD121 |
|----------|--------|--------|----------|------------|--------|------|-------|

| | | | |
|--------------|-----------------|--------------|-----------------|
| 145 1.6 i.e. | 10/1994→12/1996 | 146 1.6 i.e. | 12/1994→12/1996 |
|--------------|-----------------|--------------|-----------------|

V91630 605 40 325 45°
33.10 x 8.00 x 92.10 MD cr

39 84.00

| | | | | | | | |
|----------|--------|--------|----------|------------|--------|------|--------|
| AR 67402 | 1756cc | 4 Cyl. | 8 Valves | 77kW/105PS | Petrol | DOHC | TD5071 |
|----------|--------|--------|----------|------------|--------|------|--------|

| | |
|--------------|-----------------|
| 155 1.8 T.S. | 02/1992→12/1997 |
|--------------|-----------------|

V91308 605 64 098 45°
44.00 x 8.00 x 116.00 MD cr

40 84.00

| | | | | | | | |
|----------|--------|--------|----------|-------------------|--------|------|-------|
| AR 67101 | 1773cc | 4 Cyl. | 8 Valves | 93-95kW/126-129PS | Petrol | DOHC | TD133 |
|----------|--------|--------|----------|-------------------|--------|------|-------|

| | | | | | | | |
|----------|--------|--------|----------|------------|--------|------|--------|
| AR 67102 | 1773cc | 4 Cyl. | 8 Valves | 93kW/127PS | Petrol | DOHC | TD5311 |
|----------|--------|--------|----------|------------|--------|------|--------|

| | | | |
|--------|-----------------|--------------|-----------------|
| 75 1.8 | 08/1989→02/1992 | 155 1.8 T.S. | 01/1992→12/1996 |
|--------|-----------------|--------------|-----------------|

V91308 605 64 098 45°
44.00 x 8.00 x 116.00 MD cr

41 84.00

| | | | | | | | |
|----------|--------|--------|----------|-------------|--------|------|------|
| AR 06166 | 1962cc | 4 Cyl. | 8 Valves | 107kW/146PS | Petrol | DOHC | TD53 |
|----------|--------|--------|----------|-------------|--------|------|------|

| | | | | | | | |
|----------|--------|--------|----------|---------------------|--------|------|------|
| AR 06224 | 1962cc | 4 Cyl. | 8 Valves | 107-109kW/146-148PS | Petrol | DOHC | TD58 |
|----------|--------|--------|----------|---------------------|--------|------|------|

| | | | | | | | |
|----------|--------|--------|----------|---------------------|--------|----------|------|
| AR 06416 | 1962cc | 4 Cyl. | 8 Valves | 102-105kW/138-143PS | Petrol | TS, DOHC | TD62 |
|----------|--------|--------|----------|---------------------|--------|----------|------|

| | | | | | | | |
|----------|--------|--------|----------|---------------------|--------|----------|------|
| AR 06420 | 1962cc | 4 Cyl. | 8 Valves | 105-109kW/143-148PS | Petrol | TS, DOHC | TD63 |
|----------|--------|--------|----------|---------------------|--------|----------|------|

| | | | |
|--------------------|-----------------|-----------------|-----------------|
| 75 2.0 T.S. | 01/1987→02/1992 | 75 2.0 T.S. Cat | 05/1985→02/1992 |
| 164 2.0 | 06/1987→09/1998 | 164 2.0 T.S. | 06/1987→09/1992 |
| 164 2.0 Twin Spark | 06/1987→10/1992 | | |



V91308 605 64 098 45°
44.00 x 8.00 x 116.00 MD cr

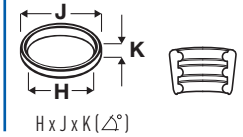
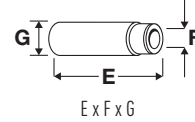
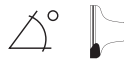

OE





42  **84.00**

| | | | | | | | |
|-----------------------|---------|---|----------|----------------------|------------|---|------|
| AR 06476 | 1995cc | 4 Cyl. | 8 Valves | 128-129kW/174-175PS | Petrol | Turbo, DOHC | TD65 |
| 164 2.0 Turbo | | 10/1987→09/1998 | | | | | |
| V91290 ■ | 7547400 |  | 45° | H | VAG96171 ■ |  | |
| 43.50 x 8.00 x 105.70 | | MB | | 42.00 x 8.02 x 14.06 | | | |

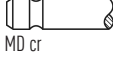

43  **84.00**

| | | | | | | | |
|-----------------------|------------|---|----------|---------------------|--------|-----------------|-------|
| AR 64103 | 1995cc | 4 Cyl. | 8 Valves | 106kW/144PS | Petrol | TS, DOHC | TD129 |
| AR 67201 | 1995cc | 4 Cyl. | 8 Valves | 104-106kW/141-144PS | Petrol | DOHC | TD136 |
| AR 67202 | 1995cc | 4 Cyl. | 8 Valves | 104-106kW/141-144PS | Petrol | DOHC | TD137 |
| 155 2.0 T.S. | | 02/1992→02/1995 | | 164 2.0 T.S. | | 09/1992→09/1998 | |
| V91308 ■ | 605 64 098 |  | 45° | | | | |
| 44.00 x 8.00 x 116.00 | | MD cr | | | | | |

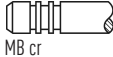

44  **84.00**

| | | | | | | | |
|-----------------------|-----------|---|-----------|----------------------|----------------|---|-------|
| AR 67203 | 1995cc | 4 Cyl. | 16 Valves | 137-140kW/186-190PS | Petrol | Turbo, DOHC | TD138 |
| 155 2.0 16V Turbo Q4 | | 01/1992→12/1997 | | | | | |
| V91935 ■ | 7 722 907 |  | 45° | | VAG92496 ■ ■ ■ |  | |
| 34.40 x 7.00 x 128.00 | | MD cr | | 51.00 x 7.03 x 14.04 | | | |
| V91936 ■ | 7 650 916 |  | 45° | | | | |
| 28.35 x 7.00 x 125.50 | | MD cr | | | | | |

45  **86.00**

| | | | | | | | |
|-----------------------|----------|---|-----------|-------------|--------|-----------------|---------|
| 939 A6.000 | 1859cc | 4 Cyl. | 16 Valves | 118kW/160PS | Petrol | DOHC, Injection | TD18475 |
| 159 1.9 JTS | | 09/2005→11/2011 | | | | | |
| V94962 ■ | 71739277 |  | 45° | H | | | |
| 35.15 x 6.00 x 102.20 | | MB cr | | | | | |
| V94963 ■ | 71739320 |  | 45° | ss | H | | |
| 30.10 x 6.00 x 100.90 | | MD + MB cr | | | | | |

46  **86.00**

| | | | | | | | |
|-----------------------|----------|---|-----------|----------------|--------|-----------------|---------|
| 939 A5.000 | 2198cc | 4 Cyl. | 16 Valves | 136kW/185PS | Petrol | DOHC, Injection | TD18913 |
| 159 2.2 JTS | | 09/2005→11/2011 | | 159 2.2 Q4 | | 09/2006→12/2007 | |
| BRERA 2.2 JTS | | 01/2006→05/2011 | | SPIDER 2.2 JTS | | 03/2006→03/2011 | |
| V94962 ■ | 71739277 |  | 45° | H | | | |
| 35.15 x 6.00 x 102.20 | | MB cr | | | | | |
| V94963 ■ | 71739320 |  | 45° | ss | H | | |
| 30.10 x 6.00 x 100.90 | | MD + MB cr | | | | | |

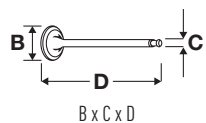

OE

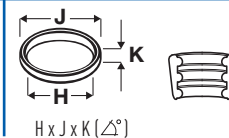
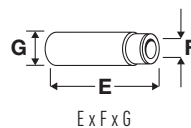

47 87.00

| | | | | | | | |
|-------------|--------|-----------------|----------|-------------------|--------|-----------------|--------|
| AR 30550 | 1712cc | 4 Cyl. | 8 Valves | 84-95kW/114-129PS | Petrol | SOHC | TD4186 |
| AR 30558 | 1712cc | 4 Cyl. | 8 Valves | 77kW/105PS | Petrol | SOHC | TD93 |
| AR 30736 | 1712cc | 4 Cyl. | 8 Valves | 79-81kW/107-110PS | Petrol | SOHC | TD109 |
| AR 30737 | 1712cc | 4 Cyl. | 8 Valves | 77-80kW/105-109PS | Petrol | SOHC | TD110 |
| AR 30737 A | 1712cc | 4 Cyl. | 8 Valves | 77-79kW/105-107PS | Petrol | SOHC | TD111 |
| 33 1.7 | | 01/1986→12/1989 | | 33 1.7 i.e. | | 09/1988→09/1994 | |
| 33 1.7 QV | | 03/1988→12/1989 | | 145 1.7 | | 07/1994→10/1997 | |
| ALFASUD 1.7 | | 03/1987→12/1989 | | ALFASUD 1.7 i.e. | | 10/1987→12/1989 | |

V91630 33.10 x 8.00 x 92.10

605 40 325

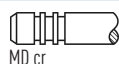

45°

48 87.30

| | | | | | | | |
|------------------|--------|-----------------|-----------|-------------------|--------|-----------------|---------|
| 939 A.000 | 3196cc | V6 Cyl. | 24 Valves | 191kW/260PS | Petrol | DOHC, Injection | TD18914 |
| 147 3.2 GTA | | 08/2008→03/2010 | | 159 3.2 JTS | | 02/2008→11/2011 | |
| 159 3.2 JTS Q4 | | 12/2005→11/2011 | | BRERA 3.2 JTS | | 03/2008→06/2010 | |
| BRERA 3.2 JTS Q4 | | 01/2006→05/2011 | | GT 3.2 GTA | | 08/2008→09/2010 | |
| SPIDER 3.2 JTS | | 03/2008→06/2010 | | SPIDER 3.2 JTS Q4 | | 03/2006→03/2011 | |

V98001 35.00 x 6.00 x 101.40

717 41 112

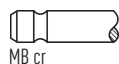

45°

V98002 30.60 x 6.00 x 97.20

717 41 113

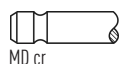

45°

49 88.00

| | | | | | | | |
|-----------|--------|-----------------|----------|----------------|--------|-----------------|-------|
| VM 4HT/2 | 1995cc | 4 Cyl. | 8 Valves | 60kW/82PS | Diesel | Turbo | TD160 |
| VM 80 A | 1995cc | 4 Cyl. | 8 Valves | 70kW/95PS | Diesel | Turbo, SOHC | TD151 |
| 75 2.0 TD | | 05/1985→09/1992 | | ALFETTA 2.0 TD | | 10/1979→03/1983 | |

V91437 40.00 x 8.00 x 121.00

605 07 189



35°

VAG96187 55.00 x 8.02 x 14.06

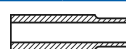

V91438 34.00 x 8.00 x 121.00

605 07 190

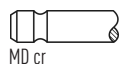

45°

50 88.00

| | | | | | | | |
|------------|--------|-----------------|-----------|-------------|--------|-----------------|---------|
| AR 32401 | 2492cc | V6 Cyl. | 24 Valves | 140kW/190PS | Petrol | DOHC | TD9464 |
| AR 32405 | 2492cc | V6 Cyl. | 24 Valves | 141kW/192PS | Petrol | DOHC | TD15634 |
| AR 34201 | 2492cc | V6 Cyl. | 24 Valves | 140kW/190PS | Petrol | DOHC | TD11601 |
| AR 36201 | 2492cc | V6 Cyl. | 24 Valves | 138kW/188PS | Petrol | DOHC | TD15635 |
| 156 2.5 V6 | | 09/1997→05/2006 | | 166 2.5 V6 | | 09/1998→06/2007 | |

V94211 29.10 x 7.00 x 102.20

605 82 739

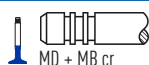

45°

ss

H

VAG96184 43.00 x 7.04 x 12.08

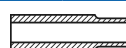

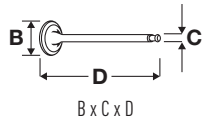



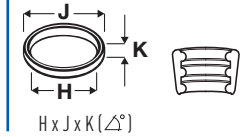
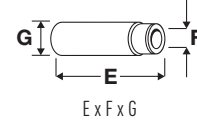





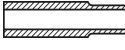

OE









51  **88.00**

| | | | | | | | |
|---|-----------------|---|------------------|---|---|--------------|--------------|
| VM HR 588 HT | 2493cc | 5 Cyl. | 10 Valves | 76-77kW/103-105PS | Diesel | Turbo | TD158 |
| 6 2.5 TD | 07/1981→05/1986 | | | | | | |
| V91437  | 605 07 189 |  | 35° | VAG96187  |  | | |
| 40.00 x 8.00 x 121.00 | | MD cr | | 55.00 x 8.02 x 14.06 | | | |
| V91438  | 605 07 190 |  | 45° | | | | |
| 34.00 x 8.00 x 121.00 | | MD cr | | | | | |







52  **92.00**

| | | | | | | | |
|---|-----------------|---|-----------------|---|---|-------------------|--------------|
| VM 82 A | 1779cc | 3 Cyl. | 6 Valves | 54kW/73PS | Diesel | Turbo, OHV | TD153 |
| VM 96 A | 1779cc | 3 Cyl. | 6 Valves | 62kW/84PS | Diesel | Turbo, OHV | TD155 |
| 33 1.8 TD | 01/1986→09/1994 | | | | | | |
| V91437  | 605 07 189 |  | 35° | VAG96187  |  | | |
| 40.00 x 8.00 x 121.00 | | MD cr | | 55.00 x 8.02 x 14.06 | | | |
| V91438  | 605 07 190 |  | 45° | | | | |
| 34.00 x 8.00 x 121.00 | | MD cr | | | | | |

53  **92.00**

| | | | | | | | |
|---|-----------------|---|-----------------|---|---|--------------|--------------|
| VM 4HT 2.4 | 2393cc | 4 Cyl. | 8 Valves | 69-70kW/94-95PS | Diesel | Turbo | TD159 |
| VM 81 A | 2393cc | 4 Cyl. | 8 Valves | 81kW/110PS | Diesel | Turbo | TD152 |
| 75 2.4 TD | 01/1989→02/1992 | | 90 2.4 TD | | 10/1984→07/1987 | | |
| ALFETTA 2.4 TD | 04/1983→12/1984 | | | | | | |
| V91437  | 605 07 189 |  | 35° | VAG96187  |  | | |
| 40.00 x 8.00 x 121.00 | | MD cr | | 55.00 x 8.02 x 14.06 | | | |
| V91438  | 605 07 190 |  | 45° | | | | |
| 34.00 x 8.00 x 121.00 | | MD cr | | | | | |

54  **92.00**

| | | | | | | | |
|---|-----------------|---|-----------------|---|---|--------------|---------------|
| VM 07 B | 2499cc | 4 Cyl. | 8 Valves | 92kW/125PS | Diesel | Turbo | TD149 |
| VM 08 B | 2499cc | 4 Cyl. | 8 Valves | 92kW/125PS | Diesel | Turbo | TD9771 |
| VM 31 B | 2499cc | 4 Cyl. | 8 Valves | 92-125kW/125-170PS | Diesel | Turbo | TD9768 |
| VM 32 B | 2499cc | 4 Cyl. | 8 Valves | 92kW/125PS | Diesel | Turbo | TD127 |
| VM 84 A | 2499cc | 4 Cyl. | 8 Valves | 84kW/114PS | Diesel | Turbo | TD154 |
| 155 2.5 TD | 04/1993→12/1997 | | 164 2.5 TD | | 06/1987→09/1998 | | |
| V91437  | 605 07 189 |  | 35° | VAG96187  |  | | |
| 40.00 x 8.00 x 121.00 | | MD cr | | 55.00 x 8.02 x 14.06 | | | |
| V91438  | 605 07 190 |  | 45° | | | | |
| 34.00 x 8.00 x 121.00 | | MD cr | | | | | |

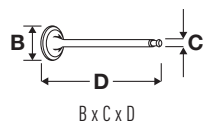

OE

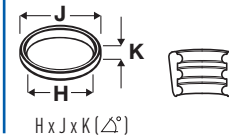
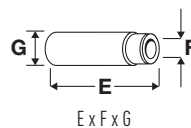

55 93.00

| | | | | | | | |
|------------------|-----------------|--------|-------------|-----------|-----------------|--------------------|-------|
| 8140.21.200 D.I. | 2445cc | 4 Cyl. | 8 Valves | 68kW/92PS | Diesel | Turbo, SOHC | TD143 |
| 8140.61.200 | 2445cc | 4 Cyl. | 8 Valves | 53kW/72PS | Diesel | SOHC | TD144 |
| 8144.21.220 | 2445cc | 4 Cyl. | 8 Valves | 68kW/92PS | Diesel | Sofim, Turbo, SOHC | TD145 |
| 8144.61.200 | 2445cc | 4 Cyl. | 8 Valves | 53kW/72PS | Diesel | SOHC | TD146 |
| AR 6 2.4 D | 04/1985→02/1986 | | AR 6 2.4 TD | | 09/1986→12/1989 | | |
| AR 8 2.4 D | 04/1978→08/1986 | | AR 8 2.4 TD | | 04/1985→12/1989 | | |

V91292
40.80 x 8.00 x 120.70

7 301 820

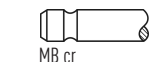

30°

Y

H

VAG92193
56.00 x 8.04 x 13.05



V91293
34.50 x 8.00 x 122.00

7 301 821

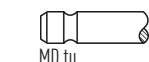

45°

H

VAG92369
60.00 x 8.00 x 13.07



V91294
34.50 x 8.00 x 122.00

7 302 157

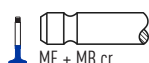

45°

H

VAG92373
56.00 x 8.03 x 13.04



56 93.00

| | | | | | | | |
|-------------|-----------------|--------|------------|-----------|-----------------|------|-------|
| 8144.67.220 | 2500cc | 4 Cyl. | 8 Valves | 55kW/75PS | Diesel | SOHC | TD147 |
| AR 6 2.5 D | 03/1986→12/1989 | | AR 8 2.5 D | | 09/1986→12/1989 | | |

V91292
40.80 x 8.00 x 120.70

7 301 820

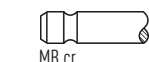

30°

Y

H

VAG92193
56.00 x 8.04 x 13.05



V91293
34.50 x 8.00 x 122.00

7 301 821

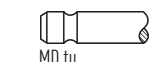

45°

H

VAG92369
60.00 x 8.00 x 13.07



V91294
34.50 x 8.00 x 122.00

7 302 157

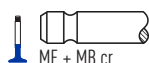











45°







H





VAG92373
56.00 x 8.03 x 13.04













|  |  | ccm |  |  |  |  | |
|---|---|-------|---|---|---|---|-----|
| 1B | | 81.00 | 2226 | 5 | 10 | Petrol | 54 |
| 1T | | 81.00 | 2461 | 5 | 10 | Diesel | 65 |
| 1Y | | 79.50 | 1896 | 4 | 8 | Diesel | 20 |
| 1Z | | 79.50 | 1896 | 4 | 8 | Diesel | 21 |
| 2B | | 81.00 | 2226 | 5 | 10 | Petrol | 54 |
| 3A | | 82.50 | 1984 | 4 | 8 | Petrol | 71 |
| 3B | | 81.00 | 2226 | 5 | 20 | Petrol | 55 |
| 3D | | 79.50 | 2370 | 5 | 10 | Diesel | 30 |
| 4B | | 81.00 | 1781 | 4 | 8 | Petrol | 37 |
| 6A | | 82.50 | 1984 | 4 | 16 | Petrol | 72 |
| 7A | | 82.50 | 2309 | 5 | 20 | Petrol | 79 |
| AAD | | 82.50 | 1984 | 4 | 8 | Petrol | 71 |
| AAE | | 82.50 | 1984 | 4 | 8 | Petrol | 71 |
| AAH | | 82.50 | 2771 | 6 | 12 | Petrol | 85 |
| AAN | | 81.00 | 2226 | 5 | 20 | Petrol | 55 |
| AAR | | 82.50 | 2309 | 5 | 10 | Petrol | 80 |
| AAS | | 79.50 | 2370 | 5 | 10 | Diesel | 30 |
| AAT | | 81.00 | 2461 | 5 | 10 | Diesel | 65 |
| AAZ | | 79.50 | 1896 | 4 | 8 | Diesel | 22 |
| ABB | | 81.00 | 1595 | 4 | 8 | Petrol | 31 |
| ABC | | 82.50 | 2598 | 6 | 12 | Petrol | 83 |
| ABH | | 84.50 | 4172 | 8 | 32 | Petrol | 104 |
| ABK | | 82.50 | 1984 | 4 | 8 | Petrol | 71 |
| ABM | | 81.00 | 1595 | 4 | 8 | Petrol | 32 |
| ABP | | 81.00 | 2461 | 5 | 10 | Diesel | 65 |
| ABT | | 82.50 | 1984 | 4 | 8 | Petrol | 71 |
| ABY | | 81.00 | 2226 | 5 | 20 | Petrol | 56 |
| ABZ | | 84.50 | 4172 | 8 | 32 | Petrol | 105 |
| ACE | | 82.50 | 1984 | 4 | 16 | Petrol | 73 |
| ACK | | 82.50 | 2771 | 6 | 30 | Petrol | 86 |
| ACZ | | 82.50 | 2598 | 6 | 12 | Petrol | 84 |
| ADA | | 81.00 | 1595 | 4 | 8 | Petrol | 31 |
| ADP | | 81.00 | 1595 | 4 | 8 | Petrol | 33 |
| ADR | | 81.00 | 1781 | 4 | 20 | Petrol | 38 |
| ADU | | 81.00 | 2226 | 5 | 20 | Petrol | 57 |
| ADW | | 82.50 | 1984 | 4 | 8 | Petrol | 71 |
| AEB | | 81.00 | 1781 | 4 | 20 | Petrol | 39 |
| AEC | | 84.50 | 4172 | 8 | 32 | Petrol | 105 |
| AEH | | 81.00 | 1595 | 4 | 8 | Petrol | 33 |
| AEJ | | 82.50 | 2771 | 6 | 12 | Petrol | 85 |
| AEL | | 81.00 | 2461 | 5 | 10 | Diesel | 65 |
| AFB | | 78.30 | 2496 | 6 | 24 | Diesel | 15 |
| AFC | | 82.50 | 2771 | 6 | 12 | Petrol | 85 |
| AFF | | 79.50 | 1896 | 4 | 8 | Diesel | 23 |
| AFN | | 79.50 | 1896 | 4 | 8 | Diesel | 23 |
| AFY | | 81.00 | 1781 | 4 | 20 | Petrol | 38 |
| AGA | | 81.00 | 2393 | 6 | 30 | Petrol | 62 |
| AGB | | 81.00 | 2671 | 6 | 30 | Petrol | 66 |
| AGE | | 82.50 | 2771 | 6 | 30 | Petrol | 86 |
| AGN | | 81.00 | 1781 | 4 | 20 | Petrol | 38 |
| AGR | | 79.50 | 1896 | 4 | 8 | Diesel | 24 |
| AGU | | 81.00 | 1781 | 4 | 20 | Petrol | 39 |
| AHF | | 79.50 | 1896 | 4 | 8 | Diesel | 24 |
| AHH | | 79.50 | 1896 | 4 | 8 | Diesel | 24 |
| AHL | | 81.00 | 1595 | 4 | 8 | Petrol | 33 |
| AHU | | 79.50 | 1896 | 4 | 8 | Diesel | 23 |
| AJG | | 81.00 | 2393 | 6 | 30 | Petrol | 62 |
| AJK | | 81.00 | 2671 | 6 | 30 | Petrol | 66 |
| AJL | | 81.00 | 1781 | 4 | 20 | Petrol | 39 |
| AJM | | 79.50 | 1896 | 4 | 8 | Diesel | 25 |
| AJP | | 81.00 | 1781 | 4 | 20 | Petrol | 38 |
| AJQ | | 81.00 | 1781 | 4 | 20 | Petrol | 39 |
| AKE | | 78.30 | 2496 | 6 | 24 | Diesel | 15 |
| AKG | | 84.50 | 4172 | 8 | 32 | Petrol | 105 |
| AKL | | 81.00 | 1595 | 4 | 8 | Petrol | 33 |
| AKN | | 78.30 | 2496 | 6 | 24 | Diesel | 15 |







| |  | ccm |  |  |  |  |
|-----|---|------|--|---|---|---|
| ALF | 81.00 | 2393 | 6 | 30 | Petrol | 63 |
| ALG | 82.50 | 2771 | 6 | 30 | Petrol | 86 |
| ALH | 79.50 | 1896 | 4 | 8 | Diesel | 24 |
| ALT | 82.50 | 1984 | 4 | 20 | Petrol | 74 |
| ALW | 81.00 | 2393 | 6 | 30 | Petrol | 63 |
| ALZ | 81.00 | 1595 | 4 | 8 | Petrol | 34 |
| AMF | 79.50 | 1422 | 3 | 6 | Diesel | 17 |
| AMK | 81.00 | 1781 | 4 | 20 | Petrol | 39 |
| AML | 81.00 | 2393 | 6 | 30 | Petrol | 62 |
| AMM | 81.00 | 2393 | 6 | 30 | Petrol | 62 |
| AMX | 82.50 | 2771 | 6 | 30 | Petrol | 86 |
| ANA | 81.00 | 1595 | 4 | 8 | Petrol | 33 |
| ANB | 81.00 | 1781 | 4 | 20 | Petrol | 39 |
| ANU | 79.50 | 1896 | 4 | 8 | Diesel | 25 |
| APC | 81.00 | 2393 | 6 | 30 | Petrol | 63 |
| APF | 81.00 | 1595 | 4 | 8 | Petrol | 33 |
| APG | 81.00 | 1781 | 4 | 20 | Petrol | 38 |
| APP | 81.00 | 1781 | 4 | 20 | Petrol | 39 |
| APR | 82.50 | 2771 | 6 | 30 | Petrol | 86 |
| APS | 81.00 | 2393 | 6 | 30 | Petrol | 63 |
| APT | 81.00 | 1781 | 4 | 20 | Petrol | 38 |
| APU | 81.00 | 1781 | 4 | 20 | Petrol | 39 |
| APX | 81.00 | 1781 | 4 | 20 | Petrol | 39 |
| APY | 81.00 | 1781 | 4 | 20 | Petrol | 39 |
| APZ | 81.00 | 2393 | 6 | 30 | Petrol | 63 |
| AQA | 81.00 | 1781 | 4 | 20 | Petrol | 39 |
| AQD | 82.50 | 2771 | 6 | 30 | Petrol | 86 |
| AQE | 81.00 | 1781 | 4 | 20 | Petrol | 38 |
| ARE | 81.00 | 2671 | 6 | 30 | Petrol | 66 |
| ARG | 81.00 | 1781 | 4 | 20 | Petrol | 38 |
| ARH | 81.00 | 1781 | 4 | 20 | Petrol | 38 |
| ARJ | 81.00 | 2393 | 6 | 30 | Petrol | 62 |
| ARK | 81.00 | 1781 | 4 | 20 | Petrol | 39 |
| ARM | 81.00 | 1595 | 4 | 8 | Petrol | 33 |
| ARN | 81.00 | 2393 | 6 | 30 | Petrol | 63 |
| ARX | 81.00 | 1781 | 4 | 20 | Petrol | 39 |
| ARY | 81.00 | 1781 | 4 | 20 | Petrol | 39 |
| ARZ | 81.00 | 1781 | 4 | 20 | Petrol | 39 |
| ASB | 83.00 | 2967 | 6 | 24 | Diesel | 89 |
| ASM | 81.00 | 2393 | 6 | 30 | Petrol | 63 |
| ASN | 82.50 | 2976 | 6 | 30 | Petrol | 87 |
| ASV | 79.50 | 1896 | 4 | 8 | Diesel | 24 |
| ASZ | 79.50 | 1896 | 4 | 8 | Diesel | 25 |
| ATD | 79.50 | 1896 | 4 | 8 | Diesel | 25 |
| ATJ | 79.50 | 1896 | 4 | 8 | Diesel | 25 |
| ATL | 79.50 | 1422 | 3 | 6 | Diesel | 18 |
| ATX | 82.50 | 2771 | 6 | 30 | Petrol | 86 |
| AUA | 76.50 | 1390 | 4 | 16 | Petrol | 5 |
| AUK | 84.50 | 3123 | 6 | 24 | Petrol | 99 |
| AUL | 81.00 | 1781 | 4 | 20 | Petrol | 39 |
| AUM | 81.00 | 1781 | 4 | 20 | Petrol | 39 |
| AUQ | 81.00 | 1781 | 4 | 20 | Petrol | 39 |
| AVB | 79.50 | 1896 | 4 | 8 | Diesel | 25 |
| AVF | 79.50 | 1896 | 4 | 8 | Diesel | 25 |
| AVG | 79.50 | 1896 | 4 | 8 | Diesel | 24 |
| AVJ | 81.00 | 1781 | 4 | 20 | Petrol | 38 |
| AVK | 82.50 | 2976 | 6 | 30 | Petrol | 87 |
| AVU | 81.00 | 1595 | 4 | 8 | Petrol | 34 |
| AVV | 81.00 | 1781 | 4 | 20 | Petrol | 38 |
| AWA | 82.50 | 1984 | 4 | 16 | Petrol | 75 |
| AWP | 81.00 | 1781 | 4 | 20 | Petrol | 39 |
| AWT | 81.00 | 1781 | 4 | 20 | Petrol | 39 |
| AWX | 79.50 | 1896 | 4 | 8 | Diesel | 25 |
| AXA | 82.50 | 1984 | 4 | 8 | Petrol | 76 |
| AXR | 79.50 | 1896 | 4 | 8 | Diesel | 26 |
| AXW | 82.50 | 1984 | 4 | 16 | Petrol | 75 |

|  |  | ccm |  |  |  |  |
|---|---|------|---|---|---|---|
| AXX | 82.50 | 1984 | 4 | 16 | Petrol | 77 |
| AYM | 78.30 | 2496 | 6 | 24 | Diesel | 15 |
| AZA | 81.00 | 2671 | 6 | 30 | Petrol | 66 |
| AZB | 81.00 | 2671 | 6 | 30 | Petrol | 66 |
| AZV | 81.00 | 1968 | 4 | 16 | Diesel | 44 |
| BAD | 76.50 | 1598 | 4 | 16 | Petrol | 10 |
| BAG | 76.50 | 1598 | 4 | 16 | Petrol | 10 |
| BAH | 76.50 | 1598 | 4 | 8 | Petrol | 11 |
| BAM | 81.00 | 1781 | 4 | 20 | Petrol | 39 |
| BAR | 84.50 | 4163 | 8 | 32 | Petrol | 103 |
| BAU | 78.30 | 2496 | 6 | 24 | Diesel | 16 |
| BBG | 82.50 | 2771 | 6 | 30 | Petrol | 86 |
| BBJ | 82.50 | 2976 | 6 | 30 | Petrol | 87 |
| BBY | 76.50 | 1390 | 4 | 16 | Petrol | 5 |
| BCZ | 78.30 | 2496 | 6 | 24 | Diesel | 16 |
| BDB | 84.00 | 3189 | 6 | 24 | Petrol | 93 |
| BDG | 78.30 | 2496 | 6 | 24 | Diesel | 16 |
| BDH | 78.30 | 2496 | 6 | 24 | Diesel | 16 |
| BDV | 81.00 | 2393 | 6 | 30 | Petrol | 63 |
| BDW | 81.00 | 2393 | 6 | 24 | Petrol | 64 |
| BDX | 84.50 | 2773 | 6 | 24 | Petrol | 95 |
| BES | 81.00 | 2671 | 6 | 30 | Petrol | 66 |
| BEX | 81.00 | 1781 | 4 | 20 | Petrol | 39 |
| BFB | 81.00 | 1781 | 4 | 20 | Petrol | 39 |
| BFC | 78.30 | 2496 | 6 | 24 | Diesel | 16 |
| BFQ | 81.00 | 1595 | 4 | 8 | Petrol | 34 |
| BGB | 82.50 | 1984 | 4 | 16 | Petrol | 77 |
| BGU | 81.00 | 1595 | 4 | 8 | Petrol | 34 |
| BHC | 79.50 | 1422 | 3 | 6 | Diesel | 18 |
| BHE | 84.00 | 3189 | 6 | 24 | Petrol | 93 |
| BHK | 89.00 | 3597 | 6 | 24 | Petrol | 108 |
| BHZ | 82.50 | 1984 | 4 | 16 | Petrol | 78 |
| BKB | 81.00 | 1781 | 4 | 20 | Petrol | 39 |
| BKC | 79.50 | 1896 | 4 | 8 | Diesel | 26 |
| BKD | 81.00 | 1968 | 4 | 16 | Diesel | 44 |
| BKE | 79.50 | 1896 | 4 | 8 | Diesel | 26 |
| BKH | 84.50 | 3123 | 6 | 24 | Petrol | 99 |
| BKN | 83.00 | 2967 | 6 | 24 | Diesel | 89 |
| BLB | 81.00 | 1968 | 4 | 16 | Diesel | 45 |
| BLF | 76.50 | 1598 | 4 | 16 | Petrol | 10 |
| BLP | 76.50 | 1598 | 4 | 16 | Petrol | 10 |
| BLR | 82.50 | 1984 | 4 | 16 | Petrol | 75 |
| BLS | 79.50 | 1896 | 4 | 8 | Diesel | 26 |
| BLX | 82.50 | 1984 | 4 | 16 | Petrol | 75 |
| BLY | 82.50 | 1984 | 4 | 16 | Petrol | 75 |
| BMB | 82.50 | 1984 | 4 | 16 | Petrol | 75 |
| BMJ | 84.00 | 3189 | 6 | 24 | Petrol | 93 |
| BMK | 83.00 | 2967 | 6 | 24 | Diesel | 89 |
| BMM | 81.00 | 1968 | 4 | 8 | Diesel | 46 |
| BMN | 81.00 | 1968 | 4 | 16 | Diesel | 44 |
| BNA | 81.00 | 1968 | 4 | 16 | Diesel | 45 |
| BNG | 83.00 | 2967 | 6 | 24 | Diesel | 89 |
| BPF | 84.00 | 3189 | 6 | 24 | Petrol | 94 |
| BPG | 82.50 | 1984 | 4 | 16 | Petrol | 77 |
| BPJ | 82.50 | 1984 | 4 | 16 | Petrol | 77 |
| BPK | 84.50 | 3123 | 6 | 24 | Petrol | 100 |
| BPP | 83.00 | 2698 | 6 | 24 | Diesel | 88 |
| BPW | 81.00 | 1968 | 4 | 8 | Diesel | 47 |
| BPY | 82.50 | 1984 | 4 | 16 | Petrol | 77 |
| BRB | 79.50 | 1896 | 4 | 8 | Diesel | 26 |
| BRC | 81.00 | 1968 | 4 | 8 | Diesel | 47 |
| BRD | 81.00 | 1968 | 4 | 16 | Diesel | 44 |
| BRE | 81.00 | 1968 | 4 | 16 | Diesel | 45 |
| BRF | 81.00 | 1968 | 4 | 16 | Diesel | 45 |
| BSE | 81.00 | 1595 | 4 | 8 | Petrol | 34 |
| BSF | 81.00 | 1595 | 4 | 8 | Petrol | 34 |

| |  | ccm |  |  |  |  |
|------|---|------|--|---|---|---|
| BSG | 83.00 | 2698 | 6 | 24 | Diesel | 88 |
| BTR | 83.00 | 4134 | 8 | 32 | Diesel | 91 |
| BUB | 84.00 | 3189 | 6 | 24 | Petrol | 93 |
| BUJ | 84.50 | 5204 | 10 | 40 | Petrol | 106 |
| BUL | 82.50 | 1984 | 4 | 16 | Petrol | 78 |
| BUN | 83.00 | 2967 | 6 | 24 | Diesel | 89 |
| BUY | 81.00 | 1968 | 4 | 16 | Diesel | 44 |
| BVF | 81.00 | 1968 | 4 | 16 | Diesel | 44 |
| BVG | 81.00 | 1968 | 4 | 16 | Diesel | 44 |
| BVJ | 84.50 | 4163 | 8 | 32 | Petrol | 103 |
| BVY | 82.50 | 1984 | 4 | 16 | Petrol | 75 |
| BVZ | 82.50 | 1984 | 4 | 16 | Petrol | 75 |
| BWA | 82.50 | 1984 | 4 | 16 | Petrol | 77 |
| BWE | 82.50 | 1984 | 4 | 16 | Petrol | 77 |
| BWT | 82.50 | 1984 | 4 | 16 | Petrol | 77 |
| BXA | 84.50 | 5204 | 10 | 40 | Petrol | 106 |
| BXE | 79.50 | 1896 | 4 | 8 | Diesel | 26 |
| BYH | 84.50 | 4163 | 8 | 32 | Petrol | 103 |
| BYK | 82.50 | 1984 | 4 | 16 | Petrol | 75 |
| BYT | 82.50 | 1781 | 4 | 16 | Petrol | 68 |
| BYU | 84.50 | 3123 | 6 | 24 | Petrol | 100 |
| BZB | 82.50 | 1798 | 4 | 16 | Petrol | 69 |
| BZC | 82.50 | 1984 | 4 | 16 | Petrol | 78 |
| CABA | 82.50 | 1798 | 4 | 16 | Petrol | 69 |
| CABB | 82.50 | 1798 | 4 | 16 | Petrol | 69 |
| CABD | 82.50 | 1798 | 4 | 16 | Petrol | 69 |
| CAEA | 82.50 | 1984 | 4 | 16 | Petrol | 77 |
| CAEB | 82.50 | 1984 | 4 | 16 | Petrol | 78 |
| CAED | 82.50 | 1984 | 4 | 16 | Petrol | 78 |
| CAGA | 81.00 | 1968 | 4 | 16 | Diesel | 48 |
| CAGB | 81.00 | 1968 | 4 | 16 | Diesel | 48 |
| CAGC | 81.00 | 1968 | 4 | 16 | Diesel | 48 |
| CAHA | 81.00 | 1968 | 4 | 16 | Diesel | 48 |
| CAHB | 81.00 | 1968 | 4 | 16 | Diesel | 48 |
| CAJA | 84.50 | 2995 | 6 | 24 | Petrol | 98 |
| CAKA | 84.50 | 2995 | 6 | 24 | Petrol | 98 |
| CALA | 85.50 | 3197 | 6 | 24 | Petrol | 107 |
| CALB | 85.50 | 3197 | 6 | 24 | Petrol | 107 |
| CAMA | 83.00 | 2698 | 6 | 24 | Diesel | 88 |
| CAMB | 83.00 | 2698 | 6 | 24 | Diesel | 88 |
| CANA | 83.00 | 2698 | 6 | 24 | Diesel | 88 |
| CANB | 83.00 | 2698 | 6 | 24 | Diesel | 88 |
| CANC | 83.00 | 2698 | 6 | 24 | Diesel | 88 |
| CAND | 83.00 | 2698 | 6 | 24 | Diesel | 88 |
| CAPA | 83.00 | 2967 | 6 | 24 | Diesel | 89 |
| CASA | 83.00 | 2967 | 6 | 24 | Diesel | 89 |
| CASB | 83.00 | 2967 | 6 | 24 | Diesel | 89 |
| CATA | 83.00 | 2967 | 6 | 24 | Diesel | 89 |
| CAWB | 82.50 | 1984 | 4 | 16 | Petrol | 77 |
| CAXA | 76.50 | 1390 | 4 | 16 | Petrol | 5 |
| CAXC | 76.50 | 1390 | 4 | 16 | Petrol | 5 |
| CAYB | 79.50 | 1598 | 4 | 16 | Diesel | 19 |
| CAYC | 79.50 | 1598 | 4 | 16 | Diesel | 19 |
| CBAA | 81.00 | 1968 | 4 | 16 | Diesel | 48 |
| CBAB | 81.00 | 1968 | 4 | 16 | Diesel | 48 |
| CBBB | 81.00 | 1968 | 4 | 16 | Diesel | 48 |
| CBFA | 82.50 | 1984 | 4 | 16 | Petrol | 77 |
| CBZA | 71.00 | 1197 | 4 | 8 | Petrol | 1 |
| CBZB | 71.00 | 1197 | 4 | 8 | Petrol | 1 |
| CCAA | 84.50 | 2976 | 6 | 24 | Petrol | 97 |
| CCBA | 84.50 | 2995 | 6 | 24 | Petrol | 98 |
| CCDA | 84.50 | 2773 | 6 | 24 | Petrol | 96 |
| CCEA | 84.50 | 2773 | 6 | 24 | Petrol | 96 |
| CCFA | 83.00 | 4134 | 8 | 32 | Diesel | 91 |
| CCFC | 83.00 | 4134 | 8 | 32 | Diesel | 91 |
| CCGA | 83.00 | 5934 | 12 | 48 | Diesel | 92 |

|  |  | ccm |  |  |  |  |
|---|---|------|---|---|---|---|
| CCLA | 83.00 | 2967 | 6 | 24 | Diesel | 89 |
| CCMA | 83.00 | 2967 | 6 | 24 | Diesel | 89 |
| CCSA | 81.00 | 1595 | 4 | 8 | Petrol | 34 |
| CCTA | 82.50 | 1984 | 4 | 16 | Petrol | 77 |
| CCWA | 83.00 | 2967 | 6 | 24 | Diesel | 89 |
| CCWB | 83.00 | 2967 | 6 | 24 | Diesel | 89 |
| CCZA | 82.50 | 1984 | 4 | 16 | Petrol | 77 |
| CCZC | 82.50 | 1984 | 4 | 16 | Petrol | 77 |
| CDA A | 82.50 | 1798 | 4 | 16 | Petrol | 69 |
| CDHA | 82.50 | 1798 | 4 | 16 | Petrol | 69 |
| CDHB | 82.50 | 1798 | 4 | 16 | Petrol | 69 |
| CDLA | 82.50 | 1984 | 4 | 16 | Petrol | 78 |
| CDLB | 82.50 | 1984 | 4 | 16 | Petrol | 78 |
| CDLC | 82.50 | 1984 | 4 | 16 | Petrol | 78 |
| CDLH | 82.50 | 1984 | 4 | 16 | Petrol | 78 |
| CDMA | 82.50 | 1984 | 4 | 16 | Petrol | 78 |
| CDNA | 82.50 | 1984 | 4 | 16 | Petrol | 77 |
| CDNB | 82.50 | 1984 | 4 | 16 | Petrol | 77 |
| CDNC | 82.50 | 1984 | 4 | 16 | Petrol | 78 |
| CDSB | 83.00 | 4134 | 8 | 32 | Diesel | 91 |
| CDTA | 83.00 | 2967 | 6 | 24 | Diesel | 90 |
| CDTB | 83.00 | 2967 | 6 | 24 | Diesel | 90 |
| CDUC | 83.00 | 2967 | 6 | 24 | Diesel | 90 |
| CDUD | 83.00 | 2967 | 6 | 24 | Diesel | 90 |
| CDYA | 83.00 | 2967 | 6 | 24 | Diesel | 89 |
| CDYB | 83.00 | 2967 | 6 | 24 | Diesel | 89 |
| CDYC | 83.00 | 2967 | 6 | 24 | Diesel | 89 |
| CEPA | 82.50 | 2480 | 5 | 20 | Petrol | 81 |
| CEPB | 82.50 | 2480 | 5 | 20 | Petrol | 81 |
| CESA | 82.50 | 1984 | 4 | 16 | Petrol | 78 |
| CETA | 82.50 | 1984 | 4 | 16 | Petrol | 78 |
| CEUA | 84.50 | 3993 | 8 | 32 | Petrol | 101 |
| CEUC | 84.50 | 3993 | 8 | 32 | Petrol | 102 |
| CFFA | 81.00 | 1968 | 4 | 16 | Diesel | 48 |
| CFFB | 81.00 | 1968 | 4 | 16 | Diesel | 48 |
| CFGB | 81.00 | 1968 | 4 | 16 | Diesel | 48 |
| CFGC | 81.00 | 1968 | 4 | 16 | Diesel | 48 |
| CFGD | 81.00 | 1968 | 4 | 16 | Diesel | 48 |
| CFHB | 81.00 | 1968 | 4 | 16 | Diesel | 48 |
| CFHD | 81.00 | 1968 | 4 | 16 | Diesel | 48 |
| CFKA | 82.50 | 1984 | 4 | 16 | Petrol | 77 |
| CGKA | 83.00 | 2698 | 6 | 24 | Diesel | 88 |
| CGKB | 83.00 | 2698 | 6 | 24 | Diesel | 88 |
| CGLA | 81.00 | 1968 | 4 | 16 | Diesel | 48 |
| CGLB | 81.00 | 1968 | 4 | 16 | Diesel | 48 |
| CGLC | 81.00 | 1968 | 4 | 16 | Diesel | 48 |
| CGLD | 81.00 | 1968 | 4 | 16 | Diesel | 48 |
| CGLE | 81.00 | 1968 | 4 | 16 | Diesel | 48 |
| CGQB | 83.00 | 2967 | 6 | 24 | Diesel | 90 |
| CGTA | 84.50 | 3993 | 8 | 32 | Petrol | 101 |
| CGWC | 84.50 | 2995 | 6 | 24 | Petrol | 98 |
| CGXC | 84.50 | 2995 | 6 | 24 | Petrol | 98 |
| CHJA | 82.50 | 1984 | 4 | 16 | Petrol | 78 |
| CHPB | 74.50 | 1395 | 4 | 16 | Petrol | 4 |
| CHZJ | 74.50 | 999 | 3 | 12 | Petrol | 3 |
| CJBA | 84.50 | 2773 | 6 | 24 | Petrol | 95 |
| CJCA | 81.00 | 1968 | 4 | 16 | Diesel | 48 |
| CJCB | 81.00 | 1968 | 4 | 16 | Diesel | 48 |
| CJCC | 81.00 | 1968 | 4 | 16 | Diesel | 48 |
| CJCD | 81.00 | 1968 | 4 | 16 | Diesel | 48 |
| CJGA | 83.00 | 2967 | 6 | 24 | Diesel | 90 |
| CJGC | 83.00 | 2967 | 6 | 24 | Diesel | 90 |
| CJGD | 83.00 | 2967 | 6 | 24 | Diesel | 90 |
| CJMA | 83.00 | 2967 | 6 | 24 | Diesel | 90 |
| CJZA | 71.00 | 1197 | 4 | 16 | Petrol | 2 |
| CJZB | 71.00 | 1197 | 4 | 16 | Petrol | 2 |

| |  | ccm |  |  |  |  |
|------|---|------|--|---|---|---|
| CKVB | 83.00 | 2967 | 6 | 24 | Diesel | 90 |
| CKVC | 83.00 | 2967 | 6 | 24 | Diesel | 90 |
| CLAA | 83.00 | 2967 | 6 | 24 | Diesel | 90 |
| CLAB | 83.00 | 2967 | 6 | 24 | Diesel | 90 |
| CLHA | 79.50 | 1598 | 4 | 16 | Diesel | 19 |
| CLJA | 81.00 | 1968 | 4 | 16 | Diesel | 48 |
| CLLB | 81.00 | 1968 | 4 | 16 | Diesel | 48 |
| CLZB | 83.00 | 2967 | 6 | 24 | Diesel | 90 |
| CMBA | 74.50 | 1395 | 4 | 16 | Petrol | 4 |
| CMEA | 81.00 | 1968 | 4 | 16 | Diesel | 48 |
| CMFA | 81.00 | 1968 | 4 | 16 | Diesel | 48 |
| CMFB | 81.00 | 1968 | 4 | 16 | Diesel | 48 |
| CMGA | 81.00 | 1968 | 4 | 16 | Diesel | 48 |
| CMGB | 81.00 | 1968 | 4 | 16 | Diesel | 48 |
| CMHA | 83.00 | 2967 | 6 | 24 | Diesel | 90 |
| CMSA | 76.50 | 1390 | 4 | 16 | Petrol | 5 |
| CMUA | 84.50 | 2995 | 6 | 24 | Petrol | 98 |
| CMXA | 81.00 | 1595 | 4 | 8 | Petrol | 34 |
| CN | 76.50 | 1986 | 5 | 10 | Diesel | 12 |
| CNHA | 81.00 | 1968 | 4 | 16 | Diesel | 48 |
| CNHC | 81.00 | 1968 | 4 | 16 | Diesel | 48 |
| CNRB | 83.00 | 2967 | 6 | 24 | Diesel | 90 |
| CPMA | 82.50 | 1984 | 4 | 16 | Petrol | 78 |
| CPMB | 82.50 | 1984 | 4 | 16 | Petrol | 78 |
| CPNA | 83.00 | 2967 | 6 | 24 | Diesel | 90 |
| CPNB | 83.00 | 2967 | 6 | 24 | Diesel | 90 |
| CPSA | 82.50 | 1984 | 4 | 16 | Petrol | 78 |
| CPTA | 74.50 | 1395 | 4 | 16 | Petrol | 4 |
| CPWA | 74.50 | 1395 | 4 | 16 | Petrol | 4 |
| CR | 76.50 | 1588 | 4 | 8 | Diesel | 6 |
| CRBC | 81.00 | 1968 | 4 | 16 | Diesel | 48 |
| CRBD | 81.00 | 1968 | 4 | 16 | Diesel | 48 |
| CRCA | 83.00 | 2967 | 6 | 24 | Diesel | 90 |
| CRDB | 84.50 | 3993 | 8 | 32 | Petrol | 101 |
| CRFA | 81.00 | 1968 | 4 | 16 | Diesel | 48 |
| CRFC | 81.00 | 1968 | 4 | 16 | Diesel | 48 |
| CRKB | 79.50 | 1598 | 4 | 16 | Diesel | 19 |
| CRLB | 81.00 | 1968 | 4 | 16 | Diesel | 48 |
| CRLC | 81.00 | 1968 | 4 | 16 | Diesel | 48 |
| CRUA | 81.00 | 1968 | 4 | 16 | Diesel | 48 |
| CSUA | 81.00 | 1968 | 4 | 16 | Diesel | 48 |
| CSUB | 81.00 | 1968 | 4 | 16 | Diesel | 48 |
| CTBA | 83.00 | 2967 | 6 | 24 | Diesel | 90 |
| CTEC | 83.00 | 4134 | 8 | 32 | Diesel | 91 |
| CTGA | 84.50 | 3993 | 8 | 32 | Petrol | 101 |
| CTGE | 84.50 | 3993 | 8 | 32 | Petrol | 102 |
| CTSA | 82.50 | 2480 | 5 | 20 | Petrol | 82 |
| CTUB | 84.50 | 2995 | 6 | 24 | Petrol | 98 |
| CUKB | 74.50 | 1395 | 4 | 16 | Petrol | 4 |
| CUNA | 81.00 | 1968 | 4 | 16 | Diesel | 48 |
| CUPA | 81.00 | 1968 | 4 | 16 | Diesel | 48 |
| CUVC | 81.00 | 1968 | 4 | 16 | Diesel | 48 |
| CUWA | 81.00 | 1968 | 4 | 16 | Diesel | 48 |
| CXMA | 79.50 | 1598 | 4 | 16 | Diesel | 19 |
| CXSA | 74.50 | 1395 | 4 | 16 | Petrol | 4 |
| CXSB | 74.50 | 1395 | 4 | 16 | Petrol | 4 |
| CY | 76.50 | 1588 | 4 | 8 | Diesel | 7 |
| CYVA | 71.00 | 1197 | 4 | 16 | Petrol | 2 |
| CYVB | 71.00 | 1197 | 4 | 16 | Petrol | 2 |
| CZCA | 74.50 | 1395 | 4 | 16 | Petrol | 4 |
| CZDA | 74.50 | 1395 | 4 | 16 | Petrol | 4 |
| CZEA | 74.50 | 1395 | 4 | 16 | Petrol | 4 |
| DD | 81.00 | 1781 | 4 | 8 | Petrol | 40 |
| DE | 76.50 | 1986 | 5 | 10 | Diesel | 13 |
| DFGA | 81.00 | 1968 | 4 | 16 | Diesel | 48 |
| DR | 81.00 | 1781 | 4 | 8 | Petrol | 40 |

|  |  | ccm |  |  |  |  | |
|---|---|-------|---|---|---|---|----|
| DS | | 81.00 | 1781 | 4 | 8 | Petrol | 41 |
| DTA | | 81.00 | 1595 | 4 | 8 | Petrol | 32 |
| DZ | | 81.00 | 1781 | 4 | 8 | Petrol | 37 |
| HP | | 81.00 | 1994 | 5 | 10 | Petrol | 49 |
| HX | | 81.00 | 2226 | 5 | 10 | Petrol | 58 |
| HY | | 81.00 | 2144 | 5 | 10 | Petrol | 53 |
| JK | | 76.50 | 1588 | 4 | 8 | Diesel | 8 |
| JN | | 81.00 | 1781 | 4 | 8 | Petrol | 41 |
| JS | | 81.00 | 1994 | 5 | 10 | Petrol | 50 |
| JT | | 81.00 | 2226 | 5 | 10 | Petrol | 59 |
| JU | | 81.00 | 1595 | 4 | 8 | Petrol | 35 |
| JV | | 81.00 | 1781 | 4 | 8 | Petrol | 42 |
| JW | | 81.00 | 1781 | 4 | 8 | Petrol | 41 |
| KE | | 79.50 | 2144 | 5 | 10 | Petrol | 28 |
| KG | | 79.50 | 2144 | 5 | 10 | Petrol | 28 |
| KK | | 79.50 | 2144 | 5 | 10 | Petrol | 28 |
| KL | | 79.50 | 2144 | 5 | 10 | Petrol | 29 |
| KP | | 81.00 | 1994 | 5 | 10 | Petrol | 50 |
| KU | | 81.00 | 2226 | 5 | 10 | Petrol | 58 |
| KV | | 81.00 | 2226 | 5 | 10 | Petrol | 59 |
| KX | | 81.00 | 2226 | 5 | 10 | Petrol | 54 |
| KZ | | 81.00 | 2226 | 5 | 10 | Petrol | 59 |
| MB | | 81.00 | 2226 | 5 | 10 | Petrol | 59 |
| MC | | 81.00 | 2226 | 5 | 10 | Petrol | 60 |
| NC | | 76.50 | 1986 | 5 | 10 | Diesel | 14 |
| NE | | 81.00 | 1781 | 4 | 8 | Petrol | 41 |
| NF | | 82.50 | 2309 | 5 | 10 | Petrol | 80 |
| NG | | 82.50 | 2309 | 5 | 10 | Petrol | 80 |
| NM | | 81.00 | 1994 | 5 | 20 | Petrol | 51 |
| NP | | 81.00 | 1781 | 4 | 8 | Petrol | 41 |
| PH | | 81.00 | 1781 | 4 | 8 | Petrol | 41 |
| PM | | 81.00 | 1781 | 4 | 8 | Petrol | 41 |
| PP | | 81.00 | 1595 | 4 | 8 | Petrol | 32 |
| PS | | 81.00 | 1994 | 5 | 10 | Petrol | 52 |
| PT | | 81.00 | 3562 | 8 | 32 | Petrol | 67 |
| PV | | 81.00 | 1781 | 4 | 8 | Petrol | 43 |
| PX | | 81.00 | 2226 | 5 | 10 | Petrol | 58 |
| RA | | 76.50 | 1588 | 4 | 8 | Diesel | 9 |
| RN | | 81.00 | 1595 | 4 | 8 | Petrol | 32 |
| RR | | 81.00 | 2226 | 5 | 20 | Petrol | 61 |
| RS | | 81.00 | 1781 | 4 | 8 | Petrol | 41 |
| RT | | 81.00 | 1994 | 5 | 10 | Petrol | 52 |
| RU | | 81.00 | 1781 | 4 | 8 | Petrol | 41 |
| SA | | 81.00 | 1595 | 4 | 8 | Petrol | 36 |
| SB | | 76.50 | 1588 | 4 | 8 | Diesel | 9 |
| SD | | 82.50 | 1847 | 4 | 8 | Petrol | 70 |
| SF | | 81.00 | 1781 | 4 | 8 | Petrol | 41 |
| SH | | 81.00 | 1781 | 4 | 8 | Petrol | 41 |
| SK | | 81.00 | 1994 | 5 | 10 | Petrol | 49 |
| SL | | 81.00 | 1994 | 5 | 10 | Petrol | 49 |
| WB | | 79.50 | 2144 | 5 | 10 | Petrol | 28 |
| WC | | 79.50 | 2144 | 5 | 10 | Petrol | 28 |
| WH | | 79.50 | 1921 | 5 | 10 | Petrol | 27 |
| WJ | | 79.50 | 2144 | 5 | 10 | Petrol | 28 |
| WN | | 79.50 | 1921 | 5 | 10 | Petrol | 27 |



OE

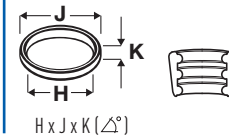
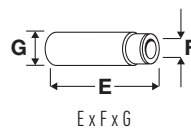

1 **71.00**

| | | | | | | | |
|-------------|-----------------|--------|-----------------|------------|-----------------|-------------------------------|----------------|
| CBZA | 1197cc | 4 Cyl. | 8 Valves | 63kW/86PS | Petrol | Turbo, SOHC, Injection | TD24385 |
| CBZB | 1197cc | 4 Cyl. | 8 Valves | 77kW/105PS | Petrol | Turbo, SOHC, Injection | TD23907 |
| A1 1.2 TFSI | 05/2010→ | | A3 1.2 TFSI | | 03/2010→05/2013 | | |
| A3 1.2 TSI | 04/2010→03/2013 | | | | | | |

| | | | | | | |
|----------------------|--------------|------------|-----|----|----------------------|--|
| V95149 | 03F 109 601A | | 45° | Y | VAG96073B | |
| 35.45 x 5.98 x 98.70 | | MB | | | 36.00 x 6.02 x 11.06 | |
| V95150 | 03F 109 611C | | 45° | SS | H | |
| 30.00 x 5.95 x 98.40 | | MD + MB cr | | | | |

2 **71.00**

| | | | | | | | |
|-------------|----------|--------|------------------|------------|--------|-------------------------------|----------------|
| CJZA | 1197cc | 4 Cyl. | 16 Valves | 77kW/105PS | Petrol | Turbo, DOHC, Injection | TD27151 |
| CJZB | 1197cc | 4 Cyl. | 16 Valves | 63kW/86PS | Petrol | Turbo, DOHC, Injection | TD27188 |
| CYVA | 1197cc | 4 Cyl. | 16 Valves | 63kW/86PS | Petrol | Turbo, DOHC, Injection | TD34746 |
| CYVB | 1197cc | 4 Cyl. | 16 Valves | 81kW/110PS | Petrol | Turbo, DOHC, Injection | TD29301 |
| A3 1.2 TFSI | 02/2013→ | | | | | | |

| | | | | | | |
|-----------------------|--------------|------------|-----|----|---|--|
| V80012 | 04E 109 601A | | 45° | | | |
| 26.50 x 5.00 x 110.25 | | MB | | | | |
| V80013 | 04E 109 611K | | 30° | SS | H | |
| 23.50 x 5.00 x 110.09 | | ME + MB cr | | | | |

3 **74.50**

| | | | | | | | |
|-------------|----------|--------|------------------|------------|--------|------------------------|----------------|
| CHZJ | 999cc | 3 Cyl. | 12 Valves | 85kW/115PS | Petrol | DOHC, Injection | TD33893 |
| Q2 1.0 TFSI | 10/2016→ | | | | | | |

| | | | | | | |
|-----------------------|--------------|-------|-----|---|--|--|
| V95237 | 04E 109 601 | | 45° | H | | |
| 29.50 x 5.00 x 110.23 | | MB | | | | |
| V95238 | 04E 109 611L | | 30° | | | |
| 26.90 x 5.00 x 110.30 | | MD cr | | | | |

4 **74.50**

| | | | | | | | |
|--------------------|----------|--------|--------------------|-------------|----------|-------------------------------|----------------|
| CHPB | 1395cc | 4 Cyl. | 16 Valves | 110kW/150PS | Petrol | Turbo, DOHC, Injection | TD28307 |
| CMBA | 1395cc | 4 Cyl. | 16 Valves | 90kW/122PS | Petrol | Turbo, DOHC, Injection | TD26718 |
| CPTA | 1395cc | 4 Cyl. | 16 Valves | 103kW/140PS | Petrol | Turbo, DOHC, Injection | TD25658 |
| CPWA | 1395cc | 4 Cyl. | 16 Valves | 81kW/110PS | Petrol | Turbo, DOHC, Injection | TD28359 |
| CUKB | 1395cc | 4 Cyl. | 16 Valves | 110kW/150PS | Petrol | Turbo, DOHC, Injection | TD29356 |
| CXSA | 1395cc | 4 Cyl. | 16 Valves | 90kW/122PS | Petrol | Turbo, DOHC, Injection | TD28200 |
| CXSB | 1395cc | 4 Cyl. | 16 Valves | 92kW/125PS | Petrol | Turbo, DOHC, Injection | TD28201 |
| CZCA | 1395cc | 4 Cyl. | 16 Valves | 92kW/125PS | Petrol | Turbo, DOHC, Injection | TD29303 |
| CZDA | 1395cc | 4 Cyl. | 16 Valves | 110kW/150PS | Petrol | Turbo, DOHC, Injection | TD30786 |
| CZEA | 1395cc | 4 Cyl. | 16 Valves | 110kW/150PS | Petrol | Turbo, DOHC, Injection | TD29280 |
| A1 1.4 TFSI | 04/2012→ | | A1 1.4 TSI | | 11/2014→ | | |
| A3 1.4 TFSI | 04/2012→ | | A3 1.4 TFSI e-tron | | 05/2014→ | | |
| A3 1.4 TFSI g-tron | 11/2013→ | | A3 1.4 TSI | | 05/2014→ | | |
| Q2 1.4 TSI | 06/2016→ | | | | | | |

| | | | | | | |
|-----------------------|--------------|---------|-----|----|---|--|
| V95192 | 04E 109 601B | | 45° | Y | H | |
| 28.45 x 4.70 x 110.30 | | MB | | | | |
| V95193 | 04E 109 611J | | 30° | SS | H | |
| 25.00 x 4.97 x 110.15 | | MD + MB | | | | |





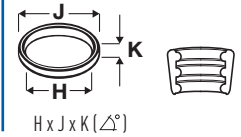
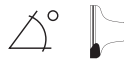

OE



5  **76.50**





| | | | | | | | |
|-------------|--------|--------|------------------|------------|--------|-------------------------------|----------------|
| AUA | 1390cc | 4 Cyl. | 16 Valves | 55kW/75PS | Petrol | DOHC | TD15248 |
| BBY | 1390cc | 4 Cyl. | 16 Valves | 55kW/75PS | Petrol | DOHC | TD16414 |
| CAXA | 1390cc | 4 Cyl. | 16 Valves | 90kW/122PS | Petrol | Turbo, DOHC, Injection | TD24386 |
| CAXC | 1390cc | 4 Cyl. | 16 Valves | 92kW/125PS | Petrol | Turbo, DOHC, Injection | TD20715 |
| CMSA | 1390cc | 4 Cyl. | 16 Valves | 92kW/125PS | Petrol | Turbo, DOHC, Injection | TD23936 |

| | | | |
|-------------|-----------------|--------|-----------------|
| A1 1.4 TFSI | 05/2010→ | A2 1.4 | 02/2000→08/2005 |
| A3 1.4 TFSI | 09/2007→05/2013 | | |

| | | | | | | | |
|---|--------------|--|-----|---|---|--|---|
| V94116  | 036 109 601S |  MB | 45° | Y | H | VAG96073B  |  36.00 x 6.02 x 11.06 |
| V94117  | 036 109 611K |  MD + MB | 45° | | | | |



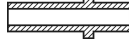





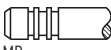

6  **76.50**

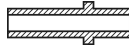
| | | | | | | | |
|-----------|-----------------|--------|-----------------|-----------|--------|-------------|--------------|
| CR | 1588cc | 4 Cyl. | 8 Valves | 40kW/54PS | Diesel | SOHC | TD248 |
| 80 1.6 D | 08/1980→08/1986 | | | | | | |

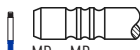
| | | | | | | | |
|---|--------------|---|-----|--|---|---|--|
| V90179  | 068 109 601C |  MB | 45° | | H | VAG92061B  |  36.70 x 8.00 x 12.08 |
| V90180  | 068 109 611C |  MD | 45° | | | | |

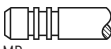



7  **76.50**

| | | | | | | | |
|-----------|-----------------|--------|-----------------|-----------|-----------------|--------------------|---------------|
| CY | 1588cc | 4 Cyl. | 8 Valves | 51kW/70PS | Diesel | Turbo, SOHC | TD4205 |
| 80 1.6 TD | 08/1981→05/1986 | | | 90 1.6 TD | 10/1985→01/1987 | | |

| | | | | | | | |
|---|--------------|--|-----|----|---|--|---|
| V91173  | 068 109 601D |  MD | 45° | | | VAG92061B  |  36.70 x 8.00 x 12.08 |
| V91367  | 068 109 601N |  MD + MB | 45° | SS | H | | |
| V91174  | 068 109 611D |  MD | 45° | SS | | | |
| V91368  | 068 109 611L |  MD + MB | 45° | | H | | |
| V91409  | 068 109 611L |  MD + MB | 45° | | H | | |

8  **76.50**

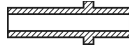
| | | | | | | | |
|-----------|-----------------|--------|-----------------|-----------|--------|-------------|--------------|
| JK | 1588cc | 4 Cyl. | 8 Valves | 40kW/54PS | Diesel | SOHC | TD269 |
| 80 1.6 D | 08/1980→07/1989 | | | | | | |

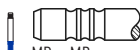



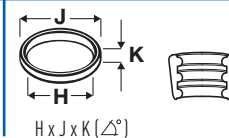
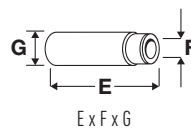

| | | | | | | | |
|---|--------------|--|-----|--|---|--|---|
| V91335  | 068 109 601L |  MB | 45° | | H | VAG92061B  |  36.70 x 8.00 x 12.08 |
| V91368  | 068 109 611L |  MD + MB | 45° | | H | | |





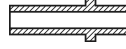

OE





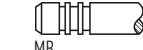



9  **76.50**

| RA | 1588cc | 4 Cyl. | 8 Valves | 59kW/80PS | Diesel | Turbo, SOHC | TD313 |
|---|-----------------|---|-----------|-----------|-----------------|--|--------|
| SB | 1588cc | 4 Cyl. | 8 Valves | 59kW/80PS | Diesel | Turbo, SOHC | TD4211 |
| 80 1.6 TD | 09/1986→08/1991 | | 90 1.6 TD | | 04/1987→09/1991 | | |
| V91367  | 068 109 601N |  | 45° | ss | H | VAG92061B  | |
| 34.10 x 7.97 x 95.10 | | MD + MB | | | | 36.70 x 8.00 x 12.08 | |
| V91368  | 068 109 611L |  | 45° | | H | | |
| 31.30 x 7.95 x 95.00 | | MD + MB | | | | | |
| V91409  | 068 109 611L |  | 45° | | H | | |
| 31.30 x 7.95 x 95.10 | | MD + MB | | | | | |



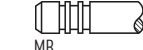

10  **76.50**

| BAD | 1598cc | 4 Cyl. | 16 Valves | 81kW/110PS | Petrol | DOHC, Injection | TD16415 |
|---|-----------------|---|------------|------------|-----------------|--|---------|
| BAG | 1598cc | 4 Cyl. | 16 Valves | 85kW/115PS | Petrol | DOHC, Injection | TD17069 |
| BLF | 1598cc | 4 Cyl. | 16 Valves | 85kW/115PS | Petrol | DOHC, Injection | TD20713 |
| BLP | 1598cc | 4 Cyl. | 16 Valves | 85kW/115PS | Petrol | DOHC, Injection | TD17401 |
| A2 1.6 FSI | 05/2002→08/2005 | | A3 1.6 FSI | | 08/2003→09/2007 | | |
| V94116  | 036 109 601S |  | 45° | Y | H | VAG96073B  | |
| 29.50 x 6.00 x 100.90 | | MB | | | | 36.00 x 6.02 x 11.06 | |
| V94117  | 036 109 611K |  | 45° | | | | |
| 26.00 x 6.00 x 100.50 | | MD + MB | | | | | |



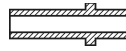

11  **76.50**

| BAH | 1598cc | 4 Cyl. | 8 Valves | 74kW/101PS | Petrol | SOHC | TD26492 |
|---|--------------|---|----------|------------|--------|--|---------|
| V94646  | 032 109 601M |  | 45° | Y | H | VAG96073B  | |
| 34.50 x 6.00 x 99.10 | | MB | | | | 36.00 x 6.02 x 11.06 | |
| V94405  | 030 109 611T |  | 45° | ss | H | | |
| 28.00 x 6.00 x 99.10 | | MD + MB | | | | | |

12  **76.50**

| CN | 1986cc | 5 Cyl. | 10 Valves | 51kW/69PS | Diesel | SOHC | TD247 |
|---|-----------------|---|-----------|-----------|--------|--|-------|
| 100 2.0 D | 08/1978→11/1990 | | | | | | |
| V90321  | 069 109 601D |  | 45° | | H | VAG92061B  | |
| 36.13 x 7.96 x 104.63 | | MB | | | | 36.70 x 8.00 x 12.08 | |
| V90180  | 068 109 611C |  | 45° | | | | |
| 31.32 x 7.94 x 104.60 | | MD | | | | | |

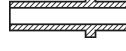
13  **76.50**





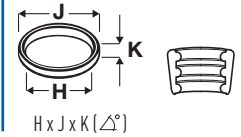
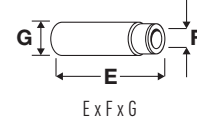

| DE | 1986cc | 5 Cyl. | 10 Valves | 64kW/87PS | Diesel | Turbo, SOHC | TD251 |
|---|-----------------|---|------------|-----------|-----------------|--|-------|
| 100 2.0 D Turbo | 08/1982→02/1988 | | 100 2.0 TD | | 03/1983→10/1987 | | |
| V90321  | 069 109 601D |  | 45° | | H | VAG92061B  | |
| 36.13 x 7.96 x 104.63 | | MB | | | | 36.70 x 8.00 x 12.08 | |
| V91174  | 068 109 611D |  | 45° | ss | | | |
| 31.00 x 7.95 x 104.60 | | MD | | | | | |



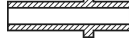

OE



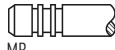
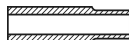

14  **76.50**

| NC | 1986cc | 5 Cyl. | 10 Valves | 74kW/100PS | Diesel | Turbo | TD299 |
|---|--------------|--|-----------|------------|--------|---|-------|
| 100 2.0 D Turbo | | 03/1988→11/1990 | | 100 2.0 TD | | 03/1988→11/1990 | |
| V91336  | 069 109 601H |  MD | 45° | | |  | |
| V91368  | 068 109 611L |  MD + MB | 45° | H | | | |
| V91409  | 068 109 611L |  MD + MB | 45° | H | | | |

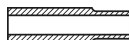



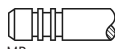
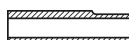

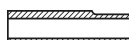
15  **78.30**

| AFB | 2496cc | V6 Cyl. | 24 Valves | 110kW/150PS | Diesel | Turbo, DOHC | TD9517 |
|---|--------------|--|-----------|-----------------|--------|---|---------|
| AKE | 2496cc | V6 Cyl. | 24 Valves | 132kW/180PS | Diesel | Turbo, DOHC | TD15312 |
| AKN | 2496cc | V6 Cyl. | 24 Valves | 110kW/150PS | Diesel | Turbo, DOHC | TD11356 |
| AYM | 2496cc | V6 Cyl. | 24 Valves | 114kW/155PS | Diesel | Turbo, DOHC | TD16384 |
| A4 2.5 TDI | | 09/1997→12/2004 | | A6 2.5 TDI | | 07/1997→01/2005 | |
| A8 2.5 TDI | | 01/1997→09/2002 | | ALLROAD 2.5 TDI | | 05/2000→08/2005 | |
| V94653  | 059 109 601B |  MB | 45° | H | |  | |
| V94423  | 059 109 611B |  MD + MB | 45° | SS H | |  | |

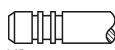
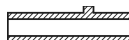
16  **78.30**

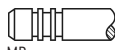
| BAU | 2496cc | V6 Cyl. | 24 Valves | 132kW/180PS | Diesel | Turbo, DOHC | TD17033 |
|---|--------------|---|-----------|-------------|--------|---|---------|
| BCZ | 2496cc | V6 Cyl. | 24 Valves | 120kW/163PS | Diesel | Turbo, DOHC | TD16859 |
| BDG | 2496cc | V6 Cyl. | 24 Valves | 120kW/163PS | Diesel | Turbo, DOHC | TD16860 |
| BDH | 2496cc | V6 Cyl. | 24 Valves | 132kW/180PS | Diesel | Turbo, DOHC | TD17034 |
| BFC | 2496cc | V6 Cyl. | 24 Valves | 120kW/163PS | Diesel | Turbo, DOHC | TD16858 |
| A4 2.5 TDI | | 11/2000→05/2006 | | A6 2.5 TDI | | 02/2000→01/2005 | |
| ALLROAD 2.5 TDI | | 05/2000→08/2005 | | | | | |
| V98008  | 059 109 601F |  MB cr | 45° | | |  | |
| V98009  | 059 109 611G |  MD + MB cr | 45° | SS | |  | |

17  **79.50**

| AMF | 1422cc | 3 Cyl. | 6 Valves | 55kW/75PS | Diesel | Turbo, SOHC | TD17156 |
|---|--------------|--|----------|-----------|--------|---|---------|
| A2 1.4 TDI | | 02/2000→08/2005 | | | | | |
| V94147  | 038 109 601B |  MB | 45° | H | |  | |
| V94649  | 038 109 601E |  MB | 45° | Y H | | | |
| V94148  | 038 109 611F |  MD + MB | 45° | SS H | | | |
| V94650  | 038 109 611E |  MD + MB | 45° | SS H | | | |

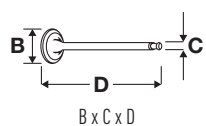

OE

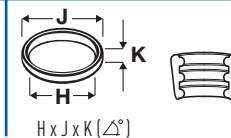
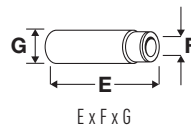

18 79.50

| | | | | | | | |
|-----|--------|--------|----------|-----------|--------|-------------|---------|
| ATL | 1422cc | 3 Cyl. | 6 Valves | 66kW/90PS | Diesel | Turbo, SOHC | TD17071 |
| BHC | 1422cc | 3 Cyl. | 6 Valves | 55kW/75PS | Diesel | SOHC | TD18133 |

| | | | | | | | |
|----------------------|--------------|-----------------|-----|----|---|------------------------|--|
| A2 1.4 TDI | | 02/2000→08/2005 | | | | | |
| V94649 ■ | 038 109 601E | | 45° | Y | H | VAG96041B ■ ■ ■ | |
| 36.00 x 7.00 x 89.40 | | MB | | | | 36.50 x 7.00 x 12.08 | |
| V94650 ■ | 038 109 611E | | 45° | ss | H | | |
| 31.40 x 7.00 x 89.00 | | MD + MB | | | | | |

19 79.50

| | | | | | | | |
|------|--------|--------|-----------|------------|--------|-------------|---------|
| CAYB | 1598cc | 4 Cyl. | 16 Valves | 66kW/90PS | Diesel | Turbo, DOHC | TD22661 |
| CAYC | 1598cc | 4 Cyl. | 16 Valves | 77kW/105PS | Diesel | Turbo, DOHC | TD22662 |
| CLHA | 1598cc | 4 Cyl. | 16 Valves | 77kW/105PS | Diesel | Turbo, DOHC | TD26721 |
| CRKB | 1598cc | 4 Cyl. | 16 Valves | 81kW/110PS | Diesel | Turbo, DOHC | TD28311 |
| CXMA | 1598cc | 4 Cyl. | 16 Valves | 85kW/115PS | Diesel | Turbo, DOHC | TD29749 |

| | | | | | | | |
|----------------------|--------------|----------|-----|------------|---|------------------------|--|
| A1 1.6 TDI | | 05/2010→ | | A3 1.6 TDI | | 05/2009→ | |
| V95125 ■ | 03L 109 601A | | 45° | Y | H | VAG96388B ■ ■ ■ | |
| 26.60 x 5.97 x 99.30 | | MD + MB | | | | 36.00 x 6.00 x 10.06 | |
| V95126 ■ | 03L 109 611A | | 45° | ss | H | | |
| 24.50 x 5.97 x 99.00 | | MD | | | | | |

20 79.50

| | | | | | | | |
|----|--------|--------|----------|-----------|--------|------|-------|
| 1Y | 1896cc | 4 Cyl. | 8 Valves | 50kW/68PS | Diesel | SOHC | TD213 |
|----|--------|--------|----------|-----------|--------|------|-------|

| | | | | | | | |
|--------------------------------------|--------------|-----------------|-----|----|---|--------------------------------------|--|
| 80 1.9 D | | 08/1989→08/1991 | | | | | |
| V91337 ■ | 069 109 601F | | 45° | | H | VAG92061B ■ ■ ■ | |
| 36.10 x 7.97 x 95.10 Eng.→580.000 | | MB | | | | 36.70 x 8.00 x 12.08 Eng.→580.000 | |
| V94108 ■ | 028 109 601B | | 45° | Y | H | VAG96041B ■ ■ ■ | |
| 36.00 x 7.00 x 95.50 Eng.580.001→ | | MB | | | | 36.50 x 7.00 x 12.08 Eng.580.001→ | |
| V94414 ■ | 028 109 601C | | 45° | | | | |
| 36.00 x 7.00 x 95.50 Eng.580.001→ | | MD cr | | | | | |
| V91334 ■ | 074 109 611 | | 45° | ss | H | | |
| 31.30 x 7.95 x 95.10 Eng.→580.000 | | ME + MB | | | | | |
| V94109 ■ | 028 109 611E | | 45° | | H | | |
| 31.10 x 7.00 x 95.60 Eng.580.001→ | | MD + MB | | | | | |



OE

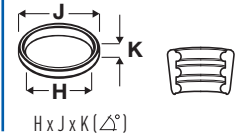

21 **79.50**

| 1Z | 1896cc | 4 Cyl. | 8 Valves | 66kW/90PS | Diesel | Turbo, SOHC | TD214 |
|----------------------|--------------|---------|----------|----------------------|--------|-----------------|-------|
| 80 1.9 TDI | | | | A4 1.9 TDI | | 01/1995→09/2001 | |
| A6 1.9 TDI | | | | CABRIOLET 1.9 TDI | | 06/1995→08/2000 | |
| V94010 | 028 109 601H | | 45° Y H | VAG92061B | | | |
| 36.00 x 8.00 x 96.80 | | MB | | 36.70 x 8.00 x 12.08 | | | |
| V94011 | 046 109 611F | | 45° ss | | | | |
| 31.50 x 7.95 x 96.85 | | MD + MB | | | | | |

22 **79.50**

| AAZ | 1896cc | 4 Cyl. | 8 Valves | 55kW/75PS | Diesel | Turbo, SOHC | TD229 |
|----------------------|--------------|---------|----------|----------------------|--------|-------------|-------|
| 80 1.9 TD | | | | | | | |
| | | | | | | | |
| V91336 | 069 109 601H | | 45° | VAG92061B | | | |
| 36.10 x 7.97 x 95.00 | | MD | | 36.70 x 8.00 x 12.08 | | | |
| Eng.→678000 | | | | Eng.→678000 | | | |
| V94108 | 028 109 601B | | 45° Y H | VAG96041B | | | |
| 36.00 x 7.00 x 95.50 | | MB | | 36.50 x 7.00 x 12.08 | | | |
| Eng.678000→ | | | | Eng.678001→ | | | |
| V94414 | 028 109 601C | | 45° | | | | |
| 36.00 x 7.00 x 95.50 | | MD cr | | | | | |
| Eng.678000→ | | | | | | | |
| V91334 | 074 109 611 | | 45° ss H | | | | |
| 31.30 x 7.95 x 95.10 | | ME + MB | | | | | |
| Eng.→678000 | | | | | | | |
| V94109 | 028 109 611E | | 45° H | | | | |
| 31.10 x 7.00 x 95.60 | | MD + MB | | | | | |
| Eng.678001→ | | | | | | | |

23 **79.50**

| AFF | 1896cc | 4 Cyl. | 8 Valves | 55kW/75PS | Diesel | Turbo, SOHC | TD11597 |
|----------------------|--------------|---------|----------|----------------------|--------|-----------------|---------|
| AFN | 1896cc | 4 Cyl. | 8 Valves | 81kW/110PS | Diesel | Turbo, SOHC | TD4202 |
| AHU | 1896cc | 4 Cyl. | 8 Valves | 66kW/90PS | Diesel | Turbo, SOHC | TD10814 |
| A4 1.9 | | | | A4 1.9 TDI | | 01/1995→09/2001 | |
| A6 1.9 TDI | | | | CABRIOLET 1.9 TDI | | 06/1995→08/2000 | |
| V94084 | 028 109 601D | | 45° Y H | VAG96041B | | | |
| 35.90 x 7.00 x 96.80 | | MB | | 36.50 x 7.00 x 12.08 | | | |
| Eng.002001→ | | | | | | | |
| V94085 | 028 109 611G | | 45° H | | | | |
| 31.40 x 7.00 x 96.90 | | MD + MB | | | | | |
| Eng.002001→ | | | | | | | |



OE

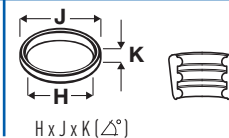
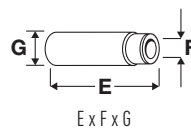

24 **79.50**

| | | | | | | | |
|-----|--------|--------|-----------------|------------|--------|--------------------|---------|
| AGR | 1896cc | 4 Cyl. | 8 Valves | 66kW/90PS | Diesel | Turbo, SOHC | TD5076 |
| AHF | 1896cc | 4 Cyl. | 8 Valves | 81kW/110PS | Diesel | Turbo, SOHC | TD9371 |
| AHH | 1896cc | 4 Cyl. | 8 Valves | 66kW/90PS | Diesel | Turbo, SOHC | TD16413 |
| ALH | 1896cc | 4 Cyl. | 8 Valves | 66kW/90PS | Diesel | Turbo, SOHC | TD11595 |
| ASV | 1896cc | 4 Cyl. | 8 Valves | 81kW/110PS | Diesel | Turbo, SOHC | TD15354 |
| AVG | 1896cc | 4 Cyl. | 8 Valves | 81kW/110PS | Diesel | Turbo, SOHC | TD13774 |

| | | | |
|------------|-----------------|------------|-----------------|
| A3 1.9 TDI | 09/1996→07/2001 | A4 1.9 TDI | 01/1995→09/2001 |
| A6 1.9 TDI | 04/1997→10/2000 | | |

V94084
 35.90 x 7.00 x 96.80

028 109 601D

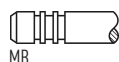

45° Y H

VAG96041B
 36.50 x 7.00 x 12.08

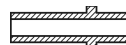

V94085
 31.40 x 7.00 x 96.90

028 109 611G

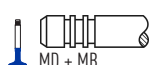

45° H

25 **79.50**

| | | | | | | | |
|-----|--------|--------|-----------------|------------|--------|--------------------|---------|
| AJM | 1896cc | 4 Cyl. | 8 Valves | 85kW/115PS | Diesel | Turbo, SOHC | TD11527 |
| ANU | 1896cc | 4 Cyl. | 8 Valves | 66kW/90PS | Diesel | Turbo, SOHC | TD11596 |
| ASZ | 1896cc | 4 Cyl. | 8 Valves | 96kW/130PS | Diesel | Turbo, SOHC | TD15351 |
| ATD | 1896cc | 4 Cyl. | 8 Valves | 74kW/101PS | Diesel | Turbo, SOHC | TD16028 |
| ATJ | 1896cc | 4 Cyl. | 8 Valves | 85kW/115PS | Diesel | Turbo, SOHC | TD15989 |
| AVB | 1896cc | 4 Cyl. | 8 Valves | 74kW/101PS | Diesel | SOHC | TD16518 |
| AVF | 1896cc | 4 Cyl. | 8 Valves | 96kW/130PS | Diesel | Turbo, SOHC | TD15348 |
| AWX | 1896cc | 4 Cyl. | 8 Valves | 96kW/130PS | Diesel | Turbo, SOHC | TD16133 |

| | | | |
|------------|-----------------|------------|-----------------|
| A3 1.9 TDI | 08/2000→05/2003 | A4 1.9 TDI | 03/2000→12/2004 |
| A6 1.9 TDI | 07/2000→01/2005 | | |

V94147
 35.90 x 7.00 x 89.90

038 109 601B

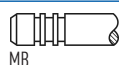

45° H

VAG96041B
 36.50 x 7.00 x 12.08



V94148
 31.50 x 7.00 x 90.00

038 109 611F

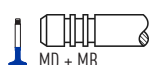

45° ss H

26 **79.50**

| | | | | | | | |
|-----|--------|--------|-----------------|------------|--------|--------------------|---------|
| AXR | 1896cc | 4 Cyl. | 8 Valves | 74kW/100PS | Diesel | SOHC | TD16416 |
| BKC | 1896cc | 4 Cyl. | 8 Valves | 77kW/105PS | Diesel | Turbo, SOHC | TD17026 |
| BKE | 1896cc | 4 Cyl. | 8 Valves | 85kW/116PS | Diesel | Turbo, SOHC | TD17596 |
| BLS | 1896cc | 4 Cyl. | 8 Valves | 77kW/105PS | Diesel | Turbo, SOHC | TD20823 |
| BRB | 1896cc | 4 Cyl. | 8 Valves | 85kW/116PS | Diesel | Turbo, SOHC | TD20492 |
| BXE | 1896cc | 4 Cyl. | 8 Valves | 77kW/105PS | Diesel | Turbo, SOHC | TD22657 |

| | | | |
|------------|-----------------|------------|-----------------|
| A3 1.9 TDI | 10/2000→05/2010 | A4 1.9 TDI | 06/2004→06/2008 |
|------------|-----------------|------------|-----------------|

V94649
 36.00 x 7.00 x 89.40

038 109 601E

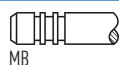

45° Y H

VAG96041B
 36.50 x 7.00 x 12.08



V94650
 31.40 x 7.00 x 89.00

038 109 611E

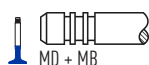

45° ss H



OE

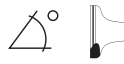

E x F x G

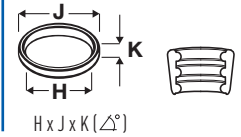

H x J x K (Δ°)

27  **79.50**

| | | | | | | | |
|---------------------------|--------|------------------------------------|-----------|------------|--------|-----------------|-------|
| WH | 1921cc | 5 Cyl. | 10 Valves | 74kW/100PS | Petrol | SOHC | TD336 |
| WN | 1921cc | 5 Cyl. | 10 Valves | 85kW/115PS | Petrol | SOHC | TD339 |
| 80 1.9 CD-5S COUPE 1.9 | | 09/1981→07/1983 08/1980→07/1983 | | 100 1.9 | | 08/1980→07/1984 | |

V91030 
33.30 x 7.95 x 98.60

035 109 611F



45° ss H

VAG92061B 
36.70 x 8.00 x 12.08



VAG92105B 
42.30 x 7.99 x 12.08



28  **79.50**

| | | | | | | | |
|---------------------------------------|--------|---|-----------|---------------------------------------|--------|---|-------|
| KE | 2144cc | 5 Cyl. | 10 Valves | 96kW/131PS | Petrol | SOHC | TD281 |
| KG | 2144cc | 5 Cyl. | 10 Valves | 134kW/182PS | Petrol | Turbo, SOHC | TD283 |
| KK | 2144cc | 5 Cyl. | 10 Valves | 100kW/136PS | Petrol | SOHC | TD286 |
| WB | 2144cc | 5 Cyl. | 10 Valves | 85kW/115PS | Petrol | SOHC | TD330 |
| WC | 2144cc | 5 Cyl. | 10 Valves | 100kW/136PS | Petrol | SOHC | TD331 |
| WJ | 2144cc | 5 Cyl. | 10 Valves | 125kW/170PS | Petrol | Turbo, SOHC | TD337 |
| 80 2.2 200 2.1 5E 200 2.1 Turbo | | 08/1982→07/1984 10/1979→07/1984 08/1983→01/1988 | | 100 2.1 200 2.1 5T COUPE 2.1 GT | | 03/1977→07/1984 10/1979→08/1982 09/1982→10/1987 | |

V91030 
33.30 x 7.95 x 98.60

035 109 611F



45° ss H

VAG92061B 
36.70 x 8.00 x 12.08

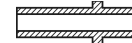

VAG92105B 
42.30 x 7.99 x 12.08

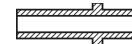

29  **79.50**

| | | | | | | | |
|--------|--------|-----------------|-----------|--------------|--------|-----------------|-------|
| KL | 2144cc | 5 Cyl. | 10 Valves | 96kW/131PS | Petrol | SOHC | TD288 |
| 80 2.2 | | 08/1982→07/1984 | | COUPE 2.1 GT | | 09/1982→10/1987 | |

V91030 
33.30 x 7.95 x 98.60

035 109 611F



45° ss H

VAG92061B 
36.70 x 8.00 x 12.08



30  **79.50**

| | | | | | | | |
|-----------|--------|-----------------|-----------|-----------|--------|------|-------|
| 3D | 2370cc | 5 Cyl. | 10 Valves | 60kW/82PS | Diesel | SOHC | TD218 |
| AAS | 2370cc | 5 Cyl. | 10 Valves | 60kW/82PS | Diesel | SOHC | TD227 |
| 100 2.4 D | | 08/1989→07/1994 | | | | | |

V91337 
36.10 x 7.97 x 95.10

069 109 601F



45° H

VAG92061B 
36.70 x 8.00 x 12.08



V94547 
35.95 x 8.00 x 96.85

046 109 601J

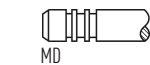

45° ss

V91334 
31.30 x 7.95 x 95.10

074 109 611



45° ss H



OE

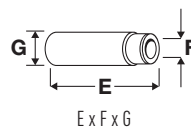

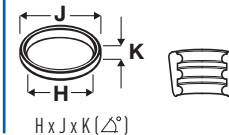

E x F x G



H x J x K (Δ°)

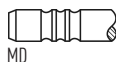
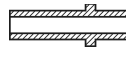

31  **81.00**

| | | | | | | | |
|--------|-----------------|--------|----------|------------------|-----------------|------|-------|
| ABB | 1595cc | 4 Cyl. | 8 Valves | 73-75kW/99-102PS | Petrol | SOHC | TD230 |
| ADA | 1595cc | 4 Cyl. | 8 Valves | 74kW/101PS | Petrol | SOHC | TD240 |
| 80 1.6 | 08/1990→10/1991 | | 80 1.6 E | | 06/1993→01/1996 | | |

| | | | | | | |
|---|--------------|---|-----|---|--|--|
| V91407  | 048 109 601A |  MD | 45° | | VAG92061B  | |
| 39.60 x 7.97 x 91.90 | | | | | 36.70 x 8.00 x 12.08 | |
| V91340  | 048 109 611A |  MD + MB | 45° | H | | |
| 33.30 x 7.95 x 91.20 | | | | | | |

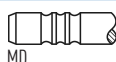
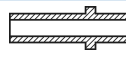

32  **81.00**

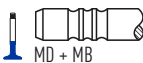
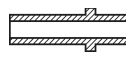
| | | | | | | | |
|--------|-----------------|--------|----------|-----------------|--------|------|-------|
| ABM | 1595cc | 4 Cyl. | 8 Valves | 52kW/71PS | Petrol | SOHC | TD234 |
| DTA | 1595cc | 4 Cyl. | 8 Valves | 51-55kW/69-75PS | Petrol | SOHC | TD255 |
| PP | 1595cc | 4 Cyl. | 8 Valves | 51kW/70PS | Petrol | SOHC | TD307 |
| RN | 1595cc | 4 Cyl. | 8 Valves | 55kW/75PS | Petrol | SOHC | TD314 |
| 80 1.6 | 09/1986→12/1994 | | | | | | |

| | | | | | | |
|---|--------------|---|-----|---|--|--|
| V91338  | 035 109 601K |  MD | 45° | | VAG92061B  | |
| 38.10 x 7.97 x 91.90 | | | | | 36.70 x 8.00 x 12.08 | |
| V91340  | 048 109 611A |  MD + MB | 45° | H | VAG92105B  | |
| 33.30 x 7.95 x 91.20 | | | | | 42.30 x 7.99 x 12.08 | |

33  **81.00**

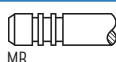
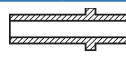
| | | | | | | | |
|--------|-----------------|--------|----------|------------|-----------------|------|---------|
| ADP | 1595cc | 4 Cyl. | 8 Valves | 74kW/100PS | Petrol | SOHC | TD4198 |
| AEH | 1595cc | 4 Cyl. | 8 Valves | 74kW/101PS | Petrol | SOHC | TD5074 |
| AHL | 1595cc | 4 Cyl. | 8 Valves | 74kW/100PS | Petrol | SOHC | TD10816 |
| AKL | 1595cc | 4 Cyl. | 8 Valves | 74kW/101PS | Petrol | SOHC | TD9990 |
| ANA | 1595cc | 4 Cyl. | 8 Valves | 74kW/100PS | Petrol | SOHC | TD14128 |
| APF | 1595cc | 4 Cyl. | 8 Valves | 74kW/101PS | Petrol | SOHC | TD11588 |
| ARM | 1595cc | 4 Cyl. | 8 Valves | 74kW/100PS | Petrol | SOHC | TD14148 |
| A3 1.6 | 09/1996→05/2003 | | A4 1.6 | | 11/1994→09/2001 | | |

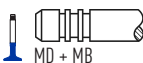
| | | | | | | |
|---|--------------|---|-----|---|--|--|
| V94079  | 078 109 601B |  MB | 45° | H | VAG96041B  | |
| 39.40 x 7.00 x 92.10 | | | | | 36.50 x 7.00 x 12.08 | |
| V94080  | 048 109 611B |  MD + MB | 45° | H | | |
| 32.80 x 7.00 x 91.20 | | | | | | |



OE

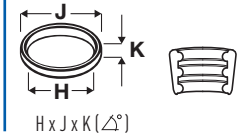
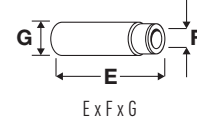

34 **81.00**

| | | | | | | | |
|--------|-----------------|--------|----------------|------------|-----------------|------|---------|
| ALZ | 1595cc | 4 Cyl. | 8 Valves | 75kW/102PS | Petrol | SOHC | TD15748 |
| AVU | 1595cc | 4 Cyl. | 8 Valves | 75kW/102PS | Petrol | SOHC | TD15350 |
| BFO | 1595cc | 4 Cyl. | 8 Valves | 75kW/102PS | Petrol | SOHC | TD17166 |
| BGU | 1595cc | 4 Cyl. | 8 Valves | 75kW/102PS | Petrol | SOHC | TD16871 |
| BSE | 1595cc | 4 Cyl. | 8 Valves | 75kW/102PS | Petrol | SOHC | TD20711 |
| BSF | 1595cc | 4 Cyl. | 8 Valves | 75kW/102PS | Petrol | SOHC | TD20712 |
| CCSA | 1595cc | 4 Cyl. | 8 Valves | 75kW/102PS | Petrol | SOHC | TD22665 |
| CMXA | 1595cc | 4 Cyl. | 8 Valves | 75kW/102PS | Petrol | SOHC | TD23937 |
| A3 1.6 | 08/2000→03/2013 | | A3 1.6 E-Power | | 01/2011→03/2013 | | |
| A4 1.6 | 07/2000→06/2008 | | | | | | |

V94424
39.50 x 6.00 x 94.00

06B 109 601D

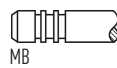

45° Y H

VAG96353B
36.50 x 6.02 x 12.08



V94425
32.90 x 6.00 x 93.90

06B 109 611C



45° ss H

35 **81.00**

| | | | | | | | |
|---------------------------------------|--------------|--------|----------|-----------|--------|--|-------|
| JU | 1595cc | 4 Cyl. | 8 Valves | 55kW/75PS | Petrol | SOHC | TD277 |
| V91338 38.10 x 7.97 x 91.90 | 035 109 601K | | 45° | | | VAG92105B 42.30 x 7.99 x 12.08 | |
| V91030 33.30 x 7.95 x 98.60 | 035 109 611F | | 45° ss H | | | | |
| V91340 33.30 x 7.95 x 91.20 | 048 109 611A | | 45° H | | | | |

36 **81.00**

| | | | | | | | |
|---------------------------------------|-----------------|--------|----------|-----------|--------|--|-------|
| SA | 1595cc | 4 Cyl. | 8 Valves | 54kW/73PS | Petrol | SOHC | TD321 |
| 80 1.6 | 02/1986→07/1986 | | | | | | |
| V91340 33.30 x 7.95 x 91.20 | 048 109 611A | | 45° H | | | VAG92061B 36.70 x 8.00 x 12.08 | |

37 **81.00**

| | | | | | | | |
|---------------------------------------|-----------------|--------|------------|------------|-----------------|--|-------|
| 4B | 1781cc | 4 Cyl. | 8 Valves | 66kW/90PS | Petrol | SOHC | TD219 |
| DZ | 1781cc | 4 Cyl. | 8 Valves | 82kW/112PS | Petrol | SOHC | TD256 |
| 80 1.8 E | 06/1986→08/1991 | | 80 1.8 GTE | | 08/1984→08/1986 | | |
| 100 1.8 Cat | 03/1985→11/1990 | | COUPE 1.8 | | 08/1989→07/1991 | | |
| COUPE 1.8 GT | 12/1984→10/1988 | | | | | | |
| V91338 38.10 x 7.97 x 91.90 | 035 109 601K | | 45° | | | VAG92061B 36.70 x 8.00 x 12.08 | |
| V91340 33.30 x 7.95 x 91.20 | 048 109 611A | | 45° H | | | | |



OE

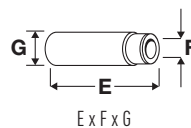
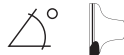

E x F x G

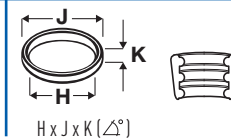

H x J x K (Δ°)

38



81.00

| | | | | | | | |
|---------------|-----------------|--------|-----------|-------------------|--------|-----------------|---------|
| ADR | 1781cc | 4 Cyl. | 20 Valves | 92-95kW/125-129PS | Petrol | DOHC | TD241 |
| AFY | 1781cc | 4 Cyl. | 20 Valves | 85kW/115PS | Petrol | DOHC | TD13948 |
| AGN | 1781cc | 4 Cyl. | 20 Valves | 92kW/125PS | Petrol | DOHC | TD5073 |
| AJP | 1781cc | 4 Cyl. | 20 Valves | 92kW/125PS | Petrol | DOHC | TD9518 |
| APG | 1781cc | 4 Cyl. | 20 Valves | 92kW/125PS | Petrol | DOHC | TD11589 |
| APT | 1781cc | 4 Cyl. | 20 Valves | 92kW/125PS | Petrol | DOHC | TD13775 |
| AQE | 1781cc | 4 Cyl. | 20 Valves | 92kW/125PS | Petrol | DOHC | TD14029 |
| ARG | 1781cc | 4 Cyl. | 20 Valves | 92kW/125PS | Petrol | DOHC | TD13776 |
| ARH | 1781cc | 4 Cyl. | 20 Valves | 92kW/125PS | Petrol | DOHC | TD15329 |
| AVJ | 1781cc | 4 Cyl. | 20 Valves | 110kW/150PS | Petrol | Turbo, DOHC | TD15349 |
| AVV | 1781cc | 4 Cyl. | 20 Valves | 92kW/125PS | Petrol | DOHC | TD16412 |
| A3 1.8 | 09/1996→05/2003 | | | A4 1.8 | | 11/1994→09/2001 | |
| A4 1.8 T | 11/2000→07/2002 | | | A6 1.8 | | 12/1995→01/2005 | |
| CABRIOLET 1.8 | 01/1997→08/2000 | | | | | | |

V94081 ■
26.90 x 6.00 x 105.10

058 109 601C

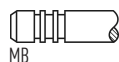

45° Y H

VAG96073B ■ ■
36.00 x 6.02 x 11.06



V94083 ■
29.90 x 6.00 x 103.90

058 109 611M

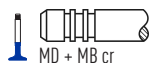

45° H



OE

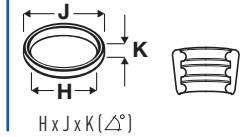
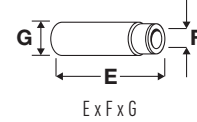

39



81.00

| | | | | | | | |
|-----|--------|--------|-----------|---------------------|--------|-------------|---------|
| AEB | 1781cc | 4 Cyl. | 20 Valves | 110-112kW/150-152PS | Petrol | Turbo, DOHC | TD4199 |
| AGU | 1781cc | 4 Cyl. | 20 Valves | 110kW/150PS | Petrol | Turbo, DOHC | TD5075 |
| AJL | 1781cc | 4 Cyl. | 20 Valves | 132kW/180PS | Petrol | Turbo, DOHC | TD9470 |
| AJQ | 1781cc | 4 Cyl. | 20 Valves | 132kW/180PS | Petrol | Turbo, DOHC | TD11347 |
| AMK | 1781cc | 4 Cyl. | 20 Valves | 154kW/209PS | Petrol | Turbo, DOHC | TD12648 |
| ANB | 1781cc | 4 Cyl. | 20 Valves | 110kW/150PS | Petrol | Turbo, DOHC | TD13949 |
| APP | 1781cc | 4 Cyl. | 20 Valves | 132kW/180PS | Petrol | Turbo, DOHC | TD11591 |
| APU | 1781cc | 4 Cyl. | 20 Valves | 110kW/150PS | Petrol | Turbo, DOHC | TD13950 |
| APX | 1781cc | 4 Cyl. | 20 Valves | 165kW/224PS | Petrol | Turbo, DOHC | TD11349 |
| APY | 1781cc | 4 Cyl. | 20 Valves | 154kW/209PS | Petrol | Turbo, DOHC | TD11594 |
| AQA | 1781cc | 4 Cyl. | 20 Valves | 110kW/150PS | Petrol | Turbo, DOHC | TD11592 |
| ARK | 1781cc | 4 Cyl. | 20 Valves | 110kW/150PS | Petrol | Turbo, DOHC | TD13929 |
| ARX | 1781cc | 4 Cyl. | 20 Valves | 110kW/150PS | Petrol | Turbo, DOHC | TD15988 |
| ARY | 1781cc | 4 Cyl. | 20 Valves | 132kW/180PS | Petrol | Turbo, DOHC | TD15352 |
| ARZ | 1781cc | 4 Cyl. | 20 Valves | 110kW/150PS | Petrol | Turbo, DOHC | TD11593 |
| AUL | 1781cc | 4 Cyl. | 20 Valves | 154kW/209PS | Petrol | Turbo, DOHC | TD15355 |
| AUM | 1781cc | 4 Cyl. | 20 Valves | 110kW/150PS | Petrol | Turbo, DOHC | TD15629 |
| AUQ | 1781cc | 4 Cyl. | 20 Valves | 132kW/180PS | Petrol | Turbo, DOHC | TD15353 |
| AWP | 1781cc | 4 Cyl. | 20 Valves | 132-134kW/180-182PS | Petrol | Turbo, DOHC | TD15356 |
| AWT | 1781cc | 4 Cyl. | 20 Valves | 110kW/150PS | Petrol | Turbo, DOHC | TD15335 |
| BAM | 1781cc | 4 Cyl. | 20 Valves | 165kW/224PS | Petrol | Turbo, DOHC | TD16331 |
| BEX | 1781cc | 4 Cyl. | 20 Valves | 140kW/190PS | Petrol | Turbo, DOHC | TD16730 |
| BFB | 1781cc | 4 Cyl. | 20 Valves | 120kW/163PS | Petrol | Turbo, DOHC | TD16728 |
| BKB | 1781cc | 4 Cyl. | 20 Valves | 120kW/163PS | Petrol | Turbo, DOHC | TD19135 |

A3 1.8 T 12/1996→05/2003
A4 1.8 T 01/1995→05/2010
TT 1.8 T 10/1998→06/2006

A3 S3 03/1999→05/2003
A6 1.8 T 01/1997→01/2005

V94081 ■
26.90 x 6.00 x 105.10

058 109 601C

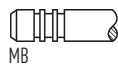

45° Y H

VAG96073B ■ ■ ■
36.00 x 6.02 x 11.06



V94082 ■
29.90 x 6.00 x 103.90

058 109 611E



45° ss H

40



81.00

| | | | | | | | |
|----|--------|--------|----------|-----------|--------|------|-------|
| DD | 1781cc | 4 Cyl. | 8 Valves | 55kW/75PS | Petrol | SOHC | TD250 |
| DR | 1781cc | 4 Cyl. | 8 Valves | 55kW/75PS | Petrol | SOHC | TD252 |

100 1.8 08/1982→12/1987

COUPE 1.8 08/1981→07/1983

V91030 ■
33.30 x 7.95 x 98.60

035 109 611F

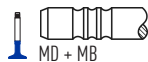

45° ss H

VAG92105B ■ ■ ■
42.30 x 7.99 x 12.08



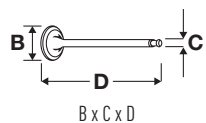

OE

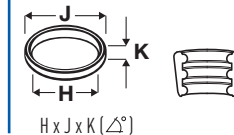
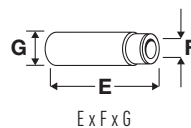

41 **81.00**

| | | | | | | | |
|-------------|--------|-----------------|-----------------|-----------------|--------|-----------------|---------------|
| DS | 1781cc | 4 Cyl. | 8 Valves | 66kW/90PS | Petrol | SOHC | TD253 |
| JN | 1781cc | 4 Cyl. | 8 Valves | 66-68kW/90-93PS | Petrol | SOHC | TD4208 |
| JW | 1781cc | 4 Cyl. | 8 Valves | 66kW/90PS | Petrol | SOHC | TD279 |
| NE | 1781cc | 4 Cyl. | 8 Valves | 66kW/90PS | Petrol | SOHC | TD4210 |
| NP | 1781cc | 4 Cyl. | 8 Valves | 66kW/90PS | Petrol | SOHC | TD304 |
| PH | 1781cc | 4 Cyl. | 8 Valves | 66kW/90PS | Petrol | SOHC | TD305 |
| PM | 1781cc | 4 Cyl. | 8 Valves | 66kW/90PS | Petrol | SOHC | TD306 |
| RS | 1781cc | 4 Cyl. | 8 Valves | 55kW/75PS | Petrol | SOHC | TD317 |
| RU | 1781cc | 4 Cyl. | 8 Valves | 55kW/75PS | Petrol | SOHC | TD320 |
| SF | 1781cc | 4 Cyl. | 8 Valves | 65kW/88PS | Petrol | SOHC | TD325 |
| SH | 1781cc | 4 Cyl. | 8 Valves | 65-66kW/88-90PS | Petrol | SOHC | TD326 |
| 80 1.8 | | 01/1983→01/1990 | | 80 1.8 CC | | 08/1984→08/1986 | |
| 80 1.8 S | | 08/1986→10/1991 | | 100 1.8 | | 08/1982→07/1990 | |
| 100 1.8 Cat | | 03/1985→11/1990 | | COUPE 1.8 GT | | 09/1982→10/1988 | |

V91338
38.10 x 7.97 x 91.90

035 109 601K

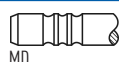

45°

VAG92061B
36.70 x 8.00 x 12.08

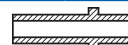

V91340
33.30 x 7.95 x 91.20

048 109 611A

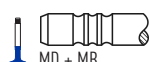

45°

H

VAG92105B
42.30 x 7.99 x 12.08

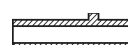

42 **81.00**

| | | | | | | | |
|-----------|--------|-----------------|-----------------|--------------|--------|-----------------|--------------|
| JV | 1781cc | 4 Cyl. | 8 Valves | 66kW/90PS | Petrol | SOHC | TD278 |
| 80 1.8 | | 01/1983→08/1986 | | 80 1.8 CC | | 08/1984→08/1986 | |
| 80 1.8 S | | 09/1986→10/1991 | | COUPE 1.8 GT | | 09/1982→10/1988 | |

V91338
38.10 x 7.97 x 91.90

035 109 601K

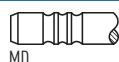

45°

VAG92061B
36.70 x 8.00 x 12.08



V91030
33.30 x 7.95 x 98.60

035 109 611F

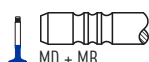

45°

ss

H

VAG92105B
42.30 x 7.99 x 12.08

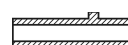

V91340
33.30 x 7.95 x 91.20

048 109 611A

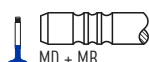

45°

H

43 **81.00**

| | | | | | | | |
|------------|--------|-----------------|-----------------|-------------------|--------|-----------------|--------------|
| PV | 1781cc | 4 Cyl. | 8 Valves | 79-81kW/107-110PS | Petrol | | TD311 |
| 80 1.8 GTE | | 03/1985→08/1986 | | COUPE 1.8 GT | | 08/1986→10/1987 | |

V91407
39.60 x 7.97 x 91.90

048 109 601A

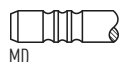

45°

VAG92061B
36.70 x 8.00 x 12.08



V91340
33.30 x 7.95 x 91.20

048 109 611A

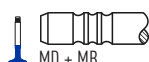

45°

H

VAG92105B
42.30 x 7.99 x 12.08

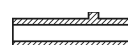



OE

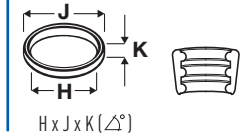
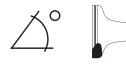

44



81.00

| | | | | | | | |
|-----|--------|--------|-----------|-------------|--------|-------------|---------|
| AZV | 1968cc | 4 Cyl. | 16 Valves | 100kW/136PS | Diesel | Turbo, DOHC | TD17027 |
| BKD | 1968cc | 4 Cyl. | 16 Valves | 103kW/140PS | Diesel | Turbo, DOHC | TD17025 |
| BMN | 1968cc | 4 Cyl. | 16 Valves | 125kW/170PS | Diesel | Turbo, DOHC | TD18991 |
| BRD | 1968cc | 4 Cyl. | 16 Valves | 125kW/170PS | Diesel | Turbo, DOHC | TD20402 |
| BUY | 1968cc | 4 Cyl. | 16 Valves | 120kW/163PS | Diesel | Turbo, DOHC | TD20403 |
| BVF | 1968cc | 4 Cyl. | 16 Valves | 93kW/126PS | Diesel | Turbo, DOHC | TD20497 |
| BVG | 1968cc | 4 Cyl. | 16 Valves | 89kW/121PS | Diesel | Turbo, DOHC | TD20496 |

| | | | |
|------------|-----------------|----------------|-----------------|
| A3 2.0 TDI | 05/2003→03/2013 | A3 2.0 TDI 16V | 05/2003→03/2013 |
| A4 2.0 TDI | 09/2005→06/2008 | A6 2.0 TDI | 09/2005→06/2006 |

| | | | | | | | |
|----------------------|--------------|---------|-----|----|---|----------------------|--|
| V94697 | 03G 109 601B | | 45° | Y | H | VAG96237B | |
| 29.20 x 6.00 x 87.80 | | MB | | | | 42.00 x 6.02 x 10.07 | |
| V98007 | 03G 109 601A | | 45° | | | | |
| 29.20 x 6.00 x 88.45 | | MB | | | | | |
| V94698 | 03G 109 611B | | 45° | ss | H | | |
| 25.50 x 6.00 x 88.10 | | MD + MB | | | | | |
| V98097 | 03G 109 611D | | 45° | | | | |
| 25.40 x 6.00 x 87.50 | | MD + MB | | | | | |

45



81.00

| | | | | | | | |
|-----|--------|--------|-----------|-------------|--------|-------------|---------|
| BLB | 1968cc | 4 Cyl. | 16 Valves | 103kW/140PS | Diesel | Turbo, DOHC | TD17377 |
| BNA | 1968cc | 4 Cyl. | 16 Valves | 100kW/136PS | Diesel | Turbo, DOHC | TD18009 |
| BRE | 1968cc | 4 Cyl. | 16 Valves | 103kW/140PS | Diesel | Turbo, DOHC | TD18029 |
| BRF | 1968cc | 4 Cyl. | 16 Valves | 100kW/136PS | Diesel | Turbo, DOHC | TD18748 |

| | | | |
|------------|-----------------|----------------|----------|
| A4 2.0 TDI | 11/2004→06/2008 | A4 2.0 TDI 16V | 11/2004→ |
| A6 2.0 TDI | 07/2004→08/2011 | | |

| | | | | | | | |
|----------------------|--------------|---------|-----|---|---|----------------------|--|
| V94697 | 03G 109 601B | | 45° | Y | H | VAG96237B | |
| 29.20 x 6.00 x 87.80 | | MB | | | | 42.00 x 6.02 x 10.07 | |
| V98097 | 03G 109 611D | | 45° | | | | |
| 25.40 x 6.00 x 87.50 | | MD + MB | | | | | |

46



81.00

| | | | | | | | |
|-----|--------|--------|----------|-------------|--------|-------------|---------|
| BMM | 1968cc | 4 Cyl. | 8 Valves | 103kW/140PS | Diesel | Turbo, SOHC | TD18203 |
|-----|--------|--------|----------|-------------|--------|-------------|---------|

| | | | |
|------------|-----------------|--|--|
| A3 2.0 TDI | 06/2005→06/2008 | | |
|------------|-----------------|--|--|

| | | | | | | | |
|----------------------|--------------|---------|-----|----|---|----------------------|--|
| V94649 | 038 109 601E | | 45° | Y | H | VAG96041B | |
| 36.00 x 7.00 x 89.40 | | MB | | | | 36.50 x 7.00 x 12.08 | |
| V94650 | 038 109 611E | | 45° | ss | H | | |
| 31.40 x 7.00 x 89.00 | | MD + MB | | | | | |

47



81.00

| | | | | | | | |
|-----|--------|--------|----------|-------------|--------|-------------|---------|
| BPW | 1968cc | 4 Cyl. | 8 Valves | 103kW/140PS | Diesel | Turbo, SOHC | TD18010 |
| BRC | 1968cc | 4 Cyl. | 8 Valves | 100kW/136PS | Diesel | Turbo, SOHC | TD20672 |

| | | | |
|------------|-----------------|--|--|
| A4 2.0 TDI | 11/2004→03/2009 | | |
|------------|-----------------|--|--|

| | | | | | | | |
|----------------------|--------------|---------|-----|----|---|----------------------|--|
| V95087 | 038 109 601F | | 45° | | H | VAG96041B | |
| 35.50 x 6.98 x 88.80 | | MB tu | | | | 36.50 x 7.00 x 12.08 | |
| V95088 | 038 109 611G | | 45° | ss | H | | |
| 31.45 x 6.96 x 88.40 | | MD + MB | | | | | |

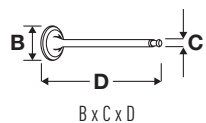

OE

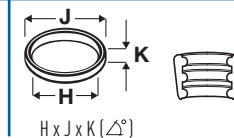
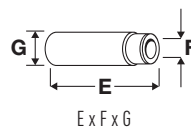

48



81.00

| | | | | | | | |
|------|--------|--------|-----------|-------------|--------|-------------|---------|
| CAGA | 1968cc | 4 Cyl. | 16 Valves | 105kW/143PS | Diesel | Turbo, DOHC | TD20597 |
| CAGB | 1968cc | 4 Cyl. | 16 Valves | 100kW/136PS | Diesel | Turbo, DOHC | TD20598 |
| CAGC | 1968cc | 4 Cyl. | 16 Valves | 88kW/120PS | Diesel | Turbo, DOHC | TD21118 |
| CAHA | 1968cc | 4 Cyl. | 16 Valves | 125kW/170PS | Diesel | Turbo, DOHC | TD20602 |
| CAHB | 1968cc | 4 Cyl. | 16 Valves | 120kW/163PS | Diesel | Turbo, DOHC | TD20864 |
| CBAA | 1968cc | 4 Cyl. | 16 Valves | 100kW/136PS | Diesel | Turbo, DOHC | TD20825 |
| CBAB | 1968cc | 4 Cyl. | 16 Valves | 103kW/140PS | Diesel | Turbo, DOHC | TD20828 |
| CBBB | 1968cc | 4 Cyl. | 16 Valves | 125kW/170PS | Diesel | Turbo, DOHC | TD20939 |
| CFFA | 1968cc | 4 Cyl. | 16 Valves | 100kW/136PS | Diesel | Turbo, DOHC | TD23858 |
| CFFB | 1968cc | 4 Cyl. | 16 Valves | 103kW/140PS | Diesel | Turbo, DOHC | TD23859 |
| CFGB | 1968cc | 4 Cyl. | 16 Valves | 125kW/170PS | Diesel | Turbo, DOHC | TD23857 |
| CFGC | 1968cc | 4 Cyl. | 16 Valves | 130kW/177PS | Diesel | Turbo, DOHC | TD25727 |
| CFGD | 1968cc | 4 Cyl. | 16 Valves | 120kW/163PS | Diesel | Turbo, DOHC | TD25728 |
| CFHB | 1968cc | 4 Cyl. | 16 Valves | 100kW/136PS | Diesel | Turbo, DOHC | TD25662 |
| CFHD | 1968cc | 4 Cyl. | 16 Valves | 105kW/143PS | Diesel | Turbo, DOHC | TD24939 |
| CGLA | 1968cc | 4 Cyl. | 16 Valves | 120kW/163PS | Diesel | Turbo, DOHC | TD24406 |
| CGLB | 1968cc | 4 Cyl. | 16 Valves | 125kW/170PS | Diesel | Turbo, DOHC | TD24948 |
| CGLC | 1968cc | 4 Cyl. | 16 Valves | 130kW/177PS | Diesel | Turbo, DOHC | TD24870 |
| CGLD | 1968cc | 4 Cyl. | 16 Valves | 120kW/163PS | Diesel | Turbo, DOHC | TD24943 |
| CGLE | 1968cc | 4 Cyl. | 16 Valves | 100kW/136PS | Diesel | Turbo, DOHC | TD26329 |
| CJCA | 1968cc | 4 Cyl. | 16 Valves | 105kW/143PS | Diesel | Turbo, DOHC | TD24949 |
| CJCB | 1968cc | 4 Cyl. | 16 Valves | 100kW/136PS | Diesel | Turbo, DOHC | TD24941 |
| CJCC | 1968cc | 4 Cyl. | 16 Valves | 88kW/120PS | Diesel | Turbo, DOHC | TD26713 |
| CJCD | 1968cc | 4 Cyl. | 16 Valves | 110kW/150PS | Diesel | Turbo, DOHC | TD27985 |
| CLJA | 1968cc | 4 Cyl. | 16 Valves | 103kW/140PS | Diesel | Turbo, DOHC | TD23938 |
| CLLB | 1968cc | 4 Cyl. | 16 Valves | 130kW/177PS | Diesel | Turbo, DOHC | TD25729 |
| CMEA | 1968cc | 4 Cyl. | 16 Valves | 105kW/143PS | Diesel | Turbo, DOHC | TD23939 |
| CMFA | 1968cc | 4 Cyl. | 16 Valves | 105kW/143PS | Diesel | Turbo, DOHC | TD26714 |
| CMFB | 1968cc | 4 Cyl. | 16 Valves | 110kW/150PS | Diesel | Turbo, DOHC | TD28002 |
| CMGA | 1968cc | 4 Cyl. | 16 Valves | 125kW/170PS | Diesel | Turbo, DOHC | TD25767 |
| CMGB | 1968cc | 4 Cyl. | 16 Valves | 130kW/177PS | Diesel | Turbo, DOHC | TD24871 |
| CNHA | 1968cc | 4 Cyl. | 16 Valves | 140kW/190PS | Diesel | Turbo, DOHC | TD28003 |
| CNHC | 1968cc | 4 Cyl. | 16 Valves | 120kW/163PS | Diesel | Turbo, DOHC | TD30652 |
| CRBC | 1968cc | 4 Cyl. | 16 Valves | 110kW/150PS | Diesel | Turbo, DOHC | TD26724 |
| CRBD | 1968cc | 4 Cyl. | 16 Valves | 100kW/136PS | Diesel | Turbo, DOHC | TD28036 |
| CRFA | 1968cc | 4 Cyl. | 16 Valves | 81kW/110PS | Diesel | Turbo, DOHC | TD26722 |
| CRFC | 1968cc | 4 Cyl. | 16 Valves | 105kW/143PS | Diesel | Turbo, DOHC | TD26723 |
| CRLB | 1968cc | 4 Cyl. | 16 Valves | 110kW/150PS | Diesel | Turbo, DOHC | TD26725 |
| CRLC | 1968cc | 4 Cyl. | 16 Valves | 100kW/136PS | Diesel | Turbo, DOHC | TD29305 |
| CRUA | 1968cc | 4 Cyl. | 16 Valves | 110kW/150PS | Diesel | Turbo, DOHC | TD29213 |
| CSUA | 1968cc | 4 Cyl. | 16 Valves | 110kW/150PS | Diesel | Turbo, DOHC | TD30651 |
| CSUB | 1968cc | 4 Cyl. | 16 Valves | 100kW/136PS | Diesel | Turbo, DOHC | TD30650 |
| CUNA | 1968cc | 4 Cyl. | 16 Valves | 135kW/184PS | Diesel | Turbo, DOHC | TD28035 |
| CUPA | 1968cc | 4 Cyl. | 16 Valves | 135kW/184PS | Diesel | Turbo, DOHC | TD26726 |
| CUVC | 1968cc | 4 Cyl. | 16 Valves | 110kW/150PS | Diesel | Turbo, DOHC | TD30258 |
| CUWA | 1968cc | 4 Cyl. | 16 Valves | 135kW/184PS | Diesel | Turbo, DOHC | TD30259 |
| DFGA | 1968cc | 4 Cyl. | 16 Valves | 110kW/150PS | Diesel | Turbo, DOHC | TD33895 |

A1 2.0 TDI

09/2011→

A3 2.0 TDI

05/2003→



OE

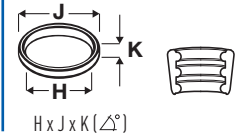
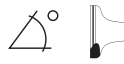

| | | | |
|----------------|-----------------|------------|-----------------|
| A3 2.0 TDI 16V | 05/2003→03/2013 | A4 2.0 TDI | 11/2007→05/2016 |
| A5 2.0 TDI | 08/2008→01/2017 | A6 2.0 TDI | 07/2004→ |
| Q2 2.0 TDI | 09/2016→ | Q3 2.0 TDI | 06/2011→ |
| Q5 2.0 TDI | 11/2008→ | TT 2.0 TDI | 06/2008→ |

| | | | | | | |
|----------------------|-------------|---------|-----|------|----------------------|--|
| V95099 | 03L 109 601 | | 45° | H | VAG96237B | |
| 28.10 x 5.97 x 99.30 | | MB | | | 42.00 x 6.02 x 10.07 | |
| V95114 | 03L 109 611 | | 45° | SS H | | |
| 26.00 x 5.97 x 99.10 | | MD + MB | | | | |

49



81.00

| | | | | | | | |
|-----------|--------|--------|-----------|------------|--------|------|-------|
| HP | 1994cc | 5 Cyl. | 10 Valves | 85kW/115PS | Petrol | SOHC | TD266 |
| SK | 1994cc | 5 Cyl. | 10 Valves | 83kW/113PS | Petrol | SOHC | TD327 |
| SL | 1994cc | 5 Cyl. | 10 Valves | 83kW/113PS | Petrol | SOHC | TD328 |

| | | | |
|---------|-----------------|-----------|-----------------|
| 80 2.0 | 10/1983→09/1984 | 90 2.0 | 10/1984→03/1987 |
| 100 2.0 | 08/1986→11/1987 | COUPE 2.0 | 09/1983→04/1988 |

| | | | | | | |
|----------------------|--------------|---------|-----|---|----------------------|--|
| V91338 | 035 109 601K | | 45° | | VAG92061B | |
| 38.10 x 7.97 x 91.90 | | MD | | | 36.70 x 8.00 x 12.08 | |
| V91340 | 048 109 611A | | 45° | H | VAG92105B | |
| 33.30 x 7.95 x 91.20 | | MD + MB | | | 42.30 x 7.99 x 12.08 | |

50



81.00

| | | | | | | | |
|-----------|--------|--------|-----------|------------|--------|------|-------|
| JS | 1994cc | 5 Cyl. | 10 Valves | 85kW/115PS | Petrol | SOHC | TD274 |
| KP | 1994cc | 5 Cyl. | 10 Valves | 85kW/115PS | Petrol | SOHC | TD289 |

| | | | |
|-----------|-----------------|-----------|-----------------|
| 80 2.0 | 10/1983→09/1984 | 90 2.0 | 08/1984→03/1987 |
| 100 2.0 | 08/1984→12/1987 | 100 2.0 E | 01/1985→12/1987 |
| COUPE 2.0 | 09/1983→07/1986 | | |

| | | | | | | |
|----------------------|--------------|---------|-----|------|----------------------|--|
| V91338 | 035 109 601K | | 45° | | VAG92061B | |
| 38.10 x 7.97 x 91.90 | | MD | | | 36.70 x 8.00 x 12.08 | |
| V91030 | 035 109 611F | | 45° | SS H | VAG92105B | |
| 33.30 x 7.95 x 98.60 | | MD + MB | | | 42.30 x 7.99 x 12.08 | |
| V91340 | 048 109 611A | | 45° | H | | |
| 33.30 x 7.95 x 91.20 | | MD + MB | | | | |

51



81.00

| | | | | | | | |
|-----------|--------|--------|-----------|-------------|--------|------|-------|
| NM | 1994cc | 5 Cyl. | 20 Valves | 118kW/160PS | Petrol | SOHC | TD303 |
|-----------|--------|--------|-----------|-------------|--------|------|-------|

| | | | |
|-------------|-----------------|----------------|-----------------|
| 90 2.0 20 V | 08/1988→09/1991 | COUPE 2.0 20 V | 08/1989→07/1991 |
|-------------|-----------------|----------------|-----------------|

| | | | | | | |
|----------------------|--------------|------------|-----|---|----------------------|--|
| V91416 | 027 109 601C | | 45° | H | VAG96157B | |
| 32.10 x 6.97 x 95.50 | | MB | | | 38.00 x 7.00 x 12.00 | |
| V91372 | 027 109 611D | | 45° | H | | |
| 28.10 x 6.95 x 98.20 | | MD + MB cr | | | | |



OE

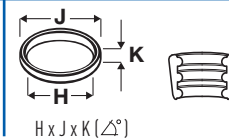
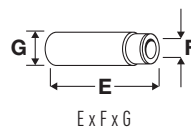
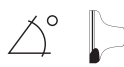

52 **81.00**

| | | | | | | | |
|-------------------------|--------|------------------------------------|------------------|-------------|--------|-------------|-----------------|
| PS | 1994cc | 5 Cyl. | 10 Valves | 85kW/115PS | Petrol | SOHC | TD308 |
| RT | 1994cc | 5 Cyl. | 10 Valves | 85kW/115PS | Petrol | SOHC | TD318 |
| 90 2.0 100 2.0 E Cat | | 07/1988→09/1991 01/1988→11/1990 | | 100 2.0 Cat | | | 01/1988→11/1990 |

| | | | | | | | |
|----------------------|--------------|---------|-----|---|--|----------------------|--|
| V91407 | 048 109 601A | | 45° | | | VAG92061B | |
| 39.60 x 7.97 x 91.90 | | MD | | | | 36.70 x 8.00 x 12.08 | |
| V91340 | 048 109 611A | | 45° | H | | | |
| 33.30 x 7.95 x 91.20 | | MD + MB | | | | | |

53 **81.00**

| | | | | | | | |
|------------------------|--------|------------------------------------|------------------|-----------------------|--------|-------------|------------------------------------|
| HY | 2144cc | 5 Cyl. | 10 Valves | 100kW/136PS | Petrol | SOHC | TD268 |
| 80 2.2 COUPE 2.2 GT | | 08/1982→07/1984 09/1984→10/1988 | | 90 2.2 QUATTRO 2.2 | | | 10/1984→03/1987 12/1984→07/1987 |

| | | | | | | | |
|----------------------|--------------|---------|-----|---|--|----------------------|--|
| V91338 | 035 109 601K | | 45° | | | VAG92061B | |
| 38.10 x 7.97 x 91.90 | | MD | | | | 36.70 x 8.00 x 12.08 | |
| V91340 | 048 109 611A | | 45° | H | | VAG92105B | |
| 33.30 x 7.95 x 91.20 | | MD + MB | | | | 42.30 x 7.99 x 12.08 | |

54 **81.00**

| | | | | | | | |
|---|--------|---|------------------|---------------------|--------|--------------------|------------------------------------|
| 1B | 2226cc | 5 Cyl. | 10 Valves | 147kW/200PS | Petrol | Turbo, SOHC | TD211 |
| 2B | 2226cc | 5 Cyl. | 10 Valves | 140kW/190PS | Petrol | Turbo, SOHC | TD215 |
| KX | 2226cc | 5 Cyl. | 10 Valves | 75-85kW/102-116PS | Petrol | SOHC | TD293 |
| 80 2.2 200 2.2 Turbo COUPE 2.2 GT | | 09/1984→12/1986 02/1988→12/1991 07/1981→10/1987 | | 90 2.2 COUPE 2.2 | | | 01/1985→03/1987 09/1983→12/1987 |

| | | | | | | | |
|----------------------|--------------|---------|-----|---|--|----------------------|--|
| V91338 | 035 109 601K | | 45° | | | VAG92061B | |
| 38.10 x 7.97 x 91.90 | | MD | | | | 36.70 x 8.00 x 12.08 | |
| V91340 | 048 109 611A | | 45° | H | | VAG92105B | |
| 33.30 x 7.95 x 91.20 | | MD + MB | | | | 42.30 x 7.99 x 12.08 | |

55 **81.00**

| | | | | | | | |
|-----------------------------|--------|------------------------------------|------------------|-------------------------------|--------|--------------------|------------------------------------|
| 3B | 2226cc | 5 Cyl. | 20 Valves | 162kW/220PS | Petrol | Turbo, DOHC | TD4192 |
| AAN | 2226cc | 5 Cyl. | 20 Valves | 169kW/230PS | Petrol | Turbo, DOHC | TD225 |
| 100 S4 Turbo A6 S6 Turbo | | 08/1991→07/1994 06/1994→12/1997 | | 200 2.2 20V Turbo COUPE S2 | | | 03/1989→12/1990 09/1990→09/1992 |

| | | | | | | | |
|----------------------|--------------|------------|-----|---|--|----------------------|--|
| V91416 | 027 109 601C | | 45° | H | | VAG96157B | |
| 32.10 x 6.97 x 95.50 | | MB | | | | 38.00 x 7.00 x 12.00 | |
| V91372 | 027 109 611D | | 45° | H | | | |
| 28.10 x 6.95 x 98.20 | | MD + MB cr | | | | | |



OE

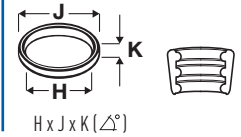
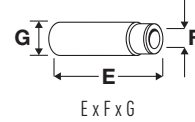
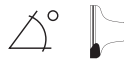

56



81.00

| | | | | | | | |
|----------------------|--------------|-----------------|-----------|-------------|------------------------|-----------------|-------|
| ABY | 2226cc | 5 Cyl. | 20 Valves | 169kW/230PS | Petrol | Turbo, DOHC | TD237 |
| 80 S2 | | 02/1993→07/1995 | | COUPE S2 | | 10/1992→12/1996 | |
| V91416 ■ | 027 109 601C | | 45° | H | VAG92382B ■ ■ ■ | | |
| 32.10 x 6.97 x 95.50 | | MB | | | 38.00 x 7.00 x 12.05 | | |
| V91372 ■ | 027 109 611D | | 45° | H | | | |
| 28.10 x 6.95 x 98.20 | | MD + MB cr | | | | | |

57



81.00

| | | | | | | | |
|----------------------|--------------|-----------------|-----------|-------------|--------|------------------------|-------|
| ADU | 2226cc | 5 Cyl. | 20 Valves | 232kW/315PS | Petrol | Turbo, DOHC | TD242 |
| 80 RS2 | | 03/1994→05/1995 | | | | | |
| V94110 ■ | 051 109 601B | | 45° | Y | H | VAG96157B ■ ■ ■ | |
| 32.00 x 7.00 x 95.50 | | MB | | | | 38.00 x 7.00 x 12.00 | |

58



81.00

| | | | | | | | |
|----------------------|--------------|-----------------|-----------|---------------------|--------|------------------------|--------|
| HX | 2226cc | 5 Cyl. | 10 Valves | 101kW/138PS | Petrol | SOHC | TD267 |
| KU | 2226cc | 5 Cyl. | 10 Valves | 101-103kW/137-140PS | Petrol | SOHC | TD9375 |
| PX | 2226cc | 5 Cyl. | 10 Valves | 88kW/120PS | Petrol | SOHC | TD312 |
| 100 2.2 | | 08/1984→12/1988 | | 100 2.2 Cat | | 06/1989→11/1990 | |
| 100 2.2 E | | 08/1985→07/1986 | | 200 2.2 | | 08/1984→07/1985 | |
| V91338 ■ | 035 109 601K | | 45° | | | VAG92105B ■ ■ ■ | |
| 38.10 x 7.97 x 91.90 | | MD | | | | 42.30 x 7.99 x 12.08 | |
| V91340 ■ | 048 109 611A | | 45° | H | | | |
| 33.30 x 7.95 x 91.20 | | MD + MB | | | | | |

59



81.00

| | | | | | | | |
|----------------------|--------------|-----------------|-----------|-------------------|--------|------------------------|--------|
| JT | 2226cc | 5 Cyl. | 10 Valves | 82-89kW/112-121PS | Petrol | SOHC | TD276 |
| KV | 2226cc | 5 Cyl. | 10 Valves | 100kW/136PS | Petrol | SOHC | TD4209 |
| KZ | 2226cc | 5 Cyl. | 10 Valves | 82-85kW/112-116PS | Petrol | SOHC | TD294 |
| MB | 2226cc | 5 Cyl. | 10 Valves | 147kW/200PS | Petrol | Turbo, SOHC | TD295 |
| 80 2.2 | | 09/1983→12/1986 | | 90 2.2 | | 10/1984→03/1987 | |
| 90 2.2 E | | 11/1984→09/1991 | | 100 2.2 | | 10/1984→12/1987 | |
| COUPE 2.2 | | 10/1984→07/1991 | | COUPE 2.2 GT | | 09/1984→10/1988 | |
| QUATTRO 2.2 | | 12/1984→07/1987 | | QUATTRO 2.2 Turbo | | 08/1987→07/1989 | |
| V91338 ■ | 035 109 601K | | 45° | | | VAG92061B ■ ■ ■ | |
| 38.10 x 7.97 x 91.90 | | MD | | | | 36.70 x 8.00 x 12.08 | |
| V91340 ■ | 048 109 611A | | 45° | H | | | |
| 33.30 x 7.95 x 91.20 | | MD + MB | | | | | |



OE

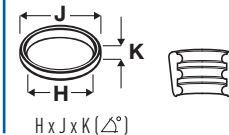
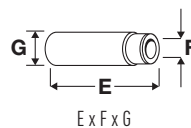
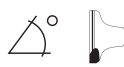

60 81.00

| MC | 2226cc | 5 Cyl. | 10 Valves | 97-121kW/132-165PS | Petrol | Turbo, SOHC | TD296 |
|---------------|--------|--------|-----------|--------------------|--------|-----------------|-------|
| 100 2.2 | | | | 100 2.2 E Turbo | | 08/1986→11/1990 | |
| 100 2.2 Turbo | | | | 200 2.2 | | 09/1988→12/1991 | |
| 200 2.2 Turbo | | | | | | | |

| | | | | | | | |
|----------------------|--------------|---------|-----|----|---|----------------------|--|
| V91338 | 035 109 601K | | 45° | | | VAG92061B | |
| 38.10 x 7.97 x 91.90 | | MD | | | | 36.70 x 8.00 x 12.08 | |
| V91030 | 035 109 611F | | 45° | ss | H | VAG92105B | |
| 33.30 x 7.95 x 98.60 | | MD + MB | | | | 42.30 x 7.99 x 12.08 | |
| V91340 | 048 109 611A | | 45° | | H | | |
| 33.30 x 7.95 x 91.20 | | MD + MB | | | | | |

61 81.00

| RR | 2226cc | 5 Cyl. | 20 Valves | 162kW/220PS | Petrol | Turbo, DOHC | TD316 |
|-----------------------|--------|--------|-----------|-------------|--------|-------------|-------|
| QUATTRO 2.2 20V Turbo | | | | | | | |
| | | | | | | | |

| | | | | | | | |
|----------------------|--------------|----|-----|--|---|----------------------|--|
| V91416 | 027 109 601C | | 45° | | H | VAG96157B | |
| 32.10 x 6.97 x 95.50 | | MB | | | | 38.00 x 7.00 x 12.00 | |

62 81.00

| AGA | 2393cc | V6 Cyl. | 30 Valves | 121kW/165PS | Petrol | DOHC | TD9515 |
|--------|--------|---------|-----------|-------------|--------|------|---------|
| AJG | 2393cc | V6 Cyl. | 30 Valves | 120kW/163PS | Petrol | DOHC | TD13928 |
| AML | 2393cc | V6 Cyl. | 30 Valves | 121kW/165PS | Petrol | DOHC | TD13951 |
| AMM | 2393cc | V6 Cyl. | 30 Valves | 120kW/163PS | Petrol | DOHC | TD15331 |
| ARJ | 2393cc | V6 Cyl. | 30 Valves | 121kW/165PS | Petrol | DOHC | TD13953 |
| A4 2.4 | | | | | | | |
| | | | | | | | |
| | | | | | | | |

| | | | | | | | |
|-----------------------|--------------|------------|-----|----|---|----------------------|--|
| V94081 | 058 109 601C | | 45° | Y | H | VAG96073B | |
| 26.90 x 6.00 x 105.10 | | MB | | | | 36.00 x 6.02 x 11.06 | |
| V94082 | 058 109 611E | | 45° | ss | H | | |
| 29.90 x 6.00 x 103.90 | | MD + MB cr | | | | | |

63 81.00

| ALF | 2393cc | V6 Cyl. | 30 Valves | 121kW/165PS | Petrol | DOHC | TD11359 |
|--------|--------|---------|-----------|-------------|--------|------|---------|
| ALW | 2393cc | V6 Cyl. | 30 Valves | 100kW/136PS | Petrol | DOHC | TD11088 |
| APC | 2393cc | V6 Cyl. | 30 Valves | 115kW/156PS | Petrol | DOHC | TD11360 |
| APS | 2393cc | V6 Cyl. | 30 Valves | 121kW/165PS | Petrol | DOHC | TD13952 |
| APZ | 2393cc | V6 Cyl. | 30 Valves | 120kW/163PS | Petrol | DOHC | TD13954 |
| ARN | 2393cc | V6 Cyl. | 30 Valves | 100kW/136PS | Petrol | DOHC | TD14028 |
| ASM | 2393cc | V6 Cyl. | 30 Valves | 100kW/136PS | Petrol | DOHC | TD15330 |
| BDV | 2393cc | V6 Cyl. | 30 Valves | 125kW/170PS | Petrol | DOHC | TD16410 |
| A4 2.4 | | | | | | | |
| | | | | | | | |
| | | | | | | | |

| | | | | | | | |
|-----------------------|--------------|------------|-----|---|---|----------------------|--|
| V94081 | 058 109 601C | | 45° | Y | H | VAG96073B | |
| 26.90 x 6.00 x 105.10 | | MB | | | | 36.00 x 6.02 x 11.06 | |
| V94083 | 058 109 611M | | 45° | | H | | |
| 29.90 x 6.00 x 103.90 | | MD + MB cr | | | | | |



OE

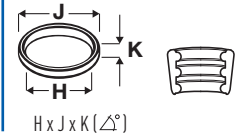
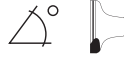

64



81.00

| BDW | 2393cc | V6 Cyl. | 24 Valves | 130kW/177PS | Petrol | DOHC | TD17374 |
|-----------------------|--------------|-----------------|-----------|-------------|------------------------|------|---------|
| A6 2.4 | | 05/2004→10/2008 | | | | | |
| V95097 ■ | 06E 109 601H | | 45° | H | VAG96073B ■ ■ ■ | | |
| 32.35 x 5.98 x 103.90 | | MB cr | | | 36.00 x 6.02 x 11.06 | | |
| V95098 ■ | 06D 109 601M | | 45° | H | | | |
| 33.80 x 5.98 x 103.95 | | MB | | | | | |
| V94692 ■ | 06D 109 611L | | 45° | H | | | |
| 28.00 x 6.00 x 101.80 | | MD + MB cr | | | | | |
| V95152 ■ | 06D 109 611L | | 45° | H | | | |
| 28.10 x 5.97 x 101.90 | | MD + MB cr | | | | | |

65



81.00

| 1T | 2461cc | 5 Cyl. | 10 Valves | 88kW/120PS | Diesel | Turbo, SOHC | TD212 |
|----------------------|--------------|-----------------|-----------|-------------|--------|------------------------|-------|
| AAT | 2461cc | 5 Cyl. | 10 Valves | 85kW/116PS | Diesel | Turbo, SOHC | TD228 |
| ABP | 2461cc | 5 Cyl. | 10 Valves | 85kW/115PS | Diesel | Turbo, SOHC | TD235 |
| AEL | 2461cc | 5 Cyl. | 10 Valves | 103kW/140PS | Diesel | Turbo, SOHC | TD245 |
| 100 2.5 TDI | | 01/1990→07/1994 | | A6 2.5 TDI | | 06/1994→12/1997 | |
| V94010 ■ | 028 109 601H | | 45° | Y | H | VAG92061B ■ ■ ■ | |
| 36.00 x 8.00 x 96.80 | | MB | | | | 36.70 x 8.00 x 12.08 | |
| V94547 ■ | 046 109 601J | | 45° | SS | | | |
| 35.95 x 8.00 x 96.85 | | MD | | | | | |
| V91334 ■ | 074 109 611 | | 45° | SS | H | | |
| 31.30 x 7.95 x 95.10 | | ME + MB | | | | | |
| V94011 ■ | 046 109 611F | | 45° | SS | | | |
| 31.50 x 7.95 x 96.85 | | MD + MB | | | | | |

66



81.00

| AGB | 2671cc | V6 Cyl. | 30 Valves | 195kW/265PS | Petrol | Turbo, DOHC | TD11888 |
|-----------------------|--------------|-----------------|-----------|---------------|--------|------------------------|---------|
| AJK | 2671cc | V6 Cyl. | 30 Valves | 169kW/230PS | Petrol | Turbo, DOHC | TD10813 |
| ARE | 2671cc | V6 Cyl. | 30 Valves | 184kW/250PS | Petrol | Turbo, DOHC | TD15328 |
| AZA | 2671cc | V6 Cyl. | 30 Valves | 169kW/230PS | Petrol | DOHC | TD17164 |
| AZB | 2671cc | V6 Cyl. | 30 Valves | 195kW/265PS | Petrol | DOHC | TD20534 |
| BES | 2671cc | V6 Cyl. | 30 Valves | 184kW/250PS | Petrol | Turbo, DOHC | TD16432 |
| A4 2.7 Turbo | | 02/1999→09/2000 | | A4 S4 | | 09/1997→09/2001 | |
| A6 2.7 T | | 12/1997→01/2005 | | ALLROAD 2.7 T | | 05/2000→08/2005 | |
| V94081 ■ | 058 109 601C | | 45° | Y | H | VAG96073B ■ ■ ■ | |
| 26.90 x 6.00 x 105.10 | | MB | | | | 36.00 x 6.02 x 11.06 | |
| V94082 ■ | 058 109 611E | | 45° | SS | H | | |
| 29.90 x 6.00 x 103.90 | | MD + MB cr | | | | | |

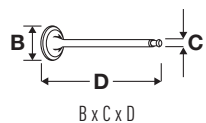

OE

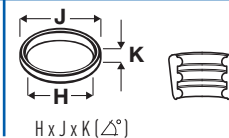
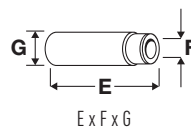
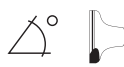

67 **81.00**

| PT | 3562cc | V8 Cyl. | 32 Valves | 180-184kW/245-250PS | Petrol | DOHC | TD310 |
|----------------------|-----------------|------------|-----------|---------------------|----------------------|------|-------|
| V8 3.6 | 10/1988→02/1994 | | | | | | |
| V91416 | 027 109 601C | | 45° | H | VAG96157B | | |
| 32.10 x 6.97 x 95.50 | | MB | | | 38.00 x 7.00 x 12.00 | | |
| V91372 | 027 109 611D | | 45° | H | | | |
| 28.10 x 6.95 x 98.20 | | MD + MB cr | | | | | |

68 **82.50**

| BYT | 1781cc | 4 Cyl. | 16 Valves | 118kW/160PS | Petrol | Turbo, DOHC, Injection | TD20089 |
|-----------------------|-----------------|------------|-----------|-------------|----------------------|------------------------|---------|
| A3 1.8 TFSI | 11/2006→03/2013 | | | | | | |
| V95098 | 06D 109 601M | | 45° | H | VAG96073B | | |
| 33.80 x 5.98 x 103.95 | | MB | | | 36.00 x 6.02 x 11.06 | | |
| V94692 | 06D 109 611L | | 45° | H | | | |
| 28.00 x 6.00 x 101.80 | | MD + MB cr | | | | | |
| V95152 | 06D 109 611L | | 45° | H | | | |
| 28.10 x 5.97 x 101.90 | | MD + MB cr | | | | | |

69 **82.50**

| BZB | 1798cc | 4 Cyl. | 16 Valves | 118kW/160PS | Petrol | Turbo, DOHC, Injection | TD20090 |
|-----------------------|-----------------|------------|-----------|-------------|----------------------|------------------------|---------|
| CABA | 1798cc | 4 Cyl. | 16 Valves | 88kW/120PS | Petrol | Turbo, DOHC, Injection | TD20590 |
| CABB | 1798cc | 4 Cyl. | 16 Valves | 118kW/160PS | Petrol | Turbo, DOHC, Injection | TD20594 |
| CABD | 1798cc | 4 Cyl. | 16 Valves | 125kW/170PS | Petrol | Turbo, DOHC, Injection | TD20113 |
| CDAA | 1798cc | 4 Cyl. | 16 Valves | 118kW/160PS | Petrol | Turbo, DOHC, Injection | TD20938 |
| CDHA | 1798cc | 4 Cyl. | 16 Valves | 88kW/120PS | Petrol | Turbo, DOHC, Injection | TD21113 |
| CDHB | 1798cc | 4 Cyl. | 16 Valves | 118kW/160PS | Petrol | Turbo, DOHC, Injection | TD21114 |
| A3 1.8 TFSI | 11/2006→05/2013 | | | A4 1.8 TFSI | 11/2007→12/2015 | | |
| A5 1.8 TFSI | 10/2007→01/2017 | | | TT 1.8 TFSI | 06/2008→06/2014 | | |
| V95098 | 06D 109 601M | | 45° | H | VAG96073B | | |
| 33.80 x 5.98 x 103.95 | | MB | | | 36.00 x 6.02 x 11.06 | | |
| V94692 | 06D 109 611L | | 45° | H | | | |
| 28.00 x 6.00 x 101.80 | | MD + MB cr | | | | | |
| V95152 | 06D 109 611L | | 45° | H | | | |
| 28.10 x 5.97 x 101.90 | | MD + MB cr | | | | | |

70 **82.50**

| SD | 1847cc | 4 Cyl. | 8 Valves | 83kW/113PS | Petrol | SOHC | TD323 |
|----------------------|-----------------|---------|----------|------------|----------------------|------|-------|
| 80 1.8 | 09/1986→08/1990 | | | | | | |
| V91407 | 048 109 601A | | 45° | | VAG92105B | | |
| 39.60 x 7.97 x 91.90 | | MD | | | 42.30 x 7.99 x 12.08 | | |
| V91340 | 048 109 611A | | 45° | H | | | |
| 33.30 x 7.95 x 91.20 | | MD + MB | | | | | |



OE

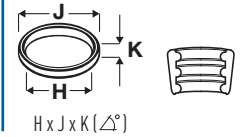
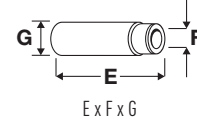

71  **82.50**

| | | | | | | | |
|-----------------|--------|-----------------|-----------------|-------------------|--------|-----------------|---------------|
| 3A | 1984cc | 4 Cyl. | 8 Valves | 80-83kW/109-113PS | Petrol | SOHC | TD4191 |
| AAD | 1984cc | 4 Cyl. | 8 Valves | 82-85kW/112-115PS | Petrol | SOHC | TD222 |
| AAE | 1984cc | 4 Cyl. | 8 Valves | 74kW/100PS | Petrol | SOHC | TD223 |
| ABK | 1984cc | 4 Cyl. | 8 Valves | 85kW/115PS | Petrol | SOHC | TD233 |
| ABT | 1984cc | 4 Cyl. | 8 Valves | 66kW/90PS | Petrol | SOHC | TD236 |
| ADW | 1984cc | 4 Cyl. | 8 Valves | 79kW/107PS | Petrol | SOHC | TD243 |
| 80 2.0 | | 09/1987→01/1996 | | 80 2.0 E | | 08/1988→01/1996 | |
| 90 2.0 | | 09/1987→12/1988 | | 100 2.0 | | 12/1990→07/1994 | |
| 100 2.0 E | | 12/1990→07/1994 | | A6 2.0 | | 06/1994→12/1997 | |
| CABRIOLET 2.0 E | | 01/1993→07/1998 | | COUPE 2.0 | | 05/1989→12/1996 | |

V91407 
39.60 x 7.97 x 91.90

048 109 601A

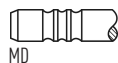

45°

VAG92061B 
36.70 x 8.00 x 12.08

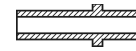

V91340 
33.30 x 7.95 x 91.20

048 109 611A

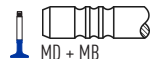

45°

H

72  **82.50**

| | | | | | | | |
|----------------|--------|-----------------|------------------|-------------|--------|-----------------|---------------|
| 6A | 1984cc | 4 Cyl. | 16 Valves | 101kW/137PS | Petrol | DOHC | TD4193 |
| 80 2.0 E 16V | | 03/1990→07/1992 | | 90 2.0 | | 08/1989→07/1990 | |
| COUPE 2.0 16 V | | 01/1992→07/1992 | | | | | |

V91416 
32.10 x 6.97 x 95.50

027 109 601C

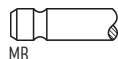

45°

H

VAG96157B 
38.00 x 7.00 x 12.00

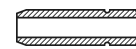

V91372 
28.10 x 6.95 x 98.20

027 109 611D

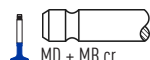

45°

H

73  **82.50**

| | | | | | | | |
|----------------|--------|-----------------|------------------|---------------------|--------|-----------------|--------------|
| ACE | 1984cc | 4 Cyl. | 16 Valves | 101-103kW/137-140PS | Petrol | DOHC | TD238 |
| 80 2.0 E 16V | | 04/1992→01/1996 | | 100 2.0 E 16V | | 01/1992→07/1994 | |
| A6 2.0 16V | | 06/1994→12/1997 | | CABRIOLET 2.0 16V | | 06/1995→07/1996 | |
| COUPE 2.0 16 V | | 08/1992→12/1996 | | | | | |

V94110 
32.00 x 7.00 x 95.50

051 109 601B

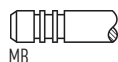

45°

Y

H

VAG96041B 
36.50 x 7.00 x 12.08

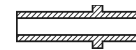

V94111 
27.00 x 7.00 x 97.95

051 109 611B

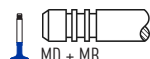

45°

H

74  **82.50**

| | | | | | | | |
|------------|--------|-----------------|------------------|------------|--------|-----------------|----------------|
| ALT | 1984cc | 4 Cyl. | 20 Valves | 96kW/130PS | Petrol | DOHC | TD15345 |
| A4 2.0 | | 11/2000→06/2008 | | A6 2.0 | | 08/2001→01/2005 | |

V94081 
26.90 x 6.00 x 105.10

058 109 601C

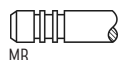

45°

Y

H

VAG96073B 
36.00 x 6.02 x 11.06



V94083 
29.90 x 6.00 x 103.90

058 109 611M

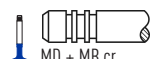

45°

H

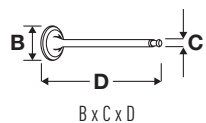



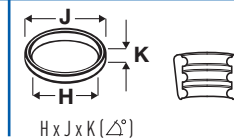
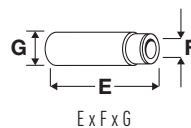



OE

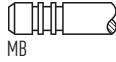

75  **82.50**







| | | | | | | | |
|------------|--------|--------|------------------|-------------|--------|-------------------------------|----------------|
| AWA | 1984cc | 4 Cyl. | 16 Valves | 110kW/150PS | Petrol | DOHC, Injection | TD17035 |
| AXW | 1984cc | 4 Cyl. | 16 Valves | 110kW/150PS | Petrol | DOHC, Injection | TD16872 |
| BLR | 1984cc | 4 Cyl. | 16 Valves | 110kW/150PS | Petrol | DOHC, Injection | TD18199 |
| BLX | 1984cc | 4 Cyl. | 16 Valves | 110kW/150PS | Petrol | DOHC, Injection | TD17404 |
| BLY | 1984cc | 4 Cyl. | 16 Valves | 110kW/150PS | Petrol | DOHC, Injection | TD17405 |
| BMB | 1984cc | 4 Cyl. | 16 Valves | 110kW/150PS | Petrol | DOHC, Injection | TD17406 |
| BVY | 1984cc | 4 Cyl. | 16 Valves | 110kW/150PS | Petrol | DOHC, Injection | TD18200 |
| BVZ | 1984cc | 4 Cyl. | 16 Valves | 110kW/150PS | Petrol | DOHC, Injection | TD18201 |
| BYK | 1984cc | 4 Cyl. | 16 Valves | 125kW/170PS | Petrol | Turbo, DOHC, Injection | TD20404 |

| | | | |
|-------------|-----------------|-------------|-----------------|
| A3 2.0 FSI | 05/2003→06/2008 | A4 2.0 FSI | 07/2002→12/2004 |
| A4 2.0 TFSI | 10/2006→06/2008 | A6 2.0 TFSI | 06/2005→03/2011 |

| | | | | | | | |
|---|--------------|--|-----|---|---|--|---|
| V94691  | 06D 109 601K |  | 45° | Y | H | VAG96073B  |  |
| 33.85 x 6.00 x 103.90 | | MB | | | | 36.00 x 6.02 x 11.06 | |
| V94692  | 06D 109 611L |  | 45° | | H | | |
| 28.00 x 6.00 x 101.80 | | MD + MB cr | | | | | |
| V95152  | 06D 109 611L |  | 45° | | H | | |
| 28.10 x 5.97 x 101.90 | | MD + MB cr | | | | | |

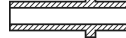
76  **82.50**

| | | | | | | | |
|------------|--------|--------|-----------------|------------|--------|------------------------|----------------|
| AXA | 1984cc | 4 Cyl. | 8 Valves | 85kW/115PS | Petrol | SOHC, Injection | TD16865 |
|------------|--------|--------|-----------------|------------|--------|------------------------|----------------|

| | | | | | | | |
|---|--------------|---|-----|----|---|--|---|
| V94079  | 078 109 601B |  | 45° | | H | VAG96041B  |  |
| 39.40 x 7.00 x 92.10 | | MB | | | | 36.50 x 7.00 x 12.08 | |
| V94080  | 048 109 611B |  | 45° | | H | | |
| 32.80 x 7.00 x 91.20 | | MD + MB | | | | | |
| V94303  | 078 109 611C |  | 45° | ss | H | | |
| 32.90 x 7.00 x 91.20 | | MD + MB | | | | | |



OE

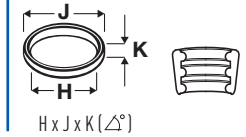
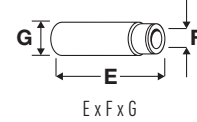

77



82.50

| | | | | | | | |
|-----------------|-----------------|--------|-----------|---------------------------|--------|------------------------|---------|
| AXX | 1984cc | 4 Cyl. | 16 Valves | 147kW/200PS | Petrol | Turbo, DOHC, Injection | TD17450 |
| BGB | 1984cc | 4 Cyl. | 16 Valves | 147kW/200PS | Petrol | Turbo, DOHC, Injection | TD18008 |
| BPG | 1984cc | 4 Cyl. | 16 Valves | 147kW/200PS | Petrol | Turbo, DOHC, Injection | TD20530 |
| BPJ | 1984cc | 4 Cyl. | 16 Valves | 125kW/170PS | Petrol | Turbo, DOHC, Injection | TD18486 |
| BPY | 1984cc | 4 Cyl. | 16 Valves | 147kW/200PS | Petrol | Turbo, DOHC, Injection | TD20704 |
| BWA | 1984cc | 4 Cyl. | 16 Valves | 147kW/200PS | Petrol | Turbo, DOHC, Injection | TD19199 |
| BWE | 1984cc | 4 Cyl. | 16 Valves | 147kW/200PS | Petrol | Turbo, DOHC, Injection | TD18968 |
| BWT | 1984cc | 4 Cyl. | 16 Valves | 147-149kW/200-203PS | Petrol | Turbo, DOHC, Injection | TD19705 |
| CAEA | 1984cc | 4 Cyl. | 16 Valves | 132kW/180PS | Petrol | Turbo, DOHC, Injection | TD21115 |
| CAWB | 1984cc | 4 Cyl. | 16 Valves | 147kW/200PS | Petrol | Turbo, DOHC, Injection | TD20714 |
| CBFA | 1984cc | 4 Cyl. | 16 Valves | 147kW/200PS | Petrol | Turbo, DOHC, Injection | TD22663 |
| CCTA | 1984cc | 4 Cyl. | 16 Valves | 147kW/200PS | Petrol | Turbo, DOHC, Injection | TD22666 |
| CCZA | 1984cc | 4 Cyl. | 16 Valves | 147kW/200PS | Petrol | Turbo, DOHC, Injection | TD22170 |
| CCZC | 1984cc | 4 Cyl. | 16 Valves | 125kW/170PS | Petrol | Turbo, DOHC, Injection | TD25726 |
| CDNA | 1984cc | 4 Cyl. | 16 Valves | 130kW/177PS | Petrol | Turbo, DOHC, Injection | TD23860 |
| CDNB | 1984cc | 4 Cyl. | 16 Valves | 132kW/180PS | Petrol | Turbo, DOHC, Injection | TD20936 |
| CFKA | 1984cc | 4 Cyl. | 16 Valves | 132kW/180PS | Petrol | Turbo, DOHC, Injection | TD23856 |
| A3 2.0 TFSI | 09/2004→05/2013 | | | A4 2.0 TFSI | | 11/2004→12/2015 | |
| A4 2.0 TFSI 16V | 01/2006→03/2009 | | | A4 2.0 TFSI flexible fuel | | 11/2009→12/2015 | |
| A5 2.0 TFSI | 11/2008→06/2014 | | | A6 2.0 TFSI | | 06/2005→ | |
| Q3 2.0 TFSI | 06/2011→ | | | Q5 2.0 TFSI | | 08/2009→ | |
| TT 2.0 TFSI | 08/2006→06/2010 | | | | | | |

V95098 ■
33.80 x 5.98 x 103.95

06D 109 601M

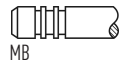

45°

H

VAG96073B ■ ■ ■
36.00 x 6.02 x 11.06

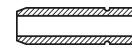

V94692 ■
28.00 x 6.00 x 101.80

06D 109 611L



45°

H

V95152 ■
28.10 x 5.97 x 101.90

06D 109 611L



45°

H



OE

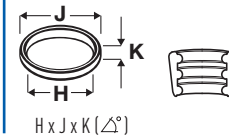
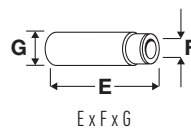

78 **82.50**

| | | | | | | | |
|---------------------|-----------------|--------|-----------|---------------------|-----------------|------------------------|---------|
| BHZ | 1984cc | 4 Cyl. | 16 Valves | 195kW/265PS | Petrol | Turbo, DOHC, Injection | TD19821 |
| BUL | 1984cc | 4 Cyl. | 16 Valves | 162kW/220PS | Petrol | Turbo, DOHC, Injection | TD18484 |
| BZC | 1984cc | 4 Cyl. | 16 Valves | 188kW/256PS | Petrol | Turbo, DOHC, Injection | TD20842 |
| CAEB | 1984cc | 4 Cyl. | 16 Valves | 155kW/211PS | Petrol | Turbo, DOHC, Injection | TD21116 |
| CAED | 1984cc | 4 Cyl. | 16 Valves | 162kW/220PS | Petrol | Turbo, DOHC, Injection | TD28001 |
| CDLA | 1984cc | 4 Cyl. | 16 Valves | 195kW/265PS | Petrol | Turbo, DOHC, Injection | TD21734 |
| CDLB | 1984cc | 4 Cyl. | 16 Valves | 200kW/272PS | Petrol | Turbo, DOHC, Injection | TD21735 |
| CDLC | 1984cc | 4 Cyl. | 16 Valves | 188kW/256PS | Petrol | Turbo, DOHC, Injection | TD22470 |
| CDLH | 1984cc | 4 Cyl. | 16 Valves | 188kW/256PS | Petrol | Turbo, DOHC, Injection | TD26515 |
| CDMA | 1984cc | 4 Cyl. | 16 Valves | 195kW/265PS | Petrol | DOHC, Injection | TD24962 |
| CDNC | 1984cc | 4 Cyl. | 16 Valves | 155kW/211PS | Petrol | Turbo, DOHC, Injection | TD20937 |
| CESA | 1984cc | 4 Cyl. | 16 Valves | 155kW/211PS | Petrol | Turbo, DOHC, Injection | TD24753 |
| CETA | 1984cc | 4 Cyl. | 16 Valves | 155kW/211PS | Petrol | Turbo, DOHC, Injection | TD24754 |
| CHJA | 1984cc | 4 Cyl. | 16 Valves | 155kW/211PS | Petrol | Turbo, DOHC, Injection | TD25428 |
| CPMA | 1984cc | 4 Cyl. | 16 Valves | 155kW/211PS | Petrol | Turbo, DOHC, Injection | TD26715 |
| CPMB | 1984cc | 4 Cyl. | 16 Valves | 162kW/220PS | Petrol | Turbo, DOHC, Injection | TD26891 |
| CPSA | 1984cc | 4 Cyl. | 16 Valves | 155kW/211PS | Petrol | Turbo, DOHC, Injection | TD25730 |
| A1 2.0 TFSI | 03/2012→ | | | A3 2.0 TFSI | 10/2013→ | | |
| A3 S3 | 11/2006→03/2013 | | | A4 2.0 TFSI | 06/2005→05/2016 | | |
| A4 2.0 TFSI quattro | 09/2012→05/2016 | | | A5 2.0 TFSI | 06/2008→01/2017 | | |
| A5 2.0 TFSI quattro | 03/2012→01/2017 | | | A6 2.0 TFSI | 03/2011→ | | |
| A6 2.0 TFSI hybrid | 11/2011→ | | | A8 2.0 TFSI hybrid | 02/2012→ | | |
| Q3 2.0 TFSI | 06/2011→ | | | Q5 2.0 TFSI | 11/2008→ | | |
| Q5 2.0 TFSI hybrid | 06/2011→ | | | Q5 2.0 TFSI quattro | 09/2012→ | | |
| TT 2.0 TFSI | 05/2010→06/2014 | | | TT 2.0 TTS | 05/2008→06/2014 | | |

V95098
 33.80 x 5.98 x 103.95

06D 109 601M

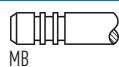

45°

H

VAG96073B
 36.00 x 6.02 x 11.06

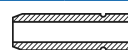

V80028
 28.00 x 6.00 x 101.90

06D 109 611H



45°

SS

79 **82.50**

| | | | | | | | |
|--------------|-----------------|--------|-----------|---------------------|--------|------|-----------------|
| 7A | 2309cc | 5 Cyl. | 20 Valves | 122-125kW/166-170PS | Petrol | DOHC | TD221 |
| 90 2.3 E 20V | 06/1988→09/1991 | | | COUPE 2.3 20V | | | 11/1988→12/1996 |

V91416
 32.10 x 6.97 x 95.50

027 109 601C



45°

H

VAG96157B
 38.00 x 7.00 x 12.00



V91372
 28.10 x 6.95 x 98.20

027 109 611D

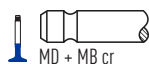

45°

H



OE



MAT.

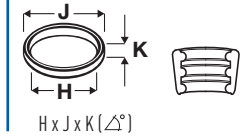
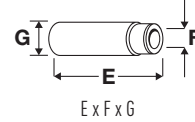
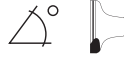

80



82.50

| | | | | | | | |
|-----------|--------|-----------------|-----------|--------------------|--------|-----------------|--------|
| AAR | 2309cc | 5 Cyl. | 10 Valves | 98kW/133PS | Petrol | SOHC | TD4194 |
| NF | 2309cc | 5 Cyl. | 10 Valves | 97-100kW/132-136PS | Petrol | SOHC | TD301 |
| NG | 2309cc | 5 Cyl. | 10 Valves | 97-100kW/132-136PS | Petrol | SOHC | TD302 |
| 80 2.3 | | 10/1987→10/1991 | | 80 2.3 E | | 09/1991→01/1996 | |
| 90 2.3 E | | 04/1987→09/1991 | | 100 2.3 | | 08/1986→11/1990 | |
| 100 2.3 E | | 08/1986→07/1994 | | 200 2.3 | | 11/1986→09/1991 | |
| A6 2.3 | | 06/1994→12/1995 | | CABRIOLET 2.3 E | | 05/1991→07/1994 | |
| COUPE 2.3 | | 09/1986→12/1996 | | | | | |

V91407 ■
39.60 x 7.97 x 91.90

048 109 601A

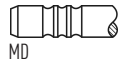

MD

45°

VAG92061B ■ ■ ■
36.70 x 8.00 x 12.08

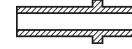

V91340 ■
33.30 x 7.95 x 91.20

048 109 611A



MD + MB

45°

H

81



82.50

| | | | | | | | |
|--------|--------|-----------------|-----------|-------------|--------|------------------------|---------|
| CEPA | 2480cc | 5 Cyl. | 20 Valves | 250kW/340PS | Petrol | Turbo, DOHC, Injection | TD23089 |
| CEPB | 2480cc | 5 Cyl. | 20 Valves | 265kW/360PS | Petrol | Turbo, DOHC, Injection | TD25430 |
| A3 RS3 | | 01/2011→12/2012 | | TT 2.5 RS | | 07/2009→06/2014 | |

V95098 ■
33.80 x 5.98 x 103.95

06D 109 601M

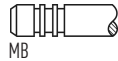

MB

45°

H

VAG96073B ■ ■ ■
36.00 x 6.02 x 11.06



V80028 ■
28.00 x 6.00 x 101.90

06D 109 611H



ME + MB cr

45°

SS

82



82.50

| | | | | | | | |
|-----------|--------|----------|-----------|-------------|--------|------------------------|---------|
| CTSA | 2480cc | 5 Cyl. | 20 Valves | 228kW/310PS | Petrol | Turbo, DOHC, Injection | TD29520 |
| Q3 RS 2.5 | | 10/2013→ | | | | | |

V95098 ■
33.80 x 5.98 x 103.95

06D 109 601M

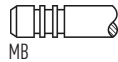

MB

45°

H

VAG96073B ■ ■ ■
36.00 x 6.02 x 11.06



V94692 ■
28.00 x 6.00 x 101.80

06D 109 611L



MD + MB cr

45°

H

V95152 ■
28.10 x 5.97 x 101.90

06D 109 611L



MD + MB cr

45°

H



OE

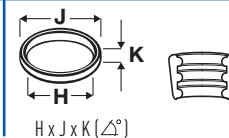
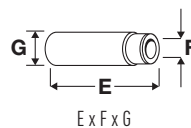
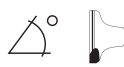

83 **82.50**

| ABC | 2598cc | V6 Cyl. | 12 Valves | 110kW/150PS | Petrol | SOHC | TD231 |
|--|--------------|-----------------|-----------|-------------|--------|--|-------|
| 80 2.6 | | 06/1992→01/1996 | | 100 2.6 | | 03/1992→07/1994 | |
| A4 2.6 | | 01/1995→09/2001 | | A6 2.6 | | 06/1994→12/1997 | |
| CABRIOLET 2.6 | | 06/1993→08/2000 | | COUPE 2.6 | | 08/1992→12/1996 | |
| V91407 | 048 109 601A | | 45° | | | VAG92061B | |
| 39.60 x 7.97 x 91.90 Eng.→8C-S-025820 | | MD | | | | 36.70 x 8.00 x 12.08 Eng.→8C-S-025820 | |
| V94079 | 078 109 601B | | 45° | H | | VAG96041B | |
| 39.40 x 7.00 x 92.10 Eng.8C-S-025821→ | | MB | | | | 36.50 x 7.00 x 12.08 Eng.8C-S-025821→ | |
| V91340 | 048 109 611A | | 45° | H | | | |
| 33.30 x 7.95 x 91.20 Eng.→8C-S-025820 | | MD + MB | | | | | |
| V94303 | 078 109 611C | | 45° | ss | H | | |
| 32.90 x 7.00 x 91.20 Eng.8C-S-025821→ | | MD + MB | | | | | |

84 **82.50**

| ACZ | 2598cc | V6 Cyl. | 12 Valves | 102kW/139PS | Petrol | SOHC | TD239 |
|----------------------|--------------|-----------------|-----------|-------------|--------|----------------------|-------|
| 100 2.6 | | 07/1993→07/1994 | | 100 2.6 E | | 08/1993→07/1994 | |
| A4 2.6 | | 01/1996→07/1997 | | A6 2.6 | | 06/1994→10/1997 | |
| CABRIOLET 2.6 | | 05/1995→08/2000 | | | | | |
| V91407 | 048 109 601A | | 45° | | | VAG92061B | |
| 39.60 x 7.97 x 91.90 | | MD | | | | 36.70 x 8.00 x 12.08 | |
| V91340 | 048 109 611A | | 45° | H | | | |
| 33.30 x 7.95 x 91.20 | | MD + MB | | | | | |

85 **82.50**

| AAH | 2771cc | V6 Cyl. | 12 Valves | 128kW/174PS | Petrol | SOHC | TD224 |
|----------------------|--------------|-----------------|-----------|---------------------|--------|----------------------|--------|
| AEJ | 2771cc | V6 Cyl. | 12 Valves | 120-128kW/163-174PS | Petrol | SOHC | TD9541 |
| AFC | 2771cc | V6 Cyl. | 12 Valves | 120-128kW/163-174PS | Petrol | SOHC | TD246 |
| 80 2.8 | | 09/1991→01/1996 | | 100 2.8 E | | 12/1990→07/1994 | |
| A4 2.8 | | 01/1995→07/1997 | | A6 2.8 | | 06/1994→12/1997 | |
| A8 2.8 | | 03/1994→03/1996 | | CABRIOLET 2.8 | | 11/1992→08/2000 | |
| COUPE 2.8 | | 08/1991→12/1996 | | | | | |
| V91407 | 048 109 601A | | 45° | | | VAG92061B | |
| 39.60 x 7.97 x 91.90 | | MD | | | | 36.70 x 8.00 x 12.08 | |
| V91340 | 048 109 611A | | 45° | H | | | |
| 33.30 x 7.95 x 91.20 | | MD + MB | | | | | |



OE

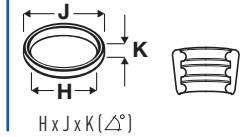
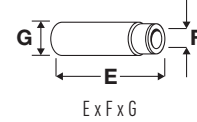

86  **82.50**



| | | | | | | | |
|--------|--------|-----------------|-----------|-------------|--------|-----------------|---------|
| ACK | 2771cc | V6 Cyl. | 30 Valves | 142kW/193PS | Petrol | DOHC | TD4197 |
| AGE | 2771cc | V6 Cyl. | 30 Valves | 132kW/180PS | Petrol | DOHC | TD15616 |
| ALG | 2771cc | V6 Cyl. | 30 Valves | 142kW/193PS | Petrol | DOHC | TD9516 |
| AMX | 2771cc | V6 Cyl. | 30 Valves | 142kW/193PS | Petrol | DOHC | TD13930 |
| APR | 2771cc | V6 Cyl. | 30 Valves | 142kW/193PS | Petrol | DOHC | TD13931 |
| AQD | 2771cc | V6 Cyl. | 30 Valves | 142kW/193PS | Petrol | DOHC | TD13932 |
| ATX | 2771cc | V6 Cyl. | 30 Valves | 140kW/190PS | Petrol | DOHC | TD15617 |
| BBG | 2771cc | V6 Cyl. | 30 Valves | 140kW/190PS | Petrol | DOHC | TD19142 |
| A4 2.8 | | 10/1996→09/2001 | | A6 2.8 | | 12/1995→01/2005 | |
| A8 2.8 | | 04/1996→09/2002 | | | | | |

V94081 
26.90 x 6.00 x 105.10

058 109 601C



45° Y H

VAG96073B  
36.00 x 6.02 x 11.06



V94083 
29.90 x 6.00 x 103.90

058 109 611M



45° H

87  **82.50**



| | | | | | | | |
|--------|--------|-----------------|-----------|---------------------|--------|-----------------|---------|
| ASN | 2976cc | V6 Cyl. | 30 Valves | 162kW/220PS | Petrol | DOHC | TD15346 |
| AVK | 2976cc | V6 Cyl. | 30 Valves | 162-164kW/220-223PS | Petrol | DOHC | TD17863 |
| BBJ | 2976cc | V6 Cyl. | 30 Valves | 160-162kW/218-220PS | Petrol | DOHC | TD16516 |
| A4 3.0 | | 11/2000→07/2006 | | A6 3.0 | | 06/2001→05/2006 | |
| A8 3.0 | | 07/2003→05/2006 | | | | | |

V94081 
26.90 x 6.00 x 105.10

058 109 601C



45° Y H

VAG96073B  
36.00 x 6.02 x 11.06



V94083 
29.90 x 6.00 x 103.90

058 109 611M



45° H

88  **83.00**

| | | | | | | | |
|------------|--------|-----------------|-----------|-------------|--------|-----------------|---------|
| BPP | 2698cc | V6 Cyl. | 24 Valves | 132kW/180PS | Diesel | Turbo, DOHC | TD18926 |
| BSG | 2698cc | V6 Cyl. | 24 Valves | 120kW/163PS | Diesel | Turbo, DOHC | TD18030 |
| CAMA | 2698cc | V6 Cyl. | 24 Valves | 140kW/190PS | Diesel | Turbo, DOHC | TD20006 |
| CAMB | 2698cc | V6 Cyl. | 24 Valves | 120kW/163PS | Diesel | Turbo, DOHC | TD20599 |
| CANA | 2698cc | V6 Cyl. | 24 Valves | 140kW/190PS | Diesel | Turbo, DOHC | TD21172 |
| CANB | 2698cc | V6 Cyl. | 24 Valves | 120kW/163PS | Diesel | Turbo, DOHC | TD22658 |
| CANC | 2698cc | V6 Cyl. | 24 Valves | 140kW/190PS | Diesel | Turbo, DOHC | TD22659 |
| CAND | 2698cc | V6 Cyl. | 24 Valves | 120kW/163PS | Diesel | Turbo, DOHC | TD23099 |
| CGKA | 2698cc | V6 Cyl. | 24 Valves | 140kW/190PS | Diesel | Turbo, DOHC | TD21065 |
| CGKB | 2698cc | V6 Cyl. | 24 Valves | 120kW/163PS | Diesel | Turbo, DOHC | TD21064 |
| A4 2.7 TDI | | 11/2005→03/2012 | | A4 2.7 TDi | | 11/2005→03/2008 | |
| A5 2.7 TDI | | 06/2007→01/2017 | | A6 2.7 TDI | | 11/2004→08/2011 | |

V98010 
28.80 x 6.00 x 99.50

059 109 601G



45°

V98011 
26.80 x 6.00 x 99.50

059 109 611M



45° SS

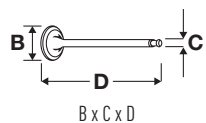

OE

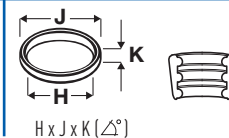
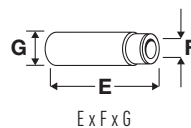
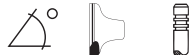

89



83.00

| | | | | | | | |
|------|--------|---------|-----------|-------------|--------|-------------|---------|
| ASB | 2967cc | V6 Cyl. | 24 Valves | 171kW/233PS | Diesel | Turbo, DOHC | TD17336 |
| BKN | 2967cc | V6 Cyl. | 24 Valves | 150kW/204PS | Diesel | Turbo, DOHC | TD18027 |
| BMK | 2967cc | V6 Cyl. | 24 Valves | 165kW/225PS | Diesel | Turbo, DOHC | TD17845 |
| BNG | 2967cc | V6 Cyl. | 24 Valves | 155kW/211PS | Diesel | Turbo, DOHC | TD17337 |
| BUN | 2967cc | V6 Cyl. | 24 Valves | 155kW/211PS | Diesel | Turbo, DOHC | TD19881 |
| CAPA | 2967cc | V6 Cyl. | 24 Valves | 176kW/240PS | Diesel | Turbo, DOHC | TD20007 |
| CASA | 2967cc | V6 Cyl. | 24 Valves | 176kW/240PS | Diesel | Turbo, DOHC | TD20709 |
| CASB | 2967cc | V6 Cyl. | 24 Valves | 155kW/211PS | Diesel | Turbo, DOHC | TD21315 |
| CATA | 2967cc | V6 Cyl. | 24 Valves | 165kW/224PS | Diesel | Turbo, DOHC | TD22660 |
| CCLA | 2967cc | V6 Cyl. | 24 Valves | 176kW/240PS | Diesel | Turbo, DOHC | TD23861 |
| CCMA | 2967cc | V6 Cyl. | 24 Valves | 176kW/240PS | Diesel | Turbo, DOHC | TD21316 |
| CCWA | 2967cc | V6 Cyl. | 24 Valves | 176kW/240PS | Diesel | Turbo, DOHC | TD20600 |
| CCWB | 2967cc | V6 Cyl. | 24 Valves | 155kW/211PS | Diesel | Turbo, DOHC | TD21029 |
| CDYA | 2967cc | V6 Cyl. | 24 Valves | 176kW/240PS | Diesel | Turbo, DOHC | TD21177 |
| CDYB | 2967cc | V6 Cyl. | 24 Valves | 155kW/211PS | Diesel | Turbo, DOHC | TD22955 |
| CDYC | 2967cc | V6 Cyl. | 24 Valves | 176kW/240PS | Diesel | Turbo, DOHC | TD22973 |

| | | | |
|------------|-----------------|------------|-----------------|
| A4 3.0 TDI | 11/2004→ | A5 3.0 TDI | 06/2007→03/2012 |
| A6 3.0 TDI | 05/2004→08/2011 | A6 3.0 TDi | 06/2006→08/2011 |
| A8 3.0 TDI | 08/2003→07/2010 | Q5 3.0 TDI | 11/2008→ |
| Q7 3.0 TDI | 03/2006→08/2015 | | |

V98010 ■
28.80 x 6.00 x 99.50

059 109 601G

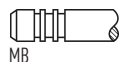

45°

V98011 ■
26.80 x 6.00 x 99.50

059 109 611M

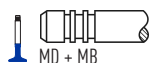

45°

SS



OE

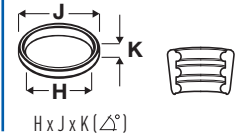
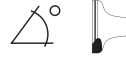

90  83.00

| | | | | | | | |
|------------|--------|-----------------|-----------|-------------|--------|-----------------|---------|
| CDTA | 2967cc | V6 Cyl. | 24 Valves | 184kW/250PS | Diesel | Turbo, DOHC | TD23973 |
| CDTB | 2967cc | V6 Cyl. | 24 Valves | 155kW/211PS | Diesel | Turbo, DOHC | TD25770 |
| CDUC | 2967cc | V6 Cyl. | 24 Valves | 180kW/245PS | Diesel | Turbo, DOHC | TD24761 |
| CDUD | 2967cc | V6 Cyl. | 24 Valves | 180kW/245PS | Diesel | Turbo, DOHC | TD25669 |
| CGQB | 2967cc | V6 Cyl. | 24 Valves | 230kW/313PS | Diesel | Turbo, DOHC | TD24944 |
| CJGA | 2967cc | V6 Cyl. | 24 Valves | 176kW/240PS | Diesel | Turbo, DOHC | TD24959 |
| CJGC | 2967cc | V6 Cyl. | 24 Valves | 150kW/204PS | Diesel | Turbo, DOHC | TD24396 |
| CJGD | 2967cc | V6 Cyl. | 24 Valves | 180kW/245PS | Diesel | Turbo, DOHC | TD25215 |
| CJMA | 2967cc | V6 Cyl. | 24 Valves | 150kW/204PS | Diesel | Turbo, DOHC | TD24397 |
| CKVB | 2967cc | V6 Cyl. | 24 Valves | 180kW/245PS | Diesel | Turbo, DOHC | TD24762 |
| CKVC | 2967cc | V6 Cyl. | 24 Valves | 180kW/245PS | Diesel | Turbo, DOHC | TD25668 |
| CLAA | 2967cc | V6 Cyl. | 24 Valves | 150kW/204PS | Diesel | Turbo, DOHC | TD24873 |
| CLAB | 2967cc | V6 Cyl. | 24 Valves | 150kW/204PS | Diesel | Turbo, DOHC | TD24760 |
| CLZB | 2967cc | V6 Cyl. | 24 Valves | 180kW/245PS | Diesel | Turbo, DOHC | TD25402 |
| CMHA | 2967cc | V6 Cyl. | 24 Valves | 184kW/250PS | Diesel | Turbo, DOHC | TD25723 |
| CNRB | 2967cc | V6 Cyl. | 24 Valves | 176kW/240PS | Diesel | Turbo, DOHC | TD26228 |
| CPNA | 2967cc | V6 Cyl. | 24 Valves | 176kW/239PS | Diesel | Turbo, DOHC | TD27956 |
| CPNB | 2967cc | V6 Cyl. | 24 Valves | 176kW/239PS | Diesel | Turbo, DOHC | TD27526 |
| CRCA | 2967cc | V6 Cyl. | 24 Valves | 180kW/245PS | Diesel | Turbo, DOHC | TD25216 |
| CTBA | 2967cc | V6 Cyl. | 24 Valves | 190kW/258PS | Diesel | Turbo, DOHC | TD28254 |
| A4 3.0 TDI | | 11/2011→05/2016 | | A5 3.0 TDI | | 10/2011→01/2017 | |
| A6 3.0 TDI | | 11/2010→ | | A7 3.0 TDI | | 10/2010→ | |
| A8 3.0 TDI | | 07/2010→ | | Q5 3.0 TDI | | 11/2008→ | |
| Q5 SQ5 TDI | | 12/2012→ | | Q7 3.0 TDI | | 11/2007→08/2015 | |

V98010  059 109 601G
28.80 x 6.00 x 99.50

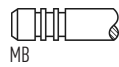

45°

VAG96237B  42.00 x 6.02 x 10.07



V95114  03L 109 611
26.00 x 5.97 x 99.10



45°

SS

H

91  83.00

| | | | | | | | |
|------------|--------|----------|-----------|-------------|--------|-----------------|---------|
| BTR | 4134cc | V8 Cyl. | 32 Valves | 240kW/326PS | Diesel | Turbo, DOHC | TD19883 |
| CCFA | 4134cc | V8 Cyl. | 32 Valves | 250kW/340PS | Diesel | Turbo, DOHC | TD23106 |
| CCFC | 4134cc | V8 Cyl. | 32 Valves | 250kW/340PS | Diesel | Turbo, DOHC | TD24958 |
| CDSB | 4134cc | V8 Cyl. | 32 Valves | 258kW/351PS | Diesel | Turbo, DOHC | TD23974 |
| CTEC | 4134cc | V8 Cyl. | 32 Valves | 283kW/385PS | Diesel | Turbo, DOHC | TD28253 |
| A8 4.2 TDI | | 11/2009→ | | Q7 4.2 TDI | | 03/2007→08/2015 | |

V98010  059 109 601G
28.80 x 6.00 x 99.50

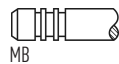

45°

V98011  059 109 611M
26.80 x 6.00 x 99.50

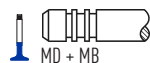

45°

SS



OE

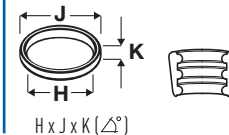
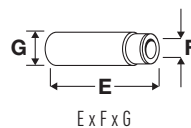

92 **83.00**

| | | | | | | | |
|----------------------|--------------|-----------------|------------------|-------------|--------|--------------------|----------------|
| CCGA | 5934cc | V12 Cyl. | 48 Valves | 368kW/500PS | Diesel | Turbo, DOHC | TD21318 |
| Q7 6.0 TDI | | 09/2008→05/2014 | | | | | |
| V98010 | 059 109 601G | | 45° | | | | |
| 28.80 x 6.00 x 99.50 | | MB | | | | | |
| V98011 | 059 109 611M | | 45° | SS | | | |
| 26.80 x 6.00 x 99.50 | | MD + MB | | | | | |

93 **84.00**

| | | | | | | | |
|-----------------------|--------------|-----------------|------------------|---------------------|--------|----------------------|----------------|
| BDB | 3189cc | VR6 Cyl. | 24 Valves | 184kW/250PS | Petrol | DOHC | TD17068 |
| BHE | 3189cc | V6 Cyl. | 24 Valves | 184kW/250PS | Petrol | DOHC | TD17029 |
| BMJ | 3189cc | VR6 Cyl. | 24 Valves | 184kW/250PS | Petrol | DOHC | TD17407 |
| BUB | 3189cc | V6 Cyl. | 24 Valves | 184-186kW/250-253PS | Petrol | DOHC | TD19200 |
| A3 3.2 | | 09/2005→12/2009 | | A3 3.2 V6 | | 07/2003→05/2009 | |
| TT 3.2 V6 | | 08/2006→06/2010 | | TT 3.2 VR6 | | 07/2003→06/2006 | |
| V95085 | 022 109 601G | | 45° | Y | H | VAG96389B | |
| 33.20 x 5.98 x 102.40 | | MB | | | | 44.00 x 6.00 x 10.06 | |
| V95127 | 022 109 601H | | 45° | Y | H | VAG96390B | |
| 33.20 x 5.98 x 136.35 | | MB | | | | 65.00 x 6.00 x 10.06 | |
| V95086 | 022 109 611N | | 45° | SS | H | | |
| 30.20 x 5.97 x 102.20 | | MD + MB cr | | | | | |
| V95128 | 022 109 611M | | 45° | SS | H | | |
| 30.20 x 5.97 x 136.10 | | MD | | | | | |

94 **84.00**

| | | | | | | | |
|-----------------------|--------------|-----------------|------------------|-------------|--------|-------------|----------------|
| BPF | 3189cc | VR6 Cyl. | 24 Valves | 184kW/250PS | Petrol | DOHC | TD20705 |
| TT 3.2 VR6 | | 07/2003→06/2006 | | | | | |
| V95085 | 022 109 601G | | 45° | Y | H | | |
| 33.20 x 5.98 x 102.40 | | MB | | | | | |
| V95127 | 022 109 601H | | 45° | Y | H | | |
| 33.20 x 5.98 x 136.35 | | MB | | | | | |
| V95086 | 022 109 611N | | 45° | SS | H | | |
| 30.20 x 5.97 x 102.20 | | MD + MB cr | | | | | |
| V95128 | 022 109 611M | | 45° | SS | H | | |
| 30.20 x 5.97 x 136.10 | | MD | | | | | |

95 **84.50**

| | | | | | | | |
|-----------------------|--------------|-----------------|------------------|-------------|--------|------------------------|----------------|
| BDX | 2773cc | V6 Cyl. | 24 Valves | 154kW/210PS | Petrol | DOHC, Injection | TD20108 |
| CJBA | 2773cc | V6 Cyl. | 24 Valves | 170kW/231PS | Petrol | DOHC | TD25768 |
| A6 2.8 FSI | | 11/2006→10/2008 | | A8 2.8 FSI | | 08/2007→07/2010 | |
| V94691 | 06D 109 601K | | 45° | Y | H | VAG96073B | |
| 33.85 x 6.00 x 103.90 | | MB | | | | 36.00 x 6.02 x 11.06 | |
| V94692 | 06D 109 611L | | 45° | | H | | |
| 28.00 x 6.00 x 101.80 | | MD + MB cr | | | | | |
| V95152 | 06D 109 611L | | 45° | | H | | |
| 28.10 x 5.97 x 101.90 | | MD + MB cr | | | | | |



OE



MAT.

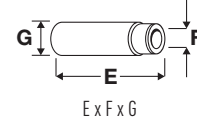
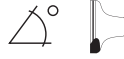

E x F x G

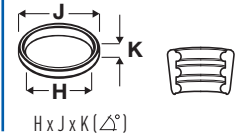

H x J x K (45°)

96 **84.50**

| | | | | | | | |
|------|--------|---------|-----------|-------------|--------|-----------------|---------|
| CCDA | 2773cc | V6 Cyl. | 24 Valves | 140kW/190PS | Petrol | DOHC, Injection | TD21174 |
| CCEA | 2773cc | V6 Cyl. | 24 Valves | 162kW/220PS | Petrol | DOHC, Injection | TD21175 |

A6 2.8 FSI 10/2008→08/2011

| | | | | | | | |
|--|--------------|-------------------|-----|----|---|--|--|
| V94691 33.85 x 6.00 x 103.90 | 06D 109 601K | MB | 45° | Y | H | VAG96073B 36.00 x 6.02 x 11.06 | |
| V80028 28.00 x 6.00 x 101.90 | 06D 109 611H | ME + MB cr Na | 45° | ss | | | |
| V94692 28.00 x 6.00 x 101.80 | 06D 109 611L | MD + MB cr | 45° | | H | | |

97 **84.50**

| | | | | | | | |
|-----|--------|---------|-----------|-------------|--------|-------------------------------|---------|
| CCA | 2976cc | V6 Cyl. | 24 Valves | 220kW/299PS | Petrol | Supercharged, DOHC, Injection | TD22664 |
|-----|--------|---------|-----------|-------------|--------|-------------------------------|---------|

A6 3.0 TFSI 10/2008→08/2011

| | | | | | | | |
|--|--------------|-------------------|-----|----|---|--|--|
| V94691 33.85 x 6.00 x 103.90 | 06D 109 601K | MB | 45° | Y | H | VAG96073B 36.00 x 6.02 x 11.06 | |
| V80028 28.00 x 6.00 x 101.90 | 06D 109 611H | ME + MB cr Na | 45° | ss | | | |

98 **84.50**

| | | | | | | | |
|------|--------|---------|-----------|-------------|--------|-------------------------------|---------|
| CAJA | 2995cc | V6 Cyl. | 24 Valves | 213kW/290PS | Petrol | Supercharged, DOHC, Injection | TD21178 |
| CAKA | 2995cc | V6 Cyl. | 24 Valves | 245kW/333PS | Petrol | Supercharged, DOHC, Injection | TD21117 |
| CCBA | 2995cc | V6 Cyl. | 24 Valves | 245kW/333PS | Petrol | Supercharged, DOHC, Injection | TD23862 |
| CGWC | 2995cc | V6 Cyl. | 24 Valves | 245kW/333PS | Petrol | Supercharged, DOHC, Injection | TD26472 |
| CGXC | 2995cc | V6 Cyl. | 24 Valves | 245kW/333PS | Petrol | Supercharged, DOHC, Injection | TD25721 |
| CMUA | 2995cc | V6 Cyl. | 24 Valves | 200kW/272PS | Petrol | Supercharged, DOHC, Injection | TD26327 |
| CTUB | 2995cc | V6 Cyl. | 24 Valves | 245kW/333PS | Petrol | Supercharged, DOHC, Injection | TD25722 |

A4 3.0 TFSI 02/2012→12/2015 A4 S4 11/2008→12/2015
 A5 3.0 TFSI 11/2011→01/2017 A5 S5 06/2009→01/2017
 A6 3.0 TFSI 10/2008→08/2011 A8 3.0 TFSI 06/2010→

| | | | | | | | |
|--|--------------|-------------------|-----|----|---|--|--|
| V94691 33.85 x 6.00 x 103.90 | 06D 109 601K | MB | 45° | Y | H | VAG96073B 36.00 x 6.02 x 11.06 | |
| V80028 28.00 x 6.00 x 101.90 | 06D 109 611H | ME + MB cr Na | 45° | ss | | | |

99 **84.50**

| | | | | | | | |
|-----|--------|---------|-----------|-------------|--------|-----------------|---------|
| AUK | 3123cc | V6 Cyl. | 24 Valves | 188kW/255PS | Petrol | DOHC, Injection | TD17376 |
| BKH | 3123cc | V6 Cyl. | 24 Valves | 188kW/255PS | Petrol | DOHC, Injection | TD19706 |

A4 3.2 FSI 01/2005→03/2009 A6 3.2 FSI 05/2004→05/2009

| | | | | | | | |
|--|--------------|-------------------|-----|----|---|--|--|
| V94691 33.85 x 6.00 x 103.90 | 06D 109 601K | MB | 45° | Y | H | VAG96073B 36.00 x 6.02 x 11.06 | |
| V80028 28.00 x 6.00 x 101.90 | 06D 109 611H | ME + MB cr Na | 45° | ss | | | |
| V94692 28.00 x 6.00 x 101.80 | 06D 109 611L | MD + MB cr | 45° | | H | | |



OE

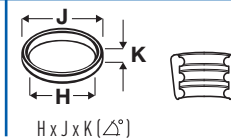
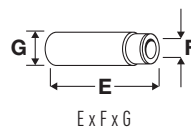
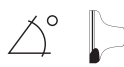

100 84.50

| | | | | | | | |
|------------|-----------------|---------|------------------|-------------|-----------------|------------------------|----------------|
| BPK | 3123cc | V6 Cyl. | 24 Valves | 191kW/260PS | Petrol | DOHC, Injection | TD18191 |
| BYU | 3123cc | V6 Cyl. | 24 Valves | 183kW/249PS | Petrol | DOHC, Injection | TD19711 |
| A6 3.2 FSI | 09/2006→10/2008 | | A8 3.2 FSI | | 06/2005→07/2010 | | |

| | | | | | | | |
|-----------------------|--------------|------------|-----|---|---|----------------------|--|
| V94691 | 06D 109 601K | | 45° | Y | H | VAG96073B | |
| 33.85 x 6.00 x 103.90 | | MB | | | | 36.00 x 6.02 x 11.06 | |
| V94692 | 06D 109 611L | | 45° | | H | | |
| 28.00 x 6.00 x 101.80 | | MD + MB cr | | | | | |
| V95152 | 06D 109 611L | | 45° | | H | | |
| 28.10 x 5.97 x 101.90 | | MD + MB cr | | | | | |

101 84.50

| | | | | | | | |
|-------------|----------|---------|------------------|-------------|----------|-------------------------------|----------------|
| CEUA | 3993cc | V8 Cyl. | 32 Valves | 309kW/420PS | Petrol | DOHC, Injection | TD25720 |
| CGTA | 3993cc | V8 Cyl. | 32 Valves | 382kW/520PS | Petrol | Turbo, DOHC, Injection | TD25685 |
| CRDB | 3993cc | V8 Cyl. | 32 Valves | 412kW/560PS | Petrol | Turbo, DOHC, Injection | TD27986 |
| CTGA | 3993cc | V8 Cyl. | 32 Valves | 320kW/435PS | Petrol | DOHC, Injection | TD28255 |
| A6 RS6 | 01/2013→ | | A7 RS7 | | 10/2013→ | | |
| A8 4.0 TFSI | 03/2012→ | | A8 S8 | | 04/2012→ | | |

| | | | | | | | |
|-----------------------|--------------|------------|-----|----|---|--|--|
| V95098 | 06D 109 601M | | 45° | | H | | |
| 33.80 x 5.98 x 103.95 | | MB | | | | | |
| V80028 | 06D 109 611H | | 45° | ss | | | |
| 28.00 x 6.00 x 101.90 | | ME + MB cr | | Na | | | |

102 84.50

| | | | | | | | |
|-------------|----------|---------|------------------|-------------|----------|-------------------------------|----------------|
| CEUC | 3993cc | V8 Cyl. | 32 Valves | 309kW/420PS | Petrol | DOHC, Injection | TD25634 |
| CTGE | 3993cc | V8 Cyl. | 32 Valves | 331kW/450PS | Petrol | Turbo, DOHC, Injection | TD29592 |
| A6 S6 | 02/2012→ | | A7 S7 | | 02/2012→ | | |

| | | | | | | | |
|-----------------------|--------------|------------|-----|----|---|----------------------|--|
| V94691 | 06D 109 601K | | 45° | Y | H | VAG96073B | |
| 33.85 x 6.00 x 103.90 | | MB | | | | 36.00 x 6.02 x 11.06 | |
| V80024 | 079 109 611D | | 45° | ss | | | |
| 28.00 x 6.00 x 101.90 | | ME + MB cr | | Na | | | |

103 84.50

| | | | | | | | |
|------------|--------|---------|------------------|---------------------|--------|------------------------|----------------|
| BAR | 4163cc | V8 Cyl. | 32 Valves | 231-257kW/314-350PS | Petrol | DOHC, Injection | TD18995 |
| BVJ | 4163cc | V8 Cyl. | 32 Valves | 250-257kW/340-350PS | Petrol | DOHC, Injection | TD18927 |
| BYH | 4163cc | V8 Cyl. | 32 Valves | 309kW/420PS | Petrol | DOHC, Injection | TD19876 |





| | | | | | | | |
|-----------------------|-----------------|------------|------------|----|-----------------|----------------------|--|
| A6 4.2 FSI | 05/2006→08/2011 | | A8 4.2 | | 09/2006→07/2010 | | |
| A8 4.2 FSI | 06/2006→07/2010 | | Q7 4.2 | | 03/2006→12/2010 | | |
| Q7 4.2 FSI | 03/2006→05/2010 | | R8 4.2 FSI | | 04/2007→09/2010 | | |
| V94691 | 06D 109 601K | | 45° | Y | H | VAG96073B | |
| 33.85 x 6.00 x 103.90 | | MB | | | | 36.00 x 6.02 x 11.06 | |
| V80028 | 06D 109 611H | | 45° | ss | | | |
| 28.00 x 6.00 x 101.90 | | ME + MB cr | | Na | | | |

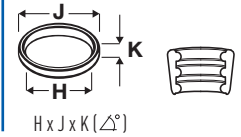
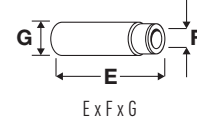



OE





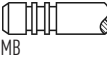

104  **84.50**

| ABH | 4172cc | V8 Cyl. | 32 Valves | 206kW/280PS | Petrol | DOHC | TD4195 |
|---|--------------|---|-----------|-------------|--|-----------------|--------|
| 100 S4 V8 | | 10/1992→07/1994 | | V8 4.2 | | 10/1991→02/1994 | |
| V91416  | 027 109 601C |  | 45° | H | VAG96157B  | | |
| | | MB | | | 38.00 x 7.00 x 12.00 | | |
| V91372  | 027 109 611D |  | 45° | H | | | |
| | | MD + MB cr | | | | | |





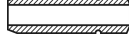

105  **84.50**

| ABZ | 4172cc | V8 Cyl. | 32 Valves | 220-224kW/299-305PS | Petrol | DOHC | TD4196 |
|---|--------------|--|-----------|---------------------|--------|-----------------|---------|
| AEC | 4172cc | V8 Cyl. | 32 Valves | 213kW/290PS | Petrol | DOHC | TD244 |
| AKG | 4172cc | V8 Cyl. | 32 Valves | 220kW/299PS | Petrol | DOHC | TD17152 |
| A6 S6 4.2 | | 06/1994→12/1997 | | A8 4.2 | | 03/1994→12/1999 | |
| V94110  | 051 109 601B |  | 45° | Y H | | | |
| | | MB | | | | | |
| V94111  | 051 109 611B |  | 45° | H | | | |
| | | MD + MB | | | | | |

106  **84.50**

| BUJ | 5204cc | V10 Cyl. | 40 Valves | 386kW/525PS | Petrol | DOHC, Injection | TD23311 |
|---|--------------|---|-----------|-------------|--|-----------------|---------|
| BXA | 5204cc | V10 Cyl. | 40 Valves | 320kW/435PS | Petrol | DOHC, Injection | TD18928 |
| A6 S6 | | 03/2006→08/2011 | | R8 5.2 FSI | | 04/2009→07/2015 | |
| V94691  | 06D 109 601K |  | 45° | Y H | VAG96073B  | | |
| | | MB | | | 36.00 x 6.02 x 11.06 | | |
| V80028  | 06D 109 611H |  | 45° | SS | | | |
| | | ME + MB cr Na | | | | | |

107  **85.50**

| CALA | 3197cc | V6 Cyl. | 24 Valves | 190-195kW/258-265PS | Petrol | DOHC, Injection | TD20005 |
|---|--------------|---|-----------|---------------------|--|-----------------|---------|
| CALB | 3197cc | V6 Cyl. | 24 Valves | 199kW/270PS | Petrol | DOHC, Injection | TD21357 |
| A4 3.2 FSI | | 11/2007→03/2012 | | A5 3.2 | | 09/2007→12/2010 | |
| A5 3.2 FSI | | 06/2007→03/2012 | | A6 3.2 FSI | | 05/2009→03/2011 | |
| Q5 3.2 FSI | | 11/2008→ | | | | | |
| V94691  | 06D 109 601K |  | 45° | Y H | VAG96073B  | | |
| | | MB | | | 36.00 x 6.02 x 11.06 | | |
| V94692  | 06D 109 611L |  | 45° | H | | | |
| | | MD + MB cr | | | | | |
| V95152  | 06D 109 611L |  | 45° | H | | | |
| | | MD + MB cr | | | | | |

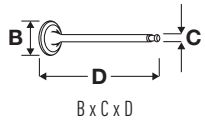



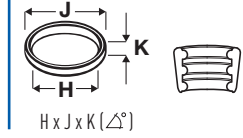
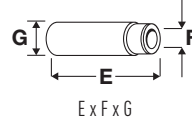
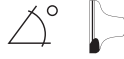



OE



108 **89.00**

| BHK | 3597cc | V6 Cyl. | 24 Valves | 206kW/280PS | Petrol | DOHC, Injection | TD19880 |
|---------------|--------------|-----------------|-----------|------------------|----------------------|-----------------|---------|
| Q7 3.6 FSI | | 08/2006→05/2010 | | | | | |
| V95085 | 022 109 601G | MB | 45° Y H | VAG96389B | 44.00 x 6.00 x 10.06 | | |
| V95127 | 022 109 601H | MB | 45° Y H | VAG96390B | 65.00 x 6.00 x 10.06 | | |
| V95086 | 022 109 611N | MD + MB cr | 45° SS H | | | | |
| V95128 | 022 109 611M | MD | 45° SS H | | | | |

|  |  | ccm |  |  |  |  |
|---|---|------|---|---|---|---|
| A Series | 62.92 | 848 | 4 | 8 | Petrol | 1 |
| A Series (12 H) | 70.62 | 1275 | 4 | 8 | Petrol | 3 |
| A/A+ Series (99H) | 64.56 | 998 | 4 | 8 | Petrol | 2 |
| A+ Series (99H) | 64.56 | 998 | 4 | 8 | Petrol | 2 |
| A+ Series (99H) | 64.56 | 998 | 4 | 8 | Petrol | 2 |
| A+ Series (99H) | 64.56 | 998 | 4 | 8 | Petrol | 2 |
| B Series (18 H) | 80.25 | 1798 | 4 | 8 | Petrol | 4 |

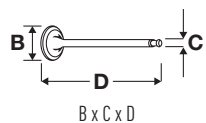

OE

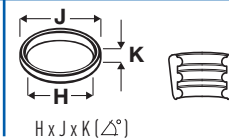
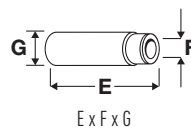

1 62.92

| | | | | | | | |
|-----------------|-------|--------|-----------------|-----------------|--------|--|----------------|
| A Series | 848cc | 4 Cyl. | 8 Valves | 25-26kW/34-35PS | Petrol | | TD13428 |
|-----------------|-------|--------|-----------------|-----------------|--------|--|----------------|

MINI 850 01/1967→08/1979

V34858 ■ 12A1986
27.86 x 7.10 x 87.45
01/69→12/80, Eng.85H-121689;121700 & 122413→

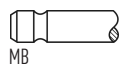

45°

H

VAG50911 ■ ■
43.00 x 7.16 x 11.96



V34859 ■ 12A1987
25.53 x 7.09 x 86.92
01/69→12/80, Eng.85H-121689;121700 & 122413→

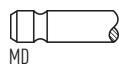

45°

2 64.56

| | | | | | | | |
|--------------------------|-------|--------|-----------------|-----------------|--------|------------|---------------|
| A/A+ Series (99H) | 998cc | 4 Cyl. | 8 Valves | 28-41kW/38-56PS | Petrol | OHV | TD4215 |
| A+ Series (99H) | 998cc | 4 Cyl. | 8 Valves | 31kW/42PS | Petrol | OHV | TD5473 |
| A+ Series (99H) | 998cc | 4 Cyl. | 8 Valves | 31kW/42PS | Petrol | OHV | TD5474 |
| A+ Series (99H) | 998cc | 4 Cyl. | 8 Valves | 31kW/42PS | Petrol | OHV | TD5472 |

ALLEGRO 1.0 01/1980→10/1983 METRO 1.0 10/1980→04/1990
MINI 1000 10/1967→09/1984 MINI 1000 Mayfair 08/1982→06/1993
MINI Cooper 01/1961→12/1967

V91142 ■ TAM1770
25.43 x 7.08 x 86.85

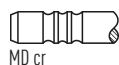

45°

VAG50911 ■ ■
43.00 x 7.16 x 11.96



3 70.62

| | | | | | | | |
|------------------------|--------|--------|-----------------|-----------------|--------|------------|--------------|
| A Series (12 H) | 1275cc | 4 Cyl. | 8 Valves | 39-49kW/53-67PS | Petrol | OHV | TD381 |
|------------------------|--------|--------|-----------------|-----------------|--------|------------|--------------|

1000-Series MK II 1300 03/1967→04/1969 ALLEGRO 1.3 02/1973→12/1984
AMERICA 1.3 09/1967→12/1972 MAESTRO 1.3 03/1983→09/1992
MAESTRO 1.3 LS 03/1983→08/1990 METRO 1.3 L,HLE,S 10/1980→04/1990
MINI 1.3 04/1974→09/1980 MINI 1275 GT 10/1969→08/1980

V34274 ■ 12G941
33.40 x 7.10 x 90.93
01/80→12/82



45°

H

VAG50969 ■ ■
42.70 x 7.16 x 11.97



V90193 ■ CAM6669
35.76 x 7.10 x 90.68
01/83→12/90

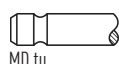

45°

V90194 ■ AHU1049
29.44 x 7.08 x 90.81
01/80→12/82

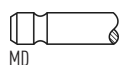

45°

V90357 ■ TAM1061
29.40 x 7.10 x 90.68
01/83→12/90

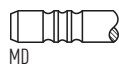

45°

4 80.25

| | | | | | | | |
|------------------------|--------|--------|-----------------|-----------|--------|------------|---------------|
| B Series (18 H) | 1798cc | 4 Cyl. | 8 Valves | 60kW/82PS | Petrol | OHV | TD5478 |
|------------------------|--------|--------|-----------------|-----------|--------|------------|---------------|

PRINCESS 1800 HL 04/1976→09/1978

V34401 ■ 12H2520
41.40 x 8.72 x 110.80

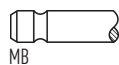

45°

H

VAG50963 ■
47.80 x 8.76 x 14.35





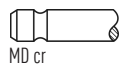



V34352 ■ CAM1717
34.23 x 8.69 x 110.26

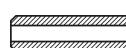

45°

VAG50909 ■
56.40 x 8.76 x 14.37



|  |  | ccm |  |  |  |  |
|---|---|------|---|---|---|---|
| 146 A5.046 | 76.00 | 1297 | 4 | 8 | Petrol | 7 |
| 156 A.000 | 76.00 | 1049 | 4 | 8 | Petrol | 6 |
| 156 A2.000 | 70.00 | 999 | 4 | 8 | Petrol | 3 |
| 156 A2.100 | 70.00 | 999 | 4 | 8 | Petrol | 4 |
| 156 A2.246 | 70.00 | 999 | 4 | 8 | Petrol | 4 |
| 156 A3.000 | 70.00 | 999 | 4 | 8 | Petrol | 3 |
| 156 B.000;131 A.000 | 76.10 | 1301 | 4 | 8 | Petrol | 8 |
| 156 C.000 | 70.00 | 1108 | 4 | 8 | Petrol | 5 |
| 156 C.046 | 70.00 | 1108 | 4 | 8 | Petrol | 5 |
| A112 A5.000 | 65.00 | 903 | 4 | 8 | Petrol | 1 |
| A112 B1.054 | 67.20 | 965 | 4 | 8 | Petrol | 2 |
| A112 B2.000 | 65.00 | 903 | 4 | 8 | Petrol | 1 |

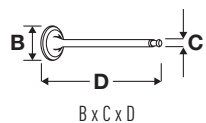

OE

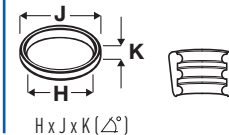
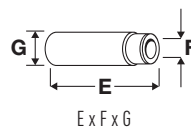

1 65.00

| | | | | | | |
|------------------|-----------------|-------------|----------|-----------------|--------|---------|
| A112 A5.000 | 903cc | 4 Cyl. | 8 Valves | 31-34kW/42-46PS | Petrol | TD5111 |
| A112 B2.000 | 903cc | 4 Cyl. | 8 Valves | 31kW/42PS | Petrol | TD13430 |
| A 112 0.9 | 10/1969→12/1978 | A 112 0.9 E | | 01/1973→12/1977 | | |
| A 112 0.9 Junior | 07/1975→12/1985 | | | | | |

| | | | | | | |
|----------------------|-----------|----|-----|---|----------------------|--|
| V34457 | 4 265 695 | | 45° | H | VAG92364 | |
| 29.10 x 7.02 x 95.65 | | MB | | | 42.50 x 7.00 x 13.07 | |
| V91282 | 4 377 979 | | 45° | | | |
| 26.00 x 7.00 x 95.50 | | MD | | | | |

2 67.20

| | | | | | | | |
|-------------|-------|--------|----------|-----------------|--------|------|-------|
| A112 B1.054 | 965cc | 4 Cyl. | 8 Valves | 30-36kW/40-48PS | Petrol | SOHC | TD404 |
|-------------|-------|--------|----------|-----------------|--------|------|-------|

| | | | | | | |
|----------------------|-----------|----|-----|---|----------------------|--|
| V34457 | 4 265 695 | | 45° | H | VAG92364 | |
| 29.10 x 7.02 x 95.65 | | MB | | | 42.50 x 7.00 x 13.07 | |

3 70.00

| | | | | | | | |
|------------|-------|--------|----------|-----------------|--------|------|-------|
| 156 A2.000 | 999cc | 4 Cyl. | 8 Valves | 33kW/45PS | Petrol | SOHC | TD393 |
| 156 A3.000 | 999cc | 4 Cyl. | 8 Valves | 32-37kW/44-50PS | Petrol | SOHC | TD397 |

Y10 1.0 03/1985→10/1995

| | | | | | | |
|----------------------|-----------|----|-----|---|----------------------|--|
| V91288 | 5 942 727 | | 45° | H | VAG50895 | |
| 30.50 x 7.00 x 97.00 | | MB | | | 46.00 x 7.04 x 13.03 | |
| V91929 | 7 770 334 | | 45° | H | VAG92364 | |
| 31.50 x 7.00 x 97.00 | | MB | | | 42.50 x 7.00 x 13.07 | |
| V91289 | 5 942 728 | | 45° | | | |
| 27.50 x 7.00 x 97.50 | | MD | | | | |

4 70.00

| | | | | | | | |
|------------|-------|--------|----------|-----------------|--------|------|---------|
| 156 A2.100 | 999cc | 4 Cyl. | 8 Valves | 31-33kW/42-45PS | Petrol | SOHC | TD394 |
| 156 A2.246 | 999cc | 4 Cyl. | 8 Valves | 33kW/45PS | Petrol | SOHC | TD16210 |

Y10 1.0 Cat 10/1987→10/1995

| | | | | | | |
|----------------------|-----------|----|-----|---|----------------------|--|
| V91288 | 5 942 727 | | 45° | H | VAG50895 | |
| 30.50 x 7.00 x 97.00 | | MB | | | 46.00 x 7.04 x 13.03 | |
| V91289 | 5 942 728 | | 45° | | VAG92364 | |
| 27.50 x 7.00 x 97.50 | | MD | | | 42.50 x 7.00 x 13.07 | |

5 70.00

| | | | | | | | |
|-----------|--------|--------|----------|-----------|--------|------|-------|
| 156 C.000 | 1108cc | 4 Cyl. | 8 Valves | 42kW/57PS | Petrol | SOHC | TD398 |
| 156 C.046 | 1108cc | 4 Cyl. | 8 Valves | 42kW/57PS | Petrol | SOHC | TD399 |

Y10 1.1 06/1989→10/1995 Y10 1.1 i.e. Cat 09/1990→10/1995

| | | | | | | |
|----------------------|-----------|----|-----|---|----------------------|--|
| V91288 | 5 942 727 | | 45° | H | VAG50895 | |
| 30.50 x 7.00 x 97.00 | | MB | | | 46.00 x 7.04 x 13.03 | |
| V91289 | 5 942 728 | | 45° | | VAG92364 | |
| 27.50 x 7.00 x 97.50 | | MD | | | 42.50 x 7.00 x 13.07 | |

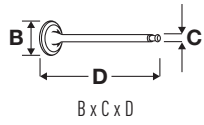



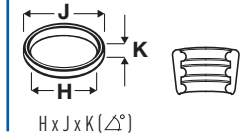
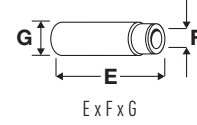



OE







6  **76.00**

| | | | | | | | |
|------------------|-----------------|--------|-----------------|-----------------|--------|-------------|--------------|
| 156 A.000 | 1049cc | 4 Cyl. | 8 Valves | 38-41kW/52-56PS | Petrol | SOHC | TD391 |
| Y10 1.0 | 03/1985→10/1995 | | | | | | |

| | | | | | | | |
|---|-----------|---|-----|---|---|---|--|
| V90398  | 4 412 816 |  MB | 45° | H | VAG96175  |  | |
| 36.60 x 7.98 x 110.50 | | | | | 46.50 x 8.04 x 15.11 | | |
| V90399  | 4 340 119 |  MD | 45° | | | | |
| 29.10 x 7.99 x 110.50 | | | | | | | |

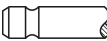

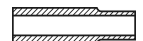

7  **76.00**





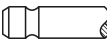

| | | | | | | | |
|-------------------|-----------------|--------|-----------------|-----------|--------|-------------|--------------|
| 146 A5.046 | 1297cc | 4 Cyl. | 8 Valves | 54kW/73PS | Petrol | SOHC | TD390 |
| Y10 1.3 i.e. GT | 06/1989→10/1995 | | | | | | |

| | | | | | | | |
|---|-----------|---|-----|---|---|---|--|
| V90398  | 4 412 816 |  MB | 45° | H | VAG96175  |  | |
| 36.60 x 7.98 x 110.50 | | | | | 46.50 x 8.04 x 15.11 | | |
| V90399  | 4 340 119 |  MD | 45° | | | | |
| 29.10 x 7.99 x 110.50 | | | | | | | |

8  **76.10**

| | | | | | | | |
|----------------------------|-----------------|--------|-----------------|-----------|--------|-------------|----------------|
| 156 B.000;131 A.000 | 1301cc | 4 Cyl. | 8 Valves | 57kW/78PS | Petrol | SOHC | TD16212 |
| Y10 1.3 i.e. GT | 06/1989→10/1995 | | | | | | |

| | | | | | | | |
|---|-----------|---|-----|---|---|---|--|
| V90398  | 4 412 816 |  MB | 45° | H | VAG96175  |  | |
| 36.60 x 7.98 x 110.50 | | | | | 46.50 x 8.04 x 15.11 | | |
| V90399  | 4 340 119 |  MD | 45° | | | | |
| 29.10 x 7.99 x 110.50 | | | | | | | |

|  |  | ccm |  |  |  |  |
|---|---|------|--|---|---|---|
| 13 N | 75.00 | 1297 | 4 | 8 | Petrol | 2 |
| 13 NB | 75.00 | 1297 | 4 | 8 | Petrol | 2 |
| 13 S | 75.00 | 1297 | 4 | 8 | Petrol | 2 |
| 14 NV | 77.60 | 1389 | 4 | 8 | Petrol | 3 |
| 16 D | 80.00 | 1598 | 4 | 8 | Diesel | 5 |
| 16 DA | 80.00 | 1598 | 4 | 8 | Diesel | 5 |
| 16 SV | 79.00 | 1598 | 4 | 8 | Petrol | 4 |
| 17 D | 82.50 | 1699 | 4 | 8 | Diesel | 6 |
| 220 | 103.19 | 3614 | 4 | 8 | Diesel | 8 |
| 330 | 103.19 | 5420 | 6 | 12 | Diesel | 9 |
| C223 | 88.00 | 2238 | 4 | 8 | Diesel | 7 |
| FA10A | 65.50 | 970 | 4 | 8 | Petrol | 1 |



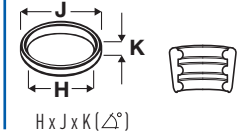

OE





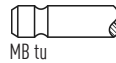



1

 65.50

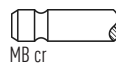
| | | | | | | | |
|---|-------------|---|-----------------|-----------|--------|-------------|---------------|
| FA10A | 970cc | 4 Cyl. | 8 Valves | 34kW/46PS | Petrol | SOHC | TD9933 |
| RASCAL 1.0 | | 06/1986→06/1990 | | | | | |
| V91253  | 12911-78101 |  | 45° | H | | | |
| 31.70 x 6.98 x 110.00 | | MB tu | | | | | |
| V91254  | 12915-84000 |  | 45° | | | | |
| 27.65 x 6.97 x 109.85 | | MD | | | | | |

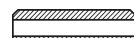

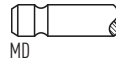

2

 75.00

| | | | | | | | |
|---|----------|--|-----------------|-----------------|---|---|----------------|
| 13 N | 1297cc | 4 Cyl. | 8 Valves | 34kW/46PS | Petrol | SOHC | TD29217 |
| 13 NB | 1297cc | 4 Cyl. | 8 Valves | 44kW/60PS | Petrol | SOHC | TD26852 |
| 13 S | 1297cc | 4 Cyl. | 8 Valves | 42-55kW/57-75PS | Petrol | SOHC | TD410 |
| ASTRAMAX 1.3 | | 09/1985→06/1990 | | ASTRA VAN 1.3 | | 09/1984→09/1989 | |
| V90107  | 90106098 |  | 45° | H | VAG96022  |  | |
| 33.02 x 7.01 x 104.90 | | MB cr | | | 45.80 x 7.02 x 11.04 | | |
| V90108  | 90106086 |  | 45° | | VAG96026  |  | |
| 29.00 x 6.99 x 104.60 | | MD | | | 43.00 x 7.02 x 11.04 | | |

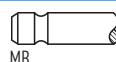

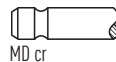

3

 77.60

| | | | | | | | |
|---|----------|---|-----------------|-----------------|---|---|--------------|
| 14 NV | 1389cc | 4 Cyl. | 8 Valves | 44-55kW/60-75PS | Petrol | SOHC, Carburettor | TD411 |
| ASTRAMAX 1.4 | | 09/1989→06/1990 | | ASTRA VAN 1.4 | | 09/1989→08/1991 | |
| V91211  | 90323519 |  | 45° | H | VAG96022  |  | |
| 33.10 x 7.00 x 104.50 | | MB | | | 45.80 x 7.02 x 11.04 | | |
| V91212  | 90323524 |  | 45° | | | | |
| 29.10 x 6.99 x 104.60 | | MD cr | | | | | |

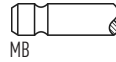
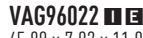



4

 79.00

| | | | | | | | |
|---|----------|---|-----------------|-----------------|---|---|--------------|
| 16 SV | 1598cc | 4 Cyl. | 8 Valves | 60-66kW/82-90PS | Petrol | SOHC, Carburettor | TD413 |
| ASTRA VAN 1.6 | | 09/1984→08/1991 | | | | | |
| V91137  | 90295011 |  | 45° | H | VAG96022  |  | |
| 37.92 x 7.00 x 101.00 | | MB | | | 45.80 x 7.02 x 11.04 | | |
| V91138  | 90295015 |  | 45° | | | | |
| 30.87 x 6.98 x 101.08 | | MD | | | | | |

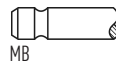
5

 80.00

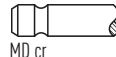
| | | | | | | | |
|---|----------|---|-----------------|-----------------|---|---|----------------|
| 16 D | 1598cc | 4 Cyl. | 8 Valves | 39-40kW/53-54PS | Diesel | SOHC | TD412 |
| 16 DA | 1598cc | 4 Cyl. | 8 Valves | 40-42kW/54-57PS | Diesel | SOHC | TD26851 |
| ASTRAMAX 1.6 D | | 09/1985→08/1988 | | ASTRA VAN 1.6 D | | 07/1982→08/1989 | |
| V90230  | 90009534 |  | 45° | H | VAG96021  |  | |
| 36.10 x 7.98 x 123.40 | | MB | | | 50.00 x 8.00 x 12.02 | | |
| V90231  | 90499097 |  | 45° | | | | |
| 32.10 x 7.97 x 123.40 | | MD cr | | | | | |

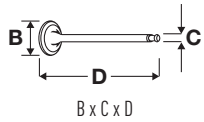

OE

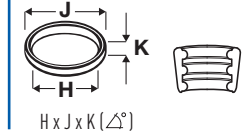
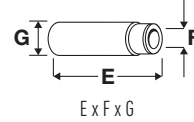
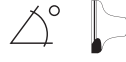

6 82.50

| 17 D | 1699cc | 4 Cyl. | 8 Valves | 42kW/57PS | Diesel | SOHC | TD26850 |
|-----------------------|-----------------|--------|-----------------|-----------|----------------------|------|---------|
| ASTRMAX 1.7 D | 09/1988→06/1990 | | ASTRA VAN 1.7 D | | 09/1988→08/1991 | | |
| V90230 ■ | 90009534 | | 45° | H | VAG96021 ■ ■ | | |
| 36.10 x 7.98 x 123.40 | | MB | | | 50.00 x 8.00 x 12.02 | | |
| V90231 ■ | 90499097 | | 45° | | | | |
| 32.10 x 7.97 x 123.40 | | MD cr | | | | | |

7 88.00







| C223 | 2238cc | 4 Cyl. | 8 Valves | 39-54kW/53-73PS | Diesel | OHV | TD34465 |
|-----------------------|-----------------|--------|----------|-----------------|----------------------|-----|---------|
| BRAVA 2.2 D | 12/1988→02/1990 | | | | | | |
| V91498 ■ | 5-12552-034-2 | | 45° | st | VAG92372 ■ ■ | | |
| 34.10 x 7.94 x 115.80 | | MD tu | | | 50.00 x 8.00 x 14.03 | | |







8 103.19







| 220 | 3614cc | 4 Cyl. | 8 Valves | 48-52kW/65-71PS | Diesel | | TD6483 |
|---------------------------------------|------------|--------|----------|-----------------|----------------------|--|--------|
| V33981 ■ | 910 07 950 | | 30° | H | VAG474 ■ ■ | | |
| 42.90 x 8.68 x 141.60 Eng.→6504747 | | MB | | | 72.00 x 8.74 x 15.93 | | |
| V33987 ■ | 088 54 549 | | 45° | | VAG50828 ■ ■ | | |
| 37.45 x 8.65 x 141.10 | | MD | | | 62.50 x 8.72 x 15.92 | | |

9 103.19

| 330 | 5420cc | 6 Cyl. | 12 Valves | 72-99kW/98-135PS | Diesel | Turbo | TD6485 |
|--|------------|--------|-----------|------------------|-------------------------------------|-------|--------|
| V33981 ■ | 910 07 950 | | 30° | H | VAG474 ■ ■ | | |
| 42.90 x 8.68 x 141.60 01/65→12/81, Eng.→6498406 | | MB | | | 72.00 x 8.74 x 15.93 | | |
| V33987 ■ | 088 54 549 | | 45° | | VAG50828 ■ ■ | | |
| 37.45 x 8.65 x 141.10 01/65→12/81, Eng.→6450235 | | MD | | | 62.50 x 8.72 x 15.92 01/65→12/83 | | |

|  |  | ccm |  |  |  |  |
|---|---|------|---|---|---|---|
| B37 C15 A | 84.00 | 1496 | 3 | 12 | Diesel | 14 |
| B37 D15 A | 84.00 | 1496 | 3 | 12 | Diesel | 14 |
| B47 C20 A | 84.00 | 1995 | 4 | 16 | Diesel | 24 |
| B47 D20 A | 84.00 | 1995 | 4 | 16 | Diesel | 24 |
| B57 D30 A | 84.00 | 2993 | 6 | 24 | Diesel | 41 |
| B57 D30 B | 84.00 | 2993 | 6 | 24 | Diesel | 41 |
| B57 D30 C | 84.00 | 2993 | 6 | 24 | Diesel | 41 |
| M10 B16 | 84.00 | 1573 | 4 | 8 | Petrol | 15 |
| M10 B16 (164VA) | 84.00 | 1573 | 4 | 8 | Petrol | 15 |
| M20 B20 | 80.00 | 1991 | 6 | 12 | Petrol | 4 |
| M20 B20 (206EA) | 80.00 | 1991 | 6 | 12 | Petrol | 4 |
| M20 B20 (206EB) | 80.00 | 1991 | 6 | 12 | Petrol | 4 |
| M20 B20 (206KA) | 80.00 | 1991 | 6 | 12 | Petrol | 4 |
| M20 B20 (206VA) | 80.00 | 1991 | 6 | 12 | Petrol | 4 |
| M20 B23 (236EA) | 80.00 | 2316 | 6 | 12 | Petrol | 8 |
| M20 B23 (236EC) | 80.00 | 2316 | 6 | 12 | Petrol | 8 |
| M20 B25 (256E1) | 84.00 | 2494 | 6 | 12 | Petrol | 30 |
| M20 B25 (256E2) | 84.00 | 2494 | 6 | 12 | Petrol | 30 |
| M20 B25 (256EX) | 84.00 | 2494 | 6 | 12 | Petrol | 30 |
| M20 B25 (256K1) | 84.00 | 2494 | 6 | 12 | Petrol | 30 |
| M20 B27 (276EA) | 84.00 | 2693 | 6 | 12 | Petrol | 34 |
| M20 B27 (276EB) | 84.00 | 2693 | 6 | 12 | Petrol | 34 |
| M20 B27 (276KA) | 84.00 | 2693 | 6 | 12 | Petrol | 34 |
| M20 B27 (276KB) | 84.00 | 2693 | 6 | 12 | Petrol | 34 |
| M30 B34 (346KA) | 92.00 | 3430 | 6 | 12 | Petrol | 62 |
| M30 B35 | 92.00 | 3430 | 6 | 12 | Petrol | 62 |
| M30 B35 | 92.00 | 3430 | 6 | 12 | Petrol | 62 |
| M40 B16 | 84.00 | 1596 | 4 | 8 | Petrol | 16 |
| M40 B16 (164E1) | 84.00 | 1596 | 4 | 8 | Petrol | 16 |
| M40 B18 (184E1) | 84.00 | 1796 | 4 | 8 | Petrol | 19 |
| M41 D17 (174T1) | 80.00 | 1665 | 4 | 8 | Diesel | 3 |
| M42 B18 | 84.00 | 1796 | 4 | 16 | Petrol | 20 |
| M42 B18 (184S1) | 84.00 | 1796 | 4 | 16 | Petrol | 20 |
| M43 B16 (164E2) | 84.00 | 1596 | 4 | 8 | Petrol | 17 |
| M43 B16 (164E3) | 84.00 | 1596 | 4 | 8 | Petrol | 17 |
| M43 B18 (184E2) | 84.00 | 1796 | 4 | 8 | Petrol | 21 |
| M43 B19 (194E1) | 85.00 | 1895 | 4 | 8 | Petrol | 53 |
| M44 B19 (194S1) | 85.00 | 1895 | 4 | 16 | Petrol | 54 |
| M47 204 D1 | 84.00 | 1951 | 4 | 16 | Diesel | 23 |
| M47 D20 | 84.00 | 1951 | 4 | 16 | Diesel | 23 |
| M47 D20 (204D4) | 84.00 | 1995 | 4 | 16 | Diesel | 25 |
| M47 D20 TU | 84.00 | 1951 | 4 | 16 | Diesel | 23 |
| M47N 204 D4 | 84.00 | 1995 | 4 | 16 | Diesel | 25 |
| M47N 204 D5 | 84.00 | 1995 | 4 | 16 | Diesel | 25 |
| M50 B (206S1) | 80.00 | 1991 | 6 | 24 | Petrol | 5 |
| M50 B (206S2) Vanos | 80.00 | 1991 | 6 | 24 | Petrol | 6 |
| M50 B20 | 80.00 | 1991 | 6 | 24 | Petrol | 5 |
| M50 B20 (206S1) | 80.00 | 1991 | 6 | 24 | Petrol | 5 |
| M50 B20 (206S2) | 80.00 | 1991 | 6 | 24 | Petrol | 5 |
| M50 B20 TU | 80.00 | 1991 | 6 | 24 | Petrol | 5 |
| M50 B25 (256S1) | 84.00 | 2494 | 6 | 24 | Petrol | 31 |
| M50 B25 (256S2) | 84.00 | 2494 | 6 | 24 | Petrol | 31 |
| M50 B25 (Vanos) | 84.00 | 2494 | 6 | 24 | Petrol | 31 |
| M50 B25 TU | 84.00 | 2494 | 6 | 24 | Petrol | 31 |
| M51 D25 | 80.00 | 2497 | 6 | 12 | Diesel | 9 |
| M51 D25 (256T1) | 80.00 | 2497 | 6 | 12 | Diesel | 10 |
| M52 B (206S3) Vanos | 80.00 | 1991 | 6 | 24 | Petrol | 5 |
| M52 B20 | 80.00 | 1991 | 6 | 24 | Petrol | 5 |
| M52 B20 (206S3) | 80.00 | 1991 | 6 | 24 | Petrol | 5 |
| M52 B20 (206S4) | 80.00 | 1991 | 6 | 24 | Petrol | 6 |
| M52 B25 (256S3) | 84.00 | 2494 | 6 | 24 | Petrol | 32 |
| M52 B25 (256S4) | 84.00 | 2494 | 6 | 24 | Petrol | 32 |
| M52 B25 (Vanos) | 84.00 | 2494 | 6 | 24 | Petrol | 31 |
| M52 B25 TU | 84.00 | 2494 | 6 | 24 | Petrol | 32 |
| M52 B28 | 84.00 | 2793 | 6 | 24 | Petrol | 35 |
| M52 B28 (286S1) | 84.00 | 2793 | 6 | 24 | Petrol | 35 |

|  |  | ccm |  |  |  |  |
|---|---|------|--|---|---|---|
| M52 B28 (286S2) | 84.00 | 2793 | 6 | 24 | Petrol | 35 |
| M52 B28 GG | 84.00 | 2793 | 6 | 24 | Petrol | 35 |
| M52 B28 TU | 84.00 | 2793 | 6 | 24 | Petrol | 35 |
| M54 226 S1 | 80.00 | 2171 | 6 | 24 | Petrol | 7 |
| M54 256 S5 | 84.00 | 2494 | 6 | 24 | Petrol | 32 |
| M54 306 S3 | 84.00 | 2979 | 6 | 24 | Petrol | 37 |
| M54 B22 (226S1) | 80.00 | 2171 | 6 | 24 | Petrol | 7 |
| M54 B25 (256S3) | 84.00 | 2494 | 6 | 24 | Petrol | 32 |
| M54 B25 (256S5) | 84.00 | 2494 | 6 | 24 | Petrol | 32 |
| M54 B30 (306S3) | 84.00 | 2979 | 6 | 24 | Petrol | 38 |
| M57 306 D3 | 84.00 | 2993 | 6 | 24 | Diesel | 42 |
| M57 D25 (256D1) | 80.00 | 2497 | 6 | 24 | Diesel | 11 |
| M57 D25 (256D2) | 80.00 | 2497 | 6 | 24 | Diesel | 11 |
| M57 D25 TU | 80.00 | 2497 | 6 | 24 | Diesel | 11 |
| M57 D30 (306D1) | 84.00 | 2926 | 6 | 24 | Diesel | 36 |
| M57 D30 (306D2) | 84.00 | 2993 | 6 | 24 | Diesel | 42 |
| M57 D30 (306D3) | 84.00 | 2993 | 6 | 24 | Diesel | 42 |
| M57 D30 (306D4) | 84.00 | 2993 | 6 | 24 | Diesel | 42 |
| M57 D30 (306D5) | 84.00 | 2993 | 6 | 24 | Diesel | 42 |
| M57 D30 TU2 | 84.00 | 2993 | 6 | 24 | Diesel | 43 |
| M57N 256 D4 | 84.00 | 2497 | 6 | 24 | Diesel | 33 |
| M57N 306 D2 | 84.00 | 2993 | 6 | 24 | Diesel | 42 |
| M57N 306 D4 | 84.00 | 2993 | 6 | 24 | Diesel | 42 |
| M57N 306 D5 | 84.00 | 2993 | 6 | 24 | Diesel | 42 |
| M57N2 306 D2 | 84.00 | 2993 | 6 | 24 | Diesel | 43 |
| M57N2 306 D3 | 84.00 | 2993 | 6 | 24 | Diesel | 43 |
| M60 B30 | 84.00 | 2997 | 8 | 32 | Petrol | 46 |
| M60 B30 (308S1) | 84.00 | 2997 | 8 | 32 | Petrol | 47 |
| M60 B40 (408S1) | 89.00 | 3982 | 8 | 32 | Petrol | 59 |
| M62 B35 (358S1) | 84.00 | 3498 | 8 | 32 | Petrol | 48 |
| M62 B35 (358S2) | 84.00 | 3498 | 8 | 32 | Petrol | 48 |
| M62 B35 TU | 84.00 | 3498 | 8 | 32 | Petrol | 48 |
| M62 B44 | 92.00 | 4398 | 8 | 32 | Petrol | 63 |
| M62 B44 (448S1) | 92.00 | 4398 | 8 | 32 | Petrol | 63 |
| M62 B44 (448S2) | 92.00 | 4398 | 8 | 32 | Petrol | 63 |
| M62 B44 TU | 92.00 | 4398 | 8 | 32 | Petrol | 63 |
| M62 B46 (468S1) | 93.00 | 4619 | 8 | 32 | Petrol | 65 |
| M67 D39 (398D1) | 84.00 | 3901 | 8 | 32 | Diesel | 50 |
| M70 B50 (5012A) | 84.00 | 4988 | 12 | 24 | Petrol | 51 |
| M70 B56 | 86.00 | 5576 | 12 | 24 | Petrol | 58 |
| M73 B54 | 85.00 | 5379 | 12 | 24 | Petrol | 56 |
| M73 B54 (54121) | 85.00 | 5379 | 12 | 24 | Petrol | 56 |
| M73 B54 (54122) | 85.00 | 5379 | 12 | 24 | Petrol | 56 |
| N13 B16 A | 77.00 | 1598 | 4 | 16 | Petrol | 1 |
| N20 B20 A | 84.00 | 1997 | 4 | 16 | Petrol | 29 |
| N20 B20 B | 84.00 | 1997 | 4 | 16 | Petrol | 29 |
| N40 B16 A | 84.00 | 1596 | 4 | 16 | Petrol | 18 |
| N42 B18 A | 84.00 | 1796 | 4 | 16 | Petrol | 22 |
| N42 B20 | 84.00 | 1995 | 4 | 16 | Petrol | 26 |
| N42 B20 A | 84.00 | 1995 | 4 | 16 | Petrol | 26 |
| N42 B20 B | 84.00 | 1995 | 4 | 16 | Petrol | 26 |
| N43 B16 A | 82.00 | 1599 | 4 | 16 | Petrol | 12 |
| N43 B20 A | 84.00 | 1995 | 4 | 16 | Petrol | 27 |
| N45 B16 | 84.00 | 1596 | 4 | 16 | Petrol | 18 |
| N45 B16 A | 84.00 | 1596 | 4 | 16 | Petrol | 18 |
| N46 B18 A | 84.00 | 1796 | 4 | 16 | Petrol | 22 |
| N46 B20 A | 84.00 | 1995 | 4 | 16 | Petrol | 26 |
| N46 B20 B | 84.00 | 1995 | 4 | 16 | Petrol | 26 |
| N46 B20 C | 84.00 | 1995 | 4 | 16 | Petrol | 28 |
| N47 D16 A | 78.00 | 1598 | 4 | 16 | Diesel | 2 |
| N47 D20 A | 84.00 | 1995 | 4 | 16 | Diesel | 24 |
| N47 D20 B | 84.00 | 1995 | 4 | 16 | Diesel | 24 |
| N47 D20 C | 84.00 | 1995 | 4 | 16 | Diesel | 24 |
| N47 D20 D | 84.00 | 1995 | 4 | 16 | Diesel | 24 |
| N47S D20 D | 84.00 | 1995 | 4 | 16 | Diesel | 24 |
| N52 B25 | 82.00 | 2497 | 6 | 24 | Petrol | 13 |

|  |  | ccm |  |  |  |  |
|---|---|------|---|---|---|---|
| N52 B25 A | 82.00 | 2497 | 6 | 24 | Petrol | 13 |
| N52 B25 C | 82.00 | 2497 | 6 | 24 | Petrol | 13 |
| N52 B30 | 85.00 | 2996 | 6 | 24 | Petrol | 55 |
| N52 B30 A | 85.00 | 2996 | 6 | 24 | Petrol | 55 |
| N52 B30 B | 85.00 | 2996 | 6 | 24 | Petrol | 55 |
| N52N B30 B | 85.00 | 2996 | 6 | 24 | Petrol | 55 |
| N53 B25 A | 82.00 | 2497 | 6 | 24 | Petrol | 13 |
| N53 B30 | 85.00 | 2996 | 6 | 24 | Petrol | 55 |
| N53 B30 A | 85.00 | 2996 | 6 | 24 | Petrol | 55 |
| N54 B30 A | 84.00 | 2996 | 6 | 24 | Petrol | 45 |
| N54 B30 B | 84.00 | 2979 | 6 | 24 | Petrol | 39 |
| N55 B30 A | 84.00 | 2979 | 6 | 24 | Petrol | 40 |
| N57 306 D2 | 84.00 | 2993 | 6 | 24 | Diesel | 44 |
| N57 306 D3 | 84.00 | 2993 | 6 | 24 | Diesel | 44 |
| N57 D30 A | 84.00 | 2993 | 6 | 24 | Diesel | 41 |
| N57 D30 B | 84.00 | 2993 | 6 | 24 | Diesel | 41 |
| N57 D30 C | 84.00 | 2993 | 6 | 24 | Diesel | 41 |
| N57N 306 D2 | 84.00 | 2993 | 6 | 24 | Diesel | 44 |
| N57N 306 D3 | 84.00 | 2993 | 6 | 24 | Diesel | 44 |
| N57N 306 D5 | 84.00 | 2993 | 6 | 24 | Diesel | 44 |
| N57S D30 B | 84.00 | 2993 | 6 | 24 | Diesel | 44 |
| N62 B36 | 84.00 | 3600 | 8 | 32 | Petrol | 49 |
| N62 B40 A | 84.10 | 4000 | 8 | 32 | Petrol | 52 |
| N62 B44 | 92.00 | 4398 | 8 | 32 | Petrol | 64 |
| N62 B44 A | 92.00 | 4398 | 8 | 32 | Petrol | 64 |
| N62 B48 B | 93.00 | 4799 | 8 | 32 | Petrol | 66 |
| N63 B44 A | 89.00 | 4395 | 8 | 32 | Petrol | 60 |
| N63 B44 B | 89.00 | 4395 | 8 | 32 | Petrol | 60 |
| S14 B23 (234EA) | 93.40 | 2303 | 4 | 16 | Petrol | 68 |
| S14 B23 (234S1) | 93.40 | 2303 | 4 | 16 | Petrol | 68 |
| S14 B23 (234S2) | 93.40 | 2303 | 4 | 16 | Petrol | 68 |
| S14 B23 (EVO I) | 93.40 | 2302 | 4 | 16 | Petrol | 67 |
| S38 B38 (386S1) | 94.60 | 3795 | 6 | 24 | Petrol | 69 |
| S50 B30 (306S1) | 86.00 | 2990 | 6 | 24 | Petrol | 57 |
| S63 B44 A | 89.00 | 4395 | 8 | 32 | Petrol | 61 |
| S70 B56 (56121) | 86.00 | 5576 | 12 | 24 | Petrol | 58 |

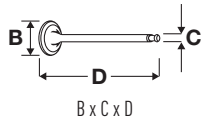

OE

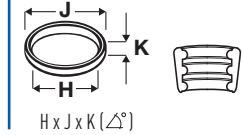
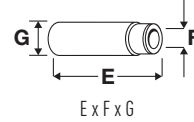
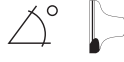

1 **77.00**

| N13 B16 A | 1598cc | 4 Cyl. | 16 Valves | 75-130kW/102-177PS | Petrol | Turbo, DOHC, Injection | TD26581 |
|--------------------|--------|--------|-----------|--------------------|--------|------------------------|---------|
| 1 (F20) 114 i | | | | 1 (F20) 116 i | | 12/2010→ | |
| 1 (F20) 118 i | | | | 1 (F20) 120 i | | 03/2015→ | |
| 1 (F21) 114 i | | | | 1 (F21) 116 i | | 12/2011→ | |
| 1 (F21) 118 i | | | | 1 (F21) 120 i | | 03/2015→ | |
| 3 (F30, F80) 316 i | | | | 3 (F30, F80) 320 i | | 04/2012→06/2016 | |
| 3 (F31) 316 i | | | | | | | |

V95153
29.70 x 4.97 x 95.10

11 34 7 585 901

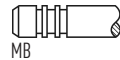

45° Y H

VAG96392B
41.50 x 5.01 x 9.05



V95038
26.25 x 5.00 x 110.10

11 34 7 547 187



45° H

VAG96393B
44.50 x 5.01 x 9.05



2 **78.00**

| N47 D16 A | 1598cc | 4 Cyl. | 16 Valves | 70-85kW/95-116PS | Diesel | DOHC | TD26346 |
|---------------|--------|--------|-----------|------------------|--------|----------|---------|
| 1 (F20) 114 d | | | | 1 (F20) 116 d | | 11/2012→ | |
| 1 (F21) 114 d | | | | 1 (F21) 116 d | | 12/2011→ | |

V95162
24.85 x 4.97 x 93.95

11 34 7 812 618

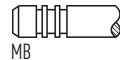

45° H

VAG96387B
36.00 x 5.00 x 10.05



V95154
21.15 x 4.96 x 94.00

11 34 7 812 616

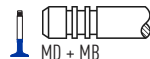

45° H

3 **80.00**

| M41 D17 (174T1) | 1665cc | 4 Cyl. | 8 Valves | 66kW/90PS | Diesel | Turbo, SOHC | TD28369 |
|-----------------|--------|--------|----------|-----------|--------|-------------|---------|
| 3 (E36) 318 tds | | | | | | | |

V94555
30.90 x 6.00 x 103.50

11 34 2 244 815



45° ss H

VAG96148B
39.50 x 6.00 x 12.57



4 **80.00**

| M20 B20 | 1991cc | 6 Cyl. | 12 Valves | 90-110kW/122-150PS | Petrol | SOHC | TD5117 |
|-----------------|--------|--------|-----------|--------------------|--------|-----------------|---------|
| M20 B20 (206EA) | 1991cc | 6 Cyl. | 12 Valves | 90-110kW/122-150PS | Petrol | SOHC | TD28329 |
| M20 B20 (206EB) | 1991cc | 6 Cyl. | 12 Valves | 90-110kW/122-150PS | Petrol | SOHC | TD28330 |
| M20 B20 (206KA) | 1991cc | 6 Cyl. | 12 Valves | 90-110kW/122-150PS | Petrol | SOHC | TD28335 |
| M20 B20 (206VA) | 1991cc | 6 Cyl. | 12 Valves | 90-110kW/122-150PS | Petrol | SOHC | TD28336 |
| 3 (E21) 320/6 | | | | 3 (E30) 320 i | | 09/1982→10/1993 | |
| 5 (E12) 520/6 | | | | 5 (E28) 520 i | | 06/1981→12/1987 | |
| 5 (E34) 520 i | | | | | | | |

V91189
40.00 x 6.98 x 102.70

11 34 1 267 721

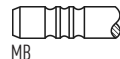

45° Y H

VAG92303B
45.00 x 7.02 x 13.05

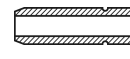

V91190
34.00 x 6.96 x 102.70

11 34 1 280 643

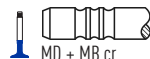

45° H

VAG92347B
45.00 x 7.02 x 13.14

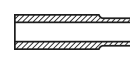

VAG96143B
45.00 x 7.02 x 13.24





OE

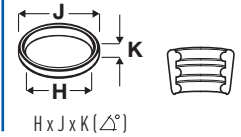
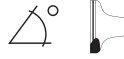

5 **80.00**

| | | | | | | | |
|----------------------------|-----------------|--------|------------------|---------------------|--------|-----------------------|----------------|
| M50 B (206S1) | 1991cc | 6 Cyl. | 24 Valves | 110kW/150PS | Petrol | DOHC, Motronic | TD4227 |
| M50 B20 | 1991cc | 6 Cyl. | 24 Valves | 110kW/150PS | Petrol | DOHC | TD21402 |
| M50 B20 (206S1) | 1991cc | 6 Cyl. | 24 Valves | 110kW/150PS | Petrol | DOHC | TD28375 |
| M50 B20 (206S2) | 1991cc | 6 Cyl. | 24 Valves | 110kW/150PS | Petrol | DOHC | TD28376 |
| M50 B20 TU | 1991cc | 6 Cyl. | 24 Valves | 110kW/150PS | Petrol | DOHC | TD21239 |
| M52 B (206S3) Vanos | 1991cc | 6 Cyl. | 24 Valves | 100-110kW/136-150PS | Petrol | DOHC, Motronic | TD460 |
| M52 B20 | 1991cc | 6 Cyl. | 24 Valves | 110kW/150PS | Petrol | DOHC | TD21403 |
| M52 B20 (206S3) | 1991cc | 6 Cyl. | 24 Valves | 100-110kW/136-150PS | Petrol | DOHC | TD28380 |
| 3 (E36) 320 i | 09/1990→10/1999 | | | 5 (E34) 520 i | | 09/1989→01/1997 | |
| 5 (E39) 520 i | 01/1996→05/2004 | | | | | | |

| | | | | | | | |
|---------------------------------|-----------------|------------|-----|---|---|--------------------------------|--|
| V91420 | 11 34 1 722 910 | | 45° | Y | H | VAG96042B | |
| 29.90 x 7.00 x 107.70 →08/92 | | MB cr | | | | 43.50 x 7.00 x 12.55 →08/92 | |
| V94008 | 11 34 1 738 220 | | 45° | Y | H | VAG96043B | |
| 30.00 x 5.98 x 107.15 09/92→ | | MB | | | | 43.50 x 6.01 x 12.56 09/92→ | |
| V94009 | 11 34 7 502 351 | | 45° | | H | VAG96044B | |
| 27.00 x 5.96 x 106.20 09/92→ | | MD + MB cr | | | | 43.50 x 6.00 x 12.77 09/92→ | |

6 **80.00**

| | | | | | | | |
|----------------------------|-----------------|--------|------------------|---------------|--------|-----------------------|----------------|
| M50 B (206S2) Vanos | 1991cc | 6 Cyl. | 24 Valves | 110kW/150PS | Petrol | DOHC, Motronic | TD10027 |
| M52 B20 (206S4) | 1991cc | 6 Cyl. | 24 Valves | 110kW/150PS | Petrol | DOHC | TD28381 |
| 3 (E46) 320 Ci | 02/1999→08/2001 | | | 3 (E46) 320 i | | 03/1998→09/2000 | |
| Z3 (E36) 2.0 i | 04/1999→01/2003 | | | | | | |

| | | | | | | | |
|-----------------------|-----------------|------------|-----|---|---|----------------------|--|
| V94008 | 11 34 1 738 220 | | 45° | Y | H | VAG96043B | |
| 30.00 x 5.98 x 107.15 | | MB | | | | 43.50 x 6.01 x 12.56 | |
| V94009 | 11 34 7 502 351 | | 45° | | H | VAG96044B | |
| 27.00 x 5.96 x 106.20 | | MD + MB cr | | | | 43.50 x 6.00 x 12.77 | |

7 **80.00**

| | | | | | | | |
|------------------------|-----------------|--------|------------------|---------------------|--------|-----------------|----------------|
| M54 226 S1 | 2171cc | 6 Cyl. | 24 Valves | 125kW/170PS | Petrol | DOHC | TD17522 |
| M54 B22 (226S1) | 2171cc | 6 Cyl. | 24 Valves | 120-125kW/163-170PS | Petrol | DOHC | TD28215 |
| 3 (E46) 320 Ci | 01/2000→12/2007 | | | 3 (E46) 320 i | | 09/2000→02/2005 | |
| 5 (E39) 520 i | 09/2000→05/2004 | | | 5 (E60) 520 i | | 07/2003→03/2010 | |
| Z3 (E36) 2.2 i | 08/2000→01/2003 | | | Z4 (E85) 2.2 i | | 10/2003→10/2005 | |

| | | | | | | | |
|-----------------------|-----------------|------------|-----|---|---|----------------------|--|
| V94008 | 11 34 1 738 220 | | 45° | Y | H | VAG96043B | |
| 30.00 x 5.98 x 107.15 | | MB | | | | 43.50 x 6.01 x 12.56 | |
| V94009 | 11 34 7 502 351 | | 45° | | H | VAG96044B | |
| 27.00 x 5.96 x 106.20 | | MD + MB cr | | | | 43.50 x 6.00 x 12.77 | |

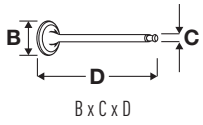

OE

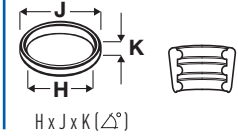
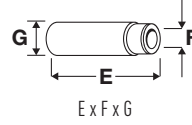
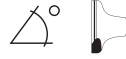

8



80.00

| M20 B23 (236EA) | 2316cc | 6 Cyl. | 12 Valves | 102-110kW/139-150PS | Petrol | SOHC | TD28337 |
|--|-----------------|--------|-----------|--|--------|-----------------|---------|
| M20 B23 (236EC) | 2316cc | 6 Cyl. | 12 Valves | 102-110kW/139-150PS | Petrol | SOHC | TD28339 |
| 3 (E21) 323 i | 01/1978→08/1982 | | | 3 (E30) 323 i | | 09/1982→08/1986 | |
| V91189 ■ 40.00 x 6.98 x 102.70 | 11 34 1 267 721 | | 45° Y H | VAG92303B ■ ■ ■ 45.00 x 7.02 x 13.05 | | | |
| V91190 ■ 34.00 x 6.96 x 102.70 | 11 34 1 280 643 | | 45° H | VAG92347B ■ ■ ■ 45.00 x 7.02 x 13.14 | | | |
| | | | | VAG96143B ■ ■ ■ 45.00 x 7.02 x 13.24 | | | |

9



80.00

| M51 D25 | 2497cc | 6 Cyl. | 12 Valves | 105kW/143PS | Diesel | Turbo, SOHC | TD5285 |
|--|-----------------|--------|-----------|--|--------|-------------|--------|
| V94089 ■ 35.90 x 6.00 x 103.70 | 11 34 2 246 524 | | 45° Y H | VAG96148B ■ ■ ■ 39.50 x 6.00 x 12.57 | | | |
| V94090 ■ 30.90 x 6.00 x 103.50 | 11 34 2 246 525 | | 45° H | | | | |
| V94555 ■ 30.90 x 6.00 x 103.50 | 11 34 2 244 815 | | 45° ss H | | | | |

10



80.00

| M51 D25 (256T1) | 2497cc | 6 Cyl. | 12 Valves | 85-105kW/115-143PS | Diesel | Turbo, SOHC | TD28379 |
|--|-----------------|--------|-----------|--|--------|-----------------|---------|
| 3 (E36) 325 td | 09/1991→02/1998 | | | 3 (E36) 325 tds | | 05/1993→10/1999 | |
| 5 (E34) 525 td | 03/1993→01/1997 | | | 5 (E34) 525 tds | | 09/1991→01/1997 | |
| 5 (E39) 525 td | 01/1997→06/2003 | | | 5 (E39) 525 tds | | 01/1996→05/2004 | |
| 7 (E38) 725 tds | 04/1996→11/2001 | | | | | | |
| V94555 ■ 30.90 x 6.00 x 103.50 | 11 34 2 244 815 | | 45° ss H | VAG96148B ■ ■ ■ 39.50 x 6.00 x 12.57 | | | |

11



80.00

| M57 D25 (256D1) | 2497cc | 6 Cyl. | 24 Valves | 120kW/163PS | Diesel | Turbo, DOHC | TD27988 |
|---|-----------------|--------|-----------|--|--------|-----------------|---------|
| M57 D25 (256D2) | 2497cc | 6 Cyl. | 24 Valves | 120-130kW/163-177PS | Diesel | Turbo, DOHC | TD30331 |
| M57 D25 TU | 2497cc | 6 Cyl. | 24 Valves | 130kW/177PS | Diesel | Turbo, DOHC | TD21234 |
| 5 (E39) 525 d | 02/2000→05/2004 | | | 5 (E60) 525 d | | 06/2004→03/2010 | |
| 5 (E61) 525 d | 03/2004→03/2007 | | | | | | |
| V94086 ■ 26.00 x 6.00 x 99.90 | 11 34 2 247 077 | | 45° H | VAG96266B ■ ■ ■ 39.00 x 6.00 x 11.54 | | | |
| V94086 ■ 26.00 x 6.00 x 99.90 | 11 34 2 247 077 | | 45° H | | | | |



OE

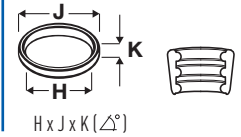
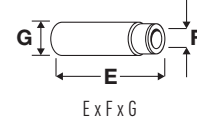

12  82.00

| N43 B16 A | 1599cc | 4 Cyl. | 16 Valves | 85-90kW/115-122PS | Petrol | DOHC, Injection | TD20844 |
|---------------|--------|--------|-----------|-------------------|--------|-----------------|-----------------|
| 1 (E81) 116 i | | | | 03/2007→11/2011 | | 1 (E87) 116 i | 03/2007→06/2011 |
| 3 (E90) 316 i | | | | 09/2007→10/2011 | | 3 (E91) 316 i | 05/2008→05/2012 |
| 3 (E92) 316 i | | | | 09/2007→12/2013 | | | |

V80000  11 34 7 555 760
30.00 x 6.00 x 106.60



45°

VAG96386B   39.00 x 6.01 x 10.15



V80001  11 34 7 552 053
27.00 x 6.00 x 114.70



45°

SS

13  82.00

| N52 B25 | 2497cc | 6 Cyl. | 24 Valves | 130-163kW/177-222PS | Petrol | DOHC | TD21408 |
|----------------------|--------|--------|-----------|---------------------|--------|----------------------|-----------------|
| N52 B25 A | 2497cc | 6 Cyl. | 24 Valves | 130-160kW/177-218PS | Petrol | DOHC | TD18517 |
| N52 B25 C | 2497cc | 6 Cyl. | 24 Valves | 160kW/218PS | Petrol | DOHC | TD18169 |
| N53 B25 A | 2497cc | 6 Cyl. | 24 Valves | 140kW/190PS | Petrol | DOHC, Injection | TD20588 |
| 3 (E90) 323 i | | | | 09/2005→12/2011 | | 3 (E90) 325 i | 01/2005→12/2011 |
| 3 (E90) 325 xi | | | | 03/2005→10/2011 | | 3 (E91) 323 i | 04/2006→07/2008 |
| 3 (E91) 325 i | | | | 12/2004→12/2010 | | 3 (E91) 325 xi | 08/2005→08/2011 |
| 3 (E92) 323 i | | | | 04/2006→02/2012 | | 3 (E92) 325 i | 11/2005→06/2013 |
| 3 (E92) 325 xi | | | | 09/2006→02/2010 | | 3 (E93) 323 i | 03/2007→09/2011 |
| 3 (E93) 325 i | | | | 03/2007→12/2013 | | 5 (E60) 523 i | 10/2004→03/2010 |
| 5 (E60) 525 i | | | | 10/2004→03/2010 | | 5 (E60) 525 xi | 07/2005→03/2010 |
| 5 (E61) 523 i | | | | 10/2004→12/2010 | | 5 (E61) 525 i | 10/2004→12/2010 |
| 5 (E61) 525 xi | | | | 07/2005→12/2010 | | 5 (F10) 523 i | 01/2009→08/2011 |
| 5 (F11) 523 i | | | | 11/2009→08/2011 | | X3 (E83) 2.5 si | 07/2006→12/2008 |
| X3 (E83) xDrive 25 i | | | | 09/2008→12/2011 | | Z4 (E85) 2.5 i | 09/2005→02/2009 |
| Z4 (E85) 2.5 si | | | | 09/2005→02/2009 | | Z4 (E89) sDrive 23 i | 05/2009→ |
| Z4 (E89) sDrive 25 i | | | | 09/2009→ | | | |

V95045  11 34 7 539 919
32.20 x 5.00 x 104.50



45°

H

VAG96402B  42.00 x 5.00 x 10.04



V95046  11 34 7 553 774
27.00 x 6.00 x 110.40



45°

H

VAG96403B  48.00 x 6.00 x 10.04



14  84.00

| B37 C15 A | 1496cc | 3 Cyl. | 12 Valves | 70-85kW/95-116PS | Diesel | Turbo, DOHC | TD29839 |
|----------------------|--------|--------|-----------|------------------|--------|---------------|----------|
| B37 D15 A | 1496cc | 3 Cyl. | 12 Valves | 70-85kW/95-116PS | Diesel | Turbo | TD30399 |
| 1 (F20) 114 d | | | | 06/2015→ | | 1 (F20) 116 d | 03/2015→ |
| 1 (F21) 114 d | | | | 06/2015→ | | 1 (F21) 116 d | 03/2015→ |
| 2 (F45) 214 d | | | | 07/2014→02/2018 | | 2 (F45) 216 d | 03/2014→ |
| 2 (F46) 214 d | | | | 07/2015→02/2018 | | 2 (F46) 216 d | 08/2014→ |
| X1 (F48) sDrive 16 d | | | | 11/2014→ | | | |

V95040  11 12 7 797 711
27.20 x 5.00 x 94.00



45°

H

VAG96387B   36.00 x 5.00 x 10.05



V95041  11 34 8 511 622
24.60 x 5.00 x 94.00



45°

H

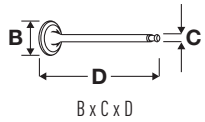

OE

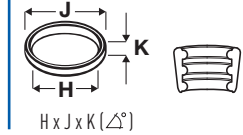
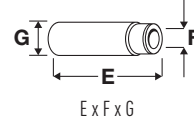

15 **84.00**

| | | | | | | | |
|-------------------------------------|-----------------|--------|-----------------|-------------------------------------|--------|-----------------|----------------|
| M10 B16 | 1573cc | 4 Cyl. | 8 Valves | 55-77kW/75-105PS | Petrol | SOHC | TD5170 |
| M10 B16 (164VA) | 1573cc | 4 Cyl. | 8 Valves | 55-77kW/75-105PS | Petrol | SOHC | TD28312 |
| 02 (E6) 1600 | 05/1971→04/1973 | | | 02 (E10) 1502 | | 01/1975→07/1977 | |
| 02 (E10) 1600/2 | 12/1967→12/1971 | | | 02 (E10) 1600-2 | | 12/1967→10/1971 | |
| 02 (E10) 1600 Ti | 09/1967→11/1969 | | | 02 (E10) 1602 | | 04/1971→07/1975 | |
| 3 (E21) 316 | 08/1975→08/1980 | | | 3 (E30) 315 | | 09/1982→12/1991 | |
| 1500-2000 (115, 116, 118, 121) 1500 | 09/1963→07/1966 | | | 1500-2000 (115, 116, 118, 121) 1600 | | 09/1963→12/1971 | |
| 1600 GT 1.6 | 10/1967→05/1969 | | | | | | |

V34335
41.98 x 7.97 x 103.91

11 34 1 251 879

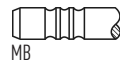

45°

H

VAG92170B
50.00 x 8.02 x 14.06



VAG96176B
50.00 x 8.02 x 14.24



16 **84.00**

| | | | | | | | |
|------------------------|-----------------|--------|-----------------|------------------|--------|-----------------|----------------|
| M40 B16 | 1596cc | 4 Cyl. | 8 Valves | 73-75kW/99-102PS | Petrol | SOHC | TD5255 |
| M40 B16 (164E1) | 1596cc | 4 Cyl. | 8 Valves | 73-75kW/99-102PS | Petrol | SOHC | TD28367 |
| 3 (E30) 316 i | 09/1987→06/1994 | | | 3 (E36) 316 i | | 09/1990→09/1993 | |

V91418
41.90 x 7.00 x 102.10

11 34 1 727 358

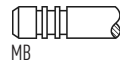

45°

Y

H

VAG96042B
43.50 x 7.00 x 12.55



V91955
35.90 x 7.00 x 101.10

11 34 1 727 352



45°

SS

H

17 **84.00**

| | | | | | | | |
|------------------------|-----------------|--------|-----------------|-------------------|--------|-----------------|----------------|
| M43 B16 (164E2) | 1596cc | 4 Cyl. | 8 Valves | 75-77kW/102-105PS | Petrol | SOHC | TD28371 |
| M43 B16 (164E3) | 1596cc | 4 Cyl. | 8 Valves | 77kW/105PS | Petrol | SOHC | TD17055 |
| 3 (E36) 316 g | 03/1994→08/2000 | | | 3 (E36) 316 i | | 09/1990→08/2000 | |
| 3 (E46) 316 Ci | 04/2000→07/2006 | | | 3 (E46) 316 i | | 04/2000→02/2005 | |

V94087
42.00 x 7.00 x 104.00

11 34 1 739 658

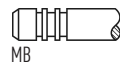

45°

Y

H

VAG96042B
43.50 x 7.00 x 12.55



V94088
35.90 x 7.00 x 103.00

11 34 1 739 665

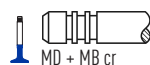

45°

SS

H

18 **84.00**

| | | | | | | | |
|------------------|-----------------|--------|------------------|-------------------|--------|-----------------|----------------|
| N40 B16 A | 1596cc | 4 Cyl. | 16 Valves | 77-85kW/105-115PS | Petrol | DOHC | TD18037 |
| N45 B16 | 1596cc | 4 Cyl. | 16 Valves | 85kW/115PS | Petrol | DOHC | TD21404 |
| N45 B16 A | 1596cc | 4 Cyl. | 16 Valves | 85kW/115PS | Petrol | DOHC | TD18358 |
| 1 (E81) 116 i | 04/2007→12/2011 | | | 1 (E87) 116 i | | 11/2003→06/2011 | |
| 3 (E46) 316 Ci | 06/2002→07/2006 | | | 3 (E46) 316 i | | 06/2002→02/2005 | |
| 3 (E46) 316 ti | 06/2002→02/2005 | | | 3 (E90) 316 i | | 09/2005→10/2011 | |

V94957
35.00 x 6.00 x 100.00

11 34 1 435 461

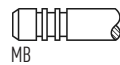

45°

H

VAG96386B
39.00 x 6.01 x 10.15



V94403
29.00 x 6.00 x 100.10

11 34 7 503 839



45°

SS

H



OE

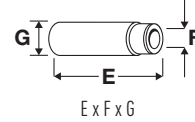
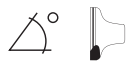

E x F x G

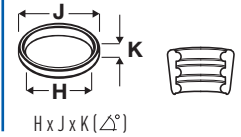

H x J x K (△°)

19 **84.00**

| | | | | | | | |
|------------------------|--------|--------|-----------------|-------------------|--------|-------------|-----------------|
| M40 B18 (184E1) | 1796cc | 4 Cyl. | 8 Valves | 83-85kW/113-116PS | Petrol | SOHC | TD28368 |
| 3 (E30) 318 i | | | | 3 (E36) 318 i | | | 12/1990→06/1994 |
| 5 (E34) 518 i | | | | | | | 08/1989→09/1995 |

V91418 11 34 1 727 358
41.90 x 7.00 x 102.10

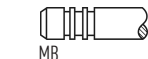

45° Y H

VAG96042B 43.50 x 7.00 x 12.55



V91955 11 34 1 727 352
35.90 x 7.00 x 101.10



45° ss H

20 **84.00**

| | | | | | | | |
|------------------------|--------|--------|------------------|---------------------|--------|-------------|-----------------|
| M42 B18 | 1796cc | 4 Cyl. | 16 Valves | 100-103kW/136-140PS | Petrol | DOHC | TD454 |
| M42 B18 (184S1) | 1796cc | 4 Cyl. | 16 Valves | 100-103kW/136-140PS | Petrol | DOHC | TD28370 |
| 3 (E30) 318 i | | | | 3 (E30) 318 is | | | 09/1989→08/1991 |
| 3 (E36) 318 i | | | | 3 (E36) 318 is | | | 03/1992→02/1998 |
| 3 (E36) 318 ti | | | | | | | 09/1994→12/1995 |

V91925 11 34 1 739 822
32.90 x 6.00 x 106.10



45° H

VAG96043B 43.50 x 6.01 x 12.56



V94594 11 34 1 438 284
33.00 x 6.00 x 106.10

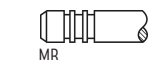

45° Y H

VAG96044B 43.50 x 6.00 x 12.77



V91926 11 34 1 739 823
30.50 x 6.00 x 105.70

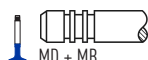

45° ss H

V94595 11 34 7 505 704
30.40 x 6.00 x 105.70

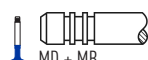

45° H

21 **84.00**

| | | | | | | | |
|------------------------|--------|--------|-----------------|-------------------|--------|-------------|-----------------|
| M43 B18 (184E2) | 1796cc | 4 Cyl. | 8 Valves | 83-85kW/113-116PS | Petrol | SOHC | TD28372 |
| 3 (E36) 318 i | | | | 5 (E34) 518 g | | | 11/1995→06/1996 |
| 5 (E34) 518 i | | | | Z3 (E36) 1.8 i | | | 10/1995→10/1998 |

V94087 11 34 1 739 658
42.00 x 7.00 x 104.00



45° Y H

VAG96042B 43.50 x 7.00 x 12.55

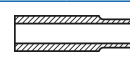

V94088 11 34 1 739 665
35.90 x 7.00 x 103.00

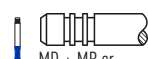

45° ss H

22 **84.00**

| | | | | | | | |
|------------------|--------|--------|------------------|----------------|--------|-------------|-----------------|
| N42 B18 A | 1796cc | 4 Cyl. | 16 Valves | 85kW/115PS | Petrol | DOHC | TD30334 |
| N46 B18 A | 1796cc | 4 Cyl. | 16 Valves | 85kW/115PS | Petrol | DOHC | TD20538 |
| 3 (E46) 316 i | | | | 3 (E46) 316 ti | | | 06/2001→02/2005 |

V94402 11 34 1 440 304
32.00 x 6.00 x 100.00

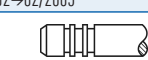

45° Y H

VAG96386B 39.00 x 6.01 x 10.15

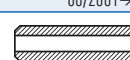

V94403 11 34 7 503 839
29.00 x 6.00 x 100.10

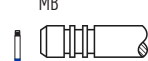

45° ss H

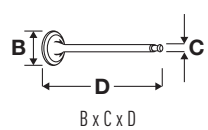

OE

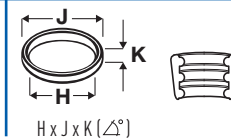
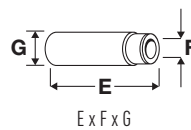

23  **84.00**

| | | | | | | | |
|-------------------|--------|--------|------------------|--------------------|--------|--------------------|----------------|
| M47 204 D1 | 1951cc | 4 Cyl. | 16 Valves | 85-100kW/116-136PS | Diesel | | TD18305 |
| M47 D20 | 1951cc | 4 Cyl. | 16 Valves | 85-100kW/116-136PS | Diesel | Turbo, DOHC | TD9521 |
| M47 D20 TU | 1951cc | 4 Cyl. | 16 Valves | 85-110kW/116-150PS | Diesel | Turbo, DOHC | TD21236 |

V94086 
 26.00 x 6.00 x 99.90

11 34 2 247 077



45°

H

VAG96266B 
 39.00 x 6.00 x 11.54



V94086 
 26.00 x 6.00 x 99.90

11 34 2 247 077



45°

H



OE

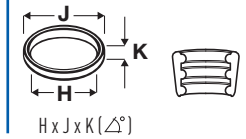
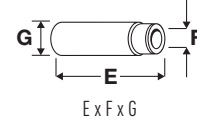
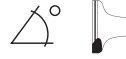

24



84.00

| Part No. | Capacity | Cyl. | Valves | Power | Fuel | Configuration | Part No. |
|---------------------------|-----------------|--------|-----------|---------------------------|--------|-----------------|----------|
| B47 C20 A | 1995cc | 4 Cyl. | 16 Valves | 100-140kW/136-190PS | Diesel | Turbo, DOHC | TD29580 |
| B47 D20 A | 1995cc | 4 Cyl. | 16 Valves | 85-170kW/116-231PS | Diesel | Turbo, DOHC | TD29233 |
| N47 D20 A | 1995cc | 4 Cyl. | 16 Valves | 66-145kW/90-197PS | Diesel | Turbo, DOHC | TD19922 |
| N47 D20 B | 1995cc | 4 Cyl. | 16 Valves | 150kW/204PS | Diesel | Turbo, DOHC | TD20845 |
| N47 D20 C | 1995cc | 4 Cyl. | 16 Valves | 66-150kW/90-204PS | Diesel | Turbo, DOHC | TD24405 |
| N47 D20 D | 1995cc | 4 Cyl. | 16 Valves | 150-160kW/204-218PS | Diesel | Turbo, DOHC | TD26347 |
| N47S D20 D | 1995cc | 4 Cyl. | 16 Valves | 150kW/204PS | Diesel | Turbo | TD24642 |
| 1 [E81] 116 d | 11/2008→12/2011 | | | 1 [E81] 118 d | | 09/2006→12/2011 | |
| 1 [E81] 120 d | 09/2006→12/2011 | | | 1 [E81] 123 d | | 03/2007→12/2011 | |
| 1 [E82] 118 d | 09/2009→10/2013 | | | 1 [E82] 120 d | | 10/2006→10/2013 | |
| 1 [E82] 123 d | 10/2007→10/2013 | | | 1 [E87] 116 d | | 12/2008→09/2012 | |
| 1 [E87] 118 d | 09/2006→06/2011 | | | 1 [E87] 120 d | | 03/2003→06/2011 | |
| 1 [E87] 123 d | 03/2007→09/2012 | | | 1 [E88] 118 d | | 09/2008→12/2013 | |
| 1 [E88] 120 d | 03/2008→12/2013 | | | 1 [E88] 123 d | | 09/2008→12/2013 | |
| 1 [F20] 116 d | 12/2010→ | | | 1 [F20] 118 d | | 12/2010→ | |
| 1 [F20] 120 d | 12/2010→ | | | 1 [F20] 125 d | | 08/2011→ | |
| 1 [F21] 116 d | 01/2012→ | | | 1 [F21] 118 d | | 12/2011→ | |
| 1 [F21] 120 d | 01/2012→ | | | 1 [F21] 125 d | | 12/2011→ | |
| 2 [F22, F87] 218 d | 01/2014→ | | | 2 [F22, F87] 220 d | | 10/2012→ | |
| 2 [F22, F87] 225 d | 01/2014→ | | | 2 [F23] 218 d | | 07/2015→ | |
| 2 [F23] 220 d | 03/2014→ | | | 2 [F45] 218 d | | 11/2013→ | |
| 2 [F45] 220 d | 03/2014→ | | | 2 [F46] 218 d | | 07/2014→ | |
| 2 [F46] 220 d | 07/2014→ | | | 3 [E90] 316 d | | 07/2009→12/2011 | |
| 3 [E90] 318 d | 02/2007→10/2011 | | | 3 [E90] 320 d | | 12/2004→12/2011 | |
| 3 [E90] 320 xd | 09/2007→12/2011 | | | 3 [E91] 316 d | | 09/2009→06/2012 | |
| 3 [E91] 318 d | 07/2007→06/2012 | | | 3 [E91] 320 d | | 02/2007→06/2012 | |
| 3 [E91] 320 d ed | 10/2010→05/2012 | | | 3 [E92] 320 d | | 09/2006→06/2013 | |
| 3 [E92] 320 xd | 03/2008→02/2010 | | | 3 [E93] 320 d | | 09/2007→12/2013 | |
| 3 [F30, F80] 316 d | 05/2011→ | | | 3 [F30, F80] 318 d | | 05/2011→ | |
| 3 [F30, F80] 320 d | 03/2011→ | | | 3 [F30, F80] 325 d | | 07/2012→02/2016 | |
| 3 [F31] 316 d | 02/2012→ | | | 3 [F31] 318 d | | 07/2011→ | |
| 3 [F31] 320 d | 07/2011→ | | | 3 [F31] 325 d | | 09/2012→02/2016 | |
| 3 [F34] 318 d | 03/2013→ | | | 3 [F34] 320 d | | 03/2013→ | |
| 3 [F34] 325 d | 03/2013→ | | | 4 [F32, F82] 418 d | | 03/2015→ | |
| 4 [F32, F82] 420 d | 07/2013→ | | | 4 [F32, F82] 425 d | | 01/2014→ | |
| 4 [F33, F83] 420 d | 10/2013→ | | | 4 [F33, F83] 425 d | | 07/2014→ | |
| 4 [F36] 418 d | 03/2014→ | | | 4 [F36] 420 d | | 03/2014→ | |
| 5 [E60] 520 d | 04/2006→12/2009 | | | 5 [E61] 520 d | | 03/2007→05/2010 | |
| 5 [F07] 520 d | 04/2011→02/2017 | | | 5 [F10] 518 d | | 02/2013→10/2016 | |
| 5 [F10] 520 d | 01/2009→10/2016 | | | 5 [F10] 525 d | | 01/2011→10/2016 | |
| 5 [F11] 518 d | 10/2012→ | | | 5 [F11] 520 d | | 11/2009→ | |
| 5 [F11] 525 d | 02/2011→ | | | 5 [G30, F90] 520 d | | 09/2016→ | |
| 5 [G31] 520 d | 03/2017→ | | | X1 [E84] sDrive 16 d | | 04/2012→06/2015 | |
| X1 [E84] sDrive 18 d | 03/2009→06/2015 | | | X1 [E84] sDrive 20 d | | 10/2009→06/2015 | |
| X1 [E84] xDrive 18 d | 03/2009→06/2015 | | | X1 [E84] xDrive 20 d | | 10/2009→06/2015 | |
| X1 [E84] xDrive 23 d | 10/2009→06/2015 | | | X1 [E84] xDrive 25 d | | 10/2009→06/2015 | |
| X1 [F48] sDrive 18 d | 11/2014→ | | | X1 [F48] sDrive 20 d | | 01/2015→ | |
| X1 [F48] xDrive 18 d | 11/2014→ | | | X1 [F48] xDrive 20 d | | 11/2014→ | |
| X3 [E83] 2.0 d | 03/2007→08/2007 | | | X3 [E83] xDrive 18 d | | 09/2008→12/2011 | |
| X3 [E83] xDrive 20 d | 09/2007→08/2010 | | | X3 [F25] sDrive 18 d | | 08/2011→ | |
| X3 [F25] xDrive 20 d | 09/2010→ | | | X3 [F25] xDrive 28 d | | 09/2014→ | |
| X3 [G01] xDrive 20 d | 10/2017→ | | | X4 [F26] xDrive 20 d | | 04/2014→03/2018 | |
| X5 [F15, F85] sDrive 25 d | 11/2013→ | | | X5 [F15, F85] xDrive 25 d | | 11/2013→ | |

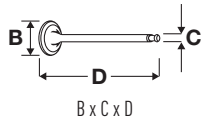

OE

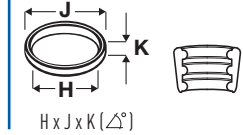
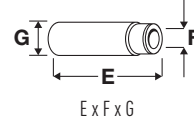
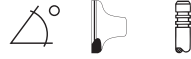

V95040 ■
27.20 x 5.00 x 94.00

11 12 7 797 711

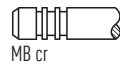

45°

H

VAG96387B ■ ■ ■
36.00 x 5.00 x 10.05

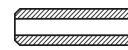

V95041 ■
24.60 x 5.00 x 94.00

11 34 8 511 622



45°

H

25 **84.00**

| | | | | | | | |
|------------------------|-----------------|--------|------------------|--------------------|--------|--------------------|----------------|
| M47 D20 (204D4) | 1995cc | 4 Cyl. | 16 Valves | 85-120kW/116-163PS | Diesel | Turbo, DOHC | TD27472 |
| M47N 204 D4 | 1995cc | 4 Cyl. | 16 Valves | 85-130kW/116-177PS | Diesel | Turbo, DOHC | TD17523 |
| M47N 204 D5 | 1995cc | 4 Cyl. | 16 Valves | 120kW/163PS | Diesel | | TD18171 |
| 1 (E87) 118 d | 11/2003→02/2007 | | | 1 (E87) 120 d | | 03/2003→06/2011 | |
| 3 (E46) 318 d | 03/2003→02/2005 | | | 3 (E46) 318 td | | 03/2003→02/2005 | |
| 3 (E46) 320 Cd | 11/2003→12/2007 | | | 3 (E46) 320 d | | 09/2001→02/2005 | |
| 3 (E46) 320 td | 09/2001→02/2005 | | | 3 (E90) 318 d | | 03/2005→08/2007 | |
| 3 (E90) 320 d | 12/2004→12/2011 | | | 3 (E91) 318 d | | 09/2005→08/2007 | |
| 3 (E91) 320 d | 12/2004→06/2012 | | | 5 (E60) 520 d | | 02/2005→02/2008 | |
| 5 (E61) 520 d | 04/2005→02/2008 | | | X3 (E83) 2.0 d | | 11/2003→08/2007 | |

V94086 ■
26.00 x 6.00 x 99.90

11 34 2 247 077



45°

H

VAG96266B ■ ■ ■
39.00 x 6.00 x 11.54



V94086 ■
26.00 x 6.00 x 99.90

11 34 2 247 077

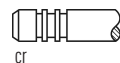

45°

H

26 **84.00**

| | | | | | | | |
|----------------------|-----------------|--------|------------------|---------------------|--------|-----------------|----------------|
| N42 B20 | 1995cc | 4 Cyl. | 16 Valves | 105kW/143PS | Petrol | DOHC | TD17052 |
| N42 B20 A | 1995cc | 4 Cyl. | 16 Valves | 100-110kW/136-150PS | Petrol | DOHC | TD18038 |
| N42 B20 B | 1995cc | 4 Cyl. | 16 Valves | 95kW/129PS | Petrol | DOHC | TD18304 |
| N46 B20 A | 1995cc | 4 Cyl. | 16 Valves | 95-125kW/129-170PS | Petrol | DOHC | TD18167 |
| N46 B20 B | 1995cc | 4 Cyl. | 16 Valves | 95-125kW/129-170PS | Petrol | DOHC | TD18945 |
| 1 (E81) 118 i | 09/2006→12/2011 | | | 1 (E81) 120 i | | 09/2006→10/2011 | |
| 1 (E82) 120 i | 09/2009→10/2013 | | | 1 (E87) 118 i | | 07/2004→06/2011 | |
| 1 (E87) 120 i | 11/2003→06/2011 | | | 1 (E88) 118 i | | 09/2008→12/2013 | |
| 1 (E88) 120 i | 03/2008→12/2013 | | | 1 (F21) 120 i | | 12/2011→ | |
| 3 (E46) 318 Ci | 12/2000→12/2007 | | | 3 (E46) 318 i | | 09/2001→02/2005 | |
| 3 (E46) 318 ti | 03/2001→12/2004 | | | 3 (E90) 318 i | | 03/2005→10/2011 | |
| 3 (E90) 320 i | 06/2004→12/2011 | | | 3 (E91) 318 i | | 01/2006→03/2012 | |
| 3 (E91) 320 i | 09/2005→06/2012 | | | 3 (E92) 320 i | | 11/2006→12/2013 | |
| 3 (E93) 320 i | 01/2007→12/2013 | | | 5 (E60) 520 i | | 04/2006→12/2009 | |
| X1 (E84) sDrive 18 i | 03/2009→06/2015 | | | X3 (E83) 2.0 i | | 07/2005→08/2008 | |
| X3 (E83) xDrive 20 i | 09/2008→08/2011 | | | Z4 (E85) 2.0 i | | 03/2005→02/2009 | |

V94402 ■
32.00 x 6.00 x 100.00

11 34 1 440 304

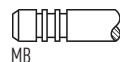

45°

Y

H

VAG96386B ■ ■ ■
39.00 x 6.01 x 10.15

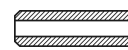

V94403 ■
29.00 x 6.00 x 100.10

11 34 7 503 839

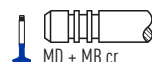

45°

SS

H



OE

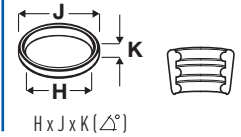
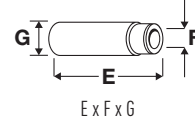
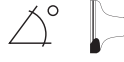

27  84.00

| N43 B20 A | 1995cc | 4 Cyl. | 16 Valves | 90-125kW/122-170PS | Petrol | DOHC, Injection | TD20584 |
|---------------|--------|--------|-----------|--------------------|--------|-----------------|---------|
| 1 (E81) 116 i | | | | 1 (E81) 118 i | | 09/2006→12/2011 | |
| 1 (E81) 120 i | | | | 1 (E82) 120 i | | 10/2007→10/2013 | |
| 1 (E87) 116 i | | | | 1 (E87) 118 i | | 09/2006→06/2011 | |
| 1 (E87) 120 i | | | | 1 (E88) 118 i | | 03/2008→12/2013 | |
| 1 (E88) 120 i | | | | 3 (E90) 318 i | | 02/2007→10/2011 | |
| 3 (E90) 320 i | | | | 3 (E91) 318 i | | 05/2007→05/2012 | |
| 3 (E91) 320 i | | | | 3 (E92) 318 i | | 03/2010→12/2013 | |
| 3 (E92) 320 i | | | | 3 (E93) 318 i | | 03/2010→12/2013 | |
| 3 (E93) 320 i | | | | 5 (E60) 520 i | | 12/2006→03/2010 | |
| 5 (E61) 520 i | | | | | | | |

V95047  11 34 7 548 280
31.40 x 6.00 x 106.65



45°

H

VAG96043B  
43.50 x 6.01 x 12.56



V95048  11 34 7 573 840
28.00 x 6.00 x 114.65



45°

H

28  84.00

| N46 B20 C | 1995cc | 4 Cyl. | 16 Valves | 95-125kW/129-170PS | Petrol | DOHC | TD18168 |
|---------------|--------|--------|-----------|--------------------|--------|-----------------|---------|
| 1 (E81) 120 i | | | | 1 (E87) 120 i | | 11/2003→06/2011 | |
| 1 (E88) 120 i | | | | 3 (E46) 318 Ci | | 12/2000→05/2006 | |
| 3 (E90) 320 i | | | | 3 (E91) 320 i | | 09/2005→06/2012 | |

V94402  11 34 1 440 304
32.00 x 6.00 x 100.00



45°

Y

H

VAG96386B  
39.00 x 6.01 x 10.15



V95047  11 34 7 548 280
31.40 x 6.00 x 106.65



45°

H

V94403  11 34 7 503 839
29.00 x 6.00 x 100.10



45°

ss

H

V95048  11 34 7 573 840
28.00 x 6.00 x 114.65



45°

H

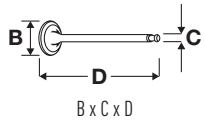

OE

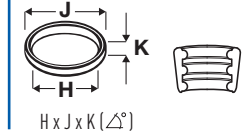
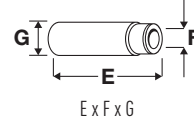
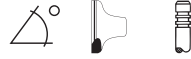

29 **84.00**

| M20 B20 A | 1997cc | 4 Cyl. | 16 Valves | 110-205kW/150-279PS | Petrol | Turbo, DOHC, Injection | TD25629 |
|----------------------------|-----------------|--------|-----------|--------------------------|--------|------------------------|---------|
| M20 B20 B | 1997cc | 4 Cyl. | 16 Valves | 120-135kW/163-184PS | Petrol | Turbo, DOHC, Injection | TD26908 |
| 1 (F20) 120 i Flex | 03/2015→ | | | 1 (F20) 125 i | | 08/2011→ | |
| 1 (F20) 125 i M Sport Flex | 03/2015→ | | | 1 (F21) 120 i Flex | | 11/2015→ | |
| 1 (F21) 125 i | 12/2011→ | | | 2 (F22, F87) 220 i | | 10/2013→ | |
| 2 (F22, F87) 228 i | 01/2014→ | | | 2 (F23) 220 i | | 04/2014→07/2016 | |
| 2 (F23) 228 i | 11/2014→ | | | 3 (F30, F80) 320 i | | 04/2011→ | |
| 3 (F30, F80) 320 iFlex | 12/2013→ | | | 3 (F30, F80) 328 i | | 04/2011→ | |
| 3 (F30, F80) 328 iFlex | 08/2014→ | | | 3 (F31) 320 i | | 01/2012→06/2015 | |
| 3 (F31) 328 i | 01/2012→06/2016 | | | 3 (F34) 320 i | | 07/2012→06/2016 | |
| 3 (F34) 328 i | 08/2012→07/2016 | | | 4 (F32, F82) 420 i | | 11/2013→ | |
| 4 (F32, F82) 428 i | 07/2013→ | | | 4 (F33, F83) 420 i | | 07/2014→ | |
| 4 (F33, F83) 428 i | 10/2013→ | | | 4 (F36) 420 i | | 03/2014→ | |
| 4 (F36) 428 i | 03/2014→ | | | 5 (F07) 528 i | | 07/2013→02/2017 | |
| 5 (F10) 520 i | 10/2010→10/2016 | | | 5 (F10) 528 i | | 10/2010→10/2016 | |
| 5 (F11) 520 i | 10/2010→ | | | 5 (F11) 528 i | | 10/2010→ | |
| X1 (E84) sDrive 20 i | 09/2011→06/2015 | | | X1 (E84) sDrive 28 i | | 09/2012→06/2015 | |
| X1 (E84) xDrive 20 i | 09/2011→06/2015 | | | X1 (E84) xDrive 28 i | | 04/2011→06/2015 | |
| X3 (F25) sDrive 20 i | 02/2014→ | | | X3 (F25) sDrive 28 i | | 08/2011→ | |
| X3 (F25) xDrive 20 i | 09/2011→ | | | X3 (F25) xDrive 28 i | | 08/2011→ | |
| X4 (F26) xDrive 20 i | 04/2014→03/2018 | | | X4 (F26) xDrive 28 i | | 04/2014→03/2018 | |
| X5 (F15, F85) xDrive 28 i | 09/2015→ | | | X5 (F15, F85) xDrive 40e | | 09/2015→ | |
| X6 (F16, F86) xDrive 28 i | 09/2015→ | | | Z4 (E89) sDrive 18 i | | 04/2013→ | |
| Z4 (E89) sDrive 20 i | 09/2011→ | | | Z4 (E89) sDrive 28 i | | 09/2011→ | |

V95191 32.00 x 4.97 x 105.00

11 34 7 583 777



45°

H

VAG96402B 42.00 x 5.00 x 10.04



V95155 28.00 x 5.96 x 112.90

11 34 7 583 780

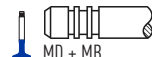

45°

SS

H

VAG96403B 48.00 x 6.00 x 10.04

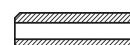

30 **84.00**

| M20 B25 (256E1) | 2494cc | 6 Cyl. | 12 Valves | 125-126kW/170-171PS | Petrol | SOHC | TD28341 |
|-----------------|-----------------|--------|-----------|---------------------|--------|-----------------|---------|
| M20 B25 (256E2) | 2494cc | 6 Cyl. | 12 Valves | 125-141kW/170-192PS | Petrol | SOHC | TD28342 |
| M20 B25 (256EX) | 2494cc | 6 Cyl. | 12 Valves | 125-126kW/170-171PS | Petrol | SOHC | TD28343 |
| M20 B25 (256K1) | 2494cc | 6 Cyl. | 12 Valves | 125-126kW/170-171PS | Petrol | SOHC | TD28344 |
| 3 (E30) 325 i | 09/1983→10/1993 | | | 3 (E30) 325 i X | | 03/1986→10/1993 | |
| 5 (E34) 525 i | 01/1988→08/1991 | | | Z1 2.5 | | 06/1988→06/1991 | |

V91187 42.00 x 6.98 x 102.70

11 34 1 720 827

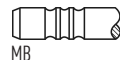

45°

Y

H

VAG92303B 45.00 x 7.02 x 13.05



V91188 36.00 x 6.96 x 102.50

11 34 1 720 828

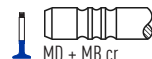

45°

H

VAG92347B 45.00 x 7.02 x 13.14

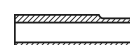

VAG96143B 45.00 x 7.02 x 13.24





OE

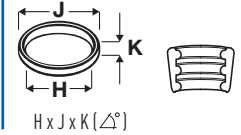
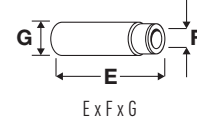
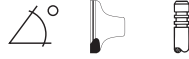

31



84.00

| | | | | | | | |
|-----------------|--------|--------|-----------|---------------------|--------|----------------|---------|
| M50 B25 (256S1) | 2494cc | 6 Cyl. | 24 Valves | 141kW/192PS | Petrol | DOHC | TD28377 |
| M50 B25 (256S2) | 2494cc | 6 Cyl. | 24 Valves | 141kW/192PS | Petrol | DOHC | TD28378 |
| M50 B25 (Vanos) | 2494cc | 6 Cyl. | 24 Valves | 141kW/192PS | Petrol | DOHC, Motronic | TD18476 |
| M50 B25 TU | 2494cc | 6 Cyl. | 24 Valves | 141kW/192PS | Petrol | DOHC | TD21240 |
| M52 B25 (Vanos) | 2494cc | 6 Cyl. | 24 Valves | 125-141kW/170-192PS | Petrol | DOHC | TD4230 |

| | | | |
|----------------|-----------------|----------------|-----------------|
| 3 (E36) 325 i | 09/1990→04/1999 | 3 (E36) 325 is | 03/1992→12/1995 |
| 5 (E34) 525 i | 09/1989→01/1997 | 5 (E34) 525 iX | 10/1991→09/1995 |
| 5 (E34) 525 ix | 02/1992→01/1997 | | |

V91410
33.10 x 6.98 x 106.70
→08/92

11 34 1 722 908

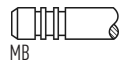

45° Y H

VAG96042B
43.50 x 7.00 x 12.55
→08/92



V91925
32.90 x 6.00 x 106.10
09/92→

11 34 1 739 822

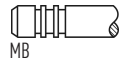

45° H

VAG96043B
43.50 x 6.01 x 12.56
09/92→



V94594
33.00 x 6.00 x 106.10
09/92→

11 34 1 438 284

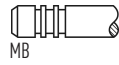

45° Y H

VAG96044B
43.50 x 6.00 x 12.77
09/92→



V91411
30.40 x 6.96 x 106.40
→08/92

11 34 1 726 903



45° ss H

V91926
30.50 x 6.00 x 105.70
09/92→

11 34 1 739 823



45° ss H

V94595
30.40 x 6.00 x 105.70
09/92→

11 34 7 505 704



45° H

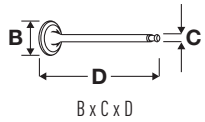

OE

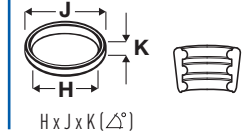
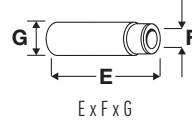
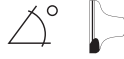

32 **84.00**

| | | | | | | | |
|------------------------|-----------------|--------|------------------|---------------------|--------|-----------------|----------------|
| M52 B25 (256S3) | 2494cc | 6 Cyl. | 24 Valves | 120-141kW/163-192PS | Petrol | DOHC | TD28382 |
| M52 B25 (256S4) | 2494cc | 6 Cyl. | 24 Valves | 120-141kW/163-192PS | Petrol | DOHC | TD28383 |
| M52 B25 TU | 2494cc | 6 Cyl. | 24 Valves | 125kW/170PS | Petrol | DOHC | TD21241 |
| M54 256 S5 | 2494cc | 6 Cyl. | 24 Valves | 137-141kW/186-192PS | Petrol | DOHC | TD17516 |
| M54 B25 (256S3) | 2494cc | 6 Cyl. | 24 Valves | 141kW/192PS | Petrol | DOHC | TD28216 |
| M54 B25 (256S5) | 2494cc | 6 Cyl. | 24 Valves | 137-141kW/186-192PS | Petrol | DOHC | TD28217 |
| 3 (E36) 323 i | 03/1995→10/1999 | | | 3 (E36) 323 i 2.5 | | 03/1995→02/1998 | |
| 3 (E36) 323 ti | 08/1997→08/2000 | | | 3 (E46) 323 Ci | | 04/1999→09/2000 | |
| 3 (E46) 323 i | 03/1998→12/2000 | | | 3 (E46) 325 Ci | | 09/2000→12/2007 | |
| 3 (E46) 325 i | 09/2000→04/2005 | | | 3 (E46) 325 xi | | 09/2000→04/2005 | |
| 3 (E46) 325 ti | 06/2001→02/2005 | | | 5 (E39) 523 i | | 11/1995→09/2000 | |
| 5 (E39) 525 i | 09/2000→05/2004 | | | 5 (E60) 525 i | | 07/2003→03/2010 | |
| 5 (E61) 525 i | 06/2004→12/2010 | | | X3 (E83) 2.5 i | | 01/2004→12/2006 | |
| Z3 (E36) 2.5 | 09/1998→09/2000 | | | Z3 (E36) 2.5 i | | 10/2000→08/2002 | |
| Z4 (E85) 2.5 i | 02/2003→12/2005 | | | Z4 (E86) 2.5 i | | 11/2006→04/2008 | |

V91925
 32.90 x 6.00 x 106.10

11 34 1 739 822

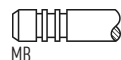

45°

H

VAG96043B
 43.50 x 6.01 x 12.56

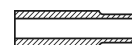

V94594
 33.00 x 6.00 x 106.10

11 34 1 438 284

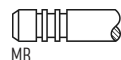

45°

Y

H

VAG96044B
 43.50 x 6.00 x 12.77



V91926
 30.50 x 6.00 x 105.70

11 34 1 739 823

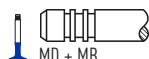

45°

ss

H

V94595
 30.40 x 6.00 x 105.70

11 34 7 505 704

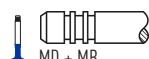

45°

H

33 **84.00**

| | | | | | | | |
|--------------------|-----------------|--------|------------------|---------------------|--------|--------------------|----------------|
| M57N 256 D4 | 2497cc | 6 Cyl. | 24 Valves | 120-130kW/163-177PS | Diesel | Turbo, DOHC | TD18033 |
| 5 (E61) 525 d | 03/2004→03/2007 | | | | | | |

V94086
 26.00 x 6.00 x 99.90

11 34 2 247 077

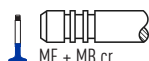

45°

H

VAG96266B
 39.00 x 6.00 x 11.54



V94086
 26.00 x 6.00 x 99.90

11 34 2 247 077

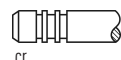

45°

H

34 **84.00**

| | | | | | | | |
|------------------------|-----------------|--------|------------------|-------------------|--------|-----------------|----------------|
| M20 B27 (276EA) | 2693cc | 6 Cyl. | 12 Valves | 90-95kW/122-129PS | Petrol | SOHC | TD28345 |
| M20 B27 (276EB) | 2693cc | 6 Cyl. | 12 Valves | 90-95kW/122-129PS | Petrol | SOHC | TD28346 |
| M20 B27 (276KA) | 2693cc | 6 Cyl. | 12 Valves | 90-95kW/122-129PS | Petrol | SOHC | TD28347 |
| M20 B27 (276KB) | 2693cc | 6 Cyl. | 12 Valves | 90-95kW/122-129PS | Petrol | SOHC | TD28348 |
| 3 (E30) 325 e 2.7 | 10/1983→12/1988 | | | 5 (E28) 525 e | | 09/1981→12/1987 | |

V91189
 40.00 x 6.98 x 102.70

11 34 1 267 721



45°

Y

H

VAG92303B
 45.00 x 7.02 x 13.05



V91190
 34.00 x 6.96 x 102.70

11 34 1 280 643

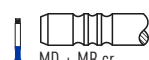

45°

H

VAG92347B
 45.00 x 7.02 x 13.14



VAG96143B
 45.00 x 7.02 x 13.24

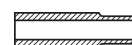



OE

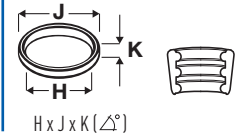
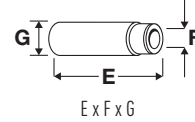
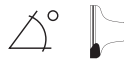

35 **84.00**

| | | | | | | | |
|------------------------|-----------------|--------|------------------|---------------------|--------|-----------------------|----------------|
| M52 B28 | 2793cc | 6 Cyl. | 24 Valves | 141-142kW/192-193PS | Petrol | DOHC, Motronic | TD4231 |
| M52 B28 (286S1) | 2793cc | 6 Cyl. | 24 Valves | 141-143kW/192-194PS | Petrol | DOHC | TD28384 |
| M52 B28 (286S2) | 2793cc | 6 Cyl. | 24 Valves | 141-144kW/192-196PS | Petrol | DOHC | TD28385 |
| M52 B28 GG | 2793cc | 6 Cyl. | 24 Valves | 142kW/193PS | Petrol | DOHC | TD26671 |
| M52 B28 TU | 2793cc | 6 Cyl. | 24 Valves | 142kW/193PS | Petrol | DOHC | TD21242 |
| 3 (E36) 328 i | 01/1995→10/1999 | | | 3 (E46) 328 Ci | | 04/1999→06/2000 | |
| 3 (E46) 328 i | 02/1998→12/2000 | | | 5 (E39) 528 i | | 11/1995→09/2000 | |
| 7 (E38) 728i X | 11/1995→09/2001 | | | 7 (E38) 728 i. iL | | 08/1995→11/2001 | |
| Z3 (E36) 2.8 i | 01/1996→07/2000 | | | | | | |

V91925
32.90 x 6.00 x 106.10

11 34 1 739 822



45° H

VAG96043B
43.50 x 6.01 x 12.56

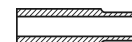

V94594
33.00 x 6.00 x 106.10

11 34 1 438 284



45° Y H

VAG96044B
43.50 x 6.00 x 12.77

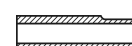

V91926
30.50 x 6.00 x 105.70

11 34 1 739 823



45° ss H

V94595
30.40 x 6.00 x 105.70

11 34 7 505 704



45° H

36 **84.00**

| | | | | | | | |
|------------------------|-----------------|--------|------------------|---------------------|--------|--------------------|----------------|
| M57 D30 (306D1) | 2926cc | 6 Cyl. | 24 Valves | 135-142kW/184-193PS | Diesel | Turbo, DOHC | TD27992 |
| 3 (E46) 330 d | 10/1999→02/2005 | | | 3 (E46) 330 xd | | 01/2000→03/2003 | |
| 5 (E39) 530 d | 08/1998→05/2004 | | | 7 (E38) 730 d | | 08/1998→11/2001 | |
| X5 (E53) 3.0 d | 05/2001→12/2003 | | | X5 (E70) 3.0 d | | 12/2006→03/2010 | |

V94086
26.00 x 6.00 x 99.90

11 34 2 247 077



45° H

VAG96266B
39.00 x 6.00 x 11.54



V94086
26.00 x 6.00 x 99.90

11 34 2 247 077

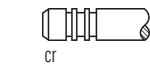

45° H

37 **84.00**

| | | | | | | | |
|-------------------|--------|--------|------------------|---------------------|--------|-------------|----------------|
| M54 306 S3 | 2979cc | 6 Cyl. | 24 Valves | 163-170kW/222-231PS | Petrol | DOHC | TD17517 |
|-------------------|--------|--------|------------------|---------------------|--------|-------------|----------------|

V91925
32.90 x 6.00 x 106.10

11 34 1 739 822



45° H

VAG96043B
43.50 x 6.01 x 12.56



V94594
33.00 x 6.00 x 106.10

11 34 1 438 284



45° Y H

V91926
30.50 x 6.00 x 105.70

11 34 1 739 823

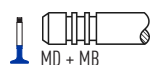

45° ss H

V94595
30.40 x 6.00 x 105.70

11 34 7 505 704

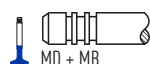

45° H

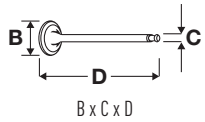

OE

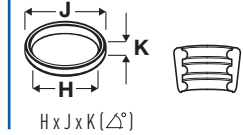
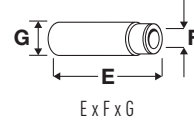

38 **84.00**

| M54 B30 (306S3) | 2979cc | 6 Cyl. | 24 Valves | 163-170kW/222-231PS | Petrol | DOHC | TD28218 |
|-----------------|-----------------|--------|-----------|-----------------------------|--------|-----------------|---------|
| 3 (E46) 330 Ci | 06/2000→12/2007 | | | 3 (E46) 330 i | | 06/2000→04/2005 | |
| 3 (E46) 330 xi | 06/2000→07/2006 | | | 5 (E39) 530 i | | 09/2000→05/2004 | |
| 5 (E60) 530 i | 12/2001→12/2005 | | | 7 (E65, E66, E67) 730 i, Li | | 03/2003→07/2008 | |
| X3 (E83) 3.0 i | 01/2004→12/2006 | | | X5 (E53) 3.0 i | | 05/2000→12/2006 | |
| Z3 (E36) 3.0 i | 06/2000→06/2003 | | | Z4 (E85) 3.0 i | | 02/2003→12/2005 | |

| | | | | | | |
|-----------------------|-----------------|---------|-----|----|----------------------|--|
| V91925 | 11 34 1 739 822 | | 45° | H | VAG96043B | |
| 32.90 x 6.00 x 106.10 | | MB | | | 43.50 x 6.01 x 12.56 | |
| V94594 | 11 34 1 438 284 | | 45° | Y | VAG96044B | |
| 33.00 x 6.00 x 106.10 | | MB | | H | 43.50 x 6.00 x 12.77 | |
| V91926 | 11 34 1 739 823 | | 45° | ss | | |
| 30.50 x 6.00 x 105.70 | | MD + MB | | H | | |
| V94595 | 11 34 7 505 704 | | 45° | H | | |
| 30.40 x 6.00 x 105.70 | | MD + MB | | | | |

39 **84.00**

| N54 B30 B | 2979cc | 6 Cyl. | 24 Valves | 225kW/306PS | Petrol | Turbo, DOHC, Injection | TD20586 |
|---------------|-----------------|--------|-----------|-------------|--------|------------------------|---------|
| 3 (E93) 335 i | 05/2006→10/2013 | | | | | | |

| | | | | | | |
|-----------------------|-----------------|------------|-----|---|----------------------|--|
| V80025 | 11 34 7 553 775 | | 45° | | VAG96402B | |
| 31.40 x 5.00 x 106.60 | | MB cr | | | 42.00 x 5.00 x 10.04 | |
| V95048 | 11 34 7 573 840 | | 45° | H | VAG96403B | |
| 28.00 x 6.00 x 114.65 | | MD + MB cr | | | 48.00 x 6.00 x 10.04 | |

40 **84.00**

| N55 B30 A | 2979cc | 6 Cyl. | 24 Valves | 200-272kW/272-370PS | Petrol | Turbo, DOHC, Injection | TD24624 |
|-----------|--------|--------|-----------|---------------------|--------|------------------------|---------|
|-----------|--------|--------|-----------|---------------------|--------|------------------------|---------|

| | | | | | | | |
|----------------------------------|-----------------|--|--|-------------------------------------|--|-----------------|--|
| 1 (E82) 135 i | 10/2007→10/2013 | | | 1 (E88) 135 i | | 03/2008→12/2013 | |
| 1 (F20) M 135 i | 11/2011→ | | | 1 (F21) M 135 i | | 12/2011→ | |
| 2 (F22, F87) M2 | 11/2015→06/2018 | | | 2 (F22, F87) M 235 i | | 10/2013→ | |
| 2 (F23) M 235 i | 11/2014→ | | | 3 (E90) 335 i | | 03/2006→12/2011 | |
| 3 (E90) 335 xi | 09/2006→06/2008 | | | 3 (E91) 335 i | | 03/2006→05/2012 | |
| 3 (E91) 335 xi | 09/2006→08/2008 | | | 3 (E92) 335 i | | 11/2005→12/2013 | |
| 3 (E92) 335 xi | 03/2007→02/2010 | | | 3 (E93) 335 i | | 05/2006→10/2013 | |
| 3 (F30, F80) 335 i | 04/2011→ | | | 3 (F30, F80) ActiveHybrid | | 11/2011→05/2015 | |
| 3 (F31) 335 i | 07/2012→06/2015 | | | 3 (F34) 335 i | | 03/2013→ | |
| 4 (F32, F82) 435 i | 07/2013→ | | | 4 (F33, F83) 435 i | | 10/2013→ | |
| 4 (F36) 435 i | 03/2014→ | | | 5 (F07) 535 i | | 01/2009→02/2017 | |
| 5 (F10) 535 i | 01/2009→10/2016 | | | 5 (F10) ActiveHybrid | | 09/2010→08/2016 | |
| 5 (F11) 535 i | 11/2009→ | | | 6 (F06) 640 i | | 09/2011→ | |
| 6 (F12) 640 i | 03/2011→ | | | 6 (F13) 640 i | | 11/2010→ | |
| 7 (F01, F02, F03, F04) 740 i, Li | 07/2012→12/2015 | | | 7 (F01, F02, F03, F04) ActiveHybrid | | 05/2011→05/2015 | |
| X1 (E84) xDrive 35 i | 09/2012→06/2015 | | | X3 (F25) xDrive 35 i | | 09/2010→ | |
| X4 (F26) M 40 i | 12/2015→03/2018 | | | X4 (F26) xDrive 35 i | | 04/2014→03/2018 | |
| X5 (E70) xDrive 35 i | 09/2010→06/2013 | | | X5 (E70) xDrive 40 i | | 01/2012→06/2013 | |
| X5 (F15, F85) sDrive 35 i | 07/2013→ | | | X5 (F15, F85) xDrive 35 i | | 11/2013→ | |
| X6 (E71, E72) xDrive 35 i | 06/2007→06/2014 | | | X6 (F16, F86) sDrive 35 i | | 09/2014→ | |
| X6 (F16, F86) xDrive 35 i | 12/2014→ | | | | | | |

| | | | | | | |
|-----------------------|-----------------|---------|-----|----|----------------------|--|
| V95191 | 11 34 7 583 777 | | 45° | H | VAG96402B | |
| 32.00 x 4.97 x 105.00 | | MB | | | 42.00 x 5.00 x 10.04 | |
| V95155 | 11 34 7 583 780 | | 45° | ss | VAG96403B | |
| 28.00 x 5.96 x 112.90 | | MD + MB | | H | 48.00 x 6.00 x 10.04 | |



OE

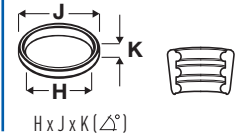
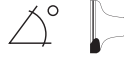

41



84.00

| | | | | | | | |
|------------------------------|-----------------|--------|------------------|------------------------------|--------|--------------------|----------------|
| B57 D30 A | 2993cc | 6 Cyl. | 24 Valves | 155-235kW/211-320PS | Diesel | Turbo, DOHC | TD31362 |
| B57 D30 B | 2993cc | 6 Cyl. | 24 Valves | 235kW/320PS | Diesel | Turbo, DOHC | TD32088 |
| B57 D30 C | 2993cc | 6 Cyl. | 24 Valves | 294kW/400PS | Diesel | Turbo, DOHC | TD33183 |
| N57 D30 A | 2993cc | 6 Cyl. | 24 Valves | 150-210kW/204-286PS | Diesel | Turbo, DOHC | TD24613 |
| N57 D30 B | 2993cc | 6 Cyl. | 24 Valves | 220-230kW/299-313PS | Diesel | Turbo, DOHC | TD26305 |
| N57 D30 C | 2993cc | 6 Cyl. | 24 Valves | 280kW/381PS | Diesel | Turbo, DOHC | TD26349 |
| 3 (E90) 325 d | 03/2010→10/2011 | | | 3 (E90) 330 d | | 09/2005→12/2011 | |
| 3 (E91) 325 d | 02/2010→06/2012 | | | 3 (E91) 330 d | | 12/2004→06/2012 | |
| 3 (E92) 325 d | 09/2009→12/2013 | | | 3 (E92) 330 d | | 01/2009→12/2013 | |
| 3 (E92) 330 xd | 03/2008→02/2010 | | | 3 (E93) 325 d | | 09/2009→09/2013 | |
| 3 (E93) 330 d | 01/2009→12/2013 | | | 3 (F30, F80) 330 d | | 01/2012→ | |
| 3 (F30, F80) 335 d | 11/2012→ | | | 3 (F31) 330 d | | 01/2012→ | |
| 3 (F31) 335 d | 04/2013→ | | | 3 (F34) 330 d | | 01/2014→ | |
| 3 (F34) 335 d | 01/2014→ | | | 4 (F32, F82) 430 d | | 11/2013→ | |
| 4 (F32, F82) 435 d | 11/2013→ | | | 4 (F33, F83) 430 d | | 10/2013→ | |
| 4 (F33, F83) 435 d | 07/2014→ | | | 4 (F36) 430 d | | 07/2014→ | |
| 4 (F36) 435 d | 07/2014→ | | | 5 (F07) 530 d | | 08/2009→02/2017 | |
| 5 (F07) 535 d | 05/2009→02/2017 | | | 5 (F10) 525 d | | 03/2010→08/2011 | |
| 5 (F10) 530 d | 01/2009→10/2016 | | | 5 (F10) 535 d | | 03/2010→10/2016 | |
| 5 (F10) M 550 d | 07/2011→10/2016 | | | 5 (F11) 525 d | | 11/2009→08/2011 | |
| 5 (F11) 530 d | 11/2009→ | | | 5 (F11) 535 d | | 03/2010→ | |
| 5 (F11) M 550 d | 10/2010→ | | | 5 (G30, F90) 530 d | | 09/2016→ | |
| 5 (G30, F90) 540 d | 07/2017→ | | | 5 (G30, F90) M 550 d | | 06/2017→ | |
| 5 (G31) 530 d | 03/2017→ | | | 5 (G31) 540 d | | 07/2017→ | |
| 5 (G31) M 550 d | 07/2017→ | | | 6 (F06) 640 d | | 09/2011→ | |
| 6 (F12) 640 d | 09/2011→ | | | 6 (F13) 640 d | | 11/2010→ | |
| 6 (G32) 630 d | 06/2017→ | | | 6 (G32) 640 d | | 11/2017→ | |
| 7 (F01, F02, F03, F04) 730 d | 02/2008→05/2015 | | | 7 (F01, F02, F03, F04) 740 d | | 09/2009→12/2015 | |
| 7 (F01, F02, F03, F04) 750 d | 07/2012→12/2015 | | | 7 (G11, G12) 730 d | | 09/2015→ | |
| 7 (G11, G12) 730 d, Ld | 09/2015→ | | | 7 (G11, G12) 740 d, Ld | | 11/2015→ | |
| 7 (G11, G12) 750 d, Ld | 07/2016→ | | | X3 (F25) xDrive 30 d | | 05/2011→ | |
| X3 (F25) xDrive 35 d | 09/2011→ | | | X3 (G01) xDrive 30d | | 08/2017→ | |
| X4 (F26) xDrive 30 d | 04/2014→03/2018 | | | X4 (F26) xDrive 35 d | | 04/2014→03/2018 | |
| X5 (E70) M 50 d | 08/2011→06/2013 | | | X5 (E70) xDrive 30 d | | 10/2008→07/2013 | |
| X5 (E70) xDrive 40 d | 09/2010→06/2013 | | | X5 (F15, F85) M 50 d | | 07/2013→ | |
| X5 (F15, F85) xDrive 25 d | 04/2014→ | | | X5 (F15, F85) xDrive 30 d | | 07/2013→ | |
| X5 (F15, F85) xDrive 40 d | 12/2013→ | | | X6 (E71, E72) M 50 d | | 08/2011→06/2014 | |
| X6 (E71, E72) xDrive 30 d | 04/2009→06/2014 | | | X6 (E71, E72) xDrive 40 d | | 07/2009→06/2014 | |
| X6 (F16, F86) M 50 d | 08/2014→ | | | X6 (F16, F86) xDrive 30 d | | 08/2014→ | |
| X6 (F16, F86) xDrive 40 d | 12/2014→ | | | | | | |

V95040 ■
27.20 x 5.00 x 94.00

11 12 7 797 711

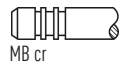

MB cr

45°

H

VAG96387B ■ ■ ■
36.00 x 5.00 x 10.05



V95041 ■
24.60 x 5.00 x 94.00

11 34 8 511 622

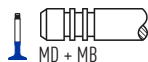

MD + MB

45°

H

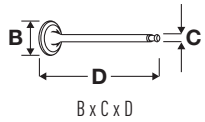

OE

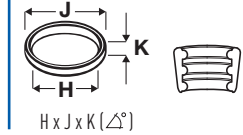
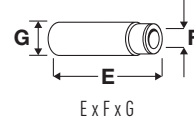
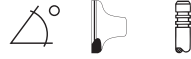

42 **84.00**

| | | | | | | | |
|------------------------|--------|--------|------------------|---------------------|--------|--------------------|----------------|
| M57 306 D3 | 2993cc | 6 Cyl. | 24 Valves | 145-173kW/197-235PS | Diesel | DOHC | TD18985 |
| M57 D30 (306D2) | 2993cc | 6 Cyl. | 24 Valves | 150-160kW/204-218PS | Diesel | Turbo, DOHC | TD27248 |
| M57 D30 (306D3) | 2993cc | 6 Cyl. | 24 Valves | 135-173kW/184-235PS | Diesel | Turbo, DOHC | TD27267 |
| M57 D30 (306D4) | 2993cc | 6 Cyl. | 24 Valves | 198-200kW/269-272PS | Diesel | Turbo, DOHC | TD28386 |
| M57 D30 (306D5) | 2993cc | 6 Cyl. | 24 Valves | 198-221kW/269-301PS | Diesel | Turbo, DOHC | TD28387 |
| M57N 306 D2 | 2993cc | 6 Cyl. | 24 Valves | 150-155kW/204-211PS | Diesel | Turbo, DOHC | TD17525 |
| M57N 306 D4 | 2993cc | 6 Cyl. | 24 Valves | 160kW/218PS | Diesel | DOHC | TD18306 |
| M57N 306 D5 | 2993cc | 6 Cyl. | 24 Valves | 210kW/286PS | Diesel | DOHC | TD20581 |

| | | | |
|---------------------------|-----------------|---------------------------|-----------------|
| 3 (E46) 330 Cd | 03/2003→12/2007 | 3 (E46) 330 d | 03/2003→02/2005 |
| 3 (E46) 330 xd | 08/2002→05/2005 | 3 (E90) 325 d | 09/2006→02/2010 |
| 3 (E90) 330 d | 09/2005→12/2011 | 3 (E90) 330 xd | 09/2005→08/2008 |
| 3 (E90) 335 d | 09/2006→12/2011 | 3 (E91) 325 d | 09/2006→06/2012 |
| 3 (E91) 330 d | 12/2004→05/2012 | 3 (E91) 330 xd | 09/2005→06/2012 |
| 3 (E91) 335 d | 09/2006→06/2012 | 3 (E92) 325 d | 02/2007→02/2010 |
| 3 (E92) 330 d | 03/2006→08/2008 | 3 (E92) 330 xd | 03/2006→08/2008 |
| 3 (E92) 335 d | 03/2006→03/2013 | 3 (E93) 325 d | 03/2007→12/2010 |
| 3 (E93) 330 d | 03/2007→12/2013 | 5 (E60) 525 d | 01/2007→03/2010 |
| 5 (E60) 525 xd | 11/2006→08/2007 | 5 (E60) 530 d | 09/2002→12/2009 |
| 5 (E60) 530 xd | 02/2005→08/2007 | 5 (E60) 535 d | 09/2004→03/2010 |
| 5 (E61) 525 d | 03/2007→05/2010 | 5 (E61) 525 xd | 09/2007→09/2008 |
| 5 (E61) 530 d | 03/2004→05/2010 | 5 (E61) 530 xd | 02/2005→08/2007 |
| 5 (E61) 535 d | 09/2004→12/2010 | 6 (E63) 635 d | 07/2007→07/2010 |
| 6 (E64) 635 d | 07/2007→07/2010 | 7 (E65, E66, E67) 730 d | 06/2002→07/2008 |
| 7 (E65, E66, E67) 730 Ld | 07/2005→08/2008 | X3 (E83) 3.0 d | 01/2004→08/2008 |
| X3 (E83) 3.0 sd | 09/2006→08/2008 | X3 (E83) xDrive 30 d | 09/2008→08/2010 |
| X3 (E83) xDrive 35 d | 09/2008→08/2011 | X5 (E53) 3.0 d | 09/2003→12/2006 |
| X5 (E70) 3.0 d | 12/2006→03/2010 | X5 (E70) 3.0 sd | 10/2007→03/2010 |
| X5 (E70) xDrive 35 d | 09/2008→06/2013 | X6 (E71, E72) xDrive 30 d | 09/2007→06/2014 |
| X6 (E71, E72) xDrive 35 d | 06/2007→03/2010 | | |

V94086 11 34 2 247 077
26.00 x 6.00 x 99.90



45°

H

VAG96266B
39.00 x 6.00 x 11.54



V94086 11 34 2 247 077
26.00 x 6.00 x 99.90

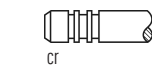

45°

H

43 **84.00**

| | | | | | | | |
|---------------------|--------|--------|------------------|---------------------|--------|--------------------|----------------|
| M57 D30 TU2 | 2993cc | 6 Cyl. | 24 Valves | 145-173kW/197-235PS | Diesel | Turbo, DOHC | TD20843 |
| M57N2 306 D2 | 2993cc | 6 Cyl. | 24 Valves | 160kW/218PS | Diesel | DOHC | TD20589 |
| M57N2 306 D3 | 2993cc | 6 Cyl. | 24 Valves | 150-180kW/204-245PS | Diesel | Turbo, DOHC | TD24615 |

V95042 11 34 7 799 612
27.40 x 6.00 x 99.80

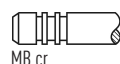

45°

H

VAG96266B
39.00 x 6.00 x 11.54



V94086 11 34 2 247 077
26.00 x 6.00 x 99.90

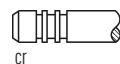

45°

H



OE

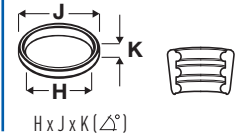
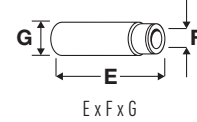

44  **84.00**

| | | | | | | |
|-------------|--------|--------|-----------|---------------------|--------|---------|
| N57 306 D2 | 2993cc | 6 Cyl. | 24 Valves | 160kW/218PS | Diesel | TD18307 |
| N57 306 D3 | 2993cc | 6 Cyl. | 24 Valves | 145kW/197PS | Diesel | TD20587 |
| N57N 306 D2 | 2993cc | 6 Cyl. | 24 Valves | 170kW/231PS | Diesel | TD20592 |
| N57N 306 D3 | 2993cc | 6 Cyl. | 24 Valves | 145-170kW/197-231PS | Diesel | TD20583 |
| N57N 306 D5 | 2993cc | 6 Cyl. | 24 Valves | 210kW/286PS | Diesel | TD20595 |
| N57S D30 B | 2993cc | 6 Cyl. | 24 Valves | 220-225kW/299-306PS | Diesel | TD24635 |

V95040  27.20 x 5.00 x 94.00

11 12 7 797 711

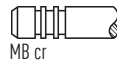

45°

H

VAG96266B  39.00 x 6.00 x 11.54



V95041  24.60 x 5.00 x 94.00

11 34 8 511 622



45°

H

45  **84.00**

| | | | | | | | |
|------------------------------|-----------------|--------|-----------|----------------------------------|--------|-------------------------------|---------|
| N54 B30 A | 2996cc | 6 Cyl. | 24 Valves | 200-264kW/272-359PS | Petrol | Turbo, DOHC, Injection | TD20342 |
| 1 [E81] 125i | 09/2007→12/2011 | | | 1 [E82] 135 i | | 10/2007→10/2013 | |
| 1 [E82] M | 04/2011→06/2012 | | | 1 [E88] 135 i | | 03/2008→12/2013 | |
| 3 [E90] 335 i | 03/2006→12/2011 | | | 3 [E90] 335 xi | | 09/2006→06/2008 | |
| 3 [E91] 335 i | 03/2006→05/2012 | | | 3 [E91] 335 xi | | 09/2006→08/2008 | |
| 3 [E92] 335 i | 11/2005→12/2013 | | | 3 [E92] 335 xi | | 03/2007→02/2010 | |
| 3 [E93] 335 i | 05/2006→10/2013 | | | 3 [F34] 335 i | | 01/2014→ | |
| 5 [E60] 535 i | 04/2006→03/2010 | | | 5 [E60] 535 ix | | 10/2006→08/2007 | |
| 5 [E61] 535 i | 09/2008→12/2010 | | | 5 [E61] 535 xi | | 09/2007→12/2010 | |
| 7 [F01, F02, F03, F04] 740 i | 10/2008→12/2015 | | | 7 [F01, F02, F03, F04] 740 i, Li | | 09/2010→12/2015 | |
| X6 [E71, E72] xDrive 35 i | 06/2007→06/2014 | | | Z4 [E89] sDrive 35 i | | 05/2009→ | |
| Z4 [E89] sDrive 35 i | 09/2009→ | | | | | | |

V80025  31.40 x 5.00 x 106.60

11 34 7 553 775

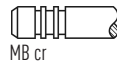

45°

VAG96402B  42.00 x 5.00 x 10.04

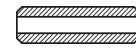

V95048  28.00 x 6.00 x 114.65

11 34 7 573 840







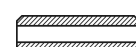

45°

H

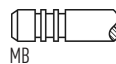



VAG96403B  48.00 x 6.00 x 10.04

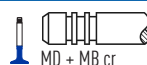

46  **84.00**

| | | | | | | | |
|---|-----------------|---|-----------|---------------------|---|---|--------|
| M60 B30 | 2997cc | V8 Cyl. | 32 Valves | 155-160kW/211-218PS | Petrol | DOHC, Motronic | TD4232 |
| V95059  32.00 x 5.97 x 104.10 | 11 34 1 435 476 |  | 45° | H | VAG96043B  43.50 x 6.01 x 12.56 |  | |
| V95060  28.45 x 5.96 x 103.60 | 11 34 1 433 483 |  | 45° | SS H | VAG96044B  43.50 x 6.00 x 12.77 |  | |

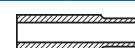
47  **84.00**

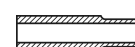
| | | | | | | | |
|---|-----------------|---|-----------|---------------------|---|---|---------|
| M60 B30 (308S1) | 2997cc | V8 Cyl. | 32 Valves | 155-160kW/211-218PS | Petrol | DOHC | TD28388 |
| 5 [E34] 530 i | 09/1994→11/1995 | | | 5 [E34] 530 i V8 | | 09/1992→01/1997 | |
| 7 [E32] 730 i, iL V8 | 04/1992→09/1994 | | | 7 [E38] 730 i, iL | | 10/1994→11/2001 | |
| V95060  28.45 x 5.96 x 103.60 | 11 34 1 433 483 |  | 45° | SS H | VAG96043B  43.50 x 6.01 x 12.56 |  | |
| | | | | | VAG96044B  43.50 x 6.00 x 12.77 |  | |

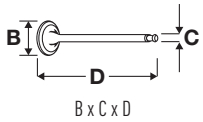

OE

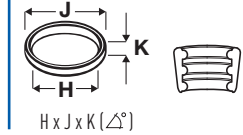
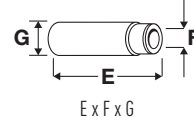
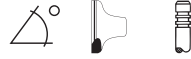

48 **84.00**

| | | | | | | | |
|------------------------|-----------------|---------|-------------------|---------------------|-----------------|-------------|----------------|
| M62 B35 (358S1) | 3498cc | V8 Cyl. | 32 Valves | 173kW/235PS | Petrol | DOHC | TD28390 |
| M62 B35 (358S2) | 3498cc | V8 Cyl. | 32 Valves | 173-180kW/235-245PS | Petrol | DOHC | TD28391 |
| M62 B35 TU | 3498cc | V8 Cyl. | 32 Valves | 175-180kW/238-245PS | Petrol | DOHC | TD21244 |
| 5 (E39) 535 i | 04/1996→06/2003 | | 7 (E38) 735 i, iL | | 01/1996→07/2001 | | |

| | | | | | | |
|-----------------------|-----------------|------------|-----|------|----------------------|--|
| V95059 | 11 34 1 435 476 | | 45° | H | VAG96043B | |
| 32.00 x 5.97 x 104.10 | | MB | | | 43.50 x 6.01 x 12.56 | |
| V95060 | 11 34 1 433 483 | | 45° | ss H | VAG96044B | |
| 28.45 x 5.96 x 103.60 | | MD + MB cr | | | 43.50 x 6.00 x 12.77 | |

49 **84.00**

| | | | | | | | |
|----------------|--------|---------|------------------|-------------|--------|-------------|----------------|
| N62 B36 | 3600cc | V8 Cyl. | 32 Valves | 200kW/272PS | Petrol | DOHC | TD16267 |
|----------------|--------|---------|------------------|-------------|--------|-------------|----------------|

| | | | | | | |
|-----------------------|-----------------|------------|-----|------|--|--|
| V94403 | 11 34 7 503 839 | | 45° | ss H | | |
| 29.00 x 6.00 x 100.10 | | MD + MB cr | | | | |

50 **84.00**

| | | | | | | | |
|------------------------|-----------------|---------|-------------------------|---------------------|-----------------|--------------------|----------------|
| M67 D39 (398D1) | 3901cc | V8 Cyl. | 32 Valves | 180-190kW/245-258PS | Diesel | Turbo, DOHC | TD28394 |
| 7 (E38) 740 d | 05/1999→11/2001 | | 7 (E65, E66, E67) 740 d | | 10/2002→02/2005 | | |

| | | | | | | |
|----------------------|-----------------|------------|-----|---|----------------------|--|
| V94086 | 11 34 2 247 077 | | 45° | H | VAG96266B | |
| 26.00 x 6.00 x 99.90 | | MF + MB cr | | | 39.00 x 6.00 x 11.54 | |
| V94086 | 11 34 2 247 077 | | 45° | H | | |
| 26.00 x 6.00 x 99.90 | | cr | | | | |

51 **84.00**

| | | | | | | | |
|------------------------|-----------------|----------|-------------------|---------------------|-----------------|-------------|----------------|
| M70 B50 (5012A) | 4988cc | V12 Cyl. | 24 Valves | 220-230kW/300-313PS | Petrol | SOHC | TD28396 |
| 7 (E32) 750 i, iL V12 | 09/1987→09/1994 | | 8 (E31) 850 i, Ci | | 04/1990→10/1994 | | |

| | | | | | | |
|-----------------------|-----------------|------------|-----|------|----------------------|--|
| V91418 | 11 34 1 727 358 | | 45° | Y H | VAG96042B | |
| 41.90 x 7.00 x 102.10 | | MB | | | 43.50 x 7.00 x 12.55 | |
| V91955 | 11 34 1 727 352 | | 45° | ss H | | |
| 35.90 x 7.00 x 101.10 | | MD + MB cr | | | | |

52 **84.10**

| | | | | | | | |
|-----------------------------|-----------------|---------|-------------------------|-------------|-----------------|-------------|----------------|
| N62 B40 A | 4000cc | V8 Cyl. | 32 Valves | 225kW/306PS | Petrol | DOHC | TD18516 |
| 5 (E60) 540 i | 07/2005→03/2010 | | 7 (E65, E66, E67) 735 i | | 03/2005→12/2009 | | |
| 7 (E65, E66, E67) 740 i, Li | 07/2005→07/2008 | | | | | | |

| | | | | | | |
|-----------------------|-----------------|------------|-----|------|--|--|
| V94403 | 11 34 7 503 839 | | 45° | ss H | | |
| 29.00 x 6.00 x 100.10 | | MD + MB cr | | | | |



OE

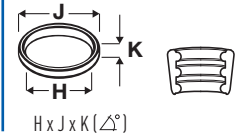
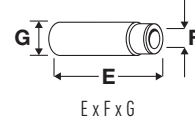

53



85.00

| M43 B19 (194E1) | 1895cc | 4 Cyl. | 8 Valves | 85-87kW/116-118PS | Petrol | SOHC | TD27701 |
|-----------------|--------|--------|----------|-------------------|--------|------|-----------------|
| 3 (E36) 316 i | | | | 12/1998→08/2000 | | | 3 (E46) 316 i |
| 3 (E46) 318 Ci | | | | 11/1999→09/2001 | | | 3 (E46) 318 i |
| Z3 (E36) 1.9 i | | | | 07/1998→01/2003 | | | 09/1998→02/2005 |
| | | | | | | | 02/1998→09/2001 |

V94087 42.00 x 7.00 x 104.00

11 34 1 739 658

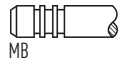

45° Y H

VAG96042B 43.50 x 7.00 x 12.55



V94088 35.90 x 7.00 x 103.00

11 34 1 739 665



45° ss H

54



85.00

| M44 B19 (194S1) | 1895cc | 4 Cyl. | 16 Valves | 103kW/140PS | Petrol | DOHC | TD28373 |
|-----------------|--------|--------|-----------|-----------------|--------|------|-----------------|
| 3 (E36) 318 i | | | | 09/1995→04/1999 | | | 3 (E36) 318 is |
| 3 (E36) 318 ti | | | | 07/1995→08/2000 | | | Z3 (E36) 1.9 i |
| | | | | | | | 09/1995→04/1999 |
| | | | | | | | 10/1995→03/1999 |

V91925 32.90 x 6.00 x 106.10

11 34 1 739 822

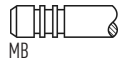

45° H

VAG96043B 43.50 x 6.01 x 12.56



V94594 33.00 x 6.00 x 106.10

11 34 1 438 284

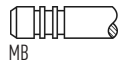

45° Y H

VAG96044B 43.50 x 6.00 x 12.77



V91926 30.50 x 6.00 x 105.70

11 34 1 739 823



45° ss H

V94595 30.40 x 6.00 x 105.70

11 34 7 505 704



45° H

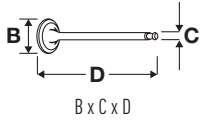

OE

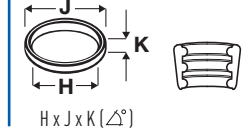
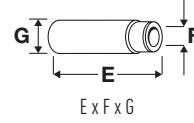

55 **85.00**

| | | | | | | | |
|----------------------------------|-----------------|--------|------------------|-----------------------------|--------|------------------------|-----------------|
| N52 B30 | 2996cc | 6 Cyl. | 24 Valves | 190-200kW/258-272PS | Petrol | DOHC | TD21409 |
| N52 B30 A | 2996cc | 6 Cyl. | 24 Valves | 155-200kW/211-272PS | Petrol | DOHC | TD18170 |
| N52 B30 B | 2996cc | 6 Cyl. | 24 Valves | 190-200kW/258-272PS | Petrol | DOHC | TD26670 |
| N52N B30 B | 2996cc | 6 Cyl. | 24 Valves | 190kW/258PS | Petrol | DOHC | TD20961 |
| N53 B30 | 2996cc | 6 Cyl. | 24 Valves | 160-200kW/218-272PS | Petrol | DOHC, Injection | TD21410 |
| N53 B30 A | 2996cc | 6 Cyl. | 24 Valves | 150-200kW/204-272PS | Petrol | DOHC, Injection | TD20585 |
| 1 (E81) 130 i | 09/2006→12/2011 | | | 1 (E82) 125 i | | | 10/2007→10/2013 |
| 1 (E82) 128 i | 10/2007→10/2013 | | | 1 (E87) 130 i | | | 03/2005→09/2012 |
| 1 (E88) 125 i | 03/2008→12/2013 | | | 3 (E90) 325 i | | | 03/2007→12/2011 |
| 3 (E90) 325 xi | 03/2007→06/2008 | | | 3 (E90) 328 i | | | 07/2005→12/2010 |
| 3 (E90) 328 xi | 09/2006→12/2008 | | | 3 (E90) 330 i | | | 12/2004→12/2011 |
| 3 (E90) 330 xi | 09/2005→08/2008 | | | 3 (E91) 325 i | | | 09/2007→06/2012 |
| 3 (E91) 325 xi | 09/2007→06/2012 | | | 3 (E91) 328 i | | | 03/2007→06/2012 |
| 3 (E91) 330 i | 08/2005→06/2012 | | | 3 (E91) 330 xi | | | 09/2005→06/2012 |
| 3 (E92) 325 i | 03/2007→12/2013 | | | 3 (E92) 325 xi | | | 09/2007→02/2010 |
| 3 (E92) 330 i | 09/2006→06/2013 | | | 3 (E92) 330 xi | | | 09/2006→08/2007 |
| 3 (E93) 325 i | 10/2006→12/2013 | | | 3 (E93) 330 i | | | 03/2007→12/2013 |
| 5 (E60) 525 i | 01/2007→03/2010 | | | 5 (E60) 525 xi | | | 01/2007→03/2010 |
| 5 (E60) 528 i | 09/2006→03/2010 | | | 5 (E60) 530 i | | | 09/2004→03/2010 |
| 5 (E60) 530 xi | 09/2004→08/2008 | | | 5 (E61) 525 i | | | 01/2007→12/2010 |
| 5 (E61) 525 xi | 01/2007→12/2010 | | | 5 (E61) 530 i | | | 09/2004→12/2010 |
| 5 (E61) 530 xi | 04/2005→05/2010 | | | 5 (F10) 523 i | | | 06/2009→08/2011 |
| 5 (F10) 528 i | 01/2009→08/2011 | | | 5 (F10) 530 i | | | 06/2009→06/2013 |
| 5 (F11) 523 i | 11/2009→08/2011 | | | 5 (F11) 528 i | | | 11/2009→08/2011 |
| 5 (F11) 530 i | 03/2010→06/2013 | | | 6 (E63) 630 i | | | 02/2004→07/2010 |
| 6 (E64) 630 i | 03/2004→07/2010 | | | 7 (E65, E66, E67) 730 i, Li | | | 03/2005→07/2008 |
| 7 (F01, F02, F03, F04) 730 i, Li | 06/2008→12/2015 | | | X1 (E84) sDrive 28 i | | | 09/2011→06/2015 |
| X1 (E84) xDrive 25 i | 01/2010→06/2015 | | | X1 (E84) xDrive 28 i | | | 10/2009→06/2015 |
| X3 (E83) 3.0 si | 09/2006→08/2008 | | | X3 (E83) xDrive 28 i | | | 09/2008→12/2010 |
| X3 (E83) xDrive 30 i | 03/2006→12/2011 | | | X3 (F25) xDrive 28 i | | | 09/2010→ |
| X5 (E70) 3.0 si | 02/2006→09/2008 | | | X5 (E70) xDrive 30 i | | | 02/2007→12/2012 |
| Z4 (E85) 3.0 si | 09/2005→12/2009 | | | Z4 (E86) 3.0 si | | | 03/2006→01/2009 |
| Z4 (E89) sDrive 30 i | 05/2009→ | | | | | | |

| | | | | | |
|-----------------------|-----------------|--|-----|----|---|
| V95043 | 11 34 7 553 771 | | 45° | Y | H |
| 34.20 x 5.00 x 104.50 | | | | | |
| V95191 | 11 34 7 583 777 | | 45° | | H |
| 32.00 x 4.97 x 105.00 | | | | | |
| V95044 | 11 34 7 553 772 | | 45° | | H |
| 29.00 x 6.00 x 110.55 | | | | | |
| V95155 | 11 34 7 583 780 | | 45° | ss | H |
| 28.00 x 5.96 x 112.90 | | | | | |

| | | |
|------------------|----------------------|--|
| VAG96402B | 42.00 x 5.00 x 10.04 | |
| VAG96403B | 48.00 x 6.00 x 10.04 | |

56 **85.00**

| | | | | | | | |
|------------------------|-----------------|----------|------------------|---------------------|--------|------------------------|-----------------|
| M73 B54 | 5379cc | V12 Cyl. | 24 Valves | 240kW/326PS | Petrol | DOHC, Injection | TD466 |
| M73 B54 (54121) | 5379cc | V12 Cyl. | 24 Valves | 240kW/326PS | Petrol | DOHC | TD28397 |
| M73 B54 (54122) | 5379cc | V12 Cyl. | 24 Valves | 240-243kW/326-330PS | Petrol | DOHC | TD28398 |
| 7 (E38) 750 i, iL | 12/1994→11/2001 | | | 8 (E31) 850 Ci | | | 09/1994→12/1999 |

| | | | | | |
|-----------------------|-----------------|--|-----|----|---|
| V94087 | 11 34 1 739 658 | | 45° | Y | H |
| 42.00 x 7.00 x 104.00 | | | | | |
| V94088 | 11 34 1 739 665 | | 45° | ss | H |
| 35.90 x 7.00 x 103.00 | | | | | |





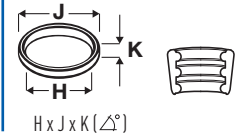
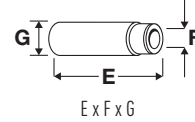
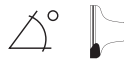

| | | |
|------------------|----------------------|--|
| VAG96042B | 43.50 x 7.00 x 12.55 | |
|------------------|----------------------|--|













OE

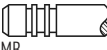













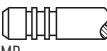

57  **86.00**

| | | | | | | | |
|---|-----------------|---|---|---------------------|--------|-------------|----------------|
| S50 B30 (306S1) | 2990cc | 6 Cyl. | 24 Valves | 179-217kW/243-295PS | Petrol | DOHC | TD28411 |
| 3 (E36) M3 3.0 | | 10/1992→12/1995 | | | | | |
| V94776  | 11 34 1 401 104 |  |  | 45° | ss | H | |
| 34.00 x 7.00 x 119.70 | | | MD + MB cr | | | | |
| V94774  | 11 34 1 401 105 |  |  | 45° | ss | H | |
| 30.50 x 7.00 x 121.30 | | | MD + MB cr | | | | |







58  **86.00**

| | | | | | | | |
|---|-----------------|---|---|---------------------|--------|-----------------------|--|
| M70 B56 | 5576cc | V12 Cyl. | 24 Valves | 280kW/380PS | Petrol | SOHC, Motronic | TD4237 |
| S70 B56 (56121) | 5576cc | V12 Cyl. | 24 Valves | 278-280kW/378-381PS | Petrol | SOHC | TD28416 |
| 8 (E31) 850 CSi | | 04/1993→12/1996 | | | | | |
| V94087  | 11 34 1 739 658 |  |  | 45° | Y | H | VAG96042B    43.50 x 7.00 x 12.55 |
| 42.00 x 7.00 x 104.00 | | | MB | | | |  |
| V94088  | 11 34 1 739 665 |  |  | 45° | ss | H | |
| 35.90 x 7.00 x 103.00 | | | MD + MB cr | | | | |

59  **89.00**

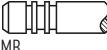
| | | | | | | | |
|---|-----------------|---|---|-------------------|--------|-----------------|--|
| M60 B40 (408S1) | 3982cc | V8 Cyl. | 32 Valves | 210kW/286PS | Petrol | DOHC | TD28389 |
| 5 (E34) 540 i | | 09/1993→01/1997 | | 5 (E34) 540 i V8 | | 09/1992→09/1995 | |
| 7 (E32) 740 i, iL V8 | | 04/1992→09/1994 | | 7 (E38) 740 i, iL | | 10/1994→11/2001 | |
| 8 (E31) 840 i | | 02/1993→02/1996 | | | | | |
| V94091  | 11 34 1 736 549 |  |  | 45° | | H | VAG96043B    43.50 x 6.01 x 12.56 |
| 35.00 x 6.00 x 104.10 | | | MB | | | |  |
| V94092  | 11 34 1 741 231 |  |  | 45° | ss | H | VAG96044B    43.50 x 6.00 x 12.77 |
| 30.50 x 6.00 x 103.60 | | | ME + MB cr | | | |  |

60  **89.00**

| | | | | | | | |
|---|-----------------|---|---|-------------------------------|--------|-------------------------------|----------------|
| N63 B44 A | 4395cc | V8 Cyl. | 32 Valves | 298-330kW/405-449PS | Petrol | Turbo, DOHC, Injection | TD24607 |
| N63 B44 B | 4395cc | V8 Cyl. | 32 Valves | 298-339kW/405-461PS | Petrol | Turbo, DOHC, Injection | TD26582 |
| 5 (F07) 550 i | | 08/2009→02/2017 | | 5 (F10) 550 i | | 01/2009→10/2016 | |
| 5 (F11) 550 i | | 09/2010→ | | 6 (F06) 650 i | | 11/2011→ | |
| 6 (F12) 650 i | | 03/2011→ | | 6 (F13) 650 i | | 11/2010→ | |
| 7 (F01, F02, F03, F04) 750 i | | 10/2008→12/2015 | | 7 (F01, F02, F03, F04) 750 Li | | 09/2008→12/2015 | |
| 7 (F01, F02, F03, F04) ActiveHybrid | | 09/2009→06/2012 | | X5 (E70) xDrive 50 i | | 07/2009→06/2013 | |
| X5 (F15, F85) xDrive 50 i | | 07/2013→ | | X6 (E71, E72) ActiveHybrid | | 01/2009→10/2011 | |
| X6 (E71, E72) xDrive 50 i | | 10/2007→06/2014 | | X6 (F16, F86) xDrive 50 i | | 08/2014→ | |
| V80002  | 11 34 7 570 163 |  |  | 45° | | | |
| 33.20 x 6.00 x 102.80 | | | MB | | | | |
| V80003  | 11 34 7 570 164 |  |  | 45° | ss | | |
| 29.00 x 6.00 x 106.00 | | | ME + MB | | | | |

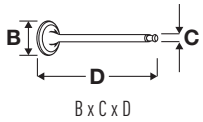

OE

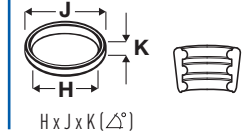
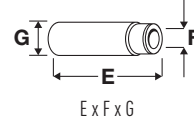

61 **89.00**

| | | | | | | | |
|-----------------------|-----------------|------------|------------------|---------------------|----------------------|-------------------------------|----------------|
| S63 B44 A | 4395cc | V8 Cyl. | 32 Valves | 408-414kW/555-563PS | Petrol | Turbo, DOHC, Injection | TD24606 |
| X5 (E70) M | 09/2009→06/2013 | | X6 (E71, E72) M | | 07/2008→06/2014 | | |
| V94957 | 11 34 1 435 461 | | 45° | H | VAG96386B | | |
| 35.00 x 6.00 x 100.00 | | MB | | | 39.00 x 6.01 x 10.15 | | |
| V94403 | 11 34 7 503 839 | | 45° | ss H | | | |
| 29.00 x 6.00 x 100.10 | | MD + MB cr | | | | | |

62 **92.00**

| | | | | | | | |
|------------------------|-----------------|--------|------------------|---------------------|----------------------|-------------|----------------|
| M30 B34 (346KA) | 3430cc | 6 Cyl. | 12 Valves | 136-160kW/185-218PS | Petrol | SOHC | TD28419 |
| M30 B35 | 3430cc | 6 Cyl. | 12 Valves | 141kW/192PS | Petrol | SOHC | TD5272 |
| M30 B35 | 3430cc | 6 Cyl. | 12 Valves | 160kW/218PS | Petrol | SOHC | TD5246 |
| 5 (E28) 535 i, M 535 i | 01/1985→12/1987 | | 6 (E24) 635 CSI | | 12/1977→04/1989 | | |
| 7 (E23) 735 i | 09/1979→08/1986 | | | | | | |
| V94521 | 11 34 1 705 560 | | 45° | Y H | VAG92170B | | |
| 46.90 x 8.00 x 106.50 | | MB cr | | | 50.00 x 8.02 x 14.06 | | |
| | | | | | VAG96176B | | |
| | | | | | 50.00 x 8.02 x 14.24 | | |

63 **92.00**

| | | | | | | | |
|------------------------|-----------------|------------|-------------------|-------------|----------------------|-----------------------|----------------|
| M62 B44 | 4398cc | V8 Cyl. | 32 Valves | 210kW/286PS | Petrol | DOHC, Motronic | TD4235 |
| M62 B44 (448S1) | 4398cc | V8 Cyl. | 32 Valves | 210kW/286PS | Petrol | DOHC | TD28392 |
| M62 B44 (448S2) | 4398cc | V8 Cyl. | 32 Valves | 210kW/286PS | Petrol | DOHC | TD28393 |
| M62 B44 TU | 4398cc | V8 Cyl. | 32 Valves | 210kW/286PS | Petrol | DOHC | TD21245 |
| 5 (E39) 540 i | 04/1996→05/2004 | | 7 (E38) 740 i, iL | | 01/1996→11/2001 | | |
| 8 (E31) 840 Ci | 01/1996→12/1999 | | X5 (E53) 4.4 i | | 05/2000→12/2003 | | |
| V94091 | 11 34 1 736 549 | | 45° | H | VAG96043B | | |
| 35.00 x 6.00 x 104.10 | | MB | | | 43.50 x 6.01 x 12.56 | | |
| V94092 | 11 34 1 741 231 | | 45° | ss H | VAG96044B | | |
| 30.50 x 6.00 x 103.60 | | ME + MB cr | | | 43.50 x 6.00 x 12.77 | | |

64 **92.00**

| | | | | | | | |
|-------------------------|-----------------|------------|-----------------------------|---------------------|----------------------|-------------|----------------|
| N62 B44 | 4398cc | V8 Cyl. | 32 Valves | 235-245kW/320-333PS | Petrol | DOHC | TD16268 |
| N62 B44 A | 4398cc | V8 Cyl. | 32 Valves | 235-245kW/320-333PS | Petrol | DOHC | TD18546 |
| 5 (E60) 545 i | 09/2003→03/2010 | | 5 (E61) 545 i | | 06/2004→12/2010 | | |
| 6 (E63) 645 Ci | 01/2004→12/2005 | | 6 (E64) 645 Ci | | 04/2004→12/2005 | | |
| 7 (E65, E66, E67) 745 i | 11/2001→12/2005 | | 7 (E65, E66, E67) 745 i, Li | | 11/2001→07/2008 | | |
| X5 (E53) 4.4 i | 12/2003→09/2006 | | | | | | |
| V94957 | 11 34 1 435 461 | | 45° | H | VAG96386B | | |
| 35.00 x 6.00 x 100.00 | | MB | | | 39.00 x 6.01 x 10.15 | | |
| V94403 | 11 34 7 503 839 | | 45° | ss H | | | |
| 29.00 x 6.00 x 100.10 | | MD + MB cr | | | | | |



OE

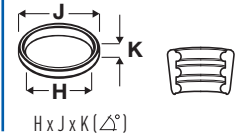
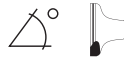

65 **93.00**

| | | | | | | | |
|------------------------|--------|-----------------|------------------|---------------------|--------|-------------|----------------|
| M62 B46 (468S1) | 4619cc | V8 Cyl. | 32 Valves | 255-261kW/347-355PS | Petrol | DOHC | TD28423 |
| X5 (E53) 4.6 is | | 09/2001→12/2003 | | | | | |

| | | | | | | | |
|-----------------------|-----------------|------------|-----|----|---|----------------------|--|
| V94091 | 11 34 1 736 549 | | 45° | | H | VAG96043B | |
| 35.00 x 6.00 x 104.10 | | MB | | | | 43.50 x 6.01 x 12.56 | |
| V94092 | 11 34 1 741 231 | | 45° | ss | H | VAG96044B | |
| 30.50 x 6.00 x 103.60 | | ME + MB cr | | | | 43.50 x 6.00 x 12.77 | |

66 **93.00**

| | | | | | | | |
|-------------------------|-----------------|---------|------------------|-----------------------------|-----------------|-------------|----------------|
| N62 B48 B | 4799cc | V8 Cyl. | 32 Valves | 261-270kW/355-367PS | Petrol | DOHC | TD18515 |
| 5 (E60) 550 i | 07/2005→03/2010 | | | 5 (E61) 550 i | 07/2005→12/2010 | | |
| 6 (E63) 650 i | 07/2005→12/2010 | | | 6 (E64) 650 i | 07/2005→12/2010 | | |
| 7 (E65, E66, E67) 750 i | 09/2005→12/2008 | | | 7 (E65, E66, E67) 750 i, Li | 07/2005→07/2008 | | |
| X5 (E70) 4.8 i | 02/2007→09/2008 | | | X5 (E70) xDrive 48 i | 09/2008→06/2013 | | |

| | | | | | | | |
|-----------------------|-----------------|------------|-----|----|---|----------------------|--|
| V94957 | 11 34 1 435 461 | | 45° | | H | VAG96386B | |
| 35.00 x 6.00 x 100.00 | | MB | | | | 39.00 x 6.01 x 10.15 | |
| V94403 | 11 34 7 503 839 | | 45° | ss | H | | |
| 29.00 x 6.00 x 100.10 | | MD + MB cr | | | | | |

67 **93.40**







| | | | | | | | |
|------------------------|-----------------|------------|------------------|-------------|--------|-------------|---------------|
| S14 B23 (EVO I) | 2302cc | 4 Cyl. | 16 Valves | 162kW/220PS | Petrol | DOHC | TD5265 |
| V94275 | 11 34 1 309 343 | | 45° | ss | H | | |
| 36.95 x 7.00 x 121.40 | | MD + MB cr | | | | | |
| V94276 | 11 34 1 309 487 | | 45° | ss | H | | |
| 31.95 x 7.00 x 123.80 | | MF + MB cr | | | | | |

68 **93.40**

| | | | | | | | |
|------------------------|-----------------|------------|------------------|----------------------|-----------------|-------------|----------------|
| S14 B23 (234EA) | 2303cc | 4 Cyl. | 16 Valves | 143-162kW/195-220PS | Petrol | DOHC | TD28400 |
| S14 B23 (234S1) | 2303cc | 4 Cyl. | 16 Valves | 143-162kW/195-220PS | Petrol | DOHC | TD28401 |
| S14 B23 (234S2) | 2303cc | 4 Cyl. | 16 Valves | 143-162kW/195-220PS | Petrol | DOHC | TD28402 |
| 3 (E30) M3 2.3 | 07/1985→06/1991 | | | 3 (E30) M3 EVO I 2.3 | 10/1988→10/1990 | | |
| V94275 | 11 34 1 309 343 | | 45° | ss | H | | |
| 36.95 x 7.00 x 121.40 | | MD + MB cr | | | | | |
| V94276 | 11 34 1 309 487 | | 45° | ss | H | | |
| 31.95 x 7.00 x 123.80 | | MF + MB cr | | | | | |

69 **94.60**

| | | | | | | | |
|------------------------|-----------------|------------|------------------|-------------|--------|-------------|----------------|
| S38 B38 (386S1) | 3795cc | 6 Cyl. | 24 Valves | 250kW/340PS | Petrol | DOHC | TD28410 |
| 5 (E34) M5 | 03/1992→01/1997 | | | | | | |
| V94797 | 11 34 1 315 508 | | 45° | ss | H | | |
| 38.50 x 7.00 x 121.40 | | MD + MB cr | | | | | |





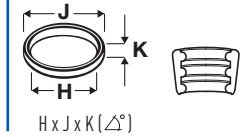
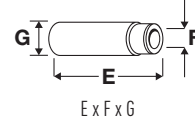
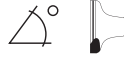

|  |  | ccm |  |  |  |  | |
|---|---|-------|--|---|---|---|----|
| 16 LZ2 | | 79.00 | 1598 | 4 | 8 | Petrol | 18 |
| 16S | | 80.00 | 1598 | 4 | 8 | Petrol | 27 |
| 20 NEJ | | 86.00 | 1998 | 4 | 8 | Petrol | 35 |
| 7A-FE | | 81.00 | 1762 | 4 | 16 | Petrol | 31 |
| A 12 XEL | | 73.40 | 1229 | 4 | 16 | Petrol | 8 |
| A 12 XER | | 73.40 | 1229 | 4 | 16 | Petrol | 8 |
| A 14 NET | | 72.50 | 1364 | 4 | 16 | Petrol | 7 |
| A 14 XER | | 73.40 | 1398 | 4 | 16 | Petrol | 9 |
| A 17 DTE | | 79.00 | 1686 | 4 | 16 | Diesel | 24 |
| A15SMS | | 76.50 | 1498 | 4 | 8 | Petrol | 10 |
| A16DMS | | 79.00 | 1598 | 4 | 16 | Petrol | 19 |
| B 12D1 | | 69.70 | 1206 | 4 | 16 | Petrol | 5 |
| B 12S1 | | 68.50 | 1150 | 4 | 8 | Petrol | 2 |
| C 14 NZ | | 77.60 | 1389 | 4 | 8 | Petrol | 11 |
| C 16 XE | | 79.00 | 1598 | 4 | 16 | Petrol | 20 |
| C 20 SEL | | 86.00 | 1998 | 4 | 16 | Petrol | 36 |
| C 20 XE | | 86.00 | 1998 | 4 | 16 | Petrol | 37 |
| C 22 SEL | | 86.00 | 2198 | 4 | 16 | Petrol | 38 |
| F 14D3 | | 77.90 | 1399 | 4 | 16 | Petrol | 14 |
| F 14S3 | | 77.90 | 1399 | 4 | 8 | Petrol | 15 |
| F 16D3 | | 79.00 | 1598 | 4 | 16 | Petrol | 21 |
| F 16D4 | | 79.00 | 1598 | 4 | 16 | Petrol | 21 |
| F 18D3 | | 80.50 | 1796 | 4 | 16 | Petrol | 28 |
| F 8CV | | 68.50 | 796 | 3 | 6 | Petrol | 1 |
| L95 | | 77.90 | 1399 | 4 | 16 | Petrol | 16 |
| LDE | | 79.00 | 1598 | 4 | 16 | Petrol | 21 |
| LDV | | 69.60 | 1248 | 4 | 16 | Diesel | 3 |
| LSF | | 69.60 | 1248 | 4 | 16 | Diesel | 3 |
| LUJ | | 72.50 | 1364 | 4 | 16 | Petrol | 7 |
| LV6 | | 79.00 | 1794 | 4 | 16 | Petrol | 26 |
| M13A | | 78.00 | 1328 | 4 | 16 | Petrol | 17 |
| X 14 XE | | 77.60 | 1389 | 4 | 16 | Petrol | 12 |
| X 16 XE | | 79.00 | 1598 | 4 | 16 | Petrol | 20 |
| X 18 XE | | 81.60 | 1799 | 4 | 16 | Petrol | 32 |
| X 20 SED | | 86.00 | 1998 | 4 | 16 | Petrol | 36 |
| X 20 XEV | | 86.00 | 1998 | 4 | 16 | Petrol | 36 |
| X 22 XE | | 86.00 | 2198 | 4 | 16 | Petrol | 38 |
| Y 17 DT | | 79.00 | 1686 | 4 | 16 | Diesel | 25 |
| Y 20 DTH | | 84.00 | 1995 | 4 | 16 | Diesel | 34 |
| Z 12 XE | | 72.50 | 1199 | 4 | 16 | Petrol | 6 |
| Z 13 DT | | 69.60 | 1248 | 4 | 16 | Diesel | 4 |
| Z 13 DTJ | | 69.60 | 1248 | 4 | 16 | Diesel | 4 |
| Z 14 XE | | 77.60 | 1389 | 4 | 16 | Petrol | 13 |
| Z 16 SE | | 79.00 | 1598 | 4 | 8 | Petrol | 22 |
| Z 16 XE | | 79.00 | 1598 | 4 | 16 | Petrol | 23 |
| Z 18 XE | | 80.50 | 1796 | 4 | 16 | Petrol | 29 |
| Z 18 XER | | 80.50 | 1796 | 4 | 16 | Petrol | 30 |
| Z 20 DM | | 83.00 | 1991 | 4 | 16 | Diesel | 33 |
| Z 20 DMH | | 83.00 | 1991 | 4 | 16 | Diesel | 33 |
| Z 22 SE | | 86.00 | 2198 | 4 | 16 | Petrol | 39 |
| Z 22 YH | | 86.00 | 2198 | 4 | 16 | Petrol | 39 |
| Z 32 SE | | 88.50 | 3175 | 6 | 24 | Petrol | 40 |







OE





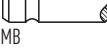

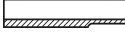

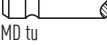

1  **68.50**

| | | | | | | | |
|---|-------------|---|-----------------|---------------|---|---|----------------|
| F 8CV | 796cc | 3 Cyl. | 6 Valves | 38kW/52PS | Petrol | SOHC | TD18521 |
| MATIZ 0.8 | | 03/2005→ | | MATIZ 0.8 LPG | | 03/2005→ | |
| SPARK 0.8 | | 09/2000→ | | | | | |
| V94368  | 12911-78B00 |  | 45° | H | VAG96114  |  | |
| 35.70 x 5.50 x 110.50 | | MB | | | 43.00 x 5.50 x 11.00 | | |
| V94369  | 96352793 |  | 45° | st | | | |
| 31.80 x 5.50 x 110.20 | | MD tu | | | | | |

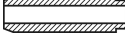



2  **68.50**

| | | | | | | | |
|---|-------------|---|-----------------|-----------------|---|---|----------------|
| B 12S1 | 1150cc | 4 Cyl. | 8 Valves | 53-56kW/72-76PS | Petrol | SOHC | TD18524 |
| AVEO 1.2 | | 03/2005→ | | KALOS 1.2 | | 03/2005→ | |
| V94368  | 12911-78B00 |  | 45° | H | VAG96114  |  | |
| 35.70 x 5.50 x 110.50 | | MB | | | 43.00 x 5.50 x 11.00 | | |
| V94369  | 96352793 |  | 45° | st | | | |
| 31.80 x 5.50 x 110.20 | | MD tu | | | | | |



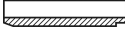

3  **69.60**

| | | | | | | | |
|---|------------|---|------------------|-----------------|--------|---|---|
| LDV | 1248cc | 4 Cyl. | 16 Valves | 55-57kW/75-78PS | Diesel | 1.3 CDTI, Turbo, DOHC | TD26193 |
| LSF | 1248cc | 4 Cyl. | 16 Valves | 70kW/95PS | Diesel | 1.3 CDTI, Turbo, DOHC | TD26189 |
| AVEO 1.3 D | | 07/2011→ | | SAIL 1.3 D | | 01/2013→ | |
| V95015  | 55 195 680 |  | 45° | Y | H | VAG96359  |  |
| 21.85 x 6.00 x 109.20 | | MB cr | | | | 43.28 x 6.00 x 10.25 | |
| V95182  | 55204574 |  | 45° | | H | | |
| 21.85 x 5.98 x 109.25 | | MB cr | | | | | |
| V95016  | 55 208 213 |  | 45° | | H | | |
| 21.80 x 6.00 x 109.20 | | MD + MB cr | | | | | |
| V95183  | 55223836 |  | 45° | ss | H | | |
| 22.50 x 5.99 x 109.20 | | MD + MB cr | | | | | |

4  **69.60**

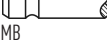
| | | | | | | | |
|---|------------|---|------------------|------------|--------|---|---|
| Z 13 DT | 1248cc | 4 Cyl. | 16 Valves | 55kW/75PS | Diesel | Turbo, DOHC | TD32912 |
| Z 13 DTJ | 1248cc | 4 Cyl. | 16 Valves | 55kW/75PS | Diesel | Turbo, DOHC | TD29414 |
| COBALT 1.3 D | | 03/2013→ | | SPIN 1.3 D | | 01/2012→ | |
| V95015  | 55 195 680 |  | 45° | Y | H | VAG96359  |  |
| 21.85 x 6.00 x 109.20 | | MB cr | | | | 43.28 x 6.00 x 10.25 | |
| V95016  | 55 208 213 |  | 45° | | H | | |
| 21.80 x 6.00 x 109.20 | | MD + MB cr | | | | | |

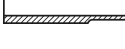
5  **69.70**

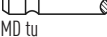
| | | | | | | | |
|---|-------------|---|------------------|-----------------|---|---|----------------|
| B 12D1 | 1206cc | 4 Cyl. | 16 Valves | 53-65kW/72-88PS | Petrol | DOHC | TD24816 |
| AVEO 1.2 | | 01/2008→ | | AVEO 1.2 LPG | | 04/2008→ | |
| SPARK 1.2 | | 03/2010→ | | SPARK 1.2 LPG | | 03/2010→ | |
| V94368  | 12911-78B00 |  | 45° | H | VAG96114  |  | |
| 35.70 x 5.50 x 110.50 | | MB | | | 43.00 x 5.50 x 11.00 | | |
| V94369  | 96352793 |  | 45° | st | | | |
| 31.80 x 5.50 x 110.20 | | MD tu | | | | | |



OE

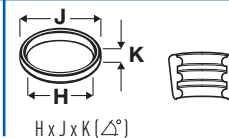
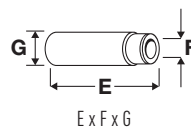
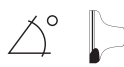

6 72.50

| | | | | | | | |
|----------------|----------|--------|------------------|-----------------|--------|---------------------|----------------|
| Z 12 XE | 1199cc | 4 Cyl. | 16 Valves | 57-63kW/77-86PS | Petrol | ECOTEC, DOHC | TD26428 |
| SAIL 1.2 | 01/2013→ | | | SPARK 1.2 | | 12/2009→ | |
| SPARK 1.2 LPG | 01/2011→ | | | | | | |

| | | | | | | |
|----------------------|----------|-------|-----|---|----------------------|--|
| V94245 | 90529527 | | 45° | H | VAG96077 | |
| 28.00 x 5.00 x 93.90 | | MB cr | | | 39.00 x 5.00 x 10.04 | |
| V94246 | 90529529 | | 45° | | | |
| 25.00 x 5.00 x 93.90 | | MD cr | | | | |

7 72.50

| | | | | | | | |
|-----------------|----------|--------|------------------|-------------|--------|--------------------|----------------|
| A 14 NET | 1364cc | 4 Cyl. | 16 Valves | 103kW/140PS | Petrol | Turbo, DOHC | TD29268 |
| LUJ | 1364cc | 4 Cyl. | 16 Valves | 103kW/140PS | Petrol | Turbo, DOHC | TD26818 |
| AVEO 1.4 Turbo | 08/2013→ | | | CRUZE 1.4 | | 09/2010→ | |
| ORLANDO 1.4 | 06/2012→ | | | TRAX 1.4 | | 12/2012→ | |
| TRAX 1.4 LPG | 04/2013→ | | | | | | |

| | | | | | | |
|----------------------|----------|-------|-----|---|----------------------|--|
| V94245 | 90529527 | | 45° | H | VAG96077 | |
| 28.00 x 5.00 x 93.90 | | MB cr | | | 39.00 x 5.00 x 10.04 | |
| V94246 | 90529529 | | 45° | | | |
| 25.00 x 5.00 x 93.90 | | MD cr | | | | |

8 73.40

| | | | | | | | |
|-----------------|----------|--------|------------------|--------------|--------|-------------|----------------|
| A 12 XEL | 1229cc | 4 Cyl. | 16 Valves | 51kW/69PS | Petrol | DOHC | TD25432 |
| A 12 XER | 1229cc | 4 Cyl. | 16 Valves | 63kW/86PS | Petrol | DOHC | TD26084 |
| AVEO 1.2 | 03/2011→ | | | AVEO 1.2 LPG | | 11/2012→ | |

| | | | | | | |
|----------------------|----------|-------|-----|---|----------------------|--|
| V94245 | 90529527 | | 45° | H | VAG96077 | |
| 28.00 x 5.00 x 93.90 | | MB cr | | | 39.00 x 5.00 x 10.04 | |
| V94246 | 90529529 | | 45° | | | |
| 25.00 x 5.00 x 93.90 | | MD cr | | | | |

9 73.40

| | | | | | | | |
|-----------------|----------|--------|------------------|------------|--------|-------------|----------------|
| A 14 XER | 1398cc | 4 Cyl. | 16 Valves | 74kW/101PS | Petrol | DOHC | TD25431 |
| AVEO 1.4 | 03/2011→ | | | CRUZE 1.4 | | 07/2013→ | |

| | | | | | | |
|----------------------|----------|-------|-----|---|----------------------|--|
| V94245 | 90529527 | | 45° | H | VAG96077 | |
| 28.00 x 5.00 x 93.90 | | MB cr | | | 39.00 x 5.00 x 10.04 | |
| V94246 | 90529529 | | 45° | | | |
| 25.00 x 5.00 x 93.90 | | MD cr | | | | |

10 76.50

| | | | | | | | |
|---------------|----------|--------|-----------------|-----------|--------|-------------|----------------|
| A15SMS | 1498cc | 4 Cyl. | 8 Valves | 63kW/86PS | Petrol | SOHC | TD26129 |
| LANOS 1.5 | 11/2005→ | | | | | | |

| | | | | | | |
|-----------------------|----------|------------|-----|---|--|--|
| V94636 | 96182934 | | 45° | H | | |
| 37.90 x 7.00 x 103.50 | | MB cr | | | | |
| V94637 | 96182933 | | 45° | H | | |
| 31.00 x 7.00 x 103.50 | | MD + MB cr | | | | |



OE

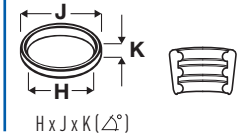
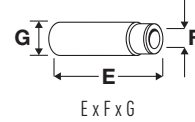
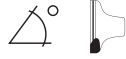

11 **77.60**

| C 14 NZ | 1389cc | 4 Cyl. | 8 Valves | 44-45kW/60-61PS | Petrol | SOHC | TD19861 |
|-----------------------|-----------------|--------|----------|-----------------|----------------------|-----------------|---------|
| CHEVY 1.4 | 12/1995→07/2006 | | | CORSA 1.4 GLS | | 08/1994→07/1997 | |
| MONZA 1.4 | 12/1995→09/2002 | | | | | | |
| V91211 | 90323519 | | 45° | H | VAG96022 | | |
| 33.10 x 7.00 x 104.50 | | MB | | | 45.80 x 7.02 x 11.04 | | |
| V91212 | 90323524 | | 45° | | | | |
| 29.10 x 6.99 x 104.60 | | MD cr | | | | | |

12 **77.60**

| X 14 XE | 1389cc | 4 Cyl. | 16 Valves | 68kW/92PS | Petrol | ECOTEC, DOHC | TD32220 |
|-----------------------|----------|--------|-----------|-----------|----------------------|--------------|---------|
| CLASSIC 1.4 | 01/2002→ | | | | | | |
| V91995 | 90412912 | | 45° | H | VAG96028 | | |
| 31.10 x 6.00 x 103.10 | | MB cr | | | 45.80 x 5.99 x 10.05 | | |
| V94050 [2] | | | 45° | H | | | |
| 31.10 x 5.97 x 102.90 | | MB cr | | | | | |
| V91996 | 90412974 | | 45° | SS | | | |
| 27.60 x 6.00 x 102.20 | | MD cr | | | | | |
| V94051 [2] | | | 45° | SS | | | |
| 27.60 x 5.95 x 101.95 | | MD cr | | | | | |

[2] Service valve, for use on re-surfaced cylinder head only [2] Reparatur-Ventil, nur bei geplanten Zylinderkopf verwen den [2] Soupape de réparation, pour utilisation uniquement sur une culasse ré-usinée [2] Válvula de servicio, para uso solamente en culatas baj adas. [2] Ricambio valvola per uso su testate cilindro spianate

13 **77.60**

| Z 14 XE | 1389cc | 4 Cyl. | 16 Valves | 66kW/90PS | Petrol | ECOTEC, DOHC | TD28086 |
|-----------------------|-----------------|--------|-----------|-----------|----------------------|-----------------|---------|
| CHEVY 1.4 | 08/2002→09/2006 | | | CORSA 1.4 | | 09/2001→07/2002 | |
| V91995 | 90412912 | | 45° | H | VAG96137 | | |
| 31.10 x 6.00 x 103.10 | | MB cr | | | 45.00 x 6.02 x 10.05 | | |
| V91996 | 90412974 | | 45° | SS | VAG96151 | | |
| 27.60 x 6.00 x 102.20 | | MD cr | | | 45.00 x 6.02 x 10.09 | | |

14 **77.90**

| F 14D3 | 1399cc | 4 Cyl. | 16 Valves | 69-70kW/94-95PS | Petrol | DOHC | TD18525 |
|-----------------------|-----------------|--------|-----------|-----------------|----------------------|-----------------|---------|
| AVEO 1.4 | 05/2003→12/2007 | | | AVEO 1.4 16V | | 03/2005→05/2008 | |
| KALOS 1.4 16V | 03/2005→ | | | LACETTI 1.4 | | 03/2005→ | |
| LACETTI 1.4 16V | 03/2005→ | | | NUBIRA 1.4 | | 01/2005→12/2008 | |
| V98014 | 96376881 | | 45° | | VAG96112 | | |
| 28.50 x 6.00 x 101.60 | | MB cr | | | 40.00 x 6.00 x 11.00 | | |
| V98015 | 96376980 | | 45° | | | | |
| 27.30 x 6.00 x 101.30 | | MD cr | | | | | |

15 **77.90**

| F 14S3 | 1399cc | 4 Cyl. | 8 Valves | 61kW/83PS | Petrol | DOHC | TD18526 |
|-----------------------|----------|--------|----------|-----------|----------------------|------|---------|
| AVEO 1.4 | 03/2005→ | | | | | | |
| V98013 | 96335948 | | 45° | | VAG96112 | | |
| 31.00 x 6.00 x 104.00 | | MD tu | | | 40.00 x 6.00 x 11.00 | | |

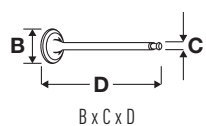

OE

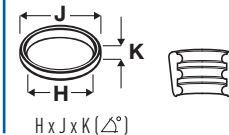
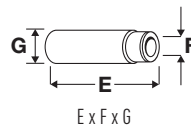
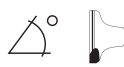

16 77.90

L95 1399cc 4 Cyl. 16 Valves 69kW/93PS Petrol DOHC TD26429

AVEO 1.4 CNG 01/2008→

V98077 [3] 31.20 x 5.00 x 117.20

55557862

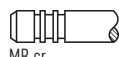

45°

VAG96346 [1] [E] 37.00 x 4.99 x 10.04



V98078 [E] [3] 27.50 x 5.00 x 116.20

55558728

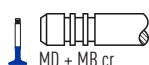

45°

SS

[3] LPG

[3] LPG

[3] LPG

[3] LPG

[3] LPG

17 78.00

M13A 1328cc 4 Cyl. 16 Valves 60-69kW/82-94PS Petrol DOHC TD19864

CRUZE 1.3 07/2000→09/2008

MW 1.3

09/2000→12/2010

V95007 [1] 30.00 x 6.00 x 100.80
→12/03

12911-69G00

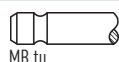

45°

H

VAG96391 [1] [E] 40.00 x 5.50 x 10.57



V95141 [1] 30.00 x 5.47 x 100.75
01/04→

12911-54G00

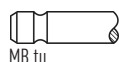

45°

H

V95008 [E] 25.00 x 6.00 x 99.10
→12/03

12915-69G50

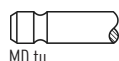

45°

SS

V95142 [E] 25.00 x 5.44 x 99.00
01/04→

12915-54G00

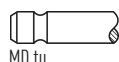

45°

SS

18 79.00

16 LZ2 1598cc 4 Cyl. 8 Valves 55kW/75PS Petrol SOHC TD32251

VECTRA 1.6 09/1996→12/2005

V91137 [1] 37.92 x 7.00 x 101.00

90295011

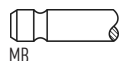

45°

H

VAG96022 [1] [E] 45.80 x 7.02 x 11.04



V91138 [E] 30.87 x 6.98 x 101.08

90295015

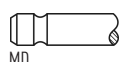

45°

19 79.00

A16DMS 1598cc 4 Cyl. 16 Valves 74-79kW/101-107PS Petrol DOHC TD18529

AVEO 1.6 09/2003→

CHEVY 1.6 SRV

05/2006→

LANOS 1.6 16V 11/2005→

REZZO 1.6

03/2005→

VIVANT 1.6 08/2001→

V94366 [1] 30.30 x 6.00 x 102.50

96182806

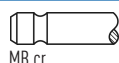

45°

H

VAG96112 [1] [E] 40.00 x 6.00 x 11.00



V94367 [E] 26.00 x 5.94 x 101.95

96182805

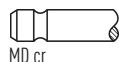

45°







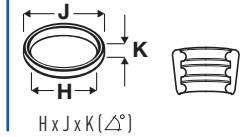
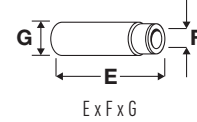

SS

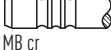

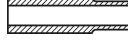
OE









20  **79.00**

| | | | | | | | |
|---|----------|---|------------------|-----------------------|---|---|----------------|
| C 16 XE | 1598cc | 4 Cyl. | 16 Valves | 80kW/109PS | Petrol | ECOTEC, DOHC | TD23209 |
| X 16 XE | 1598cc | 4 Cyl. | 16 Valves | 75-80kW/102-108PS | Petrol | ECOTEC, DOHC | TD19866 |
| CORSA 1.6 GS | | 08/1997→07/2002 | | CORSA 1.6 GSI 16V SFI | | 08/1994→07/1997 | |
| V91995  | 90412912 |  | 45° | H | VAG96028  |  | |
| 31.10 x 6.00 x 103.10 | | MB cr | | | 45.00 x 5.99 x 10.05 | | |
| V94050  [2] | |  | 45° | H | | | |
| 31.10 x 5.97 x 102.90 | | MB cr | | | | | |
| V91996  | 90412974 |  | 45° | SS | | | |
| 27.60 x 6.00 x 102.20 | | MD cr | | | | | |
| V94051  [2] | |  | 45° | SS | | | |
| 27.60 x 5.95 x 101.95 | | MD cr | | | | | |

[2] Service valve, for use on re-surfaced cylinder head only [2] Reparatur-Ventil, nur bei geplanten Zylinderkopf verwen den [2] Soupape de réparation, pour utilisation uniquement sur une culasse ré-usinée [2] Válvula de servicio, para uso solamente en culatas rebaj adas. [2] Ricambio valvola per uso su testate cilindro spianate

21  **79.00**

| | | | | | | | |
|---|----------|---|------------------|-------------------|---|---|----------------|
| F 16D3 | 1598cc | 4 Cyl. | 16 Valves | 74-80kW/101-109PS | Petrol | DOHC | TD18527 |
| F 16D4 | 1598cc | 4 Cyl. | 16 Valves | 83-91kW/113-124PS | Petrol | DOHC | TD24612 |
| LDE | 1598cc | 4 Cyl. | 16 Valves | 83-91kW/113-124PS | Petrol | DOHC | TD26188 |
| AVEO 1.6 | | 05/2005→ | | CRUZE 1.6 | | 05/2009→ | |
| LACETTI 1.6 | | 03/2005→ | | LACETTI 1.6 LPG | | 06/2009→12/2011 | |
| NUBIRA 1.6 | | 03/2005→12/2011 | | OPTRA 1.6 | | 08/2003→12/2008 | |
| OPTRA 1.6 SRV | | 06/2006→ | | TRAX 1.6 | | 12/2012→ | |
| V98077  [3] | 55557862 |  | 45° | | VAG96346  |  | |
| 31.20 x 5.00 x 117.20 | | MB cr | | | 37.00 x 4.99 x 10.04 | | |
| V98078  [3] | 55558728 |  | 45° | SS | | | |
| 27.50 x 5.00 x 116.20 | | MD + MB cr | | | | | |

[3] LPG





[3] LPG

[3] LPG



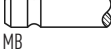

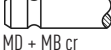

[3] LPG

[3] LPG

22  **79.00**

| | | | | | | | |
|---|----------|---|-----------------|-----------------|---|---|----------------|
| Z 16 SE | 1598cc | 4 Cyl. | 8 Valves | 62-67kW/84-91PS | Petrol | SOHC | TD19869 |
| COMBO 1.6 | | 04/2001→ | | CORSA 1.6 | | 08/2001→ | |
| V91137  | 90295011 |  | 45° | H | VAG96022  |  | |
| 37.92 x 7.00 x 101.00 | | MB | | | 45.80 x 7.02 x 11.04 | | |
| V94353  | 09117912 |  | 45° | H | | | |
| 31.00 x 7.00 x 101.00 | | MD + MB cr | | | | | |

23  **79.00**

| | | | | | | | |
|---|----------|---|------------------|------------|---|---|----------------|
| Z 16 XE | 1598cc | 4 Cyl. | 16 Valves | 74kW/101PS | Petrol | ECOTEC, DOHC | TD27250 |
| CHEVY 1.6 | | 08/2002→ | | | | | |
| V91995  | 90412912 |  | 45° | H | VAG96028  |  | |
| 31.10 x 6.00 x 103.10 | | MB cr | | | 45.00 x 5.99 x 10.05 | | |
| V91996  | 90412974 |  | 45° | SS | | | |
| 27.60 x 6.00 x 102.20 | | MD cr | | | | | |

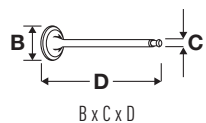

OE



MAT.

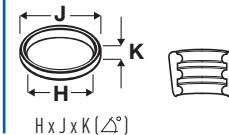
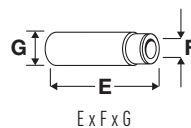
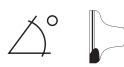

24 79.00

A 17 DTE 1686cc 4 Cyl. 16 Valves 81kW/110PS Diesel ECOTEC, Turbo, DOHC TD31419

CRUZE 1.7 TD 08/2013→

V95186 ■
27.50 x 5.97 x 102.50

97385841

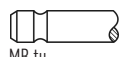

MB tu

45°

H

VAG96291 ■ ■ ■
42.00 x 6.00 x 11.05



V95157 ■
25.45 x 5.96 x 102.20

97385842

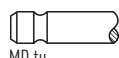

MD tu

25 79.00

Y 17 DT 1686cc 4 Cyl. 16 Valves 55kW/75PS Diesel Turbo, DOHC TD19867

ASTRA 1.7 Di 08/2000→08/2003

CORSA 1.7 DTi

08/2001→

V94426 ■
27.50 x 6.00 x 98.40

97185860

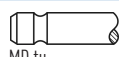

MD tu

45°

VAG96291 ■ ■ ■
42.00 x 6.00 x 11.05

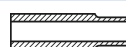

V94427 ■
26.50 x 6.00 x 98.10

97358650

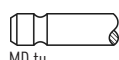

MD tu

45°

SS

26 79.00

LV6 1794cc 4 Cyl. 16 Valves 90-95kW/122-129PS Petrol DOHC TD32421

PRIZM 1.8 05/1997→08/2001

V94142 ■
31.00 x 5.50 x 88.70

13711-0D020

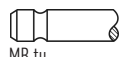

MB tu

45°

H

VAG96110 ■ ■ ■
34.50 x 5.50 x 10.36



V94143 ■
26.00 x 5.50 x 88.70

13715-22040

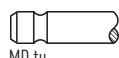

MD tu

45°

27 80.00

16S 1598cc 4 Cyl. 8 Valves 53-55kW/72-75PS Petrol SOHC TD495

MONZA 1.6 01/1982→12/1986

V90166 ■
35.00 x 7.98 x 105.99

90106792

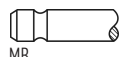

MB

45°

H

VAG96023 ■ ■ ■
43.00 x 8.02 x 12.02



28 80.50

F 18D3 1796cc 4 Cyl. 16 Valves 89kW/121PS Petrol DOHC TD23579

LACETTI 1.8 08/2005→

NUBIRA 1.8

08/2005→12/2011

V95189 ■
31.25 x 5.96 x 101.40

93333561

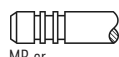

MB cr

45°

H

V95190 ■
27.50 x 5.94 x 100.80

93333562

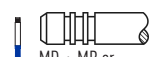

MD + MB cr

45°

SS

H

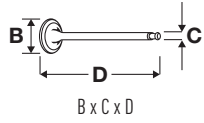

OE

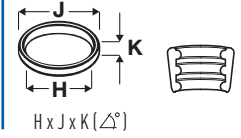
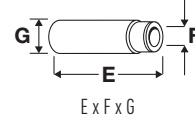
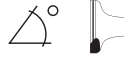

29 **80.50**

| Z 18 XE | 1796cc | 4 Cyl. | 16 Valves | 90-92kW/122-125PS | Petrol | ECOTEC, DOHC | TD21857 |
|------------|-----------------|--------|------------|-------------------|-----------------|--------------|---------|
| ASTRA 1.8 | 08/2002→06/2005 | | MERIVA 1.8 | | 05/2003→05/2008 | | |
| NIVA 1.8 | 01/2007→12/2009 | | VIVA 1.8 | | 09/2003→03/2008 | | |
| ZAFIRA 1.8 | 07/2000→06/2005 | | | | | | |

V94249
31.20 x 5.00 x 101.40

90536095

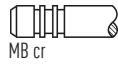

45°

H

VAG96076
39.00 x 5.00 x 10.04



V94250
27.50 x 5.00 x 100.80

90536164

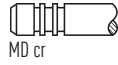

45°

SS

VAG96077
39.00 x 5.00 x 10.04



30 **80.50**

| Z 18 XER | 1796cc | 4 Cyl. | 16 Valves | 103kW/140PS | Petrol | DOHC | TD32222 |
|-----------|-----------------|--------|-----------|-------------|--------|------|---------|
| ASTRA 1.8 | 08/2006→03/2009 | | | | | | |

V80016 [3]
31.20 x 5.00 x 113.80

55572520

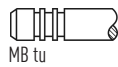

45°

SS

VAG96346 [3]
37.00 x 4.99 x 10.04



V98024
31.00 x 5.00 x 114.00

55557741

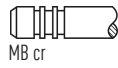

45°

V80017 [3]
27.50 x 5.00 x 113.20

55572521



45°

SS

V98025
27.50 x 5.00 x 113.20

24405815



45°

[3] LPG

[3] LPG

[3] LPG

[3] LPG

[3] LPG

31 **81.00**

| 7A-FE | 1762cc | 4 Cyl. | 16 Valves | 92kW/125PS | Petrol | DOHC, Injection | TD21849 |
|-------|--------|--------|-----------|------------|--------|-----------------|---------|
|-------|--------|--------|-----------|------------|--------|-----------------|---------|

V94144
30.90 x 6.00 x 87.50

13711-15090

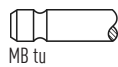

45°

H

VAG96068
38.50 x 6.03 x 11.06

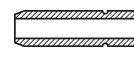

V94137
24.50 x 6.00 x 87.90

13715-16060

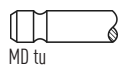

45°

32 **81.60**

| X 18 XE | 1799cc | 4 Cyl. | 16 Valves | 82-85kW/111-116PS | Petrol | ECOTEC, DOHC | TD32242 |
|---------|--------|--------|-----------|-------------------|--------|--------------|---------|
|---------|--------|--------|-----------|-------------------|--------|--------------|---------|

CORSA 1.8

08/2002→08/2005

V91997
32.10 x 5.97 x 102.10

90412277

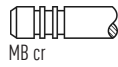

45°

H

VAG96028
45.00 x 5.99 x 10.05



V91998
29.10 x 5.96 x 92.25

90410813

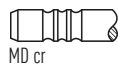

45°

SS



OE

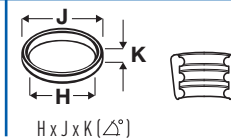
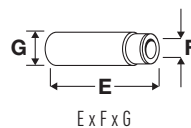

33 83.00

| | | | | | | | |
|-----------------|-----------------|--------|------------------|--------------------|--------|-------------|----------------|
| Z 20 DM | 1991cc | 4 Cyl. | 16 Valves | 89kW/121PS | Diesel | DOHC | TD21856 |
| Z 20 DMH | 1991cc | 4 Cyl. | 16 Valves | 92-110kW/125-150PS | Diesel | DOHC | TD28118 |
| CAPTIVA 2.0 D | 10/2006→ | | | CRUZE 2.0 CDI | | 05/2009→ | |
| CRUZE 2.0 VCDi | 12/2010→ | | | LACETTI 2.0 D | | 01/2007→ | |
| NUBIRA 2.0 D | 01/2007→12/2011 | | | | | | |

V95187 ■
28.50 x 5.95 x 95.70

96440147

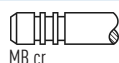

H

V95188 ■
24.50 x 5.92 x 95.75

93743882

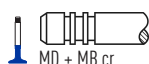

45°

H

34 84.00

| | | | | | | | |
|-----------------|-----------------|--------|------------------|-------------------|--------|--------------------|----------------|
| Y 20 DTH | 1995cc | 4 Cyl. | 16 Valves | 74kW/101PS | Diesel | Turbo, SOHC | TD19868 |
| ASTRA 2.0 DTi | 08/2002→12/2011 | | | ASTRA 2.0 DTi GLS | | 08/2002→12/2011 | |

V94097 ■
29.00 x 6.00 x 97.20

90502319

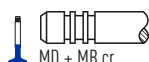

45°

ss

H

VAG96028 ■ ■
45.00 x 5.99 x 10.05



V94098 ■
26.00 x 6.00 x 97.00

90502326

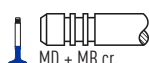

45°

ss

H

35 86.00

| | | | | | | | |
|---------------|-----------------|--------|-----------------|------------|--------|-------------|----------------|
| 20 NEJ | 1998cc | 4 Cyl. | 8 Valves | 81kW/110PS | Petrol | SOHC | TD26438 |
| VECTRA 2.0 | 03/1996→12/2005 | | | | | | |

V91148 ■
41.80 x 7.00 x 103.80

90295019

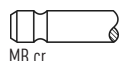

45°

H

VAG96022 ■ ■
45.80 x 7.02 x 11.04



V91149 ■
36.57 x 6.97 x 103.63

90323757

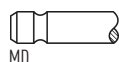

45°

36 86.00

| | | | | | | | |
|-----------------|--------|--------|------------------|---------------------|--------|-------------|----------------|
| C 20 SEL | 1998cc | 4 Cyl. | 16 Valves | 100-101kW/136-137PS | Petrol | DOHC | TD19856 |
| X 20 SED | 1998cc | 4 Cyl. | 16 Valves | 89-98kW/121-133PS | Petrol | DOHC | TD18531 |
| X 20 XEV | 1998cc | 4 Cyl. | 16 Valves | 94kW/128PS | Petrol | DOHC | TD26430 |

| | | | | | | | |
|------------|-----------------|--|--|----------------|--|-----------------|--|
| ASTRA 2.0 | 03/1999→12/2011 | | | ASTRA 2.0 GLS | | 03/1999→12/2011 | |
| EVANDA 2.0 | 03/2005→ | | | OPTRA 2.0 | | 06/1999→07/2003 | |
| VECTRA 2.0 | 03/1996→02/2012 | | | VECTRA 2.0 16V | | 07/2008→ | |
| VIVANT 2.0 | 08/2000→ | | | ZAFIRA 2.0 | | 04/2001→07/2012 | |

V91997 ■
32.10 x 5.97 x 102.10

90412277

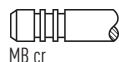

45°

H

VAG96028 ■ ■
45.00 x 5.99 x 10.05



V91998 ■
29.10 x 5.96 x 92.25

90410813



45°





ss

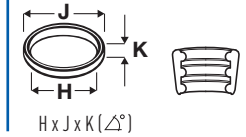
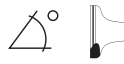







OE





37  **86.00**

| | | | | | | | |
|---|----------|---|------------------|--------------------|--------|-----------------|----------------|
| C 20 XE | 1998cc | 4 Cyl. | 16 Valves | 89-110kW/121-150PS | Petrol | DOHC | TD28273 |
| CALIBRA 2.0 16V | | 10/1993→03/1996 | | OPTRA 2.0 | | 09/2005→12/2007 | |
| VECTRA 2.0 GSi | | 10/1993→03/1996 | | | | | |
| V91429  | 90322694 |  | 45° | H | | | |
| 33.00 x 7.00 x 104.90 | | MB cr | | | | | |
| V91430  | 90322697 |  | 45° | SS | H | | |
| 29.10 x 6.96 x 104.90 | | MD + MB cr | | | | | |





38  **86.00**

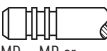



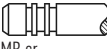

| | | | | | | | |
|---|----------|--|------------------|---------------------|---|---|----------------|
| C 22 SEL | 2198cc | 4 Cyl. | 16 Valves | 101-106kW/137-144PS | Petrol | DOHC | TD22563 |
| X 22 XE | 2198cc | 4 Cyl. | 16 Valves | 94-104kW/128-141PS | Petrol | ECOTEC, DOHC | TD27421 |
| VECTRA 2.2 | | 12/1997→12/2005 | | | | | |
| V91997  | 90412277 |  | 45° | H | VAG96028  |  | |
| 32.10 x 5.97 x 102.10 | | MB cr | | | 45.00 x 5.99 x 10.05 | | |
| V91998  | 90410813 |  | 45° | SS | | | |
| 29.10 x 5.96 x 92.25 | | MD cr | | | | | |

39  **86.00**

| | | | | | | | |
|---|----------|---|------------------|---------------------|--------|---------------------|----------------|
| Z 22 SE | 2198cc | 4 Cyl. | 16 Valves | 108-110kW/147-150PS | Petrol | ECOTEC, DOHC | TD21854 |
| Z 22 YH | 2198cc | 4 Cyl. | 16 Valves | 110-114kW/150-155PS | Petrol | DOHC | TD21853 |
| ASTRA 2.2 | | 08/2000→08/2004 | | VECTRA 2.2 | | 04/2002→07/2006 | |
| ZAFIRA 2.2 | | 09/2001→ | | | | | |
| V94962  | 12575793 |  | 45° | H | | | |
| 35.15 x 6.00 x 102.20 | | MB cr | | | | | |
| V94963  | 24454518 |  | 45° | SS | H | | |
| 30.10 x 6.00 x 100.90 | | MD + MB cr | | | | | |

40  **88.50**

| | | | | | | | |
|---|----------|---|------------------|-------------|---|---|----------------|
| Z 32 SE | 3175cc | V6 Cyl. | 24 Valves | 155kW/211PS | Petrol | DOHC | TD21851 |
| VECTRA 3.2 | | 09/2001→07/2004 | | | | | |
| V91997  | 90412277 |  | 45° | H | VAG96028  |  | |
| 32.10 x 5.97 x 102.10 | | MB cr | | | 45.00 x 5.99 x 10.05 | | |
| V91998  | 90410813 |  | 45° | SS | | | |
| 29.10 x 5.96 x 92.25 | | MD cr | | | | | |

|  |  | ccm |  |  |  |  |
|---|---|------|--|---|---|---|
| 169 A4.000 | 70.80 | 1242 | 4 | 8 | Petrol | 2 |
| 198 A2.000 | 79.50 | 1598 | 4 | 16 | Diesel | 4 |
| 198 A5.000 | 83.00 | 1956 | 4 | 16 | Diesel | 5 |
| 199 B1.000 | 69.60 | 1248 | 4 | 16 | Diesel | 1 |
| ECC | 87.50 | 1996 | 4 | 16 | Petrol | 7 |
| EDV | 87.50 | 2429 | 4 | 16 | Petrol | 8 |
| EDZ | 87.50 | 2429 | 4 | 16 | Petrol | 8 |
| EJD | 77.00 | 1598 | 4 | 16 | Petrol | 3 |
| ENC | 92.00 | 2499 | 4 | 8 | Diesel | 9 |
| ENJ | 92.00 | 2499 | 4 | 16 | Diesel | 10 |
| ENR | 94.00 | 2776 | 4 | 16 | Diesel | 12 |
| J8S | 86.00 | 2068 | 4 | 8 | Diesel | 6 |
| J8S 890 | 86.00 | 2068 | 4 | 8 | Diesel | 6 |
| M00 (HR 425 CL) | 92.00 | 2500 | 4 | 8 | Diesel | 11 |
| VM 425HR (M51) | 92.00 | 2499 | 4 | 8 | Diesel | 9 |
| VM 425HS (M52) | 92.00 | 2499 | 4 | 8 | Diesel | 9 |





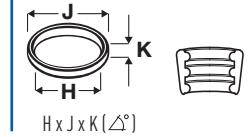
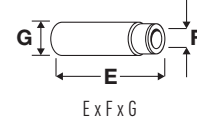
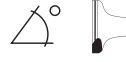

OE



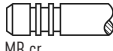

1  **69.60**

| | | | | | | | |
|----------------------|--------|----------|------------------|-----------|--------|--------------------|----------------|
| 199 B1.000 | 1248cc | 4 Cyl. | 16 Valves | 70kW/95PS | Diesel | Turbo, DOHC | TD26556 |
| YPSILON 1.3 Multijet | | 05/2011→ | | | | | |

| | | | | | | |
|---|----------|---|-----|------|---|--|
| V95182  | 55204574 |  | 45° | H | VAG96359  | |
| 21.85 x 5.98 x 109.25 | | MB cr | | | 43.28 x 6.00 x 10.25 | |
| V95183  | 55223836 |  | 45° | SS H | | |
| 22.50 x 5.99 x 109.20 | | MD + MB cr | | | | |

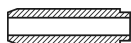

2  **70.80**

| | | | | | | | |
|-------------------|--------|----------|-----------------|-----------|--------|-------------|----------------|
| 169 A4.000 | 1242cc | 4 Cyl. | 8 Valves | 51kW/69PS | Petrol | SOHC | TD26555 |
| YPSILON 1.2 | | 05/2011→ | | | | | |

| | | | | | | |
|---|------------|---|-----|--|---|--|
| V98022  | 55 194 219 |  | 45° | | VAG96384  | |
| 33.30 x 5.00 x 99.90 | | MB cr | | | 44.00 x 5.00 x 10.04 | |
| V98023  | 55 200 422 |  | 45° | | | |
| 28.10 x 5.00 x 100.50 | | MD + MB cr | | | | |

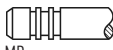

3  **77.00**

| | | | | | | | |
|-------------|--------|-----------------|------------------|----------------|--------|-----------------|----------------|
| EJD | 1598cc | 4 Cyl. | 16 Valves | 85kW/116PS | Petrol | SOHC | TD18383 |
| NEON II 1.6 | | 11/2001→12/2006 | | PT CRUISER 1.6 | | 11/2001→12/2010 | |

| | | | | | | |
|---|--------------|---|-----|---|--|--|
| V94349  | 04777770AB |  | 45° | H | | |
| 30.30 x 6.00 x 109.00 | | MB | | | | |
| V94350  | 047 777 72AB |  | 45° | H | | |
| 23.20 x 6.00 x 117.85 | | MD + MB cr | | | | |



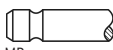
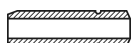

4  **79.50**

| | | | | | | | |
|----------------------|--------|----------|------------------|------------|--------|--------------------|----------------|
| 198 A2.000 | 1598cc | 4 Cyl. | 16 Valves | 88kW/120PS | Diesel | Turbo, DOHC | TD26557 |
| DELTA 1.6 D Multijet | | 08/2011→ | | | | | |

| | | | | | | |
|---|----------|---|-----|-----|---|--|
| V95223  | 55205125 |  | 45° | Y H | VAG96360  | |
| 26.55 x 5.00 x 114.40 | | MB | | | 46.70 x 5.00 x 10.03 | |
| V98006  | 55207955 |  | 45° | | | |
| 24.50 x 5.00 x 114.40 | | MD + MB cr | | | | |

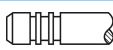
5  **83.00**

| | | | | | | | |
|----------------------|--------|----------|------------------|-------------|--------|--------------------|----------------|
| 198 A5.000 | 1956cc | 4 Cyl. | 16 Valves | 121kW/165PS | Diesel | Turbo, DOHC | TD26560 |
| DELTA 2.0 D Multijet | | 08/2011→ | | | | | |

| | | | | | | |
|---|----------|---|-----|--|---|--|
| V98005  | 55207517 |  | 45° | | VAG96360  | |
| 28.00 x 5.00 x 114.40 | | MB cr | | | 46.70 x 5.00 x 10.03 | |
| V98006  | 55207955 |  | 45° | | | |
| 24.50 x 5.00 x 114.40 | | MD + MB cr | | | | |

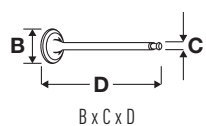

OE

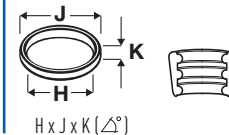
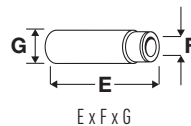

6 86.00

| | | | | | | | |
|-----------------------|--------------|--------|-----------------|-----------------|--------|--------------|---------------|
| J8S | 2068cc | 4 Cyl. | 8 Valves | 59-64kW/80-87PS | Diesel | | TD4254 |
| J8S 890 | 2068cc | 4 Cyl. | 8 Valves | 64kW/87PS | Diesel | Turbo | TD4255 |
| V91264 ■ | 7701 461 338 | | 45° | H | | | |
| 40.50 x 8.00 x 111.50 | | MB | | | | | |
| V91265 ■ | 7701 461 339 | | 45° | | | | |
| 33.50 x 8.00 x 111.50 | | MD | | | | | |

7 87.50

| | | | | | | | |
|-----------------------|-----------------|------------|------------------|---------------------|--------|-----------------|----------------|
| ECC | 1996cc | 4 Cyl. | 16 Valves | 100-118kW/136-160PS | Petrol | DOHC | TD18328 |
| CIRRUS 2.0 | 09/2000→04/2007 | | | NEON 2.0 | | 10/1996→09/2000 | |
| NEON 2.0 16V | 06/1994→08/1999 | | | PT CRUISER 2.0 | | 06/2000→12/2010 | |
| SEBRING 2.0 | 04/2001→06/2007 | | | | | | |
| V95218 ■ | 04667969AB | | 45° | H | | | |
| 34.80 x 5.95 x 111.75 | | MB cr | | | | | |
| V95219 ■ | 04777898AA | | 45° | H | | | |
| 28.45 x 5.92 x 109.90 | | MD + MB cr | | | | | |

8 87.50

| | | | | | | | |
|---------------------------------|-----------------|------------|------------------|---------------------|--------|--------------------|----------------|
| EDV | 2429cc | 4 Cyl. | 16 Valves | 125-169kW/170-230PS | Petrol | Turbo, DOHC | TD18407 |
| EDZ | 2429cc | 4 Cyl. | 16 Valves | 103-120kW/140-163PS | Petrol | DOHC | TD18326 |
| CARAVAN 2.4 | 01/1995→12/2000 | | | CHRYSLER R/T 2.4 | | 09/1996→12/1997 | |
| CIRRUS 2.4 | 09/1994→04/2007 | | | CIRRUS 2.4 LX | | 05/1994→09/2000 | |
| CIRRUS 2.4 Turbo | 01/2001→12/2006 | | | GRAND CARAVAN 2.4 | | 04/2003→12/2007 | |
| INTREPID 2.4 | 09/1992→12/1997 | | | NEON II 2.4 | | 10/2001→09/2005 | |
| PT CRUISER 2.4 | 06/2000→12/2010 | | | PT CRUISER 2.4 GT | | 03/2004→03/2008 | |
| PT CRUISER GT 2.4 | 08/2003→12/2010 | | | SEBRING 2.4 | | 09/1995→06/2007 | |
| SEBRING 2.4 Turbo | 09/2001→06/2007 | | | STRATUS 2.4 | | 01/1996→10/2006 | |
| STRATUS 2.4 16V | 12/1995→04/2001 | | | STRATUS 2.4 16 V | | 12/1995→04/2001 | |
| VOYAGER / GRAND VOYAGER III 2.4 | 02/1997→03/2001 | | | VOYAGER IV 2.4 | | 02/2000→12/2008 | |
| V95218 ■ | 04667969AB | | 45° | H | | | |
| 34.80 x 5.95 x 111.75 | | MB cr | | | | | |
| V95219 ■ | 04777898AA | | 45° | H | | | |
| 28.45 x 5.92 x 109.90 | | MD + MB cr | | | | | |

9 92.00

| | | | | | | | |
|--------------------------------------|-----------------|--------|-----------------|------------------------------------|----------------------|-------------------|----------------|
| ENC | 2499cc | 4 Cyl. | 8 Valves | 85-105kW/116-141PS | Diesel | Turbo, OHV | TD18322 |
| VM 425HR (M51) | 2499cc | 4 Cyl. | 8 Valves | 85-89kW/115-121PS | Diesel | Turbo | TD4257 |
| VM 425HS (M52) | 2499cc | 4 Cyl. | 8 Valves | 85kW/115PS | Diesel | Turbo | TD535 |
| GRAND CARAVAN 2.5 TDi | 02/2006→05/2007 | | | VOYAGER / GRAND VOYAGER III 2.5 TD | | 01/1995→03/2001 | |
| VOYAGER / GRAND VOYAGER III 2.5 TDiC | 10/1995→03/2001 | | | | | | |
| V91437 ■ | 605 07 189 | | 35° | | VAG96187 ■ ■ | | |
| 40.00 x 8.00 x 121.00 | | MD cr | | | 55.00 x 8.02 x 14.06 | | |
| V91438 ■ | 605 07 190 | | 45° | | | | |
| 34.00 x 8.00 x 121.00 | | MD cr | | | | | |



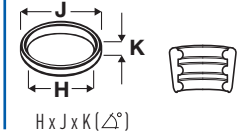
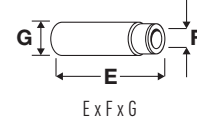
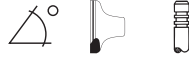

OE



10  **92.00**

| | | | | | | | |
|--------------------|--------|-----------------|------------------|-------------|--------|--------------------|----------------|
| ENJ | 2499cc | 4 Cyl. | 16 Valves | 105kW/143PS | Diesel | Turbo, DOHC | TD18323 |
| VOYAGER IV 2.5 CRD | | 02/2000→12/2008 | | | | | |

V98016  05066770AA  45°
32.40 x 6.00 x 109.00 MB cr

V98017  05066769AA   45°
30.90 x 6.00 x 108.30 MD + MB cr

11  **92.00**

| | | | | | | | |
|------------------------|--------|-----------------|-----------------|-------------------|--------|--|---------------|
| M00 (HR 425 CL) | 2500cc | 4 Cyl. | 8 Valves | 85-87kW/116-118PS | Diesel | | TD4253 |
| VOYAGER II 2.5 TD | | 01/1992→09/1995 | | | | | |

V91437  605 07 189  35°
40.00 x 8.00 x 121.00 MD cr



VAG96187     
55.00 x 8.02 x 14.06 







V91438  605 07 190  45°
34.00 x 8.00 x 121.00 MD cr







12  **94.00**







| | | | | | | | |
|--------------------|--------|-----------------|------------------|---------------------|--------|--------------------|----------------|
| ENR | 2776cc | 4 Cyl. | 16 Valves | 110-120kW/150-163PS | Diesel | Turbo, DOHC | TD18329 |
| VOYAGER IV 2.8 CRD | | 06/2004→12/2008 | | | | | |







V98016  05066770AA  45°
32.40 x 6.00 x 109.00 MB cr

V98017  05066769AA   45°
30.90 x 6.00 x 108.30 MD + MB cr

|  |  | ccm |  |  |  |  | |
|---|---|-------|--|---|---|---|----|
| 108C | | 70.00 | 954 | 4 | 8 | Petrol | 1 |
| 1KR-FE | | 71.00 | 998 | 3 | 12 | Petrol | 2 |
| 220 A2.000 | | 86.40 | 1581 | 4 | 8 | Petrol | 64 |
| 384F (CFA) | | 71.00 | 998 | 3 | 12 | Petrol | 2 |
| 8140.43N | | 94.40 | 2800 | 4 | 8 | Diesel | 73 |
| 8140.43S | | 94.40 | 2800 | 4 | 8 | Diesel | 73 |
| 829 A5 | | 88.00 | 1995 | 4 | 8 | Petrol | 68 |
| C1A | | 70.00 | 954 | 4 | 8 | Petrol | 1 |
| DJ5 (T9A) | | 92.00 | 2446 | 4 | 12 | Diesel | 70 |
| DJ5T (T8A) | | 92.00 | 2446 | 4 | 12 | Diesel | 71 |
| DJ5T (THZ) | | 92.00 | 2446 | 4 | 12 | Diesel | 71 |
| DJ5TED (THX) | | 92.00 | 2446 | 4 | 8 | Diesel | 72 |
| DK5ATE (THY) | | 92.00 | 2446 | 4 | 12 | Diesel | 70 |
| DT17BTED4 (UHZ) | | 81.00 | 2720 | 6 | 24 | Diesel | 29 |
| DT17ED4 | | 81.00 | 2720 | 6 | 24 | Diesel | 29 |
| DT17TED4 (UHZ) | | 81.00 | 2720 | 6 | 24 | Diesel | 29 |
| DT20C | | 84.00 | 2993 | 6 | 24 | Diesel | 42 |
| DV4C (8HR) | | 73.70 | 1398 | 4 | 8 | Diesel | 5 |
| DV4D | | 73.70 | 1398 | 4 | 8 | Diesel | 6 |
| DV4TD (8HT) | | 73.70 | 1398 | 4 | 8 | Diesel | 6 |
| DV4TD (8HX) | | 73.70 | 1398 | 4 | 8 | Diesel | 6 |
| DV4TD (8HZ) | | 73.70 | 1398 | 4 | 8 | Diesel | 6 |
| DV4TED4 (8HY) | | 73.70 | 1398 | 4 | 16 | Diesel | 7 |
| DV6ATED4 (9HX) | | 75.00 | 1560 | 4 | 16 | Diesel | 17 |
| DV6AUTED4 (9HX) | | 75.00 | 1560 | 4 | 16 | Diesel | 17 |
| DV6B | | 75.00 | 1560 | 4 | 16 | Diesel | 17 |
| DV6BTED4 (9HT) | | 75.00 | 1560 | 4 | 16 | Diesel | 17 |
| DV6BTED4 (9HW) | | 75.00 | 1560 | 4 | 16 | Diesel | 17 |
| DV6BUTED4 (9HT) | | 75.00 | 1560 | 4 | 16 | Diesel | 17 |
| DV6C (9HD) | | 75.00 | 1560 | 4 | 8 | Diesel | 18 |
| DV6C (9HL) | | 75.00 | 1560 | 4 | 8 | Diesel | 18 |
| DV6C (9HR) | | 75.00 | 1560 | 4 | 8 | Diesel | 18 |
| DV6DBM (9HE) | | 75.00 | 1560 | 4 | 8 | Diesel | 18 |
| DV6DTE4 (9HP) | | 75.00 | 1560 | 4 | 8 | Diesel | 18 |
| DV6DTE4M (9HJ) | | 75.00 | 1560 | 4 | 8 | Diesel | 18 |
| DV6DUM (9HH) | | 75.00 | 1560 | 4 | 8 | Diesel | 18 |
| DV6ETED (9HN) | | 75.00 | 1560 | 4 | 8 | Diesel | 18 |
| DV6ETED (9HW) | | 75.00 | 1560 | 4 | 8 | Diesel | 18 |
| DV6ETEDM (9HK) | | 75.00 | 1560 | 4 | 8 | Diesel | 18 |
| DV6FC (BHZ) | | 75.00 | 1560 | 4 | 8 | Diesel | 18 |
| DV6TED4 (9HY) | | 75.00 | 1560 | 4 | 16 | Diesel | 17 |
| DV6TED4 (9HZ) | | 75.00 | 1560 | 4 | 16 | Diesel | 17 |
| DV6TED4BU (9HS) | | 75.00 | 1560 | 4 | 16 | Diesel | 17 |
| DV6UC (9HM) | | 75.00 | 1560 | 4 | 8 | Diesel | 18 |
| DV6UTED4 (9HU) | | 75.00 | 1560 | 4 | 16 | Diesel | 17 |
| DW10 C HYBRID (RHC) | | 85.00 | 1997 | 4 | 16 | Diesel | 43 |
| DW10ATED (RHS) | | 85.00 | 1997 | 4 | 8 | Diesel | 44 |
| DW10ATED (RHZ) | | 85.00 | 1997 | 4 | 8 | Diesel | 44 |
| DW10ATED4 (RHM) | | 85.00 | 1997 | 4 | 16 | Diesel | 45 |
| DW10ATED4 (RHT) | | 85.00 | 1997 | 4 | 16 | Diesel | 45 |
| DW10ATED4 (RHW) | | 85.00 | 1997 | 4 | 16 | Diesel | 45 |
| DW10BTED (RHX) | | 85.00 | 1997 | 4 | 8 | Diesel | 44 |
| DW10BTED4 (RHF) | | 85.00 | 1997 | 4 | 16 | Diesel | 43 |
| DW10BTED4 (RHJ) | | 85.00 | 1997 | 4 | 16 | Diesel | 46 |
| DW10BTED4 (RHR) | | 85.00 | 1997 | 4 | 16 | Diesel | 46 |
| DW10CB (RHD) | | 85.00 | 1997 | 4 | 16 | Diesel | 43 |
| DW10CTED4 (RHD) | | 85.00 | 1997 | 4 | 16 | Diesel | 43 |
| DW10CTED4 (RHE) | | 85.00 | 1997 | 4 | 16 | Diesel | 43 |
| DW10CTED4 (RHH) | | 85.00 | 1997 | 4 | 16 | Diesel | 43 |
| DW10DTE4 (RHB) | | 85.00 | 1997 | 4 | 16 | Diesel | 43 |
| DW10FC (AHT) | | 85.00 | 1997 | 4 | 16 | Diesel | 43 |
| DW10FC (AHW) | | 85.00 | 1997 | 4 | 16 | Diesel | 47 |
| DW10FD (AHS) | | 85.00 | 1997 | 4 | 16 | Diesel | 48 |
| DW10FD (AHU) | | 85.00 | 1997 | 4 | 16 | Diesel | 43 |
| DW10FD (AHX) | | 85.00 | 1997 | 4 | 16 | Diesel | 47 |
| DW10FDD (AHV) | | 85.00 | 1997 | 4 | 16 | Diesel | 48 |

|  |  | ccm |  |  |  |  |
|---|---|------|---|---|---|---|
| DW10TD (RHV) | 85.00 | 1997 | 4 | 8 | Diesel | 44 |
| DW10TD (RHY) | 85.00 | 1997 | 4 | 8 | Diesel | 44 |
| DW10UTD (RHV) | 85.00 | 1997 | 4 | 8 | Diesel | 44 |
| DW10UTED4 (RHK) | 85.00 | 1997 | 4 | 16 | Diesel | 45 |
| DW12BTED4 (4HP) | 85.00 | 2179 | 4 | 16 | Diesel | 52 |
| DW12BTED4 (4HR) | 85.00 | 2179 | 4 | 16 | Diesel | 52 |
| DW12BTED4 (4HT) | 85.00 | 2179 | 4 | 16 | Diesel | 52 |
| DW12TED4 (4HW) | 85.00 | 2179 | 4 | 16 | Diesel | 53 |
| DW12TED4/FAP (4HX) | 85.00 | 2179 | 4 | 16 | Diesel | 53 |
| DW12UTED (4HY) | 85.00 | 2179 | 4 | 8 | Diesel | 54 |
| DW8 (WJZ);DW8B (WJY) | 82.20 | 1868 | 4 | 8 | Diesel | 30 |
| DW8B (WJY) | 82.20 | 1868 | 4 | 8 | Diesel | 30 |
| EB2D (HMT) | 75.00 | 1199 | 3 | 12 | Petrol | 8 |
| EB2DT (HNZ) | 75.00 | 1199 | 3 | 12 | Petrol | 8 |
| EB2DTS (HNY) | 75.00 | 1199 | 3 | 12 | Petrol | 9 |
| EB2F (HMZ) | 75.00 | 1199 | 3 | 12 | Petrol | 8 |
| EP3 (8FP) | 77.00 | 1397 | 4 | 16 | Petrol | 19 |
| EP3 (8FS) | 77.00 | 1397 | 4 | 16 | Petrol | 19 |
| EP6 (5FW) | 77.00 | 1598 | 4 | 16 | Petrol | 21 |
| EP6 CB (5FK) | 77.00 | 1598 | 4 | 16 | Petrol | 22 |
| EP6C (5FS) | 77.00 | 1598 | 4 | 16 | Petrol | 21 |
| EP6CDT (5FN) | 77.00 | 1598 | 4 | 16 | Petrol | 23 |
| EP6CDT (5FV) | 77.00 | 1598 | 4 | 16 | Petrol | 23 |
| EP6CDTX (5FU) | 77.00 | 1598 | 4 | 16 | Petrol | 23 |
| EP6CDTX (5FY) | 77.00 | 1598 | 4 | 16 | Petrol | 22 |
| EP6DT (5FR) | 77.00 | 1598 | 4 | 16 | Petrol | 23 |
| EP6DT (5FX) | 77.00 | 1598 | 4 | 16 | Petrol | 23 |
| EP6DTS (5FD) | 77.00 | 1598 | 4 | 16 | Petrol | 23 |
| EP6DTS (5FY) | 77.00 | 1598 | 4 | 16 | Petrol | 23 |
| EP6DTX (5FU) | 77.00 | 1598 | 4 | 16 | Petrol | 22 |
| EP6FDT (5GZ) | 77.00 | 1598 | 4 | 16 | Petrol | 23 |
| ES9A (XFV) | 87.00 | 2946 | 6 | 24 | Petrol | 65 |
| ES9J4 (XFZ) | 87.00 | 2946 | 6 | 24 | Petrol | 66 |
| ES9J4S (XFX) | 87.00 | 2946 | 6 | 24 | Petrol | 65 |
| ET3J4 (KFU) | 75.00 | 1360 | 4 | 16 | Petrol | 10 |
| EW10A (RFJ) | 85.00 | 1997 | 4 | 16 | Petrol | 49 |
| EW10D (RLZ) | 85.00 | 1997 | 4 | 16 | Petrol | 50 |
| EW10J4 (RFN) | 85.00 | 1997 | 4 | 16 | Petrol | 49 |
| EW10J4S (RFK) | 85.00 | 1997 | 4 | 16 | Petrol | 49 |
| EW12J4 (3FY) | 86.00 | 2230 | 4 | 16 | Petrol | 63 |
| EW12J4 (3FZ) | 86.00 | 2230 | 4 | 16 | Petrol | 63 |
| EW7A (6FY) | 82.70 | 1749 | 4 | 16 | Petrol | 31 |
| EW7J4 (6FZ) | 82.70 | 1749 | 4 | 16 | Petrol | 31 |
| F1CE0481D (F30DT) | 95.80 | 2999 | 4 | 16 | Diesel | 74 |
| J6TA 500 / J6RA 500 | 88.00 | 2165 | 4 | 8 | Petrol | 69 |
| K1B | 75.00 | 1360 | 4 | 8 | Petrol | 11 |
| K1G | 75.00 | 1360 | 4 | 8 | Petrol | 11 |
| KAZ | 75.00 | 1360 | 4 | 8 | Petrol | 11 |
| P22DTE (4HU) | 86.00 | 2198 | 4 | 16 | Diesel | 62 |
| P22DTE (4HV) | 86.00 | 2198 | 4 | 16 | Diesel | 62 |
| TU1 (H1B) | 72.00 | 1124 | 4 | 8 | Petrol | 3 |
| TU1 K (H1A) | 72.00 | 1124 | 4 | 8 | Petrol | 3 |
| TU1CP (HAZ) | 72.00 | 1124 | 4 | 8 | Petrol | 3 |
| TU1JP (HFX) | 72.00 | 1124 | 4 | 8 | Petrol | 4 |
| TU1M (HDZ) | 72.00 | 1124 | 4 | 8 | Petrol | 3 |
| TU3 (K3A) | 75.00 | 1360 | 4 | 8 | Petrol | 11 |
| TU3A (K1H) | 75.00 | 1360 | 4 | 8 | Petrol | 12 |
| TU3A (K6D) | 75.00 | 1360 | 4 | 8 | Petrol | 12 |
| TU3A (K6E) | 75.00 | 1360 | 4 | 8 | Petrol | 12 |
| TU3A (K6F) | 75.00 | 1360 | 4 | 8 | Petrol | 12 |
| TU3A (KFT) | 75.00 | 1360 | 4 | 8 | Petrol | 12 |
| TU3A (KFV) | 75.00 | 1360 | 4 | 8 | Petrol | 12 |
| TU3A (KFW) | 75.00 | 1360 | 4 | 8 | Petrol | 12 |
| TU3A (KFX) | 75.00 | 1360 | 4 | 8 | Petrol | 13 |
| TU3CP (KAY) | 75.00 | 1360 | 4 | 8 | Petrol | 14 |
| TU3F2 (K1F) | 75.00 | 1360 | 4 | 8 | Petrol | 13 |

|  |  | ccm |  |  |  |  |
|---|---|------|--|---|---|---|
| TU3F2 (K2B) | 75.00 | 1360 | 4 | 8 | Petrol | 13 |
| TU3FJ2 (K2D) | 75.00 | 1360 | 4 | 8 | Petrol | 11 |
| TU3FJ2 (KFY) | 75.00 | 1360 | 4 | 8 | Petrol | 14 |
| TU3FJ2 (KFZ) | 75.00 | 1360 | 4 | 8 | Petrol | 14 |
| TU3FM (K2A) | 75.00 | 1360 | 4 | 8 | Petrol | 13 |
| TU3FM (KDY) | 75.00 | 1360 | 4 | 8 | Petrol | 14 |
| TU3JP (KFW) | 75.00 | 1360 | 4 | 8 | Petrol | 15 |
| TU3JP (KFX) | 75.00 | 1360 | 4 | 8 | Petrol | 15 |
| TU3JP-L4 (KJV) | 75.00 | 1360 | 4 | 8 | Petrol | 15 |
| TU3M (KDX) | 75.00 | 1360 | 4 | 8 | Petrol | 14 |
| TU3M (KDY) | 75.00 | 1360 | 4 | 8 | Petrol | 14 |
| TU3M/Z (KDZ) | 75.00 | 1360 | 4 | 8 | Petrol | 14 |
| TU5J4 (NFX) | 78.50 | 1587 | 4 | 16 | Petrol | 24 |
| TU5JP (NFV) | 78.50 | 1587 | 4 | 8 | Petrol | 25 |
| TU5JP (NFZ) | 78.50 | 1587 | 4 | 8 | Petrol | 26 |
| TU5JP4 (NFU) | 78.50 | 1587 | 4 | 16 | Petrol | 24 |
| TU5JP4S (NFS) | 78.50 | 1587 | 4 | 16 | Petrol | 24 |
| TU9 | 70.00 | 954 | 4 | 8 | Petrol | 1 |
| TU9 (CDY) | 70.00 | 954 | 4 | 8 | Petrol | 1 |
| TU9M (CDY/CDZ) | 70.00 | 954 | 4 | 8 | Petrol | 1 |
| TUD3 (K9A) | 75.00 | 1360 | 4 | 8 | Diesel | 16 |
| TUD3Y (K9Y) | 75.00 | 1360 | 4 | 8 | Diesel | 16 |
| TUD5 (VJY) | 77.00 | 1527 | 4 | 8 | Diesel | 20 |
| TUD5 (VJZ) | 77.00 | 1527 | 4 | 8 | Diesel | 20 |
| XM7T (169) | 84.00 | 1796 | 4 | 8 | Petrol | 41 |
| XN1T (170A) | 88.00 | 1971 | 4 | 8 | Petrol | 67 |
| XN1T (170B) | 88.00 | 1971 | 4 | 8 | Petrol | 67 |
| XN1T (170C) | 88.00 | 1971 | 4 | 8 | Petrol | 67 |
| XU102C (R2A) | 86.00 | 1998 | 4 | 8 | Petrol | 55 |
| XU10J2 | 86.00 | 1998 | 4 | 8 | Petrol | 55 |
| XU10J2 (RFZ) | 86.00 | 1998 | 4 | 8 | Petrol | 55 |
| XU10J2C (RFU) | 86.00 | 1998 | 4 | 8 | Petrol | 55 |
| XU10J2C (RFX) | 86.00 | 1998 | 4 | 8 | Petrol | 55 |
| XU10J2TE (RGX) | 86.00 | 1998 | 4 | 8 | Petrol | 56 |
| XU10J2TE (RGX/RGY) | 86.00 | 1998 | 4 | 8 | Petrol | 56 |
| XU10J2U (RFW) | 86.00 | 1998 | 4 | 8 | Petrol | 55 |
| XU10J4 (RFT) | 86.00 | 1998 | 4 | 16 | Petrol | 57 |
| XU10J4 (RFY) | 86.00 | 1998 | 4 | 16 | Petrol | 57 |
| XU10J4R (RFV) | 86.00 | 1998 | 4 | 16 | Petrol | 58 |
| XU10J4RS (RFS) | 86.00 | 1998 | 4 | 16 | Petrol | 59 |
| XU10MZ (RDZ) | 86.00 | 1998 | 4 | 8 | Petrol | 60 |
| XU5 (B1AA) | 83.00 | 1580 | 4 | 8 | Petrol | 32 |
| XU51C (B1E) | 83.00 | 1580 | 4 | 8 | Petrol | 32 |
| XU52C | 83.00 | 1580 | 4 | 8 | Petrol | 32 |
| XU5CP (BAY/BAZ) | 83.00 | 1580 | 4 | 8 | Petrol | 32 |
| XU5J (180A/B6D) | 83.00 | 1580 | 4 | 8 | Petrol | 33 |
| XU5J (180Z) | 83.00 | 1580 | 4 | 8 | Petrol | 33 |
| XU5J/J2/JA | 83.00 | 1580 | 4 | 8 | Petrol | 32 |
| XU5JA (B6D) | 83.00 | 1580 | 4 | 8 | Petrol | 33 |
| XU5JP (BFZ) | 83.00 | 1580 | 4 | 8 | Petrol | 33 |
| XU5M (BDY/B4A) | 83.00 | 1580 | 4 | 8 | Petrol | 32 |
| XU5M (BDZ) | 83.00 | 1580 | 4 | 8 | Petrol | 32 |
| XU5S (171D) | 83.00 | 1580 | 4 | 8 | Petrol | 32 |
| XU7JB (LFX) | 83.00 | 1762 | 4 | 8 | Petrol | 34 |
| XU7JP (LFW/LFZ) | 83.00 | 1762 | 4 | 8 | Petrol | 34 |
| XU7JP4 (LFY) | 83.00 | 1762 | 4 | 16 | Petrol | 35 |
| XU92C (D2A) | 83.00 | 1905 | 4 | 8 | Petrol | 36 |
| XU92C (D2C) | 83.00 | 1905 | 4 | 8 | Petrol | 36 |
| XU9J1 (DFZ) | 83.00 | 1905 | 4 | 8 | Petrol | 36 |
| XU9J2 (D6A) | 83.00 | 1905 | 4 | 8 | Petrol | 36 |
| XU9J4 (D6C/DFW) | 83.00 | 1905 | 4 | 16 | Petrol | 37 |
| XU9J4 (DFW) | 83.00 | 1905 | 4 | 16 | Petrol | 37 |
| XU9JA (DKZ) | 83.00 | 1905 | 4 | 8 | Petrol | 36 |
| XU9M (DDZ) | 83.00 | 1905 | 4 | 8 | Petrol | 36 |
| XUD11A (P9A/PJZ) | 86.00 | 2138 | 4 | 12 | Diesel | 61 |
| XUD11ATE (P8A) | 85.00 | 2088 | 4 | 12 | Diesel | 51 |

|  |  | ccm |  |  |  |  |
|---|---|------|---|---|---|---|
| XUD11ATE (PHZ) | 85.00 | 2088 | 4 | 12 | Diesel | 51 |
| XUD11ATE (PJZ) | 85.00 | 2088 | 4 | 12 | Diesel | 51 |
| XUD11BTE (P8C) | 85.00 | 2088 | 4 | 12 | Diesel | 51 |
| XUD7 (161) | 80.00 | 1769 | 4 | 8 | Diesel | 27 |
| XUD7 (161A) | 80.00 | 1769 | 4 | 8 | Diesel | 27 |
| XUD7 (A9A/161A) | 80.00 | 1769 | 4 | 8 | Diesel | 27 |
| XUD7TE (A8A) | 80.00 | 1769 | 4 | 8 | Diesel | 28 |
| XUD7TE (AJZ) | 80.00 | 1769 | 4 | 8 | Diesel | 28 |
| XUD9 (162) | 83.00 | 1905 | 4 | 8 | Diesel | 38 |
| XUD9 (D9A) | 83.00 | 1905 | 4 | 8 | Diesel | 38 |
| XUD9 (DJZ) | 83.00 | 1905 | 4 | 8 | Diesel | 38 |
| XUD9A (DJY) | 83.00 | 1905 | 4 | 8 | Diesel | 38 |
| XUD9A/L (D9B) | 83.00 | 1905 | 4 | 8 | Diesel | 38 |
| XUD9A/U (D9B) | 83.00 | 1905 | 4 | 8 | Diesel | 38 |
| XUD9BSD (DHV) | 83.00 | 1905 | 4 | 8 | Diesel | 39 |
| XUD9BTF (DHX) | 83.00 | 1905 | 4 | 8 | Diesel | 40 |
| XUD9SD (DHW) | 83.00 | 1905 | 4 | 8 | Diesel | 40 |
| XUD9TE (DHY) | 83.00 | 1905 | 4 | 8 | Diesel | 40 |
| XUD9TF (D8B) | 83.00 | 1905 | 4 | 8 | Diesel | 40 |
| XUD9UTF (D8C) | 83.00 | 1905 | 4 | 8 | Diesel | 40 |
| XV8 (108C) | 70.00 | 954 | 4 | 8 | Petrol | 1 |
| XY6 (150F);XY8 (150A) | 75.00 | 1360 | 4 | 8 | Petrol | 11 |



OE

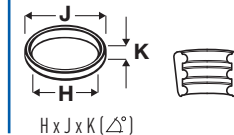
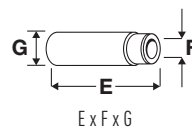

1 70.00

| | | | | | | | |
|----------------|-------|--------|----------|-----------------|--------|------|---------|
| 108C | 954cc | 4 Cyl. | 8 Valves | 30-33kW/41-45PS | Petrol | SOHC | TD6560 |
| C1A | 954cc | 4 Cyl. | 8 Valves | 32-34kW/44-46PS | Petrol | SOHC | TD6559 |
| TU9 | 954cc | 4 Cyl. | 8 Valves | 33kW/45PS | Petrol | SOHC | TD18545 |
| TU9 (CDY) | 954cc | 4 Cyl. | 8 Valves | 33-37kW/45-50PS | Petrol | SOHC | TD5095 |
| TU9M (CDY/CDZ) | 954cc | 4 Cyl. | 8 Valves | 33-37kW/45-50PS | Petrol | SOHC | TD10787 |
| XV8 (108C) | 954cc | 4 Cyl. | 8 Valves | 33kW/45PS | Petrol | SOHC | TD18544 |

| | | | |
|----------|-----------------|------------|-----------------|
| AX 10 | 07/1986→12/1998 | C15 1.0 | 10/1984→12/1997 |
| LNA 1.0 | 07/1984→10/1986 | SAXO 1.0 X | 05/1996→06/2003 |
| VISA 1.0 | 09/1984→06/1988 | | |

V91270 ■
34.50 x 7.00 x 113.00

97 531 079

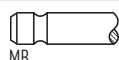

30°

H

VAG92401 ■ ■ ■
47.50 x 7.01 x 13.06

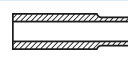

V91272 ■
27.50 x 7.00 x 112.50

97 531 046

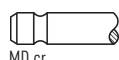

45°

VAG96132 ■ ■ ■
47.60 x 7.03 x 13.11



2 71.00

| | | | | | | | |
|------------|-------|--------|-----------|-----------------|--------|------|---------|
| 1KR-FE | 998cc | 3 Cyl. | 12 Valves | 50-51kW/68-69PS | Petrol | DOHC | TD18548 |
| 384F (CFA) | 998cc | 3 Cyl. | 12 Valves | 50kW/68PS | Petrol | DOHC | TD25073 |

| | | | |
|--------|-----------------|------------------|----------|
| C1 1.0 | 06/2005→09/2014 | C1 II 1.0 Vti 68 | 04/2014→ |
|--------|-----------------|------------------|----------|

V94969 ■
27.65 x 4.98 x 88.35

0948.E2

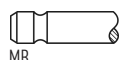

45°

H

VAG96067 ■ ■ ■
34.50 x 5.00 x 9.70

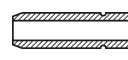

V94970 ■
23.70 x 4.98 x 89.10

0949.C8

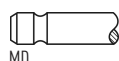

45°

3 72.00

| | | | | | | | |
|-------------|--------|--------|----------|-----------------|--------|------|--------|
| TU1 (H1B) | 1124cc | 4 Cyl. | 8 Valves | 40-44kW/55-60PS | Petrol | SOHC | TD658 |
| TU1 K (H1A) | 1124cc | 4 Cyl. | 8 Valves | 40-44kW/54-60PS | Petrol | SOHC | TD6562 |
| TU1CP (HAZ) | 1124cc | 4 Cyl. | 8 Valves | 40kW/54PS | Petrol | SOHC | TD5083 |
| TU1M (HDZ) | 1124cc | 4 Cyl. | 8 Valves | 40-44kW/55-60PS | Petrol | SOHC | TD661 |

| | | | |
|----------------|-----------------|---------------|-----------------|
| AX 11 | 09/1986→12/1997 | AX 11 Cat | 09/1988→12/1989 |
| BERLINGO 1.1 i | 07/1996→05/2008 | BX 11 | 10/1986→06/1992 |
| C15 1.1 | 08/1988→07/1996 | C15 1.1 i | 07/1988→12/1996 |
| SAXO 1.1 | 07/2000→06/2003 | SAXO 1.1 X,SX | 05/1996→09/2003 |
| ZX 1.1 | 03/1991→08/1993 | ZX 1.1 | 03/1991→06/1997 |

V91271 ■
37.00 x 7.00 x 112.50

97 533 266

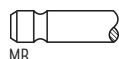

30°

H

VAG92401 ■ ■ ■
47.50 x 7.01 x 13.06

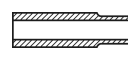

V91273 ■
29.50 x 7.00 x 112.50

97 533 264

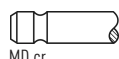

45°

VAG96132 ■ ■ ■
47.60 x 7.03 x 13.11





OE

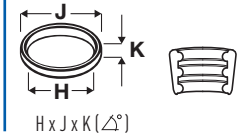
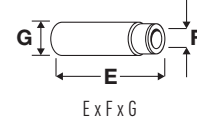

4  **72.00**

| | | | | | | |
|--------------------|-----------------|--------|-----------------|-----------|----------|----------------|
| TU1JP (HFX) | 1124cc | 4 Cyl. | 8 Valves | 44kW/60PS | Petrol | TD14730 |
| BERLINGO 1.1 i | 07/1996→05/2008 | | | C2 1.1 | 09/2003→ | |
| C3 I 1.1 i | 02/2002→ | | | C3 II 1.1 | 11/2009→ | |
| SAXO 1.1 X,SX | 05/1996→09/2003 | | | | | |

V94202 
36.70 x 7.00 x 112.70

0948.91

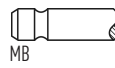

45°

H

VAG92401 
47.50 x 7.01 x 13.06



V91273 
29.50 x 7.00 x 112.50

97 533 264

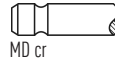

45°

VAG96132 
47.60 x 7.03 x 13.11



5  **73.70**

| | | | | | | | |
|-------------------|----------|--------|-----------------|----------------|-----------------|--------------------|----------------|
| DV4C (8HR) | 1398cc | 4 Cyl. | 8 Valves | 50kW/68PS | Diesel | Turbo, SOHC | TD25061 |
| C3 II 1.4 HDi 70 | 11/2009→ | | | DS3 1.4 HDi 70 | 04/2010→07/2015 | | |

V95137 
30.15 x 5.48 x 95.55

0948.F7

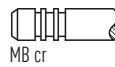

45°

Y

H

VAG96364 
34.20 x 5.50 x 9.53



V95138 
27.50 x 5.47 x 95.45

0949.F5



45°

SS

H

6  **73.70**

| | | | | | | | |
|--------------------|-----------------|--------|-----------------|-----------------|-----------------|--------------------|----------------|
| DV4D | 1398cc | 4 Cyl. | 8 Valves | 40kW/54PS | Diesel | SOHC | TD18550 |
| DV4TD (8HT) | 1398cc | 4 Cyl. | 8 Valves | 40kW/54PS | Diesel | Turbo, SOHC | TD25062 |
| DV4TD (8HX) | 1398cc | 4 Cyl. | 8 Valves | 50-55kW/68-75PS | Diesel | Turbo, SOHC | TD16425 |
| DV4TD (8HZ) | 1398cc | 4 Cyl. | 8 Valves | 50-52kW/68-71PS | Diesel | Turbo, SOHC | TD23773 |
| C1 1.4 HDi | 06/2005→09/2014 | | | C2 1.4 HDi | 09/2003→ | | |
| C3 1.4 HDi | 04/2004→ | | | C3 I 1.4 HDi | 02/2002→ | | |
| C3 II 1.4 HDi 70 | 11/2009→ | | | XSARA 1.4 HDi | 01/2003→08/2005 | | |

V94601 
32.80 x 5.50 x 97.30

0948.C2

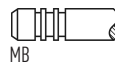

45°

Y

H

VAG96364 
34.20 x 5.50 x 9.53



V94602 
30.30 x 5.50 x 97.30

0949.B1



45°

H

7  **73.70**

| | | | | | | | |
|----------------------|----------|--------|------------------|-----------|--------|-------------|----------------|
| DV4TED4 (8HY) | 1398cc | 4 Cyl. | 16 Valves | 66kW/90PS | Diesel | DOHC | TD16426 |
| C3 I 1.4 16V HDi | 02/2002→ | | | | | | |

V94603 
24.30 x 5.50 x 96.40

0948.C4

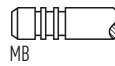

45°

Y

H

VAG96364 
34.20 x 5.50 x 9.53

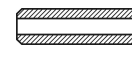

V94604 
22.35 x 5.50 x 96.60

0949.C1



45°

SS

H



OE

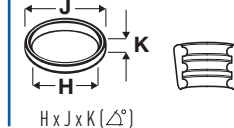
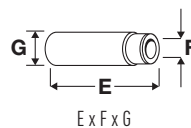
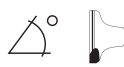

8



75.00

| | | | | | | | |
|-----------------------|-----------------|--------|------------------|---------------------------|--------|-------------------------------|----------------|
| EB2D (HMT) | 1199cc | 3 Cyl. | 12 Valves | 60kW/82PS | Petrol | DOHC | TD32498 |
| EB2DT (HNZ) | 1199cc | 3 Cyl. | 12 Valves | 81kW/110PS | Petrol | Turbo, DOHC, Injection | TD29366 |
| EB2F (HMZ) | 1199cc | 3 Cyl. | 12 Valves | 60kW/82PS | Petrol | DOHC | TD32341 |
| C1 II 1.2 VTi 82 | 04/2014→ | | | C3 II 1.2 THP 110 | | 10/2014→ | |
| C3 II 1.2 VTi 82 | 06/2012→ | | | C3 III 1.2 THP 110 | | 07/2016→ | |
| C3 III 1.2 VTi 82 | 07/2016→ | | | C3 Picasso 1.2 THP 110 | | 01/2015→ | |
| C4 CACTUS 1.2 THP 110 | 09/2014→ | | | C4 CACTUS 1.2 VTi 82 | | 09/2014→ | |
| C4 II 1.2 THP 110 | 02/2015→ | | | C4 Picasso II 1.2 THP 110 | | 04/2016→ | |
| DS3 1.2 THP 110 | 10/2014→07/2015 | | | DS3 1.2 VTi 82 | | 01/2013→07/2015 | |

V95159 ■

29.15 x 4.98 x 92.60

96 763 590 80

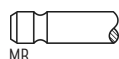

MB

45°

H

V95163 ■

26.00 x 4.96 x 91.90

96 763 591 80

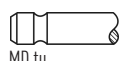

MD tu

45°

9



75.00

| | | | | | | | |
|---------------------------------|----------|--------|------------------|-------------------|--------|-------------------------------|----------------|
| EB2DTS (HNY) | 1199cc | 3 Cyl. | 12 Valves | 96kW/130PS | Petrol | Turbo, DOHC, Injection | TD32357 |
| C4 Grand Picasso II 1.2 THP 130 | 04/2014→ | | | C4 II 1.2 THP 130 | | 04/2014→ | |
| C4 Picasso II 1.2 THP 130 | 04/2014→ | | | DS4 1.2 THP 130 | | 07/2014→07/2015 | |

V80020 ■

26.42 x 5.00 x 93.50

98 019 609 80

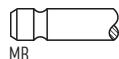

MB

45°

V80021 ■

23.78 x 5.00 x 92.91

98 076 459 80

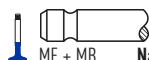

ME + MB

Na

45°

SS

10



75.00

| | | | | | | | |
|--------------------|-----------------|--------|------------------|------------|--------|-----------------|----------------|
| ET3J4 (KFU) | 1360cc | 4 Cyl. | 16 Valves | 65kW/88PS | Petrol | DOHC | TD17977 |
| C2 1.4 16V | 06/2006→ | | | C3 1.4 16V | | 12/2003→ | |
| C4 1.4 16V | 11/2004→07/2011 | | | C4 1.4 16V | | 11/2004→07/2011 | |

V98081 ■

28.20 x 5.50 x 100.70

0948.C8

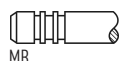

MB

45°

VAG96365B ■ ■ ■

38.00 x 5.50 x 10.58



V98082 ■

24.35 x 5.50 x 101.10

0949.C4

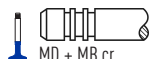

MD + MB cr

45°

11



75.00

| | | | | | | | |
|------------------------------|-----------------|--------|-----------------|-----------------|--------|-----------------|---------------|
| K1B | 1360cc | 4 Cyl. | 8 Valves | 44kW/61PS | Petrol | SOHC | TD665 |
| K1G | 1360cc | 4 Cyl. | 8 Valves | 51-52kW/69-71PS | Petrol | SOHC | TD6567 |
| KAZ | 1360cc | 4 Cyl. | 8 Valves | 44-55kW/54-75PS | Petrol | SOHC | TD6566 |
| TU3 (K3A) | 1360cc | 4 Cyl. | 8 Valves | 40-46kW/54-63PS | Petrol | SOHC | TD6569 |
| TU3FJ2 (K2D) | 1360cc | 4 Cyl. | 8 Valves | 55kW/75PS | Petrol | SOHC | TD6568 |
| XY6 (150F);XY8 (150A) | 1360cc | 4 Cyl. | 8 Valves | 49-52kW/67-72PS | Petrol | SOHC | TD578 |
| AX 14 | 01/1989→12/1991 | | | BX 14 E | | 04/1983→02/1993 | |
| C15 1.4 | 05/1987→09/1992 | | | C15 1.4 E | | 07/1987→12/1996 | |

V91271 ■

37.00 x 7.00 x 112.50

97 533 266

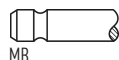

MB

30°

H

VAG92401 ■ ■ ■

47.50 x 7.01 x 13.06



V94202 ■

36.70 x 7.00 x 112.70

0948.91

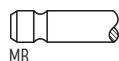

MB

45°

H

VAG96132 ■ ■ ■

47.60 x 7.03 x 13.11

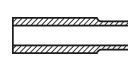

V91273 ■

29.50 x 7.00 x 112.50

97 533 264

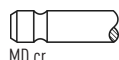

MD cr

45°



OE

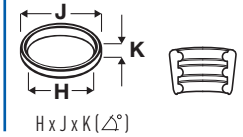
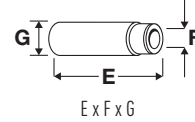
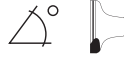

12 **75.00**

| | | | | | | | |
|------------|--------|-----------------|----------|-----------------|--------|----------|---------|
| TU3A (K1H) | 1360cc | 4 Cyl. | 8 Valves | 47-55kW/64-75PS | Petrol | SOHC | TD4272 |
| TU3A (K6D) | 1360cc | 4 Cyl. | 8 Valves | 53kW/72PS | Petrol | SOHC | TD25067 |
| TU3A (K6E) | 1360cc | 4 Cyl. | 8 Valves | 53kW/72PS | Petrol | SOHC | TD25069 |
| TU3A (K6F) | 1360cc | 4 Cyl. | 8 Valves | 53kW/72PS | Petrol | SOHC | TD25068 |
| TU3A (KFT) | 1360cc | 4 Cyl. | 8 Valves | 54kW/73PS | Petrol | SOHC | TD25070 |
| TU3A (KFV) | 1360cc | 4 Cyl. | 8 Valves | 49-59kW/67-80PS | Petrol | SOHC | TD23774 |
| TU3A (KFW) | 1360cc | 4 Cyl. | 8 Valves | 55kW/75PS | Petrol | SOHC | TD25066 |
| BX 1.4 | | 01/1989→12/1989 | | C3 1.4 | | 07/2003→ | |
| C3 I 1.4 | | 12/2005→07/2012 | | C3 I 1.4 i | | 02/2002→ | |
| C3 II 1.4 | | 11/2009→ | | C3 II 1.4 LPG | | 07/2010→ | |
| C15 1.4 | | 07/1987→12/1996 | | NEMO 1.4 | | 02/2008→ | |

V94202
36.70 x 7.00 x 112.70

0948.91

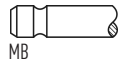

45°

H

VAG92401
47.50 x 7.01 x 13.06



V91273
29.50 x 7.00 x 112.50

97 533 264

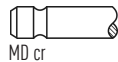

45°

VAG96132
47.60 x 7.03 x 13.11

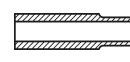

13 **75.00**

| | | | | | | | |
|----------------|--------|-----------------|----------|-----------------|--------|-----------------|---------|
| TU3A (KFX) | 1360cc | 4 Cyl. | 8 Valves | 55kW/75PS | Petrol | SOHC | TD25074 |
| TU3F2 (K1F) | 1360cc | 4 Cyl. | 8 Valves | 44-49kW/60-67PS | Petrol | SOHC | TD666 |
| TU3F2 (K2B) | 1360cc | 4 Cyl. | 8 Valves | 62-65kW/85-89PS | Petrol | SOHC | TD669 |
| TU3FM (K2A) | 1360cc | 4 Cyl. | 8 Valves | 61-65kW/84-88PS | Petrol | SOHC | TD668 |
| AX 1.4 | | 09/1986→04/1994 | | AX 14 | | 01/1988→12/1992 | |
| BERLINGO 1.4 i | | 07/2011→ | | BX 1.4 | | 01/1987→01/1992 | |

V91271
37.00 x 7.00 x 112.50
→05/98

97 533 266

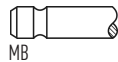

30°

H

VAG92401
47.50 x 7.01 x 13.06

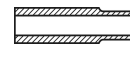

V94202
36.70 x 7.00 x 112.70
06/98→

0948.91

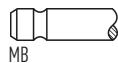

45°

H

VAG96132
47.60 x 7.03 x 13.11

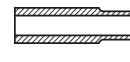

V91273
29.50 x 7.00 x 112.50

97 533 264

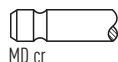

45°

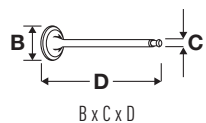

OE

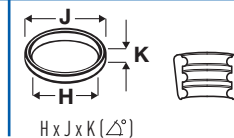
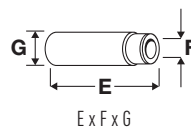
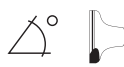

14 75.00

| | | | | | | | |
|--------------|-----------------|--------|----------|------------------|--------|------|-----------------|
| TU3CP (KAY) | 1360cc | 4 Cyl. | 8 Valves | 44kW/60PS | Petrol | SOHC | TD9546 |
| TU3FJ2 (KFY) | 1360cc | 4 Cyl. | 8 Valves | 66kW/90PS | Petrol | SOHC | TD5078 |
| TU3FJ2 (KFZ) | 1360cc | 4 Cyl. | 8 Valves | 69-74kW/94-100PS | Petrol | SOHC | TD5096 |
| TU3FM (KDY) | 1360cc | 4 Cyl. | 8 Valves | 55-58kW/75-79PS | Petrol | SOHC | TD4277 |
| TU3M (KDX) | 1360cc | 4 Cyl. | 8 Valves | 55kW/75PS | Petrol | SOHC | TD5080 |
| TU3M (KDY) | 1360cc | 4 Cyl. | 8 Valves | 55-58kW/75-79PS | Petrol | SOHC | TD5160 |
| TU3M/Z (KDZ) | 1360cc | 4 Cyl. | 8 Valves | 55-59kW/75-80PS | Petrol | SOHC | TD683 |
| AX 1.4 GTi | 06/1991→12/1996 | | | AX 14 | | | 12/1986→04/1997 |
| AX 14 GT | 01/1989→12/1991 | | | BX 14 | | | 01/1989→02/1993 |
| C15 1.4 | 05/1991→07/1996 | | | C15 1.4 i | | | 05/1991→12/1996 |
| ZX 1.4 | 03/1991→06/1997 | | | ZX 1.4 i | | | 03/1991→10/1997 |

V91271
37.00 x 7.00 x 112.50

97 533 266



30°

H

VAG92401
47.50 x 7.01 x 13.06



V91273
29.50 x 7.00 x 112.50

97 533 264

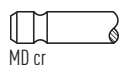

45°

VAG96132
47.60 x 7.03 x 13.11

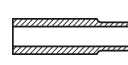

15 75.00

| | | | | | | | |
|----------------|-----------------|--------|----------|---------------------|--------|------|-----------------|
| TU3JP (KFW) | 1360cc | 4 Cyl. | 8 Valves | 47-55kW/64-75PS | Petrol | SOHC | TD14731 |
| TU3JP (KFX) | 1360cc | 4 Cyl. | 8 Valves | 53-55kW/72-75PS | Petrol | SOHC | TD6554 |
| TU3JP-L4 (KFW) | 1360cc | 4 Cyl. | 8 Valves | 54-60kW/73-82PS | Petrol | SOHC | TD16464 |
| BERLINGO 1.4 | 11/2002→12/2011 | | | BERLINGO 1.4 CNG | | | 11/2002→03/2008 |
| BERLINGO 1.4 i | 07/1996→12/2011 | | | C2 1.4 | | | 09/2003→ |
| C3 1.4 | 05/2003→ | | | C3 1.4 | | | 12/2005→ |
| C3 1 1.4 i | 02/2002→ | | | C3 1 1.4 i Bivalent | | | 02/2002→ |
| SAXO 1.4 VTS | 05/1996→06/2003 | | | XSARA 1.4 | | | 05/1998→03/2005 |
| XSARA 1.4 i | 04/1997→08/2005 | | | XSARA 1.4 LPG | | | 05/1998→08/2000 |
| ZX 1.4 i | 03/1991→10/1997 | | | | | | |

V91271
37.00 x 7.00 x 112.50
→05/98, Eng.→07874

97 533 266

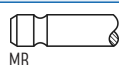

30°

H

VAG92401
47.50 x 7.01 x 13.06



V94202
36.70 x 7.00 x 112.70
06/98→, Eng.07875→

0948.91

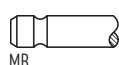

45°

H

VAG96132
47.60 x 7.03 x 13.11

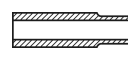

V91273
29.50 x 7.00 x 112.50

97 533 264

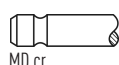

45°

16 75.00

| | | | | | | | |
|-------------|-----------------|--------|----------|-----------------|--------|------|-----------------|
| TUD3 (K9A) | 1360cc | 4 Cyl. | 8 Valves | 38-39kW/52-53PS | Diesel | SOHC | TD5079 |
| TUD3Y (K9Y) | 1360cc | 4 Cyl. | 8 Valves | 37-39kW/50-53PS | Diesel | SOHC | TD5092 |
| AX 1.4 D | 06/1991→07/1992 | | | AX 14 D | | | 09/1988→12/1997 |
| ZX 1.4 D | 07/1994→10/1997 | | | | | | |

VAG96049B
40.20 x 7.02 x 13.08

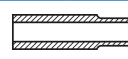



OE

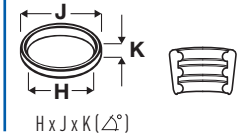
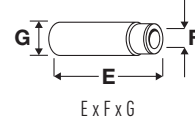
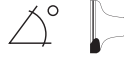

17  75.00

| | | | | | | | |
|----------------------------|-----------------|--------|-----------|-------------------------|--------|-----------------|---------|
| DV6ATED4 (9HX) | 1560cc | 4 Cyl. | 16 Valves | 66-68kW/90-92PS | Diesel | Turbo, DOHC | TD19913 |
| DV6AUTED4 (9HX) | 1560cc | 4 Cyl. | 16 Valves | 66kW/90PS | Diesel | Turbo, DOHC | TD25064 |
| DV6B | 1560cc | 4 Cyl. | 16 Valves | 55kW/75PS | Diesel | Turbo, DOHC | TD18832 |
| DV6BTED4 (9HT) | 1560cc | 4 Cyl. | 16 Valves | 55kW/75PS | Diesel | Turbo, DOHC | TD21321 |
| DV6BTED4 (9HW) | 1560cc | 4 Cyl. | 16 Valves | 55kW/75PS | Diesel | Turbo, DOHC | TD27840 |
| DV6BUTED4 (9HT) | 1560cc | 4 Cyl. | 16 Valves | 55kW/75PS | Diesel | Turbo, DOHC | TD21322 |
| DV6TED4 (9HY) | 1560cc | 4 Cyl. | 16 Valves | 80-85kW/109-116PS | Diesel | Turbo, DOHC | TD19911 |
| DV6TED4 (9HZ) | 1560cc | 4 Cyl. | 16 Valves | 80kW/109PS | Diesel | Turbo, DOHC | TD19824 |
| DV6TED4BU (9HS) | 1560cc | 4 Cyl. | 16 Valves | 66kW/90PS | Diesel | Turbo, DOHC | TD29161 |
| DV6UTED4 (9HU) | 1560cc | 4 Cyl. | 16 Valves | 66kW/90PS | Diesel | Turbo, DOHC | TD24692 |
| BERLINGO 1.6 HDi 75 | 04/2008→ | | | BERLINGO 1.6 HDi 75 | | 07/2005→12/2011 | |
| BERLINGO 1.6 HDi 75 16V | 04/2008→ | | | BERLINGO 1.6 HDi 90 | | 07/2005→12/2011 | |
| BERLINGO 1.6 HDi 90 | 04/2008→ | | | BERLINGO 1.6 HDi 90 16V | | 04/2008→ | |
| BERLINGO 1.6 HDi 110 | 04/2008→ | | | C2 1.6 HDi | | 09/2005→ | |
| C3 I 1.6 16V HDi | 09/2005→ | | | C3 II 1.6 HDi 90 | | 11/2009→ | |
| C3 Picasso 1.6 HDi | 02/2009→ | | | C4 1.6 HDi | | 11/2004→07/2011 | |
| C4 Grand Picasso I 1.6 HDi | 10/2006→ | | | C4 I 1.6 HDi | | 11/2004→07/2011 | |
| C4 Picasso I 1.6 HDi | 02/2007→08/2013 | | | C5 II 1.6 HDi | | 09/2004→ | |
| C5 III 1.6 HDi 110 | 02/2008→ | | | JUMPY 1.6 HDi 90 16V | | 01/2007→ | |
| XSARA PICASSO 1.6 HDi | 05/2004→ | | | | | | |

V94960 
25.60 x 5.50 x 96.35

0948.C7

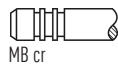

45°

H

VAG96364 
34.20 x 5.50 x 9.53

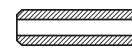

V94961 
23.40 x 5.50 x 96.50

9 640 840 080



45°

SS

H



OE

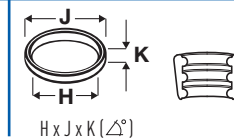
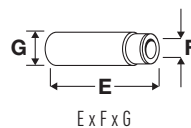

18 **75.00**

| | | | | | | | |
|-----------------------|--------|--------|-----------------|-------------------|--------|--------------------|----------------|
| DV6C (9HD) | 1560cc | 4 Cyl. | 8 Valves | 82-84kW/112-114PS | Diesel | Turbo, SOHC | TD29578 |
| DV6C (9HL) | 1560cc | 4 Cyl. | 8 Valves | 82-84kW/112-114PS | Diesel | Turbo, SOHC | TD26985 |
| DV6C (9HR) | 1560cc | 4 Cyl. | 8 Valves | 81-84kW/110-114PS | Diesel | Turbo, SOHC | TD25690 |
| DV6DBM (9HE) | 1560cc | 4 Cyl. | 8 Valves | 66kW/90PS | Diesel | Turbo, SOHC | TD25095 |
| DV6DTED (9HP) | 1560cc | 4 Cyl. | 8 Valves | 68-69kW/92-94PS | Diesel | Turbo, SOHC | TD25092 |
| DV6DTEDM (9HJ) | 1560cc | 4 Cyl. | 8 Valves | 68kW/92PS | Diesel | Turbo, SOHC | TD25093 |
| DV6DUM (9HH) | 1560cc | 4 Cyl. | 8 Valves | 66kW/90PS | Diesel | Turbo, SOHC | TD29698 |
| DV6ETED (9HN) | 1560cc | 4 Cyl. | 8 Valves | 55kW/75PS | Diesel | Turbo, SOHC | TD25096 |
| DV6ETED (9HW) | 1560cc | 4 Cyl. | 8 Valves | 55kW/75PS | Diesel | Turbo, SOHC | TD25632 |
| DV6ETEDM (9HK) | 1560cc | 4 Cyl. | 8 Valves | 55kW/75PS | Diesel | Turbo, SOHC | TD25097 |
| DV6FC (BHZ) | 1560cc | 4 Cyl. | 8 Valves | 88kW/120PS | Diesel | Turbo, SOHC | TD28612 |
| DV6UC (9HM) | 1560cc | 4 Cyl. | 8 Valves | 66kW/90PS | Diesel | Turbo, SOHC | TD28622 |

| | | | |
|--------------------------------|-----------------|-----------------------------|-----------------|
| BERLINGO 1.6 120 | 12/2014→ | BERLINGO 1.6 HDi / | 07/2010→ |
| BERLINGO 1.6 HDi 75 / | 04/2008→ | BERLINGO 1.6 HDi 75 | 02/2012→ |
| BERLINGO 1.6 HDi 90 | 07/2010→ | BERLINGO 1.6 HDi 92 | 07/2010→ |
| BERLINGO 1.6 HDi 110 | 07/2010→ | BERLINGO 1.6 HDi 115 | 07/2010→ |
| C3 II 1.6 HDi | 11/2009→ | C3 II 1.6 HDi 110 | 11/2009→ |
| C3 II 1.6 HDi 115 | 09/2012→ | C3 Picasso 1.6 HDi 90 | 07/2010→ |
| C3 Picasso 1.6 HDi 110 | 05/2010→ | C3 Picasso 1.6 HDi 115 | 01/2013→ |
| C4 1.6 HDi 115 | 04/2012→ | C4 CACTUS 1.6 HDi 90 | 09/2014→ |
| C4 Grand Picasso I 1.6 HDi 110 | 09/2010→ | C4 Grand Picasso II 1.6 120 | 07/2014→ |
| C4 Grand Picasso II 1.6 HDi 90 | 09/2013→ | C4 II 1.6 120 | 02/2015→ |
| C4 II 1.6 HDi 90 | 11/2009→ | C4 II 1.6 HDi 110 | 11/2009→ |
| C4 II 1.6 HDi 115 | 07/2012→ | C4 Picasso I 1.6 HDi 110 | 09/2010→08/2013 |
| C4 Picasso II 1.6 120 | 07/2014→ | C4 Picasso II 1.6 HDi 90 | 02/2013→ |
| C5 III 1.6 HDi 110 | 07/2010→ | C5 III 1.6 HDi 115 | 01/2012→ |
| C-ELYSEE 1.6 HDi 92 | 11/2012→ | DS3 1.6 120 | 10/2013→07/2015 |
| DS3 1.6 HDi 90 | 11/2009→07/2015 | DS3 1.6 HDi 110 | 11/2009→07/2015 |
| DS3 1.6 HDi 115 | 08/2012→07/2015 | DS4 1.6 120 | 07/2014→07/2015 |
| DS4 1.6 HDi 90 | 05/2011→07/2015 | DS4 1.6 HDi 110 | 04/2011→07/2015 |
| DS4 1.6 HDi 115 | 08/2012→07/2015 | DS5 1.6 120 | 07/2014→07/2015 |
| DS5 1.6 HDi 110 | 11/2011→07/2015 | DS5 1.6 HDi 115 | 06/2012→07/2015 |
| JUMPY 1.6 HDi 90 8V | 01/2007→ | | |

V95137 0948.F7
30.15 x 5.48 x 95.55



VAG96364
34.20 x 5.50 x 9.53



V95138 0949.F5
27.50 x 5.47 x 95.45

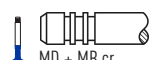

19 **77.00**

| | | | | | | | |
|------------------|--------|--------|------------------|-----------|--------|-------------|----------------|
| EP3 (8FP) | 1397cc | 4 Cyl. | 16 Valves | 70kW/95PS | Petrol | DOHC | TD25076 |
| EP3 (8FS) | 1397cc | 4 Cyl. | 16 Valves | 70kW/95PS | Petrol | DOHC | TD24725 |

| | | | |
|------------------|----------|-----------------------|-----------------|
| C3 II 1.4 VTi 95 | 11/2009→ | C3 Picasso 1.4 VTi 95 | 02/2009→ |
| C4 II 1.4 VTi 95 | 11/2009→ | DS3 1.4 VTi 95 | 04/2010→07/2015 |

V95035 753 388 480
30.00 x 5.00 x 97.00

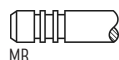

VAG96392B
41.50 x 5.01 x 9.05



V95036 753 388 580
25.10 x 5.00 x 110.65

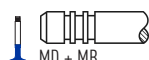

VAG96393B
44.50 x 5.01 x 9.05





OE

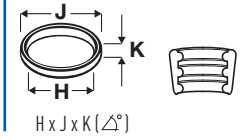
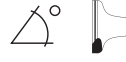

20  **77.00**

| | | | | | | | |
|-------------------|-----------------|--------|-----------------|-----------------|--------|-----------------|----------------|
| TUD5 (VJY) | 1527cc | 4 Cyl. | 8 Valves | 40-43kW/54-58PS | Diesel | SOHC | TD11890 |
| TUD5 (VJZ) | 1527cc | 4 Cyl. | 8 Valves | 42-43kW/57-58PS | Diesel | SOHC | TD4296 |
| AX 15 D | 08/1994→12/1997 | | | SAXO 1.5 D | | 09/1996→04/2004 | |
| XSARA 1.5 D | 04/1997→09/2000 | | | ZX 1.5 D | | 06/1996→02/1998 | |

V94171 
37.00 x 7.00 x 108.50

96 150 145

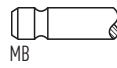

45°

H

VAG96049B 
40.20 x 7.02 x 13.08



V94172 
31.55 x 7.00 x 108.20

96 150 144

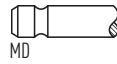

45°

21  **77.00**

| | | | | | | | |
|-------------------|--------|--------|------------------|------------|--------|-------------|----------------|
| EP6 (5FW) | 1598cc | 4 Cyl. | 16 Valves | 88kW/120PS | Petrol | DOHC | TD24724 |
| EP6C (5FS) | 1598cc | 4 Cyl. | 16 Valves | 88kW/120PS | Petrol | DOHC | TD24934 |

| | | | | | | | |
|--------------------------------|-----------------|--|--|---------------------------------|--|-----------------|--|
| BERLINGO 1.6 VTi 120 | 11/2009→ | | | C3 II 1.6 VTi 120 | | 11/2009→ | |
| C3 Picasso 1.6 VTi 120 | 02/2009→ | | | C4 1.6 VTi 120 | | 07/2008→07/2011 | |
| C4 Grand Picasso I 1.6 VTi 120 | 07/2008→ | | | C4 Grand Picasso II 1.6 VTi 120 | | 09/2013→ | |
| C4 I 1.6 VTi 120 | 07/2008→07/2011 | | | C4 II 1.6 VTi 120 | | 11/2009→ | |
| C4 II 1.6 VTi 120 LPG | 09/2011→ | | | C4 Picasso I 1.6 VTi 120 | | 07/2008→08/2013 | |
| C4 Picasso II 1.6 VTi 120 | 02/2013→ | | | C5 III 1.6 VTi 120 | | 07/2010→ | |
| C5 III 1.6 VTi 120 | 07/2010→ | | | DS3 1.6 VTi 120 | | 04/2010→07/2015 | |
| DS4 1.6 VTi 120 | 04/2011→07/2015 | | | | | | |

V95035 
30.00 x 5.00 x 97.00

753 388 480

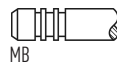

45°

H

VAG96392B 
41.50 x 5.01 x 9.05



V95036 
25.10 x 5.00 x 110.65

753 388 580



45°

H

VAG96393B 
44.50 x 5.01 x 9.05

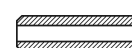

22  **77.00**

| | | | | | | | |
|----------------------|--------|--------|------------------|-------------|--------|-------------------------------|----------------|
| EP6 CB (5FK) | 1598cc | 4 Cyl. | 16 Valves | 72kW/98PS | Petrol | DOHC | TD25065 |
| EP6CDTX (5FY) | 1598cc | 4 Cyl. | 16 Valves | 147kW/200PS | Petrol | Turbo, DOHC, Injection | TD27049 |
| EP6DTX (5FU) | 1598cc | 4 Cyl. | 16 Valves | 147kW/200PS | Petrol | Turbo, DOHC, Injection | TD25084 |

| | | | | | | | |
|---------------------|-----------------|--|--|-----------------|--|-----------------|--|
| BERLINGO 1.6 VTi 95 | 07/2010→ | | | DS4 1.6 THP 200 | | 04/2011→07/2015 | |
| DS5 1.6 THP 200 | 11/2011→07/2015 | | | | | | |

V95153 
29.70 x 4.97 x 95.10

0948.G4

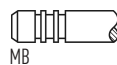

45°

Y

H

VAG96392B 
41.50 x 5.01 x 9.05



V95038 
26.25 x 5.00 x 110.10

0949.E2



45°

H

VAG96393B 
44.50 x 5.01 x 9.05





OE



MAT.

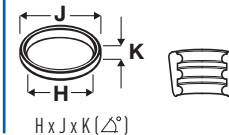
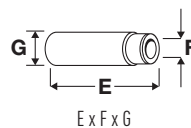
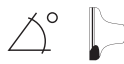

23 **77.00**

| | | | | | | | |
|----------------------|--------|--------|------------------|---------------------|--------|-------------------------------|----------------|
| EP6CDT (5FN) | 1598cc | 4 Cyl. | 16 Valves | 110kW/150PS | Petrol | Turbo, DOHC, Injection | TD28249 |
| EP6CDT (5FV) | 1598cc | 4 Cyl. | 16 Valves | 115kW/156PS | Petrol | Turbo, DOHC, Injection | TD24936 |
| EP6CDTX (5FU) | 1598cc | 4 Cyl. | 16 Valves | 147kW/200PS | Petrol | Turbo, DOHC, Injection | TD27048 |
| EP6DT (5FR) | 1598cc | 4 Cyl. | 16 Valves | 115kW/156PS | Petrol | Turbo, DOHC, Injection | TD24933 |
| EP6DT (5FX) | 1598cc | 4 Cyl. | 16 Valves | 110kW/150PS | Petrol | Turbo, DOHC, Injection | TD23516 |
| EP6DTS (5FD) | 1598cc | 4 Cyl. | 16 Valves | 152kW/207PS | Petrol | Turbo, DOHC, Injection | TD27050 |
| EP6DTS (5FY) | 1598cc | 4 Cyl. | 16 Valves | 128kW/175PS | Petrol | Turbo, DOHC, Injection | TD28250 |
| EP6FDT (5GZ) | 1598cc | 4 Cyl. | 16 Valves | 120-121kW/163-165PS | Petrol | Turbo, DOHC, Injection | TD31763 |

| | | | |
|---------------------------------|-----------------|---------------------------------|-----------------|
| C4 1.6 THP 150 | 07/2008→07/2011 | C4 Grand Picasso I 1.6 16V | 10/2008→ |
| C4 Grand Picasso I 1.6 THP 155 | 09/2010→ | C4 Grand Picasso II 1.6 THP 150 | 09/2014→ |
| C4 Grand Picasso II 1.6 THP 155 | 09/2013→ | C4 Grand Picasso II 1.6 THP 165 | 07/2014→ |
| C4 I 1.6 THP 150 | 07/2008→07/2011 | C4 II 1.6 THP 155 | 11/2009→ |
| C4 Picasso I 1.6 16V | 07/2008→08/2013 | C4 Picasso I 1.6 THP 155 | 09/2010→08/2013 |
| C4 Picasso II 1.6 THP 150 | 09/2014→ | C4 Picasso II 1.6 THP 155 | 02/2013→ |
| C4 Picasso II 1.6 THP 165 | 07/2014→ | C5 III 1.6 THP 150 | 04/2009→ |
| C5 III 1.6 THP 155 | 04/2009→ | DS3 1.6 | 02/2011→07/2015 |
| DS3 1.6 THP 150 | 01/2010→07/2015 | DS3 1.6 THP 155 | 04/2010→07/2015 |
| DS3 1.6 THP 165 | 10/2014→07/2015 | DS4 1.6 THP 155 | 04/2011→07/2015 |
| DS4 1.6 THP 165 | 01/2012→07/2015 | DS5 1.6 THP 155 | 11/2011→07/2015 |
| DS5 1.6 THP 165 | 01/2012→07/2015 | | |

V95037 28.80 x 5.00 x 105.70

0948.E8

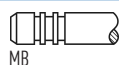

45°

H

VAG96392B 41.50 x 5.01 x 9.05

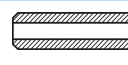

V95038 26.25 x 5.00 x 110.10

0949.E2

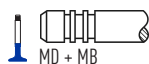

45°

H

VAG96393B 44.50 x 5.01 x 9.05



24 **78.50**

| | | | | | | | |
|----------------------|--------|--------|------------------|-------------------|--------|-------------|----------------|
| TU5J4 (NFX) | 1587cc | 4 Cyl. | 16 Valves | 80-88kW/109-120PS | Petrol | DOHC | TD10788 |
| TU5JP4 (NFU) | 1587cc | 4 Cyl. | 16 Valves | 80-90kW/109-122PS | Petrol | DOHC | TD15308 |
| TU5JP4S (NFS) | 1587cc | 4 Cyl. | 16 Valves | 90kW/122PS | Petrol | DOHC | TD18551 |

| | | | |
|-----------------------|-----------------|-------------------|-----------------|
| BERLINGO 1.6 | 04/2008→ | BERLINGO 1.6 16V | 10/2000→12/2011 |
| C2 1.6 | 09/2003→ | C2 1.6 VTS | 01/2005→ |
| C3 1.6 | 05/2003→ | C3 1.6 Vti | 06/2013→ |
| C3 I 1.6 | 06/2005→ | C3 I 1.6 16V | 02/2002→ |
| C3 Picasso 1.6 | 04/2011→ | C4 1.6 | 08/2010→ |
| C4 1.6 16V | 11/2004→07/2011 | C4 I 1.6 16V | 11/2004→07/2011 |
| C4 II 1.6 | 11/2009→ | SAXO 1.6 | 02/1996→04/2004 |
| SAXO 1.6 VTR | 05/1996→07/1999 | SAXO 1.6 VTS | 06/1996→09/2003 |
| XSARA 1.6 16V | 09/2000→08/2005 | XSARA PICASSO 1.6 | 10/2006→ |
| XSARA PICASSO 1.6 16V | 06/2005→ | | |

V94599 31.30 x 6.00 x 103.70

0948.A9

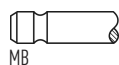

45°

Y

H

VAG96271B 40.00 x 6.00 x 11.06



V94204 24.50 x 6.00 x 104.30

96 254 645

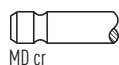

45°

MD cr



OE

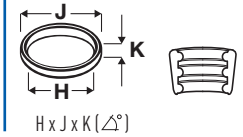
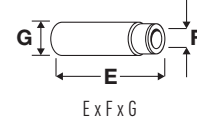

25 **78.50**

| | | | | | | | |
|--------------------|--------|----------|-----------------|------------------|--------|-------------|----------------|
| TU5JP (NFV) | 1587cc | 4 Cyl. | 8 Valves | 70-74kW/95-101PS | Petrol | SOHC | TD23392 |
| XSARA PICASSO 1.6 | | 12/1999→ | | | | | |

| | | | | | | | |
|-----------------------|------------|-------|-----|---|---|----------------------|--|
| V94155 | 96 183 535 | | 30° | Y | H | VAG96132 | |
| 39.40 x 7.00 x 111.70 | | MB | | | | 47.60 x 7.03 x 13.11 | |
| V94156 | 96 101 887 | | 45° | | | VAG96347B | |
| 31.30 x 7.00 x 111.50 | | MD cr | | | | 48.50 x 7.02 x 13.07 | |

26 **78.50**

| | | | | | | | |
|--------------------|-----------------|--------|-------------------|-----------------|-----------------|-------------|---------------|
| TU5JP (NFZ) | 1587cc | 4 Cyl. | 8 Valves | 65-67kW/88-91PS | Petrol | SOHC | TD9458 |
| SAXO 1.6 | 02/1996→06/2003 | | SAXO 1.6 VTL_VTR | | 05/1996→06/2003 | | |
| XSARA 1.6 i | 04/1997→09/2000 | | XSARA PICASSO 1.6 | | 12/1999→ | | |

| | | | | | | | |
|---|------------|-------|-----|---|---|----------------------|--|
| V94155 | 96 183 535 | | 30° | Y | H | VAG96132 | |
| 39.40 x 7.00 x 111.70 →12/97, Eng.→07874 | | MB | | | | 47.60 x 7.03 x 13.11 | |
| V94157 | 0948.93 | | 45° | | H | VAG96347B | |
| 39.30 x 7.00 x 111.40 01/98→, Eng.07875→ | | MB | | | | 48.50 x 7.02 x 13.07 | |
| V94156 | 96 101 887 | | 45° | | | | |
| 31.30 x 7.00 x 111.50 | | MD cr | | | | | |

27 **80.00**

| | | | | | | | |
|------------------------|-----------------|--------|-----------------|-----------------|-----------------|-------------|---------------|
| XUD7 (161) | 1769cc | 4 Cyl. | 8 Valves | 44kW/60PS | Diesel | SOHC | TD586 |
| XUD7 (161A) | 1769cc | 4 Cyl. | 8 Valves | 43-44kW/58-60PS | Diesel | SOHC | TD4258 |
| XUD7 (A9A/161A) | 1769cc | 4 Cyl. | 8 Valves | 43-44kW/58-60PS | Diesel | SOHC | TD6555 |
| BERLINGO 1.8 D | 07/1996→10/2002 | | BX 1.8 D | | 10/1985→09/1993 | | |
| BX 18 D | 10/1985→09/1993 | | C15 1.8 D | | 07/1986→12/2000 | | |
| VISA 17 D | 04/1984→03/1991 | | XSARA 1.8 D | | 04/1997→09/2000 | | |
| ZX 1.8 D | 06/1993→10/1997 | | | | | | |

| | | | | | | | |
|---------------------------------|------------|-------|-----|--|---|----------------------|--|
| V91143 | 93 501 279 | | 30° | | H | VAG92288B | |
| 38.00 x 8.00 x 112.40 →10/86 | | MB | | | | 52.00 x 8.03 x 14.28 | |
| V91144 | 96 005 391 | | 45° | | H | VAG92331B | |
| 38.50 x 8.00 x 112.50 11/86→ | | MB | | | | 50.00 x 8.03 x 14.08 | |
| V91145 | 96 137 360 | | 45° | | | | |
| 33.00 x 8.00 x 112.00 | | MD cr | | | | | |
| V94024 | 0949.64 | | 45° | | | | |
| 33.00 x 8.00 x 112.00 | | MD | | | | | |



OE

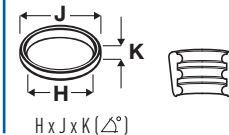
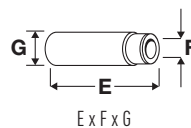

28 80.00

| | | | | | | | |
|-----------------------|------------|-----------------|-----------------|-----------|----------------------|--------------------|--------------|
| XUD7TE (A8A) | 1769cc | 4 Cyl. | 8 Valves | 66kW/90PS | Diesel | Turbo, SOHC | TD602 |
| XUD7TE (AJZ) | 1769cc | 4 Cyl. | 8 Valves | 66kW/90PS | Diesel | Turbo, SOHC | TD604 |
| BX TRD Turbo | | 03/1988→12/1994 | | | | | |
| V91144 | 96 005 391 | | 45° | H | VAG92288B | | |
| 38.50 x 8.00 x 112.50 | | MB | | | 52.00 x 8.03 x 14.28 | | |
| V91145 | 96 137 360 | | 45° | | | | |
| 33.00 x 8.00 x 112.00 | | MD cr | | | | | |
| V94024 | 0949.64 | | 45° | | | | |
| 33.00 x 8.00 x 112.00 | | MD | | | | | |

29 81.00

| | | | | | | | |
|-----------------------|---------|------------|------------------|-------------|--------|--------------------|----------------|
| DT17BTE4 (UHZ) | 2720cc | V6 Cyl. | 24 Valves | 150kW/204PS | Diesel | Turbo, DOHC | TD21319 |
| DT17ED4 | 2720cc | V6 Cyl. | 24 Valves | 150kW/204PS | Diesel | Turbo, DOHC | TD19827 |
| DT17TE4 (UHZ) | 2720cc | V6 Cyl. | 24 Valves | 150kW/204PS | Diesel | Turbo, DOHC | TD24868 |
| C5 III 2.7 HDi | | 02/2008→ | | C6 2.7 HDi | | 09/2005→ | |
| V95135 | 0948.E1 | | 45° | H | | | |
| 27.80 x 5.94 x 97.00 | | MB cr | | | | | |
| V95136 | 0949.C6 | | 45° | ss H | | | |
| 25.20 x 5.93 x 96.35 | | MD + MB cr | | | | | |

30 82.20

| | | | | | | | |
|-----------------------------|------------|-----------------|-----------------|-------------------|----------------------|-----------------|----------------|
| DW8 (WJZ);DW8B (WJY) | 1868cc | 4 Cyl. | 8 Valves | 51-52kW/69-70PS | Diesel | SOHC | TD10708 |
| DW8B (WJY) | 1868cc | 4 Cyl. | 8 Valves | 51-52kW/69-70PS | Diesel | SOHC | TD15310 |
| BERLINGO 1.9 D | | 07/1998→10/2005 | | BERLINGO 1.9 D 70 | | 07/1998→12/2011 | |
| C15 1.9 D | | 10/2000→10/2002 | | JUMPY 1.9 D 70 | | 04/1998→10/2006 | |
| XSARA 1.9 D | | 07/1998→08/2005 | | | | | |
| V91144 | 96 005 391 | | 45° | H | VAG96100 | | |
| 38.50 x 8.00 x 112.50 | | MB | | | 48.00 x 8.02 x 14.37 | | |
| V91145 | 96 137 360 | | 45° | | | | |
| 33.00 x 8.00 x 112.00 | | MD cr | | | | | |

31 82.70

| | | | | | | | |
|------------------------------|---------|-----------------|------------------|-----------------------|----------------------|-----------------|----------------|
| EW7A (6FY) | 1749cc | 4 Cyl. | 16 Valves | 92kW/125PS | Petrol | DOHC | TD19822 |
| EW7J4 (6FZ) | 1749cc | 4 Cyl. | 16 Valves | 85kW/115PS | Petrol | DOHC | TD13548 |
| C4 Grand Picasso I 1.8 i 16V | | 10/2006→ | | C4 Picasso I 1.8 | | 01/2009→10/2012 | |
| C4 Picasso I 1.8 i 16V | | 02/2007→12/2011 | | C5 I 1.8 16V | | 03/2001→08/2004 | |
| C5 II 1.8 16V | | 09/2004→ | | C5 III 1.8 16V | | 02/2008→ | |
| XSARA 1.8 VTS | | 09/2000→10/2004 | | XSARA PICASSO 1.8 16V | | 02/2000→ | |
| V94492 | 0948.A4 | | 45° | Y H | VAG96342B | | |
| 29.80 x 6.00 x 106.00 | | MB | | | 40.80 x 6.02 x 12.11 | | |
| V94493 | 0949.A4 | | 45° | H | VAG96343 | | |
| 27.20 x 6.00 x 104.00 | | MD + MB cr | | | 40.80 x 6.02 x 12.06 | | |



OE

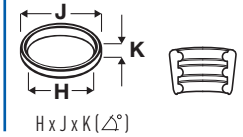
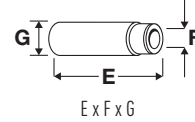
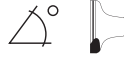

32 **83.00**

| | | | | | | | |
|------------------------|--------|-----------------|-----------------|------------------|--------|-----------------|----------------|
| XU5 (B1AA) | 1580cc | 4 Cyl. | 8 Valves | 58-59kW/79-80PS | Petrol | SOHC | TD12428 |
| XU51C (B1E) | 1580cc | 4 Cyl. | 8 Valves | 53-59kW/72-80PS | Petrol | SOHC | TD607 |
| XU52C | 1580cc | 4 Cyl. | 8 Valves | 65-85kW/88-116PS | Petrol | SOHC | TD14648 |
| XU5CP (BAY/BAZ) | 1580cc | 4 Cyl. | 8 Valves | 55kW/75PS | Petrol | SOHC | TD9550 |
| XU5J/J2/JA | 1580cc | 4 Cyl. | 8 Valves | 55kW/75PS | Petrol | SOHC | TD9551 |
| XU5M (BDY/B4A) | 1580cc | 4 Cyl. | 8 Valves | 65-66kW/88-90PS | Petrol | SOHC | TD5097 |
| XU5M (BDZ) | 1580cc | 4 Cyl. | 8 Valves | 65kW/89PS | Petrol | SOHC | TD615 |
| XU5S (171D) | 1580cc | 4 Cyl. | 8 Valves | 64kW/87PS | Petrol | SOHC | TD594 |
| BX 15 | | 01/1987→05/1992 | | BX 16 | | 10/1982→12/1994 | |
| BX 16 E | | 05/1989→02/1993 | | ZX 1.6 | | 07/1994→10/1997 | |
| ZX 1.6 i | | 03/1991→10/1997 | | | | | |

V91280
40.00 x 8.00 x 109.00

91 512 096

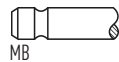

45°

H

VAG92332B
38.70 x 8.02 x 13.07



V91279
33.00 x 8.00 x 108.70

91 513 446

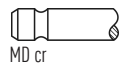

45°

VAG92333B
45.00 x 8.02 x 13.07

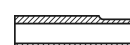

33 **83.00**

| | | | | | | | |
|------------------------|--------|-----------------|-----------------|-------------------|--------|-----------------|---------------|
| XU5J (180A/B6D) | 1580cc | 4 Cyl. | 8 Valves | 76kW/103PS | Petrol | SOHC | TD596 |
| XU5J (180Z) | 1580cc | 4 Cyl. | 8 Valves | 76kW/103PS | Petrol | SOHC | TD597 |
| XU5JA (B6D) | 1580cc | 4 Cyl. | 8 Valves | 83-85kW/113-116PS | Petrol | SOHC | TD4262 |
| XU5JP (BFZ) | 1580cc | 4 Cyl. | 8 Valves | 65-66kW/88-90PS | Petrol | SOHC | TD5101 |
| BX 1.6 | | 01/1987→01/1992 | | BX 16 | | 03/1986→12/1994 | |
| VISA 16 GTI | | 01/1985→03/1991 | | XANTIA 1.6 i | | 03/1993→01/1998 | |
| XANTIA 1.6 i SX | | 01/1998→03/2001 | | ZX 1.6 | | 07/1994→10/1997 | |
| ZX 1.6 i | | 03/1991→10/1997 | | | | | |

V91277
41.60 x 8.00 x 108.80

91 535 017

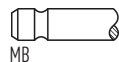

45°

Y

H

VAG92332B
38.70 x 8.02 x 13.07



V91280
40.00 x 8.00 x 109.00

91 512 096

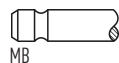

45°

H

VAG92333B
45.00 x 8.02 x 13.07

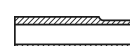

V91275
34.50 x 8.00 x 108.30

91 535 019



45°

V91279
33.00 x 8.00 x 108.70

91 513 446

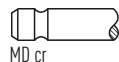

45°

34 **83.00**

| | | | | | | | |
|------------------------|--------|-----------------|-----------------|------------------|--------|-----------------|---------------|
| XU7JB (LFX) | 1762cc | 4 Cyl. | 8 Valves | 66kW/90PS | Petrol | SOHC | TD9457 |
| XU7JP (LFW/LFZ) | 1762cc | 4 Cyl. | 8 Valves | 73-76kW/99-103PS | Petrol | SOHC | TD5116 |
| BERLINGO 1.8 i | | 04/1997→10/2002 | | EVASION 1.8 | | 05/1997→07/2002 | |
| XANTIA 1.8 i | | 03/1993→04/2003 | | XSARA 1.8 i | | 04/1997→09/2000 | |
| ZX 1.8 | | 07/1994→10/1997 | | ZX 1.8 i | | 07/1992→10/1997 | |

V91277
41.60 x 8.00 x 108.80

91 535 017

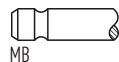

45°

Y

H

VAG92332B
38.70 x 8.02 x 13.07



V91275
34.50 x 8.00 x 108.30

91 535 019

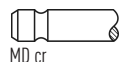

45°

VAG96056B
45.00 x 8.03 x 13.07



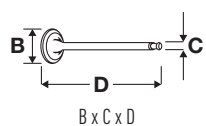

OE

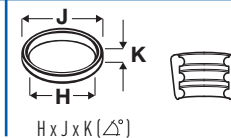
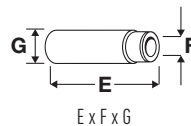

35 **83.00**

| XU7JP4 (LFY) | 1762cc | 4 Cyl. | 16 Valves | 81-85kW/110-116PS | Petrol | DOHC | TD4279 |
|------------------|-----------------|--------|-----------|-------------------|--------|-----------------|--------|
| XANTIA 1.8 i 16V | 06/1995→04/2003 | | | XSARA 1.8 | | 07/1997→08/2000 | |
| XSARA 1.8 i 16V | 04/1997→09/2000 | | | XSARA 1.8 LPG | | 01/1998→08/2000 | |
| ZX 1.8 | 04/1996→10/1997 | | | ZX 1.8 i 16V | | 01/1996→02/1998 | |

| | | | | | | | |
|-------------------------------------|------------|------------|-----|----|---|------------------------------------|--|
| V94229 | 96 172 597 | | 45° | Y | H | VAG96342B | |
| 34.60 x 7.00 x 106.40 Eng.→07359 | | MB | | | | 40.80 x 6.02 x 12.11 Eng.07360→ | |
| V94167 | 96 246 139 | | 45° | Y | H | VAG96343 | |
| 34.10 x 6.00 x 106.40 Eng.07360→ | | MB | | | | 40.80 x 6.02 x 12.06 Eng.07360→ | |
| V94175 | 96 289 433 | | 45° | Y | H | | |
| 34.60 x 6.00 x 106.40 Eng.07360→ | | MB | | | | | |
| V94217 | 96 172 795 | | 45° | | H | | |
| 29.60 x 7.00 x 105.70 Eng.→07359 | | MD + MB cr | | | | | |
| V94176 | 96 298 611 | | 45° | ss | H | | |
| 29.60 x 6.00 x 105.80 Eng.07360→ | | MD + MB cr | | | | | |

36 **83.00**

| XU92C (D2A) | 1905cc | 4 Cyl. | 8 Valves | 75-77kW/102-105PS | Petrol | SOHC | TD628 |
|-------------|-----------------|--------|----------|-------------------|--------|-----------------|--------|
| XU92C (D2C) | 1905cc | 4 Cyl. | 8 Valves | 70kW/95PS | Petrol | SOHC | TD629 |
| XU9J1 (DFZ) | 1905cc | 4 Cyl. | 8 Valves | 75kW/102PS | Petrol | SOHC | TD9548 |
| XU9J2 (D6A) | 1905cc | 4 Cyl. | 8 Valves | 90-92kW/122-125PS | Petrol | SOHC | TD631 |
| XU9JA (DKZ) | 1905cc | 4 Cyl. | 8 Valves | 88kW/120PS | Petrol | SOHC | TD647 |
| XU9M (DDZ) | 1905cc | 4 Cyl. | 8 Valves | 80kW/109PS | Petrol | SOHC | TD639 |
| BX 1.9 | 10/1985→06/1994 | | | BX 1.9 Tzi | | 02/1992→12/1994 | |
| BX 19 | 07/1986→12/1994 | | | BX 19 Cat | | 07/1986→12/1994 | |
| BX 19 E | 06/1988→02/1993 | | | BX 19 GTi | | 10/1984→06/1994 | |
| ZX 1.9 i | 03/1991→06/1997 | | | | | | |

| | | | | | | | |
|-----------------------|------------|-------|-----|---|---|--|--|
| V91277 | 91 535 017 | | 45° | Y | H | | |
| 41.60 x 8.00 x 108.80 | | MB | | | | | |
| V91275 | 91 535 019 | | 45° | | | | |
| 34.50 x 8.00 x 108.30 | | MD cr | | | | | |

37 **83.00**

| XU9J4 (D6C/DFW) | 1905cc | 4 Cyl. | 16 Valves | 116kW/158PS | Petrol | DOHC | TD632 |
|-----------------|-----------------|--------|-----------|---------------------|--------|------|-------|
| XU9J4 (DFW) | 1905cc | 4 Cyl. | 16 Valves | 108-110kW/147-150PS | Petrol | DOHC | TD640 |
| BX 19 GTi 16V | 09/1987→02/1993 | | | | | | |

| | | | | | | | |
|-----------------------|------------|-------|-----|--|---|--|--|
| V91469 | 91 540 748 | | 45° | | H | | |
| 34.50 x 7.00 x 106.50 | | MB cr | | | | | |
| V91470 | 91 540 782 | | 45° | | | | |
| 29.60 x 7.00 x 105.70 | | MD cr | | | | | |



OE

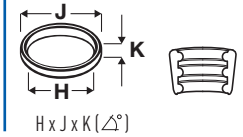
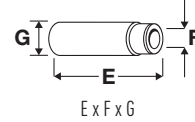

38  **83.00**

| | | | | | | | |
|----------------|-----------------|--------|----------|-----------------|--------|-----------------|--------|
| XUD9 (16Z) | 1905cc | 4 Cyl. | 8 Valves | 47kW/65PS | Diesel | SOHC | TD587 |
| XUD9 (D9A) | 1905cc | 4 Cyl. | 8 Valves | 47kW/64PS | Diesel | SOHC | TD4265 |
| XUD9 (DJZ) | 1905cc | 4 Cyl. | 8 Valves | 47-50kW/65-68PS | Diesel | SOHC | TD646 |
| XUD9A (DJY) | 1905cc | 4 Cyl. | 8 Valves | 50-52kW/68-71PS | Diesel | SOHC | TD6556 |
| XUD9A/L (D9B) | 1905cc | 4 Cyl. | 8 Valves | 50-52kW/68-71PS | Diesel | SOHC | TD4267 |
| XUD9A/U (D9B) | 1905cc | 4 Cyl. | 8 Valves | 50-53kW/68-72PS | Diesel | SOHC | TD4266 |
| BERLINGO 1.9 D | 07/1996→12/2003 | | | BX 1.9 D | | 01/1987→01/1992 | |
| BX 19 D | 09/1983→12/1994 | | | C25 1.9 D | | 07/1987→02/1994 | |
| C25 1.9 D 1400 | 01/1988→01/1994 | | | JUMPER 1.9 D | | 02/1994→04/2002 | |
| JUMPY 1.9 D | 10/1995→08/1998 | | | XANTIA 1.9 D | | 06/1994→01/1998 | |
| XSARA 1.9 D | 04/1997→09/2000 | | | ZX 1.9 D | | 03/1991→07/1999 | |

V91143 
38.00 x 8.00 x 112.40
→01/86

93 501 279

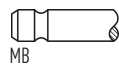

MB

30°

H

VAG92288B 
52.00 x 8.03 x 14.28



V91144 
38.50 x 8.00 x 112.50
01/86→

96 005 391

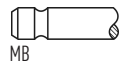

MB

45°

H

VAG92331B 
50.00 x 8.03 x 14.08



V91145 
33.00 x 8.00 x 112.00

96 137 360

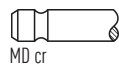

MD cr

45°

V94024 
33.00 x 8.00 x 112.00

0949.64

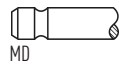

MD

45°

VAG92465B 
52.00 x 8.03 x 14.07



39  **83.00**

| | | | | | | | |
|---------------|-----------------|--------|----------|--------------|--------|-----------------|---------|
| XUD9BSD (DHV) | 1905cc | 4 Cyl. | 8 Valves | 55kW/75PS | Diesel | SOHC | TD22991 |
| XSARA 1.9 D | 01/1998→09/2000 | | | XSARA 1.9 SD | | 01/1998→09/2000 | |

V91144 
38.50 x 8.00 x 112.50

96 005 391

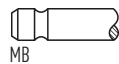

MB

45°

H

VAG92288B 
52.00 x 8.03 x 14.28



V91145 
33.00 x 8.00 x 112.00

96 137 360

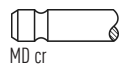

MD cr

45°

VAG92331B 
50.00 x 8.03 x 14.08

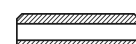

VAG92465B 
52.00 x 8.03 x 14.07





OE

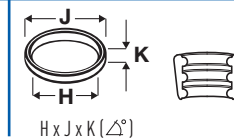
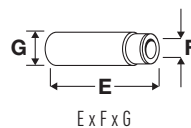

40 83.00

| | | | | | | | |
|----------------------|--------|--------|-----------------|-----------------|--------|--------------------|----------------|
| XUD9BTF (DHX) | 1905cc | 4 Cyl. | 8 Valves | 66-68kW/90-92PS | Diesel | Turbo, SOHC | TD4268 |
| XUD9SD (DHW) | 1905cc | 4 Cyl. | 8 Valves | 50-55kW/68-75PS | Diesel | Turbo, SOHC | TD10689 |
| XUD9TE (DHY) | 1905cc | 4 Cyl. | 8 Valves | 65-68kW/88-92PS | Diesel | Turbo, SOHC | TD4269 |
| XUD9TF (D8B) | 1905cc | 4 Cyl. | 8 Valves | 66-68kW/90-92PS | Diesel | Turbo, SOHC | TD5046 |
| XUD9UTF (D8C) | 1905cc | 4 Cyl. | 8 Valves | 66-68kW/90-92PS | Diesel | Turbo, SOHC | TD4264 |

| | | | |
|--------------------|-----------------|---------------|-----------------|
| EVASION 1.9 TD | 11/1994→07/2002 | JUMPER 1.9 TD | 02/1994→04/2002 |
| JUMPY 1.9 TD | 10/1995→10/2006 | XANTIA 1.9 SD | 02/1996→04/2003 |
| XANTIA 1.9 Turbo D | 05/1993→04/2003 | XSARA 1.9 D | 05/1998→08/2000 |
| XSARA 1.9 TD | 04/1997→09/2000 | ZX 1.9 DT | 06/1992→10/1997 |
| ZX 1.9 TD | 07/1992→10/1997 | | |

| | | | | | | |
|-----------------------|------------|-------|-----|---|----------------------|--|
| V91144 | 96 005 391 | | 45° | H | VAG92288B | |
| 38.50 x 8.00 x 112.50 | | MB | | | 52.00 x 8.03 x 14.28 | |
| V91145 | 96 137 360 | | 45° | | VAG92331B | |
| 33.00 x 8.00 x 112.00 | | MD cr | | | 50.00 x 8.03 x 14.08 | |
| V94017 | 0949.74 | | 45° | | VAG92465B | |
| 33.00 x 8.00 x 111.90 | | MD cr | | | 52.00 x 8.03 x 14.07 | |

41 84.00

| | | | | | | | |
|-------------------|-----------------|-----------|-----------------|-----------------|--------|------------|--------------|
| XM7T (169) | 1796cc | 4 Cyl. | 8 Valves | 49-51kW/67-69PS | Petrol | OHV | TD588 |
| C25 1.8 | 11/1981→01/1994 | C25 1.8 E | 07/1987→02/1994 | | | | |

| | | | | | | |
|-----------------------|---------|----|-----|---|----------------------|--|
| V34459 | 0948.33 | | 30° | H | VAG51007 | |
| 42.50 x 8.00 x 118.30 | | MB | | | 55.00 x 8.00 x 14.06 | |
| V34460 | 0949.21 | | 45° | | | |
| 35.50 x 8.00 x 112.00 | | MD | | | | |

42 84.00

| | | | | | | | |
|--------------------|----------|------------|------------------|---------------------|--------|--------------------|----------------|
| DT20C | 2993cc | V6 Cyl. | 24 Valves | 155-177kW/211-241PS | Diesel | Turbo, DOHC | TD23526 |
| C5 III 3.0 HDi 240 | 04/2009→ | C6 3.0 HDi | 04/2009→ | | | | |

| | | | | | | |
|----------------------|---------|------------|-----|----|---|--|
| V95135 | 0948.E1 | | 45° | H | | |
| 27.80 x 5.94 x 97.00 | | MB cr | | | | |
| V95136 | 0949.C6 | | 45° | ss | H | |
| 25.20 x 5.93 x 96.35 | | MD + MB cr | | | | |



OE

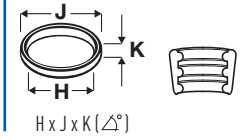

43 **85.00**

| | | | | | | | |
|--------------------------------|-----------------|--------|-----------|--------------------------------|--------|-----------------|---------|
| DW10 C HYBRID (RHC) | 1997cc | 4 Cyl. | 16 Valves | 120kW/163PS | Diesel | Turbo, DOHC | TD28242 |
| DW10BTED4 (RHF) | 1997cc | 4 Cyl. | 16 Valves | 100-103kW/136-140PS | Diesel | Turbo, DOHC | TD26795 |
| DW10CB (RHD) | 1997cc | 4 Cyl. | 16 Valves | 100kW/136PS | Diesel | Turbo, DOHC | TD29779 |
| DW10CTED4 (RHD) | 1997cc | 4 Cyl. | 16 Valves | 100kW/136PS | Diesel | Turbo, DOHC | TD29706 |
| DW10CTED4 (RHE) | 1997cc | 4 Cyl. | 16 Valves | 110kW/150PS | Diesel | Turbo, DOHC | TD24935 |
| DW10CTED4 (RHH) | 1997cc | 4 Cyl. | 16 Valves | 120kW/163PS | Diesel | Turbo, DOHC | TD23770 |
| DW10DTE4 (RHB) | 1997cc | 4 Cyl. | 16 Valves | 110kW/150PS | Diesel | Turbo, DOHC | TD29731 |
| DW10FC (AHT) | 1997cc | 4 Cyl. | 16 Valves | 133kW/181PS | Diesel | Turbo, DOHC | TD33784 |
| DW10FD (AHU) | 1997cc | 4 Cyl. | 16 Valves | 110kW/150PS | Diesel | Turbo, DOHC | TD33776 |
| C4 2.0 HDi | 06/2007→07/2011 | | | C4 Grand Picasso I 2.0 HDi 150 | | 07/2009→ | |
| C4 Grand Picasso I 2.0 HDi 165 | 09/2010→ | | | C4 I 2.0 HDi | | 07/2008→07/2011 | |
| C4 II 2.0 HDi / | 11/2009→ | | | C4 Picasso I 2.0 HDi 150 | | 07/2009→08/2013 | |
| C4 Picasso I 2.0 HDi 165 | 09/2010→08/2013 | | | C5 III 2.0 HDi | | 02/2008→ | |
| C5 III 2.0 HDi 140 | 04/2009→ | | | C5 III 2.0 HDi 150 / | | 04/2009→ | |
| C5 III 2.0 HDi 165 | 04/2009→ | | | C8 2.0 HDi 135 | | 03/2006→ | |
| C8 2.0 HDi 165 | 03/2006→ | | | DS4 2.0 HDi / | | 09/2011→07/2015 | |
| DS4 2.0 HDi 165 | 04/2011→07/2015 | | | DS5 2.0 HDi 135 | | 11/2011→07/2015 | |
| DS5 2.0 HDi 165 | 11/2011→07/2015 | | | DS5 2.0 HDi 165 4x4 | | 12/2011→07/2015 | |
| JUMPY 2.0 HDi 165 | 07/2010→ | | | | | | |

V95234 **0948.F6**
27.25 x 6.00 x 104.50

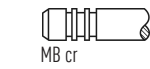

VAG96119 **41.50 x 6.03 x 10.54**



V94491 **0949.A3**
25.00 x 6.00 x 105.00



44 **85.00**

| | | | | | | | |
|-----------------------|-----------------|--------|----------|---------------------|--------|-----------------|---------|
| DW10ATED (RHS) | 1997cc | 4 Cyl. | 8 Valves | 79kW/107PS | Diesel | Turbo, SOHC | TD20782 |
| DW10ATED (RHZ) | 1997cc | 4 Cyl. | 8 Valves | 79-81kW/107-110PS | Diesel | Turbo, SOHC | TD12829 |
| DW10BTED (RHX) | 1997cc | 4 Cyl. | 8 Valves | 69kW/94PS | Diesel | Turbo, SOHC | TD21039 |
| DW10TD (RHV) | 1997cc | 4 Cyl. | 8 Valves | 62kW/84PS | Diesel | Turbo, SOHC | TD24877 |
| DW10TD (RHY) | 1997cc | 4 Cyl. | 8 Valves | 66kW/90PS | Diesel | Turbo, SOHC | TD15311 |
| DW10UTD (RHV) | 1997cc | 4 Cyl. | 8 Valves | 62kW/84PS | Diesel | Turbo, SOHC | TD16739 |
| BERLINGO 2.0 HDi | 11/2002→10/2005 | | | BERLINGO 2.0 HDi 90 | | 12/1999→12/2011 | |
| C4 2.0 HDi | 04/2007→12/2011 | | | C4 I 2.0 HDi | | 04/2007→07/2008 | |
| C5 I 2.0 HDi | 03/2001→08/2004 | | | EVASION 2.0 HDi | | 08/1999→07/2002 | |
| JUMPER 2.0 HDi | 11/2001→04/2002 | | | JUMPER 2.0 HDi | | 04/2002→ | |
| JUMPY 2.0 HDi 95 | 10/1999→10/2006 | | | JUMPY 2.0 HDi 110 | | 03/2000→10/2006 | |
| XANTIA 2.0 HDi 90 | 03/1999→04/2003 | | | XANTIA 2.0 HDi 109 | | 02/1999→04/2003 | |
| XSARA 2.0 HDi | 09/2000→03/2005 | | | XSARA 2.0 HDi 90 | | 02/1999→03/2005 | |
| XSARA 2.0 HDi 90 | 02/1999→08/2005 | | | XSARA 2.0 HDi 109 | | 05/2001→08/2005 | |
| XSARA PICASSO 2.0 HDi | 12/1999→ | | | | | | |

V94178 **0948.95**
35.60 x 6.00 x 107.10



VAG96119 **41.50 x 6.03 x 10.54**

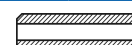

V94179 **0949.96**
33.80 x 6.00 x 107.10





OE

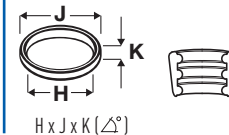
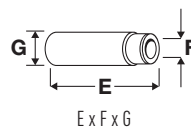
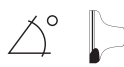

45 85.00

| | | | | | | | |
|-------------------|-----------------|--------|-----------|-----------------------|--------|-----------------|---------|
| DW10ATED4 (RHM) | 1997cc | 4 Cyl. | 16 Valves | 79kW/107PS | Diesel | Turbo, DOHC | TD20786 |
| DW10ATED4 (RHT) | 1997cc | 4 Cyl. | 16 Valves | 79-81kW/107-110PS | Diesel | Turbo, DOHC | TD20785 |
| DW10ATED4 (RHW) | 1997cc | 4 Cyl. | 16 Valves | 79-80kW/107-109PS | Diesel | Turbo, DOHC | TD20784 |
| DW10UTED4 (RHK) | 1997cc | 4 Cyl. | 16 Valves | 79-88kW/107-120PS | Diesel | Turbo, DOHC | TD20787 |
| C8 2.0 HDi | 07/2002→ | | | EVASION 2.0 HDi 16V | | 09/1999→07/2002 | |
| JUMPY 2.0 HDi 110 | 03/2000→10/2006 | | | JUMPY 2.0 HDi 110 16V | | 12/2003→10/2006 | |
| JUMPY 2.0 HDi 120 | 01/2007→ | | | | | | |

V94486 29.90 x 6.00 x 106.20

0948.C0

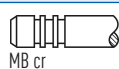

45°

Y

H

VAG96119 41.50 x 6.03 x 10.54



V94487 25.00 x 6.00 x 106.10

0949.A9

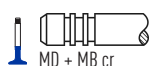

45°

SS

H

46 85.00

| | | | | | | | |
|-----------------|-----------------|--------|-----------|--------------------------------|--------|-----------------|---------|
| DW10BTED4 (RHJ) | 1997cc | 4 Cyl. | 16 Valves | 100kW/136PS | Diesel | Turbo, DOHC | TD19825 |
| DW10BTED4 (RHR) | 1997cc | 4 Cyl. | 16 Valves | 100kW/136PS | Diesel | Turbo, DOHC | TD19912 |
| C4 2.0 HDi | 11/2004→12/2010 | | | C4 Grand Picasso I 2.0 HDi 138 | | 10/2006→ | |
| C4 I 2.0 HDi | 11/2004→07/2011 | | | C4 Picasso I 2.0 HDi 138 | | 10/2006→08/2013 | |
| C5 II 2.0 HDi | 09/2004→ | | | C5 III 2.0 HDi | | 02/2008→ | |
| C8 2.0 HDi 135 | 03/2006→ | | | JUMPY 2.0 HDi 140 | | 01/2007→ | |

V94490 29.80 x 6.00 x 105.00

0948.A3

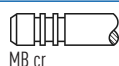

45°

Y

H

VAG96119 41.50 x 6.03 x 10.54



V94491 25.00 x 6.00 x 105.00

0949.A3



45°

SS

H

47 85.00

| | | | | | | | |
|-------------------------|-----------------|--------|-----------|-------------------|--------|-----------------|---------|
| DW10FC (AHW) | 1997cc | 4 Cyl. | 16 Valves | 133kW/181PS | Diesel | Turbo, DOHC | TD28616 |
| DW10FD (AHX) | 1997cc | 4 Cyl. | 16 Valves | 110kW/150PS | Diesel | Turbo, DOHC | TD28615 |
| C4 Grand Picasso II 2.0 | 09/2013→ | | | C4 Picasso II 2.0 | | 09/2013→ | |
| C5 III 2.0 HDi 180 | 03/2015→ | | | DS4 2.0 | | 07/2014→07/2015 | |
| DS5 2.0 | 08/2013→07/2015 | | | DS5 2.0 HDi 150 | | 11/2011→07/2015 | |
| JUMPY 2.0 | 04/2016→ | | | SPACETOUREUR 2.0 | | 04/2016→ | |

V95083 27.25 x 5.97 x 95.70

0948.E5

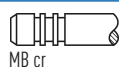

45°

Y

H

VAG96119 41.50 x 6.03 x 10.54



V95084 25.00 x 5.97 x 95.00

0949.E1



45°

SS

H

48 85.00

| | | | | | | | |
|-------------------------|-----------------|--------|-----------|--------------------------------|--------|-------------|---------|
| DW10FD (AHS) | 1997cc | 4 Cyl. | 16 Valves | 100kW/136PS | Diesel | Turbo, DOHC | TD32492 |
| DW10FDD (AHV) | 1997cc | 4 Cyl. | 16 Valves | 100kW/136PS | Diesel | Turbo, DOHC | TD28617 |
| C4 Grand Picasso II 2.0 | 09/2013→ | | | C4 Grand Picasso II 2.0 Hybrid | | 09/2013→ | |
| C4 Picasso II 2.0 | 09/2013→ | | | C4 Picasso II 2.0 Hybrid | | 09/2013→ | |
| DS4 2.0 HDi / | 09/2011→07/2015 | | | | | | |

V94491 25.00 x 6.00 x 105.00

0949.A3



45°

SS

H

VAG96119 41.50 x 6.03 x 10.54





OE

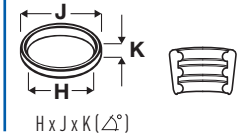
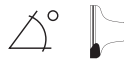

49 **85.00**

| | | | | | | | |
|------------------------------|-----------------|--------|------------------|-----------------------|--------|-----------------|----------------|
| EW10A (RFJ) | 1997cc | 4 Cyl. | 16 Valves | 103-105kW/140-143PS | Petrol | DOHC | TD19823 |
| EW10J4 (RFN) | 1997cc | 4 Cyl. | 16 Valves | 100-105kW/136-143PS | Petrol | DOHC | TD15309 |
| EW10J4S (RFK) | 1997cc | 4 Cyl. | 16 Valves | 130kW/177PS | Petrol | DOHC | TD19910 |
| C4 2.0 | 07/2006→08/2013 | | | C4 2.0 16V | | 11/2004→ | |
| C4 2.0 Exclusive 16V | 07/2007→12/2008 | | | C4 2.0 VTR | | 10/2006→12/2007 | |
| C4 Grand Picasso I 2.0 i 16V | 10/2006→ | | | C4 I 2.0 16V | | 11/2004→07/2011 | |
| C4 Picasso I 2.0 i 16V | 02/2007→08/2013 | | | C5 I 2.0 16V | | 03/2001→08/2004 | |
| C5 II 2.0 16V | 09/2004→ | | | C5 III 2.0 16V | | 02/2008→ | |
| C5 III 2.0 16V BioFlex | 02/2008→ | | | C8 2.0 | | 07/2002→ | |
| C8 2.0 16V | 09/2005→ | | | EVASION 2.0 16V | | 05/2000→07/2002 | |
| JUMPY 2.0 | 04/2000→12/2006 | | | JUMPY 2.0 i 16V | | 03/2000→10/2006 | |
| XSARA 2.0 16V | 09/2000→08/2005 | | | XSARA PICASSO 2.0 16V | | 12/1999→ | |

V94200
33.30 x 6.00 x 106.20

0948.99

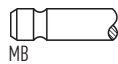

MB

45°

H

VAG96342B
40.80 x 6.02 x 12.11



V94201
29.00 x 6.00 x 103.60

0949.99



MD + MB cr

45°

SS

H

VAG96343
40.80 x 6.02 x 12.06



50 **85.00**

| | | | | | | | |
|--------------------|-----------------|--------|------------------|-------------|--------|------------------------|----------------|
| EW10D (RLZ) | 1997cc | 4 Cyl. | 16 Valves | 103kW/140PS | Petrol | DOHC, Injection | TD16233 |
| C5 I 2.0 16V HPI | 03/2001→08/2004 | | | | | | |

V94494
32.40 x 6.00 x 105.00

0948.A7

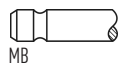

MB

45°

Y

H

VAG96342B
40.80 x 6.02 x 12.11



V94495
29.20 x 6.00 x 102.60

0949.A7



MD + MB cr

45°

SS

H

VAG96343
40.80 x 6.02 x 12.06

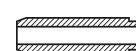

51 **85.00**

| | | | | | | | |
|-----------------------|--------|--------|------------------|-------------------|--------|--------------------|---------------|
| XUD11ATE (P8A) | 2088cc | 4 Cyl. | 12 Valves | 80-81kW/109-110PS | Diesel | Turbo, SOHC | TD711 |
| XUD11ATE (PHZ) | 2088cc | 4 Cyl. | 12 Valves | 80-81kW/109-110PS | Diesel | Turbo, SOHC | TD717 |
| XUD11ATE (PJZ) | 2088cc | 4 Cyl. | 12 Valves | 80kW/109PS | Diesel | Turbo, SOHC | TD718 |
| XUD11BTE (P8C) | 2088cc | 4 Cyl. | 12 Valves | 80kW/109PS | Diesel | Turbo, SOHC | TD4281 |

EVASION 2.1 TD
XM 2.1 TD 12V

05/1996→07/2002
05/1989→10/2000

XANTIA 2.1 Turbo D 12V

06/1995→02/1999

V94169
33.90 x 8.00 x 122.30

96 008 334

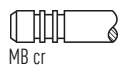

MB cr

45°

H

VAG96215B
54.50 x 8.02 x 13.09



V94170
33.90 x 8.00 x 121.90

96 109 183

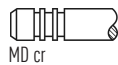

MD cr

45°



OE

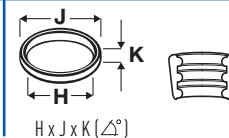
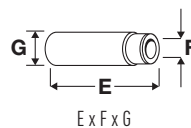
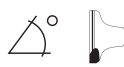

52 85.00

| | | | | | | | |
|--------------------|----------|--------|-----------|----------------|--------|-------------|---------|
| DW12BTED4 (4HP) | 2179cc | 4 Cyl. | 16 Valves | 120kW/163PS | Diesel | Turbo, DOHC | TD29271 |
| DW12BTED4 (4HR) | 2179cc | 4 Cyl. | 16 Valves | 120kW/163PS | Diesel | Turbo, DOHC | TD29272 |
| DW12BTED4 (4HT) | 2179cc | 4 Cyl. | 16 Valves | 125kW/170PS | Diesel | Turbo, DOHC | TD20812 |
| C5 II 2.2 HDi | 04/2006→ | | | C5 III 2.2 HDi | | 02/2008→ | |
| C5 III 2.2 HDi 165 | 02/2008→ | | | C6 2.2 HDi | | 06/2006→ | |
| C8 2.2 HDi | 06/2006→ | | | | | | |

V95083 ■
27.25 x 5.97 x 95.70

0948.E5

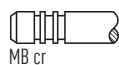

45°

Y

H

VAG96119 ■ ■
41.50 x 6.03 x 10.54



V95084 ■
25.00 x 5.97 x 95.00

0949.E1

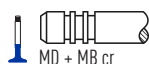

45°

ss

H

53 85.00

| | | | | | | | |
|--------------------|-----------------|--------|-----------|-------------------|--------|-------------|---------|
| DW12TED4 (4HW) | 2179cc | 4 Cyl. | 16 Valves | 94kW/128PS | Diesel | Turbo, DOHC | TD20024 |
| DW12TED4/FAP (4HX) | 2179cc | 4 Cyl. | 16 Valves | 94-98kW/128-133PS | Diesel | Turbo, DOHC | TD16165 |
| C5 I 2.2 HDi | 03/2001→08/2004 | | | C5 II 2.2 HDi | | 09/2004→ | |
| C8 2.2 HDi | 07/2002→ | | | | | | |

V94490 ■
29.80 x 6.00 x 105.00

0948.A3

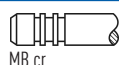

45°

Y

H

VAG96119 ■ ■
41.50 x 6.03 x 10.54

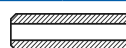

V94491 ■
25.00 x 6.00 x 105.00

0949.A3

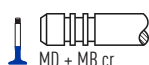

45°

ss

H

54 85.00

| | | | | | | | |
|----------------|----------|--------|----------|------------|--------|-------------|---------|
| DW12UTED (4HY) | 2179cc | 4 Cyl. | 8 Valves | 74kW/101PS | Diesel | Turbo, DOHC | TD24468 |
| JUMPER 2.2 HDi | 02/2002→ | | | | | | |

V94178 ■
35.60 x 6.00 x 107.10

0948.95

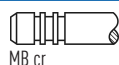

45°

H

VAG96119 ■ ■
41.50 x 6.03 x 10.54



V94179 ■
33.80 x 6.00 x 107.10

0949.96

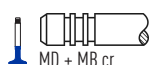

45°

H

55 86.00

| | | | | | | | |
|---------------|-----------------|--------|----------|-------------------|--------|-----------------|---------|
| XU102C (R2A) | 1998cc | 4 Cyl. | 8 Valves | 79kW/107PS | Petrol | SOHC | TD12830 |
| XU10J2 | 1998cc | 4 Cyl. | 8 Valves | 81kW/110PS | Petrol | SOHC | TD16738 |
| XU10J2 (RFZ) | 1998cc | 4 Cyl. | 8 Valves | 89-90kW/121-122PS | Petrol | SOHC | TD729 |
| XU10J2C (RFU) | 1998cc | 4 Cyl. | 8 Valves | 89kW/121PS | Petrol | SOHC | TD4284 |
| XU10J2C (RFX) | 1998cc | 4 Cyl. | 8 Valves | 89-90kW/120-122PS | Petrol | SOHC | TD727 |
| XU10J2U (RFW) | 1998cc | 4 Cyl. | 8 Valves | 80kW/109PS | Petrol | SOHC | TD4285 |
| EVASION 2.0 | 06/1994→07/2002 | | | JUMPER 2.0 | | 02/1994→ | |
| XANTIA 2.0 i | 03/1993→04/2003 | | | XM 2.0 i | | 05/1989→06/1994 | |
| ZX 2.0 | 07/1994→10/1997 | | | ZX 2.0 i | | 07/1992→06/1997 | |

V91972 ■
42.60 x 8.00 x 108.80

96 059 361

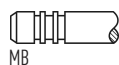

45°

H

V91970 ■
34.50 x 8.00 x 108.40

96 147 032

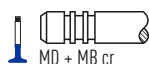

45°

ss

H

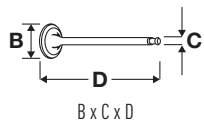

OE

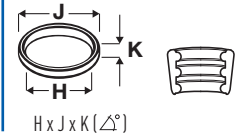
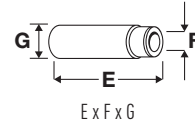

56 **86.00**

| | | | | | | | |
|---------------------------|-----------------|--------|-----------------|---------------------|--------|--------------------|---------------|
| XU10J2TE (RGX) | 1998cc | 4 Cyl. | 8 Valves | 108kW/147PS | Petrol | Turbo, SOHC | TD4290 |
| XU10J2TE (RGX/RGY) | 1998cc | 4 Cyl. | 8 Valves | 104-108kW/141-147PS | Petrol | Turbo, SOHC | TD4291 |
| EVASION 2.0 | 06/1994→07/2002 | | | XANTIA 2.0 Turbo | | 06/1995→04/2003 | |
| XM 2.0 i Turbo | 09/1992→06/1994 | | | XM 2.0 Turbo | | 09/1992→10/2000 | |

V91972 96 059 361 45° H
42.60 x 8.00 x 108.80
MB

V91971 96 049 76 45° ss H
34.50 x 8.00 x 108.40
MD + MB cr

57 **86.00**

| | | | | | | | |
|---------------------|-----------------|--------|------------------|---------------------|--------|-----------------|---------------|
| XU10J4 (RFT) | 1998cc | 4 Cyl. | 16 Valves | 110-114kW/150-155PS | Petrol | DOHC | TD5066 |
| XU10J4 (RFY) | 1998cc | 4 Cyl. | 16 Valves | 110-114kW/150-155PS | Petrol | DOHC | TD4288 |
| XANTIA 2.0 i 16V | 03/1993→01/1998 | | | ZX 2.0 i 16V | | 07/1992→10/1997 | |

V94229 96 172 597 45° Y H
34.60 x 7.00 x 106.40
MB

V94217 96 172 795 45° H
29.60 x 7.00 x 105.70
MD + MB cr

58 **86.00**

| | | | | | | | |
|----------------------|-----------------|--------|------------------|-------------------|--------|-----------------|----------------|
| XU10J4R (RFV) | 1998cc | 4 Cyl. | 16 Valves | 97-99kW/132-135PS | Petrol | DOHC | TD11667 |
| EVASION 2.0 16V | 05/1998→04/2000 | | | XANTIA 2.0 16V | | 06/1998→11/2000 | |
| XANTIA 2.0 i 16V | 06/1995→04/2003 | | | XM 2.0 i | | 05/1989→06/1994 | |
| XM 2.0 i 16V | 05/1994→10/2000 | | | XSARA 2.0 | | 08/1998→08/2000 | |
| XSARA 2.0 16V | 07/1998→09/2000 | | | | | | |

V94229 96 172 597 45° Y H
34.60 x 7.00 x 106.40
Eng.→07359
MB

VAG96342B 40.80 x 6.02 x 12.11
Eng.07360→

V94175 96 289 433 45° Y H
34.60 x 6.00 x 106.40
Eng.07360→
MB

VAG96343 40.80 x 6.02 x 12.06
Eng.07360→

V94217 96 172 795 45° H
29.60 x 7.00 x 105.70
Eng.→07359
MD + MB cr

V94176 96 298 611 45° ss H
29.60 x 6.00 x 105.80
Eng.07360→
MD + MB cr

59 **86.00**

| | | | | | | | |
|-----------------------|-----------------|--------|------------------|---------------------|--------|-----------------|----------------|
| XU10J4RS (RFS) | 1998cc | 4 Cyl. | 16 Valves | 120-122kW/163-166PS | Petrol | DOHC | TD10668 |
| XSARA 2.0 16V | 04/1997→03/2004 | | | XSARA 2.0 i 16V | | 02/1998→03/2005 | |
| ZX 2.0 | 09/1996→10/1997 | | | ZX 2.0 i 16V | | 05/1996→06/1997 | |

V94167 96 246 139 45° Y H
34.10 x 6.00 x 106.40
MB

VAG96342B 40.80 x 6.02 x 12.11

V94168 96 203 976 45° ss H
30.70 x 6.00 x 105.30
MD + MB cr

VAG96343 40.80 x 6.02 x 12.06

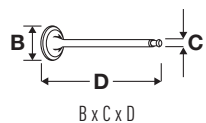

OE

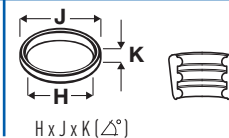
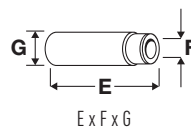
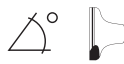

60 86.00

| XU10MZ (RDZ) | 1998cc | 4 Cyl. | 8 Valves | 79kW/107PS | Petrol | SOHC | TD9552 |
|---------------------------------|-----------------|------------|----------|------------|--------|------|--------|
| XM 2.0 i | 05/1989→04/1994 | | | | | | |
| V91972 | 96 059 361 | | 45° | H | | | |
| 42.60 x 8.00 x 108.80 01/92→ | | MB | | | | | |
| V91970 | 96 147 032 | | 45° | ss | H | | |
| 34.50 x 8.00 x 108.40 01/92→ | | MD + MB cr | | | | | |

61 86.00

| XUD11A (P9A/PJZ) | 2138cc | 4 Cyl. | 12 Valves | 60-61kW/82-83PS | Diesel | SOHC | TD713 |
|-----------------------|-----------------|--------|-----------|-----------------|----------------------|-----------------|-------|
| XM 2.1 D12 | 07/1994→06/1996 | | | XM 2.1 D 12V | | 05/1989→06/1994 | |
| XM 2.1 D12 V SX | 03/1996→08/1996 | | | | | | |
| V94169 | 96 008 334 | | 45° | H | VAG96215B | | |
| 33.90 x 8.00 x 122.30 | | MB cr | | | 54.50 x 8.02 x 13.09 | | |
| V94170 | 96 109 183 | | 45° | | | | |
| 33.90 x 8.00 x 121.90 | | MD cr | | | | | |

62 86.00

| P22DTE (4HU) | 2198cc | 4 Cyl. | 16 Valves | 88kW/120PS | Diesel | Turbo, DOHC | TD24538 |
|-----------------------|---------------|--------|-----------|--------------------|----------------------|-------------|---------|
| P22DTE (4HV) | 2198cc | 4 Cyl. | 16 Valves | 74kW/101PS | Diesel | Turbo, DOHC | TD24537 |
| JUMPER 2.2 HDi 100 | 04/2006→ | | | JUMPER 2.2 HDi 120 | | 04/2006→ | |
| V98028 | 96 600 359 80 | | 30° | | VAG96368 | | |
| 29.80 x 7.00 x 122.30 | | MB cr | | | 51.50 x 6.97 x 12.07 | | |
| V98029 | 96 757 096 80 | | 30° | | | | |
| 25.80 x 7.00 x 122.10 | | MB cr | | | | | |

63 86.00

| EW12J4 (3FY) | 2230cc | 4 Cyl. | 16 Valves | 120kW/163PS | Petrol | DOHC | TD25089 |
|-----------------------|----------|------------|-----------|-------------|--------|----------------------|---------|
| EW12J4 (3FZ) | 2230cc | 4 Cyl. | 16 Valves | 116kW/158PS | Petrol | DOHC | TD16485 |
| C8 2.2 | 07/2002→ | | | | | | |
| V94488 | 0948.A1 | | 45° | Y | H | VAG96342B | |
| 35.00 x 6.00 x 106.00 | | MB | | | | 40.80 x 6.02 x 12.11 | |
| V94489 | 0949.A2 | | 45° | ss | H | VAG96343 | |
| 31.10 x 6.00 x 102.80 | | MD + MB cr | | | | 40.80 x 6.02 x 12.06 | |

64 86.40

| 220 A2.000 | 1581cc | 4 Cyl. | 8 Valves | 59-60kW/80-81PS | Petrol | SOHC | TD6587 |
|-----------------------|-----------------|--------|----------|-----------------|----------------------|-----------------|--------|
| JUMPY 1.6 | 10/1995→08/2000 | | | JUMPY 1.6 i | | 10/1995→08/2000 | |
| V91306 | 7 617 500 | | 45° | H | VAG92366 | | |
| 39.50 x 8.00 x 108.50 | | MB | | | 46.50 x 8.00 x 14.10 | | |
| V91713 | 4 315 062 | | 45° | | | | |
| 31.00 x 8.00 x 109.00 | | MD cr | | | | | |



OE

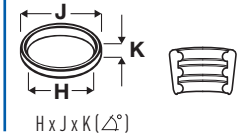
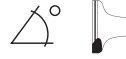

65 **87.00**

| | | | | | | | |
|---------------------|-----------------|---------|------------------|---------------------|--------|-----------------|----------------|
| ES9A (XFV) | 2946cc | V6 Cyl. | 24 Valves | 152-155kW/207-211PS | Petrol | DOHC | TD18962 |
| ES9J4S (XFX) | 2946cc | V6 Cyl. | 24 Valves | 150-173kW/204-235PS | Petrol | DOHC | TD16164 |
| C5 I 3.0 | 09/2003→08/2004 | | | C5 I 3.0 V6 | | 03/2001→08/2004 | |
| C5 II 3.0 | 09/2004→ | | | C5 II 3.0 V6 | | 09/2004→ | |
| C5 III 3.0 | 02/2008→ | | | C5 III 3.0 V6 | | 02/2008→ | |
| C6 3.0 V6 | 09/2005→ | | | C8 3.0 V6 | | 07/2002→ | |

V94198
34.95 x 5.98 x 108.45

0948.A5



45°

H

VAG96271B
40.00 x 6.00 x 11.06



V94199
30.55 x 5.98 x 106.95

0949.A5

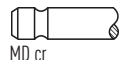

45°

SS

66 **87.00**

| | | | | | | | |
|--------------------|-----------------|---------|------------------|---------------------|--------|-----------------|---------------|
| ES9J4 (XFZ) | 2946cc | V6 Cyl. | 24 Valves | 140-142kW/190-194PS | Petrol | DOHC | TD5487 |
| XANTIA 3.0 i | 01/1997→01/1998 | | | XANTIA 3.0 V6 | | 01/1998→04/2003 | |
| XM 3.0 V6 | 04/1997→10/2000 | | | | | | |

V94173
33.80 x 6.00 x 108.40

96 219 217

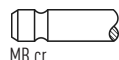

45°

Y

H

VAG96271B
40.00 x 6.00 x 11.06



67 **88.00**

| | | | | | | | |
|--------------------|-----------------|--------|-----------------|-----------------|--------|-----------------|---------------|
| XN1T (170A) | 1971cc | 4 Cyl. | 8 Valves | 57-58kW/78-79PS | Petrol | OHV | TD5164 |
| XN1T (170B) | 1971cc | 4 Cyl. | 8 Valves | 57-62kW/78-84PS | Petrol | OHV | TD589 |
| XN1T (170C) | 1971cc | 4 Cyl. | 8 Valves | 62kW/84PS | Petrol | OHV | TD590 |
| C25 2.0 | 11/1981→03/1994 | | | C25 2.0 E | | 09/1981→03/1994 | |

V34459
42.50 x 8.00 x 118.30

0948.33

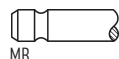

30°

H

VAG51007
55.00 x 8.00 x 14.06



V34460
35.50 x 8.00 x 112.00

0949.21

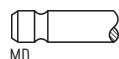

45°

68 **88.00**

| | | | | | | | |
|---------------|-----------------|--------|-----------------|-------------------|--------|-----------------|---------------|
| 829 A5 | 1995cc | 4 Cyl. | 8 Valves | 75-78kW/102-106PS | Petrol | SOHC | TD4259 |
| CX I 2000 | 06/1979→08/1985 | | | CX II 20 | | 08/1985→08/1986 | |
| CX II 20 RE | 08/1985→12/1992 | | | | | | |

V90371
44.00 x 8.00 x 112.00

95 536 524

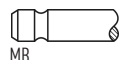

30°

H

VAG92337
51.00 x 8.00 x 13.30

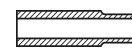

V91263
38.50 x 8.00 x 111.50

95 536 523

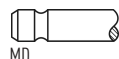

45°

69 **88.00**

| | | | | | | | |
|----------------------------|-----------------|--------|-----------------|-------------------|--------|-----------------|--------------|
| J6TA 500 / J6RA 500 | 2165cc | 4 Cyl. | 8 Valves | 83-85kW/113-115PS | Petrol | SOHC | TD663 |
| CX I 2200 | 06/1981→08/1985 | | | CX II 22 TRS | | 07/1985→12/1992 | |
| CX II 22TRS | 07/1985→07/1989 | | | | | | |

V90371
44.00 x 8.00 x 112.00

95 536 524

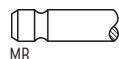

30°

H

VAG92337
51.00 x 8.00 x 13.30



V91263
38.50 x 8.00 x 111.50

95 536 523

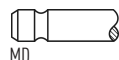

45°



OE

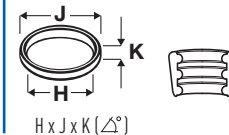
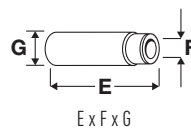

70 92.00

| | | | | | | | |
|-----------------------|-----------------|------------|------------------|------------|----------------------|--------------------|---------------|
| DJ5 (T9A) | 2446cc | 4 Cyl. | 12 Valves | 63kW/86PS | Diesel | Turbo | TD4293 |
| DK5ATE (THY) | 2446cc | 4 Cyl. | 12 Valves | 95kW/129PS | Diesel | Turbo, SOHC | TD4294 |
| JUMPER 2.5 D | 03/1994→04/2002 | | XM 2.5 TD | | 05/1994→10/2000 | | |
| V94062 | 96 095 457 | | 45° | H | VAG96046B | | |
| 36.90 x 7.00 x 127.90 | | MB | | | 54.00 x 7.04 x 13.08 | | |
| V94063 | 96 096 146 | | 45° | ss H | | | |
| 39.60 x 7.00 x 127.50 | | MD + MB cr | | | | | |

71 92.00

| | | | | | | | |
|-----------------------|-----------------|------------|------------------|------------|----------------------|--------------|---------------|
| DJ5T (T8A) | 2446cc | 4 Cyl. | 12 Valves | 76kW/103PS | Diesel | Turbo | TD4292 |
| DJ5T (THZ) | 2446cc | 4 Cyl. | 12 Valves | 76kW/103PS | Diesel | Turbo | TD6585 |
| JUMPER 2.5 DT | 10/1996→08/1997 | | JUMPER 2.5 TD | | 03/1994→04/2002 | | |
| V94062 | 96 095 457 | | 45° | H | VAG96046B | | |
| 36.90 x 7.00 x 127.90 | | MB | | | 54.00 x 7.04 x 13.08 | | |
| V94567 | 96 180 328 | | 45° | H | | | |
| 41.00 x 7.00 x 115.70 | | MB cr | | | | | |
| V94063 | 96 096 146 | | 45° | ss H | | | |
| 39.60 x 7.00 x 127.50 | | MD + MB cr | | | | | |
| V94566 | 96 267 448 | | 45° | H | | | |
| 37.80 x 7.00 x 115.40 | | MD + MB cr | | | | | |

72 92.00







| | | | | | | | |
|-----------------------|-----------------|------------|-----------------|------------|----------------------|--------------|----------------|
| DJ5TD (THX) | 2446cc | 4 Cyl. | 8 Valves | 79kW/107PS | Diesel | Turbo | TD11889 |
| JUMPER 2.5 TDi | 12/1996→04/2002 | | JUMPER 2.5 TDi | | 12/1996→11/2000 | | |
| V94567 | 96 180 328 | | 45° | H | VAG96046B | | |
| 41.00 x 7.00 x 115.70 | | MB cr | | | 54.00 x 7.04 x 13.08 | | |
| V94566 | 96 267 448 | | 45° | H | | | |
| 37.80 x 7.00 x 115.40 | | MD + MB cr | | | | | |

73 94.40

| | | | | | | | |
|-----------------------|------------|------------|-----------------|-------------|----------------------|---------------------------|----------------|
| 8140.43N | 2800cc | 4 Cyl. | 8 Valves | 107kW/145PS | Diesel | Sofim, Turbo, SOHC | TD18297 |
| 8140.43S | 2800cc | 4 Cyl. | 8 Valves | 94kW/128PS | Diesel | Sofim, Turbo, SOHC | TD17849 |
| JUMPER 2.8 HDi | 09/2000→ | | | | | | |
| V91292 | 0948.A2 | | 30° | Y H | VAG92369 | | |
| 40.80 x 8.00 x 120.70 | | MB cr | | | 60.00 x 8.00 x 13.07 | | |
| V91940 | 98 418 161 | | 45° | H | VAG92373 | | |
| 36.70 x 8.00 x 122.00 | | MD + MB cr | | | 56.00 x 8.03 x 13.04 | | |

74 95.80

| | | | | | | | |
|--------------------------|-------------|------------|--------------------|---------------------|----------|--------------------|----------------|
| F1CE0481D (F30DT) | 2999cc | 4 Cyl. | 16 Valves | 115-130kW/156-177PS | Diesel | Turbo, DOHC | TD24616 |
| JUMPER 3.0 HDi 155 | 07/2010→ | | JUMPER 3.0 HDi 160 | | 09/2006→ | | |
| V98042 | 504 072 531 | | 30° | | | | |
| 32.40 x 5.99 x 119.90 | | MB cr | | | | | |
| V98043 | 504 081 062 | | 30° | | | | |
| 32.40 x 5.98 x 119.90 | | MD + MB cr | | | | | |

|  |  | ccm |  |  |  |  |
|---|---|------|---|---|---|---|
| 810-02/-99 | 73.00 | 1289 | 4 | 8 | Petrol | 3 |
| D4F 732 | 69.00 | 1149 | 4 | 16 | Petrol | 1 |
| D4F 734 | 69.00 | 1149 | 4 | 16 | Petrol | 1 |
| F8Q 600 | 80.00 | 1870 | 4 | 8 | Diesel | 8 |
| F8Q 630 | 80.00 | 1870 | 4 | 8 | Diesel | 8 |
| H4B 400 | 72.20 | 898 | 3 | 12 | Petrol | 2 |
| H4B 410 | 72.20 | 898 | 3 | 12 | Petrol | 2 |
| K4M 690 | 79.50 | 1598 | 4 | 16 | Petrol | 6 |
| K4M 694 | 79.50 | 1598 | 4 | 16 | Petrol | 6 |
| K7J 710 | 79.50 | 1390 | 4 | 8 | Petrol | 5 |
| K7J 714 | 79.50 | 1390 | 4 | 8 | Petrol | 5 |
| K7M 690 | 79.50 | 1598 | 4 | 8 | Petrol | 7 |
| K7M 710 | 79.50 | 1598 | 4 | 8 | Petrol | 7 |
| K7M 718 | 79.50 | 1598 | 4 | 8 | Petrol | 7 |
| K7M 732 | 79.50 | 1598 | 4 | 8 | Petrol | 7 |
| K7M 800 | 79.50 | 1598 | 4 | 8 | Petrol | 7 |
| K9K 612 | 76.00 | 1461 | 4 | 8 | Diesel | 4 |
| K9K 790 | 76.00 | 1461 | 4 | 8 | Diesel | 4 |
| K9K 792 | 76.00 | 1461 | 4 | 8 | Diesel | 4 |
| K9K 794 | 76.00 | 1461 | 4 | 8 | Diesel | 4 |
| K9K 796 | 76.00 | 1461 | 4 | 8 | Diesel | 4 |
| K9K 830 | 76.00 | 1461 | 4 | 8 | Diesel | 4 |
| K9K 856 | 76.00 | 1461 | 4 | 8 | Diesel | 4 |
| K9K 858 | 76.00 | 1461 | 4 | 8 | Diesel | 4 |
| K9K 892 | 76.00 | 1461 | 4 | 8 | Diesel | 4 |
| K9K 894 | 76.00 | 1461 | 4 | 8 | Diesel | 4 |
| K9K 896 | 76.00 | 1461 | 4 | 8 | Diesel | 4 |
| K9K 898 | 76.00 | 1461 | 4 | 8 | Diesel | 4 |

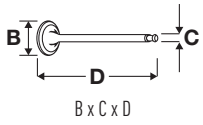

OE

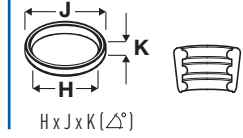
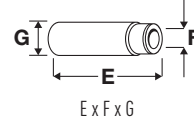
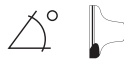

1 **69.00**

| | | | | | | | |
|------------------|----------|--------|------------------|----------------------|--------|-------------|----------------|
| D4F 732 | 1149cc | 4 Cyl. | 16 Valves | 54-55kW/73-75PS | Petrol | DOHC | TD23529 |
| D4F 734 | 1149cc | 4 Cyl. | 16 Valves | 55kW/75PS | Petrol | DOHC | TD28221 |
| LOGAN 1.2 16V | 02/2006→ | | | LOGAN 1.2 16V LPG | | 02/2006→ | |
| LOGAN II 1.2 | 10/2012→ | | | LOGAN II 1.2 LPG | | 10/2012→ | |
| LOGAN MCV II 1.2 | 02/2013→ | | | LOGAN MCV II 1.2 LPG | | 02/2013→ | |
| SANDERO 1.2 16V | 11/2008→ | | | SANDERO 1.2 16V LPG | | 11/2008→ | |
| SANDERO II 1.2 | 10/2012→ | | | SANDERO II 1.2 LPG | | 10/2012→ | |

V94705
26.00 x 5.50 x 110.80

8200 343 407

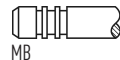

45°

VAG96292B
40.60 x 5.50 x 11.07



V94706
22.00 x 5.50 x 112.50

8200 343 412

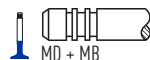

45°

H

2 **72.20**

| | | | | | | | |
|---------------------|----------|--------|------------------|-------------------------|--------|--------------------|----------------|
| H4B 400 | 898cc | 3 Cyl. | 12 Valves | 66kW/90PS | Petrol | Turbo, DOHC | TD31427 |
| H4B 410 | 898cc | 3 Cyl. | 12 Valves | 66kW/90PS | Petrol | Turbo, DOHC | TD34151 |
| LOGAN II TCe 90 | 10/2012→ | | | LOGAN II TCe 90 LPG | | 09/2015→ | |
| LOGAN MCV II TCe 90 | 02/2013→ | | | LOGAN MCV II TCe 90 LPG | | 09/2015→ | |
| SANDERO II TCe 90 | 10/2012→ | | | | | | |

V95239
26.55 x 5.50 x 100.90

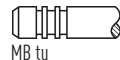

45°

H

V95240
23.50 x 5.50 x 101.70



45°

3 **73.00**

| | | | | | | | |
|-------------------|-----------------|--------|-----------------|-----------|--------|-----------------|----------------|
| 810-02/-99 | 1289cc | 4 Cyl. | 8 Valves | 40kW/54PS | Petrol | SOHC | TD13436 |
| 1300 1.3 | 12/1972→05/1983 | | | 1304 1.3 | | 06/1983→08/1990 | |
| 1310 1.3 | 05/1983→07/2004 | | | | | | |

V35117
33.38 x 6.99 x 89.79

7701 458 180

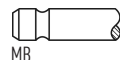

45°

H

VAG50758
41.50 x 7.00 x 11.15



V91261
29.00 x 7.00 x 89.00

7701 461 214

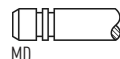

45°

V91834
29.00 x 7.00 x 89.00

7701 460 690

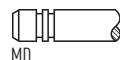

45°



OE

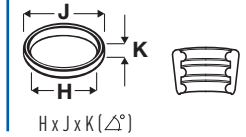
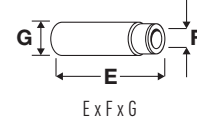
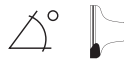

4 **76.00**

| | | | | | | | |
|-------------------|----------|--------|-----------------|------------------------|----------|--------------------|----------------|
| K9K 612 | 1461cc | 4 Cyl. | 8 Valves | 55-66kW/75-90PS | Diesel | Turbo, SOHC | TD28005 |
| K9K 790 | 1461cc | 4 Cyl. | 8 Valves | 48kW/65PS | Diesel | Turbo, SOHC | TD18514 |
| K9K 792 | 1461cc | 4 Cyl. | 8 Valves | 50kW/68PS | Diesel | Turbo, SOHC | TD19223 |
| K9K 794 | 1461cc | 4 Cyl. | 8 Valves | 48kW/65PS | Diesel | Turbo, SOHC | TD34236 |
| K9K 796 | 1461cc | 4 Cyl. | 8 Valves | 63kW/86PS | Diesel | Turbo, SOHC | TD22403 |
| K9K 830 | 1461cc | 4 Cyl. | 8 Valves | 63kW/86PS | Diesel | Turbo, SOHC | TD31047 |
| K9K 856 | 1461cc | 4 Cyl. | 8 Valves | 80kW/109PS | Diesel | Turbo, SOHC | TD28611 |
| K9K 858 | 1461cc | 4 Cyl. | 8 Valves | 80kW/109PS | Diesel | Turbo, SOHC | TD28610 |
| K9K 892 | 1461cc | 4 Cyl. | 8 Valves | 55-66kW/75-90PS | Diesel | Turbo, SOHC | TD24780 |
| K9K 894 | 1461cc | 4 Cyl. | 8 Valves | 66-67kW/90-91PS | Diesel | Turbo, SOHC | TD24783 |
| K9K 896 | 1461cc | 4 Cyl. | 8 Valves | 79kW/107PS | Diesel | Turbo, SOHC | TD24784 |
| K9K 898 | 1461cc | 4 Cyl. | 8 Valves | 79-81kW/107-110PS | Diesel | Turbo, SOHC | TD24785 |
| DOKKER 1.5 dCi | 11/2012→ | | | DOKKER Express 1.5 dCi | 12/2012→ | | |
| DUSTER 1.5 dCi | 04/2010→ | | | LOGGY 1.5 dCi | 03/2012→ | | |
| LOGAN 1.5 dCi | 09/2005→ | | | LOGAN II 1.5 dCi | 10/2012→ | | |
| LOGAN MCV 1.5 dCi | 02/2007→ | | | LOGAN MCV II 1.5 dCi | 02/2013→ | | |
| SANDERO 1.5 dCi | 11/2008→ | | | SANDERO II 1.5 dCi | 10/2012→ | | |

V94608 33.50 x 6.00 x 100.90

7701 476 573

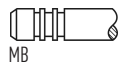

45° Y H

VAG96354B 40.50 x 6.00 x 12.08



V94609 29.00 x 6.00 x 100.70

7701 476 572



45° H

5 **79.50**

| | | | | | | | |
|-----------------|----------|--------|-----------------|-----------------|----------|-------------|----------------|
| K7J 710 | 1390cc | 4 Cyl. | 8 Valves | 55kW/75PS | Petrol | SOHC | TD18140 |
| K7J 714 | 1390cc | 4 Cyl. | 8 Valves | 53-55kW/72-75PS | Petrol | SOHC | TD23531 |
| LOGAN 1.4 | 09/2004→ | | | LOGAN 1.4 LPG | 02/2006→ | | |
| LOGAN MCV 1.4 | 02/2007→ | | | SANDERO 1.4 | 06/2008→ | | |
| SANDERO 1.4 LPG | 01/2009→ | | | | | | |

V91835 37.50 x 7.00 x 107.80

7701 465 088

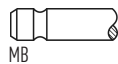

30° H

VAG96182B 42.00 x 7.02 x 12.08



V91836 33.60 x 7.00 x 107.80

7701 465 090

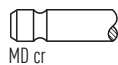

45° H

VAG96172B 49.00 x 7.02 x 12.08

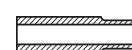

V94442 33.60 x 7.00 x 107.70

7701 468 419

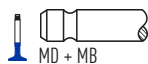

45° H

6 **79.50**

| | | | | | | | |
|-------------------|----------|--------|------------------|-----------------|----------|-------------|----------------|
| K4M 690 | 1598cc | 4 Cyl. | 16 Valves | 77kW/105PS | Petrol | DOHC | TD20941 |
| K4M 694 | 1598cc | 4 Cyl. | 16 Valves | 77kW/105PS | Petrol | DOHC | TD24876 |
| DUSTER 1.6 16V | 04/2010→ | | | LOGAN 1.6 16V | 02/2006→ | | |
| LOGAN MCV 1.6 16V | 02/2007→ | | | SANDERO 1.6 16V | 01/2011→ | | |

V94498 32.40 x 5.50 x 109.20

7701 472 124

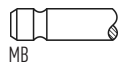

45° Y H

VAG96292B 40.60 x 5.50 x 11.07



V94499 28.00 x 5.50 x 107.50

7701 471 379

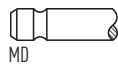

45° H

V94501 28.00 x 5.50 x 107.50

7701 472 125

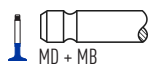

45° ss H

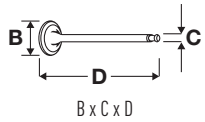

OE

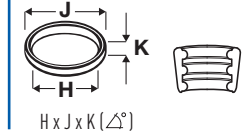
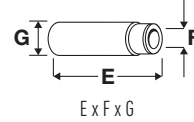
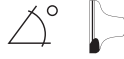

7



79.50

| | | | | | | | |
|----------------|--------|--------|-----------------|------------|--------|-------------|----------------|
| K7M 690 | 1598cc | 4 Cyl. | 8 Valves | 77kW/105PS | Petrol | SOHC | TD22402 |
| K7M 710 | 1598cc | 4 Cyl. | 8 Valves | 64kW/87PS | Petrol | SOHC | TD18141 |
| K7M 718 | 1598cc | 4 Cyl. | 8 Valves | 62kW/84PS | Petrol | SOHC | TD23535 |
| K7M 732 | 1598cc | 4 Cyl. | 8 Valves | 64kW/87PS | Petrol | SOHC | TD23533 |
| K7M 800 | 1598cc | 4 Cyl. | 8 Valves | 62kW/84PS | Petrol | SOHC | TD24779 |

| | | | |
|---------------|----------|------------------|----------|
| LOGAN 1.6 | 09/2004→ | LOGAN 1.6 85 | 05/2010→ |
| LOGAN MCV 1.6 | 02/2007→ | LOGAN MCV 1.6 85 | 05/2010→ |
| SANDERO 1.6 | 06/2008→ | SANDERO 1.6 85 | 05/2010→ |

| | | | | | | |
|-----------------------|--------------|---------|-----|---|----------------------|--|
| V91835 ■ | 7701 465 088 | | 30° | H | VAG96182B ■ | |
| 37.50 x 7.00 x 107.80 | | MB | | | 42.00 x 7.02 x 12.08 | |
| V91836 ■ | 7701 465 090 | | 45° | | VAG96172B ■ | |
| 33.60 x 7.00 x 107.80 | | MD cr | | | 49.00 x 7.02 x 12.08 | |
| V94442 ■ | 7701 468 419 | | 45° | H | | |
| 33.60 x 7.00 x 107.70 | | MD + MB | | | | |







8



80.00

| | | | | | | | |
|----------------|--------|--------|-----------------|-----------------|--------|-------------|----------------|
| F8Q 600 | 1870cc | 4 Cyl. | 8 Valves | 44-48kW/60-65PS | Diesel | SOHC | TD22200 |
| F8Q 630 | 1870cc | 4 Cyl. | 8 Valves | 46-48kW/63-65PS | Diesel | SOHC | TD22401 |

| | | | | | | |
|-----------------------|--------------|---------|-----|------|----------------------|--|
| V94338 ■ | 7701 471 704 | | 45° | H | VAG92329B ■ ■ | |
| 35.30 x 8.00 x 110.00 | | MB | | | 39.00 x 8.00 x 13.07 | |
| V94339 ■ | 7701 469 373 | | 45° | ss H | VAG96226B ■ ■ | |
| 31.50 x 8.00 x 109.80 | | MD + MB | | | 39.00 x 8.02 x 13.13 | |

|  |  | ccm |  |  |  |  |
|---|---|------|---|---|---|---|
| A14SMS | 76.50 | 1349 | 4 | 8 | Petrol | 3 |
| A15DMS | 76.50 | 1498 | 4 | 16 | Petrol | 4 |
| A15MF | 76.50 | 1498 | 4 | 16 | Petrol | 5 |
| A15SMS | 76.50 | 1498 | 4 | 16 | Petrol | 4 |
| A16DMS | 79.00 | 1598 | 4 | 16 | Petrol | 9 |
| B12S1 | 68.50 | 1150 | 4 | 8 | Petrol | 2 |
| C18LE | 84.80 | 1796 | 4 | 8 | Petrol | 12 |
| C20LE | 86.00 | 1998 | 4 | 8 | Petrol | 14 |
| C20SED | 86.00 | 1998 | 4 | 16 | Petrol | 15 |
| F14D3 | 77.90 | 1399 | 4 | 16 | Petrol | 7 |
| F14S3 | 77.90 | 1399 | 4 | 8 | Petrol | 8 |
| F16D3 | 79.00 | 1598 | 4 | 16 | Petrol | 10 |
| F8B | 68.50 | 796 | 3 | 6 | Petrol | 1 |
| F8C | 68.50 | 796 | 3 | 6 | Petrol | 1 |
| F8CV | 68.50 | 796 | 3 | 6 | Petrol | 1 |
| G15MF | 76.50 | 1498 | 4 | 8 | Petrol | 6 |
| M 104.992 | 89.90 | 3199 | 6 | 24 | Petrol | 18 |
| M 104.995 | 89.90 | 3199 | 6 | 24 | Petrol | 19 |
| M 111.970 | 90.90 | 2295 | 4 | 16 | Petrol | 20 |
| S18NV | 84.80 | 1796 | 4 | 8 | Petrol | 13 |
| X 20 SED | 86.00 | 1998 | 4 | 16 | Petrol | 15 |
| X 22 SE | 86.00 | 2198 | 4 | 16 | Petrol | 16 |
| X 22 XE | 86.00 | 2198 | 4 | 16 | Petrol | 16 |
| Z 20 DMH | 83.00 | 1991 | 4 | 16 | Diesel | 11 |
| Z 24 XED | 87.50 | 2405 | 4 | 16 | Petrol | 17 |

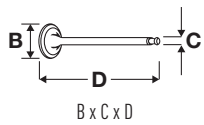

OE

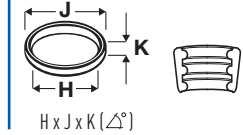
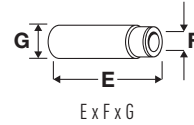
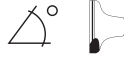

1 68.50

| | | | | | | | |
|-------------|-------|-----------------|-----------------|-----------------|--------|-----------------|----------------|
| F8B | 796cc | 3 Cyl. | 6 Valves | 28-35kW/38-48PS | Petrol | SOHC | TD18849 |
| F8C | 796cc | 3 Cyl. | 6 Valves | 35kW/48PS | Petrol | SOHC | TD4298 |
| F8CV | 796cc | 3 Cyl. | 6 Valves | 32-38kW/44-52PS | Petrol | SOHC | TD18851 |
| DAMAS 0.8 | | 03/1995→07/1998 | | DAMAS 0.8 Luxe | | 03/1995→07/1998 | |
| LABO 0.8 | | 10/1998→04/1999 | | MATIZ 0.8 | | 08/1998→ | |
| TICO 0.8 | | 02/1995→12/2000 | | | | | |

V94368 ■
35.70 x 5.50 x 110.50

12911-78B00

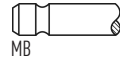

45°

H

VAG96114 ■ ■ ■
43.00 x 5.50 x 11.00



V94369 ■
31.80 x 5.50 x 110.20

96352793

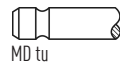

45°

st

2 68.50

| | | | | | | | |
|--------------|--------|----------|-----------------|-----------------|--------|-------------|----------------|
| B12S1 | 1150cc | 4 Cyl. | 8 Valves | 53-56kW/72-76PS | Petrol | SOHC | TD24878 |
| KALOS 1.2 | | 04/2003→ | | | | | |

V94368 ■
35.70 x 5.50 x 110.50

12911-78B00

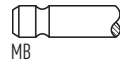

45°

H

VAG96114 ■ ■ ■
43.00 x 5.50 x 11.00

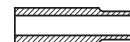

V94369 ■
31.80 x 5.50 x 110.20

96352793

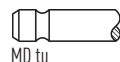

45°

st

3 76.50

| | | | | | | | |
|---------------|--------|----------|-----------------|-----------|--------|-------------|---------------|
| A14SMS | 1349cc | 4 Cyl. | 8 Valves | 55kW/75PS | Petrol | SOHC | TD9506 |
| LANOS 1.3 | | 05/1997→ | | | | | |

V94636 ■
37.90 x 7.00 x 103.50

96182934

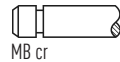

45°

H

V94637 ■
31.00 x 7.00 x 103.50

961 829 33



45°

H

4 76.50

| | | | | | | | |
|---------------|--------|--------|------------------|------------------|--------|--|----------------|
| A15DMS | 1498cc | 4 Cyl. | 16 Valves | 73-81kW/99-110PS | Petrol | | TD19847 |
| A15SMS | 1498cc | 4 Cyl. | 16 Valves | 62-73kW/84-99PS | Petrol | | TD9507 |

LACETTI 1.5 08/2003→12/2004
NUBIRA 1.5 SE 06/1999→07/2003

LANOS 1.5 05/1997→

V94636 ■
37.90 x 7.00 x 103.50

96182934



45°

H

V94637 ■
31.00 x 7.00 x 103.50

961 829 33

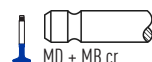

45°

H

5 76.50

| | | | | | | | |
|---------------|--------|-----------------|------------------|-----------------|--------|-----------------|--------------|
| A15MF | 1498cc | 4 Cyl. | 16 Valves | 65-70kW/88-95PS | Petrol | DOHC | TD742 |
| CIELO 1.5 | | 06/1994→03/1995 | | ESPERO 1.5 16V | | 10/1993→06/1999 | |
| NEXIA 1.5 16V | | 02/1995→08/1997 | | | | | |

V94366 ■
30.30 x 6.00 x 102.50

96182806

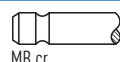

45°

H

VAG96112 ■ ■ ■
40.00 x 6.00 x 11.00



V94367 ■
26.00 x 5.94 x 101.95

96182805

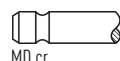

45°

ss



OE

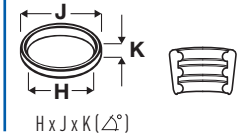
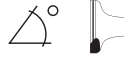

6  **76.50**

| | | | | | | | |
|-----------------------|--------|--------|-----------------|-----------------|--------|-------------|-----------------|
| G15MF | 1498cc | 4 Cyl. | 8 Valves | 44-59kW/55-80PS | Petrol | SOHC | TD5490 |
| 1.5i 1.5 | | | | CIELO 1.5 | | | 01/1995→11/2000 |
| CIELO LOAD RUNNER 1.5 | | | | NEXIA 1.5 | | | 02/1995→06/2008 |
| RACER 1.5 | | | | | | | |

| | | | | | | |
|---|----------|---|-----|---|---|----------------------|
| V91137  | 90295011 |  | 45° | H | VAG96022  | 45.80 x 7.02 x 11.04 |
| 37.92 x 7.00 x 101.00 | | MB | | | | |
| V91138  | 90295015 |  | 45° | | | |
| 30.87 x 6.98 x 101.08 | | MD | | | | |

7  **77.90**

| | | | | | | | |
|---------------|--------|--------|------------------|-----------------|--------|-------------|-----------------|
| F14D3 | 1399cc | 4 Cyl. | 16 Valves | 69-70kW/94-95PS | Petrol | DOHC | TD19854 |
| GENTRA 1.4 | | | | GENTRA 1.4 SR | | | 05/2003→04/2005 |
| GENTRA X 1.4 | | | | KALOS 1.4 | | | 05/2003→12/2004 |
| KALOS 1.4 16V | | | | LACETTI 1.4 | | | 06/2002→ |
| NUBIRA 1.4 | | | | | | | |

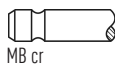
| | | | | | | |
|---|----------|---|-----|--|--|----------------------|
| V98014  | 96376881 |  | 45° | | VAG96112  | 40.00 x 6.00 x 11.00 |
| 28.50 x 6.00 x 101.60 | | MB cr | | | | |
| V98015  | 96376980 |  | 45° | | | |
| 27.30 x 6.00 x 101.30 | | MD cr | | | | |



8  **77.90**

| | | | | | | | |
|--------------|--------|--------|-----------------|-----------|--------|-------------|----------------|
| F14S3 | 1399cc | 4 Cyl. | 8 Valves | 61kW/83PS | Petrol | DOHC | TD24879 |
| KALOS 1.4 | | | | | | | 09/2002→ |

| | | | | | | |
|---|----------|---|-----|--|---|----------------------|
| V98013  | 96335948 |  | 45° | | VAG96112  | 40.00 x 6.00 x 11.00 |
| 31.00 x 6.00 x 104.00 | | MD tu | | | | |

9  **79.00**

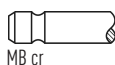
| | | | | | | | |
|---------------|--------|--------|------------------|-------------------|--------|-------------|---------------|
| A16DMS | 1598cc | 4 Cyl. | 16 Valves | 76-78kW/103-106PS | Petrol | DOHC | TD9505 |
| LACETTI 1.6 | | | | LANOS 1.6 16V | | | 02/1997→ |
| NUBIRA 1.6 | | | | NUBIRA 1.6 16V | | | 05/1997→ |
| REZZO 1.6 | | | | | | | |

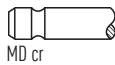
| | | | | | | |
|---|----------|---|-----|----|---|----------------------|
| V94366  | 96182806 |  | 45° | H | VAG96112  | 40.00 x 6.00 x 11.00 |
| 30.30 x 6.00 x 102.50 | | MB cr | | | | |
| V94367  | 96182805 |  | 45° | SS | | |
| 26.00 x 5.94 x 101.95 | | MD cr | | | | |

10  **79.00**

| | | | | | | | |
|---------------------|--------|--------|------------------|-----------------------|--------|-------------|----------------|
| F16D3 | 1598cc | 4 Cyl. | 16 Valves | 77-80kW/105-109PS | Petrol | DOHC | TD19853 |
| GENTRA 1.6 E-Tec LS | | | | GENTRA X 1.6 E-Tec LS | | | 05/2005→ |
| LACETTI 1.6 | | | | NEXIA 1.6 | | | 07/2008→ |
| NUBIRA 1.6 | | | | | | | |

| | | | | | | |
|---|----------|---|-----|----|---|----------------------|
| V98077  [3] | 55557862 |  | 45° | | VAG96346  | 37.00 x 4.99 x 10.04 |
| 31.20 x 5.00 x 117.20 | | MB cr | | | | |
| V98078  [3] | 55558728 |  | 45° | SS | | |
| 27.50 x 5.00 x 116.20 | | MD + MB cr | | | | |

[3] LPG

[3] LPG

[3] LPG

[3] LPG

[3] LPG

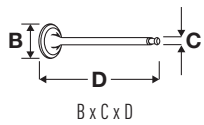

OE

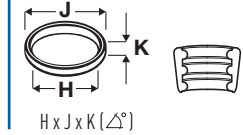
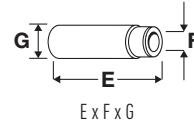
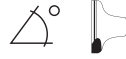

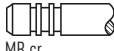
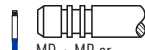

11 83.00

| | | | | | | | |
|-----------------|--------|----------|------------------|-------------|--------|-------------|----------------|
| Z 20 DMH | 1991cc | 4 Cyl. | 16 Valves | 110kW/150PS | Diesel | DOHC | TD26675 |
| TOSCA 2.0 TDCi | | 02/2006→ | | | | | |

| | | | | | | |
|----------------------|----------|---|-----|---|--|--|
| V95187 ■ | 96440147 |  | | H | | |
| 28.50 x 5.95 x 95.70 | | MB cr | | | | |
| V95188 ■ | 93743882 |  | 45° | H | | |
| 24.50 x 5.92 x 95.75 | | MD + MB cr | | | | |



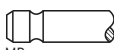

12 84.80

| | | | | | | | |
|--------------|-----------------|--------|-----------------|------------------|-----------------|-------------|---------------|
| C18LE | 1796cc | 4 Cyl. | 8 Valves | 66-76kW/90-103PS | Petrol | SOHC | TD4301 |
| ESPERO 1.8 | 02/1995→09/1999 | | | LEGANZA 1.8 CD | 06/1997→07/2003 | | |
| NEXIA 1.8 | 02/1995→06/2008 | | | NUBIRA 1.8 | 06/2004→ | | |
| PRINCE 1.8 | 08/1993→08/1998 | | | | | | |

| | | | | | | |
|-----------------------|----------|---|-----|---|-----------------------|---|
| V91148 ■ | 90295019 |  | 45° | H | VAG96022 ■ ■ ■ |  |
| 41.80 x 7.00 x 103.80 | | MB cr | | | 45.80 x 7.02 x 11.04 | |
| V91150 ■ | 90220112 |  | 45° | | | |
| 36.47 x 6.97 x 103.67 | | MD cr | | | | |

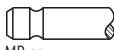

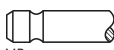
13 84.80

| | | | | | | | |
|--------------|-----------------|--------|-----------------|---------------------|-----------------|-------------|----------------|
| S18NV | 1796cc | 4 Cyl. | 8 Valves | 62-74kW/84-101PS | Petrol | SOHC | TD19851 |
| PRINCE 1.8 | 08/1990→08/1997 | | | SUPER SALOON 1.8 DX | 08/1992→08/1995 | | |

| | | | | | | |
|-----------------------|----------|---|-----|---|-----------------------|---|
| V91148 ■ | 90295019 |  | 45° | H | VAG96022 ■ ■ ■ |  |
| 41.80 x 7.00 x 103.80 | | MB cr | | | 45.80 x 7.02 x 11.04 | |
| V91149 ■ | 90323757 |  | 45° | | | |
| 36.57 x 6.97 x 103.63 | | MD | | | | |
| 01/86→12/88 | | | | | | |
| V91150 ■ | 90220112 |  | 45° | | | |
| 36.47 x 6.97 x 103.67 | | MD cr | | | | |
| 01/89→ | | | | | | |

14 86.00

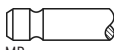
| | | | | | | | |
|--------------|-----------------|--------|-----------------|------------------|-----------------|-------------|---------------|
| C20LE | 1998cc | 4 Cyl. | 8 Valves | 72-85kW/98-116PS | Petrol | SOHC | TD4300 |
| ARANOS 2.0 | 01/1995→11/1997 | | | BROUGHAM 2.0 | 09/1991→12/1995 | | |
| ESPERO 2.0 | 10/1993→06/1999 | | | LEMANS 2.0 GSE | 09/1990→07/1993 | | |
| PRINCE 2.0 | 08/1994→12/1998 | | | | | | |

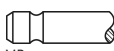
| | | | | | | |
|-----------------------|----------|---|-----|---|-----------------------|---|
| V91148 ■ | 90295019 |  | 45° | H | VAG96022 ■ ■ ■ |  |
| 41.80 x 7.00 x 103.80 | | MB cr | | | 45.80 x 7.02 x 11.04 | |
| V91150 ■ | 90220112 |  | 45° | | | |
| 36.47 x 6.97 x 103.67 | | MD cr | | | | |



OE

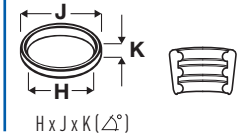
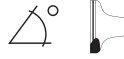

15 **86.00**

| | | | | | | | |
|-----------------|-----------------|--------|------------------|-------------------|-----------------|--|----------------|
| C20SED | 1998cc | 4 Cyl. | 16 Valves | 81kW/110PS | Petrol | | TD18847 |
| X 20 SED | 1998cc | 4 Cyl. | 16 Valves | 89-98kW/121-133PS | Petrol | | TD9504 |
| EVANDA 2.0 | 08/2002→ | | | LACETTI 2.0 | 06/1999→07/2003 | | |
| LEGANZA 2.0 16V | 06/1997→12/2002 | | | MAGNUS 2.0 | 07/1999→ | | |
| NUBIRA 2.0 | 09/1998→07/2003 | | | NUBIRA 2.0 16V | 05/1997→ | | |
| REZZO 2.0 | 09/2001→ | | | | | | |

V91997
32.10 x 5.97 x 102.10

90412277

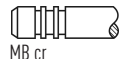

45°

H

VAG96028
45.00 x 5.99 x 10.05



V91998
29.10 x 5.96 x 92.25

90410813



45°

SS

16 **86.00**

| | | | | | | | |
|----------------|-----------------|--------|------------------|--------------------|-----------------|---------------------|----------------|
| X 22 SE | 2198cc | 4 Cyl. | 16 Valves | 98-104kW/133-141PS | Petrol | ECOTEC, DOHC | TD21443 |
| X 22 XE | 2198cc | 4 Cyl. | 16 Valves | 100kW/136PS | Petrol | ECOTEC, DOHC | TD22506 |
| LEGANZA 2.2 | 09/1998→12/2002 | | | PRINCE 2.2 | 08/1997→08/1999 | | |

V91997
32.10 x 5.97 x 102.10

90412277

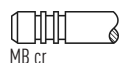

45°

H

VAG96028
45.00 x 5.99 x 10.05



V91998
29.10 x 5.96 x 92.25

90410813

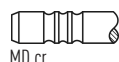

45°

SS

17 **87.50**

| | | | | | | | |
|-----------------|----------|--------|------------------|-----------------|----------|-------------|----------------|
| Z 24 XED | 2405cc | 4 Cyl. | 16 Valves | 104kW/141PS | Petrol | DOHC | TD19849 |
| WINSTORM 2.4 | 12/2006→ | | | WINSTORM 2.4 LS | 12/2006→ | | |
| WINSTORM 2.4 LT | 12/2006→ | | | | | | |

V91997
32.10 x 5.97 x 102.10

90412277

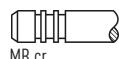

45°

H

VAG96028
45.00 x 5.99 x 10.05



V91998
29.10 x 5.96 x 92.25

90410813

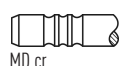

45°

SS

18 **89.90**

| | | | | | | | |
|------------------|----------|--------|------------------|-------------|--------|-------------|----------------|
| M 104.992 | 3199cc | 6 Cyl. | 24 Valves | 162kW/220PS | Petrol | DOHC | TD22988 |
| MUSSO 3.2 | 01/1999→ | | | | | | |

V94370
35.00 x 7.00 x 101.50

111 053 1101

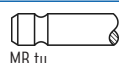

45°

H

VAG96149
37.50 x 7.02 x 12.59

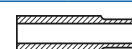

V94371
31.00 x 7.00 x 103.50

611 050 0127

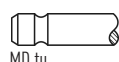

45°

SS

VAG96178
37.50 x 7.02 x 12.76

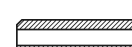



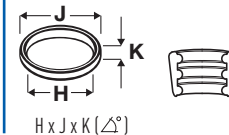
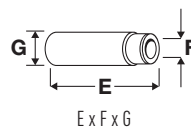

OE



19 89.90

M 104.995 3199cc 6 Cyl. 24 Valves 154-156kW/209-212PS Petrol DOHC TD22990

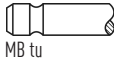

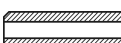
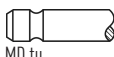
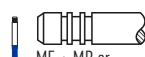

KORANDO 3.2 01/1999->





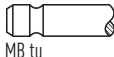

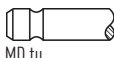
| | | | | | | |
|--|---------------|---|-----|------|---|---|
| V94370 ■ 35.00 x 7.00 x 101.50 | 111 053 1101 |  MB tu | 45° | H | VAG96149 ■ ■ ■ 37.50 x 7.02 x 12.59 |  |
| V94480 ■ 35.00 x 6.97 x 101.50 | 111 053 02 01 |  MB cr | 45° | Y H | VAG96178 ■ ■ ■ 37.50 x 7.02 x 12.76 |  |
| V94371 ■ 31.00 x 7.00 x 103.50 | 611 050 0127 |  MD tu | 45° | SS | | |
| V94377 ■ 31.00 x 7.00 x 103.50 | 111 050 05 27 |  ME + MB cr | 45° | SS H | | |

20 90.90

M 111.970 2295cc 4 Cyl. 16 Valves 103-110kW/140-150PS Petrol DOHC TD22989

MUSSO 2.3 01/1999->

| | | | | | | |
|--|--------------|--|-----|----|---|---|
| V94370 ■ 35.00 x 7.00 x 101.50 | 111 053 1101 |  MB tu | 45° | H | VAG96149 ■ ■ ■ 37.50 x 7.02 x 12.59 |  |
| V94371 ■ 31.00 x 7.00 x 103.50 | 611 050 0127 |  MD tu | 45° | SS | VAG96178 ■ ■ ■ 37.50 x 7.02 x 12.76 |  |



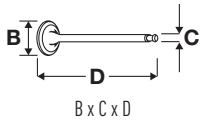

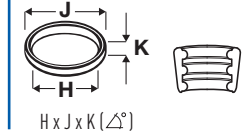
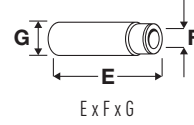
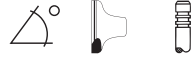

|  |  | ccm |  |  |  |  | |
|---|---|--------|---|---|---|---|----|
| DH 825 | | 118.00 | 8250 | 6 | 12 | Diesel | 6 |
| DHB 825 | | 118.00 | 8250 | 6 | 12 | Diesel | 6 |
| DHR 825 | | 118.00 | 8250 | 6 | 12 | Diesel | 6 |
| DHS 825 | | 118.00 | 8250 | 6 | 12 | Diesel | 6 |
| DHT 825 | | 118.00 | 8250 | 6 | 12 | Diesel | 6 |
| DHTD 825 | | 118.00 | 8250 | 6 | 12 | Diesel | 6 |
| DHU 825 | | 118.00 | 8250 | 6 | 12 | Diesel | 6 |
| DJ5T | | 92.00 | 2446 | 4 | 12 | Diesel | 1 |
| DKV 1160 | | 130.00 | 11600 | 6 | 12 | Diesel | 8 |
| DKX 1160 | | 130.00 | 11600 | 6 | 12 | Diesel | 8 |
| DKX 1160 ATi | | 130.00 | 11600 | 6 | 12 | Diesel | 8 |
| DKXE 1160 | | 130.00 | 11600 | 6 | 12 | Diesel | 8 |
| DKXE 1160 ATi | | 130.00 | 11630 | 6 | 12 | Diesel | 9 |
| DKZ 1160 | | 130.00 | 11630 | 6 | 12 | Diesel | 9 |
| DKZ 1160 ATi | | 130.00 | 11600 | 6 | 12 | Diesel | 8 |
| DKZE 1160 | | 130.00 | 11600 | 6 | 12 | Diesel | 8 |
| DNS 620 | | 104.18 | 6240 | 6 | 12 | Diesel | 4 |
| DNT 620 | | 104.18 | 6240 | 6 | 12 | Diesel | 4 |
| DNTD 620 | | 104.18 | 6240 | 6 | 12 | Diesel | 4 |
| DU 825 | | 118.00 | 8250 | 6 | 12 | Diesel | 6 |
| EN 55 | | 94.00 | 2498 | 4 | 8 | Diesel | 3 |
| ET 70 | | 94.00 | 2498 | 4 | 8 | Diesel | 3 |
| GR 165 S1 | | 107.00 | 6690 | 6 | 12 | Diesel | 5 |
| GR 184 S1 | | 107.00 | 6690 | 6 | 24 | Diesel | 5 |
| GR 210 S1 | | 107.00 | 6690 | 6 | 24 | Diesel | 5 |
| MX 265 | | 130.00 | 12902 | 6 | 24 | Diesel | 14 |
| MX 300 | | 130.00 | 12902 | 6 | 24 | Diesel | 14 |
| MX 340 | | 130.00 | 12902 | 6 | 24 | Diesel | 14 |
| MX 375 | | 130.00 | 12902 | 6 | 24 | Diesel | 14 |
| PE 228 C | | 118.00 | 9200 | 6 | 24 | Diesel | 7 |
| PE 265 C | | 118.00 | 9200 | 6 | 24 | Diesel | 7 |
| PE 310 C | | 118.00 | 9200 | 6 | 24 | Diesel | 7 |
| PE 360 C | | 118.00 | 9200 | 6 | 24 | Diesel | 7 |
| PR 228 S | | 118.00 | 9200 | 6 | 24 | Diesel | 7 |
| PR 265 S | | 118.00 | 9200 | 6 | 24 | Diesel | 7 |
| VF 390 M | | 140.00 | 14000 | 6 | 24 | Diesel | 15 |
| WS 222 L | | 130.00 | 11630 | 6 | 12 | Diesel | 9 |
| WS 225 | | 130.00 | 11600 | 6 | 12 | Diesel | 8 |
| WS 225 ATi | | 130.00 | 11630 | 6 | 12 | Diesel | 9 |
| WS 242 | | 130.00 | 11600 | 6 | 12 | Diesel | 8 |
| WS 242 G | | 130.00 | 11630 | 6 | 12 | Diesel | 9 |
| WS 242 L | | 130.00 | 11600 | 6 | 12 | Diesel | 8 |
| WS 242 M | | 130.00 | 11600 | 6 | 12 | Diesel | 8 |
| WS 259 | | 130.00 | 11600 | 6 | 12 | Diesel | 8 |
| WS 259 ATi | | 130.00 | 11630 | 6 | 12 | Diesel | 9 |
| WS 268 | | 130.00 | 11600 | 6 | 12 | Diesel | 8 |
| WS 268 G | | 130.00 | 11600 | 6 | 12 | Diesel | 8 |
| WS 268 L | | 130.00 | 11600 | 6 | 12 | Diesel | 8 |
| WS 268 M | | 130.00 | 11600 | 6 | 12 | Diesel | 8 |
| WS 282 | | 130.00 | 11600 | 6 | 12 | Diesel | 8 |
| WS 282 ATi | | 130.00 | 11630 | 6 | 12 | Diesel | 9 |
| WS 282 L | | 130.00 | 11630 | 6 | 12 | Diesel | 9 |
| WS 295 | | 130.00 | 11600 | 6 | 12 | Diesel | 8 |
| WS 295 G | | 130.00 | 11600 | 6 | 12 | Diesel | 8 |
| WS 295 L | | 130.00 | 11600 | 6 | 12 | Diesel | 8 |
| WS 315 L | | 130.00 | 11600 | 6 | 12 | Diesel | 8 |
| XD 3T | | 94.00 | 2497 | 4 | 8 | Diesel | 2 |
| XE 315 C | | 130.00 | 12580 | 6 | 24 | Diesel | 10 |
| XE 355 C | | 130.00 | 12580 | 6 | 24 | Diesel | 10 |
| XE 355 C1 | | 130.00 | 12580 | 6 | 24 | Diesel | 11 |
| XE 390 C | | 130.00 | 12580 | 6 | 24 | Diesel | 12 |
| XE 390 C1 | | 130.00 | 12580 | 6 | 24 | Diesel | 12 |
| XF 250 M | | 130.00 | 12580 | 6 | 24 | Diesel | 13 |
| XF 280 M | | 130.00 | 12580 | 6 | 24 | Diesel | 12 |
| XF 315 M | | 130.00 | 12580 | 6 | 24 | Diesel | 12 |
| XF 355 M | | 130.00 | 12580 | 6 | 24 | Diesel | 12 |



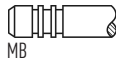
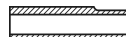
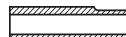

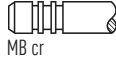

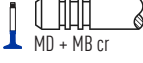
OE





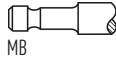

1  **92.00**

| DJ5T | 2446cc | 4 Cyl. | 12 Valves | 76-96kW/103-131PS | Diesel | Turbo | TD2210 |
|---|---------|---|-----------|-------------------|--|---|--------|
| V94062  | 0948.72 |  MB | 45° | H | VAG96046B  |  | |
| 36.90 x 7.00 x 127.90 | | | | | 54.00 x 7.04 x 13.08 | | |
| V94567  | 0948.84 |  MB cr | 45° | H | | | |
| 41.00 x 7.00 x 115.70 | | | | | | | |
| V94063  | 0949.79 |  MD + MB cr | 45° | SS H | | | |
| 39.60 x 7.00 x 127.50 | | | | | | | |
| V94566  | 0949.90 |  MD + MB cr | 45° | H | | | |
| 37.80 x 7.00 x 115.40 | | | | | | | |

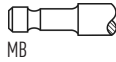

2  **94.00**

| XD 3T | 2497cc | 4 Cyl. | 8 Valves | 54-70kW/73-95PS | Diesel | Turbo, SOHC | TD2216 |
|--|---------|--|----------|-----------------|---|---|--------|
| V91151  | 0948.53 |  MB | 45° | H | VAG92179  |  | |
| 42.52 x 8.48 x 115.92 | | | | | 55.50 x 8.53 x 14.06 | | |
| V91152  | 0949.50 |  MD + MB cr | 45° | H | | | |
| 35.48 x 8.47 x 116.30 | | | | | | | |

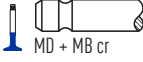
3  **94.00**

| EN 55 | 2498cc | 4 Cyl. | 8 Valves | 53kW/72PS | Diesel | | TD763 |
|---|-----------------|---|----------|--------------------------|---|---|-------|
| ET 70 | 2498cc | 4 Cyl. | 8 Valves | 71kW/96PS | Diesel | Turbo | TD764 |
| 400 2.5 D | 04/1989→12/1994 | | | 400 2.5 TD | | 04/1989→01/1997 | |
| 400-Serie 2.5 D | 04/1989→12/1994 | | | 400-Serie 2.5 TD | | 04/1989→01/1997 | |
| 400-Serie 428-435 2.5 D | 04/1989→08/1993 | | | 400-Serie 428-435 2.5 TD | | 04/1989→08/1993 | |
| V91151  | 0948.53 |  MB | 45° | H | VAG92179  |  | |
| 42.52 x 8.48 x 115.92 | | | | | 55.50 x 8.53 x 14.06 | | |
| V91152  | 0949.50 |  MD + MB cr | 45° | H | | | |
| 35.48 x 8.47 x 116.30 | | | | | | | |

4  **104.18**

| DNS 620 | 6240cc | 6 Cyl. | 12 Valves | 156kW/212PS | Diesel | Turbo, OHV | TD6617 |
|---|-----------------|---|-----------|-------------|--------|-----------------|--------|
| DNT 620 | 6240cc | 6 Cyl. | 12 Valves | 132kW/180PS | Diesel | Turbo, OHV | TD6615 |
| DNTD 620 | 6240cc | 6 Cyl. | 12 Valves | 116kW/158PS | Diesel | Turbo, OHV | TD6614 |
| F 1100 | 12/1986→11/1990 | | | F 1300 | | 12/1986→12/1992 | |
| F 1700 | 12/1986→02/1995 | | | F 1900 | | 12/1986→09/1993 | |
| V91385  | 286292 |  MD + MB cr | 30° | H | | | |
| 44.10 x 9.95 x 142.40 | | | | | | | |



OE

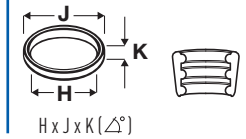
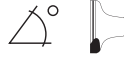

5 **107.00**

| | | | | | | | |
|-----------|-----------------|--------|-----------|-------------|--------|-------------|---------|
| GR 165 S1 | 6690cc | 6 Cyl. | 12 Valves | 165kW/224PS | Diesel | Turbo, OHV | TD18960 |
| GR 184 S1 | 6690cc | 6 Cyl. | 24 Valves | 184kW/250PS | Diesel | Turbo, SOHC | TD19699 |
| GR 210 S1 | 6690cc | 6 Cyl. | 24 Valves | 210kW/286PS | Diesel | Turbo, SOHC | TD19700 |
| CF 65 | 05/2006→05/2013 | | | LF 45 | | 03/2006→ | |
| LF 55 | 05/2006→ | | | | | | |

| | | | | | | |
|-----------------------|---------|------------|-----|---|--|--|
| V95067 | 1404919 | | 30° | H | | |
| 33.00 x 7.00 x 124.70 | | MB cr | | | | |
| V95068 | 1404918 | | 45° | H | | |
| 33.00 x 7.00 x 124.30 | | MD + MB cr | | | | |

6 **118.00**

| | | | | | | | |
|----------|-----------------|--------|-----------|---------------------|--------|-----------------|---------|
| DH 825 | 8250cc | 6 Cyl. | 12 Valves | 115-121kW/156-165PS | Diesel | OHV | TD6603 |
| DHB 825 | 8250cc | 6 Cyl. | 12 Valves | 148kW/201PS | Diesel | Turbo, OHV | TD13229 |
| DHR 825 | 8250cc | 6 Cyl. | 12 Valves | 150kW/204PS | Diesel | Turbo, OHV | TD6619 |
| DHS 825 | 8250cc | 6 Cyl. | 12 Valves | 184-195kW/250-265PS | Diesel | Turbo, OHV | TD6625 |
| DHT 825 | 8250cc | 6 Cyl. | 12 Valves | 162-167kW/220-228PS | Diesel | Turbo, OHV | TD6620 |
| DHTD 825 | 8250cc | 6 Cyl. | 12 Valves | 151kW/205PS | Diesel | Turbo, OHV | TD6621 |
| DHU 825 | 8250cc | 6 Cyl. | 12 Valves | 169kW/230PS | Diesel | Turbo, OHV | TD6623 |
| DU 825 | 8250cc | 6 Cyl. | 12 Valves | 159kW/216PS | Diesel | Turbo, OHV | TD6618 |
| F 2000 | 01/1970→12/1979 | | | F 2100 | | 07/1978→08/1991 | |
| F 2200 | 01/1971→11/1980 | | | F 2300 | | 07/1978→08/1991 | |
| F 2500 | 02/1982→08/1991 | | | SB | | | |

| | | | | | | |
|-----------------------|--------|------------|-----|----|---|--|
| V91757 | 674830 | | 30° | ss | H | |
| 51.50 x 9.95 x 148.70 | | MD + MB cr | | | | |
| V91758 | 674829 | | 30° | ss | H | |
| 42.90 x 9.93 x 148.50 | | MD + MB cr | | | | |

7 **118.00**

| | | | | | | | |
|----------|-----------------|--------|-----------|-------------|--------|----------|---------|
| PE 228 C | 9200cc | 6 Cyl. | 24 Valves | 228kW/310PS | Diesel | Turbo | TD16701 |
| PE 265 C | 9200cc | 6 Cyl. | 24 Valves | 265kW/360PS | Diesel | Turbo | TD16700 |
| PE 310 C | 9200cc | 6 Cyl. | 24 Valves | 228kW/310PS | Diesel | Turbo | TD22814 |
| PE 360 C | 9200cc | 6 Cyl. | 24 Valves | 265kW/360PS | Diesel | Turbo | TD22815 |
| PR 228 S | 9200cc | 6 Cyl. | 24 Valves | 228kW/310PS | Diesel | Turbo | TD20054 |
| PR 265 S | 9200cc | 6 Cyl. | 24 Valves | 265kW/360PS | Diesel | Turbo | TD20055 |
| A-Serie | 01/2004→ | | | AVENUE | | 09/2010→ | |
| CF 75 | 01/2001→05/2013 | | | Citea | | 07/2008→ | |
| Futura | 10/2006→09/2008 | | | Jonkheere | | | |
| Lexio | 09/2005→ | | | TOURMALIN | | 10/2006→ | |
| T-Serie | 10/2006→ | | | URBINO | | 10/2006→ | |
| X-Series | 10/1999→ | | | | | | |

| | | | | | | |
|-----------------------|---------|---------|-----|----|---|----------------------|
| V95211 | 1345509 | | 20° | H | | VAG96247 |
| 40.55 x 8.94 x 158.15 | | MB cr | | | | 76.50 x 9.02 x 15.00 |
| V95212 | 1352127 | | 45° | ss | H | |
| 37.00 x 8.94 x 154.35 | | MD + MB | | | | |

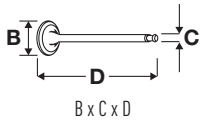

OE

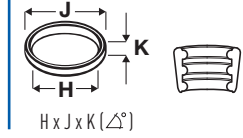
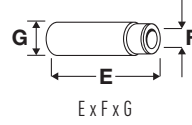
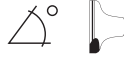

8



130.00

| | | | | | | | |
|--------------|---------|--------|-----------|-------------|--------|------------|---------|
| DKV 1160 | 11600cc | 6 Cyl. | 12 Valves | 212kW/280PS | Diesel | Turbo, OHV | TD6633 |
| DKX 1160 | 11600cc | 6 Cyl. | 12 Valves | 243kW/330PS | Diesel | Turbo, OHV | TD6637 |
| DKX 1160 ATi | 11600cc | 6 Cyl. | 12 Valves | 260kW/354PS | Diesel | Turbo, OHV | TD6638 |
| DKXE 1160 | 11600cc | 6 Cyl. | 12 Valves | 212kW/280PS | Diesel | Turbo, OHV | TD6634 |
| DKZ 1160 ATi | 11600cc | 6 Cyl. | 12 Valves | 274kW/373PS | Diesel | Turbo, OHV | TD6639 |
| DKZE 1160 | 11600cc | 6 Cyl. | 12 Valves | 226kW/307PS | Diesel | Turbo, OHV | TD12828 |
| WS 225 | 11600cc | 6 Cyl. | 12 Valves | 225kW/306PS | Diesel | Turbo, OHV | TD6668 |
| WS 242 | 11600cc | 6 Cyl. | 12 Valves | 242kW/330PS | Diesel | Turbo, OHV | TD6669 |
| WS 242 L | 11600cc | 6 Cyl. | 12 Valves | 242kW/330PS | Diesel | Turbo, OHV | TD6662 |
| WS 242 M | 11600cc | 6 Cyl. | 12 Valves | 242kW/330PS | Diesel | Turbo, OHV | TD6663 |
| WS 259 | 11600cc | 6 Cyl. | 12 Valves | 259kW/352PS | Diesel | Turbo, OHV | TD6670 |
| WS 268 | 11600cc | 6 Cyl. | 12 Valves | 268kW/365PS | Diesel | Turbo, OHV | TD6671 |
| WS 268 G | 11600cc | 6 Cyl. | 12 Valves | 268kW/364PS | Diesel | Turbo, OHV | TD6672 |
| WS 268 L | 11600cc | 6 Cyl. | 12 Valves | 268kW/365PS | Diesel | Turbo, OHV | TD6664 |
| WS 268 M | 11600cc | 6 Cyl. | 12 Valves | 268kW/365PS | Diesel | Turbo, OHV | TD6665 |
| WS 282 | 11600cc | 6 Cyl. | 12 Valves | 282kW/384PS | Diesel | Turbo, OHV | TD11907 |
| WS 295 | 11600cc | 6 Cyl. | 12 Valves | 295kW/401PS | Diesel | Turbo, OHV | TD6675 |
| WS 295 G | 11600cc | 6 Cyl. | 12 Valves | 295kW/401PS | Diesel | Turbo, OHV | TD6676 |
| WS 295 L | 11600cc | 6 Cyl. | 12 Valves | 295kW/401PS | Diesel | Turbo, OHV | TD6677 |
| WS 315 L | 11600cc | 6 Cyl. | 12 Valves | 315kW/428PS | Diesel | Turbo, OHV | TD6680 |

| | | | |
|------------|-----------------|------------|-----------------|
| 85 | 07/1992→02/1998 | 95 | 09/1987→01/1998 |
| Cityliner | 09/1992→ | F 2800 | 01/1980→09/1991 |
| F 3300 | 06/1981→09/1991 | F 3600 | 06/1985→09/1991 |
| Jettliner | 09/1992→ | N 3300 | 01/1981→09/1991 |
| SB | | Skyliner | 09/1992→ |
| Spaceliner | 09/1992→ | Transliner | 09/1992→ |

V91755 ■
55.00 x 10.99 x 175.00

1259989

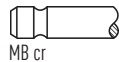

30° Y H

VAG92484 ■ ■ ■
75.00 x 11.09 x 175.56



V91756 ■
49.90 x 10.97 x 175.00

1254382

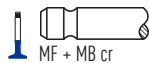

30° H

9



130.00

| | | | | | | | |
|---------------|---------|--------|-----------|---------------------|--------|------------|---------|
| DKXE 1160 ATi | 11630cc | 6 Cyl. | 12 Valves | 139-274kW/189-373PS | Diesel | Turbo, OHV | TD22212 |
| DKZ 1160 | 11630cc | 6 Cyl. | 12 Valves | 139-274kW/189-373PS | Diesel | Turbo, OHV | TD22213 |
| WS 222 L | 11630cc | 6 Cyl. | 12 Valves | 222kW/302PS | Diesel | Turbo, OHV | TD6660 |
| WS 225 ATi | 11630cc | 6 Cyl. | 12 Valves | 225kW/306PS | Diesel | Turbo, OHV | TD7517 |
| WS 242 G | 11630cc | 6 Cyl. | 12 Valves | 242kW/330PS | Diesel | Turbo, OHV | TD22214 |
| WS 259 ATi | 11630cc | 6 Cyl. | 12 Valves | 259kW/352PS | Diesel | Turbo, OHV | TD7518 |
| WS 282 ATi | 11630cc | 6 Cyl. | 12 Valves | 282kW/383PS | Diesel | Turbo, OHV | TD7519 |
| WS 282 L | 11630cc | 6 Cyl. | 12 Valves | 282kW/383PS | Diesel | Turbo, OHV | TD6674 |

V91755 ■
55.00 x 10.99 x 175.00

1259989

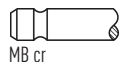

30° Y H

VAG92484 ■ ■ ■
75.00 x 11.09 x 175.56

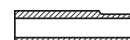

V91756 ■
49.90 x 10.97 x 175.00

1254382

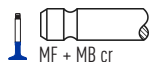

30° H



OE

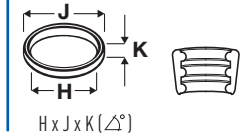
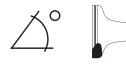

10 **130.00**

| | | | | | | | |
|-----------------|-----------------|--------|------------------|-------------|--------|-------------------|----------------|
| XE 315 C | 12580cc | 6 Cyl. | 24 Valves | 315kW/428PS | Diesel | Turbo, OHV | TD13333 |
| XE 355 C | 12580cc | 6 Cyl. | 24 Valves | 355kW/483PS | Diesel | Turbo, OHV | TD13334 |
| 95 XF | 01/1997→09/2002 | | | CF 85 | | 01/2001→05/2013 | |
| Futura | 09/2001→09/2006 | | | Magiq | | 10/1999→ | |
| Synergy | 09/2004→ | | | VACANZA | | 10/2003→12/2006 | |
| XF 95 | 01/2002→12/2006 | | | X-Series | | 10/1999→ | |

V94638
45.45 x 9.00 x 163.60
→12/99

1307654

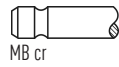

30° Y H

VAG96247
76.50 x 9.02 x 15.00



V94967
45.50 x 9.00 x 163.50
12/99→

1342220

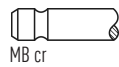

20° Y

V94639
42.45 x 9.00 x 158.70
→12/99

1327029

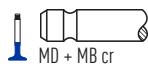

30° H

V94968
42.50 x 9.00 x 158.60
12/99→

1362696

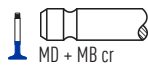

45° H

11 **130.00**

| | | | | | | | |
|------------------|---------|--------|------------------|-------------|--------|---|----------------|
| XE 355 C1 | 12580cc | 6 Cyl. | 24 Valves | 355kW/483PS | Diesel | Turbo, OHV | TD22219 |
| V94968 | 1362696 | | | | | VAG96247 76.50 x 9.02 x 15.00 | |

12 **130.00**

| | | | | | | | |
|------------------|-----------------|--------|------------------|-------------|--------|-------------------|----------------|
| XE 390 C | 12580cc | 6 Cyl. | 24 Valves | 390kW/530PS | Diesel | Turbo, OHV | TD13335 |
| XE 390 C1 | 12580cc | 6 Cyl. | 24 Valves | 390kW/530PS | Diesel | Turbo, OHV | TD22220 |
| XF 280 M | 12580cc | 6 Cyl. | 24 Valves | 280kW/381PS | Diesel | Turbo, OHV | TD11913 |
| XF 315 M | 12580cc | 6 Cyl. | 24 Valves | 315kW/428PS | Diesel | Turbo, OHV | TD11914 |
| XF 355 M | 12580cc | 6 Cyl. | 24 Valves | 355kW/483PS | Diesel | Turbo, OHV | TD11915 |
| 85 CF | 02/1998→12/2000 | | | 95 XF | | 01/1997→09/2002 | |
| CF 85 | 01/2001→05/2013 | | | XF 95 | | 01/2002→ | |

V94638
45.45 x 9.00 x 163.60
→12/99

1307654

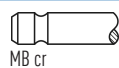

30° Y H

VAG96247
76.50 x 9.02 x 15.00



V94967
45.50 x 9.00 x 163.50
12/99→

1342220

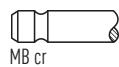

20° Y

V95213
45.50 x 8.94 x 163.55
12/99→

1603846

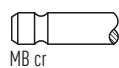

20° H

V94639
42.45 x 9.00 x 158.70
→12/99

1327029

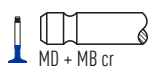

30° H

V94968
42.50 x 9.00 x 158.60
12/99→

1362696

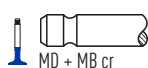

45° H

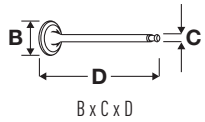

OE

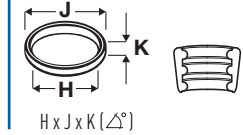
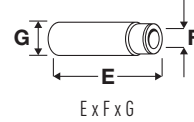
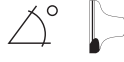

13 **130.00**

| XF 250 M | 12580cc | 6 Cyl. | 24 Valves | 250kW/340PS | Diesel | Turbo, OHV | TD11912 |
|-----------------------|-----------------|------------|-----------|-------------|--------|---|---------|
| 85 CF | 02/1998→12/2000 | | | | | | |
| V94638 | 1307654 | | 30° | Y | H | VAG96247 76.50 x 9.02 x 15.00 | |
| 45.45 x 9.00 x 163.60 | | MB cr | | | | | |
| V94967 | 1342220 | | 20° | Y | | | |
| 45.50 x 9.00 x 163.50 | | MB cr | | | | | |
| V94639 | 1327029 | | 30° | | H | | |
| 42.45 x 9.00 x 158.70 | | MD + MB cr | | | | | |
| V94968 | 1362696 | | 45° | | H | | |
| 42.50 x 9.00 x 158.60 | | MD + MB cr | | | | | |

14 **130.00**

| MX 265 | 12902cc | 6 Cyl. | 24 Valves | 265kW/360PS | Diesel | Paccar MX, Turbo, OHV | TD20056 |
|-----------|-----------------|--------|-----------|-------------|--------|-----------------------|---------|
| MX 300 | 12902cc | 6 Cyl. | 24 Valves | 300kW/408PS | Diesel | Paccar MX, Turbo, OHV | TD18902 |
| MX 340 | 12902cc | 6 Cyl. | 24 Valves | 340kW/462PS | Diesel | Paccar MX, Turbo, OHV | TD18903 |
| MX 375 | 12902cc | 6 Cyl. | 24 Valves | 375kW/510PS | Diesel | Paccar MX, Turbo, OHV | TD18904 |
| CF 85 | 10/2005→05/2013 | | | i6 | | 09/2014→ | |
| Jonkheere | | | | Magiq | | 10/2006→ | |
| PB | 10/2009→ | | | SAFARI | | 10/2010→ | |
| SAFIR | 10/2009→ | | | SAFIR PLUS | | 10/2009→ | |
| Synergy | 07/2007→ | | | T-Serie | | 10/2005→ | |
| VACANZA | 10/2005→ | | | XF 105 | | 10/2005→ | |
| X-Series | 07/2008→ | | | | | | |

| | | | | | | | |
|-----------------------|---------|------------|-----|----|---|--|--|
| V95209 | 1684513 | | 20° | | H | | |
| 45.50 x 9.93 x 169.35 | | MB cr | | | | | |
| V95210 | 1678541 | | 30° | ss | H | | |
| 42.55 x 9.93 x 168.60 | | MD + MB cr | | | | | |

15 **140.00**

| VF 390 M | 14000cc | 6 Cyl. | 24 Valves | 390kW/530PS | Diesel | Turbo, OHV | TD11917 |
|---------------------------------|----------|------------|-----------|-------------|--------|---|---------|
| 95 XF | 01/1997→ | | | | | | |
| V94638 | 1307654 | | 30° | Y | H | VAG96247 76.50 x 9.02 x 15.00 | |
| 45.45 x 9.00 x 163.60 →12/99 | | MB cr | | | | | |
| V94967 | 1342220 | | 20° | Y | | | |
| 45.50 x 9.00 x 163.50 12/99→ | | MB cr | | | | | |
| V94639 | 1327029 | | 30° | | H | | |
| 42.45 x 9.00 x 158.70 →12/99 | | MD + MB cr | | | | | |
| V94968 | 1362696 | | 45° | | H | | |
| 42.50 x 9.00 x 158.60 12/99→ | | MD + MB cr | | | | | |



OE

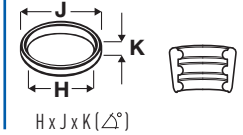

1

71.00

| 1KR-FE | 998cc | 3 Cyl. | 12 Valves | 51kW/70PS | Petrol | DOHC | TD20287 |
|-------------|-------|--------|-----------|-----------------|--------|----------|---------|
| CHARADE 1.0 | | | | CUORE VII 1.0 | | 04/2007→ | |
| SIRION 1.0 | | | | SIRION 1.0 DVVT | | 04/2005→ | |
| THOR 1.0 | | | | | | | |

V94969
27.65 x 4.98 x 88.35

0948.E2

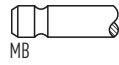

45°

H

VAG96067
34.50 x 5.00 x 9.70



V94970
23.70 x 4.98 x 89.10

0949.C8

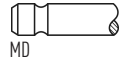

45°

2

72.00

| K3-VE | 1298cc | 4 Cyl. | 16 Valves | 63-75kW/86-102PS | Petrol | DOHC | TD16469 |
|------------------|--------|--------|-----------|------------------|--------|-----------------|---------|
| ATRAI WAGON 1.3 | | | | BEGO 1.3 DVVT | | 11/2005→ | |
| COO 1.3 | | | | COPEN 1.3 | | 03/2006→09/2012 | |
| EXTOL 1.3 | | | | EXTOL 1.3 L | | 10/2003→12/2005 | |
| MATERIA 1.3 | | | | RUSH 1.3 | | 11/2005→ | |
| SIRION 1.3 | | | | TERIOS 1.3 | | 10/2000→10/2005 | |
| TERIOS 1.3 VWT-i | | | | XENIA 1.3 VWT-i | | 05/2007→ | |
| YRV 1.3 | | | | | | | |

V94132
26.00 x 5.00 x 88.20

13711-23030

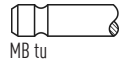

45°

H

VAG96067
34.50 x 5.00 x 9.70



V94133
22.60 x 5.00 x 89.10

13715-23030

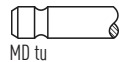

45°

3

72.50

| 1NR-FE | 1329cc | 4 Cyl. | 16 Valves | 70-73kW/95-99PS | Petrol | DOHC | TD26206 |
|------------------|--------|--------|-----------|-----------------|--------|----------|---------|
| CHARADE 1.33 16V | | | | SIRION 1.3 | | 02/2010→ | |

V95143
28.90 x 5.48 x 103.35

13711-47010

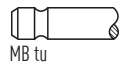

45°

H

VAG96381
43.60 x 5.50 x 10.34



V95144
24.20 x 5.47 x 104.55

13715-47010

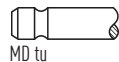

45°

4

86.00

| 3S-FE | 1998cc | 4 Cyl. | 16 Valves | 85-103kW/116-140PS | Petrol | DOHC | TD22221 |
|-------|--------|--------|-----------|--------------------|--------|------|---------|
|-------|--------|--------|-----------|--------------------|--------|------|---------|

V94138
32.00 x 6.00 x 97.50

13711-74101

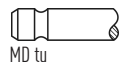

45°

VAG96069
38.50 x 6.02 x 11.04



V94139
27.00 x 6.00 x 98.50

13715-74100

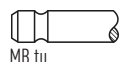







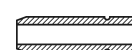





45°

SS

VAG96070
40.50 x 6.02 x 11.06



|  |  | ccm |  |  |  |  |
|---|---|-------|--|---|---|---|
| BF 10L 413 F | 125.00 | 15953 | 10 | 20 | Diesel | 53 |
| BF 10L 413 FW | 125.00 | 15953 | 10 | 20 | Diesel | 53 |
| BF 10L 513 | 125.00 | 15953 | 10 | 20 | Diesel | 53 |
| BF 10L 513 C | 125.00 | 15953 | 10 | 20 | Diesel | 53 |
| BF 10L 513 F | 125.00 | 15945 | 10 | 20 | Diesel | 52 |
| BF 12L 413 | 120.00 | 16964 | 12 | 24 | Diesel | 47 |
| BF 12L 413 F | 125.00 | 19144 | 12 | 24 | Diesel | 54 |
| BF 12L 513 | 125.00 | 19144 | 12 | 24 | Diesel | 54 |
| BF 12L 513 F | 125.00 | 19144 | 12 | 24 | Diesel | 54 |
| BF 4L 1011 F | 91.00 | 2731 | 4 | 8 | Diesel | 5 |
| BF 4L 1011 FT | 91.00 | 2732 | 4 | 8 | Diesel | 6 |
| BF 4L 913 | 102.00 | 4086 | 4 | 8 | Diesel | 29 |
| BF 4L 913 C | 102.00 | 4086 | 4 | 8 | Diesel | 30 |
| BF 4L 913 T | 102.00 | 4086 | 4 | 8 | Diesel | 31 |
| BF 4M 1013 | 108.00 | 4764 | 4 | 8 | Diesel | 35 |
| BF 4M 1013 C | 108.00 | 4764 | 4 | 8 | Diesel | 35 |
| BF 4M 1013 E | 108.00 | 4764 | 4 | 8 | Diesel | 35 |
| BF 4M 1013 EC | 108.00 | 4764 | 4 | 8 | Diesel | 35 |
| BF 4M 1013 FC | 108.00 | 4764 | 4 | 8 | Diesel | 36 |
| BF 6L 413 | 120.00 | 8478 | 6 | 12 | Diesel | 42 |
| BF 6L 413 FR | 125.00 | 9572 | 6 | 12 | Diesel | 50 |
| BF 6L 413 FW | 125.00 | 9572 | 6 | 12 | Diesel | 50 |
| BF 6L 513 | 125.00 | 9572 | 6 | 12 | Diesel | 50 |
| BF 6L 513 C | 125.00 | 9572 | 6 | 12 | Diesel | 50 |
| BF 6L 912 | 100.00 | 5655 | 6 | 12 | Diesel | 26 |
| BF 6L 913 | 102.00 | 6128 | 6 | 12 | Diesel | 32 |
| BF 6L 913 C | 102.00 | 6128 | 6 | 12 | Diesel | 33 |
| BF 6L 913 T | 102.00 | 6128 | 6 | 12 | Diesel | 34 |
| BF 6M 1013 | 108.00 | 7146 | 6 | 12 | Diesel | 37 |
| BF 6M 1013 C | 108.00 | 7146 | 6 | 12 | Diesel | 37 |
| BF 6M 1013 CP | 108.00 | 7146 | 6 | 12 | Diesel | 37 |
| BF 6M 1013 E | 108.00 | 7146 | 6 | 12 | Diesel | 37 |
| BF 6M 1013 EC | 108.00 | 7146 | 6 | 12 | Diesel | 37 |
| BF 6M 1013 ECP | 108.00 | 7146 | 6 | 12 | Diesel | 37 |
| BF 6M 1013 FC | 108.00 | 7146 | 6 | 12 | Diesel | 38 |
| BF 6M 1015 | 132.00 | 11905 | 6 | 24 | Diesel | 58 |
| BF 6M 1015 C | 132.00 | 11905 | 6 | 24 | Diesel | 59 |
| BF 6M 1015 CP | 132.00 | 11905 | 6 | 24 | Diesel | 59 |
| BF 6M 1015 CU | 132.00 | 11905 | 6 | 24 | Diesel | 58 |
| BF 8L 413 | 120.00 | 11310 | 8 | 16 | Diesel | 44 |
| BF 8L 413 F | 125.00 | 12763 | 8 | 16 | Diesel | 51 |
| BF 8L 513 | 125.00 | 12763 | 8 | 16 | Diesel | 51 |
| BF 8M 1015 | 132.00 | 15874 | 8 | 32 | Diesel | 60 |
| BF 8M 1015 C | 132.00 | 15874 | 8 | 32 | Diesel | 61 |
| BF 8M 1015 CP | 132.00 | 15874 | 8 | 32 | Diesel | 61 |
| F 10L 413 | 120.00 | 14140 | 10 | 20 | Diesel | 45 |
| F 10L 413 F | 125.00 | 15953 | 10 | 20 | Diesel | 53 |
| F 10L 413 FW | 125.00 | 15953 | 10 | 20 | Diesel | 53 |
| F 10L 513 | 128.00 | 16728 | 10 | 20 | Diesel | 56 |
| F 10L 513 F | 125.00 | 15953 | 10 | 20 | Diesel | 53 |
| F 12L 413 | 120.00 | 16960 | 12 | 24 | Diesel | 46 |
| F 12L 413 F | 125.00 | 19144 | 12 | 24 | Diesel | 54 |
| F 12L 413 FW | 125.00 | 19144 | 12 | 24 | Diesel | 54 |
| F 12L 513 | 128.00 | 20074 | 12 | 24 | Diesel | 57 |
| F 12L 513 F | 125.00 | 19144 | 12 | 24 | Diesel | 54 |
| F 12L 513 L | 128.00 | 20074 | 12 | 24 | Diesel | 57 |
| F 1L 511 | 100.00 | 824 | 1 | 2 | Diesel | 18 |
| F 1L 511 D | 100.00 | 825 | 1 | 2 | Diesel | 19 |
| F 1L 712 | 95.00 | 850 | 1 | 2 | Diesel | 8 |
| F 1L 812 | 95.00 | 850 | 1 | 2 | Diesel | 9 |
| F 2L 1011 F | 91.00 | 1366 | 2 | 4 | Diesel | 1 |
| F 2L 511 | 100.00 | 824 | 2 | 4 | Diesel | 18 |
| F 2L 511 D | 100.00 | 1650 | 2 | 4 | Diesel | 20 |
| F 2L 712 | 95.00 | 1700 | 2 | 4 | Diesel | 10 |
| F 2L 812 | 95.00 | 1700 | 2 | 4 | Diesel | 11 |
| F 2L 912 | 100.00 | 1885 | 2 | 4 | Diesel | 21 |

|  |  | ccm |  |  |  |  | |
|---|---|--------|---|---|---|---|----|
| F 2M 1011 | | 91.00 | 1366 | 2 | 4 | Diesel | 2 |
| F 3L 1011 F | | 91.00 | 2049 | 3 | 6 | Diesel | 3 |
| F 3L 712 | | 95.00 | 2552 | 3 | 6 | Diesel | 12 |
| F 3L 812 | | 95.00 | 2552 | 3 | 6 | Diesel | 13 |
| F 3L 912 | | 100.00 | 2827 | 3 | 6 | Diesel | 23 |
| F 3L 912 D | | 100.00 | 2826 | 3 | 6 | Diesel | 22 |
| F 3L 912 W | | 100.00 | 2826 | 3 | 6 | Diesel | 22 |
| F 3L 913 | | 102.00 | 3064 | 3 | 6 | Diesel | 28 |
| F 3M 1011 F | | 91.00 | 2185 | 3 | 6 | Diesel | 4 |
| F 4L 1011 F | | 91.00 | 2732 | 4 | 8 | Diesel | 7 |
| F 4L 413 FR | | 125.00 | 6381 | 4 | 8 | Diesel | 48 |
| F 4L 413 R | | 120.00 | 5880 | 4 | 8 | Diesel | 40 |
| F 4L 712 | | 95.00 | 3400 | 4 | 8 | Diesel | 14 |
| F 4L 812 | | 95.00 | 3400 | 4 | 8 | Diesel | 15 |
| F 4L 912 D | | 100.00 | 3770 | 4 | 8 | Diesel | 24 |
| F 4L 912 W | | 100.00 | 3770 | 4 | 8 | Diesel | 24 |
| F 4L 913 D | | 102.00 | 4086 | 4 | 8 | Diesel | 31 |
| F 4M 1011 F | | 91.00 | 2732 | 4 | 8 | Diesel | 6 |
| F 5L 413 FR | | 125.00 | 7976 | 5 | 10 | Diesel | 49 |
| F 5L 413 R | | 120.00 | 7350 | 5 | 10 | Diesel | 41 |
| F 5L 912 | | 100.00 | 4712 | 5 | 10 | Diesel | 25 |
| F 5L 912 D | | 100.00 | 4712 | 5 | 10 | Diesel | 25 |
| F 6L 413 | | 120.00 | 8478 | 6 | 12 | Diesel | 42 |
| F 6L 413 F | | 125.00 | 9572 | 6 | 12 | Diesel | 50 |
| F 6L 413 FR | | 125.00 | 9572 | 6 | 12 | Diesel | 50 |
| F 6L 413 FW | | 125.00 | 9572 | 6 | 12 | Diesel | 50 |
| F 6L 413 R | | 120.00 | 8822 | 6 | 12 | Diesel | 43 |
| F 6L 712 | | 95.00 | 5104 | 6 | 12 | Diesel | 16 |
| F 6L 812 | | 95.00 | 5104 | 6 | 12 | Diesel | 17 |
| F 6L 912 | | 100.00 | 5655 | 6 | 12 | Diesel | 27 |
| F 6L 912 D | | 100.00 | 5655 | 6 | 12 | Diesel | 27 |
| F 6L 912 W | | 100.00 | 5655 | 6 | 12 | Diesel | 27 |
| F 6L 913 D | | 102.00 | 6128 | 6 | 12 | Diesel | 33 |
| F 8L 413 | | 120.00 | 11310 | 8 | 16 | Diesel | 44 |
| F 8L 413 F | | 125.00 | 12763 | 8 | 16 | Diesel | 51 |
| F 8L 413 FW | | 125.00 | 12763 | 8 | 16 | Diesel | 51 |
| F 8L 513 | | 128.00 | 13382 | 8 | 16 | Diesel | 55 |
| TCD 2013 L06 4V | | 108.00 | 7146 | 6 | 24 | Diesel | 39 |
| TCD 2013 L6 4V | | 108.00 | 7146 | 6 | 24 | Diesel | 39 |
| TCD 2015 V6 | | 132.00 | 11905 | 6 | 24 | Diesel | 58 |
| TCD 2015 V8 | | 132.00 | 15874 | 8 | 32 | Diesel | 61 |

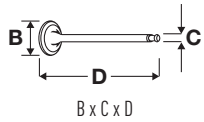

OE

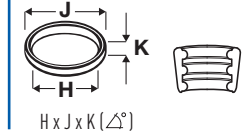
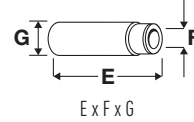
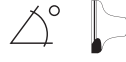

1 91.00

| | | | | | | | |
|--|-----------|------------|-----------------|-----------------|---|------------|----------------|
| F 2L 1011 F | 1366cc | 2 Cyl. | 4 Valves | 20-22kW/27-30PS | Diesel | OHV | TD17224 |
| V94575 ■ 40.10 x 8.00 x 124.70 | 0417 0898 | MB cr | 45° | H | VAG96341 ■ ■ ■ 48.00 x 8.03 x 12.04 | | |
| V94529 ■ 34.90 x 8.00 x 124.70 | 0417 0899 | MD + MB cr | 45° | H | | | |

2 91.00

| | | | | | | | |
|--|-----------|------------|-----------------|-----------------|---|--|----------------|
| F 2M 1011 | 1366cc | 2 Cyl. | 4 Valves | 21-23kW/29-31PS | Diesel | | TD17231 |
| V94529 ■ 34.90 x 8.00 x 124.70 | 0417 0899 | MD + MB cr | 45° | H | VAG96341 ■ ■ ■ 48.00 x 8.03 x 12.04 | | |

3 91.00

| | | | | | | | |
|--|-----------|------------|-----------------|-----------------|---|------------|----------------|
| F 3L 1011 F | 2049cc | 3 Cyl. | 6 Valves | 16-33kW/22-45PS | Diesel | OHV | TD17225 |
| V94575 ■ 40.10 x 8.00 x 124.70 | 0417 0898 | MB cr | 45° | H | VAG96341 ■ ■ ■ 48.00 x 8.03 x 12.04 | | |
| V94529 ■ 34.90 x 8.00 x 124.70 | 0417 0899 | MD + MB cr | 45° | H | | | |

4 91.00

| | | | | | | | |
|--|-----------|------------|-----------------|-----------------|---|--|----------------|
| F 3M 1011 F | 2185cc | 3 Cyl. | 6 Valves | 17-36kW/23-49PS | Diesel | | TD17232 |
| V94529 ■ 34.90 x 8.00 x 124.70 | 0417 0899 | MD + MB cr | 45° | H | VAG96341 ■ ■ ■ 48.00 x 8.03 x 12.04 | | |

5 91.00

| | | | | | | | |
|--|-----------|------------|-----------------|-----------------|---|-------------------|----------------|
| BF 4L 1011 F | 2731cc | 4 Cyl. | 8 Valves | 28-55kW/38-75PS | Diesel | Turbo, OHV | TD17230 |
| V94529 ■ 34.90 x 8.00 x 124.70 | 0417 0899 | MD + MB cr | 45° | H | VAG96341 ■ ■ ■ 48.00 x 8.03 x 12.04 | | |

6 91.00

| | | | | | | | |
|--|-----------|------------|-----------------|-----------------|---|-------------------|----------------|
| BF 4L 1011 FT | 2732cc | 4 Cyl. | 8 Valves | 46kW/63PS | Diesel | Turbo, OHV | TD17228 |
| F 4M 1011 F | 2732cc | 4 Cyl. | 8 Valves | 24-48kW/33-65PS | Diesel | OHV | TD18488 |
| V94529 ■ 34.90 x 8.00 x 124.70 | 0417 0899 | MD + MB cr | 45° | H | VAG96341 ■ ■ ■ 48.00 x 8.03 x 12.04 | | |

7 91.00



| | | | | | | | |
|--|-----------|------------|-----------------|-----------------|---|------------|----------------|
| F 4L 1011 F | 2732cc | 4 Cyl. | 8 Valves | 24-47kW/33-64PS | Diesel | OHV | TD17227 |
| V94575 ■ 40.10 x 8.00 x 124.70 | 0417 0898 | MB cr | 45° | H | VAG96341 ■ ■ ■ 48.00 x 8.03 x 12.04 | | |
| V94529 ■ 34.90 x 8.00 x 124.70 | 0417 0899 | MD + MB cr | 45° | H | | | |



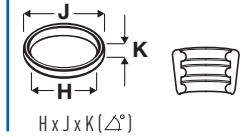
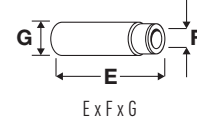







OE

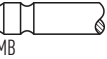





8  **95.00**

| | | | | | | |
|---|-----------------|---|---|----------------|-----------------|----------------|
| F 1L 712 | 850cc | 1 Cyl. | 2 Valves | 9-10kW/12-14PS | Diesel | TD17870 |
| F-Serie | 01/1953→ | | | KL-Serie | 01/1958→12/1967 | |
| KLS-Serie | 01/1958→12/1961 | | | Pionier | 01/1959→12/1962 | |
| V90312  | 0337 1664 |  |  MD + MB cr | 45° | H | |









9  **95.00**

| | | | | | | |
|---|-----------------|---|---|----------------|--------|---|
| F 1L 812 | 850cc | 1 Cyl. | 2 Valves | 9-10kW/12-14PS | Diesel | TD17871 |
| KL-Serie | 01/1961→12/1967 | | | | | |
| V90050  | 0415 3629 |  | MB | 45° | H | VAG92155  57.40 x 8.02 x 15.07 |
| V90114  | 0415 3773 |  | MD cr | 45° | | |
| V90051  | 0415 3697 |  | MD cr | 45° | | |
| V94530  | 0337 1746 |  |  MD + MB cr | 45° | H | |



10  **95.00**

| | | | | | | |
|---|-----------------|---|---|-----------------|-----------------|----------------|
| F 2L 712 | 1700cc | 2 Cyl. | 4 Valves | 13-18kW/18-24PS | Diesel | TD17874 |
| KL-Serie | 01/1957→12/1961 | | | KT | 01/1961→12/1965 | |
| V90312  | 0337 1664 |  |  MD + MB cr | 45° | H | |

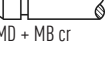
11  **95.00**

| | | | | | | |
|---|-----------|---|---|-----------------|-----------------|---|
| F 2L 812 | 1700cc | 2 Cyl. | 4 Valves | 15-22kW/20-30PS | Diesel | TD17875 |
| D05 | 01/1965→ | | | KL-Serie | 01/1960→12/1968 | |
| V90050  | 0415 3629 |  | MB | 45° | H | VAG92155  57.40 x 8.02 x 15.07 |
| V90114  | 0415 3773 |  | MD cr | 45° | | |
| V90051  | 0415 3697 |  | MD cr | 45° | | |
| V94530  | 0337 1746 |  |  MD + MB cr | 45° | H | |

12  **95.00**

| | | | | | | |
|---|-----------------|---|---|-----------|--------|----------------|
| F 3L 712 | 2552cc | 3 Cyl. | 6 Valves | 28kW/38PS | Diesel | TD17877 |
| KL-Serie | 01/1960→12/1967 | | | | | |
| V90312  | 0337 1664 |  |  MD + MB cr | 45° | H | |

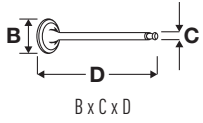

OE

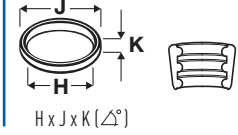
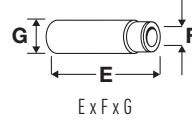
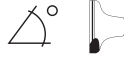

13 95.00

| F 3L 812 | 2552cc | 3 Cyl. | 6 Valves | 25-32kW/34-44PS | Diesel | TD17878 |
|-----------------------|-----------|------------|----------|-----------------|----------------------|---------|
| D05 | 01/1965→ | KL-Serie | | 01/1960→12/1970 | | |
| V90050 ■ | 0415 3629 | | 45° | H | VAG92155 ■■ ■ | |
| 43.18 x 7.96 x 132.97 | | MB | | | 57.40 x 8.02 x 15.07 | |
| V90114 ■ | 0415 3773 | | 45° | | | |
| 43.13 x 7.96 x 132.97 | | MD cr | | | | |
| V90051 ■ | 0415 3697 | | 45° | | | |
| 37.11 x 7.94 x 133.27 | | MD cr | | | | |
| V94530 ■ | 0337 1746 | | 45° | H | | |
| 35.00 x 8.00 x 133.00 | | MD + MB cr | | | | |

14 95.00

| F 4L 712 | 3400cc | 4 Cyl. | 8 Valves | 38kW/52PS | Diesel | TD17879 |
|-----------------------|-----------|-----------------|----------|-----------|--------|---------|
| KL-Serie | | 01/1962→12/1965 | | | | |
| V90312 ■ | 0337 1664 | | 45° | H | | |
| 35.00 x 9.85 x 132.85 | | MD + MB cr | | | | |

15 95.00

| F 4L 812 | 3400cc | 4 Cyl. | 8 Valves | 33-39kW/45-53PS | Diesel | TD17880 |
|-----------------------|-----------|------------|----------|-----------------|----------------------|---------|
| D05 | 01/1965→ | KL-Serie | | 01/1962→12/1970 | | |
| V90050 ■ | 0415 3629 | | 45° | H | VAG92155 ■■ ■ | |
| 43.18 x 7.96 x 132.97 | | MB | | | 57.40 x 8.02 x 15.07 | |
| V90114 ■ | 0415 3773 | | 45° | | | |
| 43.13 x 7.96 x 132.97 | | MD cr | | | | |
| V90051 ■ | 0415 3697 | | 45° | | | |
| 37.11 x 7.94 x 133.27 | | MD cr | | | | |
| V94530 ■ | 0337 1746 | | 45° | H | | |
| 35.00 x 8.00 x 133.00 | | MD + MB cr | | | | |

16 95.00

| F 6L 712 | 5104cc | 6 Cyl. | 12 Valves | 66kW/90PS | Diesel | OHV | TD19239 |
|-----------------------|-----------|------------|-----------|-----------|--------|-----|---------|
| V90312 ■ | 0337 1664 | | 45° | H | | | |
| 35.00 x 9.85 x 132.85 | | MD + MB cr | | | | | |

17 95.00





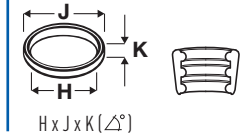
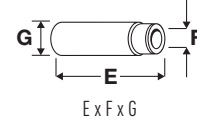

| F 6L 812 | 5104cc | 6 Cyl. | 12 Valves | 59-74kW/80-101PS | Diesel | TD26418 |
|-----------------------|-----------|------------|-----------|------------------|----------------------|---------|
| D05 | 01/1965→ | | | | | |
| V90050 ■ | 0415 3629 | | 45° | H | VAG92155 ■■ ■ | |
| 43.18 x 7.96 x 132.97 | | MB | | | 57.40 x 8.02 x 15.07 | |
| V90114 ■ | 0415 3773 | | 45° | | | |
| 43.13 x 7.96 x 132.97 | | MD cr | | | | |
| V90051 ■ | 0415 3697 | | 45° | | | |
| 37.11 x 7.94 x 133.27 | | MD cr | | | | |
| V94530 ■ | 0337 1746 | | 45° | H | | |
| 35.00 x 8.00 x 133.00 | | MD + MB cr | | | | |



OE



18  **100.00**

| | | | | | | | |
|---|----------------------|--|-----------------|-----------|--------|---|----------------|
| F 1L 511 | 824cc | 1 Cyl. | 2 Valves | 13kW/18PS | Diesel | OHV | TD26611 |
| F 2L 511 | 824cc | 2 Cyl. | 4 Valves | 25kW/34PS | Diesel | OHV | TD26612 |
| V90114  | 0415 3773 |  MD cr | 45° | | |  | |
| V90051  | 0415 3697 |  MD cr | 45° | | | | |
| VAG92155  | 57.40 x 8.02 x 15.07 | | | | |  | |









19  **100.00**

| | | | | | | | |
|---|----------------------|--|-----------------|-----------------|--------|---|----------------|
| F 1L 511 D | 825cc | 1 Cyl. | 2 Valves | 11-13kW/15-18PS | Diesel | | TD17869 |
| V90114  | 0415 3773 |  MD cr | 45° | | |  | |
| V90051  | 0415 3697 |  MD cr | 45° | | | | |
| VAG92155  | 57.40 x 8.02 x 15.07 | | | | |  | |

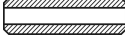



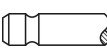

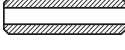
20  **100.00**

| | | | | | | | |
|---|----------------------|--|-----------------|-----------------|--------|---|----------------|
| F 2L 511 D | 1650cc | 2 Cyl. | 4 Valves | 22-26kW/30-35PS | Diesel | | TD17872 |
| V90114  | 0415 3773 |  MD cr | 45° | | |  | |
| V90051  | 0415 3697 |  MD cr | 45° | | | | |
| VAG92155  | 57.40 x 8.02 x 15.07 | | | | |  | |

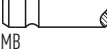
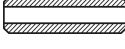
21  **100.00**

| | | | | | | | |
|---|----------------------|--|-----------------|-----------------|--------|---|----------------|
| F 2L 912 | 1885cc | 2 Cyl. | 4 Valves | 16-28kW/22-38PS | Diesel | | TD18128 |
| 14-Serie | 01/1970→12/1970 | | | D06 | | 01/1968→ | |
| D07 | 01/1982→ | | | KL-Serie | | 01/1968→12/1970 | |
| V90050  | 0415 3629 |  MB | 45° | H | |  | |
| V90114  | 0415 3773 |  MD cr | 45° | | | | |
| V90051  | 0415 3697 |  MD cr | 45° | | | | |
| VAG92155  | 57.40 x 8.02 x 15.07 | | | | |  | |

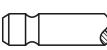
22  **100.00**

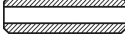
| | | | | | | | |
|---|----------------------|--|-----------------|-----------------|--------|---|----------------|
| F 3L 912 D | 2826cc | 3 Cyl. | 6 Valves | 24-44kW/33-60PS | Diesel | OHV | TD19020 |
| F 3L 912 W | 2826cc | 3 Cyl. | 6 Valves | 25-43kW/34-58PS | Diesel | OHV | TD19019 |
| KL-Serie | 01/1966→12/1970 | | | | | | |
| V90050  | 0415 3629 |  MB | 45° | H | |  | |
| V90114  | 0415 3773 |  MD cr | 45° | | | | |
| V90051  | 0415 3697 |  MD cr | 45° | | | | |
| VAG92155  | 57.40 x 8.02 x 15.07 | | | | |  | |

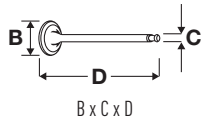

OE



MAT.

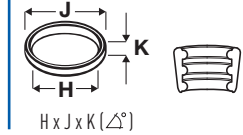
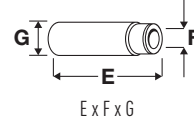
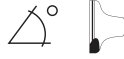

23 100.00

| F 3L 912 | 2827cc | 3 Cyl. | 6 Valves | 24-48kW/33-65PS | Diesel | OHV | TD17207 |
|-----------------------|-----------|-----------------|----------|-----------------|----------------------|-----------------|---------|
| 14-Serie | | 01/1970→12/1973 | | D06 | | 01/1968→12/1982 | |
| D07 | | 01/1980→ | | DX | | | |
| Farmer | | 01/1968→ | | GT | | 01/1976→ | |
| V90050 | 0415 3629 | | 45° | H | VAG92155 | | |
| 43.18 x 7.96 x 132.97 | | MB | | | 57.40 x 8.02 x 15.07 | | |
| V90114 | 0415 3773 | | 45° | | | | |
| 43.13 x 7.96 x 132.97 | | MD cr | | | | | |
| V90051 | 0415 3697 | | 45° | | | | |
| 37.11 x 7.94 x 133.27 | | MD cr | | | | | |

24 100.00

| F 4L 912 D | 3770cc | 4 Cyl. | 8 Valves | 38-62kW/52-84PS | Diesel | OHV | TD19021 |
|-----------------------|-----------|--------|----------|-----------------|----------------------|-----|---------|
| F 4L 912 W | 3770cc | 4 Cyl. | 8 Valves | 38-49kW/52-67PS | Diesel | OHV | TD19022 |
| V90050 | 0415 3629 | | 45° | H | VAG92155 | | |
| 43.18 x 7.96 x 132.97 | | MB | | | 57.40 x 8.02 x 15.07 | | |
| V90114 | 0415 3773 | | 45° | | | | |
| 43.13 x 7.96 x 132.97 | | MD cr | | | | | |
| V90051 | 0415 3697 | | 45° | | | | |
| 37.11 x 7.94 x 133.27 | | MD cr | | | | | |

25 100.00

| F 5L 912 | 4712cc | 5 Cyl. | 10 Valves | 40-68kW/54-92PS | Diesel | OHV | TD17209 |
|-----------------------|-----------|-----------------|-----------|------------------|----------------------|-----|---------|
| F 5L 912 D | 4712cc | 5 Cyl. | 10 Valves | 58-78kW/79-106PS | Diesel | OHV | TD19023 |
| DX | | 01/1978→12/1982 | | | | | |
| V90050 | 0415 3629 | | 45° | H | VAG92155 | | |
| 43.18 x 7.96 x 132.97 | | MB | | | 57.40 x 8.02 x 15.07 | | |
| V90114 | 0415 3773 | | 45° | | | | |
| 43.13 x 7.96 x 132.97 | | MD cr | | | | | |
| V90051 | 0415 3697 | | 45° | | | | |
| 37.11 x 7.94 x 133.27 | | MD cr | | | | | |

26 100.00

| BF 6L 912 | 5655cc | 6 Cyl. | 12 Valves | 88-100kW/120-136PS | Diesel | Turbo, OHV | TD18348 |
|-----------------------|-----------|-----------------|-----------|--------------------|----------------------|------------|---------|
| 14-Serie | | 01/1970→12/1970 | | D06 | | 01/1972→ | |
| V90114 | 0415 3773 | | 45° | | VAG92155 | | |
| 43.13 x 7.96 x 132.97 | | MD cr | | | 57.40 x 8.02 x 15.07 | | |
| V90051 | 0415 3697 | | 45° | | | | |
| 37.11 x 7.94 x 133.27 | | MD cr | | | | | |



OE

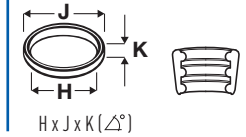
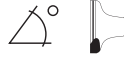

27 **100.00**

| | | | | | | | |
|-------------------|-----------------|--------|------------------|------------------|--------|-----------------|----------------|
| F 6L 912 | 5655cc | 6 Cyl. | 12 Valves | 48-82kW/65-112PS | Diesel | OHV | TD17210 |
| F 6L 912 D | 5655cc | 6 Cyl. | 12 Valves | 42-92kW/57-125PS | Diesel | OHV | TD19030 |
| F 6L 912 W | 5655cc | 6 Cyl. | 12 Valves | 57-74kW/78-101PS | Diesel | OHV | TD19024 |
| 14-Serie | 01/1974→12/1980 | | AGROPRIMA | | | 01/1990→12/1995 | |
| AGROSTAR | 01/1993→12/1995 | | AGROXTRA | | | 01/1991→12/1995 | |
| DD6 | 01/1968→ | | DX | | | 01/1978→ | |
| GT | 01/1985→12/1995 | | | | | | |

| | | | | | | |
|-----------------------|-----------|-------|-----|---|----------------------|--|
| V90050 | 0415 3629 | | 45° | H | VAG92155 | |
| 43.18 x 7.96 x 132.97 | | MB | | | 57.40 x 8.02 x 15.07 | |
| V90114 | 0415 3773 | | 45° | | | |
| 43.13 x 7.96 x 132.97 | | MD cr | | | | |
| V90051 | 0415 3697 | | 45° | | | |
| 37.11 x 7.94 x 133.27 | | MD cr | | | | |

28 **102.00**

| | | | | | | | |
|-----------------|-----------------|--------|-----------------|-----------------|--------|-----------------|----------------|
| F 3L 913 | 3064cc | 3 Cyl. | 6 Valves | 25-44kW/34-60PS | Diesel | OHV | TD17201 |
| AGROLUX | 01/2001→12/2006 | | AGROPLUS | | | 01/1996→12/2004 | |
| AGROXTRA | 01/1991→12/1995 | | DD7 | | | 01/1980→ | |
| DX | 01/1984→ | | Farmer | | | 01/1974→12/1996 | |
| GT | 01/1984→12/1996 | | | | | | |

| | | | | | | |
|-----------------------|-----------|-------|-----|---|----------------------|--|
| V90050 | 0415 3629 | | 45° | H | VAG92155 | |
| 43.18 x 7.96 x 132.97 | | MB | | | 57.40 x 8.02 x 15.07 | |
| V90114 | 0415 3773 | | 45° | | | |
| 43.13 x 7.96 x 132.97 | | MD cr | | | | |
| V90051 | 0415 3697 | | 45° | | | |
| 37.11 x 7.94 x 133.27 | | MD cr | | | | |

29 **102.00**

| | | | | | | | |
|------------------|-----------------|--------|-----------------|------------------|--------|-------------------|----------------|
| BF 4L 913 | 4086cc | 4 Cyl. | 8 Valves | 47-81kW/64-110PS | Diesel | Turbo, OHV | TD17203 |
| AGROPRIMA | 01/1989→12/1995 | | AGROSTAR | | | 01/1990→12/1993 | |
| AGROXTRA | 01/1991→12/1995 | | SERIE 6 | | | 01/2005→ | |
| STARK | 01/1995→12/1999 | | | | | | |

| | | | | | | |
|-----------------------|-----------|------------|-----|---|----------------------|--|
| V94757 | 0415 9140 | | 30° | H | VAG92155 | |
| 43.00 x 7.96 x 133.00 | | MD + MB cr | | | 57.40 x 8.02 x 15.07 | |

30 **102.00**

| | | | | | | | |
|--------------------|--------|--------|-----------------|-------------------|--------|-------------------|----------------|
| BF 4L 913 C | 4086cc | 4 Cyl. | 8 Valves | 78-92kW/106-125PS | Diesel | Turbo, OHV | TD21059 |
|--------------------|--------|--------|-----------------|-------------------|--------|-------------------|----------------|

| | | | | | | |
|-----------------------|-----------|------------|-----|---|----------------------|--|
| V90050 | 0415 3629 | | 45° | H | VAG92155 | |
| 43.18 x 7.96 x 132.97 | | MB | | | 57.40 x 8.02 x 15.07 | |
| V90114 | 0415 3773 | | 45° | | | |
| 43.13 x 7.96 x 132.97 | | MD cr | | | | |
| V94757 | 0415 9140 | | 30° | H | | |
| 43.00 x 7.96 x 133.00 | | MD + MB cr | | | | |
| V90051 | 0415 3697 | | 45° | | | |
| 37.11 x 7.94 x 133.27 | | MD cr | | | | |

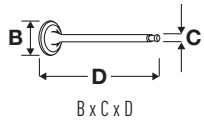

OE

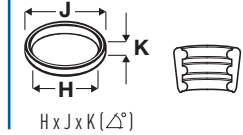
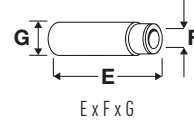
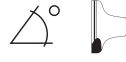

31 102.00

| Part No. | Capacity | Cyls | Valves | Power | Fuel | Configuration | Code |
|-------------|-----------------|--------|----------|------------------|--------|-----------------|---------|
| BF 4L 913 T | 4086cc | 4 Cyl. | 8 Valves | 60-78kW/82-106PS | Diesel | Turbo, OHV | TD18347 |
| F 4L 913 D | 4086cc | 4 Cyl. | 8 Valves | 34-66kW/46-90PS | Diesel | OHV | TD17202 |
| AGROLUX | 01/2000→12/2008 | | | AGROPLUS | | 01/1996→12/2004 | |
| AGROPRIMA | 01/1989→12/1995 | | | AGROXTRA | | 01/1991→12/1995 | |
| D07 | 01/1981→12/1984 | | | D-Series | | 01/1971→ | |
| DX | 01/1982→ | | | Farmer | | 01/1983→ | |
| GT | 01/1984→ | | | SERIE 6 | | 01/2005→ | |
| STARK | 01/1995→08/2001 | | | | | | |

| | | | | | | |
|--|-----------|--|-----|---|---|--|
| V90050 ■ 43.18 x 7.96 x 132.97 | 0415 3629 | | 45° | H | VAG92155 ■ ■ ■ 57.40 x 8.02 x 15.07 | |
| V90114 ■ 43.13 x 7.96 x 132.97 | 0415 3773 | | 45° | | | |
| V90051 ■ 37.11 x 7.94 x 133.27 | 0415 3697 | | 45° | | | |

32 102.00

| Part No. | Capacity | Cyls | Valves | Power | Fuel | Configuration | Code |
|-----------|-----------------|--------|-----------|-------------------|--------|---------------|---------|
| BF 6L 913 | 6128cc | 6 Cyl. | 12 Valves | 70-125kW/95-170PS | Diesel | Turbo, OHV | TD17205 |
| AGROSTAR | 01/1990→12/1995 | | | DX | | 01/1978→ | |
| Gondola | 01/1987→12/2000 | | | SERIE 6 | | 01/2005→ | |

| | | | | | | |
|--|-----------|--|-----|--|---|--|
| V90114 ■ 43.13 x 7.96 x 132.97 | 0415 3773 | | 45° | | VAG92155 ■ ■ ■ 57.40 x 8.02 x 15.07 | |
| V90051 ■ 37.11 x 7.94 x 133.27 | 0415 3697 | | 45° | | | |

33 102.00

| Part No. | Capacity | Cyls | Valves | Power | Fuel | Configuration | Code |
|-------------|-----------------|--------|-----------|--------------------|--------|-----------------|---------|
| BF 6L 913 C | 6128cc | 6 Cyl. | 12 Valves | 81-162kW/110-220PS | Diesel | Turbo, OHV | TD17206 |
| F 6L 913 D | 6128cc | 6 Cyl. | 12 Valves | 51-101kW/69-138PS | Diesel | OHV | TD17204 |
| AGROPRIMA | 01/1991→12/1995 | | | AGROSTAR | | 01/1990→12/1995 | |
| AGROXTRA | 01/1991→12/1995 | | | DX | | 01/1980→ | |
| Gondola | 01/1987→12/2000 | | | GT | | 01/1989→12/1998 | |
| SERIE 6 | 01/2005→ | | | | | | |

| | | | | | | |
|--|-----------|--|-----|---|---|--|
| V90050 ■ 43.18 x 7.96 x 132.97 | 0415 3629 | | 45° | H | VAG92155 ■ ■ ■ 57.40 x 8.02 x 15.07 | |
| V90114 ■ 43.13 x 7.96 x 132.97 | 0415 3773 | | 45° | | | |
| V94757 ■ 43.00 x 7.96 x 133.00 | 0415 9140 | | 30° | H | | |
| V90051 ■ 37.11 x 7.94 x 133.27 | 0415 3697 | | 45° | | | |



OE

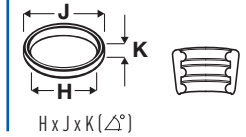
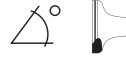

34 **102.00**

| | | | | | | | |
|-----------------------|-----------|-----------------|------------------|--------------------|----------------------|-------------------|----------------|
| BF 6L 913 T | 6128cc | 6 Cyl. | 12 Valves | 85-112kW/115-152PS | Diesel | Turbo, OHV | TD18350 |
| AGROSTAR | | 01/1990→12/1996 | | | | | |
| V90050 | 0415 3629 | | 45° | H | VAG92155 | | |
| 43.18 x 7.96 x 132.97 | | MB | | | 57.40 x 8.02 x 15.07 | | |
| V90114 | 0415 3773 | | 45° | | | | |
| 43.13 x 7.96 x 132.97 | | MD cr | | | | | |
| V90051 | 0415 3697 | | 45° | | | | |
| 37.11 x 7.94 x 133.27 | | MD cr | | | | | |

35 **108.00**

| | | | | | | | |
|-----------------------|-----------|------------|-----------------|---------------------|--------|----------------------|----------------|
| BF 4M 1013 | 4764cc | 4 Cyl. | 8 Valves | 84-93kW/114-126PS | Diesel | Turbo | TD17246 |
| BF 4M 1013 C | 4764cc | 4 Cyl. | 8 Valves | 104-115kW/141-156PS | Diesel | Turbo | TD17247 |
| BF 4M 1013 E | 4764cc | 4 Cyl. | 8 Valves | 77-95kW/105-129PS | Diesel | Turbo | TD17244 |
| BF 4M 1013 EC | 4764cc | 4 Cyl. | 8 Valves | 92-125kW/125-170PS | Diesel | Turbo | TD17241 |
| V95102 | 0420 4014 | | 30° | Y | H | VAG96328 | |
| 48.00 x 8.98 x 139.00 | | MB cr | | | | 62.80 x 9.05 x 15.04 | |
| V95024 | 0420 4015 | | 45° | | H | | |
| 42.00 x 8.95 x 138.95 | | MD + MB cr | | | | | |
| V95103 | 0420 4015 | | 45° | | H | | |
| 42.00 x 8.96 x 139.00 | | MD + MB cr | | | | | |

36 **108.00**

| | | | | | | | |
|-----------------------|-----------|------------|-----------------|---------------------|----------|----------------------|----------------|
| BF 4M 1013 FC | 4764cc | 4 Cyl. | 8 Valves | 105-157kW/143-214PS | Diesel | Turbo | TD20767 |
| D10.5 | | | | NAVIGO | 09/2002→ | | |
| Serie 170 | | 01/2005→ | | Serie 200 | 01/2005→ | | |
| V95102 | 0420 4014 | | 30° | Y | H | VAG96328 | |
| 48.00 x 8.98 x 139.00 | | MB cr | | | | 62.80 x 9.05 x 15.04 | |
| V95103 | 0420 4015 | | 45° | | H | | |
| 42.00 x 8.96 x 139.00 | | MD + MB cr | | | | | |

37 **108.00**

| | | | | | | | |
|-----------------------|-----------|-----------------|------------------|---------------------|----------|----------------------|----------------|
| BF 6M 1013 | 7146cc | 6 Cyl. | 12 Valves | 126-141kW/171-192PS | Diesel | Turbo | TD17248 |
| BF 6M 1013 C | 7146cc | 6 Cyl. | 12 Valves | 153-170kW/208-231PS | Diesel | Turbo | TD17249 |
| BF 6M 1013 CP | 7146cc | 6 Cyl. | 12 Valves | 171-190kW/233-258PS | Diesel | Turbo | TD17250 |
| BF 6M 1013 E | 7146cc | 6 Cyl. | 12 Valves | 85-145kW/115-197PS | Diesel | Turbo | TD17245 |
| BF 6M 1013 EC | 7146cc | 6 Cyl. | 12 Valves | 139-191kW/189-260PS | Diesel | Turbo | TD17242 |
| BF 6M 1013 ECP | 7146cc | 6 Cyl. | 12 Valves | 176-195kW/239-265PS | Diesel | Turbo | TD17243 |
| AGROTRON | | 01/1995→12/2004 | | AS 950 | 09/2004→ | | |
| V95102 | 0420 4014 | | 30° | Y | H | VAG96328 | |
| 48.00 x 8.98 x 139.00 | | MB cr | | | | 62.80 x 9.05 x 15.04 | |
| V95024 | 0420 4015 | | 45° | | H | | |
| 42.00 x 8.95 x 138.95 | | MD + MB cr | | | | | |
| V95103 | 0420 4015 | | 45° | | H | | |
| 42.00 x 8.96 x 139.00 | | MD + MB cr | | | | | |

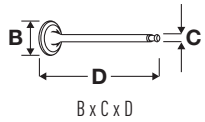

OE

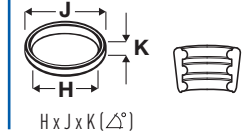
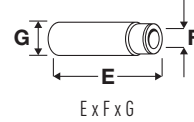
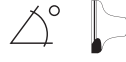

38 108.00

| | | | | | | |
|----------------------|----------|--------|------------------|----------------------------|--------------|----------------|
| BF 6M 1013 FC | 7146cc | 6 Cyl. | 12 Valves | 147-210kW/200-286PS Diesel | Turbo | TD20768 |
| AGROTRON | 01/1998→ | | | COBRA | | |
| D12 | | | | D12F | | |
| D12MEDIS | | | | D13.2MEDIS | | |
| Serie 100 | 01/1996→ | | | | | |

V95102 ■
48.00 x 8.98 x 139.00

0420 4014

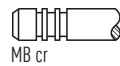

30° Y H

VAG96328 ■ ■
62.80 x 9.05 x 15.04



V95103 ■
42.00 x 8.96 x 139.00

0420 4015



45° H

39 108.00

| | | | | | | |
|------------------------|----------|--------|------------------|----------------------------|-------------------|----------------|
| TCD 2013 L06 4V | 7146cc | 6 Cyl. | 24 Valves | 147-243kW/200-330PS Diesel | Turbo, OHV | TD29652 |
| TCD 2013 L6 4V | 7146cc | 6 Cyl. | 24 Valves | 147-243kW/200-330PS Diesel | Turbo, OHV | TD20765 |
| AGROTRON | 01/2006→ | | | AVANCITY | 10/2008→ | |
| KENT | 09/2009→ | | | LEMBERG | 01/2012→ | |
| TERRITO | 09/2010→ | | | | | |

V95164 ■
38.20 x 7.96 x 145.80

7420 833 932

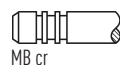

30° ss H

VAG96382 ■ ■
58.30 x 7.50 x 13.03



V95165 ■
35.75 x 7.95 x 145.80

7420 833 936



45° H

40 120.00

| | | | | | | |
|-------------------|--------|--------|-----------------|-------------------|-------------|----------------|
| F 4L 413 R | 5880cc | 4 Cyl. | 8 Valves | 90kW/122PS Diesel | SOHC | TD19026 |
|-------------------|--------|--------|-----------------|-------------------|-------------|----------------|

V90418 ■
46.60 x 9.92 x 165.40

0241 2165

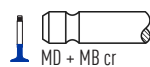

45° H

VAG96211 ■
90.00 x 10.02 x 16.06

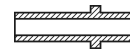

VAG92492 ■
78.00 x 10.00 x 16.00

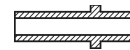

41 120.00

| | | | | | | |
|-------------------|--------|--------|------------------|---------------------------|--|----------------|
| F 5L 413 R | 7350cc | 5 Cyl. | 10 Valves | 83-112kW/113-152PS Diesel | | TD17881 |
|-------------------|--------|--------|------------------|---------------------------|--|----------------|

V90418 ■
46.60 x 9.92 x 165.40

0241 2165

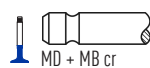

45° H

VAG96211 ■
90.00 x 10.02 x 16.06

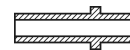

VAG92492 ■
78.00 x 10.00 x 16.00

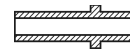

42 120.00

| | | | | | | |
|------------------|--------|---------|------------------|---------------------------|-------------------|----------------|
| BF 6L 413 | 8478cc | V6 Cyl. | 12 Valves | 99-154kW/135-209PS Diesel | Turbo, OHV | TD19027 |
| F 6L 413 | 8478cc | V6 Cyl. | 12 Valves | 99-130kW/135-177PS Diesel | OHV | TD18362 |

V90418 ■
46.60 x 9.92 x 165.40

0241 2165

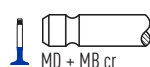

45° H

VAG96211 ■
90.00 x 10.02 x 16.06



VAG92492 ■
78.00 x 10.00 x 16.00





OE

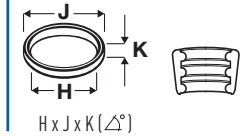
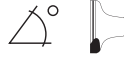

43  **120.00**

F 6L 413 R 8822cc V6 Cyl. 12 Valves 100-135kW/136-184PS Diesel TD17884

V90418  46.60 x 9.92 x 165.40

0241 2165



45°

H

VAG96211  90.00 x 10.02 x 16.06



VAG92492  78.00 x 10.00 x 16.00

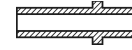

44  **120.00**

BF 8L 413 11310cc V8 Cyl. 16 Valves 99-206kW/135-280PS Diesel Turbo TD19025

F 8L 413 11310cc V8 Cyl. 16 Valves 169kW/230PS Diesel OHV TD18363

V90418  46.60 x 9.92 x 165.40

0241 2165



45°

H

VAG96211  90.00 x 10.02 x 16.06

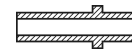

VAG92492  78.00 x 10.00 x 16.00

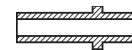

45  **120.00**

F 10L 413 14140cc V10 Cyl. 20 Valves 167-224kW/227-305PS Diesel OHV TD18352

V90418  46.60 x 9.92 x 165.40

0241 2165



45°

H

VAG96211  90.00 x 10.02 x 16.06

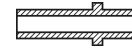

VAG92492  78.00 x 10.00 x 16.00

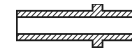

46  **120.00**

F 12L 413 16960cc V12 Cyl. 24 Valves 250kW/340PS Diesel TD18354

V90418  46.60 x 9.92 x 165.40

0241 2165



45°

H

VAG96211  90.00 x 10.02 x 16.06

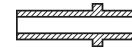

VAG92492  78.00 x 10.00 x 16.00

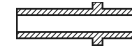

47  **120.00**

BF 12L 413 16964cc V12 Cyl. 24 Valves 305kW/415PS Diesel Turbo, OHV TD18345

V90418  46.60 x 9.92 x 165.40

0241 2165



45°

H

VAG96211  90.00 x 10.02 x 16.06

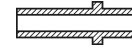

VAG92492  78.00 x 10.00 x 16.00

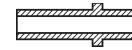

48  **125.00**

F 4L 413 FR 6381cc 4 Cyl. 8 Valves 94kW/128PS Diesel SOHC TD18340

V90418  46.60 x 9.92 x 165.40

0241 2165



45°

H

VAG96211  90.00 x 10.02 x 16.06

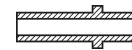

VAG92492  78.00 x 10.00 x 16.00

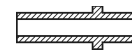

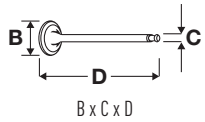

OE

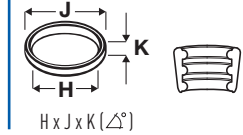
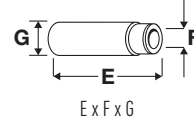
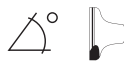

49 125.00

| | | | | | | | |
|---------------|-----------------------|------------|-----------|--------------------|-----------------------|--|---------|
| F 5L 413 FR | 7976cc | 5 Cyl. | 10 Valves | 94-118kW/128-160PS | Diesel | | TD17882 |
| V90418 | 0241 2165 | MD + MB cr | 45° | H | VAG96211 | | |
| | 46.60 x 9.92 x 165.40 | | | | VAG92492 | | |
| | | | | | 90.00 x 10.02 x 16.06 | | |
| | | | | | 78.00 x 10.00 x 16.00 | | |

50 125.00

| | | | | | | | |
|---------------|-----------------------|-----------------|-----------|---------------------|-----------------------|------------|---------|
| BF 6L 413 FR | 9572cc | V6 Cyl. | 12 Valves | 143-177kW/194-241PS | Diesel | Turbo, OHV | TD19028 |
| BF 6L 413 FW | 9572cc | V6 Cyl. | 12 Valves | 112-121kW/152-165PS | Diesel | Turbo, OHV | TD21276 |
| BF 6L 513 | 9572cc | V6 Cyl. | 12 Valves | 141-210kW/192-286PS | Diesel | Turbo, OHV | TD19240 |
| BF 6L 513 C | 9572cc | V6 Cyl. | 12 Valves | 112-177kW/152-241PS | Diesel | Turbo | TD21275 |
| F 6L 413 F | 9572cc | V6 Cyl. | 12 Valves | 104-188kW/141-256PS | Diesel | | TD18341 |
| F 6L 413 FR | 9572cc | V6 Cyl. | 12 Valves | 112-141kW/152-192PS | Diesel | | TD21274 |
| F 6L 413 FW | 9572cc | V6 Cyl. | 12 Valves | 96-121kW/131-165PS | Diesel | | TD17883 |
| AGROSTAR | | 01/1993→12/1996 | | DX | | 01/1980→ | |
| V90418 | 0241 2165 | MD + MB cr | 45° | H | VAG96211 | | |
| | 46.60 x 9.92 x 165.40 | | | | VAG92492 | | |
| | | | | | 90.00 x 10.02 x 16.06 | | |
| | | | | | 78.00 x 10.00 x 16.00 | | |

51 125.00

| | | | | | | | |
|---------------|-----------------------|------------|-----------|---------------------|-----------------------|-------|---------|
| BF 8L 413 F | 12763cc | V8 Cyl. | 16 Valves | 212-235kW/288-320PS | Diesel | Turbo | TD18351 |
| BF 8L 513 | 12763cc | V8 Cyl. | 16 Valves | 235-250kW/320-340PS | Diesel | Turbo | TD18495 |
| F 8L 413 F | 12763cc | V8 Cyl. | 16 Valves | 147-188kW/200-256PS | Diesel | | TD18342 |
| F 8L 413 FW | 12763cc | V8 Cyl. | 16 Valves | 129-150kW/175-204PS | Diesel | OHV | TD17885 |
| V90418 | 0241 2165 | MD + MB cr | 45° | H | VAG96211 | | |
| | 46.60 x 9.92 x 165.40 | | | | VAG92492 | | |
| | | | | | 90.00 x 10.02 x 16.06 | | |
| | | | | | 78.00 x 10.00 x 16.00 | | |

52 125.00

| | | | | | | | |
|---------------|-----------------------|------------|-----------|---------------------|-----------------------|------------|---------|
| BF 10L 513 F | 15945cc | V10 Cyl. | 20 Valves | 253-294kW/344-400PS | Diesel | Turbo, OHV | TD19241 |
| V90418 | 0241 2165 | MD + MB cr | 45° | H | VAG96211 | | |
| | 46.60 x 9.92 x 165.40 | | | | VAG92492 | | |
| | | | | | 90.00 x 10.02 x 16.06 | | |
| | | | | | 78.00 x 10.00 x 16.00 | | |



OE

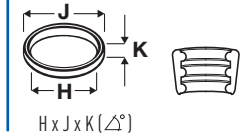

53



125.00

| | | | | | | | |
|---------------|---------|----------|-----------|---------------------|--------|------------|---------|
| BF 10L 413 F | 15953cc | V10 Cyl. | 20 Valves | 265-294kW/360-400PS | Diesel | Turbo, OHV | TD18344 |
| BF 10L 413 FW | 15953cc | V10 Cyl. | 20 Valves | 265-294kW/360-400PS | Diesel | Turbo, OHV | TD21061 |
| BF 10L 513 | 15953cc | V10 Cyl. | 20 Valves | 218-305kW/296-415PS | Diesel | Turbo | TD18127 |
| BF 10L 513 C | 15953cc | V10 Cyl. | 20 Valves | 265-294kW/360-400PS | Diesel | Turbo | TD21060 |
| F 10L 413 F | 15953cc | V10 Cyl. | 20 Valves | 235kW/320PS | Diesel | OHV | TD18353 |
| F 10L 413 FW | 15953cc | V10 Cyl. | 20 Valves | 161-202kW/219-275PS | Diesel | OHV | TD17886 |
| F 10L 513 F | 15953cc | V10 Cyl. | 20 Valves | 235-294kW/320-400PS | Diesel | OHV | TD19242 |

V90418 46.60 x 9.92 x 165.40

0241 2165



45°

H

VAG96211 90.00 x 10.02 x 16.06

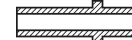

VAG92492 78.00 x 10.00 x 16.00



54



125.00

| | | | | | | | |
|--------------|---------|----------|-----------|---------------------|--------|------------|---------|
| BF 12L 413 F | 19144cc | V12 Cyl. | 24 Valves | 268-353kW/364-480PS | Diesel | Turbo, OHV | TD18344 |
| BF 12L 513 | 19144cc | V12 Cyl. | 24 Valves | 353-367kW/480-499PS | Diesel | Turbo, OHV | TD18496 |
| BF 12L 513 F | 19144cc | V12 Cyl. | 24 Valves | 282-353kW/384-480PS | Diesel | Turbo, OHV | TD19029 |
| F 12L 413 F | 19144cc | V12 Cyl. | 24 Valves | 224-282kW/305-384PS | Diesel | OHV | TD18355 |
| F 12L 413 FW | 19144cc | V12 Cyl. | 24 Valves | 193-243kW/262-330PS | Diesel | | TD17888 |
| F 12L 513 F | 19144cc | V12 Cyl. | 24 Valves | 193-405kW/262-551PS | Diesel | | TD21062 |

V90418 46.60 x 9.92 x 165.40

0241 2165



45°

H

VAG96211 90.00 x 10.02 x 16.06

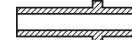

VAG92492 78.00 x 10.00 x 16.00



55



128.00

| | | | | | | | |
|----------|---------|---------|-----------|---------------------|--------|------|---------|
| F 8L 513 | 13382cc | V8 Cyl. | 16 Valves | 155-194kW/211-264PS | Diesel | SOHC | TD18343 |
|----------|---------|---------|-----------|---------------------|--------|------|---------|

V90418 46.60 x 9.92 x 165.40

0241 2165



45°

H

VAG96211 90.00 x 10.02 x 16.06

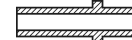

VAG92492 78.00 x 10.00 x 16.00

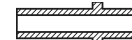

56



128.00

| | | | | | | | |
|-----------|---------|----------|-----------|---------------------|--------|--|---------|
| F 10L 513 | 16728cc | V10 Cyl. | 20 Valves | 188-242kW/256-329PS | Diesel | | TD17887 |
|-----------|---------|----------|-----------|---------------------|--------|--|---------|

V90418 46.60 x 9.92 x 165.40

0241 2165



45°

H

VAG96211 90.00 x 10.02 x 16.06

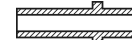

VAG92492 78.00 x 10.00 x 16.00



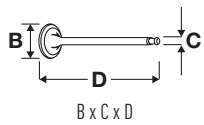

OE

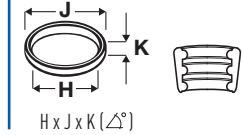
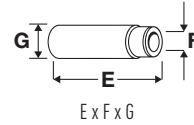
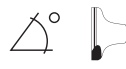

57 128.00

| | | | | | | | |
|--------------|---------|----------|-----------|---------------------|--------|-----|---------|
| BF 12L 513 | 20074cc | V12 Cyl. | 24 Valves | 282kW/384PS | Diesel | OHV | TD18492 |
| BF 12L 513 L | 20074cc | V12 Cyl. | 24 Valves | 231-291kW/318-396PS | Diesel | | TD21058 |

V90418 46.60 x 9.92 x 165.40

0241 2165



45°

H

VAG96211 90.00 x 10.02 x 16.06

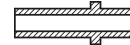

VAG92492 78.00 x 10.00 x 16.00



58 132.00

| | | | | | | | |
|---------------|---------|---------|-----------|---------------------|--------|------------|---------|
| BF 6M 1015 | 11905cc | V6 Cyl. | 24 Valves | 195-250kW/265-340PS | Diesel | Turbo, OHV | TD17254 |
| BF 6M 1015 CU | 11905cc | V6 Cyl. | 24 Valves | 226-305kW/307-415PS | Diesel | Turbo, OHV | TD29627 |
| TCD 2015 V6 | 11905cc | V6 Cyl. | 24 Valves | 360kW/490PS | Diesel | Turbo, OHV | TD20091 |

V95227 42.00 x 7.96 x 133.00

0422 0142

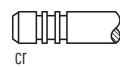

45°

H

59 132.00

| | | | | | | | |
|---------------|---------|---------|-----------|---------------------|--------|------------|---------|
| BF 6M 1015 C | 11905cc | V6 Cyl. | 24 Valves | 250-345kW/340-469PS | Diesel | Turbo, OHV | TD17252 |
| BF 6M 1015 CP | 11905cc | V6 Cyl. | 24 Valves | 300-384kW/408-522PS | Diesel | Turbo, OHV | TD17255 |

Gondola 01/1991→12/1997

V95226 46.00 x 7.97 x 132.80

0422 5353



30°

ss

H

V95227 42.00 x 7.96 x 133.00

0422 0142

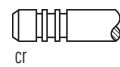

45°

H

60 132.00

| | | | | | | | |
|------------|---------|---------|-----------|-------------|--------|--|---------|
| BF 8M 1015 | 15874cc | V8 Cyl. | 32 Valves | 290kW/394PS | Diesel | | TD18499 |
|------------|---------|---------|-----------|-------------|--------|--|---------|

V95227 42.00 x 7.96 x 133.00

0422 0142

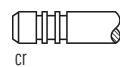

45°

H

61 132.00

| | | | | | | | |
|---------------|---------|---------|-----------|---------------------|--------|------------|---------|
| BF 8M 1015 C | 15874cc | V8 Cyl. | 32 Valves | 333-459kW/453-624PS | Diesel | Turbo | TD17253 |
| BF 8M 1015 CP | 15874cc | V8 Cyl. | 32 Valves | 399-517kW/543-703PS | Diesel | Turbo | TD17256 |
| TCD 2015 V8 | 15874cc | V8 Cyl. | 32 Valves | 500kW/680PS | Diesel | Turbo, OHV | TD20092 |

6 05/2004→

V95226 46.00 x 7.97 x 132.80

0422 5353



30°

ss

H





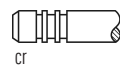

V95227 42.00 x 7.96 x 133.00





0422 0142















45°







H

|  |  | ccm |  |  |  |  |
|---|---|------|---|---|---|---|
| 100 GF.000 | 65.00 | 903 | 4 | 8 | Petrol | 2 |
| 100 GL.000 | 65.00 | 903 | 4 | 8 | Petrol | 2 |
| 100 GL.048 | 65.00 | 903 | 4 | 8 | Petrol | 2 |
| 100 GL3.000 | 65.00 | 903 | 4 | 8 | Petrol | 2 |
| 110 F.000 | 67.40 | 499 | 2 | 4 | Petrol | 8 |
| 1170 A1.000 | 65.00 | 899 | 4 | 8 | Petrol | 1 |
| 1170 A1.046 | 65.00 | 899 | 4 | 8 | Petrol | 1 |
| 120.000 | 67.40 | 499 | 2 | 4 | Petrol | 8 |
| 126 A.000 | 73.50 | 594 | 2 | 4 | Petrol | 26 |
| 126 A1.000 | 77.00 | 652 | 2 | 4 | Petrol | 35 |
| 126 A1.048 | 77.00 | 652 | 2 | 4 | Petrol | 35 |
| 126 A2.000 | 80.00 | 704 | 2 | 4 | Petrol | 41 |
| 126 A2.048 | 80.00 | 704 | 2 | 4 | Petrol | 41 |
| 127 A.000 | 65.00 | 903 | 4 | 8 | Petrol | 3 |
| 127 A1.000 | 76.00 | 1049 | 4 | 8 | Petrol | 30 |
| 127 A3.000 | 76.00 | 1301 | 4 | 8 | Petrol | 32 |
| 127 A5.000 | 76.00 | 1301 | 4 | 8 | Diesel | 33 |
| 127 A6.000 | 76.00 | 1049 | 4 | 8 | Petrol | 30 |
| 128 A 064 | 80.00 | 1116 | 4 | 8 | Petrol | 42 |
| 128 A.000 | 80.00 | 1116 | 4 | 8 | Petrol | 42 |
| 128 A.048 | 80.00 | 1116 | 4 | 8 | Petrol | 42 |
| 128 A1.000 | 86.00 | 1290 | 4 | 8 | Petrol | 86 |
| 128 AC.000 | 86.00 | 1290 | 4 | 8 | Petrol | 86 |
| 128 AC5.000 | 80.00 | 1116 | 4 | 8 | Petrol | 42 |
| 128 AR.000 | 86.00 | 1290 | 4 | 8 | Petrol | 86 |
| 128 AS.000 | 86.00 | 1290 | 4 | 8 | Petrol | 86 |
| 128 BB.0A0 | 80.00 | 1116 | 4 | 8 | Petrol | 42 |
| 131 B2.000 | 84.00 | 1995 | 4 | 8 | Petrol | 72 |
| 131 C1.000 | 78.00 | 1367 | 4 | 8 | Petrol | 37 |
| 132 C2.000 | 84.00 | 1995 | 4 | 8 | Petrol | 72 |
| 132 D1.000 | 84.00 | 1995 | 4 | 8 | Petrol | 72 |
| 138 A.000 | 86.40 | 1302 | 4 | 8 | Petrol | 92 |
| 138 A1.000 | 86.40 | 1302 | 4 | 8 | Petrol | 92 |
| 138 A2.000 | 86.40 | 1498 | 4 | 8 | Petrol | 93 |
| 138 A3.000 | 86.40 | 1302 | 4 | 8 | Petrol | 92 |
| 138 A4.000 | 86.40 | 1498 | 4 | 8 | Petrol | 93 |
| 138 AE 0A.0 | 80.00 | 1116 | 4 | 8 | Petrol | 42 |
| 138 AR1.000 | 84.00 | 1995 | 4 | 8 | Petrol | 73 |
| 138 AR2.000 | 84.00 | 1995 | 4 | 8 | Petrol | 73 |
| 138 B.000 | 80.00 | 1116 | 4 | 8 | Petrol | 42 |
| 138 B1.000 | 80.00 | 1116 | 4 | 8 | Petrol | 42 |
| 138 B2.000 | 86.40 | 1302 | 4 | 8 | Petrol | 92 |
| 138 B3.000 | 86.40 | 1498 | 4 | 8 | Petrol | 93 |
| 138 B3.048 | 86.40 | 1498 | 4 | 8 | Petrol | 93 |
| 138 C1.000 | 80.00 | 1116 | 4 | 8 | Petrol | 42 |
| 138 C2.048 | 86.40 | 1498 | 4 | 8 | Petrol | 93 |
| 138 C3.048 | 86.40 | 1498 | 4 | 8 | Petrol | 93 |
| 141 A.000 | 77.00 | 652 | 2 | 4 | Petrol | 36 |
| 141 C2.000 | 70.00 | 999 | 4 | 8 | Petrol | 11 |
| 146 A.000 | 65.00 | 903 | 4 | 8 | Petrol | 4 |
| 146 A.048 | 65.00 | 903 | 4 | 8 | Petrol | 5 |
| 146 A1.000 | 65.00 | 903 | 4 | 8 | Petrol | 6 |
| 146 A4.000 | 80.00 | 1116 | 4 | 8 | Petrol | 42 |
| 146 A4.044 | 80.00 | 1116 | 4 | 8 | Petrol | 42 |
| 146 A4.048 | 80.00 | 1116 | 4 | 8 | Petrol | 42 |
| 146 A5.000 | 76.00 | 1301 | 4 | 8 | Petrol | 32 |
| 146 A6.000 | 76.00 | 1116 | 4 | 8 | Petrol | 31 |
| 146 A9.000 | 76.00 | 1116 | 4 | 8 | Petrol | 31 |
| 146 B1.000 | 76.00 | 1301 | 4 | 8 | Diesel | 33 |
| 146 B2.000 | 82.60 | 1698 | 4 | 8 | Diesel | 61 |
| 146 C1.000 | 80.50 | 1372 | 4 | 8 | Petrol | 43 |
| 146 C5.000 | 80.50 | 1372 | 4 | 8 | Petrol | 43 |
| 146 D5.000 | 80.50 | 1372 | 4 | 8 | Petrol | 43 |
| 146 D7.000 | 82.60 | 1698 | 4 | 8 | Diesel | 61 |
| 149 A1.000 | 82.60 | 1929 | 4 | 8 | Diesel | 62 |
| 149 A3.000 | 86.40 | 1302 | 4 | 8 | Petrol | 92 |

| |  | ccm |  |  |  |  |
|------------|---|------|--|---|---|---|
| 149 A5.000 | 86.40 | 1498 | 4 | 8 | Petrol | 93 |
| 149 A7.000 | 86.40 | 1302 | 4 | 8 | Petrol | 92 |
| 149 B1.000 | 82.60 | 1929 | 4 | 8 | Diesel | 62 |
| 149 B3.000 | 82.60 | 1698 | 4 | 8 | Diesel | 61 |
| 149 B4.000 | 82.60 | 1698 | 4 | 8 | Diesel | 61 |
| 149 C1.000 | 86.40 | 1499 | 4 | 8 | Petrol | 94 |
| 154 A1.000 | 84.00 | 1995 | 4 | 8 | Petrol | 73 |
| 154 A2.000 | 84.00 | 1995 | 4 | 8 | Petrol | 73 |
| 154 C3.046 | 84.00 | 1995 | 4 | 8 | Petrol | 72 |
| 154 C4.046 | 84.00 | 1995 | 4 | 8 | Petrol | 73 |
| 154 E1.000 | 84.00 | 1995 | 4 | 16 | Petrol | 74 |
| 156 A.000 | 76.10 | 1049 | 4 | 8 | Petrol | 34 |
| 156 A2.000 | 70.00 | 999 | 4 | 8 | Petrol | 12 |
| 156 A2.048 | 70.00 | 999 | 4 | 8 | Petrol | 12 |
| 156 A2.100 | 70.00 | 999 | 4 | 8 | Petrol | 12 |
| 156 A2.246 | 70.00 | 999 | 4 | 8 | Petrol | 12 |
| 156 A3.000 | 70.00 | 999 | 4 | 8 | Petrol | 12 |
| 156 A3.100 | 70.00 | 999 | 4 | 8 | Petrol | 12 |
| 156 A5.000 | 76.00 | 1301 | 4 | 8 | Diesel | 33 |
| 156 C.046 | 70.00 | 1108 | 4 | 8 | Petrol | 13 |
| 159 A2.000 | 80.50 | 1372 | 4 | 8 | Petrol | 43 |
| 159 A3.000 | 86.40 | 1581 | 4 | 8 | Petrol | 95 |
| 159 A3.046 | 86.40 | 1581 | 4 | 8 | Petrol | 95 |
| 159 A3.048 | 86.40 | 1581 | 4 | 8 | Petrol | 95 |
| 159 A4.000 | 84.00 | 1756 | 4 | 8 | Petrol | 69 |
| 159 A4.046 | 84.00 | 1756 | 4 | 8 | Petrol | 69 |
| 159 A6.046 | 84.00 | 1995 | 4 | 8 | Petrol | 72 |
| 160 A1.000 | 80.50 | 1372 | 4 | 8 | Petrol | 43 |
| 160 A1.046 | 80.50 | 1372 | 4 | 8 | Petrol | 43 |
| 160 A1.048 | 80.50 | 1372 | 4 | 8 | Petrol | 43 |
| 160 A2.000 | 86.40 | 1581 | 4 | 8 | Petrol | 95 |
| 160 A3.000 | 70.00 | 1108 | 4 | 8 | Petrol | 13 |
| 160 A5.000 | 84.00 | 1756 | 4 | 16 | Petrol | 70 |
| 160 A6.000 | 82.60 | 1929 | 4 | 8 | Diesel | 63 |
| 160 A6.046 | 82.60 | 1929 | 4 | 8 | Diesel | 63 |
| 160 A7.000 | 82.60 | 1929 | 4 | 8 | Diesel | 62 |
| 160 B6.046 | 82.60 | 1929 | 4 | 8 | Diesel | 63 |
| 160 D1.000 | 82.60 | 1929 | 4 | 8 | Diesel | 63 |
| 169 A1.000 | 69.60 | 1248 | 4 | 16 | Diesel | 9 |
| 169 A4.000 | 70.80 | 1242 | 4 | 8 | Petrol | 16 |
| 170 A1.000 | 65.00 | 903 | 4 | 8 | Petrol | 6 |
| 170 A1.046 | 65.00 | 903 | 4 | 8 | Petrol | 6 |
| 170 B | 88.00 | 1971 | 4 | 8 | Petrol | 99 |
| 170 D | 88.00 | 1971 | 4 | 8 | Petrol | 99 |
| 175 A1.000 | 84.00 | 1995 | 4 | 16 | Petrol | 75 |
| 175 A3.000 | 82.00 | 1998 | 5 | 20 | Petrol | 55 |
| 176 A3.000 | 82.60 | 1698 | 4 | 8 | Diesel | 61 |
| 176 A5.000 | 82.60 | 1698 | 4 | 8 | Diesel | 61 |
| 176 A6.000 | 70.00 | 1108 | 4 | 8 | Petrol | 13 |
| 176 A7.000 | 70.80 | 1242 | 4 | 8 | Petrol | 17 |
| 176 A8.000 | 70.80 | 1242 | 4 | 8 | Petrol | 18 |
| 176 A9.000 | 86.40 | 1581 | 4 | 8 | Petrol | 96 |
| 176 B1.000 | 70.80 | 1242 | 4 | 8 | Petrol | 18 |
| 176 B2.000 | 70.00 | 1108 | 4 | 8 | Petrol | 14 |
| 176 B3.000 | 82.60 | 1698 | 4 | 8 | Diesel | 61 |
| 176 B4.000 | 70.80 | 1242 | 4 | 8 | Petrol | 17 |
| 176 B7.000 | 82.60 | 1698 | 4 | 8 | Diesel | 61 |
| 176 B9.000 | 70.80 | 1242 | 4 | 16 | Petrol | 19 |
| 178 B3.000 | 86.40 | 1581 | 4 | 16 | Petrol | 97 |
| 178 B5.000 | 70.80 | 1242 | 4 | 8 | Petrol | 18 |
| 178 E2.000 | 70.80 | 1242 | 4 | 8 | Petrol | 18 |
| 182 A1.000 | 82.00 | 1998 | 5 | 20 | Petrol | 55 |
| 182 A2.000 | 82.00 | 1747 | 4 | 16 | Petrol | 47 |
| 182 A3.000 | 82.00 | 1370 | 4 | 12 | Petrol | 46 |
| 182 A4.000 | 86.40 | 1581 | 4 | 16 | Petrol | 97 |
| 182 A5.000 | 82.00 | 1370 | 4 | 12 | Petrol | 46 |

|  |  | ccm |  |  |  |  |
|---|---|------|---|---|---|---|
| 182 A6.000 | 86.40 | 1581 | 4 | 16 | Petrol | 97 |
| 182 A7.000 | 82.00 | 1910 | 4 | 8 | Diesel | 48 |
| 182 A8.000 | 82.00 | 1910 | 4 | 8 | Diesel | 48 |
| 182 B2.000 | 70.80 | 1242 | 4 | 16 | Petrol | 19 |
| 182 B3.000 | 82.00 | 1998 | 5 | 20 | Petrol | 56 |
| 182 B4.000 | 82.00 | 1910 | 4 | 8 | Diesel | 49 |
| 182 B6.000 | 80.50 | 1596 | 4 | 16 | Petrol | 44 |
| 182 B7.000 | 82.00 | 1998 | 5 | 20 | Petrol | 56 |
| 182 B9.000 | 82.00 | 1910 | 4 | 8 | Diesel | 49 |
| 183 A1.000 | 82.00 | 1747 | 4 | 16 | Petrol | 47 |
| 185 A2.000 | 82.00 | 2387 | 5 | 10 | Diesel | 57 |
| 185 A3.000 | 86.40 | 1581 | 4 | 16 | Petrol | 97 |
| 185 A6.000 | 82.00 | 2387 | 5 | 10 | Diesel | 58 |
| 185 A8.000 | 82.00 | 1998 | 5 | 20 | Petrol | 56 |
| 185 B4.000 | 82.00 | 1910 | 4 | 8 | Diesel | 50 |
| 186 A3.000 | 86.40 | 1581 | 4 | 16 | Petrol | 97 |
| 186 A4.000 | 86.40 | 1581 | 4 | 16 | Petrol | 97 |
| 186 A6.000 | 82.00 | 1910 | 4 | 8 | Diesel | 49 |
| 186 A8.000 | 82.00 | 1910 | 4 | 8 | Diesel | 50 |
| 186 A9.000 | 82.00 | 1910 | 4 | 8 | Diesel | 49 |
| 187 A1.000 | 70.00 | 1108 | 4 | 8 | Petrol | 15 |
| 188 A2.000 | 82.00 | 1910 | 4 | 8 | Diesel | 49 |
| 188 A3.000 | 82.00 | 1910 | 4 | 8 | Diesel | 51 |
| 188 A4.000 | 70.80 | 1242 | 4 | 8 | Petrol | 20 |
| 188 A5.000 | 70.80 | 1242 | 4 | 16 | Petrol | 21 |
| 188 A6.000 | 82.00 | 1747 | 4 | 16 | Petrol | 47 |
| 188 A7.000 | 82.00 | 1910 | 4 | 8 | Diesel | 49 |
| 188 A8.000 | 69.60 | 1248 | 4 | 16 | Diesel | 9 |
| 188 A9.000 | 69.60 | 1248 | 4 | 16 | Diesel | 9 |
| 188 B2.000 | 82.00 | 1910 | 4 | 8 | Diesel | 50 |
| 192 A1.000 | 82.00 | 1910 | 4 | 8 | Diesel | 50 |
| 192 A2.000 | 83.00 | 2446 | 5 | 20 | Petrol | 68 |
| 192 A3.000 | 82.00 | 1910 | 4 | 8 | Diesel | 49 |
| 192 A4.000 | 82.00 | 1747 | 4 | 16 | Petrol | 47 |
| 192 A5.000 | 82.00 | 1910 | 4 | 16 | Diesel | 52 |
| 192 A8.000 | 82.00 | 1910 | 4 | 8 | Diesel | 50 |
| 192 A9.000 | 82.00 | 1910 | 4 | 8 | Diesel | 50 |
| 192 B1.000 | 82.00 | 1910 | 4 | 16 | Diesel | 52 |
| 192 B2.000 | 72.00 | 1368 | 4 | 16 | Petrol | 22 |
| 192 B3.000 | 79.00 | 1598 | 4 | 16 | Petrol | 39 |
| 192 B5.000 | 82.00 | 1910 | 4 | 8 | Diesel | 50 |
| 194 A1.000 | 86.00 | 2198 | 4 | 16 | Petrol | 90 |
| 198 A1.000 | 72.00 | 1368 | 4 | 16 | Petrol | 23 |
| 198 A2.000 | 79.50 | 1598 | 4 | 16 | Diesel | 40 |
| 198 A4.000 | 72.00 | 1368 | 4 | 16 | Petrol | 23 |
| 198 A5.000 | 83.00 | 1956 | 4 | 16 | Diesel | 67 |
| 198 A6.000 | 79.50 | 1598 | 4 | 16 | Diesel | 40 |
| 199 A2.000 | 69.60 | 1248 | 4 | 16 | Diesel | 9 |
| 199 A3.000 | 69.60 | 1248 | 4 | 16 | Diesel | 10 |
| 199 A4.000 | 70.80 | 1242 | 4 | 8 | Petrol | 16 |
| 199 A5.000 | 82.00 | 1910 | 4 | 8 | Diesel | 50 |
| 199 A6.000 | 72.00 | 1368 | 4 | 16 | Petrol | 24 |
| 199 A7.000 | 72.00 | 1368 | 4 | 8 | Petrol | 25 |
| 199 A8.000 | 72.00 | 1368 | 4 | 16 | Petrol | 23 |
| 199 A9.000 | 69.60 | 1248 | 4 | 16 | Diesel | 10 |
| 199 B1.000 | 69.60 | 1248 | 4 | 16 | Diesel | 10 |
| 199 B2.000 | 69.60 | 1248 | 4 | 16 | Diesel | 10 |
| 199 B4.000 | 69.60 | 1248 | 4 | 16 | Diesel | 10 |
| 199 B5.000 | 79.50 | 1598 | 4 | 16 | Diesel | 40 |
| 199 B8.000 | 69.60 | 1248 | 4 | 16 | Diesel | 10 |
| 220 A 2.000 | 86.40 | 1581 | 4 | 8 | Petrol | 98 |
| 223 A5.000 | 70.80 | 1242 | 4 | 8 | Petrol | 20 |
| 223 A6.000 | 82.00 | 1910 | 4 | 8 | Diesel | 51 |
| 223 A9.000 | 69.60 | 1248 | 4 | 16 | Diesel | 10 |
| 223 B2.000 | 82.00 | 1910 | 4 | 8 | Diesel | 50 |
| 230 A2.000 | 82.60 | 1929 | 4 | 8 | Diesel | 62 |

|  |  | ccm |  |  |  |  |
|---|---|------|--|---|---|---|
| 230 A3.000 | 82.60 | 1929 | 4 | 8 | Diesel | 62 |
| 230 A4.000 | 82.60 | 1929 | 4 | 8 | Diesel | 62 |
| 263 A4.000 | 79.50 | 1598 | 4 | 16 | Diesel | 40 |
| 280 A1.000 | 82.60 | 1929 | 4 | 8 | Diesel | 62 |
| 312 A1.000 | 72.00 | 1368 | 4 | 16 | Petrol | 23 |
| 350 A1.000 | 72.00 | 1368 | 4 | 8 | Petrol | 25 |
| 350 A2.000 | 79.50 | 1598 | 4 | 16 | Diesel | 40 |
| 350 A3.000 | 79.50 | 1598 | 4 | 16 | Diesel | 40 |
| 4HT (DW12BTED4) | 85.00 | 2179 | 4 | 16 | Diesel | 84 |
| 4HU (P22 DTE PUMA) | 86.00 | 2198 | 4 | 16 | Diesel | 91 |
| 4HV (P22 DTE PUMA) | 86.00 | 2198 | 4 | 16 | Diesel | 91 |
| 4HW (DW12ATED4) | 85.00 | 2179 | 4 | 16 | Diesel | 85 |
| 4HX (DW12TED4) | 85.00 | 2179 | 4 | 16 | Diesel | 85 |
| 8030.00 | 95.00 | 2340 | 3 | 6 | Diesel | 108 |
| 8040.00 | 95.00 | 3120 | 4 | 8 | Diesel | 109 |
| 8140.27 | 93.00 | 2500 | 4 | 8 | Diesel | 104 |
| 8140.27.2100 | 93.00 | 2500 | 4 | 8 | Diesel | 104 |
| 8140.43 | 94.40 | 2800 | 4 | 8 | Diesel | 105 |
| 8140.43N | 94.40 | 2800 | 4 | 8 | Diesel | 106 |
| 8140.43S | 94.40 | 2800 | 4 | 8 | Diesel | 106 |
| 8140.47 | 93.00 | 2500 | 4 | 8 | Diesel | 104 |
| 8140.47.3700 | 93.00 | 2500 | 4 | 8 | Diesel | 104 |
| 8140.47R | 93.00 | 2500 | 4 | 8 | Diesel | 104 |
| 8140.61 | 93.00 | 2445 | 4 | 8 | Diesel | 103 |
| 8140.61.204 | 93.00 | 2445 | 4 | 8 | Diesel | 103 |
| 8140.63 | 94.40 | 2800 | 4 | 8 | Diesel | 107 |
| 8140.67 | 93.00 | 2500 | 4 | 8 | Diesel | 104 |
| 8144.21 | 93.00 | 2445 | 4 | 8 | Diesel | 103 |
| 8144.21.220 | 93.00 | 2445 | 4 | 8 | Diesel | 103 |
| 8144.61 | 93.00 | 2445 | 4 | 8 | Diesel | 103 |
| 8144.61.200 (Sofim) | 93.00 | 2445 | 4 | 8 | Diesel | 103 |
| 8144.61.500.81 | 93.00 | 2445 | 4 | 8 | Diesel | 103 |
| 8144.67 | 93.00 | 2500 | 4 | 8 | Diesel | 104 |
| 8144.67.220 | 93.00 | 2500 | 4 | 8 | Diesel | 104 |
| 8144.81.2000 | 93.00 | 2500 | 4 | 8 | Diesel | 104 |
| 8144.91.2000 | 93.00 | 2445 | 4 | 8 | Diesel | 103 |
| 8144.97 | 93.00 | 2500 | 4 | 8 | Diesel | 104 |
| 8144.97 S | 93.00 | 2500 | 4 | 8 | Diesel | 104 |
| 8144.97 Y | 93.00 | 2500 | 4 | 8 | Diesel | 104 |
| 831 D1.000 | 82.60 | 1929 | 4 | 8 | Diesel | 63 |
| 834 B.000 | 84.00 | 1995 | 4 | 8 | Petrol | 73 |
| 834 B.048 | 84.00 | 1995 | 4 | 8 | Petrol | 73 |
| 834 B.146 | 84.00 | 1995 | 4 | 8 | Petrol | 73 |
| 834 C.146 | 84.00 | 1995 | 4 | 8 | Petrol | 73 |
| 835 C1.000 | 86.40 | 1581 | 4 | 8 | Petrol | 96 |
| 835 C2.000 | 84.00 | 1756 | 4 | 8 | Petrol | 71 |
| 835 C4.000 | 84.00 | 1756 | 4 | 8 | Petrol | 71 |
| 836 A3.000 | 84.00 | 1995 | 4 | 16 | Petrol | 74 |
| 836 A4.000 | 80.50 | 1372 | 4 | 8 | Petrol | 43 |
| 836 A5.000 | 84.00 | 1756 | 4 | 8 | Petrol | 71 |
| 836 A6.000 | 84.00 | 1756 | 4 | 8 | Petrol | 71 |
| 839 A5.000 | 82.00 | 2387 | 5 | 10 | Diesel | 58 |
| 843 A1.000 | 72.00 | 1368 | 4 | 16 | Petrol | 22 |
| 844 A2.000 | 83.00 | 1956 | 4 | 16 | Diesel | 67 |
| 937 A4.000 | 82.00 | 1910 | 4 | 16 | Diesel | 53 |
| 937 A5.000 | 82.00 | 1910 | 4 | 16 | Diesel | 54 |
| 937 A7.000 | 82.00 | 1910 | 4 | 8 | Diesel | 50 |
| 939 A1.000 | 82.00 | 1910 | 4 | 8 | Diesel | 50 |
| 939 A2.000 | 82.00 | 1910 | 4 | 16 | Diesel | 52 |
| 939 A3.000 | 82.00 | 2387 | 5 | 20 | Diesel | 59 |
| 939 A4.000 | 80.50 | 1796 | 4 | 16 | Petrol | 45 |
| 939 B5.000 | 83.00 | 1956 | 4 | 16 | Diesel | 67 |
| 940 A5.000 | 83.00 | 1956 | 4 | 16 | Diesel | 67 |
| 955 A2.000 | 72.00 | 1368 | 4 | 16 | Petrol | 23 |
| 955 A3.000 | 79.50 | 1598 | 4 | 16 | Diesel | 40 |
| 955 A4.000 | 79.50 | 1598 | 4 | 16 | Diesel | 40 |

|  |  | ccm |  |  |  |  |
|---|---|------|---|---|---|---|
| 955 A8.000 | 72.00 | 1368 | 4 | 16 | Petrol | 23 |
| 9HM (DV6UC) | 75.00 | 1560 | 4 | 8 | Diesel | 28 |
| 9HU | 75.00 | 1560 | 4 | 16 | Diesel | 29 |
| A 112 B1.054 | 67.20 | 965 | 4 | 8 | Petrol | 7 |
| D19AA | 82.00 | 1910 | 4 | 8 | Diesel | 50 |
| D8B | 83.00 | 1905 | 4 | 8 | Diesel | 65 |
| D8B (XUD9TE) | 83.00 | 1905 | 4 | 8 | Diesel | 65 |
| D9B (XUD9/A/B/L/Y) | 83.00 | 1905 | 4 | 8 | Diesel | 66 |
| D9B (XUD9A) | 83.00 | 1905 | 4 | 8 | Diesel | 66 |
| DHX (XUD9TE) | 83.00 | 1905 | 4 | 8 | Diesel | 65 |
| DHX (XUD9TF/L) | 83.00 | 1905 | 4 | 8 | Diesel | 65 |
| DJY (XUD9A) | 83.00 | 1905 | 4 | 8 | Diesel | 66 |
| DW10 (RHV) | 85.00 | 1997 | 4 | 8 | Diesel | 76 |
| DW10 (RHX) | 85.00 | 1997 | 4 | 8 | Diesel | 76 |
| DW10 (RHZ) | 85.00 | 1997 | 4 | 8 | Diesel | 76 |
| DW10ATED4 (RHM) | 85.00 | 1997 | 4 | 16 | Diesel | 77 |
| DW10ATED4 (RHS) | 85.00 | 1997 | 4 | 16 | Diesel | 77 |
| DW10BTED4 | 85.00 | 1997 | 4 | 16 | Diesel | 78 |
| F1AE0481C | 88.00 | 2287 | 4 | 16 | Diesel | 101 |
| F1AE0481D | 88.00 | 2287 | 4 | 16 | Diesel | 101 |
| F1AE0481N | 88.00 | 2287 | 4 | 16 | Diesel | 101 |
| F1AE3481D | 88.00 | 2287 | 4 | 16 | Diesel | 101 |
| F1CE0481D | 95.80 | 2999 | 4 | 16 | Diesel | 110 |
| KFT | 75.00 | 1360 | 4 | 8 | Petrol | 27 |
| KFV | 75.00 | 1360 | 4 | 8 | Petrol | 27 |
| LFW (XU7 JP) | 83.00 | 1761 | 4 | 8 | Petrol | 64 |
| M16A | 78.00 | 1586 | 4 | 16 | Petrol | 38 |
| P8C (XUD 11 BTE) | 85.00 | 2088 | 4 | 12 | Diesel | 83 |
| RFL (XU10) | 86.00 | 1998 | 4 | 8 | Petrol | 87 |
| RFN (EW10J4) | 85.00 | 1997 | 4 | 16 | Petrol | 79 |
| RFU (XU10J2C) | 86.00 | 1998 | 4 | 8 | Petrol | 87 |
| RFW (XU10J2) | 86.00 | 1998 | 4 | 8 | Petrol | 87 |
| RH02 | 85.00 | 1997 | 4 | 16 | Diesel | 80 |
| RHH | 85.00 | 1997 | 4 | 16 | Diesel | 81 |
| RHK | 85.00 | 1997 | 4 | 16 | Diesel | 78 |
| RHK (DW10UTED4) | 85.00 | 1997 | 4 | 16 | Diesel | 82 |
| RHR | 85.00 | 1997 | 4 | 16 | Diesel | 78 |
| THY (DK5ATE) | 92.00 | 2446 | 4 | 12 | Diesel | 102 |
| WJY (DW8) | 82.20 | 1868 | 4 | 8 | Diesel | 60 |
| WJY (DW8B) | 82.20 | 1868 | 4 | 8 | Diesel | 60 |
| WJZ (DW8) | 82.20 | 1868 | 4 | 8 | Diesel | 60 |
| XN 1T | 88.00 | 1971 | 4 | 8 | Petrol | 100 |
| XU10 (RFV) | 86.00 | 1998 | 4 | 16 | Petrol | 88 |
| XU10J2CTE (RGX) | 86.00 | 1998 | 4 | 8 | Petrol | 89 |

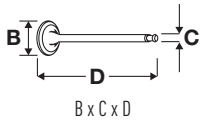

OE

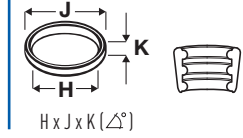
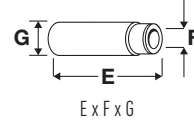
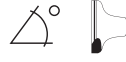

1 **65.00**

| | | | | | | | |
|--|-------|------------------------------------|-----------------|-----------------|--------|-------------|-----------------|
| 1170 A1.000 | 899cc | 4 Cyl. | 8 Valves | 29-30kW/40-41PS | Petrol | SOHC | TD1030 |
| 1170 A1.046 | 899cc | 4 Cyl. | 8 Valves | 29kW/39PS | Petrol | SOHC | TD872 |
| CINQUECENTO 0.9 i.e. S SEICENTO / 600 0.9 | | 07/1991→07/1999 01/1998→01/2010 | | PANDA 900 | | | 04/1992→12/1996 |

| | | | | | | |
|----------------------|-----------|----|-----|---|----------------------|--|
| V34457 | 4 265 695 | | 45° | H | VAG92364 | |
| 29.10 x 7.02 x 95.65 | | MB | | | 42.50 x 7.00 x 13.07 | |
| V91282 | 7 783 841 | | 45° | | | |
| 26.00 x 7.00 x 95.50 | | MD | | | | |

2 **65.00**

| | | | | | | | |
|--------------------|-------|-----------------|-----------------|-----------------|--------|------------|-----------------|
| 100 GF 000 | 903cc | 4 Cyl. | 8 Valves | 26kW/35PS | Petrol | OHV | TD6939 |
| 100 GL.000 | 903cc | 4 Cyl. | 8 Valves | 30-33kW/41-45PS | Petrol | OHV | TD870 |
| 100 GL.048 | 903cc | 4 Cyl. | 8 Valves | 29kW/40PS | Petrol | OHV | TD4413 |
| 100 GL3.000 | 903cc | 4 Cyl. | 8 Valves | 33kW/45PS | Petrol | OHV | TD869 |
| 127 0.9 | | 06/1971→12/1986 | | 147 0.9 | | | 04/1977→12/1981 |
| 900T/E 0.9 | | 01/1978→01/1986 | | FIORINO 900 | | | 10/1977→10/1986 |
| PANDA 900 | | 10/1980→06/1994 | | UNO 0.9 | | | 02/1984→08/1989 |

| | | | | | | |
|----------------------|-----------|----|-----|---|----------------------|--|
| V34457 | 4 265 695 | | 45° | H | VAG92364 | |
| 29.10 x 7.02 x 95.65 | | MB | | | 42.50 x 7.00 x 13.07 | |
| V91282 | 7 783 841 | | 45° | | | |
| 26.00 x 7.00 x 95.50 | | MD | | | | |

3 **65.00**

| | | | | | | | |
|---------------------|-------|-----------------|-----------------|---------------|--------|-------------|-----------------|
| 127 A.000 | 903cc | 4 Cyl. | 8 Valves | 34--kW/46--PS | Petrol | SOHC | TD887 |
| 127 1.0 | | 01/1977→12/1986 | | 147 1.0 | | | 10/1976→12/1995 |
| FIORINO 1.0 | | 01/1980→12/1987 | | FIORINO 1050 | | | 01/1980→12/1987 |
| FIORINO Pick up 1.0 | | 06/1982→10/1987 | | | | | |

| | | | | | | |
|-----------------------|-----------|----|-----|--|--|--|
| V90399 | 4 340 119 | | 45° | | | |
| 29.10 x 7.99 x 110.50 | | MD | | | | |

4 **65.00**

| | | | | | | | |
|------------------|-------|-----------------|-----------------|------------|--------|------------|-----------------|
| 146 A.000 | 903cc | 4 Cyl. | 8 Valves | 33kW/45PS | Petrol | OHV | TD4371 |
| PANDA 900 | | 10/1980→06/1994 | | UNO 45 0.9 | | | 03/1983→07/1996 |

| | | | | | | |
|----------------------|-----------|----|-----|---|----------------------|--|
| V34457 | 4 265 695 | | 45° | H | VAG50895 | |
| 29.10 x 7.02 x 95.65 | | MB | | | 46.00 x 7.04 x 13.03 | |
| V91282 | 7 783 841 | | 45° | | VAG92364 | |
| 26.00 x 7.00 x 95.50 | | MD | | | 42.50 x 7.00 x 13.07 | |

5 **65.00**

| | | | | | | | |
|------------------|-------|-----------------|-----------------|------------------|--------|------------|-----------------|
| 146 A.048 | 903cc | 4 Cyl. | 8 Valves | 33kW/45PS | Petrol | OHV | TD934 |
| DUNA 0.9 | | 07/1991→10/1995 | | PANDA 0.9 Fire S | | | 10/1980→04/1986 |

| | | | | | | |
|-----------------------|-----------|-------|-----|--|--|--|
| V91713 | 4 315 062 | | 45° | | | |
| 31.00 x 8.00 x 109.00 | | MD cr | | | | |



OE

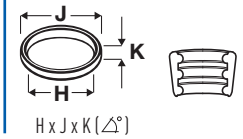
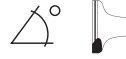

6  **65.00**

| | | | | | | | |
|-------------------------------|-------|------------------------------------|-----------------|----------------------|--------|-----------------|----------------|
| 146 A1.000 | 903cc | 4 Cyl. | 8 Valves | 33kW/45PS | Petrol | OHV | TD4372 |
| 170 A1.000 | 903cc | 4 Cyl. | 8 Valves | 30kW/41PS | Petrol | OHV | TD15810 |
| 170 A1.046 | 903cc | 4 Cyl. | 8 Valves | 30kW/41PS | Petrol | OHV | TD15811 |
| CINQUECENTO 0.9 UNO 45 0.9 | | 07/1991→12/1993 03/1983→07/1996 | | CINQUECENTO 0.9 i.e. | | 07/1991→12/1993 | |

V91282 
26.00 x 7.00 x 95.50

7 783 841

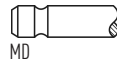

45°

VAG50895 
46.00 x 7.04 x 13.03

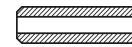

VAG92364 
42.50 x 7.00 x 13.07



7  **67.20**

| | | | | | | | |
|---------------------|-------|-----------------|-----------------|-----------------|--------|------------|---------------|
| A 112 B1.054 | 965cc | 4 Cyl. | 8 Valves | 35-36kW/48-49PS | Petrol | OHV | TD4412 |
| PANDA 950 | | 09/1982→12/1986 | | | | | |

V34457 
29.10 x 7.02 x 95.65

4 265 695



45°

H

VAG50895 
46.00 x 7.04 x 13.03



V91282 
26.00 x 7.00 x 95.50

7 783 841

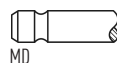

45°

VAG92364 
42.50 x 7.00 x 13.07

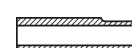

8  **67.40**

| | | | | | | | |
|------------------|-------|-----------------|-----------------|-----------|--------|------------|--------------|
| 110 F.000 | 499cc | 2 Cyl. | 4 Valves | 13kW/18PS | Petrol | OHV | TD871 |
| 120.000 | 499cc | 2 Cyl. | 4 Valves | 13kW/18PS | Petrol | OHV | TD873 |
| 500 0.5 | | 01/1960→01/1976 | | | | | |

V91739 
32.00 x 8.00 x 115.00

4 294 098

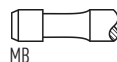

45°

H

V91633 
28.00 x 8.00 x 115.80

4 374 855

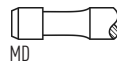

45°

V91712 
28.00 x 8.00 x 116.10

4 374 855

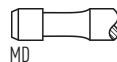

45°

9  **69.60**

| | | | | | | | |
|-------------------|--------|--------|------------------|-----------------|--------|--------------------|----------------|
| 169 A1.000 | 1248cc | 4 Cyl. | 16 Valves | 55kW/75PS | Diesel | DOHC | TD20236 |
| 188 A8.000 | 1248cc | 4 Cyl. | 16 Valves | 51kW/70PS | Diesel | Turbo, DOHC | TD23866 |
| 188 A9.000 | 1248cc | 4 Cyl. | 16 Valves | 51-55kW/70-75PS | Diesel | Turbo, DOHC | TD17456 |
| 199 A2.000 | 1248cc | 4 Cyl. | 16 Valves | 55-68kW/75-93PS | Diesel | Turbo, DOHC | TD20240 |

| | | | |
|-----------------------------|-----------------|--------------------------|-----------------|
| 500 1.3 D Multijet | 10/2007→ | 500 C 1.3 D Multijet | 09/2009→ |
| DOBLO 1.3 D Multijet | 10/2005→01/2010 | DOBLO 1.3 JTD | 05/2005→ |
| DOBLO 1.3 JTD 16V | 05/2004→12/2006 | FIORINO 1.3 D Multijet | 11/2007→ |
| GRANDE PUNTO 1.3 D Multijet | 10/2005→ | IDEA 1.3 D Multijet | 01/2004→ |
| LINEA 1.3 D Multijet | 01/2008→ | PALIO 1.3 D Multijet | 03/2008→ |
| PALIO 1.3 JTD Multijet | 06/2003→ | PANDA 1.3 D Multijet | 09/2003→ |
| PUNTO 1.3 D Multijet | 02/2005→ | PUNTO 1.3 JTD | 06/2003→10/2005 |
| PUNTO 1.3 JTD 16V | 06/2003→03/2012 | PUNTO EVO 1.3 D Multijet | 10/2009→ |
| QUBO 1.3 D Multijet | 02/2008→ | SIENA 1.3 JTD | 09/2003→ |

V95015 
21.85 x 6.00 x 109.20

55 195 680

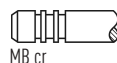

45°

Y

H

VAG96359 
43.28 x 6.00 x 10.25



V95016 
21.80 x 6.00 x 109.20

55 208 213

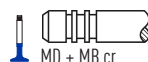

45°

H

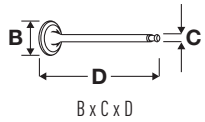

OE

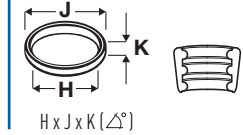
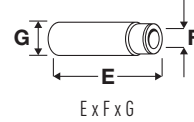
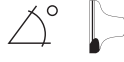

10 **69.60**

| | | | | | | | |
|-------------------|--------|--------|------------------|-----------------|--------|--------------------|----------------|
| 199 A3.000 | 1248cc | 4 Cyl. | 16 Valves | 66-70kW/90-95PS | Diesel | Turbo, DOHC | TD20241 |
| 199 A9.000 | 1248cc | 4 Cyl. | 16 Valves | 55-59kW/75-80PS | Diesel | Turbo, DOHC | TD23573 |
| 199 B1.000 | 1248cc | 4 Cyl. | 16 Valves | 70kW/95PS | Diesel | Turbo, DOHC | TD23574 |
| 199 B2.000 | 1248cc | 4 Cyl. | 16 Valves | 51kW/69PS | Diesel | Turbo, SOHC | TD23578 |
| 199 B4.000 | 1248cc | 4 Cyl. | 16 Valves | 62kW/84PS | Diesel | Turbo, DOHC | TD24898 |
| 199 B8.000 | 1248cc | 4 Cyl. | 16 Valves | 59kW/80PS | Diesel | DOHC | TD29432 |
| 223 A9.000 | 1248cc | 4 Cyl. | 16 Valves | 62kW/84PS | Diesel | Turbo, DOHC | TD20243 |

| | | | |
|-----------------------------|----------|------------------------|----------|
| 500 1.3 D Multijet | 12/2009→ | 500 C 1.3 D Multijet | 09/2009→ |
| 500L 1.3 D Multijet | 09/2012→ | DOBLO 1.3 D Multijet | 10/2005→ |
| DOBLO 1.3 JTD 16V Multijet | 08/2006→ | FIORINO 1.3 D Multijet | 11/2007→ |
| GRANDE PUNTO 1.3 D Multijet | 10/2005→ | IDEA 1.3 D Multijet | 10/2005→ |
| LINEA 1.3 D Multijet | 06/2007→ | PANDA 1.3 D Multijet | 02/2012→ |
| PANDA VAN 1.3 D Multijet | 02/2012→ | PUNTO 1.3 D Multijet | 04/2008→ |
| PUNTO EVO 1.3 D Multijet | 07/2008→ | QUBO 1.3 D Multijet | 02/2008→ |
| STRADA 1.3 D Multijet | 05/2006→ | TIPO 1.3 D | 10/2015→ |

V95182
 21.85 x 5.98 x 109.25

55204574

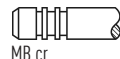

45°

H

VAG96359
 43.28 x 6.00 x 10.25



V95183
 22.50 x 5.99 x 109.20

55223836

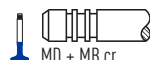

45°

ss

H

11 **70.00**

| | | | | | | | |
|-------------------|-----------------|---------------------|-----------------|-----------------|--------|-------------|---------------|
| 141 C2.000 | 999cc | 4 Cyl. | 8 Valves | 31-33kW/42-45PS | Petrol | SOHC | TD1070 |
| PANDA 1000 | 05/1986→12/1994 | PANDA 1000 i.e. Cat | 10/1987→08/1998 | | | | |

V91929
 31.50 x 7.00 x 97.00

7 770 334

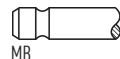

45°

H

V91289
 27.50 x 7.00 x 97.50

7 666 227

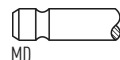

45°

12 **70.00**

| | | | | | | | |
|-------------------|-------|--------|-----------------|-----------------|--------|-------------------|----------------|
| 156 A2.000 | 999cc | 4 Cyl. | 8 Valves | 31-37kW/42-50PS | Petrol | SOHC | TD16230 |
| 156 A2.048 | 999cc | 4 Cyl. | 8 Valves | 32kW/44PS | Petrol | Fire, SOHC | TD992 |
| 156 A2.100 | 999cc | 4 Cyl. | 8 Valves | 32-33kW/44-45PS | Petrol | Fire, SOHC | TD4387 |
| 156 A2.246 | 999cc | 4 Cyl. | 8 Valves | 33-40kW/45-54PS | Petrol | Fire, SOHC | TD994 |
| 156 A3.000 | 999cc | 4 Cyl. | 8 Valves | 37kW/50PS | Petrol | SOHC | TD16209 |
| 156 A3.100 | 999cc | 4 Cyl. | 8 Valves | 32-33kW/44-45PS | Petrol | SOHC | TD4386 |

| | | | |
|--------------------|-----------------|---------------------|-----------------|
| FIORINO 1.0 iE | 11/1992→04/1996 | PANDA 1000 | 01/1985→12/1994 |
| PANDA 1000 i.e | 08/1992→02/2004 | PANDA 1000 i.e. Cat | 10/1987→08/1998 |
| UNO 1.0 | 06/1989→12/2003 | UNO 1.0 iE | 05/1998→08/2000 |
| UNO 1.0 Mille Fire | 09/1998→12/2003 | UNO 45 1.0 | 06/1986→12/1993 |
| UNO 45 i.e. 1.0 | 04/1984→10/1995 | | |

V91288
 30.50 x 7.00 x 97.00

5 942 727

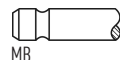

45°

H

VAG50895
 46.00 x 7.04 x 13.03



V91289
 27.50 x 7.00 x 97.50

7 666 227

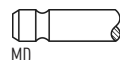

45°

VAG92364
 42.50 x 7.00 x 13.07





OE

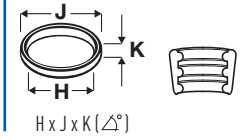
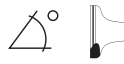

13 **70.00**

| | | | | | | | |
|-------------------|-----------------|--------|-----------------|-----------------|--------|-------------------|----------------|
| 156 C.046 | 1108cc | 4 Cyl. | 8 Valves | 37-43kW/50-58PS | Petrol | Fire, SOHC | TD4389 |
| 160 A3.000 | 1108cc | 4 Cyl. | 8 Valves | 41-43kW/56-58PS | Petrol | Fire, SOHC | TD10189 |
| 176 A6.000 | 1108cc | 4 Cyl. | 8 Valves | 40kW/54PS | Petrol | Fire, SOHC | TD1036 |
| PANDA 1.1 | 05/1991→03/1995 | | | PANDA 1100 | | 05/1991→12/1999 | |
| PANDA 1100 4x4 | 10/1991→07/2004 | | | PUNTO 55 1.1 | | 09/1993→09/1999 | |
| TIPO 1.1 | 01/1988→10/1991 | | | UNO 1.1 | | 04/1986→06/2006 | |
| UNO 50 1.1 | 01/1990→12/1993 | | | UNO 60 1.1 | | 04/1989→12/1992 | |

V91288
30.50 x 7.00 x 97.00

5 942 727

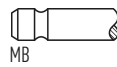

45°

H

VAG50895
46.00 x 7.04 x 13.03

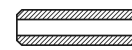

V91289
27.50 x 7.00 x 97.50

7 666 227

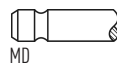

45°

VAG92364
42.50 x 7.00 x 13.07

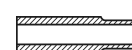

14 **70.00**

| | | | | | | | |
|--------------------|-----------------|--------|-----------------|--------------|--------|-------------------|---------------|
| 176 B2.000 | 1108cc | 4 Cyl. | 8 Valves | 40kW/54PS | Petrol | Fire, SOHC | TD4396 |
| CINQUECENTO 1.1ing | 10/1994→01/1998 | | | PANDA 1100 | | 02/1995→07/2004 | |
| PUNTO 1.1 | 04/1996→02/2000 | | | PUNTO 55 1.1 | | 09/1993→09/1999 | |
| SEICENTO / 600 1.1 | 01/1998→01/2010 | | | | | | |

V91929
31.50 x 7.00 x 97.00

7 770 334

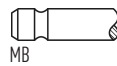

45°

H

VAG50895
46.00 x 7.04 x 13.03

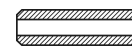

V91289
27.50 x 7.00 x 97.50

7 666 227

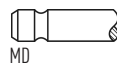

45°

VAG92364
42.50 x 7.00 x 13.07

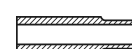

15 **70.00**

| | | | | | | | |
|-------------------|-----------------|--------|-----------------|--------------------|--------|-------------------|----------------|
| 187 A1.000 | 1108cc | 4 Cyl. | 8 Valves | 40-42kW/54-57PS | Petrol | Fire, SOHC | TD17847 |
| PALIO 1.1 | 06/2006→ | | | PANDA 1.1 | | 09/2000→ | |
| PANDA 1100 | 02/1995→09/2003 | | | SEICENTO / 600 1.1 | | 01/1998→01/2010 | |

V91288
30.50 x 7.00 x 97.00
Eng.→2533527

5 942 727

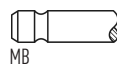

45°

H

VAG50895
46.00 x 7.04 x 13.03
Eng.→2533527



V98020
31.90 x 5.00 x 98.40
Eng.2533528→

55 194 993

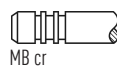

45°

VAG92364
42.50 x 7.00 x 13.07
Eng.→2533527

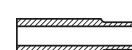

V91289
27.50 x 7.00 x 97.50
Eng.→2533527

7 666 227

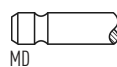

45°

V98021
27.30 x 5.00 x 98.70
Eng.2533528→

55 194 994



45°

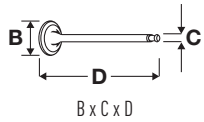

OE

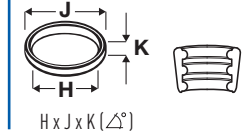
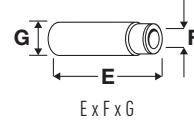
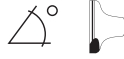

16 **70.80**

| | | | | | | | |
|----------------------|-----------------|--------|-----------------|------------------|--------|-------------|----------------|
| 169 A4.000 | 1242cc | 4 Cyl. | 8 Valves | 51kW/69PS | Petrol | SOHC | TD20928 |
| 199 A4.000 | 1242cc | 4 Cyl. | 8 Valves | 48-51kW/65-69PS | Petrol | SOHC | TD20242 |
| 500 1.2 | 10/2007→ | | | 500 1.2 LPG | | 12/2010→ | |
| 500 C 1.2 | 09/2009→ | | | GRANDE PUNTO 1.2 | | 10/2005→ | |
| GRANDE PUNTO 1.2 LPG | 07/2008→ | | | PANDA 1.2 | | 11/2009→ | |
| PANDA 1.2 LPG | 09/2010→ | | | PANDA VAN 1.2 | | 02/2012→ | |
| PANDA VAN 1.2 LPG | 06/2012→ | | | PUNTO 1.2 | | 03/2012→ | |
| PUNTO EVO 1.2 | 10/2009→02/2012 | | | | | | |

V98022
33.30 x 5.00 x 99.90

55 194 219



45°

VAG96384
44.00 x 5.00 x 10.04



V98023
28.10 x 5.00 x 100.50

55 200 422



45°

17 **70.80**

| | | | | | | | |
|-------------------|-----------------|--------|-----------------|-----------------|--------|-------------------|---------------|
| 176 A7.000 | 1242cc | 4 Cyl. | 8 Valves | 43-44kW/58-60PS | Petrol | Fire, SOHC | TD1037 |
| 176 B4.000 | 1242cc | 4 Cyl. | 8 Valves | 44kW/60PS | Petrol | Fire, SOHC | TD1076 |
| PUNTO 60 1.2 | 09/1993→06/2000 | | | | | | |

V91288
30.50 x 7.00 x 97.00

5 942 727

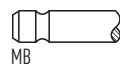

45°

H

VAG50895
46.00 x 7.04 x 13.03



V91289
27.50 x 7.00 x 97.50

7 666 227

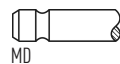

45°

VAG92364
42.50 x 7.00 x 13.07



18 **70.80**

| | | | | | | | |
|-------------------|-----------------|--------|-----------------|-----------------|--------|-------------------|----------------|
| 176 A8.000 | 1242cc | 4 Cyl. | 8 Valves | 54kW/73PS | Petrol | Fire, SOHC | TD1038 |
| 176 B1.000 | 1242cc | 4 Cyl. | 8 Valves | 44kW/60PS | Petrol | SOHC | TD1032 |
| 178 B5.000 | 1242cc | 4 Cyl. | 8 Valves | 50-55kW/68-75PS | Petrol | Fire, SOHC | TD10188 |
| 178 E2.000 | 1242cc | 4 Cyl. | 8 Valves | 50-54kW/68-73PS | Petrol | Fire, SOHC | TD16737 |
| FIORINO 1.2 | 01/2004→ | | | PALIO 1.2 | | 04/1996→ | |
| PUNTO 60 1.2 | 09/1993→06/2000 | | | PUNTO 75 1.2 | | 10/1993→09/1999 | |
| SIENA 1.2 | 09/1998→12/2009 | | | STRADA 1.2 | | 06/1999→12/2006 | |

V91929
31.50 x 7.00 x 97.00

7 770 334

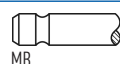

45°

H

VAG50895
46.00 x 7.04 x 13.03



V91289
27.50 x 7.00 x 97.50

7 666 227

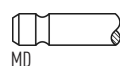

45°

VAG92364
42.50 x 7.00 x 13.07

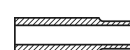

19 **70.80**

| | | | | | | | |
|--------------------|-----------------|--------|------------------|------------------|--------|-------------------|----------------|
| 176 B9.000 | 1242cc | 4 Cyl. | 16 Valves | 63kW/86PS | Petrol | Fire, DOHC | TD9727 |
| 182 B2.000 | 1242cc | 4 Cyl. | 16 Valves | 60-64kW/82-87PS | Petrol | Fire, DOHC | TD11807 |
| BRAVA 1.2 16V | 12/1998→12/2002 | | | BRAVA 1.2 16V 80 | | 12/1998→12/2002 | |
| BRAVO I 1.2 16V 80 | 12/1998→10/2001 | | | MAREA 1.2 16V | | 10/1998→05/2002 | |
| PUNTO 1.2 16V | 04/1997→09/1999 | | | PUNTO 85 16V 1.2 | | 04/1997→06/2000 | |

V94029
26.90 x 6.00 x 95.20

46 403 681

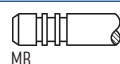

45°

H

VAG96272
39.70 x 6.02 x 10.03

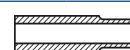

V94030
22.50 x 6.00 x 96.20

46 471 639



45°



OE

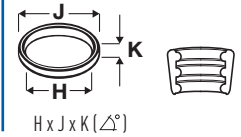
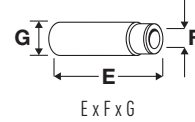
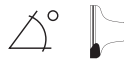

20 **70.80**

| | | | | | | | |
|-------------------|-----------------|--------|-----------------|-----------|--------|-------------------|----------------|
| 188 A4.000 | 1242cc | 4 Cyl. | 8 Valves | 44kW/60PS | Petrol | Fire, SOHC | TD12790 |
| 223 A5.000 | 1242cc | 4 Cyl. | 8 Valves | 48kW/65PS | Petrol | Fire, SOHC | TD15828 |
| DOBLO 1.2 | 03/2001→ | | | PALIO 1.2 | | 07/1997→10/2004 | |
| PALIO 1.2 LPG | 07/1997→08/2002 | | | PANDA 1.2 | | 09/2003→ | |
| PANDA 1.2 LPG | 04/2009→ | | | PUNTO 1.2 | | 09/2003→03/2012 | |
| PUNTO 1.2 60 | 09/1999→12/2010 | | | SIENA 1.2 | | 09/2001→12/2012 | |
| STRADA 1.2 | 04/2003→ | | | UNO 1.2 | | 08/2000→04/2010 | |

V91929
31.50 x 7.00 x 97.00
Eng.→2533527

7 770 334

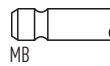

45°

H

VAG92364
42.50 x 7.00 x 13.07
Eng.→2533527



V98020
31.90 x 5.00 x 98.40
Eng.2533528→

55 194 993

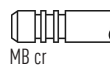

45°

VAG96273
40.00 x 7.02 x 13.06
Eng.→2533527



V91289
27.50 x 7.00 x 97.50
Eng.→2533527

7 666 227

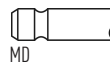

45°

V98021
27.30 x 5.00 x 98.70
Eng.2533528→

55 194 994



45°

21 **70.80**

| | | | | | | | |
|-------------------|-----------------|--------|------------------|--------------------|--------|-------------------|----------------|
| 188 A5.000 | 1242cc | 4 Cyl. | 16 Valves | 57-60kW/78-82PS | Petrol | Fire, DOHC | TD12791 |
| BRAVA 1.2 16V 80 | 10/2000→10/2001 | | | BRAVO I 1.2 16V 80 | | 10/2000→10/2001 | |
| IDEA 1.2 16V | 01/2004→ | | | PALIO 1.2 | | 06/2001→ | |
| PUNTO 1.2 16V 80 | 09/1999→12/2006 | | | SIENA 1.2 | | 06/2001→12/2009 | |
| STILO 1.2 16V | 02/2002→11/2006 | | | | | | |

V94029
26.90 x 6.00 x 95.20
Eng.→985540

46 403 681

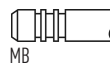

45°

H

VAG96272
39.70 x 6.02 x 10.03

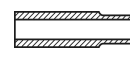

V98026
26.80 x 6.00 x 95.20
Eng.985541→

55 185 028

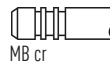

45°

V94030
22.50 x 6.00 x 96.20
Eng.→985540

46 471 639

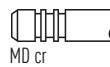

45°

V98027
22.45 x 5.97 x 94.70
Eng.985541→

55 185 080

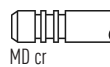

45°



OE

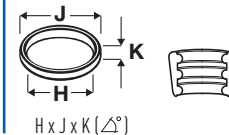
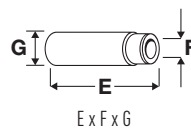

22 **72.00**

| | | | | | | | |
|-------------------|--------|-----------------|------------------|-----------------|--------|-------------------|----------------|
| 192 B2.000 | 1368cc | 4 Cyl. | 16 Valves | 66kW/90PS | Petrol | DOHC | TD18571 |
| 843 A1.000 | 1368cc | 4 Cyl. | 16 Valves | 65-70kW/88-95PS | Petrol | Fire, DOHC | TD17978 |
| 500L 1.4 | | 09/2012→ | | BRAVO II 1.4 | | 04/2007→ | |
| BRAVO II 1.4 LPG | | 12/2008→12/2014 | | DOBLO 1.4 | | 02/2010→ | |
| IDEA 1.4 | | 12/2003→ | | IDEA 1.4 16V | | 01/2004→ | |
| PUNTO 1.4 | | 09/2003→03/2012 | | STILO 1.4 16V | | 01/2004→08/2008 | |
| TIPO 1.4 | | 10/2015→ | | | | | |

V94029
26.90 x 6.00 x 95.20
Eng.→984712

46 403 681

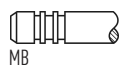

45°

H

VAG96272
39.70 x 6.02 x 10.03

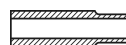

V98026
26.80 x 6.00 x 95.20
Eng.984713→

55 185 028

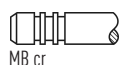

45°

V94030
22.50 x 6.00 x 96.20
Eng.→984712

46 471 639

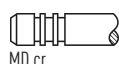

45°

V98027
22.45 x 5.97 x 94.70
Eng.984713→

55 185 080

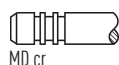

45°

23 **72.00**

| | | | | | | | |
|---------------------------|--------|-----------------|------------------|------------------------|--------|--------------------|----------------|
| 198 A1.000 | 1368cc | 4 Cyl. | 16 Valves | 104-112kW/141-152PS | Petrol | Turbo, DOHC | TD21045 |
| 198 A4.000 | 1368cc | 4 Cyl. | 16 Valves | 88kW/120PS | Petrol | Turbo, DOHC | TD21046 |
| 199 A8.000 | 1368cc | 4 Cyl. | 16 Valves | 114-132kW/155-180PS | Petrol | Turbo, DOHC | TD24567 |
| 312 A1.000 | 1368cc | 4 Cyl. | 16 Valves | 99-140kW/135-190PS | Petrol | Turbo, DOHC | TD21036 |
| 955 A2.000 | 1368cc | 4 Cyl. | 16 Valves | 99-101kW/135-137PS | Petrol | DOHC | TD23576 |
| 955 A8.000 | 1368cc | 4 Cyl. | 16 Valves | 120-132kW/163-180PS | Petrol | Turbo, DOHC | TD24767 |
| 500 1.4 | | 11/2014→ | | 500L 1.4 | | 09/2013→ | |
| BRAVO II 1.4 T-Jet | | 09/2007→ | | DOBLO 1.4 | | 02/2010→ | |
| GRANDE PUNTO 1.4 16V | | 09/2007→07/2012 | | GRANDE PUNTO 1.4 T-Jet | | 09/2007→ | |
| LINEA 1.4 T-Jet | | 09/2007→ | | PUNTO 1.4 | | 09/2012→ | |
| PUNTO 1.4 Turbo Multi Air | | 03/2012→ | | PUNTO EVO 1.4 16V | | 10/2009→02/2012 | |

V98026
26.80 x 6.00 x 95.20

55 185 028

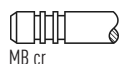

45°

V95220
22.40 x 5.99 x 94.65

55206233



45°

H

24 **72.00**

| | | | | | | | |
|----------------------|--------|----------|------------------|-----------------|--------|-----------------|----------------|
| 199 A6.000 | 1368cc | 4 Cyl. | 16 Valves | 70-71kW/95-97PS | Petrol | DOHC | TD20929 |
| GRANDE PUNTO 1.4 16V | | 10/2005→ | | PUNTO 1.4 | | 11/2005→03/2012 | |

V98026
26.80 x 6.00 x 95.20

55 185 028

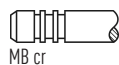

45°

VAG96272
39.70 x 6.02 x 10.03

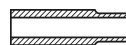

V98027
22.45 x 5.97 x 94.70

55 185 080

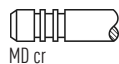

45°

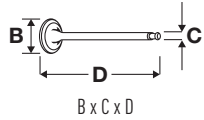

OE

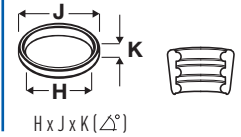
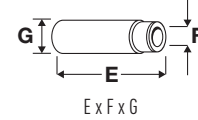

25 **72.00**

| | | | | | | | |
|-------------------|--------|-----------------|-----------------|----------------------|--------|-----------------|----------------|
| 199 A7.000 | 1368cc | 4 Cyl. | 8 Valves | 55kW/75PS | Petrol | SOHC | TD23572 |
| 350 A1.000 | 1368cc | 4 Cyl. | 8 Valves | 51-57kW/69-78PS | Petrol | SOHC | TD20248 |
| DOBLO 1.4 | | 10/2005→ | | FIORINO 1.4 | | 06/2008→ | |
| GRANDE PUNTO 1.4 | | 10/2005→ | | GRANDE PUNTO 1.4 LPG | | 12/2008→ | |
| IDEA 1.4 | | 10/2005→ | | IDEA 1.4 LPG | | 03/2009→ | |
| LINEA 1.4 | | 06/2007→ | | PALIO 1.4 | | 10/2005→ | |
| PANDA 1.4 | | 10/2009→ | | PUNTO 1.4 | | 02/2006→ | |
| PUNTO 1.4 LPG | | 03/2009→ | | PUNTO EVO 1.4 | | 07/2009→02/2012 | |
| PUNTO EVO 1.4 LPG | | 06/2009→02/2012 | | QUBO 1.4 | | 10/2009→ | |
| SIENA 1.4 | | 01/2007→12/2009 | | | | | |

V98022
33.30 x 5.00 x 99.90

55 194 219

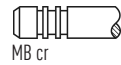

45°

VAG96384
44.00 x 5.00 x 10.04



V98023
28.10 x 5.00 x 100.50

55 200 422



45°

26 **73.50**

| | | | | | | | |
|------------------|-------|-----------------|-----------------|-----------|--------|------------|--------------|
| 126 A.000 | 594cc | 2 Cyl. | 4 Valves | 17kW/23PS | Petrol | OHV | TD880 |
| 126 600 | | 09/1972→06/1977 | | | | | |

V91739
32.00 x 8.00 x 115.00

4 294 098

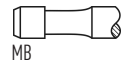

45°

H

VAG96366
59.00 x 8.03 x 14.23

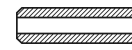

27 **75.00**

| | | | | | | | |
|-------------|--------|----------|-----------------|-----------|--------|-------------|----------------|
| KFT | 1360cc | 4 Cyl. | 8 Valves | 54kW/73PS | Petrol | SOHC | TD24950 |
| KFV | 1360cc | 4 Cyl. | 8 Valves | 54kW/73PS | Petrol | SOHC | TD24771 |
| FIORINO 1.4 | | 11/2007→ | | QUBO 1.4 | | 02/2008→ | |

V91271
37.00 x 7.00 x 112.50

97 533 266

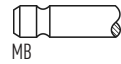

30°

H

VAG92401
47.50 x 7.01 x 13.06



V91273
29.50 x 7.00 x 112.50

97 533 264

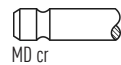

45°

VAG96132
47.60 x 7.03 x 13.11

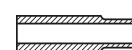

28 **75.00**

| | | | | | | | |
|----------------------|--------|----------|-----------------|-----------|--------|--------------------|----------------|
| 9HM (DV6UC) | 1560cc | 4 Cyl. | 8 Valves | 66kW/90PS | Diesel | Turbo, DOHC | TD32529 |
| SCUDO 1.6 D Multijet | | 01/2007→ | | | | | |

V95137
30.15 x 5.48 x 95.55

0948.F7

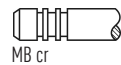

45°

Y

H

VAG96364
34.20 x 5.50 x 9.53



V95138
27.50 x 5.47 x 95.45

0949.F5



45°

SS

H

29 **75.00**

| | | | | | | | |
|----------------------|--------|----------|------------------|-----------|--------|--------------------|----------------|
| 9HU | 1560cc | 4 Cyl. | 16 Valves | 66kW/90PS | Diesel | Turbo, DOHC | TD24776 |
| SCUDO 1.6 D Multijet | | 01/2007→ | | | | | |

V94960
25.60 x 5.50 x 96.35

9 645 024 780

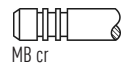

45°

H

VAG96364
34.20 x 5.50 x 9.53



V94961
23.40 x 5.50 x 96.50

9 640 840 080



45°

SS

H

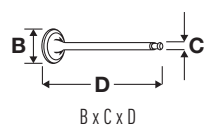

OE

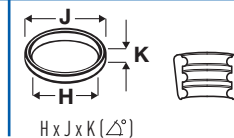
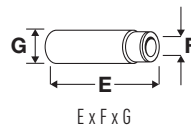
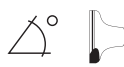

30 **76.00**

| | | | | | | | |
|-----------------------|-----------|-----------------|-----------------|-----------|--------|-----------------|---------------|
| 127 A1.000 | 1049cc | 4 Cyl. | 8 Valves | 51kW/70PS | Petrol | | TD4345 |
| 127 A6.000 | 1049cc | 4 Cyl. | 8 Valves | 44kW/60PS | Petrol | | TD4347 |
| 127 1.0 | | 07/1978→02/1982 | | RITMO 1.0 | | 09/1978→09/1982 | |
| V90398 | 4 412 816 | | 45° | H | | | |
| 36.60 x 7.98 x 110.50 | | MB | | | | | |
| V90399 | 4 340 119 | | 45° | | | | |
| 29.10 x 7.99 x 110.50 | | MD | | | | | |

31 **76.00**

| | | | | | | | |
|-----------------------|-----------|-----------------|-----------------|----------------|--------|-----------------|---------------|
| 146 A6.000 | 1116cc | 4 Cyl. | 8 Valves | 43kW/58PS | Petrol | SOHC | TD9493 |
| 146 A9.000 | 1116cc | 4 Cyl. | 8 Valves | 40kW/55PS | Petrol | SOHC | TD945 |
| DUNA 60 1.1 | | 01/1987→12/1991 | | FIORINO 1.1 60 | | 11/1986→04/1988 | |
| FIORINO 60 1.1 | | 05/1988→12/1993 | | PENNY 1.1 | | 01/1986→12/1990 | |
| UNO 60 1.1 | | 02/1988→02/1992 | | | | | |
| V90398 | 4 412 816 | | 45° | H | | | |
| 36.60 x 7.98 x 110.50 | | MB | | | | | |
| V90399 | 4 340 119 | | 45° | | | | |
| 29.10 x 7.99 x 110.50 | | MD | | | | | |

32 **76.00**

| | | | | | | | |
|-----------------------|-----------|-----------------|-----------------|---------------------|--------|-----------------|---------------|
| 127 A3.000 | 1301cc | 4 Cyl. | 8 Valves | 55kW/75PS | Petrol | SOHC | TD4415 |
| 146 A5.000 | 1301cc | 4 Cyl. | 8 Valves | 49kW/67PS | Petrol | SOHC | TD4376 |
| 127 1.3 | | 12/1981→05/1983 | | DUNA 70 1.3 | | 01/1987→12/1991 | |
| ELBA 1.3 | | 04/1991→02/1995 | | FIORINO 1.3 | | 12/1987→08/1993 | |
| FIORINO 70 1.3 | | 01/1988→12/1994 | | FIORINO Pick up 1.3 | | 01/1988→12/1994 | |
| PENNY 1.3 | | 01/1986→12/1990 | | | | | |
| V90398 | 4 412 816 | | 45° | H | | | |
| 36.60 x 7.98 x 110.50 | | MB | | | | | |
| V90399 | 4 340 119 | | 45° | | | | |
| 29.10 x 7.99 x 110.50 | | MD | | | | | |

33 **76.00**



| | | | | | | | |
|-----------------------|---------|-----------------|-----------------|-----------------------|--------|-----------------|---------------|
| 127 A5.000 | 1301cc | 4 Cyl. | 8 Valves | 33-38kW/45-52PS | Diesel | SOHC | TD4346 |
| 146 B1.000 | 1301cc | 4 Cyl. | 8 Valves | 33kW/45PS | Diesel | SOHC | TD948 |
| 156 A5.000 | 1301cc | 4 Cyl. | 8 Valves | 27kW/37PS | Diesel | SOHC | TD999 |
| 127 1.3 D | | 06/1981→05/1996 | | 127 1.3 Diesel | | 04/1981→12/1986 | |
| 147 1.3 D | | 10/1980→10/1995 | | ELBA 1.3 D | | 04/1986→10/1992 | |
| FIORINO 1.3 D | | 03/1982→01/1988 | | FIORINO Pick up 1.3 D | | 05/1984→12/1988 | |
| PANDA 1300 D | | 04/1986→12/1992 | | PANDA D | | 05/1986→04/1991 | |
| PENNY 1.3 D | | 04/1986→12/1988 | | UNO 1.3 Super Diesel | | 06/1983→03/1992 | |
| V91653 | 4424174 | | 45° | | | | |
| 29.00 x 8.00 x 112.00 | | MD | | | | | |



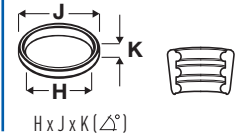
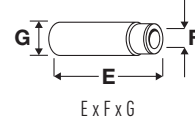
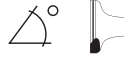



OE

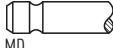



34  **76.10**

| | | | | | | | |
|---|-----------|---|-----------------|-----------------|--------|-------------|-----------------|
| 156 A.000 | 1049cc | 4 Cyl. | 8 Valves | 37-41kW/50-56PS | Petrol | SOHC | TD4411 |
| 147 1.0 FIORINO Pick up 1.0 | | | | FIORINO 1.0 | | | 12/1986→04/1988 |
| V90398  | 4 412 816 |  | 45° | H | | | |
| 36.60 x 7.98 x 110.50 | | MB | | | | | |
| V90399  | 4 340 119 |  | 45° | | | | |
| 29.10 x 7.99 x 110.50 | | MD | | | | | |

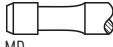

35  **77.00**

| | | | | | | | |
|--|-----------|--|-----------------|-----------------|---|------------|-----------------|
| 126 A1.000 | 652cc | 2 Cyl. | 4 Valves | 17kW/23PS | Petrol | OHV | TD4343 |
| 126 A1.048 | 652cc | 2 Cyl. | 4 Valves | 17-20kW/23-27PS | Petrol | OHV | TD881 |
| 126 650 | | 07/1977→09/2000 | | 133 0.65 | | | 06/1974→12/1976 |
| V91739  | 4 294 098 |  | 45° | H | VAG96366  | | |
| 32.00 x 8.00 x 115.00 | | MB | | | 59.00 x 8.03 x 14.23 | | |
| V91712  | 4 374 855 |  | 45° | | | | |
| 28.00 x 8.00 x 116.10 | | MD | | | | | |







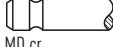

36  **77.00**

| | | | | | | | |
|---|-----------|---|-----------------|-----------|--------|------------|---------------|
| 141 A.000 | 652cc | 2 Cyl. | 4 Valves | 22kW/30PS | Petrol | OHV | TD9385 |
| PANDA 650 | | 01/1982→07/2004 | | | | | |
| V91712  | 4 374 855 |  | 45° | | | | |
| 28.00 x 8.00 x 116.10 | | MD | | | | | |

37  **78.00**

| | | | | | | | |
|---|-----------|---|-----------------|-------------------------|--------|-------------|-----------------|
| 131 C1.000 | 1367cc | 4 Cyl. | 8 Valves | 51-55kW/69-75PS | Petrol | SOHC | TD903 |
| 131 1.4 Mirafiori | | 11/1980→01/1984 | | 131 1.4 Super Mirafiori | | | 04/1981→12/1983 |
| V91305  | 7 597 080 |  | 45° | | | | |
| 36.00 x 8.00 x 105.55 | | MD cr | | | | | |
| V91636  | 5 975 341 |  | 45° | | | | |
| 36.50 x 8.00 x 106.10 | | MD cr | | | | | |

38  **78.00**

| | | | | | | | |
|---|-------------|---|------------------|-------------------|---|-------------|----------------|
| M16A | 1586cc | 4 Cyl. | 16 Valves | 78-88kW/106-120PS | Petrol | DOHC | TD20932 |
| SEDICI 1.6 16V | | 06/2006→10/2014 | | | | | |
| V95007  | 12911-69G00 |  | 45° | H | VAG96391  | | |
| 30.00 x 6.00 x 100.80 →12/03 | | MB tu | | | 40.00 x 5.50 x 10.57 01/04→ | | |
| V95141  | 71742050 |  | 45° | H | | | |
| 30.00 x 5.47 x 100.75 01/04→ | | MB tu | | | | | |
| V95008  | 12915-69G50 |  | 45° | SS | | | |
| 25.00 x 6.00 x 99.10 →12/03 | | MD tu | | | | | |
| V95142  | 71747245 |  | 45° | SS | | | |
| 25.00 x 5.44 x 99.00 01/04→ | | MD tu | | | | | |

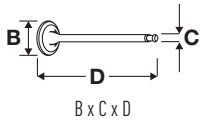

OE

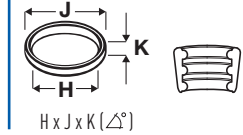
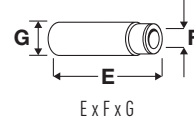
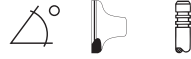

39 **79.00**

| | | | | | | | |
|-------------------|--------|--------|------------------|------------|--------|-------------|----------------|
| 192 B3.000 | 1598cc | 4 Cyl. | 16 Valves | 77kW/105PS | Petrol | DOHC | TD22147 |
|-------------------|--------|--------|------------------|------------|--------|-------------|----------------|

STILO 1.6 16V 03/2005→12/2007

V98077 [3]
31.20 x 5.00 x 117.20

55557862

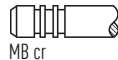

45°

VAG96346 [3]
37.00 x 4.99 x 10.04

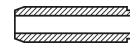

V98078 [3]
27.50 x 5.00 x 116.20

55558728



45°

SS

[3] LPG

[3] LPG

[3] LPG

[3] LPG

[3] LPG

40 **79.50**

| | | | | | | | |
|-------------------|--------|--------|------------------|-------------------|--------|--------------------|----------------|
| 198 A2.000 | 1598cc | 4 Cyl. | 16 Valves | 88kW/120PS | Diesel | Turbo, DOHC | TD21047 |
| 198 A6.000 | 1598cc | 4 Cyl. | 16 Valves | 66kW/90PS | Diesel | Turbo, DOHC | TD24596 |
| 199 B5.000 | 1598cc | 4 Cyl. | 16 Valves | 77kW/105PS | Diesel | Turbo, DOHC | TD27727 |
| 263 A4.000 | 1598cc | 4 Cyl. | 16 Valves | 66kW/90PS | Diesel | Turbo, DOHC | TD24769 |
| 350 A2.000 | 1598cc | 4 Cyl. | 16 Valves | 85-88kW/116-120PS | Diesel | Turbo, DOHC | TD24899 |
| 350 A3.000 | 1598cc | 4 Cyl. | 16 Valves | 85kW/116PS | Diesel | Turbo, DOHC | TD24973 |
| 955 A3.000 | 1598cc | 4 Cyl. | 16 Valves | 88kW/120PS | Diesel | Turbo, DOHC | TD23575 |
| 955 A4.000 | 1598cc | 4 Cyl. | 16 Valves | 85kW/115PS | Diesel | Turbo, DOHC | TD25735 |

500L 1.6 D Multijet 09/2012→
DOBLO 1.6 D Multijet 02/2010→
IDEA 1.6 D Multijet 05/2008→

BRAVO II 1.6 D Multijet 03/2008→
GRANDE PUNTO 1.6 D Multijet 07/2008→
PUNTO EVO 1.6 D Multijet 10/2009→02/2012

V95223 [3]
26.55 x 5.00 x 114.40

55205125

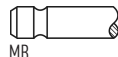

45°

Y

H

VAG96360 [3]
46.70 x 5.00 x 10.03



V98006 [3]
24.50 x 5.00 x 114.40

55207955

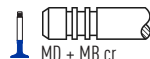

45°

41 **80.00**

| | | | | | | | |
|-------------------|-------|--------|-----------------|-----------|--------|------------|---------------|
| 126 A2.000 | 704cc | 2 Cyl. | 4 Valves | 19kW/26PS | Petrol | OHV | TD4342 |
| 126 A2.048 | 704cc | 2 Cyl. | 4 Valves | 19kW/26PS | Petrol | OHV | TD4344 |

126 700 09/1987→06/1996

V91739 [3]
32.00 x 8.00 x 115.00

4 294 098

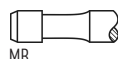

45°

H

VAG96366 [3]
59.00 x 8.03 x 14.23



V91712 [3]
28.00 x 8.00 x 116.10

4 374 855

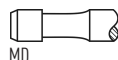

45°



OE

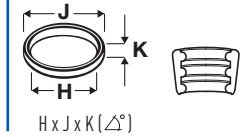
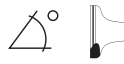

42  **80.00**

| | | | | | | | |
|-------------|-----------------|--------|----------|-----------------|--------|-----------------|---------|
| 128 A 064 | 1116cc | 4 Cyl. | 8 Valves | 40-44kW/54-60PS | Petrol | SOHC | TD23118 |
| 128 A.000 | 1116cc | 4 Cyl. | 8 Valves | 33-48kW/45-65PS | Petrol | SOHC | TD888 |
| 128 A.048 | 1116cc | 4 Cyl. | 8 Valves | 33kW/45PS | Petrol | SOHC | TD5378 |
| 128 AC5.000 | 1116cc | 4 Cyl. | 8 Valves | 48kW/65PS | Petrol | SOHC | TD891 |
| 128 BB.0A0 | 1116cc | 4 Cyl. | 8 Valves | 48kW/65PS | Petrol | SOHC | TD23459 |
| 138 AE 0A.0 | 1116cc | 4 Cyl. | 8 Valves | 44kW/60PS | Petrol | SOHC | TD23461 |
| 138 B.000 | 1116cc | 4 Cyl. | 8 Valves | 40-44kW/55-60PS | Petrol | SOHC | TD923 |
| 138 B1.000 | 1116cc | 4 Cyl. | 8 Valves | 40kW/55PS | Petrol | SOHC | TD924 |
| 138 C1.000 | 1116cc | 4 Cyl. | 8 Valves | 40-42kW/55-57PS | Petrol | SOHC | TD18371 |
| 146 A4.000 | 1116cc | 4 Cyl. | 8 Valves | 43-44kW/58-60PS | Petrol | SOHC | TD22226 |
| 146 A4.044 | 1116cc | 4 Cyl. | 8 Valves | 37kW/50PS | Petrol | SOHC | TD9469 |
| 146 A4.048 | 1116cc | 4 Cyl. | 8 Valves | 43kW/58PS | Petrol | SOHC | TD4375 |
| 128 1.1 | 03/1969→12/1984 | | | 147 1.1 | | 10/1984→11/1992 | |
| DUNA 1.1 | 07/1991→07/1996 | | | RITMO 1.1 | | 08/1980→08/1988 | |
| UNO 1.1 | 10/1988→06/2006 | | | UNO 50 1.1 | | 01/1986→12/1989 | |
| UNO 55 1.1 | 01/1983→08/1989 | | | UNO 60 1.1 | | 05/1985→02/1992 | |

V91713 
31.00 x 8.00 x 109.00

4 315 062

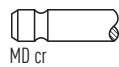

45°

VAG92366 
46.50 x 8.00 x 14.10



43  **80.50**

| | | | | | | | |
|---------------------|-----------------|--------|----------|---------------------|--------|-----------------|---------|
| 146 C1.000 | 1372cc | 4 Cyl. | 8 Valves | 51-57kW/69-78PS | Petrol | SOHC | TD18821 |
| 146 C5.000 | 1372cc | 4 Cyl. | 8 Valves | 46-52kW/63-71PS | Petrol | SOHC | TD6816 |
| 146 D5.000 | 1372cc | 4 Cyl. | 8 Valves | 46-49kW/63-67PS | Petrol | SOHC | TD6817 |
| 159 A2.000 | 1372cc | 4 Cyl. | 8 Valves | 51-57kW/69-78PS | Petrol | SOHC | TD9728 |
| 160 A1.000 | 1372cc | 4 Cyl. | 8 Valves | 52-56kW/71-76PS | Petrol | SOHC | TD1015 |
| 160 A1.046 | 1372cc | 4 Cyl. | 8 Valves | 49-52kW/67-71PS | Petrol | SOHC | TD1016 |
| 160 A1.048 | 1372cc | 4 Cyl. | 8 Valves | 50-57kW/69-78PS | Petrol | SOHC | TD4393 |
| 836 A4.000 | 1372cc | 4 Cyl. | 8 Valves | 51kW/69PS | Petrol | SOHC | TD893 |
| DUNA 1.4 | 07/1991→07/1996 | | | ELBA 1.4 | | 10/1993→02/1995 | |
| FIORINO 1.4 | 01/1989→03/2000 | | | FIORINO 70 i.e. 1.4 | | 05/1994→05/2001 | |
| FIORINO Pick up 1.4 | 01/1989→05/2001 | | | TEMPRA 1.4 i.e. | | 04/1990→08/1996 | |
| TIPO 1.4 | 07/1987→12/1989 | | | TIPO 1.4 i.e. | | 05/1989→04/1995 | |
| UNO 1.4 | 10/1988→03/2001 | | | UNO 70 i.e. 1.4 | | 09/1989→07/1996 | |
| UNO 70 S 1.4 | 10/1988→06/2006 | | | | | | |

V91300 
37.50 x 8.00 x 108.50

96 700 311

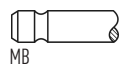

45°

H

VAG92366 
46.50 x 8.00 x 14.10



V91713 
31.00 x 8.00 x 109.00

4 315 062

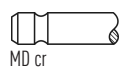

45°

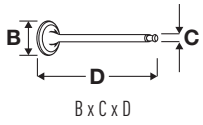

OE

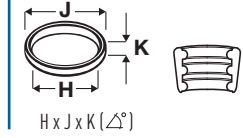
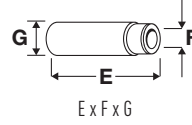
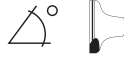

44 **80.50**

| 182 B6.000 | 1596cc | 4 Cyl. | 16 Valves | 68-100kW/92-136PS | Petrol | DOHC | TD16166 |
|------------------|--------|--------|-----------|----------------------|--------|-----------------|---------|
| BRAVA 1.6 16V | | | | BRAVO I 1.6 | | 09/2000→10/2001 | |
| DOBLO 1.6 | | | | DOBLO 1.6 16V | | 10/2001→ | |
| MAREA 1.6 | | | | MULTIPLA 1.6 | | 09/2000→06/2010 | |
| MULTIPLA 1.6 16V | | | | MULTIPLA 1.6 16V GPL | | 10/2001→06/2010 | |
| PALIO 1.6 | | | | PALIO 1.6 16V | | 02/2001→ | |
| SIENA 1.6 | | | | SIENA 1.6 16V | | 09/1998→12/2009 | |
| STILO 1.6 | | | | STILO 1.6 16V | | 10/2001→08/2008 | |

| | | | | | | |
|-----------------------|------------|------------|-----|------|----------------------|--|
| V91949 | 46 517 325 | | 45° | H | VAG50895 | |
| 30.40 x 7.00 x 102.00 | | MB cr | | | 46.00 x 7.04 x 13.03 | |
| V91950 | 46 462 159 | | 45° | | VAG92364 | |
| 29.80 x 7.00 x 102.60 | | MD cr | | | 42.50 x 7.00 x 13.07 | |
| V94468 | 46 461 209 | | 45° | ss H | | |
| 30.00 x 7.00 x 102.40 | | MD + MB cr | | | | |

45 **80.50**

| 939 A4.000 | 1796cc | 4 Cyl. | 16 Valves | 96-103kW/131-140PS | Petrol | DOHC | TD20262 |
|---------------|--------|--------|-----------|--------------------|--------|------|----------|
| CROMA 1.8 16V | | | | | | | 12/2005→ |

| | | | | | | |
|-----------------------|------------|------------|-----|--|----------------------|--|
| V98024 | 55557741 | | 45° | | VAG96346 | |
| 31.00 x 5.00 x 114.00 | | MB cr | | | 37.00 x 4.99 x 10.04 | |
| V98025 | 71 744 388 | | 45° | | | |
| 27.50 x 5.00 x 113.20 | | MD + MB cr | | | | |

46 **82.00**

| 182 A3.000 | 1370cc | 4 Cyl. | 12 Valves | 59kW/80PS | Petrol | SOHC | TD4399 |
|-------------|--------|--------|-----------|------------------|--------|-----------------|--------|
| 182 A5.000 | 1370cc | 4 Cyl. | 12 Valves | 55kW/75PS | Petrol | SOHC | TD4401 |
| BRAVA 1.4 | | | | BRAVA 1.4 12 V | | 10/1995→08/1998 | |
| BRAVO I 1.4 | | | | MAREA 1.4 80 12V | | 09/1996→05/2002 | |

| | | | | | | |
|-----------------------|------------|-------|-----|---|----------------------|--|
| V91927 | 7 712 114 | | 45° | H | VAG96123 | |
| 30.30 x 7.00 x 110.40 | | MB | | | 42.25 x 7.02 x 13.05 | |
| V91928 | 46 423 334 | | 45° | | VAG96146 | |
| 35.50 x 7.00 x 110.40 | | MD cr | | | 42.50 x 7.04 x 13.05 | |



OE

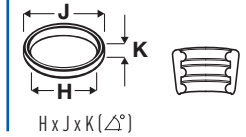

47 **82.00**

| | | | | | | | |
|-------------------|--------|--------|------------------|-------------------|--------|-------------|----------------|
| 182 A2.000 | 1747cc | 4 Cyl. | 16 Valves | 83kW/113PS | Petrol | DOHC | TD4398 |
| 183 A1.000 | 1747cc | 4 Cyl. | 16 Valves | 92-97kW/125-132PS | Petrol | DOHC | TD4405 |
| 188 A6.000 | 1747cc | 4 Cyl. | 16 Valves | 96kW/130PS | Petrol | DOHC | TD16408 |
| 192 A4.000 | 1747cc | 4 Cyl. | 16 Valves | 90-98kW/122-133PS | Petrol | DOHC | TD16395 |

| | | | |
|-------------------|-----------------|-------------------|-----------------|
| BARCETTA 1.8 16V | 04/1995→05/2005 | BRAVA 1.8 16V | 02/2000→06/2003 |
| BRAVA 1.8 GT 16V | 10/1995→10/2001 | BRAVO I 1.8 GT | 10/1995→10/2001 |
| COUPE 1.8 16V | 03/1996→08/2000 | MAREA 1.8 | 09/1996→12/2007 |
| MAREA 1.8 115 16V | 09/1996→05/2002 | PUNTO 1.8 130 HGT | 09/1999→03/2012 |
| STILO 1.8 16V | 10/2001→08/2008 | STRADA 1.8 | 06/2012→ |

V91933
33.40 x 7.00 x 113.10

7 766 564



45°

H

VAG96123
42.25 x 7.02 x 13.05



V91934
28.00 x 7.00 x 108.60

7 766 565



45°

SS

VAG96146
42.50 x 7.04 x 13.05



V94582
28.00 x 7.00 x 108.50

7 766 565

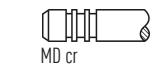

45°

VAG96145
46.00 x 7.02 x 13.03

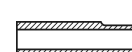

V94591
28.00 x 7.00 x 108.80

606 74 496



45°

SS

H

VAG96230
46.00 x 7.02 x 13.06



48 **82.00**

| | | | | | | | |
|-------------------|--------|--------|-----------------|------------|--------|--------------------|---------------|
| 182 A7.000 | 1910cc | 4 Cyl. | 8 Valves | 74kW/100PS | Diesel | Turbo, SOHC | TD4403 |
| 182 A8.000 | 1910cc | 4 Cyl. | 8 Valves | 55kW/75PS | Diesel | Turbo, SOHC | TD4404 |

| | | | |
|---------------------|-----------------|----------------------|-----------------|
| BRAVA 1.9 TD 75 S | 03/1996→10/2001 | BRAVA 1.9 TD 100 S | 03/1996→10/2001 |
| BRAVO I 1.9 TD 75 S | 03/1996→10/2001 | BRAVO I 1.9 TD 100 S | 03/1996→10/2001 |
| MAREA 1.9 TD 75 | 09/1996→05/2002 | MAREA 1.9 TD 100 | 09/1996→05/2002 |

V91937
37.50 x 8.00 x 114.20

7 798 620



45°

VAG96124
42.90 x 8.02 x 14.06



V94470
35.30 x 8.00 x 115.00

46 750 859



45°

H

VAG96203
43.00 x 8.03 x 14.08



V91938
31.00 x 8.00 x 114.00

7 783 225

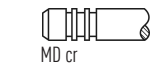

45°

VAG96210
43.00 x 8.04 x 14.04

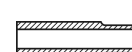

V94471
34.50 x 8.00 x 115.00

46 783 962



45°

H

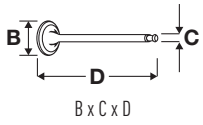

OE

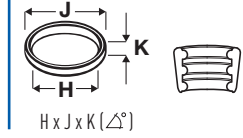
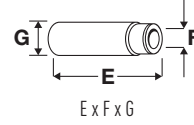
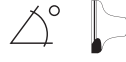

49 **82.00**

| | | | | | | | |
|------------------------|-----------------|--------|-----------------|----------------------|--------|--------------------|----------------|
| 182 B4.000 | 1910cc | 4 Cyl. | 8 Valves | 77-79kW/105-107PS | Diesel | Turbo, SOHC | TD11168 |
| 182 B9.000 | 1910cc | 4 Cyl. | 8 Valves | 74-79kW/100-107PS | Diesel | Turbo, SOHC | TD16399 |
| 186 A6.000 | 1910cc | 4 Cyl. | 8 Valves | 81kW/110PS | Diesel | Turbo, SOHC | TD15831 |
| 186 A9.000 | 1910cc | 4 Cyl. | 8 Valves | 88kW/120PS | Diesel | Turbo, SOHC | TD19306 |
| 188 A2.000 | 1910cc | 4 Cyl. | 8 Valves | 59kW/80PS | Diesel | Turbo, SOHC | TD12788 |
| 188 A7.000 | 1910cc | 4 Cyl. | 8 Valves | 63kW/86PS | Diesel | Turbo, SOHC | TD16409 |
| 192 A3.000 | 1910cc | 4 Cyl. | 8 Valves | 59kW/80PS | Diesel | Turbo, SOHC | TD16397 |
| BRAVA 1.9 JTD | 09/2000→12/2002 | | | BRAVA 1.9 JTD 105 | | 12/1998→10/2001 | |
| BRAVO I 1.9 JTD | 09/2000→10/2001 | | | BRAVO I 1.9 JTD 105 | | 12/1998→10/2001 | |
| DOBLO 1.9 D Multijet | 10/2005→ | | | DOBLO 1.9 JTD | | 10/2001→ | |
| DOBLO 1.9 JTD Multijet | 12/2006→ | | | MAREA 1.9 JTD | | 01/2001→12/2007 | |
| MAREA 1.9 JTD 105 | 04/1999→05/2002 | | | MAREA 1.9 JTD 110 | | 01/2001→05/2002 | |
| MAREA 1.9 TD 100 | 09/1996→05/2002 | | | MULTIPLA 1.9 JTD | | 04/2002→06/2010 | |
| MULTIPLA 1.9 JTD 105 | 04/1999→06/2010 | | | MULTIPLA 1.9 JTD 110 | | 03/2001→07/2002 | |
| PALIO 1.9 JTD | 09/2001→ | | | PUNTO 1.9 JTD | | 02/2000→03/2012 | |
| PUNTO 1.9 JTD 80 | 09/1999→03/2012 | | | STILO 1.9 JTD | | 02/2002→08/2008 | |
| STRADA 1.9 JTD | 04/2003→ | | | | | | |

V94064
 35.50 x 8.00 x 115.00

608 14 605

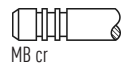

45°

H

VAG96124
 42.90 x 8.02 x 14.06

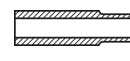

V94470
 35.30 x 8.00 x 115.00

46 750 859



45°

H

VAG96203
 43.00 x 8.03 x 14.08

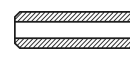

V94065
 34.50 x 8.00 x 115.00

608 14 604

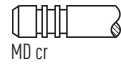

45°

H

VAG96210
 43.00 x 8.04 x 14.04



V94471
 34.50 x 8.00 x 115.00

46 783 962



45°

H

V94590
 34.45 x 8.00 x 115.00

55202630



45°

SS

H



OE

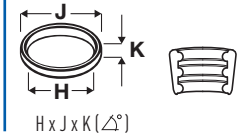
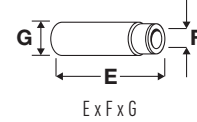

50



82.00

| | | | | | | | |
|-------------------------|-----------------|--------|----------|-----------------------------|-----------------|-------------|---------|
| 185 B4.000 | 1910cc | 4 Cyl. | 8 Valves | 77kW/105PS | Diesel | Turbo, SOHC | TD23359 |
| 186 A8.000 | 1910cc | 4 Cyl. | 8 Valves | 85kW/115PS | Diesel | Turbo, SOHC | TD18309 |
| 188 B2.000 | 1910cc | 4 Cyl. | 8 Valves | 74kW/101PS | Diesel | Turbo, SOHC | TD18291 |
| 192 A1.000 | 1910cc | 4 Cyl. | 8 Valves | 85kW/115PS | Diesel | Turbo, SOHC | TD16398 |
| 192 A8.000 | 1910cc | 4 Cyl. | 8 Valves | 88kW/120PS | Diesel | Turbo, SOHC | TD20238 |
| 192 A9.000 | 1910cc | 4 Cyl. | 8 Valves | 74kW/100PS | Diesel | Turbo, SOHC | TD18451 |
| 192 B5.000 | 1910cc | 4 Cyl. | 8 Valves | 66kW/90PS | Diesel | Turbo, SOHC | TD19308 |
| 199 A5.000 | 1910cc | 4 Cyl. | 8 Valves | 96kW/131PS | Diesel | Turbo, SOHC | TD20762 |
| 223 B2.000 | 1910cc | 4 Cyl. | 8 Valves | 74kW/100PS | Diesel | Turbo, SOHC | TD20246 |
| 937 A7.000 | 1910cc | 4 Cyl. | 8 Valves | 85kW/115PS | Diesel | Turbo, SOHC | TD19307 |
| 939 A1.000 | 1910cc | 4 Cyl. | 8 Valves | 88kW/120PS | Diesel | Turbo, SOHC | TD18448 |
| D19AA | 1910cc | 4 Cyl. | 8 Valves | 88kW/120PS | Diesel | Turbo, SOHC | TD20930 |
| BRAVO II 1.9 D Multijet | 11/2006→ | | | CROMA 1.9 D Multijet | 06/2005→ | | |
| DOBLO 1.9 JTD | 10/2001→ | | | GRANDE PUNTO 1.9 D Multijet | 10/2005→ | | |
| IDEA 1.9 JTD | 01/2004→ | | | MULTIPLA 1.9 JTD 115 | 07/2002→06/2010 | | |
| PUNTO 1.9 JTD | 06/2003→03/2012 | | | SEDICI 1.9 D Multijet | 06/2006→10/2011 | | |
| STILO 1.9 D | 09/2004→08/2008 | | | STILO 1.9 D Multijet | 09/2005→08/2008 | | |
| STILO 1.9 JTD | 10/2001→08/2008 | | | | | | |

V94470 ■
35.30 x 8.00 x 115.00

46 750 859



45°

H

VAG96124 ■ ■ ■
42.90 x 8.02 x 14.06



V94471 ■
34.50 x 8.00 x 115.00

46 783 962



45°

H

VAG96203 ■ ■ ■
43.00 x 8.03 x 14.08



VAG96210 ■ ■ ■
43.00 x 8.04 x 14.04

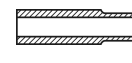

51



82.00

| | | | | | | | |
|----------------|-----------------|--------|----------|-----------------|-----------------|------|---------|
| 188 A3.000 | 1910cc | 4 Cyl. | 8 Valves | 44kW/60PS | Diesel | SOHC | TD12789 |
| 223 A6.000 | 1910cc | 4 Cyl. | 8 Valves | 46-48kW/63-65PS | Diesel | SOHC | TD15829 |
| DOBLO 1.9 D | 03/2001→ | | | PALIO 1.9 D | 09/2000→ | | |
| PUNTO 1.9 D 60 | 02/2000→10/2009 | | | PUNTO 1.9 DS 60 | 09/1999→03/2012 | | |
| SIENA 1.9 D | 11/2000→12/2009 | | | STRADA 1.9 D | 12/2000→ | | |

V91937 ■
37.50 x 8.00 x 114.20

7 798 620

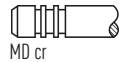

45°

VAG96124 ■ ■ ■
42.90 x 8.02 x 14.06

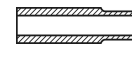

V91938 ■
31.00 x 8.00 x 114.00

7 783 225

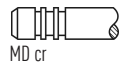

45°

VAG96203 ■ ■ ■
43.00 x 8.03 x 14.08



VAG96210 ■ ■ ■
43.00 x 8.04 x 14.04



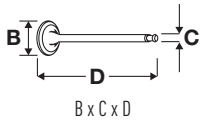

OE

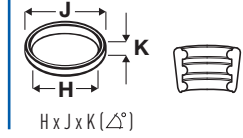
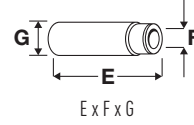
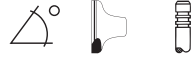

52 **82.00**

| Part No. | Capacity | Cyls | Valves | Power | Fuel | Configuration | Code |
|----------------------|------------|----------|-----------|---------------|--------|-----------------|--------------------------------|
| 192 A5.000 | 1910cc | 4 Cyl. | 16 Valves | 103kW/140PS | Diesel | Turbo, DOHC | TD17980 |
| 192 B1.000 | 1910cc | 4 Cyl. | 16 Valves | 100kW/136PS | Diesel | Turbo, DOHC | TD18944 |
| 939 A2.000 | 1910cc | 4 Cyl. | 16 Valves | 110kW/150PS | Diesel | Turbo, DOHC | TD18449 |
| CROMA 1.9 D Multijet | | 06/2005→ | | STILO 1.9 JTD | | 01/2004→08/2008 | |
| V94588 | 46 802 049 | | 45° | Y | H | VAG96360 | 46.70 x 5.00 x 10.03 07/06→ |
| V98005 | 55207517 | | 45° | | | | |
| V94589 | 46 787 902 | | 45° | | H | | |
| V98006 | 55207955 | | 45° | | | | |

53 **82.00**

| Part No. | Capacity | Cyls | Valves | Power | Fuel | Configuration | Code |
|---------------|------------|-----------------|-----------|------------|--------|---------------|---------|
| 937 A4.000 | 1910cc | 4 Cyl. | 16 Valves | 93kW/126PS | Diesel | Turbo, DOHC | TD18943 |
| STILO 1.9 JTD | | 09/2003→08/2008 | | | | | |
| V94588 | 46 802 049 | | 45° | Y | H | | |
| V94589 | 46 787 902 | | 45° | | H | | |

54 **82.00**

| Part No. | Capacity | Cyls | Valves | Power | Fuel | Configuration | Code |
|-------------------------|------------|----------|-----------|----------------------|--------|-----------------|--------------------------------------|
| 937 A5.000 | 1910cc | 4 Cyl. | 16 Valves | 110kW/150PS | Diesel | Turbo, DOHC | TD18929 |
| BRAVO II 1.9 D Multijet | | 04/2007→ | | STILO 1.9 D Multijet | | 09/2005→08/2008 | |
| V94588 | 46 802 049 | | 45° | Y | H | VAG96360 | 46.70 x 5.00 x 10.03 Eng.5192516→ |
| V98005 | 55207517 | | 45° | | | | |
| V94589 | 46 787 902 | | 45° | | H | | |
| V98006 | 55207955 | | 45° | | | | |



OE

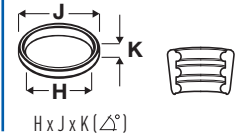

55



82.00

| | | | | | | | |
|---------------------|--------|-----------------|-----------|-------------------|--------|-----------------|--------|
| 175 A3.000 | 1998cc | 5 Cyl. | 20 Valves | 162kW/220PS | Petrol | Turbo, DOHC | TD5491 |
| 182 A1.000 | 1998cc | 5 Cyl. | 20 Valves | 108kW/147PS | Petrol | DOHC | TD4397 |
| BRAVO I 2.0 HGT 20V | | 10/1995→07/1998 | | COUPE 2.0 20V | | 08/1996→04/1998 | |
| COUPE 2.0 20V Turbo | | 08/1996→08/2000 | | MAREA 2.0 150 20V | | 09/1996→04/1999 | |

V91931 ■
30.00 x 7.00 x 113.00

7 735 898

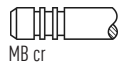

MB cr

45°

H

VAG96123 ■
42.25 x 7.02 x 13.05



V91932 ■
26.00 x 7.00 x 108.50

7 735 899



MD + MB cr

45°

H

VAG96146 ■
42.50 x 7.04 x 13.05



VAG96145 ■
46.00 x 7.02 x 13.03



VAG96230 ■
46.00 x 7.02 x 13.06

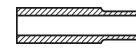

56



82.00

| | | | | | | | |
|-------------------|--------|-----------------|-----------|---------------------|--------|-----------------|---------|
| 182 B3.000 | 1998cc | 5 Cyl. | 20 Valves | 113kW/154PS | Petrol | DOHC | TD11789 |
| 182 B7.000 | 1998cc | 5 Cyl. | 20 Valves | 113kW/154PS | Petrol | DOHC | TD15498 |
| 185 A8.000 | 1998cc | 5 Cyl. | 20 Valves | 110kW/150PS | Petrol | DOHC | TD15830 |
| BRAVA 2.0 | | 09/1998→08/2000 | | BRAVO I 2.0 HGT 20V | | 07/1998→10/2001 | |
| COUPE 2.0 20V | | 04/1998→08/2000 | | MAREA 2.0 150 20V | | 01/2001→05/2002 | |
| MAREA 2.0 155 20V | | 04/1999→02/2003 | | | | | |

V91933 ■
33.40 x 7.00 x 113.10

7 766 564

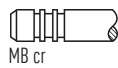

MB cr

45°

H

VAG96123 ■
42.25 x 7.02 x 13.05

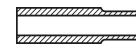

V91934 ■
28.00 x 7.00 x 108.60

7 766 565

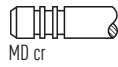

MD cr

45°

SS

VAG96146 ■
42.50 x 7.04 x 13.05



VAG96145 ■
46.00 x 7.02 x 13.03



VAG96230 ■
46.00 x 7.02 x 13.06



57



82.00

| | | | | | | | |
|------------------|--------|-----------------|-----------|------------|--------|-------------|--------|
| 185 A2.000 | 2387cc | 5 Cyl. | 10 Valves | 91kW/125PS | Diesel | Turbo, SOHC | TD4406 |
| MAREA 2.4 TD 125 | | 09/1996→04/1999 | | | | | |

V91937 ■
37.50 x 8.00 x 114.20

7 798 620

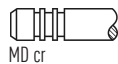

MD cr

45°

VAG96124 ■ ■ ■
42.90 x 8.02 x 14.06



V91938 ■
31.00 x 8.00 x 114.00

7 783 225

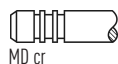

MD cr

45°

VAG96203 ■ ■ ■
43.00 x 8.03 x 14.08



VAG96210 ■ ■ ■
43.00 x 8.04 x 14.04



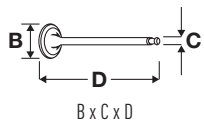



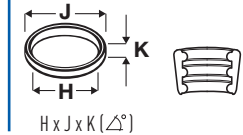
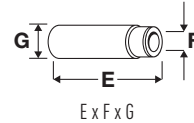







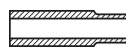

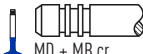

OE









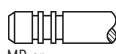

58  **82.00**

| | | | | | | | |
|-------------------|--------|-----------------|------------------|-------------------|--------|--------------------|----------------|
| 185 A6.000 | 2387cc | 5 Cyl. | 10 Valves | 96kW/130PS | Diesel | Turbo, SOHC | TD18145 |
| 839 A5.000 | 2387cc | 5 Cyl. | 10 Valves | 96-99kW/131-135PS | Diesel | Turbo, SOHC | TD14408 |
| MAREA 2.4 JTD 130 | | 04/1999→05/2002 | | | | | |

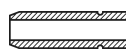
| | | | | | | |
|---|------------|---|-----|------|--|---|
| V94064  | 608 14 605 |  | 45° | H | VAG96124  |  |
| 35.50 x 8.00 x 115.00 | | MB cr | | | 42.90 x 8.02 x 14.06 | |
| V94470  | 46 750 859 |  | 45° | H | VAG96203  |  |
| 35.30 x 8.00 x 115.00 | | MD + MB cr | | | 43.00 x 8.03 x 14.08 | |
| V94065  | 608 14 604 |  | 45° | | VAG96210  |  |
| 34.50 x 8.00 x 115.00 | | MD cr | | | 43.00 x 8.04 x 14.04 | |
| V94471  | 46 783 962 |  | 45° | H | | |
| 34.50 x 8.00 x 115.00 | | MD + MB cr | | | | |
| V94590  | 55202630 |  | 45° | ss H | | |
| 34.45 x 8.00 x 115.00 | | MD + MB cr | | | | |



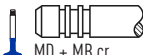

59  **82.00**

| | | | | | | | |
|----------------------|--------|----------|------------------|-------------|--------|--------------------|----------------|
| 939 A3.000 | 2387cc | 5 Cyl. | 20 Valves | 147kW/200PS | Diesel | Turbo, DOHC | TD18450 |
| CROMA 2.4 D Multijet | | 06/2005→ | | | | | |

| | | | | | | |
|---|------------|---|-----|-----|--|---|
| V94588  | 46 802 049 |  | 45° | Y H | VAG96360  |  |
| 27.90 x 6.00 x 114.00 →06/06 | | MB cr | | | 46.70 x 5.00 x 10.03 07/06→ | |
| V98005  | 55207517 |  | 45° | | | |
| 28.00 x 5.00 x 114.40 07/06→ | | MB cr | | | | |
| V94589  | 46 787 902 |  | 45° | H | | |
| 25.80 x 6.00 x 114.30 →06/06 | | MD + MB cr | | | | |
| V98006  | 55207955 |  | 45° | | | |
| 24.50 x 5.00 x 114.40 07/06→ | | MD + MB cr | | | | |

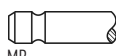
60  **82.20**

| | | | | | | | |
|-------------------|--------|-----------------|-----------------|-----------------|--------|-------------|----------------|
| WJY (DW8) | 1868cc | 4 Cyl. | 8 Valves | 51kW/69PS | Diesel | SOHC | TD21266 |
| WJY (DW8B) | 1868cc | 4 Cyl. | 8 Valves | 51kW/69PS | Diesel | SOHC | TD22240 |
| WJZ (DW8) | 1868cc | 4 Cyl. | 8 Valves | 51-52kW/69-71PS | Diesel | SOHC | TD16300 |
| SCUDO 1.9 D | | 04/1998→12/2006 | | | | | |

| | | | | | | |
|---|------------|---|-----|---|--|---|
| V91144  | 96 005 391 |  | 45° | H | VAG96100  |  |
| 38.50 x 8.00 x 112.50 | | MB | | | 48.00 x 8.02 x 14.37 | |
| V91145  | 96 137 360 |  | 45° | | | |
| 33.00 x 8.00 x 112.00 | | MD cr | | | | |



OE

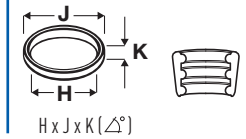
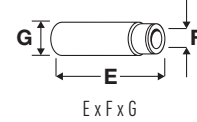

61  **82.60**

| | | | | | | | |
|-----------------------|-----------------|--------|----------|------------------------|--------|-----------------|--------|
| 146 B2.000 | 1698cc | 4 Cyl. | 8 Valves | 42-44kW/57-60PS | Diesel | SOHC | TD949 |
| 146 D7.000 | 1698cc | 4 Cyl. | 8 Valves | 46kW/63PS | Diesel | Turbo, SOHC | TD9472 |
| 149 B3.000 | 1698cc | 4 Cyl. | 8 Valves | 44kW/60PS | Diesel | SOHC | TD967 |
| 149 B4.000 | 1698cc | 4 Cyl. | 8 Valves | 42-45kW/57-61PS | Diesel | SOHC | TD968 |
| 176 A3.000 | 1698cc | 4 Cyl. | 8 Valves | 51-53kW/69-72PS | Diesel | Turbo, SOHC | TD1033 |
| 176 A5.000 | 1698cc | 4 Cyl. | 8 Valves | 52-59kW/71-80PS | Diesel | Turbo, SOHC | TD1035 |
| 176 B3.000 | 1698cc | 4 Cyl. | 8 Valves | 42kW/57PS | Diesel | SOHC | TD9477 |
| 176 B7.000 | 1698cc | 4 Cyl. | 8 Valves | 46-47kW/63-64PS | Diesel | Turbo, SOHC | TD5493 |
| DUNA 1.7 DS | 01/1987→12/1991 | | | ELBA 1.7 D | | 04/1989→10/1997 | |
| FIORINO 1.7 D | 01/1988→10/1999 | | | FIORINO 1.7 TD | | 11/1996→08/2006 | |
| FIORINO 60 1.7 D | 05/1988→05/2000 | | | FIORINO 65 1.7 TD | | 01/1997→05/2001 | |
| FIORINO Pick up 1.7 D | 05/1988→10/1999 | | | FIORINO Pick up 1.7 TD | | 01/1997→05/2001 | |
| PALIO 1.7 D | 04/1996→09/2002 | | | PALIO 1.7 TD | | 04/1996→ | |
| PENNY 1.7 D | 01/1986→12/1990 | | | PUNTO 1.7 D | | 04/1994→02/2000 | |
| PUNTO 1.7 TD | 01/1994→02/2000 | | | REGATA 60 Diesel 1.7 | | 01/1984→12/1989 | |
| RITMO 1.7 Diesel | 05/1985→12/1987 | | | SIENA 1.7 D | | 05/1999→12/2009 | |
| SIENA 1.7 TD | 02/2006→12/2009 | | | STRADA 1.7 TD | | 06/1999→01/2010 | |
| TIPO 1.7 D | 01/1988→10/1995 | | | UNO 1.7 D | | 02/1988→08/2000 | |
| UNO 60 Diesel 1.7 | 07/1986→12/1993 | | | | | | |

V91767 
37.50 x 8.00 x 117.00

5 990 532

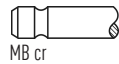

45°

H

VAG92366 
46.50 x 8.00 x 14.10



V91392 
33.50 x 8.00 x 116.70

5 990 533

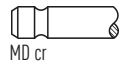

45°

62  **82.60**

| | | | | | | | |
|----------------------|-----------------|--------|----------|-------------------------|--------|-----------------|--------|
| 149 A1.000 | 1929cc | 4 Cyl. | 8 Valves | 48kW/65PS | Diesel | SOHC | TD4378 |
| 149 B1.000 | 1929cc | 4 Cyl. | 8 Valves | 51-52kW/70-71PS | Diesel | SOHC | TD963 |
| 160 A7.000 | 1929cc | 4 Cyl. | 8 Valves | 48kW/65PS | Diesel | SOHC | TD1023 |
| 230 A2.000 | 1929cc | 4 Cyl. | 8 Valves | 51kW/70PS | Diesel | SOHC | TD862 |
| 230 A3.000 | 1929cc | 4 Cyl. | 8 Valves | 60kW/82PS | Diesel | Turbo, SOHC | TD5481 |
| 230 A4.000 | 1929cc | 4 Cyl. | 8 Valves | 59kW/80PS | Diesel | Turbo, SOHC | TD4407 |
| 280 A1.000 | 1929cc | 4 Cyl. | 8 Valves | 60kW/82PS | Diesel | Turbo, SOHC | TD1043 |
| BRAVA 1.9 D | 10/1995→10/2001 | | | BRAVO I 1.9 D | | 10/1995→10/2001 | |
| DUCATO 1.9 D | 02/1987→04/2002 | | | DUCATO 1.9 TD | | 03/1989→04/2002 | |
| DUCATO 1.9 TD CAT | 08/1994→04/2002 | | | DUCATO 1.9 TD/Combinato | | 03/1994→04/2002 | |
| REGATA 65 Diesel 1.9 | 04/1984→07/1989 | | | TALENTO 1.9 D | | 03/1989→03/1994 | |
| TEMPRA 1.9 D | 07/1991→08/1996 | | | TIPO 1.9 D | | 07/1991→08/1995 | |

V91767 
37.50 x 8.00 x 117.00

5 990 532

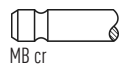

45°

H

VAG92366 
46.50 x 8.00 x 14.10



V91392 
33.50 x 8.00 x 116.70

5 990 533

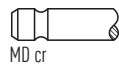

45°

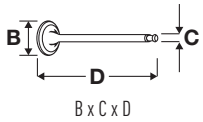

OE

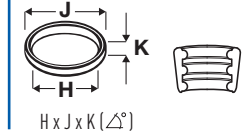
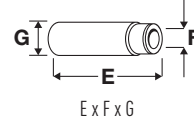

63 **82.60**

| | | | | | | | |
|----------------------------|-----------------|--------|-----------------|-----------------|--------|--------------------|---------------|
| 160 A6.000 | 1929cc | 4 Cyl. | 8 Valves | 66-68kW/90-92PS | Diesel | Turbo, SOHC | TD4394 |
| 160 A6.046 | 1929cc | 4 Cyl. | 8 Valves | 66kW/90PS | Diesel | Turbo, SOHC | TD1022 |
| 160 B6.046 | 1929cc | 4 Cyl. | 8 Valves | 59kW/82PS | Diesel | Turbo, SOHC | TD1025 |
| 160 D1.000 | 1929cc | 4 Cyl. | 8 Valves | 65-66kW/88-90PS | Diesel | Turbo, SOHC | TD1026 |
| 831 D1.000 | 1929cc | 4 Cyl. | 8 Valves | 59kW/80PS | Diesel | Turbo, SOHC | TD4410 |
| REGATA 80 Turbo Diesel 1.9 | 05/1986→07/1989 | | | RITMO 1.9 TD | | 12/1985→12/1987 | |
| TEMPRA 1.9 TD | 05/1990→08/1996 | | | TIPO 1.9 TD | | 09/1990→04/1995 | |

| | | | | | | | |
|-----------------------|-----------|-------|-----|--|--|----------------------|--|
| V91291 | 7 547 158 | | 45° | | | VAG92366 | |
| 37.50 x 8.00 x 116.50 | | MD cr | | | | 46.50 x 8.00 x 14.10 | |
| V91321 | 7 588 577 | | 45° | | | | |
| 33.50 x 8.00 x 116.45 | | MD cr | | | | | |
| Eng.→674284 | | | | | | | |
| V91392 | 5 990 533 | | 45° | | | | |
| 33.50 x 8.00 x 116.70 | | MD cr | | | | | |
| Eng.674285→ | | | | | | | |

64 **83.00**

| | | | | | | | |
|---------------------|-----------------|--------|-----------------|-----------|--------|-------------|----------------|
| LFW (XU7 JP) | 1761cc | 4 Cyl. | 8 Valves | 73kW/99PS | Petrol | SOHC | TD10167 |
| ULYSSE 1.8 | 05/1997→08/2002 | | | | | | |

| | | | | | | | |
|-----------------------|------------|-------|-----|---|---|----------------------|--|
| V91277 | 91 535 017 | | 45° | Y | H | VAG92332B | |
| 41.60 x 8.00 x 108.80 | | MB | | | | 38.70 x 8.02 x 13.07 | |
| V91275 | 91 535 019 | | 45° | | | VAG96056B | |
| 34.50 x 8.00 x 108.30 | | MD cr | | | | 45.00 x 8.03 x 13.07 | |

65 **83.00**

| | | | | | | | |
|-----------------------|--------|--------|-----------------|-----------------|--------|--------------------|----------------|
| D8B | 1905cc | 4 Cyl. | 8 Valves | 68kW/92PS | Diesel | Turbo, SOHC | TD6828 |
| D8B (XUD9TE) | 1905cc | 4 Cyl. | 8 Valves | 66-69kW/90-94PS | Diesel | Turbo, SOHC | TD21263 |
| DHX (XUD9TE) | 1905cc | 4 Cyl. | 8 Valves | 66-69kW/90-94PS | Diesel | Turbo, SOHC | TD21264 |
| DHX (XUD9TF/L) | 1905cc | 4 Cyl. | 8 Valves | 66-68kW/90-92PS | Diesel | Turbo, SOHC | TD4352 |

| | | | | | | | |
|------------------|-----------------|--|--|---------------|--|-----------------|--|
| DUCATO 1.9 TD | 04/1998→04/2002 | | | SCUDO 1.9 TD | | 02/1996→12/2006 | |
| SCUDO 1.9 TD Eco | 02/1996→12/2006 | | | ULYSSE 1.9 TD | | 02/1995→08/2002 | |



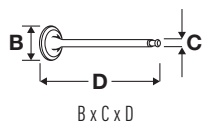



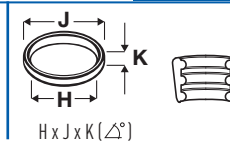
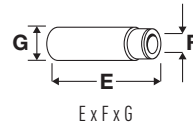

| | | | | | | | |
|-----------------------|------------|-------|-----|--|---|----------------------|--|
| V91144 | 96 005 391 | | 45° | | H | VAG92288B | |
| 38.50 x 8.00 x 112.50 | | MB | | | | 52.00 x 8.03 x 14.28 | |
| V91145 | 96 137 360 | | 45° | | | VAG92465B | |
| 33.00 x 8.00 x 112.00 | | MD cr | | | | 52.00 x 8.03 x 14.07 | |
| V94017 | 0949.74 | | 45° | | | | |
| 33.00 x 8.00 x 111.90 | | MD cr | | | | | |







OE

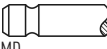







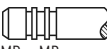





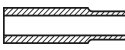

66  **83.00**

| | | | | | | | |
|---|-----------------|---|-----------------|-----------------|--|---|----------------|
| D9B (XUD9/A/B/L/Y) | 1905cc | 4 Cyl. | 8 Valves | 50-51kW/68-69PS | Diesel | SOHC | TD6827 |
| D9B (XUD9A) | 1905cc | 4 Cyl. | 8 Valves | 47-52kW/64-71PS | Diesel | SOHC | TD21265 |
| DJY (XUD9A) | 1905cc | 4 Cyl. | 8 Valves | 50kW/68PS | Diesel | SOHC | TD12748 |
| DUCATO 1.9 D | 04/1998→04/2002 | | SCUDO 1.9 D | | 02/1996→12/2006 | | |
| V91144  | 96 005 391 |  | 45° | H | VAG92288B  |  | |
| 38.50 x 8.00 x 112.50 | | MB | | | 52.00 x 8.03 x 14.28 | | |
| V91145  | 96 137 360 |  | 45° | | VAG92331B  |  | |
| 33.00 x 8.00 x 112.00 | | MD cr | | | 50.00 x 8.03 x 14.08 | | |
| V94024  | 0949.64 |  | 45° | | | | |
| 33.00 x 8.00 x 112.00 | | MD | | | | | |





67  **83.00**

| | | | | | | | |
|---|----------|---|------------------|---------------------|---|---|----------------|
| 198 A5.000 | 1956cc | 4 Cyl. | 16 Valves | 121kW/165PS | Diesel | Turbo, DOHC | TD24569 |
| 844 A2.000 | 1956cc | 4 Cyl. | 16 Valves | 120kW/163PS | Diesel | Turbo, DOHC | TD24593 |
| 939 B5.000 | 1956cc | 4 Cyl. | 16 Valves | 100-125kW/140-170PS | Diesel | Turbo, DOHC | TD26620 |
| 940 A5.000 | 1956cc | 4 Cyl. | 16 Valves | 103-125kW/140-170PS | Diesel | Turbo, DOHC | TD26672 |
| BRAVO II 2.0 D Multijet | 09/2008→ | | FREEMONT 2.0 JTD | | 08/2011→ | | |
| V98005  | 55207517 |  | 45° | | VAG96360  |  | |
| 28.00 x 5.00 x 114.40 | | MB cr | | | 46.70 x 5.00 x 10.03 | | |
| V98006  | 55207955 |  | 45° | | | | |
| 24.50 x 5.00 x 114.40 | | MD + MB cr | | | | | |

68  **83.00**

| | | | | | | | |
|---|-----------------|---|------------------|---------------------|---|---|----------------|
| 192 A2.000 | 2446cc | 5 Cyl. | 20 Valves | 117-125kW/159-170PS | Petrol | DOHC | TD16396 |
| MAREA 2.4 | 09/2000→06/2006 | | STILO 2.4 20V | | 10/2001→11/2006 | | |
| V91933  | 7 766 564 |  | 45° | H | VAG96123  |  | |
| 33.40 x 7.00 x 113.10 | | MB cr | | | 42.25 x 7.02 x 13.05 | | |
| V91934  | 7 766 565 |  | 45° | SS | VAG96146  |  | |
| 28.00 x 7.00 x 108.60 | | MD cr | | | 42.50 x 7.04 x 13.05 | | |
| V94582  | 7 766 565 |  | 45° | | VAG96145  |  | |
| 28.00 x 7.00 x 108.50 | | MD cr | | | 46.00 x 7.02 x 13.03 | | |
| V94591  | 606 74 496 |  | 45° | SS H | VAG96230  |  | |
| 28.00 x 7.00 x 108.80 | | MD + MB cr | | | 46.00 x 7.02 x 13.06 | | |

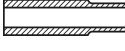
69  **84.00**

| | | | | | | | |
|---|-----------------|---|-----------------|-------------------|---|---|---------------|
| 159 A4.000 | 1756cc | 4 Cyl. | 8 Valves | 74-81kW/101-110PS | Petrol | | TD1008 |
| 159 A4.046 | 1756cc | 4 Cyl. | 8 Valves | 77kW/105PS | Petrol | | TD1009 |
| TEMPRA 1.8 i.e. | 03/1990→08/1996 | | TIPO 1.8 i.e. | | 10/1990→10/1995 | | |
| V91290  | 7547400 |  | 45° | H | VAG96171  |  | |
| 43.50 x 8.00 x 105.70 | | MB | | | 42.00 x 8.02 x 14.06 | | |
| V91305  | 7 597 080 |  | 45° | | | | |
| 36.00 x 8.00 x 105.55 | | MD cr | | | | | |

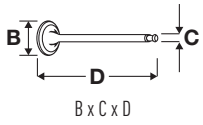



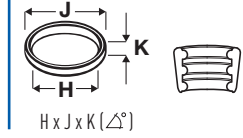
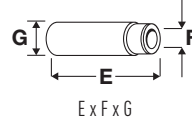
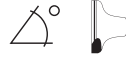

OE





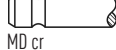

70  **84.00**

| | | | | | | | |
|-------------------|--------|-----------------|------------------|-------------|--------|-------------|----------------|
| 160 A5.000 | 1756cc | 4 Cyl. | 16 Valves | 100kW/136PS | Petrol | DOHC | TD13669 |
| TIPO 1.8 i.e.16V | | 11/1989→06/1992 | | | | | |

| | | | | | | |
|---|-----------|---|-----|----|---|---|
| V91935  | 7 722 907 |  | 45° | | VAG92496  |  |
| 34.40 x 7.00 x 128.00 | | MD cr | | | 51.00 x 7.03 x 14.04 | |
| V91638  | 7 958 073 |  | 45° | SS | VAG96199  |  |
| 28.50 x 7.00 x 126.00 | | MD cr | | | 51.30 x 7.04 x 14.08 | |

71  **84.00**

| | | | | | | | |
|-------------------|--------|-----------------|-----------------|------------------|--------|------------------------|----------------|
| 835 C2.000 | 1756cc | 4 Cyl. | 8 Valves | 76kW/103PS | Petrol | SOHC | TD1068 |
| 835 C4.000 | 1756cc | 4 Cyl. | 8 Valves | 66kW/90PS | Petrol | SOHC | TD1069 |
| 836 A5.000 | 1756cc | 4 Cyl. | 8 Valves | 71-74kW/97-101PS | Petrol | SOHC | TD892 |
| 836 A6.000 | 1756cc | 4 Cyl. | 8 Valves | 66kW/90PS | Petrol | SOHC, Injection | TD18890 |
| TEMPRA 1.8 i.e. | | 09/1993→08/1996 | | TIPO 1.8 i.e. | | 03/1993→04/1995 | |
| TIPO 1.8 i.e. | | 04/1993→10/1995 | | | | | |

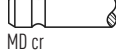
| | | | | | | |
|---|-----------|---|-----|----|--|--|
| V91290  | 7547400 |  | 45° | H | VAG96171  |  |
| 43.50 x 8.00 x 105.70 | | MB | | | 42.00 x 8.02 x 14.06 | |
| V91638  | 7 958 073 |  | 45° | SS | | |
| 28.50 x 7.00 x 126.00 | | MD cr | | | | |

72  **84.00**

| | | | | | | | |
|-------------------|-----------------|----------------------|-----------------|--------------------|--------|-------------|---------------|
| 131 B2.000 | 1995cc | 4 Cyl. | 8 Valves | 85-103kW/115-140PS | Petrol | DOHC | TD900 |
| 132 C2.000 | 1995cc | 4 Cyl. | 8 Valves | 82-84kW/112-115PS | Petrol | DOHC | TD910 |
| 132 D1.000 | 1995cc | 4 Cyl. | 8 Valves | 83kW/113PS | Petrol | DOHC | TD4354 |
| 154 C3.046 | 1995cc | 4 Cyl. | 8 Valves | 85kW/116PS | Petrol | DOHC | TD984 |
| 159 A6.046 | 1995cc | 4 Cyl. | 8 Valves | 76-85kW/103-116PS | Petrol | DOHC | TD1012 |
| 131 2.0 | 06/1978→12/1981 | 131 2.0 Abarth Rally | | 01/1976→07/1980 | | | |
| 132 2.0 | 01/1976→06/1981 | ARGENTA 2000 | | 06/1978→12/1985 | | | |
| CROMA 2000 i.e. | 10/1987→08/1996 | TEMPRA 2.0 | | 04/1990→12/1998 | | | |
| TEMPRA 2.0 i.e. | 10/1990→08/1996 | TIPO 2.0 | | 10/1990→10/1992 | | | |
| TIPO 2.0 i.e. | 03/1990→04/1995 | | | | | | |

| | | | | | | |
|---|-----------|---|-----|--|---|---|
| V91636  | 5 975 341 |  | 45° | | VAG96171  |  |
| 36.50 x 8.00 x 106.10 | | MD cr | | | 42.00 x 8.02 x 14.06 | |



OE

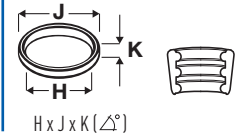
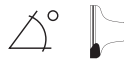

73  **84.00**

| | | | | | | | |
|-----------------------|-----------------|--------|----------|---------------------|-----------------|-------------|---------|
| 138 AR1.000 | 1995cc | 4 Cyl. | 8 Valves | 92kW/125PS | Petrol | DOHC | TD4360 |
| 138 AR2.000 | 1995cc | 4 Cyl. | 8 Valves | 96kW/130PS | Petrol | DOHC | TD4361 |
| 154 A1.000 | 1995cc | 4 Cyl. | 8 Valves | 66-74kW/90-101PS | Petrol | DOHC | TD1077 |
| 154 A2.000 | 1995cc | 4 Cyl. | 8 Valves | 114kW/155PS | Petrol | Turbo, DOHC | TD1083 |
| 154 C4.046 | 1995cc | 4 Cyl. | 8 Valves | 110kW/150PS | Petrol | Turbo, DOHC | TD986 |
| 834 B.000 | 1995cc | 4 Cyl. | 8 Valves | 88kW/120PS | Petrol | DOHC | TD1084 |
| 834 B.048 | 1995cc | 4 Cyl. | 8 Valves | 83kW/113PS | Petrol | DOHC | TD1085 |
| 834 B.146 | 1995cc | 4 Cyl. | 8 Valves | 85kW/116PS | Petrol | DOHC | TD11707 |
| 834 C.146 | 1995cc | 4 Cyl. | 8 Valves | 110-112kW/150-152PS | Petrol | Turbo, DOHC | TD1064 |
| CROMA 2000 CHT | 12/1985→09/1992 | | | CROMA 2000 i.e. | 03/1986→08/1996 | | |
| CROMA 2000 i.e. Turbo | 12/1985→08/1996 | | | | | | |

V91290 
43.50 x 8.00 x 105.70

7547400

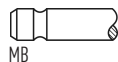

45°

H

VAG96171 
42.00 x 8.02 x 14.06



V91636 
36.50 x 8.00 x 106.10

5 975 341

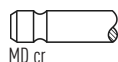

45°

74  **84.00**

| | | | | | | | |
|----------------|-----------------|--------|-----------|--------------------|-----------------|------|--------|
| 154 E1.000 | 1995cc | 4 Cyl. | 16 Valves | 93-101kW/126-137PS | Petrol | DOHC | TD989 |
| 836 A3.000 | 1995cc | 4 Cyl. | 16 Valves | 102kW/139PS | Petrol | DOHC | TD1071 |
| COUPE 2.0 16V | 11/1993→08/1996 | | | CROMA 2000 16V | 08/1992→08/1996 | | |
| TEMPRA 2.0 16V | 10/1995→12/1998 | | | TIPO 2.0 i.e. 16V | 03/1993→04/1995 | | |

V91935 
34.40 x 7.00 x 128.00

7 722 907

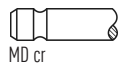

45°

VAG92496 
51.00 x 7.03 x 14.04



V91638 
28.50 x 7.00 x 126.00

7 958 073

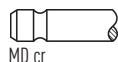

45°

SS

VAG96181B 
51.30 x 7.04 x 14.05

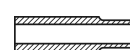

VAG96199 
51.30 x 7.04 x 14.08



75  **84.00**

| | | | | | | | |
|---------------------|-----------------|--------|-----------|-------------|--------|-------------|--------|
| 175 A1.000 | 1995cc | 4 Cyl. | 16 Valves | 140kW/190PS | Petrol | Turbo, DOHC | TD4395 |
| COUPE 2.0 16V Turbo | 11/1993→08/1996 | | | | | | |

V91935 
34.40 x 7.00 x 128.00

7 722 907



45°

VAG92496 
51.00 x 7.03 x 14.04



V91936 
28.35 x 7.00 x 125.50

7 650 916

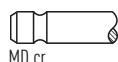

45°

VAG96181B 
51.30 x 7.04 x 14.05

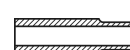

VAG96199 
51.30 x 7.04 x 14.08



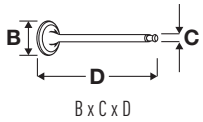



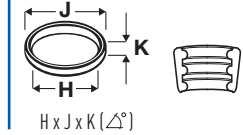
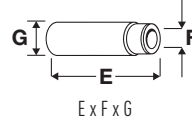
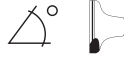

OE



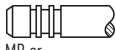



76  **85.00**

| | | | | | | | |
|-------------------|-----------------|--------|-----------------|---------------|--------|--------------------|----------------|
| DW10 (RHW) | 1997cc | 4 Cyl. | 8 Valves | 62kW/84PS | Diesel | Turbo, SOHC | TD16406 |
| DW10 (RHX) | 1997cc | 4 Cyl. | 8 Valves | 69kW/94PS | Diesel | Turbo, SOHC | TD16299 |
| DW10 (RHZ) | 1997cc | 4 Cyl. | 8 Valves | 80kW/109PS | Diesel | Turbo, SOHC | TD16324 |
| DUCATO 2.0 JTD | 07/2001→ | | | SCUDO 2.0 JTD | | 10/1999→12/2006 | |
| ULYSSE 2.0 JTD | 10/1999→08/2002 | | | | | | |

| | | | | | | | |
|---|---------------|---|-----|---|---|---|--|
| V94178  | 9 624 774 280 |  | 45° | H | VAG96119  |  | |
| 35.60 x 6.00 x 107.10 | | MB cr | | | 41.50 x 6.03 x 10.54 | | |
| V94179  | 9 624 774 580 |  | 45° | H | | | |
| 33.80 x 6.00 x 107.10 | | MD + MB cr | | | | | |

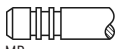



77  **85.00**

| | | | | | | | |
|------------------------|-----------------|--------|------------------|-------------------|--------|--------------------|----------------|
| DW10ATED4 (RHM) | 1997cc | 4 Cyl. | 16 Valves | 79-80kW/107-109PS | Diesel | Turbo, DOHC | TD18906 |
| DW10ATED4 (RHS) | 1997cc | 4 Cyl. | 16 Valves | 80kW/109PS | Diesel | Turbo, DOHC | TD16789 |
| SCUDO 2.0 JTD 16V | 05/1999→12/2006 | | | ULYSSE 2.0 JTD | | 08/2002→08/2006 | |
| ULYSSE 2.0 JTD 16V | 05/1999→08/2002 | | | | | | |

| | | | | | | | |
|---|---------------|---|-----|----|--|--|--|
| V94486  | 9 635 317 980 |  | 45° | Y | VAG96119  |  | |
| 29.90 x 6.00 x 106.20 | | MB cr | | H | 41.50 x 6.03 x 10.54 | | |
| V94487  | 9 635 318 480 |  | 45° | ss | | | |
| 25.00 x 6.00 x 106.10 | | MD + MB cr | | H | | | |

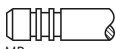



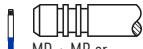

78  **85.00**

| | | | | | | | |
|----------------------|----------|--------|------------------|-----------------------|--------|--------------------|----------------|
| DW10BTED4 | 1997cc | 4 Cyl. | 16 Valves | 100kW/136PS | Diesel | Turbo, DOHC | TD25755 |
| RHK | 1997cc | 4 Cyl. | 16 Valves | 88kW/120PS | Diesel | Turbo, DOHC | TD20267 |
| RHR | 1997cc | 4 Cyl. | 16 Valves | 100kW/136PS | Diesel | Turbo, DOHC | TD20268 |
| SCUDO 2.0 D Multijet | 01/2007→ | | | ULYSSE 2.0 D Multijet | | 05/2006→06/2011 | |

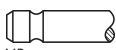
| | | | | | | | |
|---|---------------|---|-----|----|---|---|--|
| V94490  | 9 627 184 380 |  | 45° | Y | VAG96119  |  | |
| 29.80 x 6.00 x 105.00 | | MB cr | | H | 41.50 x 6.03 x 10.54 | | |
| V94491  | 9 634 437 580 |  | 45° | ss | | | |
| 25.00 x 6.00 x 105.00 | | MD + MB cr | | H | | | |

79  **85.00**

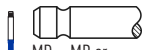
| | | | | | | | |
|---------------------|-----------------|--------|------------------|----------------|--------|-----------------|----------------|
| RFN (EW10J4) | 1997cc | 4 Cyl. | 16 Valves | 100kW/136PS | Petrol | DOHC | TD16788 |
| SCUDO 2.0 | 05/2000→12/2006 | | | SCUDO 2.0 16V | | 06/2000→12/2006 | |
| ULYSSE 2.0 | 08/2002→06/2011 | | | ULYSSE 2.0 16V | | 09/2000→08/2002 | |





| | | | | | | | |
|---|---------------|---|-----|----|--|---|--|
| V94200  | 9 623 950 380 |  | 45° | H | VAG96342B  |  | |
| 33.30 x 6.00 x 106.20 | | MB | | | 40.80 x 6.02 x 12.11 | | |
| V94201  | 9 636 001 780 |  | 45° | ss | VAG96343  |  | |
| 29.00 x 6.00 x 103.60 | | MD + MB cr | | H | 40.80 x 6.02 x 12.06 | | |

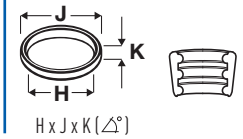







OE





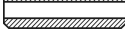



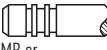

80  **85.00**

| RH02 | 1997cc | 4 Cyl. | 16 Valves | 94-120kW/128-163PS | Diesel | Turbo, DOHC | TD26194 |
|---|---------------|---|-----------|--------------------|--------|---|---------|
| SCUDO 2.0 D Multijet | | 07/2010→ | | | | | |
| V95234  | 0948.F6 |  | 45° | H | | VAG96119  | |
| 27.25 x 6.00 x 104.50 | | MB cr | | | | | |
| V94491  | 9 634 437 580 |  | 45° | ss | H | | |
| 25.00 x 6.00 x 105.00 | | MD + MB cr | | | | | |



81  **85.00**

| RHH | 1997cc | 4 Cyl. | 16 Valves | 120kW/163PS | Diesel | Turbo, DOHC | TD26774 |
|--|---------------|--|-----------|-------------|--------|---|---------|
| SCUDO 2.0 D Multijet | | 07/2010→ | | | | | |
| V94490  | 9 627 184 380 |  | 45° | Y | H | VAG96119  | |
| 29.80 x 6.00 x 105.00 | | MB cr | | | | | |
| V95234  | 0948.F6 |  | 45° | H | | | |
| 27.25 x 6.00 x 104.50 | | MB cr | | | | | |
| V94491  | 9 634 437 580 |  | 45° | ss | H | | |
| 25.00 x 6.00 x 105.00 | | MD + MB cr | | | | | |



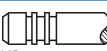

82  **85.00**

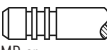
| RHK (DW10UTED4) | 1997cc | 4 Cyl. | 16 Valves | 79-88kW/107-120PS | Diesel | Turbo, DOHC | TD32639 |
|---|---------------|---|-----------|-------------------|--------|---|---------|
| SCUDO 2.0 JTD 16V | | 05/1999→12/2006 | | | | | |
| V94486  | 9 635 317 980 |  | 45° | Y | H | VAG96119  | |
| 29.90 x 6.00 x 106.20 | | MB cr | | | | | |
| V94490  | 9 627 184 380 |  | 45° | Y | H | | |
| 29.80 x 6.00 x 105.00 | | MB cr | | | | | |
| V94487  | 9 635 318 480 |  | 45° | ss | H | | |
| 25.00 x 6.00 x 106.10 | | MD + MB cr | | | | | |
| V94491  | 9 634 437 580 |  | 45° | ss | H | | |
| 25.00 x 6.00 x 105.00 | | MD + MB cr | | | | | |

83  **85.00**

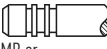
| P8C (XUD 11 BTE) | 2088cc | 4 Cyl. | 12 Valves | 80kW/109PS | Diesel | Turbo, SOHC | TD960 |
|---|---------------|---|-----------|------------|--------|--|-------|
| ULYSSE 2.1 TD | | 03/1996→10/1999 | | | | | |
| V94169  | 9 600 781 780 |  | 45° | H | | VAG96215B  | |
| 33.90 x 8.00 x 122.30 | | MB cr | | | | | |
| V94170  | 9 604 295 780 |  | 45° | | | | |
| 33.90 x 8.00 x 121.90 | | MD cr | | | | | |

84  **85.00**

| 4HT (DW12BTED4) | 2179cc | 4 Cyl. | 16 Valves | 125kW/170PS | Diesel | Turbo, DOHC | TD25656 |
|---|---------------|---|-----------|-------------|--------|---|---------|
| ULYSSE 2.2 D Multijet | | 03/2008→06/2011 | | | | | |
| V95083  | 9 676 718 180 |  | 45° | Y | H | VAG96119  | |
| 27.25 x 5.97 x 95.70 | | MB cr | | | | | |
| V95084  | 9 676 718 280 |  | 45° | ss | H | | |
| 25.00 x 5.97 x 95.00 | | MD + MB cr | | | | | |





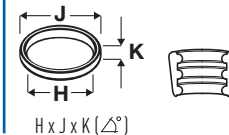
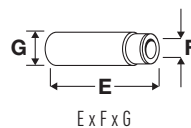



OE



85  **85.00**

| | | | | | | | |
|------------------------|--------|-----------------|------------------|--------------------|--------|--------------------|----------------|
| 4HW (DW12ATED4) | 2179cc | 4 Cyl. | 16 Valves | 94kW/128PS | Diesel | Turbo, DOHC | TD16790 |
| 4HX (DW12TED4) | 2179cc | 4 Cyl. | 16 Valves | 94-100kW/128-136PS | Diesel | Turbo, DOHC | TD22230 |
| ULYSSE 2.2 JTD | | 08/2002→08/2006 | | | | | |

| | | | | | | | |
|---|---------------|---|-----|----|---|---|---|
| V94490  | 9 627 184 380 |  | 45° | Y | H | VAG96119  |  |
| 29.80 x 6.00 x 105.00 | | MB cr | | | | 41.50 x 6.03 x 10.54 | |
| V94491  | 9 634 437 580 |  | 45° | ss | H | | |
| 25.00 x 6.00 x 105.00 | | MD + MB cr | | | | | |



86  **86.00**

| | | | | | | | |
|-------------------|--------|-----------------|-----------------|--------------------|--------|-----------------|----------------|
| 128 A1.000 | 1290cc | 4 Cyl. | 8 Valves | 44-55kW/60-75PS | Petrol | SOHC | TD889 |
| 128 AC.000 | 1290cc | 4 Cyl. | 8 Valves | 55kW/75PS | Petrol | SOHC | TD890 |
| 128 AR.000 | 1290cc | 4 Cyl. | 8 Valves | 50-53kW/68-72PS | Petrol | SOHC | TD21448 |
| 128 AS.000 | 1290cc | 4 Cyl. | 8 Valves | 46-55kW/63-75PS | Petrol | SOHC | TD995 |
| 128 1.3 | | 03/1972→09/1991 | | 128 1.3 Berlinetta | | 06/1975→12/1979 | |
| 128 1.3 Rally | | 09/1971→02/1976 | | X 1/9 1.3 | | 05/1973→12/1979 | |

| | | | | | | | |
|--|-----------|--|-----|--|--|--|--|
| V91713  | 4 315 062 |  | 45° | | | VAG92366  |  |
| 31.00 x 8.00 x 109.00 | | MD cr | | | | 46.50 x 8.00 x 14.10 | |



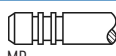



87  **86.00**

| | | | | | | | |
|----------------------|--------|-----------------|-----------------|----------------------|--------|-----------------|----------------|
| RFL (XU10) | 1998cc | 4 Cyl. | 8 Valves | 81kW/110PS | Petrol | SOHC | TD16405 |
| RFU (XU10J2C) | 1998cc | 4 Cyl. | 8 Valves | 89kW/121PS | Petrol | SOHC | TD4349 |
| RFW (XU10J2) | 1998cc | 4 Cyl. | 8 Valves | 80kW/109PS | Petrol | SOHC | TD6808 |
| DUCATO 2.0 | | 03/1994→ | | DUCATO 2.0/Combinato | | 03/1994→04/2002 | |
| ULYSSE 2.0 | | 06/1994→08/2002 | | | | | |

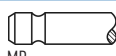
| | | | | | | | |
|---|------------|---|-----|----|---|--|--|
| V91972  | 96 059 361 |  | 45° | | H | | |
| 42.60 x 8.00 x 108.80 | | MB | | | | | |
| V91970  | 96 147 032 |  | 45° | ss | H | | |
| 34.50 x 8.00 x 108.40 | | MD + MB cr | | | | | |

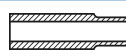



88  **86.00**

| | | | | | | | |
|-------------------|--------|-----------------|------------------|--------------------|--------|-------------|----------------|
| XU10 (RFV) | 1998cc | 4 Cyl. | 16 Valves | 97-100kW/132-136PS | Petrol | DOHC | TD18824 |
| ULYSSE 2.0 16V | | 05/1998→09/2000 | | | | | |

| | | | | | | | |
|---|---------------|---|-----|----|---|--|---|
| V94175  | 9 628 943 380 |  | 45° | Y | H | VAG96342B  |  |
| 34.60 x 6.00 x 106.40 | | MB | | | | 40.80 x 6.02 x 12.11 | |
| V94176  | 9 629 861 180 |  | 45° | ss | H | VAG96343  |  |
| 29.60 x 6.00 x 105.80 | | MD + MB cr | | | | 40.80 x 6.02 x 12.06 | |

89  **86.00**

| | | | | | | | |
|------------------------|--------|-----------------|-----------------|-------------|--------|--------------------|---------------|
| XU10J2CTE (RGX) | 1998cc | 4 Cyl. | 8 Valves | 108kW/147PS | Petrol | Turbo, SOHC | TD4355 |
| ULYSSE 2.0 Turbo | | 06/1994→08/2002 | | | | | |

| | | | | | | | |
|---|---------------|---|-----|----|---|--|--|
| V91972  | 96 059 361 |  | 45° | | H | | |
| 42.60 x 8.00 x 108.80 | | MB | | | | | |
| V91971  | 9 611 782 880 |  | 45° | ss | H | | |
| 34.50 x 8.00 x 108.40 | | MD + MB cr | | | | | |



OE

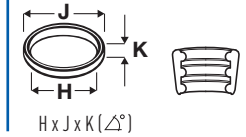

90 **86.00**

| | | | | | | | |
|-------------------|--------|----------|------------------|-------------|--------|-------------|----------------|
| 194 A1.000 | 2198cc | 4 Cyl. | 16 Valves | 108kW/147PS | Petrol | DOHC | TD18447 |
| CROMA 2.2 16V | | 06/2005→ | | | | | |

| | | | | | | | |
|-----------------------|----------|------------|-----|----|---|--|--|
| V94962 | 71739277 | | 45° | H | | | |
| 35.15 x 6.00 x 102.20 | | MB cr | | | | | |
| V94963 | 71739320 | | 45° | ss | H | | |
| 30.10 x 6.00 x 100.90 | | MD + MB cr | | | | | |

91 **86.00**

| | | | | | | | |
|---------------------------|--------|----------|------------------|-------------------|--------|--------------------|----------------|
| 4HU (P22 DTE PUMA) | 2198cc | 4 Cyl. | 16 Valves | 88kW/120PS | Diesel | Turbo, DOHC | TD25655 |
| 4HV (P22 DTE PUMA) | 2198cc | 4 Cyl. | 16 Valves | 74-88kW/101-120PS | Diesel | Turbo, DOHC | TD20266 |
| DUCATO 100 Multijet 2,2 D | | 07/2006→ | | | | | |

| | | | | | | | |
|-----------------------|---------------|-------|-----|--|----------------------|--|--|
| V98028 | 96 757 088 80 | | 30° | | VAG96368 | | |
| 29.80 x 7.00 x 122.30 | | MB cr | | | 51.50 x 6.97 x 12.07 | | |
| V98029 | 96 606 400 80 | | 30° | | | | |
| 25.80 x 7.00 x 122.10 | | MB cr | | | | | |

92 **86.40**

| | | | | | | | |
|-------------------|--------|-----------------|-----------------|-----------------|--------|-----------------|----------------|
| 138 A.000 | 1302cc | 4 Cyl. | 8 Valves | 37-48kW/50-65PS | Petrol | SOHC | TD18855 |
| 138 A1.000 | 1302cc | 4 Cyl. | 8 Valves | 48kW/65PS | Petrol | SOHC | TD4368 |
| 138 A3.000 | 1302cc | 4 Cyl. | 8 Valves | 55kW/75PS | Petrol | SOHC | TD4362 |
| 138 B2.000 | 1302cc | 4 Cyl. | 8 Valves | 50-51kW/68-69PS | Petrol | SOHC | TD4363 |
| 149 A3.000 | 1302cc | 4 Cyl. | 8 Valves | 48kW/65PS | Petrol | SOHC | TD958 |
| 149 A7.000 | 1302cc | 4 Cyl. | 8 Valves | 48kW/65PS | Petrol | SOHC | TD4382 |
| REGATA 70 1.3 | | 09/1983→07/1989 | | RITMO 1.3 | | 01/1978→08/1985 | |
| RITMO 50 1.3 | | 10/1985→12/1987 | | UNO 70 1.3 | | 01/1983→08/1989 | |

| | | | | | | | |
|-----------------------|-----------|-------|-----|--|----------------------|--|--|
| V91713 | 4 315 062 | | 45° | | VAG92366 | | |
| 31.00 x 8.00 x 109.00 | | MD cr | | | 46.50 x 8.00 x 14.10 | | |

93 **86.40**

| | | | | | | | |
|-------------------|--------|--------|-----------------|-----------------|--------|-------------|---------------|
| 138 A2.000 | 1498cc | 4 Cyl. | 8 Valves | 55-57kW/75-78PS | Petrol | SOHC | TD916 |
| 138 A4.000 | 1498cc | 4 Cyl. | 8 Valves | 63kW/86PS | Petrol | SOHC | TD4357 |
| 138 B3.000 | 1498cc | 4 Cyl. | 8 Valves | 55-63kW/75-86PS | Petrol | SOHC | TD4365 |
| 138 B3.048 | 1498cc | 4 Cyl. | 8 Valves | 55-57kW/75-78PS | Petrol | SOHC | TD4364 |
| 138 C2.048 | 1498cc | 4 Cyl. | 8 Valves | 55kW/75PS | Petrol | SOHC | TD926 |
| 138 C3.048 | 1498cc | 4 Cyl. | 8 Valves | 55-57kW/75-78PS | Petrol | SOHC | TD4366 |
| 149 A5.000 | 1498cc | 4 Cyl. | 8 Valves | 58kW/79PS | Petrol | SOHC | TD4381 |

| | | | | | | | |
|---------------------|--|-----------------|--|-----------------|--|-----------------|--|
| REGATA 75 1.5 | | 12/1983→07/1989 | | REGATA 85 1.5 | | 06/1983→04/1989 | |
| REGATA 85 Super 1.5 | | 09/1983→04/1985 | | RITMO 1.5 | | 01/1978→12/1988 | |
| RITMO 85 1.5 | | 01/1980→07/1989 | | UNO 75 i.e. 1.5 | | 10/1985→12/1993 | |

| | | | | | | | |
|-----------------------|-----------|----|-----|--|----------------------|--|--|
| V91762 | 5 973 129 | | 45° | | VAG92366 | | |
| 33.00 x 8.00 x 109.00 | | MD | | | 46.50 x 8.00 x 14.10 | | |

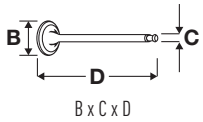

OE

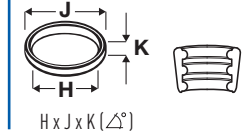
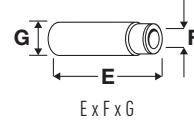
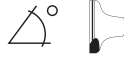

94 **86.40**

| | | | | | | | |
|---------------------|--------|-----------------|-----------------|------------------------|--------|-----------------|--------------|
| 149 C1.000 | 1499cc | 4 Cyl. | 8 Valves | 49-55kW/67-75PS | Petrol | SOHC | TD973 |
| ELBA 1.5 | | 04/1986→12/1996 | | FIORINO 1.5 SPI | | 11/1994→09/1996 | |
| FIORINO 75 i.e. 1.5 | | 05/1988→12/1993 | | FIORINO Pick up 1.5 iE | | 01/1988→10/1992 | |
| REGATA 75 1.5 | | 12/1983→07/1989 | | RITMO 1.5 | | 01/1978→12/1988 | |
| UNO 1.5 | | 10/1993→01/1996 | | UNO 1.5 SPI | | 03/1987→01/1996 | |
| UNO 75 i.e. 1.5 | | 10/1985→12/1993 | | | | | |

V91762
33.00 x 8.00 x 109.00

5 973 129

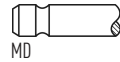

45°

VAG92366
46.50 x 8.00 x 14.10

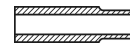

95 **86.40**

| | | | | | | | |
|-------------------|--------|-----------------|-----------------|-----------------|--------|-----------------|---------------|
| 159 A3.000 | 1581cc | 4 Cyl. | 8 Valves | 62-66kW/84-90PS | Petrol | SOHC | TD9787 |
| 159 A3.046 | 1581cc | 4 Cyl. | 8 Valves | 56-65kW/76-88PS | Petrol | SOHC | TD1006 |
| 159 A3.048 | 1581cc | 4 Cyl. | 8 Valves | 51-66kW/69-90PS | Petrol | SOHC | TD1007 |
| 160 A2.000 | 1581cc | 4 Cyl. | 8 Valves | 58-62kW/79-84PS | Petrol | SOHC | TD1019 |
| DUNA 1.6 | | 02/1996→09/2000 | | ELBA 1.6 | | 04/1989→12/1993 | |
| PREMIO 1.6 | | 03/1985→12/1996 | | TEMPRA 1.6 | | 03/1990→08/1996 | |
| TEMPRA 1.6 i.e. | | 06/1990→08/1996 | | TIPO 1.6 | | 01/1988→10/1995 | |
| TIPO 1.6 i.e. | | 07/1990→04/1995 | | TIPO 1.6 SX DGT | | 05/1989→10/1995 | |
| UNO 1.6 | | 12/1989→04/1993 | | UNO 1.6 R | | 12/1992→12/1995 | |

V91300
37.50 x 8.00 x 108.50

96 700 311

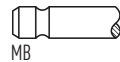

45°

H

VAG92366
46.50 x 8.00 x 14.10



V91762
33.00 x 8.00 x 109.00

5 973 129

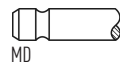

45°

96 **86.40**

| | | | | | | | |
|-------------------|--------|-----------------|-----------------|-----------------|--------|-----------------|---------------|
| 176 A9.000 | 1581cc | 4 Cyl. | 8 Valves | 65kW/88PS | Petrol | SOHC | TD1039 |
| 835 C1.000 | 1581cc | 4 Cyl. | 8 Valves | 55-57kW/75-78PS | Petrol | SOHC | TD1067 |
| PUNTO 1.6 | | 01/1994→04/1997 | | PUNTO 90 1.6 | | 04/1994→04/1997 | |
| TEMPRA 1.6 i.e. | | 10/1990→08/1996 | | TIPO 1.6 | | 03/1993→10/1995 | |
| TIPO 1.6 i.e. | | 10/1992→04/1995 | | | | | |

V91306
39.50 x 8.00 x 108.50

7 617 500

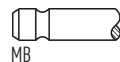

45°

H

VAG92366
46.50 x 8.00 x 14.10

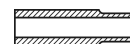

V91713
31.00 x 8.00 x 109.00

4 315 062

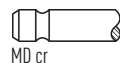

45°

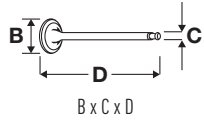

OE

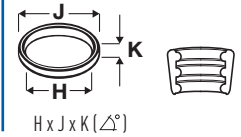
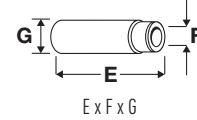

97



86.40

| | | | | | | | |
|------------|--------|--------|-----------|-------------------|--------|------|---------|
| 178 B3.000 | 1581cc | 4 Cyl. | 16 Valves | 74-78kW/100-106PS | Petrol | DOHC | TD10187 |
| 182 A4.000 | 1581cc | 4 Cyl. | 16 Valves | 76-85kW/103-116PS | Petrol | DOHC | TD4400 |
| 182 A6.000 | 1581cc | 4 Cyl. | 16 Valves | 66kW/90PS | Petrol | DOHC | TD4402 |
| 185 A3.000 | 1581cc | 4 Cyl. | 16 Valves | 68-76kW/92-103PS | Petrol | DOHC | TD15650 |
| 186 A3.000 | 1581cc | 4 Cyl. | 16 Valves | 70kW/95PS | Petrol | DOHC | TD11787 |
| 186 A4.000 | 1581cc | 4 Cyl. | 16 Valves | 68-76kW/92-103PS | Petrol | DOHC | TD11788 |

| | | | |
|---------------------------|-----------------|----------------------|-----------------|
| BRAVA 1.6 16V | 10/1995→10/2001 | BRAVO I 1.6 16V | 10/1995→10/2001 |
| MAREA 1.6 | 03/1999→08/2000 | MAREA 1.6 16V | 04/1997→02/1999 |
| MAREA 1.6 100 16V | 09/1996→05/2002 | MULTIPLA 1.6 16V | 04/1999→06/2010 |
| MULTIPLA 1.6 16V Btupower | 04/1999→06/2010 | MULTIPLA 1.6 100 16V | 04/1999→06/2010 |
| PALIO 1.6 | 02/2001→ | PALIO 1.6 16V | 04/1996→02/2003 |
| SIENA 1.6 | 05/2004→12/2006 | SIENA 1.6 16V | 09/1998→12/2009 |

| | | | | | | |
|-----------------------|------------|------------|-----|------|----------------------|--|
| V91949 ■ | 46 517 325 | | 45° | H | VAG92364 ■ | |
| 30.40 x 7.00 x 102.00 | | MB cr | | | 42.50 x 7.00 x 13.07 | |
| V91950 ■ | 46 462 159 | | 45° | | VAG96123 ■ | |
| 29.80 x 7.00 x 102.60 | | MD cr | | | 42.25 x 7.02 x 13.05 | |
| V94468 ■ | 46 461 209 | | 45° | SS H | VAG96146 ■ | |
| 30.00 x 7.00 x 102.40 | | MD + MB cr | | | 42.50 x 7.04 x 13.05 | |

98



86.40

| | | | | | | | |
|-----------|-----------------|--------|----------|-----------|--------|--|--------|
| 220 A.200 | 1581cc | 4 Cyl. | 8 Valves | 58kW/79PS | Petrol | | TD6826 |
| SCUDO 1.6 | 02/1996→12/2006 | | | | | | |

| | | | | | | |
|-----------------------|------------|-------|-----|---|----------------------|--|
| V91300 ■ | 96 700 311 | | 45° | H | VAG92366 ■ ■ | |
| 37.50 x 8.00 x 108.00 | | MB | | | 46.50 x 8.00 x 14.10 | |
| V91713 ■ | 4 315 062 | | 45° | | | |
| 31.00 x 8.00 x 109.00 | | MD cr | | | | |

99



88.00

| | | | | | | | |
|------------|-----------------|--------|-------------|-----------------|--------|-----|--------|
| 170 B | 1971cc | 4 Cyl. | 8 Valves | 55kW/75PS | Petrol | OHV | TD4417 |
| 170 D | 1971cc | 4 Cyl. | 8 Valves | 62kW/84PS | Petrol | OHV | TD5102 |
| DUCATO 2.0 | 07/1985→05/1994 | | TALENTO 2.0 | 03/1989→03/1994 | | | |

| | | | | | | |
|-----------------------|------------|------------|-----|------|--|--|
| V91972 ■ | 96 059 361 | | 45° | H | | |
| 42.60 x 8.00 x 108.80 | | MB | | | | |
| V91970 ■ | 96 147 032 | | 45° | SS H | | |
| 34.50 x 8.00 x 108.40 | | MD + MB cr | | | | |

100



88.00

| | | | | | | | |
|------------|-----------------|--------|----------|-----------------|--------|-----|--------|
| XN 1T | 1971cc | 4 Cyl. | 8 Valves | 55-60kW/75-82PS | Petrol | OHV | TD4418 |
| DUCATO 2.0 | 01/1982→08/1990 | | | | | | |

| | | | | | | |
|-----------------------|---------------|----|-----|---|----------------------|--|
| V34459 ■ | 7 910 029 730 | | 30° | H | VAG51007 ■ ■ | |
| 42.50 x 8.00 x 118.30 | | MB | | | 55.00 x 8.00 x 14.06 | |
| V34460 ■ | 7 910 028 074 | | 45° | | | |
| 35.50 x 8.00 x 112.00 | | MD | | | | |

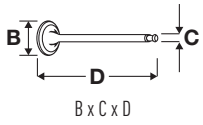



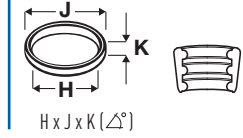
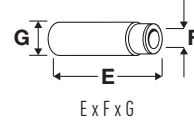



OE



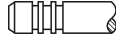





101  **88.00**

| | | | | | | | |
|---------------------------|----------|--------|------------------|---------------------------|--------|--------------------|----------------|
| F1AE0481C | 2287cc | 4 Cyl. | 16 Valves | 81kW/110PS | Diesel | Turbo, DOHC | TD16407 |
| F1AE0481D | 2287cc | 4 Cyl. | 16 Valves | 88kW/120PS | Diesel | Turbo, DOHC | TD20264 |
| F1AE0481N | 2287cc | 4 Cyl. | 16 Valves | 96kW/131PS | Diesel | Turbo, DOHC | TD24778 |
| F1AE3481D | 2287cc | 4 Cyl. | 16 Valves | 96kW/131PS | Diesel | Turbo, DOHC | TD25174 |
| DUCATO 2.3 JTD | 04/2002→ | | | DUCATO 120 Multijet 2,3 D | | | 07/2006→ |
| DUCATO 130 Multijet 2,3 D | 07/2006→ | | | | | | |













| | | | | | | | |
|---|-------------|---|-----|---|--|--|--|
| V94592  | 504 069 199 |  | 45° | H | | | |
| 30.00 x 6.00 x 120.40 | | MB cr | | | | | |
| V98018  | 504 069 199 |  | 45° | | | | |
| 30.00 x 6.00 x 120.40 | | MB cr | | | | | |
| V94593  | 504 378 070 |  | 45° | H | | | |
| 30.00 x 6.00 x 120.35 | | MD + MB cr | | | | | |
| V98019  | 500 362 856 |  | 45° | | | | |
| 30.00 x 6.00 x 120.35 | | MD + MB cr | | | | | |

102  **92.00**

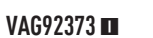
| | | | | | | | |
|---|------------|---|------------------|------------|---|---|----------------|
| THY (DK5ATE) | 2446cc | 4 Cyl. | 12 Valves | 96kW/131PS | Diesel | Turbo, SOHC | TD22239 |
| V94062  | 96 095 457 |  | 45° | H | VAG96046B  |  | |
| 36.90 x 7.00 x 127.90 | | MB | | | 54.00 x 7.04 x 13.08 | | |
| V94063  | 96 096 146 |  | 45° | ss | H | | |
| 39.60 x 7.00 x 127.50 | | MD + MB cr | | | | | |

103  **93.00**

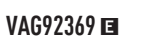
| | | | | | | | |
|----------------------------|-----------------|--------|-----------------|----------------------|--------|---------------------------|-----------------|
| 8140.61 | 2445cc | 4 Cyl. | 8 Valves | 53-55kW/72-75PS | Diesel | SOHC | TD1050 |
| 8140.61.204 | 2445cc | 4 Cyl. | 8 Valves | 53kW/72PS | Diesel | SOHC | TD1051 |
| 8144.21 | 2445cc | 4 Cyl. | 8 Valves | 68kW/92PS | Diesel | Sofim, Turbo, SOHC | TD4419 |
| 8144.21.220 | 2445cc | 4 Cyl. | 8 Valves | 68kW/92PS | Diesel | Turbo, SOHC | TD6803 |
| 8144.61 | 2445cc | 4 Cyl. | 8 Valves | 53-55kW/72-75PS | Diesel | SOHC | TD4408 |
| 8144.61.200 (Sofim) | 2445cc | 4 Cyl. | 8 Valves | 53kW/72PS | Diesel | SOHC | TD6796 |
| 8144.61.500.81 | 2445cc | 4 Cyl. | 8 Valves | 66kW/90PS | Diesel | SOHC | TD1054 |
| 8144.91.2000 | 2445cc | 4 Cyl. | 8 Valves | 74kW/101PS | Diesel | Turbo, SOHC | TD1058 |
| 131 2.5 D | 06/1978→02/1984 | | | 131 2.5 Super Diesel | | | 03/1979→12/1984 |
| 132 2.5 D | 07/1978→07/1982 | | | ARGENTA 2500 Diesel | | | 06/1981→11/1985 |
| ARGENTA 2500 Turbodiesel | 07/1983→08/1985 | | | CAMPAGNOLA 2.4 D | | | 06/1974→10/1989 |
| CROMA 2500 TD | 12/1985→08/1989 | | | DUCATO 2.4 D | | | 01/1982→08/1990 |
| DUCATO 2.5 D | 09/1986→05/1990 | | | DUCATO 2.5 TD | | | 01/1986→09/1990 |

| | | | | | | | |
|---|-----------|---|-----|---|---|--|---|
| V91292  | 4757358 |  | 30° | Y | H | VAG92193  |  |
| 40.80 x 8.00 x 120.70 | | MB cr | | | | 56.00 x 8.04 x 13.05 | |
| V91293  | 7 301 821 |  | 45° | | | VAG92373  |  |
| 34.50 x 8.00 x 122.00 | | MD tu | | | | 56.00 x 8.03 x 13.04 | |
| V91294  | 7 302 157 |  | 45° | | H | VAG92369  |  |
| 34.50 x 8.00 x 122.00 | | MF + MB cr | | | | 60.00 x 8.00 x 13.07 | |



OE

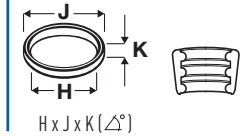

104 **93.00**

| | | | | | | | |
|--------------------------|--------|-----------------|-----------------|-------------------|--------|---------------------------|---------------|
| 8140.27 | 2500cc | 4 Cyl. | 8 Valves | 68-70kW/92-95PS | Diesel | Sofim, Turbo, SOHC | TD1047 |
| 8140.27.2100 | 2500cc | 4 Cyl. | 8 Valves | 70kW/95PS | Diesel | Turbo, SOHC | TD6800 |
| 8140.47 | 2500cc | 4 Cyl. | 8 Valves | 80-85kW/109-116PS | Diesel | Turbo, SOHC | TD1048 |
| 8140.47.3700 | 2500cc | 4 Cyl. | 8 Valves | 85kW/116PS | Diesel | Turbo, SOHC | TD6809 |
| 8140.47R | 2500cc | 4 Cyl. | 8 Valves | 80kW/110PS | Diesel | Sofim, Turbo, SOHC | TD1049 |
| 8140.67 | 2500cc | 4 Cyl. | 8 Valves | 55-62kW/75-84PS | Diesel | SOHC | TD1052 |
| 8144.67 | 2500cc | 4 Cyl. | 8 Valves | 55kW/75PS | Diesel | SOHC | TD1056 |
| 8144.67.220 | 2500cc | 4 Cyl. | 8 Valves | 55kW/75PS | Diesel | SOHC | TD6797 |
| 8144.81.2000 | 2500cc | 4 Cyl. | 8 Valves | 66-74kW/90-101PS | Diesel | Turbo, SOHC | TD1057 |
| 8144.97 | 2500cc | 4 Cyl. | 8 Valves | 85kW/115PS | Diesel | Sofim, Turbo, SOHC | TD1061 |
| 8144.97 S | 2500cc | 4 Cyl. | 8 Valves | 77kW/105PS | Diesel | Sofim, Turbo, SOHC | TD1059 |
| 8144.97 Y | 2500cc | 4 Cyl. | 8 Valves | 85kW/115PS | Diesel | Sofim, Turbo, SOHC | TD1060 |
| CROMA 2500 D | | 12/1985→12/1989 | | CROMA 2500 TD | | 05/1989→08/1996 | |
| CROMA 2500 TDE | | 12/1991→08/1996 | | DUCATO 2.5 D | | 01/1982→04/2002 | |
| DUCATO 2.5 TD | | 09/1986→04/2002 | | DUCATO 2.5 TDI | | 03/1994→04/2002 | |
| DUCATO 2.5 TDI/Combinato | | 03/1994→04/2002 | | | | | |

V91292 **4757358**
40.80 x 8.00 x 120.70

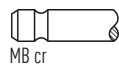

30° Y H

VAG92193 **56.00 x 8.04 x 13.05**

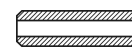

V91293 **7 301 821**
34.50 x 8.00 x 122.00

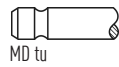

45°

VAG92373 **56.00 x 8.03 x 13.04**



V91294 **7 302 157**
34.50 x 8.00 x 122.00



45°

VAG92369 **60.00 x 8.00 x 13.07**



105 **94.40**

| | | | | | | | |
|-----------------|--------|-----------------|-----------------|----------------|--------|---------------------------|----------------|
| 8140.43 | 2800cc | 4 Cyl. | 8 Valves | 90kW/122PS | Diesel | Sofim, Turbo, SOHC | TD11769 |
| DUCATO 2.8 iDTD | | 05/1998→09/2001 | | DUCATO 2.8 JTD | | 11/2003→07/2006 | |
| DUCATO 2.8 TD | | 05/1998→07/2006 | | DUCATO 2.8 TDI | | 10/1997→04/2002 | |

V91292 **4757358**
40.80 x 8.00 x 120.70

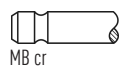

30° Y H

VAG92193 **56.00 x 8.04 x 13.05**



V91994 **99 432 837**
35.80 x 8.00 x 121.90

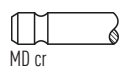

45°

VAG92373 **56.00 x 8.03 x 13.04**

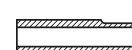

VAG92369 **60.00 x 8.00 x 13.07**



106 **94.40**

| | | | | | | | |
|-----------------|--------|----------|-----------------|--------------------|--------|---------------------------|----------------|
| 8140.43N | 2800cc | 4 Cyl. | 8 Valves | 107kW/146PS | Diesel | Sofim, Turbo, SOHC | TD20450 |
| 8140.43S | 2800cc | 4 Cyl. | 8 Valves | 93-103kW/127-140PS | Diesel | Sofim, Turbo, SOHC | TD16196 |
| DUCATO 2.8 JTD | | 11/1997→ | | | | | |

V91292 **4757358**
40.80 x 8.00 x 120.70

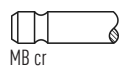

30° Y H

VAG92373 **56.00 x 8.03 x 13.04**



V91994 **99 432 837**
35.80 x 8.00 x 121.90

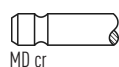

45°

VAG92369 **60.00 x 8.00 x 13.07**

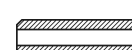

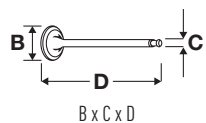

OE

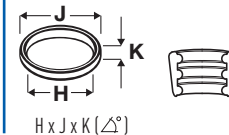
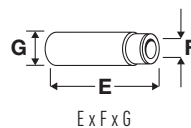

107 **94.40**

| 8140.63 | 2800cc | 4 Cyl. | 8 Valves | 64kW/87PS | Diesel | Sofim, SOHC | TD12749 |
|-----------------------|------------|-----------------|----------|---------------|----------------------|-----------------|---------|
| DUCATO 2.8 D | | 02/1998→04/2002 | | DUCATO 2.8 TD | | 05/1998→11/2001 | |
| V91939 ■ | 98 468 338 | MB cr | 30° | H | VAG92193 ■ | | |
| 43.50 x 8.00 x 122.00 | | | | | 56.00 x 8.04 x 13.05 | | |
| V91940 ■ | 98 418 161 | MD + MB cr | 45° | H | VAG92373 ■ | | |
| 36.70 x 8.00 x 122.00 | | | | | 56.00 x 8.03 x 13.04 | | |
| V91994 ■ | 99 432 837 | MD cr | 45° | | VAG92369 ■ | | |
| 35.80 x 8.00 x 121.90 | | | | | 60.00 x 8.00 x 13.07 | | |

108 **95.00**







| 8030.00 | 2340cc | 3 Cyl. | 6 Valves | 28-38kW/38-51PS | Diesel | OHV | TD22232 |
|-----------------------|-----------|------------|----------|-----------------|----------------------|-----|---------|
| V91709 ■ | 4 802 200 | MB tu | 45° | H | VAG92373 ■ ■ | | |
| 44.00 x 8.00 x 125.50 | | | | | 56.00 x 8.03 x 13.04 | | |
| V91667 ■ | 4 673 608 | MD + MB tu | 45° | H | VAG92497 ■ ■ | | |
| 37.00 x 8.00 x 125.70 | | | | | 56.00 x 8.04 x 14.03 | | |







109 **95.00**







| 8040.00 | 3120cc | 4 Cyl. | 8 Valves | 51kW/70PS | Diesel | OHV | TD24575 |
|-----------------------|-----------|------------|----------|-----------|----------------------|-----|---------|
| V91676 ■ | 4 659 379 | MB tu | 45° | H | VAG92373 ■ ■ | | |
| 44.00 x 8.00 x 125.50 | | | | | 56.00 x 8.03 x 13.04 | | |
| V91667 ■ | 4 673 608 | MD + MB tu | 45° | H | VAG92497 ■ ■ | | |
| 37.00 x 8.00 x 125.70 | | | | | 56.00 x 8.04 x 14.03 | | |







110 **95.80**







| F1CE0481D | 2999cc | 4 Cyl. | 16 Valves | 115-116kW/156-158PS | Diesel | Turbo, DOHC | TD20265 |
|---------------------------|-------------|------------|-----------|---------------------|--------|-------------|---------|
| DUCATO 160 Multijet 3.0 D | | 07/2006→ | | | | | |
| V98042 ■ | 504 072 531 | MB cr | 30° | | | | |
| 32.40 x 5.99 x 119.90 | | | | | | | |
| V98043 ■ | 504 081 062 | MD + MB cr | 30° | | | | |
| 32.40 x 5.98 x 119.90 | | | | | | | |





|  |  | ccm |  |  |  |  | |
|---|---|--------|---|---|---|---|-----|
| 110/6 AA-Dover | | 104.78 | 5944 | 6 | 12 | Diesel | 99 |
| 130/7 AA-Dover | | 107.18 | 6223 | 6 | 12 | Diesel | 101 |
| 150/6 CA-Dover | | 104.78 | 5944 | 6 | 12 | Diesel | 99 |
| 1Z | | 79.50 | 1896 | 4 | 8 | Diesel | 36 |
| 4 D 55 T | | 91.10 | 2347 | 4 | 8 | Diesel | 91 |
| 4AB | | 93.67 | 2496 | 4 | 8 | Diesel | 95 |
| 4BA | | 93.67 | 2496 | 4 | 8 | Diesel | 95 |
| 4BC | | 93.67 | 2496 | 4 | 8 | Diesel | 95 |
| 4CA | | 93.67 | 2496 | 4 | 8 | Diesel | 95 |
| 4CC | | 93.67 | 2496 | 4 | 8 | Diesel | 95 |
| 4DA | | 93.67 | 2496 | 4 | 8 | Diesel | 95 |
| 4EA | | 93.67 | 2496 | 4 | 8 | Diesel | 95 |
| 4EB | | 93.67 | 2496 | 4 | 8 | Diesel | 95 |
| 4EC | | 93.67 | 2496 | 4 | 8 | Diesel | 95 |
| 4ED | | 93.67 | 2496 | 4 | 8 | Diesel | 95 |
| 4FA | | 93.67 | 2496 | 4 | 8 | Diesel | 95 |
| 4FB | | 93.67 | 2496 | 4 | 8 | Diesel | 95 |
| 4FC | | 93.67 | 2496 | 4 | 8 | Diesel | 95 |
| 4FD | | 93.67 | 2496 | 4 | 8 | Diesel | 95 |
| 4GA | | 93.67 | 2496 | 4 | 8 | Diesel | 95 |
| 4GB | | 93.67 | 2496 | 4 | 8 | Diesel | 95 |
| 4GC | | 93.67 | 2496 | 4 | 8 | Diesel | 95 |
| 4GD | | 93.67 | 2496 | 4 | 8 | Diesel | 95 |
| 4GE | | 93.67 | 2496 | 4 | 8 | Diesel | 95 |
| 4GF | | 93.67 | 2496 | 4 | 8 | Diesel | 95 |
| 4HA | | 93.67 | 2496 | 4 | 8 | Diesel | 95 |
| 4HB | | 93.67 | 2496 | 4 | 8 | Diesel | 95 |
| 4HC | | 93.67 | 2496 | 4 | 8 | Diesel | 95 |
| 4HD | | 93.67 | 2496 | 4 | 8 | Diesel | 95 |
| 4RB | | 87.65 | 1593 | 4 | 8 | Petrol | 82 |
| 4RC | | 90.80 | 1993 | 4 | 8 | Petrol | 89 |
| 90/5 AA-Dover | | 107.18 | 4162 | 4 | 8 | Diesel | 100 |
| A9A | | 74.00 | 1299 | 4 | 8 | Petrol | 19 |
| A9B | | 74.00 | 1299 | 4 | 8 | Petrol | 19 |
| A9JA | | 74.00 | 1299 | 4 | 8 | Petrol | 19 |
| A9JB | | 74.00 | 1299 | 4 | 8 | Petrol | 19 |
| AAA | | 81.00 | 2792 | 6 | 12 | Petrol | 52 |
| ABFA | | 86.00 | 1998 | 4 | 16 | Diesel | 72 |
| AFN | | 79.50 | 1896 | 4 | 8 | Diesel | 37 |
| AHU | | 79.50 | 1896 | 4 | 8 | Diesel | 37 |
| AJM | | 79.50 | 1896 | 4 | 8 | Diesel | 38 |
| ALDA | | 84.80 | 1988 | 4 | 16 | Petrol | 64 |
| AMY | | 81.00 | 2792 | 6 | 12 | Petrol | 52 |
| ANU | | 79.50 | 1896 | 4 | 8 | Diesel | 38 |
| AOBA | | 87.50 | 1999 | 4 | 16 | Petrol | 79 |
| AOBC | | 87.50 | 1999 | 4 | 16 | Petrol | 79 |
| AODA | | 87.50 | 1999 | 4 | 16 | Petrol | 79 |
| AODB | | 87.50 | 1999 | 4 | 16 | Petrol | 79 |
| AODE | | 87.50 | 1999 | 4 | 16 | Petrol | 79 |
| AOWA | | 87.50 | 1999 | 4 | 16 | Petrol | 79 |
| AOWB | | 87.50 | 1999 | 4 | 16 | Petrol | 79 |
| ASDA | | 76.00 | 1388 | 4 | 16 | Petrol | 24 |
| ASDB | | 76.00 | 1388 | 4 | 16 | Petrol | 24 |
| ASZ | | 79.50 | 1896 | 4 | 8 | Diesel | 38 |
| AUY | | 79.50 | 1896 | 4 | 8 | Diesel | 38 |
| AVG | | 79.50 | 1896 | 4 | 8 | Diesel | 37 |
| AZBA | | 85.00 | 1997 | 4 | 16 | Diesel | 67 |
| AZWA | | 85.00 | 1997 | 4 | 16 | Diesel | 67 |
| B | | 87.65 | 1593 | 4 | 8 | Petrol | 82 |
| BAA | | 74.00 | 1299 | 4 | 8 | Petrol | 19 |
| BAJA | | 74.00 | 1299 | 4 | 8 | Petrol | 20 |
| BHDA | | 82.50 | 1753 | 4 | 8 | Diesel | 58 |
| BHDB | | 82.50 | 1753 | 4 | 8 | Diesel | 58 |
| BHPA | | 82.50 | 1753 | 4 | 8 | Diesel | 58 |
| BTB | | 79.50 | 1896 | 4 | 8 | Diesel | 38 |
| C9DA | | 82.50 | 1753 | 4 | 8 | Diesel | 58 |







|  |  | ccm |  |  |  |  |
|---|---|------|--|---|---|---|
| C9DB | 82.50 | 1753 | 4 | 8 | Diesel | 58 |
| C9DC | 82.50 | 1753 | 4 | 8 | Diesel | 58 |
| CDB | 82.00 | 1597 | 4 | 8 | Petrol | 56 |
| CDC | 82.00 | 1597 | 4 | 8 | Petrol | 56 |
| CDRA | 82.00 | 1599 | 4 | 8 | Petrol | 57 |
| CDRB | 82.00 | 1599 | 4 | 8 | Petrol | 57 |
| CFBA | 83.00 | 1798 | 4 | 16 | Petrol | 62 |
| CGBA | 83.00 | 1798 | 4 | 16 | Petrol | 62 |
| CGBB | 83.00 | 1798 | 4 | 16 | Petrol | 62 |
| CHBA | 83.00 | 1798 | 4 | 16 | Petrol | 62 |
| CHBB | 83.00 | 1798 | 4 | 16 | Petrol | 62 |
| CJBA | 87.50 | 1999 | 4 | 16 | Petrol | 80 |
| CJBB | 87.50 | 1999 | 4 | 16 | Petrol | 80 |
| CSDA | 83.00 | 1798 | 4 | 16 | Petrol | 62 |
| CSDB | 83.00 | 1798 | 4 | 16 | Petrol | 62 |
| CVRA | 86.00 | 2198 | 4 | 16 | Diesel | 76 |
| CVRB | 86.00 | 2198 | 4 | 16 | Diesel | 76 |
| CVRC | 86.00 | 2198 | 4 | 16 | Diesel | 76 |
| CYFA | 86.00 | 2198 | 4 | 16 | Diesel | 76 |
| CYFB | 86.00 | 2198 | 4 | 16 | Diesel | 76 |
| CYFC | 86.00 | 2198 | 4 | 16 | Diesel | 76 |
| CYFD | 86.00 | 2198 | 4 | 16 | Diesel | 76 |
| CYRA | 86.00 | 2198 | 4 | 16 | Diesel | 76 |
| CYRB | 86.00 | 2198 | 4 | 16 | Diesel | 76 |
| CYRC | 86.00 | 2198 | 4 | 16 | Diesel | 76 |
| D2FA | 89.90 | 2402 | 4 | 16 | Diesel | 84 |
| D2FB | 89.90 | 2402 | 4 | 16 | Diesel | 84 |
| D2FE | 89.90 | 2402 | 4 | 16 | Diesel | 84 |
| D3FA | 86.00 | 1998 | 4 | 16 | Diesel | 72 |
| D4FA | 89.90 | 2402 | 4 | 16 | Diesel | 84 |
| D5BA | 86.00 | 1998 | 4 | 16 | Diesel | 72 |
| D6BA | 86.00 | 1998 | 4 | 16 | Diesel | 72 |
| DHA | 71.90 | 1242 | 4 | 16 | Petrol | 9 |
| DHB | 71.90 | 1242 | 4 | 16 | Petrol | 9 |
| DHC | 71.90 | 1242 | 4 | 16 | Petrol | 9 |
| DHD | 71.90 | 1242 | 4 | 16 | Petrol | 9 |
| DHE | 71.90 | 1242 | 4 | 16 | Petrol | 9 |
| DHF | 71.90 | 1242 | 4 | 16 | Petrol | 9 |
| DHG | 71.90 | 1242 | 4 | 16 | Petrol | 9 |
| DOFA (DT24) | 89.90 | 2402 | 4 | 16 | Diesel | 84 |
| DRF5 | 86.00 | 2198 | 4 | 16 | Diesel | 76 |
| DRFA | 86.00 | 2198 | 4 | 16 | Diesel | 76 |
| DRFB | 86.00 | 2198 | 4 | 16 | Diesel | 76 |
| DRFC | 86.00 | 2198 | 4 | 16 | Diesel | 76 |
| DRFD | 86.00 | 2198 | 4 | 16 | Diesel | 76 |
| DRFE | 86.00 | 2198 | 4 | 16 | Diesel | 76 |
| DRFF | 86.00 | 2198 | 4 | 16 | Diesel | 76 |
| DRFG | 86.00 | 2198 | 4 | 16 | Diesel | 76 |
| DRR5 | 86.00 | 2198 | 4 | 16 | Diesel | 76 |
| DRRA | 86.00 | 2198 | 4 | 16 | Diesel | 76 |
| DRRB | 86.00 | 2198 | 4 | 16 | Diesel | 76 |
| DRRC | 86.00 | 2198 | 4 | 16 | Diesel | 76 |
| EDBA | 84.80 | 1988 | 4 | 16 | Petrol | 65 |
| EDBB | 84.80 | 1988 | 4 | 16 | Petrol | 65 |
| EDBC | 84.80 | 1988 | 4 | 16 | Petrol | 65 |
| EDBD | 84.80 | 1988 | 4 | 16 | Petrol | 65 |
| EDDB | 84.80 | 1988 | 4 | 16 | Petrol | 65 |
| EDDC | 84.80 | 1988 | 4 | 16 | Petrol | 65 |
| EDDD | 84.80 | 1988 | 4 | 16 | Petrol | 65 |
| EDDF | 84.80 | 1988 | 4 | 16 | Petrol | 65 |
| EYDB | 80.60 | 1796 | 4 | 16 | Petrol | 48 |
| EYDC | 80.60 | 1796 | 4 | 16 | Petrol | 48 |
| EYDD | 80.60 | 1796 | 4 | 16 | Petrol | 48 |
| EYDE | 80.60 | 1796 | 4 | 16 | Petrol | 48 |
| EYDF | 80.60 | 1796 | 4 | 16 | Petrol | 48 |
| EYDG | 80.60 | 1796 | 4 | 16 | Petrol | 48 |







|  |  | ccm |  |  |  |  |
|---|---|------|---|---|---|---|
| EYDI | 80.60 | 1796 | 4 | 16 | Petrol | 48 |
| EYDJ | 80.60 | 1796 | 4 | 16 | Petrol | 48 |
| EYDL | 80.60 | 1796 | 4 | 16 | Petrol | 48 |
| EYPA | 80.60 | 1796 | 4 | 16 | Petrol | 48 |
| EYPC | 80.60 | 1796 | 4 | 16 | Petrol | 48 |
| EYPD | 80.60 | 1796 | 4 | 16 | Petrol | 48 |
| F3FA | 86.00 | 1998 | 4 | 16 | Diesel | 72 |
| F4A | 77.24 | 1392 | 4 | 8 | Petrol | 32 |
| F4B | 77.24 | 1392 | 4 | 8 | Petrol | 32 |
| F4FA | 89.90 | 2402 | 4 | 16 | Diesel | 84 |
| F6A | 77.24 | 1392 | 4 | 8 | Petrol | 32 |
| F6B | 77.24 | 1392 | 4 | 8 | Petrol | 32 |
| F6C | 77.24 | 1392 | 4 | 8 | Petrol | 32 |
| F6D | 77.24 | 1392 | 4 | 8 | Petrol | 32 |
| F6E | 77.24 | 1392 | 4 | 8 | Petrol | 32 |
| F6F | 77.24 | 1392 | 4 | 8 | Petrol | 32 |
| F6G | 77.24 | 1392 | 4 | 8 | Petrol | 32 |
| F6JA (DV4TD) | 73.70 | 1399 | 4 | 8 | Diesel | 11 |
| F6JB (DV4TD) | 73.70 | 1399 | 4 | 8 | Diesel | 11 |
| F6JC | 73.70 | 1399 | 4 | 8 | Diesel | 11 |
| F6JD | 73.70 | 1399 | 4 | 8 | Diesel | 12 |
| F9DA | 82.50 | 1753 | 4 | 8 | Diesel | 58 |
| F9DB | 82.50 | 1753 | 4 | 8 | Diesel | 58 |
| FD4 | 69.60 | 1248 | 4 | 16 | Diesel | 5 |
| FFBA | 82.50 | 1753 | 4 | 8 | Diesel | 58 |
| FFDA | 82.50 | 1753 | 4 | 8 | Diesel | 58 |
| FFWA | 82.50 | 1753 | 4 | 8 | Diesel | 58 |
| FHA | 76.00 | 1388 | 4 | 16 | Petrol | 25 |
| FHD | 76.00 | 1388 | 4 | 16 | Petrol | 26 |
| FHE | 76.00 | 1388 | 4 | 16 | Petrol | 25 |
| FHF | 76.00 | 1388 | 4 | 16 | Petrol | 26 |
| FIFA | 86.00 | 1998 | 4 | 16 | Diesel | 72 |
| FMBA | 86.00 | 1998 | 4 | 16 | Diesel | 72 |
| FP4 | 70.80 | 1242 | 4 | 8 | Petrol | 6 |
| FUA | 77.24 | 1392 | 4 | 8 | Petrol | 32 |
| FUAA | 77.24 | 1392 | 4 | 8 | Petrol | 32 |
| FUB | 77.24 | 1392 | 4 | 8 | Petrol | 32 |
| FUC | 77.24 | 1392 | 4 | 8 | Petrol | 32 |
| FUD | 77.24 | 1392 | 4 | 8 | Petrol | 32 |
| FUF | 77.24 | 1392 | 4 | 8 | Petrol | 32 |
| FUG | 77.24 | 1392 | 4 | 8 | Petrol | 32 |
| FUH | 77.24 | 1392 | 4 | 8 | Petrol | 32 |
| FUJ | 77.24 | 1392 | 4 | 8 | Petrol | 32 |
| FUJA | 71.90 | 1242 | 4 | 16 | Petrol | 10 |
| FUJB | 71.90 | 1242 | 4 | 16 | Petrol | 10 |
| FXDA | 76.00 | 1388 | 4 | 16 | Petrol | 27 |
| FXDB | 76.00 | 1388 | 4 | 16 | Petrol | 27 |
| FXDC | 76.00 | 1388 | 4 | 16 | Petrol | 27 |
| FXDD | 76.00 | 1388 | 4 | 16 | Petrol | 27 |
| FXFA | 89.90 | 2402 | 4 | 16 | Diesel | 84 |
| FXJA | 76.00 | 1388 | 4 | 16 | Petrol | 24 |
| FXJB | 76.00 | 1388 | 4 | 16 | Petrol | 24 |
| FYDA | 79.00 | 1596 | 4 | 16 | Petrol | 33 |
| FYDB | 79.00 | 1596 | 4 | 16 | Petrol | 33 |
| FYDC | 79.00 | 1596 | 4 | 16 | Petrol | 33 |
| FYDD | 79.00 | 1596 | 4 | 16 | Petrol | 33 |
| FYDH | 79.00 | 1596 | 4 | 16 | Petrol | 33 |
| FYJA | 79.00 | 1596 | 4 | 16 | Petrol | 33 |
| FYJB | 79.00 | 1596 | 4 | 16 | Petrol | 33 |
| G6A | 68.70 | 1119 | 4 | 8 | Petrol | 3 |
| G6DA | 85.00 | 1997 | 4 | 16 | Diesel | 67 |
| G6DB | 85.00 | 1997 | 4 | 16 | Diesel | 67 |
| G6DC | 85.00 | 1997 | 4 | 16 | Diesel | 67 |
| G6DD | 85.00 | 1997 | 4 | 16 | Diesel | 67 |
| G6DE | 85.00 | 1997 | 4 | 16 | Diesel | 67 |
| G6DF | 85.00 | 1997 | 4 | 16 | Diesel | 67 |







|  |  | ccm |  |  |  |  |
|---|---|------|--|---|---|---|
| G6DG | 85.00 | 1997 | 4 | 16 | Diesel | 67 |
| G8DA | 75.00 | 1560 | 4 | 16 | Diesel | 22 |
| G8DB | 75.00 | 1560 | 4 | 16 | Diesel | 22 |
| G8DC | 75.00 | 1560 | 4 | 16 | Diesel | 22 |
| GBVAJPF | 86.00 | 2198 | 4 | 16 | Diesel | 76 |
| GBVAJQJ | 86.00 | 2198 | 4 | 16 | Diesel | 76 |
| GBVAJQW | 86.00 | 2198 | 4 | 16 | Diesel | 76 |
| GL | 75.00 | 1043 | 4 | 8 | Petrol | 21 |
| GLC | 74.00 | 1117 | 4 | 8 | Petrol | 16 |
| GPDA | 75.00 | 1560 | 4 | 16 | Diesel | 22 |
| GPDC | 75.00 | 1560 | 4 | 16 | Diesel | 22 |
| GSE | 74.00 | 1117 | 4 | 8 | Petrol | 16 |
| GSF | 74.00 | 1117 | 4 | 8 | Petrol | 16 |
| GSG | 74.00 | 1117 | 4 | 8 | Petrol | 16 |
| GUD | 68.70 | 1119 | 4 | 8 | Petrol | 4 |
| GUE | 68.70 | 1119 | 4 | 8 | Petrol | 4 |
| GUF | 68.70 | 1118 | 4 | 8 | Petrol | 2 |
| GZ | 87.50 | 2261 | 4 | 16 | Petrol | 81 |
| H9FA | 89.90 | 2402 | 4 | 16 | Diesel | 84 |
| H9FB | 89.90 | 2402 | 4 | 16 | Diesel | 85 |
| H9FD | 89.90 | 2402 | 4 | 16 | Diesel | 85 |
| HCPA | 82.50 | 1753 | 4 | 8 | Diesel | 58 |
| HCPB | 82.50 | 1753 | 4 | 8 | Diesel | 58 |
| HHDA | 75.00 | 1560 | 4 | 16 | Diesel | 22 |
| HHDB | 75.00 | 1560 | 4 | 16 | Diesel | 22 |
| HHJA | 75.00 | 1560 | 4 | 16 | Diesel | 22 |
| HHJB | 75.00 | 1560 | 4 | 16 | Diesel | 22 |
| HHJC | 75.00 | 1560 | 4 | 16 | Diesel | 22 |
| HHJD | 75.00 | 1560 | 4 | 16 | Diesel | 22 |
| HHJE | 75.00 | 1560 | 4 | 16 | Diesel | 22 |
| HHJF | 75.00 | 1560 | 4 | 16 | Diesel | 22 |
| HJBA | 86.00 | 1998 | 4 | 16 | Diesel | 72 |
| HJBB | 86.00 | 1998 | 4 | 16 | Diesel | 72 |
| HJBC | 86.00 | 1998 | 4 | 16 | Diesel | 72 |
| HUWA | 83.00 | 2521 | 5 | 20 | Petrol | 63 |
| HWDA | 79.00 | 1596 | 4 | 16 | Petrol | 34 |
| HWDB | 79.00 | 1596 | 4 | 16 | Petrol | 34 |
| HXDA | 79.00 | 1596 | 4 | 16 | Petrol | 34 |
| HXDB | 79.00 | 1596 | 4 | 16 | Petrol | 34 |
| J4B / BL13 | 74.00 | 1299 | 4 | 8 | Petrol | 19 |
| J4C | 74.00 | 1299 | 4 | 8 | Petrol | 19 |
| J4D | 74.00 | 1299 | 4 | 8 | Petrol | 19 |
| J4J | 74.00 | 1299 | 4 | 8 | Petrol | 19 |
| J4K | 74.00 | 1299 | 4 | 8 | Petrol | 19 |
| J4L | 74.00 | 1299 | 4 | 8 | Petrol | 19 |
| J4M | 74.00 | 1299 | 4 | 8 | Petrol | 19 |
| J4N | 74.00 | 1299 | 4 | 8 | Petrol | 19 |
| J4P | 74.00 | 1299 | 4 | 8 | Petrol | 19 |
| J4Q | 74.00 | 1299 | 4 | 8 | Petrol | 19 |
| J4R | 74.00 | 1299 | 4 | 8 | Petrol | 19 |
| J4S | 74.00 | 1299 | 4 | 8 | Petrol | 19 |
| J4T | 74.00 | 1299 | 4 | 8 | Petrol | 19 |
| J6A | 74.00 | 1299 | 4 | 8 | Petrol | 19 |
| J6B | 74.00 | 1299 | 4 | 8 | Petrol | 19 |
| JBA | 74.00 | 1297 | 4 | 8 | Petrol | 17 |
| JBB | 74.00 | 1297 | 4 | 8 | Petrol | 17 |
| JBC | 74.00 | 1299 | 4 | 8 | Petrol | 19 |
| JBD | 74.00 | 1297 | 4 | 8 | Petrol | 17 |
| JJA | 74.00 | 1299 | 4 | 8 | Petrol | 19 |
| JJB | 74.00 | 1299 | 4 | 8 | Petrol | 19 |
| JJC | 74.00 | 1299 | 4 | 8 | Petrol | 19 |
| JJD | 74.00 | 1299 | 4 | 8 | Petrol | 19 |
| JJE | 74.00 | 1299 | 4 | 8 | Petrol | 19 |
| JJF | 74.00 | 1299 | 4 | 8 | Petrol | 19 |
| JJG | 74.00 | 1299 | 4 | 8 | Petrol | 19 |
| JJH | 74.00 | 1299 | 4 | 8 | Petrol | 19 |

|  |  | ccm |  |  |  |  | |
|---|---|-------|---|---|---|---|----|
| JJJ | | 74.00 | 1299 | 4 | 8 | Petrol | 19 |
| JJK | | 74.00 | 1299 | 4 | 8 | Petrol | 19 |
| JJL | | 74.00 | 1299 | 4 | 8 | Petrol | 19 |
| JJM | | 74.00 | 1299 | 4 | 8 | Petrol | 19 |
| JLA | | 74.00 | 1297 | 4 | 8 | Petrol | 18 |
| JLB | | 74.00 | 1297 | 4 | 8 | Petrol | 18 |
| JPA | | 79.96 | 1297 | 4 | 8 | Petrol | 40 |
| JPC | | 79.96 | 1297 | 4 | 8 | Petrol | 40 |
| JXFA | | 89.90 | 2402 | 4 | 16 | Diesel | 85 |
| JXFC | | 89.90 | 2402 | 4 | 16 | Diesel | 85 |
| KHBA | | 82.50 | 1753 | 4 | 8 | Diesel | 58 |
| KKDA | | 82.50 | 1753 | 4 | 8 | Diesel | 58 |
| KKDB | | 82.50 | 1753 | 4 | 8 | Diesel | 58 |
| KLBA | | 85.00 | 1997 | 4 | 16 | Diesel | 67 |
| KLWA | | 85.00 | 1997 | 4 | 16 | Diesel | 68 |
| KVJA | | 73.70 | 1399 | 4 | 8 | Diesel | 13 |
| L1E | | 76.00 | 1597 | 4 | 16 | Petrol | 29 |
| L1F | | 76.00 | 1597 | 4 | 16 | Petrol | 30 |
| L1G | | 76.00 | 1597 | 4 | 16 | Petrol | 30 |
| L1H | | 76.00 | 1597 | 4 | 16 | Petrol | 29 |
| L1J | | 76.00 | 1597 | 4 | 16 | Petrol | 29 |
| L1K | | 76.00 | 1597 | 4 | 16 | Petrol | 29 |
| L1L | | 76.00 | 1597 | 4 | 16 | Petrol | 29 |
| L1N | | 76.00 | 1597 | 4 | 16 | Petrol | 29 |
| L1Q | | 76.00 | 1597 | 4 | 16 | Petrol | 29 |
| L1T | | 79.00 | 1596 | 4 | 16 | Petrol | 35 |
| L1V | | 79.00 | 1596 | 4 | 16 | Petrol | 35 |
| L3E | | 80.98 | 1598 | 4 | 8 | Petrol | 51 |
| L4B | | 79.96 | 1598 | 4 | 8 | Petrol | 43 |
| L6B | | 79.96 | 1598 | 4 | 8 | Petrol | 43 |
| LAR | | 87.65 | 1593 | 4 | 8 | Petrol | 83 |
| LAT | | 87.65 | 1593 | 4 | 8 | Petrol | 83 |
| LCBD | | 81.60 | 2495 | 6 | 24 | Petrol | 55 |
| LCE | | 87.65 | 1593 | 4 | 8 | Petrol | 83 |
| LCJ | | 87.65 | 1593 | 4 | 8 | Petrol | 83 |
| LCN | | 87.65 | 1593 | 4 | 8 | Petrol | 83 |
| LCS | | 81.30 | 1593 | 4 | 8 | Petrol | 53 |
| LCT | | 81.30 | 1593 | 4 | 8 | Petrol | 53 |
| LHA | | 79.96 | 1598 | 4 | 8 | Petrol | 44 |
| LJA | | 79.96 | 1598 | 4 | 8 | Petrol | 44 |
| LJB | | 79.96 | 1597 | 4 | 8 | Petrol | 41 |
| LJC | | 80.00 | 1597 | 4 | 8 | Petrol | 45 |
| LJD | | 79.96 | 1598 | 4 | 8 | Petrol | 43 |
| LJE | | 80.00 | 1598 | 4 | 8 | Petrol | 46 |
| LJF | | 79.96 | 1598 | 4 | 8 | Petrol | 43 |
| LNA | | 79.96 | 1597 | 4 | 8 | Petrol | 41 |
| LNB | | 79.96 | 1597 | 4 | 8 | Petrol | 41 |
| LP1 | | 79.96 | 1597 | 4 | 8 | Petrol | 41 |
| LP2 | | 79.96 | 1597 | 4 | 8 | Petrol | 42 |
| LP3 | | 79.96 | 1597 | 4 | 8 | Petrol | 42 |
| LPA | | 79.96 | 1597 | 4 | 8 | Petrol | 41 |
| LPBA | | 85.00 | 1997 | 4 | 16 | Diesel | 69 |
| LR1 | | 79.96 | 1597 | 4 | 8 | Petrol | 41 |
| LR2 | | 79.96 | 1597 | 4 | 8 | Petrol | 42 |
| LRA | | 79.96 | 1597 | 4 | 8 | Petrol | 41 |
| LRB | | 79.96 | 1597 | 4 | 8 | Petrol | 41 |
| LSD | | 81.30 | 1597 | 4 | 8 | Petrol | 54 |
| LSE | | 81.30 | 1597 | 4 | 8 | Petrol | 54 |
| LUA | | 79.96 | 1597 | 4 | 8 | Petrol | 41 |
| LUAE | | 79.96 | 1597 | 4 | 8 | Petrol | 42 |
| LUB | | 79.96 | 1597 | 4 | 8 | Petrol | 41 |
| LUC | | 79.96 | 1597 | 4 | 8 | Petrol | 41 |
| LUD | | 79.96 | 1597 | 4 | 8 | Petrol | 41 |
| LUG | | 79.96 | 1597 | 4 | 8 | Petrol | 41 |
| LUH | | 76.00 | 1597 | 4 | 8 | Petrol | 31 |
| LUJ | | 79.96 | 1598 | 4 | 8 | Petrol | 43 |

| |  | ccm |  |  |  |  |
|-------------|---|------|--|---|---|---|
| LUK | 79.96 | 1598 | 4 | 8 | Petrol | 43 |
| M1CA | 71.90 | 998 | 3 | 12 | Petrol | 7 |
| M1CB | 71.90 | 998 | 3 | 12 | Petrol | 7 |
| M1DA | 71.90 | 998 | 3 | 12 | Petrol | 7 |
| M1JA | 71.90 | 998 | 3 | 12 | Petrol | 7 |
| M1JC | 71.90 | 998 | 3 | 12 | Petrol | 7 |
| M1JE | 71.90 | 998 | 3 | 12 | Petrol | 7 |
| M2DA | 71.90 | 998 | 3 | 12 | Petrol | 8 |
| M2GA | 71.90 | 998 | 3 | 12 | Petrol | 8 |
| M2GB | 71.90 | 998 | 3 | 12 | Petrol | 8 |
| M7JA | 71.90 | 1242 | 4 | 16 | Petrol | 10 |
| M7JB | 71.90 | 1242 | 4 | 16 | Petrol | 10 |
| MHA | 80.00 | 1679 | 4 | 16 | Petrol | 47 |
| MHB | 80.00 | 1679 | 4 | 16 | Petrol | 47 |
| MTDA | 75.00 | 1560 | 4 | 16 | Diesel | 22 |
| MY | 90.00 | 1699 | 4 | 8 | Petrol | 87 |
| MYE | 90.00 | 1699 | 4 | 8 | Petrol | 88 |
| N4A | 90.80 | 1993 | 4 | 8 | Petrol | 90 |
| N4B | 90.80 | 1993 | 4 | 8 | Petrol | 90 |
| N4I | 90.80 | 1993 | 4 | 8 | Petrol | 90 |
| N4JB | 87.50 | 1999 | 4 | 16 | Petrol | 80 |
| N6T | 90.80 | 1993 | 4 | 8 | Petrol | 90 |
| N7A | 86.00 | 1998 | 4 | 16 | Petrol | 73 |
| N7BA | 86.00 | 1998 | 4 | 16 | Diesel | 72 |
| N8C (DL20H) | 86.00 | 1998 | 4 | 8 | Petrol | 74 |
| N8D | 86.00 | 1998 | 4 | 8 | Petrol | 75 |
| N9A | 86.00 | 1998 | 4 | 8 | Petrol | 74 |
| N9B | 86.00 | 1998 | 4 | 8 | Petrol | 74 |
| N9C | 86.00 | 1998 | 4 | 8 | Petrol | 74 |
| N9D | 86.00 | 1998 | 4 | 8 | Petrol | 74 |
| N9E | 86.00 | 1998 | 4 | 8 | Petrol | 74 |
| N9F | 86.00 | 1998 | 4 | 8 | Petrol | 74 |
| NAE | 90.80 | 1993 | 4 | 8 | Petrol | 90 |
| NAT | 90.80 | 1993 | 4 | 8 | Petrol | 90 |
| NAV | 90.80 | 1993 | 4 | 8 | Petrol | 90 |
| NBA | 90.80 | 1993 | 4 | 8 | Petrol | 90 |
| NCA | 90.80 | 1993 | 4 | 8 | Petrol | 90 |
| NE | 90.80 | 1993 | 4 | 8 | Petrol | 90 |
| NE5 | 90.80 | 1993 | 4 | 8 | Petrol | 90 |
| NEE | 90.80 | 1993 | 4 | 8 | Petrol | 90 |
| NEG | 90.80 | 1993 | 4 | 8 | Petrol | 90 |
| NEJ | 90.80 | 1993 | 4 | 8 | Petrol | 90 |
| NEK | 90.80 | 1993 | 4 | 8 | Petrol | 89 |
| NEL | 90.80 | 1993 | 4 | 8 | Petrol | 89 |
| NEN | 90.80 | 1993 | 4 | 8 | Petrol | 90 |
| NEP | 90.80 | 1993 | 4 | 8 | Petrol | 89 |
| NER | 90.80 | 1993 | 4 | 8 | Petrol | 89 |
| NES | 90.80 | 1993 | 4 | 8 | Petrol | 90 |
| NET | 90.80 | 1993 | 4 | 8 | Petrol | 89 |
| NGA | 84.80 | 1988 | 4 | 16 | Petrol | 66 |
| NGB | 84.80 | 1988 | 4 | 16 | Petrol | 66 |
| NGC | 84.80 | 1988 | 4 | 16 | Petrol | 66 |
| NGD | 84.80 | 1988 | 4 | 16 | Petrol | 66 |
| NR2 | 90.80 | 1993 | 4 | 8 | Petrol | 90 |
| NRA | 90.80 | 1993 | 4 | 8 | Petrol | 90 |
| NRB | 90.80 | 1993 | 4 | 8 | Petrol | 89 |
| NRC | 90.80 | 1993 | 4 | 8 | Petrol | 89 |
| NRD | 90.80 | 1993 | 4 | 8 | Petrol | 90 |
| NRI | 90.80 | 1993 | 4 | 8 | Petrol | 90 |
| NSD | 86.00 | 1998 | 4 | 8 | Petrol | 74 |
| NSE | 86.00 | 1998 | 4 | 8 | Petrol | 74 |
| NSF | 86.00 | 1998 | 4 | 8 | Petrol | 74 |
| NSG | 86.00 | 1998 | 4 | 8 | Petrol | 74 |
| NSH | 86.00 | 1998 | 4 | 8 | Petrol | 74 |
| P4JA | 71.90 | 998 | 3 | 12 | Petrol | 8 |
| P4JB | 71.90 | 998 | 3 | 12 | Petrol | 8 |

|  |  | ccm |  |  |  |  | |
|---|---|-------|---|---|---|---|----|
| P4JC | | 71.90 | 998 | 3 | 12 | Petrol | 8 |
| P4JD | | 71.90 | 998 | 3 | 12 | Petrol | 8 |
| P7PA | | 82.50 | 1753 | 4 | 8 | Diesel | 58 |
| P7PB | | 82.50 | 1753 | 4 | 8 | Diesel | 58 |
| P8FA | | 86.00 | 2198 | 4 | 16 | Diesel | 76 |
| P8FB | | 86.00 | 2198 | 4 | 16 | Diesel | 76 |
| P9PA | | 82.50 | 1753 | 4 | 8 | Diesel | 58 |
| P9PB | | 82.50 | 1753 | 4 | 8 | Diesel | 58 |
| P9PC | | 82.50 | 1753 | 4 | 8 | Diesel | 58 |
| P9PD | | 82.50 | 1753 | 4 | 8 | Diesel | 58 |
| PGFA | | 86.00 | 2198 | 4 | 16 | Diesel | 76 |
| PGFB | | 86.00 | 2198 | 4 | 16 | Diesel | 76 |
| PHFA | | 89.90 | 2402 | 4 | 16 | Diesel | 85 |
| PHFC | | 89.90 | 2402 | 4 | 16 | Diesel | 85 |
| PNBA | | 79.00 | 1596 | 4 | 16 | Petrol | 34 |
| PR5 | | 93.00 | 2792 | 6 | 12 | Petrol | 94 |
| PR6 | | 93.00 | 2792 | 6 | 12 | Petrol | 94 |
| PR7 | | 93.00 | 2792 | 6 | 12 | Petrol | 94 |
| PR8 | | 93.00 | 2792 | 6 | 12 | Petrol | 94 |
| PRB | | 93.00 | 2792 | 6 | 12 | Petrol | 94 |
| PRC | | 93.00 | 2792 | 6 | 12 | Petrol | 94 |
| PRD | | 93.00 | 2792 | 6 | 12 | Petrol | 94 |
| PRE | | 93.00 | 2792 | 6 | 12 | Petrol | 94 |
| PRG | | 93.00 | 2792 | 6 | 12 | Petrol | 94 |
| PRN | | 93.00 | 2792 | 6 | 12 | Petrol | 94 |
| PRT | | 93.00 | 2792 | 6 | 12 | Petrol | 94 |
| PYA | | 93.00 | 2792 | 6 | 12 | Petrol | 94 |
| PYU | | 93.00 | 2792 | 6 | 12 | Petrol | 94 |
| Q4BA | | 85.00 | 2179 | 4 | 16 | Diesel | 71 |
| Q7DA | | 83.00 | 1798 | 4 | 16 | Petrol | 62 |
| QJBA | | 86.00 | 2198 | 4 | 16 | Diesel | 76 |
| QJBB | | 86.00 | 2198 | 4 | 16 | Diesel | 76 |
| QJBC | | 86.00 | 2198 | 4 | 16 | Diesel | 76 |
| QJBD | | 86.00 | 2198 | 4 | 16 | Diesel | 76 |
| QQDA | | 83.00 | 1798 | 4 | 16 | Petrol | 62 |
| QQDB | | 83.00 | 1798 | 4 | 16 | Petrol | 62 |
| QQDC | | 83.00 | 1798 | 4 | 16 | Petrol | 62 |
| QQDD | | 83.00 | 1798 | 4 | 16 | Petrol | 62 |
| QVFA | | 86.00 | 2198 | 4 | 16 | Diesel | 76 |
| QWFA | | 86.00 | 2198 | 4 | 16 | Diesel | 76 |
| QXBA | | 85.00 | 1997 | 4 | 16 | Diesel | 67 |
| QXBB | | 85.00 | 1997 | 4 | 16 | Diesel | 67 |
| QXWA | | 85.00 | 1997 | 4 | 16 | Diesel | 67 |
| QXWB | | 85.00 | 1997 | 4 | 16 | Diesel | 67 |
| QXWC | | 85.00 | 1997 | 4 | 16 | Diesel | 67 |
| QYBA | | 82.50 | 1753 | 4 | 8 | Diesel | 58 |
| QYWA | | 82.50 | 1753 | 4 | 8 | Diesel | 58 |
| R2A | | 86.20 | 1796 | 4 | 8 | Petrol | 77 |
| R2C | | 79.94 | 1769 | 4 | 8 | Petrol | 39 |
| R2PA | | 82.50 | 1753 | 4 | 8 | Diesel | 58 |
| R3PA | | 82.50 | 1753 | 4 | 8 | Diesel | 58 |
| R6A | | 79.94 | 1769 | 4 | 8 | Petrol | 39 |
| RDA | | 80.60 | 1796 | 4 | 16 | Petrol | 49 |
| RDB | | 80.60 | 1796 | 4 | 16 | Petrol | 49 |
| REB | | 86.20 | 1796 | 4 | 8 | Petrol | 78 |
| REC | | 86.20 | 1796 | 4 | 8 | Petrol | 78 |
| RED | | 86.20 | 1796 | 4 | 8 | Petrol | 78 |
| REF | | 86.20 | 1796 | 4 | 8 | Petrol | 78 |
| RFA | | 82.50 | 1753 | 4 | 8 | Diesel | 59 |
| RFB | | 82.50 | 1753 | 4 | 8 | Diesel | 59 |
| RFD | | 82.50 | 1753 | 4 | 8 | Diesel | 59 |
| RFK | | 82.50 | 1753 | 4 | 8 | Diesel | 59 |
| RFL | | 82.50 | 1753 | 4 | 8 | Diesel | 60 |
| RFM | | 82.50 | 1753 | 4 | 8 | Diesel | 59 |
| RFN | | 82.50 | 1753 | 4 | 8 | Diesel | 59 |
| RFS | | 82.50 | 1753 | 4 | 8 | Diesel | 59 |

|  |  | ccm |  |  |  |  |
|---|---|------|--|---|---|---|
| RHBA | 79.00 | 1596 | 4 | 16 | Petrol | 34 |
| RKA | 80.60 | 1796 | 4 | 16 | Petrol | 50 |
| RKB | 80.60 | 1796 | 4 | 16 | Petrol | 49 |
| RKC | 80.60 | 1796 | 4 | 16 | Petrol | 49 |
| RKF | 80.60 | 1796 | 4 | 16 | Petrol | 49 |
| RKH | 80.60 | 1796 | 4 | 16 | Petrol | 49 |
| RKJ | 80.60 | 1796 | 4 | 16 | Petrol | 49 |
| RKK | 80.60 | 1796 | 4 | 16 | Petrol | 49 |
| RQB | 80.60 | 1796 | 4 | 16 | Petrol | 49 |
| RQC | 80.60 | 1796 | 4 | 16 | Petrol | 49 |
| RTA (D18NA) | 82.50 | 1753 | 4 | 8 | Diesel | 61 |
| RTB (D18NA) | 82.50 | 1753 | 4 | 8 | Diesel | 61 |
| RTC (D18NA) | 82.50 | 1753 | 4 | 8 | Diesel | 61 |
| RTD (D18NA) | 82.50 | 1753 | 4 | 8 | Diesel | 61 |
| RTE (D18NA) | 82.50 | 1753 | 4 | 8 | Diesel | 61 |
| RTF (D18NA) | 82.50 | 1753 | 4 | 8 | Diesel | 61 |
| RTG (D18NA) | 82.50 | 1753 | 4 | 8 | Diesel | 61 |
| RTH (D18NA) | 82.50 | 1753 | 4 | 8 | Diesel | 61 |
| RTJ | 82.50 | 1753 | 4 | 8 | Diesel | 61 |
| RTJA | 76.00 | 1388 | 4 | 16 | Petrol | 28 |
| RTJB | 76.00 | 1388 | 4 | 16 | Petrol | 28 |
| RTK | 82.50 | 1753 | 4 | 8 | Diesel | 61 |
| RTN | 82.50 | 1753 | 4 | 8 | Diesel | 58 |
| RTP | 82.50 | 1753 | 4 | 8 | Diesel | 58 |
| RTQ | 82.50 | 1753 | 4 | 8 | Diesel | 58 |
| RVA | 82.50 | 1753 | 4 | 8 | Diesel | 59 |
| RWPA | 82.50 | 1753 | 4 | 8 | Diesel | 58 |
| RWPC | 82.50 | 1753 | 4 | 8 | Diesel | 58 |
| RWPD | 82.50 | 1753 | 4 | 8 | Diesel | 58 |
| RWPE | 82.50 | 1753 | 4 | 8 | Diesel | 58 |
| RWPF | 82.50 | 1753 | 4 | 8 | Diesel | 58 |
| SAFA | 89.90 | 3198 | 5 | 20 | Diesel | 86 |
| SAFB | 89.90 | 3198 | 5 | 20 | Diesel | 86 |
| SEBA | 87.50 | 2261 | 4 | 16 | Petrol | 81 |
| SFA (XD3T) | 94.00 | 2498 | 4 | 8 | Diesel | 97 |
| SFB (XD3T) | 94.00 | 2498 | 4 | 8 | Diesel | 97 |
| SFCA | 71.90 | 998 | 3 | 12 | Petrol | 8 |
| SFCB | 71.90 | 998 | 3 | 12 | Petrol | 8 |
| SFCC | 71.90 | 998 | 3 | 12 | Petrol | 8 |
| SFCD | 71.90 | 998 | 3 | 12 | Petrol | 8 |
| SFDA | 71.90 | 998 | 3 | 12 | Petrol | 8 |
| SFJA | 71.90 | 998 | 3 | 12 | Petrol | 8 |
| SFJB | 71.90 | 998 | 3 | 12 | Petrol | 8 |
| SFJC | 71.90 | 998 | 3 | 12 | Petrol | 8 |
| SFJD | 71.90 | 998 | 3 | 12 | Petrol | 8 |
| SHDA | 79.00 | 1596 | 4 | 16 | Petrol | 34 |
| SHDB | 79.00 | 1596 | 4 | 16 | Petrol | 34 |
| SHDC | 79.00 | 1596 | 4 | 16 | Petrol | 34 |
| SIDA | 79.00 | 1596 | 4 | 16 | Petrol | 34 |
| SNJA | 71.90 | 1242 | 4 | 16 | Petrol | 10 |
| SNJB | 71.90 | 1242 | 4 | 16 | Petrol | 10 |
| SPJA | 76.00 | 1388 | 4 | 16 | Petrol | 24 |
| SPJC | 76.00 | 1388 | 4 | 16 | Petrol | 24 |
| SRFA | 86.00 | 2198 | 4 | 16 | Diesel | 76 |
| SRFB | 86.00 | 2198 | 4 | 16 | Diesel | 76 |
| SRFC | 86.00 | 2198 | 4 | 16 | Diesel | 76 |
| SRFD | 86.00 | 2198 | 4 | 16 | Diesel | 76 |
| SRFE | 86.00 | 2198 | 4 | 16 | Diesel | 76 |
| STJA | 71.90 | 1242 | 4 | 16 | Petrol | 10 |
| STJB | 71.90 | 1242 | 4 | 16 | Petrol | 10 |
| STP (XD3/XD3P) | 94.00 | 2498 | 4 | 8 | Diesel | 97 |
| STR (XD3/XD3P) | 94.00 | 2498 | 4 | 8 | Diesel | 97 |
| SYDA | 87.50 | 1999 | 4 | 16 | Petrol | 79 |
| T1BA | 75.00 | 1560 | 4 | 8 | Diesel | 23 |
| T1BB | 75.00 | 1560 | 4 | 8 | Diesel | 23 |
| T1BC | 75.00 | 1560 | 4 | 8 | Diesel | 23 |



|  |  | ccm |  |  |  |  | |
|---|---|-------|---|---|---|---|----|
| T1DA | | 75.00 | 1560 | 4 | 8 | Diesel | 23 |
| T1DB | | 75.00 | 1560 | 4 | 8 | Diesel | 23 |
| T1WB | | 75.00 | 1560 | 4 | 8 | Diesel | 23 |
| T3DA | | 75.00 | 1560 | 4 | 8 | Diesel | 23 |
| T3DB | | 75.00 | 1560 | 4 | 8 | Diesel | 23 |
| T3JA | | 75.00 | 1560 | 4 | 8 | Diesel | 23 |
| TBBA | | 87.50 | 1999 | 4 | 16 | Petrol | 79 |
| TBBB | | 87.50 | 1999 | 4 | 16 | Petrol | 79 |
| TD27 | | 96.00 | 2663 | 4 | 8 | Diesel | 98 |
| TKA | | 74.00 | 957 | 4 | 8 | Petrol | 14 |
| TKB | | 74.00 | 957 | 4 | 8 | Petrol | 15 |
| TKW | | 74.00 | 957 | 4 | 8 | Petrol | 15 |
| TL 20 H | | 90.80 | 1993 | 4 | 8 | Petrol | 90 |
| TLA | | 74.00 | 957 | 4 | 8 | Petrol | 15 |
| TLB | | 68.70 | 999 | 4 | 8 | Petrol | 1 |
| TXBA | | 85.00 | 1997 | 4 | 16 | Diesel | 68 |
| TXBB | | 85.00 | 1997 | 4 | 16 | Diesel | 70 |
| TXDA | | 85.00 | 1997 | 4 | 16 | Diesel | 68 |
| TXDB | | 85.00 | 1997 | 4 | 16 | Diesel | 68 |
| TXMA | | 85.00 | 1997 | 4 | 16 | Diesel | 70 |
| TXWA | | 85.00 | 1997 | 4 | 16 | Diesel | 68 |
| TYDA | | 85.00 | 1997 | 4 | 16 | Diesel | 68 |
| TYWA | | 85.00 | 1997 | 4 | 16 | Diesel | 68 |
| TZJA | | 75.00 | 1560 | 4 | 8 | Diesel | 23 |
| TZJB | | 75.00 | 1560 | 4 | 8 | Diesel | 23 |
| UBJA | | 75.00 | 1560 | 4 | 16 | Diesel | 22 |
| UFDA | | 85.00 | 1997 | 4 | 16 | Diesel | 68 |
| UFDB | | 85.00 | 1997 | 4 | 16 | Diesel | 68 |
| UFWA | | 85.00 | 1997 | 4 | 16 | Diesel | 67 |
| UHFA | | 86.00 | 2198 | 4 | 16 | Diesel | 76 |
| UHFB | | 86.00 | 2198 | 4 | 16 | Diesel | 76 |
| UHFC | | 86.00 | 2198 | 4 | 16 | Diesel | 76 |
| UKDA | | 85.00 | 1997 | 4 | 16 | Diesel | 68 |
| UKDB | | 85.00 | 1997 | 4 | 16 | Diesel | 68 |
| USR6 | | 86.00 | 2198 | 4 | 16 | Diesel | 76 |
| USRA | | 86.00 | 2198 | 4 | 16 | Diesel | 76 |
| USRB | | 86.00 | 2198 | 4 | 16 | Diesel | 76 |
| VM | | 92.00 | 2500 | 4 | 8 | Diesel | 92 |
| WL-T | | 93.00 | 2500 | 4 | 12 | Diesel | 93 |
| XMJA | | 71.90 | 998 | 3 | 12 | Petrol | 8 |
| XMJB | | 71.90 | 998 | 3 | 12 | Petrol | 8 |
| YTR (XD2/XD2P/XD94) | | 94.00 | 2304 | 4 | 8 | Diesel | 96 |
| YTT (XD2/XD2P/XD94) | | 94.00 | 2304 | 4 | 8 | Diesel | 96 |
| YYJA | | 71.90 | 998 | 3 | 12 | Petrol | 7 |
| YYJB | | 71.90 | 998 | 3 | 12 | Petrol | 7 |
| ZVSA | | 86.00 | 1998 | 4 | 8 | Petrol | 74 |

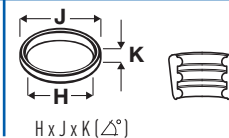
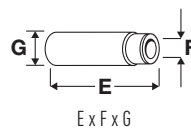

OE

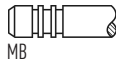

1  **68.70**

| TLB | 999cc | 4 Cyl. | 8 Valves | 33kW/45PS | Petrol | HCS | TD1454 |
|--|-----------------|---|----------|----------------|-----------------|-----|--------|
| FIESTA II 1.0 | 09/1983→11/1989 | | | FIESTA III 1.0 | 03/1989→12/1995 | | |
| V91158 ■ 32.95 x 7.03 x 104.02 | 6165227 |  MB | 45° | H | | | |
| V91159 ■ 29.12 x 7.01 x 104.39 | 1653978 |  MD | 45° | | | | |

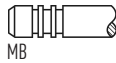
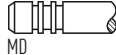

2  **68.70**

| GUF | 1118cc | 4 Cyl. | 8 Valves | 40kW/54PS | Petrol | HCS | TD1211 |
|--|---------|---|----------|-----------|--------|-----|--------|
| V91158 ■ 32.95 x 7.03 x 104.02 | 6165227 |  MB | 45° | H | | | |
| V91159 ■ 29.12 x 7.01 x 104.39 | 1653978 |  MD | 45° | | | | |

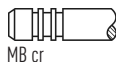
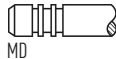

3  **68.70**

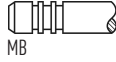
| G6A | 1119cc | 4 Cyl. | 8 Valves | 37kW/50PS | Petrol | HCS | TD4455 |
|--|-----------------|--|----------|-----------|--------|-----|--------|
| FIESTA III 1.1 | 03/1989→12/1995 | | | | | | |
| V91162 ■ 34.47 x 7.03 x 104.02 | 6165228 |  MB cr | 45° | H | | | |
| V91159 ■ 29.12 x 7.01 x 104.39 | 1653978 |  MD | 45° | | | | |

4  **68.70**

| GUD | 1119cc | 4 Cyl. | 8 Valves | 40kW/55PS | Petrol | HCS | TD1209 |
|--|---------|---|----------|-----------|--------|-----|--------|
| V91158 ■ 32.95 x 7.03 x 104.02 | 6165227 |  MB | 45° | H | | | |
| V91159 ■ 29.12 x 7.01 x 104.39 | 1653978 |  MD | 45° | | | | |

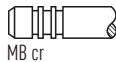
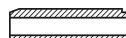
5  **69.60**

| FD4 | 1248cc | 4 Cyl. | 16 Valves | 55kW/75PS | Diesel | Duratorq, DOHC | TD24409 |
|--|------------|---|-----------|-----------|--------|---|---|
| KA 1.3 TDCi | 10/2008→ | | | | | | |
| V95015 ■ 21.85 x 6.00 x 109.20 | 1538735 |  MB cr | 45° | Y | H | VAG96359 ■ ■ 43.28 x 6.00 x 10.25 |  |
| V95016 ■ 21.80 x 6.00 x 109.20 | 55 208 213 |  MD + MB cr | 45° | | H | | |

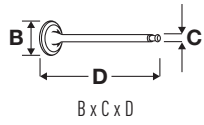

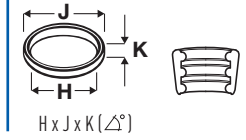
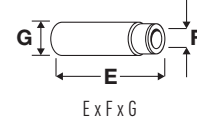

OE



6  **70.80**



| | | | | | | | |
|--------|----------|--------|----------|-----------|--------|---------------|---------|
| FP4 | 1242cc | 4 Cyl. | 8 Valves | 51kW/69PS | Petrol | Duratec, SOHC | TD24408 |
| KA 1.2 | 10/2008→ | | | | | | |

| | | | | | | |
|---|------------|---|-----|---|----------------------|--|
| V98022  | 55 194 219 |  MB cr | 45° | VAG96384  | 44.00 x 5.00 x 10.04 | |
| V98023  | 55 200 422 |  MD + MB cr | 45° | | | |

7  **71.90**

| | | | | | | | |
|------|-------|--------|-----------|-------------------|--------|-----------------------|---------|
| M1CA | 998cc | 3 Cyl. | 12 Valves | 92kW/125PS | Petrol | EcoBoost, Turbo, DOHC | TD30757 |
| M1CB | 998cc | 3 Cyl. | 12 Valves | 92kW/125PS | Petrol | EcoBoost, Turbo, DOHC | TD30758 |
| M1DA | 998cc | 3 Cyl. | 12 Valves | 88-92kW/120-125PS | Petrol | EcoBoost, Turbo, DOHC | TD26478 |
| M1JA | 998cc | 3 Cyl. | 12 Valves | 88kW/120PS | Petrol | EcoBoost, Turbo, DOHC | TD28068 |
| M1JC | 998cc | 3 Cyl. | 12 Valves | 92kW/125PS | Petrol | EcoBoost, Turbo, DOHC | TD29434 |
| M1JE | 998cc | 3 Cyl. | 12 Valves | 92kW/125PS | Petrol | EcoBoost, Turbo, DOHC | TD27831 |
| YYJA | 998cc | 3 Cyl. | 12 Valves | 103kW/140PS | Petrol | EcoBoost, Turbo, DOHC | TD31077 |
| YYJB | 998cc | 3 Cyl. | 12 Valves | 103kW/140PS | Petrol | EcoBoost, Turbo, DOHC | TD31078 |

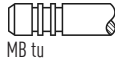
| | | | |
|-----------------|----------|---------------|----------|
| B-MAX 1.0 | 10/2012→ | C-MAX II 1.0 | 10/2012→ |
| ECOSPORT 1.0 | 10/2013→ | FIESTA 1.0 | 09/2013→ |
| FIESTA VI 1.0 | 09/2012→ | FOCUS III 1.0 | 02/2012→ |
| GRAND C-MAX 1.0 | 10/2012→ | MONDEO V 1.0 | 02/2015→ |

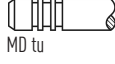
| | | | | | |
|---|---------|--|-----|----|--|
| V95156  | 1760579 |  MB tu | 45° | H | |
| V95179  | 1760589 |  MD tu | 45° | SS | |



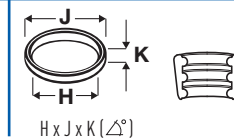
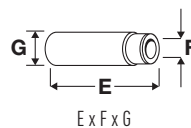

OE



8  **71.90**

| | | | | | | | |
|------|-------|--------|-----------|------------|--------|-----------------------|---------|
| M2DA | 998cc | 3 Cyl. | 12 Valves | 74kW/100PS | Petrol | EcoBoost, Turbo, DOHC | TD26479 |
| M2GA | 998cc | 3 Cyl. | 12 Valves | 74kW/100PS | Petrol | EcoBoost, Turbo, DOHC | TD28261 |
| M2GB | 998cc | 3 Cyl. | 12 Valves | 74kW/100PS | Petrol | EcoBoost, Turbo, DOHC | TD31109 |
| P4JA | 998cc | 3 Cyl. | 12 Valves | 59kW/80PS | Petrol | EcoBoost, Turbo, DOHC | TD27837 |
| P4JB | 998cc | 3 Cyl. | 12 Valves | 59kW/80PS | Petrol | EcoBoost, Turbo, DOHC | TD27838 |
| P4JC | 998cc | 3 Cyl. | 12 Valves | 59kW/80PS | Petrol | EcoBoost, Turbo, DOHC | TD31511 |
| P4JD | 998cc | 3 Cyl. | 12 Valves | 59kW/80PS | Petrol | EcoBoost, Turbo, DOHC | TD31512 |
| SFCA | 998cc | 3 Cyl. | 12 Valves | 74kW/100PS | Petrol | EcoBoost, Turbo, DOHC | TD29694 |
| SFCB | 998cc | 3 Cyl. | 12 Valves | 74kW/100PS | Petrol | EcoBoost, Turbo, DOHC | TD29695 |
| SFCC | 998cc | 3 Cyl. | 12 Valves | 74kW/100PS | Petrol | EcoBoost, Turbo, DOHC | TD31101 |
| SFCD | 998cc | 3 Cyl. | 12 Valves | 74kW/100PS | Petrol | EcoBoost, Turbo, DOHC | TD31102 |
| SFDA | 998cc | 3 Cyl. | 12 Valves | 74kW/100PS | Petrol | EcoBoost, Turbo, DOHC | TD30309 |
| SFJA | 998cc | 3 Cyl. | 12 Valves | 74kW/101PS | Petrol | EcoBoost, Turbo, DOHC | TD27833 |
| SFJB | 998cc | 3 Cyl. | 12 Valves | 74kW/101PS | Petrol | EcoBoost, Turbo, DOHC | TD27834 |
| SFJC | 998cc | 3 Cyl. | 12 Valves | 74kW/100PS | Petrol | EcoBoost, Turbo, DOHC | TD31015 |
| SFJD | 998cc | 3 Cyl. | 12 Valves | 74kW/100PS | Petrol | EcoBoost, Turbo, DOHC | TD31016 |
| XMJA | 998cc | 3 Cyl. | 12 Valves | 48kW/65PS | Petrol | EcoBoost, Turbo, DOHC | TD27835 |
| XMJB | 998cc | 3 Cyl. | 12 Valves | 48kW/65PS | Petrol | EcoBoost, Turbo, DOHC | TD27836 |

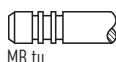



| | | | |
|---------------------|----------|---|----------|
| B-MAX 1.0 | 10/2012→ | C-MAX II 1.0 | 10/2012→ |
| FIESTA VI 1.0 | 10/2012→ | FOCUS III 1.0 | 02/2012→ |
| GRAND C-MAX 1.0 | 10/2012→ | TOURNEO CONNECT / GRAND TOURNEO CONNECT 1.0 | 11/2013→ |
| TOURNEO COURIER 1.0 | 02/2014→ | TRANSIT CONNECT 1.0 | 02/2013→ |
| TRANSIT COURIER 1.0 | 02/2014→ | | |

| | | | | |
|---|---------|---|-----|---|
| V95156  | 1760579 |  | 45° | H |
| 27.15 x 4.97 x 96.30 | | MB tu | | |
| V95178  | 1760588 |  | 45° | H |
| 23.10 x 4.96 x 98.15 | | MD + MB cr | | |

9  **71.90**

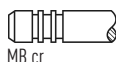
| | | | | | | | |
|-----|--------|--------|-----------|-----------|--------|----------------|---------|
| DHA | 1242cc | 4 Cyl. | 16 Valves | 55kW/75PS | Petrol | Zetec-SE, DOHC | TD12069 |
| DHB | 1242cc | 4 Cyl. | 16 Valves | 55kW/75PS | Petrol | Zetec-SE, DOHC | TD12070 |
| DHC | 1242cc | 4 Cyl. | 16 Valves | 55kW/75PS | Petrol | Zetec-SE, DOHC | TD15921 |
| DHD | 1242cc | 4 Cyl. | 16 Valves | 55kW/75PS | Petrol | Zetec-SE, DOHC | TD15922 |
| DHE | 1242cc | 4 Cyl. | 16 Valves | 55kW/75PS | Petrol | Zetec-SE, DOHC | TD15923 |
| DHF | 1242cc | 4 Cyl. | 16 Valves | 55kW/75PS | Petrol | Zetec-SE, DOHC | TD15924 |
| DHG | 1242cc | 4 Cyl. | 16 Valves | 55kW/75PS | Petrol | Zetec-SE, DOHC | TD15925 |

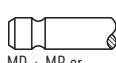
| | | | | | | | |
|----------------------|-----------------|--|--|--|--|--|--|
| FIESTA IV 1.25 i 16V | 08/1995→01/2002 | | | | | | |
|----------------------|-----------------|--|--|--|--|--|--|

| | | | | | |
|---|---------|---|-----|---|---|
| V94056  | 1051772 |  | 45° | Y | H |
| 26.10 x 6.00 x 97.65 | | MB cr | | | |
| 08/97→ | | | | | |
| V94001  | 1004444 |  | 45° | | H |
| 22.10 x 5.97 x 99.70 | | MD + MB cr | | | |
| 01/95→08/97 | | | | | |
| V94057  | 1051770 |  | 45° | | H |
| 22.10 x 6.00 x 99.70 | | MD + MB cr | | | |
| 08/97→ | | | | | |

| | | |
|---|----------------------|---|
| VAG96277  | 39.00 x 6.00 x 11.05 |  |
|---|----------------------|---|



OE

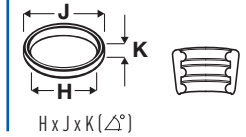
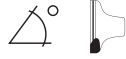

10 **71.90**

| | | | | | | | |
|----------------|--------|----------|------------------|-------------------|--------|----------------------|----------------|
| FUJA | 1242cc | 4 Cyl. | 16 Valves | 55kW/75PS | Petrol | DOHC | TD17159 |
| FUJB | 1242cc | 4 Cyl. | 16 Valves | 55kW/75PS | Petrol | DOHC | TD17160 |
| M7JA | 1242cc | 4 Cyl. | 16 Valves | 51kW/70PS | Petrol | DOHC | TD17161 |
| M7JB | 1242cc | 4 Cyl. | 16 Valves | 51kW/70PS | Petrol | DOHC | TD17162 |
| SNJA | 1242cc | 4 Cyl. | 16 Valves | 60kW/82PS | Petrol | Duratec, DOHC | TD23540 |
| SNJB | 1242cc | 4 Cyl. | 16 Valves | 60kW/82PS | Petrol | Duratec, DOHC | TD24411 |
| STJA | 1242cc | 4 Cyl. | 16 Valves | 44kW/60PS | Petrol | Duratec, DOHC | TD23539 |
| STJB | 1242cc | 4 Cyl. | 16 Valves | 44kW/60PS | Petrol | Duratec, DOHC | TD24410 |
| FIESTA 1.25 | | 10/2012→ | | FIESTA V 1.25 16V | | 05/2002→06/2008 | |
| FIESTA VI 1.25 | | 06/2008→ | | FUSION 1.25 | | 08/2004→12/2012 | |

V98036 26.00 x 6.00 x 99.70

1320928

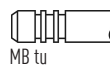

45°

VAG96277 39.00 x 6.00 x 11.05



V98037 22.00 x 6.00 x 101.80

1113187

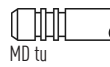

45°

11 **73.70**

| | | | | | | | |
|---------------------|--------|-----------------|-----------------|-------------------|--------|--------------------|----------------|
| F6JA (DV4TD) | 1399cc | 4 Cyl. | 8 Valves | 50-51kW/68-69PS | Diesel | Turbo, SOHC | TD17307 |
| F6JB (DV4TD) | 1399cc | 4 Cyl. | 8 Valves | 50kW/68PS | Diesel | Turbo, SOHC | TD17346 |
| F6JC | 1399cc | 4 Cyl. | 8 Valves | 50kW/68PS | Diesel | Turbo, SOHC | TD26167 |
| FIESTA 1.4 TDCi | | 05/2002→11/2011 | | FIESTA V 1.4 TDCi | | 11/2001→12/2010 | |
| FIESTA VI 1.4 TDCi | | 01/2009→ | | FUSION 1.4 TDCi | | 08/2002→12/2012 | |

V94601 32.80 x 5.50 x 97.30

1145933

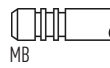

45°

Y

H

VAG96364 34.20 x 5.50 x 9.53



V94602 30.30 x 5.50 x 97.30

1152190



45°

H

12 **73.70**

| | | | | | | | |
|--------------------|--------|----------|-----------------|-----------------|--------|------------------------------|----------------|
| F6JD | 1399cc | 4 Cyl. | 8 Valves | 50-51kW/68-70PS | Diesel | Duratorq, Turbo, SOHC | TD23542 |
| FIESTA VI 1.4 TDCi | | 01/2009→ | | | | | |

V95015 21.85 x 6.00 x 109.20

1538735

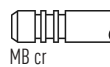

45°

Y

H

VAG96359 43.28 x 6.00 x 10.25



V95182 21.85 x 5.98 x 109.25

55204574

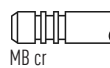

45°

H

V95016 21.80 x 6.00 x 109.20

55 208 213



45°

H

V95183 22.50 x 5.99 x 109.20

55223836

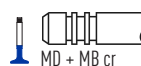

45°

ss

H

13 **73.70**

| | | | | | | | |
|--------------------|--------|----------|-----------------|-----------|--------|------------------------------|----------------|
| KVJA | 1399cc | 4 Cyl. | 8 Valves | 51kW/70PS | Diesel | Duratorq, Turbo, SOHC | TD26332 |
| FIESTA VI 1.4 TDCi | | 07/2010→ | | | | | |

V95137 30.15 x 5.48 x 95.55

1685847

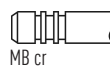

45°

Y

H

VAG96364 34.20 x 5.50 x 9.53



V95138 27.50 x 5.47 x 95.45

1685845

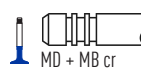

45°

ss

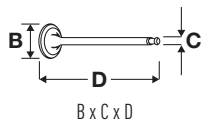

H



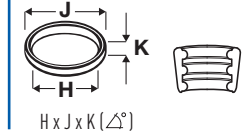
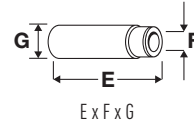
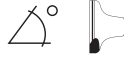



OE

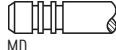



14  **74.00**

| | | | | | | | |
|---|-----------------|---|-----------------|--------------|-----------------|------------|---------------|
| TKA | 957cc | 4 Cyl. | 8 Valves | 29kW/40PS | Petrol | OHV | TD4495 |
| FIESTA 1.0 | 10/1977→11/1986 | | | FIESTA I 0.9 | 05/1976→08/1983 | | |
| V91162  | 6165228 |  | 45° | H | | | |
| 34.47 x 7.03 x 104.02 | | MB cr | | | | | |
| V91159  | 1653978 |  | 45° | | | | |
| 29.12 x 7.01 x 104.39 | | MD | | | | | |



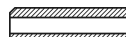

15  **74.00**

| | | | | | | | |
|---|-----------------|---|-----------------|--|---|------------|---------------|
| TKB | 957cc | 4 Cyl. | 8 Valves | 33kW/45PS | Petrol | OHV | TD1452 |
| TKW | 957cc | 4 Cyl. | 8 Valves | 29kW/40PS | Petrol | OHV | TD4496 |
| TLA | 957cc | 4 Cyl. | 8 Valves | 33kW/45PS | Petrol | OHV | TD1453 |
| FIESTA 1.0 | 08/1983→11/1989 | | | FIESTA I 0.9 | 05/1976→08/1983 | | |
| FIESTA II 1.0 | 09/1983→02/1989 | | | | | | |
| V90165  | 77BM 6505 DB |  | 45° | VAG96014  |  | | |
| 29.10 x 7.86 x 106.70 | | MD | | 54.00 x 7.91 x 12.77 | | | |

16  **74.00**

| | | | | | | | |
|---|-----------------|---|-----------------|--|---|------------|---------------|
| GLC | 1117cc | 4 Cyl. | 8 Valves | 37kW/50PS | Petrol | OHV | TD1198 |
| GSE | 1117cc | 4 Cyl. | 8 Valves | 37-40kW/50-55PS | Petrol | OHV | TD1203 |
| GSF | 1117cc | 4 Cyl. | 8 Valves | 37kW/50PS | Petrol | OHV | TD1204 |
| GSG | 1117cc | 4 Cyl. | 8 Valves | 37kW/50PS | Petrol | OHV | TD1205 |
| ESCORT '86 Express 1.1 | 05/1986→07/1990 | | | ESCORT III 1.1 | 08/1983→12/1985 | | |
| ESCORT IV 1.1 | 10/1985→09/1990 | | | FIESTA II 1.1 | 09/1983→02/1989 | | |
| V90165  | 77BM 6505 DB |  | 45° | VAG96014  |  | | |
| 29.10 x 7.86 x 106.70 | | MD | | 54.00 x 7.91 x 12.77 | | | |

17  **74.00**

| | | | | | | | |
|---|-----------------|---|-----------------|------------------------|-----------------|------------|---------------|
| JBA | 1297cc | 4 Cyl. | 8 Valves | 44-46kW/60-63PS | Petrol | HCS | TD1227 |
| JBB | 1297cc | 4 Cyl. | 8 Valves | 44kW/60PS | Petrol | HCS | TD4459 |
| JBD | 1297cc | 4 Cyl. | 8 Valves | 46kW/63PS | Petrol | HCS | TD1230 |
| ESCORT '86 Express 1.3 | 02/1986→07/1990 | | | ESCORT '91 Express 1.3 | 07/1990→12/1994 | | |
| ESCORT IV 1.3 | 01/1986→10/1990 | | | FIESTA III 1.3 | 03/1989→12/1995 | | |
| ORION II 1.3 | 12/1985→07/1990 | | | | | | |
| V91162  | 6165228 |  | 45° | H | | | |
| 34.47 x 7.03 x 104.02 | | MB cr | | | | | |
| V91159  | 1653978 |  | 45° | | | | |
| 29.12 x 7.01 x 104.39 | | MD | | | | | |

18  **74.00**

| | | | | | | | |
|---|-----------------|---|-----------------|--|---|------------|---------------|
| JLA | 1297cc | 4 Cyl. | 8 Valves | 44kW/60PS | Petrol | OHV | TD1236 |
| JLB | 1297cc | 4 Cyl. | 8 Valves | 44kW/60PS | Petrol | OHV | TD1237 |
| ESCORT '86 Express 1.3 | 02/1986→07/1990 | | | ESCORT IV 1.3 | 01/1986→07/1990 | | |
| ORION II 1.3 | 12/1985→07/1990 | | | | | | |
| V90165  | 77BM 6505 DB |  | 45° | VAG96014  |  | | |
| 29.10 x 7.86 x 106.70 | | MD | | 54.00 x 7.91 x 12.77 | | | |



OE

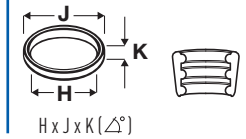
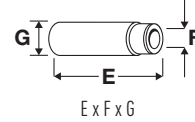
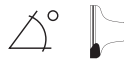

19



74.00

| | | | | | | | |
|------------|--------|--------|----------|-----------|--------|----------|---------|
| A9A | 1299cc | 4 Cyl. | 8 Valves | 51kW/70PS | Petrol | OHV | TD18764 |
| A9B | 1299cc | 4 Cyl. | 8 Valves | 51kW/70PS | Petrol | OHV | TD18765 |
| A9JA | 1299cc | 4 Cyl. | 8 Valves | 51kW/69PS | Petrol | OHV | TD17302 |
| A9JB | 1299cc | 4 Cyl. | 8 Valves | 51kW/69PS | Petrol | OHV | TD17303 |
| BAA | 1299cc | 4 Cyl. | 8 Valves | 44kW/60PS | Petrol | OHV | TD17169 |
| J4B / BL13 | 1299cc | 4 Cyl. | 8 Valves | 44kW/60PS | Petrol | Endura-E | TD4458 |
| J4C | 1299cc | 4 Cyl. | 8 Valves | 44kW/60PS | Petrol | Endura-E | TD11087 |
| J4D | 1299cc | 4 Cyl. | 8 Valves | 44kW/60PS | Petrol | Endura-E | TD12084 |
| J4J | 1299cc | 4 Cyl. | 8 Valves | 44kW/60PS | Petrol | Endura-E | TD12073 |
| J4K | 1299cc | 4 Cyl. | 8 Valves | 44kW/60PS | Petrol | Endura-E | TD12085 |
| J4L | 1299cc | 4 Cyl. | 8 Valves | 44kW/60PS | Petrol | Endura-E | TD15930 |
| J4M | 1299cc | 4 Cyl. | 8 Valves | 44kW/60PS | Petrol | Endura-E | TD15952 |
| J4N | 1299cc | 4 Cyl. | 8 Valves | 44kW/60PS | Petrol | Endura-E | TD15953 |
| J4P | 1299cc | 4 Cyl. | 8 Valves | 44kW/60PS | Petrol | Endura-E | TD15954 |
| J4Q | 1299cc | 4 Cyl. | 8 Valves | 44kW/60PS | Petrol | Endura-E | TD15931 |
| J4R | 1299cc | 4 Cyl. | 8 Valves | 44kW/60PS | Petrol | Endura-E | TD15932 |
| J4S | 1299cc | 4 Cyl. | 8 Valves | 44kW/60PS | Petrol | Endura-E | TD15955 |
| J4T | 1299cc | 4 Cyl. | 8 Valves | 44kW/60PS | Petrol | Endura-E | TD15933 |
| J6A | 1299cc | 4 Cyl. | 8 Valves | 44kW/60PS | Petrol | HCS | TD1223 |
| J6B | 1299cc | 4 Cyl. | 8 Valves | 44kW/60PS | Petrol | HCS | TD1224 |
| JBC | 1299cc | 4 Cyl. | 8 Valves | 44kW/60PS | Petrol | HCS | TD1229 |
| JJA | 1299cc | 4 Cyl. | 8 Valves | 37kW/50PS | Petrol | Endura-E | TD12071 |
| JJB | 1299cc | 4 Cyl. | 8 Valves | 37kW/50PS | Petrol | Endura-E | TD12083 |
| JJC | 1299cc | 4 Cyl. | 8 Valves | 37kW/50PS | Petrol | Endura-E | TD12072 |
| JJD | 1299cc | 4 Cyl. | 8 Valves | 36kW/49PS | Petrol | Endura-E | TD12082 |
| JJE | 1299cc | 4 Cyl. | 8 Valves | 37kW/50PS | Petrol | Endura-E | TD15926 |
| JJF | 1299cc | 4 Cyl. | 8 Valves | 36kW/49PS | Petrol | Endura-E | TD15948 |
| JJG | 1299cc | 4 Cyl. | 8 Valves | 36kW/49PS | Petrol | Endura-E | TD15949 |
| JJH | 1299cc | 4 Cyl. | 8 Valves | 36kW/49PS | Petrol | Endura-E | TD15950 |
| JJJ | 1299cc | 4 Cyl. | 8 Valves | 37kW/50PS | Petrol | Endura-E | TD15927 |
| JJK | 1299cc | 4 Cyl. | 8 Valves | 37kW/50PS | Petrol | Endura-E | TD15928 |
| JJL | 1299cc | 4 Cyl. | 8 Valves | 36kW/49PS | Petrol | Endura-E | TD15951 |
| JJM | 1299cc | 4 Cyl. | 8 Valves | 37kW/50PS | Petrol | Endura-E | TD15929 |

BANTAM 1.3
ESCORT VI 1.3
FIESTA 1.3
FIESTA III 1.3 Cat
FIESTA V 1.3
ORION III 1.3

09/2001→08/2006
09/1992→01/1995
09/1991→08/2003
05/1991→01/1997
11/2001→06/2008
07/1990→12/1993

ESCORT V 1.3
ESCORT VII 1.3
FIESTA III 1.3
FIESTA IV 1.3 i
KA 1.3 i

07/1990→09/1992
01/1995→02/1999
03/1989→12/1995
08/1995→01/2002
09/1996→11/2008

V91162 ■
34.47 x 7.03 x 104.02

6165228

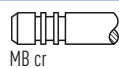

45°

H

V91159 ■
29.12 x 7.01 x 104.39

1653978

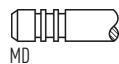

45°

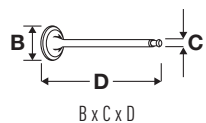

OE

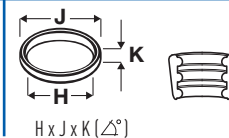
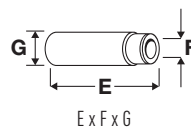

20 **74.00**

| BAJA | 1299cc | 4 Cyl. | 8 Valves | 44kW/60PS | Petrol | SOHC | TD17301 |
|-----------------------|---------|-----------------|----------|------------|--------|-----------------|---------|
| FIESTA V 1.3 | | 11/2001→06/2008 | | FUSION 1.3 | | 11/2002→07/2005 | |
| V95061 | 1144340 | | 45° | H | | | |
| 35.10 x 5.97 x 109.60 | | MB cr | | | | | |
| V95062 | 1144339 | | 45° | H | | | |
| 29.70 x 5.96 x 109.85 | | MD + MB cr | | | | | |

21 **75.00**

| GL | 1043cc | 4 Cyl. | 8 Valves | 41kW/56PS | Petrol | SOHC | TD1194 |
|-----------------------|-------------|--------|----------|----------------------|--------|------|--------|
| V90327 | 036 109 611 | | 45° | VAG92105B | | | |
| 28.14 x 7.95 x 110.00 | | MD | | 42.30 x 7.99 x 12.08 | | | |

22 **75.00**

| | | | | | | | |
|----------------------|--------|-----------------|-----------|--------------------|--------|-----------------------|---------|
| G8DA | 1560cc | 4 Cyl. | 16 Valves | 80kW/109PS | Diesel | Turbo, DOHC | TD18508 |
| G8DB | 1560cc | 4 Cyl. | 16 Valves | 80kW/109PS | Diesel | Turbo, DOHC | TD18509 |
| G8DC | 1560cc | 4 Cyl. | 16 Valves | 74kW/100PS | Diesel | Turbo, DOHC | TD25205 |
| GPDA | 1560cc | 4 Cyl. | 16 Valves | 66kW/90PS | Diesel | Turbo, DOHC | TD24348 |
| GPDC | 1560cc | 4 Cyl. | 16 Valves | 66kW/90PS | Diesel | Turbo, DOHC | TD24660 |
| HHDA | 1560cc | 4 Cyl. | 16 Valves | 66kW/90PS | Diesel | Turbo, DOHC | TD18478 |
| HHDB | 1560cc | 4 Cyl. | 16 Valves | 66kW/90PS | Diesel | Turbo, DOHC | TD18479 |
| HHJA | 1560cc | 4 Cyl. | 16 Valves | 66kW/90PS | Diesel | Turbo, DOHC | TD17988 |
| HHJB | 1560cc | 4 Cyl. | 16 Valves | 66kW/90PS | Diesel | Turbo, DOHC | TD17989 |
| HHJC | 1560cc | 4 Cyl. | 16 Valves | 66kW/90PS | Diesel | Duratorq, Turbo, DOHC | TD24416 |
| HHJD | 1560cc | 4 Cyl. | 16 Valves | 66kW/90PS | Diesel | Duratorq, Turbo, DOHC | TD23543 |
| HHJE | 1560cc | 4 Cyl. | 16 Valves | 66kW/90PS | Diesel | Duratorq, Turbo, DOHC | TD24417 |
| HHJF | 1560cc | 4 Cyl. | 16 Valves | 55kW/75PS | Diesel | Duratorq, Turbo, DOHC | TD24418 |
| MTDA | 1560cc | 4 Cyl. | 16 Valves | 74kW/100PS | Diesel | Turbo, DOHC | TD25206 |
| UBJA | 1560cc | 4 Cyl. | 16 Valves | 55kW/75PS | Diesel | Duratorq, Turbo, DOHC | TD24419 |
| C-MAX 1.6 TDCi | | 02/2007→09/2010 | | FIESTA 1.6 TDCi | | 10/2010→ | |
| FIESTA V 1.6 TDCi | | 11/2004→09/2009 | | FIESTA VI 1.6 TDCi | | 06/2008→ | |
| FOCUS C-MAX 1.6 TDCi | | 10/2003→03/2007 | | FOCUS II 1.6 TDCi | | 07/2004→09/2012 | |
| FUSION 1.6 TDCi | | 11/2004→12/2012 | | | | | |

| | | | | | | | |
|----------------------|---------|------------|-----|------|---------------------|--|--|
| V94960 | 1229882 | | 45° | H | VAG96364 | | |
| 25.60 x 5.50 x 96.35 | | MB cr | | | 34.20 x 5.50 x 9.53 | | |
| V94961 | 1229883 | | 45° | SS H | | | |
| 23.40 x 5.50 x 96.50 | | MD + MB cr | | | | | |



OE

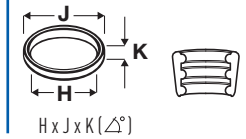
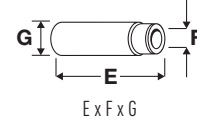

23 **75.00**

| | | | | | | | |
|----------------------|--------|-----------------|----------|--------------------|--------|----------------------------|---------|
| T1BA | 1560cc | 4 Cyl. | 8 Valves | 85kW/116PS | Diesel | Duratorq (DV), Turbo, SOHC | TD26475 |
| T1BB | 1560cc | 4 Cyl. | 8 Valves | 85kW/116PS | Diesel | Duratorq (DV), Turbo, SOHC | TD26476 |
| T1BC | 1560cc | 4 Cyl. | 8 Valves | 85kW/115PS | Diesel | Duratorq (DV), Turbo, SOHC | TD26477 |
| T1DA | 1560cc | 4 Cyl. | 8 Valves | 85kW/115PS | Diesel | Duratorq (DV), Turbo, SOHC | TD25883 |
| T1DB | 1560cc | 4 Cyl. | 8 Valves | 85kW/115PS | Diesel | Duratorq (DV), Turbo, SOHC | TD25884 |
| T1WB | 1560cc | 4 Cyl. | 8 Valves | 85kW/115PS | Diesel | Duratorq (DV), Turbo, SOHC | TD29370 |
| T3DA | 1560cc | 4 Cyl. | 8 Valves | 70kW/95PS | Diesel | Duratorq (DV), Turbo, SOHC | TD25881 |
| T3DB | 1560cc | 4 Cyl. | 8 Valves | 70kW/95PS | Diesel | Duratorq (DV), Turbo, SOHC | TD25882 |
| T3JA | 1560cc | 4 Cyl. | 8 Valves | 70kW/95PS | Diesel | Duratorq, Turbo, SOHC | TD26473 |
| TZJA | 1560cc | 4 Cyl. | 8 Valves | 70kW/95PS | Diesel | Duratorq, Turbo, SOHC | TD24420 |
| TZJB | 1560cc | 4 Cyl. | 8 Valves | 70kW/95PS | Diesel | Duratorq, Turbo, SOHC | TD24421 |
| C-MAX II 1.6 TDCi | | 12/2010→ | | FIESTA VI 1.6 TDCi | | 02/2010→ | |
| FOCUS III 1.6 TDCi | | 07/2010→ | | GALAXY 1.6 TDCi | | 02/2011→06/2015 | |
| GRAND C-MAX 1.6 TDCi | | 12/2010→ | | MONDEO IV 1.6 TDCi | | 12/2010→01/2015 | |
| S-MAX 1.6 TDCi | | 02/2011→12/2014 | | | | | |

V95137
30.15 x 5.48 x 95.55

1685847



45° Y H

VAG96364
34.20 x 5.50 x 95.53

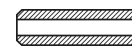

V95138
27.50 x 5.47 x 95.45

1685845



45° ss H

V95181
27.45 x 5.47 x 95.50

1685845



45° ss H

24 **76.00**

| | | | | | | | |
|------------------|--------|-----------------|-----------|-----------------|--------|-----------------|---------|
| ASDA | 1388cc | 4 Cyl. | 16 Valves | 59kW/80PS | Petrol | DOHC | TD18501 |
| ASDB | 1388cc | 4 Cyl. | 16 Valves | 59kW/80PS | Petrol | DOHC | TD18502 |
| FXJA | 1388cc | 4 Cyl. | 16 Valves | 59-62kW/80-84PS | Petrol | DOHC | TD17304 |
| FXJB | 1388cc | 4 Cyl. | 16 Valves | 59-62kW/80-84PS | Petrol | DOHC | TD17305 |
| SPJA | 1388cc | 4 Cyl. | 16 Valves | 71kW/97PS | Petrol | Duratec, DOHC | TD23538 |
| SPJC | 1388cc | 4 Cyl. | 16 Valves | 71kW/97PS | Petrol | Duratec, DOHC | TD24412 |
| FIESTA V 1.4 16V | | 11/2001→06/2008 | | FIESTA VI 1.4 | | 06/2008→ | |
| FOCUS II 1.4 | | 07/2004→09/2012 | | FUSION 1.4 | | 08/2002→12/2012 | |

V95039
28.10 x 6.00 x 99.35

1320926



45° H

V95014
24.10 x 6.00 x 101.45

1113189



45°

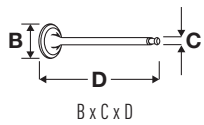

OE

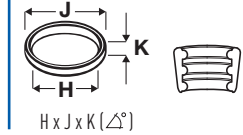
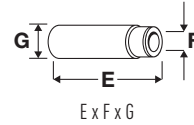

25 **76.00**

| | | | | | | | |
|--------------------------------|---------|-----------------|------------------|---------------------|--------|-----------------------|----------------|
| FHA | 1388cc | 4 Cyl. | 16 Valves | 66kW/90PS | Petrol | Zetec-SE, DOHC | TD12074 |
| FHE | 1388cc | 4 Cyl. | 16 Valves | 66kW/90PS | Petrol | Zetec-SE, DOHC | TD15934 |
| FIESTA 1.4 i | | 04/1996→10/1999 | | FIESTA IV 1.4 i 16V | | 04/1996→01/2002 | |
| V94058 | 1051773 | | 45° | Y | H | VAG96277 | |
| 28.00 x 6.00 x 97.35 08/97→ | | MB | | | | 39.00 x 6.00 x 11.05 | |
| V94003 | 1012747 | | 45° | | | | |
| 24.15 x 5.97 x 99.40 →08/97 | | MD cr | | | | | |
| V94059 | 1051771 | | 45° | | H | | |
| 24.10 x 5.96 x 99.35 08/97→ | | MD + MB cr | | | | | |
| V94215 | 1101934 | | 45° | | | | |
| 24.10 x 6.00 x 99.40 08/97→ | | MD tu | | | | | |

26 **76.00**

| | | | | | | | |
|----------------------|---------|-----------------|------------------|-----------|--------|-----------------------|----------------|
| FHD | 1388cc | 4 Cyl. | 16 Valves | 66kW/90PS | Petrol | Zetec-SE, DOHC | TD11327 |
| FHF | 1388cc | 4 Cyl. | 16 Valves | 66kW/90PS | Petrol | Zetec-SE, DOHC | TD15919 |
| PUMA 1.4 16V | | 11/1997→10/2000 | | | | | |
| V94058 | 1051773 | | 45° | Y | H | VAG96277 | |
| 28.00 x 6.00 x 97.35 | | MB | | | | 39.00 x 6.00 x 11.05 | |
| V94059 | 1051771 | | 45° | | H | | |
| 24.10 x 5.96 x 99.35 | | MD + MB cr | | | | | |
| V94215 | 1101934 | | 45° | | | | |
| 24.10 x 6.00 x 99.40 | | MD tu | | | | | |

27 **76.00**

| | | | | | | | |
|---------------------------------|---------|-----------------|------------------|-----------|--------|-----------------------|----------------|
| FXDA | 1388cc | 4 Cyl. | 16 Valves | 55kW/75PS | Petrol | Zetec-SE, DOHC | TD12075 |
| FXDB | 1388cc | 4 Cyl. | 16 Valves | 55kW/75PS | Petrol | Zetec-SE, DOHC | TD15892 |
| FXDC | 1388cc | 4 Cyl. | 16 Valves | 55kW/75PS | Petrol | Zetec-SE, DOHC | TD12076 |
| FXDD | 1388cc | 4 Cyl. | 16 Valves | 55kW/75PS | Petrol | Zetec-SE, DOHC | TD15893 |
| FOCUS 1.4 16V | | 10/1998→11/2004 | | | | | |
| V94058 | 1051773 | | 45° | Y | H | VAG96277 | |
| 28.00 x 6.00 x 97.35 →01/01 | | MB | | | | 39.00 x 6.00 x 11.05 | |
| V94059 | 1051771 | | 45° | | H | | |
| 24.10 x 5.96 x 99.35 →01/01 | | MD + MB cr | | | | | |
| V94215 | 1101934 | | 45° | | | | |
| 24.10 x 6.00 x 99.40 →01/01 | | MD tu | | | | | |
| V95014 | 1113189 | | 45° | | | | |
| 24.10 x 6.00 x 101.45 01/01→ | | MD tu | | | | | |



OE

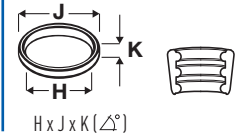
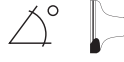

28



76.00

| | | | | | | | |
|-------------------|----------|--------|-----------|-----------------|--------|---------------|---------|
| RTJA | 1388cc | 4 Cyl. | 16 Valves | 68-71kW/92-97PS | Petrol | Duratec, DOHC | TD24413 |
| RTJB | 1388cc | 4 Cyl. | 16 Valves | 68-71kW/92-97PS | Petrol | Duratec, DOHC | TD24414 |
| FIESTA VI 1.4 LPG | 01/2009→ | | | | | | |

| | | | | |
|-----------------------|---------|--|-----|----|
| V95039 ■ | 1320926 | | 45° | H |
| 28.10 x 6.00 x 99.35 | | | | |
| V95093 ■ | 1693681 | | 45° | SS |
| 24.10 x 5.96 x 101.40 | | | | |

29



76.00

| | | | | | | | |
|-----|--------|--------|-----------|-----------------|--------|----------------|---------|
| L1E | 1597cc | 4 Cyl. | 16 Valves | 66kW/90PS | Petrol | Zetec-SE, DOHC | TD1249 |
| L1H | 1597cc | 4 Cyl. | 16 Valves | 65kW/88PS | Petrol | Zetec-E, DOHC | TD5105 |
| L1J | 1597cc | 4 Cyl. | 16 Valves | 65-66kW/88-90PS | Petrol | Zetec-E, DOHC | TD4464 |
| L1K | 1597cc | 4 Cyl. | 16 Valves | 66-70kW/90-95PS | Petrol | Zetec-E, DOHC | TD10849 |
| L1L | 1597cc | 4 Cyl. | 16 Valves | 70kW/95PS | Petrol | Zetec-E, DOHC | TD12087 |
| L1N | 1597cc | 4 Cyl. | 16 Valves | 70kW/95PS | Petrol | Zetec-E, DOHC | TD15990 |
| L1Q | 1597cc | 4 Cyl. | 16 Valves | 70kW/95PS | Petrol | Zetec-E, DOHC | TD16010 |

| | | | |
|------------------------|-----------------|-------------------------|-----------------|
| ESCORT CLASSIC 1.6 16V | 10/1998→07/2000 | ESCORT VI 1.6 16V XR3i | 12/1992→01/1995 |
| ESCORT VI 1.6 i 16V | 09/1992→01/1995 | ESCORT VII 1.6 | 01/2001→08/2002 |
| ESCORT VII 1.6 16V | 01/1995→02/1999 | ESCORT VII 1.6 16V XR3i | 02/1995→09/1999 |
| ESCORT VII 1.6 i 16V | 01/1995→02/1999 | MONDEO I 1.6 i 16V | 07/1994→08/1996 |
| MONDEO II 1.6 i | 08/1996→09/2000 | MONDEO II 1.6 i 16V | 05/1998→09/2000 |
| ORION III 1.6 i 16V | 07/1992→12/1993 | | |

| | | | | |
|----------------------|---------|--|-----|---|
| V91898 ■ | 6742922 | | 45° | H |
| 26.10 x 6.04 x 97.10 | | | | |
| →08/97 | | | | |
| V94072 ■ | 1041830 | | 45° | H |
| 26.00 x 6.04 x 97.15 | | | | |
| 08/97→ | | | | |
| V91991 ■ | 7314594 | | 45° | H |
| 24.60 x 6.03 x 96.70 | | | | |
| →08/97 | | | | |
| V94073 ■ | 1033898 | | 45° | H |
| 24.50 x 6.02 x 96.70 | | | | |
| 08/97→ | | | | |

| | |
|-----------------------|--|
| VAG96027 ■ ■ ■ | |
| 36.00 x 6.06 x 12.04 | |

30



76.00

| | | | | | | | |
|-----|--------|--------|-----------|-----------------|--------|----------------|---------|
| L1F | 1597cc | 4 Cyl. | 16 Valves | 66kW/90PS | Petrol | Zetec-SE, DOHC | TD10069 |
| L1G | 1597cc | 4 Cyl. | 16 Valves | 65-66kW/88-90PS | Petrol | Zetec-SE, DOHC | TD9467 |

| | | | |
|----------------------|-----------------|--------------------|-----------------|
| FIESTA III 1.6 i 16V | 01/1994→12/1995 | MONDEO I 1.6 i 16V | 02/1993→08/1996 |
|----------------------|-----------------|--------------------|-----------------|

| | | | | |
|----------------------|---------|--|-----|---|
| V91898 ■ | 6742922 | | 45° | H |
| 26.10 x 6.04 x 97.10 | | | | |
| V91991 ■ | 7314594 | | 45° | H |
| 24.60 x 6.03 x 96.70 | | | | |

| | |
|-----------------------|--|
| VAG96027 ■ ■ ■ | |
| 36.00 x 6.06 x 12.04 | |

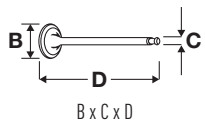

OE

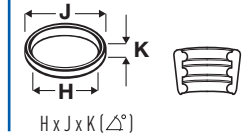
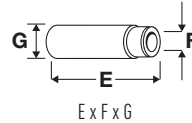
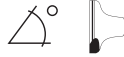

31 **76.00**

| | | | | | | | |
|----------------|--------|-----------------|-----------------|-----------------|--------|------------|---------------|
| LUH | 1597cc | 4 Cyl. | 8 Valves | 65-66kW/88-90PS | Petrol | CVH | TD1305 |
| FIESTA III 1.6 | | 01/1989→01/1994 | | | | | |

| | | | | | | | |
|-----------------------|---------|-------|-----|---|---|----------------------|--|
| V90132 | 6086114 | | 45° | Y | H | VAG92044V1 | |
| 42.16 x 8.04 x 135.05 | | MB cr | | | | 65.00 x 8.08 x 13.58 | |
| V90134V1 | 6103818 | | 45° | | | | |
| 37.15 x 8.00 x 131.85 | | MD cr | | | | | |

32 **77.24**

| | | | | | | | |
|-------------|--------|--------|-----------------|-----------------|--------|------------|----------------|
| F4A | 1392cc | 4 Cyl. | 8 Valves | 54kW/73PS | Petrol | CVH | TD10007 |
| F4B | 1392cc | 4 Cyl. | 8 Valves | 54-55kW/73-75PS | Petrol | CVH | TD4447 |
| F6A | 1392cc | 4 Cyl. | 8 Valves | 52-54kW/71-73PS | Petrol | CVH | TD4448 |
| F6B | 1392cc | 4 Cyl. | 8 Valves | 52-54kW/71-73PS | Petrol | CVH | TD1171 |
| F6C | 1392cc | 4 Cyl. | 8 Valves | 52kW/71PS | Petrol | CVH | TD4450 |
| F6D | 1392cc | 4 Cyl. | 8 Valves | 54kW/73PS | Petrol | CVH | TD1174 |
| F6E | 1392cc | 4 Cyl. | 8 Valves | 52kW/71PS | Petrol | CVH | TD4451 |
| F6F | 1392cc | 4 Cyl. | 8 Valves | 52kW/71PS | Petrol | CVH | TD1177 |
| F6G | 1392cc | 4 Cyl. | 8 Valves | 52kW/71PS | Petrol | CVH | TD1178 |
| FUA | 1392cc | 4 Cyl. | 8 Valves | 55kW/75PS | Petrol | CVH | TD4453 |
| FUAA | 1392cc | 4 Cyl. | 8 Valves | 51-55kW/69-75PS | Petrol | CVH | TD1181 |
| FUB | 1392cc | 4 Cyl. | 8 Valves | 55kW/75PS | Petrol | CVH | TD1182 |
| FUC | 1392cc | 4 Cyl. | 8 Valves | 54kW/73PS | Petrol | CVH | TD1184 |
| FUD | 1392cc | 4 Cyl. | 8 Valves | 54kW/73PS | Petrol | CVH | TD1185 |
| FUF | 1392cc | 4 Cyl. | 8 Valves | 55kW/75PS | Petrol | CVH | TD1186 |
| FUG | 1392cc | 4 Cyl. | 8 Valves | 54kW/73PS | Petrol | CVH | TD1187 |
| FUH | 1392cc | 4 Cyl. | 8 Valves | 54-55kW/71-75PS | Petrol | CVH | TD1188 |
| FUJ | 1392cc | 4 Cyl. | 8 Valves | 54kW/73PS | Petrol | CVH | TD1189 |

| | | | |
|--------------------------|-----------------|------------------------|-----------------|
| ESCORT '86 Express 1.4 i | 02/1986→07/1990 | ESCORT '91 Express 1.4 | 07/1990→12/1994 |
| ESCORT '95 1.4 | 01/1995→08/2000 | ESCORT IV 1.4 | 10/1985→10/1990 |
| ESCORT V 1.4 | 07/1990→12/1992 | ESCORT VI 1.4 | 09/1992→01/1995 |
| ESCORT VI 1.4 i | 07/1993→01/1995 | ESCORT VII 1.4 | 01/1995→12/1999 |
| FIESTA 1.4 | 09/1986→09/1989 | FIESTA II 1.4 | 10/1985→11/1989 |
| FIESTA III 1.4 | 03/1989→12/1996 | FIESTA III 1.4 Cat | 03/1989→12/1995 |
| ORION II 1.4 | 12/1985→07/1990 | ORION II 1.4 Cat | 02/1987→07/1990 |
| ORION III 1.4 | 07/1990→12/1993 | | |

| | | | | | | |
|-----------------------|--------------|-------|-----|---|----------------------|--|
| V91146 | 6137194 | | 45° | H | VAG92044V1 | |
| 40.04 x 8.03 x 136.55 | | MB | | | 65.00 x 8.08 x 13.58 | |
| V91147 | 86SM 6505 AD | | 45° | | | |
| 34.05 x 8.02 x 133.22 | | MD cr | | | | |



OE

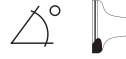

E x F x G

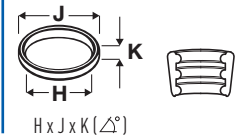

H x J x K (45°)

33



79.00

| | | | | | | | |
|------|--------|--------|-----------|-------------------|--------|----------------|---------|
| FYDA | 1596cc | 4 Cyl. | 16 Valves | 74-75kW/100-102PS | Petrol | Zetec-SE, DOHC | TD12077 |
| FYDB | 1596cc | 4 Cyl. | 16 Valves | 74kW/100PS | Petrol | Zetec-SE, DOHC | TD15894 |
| FYDC | 1596cc | 4 Cyl. | 16 Valves | 74kW/100PS | Petrol | Zetec-SE, DOHC | TD12078 |
| FYDD | 1596cc | 4 Cyl. | 16 Valves | 74kW/100PS | Petrol | Zetec-SE, DOHC | TD15895 |
| FYDH | 1596cc | 4 Cyl. | 16 Valves | 74-75kW/100-102PS | Petrol | Zetec-SE, DOHC | TD18776 |
| FYJA | 1596cc | 4 Cyl. | 16 Valves | 74kW/100PS | Petrol | DOHC | TD17306 |
| FYJB | 1596cc | 4 Cyl. | 16 Valves | 74kW/100PS | Petrol | Duratec, DOHC | TD18778 |

| | | | |
|------------------|-----------------|------------|-----------------|
| FIESTA V 1.6 16V | 11/2001→06/2008 | FOCUS 1.6 | 09/2003→03/2007 |
| FOCUS 1.6 16V | 10/1998→11/2004 | FUSION 1.6 | 08/2002→11/2008 |

| | | | | | | |
|--|---------|-----------|-----|---|---|--|
| V94214 ■ 30.10 x 6.00 x 97.00 10/98→01/01 | 1072048 | MB | 45° | H | VAG92325 ■ ■ ■ 40.50 x 6.00 x 11.04 | |
| V95013 ■ 30.10 x 6.00 x 99.00 01/01→ | 1320927 | MB tu | 45° | H | | |
| V94215 ■ 24.10 x 6.00 x 99.40 10/98→01/01 | 1101934 | MD tu | 45° | | | |
| V95014 ■ 24.10 x 6.00 x 101.45 01/01→ | 1113189 | MD tu | 45° | | | |

34



79.00

| | | | | | | | |
|------|--------|--------|-----------|------------|--------|---------------|---------|
| HWDA | 1596cc | 4 Cyl. | 16 Valves | 74kW/100PS | Petrol | DOHC | TD18503 |
| HWDB | 1596cc | 4 Cyl. | 16 Valves | 74kW/100PS | Petrol | DOHC | TD18504 |
| HXDA | 1596cc | 4 Cyl. | 16 Valves | 85kW/115PS | Petrol | Duratec, DOHC | TD18505 |
| HXDB | 1596cc | 4 Cyl. | 16 Valves | 85kW/115PS | Petrol | Duratec, DOHC | TD23365 |
| PNBA | 1596cc | 4 Cyl. | 16 Valves | 92kW/125PS | Petrol | Duratec, DOHC | TD23302 |
| RHBA | 1596cc | 4 Cyl. | 16 Valves | 81kW/110PS | Petrol | Duratec, DOHC | TD23301 |
| SHDA | 1596cc | 4 Cyl. | 16 Valves | 74kW/101PS | Petrol | DOHC | TD21247 |
| SHDB | 1596cc | 4 Cyl. | 16 Valves | 74kW/101PS | Petrol | DOHC | TD24345 |
| SHDC | 1596cc | 4 Cyl. | 16 Valves | 74kW/101PS | Petrol | DOHC | TD24346 |
| SIDA | 1596cc | 4 Cyl. | 16 Valves | 85kW/115PS | Petrol | Duratec, DOHC | TD23366 |

| | | | |
|--------------------|-----------------|-----------------|-----------------|
| C-MAX 1.6 | 02/2007→09/2010 | FOCUS C-MAX 1.6 | 10/2003→03/2007 |
| FOCUS C-MAX 1.6 Ti | 08/2004→03/2007 | FOCUS II 1.6 | 07/2004→09/2012 |
| FOCUS II 1.6 LPG | 10/2009→09/2012 | FOCUS II 1.6 Ti | 07/2004→09/2012 |
| MONDEO IV 1.6 Ti | 03/2007→01/2015 | | |

| | | | | | | |
|--|---------|-----------|-----|---|---|--|
| V95013 ■ 30.10 x 6.00 x 99.00 | 1320927 | MB tu | 45° | H | VAG92325 ■ ■ ■ 40.50 x 6.00 x 11.04 | |
| V95014 ■ 24.10 x 6.00 x 101.45 | 1113189 | MD tu | 45° | | | |

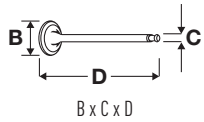

OE

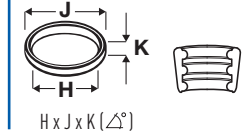
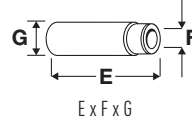
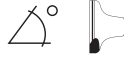

35 79.00

| | | | | | | | |
|-------------------|--------|-----------------|-----------|------------|--------|----------------|---------|
| L1T | 1596cc | 4 Cyl. | 16 Valves | 76kW/103PS | Petrol | Zetec-SE, DOHC | TD15935 |
| L1V | 1596cc | 4 Cyl. | 16 Valves | 76kW/103PS | Petrol | Zetec-SE, DOHC | TD15936 |
| FIESTA IV 1.6 16V | | 02/2000→01/2002 | | | | | |

| | | | | | | |
|----------------------|---------|------------|-----|---|----------------------|--|
| V94072 | 1041830 | | 45° | H | VAG96027 | |
| 26.00 x 6.04 x 97.15 | | MB cr | | | 36.00 x 6.06 x 12.04 | |
| V94073 | 1033898 | | 45° | H | | |
| 24.50 x 6.02 x 96.70 | | ME + MB cr | | | | |

36 79.50

| | | | | | | | |
|----------------|--------|-----------------|----------|-----------|--------|-------------|---------|
| 1Z | 1896cc | 4 Cyl. | 8 Valves | 66kW/90PS | Diesel | Turbo, SOHC | TD11370 |
| GALAXY 1.9 TDI | | 03/1995→05/2006 | | | | | |

| | | | | | | | |
|----------------------|---------|---------|-----|----|---|----------------------|--|
| V94010 | 1669766 | | 45° | Y | H | VAG92061B | |
| 36.00 x 8.00 x 96.80 | | MB | | | | 36.70 x 8.00 x 12.08 | |
| V94011 | 1669772 | | 45° | SS | | | |
| 31.50 x 7.95 x 96.85 | | MD + MB | | | | | |

37 79.50

| | | | | | | | |
|----------------|--------|-----------------|----------|------------|--------|-------------|---------|
| AFN | 1896cc | 4 Cyl. | 8 Valves | 81kW/110PS | Diesel | Turbo, SOHC | TD11368 |
| AHU | 1896cc | 4 Cyl. | 8 Valves | 66kW/90PS | Diesel | Turbo, SOHC | TD11369 |
| AVG | 1896cc | 4 Cyl. | 8 Valves | 81kW/110PS | Diesel | Turbo, SOHC | TD17557 |
| GALAXY 1.9 TDI | | 03/1995→05/2006 | | | | | |

| | | | | | | | |
|----------------------|--------------|---------|-----|---|---|----------------------|--|
| V94084 | 028 109 601D | | 45° | Y | H | VAG96041B | |
| 35.90 x 7.00 x 96.80 | | MB | | | | 36.50 x 7.00 x 12.08 | |
| V94085 | 028 109 611G | | 45° | | H | | |
| 31.40 x 7.00 x 96.90 | | MD + MB | | | | | |

38 79.50

| | | | | | | | |
|----------------|--------|-----------------|----------|-------------|--------|-------------|---------|
| AJM | 1896cc | 4 Cyl. | 8 Valves | 85kW/116PS | Diesel | Turbo, SOHC | TD14108 |
| ANU | 1896cc | 4 Cyl. | 8 Valves | 66kW/90PS | Diesel | Turbo, SOHC | TD14917 |
| ASZ | 1896cc | 4 Cyl. | 8 Valves | 96kW/130PS | Diesel | Turbo, SOHC | TD17167 |
| AUY | 1896cc | 4 Cyl. | 8 Valves | 85kW/115PS | Diesel | Turbo, SOHC | TD14918 |
| BTB | 1896cc | 4 Cyl. | 8 Valves | 110kW/150PS | Diesel | Turbo, SOHC | TD18795 |
| GALAXY 1.9 TDI | | 03/1995→05/2006 | | | | | |

| | | | | | | | |
|----------------------|--------------|---------|-----|----|---|----------------------|--|
| V94147 | 038 109 601B | | 45° | | H | VAG96041B | |
| 35.90 x 7.00 x 89.90 | | MB | | | | 36.50 x 7.00 x 12.08 | |
| V94148 | 038 109 611F | | 45° | SS | H | | |
| 31.50 x 7.00 x 90.00 | | MD + MB | | | | | |
| V94415 | 038 109 611F | | 45° | SS | H | | |
| 31.40 x 7.00 x 89.50 | | MD + MB | | | | | |



OE

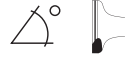

E x F x G

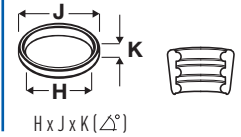

H x J x K (45°)

39  **79.94**

| | | | | | | | |
|------------|-----------------|--------|----------|-----------------|--------|-----|---------|
| R2C | 1769cc | 4 Cyl. | 8 Valves | 64kW/87PS | Petrol | CVH | TD1418 |
| R6A | 1769cc | 4 Cyl. | 8 Valves | 64-66kW/87-90PS | Petrol | CVH | TD17422 |
| SIERRA 1.8 | 05/1988→02/1993 | | | | | | |

V91198 ■
39.10 x 8.04 x 136.96

1649214

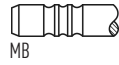

45° H

VAG92044V1 ■ ■ ■
65.00 x 8.08 x 13.58



V91199 ■
34.11 x 8.02 x 134.12

E7EE 6505 B2C



45° ss H

40  **79.96**

| | | | | | | | |
|------------------------|-----------------|--------|----------|----------------|--------|-----------------|--------|
| JPA | 1297cc | 4 Cyl. | 8 Valves | 51kW/69PS | Petrol | | TD1238 |
| JPC | 1297cc | 4 Cyl. | 8 Valves | 51kW/69PS | Petrol | | TD1239 |
| ESCORT '81 Express 1.3 | 03/1981→02/1986 | | | ESCORT III 1.3 | | 09/1980→12/1985 | |
| ESCORT IV 1.3 | 11/1986→07/1988 | | | FIESTA II 1.3 | | 09/1983→09/1989 | |
| ORION I 1.3 | 07/1983→03/1986 | | | ORION II 1.3 | | 11/1986→07/1988 | |

V90132 ■
42.16 x 8.04 x 135.05

6086114

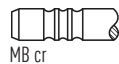

45° Y H

VAG92044V1 ■ ■ ■
65.00 x 8.08 x 13.58



41  **79.96**

| | | | | | | | |
|-------------------------|-----------------|--------|----------|------------------------|--------|-----------------|--------|
| LJB | 1597cc | 4 Cyl. | 8 Valves | 75kW/102PS | Petrol | CVH | TD1275 |
| LNA | 1597cc | 4 Cyl. | 8 Valves | 97kW/132PS | Petrol | CVH, Turbo | TD1281 |
| LNB | 1597cc | 4 Cyl. | 8 Valves | 97kW/132PS | Petrol | CVH, Turbo | TD1282 |
| LP1 | 1597cc | 4 Cyl. | 8 Valves | 52-58kW/71-79PS | Petrol | CVH | TD1283 |
| LPA | 1597cc | 4 Cyl. | 8 Valves | 58kW/79PS | Petrol | CVH | TD1286 |
| LR1 | 1597cc | 4 Cyl. | 8 Valves | 77kW/105PS | Petrol | CVH | TD1287 |
| LRA | 1597cc | 4 Cyl. | 8 Valves | 77kW/105PS | Petrol | CVH | TD1289 |
| LRB | 1597cc | 4 Cyl. | 8 Valves | 77kW/105PS | Petrol | CVH | TD1290 |
| LUA | 1597cc | 4 Cyl. | 8 Valves | 71kW/96PS | Petrol | CVH | TD1298 |
| LUB | 1597cc | 4 Cyl. | 8 Valves | 70-71kW/95-97PS | Petrol | CVH | TD1300 |
| LUC | 1597cc | 4 Cyl. | 8 Valves | 60-66kW/81-90PS | Petrol | CVH | TD1301 |
| LUD | 1597cc | 4 Cyl. | 8 Valves | 70kW/95PS | Petrol | CVH | TD1302 |
| LUG | 1597cc | 4 Cyl. | 8 Valves | 65-66kW/88-90PS | Petrol | CVH | TD1304 |
| BANTAM 1.6 | 03/1986→08/1990 | | | ESCORT '86 Express 1.6 | | 02/1986→07/1990 | |
| ESCORT III 1.6 | 09/1980→12/1985 | | | ESCORT III 1.6 i | | 09/1983→12/1985 | |
| ESCORT III 1.6 RS Turbo | 11/1984→12/1985 | | | ESCORT III 1.6 XR3i | | 10/1982→12/1985 | |
| ESCORT IV 1.6 | 01/1986→07/1990 | | | ESCORT IV 1.6 i | | 08/1989→07/1990 | |
| ESCORT IV 1.6 Turbo RS | 01/1986→07/1990 | | | ESCORT IV 1.6 XR3i | | 01/1986→07/1990 | |
| FIESTA II 1.6 XR2 | 03/1984→02/1989 | | | METEOR 1.6 | | 03/1983→08/1990 | |
| ORION I 1.6 | 07/1983→03/1986 | | | ORION I 1.6 i | | 07/1983→03/1986 | |
| ORION II 1.6 | 12/1985→07/1990 | | | ORION II 1.6 i | | 03/1986→07/1990 | |

V90132 ■
42.16 x 8.04 x 135.05

6086114

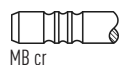

45° Y H

VAG92044V1 ■ ■ ■
65.00 x 8.08 x 13.58

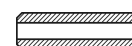

V90134V1 ■
37.15 x 8.00 x 131.85

6103818

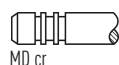

45°

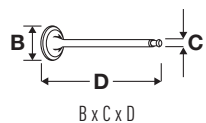

OE

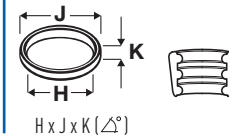
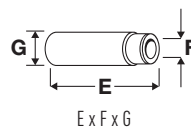

42 **79.96**

| | | | | | | | |
|---------------------|-----------------|--------|-----------------|---------------|--------|------------|-----------------|
| LP2 | 1597cc | 4 Cyl. | 8 Valves | 58kW/79PS | Petrol | CVH | TD1284 |
| LP3 | 1597cc | 4 Cyl. | 8 Valves | 58kW/79PS | Petrol | CVH | TD1285 |
| LR2 | 1597cc | 4 Cyl. | 8 Valves | 77kW/105PS | Petrol | CVH | TD1288 |
| LUAE | 1597cc | 4 Cyl. | 8 Valves | 85kW/115PS | Petrol | CVH | TD1299 |
| ESCORT III RS 1600i | 05/1982→12/1985 | | | ESCORT IV 1.6 | | | 01/1986→07/1990 |
| ESCORT IV 1.6 XR3i | 01/1986→07/1990 | | | FIESTA II 1.6 | | | 01/1985→11/1989 |
| ORION II 1.6 | 04/1986→12/1988 | | | | | | |

V91992
42.10 x 8.04 x 134.85

6172656

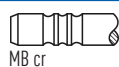

45° Y H

VAG92044V1
65.00 x 8.08 x 13.58

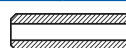

V90134V1
37.15 x 8.00 x 131.85

6103818

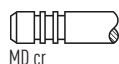

45°

43 **79.96**

| | | | | | | | |
|---------------------|-----------------|--------|-----------------|------------------|--------|------------|-----------------|
| L4B | 1598cc | 4 Cyl. | 8 Valves | 66kW/90PS | Petrol | CVH | TD1252 |
| L6B | 1598cc | 4 Cyl. | 8 Valves | 59kW/80PS | Petrol | CVH | TD1254 |
| LJD | 1598cc | 4 Cyl. | 8 Valves | 76kW/103PS | Petrol | CVH | TD4465 |
| LJF | 1598cc | 4 Cyl. | 8 Valves | 77kW/105PS | Petrol | CVH | TD4466 |
| LUJ | 1598cc | 4 Cyl. | 8 Valves | 65-66kW/88-90PS | Petrol | CVH | TD1306 |
| LUK | 1598cc | 4 Cyl. | 8 Valves | 65-66kW/88-90PS | Petrol | CVH | TD1308 |
| BANTAM 1.6 | 09/1990→10/1994 | | | ESCORT III 1.6 i | | | 07/1985→12/1985 |
| ESCORT IV 1.6 i | 01/1986→07/1990 | | | ESCORT V 1.6 | | | 07/1990→12/1992 |
| FIESTA III 1.6 XR2i | 03/1989→03/1993 | | | METEOR 1.6 | | | 09/1990→11/1993 |
| ORION II 1.6 i Cat | 03/1986→07/1990 | | | ORION III 1.6 | | | 07/1990→12/1992 |
| ORION III 1.6 i | 07/1990→09/1992 | | | SIERRA 1.6 i | | | 10/1989→02/1993 |

V90132
42.16 x 8.04 x 135.05

6086114



45° Y H

VAG92044V1
65.00 x 8.08 x 13.58

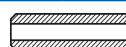

V90134V1
37.15 x 8.00 x 131.85

6103818

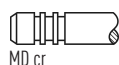

45°

44 **79.96**

| | | | | | | | |
|----------------------|-----------------|--------|-----------------|-------------------|--------|-------------------|--------|
| LHA | 1598cc | 4 Cyl. | 8 Valves | 96-98kW/131-133PS | Petrol | CVH, Turbo | TD1273 |
| LJA | 1598cc | 4 Cyl. | 8 Valves | 77kW/105PS | Petrol | CVH | TD1274 |
| FIESTA III 1.6 Turbo | 03/1990→10/1994 | | | | | | |

V91992
42.10 x 8.04 x 134.85

6172656

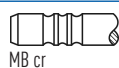

45° Y H

VAG92044V1
65.00 x 8.08 x 13.58



V90134V1
37.15 x 8.00 x 131.85

6103818

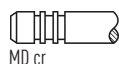

45°

45 **80.00**

| | | | | | | | |
|---------------------|-----------------|--------|-----------------|------------|--------|------------|--------|
| LJC | 1597cc | 4 Cyl. | 8 Valves | 81kW/110PS | Petrol | CVH | TD1277 |
| FIESTA III 1.6 XR2i | 03/1989→01/1994 | | | | | | |

V90132
42.16 x 8.04 x 135.05

6086114

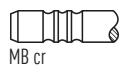

45° Y H

VAG92044V1
65.00 x 8.08 x 13.58



V90134V1
37.15 x 8.00 x 131.85

6103818

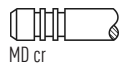





45°

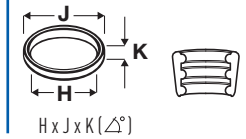
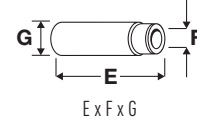

OE





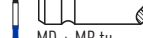

46  **80.00**

| LJE | 1598cc | 4 Cyl. | 8 Valves | 79kW/108PS | Petrol | CVH | TD1279 |
|---|---------|---|----------|------------|--------|---|--------|
| V91992  | 6172656 |  | 45° Y H | | | VAG92044V1  | |
| 42.10 x 8.04 x 134.85 | | MB cr | | | | 65.00 x 8.08 x 13.58 | |
| V90134V1  | 6103818 |  | 45° | | | | |
| 37.15 x 8.00 x 131.85 | | MD cr | | | | | |

47  **80.00**

| MHA | 1679cc | 4 Cyl. | 16 Valves | 92kW/125PS | Petrol | Zetec-S, DOHC | TD5498 |
|---|---------|---|-----------|------------|--------|---------------|---------|
| MHB | 1679cc | 4 Cyl. | 16 Valves | 92kW/125PS | Petrol | Zetec-S, DOHC | TD15920 |
| PUMA 1.7 16V | | 03/1997→06/2002 | | | | | |
| V94061  | 1031007 |  | 45° ss H | | | | |
| 26.00 x 6.00 x 98.35 | | MD + MB tu | | | | | |

48  **80.60**

| | | | | | | | |
|---|---------|---|-----------|-------------------------|--------|---|---------|
| EYDB | 1796cc | 4 Cyl. | 16 Valves | 85kW/115PS | Petrol | Zetec-E, DOHC | TD15896 |
| EYDC | 1796cc | 4 Cyl. | 16 Valves | 85kW/115PS | Petrol | Zetec-E, DOHC | TD12079 |
| EYDD | 1796cc | 4 Cyl. | 16 Valves | 85kW/115PS | Petrol | Zetec-E, DOHC | TD15897 |
| EYDE | 1796cc | 4 Cyl. | 16 Valves | 85kW/115PS | Petrol | Zetec-E, DOHC | TD15898 |
| EYDF | 1796cc | 4 Cyl. | 16 Valves | 85kW/115PS | Petrol | Zetec-E, DOHC | TD15899 |
| EYDG | 1796cc | 4 Cyl. | 16 Valves | 85kW/115PS | Petrol | Zetec-E, DOHC | TD18772 |
| EYDI | 1796cc | 4 Cyl. | 16 Valves | 85kW/115PS | Petrol | Zetec-E, DOHC | TD18774 |
| EYDJ | 1796cc | 4 Cyl. | 16 Valves | 85kW/115PS | Petrol | Zetec-E, DOHC | TD18775 |
| EYDL | 1796cc | 4 Cyl. | 16 Valves | 82-85kW/111-115PS | Petrol | Zetec-E, DOHC | TD18784 |
| EYPA | 1796cc | 4 Cyl. | 16 Valves | 85kW/116PS | Petrol | Duratec, DOHC | TD18773 |
| EYPC | 1796cc | 4 Cyl. | 16 Valves | 85kW/116PS | Petrol | Duratec, DOHC | TD18843 |
| EYPD | 1796cc | 4 Cyl. | 16 Valves | 85kW/115PS | Petrol | Duratec, DOHC | TD24464 |
| FOCUS 1.8 | | 02/2003→01/2005 | | FOCUS 1.8 16V | | 10/1998→11/2004 | |
| TOURNEO CONNECT 1.8 16V | | 06/2002→12/2013 | | TRANSIT CONNECT 1.8 16V | | 06/2002→12/2013 | |
| TRANSIT CONNECT 1.8 16V LPG | | 06/2002→12/2013 | | | | | |
| V94223  | 1053845 |  | 45° H | | | VAG96027  | |
| 33.00 x 6.00 x 98.10 | | MB | | | | 36.00 x 6.06 x 12.04 | |
| V94225  | 1066045 |  | 45° | | | | |
| 28.00 x 6.00 x 97.60 | | MD cr | | | | | |

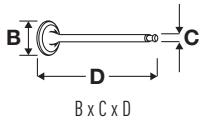

OE

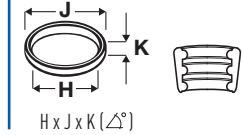
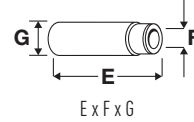
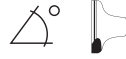

49



80.60

| | | | | | | | |
|------------|--------|--------|------------------|-------------------|--------|-----------------------|----------------|
| RDA | 1796cc | 4 Cyl. | 16 Valves | 77kW/105PS | Petrol | Zetec-SE, DOHC | TD1419 |
| RDB | 1796cc | 4 Cyl. | 16 Valves | 77kW/105PS | Petrol | Zetec-SE, DOHC | TD1420 |
| RKB | 1796cc | 4 Cyl. | 16 Valves | 82-85kW/111-116PS | Petrol | Zetec-E, DOHC | TD12091 |
| RKC | 1796cc | 4 Cyl. | 16 Valves | 85kW/115PS | Petrol | Zetec-E, DOHC | TD5107 |
| RKF | 1796cc | 4 Cyl. | 16 Valves | 85kW/115PS | Petrol | Zetec-E, DOHC | TD12088 |
| RKH | 1796cc | 4 Cyl. | 16 Valves | 85kW/115PS | Petrol | Zetec-E, DOHC | TD15991 |
| RKJ | 1796cc | 4 Cyl. | 16 Valves | 85kW/115PS | Petrol | Zetec-E, DOHC | TD12089 |
| RKK | 1796cc | 4 Cyl. | 16 Valves | 85kW/115PS | Petrol | Zetec-E, DOHC | TD16011 |
| RQB | 1796cc | 4 Cyl. | 16 Valves | 96kW/130PS | Petrol | Zetec-SE, DOHC | TD1431 |
| RQC | 1796cc | 4 Cyl. | 16 Valves | 96kW/130PS | Petrol | Zetec-SE, DOHC | TD1432 |

| | | | |
|-------------------------|-----------------|-----------------------|-----------------|
| ESCORT V 1.8 16V | 02/1992→12/1992 | ESCORT V 1.8 16V XR3i | 02/1992→12/1992 |
| ESCORT VI 1.8 16V XR3i | 09/1992→01/1995 | ESCORT VI 1.8 i 16V | 09/1992→01/1995 |
| ESCORT VI 1.8 XR3i 16V | 08/1993→01/1995 | ESCORT VII 1.8 16V | 01/1995→02/1999 |
| ESCORT VII 1.8 16V XR3i | 02/1995→08/2000 | FIESTA III 1.8 16V | 02/1992→12/1995 |
| FIESTA III 1.8 XR2i 16V | 02/1992→12/1995 | MONDEO I 1.8 i 16V | 01/1994→08/1996 |
| MONDEO II 1.8 i | 08/1996→09/2000 | ORION III 1.8 i 16V | 01/1992→12/1993 |

| | | | | | | |
|-------------------------------------|----------|------------|-----|---|----------------------|--|
| V91356 | 664 0543 | | 45° | H | VAG96027 | |
| 32.20 x 6.04 x 97.10 01/92→08/97 | | MB | | | 36.00 x 6.06 x 12.04 | |
| V94074 | 1041838 | | 45° | H | VAG96159 | |
| 32.00 x 6.04 x 97.15 08/97→05/98 | | MB cr | | | 36.00 x 6.08 x 12.04 | |
| V94223 | 1053845 | | 45° | H | | |
| 33.00 x 6.00 x 98.10 06/98→ | | MB | | | | |
| V94075 | 6640542 | | 45° | H | | |
| 28.10 x 6.02 x 96.80 01/92→08/97 | | ME + MB cr | | | | |
| V94076 | 1033899 | | 45° | H | | |
| 28.10 x 6.02 x 96.80 08/97→05/98 | | ME + MB cr | | | | |
| V94225 | 1066045 | | 45° | H | | |
| 28.00 x 6.00 x 97.60 06/98→ | | MD cr | | | | |

50



80.60

| | | | | | | | |
|--------------------|-----------------|--------------|------------------|------------|--------|-----------------------|---------------|
| RKA | 1796cc | 4 Cyl. | 16 Valves | 85kW/115PS | Petrol | Zetec-SE, DOHC | TD4487 |
| COURIER 1.8 | 03/1998→02/2002 | MONDEO I 1.8 | 02/1993→08/1996 | | | | |
| MONDEO I 1.8 i 16V | 02/1993→08/1996 | RANGER 1.8 | 06/1999→02/2002 | | | | |





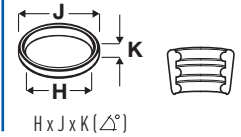
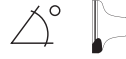

| | | | | | | |
|----------------------|----------|------------|-----|---|----------------------|--|
| V91356 | 664 0543 | | 45° | H | VAG96027 | |
| 32.20 x 6.04 x 97.10 | | MB | | | 36.00 x 6.06 x 12.04 | |
| V94075 | 6640542 | | 45° | H | | |
| 28.10 x 6.02 x 96.80 | | ME + MB cr | | | | |









OE





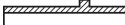
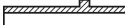

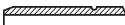
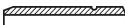

51  **80.98**

| | | | | | | | |
|---|--------------|---|-----------------|-----------------|---|---|---------------|
| L3E | 1598cc | 4 Cyl. | 8 Valves | 62-71kW/84-97PS | Petrol | OHV | TD1251 |
| FIESTA I 1.6 XR2 | | 08/1981→08/1983 | | | | | |
| V34524  | 711M 6507 DA |  | 45° | H | VAG96001  |  | |
| 39.30 x 7.87 x 111.15 | | MB tu | | | 60.30 x 7.93 x 11.18 | | |
| V34525  | 791M 6505 DA |  | 45° | H | | | |
| 33.70 x 7.86 x 110.87 | | MD + MB tu | | | | | |







52  **81.00**

| | | | | | | | |
|---|--------------|---|------------------|-------------|--|---|----------------|
| AAA | 2792cc | VR6 Cyl. | 12 Valves | 128kW/174PS | Petrol | DOHC | TD5106 |
| AMY | 2792cc | VR6 Cyl. | 12 Valves | 128kW/174PS | Petrol | DOHC | TD17559 |
| GALAXY 2.8 i V6 | | 11/1995→04/2000 | | | | | |
| V94145  | 1004128 |  | 45° | H | VAG96041B  |  | |
| 39.10 x 7.00 x 106.00 | | MB | | | 36.50 x 7.00 x 12.08 | | |
| V94374  | 021 109 601L |  | 45° | H | VAG96157B  |  | |
| 39.00 x 7.00 x 106.00 | | MB | | | 38.00 x 7.00 x 12.00 | | |
| V94146  | 021 109 611F |  | 45° | SS H | | | |
| 34.10 x 7.00 x 107.00 | | MD + MB | | | | | |



53  **81.30**

| | | | | | | | |
|---|---------|---|-----------------|-----------|---|---|---------------|
| LCS | 1593cc | 4 Cyl. | 8 Valves | 55kW/75PS | Petrol | SOHC | TD1268 |
| LCT | 1593cc | 4 Cyl. | 8 Valves | 55kW/75PS | Petrol | SOHC | TD1269 |
| SIERRA 1.6 | | 08/1982→12/1986 | | | | | |
| V90152  | 1595025 |  | 45° | H | VAG96001  |  | |
| 42.16 x 8.03 x 113.13 | | MB | | | 60.30 x 7.93 x 11.18 | | |
| V91810  | 6119437 |  | 45° | H | | | |
| 32.10 x 8.02 x 113.30 | | MD + MB | | | | | |

54  **81.30**

| | | | | | | | |
|---|---------|---|-----------------|-----------------|---|---|---------------|
| LSD | 1597cc | 4 Cyl. | 8 Valves | 55-58kW/75-79PS | Petrol | TL16E E-MAX, SOHC | TD1291 |
| LSE | 1597cc | 4 Cyl. | 8 Valves | 55kW/75PS | Petrol | SOHC | TD1293 |
| SIERRA 1.6 | | 08/1982→02/1993 | | | | | |
| V90152  | 1595025 |  | 45° | H | VAG96001  |  | |
| 42.16 x 8.03 x 113.13 | | MB | | | 60.30 x 7.93 x 11.18 | | |
| V91810  | 6119437 |  | 45° | H | | | |
| 32.10 x 8.02 x 113.30 | | MD + MB | | | | | |

55  **81.60**

| | | | | | | | |
|---|---------|---|------------------|---------------|--------|----------------------|----------------|
| LCBD | 2495cc | V6 Cyl. | 24 Valves | 125kW/170PS | Petrol | Duratec, DOHC | TD15913 |
| METROSTAR 2.5 | | 10/2000→02/2007 | | MONDEO II 2.5 | | 06/2000→09/2000 | |
| MONDEO III 2.5 V6 | | 10/2000→03/2007 | | | | | |
| V94386  | 7221531 |  | 45° | H | | | |
| 32.00 x 6.00 x 114.80 | | MB cr | | | | | |

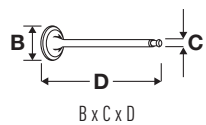

OE

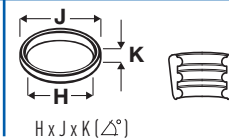
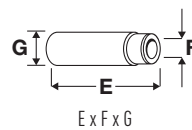

56 **82.00**

| | | | | | | | |
|------------|----------|--------|-----------------|-----------|-----------------|-------------|----------------|
| CDB | 1597cc | 4 Cyl. | 8 Valves | 70kW/95PS | Petrol | SOHC | TD18766 |
| CDC | 1597cc | 4 Cyl. | 8 Valves | 70kW/95PS | Petrol | SOHC | TD18767 |
| KA 1.6 | 09/2000→ | | | KA 1.6 i | 07/2003→11/2008 | | |

| | | | |
|-----------------------|---------|------------|-----|
| V98034 | 1127416 | | 45° |
| 40.00 x 5.98 x 109.65 | | MB cr | |
| V98035 | 1089830 | | 45° |
| 34.00 x 5.97 x 109.80 | | MD + MB cr | |

57 **82.00**

| | | | | | | | |
|---------------|-----------------|--------|-----------------|-----------|--------|-------------|----------------|
| CDRA | 1599cc | 4 Cyl. | 8 Valves | 70kW/95PS | Petrol | SOHC | TD18768 |
| CDRB | 1599cc | 4 Cyl. | 8 Valves | 70kW/95PS | Petrol | SOHC | TD18769 |
| STREET KA 1.6 | 05/2003→07/2005 | | | | | | |

| | | | |
|-----------------------|---------|------------|-----|
| V98034 | 1127416 | | 45° |
| 40.00 x 5.98 x 109.65 | | MB cr | |
| V98035 | 1089830 | | 45° |
| 34.00 x 5.97 x 109.80 | | MD + MB cr | |



OE

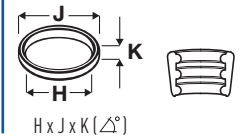

58



82.50

| | | | | | | | |
|------|--------|--------|----------|-----------------|--------|------------------------|---------|
| BHDA | 1753cc | 4 Cyl. | 8 Valves | 55-57kW/75-78PS | Diesel | Endura-DI, Turbo, SOHC | TD15903 |
| BHDB | 1753cc | 4 Cyl. | 8 Valves | 55-57kW/75-78PS | Diesel | Endura-DI, Turbo, SOHC | TD15904 |
| BHPA | 1753cc | 4 Cyl. | 8 Valves | 55-57kW/75-78PS | Diesel | Endura-DI, Turbo, SOHC | TD20062 |
| C9DA | 1753cc | 4 Cyl. | 8 Valves | 66kW/90PS | Diesel | Endura-DI, Turbo, SOHC | TD15905 |
| C9DB | 1753cc | 4 Cyl. | 8 Valves | 66kW/90PS | Diesel | Endura-DI, Turbo, SOHC | TD15906 |
| C9DC | 1753cc | 4 Cyl. | 8 Valves | 66kW/90PS | Diesel | Endura-DI, Turbo, SOHC | TD12081 |
| F9DA | 1753cc | 4 Cyl. | 8 Valves | 85kW/115PS | Diesel | Turbo, SOHC | TD17524 |
| F9DB | 1753cc | 4 Cyl. | 8 Valves | 85kW/115PS | Diesel | Turbo, SOHC | TD17526 |
| FFBA | 1753cc | 4 Cyl. | 8 Valves | 74kW/100PS | Diesel | Turbo, SOHC | TD23304 |
| FFDA | 1753cc | 4 Cyl. | 8 Valves | 74kW/100PS | Diesel | Turbo, SOHC | TD17521 |
| FFWA | 1753cc | 4 Cyl. | 8 Valves | 74kW/100PS | Diesel | Turbo, SOHC | TD20047 |
| HCPA | 1753cc | 4 Cyl. | 8 Valves | 66kW/90PS | Diesel | Duratorq, Turbo, SOHC | TD18779 |
| HCPB | 1753cc | 4 Cyl. | 8 Valves | 66kW/90PS | Diesel | Duratorq, Turbo, SOHC | TD18780 |
| KHBA | 1753cc | 4 Cyl. | 8 Valves | 92kW/125PS | Diesel | Duratorq, Turbo, SOHC | TD23372 |
| KKDA | 1753cc | 4 Cyl. | 8 Valves | 85kW/115PS | Diesel | Turbo, SOHC | TD18480 |
| KKDB | 1753cc | 4 Cyl. | 8 Valves | 85kW/115PS | Diesel | Turbo, SOHC | TD23303 |
| P7PA | 1753cc | 4 Cyl. | 8 Valves | 55kW/75PS | Diesel | Duratorq, Turbo, SOHC | TD24465 |
| P7PB | 1753cc | 4 Cyl. | 8 Valves | 55kW/75PS | Diesel | Duratorq, Turbo, SOHC | TD24466 |
| P9PA | 1753cc | 4 Cyl. | 8 Valves | 66kW/90PS | Diesel | Duratorq, Turbo, SOHC | TD25795 |
| P9PB | 1753cc | 4 Cyl. | 8 Valves | 66kW/90PS | Diesel | Duratorq, Turbo, SOHC | TD25796 |
| P9PC | 1753cc | 4 Cyl. | 8 Valves | 66kW/90PS | Diesel | Duratorq, Turbo, SOHC | TD25797 |
| P9PD | 1753cc | 4 Cyl. | 8 Valves | 66kW/90PS | Diesel | Duratorq, Turbo, SOHC | TD25798 |
| QYBA | 1753cc | 4 Cyl. | 8 Valves | 92kW/125PS | Diesel | Duratorq, Turbo, SOHC | TD23371 |
| QYWA | 1753cc | 4 Cyl. | 8 Valves | 92kW/125PS | Diesel | Duratorq, Turbo, SOHC | TD19112 |
| R2PA | 1753cc | 4 Cyl. | 8 Valves | 55kW/75PS | Diesel | Duratorq, Turbo, SOHC | TD24467 |
| R3PA | 1753cc | 4 Cyl. | 8 Valves | 66kW/90PS | Diesel | Duratorq, Turbo, SOHC | TD25799 |
| RTN | 1753cc | 4 Cyl. | 8 Valves | 55-57kW/75-78PS | Diesel | Endura-DI, Turbo, SOHC | TD15937 |
| RTP | 1753cc | 4 Cyl. | 8 Valves | 55-57kW/75-78PS | Diesel | Endura-DI, Turbo, SOHC | TD15938 |
| RTQ | 1753cc | 4 Cyl. | 8 Valves | 55-57kW/75-78PS | Diesel | Endura-DI, Turbo, SOHC | TD15939 |
| RWPA | 1753cc | 4 Cyl. | 8 Valves | 81kW/110PS | Diesel | Duratorq, Turbo, SOHC | TD20063 |
| RWPC | 1753cc | 4 Cyl. | 8 Valves | 81kW/110PS | Diesel | Duratorq, Turbo, SOHC | TD25793 |
| RWPD | 1753cc | 4 Cyl. | 8 Valves | 81kW/110PS | Diesel | Duratorq, Turbo, SOHC | TD25794 |
| RWPE | 1753cc | 4 Cyl. | 8 Valves | 66kW/90PS | Diesel | Duratorq, Turbo, SOHC | TD25800 |
| RWPF | 1753cc | 4 Cyl. | 8 Valves | 66kW/90PS | Diesel | Duratorq, Turbo, SOHC | TD25801 |

| | | | |
|--------------------------------------|-----------------|---------------------------|-----------------|
| BANTAM 1.8 TdDi | 09/2001→08/2006 | C-MAX 1.8 TDCi | 02/2007→09/2010 |
| FIESTA 1.8 DI | 09/2000→08/2003 | FIESTA IV 1.8 DI | 04/2000→01/2002 |
| FIESTA TD 1.8 | 03/2000→08/2003 | FOCUS 1.8 DI / TDDi | 08/1999→11/2004 |
| FOCUS 1.8 TDCi | 03/2001→11/2004 | FOCUS 1.8 Turbo DI / TDDi | 10/1998→03/2005 |
| FOCUS C-MAX 1.8 TDCi | 01/2005→03/2007 | FOCUS II 1.8 TDCi | 07/2004→09/2012 |
| GALAXY 1.8 TDCi | 05/2006→06/2015 | MONDEO IV 1.8 TDCi | 03/2007→01/2015 |
| S-MAX 1.8 TDCi | 05/2006→12/2014 | TOURNEO CONNECT 1.8 TDCi | 06/2002→12/2013 |
| TOURNEO CONNECT 1.8 TDCi / TDDi / DI | 06/2002→12/2013 | TRANSIT CONNECT 1.8 Di | 06/2002→12/2013 |
| TRANSIT CONNECT 1.8 TDCi | 06/2002→12/2013 | | |

V94695 ■
36.50 x 8.00 x 107.00

1113197

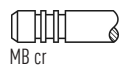

45° Y H

VAG96024 ■ ■ ■
37.50 x 7.92 x 12.77



V94696 ■
32.00 x 8.00 x 108.70

1352129

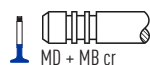

45° SS H



OE

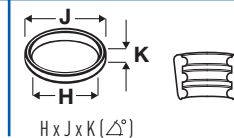
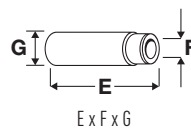

59 **82.50**

| | | | | | | | |
|------------|--------|--------|-----------------|-----------------|--------|-------------------------------|----------------|
| RFA | 1753cc | 4 Cyl. | 8 Valves | 55-57kW/75-78PS | Diesel | Turbo, SOHC | TD1426 |
| RFB | 1753cc | 4 Cyl. | 8 Valves | 55-57kW/75-78PS | Diesel | Turbo, SOHC | TD1427 |
| RFD | 1753cc | 4 Cyl. | 8 Valves | 66kW/90PS | Diesel | Turbo, SOHC | TD4484 |
| RFK | 1753cc | 4 Cyl. | 8 Valves | 66kW/90PS | Diesel | Turbo, SOHC | TD4485 |
| RFM | 1753cc | 4 Cyl. | 8 Valves | 65-66kW/88-90PS | Diesel | Turbo, SOHC | TD1428 |
| RFN | 1753cc | 4 Cyl. | 8 Valves | 65-66kW/88-90PS | Diesel | Turbo, SOHC | TD1429 |
| RFS | 1753cc | 4 Cyl. | 8 Valves | 66kW/90PS | Diesel | Endura-DE, Turbo, SOHC | TD16143 |
| RVA | 1753cc | 4 Cyl. | 8 Valves | 51kW/70PS | Diesel | Endura-DE, Turbo, SOHC | TD5104 |

| | | | |
|-----------------------|-----------------|------------------------|-----------------|
| ESCORT '95 1.8 TD | 01/1995→08/2000 | ESCORT '95 1.8 Turbo D | 12/1995→06/2001 |
| ESCORT CLASSIC 1.8 TD | 10/1998→07/2000 | ESCORT VI 1.8 TD | 02/1993→01/1995 |
| ESCORT VII 1.8 TD | 01/1995→02/1999 | ESCORT VII 1.8 Turbo D | 12/1995→08/1999 |
| MONDEO I 1.8 TD | 06/1993→08/1996 | MONDEO II 1.8 TD | 08/1996→09/2000 |
| ORION III 1.8 TD | 03/1992→12/1993 | P 100 II 1.8 TD | 10/1987→12/1992 |
| SIERRA 1.8 TD | 08/1988→02/1993 | | |

V91993
36.60 x 7.97 x 107.10

6172851



45° Y H

VAG96024
37.50 x 7.92 x 12.77



V91428
32.10 x 7.96 x 109.20

6172848



45° ss H

60 **82.50**

| | | | | | | | |
|-------------------|-----------------|---------------|-----------------|-----------------|--------|--------------------|---------------|
| RFL | 1753cc | 4 Cyl. | 8 Valves | 55-57kW/75-78PS | Diesel | Turbo, SOHC | TD4486 |
| FIESTA III 1.8 TD | 03/1993→12/1995 | SIERRA 1.8 TD | 08/1988→02/1993 | | | | |

V91821
36.60 x 7.99 x 107.15

6781621

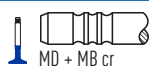

45° H

VAG96024
37.50 x 7.92 x 12.77



V91428
32.10 x 7.96 x 109.20

6172848

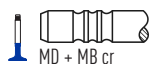

45° ss H



OE

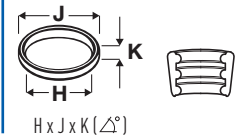
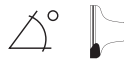

61  **82.50**

| | | | | | | | |
|--------------------------|-----------------|--------|----------|--------------------------|--------|-----------------|---------|
| RTA (D18NA) | 1753cc | 4 Cyl. | 8 Valves | 44kW/60PS | Diesel | SOHC | TD1434 |
| RTB (D18NA) | 1753cc | 4 Cyl. | 8 Valves | 44kW/60PS | Diesel | SOHC | TD1435 |
| RTC (D18NA) | 1753cc | 4 Cyl. | 8 Valves | 43-44kW/58-60PS | Diesel | SOHC | TD4489 |
| RTD (D18NA) | 1753cc | 4 Cyl. | 8 Valves | 43-44kW/58-60PS | Diesel | SOHC | TD1437 |
| RTE (D18NA) | 1753cc | 4 Cyl. | 8 Valves | 44kW/60PS | Diesel | SOHC | TD1438 |
| RTF (D18NA) | 1753cc | 4 Cyl. | 8 Valves | 44kW/60PS | Diesel | SOHC | TD1439 |
| RTG (D18NA) | 1753cc | 4 Cyl. | 8 Valves | 43-44kW/58-60PS | Diesel | SOHC | TD1440 |
| RTH (D18NA) | 1753cc | 4 Cyl. | 8 Valves | 44kW/60PS | Diesel | SOHC | TD1441 |
| RTJ | 1753cc | 4 Cyl. | 8 Valves | 44kW/60PS | Diesel | Endura-DE, SOHC | TD10068 |
| RTK | 1753cc | 4 Cyl. | 8 Valves | 44kW/60PS | Diesel | Endura-DE, SOHC | TD10067 |
| COURIER 1.8 D | 06/1999→02/2002 | | | ESCORT '86 Express 1.8 D | | 07/1988→07/1990 | |
| ESCORT '91 Express 1.8 D | 07/1990→12/1994 | | | ESCORT '95 1.8 D | | 01/1995→08/2000 | |
| ESCORT IV 1.8 D | 01/1989→07/1990 | | | ESCORT V 1.8 D | | 07/1990→12/1992 | |
| ESCORT VI 1.8 D | 09/1992→01/1995 | | | ESCORT VII 1.8 D | | 01/1995→02/1999 | |
| FIESTA 1.8 D | 03/1989→04/2002 | | | FIESTA D 1.8 | | 05/1998→04/2002 | |
| FIESTA III 1.8 D | 03/1989→12/1995 | | | FIESTA IV 1.8 D | | 08/1995→04/2000 | |
| ORION II 1.8 D | 01/1989→07/1990 | | | ORION III 1.8 D | | 11/1990→12/1993 | |

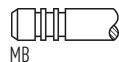

V94321  [4]
36.50 x 8.20 x 107.15

6172852



45°

H

VAG96024  
37.50 x 7.92 x 12.77

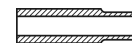

V91821 
36.60 x 7.99 x 107.15
09/88→10/95

6781621



45°

H

V91993 
36.60 x 7.97 x 107.10
10/95→

6172851

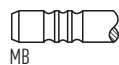

45°

Y

H

V94322  [4]
32.00 x 8.20 x 109.25

6172846

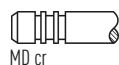

45°

V91168 
32.11 x 7.96 x 109.25
09/88→10/95

6172845

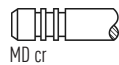

45°

V91428 
32.10 x 7.96 x 109.20
10/95→

6172848



45°

SS

H

[4] Oversize stem

[4] Ventilschaftdichtung mit Übermaß

[4] Tige surdimensionnée

[4] Vástago sobredimensionado

[4] Gambo valvola maggiorato

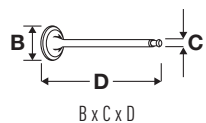

OE

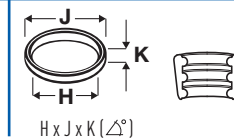
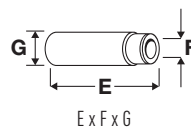

62 **83.00**

| | | | | | | | |
|------|--------|--------|-----------|------------|--------|-----------------|---------|
| CFBA | 1798cc | 4 Cyl. | 16 Valves | 96kW/130PS | Petrol | DOHC, Injection | TD18758 |
| CGBA | 1798cc | 4 Cyl. | 16 Valves | 81kW/110PS | Petrol | Duratec, DOHC | TD15907 |
| CGBB | 1798cc | 4 Cyl. | 16 Valves | 81kW/110PS | Petrol | Duratec, DOHC | TD15908 |
| CHBA | 1798cc | 4 Cyl. | 16 Valves | 92kW/125PS | Petrol | Duratec, DOHC | TD15909 |
| CHBB | 1798cc | 4 Cyl. | 16 Valves | 92kW/125PS | Petrol | Duratec, DOHC | TD15910 |
| CSDA | 1798cc | 4 Cyl. | 16 Valves | 88kW/120PS | Petrol | Duratec, DOHC | TD18975 |
| CSDB | 1798cc | 4 Cyl. | 16 Valves | 88kW/120PS | Petrol | Duratec, DOHC | TD18976 |
| Q7DA | 1798cc | 4 Cyl. | 16 Valves | 92kW/125PS | Petrol | Duratec, DOHC | TD18974 |
| QQDA | 1798cc | 4 Cyl. | 16 Valves | 92kW/125PS | Petrol | Duratec, DOHC | TD18788 |
| QQDB | 1798cc | 4 Cyl. | 16 Valves | 92kW/125PS | Petrol | Duratec, DOHC | TD18787 |
| QQDC | 1798cc | 4 Cyl. | 16 Valves | 90kW/122PS | Petrol | Duratec, DOHC | TD18789 |
| QQDD | 1798cc | 4 Cyl. | 16 Valves | 96kW/131PS | Petrol | Duratec, DOHC | TD25792 |

| | | | |
|--------------------|-----------------|--------------------|-----------------|
| C-MAX 1.8 | 02/2007→09/2010 | FOCUS C-MAX 1.8 | 10/2003→03/2007 |
| FOCUS II 1.8 | 12/2005→09/2012 | MONDEO III 1.8 16V | 10/2000→03/2007 |
| MONDEO III 1.8 SCi | 06/2003→03/2007 | | |

V94693 32.50 x 5.50 x 103.40

1324691

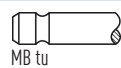

45°

H

VAG96367 39.00 x 5.50 x 11.05

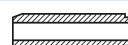

V94694 28.00 x 5.50 x 104.60

1324690

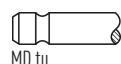

45°

63 **83.00**

| | | | | | | | |
|------|--------|--------|-----------|-------------|--------|-------------|---------|
| HUWA | 2521cc | 5 Cyl. | 20 Valves | 162kW/220PS | Petrol | Turbo, DOHC | TD20032 |
|------|--------|--------|-----------|-------------|--------|-------------|---------|

S-MAX 2.5 ST 05/2006→12/2014

V95049 31.00 x 6.00 x 104.25

9454607

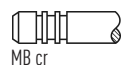

45°

H

V95050 27.00 x 6.00 x 103.35

9454610

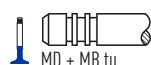

45°

H

64 **84.80**

| | | | | | | | |
|------|--------|--------|-----------|-------------|--------|---------------|---------|
| ALDA | 1988cc | 4 Cyl. | 16 Valves | 127kW/173PS | Petrol | Duratec, DOHC | TD18785 |
|------|--------|--------|-----------|-------------|--------|---------------|---------|

FOCUS ST170 03/2002→11/2004

V95063 33.50 x 6.04 x 102.65

1143059

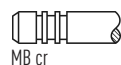

45°

H

V95064 28.00 x 6.02 x 102.25

1143057

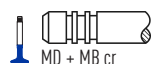

45°

SS

H



OE

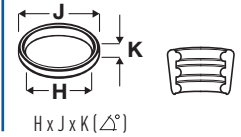
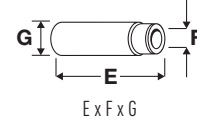

65



84.80

| | | | | | | | |
|----------------|--------|-----------------|------------------|---------------|--------|----------------------|----------------|
| EDBA | 1988cc | 4 Cyl. | 16 Valves | 96kW/131PS | Petrol | Zetec-E, DOHC | TD12068 |
| EDBB | 1988cc | 4 Cyl. | 16 Valves | 96kW/131PS | Petrol | Zetec-E, DOHC | TD15916 |
| EDBC | 1988cc | 4 Cyl. | 16 Valves | 96kW/131PS | Petrol | Zetec-E, DOHC | TD15917 |
| EDBD | 1988cc | 4 Cyl. | 16 Valves | 96kW/131PS | Petrol | Zetec-E, DOHC | TD15918 |
| EDDB | 1988cc | 4 Cyl. | 16 Valves | 96kW/131PS | Petrol | Zetec-E, DOHC | TD15900 |
| EDDC | 1988cc | 4 Cyl. | 16 Valves | 96kW/131PS | Petrol | Zetec-E, DOHC | TD12080 |
| EDDD | 1988cc | 4 Cyl. | 16 Valves | 96kW/131PS | Petrol | Zetec-E, DOHC | TD15901 |
| EDDF | 1988cc | 4 Cyl. | 16 Valves | 96kW/131PS | Petrol | Zetec-E, DOHC | TD15902 |
| COUGAR 2.0 16V | | 08/1998→12/2001 | | FOCUS 2.0 16V | | 10/1998→11/2004 | |

V94074 ■
32.00 x 6.04 x 97.15
08/97→05/98

1041838

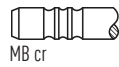

45°

H

VAG96027 ■ ■ ■
36.00 x 6.06 x 12.04



V94223 ■
33.00 x 6.00 x 98.10
06/98→

1053845

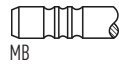

45°

H

VAG96159 ■ ■ ■
36.00 x 6.08 x 12.04



V94076 ■
28.10 x 6.02 x 96.80
08/97→05/98

1033899



45°

H

V94225 ■
28.00 x 6.00 x 97.60
06/98→

1066045

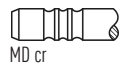

45°

66



84.80

| | | | | | | | |
|--------------------|--------|-----------------|------------------|--------------------|--------|----------------------|----------------|
| NGA | 1988cc | 4 Cyl. | 16 Valves | 96-100kW/131-136PS | Petrol | Zetec-E, DOHC | TD4475 |
| NGB | 1988cc | 4 Cyl. | 16 Valves | 96kW/131PS | Petrol | Zetec-E, DOHC | TD12090 |
| NGC | 1988cc | 4 Cyl. | 16 Valves | 96kW/131PS | Petrol | Zetec-E, DOHC | TD15994 |
| NGD | 1988cc | 4 Cyl. | 16 Valves | 96kW/131PS | Petrol | Zetec-E, DOHC | TD16012 |
| MONDEO I 2.0 i 16V | | 01/1993→08/1996 | | MONDEO II 2.0 i | | 08/1996→09/2000 | |

V91356 ■
32.20 x 6.04 x 97.10
→08/97

664 0543

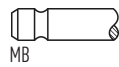

45°

H

VAG96027 ■ ■ ■
36.00 x 6.06 x 12.04



V94074 ■
32.00 x 6.04 x 97.15
08/97→05/98

1041838

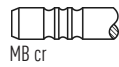

45°

H

V94223 ■
33.00 x 6.00 x 98.10
06/98→

1053845

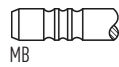

45°

H

V94075 ■
28.10 x 6.02 x 96.80
→08/97

6640542



45°

H

V94076 ■
28.10 x 6.02 x 96.80
08/97→05/98

1033899

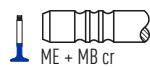

45°

H

V94225 ■
28.00 x 6.00 x 97.60
06/98→

1066045

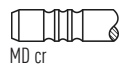

45°

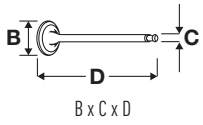

OE



MAT.

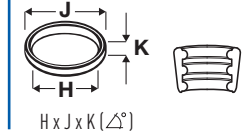
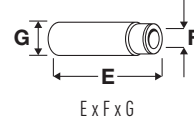
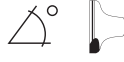



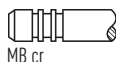

67  **85.00**

| | | | | | | | |
|------|--------|--------|-----------|-------------|--------|----------------------------|---------|
| AZBA | 1997cc | 4 Cyl. | 16 Valves | 96kW/131PS | Diesel | Duratorq (DW), Turbo, DOHC | TD23367 |
| AZWA | 1997cc | 4 Cyl. | 16 Valves | 96kW/130PS | Diesel | Duratorq (DW), Turbo, DOHC | TD20040 |
| G6DA | 1997cc | 4 Cyl. | 16 Valves | 100kW/136PS | Diesel | Duratorq (DW), Turbo, DOHC | TD18510 |
| G6DB | 1997cc | 4 Cyl. | 16 Valves | 100kW/136PS | Diesel | Duratorq (DW), Turbo, DOHC | TD18511 |
| G6DC | 1997cc | 4 Cyl. | 16 Valves | 98kW/133PS | Diesel | Duratorq (DW), Turbo, DOHC | TD18791 |
| G6DD | 1997cc | 4 Cyl. | 16 Valves | 100kW/136PS | Diesel | Duratorq (DW), Turbo, DOHC | TD18790 |
| G6DE | 1997cc | 4 Cyl. | 16 Valves | 98kW/133PS | Diesel | Duratorq (DW), Turbo, DOHC | TD18792 |
| G6DF | 1997cc | 4 Cyl. | 16 Valves | 98kW/133PS | Diesel | Duratorq (DW), Turbo, DOHC | TD18793 |
| G6DG | 1997cc | 4 Cyl. | 16 Valves | 100kW/136PS | Diesel | Duratorq (DW), Turbo, DOHC | TD24352 |
| KLBA | 1997cc | 4 Cyl. | 16 Valves | 85kW/116PS | Diesel | Duratorq (DW), Turbo, DOHC | TD23305 |
| QXBA | 1997cc | 4 Cyl. | 16 Valves | 103kW/140PS | Diesel | Duratorq (DW), Turbo, DOHC | TD23306 |
| QXBB | 1997cc | 4 Cyl. | 16 Valves | 103kW/140PS | Diesel | Duratorq (DW), Turbo, DOHC | TD23307 |
| QXWA | 1997cc | 4 Cyl. | 16 Valves | 103kW/140PS | Diesel | Duratorq (DW), Turbo, DOHC | TD20041 |
| QXWB | 1997cc | 4 Cyl. | 16 Valves | 103kW/140PS | Diesel | Duratorq (DW), Turbo, DOHC | TD20046 |
| QXWC | 1997cc | 4 Cyl. | 16 Valves | 103kW/140PS | Diesel | Duratorq (DW), Turbo, DOHC | TD24437 |
| UFWA | 1997cc | 4 Cyl. | 16 Valves | 103kW/140PS | Diesel | Duratorq (DW), Turbo, DOHC | TD24438 |

| | | | |
|-------------------|-----------------|----------------------|-----------------|
| C-MAX 2.0 TDCi | 02/2007→09/2010 | FOCUS C-MAX 2.0 TDCi | 10/2003→03/2007 |
| FOCUS II 2.0 TDCi | 07/2004→09/2012 | GALAXY 2.0 TDCi | 05/2006→06/2015 |
| KUGA I 2.0 TDCi | 03/2008→11/2012 | MONDEO IV 2.0 TDCi | 03/2007→01/2015 |
| S-MAX 2.0 TDCi | 05/2006→12/2014 | | |

V94490  1231931  45° Y H

V94491  1231930  45° SS H



VAG96119  41.50 x 6.03 x 10.54 

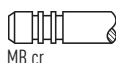

68  **85.00**

| | | | | | | | |
|------|--------|--------|-----------|---------------------|--------|----------------------------|---------|
| KLWA | 1997cc | 4 Cyl. | 16 Valves | 85kW/115PS | Diesel | Duratorq (DW), Turbo, DOHC | TD24436 |
| TXBA | 1997cc | 4 Cyl. | 16 Valves | 120kW/163PS | Diesel | Duratorq (DW), Turbo, DOHC | TD25804 |
| TXDA | 1997cc | 4 Cyl. | 16 Valves | 118-120kW/160-163PS | Diesel | Duratorq (DW), Turbo, DOHC | TD25805 |
| TXDB | 1997cc | 4 Cyl. | 16 Valves | 120kW/163PS | Diesel | Duratorq (DW), Turbo, DOHC | TD25803 |
| TXWA | 1997cc | 4 Cyl. | 16 Valves | 118-120kW/160-163PS | Diesel | Duratorq (DW), Turbo, DOHC | TD25806 |
| TYDA | 1997cc | 4 Cyl. | 16 Valves | 85kW/116PS | Diesel | Duratorq (DW), Turbo, DOHC | TD25885 |
| TYWA | 1997cc | 4 Cyl. | 16 Valves | 85kW/115PS | Diesel | Duratorq (DW), Turbo, DOHC | TD24435 |
| UFDA | 1997cc | 4 Cyl. | 16 Valves | 103kW/140PS | Diesel | Duratorq (DW), Turbo, DOHC | TD24429 |
| UFDB | 1997cc | 4 Cyl. | 16 Valves | 103kW/140PS | Diesel | Duratorq (DW), Turbo, DOHC | TD25886 |
| UKDA | 1997cc | 4 Cyl. | 16 Valves | 100kW/136PS | Diesel | Duratorq (DW), Turbo, DOHC | TD24428 |
| UKDB | 1997cc | 4 Cyl. | 16 Valves | 100kW/136PS | Diesel | Duratorq (DW), Turbo, DOHC | TD25887 |

| | | | |
|----------------------|-----------------|----------------------|-----------------|
| C-MAX II 2.0 TDCi | 04/2010→ | FOCUS III 2.0 TDCi | 07/2010→ |
| GALAXY 2.0 TDCi | 11/2007→06/2015 | GRAND C-MAX 2.0 TDCi | 12/2010→ |
| GRAND C-MAX 2.0 TDCi | 02/2011→ | KUGA I 2.0 TDCi | 03/2008→11/2012 |
| KUGA II 2.0 TDCi | 03/2013→ | MONDEO IV 2.0 TDCi | 03/2010→01/2015 |
| S-MAX 2.0 TDCi | 11/2007→12/2014 | | |

V95234  1683701  45° H

V94491  1231930  45° SS H

VAG96119  41.50 x 6.03 x 10.54 



OE





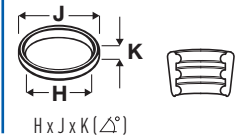





E x F x G







H x J x K (45°)

69  **85.00**

| | | | | | | | |
|--|---------|---|-----------|------------|--------|--|---|
| LPBA | 1997cc | 4 Cyl. | 16 Valves | 85kW/115PS | Diesel | Duratorq (DW), Turbo, DOHC | TD23354 |
| MONDEO IV 2.0 TDCi | | 11/2007→01/2015 | | | | | |
| V94490  | 1231931 |  | 45° | Y | H | VAG96119  |  |
| 29.80 x 6.00 x 105.00 | | MB cr | | | | 41.50 x 6.03 x 10.54 | |
| V95234  | 1683701 |  | 45° | | H | | |
| 27.25 x 6.00 x 104.50 | | MB cr | | | | | |
| V94491  | 1231930 |  | 45° | SS | H | | |
| 25.00 x 6.00 x 105.00 | | MD + MB cr | | | | | |





70  **85.00**

| | | | | | | | |
|--|---------|---|-----------|--------------------|--------|--|---|
| TXBB | 1997cc | 4 Cyl. | 16 Valves | 120kW/163PS | Diesel | Duratorq (DW), Turbo, DOHC | TD31045 |
| TXMA | 1997cc | 4 Cyl. | 16 Valves | 120kW/163PS | Diesel | Duratorq (DW), Turbo, DOHC | TD30566 |
| KUGA II 2.0 TDCi | | 03/2013→ | | MONDEO IV 2.0 TDCi | | 03/2010→01/2015 | |
| V94491  | 1231930 |  | 45° | SS | H | VAG96119  |  |
| 25.00 x 6.00 x 105.00 | | MD + MB cr | | | | 41.50 x 6.03 x 10.54 | |

71  **85.00**

| | | | | | | | |
|--|---------|---|-----------|--------------------|--------|--|---|
| Q4BA | 2179cc | 4 Cyl. | 16 Valves | 129kW/175PS | Diesel | Duratorq, Turbo, DOHC | TD20838 |
| GALAXY 2.2 TDCi | | 03/2008→12/2012 | | MONDEO IV 2.2 TDCi | | 03/2008→10/2010 | |
| V95083  | 1451597 |  | 45° | Y | H | VAG96119  |  |
| 27.25 x 5.97 x 95.70 | | MB cr | | | | 41.50 x 6.03 x 10.54 | |
| V95084  | 1427813 |  | 45° | SS | H | | |
| 25.00 x 5.97 x 95.00 | | MD + MB cr | | | | | |

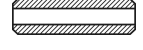
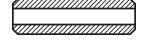
72  **86.00**

| | | | | | | | |
|--|---------|---|-----------|--------------------------------|--------|--|---|
| ABFA | 1998cc | 4 Cyl. | 16 Valves | 74kW/100PS | Diesel | Duratorq, Turbo, DOHC | TD15888 |
| D3FA | 1998cc | 4 Cyl. | 16 Valves | 55kW/75PS | Diesel | DOHC | TD15551 |
| D5BA | 1998cc | 4 Cyl. | 16 Valves | 66kW/90PS | Diesel | Dura Torq, Turbo, DOHC | TD15914 |
| D6BA | 1998cc | 4 Cyl. | 16 Valves | 85kW/115PS | Diesel | Dura Torq, DOHC | TD15915 |
| F3FA | 1998cc | 4 Cyl. | 16 Valves | 63kW/86PS | Diesel | Duratorq, Turbo, DOHC | TD18777 |
| F1FA | 1998cc | 4 Cyl. | 16 Valves | 92kW/125PS | Diesel | Duratorq, Turbo, DOHC | TD18839 |
| FMBA | 1998cc | 4 Cyl. | 16 Valves | 96kW/130PS | Diesel | Turbo, DOHC | TD18761 |
| HJBA | 1998cc | 4 Cyl. | 16 Valves | 85kW/115PS | Diesel | Turbo, DOHC | TD17547 |
| HJBB | 1998cc | 4 Cyl. | 16 Valves | 85kW/115PS | Diesel | Turbo, DOHC | TD17548 |
| HJBC | 1998cc | 4 Cyl. | 16 Valves | 85kW/115PS | Diesel | Turbo, DOHC | TD17549 |
| N7BA | 1998cc | 4 Cyl. | 16 Valves | 96kW/130PS | Diesel | Turbo, DOHC | TD18762 |
| MONDEO III 2.0 16V DI / TDDi / TDCi | | 10/2000→03/2007 | | MONDEO III 2.0 16V TDDi / TDCi | | 10/2000→03/2007 | |
| MONDEO III 2.0 TDCi | | 10/2001→03/2007 | | TRANSIT 2.0 DI | | 08/2000→05/2006 | |
| TRANSIT 2.0 TDCi | | 08/2002→05/2006 | | | | | |
| V94378  | 1217148 |  | 30° | Y | H | VAG96368  |  |
| 29.80 x 7.00 x 122.20 | | MD + MB cr | | | | 51.50 x 6.97 x 12.07 | |
| V94379  | 1121332 |  | 45° | SS | H | | |
| 25.80 x 7.00 x 122.10 | | MD + MB cr | | | | | |



OE

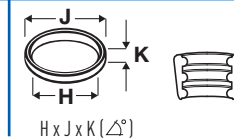
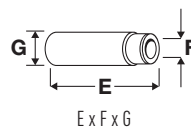
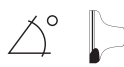

73 86.00

| | | | | | | | |
|--------------------|-----------------|--------|-------------------|-------------|-----------------|-------------|---------------|
| N7A | 1998cc | 4 Cyl. | 16 Valves | 110kW/150PS | Petrol | DOHC | TD1328 |
| ESCORT V RS 2000 | 05/1991→12/1992 | | ESCORT VI RS 2000 | | 09/1992→01/1995 | | |
| ESCORT VII RS 2000 | 02/1995→10/1998 | | | | | | |

| | | | | | | |
|----------------------|----------|------------|-----|---|----------------------|--|
| V91356 | 664 0543 | | 45° | H | VAG96027 | |
| 32.20 x 6.04 x 97.10 | | MB | | | 36.00 x 6.06 x 12.04 | |
| V94075 | 6640542 | | 45° | H | | |
| 28.10 x 6.02 x 96.80 | | ME + MB cr | | | | |

74 86.00

| | | | | | | | |
|---------------------|-----------------|--------|-------------------|-------------------|-----------------|-------------|----------------|
| N8C (DL20H) | 1998cc | 4 Cyl. | 8 Valves | 77kW/105PS | Petrol | DOHC | TD1332 |
| N9A | 1998cc | 4 Cyl. | 8 Valves | 90kW/122PS | Petrol | DOHC | TD1335 |
| N9B | 1998cc | 4 Cyl. | 8 Valves | 92kW/125PS | Petrol | DOHC | TD1336 |
| N9C | 1998cc | 4 Cyl. | 8 Valves | 88-92kW/120-125PS | Petrol | DOHC | TD1337 |
| N9D | 1998cc | 4 Cyl. | 8 Valves | 88kW/120PS | Petrol | DOHC | TD1338 |
| N9E | 1998cc | 4 Cyl. | 8 Valves | 85kW/115PS | Petrol | DOHC | TD4471 |
| N9F | 1998cc | 4 Cyl. | 8 Valves | 85kW/115PS | Petrol | DOHC | TD1339 |
| NSD | 1998cc | 4 Cyl. | 8 Valves | 85kW/115PS | Petrol | DOHC | TD4476 |
| NSE | 1998cc | 4 Cyl. | 8 Valves | 85kW/116PS | Petrol | DOHC | TD5109 |
| NSF | 1998cc | 4 Cyl. | 8 Valves | 84kW/114PS | Petrol | DOHC | TD4477 |
| NSG | 1998cc | 4 Cyl. | 8 Valves | 84kW/114PS | Petrol | DOHC | TD4478 |
| NSH | 1998cc | 4 Cyl. | 8 Valves | 74-84kW/101-114PS | Petrol | DOHC | TD16364 |
| ZVSA | 1998cc | 4 Cyl. | 8 Valves | 85kW/116PS | Petrol | | TD17158 |
| GALAXY 2.0 i | 11/1995→05/2006 | | SCORPIO I 2.0 i | | 05/1989→09/1994 | | |
| SCORPIO II 2.0 i | 10/1994→08/1998 | | SIERRA 2.0 | | 01/1987→03/1993 | | |
| SIERRA 2.0 i | 05/1989→02/1993 | | SIERRA 2.0 i DOHC | | 12/1991→02/1993 | | |
| TRANSIT 2.0 | 06/1994→03/2006 | | TRANSIT 2.0 CNG | | 06/1994→03/2000 | | |
| TRANSIT TOURNEO 2.0 | 11/1994→12/2000 | | | | | | |

| | | | | | | |
|-----------------------|---------|------------|-----|---|----------------------|--|
| V94006 | 7078139 | | 45° | H | VAG96025 | |
| 42.70 x 7.04 x 108.70 | | MB | | | 43.00 x 7.06 x 13.54 | |
| V94007 | 7078136 | | 45° | H | | |
| 38.10 x 7.02 x 109.20 | | MD + MB cr | | | | |

75 86.00

| | | | | | | | |
|---------------|-----------------|--------|-----------------|------------|--------|-------------|---------------|
| N8D | 1998cc | 4 Cyl. | 8 Valves | 77kW/105PS | Petrol | DOHC | TD1334 |
| SCORPIO I 2.0 | 04/1985→08/1989 | | | | | | |

| | | | | | | |
|-----------------------|---------------|-------|-----|---|----------------------|--|
| V90178 | 70HM 6507 DD | | 45° | H | VAG96004 | |
| 42.10 x 8.05 x 111.25 | | MB | | | 60.30 x 8.06 x 12.75 | |
| V34499 | 70HM 6505 D3C | | 45° | | VAG96003 | |
| 36.20 x 8.02 x 110.55 | | MD cr | | | 60.30 x 8.08 x 12.75 | |

76 86.00

| | | | | | | | |
|-------------|--------|--------|------------------|-------------|--------|------------------------------|----------------|
| CVRA | 2198cc | 4 Cyl. | 16 Valves | 114kW/155PS | Diesel | Duratorq, Turbo, DOHC | TD26453 |
| CVRB | 2198cc | 4 Cyl. | 16 Valves | 114kW/155PS | Diesel | Duratorq, Turbo, DOHC | TD26454 |
| CVRC | 2198cc | 4 Cyl. | 16 Valves | 114kW/155PS | Diesel | Duratorq, Turbo, DOHC | TD26455 |
| CYFA | 2198cc | 4 Cyl. | 16 Valves | 92kW/125PS | Diesel | Duratorq, Turbo, DOHC | TD26461 |
| CYFB | 2198cc | 4 Cyl. | 16 Valves | 92kW/125PS | Diesel | Duratorq, Turbo, DOHC | TD26462 |
| CYFC | 2198cc | 4 Cyl. | 16 Valves | 92kW/125PS | Diesel | Duratorq, Turbo, DOHC | TD26463 |



OE



MAT.

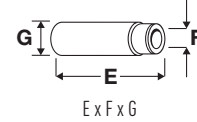
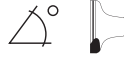

E x F x G

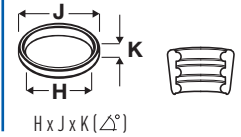

H x J x K (Δ°)

| | | | | | | | |
|---------|--------|--------|-----------|-------------|--------|-----------------------|---------|
| CYFD | 2198cc | 4 Cyl. | 16 Valves | 92kW/125PS | Diesel | Duratorq, Turbo, DOHC | TD26464 |
| CYRA | 2198cc | 4 Cyl. | 16 Valves | 92kW/125PS | Diesel | Duratorq, Turbo, DOHC | TD26716 |
| CYRB | 2198cc | 4 Cyl. | 16 Valves | 92kW/125PS | Diesel | Duratorq, Turbo, DOHC | TD26465 |
| CYRC | 2198cc | 4 Cyl. | 16 Valves | 92kW/125PS | Diesel | Duratorq, Turbo, DOHC | TD26466 |
| DRF5 | 2198cc | 4 Cyl. | 16 Valves | 74kW/100PS | Diesel | Duratorq, Turbo, DOHC | TD29442 |
| DRFA | 2198cc | 4 Cyl. | 16 Valves | 74kW/101PS | Diesel | Duratorq, Turbo, DOHC | TD26456 |
| DRFB | 2198cc | 4 Cyl. | 16 Valves | 74kW/101PS | Diesel | Duratorq, Turbo, DOHC | TD26457 |
| DRFC | 2198cc | 4 Cyl. | 16 Valves | 74kW/101PS | Diesel | Duratorq, Turbo, DOHC | TD26458 |
| DRFD | 2198cc | 4 Cyl. | 16 Valves | 74kW/101PS | Diesel | Duratorq, Turbo, DOHC | TD26459 |
| DRFE | 2198cc | 4 Cyl. | 16 Valves | 74kW/101PS | Diesel | Duratorq, Turbo, DOHC | TD26460 |
| DRFF | 2198cc | 4 Cyl. | 16 Valves | 74kW/100PS | Diesel | Duratorq, Turbo, DOHC | TD29677 |
| DRFG | 2198cc | 4 Cyl. | 16 Valves | 74kW/100PS | Diesel | Duratorq, Turbo, DOHC | TD29656 |
| DRR5 | 2198cc | 4 Cyl. | 16 Valves | 74kW/100PS | Diesel | Duratorq, Turbo, DOHC | TD29655 |
| DRRA | 2198cc | 4 Cyl. | 16 Valves | 74kW/101PS | Diesel | Duratorq, Turbo, DOHC | TD26450 |
| DRRB | 2198cc | 4 Cyl. | 16 Valves | 74kW/101PS | Diesel | Duratorq, Turbo, DOHC | TD26451 |
| DRRC | 2198cc | 4 Cyl. | 16 Valves | 74kW/101PS | Diesel | Duratorq, Turbo, DOHC | TD26452 |
| GBVAJPF | 2198cc | 4 Cyl. | 16 Valves | 88kW/120PS | Diesel | Duratorq, Turbo, DOHC | TD26487 |
| GBVAJQJ | 2198cc | 4 Cyl. | 16 Valves | 110kW/150PS | Diesel | Duratorq, Turbo, DOHC | TD26483 |
| GBVAJQW | 2198cc | 4 Cyl. | 16 Valves | 92kW/125PS | Diesel | Duratorq, Turbo, DOHC | TD26486 |
| P8FA | 2198cc | 4 Cyl. | 16 Valves | 63kW/85PS | Diesel | Duratorq, Turbo, DOHC | TD20042 |
| P8FB | 2198cc | 4 Cyl. | 16 Valves | 63kW/85PS | Diesel | Duratorq, Turbo, DOHC | TD21066 |
| PGFA | 2198cc | 4 Cyl. | 16 Valves | 103kW/140PS | Diesel | Duratorq, Turbo, DOHC | TD21067 |
| PGFB | 2198cc | 4 Cyl. | 16 Valves | 103kW/140PS | Diesel | Duratorq, Turbo, DOHC | TD24463 |
| QJBA | 2198cc | 4 Cyl. | 16 Valves | 114kW/155PS | Diesel | Duratorq, Turbo, DOHC | TD18756 |
| QJBB | 2198cc | 4 Cyl. | 16 Valves | 114kW/155PS | Diesel | Duratorq, Turbo, DOHC | TD18757 |
| QJBC | 2198cc | 4 Cyl. | 16 Valves | 110kW/150PS | Diesel | Duratorq, Turbo, DOHC | TD18782 |
| QJBD | 2198cc | 4 Cyl. | 16 Valves | 110kW/150PS | Diesel | Duratorq, Turbo, DOHC | TD18783 |
| QVFA | 2198cc | 4 Cyl. | 16 Valves | 81kW/110PS | Diesel | Duratorq, Turbo, DOHC | TD20043 |
| QWFA | 2198cc | 4 Cyl. | 16 Valves | 96kW/130PS | Diesel | Duratorq, Turbo, DOHC | TD20044 |
| SRFA | 2198cc | 4 Cyl. | 16 Valves | 85kW/115PS | Diesel | Duratorq, Turbo, DOHC | TD24458 |
| SRFB | 2198cc | 4 Cyl. | 16 Valves | 85kW/115PS | Diesel | Duratorq, Turbo, DOHC | TD24459 |
| SRFC | 2198cc | 4 Cyl. | 16 Valves | 85kW/115PS | Diesel | Duratorq, Turbo, DOHC | TD24460 |
| SRFD | 2198cc | 4 Cyl. | 16 Valves | 85kW/115PS | Diesel | Duratorq, Turbo, DOHC | TD24461 |
| SRFE | 2198cc | 4 Cyl. | 16 Valves | 85kW/115PS | Diesel | Duratorq, Turbo, DOHC | TD24462 |
| UHFA | 2198cc | 4 Cyl. | 16 Valves | 103kW/140PS | Diesel | Duratorq, Turbo, DOHC | TD26467 |
| UHFB | 2198cc | 4 Cyl. | 16 Valves | 103kW/140PS | Diesel | Duratorq, Turbo, DOHC | TD26468 |
| UHFC | 2198cc | 4 Cyl. | 16 Valves | 103kW/140PS | Diesel | Duratorq, Turbo, DOHC | TD26469 |
| USR6 | 2198cc | 4 Cyl. | 16 Valves | 92kW/125PS | Diesel | Duratorq, Turbo, DOHC | TD29670 |
| USRA | 2198cc | 4 Cyl. | 16 Valves | 100kW/136PS | Diesel | Duratorq, Turbo, DOHC | TD26470 |
| USRB | 2198cc | 4 Cyl. | 16 Valves | 100kW/136PS | Diesel | Duratorq, Turbo, DOHC | TD26471 |

MONDEO III 2.2 TDCi
TOURNEO CUSTOM 2.2 TDCi
TRANSIT 2.2 TDCi RWD
TRANSIT TOURNEO 2.2 TDCi

09/2004→03/2007
04/2012→
09/2011→
07/2006→08/2014

RANGER 2.2 TDCi
TRANSIT 2.2 TDCi
TRANSIT CUSTOM 2.2 TDCi

04/2011→
04/2006→
04/2012→

V94378 ■
29.80 x 7.00 x 122.20

1217148



MD + MB cr

30° Y H

VAG96368 ■ ■ ■
51.50 x 6.97 x 12.07

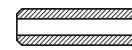

V95140 ■
25.75 x 6.93 x 121.85

1706990



MD + MB cr

45° SS H

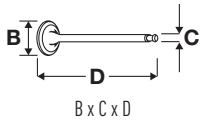

OE

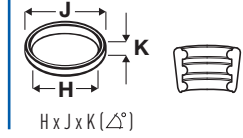
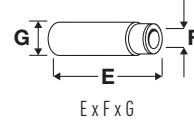
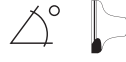

77 **86.20**

| | | | | | | | |
|------------|-----------------|--------|----------|-----------|--------|-----|--------|
| R2A | 1796cc | 4 Cyl. | 8 Valves | 66kW/90PS | Petrol | CVH | TD4483 |
| SIERRA 1.8 | 01/1987→05/1988 | | | | | | |

| | | | | | | | |
|-----------------------|---------------|------------|-----|------|----------------------|--|--|
| V91198 | 1649214 | | 45° | H | VAG92044V1 | | |
| 39.10 x 8.04 x 136.96 | | MB | | | 65.00 x 8.08 x 13.58 | | |
| V91199 | E7EE 6505 B2C | | 45° | ss H | | | |
| 34.11 x 8.02 x 134.12 | | MD + MB cr | | | | | |

78 **86.20**

| | | | | | | | |
|---------------|-----------------|--------|------------|-----------------|--------|------|--------|
| REB | 1796cc | 4 Cyl. | 8 Valves | 66kW/90PS | Petrol | SOHC | TD1421 |
| REC | 1796cc | 4 Cyl. | 8 Valves | 66kW/90PS | Petrol | SOHC | TD1422 |
| RED | 1796cc | 4 Cyl. | 8 Valves | 59-66kW/80-90PS | Petrol | SOHC | TD1423 |
| REF | 1796cc | 4 Cyl. | 8 Valves | 59kW/80PS | Petrol | SOHC | TD1424 |
| SCORPIO I 1.8 | 04/1985→02/1992 | | SIERRA 1.8 | 10/1984→09/1989 | | | |

| | | | | | | | |
|-----------------------|---------|-------|-----|--|--|--|--|
| V90933 | 6147911 | | 45° | | | | |
| 34.30 x 8.00 x 111.70 | | MD cr | | | | | |

79 **87.50**

| | | | | | | | |
|------|--------|--------|-----------|---------------------|--------|---------------|---------|
| AOBA | 1999cc | 4 Cyl. | 16 Valves | 107kW/145PS | Petrol | Duratec, DOHC | TD23308 |
| AOBC | 1999cc | 4 Cyl. | 16 Valves | 107kW/145PS | Petrol | Duratec, DOHC | TD24422 |
| AODA | 1999cc | 4 Cyl. | 16 Valves | 107kW/145PS | Petrol | DOHC | TD18506 |
| AODB | 1999cc | 4 Cyl. | 16 Valves | 107kW/145PS | Petrol | DOHC | TD18507 |
| AODE | 1999cc | 4 Cyl. | 16 Valves | 107kW/145PS | Petrol | DOHC | TD24347 |
| AOWA | 1999cc | 4 Cyl. | 16 Valves | 107kW/145PS | Petrol | DOHC | TD20039 |
| AOWB | 1999cc | 4 Cyl. | 16 Valves | 107kW/145PS | Petrol | DOHC | TD24430 |
| SYDA | 1999cc | 4 Cyl. | 16 Valves | 105-107kW/143-146PS | Petrol | Duratec, DOHC | TD23368 |
| TBBA | 1999cc | 4 Cyl. | 16 Valves | 107kW/145PS | Petrol | Duratec, DOHC | TD23309 |
| TBBB | 1999cc | 4 Cyl. | 16 Valves | 107kW/145PS | Petrol | Duratec, DOHC | TD24423 |

| | | | |
|------------------|-----------------|-------------------|-----------------|
| C-MAX 2.0 | 02/2007→09/2010 | C-MAX 2.0 CNG | 04/2009→09/2010 |
| C-MAX 2.0 LPG | 06/2008→09/2010 | FOCUS C-MAX 2.0 | 03/2004→03/2007 |
| FOCUS II 2.0 | 07/2004→09/2012 | FOCUS II 2.0 CNG | 04/2009→07/2011 |
| FOCUS II 2.0 LPG | 06/2008→07/2011 | GALAXY 2.0 | 05/2006→06/2015 |
| MONDEO IV 2.0 | 03/2007→01/2015 | MONDEO IV 2.0 LPG | 07/2009→01/2015 |
| S-MAX 2.0 | 05/2006→12/2014 | | |

| | | | | | | | |
|-----------------------|---------|-------|-----|----------------------|--|--|--|
| V98032 | 1324132 | | 45° | VAG96367 | | | |
| 35.00 x 5.50 x 103.40 | | MB tu | | 39.00 x 5.50 x 11.05 | | | |
| V94694 | 1324690 | | 45° | | | | |
| 28.00 x 5.50 x 104.60 | | MD tu | | | | | |
| V98033 | 1324131 | | 45° | | | | |
| 30.00 x 5.50 x 104.60 | | MD tu | | | | | |



OE

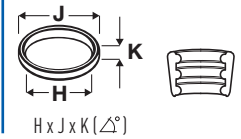
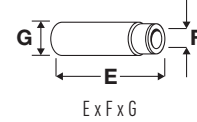

80 **87.50**

| | | | | | | | |
|--------------------|-----------------|--------|------------------|---------------------|--------|----------------------|-----------------|
| CJBA | 1999cc | 4 Cyl. | 16 Valves | 106-107kW/144-146PS | Petrol | Duratec, DOHC | TD15911 |
| CJBB | 1999cc | 4 Cyl. | 16 Valves | 107kW/146PS | Petrol | Duratec, DOHC | TD15912 |
| N4JB | 1999cc | 4 Cyl. | 16 Valves | 110kW/150PS | Petrol | Duratec, DOHC | TD18781 |
| FIESTA V ST150 | 03/2005→06/2008 | | | MONDEO III 2.0 | | | 10/2000→03/2007 |
| MONDEO III 2.0 16V | 10/2000→03/2007 | | | | | | |

V98032 ■
35.00 x 5.50 x 103.40

1324132

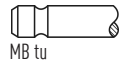

45°

VAG96367 ■ ■ ■
39.00 x 5.50 x 11.05

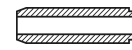

V98033 ■
30.00 x 5.50 x 104.60

1324131

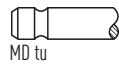

45°

81 **87.50**

| | | | | | | | |
|------------------|----------|--------|------------------|---------------------|--------|-------------|-----------------|
| GZ | 2261cc | 4 Cyl. | 16 Valves | 108-114kW/147-155PS | Petrol | DOHC | TD20057 |
| SEBA | 2261cc | 4 Cyl. | 16 Valves | 118kW/160PS | Petrol | DOHC | TD23352 |
| MAVERICK 2.3 16V | 03/2004→ | | | MONDEO IV 2.3 | | | 07/2007→01/2015 |

V98032 ■
35.00 x 5.50 x 103.40

1324132

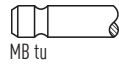

45°

VAG96367 ■ ■ ■
39.00 x 5.50 x 11.05

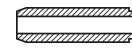

V98033 ■
30.00 x 5.50 x 104.60

1324131

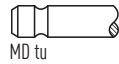

45°

82 **87.65**

| | | | | | | | |
|-------------|-----------------|--------|-----------------|-----------|--------|-------------|---------------|
| 4RB | 1593cc | 4 Cyl. | 8 Valves | 48kW/65PS | Petrol | | TD9440 |
| B | 1593cc | 4 Cyl. | 8 Valves | 48kW/65PS | Petrol | SOHC | TD4439 |
| TRANSIT 1.6 | 11/1977→10/1986 | | | | | | |

V90178 ■
42.10 x 8.05 x 111.25

70HM 6507 DD



45°

H

VAG96004 ■
60.30 x 8.06 x 12.75

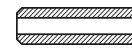

V35122 ■
36.19 x 8.00 x 111.25

78HM 6505 CA

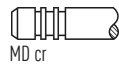

45°

VAG96003 ■
60.30 x 8.08 x 12.75



83 **87.65**

| | | | | | | | |
|------------|--------|--------|-----------------|-----------------|--------|-------------|----------------|
| LAR | 1593cc | 4 Cyl. | 8 Valves | 51kW/69PS | Petrol | SOHC | TD11328 |
| LAT | 1593cc | 4 Cyl. | 8 Valves | 46-48kW/63-65PS | Petrol | SOHC | TD17086 |
| LCE | 1593cc | 4 Cyl. | 8 Valves | 53kW/72PS | Petrol | SOHC | TD1263 |
| LCJ | 1593cc | 4 Cyl. | 8 Valves | 53-63kW/72-86PS | Petrol | SOHC | TD1264 |
| LCN | 1593cc | 4 Cyl. | 8 Valves | 54kW/73PS | Petrol | SOHC | TD1266 |

| | | | | | | | |
|-----------------|-----------------|--|--|----------------|--|--|-----------------|
| CAPRI II 1.6 | 02/1974→12/1977 | | | CAPRI III 1.6 | | | 01/1978→04/1987 |
| CORTINA 1600 GT | 10/1970→03/1972 | | | TAUNUS '80 1.6 | | | 07/1979→07/1982 |
| TAUNUS 1.6 | 05/1975→07/1979 | | | TAUNUS '80 1.6 | | | 07/1979→07/1982 |
| TAUNUS 1600 | 01/1970→02/1976 | | | TRANSIT 1.6 | | | 09/1985→09/1992 |

V90152 ■
42.16 x 8.03 x 113.13

1595025

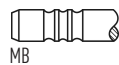

45°

H

V34509 ■
34.39 x 8.01 x 112.69

6018725

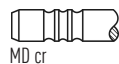

45°

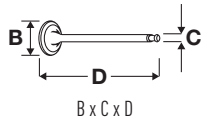

OE

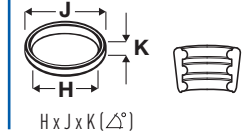
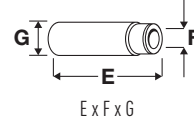

84 **89.90**

| | | | | | | | |
|-----------------|-----------------|--------|-----------|--------------------|-----------------|-----------------------|---------|
| D2FA | 2402cc | 4 Cyl. | 16 Valves | 66kW/90PS | Diesel | Duratorq, Turbo, DOHC | TD15549 |
| D2FB | 2402cc | 4 Cyl. | 16 Valves | 66kW/90PS | Diesel | Duratorq, Turbo, DOHC | TD20037 |
| D2FE | 2402cc | 4 Cyl. | 16 Valves | 66kW/90PS | Diesel | Duratorq, Turbo, DOHC | TD15552 |
| D4FA | 2402cc | 4 Cyl. | 16 Valves | 88kW/120PS | Diesel | Duratorq, Turbo, DOHC | TD15550 |
| DOFA (DT24) | 2402cc | 4 Cyl. | 16 Valves | 92kW/125PS | Diesel | Duratorq, Turbo, DOHC | TD20038 |
| F4FA | 2402cc | 4 Cyl. | 16 Valves | 55kW/75PS | Diesel | Duratorq, Turbo, DOHC | TD15548 |
| FXFA | 2402cc | 4 Cyl. | 16 Valves | 85kW/115PS | Diesel | Duratorq, Turbo, DOHC | TD18798 |
| H9FA | 2402cc | 4 Cyl. | 16 Valves | 101kW/137PS | Diesel | Duratorq, Turbo, DOHC | TD20036 |
| TRANSIT 2.4 DI | 01/2000→05/2006 | | | TRANSIT 2.4 DI RWD | 01/2000→05/2006 | | |
| TRANSIT 2.4 TD | 08/2000→08/2003 | | | TRANSIT 2.4 TDCi | 03/2004→05/2006 | | |
| TRANSIT 2.4 TDi | 10/2001→03/2006 | | | TRANSIT 2.4 TDE | 07/2001→05/2006 | | |

V94380
31.30 x 7.00 x 122.20

1305907



H

VAG96368
51.50 x 6.97 x 12.07



V94381
27.80 x 7.00 x 122.20

1305906



ss H

85 **89.90**

| | | | | | | | |
|------------------|----------|--------|-----------|----------------------|-----------------|-----------------------|---------|
| H9FB | 2402cc | 4 Cyl. | 16 Valves | 103kW/140PS | Diesel | Duratorq, Turbo, DOHC | TD20033 |
| H9FD | 2402cc | 4 Cyl. | 16 Valves | 103kW/140PS | Diesel | Duratorq, Turbo, DOHC | TD24457 |
| JXFA | 2402cc | 4 Cyl. | 16 Valves | 85kW/115PS | Diesel | Duratorq, Turbo, DOHC | TD20034 |
| JXFC | 2402cc | 4 Cyl. | 16 Valves | 85kW/115PS | Diesel | Duratorq, Turbo, DOHC | TD24456 |
| PHFA | 2402cc | 4 Cyl. | 16 Valves | 74kW/100PS | Diesel | Duratorq, Turbo, DOHC | TD20035 |
| PHFC | 2402cc | 4 Cyl. | 16 Valves | 74kW/100PS | Diesel | Duratorq, Turbo, DOHC | TD21068 |
| TRANSIT 2.4 TDCi | 04/2006→ | | | TRANSIT 2.4 TDCi RWD | 04/2006→08/2014 | | |

V94378
29.80 x 7.00 x 122.20

1217148

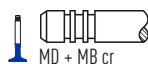

Y H

VAG96368
51.50 x 6.97 x 12.07



V95140
25.75 x 6.93 x 121.85

1706990



ss H

86 **89.90**

| | | | | | | | |
|----------------------|-----------------|--------|-----------|------------------|-----------------|-----------------------|---------|
| SAFA | 3198cc | 5 Cyl. | 20 Valves | 147kW/200PS | Diesel | Duratorq, Turbo, DOHC | TD21069 |
| SAFB | 3198cc | 5 Cyl. | 20 Valves | 147kW/200PS | Diesel | Duratorq, Turbo, DOHC | TD23369 |
| RANGER 3.2 TDCi | 04/2011→ | | | TRANSIT 3.2 TDCi | 02/2008→08/2014 | | |
| TRANSIT 3.2 TDCi RWD | 09/2007→08/2014 | | | | | | |

V94378
29.80 x 7.00 x 122.20

1217148

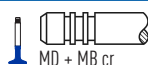

Y H

VAG96368
51.50 x 6.97 x 12.07



V95140
25.75 x 6.93 x 121.85

1706990



ss H



OE

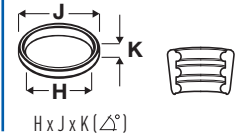
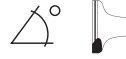

87



90.00

| MY | 1699cc | V4 Cyl. | 8 Valves | 51-55kW/69-75PS | Petrol | SOHC | TD4469 |
|-----------------------|---------------|-----------------|----------|-----------------|----------------------|----------------------|--------|
| GRANADA 1.7 | | 08/1977→07/1981 | | TAUNUS 17M 1.7 | | 07/1967→04/1974 | |
| V90178 ■ | 70HM 6507 DD | | 45° | H | VAG96004 ■ | | |
| 42.10 x 8.05 x 111.25 | | MB | | | 60.30 x 8.06 x 12.75 | | |
| V91292 ■ | 89SM-6507-AA | | 30° | Y | H | VAG96003 ■ | |
| 40.80 x 8.00 x 120.70 | | MB cr | | | | 60.30 x 8.08 x 12.75 | |
| V34499 ■ | 70HM 6505 D3C | | 45° | | | | |
| 36.20 x 8.02 x 110.55 | | MD cr | | | | | |
| V34501 ■ | 70HM 6505 EE | | 45° | | | | |
| 36.20 x 8.21 x 110.55 | | MD | | | | | |
| V35122 ■ | 78HM 6505 CA | | 45° | | | | |
| 36.19 x 8.00 x 111.25 | | MD cr | | | | | |

88



90.00

| MYE | 1699cc | V4 Cyl. | 8 Valves | 54kW/74PS | Petrol | SOHC | TD1317 |
|-----------------------|--------------|-----------------|----------|-----------|----------------------|------|--------|
| GRANADA 1.7 | | 08/1977→07/1981 | | | | | |
| V90178 ■ | 70HM 6507 DD | | 45° | H | VAG96004 ■ | | |
| 42.10 x 8.05 x 111.25 | | MB | | | 60.30 x 8.06 x 12.75 | | |
| V35122 ■ | 78HM 6505 CA | | 45° | | VAG96003 ■ | | |
| 36.19 x 8.00 x 111.25 | | MD cr | | | 60.30 x 8.08 x 12.75 | | |

89



90.80

| 4RC | 1993cc | 4 Cyl. | 8 Valves | 43-57kW/59-78PS | Petrol | TL20L, SOHC | TD9441 |
|-----------------------|---------------|-----------------|----------|-------------------|----------------------|-----------------|--------|
| NEK | 1993cc | 4 Cyl. | 8 Valves | 74-77kW/101-105PS | Petrol | SOHC | TD1356 |
| NEL | 1993cc | 4 Cyl. | 8 Valves | 77kW/105PS | Petrol | SOHC | TD1357 |
| NEP | 1993cc | 4 Cyl. | 8 Valves | 74-77kW/101-105PS | Petrol | SOHC | TD1359 |
| NER | 1993cc | 4 Cyl. | 8 Valves | 74kW/100PS | Petrol | SOHC | TD4474 |
| NET | 1993cc | 4 Cyl. | 8 Valves | 74-77kW/101-105PS | Petrol | SOHC | TD1362 |
| NRB | 1993cc | 4 Cyl. | 8 Valves | 85kW/115PS | Petrol | SOHC | TD1367 |
| NRC | 1993cc | 4 Cyl. | 8 Valves | 74kW/100PS | Petrol | SOHC | TD1368 |
| GRANADA 2.0 | | 08/1979→08/1985 | | SCORPIO I 2.0 | | 04/1985→08/1989 | |
| SCORPIO I 2.0 i | | 10/1985→12/1990 | | SIERRA 2.0 | | 08/1982→12/1986 | |
| SIERRA 2.0 i | | 03/1985→12/1986 | | TAUNUS '80 2.0 | | 07/1979→07/1982 | |
| TAUNUS '80 2.0 | | 07/1979→07/1982 | | TRANSIT 2.0 | | 11/1977→10/1986 | |
| V90178 ■ | 70HM 6507 DD | | 45° | H | VAG96004 ■ | | |
| 42.10 x 8.05 x 111.25 | | MB | | | 60.30 x 8.06 x 12.75 | | |
| V34499 ■ | 70HM 6505 D3C | | 45° | | VAG96003 ■ | | |
| 36.20 x 8.02 x 110.55 | | MD cr | | | 60.30 x 8.08 x 12.75 | | |
| V34501 ■ | 70HM 6505 EE | | 45° | | | | |
| 36.20 x 8.21 x 110.55 | | MD | | | | | |
| V35122 ■ | 78HM 6505 CA | | 45° | | | | |
| 36.19 x 8.00 x 111.25 | | MD cr | | | | | |



OE

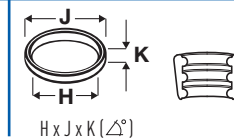
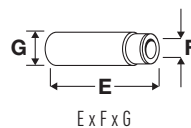

90  **90.80**

| | | | | | | | |
|-----------------|-----------------|--------|----------|------------------|--------|-----------------|--------|
| N4A | 1993cc | 4 Cyl. | 8 Valves | 85kW/115PS | Petrol | SOHC | TD1318 |
| N4B | 1993cc | 4 Cyl. | 8 Valves | 74kW/100PS | Petrol | SOHC | TD1319 |
| N4I | 1993cc | 4 Cyl. | 8 Valves | 85kW/115PS | Petrol | SOHC | TD1320 |
| N6T | 1993cc | 4 Cyl. | 8 Valves | 57kW/78PS | Petrol | SOHC | TD1327 |
| NAE | 1993cc | 4 Cyl. | 8 Valves | 57kW/78PS | Petrol | TL20L, SOHC | TD1342 |
| NAT | 1993cc | 4 Cyl. | 8 Valves | 57kW/78PS | Petrol | TL20L, SOHC | TD4472 |
| NAV | 1993cc | 4 Cyl. | 8 Valves | 55-57kW/75-78PS | Petrol | TL20L, SOHC | TD1344 |
| NBA | 1993cc | 4 Cyl. | 8 Valves | 66kW/90PS | Petrol | SOHC | TD1345 |
| NCA | 1993cc | 4 Cyl. | 8 Valves | 72kW/98PS | Petrol | SOHC | TD1346 |
| NE | 1993cc | 4 Cyl. | 8 Valves | 73-80kW/99-110PS | Petrol | SOHC | TD4473 |
| NE5 | 1993cc | 4 Cyl. | 8 Valves | 74kW/100PS | Petrol | SOHC | TD1351 |
| NEE | 1993cc | 4 Cyl. | 8 Valves | 72kW/98PS | Petrol | SOHC | TD1353 |
| NEG | 1993cc | 4 Cyl. | 8 Valves | 70-73kW/95-99PS | Petrol | SOHC | TD1354 |
| NEJ | 1993cc | 4 Cyl. | 8 Valves | 74kW/100PS | Petrol | SOHC | TD1355 |
| NEN | 1993cc | 4 Cyl. | 8 Valves | 73-74kW/99-101PS | Petrol | SOHC | TD1358 |
| NES | 1993cc | 4 Cyl. | 8 Valves | 77kW/105PS | Petrol | SOHC | TD1361 |
| NR2 | 1993cc | 4 Cyl. | 8 Valves | 85kW/115PS | Petrol | SOHC | TD1364 |
| NRA | 1993cc | 4 Cyl. | 8 Valves | 85kW/115PS | Petrol | SOHC | TD1365 |
| NRD | 1993cc | 4 Cyl. | 8 Valves | 74kW/100PS | Petrol | SOHC | TD1369 |
| NRI | 1993cc | 4 Cyl. | 8 Valves | 85kW/115PS | Petrol | SOHC | TD1370 |
| TL 20 H | 1993cc | 4 Cyl. | 8 Valves | 70-74kW/95-101PS | Petrol | SOHC | TD1391 |
| CAPRI II 2.0 | 04/1974→12/1977 | | | CAPRI III 2.0 | | 01/1978→12/1985 | |
| CONSUL 2000 | 01/1972→12/1975 | | | ESCORT II 2.0 RS | | 03/1973→08/1980 | |
| P 100 II 2.0 | 10/1987→12/1992 | | | SCORPIO I 1.9 | | 11/1992→09/1993 | |
| SCORPIO I 2.0 i | 04/1985→09/1994 | | | SIERRA 2.0 | | 03/1985→02/1993 | |
| SIERRA 2.0 i | 03/1985→02/1993 | | | SIERRA 2.0 i Cat | | 01/1987→02/1993 | |
| TAUNUS 2.0 | 08/1976→07/1979 | | | TAUNUS 2000 | | 08/1973→02/1976 | |
| TRANSIT 2.0 | 09/1985→09/1994 | | | TRANSIT 2.0 Cat | | 11/1985→09/1992 | |
| TRANSIT 2.0 i | 09/1991→07/1994 | | | | | | |

V90178  70HM 6507 DD
42.10 x 8.05 x 111.25

70HM 6507 DD



45°

H

VAG96004  60.30 x 8.06 x 12.75



V35122  78HM 6505 CA
36.19 x 8.00 x 111.25

78HM 6505 CA

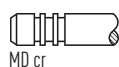





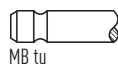

45°

VAG96003  60.30 x 8.08 x 12.75

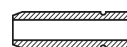

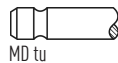
91  **91.10**

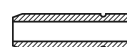



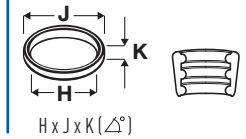
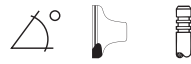

| | | | | | | | |
|---|------------|---|----------|-----------------|--|---|---------|
| 4 D 55 T | 2347cc | 4 Cyl. | 8 Valves | 62-70kW/84-95PS | Diesel | Turbo, SOHC | TD21262 |
| V94328  40.00 x 8.00 x 136.50 | MD-083 661 |  | 45° | H | VAG92322  71.00 x 8.00 x 13.13 |  | |
| V91239  34.16 x 7.96 x 136.50 | MD-083 662 |  | 45° | | VAG92323  74.00 x 8.00 x 13.13 |  | |







OE



92  **92.00**

| | | | | | | | |
|---|------------|---|-----------------|---|---|--------------------|---------------|
| VM | 2500cc | 4 Cyl. | 8 Valves | 92kW/125PS | Diesel | Turbo, SOHC | TD5496 |
| SCORPIO II 2.5 TD | | 09/1996→08/1998 | | | | | |
| V91437  | 605 07 189 |  | 35° | VAG96187  |  | | |
| 40.00 x 8.00 x 121.00 | | MD cr | | 55.00 x 8.02 x 14.06 | | | |
| V91438  | 605 07 190 |  | 45° | | | | |
| 34.00 x 8.00 x 121.00 | | MD cr | | | | | |

93  **93.00**

| | | | | | | | |
|---|--------------|---|------------------|------------------|--------|--------------------|----------------|
| WL-T | 2500cc | 4 Cyl. | 12 Valves | 62-80kW/84-109PS | Diesel | Turbo, SOHC | TD15891 |
| COURIER 2.5 TDdi | | 03/1998→09/2005 | | RANGER 2.5 TD | | 10/1999→06/2006 | |
| V98060  | WL51-12-111 |  | 45° | | | | |
| 32.70 x 7.00 x 111.90 | | MB tu | | | | | |
| V98061  | WL51-12-121A |  | 45° | | | | |
| 35.60 x 7.00 x 111.80 | | MD tu | | | | | |

94  **93.00**

| | | | | | | | |
|-----------------|-----------------|---------|------------------|---------------------|-----------------|------------------|---------------|
| PR5 | 2792cc | V6 Cyl. | 12 Valves | 107kW/145PS | Petrol | TV28, OHV | TD1404 |
| PR6 | 2792cc | V6 Cyl. | 12 Valves | 105-107kW/143-146PS | Petrol | TV28, OHV | TD1405 |
| PR7 | 2792cc | V6 Cyl. | 12 Valves | 107kW/146PS | Petrol | TV28, OHV | TD1406 |
| PR8 | 2792cc | V6 Cyl. | 12 Valves | 105-107kW/143-145PS | Petrol | TV28, OHV | TD1407 |
| PRB | 2792cc | V6 Cyl. | 12 Valves | 118kW/160PS | Petrol | TV28, OHV | TD4481 |
| PRC | 2792cc | V6 Cyl. | 12 Valves | 108-110kW/147-150PS | Petrol | TV28, OHV | TD1408 |
| PRD | 2792cc | V6 Cyl. | 12 Valves | 108-110kW/147-150PS | Petrol | TV28, OHV | TD1410 |
| PRE | 2792cc | V6 Cyl. | 12 Valves | 110kW/150PS | Petrol | TV28, OHV | TD1411 |
| PRG | 2792cc | V6 Cyl. | 12 Valves | 110kW/150PS | Petrol | TV28, OHV | TD1412 |
| PRN | 2792cc | V6 Cyl. | 12 Valves | 118kW/160PS | Petrol | TV28, OHV | TD4482 |
| PRT | 2792cc | V6 Cyl. | 12 Valves | 110kW/150PS | Petrol | TV28, OHV | TD1414 |
| PYA | 2792cc | V6 Cyl. | 12 Valves | 97-99kW/132-135PS | Petrol | TV28, OHV | TD1415 |
| PYU | 2792cc | V6 Cyl. | 12 Valves | 97-99kW/132-135PS | Petrol | TV28, OHV | TD1417 |
| CAPRI III 2.8 | 01/1981→04/1987 | | | GRANADA 2.8 | 08/1977→08/1985 | | |
| GRANADA 2.8 i | 08/1977→08/1985 | | | SCORPIO I 2.8 i | 04/1985→11/1986 | | |
| SIERRA 2.8 | 01/1987→09/1989 | | | SIERRA 2.8 i | 08/1982→02/1993 | | |
| SIERRA 2.8 i XR | 09/1983→02/1993 | | | SIERRA 2.8 XR | 02/1985→12/1986 | | |
| SIERRA 2.8 XR4i | 08/1982→12/1986 | | | | | | |

| | | | | | | | |
|---|--------------|---|-----|--|--|--|--|
| V35264  | 78TM 6505 AA |  | 45° | | | | |
| 36.10 x 8.01 x 105.70 | | MD cr | | | | | |



OE

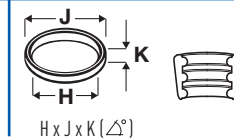
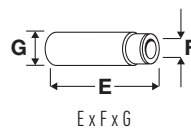

95  **93.67**

| | | | | | | | |
|------------------------|-----------------|--------|----------|------------------------|-----------------|------------|---------|
| 4AB | 2496cc | 4 Cyl. | 8 Valves | 50-52kW/68-71PS | Diesel | OHV | TD1113 |
| 4BA | 2496cc | 4 Cyl. | 8 Valves | 52kW/71PS | Diesel | OHV | TD1114 |
| 4BC | 2496cc | 4 Cyl. | 8 Valves | 52kW/70PS | Diesel | OHV | TD1115 |
| 4CA | 2496cc | 4 Cyl. | 8 Valves | 52kW/71PS | Diesel | OHV | TD1116 |
| 4CC | 2496cc | 4 Cyl. | 8 Valves | 52kW/70PS | Diesel | OHV | TD1117 |
| 4DA | 2496cc | 4 Cyl. | 8 Valves | 59kW/80PS | Diesel | OHV | TD1118 |
| 4EA | 2496cc | 4 Cyl. | 8 Valves | 74kW/100PS | Diesel | Turbo, OHV | TD1119 |
| 4EB | 2496cc | 4 Cyl. | 8 Valves | 74kW/101PS | Diesel | Turbo, OHV | TD4424 |
| 4EC | 2496cc | 4 Cyl. | 8 Valves | 74kW/101PS | Diesel | Turbo, OHV | TD15214 |
| 4ED | 2496cc | 4 Cyl. | 8 Valves | 85kW/116PS | Diesel | Turbo, OHV | TD12093 |
| 4FA | 2496cc | 4 Cyl. | 8 Valves | 51-52kW/69-70PS | Diesel | OHV | TD11120 |
| 4FB | 2496cc | 4 Cyl. | 8 Valves | 51kW/70PS | Diesel | OHV | TD4426 |
| 4FC | 2496cc | 4 Cyl. | 8 Valves | 51kW/70PS | Diesel | OHV | TD4428 |
| 4FD | 2496cc | 4 Cyl. | 8 Valves | 51kW/69PS | Diesel | OHV | TD15209 |
| 4GA | 2496cc | 4 Cyl. | 8 Valves | 63kW/85PS | Diesel | Turbo, OHV | TD4430 |
| 4GB | 2496cc | 4 Cyl. | 8 Valves | 63kW/85PS | Diesel | Turbo, OHV | TD4432 |
| 4GC | 2496cc | 4 Cyl. | 8 Valves | 63kW/85PS | Diesel | Turbo, OHV | TD4433 |
| 4GD | 2496cc | 4 Cyl. | 8 Valves | 63kW/86PS | Diesel | Turbo, OHV | TD15211 |
| 4GE | 2496cc | 4 Cyl. | 8 Valves | 63kW/86PS | Diesel | Turbo, OHV | TD15212 |
| 4GF | 2496cc | 4 Cyl. | 8 Valves | 63kW/85PS | Diesel | Turbo, OHV | TD15213 |
| 4HA | 2496cc | 4 Cyl. | 8 Valves | 55-56kW/75-76PS | Diesel | OHV | TD4434 |
| 4HB | 2496cc | 4 Cyl. | 8 Valves | 56kW/76PS | Diesel | OHV | TD4436 |
| 4HC | 2496cc | 4 Cyl. | 8 Valves | 56kW/76PS | Diesel | OHV | TD15210 |
| 4HD | 2496cc | 4 Cyl. | 8 Valves | 55kW/75PS | Diesel | Turbo, OHV | TD16250 |
| TRANSIT 2.5 D | 10/1983→09/1992 | | | TRANSIT 2.5 DI | 09/1988→03/2000 | | |
| TRANSIT 2.5 TD | 05/1991→07/2000 | | | TRANSIT 2.5 TDI | 06/1994→03/2000 | | |
| TRANSIT TOURNEO 2.4 D | 08/1994→06/2000 | | | TRANSIT TOURNEO 2.5 DI | 11/1994→12/2000 | | |
| TRANSIT TOURNEO 2.5 TD | 11/1994→12/2000 | | | | | | |

V91160 ■
42.05 x 8.96 x 124.51

6594645

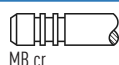

30°

H

VAG92221 ■ ■
56.50 x 9.00 x 14.76



V94033 ■
42.10 x 8.96 x 124.50

1050570

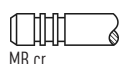

30°

H

V91161 ■
36.35 x 8.94 x 123.87
→06/97

894F 6505 A1B

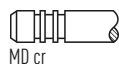

45°

V91221 ■
36.40 x 8.95 x 123.80
07/97→

6594643



45°

SS

H

96  **94.00**

| | | | | | | | |
|---------------------|-----------------|--------|----------|-----------|--------|--|--------|
| YTR (XD2/XD2P/XD94) | 2304cc | 4 Cyl. | 8 Valves | 49kW/67PS | Diesel | | TD1482 |
| YTT (XD2/XD2P/XD94) | 2304cc | 4 Cyl. | 8 Valves | 49kW/67PS | Diesel | | TD1483 |
| SIERRA 2.3 D | 08/1982→02/1993 | | | | | | |

V90351 ■
33.50 x 8.50 x 116.20

1576381

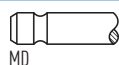

45°

VAG92179 ■ ■
55.50 x 8.53 x 14.06



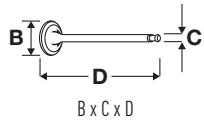

OE

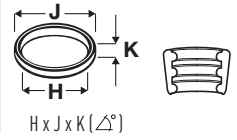
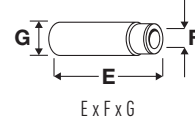
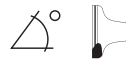

97 **94.00**

| | | | | | | | |
|------------------|-----------------|-----------------|----------|-----------------|--------|-------|--------|
| SFA (XD3T) | 2498cc | 4 Cyl. | 8 Valves | 68kW/92PS | Diesel | Turbo | TD4492 |
| SFB (XD3T) | 2498cc | 4 Cyl. | 8 Valves | 68kW/92PS | Diesel | Turbo | TD4493 |
| STP (XD3/XD3P) | 2498cc | 4 Cyl. | 8 Valves | 51kW/69PS | Diesel | OHV | TD1448 |
| STR (XD3/XD3P) | 2498cc | 4 Cyl. | 8 Valves | 51kW/69PS | Diesel | OHV | TD1449 |
| GRANADA 2.5 D | 08/1982→08/1985 | SCORPIO I 2.5 D | | 12/1985→12/1994 | | | |
| SCORPIO I 2.5 TD | 06/1988→07/1993 | | | | | | |

V91151
42.52 x 8.48 x 115.92

6152129

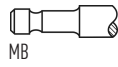

45°

H

VAG92179
55.50 x 8.53 x 14.06



V91152
35.48 x 8.47 x 116.30

83EM 6505 AB



45°

H

98 **96.00**

| | | | | | | | |
|-----------------|-----------------|---------------------|----------|-----------------|--------|------------|--------|
| TD27 | 2663cc | 4 Cyl. | 8 Valves | 74kW/100PS | Diesel | Turbo, OHV | TD4494 |
| MAVERICK 2.7 TD | 02/1993→08/1996 | MAVERICK VAN 2.7 TD | | 06/1996→04/1998 | | | |

V94352
38.00 x 8.00 x 117.00

1962501



45°

H

VAG92384
47.00 x 8.02 x 12.04



99 **104.78**

| | | | | | | | |
|----------------|-----------------|--------|-----------|-------------|--------|-------|---------|
| 110/6 AA-Dover | 5944cc | 6 Cyl. | 12 Valves | 81kW/110PS | Diesel | | TD22248 |
| 150/6 CA-Dover | 5944cc | 6 Cyl. | 12 Valves | 110kW/150PS | Diesel | Turbo | TD6957 |
| Cargo | 01/1982→01/1996 | | | | | | |

V90232
45.70 x 9.49 x 155.80

6093969

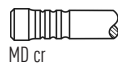

30°

VAG330
76.50 x 9.53 x 15.93



V90233
38.30 x 9.48 x 156.50

826F 6505 DAA

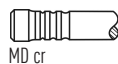

30°

100 **107.18**

| | | | | | | | |
|---------------|-----------------|--------|----------|-----------------|--------|--|--------|
| 90/5 AA-Dover | 4162cc | 4 Cyl. | 8 Valves | 63-66kW/86-90PS | Diesel | | TD6954 |
| Cargo | 01/1982→01/1996 | | | | | | |

V90232
45.70 x 9.49 x 155.80

6093969

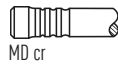

30°

VAG330
76.50 x 9.53 x 15.93



V90233
38.30 x 9.48 x 156.50

826F 6505 DAA

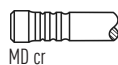

30°

101 **107.18**

| | | | | | | | |
|----------------|-----------------|--------|-----------|------------|--------|--|--------|
| 130/7 AA-Dover | 6223cc | 6 Cyl. | 12 Valves | 94kW/128PS | Diesel | | TD6956 |
| Cargo | 05/1981→01/1996 | | | | | | |

V90232
45.70 x 9.49 x 155.80

6093969

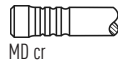

30°

VAG330
76.50 x 9.53 x 15.93







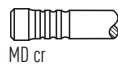

V90233
38.30 x 9.48 x 156.50

826F 6505 DAA





30°



|  |  | ccm |  |  |  |  |
|---|---|------|--|---|---|---|
| 20T2N (L Series) | 84.45 | 1994 | 4 | 8 | Diesel | 20 |
| 4EE-2 | 79.00 | 1686 | 4 | 16 | Diesel | 15 |
| B20B | 84.00 | 1972 | 4 | 16 | Petrol | 19 |
| C32A2 | 90.00 | 3206 | 6 | 24 | Petrol | 27 |
| C35A2 | 90.00 | 3474 | 6 | 24 | Petrol | 28 |
| D13B | 75.00 | 1343 | 4 | 16 | Petrol | 6 |
| D13B7 | 75.00 | 1343 | 4 | 8 | Petrol | 7 |
| D13C | 73.70 | 1296 | 4 | 8 | Petrol | 3 |
| D14A1 | 75.00 | 1396 | 4 | 16 | Petrol | 8 |
| D14A2 | 75.00 | 1396 | 4 | 16 | Petrol | 8 |
| D14A3 | 75.00 | 1396 | 4 | 16 | Petrol | 8 |
| D14A4 | 75.00 | 1396 | 4 | 16 | Petrol | 8 |
| D14A5 | 75.00 | 1396 | 4 | 16 | Petrol | 8 |
| D14A7 | 75.00 | 1396 | 4 | 16 | Petrol | 8 |
| D14A8 | 75.00 | 1396 | 4 | 16 | Petrol | 8 |
| D14Z4 | 75.00 | 1396 | 4 | 16 | Petrol | 9 |
| D14Z5 | 75.00 | 1396 | 4 | 16 | Petrol | 9 |
| D15B | 75.00 | 1493 | 4 | 16 | Petrol | 10 |
| D15B1 | 75.00 | 1493 | 4 | 16 | Petrol | 10 |
| D15B2 | 75.00 | 1493 | 4 | 16 | Petrol | 10 |
| D15Z1 | 75.00 | 1493 | 4 | 16 | Petrol | 10 |
| D16A | 75.00 | 1590 | 4 | 16 | Petrol | 11 |
| D16A7 | 75.00 | 1590 | 4 | 16 | Petrol | 12 |
| D16A8 | 75.00 | 1590 | 4 | 16 | Petrol | 11 |
| D16A9 | 75.00 | 1590 | 4 | 16 | Petrol | 11 |
| D16B2 | 75.00 | 1590 | 4 | 16 | Petrol | 12 |
| D16B6 | 75.00 | 1590 | 4 | 16 | Petrol | 13 |
| D16W1 | 75.00 | 1590 | 4 | 16 | Petrol | 13 |
| D16W5 | 75.00 | 1590 | 4 | 16 | Petrol | 13 |
| D16Y5 | 75.00 | 1590 | 4 | 16 | Petrol | 13 |
| D16Z2 | 75.00 | 1590 | 4 | 16 | Petrol | 12 |
| D16Z5 | 75.00 | 1590 | 4 | 16 | Petrol | 12 |
| D16Z9 | 75.00 | 1590 | 4 | 16 | Petrol | 13 |
| D17A2 | 75.00 | 1668 | 4 | 16 | Petrol | 14 |
| EV2 | 74.00 | 1342 | 4 | 12 | Petrol | 4 |
| EW | 81.00 | 1595 | 4 | 8 | Petrol | 17 |
| EW3 | 74.00 | 1488 | 4 | 12 | Petrol | 5 |
| EW4 | 74.00 | 1488 | 4 | 12 | Petrol | 5 |
| F18A3 | 85.00 | 1850 | 4 | 16 | Petrol | 21 |
| F18B2 | 85.00 | 1850 | 4 | 16 | Petrol | 22 |
| F20B2 | 85.00 | 1997 | 4 | 16 | Petrol | 23 |
| F20B3 | 85.00 | 1997 | 4 | 16 | Petrol | 24 |
| F20B5 | 85.00 | 1997 | 4 | 16 | Petrol | 23 |
| F20B6 | 85.00 | 1997 | 4 | 16 | Petrol | 23 |
| F20Z1 | 85.00 | 1997 | 4 | 16 | Petrol | 23 |
| K24A4 | 87.00 | 2354 | 4 | 16 | Petrol | 26 |
| L12A1 | 73.00 | 1243 | 4 | 8 | Petrol | 1 |
| L13A1 | 73.00 | 1339 | 4 | 8 | Petrol | 2 |
| N22A1 | 85.00 | 2204 | 4 | 16 | Diesel | 25 |
| N22A2 | 85.00 | 2204 | 4 | 16 | Diesel | 25 |
| R18A1 | 81.00 | 1799 | 4 | 16 | Petrol | 18 |
| R18A2 | 81.00 | 1799 | 4 | 16 | Petrol | 18 |
| XUD7T | 80.00 | 1769 | 4 | 8 | Diesel | 16 |
| ZC1 | 75.00 | 1590 | 4 | 16 | Petrol | 12 |

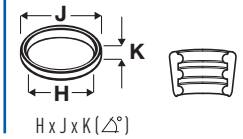



OE

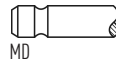

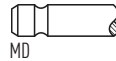

1  **73.00**

| | | | | | | | |
|---|---------------|---|-----------------|---|--------|-----------------|----------------|
| L12A1 | 1243cc | 4 Cyl. | 8 Valves | 57kW/78PS | Petrol | | TD18261 |
| CIVIC VII 1.2 i-DSI | | 04/2001→10/2004 | | JAZZ II 1.2 i-DSI | | 03/2002→07/2008 | |
| V91731  | 14721-PM3-000 |  | 45° | VAG92397  | | | |
| 25.10 x 5.46 x 118.80 | | MD | | 47.50 x 5.53 x 11.06 | | | |

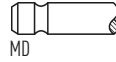

2  **73.00**

| | | | | | | | |
|---|---------------|---|-----------------|---|--------|-----------------|----------------|
| L13A1 | 1339cc | 4 Cyl. | 8 Valves | 59-63kW/80-86PS | Petrol | SOHC | TD18259 |
| CITY 1.3 i-DSI | | 11/2002→07/2008 | | CITY 1.3 SES | | 05/2003→07/2008 | |
| JAZZ 1.3 | | 05/2003→07/2008 | | JAZZ II 1.3 | | 03/2002→07/2008 | |
| JAZZ II 1.3 iDSi | | 03/2002→09/2007 | | JAZZ II 1.4 | | 12/2006→10/2008 | |
| V91731  | 14721-PM3-000 |  | 45° | VAG92397  | | | |
| 25.10 x 5.46 x 118.80 | | MD | | 47.50 x 5.53 x 11.06 | | | |

3  **73.70**

| | | | | | | | |
|---|---------------|---|-----------------|---|--------|-------------|---------------|
| D13C | 1296cc | 4 Cyl. | 8 Valves | 60kW/82PS | Petrol | SOHC | TD1540 |
| V91731  | 14721-PM3-000 |  | 45° | VAG92397  | | | |
| 25.10 x 5.46 x 118.80 | | MD | | 47.50 x 5.53 x 11.06 | | | |

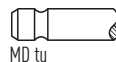
4  **74.00**

| | | | | | | | |
|---|---------------|---|------------------|---|--------|-----------------|---------------|
| EV2 | 1342cc | 4 Cyl. | 12 Valves | 52kW/71PS | Petrol | SOHC | TD4538 |
| CIVIC I 1.3 | | 08/1983→12/1987 | | CIVIC III 1.3 | | 10/1983→10/1987 | |
| CRX I 1.3 | | 10/1983→10/1987 | | | | | |
| V90935  | 14721-PE0-000 |  | 45° | VAG92210  | | | |
| 32.00 x 6.56 x 113.75 | | MD tu | | 55.00 x 6.52 x 12.09 | | | |

5  **74.00**

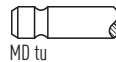
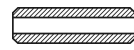
| | | | | | | | |
|---|---------------|---|------------------|---|--------|-----------------|---------------|
| EW3 | 1488cc | 4 Cyl. | 12 Valves | 74kW/101PS | Petrol | SOHC | TD4540 |
| EW4 | 1488cc | 4 Cyl. | 12 Valves | 66-69kW/90-94PS | Petrol | SOHC | TD1589 |
| CIVIC III 1.5 | | 01/1984→10/1987 | | CIVIC III 1.5 GT | | 01/1985→10/1987 | |
| CIVIC III 1.5 GTI | | 03/1986→10/1987 | | CIVIC IV 1.5 | | 01/1988→08/1988 | |
| CRX I 1.5 i | | 10/1983→11/1986 | | | | | |
| V90935  | 14721-PE0-000 |  | 45° | VAG92210  | | | |
| 32.00 x 6.56 x 113.75 | | MD tu | | 55.00 x 6.52 x 12.09 | | | |

6  **75.00**

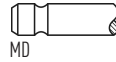
| | | | | | | | |
|---|---------------|---|------------------|---|--------|-------------|---------------|
| D13B | 1343cc | 4 Cyl. | 16 Valves | 66kW/90PS | Petrol | SOHC | TD4509 |
| V91731  | 14721-PM3-000 |  | 45° | VAG92397  | | | |
| 25.10 x 5.46 x 118.80 | | MD | | 47.50 x 5.53 x 11.06 | | | |

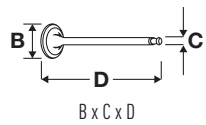

OE

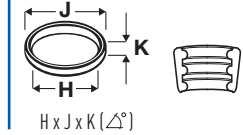
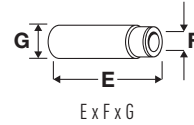
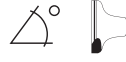

7



75.00

| | | | | | | | |
|----------|-----------------|--------|----------|-----------|--------|------|---------|
| D13B7 | 1343cc | 4 Cyl. | 8 Valves | 48kW/65PS | Petrol | SOHC | TD13188 |
| LOGO 1.3 | 03/1999→03/2002 | | | | | | |

V94099 ■
30.00 x 5.50 x 118.60

LGH101310

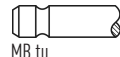

45°

VAG92397 ■
47.50 x 5.53 x 11.06

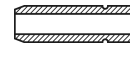

V94100 ■
26.00 x 5.50 x 116.00

LGH101330

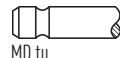

45°

8



75.00

| | | | | | | | |
|-------|--------|--------|-----------|-----------------|--------|------|--------|
| D14A1 | 1396cc | 4 Cyl. | 16 Valves | 61-66kW/83-90PS | Petrol | SOHC | TD1544 |
| D14A2 | 1396cc | 4 Cyl. | 16 Valves | 66kW/90PS | Petrol | SOHC | TD4511 |
| D14A3 | 1396cc | 4 Cyl. | 16 Valves | 55kW/75PS | Petrol | SOHC | TD4512 |
| D14A4 | 1396cc | 4 Cyl. | 16 Valves | 55-66kW/75-90PS | Petrol | SOHC | TD4513 |
| D14A5 | 1396cc | 4 Cyl. | 16 Valves | 55kW/75PS | Petrol | SOHC | TD1543 |
| D14A7 | 1396cc | 4 Cyl. | 16 Valves | 55kW/75PS | Petrol | SOHC | TD9807 |
| D14A8 | 1396cc | 4 Cyl. | 16 Valves | 66kW/90PS | Petrol | SOHC | TD9808 |

CIVIC II 1.4 i 16V
CIVIC VI 1.4
CIVIC VI 1.4 i
CONCERTO 1.4

01/1988→12/1992
11/1995→10/1998
06/1995→02/2001
08/1989→10/1992

CIVIC IV 1.4 L
CIVIC VI 1.4 16V
CIVIC VI 1.4 i S
CRX II 1.4 GL

10/1987→12/1989
04/1998→02/2001
11/1995→02/2001
01/1990→12/1991

V91731 ■
25.10 x 5.46 x 118.80

14721-PM3-000

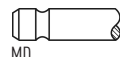

45°

VAG92397 ■
47.50 x 5.53 x 11.06



9



75.00

| | | | | | | | |
|--|---|--------|-----------|-----------|--------|------|---------|
| D14Z4 | 1396cc | 4 Cyl. | 16 Valves | 66kW/90PS | Petrol | SOHC | TD18858 |
| D14Z5 | 1396cc | 4 Cyl. | 16 Valves | 66kW/90PS | Petrol | SOHC | TD18255 |
| CIVIC VI 1.4 i CIVIC VI 1.4 LPG CIVIC VII 1.4 iS | 06/1995→02/2001 01/1997→02/2001 02/2001→09/2005 | | | | | | |
| CIVIC VI 1.4 i S CIVIC VII 1.4 | 11/1995→02/2001 12/2000→09/2005 | | | | | | |

V94099 ■
30.00 x 5.50 x 118.60

LGH101310

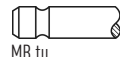

45°

VAG92397 ■
47.50 x 5.53 x 11.06

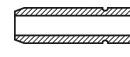

V95094 ■
26.00 x 5.46 x 115.95

14721-P08000

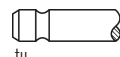

45°

H

10



75.00

| | | | | | | | |
|-------|--------|--------|-----------|------------------|--------|-----------------|---------|
| D15B | 1493cc | 4 Cyl. | 16 Valves | 66-96kW/90-131PS | Petrol | SOHC | TD4514 |
| D15B1 | 1493cc | 4 Cyl. | 16 Valves | 52-60kW/71-82PS | Petrol | SOHC | TD18859 |
| D15B2 | 1493cc | 4 Cyl. | 16 Valves | 61-74kW/83-101PS | Petrol | SOHC, Injection | TD4516 |
| D15Z1 | 1493cc | 4 Cyl. | 16 Valves | 66-88kW/90-120PS | Petrol | SOHC | TD1551 |

CAPA 1.5
CITY 1.5
CIVIC IV 1.5
CIVIC V 1.5
CIVIC VI 1.5 i
CRX II 1.5
ORTHIA / PARTNER 1.5

01/1998→09/2002
12/1999→09/2003
01/1988→12/1989
10/1991→12/1995
10/1995→03/2001
10/1987→12/1991
10/1995→09/2002

CAPA 1.5 16V
CIVIC II 1.5 i 16V
CIVIC IV 1.5 i 16V
CIVIC V 1.5 i 16V
CONCERTO 1.5 i 16V
INTEGRA 1.5

04/1998→09/2002
01/1988→11/1991
09/1987→10/1993
10/1991→11/1995
08/1989→05/1995
09/1995→08/1999

V91731 ■
25.10 x 5.46 x 118.80

14721-PM3-000

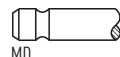

45°

VAG92397 ■
47.50 x 5.53 x 11.06

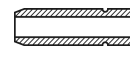



OE

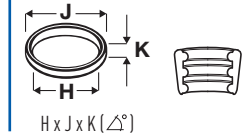
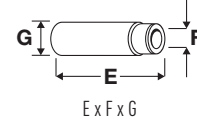

11 **75.00**

| | | | | | | |
|----------------------|--------|-----------------|------------------|--------------------|--------|-----------------|
| D16A | 1590cc | 4 Cyl. | 16 Valves | 79-91kW/107-124PS | Petrol | TD17638 |
| D16A8 | 1590cc | 4 Cyl. | 16 Valves | 90-96kW/122-131PS | Petrol | TD1552 |
| D16A9 | 1590cc | 4 Cyl. | 16 Valves | 96kW/131PS | Petrol | TD1553 |
| CIVIC II 1.6 | | 01/1988→12/1992 | | CIVIC IV 1.6 i 16V | | 09/1987→09/1991 |
| CIVIC V 1.6 | | 10/1991→09/1995 | | CIVIC V 1.6 si 16V | | 10/1991→10/1993 |
| CONCERTO 1.6 | | 10/1989→10/1992 | | CONCERTO 1.6 i 16V | | 08/1989→03/1995 |
| CRX II 1.6 i 16V | | 10/1987→12/1991 | | DOMANI 1.6 | | 10/1995→09/1999 |
| ORTHIA / PARTNER 1.6 | | 10/1995→09/1996 | | | | |

V91733 14721-PG6-000 45°
27.10 x 6.56 x 104.60

12 **75.00**

| | | | | | | |
|--------------------|--------|-----------------|------------------|-------------------|--------|-----------------|
| D16A7 | 1590cc | 4 Cyl. | 16 Valves | 85-96kW/115-131PS | Petrol | TD1558 |
| D16B2 | 1590cc | 4 Cyl. | 16 Valves | 85kW/116PS | Petrol | TD9810 |
| D16Z2 | 1590cc | 4 Cyl. | 16 Valves | 78-82kW/106-112PS | Petrol | TD1561 |
| D16Z5 | 1590cc | 4 Cyl. | 16 Valves | 91kW/124PS | Petrol | TD4524 |
| ZC1 | 1590cc | 4 Cyl. | 16 Valves | 88-92kW/120-125PS | Petrol | TD4556 |
| CIVIC II 1.6 | | 01/1988→12/1992 | | CIVIC IV 1.6 | | 01/1988→12/1989 |
| CIVIC IV 1.6 i 16V | | 09/1987→12/1991 | | CIVIC V 1.6 | | 10/1991→09/1995 |
| CIVIC V 1.6 EX | | 08/1993→10/1995 | | CIVIC VI 1.6 | | 10/1995→09/2000 |
| CIVIC VI 1.6 16V | | 01/1997→02/2001 | | CONCERTO 1.6 16V | | 08/1989→03/1995 |
| CONCERTO 1.6 i 16V | | 08/1989→03/1995 | | CRX I 1.6 i 16V | | 03/1986→10/1987 |
| CRX II 1.6 i 16V | | 10/1987→02/1992 | | DOMANI 1.6 | | 10/1992→12/1997 |
| INTEGRA 1.6 | | 09/1993→08/2001 | | | | |

V91731 14721-PM3-000 45°
25.10 x 5.46 x 118.80

VAG92397
47.50 x 5.53 x 11.06

13 **75.00**

| | | | | | | | |
|--------------------|--------|-----------------|------------------|-------------------|--------|-----------------|----------------|
| D16B6 | 1590cc | 4 Cyl. | 16 Valves | 85kW/116PS | Petrol | SOHC | TD14254 |
| D16W1 | 1590cc | 4 Cyl. | 16 Valves | 77kW/105PS | Petrol | SOHC | TD14248 |
| D16W5 | 1590cc | 4 Cyl. | 16 Valves | 91kW/124PS | Petrol | SOHC | TD18262 |
| D16Y5 | 1590cc | 4 Cyl. | 16 Valves | 84-86kW/114-117PS | Petrol | SOHC | TD14488 |
| D16Z9 | 1590cc | 4 Cyl. | 16 Valves | 92kW/125PS | Petrol | SOHC | TD1565 |
| ACCORD VI 1.6 | | 12/1999→12/2002 | | ACCORD VI 1.6 i | | 10/1998→12/2002 | |
| CIVIC V 1.6 i Vtec | | 01/1994→03/1996 | | CIVIC VI 1.6 | | 09/1997→12/1999 | |
| CIVIC VI 1.6 i | | 11/1995→02/2001 | | HR-V 1.6 16V | | 03/1999→ | |
| TORNED 1.6 | | 10/1999→09/2002 | | | | | |

V94099 LGH101310 45°
30.00 x 5.50 x 118.60

VAG92397
47.50 x 5.53 x 11.06

14 **75.00**

| | | | | | | | |
|----------------|--------|-----------------|------------------|-------------------|--------|-----------------|----------------|
| D17A2 | 1668cc | 4 Cyl. | 16 Valves | 92-95kW/125-129PS | Petrol | SOHC | TD18253 |
| CIVIC VII 1.7 | | 09/2001→12/2005 | | FR-V 1.7 | | 08/2004→ | |
| FR-V 1.7 Vtec | | 08/2004→09/2006 | | JAZZ II 1.7 | | 10/2003→09/2007 | |
| STREAM 1.7 16V | | 05/2001→ | | | | | |

V94099 LGH101310 45°
30.00 x 5.50 x 118.60

VAG92397
47.50 x 5.53 x 11.06

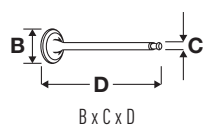

OE

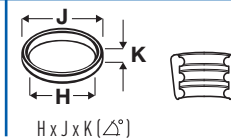
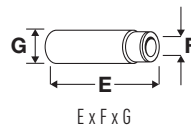

15 79.00

| | | | | | | | |
|-------|--------|--------|-----------|------------|--------|-------------|---------|
| 4EE-2 | 1686cc | 4 Cyl. | 16 Valves | 74kW/101PS | Diesel | Turbo, SOHC | TD18735 |
|-------|--------|--------|-----------|------------|--------|-------------|---------|

CIVIC VII 1.7 CTDi 01/2002→09/2005

| | | | | | | | |
|----------------------|----------|-------|-----|----|----------------------|--|--|
| V94426 | 97185860 | | 45° | | VAG96291 | | |
| 27.50 x 6.00 x 98.40 | | MD tu | | | 42.00 x 6.00 x 11.05 | | |
| V94427 | 97358650 | | 45° | SS | | | |
| 26.50 x 6.00 x 98.10 | | MD tu | | | | | |

16 80.00

| | | | | | | | |
|-------|--------|--------|----------|-----------------|--------|-------------|---------|
| XUD7T | 1769cc | 4 Cyl. | 8 Valves | 58-65kW/79-88PS | Diesel | Turbo, SOHC | TD18393 |
|-------|--------|--------|----------|-----------------|--------|-------------|---------|

CITY 1.8 D 02/1997→11/1999

| | | | | | | | |
|-----------------------|---------|-------|-----|---|----------------------|--|--|
| V91144 | 0948.63 | | 45° | H | VAG92288B | | |
| 38.50 x 8.00 x 112.50 | | MB | | | 52.00 x 8.03 x 14.28 | | |
| V91145 | 0949.47 | | 45° | | | | |
| 33.00 x 8.00 x 112.00 | | MD cr | | | | | |
| V94024 | 0949.64 | | 45° | | | | |
| 33.00 x 8.00 x 112.00 | | MD | | | | | |

17 81.00

| | | | | | | | |
|----|--------|--------|----------|------------|--------|------|--------|
| EW | 1595cc | 4 Cyl. | 8 Valves | 88kW/120PS | Petrol | SOHC | TD1588 |
|----|--------|--------|----------|------------|--------|------|--------|

| | | | | | | | |
|----------------------|--------------|---------|-----|----|----------------------|--|--|
| V91338 | 035 109 601K | | 45° | | VAG92061B | | |
| 38.10 x 7.97 x 91.90 | | MD | | | 36.70 x 8.00 x 12.08 | | |
| V91030 | 035 109 611F | | 45° | SS | VAG92105B | | |
| 33.30 x 7.95 x 98.60 | | MD + MB | | H | 42.30 x 7.99 x 12.08 | | |
| V91340 | 048 109 611A | | 45° | H | | | |
| 33.30 x 7.95 x 91.20 | | MD + MB | | | | | |

18 81.00

| | | | | | | | |
|-------|--------|--------|-----------|--------------------|--------|--------------|---------|
| R18A1 | 1799cc | 4 Cyl. | 16 Valves | 97-104kW/132-141PS | Petrol | i-VTEC, SOHC | TD19281 |
| R18A2 | 1799cc | 4 Cyl. | 16 Valves | 103kW/140PS | Petrol | i-VTEC, SOHC | TD20326 |

| | | | |
|--------------------|-----------------|----------------------|-----------------|
| CIVIC 1.8 | 09/2005→12/2011 | CIVIC VIII 1.8 | 09/2005→ |
| CIVIC VIII 1.8 EXS | 11/2006→ | CIVIC IX 1.8 | 09/2011→ |
| CIVIC IX 1.8 LXS | 01/2012→ | CROSSROAD 1.8 i-VTEC | 02/2007→08/2010 |
| FR-V 1.8 | 01/2007→ | HR-V 1.8 i-VTEC | 06/2015→ |
| STREAM 1.8 Vtec | 10/2005→ | | |

| | | | | | | | |
|-----------------------|---------------|-------|-----|---|----------------------|--|--|
| V95200 | 14711-RNA-000 | | 45° | H | VAG92397 | | |
| 32.00 x 5.49 x 116.70 | | MB tu | | | 47.50 x 5.53 x 11.06 | | |
| V95094 | 14721-P08000 | | 45° | H | | | |
| 26.00 x 5.46 x 115.95 | | tu | | | | | |



OE

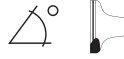

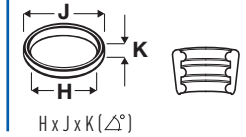

E x F x G





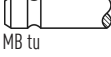

H x J x K (L)

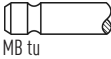

19  **84.00**

| | | | | | | | |
|---|-----------------|---|------------------|----------------------|--------|-----------------|---------------|
| B20B | 1972cc | 4 Cyl. | 16 Valves | 92-107kW/125-146PS | Petrol | DOHC | TD9398 |
| CR-V I 2.0 16V | 10/1995→12/2001 | | | ORTHIA / PARTNER 2.0 | | 10/1995→09/2001 | |
| SMX 2.0 | 01/1996→12/2001 | | | STEPWGN 2.0 | | 05/1996→09/2000 | |
| V94093  | 14711-P75-A00 |  | 45° | H | | | |
| 31.00 x 6.55 x 105.55 | | MB | | | | | |
| V94094  | 14721-P75-A00 |  | 45° | | | | |
| 28.00 x 6.55 x 106.00 | | MB tu | | | | | |



20  **84.45**

| | | | | | | | |
|--|-----------------|--|-----------------|-------------------|---|--------------------|---------------|
| 20T2N (L Series) | 1994cc | 4 Cyl. | 8 Valves | 74-77kW/101-105PS | Diesel | Turbo, SOHC | TD5390 |
| ACCORD V 2.0 TDi | 04/1996→10/1998 | | | ACCORD VI 2.0 TDi | | 12/1999→10/2000 | |
| ACCORD VI 2.0 Turbo DI | 02/1999→12/2002 | | | CIVIC VI 2.0 i D | | 04/1998→02/2001 | |
| CIVIC VI 2.0 TDiC | 11/1998→10/2000 | | | | | | |
| V94018  | LGH100990 |  | 45° | | VAG92511  | | |
| 37.20 x 6.92 x 87.00 | | MB tu | | | 28.30 x 6.96 x 12.05 | | |
| V94019  | LGH100980 |  | 45° | | | | |
| 32.60 x 6.91 x 87.00 | | MD tu | | | | | |

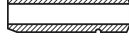
21  **85.00**

| | | | | | | | |
|---|-----------------|---|------------------|------------|---|-------------|---------------|
| F18A3 | 1850cc | 4 Cyl. | 16 Valves | 85kW/116PS | Petrol | SOHC | TD4542 |
| ACCORD V 1.9 i | 02/1996→10/1998 | | | | | | |
| V94096  | 14721-PT6-A00 |  | 45° | | VAG92397  | | |
| 29.00 x 5.50 x 123.40 | | MD tu | | | 47.50 x 5.53 x 11.06 | | |

22  **85.00**

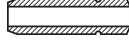
| | | | | | | | |
|---|-----------------|---|------------------|-------------|---|-------------|----------------|
| F18B2 | 1850cc | 4 Cyl. | 16 Valves | 100kW/136PS | Petrol | SOHC | TD14251 |
| ACCORD VI 1.8 i | 10/1998→12/2002 | | | | | | |
| V91731  | 14721-PM3-000 |  | 45° | | VAG92397  | | |
| 25.10 x 5.46 x 118.80 | | MD | | | 47.50 x 5.53 x 11.06 | | |

23  **85.00**

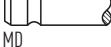
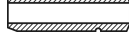
| | | | | | | | |
|---|-----------------|---|------------------|------------------|---|-----------------|----------------|
| F20B2 | 1997cc | 4 Cyl. | 16 Valves | 110kW/150PS | Petrol | SOHC | TD20677 |
| F20B5 | 1997cc | 4 Cyl. | 16 Valves | 108kW/147PS | Petrol | SOHC | TD14249 |
| F20B6 | 1997cc | 4 Cyl. | 16 Valves | 108kW/147PS | Petrol | SOHC | TD14252 |
| F20Z1 | 1997cc | 4 Cyl. | 16 Valves | 96kW/131PS | Petrol | SOHC | TD4545 |
| ACCORD V 2.0 i LS | 02/1996→10/1998 | | | ACCORD V 2.0 i S | | 03/1993→01/1996 | |
| ACCORD VI 2.0 | 12/1999→12/2002 | | | ACCORD VI 2.0 i | | 10/1998→01/2001 | |
| ACCORD VI 2.0 i 16V | 02/1998→06/2003 | | | | | | |
| V91731  | 14721-PM3-000 |  | 45° | | VAG92397  | | |
| 25.10 x 5.46 x 118.80 | | MD | | | 47.50 x 5.53 x 11.06 | | |



OE

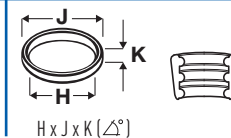
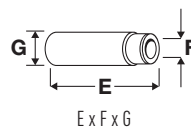
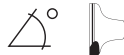

24 85.00

| | | | | | | | |
|-----------------------|-----------------|--------|------------------|--------------------|--------|-----------------|---------------|
| F20B3 | 1997cc | 4 Cyl. | 16 Valves | 98-100kW/133-136PS | Petrol | SOHC | TD4544 |
| ACCORD V 2.0 | 09/1993→12/1997 | | | ACCORD V 2.0 i | | 04/1993→06/1997 | |
| ACCORD V 2.0 i LS 16V | 09/1993→02/1998 | | | CIVIC VI 2.0 | | 06/1995→10/1999 | |

V94096
29.00 x 5.50 x 123.40

14721-PT6-A00

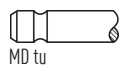

45°

VAG92397
47.50 x 5.53 x 11.06



25 85.00

| | | | | | | | |
|-----------------------|-----------------|--------|------------------|---------------------|--------|--------------------|----------------|
| N22A1 | 2204cc | 4 Cyl. | 16 Valves | 103kW/140PS | Diesel | Turbo, DOHC | TD18260 |
| N22A2 | 2204cc | 4 Cyl. | 16 Valves | 103kW/140PS | Diesel | Turbo, DOHC | TD20327 |
| ACCORD VII 2.2 i-CTDi | 01/2004→05/2008 | | | CIVIC VIII 2.2 CTDi | | 09/2005→ | |
| CR-V II 2.2 CTDi | 02/2005→09/2006 | | | CR-V III 2.2 i-CTDi | | 01/2007→ | |
| FR-V 2.2 i CTDi | 07/2005→ | | | | | | |

V95065
28.00 x 5.49 x 100.70

14711-RBD-E00

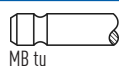

45°

H

V95066
26.00 x 5.46 x 100.35

14721-RBD-E00

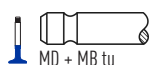

45°

H

26 87.00

| | | | | | | | |
|-----------------------|-----------------|--------|------------------|---------------------|--------|-----------------|----------------|
| K24A4 | 2354cc | 4 Cyl. | 16 Valves | 116-140kW/158-190PS | Petrol | DOHC | TD19248 |
| ACCORD 2.4 | 07/2003→03/2006 | | | ACCORD VII 2.4 Vtec | | 01/2003→12/2005 | |
| ACCORD VII 2.4 Vtec E | 09/2002→01/2008 | | | ELEMENT 2.4 | | 07/2002→12/2006 | |
| ODYSSEY 2.4 | 10/2005→ | | | | | | |

V95200
32.00 x 5.49 x 116.70

14711-RNA-000

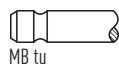

45°

H

VAG92397
47.50 x 5.53 x 11.06



V95094
26.00 x 5.46 x 115.95

14721-P08000

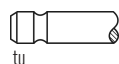

45°

H

27 90.00

| | | | | | | | |
|-----------------|-----------------|---------|------------------|-------------|--------|-------------|---------------|
| C32A2 | 3206cc | V6 Cyl. | 24 Valves | 151kW/205PS | Petrol | SOHC | TD4508 |
| LEGEND II 3.2 i | 01/1991→02/1996 | | | | | | |

V91731
25.10 x 5.46 x 118.80

14721-PM3-000

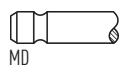

45°

VAG92397
47.50 x 5.53 x 11.06



28 90.00

| | | | | | | | |
|------------------|-----------------|---------|------------------|---------------------|--------|-------------|---------------|
| C35A2 | 3474cc | V6 Cyl. | 24 Valves | 151-153kW/205-208PS | Petrol | SOHC | TD5394 |
| LEGEND III 3.5 i | 02/1996→09/2004 | | | | | | |

V91731
25.10 x 5.46 x 118.80



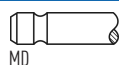



14721-PM3-000

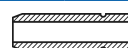

45°

VAG92397
47.50 x 5.53 x 11.06



|  |  | ccm |  |  |  |  |
|---|---|------|---|---|---|---|
| 4D56T | 91.10 | 2477 | 4 | 8 | Diesel | 30 |
| 4G61 | 82.30 | 1599 | 4 | 16 | Petrol | 18 |
| D3EA | 83.00 | 1493 | 3 | 12 | Diesel | 19 |
| D3FA | 75.00 | 1120 | 3 | 12 | Diesel | 6 |
| D4BA | 91.10 | 2477 | 4 | 8 | Diesel | 30 |
| D4BB | 91.10 | 2607 | 4 | 8 | Diesel | 31 |
| D4BF | 91.10 | 2476 | 4 | 8 | Diesel | 28 |
| D4BH | 91.10 | 2476 | 4 | 8 | Diesel | 29 |
| D4BX | 91.10 | 2477 | 4 | 8 | Diesel | 30 |
| D4CB | 91.00 | 2497 | 4 | 16 | Diesel | 27 |
| D4EA | 83.00 | 1991 | 4 | 16 | Diesel | 21 |
| D4EA-F | 83.00 | 1991 | 4 | 16 | Diesel | 21 |
| D4EA-V | 83.00 | 1991 | 4 | 16 | Diesel | 21 |
| D4EB | 87.00 | 2188 | 4 | 16 | Diesel | 25 |
| D4FA | 75.00 | 1493 | 4 | 16 | Diesel | 8 |
| D4FB | 77.20 | 1582 | 4 | 16 | Diesel | 14 |
| D4FC | 75.00 | 1396 | 4 | 16 | Diesel | 7 |
| D4FD | 77.20 | 1685 | 4 | 16 | Diesel | 15 |
| DJY | 83.00 | 1905 | 4 | 8 | Diesel | 20 |
| G13B | 71.00 | 1299 | 4 | 8 | Petrol | 4 |
| G15B | 75.50 | 1468 | 4 | 8 | Petrol | 9 |
| G4CS | 86.50 | 2351 | 4 | 8 | Petrol | 22 |
| G4DJ | 75.50 | 1468 | 4 | 8 | Petrol | 9 |
| G4EA | 71.50 | 1341 | 4 | 12 | Petrol | 5 |
| G4EB | 75.50 | 1495 | 4 | 12 | Petrol | 10 |
| G4ED | 76.50 | 1599 | 4 | 16 | Petrol | 11 |
| G4ED-G | 76.50 | 1599 | 4 | 16 | Petrol | 11 |
| G4EH | 71.50 | 1341 | 4 | 12 | Petrol | 5 |
| G4EK | 75.50 | 1495 | 4 | 12 | Petrol | 10 |
| G4FA | 77.00 | 1396 | 4 | 16 | Petrol | 12 |
| G4FC | 77.00 | 1591 | 4 | 16 | Petrol | 13 |
| G4FD | 77.00 | 1591 | 4 | 16 | Petrol | 13 |
| G4GB | 82.00 | 1795 | 4 | 16 | Petrol | 16 |
| G4GC | 82.00 | 1975 | 4 | 16 | Petrol | 17 |
| G4GC-G | 82.00 | 1975 | 4 | 16 | Petrol | 17 |
| G4HC | 66.00 | 999 | 4 | 12 | Petrol | 1 |
| G4HG | 67.00 | 1086 | 4 | 12 | Petrol | 2 |
| G4KE | 88.00 | 2359 | 4 | 16 | Petrol | 26 |
| G4LA | 71.00 | 1248 | 4 | 16 | Petrol | 3 |
| G6BA | 86.70 | 2656 | 6 | 24 | Petrol | 23 |
| G6BA-G | 86.70 | 2656 | 6 | 24 | Petrol | 24 |
| J3 | 97.10 | 2902 | 4 | 16 | Diesel | 32 |



OE

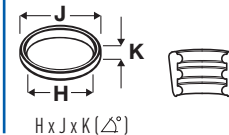
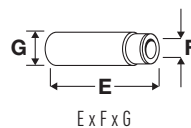
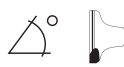

1 66.00

| | | | | | | | |
|------------------|-----------------|--------|------------------|-----------------|--------|-----------------|----------------|
| G4HC | 999cc | 4 Cyl. | 12 Valves | 40-46kW/54-63PS | Petrol | SOHC | TD16145 |
| ATOS 1.0 | 09/2005→08/2008 | | | ATOS 1.0 i | | 02/1998→03/2002 | |
| ATOS PRIME 1.0 i | 08/1999→ | | | | | | |

| | | | | | | |
|-----------------------|-------------|------------|-----|---|----------------------|--|
| V94461 | 22211-02500 | | 45° | H | VAG96394 | |
| 23.00 x 5.50 x 100.30 | | MB tu | | | 48.00 x 5.50 x 10.00 | |
| V94462 | 22212-02500 | | 45° | H | | |
| 27.00 x 5.50 x 100.00 | | MD + MB tu | | | | |

2 67.00

| | | | | | | | |
|--------------|-----------------|--------|------------------|-----------------|--------|-----------------|----------------|
| G4HG | 1086cc | 4 Cyl. | 12 Valves | 45-51kW/61-69PS | Petrol | SOHC | TD20724 |
| ATOS 1.1 | 06/2003→12/2010 | | | ATOS 1.1 CNG | | 07/2007→ | |
| ATOS 1.1 LPG | 07/2007→ | | | ATOS PRIME 1.1 | | 01/1997→12/2008 | |
| GETZ 1.1 | 09/2005→06/2009 | | | i10 1.1 | | 12/2007→12/2013 | |
| i10 1.1 LPG | 04/2011→12/2013 | | | | | | |

| | | | | | | |
|----------------------|-------------|------------|-----|---|----------------------|--|
| V95069 | 22211-02200 | | 45° | H | VAG96394 | |
| 23.50 x 5.47 x 99.60 | | MB tu | | | 48.00 x 5.50 x 10.00 | |
| V95070 | 22212-02200 | | 45° | H | | |
| 27.00 x 5.45 x 99.10 | | MD + MB tu | | | | |

3 71.00

| | | | | | | | |
|--------------|----------|--------|------------------|-----------------|--------|------------------------|----------------|
| G4LA | 1248cc | 4 Cyl. | 16 Valves | 55-65kW/75-88PS | Petrol | DOHC, Injection | TD24880 |
| i10 1.2 | 11/2008→ | | | i20 1.2 | | 09/2008→ | |
| i20 1.2 LPGI | 11/2014→ | | | | | | |

| | | | | | | |
|-----------------------|-------------|------------|-----|---|----------------------|--|
| V95203 | 22211-03200 | | 45° | H | VAG96394 | |
| 26.80 x 5.47 x 101.20 | | MB tu | | | 48.00 x 5.50 x 10.00 | |
| V95204 | 22212-03200 | | 45° | H | | |
| 24.10 x 5.46 x 101.20 | | MD + MB tu | | | | |

4 71.00

| | | | | | | | |
|-------------|-----------------|--------|-----------------|-----------------|--------|-------------|----------------|
| G13B | 1299cc | 4 Cyl. | 8 Valves | 50-55kW/68-75PS | Petrol | SOHC | TD12988 |
| PONY 1.3 | 10/1985→09/1989 | | | | | | |

| | | | | | | |
|-----------------------|-----------|----|-----|---|----------------------|--|
| V90123 | MD-016460 | | 45° | H | VAG92046 | |
| 34.16 x 6.57 x 102.08 | | MB | | | 44.00 x 6.62 x 12.13 | |
| V90124 | MD-016461 | | 45° | | VAG92047 | |
| 29.97 x 6.54 x 100.97 | | MD | | | 49.50 x 6.62 x 12.13 | |

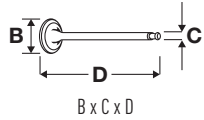

OE

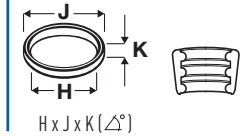
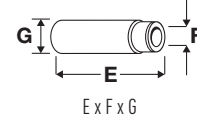
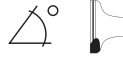

5  **71.50**

| | | | | | | | |
|---------------|--------|-----------------|------------------|--------------------|--------|-----------------|----------------|
| G4EA | 1341cc | 4 Cyl. | 12 Valves | 55-63kW/75-86PS | Petrol | SOHC | TD16149 |
| G4EH | 1341cc | 4 Cyl. | 12 Valves | 40-62kW/54-84PS | Petrol | SOHC | TD4568 |
| ACCENT 1.3 | | 10/1994→01/2000 | | ACCENT 1.3 i 12V | | 10/1994→01/2000 | |
| ACCENT I 1.3 | | 10/1994→01/2000 | | ACCENT I 1.3 i 12V | | 10/1994→01/2000 | |
| ACCENT II 1.3 | | 01/2000→11/2005 | | GETZ 1.3 | | 09/2003→06/2009 | |
| GETZ 1.3 i | | 09/2002→03/2004 | | | | | |

V95017 
27.40 x 6.00 x 99.00

22211-22003

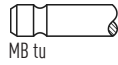

45°

H

VAG96396 
42.70 x 6.00 x 11.10



V95018 
32.00 x 6.00 x 98.30

22212-22011



45°

H

VAG96397 
39.00 x 6.00 x 11.10



6  **75.00**

| | | | | | | | |
|--------------|--------|----------|------------------|-----------------|--------|--------------------|----------------|
| D3FA | 1120cc | 3 Cyl. | 12 Valves | 52-55kW/71-75PS | Diesel | Turbo, DOHC | TD21020 |
| i10 1.1 CRDi | | 01/2008→ | | i10 1.1 D | | 03/2014→ | |
| i20 1.1 CRDi | | 03/2012→ | | XCENT 1.1 D | | 03/2014→ | |

V95228 
26.30 x 5.47 x 93.00

22211-2A100

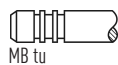

45°

H

VAG96395 
31.50 x 5.50 x 11.03



V95229 
21.10 x 5.46 x 93.80

22212-2A100

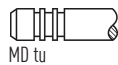

45°

7  **75.00**

| | | | | | | | |
|--------------------|--------|----------|------------------|------------------|--------|--------------------|----------------|
| D4FC | 1396cc | 4 Cyl. | 16 Valves | 55-66kW/75-90PS | Diesel | Turbo, DOHC | TD24883 |
| ACCENT IV 1.4 CRDi | | 11/2010→ | | ACCENT IV 1.4 TD | | 12/2010→ | |
| CRETA 1.4 CRDi | | 01/2016→ | | i20 1.4 CRDi | | 09/2015→ | |
| i20 1.4 CRDi | | 08/2008→ | | i30 1.4 CRDi | | 12/2011→ | |
| ix20 1.4 CRDi | | 11/2010→ | | | | | |

V95228 
26.30 x 5.47 x 93.00

22211-2A100

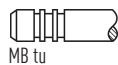

45°

H

VAG96395 
31.50 x 5.50 x 11.03



V95229 
21.10 x 5.46 x 93.80

22212-2A100

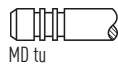

45°

8  **75.00**

| | | | | | | | |
|-------------------------|--------|-----------------|------------------|------------------|--------|-----------------|----------------|
| D4FA | 1493cc | 4 Cyl. | 16 Valves | 65-82kW/88-112PS | Diesel | DOHC | TD18229 |
| ACCENT III 1.5 CRDi GLS | | 11/2005→11/2010 | | ACCENT IV 1.5 D | | 08/2010→ | |
| ELANTRA 1.5 D | | 06/2000→07/2006 | | GETZ 1.5 CRDi | | 08/2005→06/2009 | |
| GETZ 1.5 CRDi GLS | | 07/2004→06/2009 | | MATRIX 1.5 CRDi | | 12/2004→08/2010 | |
| MATRIX 1.5 CRDi VGT | | 08/2005→08/2010 | | | | | |

V95228 
26.30 x 5.47 x 93.00

22211-2A100

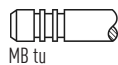

45°

H

VAG96395 
31.50 x 5.50 x 11.03



V95229 
21.10 x 5.46 x 93.80

22212-2A100

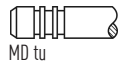

45°

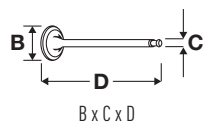

OE

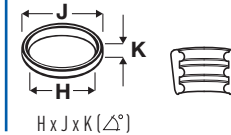
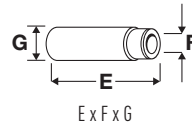
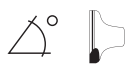

9 75.50

| | | | | | | | |
|------------------|-----------------|--------|-----------------|--------------------|--------|-------------|-----------------|
| G15B | 1468cc | 4 Cyl. | 8 Valves | 53-63kW/72-86PS | Petrol | SOHC | TD1636 |
| G4DJ | 1468cc | 4 Cyl. | 8 Valves | 51-63kW/69-86PS | Petrol | SOHC | TD9400 |
| ACCENT i | 10/1991→11/1994 | | | LANTRA I 1.5 i.e. | | | 10/1990→11/1995 |
| PONY 1.5 | 09/1985→01/1995 | | | PONY 1.5 i | | | 10/1989→01/1995 |
| PONY / EXCEL 1.5 | 01/1990→01/1995 | | | PONY / EXCEL 1.5 i | | | 01/1990→01/1995 |
| S COUPE 1.5 | 09/1990→12/1992 | | | S COUPE 1.5 GS | | | 03/1990→12/1992 |
| S COUPE 1.5 i | 02/1990→05/1996 | | | | | | |

V90123 ■
34.16 x 6.57 x 102.08

MD-016460

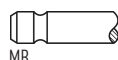

45°

H

VAG92046 ■
44.00 x 6.62 x 12.13



V90124 ■
29.97 x 6.54 x 100.97

MD-016461

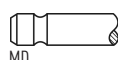

45°

VAG92047 ■
49.50 x 6.62 x 12.13



10 75.50

| | | | | | | | |
|--------------------|-----------------|--------|------------------|--------------------|--------|-------------|-----------------|
| G4EB | 1495cc | 4 Cyl. | 12 Valves | 66kW/90PS | Petrol | SOHC | TD16371 |
| G4EK | 1495cc | 4 Cyl. | 12 Valves | 63-71kW/85-97PS | Petrol | SOHC | TD4569 |
| ACCENT 1.5 | 10/1994→12/1999 | | | ACCENT 1.5 i 12V | | | 10/1994→01/2000 |
| ACCENT I 1.5 | 10/1994→12/1997 | | | ACCENT I 1.5 i 12V | | | 10/1994→01/2000 |
| ACCENT II 1.5 | 09/1999→12/2006 | | | ACCENT II 1.5 LPG | | | 01/2000→12/2006 |
| ACCENT III 1.5 | 01/2008→11/2010 | | | ACCENT III 1.5 CNG | | | 01/2009→01/2010 |
| ACCENT III 1.5 LPG | 01/2008→11/2010 | | | LANTRA II 1.5 12V | | | 12/1996→10/2000 |
| S COUPE 1.5 | 09/1992→12/1995 | | | S COUPE 1.5 i | | | 04/1992→05/1996 |

V95017 ■
27.40 x 6.00 x 99.00

22211-22003

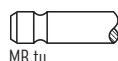

45°

H

VAG96396 ■
42.70 x 6.00 x 11.10



V95018 ■
32.00 x 6.00 x 98.30

22212-22011

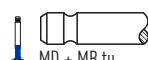

45°

H

VAG96397 ■
39.00 x 6.00 x 11.10



11 76.50

| | | | | | | | |
|-----------------|-----------------|--------|------------------|--------------------|--------|-------------|-----------------|
| G4ED | 1599cc | 4 Cyl. | 16 Valves | 76-84kW/104-114PS | Petrol | DOHC | TD20721 |
| G4ED-G | 1599cc | 4 Cyl. | 16 Valves | 76-79kW/103-107PS | Petrol | DOHC | TD16146 |
| ACCENT II 1.6 | 01/2000→12/2005 | | | ACCENT III 1.6 GLS | | | 11/2005→11/2010 |
| ACCENT IV 1.6 | 08/2010→ | | | COUPE 1.6 16V | | | 03/2002→08/2009 |
| COUPE 1.6 i 16V | 08/2000→01/2002 | | | ELANTRA 1.6 | | | 06/2000→07/2006 |
| GETZ 1.6 | 09/2002→12/2006 | | | MATRIX 1.6 | | | 06/2001→08/2010 |
| TIBURON 1.6 | 10/2006→12/2008 | | | | | | |

V95021 ■
29.10 x 6.00 x 91.80

22211-26600

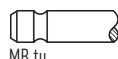

45°

H

V95022 ■
25.00 x 6.00 x 92.35

22212-26000

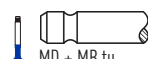

45°

H

12 77.00

| | | | | | | | |
|---------------|----------|--------|------------------|------------------|--------|-------------|-----------------|
| G4FA | 1396cc | 4 Cyl. | 16 Valves | 66-80kW/90-109PS | Petrol | DOHC | TD24881 |
| ACCENT IV 1.4 | 11/2010→ | | | i20 1.4 | | | 09/2008→12/2015 |
| i30 1.4 | 10/2007→ | | | ix20 1.4 | | | 11/2010→ |

V95198 ■
31.50 x 5.47 x 93.20

22211-2B000

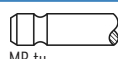

45°

H

VAG96398 ■ ■
40.50 x 5.50 x 10.05

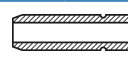

V95199 ■
26.00 x 5.46 x 92.60

22212-2B000

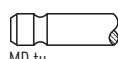

45°

H



OE

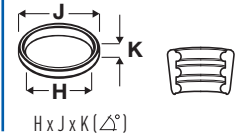
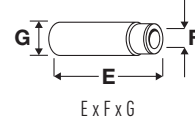
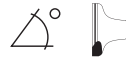

13  **77.00**

| G4FC | 1591cc | 4 Cyl. | 16 Valves | 84-97kW/114-132PS | Petrol | DOHC | TD24882 |
|------------------|-----------------|--------|-----------|--------------------|--------|-----------------|---------|
| G4FD | 1591cc | 4 Cyl. | 16 Valves | 96-103kW/130-140PS | Petrol | DOHC, Injection | TD26604 |
| ACCENT IV 1.6 | 11/2010→ | | | ACCENT IV 1.6 GDI | | 09/2011→ | |
| ELANTRA 1.6 | 06/2006→08/2015 | | | HB20 1.6 | | 11/2012→ | |
| HB20S 1.6 | 04/2013→ | | | i20 1.6 | | 09/2008→ | |
| i30 1.6 | 10/2007→ | | | i30 1.6 16V | | 11/2011→12/2016 | |
| i30 1.6 GDI | 06/2011→ | | | i40 1.6 GDI | | 07/2011→ | |
| ix20 1.6 | 11/2010→ | | | ix35 1.6 | | 11/2010→ | |
| TUCSON 1.6 GDi | 06/2015→ | | | VELOSTER 1.6 | | 10/2011→ | |
| VELOSTER 1.6 GDI | 03/2011→ | | | | | | |

V95198 
31.50 x 5.47 x 93.20

22211-2B000

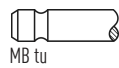

45°

H

VAG96398 
40.50 x 5.50 x 10.05



V95199 
26.00 x 5.46 x 92.60

22212-2B000

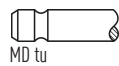

45°

14  **77.20**

| D4FB | 1582cc | 4 Cyl. | 16 Valves | 66-100kW/90-136PS | Diesel | Turbo, DOHC | TD20726 |
|--------------------|----------|--------|-----------|--------------------|--------|-----------------|---------|
| ACCENT IV 1.6 CRDi | 04/2011→ | | | ACCENT IV 1.6 CRDi | | 11/2010→ | |
| CRETA 1.6 CRDi | 01/2016→ | | | ELANTRA 1.6 CRDi | | 11/2005→ | |
| ELANTRA 1.6 D | 02/2016→ | | | i20 1.6 CRDi | | 09/2008→12/2012 | |
| i30 1.6 CDi | 11/2016→ | | | i30 1.6 CDi | | 11/2016→ | |
| i30 1.6 CRDi | 10/2007→ | | | ix20 1.6 CRDi | | 06/2011→ | |
| KONA 1.6 e-VGT | 07/2017→ | | | SOLARIS 1.6 CRDi | | 01/2017→ | |

V95228 
26.30 x 5.47 x 93.00

22211-2A100

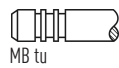

45°

H

VAG96395 
31.50 x 5.50 x 11.03

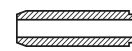

V95229 
21.10 x 5.46 x 93.80

22212-2A100

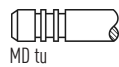

45°

15  **77.20**

| D4FD | 1685cc | 4 Cyl. | 16 Valves | 85-104kW/116-141PS | Diesel | Turbo, DOHC | TD26344 |
|---------------|----------|--------|-----------|--------------------|--------|-------------|---------|
| i40 1.7 CRDi | 07/2011→ | | | i40 1.7 CRDi | | 03/2012→ | |
| ix35 1.7 CRDi | 11/2010→ | | | TUCSON 1.7 CRDi | | 06/2015→ | |

V95228 
26.30 x 5.47 x 93.00

22211-2A100

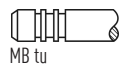

45°

H

VAG96395 
31.50 x 5.50 x 11.03



V95229 
21.10 x 5.46 x 93.80

22212-2A100

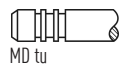

45°

16  **82.00**

| G4GB | 1795cc | 4 Cyl. | 16 Valves | 93-98kW/127-133PS | Petrol | DOHC | TD19154 |
|-------------|-----------------|--------|-----------|-------------------|--------|------|---------|
| ELANTRA 1.8 | 03/1998→07/2006 | | | | | | |

V98038 
32.00 x 6.00 x 102.30

22211-23000

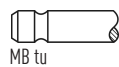

45°

VAG96399 
46.00 x 6.00 x 11.05

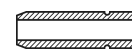

V98039 
27.50 x 6.00 x 104.70

22212-23000

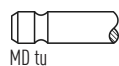

45°

VAG96400 
54.50 x 6.00 x 11.05

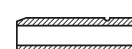



OE

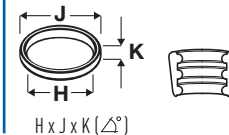
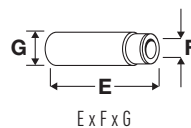

17 82.00

| | | | | | | | |
|---------------|-----------------|--------|------------------|---------------------|--------|-----------------|----------------|
| G4GC | 1975cc | 4 Cyl. | 16 Valves | 102-107kW/139-146PS | Petrol | DOHC | TD20723 |
| G4GC-G | 1975cc | 4 Cyl. | 16 Valves | 100-105kW/136-143PS | Petrol | DOHC | TD16147 |
| COUPE 2.0 | 08/2001→08/2009 | | | COUPE 2.0 GLS | | 02/2003→08/2009 | |
| ELANTRA 2.0 | 06/2000→ | | | HIGHWAY VAN 2.0 | | 11/2003→03/2004 | |
| i30 2.0 | 10/2007→06/2012 | | | ix35 2.0 | | 07/2014→ | |
| TIBURON 2.0 | 01/1996→12/2008 | | | TRAJET 2.0 | | 11/2003→07/2008 | |
| TUCSON 2.0 | 08/2004→ | | | TUCSON 2.0 GLS | | 01/2017→ | |

V95201 ■
32.00 x 5.97 x 114.40

22211-23600

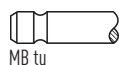

45°

H

VAG96399 ■
46.00 x 6.00 x 11.05



V98038 ■
32.00 x 6.00 x 102.30

22211-23000

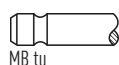

45°

VAG96400 ■
54.50 x 6.00 x 11.05

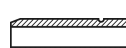

V95202 ■
27.50 x 5.96 x 116.85

22212-23600

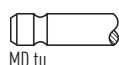

45°

V98039 ■
27.50 x 6.00 x 104.70

22212-23000

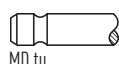

45°

18 82.30

| | | | | | | | |
|--|------------|--------|------------------|------------|---|-------------|---------------|
| 4G61 | 1599cc | 4 Cyl. | 16 Valves | 84kW/114PS | Petrol | DOHC | TD9399 |
| V94451 ■ 34.00 x 6.55 x 109.70 | MD-127 840 | | 45° | H | VAG92046 ■ 44.00 x 6.62 x 12.13 | | |
| V94446 ■ 30.50 x 6.54 x 109.80 | MD-127 841 | | 45° | st | VAG92047 ■ 49.50 x 6.62 x 12.13 | | |

19 83.00

| | | | | | | | |
|---|-----------------|--------|------------------|---------------|---|-----------------|----------------|
| D3EA | 1493cc | 3 Cyl. | 12 Valves | 60kW/82PS | Diesel | SOHC | TD16283 |
| ACCENT II 1.5 CRDi | 01/2002→11/2005 | | | GETZ 1.5 CRDi | | 03/2003→09/2005 | |
| MATRIX 1.5 CRDi | 10/2001→08/2010 | | | | | | |
| V95133 ■ 28.55 x 5.94 x 95.70 | 22211-27000 | | 45° | H | VAG96401 ■ ■ 36.60 x 6.00 x 11.05 | | |
| V95134 ■ 24.40 x 5.92 x 95.55 | 22212-27000 | | 45° | H | | | |

20 83.00

| | | | | | | | |
|--|-----------------|--------|-----------------|-----------------|--|-------------|----------------|
| DJY | 1905cc | 4 Cyl. | 8 Valves | 50-52kW/68-71PS | Diesel | SOHC | TD22267 |
| LANTRA II 1.9 D | 03/1998→10/2000 | | | | | | |
| V91144 ■ 38.50 x 8.00 x 112.50 | 0948.63 | | 45° | H | VAG92288B ■ ■ ■ 52.00 x 8.03 x 14.28 | | |
| V91145 ■ 33.00 x 8.00 x 112.00 | 0949.47 | | 45° | | VAG92331B ■ ■ ■ 50.00 x 8.03 x 14.08 | | |
| V94024 ■ 33.00 x 8.00 x 112.00 | 0949.64 | | 45° | | | | |



OE

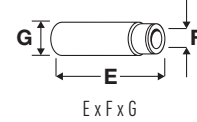

21  **83.00**

| | | | | | | | |
|----------------------|-----------------|--------|------------------|----------------------------|--------|--------------------|----------------|
| D4EA | 1991cc | 4 Cyl. | 16 Valves | 83-85kW/113-116PS | Diesel | Turbo, SOHC | TD16321 |
| D4EA-F | 1991cc | 4 Cyl. | 16 Valves | 88-110kW/120-150PS | Diesel | Turbo, SOHC | TD20720 |
| D4EA-V | 1991cc | 4 Cyl. | 16 Valves | 92kW/125PS | Diesel | Turbo, SOHC | TD20719 |
| ELANTRA 2.0 CRDi | 04/2001→07/2006 | | | HIGHWAY VAN 2.0 CRDi | | 03/2001→03/2004 | |
| i30 2.0 CRDi | 10/2007→06/2012 | | | SANTA FÉ I 2.0 CRDi | | 04/2001→03/2006 | |
| SANTA FÉ II 2.0 CRDi | 03/2006→12/2012 | | | SONATA IV 2.0 CRDi Dynamic | | 10/2001→11/2004 | |
| SONATA V 2.0 CRDi | 02/2006→12/2010 | | | TRAJET 2.0 CRDi | | 04/2001→07/2008 | |
| TUCSON 2.0 CRDi | 08/2004→03/2010 | | | TUCSON 2.0 CRDi | | 01/2005→03/2010 | |

V95133  **22211-27000**
28.55 x 5.94 x 95.70

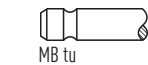

VAG96401  **36.60 x 6.00 x 11.05**



V95134  **22212-27000**
24.40 x 5.92 x 95.55

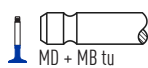

22  **86.50**

| | | | | | | | |
|------------------|-----------------|--------|-----------------|--------------------|--------|-----------------|----------------|
| G4CS | 2351cc | 4 Cyl. | 8 Valves | 82-101kW/111-137PS | Petrol | SOHC | TD16109 |
| GRACE 2.4 | 07/1993→12/2004 | | | H-1 2.4 | | 03/2000→ | |
| H-1 / STAREX 2.4 | 06/1997→04/2004 | | | H100 2.4 | | 07/1993→12/2004 | |
| H100 2.4 TD | 07/1993→07/1997 | | | PORTER 2.4 | | 03/1996→04/2004 | |
| SONATA II 2.4 i | 09/1988→12/1991 | | | | | | |

V94463  **22211-33000**
34.00 x 6.57 x 109.50

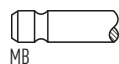

V94464  **22212-33000**
30.50 x 6.53 x 109.70

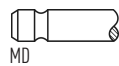

23  **86.70**

| | | | | | | | |
|------------------|-----------------|---------|------------------|---------------------|--------|-----------------|----------------|
| G6BA | 2656cc | V6 Cyl. | 24 Valves | 123-147kW/167-200PS | Petrol | DOHC | TD19133 |
| GRANDEUR 2.7 | 05/2006→ | | | HIGHWAY VAN 2.7 V6 | | 03/2000→03/2004 | |
| SANTA FÉ I 2.7 | 09/2004→12/2005 | | | SANTA FÉ II 2.7 | | 03/2006→12/2012 | |
| SONATA IV 2.7 V6 | 11/2002→11/2004 | | | TIBURON 2.7 | | 09/2002→12/2008 | |
| TRAJET 2.7 V6 | 03/2000→06/2007 | | | TUCSON 2.7 | | 08/2004→12/2009 | |

V98040  **22211-37201**
32.00 x 6.00 x 96.20
→12/03

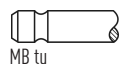

VAG96399  **46.00 x 6.00 x 11.05**



V95201  **22211-23600**
32.00 x 5.97 x 114.40

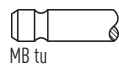

VAG96400  **54.50 x 6.00 x 11.05**



V95202  **22212-23600**
27.50 x 5.96 x 116.85

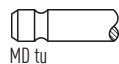

24  **86.70**

| | | | | | | | |
|-------------------|-----------------|---------|------------------|---------------------|--------|-----------------|----------------|
| G6BA-G | 2656cc | V6 Cyl. | 24 Valves | 121-129kW/165-175PS | Petrol | DOHC | TD16154 |
| COUPE 2.7 V6 | 01/2001→08/2009 | | | SANTA FÉ I 2.7 | | 09/2002→12/2004 | |
| SANTA FÉ I 2.7 V6 | 02/2001→03/2006 | | | SONATA IV 2.7 V6 | | 10/2001→11/2004 | |
| TRAJET 2.7 V6 | 09/2000→07/2008 | | | TUCSON 2.7 | | 08/2004→ | |

V95201  **22211-23600**
32.00 x 5.97 x 114.40

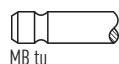

V95202  **22212-23600**
27.50 x 5.96 x 116.85

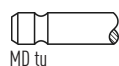



OE



MAT.

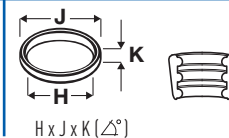
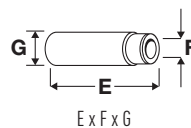
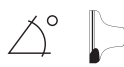

25 87.00

| D4EB | 2188cc | 4 Cyl. | 16 Valves | 102-114kW/139-155PS Diesel | SOHC | TD20717 |
|--------------------------|-----------------|------------|-----------|----------------------------|----------------------|---------|
| GRANDEUR 2.2 CRDi | 06/2006→12/2011 | | | SANTA FÉ II 2.2 CRDi | 03/2006→12/2012 | |
| SANTA FÉ II 2.2 CRDi GLS | 03/2006→12/2009 | | | SONATA IV 2.2 CRDi | 06/2002→11/2004 | |
| V95133 | 22211-27000 | | 45° | H | VAG96401 | |
| 28.55 x 5.94 x 95.70 | | MB tu | | | 36.60 x 6.00 x 11.05 | |
| V95134 | 22212-27000 | | 45° | H | | |
| 24.40 x 5.92 x 95.55 | | MD + MB tu | | | | |

26 88.00

| G4KE | 2359cc | 4 Cyl. | 16 Valves | 127-132kW/173-180PS Petrol | DOHC | TD24885 |
|-----------------------|-----------------|--------|-----------|----------------------------|-----------------|---------|
| GRANDEUR 2.4 | 07/2011→ | | | H-1 2.4 | 08/2015→ | |
| ix35 2.4 | 01/2010→ | | | ix35 2.4 DCWT-I | 07/2010→12/2013 | |
| SANTA FÉ II 2.4 | 09/2009→12/2012 | | | SANTA FÉ III 2.4 CCVT | 09/2012→ | |
| SONATA V 2.4 | 06/2008→12/2010 | | | | | |
| V95235 | 22211-2G000 | | 45° | H | | |
| 35.00 x 5.50 x 113.30 | | MB tu | | | | |
| V95236 | 22212-25002 | | 45° | | | |
| 28.95 x 5.50 x 106.00 | | MD tu | | | | |

27 91.00

| D4CB | 2497cc | 4 Cyl. | 16 Valves | 81-129kW/110-175PS Diesel | Turbo | TD21021 |
|-----------------------|-------------|--------|-----------|---------------------------|----------|---------|
| H-1 2.5 CRDi | 07/2001→ | | | H-1 2.5 CRDi | 02/2008→ | |
| H-1 / STAREX 2.5 CRDi | 06/1997→ | | | H100 2.5 CRDi | 01/2004→ | |
| H350 2.5 CRDi | 04/2015→ | | | PORTER 2.5 CRDi | 02/2003→ | |
| PORTER 2.5 D | 01/2012→ | | | | | |
| V98052 | 22211-4A061 | | 45° | | | |
| 31.70 x 7.00 x 110.50 | | MB tu | | | | |
| V98053 | 22212-4A061 | | 45° | | | |
| 28.00 x 7.00 x 110.50 | | MD tu | | | | |

28 91.10

| D4BF | 2476cc | 4 Cyl. | 8 Valves | 54-65kW/73-88PS Diesel | Turbo, SOHC | TD16108 |
|-----------------------|-----------------|------------|----------|------------------------|----------------------|---------|
| GALLOPER II 2.5 TD | 08/1998→12/2003 | | | GRACE 2.5 TD | 06/1998→10/2001 | |
| H-1 2.5 TD | 10/1998→04/2008 | | | H-1 / STAREX 2.5 D | 10/1997→04/2004 | |
| H-1 / STAREX 2.5 TD | 06/1997→04/2004 | | | H100 2.5 D | 05/1996→12/1997 | |
| H100 2.5 Td | 09/1994→08/1998 | | | H100 2.5 TD | 07/1993→03/2000 | |
| H100 2.5 TDiC | 06/1998→10/2003 | | | | | |
| V95077 | MD198404 | | 45° | H | VAG92322 | |
| 40.00 x 7.97 x 130.20 | | MB tu | | | 71.00 x 8.00 x 13.13 | |
| V95078 | MD198406 | | 45° | H | VAG92323 | |
| 34.00 x 7.94 x 129.90 | | MD + MB tu | | | 74.00 x 8.00 x 13.13 | |



OE

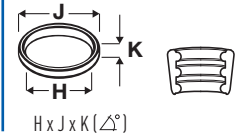
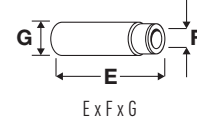
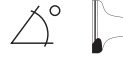

29  **91.10**

| D4BH | 2476cc | 4 Cyl. | 8 Valves | 59-78kW/80-106PS | Diesel | Turbo, SOHC | TD11429 |
|-----------------------|--------|--------|----------|---------------------|--------|-----------------|---------|
| GALLOPER II 2.5 TCi D | | | | GALLOPER II 2.5 TD | | 08/1998→12/2003 | |
| H-1 2.5 D | | | | H-1 2.5 TD | | 03/2000→08/2007 | |
| H-1 / STAREX 2.5 TCi | | | | H-1 / STAREX 2.5 TD | | 03/2001→04/2004 | |
| H100 2.5 D | | | | PORTER 2.5 D | | 04/2007→ | |
| PORTER 2.5 TCi | | | | PORTER 2.5 TD | | 07/1994→04/2004 | |
| TERRACAN 2.5 D | | | | TERRACAN 2.5 TD | | 12/2001→12/2006 | |

V94328 
40.00 x 8.00 x 136.50

MD-083 661

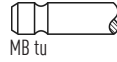

45°

H

VAG92322 
71.00 x 8.00 x 13.13



V95077 
40.00 x 7.97 x 130.20

MD198404

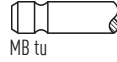

45°

H

VAG96279 
71.00 x 8.00 x 13.07

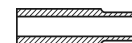

V91239 
34.16 x 7.96 x 136.50

22212-42850

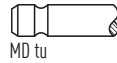

45°

VAG92323 
74.00 x 8.00 x 13.13



V95078 
34.00 x 7.94 x 129.90

MD198406



45°

H

VAG96280 
74.00 x 8.00 x 13.07



30  **91.10**

| D456T | 2477cc | 4 Cyl. | 8 Valves | 62-74kW/84-101PS | Diesel | Turbo, SOHC | TD18860 |
|-------------------|--------|--------|----------|--------------------|--------|-----------------|---------|
| D4BA | 2477cc | 4 Cyl. | 8 Valves | 55-65kW/75-88PS | Diesel | SOHC | TD7147 |
| D4BX | 2477cc | 4 Cyl. | 8 Valves | 54-55kW/73-75PS | Diesel | SOHC | TD7148 |
| GALLOPER I 2.5 TD | | | | GALLOPER II 2.5 TD | | 08/1998→12/2003 | |
| GRACE 2.5 D | | | | H-1 2.5 D | | 10/1997→04/2004 | |
| H100 2.5 D | | | | H100 2.5 TD | | 11/2006→ | |
| PORTER 2.5 D | | | | PORTER 2.5 TD | | 07/1994→04/2004 | |

V94328 
40.00 x 8.00 x 136.50

MD-083 661

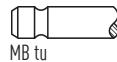

45°

H

VAG92322 
71.00 x 8.00 x 13.13

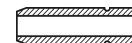

V95077 
40.00 x 7.97 x 130.20

MD198404

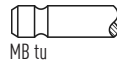

45°

H

VAG92323 
74.00 x 8.00 x 13.13

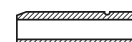

V91239 
34.16 x 7.96 x 136.50

22212-42850

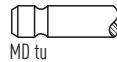

45°

H

V95078 
34.00 x 7.94 x 129.90

MD198406

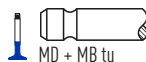

45°

H

31  **91.10**

| D4BB | 2607cc | 4 Cyl. | 8 Valves | 57-79kW/78-107PS | Diesel | SOHC | TD16110 |
|--------------------|--------|--------|----------|-----------------------|--------|-----------------|---------|
| GALLOPER II 2.6 TD | | | | GRACE 2.6 D | | 10/1999→10/2004 | |
| H-1 2.6 CRDi | | | | H-1 / STAREX 2.6 TDiC | | 10/1997→04/2004 | |
| H100 2.6 D | | | | H100 2.6 TD | | 07/1993→05/1998 | |
| HD LIGHT | | | | PORTER 2.6 TD | | 07/1994→12/2004 | |

V95077 
40.00 x 7.97 x 130.20

MD198404

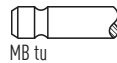

45°

H

VAG92322 
71.00 x 8.00 x 13.13



V95078 
34.00 x 7.94 x 129.90

MD198406



45°

H

VAG92323 
74.00 x 8.00 x 13.13



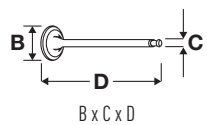

OE

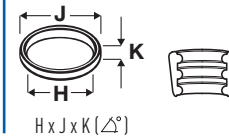
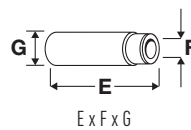

32  **97.10**

| | | | | | | |
|-------------------|--------|-----------------|------------------|----------------------------|--------------------|----------------|
| J3 | 2902cc | 4 Cyl. | 16 Valves | 110-120kW/150-163PS Diesel | Turbo, DOHC | TD18360 |
| TERRACAN 2.9 CRDi | | 11/2001→12/2006 | | | | |

V94428 
34.00 x 7.00 x 126.20

OK551-12111A

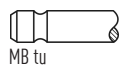

45°

H

VAG96111 
52.50 x 7.00 x 12.00







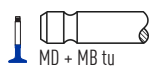

V94429 
31.60 x 7.00 x 126.00

OK551-12121A



45°

H



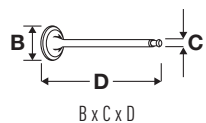

|  |  | ccm |  |  |  |  |
|---|---|------|---|---|---|---|
| 4EC1 | 76.00 | 1488 | 4 | 8 | Diesel | 1 |
| 4EC1T | 76.00 | 1488 | 4 | 8 | Diesel | 2 |
| 4EE1 | 79.00 | 1686 | 4 | 8 | Diesel | 3 |
| 4JG2T | 95.40 | 3059 | 4 | 8 | Diesel | 8 |
| 6VD1 | 93.40 | 3165 | 6 | 24 | Petrol | 7 |
| C 223 | 88.00 | 2238 | 4 | 8 | Diesel | 6 |
| C190 | 86.00 | 1951 | 4 | 8 | Diesel | 4 |
| TD27 | 96.00 | 2663 | 4 | 8 | Diesel | 9 |
| X 1.7 D 4EE1 OHC | 79.00 | 1686 | 4 | 8 | Diesel | 3 |
| X 22 SE | 86.00 | 2198 | 4 | 16 | Petrol | 5 |

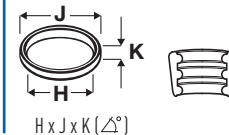
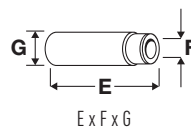
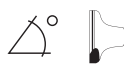



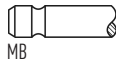

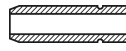
OE

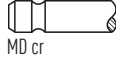



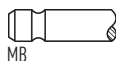

1  **76.00**

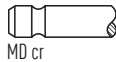
| | | | | | | | |
|---|---------------|---|-----------------|-----------|---|---|---------------|
| 4EC1 | 1488cc | 4 Cyl. | 8 Valves | 37kW/50PS | Diesel | SOHC | TD4575 |
| GEMINI 1.5 D | | 09/1980→12/1990 | | | | | |
| V91230  | 8-94326-843-0 |  | 45° | H | VAG92321  |  | |
| 34.70 x 6.99 x 104.00 | | MB | | | 43.00 x 7.00 x 11.56 | | |
| V91231  | 8-94110-017-3 |  | 45° | st | | | |
| 30.70 x 6.98 x 104.00 | | MD cr | | | | | |

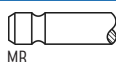

2  **76.00**

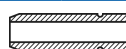
| | | | | | | | |
|---|---------------|---|-----------------|-----------------|---|---|---------------|
| 4EC1T | 1488cc | 4 Cyl. | 8 Valves | 49-54kW/67-73PS | Diesel | Turbo, SOHC | TD4576 |
| GEMINI 1.5 TD | | 02/1988→12/1990 | | | | | |
| V91230  | 8-94326-843-0 |  | 45° | H | VAG92321  |  | |
| 34.70 x 6.99 x 104.00 | | MB | | | 43.00 x 7.00 x 11.56 | | |
| V91232  | 8-94115-059-2 |  | 45° | ss st | | | |
| 30.70 x 6.98 x 104.15 | | MD cr | | | | | |



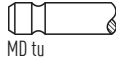

3  **79.00**

| | | | | | | | |
|---|---------------|---|-----------------|-----------|---|---|----------------|
| 4EE1 | 1686cc | 4 Cyl. | 8 Valves | 65kW/88PS | Diesel | SOHC | TD26233 |
| X 1.7 D 4EE1 OHC | | 01/1990→12/1993 | | | | | |
| V91230  | 8-94326-843-0 |  | 45° | H | VAG92321  |  | |
| 34.70 x 6.99 x 104.00 | | MB | | | 43.00 x 7.00 x 11.56 | | |
| V91231  | 8-94110-017-3 |  | 45° | st | | | |
| 30.70 x 6.98 x 104.00 | | MD cr | | | | | |

4  **86.00**

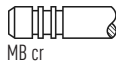
| | | | | | | | |
|---|---------------|---|-----------------|-----------|---|---|---------------|
| C190 | 1951cc | 4 Cyl. | 8 Valves | 40kW/54PS | Diesel | OHV | TD1685 |
| V91498  | 5-12552-034-2 |  | 45° | st | VAG92372  |  | |
| 34.10 x 7.94 x 115.80 01/81→ | | MD tu | | | 50.00 x 8.00 x 14.03 01/81→ | | |

5  **86.00**

| | | | | | | | |
|---|-----------------|---|------------------|-------------------|---|---|----------------|
| X 22 SE | 2198cc | 4 Cyl. | 16 Valves | 85-97kW/116-132PS | Petrol | ECOTEC, DOHC | TD25588 |
| AMIGO 2.2 | 09/1997→12/2000 | | KB 2.2 | | 01/1998→09/2003 | | |
| RODEO 2.2 | 09/1997→12/2003 | | RODEO SPORT 2.2 | | 09/2000→12/2003 | | |
| V91997  | 90412277 |  | 45° | H | VAG96028  |  | |
| 32.10 x 5.97 x 102.10 | | MB cr | | | 45.00 x 5.99 x 10.05 | | |
| V91998  | 90410813 |  | 45° | ss | | | |
| 29.10 x 5.96 x 92.25 | | MD cr | | | | | |



OE

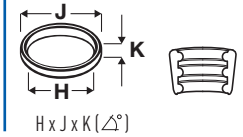
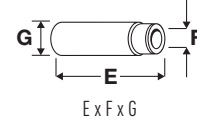

6



88.00

| C 223 | 2238cc | 4 Cyl. | 8 Valves | 39-54kW/53-73PS | Diesel | OHV | TD1686 |
|-----------------------|---------------|-----------------|----------|-----------------|----------------------|-----------------|--------|
| 117 2.2 D | | 06/1979→06/1981 | | CAMPO 2.2 D | | 01/1983→12/1991 | |
| KB 2.2 D | | 01/1983→03/1988 | | TROOPER I 2.2 D | | 05/1984→12/1989 | |
| V91498 | 5-12552-034-2 | | 45° | st | VAG92372 | | |
| 34.10 x 7.94 x 115.80 | | MD tu | | | 50.00 x 8.00 x 14.03 | | |

7



93.40

| 6VD1 | 3165cc | V6 Cyl. | 24 Valves | 130-158kW/177-215PS | Petrol | DOHC | TD21399 |
|-----------------------|----------|-----------------|-----------|---------------------|--------|-----------------|---------|
| AMIGO 3.2 | | 06/1998→12/2000 | | FRONTIER 3.2 | | 08/1997→07/2002 | |
| KB 3.2 | | 01/1998→09/2003 | | MU 3.2 | | 06/1998→08/2002 | |
| RODEO 3.2 | | 09/1992→12/1997 | | RODEO 3.2 V6 | | 09/1997→08/2004 | |
| RODEO SPORT 3.2 | | 09/2000→12/2003 | | TROOPER II 3.2 | | 08/1991→07/1998 | |
| VEHICROSS 3.2 | | 04/1997→12/2000 | | WIZARD 3.2 | | 06/1998→08/2002 | |
| V94344 | 97131962 | | 45° | | | | |
| 29.00 x 6.00 x 103.50 | | MD tu | | | | | |

8



95.40







| 4JG2T | 3059cc | 4 Cyl. | 8 Valves | 80-85kW/109-116PS | Diesel | Turbo, OHV | TD8402 |
|-----------------------|--------|-----------------|----------|-------------------|--------|-----------------|--------|
| PICKUP 3.1 TD | | 05/1997→06/2005 | | TROOPER II 3.1 TD | | 08/1991→07/1998 | |
| V94662 | 641020 | | 45° | st | | | |
| 40.10 x 8.00 x 117.50 | | MD tu | | | | | |
| V94663 | 641324 | | 45° | st | | | |
| 35.70 x 8.00 x 117.50 | | MD tu | | | | | |







9















96.00







| TD27 | 2663cc | 4 Cyl. | 8 Valves | 58-73kW/79-99PS | Diesel | OHV | TD21156 |
|-----------------------|-------------|-----------------|----------|-----------------|----------------------|-----|---------|
| ELF 2.7 TD | | 10/1999→09/2001 | | | | | |
| V94352 | 13202-G2403 | | 45° | H | VAG92384 | | |
| 38.00 x 8.00 x 117.00 | | MD + MB cr | | | 47.00 x 8.02 x 12.04 | | |







|  |  | ccm |  |  |  |  |
|---|---|------|--|---|---|---|
| 8030.02 | 100.00 | 2592 | 3 | 6 | Diesel | 15 |
| 8035.02 | 100.00 | 2592 | 3 | 6 | Diesel | 16 |
| 8035.05.214 | 104.00 | 2931 | 3 | 6 | Diesel | 40 |
| 8035.05.215 | 104.00 | 2931 | 3 | 6 | Diesel | 40 |
| 8035.06.200 | 100.00 | 2708 | 3 | 6 | Diesel | 17 |
| 8035.06.206 | 100.00 | 2708 | 3 | 6 | Diesel | 17 |
| 8035.06.208 | 100.00 | 2708 | 3 | 6 | Diesel | 17 |
| 8035.06.222 | 100.00 | 2708 | 3 | 6 | Diesel | 17 |
| 8035.06.307 | 100.00 | 2708 | 3 | 6 | Diesel | 17 |
| 8035.06.308 | 100.00 | 2708 | 3 | 6 | Diesel | 17 |
| 8035.06.323 | 100.00 | 2708 | 3 | 6 | Diesel | 17 |
| 8040.02 | 100.00 | 3456 | 4 | 8 | Diesel | 18 |
| 8040.02.041 | 100.00 | 3456 | 4 | 8 | Diesel | 18 |
| 8040.02.267 | 100.00 | 3456 | 4 | 8 | Diesel | 18 |
| 8040.02.300 | 100.00 | 3456 | 4 | 8 | Diesel | 18 |
| 8040.02.360 | 100.00 | 3456 | 4 | 8 | Diesel | 18 |
| 8040.02.367 | 100.00 | 3456 | 4 | 8 | Diesel | 18 |
| 8040.04.200 | 103.00 | 3666 | 4 | 8 | Diesel | 30 |
| 8040.04.200 | 103.00 | 3666 | 4 | 8 | Diesel | 31 |
| 8040.04.280 | 103.00 | 3666 | 4 | 8 | Diesel | 30 |
| 8040.05.200 | 104.00 | 3908 | 4 | 8 | Diesel | 42 |
| 8040.05.200 | 104.00 | 3908 | 4 | 8 | Diesel | 41 |
| 8040.05.203 | 104.00 | 3908 | 4 | 8 | Diesel | 41 |
| 8040.05.230 | 104.00 | 3908 | 4 | 8 | Diesel | 42 |
| 8040.05.230 | 104.00 | 3908 | 4 | 8 | Diesel | 41 |
| 8040.05.232 | 104.00 | 3908 | 4 | 8 | Diesel | 43 |
| 8040.05.233 | 104.00 | 3908 | 4 | 8 | Diesel | 41 |
| 8040.05.235 | 104.00 | 3908 | 4 | 8 | Diesel | 41 |
| 8040.25.200 | 104.00 | 3908 | 4 | 8 | Diesel | 42 |
| 8040.25.200 | 104.00 | 3908 | 4 | 8 | Diesel | 41 |
| 8040.25.220 | 104.00 | 3908 | 4 | 8 | Diesel | 44 |
| 8040.25.220 | 104.00 | 3908 | 4 | 8 | Diesel | 41 |
| 8040.25.230 | 104.00 | 3908 | 4 | 8 | Diesel | 44 |
| 8040.25.230 R | 104.00 | 3908 | 4 | 8 | Diesel | 43 |
| 8040.25B.4200 | 104.00 | 3908 | 4 | 8 | Diesel | 41 |
| 8040.25B.4200 (LTC) | 104.00 | 3908 | 4 | 8 | Diesel | 44 |
| 8040.25B.4220 | 104.00 | 3908 | 4 | 8 | Diesel | 41 |
| 8040.25X.4000 | 104.00 | 3908 | 4 | 8 | Diesel | 44 |
| 8040.25X.4000 | 104.00 | 3908 | 4 | 8 | Diesel | 43 |
| 8040.45.4000 | 104.00 | 3908 | 4 | 8 | Diesel | 41 |
| 8040.45.4000 (TCA) | 104.00 | 3908 | 4 | 8 | Diesel | 44 |
| 8040.45.4180 | 104.00 | 3908 | 4 | 8 | Diesel | 41 |
| 8040.45.4180 (TCA) | 104.00 | 3908 | 4 | 8 | Diesel | 44 |
| 8040.45.4380 | 104.00 | 3908 | 4 | 8 | Diesel | 41 |
| 8040.45.5200 | 104.00 | 3908 | 4 | 8 | Diesel | 43 |
| 8040.45.5200 | 104.00 | 3908 | 4 | 8 | Diesel | 44 |
| 8040.45.5281 | 104.00 | 3908 | 4 | 8 | Diesel | 44 |
| 8040.45D.5100 | 104.00 | 3908 | 4 | 8 | Diesel | 43 |
| 8040.45D.5100 | 104.00 | 3908 | 4 | 8 | Diesel | 44 |
| 8040.45D.5103 | 104.00 | 3908 | 4 | 8 | Diesel | 44 |
| 8040.45X.4180 | 104.00 | 3908 | 4 | 8 | Diesel | 43 |
| 8045.02 | 100.00 | 3456 | 4 | 8 | Diesel | 19 |
| 8045.06.200 | 100.00 | 3613 | 4 | 8 | Diesel | 20 |
| 8045.06.208 | 100.00 | 3613 | 4 | 8 | Diesel | 20 |
| 8045.06.213 | 100.00 | 3613 | 4 | 8 | Diesel | 20 |
| 8045.06.225 | 100.00 | 3613 | 4 | 8 | Diesel | 20 |
| 8045.06.319 | 100.00 | 3613 | 4 | 8 | Diesel | 20 |
| 8045.06.326 | 100.00 | 3613 | 4 | 8 | Diesel | 20 |
| 8060.02.000 | 100.00 | 5184 | 6 | 12 | Diesel | 21 |
| 8060.02.001 | 100.00 | 5184 | 6 | 12 | Diesel | 22 |
| 8060.02.001 | 100.00 | 5184 | 6 | 12 | Diesel | 23 |
| 8060.02.003 | 100.00 | 5184 | 6 | 12 | Diesel | 22 |
| 8060.02.003 | 100.00 | 5184 | 6 | 12 | Diesel | 23 |
| 8060.02.070 | 100.00 | 5184 | 6 | 12 | Diesel | 22 |
| 8060.04 | 103.00 | 5499 | 6 | 12 | Diesel | 32 |
| 8060.04.051 | 103.00 | 5499 | 6 | 12 | Diesel | 33 |







|  |  | ccm |  |  |  |  |
|---|---|------|---|---|---|---|
| 8060.04.055 | 103.00 | 5499 | 6 | 12 | Diesel | 33 |
| 8060.04.055 | 103.00 | 5499 | 6 | 12 | Diesel | 32 |
| 8060.04.060 | 103.00 | 5499 | 6 | 12 | Diesel | 33 |
| 8060.04.060 | 103.00 | 5500 | 6 | 12 | Diesel | 38 |
| 8060.04.070 | 103.00 | 5499 | 6 | 12 | Diesel | 32 |
| 8060.04.070 | 103.00 | 5499 | 6 | 12 | Diesel | 33 |
| 8060.04.620 | 103.00 | 5499 | 6 | 12 | Diesel | 33 |
| 8060.04.620 | 103.00 | 5499 | 6 | 12 | Diesel | 32 |
| 8060.04.621 | 103.00 | 5499 | 6 | 12 | Diesel | 33 |
| 8060.04.621 | 103.00 | 5499 | 6 | 12 | Diesel | 32 |
| 8060.04.630 | 103.00 | 5499 | 6 | 12 | Diesel | 33 |
| 8060.04.630 | 103.00 | 5500 | 6 | 12 | Diesel | 38 |
| 8060.04.639 | 103.00 | 5499 | 6 | 12 | Diesel | 33 |
| 8060.04.639 | 103.00 | 5500 | 6 | 12 | Diesel | 38 |
| 8060.04.658 | 103.00 | 5499 | 6 | 12 | Diesel | 33 |
| 8060.04.658 | 103.00 | 5499 | 6 | 12 | Diesel | 32 |
| 8060.04.660 | 103.00 | 5499 | 6 | 12 | Diesel | 33 |
| 8060.04.660 | 103.00 | 5500 | 6 | 12 | Diesel | 38 |
| 8060.04.669 | 103.00 | 5499 | 6 | 12 | Diesel | 33 |
| 8060.04.669 | 103.00 | 5500 | 6 | 12 | Diesel | 38 |
| 8060.04.670 | 103.00 | 5499 | 6 | 12 | Diesel | 33 |
| 8060.04.670 | 103.00 | 5500 | 6 | 12 | Diesel | 38 |
| 8060.04.672 | 103.00 | 5499 | 6 | 12 | Diesel | 33 |
| 8060.04.672 | 103.00 | 5500 | 6 | 12 | Diesel | 38 |
| 8060.04.675 | 103.00 | 5499 | 6 | 12 | Diesel | 33 |
| 8060.04.675 | 103.00 | 5500 | 6 | 12 | Diesel | 38 |
| 8060.04.689 | 103.00 | 5499 | 6 | 12 | Diesel | 33 |
| 8060.04.689 | 103.00 | 5500 | 6 | 12 | Diesel | 38 |
| 8060.05.000 | 104.00 | 5861 | 6 | 12 | Diesel | 46 |
| 8060.05.000 | 104.00 | 5861 | 6 | 12 | Diesel | 45 |
| 8060.05.200 | 104.00 | 5861 | 6 | 12 | Diesel | 46 |
| 8060.05.200 | 104.00 | 5861 | 6 | 12 | Diesel | 45 |
| 8060.05.246 | 104.00 | 5861 | 6 | 12 | Diesel | 46 |
| 8060.05.246 | 104.00 | 5861 | 6 | 12 | Diesel | 45 |
| 8060.05.270 | 104.00 | 5861 | 6 | 12 | Diesel | 46 |
| 8060.05.270 | 104.00 | 5861 | 6 | 12 | Diesel | 45 |
| 8060.05.280 | 104.00 | 5861 | 6 | 12 | Diesel | 45 |
| 8060.05.280 | 104.00 | 5861 | 6 | 12 | Diesel | 46 |
| 8060.05.285 | 104.00 | 5861 | 6 | 12 | Diesel | 46 |
| 8060.05.285 | 104.00 | 5861 | 6 | 12 | Diesel | 45 |
| 8060.05.289 | 104.00 | 5861 | 6 | 12 | Diesel | 46 |
| 8060.05.289 | 104.00 | 5861 | 6 | 12 | Diesel | 45 |
| 8060.12 | 100.00 | 5184 | 6 | 12 | Diesel | 21 |
| 8060.24.601 | 103.00 | 5499 | 6 | 12 | Diesel | 34 |
| 8060.24.601 | 103.00 | 5500 | 6 | 12 | Diesel | 39 |
| 8060.24.670 | 103.00 | 5499 | 6 | 12 | Diesel | 34 |
| 8060.24.670 | 103.00 | 5499 | 6 | 12 | Diesel | 35 |
| 8060.24.671 | 103.00 | 5499 | 6 | 12 | Diesel | 34 |
| 8060.24.671 | 103.00 | 5499 | 6 | 12 | Diesel | 35 |
| 8060.24.678 | 103.00 | 5500 | 6 | 12 | Diesel | 39 |
| 8060.24.678 | 103.00 | 5499 | 6 | 12 | Diesel | 34 |
| 8060.25.4600 | 103.00 | 5499 | 6 | 12 | Diesel | 36 |
| 8060.25.600 | 104.00 | 5861 | 6 | 12 | Diesel | 48 |
| 8060.25.600 | 104.00 | 5861 | 6 | 12 | Diesel | 47 |
| 8060.25R.4200 | 104.00 | 5861 | 6 | 12 | Diesel | 46 |
| 8060.25R.4200 | 104.00 | 5861 | 6 | 12 | Diesel | 45 |
| 8060.25R.4200 LTC | 104.00 | 5861 | 6 | 12 | Diesel | 45 |
| 8060.25R.4280 | 104.00 | 5861 | 6 | 12 | Diesel | 48 |
| 8060.25R.4280 | 104.00 | 5861 | 6 | 12 | Diesel | 45 |
| 8060.25R.4300 | 104.00 | 5861 | 6 | 12 | Diesel | 45 |
| 8060.25V.4000 | 104.00 | 5861 | 6 | 12 | Diesel | 46 |
| 8060.25V.4000 | 104.00 | 5861 | 6 | 12 | Diesel | 45 |
| 8060.25V.4080 | 104.00 | 5861 | 6 | 12 | Diesel | 48 |
| 8060.25V.4080 | 104.00 | 5861 | 6 | 12 | Diesel | 45 |
| 8060.25V.4800 | 104.00 | 5861 | 6 | 12 | Diesel | 45 |
| 8060.45.4100 | 104.00 | 5861 | 6 | 12 | Diesel | 46 |







|  |  | ccm |  |  |  |  |
|---|---|------|--|---|---|---|
| 8060.45.4100 | 104.00 | 5861 | 6 | 12 | Diesel | 45 |
| 8060.45.4100 TCA | 104.00 | 5861 | 6 | 12 | Diesel | 47 |
| 8060.45.4180 | 104.00 | 5861 | 6 | 12 | Diesel | 47 |
| 8060.45.4180 | 104.00 | 5861 | 6 | 12 | Diesel | 48 |
| 8060.45.4700 | 104.00 | 5861 | 6 | 12 | Diesel | 45 |
| 8060.45.4702 | 104.00 | 5861 | 6 | 12 | Diesel | 45 |
| 8060.45.4704 | 104.00 | 5861 | 6 | 12 | Diesel | 45 |
| 8060.45.4706 | 104.00 | 5861 | 6 | 12 | Diesel | 45 |
| 8060.45.4708 | 104.00 | 5861 | 6 | 12 | Diesel | 45 |
| 8060.45.5250 | 104.00 | 5861 | 6 | 12 | Diesel | 45 |
| 8060.45.5251 | 104.00 | 5861 | 6 | 12 | Diesel | 45 |
| 8060.45.5255 | 104.00 | 5861 | 6 | 12 | Diesel | 45 |
| 8060.45.600 | 104.00 | 5861 | 6 | 12 | Diesel | 48 |
| 8060.45.6090 | 104.00 | 5861 | 6 | 12 | Diesel | 48 |
| 8060.45.6090 | 104.00 | 5861 | 6 | 12 | Diesel | 45 |
| 8060.45B.5100 | 104.00 | 5861 | 6 | 12 | Diesel | 47 |
| 8060.45K.6090 | 104.00 | 5861 | 6 | 12 | Diesel | 49 |
| 8060.45R.5000 | 104.00 | 5861 | 6 | 12 | Diesel | 45 |
| 8060.45R.5001 | 104.00 | 5861 | 6 | 12 | Diesel | 45 |
| 8060.45R.5003 | 104.00 | 5861 | 6 | 12 | Diesel | 45 |
| 8060.45R.5005 | 104.00 | 5861 | 6 | 12 | Diesel | 45 |
| 8060.45R.5050 | 104.00 | 5861 | 6 | 12 | Diesel | 45 |
| 8060.45R.5051 | 104.00 | 5861 | 6 | 12 | Diesel | 45 |
| 8060.45S TCA | 104.00 | 5861 | 6 | 12 | Diesel | 49 |
| 8060.45S.6000 | 104.00 | 5861 | 6 | 12 | Diesel | 49 |
| 8060.45S.6000 | 104.00 | 5861 | 6 | 12 | Diesel | 49 |
| 8060.45S.6010 | 104.00 | 5861 | 6 | 12 | Diesel | 49 |
| 8060.45S.6020 | 104.00 | 5861 | 6 | 12 | Diesel | 49 |
| 8060.45S.6030 | 104.00 | 5861 | 6 | 12 | Diesel | 49 |
| 8060.45S.6040 | 104.00 | 5861 | 6 | 12 | Diesel | 49 |
| 8060.45S.6045 | 104.00 | 5861 | 6 | 12 | Diesel | 49 |
| 8060.45S.6052 | 104.00 | 5861 | 6 | 12 | Diesel | 49 |
| 8060.45S.6110 | 104.00 | 5861 | 6 | 12 | Diesel | 49 |
| 8060.45S.6120 | 104.00 | 5861 | 6 | 12 | Diesel | 49 |
| 8060.45S.6130 | 104.00 | 5861 | 6 | 12 | Diesel | 49 |
| 8060.45S.6140 | 104.00 | 5861 | 6 | 12 | Diesel | 49 |
| 8060.45S.6150 | 104.00 | 5861 | 6 | 12 | Diesel | 49 |
| 8060.45S.6203 | 104.00 | 5861 | 6 | 12 | Diesel | 49 |
| 8060.45S.6700 | 104.00 | 5861 | 6 | 12 | Diesel | 49 |
| 8060.45S.6700 | 104.00 | 5861 | 6 | 12 | Diesel | 49 |
| 8060.45S.6705 | 104.00 | 5861 | 6 | 12 | Diesel | 49 |
| 8060.45S.6706 | 104.00 | 5861 | 6 | 12 | Diesel | 49 |
| 8060.45S.6707 | 104.00 | 5861 | 6 | 12 | Diesel | 49 |
| 8060.45S.6710 | 104.00 | 5861 | 6 | 12 | Diesel | 49 |
| 8060.45S.6711 | 104.00 | 5861 | 6 | 12 | Diesel | 49 |
| 8060.45S.6800 | 104.00 | 5861 | 6 | 12 | Diesel | 49 |
| 8060.45S.6800 | 104.00 | 5861 | 6 | 12 | Diesel | 49 |
| 8060.45S.6912 | 104.00 | 5861 | 6 | 12 | Diesel | 49 |
| 8060.45S.7200 | 104.00 | 5861 | 6 | 12 | Diesel | 49 |
| 8060.45S.7203 | 104.00 | 5861 | 6 | 12 | Diesel | 49 |
| 8060.45S.7205 | 104.00 | 5861 | 6 | 12 | Diesel | 49 |
| 8060.45S.7210 | 104.00 | 5861 | 6 | 12 | Diesel | 49 |
| 8060.45S.7211 | 104.00 | 5861 | 6 | 12 | Diesel | 49 |
| 8060.45S.7213 | 104.00 | 5861 | 6 | 12 | Diesel | 49 |
| 8060.45S.7250 | 104.00 | 5861 | 6 | 12 | Diesel | 49 |
| 8060.45S.7251 | 104.00 | 5861 | 6 | 12 | Diesel | 49 |
| 8060.45S.7255 | 104.00 | 5861 | 6 | 12 | Diesel | 49 |
| 8065.02.007 | 100.00 | 5184 | 6 | 12 | Diesel | 24 |
| 8065.02.200 | 100.00 | 5184 | 6 | 12 | Diesel | 21 |
| 8065.06.000 | 100.00 | 5418 | 6 | 12 | Diesel | 25 |
| 8065.06.230 | 100.00 | 5418 | 6 | 12 | Diesel | 25 |
| 8065.06.300 | 100.00 | 5418 | 6 | 12 | Diesel | 25 |
| 8065.24.000 | 103.00 | 5499 | 6 | 12 | Diesel | 37 |
| 8065.24.300 | 103.00 | 5499 | 6 | 12 | Diesel | 37 |
| 8140.07.2585 | 93.00 | 2499 | 4 | 8 | Diesel | 4 |
| 8140.07.2700 | 93.00 | 2500 | 4 | 8 | Diesel | 5 |

|  |  | ccm |  |  |  |  |
|---|---|------|---|---|---|---|
| 8140.07.2701 | 93.00 | 2500 | 4 | 8 | Diesel | 5 |
| 8140.07.2710 | 93.00 | 2500 | 4 | 8 | Diesel | 6 |
| 8140.07.2711 | 93.00 | 2500 | 4 | 8 | Diesel | 6 |
| 8140.07.2712 | 93.00 | 2500 | 4 | 8 | Diesel | 5 |
| 8140.07.3700 | 93.00 | 2500 | 4 | 8 | Diesel | 7 |
| 8140.07.3710 | 93.00 | 2500 | 4 | 8 | Diesel | 5 |
| 8140.07.3711 | 93.00 | 2500 | 4 | 8 | Diesel | 6 |
| 8140.07.3712 | 93.00 | 2500 | 4 | 8 | Diesel | 6 |
| 8140.07.3713 | 93.00 | 2500 | 4 | 8 | Diesel | 6 |
| 8140.21.200 | 93.00 | 2445 | 4 | 8 | Diesel | 2 |
| 8140.21.201 | 93.00 | 2445 | 4 | 8 | Diesel | 2 |
| 8140.21.202 | 93.00 | 2445 | 4 | 8 | Diesel | 2 |
| 8140.21.203 | 93.00 | 2445 | 4 | 8 | Diesel | 2 |
| 8140.21.212 | 93.00 | 2445 | 4 | 8 | Diesel | 2 |
| 8140.21.214 | 93.00 | 2445 | 4 | 8 | Diesel | 2 |
| 8140.21.290 | 93.00 | 2445 | 4 | 8 | Diesel | 2 |
| 8140.23 | 94.40 | 2800 | 4 | 8 | Diesel | 12 |
| 8140.23.2585 | 94.40 | 2800 | 4 | 8 | Diesel | 12 |
| 8140.23.3700 | 94.40 | 2800 | 4 | 8 | Diesel | 12 |
| 8140.23.3701 | 94.40 | 2800 | 4 | 8 | Diesel | 12 |
| 8140.23.3710 | 94.40 | 2800 | 4 | 8 | Diesel | 12 |
| 8140.23.3711 | 94.40 | 2800 | 4 | 8 | Diesel | 12 |
| 8140.23.3713 | 94.40 | 2800 | 4 | 8 | Diesel | 12 |
| 8140.23.3720 | 94.40 | 2800 | 4 | 8 | Diesel | 12 |
| 8140.23.3721 | 94.40 | 2800 | 4 | 8 | Diesel | 12 |
| 8140.23.3730 | 94.40 | 2800 | 4 | 8 | Diesel | 12 |
| 8140.23.3731 | 94.40 | 2800 | 4 | 8 | Diesel | 12 |
| 8140.23.3750 | 94.40 | 2800 | 4 | 8 | Diesel | 12 |
| 8140.23.3751 | 94.40 | 2800 | 4 | 8 | Diesel | 12 |
| 8140.23.3760 | 94.40 | 2800 | 4 | 8 | Diesel | 12 |
| 8140.27 S | 93.00 | 2445 | 4 | 8 | Diesel | 2 |
| 8140.27.215 | 93.00 | 2500 | 4 | 8 | Diesel | 8 |
| 8140.27.218 | 93.00 | 2500 | 4 | 8 | Diesel | 8 |
| 8140.27.2582 | 93.00 | 2500 | 4 | 8 | Diesel | 6 |
| 8140.27.2700 | 93.00 | 2500 | 4 | 8 | Diesel | 6 |
| 8140.27.2720 | 93.00 | 2500 | 4 | 8 | Diesel | 6 |
| 8140.27.2811 | 93.00 | 2500 | 4 | 8 | Diesel | 6 |
| 8140.27R.2700 | 93.00 | 2500 | 4 | 8 | Diesel | 6 |
| 8140.27R.2782 | 93.00 | 2500 | 4 | 8 | Diesel | 9 |
| 8140.27R.2786 | 93.00 | 2500 | 4 | 8 | Diesel | 9 |
| 8140.27S.2700 | 93.00 | 2500 | 4 | 8 | Diesel | 10 |
| 8140.27S.2701 | 93.00 | 2500 | 4 | 8 | Diesel | 8 |
| 8140.27S.2710 | 93.00 | 2500 | 4 | 8 | Diesel | 8 |
| 8140.27S.2711 | 93.00 | 2500 | 4 | 8 | Diesel | 8 |
| 8140.27S.2720 | 93.00 | 2500 | 4 | 8 | Diesel | 8 |
| 8140.27S.2721 | 93.00 | 2500 | 4 | 8 | Diesel | 8 |
| 8140.27S.2730 | 93.00 | 2500 | 4 | 8 | Diesel | 8 |
| 8140.27S.2731 | 93.00 | 2500 | 4 | 8 | Diesel | 8 |
| 8140.27S.2750 | 93.00 | 2500 | 4 | 8 | Diesel | 8 |
| 8140.27S.2760 | 93.00 | 2500 | 4 | 8 | Diesel | 8 |
| 8140.27S.2761 | 93.00 | 2500 | 4 | 8 | Diesel | 8 |
| 8140.27S.2770 | 93.00 | 2500 | 4 | 8 | Diesel | 8 |
| 8140.27S.2771 | 93.00 | 2500 | 4 | 8 | Diesel | 8 |
| 8140.27S.2801 | 93.00 | 2500 | 4 | 8 | Diesel | 6 |
| 8140.27S.2811 | 93.00 | 2500 | 4 | 8 | Diesel | 8 |
| 8140.27S.2885 | 93.00 | 2500 | 4 | 8 | Diesel | 6 |
| 8140.27S.3701 | 93.00 | 2500 | 4 | 8 | Diesel | 8 |
| 8140.27S.3711 | 93.00 | 2500 | 4 | 8 | Diesel | 8 |
| 8140.27S.3720 | 93.00 | 2500 | 4 | 8 | Diesel | 8 |
| 8140.27S.3721 | 93.00 | 2500 | 4 | 8 | Diesel | 8 |
| 8140.27S.3750 | 93.00 | 2500 | 4 | 8 | Diesel | 8 |
| 8140.27S.3751 | 93.00 | 2500 | 4 | 8 | Diesel | 8 |
| 8140.27S.3760 | 93.00 | 2500 | 4 | 8 | Diesel | 8 |
| 8140.27S.3761 | 93.00 | 2500 | 4 | 8 | Diesel | 8 |
| 8140.27S.3770 | 93.00 | 2500 | 4 | 8 | Diesel | 8 |
| 8140.27S.3771 | 93.00 | 2500 | 4 | 8 | Diesel | 8 |

|  |  | ccm |  |  |  |  |
|---|---|------|--|---|---|---|
| 8140.27S.3780 | 93.00 | 2500 | 4 | 8 | Diesel | 8 |
| 8140.27S.3811 | 93.00 | 2500 | 4 | 8 | Diesel | 8 |
| 8140.43 | 94.40 | 2800 | 4 | 8 | Diesel | 12 |
| 8140.43.2585 | 94.40 | 2800 | 4 | 8 | Diesel | 12 |
| 8140.43.3700 | 94.40 | 2800 | 4 | 8 | Diesel | 12 |
| 8140.43.3728 | 94.40 | 2800 | 4 | 8 | Diesel | 12 |
| 8140.43.3900 | 94.40 | 2800 | 4 | 8 | Diesel | 12 |
| 8140.43B | 94.40 | 2800 | 4 | 8 | Diesel | 13 |
| 8140.43B.4300 | 94.40 | 2800 | 4 | 8 | Diesel | 13 |
| 8140.43B.4305 | 94.40 | 2800 | 4 | 8 | Diesel | 13 |
| 8140.43B.4320 | 94.40 | 2800 | 4 | 8 | Diesel | 13 |
| 8140.43B.4325 | 94.40 | 2800 | 4 | 8 | Diesel | 13 |
| 8140.43B.4330 | 94.40 | 2800 | 4 | 8 | Diesel | 13 |
| 8140.43B.4335 | 94.40 | 2800 | 4 | 8 | Diesel | 13 |
| 8140.43C | 94.40 | 2800 | 4 | 8 | Diesel | 12 |
| 8140.43C.4000 | 94.40 | 2800 | 4 | 8 | Diesel | 13 |
| 8140.43C.4005 | 94.40 | 2800 | 4 | 8 | Diesel | 13 |
| 8140.43C.4020 | 94.40 | 2800 | 4 | 8 | Diesel | 13 |
| 8140.43C.4021 | 94.40 | 2800 | 4 | 8 | Diesel | 13 |
| 8140.43C.4025 | 94.40 | 2800 | 4 | 8 | Diesel | 13 |
| 8140.43C.4026 | 94.40 | 2800 | 4 | 8 | Diesel | 13 |
| 8140.43C.4035 | 94.40 | 2800 | 4 | 8 | Diesel | 13 |
| 8140.43C.4036 | 94.40 | 2800 | 4 | 8 | Diesel | 13 |
| 8140.43K.4000 | 94.40 | 2800 | 4 | 8 | Diesel | 12 |
| 8140.43K.4020 | 94.40 | 2800 | 4 | 8 | Diesel | 13 |
| 8140.43N | 94.40 | 2800 | 4 | 8 | Diesel | 12 |
| 8140.43N.4300 | 94.40 | 2800 | 4 | 8 | Diesel | 12 |
| 8140.43N.4320 | 94.40 | 2800 | 4 | 8 | Diesel | 12 |
| 8140.43N.4330 | 94.40 | 2800 | 4 | 8 | Diesel | 12 |
| 8140.43N.4400 | 94.40 | 2800 | 4 | 8 | Diesel | 12 |
| 8140.43N.4430 | 94.40 | 2800 | 4 | 8 | Diesel | 12 |
| 8140.43R.4300 | 94.40 | 2800 | 4 | 8 | Diesel | 12 |
| 8140.43R.4320 | 94.40 | 2800 | 4 | 8 | Diesel | 12 |
| 8140.43R.4330 | 94.40 | 2800 | 4 | 8 | Diesel | 12 |
| 8140.43R.4400 | 94.40 | 2800 | 4 | 8 | Diesel | 12 |
| 8140.43R.4420 | 94.40 | 2800 | 4 | 8 | Diesel | 12 |
| 8140.43S | 94.40 | 2800 | 4 | 8 | Diesel | 12 |
| 8140.43S.4000 | 94.40 | 2800 | 4 | 8 | Diesel | 12 |
| 8140.43S.4020 | 94.40 | 2800 | 4 | 8 | Diesel | 12 |
| 8140.43S.4030 | 94.40 | 2800 | 4 | 8 | Diesel | 12 |
| 8140.43S.4140 | 94.40 | 2800 | 4 | 8 | Diesel | 12 |
| 8140.43S.4300 | 94.40 | 2800 | 4 | 8 | Diesel | 12 |
| 8140.43S.4320 | 94.40 | 2800 | 4 | 8 | Diesel | 12 |
| 8140.43S.4330 | 94.40 | 2800 | 4 | 8 | Diesel | 12 |
| 8140.43S.4400 | 94.40 | 2800 | 4 | 8 | Diesel | 12 |
| 8140.43S.4420 | 94.40 | 2800 | 4 | 8 | Diesel | 12 |
| 8140.43S.4430 | 94.40 | 2800 | 4 | 8 | Diesel | 12 |
| 8140.47.2700 | 93.00 | 2500 | 4 | 8 | Diesel | 6 |
| 8140.47.2711 | 93.00 | 2500 | 4 | 8 | Diesel | 6 |
| 8140.47.2721 | 93.00 | 2500 | 4 | 8 | Diesel | 6 |
| 8140.47.2785 | 93.00 | 2500 | 4 | 8 | Diesel | 6 |
| 8140.47.3700 | 93.00 | 2500 | 4 | 8 | Diesel | 6 |
| 8140.47.3711 | 93.00 | 2500 | 4 | 8 | Diesel | 8 |
| 8140.47.3721 | 93.00 | 2500 | 4 | 8 | Diesel | 8 |
| 8140.47B.3790 | 93.00 | 2500 | 4 | 8 | Diesel | 8 |
| 8140.47B.3795 | 93.00 | 2500 | 4 | 8 | Diesel | 8 |
| 8140.47R | 93.00 | 2500 | 4 | 8 | Diesel | 6 |
| 8140.47R.2790 | 93.00 | 2500 | 4 | 8 | Diesel | 6 |
| 8140.47R.2795 | 93.00 | 2500 | 4 | 8 | Diesel | 8 |
| 8140.47S | 93.00 | 2500 | 4 | 8 | Diesel | 6 |
| 8140.61.200 | 93.00 | 2445 | 4 | 8 | Diesel | 2 |
| 8140.61.300 | 93.00 | 2445 | 4 | 8 | Diesel | 3 |
| 8140.63 | 94.40 | 2800 | 4 | 8 | Diesel | 12 |
| 8140.63.4000 | 94.40 | 2800 | 4 | 8 | Diesel | 13 |
| 8140.67.2585 | 93.00 | 2500 | 4 | 8 | Diesel | 11 |
| 8140.67F. | 93.00 | 2500 | 4 | 8 | Diesel | 11 |

|  |  | ccm |  |  |  |  |
|---|---|-------|---|---|---|---|
| 8140.67F.3700 | 93.00 | 2500 | 4 | 8 | Diesel | 11 |
| 8140.97.2781 | 93.00 | 2500 | 4 | 8 | Diesel | 6 |
| 8144.61.200 | 93.00 | 2445 | 4 | 8 | Diesel | 3 |
| 8210.02 | 137.00 | 13800 | 6 | 12 | Diesel | 69 |
| 8210.02.000 | 137.00 | 13798 | 6 | 12 | Diesel | 66 |
| 8210.02.020 | 137.00 | 13798 | 6 | 12 | Diesel | 66 |
| 8210.02.022 | 137.00 | 13798 | 6 | 12 | Diesel | 66 |
| 8210.02.032 | 137.00 | 13798 | 6 | 12 | Diesel | 66 |
| 8210.02.033 | 137.00 | 13798 | 6 | 12 | Diesel | 66 |
| 8210.02.053 | 137.00 | 13798 | 6 | 12 | Diesel | 66 |
| 8210.02.067 | 137.00 | 13798 | 6 | 12 | Diesel | 66 |
| 8210.02.067 | 137.00 | 13798 | 6 | 12 | Diesel | 66 |
| 8210.02.069 | 137.00 | 13798 | 6 | 12 | Diesel | 66 |
| 8210.02.069 | 137.00 | 13798 | 6 | 12 | Diesel | 66 |
| 8210.02.081 | 137.00 | 13798 | 6 | 12 | Diesel | 66 |
| 8210.02.266 | 137.00 | 13798 | 6 | 12 | Diesel | 66 |
| 8210.02.267 | 137.00 | 13798 | 6 | 12 | Diesel | 66 |
| 8210.02.371 | 137.00 | 13798 | 6 | 12 | Diesel | 66 |
| 8210.02.371 | 137.00 | 13798 | 6 | 12 | Diesel | 66 |
| 8210.02.373 | 137.00 | 13798 | 6 | 12 | Diesel | 66 |
| 8210.02.373 | 137.00 | 13798 | 6 | 12 | Diesel | 66 |
| 8210.02.377 | 137.00 | 13798 | 6 | 12 | Diesel | 66 |
| 8210.02.377 | 137.00 | 13798 | 6 | 12 | Diesel | 66 |
| 8210.02.385 | 137.00 | 13798 | 6 | 12 | Diesel | 66 |
| 8210.02.393 | 137.00 | 13798 | 6 | 12 | Diesel | 66 |
| 8210.02.393 | 137.00 | 13798 | 6 | 12 | Diesel | 66 |
| 8210.02.405 | 137.00 | 13798 | 6 | 12 | Diesel | 66 |
| 8210.02.426 | 137.00 | 13798 | 6 | 12 | Diesel | 66 |
| 8210.02.440 | 137.00 | 13798 | 6 | 12 | Diesel | 66 |
| 8210.02.440 | 137.00 | 13798 | 6 | 12 | Diesel | 66 |
| 8210.02.441 | 137.00 | 13798 | 6 | 12 | Diesel | 66 |
| 8210.02.441 | 137.00 | 13798 | 6 | 12 | Diesel | 66 |
| 8210.02.731 | 137.00 | 13798 | 6 | 12 | Diesel | 66 |
| 8210.02.731 | 137.00 | 13798 | 6 | 12 | Diesel | 66 |
| 8210.22.000 | 137.00 | 13798 | 6 | 12 | Diesel | 67 |
| 8210.22.069 | 137.00 | 13798 | 6 | 12 | Diesel | 67 |
| 8210.22.101 | 137.00 | 13798 | 6 | 12 | Diesel | 67 |
| 8210.22.105 | 137.00 | 13798 | 6 | 12 | Diesel | 67 |
| 8210.22.105 | 137.00 | 13798 | 6 | 12 | Diesel | 68 |
| 8210.22.171 | 137.00 | 13798 | 6 | 12 | Diesel | 67 |
| 8210.22.171 | 137.00 | 13798 | 6 | 12 | Diesel | 68 |
| 8210.22.175 | 137.00 | 13798 | 6 | 12 | Diesel | 67 |
| 8210.22.175 | 137.00 | 13798 | 6 | 12 | Diesel | 68 |
| 8210.22.183 | 137.00 | 13798 | 6 | 12 | Diesel | 67 |
| 8210.22.183 | 137.00 | 13798 | 6 | 12 | Diesel | 68 |
| 8210.22.210 | 137.00 | 13798 | 6 | 12 | Diesel | 68 |
| 8210.22.235 | 137.00 | 13798 | 6 | 12 | Diesel | 67 |
| 8210.22.236 | 137.00 | 13798 | 6 | 12 | Diesel | 68 |
| 8210.22.269 | 137.00 | 13798 | 6 | 12 | Diesel | 67 |
| 8210.22.269 | 137.00 | 13798 | 6 | 12 | Diesel | 68 |
| 8210.22.290 | 137.00 | 13798 | 6 | 12 | Diesel | 67 |
| 8210.22.317 | 137.00 | 13798 | 6 | 12 | Diesel | 67 |
| 8210.22.317 | 137.00 | 13798 | 6 | 12 | Diesel | 68 |
| 8210.22.327 | 137.00 | 13798 | 6 | 12 | Diesel | 67 |
| 8210.22.327 | 137.00 | 13798 | 6 | 12 | Diesel | 68 |
| 8210.22.373 | 137.00 | 13798 | 6 | 12 | Diesel | 67 |
| 8210.22.385 | 137.00 | 13798 | 6 | 12 | Diesel | 67 |
| 8210.22.385 | 137.00 | 13798 | 6 | 12 | Diesel | 68 |
| 8210.22.406 | 137.00 | 13798 | 6 | 12 | Diesel | 67 |
| 8210.22.511 | 137.00 | 13798 | 6 | 12 | Diesel | 68 |
| 8210.22.521 | 137.00 | 13798 | 6 | 12 | Diesel | 68 |
| 8210.22.523 | 137.00 | 13798 | 6 | 12 | Diesel | 68 |
| 8210.22.525 | 137.00 | 13798 | 6 | 12 | Diesel | 68 |
| 8210.22.535 | 137.00 | 13798 | 6 | 12 | Diesel | 68 |
| 8210.22.537 | 137.00 | 13798 | 6 | 12 | Diesel | 68 |
| 8210.22.569 | 137.00 | 13798 | 6 | 12 | Diesel | 67 |

|  |  | ccm |  |  |  |  |
|---|---|-------|--|---|---|---|
| 8210.22.569 | 137.00 | 13798 | 6 | 12 | Diesel | 68 |
| 8210.22.869 | 137.00 | 13798 | 6 | 12 | Diesel | 67 |
| 8210.22.869 | 137.00 | 13798 | 6 | 12 | Diesel | 68 |
| 8210.22X.069 | 137.00 | 13798 | 6 | 12 | Diesel | 68 |
| 8210.22X.069 | 137.00 | 13798 | 6 | 12 | Diesel | 67 |
| 8210.22X.235 | 137.00 | 13798 | 6 | 12 | Diesel | 68 |
| 8210.22X.523 | 137.00 | 13798 | 6 | 12 | Diesel | 68 |
| 8210.22X.575 | 137.00 | 13798 | 6 | 12 | Diesel | 68 |
| 8210.42 | 137.00 | 13798 | 6 | 12 | Diesel | 68 |
| 8210.42.500 | 137.00 | 13798 | 6 | 12 | Diesel | 68 |
| 8210.42K | 137.00 | 13798 | 6 | 12 | Diesel | 68 |
| 8210.42K (TCA) | 137.00 | 13798 | 6 | 12 | Diesel | 68 |
| 8210.42M | 137.00 | 13798 | 6 | 12 | Diesel | 68 |
| 8210.42M (TCA) | 137.00 | 13798 | 6 | 12 | Diesel | 68 |
| 8211.02.032 | 137.00 | 13798 | 6 | 12 | Diesel | 66 |
| 8261.02.002 | 145.00 | 12880 | 6 | 12 | Diesel | 70 |
| 8280.22.201 | 145.00 | 17174 | 8 | 16 | Diesel | 72 |
| 8280.22.205 | 145.00 | 17174 | 8 | 16 | Diesel | 72 |
| 8280.42.001 | 145.00 | 17174 | 8 | 32 | Diesel | 72 |
| 8280.42.050 | 145.00 | 17174 | 8 | 32 | Diesel | 72 |
| 8280.42S (TCA) | 145.00 | 17173 | 8 | 16 | Diesel | 71 |
| 8280.42S.342 | 145.00 | 17174 | 8 | 16 | Diesel | 72 |
| 8280.42S.350 | 145.00 | 17174 | 8 | 16 | Diesel | 72 |
| 8280.42S.352 | 145.00 | 17174 | 8 | 16 | Diesel | 72 |
| 8280.42S.362 | 145.00 | 17174 | 8 | 16 | Diesel | 72 |
| 8340.05 | 115.00 | 5401 | 4 | 8 | Diesel | 51 |
| 8340.05.200 | 115.00 | 5401 | 4 | 8 | Diesel | 51 |
| 8360.05 | 115.00 | 8100 | 6 | 12 | Diesel | 53 |
| 8360.05.200 | 115.00 | 8102 | 6 | 12 | Diesel | 55 |
| 8360.05.254 | 115.00 | 8102 | 6 | 12 | Diesel | 55 |
| 8360.05.673 | 115.00 | 8102 | 6 | 12 | Diesel | 55 |
| 8365.05.500 | 115.00 | 8101 | 6 | 12 | Diesel | 54 |
| 8365.05.520 | 115.00 | 8101 | 6 | 12 | Diesel | 54 |
| 8365.05.530 | 115.00 | 8101 | 6 | 12 | Diesel | 54 |
| 8365.05.531 | 115.00 | 8101 | 6 | 12 | Diesel | 54 |
| 8365.05.555 | 115.00 | 8101 | 6 | 12 | Diesel | 54 |
| 8365.05.560 | 115.00 | 8101 | 6 | 12 | Diesel | 54 |
| 8365.05.570 | 115.00 | 8101 | 6 | 12 | Diesel | 54 |
| 8365.05.580 | 115.00 | 8101 | 6 | 12 | Diesel | 54 |
| 8365.05.590 | 115.00 | 8101 | 6 | 12 | Diesel | 54 |
| 8365.25.500 | 115.00 | 8102 | 6 | 12 | Diesel | 55 |
| 8365.25.500 | 115.00 | 8101 | 6 | 12 | Diesel | 54 |
| 8365.25.533 | 115.00 | 8102 | 6 | 12 | Diesel | 55 |
| 8460.21.002 | 120.00 | 9500 | 6 | 12 | Diesel | 58 |
| 8460.21.010 | 120.00 | 9500 | 6 | 12 | Diesel | 58 |
| 8460.21.102 | 120.00 | 9500 | 6 | 12 | Diesel | 58 |
| 8460.21.601 | 120.00 | 9498 | 6 | 12 | Diesel | 57 |
| 8460.41 M | 120.00 | 9500 | 6 | 12 | Diesel | 58 |
| 8460.41 R | 120.00 | 9500 | 6 | 12 | Diesel | 58 |
| 8460.41 S | 120.00 | 9500 | 6 | 12 | Diesel | 58 |
| 8460.41.102 | 120.00 | 9500 | 6 | 12 | Diesel | 58 |
| 8460.41.124 | 120.00 | 9500 | 6 | 12 | Diesel | 58 |
| 8460.41.160 | 120.00 | 9500 | 6 | 12 | Diesel | 58 |
| 8460.41C | 120.00 | 9500 | 6 | 12 | Diesel | 58 |
| 8460.41C (TCA) | 120.00 | 9500 | 6 | 12 | Diesel | 58 |
| 8460.41C.320 | 120.00 | 9500 | 6 | 12 | Diesel | 58 |
| 8460.41K | 120.00 | 9500 | 6 | 12 | Diesel | 58 |
| 8460.41K. TCA | 120.00 | 9500 | 6 | 12 | Diesel | 58 |
| 8460.41K.406 | 120.00 | 9500 | 6 | 12 | Diesel | 58 |
| 8460.41K.410 | 120.00 | 9500 | 6 | 12 | Diesel | 58 |
| 8460.41L (TCA) | 120.00 | 9500 | 6 | 12 | Diesel | 58 |
| 8460.41L.5020 | 120.00 | 9500 | 6 | 12 | Diesel | 58 |
| 8460.41N | 120.00 | 9500 | 6 | 12 | Diesel | 58 |
| BF4L 913 T | 102.00 | 4086 | 4 | 8 | Diesel | 27 |
| BF6L 913 | 102.00 | 6128 | 6 | 12 | Diesel | 29 |
| BF6L 913 T | 102.00 | 6128 | 6 | 12 | Diesel | 29 |

|  |  | ccm |  |  |  |  | |
|---|---|--------|---|---|---|---|----|
| BF6L 913/U | | 102.00 | 6128 | 6 | 12 | Diesel | 29 |
| BF8L 413 F | | 125.00 | 12763 | 8 | 16 | Diesel | 61 |
| BF8L 513 | | 125.00 | 12763 | 8 | 16 | Diesel | 61 |
| CP 3 | | 110.00 | 7412 | 6 | 12 | Diesel | 50 |
| F10L 413 F | | 125.00 | 15953 | 10 | 20 | Diesel | 62 |
| F1AE0481A | | 88.00 | 2287 | 4 | 16 | Diesel | 1 |
| F1AE0481B | | 88.00 | 2287 | 4 | 16 | Diesel | 1 |
| F1AE0481FA | | 88.00 | 2287 | 4 | 16 | Diesel | 1 |
| F1AE0481GA | | 88.00 | 2287 | 4 | 16 | Diesel | 1 |
| F1AE0481H | | 88.00 | 2287 | 4 | 16 | Diesel | 1 |
| F1AE0481M | | 88.00 | 2287 | 4 | 16 | Diesel | 1 |
| F1AE0481R | | 88.00 | 2287 | 4 | 16 | Diesel | 1 |
| F1AE0481V | | 88.00 | 2287 | 4 | 16 | Diesel | 1 |
| F1CE0481A | | 95.80 | 2998 | 4 | 16 | Diesel | 14 |
| F1CE0481B | | 95.80 | 2998 | 4 | 16 | Diesel | 14 |
| F1CE0481FA | | 95.80 | 2998 | 4 | 16 | Diesel | 14 |
| F1CE0481HA | | 95.80 | 2998 | 4 | 16 | Diesel | 14 |
| F1CE0481HC | | 95.80 | 2998 | 4 | 16 | Diesel | 14 |
| F1CE0481L | | 95.80 | 2998 | 4 | 16 | Diesel | 14 |
| F2BE0681A | | 115.00 | 7790 | 6 | 24 | Diesel | 52 |
| F2BE0681B | | 115.00 | 7790 | 6 | 24 | Diesel | 52 |
| F2BE0681C | | 115.00 | 7790 | 6 | 24 | Diesel | 52 |
| F2BE0681D | | 115.00 | 7790 | 6 | 24 | Diesel | 52 |
| F2BE0681DA | | 115.00 | 7790 | 6 | 24 | Diesel | 52 |
| F2BE0681DB | | 115.00 | 7790 | 6 | 24 | Diesel | 52 |
| F2BE0681E | | 115.00 | 7790 | 6 | 24 | Diesel | 52 |
| F2BE0681F | | 115.00 | 7790 | 6 | 24 | Diesel | 52 |
| F3A3681A | | 125.00 | 10300 | 6 | 24 | Diesel | 60 |
| F3A3681B | | 125.00 | 10300 | 6 | 24 | Diesel | 60 |
| F3AE0681B | | 125.00 | 10300 | 6 | 24 | Diesel | 60 |
| F3AE0681D | | 125.00 | 10300 | 6 | 24 | Diesel | 60 |
| F3AE0681E | | 125.00 | 10300 | 6 | 24 | Diesel | 60 |
| F3AE0681H | | 125.00 | 10300 | 6 | 24 | Diesel | 60 |
| F3AE3681D | | 125.00 | 10300 | 6 | 24 | Diesel | 60 |
| F3B3681B | | 135.00 | 12882 | 6 | 24 | Diesel | 65 |
| F3BE0681A | | 135.00 | 12880 | 6 | 24 | Diesel | 64 |
| F3BE0681B | | 135.00 | 12880 | 6 | 24 | Diesel | 64 |
| F3BE0681E | | 135.00 | 12880 | 6 | 24 | Diesel | 64 |
| F3BE0681G | | 135.00 | 12880 | 6 | 24 | Diesel | 64 |
| F3BE3681B | | 135.00 | 12880 | 6 | 24 | Diesel | 64 |
| F4AE0481A | | 102.00 | 3920 | 4 | 16 | Diesel | 26 |
| F4AE0481C | | 102.00 | 3920 | 4 | 16 | Diesel | 26 |
| F4AE0481D | | 102.00 | 3920 | 4 | 16 | Diesel | 26 |
| F4AE0681A | | 102.00 | 5880 | 6 | 24 | Diesel | 28 |
| F4AE0681B | | 102.00 | 5880 | 6 | 24 | Diesel | 28 |
| F4AE0681C | | 102.00 | 5880 | 6 | 24 | Diesel | 28 |
| F4AE0681D | | 102.00 | 5880 | 6 | 24 | Diesel | 28 |
| F4AE0681E | | 102.00 | 5880 | 6 | 24 | Diesel | 28 |
| F4AE3481A | | 102.00 | 3920 | 4 | 16 | Diesel | 26 |
| F4AE3481B | | 102.00 | 3920 | 4 | 16 | Diesel | 26 |
| F4AE3481C | | 102.00 | 3920 | 4 | 16 | Diesel | 26 |
| F4AE3481D | | 102.00 | 3920 | 4 | 16 | Diesel | 26 |
| F4AE3681B | | 102.00 | 5880 | 6 | 24 | Diesel | 28 |
| F4AE3681D | | 102.00 | 5880 | 6 | 24 | Diesel | 28 |
| F4AE3681E | | 102.00 | 5880 | 6 | 24 | Diesel | 28 |
| F4L 913 | | 102.00 | 4086 | 4 | 8 | Diesel | 27 |
| F6L 413 | | 120.00 | 8478 | 6 | 12 | Diesel | 56 |
| F6L 413 F | | 125.00 | 9570 | 6 | 12 | Diesel | 59 |
| F6L 913 | | 102.00 | 6128 | 6 | 12 | Diesel | 29 |
| F8L 413 F | | 125.00 | 12763 | 8 | 16 | Diesel | 61 |
| F8L 513 | | 128.00 | 13383 | 8 | 16 | Diesel | 63 |



OE

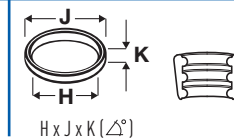
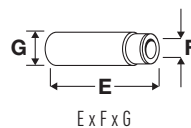
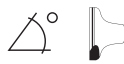



1



88.00

| | | | | | | | |
|-------------------|--------|--------|------------------|-------------------|--------|--------------------|----------------|
| F1AE0481A | 2287cc | 4 Cyl. | 16 Valves | 70kW/95PS | Diesel | Turbo, DOHC | TD17144 |
| F1AE0481B | 2287cc | 4 Cyl. | 16 Valves | 85kW/116PS | Diesel | Turbo, DOHC | TD17145 |
| F1AE0481FA | 2287cc | 4 Cyl. | 16 Valves | 70-78kW/95-106PS | Diesel | Turbo, DOHC | TD19231 |
| F1AE0481GA | 2287cc | 4 Cyl. | 16 Valves | 85-93kW/116-126PS | Diesel | Turbo, DOHC | TD19232 |
| F1AE0481H | 2287cc | 4 Cyl. | 16 Valves | 85kW/116PS | Diesel | Turbo, DOHC | TD28233 |
| F1AE0481M | 2287cc | 4 Cyl. | 16 Valves | 100kW/136PS | Diesel | Turbo, DOHC | TD19156 |
| F1AE0481R | 2287cc | 4 Cyl. | 16 Valves | 85kW/116PS | Diesel | Turbo, DOHC | TD28234 |
| F1AE0481V | 2287cc | 4 Cyl. | 16 Valves | 93kW/126PS | Diesel | Turbo, DOHC | TD26637 |

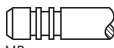
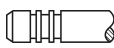
| | | | |
|---|-----------------|--|-----------------|
| DAILY III 29 L 10 | 09/2002→04/2006 | DAILY III 29 L 10 V | 09/2002→07/2007 |
| DAILY III 29 L 12 | 09/2002→04/2006 | DAILY III 29 L 12 V | 09/2002→07/2007 |
| DAILY III 29 L 14 | 01/2005→04/2006 | DAILY III 35 C 10 V, 35 S 10 V | 09/2002→04/2006 |
| DAILY III 35 C 12, 35 S 12 | 09/2002→04/2006 | DAILY III 35 C 12 V, 35 S 12 V | 09/2002→07/2007 |
| DAILY III 35 C 14, 35 S 14 | 01/2005→04/2006 | DAILY III 35 S 10 | 09/2002→07/2007 |
| DAILY III 35 S 12, 35 C 12, 40 C 12 | 01/2003→05/2006 | DAILY III 40 C 10 | 09/2002→04/2006 |
| DAILY III 40 C 14 | 01/2005→04/2006 | DAILY IV 29L10 | 05/2006→08/2011 |
| DAILY IV 29L10 V | 05/2006→08/2011 | DAILY IV 29L12 | 05/2006→08/2011 |
| DAILY IV 29L12 V, 29L12 V/P | 05/2006→08/2011 | DAILY IV 35C10, 35S10 | 05/2006→08/2011 |
| DAILY IV 35C10 K | 05/2006→08/2011 | DAILY IV 35C11, 35S11, 35S11 D, 35S11 /P | 07/2007→08/2011 |
| DAILY IV 35C11 V, 35S11 V | 07/2007→08/2011 | DAILY IV 35C11 K, 35C11 DK, 35S11 K, 35S11 DK | 07/2007→08/2011 |
| DAILY IV 35C12 | 05/2006→08/2011 | DAILY IV 35C12, 35S12 | 05/2006→08/2011 |
| DAILY IV 35C12 V, 35C12 V/P, 35S12 V, 35S12 V/P | 05/2006→08/2011 | DAILY IV 35C13, 35C13 /P, 35S13 D, 35S13, 35S13 /P | 07/2007→08/2011 |
| DAILY IV 35C13 V, 35C13 V/P, 35S13 V, 35S13 V/P | 07/2007→08/2011 | DAILY IV 35C13 K, 35C13 DK, 35S13 K, 35S13 DK | 07/2007→08/2011 |
| DAILY IV 40C10 | 05/2006→08/2011 | DAILY IV 40C10 V | 05/2006→08/2011 |
| DAILY IV 40C11, 40C11 D | 07/2007→08/2011 | DAILY IV 40C11 V | 07/2007→08/2011 |
| DAILY IV 40C12 | 05/2006→08/2011 | DAILY IV 40C12 V, 40C14 V/P | 05/2006→08/2011 |
| DAILY IV 40C13, 40C13 /P | 07/2007→08/2011 | DAILY IV 40C13 V, 40C13 V/P | 07/2007→08/2011 |

| | | | | |
|--|-------------|---|-----|---|
| V94592 ■ 30.00 x 6.00 x 120.40 | 504 069 199 |  | 45° | H |
| V98018 ■ 30.00 x 6.00 x 120.40 | 504 069 199 |  | 45° | |
| V94593 ■ 30.00 x 6.00 x 120.35 | 504 378 070 |  | 45° | H |
| V98019 ■ 30.00 x 6.00 x 120.35 | 500 362 856 |  | 45° | |



OE

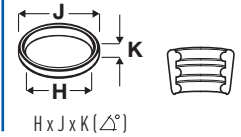
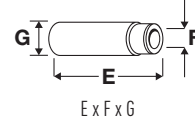
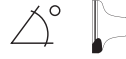

2



93.00

| | | | | | | | |
|-----------------|--------|-----------------|----------|---------------|--------|-----------------|---------|
| 8140.21.200 | 2445cc | 4 Cyl. | 8 Valves | 68kW/92PS | Diesel | Turbo | TD1703 |
| 8140.21.201 | 2445cc | 4 Cyl. | 8 Valves | 68kW/92PS | Diesel | Turbo | TD27368 |
| 8140.21.202 | 2445cc | 4 Cyl. | 8 Valves | 68kW/92PS | Diesel | Turbo | TD27369 |
| 8140.21.203 | 2445cc | 4 Cyl. | 8 Valves | 68kW/92PS | Diesel | Turbo | TD27370 |
| 8140.21.212 | 2445cc | 4 Cyl. | 8 Valves | 68kW/92PS | Diesel | Turbo | TD27371 |
| 8140.21.214 | 2445cc | 4 Cyl. | 8 Valves | 77kW/105PS | Diesel | Sofim, Turbo | TD1704 |
| 8140.21.290 | 2445cc | 4 Cyl. | 8 Valves | 68kW/92PS | Diesel | Turbo | TD27372 |
| 8140.27 S | 2445cc | 4 Cyl. | 8 Valves | 68kW/92PS | Diesel | Turbo | TD1705 |
| 8140.61.200 | 2445cc | 4 Cyl. | 8 Valves | 53kW/72PS | Diesel | | TD7225 |
| DAILY I 30-8 | | 01/1978→12/1989 | | DAILY I 35-8 | | 01/1978→12/1989 | |
| DAILY I 35-10 | | 01/1985→12/1989 | | DAILY I 40-8 | | 01/1983→06/1989 | |
| DAILY I 40-8 V | | 01/1983→06/1989 | | DAILY I 40-10 | | 01/1985→12/1989 | |
| DAILY I 40-10 V | | 01/1985→12/1989 | | DAILY I 45-10 | | 01/1985→12/1989 | |
| DAILY I 45-10 V | | 01/1985→12/1989 | | DAILY I 49-10 | | 01/1985→12/1989 | |
| DAILY I 49-10 V | | 01/1985→12/1989 | | | | | |

V91292 ■
40.80 x 8.00 x 120.70

4757358

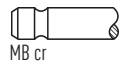

MB cr

30° Y H

VAG92193 ■
56.00 x 8.04 x 13.05

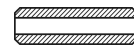

V91293 ■
34.50 x 8.00 x 122.00

4 826 033

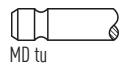

MD tu

45°

VAG92373 ■
56.00 x 8.03 x 13.04



V91294 ■
34.50 x 8.00 x 122.00

7 302 157



MF + MB cr

45° H

VAG92444 ■
56.00 x 8.00 x 13.04

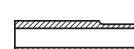

VAG92369 ■
60.00 x 8.00 x 13.07

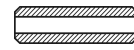

3



93.00

| | | | | | | | |
|-----------------------------------|-----------|--------|----------|------------------------------------|--------|------|---------|
| 8140.61.300 | 2445cc | 4 Cyl. | 8 Valves | 53kW/72PS | Diesel | | TD20426 |
| 8144.61.200 | 2445cc | 4 Cyl. | 8 Valves | 53kW/72PS | Diesel | SOHC | TD20429 |
| V91292 ■ 40.80 x 8.00 x 120.70 | 4757358 | MB cr | 30° Y H | VAG92193 ■ 56.00 x 8.04 x 13.05 | | | |
| V91293 ■ 34.50 x 8.00 x 122.00 | 4 826 033 | MD tu | 45° | VAG92373 ■ 56.00 x 8.03 x 13.04 | | | |
| | | | | VAG92444 ■ 56.00 x 8.00 x 13.04 | | | |
| | | | | VAG92369 ■ 60.00 x 8.00 x 13.07 | | | |

4



93.00

| | | | | | | | |
|-----------------------------------|-----------|------------|----------|------------------------------------|--------|--|---------|
| 8140.07.2585 | 2499cc | 4 Cyl. | 8 Valves | 55kW/75PS | Diesel | | TD20437 |
| V91399 ■ 41.00 x 8.00 x 122.00 | 4 813 760 | MB tu | 30° H | VAG92193 ■ 56.00 x 8.04 x 13.05 | | | |
| V91400 ■ 34.50 x 8.00 x 122.00 | 7 303 309 | MD + MB tu | 45° H | VAG92373 ■ 56.00 x 8.03 x 13.04 | | | |
| | | | | VAG92444 ■ 56.00 x 8.00 x 13.04 | | | |
| | | | | VAG92369 ■ 60.00 x 8.00 x 13.07 | | | |

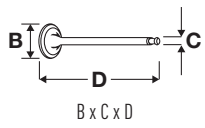



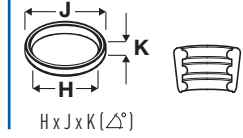
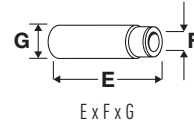
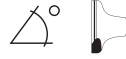

OE

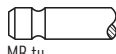

5  **93.00**

| | | | | | | |
|---------------------|--------|--------|-----------------|-----------|--------|----------------|
| 8140.07.2700 | 2500cc | 4 Cyl. | 8 Valves | 55kW/75PS | Diesel | TD1700 |
| 8140.07.2701 | 2500cc | 4 Cyl. | 8 Valves | 55kW/75PS | Diesel | TD1701 |
| 8140.07.2712 | 2500cc | 4 Cyl. | 8 Valves | 55kW/75PS | Diesel | TD1702 |
| 8140.07.3710 | 2500cc | 4 Cyl. | 8 Valves | 53kW/72PS | Diesel | TD20418 |

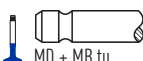
| | | | |
|---------------|-----------------|---------------|-----------------|
| DAILY II 30-8 | 01/1989→08/1998 | DAILY II 35-8 | 01/1989→08/1998 |
|---------------|-----------------|---------------|-----------------|

| | | | | | | |
|--|-----------|---|-----|---|---|---|
| V91399 ■ 41.00 x 8.00 x 122.00 | 4 813 760 |  MB tu | 30° | H | VAG92193 ■ 56.00 x 8.04 x 13.05 |  |
| V91400 ■ 34.50 x 8.00 x 122.00 | 7 303 309 |  MD + MB tu | 45° | H | VAG92373 ■ 56.00 x 8.03 x 13.04 |  |
| | | | | | VAG92369 ■ 60.00 x 8.00 x 13.07 |  |



OE

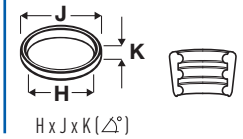

6



93.00

| | | | | | | | |
|------------------|--------|-----------------|----------|-------------------|--------|-----------------|---------|
| 8140.07.2710 | 2500cc | 4 Cyl. | 8 Valves | 55kW/75PS | Diesel | | TD27358 |
| 8140.07.2711 | 2500cc | 4 Cyl. | 8 Valves | 55kW/75PS | Diesel | | TD27359 |
| 8140.07.3711 | 2500cc | 4 Cyl. | 8 Valves | 53kW/72PS | Diesel | | TD27365 |
| 8140.07.3712 | 2500cc | 4 Cyl. | 8 Valves | 53kW/72PS | Diesel | | TD27366 |
| 8140.07.3713 | 2500cc | 4 Cyl. | 8 Valves | 53kW/72PS | Diesel | | TD27367 |
| 8140.27.2582 | 2500cc | 4 Cyl. | 8 Valves | 74-79kW/101-107PS | Diesel | Turbo | TD7260 |
| 8140.27.2700 | 2500cc | 4 Cyl. | 8 Valves | 76kW/103PS | Diesel | | TD1706 |
| 8140.27.2720 | 2500cc | 4 Cyl. | 8 Valves | 76kW/103PS | Diesel | | TD1707 |
| 8140.27.2811 | 2500cc | 4 Cyl. | 8 Valves | 76kW/103PS | Diesel | | TD1708 |
| 8140.27R.2700 | 2500cc | 4 Cyl. | 8 Valves | 67-70kW/92-95PS | Diesel | Turbo | TD20420 |
| 8140.27S.2801 | 2500cc | 4 Cyl. | 8 Valves | 76kW/103PS | Diesel | Sofim, Turbo | TD20419 |
| 8140.27S.2885 | 2500cc | 4 Cyl. | 8 Valves | 76kW/103PS | Diesel | Sofim, Turbo | TD20422 |
| 8140.47.2700 | 2500cc | 4 Cyl. | 8 Valves | 85kW/116PS | Diesel | Turbo | TD1711 |
| 8140.47.2711 | 2500cc | 4 Cyl. | 8 Valves | 85kW/116PS | Diesel | Turbo | TD1712 |
| 8140.47.2721 | 2500cc | 4 Cyl. | 8 Valves | 85kW/116PS | Diesel | Turbo | TD1713 |
| 8140.47.2785 | 2500cc | 4 Cyl. | 8 Valves | 85kW/116PS | Diesel | Turbo | TD1715 |
| 8140.47.3700 | 2500cc | 4 Cyl. | 8 Valves | 85kW/116PS | Diesel | Turbo | TD20477 |
| 8140.47R | 2500cc | 4 Cyl. | 8 Valves | 80kW/109PS | Diesel | Turbo | TD7234 |
| 8140.47R.2790 | 2500cc | 4 Cyl. | 8 Valves | 76-80kW/103-109PS | Diesel | Turbo | TD1716 |
| 8140.47S | 2500cc | 4 Cyl. | 8 Valves | 85kW/116PS | Diesel | Turbo | TD20453 |
| 8140.97.2781 | 2500cc | 4 Cyl. | 8 Valves | 68kW/92PS | Diesel | Turbo | TD1717 |
| DAILY II 2.5 | | 11/1989→05/1996 | | DAILY II 35-10 | | 01/1989→08/1998 | |
| DAILY II 35-12 | | 01/1990→04/1996 | | DAILY II 40-10 V | | 01/1990→04/1996 | |
| DAILY II 45-10 | | 01/1989→04/1996 | | DAILY II 45-10 V | | 01/1989→04/1996 | |
| DAILY II 49-10 | | 01/1989→04/1996 | | DAILY II 49-10 V | | 01/1989→04/1996 | |
| DAILY II 49-10 K | | 01/1989→04/1996 | | DAILY II 49-12 | | 06/1990→04/1996 | |
| DAILY II 49-12 V | | 06/1990→04/1996 | | DAILY II 49-12 K | | 06/1990→04/1996 | |
| DAILY II 59-12 | | 05/1991→04/1996 | | DAILY II 59-12 V | | 05/1991→04/1996 | |
| DAILY II 59-12 K | | 05/1991→04/1996 | | DAILY II A 40-10 | | 01/1991→12/1996 | |
| DAILY II A 45-10 | | 01/1991→04/1996 | | DAILY II A 45-12 | | 06/1990→04/1996 | |

V91292 ■
40.80 x 8.00 x 120.70

4757358

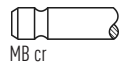

MB cr

30° Y H

VAG92193 ■
56.00 x 8.04 x 13.05



V91293 ■
34.50 x 8.00 x 122.00

4 826 033

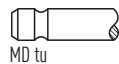

MD tu

45° H

VAG92373 ■
56.00 x 8.03 x 13.04

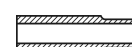

V91294 ■
34.50 x 8.00 x 122.00

7 302 157



MF + MB cr

45° H

VAG92444 ■
56.00 x 8.00 x 13.04



VAG92369 ■
60.00 x 8.00 x 13.07



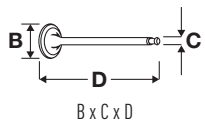

OE





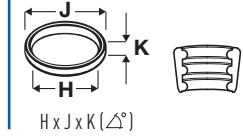
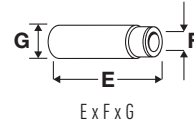
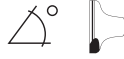

MAT.



7

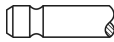

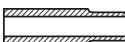
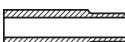
93.00

| 8140.07.3700 | 2500cc | 4 Cyl. | 8 Valves | 53kW/72PS | Diesel | TD27364 |
|--|-----------|--|----------|---|---|---------|
| V91292 ■ 40.80 x 8.00 x 120.70 | 4757358 |  MB cr | 30° Y H | VAG92193 ■ 56.00 x 8.04 x 13.05 |  | |
| V91293 ■ 34.50 x 8.00 x 122.00 | 4 826 033 |  MD tu | 45° | VAG92373 ■ 56.00 x 8.03 x 13.04 |  | |
| | | | | VAG92444 ■ 56.00 x 8.00 x 13.04 |  | |
| | | | | VAG92369 ■ 60.00 x 8.00 x 13.07 |  | |



OE

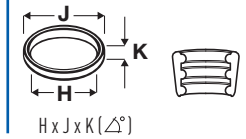

8



93.00

| | | | | | | | |
|---------------|--------|--------|----------|-------------------|--------|-------|---------|
| 8140.27.215 | 2500cc | 4 Cyl. | 8 Valves | 76kW/103PS | Diesel | Turbo | TD27387 |
| 8140.27.218 | 2500cc | 4 Cyl. | 8 Valves | 76kW/103PS | Diesel | Turbo | TD26268 |
| 8140.27S.2701 | 2500cc | 4 Cyl. | 8 Valves | 76kW/103PS | Diesel | Turbo | TD27396 |
| 8140.27S.2710 | 2500cc | 4 Cyl. | 8 Valves | 76kW/103PS | Diesel | Turbo | TD27397 |
| 8140.27S.2711 | 2500cc | 4 Cyl. | 8 Valves | 76kW/103PS | Diesel | Turbo | TD27398 |
| 8140.27S.2720 | 2500cc | 4 Cyl. | 8 Valves | 76kW/103PS | Diesel | Turbo | TD27399 |
| 8140.27S.2721 | 2500cc | 4 Cyl. | 8 Valves | 76kW/103PS | Diesel | Turbo | TD27400 |
| 8140.27S.2730 | 2500cc | 4 Cyl. | 8 Valves | 76kW/103PS | Diesel | Turbo | TD27401 |
| 8140.27S.2731 | 2500cc | 4 Cyl. | 8 Valves | 76kW/103PS | Diesel | Turbo | TD27402 |
| 8140.27S.2750 | 2500cc | 4 Cyl. | 8 Valves | 76kW/103PS | Diesel | Turbo | TD27403 |
| 8140.27S.2760 | 2500cc | 4 Cyl. | 8 Valves | 76kW/103PS | Diesel | Turbo | TD27405 |
| 8140.27S.2761 | 2500cc | 4 Cyl. | 8 Valves | 76kW/103PS | Diesel | Turbo | TD27406 |
| 8140.27S.2770 | 2500cc | 4 Cyl. | 8 Valves | 76kW/103PS | Diesel | Turbo | TD27407 |
| 8140.27S.2771 | 2500cc | 4 Cyl. | 8 Valves | 76kW/103PS | Diesel | Turbo | TD27408 |
| 8140.27S.2811 | 2500cc | 4 Cyl. | 8 Valves | 76kW/103PS | Diesel | Turbo | TD27409 |
| 8140.27S.3701 | 2500cc | 4 Cyl. | 8 Valves | 77kW/104PS | Diesel | Turbo | TD27411 |
| 8140.27S.3711 | 2500cc | 4 Cyl. | 8 Valves | 77kW/104PS | Diesel | Turbo | TD27412 |
| 8140.27S.3720 | 2500cc | 4 Cyl. | 8 Valves | 77kW/104PS | Diesel | Turbo | TD27413 |
| 8140.27S.3721 | 2500cc | 4 Cyl. | 8 Valves | 77kW/104PS | Diesel | Turbo | TD27414 |
| 8140.27S.3750 | 2500cc | 4 Cyl. | 8 Valves | 77kW/104PS | Diesel | Turbo | TD27415 |
| 8140.27S.3751 | 2500cc | 4 Cyl. | 8 Valves | 77kW/104PS | Diesel | Turbo | TD27416 |
| 8140.27S.3760 | 2500cc | 4 Cyl. | 8 Valves | 77kW/104PS | Diesel | Turbo | TD27419 |
| 8140.27S.3761 | 2500cc | 4 Cyl. | 8 Valves | 77kW/104PS | Diesel | Turbo | TD27420 |
| 8140.27S.3770 | 2500cc | 4 Cyl. | 8 Valves | 77kW/104PS | Diesel | Turbo | TD27422 |
| 8140.27S.3771 | 2500cc | 4 Cyl. | 8 Valves | 77kW/104PS | Diesel | Turbo | TD27423 |
| 8140.27S.3780 | 2500cc | 4 Cyl. | 8 Valves | 77kW/104PS | Diesel | Turbo | TD27424 |
| 8140.27S.3811 | 2500cc | 4 Cyl. | 8 Valves | 77kW/104PS | Diesel | Turbo | TD27426 |
| 8140.47.3711 | 2500cc | 4 Cyl. | 8 Valves | 85kW/116PS | Diesel | Turbo | TD26005 |
| 8140.47.3721 | 2500cc | 4 Cyl. | 8 Valves | 85kW/116PS | Diesel | Turbo | TD26006 |
| 8140.47B.3790 | 2500cc | 4 Cyl. | 8 Valves | 78-83kW/106-113PS | Diesel | Turbo | TD26008 |
| 8140.47B.3795 | 2500cc | 4 Cyl. | 8 Valves | 78-83kW/106-113PS | Diesel | Turbo | TD26009 |
| 8140.47R.2795 | 2500cc | 4 Cyl. | 8 Valves | 80kW/109PS | Diesel | Turbo | TD26010 |

V91292 ■ 40.80 x 8.00 x 120.70

4757358

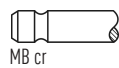

30° Y

H

VAG92193 ■ 56.00 x 8.04 x 13.05



V91939 ■ 43.50 x 8.00 x 122.00

98 468 338

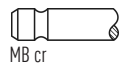

30°

H

VAG92373 ■ 56.00 x 8.03 x 13.04

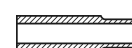

V91293 ■ 34.50 x 8.00 x 122.00

4 826 033

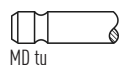

45°

H

VAG92444 ■ 56.00 x 8.00 x 13.04

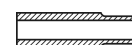

V91940 ■ 36.70 x 8.00 x 122.00

98 418 161

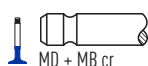

45°

H

VAG92369 ■ 60.00 x 8.00 x 13.07



V91994 ■ 35.80 x 8.00 x 121.90

99 432 837

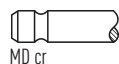



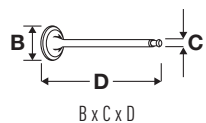



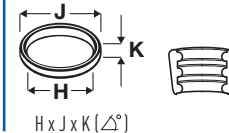
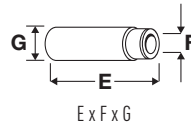
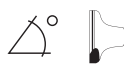

45°





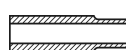
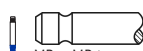

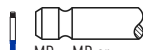

OE









9  **93.00**

| Part No. | Capacity | Cyls | Valves | Power | Fuel | Configuration | Code |
|--|------------|---|----------|-----------------|--------|---|---|
| 8140.27R.2782 | 2500cc | 4 Cyl. | 8 Valves | 70kW/96PS | Diesel | Turbo | TD1710 |
| 8140.27R.2786 | 2500cc | 4 Cyl. | 8 Valves | 67-70kW/91-95PS | Diesel | Turbo | TD27394 |
| V91292 ■ 40.80 x 8.00 x 120.70 | 4757358 |  | 30° | Y | H | VAG92193 ■ 56.00 x 8.04 x 13.05 |  |
| V91399 ■ 41.00 x 8.00 x 122.00 | 4 813 760 |  | 30° | | H | VAG92373 ■ 56.00 x 8.03 x 13.04 |  |
| V91293 ■ 34.50 x 8.00 x 122.00 | 4 826 033 |  | 45° | | | VAG92444 ■ 56.00 x 8.00 x 13.04 |  |
| V91400 ■ 34.50 x 8.00 x 122.00 | 7 303 309 |  | 45° | | H | VAG92369 ■ 60.00 x 8.00 x 13.07 |  |
| V91940 ■ 36.70 x 8.00 x 122.00 | 98 418 161 |  | 45° | | H | | |
| V91994 ■ 35.80 x 8.00 x 121.90 | 99 432 837 |  | 45° | | | | |

10  **93.00**

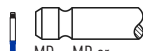
| Part No. | Capacity | Cyls | Valves | Power | Fuel | Configuration | Code |
|--|-----------|---|----------|------------|--------|---|---|
| 8140.27S.2700 | 2500cc | 4 Cyl. | 8 Valves | 76kW/103PS | Diesel | Sofim, Turbo, SOHC | TD20421 |
| V91292 ■ 40.80 x 8.00 x 120.70 | 4757358 |  | 30° | Y | H | VAG92193 ■ 56.00 x 8.04 x 13.05 |  |
| V91294 ■ 34.50 x 8.00 x 122.00 | 7 302 157 |  | 45° | | H | VAG92373 ■ 56.00 x 8.03 x 13.04 |  |
| | | | | | | VAG92444 ■ 56.00 x 8.00 x 13.04 |  |
| | | | | | | VAG92369 ■ 60.00 x 8.00 x 13.07 |  |

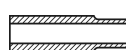
11  **93.00**

| Part No. | Capacity | Cyls | Valves | Power | Fuel | Configuration | Code |
|--|-----------------|---|----------|-----------------|--------|---|---|
| 8140.67.2585 | 2500cc | 4 Cyl. | 8 Valves | 55-63kW/75-86PS | Diesel | Turbo, SOHC | TD20427 |
| 8140.67F. | 2500cc | 4 Cyl. | 8 Valves | 60kW/82PS | Diesel | SOHC | TD7226 |
| 8140.67F.3700 | 2500cc | 4 Cyl. | 8 Valves | 60-63kW/82-86PS | Diesel | SOHC | TD20428 |
| DAILY II 30-8 | 01/1989→08/1998 | | | DAILY II 35-8 | | 01/1989→08/1998 | |
| V91939 ■ 43.50 x 8.00 x 122.00 | 98 468 338 |  | 30° | | H | VAG92193 ■ 56.00 x 8.04 x 13.05 |  |
| V91940 ■ 36.70 x 8.00 x 122.00 | 98 418 161 |  | 45° | | H | VAG92373 ■ 56.00 x 8.03 x 13.04 |  |
| | | | | | | VAG92444 ■ 56.00 x 8.00 x 13.04 |  |
| | | | | | | VAG92369 ■ 60.00 x 8.00 x 13.07 |  |

12  **94.40**

| Part No. | Capacity | Cyls | Valves | Power | Fuel | Configuration | Code |
|--------------|----------|--------|----------|-------------------|--------|--------------------|---------|
| 8140.23 | 2800cc | 4 Cyl. | 8 Valves | 76kW/103PS | Diesel | Sofim, Turbo, SOHC | TD7229 |
| 8140.23.2585 | 2800cc | 4 Cyl. | 8 Valves | 76-78kW/103-106PS | Diesel | Sofim, Turbo, SOHC | TD16183 |
| 8140.23.3700 | 2800cc | 4 Cyl. | 8 Valves | 76kW/103PS | Diesel | Sofim, Turbo, SOHC | TD10387 |
| 8140.23.3701 | 2800cc | 4 Cyl. | 8 Valves | 76kW/103PS | Diesel | Sofim, Turbo, SOHC | TD27373 |



OE

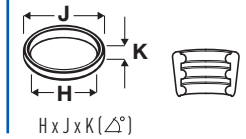
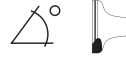

| | | | | | | | |
|------------------|-----------------|--------|----------|-------------------|--------|--------------------|---------|
| 8140.23.3710 | 2800cc | 4 Cyl. | 8 Valves | 76kW/103PS | Diesel | Sofim, Turbo, SOHC | TD27374 |
| 8140.23.3711 | 2800cc | 4 Cyl. | 8 Valves | 76kW/103PS | Diesel | Sofim, Turbo, SOHC | TD27375 |
| 8140.23.3713 | 2800cc | 4 Cyl. | 8 Valves | 76kW/103PS | Diesel | Sofim, Turbo, SOHC | TD27376 |
| 8140.23.3720 | 2800cc | 4 Cyl. | 8 Valves | 76kW/103PS | Diesel | Sofim, Turbo, SOHC | TD27377 |
| 8140.23.3721 | 2800cc | 4 Cyl. | 8 Valves | 76kW/103PS | Diesel | Sofim, Turbo, SOHC | TD27378 |
| 8140.23.3730 | 2800cc | 4 Cyl. | 8 Valves | 76kW/103PS | Diesel | Sofim, Turbo, SOHC | TD27379 |
| 8140.23.3731 | 2800cc | 4 Cyl. | 8 Valves | 76kW/103PS | Diesel | Sofim, Turbo, SOHC | TD27380 |
| 8140.23.3750 | 2800cc | 4 Cyl. | 8 Valves | 76kW/103PS | Diesel | Sofim, Turbo, SOHC | TD27381 |
| 8140.23.3751 | 2800cc | 4 Cyl. | 8 Valves | 76kW/103PS | Diesel | Sofim, Turbo, SOHC | TD27382 |
| 8140.23.3760 | 2800cc | 4 Cyl. | 8 Valves | 76kW/103PS | Diesel | Sofim, Turbo, SOHC | TD27383 |
| 8140.43 | 2800cc | 4 Cyl. | 8 Valves | 90kW/122PS | Diesel | Sofim, Turbo, SOHC | TD7235 |
| 8140.43.2585 | 2800cc | 4 Cyl. | 8 Valves | 84-90kW/114-122PS | Diesel | Sofim, Turbo, SOHC | TD20423 |
| 8140.43.3700 | 2800cc | 4 Cyl. | 8 Valves | 90kW/122PS | Diesel | Sofim, Turbo, SOHC | TD20424 |
| 8140.43.3728 | 2800cc | 4 Cyl. | 8 Valves | 90kW/122PS | Diesel | Sofim, Turbo, SOHC | TD27432 |
| 8140.43.3900 | 2800cc | 4 Cyl. | 8 Valves | 90kW/122PS | Diesel | Sofim, Turbo, SOHC | TD20425 |
| 8140.43C | 2800cc | 4 Cyl. | 8 Valves | 78kW/106PS | Diesel | Sofim, Turbo, SOHC | TD14449 |
| 8140.43K.4000 | 2800cc | 4 Cyl. | 8 Valves | 107kW/146PS | Diesel | Sofim, Turbo, SOHC | TD17143 |
| 8140.43N | 2800cc | 4 Cyl. | 8 Valves | 107kW/146PS | Diesel | Sofim, Turbo, SOHC | TD16873 |
| 8140.43N.4300 | 2800cc | 4 Cyl. | 8 Valves | 107kW/146PS | Diesel | Sofim, Turbo, SOHC | TD25984 |
| 8140.43N.4320 | 2800cc | 4 Cyl. | 8 Valves | 107kW/146PS | Diesel | Sofim, Turbo, SOHC | TD25985 |
| 8140.43N.4330 | 2800cc | 4 Cyl. | 8 Valves | 107kW/146PS | Diesel | Sofim, Turbo, SOHC | TD25986 |
| 8140.43N.4400 | 2800cc | 4 Cyl. | 8 Valves | 107kW/146PS | Diesel | Sofim, Turbo, SOHC | TD25987 |
| 8140.43N.4430 | 2800cc | 4 Cyl. | 8 Valves | 107kW/146PS | Diesel | Sofim, Turbo, SOHC | TD25988 |
| 8140.43R.4300 | 2800cc | 4 Cyl. | 8 Valves | 66kW/90PS | Diesel | Sofim, Turbo, SOHC | TD25989 |
| 8140.43R.4320 | 2800cc | 4 Cyl. | 8 Valves | 66kW/90PS | Diesel | Sofim, Turbo, SOHC | TD25990 |
| 8140.43R.4330 | 2800cc | 4 Cyl. | 8 Valves | 66kW/90PS | Diesel | Sofim, Turbo, SOHC | TD25991 |
| 8140.43R.4400 | 2800cc | 4 Cyl. | 8 Valves | 66kW/90PS | Diesel | Sofim, Turbo, SOHC | TD25992 |
| 8140.43R.4420 | 2800cc | 4 Cyl. | 8 Valves | 66kW/90PS | Diesel | Sofim, Turbo, SOHC | TD25993 |
| 8140.43S | 2800cc | 4 Cyl. | 8 Valves | 92kW/125PS | Diesel | Sofim, Turbo, SOHC | TD16874 |
| 8140.43S.4000 | 2800cc | 4 Cyl. | 8 Valves | 92-94kW/125-128PS | Diesel | Sofim, Turbo, SOHC | TD25995 |
| 8140.43S.4020 | 2800cc | 4 Cyl. | 8 Valves | 92-94kW/125-128PS | Diesel | Sofim, Turbo, SOHC | TD25996 |
| 8140.43S.4030 | 2800cc | 4 Cyl. | 8 Valves | 92-94kW/125-128PS | Diesel | Sofim, Turbo, SOHC | TD25997 |
| 8140.43S.4140 | 2800cc | 4 Cyl. | 8 Valves | 92-94kW/125-128PS | Diesel | Sofim, Turbo, SOHC | TD25998 |
| 8140.43S.4300 | 2800cc | 4 Cyl. | 8 Valves | 92-94kW/125-128PS | Diesel | Sofim, Turbo, SOHC | TD25999 |
| 8140.43S.4320 | 2800cc | 4 Cyl. | 8 Valves | 92-94kW/125-128PS | Diesel | Sofim, Turbo, SOHC | TD26000 |
| 8140.43S.4330 | 2800cc | 4 Cyl. | 8 Valves | 92-94kW/125-128PS | Diesel | Sofim, Turbo, SOHC | TD26001 |
| 8140.43S.4400 | 2800cc | 4 Cyl. | 8 Valves | 92-94kW/125-128PS | Diesel | Sofim, Turbo, SOHC | TD26002 |
| 8140.43S.4420 | 2800cc | 4 Cyl. | 8 Valves | 92-94kW/125-128PS | Diesel | Sofim, Turbo, SOHC | TD26003 |
| 8140.43S.4430 | 2800cc | 4 Cyl. | 8 Valves | 92-94kW/125-128PS | Diesel | Sofim, Turbo, SOHC | TD26004 |
| 8140.63 | 2800cc | 4 Cyl. | 8 Valves | 62-64kW/84-87PS | Diesel | Sofim, SOHC | TD10389 |
| DAILY II 2.8 | 02/1995→05/1999 | | | DAILY II 30-8 | | 09/1998→05/1999 | |
| DAILY II 30-8 V | 09/1998→05/1999 | | | DAILY II 30-10 | | 01/1997→05/1999 | |
| DAILY II 30-10 C | 01/1997→05/1999 | | | DAILY II 35-8 | | 09/1998→05/1999 | |
| DAILY II 35-8 K | 09/1998→05/1999 | | | DAILY II 35-10 | | 01/1996→05/1999 | |
| DAILY II 35-10 K | 01/1997→05/1999 | | | DAILY II 35-12 | | 02/1995→05/1999 | |
| DAILY II 35-12 K | 09/1996→08/1998 | | | DAILY II 40-10 | | 01/1997→05/1999 | |
| DAILY II 40-10 W | 01/1997→05/1999 | | | DAILY II 49-10 | | 05/1996→05/1999 | |
| DAILY II 49-10 K | 05/1996→05/1999 | | | DAILY II 49-12 | | 05/1996→05/1999 | |
| DAILY II 49-12 V | 05/1996→05/1999 | | | DAILY II 49-12 K | | 05/1996→05/1999 | |
| DAILY II 59-12 | 05/1996→05/1999 | | | DAILY II 59-12 V | | 05/1996→05/1999 | |
| DAILY II 59-12 K | 05/1996→05/1999 | | | DAILY II A 40-10 | | 09/1996→05/1999 | |
| DAILY II A 40-12 | 05/1996→05/1999 | | | DAILY II A 45-10 | | 05/1996→05/1999 | |

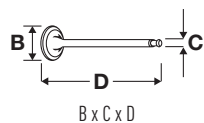

OE

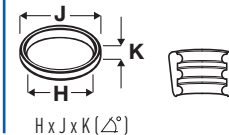
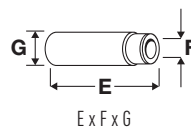
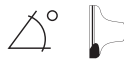

| | | | |
|-------------------------------|-----------------|-------------------------------------|-----------------|
| DAILY II A 45-12 | 05/1996→05/1999 | DAILY III 2.8 D | 11/1997→07/2007 |
| DAILY III 29 L 9 | 05/1999→04/2006 | DAILY III 29 L 9 V | 05/1999→07/2007 |
| DAILY III 29 L 11 | 05/1999→04/2006 | DAILY III 29 L 11 V | 05/1999→07/2007 |
| DAILY III 29 L 13 | 05/2001→07/2007 | DAILY III 35 C 15 | 11/2001→04/2006 |
| DAILY III 35 S 9,35 C 9 | 05/1999→04/2006 | DAILY III 35 S 9 V,35 C 9 V | 05/1999→07/2007 |
| DAILY III 35 S 11,35 C 11 | 05/1999→04/2006 | DAILY III 35 S 11 V,35 C 11 V | 05/1999→07/2007 |
| DAILY III 35 S 13,35 C 13 | 05/1999→04/2006 | DAILY III 35 S 13, 40 C 13, 50 C 13 | 05/1999→05/2006 |
| DAILY III 35 S 13 V,35 C 13 V | 05/1999→07/2007 | DAILY III 35 S 15 V, 35 C 15 V | 11/2002→07/2007 |
| DAILY III 40 C 11, 50 C 11 | 05/1999→05/2006 | DAILY III 40 C 13 | 05/1999→04/2006 |
| DAILY III 40 C 15 | 11/2001→04/2006 | DAILY III 40 C 15, 50 C 15 | 05/1999→05/2006 |
| DAILY III 50 C 11 | 05/1999→07/2007 | DAILY III 50 C 13 | 05/1999→07/2007 |
| DAILY III 50 C 15 | 01/2001→04/2006 | DAILY III 65 C 15 | 11/2001→04/2006 |
| M26 | 01/1996→12/2002 | | |

V91292 ■
40.80 x 8.00 x 120.70

4757358

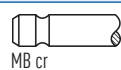

30° Y H

VAG92193 ■
56.00 x 8.04 x 13.05



V91994 ■
35.80 x 8.00 x 121.90

99 432 837

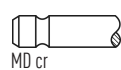

45°

VAG92373 ■
56.00 x 8.03 x 13.04

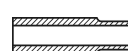

VAG92444 ■
56.00 x 8.00 x 13.04

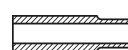

VAG92369 ■
60.00 x 8.00 x 13.07



13



94.40

| | | | | | | | |
|----------------------|--------|--------|-----------------|-----------------|--------|---------------------------|----------------|
| 8140.43B | 2800cc | 4 Cyl. | 8 Valves | 78kW/106PS | Diesel | Sofim, Turbo, SOHC | TD16514 |
| 8140.43B.4300 | 2800cc | 4 Cyl. | 8 Valves | 78kW/106PS | Diesel | Sofim, Turbo, SOHC | TD25968 |
| 8140.43B.4305 | 2800cc | 4 Cyl. | 8 Valves | 78kW/106PS | Diesel | Sofim, Turbo, SOHC | TD25966 |
| 8140.43B.4320 | 2800cc | 4 Cyl. | 8 Valves | 78kW/106PS | Diesel | Sofim, Turbo, SOHC | TD25967 |
| 8140.43B.4325 | 2800cc | 4 Cyl. | 8 Valves | 78kW/106PS | Diesel | Sofim, Turbo, SOHC | TD25969 |
| 8140.43B.4330 | 2800cc | 4 Cyl. | 8 Valves | 78kW/106PS | Diesel | Sofim, Turbo, SOHC | TD25970 |
| 8140.43B.4335 | 2800cc | 4 Cyl. | 8 Valves | 78kW/106PS | Diesel | Sofim, Turbo, SOHC | TD25971 |
| 8140.43C.4000 | 2800cc | 4 Cyl. | 8 Valves | 78kW/106PS | Diesel | Sofim, Turbo, SOHC | TD25972 |
| 8140.43C.4005 | 2800cc | 4 Cyl. | 8 Valves | 78kW/106PS | Diesel | Sofim, Turbo, SOHC | TD25973 |
| 8140.43C.4020 | 2800cc | 4 Cyl. | 8 Valves | 78kW/106PS | Diesel | Sofim, Turbo, SOHC | TD25974 |
| 8140.43C.4021 | 2800cc | 4 Cyl. | 8 Valves | 78kW/106PS | Diesel | Sofim, Turbo, SOHC | TD25975 |
| 8140.43C.4025 | 2800cc | 4 Cyl. | 8 Valves | 78kW/106PS | Diesel | Sofim, Turbo, SOHC | TD25976 |
| 8140.43C.4026 | 2800cc | 4 Cyl. | 8 Valves | 78kW/106PS | Diesel | Sofim, Turbo, SOHC | TD25977 |
| 8140.43C.4035 | 2800cc | 4 Cyl. | 8 Valves | 78kW/106PS | Diesel | Sofim, Turbo, SOHC | TD25980 |
| 8140.43C.4036 | 2800cc | 4 Cyl. | 8 Valves | 78kW/106PS | Diesel | Sofim, Turbo, SOHC | TD25981 |
| 8140.43K.4020 | 2800cc | 4 Cyl. | 8 Valves | 107kW/145PS | Diesel | Sofim, Turbo, SOHC | TD25982 |
| 8140.63.4000 | 2800cc | 4 Cyl. | 8 Valves | 62-64kW/84-87PS | Diesel | Sofim, SOHC | TD20478 |

DAILY III 29 L 11
Fumo

05/1999→04/2006
09/2001→

DAILY III 40 C 11, 50 C 11

05/1999→05/2006

V91939 ■
43.50 x 8.00 x 122.00

98 468 338

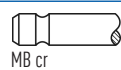

30° H

VAG92193 ■
56.00 x 8.04 x 13.05



V91940 ■
36.70 x 8.00 x 122.00

98 418 161



45° H

VAG92373 ■
56.00 x 8.03 x 13.04



VAG92444 ■
56.00 x 8.00 x 13.04



VAG92369 ■
60.00 x 8.00 x 13.07





OE

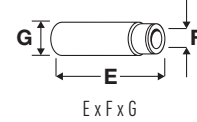

14 95.80

| | | | | | | | |
|---|-----------------|--------|------------------|--|--------|--------------------|----------------|
| F1CE0481A | 2998cc | 4 Cyl. | 16 Valves | 100-114kW/136-155PS | Diesel | Turbo, DOHC | TD19195 |
| F1CE0481B | 2998cc | 4 Cyl. | 16 Valves | 122kW/166PS | Diesel | Turbo, DOHC | TD22675 |
| F1CE0481FA | 2998cc | 4 Cyl. | 16 Valves | 107kW/146PS | Diesel | Turbo, DOHC | TD19224 |
| F1CE0481HA | 2998cc | 4 Cyl. | 16 Valves | 125-130kW/170-177PS | Diesel | Turbo, DOHC | TD19225 |
| F1CE0481HC | 2998cc | 4 Cyl. | 16 Valves | 130kW/176PS | Diesel | Turbo, DOHC | TD19230 |
| F1CE0481L | 2998cc | 4 Cyl. | 16 Valves | 107-110kW/146-150PS | Diesel | Turbo, DOHC | TD27239 |
| DAILY III 35 C 14 | 09/2004→04/2006 | | | DAILY III 35 C 17, 35 S 17 | | 01/2005→04/2006 | |
| DAILY III 35 S 14, 50 C 14 | 01/2004→05/2006 | | | DAILY III 40 C 14 | | 09/2004→04/2006 | |
| DAILY III 40 C 17, 40 S 17 | 01/2005→04/2006 | | | DAILY III 40 C 17, 50 C 17 | | 01/2004→05/2006 | |
| DAILY III 45 C 14 | 07/1999→04/2006 | | | DAILY III 50 C 14 | | 09/2004→04/2006 | |
| DAILY III 50 C 17 | 09/2004→04/2006 | | | DAILY III 65 C 14 | | 09/2004→04/2006 | |
| DAILY III 65 C 17 | 09/2004→04/2006 | | | DAILY IV 35C15 | | 05/2006→08/2011 | |
| DAILY IV 35C15 V, 35C15 V/P | 05/2006→08/2011 | | | DAILY IV 35C17, 35C17 /P, 35S17, 35S17 /P, 35S17 D | | 07/2007→08/2011 | |
| DAILY IV 35C17 V, 35C17 V/P, 35S17 V, 35S17 V/P | 07/2007→08/2011 | | | DAILY IV 35C17 K, 35C17 DK, 35S17 K, 35S17 DK | | 07/2007→08/2011 | |
| DAILY IV 35C18 | 05/2006→08/2011 | | | DAILY IV 35C18, 35S18 | | 05/2006→08/2011 | |
| DAILY IV 35C18 V, 35C18 V/P, 35S18 V, 35S18 V/P | 05/2006→08/2011 | | | DAILY IV 35S14 | | 07/2007→08/2011 | |
| DAILY IV 35S15 | 06/2006→08/2011 | | | DAILY IV 35S17 W, 35S17 WD | | 07/2007→08/2011 | |
| DAILY IV 40C15 | 05/2006→08/2011 | | | DAILY IV 40C15 V, 40C15 V/P | | 05/2006→08/2011 | |
| DAILY IV 40C17, 40C17 /P | 07/2007→08/2011 | | | DAILY IV 40C17 V, 40C17 V/P | | 07/2007→08/2011 | |
| DAILY IV 40C17 K, 40C17 DK | 07/2007→08/2011 | | | DAILY IV 40C18 | | 05/2006→08/2011 | |
| DAILY IV 40C18 V, 40C18 V/P | 05/2006→08/2011 | | | DAILY IV 45C15 | | 05/2006→08/2011 | |
| DAILY IV 45C15 V | 05/2006→08/2011 | | | DAILY IV 45C17, 45C17 /P | | 07/2007→08/2011 | |
| DAILY IV 45C17 V, 45C17 V/P | 07/2007→08/2011 | | | DAILY IV 45C18 | | 05/2006→08/2011 | |
| DAILY IV 45C18, 45C18 /P, 45C18 D, 45C18 D/P | 05/2006→08/2011 | | | DAILY IV 50C15 | | 05/2006→08/2011 | |
| DAILY IV 50C15 V, 50C15 V/P | 05/2006→08/2011 | | | DAILY IV 50C17, 50C17 /P | | 07/2007→08/2011 | |
| DAILY IV 50C17 V, 50C17 V/P | 07/2007→08/2011 | | | DAILY IV 50C17 K, 50C17 DK | | 07/2007→08/2011 | |
| DAILY IV 50C18 | 05/2006→08/2011 | | | DAILY IV 50C18 V, 50C18 V/P | | 05/2006→08/2011 | |
| DAILY IV 55C16 | 08/2007→03/2012 | | | DAILY IV 55C16, 70C16 | | 08/2008→ | |
| DAILY IV 55S17 W, 55S17 WD | 07/2007→08/2011 | | | DAILY IV 60C15 | | 05/2006→08/2011 | |
| DAILY IV 60C15, 60C15 /P, 60C15 D, 60C15 D/P | 05/2006→08/2011 | | | DAILY IV 60C15 V | | 05/2006→08/2011 | |
| DAILY IV 60C17, 60C17 /P | 07/2007→08/2011 | | | DAILY IV 60C17 V, 60C17 V/P | | 07/2007→08/2011 | |
| DAILY IV 60C17 K, 60C17 DK | 07/2007→08/2011 | | | DAILY IV 60C18 | | 05/2006→08/2011 | |
| DAILY IV 65C15 | 05/2006→08/2011 | | | DAILY IV 65C15, 65C15 /P, 65C15 D, 65C15 D/P | | 05/2006→08/2011 | |
| DAILY IV 65C17, 65C17 /P | 07/2007→08/2011 | | | DAILY IV 65C17 V, 65C17 V/P | | 07/2007→08/2011 | |
| DAILY IV 65C17 K, 65C17 DK, 65C17KK | 07/2007→08/2011 | | | DAILY IV 65C18 | | 05/2006→08/2011 | |
| DAILY IV 70C15 | 07/2008→08/2011 | | | DAILY IV 70C17, 70C17 /P | | 07/2007→08/2011 | |
| DAILY IV 70C17V, 70C17 V/P | 07/2007→08/2011 | | | DAILY IV 70C17 K, 70C17 DK, 70C17 KK | | 07/2007→08/2011 | |
| Fumo | 09/2006→ | | | MASSIF 3.0 HPI | | 10/2008→02/2011 | |
| MASSIF 3.0 HPT | 10/2008→02/2011 | | | | | | |

V98042 504 072 531
32.40 x 5.99 x 119.90

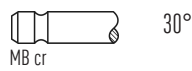

V98043 504 081 062
32.40 x 5.98 x 119.90

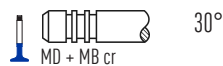

15 100.00

| | | | | | | |
|-----------------------|-----------|------------|-----------------|-----------|----------------------|---------------|
| 8030.02 | 2592cc | 3 Cyl. | 6 Valves | 46kW/62PS | Diesel | TD6922 |
| V91676 | 4 659 379 | | 45° | H | VAG92373 | |
| 44.00 x 8.00 x 125.50 | | MB tu | | | 56.00 x 8.03 x 13.04 | |
| V91709 | 4 802 200 | | 45° | H | VAG92497 | |
| 44.00 x 8.00 x 125.50 | | MB tu | | | 56.00 x 8.04 x 14.03 | |
| V91667 | 4 673 608 | | 45° | H | | |
| 37.00 x 8.00 x 125.70 | | MD + MB tu | | | | |

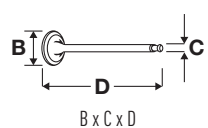

OE

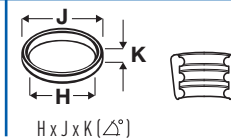
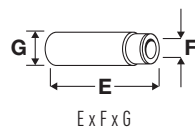

16 **100.00**

| | | | | | | | |
|-----------------------|-----------------|------------|-----------------|-----------------|----------------------|------------|----------------|
| 8035.02 | 2592cc | 3 Cyl. | 6 Valves | 33-40kW/45-54PS | Diesel | OHV | TD25194 |
| 400 Serie | 01/1968→12/1986 | | 500 Serie | 01/1971→12/1980 | | | |
| V91667 | 4 673 608 | | 45° | H | VAG92373 | | |
| 37.00 x 8.00 x 125.70 | | MD + MB tu | | | 56.00 x 8.03 x 13.04 | | |
| | | | | | VAG92497 | | |
| | | | | | 56.00 x 8.04 x 14.03 | | |

17 **100.00**

| | | | | | | | |
|-----------------------|-----------------|------------|-----------------|-----------------|----------------------|------------|----------------|
| 8035.06.200 | 2708cc | 3 Cyl. | 6 Valves | 33-41kW/45-56PS | Diesel | OHV | TD25535 |
| 8035.06.206 | 2708cc | 3 Cyl. | 6 Valves | 38-40kW/52-54PS | Diesel | OHV | TD25536 |
| 8035.06.208 | 2708cc | 3 Cyl. | 6 Valves | 38-40kW/52-54PS | Diesel | OHV | TD25537 |
| 8035.06.222 | 2708cc | 3 Cyl. | 6 Valves | 33-40kW/45-54PS | Diesel | OHV | TD25540 |
| 8035.06.307 | 2708cc | 3 Cyl. | 6 Valves | 38-40kW/52-54PS | Diesel | OHV | TD25543 |
| 8035.06.308 | 2708cc | 3 Cyl. | 6 Valves | 38-40kW/52-54PS | Diesel | OHV | TD25544 |
| 8035.06.323 | 2708cc | 3 Cyl. | 6 Valves | 33-40kW/45-54PS | Diesel | OHV | TD25550 |
| 66 Serie | 01/1985→12/1999 | | 90 Serie | 01/1984→12/1992 | | | |
| V91676 | 4 659 379 | | 45° | H | VAG92373 | | |
| 44.00 x 8.00 x 125.50 | | MB tu | | | 56.00 x 8.03 x 13.04 | | |
| V91667 | 4 673 608 | | 45° | H | VAG92497 | | |
| 37.00 x 8.00 x 125.70 | | MD + MB tu | | | 56.00 x 8.04 x 14.03 | | |

18 **100.00**

| | | | | | | | |
|-----------------------|-----------------|------------|-----------------|-----------------|----------------------|--|---------------|
| 8040.02 | 3456cc | 4 Cyl. | 8 Valves | 60kW/82PS | Diesel | | TD6840 |
| 8040.02.041 | 3456cc | 4 Cyl. | 8 Valves | 56kW/76PS | Diesel | | TD6925 |
| 8040.02.267 | 3456cc | 4 Cyl. | 8 Valves | 56kW/76PS | Diesel | | TD5606 |
| 8040.02.300 | 3456cc | 4 Cyl. | 8 Valves | 56kW/76PS | Diesel | | TD5605 |
| 8040.02.360 | 3456cc | 4 Cyl. | 8 Valves | 56kW/76PS | Diesel | | TD5944 |
| 8040.02.367 | 3456cc | 4 Cyl. | 8 Valves | 56kW/76PS | Diesel | | TD5945 |
| Series 50 | 01/1972→12/1976 | | Series 55 | 01/1972→12/1976 | | | |
| Series 65 | 01/1975→12/1979 | | | | | | |
| V91676 | 4 659 379 | | 45° | H | VAG92373 | | |
| 44.00 x 8.00 x 125.50 | | MB tu | | | 56.00 x 8.03 x 13.04 | | |
| V91709 | 4 802 200 | | 45° | H | VAG92497 | | |
| 44.00 x 8.00 x 125.50 | | MB tu | | | 56.00 x 8.04 x 14.03 | | |
| V91667 | 4 673 608 | | 45° | H | | | |
| 37.00 x 8.00 x 125.70 | | MD + MB tu | | | | | |

19 **100.00**

| | | | | | | | |
|-----------------------|-----------------|------------|-----------------|-----------------|----------------------|------------|----------------|
| 8045.02 | 3456cc | 4 Cyl. | 8 Valves | 44-50kW/60-68PS | Diesel | OHV | TD25195 |
| 600 Serie | 01/1971→12/1986 | | | | | | |
| V91667 | 4 673 608 | | 45° | H | VAG92373 | | |
| 37.00 x 8.00 x 125.70 | | MD + MB tu | | | 56.00 x 8.03 x 13.04 | | |
| | | | | | VAG92497 | | |
| | | | | | 56.00 x 8.04 x 14.03 | | |



OE

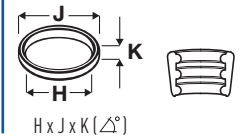
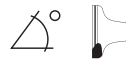

20 **100.00**

| | | | | | | | |
|-------------|-----------------|--------|----------|-----------------|-----------------|-----|---------|
| 8045.06.200 | 3613cc | 4 Cyl. | 8 Valves | 51kW/69PS | Diesel | OHV | TD25521 |
| 8045.06.208 | 3613cc | 4 Cyl. | 8 Valves | 51kW/69PS | Diesel | OHV | TD25522 |
| 8045.06.213 | 3613cc | 4 Cyl. | 8 Valves | 48-51kW/65-69PS | Diesel | OHV | TD25523 |
| 8045.06.225 | 3613cc | 4 Cyl. | 8 Valves | 48kW/65PS | Diesel | OHV | TD25526 |
| 8045.06.319 | 3613cc | 4 Cyl. | 8 Valves | 48kW/65PS | Diesel | OHV | TD25527 |
| 8045.06.326 | 3613cc | 4 Cyl. | 8 Valves | 48kW/65PS | Diesel | OHV | TD25528 |
| 66 Serie | 01/1985→12/1999 | | | 88 Serie | 01/1989→12/1993 | | |
| 90 Serie | 01/1984→12/1992 | | | 94 Serie | 01/1993→12/1996 | | |
| L Serie | 01/1996→12/1998 | | | TL Serie | 01/1998→12/2004 | | |

V91676 ■
44.00 x 8.00 x 125.50

4 659 379



45°

H

VAG92373 ■ ■ ■
56.00 x 8.03 x 13.04

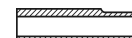

V91667 ■
37.00 x 8.00 x 125.70

4 673 608



45°

H

VAG92497 ■ ■ ■
56.00 x 8.04 x 14.03



21 **100.00**

| | | | | | | | |
|-------------|-----------------|--------|-----------|------------------|-----------------|-----|---------|
| 8060.02.000 | 5184cc | 6 Cyl. | 12 Valves | 90kW/122PS | Diesel | | TD6852 |
| 8060.12 | 5184cc | 6 Cyl. | 12 Valves | 88kW/120PS | Diesel | OHV | TD6908 |
| 8065.02.200 | 5184cc | 6 Cyl. | 12 Valves | 70-74kW/95-101PS | Diesel | OHV | TD25316 |
| 900 Serie | 01/1979→12/1984 | | | Series 75 | 01/1975→12/1979 | | |
| Series 80 | 01/1972→12/1976 | | | Series 90 | 01/1972→12/1979 | | |
| Series 100 | 01/1973→12/1976 | | | Series 110 | 01/1973→12/1983 | | |
| Series 300 | | | | Series 600 | 01/1970→12/1972 | | |

V91676 ■
44.00 x 8.00 x 125.50

4 659 379



45°

H

VAG92373 ■ ■ ■
56.00 x 8.03 x 13.04

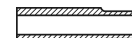

V91667 ■
37.00 x 8.00 x 125.70

4 673 608



45°

H

VAG92497 ■ ■ ■
56.00 x 8.04 x 14.03



22 **100.00**

| | | | | | | | |
|-------------|--------|--------|-----------|------------|--------|--|--------|
| 8060.02.001 | 5184cc | 6 Cyl. | 12 Valves | 90kW/122PS | Diesel | | TD5614 |
| 8060.02.003 | 5184cc | 6 Cyl. | 12 Valves | 90kW/122PS | Diesel | | TD5953 |
| 8060.02.070 | 5184cc | 6 Cyl. | 12 Valves | 90kW/122PS | Diesel | | TD6843 |

V91676 ■
44.00 x 8.00 x 125.50

4 659 379



45°

H

VAG92373 ■ ■ ■
56.00 x 8.03 x 13.04

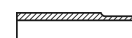

V91709 ■
44.00 x 8.00 x 125.50

4 802 200



45°

H

VAG92497 ■ ■ ■
56.00 x 8.04 x 14.03



V91667 ■
37.00 x 8.00 x 125.70

4 673 608

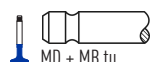

45°

H

23 **100.00**

| | | | | | | | |
|-------------|--------|--------|-----------|------------|--------|--|---------|
| 8060.02.001 | 5184cc | 6 Cyl. | 12 Valves | 90kW/122PS | Diesel | | TD10468 |
| 8060.02.003 | 5184cc | 6 Cyl. | 12 Valves | 90kW/122PS | Diesel | | TD10469 |

V91676 ■
44.00 x 8.00 x 125.50

4 659 379



45°

H

VAG92444 ■ ■ ■
56.00 x 8.00 x 13.04



V91677 ■
37.00 x 8.00 x 125.50

4 673 608

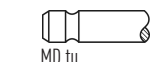

45°

VAG92497 ■ ■ ■
56.00 x 8.04 x 14.03





OE

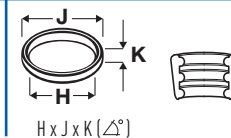
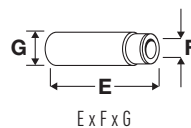

24 **100.00**

| | | | | | | | |
|-----------------------|-----------|-----------------|------------------|------------|----------------------|------------|----------------|
| 8065.02.007 | 5184cc | 6 Cyl. | 12 Valves | 74kW/101PS | Diesel | OHV | TD25315 |
| 1000 Serie | | 01/1972→12/1976 | | | | | |
| V91667 | 4 673 608 | | 45° | H | VAG92373 | | |
| 37.00 x 8.00 x 125.70 | | | | | 56.00 x 8.03 x 13.04 | | |
| | | | | | VAG92497 | | |
| | | | | | 56.00 x 8.04 x 14.03 | | |

25 **100.00**

| | | | | | | | |
|-----------------------|-----------|-----------------|------------------|------------------|----------------------|-----------------|----------------|
| 8065.06.000 | 5418cc | 6 Cyl. | 12 Valves | 74kW/100PS | Diesel | OHV | TD25390 |
| 8065.06.230 | 5418cc | 6 Cyl. | 12 Valves | 72-74kW/98-101PS | Diesel | OHV | TD25395 |
| 8065.06.300 | 5418cc | 6 Cyl. | 12 Valves | 72kW/98PS | Diesel | OHV | TD25397 |
| 90 Serie | | 01/1984→01/1988 | | F-Serie | | 01/1990→12/1993 | |
| V91667 | 4 673 608 | | 45° | H | VAG92373 | | |
| 37.00 x 8.00 x 125.70 | | | | | 56.00 x 8.03 x 13.04 | | |
| | | | | | VAG92497 | | |
| | | | | | 56.00 x 8.04 x 14.03 | | |

26 **102.00**

| | | | | | | | |
|-----------------------|---------|-----------------|------------------|---------------------|--------|--------------------------|----------------|
| F4AE0481A | 3920cc | 4 Cyl. | 16 Valves | 125kW/170PS | Diesel | Tector E17, Turbo | TD16294 |
| F4AE0481C | 3920cc | 4 Cyl. | 16 Valves | 110kW/149PS | Diesel | Tector E15, Turbo | TD16293 |
| F4AE0481D | 3920cc | 4 Cyl. | 16 Valves | 95kW/130PS | Diesel | Tector E13, Turbo | TD16292 |
| F4AE3481A | 3920cc | 4 Cyl. | 16 Valves | 130-134kW/177-182PS | Diesel | Turbo | TD21097 |
| F4AE3481B | 3920cc | 4 Cyl. | 16 Valves | 130kW/177PS | Diesel | Turbo | TD21096 |
| F4AE3481C | 3920cc | 4 Cyl. | 16 Valves | 103kW/140PS | Diesel | Turbo | TD21092 |
| F4AE3481D | 3920cc | 4 Cyl. | 16 Valves | 118kW/160PS | Diesel | Turbo | TD21095 |
| EuroCargo I-III | | 09/2000→09/2015 | | EuroFire | | 09/2000→ | |
| Vertis | | 10/2010→ | | | | | |
| V95067 | 4895052 | | 30° | H | | | |
| 33.00 x 7.00 x 124.70 | | | | | | | |
| V95068 | 4895051 | | 45° | H | | | |
| 33.00 x 7.00 x 124.30 | | | | | | | |

27 **102.00**

| | | | | | | | |
|-----------------------|-----------|-----------------|-----------------|------------------|----------------------|--------------|----------------|
| BF4L 913 T | 4086cc | 4 Cyl. | 8 Valves | 64-78kW/87-106PS | Diesel | Turbo | TD10402 |
| F4L 913 | 4086cc | 4 Cyl. | 8 Valves | 64kW/87PS | Diesel | | TD10414 |
| MK | | 01/1983→05/1989 | | | | | |
| V90050 | 0415 3629 | | 45° | H | VAG92155 | | |
| 43.18 x 7.96 x 132.97 | | | | | 57.40 x 8.02 x 15.07 | | |
| V90114 | 0415 3773 | | 45° | | | | |
| 43.13 x 7.96 x 132.97 | | | | | | | |
| V90051 | 0415 3697 | | 45° | | | | |
| 37.11 x 7.94 x 133.27 | | | | | | | |

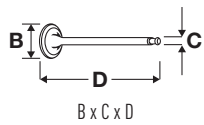

OE

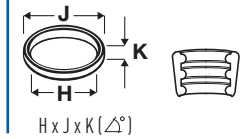
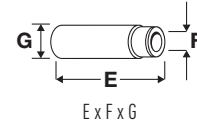

28 **102.00**

| | | | | | | | |
|-----------|----------|--------|-----------|---------------------|--------|-------------------|---------|
| F4AE0681A | 5880cc | 6 Cyl. | 24 Valves | 202-220kW/275-299PS | Diesel | Tector E28, Turbo | TD16520 |
| F4AE0681B | 5880cc | 6 Cyl. | 24 Valves | 176kW/240PS | Diesel | Tector E24, Turbo | TD16519 |
| F4AE0681C | 5880cc | 6 Cyl. | 24 Valves | 154kW/210PS | Diesel | Tector E24, Turbo | TD24238 |
| F4AE0681D | 5880cc | 6 Cyl. | 24 Valves | 132-155kW/180-211PS | Diesel | Tector E21, Turbo | TD16296 |
| F4AE0681E | 5880cc | 6 Cyl. | 24 Valves | 132-134kW/180-181PS | Diesel | Tector E18, Turbo | TD16295 |
| F4AE3681B | 5880cc | 6 Cyl. | 24 Valves | 160kW/218PS | Diesel | Turbo | TD21098 |
| F4AE3681D | 5880cc | 6 Cyl. | 24 Valves | 185kW/251PS | Diesel | Turbo | TD21099 |
| F4AE3681E | 5880cc | 6 Cyl. | 24 Valves | 205-206kW/279-280PS | Diesel | Turbo | TD21100 |
| C-Series | 09/2003→ | | | EuroCargo I-III | | 09/2000→09/2015 | |
| EuroFire | 09/2000→ | | | EUROMIDI | | 05/2007→ | |
| EUROPOLIS | 09/2009→ | | | PROWAY | | 01/2009→ | |
| Tector | 01/2012→ | | | URBIN | | 01/2007→ | |

| | | | | | |
|-----------------------|---------|------------|-----|---|--|
| V95067 | 4895052 | | 30° | H | |
| 33.00 x 7.00 x 124.70 | | MB cr | | | |
| V95068 | 4895051 | | 45° | H | |
| 33.00 x 7.00 x 124.30 | | MD + MB cr | | | |

29 **102.00**

| | | | | | | | |
|------------|-----------------|--------|-----------|----------------------|--------|-----------------|---------|
| BF6L 913 | 6128cc | 6 Cyl. | 12 Valves | 118-124kW/160-169PS | Diesel | Turbo | TD10451 |
| BF6L 913 T | 6128cc | 6 Cyl. | 12 Valves | 96-112kW/131-152PS | Diesel | Turbo | TD10425 |
| BF6L 913/U | 6128cc | 6 Cyl. | 12 Valves | 124kW/169PS | Diesel | Turbo | TD10474 |
| F6L 913 | 6128cc | 6 Cyl. | 12 Valves | 96-124kW/131-169PS | Diesel | | TD10427 |
| MK | 01/1983→12/1991 | | | P/PA-Haubenfahrzeuge | | 01/1983→12/1993 | |

| | | | | | | |
|-----------------------|-----------|-------|-----|---|----------------------|--|
| V90050 | 0415 3629 | | 45° | H | VAG92155 | |
| 43.18 x 7.96 x 132.97 | | MB | | | 57.40 x 8.02 x 15.07 | |
| V90114 | 0415 3773 | | 45° | | | |
| 43.13 x 7.96 x 132.97 | | MD cr | | | | |
| V90051 | 0415 3697 | | 45° | | | |
| 37.11 x 7.94 x 133.27 | | MD cr | | | | |

30 **103.00**

| | | | | | | | |
|-----------------------|-----------|--------|----------|-----------|----------------------|-----|--------|
| 8040.04.200 | 3666cc | 4 Cyl. | 8 Valves | 63kW/85PS | Diesel | OHV | TD7263 |
| 8040.04.280 | 3666cc | 4 Cyl. | 8 Valves | 63kW/86PS | Diesel | OHV | TD6841 |
| V91676 | 4 659 379 | | 45° | H | VAG92373 | | |
| 44.00 x 8.00 x 125.50 | | MB tu | | | 56.00 x 8.03 x 13.04 | | |
| V91709 | 4 802 200 | | 45° | H | VAG92497 | | |
| 44.00 x 8.00 x 125.50 | | MB tu | | | 56.00 x 8.04 x 14.03 | | |
| V91677 | 4 673 608 | | 45° | | | | |
| 37.00 x 8.00 x 125.50 | | MD tu | | | | | |

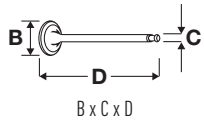

OE

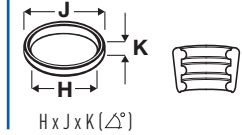
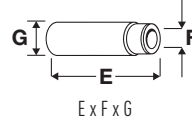
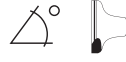

31 **103.00**

| | | | | | | |
|-----------------------|-----------|-----------------|-----------------|-----------|----------------------|----------------|
| 8040.04.200 | 3666cc | 4 Cyl. | 8 Valves | 63kW/86PS | Diesel | TD10397 |
| Zeta | | 11/1979→12/1986 | | | | |
| V91676 | 4 659 379 | | 45° | H | VAG92444 | |
| 44.00 x 8.00 x 125.50 | | MB tu | | | 56.00 x 8.00 x 13.04 | |
| V91709 | 4 802 200 | | 45° | H | | |
| 44.00 x 8.00 x 125.50 | | MB tu | | | | |
| V91677 | 4 673 608 | | 45° | | | |
| 37.00 x 8.00 x 125.50 | | MD tu | | | | |

32 **103.00**

| | | | | | | |
|-----------------------|-----------|--------|------------------|------------|----------------------|----------------|
| 8060.04 | 5499cc | 6 Cyl. | 12 Valves | 96kW/131PS | Diesel | TD10457 |
| 8060.04.055 | 5499cc | 6 Cyl. | 12 Valves | 96kW/131PS | Diesel | TD10420 |
| 8060.04.070 | 5499cc | 6 Cyl. | 12 Valves | 99kW/135PS | Diesel | TD10413 |
| 8060.04.620 | 5499cc | 6 Cyl. | 12 Valves | 99kW/135PS | Diesel | TD10408 |
| 8060.04.621 | 5499cc | 6 Cyl. | 12 Valves | 99kW/135PS | Diesel | TD10409 |
| 8060.04.658 | 5499cc | 6 Cyl. | 12 Valves | 99kW/135PS | Diesel | TD10390 |
| V91676 | 4 659 379 | | 45° | H | VAG92444 | |
| 44.00 x 8.00 x 125.50 | | MB tu | | | 56.00 x 8.00 x 13.04 | |
| V91677 | 4 673 608 | | 45° | | VAG92497 | |
| 37.00 x 8.00 x 125.50 | | MD tu | | | 56.00 x 8.04 x 14.03 | |

33 **103.00**

| | | | | | | |
|-----------------------|-----------|--------|------------------|--------------------|----------------------|---------------|
| 8060.04.051 | 5499cc | 6 Cyl. | 12 Valves | 95-96kW/130-131PS | Diesel | TD7349 |
| 8060.04.055 | 5499cc | 6 Cyl. | 12 Valves | 96kW/130PS | Diesel | TD5612 |
| 8060.04.060 | 5499cc | 6 Cyl. | 12 Valves | 96kW/131PS | Diesel | TD5916 |
| 8060.04.070 | 5499cc | 6 Cyl. | 12 Valves | 99kW/135PS | Diesel | TD7279 |
| 8060.04.620 | 5499cc | 6 Cyl. | 12 Valves | 99kW/135PS | Diesel | TD5608 |
| 8060.04.621 | 5499cc | 6 Cyl. | 12 Valves | 99kW/135PS | Diesel | TD5948 |
| 8060.04.630 | 5499cc | 6 Cyl. | 12 Valves | 99-100kW/135-136PS | Diesel | TD7298 |
| 8060.04.639 | 5499cc | 6 Cyl. | 12 Valves | 99kW/135PS | Diesel | TD5615 |
| 8060.04.658 | 5499cc | 6 Cyl. | 12 Valves | 99kW/135PS | Diesel | TD7261 |
| 8060.04.660 | 5499cc | 6 Cyl. | 12 Valves | 96-102kW/131-139PS | Diesel | TD6255 |
| 8060.04.669 | 5499cc | 6 Cyl. | 12 Valves | 99-102kW/135-139PS | Diesel | TD7292 |
| 8060.04.670 | 5499cc | 6 Cyl. | 12 Valves | 99kW/135PS | Diesel | TD5610 |
| 8060.04.672 | 5499cc | 6 Cyl. | 12 Valves | 99kW/135PS | Diesel | TD5950 |
| 8060.04.675 | 5499cc | 6 Cyl. | 12 Valves | 99kW/135PS | Diesel | TD5954 |
| 8060.04.689 | 5499cc | 6 Cyl. | 12 Valves | 99-102kW/135-139PS | Diesel | TD7296 |
| V91676 | 4 659 379 | | 45° | H | VAG92373 | |
| 44.00 x 8.00 x 125.50 | | MB tu | | | 56.00 x 8.03 x 13.04 | |
| V91677 | 4 673 608 | | 45° | | VAG92497 | |
| 37.00 x 8.00 x 125.50 | | MD tu | | | 56.00 x 8.04 x 14.03 | |



OE

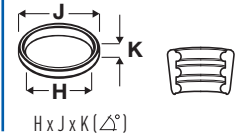
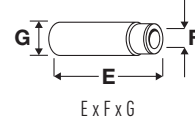

34 **103.00**

| | | | | | | | |
|-------------|--------|--------|-----------|-------------|--------|-------|--------|
| 8060.24.601 | 5499cc | 6 Cyl. | 12 Valves | 124kW/168PS | Diesel | Turbo | TD7300 |
| 8060.24.670 | 5499cc | 6 Cyl. | 12 Valves | 118kW/160PS | Diesel | Turbo | TD5611 |
| 8060.24.671 | 5499cc | 6 Cyl. | 12 Valves | 118kW/160PS | Diesel | Turbo | TD5951 |
| 8060.24.678 | 5499cc | 6 Cyl. | 12 Valves | 123kW/168PS | Diesel | Turbo | TD7297 |

V91666
44.50 x 8.00 x 125.60

4 802 204

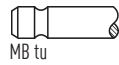

30°

H

VAG92373
56.00 x 8.03 x 13.04

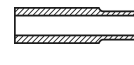

V91667
37.00 x 8.00 x 125.70

4 673 608

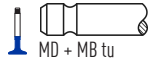

45°

H

VAG92497
56.00 x 8.04 x 14.03



35 **103.00**

| | | | | | | | |
|-------------|--------|--------|-----------|-------------|--------|-------|---------|
| 8060.24.670 | 5499cc | 6 Cyl. | 12 Valves | 118kW/160PS | Diesel | Turbo | TD10447 |
| 8060.24.671 | 5499cc | 6 Cyl. | 12 Valves | 118kW/160PS | Diesel | Turbo | TD10448 |

V91666
44.50 x 8.00 x 125.60

4 802 204

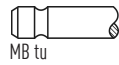

30°

H

VAG92444
56.00 x 8.00 x 13.04

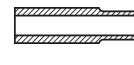

V91667
37.00 x 8.00 x 125.70

4 673 608



45°

H

36 **103.00**

| | | | | | | | |
|--------------|--------|--------|-----------|-------------|--------|-------|--------|
| 8060.25.4600 | 5499cc | 6 Cyl. | 12 Valves | 130kW/177PS | Diesel | Turbo | TD7350 |
|--------------|--------|--------|-----------|-------------|--------|-------|--------|

V91301
45.50 x 8.00 x 125.50

99 432 652

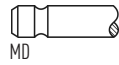

30°

VAG92373
56.00 x 8.03 x 13.04



V91679
45.50 x 8.00 x 125.50

353 722

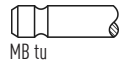

30°

H

VAG92497
56.00 x 8.04 x 14.03



V91302
37.50 x 8.00 x 125.50

99 432 717

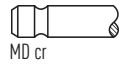

45°

V91304
37.50 x 8.00 x 125.50

99 432 718



45°

H

37 **103.00**

| | | | | | | | |
|-------------|--------|--------|-----------|-------------------|--------|-----|---------|
| 8065.24.000 | 5499cc | 6 Cyl. | 12 Valves | 99kW/135PS | Diesel | OHV | TD25348 |
| 8065.24.300 | 5499cc | 6 Cyl. | 12 Valves | 90-91kW/121-124PS | Diesel | OHV | TD25352 |

1000 Serie

01/1979→12/1984

V91676
44.00 x 8.00 x 125.50

4 659 379

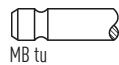

45°

H

VAG92373
56.00 x 8.03 x 13.04

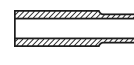

V91667
37.00 x 8.00 x 125.70

4 673 608

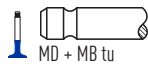

45°

H

VAG92497
56.00 x 8.04 x 14.03





OE

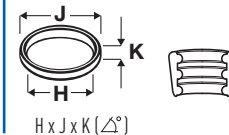
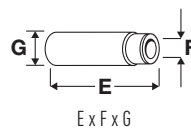

38 **103.00**

| | | | | | | | |
|-------------|--------|--------|-----------|--------------------|--------|--|---------|
| 8060.04.060 | 5500cc | 6 Cyl. | 12 Valves | 96kW/131PS | Diesel | | TD10417 |
| 8060.04.630 | 5500cc | 6 Cyl. | 12 Valves | 99kW/135PS | Diesel | | TD10470 |
| 8060.04.639 | 5500cc | 6 Cyl. | 12 Valves | 99kW/135PS | Diesel | | TD10463 |
| 8060.04.660 | 5500cc | 6 Cyl. | 12 Valves | 96-99kW/131-135PS | Diesel | | TD10421 |
| 8060.04.669 | 5500cc | 6 Cyl. | 12 Valves | 99-102kW/135-139PS | Diesel | | TD10460 |
| 8060.04.670 | 5500cc | 6 Cyl. | 12 Valves | 99kW/135PS | Diesel | | TD10449 |
| 8060.04.672 | 5500cc | 6 Cyl. | 12 Valves | 73kW/99PS | Diesel | | TD10450 |
| 8060.04.675 | 5500cc | 6 Cyl. | 12 Valves | 99kW/135PS | Diesel | | TD10464 |
| 8060.04.689 | 5500cc | 6 Cyl. | 12 Valves | 99-102kW/135-139PS | Diesel | | TD10462 |

Zeta 11/1979→03/1991

| | | | | | | | |
|-----------------------|-----------|-------|-----|---|----------------------|--|--|
| V91676 | 4 659 379 | | 45° | H | VAG92444 | | |
| 44.00 x 8.00 x 125.50 | | MB tu | | | 56.00 x 8.00 x 13.04 | | |
| V91677 | 4 673 608 | | 45° | | VAG92497 | | |
| 37.00 x 8.00 x 125.50 | | MD tu | | | 56.00 x 8.04 x 14.03 | | |

39 **103.00**

| | | | | | | | |
|-------------|--------|--------|-----------|-------------|--------|-------|---------|
| 8060.24.601 | 5500cc | 6 Cyl. | 12 Valves | 124kW/169PS | Diesel | Turbo | TD10472 |
| 8060.24.678 | 5500cc | 6 Cyl. | 12 Valves | 123kW/167PS | Diesel | Turbo | TD10465 |

M 09/1983→12/1985

| | | | | | | | |
|-----------------------|-----------|------------|-----|---|----------------------|--|--|
| V91666 | 4 802 204 | | 30° | H | VAG92444 | | |
| 44.50 x 8.00 x 125.60 | | MB tu | | | 56.00 x 8.00 x 13.04 | | |
| V91667 | 4 673 608 | | 45° | H | | | |
| 37.00 x 8.00 x 125.70 | | MD + MB tu | | | | | |

40 **104.00**

| | | | | | | | |
|-------------|--------|--------|----------|-----------------|--------|-----|---------|
| 8035.05.214 | 2931cc | 3 Cyl. | 6 Valves | 37-44kW/50-60PS | Diesel | OHV | TD22233 |
| 8035.05.215 | 2931cc | 3 Cyl. | 6 Valves | 37-44kW/50-60PS | Diesel | OHV | TD22234 |

66 Serie 01/1992→12/1996 88 Serie 01/1989→12/1993
 90 Serie 01/1984→12/1992 94 Serie 01/1993→12/1996
 L Serie 01/1996→12/1998

| | | | | | | | |
|-----------------------|------------|-------|-----|---|----------------------|--|--|
| V91679 | 353 722 | | 30° | H | VAG92373 | | |
| 45.50 x 8.00 x 125.50 | | MB tu | | | 56.00 x 8.03 x 13.04 | | |
| V91302 | 99 432 717 | | 45° | | VAG92497 | | |
| 37.50 x 8.00 x 125.50 | | MD cr | | | 56.00 x 8.04 x 14.03 | | |



OE

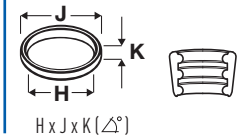

41 **104.00**

| | | | | | | | |
|---------------|--------|--------|----------|-------------|--------|------------|---------|
| 8040.05.200 | 3908cc | 4 Cyl. | 8 Valves | 65kW/88PS | Diesel | OHV | TD10399 |
| 8040.05.203 | 3908cc | 4 Cyl. | 8 Valves | 65kW/88PS | Diesel | OHV | TD16721 |
| 8040.05.230 | 3908cc | 4 Cyl. | 8 Valves | 65kW/88PS | Diesel | OHV | TD10398 |
| 8040.05.233 | 3908cc | 4 Cyl. | 8 Valves | 65kW/88PS | Diesel | OHV | TD16723 |
| 8040.05.235 | 3908cc | 4 Cyl. | 8 Valves | 65kW/88PS | Diesel | OHV | TD16724 |
| 8040.25.200 | 3908cc | 4 Cyl. | 8 Valves | 85kW/116PS | Diesel | Turbo, OHV | TD10407 |
| 8040.25.220 | 3908cc | 4 Cyl. | 8 Valves | 85kW/116PS | Diesel | Turbo | TD10416 |
| 8040.25B.4200 | 3908cc | 4 Cyl. | 8 Valves | 75kW/102PS | Diesel | Turbo | TD10403 |
| 8040.25B.4220 | 3908cc | 4 Cyl. | 8 Valves | 75kW/102PS | Diesel | Turbo | TD23360 |
| 8040.45.4000 | 3908cc | 4 Cyl. | 8 Valves | 100kW/136PS | Diesel | Turbo | TD10405 |
| 8040.45.4180 | 3908cc | 4 Cyl. | 8 Valves | 100kW/136PS | Diesel | Turbo | TD10406 |
| 8040.45.4380 | 3908cc | 4 Cyl. | 8 Valves | 100kW/136PS | Diesel | Turbo | TD20438 |

EuroCargo I-III

01/1991→09/2015

Zeta

01/1987→12/1992

V91301
45.50 x 8.00 x 125.50

99 432 652

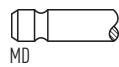

30°

VAG92497
56.00 x 8.04 x 14.03

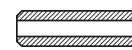

V91679
45.50 x 8.00 x 125.50

353 722

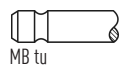

30°

H

V91302
37.50 x 8.00 x 125.50

99 432 717

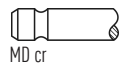

45°

V91304
37.50 x 8.00 x 125.50

99 432 718



45°

H

42 **104.00**

| | | | | | | | |
|-------------|--------|--------|----------|------------|--------|------------|--------|
| 8040.05.200 | 3908cc | 4 Cyl. | 8 Valves | 65kW/88PS | Diesel | OHV | TD7265 |
| 8040.05.230 | 3908cc | 4 Cyl. | 8 Valves | 65kW/88PS | Diesel | OHV | TD7264 |
| 8040.25.200 | 3908cc | 4 Cyl. | 8 Valves | 85kW/115PS | Diesel | Turbo, OHV | TD7272 |

V91301
45.50 x 8.00 x 125.50

99 432 652

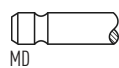

30°

VAG92373
56.00 x 8.03 x 13.04



V91679
45.50 x 8.00 x 125.50

353 722

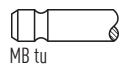

30°

H

VAG92497
56.00 x 8.04 x 14.03

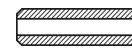

V91302
37.50 x 8.00 x 125.50

99 432 717

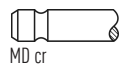

45°

V91304
37.50 x 8.00 x 125.50

99 432 718



45°

H



OE

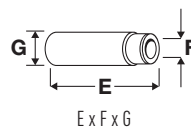
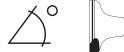

E x F x G

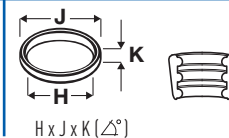

H x J x K (Δ°)

43 **104.00**

| | | | | | | | |
|---------------|--------|--------|-----------------|--------------------|--------|--------------|---------|
| 8040.05.232 | 3908cc | 4 Cyl. | 8 Valves | 65kW/88PS | Diesel | | TD16722 |
| 8040.25.230 R | 3908cc | 4 Cyl. | 8 Valves | 74kW/101PS | Diesel | Turbo | TD10401 |
| 8040.25X.4000 | 3908cc | 4 Cyl. | 8 Valves | 85kW/116PS | Diesel | Turbo | TD10404 |
| 8040.45.5200 | 3908cc | 4 Cyl. | 8 Valves | 100kW/136PS | Diesel | Turbo | TD20439 |
| 8040.45D.5100 | 3908cc | 4 Cyl. | 8 Valves | 85-100kW/116-136PS | Diesel | Turbo | TD20440 |
| 8040.45X.4180 | 3908cc | 4 Cyl. | 8 Valves | 100kW/136PS | Diesel | Turbo | TD20441 |

| | | | | | | |
|-----------------------|-----------------|------------|-----------------|-----------------|----------------------|--|
| EuroCargo I-III | 01/1991→09/2015 | Zeta | 01/1987→03/1991 | | | |
| V91301 | 99 432 652 | | 30° | VAG92373 | 56.00 x 8.03 x 13.04 | |
| 45.50 x 8.00 x 125.50 | | MD | | | | |
| V91302 | 99 432 717 | | 45° | | | |
| 37.50 x 8.00 x 125.50 | | MD cr | | | | |
| V91304 | 99 432 718 | | 45° | H | | |
| 37.50 x 8.00 x 125.50 | | ME + MB cr | | | | |

44 **104.00**

| | | | | | | | |
|---------------------|--------|--------|-----------------|-------------|--------|--------------|---------|
| 8040.25.220 | 3908cc | 4 Cyl. | 8 Valves | 85kW/115PS | Diesel | Turbo | TD7280 |
| 8040.25.230 | 3908cc | 4 Cyl. | 8 Valves | 74kW/101PS | Diesel | Turbo | TD7271 |
| 8040.25B.4200 (LTC) | 3908cc | 4 Cyl. | 8 Valves | 75kW/102PS | Diesel | Turbo | TD7267 |
| 8040.25X.4000 | 3908cc | 4 Cyl. | 8 Valves | 85kW/116PS | Diesel | Turbo | TD7268 |
| 8040.45.4000 (TCA) | 3908cc | 4 Cyl. | 8 Valves | 100kW/136PS | Diesel | Turbo | TD7269 |
| 8040.45.4180 (TCA) | 3908cc | 4 Cyl. | 8 Valves | 100kW/136PS | Diesel | Turbo | TD7275 |
| 8040.45.5200 | 3908cc | 4 Cyl. | 8 Valves | 100kW/136PS | Diesel | Turbo | TD21462 |
| 8040.45.5281 | 3908cc | 4 Cyl. | 8 Valves | 100kW/136PS | Diesel | Turbo | TD22236 |
| 8040.45D.5100 | 3908cc | 4 Cyl. | 8 Valves | 85kW/116PS | Diesel | Turbo | TD22237 |
| 8040.45D.5103 | 3908cc | 4 Cyl. | 8 Valves | 85kW/116PS | Diesel | Turbo | TD22238 |

| | | | | | | |
|-----------------------|------------|-------|-----|-----------------|----------------------|--|
| V91301 | 99 432 652 | | 30° | VAG92373 | 56.00 x 8.03 x 13.04 | |
| 45.50 x 8.00 x 125.50 | | MD | | | | |
| V91302 | 99 432 717 | | 45° | VAG92497 | 56.00 x 8.04 x 14.03 | |
| 37.50 x 8.00 x 125.50 | | MD cr | | | | |

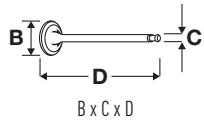

OE

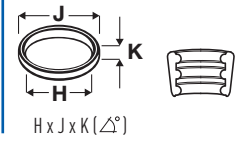
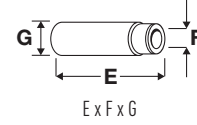
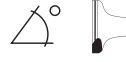

45



104.00

| | | | | | | | |
|-------------------|--------|--------|-----------|--------------------|--------|------------|---------|
| 8060.05.000 | 586lcc | 6 Cyl. | 12 Valves | 101kW/137PS | Diesel | OHV | TD10424 |
| 8060.05.200 | 586lcc | 6 Cyl. | 12 Valves | 99-102kW/135-139PS | Diesel | OHV | TD10471 |
| 8060.05.246 | 586lcc | 6 Cyl. | 12 Valves | 101kW/137PS | Diesel | OHV | TD10391 |
| 8060.05.270 | 586lcc | 6 Cyl. | 12 Valves | 101kW/137PS | Diesel | OHV | TD10412 |
| 8060.05.280 | 586lcc | 6 Cyl. | 12 Valves | 101kW/137PS | Diesel | OHV | TD10423 |
| 8060.05.285 | 586lcc | 6 Cyl. | 12 Valves | 101kW/137PS | Diesel | OHV | TD10411 |
| 8060.05.289 | 586lcc | 6 Cyl. | 12 Valves | 101kW/137PS | Diesel | OHV | TD10461 |
| 8060.25R.4200 | 586lcc | 6 Cyl. | 12 Valves | 105kW/143PS | Diesel | Turbo, OHV | TD10479 |
| 8060.25R.4200 LTC | 586lcc | 6 Cyl. | 12 Valves | 105kW/143PS | Diesel | Turbo, OHV | TD10415 |
| 8060.25R.4280 | 586lcc | 6 Cyl. | 12 Valves | 105kW/143PS | Diesel | Turbo, OHV | TD10475 |
| 8060.25R.4300 | 586lcc | 6 Cyl. | 12 Valves | 105kW/143PS | Diesel | Turbo, OHV | TD20414 |
| 8060.25V.4000 | 586lcc | 6 Cyl. | 12 Valves | 130kW/177PS | Diesel | Turbo, OHV | TD10454 |
| 8060.25V.4080 | 586lcc | 6 Cyl. | 12 Valves | 130kW/177PS | Diesel | Turbo, OHV | TD10476 |
| 8060.25V.4800 | 586lcc | 6 Cyl. | 12 Valves | 130kW/177PS | Diesel | Turbo, OHV | TD10481 |
| 8060.45.4100 | 586lcc | 6 Cyl. | 12 Valves | 152kW/207PS | Diesel | Turbo, OHV | TD10497 |
| 8060.45.4700 | 586lcc | 6 Cyl. | 12 Valves | 152kW/207PS | Diesel | Turbo, OHV | TD10913 |
| 8060.45.4702 | 586lcc | 6 Cyl. | 12 Valves | 152kW/207PS | Diesel | Turbo, OHV | TD10914 |
| 8060.45.4704 | 586lcc | 6 Cyl. | 12 Valves | 152kW/207PS | Diesel | Turbo, OHV | TD10915 |
| 8060.45.4706 | 586lcc | 6 Cyl. | 12 Valves | 152kW/207PS | Diesel | Turbo, OHV | TD10916 |
| 8060.45.4708 | 586lcc | 6 Cyl. | 12 Valves | 152kW/207PS | Diesel | Turbo, OHV | TD10917 |
| 8060.45.5250 | 586lcc | 6 Cyl. | 12 Valves | 152kW/207PS | Diesel | Turbo, OHV | TD10918 |
| 8060.45.5251 | 586lcc | 6 Cyl. | 12 Valves | 152kW/207PS | Diesel | Turbo, OHV | TD10919 |
| 8060.45.5255 | 586lcc | 6 Cyl. | 12 Valves | 152kW/207PS | Diesel | Turbo, OHV | TD10920 |
| 8060.45.6090 | 586lcc | 6 Cyl. | 12 Valves | 167kW/227PS | Diesel | Turbo, OHV | TD10477 |
| 8060.45R.5000 | 586lcc | 6 Cyl. | 12 Valves | 105kW/143PS | Diesel | Turbo, OHV | TD16717 |
| 8060.45R.5001 | 586lcc | 6 Cyl. | 12 Valves | 105kW/143PS | Diesel | Turbo, OHV | TD16718 |
| 8060.45R.5003 | 586lcc | 6 Cyl. | 12 Valves | 105kW/143PS | Diesel | Turbo, OHV | TD16719 |
| 8060.45R.5005 | 586lcc | 6 Cyl. | 12 Valves | 105kW/143PS | Diesel | Turbo, OHV | TD16720 |
| 8060.45R.5050 | 586lcc | 6 Cyl. | 12 Valves | 105kW/143PS | Diesel | Turbo, OHV | TD10911 |
| 8060.45R.5051 | 586lcc | 6 Cyl. | 12 Valves | 105kW/143PS | Diesel | Turbo, OHV | TD10912 |

EuroCargo I-III

01/1991→09/2015

Zeta

11/1985→12/1992

V91301 
45.50 x 8.00 x 125.50

99 432 652

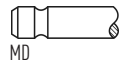

MD

30°

VAG92497  
56.00 x 8.04 x 14.03



V91679 
45.50 x 8.00 x 125.50

353 722

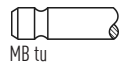

MB tu

30°

H

V91302 
37.50 x 8.00 x 125.50

99 432 717

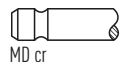

MD cr

45°

V91304 
37.50 x 8.00 x 125.50

99 432 718



ME + MB cr

45°

H

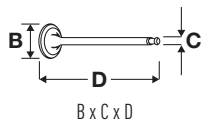

OE

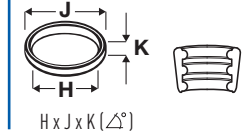
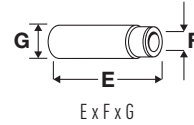

46 **104.00**

| | | | | | | | |
|---------------|--------|--------|-----------|---------------------|--------|------------|--------|
| 8060.05.000 | 5861cc | 6 Cyl. | 12 Valves | 79-102kW/108-139PS | Diesel | OHV | TD7282 |
| 8060.05.200 | 5861cc | 6 Cyl. | 12 Valves | 99-102kW/135-139PS | Diesel | OHV | TD7299 |
| 8060.05.246 | 5861cc | 6 Cyl. | 12 Valves | 101kW/138PS | Diesel | OHV | TD7262 |
| 8060.05.270 | 5861cc | 6 Cyl. | 12 Valves | 101-102kW/138-139PS | Diesel | OHV | TD7278 |
| 8060.05.280 | 5861cc | 6 Cyl. | 12 Valves | 102kW/139PS | Diesel | OHV | TD7281 |
| 8060.05.285 | 5861cc | 6 Cyl. | 12 Valves | 101kW/138PS | Diesel | OHV | TD7274 |
| 8060.05.289 | 5861cc | 6 Cyl. | 12 Valves | 102kW/139PS | Diesel | OHV | TD7293 |
| 8060.25R.4200 | 5861cc | 6 Cyl. | 12 Valves | 105kW/143PS | Diesel | Turbo, OHV | TD7276 |
| 8060.25V.4000 | 5861cc | 6 Cyl. | 12 Valves | 130kW/177PS | Diesel | Turbo, OHV | TD7283 |
| 8060.45.4100 | 5861cc | 6 Cyl. | 12 Valves | 152kW/207PS | Diesel | Turbo, OHV | TD7284 |

V91301
45.50 x 8.00 x 125.50

99 432 652

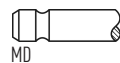

30°

VAG92373
56.00 x 8.03 x 13.04



V91679
45.50 x 8.00 x 125.50

353 722

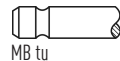

30°

H

VAG92497
56.00 x 8.04 x 14.03



V91302
37.50 x 8.00 x 125.50

99 432 717

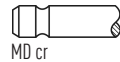

45°

V91304
37.50 x 8.00 x 125.50

99 432 718



45°

H

47 **104.00**

| | | | | | | | |
|------------------|--------|--------|-----------|---------------------|--------|------------|---------|
| 8060.25.600 | 5861cc | 6 Cyl. | 12 Valves | 130kW/177PS | Diesel | Turbo, OHV | TD10473 |
| 8060.45.4100 TCA | 5861cc | 6 Cyl. | 12 Valves | 152kW/207PS | Diesel | Turbo, OHV | TD10455 |
| 8060.45.4180 | 5861cc | 6 Cyl. | 12 Valves | 152kW/207PS | Diesel | Turbo, OHV | TD10456 |
| 8060.45B.5100 | 5861cc | 6 Cyl. | 12 Valves | 130-152kW/177-207PS | Diesel | Turbo, OHV | TD20415 |

EuroCargo I-III

01/1991→09/2015

M

01/1986→12/1992

V91301
45.50 x 8.00 x 125.50

99 432 652

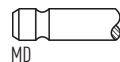

30°

VAG92373
56.00 x 8.03 x 13.04



V91302
37.50 x 8.00 x 125.50

99 432 717



45°

V91304
37.50 x 8.00 x 125.50

99 432 718



45°

H

48 **104.00**

| | | | | | | | |
|---------------|--------|--------|-----------|-------------|--------|-------|--------|
| 8060.25.600 | 5861cc | 6 Cyl. | 12 Valves | 130kW/175PS | Diesel | Turbo | TD7301 |
| 8060.25R.4280 | 5861cc | 6 Cyl. | 12 Valves | 105kW/143PS | Diesel | Turbo | TD7302 |
| 8060.25V.4080 | 5861cc | 6 Cyl. | 12 Valves | 130kW/177PS | Diesel | Turbo | TD7303 |
| 8060.45.4180 | 5861cc | 6 Cyl. | 12 Valves | 152kW/207PS | Diesel | Turbo | TD7285 |
| 8060.45.600 | 5861cc | 6 Cyl. | 12 Valves | 152kW/207PS | Diesel | Turbo | TD7295 |
| 8060.45.6090 | 5861cc | 6 Cyl. | 12 Valves | 167kW/227PS | Diesel | Turbo | TD7304 |

V91301
45.50 x 8.00 x 125.50

99 432 652

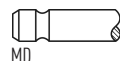

30°

VAG92373
56.00 x 8.03 x 13.04



V91302
37.50 x 8.00 x 125.50

99 432 717



45°

VAG92497
56.00 x 8.04 x 14.03

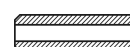

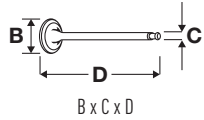

OE

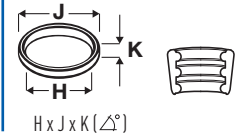
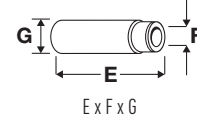

49



104.00

| | | | | | | | |
|---------------|--------|--------|-----------|-------------|--------|------------|---------|
| 8060.45K.6090 | 5861cc | 6 Cyl. | 12 Valves | 167kW/227PS | Diesel | Turbo, OHV | TD20471 |
| 8060.45S TCA | 5861cc | 6 Cyl. | 12 Valves | 167kW/227PS | Diesel | Turbo, OHV | TD10482 |
| 8060.45S.6000 | 5861cc | 6 Cyl. | 12 Valves | 167kW/227PS | Diesel | Turbo, OHV | TD7307 |
| 8060.45S.6000 | 5861cc | 6 Cyl. | 12 Valves | 167kW/227PS | Diesel | Turbo, OHV | TD10480 |
| 8060.45S.6010 | 5861cc | 6 Cyl. | 12 Valves | 167kW/227PS | Diesel | Turbo, OHV | TD27154 |
| 8060.45S.6020 | 5861cc | 6 Cyl. | 12 Valves | 167kW/227PS | Diesel | Turbo, OHV | TD27155 |
| 8060.45S.6030 | 5861cc | 6 Cyl. | 12 Valves | 167kW/227PS | Diesel | Turbo, OHV | TD27156 |
| 8060.45S.6040 | 5861cc | 6 Cyl. | 12 Valves | 167kW/227PS | Diesel | Turbo, OHV | TD27157 |
| 8060.45S.6045 | 5861cc | 6 Cyl. | 12 Valves | 167kW/227PS | Diesel | Turbo, OHV | TD27158 |
| 8060.45S.6052 | 5861cc | 6 Cyl. | 12 Valves | 167kW/227PS | Diesel | Turbo, OHV | TD27159 |
| 8060.45S.6110 | 5861cc | 6 Cyl. | 12 Valves | 167kW/227PS | Diesel | Turbo, OHV | TD27160 |
| 8060.45S.6120 | 5861cc | 6 Cyl. | 12 Valves | 167kW/227PS | Diesel | Turbo, OHV | TD27161 |
| 8060.45S.6130 | 5861cc | 6 Cyl. | 12 Valves | 167kW/227PS | Diesel | Turbo, OHV | TD27162 |
| 8060.45S.6140 | 5861cc | 6 Cyl. | 12 Valves | 167kW/227PS | Diesel | Turbo, OHV | TD27163 |
| 8060.45S.6150 | 5861cc | 6 Cyl. | 12 Valves | 167kW/227PS | Diesel | Turbo, OHV | TD27164 |
| 8060.45S.6203 | 5861cc | 6 Cyl. | 12 Valves | 167kW/227PS | Diesel | Turbo, OHV | TD27165 |
| 8060.45S.6700 | 5861cc | 6 Cyl. | 12 Valves | 167kW/227PS | Diesel | Turbo, OHV | TD7343 |
| 8060.45S.6700 | 5861cc | 6 Cyl. | 12 Valves | 167kW/227PS | Diesel | Turbo, OHV | TD27166 |
| 8060.45S.6705 | 5861cc | 6 Cyl. | 12 Valves | 167kW/227PS | Diesel | Turbo, OHV | TD27167 |
| 8060.45S.6706 | 5861cc | 6 Cyl. | 12 Valves | 167kW/227PS | Diesel | Turbo, OHV | TD27168 |
| 8060.45S.6707 | 5861cc | 6 Cyl. | 12 Valves | 167kW/227PS | Diesel | Turbo, OHV | TD27169 |
| 8060.45S.6710 | 5861cc | 6 Cyl. | 12 Valves | 167kW/227PS | Diesel | Turbo, OHV | TD27170 |
| 8060.45S.6711 | 5861cc | 6 Cyl. | 12 Valves | 167kW/227PS | Diesel | Turbo, OHV | TD27171 |
| 8060.45S.6800 | 5861cc | 6 Cyl. | 12 Valves | 167kW/227PS | Diesel | Turbo, OHV | TD7305 |
| 8060.45S.6800 | 5861cc | 6 Cyl. | 12 Valves | 167kW/227PS | Diesel | Turbo, OHV | TD10478 |
| 8060.45S.6912 | 5861cc | 6 Cyl. | 12 Valves | 167kW/227PS | Diesel | Turbo, OHV | TD27172 |
| 8060.45S.7200 | 5861cc | 6 Cyl. | 12 Valves | 167kW/227PS | Diesel | Turbo, OHV | TD20472 |
| 8060.45S.7203 | 5861cc | 6 Cyl. | 12 Valves | 167kW/227PS | Diesel | Turbo, OHV | TD27177 |
| 8060.45S.7205 | 5861cc | 6 Cyl. | 12 Valves | 167kW/227PS | Diesel | Turbo, OHV | TD27178 |
| 8060.45S.7210 | 5861cc | 6 Cyl. | 12 Valves | 167kW/227PS | Diesel | Turbo, OHV | TD27179 |
| 8060.45S.7211 | 5861cc | 6 Cyl. | 12 Valves | 167kW/227PS | Diesel | Turbo, OHV | TD27180 |
| 8060.45S.7213 | 5861cc | 6 Cyl. | 12 Valves | 167kW/227PS | Diesel | Turbo, OHV | TD27181 |
| 8060.45S.7250 | 5861cc | 6 Cyl. | 12 Valves | 167kW/227PS | Diesel | Turbo, OHV | TD27183 |
| 8060.45S.7251 | 5861cc | 6 Cyl. | 12 Valves | 167kW/227PS | Diesel | Turbo, OHV | TD27184 |
| 8060.45S.7255 | 5861cc | 6 Cyl. | 12 Valves | 167kW/227PS | Diesel | Turbo, OHV | TD27186 |

EuroCargo I-III

01/1991→09/2015

V94054 ■
46.00 x 9.00 x 141.20

98 497 235

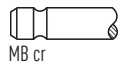

30° Y H

VAG96274 ■
81.00 x 9.02 x 15.02



V94055 ■
38.30 x 9.00 x 141.20

99 433 902

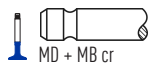

45° H

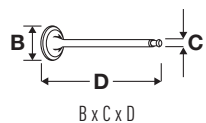

OE

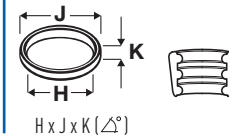
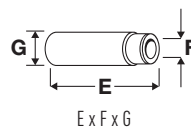

50 **110.00**

| | | | | | | |
|------------|-----------------|--------|-----------|-------------|--------|--------|
| CP 3 | 7412cc | 6 Cyl. | 12 Valves | 107kW/145PS | Diesel | TD6861 |
| Series 130 | 12/1974→12/1978 | | | | | |

| | | | | | | |
|-----------------------|-----------|-------|-----|---|----------------------|--|
| V91680 ■ | 8 823 545 | | 45° | H | VAG96089 ■ | |
| 43.00 x 8.00 x 138.00 | | MB tu | | | 55.00 x 8.01 x 14.08 | |
| V91681 ■ | 8823544 | | 45° | H | VAG96276 ■ | |
| 36.50 x 8.00 x 138.00 | | MB tu | | | 62.00 x 7.99 x 14.05 | |

51 **115.00**

| | | | | | | |
|-------------|-----------------|--------|----------|-----------------|--------|---------|
| 8340.05 | 5401cc | 4 Cyl. | 8 Valves | 63kW/86PS | Diesel | TD6849 |
| 8340.05.200 | 5401cc | 4 Cyl. | 8 Valves | 84kW/114PS | Diesel | TD10410 |
| Series 80 | 01/1978→12/1984 | | Zeta | 01/1983→01/1985 | | |

| | | | | | | |
|-----------------------|-----------|-------|-----|---|----------------------|--|
| V91693 ■ | 8 824 754 | | 45° | H | VAG96089 ■ | |
| 48.50 x 8.00 x 138.00 | | MB tu | | | 55.00 x 8.01 x 14.08 | |
| V91694 ■ | 8 830 045 | | 45° | | VAG96276 ■ | |
| 41.00 x 8.00 x 138.00 | | MD tu | | | 62.00 x 7.99 x 14.05 | |

52 **115.00**

| | | | | | | | |
|-------------|-----------------|--------|-------------|-------------|--------|-----------------------|---------|
| F2BE0681A | 7790cc | 6 Cyl. | 24 Valves | 259kW/352PS | Diesel | Cursor 8, Turbo, SOHC | TD10828 |
| F2BE0681B | 7790cc | 6 Cyl. | 24 Valves | 228kW/310PS | Diesel | Cursor 8, Turbo, SOHC | TD10829 |
| F2BE0681C | 7790cc | 6 Cyl. | 24 Valves | 200kW/272PS | Diesel | Cursor 8, Turbo, SOHC | TD10832 |
| F2BE0681D | 7790cc | 6 Cyl. | 24 Valves | 180kW/245PS | Diesel | Cursor 8, Turbo, SOHC | TD10833 |
| F2BE0681DA | 7790cc | 6 Cyl. | 24 Valves | 180kW/245PS | Diesel | Cursor 8, Turbo, SOHC | TD28228 |
| F2BE0681DB | 7790cc | 6 Cyl. | 24 Valves | 180kW/245PS | Diesel | Cursor 8, Turbo, SOHC | TD28229 |
| F2BE0681E | 7790cc | 6 Cyl. | 24 Valves | 218kW/296PS | Diesel | Cursor 8, Turbo, SOHC | TD10830 |
| F2BE0681F | 7790cc | 6 Cyl. | 24 Valves | 200kW/272PS | Diesel | Cursor 8, Turbo, SOHC | TD10831 |
| City Class | 01/1997→ | | EuroTech MH | 09/1998→ | | | |
| EuroTrakker | 09/1999→11/2004 | | Stralis | 06/2003→ | | | |
| Trakker | 10/2004→ | | | | | | |

| | | | | | | | |
|-----------------------|------------|------------|-----|---|---|----------------------|--|
| V94218 ■ | 99 456 803 | | 30° | Y | H | VAG96348 ■ | |
| 40.00 x 8.00 x 174.50 | | MB cr | | | | 75.50 x 8.04 x 13.03 | |
| V94219 ■ | 99 457 210 | | 45° | | H | VAG96349 ■ | |
| 39.00 x 8.00 x 173.30 | | MF + MB cr | | | | 75.50 x 8.04 x 13.03 | |

53 **115.00**

| | | | | | | |
|---------|--------|--------|-----------|--------------------|--------|--------|
| 8360.05 | 8100cc | 6 Cyl. | 12 Valves | 95-124kW/129-169PS | Diesel | TD6854 |
|---------|--------|--------|-----------|--------------------|--------|--------|

| | | | | | | |
|-----------------------|-----------|-------|-----|---|----------------------|--|
| V91693 ■ | 8 824 754 | | 45° | H | VAG96089 ■ | |
| 48.50 x 8.00 x 138.00 | | MB tu | | | 55.00 x 8.01 x 14.08 | |
| V91694 ■ | 8 830 045 | | 45° | | VAG96276 ■ | |
| 41.00 x 8.00 x 138.00 | | MD tu | | | 62.00 x 7.99 x 14.05 | |



OE

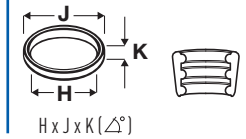
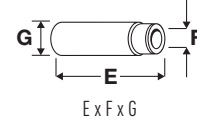

54



115.00

| | | | | | | | |
|-------------|--------|--------|-----------|-------------|--------|-------------------|---------|
| 8365.05.500 | 8101cc | 6 Cyl. | 12 Valves | 114kW/155PS | Diesel | OHV | TD25353 |
| 8365.05.520 | 8101cc | 6 Cyl. | 12 Valves | 104kW/141PS | Diesel | OHV | TD25354 |
| 8365.05.530 | 8101cc | 6 Cyl. | 12 Valves | 99kW/135PS | Diesel | OHV | TD25355 |
| 8365.05.531 | 8101cc | 6 Cyl. | 12 Valves | 104kW/141PS | Diesel | OHV | TD25356 |
| 8365.05.555 | 8101cc | 6 Cyl. | 12 Valves | 96kW/130PS | Diesel | OHV | TD25357 |
| 8365.05.560 | 8101cc | 6 Cyl. | 12 Valves | 94kW/128PS | Diesel | OHV | TD25358 |
| 8365.05.570 | 8101cc | 6 Cyl. | 12 Valves | 94kW/128PS | Diesel | OHV | TD25359 |
| 8365.05.580 | 8101cc | 6 Cyl. | 12 Valves | 94kW/128PS | Diesel | OHV | TD25360 |
| 8365.05.590 | 8101cc | 6 Cyl. | 12 Valves | 94kW/128PS | Diesel | OHV | TD25361 |
| 8365.25.500 | 8101cc | 6 Cyl. | 12 Valves | 132kW/180PS | Diesel | Supercharged, OHV | TD26505 |

| | | | |
|----------|-----------------|------------|-----------------|
| 90 Serie | 01/1984→12/1994 | 1000 Serie | 01/1979→12/1984 |
|----------|-----------------|------------|-----------------|

| | | | | | | |
|--|-----------|--|-----|---|---|--|
| V91693 ■ 48.50 x 8.00 x 138.00 | 8 824 754 | | 45° | H | VAG96089 ■ 55.00 x 8.01 x 14.08 | |
| V91694 ■ 41.00 x 8.00 x 138.00 | 8 830 045 | | 45° | | VAG96276 ■ 62.00 x 7.99 x 14.05 | |

55



115.00

| | | | | | | | |
|-------------|--------|--------|-----------|---------------------|--------|-------|---------|
| 8360.05.200 | 8102cc | 6 Cyl. | 12 Valves | 124kW/169PS | Diesel | | TD10484 |
| 8360.05.254 | 8102cc | 6 Cyl. | 12 Valves | 124kW/169PS | Diesel | | TD10488 |
| 8360.05.673 | 8102cc | 6 Cyl. | 12 Valves | 118-121kW/160-165PS | Diesel | | TD10494 |
| 8365.25.500 | 8102cc | 6 Cyl. | 12 Valves | 132kW/180PS | Diesel | Turbo | TD18678 |
| 8365.25.533 | 8102cc | 6 Cyl. | 12 Valves | 133kW/181PS | Diesel | Turbo | TD18682 |

| | | | |
|-----------|-----------------|------|-----------------|
| M | 07/1982→09/1986 | P/PA | 07/1982→09/1986 |
| Series 90 | 01/1993→ | | |

| | | | | | | |
|--|-----------|--|-----|---|---|--|
| V91693 ■ 48.50 x 8.00 x 138.00 | 8 824 754 | | 45° | H | VAG96089 ■ 55.00 x 8.01 x 14.08 | |
| V91694 ■ 41.00 x 8.00 x 138.00 | 8 830 045 | | 45° | | VAG96276 ■ 62.00 x 7.99 x 14.05 | |

56



120.00

| | | | | | | | |
|---------|--------|---------|-----------|-------------|--------|--|---------|
| F6L 413 | 8478cc | V6 Cyl. | 12 Valves | 132kW/180PS | Diesel | | TD10485 |
|---------|--------|---------|-----------|-------------|--------|--|---------|

| | | | | | | |
|--|-----------|--|-----|---|--|--|
| V90418 ■ 46.60 x 9.92 x 165.40 | 0241 2165 | | 45° | H | VAG96211 ■ 90.00 x 10.02 x 16.06 | |
| | | | | | VAG92492 ■ 78.00 x 10.00 x 16.00 | |

57



120.00

| | | | | | | | |
|-------------|--------|--------|-----------|-------------|--------|-------|---------|
| 8460.21.601 | 9498cc | 6 Cyl. | 12 Valves | 191kW/260PS | Diesel | Turbo | TD20435 |
|-------------|--------|--------|-----------|-------------|--------|-------|---------|

| | | | | | | |
|--|------------|--|-----|---|--|--|
| V91942 ■ 43.00 x 9.00 x 146.00 | 61 321 255 | | 45° | H | | |
|--|------------|--|-----|---|--|--|



OE

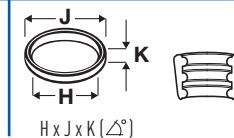
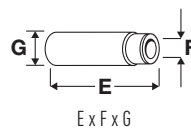

58  **120.00**

| | | | | | | | |
|----------------|-----------------|--------|-----------|---------------------|--------|-----------------|---------|
| 8460.21.002 | 9500cc | 6 Cyl. | 12 Valves | 177kW/241PS | Diesel | Turbo | TD10502 |
| 8460.21.010 | 9500cc | 6 Cyl. | 12 Valves | 177kW/241PS | Diesel | Turbo | TD10503 |
| 8460.21.102 | 9500cc | 6 Cyl. | 12 Valves | 191-192kW/260-261PS | Diesel | Turbo | TD10521 |
| 8460.41 M | 9500cc | 6 Cyl. | 12 Valves | 278kW/378PS | Diesel | Turbo | TD7250 |
| 8460.41 R | 9500cc | 6 Cyl. | 12 Valves | 214-276kW/290-375PS | Diesel | Turbo | TD7248 |
| 8460.41 S | 9500cc | 6 Cyl. | 12 Valves | 254kW/345PS | Diesel | | TD7249 |
| 8460.41.102 | 9500cc | 6 Cyl. | 12 Valves | 234kW/318PS | Diesel | Turbo | TD10548 |
| 8460.41.124 | 9500cc | 6 Cyl. | 12 Valves | 234kW/318PS | Diesel | Turbo | TD10599 |
| 8460.41.160 | 9500cc | 6 Cyl. | 12 Valves | 236kW/321PS | Diesel | Turbo | TD10547 |
| 8460.41C | 9500cc | 6 Cyl. | 12 Valves | 221kW/301PS | Diesel | Turbo | TD10807 |
| 8460.41C (TCA) | 9500cc | 6 Cyl. | 12 Valves | 221kW/301PS | Diesel | Turbo | TD10595 |
| 8460.41C.320 | 9500cc | 6 Cyl. | 12 Valves | 221kW/301PS | Diesel | Turbo | TD10512 |
| 8460.41K | 9500cc | 6 Cyl. | 12 Valves | 254kW/345PS | Diesel | Turbo | TD10808 |
| 8460.41K. TCA | 9500cc | 6 Cyl. | 12 Valves | 254kW/345PS | Diesel | Turbo | TD7342 |
| 8460.41K.406 | 9500cc | 6 Cyl. | 12 Valves | 254kW/345PS | Diesel | Turbo | TD10513 |
| 8460.41K.410 | 9500cc | 6 Cyl. | 12 Valves | 254kW/345PS | Diesel | Turbo | TD10709 |
| 8460.41L (TCA) | 9500cc | 6 Cyl. | 12 Valves | 276kW/375PS | Diesel | Turbo | TD10573 |
| 8460.41L.5020 | 9500cc | 6 Cyl. | 12 Valves | 276kW/375PS | Diesel | Turbo | TD10514 |
| 8460.41N | 9500cc | 6 Cyl. | 12 Valves | 276kW/375PS | Diesel | Turbo | TD10707 |
| EuroStar | 01/1993→02/2002 | | | EuroTech MP | | 01/1992→ | |
| EuroTech MT | 01/1992→08/1998 | | | EuroTrakker | | 01/1993→11/2004 | |
| HD 7 | 01/1996→ | | | M | | 09/1986→11/1992 | |
| TurboTech | 01/1990→12/1992 | | | | | | |

V91942 
 43.00 x 9.00 x 146.00

61 321 255

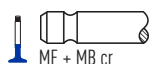

45°

H

59  **125.00**

| | | | | | | | |
|-----------|--------|---------|-----------|-------------|--------|------|---------|
| F6L 413 F | 9570cc | V6 Cyl. | 12 Valves | 141kW/192PS | Diesel | SOHC | TD10483 |
|-----------|--------|---------|-----------|-------------|--------|------|---------|

V90418 
 46.60 x 9.92 x 165.40

0241 2165

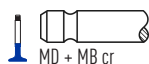

45°

H

VAG96211 
 90.00 x 10.02 x 16.06

VAG92492 
 78.00 x 10.00 x 16.00

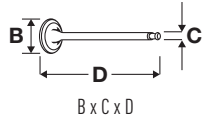

OE

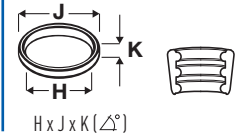
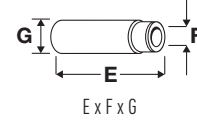

60 **125.00**

| | | | | | | | |
|-------------|----------|--------|-----------|---------------------|--------|------------------------|---------|
| F3A3681A | 10300cc | 6 Cyl. | 24 Valves | 330-331kW/449-450PS | Diesel | Cursor 10, Turbo, SOHC | TD20468 |
| F3A3681B | 10300cc | 6 Cyl. | 24 Valves | 310kW/422PS | Diesel | Cursor 10, Turbo, SOHC | TD20467 |
| F3AE0681B | 10300cc | 6 Cyl. | 24 Valves | 294kW/400PS | Diesel | Cursor 10, Turbo, SOHC | TD16551 |
| F3AE0681D | 10300cc | 6 Cyl. | 24 Valves | 316kW/430PS | Diesel | Cursor 10, Turbo, SOHC | TD14970 |
| F3AE0681E | 10300cc | 6 Cyl. | 24 Valves | 287kW/390PS | Diesel | Cursor 10, Turbo, SOHC | TD14968 |
| F3AE0681H | 10300cc | 6 Cyl. | 24 Valves | 294kW/400PS | Diesel | Turbo, SOHC | TD24541 |
| F3AE3681D | 10300cc | 6 Cyl. | 24 Valves | 310kW/422PS | Diesel | Cursor 10, Turbo, SOHC | TD24603 |
| EURORIDER | 05/2007→ | | | EuroStar | | 01/1993→ | |
| EuroTech MP | 11/1999→ | | | Stralis | | 02/2002→ | |

V94220
43.00 x 9.00 x 202.90

500 355 776

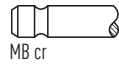

30°

Y

H

VAG96337
97.00 x 8.25 x 15.02

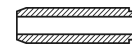

V94221
42.00 x 9.00 x 201.60

500 355 779



45°

H

VAG96335
97.00 x 8.25 x 15.02



61 **125.00**

| | | | | | | | |
|------------|-----------------|---------|-----------|----------------------|--------|-----------------|---------|
| BF8L 413 F | 12763cc | V8 Cyl. | 16 Valves | 212kW/288PS | Diesel | Turbo | TD10578 |
| BF8L 513 | 12763cc | V8 Cyl. | 16 Valves | 225-250kW/306-340PS | Diesel | Turbo | TD10501 |
| F8L 413 F | 12763cc | V8 Cyl. | 16 Valves | 162-212kW/220-288PS | Diesel | | TD10522 |
| P/PA | 12/1979→12/1993 | | | P/PA-Haubenfahrzeuge | | 07/1983→09/1990 | |

V90418
46.60 x 9.92 x 165.40

0241 2165



45°

H

VAG96211
90.00 x 10.02 x 16.06



VAG92492
78.00 x 10.00 x 16.00

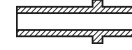

62 **125.00**

| | | | | | | | |
|------------|-----------------|----------|-----------|-------------|--------|-------|---------|
| F10L 413 F | 15953cc | V10 Cyl. | 20 Valves | 235kW/320PS | Diesel | Turbo | TD10527 |
| P/PA | 01/1983→12/1985 | | | | | | |

V90418
46.60 x 9.92 x 165.40

0241 2165



45°

H

VAG96211
90.00 x 10.02 x 16.06



VAG92492
78.00 x 10.00 x 16.00



63 **128.00**

| | | | | | | | |
|---------|-----------------|---------|-----------|----------------------|--------|-----------------|---------|
| F8L 513 | 13383cc | V8 Cyl. | 16 Valves | 168-194kW/228-264PS | Diesel | | TD10499 |
| P/PA | 04/1988→12/1993 | | | P/PA-Haubenfahrzeuge | | 04/1988→12/1993 | |

V90418
46.60 x 9.92 x 165.40

0241 2165

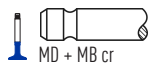

45°

H

VAG96211
90.00 x 10.02 x 16.06

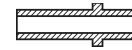

VAG92492
78.00 x 10.00 x 16.00

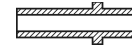



OE

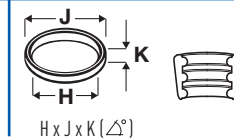
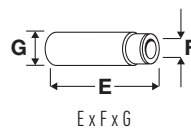

64 **135.00**

| | | | | | | | |
|------------------|-----------------|--------|------------------|---------------------|-----------------|-------------------------------|----------------|
| F3BE0681A | 12880cc | 6 Cyl. | 24 Valves | 397-412kW/540-560PS | Diesel | Cursor 13, Turbo, SOHC | TD16505 |
| F3BE0681B | 12880cc | 6 Cyl. | 24 Valves | 368kW/500PS | Diesel | Cursor 13, Turbo, SOHC | TD16550 |
| F3BE0681E | 12880cc | 6 Cyl. | 24 Valves | 353kW/480PS | Diesel | Cursor 13, Turbo, SOHC | TD16506 |
| F3BE0681G | 12880cc | 6 Cyl. | 24 Valves | 280kW/380PS | Diesel | Cursor 13, Turbo, SOHC | TD16591 |
| F3BE3681B | 12880cc | 6 Cyl. | 24 Valves | 368kW/500PS | Diesel | Cursor 13, Turbo, SOHC | TD21089 |
| EuroStar | 01/1993→02/2002 | | | EuroTrakker | 01/2001→11/2004 | | |
| HD 8 | 01/2005→ | | | HD 9 | 12/2011→ | | |
| Stralis | 02/2002→ | | | Trakker | 09/2004→ | | |

| | | | | | |
|-----------------------|-----------|------------|-----|---|---|
| V95205 | 500355778 | | 30° | Y | H |
| 47.00 x 9.97 x 199.31 | | MB cr | | | |
| V95206 | 500355780 | | 45° | | H |
| 46.05 x 9.97 x 198.05 | | MD + MB cr | | | |

65 **135.00**

| | | | | | | | |
|-----------------|----------|--------|------------------|-------------|--------|-------------------------------|----------------|
| F3B3681B | 12882cc | 6 Cyl. | 24 Valves | 368kW/500PS | Diesel | Cursor 13, Turbo, SOHC | TD20480 |
| Stralis | 07/2006→ | | | | | | |

| | | | | | |
|-----------------------|-----------|------------|-----|---|---|
| V95205 | 500355778 | | 30° | Y | H |
| 47.00 x 9.97 x 199.31 | | MB cr | | | |
| V95206 | 500355780 | | 45° | | H |
| 46.05 x 9.97 x 198.05 | | MD + MB cr | | | |



OE

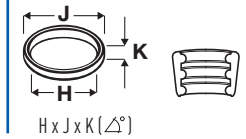
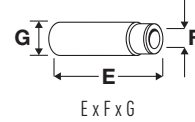
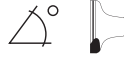

66



137.00

| | | | | | | | |
|-------------|---------|--------|-----------|-------------|--------|-----|---------|
| 8210.02.000 | 13798cc | 6 Cyl. | 12 Valves | 191kW/260PS | Diesel | OHV | TD6868 |
| 8210.02.020 | 13798cc | 6 Cyl. | 12 Valves | 191kW/260PS | Diesel | OHV | TD6864 |
| 8210.02.022 | 13798cc | 6 Cyl. | 12 Valves | 191kW/260PS | Diesel | OHV | TD6877 |
| 8210.02.032 | 13798cc | 6 Cyl. | 12 Valves | 191kW/260PS | Diesel | OHV | TD6923 |
| 8210.02.033 | 13798cc | 6 Cyl. | 12 Valves | 191kW/260PS | Diesel | OHV | TD5975 |
| 8210.02.053 | 13798cc | 6 Cyl. | 12 Valves | 191kW/260PS | Diesel | OHV | TD6266 |
| 8210.02.067 | 13798cc | 6 Cyl. | 12 Valves | 191kW/260PS | Diesel | OHV | TD5622 |
| 8210.02.067 | 13798cc | 6 Cyl. | 12 Valves | 191kW/260PS | Diesel | OHV | TD10523 |
| 8210.02.069 | 13798cc | 6 Cyl. | 12 Valves | 191kW/260PS | Diesel | OHV | TD5959 |
| 8210.02.069 | 13798cc | 6 Cyl. | 12 Valves | 191kW/260PS | Diesel | OHV | TD10525 |
| 8210.02.081 | 13798cc | 6 Cyl. | 12 Valves | 191kW/260PS | Diesel | OHV | TD6865 |
| 8210.02.266 | 13798cc | 6 Cyl. | 12 Valves | 191kW/260PS | Diesel | OHV | TD5635 |
| 8210.02.267 | 13798cc | 6 Cyl. | 12 Valves | 191kW/260PS | Diesel | OHV | TD5976 |
| 8210.02.371 | 13798cc | 6 Cyl. | 12 Valves | 191kW/260PS | Diesel | OHV | TD5619 |
| 8210.02.371 | 13798cc | 6 Cyl. | 12 Valves | 191kW/260PS | Diesel | OHV | TD10507 |
| 8210.02.373 | 13798cc | 6 Cyl. | 12 Valves | 191kW/260PS | Diesel | OHV | TD5621 |
| 8210.02.373 | 13798cc | 6 Cyl. | 12 Valves | 191kW/260PS | Diesel | OHV | TD10508 |
| 8210.02.377 | 13798cc | 6 Cyl. | 12 Valves | 191kW/260PS | Diesel | OHV | TD5958 |
| 8210.02.377 | 13798cc | 6 Cyl. | 12 Valves | 191kW/260PS | Diesel | OHV | TD10509 |
| 8210.02.385 | 13798cc | 6 Cyl. | 12 Valves | 191kW/260PS | Diesel | OHV | TD6899 |
| 8210.02.393 | 13798cc | 6 Cyl. | 12 Valves | 191kW/260PS | Diesel | OHV | TD6259 |
| 8210.02.393 | 13798cc | 6 Cyl. | 12 Valves | 191kW/260PS | Diesel | OHV | TD10510 |
| 8210.02.405 | 13798cc | 6 Cyl. | 12 Valves | 191kW/260PS | Diesel | OHV | TD7254 |
| 8210.02.426 | 13798cc | 6 Cyl. | 12 Valves | 191kW/260PS | Diesel | OHV | TD7359 |
| 8210.02.440 | 13798cc | 6 Cyl. | 12 Valves | 191kW/260PS | Diesel | OHV | TD5617 |
| 8210.02.440 | 13798cc | 6 Cyl. | 12 Valves | 191kW/260PS | Diesel | OHV | TD10491 |
| 8210.02.441 | 13798cc | 6 Cyl. | 12 Valves | 191kW/260PS | Diesel | OHV | TD5956 |
| 8210.02.441 | 13798cc | 6 Cyl. | 12 Valves | 191kW/260PS | Diesel | OHV | TD10492 |
| 8210.02.731 | 13798cc | 6 Cyl. | 12 Valves | 191kW/260PS | Diesel | OHV | TD5973 |
| 8210.02.731 | 13798cc | 6 Cyl. | 12 Valves | 191kW/260PS | Diesel | OHV | TD10524 |
| 8211.02.032 | 13798cc | 6 Cyl. | 12 Valves | 191kW/260PS | Diesel | OHV | TD6376 |

Series 300

Series 600

01/1970→12/1980

V91688 ■
59.00 x 11.00 x 170.00

4 683 025

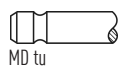

45°

V91689 ■
49.00 x 11.00 x 170.00

4 683 026



45°

H



OE

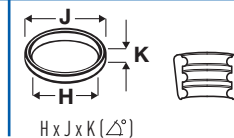
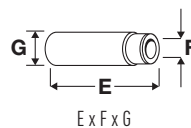
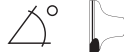

67  **137.00**

| | | | | | | | |
|--------------|---------|--------|-----------|---------------------|--------|------------|---------|
| 8210.22.000 | 13798cc | 6 Cyl. | 12 Valves | 224kW/305PS | Diesel | Turbo, OHV | TD22223 |
| 8210.22.069 | 13798cc | 6 Cyl. | 12 Valves | 221-224kW/300-305PS | Diesel | OHV | TD6885 |
| 8210.22.101 | 13798cc | 6 Cyl. | 12 Valves | 224kW/305PS | Diesel | Turbo, OHV | TD6881 |
| 8210.22.105 | 13798cc | 6 Cyl. | 12 Valves | 243kW/330PS | Diesel | Turbo, OHV | TD7335 |
| 8210.22.171 | 13798cc | 6 Cyl. | 12 Valves | 224kW/304PS | Diesel | Turbo, OHV | TD5623 |
| 8210.22.175 | 13798cc | 6 Cyl. | 12 Valves | 224kW/304PS | Diesel | Turbo, OHV | TD5960 |
| 8210.22.183 | 13798cc | 6 Cyl. | 12 Valves | 224kW/304PS | Diesel | Turbo, OHV | TD7340 |
| 8210.22.235 | 13798cc | 6 Cyl. | 12 Valves | 224kW/304PS | Diesel | Turbo, OHV | TD7352 |
| 8210.22.269 | 13798cc | 6 Cyl. | 12 Valves | 224kW/304PS | Diesel | Turbo, OHV | TD5630 |
| 8210.22.290 | 13798cc | 6 Cyl. | 12 Valves | 224kW/304PS | Diesel | Turbo, OHV | TD6385 |
| 8210.22.317 | 13798cc | 6 Cyl. | 12 Valves | 224kW/304PS | Diesel | Turbo, OHV | TD6260 |
| 8210.22.327 | 13798cc | 6 Cyl. | 12 Valves | 224kW/304PS | Diesel | Turbo, OHV | TD5968 |
| 8210.22.373 | 13798cc | 6 Cyl. | 12 Valves | 224kW/305PS | Diesel | Turbo, OHV | TD6878 |
| 8210.22.385 | 13798cc | 6 Cyl. | 12 Valves | 224kW/304PS | Diesel | Turbo, OHV | TD6264 |
| 8210.22.406 | 13798cc | 6 Cyl. | 12 Valves | 224kW/304PS | Diesel | Turbo, OHV | TD7255 |
| 8210.22.569 | 13798cc | 6 Cyl. | 12 Valves | 224kW/304PS | Diesel | Turbo, OHV | TD7330 |
| 8210.22.869 | 13798cc | 6 Cyl. | 12 Valves | 235kW/320PS | Diesel | Turbo, OHV | TD7333 |
| 8210.22X.069 | 13798cc | 6 Cyl. | 12 Valves | 224kW/304PS | Diesel | Turbo, OHV | TD5637 |

Series 300

V91310 
57.50 x 11.00 x 170.00
Eng. → 258269

4 673 862

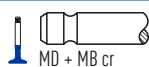

30°

H

VAG92375 
76.00 x 11.00 x 18.04



V94222 
57.40 x 11.00 x 170.00
Eng. 258270 →

98 497 025

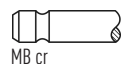

30°

Y

H

V91311 
48.00 x 11.00 x 170.00

98 474 604

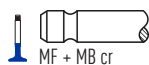

45°

H



OE

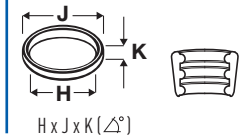
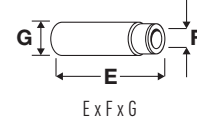

68



137.00

| | | | | | | | |
|----------------------|-----------------|--------|-----------|-------------|--------|-----------------|---------|
| 8210.22.105 | 13798cc | 6 Cyl. | 12 Valves | 243kW/330PS | Diesel | Turbo | TD10550 |
| 8210.22.171 | 13798cc | 6 Cyl. | 12 Valves | 224kW/305PS | Diesel | Turbo | TD10530 |
| 8210.22.175 | 13798cc | 6 Cyl. | 12 Valves | 224kW/305PS | Diesel | Turbo | TD10528 |
| 8210.22.183 | 13798cc | 6 Cyl. | 12 Valves | 224kW/305PS | Diesel | Turbo | TD10579 |
| 8210.22.210 | 13798cc | 6 Cyl. | 12 Valves | 224kW/305PS | Diesel | Turbo | TD11387 |
| 8210.22.236 | 13798cc | 6 Cyl. | 12 Valves | 224kW/305PS | Diesel | Turbo | TD11388 |
| 8210.22.269 | 13798cc | 6 Cyl. | 12 Valves | 224kW/305PS | Diesel | Turbo | TD10584 |
| 8210.22.317 | 13798cc | 6 Cyl. | 12 Valves | 224kW/305PS | Diesel | Turbo | TD10531 |
| 8210.22.327 | 13798cc | 6 Cyl. | 12 Valves | 224kW/305PS | Diesel | Turbo | TD10585 |
| 8210.22.385 | 13798cc | 6 Cyl. | 12 Valves | 224kW/305PS | Diesel | Turbo | TD10586 |
| 8210.22.511 | 13798cc | 6 Cyl. | 12 Valves | 224kW/305PS | Diesel | Turbo | TD11389 |
| 8210.22.521 | 13798cc | 6 Cyl. | 12 Valves | 224kW/305PS | Diesel | Turbo | TD11390 |
| 8210.22.523 | 13798cc | 6 Cyl. | 12 Valves | 224kW/305PS | Diesel | Turbo | TD11391 |
| 8210.22.525 | 13798cc | 6 Cyl. | 12 Valves | 224kW/305PS | Diesel | Turbo | TD11392 |
| 8210.22.535 | 13798cc | 6 Cyl. | 12 Valves | 224kW/305PS | Diesel | Turbo | TD11393 |
| 8210.22.537 | 13798cc | 6 Cyl. | 12 Valves | 224kW/305PS | Diesel | Turbo | TD11394 |
| 8210.22.569 | 13798cc | 6 Cyl. | 12 Valves | 224kW/305PS | Diesel | Turbo | TD10529 |
| 8210.22.869 | 13798cc | 6 Cyl. | 12 Valves | 235kW/320PS | Diesel | Turbo | TD10549 |
| 8210.22X.069 | 13798cc | 6 Cyl. | 12 Valves | 224kW/305PS | Diesel | Turbo | TD11329 |
| 8210.22X.235 | 13798cc | 6 Cyl. | 12 Valves | 224kW/305PS | Diesel | Turbo | TD11407 |
| 8210.22X.523 | 13798cc | 6 Cyl. | 12 Valves | 224kW/305PS | Diesel | Turbo | TD11408 |
| 8210.22X.575 | 13798cc | 6 Cyl. | 12 Valves | 224kW/305PS | Diesel | Turbo | TD11330 |
| 8210.42 | 13798cc | 6 Cyl. | 12 Valves | 277kW/377PS | Diesel | Turbo | TD10564 |
| 8210.42.500 | 13798cc | 6 Cyl. | 12 Valves | 346kW/471PS | Diesel | Turbo | TD18332 |
| 8210.42K | 13798cc | 6 Cyl. | 12 Valves | 272kW/370PS | Diesel | Turbo | TD10809 |
| 8210.42K (TCA) | 13798cc | 6 Cyl. | 12 Valves | 272kW/370PS | Diesel | Turbo | TD7377 |
| 8210.42M | 13798cc | 6 Cyl. | 12 Valves | 346kW/470PS | Diesel | Turbo | TD20617 |
| 8210.42M (TCA) | 13798cc | 6 Cyl. | 12 Valves | 345kW/469PS | Diesel | Turbo | TD10576 |
| EuroCargo I-III | 03/1995→08/2001 | | | EuroStar | | 01/1993→02/2002 | |
| EuroTech MH | 01/1998→01/2003 | | | EuroTrakker | | 01/1993→11/2004 | |
| HD 7 | 01/1996→ | | | HD 8 | | 01/2005→ | |
| PowerStar | 01/1999→ | | | P/PA | | 06/1984→12/1992 | |
| P/PA-Haubenfahrzeuge | 04/1987→12/1993 | | | TurboStar | | 07/1984→12/1987 | |

V91310

57.50 x 11.00 x 170.00

4 673 862



30°

H

VAG92375

76.00 x 11.00 x 18.04



V94222

57.40 x 11.00 x 170.00

98 497 025



30°

Y

H

V91311

48.00 x 11.00 x 170.00

98 474 604



45°

H

69



137.00



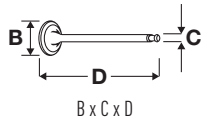

| | | | | | | | |
|---------|------------------------|-----------|------------|-------------|--------|--|---------|
| 8210.02 | 13800cc | 6 Cyl. | 12 Valves | 191kW/260PS | Diesel | | TD10598 |
| V91688 | 59.00 x 11.00 x 170.00 | 4 683 025 | MD tu | 45° | | | |
| V91689 | 49.00 x 11.00 x 170.00 | 4 683 026 | MD + MB cr | 45° | H | | |

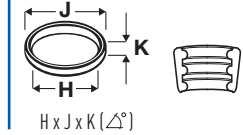
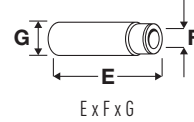
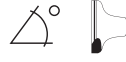





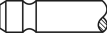

OE









70  **145.00**







| 8261.02.002 | 12880cc | 6 Cyl. | 12 Valves | 165kW/224PS | Diesel | OHV | TD20430 |
|---|-----------|---|-----------|-------------|--------|-----|---------|
| V91947  51.60 x 10.00 x 157.40 | 4846130 |   MD + MB cr | 30° | H | | | |
| V91285  45.00 x 10.00 x 156.50 | 4 704 215 |   MD + MB tu | 45° | H | | | |

71  **145.00**

| 8280.42S (TCA) | 17173cc | V8 Cyl. | 16 Valves | 378kW/514PS | Diesel | Turbo, SOHC | TD10577 |
|---|-----------|---|-----------|-------------|--------|-------------|---------|
| EuroStar | | 01/1993→02/2002 | | HD 7 | | 01/1996→ | |
| V91947  51.60 x 10.00 x 157.40 | 4846130 |   MD + MB cr | 30° | H | | | |
| V91285  45.00 x 10.00 x 156.50 | 4 704 215 |   MD + MB tu | 45° | H | | | |

72  **145.00**

| 8280.22.201 | 17174cc | V8 Cyl. | 16 Valves | 309kW/420PS | Diesel | Turbo | TD10569 |
|---|-----------|---|-----------|-------------|--------|-------|---------|
| 8280.22.205 | 17174cc | V8 Cyl. | 16 Valves | 309kW/420PS | Diesel | Turbo | TD10570 |
| 8280.42.001 | 17174cc | V8 Cyl. | 32 Valves | 350kW/476PS | Diesel | Turbo | TD10572 |
| 8280.42.050 | 17174cc | V8 Cyl. | 32 Valves | 350kW/476PS | Diesel | Turbo | TD10571 |
| 8280.42S.342 | 17174cc | V8 Cyl. | 16 Valves | 378kW/514PS | Diesel | Turbo | TD20432 |
| 8280.42S.350 | 17174cc | V8 Cyl. | 16 Valves | 375kW/510PS | Diesel | Turbo | TD10516 |
| 8280.42S.352 | 17174cc | V8 Cyl. | 16 Valves | 378kW/514PS | Diesel | Turbo | TD20433 |
| 8280.42S.362 | 17174cc | V8 Cyl. | 16 Valves | 378kW/514PS | Diesel | Turbo | TD20434 |
| TurboStar | | 07/1984→12/1993 | | | | | |
| V91947  51.60 x 10.00 x 157.40 | 4846130 |   MD + MB cr | 30° | H | | | |
| V91285  45.00 x 10.00 x 156.50 | 4 704 215 |   MD + MB tu | 45° | H | | | |

|  |  | ccm |  |  |  |  |
|---|---|------|---|---|---|---|
| 224DT | 85.00 | 2179 | 4 | 16 | Diesel | 3 |
| 306DT | 84.00 | 2993 | 6 | 24 | Diesel | 2 |
| 9BPMNA | 91.00 | 3239 | 6 | 24 | Petrol | 8 |
| 9DPANA | 91.00 | 3590 | 6 | 24 | Petrol | 9 |
| 9EPCNA | 91.00 | 3980 | 6 | 24 | Petrol | 10 |
| AJ 6 (3.6, 156KW) | 91.00 | 3590 | 6 | 24 | Petrol | 9 |
| AJD | 81.00 | 2720 | 6 | 24 | Diesel | 1 |
| AJV6D | 84.00 | 2993 | 6 | 24 | Diesel | 2 |
| FMBA | 86.00 | 1998 | 4 | 16 | Diesel | 4 |
| FMBB | 86.00 | 1998 | 4 | 16 | Diesel | 4 |
| QJBA | 86.00 | 2198 | 4 | 16 | Diesel | 5 |
| V 12 (75-79) | 90.00 | 5343 | 12 | 24 | Petrol | 6 |
| V 12 (78-82) | 90.00 | 5343 | 12 | 24 | Petrol | 6 |
| V 12 (82-90) | 90.00 | 5343 | 12 | 24 | Petrol | 7 |
| XK 4.2 (-79) | 92.07 | 4235 | 6 | 12 | Petrol | 11 |
| XK 4.2 (82-87) | 92.07 | 4235 | 6 | 12 | Petrol | 12 |

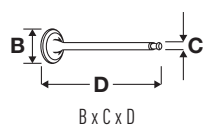

OE

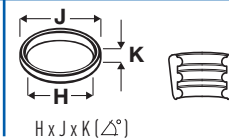
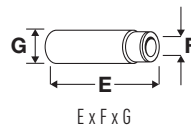

1 81.00

| | | | | | | | |
|--------------------------|------------------------------------|------------|------------------|-------------|--------|--------------------|----------------|
| AJD | 2720cc | V6 Cyl. | 24 Valves | 152kW/207PS | Diesel | Turbo, DOHC | TD25810 |
| S-TYPE 2.7 D XJ D 2.7 | 06/2004→10/2007 10/2005→03/2009 | | | XF 2.7 D | | 03/2008→04/2015 | |
| V95135 | 0948.E1 | | 45° | H | | | |
| 27.80 x 5.94 x 97.00 | | MB cr | | | | | |
| V95136 | 0949.C6 | | 45° | ss | H | | |
| 25.20 x 5.93 x 96.35 | | MD + MB cr | | | | | |

2 84.00

| | | | | | | | |
|--------------------------|----------------------|------------|------------------|---------------------|--------|--------------|----------------|
| 306DT | 2993cc | V6 Cyl. | 24 Valves | 177-221kW/241-300PS | Diesel | Turbo | TD27175 |
| AJV6D | 2993cc | V6 Cyl. | 24 Valves | 155-202kW/211-275PS | Diesel | DOHC | TD25809 |
| F-PACE 3.0 D XJ 3.0 D | 09/2015→ 10/2009→ | | | XF 3.0 D | | 03/2009→ | |
| V95135 | 0948.E1 | | 45° | H | | | |
| 27.80 x 5.94 x 97.00 | | MB cr | | | | | |
| V95136 | 0949.C6 | | 45° | ss | H | | |
| 25.20 x 5.93 x 96.35 | | MD + MB cr | | | | | |

3 85.00

| | | | | | | | |
|----------------------|-----------------|------------|------------------|---------------------|--------|----------------------|----------------|
| 224DT | 2179cc | 4 Cyl. | 16 Valves | 110-147kW/150-200PS | Diesel | Turbo, DOHC | TD26822 |
| XF 2.2 D | 04/2011→04/2015 | | | | | | |
| V95083 | 0948.E5 | | 45° | Y | H | VAG96119 | |
| 27.25 x 5.97 x 95.70 | | MB cr | | | | 41.50 x 6.03 x 10.54 | |
| V95084 | 0949.E1 | | 45° | ss | H | | |
| 25.00 x 5.97 x 95.00 | | MD + MB cr | | | | | |

4 86.00

| | | | | | | | |
|-----------------------|-----------------|------------|------------------|------------|--------|----------------------|----------------|
| FMBA | 1998cc | 4 Cyl. | 16 Valves | 96kW/130PS | Diesel | Turbo, DOHC | TD24398 |
| FMBB | 1998cc | 4 Cyl. | 16 Valves | 96kW/130PS | Diesel | Turbo, DOHC | TD24399 |
| X-TYPE 2.0 D | 07/2003→12/2009 | | | | | | |
| V94378 | 1217148 | | 30° | Y | H | VAG96368 | |
| 29.80 x 7.00 x 122.20 | | MD + MB cr | | | | 51.50 x 6.97 x 12.07 | |
| V94379 | 1121332 | | 45° | ss | H | | |
| 25.80 x 7.00 x 122.10 | | MD + MB cr | | | | | |

5 86.00

| | | | | | | | |
|-----------------------|---------|------------|------------------|-------------|--------|---|----------------|
| QJBA | 2198cc | 4 Cyl. | 16 Valves | 114kW/155PS | Diesel | ZSD-422 (Duratorq-TDCi), Turbo, DOHC | TD24400 |
| V94378 | 1217148 | | 30° | Y | H | VAG96368 | |
| 29.80 x 7.00 x 122.20 | | MD + MB cr | | | | 51.50 x 6.97 x 12.07 | |
| V94379 | 1121332 | | 45° | ss | H | | |
| 25.80 x 7.00 x 122.10 | | MD + MB cr | | | | | |



OE

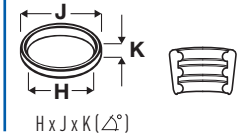
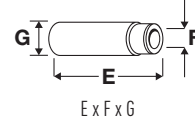
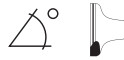

6  **90.00**

| | | | | | | | |
|--------------|-----------------|----------|-----------|---------------------|--------|------|--------|
| V 12 (75-79) | 5343cc | V12 Cyl. | 24 Valves | 211kW/287PS | Petrol | SOHC | TD1731 |
| V 12 (78-82) | 5343cc | V12 Cyl. | 24 Valves | 211-217kW/287-295PS | Petrol | SOHC | TD1728 |
| XJ 12 5.3 | 05/1975→02/1993 | | | | | | |

V90304 
41.40 x 7.85 x 115.50
Eng.→7P42299

EAC1549

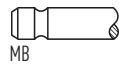

45°

VAG50923 
48.50 x 7.93 x 12.75



V90307 
34.70 x 7.88 x 115.50
Eng.→7P42299

EAC1550

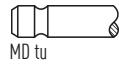

45°

VAG50924 
54.00 x 7.92 x 12.88

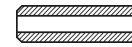

7  **90.00**

| | | | | | | | |
|---------------|-----------------|----------|------------|---------------------|-----------------|------|--------|
| V 12 (82-90) | 5343cc | V12 Cyl. | 24 Valves | 217-220kW/295-300PS | Petrol | SOHC | TD1732 |
| XJ 5.3 H.E. | 07/1981→12/1987 | | XJ 12 H.E. | | 05/1981→12/1992 | | |
| XJSC 5.3 H.E. | 09/1985→12/1990 | | | | | | |

V90304 
41.40 x 7.85 x 115.50
Eng.→7P42299

EAC1549

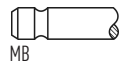

45°

VAG50923 
48.50 x 7.93 x 12.75



V90307 
34.70 x 7.88 x 115.50

EAC1550

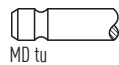

45°

VAG50924 
54.00 x 7.92 x 12.88



8  **91.00**

| | | | | | | | |
|----------|-----------------|--------|-----------|-------------|--------|------|--------|
| 9BPMNA | 3239cc | 6 Cyl. | 24 Valves | 146kW/199PS | Petrol | DOHC | TD1730 |
| XJ 6 3.2 | 09/1990→11/1994 | | | | | | |

V91058 
35.40 x 7.87 x 108.70

EAC2909

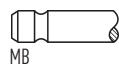

45°

H

VAG50923 
48.50 x 7.93 x 12.75



9  **91.00**

| | | | | | | | |
|-------------------|-----------------|--------|-----------|---------------------|-----------------|------|--------|
| 9DPANA | 3590cc | 6 Cyl. | 24 Valves | 136-156kW/185-212PS | Petrol | DOHC | TD1725 |
| AJ 6 (3.6, 156KW) | 3590cc | 6 Cyl. | 24 Valves | 156kW/212PS | Petrol | | TD1723 |
| XJ 3.6 | 10/1983→05/1992 | | XJ 6 3.6 | | 10/1986→08/1989 | | |
| XJSC 3.6 | 08/1987→05/1991 | | | | | | |

V91058 
35.40 x 7.87 x 108.70

EAC2909

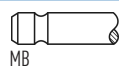

45°

H

VAG50914 
47.30 x 7.95 x 12.90



10  **91.00**

| | | | | | | | |
|----------|-----------------|--------|-----------|---------------------|-----------------|------|--------|
| 9EPCNA | 3980cc | 6 Cyl. | 24 Valves | 163-187kW/222-254PS | Petrol | DOHC | TD1724 |
| XJ 4.0 | 10/1986→09/1994 | | XJ 6 4.0 | | 09/1989→11/1994 | | |
| XJSC 4.0 | 05/1991→09/1994 | | | | | | |

V91058 
35.40 x 7.87 x 108.70

EAC2909

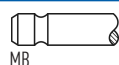

45°

H

VAG50923 
48.50 x 7.93 x 12.75

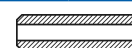



OE

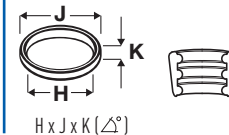
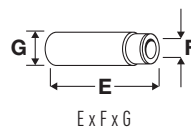

11 92.07







| | | | | | | |
|----------------------|-----------------|--------|------------------|----------------------------|-------------|---------------|
| XK 4.2 (1-79) | 4235cc | 6 Cyl. | 12 Valves | 124-137kW/169-186PS Petrol | DOHC | TD1737 |
| XJ 6 4.2 | 10/1969→01/1980 | | | | | |

| | | | | | |
|--|---------|-----------|-----|---|--|
| V90308 ■ 44.60 x 7.88 x 105.60 | EAC1547 | MB | 45° | VAG50914 ■ 47.30 x 7.95 x 12.90 | |
| V90303 ■ 41.40 x 7.88 x 103.60 | EAC1548 | MD tu | 45° | VAG92198 ■ 47.30 x 7.95 x 12.75 | |
| | | | | VAG50913 ■ 49.50 x 7.95 x 12.87 | |
| | | | | VAG92199 ■ 49.50 x 7.95 x 12.73 | |

12 92.07

| | | | | | | |
|-----------------------|-----------------|--------|------------------|----------------------------|-------------|---------------|
| XK 4.2 (82-87) | 4235cc | 6 Cyl. | 12 Valves | 151-198kW/205-269PS Petrol | DOHC | TD5199 |
| E-TYPE 4.2 | 05/1964→05/1971 | | XJ 6 4.2 | 09/1979→12/1987 | | |

| | | | | | |
|--|---------|-----------|-----|---|--|
| V90302 ■ 47.70 x 7.88 x 106.80 | EAC1395 | MB | 45° | VAG50914 ■ 47.30 x 7.95 x 12.90 | |
| V90303 ■ 41.40 x 7.88 x 103.60 | EAC1548 | MD tu | 45° | VAG92198 ■ 47.30 x 7.95 x 12.75 | |
| | | | | VAG50913 ■ 49.50 x 7.95 x 12.87 | |
| | | | | VAG92199 ■ 49.50 x 7.95 x 12.73 | |

|  |  | ccm |  |  |  |  |
|---|---|------|---|---|---|---|
| ENC | 92.00 | 2499 | 4 | 8 | Diesel | 4 |
| ENR | 94.00 | 2777 | 4 | 16 | Diesel | 5 |
| J5R-800 | 88.00 | 1995 | 4 | 8 | Petrol | 3 |
| J8S | 86.00 | 2068 | 4 | 8 | Diesel | 2 |
| J8S-800 | 86.00 | 2068 | 4 | 8 | Diesel | 2 |
| J8S-814 | 86.00 | 2068 | 4 | 8 | Diesel | 2 |
| J8S-890 | 86.00 | 2068 | 4 | 8 | Diesel | 2 |
| OM 651.925 | 83.00 | 2143 | 4 | 16 | Diesel | 1 |
| VM 425HS (M52) | 92.00 | 2499 | 4 | 8 | Diesel | 4 |



OE

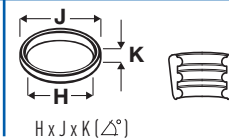
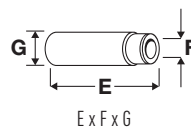

1 **83.00**

| | | | | | | | |
|-------------------|--------|-----------|------------------|---------------------|--------|--------------------|----------------|
| OM 651.925 | 2143cc | 4 Cyl. | 16 Valves | 100-120kW/136-163PS | Diesel | Turbo, DOHC | TD25244 |
| COMPASS 2.2 CRD | | 12/2010-> | | | | | |

| | | | | |
|-----------------------|---------------|--|-----|---|
| V95194 | 651 053 01 01 | | 45° | H |
| 28.40 x 5.96 x 108.95 | | | | |
| V95195 | 651 050 01 27 | | 45° | H |
| 24.65 x 5.96 x 109.20 | | | | |

2 **86.00**

| | | | | | | | |
|-----------------|------------------|--------|-----------------|-----------------|------------------|--------------------|----------------|
| J8S | 2068cc | 4 Cyl. | 8 Valves | 59-64kW/80-87PS | Diesel | SOHC | TD22946 |
| J8S-800 | 2068cc | 4 Cyl. | 8 Valves | 44kW/60PS | Diesel | SOHC | TD1750 |
| J8S-814 | 2068cc | 4 Cyl. | 8 Valves | 63-65kW/86-88PS | Diesel | Turbo, SOHC | TD1745 |
| J8S-890 | 2068cc | 4 Cyl. | 8 Valves | 65kW/88PS | Diesel | Turbo, SOHC | TD1749 |
| CHEROKEE 2.1 TD | 10/1984->09/2001 | | | CJ5 - CJ8 2.1 D | 01/1983->12/1987 | | |
| COMANCHE 2.1 D | 01/1986->09/1990 | | | | | | |

| | | | | |
|-----------------------|--------------|--|-----|---|
| V91264 | 7701 461 338 | | 45° | H |
| 40.50 x 8.00 x 111.50 | | | | |
| V91265 | 7701 461 339 | | 45° | |
| 33.50 x 8.00 x 111.50 | | | | |

3 **88.00**

| | | | | | | | |
|----------------|--------|------------------|-----------------|-----------------|--------|-------------|---------------|
| J5R-800 | 1995cc | 4 Cyl. | 8 Valves | 61-63kW/85-86PS | Petrol | SOHC | TD1747 |
| CJ5 - CJ8 2.0 | | 01/1983->12/1987 | | | | | |

| | | | | | | |
|-----------------------|--------------|--|-----|---|----------------------|--|
| V90371 | 7701 460 147 | | 30° | H | VAG92337 | |
| 44.00 x 8.00 x 112.00 | | | | | 51.00 x 8.00 x 13.30 | |
| V91263 | 7701 460 148 | | 45° | | | |
| 38.50 x 8.00 x 111.50 | | | | | | |

4 **92.00**







| | | | | | | | |
|-------------------------|------------------|--------|-----------------|------------------|------------------|--------------|----------------|
| ENC | 2499cc | 4 Cyl. | 8 Valves | 85kW/116PS | Diesel | Turbo | TD26068 |
| VM 425HS (M52) | 2499cc | 4 Cyl. | 8 Valves | 85kW/115PS | Diesel | Turbo | TD22950 |
| CHEROKEE 2.5 TD | 01/1988->09/2001 | | | CHEROKEE 2.5 Tdi | 10/1996->09/2001 | | |
| GRAND CHEROKEE I 2.5 TD | 10/1995->04/1999 | | | | | | |

| | | | | | | |
|-----------------------|------------|--|-----|--|----------------------|--|
| V91437 | 605 07 189 | | 35° | | VAG96187 | |
| 40.00 x 8.00 x 121.00 | | | | | 55.00 x 8.02 x 14.06 | |
| V91438 | 605 07 190 | | 45° | | | |
| 34.00 x 8.00 x 121.00 | | | | | | |

5 **94.00**

| | | | | | | | |
|------------------|--------|------------------|------------------|---------------------|--------|--------------------|----------------|
| ENR | 2777cc | 4 Cyl. | 16 Valves | 110-120kW/150-163PS | Diesel | Turbo, DOHC | TD24005 |
| CHEROKEE 2.8 CRD | | 11/2002->01/2008 | | | | | |

| | | | | |
|-----------------------|------------|--|-----|--|
| V98016 | 05066770AA | | 45° | |
| 32.40 x 6.00 x 109.00 | | | | |
| V98017 | 05066769AA | | 45° | |
| 30.90 x 6.00 x 108.30 | | | | |

|  |  | ccm |  |  |  |  |
|---|---|------|---|---|---|---|
| A5D | 75.50 | 1493 | 4 | 16 | Petrol | 7 |
| B6 | 78.00 | 1598 | 4 | 8 | Petrol | 12 |
| D3FA | 75.00 | 1120 | 3 | 12 | Diesel | 4 |
| D4BH | 91.10 | 2477 | 4 | 8 | Diesel | 19 |
| D4CB | 91.00 | 2497 | 4 | 16 | Diesel | 18 |
| D4EA | 83.00 | 1991 | 4 | 16 | Diesel | 14 |
| D4EA-F | 83.00 | 1991 | 4 | 16 | Diesel | 14 |
| D4FA | 75.00 | 1493 | 4 | 16 | Diesel | 6 |
| D4FB | 77.20 | 1582 | 4 | 16 | Diesel | 11 |
| D4FB-L | 77.20 | 1582 | 4 | 16 | Diesel | 11 |
| D4FC | 75.00 | 1396 | 4 | 16 | Diesel | 5 |
| G4ED | 76.50 | 1599 | 4 | 16 | Petrol | 8 |
| G4FA | 77.00 | 1396 | 4 | 16 | Petrol | 9 |
| G4FC | 77.00 | 1591 | 4 | 16 | Petrol | 10 |
| G4FD | 77.00 | 1591 | 4 | 16 | Petrol | 10 |
| G4GC | 82.00 | 1975 | 4 | 16 | Petrol | 13 |
| G4HE | 66.00 | 999 | 4 | 12 | Petrol | 1 |
| G4HG | 67.00 | 1086 | 4 | 12 | Petrol | 2 |
| G4KE | 88.00 | 2359 | 4 | 16 | Petrol | 17 |
| G4LA | 71.00 | 1248 | 4 | 16 | Petrol | 3 |
| G6BA | 86.70 | 2656 | 6 | 24 | Petrol | 16 |
| J3 | 97.10 | 2902 | 4 | 16 | Diesel | 20 |
| R2 | 86.00 | 2184 | 4 | 8 | Diesel | 15 |

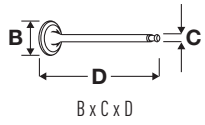

OE

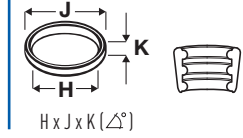
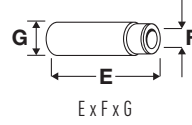
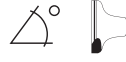

1 **66.00**

| | | | | | | | |
|-------------|-------|----------|------------------|-----------------|--------|--|----------------|
| G4HE | 999cc | 4 Cyl. | 12 Valves | 45-46kW/61-63PS | Petrol | | TD20755 |
| PICANTO 1.0 | | 04/2004→ | | | | | |

| | | | | | | | |
|----------------------|-------------|------------|-----|---|----------------------|--|--|
| V95069 | 22211-02200 | | 45° | H | VAG96394 | | |
| 23.50 x 5.47 x 99.60 | | MB tu | | | 48.00 x 5.50 x 10.00 | | |
| V95070 | 22212-02200 | | 45° | H | | | |
| 27.00 x 5.45 x 99.10 | | MD + MB tu | | | | | |

2 **67.00**

| | | | | | | | |
|-------------|--------|----------|------------------|-----------|--------|-------------|----------------|
| G4HG | 1086cc | 4 Cyl. | 12 Valves | 48kW/65PS | Petrol | SOHC | TD17408 |
| PICANTO 1.1 | | 04/2004→ | | | | | |

| | | | | | | | |
|----------------------|-------------|------------|-----|---|----------------------|--|--|
| V95069 | 22211-02200 | | 45° | H | VAG96394 | | |
| 23.50 x 5.47 x 99.60 | | MB tu | | | 48.00 x 5.50 x 10.00 | | |
| V95070 | 22212-02200 | | 45° | H | | | |
| 27.00 x 5.45 x 99.10 | | MD + MB tu | | | | | |

3 **71.00**

| | | | | | | | |
|--------------|--------|----------|------------------|------------------|--------|-------------|----------------|
| G4LA | 1248cc | 4 Cyl. | 16 Valves | 51-65kW/69-88PS | Petrol | DOHC | TD26878 |
| PICANTO 1.2 | | 09/2011→ | | RIO III 1.2 | | 09/2011→ | |
| RIO III 1.25 | | 06/2011→ | | RIO III 1.25 LPG | | 09/2011→ | |

| | | | | | | | |
|-----------------------|-------------|------------|-----|---|----------------------|--|--|
| V95203 | 22211-03200 | | 45° | H | VAG96394 | | |
| 26.80 x 5.47 x 101.20 | | MB tu | | | 48.00 x 5.50 x 10.00 | | |
| V95204 | 22212-03200 | | 45° | H | | | |
| 24.10 x 5.46 x 101.20 | | MD + MB tu | | | | | |

4 **75.00**

| | | | | | | | |
|------------------|--------|----------|------------------|------------------|--------|--------------------|----------------|
| D3FA | 1120cc | 3 Cyl. | 12 Valves | 55kW/75PS | Diesel | Turbo, DOHC | TD19960 |
| PICANTO 1.1 CRDi | | 11/2005→ | | RIO III 1.1 CRDi | | 09/2011→ | |

| | | | | | | | |
|----------------------|-------------|-------|-----|---|----------------------|--|--|
| V95228 | 22211-2A100 | | 45° | H | VAG96395 | | |
| 26.30 x 5.47 x 93.00 | | MB tu | | | 31.50 x 5.50 x 11.03 | | |
| V95229 | 22212-2A100 | | 45° | | | | |
| 21.10 x 5.46 x 93.80 | | MD tu | | | | | |

5 **75.00**

| | | | | | | | |
|--------------------|--------|----------|------------------|-----------------------|--------|--------------------|----------------|
| D4FC | 1396cc | 4 Cyl. | 16 Valves | 55-66kW/75-90PS | Diesel | Turbo, DOHC | TD25027 |
| CEE'D 1.4 CRDi 90 | | 05/2012→ | | PRO CEE'D 1.4 CRDi 90 | | 03/2013→ | |
| RIO III 1.4 CRDi | | 09/2011→ | | RIO IV 1.4 CRDi 77 | | 01/2017→ | |
| RIO IV 1.4 CRDi 90 | | 01/2017→ | | VENGA 1.4 CRDi 75 | | 02/2010→ | |
| VENGA 1.4 CRDi 90 | | 02/2010→ | | | | | |

| | | | | | | | |
|----------------------|-------------|-------|-----|---|----------------------|--|--|
| V95228 | 22211-2A100 | | 45° | H | VAG96395 | | |
| 26.30 x 5.47 x 93.00 | | MB tu | | | 31.50 x 5.50 x 11.03 | | |
| V95229 | 22212-2A100 | | 45° | | | | |
| 21.10 x 5.46 x 93.80 | | MD tu | | | | | |



OE

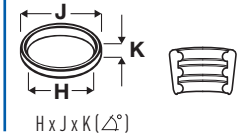
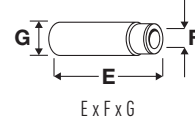

6 **75.00**

| | | | | | | | |
|-----------------|--------|----------|------------------|-------------------|--------|--------------------|----------------|
| D4FA | 1493cc | 4 Cyl. | 16 Valves | 65-81kW/88-110PS | Diesel | Turbo, DOHC | TD18454 |
| CERATO 1.5 CRDi | | 07/2005→ | | PRIDE 1.5 CRDi LX | | 03/2005→12/2011 | |
| RIO II 1.5 CRDi | | 03/2005→ | | | | | |

| | | | | | | | |
|----------------------|-------------|-------|-----|---|----------------------|--|--|
| V95228 | 22211-2A100 | | 45° | H | VAG96395 | | |
| 26.30 x 5.47 x 93.00 | | MB tu | | | 31.50 x 5.50 x 11.03 | | |
| V95229 | 22212-2A100 | | 45° | | | | |
| 21.10 x 5.46 x 93.80 | | MD tu | | | | | |

7 **75.50**

| | | | | | | | |
|------------|--------|-----------------|------------------|-----------------|--------|-----------------|----------------|
| A5D | 1493cc | 4 Cyl. | 16 Valves | 70-72kW/95-98PS | Petrol | DOHC | TD28073 |
| RIO 1.5 | | 09/2002→02/2005 | | RIO 1.5 16V | | 08/2000→02/2005 | |

| | | | | | | | |
|----------------------|-------------|-------|-----|--|----------------------|--|--|
| V98048 | OK30E-12111 | | 45° | | VAG96394 | | |
| 27.80 x 5.50 x 96.40 | | MB tu | | | 48.00 x 5.50 x 10.00 | | |
| V98049 | OK30E-12121 | | 45° | | | | |
| 24.90 x 5.50 x 95.50 | | MD tu | | | | | |

8 **76.50**

| | | | | | | | |
|-------------|--------|----------|------------------|-------------------|--------|-----------------|----------------|
| G4ED | 1599cc | 4 Cyl. | 16 Valves | 77-82kW/105-112PS | Petrol | DOHC | TD18452 |
| CERATO 1.6 | | 04/2004→ | | PRIDE 1.6 LX | | 03/2005→12/2011 | |
| RIO II 1.6 | | 03/2005→ | | RIO II 1.6 16V | | 03/2005→ | |

| | | | | | | | |
|----------------------|-------------|------------|-----|---|--|--|--|
| V95021 | 22211-26600 | | 45° | H | | | |
| 29.10 x 6.00 x 91.80 | | MB tu | | | | | |
| V95022 | 22212-26000 | | 45° | H | | | |
| 25.00 x 6.00 x 92.35 | | MD + MB tu | | | | | |

9 **77.00**

| | | | | | | | |
|---------------|--------|-----------------|------------------|-------------------|--------|-------------|----------------|
| G4FA | 1396cc | 4 Cyl. | 16 Valves | 73-80kW/100-109PS | Petrol | DOHC | TD19226 |
| CEE'D 1.4 | | 12/2006→ | | PRO CEE'D 1.4 | | 03/2013→ | |
| PRO CEE'D 1.4 | | 02/2008→09/2012 | | RIO III 1.4 | | 06/2011→ | |

| | | | | | | | |
|----------------------|-------------|-------|-----|---|----------------------|--|--|
| V95198 | 22211-2B000 | | 45° | H | VAG96398 | | |
| 31.50 x 5.47 x 93.20 | | MB tu | | | 40.50 x 5.50 x 10.05 | | |
| V95199 | 22212-2B000 | | 45° | | | | |
| 26.00 x 5.46 x 92.60 | | MD tu | | | | | |

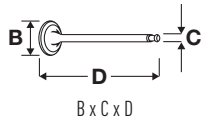

OE

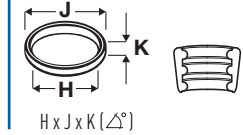
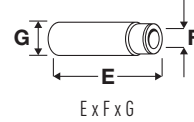
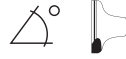

10 **77.00**

| | | | | | | | |
|---------------------|-----------------|--------|------------------|--------------------|--------|------------------------|----------------|
| G4FC | 1591cc | 4 Cyl. | 16 Valves | 77-97kW/105-132PS | Petrol | DOHC, Injection | TD19227 |
| G4FD | 1591cc | 4 Cyl. | 16 Valves | 97-103kW/132-140PS | Petrol | DOHC, Injection | TD25024 |
| CARENS III 1.6 | 08/2009→ | | | CARENS IV 1.6 GDi | | 03/2013→ | |
| CEE'D 1.6 | 12/2006→ | | | CEE'D 1.6 GDI | | 05/2012→ | |
| CEE'D 1.6 LPG | 01/2008→09/2012 | | | CERATO 1.6 | | 05/2006→ | |
| CERATO 1.6 GDI | 09/2012→ | | | CERATO 1.6 MPi | | 06/2013→ | |
| CERATO II 1.6 | 02/2009→ | | | CERATO KOUP 1.6 | | 10/2009→ | |
| CERATO KOUP 1.6 GDI | 12/2013→ | | | PRO CEE'D 1.6 | | 03/2013→ | |
| PRO CEE'D 1.6 GDI | 03/2013→ | | | PRO CEE'D 1.6 | | 02/2008→02/2013 | |
| RIO III 1.6 | 06/2011→ | | | SHUMA 1.6 | | 01/2010→12/2014 | |
| SOUL 1.6 | 02/2009→ | | | SOUL 1.6 GDI | | 06/2011→ | |
| SOUL 1.6 LPG | 02/2009→12/2014 | | | SOUL II 1.6 GDI | | 02/2014→ | |
| SPORTAGE 1.6 GDI | 02/2011→ | | | VENGA 1.6 | | 02/2010→ | |

V95198
31.50 x 5.47 x 93.20

22211-2B000

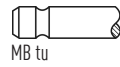

45°

H

VAG96398
40.50 x 5.50 x 10.05



V95199
26.00 x 5.46 x 92.60

22212-2B000

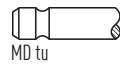

45°

11 **77.20**

| | | | | | | | |
|-------------------------|-----------------|--------|------------------|-------------------------|--------|--------------------|----------------|
| D4FB | 1582cc | 4 Cyl. | 16 Valves | 81-100kW/110-136PS | Diesel | Turbo, DOHC | TD19228 |
| D4FB-L | 1582cc | 4 Cyl. | 16 Valves | 66kW/90PS | Diesel | Turbo, DOHC | TD19229 |
| CARENS III 1.6 CRDi 110 | 10/2010→ | | | CARENS III 1.6 CRDi 128 | | 10/2010→ | |
| CEE'D 1.6 CRDi 90 | 12/2006→ | | | CEE'D 1.6 CRDi 110 | | 05/2012→ | |
| CEE'D 1.6 CRDi 115 | 12/2006→ | | | CEE'D 1.6 CRDi 128 | | 10/2010→ | |
| CEE'D 1.6 CRDi 136 | 07/2015→ | | | CERATO 1.6 CRDi | | 06/2005→ | |
| CERATO 1.6 VGT | 09/2012→07/2016 | | | PRO CEE'D 1.6 CRDi 110 | | 03/2013→ | |
| PRO CEE'D 1.6 CRDi 128 | 03/2013→ | | | PRO CEE'D 1.6 CRDi 136 | | 07/2015→ | |
| PRO CEE'D 1.6 CRDi 90 | 02/2008→09/2012 | | | PRO CEE'D 1.6 CRDi 115 | | 02/2008→09/2012 | |
| PRO CEE'D 1.6 CRDi 128 | 10/2010→09/2012 | | | SOUL 1.6 CRDi 115 | | 02/2009→ | |
| SOUL 1.6 CRDi 128 | 02/2009→ | | | SOUL II 1.6 CRDi 128 | | 02/2014→ | |
| SOUL II 1.6 CRDi 136 | 04/2015→ | | | STONIC 1.6 CRDi | | 07/2017→ | |
| VENGA 1.6 CRDi 115 | 02/2010→ | | | VENGA 1.6 CRDi 128 | | 02/2010→ | |

V95228
26.30 x 5.47 x 93.00

22211-2A100

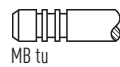

45°

H

VAG96395
31.50 x 5.50 x 11.03



V95229
21.10 x 5.46 x 93.80

22212-2A100

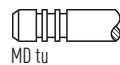

45°

12 **78.00**

| | | | | | | | |
|--------------|-----------------|--------|-----------------|-----------|--------|-------------|---------------|
| B6 | 1598cc | 4 Cyl. | 8 Valves | 59kW/80PS | Petrol | SOHC | TD4588 |
| SEPHIA 1.6 i | 09/1993→10/1997 | | | | | | |

V94572
23.50 x 6.00 x 105.00

B6ZA-12-121

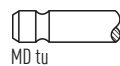

45°

st



OE

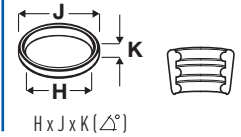
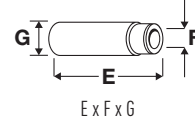
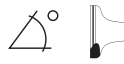

13 **82.00**

| G4GC | 1975cc | 4 Cyl. | 16 Valves | 102-106kW/139-144PS | Petrol | DOHC | TD18130 |
|-------------------|-----------------|--------|-----------|---------------------|--------|-----------------|---------|
| CARENS II 2.0 | 08/2004→ | | | CEE'D 2.0 | | 12/2006→12/2012 | |
| CERATO 2.0 | 04/2004→ | | | PRO CEE'D 2.0 | | 02/2008→09/2012 | |
| PRO CEE'D 2.0 LPG | 01/2009→12/2009 | | | SOUL 2.0 | | 09/2009→12/2011 | |
| SPORTAGE 2.0 16V | 09/2004→ | | | SPORTAGE 2.0 i 16V | | 09/2004→ | |

V95201
32.00 x 5.97 x 114.40

22211-23600

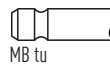

45°

H

VAG96399
46.00 x 6.00 x 11.05



V98038
32.00 x 6.00 x 102.30

22211-23000

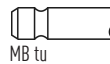

45°

VAG96400
54.50 x 6.00 x 11.05

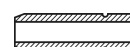

V95202
27.50 x 5.96 x 116.85

22212-23600

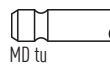

45°

V98039
27.50 x 6.00 x 104.70

22212-23000

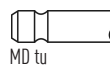

45°

14 **83.00**

| D4EA | 1991cc | 4 Cyl. | 16 Valves | 83-85kW/113-115PS | Diesel | Turbo, SOHC | TD18131 |
|--------|--------|--------|-----------|---------------------|--------|-------------|---------|
| D4EA-F | 1991cc | 4 Cyl. | 16 Valves | 103-110kW/140-150PS | Diesel | Turbo, SOHC | TD20226 |

| | | | | | | | |
|-------------------------|-----------------|--|--|-------------------------|--|-----------------|--|
| CARENS II 2.0 CRDi | 07/2002→ | | | CARENS III 2.0 CRDi | | 01/2008→04/2010 | |
| CARENS III 2.0 CRDi 115 | 05/2007→ | | | CARENS III 2.0 CRDi 135 | | 08/2009→ | |
| CARENS III 2.0 CRDi 140 | 09/2006→ | | | CEE'D 2.0 CRDi | | 06/2007→12/2012 | |
| CEE'D 2.0 CRDi 140 | 09/2007→12/2012 | | | CERATO 2.0 CRDi | | 04/2004→ | |
| MAGENTIS 2.0 CRDi | 11/2005→ | | | PRO CEE'D 2.0 CRDi 140 | | 02/2008→09/2012 | |
| SPORTAGE 2.0 CRDi | 09/2004→ | | | | | | |

V95133
28.55 x 5.94 x 95.70

22211-27000

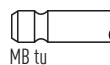

45°

H

VAG96401
36.60 x 6.00 x 11.05



V95134
24.40 x 5.92 x 95.55

22212-27000

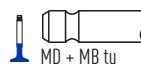

45°

H

15 **86.00**

| R2 | 2184cc | 4 Cyl. | 8 Valves | 48kW/65PS | Diesel | SOHC | TD11132 |
|----|--------|--------|----------|-----------|--------|------|---------|
|----|--------|--------|----------|-----------|--------|------|---------|

| | | | | | | | |
|-------------|-----------------|--|--|--|--|--|--|
| BESTA 2.2 D | 07/1992→12/2003 | | | | | | |
|-------------|-----------------|--|--|--|--|--|--|

V91171
41.05 x 7.98 x 106.88

RF01-12-111



45°

H

VAG92292
40.57 x 7.98 x 14.04



V91172
36.05 x 7.98 x 106.88

RF01-12-121

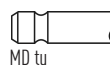

45°

VAG92293
37.66 x 7.98 x 14.02

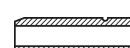

16 **86.70**

| G6BA | 2656cc | V6 Cyl. | 24 Valves | 120-147kW/165-200PS | Petrol | DOHC | TD18132 |
|------|--------|---------|-----------|---------------------|--------|------|---------|
|------|--------|---------|-----------|---------------------|--------|------|---------|

| | | | | | | | |
|-----------------|-----------------|--|--|-----------------|--|-----------------|--|
| CADENZA I 2.7 | 01/2010→ | | | MAGENTIS 2.7 | | 09/2001→12/2006 | |
| MAGENTIS 2.7 V6 | 04/2004→ | | | OPIRUS 2.7 | | 10/2003→02/2012 | |
| SPORTAGE 2.7 | 09/2005→12/2010 | | | SPORTAGE 2.7 V6 | | 09/2004→ | |

V95201
32.00 x 5.97 x 114.40

22211-23600

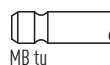

45°

H

VAG96399
46.00 x 6.00 x 11.05



V98040
32.00 x 6.00 x 96.20

22211-37201

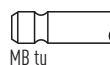

45°

VAG96400
54.50 x 6.00 x 11.05



V95202
27.50 x 5.96 x 116.85

22212-23600

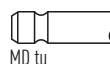

45°

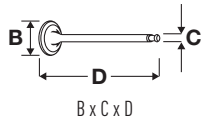

OE

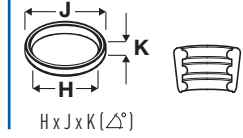
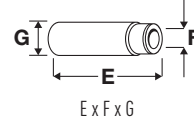
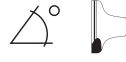

17 **88.00**

| G4KE | 2359cc | 4 Cyl. | 16 Valves | 126-132kW/172-180PS | Petrol | DOHC | TD24734 |
|-----------------|-----------------|--------|-----------|---------------------|--------|-----------------|---------|
| CADENZA I 2.4 | 06/2013→ | | | CERATO II 2.4 | | 09/2009→ | |
| CERATO KOUP 2.4 | 09/2010→12/2013 | | | MAGENTIS 2.4 | | 09/2009→12/2010 | |
| SORENTO II 2.4 | 11/2009→ | | | SORENTO II 2.4 4WD | | 11/2009→ | |
| SORENTO III 2.4 | 01/2015→ | | | SPORTAGE 2.4 | | 09/2010→ | |
| SPORTAGE 2.4 i | 08/2010→ | | | | | | |

V95235 ■
35.00 x 5.50 x 113.30

22211-2G000

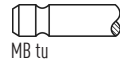

45°

H

MB tu

V95236 ■
28.95 x 5.50 x 106.00

22212-25002

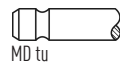

45°

MD tu

18 **91.00**

| D4CB | 2497cc | 4 Cyl. | 16 Valves | 95-131kW/129-178PS | Diesel | Turbo | TD19955 |
|----------------|----------|--------|-----------|--------------------|--------|----------|---------|
| BONGO 2.5 CRDi | 01/2012→ | | | BONGO 2.5 CRDi | | 01/2012→ | |
| K2500 2.5 CRDi | 01/2010→ | | | SORENTO I 2.5 CRDi | | 08/2002→ | |

V98052 ■
31.70 x 7.00 x 110.50

22211-4A061

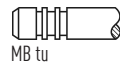

45°

MB tu

V98053 ■
28.00 x 7.00 x 110.50

22212-4A061

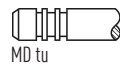

45°

MD tu

19 **91.10**

| D4BH | 2477cc | 4 Cyl. | 8 Valves | 69kW/94PS | Diesel | Turbo, SOHC | TD17409 |
|------------------|----------|--------|----------|----------------|--------|-----------------|---------|
| BONGO 2.4 TDCi | 10/2003→ | | | BONGO 2.5 TDCi | | 10/2003→ | |
| K2500 2.5 D | 01/2003→ | | | PREGIO 2.5 D | | 08/1995→09/2004 | |
| PREGIO 2.5 Tci D | 09/2002→ | | | | | | |

V94328 ■
40.00 x 8.00 x 136.50

MD-083 661

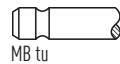

45°

H

MB tu

VAG92322 ■
71.00 x 8.00 x 13.13

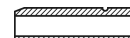

V95077 ■
40.00 x 7.97 x 130.20

MD198404

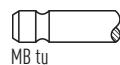

45°

H

MB tu

VAG96279 ■
71.00 x 8.00 x 13.07

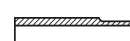

V91239 ■
34.16 x 7.96 x 136.50

22212-42850

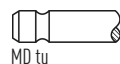

45°

H

MD tu

VAG92323 ■
74.00 x 8.00 x 13.13



V95078 ■
34.00 x 7.94 x 129.90

MD198406



45°

H

MD + MB tu

VAG96280 ■
74.00 x 8.00 x 13.07

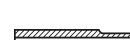

20 **97.10**

| J3 | 2902cc | 4 Cyl. | 16 Valves | 92-141kW/125-192PS | Diesel | Turbo, DOHC | TD19954 |
|--|-----------------|--------|-----------|---|--------|-----------------|---------|
| CARNIVAL / GRAND CARNIVAL III 2.9 CRDi | 06/2006→ | | | CARNIVAL / GRAND CARNIVAL III 2.9 CRDi LX | | 09/2006→ | |
| CARNIVAL I 2.9 TD | 08/1999→10/2001 | | | CARNIVAL II 2.9 CRDi | | 10/2001→06/2006 | |
| CARNIVAL II 2.9 TD | 01/1999→09/2007 | | | CARNIVAL II 2.9 TDi | | 02/1999→09/2007 | |
| K2900 2.9 D | 01/2008→ | | | | | | |

V94428 ■
34.00 x 7.00 x 126.20

OK551-12111A

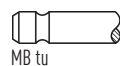

45°

H

MB tu

VAG96111 ■ ■
52.50 x 7.00 x 12.00



V94429 ■
31.60 x 7.00 x 126.00



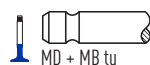

OK551-12121A



45°

H

MD + MB tu

| |  | ccm |  |  |  |  |
|----------------|---|------|---|---|---|---|
| BA3 2101 | 76.00 | 1198 | 4 | 8 | Petrol | 1 |
| BA3 2103 | 76.00 | 1452 | 4 | 8 | Petrol | 3 |
| BA3 2103 (KAT) | 76.00 | 1451 | 4 | 8 | Petrol | 2 |
| BA3 2105 | 79.00 | 1294 | 4 | 8 | Petrol | 4 |
| BA3 2106 | 79.00 | 1570 | 4 | 8 | Petrol | 6 |
| BA3 2121 | 79.00 | 1569 | 4 | 8 | Petrol | 5 |
| C 20 XE | 86.00 | 1998 | 4 | 16 | Petrol | 10 |
| VAZ-2112 | 82.00 | 1499 | 4 | 16 | Petrol | 7 |
| XUD9A | 83.00 | 1905 | 4 | 8 | Diesel | 8 |
| XUD9SD | 83.00 | 1905 | 4 | 8 | Diesel | 9 |



OE

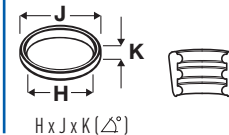
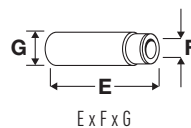
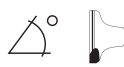

1 76.00

| | | | | | | | |
|--------------------|-----------------|--------|-----------------|--------------------|--------|-----------------|---------------|
| BA3 2101 | 1198cc | 4 Cyl. | 8 Valves | 44kW/60PS | Petrol | SOHC | TD5182 |
| 1200-1500 1200 | 09/1973→08/1984 | | | 1200-1600 1200 L/S | | 01/1970→06/1986 | |
| NOVA 1200 Junior/L | 09/1981→04/2012 | | | | | | |

| | | | | | | |
|--|--------------|--|-----|---|---|--|
| V34631 ■ 37.00 x 7.99 x 112.50 | 2101-1007010 | | 45° | H | VAG92174 ■ 42.00 x 8.04 x 14.08 | |
| V34632 ■ 31.45 x 7.99 x 113.00 | 2101-1007012 | | 45° | | VAG92175 ■ 48.00 x 8.04 x 14.08 | |

2 76.00

| | | | | | | | |
|-----------------------|-----------------|--------|-----------------|-----------------|--------|-------------|---------------|
| BA3 2103 (KAT) | 1451cc | 4 Cyl. | 8 Valves | 49-55kW/67-75PS | Petrol | SOHC | TD5389 |
| NOVA 1500 | 09/1987→12/1988 | | | | | | |

| | | | | | | |
|--|--------------|--|-----|---|---|--|
| V34631 ■ 37.00 x 7.99 x 112.50 | 2101-1007010 | | 45° | H | VAG92174 ■ 42.00 x 8.04 x 14.08 | |
| V34632 ■ 31.45 x 7.99 x 113.00 | 2101-1007012 | | 45° | | VAG92175 ■ 48.00 x 8.04 x 14.08 | |

3 76.00

| | | | | | | | |
|--------------------|-----------------|--------|-----------------|-----------------|--------|-----------------|---------------|
| BA3 2103 | 1452cc | 4 Cyl. | 8 Valves | 49-56kW/66-76PS | Petrol | SOHC | TD5181 |
| 1200-1500 1500 | 09/1973→06/1985 | | | 1200-1600 1500 | | 09/1972→08/1984 | |
| 1200-1600 1500 N/S | 11/1975→10/1986 | | | NOVA 1.5 1500 | | 10/1986→04/1998 | |
| NOVA 1500 | 03/1985→04/2012 | | | TOSCANA 1500 | | 09/1983→02/1993 | |

| | | | | | | |
|--|--------------|--|-----|---|---|--|
| V34631 ■ 37.00 x 7.99 x 112.50 | 2101-1007010 | | 45° | H | VAG92174 ■ 42.00 x 8.04 x 14.08 | |
| V34632 ■ 31.45 x 7.99 x 113.00 | 2101-1007012 | | 45° | | VAG92175 ■ 48.00 x 8.04 x 14.08 | |

4 79.00

| | | | | | | | |
|-----------------|-----------------|--------|-----------------|-----------------|--------|-----------------|---------------|
| BA3 2105 | 1294cc | 4 Cyl. | 8 Valves | 48-68kW/65-92PS | Petrol | SOHC | TD5183 |
| 1200-1500 1300 | 01/1981→12/1982 | | | 1200-1600 1300 | | 08/1974→08/1984 | |
| NOVA 1300 | 09/1983→12/1991 | | | NOVA 1300/L | | 05/1981→04/2012 | |
| TOSCANA 1300 | 12/1985→05/2012 | | | | | | |

| | | | | | | |
|--|--------------|--|-----|---|---|--|
| V34631 ■ 37.00 x 7.99 x 112.50 | 2101-1007010 | | 45° | H | VAG92174 ■ 42.00 x 8.04 x 14.08 | |
| V34632 ■ 31.45 x 7.99 x 113.00 | 2101-1007012 | | 45° | | VAG92175 ■ 48.00 x 8.04 x 14.08 | |

5 79.00

| | | | | | | | |
|-----------------|-----------------|--------|-----------------|-----------------|--------|-------------|---------------|
| BA3 2121 | 1569cc | 4 Cyl. | 8 Valves | 54-63kW/74-86PS | Petrol | SOHC | TD5184 |
| NIVA 1600 | 12/1976→03/1995 | | | | | | |

| | | | | | | |
|--|--------------|--|-----|---|---|--|
| V34631 ■ 37.00 x 7.99 x 112.50 | 2101-1007010 | | 45° | H | VAG92174 ■ 42.00 x 8.04 x 14.08 | |
| V34632 ■ 31.45 x 7.99 x 113.00 | 2101-1007012 | | 45° | | VAG92175 ■ 48.00 x 8.04 x 14.08 | |



OE

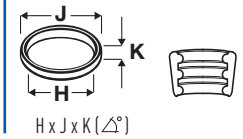
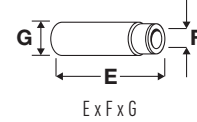

6  **79.00**

| | | | | | | | |
|-----------------|--------|-----------------|-----------------|--------------------|--------|-----------------|---------------|
| BA3 2106 | 1570cc | 4 Cyl. | 8 Valves | 54-58kW/73-79PS | Petrol | SOHC | TD5190 |
| 1200-1600 1600 | | 09/1972→01/1990 | | 1200-1600 1600 N/L | | 03/1979→12/2005 | |
| NOVA 1.6 | | 02/1993→04/2012 | | NOVA 1600 | | 01/1988→10/2001 | |
| TOSCANA 1.6 | | 05/1982→05/2012 | | | | | |

V34631 
37.00 x 7.99 x 112.50

2101-1007010

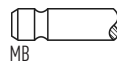

45°

H

VAG92174 
42.00 x 8.04 x 14.08

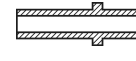

V34632 
31.45 x 7.99 x 113.00

2101-1007012

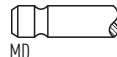

45°

VAG92175 
48.00 x 8.04 x 14.08

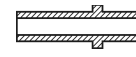

7  **82.00**

| | | | | | | | |
|-----------------|--------|-----------------|------------------|-----------------|--------|-----------------|----------------|
| VAZ-2112 | 1499cc | 4 Cyl. | 16 Valves | 67-70kW/91-95PS | Petrol | DOHC | TD11749 |
| 110 1.5 16V | | 01/1995→12/2010 | | 111 1.5 16V | | 01/1995→12/2005 | |
| 112 1.5 16V | | 01/1995→12/2005 | | | | | |

V94950 
29.20 x 7.00 x 96.00

2112-1007010

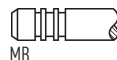

45°

H

V94951 
25.50 x 7.00 x 97.10

2112-1007012

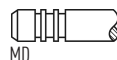

45°

8  **83.00**

| | | | | | | | |
|------------------|--------|-----------------|-----------------|-----------------|--------|-------------|----------------|
| XUD9A | 1905cc | 4 Cyl. | 8 Valves | 47-52kW/64-71PS | Diesel | SOHC | TD13350 |
| NIVA 1900 Diesel | | 01/1993→08/1999 | | | | | |

V91143 
38.00 x 8.00 x 112.40
→01/86

0948.49

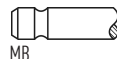

30°

H

VAG92288B 
52.00 x 8.03 x 14.28

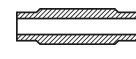

V91144 
38.50 x 8.00 x 112.50
01/86→

0948.63

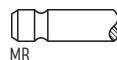

45°

H

VAG92331B 
50.00 x 8.03 x 14.08



V91145 
33.00 x 8.00 x 112.00

0949.47

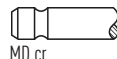

45°

VAG92465B 
52.00 x 8.03 x 14.07

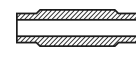

V94024 
33.00 x 8.00 x 112.00

0949.64

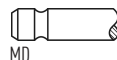

45°

9  **83.00**

| | | | | | | | |
|------------------|--------|-----------------|-----------------|-----------|--------|--------------------|----------------|
| XUD9SD | 1905cc | 4 Cyl. | 8 Valves | 55kW/75PS | Diesel | Turbo, SOHC | TD17345 |
| NIVA 1900 Diesel | | 01/1999→12/2006 | | | | | |

V91144 
38.50 x 8.00 x 112.50

0948.63

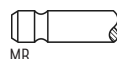

45°

H

VAG92288B 
52.00 x 8.03 x 14.28



V91145 
33.00 x 8.00 x 112.00

0949.47

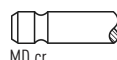

45°

VAG92331B 
50.00 x 8.03 x 14.08



VAG92465B 
52.00 x 8.03 x 14.07

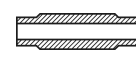

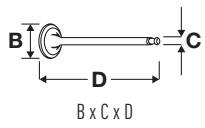



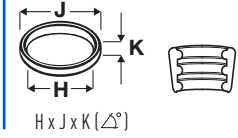
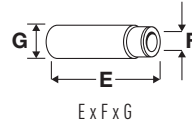
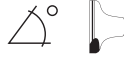







OE















10  86.00

| | | | | | | | |
|-----------|-----------------|--------|-----------|-------------|--------|------|---------|
| C 20 XE | 1998cc | 4 Cyl. | 16 Valves | 110kW/150PS | Petrol | DOHC | TD22868 |
| 110 2.0 i | 08/1996→07/2000 | | | | | | |

| | | | | | | |
|---|----------|---|-----|----|---|--|
| V91429  | 90322694 |  MB cr | 45° | H | | |
| 33.00 x 7.00 x 104.90 | | | | | | |
| V91430  | 90322697 |  MD + MB cr | 45° | SS | H | |
| 29.10 x 6.96 x 104.90 | | | | | | |

|  |  | ccm |  |  |  |  |
|---|---|------|---|---|---|---|
| 138 C2.048 | 86.40 | 1498 | 4 | 8 | Petrol | 55 |
| 146 A 5.046 | 76.00 | 1297 | 4 | 8 | Petrol | 16 |
| 156 A.000 | 76.10 | 1049 | 4 | 8 | Petrol | 17 |
| 156 A2.000 | 70.00 | 999 | 4 | 8 | Petrol | 5 |
| 156 A2.048 | 70.00 | 999 | 4 | 8 | Petrol | 5 |
| 156 A2.100 | 70.00 | 999 | 4 | 8 | Petrol | 5 |
| 156 A2.246 | 70.00 | 999 | 4 | 8 | Petrol | 5 |
| 156 B.000 | 76.10 | 1301 | 4 | 8 | Petrol | 18 |
| 156 C.000 | 70.00 | 1108 | 4 | 8 | Petrol | 6 |
| 156 C.046 | 70.00 | 1108 | 4 | 8 | Petrol | 6 |
| 160 A1.046 | 80.50 | 1372 | 4 | 8 | Petrol | 20 |
| 160 D1.000 | 82.60 | 1929 | 4 | 8 | Diesel | 33 |
| 169 A4.000 | 70.80 | 1242 | 4 | 8 | Petrol | 8 |
| 175 A3.000 | 82.00 | 1998 | 5 | 20 | Petrol | 28 |
| 175 A4.000 | 84.00 | 1995 | 4 | 16 | Petrol | 40 |
| 176 B2.000 | 70.00 | 1108 | 4 | 8 | Petrol | 7 |
| 176 B9.000 | 70.80 | 1242 | 4 | 16 | Petrol | 9 |
| 182 A2.000 | 82.00 | 1747 | 4 | 16 | Petrol | 23 |
| 182 A4.000 | 86.40 | 1581 | 4 | 16 | Petrol | 56 |
| 182 A6.000 | 86.40 | 1581 | 4 | 16 | Petrol | 56 |
| 182 B6.000 | 80.50 | 1596 | 4 | 16 | Petrol | 21 |
| 182 B7.000 | 82.00 | 1998 | 5 | 20 | Petrol | 29 |
| 183 A1.000 | 82.00 | 1747 | 4 | 16 | Petrol | 23 |
| 185 A8.000 | 82.00 | 1998 | 5 | 20 | Petrol | 29 |
| 188 A4.000 | 70.80 | 1242 | 4 | 8 | Petrol | 10 |
| 188 A5.000 | 70.80 | 1242 | 4 | 16 | Petrol | 11 |
| 188 A9.000 | 69.60 | 1248 | 4 | 16 | Diesel | 3 |
| 188 B2.000 | 82.00 | 1910 | 4 | 8 | Diesel | 24 |
| 192 B2.000 | 72.00 | 1368 | 4 | 16 | Petrol | 13 |
| 198 A1.000 | 72.00 | 1368 | 4 | 16 | Petrol | 14 |
| 198 A2.000 | 79.50 | 1598 | 4 | 16 | Diesel | 19 |
| 198 A4.000 | 72.00 | 1368 | 4 | 16 | Petrol | 14 |
| 198 A5.000 | 83.00 | 1956 | 4 | 16 | Diesel | 36 |
| 199 A2.000 | 69.60 | 1248 | 4 | 16 | Diesel | 3 |
| 199 A3.000 | 69.60 | 1248 | 4 | 16 | Diesel | 4 |
| 199 B1.000 | 69.60 | 1248 | 4 | 16 | Diesel | 4 |
| 350 A1.000 | 72.00 | 1368 | 4 | 8 | Petrol | 15 |
| 350 A2.000 | 79.50 | 1598 | 4 | 16 | Diesel | 19 |
| 350 A3.000 | 79.50 | 1598 | 4 | 16 | Diesel | 19 |
| 4HT | 85.00 | 2179 | 4 | 16 | Diesel | 50 |
| 8144. 97S | 93.00 | 2500 | 4 | 8 | Diesel | 61 |
| 8144.91 | 93.00 | 2445 | 4 | 8 | Diesel | 60 |
| 8144.97 | 93.00 | 2500 | 4 | 8 | Diesel | 61 |
| 8144.97 Y | 93.00 | 2500 | 4 | 8 | Diesel | 61 |
| 831 A1.000 | 86.40 | 1498 | 4 | 8 | Petrol | 55 |
| 831 A2.000 | 86.40 | 1301 | 4 | 8 | Petrol | 54 |
| 831 A4.000 | 84.00 | 1585 | 4 | 8 | Petrol | 38 |
| 831 B.000 | 86.40 | 1301 | 4 | 8 | Petrol | 54 |
| 831 B1.000 | 86.40 | 1498 | 4 | 8 | Petrol | 55 |
| 831 B1.048 | 86.40 | 1498 | 4 | 8 | Petrol | 55 |
| 831 B4.000 | 84.00 | 1995 | 4 | 8 | Petrol | 41 |
| 831 B5.000 | 84.00 | 1995 | 4 | 8 | Petrol | 42 |
| 831 B6.000 | 84.00 | 1585 | 4 | 8 | Petrol | 38 |
| 831 B7.000 | 84.00 | 1585 | 4 | 8 | Petrol | 38 |
| 831 B7.046 | 84.00 | 1585 | 4 | 8 | Petrol | 38 |
| 831 C5.000 | 84.00 | 1995 | 4 | 8 | Petrol | 42 |
| 831 C5.046 | 84.00 | 1995 | 4 | 8 | Petrol | 42 |
| 831 D.000 | 82.60 | 1929 | 4 | 8 | Diesel | 34 |
| 831 D1.000 | 82.60 | 1929 | 4 | 8 | Diesel | 35 |
| 831 D5.000 | 84.00 | 1995 | 4 | 16 | Petrol | 40 |
| 831 E5.000 | 84.00 | 1995 | 4 | 16 | Petrol | 40 |
| 831 E5.046 | 84.00 | 1995 | 4 | 16 | Petrol | 40 |
| 834 B.000 | 84.00 | 1995 | 4 | 8 | Petrol | 41 |
| 834 B.048 | 84.00 | 1995 | 4 | 8 | Petrol | 41 |
| 834 B.146 | 84.00 | 1995 | 4 | 8 | Petrol | 41 |
| 834 B1.000 | 84.00 | 1995 | 4 | 8 | Petrol | 41 |

|  |  | ccm |  |  |  |  |
|---|---|------|--|---|---|---|
| 834 B2.000 | 84.00 | 1995 | 4 | 16 | Petrol | 40 |
| 834 B2.246 | 84.00 | 1995 | 4 | 16 | Petrol | 40 |
| 834 C.000 | 84.00 | 1995 | 4 | 8 | Petrol | 42 |
| 834 C.146 | 84.00 | 1995 | 4 | 8 | Petrol | 42 |
| 834 C1.000 | 84.00 | 1995 | 4 | 16 | Petrol | 43 |
| 834 C1.246 | 84.00 | 1995 | 4 | 16 | Petrol | 43 |
| 834 F1.000 | 84.00 | 1995 | 4 | 16 | Petrol | 43 |
| 835 A1.000 | 86.40 | 1581 | 4 | 8 | Petrol | 57 |
| 835 A1.046 | 86.40 | 1581 | 4 | 8 | Petrol | 58 |
| 835 A2.000 | 84.00 | 1756 | 4 | 8 | Petrol | 39 |
| 835 A2.046 | 84.00 | 1756 | 4 | 8 | Petrol | 39 |
| 835 A4.000 | 82.60 | 1929 | 4 | 8 | Diesel | 35 |
| 835 A4.046 | 82.60 | 1929 | 4 | 8 | Diesel | 35 |
| 835 A5.046 | 84.00 | 1995 | 4 | 8 | Petrol | 42 |
| 835 A7.000 | 84.00 | 1995 | 4 | 8 | Petrol | 42 |
| 835 A7.046 | 84.00 | 1995 | 4 | 8 | Petrol | 42 |
| 835 C1.000 | 86.40 | 1581 | 4 | 8 | Petrol | 58 |
| 835 C2.000 | 84.00 | 1756 | 4 | 8 | Petrol | 39 |
| 835 C4.000 | 84.00 | 1756 | 4 | 8 | Petrol | 39 |
| 836 A2.000 | 84.00 | 1995 | 4 | 16 | Petrol | 40 |
| 836 A3.000 | 84.00 | 1995 | 4 | 16 | Petrol | 43 |
| 836 A4.000 | 80.50 | 1372 | 4 | 8 | Petrol | 20 |
| 836 A5.000 | 84.00 | 1756 | 4 | 8 | Petrol | 39 |
| 836 A6.000 | 84.00 | 1756 | 4 | 8 | Petrol | 39 |
| 836 C4.000 | 84.00 | 1756 | 4 | 8 | Petrol | 39 |
| 838 A1.000 | 82.00 | 1998 | 5 | 20 | Petrol | 28 |
| 838 A2.000 | 83.00 | 2446 | 5 | 20 | Petrol | 37 |
| 838 A2.027 | 83.00 | 2446 | 5 | 20 | Petrol | 37 |
| 838 A3.000 | 82.00 | 2387 | 5 | 10 | Diesel | 30 |
| 838 A4.000 | 84.00 | 1995 | 4 | 16 | Petrol | 40 |
| 838 A6.000 | 82.00 | 1998 | 5 | 20 | Petrol | 29 |
| 838 A7.000 | 82.00 | 2387 | 5 | 10 | Diesel | 30 |
| 838 A8.000 | 82.00 | 2387 | 5 | 10 | Diesel | 31 |
| 838 B2.000 | 83.00 | 2446 | 5 | 20 | Petrol | 37 |
| 839 A4.000 | 82.00 | 1747 | 4 | 16 | Petrol | 23 |
| 839 A5.000 | 82.00 | 2387 | 5 | 10 | Diesel | 31 |
| 839 A6.000 | 82.00 | 2387 | 5 | 10 | Diesel | 31 |
| 839 A7.000 | 82.00 | 1747 | 4 | 16 | Petrol | 23 |
| 840 A2.000 | 82.00 | 1370 | 4 | 12 | Petrol | 22 |
| 840 A3.000 | 70.80 | 1242 | 4 | 8 | Petrol | 12 |
| 840 A4.000 | 82.00 | 1370 | 4 | 12 | Petrol | 22 |
| 841 C.000 | 82.00 | 2387 | 5 | 10 | Diesel | 31 |
| 841 D.000 | 83.00 | 2446 | 5 | 20 | Petrol | 37 |
| 841 E.000 | 82.00 | 1998 | 5 | 20 | Petrol | 29 |
| 841 G.000 | 82.00 | 2387 | 5 | 20 | Diesel | 32 |
| 843 A1.000 | 72.00 | 1368 | 4 | 16 | Petrol | 13 |
| 844 A1.000 | 82.00 | 1910 | 4 | 16 | Diesel | 25 |
| 844 A2.000 | 83.00 | 1956 | 4 | 16 | Diesel | 36 |
| 937 A2.000 | 82.00 | 1910 | 4 | 8 | Diesel | 26 |
| 937 A5.000 | 82.00 | 1910 | 4 | 16 | Diesel | 27 |
| 955 A4.000 | 79.50 | 1598 | 4 | 16 | Diesel | 19 |
| A112 A.000 | 65.00 | 903 | 4 | 8 | Petrol | 2 |
| A112 A5.000 | 65.00 | 903 | 4 | 8 | Petrol | 2 |
| A112 B2.000 | 65.00 | 896 | 4 | 8 | Petrol | 1 |
| AR 32302 | 82.00 | 1910 | 4 | 8 | Diesel | 26 |
| AR 32501 | 82.00 | 2387 | 5 | 10 | Diesel | 31 |
| AR 37101 | 82.00 | 1910 | 4 | 8 | Diesel | 26 |
| DW10ATED4 (RHW) | 85.00 | 1997 | 4 | 16 | Diesel | 44 |
| DW12ATED4 (4HW) | 85.00 | 2179 | 4 | 16 | Diesel | 51 |
| ES9 J4S | 87.00 | 2946 | 6 | 24 | Petrol | 59 |
| P 8 C | 85.00 | 2088 | 4 | 12 | Diesel | 49 |
| RFN | 85.00 | 1997 | 4 | 16 | Petrol | 45 |
| RFN (EW10J4) | 85.00 | 1997 | 4 | 16 | Petrol | 45 |
| RFV (XU10J4R) | 86.00 | 1998 | 4 | 16 | Petrol | 52 |
| RGX (XU10J2TE) | 86.00 | 1998 | 4 | 8 | Petrol | 53 |
| RHK (DW10UTED4) | 85.00 | 1997 | 4 | 16 | Diesel | 46 |

|  |  | ccm |  |  |  |  |
|---|---|------|---|---|---|---|
| RHM (DW10ATED4) | 85.00 | 1997 | 4 | 16 | Diesel | 44 |
| RHR (DW10BTED4) | 85.00 | 1997 | 4 | 16 | Diesel | 47 |
| RHZ (DW10ATED) | 85.00 | 1997 | 4 | 8 | Diesel | 48 |

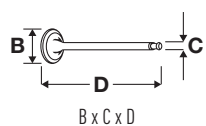

OE

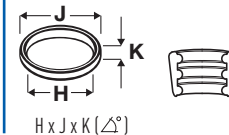
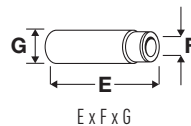

1 65.00

| | | | | | | | |
|--------------------|-------|--------|-----------------|-----------------|--------|------------|---------------|
| A112 B2.000 | 896cc | 4 Cyl. | 8 Valves | 29-32kW/40-44PS | Petrol | OHV | TD4622 |
|--------------------|-------|--------|-----------------|-----------------|--------|------------|---------------|

A 112 0.9 Junior 03/1981→06/1986

V34457 ■
29.10 x 7.02 x 95.65

4 265 695

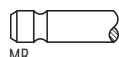

MB

45°

H

VAG92364 ■ ■ ■
42.50 x 7.00 x 13.07

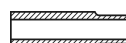

V91282 ■
26.00 x 7.00 x 95.50

7 783 841

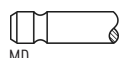

MD

45°

2 65.00

| | | | | | | | |
|--------------------|-------|--------|-----------------|-----------------|--------|------------|---------------|
| A112 A.000 | 903cc | 4 Cyl. | 8 Valves | 21-32kW/29-44PS | Petrol | OHV | TD1856 |
| A112 A5.000 | 903cc | 4 Cyl. | 8 Valves | 29-31kW/40-42PS | Petrol | OHV | TD1803 |

A 112 0.9 Junior 03/1981→06/1986

V34457 ■
29.10 x 7.02 x 95.65

4 265 695

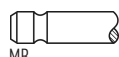

MB

45°

H

VAG92364 ■ ■ ■
42.50 x 7.00 x 13.07

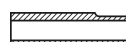

3 69.60

| | | | | | | | |
|-------------------|--------|--------|------------------|-----------|--------|--------------------|----------------|
| 188 A9.000 | 1248cc | 4 Cyl. | 16 Valves | 51kW/70PS | Diesel | DOHC | TD18314 |
| 199 A2.000 | 1248cc | 4 Cyl. | 16 Valves | 55kW/75PS | Diesel | Turbo, DOHC | TD20272 |

MUSA 1.3 D Multijet 10/2004→09/2012
YPSILON 1.3 JTD 10/2003→12/2011

YPSILON 1.3 D Multijet 09/2006→12/2011

V95015 ■
21.85 x 6.00 x 109.20

55 195 680

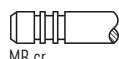

MB cr

45°

Y

H

VAG96359 ■ ■ ■
43.28 x 6.00 x 10.25

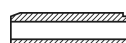

V95016 ■
21.80 x 6.00 x 109.20

55 208 213

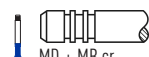

MD + MB cr

45°

H

4 69.60

| | | | | | | | |
|-------------------|--------|--------|------------------|------------------|--------|--------------------|----------------|
| 199 A3.000 | 1248cc | 4 Cyl. | 16 Valves | 66-77kW/90-105PS | Diesel | Turbo, DOHC | TD20273 |
| 199 B1.000 | 1248cc | 4 Cyl. | 16 Valves | 70kW/95PS | Diesel | Turbo, DOHC | TD24672 |

MUSA 1.3 D Multijet 09/2006→09/2012

YPSILON 1.3 D Multijet 09/2006→

V95182 ■
21.85 x 5.98 x 109.25

55 204 574

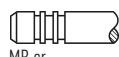

MB cr

45°

H

VAG96359 ■ ■ ■
43.28 x 6.00 x 10.25

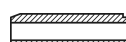

V95183 ■
22.50 x 5.99 x 109.20

55 223 836

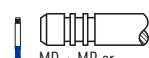

MD + MB cr

45°

SS

H

5 70.00

| | | | | | | | |
|-------------------|-------|--------|-----------------|-----------------|--------|-------------|---------------|
| 156 A2.000 | 999cc | 4 Cyl. | 8 Valves | 33-37kW/45-50PS | Petrol | SOHC | TD4592 |
| 156 A2.048 | 999cc | 4 Cyl. | 8 Valves | 32kW/44PS | Petrol | SOHC | TD1782 |
| 156 A2.100 | 999cc | 4 Cyl. | 8 Valves | 32kW/44PS | Petrol | SOHC | TD4593 |
| 156 A2.246 | 999cc | 4 Cyl. | 8 Valves | 33kW/45PS | Petrol | SOHC | TD5423 |

Y10 1.0 Fire 03/1985→02/1992

V91288 ■
30.50 x 7.00 x 97.00

5 942 727

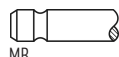

MB

45°

H

VAG50895 ■ ■ ■
46.00 x 7.04 x 13.03



V91289 ■
27.50 x 7.00 x 97.50

5 942 728

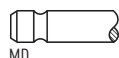

MD

45°

VAG92364 ■ ■ ■
42.50 x 7.00 x 13.07





OE

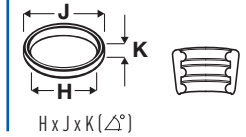
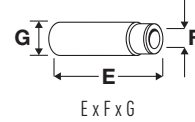
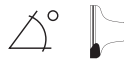

6 **70.00**

| | | | | | | | |
|----------------------|-----------|-----------------|-----------------|-------------------|-----------------------|-----------------|---------------|
| 156 C.000 | 1108cc | 4 Cyl. | 8 Valves | 42kW/57PS | Petrol | SOHC | TD1854 |
| 156 C.046 | 1108cc | 4 Cyl. | 8 Valves | 37-40kW/50-54PS | Petrol | SOHC | TD4597 |
| Y10 1.1 i.e. Fire | | 07/1989→12/1995 | | Y10 1.1 i.e. Fire | | 08/1989→06/1992 | |
| V91288 ■ | 5 942 727 | | 45° | H | VAG50895 ■ ■ ■ | | |
| 30.50 x 7.00 x 97.00 | | MB | | | 46.00 x 7.04 x 13.03 | | |
| V91289 ■ | 5 942 728 | | 45° | | VAG92364 ■ ■ ■ | | |
| 27.50 x 7.00 x 97.50 | | MD | | | 42.50 x 7.00 x 13.07 | | |

7 **70.00**

| | | | | | | | |
|----------------------|-----------|-----------------|-----------------|--------------|-----------------------|-------------------|----------------|
| 176 B2.000 | 1108cc | 4 Cyl. | 8 Valves | 40kW/54PS | Petrol | Fire, SOHC | TD11847 |
| Y 1.1 | | 11/1995→09/2003 | | Y10 1.1 Fire | | 01/1995→12/1995 | |
| V91929 ■ | 7 770 334 | | 45° | H | VAG50895 ■ ■ ■ | | |
| 31.50 x 7.00 x 97.00 | | MB | | | 46.00 x 7.04 x 13.03 | | |
| V91289 ■ | 5 942 728 | | 45° | | VAG92364 ■ ■ ■ | | |
| 27.50 x 7.00 x 97.50 | | MD | | | 42.50 x 7.00 x 13.07 | | |

8 **70.80**

| | | | | | | | |
|-----------------------|------------|------------|-----------------|-----------------|-----------------------|-------------|----------------|
| 169 A4.000 | 1242cc | 4 Cyl. | 8 Valves | 49-51kW/67-69PS | Petrol | SOHC | TD25192 |
| YPSILON 1.2 | | 08/2010→ | | | | | |
| V98022 ■ | 55 194 219 | | 45° | | VAG96384 ■ ■ ■ | | |
| 33.30 x 5.00 x 99.90 | | MB cr | | | 44.00 x 5.00 x 10.04 | | |
| V98023 ■ | 55 200 422 | | 45° | | | | |
| 28.10 x 5.00 x 100.50 | | MD + MB cr | | | | | |

9 **70.80**

| | | | | | | | |
|----------------------|------------|-----------------|------------------|-----------|-----------------------|-------------------|----------------|
| 176 B9.000 | 1242cc | 4 Cyl. | 16 Valves | 63kW/86PS | Petrol | Fire, DOHC | TD11849 |
| Y 1.2 16V | | 04/1997→09/2003 | | | | | |
| V94029 ■ | 46 403 681 | | 45° | H | VAG96272 ■ ■ ■ | | |
| 26.90 x 6.00 x 95.20 | | MB | | | 39.70 x 6.02 x 10.03 | | |
| V94030 ■ | 46 471 639 | | 45° | | | | |
| 22.50 x 6.00 x 96.20 | | MD cr | | | | | |





OE



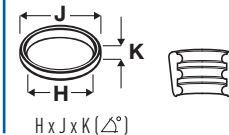
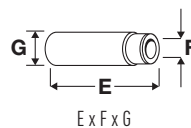

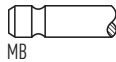

MAT.

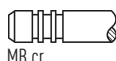
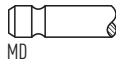
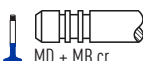

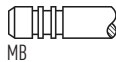

10 70.80

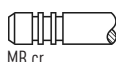
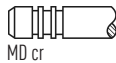
| 188 A4.000 | 1242cc | 4 Cyl. | 8 Valves | 44kW/60PS | Petrol | Fire, SOHC | TD15501 |
|---|------------|-----------------|----------|-------------|---|-----------------|---------|
| Y 1.2 | | 03/1996→09/2003 | | YPSILON 1.2 | | 10/2003→12/2011 | |
| V91929  | 7 770 334 | MB | 45° | H | VAG92364  | | |
| 31.50 x 7.00 x 97.00 Eng.→2533527 | | | | | VAG96273  | | |
| V98020  | 55 194 993 | MB cr | 45° | | | | |
| 31.90 x 5.00 x 98.40 Eng.2533528→ | | | | | | | |
| V91289  | 5 942 728 | MD | 45° | | | | |
| 27.50 x 7.00 x 97.50 Eng.→2533527 | | | | | | | |
| V98021  | 55 194 994 | MD + MB cr | 45° | | | | |
| 27.30 x 5.00 x 98.70 Eng.2533528→ | | | | | | | |

11 70.80

| 188 A5.000 | 1242cc | 4 Cyl. | 16 Valves | 59kW/80PS | Petrol | Fire, DOHC | TD15500 |
|---|------------|-----------------|-----------|-------------|---|-----------------|---------|
| Y 1.2 16V | | 10/2000→09/2003 | | YPSILON 1.2 | | 10/2003→12/2011 | |
| V94029  | 46 403 681 | MB | 45° | H | VAG96272  | | |
| 26.90 x 6.00 x 95.20 Eng.→985540 | | | | | | | |
| V98026  | 55 185 028 | MB cr | 45° | | | | |
| 26.80 x 6.00 x 95.20 Eng.985541→ | | | | | | | |
| V94030  | 46 471 639 | MD cr | 45° | | | | |
| 22.50 x 6.00 x 96.20 Eng.→985540 | | | | | | | |
| V98027  | 55 185 080 | MD cr | 45° | | | | |
| 22.45 x 5.97 x 94.70 Eng.985541→ | | | | | | | |

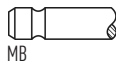
12 70.80

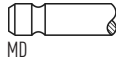
| 840 A3.000 | 1242cc | 4 Cyl. | 8 Valves | 44kW/60PS | Petrol | Fire, SOHC | TD1839 |
|---|-----------|-----------------|----------|-----------|---|------------|--------|
| Y 1.2 | | 03/1996→09/2003 | | | | | |
| V91288  | 5 942 727 | MB | 45° | H | VAG50895  | | |
| 30.50 x 7.00 x 97.00 | | | | | VAG92364  | | |
| V91289  | 5 942 728 | MD | 45° | | | | |
| 27.50 x 7.00 x 97.50 | | | | | | | |





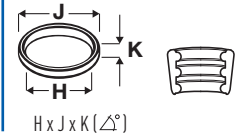
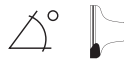



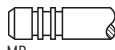

OE



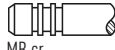

13  **72.00**

| | | | | | | | |
|-------------------|--------|-----------------|------------------|-----------------|--------|-----------------|----------------|
| 192 B2.000 | 1368cc | 4 Cyl. | 16 Valves | 66kW/90PS | Petrol | DOHC | TD20952 |
| 843 A1.000 | 1368cc | 4 Cyl. | 16 Valves | 70kW/95PS | Petrol | DOHC | TD17979 |
| MUSA 1.4 | | 10/2004→09/2012 | | YPSILON 1.4 16V | | 10/2003→12/2011 | |

| | | | | | | | |
|--|------------|--|-----|---|---|---|--|
| V94029  26.90 x 6.00 x 95.20 Eng.→984712 | 46 403 681 |  MB | 45° | H | VAG96272  39.70 x 6.02 x 10.03 |  | |
| V98026  26.80 x 6.00 x 95.20 Eng.984713→ | 55 185 028 |  MB cr | 45° | | | | |
| V94030  22.50 x 6.00 x 96.20 Eng.→984712 | 46 471 639 |  MD cr | 45° | | | | |
| V98027  22.45 x 5.97 x 94.70 Eng.984713→ | 55 185 080 |  MD cr | 45° | | | | |

14  **72.00**

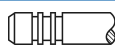
| | | | | | | | |
|-------------------|--------|-----------------|------------------|-------------|--------|--------------------|----------------|
| 198 A1.000 | 1368cc | 4 Cyl. | 16 Valves | 110kW/150PS | Petrol | Turbo, DOHC | TD21041 |
| 198 A4.000 | 1368cc | 4 Cyl. | 16 Valves | 88kW/120PS | Petrol | Turbo, DOHC | TD21040 |
| DELTA III 1.4 | | 09/2008→08/2014 | | | | | |

| | | | | | | | |
|---|------------|---|-----|---|--|--|--|
| V98026  26.80 x 6.00 x 95.20 | 55 185 028 |  MB cr | 45° | | | | |
| V95220  22.40 x 5.99 x 94.65 | 55 206 233 |  MD + MB cr | 45° | H | | | |







15  **72.00**

| | | | | | | | |
|-------------------|--------|-----------------|-----------------|-----------------|--------|-----------------|----------------|
| 350 A1.000 | 1368cc | 4 Cyl. | 8 Valves | 55-57kW/75-78PS | Petrol | SOHC | TD20274 |
| MUSA 1.4 | | 09/2005→09/2012 | | MUSA 1.4 LPG | | 11/2010→09/2012 | |
| YPSILON 1.4 | | 02/2006→12/2011 | | YPSILON 1.4 LPG | | 11/2010→12/2011 | |

| | | | | | | | |
|--|------------|---|-----|--|---|---|--|
| V98022  33.30 x 5.00 x 99.90 | 55 194 219 |  MB cr | 45° | | VAG96384  44.00 x 5.00 x 10.04 |  | |
| V98023  28.10 x 5.00 x 100.50 | 55 200 422 |  MD + MB cr | 45° | | | | |

16  **76.00**

| | | | | | | | |
|--------------------|--------|-----------------|-----------------|-----------|--------|-------------|---------------|
| 146 A 5.046 | 1297cc | 4 Cyl. | 8 Valves | 53kW/72PS | Petrol | SOHC | TD4591 |
| Y10 1.3 i.e. | | 02/1989→12/1995 | | | | | |

| | | | | | | | |
|--|-----------|---|-----|---|---|---|--|
| V90398  36.60 x 7.98 x 110.50 | 4 412 816 |  MB | 45° | H | VAG92369  60.00 x 8.00 x 13.07 |  | |
| V90399  29.10 x 7.99 x 110.50 | 4 340 119 |  MD | 45° | | | | |

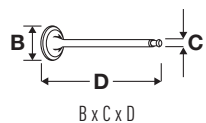

OE

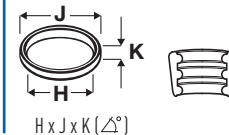
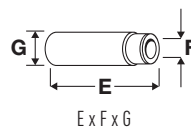
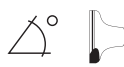

17 76.10

| | | | | | | | |
|-----------|--------|--------|----------|-----------------|--------|------|--------|
| 156 A.000 | 1049cc | 4 Cyl. | 8 Valves | 40-41kW/54-56PS | Petrol | SOHC | TD1222 |
|-----------|--------|--------|----------|-----------------|--------|------|--------|

Y10 1.0 03/1985→07/1989

| | | | | | | | |
|-----------------------|-----------|----|-----|---|--|--|--|
| V90398 | 4 412 816 | | 45° | H | | | |
| 36.60 x 7.98 x 110.50 | | MB | | | | | |
| V90399 | 4 340 119 | | 45° | | | | |
| 29.10 x 7.99 x 110.50 | | MD | | | | | |

18 76.10

| | | | | | | | |
|-----------|--------|--------|----------|-----------------|--------|------|--------|
| 156 B.000 | 1301cc | 4 Cyl. | 8 Valves | 53-56kW/72-76PS | Petrol | SOHC | TD1853 |
|-----------|--------|--------|----------|-----------------|--------|------|--------|

Y10 1.3 i.e. 11/1987→12/1995

| | | | | | | | |
|-----------------------|-----------|----|-----|---|----------------------|--|--|
| V90398 | 4 412 816 | | 45° | H | VAG92369 | | |
| 36.60 x 7.98 x 110.50 | | MB | | | 60.00 x 8.00 x 13.07 | | |
| V90399 | 4 340 119 | | 45° | | | | |
| 29.10 x 7.99 x 110.50 | | MD | | | | | |

19 79.50

| | | | | | | | |
|------------|--------|--------|-----------|-------------------|--------|-------------|---------|
| 198 A2.000 | 1598cc | 4 Cyl. | 16 Valves | 88kW/120PS | Diesel | Turbo, DOHC | TD21042 |
| 350 A2.000 | 1598cc | 4 Cyl. | 16 Valves | 85-88kW/116-120PS | Diesel | Turbo, DOHC | TD22138 |
| 350 A3.000 | 1598cc | 4 Cyl. | 16 Valves | 85kW/116PS | Diesel | Turbo, DOHC | TD24974 |
| 955 A4.000 | 1598cc | 4 Cyl. | 16 Valves | 85kW/116PS | Diesel | Turbo, DOHC | TD24651 |

DELTA III 1.6 D Multijet 08/2008→08/2014 MUSA 1.6 D Multijet 07/2008→09/2012

| | | | | | | | |
|-----------------------|------------|------------|-----|---|---|----------------------|--|
| V95223 | 55 205 125 | | 45° | Y | H | VAG96360 | |
| 26.55 x 5.00 x 114.40 | | MB | | | | 46.70 x 5.00 x 10.03 | |
| V98006 | 55 207 955 | | 45° | | | | |
| 24.50 x 5.00 x 114.40 | | MD + MB cr | | | | | |

20 80.50

| | | | | | | | |
|------------|--------|--------|----------|-----------|--------|------|---------|
| 160 A1.046 | 1372cc | 4 Cyl. | 8 Valves | 51kW/69PS | Petrol | SOHC | TD4599 |
| 836 A4.000 | 1372cc | 4 Cyl. | 8 Valves | 51kW/69PS | Petrol | SOHC | TD14568 |

DELTA II 1.4 i.e. 10/1994→08/1999

| | | | | | | | |
|-----------------------|-----------|-------|-----|--|---|----------------------|--|
| V91300 | 7 609 772 | | 45° | | H | VAG92366 | |
| 37.50 x 8.00 x 108.50 | | MB | | | | 46.50 x 8.00 x 14.10 | |
| V91713 | 4 315 062 | | 45° | | | | |
| 31.00 x 8.00 x 109.00 | | MD cr | | | | | |

21 80.50

| | | | | | | | |
|------------|--------|--------|-----------|------------|--------|------|---------|
| 182 B6.000 | 1596cc | 4 Cyl. | 16 Valves | 76kW/103PS | Petrol | DOHC | TD15632 |
|------------|--------|--------|-----------|------------|--------|------|---------|

LYBRA 1.6 10/2000→10/2005

| | | | | | | | |
|-----------------------|------------|------------|-----|----|---|----------------------|--|
| V91949 | 46 517 325 | | 45° | | H | VAG50895 | |
| 30.40 x 7.00 x 102.00 | | MB cr | | | | 46.00 x 7.04 x 13.03 | |
| V91950 | 46 462 159 | | 45° | | | VAG92364 | |
| 29.80 x 7.00 x 102.60 | | MD cr | | | | 42.50 x 7.00 x 13.07 | |
| V94468 | 46 461 209 | | 45° | ss | H | | |
| 30.00 x 7.00 x 102.40 | | MD + MB cr | | | | | |





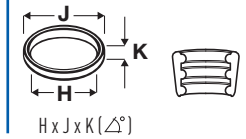
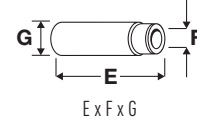

OE



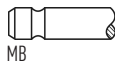



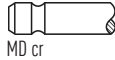





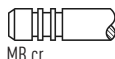

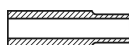

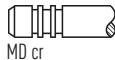
22  **82.00**

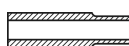
| | | | | | | | |
|-------------------|--------|-----------------|------------------|-----------------|--------|-------------|---------------|
| 840 A2.000 | 1370cc | 4 Cyl. | 12 Valves | 55-59kW/75-80PS | Petrol | SOHC | TD1858 |
| 840 A4.000 | 1370cc | 4 Cyl. | 12 Valves | 55kW/75PS | Petrol | SOHC | TD4596 |
| Y 1.4 12V | | 03/1996→09/2003 | | | | | |

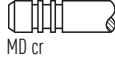
| | | | | | | |
|---|------------|---|-----|---|---|---|
| V91927  | 7 712 114 |  | 45° | H | VAG96146  |  |
| 30.30 x 7.00 x 110.40 | | MB | | | 42.50 x 7.04 x 13.05 | |
| V91928  | 46 423 334 |  | 45° | | | |
| 35.50 x 7.00 x 110.40 | | MD cr | | | | |

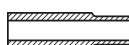



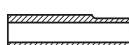

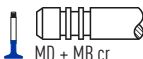

23  **82.00**

| | | | | | | | |
|-----------------------|--------|-----------------|------------------|--------------------------|--------|-----------------|----------------|
| 182 A2.000 | 1747cc | 4 Cyl. | 16 Valves | 66-83kW/90-113PS | Petrol | DOHC | TD9473 |
| 183 A1.000 | 1747cc | 4 Cyl. | 16 Valves | 96kW/131PS | Petrol | DOHC | TD9474 |
| 839 A4.000 | 1747cc | 4 Cyl. | 16 Valves | 96kW/131PS | Petrol | DOHC | TD14468 |
| 839 A7.000 | 1747cc | 4 Cyl. | 16 Valves | 96kW/131PS | Petrol | DOHC | TD15633 |
| DEDRA 1.8 16V LE | | 03/1996→07/1999 | | DEDRA 1.8 GT 16V | | 03/1996→07/1999 | |
| DELTA II 1.8 i.e. 16V | | 03/1996→08/1999 | | DELTA II 1.8 i.e. 16V GT | | 03/1996→08/1999 | |
| LYBRA 1.8 16V | | 07/1999→10/2005 | | | | | |

| | | | | | | |
|---|------------|---|-----|------|---|---|
| V91933  | 608 11 153 |  | 45° | H | VAG96123  |  |
| 33.40 x 7.00 x 113.10 | | MB cr | | | 42.25 x 7.02 x 13.05 | |
| V91934  | 608 11 154 |  | 45° | SS | VAG96146  |  |
| 28.00 x 7.00 x 108.60 | | MD cr | | | 42.50 x 7.04 x 13.05 | |
| V94582  | 7 766 565 |  | 45° | | VAG96145  |  |
| 28.00 x 7.00 x 108.50 | | MD cr | | | 46.00 x 7.02 x 13.03 | |
| V94591  | 606 74 496 |  | 45° | SS H | VAG96230  |  |
| 28.00 x 7.00 x 108.80 | | MD + MB cr | | | 46.00 x 7.02 x 13.06 | |

24  **82.00**

| | | | | | | | |
|---------------------|--------|-----------------|-----------------|------------|--------|--------------------|----------------|
| 188 B2.000 | 1910cc | 4 Cyl. | 8 Valves | 74kW/101PS | Diesel | Turbo, SOHC | TD18316 |
| MUSA 1.9 D Multijet | | 10/2004→09/2012 | | | | | |

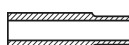
| | | | | | | |
|---|------------|---|-----|---|---|---|
| V94470  | 46 750 859 |  | 45° | H | VAG96124  |  |
| 35.30 x 8.00 x 115.00 | | MD + MB cr | | | 42.90 x 8.02 x 14.06 | |
| V94471  | 46 783 962 |  | 45° | H | VAG96203  |  |
| 34.50 x 8.00 x 115.00 | | MD + MB cr | | | 43.00 x 8.03 x 14.08 | |
| | | | | | VAG96210  |  |
| | | | | | 43.00 x 8.04 x 14.04 | |

25  **82.00**

| | | | | | | | |
|--------------------------|--------|-----------------|------------------|-------------|--------|--------------------|----------------|
| 844 A1.000 | 1910cc | 4 Cyl. | 16 Valves | 140kW/190PS | Diesel | Turbo, DOHC | TD21044 |
| DELTA III 1.9 D Multijet | | 01/2009→08/2014 | | | | | |

| | | | | | | |
|---|------------|---|-----|--|---|---|
| V98005  | 55 207 517 |  | 45° | | VAG96360  |  |
| 28.00 x 5.00 x 114.40 | | MB cr | | | 46.70 x 5.00 x 10.03 | |
| V98006  | 55 207 955 |  | 45° | | | |
| 24.50 x 5.00 x 114.40 | | MD + MB cr | | | | |

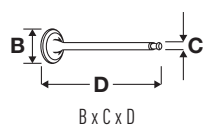



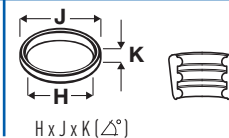
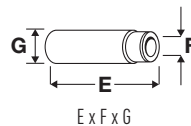



OE

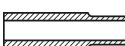





26 82.00

| | | | | | | | |
|---------------|--------|-----------------|----------|-------------------|--------|-------------|---------|
| 937 A2.000 | 1910cc | 4 Cyl. | 8 Valves | 85kW/116PS | Diesel | Turbo, SOHC | TD18313 |
| AR 32302 | 1910cc | 4 Cyl. | 8 Valves | 77kW/105PS | Diesel | Turbo, SOHC | TD17398 |
| AR 37101 | 1910cc | 4 Cyl. | 8 Valves | 80-85kW/109-116PS | Diesel | Turbo, SOHC | TD17890 |
| LYBRA 1.9 JTD | | 07/1999→10/2005 | | | | | |

| | | | | | | |
|--|------------|---|-----|------|---|---|
| V94064 ■ 35.50 x 8.00 x 115.00 | 608 14 605 |  MB cr | 45° | H | VAG96124 ■ ■ 42.90 x 8.02 x 14.06 |  |
| V94470 ■ 35.30 x 8.00 x 115.00 | 46 750 859 |  MD + MB cr | 45° | H | VAG96203 ■ ■ 43.00 x 8.03 x 14.08 |  |
| V94065 ■ 34.50 x 8.00 x 115.00 | 608 14 604 |  MD cr | 45° | | VAG96210 ■ ■ 43.00 x 8.04 x 14.04 |  |
| V94471 ■ 34.50 x 8.00 x 115.00 | 46 783 962 |  MD + MB cr | 45° | H | | |
| V94590 ■ 34.45 x 8.00 x 115.00 | 55 202 630 |  MD + MB cr | 45° | SS H | | |

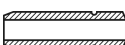

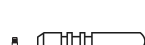
27 82.00

| | | | | | | | |
|------------|--------|--------|-----------|-------------|--------|-------------|---------|
| 937 A5.000 | 1910cc | 4 Cyl. | 16 Valves | 110kW/150PS | Diesel | Turbo, DOHC | TD21086 |
|------------|--------|--------|-----------|-------------|--------|-------------|---------|

| | | | | | | |
|--|------------|---|-----|-----|---|---|
| V94588 ■ 27.90 x 6.00 x 114.00 Eng.→5192515 | 46 802 049 |  MB cr | 45° | Y H | VAG96360 ■ ■ 46.70 x 5.00 x 10.03 Eng.5192516→ |  |
| V98005 ■ 28.00 x 5.00 x 114.40 Eng.5192516→ | 55 207 517 |  MB cr | 45° | | | |
| V94589 ■ 25.80 x 6.00 x 114.30 Eng.→5192515 | 46 787 902 |  MD + MB cr | 45° | H | | |
| V98006 ■ 24.50 x 5.00 x 114.40 Eng.5192516→ | 55 207 955 |  MD + MB cr | 45° | | | |

28 82.00

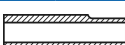
| | | | | | | | |
|---------------|--------|-----------------|-----------|---------------------|--------|-----------------|---------|
| 175 A3.000 | 1998cc | 5 Cyl. | 20 Valves | 162kW/220PS | Petrol | Turbo, DOHC | TD11550 |
| 838 A1.000 | 1998cc | 5 Cyl. | 20 Valves | 107kW/146PS | Petrol | DOHC | TD4616 |
| KAPPA 2.0 20V | | 10/1994→10/2001 | | KAPPA 2.0 20V Turbo | | 06/1998→10/2001 | |

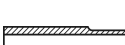
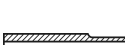
| | | | | | | |
|--|------------|---|-----|---|---|---|
| V91931 ■ 30.00 x 7.00 x 113.00 | 608 12 982 |  MB cr | 45° | H | VAG96123 ■ 42.25 x 7.02 x 13.05 |  |
| V91932 ■ 26.00 x 7.00 x 108.50 | 608 12 981 |  MD + MB cr | 45° | H | VAG96146 ■ 42.50 x 7.04 x 13.05 |  |
| | | | | | VAG96145 ■ 46.00 x 7.02 x 13.03 |  |
| | | | | | VAG96230 ■ 46.00 x 7.02 x 13.06 |  |



OE

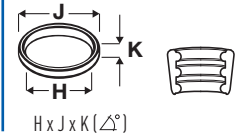

29  **82.00**

| | | | | | | | |
|-------------------|-----------------|--------|------------------|---------------|--------|--------------------|-----------------|
| 182 B7.000 | 1998cc | 5 Cyl. | 20 Valves | 113kW/154PS | Petrol | DOHC | TD14389 |
| 185 A8.000 | 1998cc | 5 Cyl. | 20 Valves | 110kW/150PS | Petrol | DOHC | TD15630 |
| 838 A6.000 | 1998cc | 5 Cyl. | 20 Valves | 114kW/155PS | Petrol | DOHC | TD5436 |
| 841 E.000 | 1998cc | 5 Cyl. | 20 Valves | 136kW/185PS | Petrol | Turbo, DOHC | TD16731 |
| KAPPA 2.0 20V | 07/1996→10/2001 | | | LYBRA 2.0 20V | | | 07/1999→10/2005 |
| THESIS 2.0 Turbo | 07/2002→07/2009 | | | | | | |

V91933 
33.40 x 7.00 x 113.10

608 11 153

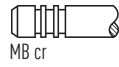

45°

H

VAG96123 
42.25 x 7.02 x 13.05



V91934 
28.00 x 7.00 x 108.60

608 11 154

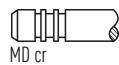

45°

SS

VAG96146 
42.50 x 7.04 x 13.05



VAG96145 
46.00 x 7.02 x 13.03

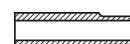

VAG96230 
46.00 x 7.02 x 13.06

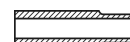

30  **82.00**

| | | | | | | | |
|-------------------|-----------------|--------|------------------|------------|--------|--------------------|---------------|
| 838 A3.000 | 2387cc | 5 Cyl. | 10 Valves | 91kW/124PS | Diesel | Turbo, SOHC | TD4618 |
| 838 A7.000 | 2387cc | 5 Cyl. | 10 Valves | 91kW/124PS | Diesel | Turbo, SOHC | TD5437 |
| KAPPA 2.4 T.DS | 08/1994→10/2001 | | | | | | |

V91937 
37.50 x 8.00 x 114.20

7 798 620

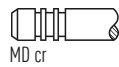

45°

VAG96124 
42.90 x 8.02 x 14.06

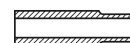

V91938 
31.00 x 8.00 x 114.00

7 783 225

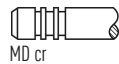

45°

VAG96203 
43.00 x 8.03 x 14.08

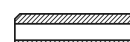

VAG96210 
43.00 x 8.04 x 14.04

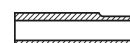

31  **82.00**

| | | | | | | | |
|-------------------|-----------------|--------|------------------|--------------------|--------|--------------------|-----------------|
| 838 A8.000 | 2387cc | 5 Cyl. | 10 Valves | 100kW/136PS | Diesel | Turbo, SOHC | TD11551 |
| 839 A5.000 | 2387cc | 5 Cyl. | 10 Valves | 96-99kW/131-135PS | Diesel | Turbo, SOHC | TD17399 |
| 839 A6.000 | 2387cc | 5 Cyl. | 10 Valves | 103kW/140PS | Diesel | Turbo, SOHC | TD15631 |
| 841 C.000 | 2387cc | 5 Cyl. | 10 Valves | 110kW/150PS | Diesel | Turbo, SOHC | TD16472 |
| AR 32501 | 2387cc | 5 Cyl. | 10 Valves | 99-100kW/135-136PS | Diesel | Turbo, SOHC | TD17400 |
| KAPPA 2.4 JTD | 06/1998→10/2001 | | | LYBRA 2.4 JTD | | | 07/1999→10/2005 |
| THESIS 2.4 JTD | 07/2002→07/2009 | | | | | | |

V94064 
35.50 x 8.00 x 115.00

608 14 605

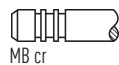

45°

H

VAG96124 
42.90 x 8.02 x 14.06

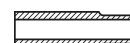

V94470 
35.30 x 8.00 x 115.00

46 750 859



45°

H

VAG96203 
43.00 x 8.03 x 14.08



V94065 
34.50 x 8.00 x 115.00

608 14 604

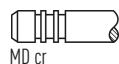

45°

VAG96210 
43.00 x 8.04 x 14.04



V94471 
34.50 x 8.00 x 115.00

46 783 962

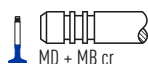

45°

H

V94590 
34.45 x 8.00 x 115.00

55 202 630

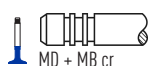

45°

SS

H



OE

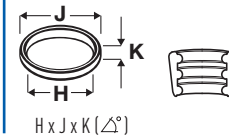
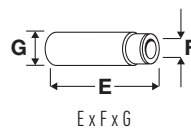

32 82.00

| 841 G.000 | 2387cc | 5 Cyl. | 20 Valves | 129kW/175PS | Diesel | Turbo, DOHC | TD18317 |
|-----------------------|------------|-----------------|-----------|-------------|--------|-------------|---------|
| THEISIS 2.4 JTD | | 05/2003→07/2009 | | | | | |
| V94588 | 46 802 049 | | 45° | Y | H | | |
| 27.90 x 6.00 x 114.00 | | MB cr | | | | | |
| V94589 | 46 787 902 | | 45° | | H | | |
| 25.80 x 6.00 x 114.30 | | MD + MB cr | | | | | |

33 82.60

| 160 D1.000 | 1929cc | 4 Cyl. | 8 Valves | 66kW/90PS | Diesel | Turbo, SOHC | TD4610 |
|-----------------------|-----------|-----------------|----------|-----------------|--------|----------------------|--------|
| DEDRA 1.9 TDS | | 04/1989→07/1999 | | DELTA II 1.9 TD | | 10/1994→08/1999 | |
| V91291 | 7 547 158 | | 45° | | | VAG92366 | |
| 37.50 x 8.00 x 116.50 | | MD cr | | | | 46.50 x 8.00 x 14.10 | |
| V91321 | 7 588 577 | | 45° | | | | |
| 33.50 x 8.00 x 116.45 | | MD cr | | | | | |
| V91392 | 5 990 533 | | 45° | | | | |
| 33.50 x 8.00 x 116.70 | | MD cr | | | | | |

34 82.60

| 831 D.000 | 1929cc | 4 Cyl. | 8 Valves | 48kW/65PS | Diesel | SOHC | TD1813 |
|-----------------------|-----------|-----------------|----------|-----------|--------|----------------------|--------|
| PRISMA 1.9 Diesel | | 01/1983→02/1992 | | | | | |
| V91767 | 5 990 532 | | 45° | H | | VAG92366 | |
| 37.50 x 8.00 x 117.00 | | MB cr | | | | 46.50 x 8.00 x 14.10 | |
| V91392 | 5 990 533 | | 45° | | | | |
| 33.50 x 8.00 x 116.70 | | MD cr | | | | | |

35 82.60

| 831 D1.000 | 1929cc | 4 Cyl. | 8 Valves | 48-59kW/55-80PS | Diesel | Turbo | TD4607 |
|--------------------------------------|-----------|-----------------|----------|-------------------------|--------|----------------------|--------|
| DEDRA 1.9 TDS | | 04/1989→07/1999 | | DELTA I 1.9 Turbo DS | | 10/1986→12/1989 | |
| DELTA II 1.9 TD | | 10/1994→08/1999 | | PRISMA 1.9 Turbo Diesel | | 05/1985→12/1989 | |
| V91291 | 7 547 158 | | 45° | | | VAG92366 | |
| 37.50 x 8.00 x 116.50 | | MD cr | | | | 46.50 x 8.00 x 14.10 | |
| V91321 | 7 588 577 | | 45° | | | | |
| 33.50 x 8.00 x 116.45 Eng.→674284 | | MD cr | | | | | |
| V91392 | 5 990 533 | | 45° | | | | |
| 33.50 x 8.00 x 116.70 Eng.674285→ | | MD cr | | | | | |



OE

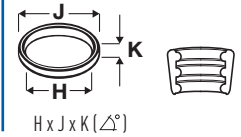
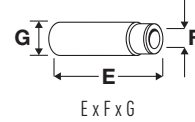
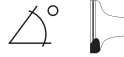











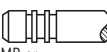

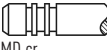

36  **83.00**

| | | | | | | | |
|--------------------------|--------|-----------------|------------------|-------------|--------|--------------------|----------------|
| 198 A5.000 | 1956cc | 4 Cyl. | 16 Valves | 121kW/165PS | Diesel | Turbo, DOHC | TD21043 |
| 844 A2.000 | 1956cc | 4 Cyl. | 16 Valves | 120kW/163PS | Diesel | Turbo, DOHC | TD24652 |
| DELTA III 2.0 D Multijet | | 09/2008→08/2014 | | | | | |

| | | | | | |
|---|------------|---|-----|---|---|
| V98005  | 55 207 517 |  | 45° | VAG96360  |  |
| 28.00 x 5.00 x 114.40 | | MB cr | | 46.70 x 5.00 x 10.03 | |
| V98006  | 55 207 955 |  | 45° | | |
| 24.50 x 5.00 x 114.40 | | MD + MB cr | | | |





37  **83.00**

| | | | | | | | |
|-------------------|--------|-----------------|------------------|-------------|--------|-----------------------|----------------|
| 838 A2.000 | 2446cc | 5 Cyl. | 20 Valves | 129kW/175PS | Petrol | DOHC | TD4617 |
| 838 A2.027 | 2446cc | 5 Cyl. | 20 Valves | 129kW/175PS | Petrol | DOHC | TD14528 |
| 838 B2.000 | 2446cc | 5 Cyl. | 20 Valves | 129kW/175PS | Petrol | DOHC, Motronic | TD18864 |
| 841 D.000 | 2446cc | 5 Cyl. | 20 Valves | 125kW/170PS | Petrol | DOHC | TD16732 |
| KAPPA 2.4 20V | | 08/1994→10/2001 | | THESIS 2.4 | | 07/2002→07/2009 | |

| | | | | | | |
|---|------------|---|-----|------|---|---|
| V91933  | 608 11 153 |  | 45° | H | VAG96123  |  |
| 33.40 x 7.00 x 113.10 | | MB cr | | | 42.25 x 7.02 x 13.05 | |
| V91934  | 608 11 154 |  | 45° | SS | VAG96146  |  |
| 28.00 x 7.00 x 108.60 | | MD cr | | | 42.50 x 7.04 x 13.05 | |
| V94582  | 7 766 565 |  | 45° | | VAG96145  |  |
| 28.00 x 7.00 x 108.50 | | MD cr | | | 46.00 x 7.02 x 13.03 | |
| V94591  | 606 74 496 |  | 45° | SS H | VAG96230  |  |
| 28.00 x 7.00 x 108.80 | | MD + MB cr | | | 46.00 x 7.02 x 13.06 | |

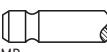
38  **84.00**

| | | | | | | | |
|----------------------|--------|-----------------|-----------------|---------------------|--------|--------------------|---------------|
| 831 A4.000 | 1585cc | 4 Cyl. | 8 Valves | 77kW/105PS | Petrol | DOHC | TD4604 |
| 831 B6.000 | 1585cc | 4 Cyl. | 8 Valves | 71-73kW/97-99PS | Petrol | DOHC | TD1815 |
| 831 B7.000 | 1585cc | 4 Cyl. | 8 Valves | 80kW/109PS | Petrol | DOHC | TD1817 |
| 831 B7.046 | 1585cc | 4 Cyl. | 8 Valves | 97kW/132PS | Petrol | Turbo, DOHC | TD4606 |
| DELTA I 1.6 GT | | 11/1982→04/1986 | | DELTA I 1.6 GT i.e. | | 08/1986→08/1988 | |
| DELTA I 1.6 HF Turbo | | 04/1987→03/1989 | | PRISMA 1.6 | | 01/1983→02/1992 | |
| PRISMA 1.6 i.e. | | 05/1986→12/1989 | | | | | |

| | | | | | | |
|---|-----------|---|-----|---|---|---|
| V91290  | 7 547 400 |  | 45° | H | VAG96171  |  |
| 43.50 x 8.00 x 105.70 | | MB | | | 42.00 x 8.02 x 14.06 | |
| V91636  | 5 975 341 |  | 45° | | | |
| 36.50 x 8.00 x 106.10 | | MD cr | | | | |



OE

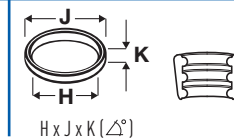
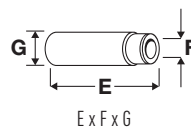

39 84.00

| | | | | | | |
|------------|--------|--------|----------|-------------------|--------|---------|
| 835 A2.000 | 1756cc | 4 Cyl. | 8 Valves | 80kW/108PS | Petrol | TD1845 |
| 835 A2.046 | 1756cc | 4 Cyl. | 8 Valves | 74-77kW/101-105PS | Petrol | TD1844 |
| 835 C2.000 | 1756cc | 4 Cyl. | 8 Valves | 76kW/103PS | Petrol | TD4612 |
| 835 C4.000 | 1756cc | 4 Cyl. | 8 Valves | 66kW/90PS | Petrol | TD5433 |
| 836 A5.000 | 1756cc | 4 Cyl. | 8 Valves | 74kW/101PS | Petrol | TD4615 |
| 836 A6.000 | 1756cc | 4 Cyl. | 8 Valves | 66kW/90PS | Petrol | TD11918 |
| 836 C4.000 | 1756cc | 4 Cyl. | 8 Valves | 66kW/90PS | Petrol | TD5434 |

| | | | |
|--|-----------------|-------------------|---|
| DEDRA 1.8 i.e. | 09/1989→07/1999 | DELTA II 1.8 i.e. | 06/1993→08/1999 |
| V91290 ■ 43.50 x 8.00 x 105.70 | 7 547 400 | 45° MB | H VAG96171 ■ ■ ■ 42.00 x 8.02 x 14.06 |
| V91305 ■ 36.00 x 8.00 x 105.55 | 7 597 080 | 45° MD cr | |

40 84.00

| | | | | | | | |
|------------|--------|--------|-----------|---------------------|--------|-------------|---------|
| 175 A4.000 | 1995cc | 4 Cyl. | 16 Valves | 142kW/193PS | Petrol | Turbo, DOHC | TD11827 |
| 831 D5.000 | 1995cc | 4 Cyl. | 16 Valves | 144kW/196PS | Petrol | Turbo, DOHC | TD1825 |
| 831 E5.000 | 1995cc | 4 Cyl. | 16 Valves | 151-155kW/205-211PS | Petrol | Turbo, DOHC | TD1827 |
| 831 E5.046 | 1995cc | 4 Cyl. | 16 Valves | 155kW/211PS | Petrol | Turbo, DOHC | TD1826 |
| 834 B2.000 | 1995cc | 4 Cyl. | 16 Valves | 108kW/147PS | Petrol | DOHC | TD14549 |
| 834 B2.246 | 1995cc | 4 Cyl. | 16 Valves | 104kW/141PS | Petrol | Turbo, DOHC | TD1832 |
| 836 A2.000 | 1995cc | 4 Cyl. | 16 Valves | 137kW/186PS | Petrol | Turbo, DOHC | TD5435 |
| 838 A4.000 | 1995cc | 4 Cyl. | 16 Valves | 151kW/205PS | Petrol | Turbo, DOHC | TD4619 |

| | | | |
|--|-----------------|------------------------------|--|
| DELTA I 2.0 16V HF Evo Integrale | 06/1993→01/1994 | DELTA I 2.0 16V HF Integrale | 03/1989→09/1991 |
| DELTA II 2.0 16V Turbo | 06/1993→08/1999 | KAPPA 2.0 16V Turbo | 02/1995→10/2001 |
| THEMA 2000 i.e. 16V | 05/1988→08/1992 | | |
| V91935 ■ 34.40 x 7.00 x 128.00 | 7 722 907 | 45° MD cr | VAG92496 ■ ■ ■ 51.00 x 7.03 x 14.04 |
| V91936 ■ 28.35 x 7.00 x 125.50 | 7 650 916 | 45° MD cr | VAG96181B ■ ■ ■ 51.30 x 7.04 x 14.05 |
| | | | VAG96199 ■ ■ ■ 51.30 x 7.04 x 14.08 |

41 84.00

| | | | | | | | |
|------------|--------|--------|----------|-------------------|--------|------|--------|
| 831 B4.000 | 1995cc | 4 Cyl. | 8 Valves | 85kW/115PS | Petrol | DOHC | TD1812 |
| 834 B.000 | 1995cc | 4 Cyl. | 8 Valves | 88kW/120PS | Petrol | DOHC | TD1833 |
| 834 B.048 | 1995cc | 4 Cyl. | 8 Valves | 83-85kW/112-113PS | Petrol | DOHC | TD1829 |
| 834 B.146 | 1995cc | 4 Cyl. | 8 Valves | 85kW/116PS | Petrol | DOHC | TD1818 |
| 834 B1.000 | 1995cc | 4 Cyl. | 8 Valves | 86kW/117PS | Petrol | DOHC | TD1830 |

| | | | |
|--|-----------------|-----------------|---|
| PRISMA 2.0 i.e. | 04/1986→12/1989 | THEMA 2000 i.e. | 09/1988→05/1992 |
| THEMA 2000 i.e. | 11/1984→05/1992 | | |
| V91290 ■ 43.50 x 8.00 x 105.70 | 7 547 400 | 45° MB | H VAG96171 ■ ■ ■ 42.00 x 8.02 x 14.06 |
| V91636 ■ 36.50 x 8.00 x 106.10 | 5 975 341 | 45° MD cr | |



OE

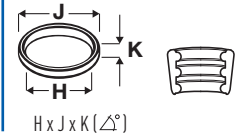
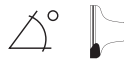

42 **84.00**

| | | | | | | | |
|--------------------------------|-----------------|--------|----------|--------------------------|--------|-----------------|--------|
| 831 B5.000 | 1995cc | 4 Cyl. | 8 Valves | 122kW/166PS | Petrol | Turbo, DOHC | TD1823 |
| 831 C5.000 | 1995cc | 4 Cyl. | 8 Valves | 133kW/181PS | Petrol | Turbo, DOHC | TD1821 |
| 831 C5.046 | 1995cc | 4 Cyl. | 8 Valves | 130kW/177PS | Petrol | Turbo, DOHC | TD1822 |
| 834 C.000 | 1995cc | 4 Cyl. | 8 Valves | 122kW/166PS | Petrol | Turbo, DOHC | TD1834 |
| 834 C.146 | 1995cc | 4 Cyl. | 8 Valves | 110kW/150PS | Petrol | Turbo, DOHC | TD1837 |
| 835 A5.046 | 1995cc | 4 Cyl. | 8 Valves | 82-83kW/112-113PS | Petrol | DOHC | TD1848 |
| 835 A7.000 | 1995cc | 4 Cyl. | 8 Valves | 121kW/165PS | Petrol | Turbo, DOHC | TD1849 |
| 835 A7.046 | 1995cc | 4 Cyl. | 8 Valves | 124kW/169PS | Petrol | Turbo, DOHC | TD1850 |
| DEDRA 2.0 HF Integrale | 11/1990→07/1994 | | | DEDRA 2.0 i.e. | | 09/1989→07/1999 | |
| DEDRA 2.0 i.e. Turbo Integrale | 05/1990→07/1994 | | | DELTA I 2.0 HF Integrale | | 11/1986→12/1992 | |
| THEMA 2000 i.e. Turbo | 11/1984→07/1994 | | | THEMA 2000 i.e. Turbo | | 07/1986→05/1990 | |
| THEMA 2000 Turbo | 12/1988→03/1992 | | | | | | |

V91290
43.50 x 8.00 x 105.70

7 547 400

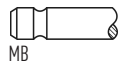

45°

H

VAG96171
42.00 x 8.02 x 14.06



43 **84.00**

| | | | | | | | |
|----------------------|-----------------|--------|-----------|---------------------------|--------|-----------------|--------|
| 834 C1.000 | 1995cc | 4 Cyl. | 16 Valves | 133kW/181PS | Petrol | Turbo, DOHC | TD1835 |
| 834 C1.246 | 1995cc | 4 Cyl. | 16 Valves | 130kW/177PS | Petrol | Turbo, DOHC | TD1836 |
| 834 F1.000 | 1995cc | 4 Cyl. | 16 Valves | 110-112kW/150-152PS | Petrol | DOHC | TD1831 |
| 836 A3.000 | 1995cc | 4 Cyl. | 16 Valves | 102-108kW/139-147PS | Petrol | DOHC | TD4614 |
| DEDRA 2.0 16V | 07/1994→07/1999 | | | DEDRA 2.0 Integrale | | 07/1994→07/1999 | |
| DELTA II 2.0 16V | 06/1993→08/1999 | | | THEMA 2000 16V | | 05/1992→07/1994 | |
| THEMA 2000 16V Turbo | 12/1988→06/1990 | | | THEMA 2000 i.e. 16V Turbo | | 12/1988→03/1993 | |

V91935
34.40 x 7.00 x 128.00

7 722 907

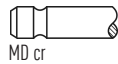

45°

VAG92496
51.00 x 7.03 x 14.04



V91638
28.50 x 7.00 x 126.00

7 958 073

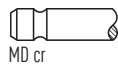

45°

SS

VAG96181B
51.30 x 7.04 x 14.05

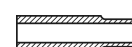

VAG96199
51.30 x 7.04 x 14.08



44 **85.00**

| | | | | | | | |
|-----------------|-----------------|--------|-----------|------------------|--------|-----------------|---------|
| DW10ATED4 (RHW) | 1997cc | 4 Cyl. | 16 Valves | 80kW/109PS | Diesel | Turbo, DOHC | TD16735 |
| RHM (DW10ATED4) | 1997cc | 4 Cyl. | 16 Valves | 79kW/107PS | Diesel | Turbo, DOHC | TD26957 |
| PHEDRA 2.0 JTD | 09/2002→11/2010 | | | ZETA 2.0 JTD 16V | | 09/1999→09/2002 | |

V94486
29.90 x 6.00 x 106.20

9 635 317 980

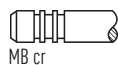

45°

Y

H

VAG96119
41.50 x 6.03 x 105.54



V94487
25.00 x 6.00 x 106.10

9 635 318 480



45°

SS

H

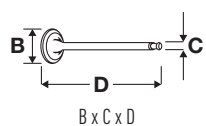

OE

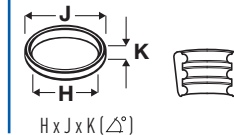
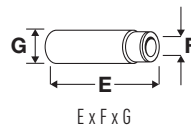

45 85.00

| | | | | | | | |
|-----------------------|-----------------|------------|--------------|-------------|----------------------|------|---------|
| RFN | 1997cc | 4 Cyl. | 16 Valves | 100kW/136PS | Petrol | DOHC | TD16322 |
| RFN (EW10J4) | 1997cc | 4 Cyl. | 16 Valves | 100kW/136PS | Petrol | DOHC | TD16734 |
| PHEDRA 2.0 | 09/2002→11/2010 | | ZETA 2.0 16V | | 07/2000→09/2002 | | |
| V94200 ■ | 9 623 950 380 | | 45° | H | VAG96342B ■ | | |
| 33.30 x 6.00 x 106.20 | | MB | | | 40.80 x 6.02 x 12.11 | | |
| V94201 ■ | 9 636 001 780 | | 45° | ss H | VAG96343 ■ | | |
| 29.00 x 6.00 x 103.60 | | MD + MB cr | | | 40.80 x 6.02 x 12.06 | | |

46 85.00

| | | | | | | | |
|-----------------------|-----------------|------------|-----------|-------------------|----------------------|-------------|---------|
| RHK (DW10UTED4) | 1997cc | 4 Cyl. | 16 Valves | 79-88kW/107-120PS | Diesel | Turbo, DOHC | TD26952 |
| PHEDRA 2.0 JTD | 06/2006→11/2010 | | | | | | |
| V94486 ■ | 9 635 317 980 | | 45° | Y H | VAG96119 ■ ■ | | |
| 29.90 x 6.00 x 106.20 | | MB cr | | | 41.50 x 6.03 x 10.54 | | |
| V94490 ■ | 9 627 184 380 | | 45° | Y H | | | |
| 29.80 x 6.00 x 105.00 | | MB cr | | | | | |
| V94487 ■ | 9 635 318 480 | | 45° | ss H | | | |
| 25.00 x 6.00 x 106.10 | | MD + MB cr | | | | | |
| V94491 ■ | 9 634 437 580 | | 45° | ss H | | | |
| 25.00 x 6.00 x 105.00 | | MD + MB cr | | | | | |

47 85.00

| | | | | | | | |
|-----------------------|-----------------|------------|-----------|-------------|----------------------|-------------|---------|
| RHR (DW10BTE4) | 1997cc | 4 Cyl. | 16 Valves | 100kW/136PS | Diesel | Turbo, DOHC | TD26955 |
| PHEDRA 2.0 D Multijet | 07/2006→11/2010 | | | | | | |
| V94490 ■ | 9 627 184 380 | | 45° | Y H | VAG96119 ■ ■ | | |
| 29.80 x 6.00 x 105.00 | | MB cr | | | 41.50 x 6.03 x 10.54 | | |
| V94491 ■ | 9 634 437 580 | | 45° | ss H | | | |
| 25.00 x 6.00 x 105.00 | | MD + MB cr | | | | | |

48 85.00

| | | | | | | | |
|-----------------------|-----------------|------------|----------|------------|----------------------|-------------|---------|
| RHZ (DW10ATED) | 1997cc | 4 Cyl. | 8 Valves | 80kW/109PS | Diesel | Turbo, SOHC | TD26954 |
| ZETA 2.0 JTD | 04/2000→09/2002 | | | | | | |
| V94178 ■ | 9 624 774 280 | | 45° | H | VAG96119 ■ ■ | | |
| 35.60 x 6.00 x 107.10 | | MB cr | | | 41.50 x 6.03 x 10.54 | | |
| V94179 ■ | 9 624 774 580 | | 45° | H | | | |
| 33.80 x 6.00 x 107.10 | | MD + MB cr | | | | | |

49 85.00

| | | | | | | | |
|-----------------------|-----------------|--------|-----------|------------|----------------------|--------------------|--------|
| P 8 C | 2088cc | 4 Cyl. | 12 Valves | 80kW/109PS | Diesel | XUD11, Turbo, SOHC | TD1859 |
| ZETA 2.1 TD | 05/1996→09/1999 | | | | | | |
| V94169 ■ | 9 600 781 780 | | 45° | H | VAG96215B ■ ■ | | |
| 33.90 x 8.00 x 122.30 | | MB cr | | | 54.50 x 8.02 x 13.09 | | |
| V94170 ■ | 9 604 295 780 | | 45° | | | | |
| 33.90 x 8.00 x 121.90 | | MD cr | | | | | |

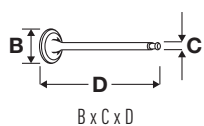



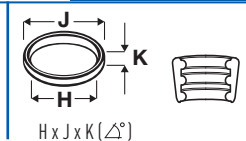
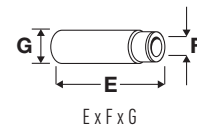



OE



50  **85.00**

| | | | | | | | |
|------------|--------|--------|------------------|-------------|--------|--------------------|----------------|
| 4HT | 2179cc | 4 Cyl. | 16 Valves | 125kW/170PS | Diesel | Turbo, DOHC | TD24686 |
|------------|--------|--------|------------------|-------------|--------|--------------------|----------------|





PHEDRA 2.2 D Multijet 03/2008→11/2010

| | | | | | | | |
|---|---------------|---|-----|----|---|---|---|
| V95083  | 9 676 718 180 |  MB cr | 45° | Y | H | VAG96119  |  |
| 27.25 x 5.97 x 95.70 | | | | | | 41.50 x 6.03 x 10.54 | |
| V95084  | 9 676 718 280 |  MD + MB cr | 45° | SS | H | | |
| 25.00 x 5.97 x 95.00 | | | | | | | |

51  **85.00**

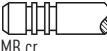
| | | | | | | | |
|------------------------|--------|--------|------------------|------------|--------|--------------------|----------------|
| DW12ATED4 (4HW) | 2179cc | 4 Cyl. | 16 Valves | 94kW/128PS | Diesel | Turbo, DOHC | TD16736 |
|------------------------|--------|--------|------------------|------------|--------|--------------------|----------------|







PHEDRA 2.2 JTD 09/2002→11/2010

| | | | | | | | |
|---|---------------|---|-----|----|---|---|---|
| V94490  | 9 627 184 380 |  MB cr | 45° | Y | H | VAG96119  |  |
| 29.80 x 6.00 x 105.00 | | | | | | 41.50 x 6.03 x 10.54 | |
| V94491  | 9 634 437 580 |  MD + MB cr | 45° | SS | H | | |
| 25.00 x 6.00 x 105.00 | | | | | | | |

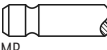
52  **86.00**

| | | | | | | | |
|----------------------|--------|--------|------------------|------------|--------|-------------|----------------|
| RFV (XU10J4R) | 1998cc | 4 Cyl. | 16 Valves | 97kW/132PS | Petrol | DOHC | TD26959 |
|----------------------|--------|--------|------------------|------------|--------|-------------|----------------|



ZETA 2.0 16V 05/1998→07/2000

| | | | | | | | |
|---|---------------|---|-----|----|---|--|---|
| V94175  | 9 628 943 380 |  MB | 45° | Y | H | VAG96342B  |  |
| 34.60 x 6.00 x 106.40 | | | | | | 40.80 x 6.02 x 12.11 | |
| V94176  | 9 629 861 180 |  MD + MB cr | 45° | SS | H | VAG96343  |  |
| 29.60 x 6.00 x 105.80 | | | | | | 40.80 x 6.02 x 12.06 | |

53  **86.00**

| | | | | | | | |
|-----------------------|--------|--------|-----------------|-------------|--------|--------------------|----------------|
| RGX (XU10J2TE) | 1998cc | 4 Cyl. | 8 Valves | 108kW/147PS | Petrol | Turbo, SOHC | TD26958 |
|-----------------------|--------|--------|-----------------|-------------|--------|--------------------|----------------|

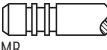
ZETA 2.0 Turbo 05/1995→09/2002



| | | | | | | | |
|---|---------------|---|-----|----|---|--|--|
| V91972  | 96 059 361 |  MB | 45° | | H | | |
| 42.60 x 8.00 x 108.80 | | | | | | | |
| V91971  | 9 611 782 880 |  MD + MB cr | 45° | SS | H | | |
| 34.50 x 8.00 x 108.40 | | | | | | | |

54  **86.40**

| | | | | | | | |
|-------------------|--------|--------|-----------------|-----------------|--------|-------------|---------------|
| 831 A2.000 | 1301cc | 4 Cyl. | 8 Valves | 55-58kW/75-79PS | Petrol | SOHC | TD4605 |
|-------------------|--------|--------|-----------------|-----------------|--------|-------------|---------------|

831 B.000 1301cc 4 Cyl. 8 Valves 55kW/75PS Petrol SOHC TD1809

DELTA I 1.3 09/1979→08/1992 PRISMA 1.3 01/1983→12/1989

| | | | | | | | |
|---|-----------|--|-----|--|--|---|---|
| V91713  | 4 315 062 |  MD cr | 45° | | | VAG92366  |  |
| 31.00 x 8.00 x 109.00 | | | | | | 46.50 x 8.00 x 14.10 | |



OE

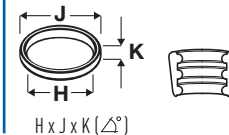
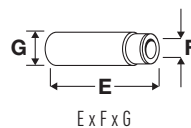
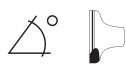

55 86.40

| | | | | | | |
|------------|--------|--------|----------|-----------------|--------|--------|
| 138 C2.048 | 1498cc | 4 Cyl. | 8 Valves | 55kW/75PS | Petrol | TD5424 |
| 831 A1.000 | 1498cc | 4 Cyl. | 8 Valves | 63kW/86PS | Petrol | TD1805 |
| 831 B1.000 | 1498cc | 4 Cyl. | 8 Valves | 59-63kW/80-86PS | Petrol | TD1811 |
| 831 B1.048 | 1498cc | 4 Cyl. | 8 Valves | 55kW/75PS | Petrol | TD1810 |

DELTA I 1.5 09/1979→12/1992 PRISMA 1.5 01/1983→02/1992

| | | | | | | |
|-----------------------|-----------|-------|-----|----|----------------------|--|
| V90397 | 5 973 129 | | 45° | SS | VAG92366 | |
| 33.10 x 7.99 x 109.00 | | MD cr | | | 46.50 x 8.00 x 14.10 | |
| V91762 | 5 973 129 | | 45° | | | |
| 33.00 x 8.00 x 109.00 | | MD | | | | |

56 86.40

| | | | | | | | |
|------------|--------|--------|-----------|------------|--------|------|--------|
| 182 A4.000 | 1581cc | 4 Cyl. | 16 Valves | 76kW/103PS | Petrol | DOHC | TD9476 |
| 182 A6.000 | 1581cc | 4 Cyl. | 16 Valves | 66kW/90PS | Petrol | DOHC | TD9475 |

DEDRA 1.6 16V 01/1996→07/1999 DELTA II 1.6 i.e. 03/1996→08/1999
DELTA II 1.6 i.e. 16V 01/1996→08/1999 LYBRA 1.6 16V 07/1999→10/2005

| | | | | | | |
|-----------------------|------------|------------|-----|----|----------------------|--|
| V91949 | 46 517 325 | | 45° | H | VAG92364 | |
| 30.40 x 7.00 x 102.00 | | MB cr | | | 42.50 x 7.00 x 13.07 | |
| V91950 | 46 462 159 | | 45° | | VAG96123 | |
| 29.80 x 7.00 x 102.60 | | MD cr | | | 42.25 x 7.02 x 13.05 | |
| V94468 | 46 461 209 | | 45° | SS | VAG96146 | |
| 30.00 x 7.00 x 102.40 | | MD + MB cr | | | 42.50 x 7.04 x 13.05 | |

57 86.40

| | | | | | | | |
|------------|--------|--------|----------|-----------------|--------|------|--------|
| 835 A1.000 | 1581cc | 4 Cyl. | 8 Valves | 65-66kW/88-90PS | Petrol | SOHC | TD1842 |
|------------|--------|--------|----------|-----------------|--------|------|--------|

DEDRA 1.6 i.e. 08/1989→06/1994

| | | | | | | |
|-----------------------|-----------|-------|-----|---|----------------------|--|
| V91300 | 7 609 772 | | 45° | H | VAG92366 | |
| 37.50 x 8.00 x 108.50 | | MB | | | 46.50 x 8.00 x 14.10 | |
| V91713 | 4 315 062 | | 45° | | | |
| 31.00 x 8.00 x 109.00 | | MD cr | | | | |

58 86.40

| | | | | | | | |
|------------|--------|--------|----------|-----------|--------|------|--------|
| 835 A1.046 | 1581cc | 4 Cyl. | 8 Valves | 57kW/77PS | Petrol | SOHC | TD1843 |
| 835 C1.000 | 1581cc | 4 Cyl. | 8 Valves | 55kW/75PS | Petrol | SOHC | TD4611 |

DEDRA 1.6 i.e. 08/1989→07/1999 DELTA II 1.6 i.e. 06/1993→08/1999

| | | | | | | |
|-----------------------|-----------|-------|-----|---|----------------------|--|
| V91306 | 7 617 500 | | 45° | H | VAG92366 | |
| 39.50 x 8.00 x 108.50 | | MB | | | 46.50 x 8.00 x 14.10 | |
| V91713 | 4 315 062 | | 45° | | | |
| 31.00 x 8.00 x 109.00 | | MD cr | | | | |



OE

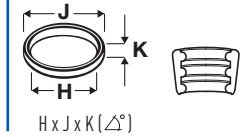
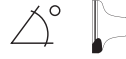



59

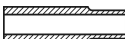

87.00

| | | | | | | | |
|---------------|--------|-----------------|-----------|-------------|--------|------|---------|
| ES9 J4S | 2946cc | V6 Cyl. | 24 Valves | 150kW/204PS | Petrol | DOHC | TD17397 |
| PHEDRA 3.0 V6 | | 09/2002→11/2010 | | | | | |







| | | | | | | |
|-----------------------|---------|---|-----|----|------------------------|---|
| V94198 ■ | 0948.A5 |  | 45° | H | VAG96271B ■ ■ ■ |  |
| 34.95 x 5.98 x 108.45 | | MB cr | | | 40.00 x 6.00 x 11.06 | |
| V94199 ■ | 0949.A5 |  | 45° | SS | | |
| 30.55 x 5.98 x 106.95 | | MD cr | | | | |

60

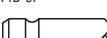

93.00

| | | | | | | | |
|--------------------|--------|-----------------|----------|---------------------|--------|--------------------|--------|
| 8144.91 | 2445cc | 4 Cyl. | 8 Valves | 74kW/101PS | Diesel | Sofim, Turbo, SOHC | TD4600 |
| THEMA 2500 Turbo D | | 11/1984→09/1988 | | THEMA 2500 Turbo DS | | 03/1987→09/1990 | |







| | | | | | | | |
|-----------------------|-----------|---|-----|---|---|----------------------|---|
| V91292 ■ | 7 301 820 |  | 30° | Y | H | VAG92193 ■ |  |
| 40.80 x 8.00 x 120.70 | | MB cr | | | | 56.00 x 8.04 x 13.05 | |
| V91293 ■ | 7 301 821 |  | 45° | | | VAG92373 ■ |  |
| 34.50 x 8.00 x 122.00 | | MD tu | | | | 56.00 x 8.03 x 13.04 | |
| V91294 ■ | 7 302 157 |  | 45° | | H | VAG92369 ■ |  |
| 34.50 x 8.00 x 122.00 | | MF + MB cr | | | | 60.00 x 8.00 x 13.07 | |





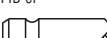

61



93.00

| | | | | | | | |
|---------------------|--------|-----------------|----------|------------|--------|--------------------|--------|
| 8144.97S | 2500cc | 4 Cyl. | 8 Valves | 77kW/105PS | Diesel | Turbo | TD1785 |
| 8144.97 | 2500cc | 4 Cyl. | 8 Valves | 85kW/115PS | Diesel | Sofim, Turbo, SOHC | TD4601 |
| 8144.97Y | 2500cc | 4 Cyl. | 8 Valves | 85kW/115PS | Diesel | Sofim, Turbo, SOHC | TD1786 |
| THEMA 2500 Turbo DS | | 05/1988→07/1994 | | | | | |

| | | | | | | | |
|-----------------------|-----------|---|-----|---|---|----------------------|---|
| V91292 ■ | 7 301 820 |  | 30° | Y | H | VAG92193 ■ |  |
| 40.80 x 8.00 x 120.70 | | MB cr | | | | 56.00 x 8.04 x 13.05 | |
| V91293 ■ | 7 301 821 |  | 45° | | | VAG92373 ■ |  |
| 34.50 x 8.00 x 122.00 | | MD tu | | | | 56.00 x 8.03 x 13.04 | |
| V91294 ■ | 7 302 157 |  | 45° | | H | VAG92369 ■ |  |
| 34.50 x 8.00 x 122.00 | | MF + MB cr | | | | 60.00 x 8.00 x 13.07 | |

|  |  | ccm |  |  |  |  |
|---|---|------|--|---|---|---|
| 10 H | 90.47 | 2286 | 4 | 8 | Petrol | 18 |
| 10 J | 90.47 | 2286 | 4 | 8 | Diesel | 19 |
| 11 D | 88.86 | 3528 | 8 | 16 | Petrol | 15 |
| 11 L (200Tdi) | 90.47 | 2495 | 4 | 8 | Diesel | 20 |
| 11H | 90.47 | 2286 | 4 | 8 | Petrol | 18 |
| 12 J | 90.47 | 2495 | 4 | 8 | Diesel | 21 |
| 12 L (200Tdi) | 90.47 | 2495 | 4 | 8 | Diesel | 20 |
| 14 L (200Tdi) | 90.47 | 2495 | 4 | 8 | Diesel | 20 |
| 14 P | 84.45 | 2495 | 5 | 10 | Diesel | 10 |
| 15 P | 84.45 | 2495 | 5 | 10 | Diesel | 10 |
| 16 L (300Tdi) | 90.47 | 2495 | 4 | 8 | Diesel | 22 |
| 17 H | 90.47 | 2495 | 4 | 8 | Petrol | 23 |
| 17 L (300Tdi) | 90.47 | 2495 | 4 | 8 | Diesel | 22 |
| 18 K4F | 80.00 | 1796 | 4 | 16 | Petrol | 1 |
| 19 J | 90.47 | 2495 | 4 | 8 | Diesel | 21 |
| 19 L (300Tdi) | 90.47 | 2495 | 4 | 8 | Diesel | 22 |
| 20 T2N (L Series) | 84.50 | 1994 | 4 | 8 | Diesel | 11 |
| 20 T4H | 84.50 | 1994 | 4 | 16 | Petrol | 12 |
| 21 L (300TDi) | 90.47 | 2495 | 4 | 8 | Diesel | 22 |
| 22 D | 88.86 | 3528 | 8 | 16 | Petrol | 16 |
| 22 L (300Tdi) | 90.47 | 2495 | 4 | 8 | Diesel | 22 |
| 224DT | 85.00 | 2179 | 4 | 16 | Diesel | 13 |
| 23 L (300Tdi) | 90.47 | 2495 | 4 | 8 | Diesel | 22 |
| 24 D | 88.86 | 3528 | 8 | 16 | Petrol | 16 |
| 25 6T (BMW M51D25) | 80.00 | 2497 | 6 | 12 | Diesel | 2 |
| 25 D | 88.86 | 3528 | 8 | 16 | Petrol | 16 |
| 25 K4F | 80.00 | 2497 | 6 | 24 | Petrol | 3 |
| 276DT | 81.00 | 2720 | 6 | 24 | Diesel | 4 |
| 306DT | 84.00 | 2993 | 6 | 24 | Diesel | 8 |
| 30DDTX | 84.00 | 2993 | 6 | 24 | Diesel | 8 |
| 31 D | 88.86 | 3528 | 8 | 16 | Petrol | 16 |
| 368DT | 81.00 | 3628 | 8 | 32 | Diesel | 5 |
| 40 D | 94.00 | 4275 | 8 | 16 | Petrol | 26 |
| 42 D | 94.00 | 3947 | 8 | 16 | Petrol | 25 |
| 448DT | 84.00 | 4367 | 8 | 32 | Diesel | 9 |
| 46 D | 94.00 | 4553 | 8 | 16 | Petrol | 27 |
| DW12BTED4 | 85.00 | 2179 | 4 | 16 | Diesel | 13 |
| M 47 | 84.00 | 1950 | 4 | 16 | Diesel | 6 |
| M 47 R | 84.00 | 1950 | 4 | 16 | Diesel | 6 |
| M57 D30 (TD6) | 84.00 | 2926 | 6 | 12 | Diesel | 7 |
| M62 B44 | 92.00 | 4398 | 8 | 32 | Petrol | 24 |
| TD5 (10P) | 84.45 | 2495 | 5 | 10 | Diesel | 10 |
| ZSD-422 | 86.00 | 2198 | 4 | 16 | Diesel | 14 |
| ZSD-424 | 89.90 | 2402 | 4 | 16 | Diesel | 17 |





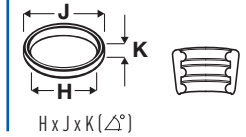
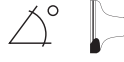



OE



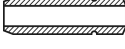

1  **80.00**

| | | | | | | | |
|----------------------|-----------------|--------|------------------|--------------------|--------|-----------------|----------------|
| 18 K4F | 1796cc | 4 Cyl. | 16 Valves | 85-88kW/116-120PS | Petrol | DOHC | TD20740 |
| FREELANDER 1.8 | 10/2000→09/2003 | | | FREELANDER 1.8 16V | | 11/2000→10/2006 | |
| FREELANDER 1.8 i 16V | 02/1998→10/2006 | | | | | | |

| | | | | | | | |
|---|------------|---|-----|----|---|---|--|
| V91209  | LGH10029L |  | 45° | | H | VAG92309  | |
| 27.80 x 5.97 x 89.60 | | MB | | | | 30.00 x 6.00 x 9.90 | |
| V94053  | LGH100820L |  | 45° | SS | | VAG92316  | |
| 24.30 x 5.96 x 90.00 | | MD tu | | | | 30.00 x 6.01 x 10.14 | |





2  **80.00**

| | | | | | | | |
|---------------------------|-----------------|--------|------------------|-------------|--------|-------------|----------------|
| 25 6T (BMW M51D25) | 2497cc | 6 Cyl. | 12 Valves | 100kW/136PS | Diesel | SOHC | TD22933 |
| RANGE ROVER II 2.5 D | 07/1994→03/2002 | | | | | | |

| | | | | | | | |
|---|-----------------|---|-----|----|---|--|--|
| V94555  | 11 34 2 244 815 |  | 45° | SS | H | VAG96148B  | |
| 30.90 x 6.00 x 103.50 | | MD + MB cr | | | | 39.50 x 6.00 x 12.57 | |





3  **80.00**

| | | | | | | | |
|-------------------|-----------------|---------|------------------|---------------------|--------|-------------|----------------|
| 25 K4F | 2497cc | V6 Cyl. | 24 Valves | 129-130kW/175-177PS | Petrol | DOHC | TD19716 |
| FREELANDER 2.5 V6 | 11/2000→10/2006 | | | | | | |

| | | | | | | | |
|---|-----------|---|-----|--|---|---|--|
| V94101  | LGH10064 |  | 45° | | H | VAG96058  | |
| 31.60 x 6.00 x 89.60 | | MB tu | | | | 30.00 x 6.01 x 9.88 | |
| V94342  | LGH101360 |  | 45° | | | | |
| 27.50 x 6.00 x 90.10 | | MD tu | | | | | |





4  **81.00**

| | | | | | | | |
|-------------------------|-----------------|---------|------------------|---------------------|--------|--------------|----------------|
| 276DT | 2720cc | V6 Cyl. | 24 Valves | 140kW/190PS | Diesel | Turbo | TD24908 |
| DISCOVERY III 2.7 TD | 07/2004→09/2009 | | | DISCOVERY IV 2.7 TD | | 09/2009→ | |
| RANGE ROVER SPORT 2.7 D | 02/2005→03/2013 | | | | | | |

| | | | | | | | |
|---|----------|---|-----|----|---|--|--|
| V95135  | 1311281 |  | 45° | | H | | |
| 27.80 x 5.94 x 97.00 | | MB cr | | | | | |
| V95136  | LR008130 |  | 45° | SS | H | | |
| 25.20 x 5.93 x 96.35 | | MD + MB cr | | | | | |

5  **81.00**

| | | | | | | | |
|-----------------------|-----------------|---------|------------------|-------------------------|--------|--------------------|----------------|
| 368DT | 3628cc | V8 Cyl. | 32 Valves | 200kW/272PS | Diesel | Turbo, DOHC | TD24986 |
| RANGE ROVER III 3.6 D | 04/2006→08/2012 | | | RANGE ROVER SPORT 3.6 D | | 04/2006→03/2013 | |

| | | | | | | | |
|---|----------|---|-----|----|---|--|--|
| V95135  | 1311281 |  | 45° | | H | | |
| 27.80 x 5.94 x 97.00 | | MB cr | | | | | |
| V95136  | LR008130 |  | 45° | SS | H | | |
| 25.20 x 5.93 x 96.35 | | MD + MB cr | | | | | |



OE

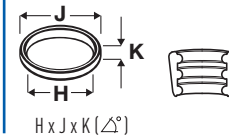
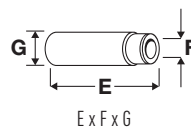

6 84.00

| | | | | | | | |
|--------------------|--------|-----------------|------------------|-------------------|--------|--------------------|---------|
| M 47 | 1950cc | 4 Cyl. | 16 Valves | 80-82kW/109-112PS | Diesel | Turbo, DOHC | TD26848 |
| M 47 R | 1950cc | 4 Cyl. | 16 Valves | 85kW/116PS | Diesel | Turbo, DOHC | TD24392 |
| FREELANDER 2.0 Td4 | | 11/2000→10/2006 | | | | | |

| | | | | | | |
|----------------------|-----------------|------------|-----|---|----------------------|--|
| V94086 | 11 34 2 247 077 | | 45° | H | VAG96266B | |
| 26.00 x 6.00 x 99.90 | | MF + MB cr | | | 39.00 x 6.00 x 11.54 | |
| V94086 | 11 34 2 247 077 | | 45° | H | | |
| 26.00 x 6.00 x 99.90 | | cr | | | | |

7 84.00

| | | | | | | | |
|----------------------|-----------------|------------|------------------|---------------------|----------------------|--------------------|---------|
| M57 D30 (TD6) | 2926cc | 6 Cyl. | 12 Valves | 130-142kW/177-193PS | Diesel | Turbo, SOHC | TD22322 |
| V94086 | 11 34 2 247 077 | | 45° | H | VAG96266B | | |
| 26.00 x 6.00 x 99.90 | | MF + MB cr | | | 39.00 x 6.00 x 11.54 | | |
| V94086 | 11 34 2 247 077 | | 45° | H | | | |
| 26.00 x 6.00 x 99.90 | | cr | | | | | |

8 84.00

| | | | | | | | |
|-----------------------------|----------|---------|------------------|----------------------------|--------|--------------------|---------|
| 306DT | 2993cc | V6 Cyl. | 24 Valves | 155-250kW/211-340PS | Diesel | Turbo | TD24909 |
| 30DDTX | 2993cc | V6 Cyl. | 24 Valves | 155-200kW/211-272PS | Diesel | Turbo, DOHC | TD25818 |
| DISCOVERY IV 3.0 SDV6 | 11/2009→ | | | DISCOVERY IV 3.0 TD | | 09/2009→ | |
| DISCOVERY V 3.0 D | 09/2016→ | | | RANGE ROVER IV 3.0 D | | 08/2012→ | |
| RANGE ROVER IV 3.0 D 4x4 | 10/2013→ | | | RANGE ROVER SPORT 3.0 D | | 09/2009→ | |
| RANGE ROVER SPORT 3.0 D 4x4 | 10/2013→ | | | RANGE ROVER VELAR 3.0 D300 | | 03/2017→ | |

| | | | | | | |
|----------------------|----------|------------|-----|----|---|--|
| V95135 | 1311281 | | 45° | H | | |
| 27.80 x 5.94 x 97.00 | | MB cr | | | | |
| V95136 | LR008130 | | 45° | ss | H | |
| 25.20 x 5.93 x 96.35 | | MD + MB cr | | | | |

9 84.00

| | | | | | | | |
|-------------------------|-----------------|---------|------------------|-------------------------|--------|--------------------|---------|
| 448DT | 4367cc | V8 Cyl. | 32 Valves | 230-250kW/313-340PS | Diesel | Turbo, DOHC | TD27000 |
| RANGE ROVER III 4.4 D | 07/2010→08/2012 | | | RANGE ROVER IV 4.4 D | | 08/2013→ | |
| RANGE ROVER IV 4.4 D V8 | 08/2012→ | | | RANGE ROVER SPORT 4.4 D | | 10/2013→ | |

| | | | | | | |
|----------------------|----------|------------|-----|----|---|--|
| V95135 | 1311281 | | 45° | H | | |
| 27.80 x 5.94 x 97.00 | | MB cr | | | | |
| V95136 | LR008130 | | 45° | ss | H | |
| 25.20 x 5.93 x 96.35 | | MD + MB cr | | | | |

10 84.45

| | | | | | | | |
|------------------|-----------------|--------|------------------|----------------------|--------|--------------------|---------|
| 14 P | 2495cc | 5 Cyl. | 10 Valves | 90kW/122PS | Diesel | Turbo, SOHC | TD25825 |
| 15 P | 2495cc | 5 Cyl. | 10 Valves | 90-102kW/122-139PS | Diesel | Turbo, SOHC | TD28552 |
| TD5 (10P) | 2495cc | 5 Cyl. | 10 Valves | 90-102kW/122-139PS | Diesel | Turbo, SOHC | TD25823 |
| DEFENDER 2.5 Td5 | 06/1998→02/2016 | | | DISCOVERY II 2.5 Td5 | | 11/1998→06/2004 | |





| | | | | | | |
|-----------------------|----------|------------|-----|----|---|--|
| V94359 | ERR 6611 | | 30° | H | | |
| 34.70 x 7.00 x 105.70 | | MB cr | | | | |
| V94360 | ERR 6612 | | 45° | ss | H | |
| 31.70 x 7.00 x 105.70 | | MD + MB cr | | | | |

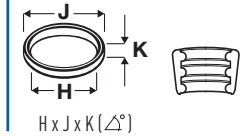
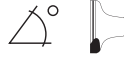



OE



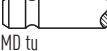

11  **84.50**

| | | | | | | | |
|---|------------|---|-----------------|-----------|--------|---|----------------|
| 20 T2N (L Series) | 1994cc | 4 Cyl. | 8 Valves | 72kW/98PS | Diesel | Turbo, SOHC | TD26632 |
| FREELANDER 2.0 DI | | 02/1998→10/2006 | | | | | |
| V94018  | LGH100990L |  | 45° | | | VAG92511  | |
| 37.20 x 6.92 x 87.00 | | MB tu | | | | 28.30 x 6.96 x 12.05 | |
| V94019  | LGH100980L |  | 45° | | | | |
| 32.60 x 6.91 x 87.00 | | MD tu | | | | | |

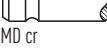

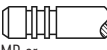
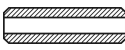

12  **84.50**

| | | | | | | | |
|---|-----------|---|------------------|--------------------|--------|--------------------|----------------|
| 20 T4H | 1994cc | 4 Cyl. | 16 Valves | 99-100kW/135-136PS | Petrol | Turbo, DOHC | TD32496 |
| DISCOVERY I 2.0 16 V | | 06/1989→10/1998 | | | | | |
| V91217  | LGH101060 |  | 45° | H | | | |
| 32.10 x 7.10 x 110.80 | | MB cr | | | | | |
| V94026  | LGH101000 |  | 45° | | | | |
| 29.40 x 7.08 x 111.00 | | MD cr | | | | | |



13  **85.00**

| | | | | | | | |
|---|---------|---|------------------|----------------------|--------|---|----------------|
| 224DT | 2179cc | 4 Cyl. | 16 Valves | 110-140kW/150-190PS | Diesel | Turbo, DOHC | TD24922 |
| DISCOVERY SPORT 2.2 D | | 09/2014→ | | FREELANDER 2 2.2 eD4 | | 08/2010→10/2014 | |
| FREELANDER 2 2.2 SD4 | | 08/2010→10/2014 | | FREELANDER 2 2.2 TD4 | | 10/2006→10/2014 | |
| RANGE ROVER EVOQUE 2.2 D | | 06/2011→ | | | | | |
| V95083  | 0948.E5 |  | 45° | Y | H | VAG96119  | |
| 27.25 x 5.97 x 95.70 | | MB cr | | | | 41.50 x 6.03 x 10.54 | |
| V95084  | 0949.E1 |  | 45° | SS | H | | |
| 25.00 x 5.97 x 95.00 | | MD + MB cr | | | | | |

14  **86.00**

| | | | | | | | |
|---|----------|---|------------------|--------------------|--------|---|----------------|
| ZSD-422 | 2198cc | 4 Cyl. | 16 Valves | 90-110kW/122-150PS | Diesel | | TD31976 |
| DEFENDER 2.2 Td4 | | 08/2011→02/2016 | | | | | |
| V94378  | LR004375 |  | 30° | Y | H | VAG96368  | |
| 29.80 x 7.00 x 122.20 | | MD + MB cr | | | | 51.50 x 6.97 x 12.07 | |
| V95140  | LR004401 |  | 45° | SS | H | | |
| 25.75 x 6.93 x 121.85 | | MD + MB cr | | | | | |

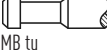
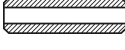
15  **88.86**

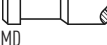
| | | | | | | | |
|---|--------|---|------------------|-------------------|--------|---|----------------|
| 11 D | 3528cc | V8 Cyl. | 16 Valves | 86-97kW/117-132PS | Petrol | | TD22941 |
| DEFENDER 3.5 | | 09/1990→08/1993 | | RANGE ROVER I 3.5 | | 10/1969→08/1991 | |
| RANGE ROVER I 3.5 Vogue | | 08/1981→09/1990 | | | | | |
| V34939  | 614088 |  | 45° | | H | VAG50919  | |
| 40.00 x 8.67 x 116.97 | | MB tu | | | | 65.90 x 8.73 x 15.14 | |
| V34940  | 614089 |  | 45° | | | | |
| 34.48 x 8.65 x 116.95 | | MD | | | | | |

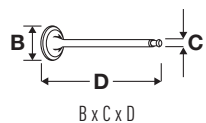

OE

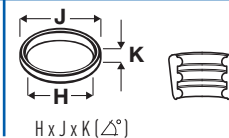
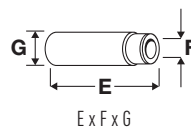
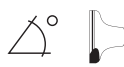

16 88.86

| | | | | | | |
|------|--------|---------|-----------|---------------------|--------|---------|
| 22 D | 3528cc | V8 Cyl. | 16 Valves | 100-122kW/136-166PS | Petrol | TD22934 |
| 24 D | 3528cc | V8 Cyl. | 16 Valves | 120kW/163PS | Petrol | TD22939 |
| 25 D | 3528cc | V8 Cyl. | 16 Valves | 120kW/163PS | Petrol | TD22940 |
| 31 D | 3528cc | V8 Cyl. | 16 Valves | 107kW/146PS | Petrol | TD22942 |

| | | | |
|-------------------|-----------------|-------------------------|-----------------|
| DEFENDER 3.5 | 09/1990→12/1998 | DISCOVERY I 3.5 | 06/1989→06/1994 |
| RANGE ROVER I 3.5 | 01/1987→09/1990 | RANGE ROVER I 3.5 Vogue | 10/1985→09/1990 |

V34940 34.48 x 8.65 x 116.95

614089

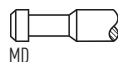

45°

VAG50919 65.90 x 8.73 x 15.14



17 89.90

| | | | | | | | |
|------------------|-----------------|------------------|-----------------|------------|--------|-------------|---------|
| ZSD-424 | 2402cc | 4 Cyl. | 16 Valves | 90kW/122PS | Diesel | Turbo, DOHC | TD31977 |
| DEFENDER 2.4 Td4 | 05/2007→02/2016 | DEFENDER 2.4 TD4 | 05/2007→02/2016 | | | | |

V94378 29.80 x 7.00 x 122.20

LR004375

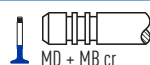

30°

Y

H

VAG96368 51.50 x 6.97 x 12.07



V95140 25.75 x 6.93 x 121.85

LR004401



45°

ss

H

18 90.47

| | | | | | | | |
|------|--------|--------|----------|-----------------|--------|-----|---------|
| 10 H | 2286cc | 4 Cyl. | 8 Valves | 51-52kW/69-71PS | Petrol | OHV | TD25821 |
| 11 H | 2286cc | 4 Cyl. | 8 Valves | 51-57kW/69-78PS | Petrol | OHV | TD25824 |

| | | | |
|------------|-----------------|------------|-----------------|
| 88/109 2.3 | 09/1961→12/1986 | 90/110 2.3 | 01/1984→08/1987 |
|------------|-----------------|------------|-----------------|

V3195 44.68 x 7.90 x 111.66

277593

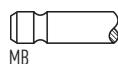

30°

VAG50948 51.00 x 7.95 x 13.55



V34365 35.12 x 8.67 x 115.58

ERC7151

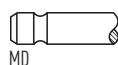

45°

VAG50949 50.00 x 8.76 x 14.36

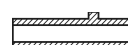

19 90.47

| | | | | | | | |
|--------------|-----------------|--------------|-----------------|-----------------|--------|-----|---------|
| 10 J | 2286cc | 4 Cyl. | 8 Valves | 46-51kW/63-69PS | Diesel | OHV | TD25822 |
| 88/109 2.3 D | 09/1963→12/1986 | 90/110 2.3 D | 06/1984→08/1987 | | | | |

V3085 39.27 x 7.90 x 116.69

527240



45°

VAG92158 46.50 x 8.00 x 13.50



VAG92159 57.00 x 8.76 x 14.30



20 90.47

| | | | | | | | |
|---------------|--------|--------|----------|-------------------|--------|-------|---------|
| 11 L (200Tdi) | 2495cc | 4 Cyl. | 8 Valves | 79-85kW/107-116PS | Diesel | Turbo | TD20407 |
| 12 L (200Tdi) | 2495cc | 4 Cyl. | 8 Valves | 83kW/113PS | Diesel | Turbo | TD20408 |
| 14 L (200Tdi) | 2495cc | 4 Cyl. | 8 Valves | 83-89kW/113-121PS | Diesel | Turbo | TD19655 |

| | | | |
|-----------------------|-----------------|----------------------|-----------------|
| DEFENDER 2.5 TD | 08/1998→12/2005 | DEFENDER 2.5 TDI | 08/1990→12/2001 |
| DISCOVERY I 2.5 TDI | 10/1989→10/1998 | RANGE ROVER I 2.5 TD | 10/1989→04/1994 |
| RANGE ROVER I 2.5 TDi | 09/1991→04/1994 | | |

V91240 39.50 x 7.98 x 116.50

ERR1157

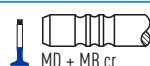

30°

H

VAG92324 49.00 x 8.02 x 14.08

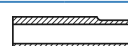

V91241 36.65 x 7.96 x 116.50

ERR1156



45°

ss

H



OE

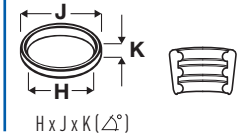
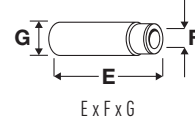
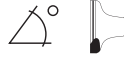

21 **90.47**

| | | | | | | | |
|---------------|--------|-----------------|-----------------|----------------|--------|-------------------|----------------|
| 12 J | 2495cc | 4 Cyl. | 8 Valves | 51kW/69PS | Diesel | Turbo, OHV | TD24370 |
| 19 J | 2495cc | 4 Cyl. | 8 Valves | 63kW/86PS | Diesel | Turbo, OHV | TD24369 |
| 88/109 2.5 D | | 11/1979→05/1984 | | 90/110 2.5 D | | 09/1983→07/1990 | |
| 90/110 2.5 TD | | 09/1986→07/1990 | | DEFENDER 2.5 D | | 09/1990→09/2001 | |

V91255 ■
39.27 x 7.91 x 116.50

ERC9739

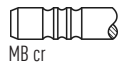

45°

H

VAG92158 ■
46.50 x 8.00 x 13.50

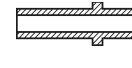

V91256 ■
33.50 x 8.69 x 117.25

ERC9738

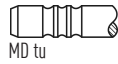

45°

VAG92159 ■
57.00 x 8.76 x 14.30

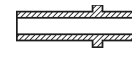

22 **90.47**

| | | | | | | | |
|----------------------|--------|-----------------|-----------------|----------------------|--------|-----------------|----------------|
| 16 L (300Tdi) | 2495cc | 4 Cyl. | 8 Valves | 83kW/113PS | Diesel | | TD20411 |
| 17 L (300Tdi) | 2495cc | 4 Cyl. | 8 Valves | 83-90kW/113-122PS | Diesel | | TD20412 |
| 19 L (300Tdi) | 2495cc | 4 Cyl. | 8 Valves | 81-90kW/110-122PS | Diesel | Turbo | TD20409 |
| 21 L (300TDi) | 2495cc | 4 Cyl. | 8 Valves | 83-89kW/113-121PS | Diesel | Turbo | TD20410 |
| 22 L (300Tdi) | 2495cc | 4 Cyl. | 8 Valves | 83-92kW/113-125PS | Diesel | | TD20413 |
| 23 L (300Tdi) | 2495cc | 4 Cyl. | 8 Valves | 83-86kW/113-117PS | Diesel | Turbo | TD20406 |
| DEFENDER 2.5 TD | | 08/1998→12/2005 | | DEFENDER 2.5 TDI | | 08/1990→12/2001 | |
| DISCOVERY I 2.5 D | | 06/1993→10/1998 | | DISCOVERY I 2.5 TDI | | 10/1989→10/1998 | |
| RANGE ROVER I 2.5 TD | | 10/1989→04/1994 | | RANGE ROVER II 2.5 D | | 08/1994→03/2002 | |

V91988 ■
39.05 x 7.98 x 116.70

ERR3777

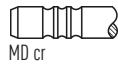

30°

VAG92324 ■ ■ ■
49.00 x 8.02 x 14.08



V91241 ■
36.65 x 7.96 x 116.50

ERR1156



45°

SS

H

23 **90.47**

| | | | | | | | |
|-------------|--------|-----------------|-----------------|--------------|--------|-----------------|----------------|
| 17 H | 2495cc | 4 Cyl. | 8 Valves | 61kW/83PS | Petrol | OHV | TD19656 |
| 90/110 2.5 | | 09/1985→07/1990 | | DEFENDER 2.5 | | 09/1990→12/1994 | |

V91169 ■
44.58 x 7.91 x 111.66

ETC4067

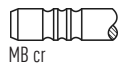

30°

H

VAG50948 ■
51.00 x 7.95 x 13.55

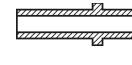

V91170 ■
34.43 x 8.70 x 111.40

ETC5866

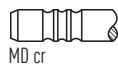

45°

SS

VAG50949 ■
50.00 x 8.76 x 14.36

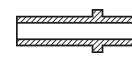

24 **92.00**

| | | | | | | | |
|---------------------|--------|-----------------|------------------|---------------------|--------|-------------|----------------|
| M62 B44 | 4398cc | V8 Cyl. | 32 Valves | 210-212kW/286-288PS | Petrol | DOHC | TD29227 |
| RANGE ROVER III 4.4 | | 03/2002→12/2005 | | | | | |

V94091 ■
35.00 x 6.00 x 104.10

11 34 1 736 549

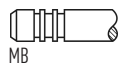

45°

H

VAG96043B ■ ■ ■
43.50 x 6.01 x 12.56



V94092 ■
30.50 x 6.00 x 103.60

11 34 1 741 231



45°

SS

H

VAG96044B ■ ■ ■
43.50 x 6.00 x 12.77



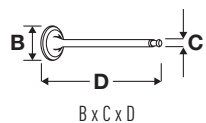

OE

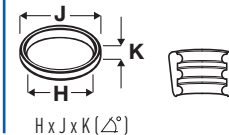
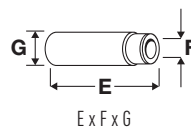

25 94.00

| | | | | | | |
|--------------------|-----------------|---------|------------------|---------------------|--------|-----------------|
| 42 D | 3947cc | V8 Cyl. | 16 Valves | 136-142kW/185-193PS | Petrol | TD22932 |
| RANGE ROVER I 3.9 | 09/1992→12/1995 | | | RANGE ROVER II 3.9 | | 07/1994→03/2002 |
| RANGE ROVER II 4.0 | 01/1995→03/2002 | | | | | |

V91485 ■
39.90 x 8.70 x 117.00

LGH000030

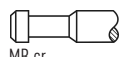

MB cr

45°

H

VAG92385 ■ ■
62.00 x 8.73 x 15.14

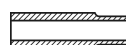

V91486 ■
34.40 x 8.70 x 117.00

ERR1781

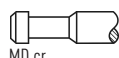

MD cr

45°

SS

26 94.00

| | | | | | | | |
|-------------------|-----------------|---------|------------------|-----------------------------|--------|-----------------|----------------|
| 40 D | 4275cc | V8 Cyl. | 16 Valves | 147-149kW/200-203PS | Petrol | OHV | TD22935 |
| RANGE ROVER I 4.3 | 09/1992→04/1996 | | | RANGE ROVER I 4.3 Vogue LSE | | 09/1992→07/1994 | |

V91485 ■
39.90 x 8.70 x 117.00

LGH000030

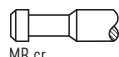

MB cr

45°

H

VAG92385 ■ ■
62.00 x 8.73 x 15.14

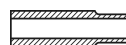

V91486 ■
34.40 x 8.70 x 117.00

ERR1781

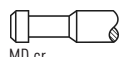

MD cr

45°

SS

27 94.00

| | | | | | | | |
|------------------|-----------------|---------|------------------|---------------------|--------|-----------------|----------------|
| 46 D | 4553cc | V8 Cyl. | 16 Valves | 165-168kW/224-228PS | Petrol | | TD22931 |
| DISCOVERY II 4.6 | 09/1999→12/2002 | | | RANGE ROVER II 4.6 | | 07/1994→03/2002 | |

V91485 ■
39.90 x 8.70 x 117.00

LGH000030

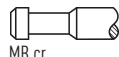

MB cr

45°

H

VAG92385 ■ ■
62.00 x 8.73 x 15.14



V91486 ■
34.40 x 8.70 x 117.00

ERR1781

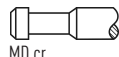

MD cr

45°

SS

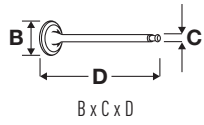

OE

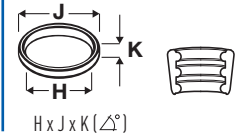
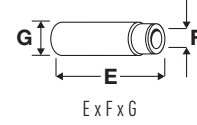
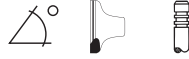

1



86.00

| | | | | | | | |
|------------|-----------------|--------|------------|---------------------|-----------------|-------------|---------|
| 2AD-FHV | 2231cc | 4 Cyl. | 16 Valves | 130kW/177PS | Diesel | Turbo, DOHC | TD18734 |
| 2AD-FTV | 2231cc | 4 Cyl. | 16 Valves | 100-110kW/136-150PS | Diesel | Turbo, DOHC | TD24506 |
| IS II 200d | 07/2010→07/2012 | | IS II 220d | | 08/2005→07/2012 | | |

V95053 ■
30.20 x 6.00 x 104.35

13711-OR010

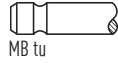

MB tu

45°

H

VAG96357 ■ ■ ■
40.60 x 6.00 x 11.04



V95054 ■
27.00 x 6.00 x 104.00

13715-OR010



MD + MB tu

45°

H



OE

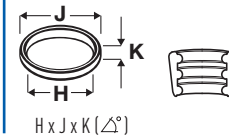
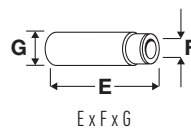

1 79.00

| | | | | | | | |
|---------------|--------|-----------|------------------|--------------------|--------|-------------|----------------|
| 1Z2-FE | 1796cc | 4 Cyl. | 16 Valves | 99-100kW/135-136PS | Petrol | DOHC | TD20080 |
| ELISE 1.8 | | 10/2003-> | | | | | |

V80018 ■
32.00 x 5.50 x 88.70

13711-22030

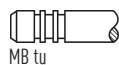

45°

VAG96110 ■ ■ ■
34.50 x 5.50 x 10.36

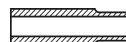

V80019 ■
27.50 x 5.50 x 88.70

13715-22030

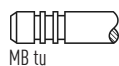

45°

2 80.00

| | | | | | | | |
|---------------|--------|------------------|------------------|-------------------|--------|-------------|----------------|
| 18 K4F | 1796cc | 4 Cyl. | 16 Valves | 85-90kW/116-122PS | Petrol | DOHC | TD18865 |
| ELISE 1.8 | | 08/1995->08/2005 | | | | | |

V91209 ■ ■
27.80 x 5.97 x 89.60

LGH10029

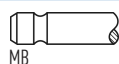

45°

H

VAG92309 ■ ■ ■
30.00 x 6.00 x 9.90

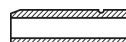

V94053 ■
24.30 x 5.96 x 90.00

LGH100820

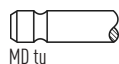

45°

SS

VAG92316 ■ ■ ■
30.00 x 6.01 x 10.14

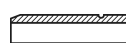

3 80.00

| | | | | | | | |
|---------------------|--------|------------------|------------------|---------------------|--------|------------------|----------------|
| 18 K4K (VVC) | 1796cc | 4 Cyl. | 16 Valves | 107-118kW/146-160PS | Petrol | DOHC | TD22926 |
| ELISE 1.8 | | 11/1998->01/2001 | | ELISE 111 S | | 03/1999->11/2000 | |

V94101 ■ ■
31.60 x 6.00 x 89.60

LGH10064

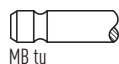

45°

H

VAG96058 ■ ■ ■
30.00 x 6.01 x 9.88

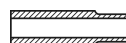

V94102 ■
27.40 x 6.00 x 90.00
->12/99

LGH10065

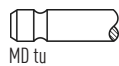

45°

V94342 ■
27.50 x 6.00 x 90.10
01/00->

LGH101360

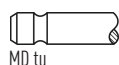

45°

4 86.00

| | | | | | | | |
|--------------------|--------|-----------|------------------|---------------------|--------|--------------------|----------------|
| Z 20 LER | 1998cc | 4 Cyl. | 16 Valves | 147-165kW/200-224PS | Petrol | Turbo, DOHC | TD24840 |
| EUROPA S 2.0 Turbo | | 07/2006-> | | | | | |

V91997 ■ ■
32.10 x 5.97 x 102.10

90412277

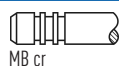

45°

H

VAG96028 ■ ■ ■
45.00 x 5.99 x 10.05

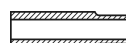





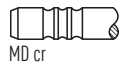

V91998 ■
29.10 x 5.96 x 92.25





90410813















45°







SS







|  |  | ccm |  |  |  |  |
|---|---|------|---|---|---|---|
| D 0224 M | 102.00 | 3790 | 4 | 8 | Diesel | 1 |
| D 0224 ME | 102.00 | 3790 | 4 | 8 | Diesel | 1 |
| D 0224 MF | 102.00 | 3790 | 4 | 8 | Diesel | 1 |
| D 0226 M | 102.00 | 5687 | 6 | 12 | Diesel | 2 |
| D 0226 MC | 102.00 | 5687 | 6 | 12 | Diesel | 2 |
| D 0226 MCFO/170 | 102.00 | 5687 | 6 | 12 | Diesel | 2 |
| D 0226 ME | 102.00 | 5687 | 6 | 12 | Diesel | 2 |
| D 0226 MF | 102.00 | 5687 | 6 | 12 | Diesel | 2 |
| D 0226 MFA | 102.00 | 5687 | 6 | 12 | Diesel | 2 |
| D 0226 MFM | 102.00 | 5687 | 6 | 12 | Diesel | 2 |
| D 0226 MFO | 102.00 | 5687 | 6 | 12 | Diesel | 2 |
| D 0226 MH | 102.00 | 5687 | 6 | 12 | Diesel | 2 |
| D 0226 MK | 102.00 | 5687 | 6 | 12 | Diesel | 2 |
| D 0226 MKF | 102.00 | 5687 | 6 | 12 | Diesel | 2 |
| D 0226 MKF/170 | 102.00 | 5687 | 6 | 12 | Diesel | 2 |
| D 0226 MKFA | 102.00 | 5687 | 6 | 12 | Diesel | 2 |
| D 0226 MKFO | 102.00 | 5687 | 6 | 12 | Diesel | 2 |
| D 0226 MKH | 102.00 | 5687 | 6 | 12 | Diesel | 2 |
| D 0226 ML | 102.00 | 5687 | 6 | 12 | Diesel | 2 |
| D 0226 MLE | 102.00 | 5687 | 6 | 12 | Diesel | 2 |
| D 0226 MT | 102.00 | 5687 | 6 | 12 | Diesel | 2 |
| D 0226 MTE | 102.00 | 5687 | 6 | 12 | Diesel | 2 |
| D 0824 FL01 | 108.00 | 4580 | 4 | 8 | Diesel | 3 |
| D 0824 GF | 108.00 | 4580 | 4 | 8 | Diesel | 3 |
| D 0824 GF01 | 108.00 | 4580 | 4 | 8 | Diesel | 3 |
| D 0824 GF02 | 108.00 | 4580 | 4 | 8 | Diesel | 3 |
| D 0824 GF03 | 108.00 | 4580 | 4 | 8 | Diesel | 3 |
| D 0824 GF04 | 108.00 | 4580 | 4 | 8 | Diesel | 3 |
| D 0824 LF01 | 108.00 | 4580 | 4 | 8 | Diesel | 3 |
| D 0824 LF02 | 108.00 | 4580 | 4 | 8 | Diesel | 3 |
| D 0824 LF03 | 108.00 | 4580 | 4 | 8 | Diesel | 3 |
| D 0824 LF04 | 108.00 | 4580 | 4 | 8 | Diesel | 3 |
| D 0824 LF05 | 108.00 | 4580 | 4 | 8 | Diesel | 3 |
| D 0824 LF06 | 108.00 | 4580 | 4 | 8 | Diesel | 3 |
| D 0824 LF07 | 108.00 | 4580 | 4 | 8 | Diesel | 3 |
| D 0824 LF08 | 108.00 | 4580 | 4 | 8 | Diesel | 3 |
| D 0824 LF09 | 108.00 | 4580 | 4 | 8 | Diesel | 3 |
| D 0824 LF10 | 108.00 | 4580 | 4 | 8 | Diesel | 3 |
| D 0824 LFG01 | 108.00 | 4580 | 4 | 8 | Diesel | 3 |
| D 0824 LFL01 | 108.00 | 4580 | 4 | 8 | Diesel | 3 |
| D 0824 LFL02 | 108.00 | 4580 | 4 | 8 | Diesel | 3 |
| D 0824 LFL03 | 108.00 | 4580 | 4 | 8 | Diesel | 3 |
| D 0824 LFL04 | 108.00 | 4580 | 4 | 8 | Diesel | 3 |
| D 0824 LFL05 | 108.00 | 4580 | 4 | 8 | Diesel | 3 |
| D 0824 LFL06 | 108.00 | 4580 | 4 | 8 | Diesel | 3 |
| D 0824 LFL07 | 108.00 | 4580 | 4 | 8 | Diesel | 3 |
| D 0824 LFL08 | 108.00 | 4580 | 4 | 12 | Diesel | 3 |
| D 0824 LFL09 | 108.00 | 4580 | 4 | 8 | Diesel | 3 |
| D 0824 LFL10 | 108.00 | 4580 | 4 | 8 | Diesel | 3 |
| D 0824 LFO | 108.00 | 4580 | 4 | 8 | Diesel | 3 |
| D 0824 LFO01 | 108.00 | 4580 | 4 | 8 | Diesel | 3 |
| D 0824 LFO02 | 108.00 | 4580 | 4 | 8 | Diesel | 3 |
| D 0824 LOH01 | 108.00 | 4580 | 4 | 8 | Diesel | 3 |
| D 0824 LOH02 | 108.00 | 4580 | 4 | 8 | Diesel | 3 |
| D 0824 LOH03 | 108.00 | 4580 | 4 | 8 | Diesel | 3 |
| D 0824 LOH04 | 108.00 | 4580 | 4 | 8 | Diesel | 3 |
| D 0824 LOH05 | 108.00 | 4580 | 4 | 8 | Diesel | 3 |
| D 0824 LUE521 | 108.00 | 4580 | 4 | 8 | Diesel | 3 |
| D 0824 LUE522 | 108.00 | 4580 | 4 | 8 | Diesel | 3 |
| D 0824 LUE523 | 108.00 | 4580 | 4 | 8 | Diesel | 3 |
| D 0824 LUE524 | 108.00 | 4580 | 4 | 8 | Diesel | 3 |
| D 0826 F01 | 108.00 | 6871 | 6 | 12 | Diesel | 7 |
| D 0826 F02 | 108.00 | 6871 | 6 | 12 | Diesel | 7 |
| D 0826 FO | 108.00 | 6871 | 6 | 12 | Diesel | 7 |
| D 0826 F001 | 108.00 | 6871 | 6 | 12 | Diesel | 7 |
| D 0826 F002 | 108.00 | 6871 | 6 | 12 | Diesel | 7 |







| |  | ccm |  |  |  |  |
|----------------------|---|------|--|---|---|---|
| D 0826 FR | 108.00 | 6871 | 6 | 12 | Diesel | 7 |
| D 0826 FR01 | 108.00 | 6871 | 6 | 12 | Diesel | 7 |
| D 0826 GF | 108.00 | 6871 | 6 | 12 | Diesel | 7 |
| D 0826 GF01 | 108.00 | 6871 | 6 | 12 | Diesel | 7 |
| D 0826 GF03 | 108.00 | 6871 | 6 | 12 | Diesel | 7 |
| D 0826 GF04 | 108.00 | 6871 | 6 | 12 | Diesel | 7 |
| D 0826 GFA | 108.00 | 6871 | 6 | 12 | Diesel | 7 |
| D 0826 GFA01 | 108.00 | 6871 | 6 | 12 | Diesel | 7 |
| D 0826 GFA02 | 108.00 | 6871 | 6 | 12 | Diesel | 7 |
| D 0826 GFA03 | 108.00 | 6871 | 6 | 12 | Diesel | 7 |
| D 0826 GFA04 | 108.00 | 6871 | 6 | 12 | Diesel | 7 |
| D 0826 LE521 | 108.00 | 6871 | 6 | 12 | Diesel | 7 |
| D 0826 LE522 | 108.00 | 6871 | 6 | 12 | Diesel | 7 |
| D 0826 LE523 | 108.00 | 6871 | 6 | 12 | Diesel | 7 |
| D 0826 LE524 | 108.00 | 6871 | 6 | 12 | Diesel | 7 |
| D 0826 LE527 | 108.00 | 6871 | 6 | 12 | Diesel | 7 |
| D 0826 LE530 | 108.00 | 6871 | 6 | 12 | Diesel | 7 |
| D 0826 LE531 | 108.00 | 6871 | 6 | 12 | Diesel | 7 |
| D 0826 LF/217/Silent | 108.00 | 6870 | 6 | 12 | Diesel | 6 |
| D 0826 LF01 | 108.00 | 6871 | 6 | 12 | Diesel | 7 |
| D 0826 LF02 | 108.00 | 6871 | 6 | 12 | Diesel | 7 |
| D 0826 LF04 | 108.00 | 6871 | 6 | 12 | Diesel | 7 |
| D 0826 LF05 | 108.00 | 6871 | 6 | 12 | Diesel | 7 |
| D 0826 LF06 | 108.00 | 6871 | 6 | 12 | Diesel | 7 |
| D 0826 LF07 | 108.00 | 6871 | 6 | 12 | Diesel | 7 |
| D 0826 LF08 | 108.00 | 6871 | 6 | 12 | Diesel | 7 |
| D 0826 LF09 | 108.00 | 6871 | 6 | 12 | Diesel | 7 |
| D 0826 LF11 | 108.00 | 6871 | 6 | 12 | Diesel | 7 |
| D 0826 LF12 | 108.00 | 6871 | 6 | 12 | Diesel | 7 |
| D 0826 LF13 | 108.00 | 6871 | 6 | 12 | Diesel | 7 |
| D 0826 LF15 | 108.00 | 6871 | 6 | 12 | Diesel | 7 |
| D 0826 LF17 | 108.00 | 6871 | 6 | 12 | Diesel | 7 |
| D 0826 LF18 | 108.00 | 6871 | 6 | 12 | Diesel | 7 |
| D 0826 LFG01 | 108.00 | 6871 | 6 | 12 | Diesel | 7 |
| D 0826 LFG02 | 108.00 | 6871 | 6 | 12 | Diesel | 7 |
| D 0826 LFG06 | 108.00 | 6871 | 6 | 12 | Diesel | 7 |
| D 0826 LFG15 | 108.00 | 6871 | 6 | 12 | Diesel | 7 |
| D 0826 LFG16 | 108.00 | 6871 | 6 | 12 | Diesel | 7 |
| D 0826 LFL | 108.00 | 6871 | 6 | 12 | Diesel | 7 |
| D 0826 LFL02 | 108.00 | 6871 | 6 | 12 | Diesel | 7 |
| D 0826 LFL03 | 108.00 | 6871 | 6 | 12 | Diesel | 7 |
| D 0826 LFL06 | 108.00 | 6871 | 6 | 12 | Diesel | 7 |
| D 0826 LFL07 | 108.00 | 6871 | 6 | 12 | Diesel | 7 |
| D 0826 LFL08 | 108.00 | 6871 | 6 | 12 | Diesel | 7 |
| D 0826 LFL09 | 108.00 | 6871 | 6 | 12 | Diesel | 7 |
| D 0826 LFL10 | 108.00 | 6871 | 6 | 12 | Diesel | 7 |
| D 0826 LOH01 | 108.00 | 6871 | 6 | 12 | Diesel | 7 |
| D 0826 LOH02 | 108.00 | 6871 | 6 | 12 | Diesel | 7 |
| D 0826 LOH03 | 108.00 | 6871 | 6 | 12 | Diesel | 7 |
| D 0826 LOH04 | 108.00 | 6871 | 6 | 12 | Diesel | 7 |
| D 0826 LOH05 | 108.00 | 6871 | 6 | 12 | Diesel | 7 |
| D 0826 LOH06 | 108.00 | 6871 | 6 | 12 | Diesel | 7 |
| D 0826 LOH07 | 108.00 | 6871 | 6 | 12 | Diesel | 7 |
| D 0826 LOH08 | 108.00 | 6871 | 6 | 12 | Diesel | 7 |
| D 0826 LOH09 | 108.00 | 6871 | 6 | 12 | Diesel | 7 |
| D 0826 LOH10 | 108.00 | 6871 | 6 | 12 | Diesel | 7 |
| D 0826 LOH11 | 108.00 | 6871 | 6 | 12 | Diesel | 7 |
| D 0826 LOH12 | 108.00 | 6871 | 6 | 12 | Diesel | 7 |
| D 0826 LOH13 | 108.00 | 6871 | 6 | 12 | Diesel | 7 |
| D 0826 LOH15 | 108.00 | 6871 | 6 | 12 | Diesel | 7 |
| D 0826 LOH17 | 108.00 | 6871 | 6 | 12 | Diesel | 7 |
| D 0826 LOH18 | 108.00 | 6871 | 6 | 12 | Diesel | 7 |
| D 0826 LOH19 | 108.00 | 6871 | 6 | 12 | Diesel | 7 |
| D 0826 LUH | 108.00 | 6870 | 6 | 12 | Diesel | 6 |
| D 0826 LUH/213 | 108.00 | 6871 | 6 | 12 | Diesel | 7 |
| D 0826 LUH01 | 108.00 | 6871 | 6 | 12 | Diesel | 7 |





|  |  | ccm |  |  |  |  | |
|---|---|--------|---|---|---|---|---|
| D 0826 LUH02 | | 108.00 | 6871 | 6 | 12 | Diesel | 7 |
| D 0826 LUH03 | | 108.00 | 6871 | 6 | 12 | Diesel | 7 |
| D 0826 LUH04 | | 108.00 | 6871 | 6 | 12 | Diesel | 7 |
| D 0826 LUH05 | | 108.00 | 6871 | 6 | 12 | Diesel | 7 |
| D 0826 LUH06 | | 108.00 | 6871 | 6 | 12 | Diesel | 7 |
| D 0826 LUH08 | | 108.00 | 6871 | 6 | 12 | Diesel | 7 |
| D 0826 LUH10 | | 108.00 | 6871 | 6 | 12 | Diesel | 7 |
| D 0826 LUH12 | | 108.00 | 6870 | 6 | 12 | Diesel | 6 |
| D 0826 LUH13 | | 108.00 | 6871 | 6 | 12 | Diesel | 7 |
| D 0826 OH | | 108.00 | 6871 | 6 | 12 | Diesel | 7 |
| D 0826 OH01 | | 108.00 | 6871 | 6 | 12 | Diesel | 7 |
| D 0826 OH02 | | 108.00 | 6871 | 6 | 12 | Diesel | 7 |
| D 0826 OH03 | | 108.00 | 6871 | 6 | 12 | Diesel | 7 |
| D 0826 TE520 | | 108.00 | 6596 | 6 | 12 | Diesel | 5 |
| D 0826 TF | | 108.00 | 6596 | 6 | 12 | Diesel | 5 |
| D 0826 TOH | | 108.00 | 6596 | 6 | 12 | Diesel | 5 |
| D 0826 TOH01 | | 108.00 | 6596 | 6 | 12 | Diesel | 5 |
| D 0834 LFL01 | | 108.00 | 4580 | 4 | 8 | Diesel | 3 |
| D 0834 LFL02 | | 108.00 | 4580 | 4 | 8 | Diesel | 3 |
| D 0834 LFL03 | | 108.00 | 4580 | 4 | 8 | Diesel | 3 |
| D 0834 LFL04 | | 108.00 | 4580 | 4 | 8 | Diesel | 3 |
| D 0834 LFL40 | | 108.00 | 4580 | 4 | 16 | Diesel | 4 |
| D 0834 LFL41 | | 108.00 | 4580 | 4 | 16 | Diesel | 4 |
| D 0834 LFL42 | | 108.00 | 4580 | 4 | 16 | Diesel | 4 |
| D 0834 LFL50 | | 108.00 | 4580 | 4 | 16 | Diesel | 4 |
| D 0834 LFL51 | | 108.00 | 4580 | 4 | 16 | Diesel | 4 |
| D 0834 LFL52 | | 108.00 | 4580 | 4 | 16 | Diesel | 4 |
| D 0834 LFL53 | | 108.00 | 4580 | 4 | 16 | Diesel | 4 |
| D 0834 LFL54 | | 108.00 | 4580 | 4 | 16 | Diesel | 4 |
| D 0834 LFL55 | | 108.00 | 4580 | 4 | 16 | Diesel | 4 |
| D 0834 LFL60 | | 108.00 | 4580 | 4 | 16 | Diesel | 4 |
| D 0834 LFL61 | | 108.00 | 4580 | 4 | 16 | Diesel | 4 |
| D 0834 LFL62 | | 108.00 | 4580 | 4 | 16 | Diesel | 4 |
| D 0834 LFL63 | | 108.00 | 4580 | 4 | 16 | Diesel | 4 |
| D 0834 LFL64 | | 108.00 | 4580 | 4 | 16 | Diesel | 4 |
| D 0834 LFL65 | | 108.00 | 4580 | 4 | 16 | Diesel | 4 |
| D 0834 LOH01 | | 108.00 | 4580 | 4 | 16 | Diesel | 3 |
| D 0834 LOH02 | | 108.00 | 4580 | 4 | 16 | Diesel | 3 |
| D 0834 LOH03 | | 108.00 | 4580 | 4 | 16 | Diesel | 3 |
| D 0834 LOH40 | | 108.00 | 4580 | 4 | 16 | Diesel | 4 |
| D 0834 LOH50 | | 108.00 | 4580 | 4 | 16 | Diesel | 4 |
| D 0834 LOH51 | | 108.00 | 4580 | 4 | 16 | Diesel | 4 |
| D 0834 LOH52 | | 108.00 | 4580 | 4 | 16 | Diesel | 4 |
| D 0834 LOH53 | | 108.00 | 4580 | 4 | 16 | Diesel | 4 |
| D 0834 LOH60 | | 108.00 | 4580 | 4 | 16 | Diesel | 4 |
| D 0834 LOH61 | | 108.00 | 4580 | 4 | 16 | Diesel | 4 |
| D 0836 LF01 | | 108.00 | 6871 | 6 | 12 | Diesel | 7 |
| D 0836 LF02 | | 108.00 | 6871 | 6 | 12 | Diesel | 7 |
| D 0836 LF03 | | 108.00 | 6871 | 6 | 12 | Diesel | 7 |
| D 0836 LF04 | | 108.00 | 6871 | 6 | 12 | Diesel | 7 |
| D 0836 LF05 | | 108.00 | 6871 | 6 | 12 | Diesel | 7 |
| D 0836 LF41 | | 108.00 | 6871 | 6 | 24 | Diesel | 8 |
| D 0836 LF44 | | 108.00 | 6871 | 6 | 24 | Diesel | 8 |
| D 0836 LFG50 | | 108.00 | 6871 | 6 | 24 | Diesel | 8 |
| D 0836 LFL01 | | 108.00 | 6871 | 6 | 12 | Diesel | 7 |
| D 0836 LFL02 | | 108.00 | 6871 | 6 | 12 | Diesel | 7 |
| D 0836 LFL03 | | 108.00 | 6871 | 6 | 12 | Diesel | 7 |
| D 0836 LFL04 | | 108.00 | 6871 | 6 | 12 | Diesel | 7 |
| D 0836 LFL05 | | 108.00 | 6871 | 6 | 12 | Diesel | 7 |
| D 0836 LFL06 | | 108.00 | 6871 | 6 | 12 | Diesel | 7 |
| D 0836 LFL40 | | 108.00 | 6871 | 6 | 24 | Diesel | 8 |
| D 0836 LFL41 | | 108.00 | 6871 | 6 | 24 | Diesel | 8 |
| D 0836 LFL44 | | 108.00 | 6871 | 6 | 24 | Diesel | 8 |
| D 0836 LFL50 | | 108.00 | 6871 | 6 | 24 | Diesel | 8 |
| D 0836 LFL51 | | 108.00 | 6871 | 6 | 24 | Diesel | 8 |
| D 0836 LFL52 | | 108.00 | 6871 | 6 | 24 | Diesel | 8 |







|  |  | ccm |  |  |  |  |
|---|---|-------|--|---|---|---|
| D 0836 LFL53 | 108.00 | 6871 | 6 | 24 | Diesel | 8 |
| D 0836 LFL54 | 108.00 | 6871 | 6 | 24 | Diesel | 8 |
| D 0836 LFL55 | 108.00 | 6871 | 6 | 24 | Diesel | 8 |
| D 0836 LFL60 | 108.00 | 6871 | 6 | 24 | Diesel | 8 |
| D 0836 LFL61 | 108.00 | 6871 | 6 | 24 | Diesel | 8 |
| D 0836 LFL62 | 108.00 | 6871 | 6 | 24 | Diesel | 8 |
| D 0836 LFL63 | 108.00 | 6871 | 6 | 24 | Diesel | 8 |
| D 0836 LFL64 | 108.00 | 6871 | 6 | 24 | Diesel | 8 |
| D 0836 LFL65 | 108.00 | 6871 | 6 | 24 | Diesel | 8 |
| D 0836 LOH01 | 108.00 | 6871 | 6 | 12 | Diesel | 7 |
| D 0836 LOH02 | 108.00 | 6871 | 6 | 12 | Diesel | 7 |
| D 0836 LOH03 | 108.00 | 6871 | 6 | 12 | Diesel | 7 |
| D 0836 LOH40 | 108.00 | 6871 | 6 | 24 | Diesel | 8 |
| D 0836 LOH41 | 108.00 | 6871 | 6 | 24 | Diesel | 8 |
| D 0836 LOH51 | 108.00 | 6871 | 6 | 24 | Diesel | 8 |
| D 0836 LOH52 | 108.00 | 6871 | 6 | 24 | Diesel | 8 |
| D 0836 LOH55 | 108.00 | 6871 | 6 | 24 | Diesel | 8 |
| D 0836 LOH56 | 108.00 | 6871 | 6 | 24 | Diesel | 8 |
| D 0836 LOH60 | 108.00 | 6871 | 6 | 24 | Diesel | 8 |
| D 0836 LOH61 | 108.00 | 6871 | 6 | 24 | Diesel | 8 |
| D 0836 LOH62 | 108.00 | 6871 | 6 | 24 | Diesel | 8 |
| D 0836 LOH63 | 108.00 | 6871 | 6 | 24 | Diesel | 8 |
| D 0836 LOH64 | 108.00 | 6871 | 6 | 24 | Diesel | 8 |
| D 0836 LOH65 | 108.00 | 6871 | 6 | 24 | Diesel | 8 |
| D 0836 LUH01 | 108.00 | 6871 | 6 | 24 | Diesel | 7 |
| D 0836 LUH02 | 108.00 | 6871 | 6 | 24 | Diesel | 7 |
| D 0836 LUH40 | 108.00 | 6871 | 6 | 24 | Diesel | 8 |
| D 0836 LUH41 | 108.00 | 6871 | 6 | 24 | Diesel | 8 |
| D 0836 LUH50 | 108.00 | 6871 | 6 | 24 | Diesel | 8 |
| D 2066 LF01 | 120.00 | 10518 | 6 | 24 | Diesel | 9 |
| D 2066 LF02 | 120.00 | 10518 | 6 | 24 | Diesel | 9 |
| D 2066 LF03 | 120.00 | 10518 | 6 | 24 | Diesel | 9 |
| D 2066 LF04 | 120.00 | 10518 | 6 | 24 | Diesel | 9 |
| D 2066 LF06 | 120.00 | 10518 | 6 | 24 | Diesel | 9 |
| D 2066 LF07 | 120.00 | 10518 | 6 | 24 | Diesel | 9 |
| D 2066 LF11 | 120.00 | 10518 | 6 | 24 | Diesel | 9 |
| D 2066 LF12 | 120.00 | 10518 | 6 | 24 | Diesel | 9 |
| D 2066 LF13 | 120.00 | 10518 | 6 | 24 | Diesel | 9 |
| D 2066 LF14 | 120.00 | 10518 | 6 | 24 | Diesel | 9 |
| D 2066 LF17 | 120.00 | 10518 | 6 | 24 | Diesel | 9 |
| D 2066 LF18 | 120.00 | 10518 | 6 | 24 | Diesel | 9 |
| D 2066 LF19 | 120.00 | 10518 | 6 | 24 | Diesel | 9 |
| D 2066 LF20 | 120.00 | 10518 | 6 | 24 | Diesel | 9 |
| D 2066 LF21 | 120.00 | 10518 | 6 | 24 | Diesel | 9 |
| D 2066 LF22 | 120.00 | 10518 | 6 | 24 | Diesel | 9 |
| D 2066 LF23 | 120.00 | 10518 | 6 | 24 | Diesel | 9 |
| D 2066 LF24 | 120.00 | 10518 | 6 | 24 | Diesel | 9 |
| D 2066 LF25 | 120.00 | 10518 | 6 | 24 | Diesel | 9 |
| D 2066 LF26 | 120.00 | 10518 | 6 | 24 | Diesel | 9 |
| D 2066 LF27 | 120.00 | 10518 | 6 | 24 | Diesel | 9 |
| D 2066 LF28 | 120.00 | 10518 | 6 | 24 | Diesel | 9 |
| D 2066 LF29 | 120.00 | 10518 | 6 | 24 | Diesel | 9 |
| D 2066 LF30 | 120.00 | 10518 | 6 | 24 | Diesel | 9 |
| D 2066 LF31 | 120.00 | 10518 | 6 | 24 | Diesel | 9 |
| D 2066 LF32 | 120.00 | 10518 | 6 | 24 | Diesel | 9 |
| D 2066 LF33 | 120.00 | 10518 | 6 | 24 | Diesel | 9 |
| D 2066 LF35 | 120.00 | 10518 | 6 | 24 | Diesel | 9 |
| D 2066 LF36 | 120.00 | 10518 | 6 | 24 | Diesel | 9 |
| D 2066 LF37 | 120.00 | 10518 | 6 | 24 | Diesel | 9 |
| D 2066 LF38 | 120.00 | 10518 | 6 | 24 | Diesel | 9 |
| D 2066 LF39 | 120.00 | 10518 | 6 | 24 | Diesel | 9 |
| D 2066 LF40 | 120.00 | 10518 | 6 | 24 | Diesel | 9 |
| D 2066 LF41 | 120.00 | 10518 | 6 | 24 | Diesel | 9 |
| D 2066 LF42 | 120.00 | 10518 | 6 | 24 | Diesel | 9 |
| D 2066 LF43 | 120.00 | 10518 | 6 | 24 | Diesel | 9 |
| D 2066 LOH01 | 120.00 | 10518 | 6 | 24 | Diesel | 9 |

|  |  | ccm |  |  |  |  |
|---|---|-------|---|---|---|---|
| D 2066 LOH02 | 120.00 | 10518 | 6 | 24 | Diesel | 9 |
| D 2066 LOH03 | 120.00 | 10518 | 6 | 24 | Diesel | 9 |
| D 2066 LOH04 | 120.00 | 10518 | 6 | 24 | Diesel | 9 |
| D 2066 LOH05 | 120.00 | 10518 | 6 | 24 | Diesel | 9 |
| D 2066 LOH06 | 120.00 | 10518 | 6 | 24 | Diesel | 9 |
| D 2066 LOH07 | 120.00 | 10518 | 6 | 24 | Diesel | 9 |
| D 2066 LOH08 | 120.00 | 10518 | 6 | 24 | Diesel | 9 |
| D 2066 LOH10 | 120.00 | 10518 | 6 | 24 | Diesel | 9 |
| D 2066 LOH11 | 120.00 | 10518 | 6 | 24 | Diesel | 9 |
| D 2066 LOH12 | 120.00 | 10518 | 6 | 24 | Diesel | 9 |
| D 2066 LUH07 | 120.00 | 10518 | 6 | 24 | Diesel | 9 |
| D 2066 LUH08 | 120.00 | 10518 | 6 | 24 | Diesel | 9 |
| D 2066 LUH09 | 120.00 | 10518 | 6 | 24 | Diesel | 9 |
| D 2066 LUH11 | 120.00 | 10518 | 6 | 24 | Diesel | 9 |
| D 2066 LUH12 | 120.00 | 10518 | 6 | 24 | Diesel | 9 |
| D 2066 LUH13 | 120.00 | 10518 | 6 | 24 | Diesel | 9 |
| D 2066 LUH14 | 120.00 | 10518 | 6 | 24 | Diesel | 9 |
| D 2066 LUH15 | 120.00 | 10518 | 6 | 24 | Diesel | 9 |
| D 2066 LUH21 | 120.00 | 10518 | 6 | 24 | Diesel | 9 |
| D 2066 LUH22 | 120.00 | 10518 | 6 | 24 | Diesel | 9 |
| D 2066 LUH23 | 120.00 | 10518 | 6 | 24 | Diesel | 9 |
| D 2066 LUH24 | 120.00 | 10518 | 6 | 24 | Diesel | 9 |
| D 2530 ME | 125.00 | 15945 | 10 | 20 | Diesel | 16 |
| D 2530 MF | 125.00 | 15945 | 10 | 20 | Diesel | 16 |
| D 2530 MTE | 125.00 | 15953 | 10 | 20 | Diesel | 17 |
| D 2530 MTXF | 125.00 | 15953 | 10 | 20 | Diesel | 17 |
| D 2530 MTXF/360 | 125.00 | 15900 | 10 | 20 | Diesel | 15 |
| D 2530 MXF | 125.00 | 15945 | 10 | 20 | Diesel | 16 |
| D 2538 M | 125.00 | 12763 | 8 | 16 | Diesel | 14 |
| D 2538 ME | 125.00 | 12763 | 8 | 16 | Diesel | 14 |
| D 2538 MF | 125.00 | 12763 | 8 | 16 | Diesel | 14 |
| D 2538 MT | 125.00 | 12763 | 8 | 16 | Diesel | 14 |
| D 2538 MTE | 125.00 | 12763 | 8 | 16 | Diesel | 14 |
| D 2540 MT | 125.00 | 17426 | 10 | 20 | Diesel | 18 |
| D 2540 MTF | 125.00 | 17426 | 10 | 20 | Diesel | 18 |
| D 2542 MLE | 125.00 | 20911 | 12 | 24 | Diesel | 19 |
| D 2542 MTE | 125.00 | 20911 | 12 | 24 | Diesel | 19 |
| D 2555 M | 125.00 | 9200 | 5 | 10 | Diesel | 10 |
| D 2555 MF | 125.00 | 9200 | 5 | 10 | Diesel | 10 |
| D 2555 MX | 125.00 | 9200 | 5 | 10 | Diesel | 10 |
| D 2555 MXF | 125.00 | 9200 | 5 | 10 | Diesel | 10 |
| D 2555 MXUL | 125.00 | 9200 | 5 | 10 | Diesel | 10 |
| D 2556 M | 125.00 | 11045 | 6 | 12 | Diesel | 12 |
| D 2556 MF | 125.00 | 11045 | 6 | 12 | Diesel | 12 |
| D 2556 MTE | 125.00 | 11045 | 6 | 12 | Diesel | 12 |
| D 2556 MX | 125.00 | 11045 | 6 | 12 | Diesel | 12 |
| D 2556 MXF | 125.00 | 11045 | 6 | 12 | Diesel | 12 |
| D 2556 MXUH/240 | 125.00 | 11045 | 6 | 12 | Diesel | 12 |
| D 2565 HM | 125.00 | 9510 | 5 | 10 | Diesel | 11 |
| D 2565 M | 125.00 | 9510 | 5 | 10 | Diesel | 11 |
| D 2565 M/168 | 125.00 | 9510 | 5 | 10 | Diesel | 11 |
| D 2565 ME | 125.00 | 9510 | 5 | 10 | Diesel | 11 |
| D 2565 MF | 125.00 | 9510 | 5 | 10 | Diesel | 11 |
| D 2565 MF/168 | 125.00 | 9510 | 5 | 10 | Diesel | 11 |
| D 2565 MFR | 125.00 | 9510 | 5 | 10 | Diesel | 11 |
| D 2565 MH | 125.00 | 9510 | 5 | 10 | Diesel | 11 |
| D 2565 MK | 125.00 | 9510 | 5 | 10 | Diesel | 11 |
| D 2565 MKUL | 125.00 | 9510 | 5 | 10 | Diesel | 11 |
| D 2565 MR | 125.00 | 9510 | 5 | 10 | Diesel | 11 |
| D 2565 MT | 125.00 | 9510 | 5 | 10 | Diesel | 11 |
| D 2565 MUE | 125.00 | 9510 | 5 | 10 | Diesel | 11 |
| D 2565 MUH | 125.00 | 9510 | 5 | 10 | Diesel | 11 |
| D 2565 MUL | 125.00 | 9510 | 5 | 10 | Diesel | 11 |
| D 2566 | 125.00 | 11413 | 6 | 12 | Diesel | 13 |
| D 2566 M | 125.00 | 11413 | 6 | 12 | Diesel | 13 |
| D 2566 ME | 125.00 | 11413 | 6 | 12 | Diesel | 13 |

|  |  | ccm |  |  |  |  |
|---|---|-------|--|---|---|---|
| D 2566 MF | 125.00 | 11413 | 6 | 12 | Diesel | 13 |
| D 2566 MF/220 | 125.00 | 11413 | 6 | 12 | Diesel | 13 |
| D 2566 MFO | 125.00 | 11413 | 6 | 12 | Diesel | 13 |
| D 2566 MH | 125.00 | 11413 | 6 | 12 | Diesel | 13 |
| D 2566 MHO | 125.00 | 11413 | 6 | 12 | Diesel | 13 |
| D 2566 MK | 125.00 | 11413 | 6 | 12 | Diesel | 13 |
| D 2566 MK/280 | 125.00 | 11413 | 6 | 12 | Diesel | 13 |
| D 2566 MKF | 125.00 | 11413 | 6 | 12 | Diesel | 13 |
| D 2566 MKF/280 | 125.00 | 11413 | 6 | 12 | Diesel | 13 |
| D 2566 MKUH/320 | 125.00 | 11413 | 6 | 12 | Diesel | 13 |
| D 2566 MKUL | 125.00 | 11413 | 6 | 12 | Diesel | 13 |
| D 2566 MLUH | 125.00 | 11413 | 6 | 12 | Diesel | 13 |
| D 2566 MLUM | 125.00 | 11413 | 6 | 12 | Diesel | 13 |
| D 2566 MLUM/US | 125.00 | 11413 | 6 | 12 | Diesel | 13 |
| D 2566 MT | 125.00 | 11413 | 6 | 12 | Diesel | 13 |
| D 2566 MTE | 125.00 | 11413 | 6 | 12 | Diesel | 13 |
| D 2566 MTF | 125.00 | 11413 | 6 | 12 | Diesel | 13 |
| D 2566 MTFG | 125.00 | 11413 | 6 | 12 | Diesel | 13 |
| D 2566 MTH | 125.00 | 11413 | 6 | 12 | Diesel | 13 |
| D 2566 MTHO | 125.00 | 11413 | 6 | 12 | Diesel | 13 |
| D 2566 MTUH | 125.00 | 11413 | 6 | 12 | Diesel | 13 |
| D 2566 MUE | 125.00 | 11413 | 6 | 12 | Diesel | 13 |
| D 2566 MUH | 125.00 | 11413 | 6 | 12 | Diesel | 13 |
| D 2566 MUH/175 | 125.00 | 11413 | 6 | 12 | Diesel | 13 |
| D 2566 MUH/192 | 125.00 | 11413 | 6 | 12 | Diesel | 13 |
| D 2566 MUH/200 | 125.00 | 11413 | 6 | 12 | Diesel | 13 |
| D 2566 MUH/220 | 125.00 | 11413 | 6 | 12 | Diesel | 13 |
| D 2566 MUH/240 | 125.00 | 11413 | 6 | 12 | Diesel | 13 |
| D 2566 MUL | 125.00 | 11413 | 6 | 12 | Diesel | 13 |
| D 2566 MUM | 125.00 | 11413 | 6 | 12 | Diesel | 13 |
| D 2566 MUM/200 | 125.00 | 11413 | 6 | 12 | Diesel | 13 |
| D 2566 MUM/220 | 125.00 | 11413 | 6 | 12 | Diesel | 13 |
| D 2566 MUM/240 | 125.00 | 11413 | 6 | 12 | Diesel | 13 |
| D 2566 MXF | 125.00 | 11413 | 6 | 12 | Diesel | 13 |
| D 2566 UH | 125.00 | 11413 | 6 | 12 | Diesel | 13 |
| D 2566 UH/205 | 125.00 | 11413 | 6 | 12 | Diesel | 13 |
| D 2676 LF01 | 126.00 | 12419 | 6 | 24 | Diesel | 20 |
| D 2676 LF02 | 126.00 | 12419 | 6 | 24 | Diesel | 20 |
| D 2676 LF03 | 126.00 | 12419 | 6 | 24 | Diesel | 20 |
| D 2676 LF04 | 126.00 | 12419 | 6 | 24 | Diesel | 20 |
| D 2676 LF05 | 126.00 | 12419 | 6 | 24 | Diesel | 20 |
| D 2676 LF06 | 126.00 | 12419 | 6 | 24 | Diesel | 20 |
| D 2676 LF07 | 126.00 | 12419 | 6 | 24 | Diesel | 20 |
| D 2676 LF11 | 126.00 | 12419 | 6 | 24 | Diesel | 20 |
| D 2676 LF12 | 126.00 | 12419 | 6 | 24 | Diesel | 20 |
| D 2676 LF13 | 126.00 | 12419 | 6 | 24 | Diesel | 20 |
| D 2676 LF14 | 126.00 | 12419 | 6 | 24 | Diesel | 20 |
| D 2676 LF21 | 126.00 | 12419 | 6 | 24 | Diesel | 20 |
| D 2676 LOH01 | 126.00 | 12419 | 6 | 24 | Diesel | 20 |
| D 2676 LOH02 | 126.00 | 12419 | 6 | 24 | Diesel | 20 |
| D 2676 LOH03 | 126.00 | 12419 | 6 | 24 | Diesel | 20 |
| D 2676 LOH04 | 126.00 | 12419 | 6 | 24 | Diesel | 20 |
| D 2676 LOH10 | 126.00 | 12419 | 6 | 24 | Diesel | 20 |
| D 2676 LOH26 | 126.00 | 12419 | 6 | 24 | Diesel | 20 |
| D 2676 LOH27 | 126.00 | 12419 | 6 | 24 | Diesel | 20 |
| D 2676 LOH28 | 126.00 | 12419 | 6 | 24 | Diesel | 20 |
| D 2840 LE | 128.00 | 18273 | 10 | 20 | Diesel | 29 |
| D 2840 LE403 | 128.00 | 18273 | 10 | 20 | Diesel | 30 |
| D 2840 LF/460 | 128.00 | 18273 | 10 | 20 | Diesel | 29 |
| D 2840 LF01 | 128.00 | 18273 | 10 | 20 | Diesel | 30 |
| D 2840 LF03 | 128.00 | 18273 | 10 | 20 | Diesel | 30 |
| D 2840 LF04 | 128.00 | 18273 | 10 | 20 | Diesel | 30 |
| D 2840 LF06 | 128.00 | 18273 | 10 | 20 | Diesel | 30 |
| D 2840 LF20 | 128.00 | 18273 | 10 | 20 | Diesel | 30 |
| D 2840 LF21 | 128.00 | 18273 | 10 | 20 | Diesel | 30 |
| D 2840 LF25 | 128.00 | 18273 | 10 | 20 | Diesel | 31 |

|  |  | ccm |  |  |  |  |
|---|---|-------|---|---|---|---|
| D 2840 LXE | 128.00 | 18273 | 10 | 20 | Diesel | 30 |
| D 2840 LXF | 128.00 | 18273 | 10 | 20 | Diesel | 30 |
| D 2840 LYE | 128.00 | 18273 | 10 | 20 | Diesel | 30 |
| D 2840 ME | 128.00 | 18273 | 10 | 20 | Diesel | 30 |
| D 2840 MF | 128.00 | 18273 | 10 | 20 | Diesel | 30 |
| D 2840 MFG | 128.00 | 18273 | 10 | 20 | Diesel | 29 |
| D 2840 MFR | 128.00 | 18273 | 10 | 20 | Diesel | 30 |
| D 2840 MH | 128.00 | 18273 | 10 | 20 | Diesel | 30 |
| D 2842 LE 02 | 128.00 | 21927 | 12 | 24 | Diesel | 32 |
| D 2842 LE202 | 128.00 | 21927 | 12 | 24 | Diesel | 32 |
| D 2842 LE401 | 128.00 | 21927 | 12 | 24 | Diesel | 32 |
| D 2842 LE402 | 128.00 | 21927 | 12 | 24 | Diesel | 32 |
| D 2842 LE403 | 128.00 | 21927 | 12 | 24 | Diesel | 32 |
| D 2842 LE404 | 128.00 | 21927 | 12 | 24 | Diesel | 32 |
| D 2842 LE405 | 128.00 | 21927 | 12 | 24 | Diesel | 32 |
| D 2842 LE406 | 128.00 | 21927 | 12 | 24 | Diesel | 32 |
| D 2842 LE408 | 128.00 | 21927 | 12 | 24 | Diesel | 32 |
| D 2842 LE604 | 128.00 | 21927 | 12 | 24 | Diesel | 32 |
| D 2842 LE606 | 128.00 | 21927 | 12 | 24 | Diesel | 32 |
| D 2842 LE607 | 128.00 | 21927 | 12 | 24 | Diesel | 32 |
| D 2842 LXE | 128.00 | 21927 | 12 | 24 | Diesel | 32 |
| D 2842 LYE | 128.00 | 21927 | 12 | 24 | Diesel | 32 |
| D 2842 LZE | 128.00 | 21927 | 12 | 24 | Diesel | 32 |
| D 2842 ME | 128.00 | 21927 | 12 | 24 | Diesel | 32 |
| D 2848 LXE | 128.00 | 14618 | 8 | 16 | Diesel | 28 |
| D 2848 LYE | 128.00 | 14618 | 8 | 16 | Diesel | 28 |
| D 2848 M | 128.00 | 14618 | 8 | 16 | Diesel | 28 |
| D 2848 MH | 128.00 | 14618 | 8 | 16 | Diesel | 28 |
| D 2865 LF/260 | 128.00 | 9973 | 5 | 10 | Diesel | 21 |
| D 2865 LF01 | 128.00 | 9973 | 5 | 10 | Diesel | 21 |
| D 2865 LF02 | 128.00 | 9973 | 5 | 10 | Diesel | 21 |
| D 2865 LF03 | 128.00 | 9973 | 5 | 10 | Diesel | 21 |
| D 2865 LF05 | 128.00 | 9973 | 5 | 10 | Diesel | 21 |
| D 2865 LF06 | 128.00 | 9973 | 5 | 10 | Diesel | 21 |
| D 2865 LF09 | 128.00 | 9973 | 5 | 10 | Diesel | 21 |
| D 2865 LF10 | 128.00 | 9973 | 5 | 10 | Diesel | 21 |
| D 2865 LF20 | 128.00 | 9973 | 5 | 10 | Diesel | 21 |
| D 2865 LF21 | 128.00 | 9973 | 5 | 10 | Diesel | 21 |
| D 2865 LF22 | 128.00 | 9973 | 5 | 10 | Diesel | 21 |
| D 2865 LF23 | 128.00 | 9973 | 5 | 10 | Diesel | 21 |
| D 2865 LF24 | 128.00 | 9973 | 5 | 10 | Diesel | 21 |
| D 2865 LFR | 128.00 | 9973 | 5 | 10 | Diesel | 21 |
| D 2865 LFR01 | 128.00 | 9973 | 5 | 10 | Diesel | 21 |
| D 2865 LOH01 | 128.00 | 9973 | 5 | 10 | Diesel | 21 |
| D 2865 LOH02 | 128.00 | 9973 | 5 | 10 | Diesel | 21 |
| D 2865 LOH05 | 128.00 | 9973 | 5 | 10 | Diesel | 21 |
| D 2865 LOH07 | 128.00 | 9973 | 5 | 10 | Diesel | 21 |
| D 2865 LOH08 | 128.00 | 9973 | 5 | 10 | Diesel | 21 |
| D 2865 LOH09 | 128.00 | 9973 | 5 | 10 | Diesel | 21 |
| D 2865 LOH10 | 128.00 | 9973 | 5 | 10 | Diesel | 21 |
| D 2865 LU01 | 128.00 | 9973 | 5 | 10 | Diesel | 21 |
| D 2865 LU02 | 128.00 | 9973 | 5 | 10 | Diesel | 21 |
| D 2865 LU03 | 128.00 | 9973 | 5 | 10 | Diesel | 21 |
| D 2865 LU04 | 128.00 | 9973 | 5 | 10 | Diesel | 21 |
| D 2865 LU05 | 128.00 | 9973 | 5 | 10 | Diesel | 21 |
| D 2865 LU06 | 128.00 | 9973 | 5 | 10 | Diesel | 21 |
| D 2865 LUH02 | 128.00 | 9973 | 5 | 10 | Diesel | 21 |
| D 2865 LUH03 | 128.00 | 9973 | 5 | 10 | Diesel | 21 |
| D 2865 LUH05 | 128.00 | 9973 | 5 | 10 | Diesel | 21 |
| D 2865 LUH06 | 128.00 | 9973 | 5 | 10 | Diesel | 21 |
| D 2865 LUH07 | 128.00 | 9973 | 5 | 10 | Diesel | 21 |
| D 2865 LUH08 | 128.00 | 9973 | 5 | 10 | Diesel | 21 |
| D 2865 LUH09 | 128.00 | 9973 | 5 | 10 | Diesel | 21 |
| D 2865 LXF | 128.00 | 9973 | 5 | 10 | Diesel | 21 |
| D 2865 LXFR | 128.00 | 9973 | 5 | 10 | Diesel | 21 |
| D 2866 F/240 | 128.00 | 11967 | 6 | 12 | Diesel | 22 |

| |  | ccm |  |  |  |  |
|----------------|---|-------|--|---|---|---|
| D 2866 FG | 128.00 | 11967 | 6 | 12 | Diesel | 22 |
| D 2866 FR | 128.00 | 11967 | 6 | 12 | Diesel | 22 |
| D 2866 KF | 128.00 | 11967 | 6 | 12 | Diesel | 22 |
| D 2866 KFZ | 128.00 | 11967 | 6 | 12 | Diesel | 22 |
| D 2866 KOH/373 | 128.00 | 11967 | 6 | 12 | Diesel | 22 |
| D 2866 KOH360 | 128.00 | 11967 | 6 | 12 | Diesel | 22 |
| D 2866 KUH/360 | 128.00 | 11967 | 6 | 12 | Diesel | 22 |
| D 2866 KUL | 128.00 | 11967 | 6 | 12 | Diesel | 22 |
| D 2866 LF | 128.00 | 11967 | 6 | 12 | Diesel | 22 |
| D 2866 LF/290 | 128.00 | 11967 | 6 | 12 | Diesel | 23 |
| D 2866 LF02 | 128.00 | 11967 | 6 | 12 | Diesel | 22 |
| D 2866 LF03 | 128.00 | 11967 | 6 | 12 | Diesel | 22 |
| D 2866 LF04 | 128.00 | 11967 | 6 | 12 | Diesel | 22 |
| D 2866 LF05 | 128.00 | 11967 | 6 | 12 | Diesel | 22 |
| D 2866 LF06 | 128.00 | 11967 | 6 | 12 | Diesel | 22 |
| D 2866 LF07 | 128.00 | 11967 | 6 | 12 | Diesel | 22 |
| D 2866 LF08 | 128.00 | 11967 | 6 | 12 | Diesel | 22 |
| D 2866 LF09 | 128.00 | 11967 | 6 | 12 | Diesel | 22 |
| D 2866 LF10 | 128.00 | 11967 | 6 | 12 | Diesel | 22 |
| D 2866 LF14 | 128.00 | 11967 | 6 | 12 | Diesel | 24 |
| D 2866 LF15 | 128.00 | 11967 | 6 | 12 | Diesel | 22 |
| D 2866 LF16 | 128.00 | 11967 | 6 | 12 | Diesel | 22 |
| D 2866 LF17 | 128.00 | 11967 | 6 | 12 | Diesel | 24 |
| D 2866 LF20 | 128.00 | 11967 | 6 | 12 | Diesel | 22 |
| D 2866 LF21 | 128.00 | 11967 | 6 | 12 | Diesel | 22 |
| D 2866 LF22 | 128.00 | 11967 | 6 | 12 | Diesel | 22 |
| D 2866 LF23 | 128.00 | 11967 | 6 | 12 | Diesel | 23 |
| D 2866 LF24 | 128.00 | 11967 | 6 | 12 | Diesel | 23 |
| D 2866 LF25 | 128.00 | 11967 | 6 | 12 | Diesel | 23 |
| D 2866 LF26 | 128.00 | 11967 | 6 | 12 | Diesel | 23 |
| D 2866 LF27 | 128.00 | 11967 | 6 | 12 | Diesel | 23 |
| D 2866 LF28 | 128.00 | 11967 | 6 | 12 | Diesel | 23 |
| D 2866 LF29 | 128.00 | 11967 | 6 | 12 | Diesel | 22 |
| D 2866 LF30 | 128.00 | 11967 | 6 | 24 | Diesel | 22 |
| D 2866 LF31 | 128.00 | 11967 | 6 | 12 | Diesel | 23 |
| D 2866 LF32 | 128.00 | 11967 | 6 | 12 | Diesel | 23 |
| D 2866 LF330 | 128.00 | 11967 | 6 | 12 | Diesel | 22 |
| D 2866 LF34 | 128.00 | 11967 | 6 | 12 | Diesel | 22 |
| D 2866 LF35 | 128.00 | 11967 | 6 | 12 | Diesel | 22 |
| D 2866 LF36 | 128.00 | 11967 | 6 | 12 | Diesel | 23 |
| D 2866 LF37 | 128.00 | 11967 | 6 | 12 | Diesel | 23 |
| D 2866 LF40 | 128.00 | 11967 | 6 | 24 | Diesel | 23 |
| D 2866 LF41 | 128.00 | 11967 | 6 | 24 | Diesel | 23 |
| D 2866 LF43 | 128.00 | 11967 | 6 | 12 | Diesel | 23 |
| D 2866 LFG | 128.00 | 11967 | 6 | 12 | Diesel | 22 |
| D 2866 LFG03 | 128.00 | 11967 | 6 | 12 | Diesel | 22 |
| D 2866 LFZ/290 | 128.00 | 11967 | 6 | 12 | Diesel | 22 |
| D 2866 LFZ/330 | 128.00 | 11967 | 6 | 12 | Diesel | 22 |
| D 2866 LH01 | 128.00 | 11967 | 6 | 12 | Diesel | 22 |
| D 2866 LOH | 128.00 | 11967 | 6 | 12 | Diesel | 22 |
| D 2866 LOH02 | 128.00 | 11967 | 6 | 12 | Diesel | 22 |
| D 2866 LOH03 | 128.00 | 11967 | 6 | 12 | Diesel | 22 |
| D 2866 LOH06 | 128.00 | 11967 | 6 | 24 | Diesel | 22 |
| D 2866 LOH07 | 128.00 | 11967 | 6 | 12 | Diesel | 22 |
| D 2866 LOH09 | 128.00 | 11967 | 6 | 12 | Diesel | 22 |
| D 2866 LOH20 | 128.00 | 11967 | 6 | 12 | Diesel | 22 |
| D 2866 LOH21 | 128.00 | 11967 | 6 | 12 | Diesel | 22 |
| D 2866 LOH22 | 128.00 | 11967 | 6 | 12 | Diesel | 22 |
| D 2866 LOH23 | 128.00 | 11967 | 6 | 12 | Diesel | 22 |
| D 2866 LOH24 | 128.00 | 11967 | 6 | 12 | Diesel | 22 |
| D 2866 LOH25 | 128.00 | 11967 | 6 | 12 | Diesel | 22 |
| D 2866 LOH26 | 128.00 | 11967 | 6 | 12 | Diesel | 22 |
| D 2866 LOH27 | 128.00 | 11967 | 6 | 24 | Diesel | 23 |
| D 2866 LOH28 | 128.00 | 11967 | 6 | 24 | Diesel | 23 |
| D 2866 LOH29 | 128.00 | 11967 | 6 | 24 | Diesel | 23 |
| D 2866 LOH31 | 128.00 | 11967 | 6 | 12 | Diesel | 22 |

|  |  | ccm |  |  |  |  |
|---|---|-------|---|---|---|---|
| D 2866 LOH32 | 128.00 | 11967 | 6 | 24 | Diesel | 23 |
| D 2866 LOH33 | 128.00 | 11967 | 6 | 24 | Diesel | 23 |
| D 2866 LOH34 | 128.00 | 11967 | 6 | 24 | Diesel | 23 |
| D 2866 LU | 128.00 | 11967 | 6 | 12 | Diesel | 22 |
| D 2866 LU01 | 128.00 | 11967 | 6 | 12 | Diesel | 22 |
| D 2866 LU03 | 128.00 | 11967 | 6 | 12 | Diesel | 22 |
| D 2866 LU04 | 128.00 | 11967 | 6 | 12 | Diesel | 22 |
| D 2866 LU07 | 128.00 | 11967 | 6 | 12 | Diesel | 22 |
| D 2866 LU08 | 128.00 | 11967 | 6 | 12 | Diesel | 22 |
| D 2866 LU330 | 128.00 | 11967 | 6 | 12 | Diesel | 22 |
| D 2866 LUH | 128.00 | 11967 | 6 | 12 | Diesel | 22 |
| D 2866 LUH05 | 128.00 | 11967 | 6 | 12 | Diesel | 22 |
| D 2866 LUH20 | 128.00 | 11967 | 6 | 12 | Diesel | 22 |
| D 2866 LUH21 | 128.00 | 11967 | 6 | 12 | Diesel | 22 |
| D 2866 LUH22 | 128.00 | 11967 | 6 | 12 | Diesel | 22 |
| D 2866 LUH23 | 128.00 | 11967 | 6 | 24 | Diesel | 23 |
| D 2866 LUH24 | 128.00 | 11967 | 6 | 24 | Diesel | 23 |
| D 2866 LUH25 | 128.00 | 11967 | 6 | 24 | Diesel | 23 |
| D 2866 LUH26 | 128.00 | 11967 | 6 | 12 | Diesel | 22 |
| D 2866 LUH29 | 128.00 | 11967 | 6 | 24 | Diesel | 23 |
| D 2866 LUH30 | 128.00 | 11967 | 6 | 24 | Diesel | 23 |
| D 2866 LUH330 | 128.00 | 11967 | 6 | 24 | Diesel | 22 |
| D 2866 LUH51 | 128.00 | 11967 | 6 | 24 | Diesel | 23 |
| D 2866 LUL330 | 128.00 | 11967 | 6 | 12 | Diesel | 22 |
| D 2866 LX | 128.00 | 11967 | 6 | 12 | Diesel | 22 |
| D 2866 LXF | 128.00 | 11967 | 6 | 12 | Diesel | 22 |
| D 2866 LXFG | 128.00 | 11967 | 6 | 12 | Diesel | 22 |
| D 2866 LXOH | 128.00 | 11967 | 6 | 12 | Diesel | 22 |
| D 2866 LXU | 128.00 | 11967 | 6 | 12 | Diesel | 22 |
| D 2866 LXUH | 128.00 | 11967 | 6 | 12 | Diesel | 22 |
| D 2866 OH | 128.00 | 11967 | 6 | 12 | Diesel | 24 |
| D 2866 T | 128.00 | 11967 | 6 | 12 | Diesel | 22 |
| D 2866 TOH | 128.00 | 11967 | 6 | 12 | Diesel | 22 |
| D 2866 TOH/290 | 128.00 | 11967 | 6 | 12 | Diesel | 22 |
| D 2866 TOH/310 | 128.00 | 11967 | 6 | 12 | Diesel | 22 |
| D 2866 TUH | 128.00 | 11967 | 6 | 12 | Diesel | 22 |
| D 2866 TUH/290 | 128.00 | 11967 | 6 | 12 | Diesel | 22 |
| D 2866 TUH01 | 128.00 | 11967 | 6 | 12 | Diesel | 22 |
| D 2866 U | 128.00 | 11967 | 6 | 12 | Diesel | 22 |
| D 2866 UH | 128.00 | 11967 | 6 | 12 | Diesel | 22 |
| D 2866 UH/240 | 128.00 | 11967 | 6 | 12 | Diesel | 22 |
| D 2866 UM | 128.00 | 11967 | 6 | 12 | Diesel | 22 |
| D 2876 LF02 | 128.00 | 12816 | 6 | 12 | Diesel | 25 |
| D 2876 LF03 | 128.00 | 12816 | 6 | 24 | Diesel | 26 |
| D 2876 LF04 | 128.00 | 12816 | 6 | 24 | Diesel | 26 |
| D 2876 LF05 | 128.00 | 12816 | 6 | 24 | Diesel | 26 |
| D 2876 LF06 | 128.00 | 12816 | 6 | 24 | Diesel | 26 |
| D 2876 LF07 | 128.00 | 12816 | 6 | 24 | Diesel | 26 |
| D 2876 LF11 | 128.00 | 12816 | 6 | 24 | Diesel | 26 |
| D 2876 LF12 | 128.00 | 12816 | 6 | 24 | Diesel | 27 |
| D 2876 LF13 | 128.00 | 12816 | 6 | 24 | Diesel | 27 |
| D 2876 LF20 | 128.00 | 12816 | 6 | 24 | Diesel | 26 |
| D 2876 LF25 | 128.00 | 12816 | 6 | 24 | Diesel | 27 |
| D 2876 LOH01 | 128.00 | 12816 | 6 | 12 | Diesel | 25 |
| D 2876 LOH02 | 128.00 | 12816 | 6 | 12 | Diesel | 26 |
| D 2876 LOH03 | 128.00 | 12816 | 6 | 24 | Diesel | 26 |
| D 2876 LOH20 | 128.00 | 12816 | 6 | 24 | Diesel | 27 |
| D 2876 LOH21 | 128.00 | 12816 | 6 | 24 | Diesel | 27 |
| G 2866 DUH04 | 128.00 | 11967 | 6 | 12 | CNG/Gas | 22 |



OE

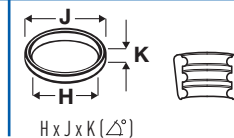
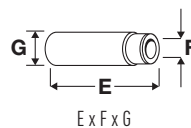
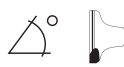

1  102.00

| | | | | | | | |
|-----------|--------|--------|----------|-----------------|--------|-----|---------|
| D 0224 M | 3790cc | 4 Cyl. | 8 Valves | 66kW/90PS | Diesel | OHV | TD19431 |
| D 0224 ME | 3790cc | 4 Cyl. | 8 Valves | 58-66kW/79-90PS | Diesel | OHV | TD19432 |
| D 0224 MF | 3790cc | 4 Cyl. | 8 Valves | 66kW/90PS | Diesel | OHV | TD7637 |

G 10/1979→09/1987

V91771 
49.00 x 10.00 x 136.60

51.04101.0425



30°

VAG92345 
60.00 x 10.02 x 16.05

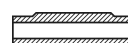

V91374 
42.00 x 9.96 x 136.45

51.04101.0410

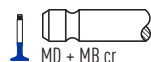

45°

H

VAG92344 
55.00 x 10.00 x 16.04



2  102.00

| | | | | | | | |
|-----------------|--------|--------|-----------|---------------------|--------|------------|---------|
| D 0226 M | 5687cc | 6 Cyl. | 12 Valves | 66-100kW/90-136PS | Diesel | OHV | TD19433 |
| D 0226 MC | 5687cc | 6 Cyl. | 12 Valves | 125-154kW/170-209PS | Diesel | Turbo, OHV | TD23123 |
| D 0226 MCF0/170 | 5687cc | 6 Cyl. | 12 Valves | 125-131kW/170-178PS | Diesel | Turbo, OHV | TD7652 |
| D 0226 ME | 5687cc | 6 Cyl. | 12 Valves | 66-100kW/90-136PS | Diesel | OHV | TD19079 |
| D 0226 MF | 5687cc | 6 Cyl. | 12 Valves | 92-100kW/125-136PS | Diesel | OHV | TD7645 |
| D 0226 MFA | 5687cc | 6 Cyl. | 12 Valves | 66-100kW/90-136PS | Diesel | OHV | TD19080 |
| D 0226 MFM | 5687cc | 6 Cyl. | 12 Valves | 66-100kW/90-136PS | Diesel | OHV | TD19081 |
| D 0226 MFO | 5687cc | 6 Cyl. | 12 Valves | 90-100kW/122-136PS | Diesel | OHV | TD19434 |
| D 0226 MH | 5687cc | 6 Cyl. | 12 Valves | 90-100kW/122-136PS | Diesel | OHV | TD19435 |
| D 0226 MK | 5687cc | 6 Cyl. | 12 Valves | 125-154kW/170-209PS | Diesel | Turbo, OHV | TD19077 |
| D 0226 MKF | 5687cc | 6 Cyl. | 12 Valves | 141kW/192PS | Diesel | Turbo, OHV | TD7685 |
| D 0226 MKF/170 | 5687cc | 6 Cyl. | 12 Valves | 125kW/170PS | Diesel | Turbo, OHV | TD7684 |
| D 0226 MKFA | 5687cc | 6 Cyl. | 12 Valves | 125-154kW/170-209PS | Diesel | Turbo, OHV | TD19436 |
| D 0226 MKFO | 5687cc | 6 Cyl. | 12 Valves | 100-125kW/136-170PS | Diesel | Turbo, OHV | TD23124 |
| D 0226 MKH | 5687cc | 6 Cyl. | 12 Valves | 125-154kW/170-209PS | Diesel | Turbo, OHV | TD19078 |
| D 0226 ML | 5687cc | 6 Cyl. | 12 Valves | 125-154kW/170-209PS | Diesel | Turbo, OHV | TD19437 |
| D 0226 MLE | 5687cc | 6 Cyl. | 12 Valves | 125-154kW/170-209PS | Diesel | Turbo, OHV | TD19438 |
| D 0226 MT | 5687cc | 6 Cyl. | 12 Valves | 110-135kW/150-184PS | Diesel | Turbo, OHV | TD19439 |
| D 0226 MTE | 5687cc | 6 Cyl. | 12 Valves | 81-135kW/110-184PS | Diesel | Turbo, OHV | TD19071 |

G 10/1979→08/1988

G 90

02/1989→10/1993

V91771 
49.00 x 10.00 x 136.60

51.04101.0425



30°

VAG92345 
60.00 x 10.02 x 16.05

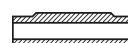

V91374 
42.00 x 9.96 x 136.45

51.04101.0410

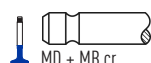

45°

H

VAG92344 
55.00 x 10.00 x 16.04



3  108.00

| | | | | | | | |
|-------------|--------|--------|----------|-------------|--------|------------|---------|
| D 0824 FL01 | 4580cc | 4 Cyl. | 8 Valves | 75kW/102PS | Diesel | Turbo, OHV | TD7655 |
| D 0824 GF | 4580cc | 4 Cyl. | 8 Valves | 75kW/102PS | Diesel | OHV | TD5648 |
| D 0824 GF01 | 4580cc | 4 Cyl. | 8 Valves | 75kW/102PS | Diesel | OHV | TD5988 |
| D 0824 GF02 | 4580cc | 4 Cyl. | 8 Valves | 75kW/102PS | Diesel | OHV | TD7639 |
| D 0824 GF03 | 4580cc | 4 Cyl. | 8 Valves | 75kW/102PS | Diesel | OHV | TD21287 |
| D 0824 GF04 | 4580cc | 4 Cyl. | 8 Valves | 75kW/102PS | Diesel | OHV | TD23126 |
| D 0824 LF01 | 4580cc | 4 Cyl. | 8 Valves | 114kW/155PS | Diesel | Turbo, OHV | TD7680 |
| D 0824 LF02 | 4580cc | 4 Cyl. | 8 Valves | 118kW/160PS | Diesel | Turbo, OHV | TD7683 |
| D 0824 LF03 | 4580cc | 4 Cyl. | 8 Valves | 118kW/160PS | Diesel | Turbo, OHV | TD21278 |
| D 0824 LF04 | 4580cc | 4 Cyl. | 8 Valves | 118kW/160PS | Diesel | Turbo, OHV | TD21279 |



OE

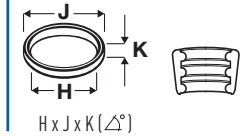
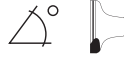

| | | | | | | | |
|---------------|--------|--------|-----------|---------------------|--------|------------|---------|
| D 0824 LF05 | 4580cc | 4 Cyl. | 8 Valves | 118kW/160PS | Diesel | Turbo, OHV | TD21280 |
| D 0824 LF06 | 4580cc | 4 Cyl. | 8 Valves | 118kW/160PS | Diesel | Turbo, OHV | TD21281 |
| D 0824 LF07 | 4580cc | 4 Cyl. | 8 Valves | 118kW/160PS | Diesel | Turbo, OHV | TD21282 |
| D 0824 LF08 | 4580cc | 4 Cyl. | 8 Valves | 118kW/160PS | Diesel | Turbo, OHV | TD21283 |
| D 0824 LF09 | 4580cc | 4 Cyl. | 8 Valves | 118kW/160PS | Diesel | Turbo, OHV | TD21284 |
| D 0824 LF10 | 4580cc | 4 Cyl. | 8 Valves | 118kW/160PS | Diesel | Turbo, OHV | TD21285 |
| D 0824 LFG01 | 4580cc | 4 Cyl. | 8 Valves | 114kW/155PS | Diesel | Turbo, OHV | TD23127 |
| D 0824 LFL01 | 4580cc | 4 Cyl. | 8 Valves | 114kW/155PS | Diesel | Turbo, OHV | TD7658 |
| D 0824 LFL02 | 4580cc | 4 Cyl. | 8 Valves | 114-118kW/155-160PS | Diesel | Turbo, OHV | TD7660 |
| D 0824 LFL03 | 4580cc | 4 Cyl. | 8 Valves | 114kW/155PS | Diesel | Turbo, OHV | TD23128 |
| D 0824 LFL04 | 4580cc | 4 Cyl. | 8 Valves | 81kW/110PS | Diesel | Turbo, OHV | TD7656 |
| D 0824 LFL05 | 4580cc | 4 Cyl. | 8 Valves | 114kW/155PS | Diesel | Turbo, OHV | TD7659 |
| D 0824 LFL06 | 4580cc | 4 Cyl. | 8 Valves | 114kW/155PS | Diesel | Turbo, OHV | TD7661 |
| D 0824 LFL07 | 4580cc | 4 Cyl. | 8 Valves | 104kW/141PS | Diesel | Turbo, OHV | TD7662 |
| D 0824 LFL08 | 4580cc | 4 Cyl. | 12 Valves | 83kW/113PS | Diesel | Turbo, OHV | TD16523 |
| D 0824 LFL09 | 4580cc | 4 Cyl. | 8 Valves | 114kW/155PS | Diesel | Turbo, OHV | TD9707 |
| D 0824 LFL10 | 4580cc | 4 Cyl. | 8 Valves | 92-162kW/125-220PS | Diesel | Turbo, OHV | TD21286 |
| D 0824 LFO | 4580cc | 4 Cyl. | 8 Valves | 118kW/160PS | Diesel | Turbo, OHV | TD7657 |
| D 0824 LF001 | 4580cc | 4 Cyl. | 8 Valves | 114kW/155PS | Diesel | Turbo, OHV | TD23129 |
| D 0824 LF002 | 4580cc | 4 Cyl. | 8 Valves | 118kW/160PS | Diesel | Turbo, OHV | TD16245 |
| D 0824 LOH01 | 4580cc | 4 Cyl. | 8 Valves | 114kW/155PS | Diesel | Turbo, OHV | TD7598 |
| D 0824 LOH02 | 4580cc | 4 Cyl. | 8 Valves | 114kW/155PS | Diesel | Turbo, OHV | TD21288 |
| D 0824 LOH03 | 4580cc | 4 Cyl. | 8 Valves | 114kW/155PS | Diesel | Turbo, OHV | TD21289 |
| D 0824 LOH04 | 4580cc | 4 Cyl. | 8 Valves | 114kW/155PS | Diesel | Turbo, OHV | TD21290 |
| D 0824 LOH05 | 4580cc | 4 Cyl. | 8 Valves | 114kW/155PS | Diesel | Turbo, OHV | TD20537 |
| D 0824 LUE521 | 4580cc | 4 Cyl. | 8 Valves | 103kW/140PS | Diesel | Turbo, OHV | TD23130 |
| D 0824 LUE522 | 4580cc | 4 Cyl. | 8 Valves | 92kW/125PS | Diesel | Turbo, OHV | TD23131 |
| D 0824 LUE523 | 4580cc | 4 Cyl. | 8 Valves | 81kW/110PS | Diesel | Turbo, OHV | TD23132 |
| D 0824 LUE524 | 4580cc | 4 Cyl. | 8 Valves | 108kW/147PS | Diesel | Turbo, OHV | TD23133 |
| D 0834 LFL01 | 4580cc | 4 Cyl. | 8 Valves | 103kW/140PS | Diesel | Turbo, OHV | TD17044 |
| D 0834 LFL02 | 4580cc | 4 Cyl. | 8 Valves | 103kW/140PS | Diesel | Turbo, OHV | TD6591 |
| D 0834 LFL03 | 4580cc | 4 Cyl. | 8 Valves | 132kW/180PS | Diesel | Turbo, OHV | TD16498 |
| D 0834 LFL04 | 4580cc | 4 Cyl. | 8 Valves | 110kW/150PS | Diesel | Turbo, OHV | TD18096 |
| D 0834 LOH01 | 4580cc | 4 Cyl. | 16 Valves | 125kW/170PS | Diesel | Turbo, OHV | TD16748 |
| D 0834 LOH02 | 4580cc | 4 Cyl. | 16 Valves | 125kW/170PS | Diesel | Turbo, OHV | TD16749 |
| D 0834 LOH03 | 4580cc | 4 Cyl. | 16 Valves | 125kW/170PS | Diesel | Turbo, OHV | TD16750 |

G 90

M 90

M-Serie

URBINO

09/1987→10/1993

05/1994→06/1996

01/1994→12/2002

01/1999→

L 2000

M 2000 L

NM

10/1993→

08/1995→

04/1992→03/1997

V91771 ■

49.00 x 10.00 x 136.60

51.04101.0425

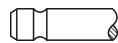

30°

V91374 ■

42.00 x 9.96 x 136.45

51.04101.0410

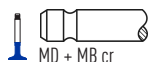

45°

H

VAG92345 ■

60.00 x 10.02 x 16.05



VAG92344 ■

55.00 x 10.00 x 16.04

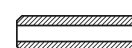

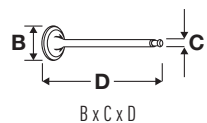

OE

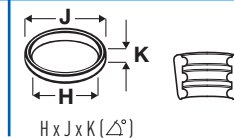
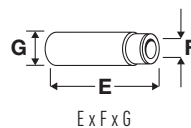

4 **108.00**

| | | | | | | | |
|--------------|--------|--------|-----------|-------------|--------|------------|---------|
| D 0834 LFL40 | 4580cc | 4 Cyl. | 16 Valves | 110kW/150PS | Diesel | Turbo, OHV | TD18179 |
| D 0834 LFL41 | 4580cc | 4 Cyl. | 16 Valves | 132kW/180PS | Diesel | Turbo, OHV | TD18180 |
| D 0834 LFL42 | 4580cc | 4 Cyl. | 16 Valves | 151kW/206PS | Diesel | Turbo, OHV | TD18181 |
| D 0834 LFL50 | 4580cc | 4 Cyl. | 16 Valves | 110kW/150PS | Diesel | Turbo, OHV | TD18182 |
| D 0834 LFL51 | 4580cc | 4 Cyl. | 16 Valves | 132kW/180PS | Diesel | Turbo, OHV | TD18183 |
| D 0834 LFL52 | 4580cc | 4 Cyl. | 16 Valves | 151kW/206PS | Diesel | Turbo, OHV | TD18184 |
| D 0834 LFL53 | 4580cc | 4 Cyl. | 16 Valves | 110kW/150PS | Diesel | Turbo, OHV | TD22957 |
| D 0834 LFL54 | 4580cc | 4 Cyl. | 16 Valves | 132kW/180PS | Diesel | Turbo, OHV | TD22958 |
| D 0834 LFL55 | 4580cc | 4 Cyl. | 16 Valves | 151kW/206PS | Diesel | Turbo, OHV | TD22969 |
| D 0834 LFL60 | 4580cc | 4 Cyl. | 16 Valves | 110kW/150PS | Diesel | Turbo, OHV | TD22962 |
| D 0834 LFL61 | 4580cc | 4 Cyl. | 16 Valves | 132kW/180PS | Diesel | Turbo, OHV | TD22963 |
| D 0834 LFL62 | 4580cc | 4 Cyl. | 16 Valves | 162kW/220PS | Diesel | Turbo, OHV | TD22965 |
| D 0834 LFL63 | 4580cc | 4 Cyl. | 16 Valves | 110kW/150PS | Diesel | Turbo, OHV | TD22959 |
| D 0834 LFL64 | 4580cc | 4 Cyl. | 16 Valves | 132kW/180PS | Diesel | Turbo, OHV | TD22960 |
| D 0834 LFL65 | 4580cc | 4 Cyl. | 16 Valves | 162kW/220PS | Diesel | Turbo, OHV | TD22961 |
| D 0834 LOH40 | 4580cc | 4 Cyl. | 16 Valves | 132kW/180PS | Diesel | Turbo, OHV | TD23680 |
| D 0834 LOH50 | 4580cc | 4 Cyl. | 16 Valves | 132kW/180PS | Diesel | Turbo, OHV | TD19968 |
| D 0834 LOH51 | 4580cc | 4 Cyl. | 16 Valves | 151kW/205PS | Diesel | Turbo, OHV | TD19969 |
| D 0834 LOH52 | 4580cc | 4 Cyl. | 16 Valves | 132kW/180PS | Diesel | Turbo, OHV | TD23057 |
| D 0834 LOH53 | 4580cc | 4 Cyl. | 16 Valves | 151kW/206PS | Diesel | Turbo, OHV | TD23058 |
| D 0834 LOH60 | 4580cc | 4 Cyl. | 16 Valves | 132kW/180PS | Diesel | Turbo, OHV | TD23669 |
| D 0834 LOH61 | 4580cc | 4 Cyl. | 16 Valves | 132kW/180PS | Diesel | Turbo, OHV | TD23679 |

| | | | |
|-------|----------|---------|----------|
| COBRA | | SOLO SR | 10/2007→ |
| TGL | 04/2005→ | VERSA | 11/2006→ |

V95029 ■
38.00 x 6.97 x 141.00

5104.101.0537

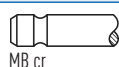

30°

H

VAG96331 ■ ■
60.00 x 7.04 x 13.05



V95030 ■
34.00 x 6.95 x 141.05

51.04101.0538



45°

H

5 **108.00**

| | | | | | | | |
|--------------|--------|--------|-----------|---------------------|--------|------------|---------|
| D 0826 TE520 | 6596cc | 6 Cyl. | 12 Valves | 121-125kW/165-170PS | Diesel | Turbo, OHV | TD23159 |
| D 0826 TF | 6596cc | 6 Cyl. | 12 Valves | 137kW/186PS | Diesel | Turbo, OHV | TD7689 |
| D 0826 TOH | 6596cc | 6 Cyl. | 12 Valves | 132-137kW/180-186PS | Diesel | Turbo, OHV | TD7600 |
| D 0826 TOH01 | 6596cc | 6 Cyl. | 12 Valves | 130kW/177PS | Diesel | Turbo, OHV | TD23160 |

| | | | |
|------|-----------------|------|-----------------|
| HOCL | 08/1987→04/2004 | M 90 | 08/1988→06/1990 |
|------|-----------------|------|-----------------|

V91771 ■
49.00 x 10.00 x 136.60

51.04101.0425



30°

H

VAG92345 ■
60.00 x 10.02 x 16.05



V91374 ■
42.00 x 9.96 x 136.45

51.04101.0410



45°

H

VAG92344 ■
55.00 x 10.00 x 16.04



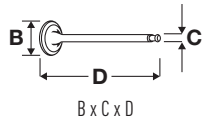

OE

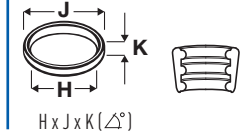
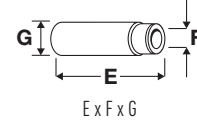
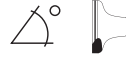

6



108.00

| | | | | | | | |
|----------------------|-----------------|--------|-----------|-------------|--------|-----------------|--------|
| D 0826 LF/217/Silent | 6870cc | 6 Cyl. | 12 Valves | 160kW/217PS | Diesel | Turbo, OHV | TD7723 |
| D 0826 LUH | 6870cc | 6 Cyl. | 12 Valves | 184kW/250PS | Diesel | Turbo, OHV | TD7583 |
| D 0826 LUH12 | 6870cc | 6 Cyl. | 12 Valves | 162kW/220PS | Diesel | Turbo, OHV | TD7586 |
| Centroliner | 10/1998→ | | | EL | | 01/1993→06/1997 | |
| EM | 02/1996→ | | | LION S CITY | | 06/1996→ | |
| M 90 | 05/1990→04/1995 | | | NL | | 04/1991→ | |
| NM | 02/1996→ | | | | | | |

V91771 ■
49.00 x 10.00 x 136.60

51.04101.0425

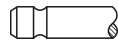

30°

VAG92345 ■
60.00 x 10.02 x 16.05



V91374 ■
42.00 x 9.96 x 136.45

51.04101.0410



45°

H

VAG92344 ■
55.00 x 10.00 x 16.04



7



108.00

| | | | | | | | |
|--------------|--------|--------|-----------|---------------------|--------|------------|---------|
| D 0826 F01 | 6871cc | 6 Cyl. | 12 Valves | 110-114kW/150-155PS | Diesel | OHV | TD7681 |
| D 0826 F02 | 6871cc | 6 Cyl. | 12 Valves | 110kW/150PS | Diesel | OHV | TD7682 |
| D 0826 F0 | 6871cc | 6 Cyl. | 12 Valves | 110-114kW/150-155PS | Diesel | OHV | TD25847 |
| D 0826 F001 | 6871cc | 6 Cyl. | 12 Valves | 114kW/155PS | Diesel | OHV | TD23134 |
| D 0826 F002 | 6871cc | 6 Cyl. | 12 Valves | 110kW/150PS | Diesel | OHV | TD23135 |
| D 0826 FR | 6871cc | 6 Cyl. | 12 Valves | 110kW/150PS | Diesel | OHV | TD25848 |
| D 0826 FR01 | 6871cc | 6 Cyl. | 12 Valves | 110kW/150PS | Diesel | OHV | TD25849 |
| D 0826 GF | 6871cc | 6 Cyl. | 12 Valves | 110-114kW/150-155PS | Diesel | Turbo, OHV | TD7647 |
| D 0826 GF01 | 6871cc | 6 Cyl. | 12 Valves | 110-114kW/150-155PS | Diesel | OHV | TD7649 |
| D 0826 GF03 | 6871cc | 6 Cyl. | 12 Valves | 110kW/150PS | Diesel | OHV | TD7648 |
| D 0826 GF04 | 6871cc | 6 Cyl. | 12 Valves | 110-114kW/150-155PS | Diesel | OHV | TD19440 |
| D 0826 GFA | 6871cc | 6 Cyl. | 12 Valves | 114kW/155PS | Diesel | OHV | TD23139 |
| D 0826 GFA01 | 6871cc | 6 Cyl. | 12 Valves | 114kW/155PS | Diesel | OHV | TD23140 |
| D 0826 GFA02 | 6871cc | 6 Cyl. | 12 Valves | 114kW/155PS | Diesel | OHV | TD23141 |
| D 0826 GFA03 | 6871cc | 6 Cyl. | 12 Valves | 110kW/150PS | Diesel | OHV | TD23142 |
| D 0826 GFA04 | 6871cc | 6 Cyl. | 12 Valves | 107kW/146PS | Diesel | OHV | TD23143 |
| D 0826 LE521 | 6871cc | 6 Cyl. | 12 Valves | 140kW/190PS | Diesel | Turbo, OHV | TD22331 |
| D 0826 LE522 | 6871cc | 6 Cyl. | 12 Valves | 154kW/209PS | Diesel | Turbo, OHV | TD23144 |
| D 0826 LE523 | 6871cc | 6 Cyl. | 12 Valves | 169kW/230PS | Diesel | Turbo, OHV | TD23146 |
| D 0826 LE524 | 6871cc | 6 Cyl. | 12 Valves | 125-132kW/170-180PS | Diesel | Turbo, OHV | TD23147 |
| D 0826 LE527 | 6871cc | 6 Cyl. | 12 Valves | 169kW/230PS | Diesel | Turbo, OHV | TD23148 |
| D 0826 LE530 | 6871cc | 6 Cyl. | 12 Valves | 147kW/200PS | Diesel | Turbo, OHV | TD23149 |
| D 0826 LE531 | 6871cc | 6 Cyl. | 12 Valves | 191kW/260PS | Diesel | Turbo, OHV | TD23150 |
| D 0826 LF01 | 6871cc | 6 Cyl. | 12 Valves | 140kW/190PS | Diesel | Turbo, OHV | TD7686 |
| D 0826 LF02 | 6871cc | 6 Cyl. | 12 Valves | 169kW/230PS | Diesel | Turbo, OHV | TD7691 |
| D 0826 LF04 | 6871cc | 6 Cyl. | 12 Valves | 198kW/270PS | Diesel | Turbo, OHV | TD7695 |
| D 0826 LF05 | 6871cc | 6 Cyl. | 12 Valves | 140kW/190PS | Diesel | Turbo, OHV | TD7687 |
| D 0826 LF06 | 6871cc | 6 Cyl. | 12 Valves | 169kW/230PS | Diesel | Turbo, OHV | TD7692 |
| D 0826 LF07 | 6871cc | 6 Cyl. | 12 Valves | 140kW/190PS | Diesel | Turbo, OHV | TD7688 |
| D 0826 LF08 | 6871cc | 6 Cyl. | 12 Valves | 169kW/230PS | Diesel | Turbo, OHV | TD7693 |
| D 0826 LF09 | 6871cc | 6 Cyl. | 12 Valves | 169kW/230PS | Diesel | Turbo, OHV | TD22332 |
| D 0826 LF11 | 6871cc | 6 Cyl. | 12 Valves | 162kW/220PS | Diesel | Turbo, OHV | TD7690 |
| D 0826 LF12 | 6871cc | 6 Cyl. | 12 Valves | 140kW/190PS | Diesel | Turbo, OHV | TD22337 |
| D 0826 LF13 | 6871cc | 6 Cyl. | 12 Valves | 191kW/260PS | Diesel | Turbo, OHV | TD7694 |
| D 0826 LF15 | 6871cc | 6 Cyl. | 12 Valves | 162kW/220PS | Diesel | Turbo, OHV | TD7726 |



OE

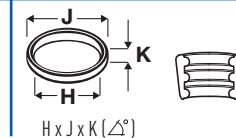
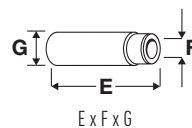

| | | | | | | | |
|----------------|--------|--------|-----------|---------------------|--------|------------|---------|
| D 0826 LF17 | 6871cc | 6 Cyl. | 12 Valves | 191kW/260PS | Diesel | Turbo, OHV | TD7727 |
| D 0826 LF18 | 6871cc | 6 Cyl. | 12 Valves | 162kW/220PS | Diesel | Turbo, OHV | TD10227 |
| D 0826 LFG01 | 6871cc | 6 Cyl. | 12 Valves | 140kW/190PS | Diesel | Turbo, OHV | TD23151 |
| D 0826 LFG02 | 6871cc | 6 Cyl. | 12 Valves | 140kW/190PS | Diesel | Turbo, OHV | TD23152 |
| D 0826 LFG06 | 6871cc | 6 Cyl. | 12 Valves | 169kW/230PS | Diesel | Turbo, OHV | TD23153 |
| D 0826 LFG15 | 6871cc | 6 Cyl. | 12 Valves | 162kW/220PS | Diesel | Turbo, OHV | TD23154 |
| D 0826 LFG16 | 6871cc | 6 Cyl. | 12 Valves | 191kW/260PS | Diesel | Turbo, OHV | TD23155 |
| D 0826 LFL | 6871cc | 6 Cyl. | 12 Valves | 162-165kW/220-224PS | Diesel | Turbo, OHV | TD19443 |
| D 0826 LFL02 | 6871cc | 6 Cyl. | 12 Valves | 169kW/230PS | Diesel | Turbo, OHV | TD7664 |
| D 0826 LFL03 | 6871cc | 6 Cyl. | 12 Valves | 162kW/220PS | Diesel | Turbo, OHV | TD7663 |
| D 0826 LFL06 | 6871cc | 6 Cyl. | 12 Valves | 162kW/220PS | Diesel | Turbo, OHV | TD7665 |
| D 0826 LFL07 | 6871cc | 6 Cyl. | 12 Valves | 188kW/256PS | Diesel | Turbo, OHV | TD21292 |
| D 0826 LFL08 | 6871cc | 6 Cyl. | 12 Valves | 162kW/220PS | Diesel | Turbo, OHV | TD21293 |
| D 0826 LFL09 | 6871cc | 6 Cyl. | 12 Valves | 191kW/260PS | Diesel | Turbo, OHV | TD7725 |
| D 0826 LFL10 | 6871cc | 6 Cyl. | 12 Valves | 162kW/220PS | Diesel | Turbo, OHV | TD10207 |
| D 0826 LOH01 | 6871cc | 6 Cyl. | 12 Valves | 140kW/190PS | Diesel | Turbo, OHV | TD7601 |
| D 0826 LOH02 | 6871cc | 6 Cyl. | 12 Valves | 140kW/190PS | Diesel | Turbo, OHV | TD7679 |
| D 0826 LOH03 | 6871cc | 6 Cyl. | 12 Valves | 162-169kW/220-230PS | Diesel | Turbo, OHV | TD16465 |
| D 0826 LOH04 | 6871cc | 6 Cyl. | 12 Valves | 169kW/230PS | Diesel | Turbo, OHV | TD16466 |
| D 0826 LOH05 | 6871cc | 6 Cyl. | 12 Valves | 169kW/230PS | Diesel | Turbo, OHV | TD21295 |
| D 0826 LOH06 | 6871cc | 6 Cyl. | 12 Valves | 140kW/190PS | Diesel | Turbo, OHV | TD7587 |
| D 0826 LOH07 | 6871cc | 6 Cyl. | 12 Valves | 169kW/230PS | Diesel | Turbo, OHV | TD16246 |
| D 0826 LOH08 | 6871cc | 6 Cyl. | 12 Valves | 198kW/269PS | Diesel | Turbo, OHV | TD21296 |
| D 0826 LOH09 | 6871cc | 6 Cyl. | 12 Valves | 169kW/230PS | Diesel | Turbo, OHV | TD21297 |
| D 0826 LOH10 | 6871cc | 6 Cyl. | 12 Valves | 184kW/250PS | Diesel | Turbo, OHV | TD16247 |
| D 0826 LOH11 | 6871cc | 6 Cyl. | 12 Valves | 140kW/190PS | Diesel | Turbo, OHV | TD21298 |
| D 0826 LOH12 | 6871cc | 6 Cyl. | 12 Valves | 140kW/190PS | Diesel | Turbo, OHV | TD21299 |
| D 0826 LOH13 | 6871cc | 6 Cyl. | 12 Valves | 151kW/205PS | Diesel | Turbo, OHV | TD21300 |
| D 0826 LOH15 | 6871cc | 6 Cyl. | 12 Valves | 162kW/220PS | Diesel | Turbo, OHV | TD7588 |
| D 0826 LOH17 | 6871cc | 6 Cyl. | 12 Valves | 162kW/220PS | Diesel | Turbo, OHV | TD17419 |
| D 0826 LOH18 | 6871cc | 6 Cyl. | 12 Valves | 191kW/260PS | Diesel | Turbo, OHV | TD17420 |
| D 0826 LOH19 | 6871cc | 6 Cyl. | 12 Valves | 162kW/220PS | Diesel | Turbo, OHV | TD23156 |
| D 0826 LUH/213 | 6871cc | 6 Cyl. | 12 Valves | 157kW/213PS | Diesel | Turbo, OHV | TD7597 |
| D 0826 LUH01 | 6871cc | 6 Cyl. | 12 Valves | 198kW/270PS | Diesel | Turbo, OHV | TD7596 |
| D 0826 LUH02 | 6871cc | 6 Cyl. | 12 Valves | 169-198kW/230-269PS | Diesel | Turbo, OHV | TD21301 |
| D 0826 LUH03 | 6871cc | 6 Cyl. | 12 Valves | 157kW/213PS | Diesel | Turbo, OHV | TD7584 |
| D 0826 LUH04 | 6871cc | 6 Cyl. | 12 Valves | 157-169kW/214-230PS | Diesel | Turbo, OHV | TD21302 |
| D 0826 LUH05 | 6871cc | 6 Cyl. | 12 Valves | 169kW/230PS | Diesel | Turbo, OHV | TD7585 |
| D 0826 LUH06 | 6871cc | 6 Cyl. | 12 Valves | 169-198kW/230-269PS | Diesel | Turbo, OHV | TD21303 |
| D 0826 LUH08 | 6871cc | 6 Cyl. | 12 Valves | 162-169kW/220-230PS | Diesel | Turbo, OHV | TD21304 |
| D 0826 LUH10 | 6871cc | 6 Cyl. | 12 Valves | 169-198kW/230-269PS | Diesel | Turbo, OHV | TD21306 |
| D 0826 LUH13 | 6871cc | 6 Cyl. | 12 Valves | 191kW/260PS | Diesel | Turbo, OHV | TD16248 |
| D 0826 OH | 6871cc | 6 Cyl. | 12 Valves | 110kW/150PS | Diesel | OHV | TD19445 |
| D 0826 OH01 | 6871cc | 6 Cyl. | 12 Valves | 114kW/155PS | Diesel | OHV | TD23157 |
| D 0826 OH02 | 6871cc | 6 Cyl. | 12 Valves | 110-114kW/150-155PS | Diesel | OHV | TD7599 |
| D 0826 OH03 | 6871cc | 6 Cyl. | 12 Valves | 107kW/146PS | Diesel | OHV | TD23158 |
| D 0836 LF01 | 6871cc | 6 Cyl. | 12 Valves | 206kW/280PS | Diesel | Turbo, OHV | TD14289 |
| D 0836 LF02 | 6871cc | 6 Cyl. | 12 Valves | 162kW/220PS | Diesel | Turbo, OHV | TD17045 |
| D 0836 LF03 | 6871cc | 6 Cyl. | 12 Valves | 206kW/280PS | Diesel | Turbo, OHV | TD16503 |
| D 0836 LF04 | 6871cc | 6 Cyl. | 12 Valves | 162kW/220PS | Diesel | Turbo, OHV | TD16500 |



OE

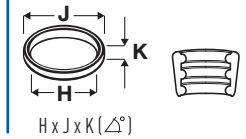

| | | | | | | | |
|---------------------|--------|--------|------------------|---------------------|--------|-------------------|----------------|
| D 0836 LF05 | 6871cc | 6 Cyl. | 12 Valves | 180kW/245PS | Diesel | Turbo, OHV | TD16504 |
| D 0836 LFL01 | 6871cc | 6 Cyl. | 12 Valves | 206-215kW/280-292PS | Diesel | Turbo, OHV | TD16875 |
| D 0836 LFL02 | 6871cc | 6 Cyl. | 12 Valves | 162kW/220PS | Diesel | Turbo, OHV | TD16499 |
| D 0836 LFL03 | 6871cc | 6 Cyl. | 12 Valves | 206kW/280PS | Diesel | Turbo, OHV | TD16502 |
| D 0836 LFL04 | 6871cc | 6 Cyl. | 12 Valves | 162kW/220PS | Diesel | Turbo, OHV | TD17049 |
| D 0836 LFL05 | 6871cc | 6 Cyl. | 12 Valves | 180kW/245PS | Diesel | Turbo, OHV | TD16501 |
| D 0836 LFL06 | 6871cc | 6 Cyl. | 12 Valves | 162kW/220PS | Diesel | Turbo, OHV | TD23163 |
| D 0836 LOH01 | 6871cc | 6 Cyl. | 12 Valves | 206kW/280PS | Diesel | Turbo, OHV | TD16753 |
| D 0836 LOH02 | 6871cc | 6 Cyl. | 12 Valves | 206kW/280PS | Diesel | Turbo, OHV | TD16752 |
| D 0836 LOH03 | 6871cc | 6 Cyl. | 12 Valves | 162kW/220PS | Diesel | Turbo, OHV | TD16751 |
| D 0836 LUH01 | 6871cc | 6 Cyl. | 24 Valves | 206kW/280PS | Diesel | Turbo, OHV | TD16756 |
| D 0836 LUH02 | 6871cc | 6 Cyl. | 24 Valves | 162kW/220PS | Diesel | Turbo, OHV | TD16757 |

| | | | |
|------------|-----------------|-------------|-----------------|
| A-Serie | 01/2004→ | Centroliner | 10/1998→ |
| COBRA | 01/2006→ | ECL | 04/2002→ |
| ECM | 04/2002→ | EL | 01/1993→06/1997 |
| EM | 08/1987→ | Favorit | 01/1993→12/2004 |
| G 90 | 09/1987→05/1995 | Hi-Ex | 09/2004→ |
| HOCL | 08/1987→ | Jettliner | 09/1990→ |
| L 2000 | 10/1993→ | LION S CITY | 07/1998→ |
| M 90 | 08/1988→06/1996 | M 2000 L | 08/1995→ |
| M 2000 M | 08/1995→ | NG | 08/1992→07/1998 |
| NL | 09/1989→ | NM | 08/1987→ |
| NÜ | 07/1998→ | SM | 11/1987→02/1995 |
| Sportliner | 01/1990→ | SÜ | 09/2003→ |
| URBINO | 01/1999→ | | |

V91771 ■
49.00 x 10.00 x 136.60

51.04101.0425

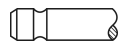

30°

V91374 ■
42.00 x 9.96 x 136.45

51.04101.0410



45°

H

VAG92345 ■
60.00 x 10.02 x 16.05



VAG92344 ■
55.00 x 10.00 x 16.04





OE

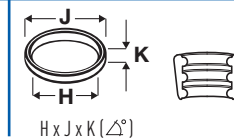
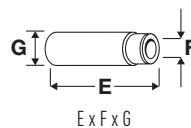

8 **108.00**

| | | | | | | | |
|--------------|--------|--------|-----------|---------------------|--------|------------|---------|
| D 0836 LF41 | 6871cc | 6 Cyl. | 24 Valves | 206kW/280PS | Diesel | Turbo, OHV | TD16827 |
| D 0836 LF44 | 6871cc | 6 Cyl. | 24 Valves | 240kW/326PS | Diesel | Turbo, OHV | TD16828 |
| D 0836 LFG50 | 6871cc | 6 Cyl. | 24 Valves | 240kW/326PS | Diesel | Turbo, OHV | TD20228 |
| D 0836 LFL40 | 6871cc | 6 Cyl. | 24 Valves | 176kW/240PS | Diesel | Turbo, OHV | TD18185 |
| D 0836 LFL41 | 6871cc | 6 Cyl. | 24 Valves | 206kW/280PS | Diesel | Turbo, OHV | TD18703 |
| D 0836 LFL44 | 6871cc | 6 Cyl. | 24 Valves | 240kW/326PS | Diesel | Turbo, OHV | TD18704 |
| D 0836 LFL50 | 6871cc | 6 Cyl. | 24 Valves | 176kW/240PS | Diesel | Turbo, OHV | TD18186 |
| D 0836 LFL51 | 6871cc | 6 Cyl. | 24 Valves | 206kW/280PS | Diesel | Turbo, OHV | TD19114 |
| D 0836 LFL52 | 6871cc | 6 Cyl. | 24 Valves | 240kW/326PS | Diesel | Turbo, OHV | TD19113 |
| D 0836 LFL53 | 6871cc | 6 Cyl. | 24 Valves | 176kW/240PS | Diesel | Turbo, OHV | TD22970 |
| D 0836 LFL54 | 6871cc | 6 Cyl. | 24 Valves | 206kW/280PS | Diesel | Turbo, OHV | TD22971 |
| D 0836 LFL55 | 6871cc | 6 Cyl. | 24 Valves | 240kW/326PS | Diesel | Turbo, OHV | TD22972 |
| D 0836 LFL60 | 6871cc | 6 Cyl. | 24 Valves | 184kW/250PS | Diesel | Turbo, OHV | TD22966 |
| D 0836 LFL61 | 6871cc | 6 Cyl. | 24 Valves | 213kW/290PS | Diesel | Turbo, OHV | TD23686 |
| D 0836 LFL62 | 6871cc | 6 Cyl. | 24 Valves | 250kW/340PS | Diesel | Turbo, OHV | TD23687 |
| D 0836 LFL63 | 6871cc | 6 Cyl. | 24 Valves | 184kW/250PS | Diesel | Turbo, OHV | TD22967 |
| D 0836 LFL64 | 6871cc | 6 Cyl. | 24 Valves | 213kW/290PS | Diesel | Turbo, OHV | TD22984 |
| D 0836 LFL65 | 6871cc | 6 Cyl. | 24 Valves | 250kW/340PS | Diesel | Turbo, OHV | TD22995 |
| D 0836 LOH40 | 6871cc | 6 Cyl. | 24 Valves | 206kW/280PS | Diesel | Turbo, OHV | TD16754 |
| D 0836 LOH41 | 6871cc | 6 Cyl. | 24 Valves | 177kW/240PS | Diesel | Turbo, OHV | TD16755 |
| D 0836 LOH51 | 6871cc | 6 Cyl. | 24 Valves | 206kW/280PS | Diesel | Turbo, OHV | TD19971 |
| D 0836 LOH52 | 6871cc | 6 Cyl. | 24 Valves | 177-178kW/240-242PS | Diesel | Turbo, OHV | TD19970 |
| D 0836 LOH55 | 6871cc | 6 Cyl. | 24 Valves | 206kW/280PS | Diesel | Turbo, OHV | TD23060 |
| D 0836 LOH56 | 6871cc | 6 Cyl. | 24 Valves | 177kW/240PS | Diesel | Turbo, OHV | TD23059 |
| D 0836 LOH60 | 6871cc | 6 Cyl. | 24 Valves | 213kW/290PS | Diesel | Turbo, OHV | TD23671 |
| D 0836 LOH61 | 6871cc | 6 Cyl. | 24 Valves | 184kW/250PS | Diesel | Turbo, OHV | TD23670 |
| D 0836 LOH62 | 6871cc | 6 Cyl. | 24 Valves | 191kW/260PS | Diesel | Turbo, OHV | TD23164 |
| D 0836 LOH63 | 6871cc | 6 Cyl. | 24 Valves | 191kW/260PS | Diesel | Turbo, OHV | TD23962 |
| D 0836 LOH64 | 6871cc | 6 Cyl. | 24 Valves | 213kW/290PS | Diesel | Turbo, OHV | TD23682 |
| D 0836 LOH65 | 6871cc | 6 Cyl. | 24 Valves | 184kW/250PS | Diesel | Turbo, OHV | TD23681 |
| D 0836 LUH40 | 6871cc | 6 Cyl. | 24 Valves | 206kW/280PS | Diesel | Turbo, OHV | TD16758 |
| D 0836 LUH41 | 6871cc | 6 Cyl. | 24 Valves | 177kW/240PS | Diesel | Turbo, OHV | TD16759 |
| D 0836 LUH50 | 6871cc | 6 Cyl. | 24 Valves | 206kW/280PS | Diesel | Turbo, OHV | TD28161 |

| | | |
|----------|----------|-------------|
| Airliner | 01/1992→ | COBRA |
| FOCL | 08/2004→ | HOCL |
| LC | | LION S CITY |
| NM | | SL II |
| SÜ | 09/2003→ | TEMPO |
| TGA | 11/2002→ | TGL |
| TGM | 10/2005→ | VECTIO |
| VIVE | 05/2010→ | |

V95029
 38.00 x 6.97 x 141.00

5104.101.0537

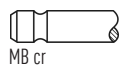

30°

H

VAG96331
 60.00 x 7.04 x 13.05

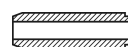

V95030
 34.00 x 6.95 x 141.05

51.04101.0538

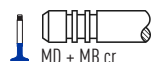

45°

H



OE

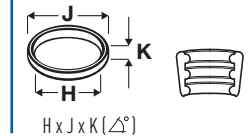
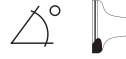

9



120.00

| | | | | | | | |
|--------------|---------|--------|-----------|-------------|--------|-------------------|---------|
| D 2066 LF01 | 10518cc | 6 Cyl. | 24 Valves | 316kW/430PS | Diesel | D 20, Turbo, DOHC | TD17370 |
| D 2066 LF02 | 10518cc | 6 Cyl. | 24 Valves | 287kW/390PS | Diesel | D 20, Turbo, DOHC | TD17371 |
| D 2066 LF03 | 10518cc | 6 Cyl. | 24 Valves | 257kW/350PS | Diesel | D 20, Turbo, DOHC | TD17372 |
| D 2066 LF04 | 10518cc | 6 Cyl. | 24 Valves | 228kW/310PS | Diesel | D 20, Turbo, DOHC | TD17373 |
| D 2066 LF06 | 10518cc | 6 Cyl. | 24 Valves | 294kW/400PS | Diesel | D 20, Turbo, DOHC | TD19951 |
| D 2066 LF07 | 10518cc | 6 Cyl. | 24 Valves | 265kW/360PS | Diesel | D 20, Turbo, DOHC | TD22899 |
| D 2066 LF11 | 10518cc | 6 Cyl. | 24 Valves | 316kW/430PS | Diesel | D 20, Turbo, DOHC | TD18098 |
| D 2066 LF12 | 10518cc | 6 Cyl. | 24 Valves | 287kW/390PS | Diesel | D 20, Turbo, DOHC | TD18097 |
| D 2066 LF13 | 10518cc | 6 Cyl. | 24 Valves | 257kW/350PS | Diesel | D 20, Turbo, DOHC | TD19111 |
| D 2066 LF14 | 10518cc | 6 Cyl. | 24 Valves | 228kW/310PS | Diesel | D 20, Turbo, DOHC | TD19109 |
| D 2066 LF17 | 10518cc | 6 Cyl. | 24 Valves | 324kW/440PS | Diesel | Turbo, DOHC | TD23081 |
| D 2066 LF18 | 10518cc | 6 Cyl. | 24 Valves | 294kW/400PS | Diesel | Turbo, DOHC | TD23083 |
| D 2066 LF19 | 10518cc | 6 Cyl. | 24 Valves | 265kW/360PS | Diesel | Turbo, DOHC | TD23084 |
| D 2066 LF20 | 10518cc | 6 Cyl. | 24 Valves | 235kW/320PS | Diesel | Turbo, DOHC | TD23085 |
| D 2066 LF21 | 10518cc | 6 Cyl. | 24 Valves | 321kW/437PS | Diesel | Turbo, DOHC | TD20230 |
| D 2066 LF22 | 10518cc | 6 Cyl. | 24 Valves | 294kW/400PS | Diesel | Turbo, DOHC | TD20229 |
| D 2066 LF23 | 10518cc | 6 Cyl. | 24 Valves | 324kW/440PS | Diesel | D 20, Turbo, DOHC | TD19098 |
| D 2066 LF24 | 10518cc | 6 Cyl. | 24 Valves | 294kW/400PS | Diesel | D 20, Turbo, DOHC | TD19099 |
| D 2066 LF25 | 10518cc | 6 Cyl. | 24 Valves | 324kW/440PS | Diesel | D 20, Turbo, DOHC | TD20363 |
| D 2066 LF26 | 10518cc | 6 Cyl. | 24 Valves | 294kW/400PS | Diesel | D 20, Turbo, DOHC | TD20364 |
| D 2066 LF27 | 10518cc | 6 Cyl. | 24 Valves | 265kW/360PS | Diesel | D 20, Turbo, DOHC | TD20365 |
| D 2066 LF28 | 10518cc | 6 Cyl. | 24 Valves | 235kW/320PS | Diesel | D 20, Turbo, DOHC | TD20366 |
| D 2066 LF29 | 10518cc | 6 Cyl. | 24 Valves | 265kW/360PS | Diesel | D 20, Turbo, DOHC | TD25603 |
| D 2066 LF30 | 10518cc | 6 Cyl. | 24 Valves | 235kW/320PS | Diesel | D 20, Turbo, DOHC | TD25604 |
| D 2066 LF31 | 10518cc | 6 Cyl. | 24 Valves | 324kW/440PS | Diesel | D 20, Turbo, DOHC | TD19094 |
| D 2066 LF32 | 10518cc | 6 Cyl. | 24 Valves | 294kW/400PS | Diesel | D 20, Turbo, DOHC | TD19095 |
| D 2066 LF33 | 10518cc | 6 Cyl. | 24 Valves | 265kW/360PS | Diesel | D 20, Turbo, DOHC | TD19096 |
| D 2066 LF35 | 10518cc | 6 Cyl. | 24 Valves | 235kW/320PS | Diesel | D 20, Turbo, DOHC | TD19097 |
| D 2066 LF36 | 10518cc | 6 Cyl. | 24 Valves | 324kW/440PS | Diesel | D 20, Turbo, DOHC | TD20368 |
| D 2066 LF37 | 10518cc | 6 Cyl. | 24 Valves | 294kW/400PS | Diesel | D 20, Turbo, DOHC | TD20369 |
| D 2066 LF38 | 10518cc | 6 Cyl. | 24 Valves | 265kW/360PS | Diesel | D 20, Turbo, DOHC | TD20370 |
| D 2066 LF39 | 10518cc | 6 Cyl. | 24 Valves | 235kW/320PS | Diesel | D 20, Turbo, DOHC | TD20396 |
| D 2066 LF40 | 10518cc | 6 Cyl. | 24 Valves | 324kW/440PS | Diesel | D 20, Turbo, DOHC | TD23119 |
| D 2066 LF41 | 10518cc | 6 Cyl. | 24 Valves | 294kW/400PS | Diesel | D 20, Turbo, DOHC | TD23104 |
| D 2066 LF42 | 10518cc | 6 Cyl. | 24 Valves | 265kW/360PS | Diesel | D 20, Turbo, DOHC | TD23094 |
| D 2066 LF43 | 10518cc | 6 Cyl. | 24 Valves | 235kW/320PS | Diesel | Turbo, DOHC | TD23003 |
| D 2066 LOH01 | 10518cc | 6 Cyl. | 24 Valves | 235kW/320PS | Diesel | Turbo, DOHC | TD19972 |
| D 2066 LOH02 | 10518cc | 6 Cyl. | 24 Valves | 265kW/360PS | Diesel | Turbo, DOHC | TD19973 |
| D 2066 LOH03 | 10518cc | 6 Cyl. | 24 Valves | 294kW/400PS | Diesel | Turbo, DOHC | TD19974 |
| D 2066 LOH04 | 10518cc | 6 Cyl. | 24 Valves | 324kW/440PS | Diesel | Turbo, DOHC | TD19975 |
| D 2066 LOH05 | 10518cc | 6 Cyl. | 24 Valves | 225kW/320PS | Diesel | Turbo, DOHC | TD23061 |
| D 2066 LOH06 | 10518cc | 6 Cyl. | 24 Valves | 265kW/360PS | Diesel | Turbo, DOHC | TD23062 |
| D 2066 LOH07 | 10518cc | 6 Cyl. | 24 Valves | 294kW/400PS | Diesel | Turbo, DOHC | TD23063 |
| D 2066 LOH08 | 10518cc | 6 Cyl. | 24 Valves | 324kW/440PS | Diesel | Turbo, DOHC | TD23064 |
| D 2066 LOH10 | 10518cc | 6 Cyl. | 24 Valves | 316kW/430PS | Diesel | Turbo, DOHC | TD23073 |
| D 2066 LOH11 | 10518cc | 6 Cyl. | 24 Valves | 287kW/390PS | Diesel | Turbo, DOHC | TD23072 |
| D 2066 LOH12 | 10518cc | 6 Cyl. | 24 Valves | 257kW/350PS | Diesel | Turbo, DOHC | TD23070 |
| D 2066 LUH07 | 10518cc | 6 Cyl. | 24 Valves | 228kW/310PS | Diesel | Turbo, DOHC | TD23074 |

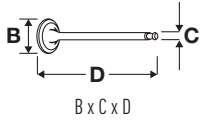

OE

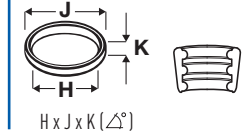
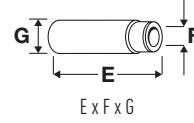

| | | | | | | | |
|--------------|---------|--------|-----------|-------------|--------|-------------|---------|
| D 2066 LUH08 | 10518cc | 6 Cyl. | 24 Valves | 257kW/350PS | Diesel | Turbo, DOHC | TD23075 |
| D 2066 LUH09 | 10518cc | 6 Cyl. | 24 Valves | 287kW/390PS | Diesel | Turbo, DOHC | TD23076 |
| D 2066 LUH11 | 10518cc | 6 Cyl. | 24 Valves | 199kW/271PS | Diesel | Turbo, DOHC | TD19976 |
| D 2066 LUH12 | 10518cc | 6 Cyl. | 24 Valves | 228kW/310PS | Diesel | Turbo, DOHC | TD19977 |
| D 2066 LUH13 | 10518cc | 6 Cyl. | 24 Valves | 257kW/350PS | Diesel | Turbo, DOHC | TD19978 |
| D 2066 LUH14 | 10518cc | 6 Cyl. | 24 Valves | 287kW/390PS | Diesel | Turbo, DOHC | TD19979 |
| D 2066 LUH15 | 10518cc | 6 Cyl. | 24 Valves | 316kW/430PS | Diesel | Turbo, DOHC | TD19980 |
| D 2066 LUH21 | 10518cc | 6 Cyl. | 24 Valves | 199kW/271PS | Diesel | Turbo, DOHC | TD22860 |
| D 2066 LUH22 | 10518cc | 6 Cyl. | 24 Valves | 228kW/310PS | Diesel | Turbo, DOHC | TD23065 |
| D 2066 LUH23 | 10518cc | 6 Cyl. | 24 Valves | 257kW/350PS | Diesel | Turbo, DOHC | TD23066 |
| D 2066 LUH24 | 10518cc | 6 Cyl. | 24 Valves | 287kW/390PS | Diesel | Turbo, DOHC | TD23067 |

| | | | |
|-----------|-----------------|-------------|-----------------|
| A-Series | | Centroliner | 10/1998→ |
| Cityliner | 09/2006→ | DIAMOND | 01/2006→ |
| ECT | 02/2005→ | HOCL | |
| NG | 01/2006→12/2014 | NL | 01/2006→10/2009 |
| PANTHER | 01/2006→ | SL II | |
| SÜ | 01/2006→10/2009 | TGA | 12/2000→ |
| TGS | 09/2007→ | TGX | 09/2007→ |
| Tourliner | 06/2006→ | T-Series | 10/2005→ |

| | | | | | |
|--|---------------|-----|---|---|--|
| V95034 ■ 40.10 x 8.97 x 160.35 | 51.04101.0574 | 30° | H | VAG96115 ■ ■ ■ 66.50 x 9.04 x 15.05 | |
| V95032 ■ 38.00 x 9.00 x 160.30 | 51.04101.0546 | 45° | H | | |

10 125.00

| | | | | | | | |
|-------------|--------|--------|-----------|-------------|--------|-----|--------|
| D 2555 M | 9200cc | 5 Cyl. | 10 Valves | 123kW/168PS | Diesel | OHV | TD7708 |
| D 2555 MF | 9200cc | 5 Cyl. | 10 Valves | 123kW/168PS | Diesel | OHV | TD7703 |
| D 2555 MX | 9200cc | 5 Cyl. | 10 Valves | 141kW/192PS | Diesel | OHV | TD7710 |
| D 2555 MXF | 9200cc | 5 Cyl. | 10 Valves | 141kW/192PS | Diesel | OHV | TD7705 |
| D 2555 MXUL | 9200cc | 5 Cyl. | 10 Valves | 141kW/192PS | Diesel | OHV | TD7720 |

| | | | | | |
|---|---------------|-----|---|--|--|
| V94583 ■ 58.00 x 12.00 x 142.50 | 51.04101.0478 | 30° | H | VAG92498 ■ ■ ■ 64.00 x 12.00 x 18.00 | |
| V94564 ■ 51.00 x 12.00 x 142.50 | 51.04101.0479 | 45° | H | | |



OE

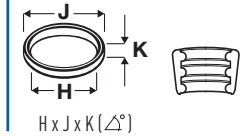

11 **125.00**

| | | | | | | | |
|---------------|--------|-----------------|-----------|--------------------|--------|------------|---------|
| D 2565 HM | 9510cc | 5 Cyl. | 10 Valves | 92-141kW/125-192PS | Diesel | OHV | TD19039 |
| D 2565 M | 9510cc | 5 Cyl. | 10 Valves | 141kW/192PS | Diesel | OHV | TD7711 |
| D 2565 M/168 | 9510cc | 5 Cyl. | 10 Valves | 123kW/168PS | Diesel | OHV | TD7709 |
| D 2565 ME | 9510cc | 5 Cyl. | 10 Valves | 84-141kW/114-192PS | Diesel | OHV | TD19040 |
| D 2565 MF | 9510cc | 5 Cyl. | 10 Valves | 141kW/192PS | Diesel | OHV | TD7706 |
| D 2565 MF/168 | 9510cc | 5 Cyl. | 10 Valves | 123kW/168PS | Diesel | OHV | TD7704 |
| D 2565 MFR | 9510cc | 5 Cyl. | 10 Valves | 92-141kW/125-192PS | Diesel | OHV | TD19041 |
| D 2565 MH | 9510cc | 5 Cyl. | 10 Valves | 141kW/192PS | Diesel | OHV | TD23167 |
| D 2565 MK | 9510cc | 5 Cyl. | 10 Valves | 169kW/230PS | Diesel | Turbo, OHV | TD19117 |
| D 2565 MKUL | 9510cc | 5 Cyl. | 10 Valves | 169kW/230PS | Diesel | Turbo, OHV | TD19072 |
| D 2565 MR | 9510cc | 5 Cyl. | 10 Valves | 141kW/192PS | Diesel | OHV | TD23168 |
| D 2565 MT | 9510cc | 5 Cyl. | 10 Valves | 169kW/230PS | Diesel | Turbo, OHV | TD19073 |
| D 2565 MUE | 9510cc | 5 Cyl. | 10 Valves | 141kW/192PS | Diesel | OHV | TD23169 |
| D 2565 MUH | 9510cc | 5 Cyl. | 10 Valves | 92-141kW/125-192PS | Diesel | OHV | TD19042 |
| D 2565 MUL | 9510cc | 5 Cyl. | 10 Valves | 141kW/192PS | Diesel | OHV | TD7721 |
| F 9 | | 01/1983→12/1986 | | | | | |

V94583
58.00 x 12.00 x 142.50

51.04101.0478

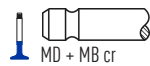

30°

H

VAG92498
64.00 x 12.00 x 18.00



V94564
51.00 x 12.00 x 142.50

51.04101.0479



45°

H

12 **125.00**

| | | | | | | | |
|-----------------|---------|--------|-----------|---------------------|--------|------------|---------|
| D 2556 M | 11045cc | 6 Cyl. | 12 Valves | 147kW/200PS | Diesel | OHV | TD7730 |
| D 2556 MF | 11045cc | 6 Cyl. | 12 Valves | 147kW/200PS | Diesel | OHV | TD7729 |
| D 2556 MTE | 11045cc | 6 Cyl. | 12 Valves | 191kW/260PS | Diesel | Turbo, OHV | TD23166 |
| D 2556 MX | 11045cc | 6 Cyl. | 12 Valves | 147-194kW/200-264PS | Diesel | OHV | TD7733 |
| D 2556 MXF | 11045cc | 6 Cyl. | 12 Valves | 172-177kW/232-240PS | Diesel | OHV | TD7731 |
| D 2556 MXUH/240 | 11045cc | 6 Cyl. | 12 Valves | 177kW/240PS | Diesel | OHV | TD7607 |

V94583
58.00 x 12.00 x 142.50

51.04101.0478



30°

H

VAG92498
64.00 x 12.00 x 18.00

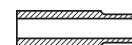

V94564
51.00 x 12.00 x 142.50

51.04101.0479



45°

H

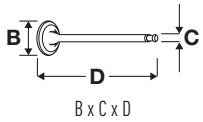

OE

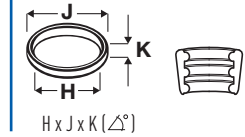
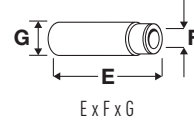

13  125.00

| | | | | | | | |
|-----------------|---------|--------|-----------|---------------------|--------|------------|---------|
| D 2566 | 11413cc | 6 Cyl. | 12 Valves | 235kW/320PS | Diesel | Turbo, OHV | TD7413 |
| D 2566 M | 11413cc | 6 Cyl. | 12 Valves | 177kW/240PS | Diesel | OHV | TD7735 |
| D 2566 ME | 11413cc | 6 Cyl. | 12 Valves | 125-177kW/170-241PS | Diesel | OHV | TD19451 |
| D 2566 MF | 11413cc | 6 Cyl. | 12 Valves | 177kW/240PS | Diesel | OHV | TD7732 |
| D 2566 MF/220 | 11413cc | 6 Cyl. | 12 Valves | 162kW/220PS | Diesel | OHV | TD7722 |
| D 2566 MFO | 11413cc | 6 Cyl. | 12 Valves | 125kW/170PS | Diesel | OHV | TD28911 |
| D 2566 MH | 11413cc | 6 Cyl. | 12 Valves | 177kW/240PS | Diesel | OHV | TD7414 |
| D 2566 MHO | 11413cc | 6 Cyl. | 12 Valves | 177kW/240PS | Diesel | OHV | TD7741 |
| D 2566 MK | 11413cc | 6 Cyl. | 12 Valves | 235kW/320PS | Diesel | Turbo, OHV | TD7801 |
| D 2566 MK/280 | 11413cc | 6 Cyl. | 12 Valves | 206kW/280PS | Diesel | Turbo, OHV | TD7800 |
| D 2566 MKF | 11413cc | 6 Cyl. | 12 Valves | 235kW/320PS | Diesel | Turbo, OHV | TD7758 |
| D 2566 MKF/280 | 11413cc | 6 Cyl. | 12 Valves | 206kW/280PS | Diesel | Turbo, OHV | TD7756 |
| D 2566 MKUH/320 | 11413cc | 6 Cyl. | 12 Valves | 235kW/320PS | Diesel | Turbo, OHV | TD7633 |
| D 2566 MKUL | 11413cc | 6 Cyl. | 12 Valves | 235kW/320PS | Diesel | Turbo, OHV | TD7804 |
| D 2566 MLUH | 11413cc | 6 Cyl. | 12 Valves | 192kW/260PS | Diesel | Turbo, OHV | TD7632 |
| D 2566 MLUM | 11413cc | 6 Cyl. | 12 Valves | 227kW/310PS | Diesel | Turbo, OHV | TD7625 |
| D 2566 MLUM/US | 11413cc | 6 Cyl. | 12 Valves | 222kW/305PS | Diesel | Turbo, OHV | TD7621 |
| D 2566 MT | 11413cc | 6 Cyl. | 12 Valves | 206kW/280PS | Diesel | Turbo, OHV | TD7799 |
| D 2566 MTE | 11413cc | 6 Cyl. | 12 Valves | 162-235kW/220-320PS | Diesel | Turbo, OHV | TD19074 |
| D 2566 MTF | 11413cc | 6 Cyl. | 12 Valves | 206kW/280PS | Diesel | Turbo, OHV | TD7738 |
| D 2566 MTFG | 11413cc | 6 Cyl. | 12 Valves | 206kW/280PS | Diesel | Turbo, OHV | TD7805 |
| D 2566 MTH | 11413cc | 6 Cyl. | 12 Valves | 213kW/290PS | Diesel | Turbo, OHV | TD7418 |
| D 2566 MTHO | 11413cc | 6 Cyl. | 12 Valves | 206-235kW/280-320PS | Diesel | Turbo, OHV | TD7744 |
| D 2566 MTUH | 11413cc | 6 Cyl. | 12 Valves | 206-235kW/280-320PS | Diesel | Turbo, OHV | TD7603 |
| D 2566 MUE | 11413cc | 6 Cyl. | 12 Valves | 125-177kW/170-241PS | Diesel | OHV | TD19452 |
| D 2566 MUH | 11413cc | 6 Cyl. | 12 Valves | 177kW/240PS | Diesel | Turbo, OHV | TD7407 |
| D 2566 MUH/175 | 11413cc | 6 Cyl. | 12 Valves | 128kW/175PS | Diesel | OHV | TD7614 |
| D 2566 MUH/192 | 11413cc | 6 Cyl. | 12 Valves | 141kW/192PS | Diesel | OHV | TD7608 |
| D 2566 MUH/200 | 11413cc | 6 Cyl. | 12 Valves | 147kW/200PS | Diesel | OHV | TD7609 |
| D 2566 MUH/220 | 11413cc | 6 Cyl. | 12 Valves | 162kW/220PS | Diesel | OHV | TD7615 |
| D 2566 MUH/240 | 11413cc | 6 Cyl. | 12 Valves | 177kW/240PS | Diesel | OHV | TD7610 |
| D 2566 MUL | 11413cc | 6 Cyl. | 12 Valves | 177kW/240PS | Diesel | OHV | TD7803 |
| D 2566 MUM | 11413cc | 6 Cyl. | 12 Valves | 147-177kW/200-241PS | Diesel | OHV | TD7440 |
| D 2566 MUM/200 | 11413cc | 6 Cyl. | 12 Valves | 147kW/200PS | Diesel | OHV | TD7622 |
| D 2566 MUM/220 | 11413cc | 6 Cyl. | 12 Valves | 162kW/220PS | Diesel | OHV | TD7623 |
| D 2566 MUM/240 | 11413cc | 6 Cyl. | 12 Valves | 177kW/240PS | Diesel | OHV | TD7624 |
| D 2566 MXF | 11413cc | 6 Cyl. | 12 Valves | 125-177kW/211-241PS | Diesel | OHV | TD19043 |
| D 2566 UH | 11413cc | 6 Cyl. | 12 Valves | 155kW/211PS | Diesel | OHV | TD7616 |
| D 2566 UH/205 | 11413cc | 6 Cyl. | 12 Valves | 147-150kW/200-205PS | Diesel | OHV | TD7611 |

| | | | |
|--------|-----------------|---------|-----------------|
| AS 280 | 01/1980→12/1987 | Favorit | 01/1981→12/1985 |
| SD | 10/1975→04/1994 | SG | 07/1976→ |
| SL | 05/1980→04/1987 | SL II | 06/1984→04/1993 |
| SR | 10/1975→11/1986 | SÜ | 10/1975→09/1989 |

V94583  58.00 x 12.00 x 142.50

51.04101.0478

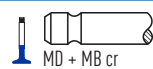

30°

H

VAG92498  64.00 x 12.00 x 18.00

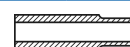

V94564  51.00 x 12.00 x 142.50

51.04101.0479



45°

H

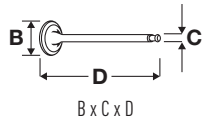

OE

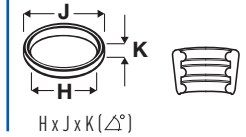
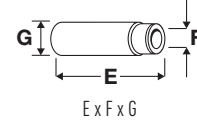
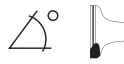

14 **125.00**

| | | | | | | | |
|-------------------|---------|---------|------------------|---------------------|--------|-------------------|----------------|
| D 2538 M | 12763cc | V8 Cyl. | 16 Valves | 188kW/256PS | Diesel | OHV | TD7743 |
| D 2538 ME | 12763cc | V8 Cyl. | 16 Valves | 188kW/256PS | Diesel | OHV | TD19447 |
| D 2538 MF | 12763cc | V8 Cyl. | 16 Valves | 188kW/256PS | Diesel | OHV | TD7737 |
| D 2538 MT | 12763cc | V8 Cyl. | 16 Valves | 178-235kW/242-320PS | Diesel | Turbo, OHV | TD7748 |
| D 2538 MTE | 12763cc | V8 Cyl. | 16 Valves | 178-235kW/242-320PS | Diesel | Turbo, OHV | TD19064 |

V94583
58.00 x 12.00 x 142.50

51.04101.0478



MD + MB cr

30°

H

VAG92498
64.00 x 12.00 x 18.00



V94564
51.00 x 12.00 x 142.50

51.04101.0479



MD + MB cr

45°

H

15 **125.00**

| | | | | | | | |
|------------------------|---------|----------|------------------|-------------|--------|-------------------|---------------|
| D 2530 MTFX/360 | 15900cc | V10 Cyl. | 20 Valves | 265kW/360PS | Diesel | Turbo, OHV | TD7760 |
|------------------------|---------|----------|------------------|-------------|--------|-------------------|---------------|

V94583
58.00 x 12.00 x 142.50

51.04101.0478

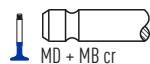

MD + MB cr

30°

H

VAG92498
64.00 x 12.00 x 18.00

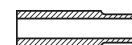

V94564
51.00 x 12.00 x 142.50

51.04101.0479



MD + MB cr

45°

H

16 **125.00**

| | | | | | | | |
|-------------------|---------|----------|------------------|---------------------|--------|------------|----------------|
| D 2530 ME | 15945cc | V10 Cyl. | 20 Valves | 156-235kW/212-320PS | Diesel | OHV | TD19446 |
| D 2530 MF | 15945cc | V10 Cyl. | 20 Valves | 235kW/320PS | Diesel | OHV | TD5650 |
| D 2530 MXF | 15945cc | V10 Cyl. | 20 Valves | 156-235kW/212-320PS | Diesel | OHV | TD19038 |

V94583
58.00 x 12.00 x 142.50

51.04101.0478



MD + MB cr

30°

H

VAG92498
64.00 x 12.00 x 18.00

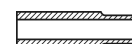

V94564
51.00 x 12.00 x 142.50

51.04101.0479



MD + MB cr

45°

H

17 **125.00**

| | | | | | | | |
|--------------------|---------|----------|------------------|---------------------|--------|-------------------|----------------|
| D 2530 MTE | 15953cc | V10 Cyl. | 20 Valves | 223-294kW/303-400PS | Diesel | Turbo, OHV | TD19065 |
| D 2530 MTFX | 15953cc | V10 Cyl. | 20 Valves | 294kW/400PS | Diesel | Turbo, OHV | TD7813 |

V94583
58.00 x 12.00 x 142.50

51.04101.0478



MD + MB cr

30°

H

VAG92498
64.00 x 12.00 x 18.00

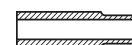

V94564
51.00 x 12.00 x 142.50

51.04101.0479



MD + MB cr

45°

H

18 **125.00**

| | | | | | | | |
|-------------------|---------|----------|------------------|---------------------|--------|-------------------|----------------|
| D 2540 MT | 17426cc | V10 Cyl. | 20 Valves | 287-324kW/390-441PS | Diesel | Turbo, OHV | TD19448 |
| D 2540 MTF | 17426cc | V10 Cyl. | 20 Valves | 324kW/440PS | Diesel | Turbo, OHV | TD7814 |

V94583
58.00 x 12.00 x 142.50

51.04101.0478



MD + MB cr

30°

H

VAG92498
64.00 x 12.00 x 18.00

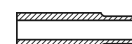

V94564
51.00 x 12.00 x 142.50

51.04101.0479



MD + MB cr

45°

H



OE

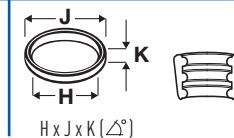
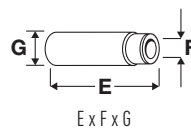

19 **125.00**

| | | | | | | | |
|------------------------|---------------|------------|------------------|---------------------|-----------------------|-------------------|----------------|
| D 2542 MLE | 20911cc | V12 Cyl. | 24 Valves | 420-515kW/571-700PS | Diesel | Turbo, OHV | TD19449 |
| D 2542 MTE | 20911cc | V12 Cyl. | 24 Valves | 283-405kW/385-551PS | Diesel | Turbo, OHV | TD19450 |
| V94583 | 51.04101.0478 | | 30° | H | VAG92498 | | |
| 58.00 x 12.00 x 142.50 | | MD + MB cr | | | 64.00 x 12.00 x 18.00 | | |
| V94564 | 51.04101.0479 | | 45° | H | | | |
| 51.00 x 12.00 x 142.50 | | MD + MB cr | | | | | |

20 **126.00**

| | | | | | | | |
|---------------------|-----------------|--------|------------------|---------------------|--------|--------------------|----------------|
| D 2676 LF01 | 12419cc | 6 Cyl. | 24 Valves | 353kW/480PS | Diesel | Turbo, DOHC | TD19100 |
| D 2676 LF02 | 12419cc | 6 Cyl. | 24 Valves | 353kW/480PS | Diesel | Turbo, DOHC | TD20542 |
| D 2676 LF03 | 12419cc | 6 Cyl. | 24 Valves | 353kW/480PS | Diesel | Turbo, DOHC | TD20543 |
| D 2676 LF04 | 12419cc | 6 Cyl. | 24 Valves | 324-324kW/440-441PS | Diesel | Turbo, DOHC | TD22906 |
| D 2676 LF05 | 12419cc | 6 Cyl. | 24 Valves | 353kW/480PS | Diesel | Turbo, DOHC | TD20371 |
| D 2676 LF06 | 12419cc | 6 Cyl. | 24 Valves | 397kW/540PS | Diesel | Turbo, DOHC | TD23145 |
| D 2676 LF07 | 12419cc | 6 Cyl. | 24 Valves | 353kW/480PS | Diesel | Turbo, DOHC | TD23137 |
| D 2676 LF11 | 12419cc | 6 Cyl. | 24 Valves | 397kW/540PS | Diesel | Turbo, DOHC | TD19104 |
| D 2676 LF12 | 12419cc | 6 Cyl. | 24 Valves | 353kW/480PS | Diesel | Turbo, DOHC | TD19103 |
| D 2676 LF13 | 12419cc | 6 Cyl. | 24 Valves | 397kW/540PS | Diesel | Turbo, DOHC | TD20372 |
| D 2676 LF14 | 12419cc | 6 Cyl. | 24 Valves | 353kW/480PS | Diesel | Turbo, DOHC | TD20373 |
| D 2676 LF21 | 12419cc | 6 Cyl. | 24 Valves | 353kW/480PS | Diesel | Turbo, DOHC | TD23691 |
| D 2676 LOH01 | 12419cc | 6 Cyl. | 24 Valves | 338kW/460PS | Diesel | Turbo, DOHC | TD19102 |
| D 2676 LOH02 | 12419cc | 6 Cyl. | 24 Valves | 353kW/480PS | Diesel | Turbo, DOHC | TD19101 |
| D 2676 LOH03 | 12419cc | 6 Cyl. | 24 Valves | 338kW/460PS | Diesel | Turbo, DOHC | TD23068 |
| D 2676 LOH04 | 12419cc | 6 Cyl. | 24 Valves | 353kW/480PS | Diesel | Turbo, DOHC | TD23069 |
| D 2676 LOH10 | 12419cc | 6 Cyl. | 24 Valves | 338kW/460PS | Diesel | Turbo, DOHC | TD23077 |
| D 2676 LOH26 | 12419cc | 6 Cyl. | 24 Valves | 324kW/440PS | Diesel | Turbo, DOHC | TD23400 |
| D 2676 LOH27 | 12419cc | 6 Cyl. | 24 Valves | 353kW/480PS | Diesel | Turbo, DOHC | TD23401 |
| D 2676 LOH28 | 12419cc | 6 Cyl. | 24 Valves | 371kW/505PS | Diesel | Turbo, DOHC | TD23678 |
| HOCL | 03/2006→12/2014 | | | TGA | | 02/2004→ | |
| TGS | 10/2007→ | | | TGX | | 09/2007→ | |
| T-Serie | 10/2005→ | | | | | | |

| | | | | | | | |
|-----------------------|---------------|------------|-----|---|----------------------|--|--|
| V95034 | 51.04101.0574 | | 30° | H | VAG96115 | | |
| 40.10 x 8.97 x 160.35 | | MD + MB cr | | | 66.50 x 9.04 x 15.05 | | |
| V95032 | 51.04101.0546 | | 45° | H | | | |
| 38.00 x 9.00 x 160.30 | | MD + MB cr | | | | | |



OE

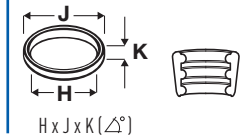
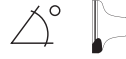

21  128.00

| | | | | | | | |
|---------------|--------|--------|-----------|---------------------|--------|------------|---------|
| D 2865 LF/260 | 9973cc | 5 Cyl. | 10 Valves | 191kW/260PS | Diesel | Turbo, OHV | TD7776 |
| D 2865 LF01 | 9973cc | 5 Cyl. | 10 Valves | 191-235kW/260-320PS | Diesel | Turbo, OHV | TD25850 |
| D 2865 LF02 | 9973cc | 5 Cyl. | 10 Valves | 198kW/270PS | Diesel | Turbo, OHV | TD7696 |
| D 2865 LF03 | 9973cc | 5 Cyl. | 10 Valves | 235kW/320PS | Diesel | Turbo, OHV | TD7780 |
| D 2865 LF05 | 9973cc | 5 Cyl. | 10 Valves | 198kW/270PS | Diesel | Turbo, OHV | TD7777 |
| D 2865 LF06 | 9973cc | 5 Cyl. | 10 Valves | 235kW/320PS | Diesel | Turbo, OHV | TD7781 |
| D 2865 LF09 | 9973cc | 5 Cyl. | 10 Valves | 250kW/340PS | Diesel | Turbo, OHV | TD7784 |
| D 2865 LF10 | 9973cc | 5 Cyl. | 10 Valves | 235kW/320PS | Diesel | Turbo, OHV | TD28917 |
| D 2865 LF20 | 9973cc | 5 Cyl. | 10 Valves | 213kW/290PS | Diesel | Turbo, OHV | TD7765 |
| D 2865 LF21 | 9973cc | 5 Cyl. | 10 Valves | 110-250kW/290-340PS | Diesel | Turbo, OHV | TD7769 |
| D 2865 LF22 | 9973cc | 5 Cyl. | 10 Valves | 198kW/270PS | Diesel | Turbo, OHV | TD7764 |
| D 2865 LF23 | 9973cc | 5 Cyl. | 10 Valves | 235kW/320PS | Diesel | Turbo, OHV | TD7767 |
| D 2865 LF24 | 9973cc | 5 Cyl. | 10 Valves | 213kW/290PS | Diesel | Turbo, OHV | TD7766 |
| D 2865 LFR | 9973cc | 5 Cyl. | 10 Valves | 191-235kW/260-320PS | Diesel | Turbo, OHV | TD25851 |
| D 2865 LFR01 | 9973cc | 5 Cyl. | 10 Valves | 191-235kW/260-320PS | Diesel | Turbo, OHV | TD25852 |
| D 2865 LOH01 | 9973cc | 5 Cyl. | 10 Valves | 198kW/270PS | Diesel | Turbo, OHV | TD9087 |
| D 2865 LOH02 | 9973cc | 5 Cyl. | 10 Valves | 235kW/320PS | Diesel | Turbo, OHV | TD7754 |
| D 2865 LOH05 | 9973cc | 5 Cyl. | 10 Valves | 191-235kW/260-320PS | Diesel | Turbo, OHV | TD25854 |
| D 2865 LOH07 | 9973cc | 5 Cyl. | 10 Valves | 191-250kW/260-340PS | Diesel | Turbo, OHV | TD25855 |
| D 2865 LOH08 | 9973cc | 5 Cyl. | 10 Valves | 191kW/260PS | Diesel | Turbo, OHV | TD25857 |
| D 2865 LOH09 | 9973cc | 5 Cyl. | 10 Valves | 228kW/310PS | Diesel | Turbo, OHV | TD25858 |
| D 2865 LOH10 | 9973cc | 5 Cyl. | 10 Valves | 213kW/290PS | Diesel | Turbo, OHV | TD25859 |
| D 2865 LU01 | 9973cc | 5 Cyl. | 10 Valves | 198kW/270PS | Diesel | Turbo, OHV | TD7724 |
| D 2865 LU02 | 9973cc | 5 Cyl. | 10 Valves | 198kW/270PS | Diesel | Turbo, OHV | TD28918 |
| D 2865 LU03 | 9973cc | 5 Cyl. | 10 Valves | 235kW/320PS | Diesel | Turbo, OHV | TD28919 |
| D 2865 LU04 | 9973cc | 5 Cyl. | 10 Valves | 198kW/270PS | Diesel | Turbo, OHV | TD28920 |
| D 2865 LU05 | 9973cc | 5 Cyl. | 10 Valves | 198kW/270PS | Diesel | Turbo, OHV | TD16484 |
| D 2865 LU06 | 9973cc | 5 Cyl. | 10 Valves | 235kW/320PS | Diesel | Turbo, OHV | TD28921 |
| D 2865 LUH02 | 9973cc | 5 Cyl. | 10 Valves | 198kW/270PS | Diesel | Turbo, OHV | TD7578 |
| D 2865 LUH03 | 9973cc | 5 Cyl. | 10 Valves | 235kW/320PS | Diesel | Turbo, OHV | TD28922 |
| D 2865 LUH05 | 9973cc | 5 Cyl. | 10 Valves | 198kW/270PS | Diesel | Turbo, OHV | TD7579 |
| D 2865 LUH06 | 9973cc | 5 Cyl. | 10 Valves | 191kW/260PS | Diesel | Turbo, OHV | TD28923 |
| D 2865 LUH07 | 9973cc | 5 Cyl. | 10 Valves | 228kW/310PS | Diesel | Turbo, OHV | TD7581 |
| D 2865 LUH08 | 9973cc | 5 Cyl. | 10 Valves | 235kW/320PS | Diesel | Turbo, OHV | TD7612 |
| D 2865 LUH09 | 9973cc | 5 Cyl. | 10 Valves | 191kW/260PS | Diesel | Turbo, OHV | TD7594 |
| D 2865 LXF | 9973cc | 5 Cyl. | 10 Valves | 191-235kW/260-320PS | Diesel | Turbo, OHV | TD25860 |
| D 2865 LXFR | 9973cc | 5 Cyl. | 10 Valves | 191-235kW/260-320PS | Diesel | Turbo, OHV | TD25861 |

| | |
|-------------|-----------------|
| F 90 | 01/1988→06/1996 |
| F 2000 | 01/1994→ |
| Megashuttle | 01/1994→ |
| NG | 09/1995→07/1998 |
| NÜ | 09/1996→07/1998 |
| SÜ | 04/1993→06/1997 |
| ÜL | 04/1992→ |

| | |
|----------------|-----------------|
| F 90 Unterflur | 02/1990→05/1994 |
| M 90 | 09/1991→05/1995 |
| M-Serie | 01/1996→12/2001 |
| NL | 11/1995→ |
| SG | 02/1994→06/1997 |
| Transliner | 09/1993→ |

V94583 ■
58.00 x 12.00 x 142.50

51.04101.0478



30°

H

VAG96309 ■
56.00 x 12.02 x 18.05

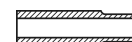

V94564 ■
51.00 x 12.00 x 142.50

51.04101.0479



45°

H

VAG92498 ■ ■
64.00 x 12.00 x 18.00

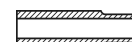



OE

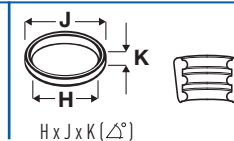
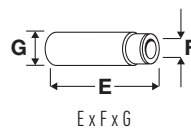

22  **128.00**

| | | | | | | | |
|----------------|---------|--------|-----------|---------------------|--------|------------|---------|
| D 2866 F/240 | 11967cc | 6 Cyl. | 12 Valves | 177kW/240PS | Diesel | OHV | TD7775 |
| D 2866 FG | 11967cc | 6 Cyl. | 12 Valves | 185kW/252PS | Diesel | OHV | TD28924 |
| D 2866 FR | 11967cc | 6 Cyl. | 12 Valves | 177-213kW/241-290PS | Diesel | OHV | TD19127 |
| D 2866 KF | 11967cc | 6 Cyl. | 12 Valves | 265kW/360PS | Diesel | Turbo, OHV | TD5651 |
| D 2866 KFZ | 11967cc | 6 Cyl. | 12 Valves | 265kW/360PS | Diesel | Turbo, OHV | TD7761 |
| D 2866 KOH/373 | 11967cc | 6 Cyl. | 12 Valves | 274kW/373PS | Diesel | Turbo, OHV | TD7415 |
| D 2866 KOH360 | 11967cc | 6 Cyl. | 12 Valves | 265kW/360PS | Diesel | Turbo, OHV | TD16487 |
| D 2866 KUH/360 | 11967cc | 6 Cyl. | 12 Valves | 265kW/360PS | Diesel | Turbo, OHV | TD7591 |
| D 2866 KUL | 11967cc | 6 Cyl. | 12 Valves | 265kW/360PS | Diesel | Turbo, OHV | TD7786 |
| D 2866 LF | 11967cc | 6 Cyl. | 12 Valves | 243kW/330PS | Diesel | Turbo, OHV | TD28926 |
| D 2866 LF02 | 11967cc | 6 Cyl. | 12 Valves | 250kW/340PS | Diesel | Turbo, OHV | TD28928 |
| D 2866 LF03 | 11967cc | 6 Cyl. | 12 Valves | 272kW/370PS | Diesel | Turbo, OHV | TD7787 |
| D 2866 LF04 | 11967cc | 6 Cyl. | 12 Valves | 220kW/300PS | Diesel | Turbo, OHV | TD7779 |
| D 2866 LF05 | 11967cc | 6 Cyl. | 12 Valves | 272kW/370PS | Diesel | Turbo, OHV | TD7788 |
| D 2866 LF06 | 11967cc | 6 Cyl. | 12 Valves | 309kW/420PS | Diesel | Turbo, OHV | TD7792 |
| D 2866 LF07 | 11967cc | 6 Cyl. | 12 Valves | 213kW/290PS | Diesel | Turbo, OHV | TD28929 |
| D 2866 LF08 | 11967cc | 6 Cyl. | 12 Valves | 243kW/330PS | Diesel | Turbo, OHV | TD28930 |
| D 2866 LF09 | 11967cc | 6 Cyl. | 12 Valves | 309kW/420PS | Diesel | Turbo, OHV | TD7793 |
| D 2866 LF10 | 11967cc | 6 Cyl. | 12 Valves | 309kW/420PS | Diesel | Turbo, OHV | TD7794 |
| D 2866 LF15 | 11967cc | 6 Cyl. | 12 Valves | 272kW/370PS | Diesel | Turbo, OHV | TD7789 |
| D 2866 LF16 | 11967cc | 6 Cyl. | 12 Valves | 294-309kW/400-420PS | Diesel | Turbo, OHV | TD7791 |
| D 2866 LF20 | 11967cc | 6 Cyl. | 12 Valves | 294-309kW/400-420PS | Diesel | Turbo, OHV | TD7771 |
| D 2866 LF21 | 11967cc | 6 Cyl. | 12 Valves | 272kW/370PS | Diesel | Turbo, OHV | TD7770 |
| D 2866 LF22 | 11967cc | 6 Cyl. | 12 Valves | 309kW/420PS | Diesel | Turbo, OHV | TD7772 |
| D 2866 LF29 | 11967cc | 6 Cyl. | 12 Valves | 294kW/400PS | Diesel | Turbo, OHV | TD21310 |
| D 2866 LF30 | 11967cc | 6 Cyl. | 24 Valves | 301kW/409PS | Diesel | Turbo, OHV | TD21311 |
| D 2866 LF330 | 11967cc | 6 Cyl. | 12 Valves | 243kW/330PS | Diesel | Turbo, OHV | TD7782 |
| D 2866 LF34 | 11967cc | 6 Cyl. | 12 Valves | 228kW/310PS | Diesel | Turbo, OHV | TD14308 |
| D 2866 LF35 | 11967cc | 6 Cyl. | 12 Valves | 265kW/360PS | Diesel | Turbo, OHV | TD14311 |
| D 2866 LFG | 11967cc | 6 Cyl. | 12 Valves | 243kW/330PS | Diesel | Turbo, OHV | TD28932 |
| D 2866 LFG03 | 11967cc | 6 Cyl. | 12 Valves | 272kW/370PS | Diesel | Turbo, OHV | TD28933 |
| D 2866 LFZ/290 | 11967cc | 6 Cyl. | 12 Valves | 213kW/290PS | Diesel | Turbo, OHV | TD7757 |
| D 2866 LFZ/330 | 11967cc | 6 Cyl. | 12 Valves | 243kW/330PS | Diesel | Turbo, OHV | TD7759 |
| D 2866 LHO1 | 11967cc | 6 Cyl. | 12 Valves | 220kW/299PS | Diesel | Turbo, OHV | TD28938 |
| D 2866 LOH | 11967cc | 6 Cyl. | 12 Valves | 243-309kW/330-420PS | Diesel | Turbo, OHV | TD7750 |
| D 2866 LOH02 | 11967cc | 6 Cyl. | 12 Valves | 272kW/370PS | Diesel | Turbo, OHV | TD28939 |
| D 2866 LOH03 | 11967cc | 6 Cyl. | 12 Valves | 309kW/420PS | Diesel | Turbo, OHV | TD7808 |
| D 2866 LOH06 | 11967cc | 6 Cyl. | 24 Valves | 309kW/420PS | Diesel | Turbo, OHV | TD7755 |
| D 2866 LOH07 | 11967cc | 6 Cyl. | 12 Valves | 272kW/370PS | Diesel | Turbo, OHV | TD7602 |
| D 2866 LOH09 | 11967cc | 6 Cyl. | 12 Valves | 230kW/313PS | Diesel | Turbo, OHV | TD28940 |
| D 2866 LOH20 | 11967cc | 6 Cyl. | 12 Valves | 309kW/420PS | Diesel | Turbo, OHV | TD5647 |
| D 2866 LOH21 | 11967cc | 6 Cyl. | 12 Valves | 309kW/420PS | Diesel | Turbo, OHV | TD28941 |
| D 2866 LOH22 | 11967cc | 6 Cyl. | 12 Valves | 272kW/370PS | Diesel | Turbo, OHV | TD7420 |
| D 2866 LOH23 | 11967cc | 6 Cyl. | 12 Valves | 294kW/400PS | Diesel | Turbo, OHV | TD7592 |
| D 2866 LOH24 | 11967cc | 6 Cyl. | 12 Valves | 230kW/310PS | Diesel | Turbo, OHV | TD7752 |
| D 2866 LOH25 | 11967cc | 6 Cyl. | 12 Valves | 228kW/310PS | Diesel | Turbo, OHV | TD7753 |
| D 2866 LOH26 | 11967cc | 6 Cyl. | 12 Valves | 257kW/350PS | Diesel | Turbo, OHV | TD7590 |
| D 2866 LOH31 | 11967cc | 6 Cyl. | 12 Valves | 191kW/260PS | Diesel | Turbo, OHV | TD28942 |



OE

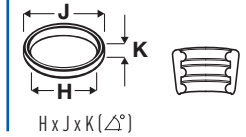

| | | | | | | | |
|----------------|---------|--------|-----------|---------------------|---------|------------|---------|
| D 2866 LU | 11967cc | 6 Cyl. | 12 Valves | 243kW/330PS | Diesel | Turbo, OHV | TD28945 |
| D 2866 LU01 | 11967cc | 6 Cyl. | 12 Valves | 272kW/370PS | Diesel | Turbo, OHV | TD21312 |
| D 2866 LU03 | 11967cc | 6 Cyl. | 12 Valves | 272kW/370PS | Diesel | Turbo, OHV | TD21313 |
| D 2866 LU04 | 11967cc | 6 Cyl. | 12 Valves | 309kW/420PS | Diesel | Turbo, OHV | TD28947 |
| D 2866 LU07 | 11967cc | 6 Cyl. | 12 Valves | 272kW/370PS | Diesel | Turbo, OHV | TD28948 |
| D 2866 LU08 | 11967cc | 6 Cyl. | 12 Valves | 230kW/313PS | Diesel | Turbo, OHV | TD28949 |
| D 2866 LU330 | 11967cc | 6 Cyl. | 12 Valves | 243kW/330PS | Diesel | Turbo, OHV | TD7809 |
| D 2866 LUH | 11967cc | 6 Cyl. | 12 Valves | 243kW/330PS | Diesel | Turbo, OHV | TD28950 |
| D 2866 LUH05 | 11967cc | 6 Cyl. | 12 Valves | 272kW/370PS | Diesel | Turbo, OHV | TD28952 |
| D 2866 LUH20 | 11967cc | 6 Cyl. | 12 Valves | 228kW/310PS | Diesel | Turbo, OHV | TD7582 |
| D 2866 LUH21 | 11967cc | 6 Cyl. | 12 Valves | 257kW/350PS | Diesel | Turbo, OHV | TD11167 |
| D 2866 LUH22 | 11967cc | 6 Cyl. | 12 Valves | 191kW/260PS | Diesel | Turbo, OHV | TD11133 |
| D 2866 LUH26 | 11967cc | 6 Cyl. | 12 Valves | 228kW/310PS | Diesel | Turbo, OHV | TD11134 |
| D 2866 LUH330 | 11967cc | 6 Cyl. | 24 Valves | 243kW/330PS | Diesel | Turbo, OHV | TD7593 |
| D 2866 LUL330 | 11967cc | 6 Cyl. | 12 Valves | 243kW/330PS | Diesel | Turbo, OHV | TD7783 |
| D 2866 LX | 11967cc | 6 Cyl. | 12 Valves | 198-344kW/269-468PS | Diesel | Turbo, OHV | TD19128 |
| D 2866 LXF | 11967cc | 6 Cyl. | 12 Valves | 198-274kW/269-372PS | Diesel | Turbo, OHV | TD7785 |
| D 2866 LXFG | 11967cc | 6 Cyl. | 12 Valves | 274kW/372PS | Diesel | Turbo, OHV | TD28961 |
| D 2866 LXOH | 11967cc | 6 Cyl. | 12 Valves | 265-274kW/360-373PS | Diesel | Turbo, OHV | TD6728 |
| D 2866 LXU | 11967cc | 6 Cyl. | 12 Valves | 265kW/360PS | Diesel | Turbo, OHV | TD28962 |
| D 2866 LXUH | 11967cc | 6 Cyl. | 12 Valves | 265kW/360PS | Diesel | Turbo, OHV | TD28963 |
| D 2866 T | 11967cc | 6 Cyl. | 12 Valves | 213kW/290PS | Diesel | Turbo, OHV | TD7580 |
| D 2866 TOH | 11967cc | 6 Cyl. | 12 Valves | 229kW/311PS | Diesel | Turbo, OHV | TD7745 |
| D 2866 TOH/290 | 11967cc | 6 Cyl. | 12 Valves | 213kW/290PS | Diesel | Turbo, OHV | TD7746 |
| D 2866 TOH/310 | 11967cc | 6 Cyl. | 12 Valves | 229kW/311PS | Diesel | Turbo, OHV | TD7747 |
| D 2866 TUH | 11967cc | 6 Cyl. | 12 Valves | 224-229kW/305-311PS | Diesel | Turbo, OHV | TD7186 |
| D 2866 TUH/290 | 11967cc | 6 Cyl. | 12 Valves | 213-224kW/290-305PS | Diesel | Turbo, OHV | TD7589 |
| D 2866 TUH01 | 11967cc | 6 Cyl. | 12 Valves | 222kW/302PS | Diesel | Turbo, OHV | TD7176 |
| D 2866 U | 11967cc | 6 Cyl. | 12 Valves | 160-180kW/218-245PS | Diesel | OHV | TD28964 |
| D 2866 UH | 11967cc | 6 Cyl. | 12 Valves | 177-186kW/241-253PS | Diesel | OHV | TD7419 |
| D 2866 UH/240 | 11967cc | 6 Cyl. | 12 Valves | 177kW/240PS | Diesel | Turbo, OHV | TD7577 |
| D 2866 UM | 11967cc | 6 Cyl. | 12 Valves | 152-177kW/206-241PS | Diesel | OHV | TD7174 |
| G 2866 DUH04 | 11967cc | 6 Cyl. | 12 Valves | 175kW/238PS | CNG/Gas | OHV | TD16770 |

| | | | |
|----------------|-----------------|----------------|-----------------|
| A-Serie | 01/2004→ | Bravo | 09/2001→ |
| Centroliner | 01/1999→ | Cityliner | 09/1990→ |
| EL | 07/1998→ | EOS | 01/1992→ |
| F 90 | 07/1986→ | F 90 Unterflur | 07/1986→05/1994 |
| F 2000 | 01/1994→ | HELICON | 01/1987→ |
| HOCL | 04/1981→ | Jettliner | 09/1990→ |
| LION S CITY | 08/1996→ | LION S COACH | 09/1995→ |
| LION S COMFORT | 09/1996→ | LION S STAR | 01/1993→ |
| NG | 07/1998→ | NL | 07/1998→ |
| NÜ | 07/1998→ | R | 05/1985→01/1993 |
| Series 300 | 09/1994→02/2002 | SG | 11/1984→04/1994 |
| Skyliner | 09/1990→ | SL | 01/1986→04/1987 |
| SL II | 06/1984→04/1994 | Spaceliner | 09/1990→ |
| Starliner | 09/1996→ | SÜ | 01/1986→04/1993 |
| Transliner | 09/1990→ | ÜL | 09/1989→ |
| URBINO | 01/1999→ | | |

V94583 ■
58.00 x 12.00 x 142.50

51.04101.0478



30°

H

VAG96309 ■
56.00 x 12.02 x 18.05



V94564 ■
51.00 x 12.00 x 142.50

51.04101.0479

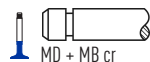

45°

H

VAG92498 ■ ■
64.00 x 12.00 x 18.00



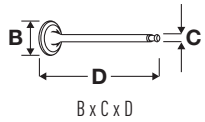

OE

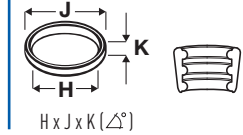
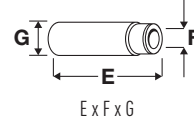

23 **128.00**

| | | | | | | | |
|---------------|---------|--------|-----------|---------------------|--------|------------|---------|
| D 2866 LF/290 | 11967cc | 6 Cyl. | 12 Valves | 213kW/290PS | Diesel | Turbo, OHV | TD7778 |
| D 2866 LF23 | 11967cc | 6 Cyl. | 12 Valves | 228kW/310PS | Diesel | Turbo, OHV | TD16521 |
| D 2866 LF24 | 11967cc | 6 Cyl. | 12 Valves | 265kW/360PS | Diesel | Turbo, OHV | TD16522 |
| D 2866 LF25 | 11967cc | 6 Cyl. | 12 Valves | 301kW/410PS | Diesel | Turbo, OHV | TD16467 |
| D 2866 LF26 | 11967cc | 6 Cyl. | 12 Valves | 228kW/310PS | Diesel | Turbo, OHV | TD16204 |
| D 2866 LF27 | 11967cc | 6 Cyl. | 12 Valves | 265kW/360PS | Diesel | Turbo, OHV | TD16205 |
| D 2866 LF28 | 11967cc | 6 Cyl. | 12 Valves | 301kW/410PS | Diesel | Turbo, OHV | TD15050 |
| D 2866 LF31 | 11967cc | 6 Cyl. | 12 Valves | 301kW/409PS | Diesel | Turbo, OHV | TD14312 |
| D 2866 LF32 | 11967cc | 6 Cyl. | 12 Valves | 301kW/410PS | Diesel | Turbo, OHV | TD15048 |
| D 2866 LF36 | 11967cc | 6 Cyl. | 12 Valves | 228kW/310PS | Diesel | Turbo, OHV | TD16202 |
| D 2866 LF37 | 11967cc | 6 Cyl. | 12 Valves | 265kW/360PS | Diesel | Turbo, OHV | TD16203 |
| D 2866 LF40 | 11967cc | 6 Cyl. | 24 Valves | 301kW/410PS | Diesel | Turbo, OHV | TD23662 |
| D 2866 LF41 | 11967cc | 6 Cyl. | 24 Valves | 301kW/410PS | Diesel | Turbo, OHV | TD23005 |
| D 2866 LF43 | 11967cc | 6 Cyl. | 12 Valves | 265kW/360PS | Diesel | Turbo, OHV | TD23004 |
| D 2866 LOH27 | 11967cc | 6 Cyl. | 24 Valves | 228kW/310PS | Diesel | Turbo, OHV | TD16760 |
| D 2866 LOH28 | 11967cc | 6 Cyl. | 24 Valves | 265kW/360PS | Diesel | Turbo, OHV | TD16761 |
| D 2866 LOH29 | 11967cc | 6 Cyl. | 24 Valves | 301kW/410PS | Diesel | Turbo, OHV | TD16493 |
| D 2866 LOH32 | 11967cc | 6 Cyl. | 24 Valves | 228kW/310PS | Diesel | Turbo, OHV | TD16746 |
| D 2866 LOH33 | 11967cc | 6 Cyl. | 24 Valves | 265kW/360PS | Diesel | Turbo, OHV | TD16747 |
| D 2866 LOH34 | 11967cc | 6 Cyl. | 24 Valves | 301kW/410PS | Diesel | Turbo, OHV | TD16297 |
| D 2866 LUH23 | 11967cc | 6 Cyl. | 24 Valves | 191kW/260PS | Diesel | Turbo, OHV | TD16764 |
| D 2866 LUH24 | 11967cc | 6 Cyl. | 24 Valves | 228kW/310PS | Diesel | Turbo, OHV | TD16765 |
| D 2866 LUH25 | 11967cc | 6 Cyl. | 24 Valves | 265kW/360PS | Diesel | Turbo, OHV | TD16766 |
| D 2866 LUH29 | 11967cc | 6 Cyl. | 24 Valves | 265kW/360PS | Diesel | Turbo, OHV | TD18040 |
| D 2866 LUH30 | 11967cc | 6 Cyl. | 24 Valves | 301-302kW/409-411PS | Diesel | Turbo, OHV | TD16767 |
| D 2866 LUH51 | 11967cc | 6 Cyl. | 24 Valves | 228kW/310PS | Diesel | Turbo, OHV | TD28163 |

| | | | |
|-------------|----------|--------------|-----------------|
| A-Serie | 01/2004→ | Bravo | 09/2001→ |
| Centroliner | 05/2004→ | Cityliner | 05/2004→ |
| E 2000 | 05/2000→ | ECT | 04/2002→ |
| Euroliner | | F 90 | 07/1986→02/1990 |
| F 2000 | 06/1998→ | HOCL | 01/1992→ |
| LION S CITY | 05/2004→ | LION S COACH | 01/2000→ |
| LION S STAR | 03/2000→ | Serie 9 | 01/1998→ |
| Serie 200 | 01/2005→ | Starliner | 01/2002→ |
| SÜ | 09/2003→ | TGA | 04/2000→ |
| Tourliner | 01/2003→ | Trendliner | 09/2004→ |
| T-Serie | 01/2005→ | | |

V94801
46.00 x 8.97 x 153.60

51.04101.0547



30°

H

VAG96115
66.50 x 9.04 x 15.05



V98055
46.00 x 8.96 x 153.75

51.04101.0482

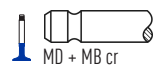

30°

H

V94800
46.00 x 8.96 x 153.60

51.04101.0548



45°

H

V98056
46.00 x 9.00 x 153.70

51.04101.0483

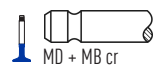

45°

H



OE

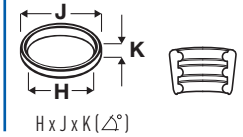

24 **128.00**

| | | | | | | | |
|------------------------|-----------------|------------|-----------|---------------------|-----------------------|------------|---------|
| D 2866 LF14 | 11967cc | 6 Cyl. | 12 Valves | 294-309kW/400-420PS | Diesel | Turbo, OHV | TD21308 |
| D 2866 LF17 | 11967cc | 6 Cyl. | 12 Valves | 260kW/354PS | Diesel | Turbo, OHV | TD21309 |
| D 2866 OH | 11967cc | 6 Cyl. | 12 Valves | 177-213kW/241-290PS | Diesel | OHV | TD23745 |
| HOCL | 01/1979→08/1996 | Series 300 | | | 09/1991→02/2002 | | |
| V94583 | 51.04101.0478 | | 30° | H | VAG92498 | | |
| 58.00 x 12.00 x 142.50 | | MD + MB cr | | | 64.00 x 12.00 x 18.00 | | |
| V94564 | 51.04101.0479 | | 45° | H | | | |
| 51.00 x 12.00 x 142.50 | | MD + MB cr | | | | | |

25 **128.00**

| | | | | | | | |
|------------------------|---------------|--------------|-----------|-------------|-----------------------|------------|---------|
| D 2876 LF02 | 12816cc | 6 Cyl. | 12 Valves | 338kW/460PS | Diesel | Turbo, OHV | TD7773 |
| D 2876 LOH01 | 12816cc | 6 Cyl. | 12 Valves | 338kW/460PS | Diesel | Turbo, OHV | TD16249 |
| F 2000 | 01/1994→ | LION S COACH | | | 01/2000→ | | |
| Starliner | 09/1996→ | | | | | | |
| V94583 | 51.04101.0478 | | 30° | H | VAG96309 | | |
| 58.00 x 12.00 x 142.50 | | MD + MB cr | | | 56.00 x 12.02 x 18.05 | | |
| V94564 | 51.04101.0479 | | 45° | H | VAG92498 | | |
| 51.00 x 12.00 x 142.50 | | MD + MB cr | | | 64.00 x 12.00 x 18.00 | | |

26 **128.00**

| | | | | | | | |
|-----------------------|---------------|--------------|-----------|-------------|----------------------|------------|---------|
| D 2876 LF03 | 12816cc | 6 Cyl. | 24 Valves | 338kW/460PS | Diesel | Turbo, OHV | TD17050 |
| D 2876 LF04 | 12816cc | 6 Cyl. | 24 Valves | 338kW/460PS | Diesel | Turbo, OHV | TD15051 |
| D 2876 LF05 | 12816cc | 6 Cyl. | 24 Valves | 375kW/510PS | Diesel | Turbo, OHV | TD16206 |
| D 2876 LF06 | 12816cc | 6 Cyl. | 24 Valves | 338kW/460PS | Diesel | Turbo, OHV | TD14313 |
| D 2876 LF07 | 12816cc | 6 Cyl. | 24 Valves | 338kW/460PS | Diesel | Turbo, OHV | TD15049 |
| D 2876 LF11 | 12816cc | 6 Cyl. | 24 Valves | 338kW/460PS | Diesel | Turbo, OHV | TD20603 |
| D 2876 LF20 | 12816cc | 6 Cyl. | 24 Valves | 375kW/510PS | Diesel | Turbo, OHV | TD23008 |
| D 2876 LOH02 | 12816cc | 6 Cyl. | 12 Valves | 338kW/460PS | Diesel | Turbo, OHV | TD16509 |
| D 2876 LOH03 | 12816cc | 6 Cyl. | 24 Valves | 338kW/460PS | Diesel | Turbo, OHV | TD16298 |
| Cityliner | 05/2004→ | E 2000 | | | 05/2000→ | | |
| F 2000 | 01/1994→ | LION S COACH | | | 01/2000→ | | |
| LION S STAR | 03/2000→ | TGA | | | 04/2000→ | | |
| Tourliner | 01/2003→ | | | | | | |
| V94801 | 51.04101.0547 | | 30° | H | VAG96115 | | |
| 46.00 x 8.97 x 153.60 | | MD + MB cr | | | 66.50 x 9.04 x 15.05 | | |
| V98055 | 51.04101.0482 | | 30° | | | | |
| 46.00 x 8.96 x 153.75 | | MD + MB cr | | | | | |
| V94800 | 51.04101.0548 | | 45° | H | | | |
| 46.00 x 8.96 x 153.60 | | MD + MB cr | | | | | |
| V98056 | 51.04101.0483 | | 45° | | | | |
| 46.00 x 9.00 x 153.70 | | MD + MB cr | | | | | |

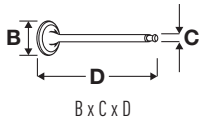

OE

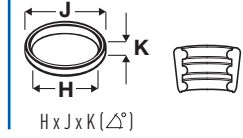
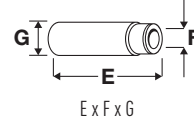

27 **128.00**

| | | | | | | | |
|---------------------|---------|--------|------------------|-------------|--------|-------------------|----------------|
| D 2876 LF12 | 12816cc | 6 Cyl. | 24 Valves | 353kW/480PS | Diesel | Turbo, OHV | TD16825 |
| D 2876 LF13 | 12816cc | 6 Cyl. | 24 Valves | 390kW/530PS | Diesel | Turbo, OHV | TD16826 |
| D 2876 LF25 | 12816cc | 6 Cyl. | 24 Valves | 353kW/480PS | Diesel | Turbo, OHV | TD19115 |
| D 2876 LOH20 | 12816cc | 6 Cyl. | 24 Valves | 353kW/480PS | Diesel | Turbo, OHV | TD16762 |
| D 2876 LOH21 | 12816cc | 6 Cyl. | 24 Valves | 390kW/530PS | Diesel | Turbo, OHV | TD18041 |

| | | | |
|-----------|----------|----------|----------|
| ECT | 02/2005→ | Skyliner | 05/2004→ |
| Starliner | 05/2005→ | TGA | 01/2001→ |

| | | | | | | |
|-----------------------|---------------|------------|-----|---|----------------------|--|
| V95005 | 51.04101.0523 | | 30° | H | VAG96115 | |
| 44.00 x 9.00 x 153.50 | | MD + MB cr | | | 66.50 x 9.04 x 15.05 | |
| V95006 | 51.04101.0524 | | 45° | H | | |
| 41.00 x 9.00 x 153.50 | | MD + MB cr | | | | |

28 **128.00**

| | | | | | | | |
|-------------------|---------|---------|------------------|-------------|--------|-------------------|----------------|
| D 2848 LXE | 14618cc | V8 Cyl. | 16 Valves | 500kW/680PS | Diesel | Turbo, OHV | TD19118 |
| D 2848 LYE | 14618cc | V8 Cyl. | 16 Valves | 500kW/680PS | Diesel | Turbo, OHV | TD19119 |
| D 2848 M | 14618cc | V8 Cyl. | 16 Valves | 206kW/280PS | Diesel | OHV | TD19075 |
| D 2848 MH | 14618cc | V8 Cyl. | 16 Valves | 206kW/280PS | Diesel | OHV | TD19076 |

| | | | | | | |
|------------------------|---------------|------------|-----|---|-----------------------|--|
| V94583 | 51.04101.0478 | | 30° | H | VAG96309 | |
| 58.00 x 12.00 x 142.50 | | MD + MB cr | | | 56.00 x 12.02 x 18.05 | |
| V94564 | 51.04101.0479 | | 45° | H | VAG92498 | |
| 51.00 x 12.00 x 142.50 | | MD + MB cr | | | 64.00 x 12.00 x 18.00 | |

29 **128.00**

| | | | | | | | |
|----------------------|---------|----------|------------------|---------------------|--------|-------------------|----------------|
| D 2840 LE | 18273cc | V10 Cyl. | 20 Valves | 346-460kW/471-626PS | Diesel | Turbo, OHV | TD19453 |
| D 2840 LF/460 | 18273cc | V10 Cyl. | 20 Valves | 338kW/460PS | Diesel | Turbo, OHV | TD7795 |
| D 2840 MFG | 18273cc | V10 Cyl. | 20 Valves | 268kW/365PS | Diesel | OHV | TD7812 |

| | | | |
|------|-----------------|--|--|
| F 90 | 05/1987→02/1990 | | |
|------|-----------------|--|--|

| | | | | | | |
|------------------------|---------------|------------|-----|---|-----------------------|--|
| V94583 | 51.04101.0478 | | 30° | H | VAG92498 | |
| 58.00 x 12.00 x 142.50 | | MD + MB cr | | | 64.00 x 12.00 x 18.00 | |
| V94564 | 51.04101.0479 | | 45° | H | | |
| 51.00 x 12.00 x 142.50 | | MD + MB cr | | | | |

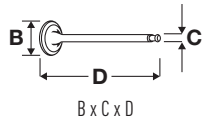

OE



MAT.

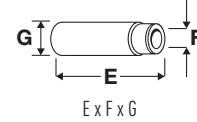
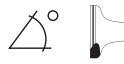

E x F x G

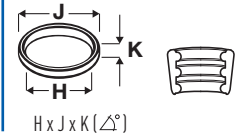

H x J x K (Δ°)

30 **128.00**

| | | | | | | | |
|--------------|---------|----------|-----------|---------------------|--------|------------|---------|
| D 2840 LE403 | 18273cc | V10 Cyl. | 20 Valves | 772kW/1050PS | Diesel | Turbo, OHV | TD27911 |
| D 2840 LF01 | 18273cc | V10 Cyl. | 20 Valves | 368kW/500PS | Diesel | Turbo, OHV | TD7796 |
| D 2840 LF03 | 18273cc | V10 Cyl. | 20 Valves | 346kW/471PS | Diesel | Turbo, OHV | TD28916 |
| D 2840 LF04 | 18273cc | V10 Cyl. | 20 Valves | 368kW/500PS | Diesel | Turbo, OHV | TD7797 |
| D 2840 LF06 | 18273cc | V10 Cyl. | 20 Valves | 368kW/500PS | Diesel | Turbo, OHV | TD7798 |
| D 2840 LF20 | 18273cc | V10 Cyl. | 20 Valves | 441kW/600PS | Diesel | Turbo, OHV | TD7774 |
| D 2840 LF21 | 18273cc | V10 Cyl. | 20 Valves | 441kW/600PS | Diesel | Turbo, OHV | TD18099 |
| D 2840 LXE | 18273cc | V10 Cyl. | 20 Valves | 603kW/820PS | Diesel | Turbo, OHV | TD19454 |
| D 2840 LXF | 18273cc | V10 Cyl. | 20 Valves | 338kW/460PS | Diesel | Turbo, OHV | TD19455 |
| D 2840 LYE | 18273cc | V10 Cyl. | 20 Valves | 603-670kW/820-911PS | Diesel | Turbo, OHV | TD19124 |
| D 2840 ME | 18273cc | V10 Cyl. | 20 Valves | 244-268kW/332-364PS | Diesel | OHV | TD19125 |
| D 2840 MF | 18273cc | V10 Cyl. | 20 Valves | 268kW/365PS | Diesel | OHV | TD7811 |
| D 2840 MFR | 18273cc | V10 Cyl. | 20 Valves | 245-268kW/333-364PS | Diesel | OHV | TD19456 |
| D 2840 MH | 18273cc | V10 Cyl. | 20 Valves | 244-268kW/332-364PS | Diesel | OHV | TD19126 |

E 2000
F 2000

05/2000→
01/1996→

F 90

02/1990→06/1996

V94583
58.00 x 12.00 x 142.50

51.04101.0478



30°

H

VAG96309
56.00 x 12.02 x 18.05



V94564
51.00 x 12.00 x 142.50

51.04101.0479



45°

H

VAG92498
64.00 x 12.00 x 18.00



31 **128.00**

| | | | | | | | |
|-------------|---------|----------|-----------|---------------------|--------|------------|---------|
| D 2840 LF25 | 18273cc | V10 Cyl. | 20 Valves | 485-515kW/660-700PS | Diesel | Turbo, OHV | TD16824 |
|-------------|---------|----------|-----------|---------------------|--------|------------|---------|

TGA

09/2002→

V95005
44.00 x 9.00 x 153.50

51.04101.0523



30°

H

VAG96115
66.50 x 9.04 x 15.05



V95006
41.00 x 9.00 x 153.50

51.04101.0524



45°

H

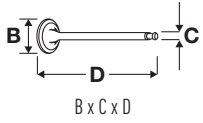

OE

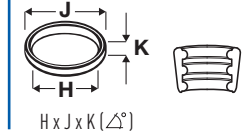
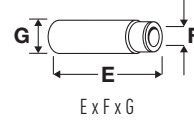

32 **128.00**

| | | | | | | | |
|--------------|---------|----------|------------------|----------------------|--------|-------------------|---------|
| D 2842 LE 02 | 21927cc | V12 Cyl. | 24 Valves | 588kW/800PS | Diesel | Turbo, OHV | TD25234 |
| D 2842 LE202 | 21927cc | V12 Cyl. | 24 Valves | 446-587kW/607-798PS | Diesel | Turbo, OHV | TD25682 |
| D 2842 LE401 | 21927cc | V12 Cyl. | 24 Valves | 588kW/800PS | Diesel | Turbo, OHV | TD27860 |
| D 2842 LE402 | 21927cc | V12 Cyl. | 24 Valves | 809kW/1100PS | Diesel | Turbo, OHV | TD27861 |
| D 2842 LE403 | 21927cc | V12 Cyl. | 24 Valves | 529kW/719PS | Diesel | Turbo, OHV | TD27862 |
| D 2842 LE404 | 21927cc | V12 Cyl. | 24 Valves | 956kW/1300PS | Diesel | Turbo, OHV | TD27702 |
| D 2842 LE405 | 21927cc | V12 Cyl. | 24 Valves | 662kW/900PS | Diesel | Turbo, OHV | TD27863 |
| D 2842 LE406 | 21927cc | V12 Cyl. | 24 Valves | 882kW/1200PS | Diesel | Turbo, OHV | TD27864 |
| D 2842 LE408 | 21927cc | V12 Cyl. | 24 Valves | 735kW/1000PS | Diesel | Turbo, OHV | TD27866 |
| D 2842 LE604 | 21927cc | V12 Cyl. | 24 Valves | 480kW/653PS | Diesel | Turbo, OHV | TD27918 |
| D 2842 LE606 | 21927cc | V12 Cyl. | 24 Valves | 662kW/900PS | Diesel | Turbo, OHV | TD27947 |
| D 2842 LE607 | 21927cc | V12 Cyl. | 24 Valves | 500kW/680PS | Diesel | Turbo, OHV | TD27919 |
| D 2842 LXE | 21927cc | V12 Cyl. | 24 Valves | 662-735kW/900-1000PS | Diesel | Turbo, OHV | TD19121 |
| D 2842 LYE | 21927cc | V12 Cyl. | 24 Valves | 735-808kW/100-1099PS | Diesel | Turbo, OHV | TD19122 |
| D 2842 LZE | 21927cc | V12 Cyl. | 24 Valves | 735-808kW/100-1099PS | Diesel | Turbo, OHV | TD19123 |
| D 2842 ME | 21927cc | V12 Cyl. | 24 Valves | 275-338kW/374-460PS | Diesel | OHV | TD19120 |

V94583
58.00 x 12.00 x 142.50

51.04101.0478

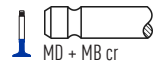

H

VAG96309
56.00 x 12.02 x 18.05



V94564
51.00 x 12.00 x 142.50







51.04101.0479



H

VAG92498
64.00 x 12.00 x 18.00



|  |  | ccm |  |  |  |  | |
|---|---|-------|---|---|---|---|----|
| 4EE1-T | | 79.00 | 1686 | 4 | 8 | Diesel | 12 |
| B6 | | 78.00 | 1598 | 4 | 16 | Petrol | 8 |
| B6 (SOHC) | | 78.00 | 1598 | 4 | 8 | Petrol | 8 |
| B6ZE | | 78.00 | 1598 | 4 | 16 | Petrol | 9 |
| CR12DE | | 71.00 | 1240 | 4 | 16 | Petrol | 1 |
| DHF | | 71.90 | 1242 | 4 | 16 | Petrol | 2 |
| DHG | | 71.90 | 1242 | 4 | 16 | Petrol | 2 |
| F6J8 | | 73.70 | 1399 | 4 | 8 | Diesel | 4 |
| F6JA | | 73.70 | 1399 | 4 | 8 | Diesel | 4 |
| F6JB | | 73.70 | 1399 | 4 | 8 | Diesel | 4 |
| FUJA | | 71.90 | 1242 | 4 | 16 | Petrol | 3 |
| FXJA | | 76.00 | 1388 | 4 | 16 | Petrol | 7 |
| FYJA | | 79.00 | 1596 | 4 | 16 | Petrol | 11 |
| HR16DE | | 78.00 | 1598 | 4 | 16 | Petrol | 10 |
| L3 | | 87.50 | 2261 | 4 | 16 | Petrol | 20 |
| L3C1 | | 87.50 | 2261 | 4 | 16 | Petrol | 20 |
| L813 | | 83.00 | 1798 | 4 | 16 | Petrol | 14 |
| L823 | | 83.00 | 1798 | 4 | 16 | Petrol | 14 |
| LF17 | | 87.50 | 1999 | 4 | 16 | Petrol | 19 |
| LF18 | | 87.50 | 1999 | 4 | 16 | Petrol | 19 |
| LFF7 | | 87.50 | 1999 | 4 | 16 | Petrol | 19 |
| R2 | | 86.00 | 2184 | 4 | 8 | Diesel | 18 |
| RF3F | | 86.00 | 1998 | 4 | 16 | Diesel | 15 |
| RF55 | | 86.00 | 1998 | 4 | 8 | Diesel | 16 |
| RF5C | | 86.00 | 1998 | 4 | 16 | Diesel | 17 |
| RTJ | | 82.50 | 1753 | 4 | 8 | Diesel | 13 |
| RTK | | 82.50 | 1753 | 4 | 8 | Diesel | 13 |
| WL-T | | 93.00 | 2500 | 4 | 12 | Diesel | 21 |
| Y601 | | 75.00 | 1560 | 4 | 16 | Diesel | 6 |
| ZJ-VE | | 74.00 | 1349 | 4 | 16 | Petrol | 5 |

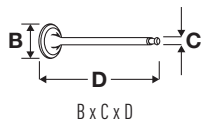

OE

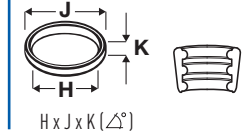
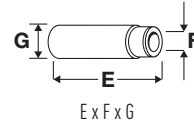
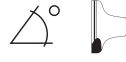

1 71.00

| | | | | | | | |
|-----------------|--------|----------|-----------|-----------------|--------|------|---------|
| CR12DE | 1240cc | 4 Cyl. | 16 Valves | 48-66kW/65-90PS | Petrol | DOHC | TD30818 |
| FAMILIA VAN 1.2 | | 01/2007→ | | | | | |

| | | | | | |
|----------------------|-------------|-------|-----|--|--|
| V98073 | 13201-1F700 | | 45° | | |
| 27.40 x 5.50 x 97.80 | | MB tu | | | |
| V98074 | 13202-F700 | | 45° | | |
| 22.50 x 5.50 x 97.90 | | MD tu | | | |

2 71.90

| | | | | | | | |
|--------------|--------|-----------------|-----------|-----------|--------|---------------------|---------|
| DHF | 1242cc | 4 Cyl. | 16 Valves | 55kW/75PS | Petrol | Zetec-SE SEFI, DOHC | TD18699 |
| DHG | 1242cc | 4 Cyl. | 16 Valves | 55kW/75PS | Petrol | Zetec-SE SEFI, DOHC | TD18700 |
| 121 III 1.25 | | 03/1996→04/2003 | | | | | |

| | | | | | | | |
|----------------------|---------|------------|-----|---|---|----------------------|--|
| V94056 | 1051772 | | 45° | Y | H | VAG96277 | |
| 26.10 x 6.00 x 97.65 | | MB cr | | | | 39.00 x 6.00 x 11.05 | |
| 08/97→ | | | | | | | |
| V94001 | 1004444 | | 45° | | H | | |
| 22.10 x 5.97 x 99.70 | | MD + MB cr | | | | | |
| →08/97 | | | | | | | |
| V94057 | 1051770 | | 45° | | H | | |
| 22.10 x 6.00 x 99.70 | | MD + MB cr | | | | | |
| 08/97→ | | | | | | | |

3 71.90

| | | | | | | | |
|-------|--------|-----------------|-----------|-----------|--------|-----------------|---------|
| FUJA | 1242cc | 4 Cyl. | 16 Valves | 55kW/75PS | Petrol | DOHC | TD18694 |
| 2 1.2 | | 02/2003→06/2007 | | 2 1.25 | | 04/2003→06/2007 | |

| | | | | | | | |
|-----------------------|-------------|-------|-----|--|--|----------------------|--|
| V98036 | C201-12111B | | 45° | | | VAG96277 | |
| 26.00 x 6.00 x 99.70 | | MB tu | | | | 39.00 x 6.00 x 11.05 | |
| V98037 | 1113187 | | 45° | | | | |
| 22.00 x 6.00 x 101.80 | | MD tu | | | | | |

4 73.70

| | | | | | | | |
|----------|--------|-----------------|----------|-----------|--------|-------------|---------|
| F6JB | 1399cc | 4 Cyl. | 8 Valves | 50kW/68PS | Diesel | SOHC | TD18457 |
| F6JA | 1399cc | 4 Cyl. | 8 Valves | 50kW/68PS | Diesel | Turbo, SOHC | TD18693 |
| F6JB | 1399cc | 4 Cyl. | 8 Valves | 50kW/68PS | Diesel | Turbo, SOHC | TD20951 |
| 2 1.4 CD | | 04/2003→06/2007 | | | | | |

| | | | | | | | |
|----------------------|------------|------------|-----|---|---|---------------------|--|
| V94601 | Y4011-2111 | | 45° | Y | H | VAG96364 | |
| 32.80 x 5.50 x 97.30 | | MB | | | | 34.20 x 5.50 x 9.53 | |
| V94602 | Y4011-2121 | | 45° | | H | | |
| 30.30 x 5.50 x 97.30 | | MD + MB cr | | | | | |



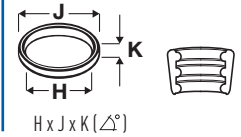
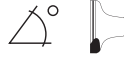

OE









5  **74.00**

| | | | | | | | |
|--------------|--------|-----------------|------------------|-----------------|--------|-----------------|----------------|
| ZJ-VE | 1349cc | 4 Cyl. | 16 Valves | 55-67kW/75-91PS | Petrol | DOHC | TD24828 |
| 2 1.3 | | 07/2007→06/2015 | | 2 1.3 MZR | | 01/2010→06/2015 | |
| 3 1.4 | | 10/2003→06/2009 | | | | | |

| | | | | | | | |
|---|--------------|---|-----|--|--|---|---|
| V98062  | ZJ01-12-111A |  | 45° | | | VAG96367  |  |
| 27.70 x 5.50 x 98.30 | | MB tu | | | | 39.00 x 5.50 x 11.05 | |
| V98063  | ZJ01-12-121 |  | 45° | | | | |
| 24.00 x 5.50 x 98.80 | | MD tu | | | | | |



6  **75.00**

| | | | | | | | |
|----------------|--------|-----------------|------------------|-------------------|--------|--------------------|----------------|
| Y601 | 1560cc | 4 Cyl. | 16 Valves | 80-81kW/109-110PS | Diesel | Turbo, DOHC | TD18512 |
| 3 1.6 DI Turbo | | 06/2004→06/2009 | | 3 1.6 MZR CD | | 12/2008→05/2013 | |

| | | | | | | | |
|---|-------------|---|-----|----|---|---|---|
| V94960  | Y6011-2111 |  | 45° | H | | VAG96364  |  |
| 25.60 x 5.50 x 96.35 | | MB cr | | | | 34.20 x 5.50 x 9.53 | |
| V94961  | Y601-12-121 |  | 45° | ss | H | | |
| 23.40 x 5.50 x 96.50 | | MD + MB cr | | | | | |

7  **76.00**

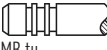
| | | | | | | | |
|-------------|--------|-----------------|------------------|-----------------|--------|-----------------|----------------|
| FXJA | 1388cc | 4 Cyl. | 16 Valves | 59-62kW/80-84PS | Petrol | DOHC | TD18695 |
| 2 1.4 | | 02/2003→06/2007 | | 3 1.4 | | 02/2004→06/2009 | |

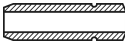
| | | | | | | | |
|---|--------------|---|-----|---|--|---|---|
| V95039  | C401-12-111A |  | 45° | H | | VAG92325  |  |
| 28.10 x 6.00 x 99.35 | | MB tu | | | | 40.50 x 6.00 x 11.04 | |
| V95014  | 1113189 |  | 45° | | | | |
| 24.10 x 6.00 x 101.45 | | MD tu | | | | | |

8  **78.00**

| | | | | | | | |
|----------------------|--------|-----------------|------------------|--------------------|--------|--------------------|---------------|
| B6 | 1598cc | 4 Cyl. | 16 Valves | 98-103kW/134-140PS | Petrol | Turbo, DOHC | TD1932 |
| B6 (SOHC) | 1598cc | 4 Cyl. | 8 Valves | 63-77kW/86-105PS | Petrol | SOHC | TD9428 |
| 323 F IV 1.6 | | 04/1987→08/1993 | | 323 F VI 1.6 | | 09/1998→05/2004 | |
| 323 III 1.6 | | 06/1986→10/1995 | | 323 III 1.6 GT | | 08/1985→08/1993 | |
| 323 III 1.6 GT Turbo | | 10/1985→08/1993 | | 323 III 1.6 Turbo | | 09/1987→12/1988 | |
| 323 S IV 1.6 | | 06/1989→10/1994 | | | | | |

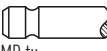
| | | | | | | | |
|---|-------------|---|-----|----|--|--|--|
| V94572  | B6ZA-12-121 |  | 45° | st | | | |
| 23.50 x 6.00 x 105.00 | | MD tu | | | | | |

9  **78.00**

| | | | | | | | |
|-------------|--------|-----------------|------------------|-------------------|--------|-----------------|---------------|
| B6ZE | 1598cc | 4 Cyl. | 16 Valves | 77-88kW/104-120PS | Petrol | DOHC | TD1943 |
| 3 1.6 | | 10/2003→06/2009 | | MX-5 I 1.6 | | 01/1990→12/1993 | |

| | | | | | | | |
|---|-------------|---|-----|--|--|---|---|
| V98065  | ZY01-12-121 |  | 45° | | | VAG96367  |  |
| 25.90 x 5.50 x 96.60 | | MD tu | | | | 39.00 x 5.50 x 11.05 | |

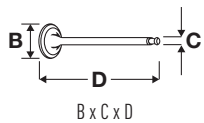

OE

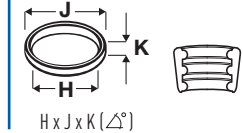
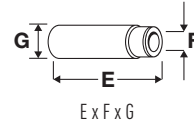
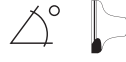

10 78.00

| | | | | | | | |
|-----------------|--------|----------|-----------|------------|--------|------|---------|
| HR16DE | 1598cc | 4 Cyl. | 16 Valves | 80kW/109PS | Petrol | DOHC | TD30817 |
| FAMILIA VAN 1.6 | | 01/2007→ | | | | | |

| | | | | | | |
|-----------------------|-------------|-------|-----|---|---------------------|--|
| V95079 | 13201-ED000 | | 45° | H | VAG96369 | |
| 31.15 x 4.97 x 101.70 | | MB tu | | | 42.20 x 5.00 x 9.24 | |
| V95080 | 13202-ED000 | | 45° | | VAG96370 | |
| 25.45 x 4.96 x 102.50 | | MD tu | | | 42.20 x 4.99 x 9.24 | |

11 79.00

| | | | | | | | |
|-------|--------|-----------------|-----------|------------|--------|------|---------|
| FYJA | 1596cc | 4 Cyl. | 16 Valves | 74kW/100PS | Petrol | DOHC | TD18692 |
| 2 1.6 | | 02/2003→06/2007 | | | | | |

| | | | | | | |
|-----------------------|---------|-------|-----|---|----------------------|--|
| V95013 | 1320927 | | 45° | H | VAG92325 | |
| 30.10 x 6.00 x 99.00 | | MB tu | | | 40.50 x 6.00 x 11.04 | |
| V95014 | 1113189 | | 45° | | | |
| 24.10 x 6.00 x 101.45 | | MD tu | | | | |

12 79.00

| | | | | | | | |
|----------------|--------|-----------------|----------|-----------------|--------|-------------|--------|
| 4EE1-T | 1686cc | 4 Cyl. | 8 Valves | 60-65kW/82-88PS | Diesel | Turbo, SOHC | TD9465 |
| 323 S V 1.6 TD | | 05/1994→09/1998 | | | | | |

| | | | | | | |
|-----------------------|---------------|-------|-----|----|----------------------|--|
| V91230 | 8-94326-843-0 | | 45° | H | VAG92321 | |
| 34.70 x 6.99 x 104.00 | | MB | | | 43.00 x 7.00 x 11.56 | |
| V91232 | 8-94115-059-2 | | 45° | ss | st | |
| 30.70 x 6.98 x 104.15 | | MD cr | | | | |

13 82.50

| | | | | | | | |
|-----|--------|--------|----------|-----------|--------|-----------|---------|
| RTJ | 1753cc | 4 Cyl. | 8 Valves | 44kW/60PS | Diesel | Endura-DE | TD18697 |
| RTK | 1753cc | 4 Cyl. | 8 Valves | 44kW/60PS | Diesel | Endura-DE | TD18698 |

| | | | | | | | |
|---------------|--|-----------------|--|--|--|--|--|
| 121 III 1.8 D | | 03/1996→04/2003 | | | | | |
|---------------|--|-----------------|--|--|--|--|--|

| | | | | | | |
|-----------------------|---------|------------|-----|----|----------------------|--|
| V94321 [4] | 6172852 | | 45° | H | VAG96024 | |
| 36.50 x 8.20 x 107.15 | | MB | | | 37.50 x 7.92 x 12.77 | |
| V91821 | 6781621 | | 45° | H | | |
| 36.60 x 7.99 x 107.15 | | MD + MB cr | | | | |
| 09/88→10/95 | | | | | | |
| V91993 | 6172851 | | 45° | Y | H | |
| 36.60 x 7.97 x 107.10 | | MB | | | | |
| 10/95→ | | | | | | |
| V94322 [4] | 6172846 | | 45° | | | |
| 32.00 x 8.20 x 109.25 | | MD cr | | | | |
| V91168 | 6172845 | | 45° | | | |
| 32.11 x 7.96 x 109.25 | | MD cr | | | | |
| 09/88→10/95 | | | | | | |
| V91428 | 6172848 | | 45° | ss | H | |
| 32.10 x 7.96 x 109.20 | | MD + MB cr | | | | |
| 10/95→ | | | | | | |

[4] Oversize stem

[4] Ventilshaftdichtung mit Übermaß

[4] Tige surdimensionnée

[4] Vástago sobredimensionado

[4] Gambo valvola maggiorato



OE

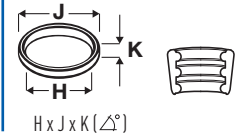
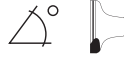

14  **83.00**

| | | | | | | | |
|---------------|-----------------|--------|------------------|-------------------|--------|-----------------|----------------|
| L813 | 1798cc | 4 Cyl. | 16 Valves | 75-88kW/102-120PS | Petrol | DOHC | TD18205 |
| L823 | 1798cc | 4 Cyl. | 16 Valves | 85-88kW/116-120PS | Petrol | DOHC | TD19204 |
| 5 1.8 | 02/2005→05/2010 | | | 6 1.8 | | 08/2002→08/2007 | |
| 6 1.8 MZR | 08/2007→07/2013 | | | BONGO TRUCK 1.8 | | 08/2010→ | |
| BONGO VAN 1.8 | 09/1999→ | | | | | | |

V94693 
32.50 x 5.50 x 103.40

L801-12-111

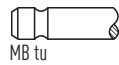

45°

H

VAG96367  
39.00 x 5.50 x 11.05



V94694 
28.00 x 5.50 x 104.60

L801-12-121C

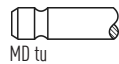

45°

15  **86.00**



| | | | | | | | |
|-----------------|-----------------|--------|------------------|----------------|--------|-----------------|----------------|
| RF3F | 1998cc | 4 Cyl. | 16 Valves | 66kW/90PS | Diesel | SOHC | TD18212 |
| 323 S VI 2.0 TD | 09/1998→05/2004 | | | 626 V 2.0 DITD | | 04/1998→10/2002 | |
| 626 V 2.0 DI TD | 04/1998→10/2002 | | | PREMACY 2.0 TD | | 10/1999→07/2000 | |

V98059 
25.50 x 6.00 x 114.60

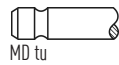
RF5C-12-121



45°

VAG96286  
45.00 x 6.05 x 11.04



16  **86.00**

| | | | | | | | |
|--------------|-----------------|--------|-----------------|--------------------------|--------|-----------------|----------------|
| RF55 | 1998cc | 4 Cyl. | 8 Valves | 55-56kW/75-76PS | Diesel | SOHC | TD31533 |
| 626 IV 2.0 D | 05/1994→06/1997 | | | 626 IV 2.0 D GLX Complex | | 10/1992→04/1997 | |

V91171 
41.05 x 7.98 x 106.88

RF01-12-111

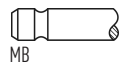

45°

H

VAG92292 
40.57 x 7.98 x 14.04



V91172 
36.05 x 7.98 x 106.88

RF01-12-121

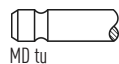

45°

VAG92293 
37.66 x 7.98 x 14.02

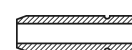

17  **86.00**

| | | | | | | | |
|-------------|-----------------|--------|------------------|--------------------|--------|-----------------|----------------|
| RF5C | 1998cc | 4 Cyl. | 16 Valves | 89-100kW/121-136PS | Diesel | | TD18204 |
| 6 2.0 DI | 06/2002→08/2007 | | | MPV II 2.0 DI | | 07/2002→02/2006 | |

V98058 
27.20 x 6.00 x 115.20

RF5C-12-111

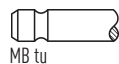

45°

VAG96286  
45.00 x 6.05 x 11.04



V98059 
25.50 x 6.00 x 114.60

RF5C-12-121

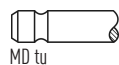

45°

18  **86.00**

| | | | | | | | |
|-----------------|-----------------|--------|-----------------|-----------------|--------|-----------------|---------------|
| R2 | 2184cc | 4 Cyl. | 8 Valves | 47-52kW/64-71PS | Diesel | SOHC | TD2030 |
| B-SERIE 2.2 D | 03/1985→10/1989 | | | E-SERIE E2200 D | | 01/1984→05/2003 | |
| SPECTRON 2.2 TD | 08/1986→10/1995 | | | | | | |

V91171 
41.05 x 7.98 x 106.88

RF01-12-111

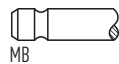

45°

H

VAG92292 
40.57 x 7.98 x 14.04



V91172 
36.05 x 7.98 x 106.88

RF01-12-121

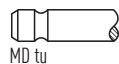

45°

VAG92293 
37.66 x 7.98 x 14.02

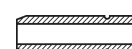

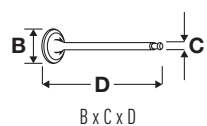

OE

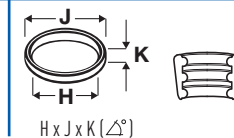
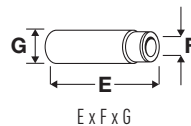

19 87.50

| | | | | | | | |
|-------------|-----------------|--------|------------------|---------------------|--------|-----------------|----------------|
| LF17 | 1999cc | 4 Cyl. | 16 Valves | 104-110kW/141-150PS | Petrol | DOHC | TD18206 |
| LF18 | 1999cc | 4 Cyl. | 16 Valves | 104kW/141PS | Petrol | DOHC | TD18207 |
| LFF7 | 1999cc | 4 Cyl. | 16 Valves | 107kW/146PS | Petrol | DOHC | TD19205 |
| 3 2.0 | 09/2003→12/2009 | | | 3 2.0 MZR | | 01/2009→09/2014 | |
| 5 2.0 | 02/2005→05/2010 | | | 6 2.0 | | 06/2002→08/2007 | |
| 6 2.0 MZR | 08/2007→07/2013 | | | PREMACY 2.0 | | 02/2005→03/2005 | |

V98032 ■
35.00 x 5.50 x 103.40

LF01-12-111

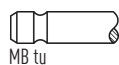

45°

VAG96367 ■ ■ ■
39.00 x 5.50 x 11.05

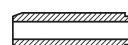

V98033 ■
30.00 x 5.50 x 104.60

LF01-12-121

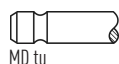

45°

20 87.50

| | | | | | | | |
|-------------|-----------------|--------|------------------|---------------------|--------|-----------------|----------------|
| L3 | 2261cc | 4 Cyl. | 16 Valves | 104-109kW/141-148PS | Petrol | DOHC | TD24710 |
| L3C1 | 2261cc | 4 Cyl. | 16 Valves | 119-122kW/162-166PS | Petrol | DOHC | TD18208 |
| 6 2.3 | 06/2002→08/2007 | | | MPV II 2.3 | | 07/2002→02/2006 | |
| TRIBUTE 2.3 | 07/2006→05/2008 | | | | | | |

V98032 ■
35.00 x 5.50 x 103.40

LF01-12-111

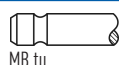

45°

VAG96367 ■ ■ ■
39.00 x 5.50 x 11.05

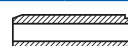

V98033 ■
30.00 x 5.50 x 104.60

LF01-12-121

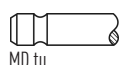

45°

21 93.00

| | | | | | | | |
|----------------|-----------------|--------|------------------|------------------|--------|--------------------|----------------|
| WL-T | 2500cc | 4 Cyl. | 12 Valves | 61-92kW/83-125PS | Diesel | Turbo, SOHC | TD21260 |
| B-SERIE 2.5 D | 04/1996→02/1999 | | | B-SERIE 2.5 TD | | 04/1996→03/2005 | |
| E-SERIE 2.5 TD | 06/1995→10/2001 | | | E-SERIE E2500 TD | | 08/1997→07/1999 | |
| MPV I 2.5 TD | 05/1996→09/1999 | | | | | | |

V98060 ■
32.70 x 7.00 x 111.90

WL51-12-111

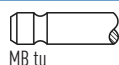





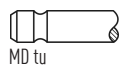

45°







V98061 ■
35.60 x 7.00 x 111.80







WL51-12-121A















45°







|  |  | ccm |  |  |  |  |
|---|---|------|---|---|---|---|
| M 102.910 | 89.00 | 1797 | 4 | 8 | Petrol | 63 |
| M 102.919 | 89.00 | 1797 | 4 | 8 | Petrol | 63 |
| M 102.920 | 89.00 | 1997 | 4 | 8 | Petrol | 64 |
| M 102.921 | 89.00 | 1997 | 4 | 8 | Petrol | 64 |
| M 102.922 | 89.00 | 1997 | 4 | 8 | Petrol | 64 |
| M 102.924 | 89.00 | 1997 | 4 | 8 | Petrol | 64 |
| M 102.938 | 89.00 | 1997 | 4 | 8 | Petrol | 64 |
| M 102.939 | 89.00 | 1997 | 4 | 8 | Petrol | 64 |
| M 102.942 | 95.50 | 2299 | 4 | 8 | Petrol | 102 |
| M 102.943 | 95.50 | 2299 | 4 | 8 | Petrol | 102 |
| M 102.945 | 95.50 | 2299 | 4 | 8 | Petrol | 103 |
| M 102.946 | 95.50 | 2299 | 4 | 8 | Petrol | 103 |
| M 102.958 | 95.50 | 2299 | 4 | 8 | Petrol | 103 |
| M 102.959 | 95.50 | 2299 | 4 | 8 | Petrol | 103 |
| M 102.961 | 89.00 | 1997 | 4 | 8 | Petrol | 64 |
| M 102.962 | 89.00 | 1997 | 4 | 8 | Petrol | 64 |
| M 102.963 | 89.00 | 1997 | 4 | 8 | Petrol | 64 |
| M 102.964 | 89.00 | 1997 | 4 | 8 | Petrol | 64 |
| M 102.965 | 89.00 | 1997 | 4 | 8 | Petrol | 64 |
| M 102.979 | 95.50 | 2299 | 4 | 8 | Petrol | 103 |
| M 102.980 | 95.50 | 2299 | 4 | 8 | Petrol | 103 |
| M 102.981 | 95.50 | 2299 | 4 | 8 | Petrol | 103 |
| M 102.982 | 95.50 | 2299 | 4 | 8 | Petrol | 103 |
| M 102.983 | 95.50 | 2299 | 4 | 16 | Petrol | 104 |
| M 102.985 | 95.50 | 2299 | 4 | 8 | Petrol | 103 |
| M 102.987 | 95.50 | 2299 | 4 | 8 | Petrol | 103 |
| M 102.989 | 95.50 | 2299 | 4 | 8 | Petrol | 103 |
| M 102.990 | 95.50 | 2498 | 4 | 16 | Petrol | 105 |
| M 102.991 | 95.50 | 2498 | 4 | 16 | Petrol | 105 |
| M 102.992 | 95.50 | 2498 | 4 | 8 | Petrol | 105 |
| M 102.996 | 95.50 | 2299 | 4 | 8 | Petrol | 103 |
| M 102.997 | 95.50 | 2299 | 4 | 8 | Petrol | 103 |
| M 102.998 | 95.50 | 2299 | 4 | 8 | Petrol | 103 |
| M 103.940 | 82.90 | 2597 | 6 | 12 | Petrol | 22 |
| M 103.941 | 82.90 | 2597 | 6 | 12 | Petrol | 22 |
| M 103.942 | 82.90 | 2597 | 6 | 12 | Petrol | 22 |
| M 103.943 | 82.90 | 2597 | 6 | 12 | Petrol | 22 |
| M 104.900 | 81.00 | 2792 | 6 | 12 | Petrol | 11 |
| M 104.941 | 89.90 | 2799 | 6 | 24 | Petrol | 75 |
| M 104.941 (AMG 3.6) | 91.00 | 3606 | 6 | 24 | Petrol | 90 |
| M 104.942 | 89.90 | 2799 | 6 | 24 | Petrol | 75 |
| M 104.943 | 89.90 | 2799 | 6 | 24 | Petrol | 75 |
| M 104.944 | 89.90 | 2799 | 6 | 24 | Petrol | 75 |
| M 104.945 | 89.90 | 2799 | 6 | 24 | Petrol | 75 |
| M 104.990 | 89.90 | 3199 | 6 | 24 | Petrol | 77 |
| M 104.991 | 89.90 | 3199 | 6 | 24 | Petrol | 78 |
| M 104.992 | 89.90 | 3199 | 6 | 24 | Petrol | 78 |
| M 104.992 (AMG 3.6) | 91.00 | 3606 | 6 | 24 | Petrol | 90 |
| M 104.994 | 89.90 | 3199 | 6 | 24 | Petrol | 78 |
| M 104.995 | 89.90 | 3199 | 6 | 24 | Petrol | 78 |
| M 104.996 | 89.90 | 3199 | 6 | 24 | Petrol | 78 |
| M 108.920 | 82.00 | 2496 | 6 | 12 | Petrol | 21 |
| M 108.924 | 82.00 | 2496 | 6 | 12 | Petrol | 21 |
| M 110.921 | 86.00 | 2746 | 6 | 12 | Petrol | 37 |
| M 110.922 | 86.00 | 2746 | 6 | 12 | Petrol | 37 |
| M 110.923 | 86.00 | 2746 | 6 | 12 | Petrol | 37 |
| M 110.924 | 86.00 | 2746 | 6 | 12 | Petrol | 38 |
| M 110.926 | 86.00 | 2746 | 6 | 12 | Petrol | 38 |
| M 110.931 | 86.00 | 2746 | 6 | 12 | Petrol | 37 |
| M 110.932 | 86.00 | 2746 | 6 | 12 | Petrol | 37 |
| M 110.981 | 86.00 | 2746 | 6 | 12 | Petrol | 37 |
| M 110.982 | 86.00 | 2746 | 6 | 12 | Petrol | 37 |
| M 110.983 | 86.00 | 2746 | 6 | 12 | Petrol | 37 |
| M 110.984 | 86.00 | 2746 | 6 | 12 | Petrol | 37 |
| M 110.985 | 86.00 | 2746 | 6 | 12 | Petrol | 37 |
| M 110.986 | 86.00 | 2746 | 6 | 12 | Petrol | 37 |







|  |  | ccm |  |  |  |  |
|---|---|------|--|---|---|---|
| M 110.987 | 86.00 | 2746 | 6 | 12 | Petrol | 38 |
| M 110.988 | 86.00 | 2746 | 6 | 12 | Petrol | 38 |
| M 110.989 | 86.00 | 2746 | 6 | 12 | Petrol | 38 |
| M 110.990 | 86.00 | 2746 | 6 | 12 | Petrol | 38 |
| M 110.991 | 86.00 | 2746 | 6 | 12 | Petrol | 37 |
| M 110.992 | 86.00 | 2746 | 6 | 12 | Petrol | 37 |
| M 110.994 | 86.00 | 2746 | 6 | 12 | Petrol | 38 |
| M 111.920 | 85.30 | 1799 | 4 | 16 | Petrol | 35 |
| M 111.921 | 85.30 | 1799 | 4 | 16 | Petrol | 35 |
| M 111.940 | 89.90 | 1998 | 4 | 16 | Petrol | 71 |
| M 111.941 | 89.90 | 1998 | 4 | 16 | Petrol | 71 |
| M 111.942 | 89.90 | 1998 | 4 | 16 | Petrol | 72 |
| M 111.943 | 89.90 | 1998 | 4 | 16 | Petrol | 72 |
| M 111.944 | 89.90 | 1998 | 4 | 16 | Petrol | 72 |
| M 111.945 | 89.90 | 1998 | 4 | 16 | Petrol | 72 |
| M 111.946 | 89.90 | 1998 | 4 | 16 | Petrol | 72 |
| M 111.947 | 89.90 | 1998 | 4 | 16 | Petrol | 72 |
| M 111.948 | 89.90 | 1998 | 4 | 16 | Petrol | 72 |
| M 111.950 | 89.90 | 1998 | 4 | 16 | Petrol | 72 |
| M 111.951 | 89.90 | 1998 | 4 | 16 | Petrol | 72 |
| M 111.952 | 89.90 | 1998 | 4 | 16 | Petrol | 72 |
| M 111.955 | 89.90 | 1998 | 4 | 16 | Petrol | 72 |
| M 111.956 | 89.90 | 1998 | 4 | 16 | Petrol | 72 |
| M 111.957 | 89.90 | 1998 | 4 | 16 | Petrol | 72 |
| M 111.958 | 89.90 | 1998 | 4 | 16 | Petrol | 72 |
| M 111.960 | 89.90 | 2199 | 4 | 16 | Petrol | 73 |
| M 111.961 | 89.90 | 2199 | 4 | 16 | Petrol | 73 |
| M 111.970 | 90.90 | 2295 | 4 | 16 | Petrol | 81 |
| M 111.973 | 90.90 | 2295 | 4 | 16 | Petrol | 81 |
| M 111.974 | 90.90 | 2295 | 4 | 16 | Petrol | 81 |
| M 111.975 | 90.90 | 2295 | 4 | 16 | Petrol | 81 |
| M 111.977 | 90.90 | 2295 | 4 | 16 | Petrol | 81 |
| M 111.978 | 90.90 | 2295 | 4 | 16 | Petrol | 81 |
| M 111.979 | 90.90 | 2295 | 4 | 16 | Petrol | 81 |
| M 111.980 | 90.90 | 2295 | 4 | 16 | Petrol | 81 |
| M 111.981 | 90.90 | 2295 | 4 | 16 | Petrol | 81 |
| M 111.982 | 90.90 | 2295 | 4 | 16 | Petrol | 81 |
| M 111.983 | 90.90 | 2295 | 4 | 16 | Petrol | 81 |
| M 111.984 | 90.90 | 2295 | 4 | 16 | Petrol | 81 |
| M 112.912 | 89.90 | 2597 | 6 | 18 | Petrol | 74 |
| M 112.913 | 89.90 | 2597 | 6 | 18 | Petrol | 74 |
| M 112.914 | 89.90 | 2597 | 6 | 18 | Petrol | 74 |
| M 112.915 | 89.90 | 2597 | 6 | 18 | Petrol | 74 |
| M 112.916 | 89.90 | 2597 | 6 | 18 | Petrol | 74 |
| M 112.917 | 89.90 | 2597 | 6 | 18 | Petrol | 74 |
| M 112.920 | 89.90 | 2799 | 6 | 18 | Petrol | 76 |
| M 112.921 | 89.90 | 2799 | 6 | 18 | Petrol | 76 |
| M 112.922 | 89.90 | 2799 | 6 | 18 | Petrol | 76 |
| M 112.923 | 89.90 | 2799 | 6 | 18 | Petrol | 76 |
| M 112.925 | 89.90 | 2799 | 6 | 18 | Petrol | 76 |
| M 112.940 | 89.90 | 3199 | 6 | 18 | Petrol | 79 |
| M 112.941 | 89.90 | 3199 | 6 | 18 | Petrol | 79 |
| M 112.942 | 89.90 | 3199 | 6 | 18 | Petrol | 79 |
| M 112.943 | 89.90 | 3199 | 6 | 18 | Petrol | 79 |
| M 112.944 | 89.90 | 3199 | 6 | 18 | Petrol | 79 |
| M 112.945 | 89.90 | 3199 | 6 | 18 | Petrol | 79 |
| M 112.946 | 89.90 | 3199 | 6 | 18 | Petrol | 79 |
| M 112.947 | 89.90 | 3199 | 6 | 18 | Petrol | 79 |
| M 112.949 | 89.90 | 3199 | 6 | 18 | Petrol | 79 |
| M 112.951 | 89.90 | 3199 | 6 | 18 | Petrol | 79 |
| M 112.953 | 89.90 | 3199 | 6 | 18 | Petrol | 79 |
| M 112.954 | 89.90 | 3199 | 6 | 18 | Petrol | 79 |
| M 112.955 | 89.90 | 3199 | 6 | 18 | Petrol | 79 |
| M 112.960 | 89.90 | 3199 | 6 | 18 | Petrol | 79 |
| M 112.961 | 89.90 | 3199 | 6 | 18 | Petrol | 79 |
| M 112.970 | 97.00 | 3724 | 6 | 18 | Petrol | 109 |







| |  |  | ccm |  |  |  |  | |
|-----------|---|---|-------|---|---|---|---|-----|
| M 112.972 | | | 97.00 | 3724 | 6 | 18 | Petrol | 109 |
| M 112.973 | | | 97.00 | 3724 | 6 | 18 | Petrol | 109 |
| M 112.975 | | | 97.00 | 3724 | 6 | 18 | Petrol | 109 |
| M 112.976 | | | 97.00 | 3724 | 6 | 18 | Petrol | 109 |
| M 113.940 | | | 89.90 | 4266 | 8 | 24 | Petrol | 80 |
| M 113.941 | | | 89.90 | 4266 | 8 | 24 | Petrol | 80 |
| M 113.942 | | | 89.90 | 4266 | 8 | 24 | Petrol | 80 |
| M 113.943 | | | 89.90 | 4266 | 8 | 24 | Petrol | 80 |
| M 113.944 | | | 89.90 | 4266 | 8 | 24 | Petrol | 80 |
| M 113.948 | | | 89.90 | 4266 | 8 | 24 | Petrol | 80 |
| M 113.960 | | | 97.00 | 4966 | 8 | 24 | Petrol | 111 |
| M 113.961 | | | 97.00 | 4966 | 8 | 24 | Petrol | 111 |
| M 113.962 | | | 97.00 | 4966 | 8 | 24 | Petrol | 111 |
| M 113.963 | | | 97.00 | 4966 | 8 | 24 | Petrol | 111 |
| M 113.964 | | | 97.00 | 4966 | 8 | 24 | Petrol | 111 |
| M 113.965 | | | 97.00 | 4966 | 8 | 24 | Petrol | 111 |
| M 113.966 | | | 97.00 | 4966 | 8 | 24 | Petrol | 111 |
| M 113.967 | | | 97.00 | 4966 | 8 | 24 | Petrol | 111 |
| M 113.968 | | | 97.00 | 4966 | 8 | 24 | Petrol | 111 |
| M 113.969 | | | 97.00 | 4966 | 8 | 24 | Petrol | 111 |
| M 113.971 | | | 97.00 | 4966 | 8 | 24 | Petrol | 111 |
| M 113.980 | | | 97.00 | 5439 | 8 | 24 | Petrol | 112 |
| M 113.981 | | | 97.00 | 5439 | 8 | 24 | Petrol | 112 |
| M 113.982 | | | 97.00 | 5439 | 8 | 24 | Petrol | 112 |
| M 113.984 | | | 97.00 | 5439 | 8 | 24 | Petrol | 112 |
| M 113.986 | | | 97.00 | 5439 | 8 | 24 | Petrol | 112 |
| M 113.987 | | | 97.00 | 5439 | 8 | 24 | Petrol | 112 |
| M 113.988 | | | 97.00 | 5439 | 8 | 24 | Petrol | 112 |
| M 113.989 | | | 97.00 | 5439 | 8 | 24 | Petrol | 112 |
| M 113.990 | | | 97.00 | 5439 | 8 | 24 | Petrol | 112 |
| M 113.991 | | | 97.00 | 5439 | 8 | 24 | Petrol | 112 |
| M 113.992 | | | 97.00 | 5439 | 8 | 24 | Petrol | 112 |
| M 113.995 | | | 97.00 | 5439 | 8 | 24 | Petrol | 112 |
| M 114.920 | | | 82.00 | 2496 | 6 | 12 | Petrol | 21 |
| M 114.923 | | | 82.00 | 2496 | 6 | 12 | Petrol | 21 |
| M 114.980 | | | 82.00 | 2496 | 6 | 12 | Petrol | 21 |
| M 114.981 | | | 82.00 | 2496 | 6 | 12 | Petrol | 21 |
| M 115.900 | | | 87.00 | 2197 | 4 | 8 | Petrol | 46 |
| M 115.920 | | | 87.00 | 2197 | 4 | 8 | Petrol | 46 |
| M 115.921 | | | 87.00 | 2197 | 4 | 8 | Petrol | 46 |
| M 115.922 | | | 87.00 | 2197 | 4 | 8 | Petrol | 46 |
| M 115.923 | | | 87.00 | 1988 | 4 | 8 | Petrol | 41 |
| M 115.924 | | | 87.00 | 2197 | 4 | 8 | Petrol | 46 |
| M 115.926 | | | 87.00 | 1988 | 4 | 8 | Petrol | 41 |
| M 115.927 | | | 87.00 | 2197 | 4 | 8 | Petrol | 46 |
| M 115.928 | | | 87.00 | 2197 | 4 | 8 | Petrol | 46 |
| M 115.929 | | | 87.00 | 2197 | 4 | 8 | Petrol | 46 |
| M 115.932 | | | 87.00 | 2197 | 4 | 8 | Petrol | 46 |
| M 115.933 | | | 87.00 | 2197 | 4 | 8 | Petrol | 46 |
| M 115.934 | | | 87.00 | 2197 | 4 | 8 | Petrol | 46 |
| M 115.935 | | | 87.00 | 2197 | 4 | 8 | Petrol | 46 |
| M 115.938 | | | 87.00 | 1988 | 4 | 8 | Petrol | 41 |
| M 115.939 | | | 87.00 | 1988 | 4 | 8 | Petrol | 41 |
| M 115.951 | | | 93.75 | 2307 | 4 | 8 | Petrol | 101 |
| M 115.952 | | | 93.75 | 2307 | 4 | 8 | Petrol | 101 |
| M 115.954 | | | 93.75 | 2307 | 4 | 8 | Petrol | 101 |
| M 115.955 | | | 93.75 | 2307 | 4 | 8 | Petrol | 101 |
| M 115.970 | | | 93.75 | 2307 | 4 | 8 | Petrol | 101 |
| M 115.971 | | | 93.75 | 2307 | 4 | 8 | Petrol | 101 |
| M 115.972 | | | 93.75 | 2307 | 4 | 8 | Petrol | 101 |
| M 115.973 | | | 93.75 | 2307 | 4 | 8 | Petrol | 101 |
| M 115.974 | | | 93.75 | 2307 | 4 | 8 | Petrol | 101 |
| M 115.I | | | 87.00 | 1990 | 4 | 8 | Petrol | 43 |
| M 115.II | | | 87.00 | 1990 | 4 | 8 | Petrol | 43 |
| M 116.960 | | | 92.00 | 3818 | 8 | 16 | Petrol | 92 |
| M 116.961 | | | 92.00 | 3818 | 8 | 16 | Petrol | 92 |







|  |  | ccm |  |  |  |  |
|---|---|------|--|---|---|---|
| M 116.962 | 88.00 | 3839 | 8 | 16 | Petrol | 62 |
| M 116.963 | 88.00 | 3839 | 8 | 16 | Petrol | 62 |
| M 116.964 | 92.00 | 4196 | 8 | 16 | Petrol | 93 |
| M 116.965 | 92.00 | 4196 | 8 | 16 | Petrol | 93 |
| M 116.980 | 92.00 | 3499 | 8 | 16 | Petrol | 91 |
| M 116.981 | 92.00 | 3499 | 8 | 16 | Petrol | 91 |
| M 116.982 | 92.00 | 3499 | 8 | 16 | Petrol | 91 |
| M 116.983 | 92.00 | 3499 | 8 | 16 | Petrol | 91 |
| M 116.984 | 92.00 | 3499 | 8 | 16 | Petrol | 91 |
| M 116.985 | 92.00 | 3499 | 8 | 16 | Petrol | 91 |
| M 116.990 | 92.00 | 3499 | 8 | 16 | Petrol | 91 |
| M 116.991 | 92.00 | 3499 | 8 | 16 | Petrol | 91 |
| M 116.992 | 92.00 | 3499 | 8 | 16 | Petrol | 91 |
| M 116.993 | 92.00 | 3499 | 8 | 16 | Petrol | 91 |
| M 117.960 | 96.50 | 4973 | 8 | 16 | Petrol | 106 |
| M 117.961 | 96.50 | 4973 | 8 | 16 | Petrol | 106 |
| M 117.962 | 96.50 | 4973 | 8 | 16 | Petrol | 106 |
| M 117.963 | 96.50 | 4973 | 8 | 16 | Petrol | 106 |
| M 117.964 | 96.50 | 4973 | 8 | 16 | Petrol | 106 |
| M 117.965 | 96.50 | 4973 | 8 | 16 | Petrol | 106 |
| M 117.967 | 96.50 | 5547 | 8 | 16 | Petrol | 108 |
| M 117.968 | 96.50 | 5547 | 8 | 16 | Petrol | 108 |
| M 117.981 | 92.00 | 4520 | 8 | 16 | Petrol | 95 |
| M 117.982 | 92.00 | 4520 | 8 | 16 | Petrol | 95 |
| M 117.983 | 92.00 | 4520 | 8 | 16 | Petrol | 95 |
| M 117.984 | 92.00 | 4520 | 8 | 16 | Petrol | 95 |
| M 117.985 | 92.00 | 4520 | 8 | 16 | Petrol | 95 |
| M 117.986 | 92.00 | 4520 | 8 | 16 | Petrol | 95 |
| M 117.992 | 92.00 | 4520 | 8 | 16 | Petrol | 95 |
| M 117.993 | 92.00 | 4520 | 8 | 16 | Petrol | 95 |
| M 119.960 | 96.50 | 4973 | 8 | 32 | Petrol | 107 |
| M 119.970 | 96.50 | 4973 | 8 | 32 | Petrol | 107 |
| M 119.971 | 92.00 | 4196 | 8 | 32 | Petrol | 94 |
| M 119.972 | 96.50 | 4973 | 8 | 32 | Petrol | 107 |
| M 119.974 | 96.50 | 4973 | 8 | 32 | Petrol | 107 |
| M 119.975 | 92.00 | 4196 | 8 | 32 | Petrol | 94 |
| M 119.980 | 96.50 | 4973 | 8 | 32 | Petrol | 107 |
| M 119.981 | 92.00 | 4196 | 8 | 32 | Petrol | 94 |
| M 119.982 | 96.50 | 4973 | 8 | 32 | Petrol | 107 |
| M 119.985 | 92.00 | 4196 | 8 | 32 | Petrol | 94 |
| M 119.985 (AMG 5.0) | 96.50 | 4973 | 8 | 32 | Petrol | 107 |
| M 120.980 | 89.00 | 5987 | 12 | 48 | Petrol | 70 |
| M 120.981 | 89.00 | 5987 | 12 | 48 | Petrol | 70 |
| M 120.982 | 89.00 | 5987 | 12 | 48 | Petrol | 70 |
| M 120.983 | 89.00 | 5987 | 12 | 48 | Petrol | 70 |
| M 121.940 | 87.00 | 1988 | 4 | 8 | Petrol | 41 |
| M 121.941 | 87.00 | 1988 | 4 | 8 | Petrol | 42 |
| M 121.942 | 87.00 | 1988 | 4 | 8 | Petrol | 42 |
| M 121.943 | 87.00 | 1988 | 4 | 8 | Petrol | 41 |
| M 121.944 | 87.00 | 1988 | 4 | 8 | Petrol | 41 |
| M 122.981 | 89.00 | 5956 | 8 | 32 | Petrol | 69 |
| M 123.920 | 86.00 | 2525 | 6 | 12 | Petrol | 36 |
| M 123.921 | 86.00 | 2525 | 6 | 12 | Petrol | 36 |
| M 127.982 | 80.00 | 2180 | 6 | 12 | Petrol | 8 |
| M 127.984 | 80.00 | 2180 | 6 | 12 | Petrol | 8 |
| M 129.980 | 82.00 | 2496 | 6 | 12 | Petrol | 21 |
| M 129.981 | 82.00 | 2496 | 6 | 12 | Petrol | 21 |
| M 129.982 | 82.00 | 2496 | 6 | 12 | Petrol | 21 |
| M 130.920 | 86.50 | 2778 | 6 | 12 | Petrol | 40 |
| M 130.921 | 86.50 | 2778 | 6 | 12 | Petrol | 40 |
| M 130.922 | 86.50 | 2778 | 6 | 12 | Petrol | 40 |
| M 130.923 | 86.50 | 2778 | 6 | 12 | Petrol | 40 |
| M 130.924 | 86.50 | 2778 | 6 | 12 | Petrol | 40 |
| M 130.925 | 86.50 | 2778 | 6 | 12 | Petrol | 40 |
| M 130.933 | 86.50 | 2778 | 6 | 12 | Petrol | 40 |
| M 130.980 | 86.50 | 2778 | 6 | 12 | Petrol | 40 |







|  |  | ccm |  |  |  |  |
|---|---|------|---|---|---|---|
| M 130.981 | 86.50 | 2778 | 6 | 12 | Petrol | 40 |
| M 130.983 | 86.50 | 2778 | 6 | 12 | Petrol | 40 |
| M 130.984 | 86.50 | 2778 | 6 | 12 | Petrol | 40 |
| M 135.950 | 75.00 | 1499 | 4 | 16 | Petrol | 2 |
| M 160 E6AL B03 | 63.50 | 599 | 3 | 6 | Petrol | 1 |
| M 160 E6AL B04 | 63.50 | 599 | 3 | 6 | Petrol | 1 |
| M 160 E6AL B05 | 63.50 | 599 | 3 | 6 | Petrol | 1 |
| M 166.940 | 80.00 | 1397 | 4 | 8 | Petrol | 4 |
| M 166.960 | 80.00 | 1598 | 4 | 8 | Petrol | 5 |
| M 166.961 | 80.00 | 1598 | 4 | 8 | Petrol | 5 |
| M 166.990 | 84.00 | 1898 | 4 | 8 | Petrol | 33 |
| M 166.991 | 84.00 | 1898 | 4 | 8 | Petrol | 33 |
| M 166.995 | 84.00 | 2084 | 4 | 8 | Petrol | 34 |
| M 180.921 | 80.00 | 2171 | 6 | 12 | Petrol | 7 |
| M 180.922 | 80.00 | 2195 | 6 | 12 | Petrol | 9 |
| M 180.926 | 80.00 | 2195 | 6 | 12 | Petrol | 9 |
| M 180.927 | 80.00 | 2195 | 6 | 12 | Petrol | 9 |
| M 180.928 | 80.00 | 2195 | 6 | 12 | Petrol | 9 |
| M 180.929 | 80.00 | 2195 | 6 | 12 | Petrol | 9 |
| M 180.940 | 80.00 | 2180 | 6 | 12 | Petrol | 8 |
| M 180.941 | 80.00 | 2180 | 6 | 12 | Petrol | 8 |
| M 180.942 | 80.00 | 2195 | 6 | 12 | Petrol | 9 |
| M 180.943 | 80.00 | 2195 | 6 | 12 | Petrol | 9 |
| M 180.945 | 81.50 | 2293 | 6 | 12 | Petrol | 13 |
| M 180.947 | 81.50 | 2281 | 6 | 12 | Petrol | 12 |
| M 180.949 | 81.50 | 2293 | 6 | 12 | Petrol | 13 |
| M 180.950 | 81.50 | 2293 | 6 | 12 | Petrol | 13 |
| M 180.951 | 82.00 | 2306 | 6 | 12 | Petrol | 20 |
| M 180.952 | 80.00 | 2195 | 6 | 12 | Petrol | 9 |
| M 180.953 | 80.00 | 2195 | 6 | 12 | Petrol | 9 |
| M 180.954 | 82.00 | 2292 | 6 | 12 | Petrol | 19 |
| M 180.955 | 82.00 | 2292 | 6 | 12 | Petrol | 19 |
| M 180.958 | 80.00 | 2196 | 6 | 24 | Petrol | 10 |
| M 266.920 | 83.00 | 1498 | 4 | 8 | Petrol | 24 |
| M 266.940 | 83.00 | 1699 | 4 | 8 | Petrol | 26 |
| M 266.960 | 83.00 | 2034 | 4 | 8 | Petrol | 30 |
| M 266.980 | 83.00 | 2034 | 4 | 8 | Petrol | 30 |
| M 270.910 | 83.00 | 1595 | 4 | 16 | Petrol | 25 |
| M 270.920 | 83.00 | 1991 | 4 | 16 | Petrol | 28 |
| M 271.820 | 82.00 | 1796 | 4 | 16 | Petrol | 15 |
| M 271.860 | 82.00 | 1796 | 4 | 16 | Petrol | 15 |
| M 271.861 | 82.00 | 1796 | 4 | 16 | Petrol | 15 |
| M 271.910 | 82.00 | 1597 | 4 | 16 | Petrol | 14 |
| M 271.911 | 82.00 | 1597 | 4 | 16 | Petrol | 14 |
| M 271.921 | 82.00 | 1796 | 4 | 16 | Petrol | 16 |
| M 271.940 | 82.00 | 1796 | 4 | 16 | Petrol | 16 |
| M 271.941 | 82.00 | 1796 | 4 | 16 | Petrol | 16 |
| M 271.942 | 82.00 | 1796 | 4 | 16 | Petrol | 16 |
| M 271.944 | 82.00 | 1796 | 4 | 16 | Petrol | 16 |
| M 271.946 | 82.00 | 1796 | 4 | 16 | Petrol | 16 |
| M 271.948 | 82.00 | 1796 | 4 | 16 | Petrol | 16 |
| M 271.950 | 82.00 | 1796 | 4 | 16 | Petrol | 17 |
| M 271.951 | 82.00 | 1796 | 4 | 16 | Petrol | 18 |
| M 271.952 | 82.00 | 1796 | 4 | 16 | Petrol | 17 |
| M 271.954 | 82.00 | 1796 | 4 | 16 | Petrol | 17 |
| M 271.955 | 82.00 | 1796 | 4 | 16 | Petrol | 17 |
| M 271.956 | 82.00 | 1796 | 4 | 16 | Petrol | 16 |
| M 271.957 | 82.00 | 1796 | 4 | 16 | Petrol | 18 |
| M 272.911 | 88.00 | 2496 | 6 | 24 | Petrol | 54 |
| M 272.920 | 88.00 | 2496 | 6 | 24 | Petrol | 54 |
| M 272.921 | 88.00 | 2496 | 6 | 24 | Petrol | 54 |
| M 272.922 | 88.00 | 2496 | 6 | 24 | Petrol | 54 |
| M 272.940 | 88.00 | 2996 | 6 | 24 | Petrol | 58 |
| M 272.941 | 88.00 | 2996 | 6 | 24 | Petrol | 58 |
| M 272.942 | 88.00 | 2996 | 6 | 24 | Petrol | 58 |
| M 272.943 | 88.00 | 2996 | 6 | 24 | Petrol | 58 |







|  |  | ccm |  |  |  |  |
|---|---|------|--|---|---|---|
| M 272.944 | 88.00 | 2996 | 6 | 24 | Petrol | 58 |
| M 272.945 | 88.00 | 2996 | 6 | 24 | Petrol | 58 |
| M 272.946 | 88.00 | 2996 | 6 | 24 | Petrol | 58 |
| M 272.947 | 88.00 | 2996 | 6 | 24 | Petrol | 58 |
| M 272.948 | 88.00 | 2996 | 6 | 24 | Petrol | 58 |
| M 272.949 | 88.00 | 2996 | 6 | 24 | Petrol | 58 |
| M 272.952 | 88.00 | 2996 | 6 | 24 | Petrol | 58 |
| M 272.960 | 92.90 | 3498 | 6 | 24 | Petrol | 96 |
| M 272.961 | 92.90 | 3498 | 6 | 24 | Petrol | 96 |
| M 272.963 | 92.90 | 3498 | 6 | 24 | Petrol | 96 |
| M 272.964 | 92.90 | 3498 | 6 | 24 | Petrol | 96 |
| M 272.965 | 92.90 | 3498 | 6 | 24 | Petrol | 96 |
| M 272.966 | 92.90 | 3498 | 6 | 24 | Petrol | 96 |
| M 272.967 | 92.90 | 3498 | 6 | 24 | Petrol | 96 |
| M 272.970 | 92.90 | 3498 | 6 | 24 | Petrol | 96 |
| M 272.971 | 92.90 | 3498 | 6 | 24 | Petrol | 96 |
| M 272.972 | 92.90 | 3498 | 6 | 24 | Petrol | 96 |
| M 272.975 | 92.90 | 3498 | 6 | 24 | Petrol | 96 |
| M 272.978 | 92.90 | 3498 | 6 | 24 | Petrol | 96 |
| M 273.922 | 92.90 | 4663 | 8 | 32 | Petrol | 98 |
| M 273.923 | 92.90 | 4663 | 8 | 32 | Petrol | 98 |
| M 273.924 | 92.90 | 4663 | 8 | 32 | Petrol | 98 |
| M 274.910 | 83.00 | 1595 | 4 | 16 | Petrol | 25 |
| M 274.920 | 83.00 | 1991 | 4 | 16 | Petrol | 28 |
| M 276.950 | 92.90 | 3498 | 6 | 24 | Petrol | 97 |
| M 276.952 | 92.90 | 3498 | 6 | 24 | Petrol | 97 |
| M 276.955 | 92.90 | 3498 | 6 | 24 | Petrol | 97 |
| M 276.956 | 92.90 | 3498 | 6 | 24 | Petrol | 97 |
| M 276.957 | 92.90 | 3498 | 6 | 24 | Petrol | 97 |
| M 276.958 | 92.90 | 3498 | 6 | 24 | Petrol | 97 |
| M 278.920 | 92.90 | 4663 | 8 | 32 | Petrol | 99 |
| M 278.922 | 92.90 | 4663 | 8 | 32 | Petrol | 99 |
| M 278.927 | 92.90 | 4663 | 8 | 32 | Petrol | 99 |
| M 278.928 | 92.90 | 4663 | 8 | 32 | Petrol | 100 |
| M 278.929 | 92.90 | 4663 | 8 | 32 | Petrol | 99 |
| M 278.932 | 92.90 | 4663 | 8 | 32 | Petrol | 99 |
| M 906.900 | 106.00 | 6884 | 6 | 18 | Petrol | 129 |
| OM 314.910 | 97.00 | 3780 | 4 | 8 | Diesel | 110 |
| OM 314.915 | 97.00 | 3780 | 4 | 8 | Diesel | 110 |
| OM 314.944 | 97.00 | 3780 | 4 | 8 | Diesel | 110 |
| OM 314.946 | 97.00 | 3780 | 4 | 8 | Diesel | 110 |
| OM 314.948 | 97.00 | 3780 | 4 | 8 | Diesel | 110 |
| OM 314.959 | 97.00 | 3780 | 4 | 8 | Diesel | 110 |
| OM 314.961 | 97.00 | 3780 | 4 | 8 | Diesel | 110 |
| OM 314.962 | 97.00 | 3780 | 4 | 8 | Diesel | 110 |
| OM 314.963 | 97.00 | 3780 | 4 | 8 | Diesel | 110 |
| OM 314.964 | 97.00 | 3780 | 4 | 8 | Diesel | 110 |
| OM 314.965 | 97.00 | 3780 | 4 | 8 | Diesel | 110 |
| OM 314.967 | 97.00 | 3780 | 4 | 8 | Diesel | 110 |
| OM 341.910 | 97.00 | 5675 | 6 | 12 | Diesel | 113 |
| OM 341.911 | 97.00 | 5675 | 6 | 12 | Diesel | 113 |
| OM 341.912 | 97.00 | 5675 | 6 | 12 | Diesel | 113 |
| OM 341.913 | 97.00 | 5675 | 6 | 12 | Diesel | 113 |
| OM 341.915 | 97.00 | 5675 | 6 | 12 | Diesel | 113 |
| OM 341.918 | 97.00 | 5675 | 6 | 12 | Diesel | 113 |
| OM 341.919 | 97.00 | 5675 | 6 | 12 | Diesel | 113 |
| OM 341.931 | 97.00 | 5675 | 6 | 12 | Diesel | 113 |
| OM 341.932 | 97.00 | 5675 | 6 | 12 | Diesel | 113 |
| OM 341.933 | 97.00 | 5675 | 6 | 12 | Diesel | 113 |
| OM 341.934 | 97.00 | 5675 | 6 | 12 | Diesel | 113 |
| OM 341.935 | 97.00 | 5675 | 6 | 12 | Diesel | 113 |
| OM 341.936 | 97.00 | 5675 | 6 | 12 | Diesel | 113 |
| OM 341.937 | 97.00 | 5675 | 6 | 12 | Diesel | 113 |
| OM 341.938 | 97.00 | 5675 | 6 | 12 | Diesel | 113 |
| OM 341.939 | 97.00 | 5675 | 6 | 12 | Diesel | 113 |
| OM 341.941 | 97.00 | 5675 | 6 | 12 | Diesel | 113 |







|  |  | ccm |  |  |  |  | |
|---|---|--------|---|---|---|---|-----|
| OM 341.943 | | 97.00 | 5675 | 6 | 12 | Diesel | 113 |
| OM 341.946 | | 97.00 | 5675 | 6 | 12 | Diesel | 113 |
| OM 341.947 | | 97.00 | 5675 | 6 | 12 | Diesel | 113 |
| OM 341.949 | | 97.00 | 5675 | 6 | 12 | Diesel | 113 |
| OM 341.995 | | 97.00 | 5675 | 6 | 12 | Diesel | 113 |
| OM 341.996 | | 97.00 | 5675 | 6 | 12 | Diesel | 113 |
| OM 344.905 | | 97.00 | 5675 | 6 | 12 | Diesel | 114 |
| OM 344.912 | | 97.00 | 5675 | 6 | 12 | Diesel | 114 |
| OM 344.913 | | 97.00 | 5675 | 6 | 12 | Diesel | 115 |
| OM 344.930 | | 97.00 | 5675 | 6 | 12 | Diesel | 114 |
| OM 344.931 | | 97.00 | 5675 | 6 | 12 | Diesel | 114 |
| OM 344.932 | | 97.00 | 5675 | 6 | 12 | Diesel | 114 |
| OM 344.933 | | 97.00 | 5675 | 6 | 12 | Diesel | 114 |
| OM 344.934 | | 97.00 | 5675 | 6 | 12 | Diesel | 115 |
| OM 344.937 | | 97.00 | 5675 | 6 | 12 | Diesel | 115 |
| OM 344.938 | | 97.00 | 5675 | 6 | 12 | Diesel | 115 |
| OM 344.939 | | 97.00 | 5675 | 6 | 12 | Diesel | 115 |
| OM 344.941 | | 97.00 | 5675 | 6 | 12 | Diesel | 114 |
| OM 344.943 | | 97.00 | 5675 | 6 | 12 | Diesel | 113 |
| OM 344.944 | | 97.00 | 5675 | 6 | 12 | Diesel | 114 |
| OM 344.945 | | 97.00 | 5675 | 6 | 12 | Diesel | 113 |
| OM 344.946 | | 97.00 | 5675 | 6 | 12 | Diesel | 114 |
| OM 344.948 | | 97.00 | 5675 | 6 | 12 | Diesel | 115 |
| OM 344.949 | | 97.00 | 5675 | 6 | 12 | Diesel | 115 |
| OM 344.951 | | 97.00 | 5675 | 6 | 12 | Diesel | 115 |
| OM 344.952 | | 97.00 | 5675 | 6 | 12 | Diesel | 115 |
| OM 344.963 | | 97.00 | 5675 | 6 | 12 | Diesel | 114 |
| OM 345.913 | | 128.00 | 11581 | 6 | 12 | Diesel | 152 |
| OM 346.910 | | 128.00 | 10809 | 6 | 12 | Diesel | 148 |
| OM 346.911 | | 128.00 | 10809 | 6 | 12 | Diesel | 148 |
| OM 346.912 | | 128.00 | 10809 | 6 | 12 | Diesel | 148 |
| OM 346.913 | | 128.00 | 10809 | 6 | 12 | Diesel | 148 |
| OM 346.914 | | 128.00 | 10809 | 6 | 12 | Diesel | 148 |
| OM 346.915 | | 128.00 | 10809 | 6 | 12 | Diesel | 148 |
| OM 346.916 | | 128.00 | 10809 | 6 | 12 | Diesel | 148 |
| OM 346.917 | | 128.00 | 10809 | 6 | 12 | Diesel | 148 |
| OM 346.918 | | 128.00 | 10809 | 6 | 12 | Diesel | 148 |
| OM 346.941 | | 128.00 | 10809 | 6 | 12 | Diesel | 148 |
| OM 346.942 | | 128.00 | 10809 | 6 | 12 | Diesel | 148 |
| OM 346.943 | | 128.00 | 10809 | 6 | 12 | Diesel | 148 |
| OM 346.944 | | 128.00 | 10809 | 6 | 12 | Diesel | 148 |
| OM 346.945 | | 128.00 | 10809 | 6 | 12 | Diesel | 148 |
| OM 346.946 | | 128.00 | 10809 | 6 | 12 | Diesel | 148 |
| OM 346.952 | | 128.00 | 10809 | 6 | 12 | Diesel | 148 |
| OM 346.953 | | 128.00 | 10809 | 6 | 12 | Diesel | 148 |
| OM 352.901 | | 97.00 | 5675 | 6 | 12 | Diesel | 114 |
| OM 352.902 | | 97.00 | 5675 | 6 | 12 | Diesel | 113 |
| OM 352.903 | | 97.00 | 5675 | 6 | 12 | Diesel | 114 |
| OM 352.904 | | 97.00 | 5675 | 6 | 12 | Diesel | 114 |
| OM 352.905 | | 97.00 | 5680 | 6 | 12 | Diesel | 117 |
| OM 352.906 | | 97.00 | 5675 | 6 | 12 | Diesel | 114 |
| OM 352.907 | | 97.00 | 5700 | 6 | 12 | Diesel | 118 |
| OM 352.908 | | 97.00 | 5675 | 6 | 12 | Diesel | 114 |
| OM 352.909 | | 97.00 | 5675 | 6 | 12 | Diesel | 114 |
| OM 352.910 | | 97.00 | 5675 | 6 | 12 | Diesel | 114 |
| OM 352.911 | | 97.00 | 5675 | 6 | 12 | Diesel | 114 |
| OM 352.912 | | 97.00 | 5675 | 6 | 12 | Diesel | 114 |
| OM 352.913 | | 97.00 | 5675 | 6 | 12 | Diesel | 114 |
| OM 352.914 | | 97.00 | 5675 | 6 | 12 | Diesel | 114 |
| OM 352.915 | | 97.00 | 5675 | 6 | 12 | Diesel | 114 |
| OM 352.916 | | 97.00 | 5675 | 6 | 12 | Diesel | 114 |
| OM 352.917 | | 97.00 | 5675 | 6 | 12 | Diesel | 114 |
| OM 352.918 | | 97.00 | 5675 | 6 | 12 | Diesel | 114 |
| OM 352.930 | | 97.00 | 5675 | 6 | 12 | Diesel | 114 |
| OM 352.931 | | 97.00 | 5675 | 6 | 12 | Diesel | 114 |
| OM 352.932 | | 97.00 | 5675 | 6 | 12 | Diesel | 114 |







|  |  | ccm |  |  |  |  |
|---|---|------|--|---|---|---|
| OM 352.933 | 97.00 | 5675 | 6 | 12 | Diesel | 113 |
| OM 352.934 | 97.00 | 5675 | 6 | 12 | Diesel | 114 |
| OM 352.935 | 97.00 | 5675 | 6 | 12 | Diesel | 114 |
| OM 352.936 | 97.00 | 5675 | 6 | 12 | Diesel | 114 |
| OM 352.937 | 97.00 | 5675 | 6 | 12 | Diesel | 114 |
| OM 352.938 | 97.00 | 5675 | 6 | 12 | Diesel | 114 |
| OM 352.939 | 97.00 | 5675 | 6 | 12 | Diesel | 114 |
| OM 352.942 | 97.00 | 5675 | 6 | 12 | Diesel | 114 |
| OM 352.943 | 97.00 | 5675 | 6 | 12 | Diesel | 114 |
| OM 352.944 | 97.00 | 5675 | 6 | 12 | Diesel | 114 |
| OM 352.945 | 97.00 | 5675 | 6 | 12 | Diesel | 114 |
| OM 352.946 | 97.00 | 5675 | 6 | 12 | Diesel | 114 |
| OM 352.948 | 97.00 | 5675 | 6 | 12 | Diesel | 114 |
| OM 352.949 | 97.00 | 5675 | 6 | 12 | Diesel | 113 |
| OM 352.950 | 97.00 | 5675 | 6 | 12 | Diesel | 114 |
| OM 352.953 | 97.00 | 5675 | 6 | 12 | Diesel | 114 |
| OM 352.954 | 97.00 | 5675 | 6 | 12 | Diesel | 114 |
| OM 352.955 | 97.00 | 5675 | 6 | 12 | Diesel | 114 |
| OM 352.959 | 97.00 | 5675 | 6 | 12 | Diesel | 113 |
| OM 352.963 | 97.00 | 5675 | 6 | 12 | Diesel | 114 |
| OM 352.964 | 97.00 | 5675 | 6 | 12 | Diesel | 114 |
| OM 352.965 | 97.00 | 5675 | 6 | 12 | Diesel | 113 |
| OM 352.966 | 97.00 | 5675 | 6 | 12 | Diesel | 113 |
| OM 352.967 | 97.00 | 5675 | 6 | 12 | Diesel | 113 |
| OM 352.968 | 97.00 | 5675 | 6 | 12 | Diesel | 114 |
| OM 352.969 | 97.00 | 5675 | 6 | 12 | Diesel | 114 |
| OM 352.970 | 97.00 | 5675 | 6 | 12 | Diesel | 114 |
| OM 352.971 | 97.00 | 5675 | 6 | 12 | Diesel | 114 |
| OM 352.972 | 97.00 | 5675 | 6 | 12 | Diesel | 114 |
| OM 352.973 | 97.00 | 5675 | 6 | 12 | Diesel | 114 |
| OM 352.974 | 97.00 | 5675 | 6 | 12 | Diesel | 114 |
| OM 352.975 | 97.00 | 5675 | 6 | 12 | Diesel | 114 |
| OM 352.976 | 97.00 | 5675 | 6 | 12 | Diesel | 114 |
| OM 352.978 | 97.00 | 5675 | 6 | 12 | Diesel | 113 |
| OM 352.979 | 97.00 | 5675 | 6 | 12 | Diesel | 114 |
| OM 352.980 | 97.00 | 5675 | 6 | 12 | Diesel | 114 |
| OM 352.981 | 97.00 | 5675 | 6 | 12 | Diesel | 114 |
| OM 352.982 | 97.00 | 5675 | 6 | 12 | Diesel | 114 |
| OM 352.983 | 97.00 | 5675 | 6 | 12 | Diesel | 114 |
| OM 352.984 | 97.00 | 5675 | 6 | 12 | Diesel | 113 |
| OM 352.985 | 97.00 | 5675 | 6 | 12 | Diesel | 114 |
| OM 352.986 | 97.00 | 5700 | 6 | 12 | Diesel | 118 |
| OM 352.987 | 97.00 | 5675 | 6 | 12 | Diesel | 114 |
| OM 352.988 | 97.00 | 5675 | 6 | 12 | Diesel | 114 |
| OM 352.989 | 97.00 | 5675 | 6 | 12 | Diesel | 114 |
| OM 352.990 | 97.00 | 5675 | 6 | 12 | Diesel | 114 |
| OM 352.991 | 97.00 | 5675 | 6 | 12 | Diesel | 114 |
| OM 352.992 | 97.00 | 5675 | 6 | 12 | Diesel | 113 |
| OM 352.993 | 97.00 | 5675 | 6 | 12 | Diesel | 114 |
| OM 352.994 | 97.00 | 5675 | 6 | 12 | Diesel | 114 |
| OM 352.996 | 97.00 | 5675 | 6 | 12 | Diesel | 114 |
| OM 352.997 | 97.00 | 5675 | 6 | 12 | Diesel | 114 |
| OM 352.998 | 97.00 | 5675 | 6 | 12 | Diesel | 114 |
| OM 352.999 | 97.00 | 5675 | 6 | 12 | Diesel | 113 |
| OM 353.900 | 97.00 | 5675 | 6 | 12 | Diesel | 114 |
| OM 353.901 | 97.00 | 5675 | 6 | 12 | Diesel | 114 |
| OM 353.902 | 97.00 | 5675 | 6 | 12 | Diesel | 114 |
| OM 353.903 | 97.00 | 5675 | 6 | 12 | Diesel | 114 |
| OM 353.904 | 97.00 | 5675 | 6 | 12 | Diesel | 114 |
| OM 353.905 | 97.00 | 5680 | 6 | 12 | Diesel | 117 |
| OM 353.907 | 97.00 | 5675 | 6 | 12 | Diesel | 114 |
| OM 353.909 | 97.00 | 5675 | 6 | 12 | Diesel | 114 |
| OM 353.910 | 97.00 | 5675 | 6 | 12 | Diesel | 114 |
| OM 353.911 | 97.00 | 5675 | 6 | 12 | Diesel | 116 |
| OM 353.912 | 97.00 | 5675 | 6 | 12 | Diesel | 116 |
| OM 353.913 | 97.00 | 5675 | 6 | 12 | Diesel | 116 |







|  |  | ccm |  |  |  |  |
|---|---|------|---|---|---|---|
| OM 353.914 | 97.00 | 5675 | 6 | 12 | Diesel | 116 |
| OM 353.915 | 97.00 | 5675 | 6 | 12 | Diesel | 114 |
| OM 353.916 | 97.00 | 5675 | 6 | 12 | Diesel | 114 |
| OM 353.917 | 97.00 | 5675 | 6 | 12 | Diesel | 114 |
| OM 353.920 | 97.00 | 5675 | 6 | 12 | Diesel | 114 |
| OM 353.921 | 97.00 | 5675 | 6 | 12 | Diesel | 114 |
| OM 353.922 | 97.00 | 5675 | 6 | 12 | Diesel | 114 |
| OM 353.923 | 97.00 | 5675 | 6 | 12 | Diesel | 114 |
| OM 353.930 | 97.00 | 5675 | 6 | 12 | Diesel | 114 |
| OM 353.931 | 97.00 | 5675 | 6 | 12 | Diesel | 114 |
| OM 353.932 | 97.00 | 5675 | 6 | 12 | Diesel | 114 |
| OM 353.933 | 97.00 | 5675 | 6 | 12 | Diesel | 114 |
| OM 353.934 | 97.00 | 5675 | 6 | 12 | Diesel | 114 |
| OM 353.935 | 97.00 | 5675 | 6 | 12 | Diesel | 114 |
| OM 353.936 | 97.00 | 5675 | 6 | 12 | Diesel | 114 |
| OM 353.937 | 97.00 | 5675 | 6 | 12 | Diesel | 114 |
| OM 353.938 | 97.00 | 5675 | 6 | 12 | Diesel | 114 |
| OM 353.939 | 97.00 | 5675 | 6 | 12 | Diesel | 114 |
| OM 353.940 | 97.00 | 5675 | 6 | 12 | Diesel | 114 |
| OM 353.941 | 97.00 | 5675 | 6 | 12 | Diesel | 114 |
| OM 353.942 | 97.00 | 5700 | 6 | 12 | Diesel | 118 |
| OM 353.943 | 97.00 | 5700 | 6 | 12 | Diesel | 118 |
| OM 353.944 | 97.00 | 5700 | 6 | 12 | Diesel | 118 |
| OM 353.945 | 97.00 | 5700 | 6 | 12 | Diesel | 118 |
| OM 353.946 | 97.00 | 5700 | 6 | 12 | Diesel | 118 |
| OM 353.949 | 97.00 | 5675 | 6 | 12 | Diesel | 114 |
| OM 353.950 | 97.00 | 5700 | 6 | 12 | Diesel | 118 |
| OM 353.951 | 97.00 | 5700 | 6 | 12 | Diesel | 118 |
| OM 353.952 | 97.00 | 5700 | 6 | 12 | Diesel | 118 |
| OM 353.953 | 97.00 | 5700 | 6 | 12 | Diesel | 118 |
| OM 353.954 | 97.00 | 5700 | 6 | 12 | Diesel | 118 |
| OM 353.957 | 97.00 | 5675 | 6 | 12 | Diesel | 116 |
| OM 353.958 | 97.00 | 5675 | 6 | 12 | Diesel | 114 |
| OM 353.959 | 97.00 | 5675 | 6 | 12 | Diesel | 116 |
| OM 353.960 | 97.00 | 5675 | 6 | 12 | Diesel | 114 |
| OM 353.961 | 97.00 | 5675 | 6 | 12 | Diesel | 114 |
| OM 353.962 | 97.00 | 5675 | 6 | 12 | Diesel | 114 |
| OM 353.963 | 97.00 | 5675 | 6 | 12 | Diesel | 114 |
| OM 353.964 | 97.00 | 5700 | 6 | 12 | Diesel | 118 |
| OM 353.965 | 97.00 | 5675 | 6 | 12 | Diesel | 114 |
| OM 353.966 | 97.00 | 5675 | 6 | 12 | Diesel | 114 |
| OM 353.967 | 97.00 | 5675 | 6 | 12 | Diesel | 114 |
| OM 353.968 | 97.00 | 5675 | 6 | 12 | Diesel | 114 |
| OM 353.969 | 97.00 | 5675 | 6 | 12 | Diesel | 114 |
| OM 353.970 | 97.00 | 5700 | 6 | 12 | Diesel | 118 |
| OM 353.971 | 97.00 | 5700 | 6 | 12 | Diesel | 118 |
| OM 353.972 | 97.00 | 5675 | 6 | 12 | Diesel | 116 |
| OM 353.973 | 97.00 | 5675 | 6 | 12 | Diesel | 116 |
| OM 353.974 | 97.00 | 5675 | 6 | 12 | Diesel | 116 |
| OM 353.975 | 97.00 | 5700 | 6 | 12 | Diesel | 118 |
| OM 353.976 | 97.00 | 5675 | 6 | 12 | Diesel | 116 |
| OM 353.977 | 97.00 | 5675 | 6 | 12 | Diesel | 114 |
| OM 353.978 | 97.00 | 5675 | 6 | 12 | Diesel | 116 |
| OM 353.980 | 97.00 | 5675 | 6 | 12 | Diesel | 114 |
| OM 353.981 | 97.00 | 5675 | 6 | 12 | Diesel | 114 |
| OM 353.982 | 97.00 | 5675 | 6 | 12 | Diesel | 114 |
| OM 353.983 | 97.00 | 5675 | 6 | 12 | Diesel | 114 |
| OM 353.984 | 97.00 | 5675 | 6 | 12 | Diesel | 114 |
| OM 353.989 | 97.00 | 5675 | 6 | 12 | Diesel | 114 |
| OM 353.991 | 97.00 | 5675 | 6 | 12 | Diesel | 116 |
| OM 353.995 | 97.00 | 5675 | 6 | 12 | Diesel | 116 |
| OM 353.997 | 97.00 | 5675 | 6 | 12 | Diesel | 116 |
| OM 354.900 | 97.50 | 3972 | 4 | 8 | Diesel | 120 |
| OM 354.901 | 97.50 | 3972 | 4 | 8 | Diesel | 120 |
| OM 354.902 | 97.50 | 3972 | 4 | 8 | Diesel | 120 |
| OM 354.903 | 97.50 | 3972 | 4 | 8 | Diesel | 120 |







|  |  | ccm |  |  |  |  |
|---|---|-------|--|---|---|---|
| OM 354.920 | 97.50 | 3972 | 4 | 8 | Diesel | 120 |
| OM 354.921 | 97.50 | 3972 | 4 | 8 | Diesel | 120 |
| OM 354.922 | 97.50 | 3972 | 4 | 8 | Diesel | 120 |
| OM 354.923 | 97.50 | 3972 | 4 | 8 | Diesel | 120 |
| OM 354.924 | 97.50 | 3972 | 4 | 8 | Diesel | 120 |
| OM 354.925 | 97.50 | 3972 | 4 | 8 | Diesel | 120 |
| OM 354.926 | 97.50 | 3972 | 4 | 8 | Diesel | 120 |
| OM 355.910 | 128.00 | 11581 | 6 | 24 | Diesel | 153 |
| OM 355.911 | 128.00 | 11581 | 6 | 24 | Diesel | 153 |
| OM 355.912 | 128.00 | 11581 | 6 | 24 | Diesel | 153 |
| OM 355.913 | 128.00 | 11581 | 6 | 24 | Diesel | 153 |
| OM 355.914 | 128.00 | 11581 | 6 | 24 | Diesel | 153 |
| OM 355.915 | 128.00 | 11581 | 6 | 24 | Diesel | 153 |
| OM 355.916 | 128.00 | 11581 | 6 | 12 | Diesel | 153 |
| OM 355.918 | 128.00 | 11581 | 6 | 24 | Diesel | 153 |
| OM 355.960 | 128.00 | 11581 | 6 | 24 | Diesel | 153 |
| OM 355.961 | 128.00 | 11581 | 6 | 24 | Diesel | 153 |
| OM 355.962 | 128.00 | 11581 | 6 | 24 | Diesel | 153 |
| OM 355.963 | 128.00 | 11581 | 6 | 24 | Diesel | 153 |
| OM 355.964 | 128.00 | 11581 | 6 | 24 | Diesel | 153 |
| OM 355.966 | 128.00 | 11581 | 6 | 24 | Diesel | 153 |
| OM 355.967 | 128.00 | 11581 | 6 | 24 | Diesel | 153 |
| OM 355.968 | 128.00 | 11581 | 6 | 12 | Diesel | 154 |
| OM 355.969 | 128.00 | 11581 | 6 | 24 | Diesel | 154 |
| OM 355.970 | 128.00 | 11581 | 6 | 24 | Diesel | 153 |
| OM 355.972 | 128.00 | 11581 | 6 | 24 | Diesel | 153 |
| OM 355.973 | 128.00 | 11581 | 6 | 24 | Diesel | 153 |
| OM 355.974 | 128.00 | 11581 | 6 | 24 | Diesel | 153 |
| OM 355.975 | 128.00 | 11581 | 6 | 24 | Diesel | 153 |
| OM 355.976 | 128.00 | 11581 | 6 | 24 | Diesel | 153 |
| OM 355.977 | 128.00 | 11581 | 6 | 24 | Diesel | 154 |
| OM 355.978 | 128.00 | 11581 | 6 | 24 | Diesel | 153 |
| OM 355.979 | 128.00 | 11581 | 6 | 24 | Diesel | 153 |
| OM 355.980 | 128.00 | 11581 | 6 | 24 | Diesel | 153 |
| OM 355.981 | 128.00 | 11581 | 6 | 24 | Diesel | 153 |
| OM 355.982 | 128.00 | 11581 | 6 | 24 | Diesel | 153 |
| OM 355.983 | 128.00 | 11581 | 6 | 24 | Diesel | 153 |
| OM 355.984 | 128.00 | 11581 | 6 | 24 | Diesel | 153 |
| OM 356.901 | 97.50 | 5958 | 6 | 12 | Diesel | 122 |
| OM 356.902 | 97.50 | 5958 | 6 | 12 | Diesel | 122 |
| OM 356.903 | 97.50 | 5958 | 6 | 12 | Diesel | 122 |
| OM 356.904 | 97.50 | 5958 | 6 | 12 | Diesel | 122 |
| OM 356.905 | 97.50 | 5958 | 6 | 12 | Diesel | 122 |
| OM 356.906 | 97.50 | 5958 | 6 | 12 | Diesel | 122 |
| OM 356.907 | 97.50 | 5958 | 6 | 12 | Diesel | 122 |
| OM 356.908 | 97.50 | 5958 | 6 | 12 | Diesel | 122 |
| OM 356.909 | 97.50 | 5958 | 6 | 12 | Diesel | 122 |
| OM 356.910 | 97.50 | 5958 | 6 | 12 | Diesel | 122 |
| OM 356.911 | 97.50 | 5958 | 6 | 12 | Diesel | 122 |
| OM 356.912 | 97.50 | 5958 | 6 | 12 | Diesel | 122 |
| OM 356.913 | 97.50 | 5958 | 6 | 12 | Diesel | 122 |
| OM 356.914 | 97.50 | 5958 | 6 | 12 | Diesel | 122 |
| OM 356.915 | 97.50 | 5958 | 6 | 12 | Diesel | 122 |
| OM 356.916 | 97.50 | 5958 | 6 | 12 | Diesel | 122 |
| OM 356.940 | 97.50 | 5958 | 6 | 12 | Diesel | 122 |
| OM 356.941 | 97.50 | 5958 | 6 | 12 | Diesel | 122 |
| OM 356.943 | 97.50 | 5958 | 6 | 12 | Diesel | 122 |
| OM 356.944 | 97.50 | 5958 | 6 | 12 | Diesel | 123 |
| OM 356.945 | 97.50 | 5958 | 6 | 12 | Diesel | 122 |
| OM 356.946 | 97.50 | 5958 | 6 | 12 | Diesel | 122 |
| OM 356.947 | 97.50 | 5958 | 6 | 12 | Diesel | 122 |
| OM 356.948 | 97.50 | 5958 | 6 | 12 | Diesel | 122 |
| OM 356.949 | 97.50 | 5958 | 6 | 12 | Diesel | 122 |
| OM 356.950 | 97.50 | 5958 | 6 | 12 | Diesel | 122 |
| OM 356.951 | 97.50 | 5958 | 6 | 12 | Diesel | 122 |
| OM 356.952 | 97.50 | 5958 | 6 | 12 | Diesel | 122 |







|  |  | ccm |  |  |  |  |
|---|---|------|---|---|---|---|
| OM 356.953 | 97.50 | 5958 | 6 | 12 | Diesel | 122 |
| OM 356.954 | 97.50 | 5958 | 6 | 12 | Diesel | 122 |
| OM 356.955 | 97.50 | 5958 | 6 | 12 | Diesel | 122 |
| OM 356.956 | 97.50 | 5958 | 6 | 12 | Diesel | 122 |
| OM 356.957 | 97.50 | 5958 | 6 | 12 | Diesel | 122 |
| OM 356.958 | 97.50 | 5958 | 6 | 12 | Diesel | 122 |
| OM 356.959 | 97.50 | 5958 | 6 | 12 | Diesel | 122 |
| OM 356.977 | 97.50 | 5958 | 6 | 12 | Diesel | 122 |
| OM 356.978 | 97.50 | 5958 | 6 | 12 | Diesel | 122 |
| OM 356.979 | 97.50 | 5958 | 6 | 12 | Diesel | 122 |
| OM 356.980 | 97.50 | 5958 | 6 | 12 | Diesel | 122 |
| OM 356.981 | 97.50 | 5958 | 6 | 12 | Diesel | 122 |
| OM 356.983 | 97.50 | 5958 | 6 | 12 | Diesel | 122 |
| OM 356.984 | 97.50 | 5958 | 6 | 12 | Diesel | 122 |
| OM 356.985 | 97.50 | 5958 | 6 | 12 | Diesel | 122 |
| OM 356.986 | 97.50 | 5958 | 6 | 12 | Diesel | 122 |
| OM 356.987 | 97.50 | 5958 | 6 | 12 | Diesel | 122 |
| OM 356.988 | 97.50 | 5958 | 6 | 12 | Diesel | 124 |
| OM 356.989 | 97.50 | 5958 | 6 | 12 | Diesel | 122 |
| OM 356.990 | 97.50 | 5958 | 6 | 12 | Diesel | 122 |
| OM 356.991 | 97.50 | 5958 | 6 | 12 | Diesel | 122 |
| OM 356.992 | 97.50 | 5958 | 6 | 12 | Diesel | 122 |
| OM 356.993 | 97.50 | 5958 | 6 | 12 | Diesel | 122 |
| OM 356.994 | 97.50 | 5958 | 6 | 12 | Diesel | 122 |
| OM 356.995 | 97.50 | 5958 | 6 | 12 | Diesel | 122 |
| OM 356.996 | 97.50 | 5958 | 6 | 12 | Diesel | 122 |
| OM 356.997 | 97.50 | 5958 | 6 | 12 | Diesel | 122 |
| OM 356.998 | 97.50 | 5958 | 6 | 12 | Diesel | 122 |
| OM 356.999 | 97.50 | 5958 | 6 | 12 | Diesel | 122 |
| OM 357.900 | 97.50 | 5958 | 6 | 12 | Diesel | 122 |
| OM 357.901 | 97.50 | 5958 | 6 | 12 | Diesel | 122 |
| OM 357.902 | 97.50 | 5958 | 6 | 12 | Diesel | 122 |
| OM 357.903 | 97.50 | 5958 | 6 | 12 | Diesel | 122 |
| OM 357.904 | 97.50 | 5958 | 6 | 12 | Diesel | 122 |
| OM 357.906 | 97.50 | 5958 | 6 | 12 | Diesel | 122 |
| OM 357.907 | 97.50 | 5958 | 6 | 12 | Diesel | 122 |
| OM 357.908 | 97.50 | 5958 | 6 | 12 | Diesel | 122 |
| OM 357.909 | 97.50 | 5958 | 6 | 12 | Diesel | 122 |
| OM 357.910 | 97.50 | 5958 | 6 | 12 | Diesel | 122 |
| OM 357.912 | 97.50 | 5958 | 6 | 12 | Diesel | 122 |
| OM 357.913 | 97.50 | 5958 | 6 | 12 | Diesel | 122 |
| OM 357.915 | 97.50 | 5958 | 6 | 12 | Diesel | 122 |
| OM 357.916 | 97.50 | 5958 | 6 | 12 | Diesel | 122 |
| OM 357.917 | 97.50 | 5958 | 6 | 12 | Diesel | 122 |
| OM 357.918 | 97.50 | 5958 | 6 | 12 | Diesel | 122 |
| OM 357.919 | 97.50 | 5958 | 6 | 12 | Diesel | 122 |
| OM 357.920 | 97.50 | 5958 | 6 | 12 | Diesel | 122 |
| OM 357.921 | 97.50 | 5958 | 6 | 12 | Diesel | 122 |
| OM 357.922 | 97.50 | 5958 | 6 | 12 | Diesel | 122 |
| OM 357.924 | 97.50 | 5958 | 6 | 12 | Diesel | 122 |
| OM 357.925 | 97.50 | 5958 | 6 | 12 | Diesel | 122 |
| OM 357.926 | 97.50 | 5958 | 6 | 12 | Diesel | 124 |
| OM 357.927 | 97.50 | 5958 | 6 | 12 | Diesel | 122 |
| OM 357.929 | 97.50 | 5958 | 6 | 12 | Diesel | 122 |
| OM 357.930 | 97.50 | 5958 | 6 | 12 | Diesel | 122 |
| OM 357.931 | 97.50 | 5958 | 6 | 12 | Diesel | 122 |
| OM 357.932 | 97.50 | 5958 | 6 | 12 | Diesel | 122 |
| OM 357.933 | 97.50 | 5958 | 6 | 12 | Diesel | 122 |
| OM 357.936 | 97.50 | 5958 | 6 | 12 | Diesel | 122 |
| OM 357.937 | 97.50 | 5958 | 6 | 12 | Diesel | 122 |
| OM 357.938 | 97.50 | 5958 | 6 | 12 | Diesel | 122 |
| OM 357.940 | 97.50 | 5958 | 6 | 12 | Diesel | 122 |
| OM 357.941 | 97.50 | 5958 | 6 | 12 | Diesel | 122 |
| OM 357.942 | 97.50 | 5958 | 6 | 12 | Diesel | 122 |
| OM 357.943 | 97.50 | 5958 | 6 | 12 | Diesel | 122 |
| OM 357.944 | 97.50 | 5958 | 6 | 12 | Diesel | 122 |







|  |  | ccm |  |  |  |  |
|---|---|------|--|---|---|---|
| OM 357.945 | 97.50 | 5958 | 6 | 12 | Diesel | 122 |
| OM 357.946 | 97.50 | 5958 | 6 | 12 | Diesel | 122 |
| OM 357.947 | 97.50 | 5958 | 6 | 12 | Diesel | 122 |
| OM 357.948 | 97.50 | 5958 | 6 | 12 | Diesel | 122 |
| OM 357.949 | 97.50 | 5958 | 6 | 12 | Diesel | 122 |
| OM 357.961 | 97.50 | 5958 | 6 | 12 | Diesel | 122 |
| OM 357.962 | 97.50 | 5958 | 6 | 12 | Diesel | 122 |
| OM 357.963 | 97.50 | 5958 | 6 | 12 | Diesel | 122 |
| OM 362.906 | 97.00 | 5700 | 6 | 12 | Diesel | 119 |
| OM 362.909 | 97.00 | 5700 | 6 | 12 | Diesel | 119 |
| OM 362.910 | 97.00 | 5675 | 6 | 12 | Diesel | 113 |
| OM 364.901 | 97.50 | 3972 | 4 | 8 | Diesel | 121 |
| OM 364.906 | 97.50 | 3972 | 4 | 8 | Diesel | 120 |
| OM 364.907 | 97.50 | 3972 | 4 | 8 | Diesel | 120 |
| OM 364.908 | 97.50 | 3972 | 4 | 8 | Diesel | 120 |
| OM 364.909 | 97.50 | 3972 | 4 | 8 | Diesel | 120 |
| OM 364.911 | 97.50 | 3972 | 4 | 8 | Diesel | 120 |
| OM 364.912 | 97.50 | 3972 | 4 | 8 | Diesel | 120 |
| OM 364.913 | 97.50 | 3972 | 4 | 8 | Diesel | 120 |
| OM 364.916 | 97.50 | 3972 | 4 | 8 | Diesel | 120 |
| OM 364.917 | 97.50 | 3972 | 4 | 8 | Diesel | 120 |
| OM 364.918 | 97.50 | 3972 | 4 | 8 | Diesel | 120 |
| OM 364.919 | 97.50 | 3972 | 4 | 8 | Diesel | 120 |
| OM 364.920 | 97.50 | 3972 | 4 | 8 | Diesel | 120 |
| OM 364.921 | 97.50 | 3972 | 4 | 8 | Diesel | 120 |
| OM 364.950 | 97.50 | 3972 | 4 | 8 | Diesel | 120 |
| OM 364.951 | 97.50 | 3972 | 4 | 8 | Diesel | 120 |
| OM 364.952 | 97.50 | 3972 | 4 | 8 | Diesel | 120 |
| OM 364.954 | 97.50 | 3972 | 4 | 8 | Diesel | 120 |
| OM 364.955 | 97.50 | 3972 | 4 | 8 | Diesel | 120 |
| OM 364.956 | 97.50 | 3972 | 4 | 8 | Diesel | 120 |
| OM 364.957 | 97.50 | 3972 | 4 | 8 | Diesel | 120 |
| OM 364.958 | 97.50 | 3972 | 4 | 8 | Diesel | 120 |
| OM 364.959 | 97.50 | 3972 | 4 | 8 | Diesel | 120 |
| OM 364.981 | 97.50 | 3972 | 4 | 8 | Diesel | 120 |
| OM 364.982 | 97.50 | 3972 | 4 | 8 | Diesel | 120 |
| OM 364.983 | 97.50 | 3972 | 4 | 8 | Diesel | 120 |
| OM 364.984 | 97.50 | 3972 | 4 | 8 | Diesel | 120 |
| OM 364.985 | 97.50 | 3972 | 4 | 8 | Diesel | 120 |
| OM 364.986 | 97.50 | 3972 | 4 | 8 | Diesel | 120 |
| OM 364.987 | 97.50 | 3972 | 4 | 8 | Diesel | 120 |
| OM 364.989 | 97.50 | 3972 | 4 | 8 | Diesel | 120 |
| OM 366.905 | 97.50 | 5958 | 6 | 12 | Diesel | 122 |
| OM 366.906 | 97.50 | 5958 | 6 | 12 | Diesel | 122 |
| OM 366.907 | 97.50 | 5958 | 6 | 12 | Diesel | 122 |
| OM 366.908 | 97.50 | 5958 | 6 | 12 | Diesel | 122 |
| OM 366.909 | 97.50 | 5958 | 6 | 12 | Diesel | 122 |
| OM 366.910 | 97.50 | 5958 | 6 | 12 | Diesel | 122 |
| OM 366.911 | 97.50 | 5958 | 6 | 12 | Diesel | 122 |
| OM 366.912 | 97.50 | 5958 | 6 | 12 | Diesel | 122 |
| OM 366.913 | 97.50 | 5958 | 6 | 12 | Diesel | 122 |
| OM 366.914 | 97.50 | 5958 | 6 | 12 | Diesel | 122 |
| OM 366.915 | 97.50 | 5958 | 6 | 12 | Diesel | 122 |
| OM 366.917 | 97.50 | 5958 | 6 | 12 | Diesel | 122 |
| OM 366.918 | 97.50 | 5958 | 6 | 12 | Diesel | 122 |
| OM 366.919 | 97.50 | 5958 | 6 | 12 | Diesel | 122 |
| OM 366.930 | 97.50 | 5958 | 6 | 12 | Diesel | 122 |
| OM 366.931 | 97.50 | 5958 | 6 | 12 | Diesel | 122 |
| OM 366.932 | 97.50 | 5958 | 6 | 12 | Diesel | 122 |
| OM 366.933 | 97.50 | 5958 | 6 | 12 | Diesel | 122 |
| OM 366.935 | 97.50 | 5958 | 6 | 12 | Diesel | 122 |
| OM 366.936 | 97.50 | 5958 | 6 | 12 | Diesel | 122 |
| OM 366.937 | 97.50 | 5958 | 6 | 12 | Diesel | 122 |
| OM 366.938 | 97.50 | 5958 | 6 | 12 | Diesel | 122 |
| OM 366.939 | 97.50 | 5958 | 6 | 12 | Diesel | 122 |
| OM 366.940 | 97.50 | 5958 | 6 | 12 | Diesel | 122 |







|  |  | ccm |  |  |  |  |
|---|---|------|---|---|---|---|
| OM 366.941 | 97.50 | 5958 | 6 | 12 | Diesel | 122 |
| OM 366.942 | 97.50 | 5958 | 6 | 12 | Diesel | 122 |
| OM 366.943 | 97.50 | 5958 | 6 | 12 | Diesel | 122 |
| OM 366.944 | 97.50 | 5958 | 6 | 12 | Diesel | 122 |
| OM 366.945 | 97.50 | 5958 | 6 | 12 | Diesel | 122 |
| OM 366.946 | 97.50 | 5958 | 6 | 12 | Diesel | 122 |
| OM 366.947 | 97.50 | 5958 | 6 | 12 | Diesel | 122 |
| OM 366.948 | 97.50 | 5958 | 6 | 12 | Diesel | 122 |
| OM 366.949 | 97.50 | 5958 | 6 | 12 | Diesel | 122 |
| OM 366.951 | 97.50 | 5958 | 6 | 12 | Diesel | 122 |
| OM 366.952 | 97.50 | 5958 | 6 | 12 | Diesel | 122 |
| OM 366.953 | 97.50 | 5958 | 6 | 12 | Diesel | 122 |
| OM 366.954 | 97.50 | 5958 | 6 | 12 | Diesel | 122 |
| OM 366.955 | 97.50 | 5958 | 6 | 12 | Diesel | 122 |
| OM 366.956 | 97.50 | 5958 | 6 | 12 | Diesel | 122 |
| OM 366.957 | 97.50 | 5958 | 6 | 12 | Diesel | 122 |
| OM 366.958 | 97.50 | 5958 | 6 | 12 | Diesel | 122 |
| OM 366.960 | 97.50 | 5958 | 6 | 12 | Diesel | 122 |
| OM 366.962 | 97.50 | 5958 | 6 | 12 | Diesel | 122 |
| OM 366.963 | 97.50 | 5958 | 6 | 12 | Diesel | 122 |
| OM 366.965 | 97.50 | 5958 | 6 | 12 | Diesel | 122 |
| OM 366.966 | 97.50 | 5958 | 6 | 12 | Diesel | 122 |
| OM 366.967 | 97.50 | 5958 | 6 | 12 | Diesel | 122 |
| OM 366.968 | 97.50 | 5958 | 6 | 12 | Diesel | 122 |
| OM 366.969 | 97.50 | 5958 | 6 | 12 | Diesel | 122 |
| OM 366.970 | 97.50 | 5958 | 6 | 12 | Diesel | 122 |
| OM 366.971 | 97.50 | 5958 | 6 | 12 | Diesel | 122 |
| OM 366.973 | 97.50 | 5958 | 6 | 12 | Diesel | 122 |
| OM 366.974 | 97.50 | 5958 | 6 | 12 | Diesel | 122 |
| OM 366.975 | 97.50 | 5958 | 6 | 12 | Diesel | 122 |
| OM 366.976 | 97.50 | 5958 | 6 | 12 | Diesel | 122 |
| OM 366.977 | 97.50 | 5958 | 6 | 12 | Diesel | 122 |
| OM 366.978 | 97.50 | 5958 | 6 | 12 | Diesel | 122 |
| OM 366.979 | 97.50 | 5958 | 6 | 12 | Diesel | 122 |
| OM 366.980 | 97.50 | 5958 | 6 | 12 | Diesel | 122 |
| OM 366.981 | 97.50 | 5958 | 6 | 12 | Diesel | 122 |
| OM 366.983 | 97.50 | 5958 | 6 | 12 | Diesel | 122 |
| OM 366.984 | 97.50 | 5958 | 6 | 12 | Diesel | 122 |
| OM 366.988 | 97.50 | 5958 | 6 | 12 | Diesel | 122 |
| OM 366.990 | 97.50 | 5958 | 6 | 12 | Diesel | 122 |
| OM 366.992 | 97.50 | 5958 | 6 | 12 | Diesel | 122 |
| OM 366.993 | 97.50 | 5958 | 6 | 12 | Diesel | 122 |
| OM 366.994 | 97.50 | 5958 | 6 | 12 | Diesel | 122 |
| OM 366.995 | 97.50 | 5958 | 6 | 12 | Diesel | 122 |
| OM 366.996 | 97.50 | 5958 | 6 | 12 | Diesel | 122 |
| OM 366.997 | 97.50 | 5958 | 6 | 12 | Diesel | 122 |
| OM 366.999 | 97.50 | 5958 | 6 | 12 | Diesel | 122 |
| OM 372.906 | 97.50 | 5958 | 6 | 12 | Diesel | 122 |
| OM 372.907 | 97.50 | 5958 | 6 | 12 | Diesel | 122 |
| OM 372.930 | 97.50 | 5958 | 6 | 12 | Diesel | 125 |
| OM 374.905 | 97.50 | 3972 | 4 | 8 | Diesel | 121 |
| OM 374.907 | 97.50 | 3972 | 4 | 8 | Diesel | 121 |
| OM 374.908 | 97.50 | 3972 | 4 | 8 | Diesel | 121 |
| OM 376.905 | 97.50 | 5958 | 6 | 12 | Diesel | 122 |
| OM 376.906 | 97.50 | 5958 | 6 | 12 | Diesel | 122 |
| OM 376.907 | 97.50 | 5958 | 6 | 12 | Diesel | 122 |
| OM 376.908 | 97.50 | 5958 | 6 | 12 | Diesel | 122 |
| OM 376.909 | 97.50 | 5958 | 6 | 12 | Diesel | 122 |
| OM 376.910 | 97.50 | 5958 | 6 | 12 | Diesel | 125 |
| OM 376.930 | 97.50 | 5958 | 6 | 12 | Diesel | 122 |
| OM 376.941 | 97.50 | 5958 | 6 | 12 | Diesel | 122 |
| OM 376.945 | 97.50 | 5958 | 6 | 12 | Diesel | 122 |
| OM 376.946 | 97.50 | 5958 | 6 | 12 | Diesel | 122 |
| OM 376.947 | 97.50 | 5958 | 6 | 12 | Diesel | 122 |
| OM 376.950 | 97.50 | 5958 | 6 | 12 | Diesel | 122 |
| OM 376.951 | 97.50 | 5958 | 6 | 12 | Diesel | 122 |







|  |  | ccm |  |  |  |  |
|---|---|------|--|---|---|---|
| OM 376.952 | 97.50 | 5958 | 6 | 12 | Diesel | 122 |
| OM 376.953 | 97.50 | 5958 | 6 | 12 | Diesel | 122 |
| OM 376.954 | 97.50 | 5958 | 6 | 12 | Diesel | 122 |
| OM 376.955 | 97.50 | 5958 | 6 | 12 | Diesel | 122 |
| OM 376.956 | 97.50 | 5958 | 6 | 12 | Diesel | 122 |
| OM 376.957 | 97.50 | 5958 | 6 | 12 | Diesel | 122 |
| OM 376.958 | 97.50 | 5958 | 6 | 12 | Diesel | 122 |
| OM 376.961 | 97.50 | 5958 | 6 | 12 | Diesel | 122 |
| OM 376.962 | 97.50 | 5958 | 6 | 12 | Diesel | 122 |
| OM 376.963 | 97.50 | 5958 | 6 | 12 | Diesel | 122 |
| OM 376.964 | 97.50 | 5958 | 6 | 12 | Diesel | 122 |
| OM 376.967 | 97.50 | 5958 | 6 | 12 | Diesel | 122 |
| OM 376.968 | 97.50 | 5958 | 6 | 12 | Diesel | 122 |
| OM 376.969 | 97.50 | 5958 | 6 | 12 | Diesel | 122 |
| OM 376.970 | 97.50 | 5958 | 6 | 12 | Diesel | 122 |
| OM 376.972 | 97.50 | 5958 | 6 | 12 | Diesel | 122 |
| OM 376.975 | 97.50 | 5958 | 6 | 12 | Diesel | 122 |
| OM 376.976 | 97.50 | 5958 | 6 | 12 | Diesel | 122 |
| OM 376.977 | 97.50 | 5958 | 6 | 12 | Diesel | 122 |
| OM 376.980 | 97.50 | 5958 | 6 | 12 | Diesel | 122 |
| OM 376.981 | 97.50 | 5958 | 6 | 12 | Diesel | 122 |
| OM 376.982 | 97.50 | 5958 | 6 | 12 | Diesel | 122 |
| OM 376.984 | 97.50 | 5958 | 6 | 12 | Diesel | 122 |
| OM 376.986 | 97.50 | 5958 | 6 | 12 | Diesel | 122 |
| OM 376.987 | 97.50 | 5958 | 6 | 12 | Diesel | 122 |
| OM 376.988 | 97.50 | 5958 | 6 | 12 | Diesel | 122 |
| OM 376.989 | 97.50 | 5958 | 6 | 12 | Diesel | 122 |
| OM 376.993 | 97.50 | 5958 | 6 | 12 | Diesel | 122 |
| OM 376.994 | 97.50 | 5958 | 6 | 12 | Diesel | 122 |
| OM 376.995 | 97.50 | 5958 | 6 | 12 | Diesel | 122 |
| OM 376.997 | 97.50 | 5958 | 6 | 12 | Diesel | 122 |
| OM 376.998 | 97.50 | 5958 | 6 | 12 | Diesel | 122 |
| OM 376.999 | 97.50 | 5958 | 6 | 12 | Diesel | 122 |
| OM 377.940 | 97.50 | 5958 | 6 | 12 | Diesel | 122 |
| OM 377.941 | 97.50 | 5958 | 6 | 12 | Diesel | 122 |
| OM 377.942 | 97.50 | 5958 | 6 | 12 | Diesel | 122 |
| OM 377.943 | 97.50 | 5958 | 6 | 12 | Diesel | 122 |
| OM 377.944 | 97.50 | 5958 | 6 | 12 | Diesel | 122 |
| OM 377.945 | 97.50 | 5958 | 6 | 12 | Diesel | 122 |
| OM 377.960 | 97.50 | 5958 | 6 | 12 | Diesel | 122 |
| OM 377.961 | 97.50 | 5958 | 6 | 12 | Diesel | 122 |
| OM 377.962 | 97.50 | 5958 | 6 | 12 | Diesel | 122 |
| OM 377.963 | 97.50 | 5958 | 6 | 12 | Diesel | 122 |
| OM 377.964 | 97.50 | 5958 | 6 | 12 | Diesel | 122 |
| OM 377.967 | 97.50 | 5958 | 6 | 12 | Diesel | 122 |
| OM 377.968 | 97.50 | 5958 | 6 | 12 | Diesel | 122 |
| OM 377.969 | 97.50 | 5958 | 6 | 12 | Diesel | 122 |
| OM 377.972 | 97.50 | 5958 | 6 | 12 | Diesel | 122 |
| OM 377.973 | 97.50 | 5958 | 6 | 12 | Diesel | 122 |
| OM 377.980 | 97.50 | 5958 | 6 | 12 | Diesel | 122 |
| OM 377.981 | 97.50 | 5958 | 6 | 12 | Diesel | 122 |
| OM 377.982 | 97.50 | 5958 | 6 | 12 | Diesel | 122 |
| OM 377.983 | 97.50 | 5958 | 6 | 12 | Diesel | 122 |
| OM 377.984 | 97.50 | 5958 | 6 | 12 | Diesel | 122 |
| OM 377.985 | 97.50 | 5958 | 6 | 12 | Diesel | 122 |
| OM 380.940 | 97.50 | 3972 | 4 | 8 | Diesel | 120 |
| OM 380.942 | 97.50 | 3972 | 4 | 8 | Diesel | 120 |
| OM 380.943 | 97.50 | 3972 | 4 | 8 | Diesel | 120 |
| OM 382.912 | 97.50 | 5958 | 6 | 12 | Diesel | 122 |
| OM 382.913 | 97.50 | 5958 | 6 | 12 | Diesel | 122 |
| OM 382.916 | 97.50 | 5958 | 6 | 12 | Diesel | 122 |
| OM 382.917 | 97.50 | 5958 | 6 | 12 | Diesel | 124 |
| OM 382.919 | 97.50 | 5958 | 6 | 12 | Diesel | 122 |
| OM 382.950 | 97.50 | 5958 | 6 | 12 | Diesel | 124 |
| OM 382.970 | 97.50 | 5958 | 6 | 12 | Diesel | 122 |
| OM 382.971 | 97.50 | 5958 | 6 | 12 | Diesel | 122 |







|  |  | ccm |  |  |  |  |
|---|---|-------|---|---|---|---|
| OM 384.906 | 97.50 | 3972 | 4 | 8 | Diesel | 120 |
| OM 384.907 | 97.50 | 3972 | 4 | 8 | Diesel | 120 |
| OM 384.908 | 97.50 | 3972 | 4 | 8 | Diesel | 120 |
| OM 386.906 | 97.50 | 5958 | 6 | 12 | Diesel | 122 |
| OM 386.950 | 97.50 | 5958 | 6 | 12 | Diesel | 122 |
| OM 386.951 | 97.50 | 5958 | 6 | 12 | Diesel | 122 |
| OM 386.952 | 97.50 | 5958 | 6 | 12 | Diesel | 122 |
| OM 386.980 | 97.50 | 5958 | 6 | 12 | Diesel | 122 |
| OM 386.981 | 97.50 | 5958 | 6 | 12 | Diesel | 122 |
| OM 386.983 | 97.50 | 5958 | 6 | 12 | Diesel | 122 |
| OM 401.905 | 125.00 | 9572 | 6 | 12 | Diesel | 133 |
| OM 401.906 | 125.00 | 9572 | 6 | 12 | Diesel | 133 |
| OM 401.907 | 125.00 | 9572 | 6 | 12 | Diesel | 133 |
| OM 401.908 | 125.00 | 9572 | 6 | 12 | Diesel | 133 |
| OM 401.909 | 125.00 | 9572 | 6 | 12 | Diesel | 133 |
| OM 401.912 | 125.00 | 9572 | 6 | 12 | Diesel | 133 |
| OM 401.913 | 125.00 | 9572 | 6 | 12 | Diesel | 133 |
| OM 401.914 | 125.00 | 9572 | 6 | 12 | Diesel | 133 |
| OM 401.915 | 125.00 | 9572 | 6 | 12 | Diesel | 133 |
| OM 401.916 | 125.00 | 9572 | 6 | 12 | Diesel | 133 |
| OM 401.917 | 125.00 | 9572 | 6 | 12 | Diesel | 133 |
| OM 401.918 | 125.00 | 9572 | 6 | 12 | Diesel | 133 |
| OM 401.919 | 125.00 | 9572 | 6 | 12 | Diesel | 133 |
| OM 401.921 | 125.00 | 9572 | 6 | 12 | Diesel | 133 |
| OM 401.922 | 125.00 | 9572 | 6 | 12 | Diesel | 133 |
| OM 401.923 | 125.00 | 9572 | 6 | 12 | Diesel | 133 |
| OM 401.924 | 125.00 | 10456 | 6 | 12 | Diesel | 134 |
| OM 401.925 | 125.00 | 9572 | 6 | 12 | Diesel | 133 |
| OM 401.926 | 125.00 | 9572 | 6 | 12 | Diesel | 133 |
| OM 401.927 | 125.00 | 9572 | 6 | 12 | Diesel | 133 |
| OM 401.928 | 125.00 | 9572 | 6 | 12 | Diesel | 133 |
| OM 401.970 | 125.00 | 9572 | 6 | 12 | Diesel | 133 |
| OM 401.972 | 125.00 | 9572 | 6 | 12 | Diesel | 133 |
| OM 401.973 | 125.00 | 9572 | 6 | 12 | Diesel | 133 |
| OM 401.974 | 125.00 | 9572 | 6 | 12 | Diesel | 133 |
| OM 401.975 | 125.00 | 9572 | 6 | 12 | Diesel | 133 |
| OM 401.976 | 125.00 | 9572 | 6 | 12 | Diesel | 133 |
| OM 401.977 | 125.00 | 9572 | 6 | 12 | Diesel | 133 |
| OM 401.978 | 125.00 | 9572 | 6 | 12 | Diesel | 133 |
| OM 401.979 | 125.00 | 9572 | 6 | 12 | Diesel | 133 |
| OM 401.980 | 125.00 | 9572 | 6 | 12 | Diesel | 133 |
| OM 401.981 | 125.00 | 9572 | 6 | 12 | Diesel | 133 |
| OM 401.984 | 125.00 | 9572 | 6 | 12 | Diesel | 133 |
| OM 401.985 | 125.00 | 9572 | 6 | 12 | Diesel | 133 |
| OM 401.986 | 125.00 | 9572 | 6 | 12 | Diesel | 133 |
| OM 401.987 | 125.00 | 9572 | 6 | 12 | Diesel | 133 |
| OM 401.989 | 125.00 | 9572 | 6 | 12 | Diesel | 133 |
| OM 401.990 | 125.00 | 9572 | 6 | 12 | Diesel | 133 |
| OM 401.991 | 125.00 | 9572 | 6 | 12 | Diesel | 133 |
| OM 401.992 | 125.00 | 9572 | 6 | 12 | Diesel | 133 |
| OM 401.993 | 125.00 | 9572 | 6 | 12 | Diesel | 133 |
| OM 401.994 | 125.00 | 9572 | 6 | 12 | Diesel | 133 |
| OM 402.905 | 125.00 | 12800 | 8 | 16 | Diesel | 142 |
| OM 402.906 | 125.00 | 12800 | 8 | 16 | Diesel | 142 |
| OM 402.907 | 125.00 | 12800 | 8 | 16 | Diesel | 142 |
| OM 402.910 | 125.00 | 12800 | 8 | 16 | Diesel | 142 |
| OM 402.911 | 125.00 | 12800 | 8 | 16 | Diesel | 142 |
| OM 402.912 | 125.00 | 12800 | 8 | 16 | Diesel | 142 |
| OM 402.913 | 125.00 | 12760 | 8 | 16 | Diesel | 140 |
| OM 402.914 | 125.00 | 12800 | 8 | 16 | Diesel | 142 |
| OM 402.916 | 125.00 | 12800 | 8 | 16 | Diesel | 142 |
| OM 402.917 | 125.00 | 12760 | 8 | 16 | Diesel | 140 |
| OM 402.919 | 125.00 | 12800 | 8 | 16 | Diesel | 142 |
| OM 402.921 | 125.00 | 12760 | 8 | 16 | Diesel | 140 |
| OM 402.923 | 125.00 | 12800 | 8 | 16 | Diesel | 142 |
| OM 402.924 | 125.00 | 12800 | 8 | 16 | Diesel | 142 |







|  |  | ccm |  |  |  |  | |
|---|---|--------|--|---|---|---|-----|
| OM 402.925 | | 125.00 | 12760 | 8 | 16 | Diesel | 140 |
| OM 402.926 | | 125.00 | 12800 | 8 | 16 | Diesel | 142 |
| OM 402.927 | | 125.00 | 12800 | 8 | 16 | Diesel | 142 |
| OM 402.928 | | 125.00 | 12800 | 8 | 16 | Diesel | 142 |
| OM 402.970 | | 125.00 | 12763 | 8 | 16 | Diesel | 141 |
| OM 402.971 | | 125.00 | 12763 | 8 | 16 | Diesel | 141 |
| OM 402.972 | | 125.00 | 12763 | 8 | 16 | Diesel | 141 |
| OM 402.973 | | 125.00 | 12763 | 8 | 16 | Diesel | 141 |
| OM 402.974 | | 125.00 | 12763 | 8 | 16 | Diesel | 141 |
| OM 402.975 | | 125.00 | 12763 | 8 | 16 | Diesel | 141 |
| OM 402.977 | | 125.00 | 12763 | 8 | 16 | Diesel | 141 |
| OM 402.978 | | 125.00 | 12763 | 8 | 16 | Diesel | 141 |
| OM 402.982 | | 125.00 | 12763 | 8 | 16 | Diesel | 141 |
| OM 402.983 | | 125.00 | 12763 | 8 | 16 | Diesel | 141 |
| OM 402.984 | | 125.00 | 12763 | 8 | 16 | Diesel | 141 |
| OM 402.985 | | 125.00 | 12763 | 8 | 16 | Diesel | 141 |
| OM 402.986 | | 125.00 | 12763 | 8 | 16 | Diesel | 141 |
| OM 402.987 | | 125.00 | 12763 | 8 | 16 | Diesel | 141 |
| OM 402.989 | | 125.00 | 12763 | 8 | 16 | Diesel | 141 |
| OM 402.990 | | 125.00 | 12763 | 8 | 16 | Diesel | 141 |
| OM 402.995 | | 125.00 | 12763 | 8 | 16 | Diesel | 141 |
| OM 402.996 | | 125.00 | 12763 | 8 | 16 | Diesel | 141 |
| OM 403.905 | | 125.00 | 15950 | 10 | 20 | Diesel | 144 |
| OM 403.906 | | 125.00 | 15950 | 10 | 20 | Diesel | 144 |
| OM 403.915 | | 125.00 | 15900 | 10 | 20 | Diesel | 143 |
| OM 403.916 | | 125.00 | 15900 | 10 | 20 | Diesel | 143 |
| OM 403.917 | | 125.00 | 15950 | 10 | 20 | Diesel | 144 |
| OM 403.918 | | 125.00 | 15900 | 10 | 20 | Diesel | 143 |
| OM 403.919 | | 125.00 | 15950 | 10 | 20 | Diesel | 144 |
| OM 403.930 | | 125.00 | 15950 | 10 | 20 | Diesel | 144 |
| OM 403.931 | | 125.00 | 15900 | 10 | 20 | Diesel | 143 |
| OM 403.932 | | 125.00 | 15900 | 10 | 20 | Diesel | 143 |
| OM 403.933 | | 125.00 | 15950 | 10 | 20 | Diesel | 144 |
| OM 403.934 | | 125.00 | 15950 | 10 | 20 | Diesel | 144 |
| OM 403.935 | | 125.00 | 15900 | 10 | 20 | Diesel | 143 |
| OM 407.905 | | 125.00 | 11000 | 6 | 12 | Diesel | 136 |
| OM 407.907 | | 125.00 | 11045 | 6 | 12 | Diesel | 137 |
| OM 407.908 | | 125.00 | 11000 | 6 | 12 | Diesel | 136 |
| OM 407.909 | | 125.00 | 11000 | 6 | 12 | Diesel | 136 |
| OM 407.910 | | 125.00 | 11000 | 6 | 12 | Diesel | 136 |
| OM 407.911 | | 125.00 | 11000 | 6 | 12 | Diesel | 136 |
| OM 407.913 | | 125.00 | 11413 | 6 | 12 | Diesel | 139 |
| OM 407.914 | | 125.00 | 11413 | 6 | 12 | Diesel | 139 |
| OM 407.915 | | 125.00 | 11413 | 6 | 12 | Diesel | 139 |
| OM 407.916 | | 125.00 | 11413 | 6 | 12 | Diesel | 139 |
| OM 407.917 | | 125.00 | 11413 | 6 | 12 | Diesel | 139 |
| OM 407.918 | | 125.00 | 11413 | 6 | 12 | Diesel | 139 |
| OM 407.919 | | 125.00 | 11413 | 6 | 12 | Diesel | 139 |
| OM 407.920 | | 125.00 | 11412 | 6 | 12 | Diesel | 138 |
| OM 407.951 | | 125.00 | 11413 | 6 | 12 | Diesel | 139 |
| OM 407.955 | | 125.00 | 11413 | 6 | 12 | Diesel | 139 |
| OM 409.906 | | 125.00 | 9204 | 5 | 10 | Diesel | 132 |
| OM 409.907 | | 125.00 | 9204 | 5 | 10 | Diesel | 132 |
| OM 409.908 | | 125.00 | 9204 | 5 | 10 | Diesel | 132 |
| OM 421.905 | | 128.00 | 10964 | 6 | 12 | Diesel | 150 |
| OM 421.906 | | 128.00 | 10900 | 6 | 12 | Diesel | 149 |
| OM 421.907 | | 128.00 | 10964 | 6 | 12 | Diesel | 150 |
| OM 421.908 | | 128.00 | 10964 | 6 | 12 | Diesel | 150 |
| OM 421.909 | | 128.00 | 10964 | 6 | 12 | Diesel | 150 |
| OM 421.910 | | 128.00 | 10964 | 6 | 12 | Diesel | 150 |
| OM 421.951 | | 128.00 | 10964 | 6 | 12 | Diesel | 150 |
| OM 422.901 | | 128.00 | 14618 | 8 | 16 | Diesel | 165 |
| OM 422.905 | | 128.00 | 14618 | 8 | 16 | Diesel | 165 |
| OM 422.906 | | 128.00 | 14618 | 8 | 16 | Diesel | 165 |
| OM 422.907 | | 128.00 | 14618 | 8 | 16 | Diesel | 165 |
| OM 422.908 | | 128.00 | 14618 | 8 | 16 | Diesel | 165 |







|  |  | ccm |  |  |  |  | |
|---|---|--------|---|---|---|---|-----|
| OM 422.909 | | 128.00 | 14618 | 8 | 16 | Diesel | 165 |
| OM 422.910 | | 128.00 | 14618 | 8 | 16 | Diesel | 165 |
| OM 422.911 | | 128.00 | 14618 | 8 | 16 | Diesel | 165 |
| OM 422.912 | | 128.00 | 14618 | 8 | 16 | Diesel | 165 |
| OM 422.913 | | 128.00 | 14618 | 8 | 16 | Diesel | 165 |
| OM 422.914 | | 128.00 | 14600 | 8 | 16 | Diesel | 164 |
| OM 422.915 | | 128.00 | 14618 | 8 | 16 | Diesel | 165 |
| OM 422.916 | | 128.00 | 14618 | 8 | 16 | Diesel | 165 |
| OM 422.917 | | 128.00 | 14618 | 8 | 16 | Diesel | 165 |
| OM 422.918 | | 128.00 | 14618 | 8 | 16 | Diesel | 165 |
| OM 422.919 | | 128.00 | 14618 | 8 | 16 | Diesel | 165 |
| OM 422.920 | | 128.00 | 14618 | 8 | 16 | Diesel | 165 |
| OM 422.921 | | 128.00 | 14618 | 8 | 16 | Diesel | 165 |
| OM 422.922 | | 128.00 | 14618 | 8 | 16 | Diesel | 165 |
| OM 422.923 | | 128.00 | 14618 | 8 | 16 | Diesel | 165 |
| OM 422.951 | | 128.00 | 14600 | 8 | 16 | Diesel | 164 |
| OM 422.952 | | 128.00 | 14600 | 8 | 16 | Diesel | 164 |
| OM 422.953 | | 128.00 | 14618 | 8 | 16 | Diesel | 165 |
| OM 422.954 | | 128.00 | 14618 | 8 | 16 | Diesel | 165 |
| OM 422.955 | | 128.00 | 14618 | 8 | 16 | Diesel | 165 |
| OM 422.956 | | 128.00 | 14600 | 8 | 16 | Diesel | 164 |
| OM 422.957 | | 128.00 | 14618 | 8 | 16 | Diesel | 165 |
| OM 422.958 | | 128.00 | 14618 | 8 | 16 | Diesel | 165 |
| OM 422.959 | | 128.00 | 14618 | 8 | 16 | Diesel | 165 |
| OM 422.963 | | 128.00 | 14618 | 8 | 16 | Diesel | 165 |
| OM 423.905 | | 128.00 | 18300 | 10 | 20 | Diesel | 170 |
| OM 423.906 | | 128.00 | 18273 | 10 | 20 | Diesel | 168 |
| OM 423.907 | | 128.00 | 18273 | 10 | 20 | Diesel | 168 |
| OM 423.908 | | 128.00 | 18300 | 10 | 20 | Diesel | 170 |
| OM 423.909 | | 128.00 | 18273 | 10 | 20 | Diesel | 168 |
| OM 423.950 | | 128.00 | 18273 | 10 | 20 | Diesel | 168 |
| OM 423.951 | | 128.00 | 18273 | 10 | 20 | Diesel | 169 |
| OM 424.900 | | 128.00 | 21930 | 12 | 24 | Diesel | 171 |
| OM 424.901 | | 128.00 | 21930 | 12 | 24 | Diesel | 172 |
| OM 424.901-510 | | 128.00 | 21930 | 12 | 24 | Diesel | 171 |
| OM 427.905 | | 128.00 | 11967 | 6 | 12 | Diesel | 155 |
| OM 427.910 | | 128.00 | 11967 | 6 | 12 | Diesel | 155 |
| OM 427.911 | | 128.00 | 11967 | 6 | 12 | Diesel | 155 |
| OM 427.950 | | 128.00 | 11967 | 6 | 12 | Diesel | 155 |
| OM 427.951 | | 128.00 | 11967 | 6 | 12 | Diesel | 155 |
| OM 427.952 | | 128.00 | 11967 | 6 | 12 | Diesel | 155 |
| OM 429.951 | | 128.00 | 9970 | 5 | 10 | Diesel | 145 |
| OM 429.953 | | 128.00 | 9970 | 5 | 10 | Diesel | 145 |
| OM 429.955 | | 128.00 | 9970 | 5 | 10 | Diesel | 145 |
| OM 440.907 | | 130.00 | 15080 | 8 | 16 | Diesel | 179 |
| OM 440.909 | | 130.00 | 15080 | 8 | 16 | Diesel | 179 |
| OM 440.910 | | 130.00 | 15080 | 8 | 16 | Diesel | 179 |
| OM 440.911 | | 130.00 | 15080 | 8 | 16 | Diesel | 179 |
| OM 440.940 | | 128.00 | 14618 | 8 | 16 | Diesel | 166 |
| OM 440.941 | | 128.00 | 14618 | 8 | 16 | Diesel | 166 |
| OM 440.942 | | 128.00 | 14618 | 8 | 16 | Diesel | 166 |
| OM 440.945 | | 128.00 | 14618 | 8 | 16 | Diesel | 166 |
| OM 440.948 | | 128.00 | 14618 | 8 | 16 | Diesel | 166 |
| OM 440.970 | | 128.00 | 14618 | 8 | 16 | Diesel | 166 |
| OM 440.971 | | 128.00 | 14618 | 8 | 16 | Diesel | 166 |
| OM 440.972 | | 128.00 | 14618 | 8 | 16 | Diesel | 166 |
| OM 440.973 | | 128.00 | 14618 | 8 | 16 | Diesel | 166 |
| OM 440.975 | | 128.00 | 14618 | 8 | 16 | Diesel | 166 |
| OM 440.976 | | 128.00 | 14618 | 8 | 16 | Diesel | 166 |
| OM 440.978 | | 128.00 | 14618 | 8 | 16 | Diesel | 166 |
| OM 440.979 | | 128.00 | 14618 | 8 | 16 | Diesel | 166 |
| OM 440.980 | | 128.00 | 14618 | 8 | 16 | Diesel | 166 |
| OM 440.981 | | 128.00 | 14618 | 8 | 16 | Diesel | 166 |
| OM 440.982 | | 128.00 | 14618 | 8 | 16 | Diesel | 166 |
| OM 440.983 | | 128.00 | 14618 | 8 | 16 | Diesel | 166 |
| OM 440.984 | | 128.00 | 14618 | 8 | 16 | Diesel | 166 |







|  |  | ccm |  |  |  |  | |
|---|---|--------|--|---|---|---|-----|
| OM 440.985 | | 128.00 | 14618 | 8 | 16 | Diesel | 166 |
| OM 440.986 | | 128.00 | 14618 | 8 | 16 | Diesel | 166 |
| OM 440.987 | | 128.00 | 14618 | 8 | 16 | Diesel | 166 |
| OM 440.988 | | 128.00 | 14618 | 8 | 16 | Diesel | 166 |
| OM 440.989 | | 128.00 | 14618 | 8 | 16 | Diesel | 166 |
| OM 440.990 | | 128.00 | 14618 | 8 | 16 | Diesel | 166 |
| OM 440.991 | | 128.00 | 14618 | 8 | 16 | Diesel | 166 |
| OM 441.905 | | 130.00 | 10964 | 6 | 12 | Diesel | 173 |
| OM 441.906 | | 130.00 | 10964 | 6 | 12 | Diesel | 173 |
| OM 441.907 | | 130.00 | 10964 | 6 | 12 | Diesel | 173 |
| OM 441.908 | | 130.00 | 10964 | 6 | 12 | Diesel | 173 |
| OM 441.909 | | 130.00 | 10964 | 6 | 12 | Diesel | 173 |
| OM 441.911 | | 130.00 | 10964 | 6 | 12 | Diesel | 173 |
| OM 441.912 | | 130.00 | 11309 | 6 | 12 | Diesel | 175 |
| OM 441.913 | | 130.00 | 10964 | 6 | 12 | Diesel | 173 |
| OM 441.914 | | 130.00 | 11309 | 6 | 12 | Diesel | 175 |
| OM 441.915 | | 130.00 | 10964 | 6 | 12 | Diesel | 173 |
| OM 441.916 | | 130.00 | 11309 | 6 | 12 | Diesel | 175 |
| OM 441.917 | | 130.00 | 10964 | 6 | 12 | Diesel | 173 |
| OM 441.918 | | 130.00 | 11309 | 6 | 12 | Diesel | 175 |
| OM 441.919 | | 130.00 | 11309 | 6 | 12 | Diesel | 175 |
| OM 441.920 | | 130.00 | 11309 | 6 | 12 | Diesel | 175 |
| OM 441.921 | | 130.00 | 11300 | 6 | 12 | Diesel | 174 |
| OM 441.922 | | 130.00 | 11300 | 6 | 12 | Diesel | 174 |
| OM 441.923 | | 130.00 | 10964 | 6 | 12 | Diesel | 173 |
| OM 441.924 | | 130.00 | 11309 | 6 | 12 | Diesel | 175 |
| OM 441.925 | | 130.00 | 10964 | 6 | 12 | Diesel | 173 |
| OM 441.926 | | 130.00 | 10964 | 6 | 12 | Diesel | 173 |
| OM 441.927 | | 130.00 | 10964 | 6 | 12 | Diesel | 173 |
| OM 441.932 | | 130.00 | 11309 | 6 | 12 | Diesel | 175 |
| OM 441.933 | | 130.00 | 11309 | 6 | 12 | Diesel | 175 |
| OM 441.950 | | 128.00 | 10964 | 6 | 12 | Diesel | 151 |
| OM 441.951 | | 128.00 | 10964 | 6 | 12 | Diesel | 151 |
| OM 441.953 | | 128.00 | 10964 | 6 | 12 | Diesel | 151 |
| OM 441.960 | | 128.00 | 10964 | 6 | 12 | Diesel | 151 |
| OM 441.961 | | 128.00 | 10964 | 6 | 12 | Diesel | 151 |
| OM 441.962 | | 128.00 | 10964 | 6 | 12 | Diesel | 151 |
| OM 441.980 | | 128.00 | 10964 | 6 | 12 | Diesel | 151 |
| OM 441.981 | | 128.00 | 10964 | 6 | 12 | Diesel | 151 |
| OM 441.982 | | 128.00 | 10964 | 6 | 12 | Diesel | 151 |
| OM 441.983 | | 128.00 | 10964 | 6 | 12 | Diesel | 151 |
| OM 441.985 | | 128.00 | 10964 | 6 | 12 | Diesel | 151 |
| OM 441.986 | | 128.00 | 10964 | 6 | 12 | Diesel | 151 |
| OM 441.987 | | 128.00 | 10964 | 6 | 12 | Diesel | 151 |
| OM 441.988 | | 128.00 | 10964 | 6 | 12 | Diesel | 151 |
| OM 441.989 | | 128.00 | 10964 | 6 | 12 | Diesel | 151 |
| OM 441.990 | | 128.00 | 10964 | 6 | 12 | Diesel | 151 |
| OM 441.991 | | 128.00 | 10964 | 6 | 12 | Diesel | 151 |
| OM 441.992 | | 128.00 | 10964 | 6 | 12 | Diesel | 151 |
| OM 441.993 | | 128.00 | 10964 | 6 | 12 | Diesel | 151 |
| OM 441.994 | | 128.00 | 10964 | 6 | 12 | Diesel | 151 |
| OM 441.995 | | 128.00 | 10964 | 6 | 12 | Diesel | 151 |
| OM 441.996 | | 128.00 | 10964 | 6 | 12 | Diesel | 151 |
| OM 441.997 | | 128.00 | 10964 | 6 | 12 | Diesel | 151 |
| OM 441.998 | | 128.00 | 10964 | 6 | 12 | Diesel | 151 |
| OM 441.999 | | 128.00 | 10964 | 6 | 12 | Diesel | 151 |
| OM 442.905 | | 130.00 | 15080 | 8 | 16 | Diesel | 179 |
| OM 442.906 | | 130.00 | 15080 | 8 | 16 | Diesel | 179 |
| OM 442.907 | | 130.00 | 15080 | 8 | 16 | Diesel | 179 |
| OM 442.908 | | 130.00 | 15080 | 8 | 16 | Diesel | 179 |
| OM 442.909 | | 130.00 | 15080 | 8 | 16 | Diesel | 179 |
| OM 442.910 | | 130.00 | 15080 | 8 | 16 | Diesel | 179 |
| OM 442.911 | | 130.00 | 15080 | 8 | 16 | Diesel | 179 |
| OM 442.914 | | 130.00 | 15080 | 8 | 16 | Diesel | 179 |
| OM 442.915 | | 130.00 | 15080 | 8 | 16 | Diesel | 179 |
| OM 442.916 | | 130.00 | 15080 | 8 | 16 | Diesel | 179 |







|  |  | ccm |  |  |  |  | |
|---|---|--------|---|---|---|---|-----|
| OM 442.917 | | 130.00 | 15080 | 8 | 16 | Diesel | 179 |
| OM 442.918 | | 130.00 | 15080 | 8 | 16 | Diesel | 179 |
| OM 442.919 | | 130.00 | 15080 | 8 | 16 | Diesel | 179 |
| OM 442.920 | | 130.00 | 15080 | 8 | 16 | Diesel | 179 |
| OM 442.921 | | 130.00 | 15080 | 8 | 16 | Diesel | 179 |
| OM 442.922 | | 130.00 | 15080 | 8 | 16 | Diesel | 179 |
| OM 442.923 | | 130.00 | 15080 | 8 | 16 | Diesel | 179 |
| OM 442.924 | | 130.00 | 15080 | 8 | 16 | Diesel | 179 |
| OM 442.925 | | 130.00 | 15080 | 8 | 16 | Diesel | 179 |
| OM 442.926 | | 130.00 | 15080 | 8 | 16 | Diesel | 179 |
| OM 442.927 | | 130.00 | 15080 | 8 | 16 | Diesel | 179 |
| OM 442.928 | | 130.00 | 15080 | 8 | 16 | Diesel | 179 |
| OM 442.929 | | 130.00 | 15080 | 8 | 16 | Diesel | 179 |
| OM 442.930 | | 130.00 | 15100 | 8 | 16 | Diesel | 180 |
| OM 442.931 | | 130.00 | 15080 | 8 | 16 | Diesel | 179 |
| OM 442.932 | | 130.00 | 15080 | 8 | 16 | Diesel | 179 |
| OM 442.933 | | 130.00 | 15080 | 8 | 16 | Diesel | 179 |
| OM 442.934 | | 130.00 | 15080 | 8 | 16 | Diesel | 179 |
| OM 442.935 | | 130.00 | 15080 | 8 | 16 | Diesel | 179 |
| OM 442.939 | | 130.00 | 15080 | 8 | 16 | Diesel | 179 |
| OM 442.940 | | 128.00 | 14618 | 8 | 16 | Diesel | 166 |
| OM 442.941 | | 128.00 | 14618 | 8 | 16 | Diesel | 166 |
| OM 442.942 | | 128.00 | 14618 | 8 | 16 | Diesel | 166 |
| OM 442.943 | | 128.00 | 14618 | 8 | 16 | Diesel | 166 |
| OM 442.944 | | 128.00 | 14618 | 8 | 16 | Diesel | 166 |
| OM 442.945 | | 128.00 | 14618 | 8 | 16 | Diesel | 166 |
| OM 442.946 | | 128.00 | 14618 | 8 | 16 | Diesel | 166 |
| OM 442.950 | | 128.00 | 14618 | 8 | 16 | Diesel | 166 |
| OM 442.951 | | 128.00 | 14618 | 8 | 16 | Diesel | 166 |
| OM 442.952 | | 128.00 | 14618 | 8 | 16 | Diesel | 166 |
| OM 442.953 | | 128.00 | 14618 | 8 | 16 | Diesel | 166 |
| OM 442.954 | | 128.00 | 14618 | 8 | 16 | Diesel | 166 |
| OM 442.955 | | 128.00 | 14618 | 8 | 16 | Diesel | 166 |
| OM 442.957 | | 128.00 | 14618 | 8 | 16 | Diesel | 166 |
| OM 442.958 | | 128.00 | 14618 | 8 | 16 | Diesel | 166 |
| OM 442.959 | | 128.00 | 14618 | 8 | 16 | Diesel | 166 |
| OM 442.960 | | 128.00 | 14618 | 8 | 16 | Diesel | 166 |
| OM 442.961 | | 128.00 | 14618 | 8 | 16 | Diesel | 166 |
| OM 442.962 | | 128.00 | 14618 | 8 | 16 | Diesel | 166 |
| OM 442.963 | | 128.00 | 14618 | 8 | 16 | Diesel | 166 |
| OM 442.964 | | 128.00 | 14618 | 8 | 16 | Diesel | 166 |
| OM 442.965 | | 128.00 | 14618 | 8 | 16 | Diesel | 166 |
| OM 442.966 | | 128.00 | 14618 | 8 | 16 | Diesel | 166 |
| OM 442.967 | | 128.00 | 14618 | 8 | 16 | Diesel | 166 |
| OM 442.968 | | 128.00 | 14618 | 8 | 16 | Diesel | 166 |
| OM 442.970 | | 128.00 | 14618 | 8 | 16 | Diesel | 166 |
| OM 442.971 | | 128.00 | 14618 | 8 | 16 | Diesel | 166 |
| OM 442.972 | | 128.00 | 14618 | 8 | 16 | Diesel | 166 |
| OM 442.973 | | 128.00 | 14618 | 8 | 16 | Diesel | 166 |
| OM 442.974 | | 128.00 | 14618 | 8 | 16 | Diesel | 166 |
| OM 442.975 | | 128.00 | 14618 | 8 | 16 | Diesel | 166 |
| OM 442.976 | | 128.00 | 14618 | 8 | 16 | Diesel | 166 |
| OM 442.977 | | 128.00 | 14618 | 8 | 16 | Diesel | 166 |
| OM 442.978 | | 128.00 | 14618 | 8 | 16 | Diesel | 166 |
| OM 442.979 | | 128.00 | 14618 | 8 | 16 | Diesel | 166 |
| OM 442.980 | | 128.00 | 14618 | 8 | 16 | Diesel | 166 |
| OM 442.982 | | 128.00 | 14618 | 8 | 16 | Diesel | 166 |
| OM 442.983 | | 128.00 | 14618 | 8 | 16 | Diesel | 166 |
| OM 442.984 | | 128.00 | 14618 | 8 | 16 | Diesel | 166 |
| OM 442.985 | | 128.00 | 14618 | 8 | 16 | Diesel | 166 |
| OM 442.989 | | 128.00 | 14618 | 8 | 16 | Diesel | 166 |
| OM 442.991 | | 128.00 | 14618 | 8 | 16 | Diesel | 166 |
| OM 442.992 | | 128.00 | 14618 | 8 | 16 | Diesel | 166 |
| OM 442.993 | | 128.00 | 14618 | 8 | 16 | Diesel | 166 |
| OM 442.994 | | 128.00 | 14618 | 8 | 16 | Diesel | 166 |
| OM 442.995 | | 128.00 | 14618 | 8 | 16 | Diesel | 166 |







|  |  | ccm |  |  |  |  |
|---|---|-------|--|---|---|---|
| OM 442.996 | 128.00 | 14618 | 8 | 16 | Diesel | 166 |
| OM 442.997 | 128.00 | 14618 | 8 | 16 | Diesel | 166 |
| OM 442.998 | 128.00 | 14618 | 8 | 16 | Diesel | 166 |
| OM 442.999 | 128.00 | 14618 | 8 | 16 | Diesel | 166 |
| OM 443.905 | 130.00 | 18848 | 10 | 20 | Diesel | 183 |
| OM 443.906 | 130.00 | 18848 | 10 | 20 | Diesel | 183 |
| OM 443.908 | 130.00 | 18848 | 10 | 20 | Diesel | 183 |
| OM 443.909 | 130.00 | 18848 | 10 | 20 | Diesel | 183 |
| OM 443.940 | 128.00 | 18270 | 10 | 20 | Diesel | 167 |
| OM 443.980 | 128.00 | 18270 | 10 | 20 | Diesel | 167 |
| OM 445.920 | 128.00 | 10964 | 6 | 12 | Diesel | 151 |
| OM 445.921 | 128.00 | 10964 | 6 | 12 | Diesel | 151 |
| OM 445.922 | 128.00 | 10964 | 6 | 12 | Diesel | 151 |
| OM 445.923 | 128.00 | 10964 | 6 | 12 | Diesel | 151 |
| OM 445.924 | 128.00 | 10964 | 6 | 12 | Diesel | 151 |
| OM 445.925 | 128.00 | 10964 | 6 | 12 | Diesel | 151 |
| OM 445.926 | 128.00 | 10964 | 6 | 12 | Diesel | 151 |
| OM 445.927 | 128.00 | 10964 | 6 | 12 | Diesel | 151 |
| OM 445.929 | 128.00 | 10964 | 6 | 12 | Diesel | 151 |
| OM 445.930 | 128.00 | 10964 | 6 | 12 | Diesel | 151 |
| OM 445.931 | 128.00 | 10964 | 6 | 12 | Diesel | 151 |
| OM 445.933 | 128.00 | 10964 | 6 | 12 | Diesel | 151 |
| OM 445.934 | 128.00 | 10964 | 6 | 12 | Diesel | 151 |
| OM 445.935 | 128.00 | 10964 | 6 | 12 | Diesel | 151 |
| OM 445.936 | 128.00 | 10964 | 6 | 12 | Diesel | 151 |
| OM 445.937 | 128.00 | 10964 | 6 | 12 | Diesel | 151 |
| OM 445.938 | 128.00 | 10964 | 6 | 12 | Diesel | 151 |
| OM 445.939 | 128.00 | 10964 | 6 | 12 | Diesel | 151 |
| OM 445.940 | 128.00 | 10964 | 6 | 12 | Diesel | 151 |
| OM 445.941 | 128.00 | 10964 | 6 | 12 | Diesel | 151 |
| OM 446.920 | 128.00 | 14618 | 8 | 16 | Diesel | 166 |
| OM 446.922 | 128.00 | 14618 | 8 | 16 | Diesel | 166 |
| OM 446.923 | 128.00 | 14618 | 8 | 16 | Diesel | 166 |
| OM 446.924 | 128.00 | 14618 | 8 | 16 | Diesel | 166 |
| OM 446.925 | 128.00 | 14618 | 8 | 16 | Diesel | 166 |
| OM 446.926 | 128.00 | 14618 | 8 | 16 | Diesel | 166 |
| OM 446.927 | 128.00 | 14618 | 8 | 16 | Diesel | 166 |
| OM 446.928 | 128.00 | 14618 | 8 | 16 | Diesel | 166 |
| OM 446.929 | 128.00 | 14618 | 8 | 16 | Diesel | 166 |
| OM 446.930 | 128.00 | 14618 | 8 | 16 | Diesel | 166 |
| OM 446.931 | 128.00 | 14618 | 8 | 16 | Diesel | 166 |
| OM 446.932 | 128.00 | 14618 | 8 | 16 | Diesel | 166 |
| OM 446.933 | 128.00 | 14618 | 8 | 16 | Diesel | 166 |
| OM 446.934 | 128.00 | 14618 | 8 | 16 | Diesel | 166 |
| OM 446.935 | 128.00 | 14618 | 8 | 16 | Diesel | 166 |
| OM 446.936 | 128.00 | 14618 | 8 | 16 | Diesel | 166 |
| OM 446.938 | 128.00 | 14618 | 8 | 16 | Diesel | 166 |
| OM 446.939 | 128.00 | 14618 | 8 | 16 | Diesel | 166 |
| OM 446.940 | 128.00 | 14618 | 8 | 16 | Diesel | 166 |
| OM 446.941 | 128.00 | 14618 | 8 | 16 | Diesel | 166 |
| OM 446.942 | 128.00 | 14618 | 8 | 16 | Diesel | 166 |
| OM 446.943 | 128.00 | 14618 | 8 | 16 | Diesel | 166 |
| OM 446.945 | 128.00 | 14618 | 8 | 16 | Diesel | 166 |
| OM 446.946 | 128.00 | 14618 | 8 | 16 | Diesel | 166 |
| OM 446.948 | 128.00 | 14618 | 8 | 16 | Diesel | 166 |
| OM 447.905 | 128.00 | 11967 | 6 | 12 | Diesel | 155 |
| OM 447.906 | 128.00 | 11967 | 6 | 12 | Diesel | 155 |
| OM 447.907 | 128.00 | 11967 | 6 | 12 | Diesel | 155 |
| OM 447.908 | 128.00 | 11967 | 6 | 12 | Diesel | 155 |
| OM 447.910 | 128.00 | 11967 | 6 | 12 | Diesel | 155 |
| OM 447.911 | 128.00 | 11967 | 6 | 12 | Diesel | 155 |
| OM 447.912 | 128.00 | 11967 | 6 | 12 | Diesel | 156 |
| OM 447.913 | 128.00 | 11967 | 6 | 12 | Diesel | 155 |
| OM 447.914 | 128.00 | 11967 | 6 | 12 | Diesel | 155 |
| OM 447.915 | 128.00 | 11967 | 6 | 12 | Diesel | 155 |
| OM 447.916 | 128.00 | 11967 | 6 | 12 | Petrol | 155 |







|  |  | ccm |  |  |  |  | |
|---|---|--------|---|---|---|---|-----|
| OM 447.947 | | 128.00 | 11967 | 6 | 12 | Diesel | 156 |
| OM 447.948 | | 128.00 | 11967 | 6 | 12 | Diesel | 157 |
| OM 447.949 | | 128.00 | 11967 | 6 | 12 | Diesel | 157 |
| OM 447.950 | | 128.00 | 11967 | 6 | 12 | Diesel | 155 |
| OM 447.951 | | 128.00 | 11967 | 6 | 12 | Diesel | 155 |
| OM 447.952 | | 128.00 | 11967 | 6 | 12 | Diesel | 155 |
| OM 447.953 | | 128.00 | 11967 | 6 | 12 | Diesel | 155 |
| OM 447.954 | | 128.00 | 11967 | 6 | 12 | Diesel | 156 |
| OM 447.955 | | 128.00 | 11967 | 6 | 12 | Diesel | 156 |
| OM 447.956 | | 128.00 | 11967 | 6 | 12 | Diesel | 156 |
| OM 447.957 | | 128.00 | 11967 | 6 | 12 | Diesel | 156 |
| OM 447.958 | | 128.00 | 11967 | 6 | 12 | Diesel | 156 |
| OM 447.959 | | 128.00 | 11967 | 6 | 12 | Diesel | 156 |
| OM 447.960 | | 128.00 | 11967 | 6 | 12 | Diesel | 156 |
| OM 447.968 | | 128.00 | 11967 | 6 | 12 | Diesel | 156 |
| OM 447.970 | | 128.00 | 11967 | 6 | 12 | Diesel | 156 |
| OM 447.971 | | 128.00 | 11967 | 6 | 12 | Diesel | 156 |
| OM 447.972 | | 128.00 | 11967 | 6 | 12 | Diesel | 156 |
| OM 447.973 | | 128.00 | 11967 | 6 | 12 | Diesel | 156 |
| OM 447.974 | | 128.00 | 11967 | 6 | 12 | Diesel | 156 |
| OM 447.975 | | 128.00 | 11967 | 6 | 12 | Diesel | 156 |
| OM 447.976 | | 128.00 | 11967 | 6 | 12 | Diesel | 156 |
| OM 447.977 | | 128.00 | 11967 | 6 | 12 | Diesel | 156 |
| OM 447.978 | | 128.00 | 11967 | 6 | 12 | Diesel | 156 |
| OM 447.979 | | 128.00 | 11967 | 6 | 12 | Diesel | 156 |
| OM 447.980 | | 128.00 | 11967 | 6 | 12 | Diesel | 155 |
| OM 447.981 | | 128.00 | 11967 | 6 | 12 | Diesel | 155 |
| OM 447.982 | | 128.00 | 11967 | 6 | 12 | Diesel | 155 |
| OM 447.983 | | 128.00 | 11967 | 6 | 12 | Diesel | 155 |
| OM 447.984 | | 128.00 | 11967 | 6 | 12 | Diesel | 156 |
| OM 447.985 | | 128.00 | 11967 | 6 | 12 | Diesel | 155 |
| OM 447.986 | | 128.00 | 11967 | 6 | 12 | Diesel | 155 |
| OM 447.987 | | 128.00 | 11967 | 6 | 12 | Diesel | 156 |
| OM 447.988 | | 128.00 | 11967 | 6 | 12 | Diesel | 156 |
| OM 447.990 | | 128.00 | 11967 | 6 | 12 | Diesel | 156 |
| OM 447.991 | | 128.00 | 11967 | 6 | 12 | Diesel | 156 |
| OM 447.992 | | 128.00 | 11967 | 6 | 12 | Diesel | 156 |
| OM 447.993 | | 128.00 | 11967 | 6 | 12 | Diesel | 156 |
| OM 447.994 | | 128.00 | 11967 | 6 | 12 | Diesel | 156 |
| OM 447.995 | | 128.00 | 11967 | 6 | 12 | Diesel | 156 |
| OM 447.996 | | 128.00 | 11967 | 6 | 12 | Diesel | 156 |
| OM 447.998 | | 128.00 | 11967 | 6 | 12 | Diesel | 156 |
| OM 447.999 | | 128.00 | 11967 | 6 | 12 | Diesel | 156 |
| OM 457.914 | | 128.00 | 11967 | 6 | 24 | Diesel | 158 |
| OM 457.915 | | 128.00 | 11967 | 6 | 24 | Diesel | 158 |
| OM 457.916 | | 128.00 | 11967 | 6 | 24 | Diesel | 158 |
| OM 457.917 | | 128.00 | 11967 | 6 | 24 | Diesel | 158 |
| OM 457.918 | | 128.00 | 11967 | 6 | 24 | Diesel | 158 |
| OM 457.919 | | 128.00 | 11967 | 6 | 24 | Diesel | 158 |
| OM 457.920 | | 128.00 | 11967 | 6 | 24 | Diesel | 158 |
| OM 457.922 | | 128.00 | 11967 | 6 | 24 | Diesel | 158 |
| OM 457.923 | | 128.00 | 11967 | 6 | 24 | Diesel | 158 |
| OM 457.924 | | 128.00 | 11967 | 6 | 24 | Diesel | 158 |
| OM 457.925 | | 128.00 | 11967 | 6 | 24 | Diesel | 158 |
| OM 457.926 | | 128.00 | 11967 | 6 | 24 | Diesel | 158 |
| OM 457.927 | | 128.00 | 11967 | 6 | 24 | Diesel | 158 |
| OM 457.928 | | 128.00 | 11967 | 6 | 24 | Diesel | 158 |
| OM 457.929 | | 128.00 | 11967 | 6 | 24 | Diesel | 158 |
| OM 457.931 | | 128.00 | 11967 | 6 | 24 | Diesel | 158 |
| OM 457.932 | | 128.00 | 11967 | 6 | 24 | Diesel | 158 |
| OM 457.933 | | 128.00 | 11967 | 6 | 24 | Diesel | 158 |
| OM 457.934 | | 128.00 | 11967 | 6 | 24 | Diesel | 158 |
| OM 457.935 | | 128.00 | 11967 | 6 | 24 | Diesel | 158 |
| OM 457.936 | | 128.00 | 11967 | 6 | 24 | Diesel | 158 |
| OM 457.937 | | 128.00 | 11967 | 6 | 24 | Diesel | 158 |
| OM 457.938 | | 128.00 | 11967 | 6 | 24 | Diesel | 158 |







|  |  | ccm |  |  |  |  |
|---|---|-------|--|---|---|---|
| OM 457.939 | 128.00 | 11967 | 6 | 24 | Diesel | 158 |
| OM 457.940 | 128.00 | 11967 | 6 | 24 | Diesel | 158 |
| OM 457.941 | 128.00 | 11967 | 6 | 24 | Diesel | 158 |
| OM 457.942 | 128.00 | 11967 | 6 | 24 | Diesel | 158 |
| OM 457.943 | 128.00 | 11967 | 6 | 24 | Diesel | 158 |
| OM 457.944 | 128.00 | 11967 | 6 | 24 | Diesel | 158 |
| OM 457.945 | 128.00 | 11967 | 6 | 24 | Diesel | 158 |
| OM 457.946 | 128.00 | 11967 | 6 | 24 | Diesel | 158 |
| OM 457.947 | 128.00 | 11967 | 6 | 24 | Diesel | 158 |
| OM 457.948 | 128.00 | 11967 | 6 | 24 | Diesel | 158 |
| OM 457.949 | 128.00 | 11967 | 6 | 24 | Diesel | 158 |
| OM 457.950 | 128.00 | 11967 | 6 | 24 | Diesel | 158 |
| OM 457.951 | 128.00 | 11967 | 6 | 24 | Diesel | 158 |
| OM 457.952 | 128.00 | 11967 | 6 | 24 | Diesel | 158 |
| OM 457.953 | 128.00 | 11967 | 6 | 24 | Diesel | 158 |
| OM 457.954 | 128.00 | 11967 | 6 | 24 | Diesel | 158 |
| OM 457.955 | 128.00 | 11967 | 6 | 24 | Diesel | 158 |
| OM 457.956 | 128.00 | 11967 | 6 | 24 | Diesel | 158 |
| OM 457.957 | 128.00 | 11967 | 6 | 24 | Diesel | 158 |
| OM 457.958 | 128.00 | 11967 | 6 | 24 | Diesel | 159 |
| OM 457.959 | 128.00 | 11967 | 6 | 24 | Diesel | 158 |
| OM 457.960 | 128.00 | 11967 | 6 | 24 | Diesel | 158 |
| OM 457.961 | 128.00 | 11967 | 6 | 24 | Diesel | 158 |
| OM 457.962 | 128.00 | 11967 | 6 | 24 | Diesel | 159 |
| OM 457.964 | 128.00 | 11967 | 6 | 24 | Diesel | 158 |
| OM 457.965 | 128.00 | 11967 | 6 | 24 | Diesel | 158 |
| OM 457.966 | 128.00 | 11967 | 6 | 24 | Diesel | 159 |
| OM 457.974 | 128.00 | 11967 | 6 | 24 | Diesel | 160 |
| OM 457.976 | 128.00 | 11967 | 6 | 24 | Diesel | 160 |
| OM 457.977 | 128.00 | 11967 | 6 | 24 | Diesel | 160 |
| OM 457.980 | 128.00 | 11967 | 6 | 24 | Diesel | 160 |
| OM 458.960 | 128.00 | 11967 | 6 | 24 | Diesel | 158 |
| OM 458.970 | 128.00 | 11967 | 6 | 24 | Diesel | 158 |
| OM 458.980 | 128.00 | 11967 | 6 | 24 | Diesel | 158 |
| OM 458.990 | 128.00 | 11967 | 6 | 24 | Diesel | 160 |
| OM 458.991 | 128.00 | 11967 | 6 | 24 | Diesel | 160 |
| OM 460.900 | 128.00 | 12816 | 6 | 24 | Diesel | 161 |
| OM 460.901 | 128.00 | 12816 | 6 | 24 | Diesel | 161 |
| OM 460.902 | 128.00 | 12816 | 6 | 24 | Diesel | 161 |
| OM 460.903 | 128.00 | 12816 | 6 | 24 | Diesel | 161 |
| OM 460.904 | 128.00 | 12816 | 6 | 24 | Diesel | 161 |
| OM 460.905 | 128.00 | 12816 | 6 | 24 | Diesel | 161 |
| OM 460.906 | 128.00 | 12816 | 6 | 24 | Diesel | 161 |
| OM 460.907 | 128.00 | 12816 | 6 | 24 | Diesel | 161 |
| OM 460.908 | 128.00 | 12816 | 6 | 24 | Diesel | 161 |
| OM 460.909 | 128.00 | 12816 | 6 | 24 | Diesel | 161 |
| OM 460.910 | 128.00 | 12816 | 6 | 24 | Diesel | 161 |
| OM 460.911 | 128.00 | 12816 | 6 | 24 | Diesel | 161 |
| OM 460.912 | 128.00 | 12816 | 6 | 24 | Diesel | 161 |
| OM 460.913 | 128.00 | 12816 | 6 | 24 | Diesel | 161 |
| OM 460.914 | 128.00 | 12816 | 6 | 24 | Diesel | 161 |
| OM 460.915 | 128.00 | 12816 | 6 | 24 | Diesel | 161 |
| OM 460.916 | 128.00 | 12816 | 6 | 24 | Diesel | 161 |
| OM 460.917 | 128.00 | 12816 | 6 | 24 | Diesel | 161 |
| OM 460.918 | 128.00 | 12816 | 6 | 24 | Diesel | 161 |
| OM 460.919 | 128.00 | 12816 | 6 | 24 | Diesel | 161 |
| OM 460.920 | 128.00 | 12816 | 6 | 24 | Diesel | 161 |
| OM 460.921 | 128.00 | 12816 | 6 | 24 | Diesel | 161 |
| OM 460.922 | 128.00 | 12816 | 6 | 24 | Diesel | 161 |
| OM 460.923 | 128.00 | 12816 | 6 | 24 | Diesel | 161 |
| OM 460.925 | 128.00 | 12816 | 6 | 24 | Diesel | 161 |
| OM 460.929 | 128.00 | 12816 | 6 | 24 | Diesel | 161 |
| OM 460.931 | 128.00 | 12816 | 6 | 24 | Diesel | 161 |
| OM 460.939 | 128.00 | 12816 | 6 | 24 | Diesel | 162 |
| OM 460.940 | 128.00 | 12816 | 6 | 24 | Diesel | 162 |
| OM 460.941 | 128.00 | 12816 | 6 | 24 | Diesel | 162 |







|  |  | ccm |  |  |  |  | |
|---|---|--------|---|---|---|---|-----|
| OM 460.942 | | 128.00 | 12816 | 6 | 24 | Diesel | 162 |
| OM 460.943 | | 128.00 | 12816 | 6 | 24 | Diesel | 162 |
| OM 460.944 | | 128.00 | 12816 | 6 | 24 | Diesel | 162 |
| OM 460.945 | | 128.00 | 12816 | 6 | 24 | Diesel | 162 |
| OM 460.946 | | 128.00 | 12816 | 6 | 24 | Diesel | 162 |
| OM 460.947 | | 128.00 | 12816 | 6 | 24 | Diesel | 162 |
| OM 460.948 | | 128.00 | 12816 | 6 | 24 | Diesel | 162 |
| OM 460.949 | | 128.00 | 12816 | 6 | 24 | Diesel | 162 |
| OM 460.950 | | 128.00 | 12816 | 6 | 24 | Diesel | 163 |
| OM 460.951 | | 128.00 | 12816 | 6 | 24 | Diesel | 161 |
| OM 460.960 | | 128.00 | 12816 | 6 | 24 | Diesel | 163 |
| OM 460.961 | | 128.00 | 12816 | 6 | 24 | Diesel | 162 |
| OM 460.970 | | 128.00 | 12816 | 6 | 24 | Diesel | 161 |
| OM 460.971 | | 128.00 | 12816 | 6 | 24 | Diesel | 161 |
| OM 460.975 | | 128.00 | 12816 | 6 | 24 | Diesel | 161 |
| OM 460.976 | | 128.00 | 12816 | 6 | 24 | Diesel | 161 |
| OM 460.977 | | 128.00 | 12816 | 6 | 24 | Diesel | 161 |
| OM 460.978 | | 128.00 | 12816 | 6 | 24 | Diesel | 161 |
| OM 460.979 | | 128.00 | 12816 | 6 | 24 | Diesel | 161 |
| OM 460.980 | | 128.00 | 12816 | 6 | 24 | Diesel | 161 |
| OM 460.981 | | 128.00 | 12816 | 6 | 24 | Diesel | 161 |
| OM 470.903 | | 125.00 | 10677 | 6 | 24 | Diesel | 135 |
| OM 470.906 | | 125.00 | 10677 | 6 | 24 | Diesel | 135 |
| OM 470.908 | | 125.00 | 10677 | 6 | 24 | Diesel | 135 |
| OM 471.900 | | 132.00 | 12809 | 6 | 24 | Diesel | 184 |
| OM 471.901 | | 132.00 | 12809 | 6 | 24 | Diesel | 184 |
| OM 471.902 | | 132.00 | 12809 | 6 | 24 | Diesel | 184 |
| OM 471.903 | | 132.00 | 12809 | 6 | 24 | Diesel | 184 |
| OM 471.905 | | 132.00 | 12809 | 6 | 24 | Diesel | 184 |
| OM 471.906 | | 132.00 | 12809 | 6 | 24 | Diesel | 184 |
| OM 471.909 | | 132.00 | 12809 | 6 | 24 | Diesel | 184 |
| OM 471.910 | | 132.00 | 12809 | 6 | 24 | Diesel | 184 |
| OM 471.911 | | 132.00 | 12809 | 6 | 24 | Diesel | 184 |
| OM 471.913 | | 132.00 | 12809 | 6 | 24 | Diesel | 184 |
| OM 471.914 | | 132.00 | 12809 | 6 | 24 | Diesel | 184 |
| OM 471.915 | | 132.00 | 12809 | 6 | 24 | Diesel | 184 |
| OM 471.917 | | 132.00 | 12809 | 6 | 24 | Diesel | 184 |
| OM 471.927 | | 132.00 | 12809 | 6 | 24 | Diesel | 184 |
| OM 471.932 | | 132.00 | 12809 | 6 | 24 | Diesel | 184 |
| OM 471.933 | | 132.00 | 12809 | 6 | 24 | Diesel | 184 |
| OM 471.934 | | 132.00 | 12809 | 6 | 24 | Diesel | 184 |
| OM 471.935 | | 132.00 | 12809 | 6 | 24 | Diesel | 184 |
| OM 475.950 | | 128.00 | 9973 | 5 | 10 | Diesel | 146 |
| OM 475.951 | | 128.00 | 9973 | 5 | 10 | Diesel | 146 |
| OM 475.952 | | 128.00 | 9973 | 5 | 10 | Diesel | 146 |
| OM 475.953 | | 128.00 | 9973 | 5 | 10 | Diesel | 146 |
| OM 475.954 | | 128.00 | 9973 | 5 | 10 | Diesel | 146 |
| OM 475.979 | | 128.00 | 9973 | 5 | 10 | Diesel | 147 |
| OM 475.982 | | 128.00 | 9973 | 5 | 10 | Diesel | 147 |
| OM 476.916 | | 128.00 | 11967 | 6 | 12 | Diesel | 156 |
| OM 476.917 | | 128.00 | 11967 | 6 | 12 | Diesel | 156 |
| OM 476.950 | | 128.00 | 11967 | 6 | 12 | Diesel | 156 |
| OM 476.971 | | 128.00 | 11967 | 6 | 12 | Diesel | 156 |
| OM 476.972 | | 128.00 | 11967 | 6 | 12 | Diesel | 156 |
| OM 476.973 | | 128.00 | 11967 | 6 | 12 | Diesel | 156 |
| OM 476.977 | | 128.00 | 11967 | 6 | 12 | Diesel | 156 |
| OM 476.978 | | 128.00 | 11967 | 6 | 12 | Diesel | 156 |
| OM 476.979 | | 128.00 | 11967 | 6 | 12 | Diesel | 156 |
| OM 476.980 | | 128.00 | 11967 | 6 | 12 | Diesel | 156 |
| OM 476.981 | | 128.00 | 11967 | 6 | 12 | Diesel | 156 |
| OM 476.982 | | 128.00 | 11967 | 6 | 12 | Diesel | 156 |
| OM 476.983 | | 128.00 | 11967 | 6 | 12 | Diesel | 156 |
| OM 476.985 | | 128.00 | 11967 | 6 | 12 | Diesel | 157 |
| OM 476.988 | | 128.00 | 11967 | 6 | 12 | Diesel | 156 |
| OM 476.991 | | 128.00 | 11967 | 6 | 12 | Diesel | 156 |
| OM 476.992 | | 128.00 | 11967 | 6 | 12 | Diesel | 156 |







|  |  | ccm |  |  |  |  |
|---|---|-------|--|---|---|---|
| OM 481.902 | 128.00 | 10964 | 6 | 12 | Diesel | 151 |
| OM 481.904 | 128.00 | 10964 | 6 | 12 | Diesel | 151 |
| OM 482.912 | 128.00 | 14618 | 8 | 16 | Diesel | 166 |
| OM 482.930 | 128.00 | 14618 | 8 | 16 | Diesel | 166 |
| OM 482.940 | 128.00 | 14618 | 8 | 16 | Diesel | 166 |
| OM 482.941 | 128.00 | 14618 | 8 | 16 | Diesel | 166 |
| OM 489.960 | 128.00 | 9973 | 5 | 10 | Diesel | 147 |
| OM 489.961 | 128.00 | 9973 | 5 | 10 | Diesel | 147 |
| OM 521.940 | 130.00 | 11946 | 6 | 24 | Diesel | 176 |
| OM 521.950 | 130.00 | 11946 | 6 | 24 | Diesel | 176 |
| OM 522.940 | 130.00 | 15928 | 8 | 32 | Diesel | 181 |
| OM 522.941 | 130.00 | 15928 | 8 | 32 | Diesel | 181 |
| OM 522.942 | 130.00 | 15928 | 8 | 32 | Diesel | 181 |
| OM 522.943 | 130.00 | 15928 | 8 | 32 | Diesel | 181 |
| OM 522.950 | 130.00 | 15928 | 8 | 32 | Diesel | 181 |
| OM 541.920 | 130.00 | 11946 | 6 | 24 | Diesel | 176 |
| OM 541.921 | 130.00 | 11946 | 6 | 24 | Diesel | 176 |
| OM 541.922 | 130.00 | 11946 | 6 | 24 | Diesel | 176 |
| OM 541.923 | 130.00 | 11946 | 6 | 24 | Diesel | 176 |
| OM 541.924 | 130.00 | 11946 | 6 | 24 | Diesel | 176 |
| OM 541.925 | 130.00 | 11946 | 6 | 24 | Diesel | 176 |
| OM 541.926 | 130.00 | 11946 | 6 | 24 | Diesel | 176 |
| OM 541.927 | 130.00 | 11946 | 6 | 24 | Diesel | 176 |
| OM 541.928 | 130.00 | 11946 | 6 | 24 | Diesel | 176 |
| OM 541.940 | 130.00 | 11946 | 6 | 24 | Diesel | 176 |
| OM 541.941 | 130.00 | 11946 | 6 | 24 | Diesel | 176 |
| OM 541.942 | 130.00 | 11946 | 6 | 24 | Diesel | 176 |
| OM 541.943 | 130.00 | 11946 | 6 | 24 | Diesel | 176 |
| OM 541.944 | 130.00 | 11946 | 6 | 24 | Diesel | 176 |
| OM 541.945 | 130.00 | 11946 | 6 | 24 | Diesel | 176 |
| OM 541.946 | 130.00 | 11946 | 6 | 24 | Diesel | 176 |
| OM 541.947 | 130.00 | 11946 | 6 | 24 | Diesel | 176 |
| OM 541.948 | 130.00 | 11946 | 6 | 24 | Diesel | 176 |
| OM 541.949 | 130.00 | 11946 | 6 | 24 | Diesel | 176 |
| OM 541.950 | 130.00 | 11946 | 6 | 24 | Diesel | 176 |
| OM 541.951 | 130.00 | 11946 | 6 | 24 | Diesel | 176 |
| OM 541.952 | 130.00 | 11946 | 6 | 24 | Diesel | 176 |
| OM 541.953 | 130.00 | 11946 | 6 | 24 | Diesel | 177 |
| OM 541.959 | 130.00 | 11946 | 6 | 24 | Diesel | 177 |
| OM 541.960 | 130.00 | 11946 | 6 | 24 | Diesel | 178 |
| OM 541.970 | 130.00 | 11946 | 6 | 24 | Diesel | 176 |
| OM 541.971 | 130.00 | 11946 | 6 | 24 | Diesel | 176 |
| OM 541.972 | 130.00 | 11946 | 6 | 24 | Diesel | 176 |
| OM 541.973 | 130.00 | 11946 | 6 | 24 | Diesel | 176 |
| OM 541.974 | 130.00 | 11946 | 6 | 24 | Diesel | 176 |
| OM 541.975 | 130.00 | 11946 | 6 | 24 | Diesel | 176 |
| OM 541.976 | 130.00 | 11946 | 6 | 24 | Diesel | 176 |
| OM 541.977 | 130.00 | 11946 | 6 | 24 | Diesel | 176 |
| OM 541.978 | 130.00 | 11946 | 6 | 24 | Diesel | 176 |
| OM 541.980 | 130.00 | 11946 | 6 | 24 | Diesel | 176 |
| OM 541.981 | 130.00 | 11946 | 6 | 24 | Diesel | 176 |
| OM 541.990 | 130.00 | 11946 | 6 | 24 | Diesel | 177 |
| OM 541.991 | 130.00 | 11946 | 6 | 24 | Diesel | 177 |
| OM 541.992 | 130.00 | 11946 | 6 | 24 | Diesel | 177 |
| OM 541.993 | 130.00 | 11946 | 6 | 24 | Diesel | 177 |
| OM 541.994 | 130.00 | 11946 | 6 | 24 | Diesel | 177 |
| OM 541.996 | 130.00 | 11946 | 6 | 24 | Diesel | 177 |
| OM 541.997 | 130.00 | 11946 | 6 | 24 | Diesel | 177 |
| OM 541.998 | 130.00 | 11946 | 6 | 24 | Diesel | 177 |
| OM 541.999 | 130.00 | 11946 | 6 | 24 | Diesel | 177 |
| OM 542.920 | 130.00 | 15928 | 8 | 32 | Diesel | 181 |
| OM 542.921 | 130.00 | 15928 | 8 | 32 | Diesel | 181 |
| OM 542.922 | 130.00 | 15928 | 8 | 32 | Diesel | 181 |
| OM 542.923 | 130.00 | 15928 | 8 | 32 | Diesel | 181 |
| OM 542.924 | 130.00 | 15928 | 8 | 32 | Diesel | 181 |
| OM 542.925 | 130.00 | 15928 | 8 | 32 | Diesel | 181 |







|  |  | ccm |  |  |  |  | |
|---|---|--------|---|---|---|---|-----|
| OM 542.926 | | 130.00 | 15928 | 8 | 32 | Diesel | 181 |
| OM 542.940 | | 130.00 | 15928 | 8 | 32 | Diesel | 181 |
| OM 542.941 | | 130.00 | 15928 | 8 | 32 | Diesel | 181 |
| OM 542.942 | | 130.00 | 15928 | 8 | 32 | Diesel | 181 |
| OM 542.943 | | 130.00 | 15928 | 8 | 32 | Diesel | 181 |
| OM 542.944 | | 130.00 | 15928 | 8 | 32 | Diesel | 181 |
| OM 542.945 | | 130.00 | 15928 | 8 | 32 | Diesel | 181 |
| OM 542.947 | | 130.00 | 15928 | 8 | 32 | Diesel | 181 |
| OM 542.948 | | 130.00 | 15928 | 8 | 32 | Diesel | 181 |
| OM 542.956 | | 130.00 | 15928 | 8 | 32 | Diesel | 181 |
| OM 542.957 | | 130.00 | 15928 | 8 | 32 | Diesel | 181 |
| OM 542.958 | | 130.00 | 15928 | 8 | 32 | Diesel | 181 |
| OM 542.960 | | 130.00 | 15928 | 8 | 32 | Diesel | 181 |
| OM 542.961 | | 130.00 | 15928 | 8 | 32 | Diesel | 181 |
| OM 542.962 | | 130.00 | 15928 | 8 | 32 | Diesel | 181 |
| OM 542.963 | | 130.00 | 15928 | 8 | 32 | Diesel | 181 |
| OM 542.964 | | 130.00 | 15928 | 8 | 32 | Diesel | 181 |
| OM 542.972 | | 130.00 | 15928 | 8 | 32 | Diesel | 182 |
| OM 601.900 | | 89.00 | 2299 | 4 | 8 | Diesel | 66 |
| OM 601.911 | | 87.00 | 1997 | 4 | 8 | Diesel | 44 |
| OM 601.912 | | 87.00 | 1997 | 4 | 8 | Diesel | 44 |
| OM 601.913 | | 87.00 | 1997 | 4 | 8 | Diesel | 44 |
| OM 601.921 | | 87.00 | 2197 | 4 | 8 | Diesel | 47 |
| OM 601.940 | | 89.00 | 2299 | 4 | 8 | Diesel | 66 |
| OM 601.941 | | 89.00 | 2299 | 4 | 8 | Diesel | 66 |
| OM 601.942 | | 89.00 | 2299 | 4 | 8 | Diesel | 66 |
| OM 601.943 | | 89.00 | 2299 | 4 | 8 | Diesel | 66 |
| OM 601A.970 | | 89.00 | 2299 | 4 | 8 | Diesel | 66 |
| OM 602.911 | | 87.00 | 2497 | 5 | 10 | Diesel | 48 |
| OM 602.912 | | 87.00 | 2497 | 5 | 10 | Diesel | 48 |
| OM 602.930 | | 87.00 | 2497 | 5 | 10 | Diesel | 48 |
| OM 602.931 | | 87.00 | 2497 | 5 | 10 | Diesel | 48 |
| OM 602.938 | | 87.00 | 2497 | 5 | 10 | Diesel | 48 |
| OM 602.939 | | 87.00 | 2497 | 5 | 10 | Diesel | 48 |
| OM 602.940 | | 89.00 | 2874 | 5 | 10 | Diesel | 67 |
| OM 602.941 | | 89.00 | 2874 | 5 | 10 | Diesel | 67 |
| OM 602.942 | | 89.00 | 2874 | 5 | 10 | Diesel | 67 |
| OM 602.946 | | 89.00 | 2874 | 5 | 10 | Diesel | 67 |
| OM 602.947 | | 89.00 | 2874 | 5 | 10 | Diesel | 67 |
| OM 602.948 | | 89.00 | 2874 | 5 | 10 | Diesel | 67 |
| OM 602.961 | | 87.00 | 2497 | 5 | 10 | Diesel | 48 |
| OM 602.980 | | 89.00 | 2874 | 5 | 10 | Diesel | 67 |
| OM 602.981 | | 89.00 | 2874 | 5 | 10 | Diesel | 67 |
| OM 602.982 | | 89.00 | 2874 | 5 | 10 | Diesel | 67 |
| OM 602.983 | | 89.00 | 2874 | 5 | 10 | Diesel | 67 |
| OM 602.984 | | 89.00 | 2874 | 5 | 10 | Diesel | 67 |
| OM 602.985 | | 89.00 | 2874 | 5 | 10 | Diesel | 67 |
| OM 602.986 | | 89.00 | 2874 | 5 | 10 | Diesel | 67 |
| OM 602.989 | | 89.00 | 2874 | 5 | 10 | Diesel | 67 |
| OM 602.990 | | 87.00 | 2497 | 5 | 10 | Diesel | 48 |
| OM 602.991 | | 89.00 | 2874 | 5 | 10 | Diesel | 67 |
| OM 602.994 | | 89.00 | 2874 | 5 | 10 | Diesel | 67 |
| OM 602A.962 | | 87.00 | 2497 | 5 | 10 | Diesel | 48 |
| OM 602A.993 | | 87.00 | 2497 | 5 | 10 | Diesel | 48 |
| OM 603.912 | | 87.00 | 2996 | 6 | 12 | Diesel | 50 |
| OM 603.913 | | 87.00 | 2996 | 6 | 12 | Diesel | 50 |
| OM 603.931 | | 87.00 | 2996 | 6 | 12 | Diesel | 50 |
| OM 603.950 | | 87.00 | 2996 | 6 | 12 | Diesel | 50 |
| OM 603.961 | | 87.00 | 2996 | 6 | 12 | Diesel | 50 |
| OM 603.962 | | 87.00 | 2996 | 6 | 12 | Diesel | 50 |
| OM 603A.960 | | 87.00 | 2996 | 6 | 12 | Diesel | 50 |
| OM 603A.963 | | 87.00 | 2996 | 6 | 12 | Diesel | 50 |
| OM 603A.970 | | 89.00 | 3449 | 6 | 12 | Diesel | 68 |
| OM 603A.971 | | 89.00 | 3449 | 6 | 12 | Diesel | 68 |
| OM 603A.972 | | 89.00 | 3449 | 6 | 12 | Diesel | 68 |
| OM 604.910 | | 89.00 | 2155 | 4 | 16 | Diesel | 65 |







|  |  | ccm |  |  |  |  |
|---|---|------|--|---|---|---|
| OM 604.912 | 89.00 | 2155 | 4 | 16 | Diesel | 65 |
| OM 604.915 | 87.00 | 1997 | 4 | 16 | Diesel | 45 |
| OM 604.917 | 87.00 | 1997 | 4 | 16 | Diesel | 45 |
| OM 605.910 | 87.00 | 2497 | 5 | 20 | Diesel | 49 |
| OM 605.911 | 87.00 | 2497 | 5 | 20 | Diesel | 49 |
| OM 605.912 | 87.00 | 2497 | 5 | 20 | Diesel | 49 |
| OM 605.960 | 87.00 | 2497 | 5 | 20 | Diesel | 49 |
| OM 605.962 | 87.00 | 2497 | 5 | 20 | Diesel | 49 |
| OM 606.910 | 87.00 | 2996 | 6 | 24 | Diesel | 51 |
| OM 606.912 | 87.00 | 2996 | 6 | 24 | Diesel | 51 |
| OM 606.961 | 87.00 | 2996 | 6 | 24 | Diesel | 51 |
| OM 606.962 | 87.00 | 2996 | 6 | 24 | Diesel | 51 |
| OM 606.964 | 87.00 | 2996 | 6 | 24 | Diesel | 51 |
| OM 607.951 | 76.00 | 1461 | 4 | 8 | Diesel | 3 |
| OM 611.960 | 88.00 | 2151 | 4 | 16 | Diesel | 53 |
| OM 611.961 | 88.00 | 2151 | 4 | 16 | Diesel | 53 |
| OM 611.962 | 88.00 | 2151 | 4 | 16 | Diesel | 53 |
| OM 611.980 | 88.00 | 2151 | 4 | 16 | Diesel | 53 |
| OM 611.981 | 88.00 | 2151 | 4 | 16 | Diesel | 53 |
| OM 611.987 | 88.00 | 2151 | 4 | 16 | Diesel | 53 |
| OM 611A (60 KW CDI) | 88.00 | 2151 | 4 | 16 | Diesel | 53 |
| OM 611LA (75 KW CDI) | 88.00 | 2151 | 4 | 16 | Diesel | 53 |
| OM 612.961 | 88.00 | 2685 | 5 | 20 | Diesel | 55 |
| OM 612.962 | 88.00 | 2685 | 5 | 20 | Diesel | 55 |
| OM 612.963 | 88.00 | 2685 | 5 | 20 | Diesel | 55 |
| OM 612.965 | 88.00 | 2685 | 5 | 20 | Diesel | 55 |
| OM 612.966 | 88.00 | 2685 | 5 | 20 | Diesel | 55 |
| OM 612.967 | 88.00 | 2685 | 5 | 20 | Diesel | 55 |
| OM 612.981 | 88.00 | 2685 | 5 | 20 | Diesel | 55 |
| OM 612.983 | 88.00 | 2685 | 5 | 20 | Diesel | 55 |
| OM 612.990 | 88.00 | 2950 | 5 | 20 | Diesel | 57 |
| OM 613.960 | 88.00 | 3222 | 6 | 24 | Diesel | 59 |
| OM 613.961 | 88.00 | 3226 | 6 | 24 | Diesel | 61 |
| OM 616 | 90.90 | 2399 | 4 | 8 | Diesel | 82 |
| OM 616.910 | 90.90 | 2399 | 4 | 8 | Diesel | 82 |
| OM 616.911 | 90.90 | 2404 | 4 | 8 | Diesel | 84 |
| OM 616.912 | 90.90 | 2399 | 4 | 8 | Diesel | 82 |
| OM 616.913 | 90.90 | 2399 | 4 | 8 | Diesel | 82 |
| OM 616.914 | 90.90 | 2399 | 4 | 8 | Diesel | 82 |
| OM 616.916 | 91.00 | 2404 | 4 | 8 | Diesel | 88 |
| OM 616.917 | 90.90 | 2399 | 4 | 8 | Diesel | 82 |
| OM 616.918 | 90.90 | 2399 | 4 | 8 | Diesel | 83 |
| OM 616.919 | 90.90 | 2399 | 4 | 8 | Diesel | 83 |
| OM 616.932 | 90.90 | 2404 | 4 | 8 | Diesel | 84 |
| OM 616.933 | 90.90 | 2404 | 4 | 8 | Diesel | 84 |
| OM 616.934 | 90.90 | 2399 | 4 | 8 | Diesel | 82 |
| OM 616.936 | 90.90 | 2399 | 4 | 8 | Diesel | 82 |
| OM 616.937 | 90.90 | 2399 | 4 | 8 | Diesel | 82 |
| OM 616.938 | 90.90 | 2399 | 4 | 8 | Diesel | 82 |
| OM 616.939 | 90.90 | 2399 | 4 | 8 | Diesel | 82 |
| OM 616.940 | 90.90 | 2399 | 4 | 8 | Diesel | 82 |
| OM 616.942 | 90.90 | 2399 | 4 | 8 | Diesel | 82 |
| OM 616.943 | 90.90 | 2399 | 4 | 8 | Diesel | 82 |
| OM 616.944 | 90.90 | 2399 | 4 | 8 | Diesel | 82 |
| OM 616.960 | 91.00 | 2399 | 4 | 8 | Diesel | 87 |
| OM 616.961 | 91.00 | 2399 | 4 | 8 | Diesel | 87 |
| OM 616.963 | 90.90 | 2399 | 4 | 8 | Diesel | 82 |
| OM 617.910 | 91.00 | 2998 | 5 | 10 | Diesel | 89 |
| OM 617.912 | 90.90 | 2998 | 5 | 10 | Diesel | 85 |
| OM 617.913 | 90.90 | 2998 | 5 | 10 | Diesel | 85 |
| OM 617.931 | 90.90 | 2998 | 5 | 10 | Diesel | 85 |
| OM 617.932 | 90.90 | 2998 | 5 | 10 | Diesel | 85 |
| OM 617.933 | 90.90 | 2998 | 5 | 10 | Diesel | 86 |
| OM 617.950 | 90.90 | 2998 | 5 | 10 | Diesel | 85 |
| OM 617.951 | 90.90 | 2998 | 5 | 10 | Diesel | 85 |
| OM 617.952 | 90.90 | 2998 | 5 | 10 | Diesel | 85 |







|  |  | ccm |  |  |  |  |
|---|---|------|---|---|---|---|
| OM 628.960 | 86.00 | 3996 | 8 | 32 | Diesel | 39 |
| OM 628.961 | 86.00 | 3996 | 8 | 32 | Diesel | 39 |
| OM 628.962 | 86.00 | 3996 | 8 | 32 | Diesel | 39 |
| OM 628.963 | 86.00 | 3996 | 8 | 32 | Diesel | 39 |
| OM 629.910 | 86.00 | 3996 | 8 | 32 | Diesel | 39 |
| OM 629.911 | 86.00 | 3996 | 8 | 32 | Diesel | 39 |
| OM 629.912 | 86.00 | 3996 | 8 | 32 | Diesel | 39 |
| OM 639.939 | 83.00 | 1493 | 3 | 12 | Diesel | 23 |
| OM 640.940 | 83.00 | 1991 | 4 | 16 | Diesel | 29 |
| OM 640.941 | 83.00 | 1991 | 4 | 16 | Diesel | 29 |
| OM 640.942 | 83.00 | 1991 | 4 | 16 | Diesel | 29 |
| OM 642.820 | 83.00 | 2987 | 6 | 24 | Diesel | 32 |
| OM 642.822 | 83.00 | 2987 | 6 | 24 | Diesel | 32 |
| OM 642.826 | 83.00 | 2987 | 6 | 24 | Diesel | 32 |
| OM 642.830 | 83.00 | 2987 | 6 | 24 | Diesel | 32 |
| OM 642.832 | 83.00 | 2987 | 6 | 24 | Diesel | 32 |
| OM 642.834 | 83.00 | 2987 | 6 | 24 | Diesel | 32 |
| OM 642.835 | 83.00 | 2987 | 6 | 24 | Diesel | 32 |
| OM 642.836 | 83.00 | 2987 | 6 | 24 | Diesel | 32 |
| OM 642.838 | 83.00 | 2987 | 6 | 24 | Diesel | 32 |
| OM 642.850 | 83.00 | 2987 | 6 | 24 | Diesel | 32 |
| OM 642.852 | 83.00 | 2987 | 6 | 24 | Diesel | 32 |
| OM 642.853 | 83.00 | 2987 | 6 | 24 | Diesel | 32 |
| OM 642.854 | 83.00 | 2987 | 6 | 24 | Diesel | 32 |
| OM 642.856 | 83.00 | 2987 | 6 | 24 | Diesel | 32 |
| OM 642.858 | 83.00 | 2987 | 6 | 24 | Diesel | 32 |
| OM 642.861 | 83.00 | 2987 | 6 | 24 | Diesel | 32 |
| OM 642.862 | 83.00 | 2987 | 6 | 24 | Diesel | 32 |
| OM 642.867 | 83.00 | 2987 | 6 | 24 | Diesel | 32 |
| OM 642.868 | 83.00 | 2987 | 6 | 24 | Diesel | 32 |
| OM 642.870 | 83.00 | 2987 | 6 | 24 | Diesel | 32 |
| OM 642.872 | 83.00 | 2987 | 6 | 24 | Diesel | 32 |
| OM 642.884 | 83.00 | 2987 | 6 | 24 | Diesel | 32 |
| OM 642.887 | 83.00 | 2987 | 6 | 24 | Diesel | 32 |
| OM 642.890 | 83.00 | 2987 | 6 | 24 | Diesel | 32 |
| OM 642.896 | 83.00 | 2987 | 6 | 24 | Diesel | 32 |
| OM 642.898 | 83.00 | 2987 | 6 | 24 | Diesel | 32 |
| OM 642.910 | 83.00 | 2987 | 6 | 24 | Diesel | 32 |
| OM 642.920 | 83.00 | 2987 | 6 | 24 | Diesel | 32 |
| OM 642.921 | 83.00 | 2987 | 6 | 24 | Diesel | 32 |
| OM 642.930 | 83.00 | 2987 | 6 | 24 | Diesel | 32 |
| OM 642.932 | 83.00 | 2987 | 6 | 24 | Diesel | 32 |
| OM 642.940 | 83.00 | 2987 | 6 | 24 | Diesel | 32 |
| OM 642.950 | 83.00 | 2987 | 6 | 24 | Diesel | 32 |
| OM 642.960 | 83.00 | 2987 | 6 | 24 | Diesel | 32 |
| OM 642.961 | 83.00 | 2987 | 6 | 24 | Diesel | 32 |
| OM 642.970 | 83.00 | 2987 | 6 | 24 | Diesel | 32 |
| OM 642.975 | 83.00 | 2987 | 6 | 24 | Diesel | 32 |
| OM 642.990 | 83.00 | 2987 | 6 | 24 | Diesel | 32 |
| OM 642.992 | 83.00 | 2987 | 6 | 24 | Diesel | 32 |
| OM 642.993 | 83.00 | 2987 | 6 | 24 | Diesel | 32 |
| OM 646.811 | 88.00 | 2148 | 4 | 16 | Diesel | 52 |
| OM 646.812 | 88.00 | 2148 | 4 | 16 | Diesel | 52 |
| OM 646.820 | 88.00 | 2148 | 4 | 16 | Diesel | 52 |
| OM 646.821 | 88.00 | 2148 | 4 | 16 | Diesel | 52 |
| OM 646.951 | 88.00 | 2148 | 4 | 16 | Diesel | 52 |
| OM 646.961 | 88.00 | 2148 | 4 | 16 | Diesel | 52 |
| OM 646.962 | 88.00 | 2148 | 4 | 16 | Diesel | 52 |
| OM 646.963 | 88.00 | 2148 | 4 | 16 | Diesel | 52 |
| OM 646.966 | 88.00 | 2148 | 4 | 16 | Diesel | 52 |
| OM 646.980 | 88.00 | 2148 | 4 | 16 | Diesel | 52 |
| OM 646.981 | 88.00 | 2148 | 4 | 16 | Diesel | 52 |
| OM 646.982 | 88.00 | 2148 | 4 | 16 | Diesel | 52 |
| OM 646.983 | 88.00 | 2148 | 4 | 16 | Diesel | 52 |
| OM 646.984 | 88.00 | 2148 | 4 | 16 | Diesel | 52 |
| OM 646.985 | 88.00 | 2148 | 4 | 16 | Diesel | 52 |

|  |  | ccm |  |  |  |  |
|---|---|------|--|---|---|---|
| OM 646.986 | 88.00 | 2148 | 4 | 16 | Diesel | 52 |
| OM 646.989 | 88.00 | 2148 | 4 | 16 | Diesel | 52 |
| OM 646.990 | 88.00 | 2148 | 4 | 16 | Diesel | 52 |
| OM 647.961 | 88.00 | 2685 | 5 | 20 | Diesel | 56 |
| OM 647.981 | 88.00 | 2685 | 5 | 20 | Diesel | 56 |
| OM 648.960 | 88.00 | 3222 | 6 | 24 | Diesel | 60 |
| OM 648.961 | 88.00 | 3222 | 6 | 24 | Diesel | 60 |
| OM 651.901 | 83.00 | 1796 | 4 | 16 | Diesel | 27 |
| OM 651.911 | 83.00 | 2143 | 4 | 16 | Diesel | 31 |
| OM 651.912 | 83.00 | 2143 | 4 | 16 | Diesel | 31 |
| OM 651.913 | 83.00 | 2143 | 4 | 16 | Diesel | 31 |
| OM 651.916 | 83.00 | 2143 | 4 | 16 | Diesel | 31 |
| OM 651.921 | 83.00 | 2143 | 4 | 16 | Diesel | 31 |
| OM 651.924 | 83.00 | 2143 | 4 | 16 | Diesel | 31 |
| OM 651.925 | 83.00 | 2143 | 4 | 16 | Diesel | 31 |
| OM 651.930 | 83.00 | 2143 | 4 | 16 | Diesel | 31 |
| OM 651.940 | 83.00 | 2143 | 4 | 16 | Diesel | 31 |
| OM 651.950 | 83.00 | 2143 | 4 | 16 | Diesel | 31 |
| OM 651.955 | 83.00 | 2143 | 4 | 16 | Diesel | 31 |
| OM 651.956 | 83.00 | 2143 | 4 | 16 | Diesel | 31 |
| OM 651.957 | 83.00 | 2143 | 4 | 16 | Diesel | 31 |
| OM 651.960 | 83.00 | 2143 | 4 | 16 | Diesel | 31 |
| OM 651.961 | 83.00 | 2143 | 4 | 16 | Diesel | 31 |
| OM 651.980 | 83.00 | 2143 | 4 | 16 | Diesel | 31 |
| OM 662.911 | 89.00 | 2874 | 5 | 10 | Diesel | 67 |
| OM 668.914 | 80.00 | 1689 | 4 | 16 | Diesel | 6 |
| OM 668.940 | 80.00 | 1689 | 4 | 16 | Diesel | 6 |
| OM 668.941 | 80.00 | 1689 | 4 | 16 | Diesel | 6 |
| OM 668.942 | 80.00 | 1689 | 4 | 16 | Diesel | 6 |
| OM 900.910 | 102.00 | 4249 | 4 | 12 | Diesel | 126 |
| OM 900.911 | 102.00 | 4249 | 4 | 12 | Diesel | 126 |
| OM 900.912 | 102.00 | 4249 | 4 | 12 | Diesel | 126 |
| OM 900.913 | 102.00 | 4249 | 4 | 12 | Diesel | 126 |
| OM 900.915 | 102.00 | 4249 | 4 | 12 | Diesel | 126 |
| OM 900.916 | 102.00 | 4249 | 4 | 12 | Diesel | 126 |
| OM 900.917 | 102.00 | 4249 | 4 | 12 | Diesel | 126 |
| OM 900.918 | 102.00 | 4249 | 4 | 12 | Diesel | 126 |
| OM 900.919 | 102.00 | 4249 | 4 | 12 | Diesel | 126 |
| OM 900.920 | 102.00 | 4249 | 4 | 12 | Diesel | 126 |
| OM 900.921 | 102.00 | 4249 | 4 | 12 | Diesel | 126 |
| OM 900.922 | 102.00 | 4249 | 4 | 12 | Diesel | 126 |
| OM 902.910 | 102.00 | 6374 | 6 | 18 | Diesel | 127 |
| OM 902.911 | 102.00 | 6374 | 6 | 18 | Diesel | 127 |
| OM 902.912 | 102.00 | 6374 | 6 | 18 | Diesel | 127 |
| OM 902.913 | 102.00 | 6374 | 6 | 18 | Diesel | 127 |
| OM 902.914 | 102.00 | 6374 | 6 | 18 | Diesel | 127 |
| OM 902.915 | 102.00 | 6374 | 6 | 18 | Diesel | 127 |
| OM 902.916 | 102.00 | 6374 | 6 | 18 | Diesel | 127 |
| OM 902.917 | 102.00 | 6374 | 6 | 18 | Diesel | 127 |
| OM 902.918 | 102.00 | 6374 | 6 | 18 | Diesel | 127 |
| OM 902.919 | 102.00 | 6374 | 6 | 18 | Diesel | 127 |
| OM 902.920 | 102.00 | 6374 | 6 | 18 | Diesel | 127 |
| OM 902.921 | 102.00 | 6374 | 6 | 18 | Diesel | 127 |
| OM 902.922 | 102.00 | 6374 | 6 | 18 | Diesel | 127 |
| OM 902.923 | 102.00 | 6374 | 6 | 18 | Diesel | 127 |
| OM 902.924 | 102.00 | 6374 | 6 | 18 | Diesel | 127 |
| OM 902.925 | 102.00 | 6374 | 6 | 18 | Diesel | 127 |
| OM 902.926 | 102.00 | 6374 | 6 | 18 | Diesel | 127 |
| OM 902.927 | 102.00 | 6374 | 6 | 18 | Diesel | 127 |
| OM 902.930 | 102.00 | 6374 | 6 | 18 | Diesel | 127 |
| OM 902.931 | 102.00 | 6374 | 6 | 18 | Diesel | 127 |
| OM 902.932 | 102.00 | 6374 | 6 | 18 | Diesel | 127 |
| OM 902.933 | 102.00 | 6374 | 6 | 18 | Diesel | 127 |
| OM 902.934 | 102.00 | 6374 | 6 | 18 | Diesel | 127 |
| OM 902.935 | 102.00 | 6374 | 6 | 18 | Diesel | 127 |
| OM 902.936 | 102.00 | 6374 | 6 | 18 | Diesel | 127 |

|  |  | ccm |  |  |  |  |
|---|---|------|---|---|---|---|
| OM 904.904 | 102.00 | 4249 | 4 | 12 | Diesel | 126 |
| OM 904.905 | 102.00 | 4249 | 4 | 12 | Diesel | 126 |
| OM 904.906 | 102.00 | 4249 | 4 | 12 | Diesel | 126 |
| OM 904.907 | 102.00 | 4249 | 4 | 12 | Diesel | 126 |
| OM 904.908 | 102.00 | 4249 | 4 | 12 | Diesel | 126 |
| OM 904.909 | 102.00 | 4249 | 4 | 12 | Diesel | 126 |
| OM 904.910 | 102.00 | 4249 | 4 | 12 | Diesel | 126 |
| OM 904.911 | 102.00 | 4249 | 4 | 12 | Diesel | 126 |
| OM 904.912 | 102.00 | 4249 | 4 | 12 | Diesel | 126 |
| OM 904.914 | 102.00 | 4249 | 4 | 12 | Diesel | 126 |
| OM 904.915 | 102.00 | 4249 | 4 | 12 | Diesel | 126 |
| OM 904.916 | 102.00 | 4249 | 4 | 12 | Diesel | 126 |
| OM 904.917 | 102.00 | 4249 | 4 | 12 | Diesel | 126 |
| OM 904.918 | 102.00 | 4249 | 4 | 12 | Diesel | 126 |
| OM 904.919 | 102.00 | 4249 | 4 | 12 | Diesel | 126 |
| OM 904.920 | 102.00 | 4249 | 4 | 12 | Diesel | 126 |
| OM 904.921 | 102.00 | 4249 | 4 | 12 | Diesel | 126 |
| OM 904.922 | 102.00 | 4249 | 4 | 12 | Diesel | 126 |
| OM 904.923 | 102.00 | 4249 | 4 | 12 | Diesel | 126 |
| OM 904.924 | 102.00 | 4249 | 4 | 12 | Diesel | 126 |
| OM 904.925 | 102.00 | 4249 | 4 | 12 | Diesel | 126 |
| OM 904.926 | 102.00 | 4249 | 4 | 12 | Diesel | 126 |
| OM 904.927 | 102.00 | 4249 | 4 | 12 | Diesel | 126 |
| OM 904.928 | 102.00 | 4249 | 4 | 12 | Diesel | 126 |
| OM 904.929 | 102.00 | 4249 | 4 | 12 | Diesel | 126 |
| OM 904.930 | 102.00 | 4249 | 4 | 12 | Diesel | 126 |
| OM 904.931 | 102.00 | 4249 | 4 | 12 | Diesel | 126 |
| OM 904.932 | 102.00 | 4249 | 4 | 12 | Diesel | 126 |
| OM 904.933 | 102.00 | 4249 | 4 | 12 | Diesel | 126 |
| OM 904.934 | 102.00 | 4249 | 4 | 12 | Diesel | 126 |
| OM 904.935 | 102.00 | 4249 | 4 | 12 | Diesel | 126 |
| OM 904.936 | 102.00 | 4249 | 4 | 12 | Diesel | 126 |
| OM 904.937 | 102.00 | 4249 | 4 | 12 | Diesel | 126 |
| OM 904.938 | 102.00 | 4249 | 4 | 12 | Diesel | 126 |
| OM 904.939 | 102.00 | 4249 | 4 | 12 | Diesel | 126 |
| OM 904.940 | 102.00 | 4249 | 4 | 12 | Diesel | 126 |
| OM 904.941 | 102.00 | 4249 | 4 | 12 | Diesel | 126 |
| OM 904.942 | 102.00 | 4249 | 4 | 12 | Diesel | 126 |
| OM 904.943 | 102.00 | 4249 | 4 | 12 | Diesel | 126 |
| OM 904.944 | 102.00 | 4249 | 4 | 12 | Diesel | 126 |
| OM 904.945 | 102.00 | 4249 | 4 | 12 | Diesel | 126 |
| OM 904.946 | 102.00 | 4249 | 4 | 12 | Diesel | 126 |
| OM 904.947 | 102.00 | 4249 | 4 | 12 | Diesel | 126 |
| OM 904.948 | 102.00 | 4249 | 4 | 12 | Diesel | 126 |
| OM 904.949 | 102.00 | 4249 | 4 | 12 | Diesel | 126 |
| OM 904.950 | 102.00 | 4249 | 4 | 12 | Diesel | 126 |
| OM 904.951 | 102.00 | 4249 | 4 | 12 | Diesel | 126 |
| OM 904.952 | 102.00 | 4249 | 4 | 12 | Diesel | 126 |
| OM 904.953 | 102.00 | 4249 | 4 | 12 | Diesel | 126 |
| OM 904.954 | 102.00 | 4249 | 4 | 12 | Diesel | 126 |
| OM 904.955 | 102.00 | 4249 | 4 | 12 | Diesel | 126 |
| OM 904.956 | 102.00 | 4249 | 4 | 12 | Diesel | 126 |
| OM 904.957 | 102.00 | 4249 | 4 | 12 | Diesel | 126 |
| OM 904.959 | 102.00 | 4249 | 4 | 12 | Diesel | 126 |
| OM 904.961 | 102.00 | 4249 | 4 | 12 | Diesel | 126 |
| OM 904.962 | 102.00 | 4249 | 4 | 12 | Diesel | 126 |
| OM 904.964 | 102.00 | 4249 | 4 | 12 | Diesel | 126 |
| OM 904.965 | 102.00 | 4249 | 4 | 12 | Diesel | 126 |
| OM 904.966 | 102.00 | 4249 | 4 | 12 | Diesel | 126 |
| OM 904.967 | 102.00 | 4249 | 4 | 12 | Diesel | 126 |
| OM 904.968 | 102.00 | 4249 | 4 | 12 | Diesel | 126 |
| OM 904.970 | 102.00 | 4249 | 4 | 12 | Diesel | 126 |
| OM 904.972 | 102.00 | 4249 | 4 | 12 | Diesel | 126 |
| OM 904.973 | 102.00 | 4249 | 4 | 12 | Diesel | 126 |
| OM 904.976 | 102.00 | 4249 | 4 | 12 | Diesel | 126 |
| OM 904.979 | 102.00 | 4249 | 4 | 12 | Diesel | 126 |

|  |  | ccm |  |  |  |  |
|---|---|------|--|---|---|---|
| OM 906.910 | 102.00 | 6374 | 6 | 18 | Diesel | 127 |
| OM 906.911 | 102.00 | 6374 | 6 | 18 | Diesel | 127 |
| OM 906.912 | 102.00 | 6374 | 6 | 18 | Diesel | 127 |
| OM 906.913 | 102.00 | 6374 | 6 | 18 | Diesel | 127 |
| OM 906.914 | 102.00 | 6374 | 6 | 18 | Diesel | 127 |
| OM 906.915 | 102.00 | 6374 | 6 | 18 | Diesel | 127 |
| OM 906.916 | 102.00 | 6374 | 6 | 18 | Diesel | 127 |
| OM 906.917 | 102.00 | 6374 | 6 | 18 | Diesel | 127 |
| OM 906.918 | 102.00 | 6374 | 6 | 18 | Diesel | 127 |
| OM 906.919 | 102.00 | 6374 | 6 | 18 | Diesel | 127 |
| OM 906.920 | 102.00 | 6374 | 6 | 18 | Diesel | 127 |
| OM 906.921 | 102.00 | 6374 | 6 | 18 | Diesel | 127 |
| OM 906.922 | 102.00 | 6374 | 6 | 18 | Diesel | 127 |
| OM 906.923 | 102.00 | 6374 | 6 | 18 | Diesel | 127 |
| OM 906.924 | 102.00 | 6374 | 6 | 18 | Diesel | 127 |
| OM 906.925 | 102.00 | 6374 | 6 | 18 | Diesel | 127 |
| OM 906.926 | 102.00 | 6374 | 6 | 18 | Diesel | 127 |
| OM 906.927 | 102.00 | 6374 | 6 | 18 | Diesel | 127 |
| OM 906.928 | 102.00 | 6374 | 6 | 18 | Diesel | 127 |
| OM 906.929 | 102.00 | 6374 | 6 | 18 | Diesel | 127 |
| OM 906.930 | 102.00 | 6374 | 6 | 18 | Diesel | 127 |
| OM 906.931 | 102.00 | 6374 | 6 | 18 | Diesel | 127 |
| OM 906.932 | 102.00 | 6374 | 6 | 18 | Diesel | 127 |
| OM 906.933 | 102.00 | 6374 | 6 | 18 | Diesel | 127 |
| OM 906.934 | 102.00 | 6374 | 6 | 18 | Diesel | 127 |
| OM 906.935 | 102.00 | 6374 | 6 | 18 | Diesel | 127 |
| OM 906.936 | 102.00 | 6374 | 6 | 18 | Diesel | 127 |
| OM 906.937 | 102.00 | 6374 | 6 | 18 | Diesel | 127 |
| OM 906.938 | 102.00 | 6374 | 6 | 18 | Diesel | 127 |
| OM 906.939 | 102.00 | 6374 | 6 | 18 | Diesel | 127 |
| OM 906.940 | 102.00 | 6374 | 6 | 18 | Diesel | 127 |
| OM 906.941 | 102.00 | 6374 | 6 | 18 | Diesel | 127 |
| OM 906.944 | 102.00 | 6374 | 6 | 18 | Diesel | 127 |
| OM 906.945 | 102.00 | 6374 | 6 | 18 | Diesel | 127 |
| OM 906.946 | 102.00 | 6374 | 6 | 18 | Diesel | 127 |
| OM 906.947 | 102.00 | 6374 | 6 | 18 | Diesel | 127 |
| OM 906.948 | 102.00 | 6374 | 6 | 18 | Diesel | 127 |
| OM 906.949 | 102.00 | 6374 | 6 | 18 | Diesel | 127 |
| OM 906.950 | 102.00 | 6374 | 6 | 18 | Diesel | 127 |
| OM 906.951 | 102.00 | 6374 | 6 | 18 | Diesel | 127 |
| OM 906.952 | 102.00 | 6374 | 6 | 18 | Diesel | 127 |
| OM 906.953 | 102.00 | 6374 | 6 | 18 | Diesel | 127 |
| OM 906.954 | 102.00 | 6374 | 6 | 18 | Diesel | 127 |
| OM 906.955 | 102.00 | 6374 | 6 | 18 | Diesel | 127 |
| OM 906.956 | 102.00 | 6374 | 6 | 18 | Diesel | 127 |
| OM 906.957 | 102.00 | 6374 | 6 | 18 | Diesel | 127 |
| OM 906.958 | 102.00 | 6374 | 6 | 18 | Diesel | 127 |
| OM 906.959 | 102.00 | 6374 | 6 | 18 | Diesel | 127 |
| OM 906.960 | 102.00 | 6374 | 6 | 18 | Diesel | 127 |
| OM 906.961 | 102.00 | 6374 | 6 | 18 | Diesel | 127 |
| OM 906.962 | 102.00 | 6374 | 6 | 18 | Diesel | 127 |
| OM 906.963 | 102.00 | 6374 | 6 | 18 | Diesel | 127 |
| OM 906.964 | 102.00 | 6374 | 6 | 18 | Diesel | 127 |
| OM 906.965 | 102.00 | 6374 | 6 | 18 | Diesel | 127 |
| OM 906.966 | 102.00 | 6374 | 6 | 18 | Diesel | 127 |
| OM 906.967 | 102.00 | 6374 | 6 | 18 | Diesel | 127 |
| OM 906.968 | 102.00 | 6374 | 6 | 18 | Diesel | 127 |
| OM 906.970 | 102.00 | 6374 | 6 | 18 | Diesel | 127 |
| OM 906.971 | 102.00 | 6374 | 6 | 18 | Diesel | 127 |
| OM 906.974 | 102.00 | 6374 | 6 | 18 | Diesel | 127 |
| OM 906.975 | 102.00 | 6374 | 6 | 18 | Diesel | 127 |
| OM 906.976 | 102.00 | 6374 | 6 | 18 | Diesel | 127 |
| OM 906.977 | 102.00 | 6374 | 6 | 18 | Diesel | 127 |
| OM 906.978 | 102.00 | 6374 | 6 | 18 | Diesel | 127 |
| OM 906.979 | 102.00 | 6374 | 6 | 18 | Diesel | 127 |
| OM 906.980 | 102.00 | 6374 | 6 | 18 | Diesel | 127 |

|  |  | ccm |  |  |  |  |
|---|---|------|---|---|---|---|
| OM 906.981 | 102.00 | 6374 | 6 | 18 | Diesel | 127 |
| OM 906.982 | 102.00 | 6374 | 6 | 18 | Diesel | 127 |
| OM 906.983 | 102.00 | 6374 | 6 | 18 | Diesel | 127 |
| OM 906.985 | 102.00 | 6374 | 6 | 18 | Diesel | 127 |
| OM 906.986 | 102.00 | 6374 | 6 | 18 | Diesel | 127 |
| OM 906.988 | 102.00 | 6374 | 6 | 18 | Diesel | 127 |
| OM 906.990 | 102.00 | 6374 | 6 | 18 | Diesel | 127 |
| OM 906.991 | 102.00 | 6374 | 6 | 18 | Diesel | 127 |
| OM 906.995 | 102.00 | 6374 | 6 | 18 | Diesel | 127 |
| OM 906.998 | 102.00 | 6374 | 6 | 18 | Diesel | 127 |
| OM 906.998 | 102.00 | 6374 | 6 | 18 | Diesel | 127 |
| OM 907.910 | 102.00 | 4249 | 4 | 12 | Diesel | 126 |
| OM 907.920 | 102.00 | 4249 | 4 | 12 | Diesel | 126 |
| OM 907.930 | 102.00 | 4249 | 4 | 12 | Diesel | 126 |
| OM 907.940 | 102.00 | 4249 | 4 | 12 | Diesel | 126 |
| OM 907.941 | 102.00 | 4249 | 4 | 12 | Diesel | 126 |
| OM 907.960 | 102.00 | 4249 | 4 | 12 | Diesel | 126 |
| OM 907.970 | 102.00 | 4249 | 4 | 12 | Diesel | 126 |
| OM 907.980 | 102.00 | 4249 | 4 | 12 | Diesel | 126 |
| OM 907.990 | 102.00 | 4249 | 4 | 12 | Diesel | 126 |
| OM 909.900 | 102.00 | 6374 | 6 | 18 | Diesel | 127 |
| OM 909.901 | 102.00 | 6374 | 6 | 18 | Diesel | 127 |
| OM 909.910 | 102.00 | 6374 | 6 | 18 | Diesel | 127 |
| OM 909.911 | 102.00 | 6374 | 6 | 18 | Diesel | 127 |
| OM 909.920 | 102.00 | 6374 | 6 | 18 | Diesel | 127 |
| OM 909.921 | 102.00 | 6374 | 6 | 18 | Diesel | 127 |
| OM 909.960 | 102.00 | 6374 | 6 | 18 | Diesel | 127 |
| OM 909.970 | 102.00 | 6374 | 6 | 18 | Diesel | 127 |
| OM 909.971 | 102.00 | 6374 | 6 | 18 | Diesel | 127 |
| OM 924.910 | 106.00 | 4801 | 4 | 12 | Diesel | 128 |
| OM 924.911 | 106.00 | 4801 | 4 | 12 | Diesel | 128 |
| OM 924.912 | 106.00 | 4801 | 4 | 12 | Diesel | 128 |
| OM 924.914 | 106.00 | 4801 | 4 | 12 | Diesel | 128 |
| OM 924.915 | 106.00 | 4801 | 4 | 12 | Diesel | 128 |
| OM 924.916 | 106.00 | 4801 | 4 | 12 | Diesel | 128 |
| OM 924.917 | 106.00 | 4801 | 4 | 12 | Diesel | 128 |
| OM 924.919 | 106.00 | 4801 | 4 | 12 | Diesel | 128 |
| OM 924.920 | 106.00 | 4801 | 4 | 12 | Diesel | 128 |
| OM 924.922 | 106.00 | 4801 | 4 | 12 | Diesel | 128 |
| OM 924.923 | 106.00 | 4801 | 4 | 12 | Diesel | 128 |
| OM 924.924 | 106.00 | 4801 | 4 | 12 | Diesel | 128 |
| OM 924.925 | 106.00 | 4801 | 4 | 12 | Diesel | 128 |
| OM 924.928 | 106.00 | 4801 | 4 | 12 | Diesel | 128 |
| OM 924.929 | 106.00 | 4801 | 4 | 12 | Diesel | 128 |
| OM 924.930 | 106.00 | 4801 | 4 | 12 | Diesel | 128 |
| OM 924.931 | 106.00 | 4801 | 4 | 12 | Diesel | 128 |
| OM 924.932 | 106.00 | 4801 | 4 | 12 | Diesel | 128 |
| OM 924.933 | 106.00 | 4801 | 4 | 12 | Diesel | 128 |
| OM 925.920 | 106.00 | 7201 | 6 | 18 | Diesel | 130 |
| OM 926.910 | 106.00 | 7201 | 6 | 18 | Diesel | 131 |
| OM 926.911 | 106.00 | 7201 | 6 | 18 | Diesel | 131 |
| OM 926.912 | 106.00 | 7201 | 6 | 18 | Diesel | 131 |
| OM 926.913 | 106.00 | 7201 | 6 | 18 | Diesel | 131 |
| OM 926.914 | 106.00 | 7201 | 6 | 18 | Diesel | 131 |
| OM 926.915 | 106.00 | 7201 | 6 | 18 | Diesel | 131 |
| OM 926.916 | 106.00 | 7201 | 6 | 18 | Diesel | 131 |
| OM 926.917 | 106.00 | 7201 | 6 | 18 | Diesel | 131 |
| OM 926.918 | 106.00 | 7201 | 6 | 18 | Diesel | 131 |
| OM 926.919 | 106.00 | 7201 | 6 | 18 | Diesel | 131 |
| OM 926.920 | 106.00 | 7201 | 6 | 18 | Diesel | 131 |
| OM 926.921 | 106.00 | 7201 | 6 | 18 | Diesel | 131 |
| OM 926.924 | 106.00 | 7201 | 6 | 18 | Diesel | 131 |
| OM 926.925 | 106.00 | 7201 | 6 | 18 | Diesel | 131 |
| OM 926.926 | 106.00 | 7201 | 6 | 18 | Diesel | 131 |
| OM 926.927 | 106.00 | 7201 | 6 | 18 | Diesel | 131 |
| OM 926.928 | 106.00 | 7201 | 6 | 18 | Diesel | 131 |

|  |  | ccm |  |  |  |  |
|---|---|-------|--|---|---|---|
| OM 926.929 | 106.00 | 7201 | 6 | 18 | Diesel | 131 |
| OM 926.930 | 106.00 | 7201 | 6 | 18 | Diesel | 131 |
| OM 926.932 | 106.00 | 7201 | 6 | 18 | Diesel | 131 |
| OM 926.934 | 106.00 | 7201 | 6 | 18 | Diesel | 131 |
| OM 926.935 | 106.00 | 7201 | 6 | 18 | Diesel | 131 |
| OM 926.937 | 106.00 | 7201 | 6 | 18 | Diesel | 131 |
| OM 926.938 | 106.00 | 7201 | 6 | 18 | Diesel | 131 |
| OM 926.939 | 106.00 | 7201 | 6 | 18 | Diesel | 131 |
| OM 926.940 | 106.00 | 7201 | 6 | 18 | Diesel | 131 |
| OM 926.941 | 106.00 | 7201 | 6 | 18 | Diesel | 131 |
| OM 926.942 | 106.00 | 7201 | 6 | 18 | Diesel | 131 |
| OM 926.945 | 106.00 | 7201 | 6 | 18 | Diesel | 131 |
| OM 926.947 | 106.00 | 7201 | 6 | 18 | Diesel | 131 |
| OM 926.948 | 106.00 | 7201 | 6 | 18 | Diesel | 131 |
| OM 926.949 | 106.00 | 7201 | 6 | 18 | Diesel | 130 |
| OM 926.950 | 106.00 | 7201 | 6 | 18 | Diesel | 131 |
| OM 941.910 | 130.00 | 11946 | 6 | 24 | Diesel | 176 |
| OM 941.920 | 130.00 | 11946 | 6 | 24 | Diesel | 176 |
| OM 941.921 | 130.00 | 11946 | 6 | 24 | Diesel | 176 |
| OM 941.929 | 130.00 | 11946 | 6 | 24 | Diesel | 176 |
| OM 941.930 | 130.00 | 11946 | 6 | 24 | Diesel | 176 |
| OM 941.940 | 130.00 | 11946 | 6 | 24 | Diesel | 176 |
| OM 941.960 | 130.00 | 11946 | 6 | 24 | Diesel | 176 |
| OM 941.970 | 130.00 | 11946 | 6 | 24 | Diesel | 176 |
| OM 941.980 | 130.00 | 11946 | 6 | 24 | Diesel | 176 |
| OM 941.981 | 130.00 | 11946 | 6 | 24 | Diesel | 176 |
| OM 941.990 | 130.00 | 11946 | 6 | 24 | Diesel | 176 |
| OM 941.991 | 130.00 | 11946 | 6 | 24 | Diesel | 177 |
| OM 942.900 | 130.00 | 15928 | 8 | 32 | Diesel | 181 |
| OM 942.910 | 130.00 | 15928 | 8 | 32 | Diesel | 181 |
| OM 942.911 | 130.00 | 15928 | 8 | 32 | Diesel | 181 |
| OM 942.912 | 130.00 | 15928 | 8 | 32 | Diesel | 181 |
| OM 942.925 | 130.00 | 15928 | 8 | 32 | Diesel | 181 |
| OM 942.930 | 130.00 | 15928 | 8 | 32 | Diesel | 181 |
| OM 942.960 | 130.00 | 15928 | 8 | 32 | Diesel | 181 |
| OM 942.967 | 130.00 | 15928 | 8 | 32 | Diesel | 181 |
| OM 942.970 | 130.00 | 15928 | 8 | 32 | Diesel | 181 |
| OM 942.980 | 130.00 | 15928 | 8 | 32 | Diesel | 181 |
| OM 942.990 | 130.00 | 15928 | 8 | 32 | Diesel | 181 |

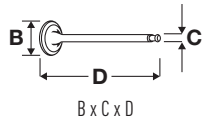

OE

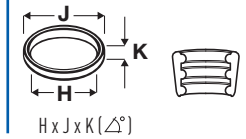
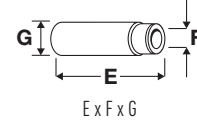
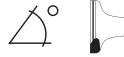

1  **63.50**

| | | | | | | | |
|-----------------------|-------|--------|-----------------|-----------|--------|-------------------------------|----------------|
| M 160 E6AL B03 | 599cc | 3 Cyl. | 6 Valves | 40kW/55PS | Petrol | Turbo, SOHC, Injection | TD9520 |
| M 160 E6AL B04 | 599cc | 3 Cyl. | 6 Valves | 33kW/45PS | Petrol | SOHC | TD16490 |
| M 160 E6AL B05 | 599cc | 3 Cyl. | 6 Valves | 45kW/61PS | Petrol | SOHC | TD16491 |

V94803  30.00 x 6.00 x 89.35

160 053 00 01

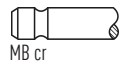

45°

H

VAG96310    34.50 x 6.00 x 12.56



V94804  25.00 x 6.00 x 89.20

160 050 00 27

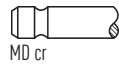

45°

SS

2  **75.00**

| | | | | | | | |
|------------------|--------|--------|------------------|------------|--------|-------------|----------------|
| M 135.950 | 1499cc | 4 Cyl. | 16 Valves | 80kW/109PS | Petrol | DOHC | TD23764 |
|------------------|--------|--------|------------------|------------|--------|-------------|----------------|

V98083  30.40 x 5.00 x 89.60

135 053 00 01

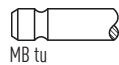

45°

V98084  25.40 x 5.00 x 90.90

135 053 00 05

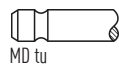

45°

3  **76.00**

| | | | | | | | |
|-------------------|--------|--------|-----------------|------------------|--------|--------------|----------------|
| OM 607.951 | 1461cc | 4 Cyl. | 8 Valves | 55-81kW/75-110PS | Diesel | Turbo | TD26816 |
|-------------------|--------|--------|-----------------|------------------|--------|--------------|----------------|

A-CLASS (W176) A 160 CDI 06/2013→
B-CLASS (W246, W242) B 160 CDI 05/2013→
CITAN (415) 108 CDI 11/2012→
CITAN (415) 111 CDI 06/2013→
CITAN Mixto (415) 111 CDI 06/2013→
CLA (X117) CLA 180 d 07/2015→

A-CLASS (W176) A 180 CDI 06/2012→
B-CLASS (W246, W242) B 180 CDI 02/2013→
CITAN (415) 109 CDI 11/2012→
CITAN Mixto (415) 109 CDI 11/2012→
CLA (C117) CLA 180 CDI 10/2013→
GLA-CLASS (X156) GLA 180 CDI 07/2014→

V94608  33.50 x 6.00 x 100.90

607 053 12 00

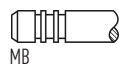

45°

Y

H

VAG96354B    40.50 x 6.00 x 12.08



V94609  29.00 x 6.00 x 100.70

626 050 09 00



45°

H

4  **80.00**

| | | | | | | | |
|------------------|--------|--------|-----------------|-----------|--------|-------------|---------------|
| M 166.940 | 1397cc | 4 Cyl. | 8 Valves | 60kW/82PS | Petrol | SOHC | TD9445 |
|------------------|--------|--------|-----------------|-----------|--------|-------------|---------------|

A-CLASS (W168) A 140 07/1997→08/2004

V94394  40.00 x 6.00 x 103.00

166 053 0101

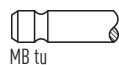

45°

H

VAG96095  37.60 x 6.00 x 12.55

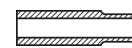

V94395  34.00 x 7.00 x 102.70

166 050 03 27

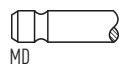

45°

SS

VAG96096  37.60 x 7.00 x 12.55

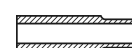

5  **80.00**

| | | | | | | | |
|------------------|--------|--------|-----------------|------------------|--------|-------------|---------------|
| M 166.960 | 1598cc | 4 Cyl. | 8 Valves | 60-75kW/82-102PS | Petrol | SOHC | TD9446 |
|------------------|--------|--------|-----------------|------------------|--------|-------------|---------------|

| | | | | | | | |
|------------------|--------|--------|-----------------|------------------|--------|-------------|----------------|
| M 166.961 | 1598cc | 4 Cyl. | 8 Valves | 60-75kW/82-102PS | Petrol | SOHC | TD18174 |
|------------------|--------|--------|-----------------|------------------|--------|-------------|----------------|

A-CLASS (W168) A 140 01/2001→08/2004
VANE0 (414) 1.6 02/2002→07/2005

A-CLASS (W168) A 160 07/1997→08/2004

V94394  40.00 x 6.00 x 103.00

166 053 0101

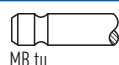

45°

H

VAG96095  37.60 x 6.00 x 12.55

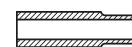

V94395  34.00 x 7.00 x 102.70

166 050 03 27

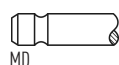

45°

SS

VAG96096  37.60 x 7.00 x 12.55

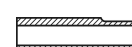



OE

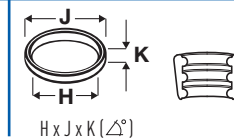
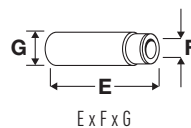

6 80.00

| | | | | | | | |
|-------------------|--------|--------|------------------|-----------------|--------|--------------------|----------------|
| OM 668.914 | 1689cc | 4 Cyl. | 16 Valves | 55-67kW/75-91PS | Diesel | Turbo, DOHC | TD18173 |
| OM 668.940 | 1689cc | 4 Cyl. | 16 Valves | 55-66kW/75-90PS | Diesel | Turbo, DOHC | TD10647 |
| OM 668.941 | 1689cc | 4 Cyl. | 16 Valves | 44kW/60PS | Diesel | Turbo, DOHC | TD10648 |
| OM 668.942 | 1689cc | 4 Cyl. | 16 Valves | 70kW/95PS | Diesel | Turbo, DOHC | TD17001 |

| | | | |
|--------------------------|-----------------|--------------------------|-----------------|
| A-CLASS (W168) A 160 CDI | 07/1998→08/2004 | A-CLASS (W168) A 170 CDI | 07/1998→08/2004 |
| VANEO (414) 1.7 CDI | 02/2002→07/2005 | | |

| | | | | | | |
|-----------------------|---------------|---------|-----|---|----------------------|--|
| V94400 | 668 053 03 01 | | 45° | H | VAG96098 | |
| 29.60 x 6.00 x 105.20 | | MB cr | | | 47.50 x 6.00 x 11.55 | |
| V94401 | 668 050 02 27 | | 45° | H | | |
| 24.60 x 7.00 x 105.00 | | MD + MB | | | | |

7 80.00

| | | | | | | | |
|-------------------|-----------------|-------------------|------------------|-----------------|--------|-------------|---------------|
| M 180.921 | 2171cc | 6 Cyl. | 12 Valves | 62-66kW/85-90PS | Petrol | SOHC | TD9958 |
| PONTON (W105) 219 | 03/1956→07/1959 | PONTON (W180) 220 | 01/1954→12/1956 | | | | |

| | | | | | | |
|------------------------|---------------|---------|-----|----|---|--|
| V94536 | 180 053 15 05 | | 45° | ss | H | |
| 35.10 x 10.00 x 112.70 | | MD + MB | | | | |

8 80.00

| | | | | | | | |
|------------------|--------|--------|------------------|------------|--------|-------------|---------------|
| M 127.982 | 2180cc | 6 Cyl. | 12 Valves | 88kW/120PS | Petrol | SOHC | TD9951 |
| M 127.984 | 2180cc | 6 Cyl. | 12 Valves | 88kW/120PS | Petrol | SOHC | TD9987 |
| M 180.940 | 2180cc | 6 Cyl. | 12 Valves | 70kW/95PS | Petrol | SOHC | TD9949 |
| M 180.941 | 2180cc | 6 Cyl. | 12 Valves | 81kW/110PS | Petrol | SOHC | TD9950 |

| | | | |
|--------------------------------|-----------------|---------------------------------|-----------------|
| COUPE (W111) 220 SEB | 01/1961→12/1965 | HECKFLOSSE (W111, W112) 220 B | 08/1959→08/1965 |
| HECKFLOSSE (W111, W112) 220 SB | 08/1959→08/1965 | HECKFLOSSE (W111, W112) 220 SEB | 08/1959→08/1965 |

| | | | | | | |
|------------------------|---------------|---------|-----|----|---|--|
| V94536 | 180 053 15 05 | | 45° | ss | H | |
| 35.10 x 10.00 x 112.70 | | MD + MB | | | | |

9 80.00

| | | | | | | | |
|------------------|--------|--------|------------------|-----------|--------|-------------|----------------|
| M 180.922 | 2195cc | 6 Cyl. | 12 Valves | 70kW/95PS | Petrol | SOHC | TD22718 |
| M 180.926 | 2195cc | 6 Cyl. | 12 Valves | 70kW/95PS | Petrol | SOHC | TD22719 |
| M 180.927 | 2195cc | 6 Cyl. | 12 Valves | 70kW/95PS | Petrol | SOHC | TD22720 |
| M 180.928 | 2195cc | 6 Cyl. | 12 Valves | 70kW/95PS | Petrol | SOHC | TD22721 |
| M 180.929 | 2195cc | 6 Cyl. | 12 Valves | 70kW/95PS | Petrol | SOHC | TD22722 |
| M 180.942 | 2195cc | 6 Cyl. | 12 Valves | 70kW/95PS | Petrol | SOHC | TD22724 |
| M 180.943 | 2195cc | 6 Cyl. | 12 Valves | 70kW/95PS | Petrol | SOHC | TD22725 |
| M 180.952 | 2195cc | 6 Cyl. | 12 Valves | 67kW/91PS | Petrol | SOHC | TD18356 |
| M 180.953 | 2195cc | 6 Cyl. | 12 Valves | 60kW/82PS | Petrol | SOHC | TD18357 |

| | |
|--------|-----------------|
| UNIMOG | 01/1955→12/1976 |
|--------|-----------------|

| | | | | | | |
|------------------------|---------------|---------|-----|----|---|--|
| V94536 | 180 053 15 05 | | 45° | ss | H | |
| 35.10 x 10.00 x 112.70 | | MD + MB | | | | |

10 80.00

| | | | | | | | |
|------------------|--------|--------|------------------|-----------|--------|-------------|----------------|
| M 180.958 | 2196cc | 6 Cyl. | 24 Valves | 60kW/82PS | Petrol | SOHC | TD16997 |
|------------------|--------|--------|------------------|-----------|--------|-------------|----------------|

| | | | | | | |
|------------------------|---------------|---------|-----|----|---|--|
| V94536 | 180 053 15 05 | | 45° | ss | H | |
| 35.10 x 10.00 x 112.70 | | MD + MB | | | | |



OE

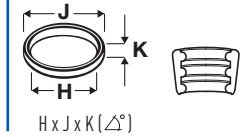
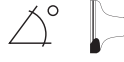

11  **81.00**

| | | | | | | | |
|-----------------------|--------|-----------------|------------------|-------------|--------|-------------|---------------|
| M 104.900 | 2792cc | V6 Cyl. | 12 Valves | 128kW/174PS | Petrol | DOHC | TD8023 |
| V-CLASS (638/2) V 280 | | 08/1997→07/2003 | | | | | |

V94145 
39.10 x 7.00 x 106.00

021 109 601K

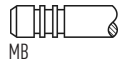

45°

H

VAG96157B 
38.00 x 7.00 x 12.00



V94306 
34.20 x 7.00 x 107.00

021 109 611D



45°

SS

H

12  **81.50**

| | | | | | | | |
|-------------------------------|--------|-----------------|------------------|------------|--------|-------------|---------------|
| M 180.947 | 2281cc | 6 Cyl. | 12 Valves | 88kW/120PS | Petrol | SOHC | TD9952 |
| HECKFLOSSE (W111, W112) 230 S | | 07/1965→01/1968 | | | | | |

V95096 
37.00 x 10.95 x 113.20

115 050 00 27

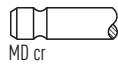

45°

SS

VAG51028B 
55.00 x 9.02 x 14.06



VAG92200B 
45.00 x 11.02 x 15.06



13  **81.50**

| | | | | | | | |
|-----------------------|--------|-----------------|------------------|-------------------------------|--------|-----------------|---------------|
| M 180.945 | 2293cc | 6 Cyl. | 12 Valves | 77kW/105PS | Petrol | SOHC | TD9964 |
| M 180.949 | 2293cc | 6 Cyl. | 12 Valves | 77kW/105PS | Petrol | SOHC | TD9965 |
| M 180.950 | 2293cc | 6 Cyl. | 12 Valves | 88kW/120PS | Petrol | SOHC | TD9953 |
| HECKFLOSSE (W110) 230 | | 07/1965→02/1968 | | HECKFLOSSE (W111, W112) 230 S | | 07/1965→01/1968 | |

V95096 
37.00 x 10.95 x 113.20

115 050 00 27

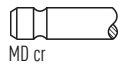

45°

SS

VAG51028B 
55.00 x 9.02 x 14.06

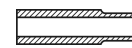

VAG92200B 
45.00 x 11.02 x 15.06

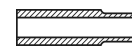

14  **82.00**

| | | | | | | | |
|---------------------------|--------|-----------------|------------------|----------------------|--------|---------------------------|----------------|
| M 271.910 | 1597cc | 4 Cyl. | 16 Valves | 105-115kW/143-156PS | Petrol | Supercharged, DOHC | TD23992 |
| M 271.911 | 1597cc | 4 Cyl. | 16 Valves | 95kW/129PS | Petrol | DOHC | TD23993 |
| C-CLASS (S204) C 180 | | 01/2008→08/2014 | | C-CLASS (W204) C 180 | | 01/2008→01/2014 | |
| CLC-CLASS (CL203) CLC 160 | | 02/2009→06/2011 | | | | | |

V95075 
30.50 x 5.96 x 105.35

271 053 05 01

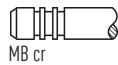

45°

H

VAG96043B 
43.50 x 6.01 x 12.56



V95076 
27.00 x 5.96 x 109.20

271 050 06 27



45°

SS

H

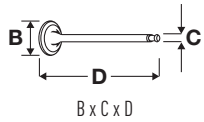

OE

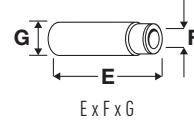
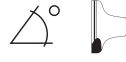

E x F x G

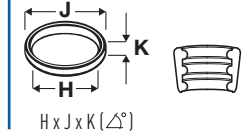

H x J x K (Δ°)

15 82.00

| | | | | | | | |
|--------------------------|-----------------|--------|------------------|--------------------------|-----------------|-------------------------------|----------------|
| M 271.820 | 1796cc | 4 Cyl. | 16 Valves | 115-137kW/156-186PS | Petrol | Turbo, DOHC, Injection | TD23776 |
| M 271.860 | 1796cc | 4 Cyl. | 16 Valves | 135-150kW/184-204PS | Petrol | Turbo, DOHC, Injection | TD23724 |
| M 271.861 | 1796cc | 4 Cyl. | 16 Valves | 135-150kW/184-204PS | Petrol | Turbo, DOHC, Injection | TD25100 |
| C-CLASS (C204) C 180 | 06/2011→ | | | C-CLASS (C204) C 200 CGI | 06/2011→ | | |
| C-CLASS (C204) C 250 | 06/2011→ | | | C-CLASS (S204) C 180 CGI | 11/2009→08/2014 | | |
| C-CLASS (S204) C 200 CGI | 08/2007→08/2014 | | | C-CLASS (S204) C 250 CGI | 07/2009→08/2014 | | |
| C-CLASS (W204) C 180 CGI | 01/2007→01/2014 | | | C-CLASS (W204) C 200 | 05/2011→01/2014 | | |
| C-CLASS (W204) C 200 CGI | 01/2007→01/2014 | | | C-CLASS (W204) C 250 CGI | 07/2009→01/2014 | | |
| E-CLASS (A207) E 200 CGI | 01/2010→ | | | E-CLASS (A207) E 250 CGI | 01/2010→ | | |
| E-CLASS (C207) E 200 CGI | 01/2010→ | | | E-CLASS (C207) E 250 CGI | 01/2009→ | | |
| E-CLASS (S212) E 200 CGI | 11/2009→ | | | E-CLASS (S212) E 250 CGI | 11/2009→ | | |
| E-CLASS (W212) E 200 CGI | 08/2009→ | | | E-CLASS (W212) E 250 CGI | 01/2009→ | | |
| SLK (R172) 200 | 02/2011→ | | | SLK (R172) 250 | 02/2011→ | | |

V80004
32.00 x 6.00 x 105.40

271 053 10 01

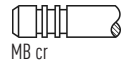

45°

VAG96043B
43.50 x 6.01 x 12.56



V80005
28.00 x 6.00 x 109.30

271 050 11 27



45° ss

16 82.00

| | | | | | | | |
|---------------------------|-----------------|--------|------------------|---------------------------|-----------------|--------------------------------------|----------------|
| M 271.921 | 1796cc | 4 Cyl. | 16 Valves | 90-95kW/122-129PS | Petrol | Supercharged, DOHC | TD18424 |
| M 271.940 | 1796cc | 4 Cyl. | 16 Valves | 120kW/163PS | Petrol | Supercharged, DOHC | TD16883 |
| M 271.941 | 1796cc | 4 Cyl. | 16 Valves | 120kW/163PS | Petrol | Supercharged, DOHC | TD17329 |
| M 271.942 | 1796cc | 4 Cyl. | 16 Valves | 125kW/170PS | Petrol | Supercharged, DOHC, Injection | TD16392 |
| M 271.944 | 1796cc | 4 Cyl. | 16 Valves | 120kW/163PS | Petrol | Supercharged, DOHC | TD17432 |
| M 271.946 | 1796cc | 4 Cyl. | 16 Valves | 105-125kW/143-170PS | Petrol | Supercharged, DOHC | TD17433 |
| M 271.948 | 1796cc | 4 Cyl. | 16 Valves | 141kW/192PS | Petrol | Supercharged, DOHC | TD17434 |
| M 271.956 | 1796cc | 4 Cyl. | 16 Valves | 135kW/184PS | Petrol | Supercharged, DOHC | TD22141 |
| C-CLASS (CL203) C 160 | 05/2002→05/2008 | | | C-CLASS (CL203) C 180 | 05/2002→05/2008 | | |
| C-CLASS (CL203) C 200 | 05/2002→05/2008 | | | C-CLASS (CL203) C 200 CGI | 03/2003→05/2008 | | |
| C-CLASS (CL203) C 220 | 05/2002→05/2008 | | | C-CLASS (CL203) C 230 | 05/2002→05/2008 | | |
| C-CLASS (S203) C 180 | 05/2002→08/2007 | | | C-CLASS (S203) C 200 | 05/2002→08/2007 | | |
| C-CLASS (S203) C 200 CGI | 07/2003→08/2007 | | | C-CLASS (S203) C 230 | 02/2004→08/2007 | | |
| C-CLASS (W203) C 180 | 05/2002→02/2007 | | | C-CLASS (W203) C 200 | 05/2002→02/2007 | | |
| C-CLASS (W203) C 200 CGI | 07/2003→02/2007 | | | C-CLASS (W203) C 230 | 02/2004→02/2007 | | |
| CLC-CLASS (CL203) CLC 180 | 05/2008→06/2011 | | | CLK (A209) CLK 200 | 02/2003→03/2010 | | |
| CLK (A209) CLK 200 CGI | 07/2003→03/2010 | | | CLK (C209) 200 | 09/2002→05/2009 | | |
| CLK (C209) 200 CGI | 07/2003→05/2009 | | | E-CLASS (S211) E 200 | 04/2006→07/2009 | | |
| E-CLASS (S211) E 200 T | 03/2003→07/2009 | | | E-CLASS (W211) E 200 | 11/2002→12/2008 | | |
| E-CLASS (W211) E 200 NGT | 03/2004→12/2008 | | | SLK (R171) 200 | 03/2004→02/2011 | | |

V95075
30.50 x 5.96 x 105.35

271 053 05 01

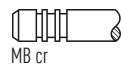

45°

H

VAG96043B
43.50 x 6.01 x 12.56



V98068
30.50 x 7.00 x 105.40

271 053 00 01

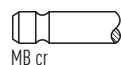

45°

VAG96338
40.00 x 7.02 x 12.56

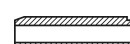

V95076
27.00 x 5.96 x 109.20

271 050 06 27



45° ss

H

V98069
27.00 x 7.00 x 109.20

271 050 04 27

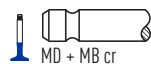

45° ss



OE

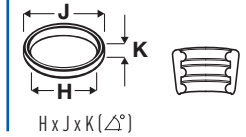
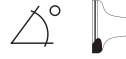

17  **82.00**

| | | | | | | | |
|----------------------|-----------------|--------|------------------|----------------------|-----------------|---------------------------|----------------|
| M 271.950 | 1796cc | 4 Cyl. | 16 Valves | 120-135kW/163-184PS | Petrol | Supercharged, DOHC | TD20359 |
| M 271.952 | 1796cc | 4 Cyl. | 16 Valves | 115kW/156PS | Petrol | Supercharged, DOHC | TD20358 |
| M 271.954 | 1796cc | 4 Cyl. | 16 Valves | 135kW/184PS | Petrol | Supercharged, DOHC | TD21027 |
| M 271.955 | 1796cc | 4 Cyl. | 16 Valves | 135kW/184PS | Petrol | Supercharged, DOHC | TD20858 |
| C-CLASS (S204) C 180 | 08/2007→08/2014 | | | C-CLASS (S204) C 200 | 08/2007→08/2014 | | |
| C-CLASS (W204) C 180 | 01/2007→01/2014 | | | C-CLASS (W204) C 200 | 01/2007→01/2014 | | |
| CLK (A209) CLK 200 | 10/2006→03/2010 | | | CLK (C209) 200 | 10/2006→05/2009 | | |
| SLK (R171) 200 | 01/2008→02/2011 | | | | | | |

V95075 
30.50 x 5.96 x 105.35

271 053 05 01

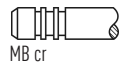

45°

H

VAG96338 
40.00 x 7.02 x 12.56



V95076 
27.00 x 5.96 x 109.20

271 050 06 27



45°

ss

H

18  **82.00**

| | | | | | | | |
|------------------------------|-----------------|--------|------------------|------------------------------|----------|---------------------------|----------------|
| M 271.951 | 1796cc | 4 Cyl. | 16 Valves | 115kW/156PS | Petrol | DOHC | TD23995 |
| M 271.957 | 1796cc | 4 Cyl. | 16 Valves | 120-135kW/163-184PS | Petrol | Supercharged, DOHC | TD23994 |
| CLC-CLASS (CL203) CLC 200 | 05/2008→06/2011 | | | SPRINTER 3,5-t (906) 316 | 09/2008→ | | |
| SPRINTER 3,5-t (906) 316 LGT | 09/2008→ | | | SPRINTER 3,5-t (906) 316 NGT | 09/2008→ | | |
| SPRINTER 3-t (906) 216 | 09/2008→ | | | SPRINTER 5-t (906) 516 | 09/2008→ | | |
| SPRINTER 5-t (906) 516 NGT | 09/2008→ | | | | | | |

V95075 
30.50 x 5.96 x 105.35

271 053 05 01

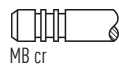

45°

H

VAG96043B 
43.50 x 6.01 x 12.56



V95076 
27.00 x 5.96 x 109.20

271 050 06 27



45°

ss

H

19  **82.00**

| | | | | | | | |
|------------------|-----------------|--------|------------------|------------|--------|-------------|----------------|
| M 180.954 | 2292cc | 6 Cyl. | 12 Valves | 88kW/120PS | Petrol | SOHC | TD2201 |
| M 180.955 | 2292cc | 6 Cyl. | 12 Valves | 88kW/120PS | Petrol | SOHC | TD19238 |
| /8 (W114) 230.6 | 01/1968→11/1976 | | | | | | |

V95096 
37.00 x 10.95 x 113.20

115 050 00 27

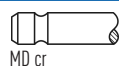

45°

ss

VAG51028B 
55.00 x 9.02 x 14.06

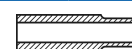

VAG92200B 
45.00 x 11.02 x 15.06



20  **82.00**

| | | | | | | | |
|------------------|--------|--------|------------------|------------|--------|-------------|----------------|
| M 180.951 | 2306cc | 6 Cyl. | 12 Valves | 79kW/107PS | Petrol | SOHC | TD22726 |
|------------------|--------|--------|------------------|------------|--------|-------------|----------------|

V95096 
37.00 x 10.95 x 113.20

115 050 00 27

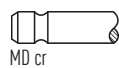

45°

ss

VAG51028B 
55.00 x 9.02 x 14.06



VAG92200B 
45.00 x 11.02 x 15.06



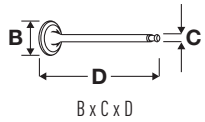

OE

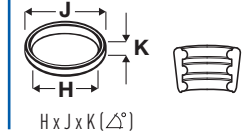
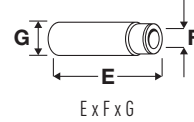
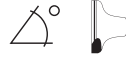

21 82.00

| | | | | | | | |
|-----------|--------|--------|-----------|---------------------|--------|------|---------|
| M 108.920 | 2496cc | 6 Cyl. | 12 Valves | 96kW/131PS | Petrol | SOHC | TD9962 |
| M 108.924 | 2496cc | 6 Cyl. | 12 Valves | 85kW/116PS | Petrol | SOHC | TD19045 |
| M 114.920 | 2496cc | 6 Cyl. | 12 Valves | 85-96kW/116-130PS | Petrol | SOHC | TD2136 |
| M 114.923 | 2496cc | 6 Cyl. | 12 Valves | 85kW/116PS | Petrol | SOHC | TD22704 |
| M 114.980 | 2496cc | 6 Cyl. | 12 Valves | 110kW/150PS | Petrol | SOHC | TD2137 |
| M 114.981 | 2496cc | 6 Cyl. | 12 Valves | 105-110kW/143-150PS | Petrol | SOHC | TD2138 |
| M 129.980 | 2496cc | 6 Cyl. | 12 Valves | 110kW/150PS | Petrol | SOHC | TD9963 |
| M 129.981 | 2496cc | 6 Cyl. | 12 Valves | 110kW/150PS | Petrol | SOHC | TD9988 |
| M 129.982 | 2496cc | 6 Cyl. | 12 Valves | 110kW/150PS | Petrol | SOHC | TD9955 |

| | | | |
|-----------------------------|-----------------|----------------------------|-----------------|
| /8 (W114) 250 | 01/1968→08/1972 | /8 (W114) 250 C | 04/1969→06/1972 |
| /8 (W114) 250 CE | 04/1969→04/1972 | COUPE (W111) 250 SE | 01/1965→12/1967 |
| PAGODE (W113) 250 SL | 01/1966→01/1968 | S-CLASS (W108, W109) 250 S | 01/1966→12/1969 |
| S-CLASS (W108, W109) 250 SE | 01/1966→12/1967 | | |

V95096 ■
37.00 x 10.95 x 113.20

115 050 00 27

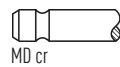

45° ss

VAG51028B ■
55.00 x 9.02 x 14.06

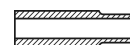

VAG92200B ■
45.00 x 11.02 x 15.06

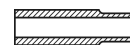

22 82.90

| | | | | | | | |
|-----------|--------|--------|-----------|---------------------|--------|------|--------|
| M 103.940 | 2597cc | 6 Cyl. | 12 Valves | 118-122kW/160-166PS | Petrol | SOHC | TD9435 |
| M 103.941 | 2597cc | 6 Cyl. | 12 Valves | 118-122kW/160-166PS | Petrol | SOHC | TD2096 |
| M 103.942 | 2597cc | 6 Cyl. | 12 Valves | 118-122kW/160-166PS | Petrol | SOHC | TD2097 |
| M 103.943 | 2597cc | 6 Cyl. | 12 Valves | 118kW/160PS | Petrol | SOHC | TD2098 |

| | | | |
|---------------------------|-----------------|---------------------|-----------------|
| 190 (W201) 2.6 | 10/1982→09/1988 | 190 (W201) E 2.6 | 09/1986→08/1993 |
| KOMBI (S124) 260 TE FGST. | 09/1985→08/1992 | SALOON (W124) 260 E | 09/1985→08/1992 |
| S-CLASS (W126) 260 SE | 09/1985→06/1991 | | |

V94284 ■
40.00 x 8.00 x 110.20

103 053 23 01

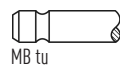

45° H

VAG92380B ■
42.00 x 8.00 x 14.04

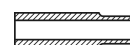

V94285 ■
35.00 x 9.00 x 110.90

103 050 13 27



45° ss H

VAG92342B ■
48.00 x 9.00 x 14.04



23 83.00

| | | | | | | | |
|------------|--------|--------|-----------|-----------------|--------|-------------|---------|
| OM 639.939 | 1493cc | 3 Cyl. | 12 Valves | 50-70kW/58-95PS | Diesel | Turbo, DOHC | TD23799 |
|------------|--------|--------|-----------|-----------------|--------|-------------|---------|

V98071 ■
28.50 x 6.00 x 102.30

642 053 04 01

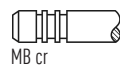

45°

VAG96371 ■ ■
34.50 x 6.00 x 11.55

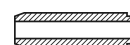

V98072 ■
25.40 x 6.00 x 102.30

642 050 05 27

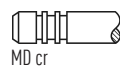







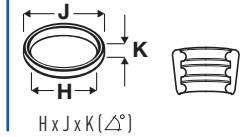
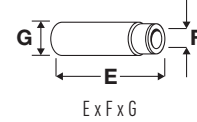

45°



OE



24  **83.00**





| M 266.920 | 1498cc | 4 Cyl. | 8 Valves | 70kW/95PS | Petrol | SOHC | TD18148 |
|---|-----------------|---|----------|----------------------|---|-----------------|---------|
| A-CLASS (W169) A 150 | 09/2004→06/2012 | | | A-CLASS (W169) A 160 | | 04/2009→06/2012 | |
| B-CLASS (W245) B 150 | 03/2005→11/2011 | | | B-CLASS (W245) B 160 | | 04/2009→11/2011 | |
| V94396  | 166 053 0201 |  | 45° | H | VAG96095  | | |
| 43.00 x 6.00 x 103.00 | | MB tu | | | 37.60 x 6.00 x 12.55 | | |
| V94397  | 166 050 04 27 |  | 45° | SS | VAG96096  | | |
| 36.00 x 7.00 x 102.70 | | MD tu | | | 37.60 x 7.00 x 12.55 | | |
| V98070  | 266 050 00 27 |  | 45° | | VAG96178  | | |
| 35.00 x 7.00 x 102.70 | | MD tu | | | 37.50 x 7.02 x 12.76 | | |

25  **83.00**

| M 270.910 | 1595cc | 4 Cyl. | 16 Valves | 75-115kW/102-156PS | Petrol | Turbo, DOHC, Injection | TD25820 |
|----------------------------|-----------------|--------|-----------|----------------------------|--------|------------------------|---------|
| M 274.910 | 1595cc | 4 Cyl. | 16 Valves | 95-115kW/129-156PS | Petrol | Turbo, DOHC, Injection | TD27830 |
| A-CLASS (W176) A 160 | 07/2015→ | | | A-CLASS (W176) A 180 | | 06/2012→ | |
| A-CLASS (W176) A 200 | 06/2012→ | | | B-CLASS (W246, W242) B 160 | | 07/2015→ | |
| B-CLASS (W246, W242) B 180 | 11/2011→ | | | B-CLASS (W246, W242) B 200 | | 11/2011→ | |
| C-CLASS (A205) C 180 | 06/2016→ | | | C-CLASS (C204) C 180 | | 01/2013→ | |
| C-CLASS (C205) C 180 | 10/2015→ | | | C-CLASS (S204) C 180 | | 02/2012→08/2014 | |
| C-CLASS (S205) C 160 | 04/2015→ | | | C-CLASS (S205) C 180 | | 09/2014→ | |
| C-CLASS (W204) C 180 CGI | 01/2008→01/2014 | | | C-CLASS (W205) C 160 | | 04/2015→ | |
| C-CLASS (W205) C 180 | 03/2014→ | | | CLA (C117) CLA 180 | | 01/2013→ | |
| CLA (C117) CLA 200 | 01/2013→ | | | CLA (X117) CLA 180 | | 01/2015→ | |
| CLA (X117) CLA 200 | 01/2015→ | | | E-CLASS (W213) E 180 | | 01/2017→ | |
| GLA-CLASS (X156) GLA 180 | 02/2015→ | | | GLA-CLASS (X156) GLA 200 | | 12/2013→ | |
| SLC (R172) 180 | 01/2016→ | | | | | | |

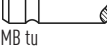
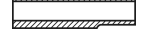
| | | | | | | | |
|---|---------------|---|-----|----|--|--|--|
| V80008  | 270 053 00 01 |  | 45° | | | | |
| 31.50 x 6.00 x 115.80 | | MB cr | | | | | |
| V80009  | 270 050 01 00 |  | 45° | SS | | | |
| 25.00 x 6.00 x 107.00 | | ME + MB cr | | | | | |

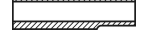
26  **83.00**

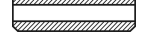
| M 266.940 | 1699cc | 4 Cyl. | 8 Valves | 85kW/116PS | Petrol | SOHC | TD18149 |
|---|-----------------|---|----------|----------------------|---|-----------------|---------|
| A-CLASS (W169) A 170 | 09/2004→06/2012 | | | A-CLASS (W169) A 180 | | 04/2009→06/2012 | |
| B-CLASS (W245) B 170 | 03/2005→11/2011 | | | B-CLASS (W245) B 180 | | 04/2009→11/2011 | |
| V94396  | 166 053 0201 |  | 45° | H | VAG96095  | | |
| 43.00 x 6.00 x 103.00 | | MB tu | | | 37.60 x 6.00 x 12.55 | | |
| V94397  | 166 050 04 27 |  | 45° | SS | VAG96096  | | |
| 36.00 x 7.00 x 102.70 | | MD tu | | | 37.60 x 7.00 x 12.55 | | |
| V98070  | 266 050 00 27 |  | 45° | | VAG96178  | | |
| 35.00 x 7.00 x 102.70 | | MD tu | | | 37.50 x 7.02 x 12.76 | | |

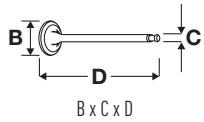

OE

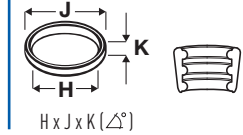
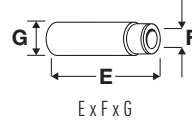
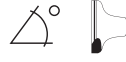

27 83.00

| OM 651.901 | 1796cc | 4 Cyl. | 16 Valves | 80-100kW/109-136PS | Diesel | Turbo, DOHC | TD25819 |
|--------------------------------|----------|--------|-----------|--------------------------------|--------|-------------|---------|
| A-CLASS (W176) A 180 CDI | 06/2012→ | | | A-CLASS (W176) A 200 CDI | | 06/2012→ | |
| B-CLASS (W246, W242) B 180 CDI | 11/2011→ | | | B-CLASS (W246, W242) B 200 CDI | | 11/2011→ | |
| CLA (C117) CLA 200 CDI | 06/2013→ | | | | | | |

V95194
28.40 x 5.96 x 108.95

651 053 01 01

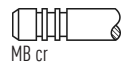

45°

H

V95195
24.65 x 5.96 x 109.20

651 050 01 27



45°

H

28 83.00

| M 270.920 | 1991cc | 4 Cyl. | 16 Valves | 115-160kW/156-218PS | Petrol | Turbo, DOHC, Injection | TD26628 |
|-----------|--------|--------|-----------|---------------------|--------|------------------------|---------|
| M 274.920 | 1991cc | 4 Cyl. | 16 Valves | 115-180kW/156-245PS | Petrol | Turbo, DOHC, Injection | TD28178 |

| | | | | | | | |
|--|-----------------|--|--|----------------------------|--|-----------------|--|
| A-CLASS (W176) A 220 | 05/2014→ | | | A-CLASS (W176) A 250 | | 06/2012→ | |
| B-CLASS (W246, W242) B 200 Natural Gas Drive / B 200 c | 11/2012→ | | | B-CLASS (W246, W242) B 220 | | 05/2013→ | |
| B-CLASS (W246, W242) B 250 | 05/2012→ | | | C-CLASS (A205) C 200 | | 06/2016→ | |
| C-CLASS (A205) C 250 | 06/2016→ | | | C-CLASS (A205) C 300 | | 06/2016→ | |
| C-CLASS (C205) C 200 | 10/2015→ | | | C-CLASS (C205) C 250 | | 10/2015→ | |
| C-CLASS (C205) C 300 | 10/2015→ | | | C-CLASS (S204) C 250 | | 03/2014→08/2014 | |
| C-CLASS (S205) C 200 | 09/2014→ | | | C-CLASS (S205) C 250 | | 09/2014→ | |
| C-CLASS (S205) C 300 | 09/2015→ | | | C-CLASS (S205) C 350 e | | 02/2015→ | |
| C-CLASS (W205) C 200 | 12/2013→ | | | C-CLASS (W205) C 250 | | 03/2014→ | |
| C-CLASS (W205) C 300 | 12/2013→ | | | C-CLASS (W205) C 350 e | | 02/2015→ | |
| CLA (C117) CLA 220 | 04/2016→ | | | CLA (C117) CLA 250 | | 01/2013→ | |
| CLA (X117) CLA 220 | 04/2016→ | | | CLA (X117) CLA 250 | | 01/2015→ | |
| CLS (C218) CLS 260 | 01/2015→ | | | E-CLASS (A207) E 200 | | 03/2013→ | |
| E-CLASS (A207) E 250 | 06/2013→ | | | E-CLASS (A238) E 200 | | 06/2017→ | |
| E-CLASS (A238) E 300 | 06/2017→ | | | E-CLASS (C207) E 200 | | 06/2013→ | |
| E-CLASS (C207) E 250 | 06/2013→ | | | E-CLASS (C238) E 200 | | 12/2016→ | |
| E-CLASS (C238) E 300 | 12/2016→ | | | E-CLASS (S212) E 200 | | 11/2012→ | |
| E-CLASS (S212) E 250 | 11/2012→ | | | E-CLASS (S213) E 200 | | 07/2016→ | |
| E-CLASS (S213) E 250 | 07/2016→ | | | E-CLASS (W212) E 200 | | 01/2013→ | |
| E-CLASS (W212) E 200 NGT | 07/2013→ | | | E-CLASS (W212) E 250 | | 01/2013→ | |
| E-CLASS (W213) E 200 | 01/2016→ | | | E-CLASS (W213) E 250 | | 07/2016→ | |
| E-CLASS (W213) E 300 | 07/2016→ | | | E-CLASS (W213) E 350 e | | 07/2016→ | |
| GLA-CLASS (X156) GLA 200 | 09/2014→ | | | GLA-CLASS (X156) GLA 220 | | 01/2017→ | |
| GLA-CLASS (X156) GLA 250 | 12/2013→ | | | GLC (C253) 250 | | 06/2016→ | |
| GLC (C253) 300 | 10/2016→ | | | GLC (C253) 350 e | | 10/2016→ | |
| GLC (X253) 200 | 06/2016→ | | | GLC (X253) 250 | | 06/2015→ | |
| GLC (X253) 300 | 07/2015→ | | | GLC (X253) 350 e | | 01/2016→ | |
| GLK-CLASS (X204) 200 | 08/2013→06/2015 | | | GLK-CLASS (X204) 250 | | 08/2013→06/2015 | |
| SLC (R172) 200 | 01/2016→ | | | SLC (R172) 300 | | 01/2016→ | |
| SLK (R172) 200 | 04/2015→ | | | SLK (R172) 300 | | 07/2015→ | |
| V-CLASS (W447) V 250 | 03/2014→ | | | VITO (W447) 2.0 | | 09/2015→ | |

V80008
31.50 x 6.00 x 115.80

270 053 00 01

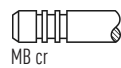

45°

V80009
25.00 x 6.00 x 107.00

270 050 01 00



45°

ss



OE

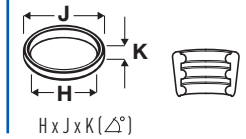
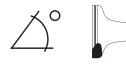

29  **83.00**

| | | | | | | | |
|--------------------------|-----------------|--------|------------------|--------------------------|-----------------|--------------------|----------------|
| OM 640.940 | 1991cc | 4 Cyl. | 16 Valves | 80kW/109PS | Diesel | Turbo, DOHC | TD18151 |
| OM 640.941 | 1991cc | 4 Cyl. | 16 Valves | 100-103kW/136-140PS | Diesel | Turbo, DOHC | TD18152 |
| OM 640.942 | 1991cc | 4 Cyl. | 16 Valves | 60kW/82PS | Diesel | Turbo, DOHC | TD18153 |
| A-CLASS (W169) A 160 CDI | 09/2004→06/2012 | | | A-CLASS (W169) A 180 CDI | 09/2004→06/2012 | | |
| A-CLASS (W169) A 200 CDI | 09/2004→06/2012 | | | B-CLASS (W245) B 180 CDI | 03/2005→11/2011 | | |
| B-CLASS (W245) B 200 CDI | 03/2005→11/2011 | | | | | | |

V98071  28.50 x 6.00 x 102.30

642 053 04 01

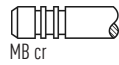

45°

VAG96371  34.50 x 6.00 x 11.55



V98072  25.40 x 6.00 x 102.30

642 050 05 27

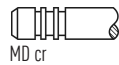

45°

30  **83.00**

| | | | | | | | |
|--------------------------|-----------------|--------|-----------------|----------------------------|-----------------|--------------------|----------------|
| M 266.960 | 2034cc | 4 Cyl. | 8 Valves | 85-100kW/116-136PS | Petrol | SOHC | TD18150 |
| M 266.980 | 2034cc | 4 Cyl. | 8 Valves | 142kW/193PS | Petrol | Turbo, SOHC | TD18415 |
| A-CLASS (W169) A 200 | 09/2004→06/2012 | | | A-CLASS (W169) A 200 TURBO | 09/2005→06/2012 | | |
| B-CLASS (W245) B 170 NGT | 04/2008→11/2011 | | | B-CLASS (W245) B 180 NGT | 04/2008→11/2011 | | |
| B-CLASS (W245) B 200 | 03/2005→11/2011 | | | B-CLASS (W245) B 200 TURBO | 03/2005→11/2011 | | |

V94396  43.00 x 6.00 x 103.00

166 053 0201

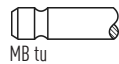

45°

H

VAG96095  37.60 x 6.00 x 12.55



V98070  35.00 x 7.00 x 102.70

266 050 00 27

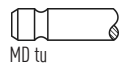

45°

VAG96096  37.60 x 7.00 x 12.55

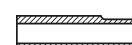

VAG96178  37.50 x 7.02 x 12.76



31  **83.00**

| | | | | | | | |
|--------------------------------|----------|--------|------------------|------------------------------------|----------|--------------------|----------------|
| OM 651.911 | 2143cc | 4 Cyl. | 16 Valves | 120-150kW/163-204PS | Diesel | Turbo, DOHC | TD23727 |
| OM 651.912 | 2143cc | 4 Cyl. | 16 Valves | 120-150kW/163-204PS | Diesel | Turbo, DOHC | TD23754 |
| OM 651.913 | 2143cc | 4 Cyl. | 16 Valves | 88-105kW/120-143PS | Diesel | Turbo, DOHC | TD24407 |
| OM 651.916 | 2143cc | 4 Cyl. | 16 Valves | 100-125kW/136-170PS | Diesel | Turbo, DOHC | TD23755 |
| OM 651.921 | 2143cc | 4 Cyl. | 16 Valves | 100-150kW/136-204PS | Diesel | Turbo, DOHC | TD28575 |
| OM 651.924 | 2143cc | 4 Cyl. | 16 Valves | 120-150kW/163-204PS | Diesel | Turbo, DOHC | TD23782 |
| OM 651.925 | 2143cc | 4 Cyl. | 16 Valves | 100kW/136PS | Diesel | Turbo, DOHC | TD23783 |
| OM 651.930 | 2143cc | 4 Cyl. | 16 Valves | 80-130kW/109-177PS | Diesel | Turbo, DOHC | TD26817 |
| OM 651.940 | 2143cc | 4 Cyl. | 16 Valves | 70-120kW/95-163PS | Diesel | Turbo, DOHC | TD25280 |
| OM 651.950 | 2143cc | 4 Cyl. | 16 Valves | 100-140kW/136-190PS | Diesel | Turbo, DOHC | TD29251 |
| OM 651.955 | 2143cc | 4 Cyl. | 16 Valves | 70-120kW/95-163PS | Diesel | Turbo, DOHC | TD24545 |
| OM 651.956 | 2143cc | 4 Cyl. | 16 Valves | 70-95kW/95-129PS | Diesel | Turbo, DOHC | TD25279 |
| OM 651.957 | 2143cc | 4 Cyl. | 16 Valves | 95-120kW/129-163PS | Diesel | Turbo, DOHC | TD24544 |
| OM 651.960 | 2143cc | 4 Cyl. | 16 Valves | 150-152kW/204-207PS | Diesel | Turbo, DOHC | TD26549 |
| OM 651.961 | 2143cc | 4 Cyl. | 16 Valves | 150kW/204PS | Diesel | Turbo, DOHC | TD25277 |
| OM 651.980 | 2143cc | 4 Cyl. | 16 Valves | 150kW/204PS | Diesel | Turbo, DOHC | TD26369 |
| A-CLASS (W176) A 180 CDI | 12/2014→ | | | A-CLASS (W176) A 200 CDI | 02/2014→ | | |
| A-CLASS (W176) A 200 CDI / d | 02/2014→ | | | A-CLASS (W176) A 220 CDI | 09/2012→ | | |
| A-CLASS (W176) A 220 d | 07/2015→ | | | B-CLASS (W246, W242) B 180 CDI | 07/2014→ | | |
| B-CLASS (W246, W242) B 200 CDI | 08/2014→ | | | B-CLASS (W246, W242) B 200 CDI / d | 08/2014→ | | |
| B-CLASS (W246, W242) B 220 CDI | 11/2011→ | | | B-CLASS (W246, W242) B 220 CDI / d | 09/2014→ | | |
| C-CLASS (A205) C 220 d | 06/2016→ | | | C-CLASS (A205) C 250 d | 06/2016→ | | |
| C-CLASS (C204) C 220 CDI | 06/2011→ | | | C-CLASS (C204) C 250 CDI | 06/2011→ | | |

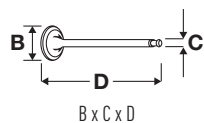

OE

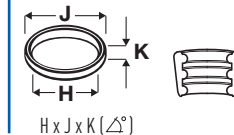
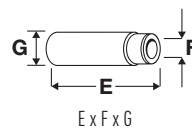

| | | | |
|--------------------------------------|-----------------|---|-----------------|
| C-CLASS (C205) C 220 d | 10/2015→ | C-CLASS (C205) C 250 d | 10/2015→ |
| C-CLASS (S204) C 180 CDI | 01/2011→08/2014 | C-CLASS (S204) C 200 CDI | 08/2010→08/2014 |
| C-CLASS (S204) C 220 CDI | 12/2008→08/2014 | C-CLASS (S204) C 250 CDI | 01/2009→08/2014 |
| C-CLASS (S205) C 200 d | 10/2015→ | C-CLASS (S205) C 220 / d | 09/2014→ |
| C-CLASS (S205) C 220 d | 04/2015→ | C-CLASS (S205) C 250 BlueTEC / d | 10/2014→ |
| C-CLASS (S205) C 250 / d | 09/2014→ | C-CLASS (S205) C 300 Hybrid / h | 10/2014→ |
| C-CLASS (W204) C 180 CDI | 01/2011→01/2014 | C-CLASS (W204) C 200 CDI | 01/2011→01/2014 |
| C-CLASS (W204) C 220 CDI | 10/2008→01/2014 | C-CLASS (W204) C 250 CDI | 08/2008→01/2014 |
| C-CLASS (W205) C 200 d | 10/2015→ | C-CLASS (W205) C 220 d | 04/2015→ |
| C-CLASS (W205) C 220 / d | 12/2013→ | C-CLASS (W205) C 250 BlueTEC / d | 02/2014→ |
| C-CLASS (W205) C 250 / d | 02/2014→ | C-CLASS (W205) C 300 Hybrid / h | 05/2014→ |
| CLA (C117) CLA 200 CDI | 07/2014→ | CLA (C117) CLA 200 CDI / d | 07/2014→ |
| CLA (C117) CLA 220 CDI | 01/2013→ | CLA (C117) CLA 220 CDI / d | 08/2014→ |
| CLA (X117) CLA 200 CDI | 01/2015→ | CLA (X117) CLA 200 CDI / d | 01/2015→ |
| CLA (X117) CLA 220 CDI | 01/2015→ | CLA (X117) CLA 220 CDI / d | 01/2015→ |
| CLS (C218) CLS 220 / d | 05/2014→ | CLS (C218) CLS 250 BlueTEC / d | 05/2014→ |
| CLS (C218) CLS 250 CDI // d | 04/2011→ | CLS (X218) CLS 220 / d | 05/2014→ |
| CLS (X218) CLS 250 BlueTEC / d | 05/2014→ | CLS (X218) CLS 250 CDI // d | 10/2012→ |
| E-CLASS (A207) E 220 | 05/2014→ | E-CLASS (A207) E 220 CDI | 02/2010→ |
| E-CLASS (A207) E 220 CDI // d | 01/2010→ | E-CLASS (A207) E 250 CDI // d | 01/2010→ |
| E-CLASS (C207) E 220 | 05/2014→ | E-CLASS (C207) E 220 CDI | 01/2010→ |
| E-CLASS (C207) E 250 CDI // d | 01/2009→ | E-CLASS (S212) E 200 CDI / | 11/2009→ |
| E-CLASS (S212) E 220 | 05/2015→ | E-CLASS (S212) E 220 BlueTEC | 12/2014→ |
| E-CLASS (S212) E 220 CDI / | 11/2009→ | E-CLASS (S212) E 220 CDI | 08/2009→ |
| E-CLASS (S212) E 250 CDI / | 11/2009→ | E-CLASS (S212) E 250 CDI / BlueTEC | 07/2010→ |
| E-CLASS (S212) E 300 Hybrid / Hybrid | 12/2011→ | E-CLASS (W212) E 200 CDI / | 01/2009→ |
| E-CLASS (W212) E 220 | 05/2014→ | E-CLASS (W212) E 220 BlueTEC | 01/2015→ |
| E-CLASS (W212) E 220 CDI / | 01/2009→ | E-CLASS (W212) E 220 CDI | 01/2009→ |
| E-CLASS (W212) E 250 CDI / | 01/2009→ | E-CLASS (W212) E 250 CDI / BlueTEC | 01/2009→ |
| E-CLASS (W212) E 300 Hybrid / Hybrid | 12/2011→ | GLA-CLASS (X156) GLA 200 CDI | 12/2013→ |
| GLA-CLASS (X156) GLA 220 CDI | 12/2013→ | GLA-CLASS (X156) GLA 220 CDI / d | 12/2013→ |
| GLA-CLASS (X156) GLA 220 d | 07/2015→ | GLC (C253) 220 d | 06/2016→ |
| GLC (C253) 250 d | 06/2016→ | GLC (X253) 220 d | 06/2015→ |
| GLC (X253) 250 d | 06/2015→ | GLE (W166) 250 d | 04/2015→ |
| GLK-CLASS (X204) 200 CDI | 07/2010→06/2015 | GLK-CLASS (X204) 220 CDI | 12/2008→06/2015 |
| GLK-CLASS (X204) 250 CDI | 09/2009→06/2015 | M-CLASS (W166) ML 250 CDI / BlueTEC | 06/2011→12/2015 |
| S-CLASS (W221) S 250 CDI | 01/2011→12/2013 | S-CLASS (W222, V222, X222) S 300 Hybrid / h | 02/2014→ |
| SLC (R172) 250 d | 01/2016→10/2017 | SLK (R172) 250 CDI | 01/2012→ |
| SPRINTER 3,5-t (906) 310 CDI | 03/2009→ | SPRINTER 3,5-t (906) 311 CDI | 05/2016→ |
| SPRINTER 3,5-t (906) 313 CDI | 06/2006→ | SPRINTER 3,5-t (906) 314 CDI | 05/2016→ |
| SPRINTER 3,5-t (906) 316 CDI | 03/2009→ | SPRINTER 3-t (906) 210 CDI | 03/2009→ |
| SPRINTER 3-t (906) 211 CDI | 04/2016→ | SPRINTER 3-t (906) 213 CDI | 06/2006→ |
| SPRINTER 3-t (906) 214 CDI | 04/2016→ | SPRINTER 3-t (906) 216 CDI | 06/2006→ |
| SPRINTER 4,6-t (906) 413 CDI | 06/2006→05/2016 | SPRINTER 4,6-t (906) 416 CDI | 03/2009→ |
| SPRINTER 4,6-t 415 CDI | 06/2006→ | SPRINTER 5-t (906) 510 CDI | 03/2009→ |
| SPRINTER 5-t (906) 511 CDI | 05/2016→ | SPRINTER 5-t (906) 513 CDI | 06/2006→ |
| SPRINTER 5-t (906) 514 CDI | 05/2016→ | SPRINTER 5-t (906) 516 CDI | 06/2006→ |
| SPRINTER 5-t 513 CDI | 06/2006→ | SPRINTER 5-t 515 CDI | 06/2006→ |
| SPRINTER 5-t 516 CDI | 03/2009→ | V-CLASS (W447) V 200 CDI | 03/2014→ |
| V-CLASS (W447) V 200 CDI / d | 04/2015→ | V-CLASS (W447) V 220 CDI | 03/2014→ |
| V-CLASS (W447) V 220 CDI / d | 04/2015→ | V-CLASS (W447) V 250 BlueTEC / d | 12/2014→ |
| V-CLASS (W447) V 250 / d | 03/2014→ | VIANO (W639) CDI 2.0 | 07/2010→ |
| VIANO (W639) CDI 2.2 | 07/2010→ | VITO (W447) 114 CDI | 10/2014→ |
| VITO (W447) 114 CDI / 114 | 10/2014→ | VITO (W447) 114 CDI / 114 4x4 | 07/2015→ |
| VITO (W447) 116 CDI | 10/2014→ | VITO (W447) 116 CDI / 116 | 10/2014→ |
| VITO (W447) 116 CDI / 116 4x4 | 07/2015→ | VITO (W447) 119 | 10/2014→ |
| VITO (W447) 119 CDI / | 10/2014→ | VITO (W447) 119 CDI / 4x4 | 07/2015→ |
| VITO (W447) 119 CDI / 119 4x4 | 12/2014→ | VITO (W639) 110 CDI | 09/2010→ |
| VITO (W639) 113 CDI | 09/2010→ | VITO (W639) 116 CDI | 09/2010→ |
| VITO Mixto (W447) 114 CDI | 10/2014→ | VITO Mixto (W447) 116 CDI | 10/2014→ |
| VITO Mixto (W447) 119 | 10/2014→ | VITO Mixto (W447) 119 4x4 | 12/2014→ |
| VITO / MIXTO (W639) 110 CDI | 09/2010→ | VITO / MIXTO (W639) 113 CDI | 09/2010→ |



OE

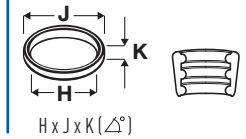
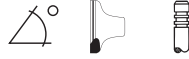

VITO / MIXTO (W639) 116 CDI

09/2010→

V95194 ■
28.40 x 5.96 x 108.95

651 053 01 01

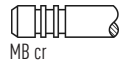

45°

H

V95195 ■
24.65 x 5.96 x 109.20

651 050 01 27



45°

H

32 | **83.00**

| | | | | | | | |
|------------|--------|---------|-----------|---------------------|--------|-------------|---------|
| OM 642.820 | 2987cc | V6 Cyl. | 24 Valves | 150-170kW/204-231PS | Diesel | Turbo, DOHC | TD23810 |
| OM 642.822 | 2987cc | V6 Cyl. | 24 Valves | 165-195kW/224-265PS | Diesel | Turbo, DOHC | TD19207 |
| OM 642.826 | 2987cc | V6 Cyl. | 24 Valves | 179-190kW/243-258PS | Diesel | Turbo, DOHC | TD26600 |
| OM 642.830 | 2987cc | V6 Cyl. | 24 Valves | 165-170kW/224-231PS | Diesel | Turbo, DOHC | TD23772 |
| OM 642.832 | 2987cc | V6 Cyl. | 24 Valves | 150-170kW/204-231PS | Diesel | Turbo, DOHC | TD23751 |
| OM 642.834 | 2987cc | V6 Cyl. | 24 Valves | 195kW/265PS | Diesel | Turbo, DOHC | TD26036 |
| OM 642.835 | 2987cc | V6 Cyl. | 24 Valves | 195kW/265PS | Diesel | Turbo, DOHC | TD26840 |
| OM 642.836 | 2987cc | V6 Cyl. | 24 Valves | 170kW/231PS | Diesel | Turbo, DOHC | TD23723 |
| OM 642.838 | 2987cc | V6 Cyl. | 24 Valves | 185-195kW/252-265PS | Diesel | Turbo, DOHC | TD26599 |
| OM 642.850 | 2987cc | V6 Cyl. | 24 Valves | 150-170kW/204-231PS | Diesel | Turbo, DOHC | TD23781 |
| OM 642.852 | 2987cc | V6 Cyl. | 24 Valves | 170-195kW/231-265PS | Diesel | Turbo, DOHC | TD23792 |
| OM 642.853 | 2987cc | V6 Cyl. | 24 Valves | 190-195kW/258-265PS | Diesel | Turbo, DOHC | TD26065 |
| OM 642.854 | 2987cc | V6 Cyl. | 24 Valves | 185-195kW/252-265PS | Diesel | Turbo, DOHC | TD26045 |
| OM 642.856 | 2987cc | V6 Cyl. | 24 Valves | 170kW/231PS | Diesel | Turbo, DOHC | TD23790 |
| OM 642.858 | 2987cc | V6 Cyl. | 24 Valves | 185-195kW/252-265PS | Diesel | Turbo, DOHC | TD23791 |
| OM 642.861 | 2987cc | V6 Cyl. | 24 Valves | 190kW/258PS | Diesel | Turbo, DOHC | TD27896 |
| OM 642.862 | 2987cc | V6 Cyl. | 24 Valves | 190kW/258PS | Diesel | Turbo, DOHC | TD26082 |
| OM 642.867 | 2987cc | V6 Cyl. | 24 Valves | 185-190kW/252-258PS | Diesel | Turbo, DOHC | TD28584 |
| OM 642.868 | 2987cc | V6 Cyl. | 24 Valves | 190kW/258PS | Diesel | Turbo, DOHC | TD25099 |
| OM 642.870 | 2987cc | V6 Cyl. | 24 Valves | 140-157kW/190-214PS | Diesel | Turbo, DOHC | TD24810 |
| OM 642.872 | 2987cc | V6 Cyl. | 24 Valves | 140-195kW/190-265PS | Diesel | Turbo, DOHC | TD25098 |
| OM 642.884 | 2987cc | V6 Cyl. | 24 Valves | 135kW/184PS | Diesel | Turbo, DOHC | TD25842 |
| OM 642.887 | 2987cc | V6 Cyl. | 24 Valves | 180kW/245PS | Diesel | Turbo, DOHC | TD31268 |
| OM 642.890 | 2987cc | V6 Cyl. | 24 Valves | 165kW/224PS | Diesel | Turbo, DOHC | TD27268 |
| OM 642.896 | 2987cc | V6 Cyl. | 24 Valves | 135-140kW/184-190PS | Diesel | Turbo, DOHC | TD25841 |
| OM 642.898 | 2987cc | V6 Cyl. | 24 Valves | 140-155kW/190-211PS | Diesel | Turbo, DOHC | TD25843 |
| OM 642.910 | 2987cc | V6 Cyl. | 24 Valves | 165kW/224PS | Diesel | Turbo, DOHC | TD18416 |
| OM 642.920 | 2987cc | V6 Cyl. | 24 Valves | 140-200kW/190-272PS | Diesel | Turbo, DOHC | TD18431 |
| OM 642.921 | 2987cc | V6 Cyl. | 24 Valves | 140-165kW/190-224PS | Diesel | Turbo, DOHC | TD18428 |
| OM 642.930 | 2987cc | V6 Cyl. | 24 Valves | 155-173kW/211-235PS | Diesel | Turbo, DOHC | TD19213 |
| OM 642.932 | 2987cc | V6 Cyl. | 24 Valves | 155-173kW/211-235PS | Diesel | Turbo, DOHC | TD23761 |
| OM 642.940 | 2987cc | V6 Cyl. | 24 Valves | 140-170kW/190-231PS | Diesel | Turbo, DOHC | TD18197 |
| OM 642.950 | 2987cc | V6 Cyl. | 24 Valves | 140-165kW/190-224PS | Diesel | Turbo, DOHC | TD19206 |
| OM 642.960 | 2987cc | V6 Cyl. | 24 Valves | 165kW/224PS | Diesel | Turbo, DOHC | TD20361 |
| OM 642.961 | 2987cc | V6 Cyl. | 24 Valves | 165kW/224PS | Diesel | Turbo, DOHC | TD20986 |
| OM 642.970 | 2987cc | V6 Cyl. | 24 Valves | 165kW/224PS | Diesel | Turbo, DOHC | TD20729 |
| OM 642.975 | 2987cc | V6 Cyl. | 24 Valves | 135kW/184PS | Diesel | Turbo, DOHC | TD28790 |
| OM 642.990 | 2987cc | V6 Cyl. | 24 Valves | 150-165kW/204-224PS | Diesel | Turbo, DOHC | TD22148 |
| OM 642.992 | 2987cc | V6 Cyl. | 24 Valves | 135-140kW/184-190PS | Diesel | Turbo, DOHC | TD22149 |
| OM 642.993 | 2987cc | V6 Cyl. | 24 Valves | 135kW/184PS | Diesel | Turbo, DOHC | TD25661 |

C-CLASS (S203) C 320 CDI

06/2005→08/2007

C-CLASS (S204) C 320 CDI

08/2007→08/2014

C-CLASS (S204) C 350 CDI

08/2007→08/2014

C-CLASS (W203) C 320 CDI

01/2005→02/2007

C-CLASS (W204) C 300 CDI

01/2011→01/2014

C-CLASS (W204) C 320 CDI

01/2007→01/2014

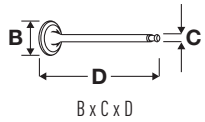

OE

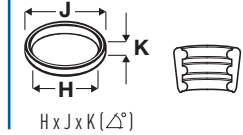
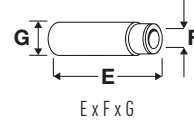
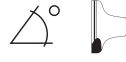

| | | | |
|--|-----------------|--|-----------------|
| C-CLASS (W204) C 350 CDI | 07/2009→01/2014 | CLK (A209) CLK 320 CDI | 03/2005→03/2010 |
| CLK (C209) 320 CDI | 01/2005→05/2009 | CLS (C218) CLS 350 BlueTEC / d | 11/2012→ |
| CLS (C218) CLS 350 CDI | 01/2011→ | CLS (C218) CLS 350 CDI / d | 09/2011→ |
| CLS (C218) CLS 350 d | 04/2015→ | CLS (C218) CLS 350 / d | 11/2012→ |
| CLS (C219) CLS 320 CDI | 01/2005→12/2010 | CLS (C219) CLS 350 CDI | 04/2009→12/2010 |
| CLS (X218) CLS 350 BlueTEC / d | 05/2014→ | CLS (X218) CLS 350 CDI | 10/2012→ |
| CLS (X218) CLS 350 CDI / d | 10/2012→ | CLS (X218) CLS 350 d | 04/2015→ |
| CLS (X218) CLS 350 / d | 05/2014→ | E-CLASS (A207) E 350 | 06/2013→ |
| E-CLASS (A207) E 350 CDI | 01/2010→ | E-CLASS (A207) E 350 / d | 05/2014→ |
| E-CLASS (C207) E 350 | 03/2013→ | E-CLASS (C207) E 350 CDI | 01/2009→ |
| E-CLASS (C207) E 350 / d | 05/2014→ | E-CLASS (S211) E 280 T CDI | 03/2005→07/2009 |
| E-CLASS (S211) E 320 T CDI | 03/2005→07/2009 | E-CLASS (S212) E 300 CDI / | 11/2009→ |
| E-CLASS (S212) E 300 CDI | 12/2009→12/2010 | E-CLASS (S212) E 350 | 11/2009→ |
| E-CLASS (S212) E 350 BlueTEC | 11/2012→ | E-CLASS (S212) E 350 CDI | 11/2009→ |
| E-CLASS (W211) E 280 CDI | 03/2005→12/2008 | E-CLASS (W211) E 300 | 09/2007→12/2008 |
| E-CLASS (W211) E 320 | 09/2008→03/2009 | E-CLASS (W211) E 320 CDI | 03/2005→12/2008 |
| E-CLASS (W211) E320 CDI | 09/2006→12/2008 | E-CLASS (W212) E 300 CDI / | 03/2011→ |
| E-CLASS (W212) E 300 CDI | 12/2009→12/2010 | E-CLASS (W212) E 350 | 01/2009→ |
| E-CLASS (W212) E 350 BlueTEC | 11/2012→ | E-CLASS (W212) E 350 CDI | 01/2009→ |
| G-CLASS (W461) G 280 CDI | 04/2009→ | G-CLASS (W461) G 300 CDI | 04/2010→ |
| G-CLASS (W463) G 320 CDI | 09/2006→ | G-CLASS (W463) G 350 CDI | 06/2009→12/2011 |
| G-CLASS (W463) G 350 d | 06/2015→ | GL-CLASS (X164) GL 320 CDI | 09/2006→12/2009 |
| GL-CLASS (X164) GL 320 CDI / 350 BlueTEC | 12/2009→ | GL-CLASS (X164) GL 350 CDI | 05/2009→ |
| GL-CLASS (X166) GL 350 CDI / BlueTEC | 07/2012→ | GL-CLASS (X166) GL 350 CDI / BlueTEC | 07/2012→ |
| GLE (C292) 350 d | 03/2015→ | GLE (W166) 350 d | 04/2015→ |
| GLK-CLASS (X204) 320 CDI | 06/2008→06/2015 | GLK-CLASS (X204) 350 CDI | 07/2009→06/2015 |
| GLS (X166) 350 d | 11/2015→ | M-CLASS (W164) ML 280 CDI | 07/2005→07/2009 |
| M-CLASS (W164) ML 300 CDI | 07/2009→12/2011 | M-CLASS (W164) ML 320 CDI | 07/2005→07/2011 |
| M-CLASS (W164) ML 350 CDI | 07/2009→12/2011 | M-CLASS (W166) ML 350 BlueTEC | 06/2011→02/2015 |
| M-CLASS (W166) ML 350 CDI | 06/2011→02/2015 | R-CLASS (W251, V251) R 280 CDI | 05/2006→ |
| R-CLASS (W251, V251) R 300 CDI | 07/2009→ | R-CLASS (W251, V251) R 320 CDI | 01/2006→ |
| R-CLASS (W251, V251) R 350 CDI | 01/2006→ | S-CLASS (W221) S 320 CDI | 10/2005→12/2013 |
| S-CLASS (W221) S 350 BlueTEC | 04/2011→12/2013 | S-CLASS (W221) S 350 BlueTEC | 04/2011→12/2013 |
| S-CLASS (W221) S 350 CDI | 01/2009→12/2013 | S-CLASS (W222, V222, X222) S 350 BlueTEC | 02/2014→ |
| S-CLASS (W222, V222, X222) S 350 BlueTEC / d | 02/2014→ | S-CLASS (W222, V222, X222) S 350 / d | 05/2013→ |
| SPRINTER 3,5-t (906) 318 CDI | 06/2006→12/2009 | SPRINTER 3,5-t (906) 319 CDI / | 03/2009→ |
| SPRINTER 3,5-t (906) 319 CDI / 4x4 | 03/2009→ | SPRINTER 3-t (906) 218 CDI | 06/2006→12/2009 |
| SPRINTER 3-t (906) 219 CDI / | 03/2009→ | SPRINTER 4,6-t (906) 418 CDI | 06/2006→05/2016 |
| SPRINTER 4,6-t (906) 419 CDI | 03/2009→ | SPRINTER 5-t (906) 518 CDI | 06/2006→12/2009 |
| SPRINTER 5-t (906) 519 CDI / | 03/2009→ | SPRINTER 5-t (906) 519 CDI / 4x4 | 03/2009→ |
| SPRINTER 5-t 519 CDI / | 03/2009→ | VIANO (W639) CDI 3.0 | 03/2006→ |
| VITO (W639) 120 CDI | 07/2006→ | VITO (W639) 122 CDI | 09/2010→ |
| VITO / MIXTO (W639) 120 CDI | 07/2006→ | VITO / MIXTO (W639) 122 CDI | 09/2010→ |

V98071 ■
28.50 x 6.00 x 102.30

642 053 04 01

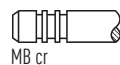

MB cr

45°

VAG96371 ■ ■ ■
34.50 x 6.00 x 11.55



V98072 ■
25.40 x 6.00 x 102.30

642 050 05 27

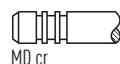

MD cr

45°

33 **84.00**

| | | | | | | | |
|----------------------|-----------------|-----------------|-----------------|-----------------|--------|-------------|----------------|
| M 166.990 | 1898cc | 4 Cyl. | 8 Valves | 92kW/125PS | Petrol | SOHC | TD15448 |
| M 166.991 | 1898cc | 4 Cyl. | 8 Valves | 92kW/125PS | Petrol | SOHC | TD18176 |
| A-CLASS (W168) A 190 | 03/1999→08/2004 | VANEQ (414) 1.9 | | 02/2002→07/2005 | | | |

V94396 ■
43.00 x 6.00 x 103.00

166 053 0201

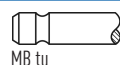

MB tu

45°

H

VAG96095 ■
37.60 x 6.00 x 12.55

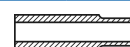

V94397 ■
36.00 x 7.00 x 102.70

166 050 04 27

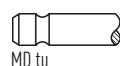

MD tu

45°

SS

VAG96096 ■
37.60 x 7.00 x 12.55

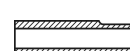



OE

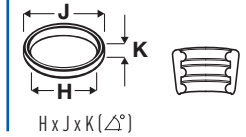
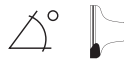

34  **84.00**

| | | | | | | | |
|----------------------|--------|-----------------|----------|-------------|--------|------|---------|
| M 166.995 | 2084cc | 4 Cyl. | 8 Valves | 103kW/140PS | Petrol | SOHC | TD16882 |
| A-CLASS (W168) A 210 | | 12/2001→08/2004 | | | | | |

V94396 ■
43.00 x 6.00 x 103.00

166 053 0201

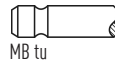

45°

H

VAG96095 ■
37.60 x 6.00 x 12.55



V94397 ■
36.00 x 7.00 x 102.70

166 050 04 27

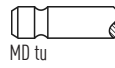

45°

SS

VAG96096 ■
37.60 x 7.00 x 12.55



35  **85.30**

| | | | | | | | |
|------------------------|--------|-----------------|-----------|----------------------|--------|-----------------|--------|
| M 111.920 | 1799cc | 4 Cyl. | 16 Valves | 90kW/122PS | Petrol | DOHC | TD2131 |
| M 111.921 | 1799cc | 4 Cyl. | 16 Valves | 89-90kW/121-122PS | Petrol | DOHC | TD5235 |
| C-CLASS (S202) C 180 T | | 06/1996→09/2000 | | C-CLASS (W202) C 180 | | 03/1993→05/2000 | |

V95011 ■
33.00 x 7.00 x 101.40

111 053 04 01

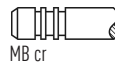

45°

H

VAG96096 ■ ■
37.60 x 7.00 x 12.55



V95012 ■
29.00 x 7.00 x 103.45

111 050 06 27



45°

H

VAG96149 ■ ■
37.50 x 7.02 x 12.59

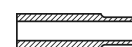

VAG96178 ■ ■
37.50 x 7.02 x 12.76



36  **86.00**

| | | | | | | | |
|--------------------|--------|-----------------|-----------|--------------------|--------|-----------------|---------|
| M 123.920 | 2525cc | 6 Cyl. | 12 Valves | 95-103kW/129-140PS | Petrol | SOHC | TD18724 |
| M 123.921 | 2525cc | 6 Cyl. | 12 Valves | 95-103kW/129-140PS | Petrol | SOHC | TD2194 |
| KOMBI (S123) 250 T | | 05/1978→08/1982 | | SALOON (W123) 250 | | 02/1976→07/1985 | |

V95096 ■
37.00 x 10.95 x 113.20

115 050 00 27

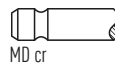

45°

SS

VAG51028B ■
55.00 x 9.02 x 14.06



VAG92200B ■
45.00 x 11.02 x 15.06

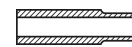

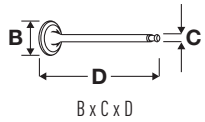

OE

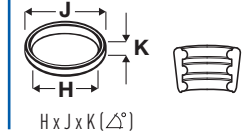
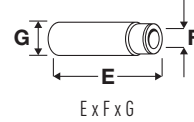
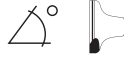

37 86.00

| | | | | | | | |
|----------------------------|-----------------|----------------------|-----------------|---------------------|--------|------|---------|
| M 110.921 | 2746cc | 6 Cyl. | 12 Valves | 118kW/160PS | Petrol | DOHC | TD2115 |
| M 110.922 | 2746cc | 6 Cyl. | 12 Valves | 115-118kW/156-160PS | Petrol | DOHC | TD2116 |
| M 110.923 | 2746cc | 6 Cyl. | 12 Valves | 115kW/156PS | Petrol | DOHC | TD2117 |
| M 110.931 | 2746cc | 6 Cyl. | 12 Valves | 107kW/145PS | Petrol | DOHC | TD17796 |
| M 110.932 | 2746cc | 6 Cyl. | 12 Valves | 105kW/143PS | Petrol | DOHC | TD17726 |
| M 110.981 | 2746cc | 6 Cyl. | 12 Valves | 136kW/185PS | Petrol | DOHC | TD2120 |
| M 110.982 | 2746cc | 6 Cyl. | 12 Valves | 130-136kW/177-185PS | Petrol | DOHC | TD2121 |
| M 110.983 | 2746cc | 6 Cyl. | 12 Valves | 130-136kW/177-185PS | Petrol | DOHC | TD2122 |
| M 110.984 | 2746cc | 6 Cyl. | 12 Valves | 136kW/185PS | Petrol | DOHC | TD4659 |
| M 110.985 | 2746cc | 6 Cyl. | 12 Valves | 101-136kW/137-185PS | Petrol | DOHC | TD2124 |
| M 110.986 | 2746cc | 6 Cyl. | 12 Valves | 130-136kW/177-185PS | Petrol | DOHC | TD2125 |
| M 110.991 | 2746cc | 6 Cyl. | 12 Valves | 125kW/170PS | Petrol | DOHC | TD17797 |
| M 110.992 | 2746cc | 6 Cyl. | 12 Valves | 125kW/170PS | Petrol | DOHC | TD17798 |
| /8 (W114) 280 | 06/1972→11/1976 | /8 (W114) 280 C | 06/1972→02/1977 | | | | |
| /8 (W114) 280 CE | 06/1972→01/1977 | /8 (W114) 280 E | 06/1972→11/1976 | | | | |
| COUPE (C123) 280 C | 03/1977→03/1980 | SALOON (W123) 280 | 02/1976→08/1981 | | | | |
| SALOON (W123) 280 E | 02/1976→11/1985 | S-CLASS (W116) 280 S | 08/1972→07/1980 | | | | |
| S-CLASS (W116) 280 SE, SEL | 08/1972→07/1980 | SL (C107) 280 SLC | 08/1974→09/1981 | | | | |
| SL (R107) 280 SL | 08/1974→07/1985 | | | | | | |

V95071
45.25 x 8.97 x 115.00

110 050 07 26

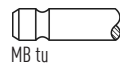

45°

H

VAG92171B
51.50 x 9.02 x 14.06



V95072
37.10 x 10.95 x 118.00

110 050 00 27

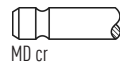

45°

SS

VAG96152
51.50 x 9.02 x 14.05

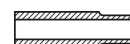

VAG92172B
54.30 x 11.02 x 15.06



VAG92414B
54.00 x 9.02 x 15.06



38 86.00

| | | | | | | | |
|----------------------|-----------------|----------------------------|-----------------|---------------------|--------|------|--------|
| M 110.924 | 2746cc | 6 Cyl. | 12 Valves | 115kW/156PS | Petrol | DOHC | TD2118 |
| M 110.926 | 2746cc | 6 Cyl. | 12 Valves | 115kW/156PS | Petrol | DOHC | TD2119 |
| M 110.987 | 2746cc | 6 Cyl. | 12 Valves | 136kW/185PS | Petrol | DOHC | TD2126 |
| M 110.988 | 2746cc | 6 Cyl. | 12 Valves | 130-136kW/177-185PS | Petrol | DOHC | TD2127 |
| M 110.989 | 2746cc | 6 Cyl. | 12 Valves | 136kW/185PS | Petrol | DOHC | TD2128 |
| M 110.990 | 2746cc | 6 Cyl. | 12 Valves | 130-136kW/177-185PS | Petrol | DOHC | TD2129 |
| M 110.994 | 2746cc | 6 Cyl. | 12 Valves | 110-115kW/150-156PS | Petrol | DOHC | TD2130 |
| COUPE (C123) 280 CE | 03/1977→11/1985 | G-CLASS (W460) 280 GE | 11/1979→08/1989 | | | | |
| KOMBI (S123) 280 TE | 09/1977→11/1985 | SALOON (W123) 280 E | 02/1976→11/1985 | | | | |
| S-CLASS (W126) 280 S | 12/1979→07/1985 | S-CLASS (W126) 280 SE, SEL | 10/1979→07/1985 | | | | |
| SL (C107) 280 SLC | 08/1974→09/1981 | SL (R107) 280 SL | 08/1974→07/1985 | | | | |

V95071
45.25 x 8.97 x 115.00

110 050 07 26

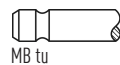

45°

H

VAG92171B
51.50 x 9.02 x 14.06



VAG96152
51.50 x 9.02 x 14.05



VAG92172B
54.30 x 11.02 x 15.06

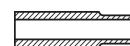

VAG92414B
54.00 x 9.02 x 15.06

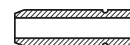



OE

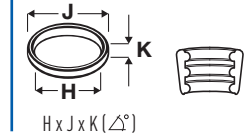
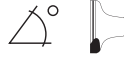

39



86.00

| | | | | | | | |
|----------------------------|-----------------|----------------------------|-----------------|---------------------|--------|-------------|---------|
| OM 628.960 | 3996cc | V8 Cyl. | 32 Valves | 184-191kW/250-260PS | Diesel | Turbo, DOHC | TD15462 |
| OM 628.961 | 3996cc | V8 Cyl. | 32 Valves | 191kW/260PS | Diesel | Turbo, DOHC | TD17545 |
| OM 628.962 | 3996cc | V8 Cyl. | 32 Valves | 184kW/250PS | Diesel | Turbo, DOHC | TD15459 |
| OM 628.963 | 3996cc | V8 Cyl. | 32 Valves | 184kW/250PS | Diesel | Turbo, DOHC | TD17010 |
| OM 629.910 | 3996cc | V8 Cyl. | 32 Valves | 231kW/314PS | Diesel | Turbo, DOHC | TD19144 |
| OM 629.911 | 3996cc | V8 Cyl. | 32 Valves | 235kW/320PS | Diesel | Turbo, DOHC | TD20332 |
| OM 629.912 | 3996cc | V8 Cyl. | 32 Valves | 225kW/306PS | Diesel | Turbo, DOHC | TD19208 |
| E-CLASS (W211) E 400 CDI | 02/2003→12/2008 | E-CLASS (W211) E 420 CDI | 01/2006→12/2008 | | | | |
| G-CLASS (W463) G 400 CDI | 12/2000→ | GL-CLASS (X164) GL 420 CDI | 09/2006→05/2009 | | | | |
| GL-CLASS (X164) GL 450 CDI | 05/2009→ | M-CLASS (W163) ML 400 CDI | 09/2001→06/2005 | | | | |
| M-CLASS (W164) ML 420 CDI | 02/2006→09/2009 | M-CLASS (W164) ML 450 CDI | 09/2009→12/2011 | | | | |
| S-CLASS (W220) S 400 CDI | 06/2000→08/2005 | S-CLASS (W221) S 420 CDI | 10/2006→12/2009 | | | | |
| S-CLASS (W221) S 450 CDI | 01/2009→12/2013 | | | | | | |

V98066 ■

28.70 x 7.00 x 104.10

628 053 00 01

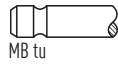

45°

MB tu

VAG96241 ■ ■ ■

37.50 x 7.02 x 12.58



V98067 ■

26.20 x 7.00 x 104.50

628 053 00 05

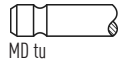

45°

MD tu

40



86.50

| | | | | | | | |
|------------------------------|-----------------|---------------------------------|-----------------|-------------|--------|------|---------|
| M 130.920 | 2778cc | 6 Cyl. | 12 Valves | 103kW/140PS | Petrol | SOHC | TD2195 |
| M 130.921 | 2778cc | 6 Cyl. | 12 Valves | 92kW/125PS | Petrol | SOHC | TD17792 |
| M 130.922 | 2778cc | 6 Cyl. | 12 Valves | 125kW/170PS | Petrol | SOHC | TD22714 |
| M 130.923 | 2778cc | 6 Cyl. | 12 Valves | 96kW/130PS | Petrol | SOHC | TD2196 |
| M 130.924 | 2778cc | 6 Cyl. | 12 Valves | 89kW/121PS | Petrol | SOHC | TD17793 |
| M 130.925 | 2778cc | 6 Cyl. | 12 Valves | 81kW/110PS | Petrol | SOHC | TD16996 |
| M 130.933 | 2778cc | 6 Cyl. | 12 Valves | 87kW/118PS | Petrol | SOHC | TD17794 |
| M 130.980 | 2778cc | 6 Cyl. | 12 Valves | 118kW/160PS | Petrol | SOHC | TD2197 |
| M 130.981 | 2778cc | 6 Cyl. | 12 Valves | 118kW/160PS | Petrol | SOHC | TD4673 |
| M 130.983 | 2778cc | 6 Cyl. | 12 Valves | 125kW/170PS | Petrol | SOHC | TD2200 |
| M 130.984 | 2778cc | 6 Cyl. | 12 Valves | 118kW/160PS | Petrol | SOHC | TD9989 |
| /8 (W114) 250 2.8 | 06/1972→11/1976 | /8 (W114) 250 C 2.8 | 06/1972→11/1976 | | | | |
| COUPE (W111) 280 SE | 01/1967→12/1971 | PAGODE (W113) 280 SL | 01/1968→03/1971 | | | | |
| S-CLASS (W108, W109) 280 S | 10/1967→07/1972 | S-CLASS (W108, W109) 280 SE,SEL | 01/1968→08/1972 | | | | |
| S-CLASS (W108, W109) 300 SEL | 01/1968→08/1972 | | | | | | |

V95096 ■

37.00 x 10.95 x 113.20

115 050 00 27

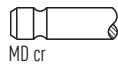

45°

SS

MD cr

VAG51028B ■

55.00 x 9.02 x 14.06



VAG92200B ■

45.00 x 11.02 x 15.06

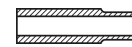

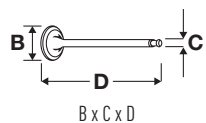

OE

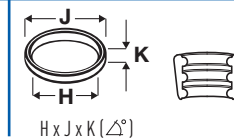
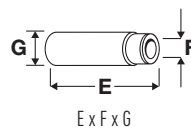

41 87.00

| | | | | | | | |
|-----------|--------|--------|----------|-----------------|--------|------|---------|
| M 115.923 | 1988cc | 4 Cyl. | 8 Valves | 62-70kW/85-95PS | Petrol | SOHC | TD2141 |
| M 115.926 | 1988cc | 4 Cyl. | 8 Valves | 62-70kW/85-95PS | Petrol | SOHC | TD2143 |
| M 115.938 | 1988cc | 4 Cyl. | 8 Valves | 62-70kW/84-95PS | Petrol | SOHC | TD2147 |
| M 115.939 | 1988cc | 4 Cyl. | 8 Valves | 62-70kW/84-95PS | Petrol | SOHC | TD2148 |
| M 121.940 | 1988cc | 4 Cyl. | 8 Valves | 61kW/83PS | Petrol | SOHC | TD9948 |
| M 121.943 | 1988cc | 4 Cyl. | 8 Valves | 59kW/80PS | Petrol | SOHC | TD17790 |
| M 121.944 | 1988cc | 4 Cyl. | 8 Valves | 59kW/80PS | Petrol | SOHC | TD17791 |

| | | | |
|---------------|-----------------|-----------------------|-----------------|
| /8 (W115) 200 | 01/1968→01/1977 | HECKFLOSSE (W110) 200 | 07/1965→02/1968 |
| 0 309 | 01/1968→02/1989 | SALOON (W123) 200 | 02/1976→08/1980 |

| | | | | | | |
|---|---------------|--|-----|----|---|--|
| V94750 ■ 44.20 x 9.00 x 128.00 | 121 053 04 01 | | 45° | H | VAG51028B ■ 55.00 x 9.02 x 14.06 | |
| V95096 ■ 37.00 x 10.95 x 113.20 | 115 050 00 27 | | 45° | SS | VAG92200B ■ 45.00 x 11.02 x 15.06 | |

42 87.00

| | | | | | | | |
|-----------|--------|--------|----------|-----------|--------|------|---------|
| M 121.941 | 1988cc | 4 Cyl. | 8 Valves | 59kW/80PS | Petrol | SOHC | TD17788 |
| M 121.942 | 1988cc | 4 Cyl. | 8 Valves | 50kW/68PS | Petrol | SOHC | TD17789 |

| | | | | | | |
|--|---------------|--|-----|---|---|--|
| V94750 ■ 44.20 x 9.00 x 128.00 | 121 053 04 01 | | 45° | H | VAG51028B ■ 55.00 x 9.02 x 14.06 | |
| | | | | | VAG92200B ■ 45.00 x 11.02 x 15.06 | |

43 87.00

| | | | | | | |
|----------|--------|--------|----------|-----------|--------|--------|
| M 115.I | 1990cc | 4 Cyl. | 8 Valves | 63kW/85PS | Petrol | TD2156 |
| M 115.II | 1990cc | 4 Cyl. | 8 Valves | 55kW/75PS | Petrol | TD2157 |

| | |
|--------------|-----------------|
| T2/L L 408 G | 01/1968→12/1972 |
|--------------|-----------------|

| | | | | | | |
|---|---------------|--|-----|----|---|--|
| V94750 ■ 44.20 x 9.00 x 128.00 | 121 053 04 01 | | 45° | H | VAG51028B ■ 55.00 x 9.02 x 14.06 | |
| V95096 ■ 37.00 x 10.95 x 113.20 | 115 050 00 27 | | 45° | SS | VAG92200B ■ 45.00 x 11.02 x 15.06 | |





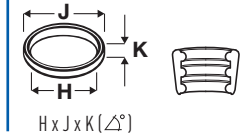
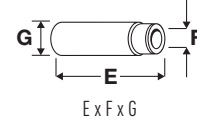
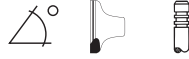



OE

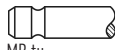











44  **87.00**

| | | | | | | | |
|------------------------|-----------------|--------|-----------------|------------------------|--------|-----------------|---------------|
| OM 601.911 | 1997cc | 4 Cyl. | 8 Valves | 53-55kW/72-75PS | Diesel | SOHC | TD2206 |
| OM 601.912 | 1997cc | 4 Cyl. | 8 Valves | 53-55kW/72-75PS | Diesel | SOHC | TD2207 |
| OM 601.913 | 1997cc | 4 Cyl. | 8 Valves | 55kW/75PS | Diesel | SOHC | TD2208 |
| 190 (W201) D 2.0 | 08/1983→08/1993 | | | C-CLASS (W202) C 200 D | | 03/1993→05/2000 | |
| E-CLASS (W124) E 200 D | 06/1993→06/1995 | | | KOMBI (S124) 200 T D | | 09/1985→08/1991 | |
| SALOON (W124) 200 D | 12/1984→06/1993 | | | | | | |

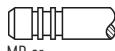
| | | | | | | |
|---|---------------|---|-----|---|---|----------------------|
| V91181  | 601 053 17 01 |  | 45° | H | VAG92297  | 39.50 x 8.00 x 14.05 |
| 38.10 x 7.97 x 106.50 | | MB tu | | | | |
| V91182  | 601 050 25 27 |  | 45° | H | VAG96214  | 39.50 x 8.02 x 14.25 |
| 35.10 x 8.96 x 106.50 | | MF + MB cr | | | | |
| | | | | | VAG92298  | 37.50 x 9.00 x 14.05 |
| | | | | | | |
| | | | | | VAG96204  | 37.50 x 9.02 x 14.25 |
| | | | | | | |

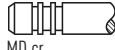
45  **87.00**

| | | | | | | | |
|--------------------------|-----------------|--------|------------------|------------------------|--------|-----------------|---------------|
| OM 604.915 | 1997cc | 4 Cyl. | 16 Valves | 65-85kW/88-116PS | Diesel | DOHC | TD4677 |
| OM 604.917 | 1997cc | 4 Cyl. | 16 Valves | 65kW/88PS | Diesel | DOHC | TD9424 |
| C-CLASS (S202) C 200 T D | 10/1996→03/2001 | | | C-CLASS (W202) C 200 D | | 10/1996→05/2000 | |
| E-CLASS (W210) E 200 D | 01/1996→03/2002 | | | | | | |

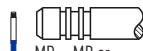
| | | | | | | |
|---|---------------|---|-----|---|---|----------------------|
| V94278  | 606 053 11 01 |  | 45° | H | VAG96095  | 37.60 x 6.00 x 12.55 |
| 28.90 x 6.00 x 105.40 | | MB tu | | | | |
| V94290  | 606 053 07 01 |  | 45° | H | VAG96149  | 37.50 x 7.02 x 12.59 |
| 29.00 x 6.00 x 105.40 | | MB cr | | | | |
| V94279  | 606 053 07 05 |  | 45° | | | |
| 26.00 x 6.00 x 105.70 | | MD cr | | | | |
| V94280  | 606 050 14 27 |  | 45° | | | |
| 26.00 x 7.00 x 105.70 | | MD cr | | | | |
| V94291  | 606 053 03 05 |  | 45° | H | | |
| 26.00 x 6.00 x 105.70 | | MD + MB cr | | | | |

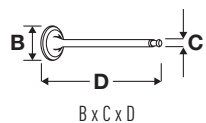

OE

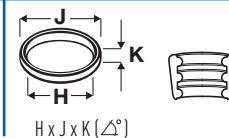
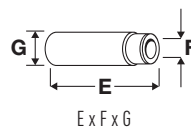

46 **87.00**

| | | | | | | | |
|-----------|--------|--------|-----------------|------------|--------|-------------|---------|
| M 115.900 | 2197cc | 4 Cyl. | 8 Valves | 40kW/54PS | Petrol | SOHC | TD22705 |
| M 115.920 | 2197cc | 4 Cyl. | 8 Valves | 77kW/105PS | Petrol | SOHC | TD2139 |
| M 115.921 | 2197cc | 4 Cyl. | 8 Valves | 63kW/86PS | Petrol | SOHC | TD2140 |
| M 115.922 | 2197cc | 4 Cyl. | 8 Valves | 62kW/85PS | Petrol | SOHC | TD17799 |
| M 115.924 | 2197cc | 4 Cyl. | 8 Valves | 66kW/90PS | Petrol | SOHC | TD2142 |
| M 115.927 | 2197cc | 4 Cyl. | 8 Valves | 63kW/85PS | Petrol | SOHC | TD2144 |
| M 115.928 | 2197cc | 4 Cyl. | 8 Valves | 55kW/75PS | Petrol | SOHC | TD2145 |
| M 115.929 | 2197cc | 4 Cyl. | 8 Valves | 55kW/75PS | Petrol | SOHC | TD2146 |
| M 115.932 | 2197cc | 4 Cyl. | 8 Valves | 48kW/65PS | Petrol | SOHC | TD17785 |
| M 115.933 | 2197cc | 4 Cyl. | 8 Valves | 62kW/85PS | Petrol | SOHC | TD17800 |
| M 115.934 | 2197cc | 4 Cyl. | 8 Valves | 55kW/75PS | Petrol | SOHC | TD17801 |
| M 115.935 | 2197cc | 4 Cyl. | 8 Valves | 55kW/75PS | Petrol | SOHC | TD17802 |

| | | | |
|---------------|-----------------|---------------|-----------------|
| /8 (W115) 220 | 01/1968→07/1973 | 0 309 | 01/1968→02/1989 |
| T2/L L 408 G | 08/1972→12/1974 | T2/L LF 408 G | 08/1972→12/1974 |
| T2/L LK 408 G | 01/1968→12/1974 | | |

V94750 ■
44.20 x 9.00 x 128.00

121 053 04 01

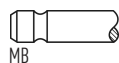

MB

45°

H

VAG51028B ■
55.00 x 9.02 x 14.06

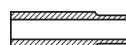

V95096 ■
37.00 x 10.95 x 113.20

115 050 00 27



MD cr

45°

SS

VAG92200B ■
45.00 x 11.02 x 15.06



47 **87.00**

| | | | | | | | |
|-------------------|--------|--------|-----------------|-----------|--------|-------------|--------|
| OM 601.921 | 2197cc | 4 Cyl. | 8 Valves | 54kW/72PS | Diesel | SOHC | TD2209 |
|-------------------|--------|--------|-----------------|-----------|--------|-------------|--------|

| | | | |
|------------------|-----------------|--|--|
| 190 (W201) 190 D | 09/1984→12/1985 | | |
|------------------|-----------------|--|--|

V91181 ■
38.10 x 7.97 x 106.50

601 053 17 01



MB tu

45°

H

VAG92297 ■
39.50 x 8.00 x 14.05

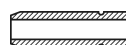

V91182 ■
35.10 x 8.96 x 106.50

601 050 25 27

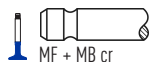

MF + MB cr

45°

H

VAG96214 ■
39.50 x 8.02 x 14.25

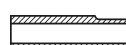

VAG92298 ■
37.50 x 9.00 x 14.05

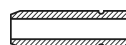

VAG96204 ■
37.50 x 9.02 x 14.25

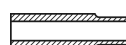



OE

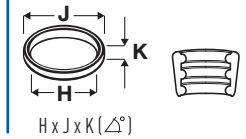
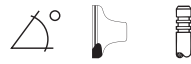

48



87.00

| | | | | | | | |
|-------------|--------|--------|-----------|-------------------|--------|-------------|---------|
| OM 602.911 | 2497cc | 5 Cyl. | 10 Valves | 66-69kW/90-94PS | Diesel | SOHC | TD2211 |
| OM 602.912 | 2497cc | 5 Cyl. | 10 Valves | 66-69kW/90-94PS | Diesel | SOHC | TD2212 |
| OM 602.930 | 2497cc | 5 Cyl. | 10 Valves | 62-69kW/84-94PS | Diesel | SOHC | TD2213 |
| OM 602.931 | 2497cc | 5 Cyl. | 10 Valves | 69kW/94PS | Diesel | SOHC | TD2214 |
| OM 602.938 | 2497cc | 5 Cyl. | 10 Valves | 68kW/92PS | Diesel | SOHC | TD17816 |
| OM 602.939 | 2497cc | 5 Cyl. | 10 Valves | 68kW/92PS | Diesel | SOHC | TD9422 |
| OM 602.961 | 2497cc | 5 Cyl. | 10 Valves | 90-93kW/122-126PS | Diesel | Turbo, SOHC | TD2216 |
| OM 602.990 | 2497cc | 5 Cyl. | 10 Valves | 63kW/86PS | Diesel | SOHC | TD17819 |
| OM 602A.962 | 2497cc | 5 Cyl. | 10 Valves | 93kW/126PS | Diesel | Turbo, SOHC | TD2217 |
| OM 602A.993 | 2497cc | 5 Cyl. | 10 Valves | 93kW/126PS | Diesel | SOHC | TD17821 |

| | | | |
|------------------------------|-----------------|------------------------------|-----------------|
| 190 (W201) D 2.5 | 04/1985→08/1993 | 190 (W201) Turbo-D 2.5 | 02/1988→08/1993 |
| E-CLASS (S124) E 250 Turbo D | 06/1993→06/1996 | E-CLASS (W124) E 250 Turbo-D | 06/1993→06/1995 |
| G-CLASS (W460) 250 GD | 10/1987→12/1992 | G-CLASS (W461) 250 GD | 02/1990→05/1993 |
| G-CLASS (W463) 250 GD | 06/1990→10/1992 | KOMBI (S124) 250 T D | 09/1985→06/1993 |
| KOMBI (S124) 250 TD Turbo | 03/1988→07/1993 | O 405 | |
| SALOON (W124) 250 D | 04/1985→06/1993 | SALOON (W124) 250 Turbo-D | 09/1988→06/1993 |

V91181 ■
38.10 x 7.97 x 106.50

601 053 17 01

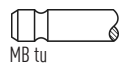

45°

H

VAG92297 ■
39.50 x 8.00 x 14.05

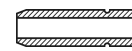

V91182 ■
35.10 x 8.96 x 106.50

601 050 25 27



45°

H

VAG96214 ■
39.50 x 8.02 x 14.25



VAG92298 ■
37.50 x 9.00 x 14.05



VAG96204 ■
37.50 x 9.02 x 14.25



49



87.00

| | | | | | | | |
|------------|--------|--------|-----------|-------------|--------|-------------|--------|
| OM 605.910 | 2497cc | 5 Cyl. | 20 Valves | 83kW/113PS | Diesel | DOHC | TD2228 |
| OM 605.911 | 2497cc | 5 Cyl. | 20 Valves | 83kW/113PS | Diesel | DOHC | TD2229 |
| OM 605.912 | 2497cc | 5 Cyl. | 20 Valves | 83kW/113PS | Diesel | DOHC | TD4678 |
| OM 605.960 | 2497cc | 5 Cyl. | 20 Valves | 110kW/150PS | Diesel | Turbo, DOHC | TD4679 |
| OM 605.962 | 2497cc | 5 Cyl. | 20 Valves | 110kW/150PS | Diesel | Turbo, DOHC | TD9892 |

| | | | |
|--------------------------------|-----------------|--------------------------------|-----------------|
| C-CLASS (S202) C 250 T Turbo-D | 06/1996→03/2001 | C-CLASS (W202) C 250 D | 05/1993→05/2000 |
| C-CLASS (W202) C 250 Turbo-D | 10/1995→05/2000 | E-CLASS (S124) E 250 TD | 06/1993→06/1996 |
| E-CLASS (S210) E 250 T D | 06/1996→07/1999 | E-CLASS (S210) E 250 T Turbo-D | 06/1997→07/1999 |
| E-CLASS (W124) E 250 D | 07/1993→06/1995 | E-CLASS (W210) E 250 D | 06/1995→07/1999 |
| E-CLASS (W210) E 250 Turbo-D | 06/1997→07/1999 | | |

V94278 ■
28.90 x 6.00 x 105.40

606 053 11 01

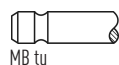

45°

H

VAG96095 ■
37.60 x 6.00 x 12.55



V94290 ■
29.00 x 6.00 x 105.40

606 053 07 01

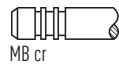

45°

H

VAG96149 ■
37.50 x 7.02 x 12.59



V94279 ■
26.00 x 6.00 x 105.70

606 053 07 05

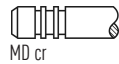

45°

V94280 ■
26.00 x 7.00 x 105.70

606 050 14 27

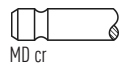

45°

V94291 ■
26.00 x 6.00 x 105.70

606 053 03 05



45°

H



OE

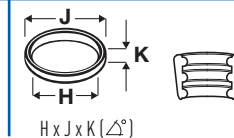
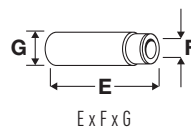
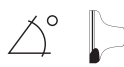

50 **87.00**

| | | | | | | | |
|--------------------|--------|--------|------------------|---------------------|--------|--------------------|----------------|
| OM 603.912 | 2996cc | 6 Cyl. | 12 Valves | 80-83kW/109-113PS | Diesel | SOHC | TD2218 |
| OM 603.913 | 2996cc | 6 Cyl. | 12 Valves | 80-83kW/109-113PS | Diesel | SOHC | TD2219 |
| OM 603.931 | 2996cc | 6 Cyl. | 12 Valves | 83kW/113PS | Diesel | SOHC | TD2220 |
| OM 603.950 | 2996cc | 6 Cyl. | 12 Valves | 100-105kW/136-143PS | Diesel | Turbo, SOHC | TD21143 |
| OM 603.961 | 2996cc | 6 Cyl. | 12 Valves | 107-110kW/143-148PS | Diesel | Turbo, SOHC | TD2222 |
| OM 603.962 | 2996cc | 6 Cyl. | 12 Valves | 105kW/143PS | Diesel | Turbo, SOHC | TD21144 |
| OM 603A.960 | 2996cc | 6 Cyl. | 12 Valves | 100-108kW/136-147PS | Diesel | Turbo, SOHC | TD2221 |
| OM 603A.963 | 2996cc | 6 Cyl. | 12 Valves | 105-108kW/143-147PS | Diesel | Turbo, SOHC | TD2223 |

| | | | |
|------------------------------|-----------------|--------------------------------|-----------------|
| E-CLASS (S124) E 300 TD | 06/1993→06/1996 | E-CLASS (S124) E 300 T Turbo-D | 06/1993→06/1996 |
| E-CLASS (W124) E 300 Turbo-D | 06/1993→06/1995 | G-CLASS (W460) 300 GD | 03/1979→07/1993 |
| G-CLASS (W463) 300 GD | 09/1989→09/1997 | KOMBI (S124) 300 T D | 09/1986→06/1993 |
| KOMBI (S124) 300 TD T | 06/1992→05/1993 | KOMBI (S124) 300 T Turbo-D | 09/1986→06/1993 |
| SALOON (W124) 300 D | 12/1984→06/1993 | SALOON (W124) 300 Turbo-D | 09/1986→06/1993 |
| S-CLASS (W126) 300 SDL | 09/1985→12/1987 | | |

V91181
38.10 x 7.97 x 106.50

601 053 17 01

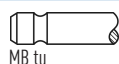

45°

H

VAG92297
39.50 x 8.00 x 14.05



V91182
35.10 x 8.96 x 106.50

601 050 25 27

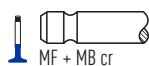

45°

H

VAG96214
39.50 x 8.02 x 14.25

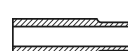

VAG92298
37.50 x 9.00 x 14.05



VAG96204
37.50 x 9.02 x 14.25



51 **87.00**

| | | | | | | | |
|-------------------|--------|--------|------------------|-------------|--------|--------------------|---------------|
| OM 606.910 | 2996cc | 6 Cyl. | 24 Valves | 100kW/136PS | Diesel | DOHC | TD2230 |
| OM 606.912 | 2996cc | 6 Cyl. | 24 Valves | 100kW/136PS | Diesel | DOHC | TD4680 |
| OM 606.961 | 2996cc | 6 Cyl. | 24 Valves | 130kW/177PS | Diesel | Turbo, DOHC | TD5238 |
| OM 606.962 | 2996cc | 6 Cyl. | 24 Valves | 130kW/177PS | Diesel | Turbo, DOHC | TD9416 |
| OM 606.964 | 2996cc | 6 Cyl. | 24 Valves | 130kW/177PS | Diesel | Turbo, DOHC | TD9425 |

| | | | |
|------------------------------|-----------------|--------------------------------|-----------------|
| E-CLASS (S124) E 300 TD | 06/1993→06/1996 | E-CLASS (S210) E 300 T Turbo-D | 12/1996→07/1999 |
| E-CLASS (W124) E 300 D | 07/1993→06/1995 | E-CLASS (W210) E 300 D | 06/1995→06/1997 |
| E-CLASS (W210) E 300 Turbo-D | 12/1996→07/1999 | G-CLASS (W463) G 300 TD | 08/1996→07/2000 |
| S-CLASS (W140) S 300 Turbo-D | 05/1996→10/1998 | | |

V94278
28.90 x 6.00 x 105.40

606 053 11 01



45°

H

VAG96095
37.60 x 6.00 x 12.55



V94290
29.00 x 6.00 x 105.40

606 053 07 01

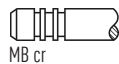

45°

H

VAG96149
37.50 x 7.02 x 12.59



V94279
26.00 x 6.00 x 105.70

606 053 07 05

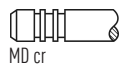

45°

H

V94280
26.00 x 7.00 x 105.70

606 050 14 27

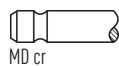

45°

H

V94291
26.00 x 6.00 x 105.70

606 053 03 05

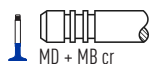

45°

H



OE

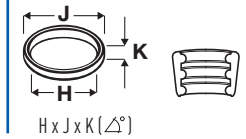
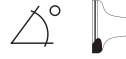

52



88.00

| | | | | | | | |
|-------------------------------|-----------------|--------|-----------|-------------------------------|-----------------|-------------|---------|
| OM 646.811 | 2148cc | 4 Cyl. | 16 Valves | 100-125kW/136-170PS | Diesel | Turbo, DOHC | TD20360 |
| OM 646.812 | 2148cc | 4 Cyl. | 16 Valves | 100kW/136PS | Diesel | Turbo, DOHC | TD22694 |
| OM 646.820 | 2148cc | 4 Cyl. | 16 Valves | 100kW/136PS | Diesel | Turbo, DOHC | TD20362 |
| OM 646.821 | 2148cc | 4 Cyl. | 16 Valves | 100-125kW/136-170PS | Diesel | Turbo, DOHC | TD20334 |
| OM 646.951 | 2148cc | 4 Cyl. | 16 Valves | 75-90kW/102-122PS | Diesel | DOHC | TD18129 |
| OM 646.961 | 2148cc | 4 Cyl. | 16 Valves | 100-110kW/136-150PS | Diesel | Turbo, DOHC | TD17007 |
| OM 646.962 | 2148cc | 4 Cyl. | 16 Valves | 75-110kW/102-150PS | Diesel | Turbo, DOHC | TD17542 |
| OM 646.963 | 2148cc | 4 Cyl. | 16 Valves | 90-110kW/122-150PS | Diesel | Turbo, DOHC | TD17543 |
| OM 646.966 | 2148cc | 4 Cyl. | 16 Valves | 100-110kW/136-150PS | Diesel | Turbo, DOHC | TD22844 |
| OM 646.980 | 2148cc | 4 Cyl. | 16 Valves | 70-110kW/95-150PS | Diesel | Turbo, DOHC | TD24573 |
| OM 646.981 | 2148cc | 4 Cyl. | 16 Valves | 70kW/95PS | Diesel | Turbo, DOHC | TD20984 |
| OM 646.982 | 2148cc | 4 Cyl. | 16 Valves | 80-110kW/109-150PS | Diesel | Turbo, DOHC | TD18289 |
| OM 646.983 | 2148cc | 4 Cyl. | 16 Valves | 65-80kW/88-109PS | Diesel | Turbo, DOHC | TD20921 |
| OM 646.984 | 2148cc | 4 Cyl. | 16 Valves | 65kW/88PS | Diesel | Turbo, DOHC | TD22140 |
| OM 646.985 | 2148cc | 4 Cyl. | 16 Valves | 80kW/109PS | Diesel | Turbo, DOHC | TD20730 |
| OM 646.986 | 2148cc | 4 Cyl. | 16 Valves | 95-110kW/129-150PS | Diesel | Turbo, DOHC | TD23620 |
| OM 646.989 | 2148cc | 4 Cyl. | 16 Valves | 110kW/150PS | Diesel | Turbo, DOHC | TD24257 |
| OM 646.990 | 2148cc | 4 Cyl. | 16 Valves | 110kW/150PS | Diesel | Turbo, DOHC | TD23618 |
| C-CLASS (CL203) C 200 CDI | 03/2003→05/2008 | | | C-CLASS (CL203) C 220 CDI | 02/2004→05/2008 | | |
| C-CLASS (S203) C 200 CDI | 03/2001→08/2007 | | | C-CLASS (S203) C 220 CDI | 02/2004→08/2007 | | |
| C-CLASS (S204) C 200 CDI | 08/2007→12/2011 | | | C-CLASS (S204) C 220 CDI | 08/2007→11/2008 | | |
| C-CLASS (W203) C 200 CDI | 04/2003→02/2007 | | | C-CLASS (W203) C 220 CDI | 05/2000→02/2007 | | |
| C-CLASS (W204) C 200 CDI | 01/2007→12/2010 | | | C-CLASS (W204) C 220 CDI | 01/2007→11/2008 | | |
| CLC-CLASS (CL203) CLC 200 CDI | 05/2008→06/2011 | | | CLC-CLASS (CL203) CLC 220 CDI | 05/2008→06/2011 | | |
| CLK (C209) 220 CDI | 01/2005→05/2009 | | | E-CLASS (S211) E 200 CDI | 04/2006→07/2009 | | |
| E-CLASS (S211) E 220 CDI | 03/2003→07/2009 | | | E-CLASS (S211) E 220 T CDI | 03/2003→07/2009 | | |
| E-CLASS (W211) E 200 CDI | 07/2002→12/2008 | | | E-CLASS (W211) E 220 CDI | 03/2002→12/2008 | | |
| SPRINTER 3,5-t (906) 309 CDI | 06/2006→12/2009 | | | SPRINTER 3,5-t (906) 311 CDI | 06/2006→12/2009 | | |
| SPRINTER 3,5-t (906) 313 CDI | 06/2006→ | | | SPRINTER 3,5-t (906) 315 CDI | 06/2006→12/2009 | | |
| SPRINTER 3-t (906) 209 CDI | 06/2006→12/2009 | | | SPRINTER 3-t (906) 211 CDI | 06/2006→12/2009 | | |
| SPRINTER 3-t (906) 213 CDI | 06/2006→12/2009 | | | SPRINTER 3-t (906) 215 CDI | 06/2006→12/2009 | | |
| SPRINTER 4,6-t (906) 411 CDI | 06/2009→12/2009 | | | SPRINTER 4,6-t (906) 413 CDI | 06/2006→05/2016 | | |
| SPRINTER 4,6-t (906) 415 CDI | 06/2006→12/2009 | | | SPRINTER 5-t (906) 509 CDI | 06/2006→12/2009 | | |
| SPRINTER 5-t (906) 511 CDI | 06/2006→12/2009 | | | SPRINTER 5-t (906) 513 CDI | 06/2006→ | | |
| SPRINTER 5-t (906) 515 CDI | 06/2006→12/2009 | | | VIANO (W639) CDI 2.0 | 09/2003→ | | |
| VIANO (W639) CDI 2.2 | 09/2003→ | | | VITO (W639) 109 CDI | 09/2003→ | | |
| VITO (W639) 111 CDI | 09/2003→ | | | VITO (W639) 115 CDI | 09/2003→ | | |
| VITO / MIXTO (W639) 109 CDI | 09/2003→ | | | VITO / MIXTO (W639) 111 CDI | 09/2003→ | | |
| VITO / MIXTO (W639) 115 CDI | 09/2003→ | | | | | | |

V98066 ■
28.70 x 7.00 x 104.10

628 053 00 01

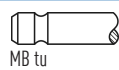

45°

V98067 ■
26.20 x 7.00 x 104.50

628 053 00 05

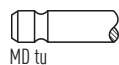

45°

VAG96241 ■■
37.50 x 7.02 x 12.58

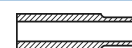



OE

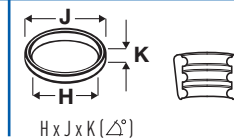
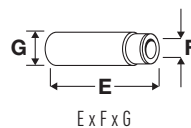

53 **88.00**

| | | | | | | | |
|-----------------------------|--------|--------|------------------|--------------------|--------|--------------------|----------------|
| OM 611.960 | 2151cc | 4 Cyl. | 16 Valves | 75-92kW/102-125PS | Diesel | Turbo, DOHC | TD9529 |
| OM 611.961 | 2151cc | 4 Cyl. | 16 Valves | 75-105kW/102-143PS | Diesel | Turbo, DOHC | TD17005 |
| OM 611.962 | 2151cc | 4 Cyl. | 16 Valves | 75-105kW/102-143PS | Diesel | Turbo, DOHC | TD15449 |
| OM 611.980 | 2151cc | 4 Cyl. | 16 Valves | 60-90kW/82-122PS | Diesel | Turbo, DOHC | TD14350 |
| OM 611.981 | 2151cc | 4 Cyl. | 16 Valves | 80-95kW/109-129PS | Diesel | Turbo, DOHC | TD17729 |
| OM 611.987 | 2151cc | 4 Cyl. | 16 Valves | 60kW/82PS | Diesel | Turbo, DOHC | TD17730 |
| OM 611A (60 KW CDI) | 2151cc | 4 Cyl. | 16 Valves | 60kW/82PS | Diesel | DOHC | TD14348 |
| OM 611LA (75 KW CDI) | 2151cc | 4 Cyl. | 16 Valves | 75kW/102PS | Diesel | DOHC | TD14349 |

| | | | |
|---------------------------------|-----------------|---------------------------------|-----------------|
| C-CLASS (CL203) C 220 CDI | 03/2001→01/2004 | C-CLASS (S202) C 200 T CDI | 03/1998→03/2001 |
| C-CLASS (S202) C 220 T CDI | 09/1997→03/2001 | C-CLASS (S203) C 200 CDI | 03/2001→08/2007 |
| C-CLASS (S203) C 220 CDI | 03/2001→08/2007 | C-CLASS (W202) C 200 CDI | 03/1998→05/2000 |
| C-CLASS (W202) C 220 CDI | 09/1997→05/2000 | C-CLASS (W203) C 200 CDI | 09/2000→02/2007 |
| C-CLASS (W203) C 220 CDI | 05/2000→02/2007 | E-CLASS (S210) E 220 T CDI | 06/1998→03/2003 |
| E-CLASS (W210) E 200 CDI | 06/1998→03/2002 | E-CLASS (W210) E 220 CDI | 06/1998→03/2002 |
| SPRINTER 2-t (901, 902) 208 CDI | 04/2000→05/2006 | SPRINTER 2-t (901, 902) 211 CDI | 04/2000→05/2006 |
| SPRINTER 2-t (901, 902) 213 CDI | 04/2000→05/2006 | SPRINTER 3-t (903) 308 CDI | 04/2000→05/2006 |
| SPRINTER 3-t (903) 311 CDI | 04/2000→05/2006 | SPRINTER 3-t (903) 313 CDI | 04/2000→05/2006 |
| SPRINTER 4-t (904) 408 CDI | 04/2000→05/2006 | SPRINTER 4-t (904) 411 CDI | 04/2000→05/2006 |
| SPRINTER 4-t (904) 413 CDI | 04/2000→05/2006 | V-CLASS (638/2) V 200 CDI | 03/1999→07/2003 |
| V-CLASS (638/2) V 220 CDI | 03/1999→07/2003 | VITO (638) 108 CDI 2.2 | 03/1999→07/2003 |
| VITO (638) 110 CDI 2.2 | 03/1999→07/2003 | VITO (638) 112 CDI 2.2 | 03/1999→07/2003 |

V94398 30.20 x 7.00 x 104.00

611 053 04 01

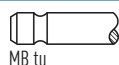

45°

H

VAG96241 37.50 x 7.02 x 12.58

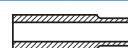

V94399 28.40 x 7.00 x 104.30

611 053 01 05

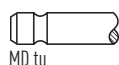

45°

MD tu

54 **88.00**

| | | | | | | | |
|------------------|--------|---------|------------------|-------------|--------|-------------|----------------|
| M 272.911 | 2496cc | V6 Cyl. | 24 Valves | 150kW/204PS | Petrol | DOHC | TD22142 |
| M 272.920 | 2496cc | V6 Cyl. | 24 Valves | 150kW/204PS | Petrol | DOHC | TD18425 |
| M 272.921 | 2496cc | V6 Cyl. | 24 Valves | 150kW/204PS | Petrol | DOHC | TD20357 |
| M 272.922 | 2496cc | V6 Cyl. | 24 Valves | 150kW/204PS | Petrol | DOHC | TD22143 |

| | | | |
|---------------------------|-----------------|---------------------------|-----------------|
| C-CLASS (CL203) C 230 | 01/2005→05/2008 | C-CLASS (S203) C 230 | 01/2005→08/2007 |
| C-CLASS (S204) C 230 | 08/2007→08/2014 | C-CLASS (W203) C 230 | 01/2005→02/2007 |
| C-CLASS (W204) C 230 | 01/2007→01/2014 | CLC-CLASS (CL203) CLC 230 | 05/2008→06/2011 |
| CLC-CLASS (CL203) CLC 250 | 06/2009→06/2011 | E-CLASS (S211) E 230 T | 05/2007→07/2009 |
| E-CLASS (W211) E 230 | 09/2007→12/2008 | | |

V95073 37.00 x 5.97 x 109.50

272 053 02 01

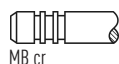

45°

H

V95074 28.00 x 5.96 x 107.45

272 050 02 27

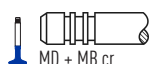

45°

ss

H

MD + MB cr



OE

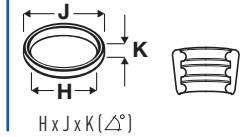
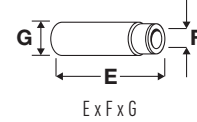

55



88.00

| | | | | | | | |
|---------------------------------|-----------------|--------|-----------|----------------------------|--------|-----------------|---------|
| OM 612.961 | 2685cc | 5 Cyl. | 20 Valves | 120-125kW/163-170PS | Diesel | Turbo, DOHC | TD15455 |
| OM 612.962 | 2685cc | 5 Cyl. | 20 Valves | 120-125kW/163-170PS | Diesel | Turbo, DOHC | TD15451 |
| OM 612.963 | 2685cc | 5 Cyl. | 20 Valves | 120kW/163PS | Diesel | Turbo, DOHC | TD17009 |
| OM 612.965 | 2685cc | 5 Cyl. | 20 Valves | 115-120kW/156-163PS | Diesel | Turbo, DOHC | TD21145 |
| OM 612.966 | 2685cc | 5 Cyl. | 20 Valves | 115kW/156PS | Diesel | Turbo, DOHC | TD16895 |
| OM 612.967 | 2685cc | 5 Cyl. | 20 Valves | 120-125kW/163-170PS | Diesel | Turbo, DOHC | TD17323 |
| OM 612.981 | 2685cc | 5 Cyl. | 20 Valves | 110-115kW/150-156PS | Diesel | Turbo, DOHC | TD17731 |
| OM 612.983 | 2685cc | 5 Cyl. | 20 Valves | 115kW/156PS | Diesel | Turbo, DOHC | TD25649 |
| ACCELO | 05/2003→ | | | C-CLASS (S203) C 270 CDI | | 03/2001→08/2007 | |
| C-CLASS (W203) C 270 CDI | 12/2000→02/2007 | | | CLK (C209) 270 CDI | | 10/2002→05/2009 | |
| E-CLASS (S210) E 270 T CDI | 07/1999→03/2003 | | | E-CLASS (W210) E 270 CDI | | 07/1999→03/2002 | |
| G-CLASS (W461) G 270 CDI | 01/2003→ | | | G-CLASS (W463) G 270 CDI | | 10/2001→ | |
| M-CLASS (W163) ML 270 CDI | 12/1999→06/2005 | | | SPRINTER (905) 616 CDI | | 04/2001→ | |
| SPRINTER 2-t (901, 902) 216 CDI | 04/2000→05/2006 | | | SPRINTER 3-t (903) 316 CDI | | 04/2000→05/2006 | |
| SPRINTER 4-t (904) 416 CDI | 04/2000→05/2006 | | | SPRINTER 5-t (905) 616 CDI | | 04/2001→05/2006 | |

V94398 ■

30.20 x 7.00 x 104.00

611 053 04 01

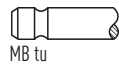

45°

H

VAG96241 ■ ■ ■
37.50 x 7.02 x 12.58



V94399 ■

28.40 x 7.00 x 104.30

611 053 01 05

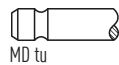

45°

56



88.00

| | | | | | | | |
|----------------------------|-----------------|--------|-----------|--------------------------|--------|-----------------|---------|
| OM 647.961 | 2685cc | 5 Cyl. | 20 Valves | 120-130kW/163-177PS | Diesel | Turbo, DOHC | TD17008 |
| OM 647.981 | 2685cc | 5 Cyl. | 20 Valves | 60-130kW/82-177PS | Diesel | Turbo, DOHC | TD21142 |
| E-CLASS (S211) E 270 T CDI | 03/2003→07/2009 | | | E-CLASS (W211) E 270 CDI | | 03/2002→12/2008 | |

V98066 ■

28.70 x 7.00 x 104.10

628 053 00 01

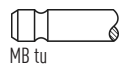

45°

VAG96241 ■ ■ ■
37.50 x 7.02 x 12.58

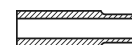

V98067 ■

26.20 x 7.00 x 104.50

628 053 00 05

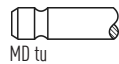

45°

57



88.00

| | | | | | | | |
|------------------------------|-----------------|--------|-----------|-----------------------------|--------|-----------------|---------|
| OM 612.990 | 2950cc | 5 Cyl. | 20 Valves | 170kW/231PS | Diesel | Turbo, DOHC | TD17544 |
| C-CLASS (CL203) C 30 CDI AMG | 09/2002→05/2008 | | | C-CLASS (S203) C 30 CDI AMG | | 01/2003→08/2007 | |
| C-CLASS (W203) C 30 CDI AMG | 01/2003→02/2007 | | | | | | |

V94398 ■

30.20 x 7.00 x 104.00

611 053 04 01

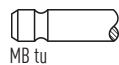

45°

H

VAG96241 ■ ■ ■
37.50 x 7.02 x 12.58



V94399 ■

28.40 x 7.00 x 104.30

611 053 01 05

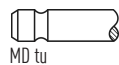

45°

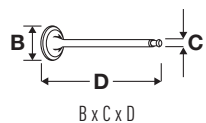

OE

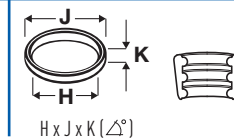
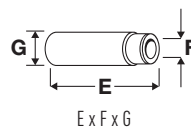

58 **88.00**

| | | | | | | | |
|-----------|--------|---------|-----------|---------------------|--------|------|---------|
| M 272.940 | 2996cc | V6 Cyl. | 24 Valves | 170kW/231PS | Petrol | DOHC | TD18420 |
| M 272.941 | 2996cc | V6 Cyl. | 24 Valves | 170kW/231PS | Petrol | DOHC | TD18423 |
| M 272.942 | 2996cc | V6 Cyl. | 24 Valves | 170kW/231PS | Petrol | DOHC | TD18427 |
| M 272.943 | 2996cc | V6 Cyl. | 24 Valves | 170kW/231PS | Petrol | DOHC | TD18430 |
| M 272.944 | 2996cc | V6 Cyl. | 24 Valves | 170kW/231PS | Petrol | DOHC | TD23758 |
| M 272.945 | 2996cc | V6 Cyl. | 24 Valves | 170-180kW/231-245PS | Petrol | DOHC | TD20570 |
| M 272.946 | 2996cc | V6 Cyl. | 24 Valves | 170-180kW/231-245PS | Petrol | DOHC | TD26966 |
| M 272.947 | 2996cc | V6 Cyl. | 24 Valves | 170kW/231PS | Petrol | DOHC | TD20356 |
| M 272.948 | 2996cc | V6 Cyl. | 24 Valves | 170kW/231PS | Petrol | DOHC | TD22968 |
| M 272.949 | 2996cc | V6 Cyl. | 24 Valves | 170kW/231PS | Petrol | DOHC | TD20863 |
| M 272.952 | 2996cc | V6 Cyl. | 24 Valves | 170kW/231PS | Petrol | DOHC | TD25212 |

| | | | |
|----------------------------|-----------------|----------------------------|-----------------|
| C-CLASS (S203) C 280 | 01/2005→08/2007 | C-CLASS (S204) C 280 | 08/2007→08/2014 |
| C-CLASS (S204) C 300 | 08/2007→08/2014 | C-CLASS (W203) C 280 | 01/2005→02/2007 |
| C-CLASS (W204) C 280 | 01/2007→01/2014 | C-CLASS (W204) C 300 | 07/2007→01/2014 |
| CLK (A209) CLK 280 | 01/2005→03/2010 | CLK (C209) 280 | 01/2005→05/2009 |
| CLS (C219) CLS 280 | 07/2008→12/2010 | CLS (C219) CLS 300 | 04/2009→12/2010 |
| E-CLASS (S211) E 280 T | 03/2005→07/2009 | E-CLASS (S212) E 300 | 11/2009→ |
| E-CLASS (W211) E 280 | 03/2005→12/2008 | E-CLASS (W212) E 300 | 01/2009→ |
| GLK-CLASS (X204) 280 | 06/2008→06/2009 | GLK-CLASS (X204) 300 | 07/2009→04/2011 |
| M-CLASS (W164) ML 300 | 03/2010→ | R-CLASS (W251, V251) R 280 | 01/2007→ |
| R-CLASS (W251, V251) R 300 | 07/2009→ | S-CLASS (W221) S 280 | 08/2006→12/2013 |
| S-CLASS (W221) S 300 | 08/2006→12/2013 | SL (R230) 280 | 03/2008→01/2012 |
| SL (R230) 300 | 04/2009→01/2012 | SLK (R171) 280 | 01/2005→02/2011 |
| SLK (R171) 300 | 04/2009→02/2011 | | |

V95073
37.00 x 5.97 x 109.50

272 053 02 01

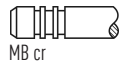

45°

H

V95074
28.00 x 5.96 x 107.45

272 050 02 27

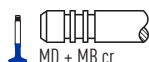

45°

ss

H

59 **88.00**

| | | | | | | | |
|------------|--------|--------|-----------|-------------|--------|-------------|---------|
| OM 613.960 | 3222cc | 6 Cyl. | 24 Valves | 145kW/197PS | Diesel | Turbo, DOHC | TD15461 |
|------------|--------|--------|-----------|-------------|--------|-------------|---------|

| | | | | | | | |
|--|-----------------|--|-----|---|---|--|--|
| S-CLASS (W220) S 320 CDI | 08/1999→09/2002 | | | | | | |
| V94398 30.20 x 7.00 x 104.00 | 611 053 04 01 | | 45° | H | VAG96241 37.50 x 7.02 x 12.58 | | |
| V94399 28.40 x 7.00 x 104.30 | 611 053 01 05 | | 45° | | | | |

60 **88.00**

| | | | | | | | |
|------------|--------|--------|-----------|---------------------|--------|-------------|---------|
| OM 648.960 | 3222cc | 6 Cyl. | 24 Valves | 150kW/204PS | Diesel | Turbo, DOHC | TD17187 |
| OM 648.961 | 3222cc | 6 Cyl. | 24 Valves | 130-150kW/177-204PS | Diesel | Turbo, DOHC | TD17328 |

| | | | |
|----------------------------|-----------------|----------------------------|-----------------|
| E-CLASS (S211) E 280 T CDI | 05/2004→07/2009 | E-CLASS (S211) E 320 T CDI | 03/2003→07/2009 |
| E-CLASS (W211) E 280 CDI | 05/2004→12/2008 | E-CLASS (W211) E 320 CDI | 11/2002→12/2008 |
| S-CLASS (W220) S 320 CDI | 09/2002→08/2005 | | |

V98066
28.70 x 7.00 x 104.10

628 053 00 01

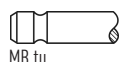

45°

VAG96241
37.50 x 7.02 x 12.58

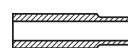

V98067
26.20 x 7.00 x 104.50

628 053 00 05

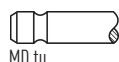





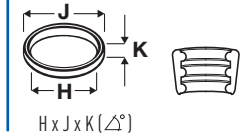
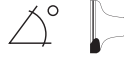

45°







OE







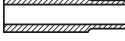

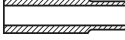
61  **88.00**

| | | | | | | | |
|---|---------------|---|------------------|--------------------------|---|---|----------------|
| OM 613.961 | 3226cc | 6 Cyl. | 24 Valves | 145kW/197PS | Diesel | Turbo, DOHC | TD15454 |
| E-CLASS (S210) E 320 T CDI | | 07/1999→03/2003 | | E-CLASS (W210) E 320 CDI | | 07/1999→03/2002 | |
| V94398  | 611 053 04 01 |  | 45° | H | VAG96241  |  | |
| 30.20 x 7.00 x 104.00 | | MB tu | | | 37.50 x 7.02 x 12.58 | | |
| V94399  | 611 053 01 05 |  | 45° | | | | |
| 28.40 x 7.00 x 104.30 | | MD tu | | | | | |

62  **88.00**

| | | | | | | | |
|---|---------------|---|------------------|----------------------------|--|--|---------------|
| M 116.962 | 3839cc | V8 Cyl. | 16 Valves | 116-150kW/158-204PS | Petrol | SOHC | TD2160 |
| M 116.963 | 3839cc | V8 Cyl. | 16 Valves | 116-150kW/158-204PS | Petrol | SOHC | TD4669 |
| S-CLASS (C126) 380 SEC | | 10/1981→07/1985 | | S-CLASS (W126) 380 SE, SEL | | 10/1981→08/1985 | |
| SL (C107) 380 SLC | | 08/1981→08/1984 | | SL (R107) 380 SL | | 09/1980→08/1985 | |
| V94333  | 116 050 04 26 |  | 45° | Y H | VAG96144B  |  | |
| 39.10 x 9.00 x 117.00 | | MB | | | 47.50 x 9.02 x 14.05 | | |
| | | | | | VAG96139B  |  | |
| | | | | | 50.50 x 9.02 x 15.05 | | |

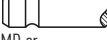
63  **89.00**

| | | | | | | | |
|---|---------------|---|-----------------|------------|--|---|---------------|
| M 102.910 | 1797cc | 4 Cyl. | 8 Valves | 80kW/109PS | Petrol | SOHC | TD2061 |
| M 102.919 | 1797cc | 4 Cyl. | 8 Valves | 77kW/105PS | Petrol | SOHC | TD2062 |
| 190 (W201) E 1.8 | | 04/1990→08/1993 | | | | | |
| V91441  | 102 053 18 01 |  | 45° | H | VAG92378B  |  | |
| 43.00 x 8.00 x 114.90 | | MB cr | | | 46.00 x 8.00 x 14.05 | | |
| V91958  | 102 050 03 27 |  | 45° | | VAG92379B  |  | |
| 39.00 x 9.00 x 115.80 | | MD cr | | | 51.00 x 9.00 x 14.05 | | |

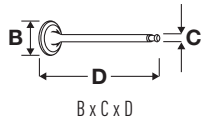

OE

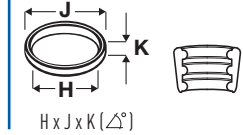
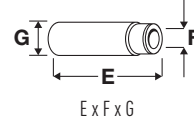
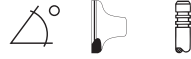

64 **89.00**

| | | | | | | | |
|------------------|--------|--------|-----------------|-------------------|--------|-------------|----------------|
| M 102.920 | 1997cc | 4 Cyl. | 8 Valves | 74-80kW/100-109PS | Petrol | SOHC | TD2063 |
| M 102.921 | 1997cc | 4 Cyl. | 8 Valves | 63-77kW/86-105PS | Petrol | SOHC | TD2064 |
| M 102.922 | 1997cc | 4 Cyl. | 8 Valves | 75-80kW/102-109PS | Petrol | SOHC | TD2065 |
| M 102.924 | 1997cc | 4 Cyl. | 8 Valves | 75-77kW/102-105PS | Petrol | SOHC | TD4653 |
| M 102.938 | 1997cc | 4 Cyl. | 8 Valves | 63kW/86PS | Petrol | SOHC | TD22701 |
| M 102.939 | 1997cc | 4 Cyl. | 8 Valves | 74-80kW/100-109PS | Petrol | SOHC | TD2069 |
| M 102.961 | 1997cc | 4 Cyl. | 8 Valves | 83-93kW/113-126PS | Petrol | SOHC | TD5050 |
| M 102.962 | 1997cc | 4 Cyl. | 8 Valves | 83-90kW/115-122PS | Petrol | SOHC | TD4655 |
| M 102.963 | 1997cc | 4 Cyl. | 8 Valves | 87-90kW/118-122PS | Petrol | SOHC | TD2078 |
| M 102.964 | 1997cc | 4 Cyl. | 8 Valves | 80kW/109PS | Petrol | SOHC | TD17723 |
| M 102.965 | 1997cc | 4 Cyl. | 8 Valves | 80-85kW/109-116PS | Petrol | SOHC | TD2080 |

| | | | |
|----------------------|-----------------|-----------------------|-----------------|
| 190 (W201) 2.0 | 10/1982→05/1990 | 190 (W201) E 2.0 | 10/1982→08/1993 |
| G-CLASS (W460) 200 G | 07/1982→08/1989 | G-CLASS (W463) 200 GE | 01/1990→07/1993 |
| KOMBI (S123) 200 T | 11/1980→11/1985 | KOMBI (S124) 200 E | 11/1992→05/1993 |
| KOMBI (S124) 200 T | 09/1985→05/1990 | KOMBI (S124) 200 TE | 09/1988→08/1992 |
| SALOON (W123) 200 | 06/1980→11/1985 | SALOON (W124) 200 | 12/1985→05/1990 |
| SALOON (W124) 200 E | 09/1988→05/1993 | | |

| | | | | | | |
|-----------------------|---------------|-------|-----|---|----------------------|--|
| V91441 | 102 053 18 01 | | 45° | H | VAG92378B | |
| 43.00 x 8.00 x 114.90 | | MB cr | | | 46.00 x 8.00 x 14.05 | |
| V91958 | 102 050 03 27 | | 45° | | VAG92379B | |
| 39.00 x 9.00 x 115.80 | | MD cr | | | 51.00 x 9.00 x 14.05 | |

65 **89.00**

| | | | | | | | |
|-------------------|--------|--------|------------------|-----------------|--------|-------------|---------------|
| OM 604.910 | 2155cc | 4 Cyl. | 16 Valves | 55-70kW/75-95PS | Diesel | DOHC | TD2227 |
| OM 604.912 | 2155cc | 4 Cyl. | 16 Valves | 55-70kW/75-95PS | Diesel | DOHC | TD4676 |

| | | | |
|--------------------------|-----------------|------------------------|-----------------|
| C-CLASS (S202) C 220 T D | 06/1996→03/2001 | C-CLASS (W202) C 220 D | 08/1993→05/2000 |
| E-CLASS (W210) E 220 D | 06/1995→03/2002 | | |

| | | | | | | |
|-----------------------|---------------|------------|-----|---|----------------------|--|
| V94278 | 606 053 11 01 | | 45° | H | VAG96095 | |
| 28.90 x 6.00 x 105.40 | | MB tu | | | 37.60 x 6.00 x 12.55 | |
| V94290 | 606 053 07 01 | | 45° | H | VAG96149 | |
| 29.00 x 6.00 x 105.40 | | MB cr | | | 37.50 x 7.02 x 12.59 | |
| V94279 | 606 053 07 05 | | 45° | | | |
| 26.00 x 6.00 x 105.70 | | MD cr | | | | |
| V94280 | 606 050 14 27 | | 45° | | | |
| 26.00 x 7.00 x 105.70 | | MD cr | | | | |
| V94291 | 606 053 03 05 | | 45° | H | | |
| 26.00 x 6.00 x 105.70 | | MD + MB cr | | | | |



OE

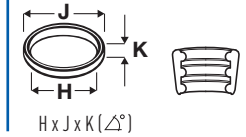

66



89.00

| | | | | | | | |
|-------------------------------|-----------------|--------|----------|--------------------------|-----------------|-------------|---------|
| OM 601.900 | 2299cc | 4 Cyl. | 8 Valves | 62kW/85PS | Diesel | SOHC | TD16185 |
| OM 601.940 | 2299cc | 4 Cyl. | 8 Valves | 58-60kW/79-82PS | Diesel | SOHC | TD2210 |
| OM 601.941 | 2299cc | 4 Cyl. | 8 Valves | 58-60kW/79-82PS | Diesel | SOHC | TD8041 |
| OM 601.942 | 2299cc | 4 Cyl. | 8 Valves | 58kW/79PS | Diesel | SOHC | TD5398 |
| OM 601.943 | 2299cc | 4 Cyl. | 8 Valves | 58-60kW/79-82PS | Diesel | SOHC | TD5400 |
| OM 601A.970 | 2299cc | 4 Cyl. | 8 Valves | 72kW/98PS | Diesel | Turbo, SOHC | TD4674 |
| SPRINTER 2-t (901, 902) 208 D | 01/1995→04/2000 | | | SPRINTER 3-t (903) 308 D | 02/1995→04/2000 | | |
| SPRINTER 3-t (903) 308 D 2.3 | 02/1995→04/2000 | | | SPRINTER 4-t (904) 408 D | 02/1996→05/2006 | | |
| T1 (601) 208 D 2.3 | 10/1988→02/1996 | | | T1 (601, 611) 208 D 2.3 | 10/1988→02/1996 | | |
| T1 (602) 308 D 2.3 | 11/1988→02/1996 | | | T1/TN 408 D | 11/1988→06/1995 | | |
| T2/LN1 508 D | 03/1989→12/1994 | | | Tremo | 09/1998→ | | |
| V-CLASS (638/2) V 230 TD | 09/1996→07/2003 | | | VITO (638) 108 D 2.3 | 02/1996→07/2003 | | |
| VITO (638) 110 D 2.3 | 03/1997→07/2003 | | | VITO (638) 110 TD 2.3 | 02/1996→07/2003 | | |

V91181 ■

38.10 x 7.97 x 106.50

601 053 17 01

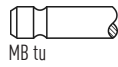

MB tu

45°

H

VAG92297 ■

39.50 x 8.00 x 14.05

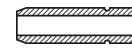

V91182 ■

35.10 x 8.96 x 106.50

601 050 25 27



MF + MB cr

45°

H

VAG96214 ■

39.50 x 8.02 x 14.25



VAG92298 ■

37.50 x 9.00 x 14.05

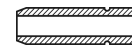

VAG96204 ■

37.50 x 9.02 x 14.25

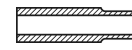

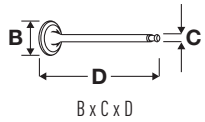

OE

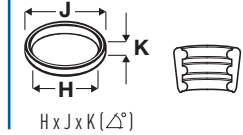
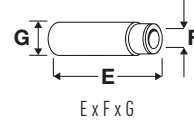
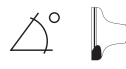

67 **89.00**

| | | | | | | | |
|-------------------|--------|--------|------------------|-------------------|--------|--------------------|----------------|
| OM 602.940 | 2874cc | 5 Cyl. | 10 Valves | 70-72kW/95-98PS | Diesel | SOHC | TD2215 |
| OM 602.941 | 2874cc | 5 Cyl. | 10 Valves | 65-70kW/88-95PS | Diesel | SOHC | TD8013 |
| OM 602.942 | 2874cc | 5 Cyl. | 10 Valves | 70-72kW/95-98PS | Diesel | SOHC | TD2054 |
| OM 602.946 | 2874cc | 5 Cyl. | 10 Valves | 70kW/95PS | Diesel | SOHC | TD17817 |
| OM 602.947 | 2874cc | 5 Cyl. | 10 Valves | 72kW/98PS | Diesel | SOHC | TD17818 |
| OM 602.948 | 2874cc | 5 Cyl. | 10 Valves | 71kW/97PS | Diesel | SOHC | TD8014 |
| OM 602.980 | 2874cc | 5 Cyl. | 10 Valves | 75-90kW/102-122PS | Diesel | Turbo, SOHC | TD8032 |
| OM 602.981 | 2874cc | 5 Cyl. | 10 Valves | 85-90kW/116-122PS | Diesel | Turbo, SOHC | TD14670 |
| OM 602.982 | 2874cc | 5 Cyl. | 10 Valves | 95kW/129PS | Diesel | Turbo, SOHC | TD4675 |
| OM 602.983 | 2874cc | 5 Cyl. | 10 Valves | 88kW/120PS | Diesel | Turbo, SOHC | TD12910 |
| OM 602.984 | 2874cc | 5 Cyl. | 10 Valves | 90kW/122PS | Diesel | Turbo, SOHC | TD5682 |
| OM 602.985 | 2874cc | 5 Cyl. | 10 Valves | 90kW/122PS | Diesel | Turbo, SOHC | TD6020 |
| OM 602.986 | 2874cc | 5 Cyl. | 10 Valves | 75-90kW/102-122PS | Diesel | Turbo, SOHC | TD9459 |
| OM 602.989 | 2874cc | 5 Cyl. | 10 Valves | 85-90kW/116-122PS | Diesel | Turbo, SOHC | TD14672 |
| OM 602.991 | 2874cc | 5 Cyl. | 10 Valves | 70kW/95PS | Diesel | SOHC | TD17820 |
| OM 602.994 | 2874cc | 5 Cyl. | 10 Valves | 72kW/98PS | Diesel | SOHC | TD17822 |
| OM 662.911 | 2874cc | 5 Cyl. | 10 Valves | 70kW/95PS | Diesel | DOHC | TD22700 |

| | | | |
|--------------------------------|-----------------|-------------------------------|-----------------|
| E-CLASS (S210) E 290 T Turbo-D | 06/1996→07/1999 | E-CLASS (W210) E 290 Turbo-D | 03/1996→07/1999 |
| G-CLASS (W461) 290 GD/G 290 D | 06/1993→07/2000 | G-CLASS (W461) G 290 TD | 07/1997→ |
| MB100 (KPA) 2.9 D | 10/2001→05/2005 | MB140 (KPA) 2.9 D | 11/1999→05/2005 |
| O 100 | 01/1994→ | O 405 | |
| SPRINTER 2-t (901, 902) 210 D | 01/1997→04/2000 | SPRINTER 2-t (901, 902) 212 D | 02/1995→04/2000 |
| SPRINTER 3-t (903) 310 D | 01/1997→08/2002 | SPRINTER 3-t (903) 310 D 2.9 | 02/1995→04/2000 |
| SPRINTER 3-t (903) 312 D 2.9 | 02/1995→08/2002 | SPRINTER 4-t (904) 410 D | 02/1996→05/2006 |
| SPRINTER 4-t (904) 412 D | 02/1996→05/2006 | SPRINTER 4-t (904) 414 D | 05/1997→05/2006 |
| T1 (601) 210 D 2.8 | 11/1988→02/1996 | T1 (601) 210 D 2.9 | 11/1988→02/1996 |
| T1 (601, 611) 210 D 2.8 | 10/1988→02/1996 | T1 (602) 310 D 2.9 | 06/1989→02/1996 |
| T1/TN 410 D | 11/1988→06/1995 | UNIMOG | 11/1992→ |
| UX100 | 01/1999→ | VARIO 512 D | 09/1996→12/2010 |
| VARIO 612 D | 09/1996→12/2010 | VARIO 812 D | 09/1996→12/2010 |
| VARIO O 812 | 09/1996→12/2010 | | |

V91181
38.10 x 7.97 x 106.50

601 053 17 01

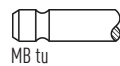

45°

H

V91182
35.10 x 8.96 x 106.50

601 050 25 27

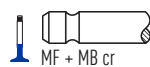

45°

H

VAG92297
39.50 x 8.00 x 14.05

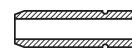

VAG96214
39.50 x 8.02 x 14.25

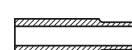

VAG92298
37.50 x 9.00 x 14.05



VAG96204
37.50 x 9.02 x 14.25

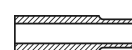



OE

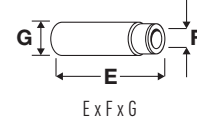

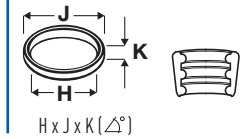

E x F x G



H x J x K (Δ°)



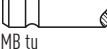
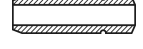
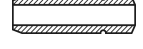

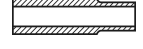
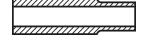
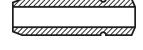
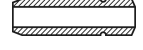
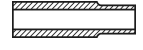
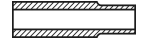
68  **89.00**

| | | | | | | | |
|------------------------------|-----------------|--------|------------------|------------------------------|-----------------|--------------------|---------------|
| OM 603A.970 | 3449cc | 6 Cyl. | 12 Valves | 100kW/136PS | Diesel | Turbo, SOHC | TD2224 |
| OM 603A.971 | 3449cc | 6 Cyl. | 12 Valves | 100-110kW/136-150PS | Diesel | Turbo, SOHC | TD2225 |
| OM 603A.972 | 3449cc | 6 Cyl. | 12 Valves | 100kW/136PS | Diesel | Turbo, SOHC | TD2226 |
| G-CLASS (W463) 350 G Turbo-D | 09/1991→09/1997 | | | G-CLASS (W463) 350 Turbo GD | 09/1991→08/1996 | | |
| G-CLASS (W463) G 320 CDI | 09/1996→08/1999 | | | S-CLASS (W140) S 350 Turbo-D | 01/1993→10/1998 | | |

| | | | | | | |
|---|---------------|---|-----|---|---|---|
| V91181  | 601 053 17 01 |  | 45° | H | VAG92297  |  |
| 38.10 x 7.97 x 106.50 | | MB tu | | | 39.50 x 8.00 x 14.05 | |
| V91182  | 601 050 25 27 |  | 45° | H | VAG96214  |  |
| 35.10 x 8.96 x 106.50 | | MF + MB cr | | | 39.50 x 8.02 x 14.25 | |
| | | | | | VAG92298  |  |
| | | | | | 37.50 x 9.00 x 14.05 | |
| | | | | | VAG96204  |  |
| | | | | | 37.50 x 9.02 x 14.25 | |

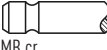













69  **89.00**

| | | | | | | | |
|------------------|-----------------|--------|------------------|-------------|--------|--|----------------|
| M 122.981 | 5956cc | 8 Cyl. | 32 Valves | 280kW/381PS | Petrol | | TD24543 |
| SL (R129) 60 AMG | 05/1997→10/2001 | | | | | | |

| | | | | | | |
|---|---------------|---|-----|----|---|---|
| V94288  | 104 053 14 01 |  | 45° | H | VAG96149  |  |
| 35.00 x 7.00 x 101.50 | | MB cr | | | 37.50 x 7.02 x 12.59 | |
| V94370  | 111 053 1101 |  | 45° | H | | |
| 35.00 x 7.00 x 101.50 | | MB tu | | | | |
| V94371  | 611 050 0127 |  | 45° | SS | | |
| 31.00 x 7.00 x 103.50 | | MD tu | | | | |

70  **89.00**

| | | | | | | | |
|---------------------------|-----------------|----------|------------------|----------------------------|-----------------|-------------|----------------|
| M 120.980 | 5987cc | V12 Cyl. | 48 Valves | 290-300kW/394-408PS | Petrol | DOHC | TD2192 |
| M 120.981 | 5987cc | V12 Cyl. | 48 Valves | 280-300kW/381-408PS | Petrol | DOHC | TD2193 |
| M 120.982 | 5987cc | V12 Cyl. | 48 Valves | 290-300kW/394-408PS | Petrol | DOHC | TD20347 |
| M 120.983 | 5987cc | V12 Cyl. | 48 Valves | 290-300kW/394-408PS | Petrol | DOHC | TD11496 |
| S-CLASS (C140) SEC/CL 600 | 07/1992→02/1999 | | | S-CLASS (W140) 600 SE, SEL | 04/1991→12/1992 | | |
| S-CLASS (W140) S 600 | 01/1993→10/1998 | | | SL (R129) 600 | 07/1992→10/2001 | | |
| SL (R129) 600 SL | 02/1992→08/1994 | | | | | | |

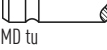
| | | | | | | | |
|---|---------------|---|-----|----|---|--|---|
| V94480  | 111 053 02 01 |  | 45° | Y | H | VAG96142B  |  |
| 35.00 x 6.97 x 101.50 Eng.→02676 | | MB cr | | | | 35.50 x 7.02 x 13.55 | |
| V94288  | 104 053 14 01 |  | 45° | | H | VAG96096  |  |
| 35.00 x 7.00 x 101.50 Eng.02677→ | | MB cr | | | | 37.60 x 7.00 x 12.55 | |
| V94370  | 111 053 1101 |  | 45° | | H | VAG96178  |  |
| 35.00 x 7.00 x 101.50 Eng.02677→ | | MB tu | | | | 37.50 x 7.02 x 12.76 | |
| V94377  | 111 050 05 27 |  | 45° | SS | H | | |
| 31.00 x 7.00 x 103.50 Eng.→02676 | | ME + MB cr | | | | | |
| V94371  | 611 050 0127 |  | 45° | SS | | | |
| 31.00 x 7.00 x 103.50 Eng.02677→ | | MD tu | | | | | |

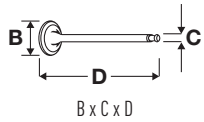

OE

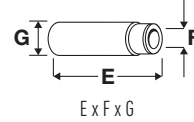
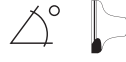

E x F x G

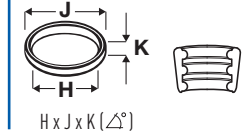

H x J x K (Δ°)

71 89.90

| | | | | | | | |
|------------------------|-----------------|--------|-----------|------------------------|--------|-----------------|--------|
| M 111.940 | 1998cc | 4 Cyl. | 16 Valves | 100kW/136PS | Petrol | DOHC | TD2132 |
| M 111.941 | 1998cc | 4 Cyl. | 16 Valves | 100kW/136PS | Petrol | DOHC | TD2133 |
| C-CLASS (S202) C 200 T | 06/1996→03/2001 | | | C-CLASS (W202) C 200 | | 01/1994→05/2000 | |
| CLK (A208) 200 | 03/1998→03/2002 | | | E-CLASS (A124) E 200 | | 06/1993→03/1998 | |
| E-CLASS (C124) E 200 | 06/1993→06/1997 | | | E-CLASS (S124) E 200 T | | 06/1993→06/1996 | |
| E-CLASS (W124) E 200 | 06/1993→06/1995 | | | KOMBI (S124) 200 TE | | 05/1986→06/1993 | |
| SALOON (W124) 200 E | 10/1992→06/1993 | | | | | | |

V94480
35.00 x 6.97 x 101.50
→12/95

111 053 02 01

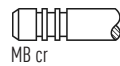

MB cr

45° Y H

VAG96096
37.60 x 7.00 x 12.55



V94370
35.00 x 7.00 x 101.50
01/96→

111 053 1101

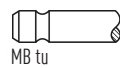

MB tu

45° H

VAG96149
37.50 x 7.02 x 12.59



V94377
31.00 x 7.00 x 103.50
→12/95

111 050 05 27



ME + MB cr

45° ss H

VAG96178
37.50 x 7.02 x 12.76

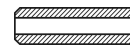

V94371
31.00 x 7.00 x 103.50
01/96→

611 050 0127

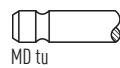

MD tu

45° ss

72 89.90

| | | | | | | | |
|-----------|--------|--------|-----------|---------------------|--------|--------------------|---------|
| M 111.942 | 1998cc | 4 Cyl. | 16 Valves | 100kW/136PS | Petrol | DOHC | TD4660 |
| M 111.943 | 1998cc | 4 Cyl. | 16 Valves | 132-141kW/180-192PS | Petrol | DOHC | TD4661 |
| M 111.944 | 1998cc | 4 Cyl. | 16 Valves | 132-141kW/180-192PS | Petrol | Supercharged, DOHC | TD4662 |
| M 111.945 | 1998cc | 4 Cyl. | 16 Valves | 100kW/136PS | Petrol | DOHC | TD5236 |
| M 111.946 | 1998cc | 4 Cyl. | 16 Valves | 100kW/136PS | Petrol | DOHC | TD4663 |
| M 111.947 | 1998cc | 4 Cyl. | 16 Valves | 137kW/186PS | Petrol | Supercharged, DOHC | TD9419 |
| M 111.948 | 1998cc | 4 Cyl. | 16 Valves | 95kW/129PS | Petrol | DOHC | TD5399 |
| M 111.950 | 1998cc | 4 Cyl. | 16 Valves | 95kW/129PS | Petrol | DOHC | TD22702 |
| M 111.951 | 1998cc | 4 Cyl. | 16 Valves | 95kW/129PS | Petrol | DOHC | TD17002 |
| M 111.952 | 1998cc | 4 Cyl. | 16 Valves | 95kW/129PS | Petrol | DOHC | TD17003 |
| M 111.955 | 1998cc | 4 Cyl. | 16 Valves | 120kW/163PS | Petrol | Supercharged, DOHC | TD14751 |
| M 111.956 | 1998cc | 4 Cyl. | 16 Valves | 120kW/163PS | Petrol | Supercharged, DOHC | TD16488 |
| M 111.957 | 1998cc | 4 Cyl. | 16 Valves | 120kW/163PS | Petrol | DOHC | TD15456 |
| M 111.958 | 1998cc | 4 Cyl. | 16 Valves | 120kW/163PS | Petrol | Supercharged, DOHC | TD14749 |

| | | | | | | | |
|------------------------|-----------------|--|--|------------------------|--|-----------------|--|
| C-CLASS (CL203) C 180 | 03/2001→05/2002 | | | C-CLASS (CL203) C 200 | | 03/2001→05/2002 | |
| C-CLASS (S202) C 180 T | 09/2000→03/2001 | | | C-CLASS (S202) C 200 T | | 06/1996→03/2001 | |
| C-CLASS (S203) C 180 | 03/2001→05/2002 | | | C-CLASS (S203) C 200 | | 03/2001→05/2002 | |
| C-CLASS (W202) C 200 | 01/1994→05/2000 | | | C-CLASS (W203) C 180 | | 10/2000→05/2002 | |
| C-CLASS (W203) C 200 | 05/2000→06/2002 | | | CLK (A208) 200 | | 03/1998→03/2002 | |
| CLK (C208) 200 | 06/1997→06/2002 | | | E-CLASS (S210) E 200 T | | 06/1996→03/2003 | |
| E-CLASS (W210) E 200 | 06/1995→03/2002 | | | SLK (R170) 200 | | 09/1996→04/2004 | |
| V-CLASS (638/2) V 200 | 02/1997→07/2003 | | | VITO (638) 113 2.0 | | 02/1996→07/2003 | |

V94370
35.00 x 7.00 x 101.50

111 053 1101

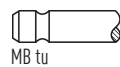

MB tu

45° H

VAG96096
37.60 x 7.00 x 12.55



V94371
31.00 x 7.00 x 103.50

611 050 0127

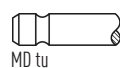

MD tu

45° ss

VAG96149
37.50 x 7.02 x 12.59



VAG96178
37.50 x 7.02 x 12.76

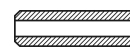



OE

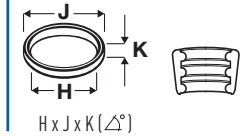
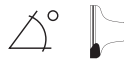

73



89.90

| | | | | | | | |
|------------------------|-----------------|--------|-----------|----------------------|--------|-----------------|--------|
| M 111.960 | 2199cc | 4 Cyl. | 16 Valves | 110kW/150PS | Petrol | DOHC | TD2134 |
| M 111.961 | 2199cc | 4 Cyl. | 16 Valves | 110kW/150PS | Petrol | DOHC | TD2135 |
| C-CLASS (W202) C 220 | 03/1993→05/2000 | | | COUPE (C124) 220 CE | | 10/1992→05/1993 | |
| E-CLASS (A124) E 220 | 06/1993→03/1998 | | | E-CLASS (C124) E 220 | | 06/1993→06/1997 | |
| E-CLASS (S124) E 220 T | 06/1993→06/1996 | | | E-CLASS (W124) E 220 | | 06/1993→06/1995 | |
| KOMBI (S124) 220 TE | 10/1992→05/1993 | | | SALOON (W124) 220 E | | 10/1992→06/1993 | |

V94480 ■
35.00 x 6.97 x 101.50
→12/95

111 053 02 01

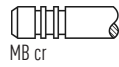

MB cr

45° Y H

VAG96096 ■ ■ ■
37.60 x 7.00 x 12.55

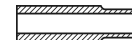

V94370 ■
35.00 x 7.00 x 101.50
01/96→

111 053 1101

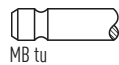

MB tu

45° H

VAG96149 ■ ■ ■
37.50 x 7.02 x 12.59

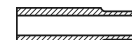

V94377 ■
31.00 x 7.00 x 103.50
→12/95

111 050 05 27



ME + MB cr

45° ss H

VAG96178 ■ ■ ■
37.50 x 7.02 x 12.76

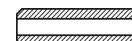

V94371 ■
31.00 x 7.00 x 103.50
01/96→

611 050 0127

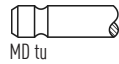

MD tu

45° ss

74



89.90

| | | | | | | | |
|------------------------|-----------------|---------|-----------|------------------------|--------|-----------------|---------|
| M 112.912 | 2597cc | V6 Cyl. | 18 Valves | 120-125kW/163-170PS | Petrol | | TD15450 |
| M 112.913 | 2597cc | V6 Cyl. | 18 Valves | 130kW/177PS | Petrol | | TD17155 |
| M 112.914 | 2597cc | V6 Cyl. | 18 Valves | 125kW/170PS | Petrol | | TD15458 |
| M 112.915 | 2597cc | V6 Cyl. | 18 Valves | 125kW/170PS | Petrol | | TD17004 |
| M 112.916 | 2597cc | V6 Cyl. | 18 Valves | 125kW/170PS | Petrol | | TD17533 |
| M 112.917 | 2597cc | V6 Cyl. | 18 Valves | 130kW/177PS | Petrol | | TD16893 |
| C-CLASS (S202) C 240 T | 09/2000→03/2001 | | | C-CLASS (S203) C 240 | | 03/2001→08/2007 | |
| C-CLASS (W203) C 240 | 05/2000→02/2007 | | | CLK (A209) CLK 240 | | 02/2003→03/2010 | |
| CLK (C209) 240 | 06/2002→05/2009 | | | E-CLASS (S210) E 240 T | | 08/2000→03/2003 | |
| E-CLASS (S211) E 240 T | 03/2003→07/2009 | | | E-CLASS (W210) E 240 | | 08/2000→03/2002 | |
| E-CLASS (W211) E 240 | 03/2002→12/2008 | | | | | | |

V94390 ■
36.00 x 7.00 x 119.40

113 053 05 01

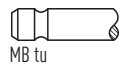

MB tu

45° H

VAG96097 ■ ■ ■
50.00 x 7.03 x 12.76

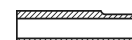

V94391 ■
41.00 x 7.00 x 122.30

113 050 02 27

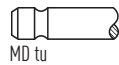

MD tu

45° ss

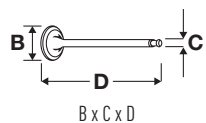

OE

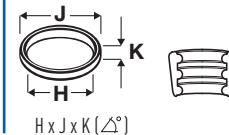
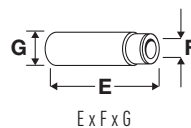

75 89.90

| | | | | | | | |
|-----------|--------|--------|-----------|---------------------|--------|------|--------|
| M 104.941 | 2799cc | 6 Cyl. | 24 Valves | 142kW/193PS | Petrol | DOHC | TD2106 |
| M 104.942 | 2799cc | 6 Cyl. | 24 Valves | 142-145kW/193-197PS | Petrol | DOHC | TD2107 |
| M 104.943 | 2799cc | 6 Cyl. | 24 Valves | 142-150kW/193-204PS | Petrol | DOHC | TD2108 |
| M 104.944 | 2799cc | 6 Cyl. | 24 Valves | 142-145kW/193-197PS | Petrol | DOHC | TD2109 |
| M 104.945 | 2799cc | 6 Cyl. | 24 Valves | 142kW/193PS | Petrol | DOHC | TD9423 |

| | | | |
|---------------------------|-----------------|------------------------|-----------------|
| C-CLASS (W202) C 280 | 05/1993→05/2000 | E-CLASS (S124) E 280 T | 06/1993→06/1996 |
| E-CLASS (W124) E 280 | 06/1993→06/1995 | E-CLASS (W210) E 280 | 01/1996→06/1997 |
| KOMBI (S124) 280 TE | 10/1992→06/1993 | SALOON (W124) 280 E | 10/1992→06/1993 |
| S-CLASS (W140) 300 SE 2.8 | 01/1993→10/1998 | S-CLASS (W140) S 280 | 02/1993→10/1998 |
| SL (R129) 280 | 08/1993→10/2001 | | |

V94370 ■
35.00 x 7.00 x 101.50

111 053 1101

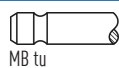

45°

H

VAG96096 ■ ■ ■
37.60 x 7.00 x 12.55



V94480 ■
35.00 x 6.97 x 101.50

111 053 02 01

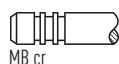

45°

Y

VAG96149 ■ ■ ■
37.50 x 7.02 x 12.59

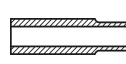

V94371 ■
31.00 x 7.00 x 103.50

611 050 0127

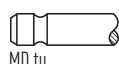

45°

SS

VAG96178 ■ ■ ■
37.50 x 7.02 x 12.76



V94377 ■
31.00 x 7.00 x 103.50

111 050 05 27



45°

SS



76 89.90

| | | | | | | | |
|-----------|--------|---------|-----------|---------------------|--------|--|---------|
| M 112.920 | 2799cc | V6 Cyl. | 18 Valves | 145-150kW/197-204PS | Petrol | | TD9421 |
| M 112.921 | 2799cc | V6 Cyl. | 18 Valves | 150kW/204PS | Petrol | | TD9417 |
| M 112.922 | 2799cc | V6 Cyl. | 18 Valves | 150kW/204PS | Petrol | | TD11490 |
| M 112.923 | 2799cc | V6 Cyl. | 18 Valves | 150kW/204PS | Petrol | | TD10888 |
| M 112.925 | 2799cc | V6 Cyl. | 18 Valves | 150kW/204PS | Petrol | | TD15463 |

| | | | |
|------------------------|-----------------|----------------------|-----------------|
| C-CLASS (S202) C 280 T | 06/1997→03/2001 | C-CLASS (W202) C 280 | 06/1997→05/2000 |
| E-CLASS (S210) E 280 T | 12/1996→03/2003 | E-CLASS (W210) E 280 | 12/1996→03/2002 |
| S-CLASS (W220) S 280 | 10/1998→08/2005 | SL (R129) 280 | 05/1998→10/2001 |

V94390 ■
36.00 x 7.00 x 119.40

113 053 05 01



45°

H

VAG96097 ■ ■ ■
50.00 x 7.03 x 12.76

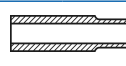

V94391 ■
41.00 x 7.00 x 122.30

113 050 02 27

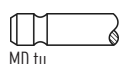

45°

SS



77 89.90

| | | | | | | | |
|---------------------------------|-----------------|---------------------|-----------------|---------------------|--------|------|--------|
| M 104.990 | 3199cc | 6 Cyl. | 24 Valves | 162-170kW/220-231PS | Petrol | DOHC | TD2112 |
| S-CLASS (W140) 300 SE, SEL/S320 | 03/1991→10/1998 | S-CLASS (W140) S320 | 10/1995→08/1998 | | | | |

V94288 ■
35.00 x 7.00 x 101.50

104 053 14 01



45°

H

VAG96142B ■ ■ ■
35.50 x 7.02 x 13.55



V94289 ■
31.00 x 8.00 x 103.50

104 050 17 27

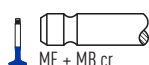

45°

SS





OE



MAT.

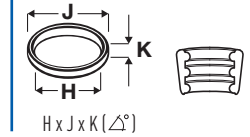
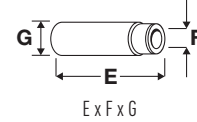
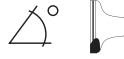

78



89.90

| | | | | | | | |
|-----------|--------|--------|-----------|---------------------|--------|------|---------|
| M 104.991 | 3199cc | 6 Cyl. | 24 Valves | 162-170kW/220-231PS | Petrol | DOHC | TD2113 |
| M 104.992 | 3199cc | 6 Cyl. | 24 Valves | 162kW/220PS | Petrol | DOHC | TD2114 |
| M 104.994 | 3199cc | 6 Cyl. | 24 Valves | 170kW/231PS | Petrol | DOHC | TD11250 |
| M 104.995 | 3199cc | 6 Cyl. | 24 Valves | 162kW/220PS | Petrol | DOHC | TD4658 |
| M 104.996 | 3199cc | 6 Cyl. | 24 Valves | 155kW/211PS | Petrol | DOHC | TD11251 |

| | | | |
|-------------------------|-----------------|---------------------------------|-----------------|
| CABRIOLET (A124) 300 CE | 10/1992→05/1993 | COUPE (C124) 320 CE | 10/1992→05/1993 |
| E-CLASS (A124) E 320 | 06/1993→03/1998 | E-CLASS (C124) E 320 | 06/1993→06/1997 |
| E-CLASS (S124) E 320 T | 06/1993→06/1996 | E-CLASS (W124) E 320 | 06/1993→06/1995 |
| E-CLASS (W210) E 320 | 06/1995→06/1997 | G-CLASS (W463) 320 GE | 09/1994→11/1997 |
| G-CLASS (W463) G 320 | 09/1994→12/1997 | KOMBI (S124) 320 TE | 10/1992→06/1993 |
| SALOON (W124) 320 E | 10/1992→06/1993 | S-CLASS (W140) 300 SE, SEL/S320 | 03/1991→10/1998 |
| SL (R129) 320 | 09/1993→10/2001 | SL (R129) SL 320 | 09/1994→12/1997 |

V94370 ■
35.00 x 7.00 x 101.50

111 053 1101

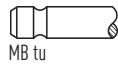

MB tu

45°

H

VAG96096 ■ ■ ■
37.60 x 7.00 x 12.55

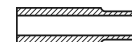

V94480 ■
35.00 x 6.97 x 101.50

111 053 02 01

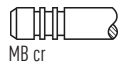

MB cr

45°

Y

H

VAG96149 ■ ■ ■
37.50 x 7.02 x 12.59

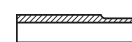

V94371 ■
31.00 x 7.00 x 103.50

611 050 0127

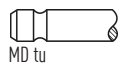

MD tu

45°

SS

VAG96178 ■ ■ ■
37.50 x 7.02 x 12.76



V94377 ■
31.00 x 7.00 x 103.50

111 050 05 27



ME + MB cr

45°

SS

H

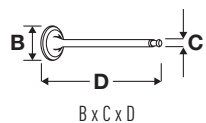

OE

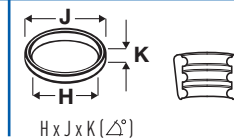
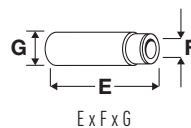

79 **89.90**

| | | | | | | |
|-----------|--------|---------|-----------|---------------------|--------|---------|
| M 112.940 | 3199cc | V6 Cyl. | 18 Valves | 160-162kW/218-220PS | Petrol | TD9407 |
| M 112.941 | 3199cc | V6 Cyl. | 18 Valves | 160-165kW/218-224PS | Petrol | TD9418 |
| M 112.942 | 3199cc | V6 Cyl. | 18 Valves | 160kW/218PS | Petrol | TD9898 |
| M 112.943 | 3199cc | V6 Cyl. | 18 Valves | 165kW/224PS | Petrol | TD11494 |
| M 112.944 | 3199cc | V6 Cyl. | 18 Valves | 165kW/224PS | Petrol | TD11491 |
| M 112.945 | 3199cc | V6 Cyl. | 18 Valves | 158kW/215PS | Petrol | TD9888 |
| M 112.946 | 3199cc | V6 Cyl. | 18 Valves | 160kW/218PS | Petrol | TD15452 |
| M 112.947 | 3199cc | V6 Cyl. | 18 Valves | 160kW/218PS | Petrol | TD14773 |
| M 112.949 | 3199cc | V6 Cyl. | 18 Valves | 165kW/224PS | Petrol | TD16894 |
| M 112.951 | 3199cc | V6 Cyl. | 18 Valves | 140-160kW/190-218PS | Petrol | TD18435 |
| M 112.953 | 3199cc | V6 Cyl. | 18 Valves | 160kW/218PS | Petrol | TD17535 |
| M 112.954 | 3199cc | V6 Cyl. | 18 Valves | 165kW/224PS | Petrol | TD17331 |
| M 112.955 | 3199cc | V6 Cyl. | 18 Valves | 160kW/218PS | Petrol | TD16885 |
| M 112.960 | 3199cc | V6 Cyl. | 18 Valves | 260kW/354PS | Petrol | TD15464 |
| M 112.961 | 3199cc | V6 Cyl. | 18 Valves | 260kW/354PS | Petrol | TD15453 |

| | | | |
|--------------------------|-----------------|-------------------------|-----------------|
| C-CLASS (CL203) C 32 AMG | 05/2002→05/2008 | C-CLASS (CL203) C 320 | 09/2002→05/2008 |
| C-CLASS (S203) C 32 AMG | 03/2001→08/2007 | C-CLASS (S203) C 320 | 03/2001→08/2007 |
| C-CLASS (W203) C 32 AMG | 02/2001→02/2007 | C-CLASS (W203) C 320 | 05/2000→02/2007 |
| CLK (A208) 320 | 03/1998→03/2002 | CLK (A209) CLK 320 | 02/2003→03/2010 |
| CLK (C208) 320 | 06/1997→06/2002 | CLK (C209) 320 | 06/2002→05/2009 |
| E-CLASS (S210) E 320 | 09/1997→12/1998 | E-CLASS (S210) E 320 T | 12/1996→03/2003 |
| E-CLASS (S211) E 320 T | 03/2003→07/2009 | E-CLASS (W210) E 320 | 06/1997→03/2002 |
| E-CLASS (W211) E 320 | 03/2002→12/2008 | G-CLASS (W463) G 320 | 07/1997→ |
| M-CLASS (W163) ML 320 | 02/1998→08/2002 | S-CLASS (W220) S 320 | 10/1998→08/2005 |
| SL (R129) 320 | 05/1998→10/2001 | SLK (R170) 32 AMG | 03/2001→04/2004 |
| SLK (R170) 320 | 03/2000→04/2004 | VIANO (W639) 3,0 | 09/2003→ |
| VIANO (W639) 3.2 | 09/2003→ | VITO (W639) 119 | 09/2003→ |
| VITO (W639) 122 | 09/2003→ | VITO / MIXTO (W639) 119 | 09/2003→ |
| VITO / MIXTO (W639) 122 | 09/2003→ | | |

V94390 ■
36.00 x 7.00 x 119.40

113 053 05 01

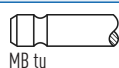

45°

H

VAG96097 ■■
50.00 x 7.03 x 12.76

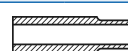

V94391 ■
41.00 x 7.00 x 122.30

113 050 02 27

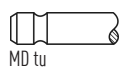

45°

SS

80 **89.90**

| | | | | | | |
|-----------|--------|---------|-----------|---------------------|--------|---------|
| M 113.940 | 4266cc | V8 Cyl. | 24 Valves | 205kW/279PS | Petrol | TD9889 |
| M 113.941 | 4266cc | V8 Cyl. | 24 Valves | 205kW/279PS | Petrol | TD11492 |
| M 113.942 | 4266cc | V8 Cyl. | 24 Valves | 199kW/271PS | Petrol | TD10949 |
| M 113.943 | 4266cc | V8 Cyl. | 24 Valves | 205kW/279PS | Petrol | TD10947 |
| M 113.944 | 4266cc | V8 Cyl. | 24 Valves | 205-225kW/279-306PS | Petrol | TD11489 |
| M 113.948 | 4266cc | V8 Cyl. | 24 Valves | 205kW/279PS | Petrol | TD17188 |

| | | | |
|-------------------------|-----------------|-------------------------|-----------------|
| C-CLASS (S202) C 43 AMG | 08/1997→03/2001 | C-CLASS (W202) C 43 AMG | 08/1997→05/2000 |
| CLK (A208) 430 | 09/1998→03/2002 | CLK (C208) 430 | 07/1998→06/2002 |
| E-CLASS (S210) E 430 T | 06/1997→03/2003 | E-CLASS (W210) E 430 | 06/1997→03/2002 |
| M-CLASS (W163) ML 430 | 02/1998→06/2005 | S-CLASS (W220) S 430 | 10/1998→08/2005 |

V94390 ■
36.00 x 7.00 x 119.40

113 053 05 01

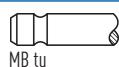

45°

H

VAG96097 ■■
50.00 x 7.03 x 12.76

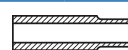

V94391 ■
41.00 x 7.00 x 122.30

113 050 02 27

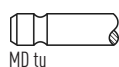

45°

SS



OE

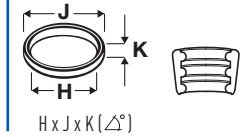
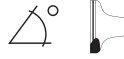

81  90.90

| | | | | | | | |
|-----------|--------|--------|-----------|---------------------|--------|--------------------|---------|
| M 111.970 | 2295cc | 4 Cyl. | 16 Valves | 110kW/150PS | Petrol | DOHC | TD4664 |
| M 111.973 | 2295cc | 4 Cyl. | 16 Valves | 138-142kW/188-193PS | Petrol | Supercharged, DOHC | TD4665 |
| M 111.974 | 2295cc | 4 Cyl. | 16 Valves | 110kW/150PS | Petrol | DOHC | TD4666 |
| M 111.975 | 2295cc | 4 Cyl. | 16 Valves | 138-142kW/188-193PS | Petrol | Supercharged, DOHC | TD4667 |
| M 111.977 | 2295cc | 4 Cyl. | 16 Valves | 110kW/150PS | Petrol | DOHC | TD10948 |
| M 111.978 | 2295cc | 4 Cyl. | 16 Valves | 105kW/143PS | Petrol | DOHC | TD4668 |
| M 111.979 | 2295cc | 4 Cyl. | 16 Valves | 105kW/143PS | Petrol | DOHC | TD5241 |
| M 111.980 | 2295cc | 4 Cyl. | 16 Valves | 105kW/143PS | Petrol | DOHC, Injection | TD22703 |
| M 111.981 | 2295cc | 4 Cyl. | 16 Valves | 143-145kW/194-197PS | Petrol | DOHC | TD17177 |
| M 111.982 | 2295cc | 4 Cyl. | 16 Valves | 145kW/197PS | Petrol | Supercharged, DOHC | TD16884 |
| M 111.983 | 2295cc | 4 Cyl. | 16 Valves | 143-145kW/194-197PS | Petrol | Supercharged, DOHC | TD14750 |
| M 111.984 | 2295cc | 4 Cyl. | 16 Valves | 92-105kW/125-143PS | Petrol | DOHC | TD17850 |

| | | | |
|---------------------------------|-----------------|-----------------------------|-----------------|
| C-CLASS (CL203) C 230 | 03/2001→12/2002 | C-CLASS (S202) C 230 T | 06/1996→09/2000 |
| C-CLASS (W202) C 230 | 10/1995→05/2000 | CLK (A208) 230 | 03/1998→03/2002 |
| CLK (C208) 230 | 06/1997→06/2002 | E-CLASS (S210) E 230 T | 06/1996→06/1997 |
| E-CLASS (W210) E 230 | 06/1995→06/1997 | M-CLASS (W163) ML 230 | 02/1998→06/2005 |
| SLK (R170) 230 | 09/1996→04/2004 | SPRINTER 2-t (901, 902) 214 | 02/1995→05/2006 |
| SPRINTER 2-t (901, 902) 214 NGT | 04/2000→05/2006 | SPRINTER 3-t (903) 314 | 02/1995→05/2006 |
| SPRINTER 3-t (903) 314 NGT | 04/2000→05/2006 | SPRINTER 4-t (904) 414 | 02/1996→05/2006 |
| V-CLASS (638/2) V 230 | 10/1996→07/2003 | VITO (638) 114 2.3 | 12/1996→07/2003 |

V94370 ■
35.00 x 7.00 x 101.50

111 053 1101

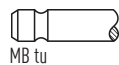

45°

H

VAG96096 ■ ■ ■
37.60 x 7.00 x 12.55



V94371 ■
31.00 x 7.00 x 103.50

611 050 0127

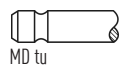

45°

SS

VAG96149 ■ ■ ■
37.50 x 7.02 x 12.59



VAG96178 ■ ■ ■
37.50 x 7.02 x 12.76

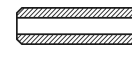



OE

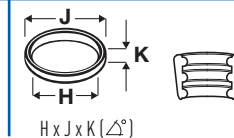
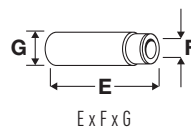
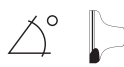

82 90.90

| | | | | | | | |
|------------|--------|--------|----------|-----------------|--------|------|---------|
| OM 616 | 2399cc | 4 Cyl. | 8 Valves | 41-55kW/56-75PS | Diesel | SOHC | TD2244 |
| OM 616.910 | 2399cc | 4 Cyl. | 8 Valves | 48-53kW/65-72PS | Diesel | SOHC | TD2245 |
| OM 616.912 | 2399cc | 4 Cyl. | 8 Valves | 46-53kW/63-72PS | Diesel | SOHC | TD9432 |
| OM 616.913 | 2399cc | 4 Cyl. | 8 Valves | 53kW/72PS | Diesel | SOHC | TD2247 |
| OM 616.914 | 2399cc | 4 Cyl. | 8 Valves | 53kW/72PS | Diesel | SOHC | TD8040 |
| OM 616.917 | 2399cc | 4 Cyl. | 8 Valves | 48kW/65PS | Diesel | SOHC | TD2249 |
| OM 616.934 | 2399cc | 4 Cyl. | 8 Valves | 48kW/65PS | Diesel | SOHC | TD2250 |
| OM 616.936 | 2399cc | 4 Cyl. | 8 Valves | 53kW/72PS | Diesel | SOHC | TD2251 |
| OM 616.937 | 2399cc | 4 Cyl. | 8 Valves | 48-53kW/65-72PS | Diesel | SOHC | TD2252 |
| OM 616.938 | 2399cc | 4 Cyl. | 8 Valves | 53kW/72PS | Diesel | SOHC | TD17733 |
| OM 616.939 | 2399cc | 4 Cyl. | 8 Valves | 53kW/72PS | Diesel | SOHC | TD2253 |
| OM 616.940 | 2399cc | 4 Cyl. | 8 Valves | 53kW/72PS | Diesel | SOHC | TD22836 |
| OM 616.942 | 2399cc | 4 Cyl. | 8 Valves | 38kW/52PS | Diesel | SOHC | TD7991 |
| OM 616.943 | 2399cc | 4 Cyl. | 8 Valves | 44kW/60PS | Diesel | SOHC | TD7992 |
| OM 616.944 | 2399cc | 4 Cyl. | 8 Valves | 44kW/60PS | Diesel | SOHC | TD16937 |
| OM 616.963 | 2399cc | 4 Cyl. | 8 Valves | 53-56kW/72-76PS | Diesel | SOHC | TD2257 |

| | | | |
|-------------------------|-----------------|-------------------------|-----------------|
| 100 (631) 2.4 D | 01/1993→01/1996 | 100 (631) D | 02/1988→02/1996 |
| G-CLASS (W460) 240 GD | 03/1979→08/1987 | KOMBI (S123) 240 T D | 09/1977→12/1985 |
| O 309 | 01/1975→12/1988 | SALOON (W123) 240 D | 02/1976→11/1985 |
| T1 (601) 207 D 2.4 | 04/1977→01/1990 | T1 (601, 611) 207 D 2.4 | 06/1982→01/1990 |
| T1 (601, 611) 407 D 2.4 | 04/1981→07/1982 | T1 (602) 307 D 2.4 | 01/1977→01/1990 |
| T1/TN 407 D | 07/1981→01/1989 | T2/L 407 D | 01/1975→12/1988 |
| T2/LN1 507 D | 04/1986→04/1989 | T2/LN1 507 DK | 04/1986→04/1989 |
| UNIMOG | 05/1988→ | | |

V90225 ■
39.90 x 9.94 x 131.69

616 053 03 01



30°

VAG92108 ■
61.00 x 9.98 x 14.02

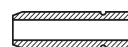

V35018 ■
34.39 x 9.94 x 131.19

616 050 05 27

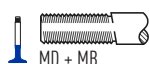

30°

H

VAG92109 ■
48.51 x 9.98 x 14.01

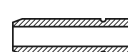

83 90.90

| | | | | | | | |
|------------|--------|--------|----------|-----------------|--------|------|---------|
| OM 616.918 | 2399cc | 4 Cyl. | 8 Valves | 35-48kW/48-65PS | Diesel | SOHC | TD28786 |
| OM 616.919 | 2399cc | 4 Cyl. | 8 Valves | 38-48kW/52-65PS | Diesel | SOHC | TD28787 |

V90225 ■
39.90 x 9.94 x 131.69

616 053 03 01

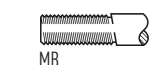

30°

VAG92108 ■ ■
61.00 x 9.98 x 14.02

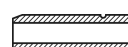

V35018 ■
34.39 x 9.94 x 131.19

616 050 05 27

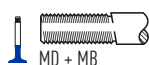

30°

H

VAG92109 ■ ■
48.51 x 9.98 x 14.01

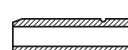

84 90.90

| | | | | | | | |
|------------|--------|--------|----------|-----------|--------|------|---------|
| OM 616.911 | 2404cc | 4 Cyl. | 8 Valves | 38kW/52PS | Diesel | SOHC | TD5675 |
| OM 616.932 | 2404cc | 4 Cyl. | 8 Valves | 44kW/60PS | Diesel | SOHC | TD6015 |
| OM 616.933 | 2404cc | 4 Cyl. | 8 Valves | 44kW/60PS | Diesel | SOHC | TD16998 |

UNIMOG 01/1977→05/1988

V90225 ■
39.90 x 9.94 x 131.69

616 053 03 01



30°

VAG92108 ■
61.00 x 9.98 x 14.02



V35018 ■
34.39 x 9.94 x 131.19

616 050 05 27



30°

H

VAG92109 ■
48.51 x 9.98 x 14.01

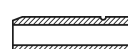



OE

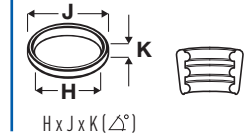
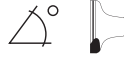

85 **90.90**

| | | | | | | | |
|------------|--------|--------|-----------|-------------------|--------|-------------|---------|
| OM 617.912 | 2998cc | 5 Cyl. | 10 Valves | 59-65kW/80-88PS | Diesel | SOHC | TD2260 |
| OM 617.913 | 2998cc | 5 Cyl. | 10 Valves | 65kW/88PS | Diesel | SOHC | TD2261 |
| OM 617.931 | 2998cc | 5 Cyl. | 10 Valves | 65kW/88PS | Diesel | SOHC | TD2262 |
| OM 617.932 | 2998cc | 5 Cyl. | 10 Valves | 65kW/88PS | Diesel | SOHC | TD17743 |
| OM 617.950 | 2998cc | 5 Cyl. | 10 Valves | 85-92kW/116-125PS | Diesel | Turbo, SOHC | TD2263 |
| OM 617.951 | 2998cc | 5 Cyl. | 10 Valves | 92kW/125PS | Diesel | Turbo, SOHC | TD2264 |
| OM 617.952 | 2998cc | 5 Cyl. | 10 Valves | 92kW/125PS | Diesel | Turbo, SOHC | TD2265 |

| | | | |
|----------------------------|-----------------|----------------------------|-----------------|
| COUPE (C123) 300 C Turbo-D | 09/1981→07/1985 | G-CLASS (W460) 300 GD | 12/1979→12/1991 |
| KOMBI (S123) 300 T D | 09/1977→11/1985 | KOMBI (S123) 300 T Turbo-D | 10/1980→11/1985 |
| SALOON (W123) 300 D | 02/1976→11/1985 | SALOON (W123) 300 Turbo-D | 08/1981→07/1985 |
| S-CLASS (W126) 300 SD | 09/1980→12/1985 | T1 (601) 209 D 2.9 | 12/1982→01/1990 |
| T1 (601, 611) 209 D 2.9 | 12/1982→01/1990 | T1 (602) 309 D 3.0 | 10/1982→01/1990 |
| T1/TN 409 D | 04/1982→01/1989 | | |

V90225
39.90 x 9.94 x 131.69

616 053 03 01

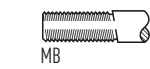

30°

VAG92108
61.00 x 9.98 x 14.02

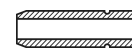

V35018
34.39 x 9.94 x 131.19

616 050 05 27

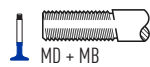

30°

H

VAG92109
48.51 x 9.98 x 14.01

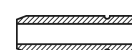

86 **90.90**

| | | | | | | | |
|------------|--------|--------|-----------|-----------|--------|------|---------|
| OM 617.933 | 2998cc | 5 Cyl. | 10 Valves | 65kW/88PS | Diesel | SOHC | TD26550 |
|------------|--------|--------|-----------|-----------|--------|------|---------|

V90225
39.90 x 9.94 x 131.69

616 053 03 01

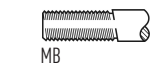

30°

VAG92108
61.00 x 9.98 x 14.02



V35018
34.39 x 9.94 x 131.19

616 050 05 27

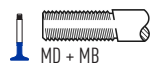

30°

H

VAG92109
48.51 x 9.98 x 14.01

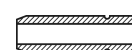

87 **91.00**

| | | | | | | | |
|------------|--------|--------|----------|-----------|--------|------|--------|
| OM 616.960 | 2399cc | 4 Cyl. | 8 Valves | 53kW/72PS | Diesel | SOHC | TD2255 |
| OM 616.961 | 2399cc | 4 Cyl. | 8 Valves | 53kW/72PS | Diesel | SOHC | TD2256 |

V90225
39.90 x 9.94 x 131.69

616 053 03 01



30°

VAG92108
61.00 x 9.98 x 14.02

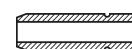

V35018
34.39 x 9.94 x 131.19

616 050 05 27



30°

H

VAG92109
48.51 x 9.98 x 14.01

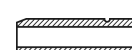

88 **91.00**

| | | | | | | | |
|------------|--------|--------|----------|-----------|--------|------|--------|
| OM 616.916 | 2404cc | 4 Cyl. | 8 Valves | 48kW/65PS | Diesel | SOHC | TD2248 |
|------------|--------|--------|----------|-----------|--------|------|--------|

| | |
|-----------------|-----------------|
| /8 (W115) 240 D | 08/1973→01/1977 |
|-----------------|-----------------|

V90225
39.90 x 9.94 x 131.69

616 053 03 01



30°

VAG92108
61.00 x 9.98 x 14.02



V35018
34.39 x 9.94 x 131.19

616 050 05 27

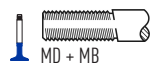

30°

H

VAG92109
48.51 x 9.98 x 14.01

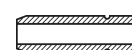



OE

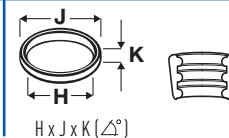
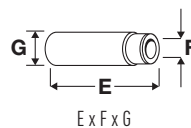

89 91.00

| | | | | | | | |
|---------------------|--------|-----------------|------------------|-----------|--------|-------------|---------------|
| OM 617.910 | 2998cc | 5 Cyl. | 10 Valves | 59kW/80PS | Diesel | SOHC | TD2259 |
| /8 (W115) 240 D 3.0 | | 08/1974→11/1976 | | | | | |

| | | | | | | | |
|-----------------------|---------------|---------|-----|---|--|----------------------|--|
| V90225 | 616 053 03 01 | | 30° | | | VAG92108 | |
| 39.90 x 9.94 x 131.69 | | MB | | | | 61.00 x 9.98 x 14.02 | |
| V35018 | 616 050 05 27 | | 30° | H | | VAG92109 | |
| 34.39 x 9.94 x 131.19 | | MD + MB | | | | 48.51 x 9.98 x 14.01 | |

90 91.00

| | | | | | | | |
|----------------------------|--------|---------|------------------|---------------------|--------|-------------|---------------|
| M 104.941 (AMG 3.6) | 3606cc | V6 Cyl. | 24 Valves | 200-206kW/272-280PS | Petrol | DOHC | TD9439 |
| M 104.992 (AMG 3.6) | 3606cc | V6 Cyl. | 24 Valves | 195-200kW/265-272PS | Petrol | DOHC | TD9434 |

| | | | |
|-------------------------|-----------------|---------------------------|-----------------|
| C-CLASS (W202) C 36 AMG | 05/1994→05/2000 | E-CLASS (A124) E 36 AMG | 05/1994→03/1998 |
| E-CLASS (C124) E 36 AMG | 06/1993→06/1997 | E-CLASS (S124) E 36 T AMG | 05/1994→06/1996 |
| E-CLASS (W124) E 36 AMG | 07/1994→01/1995 | | |

| | | | | | | | |
|-----------------------|---------------|------------|-----|----|---|----------------------|--|
| V94370 | 111 053 1101 | | 45° | H | | VAG96096 | |
| 35.00 x 7.00 x 101.50 | | MB tu | | | | 37.60 x 7.00 x 12.55 | |
| V94480 | 111 053 02 01 | | 45° | Y | H | VAG96149 | |
| 35.00 x 6.97 x 101.50 | | MB cr | | | | 37.50 x 7.02 x 12.59 | |
| V94371 | 611 050 0127 | | 45° | SS | | VAG96178 | |
| 31.00 x 7.00 x 103.50 | | MD tu | | | | 37.50 x 7.02 x 12.76 | |
| V94377 | 111 050 05 27 | | 45° | SS | H | | |
| 31.00 x 7.00 x 103.50 | | ME + MB cr | | | | | |

91 92.00

| | | | | | | | |
|------------------|--------|---------|------------------|---------------------|--------|-------------|----------------|
| M 116.980 | 3499cc | V8 Cyl. | 16 Valves | 147kW/200PS | Petrol | DOHC | TD2164 |
| M 116.981 | 3499cc | V8 Cyl. | 16 Valves | 147kW/200PS | Petrol | DOHC | TD2165 |
| M 116.982 | 3499cc | V8 Cyl. | 16 Valves | 143-147kW/194-200PS | Petrol | DOHC | TD2166 |
| M 116.983 | 3499cc | V8 Cyl. | 16 Valves | 147kW/200PS | Petrol | DOHC | TD2167 |
| M 116.984 | 3499cc | V8 Cyl. | 16 Valves | 143-147kW/194-200PS | Petrol | DOHC | TD2168 |
| M 116.985 | 3499cc | V8 Cyl. | 16 Valves | 143-152kW/195-205PS | Petrol | DOHC | TD2169 |
| M 116.990 | 3499cc | V8 Cyl. | 16 Valves | 132kW/180PS | Petrol | DOHC | TD22706 |
| M 116.991 | 3499cc | V8 Cyl. | 16 Valves | 147kW/200PS | Petrol | DOHC | TD22707 |
| M 116.992 | 3499cc | V8 Cyl. | 16 Valves | 132kW/180PS | Petrol | DOHC | TD22708 |
| M 116.993 | 3499cc | V8 Cyl. | 16 Valves | 132kW/180PS | Petrol | DOHC | TD22709 |

| | | | |
|-------------------------------------|-----------------|----------------------------------|-----------------|
| CABRIOLET (W111) 280 SE 3.5 | 01/1969→12/1971 | COUPE (W111) 280 SE 3.5 | 01/1969→12/1971 |
| S-CLASS (W108, W109) 280 SE,SEL 3.5 | 03/1971→08/1972 | S-CLASS (W108, W109) 300 SEL 3.5 | 01/1970→07/1972 |
| S-CLASS (W116) 350 SE,SEL | 08/1972→03/1980 | SL (C107) 350 SLC | 01/1972→02/1980 |
| SL (R107) 350 SL | 05/1971→02/1980 | | |

| | | | | | | | |
|------------------------|---------------|-------|-----|----|---|----------------------|--|
| V94257 | 116 050 01 26 | | 45° | Y | H | VAG96144B | |
| 44.20 x 9.00 x 117.00 | | MB cr | | | | 47.50 x 9.02 x 14.05 | |
| V95072 | 110 050 00 27 | | 45° | SS | | | |
| 37.10 x 10.95 x 118.00 | | MD cr | | | | | |



OE

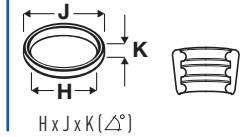
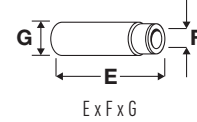

92  **92.00**

| | | | | | | |
|----------------------------|-----------------|---------|------------------|---------------------|-----------------|---------------|
| M 116.960 | 3818cc | V8 Cyl. | 16 Valves | 160kW/218PS | Petrol | TD2158 |
| M 116.961 | 3818cc | V8 Cyl. | 16 Valves | 120-160kW/163-218PS | Petrol | TD2159 |
| S-CLASS (C126) 380 SEC | 08/1980→12/1981 | | | S-CLASS (W126) 3.8 | 08/1980→08/1984 | |
| S-CLASS (W126) 380 SE, SEL | 09/1980→10/1981 | | | SL (C107) 380 SLC | 07/1980→08/1981 | |
| SL (R107) 380 SL | 09/1980→08/1981 | | | | | |

V94257 
44.20 x 9.00 x 117.00

116 050 01 26

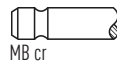

45° Y H

VAG96144B 
47.50 x 9.02 x 14.05



V94333 
39.10 x 9.00 x 117.00

116 050 04 26

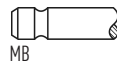

45° Y H

VAG96139B 
50.50 x 9.02 x 15.05



93  **92.00**

| | | | | | | |
|------------------------|-----------------|---------|------------------|----------------------------|-----------------|---------------|
| M 116.964 | 4196cc | V8 Cyl. | 16 Valves | 150-160kW/204-218PS | Petrol | TD2162 |
| M 116.965 | 4196cc | V8 Cyl. | 16 Valves | 150-170kW/204-231PS | Petrol | TD2163 |
| S-CLASS (C126) 420 SEC | 10/1985→06/1991 | | | S-CLASS (W126) 420 SE, SEL | 10/1985→06/1991 | |
| SL (R107) 420 SL | 01/1986→08/1989 | | | | | |

V94257 
44.20 x 9.00 x 117.00

116 050 01 26

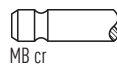

45° Y H

VAG96144B 
47.50 x 9.02 x 14.05

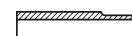

VAG96139B 
50.50 x 9.02 x 15.05

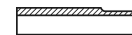

94  **92.00**

| | | | | | | | |
|---------------------------|-----------------|---------|------------------|---------------------------------|-----------------|-------------|----------------|
| M 119.971 | 4196cc | V8 Cyl. | 32 Valves | 205-210kW/279-286PS | Petrol | DOHC | TD2188 |
| M 119.975 | 4196cc | V8 Cyl. | 32 Valves | 205kW/279PS | Petrol | DOHC | TD2191 |
| M 119.981 | 4196cc | V8 Cyl. | 32 Valves | 205kW/279PS | Petrol | DOHC | TD19046 |
| M 119.985 | 4196cc | V8 Cyl. | 32 Valves | 205kW/279PS | Petrol | DOHC | TD4672 |
| E-CLASS (S210) E 420 T | 06/1996→06/1997 | | | E-CLASS (W124) E 420 | 06/1993→06/1995 | | |
| E-CLASS (W210) E 420 | 01/1996→06/1997 | | | SALOON (W124) 400 E 4.2 | 10/1992→06/1993 | | |
| S-CLASS (C140) SEC/CL 420 | 10/1994→02/1999 | | | S-CLASS (W140) 400 SE, SEL/S420 | 02/1991→10/1998 | | |
| S-CLASS (W140) S 420 | 01/1993→10/1998 | | | | | | |

V94532 
38.00 x 7.00 x 95.80

119 053 18 01

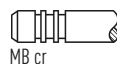

45° H

VAG96142B 
35.50 x 7.02 x 13.55



VAG96096 
37.60 x 7.00 x 12.55



VAG96178 
37.50 x 7.02 x 12.76



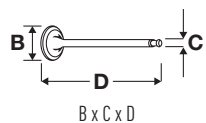

OE

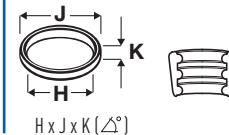
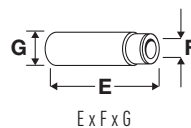
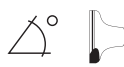

95 **92.00**

| | | | | | | |
|-----------|--------|---------|-----------|---------------------|--------|---------|
| M 117.981 | 4520cc | V8 Cyl. | 16 Valves | 143kW/195PS | Petrol | TD2180 |
| M 117.982 | 4520cc | V8 Cyl. | 16 Valves | 160-165kW/218-225PS | Petrol | TD4671 |
| M 117.983 | 4520cc | V8 Cyl. | 16 Valves | 119-165kW/162-224PS | Petrol | TD2182 |
| M 117.984 | 4520cc | V8 Cyl. | 16 Valves | 131-144kW/178-196PS | Petrol | TD2183 |
| M 117.985 | 4520cc | V8 Cyl. | 16 Valves | 119-165kW/162-225PS | Petrol | TD5051 |
| M 117.986 | 4520cc | V8 Cyl. | 16 Valves | 160-165kW/218-224PS | Petrol | TD2185 |
| M 117.992 | 4520cc | V8 Cyl. | 16 Valves | 140kW/190PS | Petrol | TD22710 |
| M 117.993 | 4520cc | V8 Cyl. | 16 Valves | 140kW/190PS | Petrol | TD22711 |

| | | | |
|---------------------------------|-----------------|----------------------------------|-----------------|
| S-CLASS (W108, W109) 280 SE 4.5 | 09/1971→08/1972 | S-CLASS (W108, W109) 280 SEL 4.5 | 09/1971→08/1972 |
| S-CLASS (W116) 450 SE | 08/1972→12/1976 | S-CLASS (W116) 450 SEL | 09/1979→07/1980 |
| S-CLASS (W116) 450 SE,SEL | 01/1973→04/1980 | SL (C107) 450 SLC | 01/1973→12/1980 |
| SL (R107) 450 SL | 10/1972→12/1980 | | |

V94257
44.20 x 9.00 x 117.00

116 050 01 26



45° Y H

VAG96144B
47.50 x 9.02 x 14.05

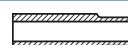

V95072
37.10 x 10.95 x 118.00

110 050 00 27



45° ss

96 **92.90**

| | | | | | | | |
|-----------|--------|---------|-----------|---------------------|--------|------|---------|
| M 272.960 | 3498cc | V6 Cyl. | 24 Valves | 170-200kW/231-272PS | Petrol | DOHC | TD18417 |
| M 272.961 | 3498cc | V6 Cyl. | 24 Valves | 200kW/272PS | Petrol | DOHC | TD22144 |
| M 272.963 | 3498cc | V6 Cyl. | 24 Valves | 200kW/272PS | Petrol | DOHC | TD18434 |
| M 272.964 | 3498cc | V6 Cyl. | 24 Valves | 200kW/272PS | Petrol | DOHC | TD18429 |
| M 272.965 | 3498cc | V6 Cyl. | 24 Valves | 200kW/272PS | Petrol | DOHC | TD19146 |
| M 272.966 | 3498cc | V6 Cyl. | 24 Valves | 200kW/272PS | Petrol | DOHC | TD20926 |
| M 272.967 | 3498cc | V6 Cyl. | 24 Valves | 200kW/272PS | Petrol | DOHC | TD19148 |
| M 272.970 | 3498cc | V6 Cyl. | 24 Valves | 200kW/272PS | Petrol | DOHC | TD18418 |
| M 272.971 | 3498cc | V6 Cyl. | 24 Valves | 200kW/272PS | Petrol | DOHC | TD22145 |
| M 272.972 | 3498cc | V6 Cyl. | 24 Valves | 200-205kW/272-279PS | Petrol | DOHC | TD19145 |
| M 272.975 | 3498cc | V6 Cyl. | 24 Valves | 200kW/272PS | Petrol | DOHC | TD23759 |
| M 272.978 | 3498cc | V6 Cyl. | 24 Valves | 190kW/258PS | Petrol | DOHC | TD20983 |

| | | | |
|----------------------------|-----------------|-----------------------|-----------------|
| C-CLASS (CL203) C 350 | 01/2005→05/2008 | C-CLASS (S203) C 350 | 01/2005→08/2007 |
| C-CLASS (S204) C 350 | 08/2007→08/2014 | C-CLASS (W203) 3.5 | 01/2005→02/2007 |
| C-CLASS (W203) C 350 | 01/2005→02/2007 | C-CLASS (W204) C 350 | 01/2007→01/2014 |
| CLC-CLASS (CL203) CLC 350 | 05/2008→06/2011 | CLK (A209) CLK 350 | 01/2005→03/2010 |
| CLK (C209) 350 | 01/2005→05/2009 | CLS (C219) CLS 350 | 10/2004→12/2010 |
| E-CLASS (C207) E 350 | 05/2011→ | E-CLASS (S211) 3.5 | 08/2004→08/2006 |
| E-CLASS (S211) E 350 T | 03/2005→07/2009 | E-CLASS (W211) E 350 | 03/2005→12/2008 |
| GLK-CLASS (X204) 350 | 06/2008→04/2011 | M-CLASS (W164) ML 350 | 07/2005→12/2011 |
| R-CLASS (W251, V251) R 350 | 01/2006→ | S-CLASS (W221) S 350 | 10/2005→12/2013 |
| SL (R230) 350 | 03/2006→01/2012 | SLK (R171) 350 | 06/2004→02/2011 |
| VIANO (W639) 3.5 | 09/2007→ | VITO (W639) 126 | 09/2007→ |
| VITO / MIXTO (W639) 126 | 09/2007→ | | |

V95176
39.50 x 5.97 x 108.75

272 053 05 01

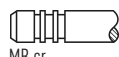

45° H

V95177
30.00 x 5.96 x 107.30

272 050 06 27

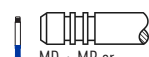

45° ss H



OE

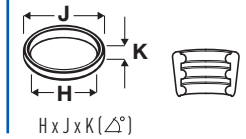
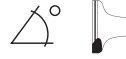

97 92.90

| | | | | | | | |
|-----------|--------|---------|-----------|---------------------|--------|-----------------|---------|
| M 276.950 | 3498cc | V6 Cyl. | 24 Valves | 225kW/306PS | Petrol | DOHC, Injection | TD26370 |
| M 276.952 | 3498cc | V6 Cyl. | 24 Valves | 185-245kW/252-333PS | Petrol | DOHC, Injection | TD26060 |
| M 276.955 | 3498cc | V6 Cyl. | 24 Valves | 183-225kW/249-306PS | Petrol | DOHC, Injection | TD26601 |
| M 276.956 | 3498cc | V6 Cyl. | 24 Valves | 225kW/306PS | Petrol | DOHC, Injection | TD26081 |
| M 276.957 | 3498cc | V6 Cyl. | 24 Valves | 182-225kW/248-306PS | Petrol | DOHC, Injection | TD25532 |
| M 276.958 | 3498cc | V6 Cyl. | 24 Valves | 225kW/306PS | Petrol | DOHC, Injection | TD26365 |

| | | | |
|--------------------------|-----------------|--------------------------------|-----------------|
| C-CLASS (C204) C 300 | 09/2012→12/2014 | C-CLASS (C204) C 350 | 06/2011→ |
| C-CLASS (S204) C 350 CGI | 06/2011→08/2014 | C-CLASS (W204) C 300 | 02/2011→01/2014 |
| C-CLASS (W204) C 350 | 01/2011→01/2014 | CLS (C218) CLS 300 | 10/2011→ |
| CLS (C218) CLS 350 | 01/2011→ | CLS (X218) CLS 350 | 10/2012→ |
| E-CLASS (A207) E 300 | 04/2011→ | E-CLASS (A207) E 350 | 04/2011→ |
| E-CLASS (C207) E 300 | 04/2011→ | E-CLASS (C207) E 350 | 04/2011→ |
| E-CLASS (S212) E 300 | 07/2011→ | E-CLASS (S212) E 350 | 09/2011→ |
| E-CLASS (W212) E 300 | 07/2011→ | E-CLASS (W212) E 350 | 09/2011→ |
| E-CLASS (W212) E 400 | 05/2015→ | GLE (W166) 350 | 11/2015→ |
| GLK-CLASS (X204) 300 | 09/2009→ | GLK-CLASS (X204) 350 | 06/2008→06/2015 |
| GLK-CLASS (X204) 350 CGI | 09/2012→06/2015 | M-CLASS (W166) ML 300 | 08/2012→02/2015 |
| M-CLASS (W166) ML 350 | 06/2011→12/2015 | R-CLASS (W251, V251) R 350 CGI | 01/2006→ |
| S-CLASS (W221) S 350 CGI | 04/2011→12/2013 | SLK (R172) 350 | 02/2011→ |

V80006 278 050 01 26
37.00 x 6.00 x 104.10

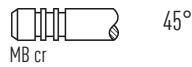

45°

V80007 276 050 00 27
30.00 x 6.00 x 107.30



45°

ss

98 92.90

| | | | | | | | |
|-----------|--------|---------|-----------|-------------|--------|------|---------|
| M 273.922 | 4663cc | V8 Cyl. | 32 Valves | 250kW/340PS | Petrol | DOHC | TD22146 |
| M 273.923 | 4663cc | V8 Cyl. | 32 Valves | 250kW/340PS | Petrol | DOHC | TD19210 |
| M 273.924 | 4663cc | V8 Cyl. | 32 Valves | 250kW/340PS | Petrol | DOHC | TD23760 |

| | | | |
|------------------------|-----------------|----------------------|-----------------|
| GL-CLASS (X164) GL 450 | 09/2006→ | S-CLASS (W221) S 400 | 09/2008→12/2009 |
| S-CLASS (W221) S 450 | 12/2005→12/2013 | | |

V95176 272 053 05 01
39.50 x 5.97 x 108.75

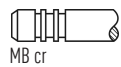

45°

H

V95177 272 050 06 27
30.00 x 5.96 x 107.30



45°

ss

H

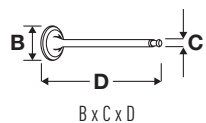

OE

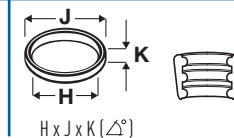
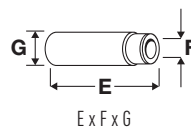

99 **92.90**

| | | | | | | | |
|------------------|--------|---------|------------------|---------------------|--------|-------------------------------|----------------|
| M 278.920 | 4663cc | V8 Cyl. | 32 Valves | 320kW/435PS | Petrol | Turbo, DOHC | TD25072 |
| M 278.922 | 4663cc | V8 Cyl. | 32 Valves | 300-320kW/408-435PS | Petrol | Turbo, DOHC, Injection | TD25516 |
| M 278.927 | 4663cc | V8 Cyl. | 32 Valves | 320-335kW/435-455PS | Petrol | Turbo, DOHC, Injection | TD26366 |
| M 278.929 | 4663cc | V8 Cyl. | 32 Valves | 320-338kW/435-460PS | Petrol | Turbo, DOHC, Injection | TD27897 |
| M 278.932 | 4663cc | V8 Cyl. | 32 Valves | 320kW/435PS | Petrol | Turbo, DOHC, Injection | TD26083 |

| | | | |
|----------------------------------|----------|--|-----------------|
| CLS (C218) CLS 500 | 02/2011→ | CLS (C218) CLS 550 | 09/2011→ |
| CLS (X218) CLS 500 | 10/2012→ | E-CLASS (A207) E 500 | 09/2011→ |
| E-CLASS (A207) E 550 | 09/2011→ | E-CLASS (C207) E 500 | 09/2011→ |
| E-CLASS (S212) E 500 | 09/2011→ | E-CLASS (W212) E 500 | 09/2011→ |
| S-CLASS (A217) S 500 | 12/2015→ | S-CLASS (C216) CL 500 | 02/2011→12/2013 |
| S-CLASS (C217) S 500 | 04/2014→ | S-CLASS (W221) S 500 CGI | 03/2011→12/2013 |
| S-CLASS (W222, V222, X222) S 500 | 05/2013→ | S-CLASS (W222, V222, X222) S 500 Maybach | 12/2014→ |
| SL (R231) 500 | 01/2012→ | SL (R231) 550 | 01/2012→ |

V80006
 37.00 x 6.00 x 104.10

278 050 01 26

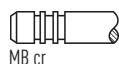

45°

100 **92.90**

| | | | | | | | |
|------------------------|----------|------------------------|------------------|---------------------|--------|-------------------------------|----------------|
| M 278.928 | 4663cc | V8 Cyl. | 32 Valves | 270-335kW/367-456PS | Petrol | Turbo, DOHC, Injection | TD26364 |
| GL-CLASS (X166) GL 450 | 07/2012→ | GL-CLASS (X166) GL 500 | 07/2012→ | | | | |
| GLE (C292) 500 | 10/2015→ | GLE (W166) 500 | 04/2015→ | | | | |
| GLS (X166) 500 | 11/2015→ | M-CLASS (W166) ML 500 | 02/2012→02/2015 | | | | |

V80006
 37.00 x 6.00 x 104.10

278 050 01 26

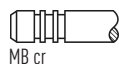

45°

V80007
 30.00 x 6.00 x 107.30

276 050 00 27



45°

ss

101 **93.75**

| | | | | | | | |
|------------------|--------|--------|-----------------|------------------|--------|-------------|----------------|
| M 115.951 | 2307cc | 4 Cyl. | 8 Valves | 81kW/110PS | Petrol | SOHC | TD2149 |
| M 115.952 | 2307cc | 4 Cyl. | 8 Valves | 66kW/90PS | Petrol | SOHC | TD2150 |
| M 115.954 | 2307cc | 4 Cyl. | 8 Valves | 80kW/109PS | Petrol | SOHC | TD2151 |
| M 115.955 | 2307cc | 4 Cyl. | 8 Valves | 62-63kW/84-86PS | Petrol | SOHC | TD2152 |
| M 115.970 | 2307cc | 4 Cyl. | 8 Valves | 66kW/90PS | Petrol | SOHC | TD2153 |
| M 115.971 | 2307cc | 4 Cyl. | 8 Valves | 66kW/90PS | Petrol | SOHC | TD17786 |
| M 115.972 | 2307cc | 4 Cyl. | 8 Valves | 62-63kW/84-86PS | Petrol | SOHC | TD2154 |
| M 115.973 | 2307cc | 4 Cyl. | 8 Valves | 66-75kW/90-102PS | Petrol | SOHC | TD2155 |
| M 115.974 | 2307cc | 4 Cyl. | 8 Valves | 66kW/90PS | Petrol | SOHC | TD17727 |

| | | | |
|-----------------------|-----------------|-----------------------|-----------------|
| /8 (W115) 230.4 | 08/1973→12/1976 | COUPE (C123) 230 C | 05/1977→04/1980 |
| G-CLASS (W460) 230 G | 03/1979→07/1993 | KOMBI (S123) 230 T | 09/1977→03/1980 |
| O 309 | 01/1968→02/1989 | SALOON (W123) 230 | 02/1976→03/1981 |
| T1 (601) 208 2.3 | 05/1977→12/1982 | T1 (601) 210 2.3 | 04/1977→10/1989 |
| T1 (601, 611) 210 2.3 | 05/1977→12/1982 | T2/L L 409 | 01/1975→08/1982 |
| T2/L LF 409 G | 01/1975→08/1982 | T2/L LK 408 G, LK 409 | 01/1975→08/1982 |

V95096
 37.00 x 10.95 x 113.20

115 050 00 27

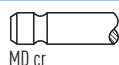

45°

ss

VAG51028B
 55.00 x 9.02 x 14.06

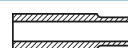

VAG92200B
 45.00 x 11.02 x 15.06

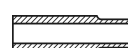



OE

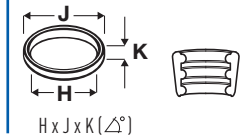
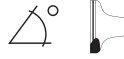

102 **95.50**

| | | | | | | | |
|-----------------------|-----------------|--------|-----------------|------------------|--------|-----------------|---------------|
| M 102.942 | 2299cc | 4 Cyl. | 8 Valves | 70kW/95PS | Petrol | SOHC | TD2070 |
| M 102.943 | 2299cc | 4 Cyl. | 8 Valves | 70kW/95PS | Petrol | SOHC | TD2071 |
| O 309 | 01/1968→02/1989 | | | T1 (601) 210 2.3 | | 04/1977→01/1990 | |
| T1 (601, 611) 210 2.3 | 07/1982→02/1996 | | | T1 (602) 310 2.3 | | 01/1982→02/1996 | |
| T1/TN 410 | 08/1982→06/1995 | | | T2/L L 410 | | 08/1982→12/1988 | |
| T2/L LK 408 G, LK 409 | 08/1982→09/1983 | | | | | | |

V91441
43.00 x 8.00 x 114.90

102 053 18 01

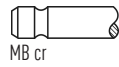

45°

H

VAG92378B
46.00 x 8.00 x 14.05



V91445
46.10 x 7.97 x 114.90

102 053 17 01

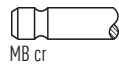

45°

H

VAG92379B
51.00 x 9.00 x 14.05

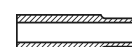

V91958
39.00 x 9.00 x 115.80

102 050 03 27

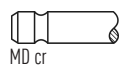

45°

H

103 **95.50**

| | | | | | | | |
|-------------------------|-----------------|--------|-----------------|-------------------------|--------|-----------------|----------------|
| M 102.945 | 2299cc | 4 Cyl. | 8 Valves | 77kW/105PS | Petrol | SOHC | TD2072 |
| M 102.946 | 2299cc | 4 Cyl. | 8 Valves | 70-77kW/95-105PS | Petrol | SOHC | TD5397 |
| M 102.958 | 2299cc | 4 Cyl. | 8 Valves | 79kW/107PS | Petrol | SOHC | TD17756 |
| M 102.959 | 2299cc | 4 Cyl. | 8 Valves | 70kW/95PS | Petrol | SOHC | TD17795 |
| M 102.979 | 2299cc | 4 Cyl. | 8 Valves | 90kW/122PS | Petrol | SOHC | TD2081 |
| M 102.980 | 2299cc | 4 Cyl. | 8 Valves | 100kW/136PS | Petrol | SOHC | TD2082 |
| M 102.981 | 2299cc | 4 Cyl. | 8 Valves | 92kW/125PS | Petrol | SOHC | TD2083 |
| M 102.982 | 2299cc | 4 Cyl. | 8 Valves | 97-100kW/132-136PS | Petrol | SOHC | TD4656 |
| M 102.985 | 2299cc | 4 Cyl. | 8 Valves | 97-100kW/132-136PS | Petrol | SOHC | TD4657 |
| M 102.987 | 2299cc | 4 Cyl. | 8 Valves | 90-92kW/122-125PS | Petrol | SOHC | TD2089 |
| M 102.989 | 2299cc | 4 Cyl. | 8 Valves | 93kW/126PS | Petrol | SOHC | TD2091 |
| M 102.996 | 2299cc | 4 Cyl. | 8 Valves | 92kW/125PS | Petrol | SOHC | TD11249 |
| M 102.997 | 2299cc | 4 Cyl. | 8 Valves | 92kW/125PS | Petrol | SOHC | TD17724 |
| M 102.998 | 2299cc | 4 Cyl. | 8 Valves | 92kW/125PS | Petrol | SOHC | TD17725 |
| 190 (W201) 2.3 | 09/1987→09/1988 | | | 190 (W201) 2.3 E | | 10/1982→09/1988 | |
| 190 (W201) E 2.3 | 09/1986→08/1993 | | | COUPE (C123) 230 CE | | 04/1980→12/1985 | |
| COUPE (C124) 230 CE | 03/1987→12/1992 | | | COUPE (C124) 230 CE Cat | | 06/1989→12/1992 | |
| G-CLASS (W460) 230 GE | 04/1982→08/1992 | | | G-CLASS (W461) 230 GE | | 09/1989→07/2000 | |
| G-CLASS (W463) 230 GE | 06/1990→06/1993 | | | KOMBI (S123) 230 TE | | 04/1980→11/1985 | |
| KOMBI (S124) 230 TE | 09/1985→08/1992 | | | KOMBI (S124) 230 TE Cat | | 06/1989→08/1992 | |
| SALOON (W123) 230 E | 04/1980→12/1985 | | | SALOON (W124) 230 E | | 12/1984→06/1993 | |
| SALOON (W124) 230 E Cat | 06/1989→06/1993 | | | T1 (601) 210 2.3 | | 05/1989→02/1996 | |
| T1 (601, 611) 210 2.3 | 07/1982→02/1996 | | | T1 (602) 310 2.3 | | 01/1989→12/1995 | |
| T1/TN 410 | 08/1982→06/1995 | | | T2/LN1 510 | | 04/1986→12/1994 | |

V91445
46.10 x 7.97 x 114.90

102 053 17 01

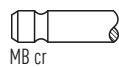

45°

H

VAG92378B
46.00 x 8.00 x 14.05



V91958
39.00 x 9.00 x 115.80

102 050 03 27

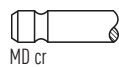

45°

H

VAG92379B
51.00 x 9.00 x 14.05

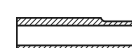

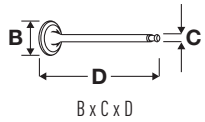

OE

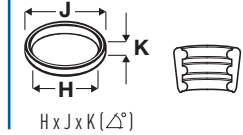
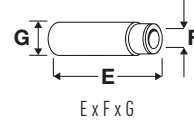
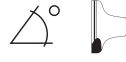

104 95.50

| | | | | | | | |
|---------------------|--------|-----------------|-----------|---------------------|--------|------|--------|
| M 102.983 | 2299cc | 4 Cyl. | 16 Valves | 125-136kW/170-185PS | Petrol | DOHC | TD2086 |
| 190 (W201) E 2.3-16 | | 04/1984→08/1988 | | | | | |

V94376 33.00 x 8.00 x 111.50

102 050 11 27



45° ss H

VAG96224B 45.50 x 7.02 x 13.05



VAG96227B 43.00 x 8.02 x 13.05



105 95.50

| | | | | | | | |
|---------------------|--------|-----------------|-----------|-------------------------------|--------|-----------------|--------|
| M 102.990 | 2498cc | 4 Cyl. | 16 Valves | 143-150kW/195-204PS | Petrol | DOHC | TD2092 |
| M 102.991 | 2498cc | 4 Cyl. | 16 Valves | 143kW/195PS | Petrol | DOHC | TD2093 |
| M 102.992 | 2498cc | 4 Cyl. | 8 Valves | 173kW/235PS | Petrol | DOHC | TD2094 |
| 190 (W201) E 2.5-16 | | 09/1988→08/1993 | | 190 (W201) E Evolution II 2.5 | | 05/1990→08/1993 | |

V94376 33.00 x 8.00 x 111.50

102 050 11 27



45° ss H

VAG96224B 45.50 x 7.02 x 13.05

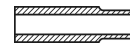

VAG96227B 43.00 x 8.02 x 13.05



106 96.50

| | | | | | | | |
|--------------------------------|--------|-----------------|-----------|----------------------------|--------|-----------------|---------|
| M 117.960 | 4973cc | V8 Cyl. | 16 Valves | 170-180kW/231-245PS | Petrol | DOHC | TD2170 |
| M 117.961 | 4973cc | V8 Cyl. | 16 Valves | 170-177kW/231-240PS | Petrol | DOHC | TD2172 |
| M 117.962 | 4973cc | V8 Cyl. | 16 Valves | 170kW/231PS | Petrol | DOHC | TD17728 |
| M 117.963 | 4973cc | V8 Cyl. | 16 Valves | 137-177kW/186-240PS | Petrol | DOHC | TD2174 |
| M 117.964 | 4973cc | V8 Cyl. | 16 Valves | 164-180kW/223-245PS | Petrol | DOHC | TD2175 |
| M 117.965 | 4973cc | V8 Cyl. | 16 Valves | 164-195kW/223-265PS | Petrol | DOHC | TD4670 |
| G-CLASS (W463) G 500 E | | 09/1993→12/1994 | | S-CLASS (C126) 500 SEC | | 08/1980→06/1991 | |
| S-CLASS (C126) 500 SEC Cat | | 06/1989→06/1991 | | S-CLASS (W126) 500 SE, SEL | | 12/1979→06/1991 | |
| S-CLASS (W126) 500 SE, SEL Cat | | 06/1989→06/1991 | | SL (C107) 450 SLC 5.0 | | 06/1978→02/1980 | |
| SL (R107) 500 SL | | 05/1980→08/1989 | | | | | |

V94257 44.20 x 9.00 x 117.00

116 050 01 26

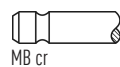

45° Y H

VAG96144B 47.50 x 9.02 x 14.05

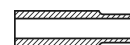

VAG96139B 50.50 x 9.02 x 15.05

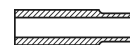

VAG96147B 54.00 x 9.02 x 15.05





OE

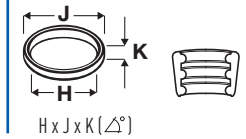
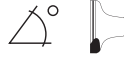

107  **96.50**

| | | | | | | | |
|---------------------|--------|---------|-----------|---------------------|--------|------|---------|
| M 119.960 | 4973cc | V8 Cyl. | 32 Valves | 235-240kW/320-326PS | Petrol | DOHC | TD2186 |
| M 119.970 | 4973cc | V8 Cyl. | 32 Valves | 235-240kW/320-326PS | Petrol | DOHC | TD2187 |
| M 119.972 | 4973cc | V8 Cyl. | 32 Valves | 235-240kW/320-326PS | Petrol | DOHC | TD2189 |
| M 119.974 | 4973cc | V8 Cyl. | 32 Valves | 235-240kW/320-326PS | Petrol | DOHC | TD2190 |
| M 119.980 | 4973cc | V8 Cyl. | 32 Valves | 235kW/320PS | Petrol | DOHC | TD19044 |
| M 119.982 | 4973cc | V8 Cyl. | 32 Valves | 235kW/320PS | Petrol | DOHC | TD20346 |
| M 119.985 (AMG 5.0) | 4973cc | V8 Cyl. | 32 Valves | 255kW/347PS | Petrol | DOHC | TD9891 |

| | | | |
|----------------------------|-----------------|---------------------------|-----------------|
| E-CLASS (W124) E 500 | 06/1993→06/1995 | E-CLASS (W210) E 50 AMG | 02/1996→08/1997 |
| SALOON (W124) 500 E | 01/1991→06/1993 | S-CLASS (C140) SEC/CL 500 | 10/1992→02/1999 |
| S-CLASS (W140) 500 SE, SEL | 02/1991→10/1998 | S-CLASS (W140) S 500 | 01/1993→10/1998 |
| SL (R129) 500 | 09/1992→10/2001 | SL (R129) 500 SL | 09/1989→08/1992 |

V94532 
38.00 x 7.00 x 95.80

119 053 18 01

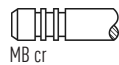

45°

H

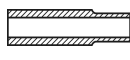
VAG96142B 
35.50 x 7.02 x 13.55

VAG96096 
37.60 x 7.00 x 12.55

VAG96178 
37.50 x 7.02 x 12.76

108  **96.50**

| | | | | | | | |
|-----------|--------|---------|-----------|---------------------|--------|------|--------|
| M 117.967 | 5547cc | V8 Cyl. | 16 Valves | 169-178kW/230-242PS | Petrol | SOHC | TD2177 |
| M 117.968 | 5547cc | V8 Cyl. | 16 Valves | 178-220kW/242-300PS | Petrol | SOHC | TD2178 |

| | | | |
|------------------------|-----------------|----------------------------|-----------------|
| S-CLASS (C126) 560 SEC | 10/1985→06/1991 | S-CLASS (W126) 560 SE, SEL | 10/1985→06/1991 |
| SL (R107) 560 SL | 09/1985→12/1989 | | |

V94257 
44.20 x 9.00 x 117.00

116 050 01 26

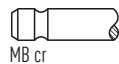

45°

Y

H

VAG96144B 
47.50 x 9.02 x 14.05

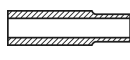
VAG96139B 
50.50 x 9.02 x 15.05

109  **97.00**

| | | | | | | | |
|-----------|--------|---------|-----------|---------------------|--------|--|---------|
| M 112.970 | 3724cc | V6 Cyl. | 18 Valves | 173-180kW/235-245PS | Petrol | | TD17532 |
| M 112.972 | 3724cc | V6 Cyl. | 18 Valves | 180kW/245PS | Petrol | | TD17189 |
| M 112.973 | 3724cc | V6 Cyl. | 18 Valves | 180kW/245PS | Petrol | | TD17537 |
| M 112.975 | 3724cc | V6 Cyl. | 18 Valves | 180kW/245PS | Petrol | | TD17190 |
| M 112.976 | 3724cc | V6 Cyl. | 18 Valves | 165-170kW/224-231PS | Petrol | | TD18426 |

| | | | |
|-----------------------|-----------------|-------------------------|-----------------|
| M-CLASS (W163) ML 350 | 08/2002→06/2005 | S-CLASS (W220) S 350 | 09/2002→08/2005 |
| SL (R230) 350 | 03/2003→01/2012 | VIANO (W639) 3.7 | 06/2004→ |
| VITO (W639) 123 | 06/2004→ | VITO / MIXTO (W639) 123 | 06/2004→07/2008 |

V94393 
43.00 x 7.00 x 121.80

113 050 03 27

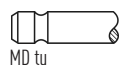

45°

ss

VAG96097 
50.00 x 7.03 x 12.76



OE

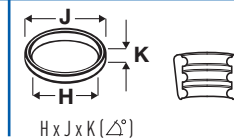
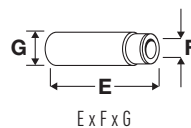
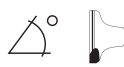

110 97.00

| | | | | | | | |
|------------|--------|--------|----------|-----------|--------|-----|---------|
| OM 314.910 | 3780cc | 4 Cyl. | 8 Valves | 63kW/85PS | Diesel | OHV | TD5691 |
| OM 314.915 | 3780cc | 4 Cyl. | 8 Valves | 63kW/85PS | Diesel | OHV | TD16557 |
| OM 314.944 | 3780cc | 4 Cyl. | 8 Valves | 63kW/85PS | Diesel | OHV | TD6028 |
| OM 314.946 | 3780cc | 4 Cyl. | 8 Valves | 63kW/85PS | Diesel | OHV | TD2202 |
| OM 314.948 | 3780cc | 4 Cyl. | 8 Valves | 63kW/85PS | Diesel | OHV | TD2203 |
| OM 314.959 | 3780cc | 4 Cyl. | 8 Valves | 63kW/85PS | Diesel | OHV | TD2204 |
| OM 314.961 | 3780cc | 4 Cyl. | 8 Valves | 63kW/85PS | Diesel | OHV | TD16552 |
| OM 314.962 | 3780cc | 4 Cyl. | 8 Valves | 63kW/85PS | Diesel | OHV | TD16553 |
| OM 314.963 | 3780cc | 4 Cyl. | 8 Valves | 63kW/85PS | Diesel | OHV | TD16554 |
| OM 314.964 | 3780cc | 4 Cyl. | 8 Valves | 63kW/85PS | Diesel | OHV | TD16555 |
| OM 314.965 | 3780cc | 4 Cyl. | 8 Valves | 63kW/85PS | Diesel | OHV | TD16556 |
| OM 314.967 | 3780cc | 4 Cyl. | 8 Valves | 63kW/85PS | Diesel | OHV | TD6026 |

| | | | |
|---------------|-----------------|-----------------|-----------------|
| LP | 09/1963→12/1984 | O 309 | 01/1970→02/1989 |
| T2/L L 408 DG | 01/1970→12/1974 | T2/L L 508 DG | 01/1970→12/1988 |
| T2/L L 608 D | 01/1970→12/1988 | T2/L LKO 508 DG | 06/1972→06/1988 |

V91131
36.06 x 9.93 x 140.56
Eng.42964→

366 050 05 27

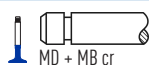

45°

H

VAG92411
72.00 x 9.01 x 15.05
Eng.42964→



V91361
36.10 x 10.00 x 140.50
Eng.42964→

366 050 01 27

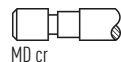

45°

VAG92412
67.00 x 10.01 x 15.05
Eng.42964→

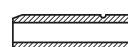

111 97.00

| | | | | | | | |
|-----------|--------|---------|-----------|---------------------|--------|------|---------|
| M 113.960 | 4966cc | V8 Cyl. | 24 Valves | 215-225kW/292-306PS | Petrol | DOHC | TD11493 |
| M 113.961 | 4966cc | V8 Cyl. | 24 Valves | 225kW/306PS | Petrol | DOHC | TD11495 |
| M 113.962 | 4966cc | V8 Cyl. | 24 Valves | 215-218kW/292-296PS | Petrol | DOHC | TD12027 |
| M 113.963 | 4966cc | V8 Cyl. | 24 Valves | 215-225kW/292-306PS | Petrol | DOHC | TD16886 |
| M 113.964 | 4966cc | V8 Cyl. | 24 Valves | 215-225kW/292-306PS | Petrol | DOHC | TD17011 |
| M 113.965 | 4966cc | V8 Cyl. | 24 Valves | 215kW/292PS | Petrol | DOHC | TD17308 |
| M 113.966 | 4966cc | V8 Cyl. | 24 Valves | 225kW/306PS | Petrol | DOHC | TD17191 |
| M 113.967 | 4966cc | V8 Cyl. | 24 Valves | 215-225kW/292-306PS | Petrol | DOHC | TD17006 |
| M 113.968 | 4966cc | V8 Cyl. | 24 Valves | 215-225kW/292-306PS | Petrol | DOHC | TD16887 |
| M 113.969 | 4966cc | V8 Cyl. | 24 Valves | 225kW/306PS | Petrol | DOHC | TD17332 |
| M 113.971 | 4966cc | V8 Cyl. | 24 Valves | 218-225kW/296-306PS | Petrol | DOHC | TD18972 |

| | | | |
|----------------------------|-----------------|------------------------|-----------------|
| CLK (A209) CLK 500 | 02/2003→03/2010 | CLK (C209) 500 | 06/2002→05/2009 |
| CLS (C219) CLS 500 | 10/2004→12/2010 | E-CLASS (S211) E 500 T | 10/2003→07/2009 |
| E-CLASS (W211) E 500 | 03/2002→12/2008 | G-CLASS (W463) G 500 | 04/1998→ |
| M-CLASS (W163) ML 500 | 09/2001→06/2005 | M-CLASS (W164) ML 500 | 07/2005→12/2011 |
| R-CLASS (W251, V251) R 500 | 01/2006→ | S-CLASS (C215) CL 500 | 03/1999→03/2006 |
| S-CLASS (W220) S 500 | 10/1998→08/2005 | SL (R129) 500 | 05/1998→10/2001 |
| SL (R230) 500 | 10/2001→01/2012 | | |

V94393
43.00 x 7.00 x 121.80

113 050 03 27



45°

SS

VAG96097
50.00 x 7.03 x 12.76

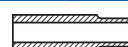



OE

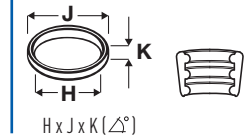
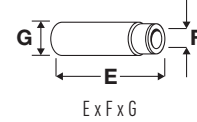

112  97.00

| | | | | | | | |
|-----------|--------|---------|-----------|---------------------|--------|--------------------|---------|
| M 113.980 | 5439cc | V8 Cyl. | 24 Valves | 255-260kW/347-354PS | Petrol | DOHC | TD9890 |
| M 113.981 | 5439cc | V8 Cyl. | 24 Valves | 255kW/347PS | Petrol | DOHC | TD14889 |
| M 113.982 | 5439cc | V8 Cyl. | 24 Valves | 260kW/354PS | Petrol | DOHC | TD16896 |
| M 113.984 | 5439cc | V8 Cyl. | 24 Valves | 255-260kW/347-354PS | Petrol | DOHC | TD15457 |
| M 113.986 | 5439cc | V8 Cyl. | 24 Valves | 265kW/360PS | Petrol | DOHC | TD16891 |
| M 113.987 | 5439cc | V8 Cyl. | 24 Valves | 260-270kW/354-367PS | Petrol | DOHC | TD16890 |
| M 113.988 | 5439cc | V8 Cyl. | 24 Valves | 260-270kW/354-367PS | Petrol | DOHC | TD17931 |
| M 113.989 | 5439cc | V8 Cyl. | 24 Valves | 260-294kW/354-400PS | Petrol | DOHC | TD18433 |
| M 113.990 | 5439cc | V8 Cyl. | 24 Valves | 350kW/476PS | Petrol | Supercharged, DOHC | TD17330 |
| M 113.991 | 5439cc | V8 Cyl. | 24 Valves | 349-368kW/475-500PS | Petrol | Supercharged, DOHC | TD17193 |
| M 113.992 | 5439cc | V8 Cyl. | 24 Valves | 350-368kW/476-500PS | Petrol | Supercharged, DOHC | TD16889 |
| M 113.995 | 5439cc | V8 Cyl. | 24 Valves | 380kW/517PS | Petrol | Supercharged, DOHC | TD23757 |

| | | | |
|---------------------------|-----------------|---------------------------|-----------------|
| C-CLASS (S203) C 55 AMG | 02/2004→08/2007 | C-CLASS (W203) C 55 AMG | 02/2004→02/2007 |
| CLK (A208) 55 AMG | 01/2000→03/2002 | CLK (A209) CLK 55 AMG | 02/2003→03/2010 |
| CLK (C208) 5.4 | 10/1998→07/2002 | CLK (C208) 55 AMG | 08/1999→06/2002 |
| CLK (C209) 55 AMG | 09/2002→05/2009 | CLS (C219) CLS 55 AMG | 01/2005→12/2010 |
| E-CLASS (S210) E 55 T AMG | 08/1997→03/2003 | E-CLASS (S211) E 55 T AMG | 07/2003→07/2009 |
| E-CLASS (W210) E 55 AMG | 08/1997→03/2002 | E-CLASS (W211) E 55 AMG | 10/2002→12/2008 |
| G-CLASS (W463) G 55 AMG | 04/1999→ | M-CLASS (W163) ML 55 AMG | 02/2000→06/2005 |
| S-CLASS (C215) CL 55 AMG | 10/1999→08/2006 | S-CLASS (W220) S 55 AMG | 04/1999→08/2005 |
| SL (R129) 55 AMG | 08/1999→07/2001 | SL (R230) 55 AMG | 10/2001→01/2012 |
| SLK (R171) 55 AMG | 06/2004→02/2011 | | |

V94393 
43.00 x 7.00 x 121.80

113 050 03 27

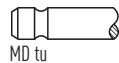

45° ss

VAG96097 
50.00 x 7.03 x 12.76



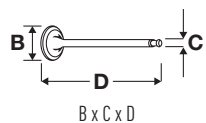

OE

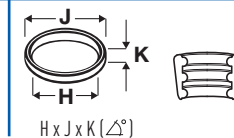
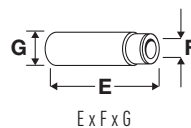

113 **97.00**

| | | | | | | | |
|------------|--------|--------|-----------|-------------|--------|------------|---------|
| OM 341.910 | 5675cc | 6 Cyl. | 12 Valves | 74kW/101PS | Diesel | OHV | TD28463 |
| OM 341.911 | 5675cc | 6 Cyl. | 12 Valves | 81kW/110PS | Diesel | OHV | TD28464 |
| OM 341.912 | 5675cc | 6 Cyl. | 12 Valves | 96kW/131PS | Diesel | OHV | TD28465 |
| OM 341.913 | 5675cc | 6 Cyl. | 12 Valves | 118kW/160PS | Diesel | Turbo, OHV | TD28466 |
| OM 341.915 | 5675cc | 6 Cyl. | 12 Valves | 96kW/131PS | Diesel | OHV | TD28467 |
| OM 341.918 | 5675cc | 6 Cyl. | 12 Valves | 66kW/90PS | Diesel | OHV | TD28468 |
| OM 341.919 | 5675cc | 6 Cyl. | 12 Valves | 74kW/101PS | Diesel | OHV | TD28472 |
| OM 341.931 | 5675cc | 6 Cyl. | 12 Valves | 74kW/101PS | Diesel | OHV | TD28469 |
| OM 341.932 | 5675cc | 6 Cyl. | 12 Valves | 96kW/131PS | Diesel | OHV | TD28473 |
| OM 341.933 | 5675cc | 6 Cyl. | 12 Valves | 96kW/131PS | Diesel | Turbo, OHV | TD28474 |
| OM 341.934 | 5675cc | 6 Cyl. | 12 Valves | 62kW/84PS | Diesel | OHV | TD28476 |
| OM 341.935 | 5675cc | 6 Cyl. | 12 Valves | 96kW/131PS | Diesel | OHV | TD28477 |
| OM 341.936 | 5675cc | 6 Cyl. | 12 Valves | 96kW/131PS | Diesel | OHV | TD28478 |
| OM 341.937 | 5675cc | 6 Cyl. | 12 Valves | 96kW/131PS | Diesel | Turbo, OHV | TD28479 |
| OM 341.938 | 5675cc | 6 Cyl. | 12 Valves | 66kW/90PS | Diesel | OHV | TD28480 |
| OM 341.939 | 5675cc | 6 Cyl. | 12 Valves | 96kW/131PS | Diesel | Turbo, OHV | TD28481 |
| OM 341.941 | 5675cc | 6 Cyl. | 12 Valves | 96kW/131PS | Diesel | OHV | TD28482 |
| OM 341.943 | 5675cc | 6 Cyl. | 12 Valves | 115kW/156PS | Diesel | Turbo, OHV | TD28483 |
| OM 341.946 | 5675cc | 6 Cyl. | 12 Valves | 96kW/131PS | Diesel | OHV | TD28484 |
| OM 341.947 | 5675cc | 6 Cyl. | 12 Valves | 96kW/131PS | Diesel | OHV | TD28485 |
| OM 341.949 | 5675cc | 6 Cyl. | 12 Valves | 96kW/131PS | Diesel | OHV | TD28487 |
| OM 341.995 | 5675cc | 6 Cyl. | 12 Valves | 96kW/131PS | Diesel | OHV | TD28489 |
| OM 341.996 | 5675cc | 6 Cyl. | 12 Valves | 115kW/156PS | Diesel | Turbo, OHV | TD28490 |
| OM 344.943 | 5675cc | 6 Cyl. | 12 Valves | 96kW/131PS | Diesel | OHV | TD28593 |
| OM 344.945 | 5675cc | 6 Cyl. | 12 Valves | 96kW/131PS | Diesel | OHV | TD28595 |
| OM 352.902 | 5675cc | 6 Cyl. | 12 Valves | 52kW/70PS | Diesel | OHV | TD7974 |
| OM 352.933 | 5675cc | 6 Cyl. | 12 Valves | 81kW/110PS | Diesel | OHV | TD16609 |
| OM 352.949 | 5675cc | 6 Cyl. | 12 Valves | 115kW/156PS | Diesel | Turbo, OHV | TD16646 |
| OM 352.959 | 5675cc | 6 Cyl. | 12 Valves | 96kW/130PS | Diesel | OHV | TD22737 |
| OM 352.965 | 5675cc | 6 Cyl. | 12 Valves | 69kW/94PS | Diesel | OHV | TD22738 |
| OM 352.966 | 5675cc | 6 Cyl. | 12 Valves | 79kW/107PS | Diesel | OHV | TD22739 |
| OM 352.967 | 5675cc | 6 Cyl. | 12 Valves | 74kW/101PS | Diesel | OHV | TD22740 |
| OM 352.978 | 5675cc | 6 Cyl. | 12 Valves | 96kW/131PS | Diesel | OHV | TD22741 |
| OM 352.984 | 5675cc | 6 Cyl. | 12 Valves | 59kW/80PS | Diesel | OHV | TD7976 |
| OM 352.992 | 5675cc | 6 Cyl. | 12 Valves | 93kW/126PS | Diesel | OHV | TD22742 |
| OM 352.999 | 5675cc | 6 Cyl. | 12 Valves | 79kW/107PS | Diesel | OHV | TD22743 |
| OM 362.910 | 5675cc | 6 Cyl. | 12 Valves | 141kW/192PS | Diesel | Turbo, OHV | TD16699 |

AGL (RoundNose)

03/1974→03/1998

UNIMOG

05/1966→

V91192
36.00 x 9.94 x 140.70

366 050 02 27

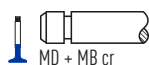

45°

H

VAG92411
72.00 x 9.01 x 15.05



VAG92412
67.00 x 10.01 x 15.05



114 **97.00**

| | | | | | | | |
|------------|--------|--------|-----------|------------|--------|-----|---------|
| OM 344.905 | 5675cc | 6 Cyl. | 12 Valves | 96kW/131PS | Diesel | OHV | TD28587 |
| OM 344.912 | 5675cc | 6 Cyl. | 12 Valves | 96kW/131PS | Diesel | OHV | TD28588 |
| OM 344.930 | 5675cc | 6 Cyl. | 12 Valves | 96kW/131PS | Diesel | OHV | TD28589 |

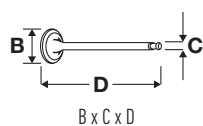

OE

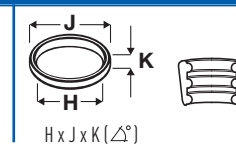
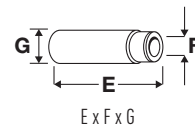

| | | | | | | | |
|------------|--------|--------|-----------|---------------------|--------|------------|---------|
| OM 344.931 | 5675cc | 6 Cyl. | 12 Valves | 115kW/156PS | Diesel | Turbo, OHV | TD28590 |
| OM 344.932 | 5675cc | 6 Cyl. | 12 Valves | 96kW/131PS | Diesel | OHV | TD28591 |
| OM 344.933 | 5675cc | 6 Cyl. | 12 Valves | 96kW/131PS | Diesel | OHV | TD28592 |
| OM 344.941 | 5675cc | 6 Cyl. | 12 Valves | 96kW/131PS | Diesel | Turbo, OHV | TD28272 |
| OM 344.944 | 5675cc | 6 Cyl. | 12 Valves | 96kW/131PS | Diesel | OHV | TD28594 |
| OM 344.946 | 5675cc | 6 Cyl. | 12 Valves | 96kW/131PS | Diesel | OHV | TD28596 |
| OM 344.963 | 5675cc | 6 Cyl. | 12 Valves | 96kW/131PS | Diesel | OHV | TD28597 |
| OM 352.901 | 5675cc | 6 Cyl. | 12 Valves | 96kW/130PS | Diesel | OHV | TD16626 |
| OM 352.903 | 5675cc | 6 Cyl. | 12 Valves | 66kW/90PS | Diesel | OHV | TD7977 |
| OM 352.904 | 5675cc | 6 Cyl. | 12 Valves | 93kW/126PS | Diesel | OHV | TD16627 |
| OM 352.906 | 5675cc | 6 Cyl. | 12 Valves | 81kW/110PS | Diesel | OHV | TD5700 |
| OM 352.908 | 5675cc | 6 Cyl. | 12 Valves | 81-96kW/110-131PS | Diesel | OHV | TD5701 |
| OM 352.909 | 5675cc | 6 Cyl. | 12 Valves | 81kW/110PS | Diesel | OHV | TD16606 |
| OM 352.910 | 5675cc | 6 Cyl. | 12 Valves | 74kW/100PS | Diesel | OHV | TD16615 |
| OM 352.911 | 5675cc | 6 Cyl. | 12 Valves | 81kW/110PS | Diesel | OHV | TD16607 |
| OM 352.912 | 5675cc | 6 Cyl. | 12 Valves | 96-97kW/130-132PS | Diesel | OHV | TD16628 |
| OM 352.913 | 5675cc | 6 Cyl. | 12 Valves | 115kW/156PS | Diesel | Turbo, OHV | TD16643 |
| OM 352.914 | 5675cc | 6 Cyl. | 12 Valves | 81kW/110PS | Diesel | OHV | TD7921 |
| OM 352.915 | 5675cc | 6 Cyl. | 12 Valves | 93kW/126PS | Diesel | OHV | TD7922 |
| OM 352.916 | 5675cc | 6 Cyl. | 12 Valves | 110-111kW/150-151PS | Diesel | Turbo, OHV | TD7923 |
| OM 352.917 | 5675cc | 6 Cyl. | 12 Valves | 93kW/126PS | Diesel | OHV | TD16629 |
| OM 352.918 | 5675cc | 6 Cyl. | 12 Valves | 110kW/150PS | Diesel | Turbo, OHV | TD16641 |
| OM 352.930 | 5675cc | 6 Cyl. | 12 Valves | 96kW/130PS | Diesel | OHV | TD16630 |
| OM 352.931 | 5675cc | 6 Cyl. | 12 Valves | 96kW/130PS | Diesel | OHV | TD16631 |
| OM 352.932 | 5675cc | 6 Cyl. | 12 Valves | 81kW/110PS | Diesel | OHV | TD16608 |
| OM 352.934 | 5675cc | 6 Cyl. | 12 Valves | 96kW/130PS | Diesel | OHV | TD16632 |
| OM 352.935 | 5675cc | 6 Cyl. | 12 Valves | 96kW/130PS | Diesel | OHV | TD16633 |
| OM 352.936 | 5675cc | 6 Cyl. | 12 Valves | 96kW/130PS | Diesel | OHV | TD8158 |
| OM 352.937 | 5675cc | 6 Cyl. | 12 Valves | 110kW/150PS | Diesel | Turbo, OHV | TD16644 |
| OM 352.938 | 5675cc | 6 Cyl. | 12 Valves | 96kW/130PS | Diesel | OHV | TD5738 |
| OM 352.939 | 5675cc | 6 Cyl. | 12 Valves | 96kW/130PS | Diesel | OHV | TD16634 |
| OM 352.942 | 5675cc | 6 Cyl. | 12 Valves | 74kW/100PS | Diesel | OHV | TD16616 |
| OM 352.943 | 5675cc | 6 Cyl. | 12 Valves | 81kW/110PS | Diesel | OHV | TD16610 |
| OM 352.944 | 5675cc | 6 Cyl. | 12 Valves | 93kW/126PS | Diesel | OHV | TD16635 |
| OM 352.945 | 5675cc | 6 Cyl. | 12 Valves | 96kW/130PS | Diesel | OHV | TD16637 |
| OM 352.946 | 5675cc | 6 Cyl. | 12 Valves | 110kW/150PS | Diesel | Turbo, OHV | TD16645 |
| OM 352.948 | 5675cc | 6 Cyl. | 12 Valves | 93kW/126PS | Diesel | OHV | TD16638 |
| OM 352.950 | 5675cc | 6 Cyl. | 12 Valves | 110kW/150PS | Diesel | Turbo, OHV | TD16647 |
| OM 352.953 | 5675cc | 6 Cyl. | 12 Valves | 93kW/126PS | Diesel | OHV | TD16639 |
| OM 352.954 | 5675cc | 6 Cyl. | 12 Valves | 93kW/126PS | Diesel | OHV | TD16640 |
| OM 352.955 | 5675cc | 6 Cyl. | 12 Valves | 93kW/126PS | Diesel | OHV | TD17012 |
| OM 352.963 | 5675cc | 6 Cyl. | 12 Valves | 96kW/130PS | Diesel | OHV | TD6071 |
| OM 352.964 | 5675cc | 6 Cyl. | 12 Valves | 96kW/130PS | Diesel | OHV | TD5714 |
| OM 352.968 | 5675cc | 6 Cyl. | 12 Valves | 115kW/156PS | Diesel | Turbo, OHV | TD16648 |
| OM 352.969 | 5675cc | 6 Cyl. | 12 Valves | 96kW/130PS | Diesel | OHV | TD8089 |
| OM 352.970 | 5675cc | 6 Cyl. | 12 Valves | 81kW/110PS | Diesel | OHV | TD16611 |
| OM 352.971 | 5675cc | 6 Cyl. | 12 Valves | 74kW/100PS | Diesel | OHV | TD16617 |
| OM 352.972 | 5675cc | 6 Cyl. | 12 Valves | 74kW/100PS | Diesel | OHV | TD16618 |
| OM 352.973 | 5675cc | 6 Cyl. | 12 Valves | 74kW/100PS | Diesel | OHV | TD16619 |
| OM 352.974 | 5675cc | 6 Cyl. | 12 Valves | 74kW/100PS | Diesel | OHV | TD16620 |

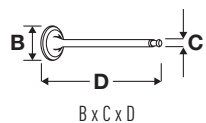

OE

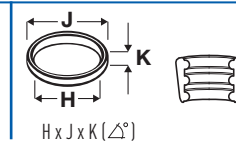
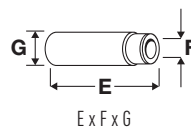

| | | | | | | | |
|------------|--------|--------|-----------|---------------------|--------|------------|---------|
| OM 352.975 | 5675cc | 6 Cyl. | 12 Valves | 74kW/100PS | Diesel | OHV | TD16621 |
| OM 352.976 | 5675cc | 6 Cyl. | 12 Valves | 81kW/110PS | Diesel | OHV | TD16612 |
| OM 352.979 | 5675cc | 6 Cyl. | 12 Valves | 81kW/110PS | Diesel | OHV | TD16613 |
| OM 352.980 | 5675cc | 6 Cyl. | 12 Valves | 96kW/130PS | Diesel | OHV | TD17015 |
| OM 352.981 | 5675cc | 6 Cyl. | 12 Valves | 81kW/110PS | Diesel | OHV | TD16622 |
| OM 352.982 | 5675cc | 6 Cyl. | 12 Valves | 81kW/110PS | Diesel | OHV | TD16614 |
| OM 352.983 | 5675cc | 6 Cyl. | 12 Valves | 81kW/110PS | Diesel | OHV | TD16623 |
| OM 352.985 | 5675cc | 6 Cyl. | 12 Valves | 81kW/110PS | Diesel | OHV | TD16624 |
| OM 352.987 | 5675cc | 6 Cyl. | 12 Valves | 93kW/126PS | Diesel | OHV | TD17013 |
| OM 352.988 | 5675cc | 6 Cyl. | 12 Valves | 96kW/130PS | Diesel | Turbo, OHV | TD16649 |
| OM 352.989 | 5675cc | 6 Cyl. | 12 Valves | 81kW/110PS | Diesel | OHV | TD16625 |
| OM 352.990 | 5675cc | 6 Cyl. | 12 Valves | 81kW/110PS | Diesel | OHV | TD6036 |
| OM 352.991 | 5675cc | 6 Cyl. | 12 Valves | 93kW/126PS | Diesel | OHV | TD17014 |
| OM 352.993 | 5675cc | 6 Cyl. | 12 Valves | 96kW/130PS | Diesel | OHV | TD7891 |
| OM 352.994 | 5675cc | 6 Cyl. | 12 Valves | 110kW/150PS | Diesel | Turbo, OHV | TD16650 |
| OM 352.996 | 5675cc | 6 Cyl. | 12 Valves | 96kW/130PS | Diesel | OHV | TD6281 |
| OM 352.997 | 5675cc | 6 Cyl. | 12 Valves | 96kW/130PS | Diesel | OHV | TD5713 |
| OM 352.998 | 5675cc | 6 Cyl. | 12 Valves | 96kW/130PS | Diesel | OHV | TD6047 |
| OM 353.900 | 5675cc | 6 Cyl. | 12 Valves | 96kW/130PS | Diesel | OHV | TD16651 |
| OM 353.901 | 5675cc | 6 Cyl. | 12 Valves | 74kW/100PS | Diesel | OHV | TD7979 |
| OM 353.902 | 5675cc | 6 Cyl. | 12 Valves | 62kW/84PS | Diesel | OHV | TD5678 |
| OM 353.903 | 5675cc | 6 Cyl. | 12 Valves | 81kW/110PS | Diesel | OHV | TD16652 |
| OM 353.904 | 5675cc | 6 Cyl. | 12 Valves | 96kW/130PS | Diesel | OHV | TD5697 |
| OM 353.907 | 5675cc | 6 Cyl. | 12 Valves | 92kW/125PS | Diesel | OHV | TD7982 |
| OM 353.909 | 5675cc | 6 Cyl. | 12 Valves | 124-125kW/168-170PS | Diesel | Turbo, OHV | TD8091 |
| OM 353.910 | 5675cc | 6 Cyl. | 12 Valves | 124kW/168PS | Diesel | Turbo, OHV | TD8162 |
| OM 353.915 | 5675cc | 6 Cyl. | 12 Valves | 81kW/110PS | Diesel | OHV | TD16653 |
| OM 353.916 | 5675cc | 6 Cyl. | 12 Valves | 81kW/110PS | Diesel | OHV | TD16654 |
| OM 353.917 | 5675cc | 6 Cyl. | 12 Valves | 96kW/130PS | Diesel | OHV | TD16655 |
| OM 353.920 | 5675cc | 6 Cyl. | 12 Valves | 124kW/169PS | Diesel | Turbo, OHV | TD26350 |
| OM 353.921 | 5675cc | 6 Cyl. | 12 Valves | 110kW/150PS | Diesel | Turbo, OHV | TD26351 |
| OM 353.922 | 5675cc | 6 Cyl. | 12 Valves | 88kW/120PS | Diesel | OHV | TD26352 |
| OM 353.923 | 5675cc | 6 Cyl. | 12 Valves | 81kW/110PS | Diesel | OHV | TD26353 |
| OM 353.930 | 5675cc | 6 Cyl. | 12 Valves | 62kW/84PS | Diesel | OHV | TD26354 |
| OM 353.931 | 5675cc | 6 Cyl. | 12 Valves | 81kW/110PS | Diesel | OHV | TD26356 |
| OM 353.932 | 5675cc | 6 Cyl. | 12 Valves | 88kW/120PS | Diesel | OHV | TD26355 |
| OM 353.933 | 5675cc | 6 Cyl. | 12 Valves | 88kW/120PS | Diesel | OHV | TD26357 |
| OM 353.934 | 5675cc | 6 Cyl. | 12 Valves | 88kW/120PS | Diesel | OHV | TD26358 |
| OM 353.935 | 5675cc | 6 Cyl. | 12 Valves | 88kW/120PS | Diesel | OHV | TD26359 |
| OM 353.936 | 5675cc | 6 Cyl. | 12 Valves | 81kW/110PS | Diesel | OHV | TD26360 |
| OM 353.937 | 5675cc | 6 Cyl. | 12 Valves | 92kW/125PS | Diesel | Turbo, OHV | TD26361 |
| OM 353.938 | 5675cc | 6 Cyl. | 12 Valves | 88kW/120PS | Diesel | OHV | TD26362 |
| OM 353.939 | 5675cc | 6 Cyl. | 12 Valves | 124kW/169PS | Diesel | Turbo, OHV | TD26363 |
| OM 353.940 | 5675cc | 6 Cyl. | 12 Valves | 81kW/110PS | Diesel | OHV | TD6016 |
| OM 353.941 | 5675cc | 6 Cyl. | 12 Valves | 96kW/130PS | Diesel | OHV | TD16656 |
| OM 353.949 | 5675cc | 6 Cyl. | 12 Valves | 81kW/110PS | Diesel | OHV | TD16994 |
| OM 353.958 | 5675cc | 6 Cyl. | 12 Valves | 110kW/150PS | Diesel | Turbo, OHV | TD7990 |
| OM 353.960 | 5675cc | 6 Cyl. | 12 Valves | 88kW/120PS | Diesel | OHV | TD7980 |
| OM 353.961 | 5675cc | 6 Cyl. | 12 Valves | 96kW/130PS | Diesel | OHV | TD7998 |
| OM 353.962 | 5675cc | 6 Cyl. | 12 Valves | 70kW/95PS | Diesel | OHV | TD7978 |



OE



MAT.



E x F x G

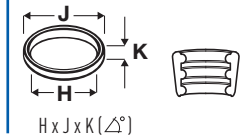

H x J x K (Δ°)

| | | | | | | | |
|------------|--------|--------|-----------|-------------|--------|------------|---------|
| OM 353.963 | 5675cc | 6 Cyl. | 12 Valves | 96kW/130PS | Diesel | OHV | TD5690 |
| OM 353.965 | 5675cc | 6 Cyl. | 12 Valves | 96kW/130PS | Diesel | OHV | TD5715 |
| OM 353.966 | 5675cc | 6 Cyl. | 12 Valves | 96kW/130PS | Diesel | OHV | TD6027 |
| OM 353.967 | 5675cc | 6 Cyl. | 12 Valves | 74kW/101PS | Diesel | OHV | TD16657 |
| OM 353.968 | 5675cc | 6 Cyl. | 12 Valves | 96kW/130PS | Diesel | OHV | TD16658 |
| OM 353.969 | 5675cc | 6 Cyl. | 12 Valves | 96kW/130PS | Diesel | OHV | TD16659 |
| OM 353.977 | 5675cc | 6 Cyl. | 12 Valves | 124kW/169PS | Diesel | Turbo, OHV | TD22744 |
| OM 353.980 | 5675cc | 6 Cyl. | 12 Valves | 81kW/110PS | Diesel | OHV | TD7996 |
| OM 353.981 | 5675cc | 6 Cyl. | 12 Valves | 96kW/130PS | Diesel | OHV | TD6034 |
| OM 353.982 | 5675cc | 6 Cyl. | 12 Valves | 96kW/130PS | Diesel | OHV | TD6048 |
| OM 353.983 | 5675cc | 6 Cyl. | 12 Valves | 96kW/130PS | Diesel | OHV | TD17016 |
| OM 353.984 | 5675cc | 6 Cyl. | 12 Valves | 96kW/130PS | Diesel | OHV | TD17017 |
| OM 353.989 | 5675cc | 6 Cyl. | 12 Valves | 96kW/130PS | Diesel | OHV | TD16663 |

| | | | |
|-----------------|-----------------|--------------------------|-----------------|
| AGL (RoundNose) | 01/1967→ | FPN (FlatNose) | 07/1987→07/1997 |
| HPN (LongNose) | 01/1983→12/1988 | LP | 09/1963→ |
| MB-TRAC | 03/1979→08/1987 | O 302 | 11/1964→11/1975 |
| O 309 | 05/1977→02/1989 | OF Series | 01/1983→ |
| T2/L | 01/1972→ | T2/L L 613 D | 04/1977→12/1988 |
| T2/L L 911 | 01/1972→07/1983 | T2/L LK 911 | 01/1972→07/1983 |
| T2/L LS 911 | 01/1972→07/1983 | T2/L Truck Tractor L 911 | 01/1972→07/1983 |
| UNIMOG | 05/1966→ | | |

V91192 36.00 x 9.94 x 140.70

366 050 02 27



45°

H

VAG92411 72.00 x 9.01 x 15.05



V91361 36.10 x 10.00 x 140.50

366 050 01 27

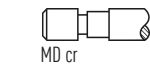

45°

VAG92412 67.00 x 10.01 x 15.05

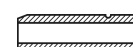

115 97.00

| | | | | | | | |
|------------|--------|--------|-----------|-------------|--------|------------|---------|
| OM 344.913 | 5675cc | 6 Cyl. | 12 Valves | 115kW/156PS | Diesel | Turbo, OHV | TD23170 |
| OM 344.934 | 5675cc | 6 Cyl. | 12 Valves | 115kW/156PS | Diesel | Turbo, OHV | TD7926 |
| OM 344.937 | 5675cc | 6 Cyl. | 12 Valves | 115kW/156PS | Diesel | Turbo, OHV | TD23171 |
| OM 344.938 | 5675cc | 6 Cyl. | 12 Valves | 115kW/156PS | Diesel | Turbo, OHV | TD23172 |
| OM 344.939 | 5675cc | 6 Cyl. | 12 Valves | 115kW/156PS | Diesel | Turbo, OHV | TD23173 |
| OM 344.948 | 5675cc | 6 Cyl. | 12 Valves | 115kW/156PS | Diesel | Turbo, OHV | TD22734 |
| OM 344.949 | 5675cc | 6 Cyl. | 12 Valves | 96kW/131PS | Diesel | Turbo, OHV | TD22735 |
| OM 344.951 | 5675cc | 6 Cyl. | 12 Valves | 115kW/156PS | Diesel | Turbo, OHV | TD23176 |
| OM 344.952 | 5675cc | 6 Cyl. | 12 Valves | 124kW/169PS | Diesel | Turbo, OHV | TD22736 |

| | | | | |
|-------------------------------|---------------|-----------|----------|---------------------------------|
| OF Series | 01/1983→ | OH Series | 01/1970→ | |
| V91191 42.00 x 8.95 x 140.70 | 366 050 03 26 | 30° | H | VAG92411 72.00 x 9.01 x 15.05 |
| V91131 36.06 x 9.93 x 140.56 | 366 050 05 27 | 45° | H | VAG92412 67.00 x 10.01 x 15.05 |
| V91192 36.00 x 9.94 x 140.70 | 366 050 02 27 | 45° | H | |

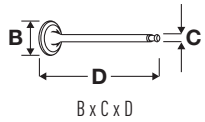

OE

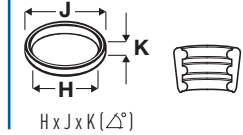
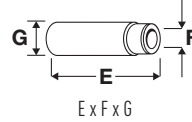
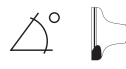

116 97.00

| | | | | | | | |
|------------|-----------------|--------|-----------|-------------|--------|-----------------|---------|
| OM 353.911 | 5675cc | 6 Cyl. | 12 Valves | 124kW/168PS | Diesel | Turbo, OHV | TD8090 |
| OM 353.912 | 5675cc | 6 Cyl. | 12 Valves | 124kW/168PS | Diesel | Turbo, OHV | TD8159 |
| OM 353.913 | 5675cc | 6 Cyl. | 12 Valves | 124kW/168PS | Diesel | Turbo, OHV | TD8097 |
| OM 353.914 | 5675cc | 6 Cyl. | 12 Valves | 124kW/168PS | Diesel | Turbo, OHV | TD16662 |
| OM 353.957 | 5675cc | 6 Cyl. | 12 Valves | 92kW/125PS | Diesel | Turbo, OHV | TD16995 |
| OM 353.959 | 5675cc | 6 Cyl. | 12 Valves | 124kW/168PS | Diesel | Turbo, OHV | TD8009 |
| OM 353.972 | 5675cc | 6 Cyl. | 12 Valves | 124kW/168PS | Diesel | Turbo, OHV | TD16660 |
| OM 353.973 | 5675cc | 6 Cyl. | 12 Valves | 92kW/125PS | Diesel | Turbo, OHV | TD7981 |
| OM 353.974 | 5675cc | 6 Cyl. | 12 Valves | 127kW/172PS | Diesel | Turbo, OHV | TD16661 |
| OM 353.976 | 5675cc | 6 Cyl. | 12 Valves | 110kW/150PS | Diesel | Turbo, OHV | TD17860 |
| OM 353.978 | 5675cc | 6 Cyl. | 12 Valves | 127kW/172PS | Diesel | Turbo, OHV | TD16664 |
| OM 353.991 | 5675cc | 6 Cyl. | 12 Valves | 124kW/168PS | Diesel | Turbo, OHV | TD16665 |
| OM 353.995 | 5675cc | 6 Cyl. | 12 Valves | 92kW/125PS | Diesel | Turbo, OHV | TD7999 |
| OM 353.997 | 5675cc | 6 Cyl. | 12 Valves | 124kW/168PS | Diesel | Turbo, OHV | TD16666 |
| LP | 11/1976→12/1984 | | | MB-TRAC | | 03/1976→12/1987 | |
| T2/L | 01/1972→ | | | UNIMOG | | 01/1977→09/1988 | |

V91361
36.10 x 10.00 x 140.50

366 050 01 27

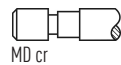

45°

MD cr

V91192
36.00 x 9.94 x 140.70
Eng.033658→

366 050 02 27



45°

H

MD + MB cr

VAG92411
72.00 x 9.01 x 15.05



VAG92412
67.00 x 10.01 x 15.05



117 97.00

| | | | | | | | |
|------------|--------|--------|-----------|------------|--------|-----|--------|
| OM 352.905 | 5680cc | 6 Cyl. | 12 Valves | 96kW/126PS | Diesel | OHV | TD7966 |
| OM 353.905 | 5680cc | 6 Cyl. | 12 Valves | 74kW/100PS | Diesel | OHV | TD7988 |

V91192
36.00 x 9.94 x 140.70

366 050 02 27



45°

H

MD + MB cr

V91361
36.10 x 10.00 x 140.50

366 050 01 27

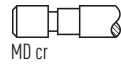

45°

MD cr

VAG92411
72.00 x 9.01 x 15.05



VAG92412
67.00 x 10.01 x 15.05

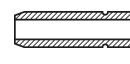



OE

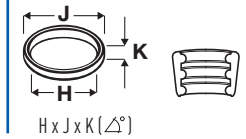

118  **97.00**

| | | | | | | | |
|------------|--------|--------|-----------|-------------|--------|------------|--------|
| OM 352.907 | 5700cc | 6 Cyl. | 12 Valves | 81kW/110PS | Diesel | OHV | TD5702 |
| OM 352.986 | 5700cc | 6 Cyl. | 12 Valves | 81kW/110PS | Diesel | OHV | TD6037 |
| OM 353.942 | 5700cc | 6 Cyl. | 12 Valves | 96kW/130PS | Diesel | OHV | TD5709 |
| OM 353.943 | 5700cc | 6 Cyl. | 12 Valves | 96kW/130PS | Diesel | OHV | TD5727 |
| OM 353.944 | 5700cc | 6 Cyl. | 12 Valves | 96kW/130PS | Diesel | OHV | TD5728 |
| OM 353.945 | 5700cc | 6 Cyl. | 12 Valves | 96kW/130PS | Diesel | OHV | TD5710 |
| OM 353.946 | 5700cc | 6 Cyl. | 12 Valves | 96kW/130PS | Diesel | OHV | TD6044 |
| OM 353.950 | 5700cc | 6 Cyl. | 12 Valves | 124kW/168PS | Diesel | Turbo, OHV | TD5711 |
| OM 353.951 | 5700cc | 6 Cyl. | 12 Valves | 124kW/168PS | Diesel | Turbo, OHV | TD5747 |
| OM 353.952 | 5700cc | 6 Cyl. | 12 Valves | 124kW/168PS | Diesel | Turbo, OHV | TD6045 |
| OM 353.953 | 5700cc | 6 Cyl. | 12 Valves | 124kW/168PS | Diesel | Turbo, OHV | TD6092 |
| OM 353.954 | 5700cc | 6 Cyl. | 12 Valves | 124kW/168PS | Diesel | Turbo, OHV | TD8096 |
| OM 353.964 | 5700cc | 6 Cyl. | 12 Valves | 96kW/130PS | Diesel | OHV | TD6284 |
| OM 353.970 | 5700cc | 6 Cyl. | 12 Valves | 124kW/168PS | Diesel | Turbo, OHV | TD5712 |
| OM 353.971 | 5700cc | 6 Cyl. | 12 Valves | 124kW/168PS | Diesel | Turbo, OHV | TD6060 |
| OM 353.975 | 5700cc | 6 Cyl. | 12 Valves | 124kW/168PS | Diesel | Turbo, OHV | TD6321 |

LP 01/1967→03/1977 NG 08/1973→09/1996

V91192  36.00 x 9.94 x 140.70

366 050 02 27



45°

H

VAG92411  72.00 x 9.01 x 15.05

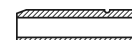

V91361  36.10 x 10.00 x 140.50

366 050 01 27

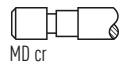

45°

VAG92412  67.00 x 10.01 x 15.05

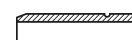

119  **97.00**

| | | | | | | | |
|------------|--------|--------|-----------|-------------|--------|------------|--------|
| OM 362.906 | 5700cc | 6 Cyl. | 12 Valves | 141kW/192PS | Diesel | Turbo, OHV | TD5750 |
| OM 362.909 | 5700cc | 6 Cyl. | 12 Valves | 141kW/192PS | Diesel | Turbo, OHV | TD6080 |

NG 08/1973→09/1996

V91192  36.00 x 9.94 x 140.70

366 050 02 27



45°

H

VAG92411  72.00 x 9.01 x 15.05

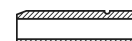

VAG92412  67.00 x 10.01 x 15.05



120  **97.50**

| | | | | | | | |
|------------|--------|--------|----------|-------------|--------|------------|---------|
| OM 354.900 | 3972cc | 4 Cyl. | 8 Valves | 77kW/105PS | Diesel | Turbo, OHV | TD8054 |
| OM 354.901 | 3972cc | 4 Cyl. | 8 Valves | 77kW/105PS | Diesel | Turbo, OHV | TD8084 |
| OM 354.902 | 3972cc | 4 Cyl. | 8 Valves | 77kW/105PS | Diesel | Turbo, OHV | TD5695 |
| OM 354.903 | 3972cc | 4 Cyl. | 8 Valves | 77kW/105PS | Diesel | Turbo, OHV | TD8083 |
| OM 354.920 | 3972cc | 4 Cyl. | 8 Valves | 103kW/140PS | Diesel | Turbo, OHV | TD8059 |
| OM 354.921 | 3972cc | 4 Cyl. | 8 Valves | 103kW/140PS | Diesel | Turbo, OHV | TD8066 |
| OM 354.922 | 3972cc | 4 Cyl. | 8 Valves | 103kW/140PS | Diesel | Turbo, OHV | TD8061 |
| OM 354.923 | 3972cc | 4 Cyl. | 8 Valves | 103kW/140PS | Diesel | Turbo, OHV | TD8057 |
| OM 354.924 | 3972cc | 4 Cyl. | 8 Valves | 103kW/140PS | Diesel | Turbo, OHV | TD8085 |
| OM 354.925 | 3972cc | 4 Cyl. | 8 Valves | 103kW/140PS | Diesel | Turbo, OHV | TD8087 |
| OM 354.926 | 3972cc | 4 Cyl. | 8 Valves | 103kW/140PS | Diesel | Turbo, OHV | TD22745 |
| OM 364.906 | 3972cc | 4 Cyl. | 8 Valves | 66kW/90PS | Diesel | OHV | TD8048 |
| OM 364.907 | 3972cc | 4 Cyl. | 8 Valves | 66kW/90PS | Diesel | OHV | TD8052 |
| OM 364.908 | 3972cc | 4 Cyl. | 8 Valves | 50kW/68PS | Diesel | OHV | TD17853 |



OE

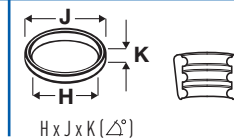
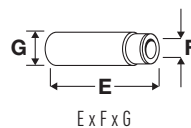
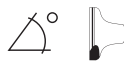

| | | | | | | | |
|------------|--------|--------|----------|---------------------|--------|------------|---------|
| OM 364.909 | 3972cc | 4 Cyl. | 8 Valves | 50kW/68PS | Diesel | OHV | TD17854 |
| OM 364.911 | 3972cc | 4 Cyl. | 8 Valves | 63-66kW/86-90PS | Diesel | OHV | TD8081 |
| OM 364.912 | 3972cc | 4 Cyl. | 8 Valves | 66kW/90PS | Diesel | OHV | TD16804 |
| OM 364.913 | 3972cc | 4 Cyl. | 8 Valves | 66kW/90PS | Diesel | OHV | TD8044 |
| OM 364.916 | 3972cc | 4 Cyl. | 8 Valves | 58kW/79PS | Diesel | OHV | TD22770 |
| OM 364.917 | 3972cc | 4 Cyl. | 8 Valves | 60kW/82PS | Diesel | OHV | TD22771 |
| OM 364.918 | 3972cc | 4 Cyl. | 8 Valves | 63kW/86PS | Diesel | OHV | TD8053 |
| OM 364.919 | 3972cc | 4 Cyl. | 8 Valves | 63kW/86PS | Diesel | OHV | TD5692 |
| OM 364.920 | 3972cc | 4 Cyl. | 8 Valves | 63kW/86PS | Diesel | OHV | TD8082 |
| OM 364.921 | 3972cc | 4 Cyl. | 8 Valves | 63kW/86PS | Diesel | OHV | TD6029 |
| OM 364.950 | 3972cc | 4 Cyl. | 8 Valves | 85kW/115PS | Diesel | Turbo, OHV | TD5696 |
| OM 364.951 | 3972cc | 4 Cyl. | 8 Valves | 66kW/90PS | Diesel | Turbo, OHV | TD17855 |
| OM 364.952 | 3972cc | 4 Cyl. | 8 Valves | 85kW/115PS | Diesel | Turbo, OHV | TD6033 |
| OM 364.954 | 3972cc | 4 Cyl. | 8 Valves | 85kW/115PS | Diesel | OHV | TD8045 |
| OM 364.955 | 3972cc | 4 Cyl. | 8 Valves | 75kW/102PS | Diesel | Turbo, OHV | TD8015 |
| OM 364.956 | 3972cc | 4 Cyl. | 8 Valves | 77kW/105PS | Diesel | Turbo, OHV | TD22772 |
| OM 364.957 | 3972cc | 4 Cyl. | 8 Valves | 77kW/105PS | Diesel | Turbo, OHV | TD5693 |
| OM 364.958 | 3972cc | 4 Cyl. | 8 Valves | 77kW/105PS | Diesel | Turbo, OHV | TD6030 |
| OM 364.959 | 3972cc | 4 Cyl. | 8 Valves | 77kW/105PS | Diesel | Turbo, OHV | TD22773 |
| OM 364.981 | 3972cc | 4 Cyl. | 8 Valves | 100kW/136PS | Diesel | Turbo, OHV | TD8086 |
| OM 364.982 | 3972cc | 4 Cyl. | 8 Valves | 98kW/133PS | Diesel | Turbo, OHV | TD8016 |
| OM 364.983 | 3972cc | 4 Cyl. | 8 Valves | 102kW/139PS | Diesel | Turbo, OHV | TD20150 |
| OM 364.984 | 3972cc | 4 Cyl. | 8 Valves | 100kW/136PS | Diesel | Turbo, OHV | TD8088 |
| OM 364.985 | 3972cc | 4 Cyl. | 8 Valves | 100-103kW/136-140PS | Diesel | Turbo, OHV | TD8017 |
| OM 364.986 | 3972cc | 4 Cyl. | 8 Valves | 100kW/136PS | Diesel | Turbo, OHV | TD5694 |
| OM 364.987 | 3972cc | 4 Cyl. | 8 Valves | 100kW/136PS | Diesel | Turbo, OHV | TD6031 |
| OM 364.989 | 3972cc | 4 Cyl. | 8 Valves | 100kW/136PS | Diesel | Turbo, OHV | TD22774 |
| OM 380.940 | 3972cc | 4 Cyl. | 8 Valves | 85kW/116PS | Diesel | Turbo, OHV | TD22776 |
| OM 380.942 | 3972cc | 4 Cyl. | 8 Valves | 85kW/116PS | Diesel | Turbo, OHV | TD22777 |
| OM 380.943 | 3972cc | 4 Cyl. | 8 Valves | 79kW/107PS | Diesel | Turbo, OHV | TD22778 |
| OM 384.906 | 3972cc | 4 Cyl. | 8 Valves | 66-100kW/90-137PS | Diesel | Turbo, OHV | TD23199 |
| OM 384.907 | 3972cc | 4 Cyl. | 8 Valves | 85kW/116PS | Diesel | Turbo, OHV | TD22788 |
| OM 384.908 | 3972cc | 4 Cyl. | 8 Valves | 79kW/107PS | Diesel | Turbo, OHV | TD22789 |

| | | | |
|-------------------------------|-----------------|----------------|-----------------|
| AGL (RoundNose) | 03/1984→12/1993 | LK/LN2 | 01/1984→12/2005 |
| MB-TRAC | 02/1987→12/1991 | OF Series | 01/1983→ |
| T2/LN1 609 D | 04/1986→12/1994 | T2/LN1 609 DK | 04/1986→12/1994 |
| T2/LN1 611 D | 06/1994→12/1994 | T2/LN1 611 DK | 06/1994→12/1994 |
| T2/LN1 709 D | 04/1986→12/1994 | T2/LN1 709 DK | 04/1986→12/1994 |
| T2/LN1 711 D | 04/1986→12/1994 | T2/LN1 714 D | 06/1994→12/1994 |
| T2/LN1 809 D | 04/1986→12/1994 | T2/LN1 809 DK | 04/1986→12/1994 |
| T2/LN1 811 D | 04/1986→12/1994 | T2/LN1 811 DK | 04/1986→12/1994 |
| T2/LN1 814 D | 11/1987→12/1994 | T2/LN1 814 DA | 11/1987→12/1994 |
| T2/LN1 Cab with engine 809 DT | 04/1986→12/1994 | T2/LN1 O 609 D | 07/1987→12/1992 |
| T2/LN1 O 611 D | 07/1987→12/1992 | T2/LN1 O 614 D | 07/1987→12/1992 |
| UNIMOG | 02/1992→ | | |

V91191 ■
42.00 x 8.95 x 140.70

366 050 03 26

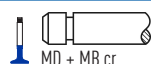

30°

H

VAG92411 ■
72.00 x 9.01 x 15.05



V91131 ■
36.06 x 9.93 x 140.56

366 050 05 27



45°

H

VAG92412 ■
67.00 x 10.01 x 15.05

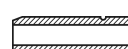

V91192 ■
36.00 x 9.94 x 140.70

366 050 02 27



45°

H



OE

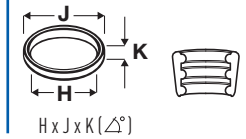
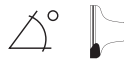

121 97.50

| | | | | | | | |
|------------|--------|--------|----------|------------|--------|------------|---------|
| OM 364.901 | 3972cc | 4 Cyl. | 8 Valves | 83kW/113PS | Diesel | Turbo, OHV | TD21464 |
| OM 374.905 | 3972cc | 4 Cyl. | 8 Valves | 66kW/90PS | Diesel | OHV | TD23197 |
| OM 374.907 | 3972cc | 4 Cyl. | 8 Valves | 66kW/90PS | Diesel | OHV | TD8058 |
| OM 374.908 | 3972cc | 4 Cyl. | 8 Valves | 66kW/90PS | Diesel | OHV | TD23198 |

V91192 36.00 x 9.94 x 140.70

366 050 02 27



45°

H

VAG92411 72.00 x 9.01 x 15.05



V91361 36.10 x 10.00 x 140.50

366 050 01 27

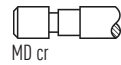

45°

VAG92412 67.00 x 10.01 x 15.05



122 97.50

| | | | | | | | |
|------------|--------|--------|-----------|---------------------|--------|------------|---------|
| OM 356.901 | 5958cc | 6 Cyl. | 12 Valves | 95kW/129PS | Diesel | OHV | TD5704 |
| OM 356.902 | 5958cc | 6 Cyl. | 12 Valves | 95kW/129PS | Diesel | OHV | TD8064 |
| OM 356.903 | 5958cc | 6 Cyl. | 12 Valves | 95kW/129PS | Diesel | OHV | TD8093 |
| OM 356.904 | 5958cc | 6 Cyl. | 12 Valves | 95kW/129PS | Diesel | OHV | TD8098 |
| OM 356.905 | 5958cc | 6 Cyl. | 12 Valves | 95kW/129PS | Diesel | OHV | TD8062 |
| OM 356.906 | 5958cc | 6 Cyl. | 12 Valves | 95kW/129PS | Diesel | OHV | TD8067 |
| OM 356.907 | 5958cc | 6 Cyl. | 12 Valves | 95kW/129PS | Diesel | OHV | TD8099 |
| OM 356.908 | 5958cc | 6 Cyl. | 12 Valves | 95kW/129PS | Diesel | OHV | TD8134 |
| OM 356.909 | 5958cc | 6 Cyl. | 12 Valves | 95kW/129PS | Diesel | OHV | TD8133 |
| OM 356.910 | 5958cc | 6 Cyl. | 12 Valves | 95kW/129PS | Diesel | OHV | TD8132 |
| OM 356.911 | 5958cc | 6 Cyl. | 12 Valves | 95kW/129PS | Diesel | OHV | TD6039 |
| OM 356.912 | 5958cc | 6 Cyl. | 12 Valves | 81kW/110PS | Diesel | OHV | TD16992 |
| OM 356.913 | 5958cc | 6 Cyl. | 12 Valves | 100kW/136PS | Diesel | OHV | TD16810 |
| OM 356.914 | 5958cc | 6 Cyl. | 12 Valves | 75kW/102PS | Diesel | OHV | TD7994 |
| OM 356.915 | 5958cc | 6 Cyl. | 12 Valves | 97kW/132PS | Diesel | OHV | TD16811 |
| OM 356.916 | 5958cc | 6 Cyl. | 12 Valves | 97kW/132PS | Diesel | OHV | TD17096 |
| OM 356.940 | 5958cc | 6 Cyl. | 12 Valves | 129kW/175PS | Diesel | Turbo, OHV | TD6098 |
| OM 356.941 | 5958cc | 6 Cyl. | 12 Valves | 116kW/158PS | Diesel | Turbo, OHV | TD5705 |
| OM 356.943 | 5958cc | 6 Cyl. | 12 Valves | 121kW/165PS | Diesel | Turbo, OHV | TD8146 |
| OM 356.945 | 5958cc | 6 Cyl. | 12 Valves | 116kW/158PS | Diesel | Turbo, OHV | TD8137 |
| OM 356.946 | 5958cc | 6 Cyl. | 12 Valves | 116kW/158PS | Diesel | Turbo, OHV | TD5756 |
| OM 356.947 | 5958cc | 6 Cyl. | 12 Valves | 116kW/158PS | Diesel | Turbo, OHV | TD8103 |
| OM 356.948 | 5958cc | 6 Cyl. | 12 Valves | 116kW/158PS | Diesel | Turbo, OHV | TD8078 |
| OM 356.949 | 5958cc | 6 Cyl. | 12 Valves | 116kW/158PS | Diesel | Turbo, OHV | TD8105 |
| OM 356.950 | 5958cc | 6 Cyl. | 12 Valves | 92kW/125PS | Diesel | Turbo, OHV | TD8000 |
| OM 356.951 | 5958cc | 6 Cyl. | 12 Valves | 116kW/158PS | Diesel | Turbo, OHV | TD8073 |
| OM 356.952 | 5958cc | 6 Cyl. | 12 Valves | 116kW/158PS | Diesel | Turbo, OHV | TD16941 |
| OM 356.953 | 5958cc | 6 Cyl. | 12 Valves | 116kW/158PS | Diesel | Turbo, OHV | TD6089 |
| OM 356.954 | 5958cc | 6 Cyl. | 12 Valves | 92kW/125PS | Diesel | Turbo, OHV | TD8001 |
| OM 356.955 | 5958cc | 6 Cyl. | 12 Valves | 114kW/155PS | Diesel | Turbo, OHV | TD5680 |
| OM 356.956 | 5958cc | 6 Cyl. | 12 Valves | 114-115kW/155-156PS | Diesel | Turbo, OHV | TD6018 |
| OM 356.957 | 5958cc | 6 Cyl. | 12 Valves | 122kW/166PS | Diesel | Turbo, OHV | TD8010 |
| OM 356.958 | 5958cc | 6 Cyl. | 12 Valves | 116kW/158PS | Diesel | Turbo, OHV | TD16812 |
| OM 356.959 | 5958cc | 6 Cyl. | 12 Valves | 121kW/165PS | Diesel | Turbo, OHV | TD16813 |
| OM 356.977 | 5958cc | 6 Cyl. | 12 Valves | 177kW/240PS | Diesel | Turbo, OHV | TD16814 |
| OM 356.978 | 5958cc | 6 Cyl. | 12 Valves | 155kW/211PS | Diesel | Turbo, OHV | TD16815 |
| OM 356.979 | 5958cc | 6 Cyl. | 12 Valves | 177kW/240PS | Diesel | Turbo, OHV | TD5726 |

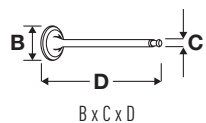

OE

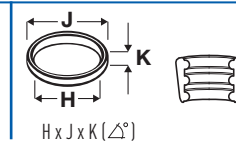
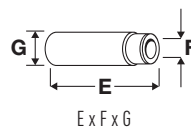

| | | | | | | | |
|------------|--------|--------|-----------|-------------|--------|------------|---------|
| OM 356.980 | 5958cc | 6 Cyl. | 12 Valves | 177kW/240PS | Diesel | Turbo, OHV | TD8005 |
| OM 356.981 | 5958cc | 6 Cyl. | 12 Valves | 127kW/170PS | Diesel | Turbo, OHV | TD8011 |
| OM 356.983 | 5958cc | 6 Cyl. | 12 Valves | 177kW/240PS | Diesel | Turbo, OHV | TD5724 |
| OM 356.984 | 5958cc | 6 Cyl. | 12 Valves | 155kW/211PS | Diesel | Turbo, OHV | TD8148 |
| OM 356.985 | 5958cc | 6 Cyl. | 12 Valves | 150kW/204PS | Diesel | Turbo, OHV | TD8189 |
| OM 356.986 | 5958cc | 6 Cyl. | 12 Valves | 155kW/211PS | Diesel | Turbo, OHV | TD8108 |
| OM 356.987 | 5958cc | 6 Cyl. | 12 Valves | 155kW/211PS | Diesel | Turbo, OHV | TD8149 |
| OM 356.989 | 5958cc | 6 Cyl. | 12 Valves | 177kW/240PS | Diesel | Turbo, OHV | TD6057 |
| OM 356.990 | 5958cc | 6 Cyl. | 12 Valves | 155kW/211PS | Diesel | Turbo, OHV | TD8165 |
| OM 356.991 | 5958cc | 6 Cyl. | 12 Valves | 177kW/240PS | Diesel | Turbo, OHV | TD6282 |
| OM 356.992 | 5958cc | 6 Cyl. | 12 Valves | 155kW/211PS | Diesel | Turbo, OHV | TD8140 |
| OM 356.993 | 5958cc | 6 Cyl. | 12 Valves | 155kW/211PS | Diesel | Turbo, OHV | TD8112 |
| OM 356.994 | 5958cc | 6 Cyl. | 12 Valves | 155kW/211PS | Diesel | Turbo, OHV | TD5721 |
| OM 356.995 | 5958cc | 6 Cyl. | 12 Valves | 155kW/211PS | Diesel | Turbo, OHV | TD6054 |
| OM 356.996 | 5958cc | 6 Cyl. | 12 Valves | 155kW/211PS | Diesel | Turbo, OHV | TD8110 |
| OM 356.997 | 5958cc | 6 Cyl. | 12 Valves | 157kW/214PS | Diesel | Turbo, OHV | TD5681 |
| OM 356.998 | 5958cc | 6 Cyl. | 12 Valves | 132kW/180PS | Diesel | Turbo, OHV | TD6019 |
| OM 356.999 | 5958cc | 6 Cyl. | 12 Valves | 177kW/240PS | Diesel | Turbo, OHV | TD8124 |
| OM 357.900 | 5958cc | 6 Cyl. | 12 Valves | 125kW/170PS | Diesel | Turbo, OHV | TD8069 |
| OM 357.901 | 5958cc | 6 Cyl. | 12 Valves | 125kW/170PS | Diesel | Turbo, OHV | TD5708 |
| OM 357.902 | 5958cc | 6 Cyl. | 12 Valves | 125kW/170PS | Diesel | Turbo, OHV | TD5740 |
| OM 357.903 | 5958cc | 6 Cyl. | 12 Valves | 125kW/170PS | Diesel | Turbo, OHV | TD5742 |
| OM 357.904 | 5958cc | 6 Cyl. | 12 Valves | 125kW/170PS | Diesel | Turbo, OHV | TD16528 |
| OM 357.906 | 5958cc | 6 Cyl. | 12 Valves | 125kW/170PS | Diesel | Turbo, OHV | TD8095 |
| OM 357.907 | 5958cc | 6 Cyl. | 12 Valves | 125kW/170PS | Diesel | Turbo, OHV | TD8138 |
| OM 357.908 | 5958cc | 6 Cyl. | 12 Valves | 125kW/170PS | Diesel | Turbo, OHV | TD8074 |
| OM 357.909 | 5958cc | 6 Cyl. | 12 Valves | 125kW/170PS | Diesel | Turbo, OHV | TD5706 |
| OM 357.910 | 5958cc | 6 Cyl. | 12 Valves | 125kW/170PS | Diesel | Turbo, OHV | TD6041 |
| OM 357.912 | 5958cc | 6 Cyl. | 12 Valves | 100kW/136PS | Diesel | Turbo, OHV | TD14689 |
| OM 357.913 | 5958cc | 6 Cyl. | 12 Valves | 120kW/163PS | Diesel | Turbo, OHV | TD16993 |
| OM 357.915 | 5958cc | 6 Cyl. | 12 Valves | 125kW/170PS | Diesel | Turbo, OHV | TD8147 |
| OM 357.916 | 5958cc | 6 Cyl. | 12 Valves | 125kW/170PS | Diesel | Turbo, OHV | TD8075 |
| OM 357.917 | 5958cc | 6 Cyl. | 12 Valves | 125kW/170PS | Diesel | Turbo, OHV | TD8079 |
| OM 357.918 | 5958cc | 6 Cyl. | 12 Valves | 125kW/170PS | Diesel | Turbo, OHV | TD6043 |
| OM 357.919 | 5958cc | 6 Cyl. | 12 Valves | 125kW/170PS | Diesel | Turbo, OHV | TD8106 |
| OM 357.920 | 5958cc | 6 Cyl. | 12 Valves | 155kW/211PS | Diesel | Turbo, OHV | TD5720 |
| OM 357.921 | 5958cc | 6 Cyl. | 12 Valves | 155kW/211PS | Diesel | Turbo, OHV | TD5743 |
| OM 357.922 | 5958cc | 6 Cyl. | 12 Valves | 155kW/211PS | Diesel | Turbo, OHV | TD8166 |
| OM 357.924 | 5958cc | 6 Cyl. | 12 Valves | 155kW/211PS | Diesel | Turbo, OHV | TD14688 |
| OM 357.925 | 5958cc | 6 Cyl. | 12 Valves | 155kW/211PS | Diesel | Turbo, OHV | TD8196 |
| OM 357.927 | 5958cc | 6 Cyl. | 12 Valves | 155kW/211PS | Diesel | Turbo, OHV | TD5723 |
| OM 357.929 | 5958cc | 6 Cyl. | 12 Valves | 155kW/211PS | Diesel | Turbo, OHV | TD8113 |
| OM 357.930 | 5958cc | 6 Cyl. | 12 Valves | 155kW/211PS | Diesel | Turbo, OHV | TD8168 |
| OM 357.931 | 5958cc | 6 Cyl. | 12 Valves | 155kW/211PS | Diesel | Turbo, OHV | TD16820 |
| OM 357.932 | 5958cc | 6 Cyl. | 12 Valves | 155kW/211PS | Diesel | Turbo, OHV | TD6056 |
| OM 357.933 | 5958cc | 6 Cyl. | 12 Valves | 155kW/211PS | Diesel | Turbo, OHV | TD8115 |
| OM 357.936 | 5958cc | 6 Cyl. | 12 Valves | 155kW/211PS | Diesel | Turbo, OHV | TD16821 |
| OM 357.937 | 5958cc | 6 Cyl. | 12 Valves | 155kW/211PS | Diesel | Turbo, OHV | TD16822 |
| OM 357.938 | 5958cc | 6 Cyl. | 12 Valves | 155kW/211PS | Diesel | Turbo, OHV | TD22748 |
| OM 357.940 | 5958cc | 6 Cyl. | 12 Valves | 177kW/240PS | Diesel | Turbo, OHV | TD5746 |

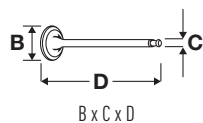

OE

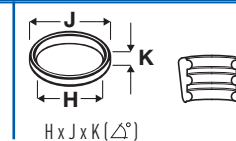
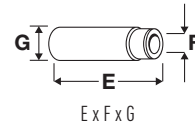
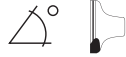

| | | | | | | | |
|------------|--------|--------|-----------|---------------------|--------|------------|---------|
| OM 357.941 | 5958cc | 6 Cyl. | 12 Valves | 177kW/240PS | Diesel | Turbo, OHV | TD8169 |
| OM 357.942 | 5958cc | 6 Cyl. | 12 Valves | 177kW/240PS | Diesel | Turbo, OHV | TD8116 |
| OM 357.943 | 5958cc | 6 Cyl. | 12 Valves | 177kW/240PS | Diesel | Turbo, OHV | TD5725 |
| OM 357.944 | 5958cc | 6 Cyl. | 12 Valves | 177kW/240PS | Diesel | Turbo, OHV | TD6058 |
| OM 357.945 | 5958cc | 6 Cyl. | 12 Valves | 177kW/241PS | Diesel | Turbo, OHV | TD14690 |
| OM 357.946 | 5958cc | 6 Cyl. | 12 Valves | 177kW/240PS | Diesel | Turbo, OHV | TD8125 |
| OM 357.947 | 5958cc | 6 Cyl. | 12 Valves | 177kW/240PS | Diesel | Turbo, OHV | TD8170 |
| OM 357.948 | 5958cc | 6 Cyl. | 12 Valves | 177kW/240PS | Diesel | Turbo, OHV | TD6077 |
| OM 357.949 | 5958cc | 6 Cyl. | 12 Valves | 177kW/240PS | Diesel | Turbo, OHV | TD16823 |
| OM 357.961 | 5958cc | 6 Cyl. | 12 Valves | 125kW/170PS | Diesel | Turbo, OHV | TD6073 |
| OM 357.962 | 5958cc | 6 Cyl. | 12 Valves | 125kW/170PS | Diesel | Turbo, OHV | TD6074 |
| OM 357.963 | 5958cc | 6 Cyl. | 12 Valves | 125kW/170PS | Diesel | Turbo, OHV | TD6090 |
| OM 366.905 | 5958cc | 6 Cyl. | 12 Valves | 100kW/136PS | Diesel | Turbo, OHV | TD5698 |
| OM 366.906 | 5958cc | 6 Cyl. | 12 Valves | 100kW/136PS | Diesel | OHV | TD5748 |
| OM 366.907 | 5958cc | 6 Cyl. | 12 Valves | 100kW/136PS | Diesel | OHV | TD5716 |
| OM 366.908 | 5958cc | 6 Cyl. | 12 Valves | 81kW/110PS | Diesel | OHV | TD17858 |
| OM 366.909 | 5958cc | 6 Cyl. | 12 Valves | 100kW/136PS | Diesel | OHV | TD6078 |
| OM 366.910 | 5958cc | 6 Cyl. | 12 Valves | 100kW/136PS | Diesel | OHV | TD8065 |
| OM 366.911 | 5958cc | 6 Cyl. | 12 Valves | 96kW/131PS | Diesel | OHV | TD22775 |
| OM 366.912 | 5958cc | 6 Cyl. | 12 Valves | 74kW/100PS | Diesel | OHV | TD17857 |
| OM 366.913 | 5958cc | 6 Cyl. | 12 Valves | 100kW/136PS | Diesel | OHV | TD17100 |
| OM 366.914 | 5958cc | 6 Cyl. | 12 Valves | 100kW/136PS | Diesel | OHV | TD6049 |
| OM 366.915 | 5958cc | 6 Cyl. | 12 Valves | 75kW/102PS | Diesel | OHV | TD7995 |
| OM 366.917 | 5958cc | 6 Cyl. | 12 Valves | 100kW/136PS | Diesel | OHV | TD7887 |
| OM 366.918 | 5958cc | 6 Cyl. | 12 Valves | 100kW/136PS | Diesel | OHV | TD5739 |
| OM 366.919 | 5958cc | 6 Cyl. | 12 Valves | 100kW/136PS | Diesel | OHV | TD16808 |
| OM 366.930 | 5958cc | 6 Cyl. | 12 Valves | 100kW/136PS | Diesel | OHV | TD8094 |
| OM 366.931 | 5958cc | 6 Cyl. | 12 Valves | 100kW/136PS | Diesel | OHV | TD5717 |
| OM 366.932 | 5958cc | 6 Cyl. | 12 Valves | 100kW/136PS | Diesel | OHV | TD8068 |
| OM 366.933 | 5958cc | 6 Cyl. | 12 Valves | 100kW/136PS | Diesel | OHV | TD8100 |
| OM 366.935 | 5958cc | 6 Cyl. | 12 Valves | 100kW/136PS | Diesel | OHV | TD6050 |
| OM 366.936 | 5958cc | 6 Cyl. | 12 Valves | 100kW/136PS | Diesel | OHV | TD8135 |
| OM 366.937 | 5958cc | 6 Cyl. | 12 Valves | 100kW/136PS | Diesel | OHV | TD6072 |
| OM 366.938 | 5958cc | 6 Cyl. | 12 Valves | 100kW/136PS | Diesel | OHV | TD16809 |
| OM 366.939 | 5958cc | 6 Cyl. | 12 Valves | 81kW/110PS | Diesel | OHV | TD7993 |
| OM 366.940 | 5958cc | 6 Cyl. | 12 Valves | 100kW/136PS | Diesel | OHV | TD6040 |
| OM 366.941 | 5958cc | 6 Cyl. | 12 Valves | 116kW/158PS | Diesel | Turbo, OHV | TD8102 |
| OM 366.942 | 5958cc | 6 Cyl. | 12 Valves | 121kW/165PS | Diesel | Turbo, OHV | TD8076 |
| OM 366.943 | 5958cc | 6 Cyl. | 12 Valves | 116kW/158PS | Diesel | Turbo, OHV | TD8070 |
| OM 366.944 | 5958cc | 6 Cyl. | 12 Valves | 125kW/170PS | Diesel | Turbo, OHV | TD5703 |
| OM 366.945 | 5958cc | 6 Cyl. | 12 Valves | 125kW/170PS | Diesel | Turbo, OHV | TD5757 |
| OM 366.946 | 5958cc | 6 Cyl. | 12 Valves | 125kW/170PS | Diesel | OHV | TD5741 |
| OM 366.947 | 5958cc | 6 Cyl. | 12 Valves | 100kW/136PS | Diesel | Turbo, OHV | TD5679 |
| OM 366.948 | 5958cc | 6 Cyl. | 12 Valves | 100-115kW/136-156PS | Diesel | Turbo, OHV | TD6017 |
| OM 366.949 | 5958cc | 6 Cyl. | 12 Valves | 92-115kW/125-156PS | Diesel | Turbo, OHV | TD6277 |
| OM 366.951 | 5958cc | 6 Cyl. | 12 Valves | 125kW/170PS | Diesel | Turbo, OHV | TD5749 |
| OM 366.952 | 5958cc | 6 Cyl. | 12 Valves | 116-129kW/158-175PS | Diesel | Turbo, OHV | TD5766 |
| OM 366.953 | 5958cc | 6 Cyl. | 12 Valves | 125kW/170PS | Diesel | Turbo, OHV | TD5718 |
| OM 366.954 | 5958cc | 6 Cyl. | 12 Valves | 115-132kW/156-180PS | Diesel | Turbo, OHV | TD17862 |
| OM 366.955 | 5958cc | 6 Cyl. | 12 Valves | 100kW/136PS | Diesel | Turbo, OHV | TD6276 |

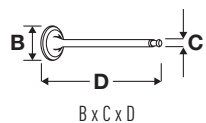

OE

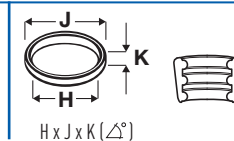
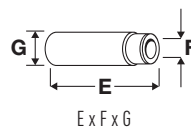

| | | | | | | | |
|------------|--------|--------|-----------|---------------------|--------|------------|---------|
| OM 366.956 | 5958cc | 6 Cyl. | 12 Valves | 100kW/136PS | Diesel | Turbo, OHV | TD6320 |
| OM 366.957 | 5958cc | 6 Cyl. | 12 Valves | 125kW/170PS | Diesel | Turbo, OHV | TD16816 |
| OM 366.958 | 5958cc | 6 Cyl. | 12 Valves | 100kW/136PS | Diesel | Turbo, OHV | TD17861 |
| OM 366.960 | 5958cc | 6 Cyl. | 12 Valves | 125kW/170PS | Diesel | Turbo, OHV | TD17101 |
| OM 366.962 | 5958cc | 6 Cyl. | 12 Valves | 125kW/170PS | Diesel | Turbo, OHV | TD5745 |
| OM 366.963 | 5958cc | 6 Cyl. | 12 Valves | 125kW/170PS | Diesel | Turbo, OHV | TD8006 |
| OM 366.965 | 5958cc | 6 Cyl. | 12 Valves | 125kW/170PS | Diesel | Turbo, OHV | TD7888 |
| OM 366.966 | 5958cc | 6 Cyl. | 12 Valves | 125kW/170PS | Diesel | Turbo, OHV | TD5707 |
| OM 366.967 | 5958cc | 6 Cyl. | 12 Valves | 125kW/170PS | Diesel | Turbo, OHV | TD5699 |
| OM 366.968 | 5958cc | 6 Cyl. | 12 Valves | 125kW/170PS | Diesel | Turbo, OHV | TD8077 |
| OM 366.969 | 5958cc | 6 Cyl. | 12 Valves | 125kW/170PS | Diesel | Turbo, OHV | TD8080 |
| OM 366.970 | 5958cc | 6 Cyl. | 12 Valves | 125kW/170PS | Diesel | Turbo, OHV | TD8104 |
| OM 366.971 | 5958cc | 6 Cyl. | 12 Valves | 125kW/170PS | Diesel | Turbo, OHV | TD8107 |
| OM 366.973 | 5958cc | 6 Cyl. | 12 Valves | 125kW/170PS | Diesel | Turbo, OHV | TD6035 |
| OM 366.974 | 5958cc | 6 Cyl. | 12 Valves | 125kW/170PS | Diesel | Turbo, OHV | TD6042 |
| OM 366.975 | 5958cc | 6 Cyl. | 12 Valves | 125kW/170PS | Diesel | Turbo, OHV | TD5719 |
| OM 366.976 | 5958cc | 6 Cyl. | 12 Valves | 125kW/170PS | Diesel | Turbo, OHV | TD6052 |
| OM 366.977 | 5958cc | 6 Cyl. | 12 Valves | 92kW/125PS | Diesel | Turbo, OHV | TD17859 |
| OM 366.978 | 5958cc | 6 Cyl. | 12 Valves | 125kW/170PS | Diesel | Turbo, OHV | TD6279 |
| OM 366.979 | 5958cc | 6 Cyl. | 12 Valves | 125kW/170PS | Diesel | Turbo, OHV | TD6091 |
| OM 366.980 | 5958cc | 6 Cyl. | 12 Valves | 148kW/201PS | Diesel | Turbo, OHV | TD8141 |
| OM 366.981 | 5958cc | 6 Cyl. | 12 Valves | 148kW/201PS | Diesel | Turbo, OHV | TD16817 |
| OM 366.983 | 5958cc | 6 Cyl. | 12 Valves | 150kW/204PS | Diesel | Turbo, OHV | TD8150 |
| OM 366.984 | 5958cc | 6 Cyl. | 12 Valves | 150-157kW/204-214PS | Diesel | Turbo, OHV | TD8007 |
| OM 366.988 | 5958cc | 6 Cyl. | 12 Valves | 148-150kW/201-204PS | Diesel | Turbo, OHV | TD5744 |
| OM 366.990 | 5958cc | 6 Cyl. | 12 Valves | 150kW/204PS | Diesel | Turbo, OHV | TD16818 |
| OM 366.992 | 5958cc | 6 Cyl. | 12 Valves | 150kW/204PS | Diesel | Turbo, OHV | TD5722 |
| OM 366.993 | 5958cc | 6 Cyl. | 12 Valves | 150kW/204PS | Diesel | Turbo, OHV | TD8114 |
| OM 366.994 | 5958cc | 6 Cyl. | 12 Valves | 150kW/204PS | Diesel | Turbo, OHV | TD6055 |
| OM 366.995 | 5958cc | 6 Cyl. | 12 Valves | 150kW/204PS | Diesel | Turbo, OHV | TD8167 |
| OM 366.996 | 5958cc | 6 Cyl. | 12 Valves | 150kW/204PS | Diesel | Turbo, OHV | TD16819 |
| OM 366.997 | 5958cc | 6 Cyl. | 12 Valves | 148-150kW/201-204PS | Diesel | Turbo, OHV | TD6075 |
| OM 366.999 | 5958cc | 6 Cyl. | 12 Valves | 170kW/231PS | Diesel | Turbo, OHV | TD8126 |
| OM 372.906 | 5958cc | 6 Cyl. | 12 Valves | 100kW/136PS | Diesel | OHV | TD23200 |
| OM 372.907 | 5958cc | 6 Cyl. | 12 Valves | 100kW/136PS | Diesel | OHV | TD23201 |
| OM 376.905 | 5958cc | 6 Cyl. | 12 Valves | 100kW/136PS | Diesel | OHV | TD23006 |
| OM 376.906 | 5958cc | 6 Cyl. | 12 Valves | 100kW/136PS | Diesel | OHV | TD23009 |
| OM 376.907 | 5958cc | 6 Cyl. | 12 Valves | 100kW/136PS | Diesel | OHV | TD23011 |
| OM 376.908 | 5958cc | 6 Cyl. | 12 Valves | 95kW/129PS | Diesel | OHV | TD23010 |
| OM 376.909 | 5958cc | 6 Cyl. | 12 Valves | 95kW/129PS | Diesel | OHV | TD23012 |
| OM 376.930 | 5958cc | 6 Cyl. | 12 Valves | 100kW/136PS | Diesel | OHV | TD23014 |
| OM 376.941 | 5958cc | 6 Cyl. | 12 Valves | 150kW/204PS | Diesel | Turbo, OHV | TD23015 |
| OM 376.945 | 5958cc | 6 Cyl. | 12 Valves | 125-135kW/170-184PS | Diesel | Turbo, OHV | TD23016 |
| OM 376.946 | 5958cc | 6 Cyl. | 12 Valves | 131-135kW/178-184PS | Diesel | Turbo, OHV | TD23017 |
| OM 376.947 | 5958cc | 6 Cyl. | 12 Valves | 131kW/178PS | Diesel | Turbo, OHV | TD23018 |
| OM 376.950 | 5958cc | 6 Cyl. | 12 Valves | 125kW/170PS | Diesel | Turbo, OHV | TD23019 |
| OM 376.951 | 5958cc | 6 Cyl. | 12 Valves | 125kW/170PS | Diesel | Turbo, OHV | TD23020 |
| OM 376.952 | 5958cc | 6 Cyl. | 12 Valves | 125kW/170PS | Diesel | Turbo, OHV | TD23021 |
| OM 376.953 | 5958cc | 6 Cyl. | 12 Valves | 125kW/170PS | Diesel | Turbo, OHV | TD23022 |
| OM 376.954 | 5958cc | 6 Cyl. | 12 Valves | 125kW/170PS | Diesel | Turbo, OHV | TD23023 |

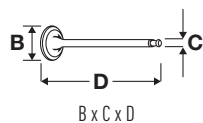

OE

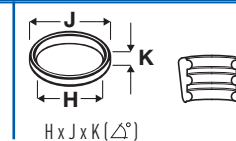
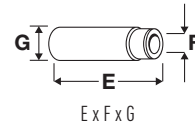
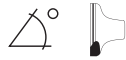

| | | | | | | | |
|------------|--------|--------|-----------|---------------------|--------|------------|---------|
| OM 376.955 | 5958cc | 6 Cyl. | 12 Valves | 125-135kW/170-184PS | Diesel | Turbo, OHV | TD23024 |
| OM 376.956 | 5958cc | 6 Cyl. | 12 Valves | 125-135kW/170-184PS | Diesel | Turbo, OHV | TD23025 |
| OM 376.957 | 5958cc | 6 Cyl. | 12 Valves | 125kW/170PS | Diesel | Turbo, OHV | TD23026 |
| OM 376.958 | 5958cc | 6 Cyl. | 12 Valves | 125-135kW/170-184PS | Diesel | Turbo, OHV | TD23027 |
| OM 376.961 | 5958cc | 6 Cyl. | 12 Valves | 125kW/170PS | Diesel | Turbo, OHV | TD23028 |
| OM 376.962 | 5958cc | 6 Cyl. | 12 Valves | 125-135kW/170-184PS | Diesel | Turbo, OHV | TD23029 |
| OM 376.963 | 5958cc | 6 Cyl. | 12 Valves | 125kW/170PS | Diesel | Turbo, OHV | TD23030 |
| OM 376.964 | 5958cc | 6 Cyl. | 12 Valves | 125kW/170PS | Diesel | Turbo, OHV | TD23031 |
| OM 376.967 | 5958cc | 6 Cyl. | 12 Valves | 125kW/170PS | Diesel | Turbo, OHV | TD23032 |
| OM 376.968 | 5958cc | 6 Cyl. | 12 Valves | 156kW/212PS | Diesel | Turbo, OHV | TD23033 |
| OM 376.969 | 5958cc | 6 Cyl. | 12 Valves | 127kW/173PS | Diesel | Turbo, OHV | TD23034 |
| OM 376.970 | 5958cc | 6 Cyl. | 12 Valves | 127kW/173PS | Diesel | Turbo, OHV | TD23035 |
| OM 376.972 | 5958cc | 6 Cyl. | 12 Valves | 140kW/190PS | Diesel | Turbo, OHV | TD23036 |
| OM 376.975 | 5958cc | 6 Cyl. | 12 Valves | 156kW/212PS | Diesel | Turbo, OHV | TD23037 |
| OM 376.976 | 5958cc | 6 Cyl. | 12 Valves | 127kW/173PS | Diesel | Turbo, OHV | TD23038 |
| OM 376.977 | 5958cc | 6 Cyl. | 12 Valves | 127kW/173PS | Diesel | Turbo, OHV | TD23039 |
| OM 376.980 | 5958cc | 6 Cyl. | 12 Valves | 127kW/173PS | Diesel | Turbo, OHV | TD23040 |
| OM 376.981 | 5958cc | 6 Cyl. | 12 Valves | 142kW/193PS | Diesel | Turbo, OHV | TD23041 |
| OM 376.982 | 5958cc | 6 Cyl. | 12 Valves | 142kW/193PS | Diesel | Turbo, OHV | TD23042 |
| OM 376.984 | 5958cc | 6 Cyl. | 12 Valves | 150kW/204PS | Diesel | Turbo, OHV | TD23043 |
| OM 376.986 | 5958cc | 6 Cyl. | 12 Valves | 150-155kW/204-211PS | Diesel | Turbo, OHV | TD23044 |
| OM 376.987 | 5958cc | 6 Cyl. | 12 Valves | 127kW/173PS | Diesel | Turbo, OHV | TD23045 |
| OM 376.988 | 5958cc | 6 Cyl. | 12 Valves | 142kW/193PS | Diesel | Turbo, OHV | TD23046 |
| OM 376.989 | 5958cc | 6 Cyl. | 12 Valves | 142kW/193PS | Diesel | Turbo, OHV | TD23047 |
| OM 376.993 | 5958cc | 6 Cyl. | 12 Valves | 150kW/204PS | Diesel | Turbo, OHV | TD23050 |
| OM 376.994 | 5958cc | 6 Cyl. | 12 Valves | 155kW/211PS | Diesel | Turbo, OHV | TD23051 |
| OM 376.995 | 5958cc | 6 Cyl. | 12 Valves | 127kW/173PS | Diesel | Turbo, OHV | TD23052 |
| OM 376.997 | 5958cc | 6 Cyl. | 12 Valves | 140kW/190PS | Diesel | Turbo, OHV | TD23053 |
| OM 376.998 | 5958cc | 6 Cyl. | 12 Valves | 134kW/182PS | Diesel | Turbo, OHV | TD23048 |
| OM 376.999 | 5958cc | 6 Cyl. | 12 Valves | 134kW/182PS | Diesel | Turbo, OHV | TD23049 |
| OM 377.940 | 5958cc | 6 Cyl. | 12 Valves | 125kW/170PS | Diesel | Turbo, OHV | TD23203 |
| OM 377.941 | 5958cc | 6 Cyl. | 12 Valves | 125kW/170PS | Diesel | Turbo, OHV | TD23204 |
| OM 377.942 | 5958cc | 6 Cyl. | 12 Valves | 125kW/170PS | Diesel | Turbo, OHV | TD23205 |
| OM 377.943 | 5958cc | 6 Cyl. | 12 Valves | 125kW/170PS | Diesel | Turbo, OHV | TD23206 |
| OM 377.944 | 5958cc | 6 Cyl. | 12 Valves | 125kW/170PS | Diesel | Turbo, OHV | TD23207 |
| OM 377.945 | 5958cc | 6 Cyl. | 12 Valves | 125kW/170PS | Diesel | Turbo, OHV | TD23208 |
| OM 377.960 | 5958cc | 6 Cyl. | 12 Valves | 150kW/204PS | Diesel | Turbo, OHV | TD23211 |
| OM 377.961 | 5958cc | 6 Cyl. | 12 Valves | 150-170kW/204-231PS | Diesel | Turbo, OHV | TD23212 |
| OM 377.962 | 5958cc | 6 Cyl. | 12 Valves | 170kW/231PS | Diesel | Turbo, OHV | TD23213 |
| OM 377.963 | 5958cc | 6 Cyl. | 12 Valves | 170kW/231PS | Diesel | Turbo, OHV | TD23214 |
| OM 377.964 | 5958cc | 6 Cyl. | 12 Valves | 150-155kW/204-211PS | Diesel | Turbo, OHV | TD23215 |
| OM 377.967 | 5958cc | 6 Cyl. | 12 Valves | 150kW/204PS | Diesel | Turbo, OHV | TD23216 |
| OM 377.968 | 5958cc | 6 Cyl. | 12 Valves | 150kW/204PS | Diesel | Turbo, OHV | TD23217 |
| OM 377.969 | 5958cc | 6 Cyl. | 12 Valves | 150kW/204PS | Diesel | Turbo, OHV | TD23218 |
| OM 377.972 | 5958cc | 6 Cyl. | 12 Valves | 150kW/204PS | Diesel | Turbo, OHV | TD23219 |
| OM 377.973 | 5958cc | 6 Cyl. | 12 Valves | 155kW/211PS | Diesel | Turbo, OHV | TD23220 |
| OM 377.980 | 5958cc | 6 Cyl. | 12 Valves | 140kW/190PS | Diesel | Turbo, OHV | TD23221 |
| OM 377.981 | 5958cc | 6 Cyl. | 12 Valves | 155kW/211PS | Diesel | Turbo, OHV | TD23222 |
| OM 377.982 | 5958cc | 6 Cyl. | 12 Valves | 150kW/204PS | Diesel | Turbo, OHV | TD23223 |
| OM 377.983 | 5958cc | 6 Cyl. | 12 Valves | 155kW/211PS | Diesel | Turbo, OHV | TD23224 |



OE

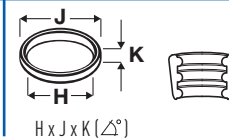
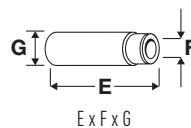

| | | | | | | | |
|------------|--------|--------|-----------|-------------|--------|------------|---------|
| OM 377.984 | 5958cc | 6 Cyl. | 12 Valves | 155kW/211PS | Diesel | Turbo, OHV | TD23225 |
| OM 377.985 | 5958cc | 6 Cyl. | 12 Valves | 155kW/211PS | Diesel | Turbo, OHV | TD23226 |
| OM 382.912 | 5958cc | 6 Cyl. | 12 Valves | 100kW/136PS | Diesel | OHV | TD22783 |
| OM 382.913 | 5958cc | 6 Cyl. | 12 Valves | 125kW/170PS | Diesel | Turbo, OHV | TD22784 |
| OM 382.916 | 5958cc | 6 Cyl. | 12 Valves | 96kW/130PS | Diesel | OHV | TD17174 |
| OM 382.919 | 5958cc | 6 Cyl. | 12 Valves | 150kW/204PS | Diesel | Turbo, OHV | TD22785 |
| OM 382.970 | 5958cc | 6 Cyl. | 12 Valves | 177kW/241PS | Diesel | Turbo, OHV | TD22786 |
| OM 382.971 | 5958cc | 6 Cyl. | 12 Valves | 150kW/204PS | Diesel | Turbo, OHV | TD22787 |
| OM 386.906 | 5958cc | 6 Cyl. | 12 Valves | 100kW/136PS | Diesel | Turbo, OHV | TD22793 |
| OM 386.950 | 5958cc | 6 Cyl. | 12 Valves | 125kW/170PS | Diesel | Turbo, OHV | TD22794 |
| OM 386.951 | 5958cc | 6 Cyl. | 12 Valves | 125kW/170PS | Diesel | Turbo, OHV | TD22795 |
| OM 386.952 | 5958cc | 6 Cyl. | 12 Valves | 125kW/170PS | Diesel | Turbo, OHV | TD22796 |
| OM 386.980 | 5958cc | 6 Cyl. | 12 Valves | 150kW/204PS | Diesel | Turbo, OHV | TD22797 |
| OM 386.981 | 5958cc | 6 Cyl. | 12 Valves | 150kW/204PS | Diesel | Turbo, OHV | TD22798 |
| OM 386.983 | 5958cc | 6 Cyl. | 12 Valves | 150kW/204PS | Diesel | Turbo, OHV | TD22799 |

| | | | |
|-----------------|-----------------|----------------|-----------------|
| AGL (RoundNose) | 01/1989→05/2000 | B-Series | 07/1984→ |
| FPN (FlatNose) | 12/1985→12/2001 | HPN (LongNose) | 04/1989→12/2005 |
| LK/LN2 | 01/1984→12/1998 | MB-TRAC | 02/1982→12/1991 |
| MK | 12/1987→09/1996 | NG | 08/1973→09/1996 |
| O 301 | 02/1986→05/1987 | O 402 | 02/1986→12/1991 |
| OF Series | 01/1983→ | OH Series | 01/1970→ |
| UNIMOG | 01/1988→ | | |

| | | | | | | |
|--|---------------|------------|-----|---|--|--|
| V91191 ■ 42.00 x 8.95 x 140.70 | 366 050 03 26 | MD + MB cr | 30° | H | VAG92411 ■ 72.00 x 9.01 x 15.05 | |
| V91131 ■ 36.06 x 9.93 x 140.56 | 366 050 05 27 | MD + MB cr | 45° | H | VAG92412 ■ 67.00 x 10.01 x 15.05 | |
| V91192 ■ 36.00 x 9.94 x 140.70 | 366 050 02 27 | MD + MB cr | 45° | H | | |

123 97.50

| | | | | | | | |
|--|-----------------|------------|-----------|-------------|--|------------|--------|
| OM 356.944 | 5958cc | 6 Cyl. | 12 Valves | 116kW/158PS | Diesel | Turbo, OHV | TD8136 |
| LK/LN2 | 01/1984→12/1998 | | | | | | |
| V91191 ■ 42.00 x 8.95 x 140.70 | 366 050 03 26 | MD + MB cr | 30° | H | VAG92411 ■ 72.00 x 9.01 x 15.05 | | |
| V94054 ■ 46.00 x 9.00 x 141.20 | 98 497 235 | MB cr | 30° | Y | VAG92412 ■ 67.00 x 10.01 x 15.05 | | |
| V91131 ■ 36.06 x 9.93 x 140.56 | 366 050 05 27 | MD + MB cr | 45° | H | | | |
| V91192 ■ 36.00 x 9.94 x 140.70 | 366 050 02 27 | MD + MB cr | 45° | H | | | |
| V94055 ■ 38.30 x 9.00 x 141.20 | 99 433 902 | MD + MB cr | 45° | H | | | |



OE

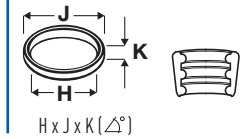
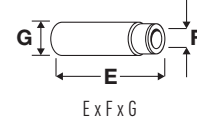

124  **97.50**

| | | | | | | | |
|------------|--------|--------|-----------|-------------|--------|------------|---------|
| OM 356.988 | 5958cc | 6 Cyl. | 12 Valves | 177kW/241PS | Diesel | Turbo, OHV | TD22747 |
| OM 357.926 | 5958cc | 6 Cyl. | 12 Valves | 155kW/211PS | Diesel | Turbo, OHV | TD16931 |
| OM 382.917 | 5958cc | 6 Cyl. | 12 Valves | 110kW/150PS | Diesel | Turbo, OHV | TD17176 |
| OM 382.950 | 5958cc | 6 Cyl. | 12 Valves | 125kW/170PS | Diesel | Turbo, OHV | TD17175 |

UNIMOG

01/1977→

V91131 
36.06 x 9.93 x 140.56

366 050 05 27



45°

H

VAG92411 
72.00 x 9.01 x 15.05



VAG92412 
67.00 x 10.01 x 15.05

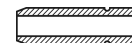

125  **97.50**

| | | | | | | | |
|------------|--------|--------|-----------|-------------------|--------|-----|---------|
| OM 372.930 | 5958cc | 6 Cyl. | 12 Valves | 100kW/136PS | Diesel | OHV | TD23202 |
| OM 376.910 | 5958cc | 6 Cyl. | 12 Valves | 69-100kW/94-136PS | Diesel | OHV | TD23013 |

V91131 
36.06 x 9.93 x 140.56

366 050 05 27

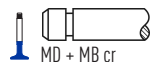

45°

H

VAG92411 
72.00 x 9.01 x 15.05

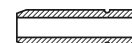

V91192 
36.00 x 9.94 x 140.70

366 050 02 27



45°

H

VAG92412 
67.00 x 10.01 x 15.05

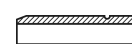

126  **102.00**

| | | | | | | | |
|------------|--------|--------|-----------|---------------------|--------|-------------------------|---------|
| OM 900.910 | 4249cc | 4 Cyl. | 12 Valves | 128kW/174PS | Diesel | Turbo, OHV | TD22699 |
| OM 900.911 | 4249cc | 4 Cyl. | 12 Valves | 95kW/129PS | Diesel | Turbo, OHV | TD18918 |
| OM 900.912 | 4249cc | 4 Cyl. | 12 Valves | 115kW/156PS | Diesel | Turbo, OHV | TD18919 |
| OM 900.913 | 4249cc | 4 Cyl. | 12 Valves | 130kW/177PS | Diesel | Turbo, OHV | TD18920 |
| OM 900.915 | 4249cc | 4 Cyl. | 12 Valves | 110-115kW/150-156PS | Diesel | Turbo, OHV | TD23299 |
| OM 900.916 | 4249cc | 4 Cyl. | 12 Valves | 110-115kW/150-156PS | Diesel | Turbo, OHV | TD23300 |
| OM 900.917 | 4249cc | 4 Cyl. | 12 Valves | 95kW/129PS | Diesel | Turbo, OHV | TD18921 |
| OM 900.918 | 4249cc | 4 Cyl. | 12 Valves | 115kW/156PS | Diesel | Turbo, OHV | TD18922 |
| OM 900.919 | 4249cc | 4 Cyl. | 12 Valves | 130kW/177PS | Diesel | Turbo, OHV | TD18923 |
| OM 900.920 | 4249cc | 4 Cyl. | 12 Valves | 115kW/156PS | Diesel | Turbo, OHV | TD22696 |
| OM 900.921 | 4249cc | 4 Cyl. | 12 Valves | 130kW/177PS | Diesel | Turbo, OHV | TD22697 |
| OM 900.922 | 4249cc | 4 Cyl. | 12 Valves | 95kW/129PS | Diesel | Turbo, OHV | TD22698 |
| OM 904.904 | 4249cc | 4 Cyl. | 12 Valves | 75kW/102PS | Diesel | Turbo, OHV | TD16441 |
| OM 904.905 | 4249cc | 4 Cyl. | 12 Valves | 90kW/122PS | Diesel | Turbo, OHV | TD8055 |
| OM 904.906 | 4249cc | 4 Cyl. | 12 Valves | 100kW/136PS | Diesel | Turbo, OHV | TD8060 |
| OM 904.907 | 4249cc | 4 Cyl. | 12 Valves | 125-130kW/170-177PS | Diesel | Turbo, OHV | TD8072 |
| OM 904.908 | 4249cc | 4 Cyl. | 12 Valves | 95-100kW/129-136PS | Diesel | Turbo, OHV | TD8024 |
| OM 904.909 | 4249cc | 4 Cyl. | 12 Valves | 90kW/122PS | Diesel | Turbo, OHV | TD12528 |
| OM 904.910 | 4249cc | 4 Cyl. | 12 Valves | 100kW/136PS | Diesel | Turbo, OHV, Common Rail | TD12529 |
| OM 904.911 | 4249cc | 4 Cyl. | 12 Valves | 125kW/170PS | Diesel | Turbo, OHV, Common Rail | TD12530 |
| OM 904.912 | 4249cc | 4 Cyl. | 12 Valves | 134kW/182PS | Diesel | Turbo, OHV | TD17711 |
| OM 904.914 | 4249cc | 4 Cyl. | 12 Valves | 100kW/136PS | Diesel | Turbo, OHV | TD16833 |
| OM 904.915 | 4249cc | 4 Cyl. | 12 Valves | 90kW/122PS | Diesel | Turbo, OHV | TD16834 |
| OM 904.916 | 4249cc | 4 Cyl. | 12 Valves | 100kW/136PS | Diesel | Turbo, OHV | TD16835 |
| OM 904.917 | 4249cc | 4 Cyl. | 12 Valves | 95-125kW/129-170PS | Diesel | Turbo, OHV | TD16836 |
| OM 904.918 | 4249cc | 4 Cyl. | 12 Valves | 90kW/122PS | Diesel | Turbo, OHV | TD17752 |
| OM 904.919 | 4249cc | 4 Cyl. | 12 Valves | 100kW/136PS | Diesel | Turbo, OHV | TD17705 |



OE

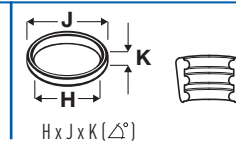
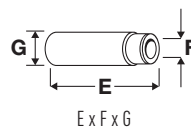

| | | | | | | | |
|------------|--------|--------|-----------|---------------------|--------|-------------------------|---------|
| OM 904.920 | 4249cc | 4 Cyl. | 12 Valves | 125kW/170PS | Diesel | Turbo, OHV | TD17706 |
| OM 904.921 | 4249cc | 4 Cyl. | 12 Valves | 112kW/152PS | Diesel | Turbo, OHV | TD16837 |
| OM 904.922 | 4249cc | 4 Cyl. | 12 Valves | 112kW/152PS | Diesel | Turbo, OHV, Common Rail | TD12531 |
| OM 904.923 | 4249cc | 4 Cyl. | 12 Valves | 112-115kW/152-156PS | Diesel | Turbo, OHV | TD16438 |
| OM 904.924 | 4249cc | 4 Cyl. | 12 Valves | 100kW/136PS | Diesel | Turbo, OHV | TD17707 |
| OM 904.925 | 4249cc | 4 Cyl. | 12 Valves | 112kW/152PS | Diesel | Turbo, OHV | TD17708 |
| OM 904.926 | 4249cc | 4 Cyl. | 12 Valves | 113kW/154PS | Diesel | Turbo, OHV | TD17709 |
| OM 904.927 | 4249cc | 4 Cyl. | 12 Valves | 110kW/150PS | Diesel | Turbo, OHV | TD17324 |
| OM 904.928 | 4249cc | 4 Cyl. | 12 Valves | 130kW/177PS | Diesel | Turbo, OHV | TD17325 |
| OM 904.929 | 4249cc | 4 Cyl. | 12 Valves | 125kW/170PS | Diesel | Turbo, OHV | TD17710 |
| OM 904.930 | 4249cc | 4 Cyl. | 12 Valves | 100kW/136PS | Diesel | Turbo, OHV | TD16838 |
| OM 904.931 | 4249cc | 4 Cyl. | 12 Valves | 135kW/180PS | Diesel | Turbo, OHV | TD16839 |
| OM 904.932 | 4249cc | 4 Cyl. | 12 Valves | 142kW/193PS | Diesel | Turbo, OHV | TD17712 |
| OM 904.933 | 4249cc | 4 Cyl. | 12 Valves | 128kW/174PS | Diesel | Turbo, OHV | TD17713 |
| OM 904.934 | 4249cc | 4 Cyl. | 12 Valves | 134kW/174PS | Diesel | Turbo, OHV | TD17714 |
| OM 904.935 | 4249cc | 4 Cyl. | 12 Valves | 134kW/174PS | Diesel | Turbo, OHV | TD17715 |
| OM 904.936 | 4249cc | 4 Cyl. | 12 Valves | 110kW/150PS | Diesel | Turbo, OHV | TD16916 |
| OM 904.937 | 4249cc | 4 Cyl. | 12 Valves | 142kW/193PS | Diesel | Turbo, OHV | TD17716 |
| OM 904.938 | 4249cc | 4 Cyl. | 12 Valves | 125kW/170PS | Diesel | Turbo, OHV | TD17717 |
| OM 904.939 | 4249cc | 4 Cyl. | 12 Valves | 128kW/174PS | Diesel | Turbo, OHV | TD17718 |
| OM 904.940 | 4249cc | 4 Cyl. | 12 Valves | 113kW/154PS | Diesel | Turbo, OHV | TD17719 |
| OM 904.941 | 4249cc | 4 Cyl. | 12 Valves | 112kW/152PS | Diesel | Turbo, OHV | TD17720 |
| OM 904.942 | 4249cc | 4 Cyl. | 12 Valves | 130kW/177PS | Diesel | Turbo, OHV | TD17721 |
| OM 904.943 | 4249cc | 4 Cyl. | 12 Valves | 112kW/152PS | Diesel | Turbo, OHV | TD17722 |
| OM 904.944 | 4249cc | 4 Cyl. | 12 Valves | 90kW/122PS | Diesel | Turbo, OHV | TD17734 |
| OM 904.945 | 4249cc | 4 Cyl. | 12 Valves | 125kW/170PS | Diesel | Turbo, OHV | TD17735 |
| OM 904.946 | 4249cc | 4 Cyl. | 12 Valves | 90-110kW/122-150PS | Diesel | Turbo, OHV | TD17736 |
| OM 904.947 | 4249cc | 4 Cyl. | 12 Valves | 130kW/177PS | Diesel | Turbo, OHV | TD17737 |
| OM 904.948 | 4249cc | 4 Cyl. | 12 Valves | 113kW/154PS | Diesel | Turbo, OHV | TD17738 |
| OM 904.949 | 4249cc | 4 Cyl. | 12 Valves | 128-130kW/174-177PS | Diesel | Turbo, OHV | TD17739 |
| OM 904.950 | 4249cc | 4 Cyl. | 12 Valves | 90-110kW/122-150PS | Diesel | Turbo, OHV | TD17740 |
| OM 904.951 | 4249cc | 4 Cyl. | 12 Valves | 130kW/177PS | Diesel | Turbo, OHV | TD17741 |
| OM 904.952 | 4249cc | 4 Cyl. | 12 Valves | 130kW/177PS | Diesel | Turbo, OHV | TD17183 |
| OM 904.953 | 4249cc | 4 Cyl. | 12 Valves | 110kW/150PS | Diesel | Turbo, OHV | TD17184 |
| OM 904.954 | 4249cc | 4 Cyl. | 12 Valves | 128kW/174PS | Diesel | Turbo, OHV | TD17742 |
| OM 904.955 | 4249cc | 4 Cyl. | 12 Valves | 110kW/150PS | Diesel | Turbo, OHV | TD16915 |
| OM 904.956 | 4249cc | 4 Cyl. | 12 Valves | 142kW/193PS | Diesel | Turbo, OHV | TD17744 |
| OM 904.957 | 4249cc | 4 Cyl. | 12 Valves | 110kW/150PS | Diesel | Turbo, OHV | TD17745 |
| OM 904.959 | 4249cc | 4 Cyl. | 12 Valves | 128kW/174PS | Diesel | Turbo, OHV | TD17746 |
| OM 904.961 | 4249cc | 4 Cyl. | 12 Valves | 90kW/122PS | Diesel | Turbo, OHV | TD16918 |
| OM 904.962 | 4249cc | 4 Cyl. | 12 Valves | 130kW/177PS | Diesel | Turbo, OHV | TD17747 |
| OM 904.964 | 4249cc | 4 Cyl. | 12 Valves | 130kW/177PS | Diesel | Turbo, OHV | TD16919 |
| OM 904.965 | 4249cc | 4 Cyl. | 12 Valves | 110kW/150PS | Diesel | Turbo, OHV | TD17748 |
| OM 904.966 | 4249cc | 4 Cyl. | 12 Valves | 110kW/150PS | Diesel | Turbo, OHV | TD17749 |
| OM 904.967 | 4249cc | 4 Cyl. | 12 Valves | 130kW/177PS | Diesel | Turbo, OHV | TD17750 |
| OM 904.968 | 4249cc | 4 Cyl. | 12 Valves | 130kW/177PS | Diesel | Turbo, OHV | TD17751 |
| OM 904.970 | 4249cc | 4 Cyl. | 12 Valves | 110kW/150PS | Diesel | Turbo, OHV | TD24856 |
| OM 904.972 | 4249cc | 4 Cyl. | 12 Valves | 130kW/177PS | Diesel | Turbo, OHV | TD24857 |
| OM 904.973 | 4249cc | 4 Cyl. | 12 Valves | 130kW/177PS | Diesel | Turbo, OHV | TD24858 |
| OM 904.976 | 4249cc | 4 Cyl. | 12 Valves | 130kW/177PS | Diesel | Turbo, OHV | TD24859 |



OE

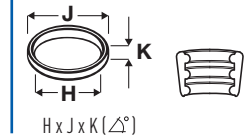
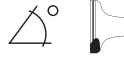

| | | | | | | | |
|------------|--------|--------|-----------|-------------|--------|------------|---------|
| OM 904.979 | 4249cc | 4 Cyl. | 12 Valves | 112kW/152PS | Diesel | Turbo, OHV | TD28801 |
| OM 907.910 | 4249cc | 4 Cyl. | 12 Valves | 75kW/102PS | Diesel | Turbo, OHV | TD16840 |
| OM 907.920 | 4249cc | 4 Cyl. | 12 Valves | 90kW/122PS | Diesel | Turbo, OHV | TD16841 |
| OM 907.930 | 4249cc | 4 Cyl. | 12 Valves | 100kW/136PS | Diesel | Turbo, OHV | TD17754 |
| OM 907.940 | 4249cc | 4 Cyl. | 12 Valves | 125kW/170PS | Diesel | Turbo, OHV | TD16842 |
| OM 907.941 | 4249cc | 4 Cyl. | 12 Valves | 125kW/170PS | Diesel | Turbo, OHV | TD17753 |
| OM 907.960 | 4249cc | 4 Cyl. | 12 Valves | 75kW/102PS | Diesel | Turbo, OHV | TD16843 |
| OM 907.970 | 4249cc | 4 Cyl. | 12 Valves | 90kW/122PS | Diesel | Turbo, OHV | TD16844 |
| OM 907.980 | 4249cc | 4 Cyl. | 12 Valves | 100kW/136PS | Diesel | Turbo, OHV | TD17755 |
| OM 907.990 | 4249cc | 4 Cyl. | 12 Valves | 125kW/170PS | Diesel | Turbo, OHV | TD16845 |

| | | | |
|------------------------------------|-----------------|------------------------------------|-----------------|
| ACCELO | 05/2003→ | ATEGO | 01/1998→10/2004 |
| ATEGO 2 | 10/2004→ | BEAVER | 01/2005→ |
| B-Series | | CITO (O 520) | 06/1999→ |
| FPN (FlatNose) | 07/2001→12/2005 | HPN (LongNose) | 07/2001→12/2005 |
| LK/LN2 | 03/1996→12/1998 | OF Series | 01/2001→ |
| OH Series | 01/1970→ | OMC | 02/2006→ |
| UNIMOG | 03/2000→ | VARIO 613 D, 614 D | 09/1996→ |
| VARIO 615 D, 616 D | 09/1998→ | VARIO 618 D | 09/2006→ |
| VARIO 813 D, 814 D | 09/1996→12/2013 | VARIO 813 DA, 814 DA | 09/1996→ |
| VARIO 815 D | 09/1996→12/2013 | VARIO 815 D, 816 D | 09/1996→ |
| VARIO 815 DA, 816 DA | 09/1996→12/2013 | VARIO 818 D | 09/2006→ |
| VARIO 818 DA | 09/2006→ | VARIO Cab with engine 613 D, 614 D | 01/2006→ |
| VARIO Cab with engine 615 D, 616 D | 01/2006→ | VARIO Cab with engine 618 D | 09/2006→ |
| VARIO Cab with engine 810 DT | 09/1996→12/2010 | VARIO Cab with engine 812 DT | 09/1996→12/2010 |
| VARIO Cab with engine 814 DT | 09/1996→ | VARIO Cab with engine 816 DT | 09/1996→ |
| VARIO O 810 | 09/1996→12/2010 | VARIO O 813 | 01/2006→ |
| VARIO O 814 | 09/1996→12/2010 | VARIO O 815 | 09/1996→12/2010 |
| VARIO O 816 D | 01/2006→ | VARIO O 818 D | 09/2006→ |
| ZEUS | 03/2008→ | | |

V95033 ■
34.00 x 7.94 x 125.85
Eng.→039739

906 050 02 26

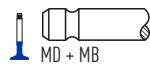

20°

H

VAG96320 ■ ■ ■
60.00 x 8.02 x 13.07

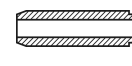

V95003 ■
34.00 x 8.00 x 128.70
Eng.039740→

906 050 03 26

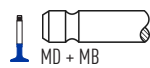

20°

H

VAG96345 ■ ■ ■
60.00 x 8.02 x 14.05



V95004 ■
38.00 x 8.00 x 152.40

906 050 03 27

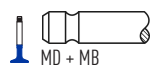

45°

H

127



102.00

| | | | | | | | |
|------------|--------|--------|-----------|---------------------|--------|------------|---------|
| OM 902.910 | 6374cc | 6 Cyl. | 18 Valves | 187kW/250PS | Diesel | Turbo, OHV | TD20244 |
| OM 902.911 | 6374cc | 6 Cyl. | 18 Valves | 172kW/230PS | Diesel | Turbo, OHV | TD20247 |
| OM 902.912 | 6374cc | 6 Cyl. | 18 Valves | 194kW/264PS | Diesel | Turbo, OHV | TD20249 |
| OM 902.913 | 6374cc | 6 Cyl. | 18 Valves | 175kW/238PS | Diesel | Turbo, OHV | TD20250 |
| OM 902.914 | 6374cc | 6 Cyl. | 18 Valves | 188kW/256PS | Diesel | Turbo, OHV | TD20251 |
| OM 902.915 | 6374cc | 6 Cyl. | 18 Valves | 210kW/286PS | Diesel | Turbo, OHV | TD20252 |
| OM 902.916 | 6374cc | 6 Cyl. | 18 Valves | 175kW/238PS | Diesel | Turbo, OHV | TD18924 |
| OM 902.917 | 6374cc | 6 Cyl. | 18 Valves | 188kW/256PS | Diesel | Turbo, OHV | TD18930 |
| OM 902.918 | 6374cc | 6 Cyl. | 18 Valves | 210kW/286PS | Diesel | Turbo, OHV | TD18931 |
| OM 902.919 | 6374cc | 6 Cyl. | 18 Valves | 157-172kW/213-234PS | Diesel | Turbo, OHV | TD20253 |
| OM 902.920 | 6374cc | 6 Cyl. | 18 Valves | 172kW/230PS | Diesel | Turbo, OHV | TD20254 |
| OM 902.921 | 6374cc | 6 Cyl. | 18 Valves | 194kW/264PS | Diesel | Turbo, OHV | TD20255 |
| OM 902.922 | 6374cc | 6 Cyl. | 18 Valves | 142kW/190PS | Diesel | Turbo, OHV | TD20256 |
| OM 902.923 | 6374cc | 6 Cyl. | 18 Valves | 175kW/238PS | Diesel | Turbo, OHV | TD23293 |

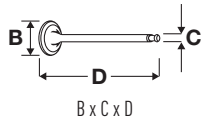

OE

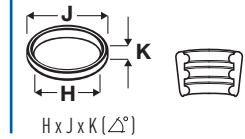
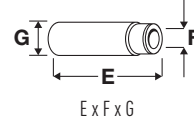

| | | | | | | | |
|------------|--------|--------|-----------|---------------------|--------|-------------------------|---------|
| OM 902.924 | 6374cc | 6 Cyl. | 18 Valves | 210kW/286PS | Diesel | Turbo, OHV | TD23294 |
| OM 902.925 | 6374cc | 6 Cyl. | 18 Valves | 210kW/286PS | Diesel | Turbo, OHV | TD23295 |
| OM 902.926 | 6374cc | 6 Cyl. | 18 Valves | 210kW/286PS | Diesel | Turbo, OHV | TD23296 |
| OM 902.927 | 6374cc | 6 Cyl. | 18 Valves | 210kW/286PS | Diesel | Turbo, OHV | TD20257 |
| OM 902.930 | 6374cc | 6 Cyl. | 18 Valves | 175kW/238PS | Diesel | Turbo, OHV | TD20258 |
| OM 902.931 | 6374cc | 6 Cyl. | 18 Valves | 188kW/256PS | Diesel | Turbo, OHV | TD20259 |
| OM 902.932 | 6374cc | 6 Cyl. | 18 Valves | 210kW/286PS | Diesel | Turbo, OHV | TD20260 |
| OM 902.933 | 6374cc | 6 Cyl. | 18 Valves | 175kW/238PS | Diesel | Turbo, OHV | TD20261 |
| OM 902.934 | 6374cc | 6 Cyl. | 18 Valves | 210kW/286PS | Diesel | Turbo, OHV | TD23297 |
| OM 902.935 | 6374cc | 6 Cyl. | 18 Valves | 170-205kW/231-279PS | Diesel | Turbo, OHV | TD28794 |
| OM 902.936 | 6374cc | 6 Cyl. | 18 Valves | 210kW/286PS | Diesel | Turbo, OHV | TD23298 |
| OM 906.910 | 6374cc | 6 Cyl. | 18 Valves | 170kW/231PS | Diesel | Turbo, OHV, Common Rail | TD11309 |
| OM 906.911 | 6374cc | 6 Cyl. | 18 Valves | 205kW/279PS | Diesel | Turbo, OHV | TD11310 |
| OM 906.912 | 6374cc | 6 Cyl. | 18 Valves | 194kW/264PS | Diesel | Turbo, OHV | TD17757 |
| OM 906.913 | 6374cc | 6 Cyl. | 18 Valves | 170kW/231PS | Diesel | Turbo, OHV | TD17758 |
| OM 906.914 | 6374cc | 6 Cyl. | 18 Valves | 157kW/231PS | Diesel | Turbo, OHV | TD17759 |
| OM 906.915 | 6374cc | 6 Cyl. | 18 Valves | 170kW/231PS | Diesel | Turbo, OHV | TD11311 |
| OM 906.916 | 6374cc | 6 Cyl. | 18 Valves | 205kW/279PS | Diesel | Turbo, OHV | TD11312 |
| OM 906.917 | 6374cc | 6 Cyl. | 18 Valves | 170kW/231PS | Diesel | Turbo, OHV | TD17760 |
| OM 906.918 | 6374cc | 6 Cyl. | 18 Valves | 180kW/245PS | Diesel | Turbo, OHV | TD17761 |
| OM 906.919 | 6374cc | 6 Cyl. | 18 Valves | 180kW/245PS | Diesel | Turbo, OHV | TD11313 |
| OM 906.920 | 6374cc | 6 Cyl. | 18 Valves | 170-172kW/231-234PS | Diesel | Turbo, OHV | TD11314 |
| OM 906.921 | 6374cc | 6 Cyl. | 18 Valves | 205kW/279PS | Diesel | Turbo, OHV | TD11315 |
| OM 906.922 | 6374cc | 6 Cyl. | 18 Valves | 170kW/231PS | Diesel | Turbo, OHV | TD11316 |
| OM 906.923 | 6374cc | 6 Cyl. | 18 Valves | 205kW/279PS | Diesel | Turbo, OHV | TD11317 |
| OM 906.924 | 6374cc | 6 Cyl. | 18 Valves | 170kW/231PS | Diesel | Turbo, OHV | TD17762 |
| OM 906.925 | 6374cc | 6 Cyl. | 18 Valves | 170kW/231PS | Diesel | Turbo, OHV | TD16920 |
| OM 906.926 | 6374cc | 6 Cyl. | 18 Valves | 205kW/279PS | Diesel | Turbo, OHV | TD16923 |
| OM 906.927 | 6374cc | 6 Cyl. | 18 Valves | 170kW/231PS | Diesel | Turbo, OHV | TD16921 |
| OM 906.928 | 6374cc | 6 Cyl. | 18 Valves | 205kW/279PS | Diesel | Turbo, OHV | TD16924 |
| OM 906.929 | 6374cc | 6 Cyl. | 18 Valves | 172kW/234PS | Diesel | Turbo, OHV | TD17763 |
| OM 906.930 | 6374cc | 6 Cyl. | 18 Valves | 205kW/279PS | Diesel | Turbo, OHV | TD11318 |
| OM 906.931 | 6374cc | 6 Cyl. | 18 Valves | 170kW/231PS | Diesel | Turbo, OHV | TD11319 |
| OM 906.932 | 6374cc | 6 Cyl. | 18 Valves | 172kW/234PS | Diesel | Turbo, OHV | TD17764 |
| OM 906.933 | 6374cc | 6 Cyl. | 18 Valves | 209kW/284PS | Diesel | Turbo, OHV | TD17765 |
| OM 906.934 | 6374cc | 6 Cyl. | 18 Valves | 209kW/284PS | Diesel | Turbo, OHV | TD17766 |
| OM 906.935 | 6374cc | 6 Cyl. | 18 Valves | 170kW/231PS | Diesel | Turbo, OHV | TD17326 |
| OM 906.936 | 6374cc | 6 Cyl. | 18 Valves | 172kW/234PS | Diesel | Turbo, OHV | TD17767 |
| OM 906.937 | 6374cc | 6 Cyl. | 18 Valves | 170kW/231PS | Diesel | Turbo, OHV | TD17768 |
| OM 906.938 | 6374cc | 6 Cyl. | 18 Valves | 205kW/279PS | Diesel | Turbo, OHV | TD17769 |
| OM 906.939 | 6374cc | 6 Cyl. | 18 Valves | 180kW/245PS | Diesel | Turbo, OHV | TD16926 |
| OM 906.940 | 6374cc | 6 Cyl. | 18 Valves | 170kW/231PS | Diesel | Turbo, OHV | TD11320 |
| OM 906.941 | 6374cc | 6 Cyl. | 18 Valves | 205kW/279PS | Diesel | Turbo, OHV | TD11321 |
| OM 906.944 | 6374cc | 6 Cyl. | 18 Valves | 142kW/193PS | Diesel | Turbo, OHV | TD17770 |
| OM 906.945 | 6374cc | 6 Cyl. | 18 Valves | 157kW/214PS | Diesel | Turbo, OHV | TD17771 |
| OM 906.946 | 6374cc | 6 Cyl. | 18 Valves | 187kW/254PS | Diesel | Turbo, OHV | TD17772 |
| OM 906.947 | 6374cc | 6 Cyl. | 18 Valves | 194kW/264PS | Diesel | Turbo, OHV | TD17774 |
| OM 906.948 | 6374cc | 6 Cyl. | 18 Valves | 224kW/305PS | Diesel | Turbo, OHV | TD17775 |
| OM 906.949 | 6374cc | 6 Cyl. | 18 Valves | 180kW/245PS | Diesel | Turbo, OHV | TD17776 |
| OM 906.950 | 6374cc | 6 Cyl. | 18 Valves | 205kW/279PS | Diesel | Turbo, OHV | TD17777 |

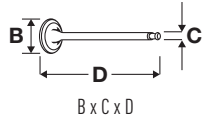

OE

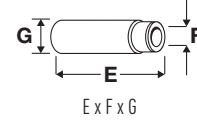
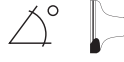

E x F x G

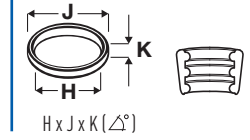

| | | | | | | | |
|----------------|-----------------|--------|-----------|---------------------|--------|-----------------|---------|
| OM 906.951 | 6374cc | 6 Cyl. | 18 Valves | 170kW/231PS | Diesel | Turbo, OHV | TD17778 |
| OM 906.952 | 6374cc | 6 Cyl. | 18 Valves | 205kW/279PS | Diesel | Turbo, OHV | TD16925 |
| OM 906.953 | 6374cc | 6 Cyl. | 18 Valves | 205kW/279PS | Diesel | Turbo, OHV | TD17779 |
| OM 906.954 | 6374cc | 6 Cyl. | 18 Valves | 172kW/234PS | Diesel | Turbo, OHV | TD17780 |
| OM 906.955 | 6374cc | 6 Cyl. | 18 Valves | 205kW/279PS | Diesel | Turbo, OHV | TD17327 |
| OM 906.956 | 6374cc | 6 Cyl. | 18 Valves | 209kW/284PS | Diesel | Turbo, OHV | TD17781 |
| OM 906.957 | 6374cc | 6 Cyl. | 18 Valves | 142kW/193PS | Diesel | Turbo, OHV | TD17782 |
| OM 906.958 | 6374cc | 6 Cyl. | 18 Valves | 157kW/214PS | Diesel | Turbo, OHV | TD17783 |
| OM 906.959 | 6374cc | 6 Cyl. | 18 Valves | 157kW/214PS | Diesel | Turbo, OHV | TD17784 |
| OM 906.960 | 6374cc | 6 Cyl. | 18 Valves | 205kW/279PS | Diesel | Turbo, OHV | TD17447 |
| OM 906.961 | 6374cc | 6 Cyl. | 18 Valves | 205kW/279PS | Diesel | Turbo, OHV | TD17459 |
| OM 906.962 | 6374cc | 6 Cyl. | 18 Valves | 180kW/245PS | Diesel | Turbo, OHV | TD17460 |
| OM 906.963 | 6374cc | 6 Cyl. | 18 Valves | 180kW/245PS | Diesel | Turbo, OHV | TD17449 |
| OM 906.964 | 6374cc | 6 Cyl. | 18 Valves | 170-180kW/231-245PS | Diesel | Turbo, OHV | TD17823 |
| OM 906.965 | 6374cc | 6 Cyl. | 18 Valves | 205kW/279PS | Diesel | Turbo, OHV | TD17824 |
| OM 906.966 | 6374cc | 6 Cyl. | 18 Valves | 172kW/230PS | Diesel | Turbo, OHV | TD17825 |
| OM 906.967 | 6374cc | 6 Cyl. | 18 Valves | 209kW/284PS | Diesel | Turbo, OHV | TD17826 |
| OM 906.968 | 6374cc | 6 Cyl. | 18 Valves | 172-187kW/230-254PS | Diesel | Turbo, OHV | TD17827 |
| OM 906.970 | 6374cc | 6 Cyl. | 18 Valves | 194-209kW/194-284PS | Diesel | Turbo, OHV | TD17828 |
| OM 906.971 | 6374cc | 6 Cyl. | 18 Valves | 170-180kW/231-245PS | Diesel | Turbo, OHV | TD17829 |
| OM 906.974 | 6374cc | 6 Cyl. | 18 Valves | 209kW/280PS | Diesel | Turbo, OHV | TD17830 |
| OM 906.975 | 6374cc | 6 Cyl. | 18 Valves | 180kW/245PS | Diesel | Turbo, OHV | TD17831 |
| OM 906.976 | 6374cc | 6 Cyl. | 18 Valves | 209kW/284PS | Diesel | Turbo, OHV | TD17773 |
| OM 906.977 | 6374cc | 6 Cyl. | 18 Valves | 209kW/280PS | Diesel | Turbo, OHV | TD17833 |
| OM 906.978 | 6374cc | 6 Cyl. | 18 Valves | 142-157kW/193-214PS | Diesel | Turbo, OHV | TD17834 |
| OM 906.979 | 6374cc | 6 Cyl. | 18 Valves | 172-187kW/193-254PS | Diesel | Turbo, OHV | TD17835 |
| OM 906.980 | 6374cc | 6 Cyl. | 18 Valves | 194-209kW/264-284PS | Diesel | Turbo, OHV | TD17836 |
| OM 906.981 | 6374cc | 6 Cyl. | 18 Valves | 224kW/300PS | Diesel | Turbo, OHV | TD17837 |
| OM 906.982 | 6374cc | 6 Cyl. | 18 Valves | 170kW/231PS | Diesel | Turbo, OHV | TD17838 |
| OM 906.983 | 6374cc | 6 Cyl. | 18 Valves | 180kW/245PS | Diesel | Turbo, OHV | TD17839 |
| OM 906.985 | 6374cc | 6 Cyl. | 18 Valves | 180kW/245PS | Diesel | Turbo, OHV | TD17840 |
| OM 906.986 | 6374cc | 6 Cyl. | 18 Valves | 205kW/279PS | Diesel | Turbo, OHV | TD25471 |
| OM 906.988 | 6374cc | 6 Cyl. | 18 Valves | 180kW/245PS | Diesel | Turbo, OHV | TD17841 |
| OM 906.990 | 6374cc | 6 Cyl. | 18 Valves | 180-191kW/245-260PS | Diesel | Turbo, OHV | TD24860 |
| OM 906.991 | 6374cc | 6 Cyl. | 18 Valves | 130-205kW/177-279PS | Diesel | Turbo, OHV | TD28805 |
| OM 906.995 | 6374cc | 6 Cyl. | 18 Valves | 206kW/279PS | Diesel | Turbo, OHV | TD25657 |
| OM 906.998 | 6374cc | 6 Cyl. | 18 Valves | 191kW/260PS | Diesel | Turbo, OHV | TD28809 |
| OM 906.998 | 6374cc | 6 Cyl. | 18 Valves | 172-194kW/234-264PS | Diesel | Turbo, OHV | TD28810 |
| OM 909.900 | 6374cc | 6 Cyl. | 18 Valves | 170kW/231PS | Diesel | Turbo, OHV | TD17443 |
| OM 909.901 | 6374cc | 6 Cyl. | 18 Valves | 205kW/279PS | Diesel | Turbo, OHV | TD17445 |
| OM 909.910 | 6374cc | 6 Cyl. | 18 Valves | 170kW/231PS | Diesel | Turbo, OHV | TD16846 |
| OM 909.911 | 6374cc | 6 Cyl. | 18 Valves | 170kW/231PS | Diesel | Turbo, OHV | TD17444 |
| OM 909.920 | 6374cc | 6 Cyl. | 18 Valves | 205kW/279PS | Diesel | Turbo, OHV | TD16847 |
| OM 909.921 | 6374cc | 6 Cyl. | 18 Valves | 205kW/279PS | Diesel | Turbo, OHV | TD17446 |
| OM 909.960 | 6374cc | 6 Cyl. | 18 Valves | 170kW/231PS | Diesel | Turbo, OHV | TD16848 |
| OM 909.970 | 6374cc | 6 Cyl. | 18 Valves | 205kW/279PS | Diesel | Turbo, OHV | TD16849 |
| OM 909.971 | 6374cc | 6 Cyl. | 18 Valves | 205kW/279PS | Diesel | Turbo, OHV | TD16850 |
| ATEGO | 01/1998→10/2004 | | | ATEGO 2 | | 10/2004→ | |
| AXOR | 01/2002→10/2004 | | | AXOR 2 | | 10/2004→ | |
| CITARO (O 530) | 01/1998→ | | | CONNECTO (O 345) | | 11/2001→ | |
| ECONIC | 01/1998→ | | | HPN (LongNose) | | 05/1999→12/2011 | |

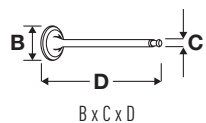

OE

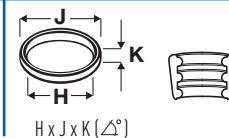
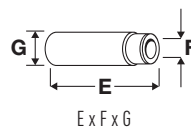
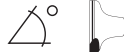

| | | | |
|---------------|----------|-----------------|----------|
| OH Series | 01/1970→ | OMC | 02/2006→ |
| Series 400 | 01/2005→ | TOURINO (0 510) | 10/2003→ |
| TOURO (0 500) | | UNIMOG | 03/2000→ |
| ZEUS | 03/2008→ | | |

V95033 ■
34.00 x 7.94 x 125.85
Eng.→039739

906 050 02 26

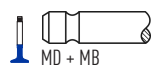

20°

H

VAG96320 ■ ■
60.00 x 8.02 x 13.07



V95003 ■
34.00 x 8.00 x 128.70
Eng.039740→

906 050 03 26



20°

H

VAG96345 ■ ■
60.00 x 8.02 x 14.05

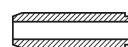

V95004 ■
38.00 x 8.00 x 152.40

906 050 03 27

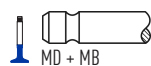

45°

H

128 106.00

| | | | | | | | |
|------------|--------|--------|-----------|---------------------|--------|------------|---------|
| OM 924.910 | 4801cc | 4 Cyl. | 12 Valves | 160kW/218PS | Diesel | Turbo, OHV | TD19181 |
| OM 924.911 | 4801cc | 4 Cyl. | 12 Valves | 160kW/218PS | Diesel | Turbo, OHV | TD19182 |
| OM 924.912 | 4801cc | 4 Cyl. | 12 Valves | 160kW/218PS | Diesel | Turbo, OHV | TD19183 |
| OM 924.914 | 4801cc | 4 Cyl. | 12 Valves | 160kW/218PS | Diesel | Turbo, OHV | TD19184 |
| OM 924.915 | 4801cc | 4 Cyl. | 12 Valves | 142-160kW/193-218PS | Diesel | Turbo, OHV | TD19185 |
| OM 924.916 | 4801cc | 4 Cyl. | 12 Valves | 160kW/218PS | Diesel | Turbo, OHV | TD17185 |
| OM 924.917 | 4801cc | 4 Cyl. | 12 Valves | 142kW/193PS | Diesel | Turbo, OHV | TD19186 |
| OM 924.919 | 4801cc | 4 Cyl. | 12 Valves | 160kW/218PS | Diesel | Turbo, OHV | TD19187 |
| OM 924.920 | 4801cc | 4 Cyl. | 12 Valves | 160kW/218PS | Diesel | Turbo, OHV | TD18917 |
| OM 924.922 | 4801cc | 4 Cyl. | 12 Valves | 160kW/218PS | Diesel | Turbo, OHV | TD19188 |
| OM 924.923 | 4801cc | 4 Cyl. | 12 Valves | 160kW/218PS | Diesel | Turbo, OHV | TD19189 |
| OM 924.924 | 4801cc | 4 Cyl. | 12 Valves | 160kW/218PS | Diesel | Turbo, OHV | TD19191 |
| OM 924.925 | 4801cc | 4 Cyl. | 12 Valves | 142kW/193PS | Diesel | Turbo, OHV | TD28811 |
| OM 924.928 | 4801cc | 4 Cyl. | 12 Valves | 160kW/218PS | Diesel | Turbo, OHV | TD28813 |
| OM 924.929 | 4801cc | 4 Cyl. | 12 Valves | 142kW/193PS | Diesel | Turbo, OHV | TD28814 |
| OM 924.930 | 4801cc | 4 Cyl. | 12 Valves | 160kW/218PS | Diesel | Turbo, OHV | TD25236 |
| OM 924.931 | 4801cc | 4 Cyl. | 12 Valves | 160kW/218PS | Diesel | Turbo, OHV | TD28815 |
| OM 924.932 | 4801cc | 4 Cyl. | 12 Valves | 145kW/197PS | Diesel | Turbo, OHV | TD28816 |
| OM 924.933 | 4801cc | 4 Cyl. | 12 Valves | 142kW/193PS | Diesel | Turbo, OHV | TD28817 |

| | | | |
|---------|----------|----------------|-----------------|
| ATEGO 2 | 10/2004→ | HPN (LongNose) | 07/2001→12/2005 |
| UNIMOG | 09/2002→ | | |

V95033 ■
34.00 x 7.94 x 125.85
Eng.→039739

906 050 02 26

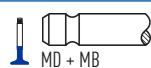

20°

H

VAG96320 ■ ■
60.00 x 8.02 x 13.07



V95003 ■
34.00 x 8.00 x 128.70
Eng.039740→

906 050 03 26

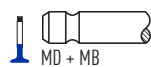

20°

H

VAG96345 ■ ■
60.00 x 8.02 x 14.05

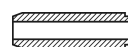

V95004 ■
38.00 x 8.00 x 152.40

906 050 03 27



45°



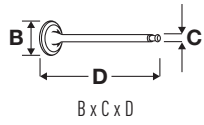



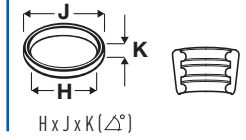
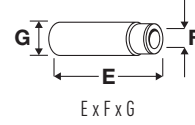
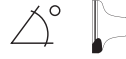





H

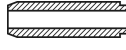





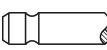

OE

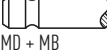

129  **106.00**

| M 906.900 | 6884cc | 6 Cyl. | 18 Valves | 205kW/279PS | Petrol | Turbo, OHV | TD17842 |
|---|---------------|--|-----------|-------------|---|---|---------|
| AVANCITY | 10/2008→ | | | ECONIC | | 10/2000→ | |
| V95033  | 906 050 02 26 |   MD + MB | 20° | H | VAG96320  |  60.00 x 8.02 x 13.07 | |
| V95003  | 906 050 03 26 |   MD + MB | 20° | H | VAG96345  |  60.00 x 8.02 x 14.05 | |
| V95004  | 906 050 03 27 |   MD + MB | 45° | H | | | |

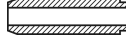
130  **106.00**

| OM 925.920 | 7201cc | 6 Cyl. | 18 Valves | 175-210kW/238-286PS | Diesel | Turbo, OHV | TD25238 |
|---|---------------|--|-----------|---------------------|---|---|---------|
| OM 926.949 | 7201cc | 6 Cyl. | 18 Valves | 210kW/286PS | Diesel | Turbo, OHV | TD28838 |
| ATEGO 2 | 10/2004→ | | | | | | |
| V95004  | 906 050 03 27 |   MD + MB | 45° | H | VAG96320  |  60.00 x 8.02 x 13.07 Eng.->039739 | |
| | | | | | VAG96345  |  60.00 x 8.02 x 14.05 Eng.->039739 | |



OE

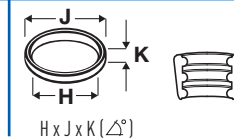
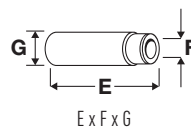

131  **106.00**

| | | | | | | | |
|------------|--------|--------|-----------|---------------------|--------|------------|---------|
| OM 926.910 | 7201cc | 6 Cyl. | 18 Valves | 240kW/326PS | Diesel | Turbo, OHV | TD19158 |
| OM 926.911 | 7201cc | 6 Cyl. | 18 Valves | 240kW/326PS | Diesel | Turbo, OHV | TD19155 |
| OM 926.912 | 7201cc | 6 Cyl. | 18 Valves | 240kW/326PS | Diesel | Turbo, OHV | TD19159 |
| OM 926.913 | 7201cc | 6 Cyl. | 18 Valves | 240kW/326PS | Diesel | Turbo, OHV | TD19160 |
| OM 926.914 | 7201cc | 6 Cyl. | 18 Valves | 240kW/326PS | Diesel | Turbo, OHV | TD19161 |
| OM 926.915 | 7201cc | 6 Cyl. | 18 Valves | 240kW/326PS | Diesel | Turbo, OHV | TD19162 |
| OM 926.916 | 7201cc | 6 Cyl. | 18 Valves | 240kW/326PS | Diesel | Turbo, OHV | TD19163 |
| OM 926.917 | 7201cc | 6 Cyl. | 18 Valves | 240kW/326PS | Diesel | Turbo, OHV | TD19164 |
| OM 926.918 | 7201cc | 6 Cyl. | 18 Valves | 215kW/292PS | Diesel | Turbo, OHV | TD19165 |
| OM 926.919 | 7201cc | 6 Cyl. | 18 Valves | 240kW/326PS | Diesel | Turbo, OHV | TD19166 |
| OM 926.920 | 7201cc | 6 Cyl. | 18 Valves | 209-224kW/284-305PS | Diesel | Turbo, OHV | TD19167 |
| OM 926.921 | 7201cc | 6 Cyl. | 18 Valves | 240kW/326PS | Diesel | Turbo, OHV | TD19168 |
| OM 926.924 | 7201cc | 6 Cyl. | 18 Valves | 240kW/326PS | Diesel | Turbo, OHV | TD19169 |
| OM 926.925 | 7201cc | 6 Cyl. | 18 Valves | 215-220kW/292-299PS | Diesel | Turbo, OHV | TD19170 |
| OM 926.926 | 7201cc | 6 Cyl. | 18 Valves | 225kW/306PS | Diesel | Turbo, OHV | TD19171 |
| OM 926.927 | 7201cc | 6 Cyl. | 18 Valves | 187kW/254PS | Diesel | Turbo, OHV | TD19172 |
| OM 926.928 | 7201cc | 6 Cyl. | 18 Valves | 187-209kW/254-284PS | Diesel | Turbo, OHV | TD19173 |
| OM 926.929 | 7201cc | 6 Cyl. | 18 Valves | 220-240kW/299-326PS | Diesel | Turbo, OHV | TD19174 |
| OM 926.930 | 7201cc | 6 Cyl. | 18 Valves | 225kW/306PS | Diesel | Turbo, OHV | TD19175 |
| OM 926.932 | 7201cc | 6 Cyl. | 18 Valves | 225kW/306PS | Diesel | Turbo, OHV | TD19176 |
| OM 926.934 | 7201cc | 6 Cyl. | 18 Valves | 240kW/326PS | Diesel | Turbo, OHV | TD19177 |
| OM 926.935 | 7201cc | 6 Cyl. | 18 Valves | 240kW/326PS | Diesel | Turbo, OHV | TD21087 |
| OM 926.937 | 7201cc | 6 Cyl. | 18 Valves | 240kW/326PS | Diesel | Turbo, OHV | TD19178 |
| OM 926.938 | 7201cc | 6 Cyl. | 18 Valves | 205kW/279PS | Diesel | Turbo, OHV | TD19179 |
| OM 926.939 | 7201cc | 6 Cyl. | 18 Valves | 210kW/286PS | Diesel | Turbo, OHV | TD19180 |
| OM 926.940 | 7201cc | 6 Cyl. | 18 Valves | 220-240kW/299-326PS | Diesel | Turbo, OHV | TD28834 |
| OM 926.941 | 7201cc | 6 Cyl. | 18 Valves | 205kW/279PS | Diesel | Turbo, OHV | TD25472 |
| OM 926.942 | 7201cc | 6 Cyl. | 18 Valves | 224kW/305PS | Diesel | Turbo, OHV | TD28835 |
| OM 926.945 | 7201cc | 6 Cyl. | 18 Valves | 240kW/326PS | Diesel | Turbo, OHV | TD25483 |
| OM 926.947 | 7201cc | 6 Cyl. | 18 Valves | 240kW/326PS | Diesel | Turbo, OHV | TD24829 |
| OM 926.948 | 7201cc | 6 Cyl. | 18 Valves | 240kW/326PS | Diesel | Turbo, OHV | TD28837 |
| OM 926.950 | 7201cc | 6 Cyl. | 18 Valves | 194kW/264PS | Diesel | Turbo, OHV | TD28839 |

| | | | |
|------------------|----------|---------------|----------|
| ATEGO 2 | 10/2004→ | AXOR 2 | 10/2004→ |
| CONNECTO (O 345) | 11/2001→ | ECONIC | 10/2001→ |
| INTEGRO (O 550) | 01/2006→ | INTOURO | 01/2005→ |
| TOURINO (O 510) | 10/2003→ | TOURO (O 500) | |
| ZETROS | 09/2008→ | ZEUS | 03/2008→ |

V95033 ■
34.00 x 7.94 x 125.85
Eng.→039739

906 050 02 26

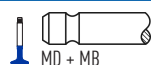

20°

H

VAG96320 ■ ■
60.00 x 8.02 x 13.07

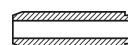

V95003 ■
34.00 x 8.00 x 128.70
Eng.039740→

906 050 03 26

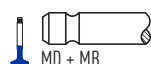

20°

H

VAG96345 ■ ■
60.00 x 8.02 x 14.05

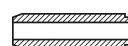

V95004 ■
38.00 x 8.00 x 152.40

906 050 03 27

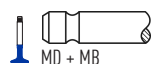

45°

H



OE

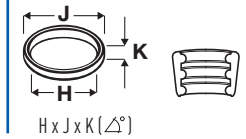
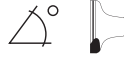

132 **125.00**

| | | | | | | | |
|------------|--------|--------|-----------|-------------|--------|-----|---------|
| OM 409.906 | 9204cc | 5 Cyl. | 10 Valves | 135kW/184PS | Diesel | OHV | TD18812 |
| OM 409.907 | 9204cc | 5 Cyl. | 10 Valves | 135kW/184PS | Diesel | OHV | TD18813 |
| OM 409.908 | 9204cc | 5 Cyl. | 10 Valves | 135kW/184PS | Diesel | OHV | TD18814 |

V91020
58.95 x 11.94 x 142.38

423 050 00 26



30°

H

VAG92089
67.05 x 11.99 x 18.03



V91132
59.00 x 11.95 x 142.50

442 050 03 26



30°

H

V91133
51.00 x 11.94 x 142.50

442 050 04 27



45°

H

V94332
51.00 x 12.00 x 142.50

442 050 02 27



45°

H

133 **125.00**

| | | | | | | | |
|------------|--------|---------|-----------|-------------|--------|------------|---------|
| OM 401.905 | 9572cc | V6 Cyl. | 12 Valves | 141kW/192PS | Diesel | OHV | TD5730 |
| OM 401.906 | 9572cc | V6 Cyl. | 12 Valves | 141kW/192PS | Diesel | OHV | TD6062 |
| OM 401.907 | 9572cc | V6 Cyl. | 12 Valves | 141kW/192PS | Diesel | OHV | TD16942 |
| OM 401.908 | 9572cc | V6 Cyl. | 12 Valves | 141kW/192PS | Diesel | OHV | TD16943 |
| OM 401.909 | 9572cc | V6 Cyl. | 12 Valves | 141kW/192PS | Diesel | OHV | TD5767 |
| OM 401.912 | 9572cc | V6 Cyl. | 12 Valves | 141kW/192PS | Diesel | OHV | TD7895 |
| OM 401.913 | 9572cc | V6 Cyl. | 12 Valves | 141kW/192PS | Diesel | OHV | TD16944 |
| OM 401.914 | 9572cc | V6 Cyl. | 12 Valves | 141kW/192PS | Diesel | OHV | TD5729 |
| OM 401.915 | 9572cc | V6 Cyl. | 12 Valves | 141kW/192PS | Diesel | OHV | TD6061 |
| OM 401.916 | 9572cc | V6 Cyl. | 12 Valves | 141kW/192PS | Diesel | OHV | TD6099 |
| OM 401.917 | 9572cc | V6 Cyl. | 12 Valves | 188kW/256PS | Diesel | Turbo, OHV | TD16949 |
| OM 401.918 | 9572cc | V6 Cyl. | 12 Valves | 141kW/192PS | Diesel | OHV | TD8118 |
| OM 401.919 | 9572cc | V6 Cyl. | 12 Valves | 141kW/192PS | Diesel | OHV | TD9596 |
| OM 401.921 | 9572cc | V6 Cyl. | 12 Valves | 141kW/192PS | Diesel | OHV | TD16945 |
| OM 401.922 | 9572cc | V6 Cyl. | 12 Valves | 141kW/192PS | Diesel | OHV | TD16946 |
| OM 401.923 | 9572cc | V6 Cyl. | 12 Valves | 141kW/192PS | Diesel | OHV | TD6081 |
| OM 401.925 | 9572cc | V6 Cyl. | 12 Valves | 141kW/192PS | Diesel | OHV | TD8229 |
| OM 401.926 | 9572cc | V6 Cyl. | 12 Valves | 141kW/192PS | Diesel | OHV | TD9597 |
| OM 401.927 | 9572cc | V6 Cyl. | 12 Valves | 141kW/192PS | Diesel | OHV | TD9598 |
| OM 401.928 | 9572cc | V6 Cyl. | 12 Valves | 141kW/192PS | Diesel | OHV | TD16948 |
| OM 401.970 | 9572cc | V6 Cyl. | 12 Valves | 213kW/290PS | Diesel | Turbo, OHV | TD7938 |
| OM 401.972 | 9572cc | V6 Cyl. | 12 Valves | 230kW/313PS | Diesel | Turbo, OHV | TD5777 |
| OM 401.973 | 9572cc | V6 Cyl. | 12 Valves | 200kW/272PS | Diesel | Turbo, OHV | TD5733 |
| OM 401.974 | 9572cc | V6 Cyl. | 12 Valves | 200kW/272PS | Diesel | Turbo, OHV | TD7939 |
| OM 401.975 | 9572cc | V6 Cyl. | 12 Valves | 180kW/245PS | Diesel | Turbo, OHV | TD5751 |
| OM 401.976 | 9572cc | V6 Cyl. | 12 Valves | 180kW/245PS | Diesel | Turbo, OHV | TD17102 |
| OM 401.977 | 9572cc | V6 Cyl. | 12 Valves | 200kW/272PS | Diesel | Turbo, OHV | TD5801 |
| OM 401.978 | 9572cc | V6 Cyl. | 12 Valves | 200kW/272PS | Diesel | Turbo, OHV | TD6065 |
| OM 401.979 | 9572cc | V6 Cyl. | 12 Valves | 230kW/313PS | Diesel | Turbo, OHV | TD5780 |
| OM 401.980 | 9572cc | V6 Cyl. | 12 Valves | 200kW/272PS | Diesel | Turbo, OHV | TD6293 |
| OM 401.981 | 9572cc | V6 Cyl. | 12 Valves | 230kW/313PS | Diesel | Turbo, OHV | TD6162 |
| OM 401.984 | 9572cc | V6 Cyl. | 12 Valves | 180kW/245PS | Diesel | Turbo, OHV | TD8127 |
| OM 401.985 | 9572cc | V6 Cyl. | 12 Valves | 200kW/272PS | Diesel | Turbo, OHV | TD5753 |
| OM 401.986 | 9572cc | V6 Cyl. | 12 Valves | 230kW/313PS | Diesel | Turbo, OHV | TD8199 |



OE



MAT.

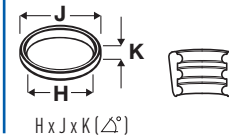
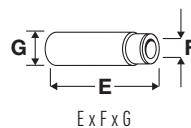

| | | | | | | | |
|-------------------|-----------------|---------|------------------|-------------|--------|-------------------|----------------|
| OM 401.987 | 9572cc | V6 Cyl. | 12 Valves | 230kW/313PS | Diesel | Turbo, OHV | TD6163 |
| OM 401.989 | 9572cc | V6 Cyl. | 12 Valves | 200kW/272PS | Diesel | Turbo, OHV | TD6068 |
| OM 401.990 | 9572cc | V6 Cyl. | 12 Valves | 180kW/245PS | Diesel | Turbo, OHV | TD16950 |
| OM 401.991 | 9572cc | V6 Cyl. | 12 Valves | 200kW/272PS | Diesel | Turbo, OHV | TD6086 |
| OM 401.992 | 9572cc | V6 Cyl. | 12 Valves | 200kW/272PS | Diesel | Turbo, OHV | TD17113 |
| OM 401.993 | 9572cc | V6 Cyl. | 12 Valves | 230kW/313PS | Diesel | Turbo, OHV | TD6113 |
| OM 401.994 | 9572cc | V6 Cyl. | 12 Valves | 180kW/245PS | Diesel | Turbo, OHV | TD6084 |
| MK | 12/1987→09/1996 | | | NG | | 08/1973→09/1996 | |
| O 303 | 10/1974→06/1983 | | | O 404 | | 09/1991→10/1999 | |
| SK | 07/1987→09/1996 | | | Transliner | | 12/1988→ | |

| | | | | | | | |
|--|---------------|--|-----|---|--|--|--|
| V91020 ■ 58.95 x 11.94 x 142.38 Eng.→265214 | 423 050 00 26 | | 30° | H | VAG92089 ■ ■ ■ 67.05 x 11.99 x 18.03 | | |
| V91132 ■ 59.00 x 11.95 x 142.50 Eng.265215→ | 442 050 03 26 | | 30° | H | | | |
| V91133 ■ 51.00 x 11.94 x 142.50 Eng.265215→ | 442 050 04 27 | | 45° | H | | | |
| V94332 ■ 51.00 x 12.00 x 142.50 Eng.265215→ | 442 050 02 27 | | 45° | H | | | |

134 125.00

| | | | | | | | |
|--|-----------------|---------|------------------|-------------|--|------------|----------------|
| OM 401.924 | 10456cc | V6 Cyl. | 12 Valves | 144kW/196PS | Diesel | OHV | TD16947 |
| NG | 01/1979→12/1982 | | | | | | |
| V91020 ■ 58.95 x 11.94 x 142.38 Eng.→265214 | 423 050 00 26 | | 30° | H | VAG92089 ■ ■ ■ 67.05 x 11.99 x 18.03 | | |
| V91132 ■ 59.00 x 11.95 x 142.50 Eng.265215→ | 442 050 03 26 | | 30° | H | | | |
| V91133 ■ 51.00 x 11.94 x 142.50 Eng.265215→ | 442 050 04 27 | | 45° | H | | | |
| V94332 ■ 51.00 x 12.00 x 142.50 Eng.265215→ | 442 050 02 27 | | 45° | H | | | |

135 125.00

| | | | | | | | |
|--|-----------------|--------|------------------|---------------------|--------|--------------------|----------------|
| OM 470.903 | 10677cc | 6 Cyl. | 24 Valves | 240-315kW/326-428PS | Diesel | Turbo, DOHC | TD29602 |
| OM 470.906 | 10677cc | 6 Cyl. | 24 Valves | 240-375kW/326-510PS | Diesel | Turbo, DOHC | TD27605 |
| OM 470.908 | 10677cc | 6 Cyl. | 24 Valves | 240-315kW/326-428PS | Diesel | Turbo, DOHC | TD30264 |
| ACTROS MP4 | 07/2011→ | | | ANTOS | | 07/2012→ | |
| AROCS | 01/2013→ | | | Series 400 | | 08/2016→ | |
| Series 500 | 01/2012→ | | | | | | |
| V95121 ■ 42.50 x 9.47 x 240.00 | A 470 050 06 26 | | 20° | H | | | |
| V95122 ■ 39.90 x 9.45 x 246.50 | A 470 050 04 27 | | 30° | H | | | |





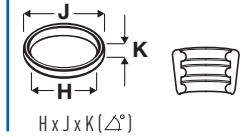
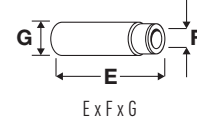











OE













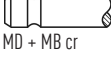

136  **125.00**

| | | | | | | | |
|-------------------|---------|--------|------------------|-------------|--------|-------------------|---------------|
| OM 407.905 | 11000cc | 6 Cyl. | 12 Valves | 132kW/180PS | Diesel | OHV | TD5664 |
| OM 407.908 | 11000cc | 6 Cyl. | 12 Valves | 132kW/180PS | Diesel | Turbo, OHV | TD6002 |
| OM 407.909 | 11000cc | 6 Cyl. | 12 Valves | 155kW/210PS | Diesel | OHV | TD5665 |
| OM 407.910 | 11000cc | 6 Cyl. | 12 Valves | 155kW/210PS | Diesel | OHV | TD6003 |
| OM 407.911 | 11000cc | 6 Cyl. | 12 Valves | 155kW/210PS | Diesel | OHV | TD6273 |

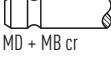
| 0 305 | | 04/1973→07/1977 | | 0 307 | | 04/1973→07/1977 | |
|---|---------------|---|-----|-------|---|---|--|
| V91020  | 423 050 00 26 |   | 30° | H | VAG92089  |  | |
| 58.95 x 11.94 x 142.38 Eng.→029460 | | MD + MB cr | | | 67.05 x 11.99 x 18.03 | | |
| V91132  | 442 050 03 26 |   | 30° | H | | | |
| 59.00 x 11.95 x 142.50 Eng.029461→ | | MD + MB cr | | | | | |
| V91133  | 442 050 04 27 |   | 45° | H | | | |
| 51.00 x 11.94 x 142.50 Eng.029461→ | | MD + MB cr | | | | | |
| V94332  | 442 050 02 27 |   | 45° | H | | | |
| 51.00 x 12.00 x 142.50 Eng.029461→ | | ME + MB cr | | | | | |

137  **125.00**

| | | | | | | | |
|-------------------|---------|--------|------------------|-------------|--------|------------|----------------|
| OM 407.907 | 11045cc | 6 Cyl. | 12 Valves | 155kW/211PS | Diesel | OHV | TD10767 |
|-------------------|---------|--------|------------------|-------------|--------|------------|----------------|

| 0 307 | | 04/1973→07/1977 | | | | | |
|---|---------------|---|-----|---|---|---|--|
| V91020  | 423 050 00 26 |   | 30° | H | VAG92089  |  | |
| 58.95 x 11.94 x 142.38 Eng.→029460 | | MD + MB cr | | | 67.05 x 11.99 x 18.03 | | |
| V91132  | 442 050 03 26 |   | 30° | H | | | |
| 59.00 x 11.95 x 142.50 Eng.029461→ | | MD + MB cr | | | | | |
| V91133  | 442 050 04 27 |   | 45° | H | | | |
| 51.00 x 11.94 x 142.50 Eng.029461→ | | MD + MB cr | | | | | |
| V94332  | 442 050 02 27 |   | 45° | H | | | |
| 51.00 x 12.00 x 142.50 Eng.029461→ | | ME + MB cr | | | | | |

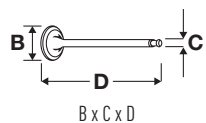

OE

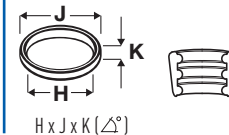
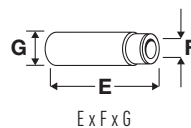

138 125.00

| OM 407.920 | 11412cc | 6 Cyl. | 12 Valves | 177kW/240PS | Diesel | OHV | TD17808 |
|---------------------------------------|---------------|------------|-----------|-------------|-----------------------|-----|---------|
| V91020 | 423 050 00 26 | | 30° | H | VAG92089 | | |
| 58.95 x 11.94 x 142.38 Eng.→029460 | | MD + MB cr | | | 67.05 x 11.99 x 18.03 | | |
| V91132 | 442 050 03 26 | | 30° | H | | | |
| 59.00 x 11.95 x 142.50 Eng.029461→ | | MD + MB cr | | | | | |
| V91133 | 442 050 04 27 | | 45° | H | | | |
| 51.00 x 11.94 x 142.50 Eng.029461→ | | MD + MB cr | | | | | |
| V94332 | 442 050 02 27 | | 45° | H | | | |
| 51.00 x 12.00 x 142.50 Eng.029461→ | | ME + MB cr | | | | | |

139 125.00

| OM 407.913 | 11413cc | 6 Cyl. | 12 Valves | 147kW/200PS | Diesel | OHV | TD5666 |
|---------------------------------------|---------------|------------|-----------|-------------|-----------------------|-----|--------|
| V91020 | 423 050 00 26 | | 30° | H | VAG92089 | | |
| 58.95 x 11.94 x 142.38 Eng.→029460 | | MD + MB cr | | | 67.05 x 11.99 x 18.03 | | |
| V91132 | 442 050 03 26 | | 30° | H | | | |
| 59.00 x 11.95 x 142.50 Eng.029461→ | | MD + MB cr | | | | | |
| V91133 | 442 050 04 27 | | 45° | H | | | |
| 51.00 x 11.94 x 142.50 Eng.029461→ | | MD + MB cr | | | | | |
| V94332 | 442 050 02 27 | | 45° | H | | | |
| 51.00 x 12.00 x 142.50 Eng.029461→ | | ME + MB cr | | | | | |



OE

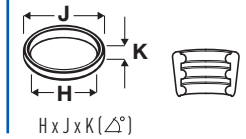
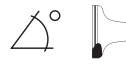

140  125.00

| | | | | | | | |
|------------|---------|---------|-----------|-------------|--------|-----|---------|
| OM 402.913 | 12760cc | V8 Cyl. | 16 Valves | 177kW/240PS | Diesel | OHV | TD17803 |
| OM 402.917 | 12760cc | V8 Cyl. | 16 Valves | 177kW/240PS | Diesel | OHV | TD17804 |
| OM 402.921 | 12760cc | V8 Cyl. | 16 Valves | 177kW/240PS | Diesel | OHV | TD17805 |
| OM 402.925 | 12760cc | V8 Cyl. | 16 Valves | 188kW/256PS | Diesel | OHV | TD17806 |

Series 200

01/1977→

V91020 
58.95 x 11.94 x 142.38
Eng.->265214

423 050 00 26



30°

H

VAG92089 
67.05 x 11.99 x 18.03

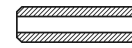

V91132 
59.00 x 11.95 x 142.50
Eng.265215→

442 050 03 26



30°

H

V91133 
51.00 x 11.94 x 142.50
Eng.265215→

442 050 04 27



45°

H

V94332 
51.00 x 12.00 x 142.50
Eng.265215→

442 050 02 27



45°

H

141  125.00

| | | | | | | | |
|------------|---------|---------|-----------|---------------------|--------|------------|---------|
| OM 402.970 | 12763cc | V8 Cyl. | 16 Valves | 280kW/381PS | Diesel | Turbo, OHV | TD7940 |
| OM 402.971 | 12763cc | V8 Cyl. | 16 Valves | 280kW/381PS | Diesel | Turbo, OHV | TD5783 |
| OM 402.972 | 12763cc | V8 Cyl. | 16 Valves | 280kW/381PS | Diesel | Turbo, OHV | TD5784 |
| OM 402.973 | 12763cc | V8 Cyl. | 16 Valves | 280kW/381PS | Diesel | Turbo, OHV | TD5832 |
| OM 402.974 | 12763cc | V8 Cyl. | 16 Valves | 280-295kW/381-401PS | Diesel | Turbo, OHV | TD17807 |
| OM 402.975 | 12763cc | V8 Cyl. | 16 Valves | 280kW/381PS | Diesel | Turbo, OHV | TD5818 |
| OM 402.977 | 12763cc | V8 Cyl. | 16 Valves | 280kW/381PS | Diesel | Turbo, OHV | TD5826 |
| OM 402.978 | 12763cc | V8 Cyl. | 16 Valves | 280kW/381PS | Diesel | Turbo, OHV | TD5786 |
| OM 402.982 | 12763cc | V8 Cyl. | 16 Valves | 280kW/381PS | Diesel | Turbo, OHV | TD5830 |
| OM 402.983 | 12763cc | V8 Cyl. | 16 Valves | 280kW/381PS | Diesel | Turbo, OHV | TD6182 |
| OM 402.984 | 12763cc | V8 Cyl. | 16 Valves | 280kW/381PS | Diesel | Turbo, OHV | TD11268 |
| OM 402.985 | 12763cc | V8 Cyl. | 16 Valves | 280kW/381PS | Diesel | Turbo, OHV | TD5806 |
| OM 402.986 | 12763cc | V8 Cyl. | 16 Valves | 280kW/381PS | Diesel | Turbo, OHV | TD6151 |
| OM 402.987 | 12763cc | V8 Cyl. | 16 Valves | 280kW/381PS | Diesel | Turbo, OHV | TD6178 |
| OM 402.989 | 12763cc | V8 Cyl. | 16 Valves | 280kW/381PS | Diesel | Turbo, OHV | TD5807 |
| OM 402.990 | 12763cc | V8 Cyl. | 16 Valves | 280kW/381PS | Diesel | Turbo, OHV | TD6153 |
| OM 402.995 | 12763cc | V8 Cyl. | 16 Valves | 280kW/381PS | Diesel | Turbo, OHV | TD11267 |
| OM 402.996 | 12763cc | V8 Cyl. | 16 Valves | 280kW/381PS | Diesel | Turbo, OHV | TD6121 |

E-Serie

O 304

O 403

SK

08/1992→

09/2003→

07/1987→09/1996

MK

O 340

O 404

TOURISMO (O 350)

12/1988→08/1994

01/1991→

09/1991→10/1999

08/1995→

V91132 
59.00 x 11.95 x 142.50

442 050 03 26



30°

H

VAG92089 
67.05 x 11.99 x 18.03



V94332 
51.00 x 12.00 x 142.50

442 050 02 27



45°

H



OE

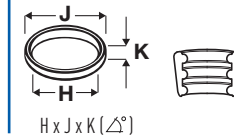
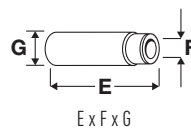

142 **125.00**

| | | | | | | | |
|-------------------|---------|---------|------------------|-------------|--------|------------|---------------|
| OM 402.905 | 12800cc | V8 Cyl. | 16 Valves | 188kW/256PS | Diesel | OHV | TD8179 |
| OM 402.906 | 12800cc | V8 Cyl. | 16 Valves | 188kW/256PS | Diesel | OHV | TD5814 |
| OM 402.907 | 12800cc | V8 Cyl. | 16 Valves | 188kW/256PS | Diesel | OHV | TD7896 |
| OM 402.910 | 12800cc | V8 Cyl. | 16 Valves | 176kW/240PS | Diesel | OHV | TD5752 |
| OM 402.911 | 12800cc | V8 Cyl. | 16 Valves | 176kW/240PS | Diesel | OHV | TD6085 |
| OM 402.912 | 12800cc | V8 Cyl. | 16 Valves | 188kW/256PS | Diesel | OHV | TD5758 |
| OM 402.914 | 12800cc | V8 Cyl. | 16 Valves | 176kW/240PS | Diesel | OHV | TD8230 |
| OM 402.916 | 12800cc | V8 Cyl. | 16 Valves | 188kW/256PS | Diesel | OHV | TD5798 |
| OM 402.919 | 12800cc | V8 Cyl. | 16 Valves | 176kW/240PS | Diesel | OHV | TD8154 |
| OM 402.923 | 12800cc | V8 Cyl. | 16 Valves | 176kW/240PS | Diesel | OHV | TD8183 |
| OM 402.924 | 12800cc | V8 Cyl. | 16 Valves | 188kW/256PS | Diesel | OHV | TD6291 |
| OM 402.926 | 12800cc | V8 Cyl. | 16 Valves | 188kW/256PS | Diesel | OHV | TD6296 |
| OM 402.927 | 12800cc | V8 Cyl. | 16 Valves | 176kW/240PS | Diesel | OHV | TD9606 |
| OM 402.928 | 12800cc | V8 Cyl. | 16 Valves | 176kW/240PS | Diesel | OHV | TD9607 |

| | | | |
|--------------------|-----------------------------|----|-----------------|
| Cityliner O 303 | 04/1973→ 03/1975→06/1983 | NG | 08/1973→09/1996 |
|--------------------|-----------------------------|----|-----------------|

V91020
58.95 x 11.94 x 142.38
Eng.→265214

423 050 00 26

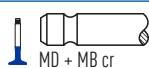

30°

H

VAG92089
67.05 x 11.99 x 18.03



V91132
59.00 x 11.95 x 142.50
Eng.265215→

442 050 03 26

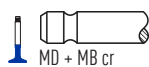

30°

H

V91133
51.00 x 11.94 x 142.50
Eng.265215→

442 050 04 27

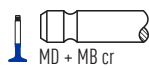

45°

H

V94332
51.00 x 12.00 x 142.50
Eng.265215→

442 050 02 27

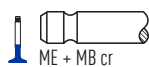

45°

H





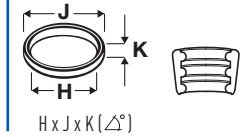



OE

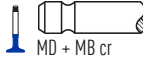
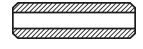
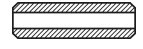

143  **125.00**

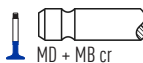
| | | | | | | | |
|------------|---------|----------|-----------|-------------|--------|-----|--------|
| OM 403.915 | 15900cc | V10 Cyl. | 20 Valves | 236kW/320PS | Diesel | OHV | TD8180 |
| OM 403.916 | 15900cc | V10 Cyl. | 20 Valves | 235kW/320PS | Diesel | OHV | TD5816 |
| OM 403.918 | 15900cc | V10 Cyl. | 20 Valves | 235kW/320PS | Diesel | OHV | TD7897 |
| OM 403.931 | 15900cc | V10 Cyl. | 20 Valves | 235kW/320PS | Diesel | OHV | TD5759 |
| OM 403.932 | 15900cc | V10 Cyl. | 20 Valves | 235kW/320PS | Diesel | OHV | TD6133 |
| OM 403.935 | 15900cc | V10 Cyl. | 20 Valves | 236kW/320PS | Diesel | OHV | TD6299 |

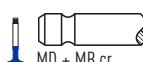

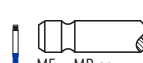





NG 08/1973→09/1996 O 303 07/1975→06/1983

| | | | | | | |
|---|---------------|---|-----|---|--|---|
| V91020  58.95 x 11.94 x 142.38 Eng.→265214 | 423 050 00 26 |  MD + MB cr | 30° | H | VAG92089  67.05 x 11.99 x 18.03 |  |
| V91132  59.00 x 11.95 x 142.50 Eng.265215→ | 442 050 03 26 |  MD + MB cr | 30° | H | | |
| V91133  51.00 x 11.94 x 142.50 Eng.265215→ | 442 050 04 27 |  MD + MB cr | 45° | H | | |
| V94332  51.00 x 12.00 x 142.50 Eng.265215→ | 442 050 02 27 |  ME + MB cr | 45° | H | | |

144  **125.00**

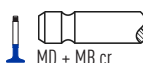
| | | | | | | | |
|------------|---------|----------|-----------|-------------|--------|-----|---------|
| OM 403.905 | 15950cc | V10 Cyl. | 20 Valves | 236kW/320PS | Diesel | OHV | TD16951 |
| OM 403.906 | 15950cc | V10 Cyl. | 20 Valves | 184kW/250PS | Diesel | OHV | TD16952 |
| OM 403.917 | 15950cc | V10 Cyl. | 20 Valves | 236kW/320PS | Diesel | OHV | TD16953 |
| OM 403.919 | 15950cc | V10 Cyl. | 20 Valves | 236kW/320PS | Diesel | OHV | TD16954 |
| OM 403.930 | 15950cc | V10 Cyl. | 20 Valves | 236kW/320PS | Diesel | OHV | TD16955 |
| OM 403.933 | 15950cc | V10 Cyl. | 20 Valves | 261kW/355PS | Diesel | OHV | TD16956 |
| OM 403.934 | 15950cc | V10 Cyl. | 20 Valves | 236kW/320PS | Diesel | OHV | TD16957 |

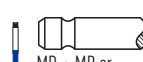
Cityliner Skyliner 01/1979→

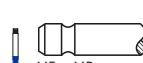
| | | | | | | |
|--|---------------|--|-----|---|--|---|
| V91020  58.95 x 11.94 x 142.38 Eng.→265214 | 423 050 00 26 |  MD + MB cr | 30° | H | VAG92089  67.05 x 11.99 x 18.03 |  |
| V91132  59.00 x 11.95 x 142.50 Eng.265215→ | 442 050 03 26 |  MD + MB cr | 30° | H | | |
| V91133  51.00 x 11.94 x 142.50 Eng.265215→ | 442 050 04 27 |  MD + MB cr | 45° | H | | |
| V94332  51.00 x 12.00 x 142.50 Eng.265215→ | 442 050 02 27 |  ME + MB cr | 45° | H | | |



OE

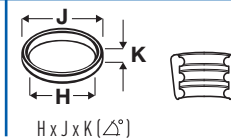
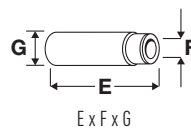

145 128.00

| | | | | | | | |
|------------|--------|--------|-----------|-------------|--------|------------|--------|
| OM 429.951 | 9970cc | 5 Cyl. | 10 Valves | 175kW/235PS | Diesel | Turbo, OHV | TD8164 |
| OM 429.953 | 9970cc | 5 Cyl. | 10 Valves | 186kW/250PS | Diesel | Turbo, OHV | TD5755 |
| OM 429.955 | 9970cc | 5 Cyl. | 10 Valves | 186kW/250PS | Diesel | Turbo, OHV | TD6088 |

V91132 442 050 03 26
59.00 x 11.95 x 142.50

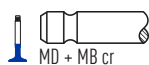

30° H

VAG92089
67.05 x 11.99 x 18.03



V91133 442 050 04 27
51.00 x 11.94 x 142.50

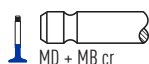

45° H

V94332 442 050 02 27
51.00 x 12.00 x 142.50

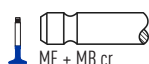

45° H

146 128.00

| | | | | | | | |
|------------|--------|--------|-----------|-------------|--------|------------|---------|
| OM 475.950 | 9973cc | 5 Cyl. | 10 Valves | 184kW/250PS | Diesel | Turbo, OHV | TD23240 |
| OM 475.951 | 9973cc | 5 Cyl. | 10 Valves | 184kW/250PS | Diesel | Turbo, OHV | TD23241 |
| OM 475.952 | 9973cc | 5 Cyl. | 10 Valves | 184kW/250PS | Diesel | Turbo, OHV | TD23242 |
| OM 475.953 | 9973cc | 5 Cyl. | 10 Valves | 184kW/250PS | Diesel | Turbo, OHV | TD23243 |
| OM 475.954 | 9973cc | 5 Cyl. | 10 Valves | 184kW/250PS | Diesel | Turbo, OHV | TD23244 |

HPN (LongNose) 05/1990→

V91132 442 050 03 26
59.00 x 11.95 x 142.50

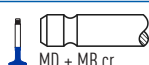

30° H

VAG92089
67.05 x 11.99 x 18.03



V91133 442 050 04 27
51.00 x 11.94 x 142.50

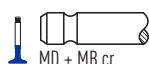

45° H

V94332 442 050 02 27
51.00 x 12.00 x 142.50

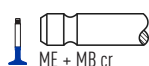

45° H

147 128.00

| | | | | | | | |
|------------|--------|--------|-----------|-------------|--------|------------|---------|
| OM 475.979 | 9973cc | 5 Cyl. | 10 Valves | 235kW/320PS | Diesel | Turbo, OHV | TD23245 |
| OM 475.982 | 9973cc | 5 Cyl. | 10 Valves | 221kW/300PS | Diesel | Turbo, OHV | TD23246 |
| OM 489.960 | 9973cc | 5 Cyl. | 10 Valves | 155kW/211PS | Diesel | Turbo, OHV | TD22820 |
| OM 489.961 | 9973cc | 5 Cyl. | 10 Valves | 184kW/250PS | Diesel | Turbo, OHV | TD22821 |

AGL (RoundNose) 05/1990→05/2005

HPN (LongNose)

05/1990→12/2002

V91132 442 050 03 26
59.00 x 11.95 x 142.50

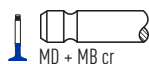

30° H

VAG92089
67.05 x 11.99 x 18.03



V94332 442 050 02 27
51.00 x 12.00 x 142.50

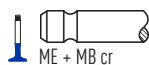

45° H



OE

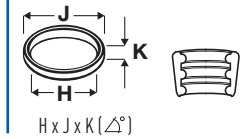
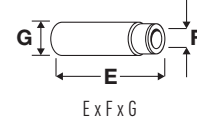









148  **128.00**

| | | | | | | | |
|------------|---------|--------|-----------|-------------|--------|-----|---------|
| OM 346.910 | 10809cc | 6 Cyl. | 12 Valves | 155kW/210PS | Diesel | OHV | TD16592 |
| OM 346.911 | 10809cc | 6 Cyl. | 12 Valves | 155kW/210PS | Diesel | OHV | TD7913 |
| OM 346.912 | 10809cc | 6 Cyl. | 12 Valves | 155kW/210PS | Diesel | OHV | TD8178 |
| OM 346.913 | 10809cc | 6 Cyl. | 12 Valves | 155kW/210PS | Diesel | OHV | TD16593 |
| OM 346.914 | 10809cc | 6 Cyl. | 12 Valves | 136kW/185PS | Diesel | OHV | TD16595 |
| OM 346.915 | 10809cc | 6 Cyl. | 12 Valves | 136kW/185PS | Diesel | OHV | TD16596 |
| OM 346.916 | 10809cc | 6 Cyl. | 12 Valves | 136kW/185PS | Diesel | OHV | TD8160 |
| OM 346.917 | 10809cc | 6 Cyl. | 12 Valves | 155kW/210PS | Diesel | OHV | TD16597 |
| OM 346.918 | 10809cc | 6 Cyl. | 12 Valves | 132kW/180PS | Diesel | OHV | TD7914 |
| OM 346.941 | 10809cc | 6 Cyl. | 12 Valves | 155kW/210PS | Diesel | OHV | TD16598 |
| OM 346.942 | 10809cc | 6 Cyl. | 12 Valves | 155kW/210PS | Diesel | OHV | TD16599 |
| OM 346.943 | 10809cc | 6 Cyl. | 12 Valves | 136kW/185PS | Diesel | OHV | TD16601 |
| OM 346.944 | 10809cc | 6 Cyl. | 12 Valves | 136kW/185PS | Diesel | OHV | TD16602 |
| OM 346.945 | 10809cc | 6 Cyl. | 12 Valves | 136kW/185PS | Diesel | OHV | TD16603 |
| OM 346.946 | 10809cc | 6 Cyl. | 12 Valves | 136kW/185PS | Diesel | OHV | TD16604 |
| OM 346.952 | 10809cc | 6 Cyl. | 12 Valves | 141kW/192PS | Diesel | OHV | TD16605 |
| OM 346.953 | 10809cc | 6 Cyl. | 12 Valves | 136kW/185PS | Diesel | OHV | TD16940 |

0 317

01/1966→01/1976









| | | | | | | | |
|--|---------------|---|-----|----|---|---|---|
| V94558  42.00 x 9.00 x 129.80 | 346 053 00 01 |  MD + MB cr | 45° | SS | H | VAG92016  67.50 x 9.02 x 15.05 |  |
| V90053  37.12 x 8.94 x 165.60 | 355 050 01 27 |  MB cr | 45° | | H | VAG92017  86.50 x 9.02 x 15.05 |  |
| V94577  37.00 x 9.00 x 165.30 | 346 053 01 05 |  MD + MB cr | 45° | | H | | |

149  **128.00**

| | | | | | | | |
|------------|---------|---------|-----------|-------------|--------|-----|--------|
| OM 421.906 | 10900cc | V6 Cyl. | 12 Valves | 159kW/216PS | Diesel | OHV | TD8120 |
|------------|---------|---------|-----------|-------------|--------|-----|--------|

NG

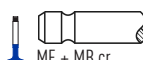
05/1982→12/1991

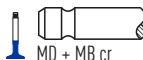
| | | | | | | | |
|--|---------------|---|-----|--|---|--|---|
| V91020  58.95 x 11.94 x 142.38 Eng.→139487 | 423 050 00 26 |  MD + MB cr | 30° | | H | VAG92089  67.05 x 11.99 x 18.03 |  |
| V91132  59.00 x 11.95 x 142.50 Eng.139488→ | 442 050 03 26 |  MD + MB cr | 30° | | H | | |
| V94332  51.00 x 12.00 x 142.50 | 442 050 02 27 |  ME + MB cr | 45° | | H | | |
| V91133  51.00 x 11.94 x 142.50 Eng.139488→ | 442 050 04 27 |  MD + MB cr | 45° | | H | | |

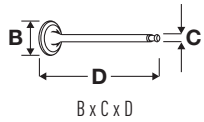

OE

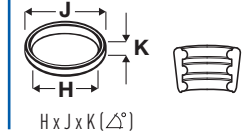
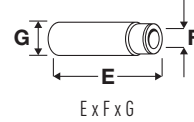
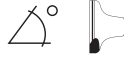

150 128.00

| | | | | | | | |
|------------|---------|---------|-----------|-------------|--------|------------|---------|
| OM 421.905 | 10964cc | V6 Cyl. | 12 Valves | 159kW/216PS | Diesel | OHV | TD5799 |
| OM 421.907 | 10964cc | V6 Cyl. | 12 Valves | 159kW/216PS | Diesel | OHV | TD6139 |
| OM 421.908 | 10964cc | V6 Cyl. | 12 Valves | 159kW/216PS | Diesel | OHV | TD7898 |
| OM 421.909 | 10964cc | V6 Cyl. | 12 Valves | 159kW/216PS | Diesel | OHV | TD17056 |
| OM 421.910 | 10964cc | V6 Cyl. | 12 Valves | 159kW/216PS | Diesel | OHV | TD16958 |
| OM 421.951 | 10964cc | V6 Cyl. | 12 Valves | 184kW/250PS | Diesel | Turbo, OHV | TD7899 |

| | | |
|-------|-----------------|-----------|
| NG | 08/1973→09/1996 | O 302 |
| O 303 | 01/1980→09/1992 | OH Series |
| | | 01/1970→ |

V91020
58.95 x 11.94 x 142.38
Eng.→139487

423 050 00 26



30°

H

VAG92089
67.05 x 11.99 x 18.03



V91132
59.00 x 11.95 x 142.50
Eng.139488→

442 050 03 26

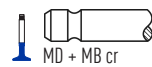

30°

H

V94332
51.00 x 12.00 x 142.50

442 050 02 27

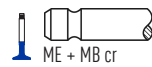

45°

H

V91133
51.00 x 11.94 x 142.50
Eng.139488→

442 050 04 27



45°

H

151 128.00

| | | | | | | | |
|------------|---------|---------|-----------|---------------------|--------|------------|---------|
| OM 441.950 | 10964cc | V6 Cyl. | 12 Valves | 191-200kW/260-272PS | Diesel | Turbo, OHV | TD5661 |
| OM 441.951 | 10964cc | V6 Cyl. | 12 Valves | 243kW/330PS | Diesel | Turbo, OHV | TD8187 |
| OM 441.953 | 10964cc | V6 Cyl. | 12 Valves | 191-200kW/260-272PS | Diesel | Turbo, OHV | TD5999 |
| OM 441.960 | 10964cc | V6 Cyl. | 12 Valves | 243-250kW/330-340PS | Diesel | Turbo, OHV | TD5772 |
| OM 441.961 | 10964cc | V6 Cyl. | 12 Valves | 250kW/340PS | Diesel | Turbo, OHV | TD16973 |
| OM 441.962 | 10964cc | V6 Cyl. | 12 Valves | 243-249kW/330-340PS | Diesel | Turbo, OHV | TD6104 |
| OM 441.980 | 10964cc | V6 Cyl. | 12 Valves | 250kW/340PS | Diesel | Turbo, OHV | TD7943 |
| OM 441.981 | 10964cc | V6 Cyl. | 12 Valves | 243-249kW/330-340PS | Diesel | Turbo, OHV | TD6103 |
| OM 441.982 | 10964cc | V6 Cyl. | 12 Valves | 250kW/340PS | Diesel | Turbo, OHV | TD5824 |
| OM 441.983 | 10964cc | V6 Cyl. | 12 Valves | 243-249kW/330-340PS | Diesel | Turbo, OHV | TD6322 |
| OM 441.985 | 10964cc | V6 Cyl. | 12 Valves | 250kW/340PS | Diesel | Turbo, OHV | TD6176 |
| OM 441.986 | 10964cc | V6 Cyl. | 12 Valves | 250kW/340PS | Diesel | Turbo, OHV | TD5779 |
| OM 441.987 | 10964cc | V6 Cyl. | 12 Valves | 250kW/340PS | Diesel | Turbo, OHV | TD5782 |
| OM 441.988 | 10964cc | V6 Cyl. | 12 Valves | 250kW/340PS | Diesel | Turbo, OHV | TD5825 |
| OM 441.989 | 10964cc | V6 Cyl. | 12 Valves | 250kW/340PS | Diesel | Turbo, OHV | TD5736 |
| OM 441.990 | 10964cc | V6 Cyl. | 12 Valves | 250kW/340PS | Diesel | Turbo, OHV | TD6177 |
| OM 441.991 | 10964cc | V6 Cyl. | 12 Valves | 250kW/340PS | Diesel | Turbo, OHV | TD6118 |
| OM 441.992 | 10964cc | V6 Cyl. | 12 Valves | 250kW/340PS | Diesel | Turbo, OHV | TD6302 |
| OM 441.993 | 10964cc | V6 Cyl. | 12 Valves | 250kW/340PS | Diesel | Turbo, OHV | TD6069 |
| OM 441.994 | 10964cc | V6 Cyl. | 12 Valves | 250kW/340PS | Diesel | Turbo, OHV | TD16974 |
| OM 441.995 | 10964cc | V6 Cyl. | 12 Valves | 250kW/340PS | Diesel | Turbo, OHV | TD16975 |
| OM 441.996 | 10964cc | V6 Cyl. | 12 Valves | 250kW/340PS | Diesel | Turbo, OHV | TD6116 |
| OM 441.997 | 10964cc | V6 Cyl. | 12 Valves | 230kW/313PS | Diesel | Turbo, OHV | TD16976 |
| OM 441.998 | 10964cc | V6 Cyl. | 12 Valves | 230kW/313PS | Diesel | Turbo, OHV | TD8222 |
| OM 441.999 | 10964cc | V6 Cyl. | 12 Valves | 250kW/340PS | Diesel | Turbo, OHV | TD16977 |
| OM 445.920 | 10964cc | V6 Cyl. | 12 Valves | 250kW/340PS | Diesel | Turbo, OHV | TD5781 |
| OM 445.921 | 10964cc | V6 Cyl. | 12 Valves | 250kW/340PS | Diesel | Turbo, OHV | TD8200 |



OE

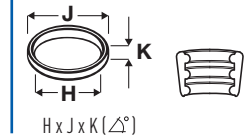
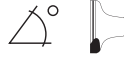

| | | | | | | | |
|------------|---------|---------|-----------|-------------|--------|------------|---------|
| OM 445.922 | 10964cc | V6 Cyl. | 12 Valves | 250kW/340PS | Diesel | Turbo, OHV | TD8252 |
| OM 445.923 | 10964cc | V6 Cyl. | 12 Valves | 250kW/340PS | Diesel | Turbo, OHV | TD5737 |
| OM 445.924 | 10964cc | V6 Cyl. | 12 Valves | 180kW/245PS | Diesel | Turbo, OHV | TD5754 |
| OM 445.925 | 10964cc | V6 Cyl. | 12 Valves | 180kW/245PS | Diesel | Turbo, OHV | TD8197 |
| OM 445.926 | 10964cc | V6 Cyl. | 12 Valves | 200kW/272PS | Diesel | Turbo, OHV | TD5776 |
| OM 445.927 | 10964cc | V6 Cyl. | 12 Valves | 200kW/272PS | Diesel | Turbo, OHV | TD8235 |
| OM 445.929 | 10964cc | V6 Cyl. | 12 Valves | 230kW/313PS | Diesel | Turbo, OHV | TD5778 |
| OM 445.930 | 10964cc | V6 Cyl. | 12 Valves | 230kW/313PS | Diesel | Turbo, OHV | TD6164 |
| OM 445.931 | 10964cc | V6 Cyl. | 12 Valves | 230kW/313PS | Diesel | Turbo, OHV | TD6298 |
| OM 445.933 | 10964cc | V6 Cyl. | 12 Valves | 200kW/272PS | Diesel | Turbo, OHV | TD6070 |
| OM 445.934 | 10964cc | V6 Cyl. | 12 Valves | 250kW/340PS | Diesel | Turbo, OHV | TD10969 |
| OM 445.935 | 10964cc | V6 Cyl. | 12 Valves | 213kW/290PS | Diesel | Turbo, OHV | TD10970 |
| OM 445.936 | 10964cc | V6 Cyl. | 12 Valves | 200kW/272PS | Diesel | Turbo, OHV | TD6109 |
| OM 445.937 | 10964cc | V6 Cyl. | 12 Valves | 230kW/313PS | Diesel | Turbo, OHV | TD6112 |
| OM 445.938 | 10964cc | V6 Cyl. | 12 Valves | 180kW/245PS | Diesel | Turbo, OHV | TD6087 |
| OM 445.939 | 10964cc | V6 Cyl. | 12 Valves | 250kW/340PS | Diesel | Turbo, OHV | TD6117 |
| OM 445.940 | 10964cc | V6 Cyl. | 12 Valves | 200kW/272PS | Diesel | Turbo, OHV | TD6148 |
| OM 445.941 | 10964cc | V6 Cyl. | 12 Valves | 180kW/245PS | Diesel | Turbo, OHV | TD6288 |
| OM 481.902 | 10964cc | V6 Cyl. | 12 Valves | 159kW/216PS | Diesel | OHV | TD17814 |
| OM 481.904 | 10964cc | V6 Cyl. | 12 Valves | 159kW/216PS | Diesel | OHV | TD17815 |

| | | | |
|------------------|-----------------|------------|-----------------|
| MK | 12/1987→09/1996 | O 302 | |
| O 303 | 11/1985→09/1992 | O 304 | |
| O 340 | 01/1991→06/1995 | O 403 | 01/2003→ |
| O 404 | 09/1991→10/1999 | OH Series | 01/1970→ |
| Series 300 | 09/1991→ | SK | 07/1987→09/1996 |
| TOURISMO (O 350) | 08/1995→ | TransLiner | 12/1988→ |

| | | | | | |
|---|---------------|-----|---|--|--|
| V91132 ■ 59.00 x 11.95 x 142.50 | 442 050 03 26 | 30° | H | VAG92089 ■ ■ ■ 67.05 x 11.99 x 18.03 | |
| V91133 ■ 51.00 x 11.94 x 142.50 | 442 050 04 27 | 45° | H | | |
| V94332 ■ 51.00 x 12.00 x 142.50 | 442 050 02 27 | 45° | H | | |

152 128.00

| | | | | | | | |
|----------------|-----------------|--------|-----------|-------------|--------|------------|---------|
| OM 345.913 | 11581cc | 6 Cyl. | 12 Valves | 210kW/286PS | Diesel | Turbo, OHV | TD28601 |
| HPN (LongNose) | 04/1983→04/1998 | | | | | | |

| | | | | | |
|--|---------------|-----|--|--|--|
| V90048 ■ 37.00 x 8.94 x 165.90 | 355 053 00 05 | 30° | | | |
|--|---------------|-----|--|--|--|

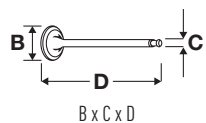

OE

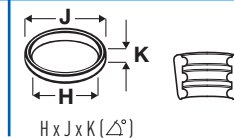
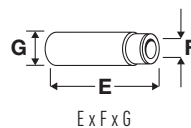

153 128.00

| | | | | | | | |
|------------|---------|--------|-----------|-------------|--------|-----|---------|
| OM 355.910 | 11581cc | 6 Cyl. | 24 Valves | 169kW/230PS | Diesel | OHV | TD16668 |
| OM 355.911 | 11581cc | 6 Cyl. | 24 Valves | 169kW/230PS | Diesel | OHV | TD16669 |
| OM 355.912 | 11581cc | 6 Cyl. | 24 Valves | 169kW/230PS | Diesel | OHV | TD16670 |
| OM 355.913 | 11581cc | 6 Cyl. | 24 Valves | 169kW/230PS | Diesel | OHV | TD16671 |
| OM 355.914 | 11581cc | 6 Cyl. | 24 Valves | 169kW/230PS | Diesel | OHV | TD16672 |
| OM 355.915 | 11581cc | 6 Cyl. | 24 Valves | 169kW/230PS | Diesel | OHV | TD7892 |
| OM 355.916 | 11581cc | 6 Cyl. | 12 Valves | 169kW/230PS | Diesel | OHV | TD22746 |
| OM 355.918 | 11581cc | 6 Cyl. | 24 Valves | 169kW/230PS | Diesel | OHV | TD16673 |
| OM 355.960 | 11581cc | 6 Cyl. | 24 Valves | 176kW/240PS | Diesel | OHV | TD5813 |
| OM 355.961 | 11581cc | 6 Cyl. | 24 Valves | 155kW/210PS | Diesel | OHV | TD16675 |
| OM 355.962 | 11581cc | 6 Cyl. | 24 Valves | 177kW/240PS | Diesel | OHV | TD16676 |
| OM 355.963 | 11581cc | 6 Cyl. | 24 Valves | 176kW/240PS | Diesel | OHV | TD5812 |
| OM 355.964 | 11581cc | 6 Cyl. | 24 Valves | 177kW/240PS | Diesel | OHV | TD16677 |
| OM 355.966 | 11581cc | 6 Cyl. | 24 Valves | 155kW/210PS | Diesel | OHV | TD16678 |
| OM 355.967 | 11581cc | 6 Cyl. | 24 Valves | 177kW/240PS | Diesel | OHV | TD7893 |
| OM 355.970 | 11581cc | 6 Cyl. | 24 Valves | 191kW/260PS | Diesel | OHV | TD16679 |
| OM 355.972 | 11581cc | 6 Cyl. | 24 Valves | 136kW/185PS | Diesel | OHV | TD16680 |
| OM 355.973 | 11581cc | 6 Cyl. | 24 Valves | 177kW/240PS | Diesel | OHV | TD16681 |
| OM 355.974 | 11581cc | 6 Cyl. | 24 Valves | 177kW/240PS | Diesel | OHV | TD16682 |
| OM 355.975 | 11581cc | 6 Cyl. | 24 Valves | 176kW/240PS | Diesel | OHV | TD6160 |
| OM 355.976 | 11581cc | 6 Cyl. | 24 Valves | 176kW/240PS | Diesel | OHV | TD6159 |
| OM 355.978 | 11581cc | 6 Cyl. | 24 Valves | 177kW/240PS | Diesel | OHV | TD16684 |
| OM 355.979 | 11581cc | 6 Cyl. | 24 Valves | 177kW/240PS | Diesel | OHV | TD16685 |
| OM 355.980 | 11581cc | 6 Cyl. | 24 Valves | 177kW/240PS | Diesel | OHV | TD16686 |
| OM 355.981 | 11581cc | 6 Cyl. | 24 Valves | 184kW/250PS | Diesel | OHV | TD16687 |
| OM 355.982 | 11581cc | 6 Cyl. | 24 Valves | 184kW/250PS | Diesel | OHV | TD16674 |
| OM 355.983 | 11581cc | 6 Cyl. | 24 Valves | 177kW/240PS | Diesel | OHV | TD5811 |
| OM 355.984 | 11581cc | 6 Cyl. | 24 Valves | 177kW/240PS | Diesel | OHV | TD6158 |

HPN (LongNose) 01/1976→12/1983 T2/L

| | | | | | | | |
|-----------------------|---------------|------------|-----|----|---|----------------------|--|
| V94558 | 346 053 00 01 | | 45° | ss | H | VAG92016 | |
| 42.00 x 9.00 x 129.80 | | MD + MB cr | | | | 67.50 x 9.02 x 15.05 | |
| V90053 | 355 050 01 27 | | 45° | | H | VAG92017 | |
| 37.12 x 8.94 x 165.60 | | MB cr | | | | 86.50 x 9.02 x 15.05 | |
| V94577 | 346 053 01 05 | | 45° | | H | | |
| 37.00 x 9.00 x 165.30 | | MD + MB cr | | | | | |

154 128.00

| | | | | | | | |
|------------|---------|--------|-----------|-------------|--------|------------|---------|
| OM 355.968 | 11581cc | 6 Cyl. | 12 Valves | 191kW/260PS | Diesel | OHV | TD23185 |
| OM 355.969 | 11581cc | 6 Cyl. | 24 Valves | 206kW/280PS | Diesel | Turbo, OHV | TD8212 |
| OM 355.977 | 11581cc | 6 Cyl. | 24 Valves | 205kW/275PS | Diesel | Turbo, OHV | TD16683 |

T2/L

| | | | | | | | |
|-----------------------|---------------|------------|-----|----|---|----------------------|--|
| V94558 | 346 053 00 01 | | 45° | ss | H | VAG92016 | |
| 42.00 x 9.00 x 129.80 | | MD + MB cr | | | | 67.50 x 9.02 x 15.05 | |
| V90048 | 355 053 00 05 | | 30° | | | VAG92017 | |
| 37.00 x 8.94 x 165.90 | | MD cr | | | | 86.50 x 9.02 x 15.05 | |



OE

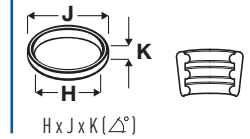
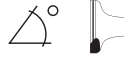

155 128.00

| | | | | | | | |
|------------|---------|--------|-----------|---------------------|--------|----------------|---------|
| OM 427.905 | 11967cc | 6 Cyl. | 12 Valves | 150kW/204PS | Diesel | OHV | TD7951 |
| OM 427.910 | 11967cc | 6 Cyl. | 12 Valves | 177kW/240PS | Diesel | OHV | TD5671 |
| OM 427.911 | 11967cc | 6 Cyl. | 12 Valves | 177kW/240PS | Diesel | OHV | TD6010 |
| OM 427.950 | 11967cc | 6 Cyl. | 12 Valves | 206kW/280PS | Diesel | Turbo, OHV | TD7946 |
| OM 427.951 | 11967cc | 6 Cyl. | 12 Valves | 206kW/280PS | Diesel | Turbo, OHV | TD16964 |
| OM 427.952 | 11967cc | 6 Cyl. | 12 Valves | 206kW/280PS | Diesel | Turbo, OHV | TD16965 |
| OM 447.905 | 11967cc | 6 Cyl. | 12 Valves | 150-177kW/204-241PS | Diesel | OHV | TD7947 |
| OM 447.906 | 11967cc | 6 Cyl. | 12 Valves | 177-184kW/240-250PS | Diesel | OHV | TD5674 |
| OM 447.907 | 11967cc | 6 Cyl. | 12 Valves | 177-184kW/240-250PS | Diesel | OHV | TD5672 |
| OM 447.908 | 11967cc | 6 Cyl. | 12 Valves | 177-184kW/240-250PS | Diesel | OHV | TD6011 |
| OM 447.910 | 11967cc | 6 Cyl. | 12 Valves | 177-184kW/240-250PS | Diesel | OHV | TD7956 |
| OM 447.911 | 11967cc | 6 Cyl. | 12 Valves | 150-157kW/204-214PS | Diesel | OHV | TD7957 |
| OM 447.913 | 11967cc | 6 Cyl. | 12 Valves | 150-157kW/204-214PS | Diesel | OHV | TD7948 |
| OM 447.914 | 11967cc | 6 Cyl. | 12 Valves | 150-157kW/204-214PS | Diesel | OHV | TD7958 |
| OM 447.915 | 11967cc | 6 Cyl. | 12 Valves | 185kW/252PS | Diesel | OHV, Injection | TD16986 |
| OM 447.916 | 11967cc | 6 Cyl. | 12 Valves | 185kW/252PS | Petrol | OHV | TD16987 |
| OM 447.950 | 11967cc | 6 Cyl. | 12 Valves | 206kW/280PS | Diesel | Turbo, OHV | TD5673 |
| OM 447.951 | 11967cc | 6 Cyl. | 12 Valves | 206kW/280PS | Diesel | Turbo, OHV | TD6012 |
| OM 447.952 | 11967cc | 6 Cyl. | 12 Valves | 206kW/280PS | Diesel | Turbo, OHV | TD16988 |
| OM 447.953 | 11967cc | 6 Cyl. | 12 Valves | 206kW/280PS | Diesel | Turbo, OHV | TD16989 |
| OM 447.980 | 11967cc | 6 Cyl. | 12 Valves | 220kW/299PS | Diesel | Turbo, OHV | TD11008 |
| OM 447.981 | 11967cc | 6 Cyl. | 12 Valves | 220kW/300PS | Diesel | Turbo, OHV | TD7950 |
| OM 447.982 | 11967cc | 6 Cyl. | 12 Valves | 220kW/300PS | Diesel | Turbo, OHV | TD17811 |
| OM 447.983 | 11967cc | 6 Cyl. | 12 Valves | 220kW/300PS | Diesel | Turbo, OHV | TD17812 |
| OM 447.985 | 11967cc | 6 Cyl. | 12 Valves | 220kW/299PS | Diesel | Turbo, OHV | TD10986 |
| OM 447.986 | 11967cc | 6 Cyl. | 12 Valves | 220kW/300PS | Diesel | Turbo, OHV | TD7960 |

| | | | |
|-------|-----------------|-------|-----------------|
| 0 405 | 12/1984→ | 0 407 | 03/1987→11/2001 |
| 0 408 | 01/1991→12/1998 | | |

V91132
59.00 x 11.95 x 142.50
Eng.001400→

442 050 03 26



30°

H

VAG92089
67.05 x 11.99 x 18.03



V94332
51.00 x 12.00 x 142.50
Eng.→001399

442 050 02 27



45°

H

V91133
51.00 x 11.94 x 142.50
Eng.001400→

442 050 04 27



45°

H

156 128.00

| | | | | | | | |
|------------|---------|--------|-----------|-------------|--------|------------|---------|
| OM 447.912 | 11967cc | 6 Cyl. | 12 Valves | 184kW/250PS | Diesel | OHV | TD7961 |
| OM 447.947 | 11967cc | 6 Cyl. | 12 Valves | 220kW/299PS | Diesel | Turbo, OHV | TD22805 |
| OM 447.954 | 11967cc | 6 Cyl. | 12 Valves | 184kW/250PS | Diesel | Turbo, OHV | TD10976 |
| OM 447.955 | 11967cc | 6 Cyl. | 12 Valves | 184kW/250PS | Diesel | Turbo, OHV | TD10977 |
| OM 447.956 | 11967cc | 6 Cyl. | 12 Valves | 184kW/250PS | Diesel | Turbo, OHV | TD7949 |
| OM 447.957 | 11967cc | 6 Cyl. | 12 Valves | 184kW/250PS | Diesel | Turbo, OHV | TD7959 |
| OM 447.958 | 11967cc | 6 Cyl. | 12 Valves | 184kW/250PS | Diesel | Turbo, OHV | TD7962 |
| OM 447.959 | 11967cc | 6 Cyl. | 12 Valves | 184kW/250PS | Diesel | Turbo, OHV | TD7954 |
| OM 447.960 | 11967cc | 6 Cyl. | 12 Valves | 184kW/250PS | Diesel | Turbo, OHV | TD22808 |

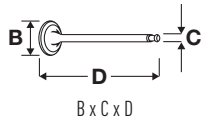

OE

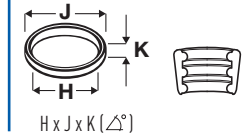
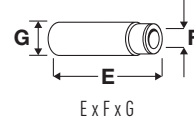

| | | | | | | | |
|------------|---------|--------|-----------|---------------------|--------|------------|---------|
| OM 447.968 | 11967cc | 6 Cyl. | 12 Valves | 235kW/320PS | Diesel | Turbo, OHV | TD22809 |
| OM 447.970 | 11967cc | 6 Cyl. | 12 Valves | 157kW/214PS | Diesel | Turbo, OHV | TD10978 |
| OM 447.971 | 11967cc | 6 Cyl. | 12 Valves | 184kW/250PS | Diesel | Turbo, OHV | TD10979 |
| OM 447.972 | 11967cc | 6 Cyl. | 12 Valves | 220kW/299PS | Diesel | Turbo, OHV | TD10980 |
| OM 447.973 | 11967cc | 6 Cyl. | 12 Valves | 157kW/214PS | Diesel | Turbo, OHV | TD10981 |
| OM 447.974 | 11967cc | 6 Cyl. | 12 Valves | 184kW/250PS | Diesel | Turbo, OHV | TD10982 |
| OM 447.975 | 11967cc | 6 Cyl. | 12 Valves | 220kW/299PS | Diesel | Turbo, OHV | TD11007 |
| OM 447.976 | 11967cc | 6 Cyl. | 12 Valves | 184kW/250PS | Diesel | Turbo, OHV | TD10983 |
| OM 447.977 | 11967cc | 6 Cyl. | 12 Valves | 220kW/299PS | Diesel | Turbo, OHV | TD11009 |
| OM 447.978 | 11967cc | 6 Cyl. | 12 Valves | 184kW/250PS | Diesel | Turbo, OHV | TD10984 |
| OM 447.979 | 11967cc | 6 Cyl. | 12 Valves | 220kW/299PS | Diesel | Turbo, OHV | TD10985 |
| OM 447.984 | 11967cc | 6 Cyl. | 12 Valves | 220kW/300PS | Diesel | Turbo, OHV | TD7955 |
| OM 447.987 | 11967cc | 6 Cyl. | 12 Valves | 220kW/300PS | Diesel | Turbo, OHV | TD7963 |
| OM 447.988 | 11967cc | 6 Cyl. | 12 Valves | 220kW/300PS | Diesel | Turbo, OHV | TD16990 |
| OM 447.990 | 11967cc | 6 Cyl. | 12 Valves | 184kW/250PS | Diesel | Turbo, OHV | TD10987 |
| OM 447.991 | 11967cc | 6 Cyl. | 12 Valves | 220kW/299PS | Diesel | Turbo, OHV | TD10988 |
| OM 447.992 | 11967cc | 6 Cyl. | 12 Valves | 184kW/250PS | Diesel | Turbo, OHV | TD10989 |
| OM 447.993 | 11967cc | 6 Cyl. | 12 Valves | 220kW/299PS | Diesel | Turbo, OHV | TD10990 |
| OM 447.994 | 11967cc | 6 Cyl. | 12 Valves | 220kW/299PS | Diesel | Turbo, OHV | TD16991 |
| OM 447.995 | 11967cc | 6 Cyl. | 12 Valves | 184kW/250PS | Diesel | Turbo, OHV | TD17813 |
| OM 447.996 | 11967cc | 6 Cyl. | 12 Valves | 184kW/250PS | Diesel | Turbo, OHV | TD22810 |
| OM 447.998 | 11967cc | 6 Cyl. | 12 Valves | 220kW/299PS | Diesel | Turbo, OHV | TD11010 |
| OM 447.999 | 11967cc | 6 Cyl. | 12 Valves | 220kW/299PS | Diesel | Turbo, OHV | TD23187 |
| OM 476.916 | 11967cc | 6 Cyl. | 12 Valves | 213-246kW/290-335PS | Diesel | Turbo, OHV | TD23807 |
| OM 476.917 | 11967cc | 6 Cyl. | 12 Valves | 287-310kW/390-422PS | Diesel | Turbo, OHV | TD23806 |
| OM 476.950 | 11967cc | 6 Cyl. | 12 Valves | 215kW/292PS | Diesel | Turbo, OHV | TD23809 |
| OM 476.971 | 11967cc | 6 Cyl. | 12 Valves | 264kW/359PS | Diesel | Turbo, OHV | TD23227 |
| OM 476.972 | 11967cc | 6 Cyl. | 12 Valves | 264kW/359PS | Diesel | Turbo, OHV | TD23228 |
| OM 476.973 | 11967cc | 6 Cyl. | 12 Valves | 264kW/359PS | Diesel | Turbo, OHV | TD23229 |
| OM 476.977 | 11967cc | 6 Cyl. | 12 Valves | 264kW/359PS | Diesel | Turbo, OHV | TD23230 |
| OM 476.978 | 11967cc | 6 Cyl. | 12 Valves | 264kW/359PS | Diesel | Turbo, OHV | TD23231 |
| OM 476.979 | 11967cc | 6 Cyl. | 12 Valves | 264kW/359PS | Diesel | Turbo, OHV | TD23232 |
| OM 476.980 | 11967cc | 6 Cyl. | 12 Valves | 257kW/350PS | Diesel | Turbo, OHV | TD23233 |
| OM 476.981 | 11967cc | 6 Cyl. | 12 Valves | 257kW/350PS | Diesel | Turbo, OHV | TD23234 |
| OM 476.982 | 11967cc | 6 Cyl. | 12 Valves | 257kW/350PS | Diesel | Turbo, OHV | TD23235 |
| OM 476.983 | 11967cc | 6 Cyl. | 12 Valves | 257-260kW/350-354PS | Diesel | Turbo, OHV | TD23236 |
| OM 476.988 | 11967cc | 6 Cyl. | 12 Valves | 257kW/350PS | Diesel | Turbo, OHV | TD23238 |
| OM 476.991 | 11967cc | 6 Cyl. | 12 Valves | 257kW/350PS | Diesel | Turbo, OHV | TD23239 |
| OM 476.992 | 11967cc | 6 Cyl. | 12 Valves | 257kW/350PS | Diesel | Turbo, OHV | TD23805 |

AGL (RoundNose)
O 405
O 408

09/1992→09/2002
12/1984→
01/1991→12/1998

HPN (LongNose)
O 407

05/1990→05/2000
03/1987→11/2001

V91132 ■
59.00 x 11.95 x 142.50

442 050 03 26

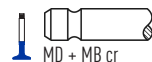

30°

H

VAG92089 ■ ■
67.05 x 11.99 x 18.03



V91133 ■
51.00 x 11.94 x 142.50

442 050 04 27

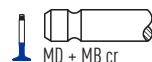

45°

H

V94332 ■
51.00 x 12.00 x 142.50

442 050 02 27



45°

H



OE

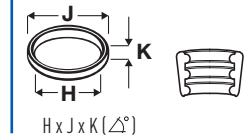
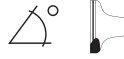

157 **128.00**

| | | | | | | | |
|------------|---------|--------|-----------|-------------|--------|------------|---------|
| OM 447.948 | 11967cc | 6 Cyl. | 12 Valves | 220kW/299PS | Diesel | Turbo, OHV | TD22806 |
| OM 447.949 | 11967cc | 6 Cyl. | 12 Valves | 157kW/214PS | Diesel | Turbo, OHV | TD22807 |
| OM 476.985 | 11967cc | 6 Cyl. | 12 Valves | 261kW/355PS | Diesel | Turbo, OHV | TD23237 |

CONECTO (0 345)

11/2001→

V91132
59.00 x 11.95 x 142.50

442 050 03 26



30°

H

VAG92089
67.05 x 11.99 x 18.03

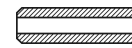

V94332
51.00 x 12.00 x 142.50

442 050 02 27



45°

H

158 **128.00**

| | | | | | | | |
|------------|---------|--------|-----------|---------------------|--------|------------|---------|
| OM 457.914 | 11967cc | 6 Cyl. | 24 Valves | 250kW/340PS | Diesel | Turbo, OHV | TD20335 |
| OM 457.915 | 11967cc | 6 Cyl. | 24 Valves | 265kW/360PS | Diesel | Turbo, OHV | TD20303 |
| OM 457.916 | 11967cc | 6 Cyl. | 24 Valves | 265kW/360PS | Diesel | Turbo, OHV | TD20304 |
| OM 457.917 | 11967cc | 6 Cyl. | 24 Valves | 260-315kW/354-428PS | Diesel | Turbo, OHV | TD20324 |
| OM 457.918 | 11967cc | 6 Cyl. | 24 Valves | 260-315kW/354-428PS | Diesel | Turbo, OHV | TD20305 |
| OM 457.919 | 11967cc | 6 Cyl. | 24 Valves | 315kW/428PS | Diesel | Turbo, OHV | TD20306 |
| OM 457.920 | 11967cc | 6 Cyl. | 24 Valves | 280kW/381PS | Diesel | Turbo, OHV | TD20307 |
| OM 457.922 | 11967cc | 6 Cyl. | 24 Valves | 320-325kW/435-442PS | Diesel | Turbo, OHV | TD20308 |
| OM 457.923 | 11967cc | 6 Cyl. | 24 Valves | 280kW/381PS | Diesel | Turbo, OHV | TD20309 |
| OM 457.924 | 11967cc | 6 Cyl. | 24 Valves | 280kW/381PS | Diesel | Turbo, OHV | TD20310 |
| OM 457.925 | 11967cc | 6 Cyl. | 24 Valves | 265kW/360PS | Diesel | Turbo, OHV | TD20311 |
| OM 457.926 | 11967cc | 6 Cyl. | 24 Valves | 265kW/360PS | Diesel | Turbo, OHV | TD20312 |
| OM 457.927 | 11967cc | 6 Cyl. | 24 Valves | 295kW/401PS | Diesel | Turbo, OHV | TD20336 |
| OM 457.928 | 11967cc | 6 Cyl. | 24 Valves | 280kW/381PS | Diesel | Turbo, OHV | TD20313 |
| OM 457.929 | 11967cc | 6 Cyl. | 24 Valves | 265kW/360PS | Diesel | Turbo, OHV | TD20314 |
| OM 457.931 | 11967cc | 6 Cyl. | 24 Valves | 280kW/381PS | Diesel | Turbo, OHV | TD20315 |
| OM 457.932 | 11967cc | 6 Cyl. | 24 Valves | 265kW/360PS | Diesel | Turbo, OHV | TD20316 |
| OM 457.933 | 11967cc | 6 Cyl. | 24 Valves | 260kW/354PS | Diesel | Turbo, OHV | TD17662 |
| OM 457.934 | 11967cc | 6 Cyl. | 24 Valves | 220kW/299PS | Diesel | Turbo, OHV | TD17473 |
| OM 457.935 | 11967cc | 6 Cyl. | 24 Valves | 185kW/252PS | Diesel | Turbo, OHV | TD17502 |
| OM 457.936 | 11967cc | 6 Cyl. | 24 Valves | 300kW/408PS | Diesel | Turbo, OHV | TD17653 |
| OM 457.937 | 11967cc | 6 Cyl. | 24 Valves | 260-315kW/354-428PS | Diesel | Turbo, OHV | TD16489 |
| OM 457.938 | 11967cc | 6 Cyl. | 24 Valves | 300kW/408PS | Diesel | Turbo, OHV | TD17645 |
| OM 457.939 | 11967cc | 6 Cyl. | 24 Valves | 260kW/354PS | Diesel | Turbo, OHV | TD20317 |
| OM 457.940 | 11967cc | 6 Cyl. | 24 Valves | 260kW/354PS | Diesel | Turbo, OHV | TD17654 |
| OM 457.941 | 11967cc | 6 Cyl. | 24 Valves | 185-300kW/252-408PS | Diesel | Turbo, OHV | TD17641 |
| OM 457.942 | 11967cc | 6 Cyl. | 24 Valves | 185-260kW/252-354PS | Diesel | Turbo, OHV | TD17448 |
| OM 457.943 | 11967cc | 6 Cyl. | 24 Valves | 185-260kW/252-354PS | Diesel | Turbo, OHV | TD17666 |
| OM 457.944 | 11967cc | 6 Cyl. | 24 Valves | 260-310kW/354-422PS | Diesel | Turbo, OHV | TD17644 |
| OM 457.945 | 11967cc | 6 Cyl. | 24 Valves | 260kW/354PS | Diesel | Turbo, OHV | TD20318 |
| OM 457.946 | 11967cc | 6 Cyl. | 24 Valves | 220kW/299PS | Diesel | Turbo, OHV | TD20319 |
| OM 457.947 | 11967cc | 6 Cyl. | 24 Valves | 260-315kW/354-428PS | Diesel | Turbo, OHV | TD20320 |
| OM 457.948 | 11967cc | 6 Cyl. | 24 Valves | 260-315kW/354-428PS | Diesel | Turbo, OHV | TD20227 |
| OM 457.949 | 11967cc | 6 Cyl. | 24 Valves | 220kW/299PS | Diesel | Turbo, OHV | TD20321 |
| OM 457.950 | 11967cc | 6 Cyl. | 24 Valves | 220-260kW/299-354PS | Diesel | Turbo, OHV | TD20337 |
| OM 457.951 | 11967cc | 6 Cyl. | 24 Valves | 260kW/354PS | Diesel | Turbo, OHV | TD23250 |
| OM 457.952 | 11967cc | 6 Cyl. | 24 Valves | 220-300kW/299-408PS | Diesel | Turbo, OHV | TD20338 |

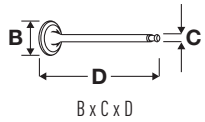

OE

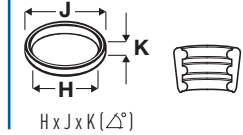
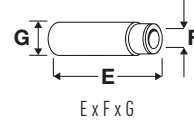
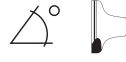

| | | | | | | | |
|-------------------|---------|--------|------------------|---------------------|--------|-------------------|----------------|
| OM 457.953 | 11967cc | 6 Cyl. | 24 Valves | 260-315kW/354-428PS | Diesel | Turbo, OHV | TD23251 |
| OM 457.954 | 11967cc | 6 Cyl. | 24 Valves | 220-260kW/299-354PS | Diesel | Turbo, OHV | TD20339 |
| OM 457.955 | 11967cc | 6 Cyl. | 24 Valves | 260-315kW/354-428PS | Diesel | Turbo, OHV | TD20323 |
| OM 457.956 | 11967cc | 6 Cyl. | 24 Valves | 260-315kW/354-428PS | Diesel | Turbo, OHV | TD20282 |
| OM 457.957 | 11967cc | 6 Cyl. | 24 Valves | 260-315kW/354-428PS | Diesel | Turbo, OHV | TD20283 |
| OM 457.959 | 11967cc | 6 Cyl. | 24 Valves | 220-260kW/299-354PS | Diesel | Turbo, OHV | TD20341 |
| OM 457.960 | 11967cc | 6 Cyl. | 24 Valves | 260-315kW/354-428PS | Diesel | Turbo, OHV | TD20322 |
| OM 457.961 | 11967cc | 6 Cyl. | 24 Valves | 260-355kW/354-483PS | Diesel | Turbo, OHV | TD23252 |
| OM 457.964 | 11967cc | 6 Cyl. | 24 Valves | 220-260kW/299-408PS | Diesel | Turbo, OHV | TD23247 |
| OM 457.965 | 11967cc | 6 Cyl. | 24 Valves | 220-300kW/299-408PS | Diesel | Turbo, OHV | TD23248 |
| OM 458.960 | 11967cc | 6 Cyl. | 24 Valves | 260kW/354PS | Diesel | Turbo, OHV | TD17668 |
| OM 458.970 | 11967cc | 6 Cyl. | 24 Valves | 295kW/401PS | Diesel | Turbo, OHV | TD17669 |
| OM 458.980 | 11967cc | 6 Cyl. | 24 Valves | 335kW/456PS | Diesel | Turbo, OHV | TD17670 |

| | | | |
|-----------------|-----------------|---------------------|-----------------|
| AGL (RoundNose) | 08/1998→12/2005 | AXOR | 01/2002→10/2004 |
| AXOR 2 | 10/2004→ | CAPACITY (O 530 GL) | 04/2007→ |
| CITARO (O 530) | 01/1998→ | CONECTO (O 345) | 11/2001→ |
| HPN (LongNose) | 09/1992→ | INTEGRO (O 550) | 01/2006→ |
| INTOURO | 01/2005→ | O 403 | 09/2003→ |
| Series 400 | 10/2001→ | TOURISMO (O 350) | 01/2003→ |
| TOURO (O 500) | 01/2001→ | TRAVEGO (O 580) | 10/1999→ |

| | | | | | | | |
|-----------------------|---------------|--|------------|-----|---|-----------------------|--|
| V94316 ■ | 541 050 02 26 | | | 30° | H | VAG96134 ■ ■ ■ | |
| 45.70 x 9.00 x 145.00 | | | MD + MB cr | | | 61.00 x 9.02 x 15.07 | |
| V94317 ■ | 541 050 02 27 | | | 45° | H | VAG96135 ■ ■ ■ | |
| 41.10 x 9.00 x 145.00 | | | MD + MB cr | | | 61.00 x 9.00 x 15.20 | |

159 128.00

| | | | | | | | |
|-------------------|---------|--------|------------------|---------------------|--------|-------------------|----------------|
| OM 457.958 | 11967cc | 6 Cyl. | 24 Valves | 230-315kW/313-428PS | Diesel | Turbo, OHV | TD20340 |
| OM 457.962 | 11967cc | 6 Cyl. | 24 Valves | 260-315kW/354-428PS | Diesel | Turbo, OHV | TD23253 |
| OM 457.966 | 11967cc | 6 Cyl. | 24 Valves | 220-260kW/299-354PS | Diesel | Turbo, OHV | TD23249 |

| | | | | | | | |
|-----------------------|-----------------|--|------------|-----|---|-----------------------|--|
| AXOR 2 | 09/2008→ | | | | | | |
| V94316 ■ | 541 050 02 26 | | | 30° | H | VAG96134 ■ ■ ■ | |
| 45.70 x 9.00 x 145.00 | | | MD + MB cr | | | 61.00 x 9.02 x 15.07 | |
| V95174 ■ | 541 053 01 01 | | | 30° | H | VAG96135 ■ ■ ■ | |
| 45.45 x 8.94 x 144.90 | | | MB cr | | | 61.00 x 9.00 x 15.20 | |
| V94317 ■ | 541 050 02 27 | | | 45° | H | | |
| 41.10 x 9.00 x 145.00 | | | MD + MB cr | | | | |
| V95175 ■ | A 457 050 03 27 | | | 36° | H | | |
| 42.10 x 8.93 x 144.80 | | | MD + MB cr | | | | |

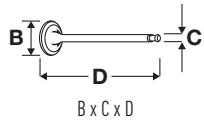

OE



MAT.

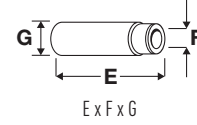
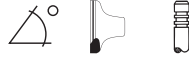

E x F x G

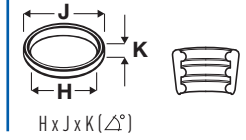

H x J x K (Δ°)

160  **128.00**

| | | | | | | | |
|------------|---------|--------|-----------|---------------------|--------|------------|---------|
| OM 457.974 | 11967cc | 6 Cyl. | 24 Valves | 220-300kW/299-408PS | Diesel | Turbo, OHV | TD28728 |
| OM 457.976 | 11967cc | 6 Cyl. | 24 Valves | 260-335kW/354-456PS | Diesel | Turbo, OHV | TD28729 |
| OM 457.977 | 11967cc | 6 Cyl. | 24 Valves | 220-260kW/299-354PS | Diesel | Turbo, OHV | TD28730 |
| OM 457.980 | 11967cc | 6 Cyl. | 24 Valves | 260-315kW/354-428PS | Diesel | Turbo, OHV | TD25446 |
| OM 458.990 | 11967cc | 6 Cyl. | 24 Valves | 220-260kW/299-354PS | Diesel | Turbo, OHV | TD28731 |
| OM 458.991 | 11967cc | 6 Cyl. | 24 Valves | 295-375kW/401-510PS | Diesel | Turbo, OHV | TD28732 |

AXOR 2

10/2004→

V95174 
45.45 x 8.94 x 144.90

541 053 01 01

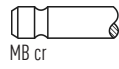

MB cr

30°

H

V95175 
42.10 x 8.93 x 144.80

A 457 050 03 27

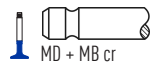

MD + MB cr

36°

H



OE

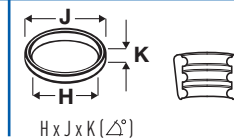
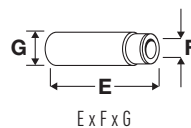

161 **128.00**

| | | | | | | | |
|------------|---------|--------|-----------|---------------------|--------|------------|---------|
| OM 460.900 | 12816cc | 6 Cyl. | 24 Valves | 324kW/441PS | Diesel | Turbo, OHV | TD23255 |
| OM 460.901 | 12816cc | 6 Cyl. | 24 Valves | 261kW/355PS | Diesel | Turbo, OHV | TD23256 |
| OM 460.902 | 12816cc | 6 Cyl. | 24 Valves | 276kW/375PS | Diesel | Turbo, OHV | TD23257 |
| OM 460.903 | 12816cc | 6 Cyl. | 24 Valves | 276kW/375PS | Diesel | Turbo, OHV | TD23258 |
| OM 460.904 | 12816cc | 6 Cyl. | 24 Valves | 306kW/416PS | Diesel | Turbo, OHV | TD23259 |
| OM 460.905 | 12816cc | 6 Cyl. | 24 Valves | 306kW/416PS | Diesel | Turbo, OHV | TD23260 |
| OM 460.906 | 12816cc | 6 Cyl. | 24 Valves | 261-276kW/355-375PS | Diesel | Turbo, OHV | TD23261 |
| OM 460.907 | 12816cc | 6 Cyl. | 24 Valves | 336kW/457PS | Diesel | Turbo, OHV | TD23262 |
| OM 460.908 | 12816cc | 6 Cyl. | 24 Valves | 261-336kW/355-457PS | Diesel | Turbo, OHV | TD23263 |
| OM 460.909 | 12816cc | 6 Cyl. | 24 Valves | 261-276kW/355-375PS | Diesel | Turbo, OHV | TD23264 |
| OM 460.910 | 12816cc | 6 Cyl. | 24 Valves | 261-276kW/355-375PS | Diesel | Turbo, OHV | TD23265 |
| OM 460.911 | 12816cc | 6 Cyl. | 24 Valves | 306-336kW/416-457PS | Diesel | Turbo, OHV | TD23266 |
| OM 460.912 | 12816cc | 6 Cyl. | 24 Valves | 261-276kW/355-375PS | Diesel | Turbo, OHV | TD23267 |
| OM 460.913 | 12816cc | 6 Cyl. | 24 Valves | 306-336kW/416-457PS | Diesel | Turbo, OHV | TD23268 |
| OM 460.914 | 12816cc | 6 Cyl. | 24 Valves | 306-336kW/416-457PS | Diesel | Turbo, OHV | TD23269 |
| OM 460.915 | 12816cc | 6 Cyl. | 24 Valves | 261-276kW/355-375PS | Diesel | Turbo, OHV | TD23270 |
| OM 460.916 | 12816cc | 6 Cyl. | 24 Valves | 261-276kW/355-375PS | Diesel | Turbo, OHV | TD23271 |
| OM 460.917 | 12816cc | 6 Cyl. | 24 Valves | 306-336kW/416-457PS | Diesel | Turbo, OHV | TD23272 |
| OM 460.918 | 12816cc | 6 Cyl. | 24 Valves | 261-276kW/355-375PS | Diesel | Turbo, OHV | TD23273 |
| OM 460.919 | 12816cc | 6 Cyl. | 24 Valves | 306-336kW/416-457PS | Diesel | Turbo, OHV | TD23274 |
| OM 460.920 | 12816cc | 6 Cyl. | 24 Valves | 306-336kW/416-457PS | Diesel | Turbo, OHV | TD23275 |
| OM 460.921 | 12816cc | 6 Cyl. | 24 Valves | 306-336kW/416-457PS | Diesel | Turbo, OHV | TD23276 |
| OM 460.922 | 12816cc | 6 Cyl. | 24 Valves | 261-276kW/355-375PS | Diesel | Turbo, OHV | TD23277 |
| OM 460.923 | 12816cc | 6 Cyl. | 24 Valves | 306-336kW/416-457PS | Diesel | Turbo, OHV | TD23278 |
| OM 460.925 | 12816cc | 6 Cyl. | 24 Valves | 306-336kW/416-457PS | Diesel | Turbo, OHV | TD23279 |
| OM 460.929 | 12816cc | 6 Cyl. | 24 Valves | 306-336kW/416-457PS | Diesel | Turbo, OHV | TD23280 |
| OM 460.931 | 12816cc | 6 Cyl. | 24 Valves | 306-336kW/416-457PS | Diesel | Turbo, OHV | TD23281 |
| OM 460.951 | 12816cc | 6 Cyl. | 24 Valves | 315-360kW/428-490PS | Diesel | Turbo, OHV | TD23254 |
| OM 460.970 | 12816cc | 6 Cyl. | 24 Valves | 261-338kW/355-460PS | Diesel | Turbo, OHV | TD23282 |
| OM 460.971 | 12816cc | 6 Cyl. | 24 Valves | 261-338kW/355-460PS | Diesel | Turbo, OHV | TD23283 |
| OM 460.975 | 12816cc | 6 Cyl. | 24 Valves | 261-338kW/355-460PS | Diesel | Turbo, OHV | TD23284 |
| OM 460.976 | 12816cc | 6 Cyl. | 24 Valves | 261-338kW/355-460PS | Diesel | Turbo, OHV | TD23285 |
| OM 460.977 | 12816cc | 6 Cyl. | 24 Valves | 261-338kW/355-460PS | Diesel | Turbo, OHV | TD23286 |
| OM 460.978 | 12816cc | 6 Cyl. | 24 Valves | 261-338kW/355-460PS | Diesel | Turbo, OHV | TD23287 |
| OM 460.979 | 12816cc | 6 Cyl. | 24 Valves | 261-338kW/355-460PS | Diesel | Turbo, OHV | TD23288 |
| OM 460.980 | 12816cc | 6 Cyl. | 24 Valves | 261-338kW/355-460PS | Diesel | Turbo, OHV | TD23289 |
| OM 460.981 | 12816cc | 6 Cyl. | 24 Valves | 261-338kW/355-460PS | Diesel | Turbo, OHV | TD23290 |

V94316 45.70 x 9.00 x 145.00

541 050 02 26

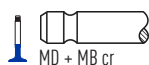

30°

H

VAG96134 61.00 x 9.02 x 15.07

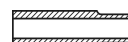

V95174 45.45 x 8.94 x 144.90

541 053 01 01



30°

H

VAG96135 61.00 x 9.00 x 15.20



V94317 41.10 x 9.00 x 145.00

541 050 02 27

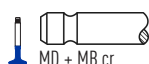

45°

H

V95175 42.10 x 8.93 x 144.80

A 457 050 03 27

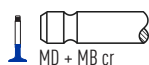

36°

H



OE

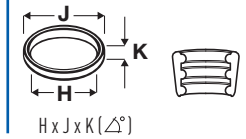
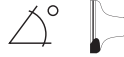

162 **128.00**

| | | | | | | | |
|------------|---------|--------|-----------|---------------------|--------|------------|---------|
| OM 460.939 | 12816cc | 6 Cyl. | 24 Valves | 261-276kW/355-375PS | Diesel | Turbo, OHV | TD28744 |
| OM 460.940 | 12816cc | 6 Cyl. | 24 Valves | 306-336kW/416-457PS | Diesel | Turbo, OHV | TD28745 |
| OM 460.941 | 12816cc | 6 Cyl. | 24 Valves | 261-276kW/355-375PS | Diesel | Turbo, OHV | TD28746 |
| OM 460.942 | 12816cc | 6 Cyl. | 24 Valves | 306-336kW/416-457PS | Diesel | Turbo, OHV | TD28747 |
| OM 460.943 | 12816cc | 6 Cyl. | 24 Valves | 261-276kW/355-375PS | Diesel | Turbo, OHV | TD28748 |
| OM 460.944 | 12816cc | 6 Cyl. | 24 Valves | 306-336kW/416-457PS | Diesel | Turbo, OHV | TD28749 |
| OM 460.945 | 12816cc | 6 Cyl. | 24 Valves | 261-276kW/355-375PS | Diesel | Turbo, OHV | TD28750 |
| OM 460.946 | 12816cc | 6 Cyl. | 24 Valves | 306-336kW/416-457PS | Diesel | Turbo, OHV | TD28751 |
| OM 460.947 | 12816cc | 6 Cyl. | 24 Valves | 261-276kW/355-375PS | Diesel | Turbo, OHV | TD28752 |
| OM 460.948 | 12816cc | 6 Cyl. | 24 Valves | 306-336kW/416-457PS | Diesel | Turbo, OHV | TD28753 |
| OM 460.949 | 12816cc | 6 Cyl. | 24 Valves | 261-276kW/355-375PS | Diesel | Turbo, OHV | TD28754 |
| OM 460.961 | 12816cc | 6 Cyl. | 24 Valves | 306-324kW/416-441PS | Diesel | Turbo, OHV | TD28755 |

V95174
45.45 x 8.94 x 144.90

541 053 01 01

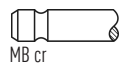

30°

H

V95175
42.10 x 8.93 x 144.80

A 457 050 03 27



36°

H

163 **128.00**

| | | | | | | | |
|------------|---------|--------|-----------|---------------------|--------|------------|---------|
| OM 460.950 | 12816cc | 6 Cyl. | 24 Valves | 315-350kW/428-476PS | Diesel | Turbo, OHV | TD22811 |
| OM 460.960 | 12816cc | 6 Cyl. | 24 Valves | 306kW/416PS | Diesel | Turbo, OHV | TD22812 |

V94316
45.70 x 9.00 x 145.00

541 050 02 26



30°

H

VAG96134
61.00 x 9.02 x 15.07



V94317
41.10 x 9.00 x 145.00

541 050 02 27



45°

H

VAG96135
61.00 x 9.00 x 15.20

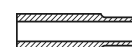

164 **128.00**

| | | | | | | | |
|------------|---------|---------|-----------|-------------|--------|------------|--------|
| OM 422.914 | 14600cc | V8 Cyl. | 16 Valves | 206kW/280PS | Diesel | OHV | TD5828 |
| OM 422.951 | 14600cc | V8 Cyl. | 16 Valves | 243kW/330PS | Diesel | Turbo, OHV | TD7901 |
| OM 422.952 | 14600cc | V8 Cyl. | 16 Valves | 243kW/330PS | Diesel | Turbo, OHV | TD5761 |
| OM 422.956 | 14600cc | V8 Cyl. | 16 Valves | 243kW/330PS | Diesel | Turbo, OHV | TD6134 |

Cityliner
0 303

08/1980→09/1987

NG
Skyliner

08/1973→09/1996
09/1990→

V91020
58.95 x 11.94 x 142.38
Eng.->139487

423 050 00 26



30°

H

VAG92089
67.05 x 11.99 x 18.03



V91132
59.00 x 11.95 x 142.50
Eng.139488→

442 050 03 26



30°

H

V94332
51.00 x 12.00 x 142.50

442 050 02 27



45°

H

V91133
51.00 x 11.94 x 142.50
Eng.139488→

442 050 04 27



45°

H

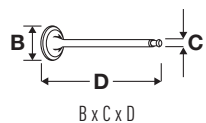

OE

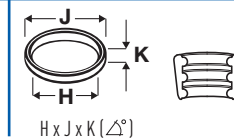
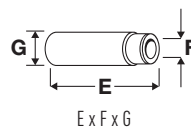

165 128.00

| | | | | | | | |
|------------|---------|---------|-----------|---------------------|--------|------------|---------|
| OM 422.901 | 14618cc | V8 Cyl. | 16 Valves | 243-276kW/330-375PS | Diesel | Turbo, OHV | TD18973 |
| OM 422.905 | 14618cc | V8 Cyl. | 16 Valves | 206kW/280PS | Diesel | OHV | TD5760 |
| OM 422.906 | 14618cc | V8 Cyl. | 16 Valves | 206kW/280PS | Diesel | OHV | TD6093 |
| OM 422.907 | 14618cc | V8 Cyl. | 16 Valves | 206kW/280PS | Diesel | OHV | TD5805 |
| OM 422.908 | 14618cc | V8 Cyl. | 16 Valves | 206kW/280PS | Diesel | OHV | TD7900 |
| OM 422.909 | 14618cc | V8 Cyl. | 16 Valves | 184kW/250PS | Diesel | OHV | TD8157 |
| OM 422.910 | 14618cc | V8 Cyl. | 16 Valves | 206kW/280PS | Diesel | OHV | TD6132 |
| OM 422.911 | 14618cc | V8 Cyl. | 16 Valves | 206kW/280PS | Diesel | OHV | TD6140 |
| OM 422.912 | 14618cc | V8 Cyl. | 16 Valves | 184kW/250PS | Diesel | OHV | TD8231 |
| OM 422.913 | 14618cc | V8 Cyl. | 16 Valves | 206kW/280PS | Diesel | OHV | TD6149 |
| OM 422.915 | 14618cc | V8 Cyl. | 16 Valves | 184kW/250PS | Diesel | OHV | TD16959 |
| OM 422.916 | 14618cc | V8 Cyl. | 16 Valves | 206kW/280PS | Diesel | OHV | TD17111 |
| OM 422.917 | 14618cc | V8 Cyl. | 16 Valves | 206kW/280PS | Diesel | OHV | TD11029 |
| OM 422.918 | 14618cc | V8 Cyl. | 16 Valves | 206kW/280PS | Diesel | OHV | TD16960 |
| OM 422.919 | 14618cc | V8 Cyl. | 16 Valves | 206kW/280PS | Diesel | OHV | TD5821 |
| OM 422.920 | 14618cc | V8 Cyl. | 16 Valves | 184kW/250PS | Diesel | OHV | TD8249 |
| OM 422.921 | 14618cc | V8 Cyl. | 16 Valves | 206kW/280PS | Diesel | OHV | TD6173 |
| OM 422.922 | 14618cc | V8 Cyl. | 16 Valves | 206kW/280PS | Diesel | OHV | TD16961 |
| OM 422.923 | 14618cc | V8 Cyl. | 16 Valves | 206kW/280PS | Diesel | OHV | TD16962 |
| OM 422.953 | 14618cc | V8 Cyl. | 16 Valves | 276kW/375PS | Diesel | Turbo, OHV | TD5763 |
| OM 422.954 | 14618cc | V8 Cyl. | 16 Valves | 243kW/330PS | Diesel | Turbo, OHV | TD6095 |
| OM 422.955 | 14618cc | V8 Cyl. | 16 Valves | 276kW/375PS | Diesel | Turbo, OHV | TD5800 |
| OM 422.957 | 14618cc | V8 Cyl. | 16 Valves | 243kW/330PS | Diesel | Turbo, OHV | TD9613 |
| OM 422.958 | 14618cc | V8 Cyl. | 16 Valves | 243kW/330PS | Diesel | Turbo, OHV | TD9614 |
| OM 422.959 | 14618cc | V8 Cyl. | 16 Valves | 276kW/375PS | Diesel | Turbo, OHV | TD6141 |
| OM 422.963 | 14618cc | V8 Cyl. | 16 Valves | 243kW/330PS | Diesel | Turbo, OHV | TD11028 |

| | | | |
|-----------|-----------------|----------|-----------------|
| Cityliner | 04/1973→ | Jetliner | 09/1990→ |
| NG | 08/1973→09/1996 | O 303 | 01/1980→09/1987 |
| OH Series | 01/1970→ | SK | 07/1987→09/1996 |
| Z-Serie | 01/1981→ | | |

| | | | | |
|---------------------------------------|---------------|------------|-----|---|
| V91020 | 423 050 00 26 | | 30° | H |
| 58.95 x 11.94 x 142.38 Eng.→139487 | | MD + MB cr | | |
| V91132 | 442 050 03 26 | | 30° | H |
| 59.00 x 11.95 x 142.50 Eng.139488→ | | MD + MB cr | | |
| V94332 | 442 050 02 27 | | 45° | H |
| 51.00 x 12.00 x 142.50 | | ME + MB cr | | |
| V91133 | 442 050 04 27 | | 45° | H |
| 51.00 x 11.94 x 142.50 Eng.139488→ | | MD + MB cr | | |

| | |
|-----------------------|--|
| VAG92089 | |
| 67.05 x 11.99 x 18.03 | |

166 128.00

| | | | | | | | |
|------------|---------|---------|-----------|-------------|--------|------------|---------|
| OM 440.940 | 14618cc | V8 Cyl. | 16 Valves | 250kW/340PS | Diesel | Turbo, OHV | TD8194 |
| OM 440.941 | 14618cc | V8 Cyl. | 16 Valves | 250kW/340PS | Diesel | Turbo, OHV | TD5794 |
| OM 440.942 | 14618cc | V8 Cyl. | 16 Valves | 250kW/340PS | Diesel | Turbo, OHV | TD6130 |
| OM 440.945 | 14618cc | V8 Cyl. | 16 Valves | 250kW/340PS | Diesel | Turbo, OHV | TD16967 |
| OM 440.948 | 14618cc | V8 Cyl. | 16 Valves | 269kW/366PS | Diesel | Turbo, OHV | TD17123 |

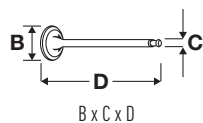

OE

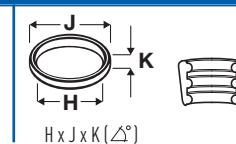
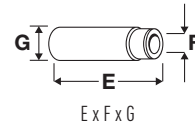

| | | | | | | | |
|------------|---------|---------|-----------|---------------------|--------|------------|---------|
| OM 440.970 | 14618cc | V8 Cyl. | 16 Valves | 320kW/435PS | Diesel | Turbo, OHV | TD5797 |
| OM 440.971 | 14618cc | V8 Cyl. | 16 Valves | 370kW/503PS | Diesel | Turbo, OHV | TD5788 |
| OM 440.972 | 14618cc | V8 Cyl. | 16 Valves | 320kW/435PS | Diesel | Turbo, OHV | TD16968 |
| OM 440.973 | 14618cc | V8 Cyl. | 16 Valves | 370kW/503PS | Diesel | Turbo, OHV | TD6124 |
| OM 440.975 | 14618cc | V8 Cyl. | 16 Valves | 370kW/503PS | Diesel | Turbo, OHV | TD5833 |
| OM 440.976 | 14618cc | V8 Cyl. | 16 Valves | 370kW/503PS | Diesel | Turbo, OHV | TD8227 |
| OM 440.978 | 14618cc | V8 Cyl. | 16 Valves | 320kW/435PS | Diesel | Turbo, OHV | TD5787 |
| OM 440.979 | 14618cc | V8 Cyl. | 16 Valves | 320kW/435PS | Diesel | Turbo, OHV | TD6138 |
| OM 440.980 | 14618cc | V8 Cyl. | 16 Valves | 320kW/435PS | Diesel | Turbo, OHV | TD6179 |
| OM 440.981 | 14618cc | V8 Cyl. | 16 Valves | 370kW/503PS | Diesel | Turbo, OHV | TD6152 |
| OM 440.982 | 14618cc | V8 Cyl. | 16 Valves | 370kW/503PS | Diesel | Turbo, OHV | TD6185 |
| OM 440.983 | 14618cc | V8 Cyl. | 16 Valves | 370kW/503PS | Diesel | Turbo, OHV | TD6306 |
| OM 440.984 | 14618cc | V8 Cyl. | 16 Valves | 320kW/435PS | Diesel | Turbo, OHV | TD6305 |
| OM 440.985 | 14618cc | V8 Cyl. | 16 Valves | 320kW/435PS | Diesel | Turbo, OHV | TD8256 |
| OM 440.986 | 14618cc | V8 Cyl. | 16 Valves | 320kW/435PS | Diesel | Turbo, OHV | TD16969 |
| OM 440.987 | 14618cc | V8 Cyl. | 16 Valves | 280kW/381PS | Diesel | Turbo, OHV | TD16970 |
| OM 440.988 | 14618cc | V8 Cyl. | 16 Valves | 280kW/381PS | Diesel | Turbo, OHV | TD17126 |
| OM 440.989 | 14618cc | V8 Cyl. | 16 Valves | 280kW/381PS | Diesel | Turbo, OHV | TD16971 |
| OM 440.990 | 14618cc | V8 Cyl. | 16 Valves | 280kW/381PS | Diesel | Turbo, OHV | TD8225 |
| OM 440.991 | 14618cc | V8 Cyl. | 16 Valves | 320kW/435PS | Diesel | Turbo, OHV | TD6122 |
| OM 442.940 | 14618cc | V8 Cyl. | 16 Valves | 260kW/354PS | Diesel | Turbo, OHV | TD17131 |
| OM 442.941 | 14618cc | V8 Cyl. | 16 Valves | 269kW/366PS | Diesel | Turbo, OHV | TD16978 |
| OM 442.942 | 14618cc | V8 Cyl. | 16 Valves | 260-269kW/354-366PS | Diesel | Turbo, OHV | TD5774 |
| OM 442.943 | 14618cc | V8 Cyl. | 16 Valves | 269kW/366PS | Diesel | Turbo, OHV | TD5793 |
| OM 442.944 | 14618cc | V8 Cyl. | 16 Valves | 260-269kW/354-366PS | Diesel | Turbo, OHV | TD5773 |
| OM 442.945 | 14618cc | V8 Cyl. | 16 Valves | 269kW/366PS | Diesel | Turbo, OHV | TD5829 |
| OM 442.946 | 14618cc | V8 Cyl. | 16 Valves | 266kW/366PS | Diesel | Turbo, OHV | TD5831 |
| OM 442.950 | 14618cc | V8 Cyl. | 16 Valves | 260-269kW/354-366PS | Diesel | Turbo, OHV | TD5764 |
| OM 442.951 | 14618cc | V8 Cyl. | 16 Valves | 320kW/435PS | Diesel | Turbo, OHV | TD5765 |
| OM 442.952 | 14618cc | V8 Cyl. | 16 Valves | 260-269kW/354-366PS | Diesel | Turbo, OHV | TD6135 |
| OM 442.953 | 14618cc | V8 Cyl. | 16 Valves | 320-329kW/435-447PS | Diesel | Turbo, OHV | TD5819 |
| OM 442.954 | 14618cc | V8 Cyl. | 16 Valves | 269kW/366PS | Diesel | Turbo, OHV | TD10972 |
| OM 442.955 | 14618cc | V8 Cyl. | 16 Valves | 269kW/366PS | Diesel | Turbo, OHV | TD10973 |
| OM 442.957 | 14618cc | V8 Cyl. | 16 Valves | 266-269kW/366-366PS | Diesel | Turbo, OHV | TD6183 |
| OM 442.958 | 14618cc | V8 Cyl. | 16 Valves | 260-269kW/354-366PS | Diesel | Turbo, OHV | TD6290 |
| OM 442.959 | 14618cc | V8 Cyl. | 16 Valves | 269kW/366PS | Diesel | Turbo, OHV | TD6161 |
| OM 442.960 | 14618cc | V8 Cyl. | 16 Valves | 260-269kW/354-365PS | Diesel | Turbo, OHV | TD5663 |
| OM 442.961 | 14618cc | V8 Cyl. | 16 Valves | 260-269kW/354-365PS | Diesel | Turbo, OHV | TD6001 |
| OM 442.962 | 14618cc | V8 Cyl. | 16 Valves | 260-269kW/354-366PS | Diesel | Turbo, OHV | TD8215 |
| OM 442.963 | 14618cc | V8 Cyl. | 16 Valves | 260-269kW/354-366PS | Diesel | Turbo, OHV | TD5802 |
| OM 442.964 | 14618cc | V8 Cyl. | 16 Valves | 260-269kW/354-366PS | Diesel | Turbo, OHV | TD6146 |
| OM 442.965 | 14618cc | V8 Cyl. | 16 Valves | 260-269kW/354-366PS | Diesel | Turbo, OHV | TD6292 |
| OM 442.966 | 14618cc | V8 Cyl. | 16 Valves | 260-269kW/354-366PS | Diesel | Turbo, OHV | TD6300 |
| OM 442.967 | 14618cc | V8 Cyl. | 16 Valves | 269kW/366PS | Diesel | Turbo, OHV | TD17809 |
| OM 442.968 | 14618cc | V8 Cyl. | 16 Valves | 260-269kW/354-366PS | Diesel | Turbo, OHV | TD6147 |
| OM 442.970 | 14618cc | V8 Cyl. | 16 Valves | 260kW/354PS | Diesel | Turbo, OHV | TD17132 |
| OM 442.971 | 14618cc | V8 Cyl. | 16 Valves | 269kW/366PS | Diesel | Turbo, OHV | TD5795 |
| OM 442.972 | 14618cc | V8 Cyl. | 16 Valves | 269kW/366PS | Diesel | Turbo, OHV | TD6131 |
| OM 442.973 | 14618cc | V8 Cyl. | 16 Valves | 269kW/366PS | Diesel | Turbo, OHV | TD17133 |
| OM 442.974 | 14618cc | V8 Cyl. | 16 Valves | 269kW/366PS | Diesel | Turbo, OHV | TD17134 |

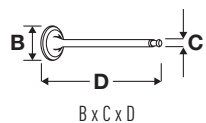

OE

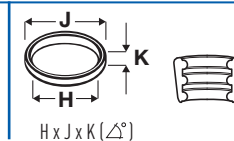
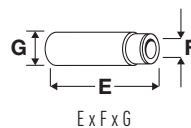

| | | | | | | | |
|------------|---------|---------|-----------|---------------------|--------|------------|---------|
| OM 442.975 | 14618cc | V8 Cyl. | 16 Valves | 269kW/366PS | Diesel | Turbo, OHV | TD17135 |
| OM 442.976 | 14618cc | V8 Cyl. | 16 Valves | 260-269kW/354-366PS | Diesel | Turbo, OHV | TD6323 |
| OM 442.977 | 14618cc | V8 Cyl. | 16 Valves | 250kW/340PS | Diesel | Turbo, OHV | TD8219 |
| OM 442.978 | 14618cc | V8 Cyl. | 16 Valves | 250kW/340PS | Diesel | Turbo, OHV | TD8216 |
| OM 442.979 | 14618cc | V8 Cyl. | 16 Valves | 250kW/340PS | Diesel | Turbo, OHV | TD17136 |
| OM 442.980 | 14618cc | V8 Cyl. | 16 Valves | 320kW/435PS | Diesel | Turbo, OHV | TD6169 |
| OM 442.982 | 14618cc | V8 Cyl. | 16 Valves | 320-362kW/435-492PS | Diesel | Turbo, OHV | TD5796 |
| OM 442.983 | 14618cc | V8 Cyl. | 16 Valves | 329kW/447PS | Diesel | Turbo, OHV | TD8248 |
| OM 442.984 | 14618cc | V8 Cyl. | 16 Valves | 353-362kW/480-492PS | Diesel | Turbo, OHV | TD5804 |
| OM 442.985 | 14618cc | V8 Cyl. | 16 Valves | 320-362kW/435-492PS | Diesel | Turbo, OHV | TD5775 |
| OM 442.989 | 14618cc | V8 Cyl. | 16 Valves | 362kW/492PS | Diesel | Turbo, OHV | TD5817 |
| OM 442.991 | 14618cc | V8 Cyl. | 16 Valves | 362kW/492PS | Diesel | Turbo, OHV | TD17137 |
| OM 442.992 | 14618cc | V8 Cyl. | 16 Valves | 320-362kW/435-492PS | Diesel | Turbo, OHV | TD6301 |
| OM 442.993 | 14618cc | V8 Cyl. | 16 Valves | 362kW/492PS | Diesel | Turbo, OHV | TD8259 |
| OM 442.994 | 14618cc | V8 Cyl. | 16 Valves | 362kW/492PS | Diesel | Turbo, OHV | TD6165 |
| OM 442.995 | 14618cc | V8 Cyl. | 16 Valves | 320kW/435PS | Diesel | Turbo, OHV | TD16979 |
| OM 442.996 | 14618cc | V8 Cyl. | 16 Valves | 370kW/503PS | Diesel | Turbo, OHV | TD16980 |
| OM 442.997 | 14618cc | V8 Cyl. | 16 Valves | 370kW/503PS | Diesel | Turbo, OHV | TD5810 |
| OM 442.998 | 14618cc | V8 Cyl. | 16 Valves | 370kW/503PS | Diesel | Turbo, OHV | TD6157 |
| OM 442.999 | 14618cc | V8 Cyl. | 16 Valves | 370kW/503PS | Diesel | Turbo, OHV | TD17810 |
| OM 446.920 | 14618cc | V8 Cyl. | 16 Valves | 390kW/530PS | Diesel | Turbo, OHV | TD5789 |
| OM 446.922 | 14618cc | V8 Cyl. | 16 Valves | 320kW/435PS | Diesel | Turbo, OHV | TD8207 |
| OM 446.923 | 14618cc | V8 Cyl. | 16 Valves | 320kW/435PS | Diesel | Turbo, OHV | TD16935 |
| OM 446.924 | 14618cc | V8 Cyl. | 16 Valves | 280kW/381PS | Diesel | Turbo, OHV | TD5785 |
| OM 446.925 | 14618cc | V8 Cyl. | 16 Valves | 280kW/381PS | Diesel | Turbo, OHV | TD6120 |
| OM 446.926 | 14618cc | V8 Cyl. | 16 Valves | 280kW/381PS | Diesel | Turbo, OHV | TD5834 |
| OM 446.927 | 14618cc | V8 Cyl. | 16 Valves | 280kW/381PS | Diesel | Turbo, OHV | TD8203 |
| OM 446.928 | 14618cc | V8 Cyl. | 16 Valves | 280kW/381PS | Diesel | Turbo, OHV | TD5808 |
| OM 446.929 | 14618cc | V8 Cyl. | 16 Valves | 280kW/381PS | Diesel | Turbo, OHV | TD6155 |
| OM 446.930 | 14618cc | V8 Cyl. | 16 Valves | 280kW/381PS | Diesel | Turbo, OHV | TD6186 |
| OM 446.931 | 14618cc | V8 Cyl. | 16 Valves | 280kW/381PS | Diesel | Turbo, OHV | TD8257 |
| OM 446.932 | 14618cc | V8 Cyl. | 16 Valves | 390kW/530PS | Diesel | Turbo, OHV | TD8260 |
| OM 446.933 | 14618cc | V8 Cyl. | 16 Valves | 390kW/530PS | Diesel | Turbo, OHV | TD5820 |
| OM 446.934 | 14618cc | V8 Cyl. | 16 Valves | 280kW/381PS | Diesel | Turbo, OHV | TD10974 |
| OM 446.935 | 14618cc | V8 Cyl. | 16 Valves | 320kW/435PS | Diesel | Turbo, OHV | TD16982 |
| OM 446.936 | 14618cc | V8 Cyl. | 16 Valves | 320kW/435PS | Diesel | Turbo, OHV | TD8247 |
| OM 446.938 | 14618cc | V8 Cyl. | 16 Valves | 280kW/381PS | Diesel | Turbo, OHV | TD10975 |
| OM 446.939 | 14618cc | V8 Cyl. | 16 Valves | 320kW/435PS | Diesel | Turbo, OHV | TD5835 |
| OM 446.940 | 14618cc | V8 Cyl. | 16 Valves | 320kW/435PS | Diesel | Turbo, OHV | TD6187 |
| OM 446.941 | 14618cc | V8 Cyl. | 16 Valves | 320kW/435PS | Diesel | Turbo, OHV | TD16983 |
| OM 446.942 | 14618cc | V8 Cyl. | 16 Valves | 320kW/435PS | Diesel | Turbo, OHV | TD5809 |
| OM 446.943 | 14618cc | V8 Cyl. | 16 Valves | 320kW/435PS | Diesel | Turbo, OHV | TD8204 |
| OM 446.945 | 14618cc | V8 Cyl. | 16 Valves | 390kW/530PS | Diesel | Turbo, OHV | TD6171 |
| OM 446.946 | 14618cc | V8 Cyl. | 16 Valves | 390kW/530PS | Diesel | Turbo, OHV | TD6125 |
| OM 446.948 | 14618cc | V8 Cyl. | 16 Valves | 320kW/435PS | Diesel | Turbo, OHV | TD6156 |
| OM 482.912 | 14618cc | V8 Cyl. | 16 Valves | 206kW/280PS | Diesel | OHV | TD22816 |
| OM 482.930 | 14618cc | V8 Cyl. | 16 Valves | 206kW/280PS | Diesel | OHV | TD22817 |
| OM 482.940 | 14618cc | V8 Cyl. | 16 Valves | 269kW/366PS | Diesel | Turbo, OHV | TD22818 |
| OM 482.941 | 14618cc | V8 Cyl. | 16 Valves | 269kW/366PS | Diesel | Turbo, OHV | TD22819 |

HPN (LongNose)

11/1991→12/2005

Megaliner

01/1993→



OE

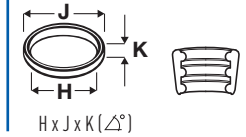

| | | | |
|------------------|-----------------|------------|-----------------|
| NG | 08/1973→09/1996 | O 303 | 09/1987→09/1992 |
| O 330 | 01/1990→ | O 404 | |
| OH Series | 01/1970→ | Series 300 | 09/1991→02/2002 |
| SK | 07/1987→ | Skyliner | 01/1979→ |
| TOURISMO (O 350) | 08/1995→ | Transliner | 12/1988→ |

| | | | | |
|------------------------|---------------|------------|-----|---|
| V91132 | 442 050 03 26 | | 30° | H |
| 59.00 x 11.95 x 142.50 | | MD + MB cr | | |
| V91133 | 442 050 04 27 | | 45° | H |
| 51.00 x 11.94 x 142.50 | | MD + MB cr | | |
| V94332 | 442 050 02 27 | | 45° | H |
| 51.00 x 12.00 x 142.50 | | ME + MB cr | | |

| | |
|-----------------------|--|
| VAG92089 | |
| 67.05 x 11.99 x 18.03 | |

167 **128.00**

| | | | | | | | |
|-------------------|-----------------|----------|-----------|-------------|--------|-----------------|--------|
| OM 443.940 | 18270cc | V10 Cyl. | 20 Valves | 340kW/462PS | Diesel | Turbo, OHV | TD8214 |
| OM 443.980 | 18270cc | V10 Cyl. | 20 Valves | 412kW/560PS | Diesel | Turbo, OHV | TD8254 |
| NG | 01/1990→03/1991 | | | SK | | 07/1988→08/1994 | |

| | | | | |
|------------------------|---------------|------------|-----|---|
| V91132 | 442 050 03 26 | | 30° | H |
| 59.00 x 11.95 x 142.50 | | MD + MB cr | | |
| V91133 | 442 050 04 27 | | 45° | H |
| 51.00 x 11.94 x 142.50 | | MD + MB cr | | |
| V94332 | 442 050 02 27 | | 45° | H |
| 51.00 x 12.00 x 142.50 | | ME + MB cr | | |

| | |
|-----------------------|--|
| VAG92089 | |
| 67.05 x 11.99 x 18.03 | |

168 **128.00**

| | | | | | | | |
|-------------------|-----------------|----------|-----------|-------------|--------|------------|---------|
| OM 423.906 | 18273cc | V10 Cyl. | 20 Valves | 261kW/355PS | Diesel | OHV | TD6126 |
| OM 423.907 | 18273cc | V10 Cyl. | 20 Valves | 261kW/355PS | Diesel | OHV | TD6289 |
| OM 423.909 | 18273cc | V10 Cyl. | 20 Valves | 261kW/355PS | Diesel | OHV | TD16963 |
| OM 423.950 | 18273cc | V10 Cyl. | 20 Valves | 368kW/500PS | Diesel | Turbo, OHV | TD5827 |
| NG | 10/1981→08/1994 | | | SK | | 07/1987→ | |

| | | | | |
|--|---------------|------------|-----|---|
| V91020 | 423 050 00 26 | | 30° | H |
| 58.95 x 11.94 x 142.38 Eng.->139487 | | MD + MB cr | | |
| V91132 | 442 050 03 26 | | 30° | H |
| 59.00 x 11.95 x 142.50 Eng.139488→ | | MD + MB cr | | |
| V94332 | 442 050 02 27 | | 45° | H |
| 51.00 x 12.00 x 142.50 | | ME + MB cr | | |
| V91133 | 442 050 04 27 | | 45° | H |
| 51.00 x 11.94 x 142.50 Eng.139488→ | | MD + MB cr | | |

| | |
|-----------------------|--|
| VAG92089 | |
| 67.05 x 11.99 x 18.03 | |



OE

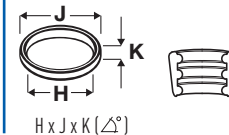
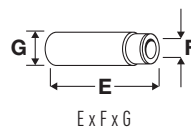
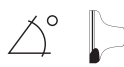

169 128.00

| | | | | | | | |
|------------|-----------------|----------|-----------|-------------|--------|------------|--------|
| OM 423.951 | 18273cc | V10 Cyl. | 20 Valves | 368kW/500PS | Diesel | Turbo, OHV | TD6180 |
| NG | 09/1985→08/1994 | | | | | | |

| | | | | | | | |
|------------------------|---------------|------------|-----|---|-----------------------|--|--|
| V91020 | 423 050 00 26 | | 30° | H | VAG92089 | | |
| 58.95 x 11.94 x 142.38 | | MD + MB cr | | | 67.05 x 11.99 x 18.03 | | |
| V91132 | 442 050 03 26 | | 30° | H | | | |
| 59.00 x 11.95 x 142.50 | | MD + MB cr | | | | | |
| V91133 | 442 050 04 27 | | 45° | H | | | |
| 51.00 x 11.94 x 142.50 | | MD + MB cr | | | | | |
| V94332 | 442 050 02 27 | | 45° | H | | | |
| 51.00 x 12.00 x 142.50 | | ME + MB cr | | | | | |

170 128.00

| | | | | | | | |
|------------|-----------------|----------|-----------|-------------|--------|-----------------|--------|
| OM 423.905 | 18300cc | V10 Cyl. | 20 Valves | 261kW/355PS | Diesel | OHV | TD5762 |
| OM 423.908 | 18300cc | V10 Cyl. | 20 Valves | 261kW/355PS | Diesel | OHV | TD6096 |
| NG | 08/1973→09/1996 | | | SK | | 03/1991→09/1996 | |

| | | | | | | | |
|---------------------------------------|---------------|------------|-----|---|-----------------------|--|--|
| V91020 | 423 050 00 26 | | 30° | H | VAG92089 | | |
| 58.95 x 11.94 x 142.38 Eng.→139487 | | MD + MB cr | | | 67.05 x 11.99 x 18.03 | | |
| V91132 | 442 050 03 26 | | 30° | H | | | |
| 59.00 x 11.95 x 142.50 Eng.139488→ | | MD + MB cr | | | | | |
| V94332 | 442 050 02 27 | | 45° | H | | | |
| 51.00 x 12.00 x 142.50 | | ME + MB cr | | | | | |
| V91133 | 442 050 04 27 | | 45° | H | | | |
| 51.00 x 11.94 x 142.50 Eng.139488→ | | MD + MB cr | | | | | |

171 128.00

| | | | | | | | |
|----------------|---------|----------|-----------|-------------|--------|------------|---------|
| OM 424.900 | 21930cc | V12 Cyl. | 24 Valves | 309kW/420PS | Diesel | OHV | TD18815 |
| OM 424.901-510 | 21930cc | V12 Cyl. | 24 Valves | 441kW/600PS | Diesel | Turbo, OHV | TD18817 |

| | | | | | | | |
|---------------------------------------|---------------|------------|-----|---|-----------------------|--|--|
| V91020 | 423 050 00 26 | | 30° | H | VAG92089 | | |
| 58.95 x 11.94 x 142.38 Eng.→002307 | | MD + MB cr | | | 67.05 x 11.99 x 18.03 | | |
| V91132 | 442 050 03 26 | | 30° | H | | | |
| 59.00 x 11.95 x 142.50 Eng.002308→ | | MD + MB cr | | | | | |
| V94332 | 442 050 02 27 | | 45° | H | | | |
| 51.00 x 12.00 x 142.50 | | ME + MB cr | | | | | |
| V91133 | 442 050 04 27 | | 45° | H | | | |
| 51.00 x 11.94 x 142.50 Eng.002308→ | | MD + MB cr | | | | | |



OE

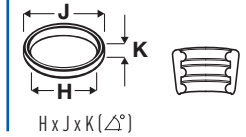
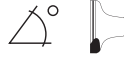

172 128.00

| OM 424.901 | 21930cc | V12 Cyl. | 24 Valves | 441kW/600PS | Diesel | Turbo, OHV | TD18816 |
|---------------|---------------|----------|------------|-------------|--------|-----------------|-----------------------|
| V91020 | 423 050 00 26 | | MD + MB cr | 30° | H | VAG92089 | 67.05 x 11.99 x 18.03 |
| V91132 | 442 050 03 26 | | MD + MB cr | 30° | H | | |
| V94332 | 442 050 02 27 | | ME + MB cr | 45° | H | | |
| V91133 | 442 050 04 27 | | MD + MB cr | 45° | H | | |

173 130.00

| | | | | | | | |
|-------------------|-----------------|---------|-----------|---------------------|--------|-----------------|--------|
| OM 441.905 | 10964cc | V6 Cyl. | 12 Valves | 165kW/224PS | Diesel | OHV | TD5731 |
| OM 441.906 | 10964cc | V6 Cyl. | 12 Valves | 150kW/204PS | Diesel | OHV | TD8184 |
| OM 441.907 | 10964cc | V6 Cyl. | 12 Valves | 150kW/204PS | Diesel | OHV | TD8185 |
| OM 441.908 | 10964cc | V6 Cyl. | 12 Valves | 160-165kW/218-224PS | Diesel | OHV | TD5660 |
| OM 441.909 | 10964cc | V6 Cyl. | 12 Valves | 160-165kW/218-224PS | Diesel | OHV | TD5998 |
| OM 441.911 | 10964cc | V6 Cyl. | 12 Valves | 160-165kW/218-224PS | Diesel | OHV | TD6271 |
| OM 441.913 | 10964cc | V6 Cyl. | 12 Valves | 165kW/224PS | Diesel | Turbo, OHV | TD6063 |
| OM 441.915 | 10964cc | V6 Cyl. | 12 Valves | 165kW/224PS | Diesel | OHV | TD8121 |
| OM 441.917 | 10964cc | V6 Cyl. | 12 Valves | 160kW/218PS | Diesel | OHV | TD8122 |
| OM 441.923 | 10964cc | V6 Cyl. | 12 Valves | 160kW/218PS | Diesel | OHV | TD5732 |
| OM 441.925 | 10964cc | V6 Cyl. | 12 Valves | 160kW/218PS | Diesel | OHV | TD6064 |
| OM 441.926 | 10964cc | V6 Cyl. | 12 Valves | 160kW/218PS | Diesel | OHV | TD8119 |
| OM 441.927 | 10964cc | V6 Cyl. | 12 Valves | 153kW/208PS | Diesel | OHV | TD8123 |
| MK | 12/1987→09/1996 | | | NG | | 08/1973→09/1996 | |
| O 303 | 01/1980→09/1992 | | | SK | | 07/1987→09/1996 | |

| | | | | | | | |
|---------------|---------------|--|------------|-----|---|-----------------|-----------------------|
| V91132 | 442 050 03 26 | | MD + MB cr | 30° | H | VAG92089 | 67.05 x 11.99 x 18.03 |
| V91133 | 442 050 04 27 | | MD + MB cr | 45° | H | | |
| V94332 | 442 050 02 27 | | ME + MB cr | 45° | H | | |

174 130.00

| | | | | | | | |
|-------------------|---------|---------|-----------|-------------|--------|-----|--------|
| OM 441.921 | 11300cc | V6 Cyl. | 12 Valves | 165kW/224PS | Diesel | OHV | TD7941 |
| OM 441.922 | 11300cc | V6 Cyl. | 12 Valves | 151kW/205PS | Diesel | OHV | TD7942 |

O 404 09/1991→01/1992

| | | | | | | | |
|---------------|---------------|--|------------|-----|---|-----------------|-----------------------|
| V91132 | 442 050 03 26 | | MD + MB cr | 30° | H | VAG92089 | 67.05 x 11.99 x 18.03 |
| V91133 | 442 050 04 27 | | MD + MB cr | 45° | H | | |
| V94332 | 442 050 02 27 | | ME + MB cr | 45° | H | | |



OE

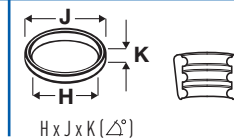
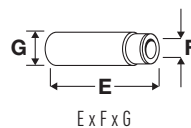
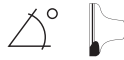

175 130.00

| | | | | | | | |
|------------|---------|---------|-----------|---------------------|--------|-----|---------|
| OM 441.912 | 11309cc | V6 Cyl. | 12 Valves | 165kW/224PS | Diesel | OHV | TD6142 |
| OM 441.914 | 11309cc | V6 Cyl. | 12 Valves | 165kW/224PS | Diesel | OHV | TD6101 |
| OM 441.916 | 11309cc | V6 Cyl. | 12 Valves | 153kW/208PS | Diesel | OHV | TD5768 |
| OM 441.918 | 11309cc | V6 Cyl. | 12 Valves | 165kW/224PS | Diesel | OHV | TD10968 |
| OM 441.919 | 11309cc | V6 Cyl. | 12 Valves | 150-165kW/204-224PS | Diesel | OHV | TD16972 |
| OM 441.920 | 11309cc | V6 Cyl. | 12 Valves | 153kW/208PS | Diesel | OHV | TD6100 |
| OM 441.924 | 11309cc | V6 Cyl. | 12 Valves | 160kW/218PS | Diesel | OHV | TD6143 |
| OM 441.932 | 11309cc | V6 Cyl. | 12 Valves | 151kW/205PS | Diesel | OHV | TD8190 |
| OM 441.933 | 11309cc | V6 Cyl. | 12 Valves | 151kW/205PS | Diesel | OHV | TD8191 |

| | | | |
|-------|-----------------|----|-----------------|
| MK | 12/1987→09/1996 | NG | 08/1973→09/1996 |
| O 303 | 12/1987→ | SK | 05/1989→08/1994 |

V91132
59.00 x 11.95 x 142.50

442 050 03 26

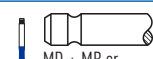

30°

H

VAG92089
67.05 x 11.99 x 18.03



V91133
51.00 x 11.94 x 142.50

442 050 04 27

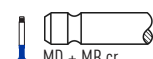

45°

H

V94332
51.00 x 12.00 x 142.50

442 050 02 27

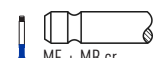

45°

H

176 130.00

| | | | | | | | |
|------------|---------|---------|-----------|---------------------|--------|------------|---------|
| OM 521.940 | 11946cc | V6 Cyl. | 24 Valves | 315kW/428PS | Diesel | Turbo, OHV | TD16791 |
| OM 521.950 | 11946cc | V6 Cyl. | 24 Valves | 260kW/354PS | Diesel | Turbo, OHV | TD17671 |
| OM 541.920 | 11946cc | V6 Cyl. | 24 Valves | 230kW/313PS | Diesel | Turbo, OHV | TD7872 |
| OM 541.921 | 11946cc | V6 Cyl. | 24 Valves | 315kW/428PS | Diesel | Turbo, OHV | TD9673 |
| OM 541.922 | 11946cc | V6 Cyl. | 24 Valves | 260kW/354PS | Diesel | Turbo, OHV | TD7873 |
| OM 541.923 | 11946cc | V6 Cyl. | 24 Valves | 290-300kW/394-408PS | Diesel | Turbo, OHV | TD7874 |
| OM 541.924 | 11946cc | V6 Cyl. | 24 Valves | 290kW/394PS | Diesel | Turbo, OHV | TD7880 |
| OM 541.925 | 11946cc | V6 Cyl. | 24 Valves | 315kW/428PS | Diesel | Turbo, OHV | TD7875 |
| OM 541.926 | 11946cc | V6 Cyl. | 24 Valves | 230kW/313PS | Diesel | Turbo, OHV | TD7879 |
| OM 541.927 | 11946cc | V6 Cyl. | 24 Valves | 260kW/354PS | Diesel | Turbo, OHV | TD9679 |
| OM 541.928 | 11946cc | V6 Cyl. | 24 Valves | 315kW/428PS | Diesel | Turbo, OHV | TD17679 |
| OM 541.940 | 11946cc | V6 Cyl. | 24 Valves | 230-235kW/313-320PS | Diesel | Turbo, OHV | TD16897 |
| OM 541.941 | 11946cc | V6 Cyl. | 24 Valves | 230-235kW/313-320PS | Diesel | Turbo, OHV | TD16898 |
| OM 541.942 | 11946cc | V6 Cyl. | 24 Valves | 260-265kW/354-360PS | Diesel | Turbo, OHV | TD16899 |
| OM 541.943 | 11946cc | V6 Cyl. | 24 Valves | 260-265kW/354-360PS | Diesel | Turbo, OHV | TD16900 |
| OM 541.944 | 11946cc | V6 Cyl. | 24 Valves | 290-300kW/394-408PS | Diesel | Turbo, OHV | TD16901 |
| OM 541.945 | 11946cc | V6 Cyl. | 24 Valves | 290-300kW/394-408PS | Diesel | Turbo, OHV | TD16902 |
| OM 541.946 | 11946cc | V6 Cyl. | 24 Valves | 315-320kW/428-435PS | Diesel | Turbo, OHV | TD16903 |
| OM 541.947 | 11946cc | V6 Cyl. | 24 Valves | 315-320kW/428-435PS | Diesel | Turbo, OHV | TD16904 |
| OM 541.948 | 11946cc | V6 Cyl. | 24 Valves | 335-355kW/456-483PS | Diesel | Turbo, OHV | TD16913 |
| OM 541.949 | 11946cc | V6 Cyl. | 24 Valves | 335-355kW/456-483PS | Diesel | Turbo, OHV | TD16914 |
| OM 541.950 | 11946cc | V6 Cyl. | 24 Valves | 260-300kW/354-408PS | Diesel | Turbo, OHV | TD17682 |
| OM 541.951 | 11946cc | V6 Cyl. | 24 Valves | 230-235kW/313-320PS | Diesel | Turbo, OHV | TD17684 |
| OM 541.952 | 11946cc | V6 Cyl. | 24 Valves | 230-260kW/313-354PS | Diesel | Turbo, OHV | TD17685 |
| OM 541.970 | 11946cc | V6 Cyl. | 24 Valves | 235kW/320PS | Diesel | Turbo, OHV | TD19250 |
| OM 541.971 | 11946cc | V6 Cyl. | 24 Valves | 235kW/320PS | Diesel | Turbo, OHV | TD21001 |
| OM 541.972 | 11946cc | V6 Cyl. | 24 Valves | 265kW/360PS | Diesel | Turbo, OHV | TD19251 |
| OM 541.973 | 11946cc | V6 Cyl. | 24 Valves | 265kW/360PS | Diesel | Turbo, OHV | TD21022 |
| OM 541.974 | 11946cc | V6 Cyl. | 24 Valves | 300kW/408PS | Diesel | Turbo, OHV | TD18997 |



OE

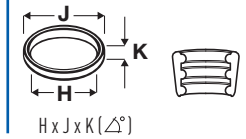
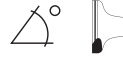

| | | | | | | | |
|------------|---------|---------|-----------|---------------------|--------|------------|---------|
| OM 541.975 | 11946cc | V6 Cyl. | 24 Valves | 300kW/408PS | Diesel | Turbo, OHV | TD21023 |
| OM 541.976 | 11946cc | V6 Cyl. | 24 Valves | 320kW/435PS | Diesel | Turbo, OHV | TD19000 |
| OM 541.977 | 11946cc | V6 Cyl. | 24 Valves | 320kW/435PS | Diesel | Turbo, OHV | TD21024 |
| OM 541.978 | 11946cc | V6 Cyl. | 24 Valves | 350kW/476PS | Diesel | Turbo, OHV | TD21007 |
| OM 541.980 | 11946cc | V6 Cyl. | 24 Valves | 335kW/456PS | Diesel | Turbo, OHV | TD21000 |
| OM 541.981 | 11946cc | V6 Cyl. | 24 Valves | 335kW/456PS | Diesel | Turbo, OHV | TD21003 |
| OM 941.910 | 11946cc | V6 Cyl. | 24 Valves | 230kW/313PS | Diesel | Turbo, OHV | TD17693 |
| OM 941.920 | 11946cc | V6 Cyl. | 24 Valves | 260kW/354PS | Diesel | Turbo, OHV | TD17693 |
| OM 941.921 | 11946cc | V6 Cyl. | 24 Valves | 260kW/354PS | Diesel | Turbo, OHV | TD17694 |
| OM 941.929 | 11946cc | V6 Cyl. | 24 Valves | 290kW/394PS | Diesel | Turbo, OHV | TD16794 |
| OM 941.930 | 11946cc | V6 Cyl. | 24 Valves | 300kW/408PS | Diesel | Turbo, OHV | TD16795 |
| OM 941.940 | 11946cc | V6 Cyl. | 24 Valves | 315kW/428PS | Diesel | Turbo, OHV | TD16796 |
| OM 941.960 | 11946cc | V6 Cyl. | 24 Valves | 230kW/313PS | Diesel | Turbo, OHV | TD16797 |
| OM 941.970 | 11946cc | V6 Cyl. | 24 Valves | 260kW/354PS | Diesel | Turbo, OHV | TD16798 |
| OM 941.980 | 11946cc | V6 Cyl. | 24 Valves | 290kW/394PS | Diesel | Turbo, OHV | TD17695 |
| OM 941.981 | 11946cc | V6 Cyl. | 24 Valves | 290-315kW/394-428PS | Diesel | Turbo, OHV | TD17696 |
| OM 941.990 | 11946cc | V6 Cyl. | 24 Valves | 315kW/428PS | Diesel | Turbo, OHV | TD16799 |

| | | | |
|-------------------|----------------------|------------------|----------|
| ACTROS Series 400 | 04/1996→ 10/2001→ | ACTROS MP2 / MP3 | 10/2002→ |
|-------------------|----------------------|------------------|----------|

| | | | | | | |
|-----------------------|-----------------|------------|-----|---|-----------------------|--|
| V94316 ■ | 541 050 02 26 | | 30° | H | VAG96134 ■ ■ ■ | |
| 45.70 x 9.00 x 145.00 | | MD + MB cr | | | 61.00 x 9.02 x 15.07 | |
| V95174 ■ | 541 053 01 01 | | 30° | H | VAG96135 ■ ■ ■ | |
| 45.45 x 8.94 x 144.90 | | MB cr | | | 61.00 x 9.00 x 15.20 | |
| V94317 ■ | 541 050 02 27 | | 45° | H | | |
| 41.10 x 9.00 x 145.00 | | MD + MB cr | | | | |
| V95175 ■ | A 457 050 03 27 | | 36° | H | | |
| 42.10 x 8.93 x 144.80 | | MD + MB cr | | | | |

177 130.00

| | | | | | | | |
|------------|---------|---------|-----------|---------------------|--------|------------|---------|
| OM 541.953 | 11946cc | V6 Cyl. | 24 Valves | 320kW/435PS | Diesel | Turbo, OHV | TD28777 |
| OM 541.959 | 11946cc | V6 Cyl. | 24 Valves | 300kW/408PS | Diesel | Turbo, OHV | TD28778 |
| OM 541.990 | 11946cc | V6 Cyl. | 24 Valves | 300kW/408PS | Diesel | Turbo, OHV | TD23767 |
| OM 541.991 | 11946cc | V6 Cyl. | 24 Valves | 300kW/408PS | Diesel | Turbo, OHV | TD25686 |
| OM 541.992 | 11946cc | V6 Cyl. | 24 Valves | 320kW/435PS | Diesel | Turbo, OHV | TD23768 |
| OM 541.993 | 11946cc | V6 Cyl. | 24 Valves | 320kW/435PS | Diesel | Turbo, OHV | TD25687 |
| OM 541.994 | 11946cc | V6 Cyl. | 24 Valves | 335kW/456PS | Diesel | Turbo, OHV | TD23769 |
| OM 541.996 | 11946cc | V6 Cyl. | 24 Valves | 235kW/320PS | Diesel | Turbo, OHV | TD25486 |
| OM 541.997 | 11946cc | V6 Cyl. | 24 Valves | 235kW/320PS | Diesel | Turbo, OHV | TD25697 |
| OM 541.998 | 11946cc | V6 Cyl. | 24 Valves | 265kW/360PS | Diesel | Turbo, OHV | TD25487 |
| OM 541.999 | 11946cc | V6 Cyl. | 24 Valves | 265kW/360PS | Diesel | Turbo, OHV | TD25698 |
| OM 941.991 | 11946cc | V6 Cyl. | 24 Valves | 260-315kW/354-428PS | Diesel | Turbo, OHV | TD28855 |

| | |
|------------------|----------|
| ACTROS MP2 / MP3 | 04/2003→ |
|------------------|----------|



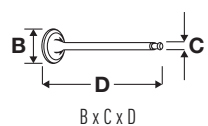



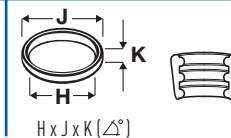
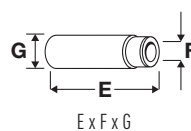

| | | | | | | |
|-----------------------|-----------------|------------|-----|---|-----------------------|--|
| V95174 ■ | 541 053 01 01 | | 30° | H | VAG96134 ■ ■ ■ | |
| 45.45 x 8.94 x 144.90 | | MB cr | | | 61.00 x 9.02 x 15.07 | |
| V95175 ■ | A 457 050 03 27 | | 36° | H | VAG96135 ■ ■ ■ | |
| 42.10 x 8.93 x 144.80 | | MD + MB cr | | | 61.00 x 9.00 x 15.20 | |



OE

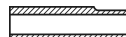

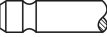
178  **130.00**

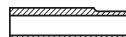
| OM 541.960 | 11946cc | V6 Cyl. | 24 Valves | 240kW/326PS | Diesel | Turbo, OHV | TD25520 |
|--|---------------|---|--|-------------|---|---|---------|
| V94316  45.70 x 9.00 x 145.00 | 541 050 02 26 |  MD + MB cr |  30° | H | VAG96134  61.00 x 9.02 x 15.07 |  | |
| V94317  41.10 x 9.00 x 145.00 | 541 050 02 27 |  MD + MB cr |  45° | H | VAG96135  61.00 x 9.00 x 15.20 |  | |



OE

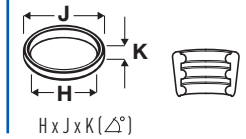
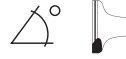

179



130.00

| | | | | | | | |
|------------|---------|---------|-----------|---------------------|--------|-----|---------|
| OM 440.907 | 15080cc | V8 Cyl. | 16 Valves | 195kW/265PS | Diesel | OHV | TD16966 |
| OM 440.909 | 15080cc | V8 Cyl. | 16 Valves | 195kW/265PS | Diesel | OHV | TD8192 |
| OM 440.910 | 15080cc | V8 Cyl. | 16 Valves | 218kW/296PS | Diesel | OHV | TD17119 |
| OM 440.911 | 15080cc | V8 Cyl. | 16 Valves | 218kW/296PS | Diesel | OHV | TD17120 |
| OM 442.905 | 15080cc | V8 Cyl. | 16 Valves | 191kW/260PS | Diesel | OHV | TD8186 |
| OM 442.906 | 15080cc | V8 Cyl. | 16 Valves | 218kW/296PS | Diesel | OHV | TD5769 |
| OM 442.907 | 15080cc | V8 Cyl. | 16 Valves | 213-218kW/290-296PS | Diesel | OHV | TD5771 |
| OM 442.908 | 15080cc | V8 Cyl. | 16 Valves | 210kW/286PS | Diesel | OHV | TD5790 |
| OM 442.909 | 15080cc | V8 Cyl. | 16 Valves | 210kW/286PS | Diesel | OHV | TD5791 |
| OM 442.910 | 15080cc | V8 Cyl. | 16 Valves | 213-218kW/290-296PS | Diesel | OHV | TD5662 |
| OM 442.911 | 15080cc | V8 Cyl. | 16 Valves | 218kW/296PS | Diesel | OHV | TD10971 |
| OM 442.914 | 15080cc | V8 Cyl. | 16 Valves | 195kW/265PS | Diesel | OHV | TD5734 |
| OM 442.915 | 15080cc | V8 Cyl. | 16 Valves | 218kW/296PS | Diesel | OHV | TD5822 |
| OM 442.916 | 15080cc | V8 Cyl. | 16 Valves | 218kW/296PS | Diesel | OHV | TD6174 |
| OM 442.917 | 15080cc | V8 Cyl. | 16 Valves | 218kW/296PS | Diesel | OHV | TD6297 |
| OM 442.918 | 15080cc | V8 Cyl. | 16 Valves | 213-218kW/290-296PS | Diesel | OHV | TD6000 |
| OM 442.919 | 15080cc | V8 Cyl. | 16 Valves | 213-218kW/290-296PS | Diesel | OHV | TD6272 |
| OM 442.920 | 15080cc | V8 Cyl. | 16 Valves | 195kW/265PS | Diesel | OHV | TD5735 |
| OM 442.921 | 15080cc | V8 Cyl. | 16 Valves | 195kW/265PS | Diesel | OHV | TD6144 |
| OM 442.922 | 15080cc | V8 Cyl. | 16 Valves | 195kW/265PS | Diesel | OHV | TD5770 |
| OM 442.923 | 15080cc | V8 Cyl. | 16 Valves | 210kW/286PS | Diesel | OHV | TD6127 |
| OM 442.924 | 15080cc | V8 Cyl. | 16 Valves | 210kW/286PS | Diesel | OHV | TD6128 |
| OM 442.925 | 15080cc | V8 Cyl. | 16 Valves | 213kW/290PS | Diesel | OHV | TD5815 |
| OM 442.926 | 15080cc | V8 Cyl. | 16 Valves | 213kW/290PS | Diesel | OHV | TD5792 |
| OM 442.927 | 15080cc | V8 Cyl. | 16 Valves | 213kW/290PS | Diesel | OHV | TD5823 |
| OM 442.928 | 15080cc | V8 Cyl. | 16 Valves | 213kW/290PS | Diesel | OHV | TD6175 |
| OM 442.929 | 15080cc | V8 Cyl. | 16 Valves | 213kW/290PS | Diesel | OHV | TD6129 |
| OM 442.931 | 15080cc | V8 Cyl. | 16 Valves | 195kW/265PS | Diesel | OHV | TD7945 |
| OM 442.932 | 15080cc | V8 Cyl. | 16 Valves | 195kW/265PS | Diesel | OHV | TD6066 |
| OM 442.933 | 15080cc | V8 Cyl. | 16 Valves | 195kW/265PS | Diesel | OHV | TD6067 |
| OM 442.934 | 15080cc | V8 Cyl. | 16 Valves | 195kW/265PS | Diesel | OHV | TD6324 |
| OM 442.935 | 15080cc | V8 Cyl. | 16 Valves | 195kW/265PS | Diesel | OHV | TD6102 |
| OM 442.939 | 15080cc | V8 Cyl. | 16 Valves | 213-218kW/290-296PS | Diesel | OHV | TD6319 |

MK

12/1987→09/1996

NG

08/1973→09/1996

O 303

09/1987→09/1992

O 330

01/1990→

O 404

09/1991→01/1992

OH Series

01/1970→

SK

07/1987→09/1996

Transliner

12/1988→

V91132 ■■

59.00 x 11.95 x 142.50

442 050 03 26



30°

H

VAG92089 ■■■

67.05 x 11.99 x 18.03

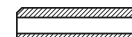

V91133 ■■

51.00 x 11.94 x 142.50

442 050 04 27



45°

H

V94332 ■■

51.00 x 12.00 x 142.50

442 050 02 27



45°

H

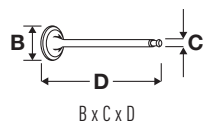



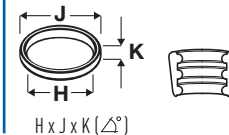
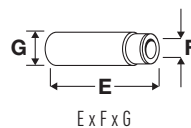







OE



180  **130.00**

| | | | | | | | |
|-------------------|-----------------|---------|------------------|-------------|--------|------------|---------------|
| OM 442.930 | 15100cc | V8 Cyl. | 16 Valves | 213kW/290PS | Diesel | OHV | TD7944 |
| Q 404 | 09/1991→01/1992 | | | | | | |

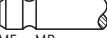
| | | | | | | |
|---|---------------|---|-----|---|--|---|
| V91132  | 442 050 03 26 |   | 30° | H | VAG92089   |  |
| 59.00 x 11.95 x 142.50 | | MD + MB cr | | | 67.05 x 11.99 x 18.03 | |
| V91133  | 442 050 04 27 |   | 45° | H | | |
| 51.00 x 11.94 x 142.50 | | MD + MB cr | | | | |
| V94332  | 442 050 02 27 |   | 45° | H | | |
| 51.00 x 12.00 x 142.50 | | ME + MB cr | | | | |



OE

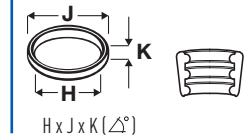
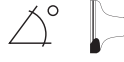

181  130.00

| | | | | | | | |
|------------------|----------|---------|-----------|---------------------|--------|------------|---------|
| OM 522.940 | 15928cc | V8 Cyl. | 32 Valves | 420kW/571PS | Diesel | Turbo, OHV | TD16800 |
| OM 522.941 | 15928cc | V8 Cyl. | 32 Valves | 413kW/562PS | Diesel | Turbo, OHV | TD17672 |
| OM 522.942 | 15928cc | V8 Cyl. | 32 Valves | 362kW/496PS | Diesel | Turbo, OHV | TD17673 |
| OM 522.943 | 15928cc | V8 Cyl. | 32 Valves | 362kW/496PS | Diesel | Turbo, OHV | TD17674 |
| OM 522.950 | 15928cc | V8 Cyl. | 32 Valves | 530kW/721PS | Diesel | Turbo, OHV | TD22822 |
| OM 542.920 | 15928cc | V8 Cyl. | 32 Valves | 390kW/530PS | Diesel | Turbo, OHV | TD7877 |
| OM 542.921 | 15928cc | V8 Cyl. | 32 Valves | 350kW/476PS | Diesel | Turbo, OHV | TD7876 |
| OM 542.922 | 15928cc | V8 Cyl. | 32 Valves | 420kW/571PS | Diesel | Turbo, OHV | TD7878 |
| OM 542.923 | 15928cc | V8 Cyl. | 32 Valves | 420kW/571PS | Diesel | Turbo, OHV | TD16905 |
| OM 542.924 | 15928cc | V8 Cyl. | 32 Valves | 420kW/571PS | Diesel | Turbo, OHV | TD17686 |
| OM 542.925 | 15928cc | V8 Cyl. | 32 Valves | 350kW/476PS | Diesel | Turbo, OHV | TD9683 |
| OM 542.926 | 15928cc | V8 Cyl. | 32 Valves | 390kW/530PS | Diesel | Turbo, OHV | TD17687 |
| OM 542.940 | 15928cc | V8 Cyl. | 32 Valves | 350-375kW/476-510PS | Diesel | Turbo, OHV | TD16909 |
| OM 542.941 | 15928cc | V8 Cyl. | 32 Valves | 370kW/503PS | Diesel | Turbo, OHV | TD16911 |
| OM 542.942 | 15928cc | V8 Cyl. | 32 Valves | 390-395kW/530-537PS | Diesel | Turbo, OHV | TD16906 |
| OM 542.943 | 15928cc | V8 Cyl. | 32 Valves | 390-395kW/530-537PS | Diesel | Turbo, OHV | TD16907 |
| OM 542.944 | 15928cc | V8 Cyl. | 32 Valves | 420-425kW/571-578PS | Diesel | Turbo, OHV | TD16912 |
| OM 542.945 | 15928cc | V8 Cyl. | 32 Valves | 420-425kW/571-578PS | Diesel | Turbo, OHV | TD17689 |
| OM 542.947 | 15928cc | V8 Cyl. | 32 Valves | 390-420kW/530-571PS | Diesel | Turbo, OHV | TD17690 |
| OM 542.948 | 15928cc | V8 Cyl. | 32 Valves | 320-370kW/435-503PS | Diesel | Turbo, OHV | TD17655 |
| OM 542.956 | 15928cc | V8 Cyl. | 32 Valves | 448kW/609PS | Diesel | Turbo, OHV | TD17691 |
| OM 542.957 | 15928cc | V8 Cyl. | 32 Valves | 448kW/609PS | Diesel | Turbo, OHV | TD17692 |
| OM 542.958 | 15928cc | V8 Cyl. | 32 Valves | 450kW/612PS | Diesel | Turbo, OHV | TD24684 |
| OM 542.960 | 15928cc | V8 Cyl. | 32 Valves | 375kW/510PS | Diesel | Turbo, OHV | TD19999 |
| OM 542.961 | 15928cc | V8 Cyl. | 32 Valves | 375kW/510PS | Diesel | Turbo, OHV | TD21026 |
| OM 542.962 | 15928cc | V8 Cyl. | 32 Valves | 405kW/551PS | Diesel | Turbo, OHV | TD18840 |
| OM 542.963 | 15928cc | V8 Cyl. | 32 Valves | 405kW/551PS | Diesel | Turbo, OHV | TD21025 |
| OM 542.964 | 15928cc | V8 Cyl. | 32 Valves | 440kW/598PS | Diesel | Turbo, OHV | TD20000 |
| OM 942.900 | 15928cc | V8 Cyl. | 32 Valves | 350kW/476PS | Diesel | Turbo, OHV | TD17697 |
| OM 942.910 | 15928cc | V8 Cyl. | 32 Valves | 350kW/470PS | Diesel | Turbo, OHV | TD17698 |
| OM 942.911 | 15928cc | V8 Cyl. | 32 Valves | 350kW/476PS | Diesel | Turbo, OHV | TD16801 |
| OM 942.912 | 15928cc | V8 Cyl. | 32 Valves | 350kW/470PS | Diesel | Turbo, OHV | TD17699 |
| OM 942.925 | 15928cc | V8 Cyl. | 32 Valves | 400kW/544PS | Diesel | Turbo, OHV | TD17700 |
| OM 942.930 | 15928cc | V8 Cyl. | 32 Valves | 420kW/570PS | Diesel | Turbo, OHV | TD16802 |
| OM 942.960 | 15928cc | V8 Cyl. | 32 Valves | 350kW/470PS | Diesel | Turbo, OHV | TD17701 |
| OM 942.967 | 15928cc | V8 Cyl. | 32 Valves | 370-380kW/503-517PS | Diesel | Turbo, OHV | TD17702 |
| OM 942.970 | 15928cc | V8 Cyl. | 32 Valves | 390kW/570PS | Diesel | Turbo, OHV | TD17703 |
| OM 942.980 | 15928cc | V8 Cyl. | 32 Valves | 420kW/570PS | Diesel | Turbo, OHV | TD16803 |
| OM 942.990 | 15928cc | V8 Cyl. | 32 Valves | 330-448kW/570-609PS | Diesel | Turbo, OHV | TD17704 |
| ACTROS | 04/1996→ | | | ACTROS MP2 / MP3 | | 10/2002→ | |
| ACTROS MP4 | 01/2014→ | | | Series 400 | | 10/2001→ | |
| Skyliner | 05/2004→ | | | Starliner | | 09/1996→ | |
| TOURISMO (O 350) | 01/2003→ | | | TRAVEGO (O 580) | | 10/1999→ | |



OE

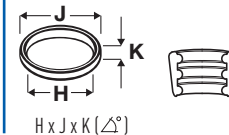
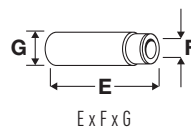

| | | | | |
|--|-----------------|------------|-----|---|
| V94316 ■ 45.70 x 9.00 x 145.00 | 541 050 02 26 | MD + MB cr | 30° | H |
| V95174 ■ 45.45 x 8.94 x 144.90 | 541 053 01 01 | MB cr | 30° | H |
| V94317 ■ 41.10 x 9.00 x 145.00 | 541 050 02 27 | MD + MB cr | 45° | H |
| V95175 ■ 42.10 x 8.93 x 144.80 | A 457 050 03 27 | MD + MB cr | 36° | H |

| | |
|---|--|
| VAG96134 ■ ■ ■ 61.00 x 9.02 x 15.07 | |
| VAG96135 ■ ■ ■ 61.00 x 9.00 x 15.20 | |

182 130.00

| | | | | | | | |
|------------|---------|---------|-----------|---------------------|--------|------------|---------|
| OM 542.972 | 15928cc | V8 Cyl. | 32 Valves | 405-480kW/551-653PS | Diesel | Turbo, OHV | TD28781 |
|------------|---------|---------|-----------|---------------------|--------|------------|---------|

| | | | | |
|--|-----------------|------------|-----|---|
| V95174 ■ 45.45 x 8.94 x 144.90 | 541 053 01 01 | MB cr | 30° | H |
| V95175 ■ 42.10 x 8.93 x 144.80 | A 457 050 03 27 | MD + MB cr | 36° | H |

| | |
|---|--|
| VAG96134 ■ ■ ■ 61.00 x 9.02 x 15.07 | |
| VAG96135 ■ ■ ■ 61.00 x 9.00 x 15.20 | |

183 130.00

| | | | | | | | |
|------------|---------|----------|-----------|-------------|--------|-----|---------|
| OM 443.905 | 18848cc | V10 Cyl. | 20 Valves | 271kW/369PS | Diesel | OHV | TD16981 |
| OM 443.906 | 18848cc | V10 Cyl. | 20 Valves | 271kW/369PS | Diesel | OHV | TD17138 |
| OM 443.908 | 18848cc | V10 Cyl. | 20 Valves | 271kW/369PS | Diesel | OHV | TD17139 |
| OM 443.909 | 18848cc | V10 Cyl. | 20 Valves | 271kW/369PS | Diesel | OHV | TD17140 |

| | | | | |
|---|---------------|------------|-----|---|
| V91132 ■ 59.00 x 11.95 x 142.50 | 442 050 03 26 | MD + MB cr | 30° | H |
| V91133 ■ 51.00 x 11.94 x 142.50 | 442 050 04 27 | MD + MB cr | 45° | H |
| V94332 ■ 51.00 x 12.00 x 142.50 | 442 050 02 27 | ME + MB cr | 45° | H |

| | |
|--|--|
| VAG92089 ■ ■ ■ 67.05 x 11.99 x 18.03 | |
|--|--|

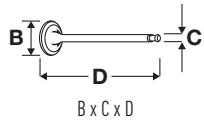

OE

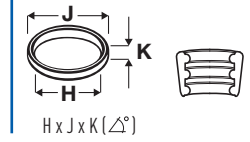
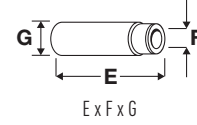

184  **132.00**

| | | | | | | | |
|------------|---------|--------|-----------|---------------------|--------|-------------|---------|
| OM 471.900 | 12809cc | 6 Cyl. | 24 Valves | 310-375kW/422-510PS | Diesel | Turbo, DOHC | TD25519 |
| OM 471.901 | 12809cc | 6 Cyl. | 24 Valves | 310-375kW/422-510PS | Diesel | Turbo, DOHC | TD29328 |
| OM 471.902 | 12809cc | 6 Cyl. | 24 Valves | 315-375kW/428-510PS | Diesel | Turbo, DOHC | TD28759 |
| OM 471.903 | 12809cc | 6 Cyl. | 24 Valves | 310-375kW/422-510PS | Diesel | Turbo, DOHC | TD29329 |
| OM 471.905 | 12809cc | 6 Cyl. | 24 Valves | 310-375kW/422-510PS | Diesel | Turbo, DOHC | TD29330 |
| OM 471.906 | 12809cc | 6 Cyl. | 24 Valves | 310-375kW/422-510PS | Diesel | Turbo, DOHC | TD29331 |
| OM 471.909 | 12809cc | 6 Cyl. | 24 Valves | 310-375kW/422-510PS | Diesel | Turbo, DOHC | TD28082 |
| OM 471.910 | 12809cc | 6 Cyl. | 24 Valves | 310-375kW/422-510PS | Diesel | Turbo, DOHC | TD29332 |
| OM 471.911 | 12809cc | 6 Cyl. | 24 Valves | 310-375kW/422-510PS | Diesel | Turbo, DOHC | TD29333 |
| OM 471.913 | 12809cc | 6 Cyl. | 24 Valves | 310-375kW/422-510PS | Diesel | Turbo, DOHC | TD29334 |
| OM 471.914 | 12809cc | 6 Cyl. | 24 Valves | 310-375kW/422-510PS | Diesel | Turbo, DOHC | TD29336 |
| OM 471.915 | 12809cc | 6 Cyl. | 24 Valves | 310-375kW/422-510PS | Diesel | Turbo, DOHC | TD29337 |
| OM 471.917 | 12809cc | 6 Cyl. | 24 Valves | 310-375kW/422-510PS | Diesel | Turbo, DOHC | TD29338 |
| OM 471.927 | 12809cc | 6 Cyl. | 24 Valves | 310-375kW/422-510PS | Diesel | Turbo, DOHC | TD29339 |
| OM 471.932 | 12809cc | 6 Cyl. | 24 Valves | 310-375kW/422-510PS | Diesel | Turbo, DOHC | TD29340 |
| OM 471.933 | 12809cc | 6 Cyl. | 24 Valves | 310-375kW/422-510PS | Diesel | Turbo, DOHC | TD29341 |
| OM 471.934 | 12809cc | 6 Cyl. | 24 Valves | 310-375kW/422-510PS | Diesel | Turbo, DOHC | TD29342 |
| OM 471.935 | 12809cc | 6 Cyl. | 24 Valves | 310-375kW/422-510PS | Diesel | Turbo, DOHC | TD29343 |

ACTROS MP4
AROCS
Series 500

07/2011→
01/2013→
01/2012→

ANTOS
Series 400

07/2012→
08/2016→

V95123 
45.00 x 9.47 x 240.00

A 471 050 04 26

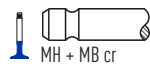

20°

H







V95124 
43.00 x 9.45 x 246.50

A 471 050 05 27



30°

H

|  |  | ccm |  |  |  |  |
|---|---|------|--|---|---|---|
| 14 K4F | 75.00 | 1396 | 4 | 16 | Petrol | 1 |
| 16 K4F | 80.00 | 1588 | 4 | 16 | Petrol | 2 |
| 18 K4F | 80.00 | 1796 | 4 | 16 | Petrol | 3 |
| 18 K4K (VVC) | 80.00 | 1796 | 4 | 16 | Petrol | 4 |
| 20 K4F | 80.00 | 1997 | 6 | 24 | Petrol | 5 |
| 20 T2N | 84.50 | 1994 | 4 | 8 | Diesel | 8 |
| 204D2 | 84.00 | 1951 | 4 | 16 | Diesel | 7 |
| 25 K4F | 80.00 | 2497 | 6 | 24 | Petrol | 6 |



OE



E x F x G

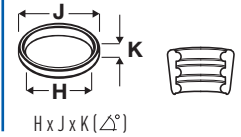

H x J x K (Δ°)

1



75.00

| 14 K4F | 1396cc | 4 Cyl. | 16 Valves | 76kW/103PS | Petrol | DOHC | TD18866 |
|----------------------|-----------|-----------------|-----------|------------|-----------------------|-----------------|---------|
| EXPRESS 1.4 | | 03/2003→05/2005 | | MG ZR 105 | | 06/2001→04/2005 | |
| V91209 ■ | LGH10029 | | 45° | H | VAG92309 ■ ■ ■ | | |
| 27.80 x 5.97 x 89.60 | | MB | | | 30.00 x 6.00 x 9.90 | | |
| V94053 ■ | LGH100820 | | 45° | SS | VAG92316 ■ ■ ■ | | |
| 24.30 x 5.96 x 90.00 | | MD tu | | | 30.00 x 6.01 x 10.14 | | |

2



80.00

| 16 K4F | 1588cc | 4 Cyl. | 16 Valves | 79-86kW/107-117PS | Petrol | DOHC | TD17597 |
|----------------------|-----------|-----------------|-----------|-------------------|-----------------------|-----------------|---------|
| MGF 1.6 | | 02/2000→03/2002 | | MG TF 115 | | 03/2002→12/2009 | |
| MG ZS 1.6 | | 11/2001→10/2005 | | | | | |
| V91209 ■ | LGH10029 | | 45° | H | VAG92309 ■ ■ ■ | | |
| 27.80 x 5.97 x 89.60 | | MB | | | 30.00 x 6.00 x 9.90 | | |
| V94053 ■ | LGH100820 | | 45° | SS | VAG92316 ■ ■ ■ | | |
| 24.30 x 5.96 x 90.00 | | MD tu | | | 30.00 x 6.01 x 10.14 | | |

3



80.00

| 18 K4F | 1796cc | 4 Cyl. | 16 Valves | 86-100kW/117-136PS | Petrol | DOHC | TD18234 |
|----------------------|-----------|-----------------|-----------|--------------------|-----------------------|-----------------|---------|
| EXPRESS 1.8 | | 03/2003→05/2005 | | MGF 1.8 i 16V | | 03/1995→03/2002 | |
| MG TF 120 | | 03/2002→12/2009 | | MG TF 135 | | 03/2002→12/2009 | |
| MG ZR 120 | | 06/2001→04/2005 | | MG ZS 120 | | 07/2001→10/2005 | |
| MG ZT 1.8 16V | | 01/2003→07/2005 | | MG ZT- 1.8 16V | | 01/2003→07/2005 | |
| V91209 ■ | LGH10029 | | 45° | H | VAG92309 ■ ■ ■ | | |
| 27.80 x 5.97 x 89.60 | | MB | | | 30.00 x 6.00 x 9.90 | | |
| V94053 ■ | LGH100820 | | 45° | SS | VAG92316 ■ ■ ■ | | |
| 24.30 x 5.96 x 90.00 | | MD tu | | | 30.00 x 6.01 x 10.14 | | |

4



80.00

| 18 K4K (VVC) | 1796cc | 4 Cyl. | 16 Valves | 107-118kW/146-160PS | Petrol | DOHC | TD18235 |
|--------------------------------|-----------|-----------------|-----------|---------------------|--------|-----------------|---------|
| EXPRESS 160 | | 03/2003→05/2005 | | MGF 1.8 i VVC | | 10/2001→03/2002 | |
| MGF 1.8 i VVC | | 03/1995→03/2002 | | MG TF 160 | | 03/2002→12/2009 | |
| MG ZR 160 | | 06/2001→04/2005 | | | | | |
| V94101 ■ | LGH10064 | | 45° | H | | | |
| 31.60 x 6.00 x 89.60 | | MB tu | | | | | |
| V94102 ■ | LGH10065 | | 45° | | | | |
| 27.40 x 6.00 x 90.00 →12/99 | | MD tu | | | | | |
| V94342 ■ | LGH101360 | | 45° | | | | |
| 27.50 x 6.00 x 90.10 01/00→ | | MD tu | | | | | |

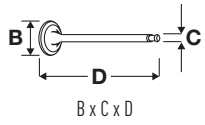

OE

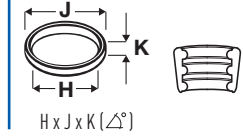
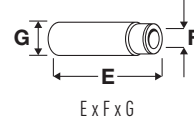
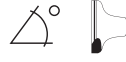

5 **80.00**

| 20 K4F | 1997cc | V6 Cyl. | 24 Valves | 110kW/150PS | Petrol | DOHC | TD19047 |
|----------------------|-----------|---------|-----------|-------------|---------------------|------|---------|
| V94101 | LGH10064 | | 45° | H | VAG96058 | | |
| 31.60 x 6.00 x 89.60 | | MB tu | | | 30.00 x 6.01 x 9.88 | | |
| V94342 | LGH101360 | | 45° | | | | |
| 27.50 x 6.00 x 90.10 | | MD tu | | | | | |

6 **80.00**







| 25 K4F | 2497cc | V6 Cyl. | 24 Valves | 118-140kW/160-190PS | Petrol | DOHC | TD18236 |
|----------------------|-----------------|---------|-----------|---------------------|---------------------|-----------------|---------|
| MG ZS 180 | 07/2001→10/2005 | | | MG ZT 160 | | 06/2001→07/2005 | |
| MG ZT- 160 | 10/2001→07/2005 | | | MG ZT 180 | | 01/2003→07/2005 | |
| MG ZT- 180 | 01/2003→07/2005 | | | MG ZT 190 | | 06/2001→07/2005 | |
| MG ZT- 190 | 10/2001→07/2005 | | | | | | |
| V94101 | LGH10064 | | 45° | H | VAG96058 | | |
| 31.60 x 6.00 x 89.60 | | MB tu | | | 30.00 x 6.01 x 9.88 | | |
| V94342 | LGH101360 | | 45° | | | | |
| 27.50 x 6.00 x 90.10 | | MD tu | | | | | |

7 **84.00**

| 204D2 | 1951cc | 4 Cyl. | 16 Valves | 85-96kW/116-131PS | Diesel | | TD18241 |
|----------------------|-----------------|------------|-----------|-------------------|----------------------|-----------------|---------|
| MG ZT 2.0 CDTi | 06/2002→07/2005 | | | MG ZT- 2.0 CDTi | | 06/2002→07/2005 | |
| V94086 | 11 34 2 247 077 | | 45° | H | VAG96266B | | |
| 26.00 x 6.00 x 99.90 | | MF + MB cr | | | 39.00 x 6.00 x 11.54 | | |
| V94086 | 11 34 2 247 077 | | 45° | H | | | |
| 26.00 x 6.00 x 99.90 | | cr | | | | | |

8 **84.50**

| 20 T2N | 1994cc | 4 Cyl. | 8 Valves | 74-83kW/101-113PS | Diesel | Turbo, SOHC | TD24113 |
|----------------------|-----------------|--------|----------|-------------------|----------------------|-----------------|---------|
| EXPRESS 2.0 TD | 03/2003→05/2005 | | | MG ZR 2.0 TD | | 06/2001→04/2005 | |
| MG ZS 2.0 TD | 01/2004→10/2005 | | | | | | |
| V94018 | LGH100990 | | 45° | | VAG92511 | | |
| 37.20 x 6.92 x 87.00 | | MB tu | | | 28.30 x 6.96 x 12.05 | | |
| V94019 | LGH100980 | | 45° | | | | |
| 32.60 x 6.91 x 87.00 | | MD tu | | | | | |

|  |  | ccm |  |  |  |  | |
|---|---|-------|---|---|---|---|----|
| 1ND | | 73.00 | 1364 | 4 | 8 | Diesel | 1 |
| 1ND-TV | | 73.00 | 1364 | 4 | 8 | Diesel | 1 |
| 9HZ (DV6TED4) | | 75.00 | 1560 | 4 | 16 | Diesel | 2 |
| B37 C15 A | | 84.00 | 1496 | 3 | 12 | Diesel | 9 |
| B47 C20 A | | 84.00 | 1995 | 4 | 16 | Diesel | 10 |
| N12 B14 A | | 77.00 | 1397 | 4 | 16 | Petrol | 3 |
| N12 B16 A | | 77.00 | 1598 | 4 | 16 | Petrol | 4 |
| N14 B16 A | | 77.00 | 1598 | 4 | 16 | Petrol | 4 |
| N14 B16 C | | 77.00 | 1598 | 4 | 16 | Petrol | 4 |
| N16 B16 A | | 77.00 | 1598 | 4 | 16 | Petrol | 5 |
| N18 B16 A | | 77.00 | 1598 | 4 | 16 | Petrol | 6 |
| N18 B16 B | | 77.00 | 1598 | 4 | 16 | Petrol | 6 |
| N18 B16 C | | 77.00 | 1598 | 4 | 16 | Petrol | 6 |
| N47 C16 A | | 78.00 | 1598 | 4 | 16 | Diesel | 8 |
| N47 C20 A | | 84.00 | 1995 | 4 | 16 | Diesel | 10 |
| W10 B16 A | | 77.00 | 1598 | 4 | 16 | Petrol | 7 |



OE

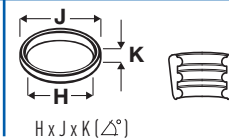
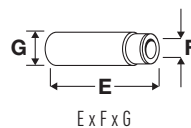

1 **73.00**

| | | | | | | | |
|---------------|-----------------|--------|-----------------|-----------------|----------------------|--------------------|----------------|
| 1ND | 1364cc | 4 Cyl. | 8 Valves | 55kW/75PS | Diesel | SOHC | TD18565 |
| 1ND-TV | 1364cc | 4 Cyl. | 8 Valves | 55-65kW/75-88PS | Diesel | Turbo, SOHC | TD22098 |
| MINI One D | 06/2003→09/2006 | | | | | | |
| V94670 | 11 34 7 791 054 | | 45° | H | VAG96357 | | |
| | | MB tu | | | 40.60 x 6.00 x 11.04 | | |
| V94671 | 11 34 7 791 055 | | 45° | | | | |
| | | MD tu | | | | | |

2 **75.00**

| | | | | | | | |
|-----------------------|-----------------|------------|------------------|------------------|---------------------|--------------------|----------------|
| 9HZ (DV6TED4) | 1560cc | 4 Cyl. | 16 Valves | 66-80kW/90-109PS | Diesel | Turbo, DOHC | TD20982 |
| MINI CLUBMAN Cooper D | 10/2007→02/2010 | | MINI Cooper D | | 11/2006→09/2010 | | |
| MINI One D | 06/2009→07/2010 | | | | | | |
| V94960 | 11 34 7 805 968 | | 45° | H | VAG96364 | | |
| | | MB cr | | | 34.20 x 5.50 x 9.53 | | |
| V94961 | 11 34 7 805 969 | | 45° | ss H | | | |
| | | MD + MB cr | | | | | |

3 **77.00**

| | | | | | | | |
|------------------|-----------------|---------|------------------|-----------------|---------------------|-------------|----------------|
| N12 B14 A | 1397cc | 4 Cyl. | 16 Valves | 55-70kW/75-95PS | Petrol | DOHC | TD24547 |
| MINI CLUBMAN One | 03/2009→02/2010 | | MINI One | | 11/2006→03/2010 | | |
| V95035 | 11 34 7 533 884 | | 45° | H | VAG96392B | | |
| | | MB | | | 41.50 x 5.01 x 9.05 | | |
| V95036 | 11 34 7 533 885 | | 45° | H | VAG96393B | | |
| | | MD + MB | | | 44.50 x 5.01 x 9.05 | | |

4 **77.00**

| | | | | | | | |
|--------------------------------|-----------------|---------|---------------------------------|---------------------|---------------------|-------------------------------|----------------|
| N12 B16 A | 1598cc | 4 Cyl. | 16 Valves | 85-90kW/116-122PS | Petrol | DOHC | TD20893 |
| N14 B16 A | 1598cc | 4 Cyl. | 16 Valves | 120-141kW/163-192PS | Petrol | Turbo, DOHC, Injection | TD24546 |
| N14 B16 C | 1598cc | 4 Cyl. | 16 Valves | 141-155kW/192-211PS | Petrol | Turbo, DOHC, Injection | TD25562 |
| MINI CLUBMAN Cooper | 10/2007→12/2013 | | MINI CLUBMAN Cooper S | | 10/2007→02/2010 | | |
| MINI CLUBMAN John Cooper Works | 11/2007→06/2014 | | MINI Cooper | | 09/2006→06/2015 | | |
| MINI Cooper S | 10/2006→06/2015 | | MINI Cooper S John Cooper Works | | 11/2006→02/2010 | | |
| MINI COUNTRYMAN Cooper S | 01/2010→10/2016 | | MINI John Cooper Works | | 11/2007→05/2015 | | |
| V95037 | 11 34 7 587 470 | | 45° | H | VAG96392B | | |
| | | MB | | | 41.50 x 5.01 x 9.05 | | |
| V95038 | 11 34 7 547 187 | | 45° | H | VAG96393B | | |
| | | MD + MB | | | 44.50 x 5.01 x 9.05 | | |



OE

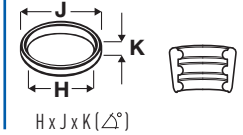
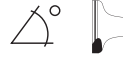

5

 77.00

| N16 B16 A | 1598cc | 4 Cyl. | 16 Valves | 55-90kW/75-122PS | Petrol | DOHC | TD25563 |
|---------------------|--------|--------|-----------|------------------|--------|------------------------|-----------------|
| MINI CLUBMAN Cooper | | | | 10/2007→06/2014 | | MINI CLUBMAN One | 03/2010→06/2014 |
| MINI CLUBVAN Cooper | | | | 12/2012→06/2014 | | MINI CLUBVAN One | 12/2012→06/2014 |
| MINI Cooper | | | | 09/2006→06/2015 | | MINI COUNTRYMAN Cooper | 01/2010→10/2016 |
| MINI COUNTRYMAN One | | | | 01/2010→09/2016 | | MINI One | 09/2009→06/2015 |
| MINI PACEMAN Cooper | | | | 04/2012→09/2016 | | | |

V95035 
30.00 x 5.00 x 97.00

11 34 7 533 884

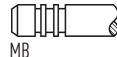

45°

H

VAG96392B 
41.50 x 5.01 x 9.05

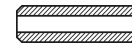

V95036 
25.10 x 5.00 x 110.65

11 34 7 533 885



45°

H

VAG96393B 
44.50 x 5.01 x 9.05



6

 77.00

| N18 B16 A | 1598cc | 4 Cyl. | 16 Valves | 90-160kW/122-218PS | Petrol | Turbo, DOHC, Injection | TD25564 |
|-----------------------------------|--------|--------|-----------|---------------------|--------|--------------------------------|-----------------|
| N18 B16 B | 1598cc | 4 Cyl. | 16 Valves | 160kW/218PS | Petrol | Turbo, DOHC, Injection | TD27246 |
| N18 B16 C | 1598cc | 4 Cyl. | 16 Valves | 155-160kW/211-218PS | Petrol | Turbo, DOHC, Injection | TD27825 |
| MINI CLUBMAN Cooper S | | | | 03/2010→06/2014 | | MINI CLUBMAN John Cooper Works | 11/2007→06/2014 |
| MINI Cooper S | | | | 10/2007→06/2015 | | MINI Cooper S JCW | 12/2010→04/2015 |
| MINI COUNTRYMAN Cooper | | | | 11/2012→10/2016 | | MINI COUNTRYMAN Cooper S | 01/2010→10/2016 |
| MINI COUNTRYMAN John Cooper Works | | | | 04/2011→10/2016 | | MINI John Cooper Works | 11/2007→05/2015 |
| MINI John Cooper Works GP | | | | 09/2012→11/2013 | | MINI PACEMAN Cooper | 11/2012→09/2016 |
| MINI PACEMAN Cooper S | | | | 03/2012→09/2016 | | MINI PACEMAN John Cooper Works | 09/2012→09/2016 |

V95035 
30.00 x 5.00 x 97.00

11 34 7 533 884

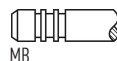

45°

H

VAG96392B 
41.50 x 5.01 x 9.05



V95153 
29.70 x 4.97 x 95.10

11 34 7 585 901

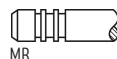

45°

Y

H

VAG96393B 
44.50 x 5.01 x 9.05



V95036 
25.10 x 5.00 x 110.65

11 34 7 533 885

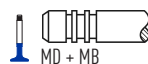

45°

H

V95038 
26.25 x 5.00 x 110.10

11 34 7 547 187

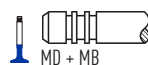

45°

H

7

 77.00

| W10 B16 A | 1598cc | 4 Cyl. | 16 Valves | 66-85kW/90-116PS | Petrol | Tritec, DOHC | TD18563 |
|-------------|--------|--------|-----------|------------------|--------|--------------|-----------------|
| MINI Cooper | | | | 06/2001→11/2007 | | MINI One | 06/2001→11/2007 |

V94349 
30.30 x 6.00 x 109.00

1134 1 485 585

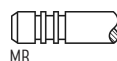

45°

H

V94350 
23.20 x 6.00 x 117.85

1134 7 829 943

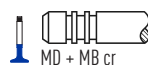

45°

H

8

 78.00

| N47 C16 A | 1598cc | 4 Cyl. | 16 Valves | 66-82kW/90-112PS | Diesel | Turbo, DOHC | TD26136 |
|--------------------------|--------|--------|-----------|------------------|--------|-----------------------|-----------------|
| MINI CLUBMAN Cooper D | | | | 03/2010→06/2014 | | MINI CLUBMAN One D | 03/2010→06/2014 |
| MINI CLUBVAN Cooper D | | | | 12/2012→06/2014 | | MINI Cooper D | 05/2009→11/2013 |
| MINI COUNTRYMAN Cooper D | | | | 01/2010→10/2016 | | MINI COUNTRYMAN One D | 01/2010→10/2016 |
| MINI One D | | | | 07/2010→11/2013 | | MINI PACEMAN Cooper D | 04/2012→09/2016 |

V95162 
24.85 x 4.97 x 93.95

11 34 7 812 618

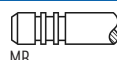

45°

H

VAG96387B 
36.00 x 5.00 x 10.05



V95154 
21.15 x 4.96 x 94.00

11 34 7 812 616

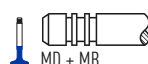

45°

H



OE

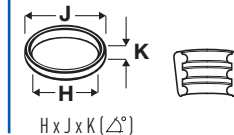
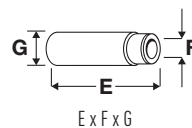







9 **84.00**

| | | | | | | | |
|-----------------------|-----------------|---------|------------------|------------------|----------------------|-------------|----------------|
| B37 C15 A | 1496cc | 3 Cyl. | 12 Valves | 70-85kW/95-116PS | Diesel | DOHC | TD28915 |
| MINI CLUBMAN One D | 02/2015→ | | | MINI Cooper D | | 10/2013→ | |
| MINI COUNTRYMAN One D | 07/2017→ | | | MINI One D | | 07/2013→ | |
| V95040 | 11 12 7 797 711 | | 45° | H | VAG96387B | | |
| 27.20 x 5.00 x 94.00 | | MB cr | | | 36.00 x 5.00 x 10.05 | | |
| V95041 | 11 34 8 511 622 | | 45° | H | | | |
| 24.60 x 5.00 x 94.00 | | MD + MB | | | | | |

10 **84.00**

| | | | | | | | |
|---------------------------|-----------------|---------|------------------|--------------------------|----------------------|--------------------|----------------|
| B47 C20 A | 1995cc | 4 Cyl. | 16 Valves | 100-140kW/136-190PS | Diesel | Turbo | TD29493 |
| N47 C20 A | 1995cc | 4 Cyl. | 16 Valves | 82-105kW/112-143PS | Diesel | Turbo, DOHC | TD25060 |
| MINI CLUBMAN Cooper D | 02/2011→ | | | MINI CLUBMAN Cooper SD | | 02/2011→ | |
| MINI CLUBVAN Cooper D | 12/2012→06/2014 | | | MINI Cooper D | | 02/2011→05/2015 | |
| MINI Cooper SD | 06/2009→ | | | MINI COUNTRYMAN Cooper D | | 01/2010→ | |
| MINI COUNTRYMAN Cooper SD | 01/2010→ | | | MINI PACEMAN Cooper D | | 03/2012→09/2016 | |
| MINI PACEMAN Cooper SD | 03/2012→09/2016 | | | | | | |
| V95040 | 11 12 7 797 711 | | 45° | H | VAG96387B | | |
| 27.20 x 5.00 x 94.00 | | MB cr | | | 36.00 x 5.00 x 10.05 | | |
| V95041 | 11 34 8 511 622 | | 45° | H | | | |
| 24.60 x 5.00 x 94.00 | | MD + MB | | | | | |

|  |  | ccm |  |  |  |  | |
|---|---|-------|---|---|---|---|----|
| 3A91 | | 75.00 | 1124 | 3 | 12 | Petrol | 5 |
| 4A90 | | 75.00 | 1332 | 4 | 16 | Petrol | 6 |
| 4A91 | | 75.00 | 1499 | 4 | 16 | Petrol | 7 |
| 4D55 | | 91.10 | 2347 | 4 | 8 | Diesel | 18 |
| 4D55 T | | 91.10 | 2347 | 4 | 8 | Diesel | 18 |
| 4D56 (12V) | | 91.10 | 2477 | 4 | 12 | Diesel | 21 |
| 4D56 (8V) | | 91.10 | 2477 | 4 | 8 | Diesel | 21 |
| 4D56 T | | 91.10 | 2477 | 4 | 8 | Diesel | 22 |
| 4D56 TD | | 91.10 | 2477 | 4 | 8 | Diesel | 22 |
| 4G12 | | 74.00 | 1410 | 4 | 8 | Petrol | 4 |
| 4G13 (12V) | | 71.00 | 1299 | 4 | 12 | Petrol | 3 |
| 4G13 (8V) | | 71.00 | 1299 | 4 | 8 | Petrol | 3 |
| 4G15 (12V) | | 75.50 | 1468 | 4 | 12 | Petrol | 8 |
| 4G15 (8V) | | 75.50 | 1468 | 4 | 8 | Petrol | 9 |
| 4G18-2 | | 76.00 | 1584 | 4 | 16 | Petrol | 10 |
| 4G61 | | 82.30 | 1596 | 4 | 16 | Petrol | 16 |
| 4P10-T2 | | 95.80 | 2998 | 4 | 16 | Diesel | 23 |
| 4P10-T4 | | 95.80 | 2998 | 4 | 16 | Diesel | 23 |
| 4P10-T6 | | 95.80 | 2998 | 4 | 16 | Diesel | 23 |
| BKD | | 81.00 | 1968 | 4 | 16 | Diesel | 14 |
| BMM | | 81.00 | 1968 | 4 | 8 | Diesel | 15 |
| CR12DE | | 71.00 | 1240 | 4 | 16 | Petrol | 2 |
| D4BF | | 91.10 | 2476 | 4 | 8 | Diesel | 19 |
| D4BH | | 91.10 | 2476 | 4 | 8 | Diesel | 20 |
| F8QT | | 80.00 | 1870 | 4 | 8 | Diesel | 12 |
| F9Q1 | | 80.00 | 1870 | 4 | 8 | Diesel | 13 |
| G11B | | 69.50 | 1244 | 4 | 8 | Petrol | 1 |
| G12B | | 74.00 | 1410 | 4 | 8 | Petrol | 4 |
| G13B | | 71.00 | 1299 | 4 | 8 | Petrol | 3 |
| G15B | | 75.50 | 1468 | 4 | 8 | Petrol | 9 |
| HR16DE | | 78.00 | 1598 | 4 | 16 | Petrol | 11 |
| OM 639.939 | | 83.00 | 1493 | 3 | 12 | Diesel | 17 |



OE

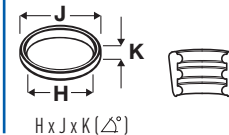
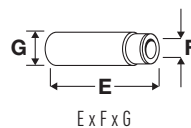

1 69.50

| | | | | | | | |
|-------------|--------|--------|-----------------|-----------------|--------|-------------|---------------|
| G11B | 1244cc | 4 Cyl. | 8 Valves | 40-53kW/54-72PS | Petrol | SOHC | TD2355 |
|-------------|--------|--------|-----------------|-----------------|--------|-------------|---------------|

MIRAGE 1.2 03/1979→09/1983

| | | | | | | |
|--|-----------|--|-----|---|---|--|
| V90123 ■ 34.16 x 6.57 x 102.08 | MD-016460 | | 45° | H | VAG92046 ■ 44.00 x 6.62 x 12.13 | |
| V90124 ■ 29.97 x 6.54 x 100.97 | MD-016461 | | 45° | | VAG92047 ■ 49.50 x 6.62 x 12.13 | |

2 71.00

| | | | | | | | |
|---------------|--------|--------|------------------|-----------|--------|-------------|----------------|
| CR12DE | 1240cc | 4 Cyl. | 16 Valves | 66kW/90PS | Petrol | DOHC | TD27462 |
|---------------|--------|--------|------------------|-----------|--------|-------------|----------------|

LANCER VIII 1.2 01/2007→

| | | | | | | |
|---|-------------|--|-----|--|--|--|
| V98073 ■ 27.40 x 5.50 x 97.80 | 13201-1F700 | | 45° | | | |
| V98074 ■ 22.50 x 5.50 x 97.90 | 13202-F700 | | 45° | | | |

3 71.00

| | | | | | | | |
|-------------------|--------|--------|------------------|-----------------|--------|-------------|----------------|
| 4G13 (12V) | 1299cc | 4 Cyl. | 12 Valves | 44-58kW/60-79PS | Petrol | SOHC | TD2305 |
| 4G13 (8V) | 1299cc | 4 Cyl. | 8 Valves | 44-51kW/60-69PS | Petrol | SOHC | TD2304 |
| G13B | 1299cc | 4 Cyl. | 8 Valves | 44-57kW/60-78PS | Petrol | SOHC | TD12952 |

| | | | |
|---------------------|-----------------|---------------------|-----------------|
| COLT II 1.3 EL, GL | 06/1986→04/1988 | COLT III 1.3 | 04/1988→05/1992 |
| COLT III 1.3 12V | 04/1988→05/1992 | COLT III 1.3 GL | 04/1988→12/1990 |
| COLT IV 1.3 GLi 12V | 04/1992→04/1996 | COLT V 1300 GL, GLX | 05/1996→06/2000 |
| LANCER III 1.3 GL | 05/1988→08/1992 | LANCER IV 1.3 | 04/1988→05/1992 |
| LANCER IV 1.3 12V | 07/1990→05/1994 | LANCER IV 1.3 GL | 05/1988→06/1990 |
| LANCER V 1.3 | 06/1992→08/2003 | LANCER VI 1.3 12V | 12/1995→08/2003 |
| MIRAGE 1.3 | 04/1986→07/2003 | MIRAGE II 1.3 GL | 04/1986→01/1988 |
| MIRAGE III 1.3 | 05/1988→11/1991 | MIRAGE III 1.3 12V | 07/1990→11/1991 |
| MIRAGE III 1.3 GS | 07/1990→11/1991 | MIRAGE V 1.3 | 09/1995→08/1999 |

| | | | | | | |
|--|-----------|--|-----|---|---|--|
| V90123 ■ 34.16 x 6.57 x 102.08 | MD-016460 | | 45° | H | VAG92046 ■ 44.00 x 6.62 x 12.13 | |
| V90124 ■ 29.97 x 6.54 x 100.97 | MD-016461 | | 45° | | VAG92047 ■ 49.50 x 6.62 x 12.13 | |

4 74.00

| | | | | | | | |
|-------------|--------|--------|-----------------|-----------------|--------|-------------|---------------|
| 4G12 | 1410cc | 4 Cyl. | 8 Valves | 50-51kW/68-70PS | Petrol | SOHC | TD2302 |
| G12B | 1410cc | 4 Cyl. | 8 Valves | 50-60kW/68-82PS | Petrol | SOHC | TD2356 |

| | | | |
|--------------------|-----------------|------------------|-----------------|
| COLT I 1.4 GLX, GT | 05/1979→01/1984 | LANCER F 1.4 GLX | 03/1983→01/1984 |
| LANCER II 1.4 GLX | 09/1979→02/1983 | MIRAGE 1.4 | 03/1979→09/1983 |
| TREDIA 1.4 GLX | 10/1982→08/1985 | | |

| | | | | | | |
|--|-----------|--|-----|---|---|--|
| V90123 ■ 34.16 x 6.57 x 102.08 | MD-016460 | | 45° | H | VAG92046 ■ 44.00 x 6.62 x 12.13 | |
| V90124 ■ 29.97 x 6.54 x 100.97 | MD-016461 | | 45° | | VAG92047 ■ 49.50 x 6.62 x 12.13 | |



OE

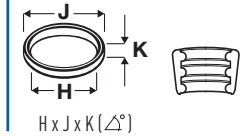
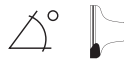

5  **75.00**

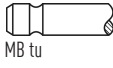
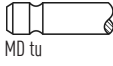
| 3A91 | 1124cc | 3 Cyl. | 12 Valves | 55kW/75PS | Petrol | DOHC | TD18553 |
|----------------------|----------|---|-----------|-----------------|--------|-----------------|---------|
| COLT VI 1.1 | | 10/2004→06/2012 | | COLT VI 1.1 LPG | | 10/2004→06/2012 | |
| V95215 ■ | MR984260 |  | 45° | H | | | |
| 30.55 x 4.97 x 89.65 | | | | | | | |
| V95216 ■ | MR984261 |  | 45° | | | | |
| 25.50 x 4.97 x 91.00 | | | | | | | |

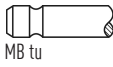
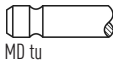

6  **75.00**

| 4A90 | 1332cc | 4 Cyl. | 16 Valves | 67-70kW/91-95PS | Petrol | 1.3 MIVEC, DOHC | TD18554 |
|----------------------|----------|---|-----------|-----------------|--------|-----------------|---------|
| COLT VI 1.3 | | 06/2004→06/2012 | | COLT VI 1.3 LPG | | 06/2004→06/2012 | |
| COLT PLUS VI 1.3 | | 08/2004→ | | | | | |
| V95215 ■ | MR984260 |  | 45° | H | | | |
| 30.55 x 4.97 x 89.65 | | | | | | | |
| V95216 ■ | MR984261 |  | 45° | | | | |
| 25.50 x 4.97 x 91.00 | | | | | | | |

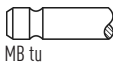
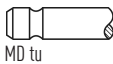
7  **75.00**

| 4A91 | 1499cc | 4 Cyl. | 16 Valves | 75-82kW/102-112PS | Petrol | DOHC | TD18555 |
|----------------------|----------|---|-----------|-------------------|--------|-----------------|---------|
| COLT CZC 1.5 | | 05/2006→07/2009 | | COLT VI 1.5 | | 06/2004→06/2012 | |
| COLT PLUS VI 1.5 | | 08/2004→ | | LANCER VIII 1.5 | | 06/2008→ | |
| V95215 ■ | MR984260 |  | 45° | H | | | |
| 30.55 x 4.97 x 89.65 | | | | | | | |
| V95216 ■ | MR984261 |  | 45° | | | | |
| 25.50 x 4.97 x 91.00 | | | | | | | |

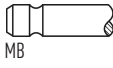
8  **75.50**

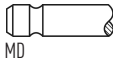
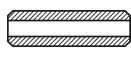
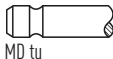
| 4G15 (12V) | 1468cc | 4 Cyl. | 12 Valves | 56-81kW/76-110PS | Petrol | SOHC | TD5327 |
|-------------------------|------------|---|-----------|--------------------|----------------------|---|--------|
| COLT III 1.5 Cat | | 07/1990→05/1992 | | COLT V 1.5 12V | | 06/1996→09/1999 | |
| LANCER III 1.5 12V | | 09/1990→12/1991 | | LANCER III 1.5 GLS | | 08/1989→08/1992 | |
| LANCER IV 1.5 | | 04/1988→09/1992 | | LANCER IV 1.5 12V | | 05/1989→05/1992 | |
| LANCER IV 1.5 GLS | | 08/1989→08/1992 | | LANCER V 1.5 | | 09/1992→10/2003 | |
| LANCER VI 1.5 12V | | 07/1996→08/2003 | | LANCER VII 1.5 | | 05/2006→ | |
| LANCER VII 1.5 LPG | | 05/2006→ | | LANCER VII 1.5 LXi | | 05/2004→ | |
| MIRAGE 1.5 | | 12/1991→12/2000 | | MIRAGE 1.5 GE MVV | | 12/1991→08/1995 | |
| MIRAGE III 1.5 | | 05/1988→06/1990 | | MIRAGE III 1.5 12V | | 05/1988→06/1990 | |
| MIRAGE III 1.5 GS - 12V | | 07/1990→11/1991 | | MIRAGE V 1.5 | | 09/1996→08/1999 | |
| V90123 ■ | MD-016460 |  | 45° | H | VAG92046 ■ |  | |
| 34.16 x 6.57 x 102.08 | | | | | 44.00 x 6.62 x 12.13 | | |
| V90124 ■ | MD-016461 |  | 45° | | VAG92047 ■ |  | |
| 29.97 x 6.54 x 100.97 | | | | | 49.50 x 6.62 x 12.13 | | |
| V94570 ■ | MD-139 755 |  | 45° | st | | | |
| 33.00 x 6.50 x 101.00 | | | | | | | |

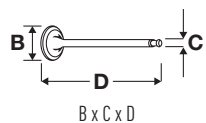

OE

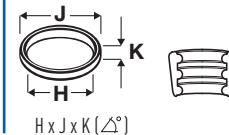
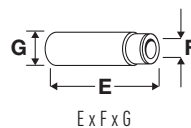

9



75.50

| | | | | | | | |
|--------------------|-----------------|--------|-----------------|-------------------|--------|-----------------|---------------|
| 4G15 (8V) | 1468cc | 4 Cyl. | 8 Valves | 51-73kW/69-99PS | Petrol | SOHC | TD2308 |
| G15B | 1468cc | 4 Cyl. | 8 Valves | 51-64kW/70-87PS | Petrol | | TD2358 |
| COLT II 1.5 GLX | 09/1984→04/1988 | | | COLT III 1.5 GLXi | | 04/1988→05/1992 | |
| COLT IV 1.5 | 03/1992→04/1996 | | | LANCER III 1.5 | | 09/1985→12/1990 | |
| LANCER III 1.5 GLX | 11/1983→04/1988 | | | LANCER IV 1.5 | | 06/1988→05/1992 | |
| MIRAGE II 1.5 | 10/1983→01/1988 | | | MIRAGE III 1.5 | | 05/1988→11/1991 | |
| MIRAGE III 1.5 E | 05/1988→06/1990 | | | MIRAGE III 1.5 GS | | 07/1990→11/1991 | |

V90123 ■
34.16 x 6.57 x 102.08

MD-016460

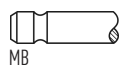

45°

H

VAG92046 ■
44.00 x 6.62 x 12.13



V90124 ■
29.97 x 6.54 x 100.97

MD-016461

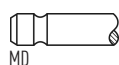

45°

H

VAG92047 ■
49.50 x 6.62 x 12.13

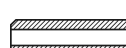

10



76.00

| | | | | | | | |
|--------------------|-----------------|--------|------------------|------------------|--------|-----------------|----------------|
| 4G18-2 | 1584cc | 4 Cyl. | 16 Valves | 72-77kW/98-105PS | Petrol | SOHC | TD18557 |
| LANCER VII 1.6 | 06/2000→ | | | PAJERO PININ 1.6 | | 03/1999→09/2001 | |
| SPACE STAR 1.6 16V | 01/2001→12/2004 | | | | | | |

V95019 ■
29.00 x 5.50 x 111.55

MD339752

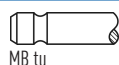

45°

H

V95020 ■
25.50 x 5.50 x 114.70

MD339754

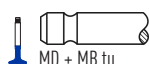

45°

H

11



78.00

| | | | | | | | |
|---------------|----------|--------|------------------|-----------------|--------|-------------|----------------|
| HR16DE | 1598cc | 4 Cyl. | 16 Valves | 80kW/109PS | Petrol | DOHC | TD26598 |
| DELICA D3 1.6 | 11/2011→ | | | LANCER VIII 1.6 | | 01/2007→ | |

V95079 ■
31.15 x 4.97 x 101.70

13201-ED000

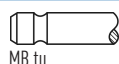

45°

H

VAG96369 ■
42.20 x 5.00 x 9.24



V95080 ■
25.45 x 4.96 x 102.50

13202-ED000

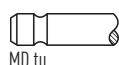

45°

H

VAG96370 ■
42.20 x 4.99 x 9.24

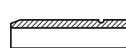

12



80.00

| | | | | | | | |
|----------------|-----------------|--------|-----------------|-----------|--------|--------------------|----------------|
| F8QT | 1870cc | 4 Cyl. | 8 Valves | 66kW/90PS | Diesel | Turbo, SOHC | TD16271 |
| CARISMA 1.9 TD | 10/1996→09/2000 | | | | | | |

V94338 ■
35.30 x 8.00 x 110.00

7701 471 704

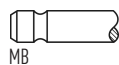

45°

H

VAG92329B ■ ■
39.00 x 8.00 x 13.07



V94667 ■
31.60 x 8.00 x 110.00

7701 469 373

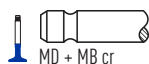

45°

SS

H

VAG96226B ■ ■
39.00 x 8.02 x 13.13

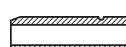

13



80.00

| | | | | | | | |
|------------------|-----------------|--------|-----------------|---------------------|--------|--------------------|----------------|
| F9Q1 | 1870cc | 4 Cyl. | 8 Valves | 75kW/102PS | Diesel | Turbo, SOHC | TD20725 |
| CARISMA 1.9 DI-D | 09/2000→06/2006 | | | SPACE STAR 1.9 DI-D | | 02/2001→12/2004 | |

V94190 ■
35.40 x 7.00 x 111.00

MW30620685

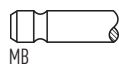

45°

H

VAG96294B ■ ■
38.30 x 7.00 x 12.03

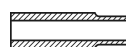

V94191 ■
32.60 x 7.00 x 110.80

MW30620686

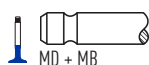

45°

H



OE

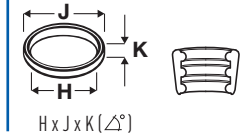
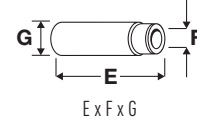
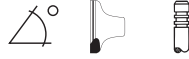

14 **81.00**

| BKD | 1968cc | 4 Cyl. | 16 Valves | 103kW/140PS | Diesel | Turbo, DOHC | TD22162 |
|----------------------|--------------|----------|-----------|-------------|--------|----------------------|---------|
| LANCER VIII 2.0 DI-D | | 01/2008→ | | | | | |
| V94697 | 03G 109 601B | | 45° | Y | H | VAG96237B | |
| 29.20 x 6.00 x 87.80 | | MB | | | | 42.00 x 6.02 x 10.07 | |
| V98007 | 03G 109 601A | | 45° | | | | |
| 29.20 x 6.00 x 88.45 | | MB | | | | | |
| V94698 | 03G 109 611B | | 45° | ss | H | | |
| 25.50 x 6.00 x 88.10 | | MD + MB | | | | | |
| V98097 | 03G 109 611D | | 45° | | | | |
| 25.40 x 6.00 x 87.50 | | MD + MB | | | | | |

15 **81.00**

| BMM | 1968cc | 4 Cyl. | 8 Valves | 103kW/140PS | Diesel | Turbo, SOHC | TD22164 |
|----------------------|--------------|---------|----------|-------------|--------|----------------------|---------|
| V94649 | 038 109 601E | | 45° | Y | H | VAG96041B | |
| 36.00 x 7.00 x 89.40 | | MB | | | | 36.50 x 7.00 x 12.08 | |
| V94650 | 038 109 611E | | 45° | ss | H | | |
| 31.40 x 7.00 x 89.00 | | MD + MB | | | | | |

16 **82.30**

| 4G61 | 1596cc | 4 Cyl. | 16 Valves | 90-100kW/122-136PS | Petrol | DOHC | TD4685 |
|-----------------------|------------|-----------------|-----------|--------------------|--------|----------------------|--------|
| COLT III 1.6 GTi 16V | | 04/1988→05/1990 | | LANCER IV 1.6 GLX | | 08/1989→08/1992 | |
| LANCER IV 1.6 GTi | | 05/1988→05/1990 | | LANCER IV 1.6 i | | 09/1990→09/1992 | |
| MIRAGE III 1.6 GTi | | 06/1988→11/1991 | | | | | |
| V94451 | MD-127 840 | | 45° | | H | VAG92046 | |
| 34.00 x 6.55 x 109.70 | | MB tu | | | | 44.00 x 6.62 x 12.13 | |
| V94446 | MD-127 841 | | 45° | | st | VAG92047 | |
| 30.50 x 6.54 x 109.80 | | MD tu | | | | 49.50 x 6.62 x 12.13 | |

17 **83.00**

| OM 639.939 | 1493cc | 3 Cyl. | 12 Valves | 50-70kW/58-95PS | Diesel | Turbo, DOHC | TD27273 |
|-----------------------|----------|-----------------|-----------|-----------------|--------|----------------------|---------|
| COLT VI 1.5 DI-D | | 08/2004→06/2012 | | | | | |
| V98071 | MN960088 | | 45° | | | VAG96371 | |
| 28.50 x 6.00 x 102.30 | | MB cr | | | | 34.50 x 6.00 x 11.55 | |
| V98072 | MN960089 | | 45° | | | | |
| 25.40 x 6.00 x 102.30 | | MD cr | | | | | |

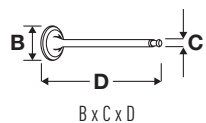

OE

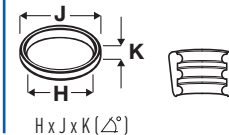
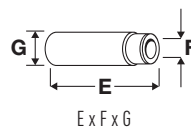

18 91.10

| | | | | | | | |
|-------------------------|-----------------|--------|-----------------|-----------------|--------|--------------------|---------------|
| 4D55 | 2347cc | 4 Cyl. | 8 Valves | 48-62kW/65-84PS | Diesel | SOHC | TD5331 |
| 4D55 T | 2347cc | 4 Cyl. | 8 Valves | 62-70kW/84-95PS | Diesel | Turbo, SOHC | TD2292 |
| GALANT II 2.3 Turbo-D | 09/1980→05/1984 | | | L 200 2.3 D | | 09/1982→10/1986 | |
| L 300 / DELICA II 2.3 D | 04/1983→10/1986 | | | PAJERO I 2.3 D | | 10/1984→09/1986 | |
| PAJERO I 2.3 TD | 12/1982→04/1986 | | | | | | |

V94328 ■
40.00 x 8.00 x 136.50

MD-083 661

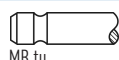

MB tu

45°

H

VAG92322 ■
71.00 x 8.00 x 13.13



V91239 ■
34.16 x 7.96 x 136.50

MD-083 662

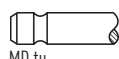

MD tu

45°

VAG92323 ■
74.00 x 8.00 x 13.13

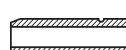

19 91.10

| | | | | | | | |
|-----------------|-----------------|--------|-----------------|-----------------|--------|--------------------|----------------|
| D4BF | 2476cc | 4 Cyl. | 8 Valves | 59-65kW/80-88PS | Diesel | Turbo, SOHC | TD26100 |
| GALLOPER 2.5 TD | 09/1998→12/2003 | | | | | | |

V95077 ■
40.00 x 7.97 x 130.20

MD198404

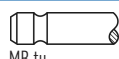

MB tu

45°

H

V95078 ■
34.00 x 7.94 x 129.90

MD198406

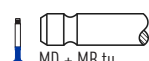

MD + MB tu

45°

H

20 91.10

| | | | | | | | |
|-----------------|-----------------|--------|-----------------|------------------|--------|--------------------|----------------|
| D4BH | 2476cc | 4 Cyl. | 8 Valves | 59-78kW/80-106PS | Diesel | Turbo, SOHC | TD22925 |
| GALLOPER 2.5 TD | 09/1998→12/2003 | | | | | | |

V95077 ■
40.00 x 7.97 x 130.20

MD198404

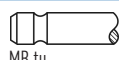

MB tu

45°

H

VAG96279 ■
71.00 x 8.00 x 13.07



V95078 ■
34.00 x 7.94 x 129.90

MD198406

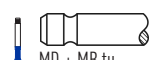

MD + MB tu

45°

H

VAG96280 ■
74.00 x 8.00 x 13.07

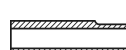

21 91.10

| | | | | | | | |
|--------------------------------|-----------------|--------|------------------|-------------------------|--------|-----------------|---------------|
| 4D56 (12V) | 2477cc | 4 Cyl. | 12 Valves | 51-85kW/69-116PS | Diesel | SOHC | TD8288 |
| 4D56 (8V) | 2477cc | 4 Cyl. | 8 Valves | 51-64kW/69-87PS | Diesel | SOHC | TD2293 |
| Canter (FE3, FE4) 5.Generation | 09/1992→09/1996 | | | L 200 2.5 D | | 10/1986→12/2007 | |
| L 200 2.5 TD | 07/1997→12/2003 | | | L 300 / DELICA II 2.5 D | | 11/1986→04/1994 | |
| L 300 III 2.5 D | 11/1986→02/2006 | | | | | | |

V94328 ■
40.00 x 8.00 x 136.50

MD-083 661

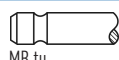

MB tu

45°

H

VAG92322 ■
71.00 x 8.00 x 13.13



V91239 ■
34.16 x 7.96 x 136.50

MD-083 662

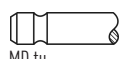

MD tu

45°

VAG92323 ■
74.00 x 8.00 x 13.13

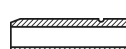



OE



MAT.

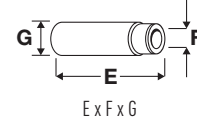
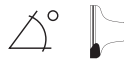

E x F x G

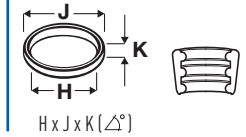

H x J x K (Δ°)

22 91.10

| | | | | | | | |
|---------------------------|-----------------|--------|-----------------|-------------------------|--------|--------------------|---------------|
| 4D56 T | 2477cc | 4 Cyl. | 8 Valves | 62-110kW/84-150PS | Diesel | Turbo, SOHC | TD4682 |
| 4D56 TD | 2477cc | 4 Cyl. | 8 Valves | 73kW/99PS | Diesel | Turbo, SOHC | TD2294 |
| L 200 2.5 TD | 09/1990→12/2007 | | | L 200 / TRITON 2.5 DI-D | | 01/2004→12/2012 | |
| L 300 III 2.5 TD | 02/1987→05/2004 | | | L 400 2.5 TD | | 05/1995→05/2000 | |
| L 400 2500 TD | 05/1995→06/2005 | | | PAJERO CLASSIC 2.5 TD | | 07/2001→ | |
| PAJERO I 2.5 TD | 05/1986→12/1991 | | | PAJERO II 2.5 TD | | 12/1990→04/2000 | |
| PAJERO II 2.5 TDiC | 03/1991→08/1999 | | | PAJERO III 2.5 TDi | | 04/2000→12/2006 | |
| PAJERO SPORT I 2.5 TD | 11/1997→ | | | PAJERO SPORT II 2.5 TD | | 09/2008→ | |
| PAJERO SPORT VAN I 2.5 TD | 12/1999→01/2008 | | | | | | |







| | | | | |
|-----------------------|------------|------------|-----|---|
| V94328 | MD-083 661 | | 45° | H |
| 40.00 x 8.00 x 136.50 | | MB tu | | |
| V95077 | MD198404 | | 45° | H |
| 40.00 x 7.97 x 130.20 | | MB tu | | |
| 01/96→ | | | | |
| V91239 | MD-083 662 | | 45° | |
| 34.16 x 7.96 x 136.50 | | MD tu | | |
| V95078 | MD198406 | | 45° | H |
| 34.00 x 7.94 x 129.90 | | MD + MB tu | | |
| 01/96→ | | | | |

| | |
|----------------------|--|
| VAG92322 | |
| 71.00 x 8.00 x 13.13 | |
| VAG92323 | |
| 74.00 x 8.00 x 13.13 | |

23 95.80

| | | | | | | | |
|--|----------|--------|------------------|--------------------------------|--------|--------------------|----------------|
| 4P10-T2 | 2998cc | 4 Cyl. | 16 Valves | 96kW/131PS | Diesel | Turbo, DOHC | TD27035 |
| 4P10-T4 | 2998cc | 4 Cyl. | 16 Valves | 110kW/150PS | Diesel | Turbo, DOHC | TD27036 |
| 4P10-T6 | 2998cc | 4 Cyl. | 16 Valves | 129kW/175PS | Diesel | Turbo, DOHC | TD27057 |
| Canter (FB7, FB8, FE7, FE8) 7.Generation | 08/2005→ | | | Canter (FE5, FE6) 6.Generation | | 01/2012→ | |

| | | | | |
|-----------------------|-------------|------------|-----|--|
| V98042 | 504 072 531 | | 30° | |
| 32.40 x 5.99 x 119.90 | | MB cr | | |
| V98043 | 504 081 062 | | 30° | |
| 32.40 x 5.98 x 119.90 | | MD + MB cr | | |

|  |  | ccm |  |  |  |  |
|---|---|------|--|---|---|---|
| AKD 112-1 | 98.00 | 905 | 1 | 2 | Diesel | 9 |
| AKD 112-2 | 98.00 | 1810 | 2 | 4 | Diesel | 10 |
| AKD 112-3 | 98.00 | 2715 | 3 | 6 | Diesel | 11 |
| AKD 112-4 | 98.00 | 3620 | 4 | 8 | Diesel | 12 |
| D 208-2 | 95.00 | 1490 | 2 | 4 | Diesel | 1 |
| D 208-3 | 95.00 | 2235 | 3 | 6 | Diesel | 3 |
| D 208-4 | 95.00 | 2980 | 4 | 8 | Diesel | 5 |
| D 208-6 | 95.00 | 4470 | 6 | 12 | Diesel | 7 |
| D 225-2 | 95.00 | 1700 | 2 | 4 | Diesel | 2 |
| D 225-3 | 95.00 | 2550 | 3 | 6 | Diesel | 4 |
| D 225-4 | 95.00 | 3400 | 4 | 8 | Diesel | 6 |
| D 225-6 | 95.00 | 5100 | 6 | 12 | Diesel | 8 |
| D 226 B-2 | 105.00 | 2080 | 2 | 4 | Diesel | 17 |
| D 226 B-3 | 105.00 | 3120 | 3 | 6 | Diesel | 19 |
| D 226 B-4 | 105.00 | 4160 | 4 | 8 | Diesel | 22 |
| D 226 B-6 | 105.00 | 6234 | 6 | 12 | Diesel | 26 |
| D 226-2 | 105.00 | 2080 | 2 | 4 | Diesel | 18 |
| D 226-3 | 105.00 | 3120 | 3 | 6 | Diesel | 20 |
| D 226-4 | 105.00 | 4160 | 4 | 8 | Diesel | 23 |
| D 226-6 | 105.00 | 6234 | 6 | 12 | Diesel | 27 |
| D 227-2 | 100.00 | 1885 | 2 | 4 | Diesel | 13 |
| D 227-3 | 100.00 | 2827 | 3 | 6 | Diesel | 14 |
| D 227-4 | 100.00 | 3768 | 4 | 8 | Diesel | 15 |
| D 227-6 | 100.00 | 5654 | 6 | 12 | Diesel | 16 |
| D 308-2 | 95.00 | 1490 | 2 | 4 | Diesel | 1 |
| D 308-3 | 95.00 | 2235 | 3 | 6 | Diesel | 3 |
| D 308-4 | 95.00 | 2980 | 4 | 8 | Diesel | 5 |
| D 308-6 | 95.00 | 4470 | 6 | 12 | Diesel | 7 |
| D 325-3 | 95.00 | 2550 | 3 | 6 | Diesel | 4 |
| D 325-4 | 95.00 | 3400 | 4 | 8 | Diesel | 6 |
| D 325-6 | 95.00 | 5100 | 6 | 12 | Diesel | 8 |
| D 327-2 | 100.00 | 1885 | 2 | 4 | Diesel | 13 |
| D 327-3 | 100.00 | 2827 | 3 | 6 | Diesel | 14 |
| D 327-4 | 100.00 | 3768 | 4 | 8 | Diesel | 15 |
| D 327-6 | 100.00 | 5654 | 6 | 12 | Diesel | 16 |
| TD 226 B-4 | 105.00 | 4160 | 4 | 8 | Diesel | 24 |
| TD 226 B-6 | 105.00 | 6234 | 6 | 12 | Diesel | 28 |
| TD 226-3 | 105.00 | 3120 | 3 | 6 | Diesel | 21 |
| TD 226-4 | 105.00 | 4160 | 4 | 8 | Diesel | 25 |
| TD 226-6 | 105.00 | 6234 | 6 | 12 | Diesel | 29 |
| TD 228-6 | 105.00 | 6234 | 6 | 12 | Diesel | 29 |





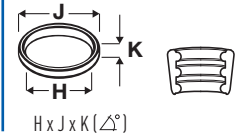
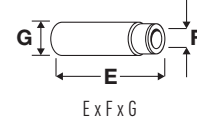



OE







1  **95.00**

| | | | | | | |
|---------|--------|--------|----------|-----------|--------|---------|
| D 208-2 | 1490cc | 2 Cyl. | 4 Valves | 23kW/31PS | Diesel | TD18053 |
| D 308-2 | 1490cc | 2 Cyl. | 4 Valves | 23kW/31PS | Diesel | TD18092 |

| | | | | | | |
|---|-------------------|--|-----|---|---|---|
| V94540  | 6 308 0 460 001 4 |  MB cr | 45° | H | VAG96088  58.00 x 9.03 x 15.04 |  |
| V90432  | 6 207 0 460 301 4 |  MB cr | 45° | H | | |



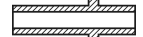

2  **95.00**

| | | | | | | |
|---------|--------|--------|----------|-----------------|--------|---------|
| D 225-2 | 1700cc | 2 Cyl. | 4 Valves | 13-24kW/18-33PS | Diesel | TD18057 |
|---------|--------|--------|----------|-----------------|--------|---------|

| | | | | | | |
|---|-------------------|--|-----|---|---|---|
| V94540  | 6 308 0 460 001 4 |  MB cr | 45° | H | VAG96088  58.00 x 9.03 x 15.04 |  |
| V90432  | 6 207 0 460 301 4 |  MB cr | 45° | H | | |



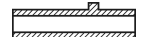

3  **95.00**

| | | | | | | |
|---------|--------|--------|----------|-----------------|--------|---------|
| D 208-3 | 2235cc | 3 Cyl. | 6 Valves | 26-34kW/35-46PS | Diesel | TD18054 |
| D 308-3 | 2235cc | 3 Cyl. | 6 Valves | 26-34kW/35-46PS | Diesel | TD18093 |

| | | | | | | |
|---|-------------------|--|-----|----|---|---|
| Farmer | 01/1961→ | | | GT | | 01/1972→ |
| V94540  | 6 308 0 460 001 4 |  MB cr | 45° | H | VAG96088  58.00 x 9.03 x 15.04 |  |
| V90432  | 6 207 0 460 301 4 |  MB cr | 45° | H | | |



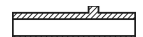

4  **95.00**

| | | | | | | |
|---------|--------|--------|----------|-----------------|--------|---------|
| D 225-3 | 2550cc | 3 Cyl. | 6 Valves | 35-37kW/48-50PS | Diesel | TD18058 |
| D 325-3 | 2550cc | 3 Cyl. | 6 Valves | 25-35kW/34-48PS | Diesel | TD18105 |

| | | | | | | |
|---|-------------------|--|-----|----|---|---|
| Farmer | 01/1971→ | | | GT | | 01/1987→ |
| V94540  | 6 308 0 460 001 4 |  MB cr | 45° | H | VAG96088  58.00 x 9.03 x 15.04 |  |
| V90432  | 6 207 0 460 301 4 |  MB cr | 45° | H | | |

5  **95.00**

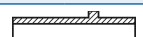
| | | | | | | |
|---------|--------|--------|----------|-----------------|--------|---------|
| D 208-4 | 2980cc | 4 Cyl. | 8 Valves | 35-48kW/48-65PS | Diesel | TD18055 |
| D 308-4 | 2980cc | 4 Cyl. | 8 Valves | 44kW/60PS | Diesel | TD18094 |

| | | | | | | |
|---|-------------------|--|-----|---------|---|---|
| Farmer | 01/1966→ | | | Favorit | | 01/1963→ |
| V94540  | 6 308 0 460 001 4 |  MB cr | 45° | H | VAG96088  58.00 x 9.03 x 15.04 |  |
| V90432  | 6 207 0 460 301 4 |  MB cr | 45° | H | | |

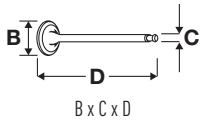

OE

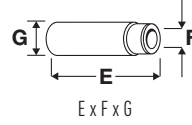
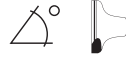



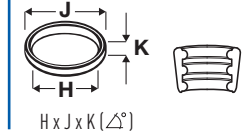

E x F x G



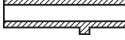

H x J x K (Δ°)



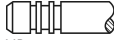

6  **95.00**

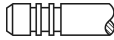
| | | | | | | |
|---|-------------------|---|----------|-----------------|---|---------|
| D 225-4 | 3400cc | 4 Cyl. | 8 Valves | 44-50kW/60-68PS | Diesel | TD6990 |
| D 325-4 | 3400cc | 4 Cyl. | 8 Valves | 43-51kW/58-69PS | Diesel | TD18106 |
| Farmer | 01/1970→ | | Favorit | 01/1967→ | | |
| V94540  | 6 308 0 460 001 4 |  | 45° | H | VAG96088  | |
| 38.00 x 9.00 x 117.00 | | MB cr | | | 58.00 x 9.03 x 15.04 | |
| V90432  | 6 207 0 460 301 4 |  | 45° | H | | |
| 35.00 x 9.00 x 116.95 | | MB cr | | | | |



7  **95.00**

| | | | | | | |
|---|-------------------|---|-----------|-----------|---|---------|
| D 208-6 | 4470cc | 6 Cyl. | 12 Valves | 68kW/92PS | Diesel | TD18056 |
| D 308-6 | 4470cc | 6 Cyl. | 12 Valves | 68kW/92PS | Diesel | TD18095 |
| V94540  | 6 308 0 460 001 4 |  | 45° | H | VAG96088  | |
| 38.00 x 9.00 x 117.00 | | MB cr | | | 58.00 x 9.03 x 15.04 | |
| V90432  | 6 207 0 460 301 4 |  | 45° | H | | |
| 35.00 x 9.00 x 116.95 | | MB cr | | | | |

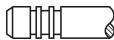

8  **95.00**

| | | | | | | |
|---|-------------------|---|-----------|------------------|---|---------|
| D 225-6 | 5100cc | 6 Cyl. | 12 Valves | 59-75kW/80-102PS | Diesel | TD18059 |
| D 325-6 | 5100cc | 6 Cyl. | 12 Valves | 63-75kW/86-102PS | Diesel | TD18107 |
| Favorit | 01/1970→ | | | | | |
| V94540  | 6 308 0 460 001 4 |  | 45° | H | VAG96088  | |
| 38.00 x 9.00 x 117.00 | | MB cr | | | 58.00 x 9.03 x 15.04 | |
| V90432  | 6 207 0 460 301 4 |  | 45° | H | | |
| 35.00 x 9.00 x 116.95 | | MB cr | | | | |



9  **98.00**

| | | | | | | |
|---|-----------------|---|-----------------|-----------------|--------|---------|
| AKD 112-1 | 905cc | 1 Cyl. | 2 Valves | 8-9kW/11-12PS | Diesel | TD18116 |
| Dieseltross | 01/1953→ | | GT | 01/1957→ | | |
| KB-Serie | 01/1953→12/1954 | | Series AS/AL/AW | 01/1952→12/1960 | | |
| V94723  | 129 111 63 |  | 45° | H | | |
| 41.00 x 10.00 x 129.00 | | MB cr | | | | |

10  **98.00**

| | | | | | | |
|---|-----------------|---|-----------------|-----------------|--------|---------|
| AKD 112-2 | 1810cc | 2 Cyl. | 4 Valves | 14-18kW/20-24PS | Diesel | TD18117 |
| D | 01/1954→ | | Dieseltross | 01/1954→ | | |
| Farmer | 01/1958→ | | GT | 01/1961→ | | |
| KB-Serie | 01/1954→12/1955 | | Series AS/AL/AW | 01/1955→12/1959 | | |
| Series D | 01/1954→ | | | | | |
| V94723  | 129 111 63 |  | 45° | H | | |
| 41.00 x 10.00 x 129.00 | | MB cr | | | | |

11  **98.00**



| | | | | | | |
|---|------------|---|----------|-----------|--------|---------|
| AKD 112-3 | 2715cc | 3 Cyl. | 6 Valves | 24kW/33PS | Diesel | TD18118 |
| V94723  | 129 111 63 |  | 45° | H | | |
| 41.00 x 10.00 x 129.00 | | MB cr | | | | |



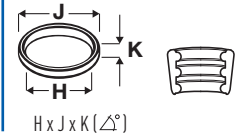
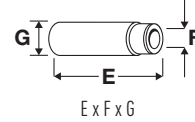
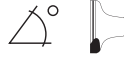

OE



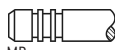
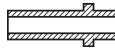

12  **98.00**

| | | | | | | |
|---|------------|---|----------|-----------|--------|---------|
| AKD 112-4 | 3620cc | 4 Cyl. | 8 Valves | 32kW/44PS | Diesel | TD18119 |
| V94723  | 129 111 63 |  | 45° | H | | |
| 41.00 x 10.00 x 129.00 | | MB cr | | | | |

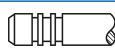
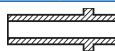

13  **100.00**

| | | | | | | |
|---|-------------------|---|----------|-----------------|---|---------|
| D 227-2 | 1885cc | 2 Cyl. | 4 Valves | 25-27kW/34-37PS | Diesel | TD18072 |
| D 327-2 | 1885cc | 2 Cyl. | 4 Valves | 24-27kW/33-37PS | Diesel | TD18108 |
| V94258  | 6 226 0 460 005 4 |  | 45° | H | VAG96088  | |
| 41.00 x 9.00 x 117.00 | | MB cr | | | 58.00 x 9.03 x 15.04 | |
| V94261  | 6 308 0 460 002 4 |  | 45° | | | |
| 38.00 x 9.00 x 117.00 | | MD cr | | | | |

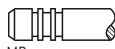

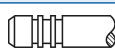

14  **100.00**

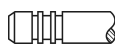
| | | | | | | |
|---|-------------------|---|----------|-----------------|---|---------|
| D 227-3 | 2827cc | 3 Cyl. | 6 Valves | 43-45kW/58-61PS | Diesel | TD18073 |
| D 327-3 | 2827cc | 3 Cyl. | 6 Valves | 26-48kW/35-65PS | Diesel | TD18109 |
| GT | 01/1987→ | | | | | |
| V94258  | 6 226 0 460 005 4 |  | 45° | H | VAG96088  | |
| 41.00 x 9.00 x 117.00 | | MB cr | | | 58.00 x 9.03 x 15.04 | |
| V94261  | 6 308 0 460 002 4 |  | 45° | | | |
| 38.00 x 9.00 x 117.00 | | MD cr | | | | |

15  **100.00**

| | | | | | | |
|---|-------------------|---|----------|-----------------|---|---------|
| D 227-4 | 3768cc | 4 Cyl. | 8 Valves | 46-61kW/63-83PS | Diesel | TD18074 |
| D 327-4 | 3768cc | 4 Cyl. | 8 Valves | 45-55kW/61-75PS | Diesel | TD18110 |
| Farmer | 01/1980→ | | | | | |
| V94258  | 6 226 0 460 005 4 |  | 45° | H | VAG96088  | |
| 41.00 x 9.00 x 117.00 | | MB cr | | | 58.00 x 9.03 x 15.04 | |
| V94261  | 6 308 0 460 002 4 |  | 45° | | | |
| 38.00 x 9.00 x 117.00 | | MD cr | | | | |

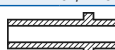
16  **100.00**

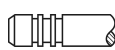

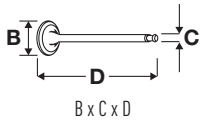

| | | | | | | |
|---|-------------------|---|-----------|------------------|---|----------|
| D 227-6 | 5654cc | 6 Cyl. | 12 Valves | 63-91kW/86-124PS | Diesel | TD18075 |
| D 327-6 | 5654cc | 6 Cyl. | 12 Valves | 68-82kW/92-112PS | Diesel | TD18111 |
| D-Series | 01/1984→ | | | Favorit | | 01/1976→ |
| V94258  | 6 226 0 460 005 4 |  | 45° | H | VAG96088  | |
| 41.00 x 9.00 x 117.00 | | MB cr | | | 58.00 x 9.03 x 15.04 | |
| V94261  | 6 308 0 460 002 4 |  | 45° | | | |
| 38.00 x 9.00 x 117.00 | | MD cr | | | | |

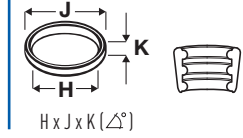
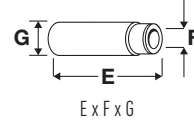
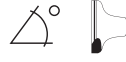





OE





17  **105.00**

| D 226 B-2 | 2080cc | 2 Cyl. | 4 Valves | 32kW/44PS | Diesel | TD18063 |
|---|-------------------|---|----------|-----------|--------|---------|
| V94539  | 6 226 0 460 501 4 |  | 45° | H | | |
| 47.00 x 9.00 x 117.00 | | MB cr | | | | |
| V94541  | 6 226 0 460 503 4 |  | 45° | H | | |
| 43.00 x 9.00 x 117.00 | | MB cr | | | | |

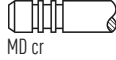

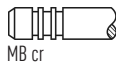

18  **105.00**

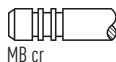
| D 226-2 | 2080cc | 2 Cyl. | 4 Valves | 27-30kW/37-41PS | Diesel | TD18060 |
|---|-------------------|---|----------|-----------------|--|---|
| V94258  | 6 226 0 460 005 4 |  | 45° | H | VAG96088  |  |
| 41.00 x 9.00 x 117.00 | | MB cr | | | 58.00 x 9.03 x 15.04 | |
| V94261  | 6 308 0 460 002 4 |  | 45° | | | |
| 38.00 x 9.00 x 117.00 | | MD cr | | | | |



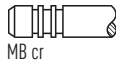

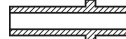
19  **105.00**

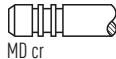
| D 226 B-3 | 3120cc | 3 Cyl. | 6 Valves | 33-55kW/45-75PS | Diesel | TD18064 |
|---|-------------------|---|----------|-----------------|--------|---------|
| V94539  | 6 226 0 460 501 4 |  | 45° | H | | |
| 47.00 x 9.00 x 117.00 | | MB cr | | | | |
| V94541  | 6 226 0 460 503 4 |  | 45° | H | | |
| 43.00 x 9.00 x 117.00 | | MB cr | | | | |



20  **105.00**

| D 226-3 | 3120cc | 3 Cyl. | 6 Valves | 33-44kW/45-60PS | Diesel | OHV | TD18061 |
|---|-------------------|---|----------|-----------------|--|---|---------|
| Farmer | 01/1972→ | | | | | | |
| V94258  | 6 226 0 460 005 4 |  | 45° | H | VAG96088  |  | |
| 41.00 x 9.00 x 117.00 | | MB cr | | | 58.00 x 9.03 x 15.04 | | |
| V94261  | 6 308 0 460 002 4 |  | 45° | | | | |
| 38.00 x 9.00 x 117.00 | | MD cr | | | | | |

21  **105.00**

| TD 226-3 | 3120cc | 3 Cyl. | 6 Valves | 52-84kW/70-114PS | Diesel | Turbo | TD18067 |
|---|-------------------|---|----------|------------------|--------|-------|---------|
| Farmer | 01/1985→ | | | | | | |
| V94538  | 6 226 0 460 701 4 |  | 30° | H | | | |
| 47.00 x 9.00 x 117.00 | | MD + MB cr | | | | | |
| V94537  | 6 226 0 460 703 4 |  | 45° | H | | | |
| 43.00 x 9.00 x 117.00 | | MD + MB cr | | | | | |

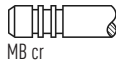
22  **105.00**

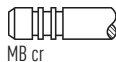
| D 226 B-4 | 4160cc | 4 Cyl. | 8 Valves | 52-74kW/70-100PS | Diesel | TD18065 |
|---|-------------------|---|----------|------------------|--------|---------|
| Farmer | 01/1987→ | | | | | |
| V94539  | 6 226 0 460 501 4 |  | 45° | H | | |
| 47.00 x 9.00 x 117.00 | | MB cr | | | | |
| V94541  | 6 226 0 460 503 4 |  | 45° | H | | |
| 43.00 x 9.00 x 117.00 | | MB cr | | | | |



OE

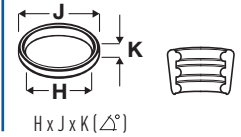
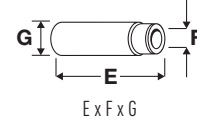

23  **105.00**

| | | | | | | | |
|----------------|--------|--------|-----------------|-----------------|--------|------------|---------------|
| D 226-4 | 4160cc | 4 Cyl. | 8 Valves | 44-64kW/60-87PS | Diesel | OHV | TD6993 |
|----------------|--------|--------|-----------------|-----------------|--------|------------|---------------|

Farmer 01/1975→

V94258 
41.00 x 9.00 x 117.00

6 226 0 460 005 4

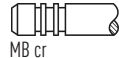

45°

H

VAG96088 
58.00 x 9.03 x 15.04



V94261 
38.00 x 9.00 x 117.00

6 308 0 460 002 4

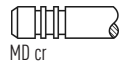

45°

24  **105.00**

| | | | | | | | |
|-------------------|--------|--------|-----------------|------------------|--------|--------------|----------------|
| TD 226 B-4 | 4160cc | 4 Cyl. | 8 Valves | 60-77kW/82-105PS | Diesel | Turbo | TD18068 |
|-------------------|--------|--------|-----------------|------------------|--------|--------------|----------------|

Farmer 01/1981→

Favorit

01/1993→12/1999

V94538 
47.00 x 9.00 x 117.00

6 226 0 460 701 4



30°

H

V94537 
43.00 x 9.00 x 117.00

6 226 0 460 703 4

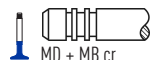

45°

H

25  **105.00**

| | | | | | | | |
|-----------------|--------|--------|-----------------|------------------|--------|--------------|----------------|
| TD 226-4 | 4160cc | 4 Cyl. | 8 Valves | 68-74kW/93-100PS | Diesel | Turbo | TD18069 |
|-----------------|--------|--------|-----------------|------------------|--------|--------------|----------------|

Farmer 01/1985→

V94260 
42.00 x 9.00 x 117.20

6 228 0 460 301 4

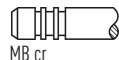

30°

H

VAG96088 
58.00 x 9.03 x 15.04



V94261 
38.00 x 9.00 x 117.00
01/88→

6 308 0 460 002 4

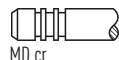

45°

26  **105.00**

| | | | | | | | |
|------------------|--------|--------|------------------|-------------------|--------|--|----------------|
| D 226 B-6 | 6234cc | 6 Cyl. | 12 Valves | 77-88kW/105-120PS | Diesel | | TD18066 |
|------------------|--------|--------|------------------|-------------------|--------|--|----------------|

Farmer 01/1991→

Favorit

01/1994→12/1999

V94539 
47.00 x 9.00 x 117.00

6 226 0 460 501 4

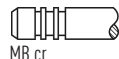

45°

H

V94541 
43.00 x 9.00 x 117.00

6 226 0 460 503 4

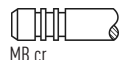

45°

H

27  **105.00**

| | | | | | | | |
|----------------|--------|--------|------------------|-------------------|--------|------------|----------------|
| D 226-6 | 6234cc | 6 Cyl. | 12 Valves | 66-114kW/90-155PS | Diesel | OHV | TD18062 |
|----------------|--------|--------|------------------|-------------------|--------|------------|----------------|

Favorit 01/1970→

V94258 
41.00 x 9.00 x 117.00

6 226 0 460 005 4

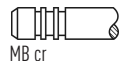

45°

H

VAG96088 
58.00 x 9.03 x 15.04



V94261 
38.00 x 9.00 x 117.00

6 308 0 460 002 4

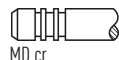

45°



OE

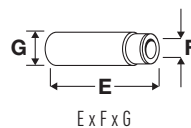



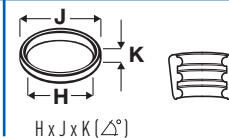



E x F x G



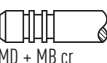









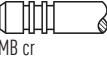

H x J x K [Δ°]







28  **105.00**

| | | | | | | | |
|---|-------------------|---|---|--------------------|-----------------|--------------|----------------|
| TD 226 B-6 | 6234cc | 6 Cyl. | 12 Valves | 81-136kW/110-185PS | Diesel | Turbo | TD23379 |
| AGROSTAR | 01/1992→12/1997 | | Farmer | | 01/1993→12/2001 | | |
| Favorit | 01/1993→12/1999 | | | | | | |
| V94538  | 6 226 0 460 701 4 |  |  | 30° | H | | |
| 47.00 x 9.00 x 117.00 | | | MD + MB cr | | | | |
| V94537  | 6 226 0 460 703 4 |  |  | 45° | H | | |
| 43.00 x 9.00 x 117.00 | | | MD + MB cr | | | | |

29  **105.00**

| | | | | | | | |
|---|-------------------|--|--|---------------------|--------|---|----------------|
| TD 226-6 | 6234cc | 6 Cyl. | 12 Valves | 107-125kW/146-170PS | Diesel | Turbo | TD18070 |
| TD 228-6 | 6234cc | 6 Cyl. | 12 Valves | 99-110kW/135-150PS | Diesel | Turbo | TD18071 |
| Favorit | 01/1976→12/1984 | | | | | | |
| V94260  | 6 228 0 460 301 4 |  |  | 30° | H | VAG96088  | |
| 42.00 x 9.00 x 117.20 | | | MB cr | | | 58.00 x 9.03 x 15.04 | |
| V94261  | 6 308 0 460 002 4 |  |  | 45° | | | |
| 38.00 x 9.00 x 117.00 | | | MD cr | | | | |

|  |  | ccm |  |  |  |  |
|---|---|------|---|---|---|---|
| CD17 | 80.00 | 1681 | 4 | 8 | Diesel | 23 |
| CD20 | 84.50 | 1974 | 4 | 8 | Diesel | 31 |
| CD20T | 84.50 | 1974 | 4 | 8 | Diesel | 31 |
| CG10DE | 71.00 | 998 | 4 | 16 | Petrol | 5 |
| CG12DE | 71.00 | 1240 | 4 | 16 | Petrol | 7 |
| CG13DE | 71.00 | 1275 | 4 | 16 | Petrol | 8 |
| CGA3DE | 72.00 | 1348 | 4 | 16 | Petrol | 9 |
| CR10DE | 71.00 | 997 | 4 | 16 | Petrol | 4 |
| CR12DE | 71.00 | 1240 | 4 | 16 | Petrol | 7 |
| CR14DE | 73.00 | 1386 | 4 | 16 | Petrol | 10 |
| D4F 712 | 69.00 | 1149 | 4 | 16 | Petrol | 2 |
| D7F 764 | 69.00 | 1149 | 4 | 8 | Petrol | 3 |
| E15 | 76.00 | 1488 | 4 | 8 | Petrol | 17 |
| E15S | 76.00 | 1488 | 4 | 8 | Petrol | 17 |
| F4R 720 | 82.70 | 1998 | 4 | 16 | Petrol | 27 |
| F4R 722 | 82.70 | 1998 | 4 | 16 | Petrol | 27 |
| F4R 820 | 82.70 | 1998 | 4 | 16 | Petrol | 27 |
| F9Q 760 | 80.00 | 1870 | 4 | 8 | Diesel | 25 |
| F9Q 762 | 80.00 | 1870 | 4 | 8 | Diesel | 25 |
| F9Q 772 | 80.00 | 1870 | 4 | 8 | Diesel | 25 |
| F9Q 774 | 80.00 | 1870 | 4 | 8 | Diesel | 25 |
| G9T 722 | 87.00 | 2188 | 4 | 16 | Diesel | 37 |
| G9T 750 | 87.00 | 2188 | 4 | 16 | Diesel | 37 |
| G9U 135 | 89.00 | 2464 | 4 | 16 | Diesel | 40 |
| G9U 630 | 89.00 | 2464 | 4 | 16 | Diesel | 40 |
| G9U 632 | 89.00 | 2464 | 4 | 16 | Diesel | 40 |
| G9U 650 | 89.00 | 2464 | 4 | 16 | Diesel | 40 |
| G9U 720 | 89.00 | 2464 | 4 | 16 | Diesel | 40 |
| G9U 724 | 89.00 | 2464 | 4 | 16 | Diesel | 40 |
| G9U 730 | 89.00 | 2464 | 4 | 16 | Diesel | 40 |
| G9U 754 | 89.00 | 2464 | 4 | 16 | Diesel | 40 |
| GA14DE | 73.60 | 1392 | 4 | 16 | Petrol | 12 |
| GA14DS | 73.60 | 1392 | 4 | 16 | Petrol | 12 |
| GA14S | 73.60 | 1392 | 4 | 16 | Petrol | 13 |
| GA16DE | 76.00 | 1597 | 4 | 16 | Petrol | 18 |
| GA16DS | 76.00 | 1597 | 4 | 16 | Petrol | 18 |
| HR12DE | 78.00 | 1198 | 3 | 12 | Petrol | 20 |
| HR16DE | 78.00 | 1598 | 4 | 16 | Petrol | 21 |
| JN | 81.00 | 1781 | 4 | 8 | Petrol | 26 |
| K10 B | 73.40 | 996 | 3 | 12 | Petrol | 11 |
| K4M 752 | 79.50 | 1598 | 4 | 16 | Petrol | 22 |
| K7J 700 | 75.80 | 1390 | 4 | 8 | Petrol | 15 |
| K9K | 76.00 | 1461 | 4 | 8 | Diesel | 16 |
| K9K 270 | 76.00 | 1461 | 4 | 8 | Diesel | 16 |
| K9K 276 | 76.00 | 1461 | 4 | 8 | Diesel | 16 |
| K9K 282 | 76.00 | 1461 | 4 | 8 | Diesel | 16 |
| K9K 292 | 76.00 | 1461 | 4 | 8 | Diesel | 16 |
| K9K 410 | 76.00 | 1461 | 4 | 8 | Diesel | 16 |
| K9K 430 | 76.00 | 1461 | 4 | 8 | Diesel | 16 |
| K9K 608 | 76.00 | 1461 | 4 | 8 | Diesel | 16 |
| K9K 636 | 76.00 | 1461 | 4 | 8 | Diesel | 16 |
| K9K 700 | 76.00 | 1461 | 4 | 8 | Diesel | 16 |
| K9K 702 | 76.00 | 1461 | 4 | 8 | Diesel | 16 |
| K9K 704 | 76.00 | 1461 | 4 | 8 | Diesel | 16 |
| K9K 708 | 76.00 | 1461 | 4 | 8 | Diesel | 16 |
| K9K 710 | 76.00 | 1461 | 4 | 8 | Diesel | 16 |
| K9K 714 | 76.00 | 1461 | 4 | 8 | Diesel | 16 |
| K9K 716 | 76.00 | 1461 | 4 | 8 | Diesel | 16 |
| K9K 722 | 76.00 | 1461 | 4 | 8 | Diesel | 16 |
| K9K 728 | 76.00 | 1461 | 4 | 8 | Diesel | 16 |
| K9K 732 | 76.00 | 1461 | 4 | 8 | Diesel | 16 |
| K9K 764 | 76.00 | 1461 | 4 | 8 | Diesel | 16 |
| K9K 772 | 76.00 | 1461 | 4 | 8 | Diesel | 16 |
| K9K 892 | 76.00 | 1461 | 4 | 8 | Diesel | 16 |
| K9K 896 | 76.00 | 1461 | 4 | 8 | Diesel | 16 |
| LD23 | 87.00 | 2283 | 4 | 8 | Diesel | 38 |

|  |  | ccm |  |  |  |  |
|---|---|------|--|---|---|---|
| M1D | 84.00 | 1994 | 4 | 16 | Diesel | 28 |
| M9R | 84.00 | 1995 | 4 | 16 | Diesel | 29 |
| M9R 630 | 84.00 | 1995 | 4 | 16 | Diesel | 29 |
| M9R 760 | 84.00 | 1995 | 4 | 16 | Diesel | 29 |
| M9R 780 | 84.00 | 1995 | 4 | 16 | Diesel | 29 |
| M9R 782 | 84.00 | 1995 | 4 | 16 | Diesel | 29 |
| M9T 670 | 85.00 | 2299 | 4 | 16 | Diesel | 32 |
| M9T 672 | 85.00 | 2299 | 4 | 16 | Diesel | 32 |
| M9T 676 | 85.00 | 2299 | 4 | 16 | Diesel | 32 |
| M9T 678 | 85.00 | 2299 | 4 | 16 | Diesel | 32 |
| M9T 680 | 85.00 | 2299 | 4 | 16 | Diesel | 32 |
| M9T 686 | 85.00 | 2299 | 4 | 16 | Diesel | 32 |
| M9T 690 | 85.00 | 2299 | 4 | 16 | Diesel | 32 |
| M9T 692 | 85.00 | 2299 | 4 | 16 | Diesel | 32 |
| M9T 694 | 85.00 | 2299 | 4 | 16 | Diesel | 32 |
| M9T 696 | 85.00 | 2299 | 4 | 16 | Diesel | 32 |
| M9T 698 | 85.00 | 2299 | 4 | 16 | Diesel | 32 |
| M9T 880 | 85.00 | 2299 | 4 | 16 | Diesel | 32 |
| M9T 896 | 85.00 | 2299 | 4 | 16 | Diesel | 32 |
| MA10 | 68.00 | 988 | 4 | 8 | Petrol | 1 |
| MA10S | 68.00 | 988 | 4 | 8 | Petrol | 1 |
| MA12S | 71.00 | 1235 | 4 | 8 | Petrol | 6 |
| MR20DE | 84.00 | 1997 | 4 | 16 | Petrol | 30 |
| QG15DE | 73.60 | 1498 | 4 | 16 | Petrol | 14 |
| QG18DE | 80.00 | 1769 | 4 | 16 | Petrol | 24 |
| QR20DE | 89.00 | 1998 | 4 | 16 | Petrol | 39 |
| RD28T | 85.00 | 2826 | 6 | 12 | Diesel | 33 |
| RD28Ti | 85.00 | 2826 | 6 | 12 | Diesel | 34 |
| SR20DE | 86.00 | 1998 | 4 | 16 | Petrol | 35 |
| TD15 (TUD5) | 77.00 | 1527 | 4 | 8 | Diesel | 19 |
| TD27 | 96.00 | 2663 | 4 | 8 | Diesel | 42 |
| TD27T | 96.00 | 2664 | 4 | 8 | Diesel | 43 |
| TD27Ti | 96.00 | 2664 | 4 | 8 | Diesel | 43 |
| TD42 | 96.00 | 4169 | 6 | 12 | Diesel | 44 |
| YD22DDT | 86.00 | 2184 | 4 | 16 | Diesel | 36 |
| YD22DDTi | 86.00 | 2184 | 4 | 16 | Diesel | 36 |
| YD22ETI | 86.00 | 2184 | 4 | 16 | Diesel | 36 |
| YD25DDTi | 89.00 | 2488 | 4 | 16 | Diesel | 41 |



OE

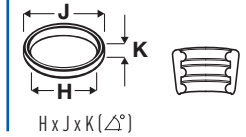
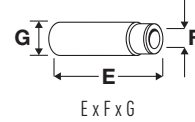
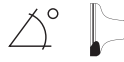

1 **68.00**

| | | | | | | | |
|--------------|-------|-----------------|-----------------|-----------------|--------|-----------------|---------------|
| MA10 | 988cc | 4 Cyl. | 8 Valves | 38kW/52PS | Petrol | SOHC | TD2492 |
| MA10S | 988cc | 4 Cyl. | 8 Valves | 37-40kW/50-54PS | Petrol | SOHC | TD2493 |
| BE 1.0 | | 12/1982→07/1992 | | MICRA I 1.0 | | 12/1982→12/1989 | |
| MICRA II 1.0 | | 01/1992→04/1993 | | PAO 1.0 | | 03/1989→11/1991 | |

| | | | | |
|-----------------------|-------------|----|-----|---|
| V91195 | 13201-10B00 | | 45° | H |
| 35.00 x 6.99 x 109.85 | | MB | | |
| V91197 | 13202-10B00 | | 45° | |
| 30.00 x 6.96 x 109.35 | | MD | | |

2 **69.00**

| | | | | | | | |
|------------------|--------|----------|------------------|-----------|--------|--|----------------|
| D4F 712 | 1149cc | 4 Cyl. | 16 Valves | 55kW/75PS | Petrol | | TD18984 |
| KUBISTAR 1.2 16V | | 04/2006→ | | | | | |

| | | | | | | |
|-----------------------|-------------|---------|-----|---|----------------------|--|
| V94705 | 13201-00QAJ | | 45° | | VAG96292B | |
| 26.00 x 5.50 x 110.80 | | MB | | | 40.60 x 5.50 x 11.07 | |
| V94706 | 13202-00QAK | | 45° | H | | |
| 22.00 x 5.50 x 112.50 | | MD + MB | | | | |

3 **69.00**

| | | | | | | | |
|----------------|--------|----------|-----------------|-----------|--------|-------------|----------------|
| D7F 764 | 1149cc | 4 Cyl. | 8 Valves | 44kW/60PS | Petrol | SOHC | TD22375 |
| KUBISTAR 1.2 | | 08/2003→ | | | | | |

| | | | | | | |
|-----------------------|--------------|----|-----|---|----------------------|--|
| V94180 | 7701 469 266 | | 30° | H | VAG96238B | |
| 32.80 x 6.00 x 106.70 | | MB | | | 45.00 x 6.00 x 11.07 | |
| V94181 | 7701 469 269 | | 45° | | | |
| 29.90 x 6.00 x 106.70 | | MD | | | | |

4 **71.00**

| | | | | | | | |
|---------------|-------|--------|------------------|-----------------|--------|-------------|----------------|
| CR10DE | 997cc | 4 Cyl. | 16 Valves | 48-50kW/65-68PS | Petrol | DOHC | TD17646 |
|---------------|-------|--------|------------------|-----------------|--------|-------------|----------------|

| | | | | |
|----------------------|-------------|-------|-----|--|
| V98073 | 13201-1F700 | | 45° | |
| 27.40 x 5.50 x 97.80 | | MB tu | | |
| V98074 | 13202-F700 | | 45° | |
| 22.50 x 5.50 x 97.90 | | MD tu | | |

5 **71.00**

| | | | | | | | |
|--------------------|-------|-----------------|------------------|-------------------|--------|-----------------|---------------|
| CG10DE | 998cc | 4 Cyl. | 16 Valves | 40-48kW/54-65PS | Petrol | DOHC | TD4700 |
| MICRA II 1.0 i 16V | | 08/1992→02/2003 | | MICRA III 1.0 16V | | 01/2003→06/2010 | |

| | | | | |
|----------------------|-------------|-------|-----|-----|
| V94447 | 13201-99B10 | | 45° | Y H |
| 27.50 x 5.50 x 95.70 | | MB tu | | |
| V94016 | 13202-99B10 | | 45° | |
| 22.50 x 5.50 x 95.90 | | MD tu | | |

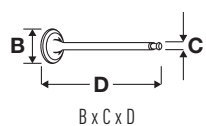

OE

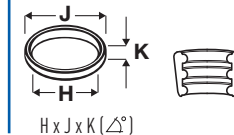
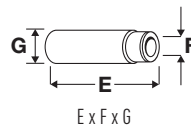

6 71.00

| MA12S | 1235cc | 4 Cyl. | 8 Valves | 40-44kW/54-60PS | Petrol | SOHC | TD2494 |
|-----------------------|-----------------|--------|----------|-----------------|--------|------|--------|
| MICRA I 1.2 | 07/1986→07/1992 | | | | | | |
| V91195 | 13201-10B00 | | 45° | H | | | |
| 35.00 x 6.99 x 109.85 | | MB | | | | | |
| V91197 | 13202-10B00 | | 45° | | | | |
| 30.00 x 6.96 x 109.35 | | MD | | | | | |

7 71.00

| CG12DE | 1240cc | 4 Cyl. | 16 Valves | 48-66kW/65-90PS | Petrol | DOHC | TD23874 |
|----------------------|-----------------|--------|-----------|-------------------|--------|-----------------|---------|
| CR12DE | 1240cc | 4 Cyl. | 16 Valves | 48-81kW/65-110PS | Petrol | DOHC | TD17647 |
| AD 1.2 | 12/2006→ | | | MICRA III 1.2 | | 10/2003→06/2010 | |
| MICRA III 1.2 16V | 01/2003→06/2010 | | | MICRA III 1.2 LPG | | 06/2005→06/2010 | |
| WINGROAD / AD 1.2 | 11/2005→ | | | | | | |
| V98073 | 13201-1F700 | | 45° | | | | |
| 27.40 x 5.50 x 97.80 | | MB tu | | | | | |
| V98074 | 13202-F700 | | 45° | | | | |
| 22.50 x 5.50 x 97.90 | | MD tu | | | | | |

8 71.00

| CG13DE | 1275cc | 4 Cyl. | 16 Valves | 54-55kW/73-75PS | Petrol | DOHC | TD2423 |
|----------------------|-----------------|--------|-----------|-----------------|--------|-----------------|--------|
| CUBE 1.3 | 03/1998→08/2000 | | | MICRA II 1.3 | | 01/1992→02/2003 | |
| MICRA II 1.3 i 16V | 08/1992→09/2000 | | | | | | |
| V94447 | 13201-99B10 | | 45° | Y | H | | |
| 27.50 x 5.50 x 95.70 | | MB tu | | | | | |
| V94016 | 13202-99B10 | | 45° | | | | |
| 22.50 x 5.50 x 95.90 | | MD tu | | | | | |

9 72.00

| CGA3DE | 1348cc | 4 Cyl. | 16 Valves | 60-74kW/82-101PS | Petrol | DOHC | TD16315 |
|----------------------|-----------------|--------|-----------|--------------------|--------|-----------------|---------|
| CUBE 1.3 | 09/2000→12/2002 | | | MICRA II 1.4 i 16V | | 09/2000→02/2003 | |
| MICRA III 1.3 | 08/2004→06/2010 | | | | | | |
| V94447 | 13201-99B10 | | 45° | Y | H | | |
| 27.50 x 5.50 x 95.70 | | MB tu | | | | | |
| V94016 | 13202-99B10 | | 45° | | | | |
| 22.50 x 5.50 x 95.90 | | MD tu | | | | | |

10 73.00





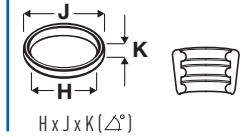
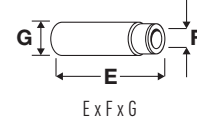

| CR14DE | 1386cc | 4 Cyl. | 16 Valves | 65-72kW/88-98PS | Petrol | DOHC | TD17648 |
|----------------------|-----------------|--------|-----------|-----------------------|--------|-----------------|---------|
| CUBE 1.4 | 01/2003→09/2005 | | | MICRA C+C III 1.4 16V | | 08/2005→ | |
| MICRA III 1.4 | 01/2007→06/2010 | | | MICRA III 1.4 16V | | 01/2003→06/2010 | |
| NOTE 1.4 | 03/2006→06/2012 | | | | | | |
| V98073 | 13201-1F700 | | 45° | | | | |
| 27.40 x 5.50 x 97.80 | | MB tu | | | | | |
| V98074 | 13202-F700 | | 45° | | | | |
| 22.50 x 5.50 x 97.90 | | MD tu | | | | | |



OE









11  **73.40**

| K10 B | 996cc | 3 Cyl. | 12 Valves | 50kW/68PS | Petrol | DOHC | TD24676 |
|---|-------------|---|-----------|-----------|---|---|---------|
| PIXO 1.0 | 06/2009→ | | | | | | |
| V95224  | 13201-4A00A |  | 45° | H | VAG96385  |  | |
| 27.50 x 5.47 x 87.50 | | MB tu | | | 34.00 x 5.51 x 10.59 | | |
| V95225  | 13202-4A00A |  | 45° | | | | |
| 22.95 x 5.46 x 87.05 | | MD tu | | | | | |



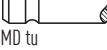

12  **73.60**

| GA14DE | 1392cc | 4 Cyl. | 16 Valves | 55-64kW/75-87PS | Petrol | DOHC | TD4703 |
|----------------------|-----------------|--------|-----------|---------------------|-----------------|------|--------|
| ALMERA I 1.4 | 09/1995→07/2000 | | | ALMERA I 1.4 GX,LX | 09/1995→07/2000 | | |
| ALMERA I 1.4 S,GX,LX | 09/1995→03/2000 | | | LUCINO 1.4 | 09/1991→01/2000 | | |
| SUNNY II 1.4 | 10/1988→09/1990 | | | SUNNY III 1.4 | 10/1990→06/1995 | | |
| SUNNY III 1.4 i | 10/1990→05/1995 | | | SUNNY III 1.4 i 16V | 10/1990→06/1995 | | |
| TSURU 1.4 | 10/1991→12/2007 | | | | | | |

| | | | | | | | |
|---|-------------|---|-----|---|--|--|--|
| V94437  | 13201-4M500 |  | 45° | H | VAG92360  |  | |
| 29.00 x 5.50 x 92.20 | | MB tu | | | 40.00 x 5.52 x 9.74 | | |
| V91243  | 13202-57Y00 |  | 45° | | | | |
| 24.10 x 5.46 x 92.82 | | MD cr | | | | | |
| V94435  | 13202-2F000 |  | 45° | | | | |
| 24.00 x 5.50 x 92.60 | | MD tu | | | | | |

13  **73.60**

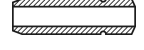
| GA14S | 1392cc | 4 Cyl. | 16 Valves | 55-60kW/75-82PS | Petrol | SOHC | TD2445 |
|--------------|-----------------|--------|-----------|-----------------|-----------------|------|--------|
| SUNNY II 1.4 | 10/1988→09/1990 | | | SUNNY II 1.4 LX | 10/1988→08/1991 | | |

| | | | | | | | |
|---|-------------|---|-----|---|---|---|--|
| V94432  | 13201-2F000 |  | 45° | H | VAG92360  |  | |
| 30.00 x 5.50 x 92.30 | | MB tu | | | 40.00 x 5.52 x 9.74 | | |
| V94435  | 13202-2F000 |  | 45° | | | | |
| 24.00 x 5.50 x 92.60 | | MD tu | | | | | |

14  **73.60**

| QG15DE | 1498cc | 4 Cyl. | 16 Valves | 66-80kW/90-109PS | Petrol | DOHC | TD16313 |
|-----------------------|-----------------|--------|-----------|------------------|-----------------|------|---------|
| ALMERA II 1.5 | 03/2000→ | | | ALMERA II 1.5 XL | 03/2001→ | | |
| BLUEBIRD SYLPHY I 1.5 | 08/2000→08/2005 | | | SUNNY IV 1.5 | 09/1997→08/2003 | | |
| WINGROAD / AD 1.5 | 05/1999→11/2005 | | | | | | |

| | | | | | | | |
|---|-------------|---|-----|---|---|---|--|
| V94437  | 13201-4M500 |  | 45° | H | VAG92360  |  | |
| 29.00 x 5.50 x 92.20 | | MB tu | | | 40.00 x 5.52 x 9.74 | | |
| V94435  | 13202-2F000 |  | 45° | | | | |
| 24.00 x 5.50 x 92.60 | | MD tu | | | | | |

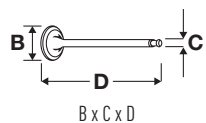

OE

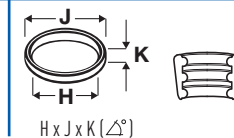
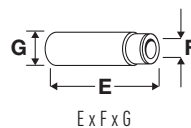
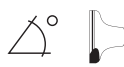

15 **75.80**

| | | | | | | | |
|----------------|--------|-----------------|-----------------|-----------|--------|-------------|----------------|
| K7J 700 | 1390cc | 4 Cyl. | 8 Valves | 55kW/75PS | Petrol | SOHC | TD31236 |
| KUBISTAR 1.4 | | 08/2003→10/2009 | | | | | |

| | | | | | | |
|-----------------------|--------------|---------|-----|---|----------------------|--|
| V91835 | 7701 465 088 | | 30° | H | VAG96182B | |
| 37.50 x 7.00 x 107.80 | | MB | | | 42.00 x 7.02 x 12.08 | |
| V91836 | 7701 465 090 | | 45° | | VAG96172B | |
| 33.60 x 7.00 x 107.80 | | MD cr | | | 49.00 x 7.02 x 12.08 | |
| V94442 | 7701 468 419 | | 45° | H | VAG96347B | |
| 33.60 x 7.00 x 107.70 | | MD + MB | | | 48.50 x 7.02 x 13.07 | |

16 **76.00**

| | | | | | | | |
|----------------|--------|--------|-----------------|-------------------|--------|--------------------|----------------|
| K9K | 1461cc | 4 Cyl. | 8 Valves | 48-81kW/65-110PS | Diesel | Turbo, SOHC | TD31672 |
| K9K 270 | 1461cc | 4 Cyl. | 8 Valves | 78-81kW/106-110PS | Diesel | Turbo, SOHC | TD32710 |
| K9K 276 | 1461cc | 4 Cyl. | 8 Valves | 62-66kW/84-90PS | Diesel | Turbo, SOHC | TD23877 |
| K9K 282 | 1461cc | 4 Cyl. | 8 Valves | 76-78kW/103-106PS | Diesel | Turbo, SOHC | TD33836 |
| K9K 292 | 1461cc | 4 Cyl. | 8 Valves | 76-78kW/103-106PS | Diesel | Turbo, SOHC | TD24675 |
| K9K 410 | 1461cc | 4 Cyl. | 8 Valves | 81kW/110PS | Diesel | Turbo, SOHC | TD29686 |
| K9K 430 | 1461cc | 4 Cyl. | 8 Valves | 81kW/110PS | Diesel | Turbo, SOHC | TD29685 |
| K9K 608 | 1461cc | 4 Cyl. | 8 Valves | 63-66kW/86-90PS | Diesel | Turbo, SOHC | TD29422 |
| K9K 636 | 1461cc | 4 Cyl. | 8 Valves | 81kW/110PS | Diesel | Turbo, SOHC | TD29420 |
| K9K 700 | 1461cc | 4 Cyl. | 8 Valves | 47-50kW/64-68PS | Diesel | Turbo, SOHC | TD21368 |
| K9K 702 | 1461cc | 4 Cyl. | 8 Valves | 60kW/82PS | Diesel | Turbo, SOHC | TD23878 |
| K9K 704 | 1461cc | 4 Cyl. | 8 Valves | 47-48kW/64-65PS | Diesel | Turbo, SOHC | TD17660 |
| K9K 708 | 1461cc | 4 Cyl. | 8 Valves | 48-50kW/65-68PS | Diesel | Turbo, SOHC | TD26291 |
| K9K 710 | 1461cc | 4 Cyl. | 8 Valves | 42-45kW/57-61PS | Diesel | Turbo, SOHC | TD26066 |
| K9K 714 | 1461cc | 4 Cyl. | 8 Valves | 42-45kW/57-61PS | Diesel | Turbo, SOHC | TD26067 |
| K9K 716 | 1461cc | 4 Cyl. | 8 Valves | 50-51kW/68-69PS | Diesel | Turbo, SOHC | TD29537 |
| K9K 722 | 1461cc | 4 Cyl. | 8 Valves | 60kW/82PS | Diesel | Turbo, SOHC | TD20971 |
| K9K 728 | 1461cc | 4 Cyl. | 8 Valves | 74-78kW/101-106PS | Diesel | Turbo, SOHC | TD24669 |
| K9K 732 | 1461cc | 4 Cyl. | 8 Valves | 78kW/106PS | Diesel | Turbo, SOHC | TD29682 |
| K9K 764 | 1461cc | 4 Cyl. | 8 Valves | 78kW/106PS | Diesel | Turbo, SOHC | TD29684 |
| K9K 772 | 1461cc | 4 Cyl. | 8 Valves | 63-76kW/86-103PS | Diesel | Turbo, SOHC | TD28006 |
| K9K 892 | 1461cc | 4 Cyl. | 8 Valves | 66kW/90PS | Diesel | Turbo, SOHC | TD31620 |
| K9K 896 | 1461cc | 4 Cyl. | 8 Valves | 81kW/110PS | Diesel | Turbo, SOHC | TD31123 |

| | | | |
|--------------------------------|-----------------|------------------------|-----------------|
| ALMERA II 1.5 dCi | 01/2003→ | CUBE 1.5 dCi | 03/2010→ |
| JUKE 1.5 dCi | 06/2010→ | KUBISTAR 1.5 dCi | 08/2003→ |
| KUBISTAR 1.5 dCi 70 | 09/2005→10/2009 | KUBISTAR 1.5 dCi 85 | 04/2006→10/2009 |
| MICRA III 1.5 dCi | 01/2003→06/2010 | MICRA IV 1.5 D | 11/2010→ |
| NOTE 1.5 dCi | 03/2006→ | NP200 1.5 dCi | 10/2008→ |
| NV200 1.5 dci | 02/2010→ | NV200 / EVALIA 1.5 dci | 07/2010→ |
| PULSAR 1.5 dCi | 10/2014→ | QASHQAI II 1.5 dCi | 11/2013→ |
| QASHQAI / QASHQAI +2 I 1.5 dCi | 02/2007→12/2013 | SUNNY 1.5 dCi | 01/2011→ |
| TERRANO 1.5 dCi | 03/2014→ | TIIDA 1.5 dCi | 01/2007→12/2012 |
| VERSA I 1.5 dCi | 01/2007→ | VERSA II 1.5 dCi | 08/2011→ |

| | | | | | | | |
|-----------------------|-------------|---------|-----|---|---|----------------------|--|
| V94608 | 13201-BN700 | | 45° | Y | H | VAG96354B | |
| 33.50 x 6.00 x 100.90 | | MB | | | | 40.50 x 6.00 x 12.08 | |
| V94609 | 13202-BN700 | | 45° | | H | | |
| 29.00 x 6.00 x 100.70 | | MD + MB | | | | | |



OE

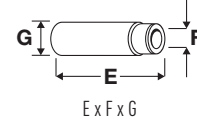

17  76.00

| | | | | | | | |
|----------------|--------|-----------------|-----------------|-----------------|--------|-----------------|---------------|
| E15 | 1488cc | 4 Cyl. | 8 Valves | 50-55kW/68-75PS | Petrol | SOHC | TD2428 |
| E15S | 1488cc | 4 Cyl. | 8 Valves | 50-55kW/68-75PS | Petrol | SOHC | TD2429 |
| AD 1.5 | | 10/1981→08/1988 | | CHERRY II 1.5 | | 08/1981→12/1982 | |
| CHERRY III 1.5 | | 11/1983→10/1986 | | PRAIRIE 1.5 S | | 01/1984→12/1987 | |
| PULSAR 1.5 | | 01/1982→12/1987 | | S-CARGO 1.5 | | 01/1989→03/1994 | |
| SENTRA 1.5 | | 09/1981→12/1983 | | SUNNY I 1.5 | | 03/1982→10/1986 | |
| SUNNY II 1.5 | | 06/1986→10/1988 | | | | | |

V90363 
30.20 x 6.97 x 118.20

13202-01M00

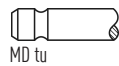

45°

st

18  76.00

| | | | | | | | |
|---------------------|--------|-----------------|------------------|---------------------|--------|-----------------|---------------|
| GA16DE | 1597cc | 4 Cyl. | 16 Valves | 60-88kW/82-120PS | Petrol | DOHC | TD4705 |
| GA16DS | 1597cc | 4 Cyl. | 16 Valves | 64-79kW/87-107PS | Petrol | DOHC | TD4706 |
| 100 NX 1.6 | | 03/1990→10/1994 | | 100 NX 1.6 SR | | 09/1993→10/1994 | |
| ALMERA I 1.6 | | 07/1995→07/2000 | | ALMERA I 1.6 SLX | | 09/1995→07/2000 | |
| ALMERA I 1.6 SR,SLX | | 09/1995→03/2000 | | ALMERA II 1.6 | | 07/2000→02/2003 | |
| BLUEBIRD 1.6 | | 09/1991→12/1995 | | ICHI 1.6 | | 09/1990→05/2001 | |
| LUCINO 1.6 | | 09/1991→01/2000 | | PRIMERA 1.6 | | 06/1990→01/1996 | |
| PRIMERA 1.6 16V | | 09/1996→07/2002 | | PRIMERA 1.6 i | | 07/1990→03/1998 | |
| PULSAR 1.6 | | 10/1992→06/1995 | | PULSAR I 1.6 | | 07/1995→07/2000 | |
| SENTRA III 1.6 | | 01/1990→12/1994 | | SENTRA IV 1.6 | | 01/1995→09/1999 | |
| SENTRA V 1.6 i 16V | | 07/1998→06/2001 | | SERENA 1.6 | | 02/1993→09/2001 | |
| SUNNY I 1.6 | | 07/1988→07/1990 | | SUNNY II 1.6 | | 02/1987→10/1988 | |
| SUNNY III 1.6 | | 08/1990→03/2000 | | SUNNY III 1.6 16V | | 11/1990→12/1995 | |
| SUNNY III 1.6 i | | 10/1990→03/2000 | | SUNNY III 1.6 i 16V | | 10/1990→03/2000 | |
| SUNNY III 1.6 L | | 11/1992→04/1996 | | SUNNY IV 1.6 | | 09/1997→09/2003 | |
| TSURU 1.6 | | 10/1991→ | | VANETTE CARGO 1.6 | | 09/1994→05/2001 | |
| VANETTE CARGO 1.6 i | | 09/1994→05/2001 | | WINGROAD / AD 1.6 | | 10/1990→08/2004 | |

V94432 
30.00 x 5.50 x 92.30

13201-2F000

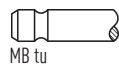

45°

H

VAG92360 
40.00 x 5.52 x 9.74

V91243 
24.10 x 5.46 x 92.82

13202-57Y00

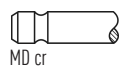

45°

V94435 
24.00 x 5.50 x 92.60

13202-2F000

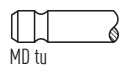

45°

19  77.00

| | | | | | | | |
|--------------------|--------|-----------------|-----------------|-----------|--------|--|----------------|
| TD15 (TUD5) | 1527cc | 4 Cyl. | 8 Valves | 42kW/57PS | Diesel | | TD16316 |
| MICRA II 1.5 D | | 02/1998→02/2003 | | | | | |

V94171 
37.00 x 7.00 x 108.50

0948.A8

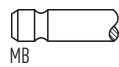

45°

H

VAG96049B 
40.20 x 7.02 x 13.08

V94172 
31.55 x 7.00 x 108.20

0949.80

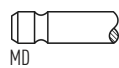

45°

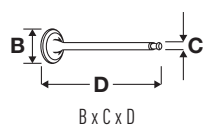

OE



MAT.

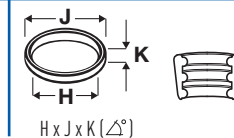
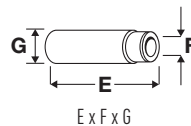
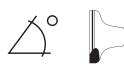

20 78.00

| HR12DE | 1198cc | 3 Cyl. | 12 Valves | 50-59kW/68-80PS | Petrol | DOHC | TD24765 |
|--------------|----------|--------|-----------|-----------------|--------|----------|---------|
| ALMERA 1.2 i | 09/2011→ | | | MICRA IV 1.2 | | 05/2010→ | |
| NOTE 1.2 | 06/2013→ | | | NOTE 1.2 LPG | | 03/2015→ | |

| | | | | | | |
|-----------------------|-------------|-------|-----|---|---------------------|--|
| V95079 | 13201-ED000 | | 45° | H | VAG96369 | |
| 31.15 x 4.97 x 101.70 | | MB tu | | | 42.20 x 5.00 x 9.24 | |
| V95080 | 13202-ED000 | | 45° | | VAG96370 | |
| 25.45 x 4.96 x 102.50 | | MD tu | | | 42.20 x 4.99 x 9.24 | |

21 78.00

| HR16DE | 1598cc | 4 Cyl. | 16 Valves | 64-103kW/87-140PS | Petrol | DOHC | TD18677 |
|----------------------------------|-----------------|--------|-----------|---------------------------|--------|-----------------|---------|
| AD 1.6 | 12/2008→ | | | ALMERA II 1.6 | | 08/2012→ | |
| BLUEBIRD SYLPHY / SYLPHY III 1.6 | 08/2012→ | | | CUBE 1.6 16V | | 03/2010→ | |
| JUKE 1.6 | 06/2010→ | | | JUKE 1.6 LPG | | 01/2012→ | |
| KICKS 1.6 | 08/2016→ | | | LIVINA / GRAND LIVINA 1.6 | | 02/2007→ | |
| MICRA C+C III 1.6 160 SR | 08/2005→ | | | MICRA III 160 SR | | 05/2005→06/2010 | |
| MICRA IV 1.6 | 09/2011→ | | | NOTE 1.6 | | 03/2006→ | |
| NOTE 1.6 NISMO S | 06/2013→ | | | NP200 1.6 | | 10/2008→ | |
| NV200 1.6 16V | 02/2010→ | | | NV200 / EVALIA 1.6 16V | | 07/2010→ | |
| QASHQAI / QASHQAI +2 I 1.6 | 02/2007→12/2013 | | | SENTRA VII 1.6 | | 05/2013→ | |
| TIIDA 1.6 | 08/2005→ | | | VERSA I 1.6 | | 09/2008→ | |
| VERSA II 1.6 | 08/2011→ | | | | | | |

| | | | | | | |
|-----------------------|-------------|-------|-----|---|---------------------|--|
| V95079 | 13201-ED000 | | 45° | H | VAG96369 | |
| 31.15 x 4.97 x 101.70 | | MB tu | | | 42.20 x 5.00 x 9.24 | |
| V95080 | 13202-ED000 | | 45° | | VAG96370 | |
| 25.45 x 4.96 x 102.50 | | MD tu | | | 42.20 x 4.99 x 9.24 | |

22 79.50

| K4M 752 | 1598cc | 4 Cyl. | 16 Valves | 70kW/95PS | Petrol | DOHC | TD21398 |
|------------------|----------|--------|-----------|-----------|--------|------|---------|
| KUBISTAR 1.6 16V | 08/2003→ | | | | | | |

| | | | | | | | |
|-----------------------|-------------|----|-----|---|---|----------------------|--|
| V94498 | 13201-00QAA | | 45° | Y | H | VAG96292B | |
| 32.40 x 5.50 x 109.20 | | MB | | | | 40.60 x 5.50 x 11.07 | |
| V94499 | 13202-00QAA | | 45° | | | | |
| 28.00 x 5.50 x 107.50 | | MD | | | | | |

23 80.00

| CD17 | 1681cc | 4 Cyl. | 8 Valves | 40-41kW/54-56PS | Diesel | SOHC | TD2419 |
|---------------------|-----------------|--------|----------|------------------|--------|-----------------|--------|
| AD 1.7 D | 10/1984→12/2008 | | | CHERRY III 1.7 D | | 10/1982→12/1986 | |
| SENTRA 1.7 D | 09/1984→12/1986 | | | SUNNY I 1.7 D | | 03/1982→12/1987 | |
| SUNNY II 1.7 D | 01/1986→06/1991 | | | SUNNY III 1.7 D | | 11/1990→03/2000 | |
| WINGROAD / AD 1.7 D | 10/1990→08/2004 | | | | | | |

| | | | | | | | |
|-----------------------|-------------|-------|-----|----|----|----------------------|--|
| V91456 | 13202-16A00 | | 45° | ss | st | VAG92284 | |
| 31.10 x 6.96 x 100.90 | | MD tu | | | | 45.07 x 6.55 x 11.24 | |
| | | | | | | VAG92285 | |
| | | | | | | 45.05 x 7.02 x 11.23 | |



OE

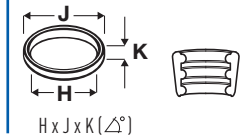
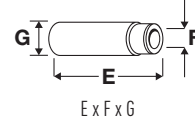
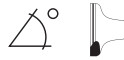

24



80.00

| QG18DE | 1769cc | 4 Cyl. | 16 Valves | 78-94kW/106-128PS | Petrol | DOHC | TD11487 |
|-------------------|--------|--------|-----------|-----------------------|--------|-----------------|---------|
| ALMERA I 1.8 | | | | ALMERA II 1.8 | | 01/2000→ | |
| ALMERA TINO 1.8 | | | | AVENIR 1.8 | | 11/1997→12/2005 | |
| BLUEBIRD 1.8 | | | | BLUEBIRD SYLPHY I 1.8 | | 01/2000→06/2006 | |
| EXPERT II 1.8 | | | | PRIMERA 1.8 | | 03/2002→ | |
| PRIMERA 1.8 16V | | | | PULSAR 1.8 | | 07/1995→05/2000 | |
| SENTRA V 1.8 | | | | SUNNY IV 1.8 | | 04/2000→09/2003 | |
| WINGROAD / AD 1.8 | | | | | | | |

V94432 ■
30.00 x 5.50 x 92.30
→12/03

13201-2F000

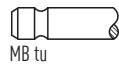

45°

H

VAG92360 ■
40.00 x 5.52 x 9.74

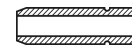

V95131 ■
30.00 x 5.47 x 94.35
01/04→

13201-AU300

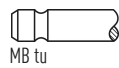

45°

H

V94434 ■
25.00 x 5.50 x 92.60
→12/03

13202-9F600

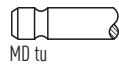

45°

V95132 ■
25.00 x 5.46 x 94.75
01/04→

13202-AU300

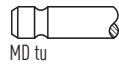

45°

25



80.00

| F9Q 760 | 1870cc | 4 Cyl. | 8 Valves | 74kW/101PS | Diesel | Turbo, SOHC | TD20980 |
|-----------------------|--------|--------|----------|----------------------|--------|-------------|---------|
| F9Q 762 | 1870cc | 4 Cyl. | 8 Valves | 60kW/82PS | Diesel | Turbo, SOHC | TD20991 |
| F9Q 772 | 1870cc | 4 Cyl. | 8 Valves | 60kW/82PS | Diesel | Turbo, SOHC | TD19378 |
| F9Q 774 | 1870cc | 4 Cyl. | 8 Valves | 60kW/82PS | Diesel | Turbo, SOHC | TD26548 |
| INTERSTAR dCi 80 | | | | PRIMASTAR 1.9 dCi 80 | | 09/2002→ | |
| PRIMASTAR 1.9 dCi 100 | | | | PRIMASTAR dCi 80 | | 03/2001→ | |
| PRIMASTAR dCi 100 | | | | | | | |

V94190 ■
35.40 x 7.00 x 111.00

13201-AW300

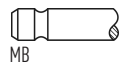

45°

H

VAG96294B ■ ■
38.30 x 7.00 x 12.03



V94191 ■
32.60 x 7.00 x 110.80

13202-AW300

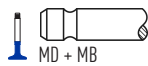

45°

H

26



81.00

| JN | 1781cc | 4 Cyl. | 8 Valves | 67kW/91PS | Petrol | SOHC | TD2457 |
|---|--------------|--------|----------|-----------|--------|------|--------|
| V91338 ■ 38.10 x 7.97 x 91.90 | 035 109 601K | | 45° | | | | |
| V91340 ■ 33.30 x 7.95 x 91.20 | 048 109 611A | | 45° | H | | | |
| | | | | | | | |

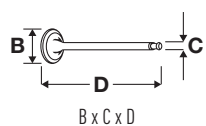

OE

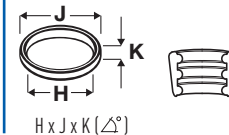
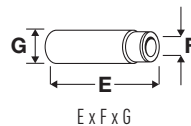
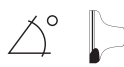

27 82.70

| | | | | | | | |
|----------------|--------|--------|------------------|------------|--------|-------------|----------------|
| F4R 720 | 1998cc | 4 Cyl. | 16 Valves | 88kW/120PS | Petrol | DOHC | TD19376 |
| F4R 722 | 1998cc | 4 Cyl. | 16 Valves | 88kW/120PS | Petrol | DOHC | TD19377 |
| F4R 820 | 1998cc | 4 Cyl. | 16 Valves | 86kW/117PS | Petrol | DOHC | TD34444 |

PRIMASTAR 2.0 03/2001→

V94606
33.60 x 5.50 x 110.00

7701 474 287

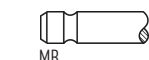

45°

H

VAG96292B
40.60 x 5.50 x 11.07



V94607
29.00 x 5.50 x 108.90

7701 474 286

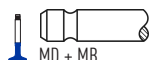

45°

H

28 84.00

| | | | | | | | |
|------------|--------|--------|------------------|-------------|--------|--------------------|----------------|
| M1D | 1994cc | 4 Cyl. | 16 Valves | 110kW/150PS | Diesel | Turbo, SOHC | TD21038 |
|------------|--------|--------|------------------|-------------|--------|--------------------|----------------|

QASHQAI / QASHQAI +2 I 2.0 dCi 02/2007→12/2013

V95001
27.70 x 5.98 x 103.90

13201-00Q0A



45°

Y

H

VAG96383B
42.40 x 6.00 x 11.07

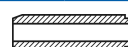

V95002
26.00 x 5.97 x 103.75

13202-00Q0A

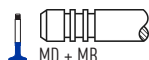

45°

H

29 84.00

| | | | | | | | |
|----------------|--------|--------|------------------|---------------------|--------|--------------------|----------------|
| M9R | 1995cc | 4 Cyl. | 16 Valves | 110-130kW/150-177PS | Diesel | Turbo, DOHC | TD22892 |
| M9R 630 | 1995cc | 4 Cyl. | 16 Valves | 66-84kW/90-114PS | Diesel | Turbo, DOHC | TD26730 |
| M9R 760 | 1995cc | 4 Cyl. | 16 Valves | 127-130kW/173-177PS | Diesel | Turbo, DOHC | TD20981 |
| M9R 780 | 1995cc | 4 Cyl. | 16 Valves | 66-84kW/90-114PS | Diesel | Turbo, DOHC | TD20890 |
| M9R 782 | 1995cc | 4 Cyl. | 16 Valves | 66kW/90PS | Diesel | Turbo, DOHC | TD24668 |

PRIMASTAR 2.0 dCi 90 09/2006→

PRIMASTAR 2.0 dCi 115 09/2006→

PRIMASTAR dCi 90 09/2006→

PRIMASTAR dCi 120 09/2006→

QASHQAI / QASHQAI +2 I 2.0 dCi 02/2007→12/2013

X-TRAIL 2.0 dCi 06/2007→

V95001
27.70 x 5.98 x 103.90

13201-00Q0A



45°

Y

H

VAG96383B
42.40 x 6.00 x 11.07

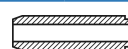

V95002
26.00 x 5.97 x 103.75

13202-00Q0A

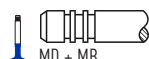

45°

H

30 84.00

| | | | | | | | |
|---------------|--------|--------|------------------|--------------------|--------|-------------|----------------|
| MR20DE | 1997cc | 4 Cyl. | 16 Valves | 95-108kW/129-147PS | Petrol | DOHC | TD19288 |
|---------------|--------|--------|------------------|--------------------|--------|-------------|----------------|

BLUEBIRD SYLPHY II 2.0 09/2005→08/2012

BLUEBIRD SYLPHY / SYLPHY III 2.0 10/2013→

LAFESTA 2.0 08/2004→10/2012

LAFESTA 2.0 CVTC 07/2005→

NV200 2.0 09/2013→

NV200 / EVALIA 2.0 09/2013→

QASHQAI / QASHQAI +2 I 2.0 02/2007→12/2013

SENTRA VI 2.0 10/2006→12/2012

SENTRA VII 2.0CS Flex 01/2014→

SERENA 2.0 04/2005→08/2012

TEANA III 2.0 09/2013→

X-TRAIL 2.0 03/2007→02/2014

V95119
34.00 x 5.48 x 106.35

13201-EN20A

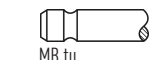

45°

Y

H

V95120
27.75 x 5.47 x 105.30

13202-EN200

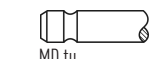

45°



OE

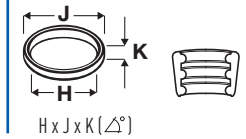
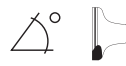

31  **84.50**

| | | | | | | | |
|---------------------|-----------------|--------|----------|-----------------|--------|-----------------|--------|
| CD20 | 1974cc | 4 Cyl. | 8 Valves | 55-56kW/75-76PS | Diesel | SOHC | TD4698 |
| CD20T | 1974cc | 4 Cyl. | 8 Valves | 66-67kW/90-91PS | Diesel | Turbo, SOHC | TD5509 |
| AD 2.0 D | 10/1994→04/1999 | | | ALMERA 1 2.0 D | | 11/1995→07/2000 | |
| AVENIR 2.0 TD | 11/1992→09/1999 | | | BLUEBIRD 2.0 D | | 09/1991→05/2002 | |
| LUCINO 2.0 D | 11/1997→01/2000 | | | PRIMERA 2.0 D | | 07/1990→01/1996 | |
| PRIMERA 2.0 TD | 09/1996→07/2002 | | | SERENA 2.0 D | | 06/1991→09/2001 | |
| SERENA 2.0 TD | 06/1991→09/1996 | | | SUNNY III 2.0 D | | 10/1990→03/2000 | |
| WINGROAD / AD 2.0 D | 04/1994→08/1998 | | | | | | |

V94441 ■
39.10 x 7.00 x 99.70

13201-60J04

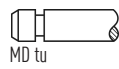

45°

V94476 ■
39.10 x 7.00 x 100.70

13201-57J02

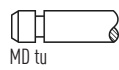

45°

V94340 ■
32.10 x 7.00 x 99.50

13202-60J02

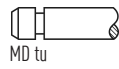

45°

V94469 ■
32.10 x 7.00 x 100.50

13202-57J02

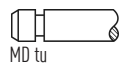

45°

VAG92284 ■
45.07 x 6.55 x 11.24

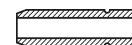

VAG92285 ■
45.05 x 7.02 x 11.23

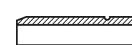

VAG92286 ■
48.01 x 7.02 x 11.22



VAG96133 ■
45.00 x 6.60 x 11.20



32  **85.00**

| | | | | | | | |
|---------|--------|--------|-----------|--------------------|--------|-------------|---------|
| M9T 670 | 2299cc | 4 Cyl. | 16 Valves | 74-92kW/101-125PS | Diesel | Turbo, DOHC | TD26543 |
| M9T 672 | 2299cc | 4 Cyl. | 16 Valves | 74-92kW/101-125PS | Diesel | Turbo, DOHC | TD26768 |
| M9T 676 | 2299cc | 4 Cyl. | 16 Valves | 74-92kW/101-125PS | Diesel | Turbo, DOHC | TD26769 |
| M9T 678 | 2299cc | 4 Cyl. | 16 Valves | 107kW/146PS | Diesel | Turbo, DOHC | TD26770 |
| M9T 680 | 2299cc | 4 Cyl. | 16 Valves | 107kW/146PS | Diesel | Turbo, DOHC | TD26771 |
| M9T 686 | 2299cc | 4 Cyl. | 16 Valves | 92kW/125PS | Diesel | Turbo, DOHC | TD26772 |
| M9T 690 | 2299cc | 4 Cyl. | 16 Valves | 74-92kW/101-125PS | Diesel | Turbo, DOHC | TD26544 |
| M9T 692 | 2299cc | 4 Cyl. | 16 Valves | 92kW/125PS | Diesel | Turbo, DOHC | TD26773 |
| M9T 694 | 2299cc | 4 Cyl. | 16 Valves | 107kW/146PS | Diesel | Turbo, DOHC | TD26774 |
| M9T 696 | 2299cc | 4 Cyl. | 16 Valves | 92-107kW/125-146PS | Diesel | Turbo, DOHC | TD26775 |
| M9T 698 | 2299cc | 4 Cyl. | 16 Valves | 92-107kW/125-146PS | Diesel | Turbo, DOHC | TD26776 |
| M9T 880 | 2299cc | 4 Cyl. | 16 Valves | 110kW/150PS | Diesel | Turbo, DOHC | TD30783 |
| M9T 896 | 2299cc | 4 Cyl. | 16 Valves | 92-107kW/125-146PS | Diesel | Turbo, DOHC | TD31982 |

| | | | | | | | |
|-----------------------|-----------------|--|--|-------------------|--|-----------------|--|
| NV400 2.3 dCi 145 RWD | 11/2011→02/2014 | | | NV400 2.3 dCi 150 | | 02/2014→09/2016 | |
| NV400 dCi 100 | 11/2011→06/2014 | | | NV400 dCi 125 | | 11/2011→09/2016 | |
| NV400 dCi 125 RWD | 11/2011→09/2016 | | | NV400 dCi 140 | | 06/2014→09/2016 | |
| NV400 dCi 140 RWD | 06/2014→09/2016 | | | NV400 dCi 145 | | 11/2011→06/2016 | |
| NV400 dCi 145 RWD | 11/2011→06/2016 | | | NV400 dCi 150 | | 02/2014→09/2016 | |
| NV400 dCi 150 RWD | 02/2014→09/2016 | | | | | | |

V95001 ■
27.70 x 5.98 x 103.90

13201-00Q0A

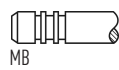

45°

Y

H

V95002 ■
26.00 x 5.97 x 103.75

13202-00Q0A



45°

H



OE

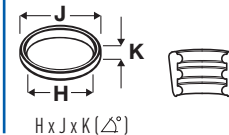
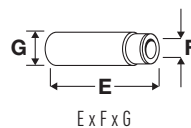
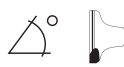

33 85.00

| RD28T | 2826cc | 6 Cyl. | 12 Valves | 74-86kW/101-117PS | Diesel | Turbo, SOHC | TD2511 |
|-----------------------|-----------------|------------|-----------|---------------------|--------|-----------------|--------|
| CEDRIC 2.8 D | 06/1991→10/1995 | | | CEDRIC 2.8 TD | | 11/1995→07/1998 | |
| PATROL GR IV 2.8 D | 07/1992→02/1998 | | | PATROL GR IV 2.8 TD | | 09/1988→02/1998 | |
| PATROL GR V 2.8 D | 03/1998→04/2001 | | | PATROL III/2 2.8 TD | | 05/1986→11/1995 | |
| V94329 | 13201-22301 | | 45° | | | | |
| 39.00 x 7.00 x 102.80 | | MD tu | | | | | |
| V94330 | 13201-22J11 | | 45° | | | | |
| 39.00 x 7.00 x 101.80 | | MD tu | | | | | |
| V94326 | 13202-40L01 | | 45° | H | | | |
| 32.00 x 7.00 x 101.60 | | ME + MB tu | | | | | |
| V94452 | 13202-V7202 | | 45° | | | | |
| 32.10 x 7.00 x 102.50 | | MD tu | | | | | |

34 85.00

| RD28Ti | 2826cc | 6 Cyl. | 12 Valves | 95-96kW/129-131PS | Diesel | Turbo, SOHC | TD13751 |
|-----------------------|-----------------|------------|-----------|----------------------|--------|-----------------|---------|
| PATROL GR V 2.8 TD | 06/1997→05/2000 | | | PATROL GR V 2.8 TDiC | | 10/1997→02/2000 | |
| V94430 | 13201-0Y000 | | 45° | | | | |
| 39.10 x 7.00 x 101.70 | | MD tu | | | | | |
| V94431 | 13202-4P400 | | 45° | H | | | |
| 32.10 x 7.00 x 101.60 | | MD + MB tu | | | | | |

35 86.00

| SR20DE | 1998cc | 4 Cyl. | 16 Valves | 92-121kW/125-165PS | Petrol | DOHC | TD2521 |
|-----------------------|-----------------|--------|-----------|---------------------|--------|-----------------|--------|
| 100 NX 2.0 | 10/1990→10/1994 | | | 100 NX 2.0 GTI | | 03/1991→10/1994 | |
| 180 SX 2.0 | 04/1991→03/1994 | | | 200 SX 2.0 | | 09/1995→12/1999 | |
| 200 SX 2.0 i 16V | 07/1988→12/1999 | | | AD 2.0 | | 10/1994→04/1999 | |
| ALMERA I 2.0 GTi | 07/1996→03/2000 | | | ALMERA II 2.0 | | 08/2002→ | |
| ALMERA TINO 2.0 | 08/2000→01/2003 | | | ALTRA 2.0 | | 11/1997→07/2001 | |
| AVENIR 2.0 | 11/1997→12/2005 | | | BLUEBIRD 2.0 | | 09/1991→05/2002 | |
| BLUEBIRD SYLPHY I 2.0 | 08/2000→06/2006 | | | CIMA 2.0 | | 07/1996→02/2001 | |
| EXPERT I 2.0 | 10/1995→04/2000 | | | LUCINO 2.0 | | 10/1991→01/2000 | |
| LUCINO 2.0 GTi | 11/1995→01/2000 | | | NAVARA 2.0 | | 01/1997→08/2001 | |
| PICK UP 2.0 | 01/1997→08/2001 | | | PRAIRIE LIBERTY 2.0 | | 11/1998→05/2001 | |
| PRAIRIE PRO 2.0 | 01/1995→10/1998 | | | PRESEA 2.0 | | 08/1997→08/2000 | |
| PRIMERA 2.0 | 06/1990→01/1998 | | | PRIMERA 2.0 16V | | 09/1996→07/2002 | |
| PRIMERA 2.0 GT | 06/1990→01/1996 | | | PRIMERA 2.0 i | | 01/1995→06/1996 | |
| PULSAR I 2.0 | 07/1995→07/2000 | | | RNESSA 2.0 | | 11/1997→07/2001 | |
| SENTRA III 2.0 | 02/1992→12/1994 | | | SENTRA V 2.0 | | 01/2000→12/2006 | |
| SERENA 2.0 | 11/1992→09/2001 | | | SERENA 2.0 SGX | | 09/2000→09/2005 | |
| SILVIA 2000 | 09/1999→08/2002 | | | SUNNY III 2.0 | | 08/1990→12/1997 | |
| SUNNY III 2.0 GTI 16V | 10/1990→05/1995 | | | SUNNY III 2.0 i 16V | | 10/1990→05/1995 | |
| SUNNY IV 2.0 | 09/1997→05/2002 | | | TSURU 2.0 | | 10/1991→12/2007 | |
| WINGROAD / AD 2.0 | 05/1999→08/2001 | | | | | | |
| V94194 | 13201-2J201 | | 45° | H | | | |
| 34.10 x 6.00 x 98.40 | | MB tu | | | | | |
| 01/96→ | | | | | | | |
| V94195 | 13202-2J201 | | 45° | | | | |
| 30.10 x 6.00 x 99.30 | | MD tu | | | | | |
| 01/96→ | | | | | | | |



OE

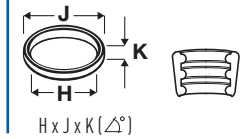
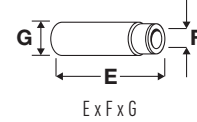

36 **86.00**

| | | | | | | | |
|---------------------|-----------------|--------|-----------|--------------------|--------|-----------------|---------|
| YD22DDT | 2184cc | 4 Cyl. | 16 Valves | 81-102kW/110-139PS | Diesel | Turbo, DOHC | TD16314 |
| YD22DDTi | 2184cc | 4 Cyl. | 16 Valves | 84-110kW/114-150PS | Diesel | Turbo, DOHC | TD16229 |
| YD22ETI | 2184cc | 4 Cyl. | 16 Valves | 84kW/114PS | Diesel | Turbo, DOHC | TD16320 |
| ALMERA II 2.2 dCi | 09/2003→ | | | ALMERA II 2.2 Di | | 03/2000→ | |
| ALMERA TINO 2.2 dCi | 08/2000→02/2006 | | | PRIMERA 2.2 dCi | | 04/2003→ | |
| PRIMERA 2.2 Di | 03/2002→ | | | X-TRAIL 2.2 dCi | | 12/2003→01/2013 | |
| X-TRAIL 2.2 DCi | 06/2001→01/2013 | | | X-TRAIL 2.2 Di | | 07/2001→10/2005 | |

V95129
28.10 x 5.97 x 106.75

13201-AD210

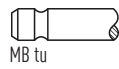

45°

H

VAG96375
60.00 x 6.00 x 10.04



V95130
26.10 x 5.95 x 106.35

13202-AD210

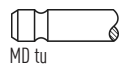

45°

VAG96376
44.20 x 6.01 x 10.05

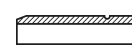

37 **87.00**

| | | | | | | | |
|------------------|----------|--------|-----------|-----------|--------|-------------|---------|
| G9T 722 | 2188cc | 4 Cyl. | 16 Valves | 66kW/90PS | Diesel | Turbo, DOHC | TD19379 |
| G9T 750 | 2188cc | 4 Cyl. | 16 Valves | 66kW/90PS | Diesel | Turbo, DOHC | TD23886 |
| INTERSTAR dCi 90 | 07/2002→ | | | | | | |

V94513
30.70 x 6.00 x 123.10

7701 472 669

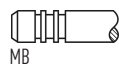

45°

H

VAG96361B
50.00 x 6.00 x 11.05

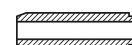

V94514
29.50 x 6.00 x 122.90

7701 472 670

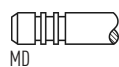

45°

38 **87.00**

| | | | | | | | |
|---------------------|-----------------|--------|----------|--------------|--------|-----------------|--------|
| LD23 | 2283cc | 4 Cyl. | 8 Valves | 55kW/75PS | Diesel | SOHC | TD8360 |
| CABSTAR E 75.28 | 10/1998→10/2006 | | | SERENA 2.3 D | | 01/1995→09/2001 | |
| TRADE 2.3 D | 06/1996→10/2001 | | | TRADE 75 | | 05/1997→12/2000 | |
| VANETTE CARGO 2.3 D | 09/1994→05/2002 | | | | | | |

V94448
41.50 x 8.00 x 118.00

13201-9C600

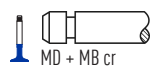

37°

H

VAG96118
59.00 x 8.02 x 12.25



V94449
33.10 x 8.00 x 117.50

13202-9C601

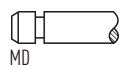

45°

39 **89.00**

| | | | | | | | |
|---------------------|-----------------|--------|-----------|---------------------|--------|-----------------|---------|
| QR20DE | 1998cc | 4 Cyl. | 16 Valves | 96-110kW/131-150PS | Petrol | DOHC | TD16319 |
| AVENIR 2.0 | 09/2001→12/2005 | | | NV350 2.0 | | 05/2012→ | |
| NV350 / CARAVAN 2.0 | 05/2012→ | | | PRAIRIE LIBERTY 2.0 | | 05/2001→12/2004 | |
| PRIMERA 2.0 | 03/2002→ | | | TEANA 1 2.0 | | 10/2003→06/2008 | |
| WINGROAD / AD 2.0 | 10/2003→11/2005 | | | X-TRAIL 2.0 | | 07/2001→01/2013 | |

V94433
30.20 x 6.00 x 99.30

13202-2F210

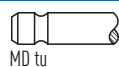

45°

SS

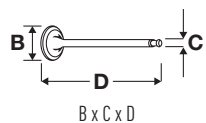

OE

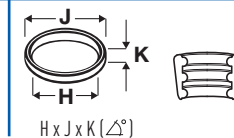
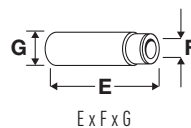
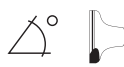

40 89.00

| Part No. | Capacity | Cyls | Valves | Power | Engine Type | Configuration | Code |
|-----------------------|----------|--------|-----------|-----------------------|-------------|---------------|---------|
| 69U 135 | 2464cc | 4 Cyl. | 16 Valves | 100kW/136PS | Diesel | Turbo, DOHC | TD17658 |
| 69U 630 | 2464cc | 4 Cyl. | 16 Valves | 84-107kW/114-146PS | Diesel | Turbo, DOHC | TD24664 |
| 69U 632 | 2464cc | 4 Cyl. | 16 Valves | 88-107kW/120-146PS | Diesel | Turbo, DOHC | TD24665 |
| 69U 650 | 2464cc | 4 Cyl. | 16 Valves | 74-88kW/101-120PS | Diesel | Turbo, DOHC | TD23875 |
| 69U 720 | 2464cc | 4 Cyl. | 16 Valves | 73-84kW/99-114PS | Diesel | Turbo, DOHC | TD21010 |
| 69U 724 | 2464cc | 4 Cyl. | 16 Valves | 84kW/115PS | Diesel | Turbo, DOHC | TD34662 |
| 69U 730 | 2464cc | 4 Cyl. | 16 Valves | 99kW/135PS | Diesel | Turbo, DOHC | TD18702 |
| 69U 754 | 2464cc | 4 Cyl. | 16 Valves | 73-84kW/99-115PS | Diesel | Turbo, DOHC | TD34661 |
| INTERSTAR dCi 100 | 11/2003→ | | | INTERSTAR dCi 120 | | 04/2002→ | |
| INTERSTAR dCi 150 | 08/2006→ | | | PRIMASTAR 2.5 dCi 115 | | 09/2008→ | |
| PRIMASTAR 2.5 dCi 140 | 07/2003→ | | | PRIMASTAR 2.5 dCi 150 | | 04/2006→ | |
| PRIMASTAR dCi 115 | 09/2008→ | | | PRIMASTAR dCi 140 | | 07/2003→ | |
| PRIMASTAR dCi 150 | 09/2006→ | | | | | | |

V94513
30.70 x 6.00 x 123.10

7701 472 669

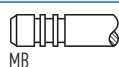

45°

H

VAG96361B
50.00 x 6.00 x 11.05



V94514
29.50 x 6.00 x 122.90

7701 472 670

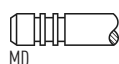

45°

41 89.00

| Part No. | Capacity | Cyls | Valves | Power | Engine Type | Configuration | Code |
|---|-----------------|--------|-----------|--|-------------|-----------------|---------|
| YD25DDTi | 2488cc | 4 Cyl. | 16 Valves | 81-140kW/110-190PS | Diesel | Turbo, DOHC | TD17650 |
| BASSARA 2.5 DCi | 11/1999→08/2003 | | | CABSTAR 2.5 dCi | | 10/2006→09/2011 | |
| CABSTAR 28.11 DCi, 32.11 DCi, 35.11 DCi 2.5 | 09/2006→12/2013 | | | CABSTAR 28.12 DCi, 32.12 DCi, 34.12 DCi, 35.12 DCi 2.5 | | 09/2006→12/2013 | |
| CABSTAR 35.13 DCi, 45.13 DCi 2.5 | 09/2006→12/2012 | | | CABSTAR 35.14 DCi, 45.14 DCi 2.5 | | 09/2006→12/2013 | |
| MURANO II 2.5 dCi | 01/2010→09/2014 | | | MURANO III 2.5 dCi | | 10/2014→ | |
| NAVARA 2.5 D | 11/2001→ | | | NAVARA 2.5 Di | | 02/2002→ | |
| NP300 NAVARA 2.5 D | 09/2008→ | | | NP300 NAVARA 2.5 dCi | | 07/2005→ | |
| NP300 PICKUP 2.5 dCi | 04/2008→ | | | NV350 2.5 dCi | | 06/2012→ | |
| NV350 / CARAVAN 2.5 dCi | 05/2012→ | | | PATHFINDER III 2.5 dCi | | 01/2005→ | |
| PATHFINDER IV 2.5 dCi | 09/2012→ | | | PICK UP 2.5 Di | | 03/2002→12/2010 | |
| PRESAGE 2.5 D | 03/1998→12/2003 | | | SANI 2.5 dCi | | 01/2005→ | |
| SERENA 2.5 DCi SGX | 06/1999→09/2005 | | | | | | |

V95129
28.10 x 5.97 x 106.75

13201-AD210

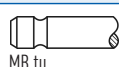

45°

H

VAG96375
60.00 x 6.00 x 10.04

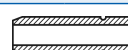

V95130
26.10 x 5.95 x 106.35

13202-AD210

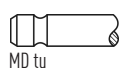

45°

VAG96376
44.20 x 6.01 x 10.05



42 96.00

| Part No. | Capacity | Cyls | Valves | Power | Engine Type | Configuration | Code |
|--------------------|-----------------|--------|----------|-----------------|-------------|-----------------|--------|
| TD27 | 2663cc | 4 Cyl. | 8 Valves | 58-73kW/79-99PS | Diesel | OHV | TD2532 |
| CABSTAR 2.7 D | 10/2000→04/2004 | | | CABSTAR 2.7 TD | | 02/1983→12/1990 | |
| NAVARA 2.7 D | 09/1987→08/1998 | | | NAVARA 2.7 TD | | 01/1997→10/2001 | |
| PATHFINDER I 2.7 D | 05/1992→10/1995 | | | PICK UP 2.7 D | | 08/1987→04/2005 | |
| SANI 2.7 TD | 01/1996→12/1999 | | | URVAN 2.7 D | | 03/1987→09/1993 | |
| URVAN 2.7 TD | 10/1994→04/1997 | | | | | | |

V91493
43.50 x 7.97 x 117.00

13201-43G01

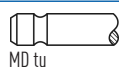

45°

st

VAG92384
47.00 x 8.02 x 12.04

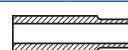



OE

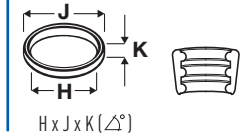
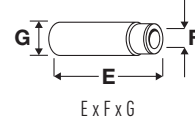

43



96.00

| | | | | | | | |
|--------------------|-----------------|--------|-----------------|--------------------------------------|--------|-----------------|---------------|
| TD27T | 2664cc | 4 Cyl. | 8 Valves | 61-74kW/83-101PS | Diesel | Turbo | TD2533 |
| TD27TI | 2664cc | 4 Cyl. | 8 Valves | 91-92kW/124-125PS | Diesel | Turbo | TD9478 |
| ATLAS 2.7 TDiC | 07/1996→10/2004 | | | CABSTAR E 90.32, 90.28, 95.32, 95.28 | | 10/1998→10/2006 | |
| HOMY 2.7 TD | 10/1993→10/1995 | | | NAVARA 2.7 TD | | 03/1997→12/2001 | |
| PATROL GR V 2.7 TD | 05/1998→06/2001 | | | PICK UP 2.7 D | | 03/2001→10/2002 | |
| PICK UP 2.7 TD | 09/1987→10/2001 | | | TERRANO I 2.7 TD | | 02/1989→02/1996 | |
| TERRANO II 2.7 TD | 02/1993→01/2002 | | | TERRANO II 2.7 TDi | | 05/1996→09/2007 | |
| TRADE 2.7 TD | 11/1998→09/2004 | | | URVAN 2.7 TD | | 10/1995→08/2000 | |

V91493 ■

43.50 x 7.97 x 117.00

13201-43G01

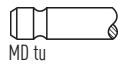

MD tu

45°

st

VAG92384 ■ ■ ■

47.00 x 8.02 x 12.04



44



96.00

| | | | | | | | |
|--------------------|-----------------|--------|------------------|--------------------|--------|-----------------|---------------|
| TD42 | 4169cc | 6 Cyl. | 12 Valves | 85-92kW/116-125PS | Diesel | SOHC | TD2535 |
| PATROL GR IV 4.2 D | 11/1988→06/1997 | | | PATROL GR V 4.2 D | | 05/1998→03/2003 | |
| PATROL III/1 4.2 D | 01/1988→12/1997 | | | PATROL III/2 4.2 D | | 01/1988→12/1997 | |

V91493 ■

43.50 x 7.97 x 117.00

13201-43G01

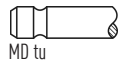

MD tu







45°







st







VAG92384 ■ ■ ■







47.00 x 8.02 x 12.04



|  |  | ccm |  |  |  |  | |
|---|---|-------|--|---|---|---|----|
| 12 NV | | 77.80 | 1196 | 4 | 8 | Petrol | 24 |
| 12 NZ | | 72.00 | 1195 | 4 | 8 | Petrol | 3 |
| 12 ST | | 77.80 | 1196 | 4 | 8 | Petrol | 24 |
| 13 N | | 75.00 | 1297 | 4 | 8 | Petrol | 15 |
| 13 NB | | 75.00 | 1297 | 4 | 8 | Petrol | 16 |
| 13 S | | 75.00 | 1297 | 4 | 8 | Petrol | 16 |
| 13 SB | | 75.00 | 1297 | 4 | 8 | Petrol | 16 |
| 14 NV | | 77.60 | 1389 | 4 | 8 | Petrol | 19 |
| 14 SE | | 77.60 | 1389 | 4 | 8 | Petrol | 20 |
| 15 D (4EC1) | | 76.00 | 1488 | 4 | 8 | Diesel | 17 |
| 15 DT (T4EC1) | | 76.00 | 1488 | 4 | 8 | Diesel | 18 |
| 16 D | | 80.00 | 1598 | 4 | 8 | Diesel | 36 |
| 16 DA | | 80.00 | 1598 | 4 | 8 | Diesel | 36 |
| 16 LZ2 | | 79.00 | 1598 | 4 | 8 | Petrol | 25 |
| 16 N | | 80.00 | 1598 | 4 | 8 | Petrol | 37 |
| 16 NZR | | 79.00 | 1598 | 4 | 8 | Petrol | 25 |
| 16 SH | | 80.00 | 1598 | 4 | 8 | Petrol | 37 |
| 16 SV | | 79.00 | 1598 | 4 | 8 | Petrol | 25 |
| 17 D | | 82.50 | 1700 | 4 | 8 | Diesel | 48 |
| 17 D (4EE1) | | 79.00 | 1686 | 4 | 8 | Diesel | 32 |
| 17 DR | | 82.50 | 1700 | 4 | 8 | Diesel | 48 |
| 17 DT (TC4EE1) | | 79.00 | 1686 | 4 | 8 | Diesel | 33 |
| 18 NV | | 84.80 | 1796 | 4 | 8 | Petrol | 58 |
| 18 SE | | 84.80 | 1796 | 4 | 8 | Petrol | 59 |
| 18 SEH | | 84.80 | 1796 | 4 | 8 | Petrol | 59 |
| 18 SV | | 84.80 | 1796 | 4 | 8 | Petrol | 59 |
| 20 NE | | 86.00 | 1998 | 4 | 8 | Petrol | 63 |
| 20 NEJ | | 86.00 | 1998 | 4 | 8 | Petrol | 64 |
| 20 SE | | 86.00 | 1998 | 4 | 8 | Petrol | 65 |
| 20 SEH | | 86.00 | 1998 | 4 | 8 | Petrol | 63 |
| 20 SER | | 86.00 | 1998 | 4 | 8 | Petrol | 65 |
| 20 XE | | 86.00 | 1998 | 4 | 16 | Petrol | 66 |
| 23 DTR | | 92.00 | 2260 | 4 | 8 | Diesel | 79 |
| 23 YDT | | 92.00 | 2260 | 4 | 8 | Diesel | 79 |
| 25 TDS (VM41B) | | 92.00 | 2499 | 4 | 8 | Diesel | 80 |
| 4 JG2T | | 95.40 | 3059 | 4 | 8 | Diesel | 85 |
| 4 JG2TC | | 95.40 | 3059 | 4 | 8 | Diesel | 85 |
| 6 VD1 | | 93.40 | 3165 | 6 | 24 | Petrol | 82 |
| A 10 XEP | | 73.40 | 998 | 3 | 12 | Petrol | 9 |
| A 12 XEL | | 73.40 | 1229 | 4 | 16 | Petrol | 10 |
| A 12 XER | | 73.40 | 1229 | 4 | 16 | Petrol | 11 |
| A 13 DTC | | 69.60 | 1248 | 4 | 16 | Diesel | 1 |
| A 13 DTE | | 69.60 | 1248 | 4 | 16 | Diesel | 1 |
| A 13 DTR | | 69.60 | 1248 | 4 | 16 | Diesel | 1 |
| A 13 FD | | 69.60 | 1248 | 4 | 16 | Diesel | 1 |
| A 14 FP | | 72.00 | 1368 | 4 | 16 | Petrol | 4 |
| A 14 NEL | | 72.50 | 1364 | 4 | 16 | Petrol | 7 |
| A 14 NET | | 72.50 | 1364 | 4 | 16 | Petrol | 7 |
| A 14 XEL | | 73.40 | 1398 | 4 | 16 | Petrol | 13 |
| A 14 XER | | 73.40 | 1398 | 4 | 16 | Petrol | 13 |
| A 16 LET | | 79.00 | 1598 | 4 | 16 | Petrol | 26 |
| A 16 XER | | 79.00 | 1598 | 4 | 16 | Petrol | 26 |
| A 17 DT | | 79.00 | 1686 | 4 | 16 | Diesel | 34 |
| A 17 DTC | | 79.00 | 1686 | 4 | 16 | Diesel | 34 |
| A 17 DTE | | 79.00 | 1686 | 4 | 16 | Diesel | 34 |
| A 17 DTJ | | 79.00 | 1686 | 4 | 16 | Diesel | 34 |
| A 17 DTL | | 79.00 | 1686 | 4 | 16 | Diesel | 34 |
| A 17 DTN | | 79.00 | 1686 | 4 | 16 | Diesel | 34 |
| A 17 DTR | | 79.00 | 1686 | 4 | 16 | Diesel | 34 |
| A 17 DTS | | 79.00 | 1686 | 4 | 16 | Diesel | 34 |
| A 18 XEL | | 80.50 | 1796 | 4 | 16 | Petrol | 41 |
| A 18 XER | | 80.50 | 1796 | 4 | 16 | Petrol | 42 |
| A 20 DTC | | 83.00 | 1956 | 4 | 16 | Diesel | 51 |
| A 20 DTH | | 83.00 | 1956 | 4 | 16 | Diesel | 51 |
| A 20 DTJ | | 83.00 | 1956 | 4 | 16 | Diesel | 51 |
| A 20 NHT | | 86.00 | 1998 | 4 | 16 | Petrol | 67 |

|  |  | ccm |  |  |  |  | |
|---|---|-------|---|---|---|---|----|
| B 12 XHT (EB2DTS) | | 75.00 | 1199 | 3 | 12 | Petrol | 14 |
| C 12 NZ | | 72.00 | 1195 | 4 | 8 | Petrol | 3 |
| C 13 N | | 75.00 | 1297 | 4 | 8 | Petrol | 16 |
| C 14 NZ | | 77.60 | 1389 | 4 | 8 | Petrol | 19 |
| C 14 SE | | 77.60 | 1389 | 4 | 8 | Petrol | 20 |
| C 14 SEL | | 77.60 | 1389 | 4 | 16 | Petrol | 21 |
| C 16 LZ | | 79.00 | 1598 | 4 | 8 | Petrol | 25 |
| C 16 LZ2 | | 79.00 | 1598 | 4 | 8 | Petrol | 25 |
| C 16 NZ | | 79.00 | 1598 | 4 | 8 | Petrol | 25 |
| C 16 NZ2 | | 79.00 | 1598 | 4 | 8 | Petrol | 25 |
| C 16 SE | | 79.00 | 1598 | 4 | 8 | Petrol | 25 |
| C 16 SEL | | 79.00 | 1598 | 4 | 16 | Petrol | 27 |
| C 16 XE | | 79.00 | 1598 | 4 | 16 | Petrol | 28 |
| C 18 NE | | 84.80 | 1796 | 4 | 8 | Petrol | 60 |
| C 18 NT | | 84.80 | 1796 | 4 | 8 | Petrol | 60 |
| C 18 NV | | 84.80 | 1796 | 4 | 8 | Petrol | 58 |
| C 18 NZ | | 84.80 | 1796 | 4 | 8 | Petrol | 59 |
| C 18 SEL | | 84.80 | 1796 | 4 | 16 | Petrol | 61 |
| C 18 XE | | 81.60 | 1799 | 4 | 16 | Petrol | 44 |
| C 18 XEL | | 81.60 | 1799 | 4 | 16 | Petrol | 44 |
| C 20 LET | | 86.00 | 1998 | 4 | 16 | Petrol | 68 |
| C 20 NE | | 86.00 | 1998 | 4 | 8 | Petrol | 65 |
| C 20 NEF | | 86.00 | 1998 | 4 | 8 | Petrol | 65 |
| C 20 NEJ | | 86.00 | 1998 | 4 | 8 | Petrol | 65 |
| C 20 SEL | | 86.00 | 1998 | 4 | 16 | Petrol | 69 |
| C 20 XE | | 86.00 | 1998 | 4 | 16 | Petrol | 68 |
| C 22 SEL | | 86.00 | 2198 | 4 | 16 | Petrol | 70 |
| C 223 | | 88.00 | 2238 | 4 | 8 | Diesel | 76 |
| C 25 XE | | 81.60 | 2498 | 6 | 24 | Petrol | 45 |
| D13A | | 69.60 | 1248 | 4 | 16 | Diesel | 1 |
| E 16 NZ | | 79.00 | 1598 | 4 | 8 | Petrol | 25 |
| E 16 SE | | 79.00 | 1598 | 4 | 8 | Petrol | 25 |
| E 18 NV | | 84.80 | 1796 | 4 | 8 | Petrol | 59 |
| E 18 NVR | | 84.80 | 1796 | 4 | 8 | Petrol | 59 |
| F4R 720 | | 82.70 | 1998 | 4 | 16 | Petrol | 50 |
| F4R 820 | | 82.70 | 1998 | 4 | 16 | Petrol | 50 |
| F8Q 600 | | 80.00 | 1870 | 4 | 8 | Diesel | 38 |
| F8Q 606 | | 80.00 | 1870 | 4 | 8 | Diesel | 38 |
| F9Q 760 | | 80.00 | 1870 | 4 | 8 | Diesel | 39 |
| F9Q 762 | | 80.00 | 1870 | 4 | 8 | Diesel | 39 |
| F9Q 770 | | 80.00 | 1870 | 4 | 8 | Diesel | 39 |
| F9Q 772 | | 80.00 | 1870 | 4 | 8 | Diesel | 39 |
| F9Q 774 | | 80.00 | 1870 | 4 | 8 | Diesel | 39 |
| G9T 720 | | 87.00 | 2188 | 4 | 16 | Diesel | 73 |
| G9T 722 | | 87.00 | 2188 | 4 | 16 | Diesel | 73 |
| G9T 750 | | 87.00 | 2188 | 4 | 16 | Diesel | 73 |
| G9U 630 | | 89.00 | 2464 | 4 | 16 | Diesel | 78 |
| G9U 632 | | 89.00 | 2464 | 4 | 16 | Diesel | 78 |
| G9U 650 | | 89.00 | 2464 | 4 | 16 | Diesel | 78 |
| G9U 720 | | 89.00 | 2464 | 4 | 16 | Diesel | 78 |
| G9U 724 | | 89.00 | 2464 | 4 | 16 | Diesel | 78 |
| G9U 730 | | 89.00 | 2464 | 4 | 16 | Diesel | 78 |
| G9U 750 | | 89.00 | 2464 | 4 | 16 | Diesel | 78 |
| G9U 754 | | 89.00 | 2464 | 4 | 16 | Diesel | 78 |
| K10B | | 73.00 | 996 | 3 | 12 | Petrol | 8 |
| M9R 630 | | 84.00 | 1995 | 4 | 16 | Diesel | 54 |
| M9R 692 | | 84.00 | 1995 | 4 | 16 | Diesel | 54 |
| M9R 780 | | 84.00 | 1995 | 4 | 16 | Diesel | 54 |
| M9R 782 | | 84.00 | 1995 | 4 | 16 | Diesel | 54 |
| M9R 784 | | 84.00 | 1995 | 4 | 16 | Diesel | 54 |
| M9R 786 | | 84.00 | 1995 | 4 | 16 | Diesel | 54 |
| M9R 788 | | 84.00 | 1995 | 4 | 16 | Diesel | 54 |
| M9T 670 | | 85.00 | 2298 | 4 | 16 | Diesel | 62 |
| M9T 672 | | 85.00 | 2298 | 4 | 16 | Diesel | 62 |
| M9T 676 | | 85.00 | 2298 | 4 | 16 | Diesel | 62 |
| M9T 678 | | 85.00 | 2298 | 4 | 16 | Diesel | 62 |

|  |  | ccm |  |  |  |  |
|---|---|------|--|---|---|---|
| M9T 680 | 85.00 | 2298 | 4 | 16 | Diesel | 62 |
| M9T 686 | 85.00 | 2298 | 4 | 16 | Diesel | 62 |
| M9T 690 | 85.00 | 2298 | 4 | 16 | Diesel | 62 |
| M9T 692 | 85.00 | 2298 | 4 | 16 | Diesel | 62 |
| M9T 694 | 85.00 | 2298 | 4 | 16 | Diesel | 62 |
| M9T 696 | 85.00 | 2298 | 4 | 16 | Diesel | 62 |
| M9T 698 | 85.00 | 2298 | 4 | 16 | Diesel | 62 |
| M9T 880 | 85.00 | 2298 | 4 | 16 | Diesel | 62 |
| M9T 896 | 85.00 | 2298 | 4 | 16 | Diesel | 62 |
| M9T 898 | 85.00 | 2298 | 4 | 16 | Diesel | 62 |
| S 18 NV | 84.80 | 1796 | 4 | 8 | Petrol | 59 |
| S8U 758 | 93.00 | 2500 | 4 | 8 | Diesel | 81 |
| S8U 770 | 93.00 | 2500 | 4 | 8 | Diesel | 81 |
| S8U 772 | 93.00 | 2500 | 4 | 8 | Diesel | 81 |
| S8U 780 | 93.00 | 2500 | 4 | 8 | Diesel | 81 |
| S8U 782 | 93.00 | 2500 | 4 | 8 | Diesel | 81 |
| S9W 700 | 94.40 | 2800 | 4 | 8 | Diesel | 83 |
| S9W 702 | 94.40 | 2800 | 4 | 8 | Diesel | 84 |
| X 10 XE | 72.50 | 973 | 3 | 12 | Petrol | 5 |
| X 12 SZ | 72.00 | 1195 | 4 | 8 | Petrol | 3 |
| X 12 XE | 72.50 | 1199 | 4 | 16 | Petrol | 6 |
| X 14 NZ | 77.60 | 1389 | 4 | 8 | Petrol | 19 |
| X 14 SZ | 77.60 | 1389 | 4 | 8 | Petrol | 20 |
| X 14 XE | 77.60 | 1389 | 4 | 16 | Petrol | 22 |
| X 15 DT (T4EC1) | 76.00 | 1488 | 4 | 8 | Diesel | 18 |
| X 16 SZ | 79.00 | 1598 | 4 | 8 | Petrol | 25 |
| X 16 SZR | 79.00 | 1598 | 4 | 8 | Petrol | 29 |
| X 16 XE | 79.00 | 1598 | 4 | 16 | Petrol | 28 |
| X 16 XEL | 79.00 | 1598 | 4 | 16 | Petrol | 28 |
| X 17 D (4EE1) | 79.00 | 1686 | 4 | 8 | Diesel | 32 |
| X 17 DT (TC4EE1) | 79.00 | 1686 | 4 | 8 | Diesel | 33 |
| X 17 DTL | 82.50 | 1700 | 4 | 8 | Diesel | 49 |
| X 18 XE | 81.60 | 1799 | 4 | 16 | Petrol | 44 |
| X 18 XE1 | 80.50 | 1796 | 4 | 16 | Petrol | 43 |
| X 20 DTH | 84.00 | 1995 | 4 | 16 | Diesel | 55 |
| X 20 DTL | 84.00 | 1995 | 4 | 16 | Diesel | 55 |
| X 20 SE | 86.00 | 1998 | 4 | 8 | Petrol | 65 |
| X 20 XER | 86.00 | 1998 | 4 | 16 | Petrol | 69 |
| X 20 XEV | 86.00 | 1998 | 4 | 16 | Petrol | 69 |
| X 22 DTH | 84.00 | 2171 | 4 | 16 | Diesel | 56 |
| X 22 SE | 86.00 | 2198 | 4 | 16 | Petrol | 70 |
| X 22 XE | 86.00 | 2198 | 4 | 16 | Petrol | 70 |
| X 25 DT | 80.00 | 2497 | 6 | 12 | Diesel | 40 |
| X 25 TD | 80.00 | 2497 | 6 | 12 | Diesel | 40 |
| X 25 XE | 81.60 | 2498 | 6 | 24 | Petrol | 45 |
| X 30 XE | 86.00 | 2962 | 6 | 24 | Petrol | 72 |
| Y 13 DT | 69.60 | 1248 | 4 | 16 | Diesel | 2 |
| Y 16 XE | 79.00 | 1598 | 4 | 16 | Petrol | 27 |
| Y 17 DT | 79.00 | 1686 | 4 | 16 | Diesel | 35 |
| Y 17 DTL | 79.00 | 1686 | 4 | 16 | Diesel | 35 |
| Y 20 DTH | 84.00 | 1995 | 4 | 16 | Diesel | 55 |
| Y 20 DTL | 84.00 | 1995 | 4 | 16 | Diesel | 55 |
| Y 22 DTH | 84.00 | 2172 | 4 | 16 | Diesel | 57 |
| Y 22 DTR | 84.00 | 2172 | 4 | 16 | Diesel | 57 |
| Y 22 SE | 86.00 | 2198 | 4 | 16 | Petrol | 70 |
| Y 22 XE | 86.00 | 2198 | 4 | 16 | Petrol | 70 |
| Y 26 SE | 83.20 | 2597 | 6 | 24 | Petrol | 53 |
| Y 32 SE | 87.50 | 3175 | 6 | 24 | Petrol | 75 |
| Z 10 XE | 72.50 | 973 | 3 | 12 | Petrol | 5 |
| Z 10 XEP | 73.40 | 998 | 3 | 12 | Petrol | 9 |
| Z 12 XE | 72.50 | 1199 | 4 | 16 | Petrol | 6 |
| Z 12 XEP | 73.40 | 1229 | 4 | 16 | Petrol | 11 |
| Z 13 DT | 69.60 | 1248 | 4 | 16 | Diesel | 2 |
| Z 13 DTE | 69.60 | 1248 | 4 | 16 | Diesel | 1 |
| Z 13 DTH | 69.60 | 1248 | 4 | 16 | Diesel | 2 |
| Z 13 DTJ | 69.60 | 1248 | 4 | 16 | Diesel | 2 |

|  |  | ccm |  |  |  |  |
|---|---|------|---|---|---|---|
| Z 13 DTR | 69.60 | 1248 | 4 | 16 | Diesel | 2 |
| Z 14 XE | 77.60 | 1389 | 4 | 16 | Petrol | 23 |
| Z 14 XEL | 73.40 | 1364 | 4 | 16 | Petrol | 12 |
| Z 14 XEP | 73.40 | 1364 | 4 | 16 | Petrol | 12 |
| Z 16 LEL | 79.00 | 1598 | 4 | 16 | Petrol | 30 |
| Z 16 LER | 79.00 | 1598 | 4 | 16 | Petrol | 30 |
| Z 16 LET | 79.00 | 1598 | 4 | 16 | Petrol | 30 |
| Z 16 SE | 79.00 | 1598 | 4 | 8 | Petrol | 29 |
| Z 16 XE | 79.00 | 1598 | 4 | 16 | Petrol | 27 |
| Z 16 XE1 | 79.00 | 1598 | 4 | 16 | Petrol | 31 |
| Z 16 XEP | 79.00 | 1598 | 4 | 16 | Petrol | 31 |
| Z 16 XER | 79.00 | 1598 | 4 | 16 | Petrol | 31 |
| Z 17 DTH | 79.00 | 1686 | 4 | 16 | Diesel | 35 |
| Z 17 DTJ | 79.00 | 1686 | 4 | 16 | Diesel | 34 |
| Z 17 DTL | 79.00 | 1686 | 4 | 16 | Diesel | 35 |
| Z 17 DTR | 79.00 | 1686 | 4 | 16 | Diesel | 34 |
| Z 18 XE | 80.50 | 1796 | 4 | 16 | Petrol | 43 |
| Z 18 XEL | 80.50 | 1796 | 4 | 16 | Petrol | 43 |
| Z 18 XEP | 80.50 | 1796 | 4 | 16 | Petrol | 41 |
| Z 18 XER | 80.50 | 1796 | 4 | 16 | Petrol | 42 |
| Z 19 DT | 82.00 | 1910 | 4 | 8 | Diesel | 46 |
| Z 19 DTH | 82.00 | 1910 | 4 | 16 | Diesel | 47 |
| Z 19 DTJ | 82.00 | 1910 | 4 | 16 | Diesel | 47 |
| Z 19 DTL | 82.00 | 1910 | 4 | 8 | Diesel | 46 |
| Z 20 DM | 83.00 | 1991 | 4 | 16 | Diesel | 52 |
| Z 20 DMH | 83.00 | 1991 | 4 | 16 | Diesel | 52 |
| Z 20 LEH | 86.00 | 1998 | 4 | 16 | Petrol | 69 |
| Z 20 LEL | 86.00 | 1998 | 4 | 16 | Petrol | 69 |
| Z 20 LER | 86.00 | 1998 | 4 | 16 | Petrol | 69 |
| Z 20 LET | 86.00 | 1998 | 4 | 16 | Petrol | 69 |
| Z 20 NET | 86.00 | 1998 | 4 | 16 | Petrol | 67 |
| Z 22 SE | 86.00 | 2198 | 4 | 16 | Petrol | 71 |
| Z 22 XE | 86.00 | 2198 | 4 | 16 | Petrol | 70 |
| Z 22 YH | 86.00 | 2198 | 4 | 16 | Petrol | 71 |
| Z 24 XE | 87.50 | 2405 | 4 | 16 | Petrol | 74 |
| Z 24 XED | 87.50 | 2405 | 4 | 16 | Petrol | 74 |
| Z 32 SE | 88.50 | 3175 | 6 | 24 | Petrol | 77 |



OE

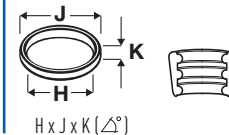
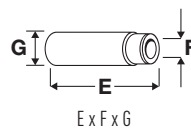

1 **69.60**

| | | | | | | | |
|-----------------|--------|--------|------------------|-----------------|--------|--------------------|----------------|
| A 13 DTC | 1248cc | 4 Cyl. | 16 Valves | 55kW/75PS | Diesel | Turbo, DOHC | TD24265 |
| A 13 DTE | 1248cc | 4 Cyl. | 16 Valves | 70kW/95PS | Diesel | Turbo, DOHC | TD23881 |
| A 13 DTR | 1248cc | 4 Cyl. | 16 Valves | 70kW/95PS | Diesel | Turbo, DOHC | TD24378 |
| A 13 FD | 1248cc | 4 Cyl. | 16 Valves | 55-70kW/75-95PS | Diesel | Turbo, DOHC | TD26182 |
| D13A | 1248cc | 4 Cyl. | 16 Valves | 55kW/75PS | Diesel | Turbo, DOHC | TD23364 |
| Z 13 DTE | 1248cc | 4 Cyl. | 16 Valves | 70kW/95PS | Diesel | Turbo, DOHC | TD24376 |

| | | | |
|-------------------------|----------|------------------|----------|
| AGILA (B) 1.3 CDTI | 04/2008→ | ASTRA J 1.3 CDTI | 12/2009→ |
| ASTRA J Tourer 1.3 CDTI | 10/2010→ | COMBO 1.3 CDTI | 02/2012→ |
| COMBO / Tour 1.3 CDTI | 02/2012→ | CORSA D 1.3 CDTI | 07/2006→ |
| MERIVA B MPV 1.3 CDTI | 06/2010→ | | |

V95182
21.85 x 5.98 x 109.25

0641475



45°

H

VAG96359
43.28 x 6.00 x 10.25



V95183
22.50 x 5.99 x 109.20

0641101

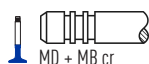

45°

SS

H

2 **69.60**

| | | | | | | | |
|-----------------|--------|--------|------------------|------------------|--------|--------------------|----------------|
| Y 13 DT | 1248cc | 4 Cyl. | 16 Valves | 51kW/70PS | Diesel | Turbo, DOHC | TD20084 |
| Z 13 DT | 1248cc | 4 Cyl. | 16 Valves | 51kW/70PS | Diesel | Turbo, DOHC | TD17477 |
| Z 13 DTH | 1248cc | 4 Cyl. | 16 Valves | 66-74kW/90-101PS | Diesel | Turbo, DOHC | TD18653 |
| Z 13 DTJ | 1248cc | 4 Cyl. | 16 Valves | 55kW/75PS | Diesel | Turbo, DOHC | TD18989 |
| Z 13 DTR | 1248cc | 4 Cyl. | 16 Valves | 70kW/95PS | Diesel | Turbo, DOHC | TD23708 |

| | | | |
|--------------------|-----------------|-------------------------|-----------------|
| AGILA (A) 1.3 CDTI | 08/2003→12/2007 | AGILA (B) 1.3 CDTI | 04/2008→ |
| ASTRA 1.3 CDTI | 01/2009→ | ASTRA H 1.3 CDTI | 08/2005→10/2010 |
| ASTRA H 1.3 CDTi | 02/2007→10/2010 | ASTRA H GTC 1.3 CDTI | 04/2005→10/2010 |
| COMBO 1.3 CDTI 16V | 08/2005→ | COMBO Tour 1.3 CDTI 16V | 10/2004→ |
| CORSA C 1.3 CDTI | 06/2003→12/2009 | CORSA C 1.3 CDTI 16V | 08/2005→ |
| CORSA D 1.3 CDTI | 07/2006→ | MERIVA A MPV 1.3 CDTI | 09/2003→05/2010 |
| TIGRA 1.3 CDTI | 06/2004→ | | |

V95015
21.85 x 6.00 x 109.20

641 072



45°

Y

H

VAG96359
43.28 x 6.00 x 10.25



V95016
21.80 x 6.00 x 109.20

641 402

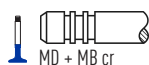

45°

H

3 **72.00**

| | | | | | | | |
|----------------|--------|--------|-----------------|-----------|--------|-------------|---------------|
| 12 NZ | 1195cc | 4 Cyl. | 8 Valves | 33kW/45PS | Petrol | SOHC | TD4719 |
| C 12 NZ | 1195cc | 4 Cyl. | 8 Valves | 33kW/45PS | Petrol | SOHC | TD4780 |
| X 12 SZ | 1195cc | 4 Cyl. | 8 Valves | 33kW/45PS | Petrol | SOHC | TD2732 |

| | | | |
|------------------|-----------------|---------------|-----------------|
| COMBO 1.2 | 07/1994→10/2001 | CORSA A 1.2 i | 09/1989→03/1993 |
| CORSA A TR 1.2 i | 09/1989→03/1993 | CORSA B 1.2 i | 03/1993→09/2000 |

V91211
33.10 x 7.00 x 104.50

641 002



45°

H

VAG96022
45.80 x 7.02 x 11.04



V91212
29.10 x 6.99 x 104.60

641 302

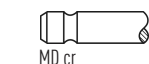

45°



OE

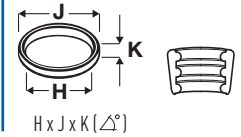
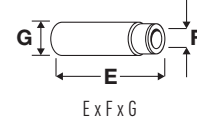

4 **72.00**

| A 14 FP | 1368cc | 4 Cyl. | 16 Valves | 70kW/95PS | Petrol | DOHC | TD26180 |
|--------------------------------------|------------|----------|-----------|------------------|----------------------|----------|---------|
| COMBO 1.4 | | 02/2012→ | | COMBO / Tour 1.4 | | 02/2012→ | |
| V94029 | 46 403 681 | | 45° | H | VAG96272 | | |
| 26.90 x 6.00 x 95.20 Eng.->984712 | | MB | | | 39.70 x 6.02 x 10.03 | | |
| V98026 | 55 185 028 | | 45° | | | | |
| 26.80 x 6.00 x 95.20 Eng.984713→ | | MB cr | | | | | |
| V94030 | 46 471 639 | | 45° | | | | |
| 22.50 x 6.00 x 96.20 Eng.->984712 | | MD cr | | | | | |
| V98027 | 55 185 080 | | 45° | | | | |
| 22.45 x 5.97 x 94.70 Eng.984713→ | | MD cr | | | | | |

5 **72.50**

| X 10 XE | 973cc | 3 Cyl. | 12 Valves | 40kW/54PS | Petrol | DOHC | TD5512 |
|----------------------|---------|-----------------|-----------|-------------------|----------------------|-----------------|---------|
| Z 10 XE | 973cc | 3 Cyl. | 12 Valves | 43kW/58PS | Petrol | DOHC | TD14008 |
| AGILA (A) 1.0 12V | | 09/2000→12/2007 | | CORSA B 1.0 i 12V | | 11/1996→09/2000 | |
| CORSA C 1.0 | | 09/2000→06/2003 | | | | | |
| V94245 | 641 051 | | 45° | H | VAG96077 | | |
| 28.00 x 5.00 x 93.90 | | MB cr | | | 39.00 x 5.00 x 10.04 | | |
| V94246 | 641 364 | | 45° | | | | |
| 25.00 x 5.00 x 93.90 | | MD cr | | | | | |

6 **72.50**

| X 12 XE | 1199cc | 4 Cyl. | 16 Valves | 48kW/65PS | Petrol | DOHC | TD9508 |
|----------------------|---------|-----------------|-----------|-----------------|----------------------|-----------------|---------|
| Z 12 XE | 1199cc | 4 Cyl. | 16 Valves | 55kW/75PS | Petrol | DOHC | TD14009 |
| AGILA (A) 1.2 16V | | 09/2000→12/2007 | | ASTRA G 1.2 16V | | 02/1998→01/2005 | |
| CORSA B 1.2 i 16V | | 03/1998→09/2000 | | CORSA C 1.2 | | 09/2000→12/2009 | |
| CORSA C 1.2 16V | | 09/2000→ | | | | | |
| V94245 | 641 051 | | 45° | H | VAG96077 | | |
| 28.00 x 5.00 x 93.90 | | MB cr | | | 39.00 x 5.00 x 10.04 | | |
| V94246 | 641 364 | | 45° | | | | |
| 25.00 x 5.00 x 93.90 | | MD cr | | | | | |

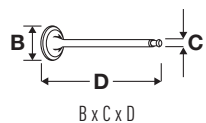

OE

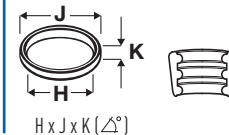
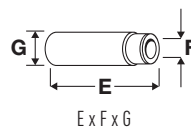
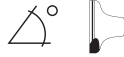

7 **72.50**

| | | | | | | | |
|--------------------------|-----------------|--------|------------------|---------------------------|--------|--------------------|----------------|
| A 14 NEL | 1364cc | 4 Cyl. | 16 Valves | 88kW/120PS | Petrol | DOHC | TD24264 |
| A 14 NET | 1364cc | 4 Cyl. | 16 Valves | 103kW/140PS | Petrol | Turbo, DOHC | TD23882 |
| ASTRA J 1.4 LPG | 01/2012→ | | | ASTRA J 1.4 Turbo | | 12/2009→ | |
| ASTRA J GTC 1.4 | 10/2011→ | | | ASTRA J Tourer 1.4 LPG | | 01/2012→ | |
| ASTRA J Tourer 1.4 Turbo | 10/2010→ | | | CASCADA 1.4 | | 03/2013→ | |
| CASCADA 1.4 Turbo | 03/2013→ | | | CORSA D 1.4 | | 07/2012→ | |
| INSIGNIA A 1.4 | 04/2011→ | | | INSIGNIA A 1.4 LPG | | 07/2012→ | |
| INSIGNIA A Tourer 1.4 | 09/2011→06/2013 | | | INSIGNIA A Tourer 1.4 LPG | | 07/2012→06/2013 | |
| MERIVA B MPV 1.4 | 06/2010→ | | | MERIVA B MPV 1.4 LPG | | 06/2011→ | |
| MOKKA / MOKKA X 1.4 | 06/2012→ | | | MOKKA / MOKKA X 1.4 LPG | | 04/2013→ | |
| ZAFIRA TOURER C 1.4 | 10/2011→ | | | ZAFIRA TOURER C 1.4 LPG | | 10/2011→ | |

V94245 641 051

28.00 x 5.00 x 93.90

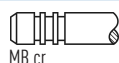

45°

H

VAG96077 **39.00 x 5.00 x 10.04**

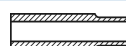

V94246 641 364

25.00 x 5.00 x 93.90

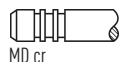

45°

8 **73.00**

| | | | | | | | |
|---------------|----------|--------|------------------|-------------------|--------|-------------|----------------|
| K10B | 996cc | 3 Cyl. | 12 Valves | 48-50kW/65-68PS | Petrol | DOHC | TD23362 |
| AGILA (B) 1.0 | 04/2008→ | | | AGILA (B) 1.0 LPG | | 01/2010→ | |

V95224 4708925

27.50 x 5.47 x 87.50

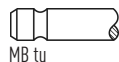

45°

H

VAG96385 **34.00 x 5.51 x 10.59**



V95225 4708933

22.95 x 5.46 x 87.05

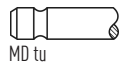

45°

9 **73.40**

| | | | | | | | |
|-----------------|-----------------|--------|------------------|-----------------|--------|-----------------|----------------|
| A 10 XEP | 998cc | 3 Cyl. | 12 Valves | 44-48kW/60-65PS | Petrol | DOHC | TD24905 |
| Z 10 XEP | 998cc | 3 Cyl. | 12 Valves | 44kW/60PS | Petrol | DOHC | TD17475 |
| AGILA (A) 1.0 | 08/2003→12/2007 | | | CORSA C 1.0 | | 06/2003→12/2009 | |
| CORSA D 1.0 | 07/2006→ | | | | | | |

V94245 641 051

28.00 x 5.00 x 93.90

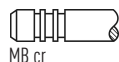

45°

H

VAG96077 **39.00 x 5.00 x 10.04**

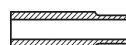

V94246 641 364

25.00 x 5.00 x 93.90

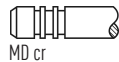

45°

10 **73.40**

| | | | | | | | |
|-----------------|----------|--------|------------------|-------------|--------|-------------|----------------|
| A 12 XEL | 1229cc | 4 Cyl. | 16 Valves | 51kW/69PS | Petrol | DOHC | TD24371 |
| ADAM 1.2 | 10/2012→ | | | CORSA D 1.2 | | 06/2010→ | |

V94245 641 051

28.00 x 5.00 x 93.90
Eng.→19RN1913

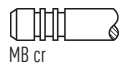

45°

H

VAG96077 **39.00 x 5.00 x 10.04**



V94246 641 364

25.00 x 5.00 x 93.90
Eng.→19RN1913

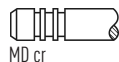

45°



OE

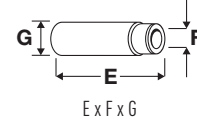

E x F x G

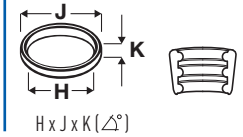

H x J x K (Δ°)

11  **73.40**

| | | | | | | | |
|-------------------|-----------------|--------|------------------|-----------------|--------|-----------------|----------------|
| A 12 XER | 1229cc | 4 Cyl. | 16 Valves | 61-63kW/83-86PS | Petrol | DOHC | TD24372 |
| Z 12 XEP | 1229cc | 4 Cyl. | 16 Valves | 55-59kW/75-80PS | Petrol | DOHC | TD18012 |
| AGILA (A) 1.2 16V | 07/2004→12/2007 | | | ASTRA H 1.2 | | 08/2005→10/2010 | |
| ASTRA H GTC 1.2 | 08/2005→10/2010 | | | CORSA C 1.2 | | 07/2004→ | |
| CORSA D 1.2 | 07/2006→ | | | CORSA D 1.2 LPG | | 09/2009→ | |

V94245  28.00 x 5.00 x 93.90

641 051

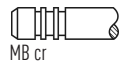

45°

H

VAG96077  39.00 x 5.00 x 10.04



V94246  25.00 x 5.00 x 93.90

641 364

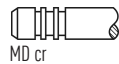

45°

12  **73.40**

| | | | | | | | |
|----------------------|-----------------|--------|------------------|--------------------------|--------|-----------------|----------------|
| Z 14 XEL | 1364cc | 4 Cyl. | 16 Valves | 55-59kW/75-80PS | Petrol | DOHC | TD18552 |
| Z 14 XEP | 1364cc | 4 Cyl. | 16 Valves | 66kW/90PS | Petrol | DOHC | TD17476 |
| ASTRA G 1.4 | 10/2004→12/2009 | | | ASTRA H 1.4 | | 03/2004→10/2010 | |
| ASTRA H 1.4 LPG | 08/2009→10/2010 | | | ASTRA H GTC 1.4 | | 03/2005→10/2010 | |
| COMBO 1.4 16V | 08/2005→ | | | COMBO Tour 1.4 | | 10/2004→ | |
| CORSA 1.4 | 07/2000→12/2003 | | | CORSA C 1.4 | | 06/2003→ | |
| CORSA D 1.4 | 07/2006→ | | | CORSA D 1.4 LPG | | 07/2006→ | |
| MERIVA A MPV 1.4 16V | 07/2004→05/2010 | | | MERIVA A MPV 1.4 16V LPG | | 07/2004→05/2010 | |
| TIGRA 1.4 | 06/2004→ | | | | | | |

V94245  28.00 x 5.00 x 93.90

641 051

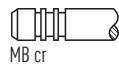

45°

H

VAG96077  39.00 x 5.00 x 10.04



V94246  25.00 x 5.00 x 93.90

641 364

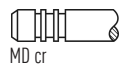

45°

13  **73.40**

| | | | | | | | |
|--------------------|----------|--------|------------------|------------------|--------|-------------|----------------|
| A 14 XEL | 1398cc | 4 Cyl. | 16 Valves | 64kW/87PS | Petrol | DOHC | TD24373 |
| A 14 XER | 1398cc | 4 Cyl. | 16 Valves | 74kW/101PS | Petrol | DOHC | TD23855 |
| ADAM 1.4 | 10/2012→ | | | ADAM 1.4 LPG | | 07/2013→ | |
| ASTRA J 1.4 | 12/2009→ | | | ASTRA J GTC 1.4 | | 10/2011→ | |
| ASTRA J Tourer 1.4 | 10/2010→ | | | CORSA D 1.4 | | 09/2009→ | |
| CORSA D 1.4 LPG | 09/2009→ | | | MERIVA B MPV 1.4 | | 06/2010→ | |

V94245  28.00 x 5.00 x 93.90

641 051

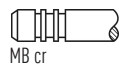

45°

H

VAG96077  39.00 x 5.00 x 10.04



V94246  25.00 x 5.00 x 93.90

641 364

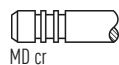

45°

14  **75.00**

| | | | | | | | |
|--------------------------|----------|--------|------------------|-------------------|--------|-------------------------------|----------------|
| B 12 XHT (EB2DTS) | 1199cc | 3 Cyl. | 12 Valves | 81-96kW/110-131PS | Petrol | Turbo, DOHC, Injection | TD34739 |
| CROSSLAND X 1.2 | 03/2017→ | | | GRANDLAND X 1.2 | | 06/2017→ | |

V80020  26.42 x 5.00 x 93.50

98 019 609 80

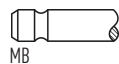

45°

V80021  23.78 x 5.00 x 92.91

98 076 459 80

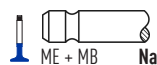

45°

SS



OE

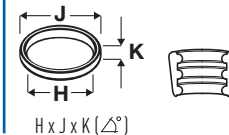
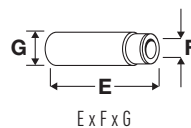

15 **75.00**

| 13 N | 1297cc | 4 Cyl. | 8 Valves | 39-44kW/53-60PS | Petrol | SOHC | TD4723 |
|----------------------|-----------------|--------|----------|-----------------|--------|-----------------|--------|
| ASCONA B 1.3 N | 03/1979→08/1981 | | | ASCONA C 1.3 N | | 09/1981→08/1986 | |
| KADETT D 1.3 N | 08/1979→08/1984 | | | KADETT E 1.3 N | | 09/1984→08/1991 | |
| KADETT E Combo 1.3 N | 01/1986→12/1989 | | | MANTA B 1.3 N | | 03/1979→12/1980 | |
| MANTA B CC 1.3 N | 03/1979→12/1980 | | | | | | |

| | | | | | | |
|-----------------------|---------|-------|-----|---|----------------------|--|
| V90107 | 642 763 | | 45° | H | VAG96026 | |
| 33.02 x 7.01 x 104.90 | | MB cr | | | 43.00 x 7.02 x 11.04 | |
| V90108 | 0642890 | | 45° | | | |
| 29.00 x 6.99 x 104.60 | | MD | | | | |

16 **75.00**

| 13 NB | 1297cc | 4 Cyl. | 8 Valves | 44kW/60PS | Petrol | SOHC | TD4724 |
|----------------------|-----------------|--------|----------|--------------------|--------|-----------------|--------|
| 13 S | 1297cc | 4 Cyl. | 8 Valves | 42-55kW/57-75PS | Petrol | SOHC | TD4725 |
| 13 SB | 1297cc | 4 Cyl. | 8 Valves | 51kW/70PS | Petrol | SOHC | TD4726 |
| C 13 N | 1297cc | 4 Cyl. | 8 Valves | 44kW/60PS | Petrol | SOHC | TD4781 |
| ASCONA B 1.3 S | 08/1979→08/1981 | | | ASCONA C 1.3 S | | 09/1981→08/1988 | |
| CORSA 1.3 | 01/1997→12/2002 | | | CORSA A 1.3 | | 09/1985→10/1989 | |
| CORSA A 1.3 i | 09/1986→09/1990 | | | CORSA A 1.3 S | | 09/1982→10/1989 | |
| CORSA A TR 1.3 | 09/1985→10/1987 | | | CORSA A TR 1.3 S | | 09/1982→10/1987 | |
| CORSA B 1.3 | 01/1996→12/2002 | | | CORSA Pickup 1.3 | | 01/1996→12/2002 | |
| KADETT D 1.3 N | 08/1979→08/1984 | | | KADETT D 1.3 S | | 08/1979→08/1984 | |
| KADETT E 1.3 | 01/1985→12/1987 | | | KADETT E 1.3 i Cat | | 09/1985→08/1991 | |
| KADETT E 1.3 N | 09/1984→08/1991 | | | KADETT E 1.3 S | | 09/1984→02/1993 | |
| KADETT E Combo 1.3 S | 01/1986→12/1989 | | | MANTA B 1.3 S | | 08/1981→08/1986 | |
| MANTA B CC 1.3 S | 08/1979→08/1986 | | | | | | |

| | | | | | | |
|-----------------------|---------|-------|-----|---|----------------------|--|
| V90107 | 642 763 | | 45° | H | VAG96022 | |
| 33.02 x 7.01 x 104.90 | | MB cr | | | 45.80 x 7.02 x 11.04 | |
| V90108 | 0642890 | | 45° | | VAG96026 | |
| 29.00 x 6.99 x 104.60 | | MD | | | 43.00 x 7.02 x 11.04 | |

17 **76.00**

| 15 D (4EC1) | 1488cc | 4 Cyl. | 8 Valves | 37kW/50PS | Diesel | SOHC | TD4732 |
|---------------|-----------------|--------|----------|------------------|--------|-----------------|--------|
| CORSA A 1.5 D | 06/1987→03/1993 | | | CORSA A TR 1.5 D | | 10/1987→11/1992 | |
| CORSA B 1.5 D | 03/1993→09/2000 | | | | | | |

| | | | | | | |
|-----------------------|---------|-------|-----|----|----------------------|--|
| V91230 | 641 007 | | 45° | H | VAG92321 | |
| 34.70 x 6.99 x 104.00 | | MB | | | 43.00 x 7.00 x 11.56 | |
| V91231 | 641 300 | | 45° | st | | |
| 30.70 x 6.98 x 104.00 | | MD cr | | | | |

18 **76.00**

| 15 DT (T4EC1) | 1488cc | 4 Cyl. | 8 Valves | 49-53kW/67-72PS | Diesel | Turbo, SOHC | TD4733 |
|-----------------|-----------------|--------|----------|-------------------|--------|-----------------|--------|
| X 15 DT (T4EC1) | 1488cc | 4 Cyl. | 8 Valves | 49kW/67PS | Diesel | Turbo, SOHC | TD5301 |
| CORSA A 1.5 TD | 03/1988→03/1993 | | | CORSA A TR 1.5 TD | | 10/1987→03/1993 | |
| CORSA B 1.5 TD | 03/1993→09/2000 | | | KADETT E 1.5 TD | | 07/1988→08/1991 | |

| | | | | | | |
|-----------------------|---------|-------|-----|-------|----------------------|--|
| V91230 | 641 007 | | 45° | H | VAG92321 | |
| 34.70 x 6.99 x 104.00 | | MB | | | 43.00 x 7.00 x 11.56 | |
| V91232 | 641 322 | | 45° | ss st | | |
| 30.70 x 6.98 x 104.15 | | MD cr | | | | |



OE

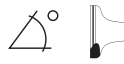

E x F x G

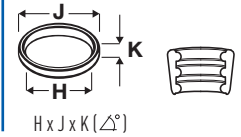

H x J x K (Δ°)

19  77.60

| | | | | | | | |
|----------------------|-----------------|--------|----------|----------------------|--------|-------------------|---------|
| 14 NV | 1389cc | 4 Cyl. | 8 Valves | 53-55kW/72-75PS | Petrol | SOHC, Carburettor | TD4728 |
| C 14 NZ | 1389cc | 4 Cyl. | 8 Valves | 40-44kW/54-60PS | Petrol | SOHC | TD4782 |
| X 14 NZ | 1389cc | 4 Cyl. | 8 Valves | 44kW/60PS | Petrol | SOHC | TD14828 |
| ASTRA F 1.4 | 09/1991→09/1993 | | | ASTRA F 1.4 i | | 09/1991→01/2005 | |
| COMBO 1.4 | 07/1994→10/2001 | | | CORSA 1.4 | | 08/1994→07/2002 | |
| CORSA A 1.4 i | 01/1985→03/1993 | | | CORSA A 1.4 S | | 01/1990→03/1993 | |
| CORSA A TR 1.4 i | 10/1989→03/1993 | | | CORSA A TR 1.4 S | | 09/1989→03/1993 | |
| CORSA B 1.4 i | 03/1993→09/2000 | | | KADETT E 1.4 i | | 01/1990→08/1991 | |
| KADETT E 1.4 S | 01/1990→02/1993 | | | KADETT E Combo 1.4 i | | 08/1991→07/1994 | |
| KADETT E Combo 1.4 S | 07/1989→08/1991 | | | VECTRA A 1.4 S | | 04/1988→06/1992 | |

V91211  641 002
33.10 x 7.00 x 104.50

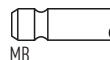

45°

H

VAG96022  641 002
45.80 x 7.02 x 11.04

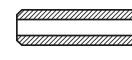

V91212  641 302
29.10 x 6.99 x 104.60

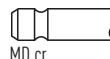

45°

20  77.60

| | | | | | | | |
|----------------|-----------------|--------|----------|-----------------|--------|-----------------|--------|
| 14 SE | 1389cc | 4 Cyl. | 8 Valves | 60kW/82PS | Petrol | SOHC | TD4730 |
| C 14 SE | 1389cc | 4 Cyl. | 8 Valves | 54-60kW/73-82PS | Petrol | SOHC | TD4783 |
| X 14 SZ | 1389cc | 4 Cyl. | 8 Valves | 40-44kW/54-60PS | Petrol | SOHC | TD8405 |
| ASTRA F 1.4 | 09/1992→09/1998 | | | ASTRA F 1.4 Si | | 03/1992→03/2001 | |
| COMBO 1.4 | 07/1994→10/2001 | | | CORSA A 1.4 Si | | 09/1991→03/1993 | |
| CORSA B 1.4 | 04/1993→08/1994 | | | CORSA B 1.4 i | | 03/1993→09/2000 | |
| CORSA B 1.4 Si | 03/1993→09/2000 | | | CORSA C 1.4 | | 01/2002→12/2009 | |
| KADETT E 1.4 S | 09/1989→08/1991 | | | | | | |

V91959  641 015
38.00 x 7.00 x 104.60

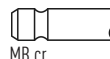

45°

H

VAG96022  641 015
45.80 x 7.02 x 11.04



V91960  641 317
31.00 x 7.00 x 104.60



45°

21  77.60

| | | | | | | | |
|-------------------|-----------------|--------|-----------|-----------|--------|------|---------|
| C 14 SEL | 1389cc | 4 Cyl. | 16 Valves | 63kW/86PS | Petrol | DOHC | TD16393 |
| CORSA B 1.4 i 16V | 08/1997→09/2000 | | | | | | |

V91995  641 034
31.10 x 6.00 x 103.10

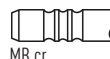

45°

H

VAG96028  641 034
45.00 x 5.99 x 10.05



V91996  641 340
27.60 x 6.00 x 102.20



45°

SS



OE

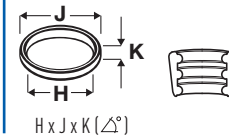
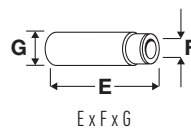

22 77.60

| X 14 XE | 1389cc | 4 Cyl. | 16 Valves | 63-69kW/86-94PS | Petrol | DOHC | TD2733 |
|-------------------|--------|--------|-----------|-------------------|--------|-----------------|--------|
| ASTRA F 1.4 i 16V | | | | ASTRA G 1.4 16V | | 02/1998→01/2005 | |
| COMBO 1.4 16V | | | | CORSA B 1.4 i 16V | | 09/1994→12/2002 | |
| TIGRA 1.4 16V | | | | | | | |

| | | | | | | | |
|-----------------------|---------|-------|-----|----|----------------------|--|--|
| V91995 | 641 034 | | 45° | H | VAG96028 | | |
| 31.10 x 6.00 x 103.10 | | MB cr | | | 45.00 x 5.99 x 10.05 | | |
| V94050 [2] | | | 45° | H | | | |
| 31.10 x 5.97 x 102.90 | | MB cr | | | | | |
| V91996 | 641 340 | | 45° | SS | | | |
| 27.60 x 6.00 x 102.20 | | MD cr | | | | | |
| V94051 [2] | | | 45° | SS | | | |
| 27.60 x 5.95 x 101.95 | | MD cr | | | | | |

[2] Service valve, for use on re-surfaced cylinder head only [2] Reparatur-Ventil, nur bei geplanten Zylinderkopf verwen- den [2] Soupape de réparation, pour utilisation uniquement sur une culasse ré-usinée [2] Válvula de servicio, para uso solamente en culatas rebaj adas. [2] Ricambio valvola per uso su testate cilindro spianate

23 77.60

| Z 14 XE | 1389cc | 4 Cyl. | 16 Valves | 66kW/90PS | Petrol | DOHC | TD14920 |
|-----------------|--------|--------|-----------|------------------|--------|-----------------|---------|
| ASTRA G 1.4 16V | | | | CORSA 1.4 | | 07/2000→05/2001 | |
| CORSA C 1.4 | | | | CORSA Pickup 1.4 | | 07/2000→12/2010 | |

| | | | | | | | |
|-----------------------|---------|-------|-----|----|----------------------|--|--|
| V91995 | 641 034 | | 45° | H | VAG96137 | | |
| 31.10 x 6.00 x 103.10 | | MB cr | | | 45.00 x 6.02 x 10.05 | | |
| V91996 | 641 340 | | 45° | SS | VAG96151 | | |
| 27.60 x 6.00 x 102.20 | | MD cr | | | 45.00 x 6.02 x 10.09 | | |

24 77.80

| 12 NV | 1196cc | 4 Cyl. | 8 Valves | 38kW/52PS | Petrol | SOHC, Carburettor | TD4718 |
|---------------|--------|--------|----------|------------------|--------|-------------------|--------|
| 12 ST | 1196cc | 4 Cyl. | 8 Valves | 40-43kW/55-58PS | Petrol | SOHC | TD4722 |
| CORSA A 1.2 | | | | CORSA A 1.2 N | | 01/1990→03/1993 | |
| CORSA A 1.2 S | | | | CORSA A TR 1.2 S | | 09/1982→03/1993 | |
| KADETT D 1.2 | | | | | | | |

| | | | | | | | |
|-----------------------|---------|-------|-----|---|----------------------|--|--|
| V90107 | 642 763 | | 45° | H | VAG96022 | | |
| 33.02 x 7.01 x 104.90 | | MB cr | | | 45.80 x 7.02 x 11.04 | | |
| V90108 | 0642890 | | 45° | | VAG96026 | | |
| 29.00 x 6.99 x 104.60 | | MD | | | 43.00 x 7.02 x 11.04 | | |



OE

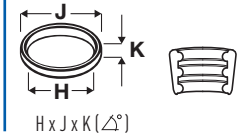
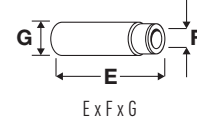

25  **79.00**

| | | | | | | | |
|--------------------|-----------------|--------|----------|----------------------|-----------------|-------------------|---------|
| 16 LZ2 | 1598cc | 4 Cyl. | 8 Valves | 55kW/75PS | Petrol | SOHC, Injection | TD4736 |
| 16 NZR | 1598cc | 4 Cyl. | 8 Valves | 55kW/75PS | Petrol | SOHC | TD16169 |
| 16 SV | 1598cc | 4 Cyl. | 8 Valves | 60kW/82PS | Petrol | SOHC, Carburettor | TD4740 |
| C 16 LZ | 1598cc | 4 Cyl. | 8 Valves | 55kW/75PS | Petrol | SOHC | TD4784 |
| C 16 LZ2 | 1598cc | 4 Cyl. | 8 Valves | 51-55kW/69-75PS | Petrol | SOHC | TD21179 |
| C 16 NZ | 1598cc | 4 Cyl. | 8 Valves | 55-60kW/75-82PS | Petrol | SOHC | TD4785 |
| C 16 NZ2 | 1598cc | 4 Cyl. | 8 Valves | 55kW/75PS | Petrol | SOHC | TD5308 |
| C 16 SE | 1598cc | 4 Cyl. | 8 Valves | 74kW/100PS | Petrol | SOHC | TD4787 |
| E 16 NZ | 1598cc | 4 Cyl. | 8 Valves | 55-65kW/75-88PS | Petrol | SOHC | TD4810 |
| E 16 SE | 1598cc | 4 Cyl. | 8 Valves | 74-75kW/100-102PS | Petrol | SOHC | TD4811 |
| X 16 SZ | 1598cc | 4 Cyl. | 8 Valves | 52kW/71PS | Petrol | SOHC | TD2734 |
| ASCONA C 1.6 | 09/1986→08/1988 | | | ASCONA C 1.6 i | 09/1987→08/1988 | | |
| ASCONA C 1.6 i Cat | 09/1986→08/1988 | | | ASTRA F 1.6 | 09/1995→09/1998 | | |
| ASTRA F 1.6 i | 09/1991→09/1998 | | | ASTRA F 1.6 Si | 03/1992→12/1994 | | |
| CORSA A 1.6 GSI | 05/1988→09/1992 | | | CORSA A 1.6 GSI Cat | 02/1992→03/1993 | | |
| KADETT E 1.6 | 09/1986→08/1991 | | | KADETT E 1.6 i | 09/1986→09/1993 | | |
| KADETT E 1.6 i Cat | 09/1986→02/1993 | | | KADETT E 1.6 S | 09/1986→08/1991 | | |
| KADETT E Combo 1.6 | 09/1986→12/1991 | | | KADETT E Combo 1.6 i | 08/1991→07/1994 | | |
| VECTRA A 1.6 | 08/1988→06/1994 | | | VECTRA A 1.6 i | 09/1988→11/1995 | | |
| VECTRA A 1.6 i Cat | 09/1988→11/1995 | | | VECTRA A 1.6 S | 09/1988→05/1993 | | |
| VECTRA B 1.6 GL | 09/1995→08/1996 | | | VECTRA B 1.6 i | 10/1995→07/2003 | | |

V91137  37.92 x 7.00 x 101.00

642 679

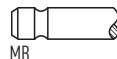

45°

H

VAG96022  45.80 x 7.02 x 11.04

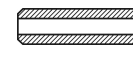

V91138  30.87 x 6.98 x 101.08

642 854

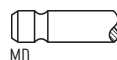

45°

26  **79.00**

| | | | | | | | |
|--------------------------|-----------------|--------|-----------|-----------------------------|-----------------|-------------|---------|
| A 16 LET | 1598cc | 4 Cyl. | 16 Valves | 132kW/180PS | Petrol | Turbo, DOHC | TD22589 |
| A 16 XER | 1598cc | 4 Cyl. | 16 Valves | 84-85kW/114-116PS | Petrol | DOHC | TD22587 |
| ASTRA H 1.6 | 12/2006→05/2014 | | | ASTRA J 1.6 | 12/2009→ | | |
| ASTRA J 1.6 Turbo | 12/2009→ | | | ASTRA J GTC 1.6 | 10/2011→ | | |
| ASTRA J Tourer 1.6 | 10/2010→ | | | ASTRA J Tourer 1.6 LPG | 10/2012→ | | |
| ASTRA J Tourer 1.6 Turbo | 10/2010→ | | | CORSA D 1.6 T | 02/2007→ | | |
| INSIGNIA A 1.6 | 07/2008→ | | | INSIGNIA A 1.6 Turbo | 07/2008→ | | |
| INSIGNIA A Tourer 1.6 | 07/2008→06/2012 | | | INSIGNIA A Tourer 1.6 Turbo | 01/2009→06/2013 | | |
| MOKKA / MOKKA X 1.6 | 06/2012→ | | | ZAFIRA B 1.6 | 01/2008→ | | |

V98024  31.00 x 5.00 x 114.00

0641076

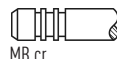

45°

VAG96346  37.00 x 4.99 x 10.04



V98077  [3] 31.20 x 5.00 x 117.20

642 011

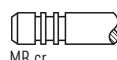

45°

V98025  27.50 x 5.00 x 113.20

0641391

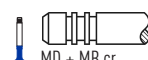

45°

V98078  [3] 27.50 x 5.00 x 116.20

641 379

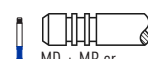

45°

SS

[3] LPG

[3] LPG

[3] LPG

[3] LPG

[3] LPG



OE

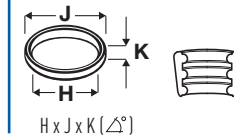
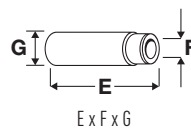

27 **79.00**

| | | | | | | | |
|----------------------|-----------------|--------|------------------|----------------------|--------|-----------------|----------------|
| C 16 SEL | 1598cc | 4 Cyl. | 16 Valves | 74kW/100PS | Petrol | DOHC | TD16394 |
| Y 16 XE | 1598cc | 4 Cyl. | 16 Valves | 74kW/101PS | Petrol | DOHC | TD13688 |
| Z 16 XE | 1598cc | 4 Cyl. | 16 Valves | 74-76kW/101-103PS | Petrol | DOHC | TD14923 |
| ASTRA G 1.6 16V | 02/1998→10/2005 | | | ASTRA G 1.6 LPG | | 03/1998→01/2005 | |
| CORSA 1.6 | 01/2000→12/2003 | | | CORSA B 1.6 i 16V | | 08/1997→09/2000 | |
| MERIVA A MPV 1.6 16V | 05/2003→01/2006 | | | TIGRA 1.6 16V | | 08/1997→08/1998 | |
| VECTRA B 1.6 i 16V | 10/1995→07/2002 | | | VECTRA C 1.6 16V | | 06/2004→ | |
| VECTRA C GTS 1.6 | 08/2005→ | | | ZAFIRA A MPV 1.6 16V | | 04/1999→06/2005 | |

| | | | | | | |
|-----------------------|---------|-------|-----|----|----------------------|--|
| V91995 | 641 034 | | 45° | H | VAG96028 | |
| 31.10 x 6.00 x 103.10 | | MB cr | | | 45.00 x 5.99 x 10.05 | |
| V91996 | 641 340 | | 45° | SS | | |
| 27.60 x 6.00 x 102.20 | | MD cr | | | | |

28 **79.00**

| | | | | | | | |
|----------------------|-----------------|--------|------------------|--------------------|--------|-----------------|---------------|
| C 16 XE | 1598cc | 4 Cyl. | 16 Valves | 80kW/109PS | Petrol | DOHC | TD4789 |
| X 16 XE | 1598cc | 4 Cyl. | 16 Valves | 78kW/106PS | Petrol | DOHC | TD2735 |
| X 16 XEL | 1598cc | 4 Cyl. | 16 Valves | 74kW/100PS | Petrol | DOHC | TD4820 |
| ASTRA F 1.6 i 16V | 08/1994→01/2005 | | | ASTRA G 1.6 16V | | 02/1998→01/2005 | |
| CORSA B 1.6 GSI 16V | 03/1993→09/2000 | | | CORSA B 1.6 i 16V | | 09/1994→09/2000 | |
| TIGRA 1.6 16V | 07/1994→08/1998 | | | VECTRA B 1.6 i 16V | | 10/1995→07/2002 | |
| ZAFIRA A MPV 1.6 16V | 04/1999→06/2005 | | | | | | |

| | | | | | | |
|-----------------------|---------|-------|-----|----|----------------------|--|
| V91995 | 641 034 | | 45° | H | VAG96028 | |
| 31.10 x 6.00 x 103.10 | | MB cr | | | 45.00 x 5.99 x 10.05 | |
| V94050 [2] | | | 45° | H | | |
| 31.10 x 5.97 x 102.90 | | MB cr | | | | |
| V91996 | 641 340 | | 45° | SS | | |
| 27.60 x 6.00 x 102.20 | | MD cr | | | | |
| V94051 [2] | | | 45° | SS | | |
| 27.60 x 5.95 x 101.95 | | MD cr | | | | |

[2] Service valve, for use on re-surfaced cylinder head only [2] Reparatur-Ventil, nur bei geplanten Zylinderkopf verwen den [2] Soupape de réparation, pour utilisation uniquement sur une culasse ré-usinée [2] Válvula de servicio, para uso solamente en culatas rebaj [2] Ricambio valvola per uso su testate cilindro spianate

29 **79.00**

| | | | | | | | |
|------------------|-----------------|--------|-----------------|-----------------|--------|-----------------|----------------|
| X 16 SZR | 1598cc | 4 Cyl. | 8 Valves | 55kW/75PS | Petrol | SOHC | TD4819 |
| Z 16 SE | 1598cc | 4 Cyl. | 8 Valves | 62-64kW/84-87PS | Petrol | SOHC | TD15089 |
| ASTRA F 1.6 i | 09/1991→01/2005 | | | ASTRA G 1.6 | | 02/1998→04/2005 | |
| COMBO 1.6 | 10/2001→ | | | COMBO Tour 1.6 | | 10/2001→ | |
| CORSA C 1.6 | 09/2000→12/2009 | | | KADETT 1.6 | | 03/1995→05/2000 | |
| MERIVA A MPV 1.6 | 05/2003→05/2010 | | | VECTRA B 1.6 i | | 10/1995→07/2003 | |
| ZAFIRA B 1.6 | 01/2006→ | | | | | | |

| | | | | | | |
|-----------------------|---------|------------|-----|---|----------------------|--|
| V91137 | 642 679 | | 45° | H | VAG96022 | |
| 37.92 x 7.00 x 101.00 | | MB | | | 45.80 x 7.02 x 11.04 | |
| V94353 | 642 911 | | 45° | H | | |
| 31.00 x 7.00 x 101.00 | | MD + MB cr | | | | |



OE

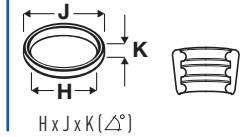
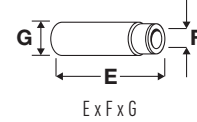

30  **79.00**

| | | | | | | | |
|------------------------|-----------------|--------|------------------|-----------------------|--------|--------------------|----------------|
| Z 16 LEL | 1598cc | 4 Cyl. | 16 Valves | 110kW/150PS | Petrol | Turbo, DOHC | TD20857 |
| Z 16 LER | 1598cc | 4 Cyl. | 16 Valves | 141kW/192PS | Petrol | Turbo, DOHC | TD20059 |
| Z 16 LET | 1598cc | 4 Cyl. | 16 Valves | 132kW/180PS | Petrol | Turbo, DOHC | TD19313 |
| ASTRA H 1.6 Turbo | 02/2007→10/2010 | | | ASTRA H GTC 1.6 Turbo | | 02/2007→10/2010 | |
| CORSA D 1.6 T | 02/2007→ | | | CORSA D 1.6 Turbo | | 02/2007→ | |
| MERIVA A MPV 1.6 Turbo | 09/2005→05/2010 | | | | | | |

V98024  0641076

31.00 x 5.00 x 114.00

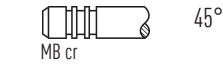

VAG96346  37.00 x 4.99 x 10.04



V98025  0641391

27.50 x 5.00 x 113.20

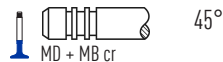

31  **79.00**

| | | | | | | | |
|------------------|-----------------|--------|------------------|-------------------|--------|-----------------|----------------|
| Z 16 XE1 | 1598cc | 4 Cyl. | 16 Valves | 77kW/105PS | Petrol | DOHC | TD23720 |
| Z 16 XEP | 1598cc | 4 Cyl. | 16 Valves | 74-77kW/101-105PS | Petrol | DOHC | TD17892 |
| Z 16 XER | 1598cc | 4 Cyl. | 16 Valves | 85kW/116PS | Petrol | DOHC | TD20060 |
| ASTRA 1.6 | 01/2009→ | | | ASTRA G 1.6 | | 12/2002→12/2009 | |
| ASTRA G 1.6 16V | 03/2000→05/2005 | | | ASTRA H 1.6 | | 02/2004→05/2014 | |
| ASTRA H 1.6 LPG | 08/2009→10/2010 | | | ASTRA H GTC 1.6 | | 03/2005→10/2010 | |
| MERIVA A MPV 1.6 | 01/2006→05/2010 | | | VECTRA C 1.6 | | 01/2006→ | |
| VECTRA C GTS 1.6 | 01/2006→ | | | ZAFIRA A MPV 1.6 | | 10/2003→06/2005 | |
| ZAFIRA B 1.6 | 07/2005→ | | | | | | |

V98077  [3] 642 011

31.20 x 5.00 x 117.20

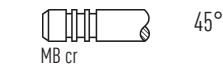

VAG96346  37.00 x 4.99 x 10.04



V98078  [3] 641 379

27.50 x 5.00 x 116.20

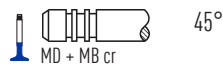

[3] LPG

[3] LPG

[3] LPG

[3] LPG

[3] LPG

32  **79.00**

| | | | | | | | |
|----------------------|-----------------|--------|-----------------|-----------------|--------|-----------------|---------------|
| 17 D (4EE1) | 1686cc | 4 Cyl. | 8 Valves | 44kW/60PS | Diesel | SOHC | TD5284 |
| X 17 D (4EE1) | 1686cc | 4 Cyl. | 8 Valves | 42-44kW/57-60PS | Diesel | SOHC | TD5298 |
| COMBO 1.7 D | 07/1994→10/2001 | | | CORSA B 1.7 D | | 02/1996→12/2002 | |
| CORSA Pickup 1.7 D | 01/2003→12/2006 | | | | | | |

V91230  641 007

34.70 x 6.99 x 104.00

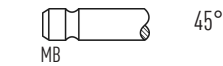

H

VAG92321  43.00 x 7.00 x 11.56

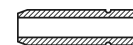

V91231  641 300

30.70 x 6.98 x 104.00

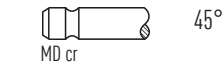

st

33  **79.00**

| | | | | | | | |
|-------------------------|-----------------|--------|-----------------|-----------------|--------|--------------------|---------------|
| 17 DT (TC4EE1) | 1686cc | 4 Cyl. | 8 Valves | 60kW/82PS | Diesel | Turbo, SOHC | TD4747 |
| X 17 DT (TC4EE1) | 1686cc | 4 Cyl. | 8 Valves | 60kW/82PS | Diesel | Turbo, SOHC | TD4822 |
| ASTRA F 1.7 TD | 03/1995→02/1998 | | | ASTRA F 1.7 TDS | | 12/1991→09/1998 | |
| VECTRA A 1.7 TD | 03/1990→11/1995 | | | VECTRA B 1.7 TD | | 10/1995→12/1998 | |

V91230  641 007

34.70 x 6.99 x 104.00

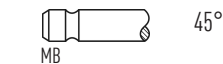

H

VAG92321  43.00 x 7.00 x 11.56

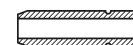

V91232  641 322

30.70 x 6.98 x 104.15

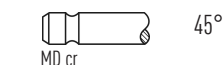

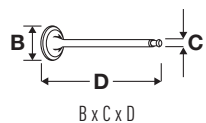

OE

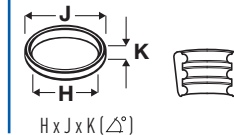
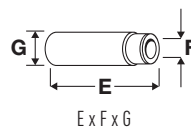
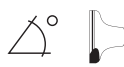

34 **79.00**

| | | | | | | | |
|-----------------|--------|--------|------------------|------------|--------|--------------------|----------------|
| A 17 DT | 1686cc | 4 Cyl. | 16 Valves | 74kW/101PS | Diesel | Turbo, DOHC | TD24266 |
| A 17 DTC | 1686cc | 4 Cyl. | 16 Valves | 81kW/110PS | Diesel | Turbo, DOHC | TD24379 |
| A 17 DTE | 1686cc | 4 Cyl. | 16 Valves | 81kW/110PS | Diesel | Turbo, DOHC | TD25743 |
| A 17 DTJ | 1686cc | 4 Cyl. | 16 Valves | 81kW/110PS | Diesel | Turbo, DOHC | TD20751 |
| A 17 DTL | 1686cc | 4 Cyl. | 16 Valves | 74kW/101PS | Diesel | Turbo, DOHC | TD25745 |
| A 17 DTN | 1686cc | 4 Cyl. | 16 Valves | 74kW/101PS | Diesel | Turbo, DOHC | TD31004 |
| A 17 DTR | 1686cc | 4 Cyl. | 16 Valves | 92kW/125PS | Diesel | Turbo, DOHC | TD20061 |
| A 17 DTS | 1686cc | 4 Cyl. | 16 Valves | 96kW/131PS | Diesel | Turbo, DOHC | TD24267 |
| Z 17 DTJ | 1686cc | 4 Cyl. | 16 Valves | 81kW/110PS | Diesel | Turbo, DOHC | TD24044 |
| Z 17 DTR | 1686cc | 4 Cyl. | 16 Valves | 92kW/125PS | Diesel | Turbo, DOHC | TD19314 |

| | | | |
|-----------------------|-----------------|--------------------------|-----------------|
| ASTRA 1.7 CDTi | 01/2009→ | ASTRA 1.7 CDTi | 01/2009→ |
| ASTRA H 1.7 CDTi | 02/2007→05/2014 | ASTRA H 1.7 CDTi | 02/2007→05/2014 |
| ASTRA H GTC 1.7 CDTi | 02/2007→10/2010 | ASTRA J 1.7 CDTi | 12/2009→ |
| ASTRA J GTC 1.7 CDTi | 10/2011→ | ASTRA J Tourer 1.7 CDTi | 10/2010→ |
| CORSA D 1.7 CDTi | 07/2006→ | MERIVA A MPV 1.7 CDTi | 09/2006→05/2010 |
| MERIVA B MPV 1.7 CDTi | 06/2010→ | MOKKA / MOKKA X 1.7 CDTi | 06/2012→ |
| ZAFIRA B 1.7 CDTi | 01/2008→ | | |

V95186 641 085
27.50 x 5.97 x 102.50

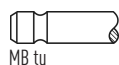

45°

H

VAG96291 **E**
42.00 x 6.00 x 11.05

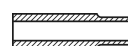

V95157 **E** 641 086
25.45 x 5.96 x 102.20

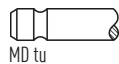

45°

H

35 **79.00**

| | | | | | | | |
|-----------------|--------|--------|------------------|------------|--------|--------------------|----------------|
| Y 17 DT | 1686cc | 4 Cyl. | 16 Valves | 55kW/75PS | Diesel | Turbo, DOHC | TD13689 |
| Y 17 DTL | 1686cc | 4 Cyl. | 16 Valves | 48kW/65PS | Diesel | DOHC | TD14921 |
| Z 17 DTH | 1686cc | 4 Cyl. | 16 Valves | 74kW/100PS | Diesel | Turbo, DOHC | TD17478 |
| Z 17 DTL | 1686cc | 4 Cyl. | 16 Valves | 59kW/80PS | Diesel | Turbo, DOHC | TD17947 |

| | | | |
|-----------------------|-----------------|-------------------------|-----------------|
| ASTRA G 1.7 CDTi | 04/2003→12/2009 | ASTRA G 1.7 DTi 16V | 02/2000→04/2005 |
| ASTRA H 1.7 CDTi | 02/2007→10/2010 | ASTRA H 1.7 CDTi | 03/2004→10/2010 |
| ASTRA H GTC 1.7 CDTi | 03/2005→10/2010 | ASTRA H GTC 1.7 CDTi | 03/2005→10/2010 |
| COMBO 1.7 CDTi 16V | 12/2004→ | COMBO 1.7 DI 16V | 10/2001→ |
| COMBO 1.7 DTi 16V | 10/2001→ | COMBO Tour 1.7 CDTi 16V | 12/2004→ |
| COMBO Tour 1.7 DI 16V | 10/2001→ | COMBO Tour 1.7 DTi 16V | 10/2001→ |
| CORSA C 1.7 CDTi | 08/2003→ | CORSA C 1.7 CDTi | 06/2003→12/2009 |
| CORSA C 1.7 DI | 09/2000→12/2009 | CORSA C 1.7 DI 16V | 09/2000→ |
| CORSA C 1.7 DTi | 09/2000→12/2009 | CORSA C 1.7 DTi 16V | 09/2000→ |
| CORSA Pickup 1.7 Di | 11/2001→06/2004 | CORSA Pickup 1.7 DTi | 08/2001→12/2010 |
| MERIVA A MPV 1.7 CDTi | 09/2003→05/2010 | MERIVA A MPV 1.7 DTi | 09/2003→05/2010 |

V94426 641 025
27.50 x 6.00 x 98.40

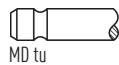

45°

VAG96291 **E**
42.00 x 6.00 x 11.05



V94427 **E** 641 387
26.50 x 6.00 x 98.10

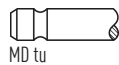

45°

SS



OE

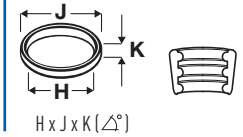
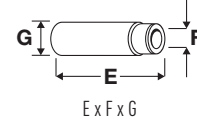

36  **80.00**

| | | | | | | | |
|----------------------------------|--------|------------------------------------|-----------------|--|--------|------------------------------------|---------------|
| 16 D | 1598cc | 4 Cyl. | 8 Valves | 40kW/54PS | Diesel | SOHC | TD4734 |
| 16 DA | 1598cc | 4 Cyl. | 8 Valves | 40kW/54PS | Diesel | SOHC | TD4735 |
| ASCONA C 1.6 D KADETT E 1.6 D | | 03/1982→08/1988 08/1984→01/1989 | | KADETT D 1.6 D KADETT E Combo 1.6 D | | 03/1982→08/1984 01/1986→12/1989 | |

V90230 
36.10 x 7.98 x 123.40

642 651

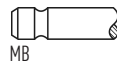

45°

H

VAG96021 
50.00 x 8.00 x 12.02



V90231 
32.10 x 7.97 x 123.40

90499097

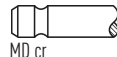

45°

37  **80.00**

| | | | | | | | |
|--|--------|---|-----------------|----------------------------------|--------|------------------------------------|---------------|
| 16 N | 1598cc | 4 Cyl. | 8 Valves | 51-55kW/69-75PS | Petrol | SOHC | TD5281 |
| 16 SH | 1598cc | 4 Cyl. | 8 Valves | 66kW/90PS | Petrol | SOHC | TD4739 |
| ASCONA C 1.6 KADETT D 1.6 S KADETT E Combo 1.6 | | 09/1981→08/1988 09/1981→08/1984 09/1986→06/1993 | | ASCONA C 1.6 S KADETT E 1.6 S | | 09/1981→08/1986 09/1984→08/1986 | |

V90166 
35.00 x 7.98 x 105.99

0642 635

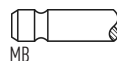

45°

H

VAG96023 
43.00 x 8.02 x 12.02



38  **80.00**

| | | | | | | | |
|----------------|--------|-----------------|-----------------|-----------|--------|-------------|----------------|
| F8Q 600 | 1870cc | 4 Cyl. | 8 Valves | 44kW/60PS | Diesel | SOHC | TD21361 |
| F8Q 606 | 1870cc | 4 Cyl. | 8 Valves | 44kW/60PS | Diesel | SOHC | TD21359 |
| ARENA 1.9 D | | 03/1998→08/2001 | | | | | |

V94338 
35.30 x 8.00 x 110.00

7701 471 704

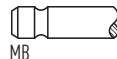

45°

H

VAG92329B 
39.00 x 8.00 x 13.07



V94339 
31.50 x 8.00 x 109.80

7701 469 373

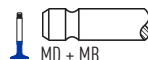

45°

SS

H

VAG96226B 
39.00 x 8.02 x 13.13



39  **80.00**

| | | | | | | | |
|-----------------------------------|--------|----------------------|-----------------|-------------------------------------|--------|----------------------|----------------|
| F9Q 760 | 1870cc | 4 Cyl. | 8 Valves | 74kW/101PS | Diesel | Turbo, SOHC | TD18872 |
| F9Q 762 | 1870cc | 4 Cyl. | 8 Valves | 59-60kW/80-82PS | Diesel | Turbo, SOHC | TD18494 |
| F9Q 770 | 1870cc | 4 Cyl. | 8 Valves | 59kW/80PS | Diesel | Turbo, SOHC | TD19374 |
| F9Q 772 | 1870cc | 4 Cyl. | 8 Valves | 60kW/82PS | Diesel | Turbo, SOHC | TD23125 |
| F9Q 774 | 1870cc | 4 Cyl. | 8 Valves | 60kW/82PS | Diesel | Turbo, SOHC | TD18252 |
| MOVANO 1.9 DTI VIVARO A 1.9 DI | | 09/2000→ 08/2001→ | | VIVARO A 1.9 Di VIVARO A 1.9 DTI | | 08/2001→ 08/2001→ | |

V94190 
35.40 x 7.00 x 111.00

44 15 921

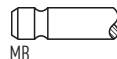

45°

H

VAG96294B 
38.30 x 7.00 x 12.03



V94191 
32.60 x 7.00 x 110.80

44 15 922

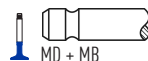

45°

H



OE

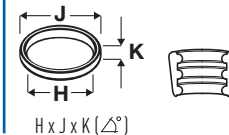
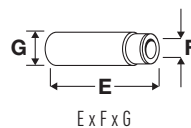
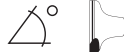

40  **80.00**

| | | | | | | | |
|----------------|-----------------|--------|------------------|-----------------|--------|--------------------|----------------|
| X 25 DT | 2497cc | 6 Cyl. | 12 Valves | 96kW/131PS | Diesel | Turbo, SOHC | TD4828 |
| X 25 TD | 2497cc | 6 Cyl. | 12 Valves | 96kW/131PS | Diesel | Turbo, SOHC | TD17322 |
| OMEGA B 2.5 D | 05/1994→05/1999 | | OMEGA B 2.5 TD | 04/1994→07/2003 | | | |

| | | | | | | | |
|---|---------|---|-----|----|---|--|--|
| V94555  | 641 346 |  | 45° | ss | H | | |
| 30.90 x 6.00 x 103.50 | | MD + MB cr | | | | | |

41  **80.50**







| | | | | | | | |
|-----------------|----------|--------|---------------------|-------------------|--------|-------------|----------------|
| A 18 XEL | 1796cc | 4 Cyl. | 16 Valves | 85-88kW/116-120PS | Petrol | DOHC | TD25517 |
| Z 18 XEP | 1796cc | 4 Cyl. | 16 Valves | 103kW/140PS | Petrol | DOHC | TD18437 |
| ZAFIRA B 1.8 | 06/2013→ | | ZAFIRA TOURER C 1.8 | 10/2011→ | | | |

| | | | | | | | |
|---|---------|---|-----|--|--|---|--|
| V98024  | 0641076 |  | 45° | | | VAG96346  | |
| 31.00 x 5.00 x 114.00 | | MB cr | | | | 37.00 x 4.99 x 10.04 | |
| V98025  | 0641391 |  | 45° | | | | |
| 27.50 x 5.00 x 113.20 | | MD + MB cr | | | | | |

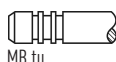
42  **80.50**

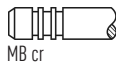
| | | | | | | | |
|-----------------|--------|--------|------------------|---------------------|--------|-------------|----------------|
| A 18 XER | 1796cc | 4 Cyl. | 16 Valves | 101-103kW/137-140PS | Petrol | DOHC | TD22591 |
| Z 18 XER | 1796cc | 4 Cyl. | 16 Valves | 101-103kW/137-140PS | Petrol | DOHC | TD18730 |

| | | | |
|-------------------------|-----------------|-----------------------|-----------------|
| ASTRA 1.8 | 02/2013→ | ASTRA H 1.8 | 08/2005→10/2010 |
| ASTRA H GTC 1.8 | 01/2006→10/2010 | ASTRA J GTC 1.8 | 10/2011→ |
| INSIGNIA A 1.8 | 07/2008→ | INSIGNIA A Tourer 1.8 | 07/2008→06/2013 |
| MOKKA / MOKKA X 1.8 | 01/2013→ | SIGNUM 1.8 | 09/2005→12/2008 |
| VECTRA C 1.8 | 01/2006→ | VECTRA C GTS 1.8 | 01/2006→ |
| ZAFIRA B 1.8 | 07/2005→ | ZAFIRA TOURER C 1.8 | 10/2011→ |
| ZAFIRA TOURER C 1.8 LPG | 10/2011→ | | |

| | | | | | | | |
|---|---------|---|-----|----|--|---|--|
| V80016  | 642 030 |  | 45° | ss | | VAG96346  | |
| 31.20 x 5.00 x 113.80 | | MB tu | | | | 37.00 x 4.99 x 10.04 | |
| V98024  | 0641076 |  | 45° | | | | |
| 31.00 x 5.00 x 114.00 | | MB cr | | | | | |
| V80017  | 641 099 |  | 45° | ss | | | |
| 27.50 x 5.00 x 113.20 | | MD + MB tu | | | | | |
| V98025  | 0641391 |  | 45° | | | | |
| 27.50 x 5.00 x 113.20 | | MD + MB cr | | | | | |

[3] LPG

[3] LPG

[3] LPG

[3] LPG

[3] LPG



OE

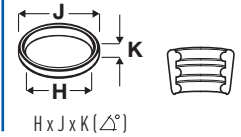
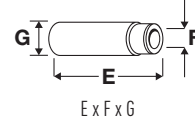
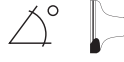

43



80.50

| | | | | | | | |
|----------------------|--------|-----------------|------------------|----------------------|--------|-----------------|----------------|
| X 18 XE1 | 1796cc | 4 Cyl. | 16 Valves | 85kW/115PS | Petrol | DOHC | TD9509 |
| Z 18 XE | 1796cc | 4 Cyl. | 16 Valves | 90-92kW/122-125PS | Petrol | DOHC | TD14922 |
| Z 18 XEL | 1796cc | 4 Cyl. | 16 Valves | 79-85kW/107-116PS | Petrol | DOHC | TD17894 |
| ASTRA G 1.8 | | 02/2003→01/2005 | | ASTRA G 1.8 16V | | 02/1998→10/2005 | |
| ASTRA H 1.8 | | 01/2004→10/2010 | | ASTRA H GTC 1.8 | | 03/2005→10/2010 | |
| CORSA 1.8 | | 01/2002→12/2005 | | CORSA C 1.8 | | 09/2000→12/2009 | |
| CORSA Pickup 1.8 | | 01/2003→12/2010 | | MERIVA A MPV 1.8 | | 05/2003→05/2010 | |
| SIGNUM 1.8 | | 05/2003→07/2005 | | TIGRA 1.8 | | 06/2004→ | |
| VECTRA B 1.8 i 16V | | 10/1995→07/2003 | | VECTRA C 1.8 | | 04/2002→ | |
| VECTRA C 1.8 16V | | 04/2002→ | | VECTRA C GTS 1.8 16V | | 08/2002→ | |
| ZAFIRA A MPV 1.8 16V | | 04/1999→06/2005 | | | | | |

V94249 ■
31.20 x 5.00 x 101.40

641 048

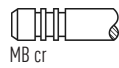

45°

H

VAG96076 ■
39.00 x 5.00 x 10.04

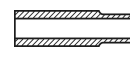

V94250 ■
27.50 x 5.00 x 100.80

641 357

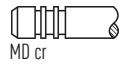

45°

SS

VAG96077 ■
39.00 x 5.00 x 10.04



44



81.60

| | | | | | | | |
|-------------------|--------|-----------------|------------------|--------------------|--------|-----------------|---------------|
| C 18 XE | 1799cc | 4 Cyl. | 16 Valves | 92kW/125PS | Petrol | DOHC | TD4795 |
| C 18 XEL | 1799cc | 4 Cyl. | 16 Valves | 85kW/116PS | Petrol | DOHC | TD4796 |
| X 18 XE | 1799cc | 4 Cyl. | 16 Valves | 85kW/115PS | Petrol | DOHC | TD4823 |
| ASTRA F 1.8 i 16V | | 06/1993→03/2001 | | VECTRA B 1.8 i 16V | | 10/1995→09/2000 | |

V91997 ■
32.10 x 5.97 x 102.10

641 022

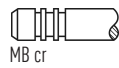

45°

H

VAG96028 ■ ■ ■
45.00 x 5.99 x 10.05

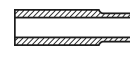

V91998 ■
29.10 x 5.96 x 92.25

641 325

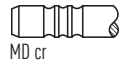

45°

SS

45



81.60

| | | | | | | | |
|--------------------|--------|-----------------|------------------|---------------------|--------|-----------------|---------------|
| C 25 XE | 2498cc | V6 Cyl. | 24 Valves | 125kW/170PS | Petrol | DOHC | TD4804 |
| X 25 XE | 2498cc | V6 Cyl. | 24 Valves | 125-144kW/170-196PS | Petrol | DOHC | TD2738 |
| CALIBRA A 2.5 i V6 | | 04/1993→07/1997 | | OMEGA B 2.5 V6 | | 03/1994→09/2000 | |
| VECTRA A 2.5 CD | | 08/1992→08/1995 | | VECTRA A 2.5 V6 | | 02/1993→11/1995 | |
| VECTRA B 2.5 | | 10/1999→06/2000 | | VECTRA B 2.5 i V6 | | 10/1995→09/2000 | |
| VECTRA B i 500 2.5 | | 05/1998→09/2000 | | | | | |

V91997 ■
32.10 x 5.97 x 102.10

641 022

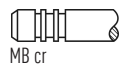

45°

H

VAG96028 ■ ■ ■
45.00 x 5.99 x 10.05

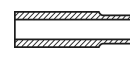

V91998 ■
29.10 x 5.96 x 92.25

641 325

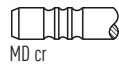

45°

SS



OE

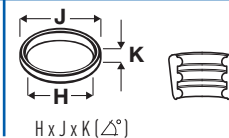
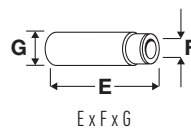

46 **82.00**

| | | | | | | | |
|-----------------------|-----------------|--------|----------------------|------------|-----------------|--------------------|----------------|
| Z 19 DT | 1910cc | 4 Cyl. | 8 Valves | 88kW/120PS | Diesel | Turbo, SOHC | TD18046 |
| Z 19 DTL | 1910cc | 4 Cyl. | 8 Valves | 74kW/101PS | Diesel | Turbo, SOHC | TD18671 |
| ASTRA H 1.9 CDTI | 06/2004→10/2010 | | ASTRA H GTC 1.9 CDTI | | 09/2005→10/2010 | | |
| SIGNUM 1.9 CDTI | 04/2004→02/2008 | | VECTRA C 1.9 CDTI | | 04/2004→ | | |
| VECTRA C GTS 1.9 CDTI | 04/2004→ | | ZAFIRA B 1.9 CDTI | | 07/2005→ | | |

| | | | | | | | | |
|-----------------------|------------|--|------------|-----|---|-----------------|--|----------------------|
| V94470 | 46 750 859 | | MD + MB cr | 45° | H | VAG96124 | | 42.90 x 8.02 x 14.06 |
| 35.30 x 8.00 x 115.00 | | | | | | VAG96203 | | 43.00 x 8.03 x 14.08 |
| V94065 | 608 14 604 | | MD cr | 45° | | VAG96210 | | 43.00 x 8.04 x 14.04 |
| 34.50 x 8.00 x 115.00 | | | | | | | | |
| V94471 | 46 783 962 | | MD + MB cr | 45° | H | | | |
| 34.50 x 8.00 x 115.00 | | | | | | | | |

47 **82.00**

| | | | | | | | |
|--------------------------|-----------------|--------|-----------------------|-------------|-----------------|--------------------|----------------|
| Z 19 DTH | 1910cc | 4 Cyl. | 16 Valves | 110kW/150PS | Diesel | Turbo, DOHC | TD18014 |
| Z 19 DTJ | 1910cc | 4 Cyl. | 16 Valves | 88kW/120PS | Diesel | Turbo, DOHC | TD18011 |
| ASTRA H 1.9 CDTi | 09/2005→10/2010 | | ASTRA H 1.9 CDTI | | 09/2004→10/2010 | | |
| ASTRA H 1.9 CDTi 16V | 04/2004→10/2010 | | ASTRA H GTC 1.9 CDTi | | 03/2005→10/2010 | | |
| ASTRA H GTC 1.9 CDTi 16V | 03/2005→10/2010 | | SIGNUM 1.9 CDTI | | 04/2004→02/2008 | | |
| VECTRA C 1.9 CDTI | 04/2004→ | | VECTRA C GTS 1.9 CDTI | | 04/2004→ | | |
| ZAFIRA B 1.9 CDTI | 07/2005→ | | | | | | |

| | | | | | | | | | |
|-----------------------|------------|--|------------|-----|---|---|-----------------|--|----------------------|
| V94588 | 641 075 | | MB cr | 45° | Y | H | VAG96291 | | 42.00 x 6.00 x 11.05 |
| 27.90 x 6.00 x 114.00 | | | | | | | VAG96360 | | 46.70 x 5.00 x 10.03 |
| Eng.→17180894 | | | | | | | Eng.17180895→ | | |
| V98005 | 0641404 | | MB cr | 45° | | | | | |
| 28.00 x 5.00 x 114.40 | | | | | | | | | |
| Eng.17180895→ | | | | | | | | | |
| V94589 | 46 787 902 | | MD + MB cr | 45° | | H | | | |
| 25.80 x 6.00 x 114.30 | | | | | | | | | |
| Eng.→17180894 | | | | | | | | | |
| V98006 | 641 106 | | MD + MB cr | 45° | | | | | |
| 24.50 x 5.00 x 114.40 | | | | | | | | | |
| Eng.17180895→ | | | | | | | | | |

48 **82.50**

| | | | | | | | |
|----------------------|-----------------|--------|-----------------|-----------------|-----------------|-------------|---------------|
| 17 D | 1700cc | 4 Cyl. | 8 Valves | 42kW/57PS | Diesel | SOHC | TD4742 |
| 17 DR | 1700cc | 4 Cyl. | 8 Valves | 42-44kW/57-60PS | Diesel | SOHC | TD4744 |
| ASTRA F 1.7 D | 12/1991→01/1999 | | KADETT E 1.7 D | | 08/1988→09/1992 | | |
| KADETT E Combo 1.7 D | 01/1989→07/1994 | | VECTRA A 1.7 D | | 09/1988→11/1995 | | |



| | | | | | | | | | |
|-----------------------|----------|--|-------|-----|--|---|-----------------|--|----------------------|
| V90230 | 642 651 | | MB | 45° | | H | VAG96021 | | 50.00 x 8.00 x 12.02 |
| 36.10 x 7.98 x 123.40 | | | | | | | | | |
| V90231 | 90499097 | | MD cr | 45° | | | | | |
| 32.10 x 7.97 x 123.40 | | | | | | | | | |



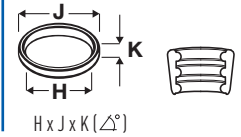
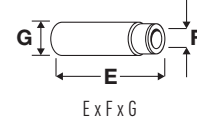

OE

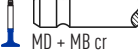

49  **82.50**

| | | | | | | | |
|-----------------------|-----------------|---|-----------------|-----------|-----------------------|---|---------------|
| X 17 DTL | 1700cc | 4 Cyl. | 8 Valves | 50kW/68PS | Diesel | Turbo, SOHC | TD4821 |
| ASTRA F 1.7 TD | 08/1994→01/1999 | | ASTRA G 1.7 TD | | 02/1998→04/2005 | | |
| V90230 ■ | 642 651 |  | 45° | H | VAG96021 ■ ■ ■ |  | |
| 36.10 x 7.98 x 123.40 | | MB | | | 50.00 x 8.00 x 12.02 | | |
| V91987 ■ | 641 353 |  | 45° | H | | | |
| 32.10 x 7.97 x 123.20 | | MD + MB cr | | | | | |

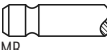
50  **82.70**

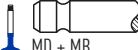

| | | | | | | | |
|-----------------------|----------|---|---------------------|------------|------------------------|---|----------------|
| F4R 720 | 1998cc | 4 Cyl. | 16 Valves | 88kW/120PS | Petrol | DOHC | TD18194 |
| F4R 820 | 1998cc | 4 Cyl. | 16 Valves | 86kW/117PS | Petrol | DOHC | TD21037 |
| VIVARO A 2.0 16V | 08/2001→ | | VIVARO A 2.0 ECOTEC | | 08/2006→ | | |
| V94606 ■ | 4411048 |  | 45° | H | VAG96292B ■ ■ ■ |  | |
| 33.60 x 5.50 x 110.00 | | MB | | | 40.60 x 5.50 x 11.07 | | |
| V94607 ■ | 4411049 |  | 45° | H | | | |
| 29.00 x 5.50 x 108.90 | | MD + MB | | | | | |

51  **83.00**

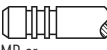

| | | | | | | | |
|----------------------------|-----------------|--------|--------------------------|---------------------|-----------------|--------------------|----------------|
| A 20 DTC | 1956cc | 4 Cyl. | 16 Valves | 81kW/110PS | Diesel | Turbo, DOHC | TD22597 |
| A 20 DTH | 1956cc | 4 Cyl. | 16 Valves | 118-121kW/160-165PS | Diesel | Turbo, DOHC | TD22601 |
| A 20 DTJ | 1956cc | 4 Cyl. | 16 Valves | 96kW/131PS | Diesel | Turbo, DOHC | TD22599 |
| ASTRA J 2.0 CDTi | 12/2009→ | | ASTRA J GTC 2.0 CDTi | | 10/2011→ | | |
| ASTRA J Tourer 2.0 CDTi | 10/2010→ | | CASCADA 2.0 CDTi | | 03/2013→ | | |
| INSIGNIA A 2.0 CDTi | 07/2008→ | | INSIGNIA A 2.0 CDTi | | 07/2008→03/2017 | | |
| INSIGNIA A Tourer 2.0 CDTi | 07/2008→06/2015 | | ZAFIRA TOURER C 2.0 CDTi | | 10/2011→ | | |

| | | | | | | | |
|-----------------------|---------|---|-----|--|-----------------------|---|--|
| V98005 ■ | 0641404 |  | 45° | | VAG96360 ■ ■ ■ |  | |
| 28.00 x 5.00 x 114.40 | | MB cr | | | 46.70 x 5.00 x 10.03 | | |
| V98006 ■ | 641 106 |  | 45° | | | | |
| 24.50 x 5.00 x 114.40 | | MD + MB cr | | | | | |

52  **83.00**

| | | | | | | | |
|----------------------|----------|---|------------------|-------------|--------|--------------------|----------------|
| Z 20 DM | 1991cc | 4 Cyl. | 16 Valves | 93kW/126PS | Diesel | Turbo, DOHC | TD21017 |
| Z 20 DMH | 1991cc | 4 Cyl. | 16 Valves | 110kW/150PS | Diesel | DOHC | TD19203 |
| ANTARA 2.0 CDTi | 05/2006→ | | | | | | |
| V95187 ■ | 4805321 |  | | H | | | |
| 28.50 x 5.95 x 95.70 | | MB cr | | | | | |
| V95188 ■ | 4805322 |  | 45° | H | | | |
| 24.50 x 5.92 x 95.75 | | MD + MB cr | | | | | |

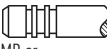
53  **83.20**

| | | | | | | | |
|-----------------------|-----------------|---|-------------------|---------------------|-----------------------|---|----------------|
| Y 26 SE | 2597cc | V6 Cyl. | 24 Valves | 125-132kW/170-180PS | Petrol | DOHC | TD14925 |
| OMEGA B 2.6 V6 | 09/2000→07/2003 | | VECTRA B 2.6 i V6 | | 09/2000→07/2003 | | |
| V91997 ■ | 641 022 |  | 45° | H | VAG96137 ■ ■ ■ |  | |
| 32.10 x 5.97 x 102.10 | | MB cr | | | 45.00 x 6.02 x 10.05 | | |
| V91998 ■ | 641 325 |  | 45° | ss | | | |
| 29.10 x 5.96 x 92.25 | | MD cr | | | | | |





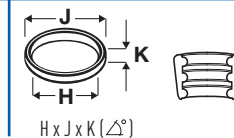
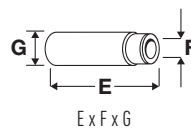

OE

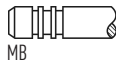

54  **84.00**



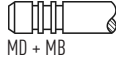





| | | | | | | | |
|----------------|--------|--------|------------------|------------------|--------|--------------------|---------|
| M9R 630 | 1995cc | 4 Cyl. | 16 Valves | 66-84kW/90-114PS | Diesel | Turbo, DOHC | TD25646 |
| M9R 692 | 1995cc | 4 Cyl. | 16 Valves | 84kW/114PS | Diesel | Turbo, DOHC | TD28089 |
| M9R 780 | 1995cc | 4 Cyl. | 16 Valves | 66-84kW/90-114PS | Diesel | Turbo, DOHC | TD20888 |
| M9R 782 | 1995cc | 4 Cyl. | 16 Valves | 66-84kW/90-114PS | Diesel | Turbo, DOHC | TD24726 |
| M9R 784 | 1995cc | 4 Cyl. | 16 Valves | 84kW/114PS | Diesel | Turbo, DOHC | TD25140 |
| M9R 786 | 1995cc | 4 Cyl. | 16 Valves | 66-84kW/90-114PS | Diesel | Turbo, DOHC | TD25139 |
| M9R 788 | 1995cc | 4 Cyl. | 16 Valves | 84kW/114PS | Diesel | Turbo, DOHC | TD25143 |

| | | | | | | | |
|---|---------|---|-----|---|---|--|---|
| VIVARO A 2.0 CDTI | | 01/2006→ | | | | | |
| V95001  | 4420439 |  | 45° | Y | H | VAG96383B  |  |
| 27.70 x 5.98 x 103.90 | | MB | | | | 42.40 x 6.00 x 11.07 | |
| V95002  | 4431241 |  | 45° | | H | | |
| 26.00 x 5.97 x 103.75 | | MD + MB | | | | | |

55  **84.00**

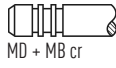







| | | | | | | | |
|-----------------|--------|--------|------------------|-----------------|--------|--------------------|---------|
| X 20 DTH | 1995cc | 4 Cyl. | 16 Valves | 74kW/101PS | Diesel | Turbo, SOHC | TD9729 |
| X 20 DTL | 1995cc | 4 Cyl. | 16 Valves | 60-63kW/82-86PS | Diesel | Turbo, SOHC | TD4824 |
| Y 20 DTH | 1995cc | 4 Cyl. | 16 Valves | 74kW/101PS | Diesel | Turbo, SOHC | TD13752 |
| Y 20 DTL | 1995cc | 4 Cyl. | 16 Valves | 60-63kW/82-86PS | Diesel | Turbo, SOHC | TD15848 |

| | | | |
|--------------------------|-----------------|--------------------------|-----------------|
| ASTRA G 2.0 DI | 02/1998→04/2005 | ASTRA G 2.0 DTI 16V | 08/1999→01/2005 |
| OMEGA B 2.0 DTI 16V | 09/1997→09/2000 | SIGNUM 2.0 DTI | 05/2003→04/2004 |
| VECTRA B 2.0 DI 16V | 11/1996→04/2002 | VECTRA B 2.0 DTI 16V | 06/1997→07/2003 |
| VECTRA C 2.0 DTI | 10/2003→ | VECTRA C 2.0 DTI 16V | 04/2002→ |
| VECTRA C GTS 2.0 DTI 16V | 08/2002→ | ZAFIRA A MPV 2.0 DI | 07/1999→06/2000 |
| ZAFIRA A MPV 2.0 DI 16V | 07/1999→06/2005 | ZAFIRA A MPV 2.0 DTI 16V | 09/2000→06/2005 |

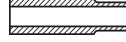
| | | | | | | | |
|---|---------|---|-----|----|---|---|---|
| V94097  | 642 168 |  | 45° | SS | H | VAG96028  |  |
| 29.00 x 6.00 x 97.20 | | MD + MB cr | | | | 45.00 x 5.99 x 10.05 | |
| V94355  | 642 165 |  | 45° | | H | | |
| 29.00 x 6.00 x 97.00 | | MD + MB cr | | | | | |
| V94098  | 642 211 |  | 45° | SS | H | | |
| 26.00 x 6.00 x 97.00 | | MD + MB cr | | | | | |
| V94356  | 642 208 |  | 45° | SS | H | | |
| 26.20 x 6.00 x 97.00 | | MD + MB cr | | | | | |

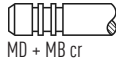
56  **84.00**

| | | | | | | | |
|--------------------|-----------------|----------------|------------------|------------|--------|--------------------|--------|
| X 22 DTH | 2171cc | 4 Cyl. | 16 Valves | 85kW/116PS | Diesel | Turbo, SOHC | TD9510 |
| FRONTERA B 2.2 DTI | 10/1998→09/2002 | SINTRA 2.2 DTI | 07/1997→04/1999 | | | | |

| | | | | | | | |
|---|---------|---|-----|----|---|---|---|
| V94097  | 642 168 |  | 45° | SS | H | VAG96028  |  |
| 29.00 x 6.00 x 97.20 | | MD + MB cr | | | | 45.00 x 5.99 x 10.05 | |
| V94355  | 642 165 |  | 45° | | H | | |
| 29.00 x 6.00 x 97.00 | | MD + MB cr | | | | | |
| V94098  | 642 211 |  | 45° | SS | H | | |
| 26.00 x 6.00 x 97.00 | | MD + MB cr | | | | | |
| V94356  | 642 208 |  | 45° | SS | H | | |
| 26.20 x 6.00 x 97.00 | | MD + MB cr | | | | | |



OE

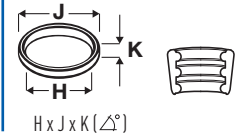
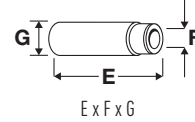
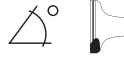

57 **84.00**

| | | | | | | | |
|--------------------------|-----------------|--------|------------------|--------------------------|--------|-----------------|----------------|
| Y 22 DTH | 2172cc | 4 Cyl. | 16 Valves | 81-88kW/110-120PS | Diesel | SOHC | TD15091 |
| Y 22 DTR | 2172cc | 4 Cyl. | 16 Valves | 86-92kW/117-125PS | Diesel | SOHC | TD14924 |
| ASTRA G 2.2 DTI | 09/2002→10/2005 | | | FRONTERA B 2.2 DTI | | 10/1998→ | |
| OMEGA B 2.2 DTI 16V | 09/2000→07/2003 | | | SIGNUM 2.2 DTI | | 05/2003→04/2004 | |
| SIGNUM 2.2 DTI 16V | 05/2003→06/2008 | | | VECTRA B 2.2 DTI 16V | | 09/2000→07/2003 | |
| VECTRA C 2.2 DTI | 10/2003→ | | | VECTRA C 2.2 DTI 16V | | 04/2002→ | |
| VECTRA C GTS 2.2 DTI 16V | 08/2002→ | | | ZAFIRA A MPV 2.2 DTI 16V | | 01/2002→06/2005 | |

V94097 29.00 x 6.00 x 97.20

642 168



45° SS H

VAG96028 45.00 x 5.99 x 10.05



V94355 29.00 x 6.00 x 97.00

642 165

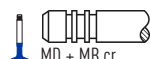

45° H

V94098 26.00 x 6.00 x 97.00

642 211

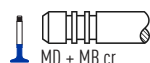

45° SS H

V94356 26.20 x 6.00 x 97.00

642 208

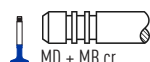

45° SS H

58 **84.80**

| | | | | | | | |
|----------------|-----------------|--------|-----------------|----------------|--------|--------------------------|---------------|
| 18 NV | 1796cc | 4 Cyl. | 8 Valves | 60kW/82PS | Petrol | SOHC, Carburettor | TD4751 |
| C 18 NV | 1796cc | 4 Cyl. | 8 Valves | 74kW/100PS | Petrol | SOHC, Carburettor | TD4792 |
| OMEGA A 1.8 N | 09/1986→08/1987 | | | REKORD E 1.8 E | | 05/1985→08/1986 | |

V91148 41.80 x 7.00 x 103.80

642 667

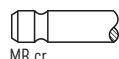

45° H

VAG96022 45.80 x 7.02 x 11.04



V91149 36.57 x 6.97 x 103.63

641 306

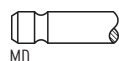

45°

59 **84.80**

| | | | | | | | |
|-------------------|-----------------|--------|-----------------|--------------------|--------|--------------------------|----------------|
| 18 SE | 1796cc | 4 Cyl. | 8 Valves | 82-85kW/112-116PS | Petrol | SOHC | TD4753 |
| 18 SEH | 1796cc | 4 Cyl. | 8 Valves | 85kW/115PS | Petrol | SOHC | TD4754 |
| 18 SV | 1796cc | 4 Cyl. | 8 Valves | 63-66kW/86-90PS | Petrol | SOHC, Carburettor | TD4755 |
| C 18 NZ | 1796cc | 4 Cyl. | 8 Valves | 66kW/90PS | Petrol | SOHC | TD4793 |
| E 18 NV | 1796cc | 4 Cyl. | 8 Valves | 62kW/84PS | Petrol | SOHC, Carburettor | TD4812 |
| E 18 NVR | 1796cc | 4 Cyl. | 8 Valves | 65kW/88PS | Petrol | SOHC, Carburettor | TD4813 |
| S 18 NV | 1796cc | 4 Cyl. | 8 Valves | 62-74kW/84-101PS | Petrol | SOHC, Carburettor | TD17891 |
| ASCONA C 1.8 | 09/1987→08/1988 | | | ASCONA C 1.8 E | | 01/1985→08/1986 | |
| ASTRA F 1.8 | 11/1991→07/1993 | | | ASTRA F 1.8 i | | 09/1991→09/1998 | |
| ASTRA F 1.8 i 16V | 09/1995→09/1996 | | | KADETT 1.8 i | | 09/1990→08/1991 | |
| KADETT E 1.8 | 01/1986→08/1991 | | | KADETT E 1.8 i | | 09/1984→08/1991 | |
| KADETT E 1.8 S | 09/1987→08/1991 | | | OMEGA A 1.8 | | 09/1986→03/1994 | |
| OMEGA A 1.8 N | 11/1986→09/1988 | | | OMEGA A 1.8 S | | 09/1986→03/1994 | |
| VECTRA A 1.8 i | 09/1988→10/1990 | | | VECTRA A 1.8 i Cat | | 03/1990→11/1995 | |
| VECTRA A 1.8 S | 09/1988→10/1990 | | | | | | |

V91148 41.80 x 7.00 x 103.80

642 667

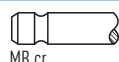

45° H

VAG96022 45.80 x 7.02 x 11.04

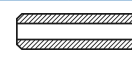

V91149 36.57 x 6.97 x 103.63
01/86→12/88

641 306

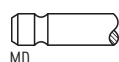

45°

V91150 36.47 x 6.97 x 103.67
01/89→

642 829

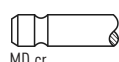

45°

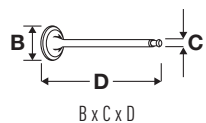

OE

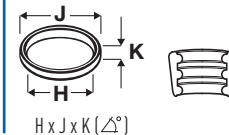
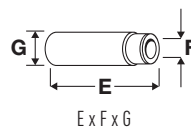
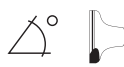

60 **84.80**

| | | | | | | | |
|----------------------------------|--------|------------------------------------|-----------------|----------------|--------|-----------------|---------------|
| C 18 NE | 1796cc | 4 Cyl. | 8 Valves | 74kW/100PS | Petrol | SOHC | TD4790 |
| C 18 NT | 1796cc | 4 Cyl. | 8 Valves | 66kW/90PS | Petrol | SOHC | TD4791 |
| ASCONA C 1.8 E KADETT E 1.8 i | | 01/1985→08/1986 08/1984→09/1992 | | KADETT E 1.8 E | | 10/1985→08/1986 | |

| | | | | | | |
|-----------------------|---------|-------|-----|---|----------------------|--|
| V91148 | 642 667 | | 45° | H | VAG96022 | |
| 41.80 x 7.00 x 103.80 | | MB cr | | | 45.80 x 7.02 x 11.04 | |
| V91150 | 642 829 | | 45° | | | |
| 36.47 x 6.97 x 103.67 | | MD cr | | | | |

61 **84.80**

| | | | | | | | |
|-------------------|--------|-----------------|------------------|------------|--------|-------------|----------------|
| C 18 SEL | 1796cc | 4 Cyl. | 16 Valves | 85kW/115PS | Petrol | DOHC | TD25435 |
| ASTRA F 1.8 i 16V | | 09/1995→08/1997 | | | | | |

| | | | | | | |
|-----------------------|---------|-------|-----|----|----------------------|--|
| V91997 | 641 022 | | 45° | H | VAG96028 | |
| 32.10 x 5.97 x 102.10 | | MB cr | | | 45.00 x 5.99 x 10.05 | |
| V91998 | 641 325 | | 45° | SS | | |
| 29.10 x 5.96 x 92.25 | | MD cr | | | | |

62 **85.00**

| | | | | | | | |
|-------------------|--------|----------|------------------|-----------------------|--------|--------------------|----------------|
| M9T 670 | 2298cc | 4 Cyl. | 16 Valves | 74-92kW/101-125PS | Diesel | Turbo, DOHC | TD25055 |
| M9T 672 | 2298cc | 4 Cyl. | 16 Valves | 74-92kW/101-125PS | Diesel | Turbo, DOHC | TD25226 |
| M9T 676 | 2298cc | 4 Cyl. | 16 Valves | 74-92kW/101-125PS | Diesel | Turbo, DOHC | TD25056 |
| M9T 678 | 2298cc | 4 Cyl. | 16 Valves | 107kW/146PS | Diesel | Turbo, DOHC | TD25157 |
| M9T 680 | 2298cc | 4 Cyl. | 16 Valves | 92-107kW/125-146PS | Diesel | Turbo, DOHC | TD25137 |
| M9T 686 | 2298cc | 4 Cyl. | 16 Valves | 92kW/125PS | Diesel | Turbo, DOHC | TD25231 |
| M9T 690 | 2298cc | 4 Cyl. | 16 Valves | 74-92kW/101-125PS | Diesel | Turbo, DOHC | TD25230 |
| M9T 692 | 2298cc | 4 Cyl. | 16 Valves | 74-92kW/101-125PS | Diesel | Turbo, DOHC | TD25224 |
| M9T 694 | 2298cc | 4 Cyl. | 16 Valves | 107-110kW/146-150PS | Diesel | Turbo, DOHC | TD25058 |
| M9T 696 | 2298cc | 4 Cyl. | 16 Valves | 92-110kW/125-150PS | Diesel | Turbo, DOHC | TD25225 |
| M9T 698 | 2298cc | 4 Cyl. | 16 Valves | 92-110kW/125-150PS | Diesel | Turbo, DOHC | TD25057 |
| M9T 880 | 2298cc | 4 Cyl. | 16 Valves | 110kW/150PS | Diesel | Turbo, DOHC | TD28582 |
| M9T 896 | 2298cc | 4 Cyl. | 16 Valves | 110kW/150PS | Diesel | Turbo, DOHC | TD28580 |
| M9T 898 | 2298cc | 4 Cyl. | 16 Valves | 110kW/150PS | Diesel | Turbo, DOHC | TD28581 |
| MOVANO B 2.3 CDTI | | 05/2010→ | | MOVANO B 2.3 CDTI RWD | | 05/2010→ | |

| | | | | | | | |
|-----------------------|---------|---------|-----|---|---|----------------------|--|
| V95001 | 4420439 | | 45° | Y | H | VAG96383B | |
| 27.70 x 5.98 x 103.90 | | MB | | | | 42.40 x 6.00 x 11.07 | |
| V95002 | 4431241 | | 45° | | H | | |
| 26.00 x 5.97 x 103.75 | | MD + MB | | | | | |



OE

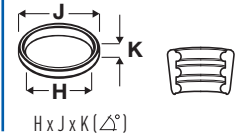
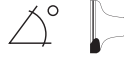

63 **86.00**

| | | | | | | | |
|----------------|-----------------|--------|-----------------|-------------------|--------|-----------------|---------------|
| 20 NE | 1998cc | 4 Cyl. | 8 Valves | 85-95kW/115-129PS | Petrol | SOHC | TD4759 |
| 20 SEH | 1998cc | 4 Cyl. | 8 Valves | 95kW/129PS | Petrol | SOHC | TD4763 |
| ASCONA C 2.0 i | 09/1986→08/1988 | | | ASCONA C 2.0 i GT | | 03/1987→08/1988 | |
| KADETT E 2.0 | 01/1986→12/1993 | | | KADETT E 2.0 GSI | | 09/1986→08/1991 | |
| KADETT E 2.0 i | 10/1986→02/1993 | | | REKORD E 2.0 | | 12/1983→12/1991 | |
| VECTRA A 2.0 i | 09/1988→09/1992 | | | VECTRA A 2.0 i GT | | 09/1988→11/1995 | |

V91148
41.80 x 7.00 x 103.80

642 667



45°

H

VAG96022
45.80 x 7.02 x 11.04



V91149
36.57 x 6.97 x 103.63
Eng.→J1216862

641 306

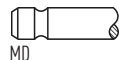

45°

V91150
36.47 x 6.97 x 103.67
Eng.J1216863→

642 829

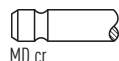

45°

64 **86.00**

| | | | | | | | |
|----------------|-----------------|--------|-----------------|------------|--------|-------------|---------------|
| 20 NEJ | 1998cc | 4 Cyl. | 8 Valves | 82kW/112PS | Petrol | SOHC | TD4761 |
| VECTRA B 2.0 i | 10/1995→04/2002 | | | | | | |

V91148
41.80 x 7.00 x 103.80

642 667

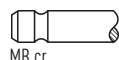

45°

H

VAG96022
45.80 x 7.02 x 11.04



V91149
36.57 x 6.97 x 103.63

641 306

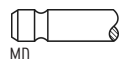

45°

65 **86.00**

| | | | | | | | |
|-----------------|--------|--------|-----------------|--------------------|--------|-------------|----------------|
| 20 SE | 1998cc | 4 Cyl. | 8 Valves | 85-90kW/115-122PS | Petrol | SOHC | TD2651 |
| 20 SER | 1998cc | 4 Cyl. | 8 Valves | 90-115kW/122-156PS | Petrol | SOHC | TD18871 |
| C 20 NE | 1998cc | 4 Cyl. | 8 Valves | 85kW/115PS | Petrol | SOHC | TD4799 |
| C 20 NEF | 1998cc | 4 Cyl. | 8 Valves | 74kW/100PS | Petrol | SOHC | TD5270 |
| C 20 NEJ | 1998cc | 4 Cyl. | 8 Valves | 73-74kW/99-100PS | Petrol | SOHC | TD4800 |
| X 20 SE | 1998cc | 4 Cyl. | 8 Valves | 85kW/115PS | Petrol | SOHC | TD2736 |

ASCONA C 2.0 i
ASTRA F 2.0 i
FRONTERA A 2.0 i
KADETT E 2.0 GSi
KADETT E 2.0 i
OMEGA A 2.0
OMEGA B 2.0
VECTRA A 2.0
VECTRA B 2.0 i

08/1987→08/1988
09/1991→09/1998
03/1992→10/1998
09/1990→05/1992
03/1987→05/1992
09/1986→04/1994
03/1994→12/2000
04/1988→09/1989
10/1995→04/2002

ASCONA C 2.0 i Cat
CALIBRA A 2.0 i
KADETT 2.0 i
KADETT E 2.0 GSI Cat
KADETT E 2.0 i Cat
OMEGA A 2.0 i
REKORD E 2.0
VECTRA A 2.0 i Cat

09/1986→08/1988
06/1990→07/1997
09/1994→05/2000
09/1986→08/1991
10/1986→02/1993
09/1986→04/1994
12/1983→12/1991
09/1988→11/1995

V91148
41.80 x 7.00 x 103.80

642 667

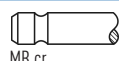

45°

H

VAG96022
45.80 x 7.02 x 11.04

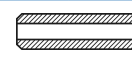

V91150
36.47 x 6.97 x 103.67

642 829

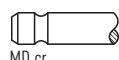

45°



OE

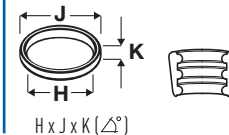
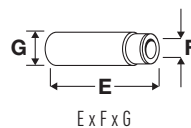

66 **86.00**

| | | | | | | | |
|--------------|--------|--------|------------------|-------------|--------|-------------|---------------|
| 20 XE | 1998cc | 4 Cyl. | 16 Valves | 115kW/156PS | Petrol | DOHC | TD4765 |
|--------------|--------|--------|------------------|-------------|--------|-------------|---------------|

| | | | | | | | |
|--|---------|-----------------|-----|------|---|--------------------------|--|
| KADETT E 2.0 GSI 16V | | 12/1987→08/1991 | | | | | |
| V91429 33.00 x 7.00 x 104.90 | 642 758 | MB cr | 45° | H | VAG96022 45.80 x 7.02 x 11.04 | 45.80 x 7.02 x 11.04 | |
| V91430 29.10 x 6.96 x 104.90 | 642 858 | MD + MB cr | 45° | SS H | | | |

67 **86.00**

| | | | | | | | |
|-----------------|--------|--------|------------------|---------------------|--------|-------------------------------|----------------|
| A 20 NHT | 1998cc | 4 Cyl. | 16 Valves | 162-184kW/220-250PS | Petrol | Turbo, DOHC, Injection | TD22593 |
| Z 20 NET | 1998cc | 4 Cyl. | 16 Valves | 129kW/175PS | Petrol | Turbo, DOHC | TD18146 |

| | | | | | | | |
|--|-----------------|----------------------|-----------------|------|---|--------------------------|--|
| INSIGNIA A 2.0 E85 Turbo | 09/2010→ | INSIGNIA A 2.0 Turbo | 07/2008→ | | | | |
| INSIGNIA A Tourer 2.0 Turbo | 07/2008→11/2014 | SIGNUM 2.0 Turbo | 05/2003→12/2008 | | | | |
| VECTRA C 2.0 16V Turbo | 03/2003→ | VECTRA C 2.0 Turbo | 10/2003→ | | | | |
| VECTRA C GTS 2.0 16V Turbo | 03/2003→ | | | | | | |
| V94962 35.15 x 6.00 x 102.20 | 641 063 | MB cr | 45° | H | VAG96028 45.00 x 5.99 x 10.05 | 45.00 x 5.99 x 10.05 | |
| V94963 30.10 x 6.00 x 100.90 | 641 376 | MD + MB cr | 45° | SS H | | | |

68 **86.00**

| | | | | | | | |
|-----------------|--------|--------|------------------|-------------|--------|--------------------|---------------|
| C 20 LET | 1998cc | 4 Cyl. | 16 Valves | 150kW/204PS | Petrol | Turbo, DOHC | TD4798 |
| C 20 XE | 1998cc | 4 Cyl. | 16 Valves | 110kW/150PS | Petrol | DOHC | TD4801 |

| | | | | | | | |
|--|-----------------|--------------------------|-----------------|------|--|--|--|
| ASTRA F 2.0 GSI 16V | 09/1991→01/1998 | ASTRA F 2.0 i 16V | 03/1993→01/1998 | | | | |
| CALIBRA A 2.0 i 16V | 06/1990→02/1994 | CALIBRA A 2.0 i Turbo | 03/1992→07/1997 | | | | |
| KADETT E 2.0 | 09/1990→05/1992 | KADETT E 2.0 GSI 16V Cat | 03/1988→08/1991 | | | | |
| VECTRA A 2.0 | 08/1989→08/1995 | VECTRA A 2.0 i 16V Cat | 02/1990→11/1995 | | | | |
| VECTRA A 2.0 i Turbo | 06/1994→11/1995 | VECTRA A 2000/GT 16V Cat | 02/1990→11/1995 | | | | |
| V91429 33.00 x 7.00 x 104.90 | 642 758 | MB cr | 45° | H | | | |
| V91430 29.10 x 6.96 x 104.90 | 642 858 | MD + MB cr | 45° | SS H | | | |

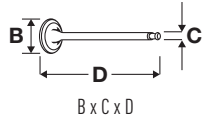

OE

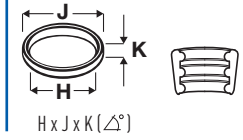
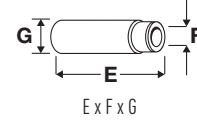
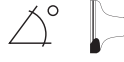

69



86.00

| | | | | | | | |
|----------|--------|--------|-----------|---------------------|--------|-------------|---------|
| C 20 SEL | 1998cc | 4 Cyl. | 16 Valves | 100kW/136PS | Petrol | DOHC | TD15968 |
| X 20 XER | 1998cc | 4 Cyl. | 16 Valves | 118kW/160PS | Petrol | DOHC | TD13690 |
| X 20 XEV | 1998cc | 4 Cyl. | 16 Valves | 100kW/136PS | Petrol | DOHC | TD2737 |
| Z 20 LEH | 1998cc | 4 Cyl. | 16 Valves | 177kW/240PS | Petrol | Turbo, DOHC | TD19201 |
| Z 20 LEL | 1998cc | 4 Cyl. | 16 Valves | 125kW/170PS | Petrol | Turbo, DOHC | TD18018 |
| Z 20 LER | 1998cc | 4 Cyl. | 16 Valves | 147kW/200PS | Petrol | Turbo, DOHC | TD18028 |
| Z 20 LET | 1998cc | 4 Cyl. | 16 Valves | 140-162kW/190-220PS | Petrol | Turbo, DOHC | TD15090 |

| | | | |
|-----------------------|-----------------|-----------------------|-----------------|
| ASTRA F 2.0 i 16V | 02/1995→09/1998 | ASTRA G 2.0 16V | 02/1998→01/2005 |
| ASTRA G 2.0 16V OPC | 11/1999→09/2002 | ASTRA G 2.0 16V Turbo | 09/2000→10/2005 |
| ASTRA G 2.0 OPC | 03/2002→10/2005 | ASTRA H 2.0 Turbo | 03/2004→10/2010 |
| ASTRA H GTC 2.0 Turbo | 03/2005→10/2010 | CALIBRA A 2.0 i 16V | 02/1994→07/1997 |
| OMEGA B 2.0 16V | 03/1994→09/1999 | SPEEDSTER 2.0 Turbo | 04/2003→ |
| VECTRA A 2.0 i 16V | 06/1994→11/1995 | VECTRA B 2.0 i 16V | 10/1995→09/2000 |
| ZAFIRA A MPV 2.0 OPC | 09/2001→06/2005 | ZAFIRA B 2.0 | 07/2005→ |

V91997 ■
32.10 x 5.97 x 102.10

641 022

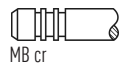

45°

H

VAG96029 ■
35.00 x 5.99 x 10.05



V91998 ■
29.10 x 5.96 x 92.25

641 325

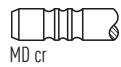

45°

SS

VAG96028 ■ ■
45.00 x 5.99 x 10.05



70



86.00

| | | | | | | | |
|----------|--------|--------|-----------|---------------------|--------|------|---------|
| C 22 SEL | 2198cc | 4 Cyl. | 16 Valves | 104kW/141PS | Petrol | DOHC | TD22202 |
| X 22 SE | 2198cc | 4 Cyl. | 16 Valves | 100-104kW/136-141PS | Petrol | DOHC | TD15849 |
| X 22 XE | 2198cc | 4 Cyl. | 16 Valves | 100-104kW/136-141PS | Petrol | DOHC | TD4827 |
| Y 22 SE | 2198cc | 4 Cyl. | 16 Valves | 100kW/136PS | Petrol | DOHC | TD15093 |
| Y 22 XE | 2198cc | 4 Cyl. | 16 Valves | 106kW/144PS | Petrol | DOHC | TD13048 |
| Z 22 XE | 2198cc | 4 Cyl. | 16 Valves | 106kW/144PS | Petrol | DOHC | TD15850 |

| | | | |
|------------------|-----------------|------------------|-----------------|
| FRONTERA A 2.2 i | 03/1995→10/1998 | FRONTERA B 2.2 i | 10/1998→ |
| OMEGA B 2.2 16V | 09/1999→07/2003 | SINTRA 2.2 i 16V | 11/1996→04/1999 |

V91997 ■
32.10 x 5.97 x 102.10

641 022

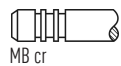

45°

H

VAG96029 ■
35.00 x 5.99 x 10.05



V91998 ■
29.10 x 5.96 x 92.25

641 325

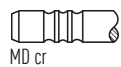

45°

SS

VAG96028 ■ ■
45.00 x 5.99 x 10.05



71



86.00

| | | | | | | | |
|---------|--------|--------|-----------|---------------------|--------|-----------------|---------|
| Z 22 SE | 2198cc | 4 Cyl. | 16 Valves | 108kW/147PS | Petrol | DOHC | TD14668 |
| Z 22 YH | 2198cc | 4 Cyl. | 16 Valves | 110-114kW/150-155PS | Petrol | DOHC, Injection | TD18020 |

| | | | |
|----------------------|-----------------|-------------------------|-----------------|
| ASTRA G 2.2 16V | 06/2000→10/2005 | SIGNUM 2.2 direct | 05/2003→09/2008 |
| SPEEDSTER 2.2 | 09/2000→ | VECTRA B 2.2 i 16V | 09/2000→07/2003 |
| VECTRA C 2.2 16V | 04/2002→ | VECTRA C 2.2 direct | 10/2003→ |
| VECTRA C GTS 2.2 16V | 08/2002→ | VECTRA C GTS 2.2 direct | 10/2003→ |
| ZAFIRA A MPV 2.2 16V | 09/2000→06/2005 | ZAFIRA B 2.2 | 07/2005→ |

V94962 ■
35.15 x 6.00 x 102.20

641 063

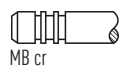

45°

H

VAG96028 ■ ■
45.00 x 5.99 x 10.05



V94963 ■
30.10 x 6.00 x 100.90

641 376



45°

SS

H



OE

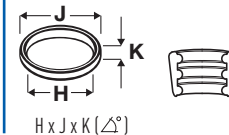
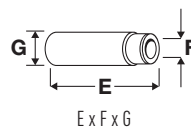
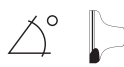

72 **86.00**

| | | | | | | | |
|-----------------------|-----------------|------------|------------------|---------------------|----------------------|-------------|---------------|
| X 30 XE | 2962cc | V6 Cyl. | 24 Valves | 148-155kW/201-211PS | Petrol | DOHC | TD2739 |
| OMEGA B 3.0 V6 | 04/1994→02/2001 | | SINTRA 3.0 i | | 11/1996→04/1999 | | |
| V91997 | 641 022 | | 45° | H | VAG96137 | | |
| 32.10 x 5.97 x 102.10 | | MB cr | | | 45.00 x 6.02 x 10.05 | | |
| V94542 | 641 331 | | 45° | ss H | | | |
| 29.00 x 6.00 x 92.25 | | MD + MB cr | | | | | |

73 **87.00**

| | | | | | | | |
|-----------------------|--------------|--------|------------------|-----------|----------------------|--------------------|----------------|
| G9T 720 | 2188cc | 4 Cyl. | 16 Valves | 66kW/90PS | Diesel | Turbo, DOHC | TD18875 |
| G9T 722 | 2188cc | 4 Cyl. | 16 Valves | 66kW/90PS | Diesel | Turbo, DOHC | TD21397 |
| G9T 750 | 2188cc | 4 Cyl. | 16 Valves | 66kW/90PS | Diesel | Turbo, DOHC | TD23885 |
| MOVANO 2.2 DTI | 09/2000→ | | | | | | |
| V94513 | 7701 472 669 | | 45° | H | VAG96361B | | |
| 30.70 x 6.00 x 123.10 | | MB | | | 50.00 x 6.00 x 11.05 | | |
| V94514 | 7701 472 670 | | 45° | | | | |
| 29.50 x 6.00 x 122.90 | | MD | | | | | |

74 **87.50**

| | | | | | | | |
|-----------------------|----------|--------|------------------|-------------|----------------------|-------------|----------------|
| Z 24 XE | 2405cc | 4 Cyl. | 16 Valves | 103kW/140PS | Petrol | DOHC | TD21016 |
| Z 24 XED | 2405cc | 4 Cyl. | 16 Valves | 104kW/141PS | Petrol | DOHC | TD19220 |
| ANTARA 2.4 | 05/2006→ | | ANTARA 2.4 LPG | | 10/2008→ | | |
| V91997 | 641 022 | | 45° | H | VAG96028 | | |
| 32.10 x 5.97 x 102.10 | | MB cr | | | 45.00 x 5.99 x 10.05 | | |
| V91998 | 641 325 | | 45° | ss | | | |
| 29.10 x 5.96 x 92.25 | | MD cr | | | | | |

75 **87.50**

| | | | | | | | |
|-----------------------|-----------------|---------|------------------|-------------|----------------------|-------------|----------------|
| Y 32 SE | 3175cc | V6 Cyl. | 24 Valves | 160kW/218PS | Petrol | DOHC | TD15851 |
| OMEGA B 3.2 V6 | 02/2001→07/2003 | | | | | | |
| V91997 | 641 022 | | 45° | H | VAG96028 | | |
| 32.10 x 5.97 x 102.10 | | MB cr | | | 45.00 x 5.99 x 10.05 | | |
| V91998 | 641 325 | | 45° | ss | | | |
| 29.10 x 5.96 x 92.25 | | MD cr | | | | | |

76 **88.00**

| | | | | | | | |
|-----------------------|-----------------|--------|-----------------|-----------------|----------------------|------------|----------------|
| C 223 | 2238cc | 4 Cyl. | 8 Valves | 39-54kW/53-73PS | Diesel | OHV | TD22878 |
| CAMPO 2.2 D | 08/1987→09/1996 | | | | | | |
| V91498 | 5-12552-034-2 | | 45° | st | VAG92372 | | |
| 34.10 x 7.94 x 115.80 | | MD tu | | | 50.00 x 8.00 x 14.03 | | |

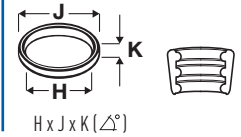

OE

77

88.50

| | | | | | | | |
|---------------------|-----------------|---------|------------------|-----------------|--------|-------------|----------------|
| Z 32 SE | 3175cc | V6 Cyl. | 24 Valves | 155kW/211PS | Petrol | DOHC | TD18013 |
| SIGNUM 3.2 V6 | 05/2003→07/2005 | | | VECTRA C 3.2 V6 | | 08/2002→ | |
| VECTRA C GTS 3.2 V6 | 08/2002→ | | | | | | |

V91997

32.10 x 5.97 x 102.10

641 022



45°

H

VAG96028

45.00 x 5.99 x 10.05

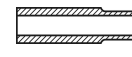
V91998

29.10 x 5.96 x 92.25

641 325



45°

SS

78

89.00

| | | | | | | | |
|------------------|----------|--------|------------------|--------------------|--------|--------------------|----------------|
| G9U 630 | 2464cc | 4 Cyl. | 16 Valves | 84-107kW/114-146PS | Diesel | Turbo, DOHC | TD20987 |
| G9U 632 | 2464cc | 4 Cyl. | 16 Valves | 88-107kW/120-146PS | Diesel | Turbo, DOHC | TD21014 |
| G9U 650 | 2464cc | 4 Cyl. | 16 Valves | 74-107kW/101-146PS | Diesel | Turbo, DOHC | TD21012 |
| G9U 720 | 2464cc | 4 Cyl. | 16 Valves | 84-85kW/114-116PS | Diesel | Turbo, DOHC | TD18874 |
| G9U 724 | 2464cc | 4 Cyl. | 16 Valves | 84kW/115PS | Diesel | Turbo, DOHC | TD19367 |
| G9U 730 | 2464cc | 4 Cyl. | 16 Valves | 99kW/135PS | Diesel | Turbo, DOHC | TD18497 |
| G9U 750 | 2464cc | 4 Cyl. | 16 Valves | 84kW/115PS | Diesel | Turbo, DOHC | TD23887 |
| G9U 754 | 2464cc | 4 Cyl. | 16 Valves | 73-84kW/99-115PS | Diesel | Turbo, DOHC | TD19817 |
| MOVANO 2.5 CDTi | 10/2003→ | | | MOVANO 2.5 DTi | | 10/2001→ | |
| MOVANO 2.5 DTi | 10/2003→ | | | VIVARO A 2.5 CDTi | | 08/2006→ | |
| VIVARO A 2.5 DTi | 08/2003→ | | | VIVARO A 2.5 DTi | | 05/2003→ | |

V94513

30.70 x 6.00 x 123.10

7701 472 669

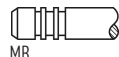

45°

H

VAG96361B

50.00 x 6.00 x 11.05

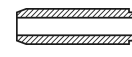
V94514

29.50 x 6.00 x 122.90

7701 472 670

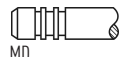

45°

79

92.00

| | | | | | | | |
|-------------------|-----------------|--------|-----------------|----------------|--------|--------------------|---------------|
| 23 DTR | 2260cc | 4 Cyl. | 8 Valves | 74kW/100PS | Diesel | Turbo, SOHC | TD4767 |
| 23 YDT | 2260cc | 4 Cyl. | 8 Valves | 66kW/90PS | Diesel | Turbo, SOHC | TD4769 |
| FRONTERA A 2.3 TD | 03/1992→10/1998 | | | OMEGA A 2.3 TD | | 09/1986→03/1994 | |

V91433

42.10 x 8.01 x 127.20

642 683

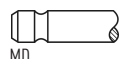

45°

80

92.00

| | | | | | | | |
|-----------------------|-----------------|--------|-----------------|------------|--------|-------------------|---------------|
| 25 TDS (VM41B) | 2499cc | 4 Cyl. | 8 Valves | 85kW/115PS | Diesel | Turbo, OHV | TD2673 |
| FRONTERA A 2.5 TDS | 09/1996→10/1998 | | | | | | |

V91437

40.00 x 8.00 x 121.00

605 07 189

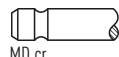

35°

VAG96187

55.00 x 8.02 x 14.06

V91438

34.00 x 8.00 x 121.00

605 07 190

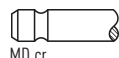

45°



OE

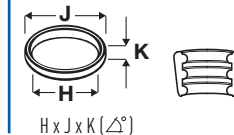
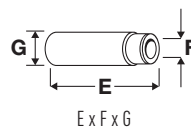

81 **93.00**

| | | | | | | | |
|----------------|--------|--------|-----------------|-----------------|--------|--------------------|----------------|
| S8U 758 | 2500cc | 4 Cyl. | 8 Valves | 55-58kW/75-79PS | Diesel | SOHC | TD22880 |
| S8U 770 | 2500cc | 4 Cyl. | 8 Valves | 59kW/80PS | Diesel | Turbo, SOHC | TD22881 |
| S8U 772 | 2500cc | 4 Cyl. | 8 Valves | 59kW/80PS | Diesel | SOHC | TD23888 |
| S8U 780 | 2500cc | 4 Cyl. | 8 Valves | 55kW/75PS | Diesel | SOHC | TD22882 |
| S8U 782 | 2500cc | 4 Cyl. | 8 Valves | 55kW/75PS | Diesel | SOHC | TD24143 |

ARENA 2.5 D 03/1998→08/2001 MOVANO 2.5 D 07/1998→09/2000

| | | | | | | | |
|-----------------------|--------------|------------|-----|---|---|----------------------|--|
| V91292 | 7701 463 603 | | 30° | Y | H | VAG92369 | |
| 40.80 x 8.00 x 120.70 | | MB cr | | | | 60.00 x 8.00 x 13.07 | |
| V91940 | 7701 467 249 | | 45° | | H | VAG92373 | |
| 36.70 x 8.00 x 122.00 | | MD + MB cr | | | | 56.00 x 8.03 x 13.04 | |

82 **93.40**

| | | | | | | | |
|--------------|--------|---------|------------------|---------------------|--------|-------------|----------------|
| 6 VD1 | 3165cc | V6 Cyl. | 24 Valves | 130-151kW/177-205PS | Petrol | DOHC | TD10627 |
|--------------|--------|---------|------------------|---------------------|--------|-------------|----------------|

FRONTERA B 3.2 i 10/1998→ MONTEREY A 3.2 06/1992→07/1998

| | | | | | | | |
|-----------------------|---------|-------|-----|--|--|--|--|
| V94344 | 641 360 | | 45° | | | | |
| 29.00 x 6.00 x 103.50 | | MD tu | | | | | |

83 **94.40**

| | | | | | | | |
|----------------|--------|--------|-----------------|------------|--------|--------------------|----------------|
| S9W 700 | 2800cc | 4 Cyl. | 8 Valves | 84kW/114PS | Diesel | Turbo, SOHC | TD21149 |
|----------------|--------|--------|-----------------|------------|--------|--------------------|----------------|

MOVANO 2.8 DTI 07/1998→10/2001

| | | | | | | | |
|-----------------------|--------------|------------|-----|---|---|----------------------|--|
| V91292 | 7701 463 603 | | 30° | Y | H | VAG92193 | |
| 40.80 x 8.00 x 120.70 | | MB cr | | | | 56.00 x 8.04 x 13.05 | |
| V91940 | 7701 467 249 | | 45° | | H | VAG92369 | |
| 36.70 x 8.00 x 122.00 | | MD + MB cr | | | | 60.00 x 8.00 x 13.07 | |
| | | | | | | VAG92373 | |
| | | | | | | 56.00 x 8.03 x 13.04 | |
| | | | | | | VAG96190 | |
| | | | | | | 56.00 x 8.04 x 13.13 | |

84 **94.40**

| | | | | | | | |
|----------------|--------|--------|-----------------|------------|--------|--------------------|----------------|
| S9W 702 | 2800cc | 4 Cyl. | 8 Valves | 84kW/114PS | Diesel | Turbo, SOHC | TD19360 |
|----------------|--------|--------|-----------------|------------|--------|--------------------|----------------|

MOVANO 2.8 DTI 07/1998→10/2001

| | | | | | | | |
|-----------------------|--------------|------------|-----|---|---|----------------------|--|
| V91292 | 7701 463 603 | | 30° | Y | H | VAG92369 | |
| 40.80 x 8.00 x 120.70 | | MB cr | | | | 60.00 x 8.00 x 13.07 | |
| V91940 | 7701 467 249 | | 45° | | H | | |
| 36.70 x 8.00 x 122.00 | | MD + MB cr | | | | | |

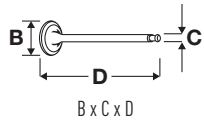

OE

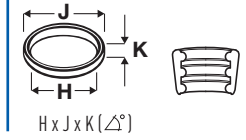
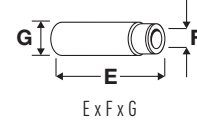
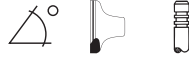







85

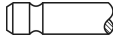

95.40

| | | | | | | | |
|--------------|-----------------|--------|-------------------|------------|-----------------|------------|--------|
| 4 JG2T | 3059cc | 4 Cyl. | 8 Valves | 80kW/109PS | Diesel | Turbo, OHV | TD5448 |
| 4 JG2TC | 3059cc | 4 Cyl. | 8 Valves | 84kW/114PS | Diesel | Turbo, OHV | TD2715 |
| CAMPO 3.1 TD | 12/1992→06/2001 | | MONTEREY A 3.1 TD | | 09/1991→07/1998 | | |

| | | | | |
|--|---------|--|-----|----|
| V94662 ■ 40.10 x 8.00 x 117.50 | 641 020 |  MD tu | 45° | st |
| V94663 ■ 35.70 x 8.00 x 117.50 | 641 324 |  MD tu | 45° | st |

|  |  | ccm |  |  |  |  |
|---|---|------|--|---|---|---|
| 1004-4 | 100.00 | 3990 | 4 | 8 | Diesel | 15 |
| 1004-40 | 100.00 | 3990 | 4 | 8 | Diesel | 15 |
| 1004-40T | 100.00 | 3990 | 4 | 8 | Diesel | 16 |
| 1006-6 | 100.00 | 5984 | 6 | 12 | Diesel | 17 |
| 1006-60 | 100.00 | 5984 | 6 | 12 | Diesel | 17 |
| 1006-60T | 100.00 | 5984 | 6 | 12 | Diesel | 18 |
| 3.144 | 88.90 | 2365 | 3 | 6 | Diesel | 3 |
| 3.152 | 91.44 | 2490 | 3 | 6 | Diesel | 6 |
| 4.107 | 79.37 | 1760 | 4 | 8 | Diesel | 2 |
| 4.108 | 79.37 | 1760 | 4 | 8 | Diesel | 2 |
| 4.192 | 88.90 | 3150 | 4 | 8 | Diesel | 4 |
| 4.236 | 98.50 | 3864 | 4 | 8 | Diesel | 11 |
| 4.99 | 76.20 | 1624 | 4 | 8 | Diesel | 1 |
| 6.288 | 88.90 | 4730 | 6 | 12 | Diesel | 5 |
| 6.305 | 91.44 | 5000 | 6 | 12 | Diesel | 7 |
| 6.354 | 98.50 | 5794 | 6 | 12 | Diesel | 12 |
| 6.354.2 | 98.50 | 5794 | 6 | 12 | Diesel | 13 |
| 6.354.4 | 98.48 | 5794 | 6 | 12 | Diesel | 10 |
| 6.372 | 101.05 | 6100 | 6 | 12 | Diesel | 20 |
| Phaser 110 T | 100.00 | 3990 | 4 | 8 | Diesel | 16 |
| Phaser 160T | 100.00 | 5985 | 6 | 12 | Diesel | 19 |
| T4.236 | 98.40 | 3864 | 4 | 8 | Diesel | 8 |
| T6.354 | 98.50 | 5794 | 6 | 12 | Diesel | 14 |
| T6.3544 | 98.40 | 5794 | 6 | 12 | Diesel | 9 |



OE

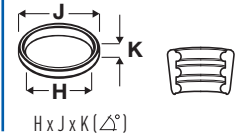
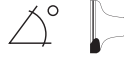

1  **76.20**

4.99 1624cc 4 Cyl. 8 Valves 37kW/50PS Diesel TD6580

V3251 ■
35.99 x 7.95 x 117.04

732 101 M1

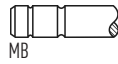

45°

H

VAG701 ■
54.00 x 8.03 x 12.77



VAG586 ■
62.00 x 8.01 x 12.76

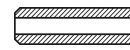

2  **79.37**

4.107 1760cc 4 Cyl. 8 Valves 30kW/41PS Diesel TD6333

4.108 1760cc 4 Cyl. 8 Valves 36-42kW/49-57PS Diesel TD6334

F-Serie 04/1974→12/1985

V3251 ■
35.99 x 7.95 x 117.04

732 101 M1

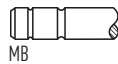

45°

H

VAG701 ■
54.00 x 8.03 x 12.77



VAG586 ■
62.00 x 8.01 x 12.76



3  **88.90**

3.144 2365cc 3 Cyl. 6 Valves 22-28kW/30-38PS Diesel TD6787

V94517 ■
39.00 x 8.00 x 114.30

3646.01

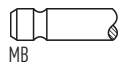

45°

H

VAG586 ■
62.00 x 8.01 x 12.76



V94518 ■
33.40 x 8.00 x 114.30

3647.02

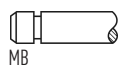

45°

H

VAG93 ■ ■
65.90 x 7.94 x 12.74

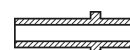

4  **88.90**

4.192 3150cc 4 Cyl. 8 Valves 29-37kW/39-50PS Diesel TD6396

V94517 ■
39.00 x 8.00 x 114.30

3646.01

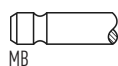

45°

H

VAG586 ■
62.00 x 8.01 x 12.76



V94518 ■
33.40 x 8.00 x 114.30

3647.02

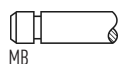

45°

H

VAG93 ■ ■
65.90 x 7.94 x 12.74

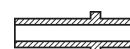

5  **88.90**

6.288 4730cc 6 Cyl. 12 Valves 45kW/61PS Diesel TD6498

V94517 ■
39.00 x 8.00 x 114.30

3646.01

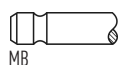

45°

H

VAG586 ■
62.00 x 8.01 x 12.76



V94518 ■
33.40 x 8.00 x 114.30

3647.02

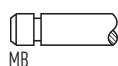

45°

H

VAG93 ■ ■
65.90 x 7.94 x 12.74



6  **91.44**

3.152 2490cc 3 Cyl. 6 Valves 22-33kW/30-45PS Diesel OHV TD6788

V94517 ■
39.00 x 8.00 x 114.30

3646.01



45°

H

VAG586 ■
62.00 x 8.01 x 12.76

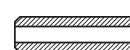

V94518 ■
33.40 x 8.00 x 114.30

3647.02

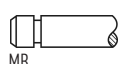

45°

H

VAG93 ■ ■
65.90 x 7.94 x 12.74

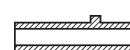

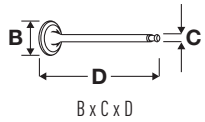

OE

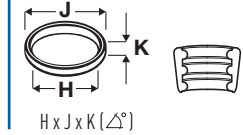
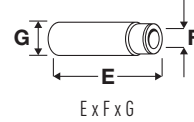
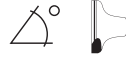

7 **91.44**

| 6.305 | 5000cc | 6 Cyl. | 12 Valves | 73kW/100PS | Diesel | TD6399 |
|-----------------------|---------|--------|-----------|------------|----------------------|--------|
| V94517 | 3646.01 | MB | 45° | H | VAG586 | |
| 39.00 x 8.00 x 114.30 | | | | | 62.00 x 8.01 x 12.76 | |
| V94518 | 3647.02 | MB | 45° | H | VAG93 | |
| 33.40 x 8.00 x 114.30 | | | | | 65.90 x 7.94 x 12.74 | |

8 **98.40**

| T4.236 | 3864cc | 4 Cyl. | 8 Valves | 66-76kW/90-103PS | Diesel | Turbo | TD6746 |
|-----------------------|-----------|-----------|----------|------------------|----------------------|-------|----------------------------|
| Delivery | | | | | | | |
| V91183 | 3142 H002 | MB cr | 30° | H | VAG92299 | | VS6072 [5] |
| 44.30 x 9.48 x 122.80 | | | | | 58.00 x 9.55 x 15.92 | | 31.70 x 42.70 x 9.50 (45°) |
| V91184 | 3142 A052 | MD cr | 45° | | VAG92300 | | |
| 36.70 x 9.47 x 123.40 | | | | | 61.00 x 9.55 x 15.92 | | |

[5] Fully finished

[5] Fertiggeschliffene

[5] Entierement finis

[5] Totalmente acabada

[5] Finite

9 **98.40**

| T6.3544 | 5794cc | 6 Cyl. | 12 Valves | 110-119kW/150-162PS | Diesel | Turbo | TD8703 |
|-----------------------|-----------|----------------|-----------|---------------------|----------------------|-------|--------|
| V35042 | 3143 1315 | MB cr | 45° | H | VAG92299 | | |
| 44.35 x 9.49 x 123.11 | | | | | 58.00 x 9.55 x 15.92 | | |
| V91248 | 3142 A051 | MD + MB cr | 45° | H | VAG92300 | | |
| 37.40 x 9.46 x 123.50 | | | | | 61.00 x 9.55 x 15.92 | | |

10 **98.48**

| 6.354.4 | 5794cc | 6 Cyl. | 12 Valves | 94kW/128PS | Diesel | TD6546 |
|-----------------------|-----------|----------------|-----------|------------|----------------------|--------|
| V35042 | 3143 1315 | MB cr | 45° | H | VAG601 | |
| 44.35 x 9.49 x 123.11 | | | | | 58.00 x 9.55 x 15.94 | |
| V91248 | 3142 A051 | MD + MB cr | 45° | H | VAG92299 | |
| 37.40 x 9.46 x 123.50 | | | | | 58.00 x 9.55 x 15.92 | |
| | | | | | VAG92300 | |
| | | | | | 61.00 x 9.55 x 15.92 | |

11 **98.50**

| 4.236 | 3864cc | 4 Cyl. | 8 Valves | 55-65kW/75-88PS | Diesel | TD6398 |
|-----------------------|-----------|-----------------|----------|-----------------|----------------------|-------------------|
| Delivery | | 01/1982→10/1986 | | L-Serie | | 05/1982→12/1985 |
| V35042 | 3143 1315 | MB cr | 45° | H | VAG601 | |
| 44.35 x 9.49 x 123.11 | | | | | 58.00 x 9.55 x 15.94 | VS6072 [5] |
| V34025 | 0910064 | MD | 45° | | VAG92299 | |
| 36.70 x 9.55 x 123.52 | | | | | 58.00 x 9.55 x 15.92 | |
| V34789 | 3143 1881 | MB | 45° | H | VAG92300 | |
| 36.70 x 9.47 x 123.32 | | | | | 61.00 x 9.55 x 15.92 | |

[5] Fully finished

[5] Fertiggeschliffene

[5] Entierement finis

[5] Totalmente acabada

[5] Finite



OE





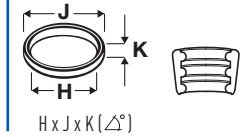





E x F x G

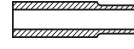

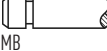
H x J x K (Δ°)

12  98.50

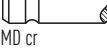
| 6.354 | 5794cc | 6 Cyl. | 12 Valves | 71-82kW/97-112PS | Diesel | | TD6713 |
|---|-----------|--|-----------|------------------|---|---|---|
| V35042  | 3143 1315 |  MB cr | 45° | H | VAG92299  |  | VS6072  [5] |
| 44.35 x 9.49 x 123.11 | | | | | 58.00 x 9.55 x 15.92 | | 31.70 x 42.70 x 9.50 (45°) |
| V94519  | 3650.01 |  MB | 45° | H | VAG92300  |  | |
| 44.20 x 9.50 x 122.90 | | | | | 61.00 x 9.55 x 15.92 | | |
| V91184  | 3142 A052 |  MD cr | 45° | | | | |
| 36.70 x 9.47 x 123.40 | | | | | | | |

[5] Fully finished









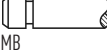

[5] Fertiggeschliffene

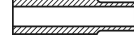
[5] Entierement finis

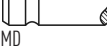
[5] Totalmente acabada

[5] Finite

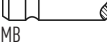
13  98.50

| 6.354.2 | 5794cc | 6 Cyl. | 12 Valves | 84-87kW/114-118PS | Diesel | | TD6548 |
|---|-----------|---|-----------|-------------------|---|---|---|
| V94519  | 3650.01 |  MB | 45° | H | VAG601  |  | VS6072  [5] |
| 44.20 x 9.50 x 122.90 | | | | | 58.00 x 9.55 x 15.94 | | 31.70 x 42.70 x 9.50 (45°) |
| V34025  | 0910064 |  MD | 45° | | VAG92299  |  | |
| 36.70 x 9.55 x 123.52 | | | | | 58.00 x 9.55 x 15.92 | | |
| V34789  | 3143 1881 |  MB | 45° | H | VAG92300  |  | |
| 36.70 x 9.47 x 123.32 | | | | | 61.00 x 9.55 x 15.92 | | |

[5] Fully finished





[5] Fertiggeschliffene

[5] Entierement finis





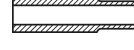

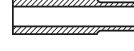

[5] Totalmente acabada

[5] Finite

14  98.50

| T6.354 | 5794cc | 6 Cyl. | 12 Valves | 119kW/162PS | Diesel | Turbo | TD6712 |
|---|---------|---|-----------|-------------|---|---|--------|
| V94519  | 3650.01 |  MB | 45° | H | VAG92299  |  | |
| 44.20 x 9.50 x 122.90 | | | | | 58.00 x 9.55 x 15.92 | | |
| | | | | | VAG92300  |  | |
| | | | | | 61.00 x 9.55 x 15.92 | | |

15  100.00

| 1004-4 | 3990cc | 4 Cyl. | 8 Valves | 63kW/86PS | Diesel | OHV | TD29134 |
|---|-----------|---|----------|-----------------|---|---|---------|
| 1004-40 | 3990cc | 4 Cyl. | 8 Valves | 48-52kW/65-71PS | Diesel | OHV | TD20891 |
| V91247  | 3142 L051 |  MB cr | 45° | H | VAG92299  |  | |
| 45.00 x 9.49 x 122.90 | | | | | 58.00 x 9.55 x 15.92 | | |
| V91248  | 3142 A051 |  MD + MB cr | 45° | H | VAG92300  |  | |
| 37.40 x 9.46 x 123.50 | | | | | 61.00 x 9.55 x 15.92 | | |

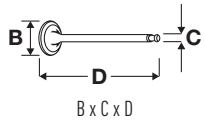

OE

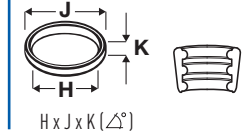
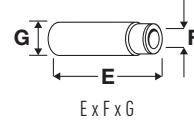
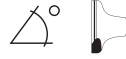

16 100.00

| | | | | | | | |
|--------------|--------|----------|----------|------------------|--------|----------------|---------|
| 1004-40T | 3990cc | 4 Cyl. | 8 Valves | 67-75kW/91-102PS | Diesel | Turbo, OHV | TD29133 |
| Phaser 110 T | 3990cc | 4 Cyl. | 8 Valves | 82kW/111PS | Diesel | 1004-4T, Turbo | TD8659 |
| VISION | | 04/2002→ | | | | | |

| | | | | | | |
|--|-----------|------------|-----|---|---|--|
| V91249 ■ 45.10 x 9.49 x 123.00 →12/98 | 3142 L071 | MD + MB cr | 45° | H | VAG92299 ■ 58.00 x 9.55 x 15.92 | |
| V91250 ■ 45.00 x 9.49 x 123.00 01/92→ | 3142 L072 | MD + MB cr | 30° | H | VAG92300 ■ 61.00 x 9.55 x 15.92 | |
| V91248 ■ 37.40 x 9.46 x 123.50 | 3142 A051 | MD + MB cr | 45° | H | | |

17 100.00

| | | | | | | | |
|---------|--------|--------|-----------|------------|--------|-----|---------|
| 1006-6 | 5984cc | 6 Cyl. | 12 Valves | 96kW/131PS | Diesel | OHV | TD29135 |
| 1006-60 | 5984cc | 6 Cyl. | 12 Valves | 79kW/107PS | Diesel | OHV | TD29136 |

| | | | | | | |
|--|-----------|------------|-----|---|---|--|
| V91247 ■ 45.00 x 9.49 x 122.90 | 3142 L051 | MB cr | 45° | H | VAG92299 ■ 58.00 x 9.55 x 15.92 | |
| V91248 ■ 37.40 x 9.46 x 123.50 | 3142 A051 | MD + MB cr | 45° | H | VAG92300 ■ 61.00 x 9.55 x 15.92 | |

18 100.00

| | | | | | | | |
|----------|--------|--------|-----------|-------------|--------|------------|---------|
| 1006-60T | 5984cc | 6 Cyl. | 12 Valves | 112kW/152PS | Diesel | Turbo, OHV | TD29137 |
|----------|--------|--------|-----------|-------------|--------|------------|---------|

| | | | | | | |
|--|-----------|------------|-----|---|---|--|
| V91249 ■ 45.10 x 9.49 x 123.00 →12/98 | 3142 L071 | MD + MB cr | 45° | H | VAG92299 ■ 58.00 x 9.55 x 15.92 | |
| V91250 ■ 45.00 x 9.49 x 123.00 01/92→ | 3142 L072 | MD + MB cr | 30° | H | VAG92300 ■ 61.00 x 9.55 x 15.92 | |
| V91248 ■ 37.40 x 9.46 x 123.50 | 3142 A051 | MD + MB cr | 45° | H | | |

19 100.00

| | | | | | | | |
|-------------|--------|--------|-----------|-------------|--------|----------------|--------|
| Phaser 160T | 5985cc | 6 Cyl. | 12 Valves | 119kW/160PS | Diesel | 1006-6T, Turbo | TD6547 |
|-------------|--------|--------|-----------|-------------|--------|----------------|--------|

| | | | | | | |
|--|-----------|------------|-----|---|---|--|
| V91249 ■ 45.10 x 9.49 x 123.00 →12/98 | 3142 L071 | MD + MB cr | 45° | H | VAG92299 ■ 58.00 x 9.55 x 15.92 | |
| V91250 ■ 45.00 x 9.49 x 123.00 01/92→ | 3142 L072 | MD + MB cr | 30° | H | VAG92300 ■ 61.00 x 9.55 x 15.92 | |
| V91248 ■ 37.40 x 9.46 x 123.50 | 3142 A051 | MD + MB cr | 45° | H | | |

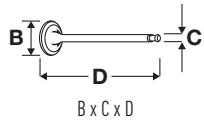

OE

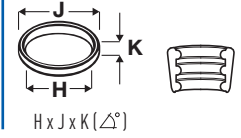
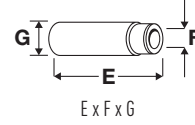

20



101.05

6.372

6100cc

6 Cyl.

12 Valves

87kW/118PS

Diesel

TD20102

V94519 ■

44.20 x 9.50 x 122.90

3650.01

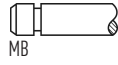

45°

H

VAG92299 ■







58.00 x 9.55 x 15.92

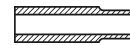













VAG92300 ■







61.00 x 9.55 x 15.92



|  |  | ccm |  |  |  |  |
|---|---|------|--|---|---|---|
| 199 A9.000 | 69.60 | 1248 | 4 | 16 | Diesel | 1 |
| 1KR-FE | 71.00 | 998 | 3 | 12 | Petrol | 3 |
| 222A2 | 86.40 | 1581 | 4 | 8 | Petrol | 64 |
| 384F (CFA) | 71.00 | 998 | 3 | 12 | Petrol | 3 |
| 8140.43N | 94.40 | 2800 | 4 | 8 | Diesel | 80 |
| 8140.43S (F28DTCR) | 94.40 | 2800 | 4 | 8 | Diesel | 80 |
| DJ5 (T9A) | 92.00 | 2446 | 4 | 12 | Diesel | 75 |
| DJ5T (T8A/THZ) | 92.00 | 2446 | 4 | 12 | Diesel | 76 |
| DJ5TED (THX) | 92.00 | 2446 | 4 | 8 | Diesel | 77 |
| DK5ATE (THY) | 92.00 | 2446 | 4 | 12 | Diesel | 75 |
| DT17 (UHZ) | 81.00 | 2721 | 6 | 24 | Diesel | 28 |
| DT17BTED4 (UHZ) | 81.00 | 2721 | 6 | 24 | Diesel | 28 |
| DT17TED4 | 81.00 | 2721 | 6 | 24 | Diesel | 28 |
| DT20C | 84.00 | 2993 | 6 | 24 | Diesel | 42 |
| DV4C (8HP) | 73.70 | 1398 | 4 | 8 | Diesel | 6 |
| DV4C (8HR) | 73.70 | 1398 | 4 | 8 | Diesel | 7 |
| DV4TD (8HT) | 73.70 | 1398 | 4 | 8 | Diesel | 6 |
| DV4TD (8HX) | 73.70 | 1398 | 4 | 8 | Diesel | 6 |
| DV4TD (8HZ) | 73.70 | 1398 | 4 | 8 | Diesel | 6 |
| DV6ATED4 (9HV) | 75.00 | 1560 | 4 | 16 | Diesel | 15 |
| DV6ATED4 (9HX) | 75.00 | 1560 | 4 | 16 | Diesel | 15 |
| DV6AUTED4 (9HX) | 75.00 | 1560 | 4 | 16 | Diesel | 15 |
| DV6BTED4 (9HT) | 75.00 | 1560 | 4 | 16 | Diesel | 15 |
| DV6BTED4 (9HW) | 75.00 | 1560 | 4 | 16 | Diesel | 15 |
| DV6C (9HD) | 75.00 | 1560 | 4 | 8 | Diesel | 16 |
| DV6C (9HL) | 75.00 | 1560 | 4 | 8 | Diesel | 16 |
| DV6C (9HR) | 75.00 | 1560 | 4 | 8 | Diesel | 16 |
| DV6CTED (9HD) | 75.00 | 1560 | 4 | 8 | Diesel | 16 |
| DV6DTE (9HP) | 75.00 | 1560 | 4 | 8 | Diesel | 16 |
| DV6DTE (9HJ) | 75.00 | 1560 | 4 | 8 | Diesel | 16 |
| DV6DUM (9HH) | 75.00 | 1560 | 4 | 8 | Diesel | 16 |
| DV6ETED (9HN) | 75.00 | 1560 | 4 | 8 | Diesel | 16 |
| DV6ETED (9HK) | 75.00 | 1560 | 4 | 8 | Diesel | 16 |
| DV6FC (BHZ) | 75.00 | 1560 | 4 | 8 | Diesel | 16 |
| DV6TED4 (9HV) | 75.00 | 1560 | 4 | 16 | Diesel | 15 |
| DV6TED4 (9HY) | 75.00 | 1560 | 4 | 16 | Diesel | 15 |
| DV6TED4 (9HZ) | 75.00 | 1560 | 4 | 16 | Diesel | 15 |
| DV6TED4BU (9HS) | 75.00 | 1560 | 4 | 16 | Diesel | 15 |
| DV6UC (9HM) | 75.00 | 1560 | 4 | 8 | Diesel | 16 |
| DV6UTED4 (9HU) | 75.00 | 1560 | 4 | 16 | Diesel | 15 |
| DW10 C HYBRID (RHC) | 85.00 | 1997 | 4 | 16 | Diesel | 43 |
| DW10ATED (RHS) | 85.00 | 1997 | 4 | 8 | Diesel | 44 |
| DW10ATED (RHZ) | 85.00 | 1997 | 4 | 8 | Diesel | 44 |
| DW10ATED4 (RHM) | 85.00 | 1997 | 4 | 16 | Diesel | 45 |
| DW10ATED4 (RHT) | 85.00 | 1997 | 4 | 16 | Diesel | 45 |
| DW10ATED4 (RHW) | 85.00 | 1997 | 4 | 16 | Diesel | 45 |
| DW10BTED (RHX) | 85.00 | 1997 | 4 | 8 | Diesel | 44 |
| DW10BTED4 (RHF) | 85.00 | 1997 | 4 | 16 | Diesel | 43 |
| DW10BTED4 (RHR) | 85.00 | 1997 | 4 | 16 | Diesel | 46 |
| DW10CTED4 (RHD) | 85.00 | 1997 | 4 | 16 | Diesel | 47 |
| DW10CTED4 (RHE) | 85.00 | 1997 | 4 | 16 | Diesel | 43 |
| DW10CTED4 (RHH) | 85.00 | 1997 | 4 | 16 | Diesel | 43 |
| DW10FC (AHW) | 85.00 | 1997 | 4 | 16 | Diesel | 48 |
| DW10FD (AHV) | 85.00 | 1997 | 4 | 16 | Diesel | 48 |
| DW10FD (AHX) | 85.00 | 1997 | 4 | 16 | Diesel | 48 |
| DW10TD (RHV) | 85.00 | 1997 | 4 | 8 | Diesel | 44 |
| DW10TD (RHY) | 85.00 | 1997 | 4 | 8 | Diesel | 44 |
| DW10UTD (RHV) | 85.00 | 1997 | 4 | 8 | Diesel | 44 |
| DW10UTED4 (RHK) | 85.00 | 1997 | 4 | 16 | Diesel | 45 |
| DW12ATED4 (4HW) | 85.00 | 2179 | 4 | 16 | Diesel | 52 |
| DW12BTED4 (4HP) | 85.00 | 2179 | 4 | 16 | Diesel | 53 |
| DW12BTED4 (4HR) | 85.00 | 2179 | 4 | 16 | Diesel | 53 |
| DW12BTED4 (4HS) | 85.00 | 2179 | 4 | 16 | Diesel | 53 |
| DW12BTED4 (4HT) | 85.00 | 2179 | 4 | 16 | Diesel | 53 |
| DW12TED4 (4HX/4HW) | 85.00 | 2179 | 4 | 16 | Diesel | 52 |
| DW12UTED (4HY) | 85.00 | 2179 | 4 | 8 | Diesel | 54 |

|  |  | ccm |  |  |  |  |
|---|---|------|---|---|---|---|
| DW8 (WJZ) | 82.20 | 1868 | 4 | 8 | Diesel | 29 |
| DW8B (WJY) | 82.20 | 1868 | 4 | 8 | Diesel | 29 |
| EB2D (HMT) | 75.00 | 1199 | 3 | 12 | Petrol | 8 |
| EB2DT (HNZ) | 75.00 | 1199 | 3 | 12 | Petrol | 8 |
| EB2DTS (HNY) | 75.00 | 1199 | 3 | 12 | Petrol | 9 |
| EB2DTS (HNX) | 75.00 | 1199 | 3 | 12 | Petrol | 9 |
| EB2DTS (HNW) | 75.00 | 1199 | 3 | 12 | Petrol | 9 |
| EB2F (HMZ) | 75.00 | 1199 | 3 | 12 | Petrol | 8 |
| EP3 | 77.00 | 1397 | 4 | 16 | Petrol | 17 |
| EP3 (8FS) | 77.00 | 1397 | 4 | 16 | Petrol | 17 |
| EP3C | 77.00 | 1397 | 4 | 16 | Petrol | 17 |
| EP6 | 77.00 | 1598 | 4 | 16 | Petrol | 19 |
| EP6 (5FW) | 77.00 | 1598 | 4 | 16 | Petrol | 20 |
| EP6C (5FS) | 77.00 | 1598 | 4 | 16 | Petrol | 20 |
| EP6CDTX | 77.00 | 1598 | 4 | 16 | Petrol | 21 |
| EP6CDTX (5FU) | 77.00 | 1598 | 4 | 16 | Petrol | 21 |
| EP6DT (5FR) | 77.00 | 1598 | 4 | 16 | Petrol | 22 |
| EP6DT (5FX) | 77.00 | 1598 | 4 | 16 | Petrol | 22 |
| EP6DTS (5FY) | 77.00 | 1598 | 4 | 16 | Petrol | 22 |
| EP6FDT (5GZ) | 77.00 | 1598 | 4 | 16 | Petrol | 22 |
| ES9A (XFV) | 87.00 | 2946 | 6 | 24 | Petrol | 65 |
| ES9J4 (XFZ) | 87.00 | 2946 | 6 | 24 | Petrol | 66 |
| ES9J4S (XFX) | 87.00 | 2946 | 6 | 24 | Petrol | 65 |
| ET3J4 (KFU) | 75.00 | 1360 | 4 | 16 | Petrol | 11 |
| EW10A (RFJ) | 85.00 | 1997 | 4 | 16 | Petrol | 49 |
| EW10D (RLZ) | 85.00 | 1997 | 4 | 16 | Petrol | 50 |
| EW10J4 (RFN) | 85.00 | 1997 | 4 | 16 | Petrol | 49 |
| EW10J4 (RFR) | 85.00 | 1997 | 4 | 16 | Petrol | 49 |
| EW10J4S (RFK) | 85.00 | 1997 | 4 | 16 | Petrol | 49 |
| EW12J4 (3FY) | 86.00 | 2230 | 4 | 16 | Petrol | 63 |
| EW12J4 (3FZ) | 86.00 | 2230 | 4 | 16 | Petrol | 63 |
| EW7A (6FY) | 82.70 | 1749 | 4 | 16 | Petrol | 30 |
| EW7J4 (6FZ) | 82.70 | 1749 | 4 | 16 | Petrol | 30 |
| F1CE0481D (F30DT) | 95.80 | 2999 | 4 | 16 | Diesel | 81 |
| F1CE0481D (FG30DT) | 95.80 | 2999 | 4 | 16 | Diesel | 81 |
| KF5 | 84.00 | 1796 | 4 | 8 | Petrol | 41 |
| KF6 | 84.00 | 1796 | 4 | 8 | Petrol | 41 |
| P22DTE (4HU) | 86.00 | 2198 | 4 | 16 | Diesel | 62 |
| P22DTE (4HV) | 86.00 | 2198 | 4 | 16 | Diesel | 62 |
| TU1 (H1A/H1B/H3A) | 72.00 | 1124 | 4 | 8 | Petrol | 4 |
| TU1JP (HFX) | 72.00 | 1124 | 4 | 8 | Petrol | 5 |
| TU1JP (HFZ) | 72.00 | 1124 | 4 | 8 | Petrol | 5 |
| TU1M (HDY) | 72.00 | 1124 | 4 | 8 | Petrol | 4 |
| TU1M (HDZ) | 72.00 | 1124 | 4 | 8 | Petrol | 4 |
| TU2J2 (MFZ) | 75.00 | 1294 | 4 | 8 | Petrol | 10 |
| TU3 (K5A) | 75.00 | 1360 | 4 | 8 | Petrol | 12 |
| TU32 | 75.00 | 1361 | 4 | 8 | Petrol | 13 |
| TU3A (K1D) | 75.00 | 1361 | 4 | 8 | Petrol | 13 |
| TU3A (K6D) | 75.00 | 1360 | 4 | 8 | Petrol | 12 |
| TU3A (K6E) | 75.00 | 1360 | 4 | 8 | Petrol | 12 |
| TU3A (K6F) | 75.00 | 1360 | 4 | 8 | Petrol | 12 |
| TU3A (KFT) | 75.00 | 1360 | 4 | 8 | Petrol | 12 |
| TU3A (KFV) | 75.00 | 1360 | 4 | 8 | Petrol | 12 |
| TU3A (KFW) | 75.00 | 1360 | 4 | 8 | Petrol | 12 |
| TU3CP (KAY) | 75.00 | 1361 | 4 | 8 | Petrol | 13 |
| TU3J2 (KFZ) | 75.00 | 1361 | 4 | 8 | Petrol | 14 |
| TU3JP (KFW) | 75.00 | 1360 | 4 | 8 | Petrol | 12 |
| TU3JP (KFX) | 75.00 | 1361 | 4 | 8 | Petrol | 13 |
| TU3JP-L4 | 75.00 | 1360 | 4 | 8 | Petrol | 12 |
| TU3M (KDY) | 75.00 | 1361 | 4 | 8 | Petrol | 13 |
| TU3M (KDZ) | 75.00 | 1361 | 4 | 8 | Petrol | 13 |
| TU3MC (KDX) | 75.00 | 1361 | 4 | 8 | Petrol | 13 |
| TU3S (K2B) | 75.00 | 1360 | 4 | 8 | Petrol | 12 |
| TU5J2 (NFW) | 78.50 | 1587 | 4 | 8 | Petrol | 23 |
| TU5J2 (NFW/NFY) | 78.50 | 1587 | 4 | 8 | Petrol | 23 |
| TU5J4 (NFX) | 78.50 | 1587 | 4 | 16 | Petrol | 24 |

|  |  | ccm |  |  |  |  | |
|---|---|-------|--|---|---|---|----|
| TU5JP (NFZ) | | 78.50 | 1587 | 4 | 8 | Petrol | 23 |
| TU5JP4 (NFU) | | 78.50 | 1587 | 4 | 16 | Petrol | 25 |
| TU9 | | 70.00 | 954 | 4 | 8 | Petrol | 2 |
| TU9M (CDY) | | 70.00 | 954 | 4 | 8 | Petrol | 2 |
| TU9M (CDZ) | | 70.00 | 954 | 4 | 8 | Petrol | 2 |
| TUD5 (VJX) | | 77.00 | 1527 | 4 | 8 | Diesel | 18 |
| TUD5 (VJY) | | 77.00 | 1527 | 4 | 8 | Diesel | 18 |
| TUD5 (VJZ) | | 77.00 | 1527 | 4 | 8 | Diesel | 18 |
| XC5P | | 84.00 | 1618 | 4 | 8 | Petrol | 40 |
| XC6 | | 84.00 | 1618 | 4 | 8 | Petrol | 40 |
| XC7P | | 84.00 | 1618 | 4 | 8 | Petrol | 40 |
| XD 4.88 | | 88.00 | 1948 | 4 | 8 | Diesel | 67 |
| XD2 (134) | | 94.00 | 2304 | 4 | 8 | Diesel | 78 |
| XD2P / XD94 | | 94.00 | 2304 | 4 | 8 | Diesel | 78 |
| XD2P94 | | 94.00 | 2304 | 4 | 8 | Diesel | 78 |
| XD25 (147) | | 94.00 | 2304 | 4 | 8 | Diesel | 78 |
| XD3 (155) | | 94.00 | 2498 | 4 | 8 | Diesel | 79 |
| XD3P | | 94.00 | 2498 | 4 | 8 | Diesel | 79 |
| XD3T | | 94.00 | 2498 | 4 | 8 | Diesel | 79 |
| XD3T (152A) | | 94.00 | 2498 | 4 | 8 | Diesel | 79 |
| XD3TE (152B) | | 94.00 | 2498 | 4 | 8 | Diesel | 79 |
| XD90 | | 90.00 | 2112 | 4 | 8 | Diesel | 72 |
| XDP88 | | 88.00 | 1948 | 4 | 8 | Diesel | 67 |
| XDP90 | | 90.00 | 2112 | 4 | 8 | Diesel | 72 |
| XM | | 84.00 | 1796 | 4 | 8 | Petrol | 41 |
| XM7 | | 84.00 | 1796 | 4 | 8 | Petrol | 41 |
| XM7 (105) | | 84.00 | 1796 | 4 | 8 | Petrol | 41 |
| XM7A (105C) | | 84.00 | 1796 | 4 | 8 | Petrol | 41 |
| XM7P | | 84.00 | 1796 | 4 | 8 | Petrol | 41 |
| XM7T (169B) | | 84.00 | 1796 | 4 | 8 | Petrol | 41 |
| XN1 | | 88.00 | 1971 | 4 | 8 | Petrol | 68 |
| XN1 (106) | | 88.00 | 1971 | 4 | 8 | Petrol | 68 |
| XN1A (106E) | | 88.00 | 1971 | 4 | 8 | Petrol | 68 |
| XN1P | | 88.00 | 1971 | 4 | 8 | Petrol | 68 |
| XN1T (170) | | 88.00 | 1971 | 4 | 8 | Petrol | 68 |
| XN1T (170B) | | 88.00 | 1971 | 4 | 8 | Petrol | 68 |
| XN2 (107) | | 88.00 | 1971 | 4 | 8 | Petrol | 68 |
| XU102C (R5A) | | 86.00 | 1998 | 4 | 8 | Petrol | 55 |
| XU10J2 (RFL) | | 86.00 | 1998 | 4 | 8 | Petrol | 55 |
| XU10J2 (RFU) | | 86.00 | 1998 | 4 | 8 | Petrol | 55 |
| XU10J2 (RFW) | | 86.00 | 1998 | 4 | 8 | Petrol | 55 |
| XU10J2 (RFX) | | 86.00 | 1998 | 4 | 8 | Petrol | 55 |
| XU10J2TE (RGX) | | 86.00 | 1998 | 4 | 8 | Petrol | 56 |
| XU10J2TE (RGY) | | 86.00 | 1998 | 4 | 8 | Petrol | 56 |
| XU10J2Z (RFZ) | | 86.00 | 1998 | 4 | 8 | Petrol | 55 |
| XU10J4 (RFT) | | 86.00 | 1998 | 4 | 16 | Petrol | 57 |
| XU10J4 (RFY) | | 86.00 | 1998 | 4 | 16 | Petrol | 57 |
| XU10J4R (RFV) | | 86.00 | 1998 | 4 | 16 | Petrol | 58 |
| XU10J4RS (RFS) | | 86.00 | 1998 | 4 | 16 | Petrol | 59 |
| XU10J4TE (RGZ) | | 86.00 | 1998 | 4 | 16 | Petrol | 60 |
| XU51C (B1A) | | 83.00 | 1580 | 4 | 8 | Petrol | 31 |
| XU51C (B1D) | | 83.00 | 1580 | 4 | 8 | Petrol | 31 |
| XU51C (B1E) | | 83.00 | 1580 | 4 | 8 | Petrol | 32 |
| XU52C/K (B2A) | | 83.00 | 1580 | 4 | 8 | Petrol | 32 |
| XU5CP (BAZ) | | 83.00 | 1580 | 4 | 8 | Petrol | 32 |
| XU5J (180) | | 83.00 | 1580 | 4 | 8 | Petrol | 33 |
| XU5J (180A) | | 83.00 | 1580 | 4 | 8 | Petrol | 33 |
| XU5J (B6B) | | 83.00 | 1580 | 4 | 8 | Petrol | 33 |
| XU5JP (BFZ) | | 83.00 | 1580 | 4 | 8 | Petrol | 33 |
| XU5M (BDZ) | | 83.00 | 1580 | 4 | 8 | Petrol | 32 |
| XU5M2Z (BDY) | | 83.00 | 1580 | 4 | 8 | Petrol | 33 |
| XU5M3Z (BDY) | | 83.00 | 1580 | 4 | 8 | Petrol | 33 |
| XU5S (171) | | 83.00 | 1580 | 4 | 8 | Petrol | 31 |
| XU7JB (LFX) | | 83.00 | 1762 | 4 | 8 | Petrol | 34 |
| XU7JP (LFW) | | 83.00 | 1762 | 4 | 8 | Petrol | 34 |
| XU7JP (LFZ) | | 83.00 | 1762 | 4 | 8 | Petrol | 34 |

|  |  | ccm |  |  |  |  |
|---|---|------|---|---|---|---|
| XU7JP4 (LFY) | 83.00 | 1762 | 4 | 16 | Petrol | 35 |
| XU92C | 83.00 | 1905 | 4 | 8 | Petrol | 36 |
| XU92C (D2A) | 83.00 | 1905 | 4 | 8 | Petrol | 36 |
| XU92C (D2C) | 83.00 | 1905 | 4 | 8 | Petrol | 36 |
| XU9J1 (DFZ) | 83.00 | 1905 | 4 | 8 | Petrol | 36 |
| XU9J2 (D6A) | 83.00 | 1905 | 4 | 8 | Petrol | 36 |
| XU9J4 (D6C/DFW) | 83.00 | 1905 | 4 | 16 | Petrol | 37 |
| XU9J4 (DFW) | 83.00 | 1905 | 4 | 16 | Petrol | 37 |
| XU9JA (D6B) | 83.00 | 1905 | 4 | 8 | Petrol | 36 |
| XU9JAZ (DKZ) | 83.00 | 1905 | 4 | 8 | Petrol | 36 |
| XU9M (DDZ) | 83.00 | 1905 | 4 | 8 | Petrol | 36 |
| XU9S (D2B) | 83.00 | 1905 | 4 | 8 | Petrol | 36 |
| XUD11A (P9A/PJZ) | 86.00 | 2138 | 4 | 12 | Diesel | 61 |
| XUD11ATE;(PHZ/P8A/P8B) | 85.00 | 2088 | 4 | 12 | Diesel | 51 |
| XUD11BTE (P8C) | 85.00 | 2088 | 4 | 12 | Diesel | 51 |
| XUD7 (161) | 80.00 | 1769 | 4 | 8 | Diesel | 26 |
| XUD7 (161A) | 80.00 | 1769 | 4 | 8 | Diesel | 26 |
| XUD7 (A9A) | 80.00 | 1769 | 4 | 8 | Diesel | 26 |
| XUD7T | 80.00 | 1769 | 4 | 8 | Diesel | 27 |
| XUD7TE (A8A) | 80.00 | 1769 | 4 | 8 | Diesel | 27 |
| XUD7TE (A8B) | 80.00 | 1769 | 4 | 8 | Diesel | 27 |
| XUD7TE (AJZ) | 80.00 | 1769 | 4 | 8 | Diesel | 27 |
| XUD9 | 83.00 | 1905 | 4 | 8 | Diesel | 38 |
| XUD9 (162) | 83.00 | 1905 | 4 | 8 | Diesel | 38 |
| XUD9 (D9A) | 83.00 | 1905 | 4 | 8 | Diesel | 38 |
| XUD9 (DJZ) | 83.00 | 1905 | 4 | 8 | Diesel | 38 |
| XUD9A (D9B) | 83.00 | 1905 | 4 | 8 | Diesel | 38 |
| XUD9A (D9B) | 83.00 | 1905 | 4 | 8 | Diesel | 38 |
| XUD9A (D9B/DJY) | 83.00 | 1905 | 4 | 8 | Diesel | 38 |
| XUD9A (DJY) | 83.00 | 1905 | 4 | 8 | Diesel | 38 |
| XUD9BSD (DHV) | 83.00 | 1905 | 4 | 8 | Diesel | 39 |
| XUD9SD (DHW) | 83.00 | 1905 | 4 | 8 | Diesel | 39 |
| XUD9TE | 83.00 | 1905 | 4 | 8 | Diesel | 39 |
| XUD9TE (D8B) | 83.00 | 1905 | 4 | 8 | Diesel | 39 |
| XUD9TE (DHX) | 83.00 | 1905 | 4 | 8 | Diesel | 39 |
| XUD9TE (DHY) | 83.00 | 1905 | 4 | 8 | Diesel | 39 |
| XUD9UTF (D8C) | 83.00 | 1905 | 4 | 8 | Diesel | 39 |
| XV8 (108C) | 70.00 | 954 | 4 | 8 | Petrol | 2 |
| ZDJ (851) | 88.00 | 2165 | 4 | 8 | Petrol | 70 |
| ZDJL (851B) | 88.00 | 2165 | 4 | 8 | Petrol | 70 |
| ZDJL (851X) | 88.00 | 2165 | 4 | 8 | Petrol | 70 |
| ZEJ (829) | 88.00 | 1995 | 4 | 8 | Petrol | 69 |
| ZM (112) | 88.00 | 2664 | 6 | 12 | Petrol | 71 |
| ZMJ (140) | 88.00 | 2664 | 6 | 12 | Petrol | 71 |
| ZMJK (154A) | 91.00 | 2849 | 6 | 12 | Petrol | 73 |
| ZN3J (154X) | 91.00 | 2849 | 6 | 12 | Petrol | 74 |



OE

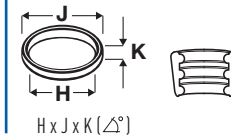
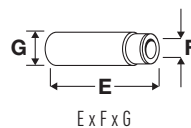

1 69.60

| | | | | | | | |
|-------------------|--------|----------|------------------|-----------|--------|--------------------|----------------|
| 199 A9.000 | 1248cc | 4 Cyl. | 16 Valves | 55kW/75PS | Diesel | Turbo, DOHC | TD26979 |
| BIPPER 1.3 HDi 75 | | 10/2010→ | | | | | |

V95182 ■
21.85 x 5.98 x 109.25

0948.H0

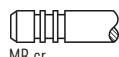

45°

H

VAG96359 ■ ■
43.28 x 6.00 x 10.25



V95183 ■
22.50 x 5.99 x 109.20

0949.G3



45°

ss

H

2 70.00

| | | | | | | | |
|-------------------|-------|--------|-----------------|-----------------|--------|-------------|---------------|
| TU9 | 954cc | 4 Cyl. | 8 Valves | 33kW/45PS | Petrol | SOHC | TD2783 |
| TU9M (CDY) | 954cc | 4 Cyl. | 8 Valves | 32-33kW/44-45PS | Petrol | SOHC | TD4841 |
| TU9M (CDZ) | 954cc | 4 Cyl. | 8 Valves | 37kW/50PS | Petrol | SOHC | TD9405 |
| XV8 (108C) | 954cc | 4 Cyl. | 8 Valves | 32-33kW/44-45PS | Petrol | SOHC | TD2894 |

| | | | |
|-----------|-----------------|--------------|-----------------|
| 104 1.0 | 09/1983→06/1988 | 106 1.0 | 09/1991→03/2001 |
| 106 I 1.0 | 09/1991→04/1996 | 106 II 1.0 i | 05/1996→03/2001 |
| 205 I 1.0 | 02/1983→10/1987 | 205 II 1.0 | 08/1987→09/1998 |

V91270 ■
34.50 x 7.00 x 113.00

0948.57

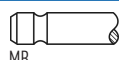

30°

H

VAG92401 ■ ■
47.50 x 7.01 x 13.06

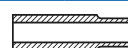

V91272 ■
27.50 x 7.00 x 112.50

0949.58

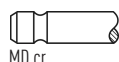

45°

VAG96132 ■ ■
47.60 x 7.03 x 13.11

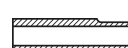

3 71.00

| | | | | | | | |
|-------------------|-------|--------|------------------|-----------------|--------|-------------|----------------|
| 1KR-FE | 998cc | 3 Cyl. | 12 Valves | 50-51kW/68-69PS | Petrol | DOHC | TD32322 |
| 384F (CFA) | 998cc | 3 Cyl. | 12 Valves | 50kW/68PS | Petrol | DOHC | TD32881 |

| | | | |
|---------|----------|-------------|----------|
| 107 1.0 | 06/2005→ | 108 1.0 VTi | 05/2014→ |
|---------|----------|-------------|----------|

V94969 ■
27.65 x 4.98 x 88.35

0948.E2

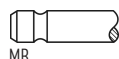

45°

H

VAG96067 ■ ■
34.50 x 5.00 x 9.70



V94970 ■
23.70 x 4.98 x 89.10

0949.C8

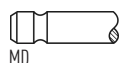

45°

4 72.00

| | | | | | | | |
|--------------------------|--------|--------|-----------------|-----------------|--------|-------------|---------------|
| TU1 (H1A/H1B/H3A) | 1124cc | 4 Cyl. | 8 Valves | 40kW/54PS | Petrol | SOHC | TD2758 |
| TU1M (HDY) | 1124cc | 4 Cyl. | 8 Valves | 40-44kW/54-60PS | Petrol | SOHC | TD9404 |
| TU1M (HDZ) | 1124cc | 4 Cyl. | 8 Valves | 44kW/60PS | Petrol | SOHC | TD4834 |

| | | | |
|--------------|-----------------|--------------|-----------------|
| 106 I 1.1 | 09/1991→04/1996 | 106 II 1.1 i | 05/1996→07/2004 |
| 205 1.1 | 08/1987→07/1990 | 205 I 1.1 | 08/1987→12/1994 |
| 205 I 1.1 CJ | 10/1989→12/1994 | 205 II 1.1 | 10/1987→09/1998 |
| 306 1.1 | 05/1993→05/2001 | 309 II 1.1 | 09/1989→12/1993 |
| PARTNER 1.1 | 06/1996→09/2005 | | |

V91271 ■
37.00 x 7.00 x 112.50

0948.58

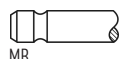

30°

H

VAG92401 ■ ■
47.50 x 7.01 x 13.06



V91273 ■
29.50 x 7.00 x 112.50

0949.59

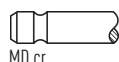

45°

VAG96132 ■ ■
47.60 x 7.03 x 13.11





OE

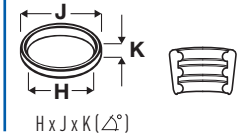
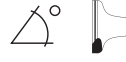

5  **72.00**

| | | | | | | | |
|--------------------|-----------------|--------|-----------------|-----------|--------|-------------|----------------|
| TU1JP (HFX) | 1124cc | 4 Cyl. | 8 Valves | 44kW/60PS | Petrol | SOHC | TD14728 |
| TU1JP (HFZ) | 1124cc | 4 Cyl. | 8 Valves | 44kW/60PS | Petrol | SOHC | TD9848 |
| 106 II 1.1 i | 05/1996→07/2004 | | | 206+ 1.1 | | 01/2009→ | |
| 206 1.1 | 07/2002→ | | | 206 1.1 i | | 09/1998→ | |
| PARTNER 1.1 | 06/1996→10/2002 | | | | | | |

V94202 
36.70 x 7.00 x 112.70

0948.91

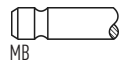

45°

H

VAG92401  
47.50 x 7.01 x 13.06



V91273 
29.50 x 7.00 x 112.50

0949.59



45°

VAG96132  
47.60 x 7.03 x 13.11



6  **73.70**

| | | | | | | | |
|--------------------|----------|--------|-----------------|---------------------|--------|--------------------|----------------|
| DV4C (8HP) | 1398cc | 4 Cyl. | 8 Valves | 50kW/68PS | Diesel | Turbo, SOHC | TD28225 |
| DV4TD (8HT) | 1398cc | 4 Cyl. | 8 Valves | 40kW/54PS | Diesel | Turbo, SOHC | TD24924 |
| DV4TD (8HX) | 1398cc | 4 Cyl. | 8 Valves | 50-51kW/68-69PS | Diesel | Turbo, SOHC | TD16368 |
| DV4TD (8HZ) | 1398cc | 4 Cyl. | 8 Valves | 50-52kW/68-70PS | Diesel | Turbo, SOHC | TD17509 |
| 107 1.4 HDi | 06/2005→ | | | 206+ 1.4 HDi eco 70 | | 01/2009→ | |
| 206 1.4 HDi | 09/2001→ | | | 206 1.4 HDi eco 70 | | 09/2001→ | |
| 207 1.4 HDi | 02/2006→ | | | 208 1.4 HDi | | 03/2012→ | |
| 307 1.4 HDi | 10/2001→ | | | 307 1.4 HDi 70 | | 03/2002→06/2005 | |
| 1007 1.4 HDi | 04/2005→ | | | | | | |

V94601 
32.80 x 5.50 x 97.30

0948.C2

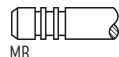

45°

Y

H

VAG96364  
34.20 x 5.50 x 9.53

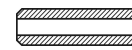

V94602 
30.30 x 5.50 x 97.30

0949.B1



45°

H

7  **73.70**

| | | | | | | | |
|---------------------|----------|--------|-----------------|--------------|--------|--------------------|----------------|
| DV4C (8HR) | 1398cc | 4 Cyl. | 8 Valves | 50kW/68PS | Diesel | Turbo, SOHC | TD28125 |
| 206+ 1.4 HDi eco 70 | 01/2009→ | | | 207 1.4 HDi | | 02/2006→ | |
| 208 1.4 HDi | 03/2012→ | | | 2008 1.4 HDi | | 06/2013→ | |

V95137 
30.15 x 5.48 x 95.55

0948.F7

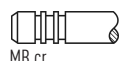

45°

Y

H

VAG96364  
34.20 x 5.50 x 9.53



V95138 
27.50 x 5.47 x 95.45

0949.F5

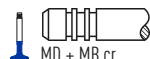

45°

SS

H

8  **75.00**

| | | | | | | | |
|-----------------------|----------|--------|------------------|-------------------|--------|-------------------------------|----------------|
| EB2D (HMT) | 1199cc | 3 Cyl. | 12 Valves | 60kW/82PS | Petrol | | TD32324 |
| EB2DT (HNZ) | 1199cc | 3 Cyl. | 12 Valves | 81kW/110PS | Petrol | Turbo, DOHC, Injection | TD29556 |
| EB2F (HMZ) | 1199cc | 3 Cyl. | 12 Valves | 60kW/82PS | Petrol | DOHC | TD32315 |
| 108 1.2 | 05/2014→ | | | 208 1.2 | | 03/2012→ | |
| 208 1.2 GPL | 06/2015→ | | | 208 1.2 THP | | 01/2013→ | |
| 308 II 1.2 THP 110 | 11/2013→ | | | 308 II 1.2 VTi 72 | | 09/2013→ | |
| 308 SW II 1.2 THP 110 | 03/2014→ | | | 2008 1.2 THP 110 | | 01/2015→ | |
| 2008 1.2 VTi | 03/2013→ | | | PARTNER 1.2 THP | | 02/2016→ | |

V95159 
29.15 x 4.98 x 92.60

96 763 590 80



45°

H

VAG96392B 
41.50 x 5.01 x 9.05



V95163 
26.00 x 4.96 x 91.90

96 763 591 80

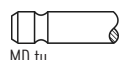

45°

VAG96393B 
44.50 x 5.01 x 9.05





OE

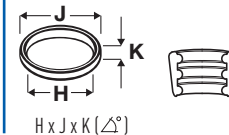
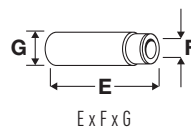
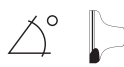

9 75.00

| | | | | | | | |
|---------------------|----------|--------|------------------|-----------------------|--------|-------------------------------|----------------|
| EB2DTS (HNY) | 1199cc | 3 Cyl. | 12 Valves | 96kW/131PS | Petrol | Turbo, DOHC, Injection | TD28613 |
| EB2DTS (HNX) | 1199cc | 3 Cyl. | 12 Valves | 81kW/110PS | Petrol | Turbo, DOHC, Injection | TD34274 |
| EB2DTS (HNW) | 1199cc | 3 Cyl. | 12 Valves | 96kW/131PS | Petrol | Turbo, DOHC, Injection | TD34273 |
| 308 II 1.2 THP 130 | 11/2013→ | | | 308 SW II 1.2 THP 130 | | 03/2014→ | |
| 2008 1.2 THP 130 | 01/2015→ | | | 3008 1.2 | | 01/2015→ | |
| 5008 1.2 | 01/2015→ | | | 5008 II 1.2 | | 12/2016→ | |

V80020 ■
26.42 x 5.00 x 93.50

98 019 609 80

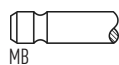

45°

VAG96392B ■
41.50 x 5.01 x 9.05



V80021 ■
23.78 x 5.00 x 92.91

98 076 459 80

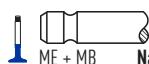

45° ss

VAG96393B ■
44.50 x 5.01 x 9.05

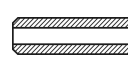

10 75.00

| | | | | | | | |
|--------------------|-----------------|--------|-----------------|------------------|--------|-------------|---------------|
| TU2J2 (MFZ) | 1294cc | 4 Cyl. | 8 Valves | 72-74kW/98-101PS | Petrol | SOHC | TD2763 |
| 106 I 1.3 | 10/1993→04/1996 | | | | | | |

V94155 ■
39.40 x 7.00 x 111.70

0948.73

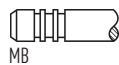

30° Y H

VAG96132 ■ ■
47.60 x 7.03 x 13.11



V94156 ■
31.30 x 7.00 x 111.50

0949.70

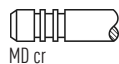

45°

VAG96347B ■ ■
48.50 x 7.02 x 13.07

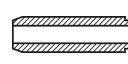

11 75.00

| | | | | | | | |
|--------------------|----------|--------|------------------|--------------|--------|-------------|----------------|
| ET3J4 (KFU) | 1360cc | 4 Cyl. | 16 Valves | 65kW/88PS | Petrol | DOHC | TD17550 |
| 206 1.4 16V | 10/2003→ | | | 207 1.4 16V | | 02/2006→ | |
| 307 1.4 16V | 11/2003→ | | | 1007 1.4 16V | | 10/2005→ | |

V98081 ■
28.20 x 5.50 x 100.70

0948.C8

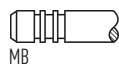

45°

VAG96365B ■ ■
38.00 x 5.50 x 10.58



V98082 ■
24.35 x 5.50 x 101.10

0949.C4



45°



OE



MAT.

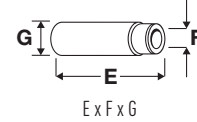
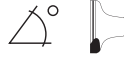

E x F x G

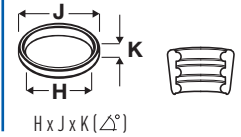

H x J x K (Δ°)

12



75.00

| | | | | | | | |
|-------------|--------|--------|----------|-----------------|--------|------|---------|
| TU3 (K5A) | 1360cc | 4 Cyl. | 8 Valves | 47-51kW/64-69PS | Petrol | SOHC | TD26412 |
| TU3A (K6D) | 1360cc | 4 Cyl. | 8 Valves | 53kW/72PS | Petrol | SOHC | TD24928 |
| TU3A (K6E) | 1360cc | 4 Cyl. | 8 Valves | 53kW/72PS | Petrol | SOHC | TD24930 |
| TU3A (K6F) | 1360cc | 4 Cyl. | 8 Valves | 53kW/72PS | Petrol | SOHC | TD24929 |
| TU3A (KFT) | 1360cc | 4 Cyl. | 8 Valves | 54kW/73PS | Petrol | SOHC | TD24931 |
| TU3A (KFV) | 1360cc | 4 Cyl. | 8 Valves | 54-60kW/73-82PS | Petrol | SOHC | TD21111 |
| TU3A (KFW) | 1360cc | 4 Cyl. | 8 Valves | 55-60kW/75-82PS | Petrol | SOHC | TD24927 |
| TU3JP (KFW) | 1360cc | 4 Cyl. | 8 Valves | 47-60kW/64-82PS | Petrol | SOHC | TD14729 |
| TU3JP-L4 | 1360cc | 4 Cyl. | 8 Valves | 48-55kW/65-75PS | Petrol | SOHC | TD18518 |
| TU3S (K2B) | 1360cc | 4 Cyl. | 8 Valves | 62kW/85PS | Petrol | SOHC | TD2779 |

106 I 1.4
205 I 1.4
206+ 1.4 i
206 1.4 CNG
206 1.4 LPG
207 SW 1.4
306 1.4 SL
309 I 1.4
1007 1.4
HOGGAR 1.4

08/1991→03/1996
08/1987→06/1994
01/2009→
05/2006→09/2007
07/2002→
06/2007→
06/1994→05/2001
03/1989→07/1989
04/2005→
05/2010→

106 II 1.4 i
205 II 1.4
206 1.4
206 1.4 i
207 1.4
306 1.4
307 1.4
405 I 1.4
BIPPER 1.4
PARTNER 1.4

05/1996→07/2004
06/1987→12/1989
07/2002→
09/1998→
02/2006→
05/1993→04/2002
08/2000→
01/1987→07/1992
02/2008→
06/1996→12/2015

V91271 ■
37.00 x 7.00 x 112.50
→05/98, Eng.→07874

0948.58

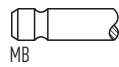

MB

30°

H

VAG92401 ■ ■ ■
47.50 x 7.01 x 13.06



V94202 ■
36.70 x 7.00 x 112.70
06/98→, Eng.07875→

0948.91

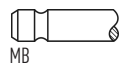

MB

45°

H

VAG96132 ■ ■ ■
47.60 x 7.03 x 13.11

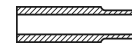

V91273 ■
29.50 x 7.00 x 112.50

0949.59

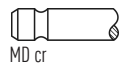

MD cr

45°



OE

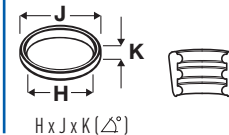
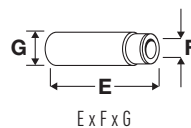
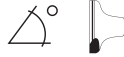

13 75.00

| | | | | | | | |
|--------------------|--------|--------|-----------------|-----------------|--------|-------------|---------------|
| TU32 | 1361cc | 4 Cyl. | 8 Valves | 51-55kW/70-75PS | Petrol | SOHC | TD8507 |
| TU3A (K1D) | 1361cc | 4 Cyl. | 8 Valves | 49-50kW/67-68PS | Petrol | SOHC | TD2766 |
| TU3CP (KAY) | 1361cc | 4 Cyl. | 8 Valves | 44kW/60PS | Petrol | SOHC | TD2767 |
| TU3JP (KFX) | 1361cc | 4 Cyl. | 8 Valves | 49-55kW/67-75PS | Petrol | SOHC | TD5396 |
| TU3M (KDY) | 1361cc | 4 Cyl. | 8 Valves | 55-58kW/75-79PS | Petrol | SOHC | TD4836 |
| TU3M (KDZ) | 1361cc | 4 Cyl. | 8 Valves | 55kW/75PS | Petrol | SOHC | TD2775 |
| TU3MC (KDX) | 1361cc | 4 Cyl. | 8 Valves | 55-58kW/75-79PS | Petrol | SOHC | TD2777 |

| | | | |
|------------------|-----------------|--------------|-----------------|
| 106 I 1.4 | 09/1991→04/1996 | 106 II 1.4 i | 05/1996→07/2004 |
| 205 I 1.4 | 08/1987→07/1990 | 205 I 1.4 CJ | 03/1989→12/1994 |
| 205 I 1.4 CJ Cat | 01/1989→09/1993 | 205 II 1.4 | 10/1987→09/1998 |
| 205 II 1.4 Cat | 08/1987→09/1993 | 206 1.4 i | 09/1998→ |
| 306 1.4 | 05/1993→04/2002 | 306 1.4 SL | 06/1994→05/2001 |
| 309 I 1.4 | 03/1989→07/1989 | 309 II 1.4 | 07/1989→12/1993 |
| 405 II 1.4 | 08/1992→10/1996 | PARTNER 1.4 | 06/1996→12/2015 |

| | | | | | | |
|---|---------|-------|-----|---|----------------------|--|
| V91271 | 0948.58 | | 30° | H | VAG92401 | |
| 37.00 x 7.00 x 112.50 →05/98, Eng.→07874 | | MB | | | 47.50 x 7.01 x 13.06 | |
| V94202 | 0948.91 | | 45° | H | VAG96132 | |
| 36.70 x 7.00 x 112.70 06/98→, Eng.07875→ | | MB | | | 47.60 x 7.03 x 13.11 | |
| V91273 | 0949.59 | | 45° | | | |
| 29.50 x 7.00 x 112.50 | | MD cr | | | | |

14 75.00

| | | | | | | | |
|--------------------|--------|--------|-----------------|-----------|--------|-------------|---------------|
| TU3J2 (KFZ) | 1361cc | 4 Cyl. | 8 Valves | 69kW/94PS | Petrol | SOHC | TD2770 |
|--------------------|--------|--------|-----------------|-----------|--------|-------------|---------------|

| | |
|-----------|-----------------|
| 106 I 1.4 | 09/1991→04/1996 |
|-----------|-----------------|

| | | | | | | | |
|-----------------------|---------|-------|-----|---|---|----------------------|--|
| V94155 | 0948.73 | | 30° | Y | H | VAG96132 | |
| 39.40 x 7.00 x 111.70 | | MB | | | | 47.60 x 7.03 x 13.11 | |
| V94156 | 0949.70 | | 45° | | | VAG96347B | |
| 31.30 x 7.00 x 111.50 | | MD cr | | | | 48.50 x 7.02 x 13.07 | |



OE

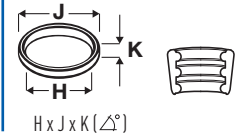
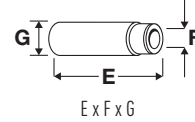
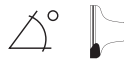

15



75.00

| | | | | | | | |
|--------------------|--------|-----------------|-----------|-----------------------|--------|-----------------|---------|
| DV6ATED4 (9HV) | 1560cc | 4 Cyl. | 16 Valves | 66kW/90PS | Diesel | Turbo, DOHC | TD24730 |
| DV6ATED4 (9HX) | 1560cc | 4 Cyl. | 16 Valves | 66-68kW/90-92PS | Diesel | Turbo, DOHC | TD20147 |
| DV6AUTED4 (9HX) | 1560cc | 4 Cyl. | 16 Valves | 66kW/90PS | Diesel | Turbo, DOHC | TD34426 |
| DV6BTED4 (9HT) | 1560cc | 4 Cyl. | 16 Valves | 55kW/75PS | Diesel | Turbo, DOHC | TD23537 |
| DV6BTED4 (9HW) | 1560cc | 4 Cyl. | 16 Valves | 55kW/75PS | Diesel | Turbo, DOHC | TD24701 |
| DV6TED4 (9HV) | 1560cc | 4 Cyl. | 16 Valves | 66kW/90PS | Diesel | Turbo, DOHC | TD28634 |
| DV6TED4 (9HY) | 1560cc | 4 Cyl. | 16 Valves | 80kW/109PS | Diesel | Turbo, DOHC | TD17506 |
| DV6TED4 (9HZ) | 1560cc | 4 Cyl. | 16 Valves | 80-84kW/109-114PS | Diesel | Turbo, DOHC | TD18520 |
| DV6TED4BU (9HS) | 1560cc | 4 Cyl. | 16 Valves | 66kW/90PS | Diesel | Turbo, DOHC | TD29162 |
| DV6UTED4 (9HU) | 1560cc | 4 Cyl. | 16 Valves | 66kW/90PS | Diesel | Turbo, DOHC | TD24693 |
| 206 1.6 HDi 110 | | 05/2004→ | | 207 1.6 HDi | | 02/2006→ | |
| 207 CC 1.6 HDi | | 02/2007→ | | 207 SW 1.6 HDi | | 06/2007→12/2012 | |
| 307 1.6 HDi | | 04/2005→ | | 307 1.6 HDi 90 | | 12/2006→04/2008 | |
| 307 1.6 HDi 110 | | 02/2004→ | | 307 1.6 HDi 110 | | 02/2004→ | |
| 308 1.6 HDi | | 09/2007→ | | 308 SW 1.6 HDi | | 09/2007→ | |
| 407 1.6 HDi 110 | | 05/2004→ | | 408 1.6 HDi | | 04/2011→ | |
| 1007 1.6 HDi | | 06/2007→ | | 3008 1.6 HDi | | 06/2009→ | |
| 5008 1.6 HDi | | 09/2009→ | | EXPERT 1.6 HDi 90 16V | | 01/2007→ | |
| PARTNER 1.6 HDi | | 04/2008→ | | PARTNER 1.6 HDi 16V | | 04/2008→ | |
| PARTNER 1.6 HDi 75 | | 02/2006→12/2013 | | PARTNER 1.6 HDi 90 | | 10/2005→12/2015 | |

V94960 □
25.60 x 5.50 x 96.35

0948.C7

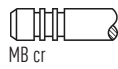

45°

H

VAG96364 □ □ □
34.20 x 5.50 x 9.53



V94961 □
23.40 x 5.50 x 96.50

0949.C3



45°

SS

H

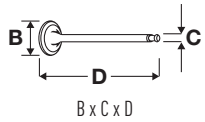

OE

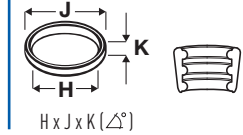
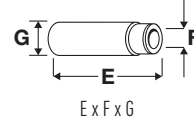
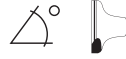

16 75.00

| | | | | | | | |
|-----------------------|--------|--------|-----------------|-------------------|--------|--------------------|----------------|
| DV6C (9HD) | 1560cc | 4 Cyl. | 8 Valves | 82-85kW/112-116PS | Diesel | Turbo, SOHC | TD32320 |
| DV6C (9HL) | 1560cc | 4 Cyl. | 8 Valves | 82-85kW/112-116PS | Diesel | Turbo, SOHC | TD26986 |
| DV6C (9HR) | 1560cc | 4 Cyl. | 8 Valves | 82-85kW/112-116PS | Diesel | Turbo, SOHC | TD26421 |
| DV6CTED (9HD) | 1560cc | 4 Cyl. | 8 Valves | 84kW/114PS | Diesel | SOHC | TD26896 |
| DV6DTED (9HP) | 1560cc | 4 Cyl. | 8 Valves | 68-69kW/92-94PS | Diesel | Turbo, SOHC | TD27064 |
| DV6DTEDM (9HJ) | 1560cc | 4 Cyl. | 8 Valves | 68kW/92PS | Diesel | Turbo, SOHC | TD27967 |
| DV6DUM (9HH) | 1560cc | 4 Cyl. | 8 Valves | 66kW/90PS | Diesel | Turbo, SOHC | TD29700 |
| DV6ETED (9HN) | 1560cc | 4 Cyl. | 8 Valves | 55kW/75PS | Diesel | Turbo, SOHC | TD32876 |
| DV6ETEDM (9HK) | 1560cc | 4 Cyl. | 8 Valves | 55kW/75PS | Diesel | Turbo, SOHC | TD27968 |
| DV6FC (BHZ) | 1560cc | 4 Cyl. | 8 Valves | 85-88kW/115-120PS | Diesel | Turbo, SOHC | TD28620 |
| DV6UC (9HM) | 1560cc | 4 Cyl. | 8 Valves | 66kW/90PS | Diesel | Turbo, SOHC | TD29699 |

| | | | |
|---------------------|----------|----------------------|----------|
| 207 1.6 HDi | 11/2009→ | 207 1.6 HDi 110 | 08/2009→ |
| 207 CC 1.6 HDi | 08/2009→ | 207 SW 1.6 HDi | 08/2009→ |
| 208 1.6 120 | 11/2013→ | 208 1.6 HDi | 03/2012→ |
| 208 1.6 HDi / | 01/2013→ | 308 1.6 HDi | 11/2009→ |
| 308 CC 1.6 HDi | 06/2009→ | 308 II 1.6 120 | 11/2013→ |
| 308 II 1.6 HDi | 09/2013→ | 308 II 1.6 HDi / | 09/2013→ |
| 308 SW 1.6 HDi | 11/2009→ | 308 SW II 1.6 120 | 03/2014→ |
| 308 SW II 1.6 HDi / | 03/2014→ | 408 1.6 HDi | 11/2010→ |
| 508 1.6 120 | 03/2014→ | 508 1.6 HDi | 11/2010→ |
| 508 SW 1.6 120 | 03/2014→ | 508 SW 1.6 HDi | 11/2010→ |
| 2008 1.6 120 | 07/2014→ | 2008 1.6 HDi | 03/2013→ |
| 3008 1.6 120 | 05/2014→ | 3008 1.6 HDi | 08/2010→ |
| 3008 1.6 HDi 115 / | 02/2013→ | 4008 1.6 HDi | 05/2012→ |
| 5008 1.6 120 | 05/2014→ | 5008 1.6 HDi | 08/2010→ |
| 5008 II 1.6 120 | 12/2016→ | EXPERT 1.6 HDi 90 8V | 01/2007→ |
| PARTNER 1.6 120 | 12/2014→ | PARTNER 1.6 HDi | 08/2010→ |
| PARTNER 1.6 HDi / | 01/2014→ | PARTNER 1.6 HDi 90 | 04/2010→ |

V95137 ■
30.15 x 5.48 x 95.55

0948.F7

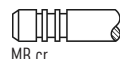

45° Y H

VAG96364 ■ ■ ■
34.20 x 5.50 x 9.53



V95138 ■
27.50 x 5.47 x 95.45

0949.F5



45° ss H

17 77.00

| | | | | | | | |
|------------------|--------|--------|------------------|-----------|--------|-------------|----------------|
| EP3 | 1397cc | 4 Cyl. | 16 Valves | 70kW/95PS | Petrol | DOHC | TD24067 |
| EP3 (8FS) | 1397cc | 4 Cyl. | 16 Valves | 70kW/95PS | Petrol | DOHC | TD24728 |
| EP3C | 1397cc | 4 Cyl. | 16 Valves | 70kW/95PS | Petrol | DOHC | TD26999 |

| | | | |
|-------------|----------|----------------|----------|
| 207 1.4 16V | 06/2007→ | 207 SW 1.4 16V | 06/2007→ |
| 208 1.4 GPL | 10/2013→ | 208 1.4 VTi | 03/2012→ |
| 308 1.4 16V | 09/2007→ | 308 SW 1.4 16V | 09/2007→ |

V95035 ■
30.00 x 5.00 x 97.00

0949.F9

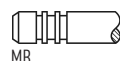

45° H

VAG96392B ■ ■
41.50 x 5.01 x 9.05



V95036 ■
25.10 x 5.00 x 110.65

0949.F6

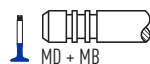

45° H

VAG96393B ■
44.50 x 5.01 x 9.05





OE

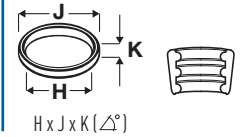
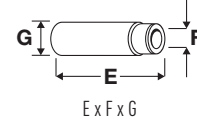

18  **77.00**

| | | | | | | | |
|-------------------|--------|-----------------|-----------------|-----------------|--------|-----------------|----------------|
| TUD5 (VJX) | 1527cc | 4 Cyl. | 8 Valves | 42kW/57PS | Diesel | SOHC | TD16193 |
| TUD5 (VJY) | 1527cc | 4 Cyl. | 8 Valves | 40-43kW/54-58PS | Diesel | SOHC | TD4842 |
| TUD5 (VJZ) | 1527cc | 4 Cyl. | 8 Valves | 42-43kW/57-58PS | Diesel | SOHC | TD33011 |
| 106 1.5 D | | 05/1996→03/2001 | | 106 1.5 D | | 06/1994→04/1996 | |
| 106 II 1.5 D | | 05/1996→07/2004 | | | | | |

V94171 ■
37.00 x 7.00 x 108.50

0948.A8

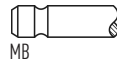

45°

H

VAG96049B ■ ■ ■
40.20 x 7.02 x 13.08



V94172 ■
31.55 x 7.00 x 108.20

0949.80

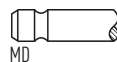

45°

19  **77.00**

| | | | | | | | |
|-----------------|--------|----------|------------------|----------------|--------|-------------|----------------|
| EP6 | 1598cc | 4 Cyl. | 16 Valves | 88kW/120PS | Petrol | DOHC | TD20086 |
| 207 1.6 16V VTi | | 02/2007→ | | 207 CC 1.6 16V | | 02/2007→ | |
| 207 SW 1.6 16V | | 06/2007→ | | 308 1.6 16V | | 09/2007→ | |
| 308 CC 1.6 16V | | 06/2009→ | | 308 SW 1.6 16V | | 09/2007→ | |
| 3008 1.6 VTi | | 06/2009→ | | 5008 1.6 16V | | 09/2009→ | |

V95035 ■
30.00 x 5.00 x 97.00

0949.F9

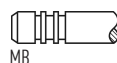

45°

H

VAG96392B ■
41.50 x 5.01 x 9.05



V95037 ■
28.80 x 5.00 x 105.70

0948.E8

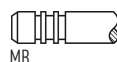

45°

H

VAG96393B ■
44.50 x 5.01 x 9.05



V95036 ■
25.10 x 5.00 x 110.65

0949.F6

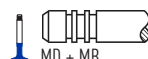

45°

H

V95038 ■
26.25 x 5.00 x 110.10

0949.E2

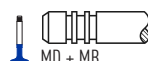

45°

H

20  **77.00**

| | | | | | | | |
|-------------------|--------|----------|------------------|-------------------|--------|-------------|----------------|
| EP6 (5FW) | 1598cc | 4 Cyl. | 16 Valves | 88kW/120PS | Petrol | DOHC | TD31969 |
| EP6C (5FS) | 1598cc | 4 Cyl. | 16 Valves | 88-89kW/120-121PS | Petrol | DOHC | TD25101 |
| 207 1.6 16V VTi | | 02/2007→ | | 207 CC 1.6 16V | | 02/2007→ | |
| 207 SW 1.6 16V | | 06/2007→ | | 208 1.6 | | 03/2012→ | |
| 308 1.6 16V | | 09/2007→ | | 308 SW 1.6 16V | | 09/2007→ | |
| 408 1.6 VTi | | 01/2012→ | | 508 1.6 VTi | | 11/2010→ | |
| 508 SW 1.6 VTi | | 11/2010→ | | 2008 1.6 VTi | | 03/2013→ | |
| 3008 1.6 VTi | | 06/2009→ | | 5008 1.6 16V | | 09/2009→ | |
| PARTNER 1.6 | | 04/2010→ | | | | | |

V95035 ■
30.00 x 5.00 x 97.00

0949.F9

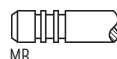

45°

H

VAG96392B ■
41.50 x 5.01 x 9.05

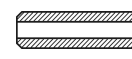

V95036 ■
25.10 x 5.00 x 110.65

0949.F6

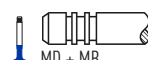

45°

H

VAG96393B ■
44.50 x 5.01 x 9.05



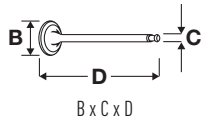

OE

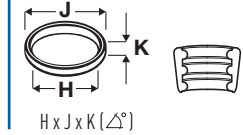
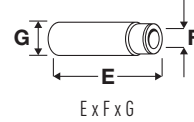
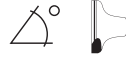

21 77.00

| | | | | | | | |
|----------------------|----------|--------|------------------|---------------------|--------|-------------------------------|----------------|
| EP6CDTX | 1598cc | 4 Cyl. | 16 Valves | 147-150kW/200-204PS | Petrol | Turbo, DOHC, Injection | TD24069 |
| EP6CDTX (5FU) | 1598cc | 4 Cyl. | 16 Valves | 147kW/200PS | Petrol | Turbo, DOHC, Injection | TD27999 |
| 208 1.6 GTi | 08/2012→ | | | 308 1.6 GTi | | 07/2010→ | |
| 308 CC 1.6 THP | 10/2010→ | | | RCZ 1.6 16V | | 06/2010→ | |

V95153 ■
29.70 x 4.97 x 95.10

0948.G4

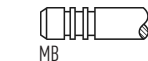

45° Y H

VAG96392B ■
41.50 x 5.01 x 9.05



V95038 ■
26.25 x 5.00 x 110.10

0949.E2



45° H

VAG96393B ■
44.50 x 5.01 x 9.05



22 77.00

| | | | | | | | |
|---------------------|--------|--------|------------------|---------------------|--------|-------------------------------|----------------|
| EP6DT (5FR) | 1598cc | 4 Cyl. | 16 Valves | 115kW/156PS | Petrol | Turbo, DOHC, Injection | TD24702 |
| EP6DT (5FX) | 1598cc | 4 Cyl. | 16 Valves | 103-110kW/140-150PS | Petrol | Turbo, DOHC, Injection | TD23766 |
| EP6DTS (5FY) | 1598cc | 4 Cyl. | 16 Valves | 128kW/175PS | Petrol | Turbo, DOHC, Injection | TD24723 |
| EP6FDT (5GZ) | 1598cc | 4 Cyl. | 16 Valves | 120-121kW/163-165PS | Petrol | Turbo, DOHC, Injection | TD31847 |

| | | | | | | | |
|----------------------|----------|--|--|---------------------|--|----------|--|
| 207 1.6 16V RC | 02/2007→ | | | 207 1.6 16V Turbo | | 02/2006→ | |
| 207 CC 1.6 16V Turbo | 02/2007→ | | | 207 SW 1.6 16V RC | | 02/2007→ | |
| 207 SW 1.6 16V Turbo | 02/2007→ | | | 308 1.6 16V | | 09/2007→ | |
| 308 CC 1.6 16V | 06/2009→ | | | 308 SW 1.6 16V | | 09/2007→ | |
| 408 1.6 THP 160 | 01/2011→ | | | 508 1.6 | | 01/2012→ | |
| 508 SW 1.6 THP | 11/2010→ | | | 3008 1.6 THP | | 06/2009→ | |
| 3008 1.6 THP 165 | 05/2016→ | | | 3008 1.6 Turbo | | 05/2014→ | |
| 5008 1.6 THP 150 | 02/2012→ | | | 5008 1.6 THP 163 | | 02/2012→ | |
| 5008 1.6 THP 165 | 02/2012→ | | | 5008 II 1.6 THP 165 | | 12/2016→ | |

V95037 ■
28.80 x 5.00 x 105.70

0948.E8



45° H

VAG96392B ■
41.50 x 5.01 x 9.05



V95038 ■
26.25 x 5.00 x 110.10

0949.E2

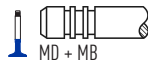

45° H

VAG96393B ■
44.50 x 5.01 x 9.05



23 78.50

| | | | | | | | |
|------------------------|--------|--------|-----------------|-------------------|--------|-------------|---------------|
| TU5J2 (NFW) | 1587cc | 4 Cyl. | 8 Valves | 74kW/101PS | Petrol | SOHC | TD4837 |
| TU5J2 (NFW/NFY) | 1587cc | 4 Cyl. | 8 Valves | 74-76kW/101-104PS | Petrol | SOHC | TD4838 |
| TU5JP (NFZ) | 1587cc | 4 Cyl. | 8 Valves | 65-66kW/88-90PS | Petrol | SOHC | TD4840 |

| | | | | | | | |
|------------|-----------------|--|--|--------------|--|-----------------|--|
| 106 I 1.6 | 06/1993→04/1996 | | | 106 II 1.6 i | | 05/1996→01/2001 | |
| 206 1.6 8V | 05/1999→10/2003 | | | 206 1.6 i | | 09/1998→12/2000 | |
| 306 1.6 | 05/1993→05/2001 | | | 306 1.6 SR | | 06/1994→10/2000 | |

V94155 ■
39.40 x 7.00 x 111.70
→12/97, Eng.→07874

0948.73

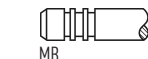

30° Y H

VAG96132 ■ ■
47.60 x 7.03 x 13.11



V94157 ■
39.30 x 7.00 x 111.40
01/98→, Eng.07875→

0948.93



45° H

VAG96347B ■ ■ ■
48.50 x 7.02 x 13.07

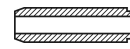

V94156 ■
31.30 x 7.00 x 111.50

0949.70

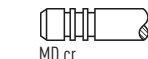





45°

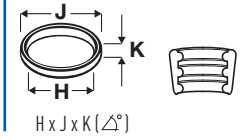



OE







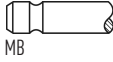

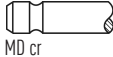

24  **78.50**

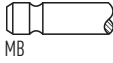
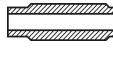
| TU5J4 (NFX) | 1587cc | 4 Cyl. | 16 Valves | 87-88kW/118-120PS | Petrol | DOHC | TD4839 |
|---|---------|---|-----------|-------------------|--------|------|--------|
| 106 II 1.6 S16 | | | | 05/1996→07/2004 | | | |
| V94203  | 0948.83 |  | 45° | Y | H | | |
| 28.80 x 6.00 x 104.40 | | MB cr | | | | | |
| V94204  | 0949.A8 |  | 45° | | | | |
| 24.50 x 6.00 x 104.30 | | MD cr | | | | | |

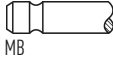
25  **78.50**

| TU5JP4 (NFU) | 1587cc | 4 Cyl. | 16 Valves | 78-90kW/106-122PS | Petrol | DOHC | TD15689 |
|---|---------|---|-----------|-------------------|--------|--|-----------------|
| 206+ 1.6 16V | | | | 07/2010→ | | | 09/2001→12/2008 |
| 206 1.6 16V | | | | 09/2000→ | | | 07/2002→ |
| 207 1.6 16V | | | | 02/2006→ | | | 11/2008→ |
| 208 1.6 | | | | 01/2013→ | | | 07/2006→ |
| 307 1.6 16V | | | | 08/2000→ | | | 09/2007→ |
| 308 1.6 BioFlex | | | | 04/2008→ | | | 03/2009→ |
| 405 II 1.6 | | | | 08/1992→05/1997 | | | 04/2005→ |
| HOGGAR 1.6 | | | | 05/2010→ | | | 09/2000→ |
| PARTNER 1.6 16V | | | | 09/2000→12/2015 | | | |
| V94599  | 0948.A9 |  | 45° | Y | H | VAG96271B  | |
| 31.30 x 6.00 x 103.70 | | MB | | | | 40.00 x 6.00 x 11.06 | |
| V94204  | 0949.A8 |  | 45° | | | | |
| 24.50 x 6.00 x 104.30 | | MD cr | | | | | |

26  **80.00**

| XUD7 (161) | 1769cc | 4 Cyl. | 8 Valves | 43-44kW/58-60PS | Diesel | SOHC | TD21268 |
|---|---------|---|----------|-----------------|--------|--|-----------------|
| XUD7 (161A) | 1769cc | 4 Cyl. | 8 Valves | 44kW/60PS | Diesel | SOHC | TD2882 |
| XUD7 (A9A) | 1769cc | 4 Cyl. | 8 Valves | 43-44kW/58-60PS | Diesel | SOHC | TD12351 |
| 205 1.7 Diesel | | | | 03/1994→05/1997 | | | 02/1983→07/1990 |
| 205 I 1.7 Diesel | | | | 08/1983→10/1987 | | | 07/1987→09/1998 |
| 305 II 1.8 D | | | | 11/1982→12/1988 | | | 04/1993→05/2001 |
| 309 II 1.8 D | | | | 10/1991→10/1993 | | | 07/1989→12/1993 |
| PARTNER 1.8 D | | | | 06/1996→12/2002 | | | |
| V91143  | 0948.49 |  | 30° | | H | VAG92288B  | |
| 38.00 x 8.00 x 112.40 →10/86 | | MB | | | | 52.00 x 8.03 x 14.28 | |
| V91144  | 0948.63 |  | 45° | | H | VAG92331B  | |
| 38.50 x 8.00 x 112.50 11/86→ | | MB | | | | 50.00 x 8.03 x 14.08 | |
| V91145  | 0949.47 |  | 45° | | | | |
| 33.00 x 8.00 x 112.00 | | MD cr | | | | | |
| V94024  | 0949.64 |  | 45° | | | | |
| 33.00 x 8.00 x 112.00 | | MD | | | | | |

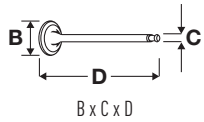

OE

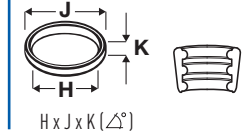
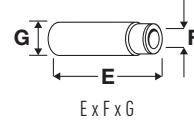
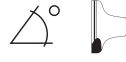

27 80.00

| | | | | | | | |
|------------------------|--------|-----------------|-----------------|----------------|--------|--------------------|----------------|
| XUD7T | 1769cc | 4 Cyl. | 8 Valves | 58kW/79PS | Diesel | Turbo, SOHC | TD18394 |
| XUD7TE (A8A) | 1769cc | 4 Cyl. | 8 Valves | 66kW/90PS | Diesel | Turbo, SOHC | TD2884 |
| XUD7TE (A8B) | 1769cc | 4 Cyl. | 8 Valves | 57kW/78PS | Diesel | Turbo, SOHC | TD10789 |
| XUD7TE (AJZ) | 1769cc | 4 Cyl. | 8 Valves | 66kW/90PS | Diesel | Turbo, SOHC | TD2885 |
| 205 II 1.8 TD | | 01/1990→09/1998 | | 205 II 1.8 XDT | | 08/1990→05/1997 | |
| 309 II 1.8 TD | | 08/1989→12/1993 | | 405 I 1.8 D | | 10/1987→07/1992 | |
| 405 I 1.8 DT | | 05/1990→07/1992 | | 405 I 1.8 TD | | 10/1988→08/1992 | |
| 405 I 1.8 Turbo Diesel | | 03/1988→12/1992 | | | | | |

V91144 ■
38.50 x 8.00 x 112.50

0948.63

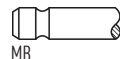

45°

H

VAG92288B ■ ■ ■
52.00 x 8.03 x 14.28



V91145 ■
33.00 x 8.00 x 112.00

0949.47



45°

V94024 ■
33.00 x 8.00 x 112.00

0949.64

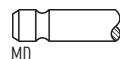

45°

28 81.00

| | | | | | | | |
|-----------------------|--------|----------|------------------|-------------|--------|--------------------|----------------|
| DT17 (UHZ) | 2721cc | V6 Cyl. | 24 Valves | 150kW/204PS | Diesel | Turbo, DOHC | TD20027 |
| DT17BTE4 (UHZ) | 2721cc | V6 Cyl. | 24 Valves | 150kW/204PS | Diesel | Turbo, DOHC | TD21317 |
| DT17TE4 | 2721cc | V6 Cyl. | 24 Valves | 150kW/204PS | Diesel | Turbo, DOHC | TD18175 |
| 407 2.7 HDi | | 10/2005→ | | 607 2.7 HDi | | 12/2004→07/2011 | |

V95135 ■
27.80 x 5.94 x 97.00

0948.E1

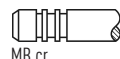

45°

H

V95136 ■
25.20 x 5.93 x 96.35

0949.C6

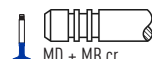

45°

ss

H

29 82.20

| | | | | | | | |
|-------------------|--------|-----------------|-----------------|-----------------|--------|-----------------|----------------|
| DW8 (WJZ) | 1868cc | 4 Cyl. | 8 Valves | 51-52kW/69-72PS | Diesel | SOHC | TD9868 |
| DW8B (WJY) | 1868cc | 4 Cyl. | 8 Valves | 51kW/69PS | Diesel | SOHC | TD13788 |
| 206 1.9 D | | 09/1998→05/2007 | | 207 1.9 D | | 10/2008→ | |
| 207 1.9 XSD | | 12/2007→ | | 306 1.9 D | | 09/1998→08/2003 | |
| EXPERT 1.9 D | | 06/1998→12/2006 | | EXPERT 1.9 D 70 | | 12/1998→12/2006 | |
| PARTNER 1.9 D | | 06/1996→12/2015 | | | | | |

V91144 ■
38.50 x 8.00 x 112.50

0948.63

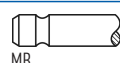

45°

H

VAG96100 ■ ■ ■
48.00 x 8.02 x 14.37

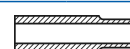

V91145 ■
33.00 x 8.00 x 112.00

0949.47

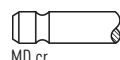

45°

30 82.70

| | | | | | | | |
|--------------------|--------|-----------------|------------------|------------|--------|-------------|----------------|
| EW7A (6FY) | 1749cc | 4 Cyl. | 16 Valves | 92kW/125PS | Petrol | DOHC | TD20026 |
| EW7J4 (6FZ) | 1749cc | 4 Cyl. | 16 Valves | 85kW/116PS | Petrol | DOHC | TD15190 |
| 406 1.8 16V | | 10/2000→10/2004 | | 407 1.8 | | 05/2004→ | |
| 407 1.8 16V | | 09/2005→ | | | | | |

V94492 ■
29.80 x 6.00 x 106.00

0948.A4

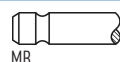

45°

Y

H

VAG96342B ■
40.80 x 6.02 x 12.11

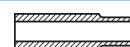

V94493 ■
27.20 x 6.00 x 104.00

0949.A4

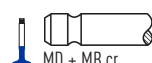

45°

H

VAG96343 ■
40.80 x 6.02 x 12.06





OE

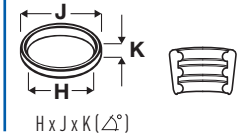

31  **83.00**

| | | | | | | | |
|--------------------|--------|-----------------|-----------------|-----------------|--------|-----------------|---------------|
| XU51C (B1A) | 1580cc | 4 Cyl. | 8 Valves | 55-59kW/75-80PS | Petrol | SOHC | TD2857 |
| XU51C (B1D) | 1580cc | 4 Cyl. | 8 Valves | 55-59kW/75-80PS | Petrol | SOHC | TD2762 |
| XU5S (171) | 1580cc | 4 Cyl. | 8 Valves | 66-71kW/90-97PS | Petrol | SOHC | TD2865 |
| 205 I 1.6 | | 08/1986→10/1987 | | 205 II 1.6 | | 10/1987→09/1998 | |
| 305 II 1.6 | | 10/1982→12/1988 | | 309 I 1.6 | | 10/1985→07/1989 | |

V91280 ■
40.00 x 8.00 x 109.00
02/84→

0948.47



45°

H

VAG92332B ■
38.70 x 8.02 x 13.07



V91279 ■
33.00 x 8.00 x 108.70
02/84→

0949.52

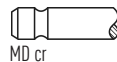

45°

VAG92333B ■
45.00 x 8.02 x 13.07



32  **83.00**

| | | | | | | | |
|----------------------|--------|-----------------|-----------------|-----------------|--------|-----------------|----------------|
| XU51C (B1E) | 1580cc | 4 Cyl. | 8 Valves | 53-59kW/72-80PS | Petrol | SOHC | TD2856 |
| XU52C/K (B2A) | 1580cc | 4 Cyl. | 8 Valves | 66-68kW/90-92PS | Petrol | SOHC | TD12430 |
| XU5CP (BAZ) | 1580cc | 4 Cyl. | 8 Valves | 54-55kW/74-75PS | Petrol | SOHC | TD2859 |
| XU5M (BDZ) | 1580cc | 4 Cyl. | 8 Valves | 65-69kW/88-94PS | Petrol | SOHC | TD2839 |
| 205 I 1.6 | | 08/1986→10/1987 | | 205 II 1.6 | | 10/1987→09/1998 | |
| 305 II 1.6 | | 11/1986→12/1988 | | 309 I 1.6 | | 08/1987→07/1989 | |
| 309 I 1.6 Cat | | 09/1986→12/1989 | | 309 II 1.6 | | 07/1989→12/1993 | |
| 405 I 1.6 | | 01/1987→12/1992 | | 405 I 1.6 SRi | | 04/1988→07/1992 | |
| 405 II 1.6 | | 08/1992→05/1997 | | | | | |

V91280 ■
40.00 x 8.00 x 109.00

0948.47



45°

H

VAG92332B ■
38.70 x 8.02 x 13.07



V91279 ■
33.00 x 8.00 x 108.70

0949.52

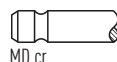

45°

VAG92333B ■
45.00 x 8.02 x 13.07

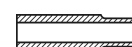

33  **83.00**

| | | | | | | | |
|---------------------|--------|-----------------|-----------------|-------------------|--------|-----------------|---------------|
| XU5J (180) | 1580cc | 4 Cyl. | 8 Valves | 76kW/103PS | Petrol | SOHC | TD2862 |
| XU5J (180A) | 1580cc | 4 Cyl. | 8 Valves | 76-77kW/104-105PS | Petrol | SOHC | TD2861 |
| XU5J (B6B) | 1580cc | 4 Cyl. | 8 Valves | 76kW/103PS | Petrol | SOHC | TD2858 |
| XU5JP (BFZ) | 1580cc | 4 Cyl. | 8 Valves | 65-68kW/88-92PS | Petrol | SOHC | TD2863 |
| XU5M2Z (BDY) | 1580cc | 4 Cyl. | 8 Valves | 65-71kW/88-97PS | Petrol | SOHC | TD4846 |
| XU5M3Z (BDY) | 1580cc | 4 Cyl. | 8 Valves | 65-66kW/88-90PS | Petrol | SOHC | TD2864 |
| 205 I 1.6 CJ | | 08/1992→12/1994 | | 205 I 1.6 CTI | | 04/1986→10/1990 | |
| 205 I 1.6 GTI | | 12/1984→10/1987 | | 205 II 1.6 | | 05/1990→09/1998 | |
| 205 II 1.6 GTI | | 10/1987→12/1989 | | 309 I 1.6 | | 11/1985→09/1988 | |
| 309 II 1.6 | | 07/1989→12/1993 | | 405 I 1.6 | | 07/1987→12/1992 | |
| 405 II 1.6 | | 08/1992→05/1997 | | 406 1.6 | | 11/1995→05/2004 | |

V91277 ■
41.60 x 8.00 x 108.80

0948.56

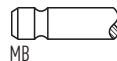

45°

Y

H

VAG92332B ■
38.70 x 8.02 x 13.07



V91280 ■
40.00 x 8.00 x 109.00

0948.47



45°

H

VAG92333B ■
45.00 x 8.02 x 13.07

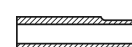

V91275 ■
34.50 x 8.00 x 108.30

0949.57

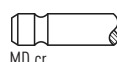

45°

V91279 ■
33.00 x 8.00 x 108.70

0949.52

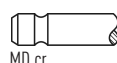

45°



OE

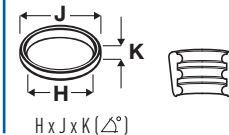
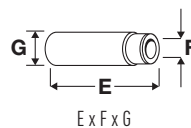
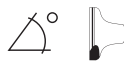

34 83.00

| | | | | | | | |
|--------------------|--------|-----------------|-----------------|-------------------|--------|-----------------|----------------|
| XU7JB (LFX) | 1762cc | 4 Cyl. | 8 Valves | 66kW/90PS | Petrol | SOHC | TD12708 |
| XU7JP (LFW) | 1762cc | 4 Cyl. | 8 Valves | 73kW/99PS | Petrol | SOHC | TD2867 |
| XU7JP (LFZ) | 1762cc | 4 Cyl. | 8 Valves | 74-76kW/101-103PS | Petrol | SOHC | TD2866 |
| 306 1.8 | | 05/1993→04/2002 | | 306 1.8 8V | | 01/1998→09/1999 | |
| 306 1.8 ST | | 06/1994→05/2001 | | 405 II 1.8 | | 08/1992→11/1999 | |
| 406 1.8 | | 10/1996→10/2004 | | 806 1.8 | | 07/1995→08/2002 | |
| EXPERT 1.8 | | 10/1996→09/2000 | | PARTNER 1.8 | | 03/1997→12/2003 | |

V91277
41.60 x 8.00 x 108.80

0948.56

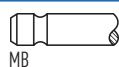

45° Y H

VAG92332B
38.70 x 8.02 x 13.07



V91275
34.50 x 8.00 x 108.30

0949.57

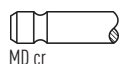

45°

VAG96056B
45.00 x 8.03 x 13.07

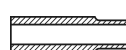

35 83.00

| | | | | | | | |
|---------------------|--------|-----------------|------------------|-------------------|--------|-----------------|---------------|
| XU7JP4 (LFY) | 1762cc | 4 Cyl. | 16 Valves | 81-86kW/110-117PS | Petrol | DOHC | TD4849 |
| 306 1.8 16V | | 03/1997→10/2003 | | 406 1.8 | | 04/1999→05/2003 | |
| 406 1.8 16V | | 11/1995→10/2000 | | | | | |

V94229
34.60 x 7.00 x 106.40
Eng.→07359

0948.75

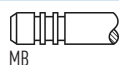

45° Y H

VAG96342B
40.80 x 6.02 x 12.11
Eng.07360→



V94167
34.10 x 6.00 x 106.40
Eng.07360→

0948.82

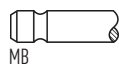

45° Y H

VAG96343
40.80 x 6.02 x 12.06
Eng.07360→



V94175
34.60 x 6.00 x 106.40
Eng.07360→

0948.92

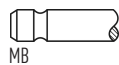

45° Y H

V94217
29.60 x 7.00 x 105.70
Eng.→07359

0949.81

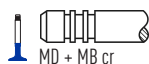

45° H

V94176
29.60 x 6.00 x 105.80
Eng.07360→

0949.92

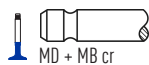

45° ss H



OE

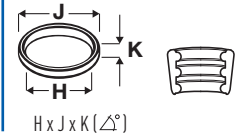
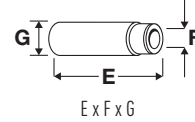
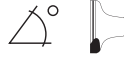

36



83.00

| | | | | | | | |
|--------------------|-----------------|--------|----------|-------------------|--------|-----------------|---------|
| XU92C | 1905cc | 4 Cyl. | 8 Valves | 75kW/102PS | Petrol | SOHC | TD2879 |
| XU92C (D2A) | 1905cc | 4 Cyl. | 8 Valves | 75kW/102PS | Petrol | SOHC | TD2869 |
| XU92C (D2C) | 1905cc | 4 Cyl. | 8 Valves | 70kW/95PS | Petrol | SOHC | TD2871 |
| XU9J1 (DFZ) | 1905cc | 4 Cyl. | 8 Valves | 72-77kW/98-105PS | Petrol | SOHC | TD2870 |
| XU9J2 (D6A) | 1905cc | 4 Cyl. | 8 Valves | 90-93kW/122-126PS | Petrol | SOHC | TD22159 |
| XU9JA (D6B) | 1905cc | 4 Cyl. | 8 Valves | 94-96kW/128-131PS | Petrol | SOHC | TD2872 |
| XU9JAZ (DKZ) | 1905cc | 4 Cyl. | 8 Valves | 88-92kW/120-125PS | Petrol | SOHC | TD2877 |
| XU9M (DDZ) | 1905cc | 4 Cyl. | 8 Valves | 80kW/109PS | Petrol | SOHC | TD2878 |
| XU9S (D2B) | 1905cc | 4 Cyl. | 8 Valves | 75kW/102PS | Petrol | SOHC | TD2772 |
| 205 I 1.9 | 05/1986→07/1987 | | | 205 I 1.9 CTi | | 08/1987→07/1992 | |
| 205 I 1.9 CTi | 10/1987→12/1994 | | | 205 I 1.9 GTi | | 10/1986→10/1987 | |
| 205 II 1.9 | 08/1990→05/1997 | | | 205 II 1.9 GTi | | 10/1987→09/1998 | |
| 205 II 1.9 GTi Cat | 10/1987→07/1994 | | | 305 II 1.9 | | 10/1982→12/1988 | |
| 309 I 1.9 | 10/1985→07/1989 | | | 309 I 1.9 GTi | | 10/1986→07/1989 | |
| 309 II 1.9 | 08/1989→12/1993 | | | 309 II 1.9 GTi | | 07/1989→12/1993 | |
| 405 I 1.9 | 06/1987→12/1993 | | | 405 I 1.9 4x4 | | 06/1987→07/1992 | |
| 405 II 1.9 | 01/1992→11/1997 | | | | | | |

V91277 ■
41.60 x 8.00 x 108.80

0948.56

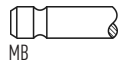

45° Y H

VAG92332B ■
38.70 x 8.02 x 13.07



V91275 ■
34.50 x 8.00 x 108.30

0949.57

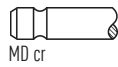

45°

VAG96056B ■
45.00 x 8.03 x 13.07



37



83.00

| | | | | | | | |
|--------------------|-----------------|--------|-----------|-----------------------|--------|-----------------|--------|
| XU9J4 (D6C/DFW) | 1905cc | 4 Cyl. | 16 Valves | 116-118kW/158-160PS | Petrol | DOHC | TD2873 |
| XU9J4 (DFW) | 1905cc | 4 Cyl. | 16 Valves | 108kW/147PS | Petrol | DOHC | TD2875 |
| 309 II 1.9 GTi 16V | 08/1989→12/1993 | | | 405 I 1.9 | | 06/1987→07/1992 | |
| 405 I 1.9 MI-16 | 07/1987→12/1992 | | | 405 I 1.9 SPort MI-16 | | 04/1988→12/1992 | |

V91469 ■
34.50 x 7.00 x 106.50

0948.61

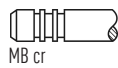

45° H

V91470 ■
29.60 x 7.00 x 105.70

0949.62

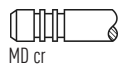

45°

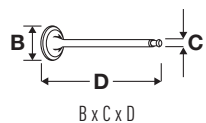

OE

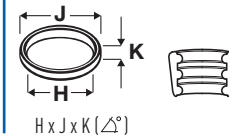
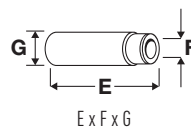

38 **83.00**

| | | | | | | | |
|------------------------|-----------------|--------|-----------------|-----------------|--------|-------------|-----------------|
| XUD9 | 1905cc | 4 Cyl. | 8 Valves | 47-52kW/64-71PS | Diesel | SOHC | TD8478 |
| XUD9 (16Z) | 1905cc | 4 Cyl. | 8 Valves | 47-48kW/64-65PS | Diesel | SOHC | TD2886 |
| XUD9 (D9A) | 1905cc | 4 Cyl. | 8 Valves | 47kW/64PS | Diesel | SOHC | TD2754 |
| XUD9 (DJZ) | 1905cc | 4 Cyl. | 8 Valves | 47kW/64PS | Diesel | SOHC | TD2891 |
| XUD9A (D9B) | 1905cc | 4 Cyl. | 8 Valves | 51-52kW/69-71PS | Diesel | SOHC | TD2834 |
| XUD9A (D9B) | 1905cc | 4 Cyl. | 8 Valves | 51kW/70PS | Diesel | SOHC | TD2880 |
| XUD9A (D9B/DJY) | 1905cc | 4 Cyl. | 8 Valves | 51kW/69PS | Diesel | SOHC | TD10827 |
| XUD9A (DJY) | 1905cc | 4 Cyl. | 8 Valves | 50-52kW/68-71PS | Diesel | SOHC | TD2887 |
| 205 II 1.9 Diesel | 08/1987→09/1998 | | | 305 II 1.9 D | | | 10/1982→07/1988 |
| 305 II 1.9 Diesel | 10/1982→12/1988 | | | 306 1.9 D | | | 04/1993→04/2002 |
| 306 1.9 SLD | 06/1994→05/2001 | | | 306 1.9 STD | | | 02/1994→05/1999 |
| 306 1.9 Td | 07/1995→08/2000 | | | 309 I 1.9 D | | | 06/1986→07/1989 |
| 309 II 1.9 Diesel | 07/1989→12/1993 | | | 405 I 1.9 D | | | 10/1988→08/1992 |
| 405 I 1.9 Diesel | 03/1988→12/1992 | | | 405 II 1.9 D | | | 08/1992→11/1999 |
| BOXER 1.9 D | 03/1994→04/2002 | | | EXPERT 1.9 D | | | 02/1996→12/1998 |
| J5 1.9 D | 09/1987→03/1994 | | | PARTNER 1.9 D | | | 05/1996→12/2002 |

V91143 0948.49
38.00 x 8.00 x 112.40
→01/86

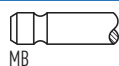

30°

H

VAG92288B **E**
52.00 x 8.03 x 14.28



V91144 0948.63
38.50 x 8.00 x 112.50
01/86→

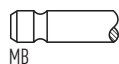

45°

H

VAG92331B **E**
50.00 x 8.03 x 14.08



V91145 0949.47
33.00 x 8.00 x 112.00

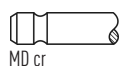

45°

MD cr

VAG92465B **E**
52.00 x 8.03 x 14.07



V94024 0949.64
33.00 x 8.00 x 112.00

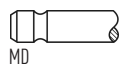

45°

MD

39 **83.00**

| | | | | | | | |
|----------------------|-----------------|--------|-----------------|-----------------|--------|--------------------|-----------------|
| XUD9BSD (DHV) | 1905cc | 4 Cyl. | 8 Valves | 55kW/75PS | Diesel | SOHC | TD9867 |
| XUD9SD (DHW) | 1905cc | 4 Cyl. | 8 Valves | 55kW/75PS | Diesel | Turbo, SOHC | TD9365 |
| XUD9TE | 1905cc | 4 Cyl. | 8 Valves | 66-69kW/90-94PS | Diesel | Turbo, SOHC | TD18953 |
| XUD9TE (D8B) | 1905cc | 4 Cyl. | 8 Valves | 68-69kW/92-94PS | Diesel | Turbo, SOHC | TD2751 |
| XUD9TE (DHX) | 1905cc | 4 Cyl. | 8 Valves | 66kW/90PS | Diesel | Turbo, SOHC | TD2889 |
| XUD9TE (DHY) | 1905cc | 4 Cyl. | 8 Valves | 66-69kW/90-93PS | Diesel | Turbo, SOHC | TD2888 |
| XUD9UTF (D8C) | 1905cc | 4 Cyl. | 8 Valves | 68kW/92PS | Diesel | Turbo, SOHC | TD2890 |
| 306 1.9 D | 04/1993→04/2002 | | | 306 1.9 DT | | | 05/1993→05/2001 |
| 306 1.9 SRDT | 06/1994→05/2001 | | | 306 1.9 TD | | | 02/1997→04/2002 |
| 405 II 1.9 D | 08/1992→12/1995 | | | 405 II 1.9 TD | | | 08/1992→05/1997 |
| 406 1.9 D | 10/1996→10/2004 | | | 406 1.9 TD | | | 10/1995→10/2004 |
| 806 1.9 TD | 07/1995→08/2002 | | | BOXER 1.9 DT | | | 03/1996→09/1998 |
| BOXER 1.9 TD | 03/1994→04/2002 | | | EXPERT 1.9 D | | | 10/1995→05/1998 |
| EXPERT 1.9 TD | 02/1996→09/2000 | | | | | | |

V91144 0948.63
38.50 x 8.00 x 112.50

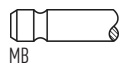

45°

H

VAG92288B **E**
52.00 x 8.03 x 14.28



V91145 0949.47
33.00 x 8.00 x 112.00

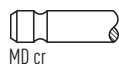

45°

MD cr

VAG92331B **E**
50.00 x 8.03 x 14.08

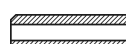

V94017 0949.74
33.00 x 8.00 x 111.90

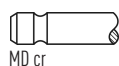

45°

MD cr

VAG92465B **E**
52.00 x 8.03 x 14.07





OE

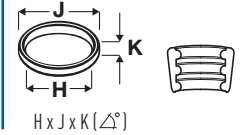
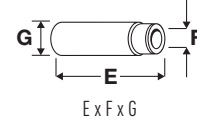
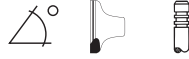

40 **84.00**

| | | | | | | | |
|-------------|--------|-----------------|-----------------|-----------------|--------|-----------------|---------------|
| XC5P | 1618cc | 4 Cyl. | 8 Valves | 50kW/68PS | Petrol | OHV | TD8495 |
| XC6 | 1618cc | 4 Cyl. | 8 Valves | 48-60kW/65-82PS | Petrol | OHV | TD2793 |
| XC7P | 1618cc | 4 Cyl. | 8 Valves | 44-46kW/60-63PS | Petrol | OHV | TD8496 |
| 404 1.6 | | 04/1963→12/1971 | | 404 1.6 GT | | 07/1971→12/1971 | |
| 504 1.6 | | 01/1980→06/1987 | | J7 1.6 | | 08/1968→03/1980 | |
| J9 1.6 | | 03/1980→06/1987 | | | | | |

| | | | | | | |
|-----------------------|---------|----|-----|---|----------------------|--|
| V34459 | 0948.33 | | 30° | H | VAG51007 | |
| 42.50 x 8.00 x 118.30 | | MB | | | 55.00 x 8.00 x 14.06 | |
| V34460 | 0949.21 | | 45° | | | |
| 35.50 x 8.00 x 112.00 | | MD | | | | |

41 **84.00**

| | | | | | | | |
|--------------------|--------|-----------------|-----------------|-----------------|--------|-----------------|---------------|
| KF5 | 1796cc | 4 Cyl. | 8 Valves | 71kW/97PS | Petrol | | TD2883 |
| KF6 | 1796cc | 4 Cyl. | 8 Valves | 71kW/97PS | Petrol | | TD2755 |
| XM | 1796cc | 4 Cyl. | 8 Valves | 60kW/82PS | Petrol | | TD2824 |
| XM7 | 1796cc | 4 Cyl. | 8 Valves | 53-58kW/72-79PS | Petrol | | TD2825 |
| XM7 (105) | 1796cc | 4 Cyl. | 8 Valves | 55-60kW/75-82PS | Petrol | | TD2826 |
| XM7A (105C) | 1796cc | 4 Cyl. | 8 Valves | 62-66kW/84-90PS | Petrol | | TD2827 |
| XM7P | 1796cc | 4 Cyl. | 8 Valves | 48-50kW/65-68PS | Petrol | | TD8497 |
| XM7T (169B) | 1796cc | 4 Cyl. | 8 Valves | 49-51kW/67-69PS | Petrol | | TD6793 |
| 504 1.8 | | 07/1968→10/1999 | | 505 1.8 | | 06/1981→09/1989 | |
| J5 1.8 | | 09/1981→01/1994 | | J7 1.8 | | 07/1970→03/1980 | |

| | | | | | | |
|-----------------------|---------|----|-----|---|----------------------|--|
| V34459 | 0948.33 | | 30° | H | VAG51007 | |
| 42.50 x 8.00 x 118.30 | | MB | | | 55.00 x 8.00 x 14.06 | |
| V34460 | 0949.21 | | 45° | | | |
| 35.50 x 8.00 x 112.00 | | MD | | | | |

42 **84.00**

| | | | | | | | |
|--------------|--------|---------|------------------|-------------|--------|--------------------|----------------|
| DT20C | 2993cc | V6 Cyl. | 24 Valves | 177kW/241PS | Diesel | Turbo, DOHC | TD23527 |
| 407 3.0 HDi | | | | | | | 06/2009→ |

| | | | | | | |
|----------------------|---------|------------|-----|----|---|--|
| V95135 | 0948.E1 | | 45° | H | | |
| 27.80 x 5.94 x 97.00 | | MB cr | | | | |
| V95136 | 0949.C6 | | 45° | ss | H | |
| 25.20 x 5.93 x 96.35 | | MD + MB cr | | | | |



OE

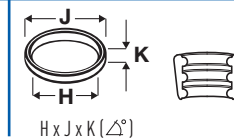
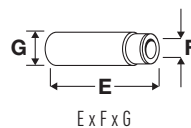

43 85.00

| | | | | | | | |
|----------------------------|----------|--------|------------------|--------------------|--------|--------------------|----------------|
| DW10 C HYBRID (RHC) | 1997cc | 4 Cyl. | 16 Valves | 120kW/163PS | Diesel | Turbo, DOHC | TD28710 |
| DW10BTED4 (RHF) | 1997cc | 4 Cyl. | 16 Valves | 103kW/140PS | Diesel | Turbo, DOHC | TD26794 |
| DW10CTED4 (RHE) | 1997cc | 4 Cyl. | 16 Valves | 110kW/150PS | Diesel | Turbo, DOHC | TD25633 |
| DW10CTED4 (RHH) | 1997cc | 4 Cyl. | 16 Valves | 120kW/163PS | Diesel | Turbo, DOHC | TD23536 |
| 308 2.0 HDi | 10/2011→ | | | 308 CC 2.0 HDi | | 04/2009→ | |
| 308 SW 2.0 HDi | 06/2009→ | | | 407 2.0 HDi | | 06/2009→ | |
| 508 2.0 HDi | 11/2010→ | | | 508 2.0 HDi AWC | | 11/2010→ | |
| 508 SW 2.0 HDi | 11/2010→ | | | 508 SW 2.0 HDi RXH | | 11/2010→ | |
| 807 2.0 HDi | 06/2009→ | | | 3008 2.0 HDi | | 06/2009→ | |
| 3008 2.0 HDi 150 / | 06/2009→ | | | 5008 2.0 HDi | | 09/2009→ | |
| 5008 2.0 HDi 150 / | 06/2009→ | | | EXPERT 2.0 HDi 165 | | 09/2009→ | |
| RCZ 2.0 HDi | 03/2010→ | | | | | | |

V95234
27.25 x 6.00 x 104.50

0948.F6

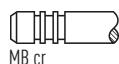

45°

H

VAG96119
41.50 x 6.03 x 10.54



V94491
25.00 x 6.00 x 105.00

0949.A3



45°

SS

H

44 85.00

| | | | | | | | |
|-----------------------|-----------------|--------|-----------------|-------------------|--------|--------------------|----------------|
| DW10ATED (RHS) | 1997cc | 4 Cyl. | 8 Valves | 79kW/107PS | Diesel | Turbo, SOHC | TD20417 |
| DW10ATED (RHZ) | 1997cc | 4 Cyl. | 8 Valves | 79-80kW/107-109PS | Diesel | Turbo, SOHC | TD10727 |
| DW10BTED (RHX) | 1997cc | 4 Cyl. | 8 Valves | 69kW/94PS | Diesel | Turbo, SOHC | TD17515 |
| DW10TD (RHV) | 1997cc | 4 Cyl. | 8 Valves | 62kW/84PS | Diesel | Turbo, SOHC | TD24911 |
| DW10TD (RHY) | 1997cc | 4 Cyl. | 8 Valves | 66kW/90PS | Diesel | Turbo, SOHC | TD12569 |
| DW10UTD (RHV) | 1997cc | 4 Cyl. | 8 Valves | 62kW/84PS | Diesel | Turbo, SOHC | TD17512 |
| 206 2.0 HDi | 07/2002→ | | | 206 2.0 HDi 90 | | 12/1999→ | |
| 207 2.0 HDi | 12/2007→ | | | 207 SW 2.0 HDi | | 10/2008→10/2011 | |
| 306 2.0 HDi | 08/1998→06/2000 | | | 306 2.0 HDi 90 | | 06/1999→04/2002 | |
| 307 2.0 HDi | 09/2006→03/2012 | | | 307 2.0 HDi 90 | | 03/2002→ | |
| 307 2.0 HDi 90 | 08/2000→ | | | 307 2.0 HDi 110 | | 03/2002→12/2009 | |
| 307 2.0 HDi 110 | 08/2000→ | | | 406 2.0 HDi 90 | | 02/1999→10/2004 | |
| 406 2.0 HDi 110 | 08/2001→10/2004 | | | 406 2.0 HDi 110 | | 06/1998→04/2004 | |
| 607 2.0 HDi | 03/2001→09/2004 | | | 607 2.0 HDi | | 05/2000→09/2005 | |
| 806 2.0 HDi | 08/1999→08/2002 | | | BOXER 2.0 HDi | | 04/2002→ | |
| BOXER 2.0 HDi | 08/2001→04/2002 | | | EXPERT 2.0 HDi | | 10/2000→10/2006 | |
| EXPERT 2.0 HDi | 07/2000→12/2006 | | | PARTNER 2.0 HDi | | 04/2000→07/2008 | |
| PARTNER 2.0 HDi | 02/2000→07/2008 | | | | | | |

V94178
35.60 x 6.00 x 107.10

0948.95

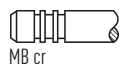

45°

H

VAG96119
41.50 x 6.03 x 10.54



V94179
33.80 x 6.00 x 107.10

0949.96

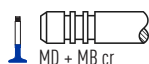

45°

H



OE

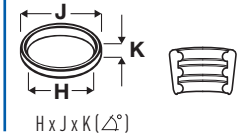
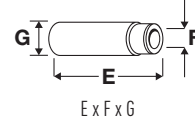
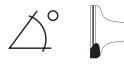

45  **85.00**

| | | | | | | | |
|------------------------|-----------------|--------|------------------|--------------------|--------|--------------------|----------------|
| DW10ATED4 (RHM) | 1997cc | 4 Cyl. | 16 Valves | 79kW/107PS | Diesel | Turbo, DOHC | TD20790 |
| DW10ATED4 (RHT) | 1997cc | 4 Cyl. | 16 Valves | 79kW/107PS | Diesel | Turbo, DOHC | TD20789 |
| DW10ATED4 (RHW) | 1997cc | 4 Cyl. | 16 Valves | 79-80kW/107-109PS | Diesel | Turbo, DOHC | TD17510 |
| DW10UTED4 (RHK) | 1997cc | 4 Cyl. | 16 Valves | 79-88kW/107-120PS | Diesel | Turbo, DOHC | TD19814 |
| 806 2.0 HDi 16V | 08/1999→08/2002 | | | 807 2.0 HDi | | 06/2002→ | |
| EXPERT 2.0 HDi | 07/2000→12/2006 | | | EXPERT 2.0 HDi | | 10/2000→10/2006 | |
| EXPERT 2.0 HDi 16V | 07/2000→12/2006 | | | EXPERT 2.0 HDi 120 | | 01/2007→ | |

V94486  **0948.C0**
29.90 x 6.00 x 106.20



45° Y H

VAG96119  **0948.C0**
41.50 x 6.03 x 10.54



V94487  **0949.A9**
25.00 x 6.00 x 106.10



45° SS H

46  **85.00**

| | | | | | | | |
|-----------------------|-----------------|--------|------------------|---------------------|--------|--------------------|----------------|
| DW10BTD4 (RHR) | 1997cc | 4 Cyl. | 16 Valves | 100-103kW/136-140PS | Diesel | Turbo, DOHC | TD17507 |
| 307 2.0 HDi 135 | 10/2003→ | | | 308 2.0 HDi | | 09/2007→ | |
| 308 CC 2.0 HDi | 04/2009→ | | | 308 SW 2.0 HDi | | 09/2007→ | |
| 407 2.0 HDi | 10/2005→ | | | 407 2.0 HDi 135 | | 05/2004→ | |
| 508 2.0 HDi | 11/2010→ | | | 508 SW 2.0 HDi | | 11/2010→ | |
| 607 2.0 HDi | 09/2005→07/2011 | | | 807 2.0 HDi | | 06/2006→ | |
| EXPERT 2.0 HDi 140 | 01/2007→ | | | | | | |

V94490  **0948.A3**
29.80 x 6.00 x 105.00



45° Y H

VAG96119  **0948.A3**
41.50 x 6.03 x 10.54



V94491  **0949.A3**
25.00 x 6.00 x 105.00



45° SS H

47  **85.00**

| | | | | | | | |
|------------------------|----------|--------|------------------|-------------|--------|--------------------|----------------|
| DW10CTED4 (RHD) | 1997cc | 4 Cyl. | 16 Valves | 100kW/136PS | Diesel | Turbo, DOHC | TD31482 |
| 5008 2.0 HDi 136 / 136 | 02/2012→ | | | | | | |

V94491  **0949.A3**
25.00 x 6.00 x 105.00



45° SS H

VAG96119  **0949.A3**
41.50 x 6.03 x 10.54



48  **85.00**

| | | | | | | | |
|---------------------|--------|--------|------------------|---------------------|--------|--------------------|----------------|
| DW10FC (AHW) | 1997cc | 4 Cyl. | 16 Valves | 133-133kW/180-181PS | Diesel | Turbo, DOHC | TD30806 |
| DW10FD (AHV) | 1997cc | 4 Cyl. | 16 Valves | 100kW/136PS | Diesel | Turbo, DOHC | TD31484 |
| DW10FD (AHX) | 1997cc | 4 Cyl. | 16 Valves | 110kW/150PS | Diesel | Turbo, DOHC | TD28614 |

308 II 2.0
308 SW II 2.0 GT
508 SW 2.0
3008 2.0 136
5008 2.0 HDi 136 / 136
5008 II 2.0
EXPERT 2.0

11/2013→
06/2014→
04/2014→
11/2016→
02/2012→
12/2016→
04/2016→

308 II 2.0 GT HDi 180
508 2.0
3008 2.0
3008 2.0 HDi 150 /
5008 2.0 HDi 150 /
5008 II 2.0 136

06/2014→
04/2014→
05/2016→
06/2009→
06/2009→
12/2016→

V95083  **0948.E5**
27.25 x 5.97 x 95.70



45° Y H

VAG96119  **0948.E5**
41.50 x 6.03 x 10.54



V95084  **0949.E1**
25.00 x 5.97 x 95.00

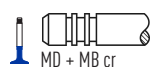

45° SS H



OE

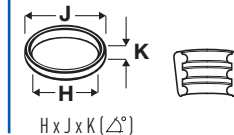
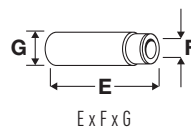
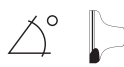

49 85.00

| | | | | | | | |
|----------------------|-----------------|--------|------------------|---------------------|--------|-----------------|----------------|
| EW10A (RFJ) | 1997cc | 4 Cyl. | 16 Valves | 103-111kW/140-151PS | Petrol | DOHC | TD18690 |
| EW10J4 (RFN) | 1997cc | 4 Cyl. | 16 Valves | 100-105kW/136-143PS | Petrol | DOHC | TD15188 |
| EW10J4 (RFR) | 1997cc | 4 Cyl. | 16 Valves | 99-101kW/135-138PS | Petrol | DOHC | TD12568 |
| EW10J4S (RFK) | 1997cc | 4 Cyl. | 16 Valves | 130-132kW/177-180PS | Petrol | DOHC | TD17846 |
| 206 2.0 16V | 07/2002→02/2007 | | | 206 2.0 RC | | 07/2003→ | |
| 206 2.0 S16 | 04/1999→ | | | 307 2.0 | | 03/2002→ | |
| 307 2.0 16V | 08/2000→ | | | 308 2.0 | | 01/2008→ | |
| 308 CC 2.0 | 07/2009→11/2014 | | | 308 SW 2.0 | | 01/2008→ | |
| 406 2.0 16V | 01/1999→12/2004 | | | 407 2.0 | | 05/2004→ | |
| 407 2.0 16V | 09/2005→ | | | 408 2.0 | | 03/2011→ | |
| 607 2.0 | 02/2000→08/2005 | | | 806 2.0 16V | | 09/2000→08/2002 | |
| 807 2.0 | 06/2002→ | | | 807 2.0 16V | | 09/2005→ | |
| EXPERT 2.0 | 07/2000→12/2006 | | | EXPERT 2.0 16V | | 01/2007→ | |

V94200
33.30 x 6.00 x 106.20

0948.99

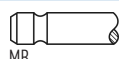

45°

H

VAG96342B
40.80 x 6.02 x 12.11

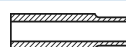

V94201
29.00 x 6.00 x 103.60

0949.99

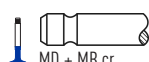

45°

SS

H

VAG96343
40.80 x 6.02 x 12.06

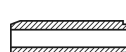

50 85.00

| | | | | | | | |
|--|-----------------|--------|------------------|-------------|--------|--|----------------|
| EW10D (RLZ) | 1997cc | 4 Cyl. | 16 Valves | 103kW/140PS | Petrol | DOHC | TD16234 |
| 406 2.0 16V HPI | 05/2001→10/2004 | | | | | | |
| V94494 32.40 x 6.00 x 105.00 | 0948.A7 | | | | | | |
| | | | 45° | Y | H | | |
| | | | | | | VAG96342B 40.80 x 6.02 x 12.11 | |
| V94495 29.20 x 6.00 x 102.60 | 0949.A7 | | | | | | |
| | | | 45° | SS | H | | |
| | | | | | | VAG96343 40.80 x 6.02 x 12.06 | |

51 85.00

| | | | | | | | |
|--|-----------------|--------|------------------|----------------|--------|--|---------------|
| XUD11ATE;(PHZ/P8A/P8B) | 2088cc | 4 Cyl. | 12 Valves | 80kW/109PS | Diesel | Turbo, SOHC | TD2881 |
| XUD11BTE (P8C) | 2088cc | 4 Cyl. | 12 Valves | 80kW/109PS | Diesel | Turbo, SOHC | TD4850 |
| 406 2.1 TD 12V | 01/1996→10/2004 | | | 605 2.1 TD 12V | | 08/1994→09/1999 | |
| 605 2.1 Turbo Diesel | 06/1989→09/1999 | | | 806 2.1 td 12V | | 06/1996→08/1999 | |
| V94169 33.90 x 8.00 x 122.30 | 0948.68 | | | | | | |
| | | | 45° | | H | | |
| | | | | | | VAG96215B 54.50 x 8.02 x 13.09 | |
| V94170 33.90 x 8.00 x 121.90 | 0949.68 | | | | | | |
| | | | 45° | | | | |

52 85.00

| | | | | | | | |
|--|-----------------|--------|------------------|-------------|--------|---|----------------|
| DW12ATED4 (4HW) | 2179cc | 4 Cyl. | 16 Valves | 94kW/128PS | Diesel | Turbo, DOHC | TD34583 |
| DW12TED4 (4HX/4HW) | 2179cc | 4 Cyl. | 16 Valves | 98kW/133PS | Diesel | Turbo, DOHC | TD16128 |
| 406 2.2 HDi | 03/2000→10/2004 | | | 406 2.2 HDi | | 03/2000→12/2004 | |
| 607 2.2 HDi | 02/2000→02/2006 | | | 807 2.2 HDi | | 06/2002→ | |
| V94490 29.80 x 6.00 x 105.00 | 0948.A3 | | | | | | |
| | | | 45° | Y | H | | |
| | | | | | | VAG96119 41.50 x 6.03 x 10.54 | |
| V94491 25.00 x 6.00 x 105.00 | 0949.A3 | | | | | | |
| | | | 45° | SS | H | | |



OE

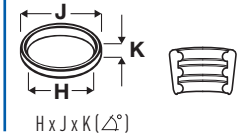
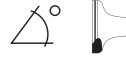

53



85.00

| | | | | | | | |
|-----------------|-----------------|--------|-----------|-----------------|--------|-------------|---------|
| DW12BTED4 (4HP) | 2179cc | 4 Cyl. | 16 Valves | 120kW/163PS | Diesel | Turbo, DOHC | TD24729 |
| DW12BTED4 (4HR) | 2179cc | 4 Cyl. | 16 Valves | 120kW/163PS | Diesel | Turbo, DOHC | TD24914 |
| DW12BTED4 (4HS) | 2179cc | 4 Cyl. | 16 Valves | 125kW/170PS | Diesel | Turbo, DOHC | TD24915 |
| DW12BTED4 (4HT) | 2179cc | 4 Cyl. | 16 Valves | 125kW/170PS | Diesel | Turbo, DOHC | TD20028 |
| 407 2.2 HDi | 06/2008→ | | | 407 2.2 HDi 170 | | 05/2006→ | |
| 607 2.2 HDi | 05/2006→06/2010 | | | 807 2.2 HDi | | 06/2006→ | |

V95083 27.25 x 5.97 x 95.70

0948.E5



45° Y H

VAG96119 41.50 x 6.03 x 10.54



V95084 25.00 x 5.97 x 95.00

0949.E1



45° ss H

54



85.00

| | | | | | | | |
|----------------|----------|--------|----------|------------|--------|-------------|---------|
| DW12UTED (4HY) | 2179cc | 4 Cyl. | 8 Valves | 74kW/101PS | Diesel | Turbo, DOHC | TD17513 |
| BOXER 2.2 HDi | 04/2002→ | | | | | | |

V94178 35.60 x 6.00 x 107.10

0948.95



45° H

VAG96119 41.50 x 6.03 x 10.54



V94179 33.80 x 6.00 x 107.10

0949.96



45° H

55



86.00

| | | | | | | | |
|---------------|-----------------|--------|----------|-------------------|--------|-----------------|---------|
| XU102C (R5A) | 1998cc | 4 Cyl. | 8 Valves | 84kW/114PS | Petrol | SOHC | TD8480 |
| XU10J2 (RFL) | 1998cc | 4 Cyl. | 8 Valves | 81kW/110PS | Petrol | SOHC | TD17511 |
| XU10J2 (RFU) | 1998cc | 4 Cyl. | 8 Valves | 89-90kW/121-123PS | Petrol | SOHC | TD2848 |
| XU10J2 (RFW) | 1998cc | 4 Cyl. | 8 Valves | 80kW/109PS | Petrol | SOHC | TD2847 |
| XU10J2 (RFX) | 1998cc | 4 Cyl. | 8 Valves | 89-96kW/121-131PS | Petrol | SOHC | TD2846 |
| XU10J2Z (RFZ) | 1998cc | 4 Cyl. | 8 Valves | 89-90kW/121-123PS | Petrol | SOHC | TD2851 |
| 306 2.0 | 03/1994→04/2002 | | | 306 2.0 ST | | 07/1994→05/2001 | |
| 306 2.0 XSi | 05/1993→05/2001 | | | 405 II 2.0 | | 08/1992→10/1996 | |
| 405 II 2.0 X4 | 08/1992→10/1995 | | | 605 2.0 | | 06/1989→09/1999 | |
| 806 2.0 | 06/1994→08/2002 | | | BOXER 2.0 | | 03/1996→ | |
| BOXER 2.0 i | 03/1994→04/2002 | | | | | | |

V91972 42.60 x 8.00 x 108.80

0948.66



45° H

V91970 34.50 x 8.00 x 108.40

0949.66

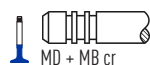

45° ss H

56



86.00

| | | | | | | | |
|----------------|-----------------|--------|----------|---------------|--------|-----------------|--------|
| XU10J2TE (RGX) | 1998cc | 4 Cyl. | 8 Valves | 108kW/147PS | Petrol | Turbo, SOHC | TD4847 |
| XU10J2TE (RGY) | 1998cc | 4 Cyl. | 8 Valves | 104kW/141PS | Petrol | Turbo, SOHC | TD2850 |
| 406 2.0 | 11/1996→03/1999 | | | 406 2.0 Turbo | | 04/1996→10/2004 | |
| 605 2.0 Turbo | 07/1991→09/1999 | | | 806 2.0 Turbo | | 06/1994→08/2002 | |

V91972 42.60 x 8.00 x 108.80

0948.66



45° H

V91971 34.50 x 8.00 x 108.40

0949.76

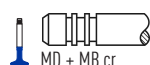

45° ss H



OE

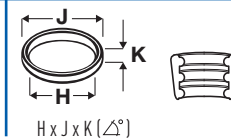
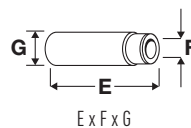
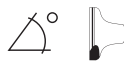

57 86.00

| | | | | | | | |
|---------------------|-----------------|--------|------------------|---------------------|-----------------|-------------|---------------|
| XU10J4 (RFT) | 1998cc | 4 Cyl. | 16 Valves | 110-114kW/150-155PS | Petrol | DOHC | TD2852 |
| XU10J4 (RFY) | 1998cc | 4 Cyl. | 16 Valves | 110-112kW/150-152PS | Petrol | DOHC | TD2855 |
| 306 2.0 S16 | 05/1993→05/2001 | | 405 II 2.0 16V | | 01/1992→10/1995 | | |
| 405 II 2.0 MI-16 | 08/1992→10/1995 | | | | | | |

| | | | | | | | |
|-----------------------|---------|------------|-----|---|---|--|--|
| V94229 ■ | 0948.75 | | 45° | Y | H | | |
| 34.60 x 7.00 x 106.40 | | MB | | | | | |
| V94217 ■ | 0949.81 | | 45° | | H | | |
| 29.60 x 7.00 x 105.70 | | MD + MB cr | | | | | |

58 86.00

| | | | | | | | |
|----------------------|-----------------|--------|------------------|--------------------|-----------------|-------------|---------------|
| XU10J4R (RFV) | 1998cc | 4 Cyl. | 16 Valves | 97-100kW/132-136PS | Petrol | DOHC | TD2853 |
| 306 2.0 | 03/1997→04/2002 | | 306 2.0 16V | | 03/1997→04/2002 | | |
| 406 2.0 16V | 11/1995→12/2004 | | 605 2.0 16V | | 07/1994→09/1999 | | |
| 806 2.0 16V | 05/1998→09/2000 | | | | | | |

| | | | | | | | |
|-----------------------|---------|------------|-----|----|---|----------------------|--|
| V94229 ■ | 0948.75 | | 45° | Y | H | VAG96342B ■ | |
| 34.60 x 7.00 x 106.40 | | MB | | | | 40.80 x 6.02 x 12.11 | |
| Eng.→07359 | | | | | | Eng.07360→ | |
| V94175 ■ | 0948.92 | | 45° | Y | H | VAG96343 ■ | |
| 34.60 x 6.00 x 106.40 | | MB | | | | 40.80 x 6.02 x 12.06 | |
| Eng.07360→ | | | | | | Eng.07360→ | |
| V94217 ■ | 0949.81 | | 45° | | H | | |
| 29.60 x 7.00 x 105.70 | | MD + MB cr | | | | | |
| Eng.→07359 | | | | | | | |
| V94176 ■ | 0949.92 | | 45° | ss | H | | |
| 29.60 x 6.00 x 105.80 | | MD + MB cr | | | | | |
| Eng.07360→ | | | | | | | |

59 86.00

| | | | | | | | |
|-----------------------|-----------------|--------|------------------|---------------------|--------|-------------|---------------|
| XU10J4RS (RFS) | 1998cc | 4 Cyl. | 16 Valves | 120-123kW/163-167PS | Petrol | DOHC | TD4848 |
| 306 2.0 S16 | 03/1996→05/2001 | | | | | | |

| | | | | | | | |
|-----------------------|---------|------------|-----|----|---|----------------------|--|
| V94167 ■ | 0948.82 | | 45° | Y | H | VAG96342B ■ | |
| 34.10 x 6.00 x 106.40 | | MB | | | | 40.80 x 6.02 x 12.11 | |
| V94168 ■ | 0949.87 | | 45° | ss | H | VAG96343 ■ | |
| 30.70 x 6.00 x 105.30 | | MD + MB cr | | | | 40.80 x 6.02 x 12.06 | |

60 86.00

| | | | | | | | |
|-----------------------|-----------------|--------|--------------------|-------------|-----------------|--------------------|---------------|
| XU10J4TE (RGZ) | 1998cc | 4 Cyl. | 16 Valves | 144kW/196PS | Petrol | Turbo, DOHC | TD2854 |
| 405 II 2.0 | 08/1992→12/1995 | | 405 II 2.0 T 16 X4 | | 08/1992→10/1995 | | |

| | | | | | | | |
|-----------------------|---------|-------|-----|--|---|--|--|
| V91469 ■ | 0948.61 | | 45° | | H | | |
| 34.50 x 7.00 x 106.50 | | MB cr | | | | | |
| V91470 ■ | 0949.62 | | 45° | | | | |
| 29.60 x 7.00 x 105.70 | | MD cr | | | | | |

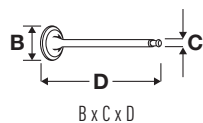

OE

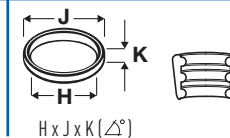
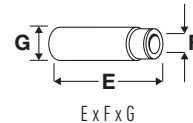

61 **86.00**

| | | | | | | | |
|-------------------------|-----------------|--------|------------------|-----------|----------------------|-------------|----------------|
| XUD11A (P9A/PJZ) | 2138cc | 4 Cyl. | 12 Valves | 60kW/82PS | Diesel | SOHC | TD11187 |
| 605 2.1 D | 06/1989→07/1995 | | | | | | |
| V94169 | 0948.68 | | 45° | H | VAG96215B | | |
| 33.90 x 8.00 x 122.30 | | MB cr | | | 54.50 x 8.02 x 13.09 | | |
| V94170 | 0949.68 | | 45° | | | | |
| 33.90 x 8.00 x 121.90 | | MD cr | | | | | |

62 **86.00**

| | | | | | | | |
|-----------------------|----------|--------|-------------------|------------|----------------------|--------------------|----------------|
| P22DTE (4HU) | 2198cc | 4 Cyl. | 16 Valves | 88kW/120PS | Diesel | Turbo, DOHC | TD24470 |
| P22DTE (4HV) | 2198cc | 4 Cyl. | 16 Valves | 74kW/101PS | Diesel | Turbo, DOHC | TD24469 |
| BOXER 2.2 HDi 100 | 04/2006→ | | BOXER 2.2 HDi 120 | | 04/2006→ | | |
| V98028 | 0948.E6 | | 30° | | VAG96368 | | |
| 29.80 x 7.00 x 122.30 | | MB cr | | | 51.50 x 6.97 x 12.07 | | |
| V98029 | 0949.E3 | | 30° | | | | |
| 25.80 x 7.00 x 122.10 | | MB cr | | | | | |

63 **86.00**

| | | | | | | | |
|-----------------------|-----------------|------------|------------------|-------------|----------------------|-------------|----------------|
| EW12J4 (3FY) | 2230cc | 4 Cyl. | 16 Valves | 120kW/163PS | Petrol | DOHC | TD20025 |
| EW12J4 (3FZ) | 2230cc | 4 Cyl. | 16 Valves | 116kW/158PS | Petrol | DOHC | TD16129 |
| 406 2.2 | 07/2000→12/2004 | | 407 2.2 | | 05/2004→ | | |
| 407 2.2 16V | 09/2005→ | | 607 2.2 16V | | 02/2000→06/2010 | | |
| 807 2.2 | 06/2002→ | | | | | | |
| V94488 | 0948.A1 | | 45° | Y H | VAG96342B | | |
| 35.00 x 6.00 x 106.00 | | MB | | | 40.80 x 6.02 x 12.11 | | |
| V94489 | 0949.A2 | | 45° | SS H | VAG96343 | | |
| 31.10 x 6.00 x 102.80 | | MD + MB cr | | | 40.80 x 6.02 x 12.06 | | |

64 **86.40**

| | | | | | | | |
|-----------------------|-----------------|--------|-----------------|-----------|----------------------|--|---------------|
| 222A2 | 1581cc | 4 Cyl. | 8 Valves | 58kW/79PS | Petrol | | TD2753 |
| EXPERT 1.6 | 02/1996→09/2000 | | | | | | |
| V91300 | 7 609 772 | | 45° | H | VAG92366 | | |
| 37.50 x 8.00 x 108.50 | | MB | | | 46.50 x 8.00 x 14.10 | | |
| V91762 | 5 973 129 | | 45° | | | | |
| 33.00 x 8.00 x 109.00 | | MD | | | | | |

65 **87.00**

| | | | | | | | |
|-----------------------|-----------------|---------|------------------|---------------------|----------------------|-------------|----------------|
| ES9A (XFV) | 2946cc | V6 Cyl. | 24 Valves | 155-158kW/211-215PS | Petrol | DOHC | TD18841 |
| ES9J4S (XFV) | 2946cc | V6 Cyl. | 24 Valves | 150-155kW/204-211PS | Petrol | DOHC | TD13908 |
| 406 3.0 V6 | 03/2000→12/2004 | | 407 3.0 | | 05/2004→ | | |
| 407 3.0 V6 | 10/2005→ | | 607 3.0 V6 | | 02/2000→07/2011 | | |
| 807 3.0 V6 | 06/2002→ | | | | | | |
| V94198 | 0948.A5 | | 45° | H | VAG96271B | | |
| 34.95 x 5.98 x 108.45 | | MB cr | | | 40.00 x 6.00 x 11.06 | | |
| V94199 | 0949.A5 | | 45° | SS | | | |
| 30.55 x 5.98 x 106.95 | | MD cr | | | | | |

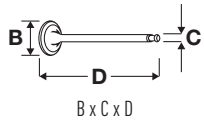

OE

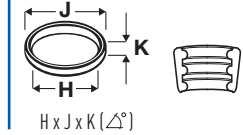
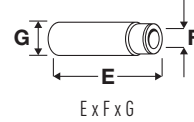
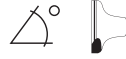

66 87.00

| | | | | | | | |
|-----------------------|---------|-----------------|------------------|----------------------|--------|-----------------|---------------|
| ES9J4 (XFZ) | 2946cc | V6 Cyl. | 24 Valves | 140-150kW/190-204PS | Petrol | DOHC | TD9406 |
| 406 3.0 | | 10/1996→10/2004 | | 406 3.0 V6 | | 03/1997→12/2004 | |
| 605 3.0 V6 | | 01/1992→09/1999 | | | | | |
| V94173 | 0948.85 | | 45° Y H | VAG96271B | | | |
| 33.80 x 6.00 x 108.40 | | MB cr | | 40.00 x 6.00 x 11.06 | | | |

67 88.00

| | | | | | | | |
|-----------------------|---------|-----------------|-----------------|----------------------|--------|-----------------|---------------|
| XD 4.88 | 1948cc | 4 Cyl. | 8 Valves | 40-41kW/54-56PS | Diesel | | TD2807 |
| XDP88 | 1948cc | 4 Cyl. | 8 Valves | 40kW/55PS | Diesel | | TD8499 |
| 504 1.9 D | | 03/1973→12/1989 | | J7 1.9 D | | 08/1968→07/1978 | |
| V90351 | 0949.25 | | 45° | VAG92179 | | | |
| 33.50 x 8.50 x 116.20 | | MD | | 55.50 x 8.53 x 14.06 | | | |

68 88.00

| | | | | | | | |
|-----------------------|---------|-----------------|-----------------|----------------------|--------|-----------------|---------------|
| XN1 | 1971cc | 4 Cyl. | 8 Valves | 64-79kW/87-107PS | Petrol | | TD2833 |
| XN1 (106) | 1971cc | 4 Cyl. | 8 Valves | 68-71kW/93-97PS | Petrol | | TD2830 |
| XN1A (106E) | 1971cc | 4 Cyl. | 8 Valves | 72kW/98PS | Petrol | | TD4845 |
| XN1P | 1971cc | 4 Cyl. | 8 Valves | 57kW/78PS | Petrol | | TD8502 |
| XN1T (170) | 1971cc | 4 Cyl. | 8 Valves | 58kW/79PS | Petrol | | TD2837 |
| XN1T (170B) | 1971cc | 4 Cyl. | 8 Valves | 55kW/75PS | Petrol | | TD2836 |
| XN2 (107) | 1971cc | 4 Cyl. | 8 Valves | 75-78kW/102-106PS | Petrol | | TD2831 |
| 504 2.0 | | 03/1971→05/1995 | | 504 2.0 TI | | 01/1971→06/1983 | |
| 505 2.0 | | 09/1980→09/1995 | | J5 2.0 | | 09/1981→09/1990 | |
| J5 2.0 Super | | 09/1981→08/1990 | | J9 2.0 | | 03/1980→06/1987 | |
| V34459 | 0948.33 | | 30° H | VAG51007 | | | |
| 42.50 x 8.00 x 118.30 | | MB | | 55.00 x 8.00 x 14.06 | | | |
| V34460 | 0949.21 | | 45° | | | | |
| 35.50 x 8.00 x 112.00 | | MD | | | | | |

69 88.00





| | | | | | | | |
|-----------------------|---------|-----------------|-----------------|----------------------|--------|-----------------|---------------|
| ZEJ (829) | 1995cc | 4 Cyl. | 8 Valves | 77-81kW/105-110PS | Petrol | SOHC | TD2911 |
| 505 2.0 | | 10/1985→09/1989 | | 505 2.0 TI,STI | | 08/1979→10/1986 | |
| V90371 | 0948.36 | | 30° H | VAG92337 | | | |
| 44.00 x 8.00 x 112.00 | | MB | | 51.00 x 8.00 x 13.30 | | | |
| V91263 | 0949.38 | | 45° | | | | |
| 38.50 x 8.00 x 111.50 | | MD | | | | | |

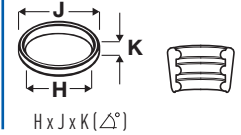
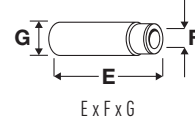
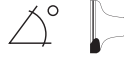





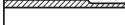

OE







70  **88.00**

| | | | | | | | |
|--|-----------------|---|-------------|------------|--|---|--------|
| ZDJ (851) | 2165cc | 4 Cyl. | 8 Valves | 85kW/115PS | Petrol | SOHC | TD2908 |
| ZDJL (851B) | 2165cc | 4 Cyl. | 8 Valves | 90kW/122PS | Petrol | SOHC | TD2909 |
| ZDJL (851X) | 2165cc | 4 Cyl. | 8 Valves | 84kW/114PS | Petrol | SOHC | TD2910 |
| 505 2.2 | 05/1981→12/1993 | | 505 2.2 GTI | | 08/1983→12/1993 | | |
| V90371  | 0948.36 |  | 30° | H | VAG92337  |  | |
| 44.00 x 8.00 x 112.00 | | MB | | | 51.00 x 8.00 x 13.30 | | |
| V91263  | 0949.38 |  | 45° | | | | |
| 38.50 x 8.00 x 111.50 | | MD | | | | | |





71  **88.00**

| | | | | | | | |
|--|-----------------|---|------------|-------------|--|---|--------|
| ZM (112) | 2664cc | V6 Cyl. | 12 Valves | 100kW/136PS | Petrol | SOHC | TD2912 |
| ZMJ (140) | 2664cc | V6 Cyl. | 12 Valves | 106kW/144PS | Petrol | Turbo, SOHC | TD2914 |
| 504 2.7 | 10/1977→08/1984 | | 604 2.7 SL | | 08/1977→05/1983 | | |
| 604 2.7 Tl,STI | 08/1977→05/1983 | | | | | | |
| V90371  | 0948.36 |  | 30° | H | VAG92337  |  | |
| 44.00 x 8.00 x 112.00 | | MB | | | 51.00 x 8.00 x 13.30 | | |
| V91263  | 0949.38 |  | 45° | | | | |
| 38.50 x 8.00 x 111.50 | | MD | | | | | |





72  **90.00**

| | | | | | | | |
|--|-----------------|---|----------|-----------------|--|---|--------|
| XD90 | 2112cc | 4 Cyl. | 8 Valves | 48-49kW/65-67PS | Diesel | | TD2808 |
| XDP90 | 2112cc | 4 Cyl. | 8 Valves | 42kW/57PS | Diesel | | TD8500 |
| 504 2.1 D | 02/1971→07/1986 | | J7 2.1 D | | 08/1968→07/1977 | | |
| V90351  | 0949.25 |  | 45° | | VAG92179  |  | |
| 33.50 x 8.50 x 116.20 | | MD | | | 55.50 x 8.53 x 14.06 | | |

73  **91.00**

| | | | | | | | |
|--|-----------------|---|-----------|-------------|--|---|--------|
| ZMJK (154A) | 2849cc | V6 Cyl. | 12 Valves | 110kW/150PS | Petrol | | TD2913 |
| 604 2.8 GTI | 09/1983→07/1987 | | | | | | |
| V90371  | 0948.36 |  | 30° | H | VAG92337  |  | |
| 44.00 x 8.00 x 112.00 | | MB | | | 51.00 x 8.00 x 13.30 | | |

74  **91.00**

| | | | | | | | |
|--|-----------------|---|-----------|-------------|--------|------|--------|
| ZN3J (154X) | 2849cc | V6 Cyl. | 12 Valves | 105kW/143PS | Petrol | SOHC | TD2917 |
| 505 2.8 GTI V6 | 06/1986→12/1993 | | | | | | |
| V94198  | 0948.A5 |  | 45° | H | | | |
| 34.95 x 5.98 x 108.45 | | MB cr | | | | | |
| V94199  | 0949.A5 |  | 45° | SS | | | |
| 30.55 x 5.98 x 106.95 | | MD cr | | | | | |

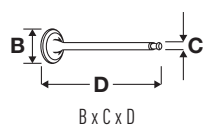

OE

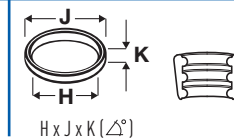
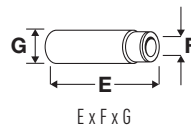

75 92.00

| | | | | | | | |
|-----------------------|-----------------|-------------|------------------|-----------------|----------------------|--------------------|---------------|
| DJ5 (T9A) | 2446cc | 4 Cyl. | 12 Valves | 63kW/86PS | Diesel | SOHC | TD4830 |
| DK5ATE (THY) | 2446cc | 4 Cyl. | 12 Valves | 95kW/129PS | Diesel | Turbo, SOHC | TD2748 |
| 605 2.5 Turbo Diesel | 07/1994→09/1999 | BOXER 2.5 D | | 03/1994→04/2002 | | | |
| V94062 | 0948.72 | | 45° | H | VAG96046B | | |
| 36.90 x 7.00 x 127.90 | | MB | | | 54.00 x 7.04 x 13.08 | | |
| V94063 | 0949.79 | | 45° | ss H | | | |
| 39.60 x 7.00 x 127.50 | | MD + MB cr | | | | | |

76 92.00

| | | | | | | | |
|-----------------------|-----------------|------------|------------------|------------|----------------------|--------------|---------------|
| DJ5T (T8A/THZ) | 2446cc | 4 Cyl. | 12 Valves | 76kW/103PS | Diesel | Turbo | TD4831 |
| BOXER 2.5 TD | 03/1994→04/2002 | | | | | | |
| V94062 | 0948.72 | | 45° | H | VAG96046B | | |
| 36.90 x 7.00 x 127.90 | | MB | | | 54.00 x 7.04 x 13.08 | | |
| V94567 | 0948.84 | | 45° | H | | | |
| 41.00 x 7.00 x 115.70 | | MB cr | | | | | |
| V94063 | 0949.79 | | 45° | ss H | | | |
| 39.60 x 7.00 x 127.50 | | MD + MB cr | | | | | |
| V94566 | 0949.90 | | 45° | H | | | |
| 37.80 x 7.00 x 115.40 | | MD + MB cr | | | | | |

77 92.00

| | | | | | | | |
|-----------------------|-----------------|------------|-----------------|------------|----------------------|--------------|----------------|
| DJ5TED (THX) | 2446cc | 4 Cyl. | 8 Valves | 79kW/107PS | Diesel | Turbo | TD11067 |
| BOXER 2.5 TDI | 01/1997→04/2002 | | | | | | |
| V94567 | 0948.84 | | 45° | H | VAG96046B | | |
| 41.00 x 7.00 x 115.70 | | MB cr | | | 54.00 x 7.04 x 13.08 | | |
| V94566 | 0949.90 | | 45° | H | | | |
| 37.80 x 7.00 x 115.40 | | MD + MB cr | | | | | |

78 94.00

| | | | | | | | |
|-----------------------|-----------------|----------------|-----------------|-----------------|----------------------|--------------|---------------|
| XD2 (134) | 2304cc | 4 Cyl. | 8 Valves | 51kW/69PS | Diesel | | TD2800 |
| XD2P / XD94 | 2304cc | 4 Cyl. | 8 Valves | 49kW/67PS | Diesel | | TD8504 |
| XD2P94 | 2304cc | 4 Cyl. | 8 Valves | 49kW/67PS | Diesel | | TD8501 |
| XD2S (147) | 2304cc | 4 Cyl. | 8 Valves | 59kW/80PS | Diesel | Turbo | TD2802 |
| 504 2.3 D | 07/1975→12/1989 | 505 2.3 Diesel | | 04/1982→06/1986 | | | |
| 505 2.3 Turbo Diesel | 09/1980→06/1986 | 604 2.3 TD | | 09/1979→05/1983 | | | |
| J7 2.3 D | 07/1977→03/1980 | J9 2.3 D | | 03/1980→07/1982 | | | |
| V90351 | 0949.25 | | 45° | | VAG92179 | | |
| 33.50 x 8.50 x 116.20 | | MD | | | 55.50 x 8.53 x 14.06 | | |



OE



MAT.

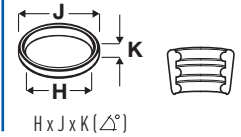

79 **94.00**

| | | | | | | | |
|---------------------|--------|--------|-----------------|-----------------|--------|--------------|----------------|
| XD3 (155) | 2498cc | 4 Cyl. | 8 Valves | 51-55kW/70-75PS | Diesel | | TD2803 |
| XD3P | 2498cc | 4 Cyl. | 8 Valves | 53-58kW/72-79PS | Diesel | | TD8505 |
| XD3T | 2498cc | 4 Cyl. | 8 Valves | 66-70kW/90-95PS | Diesel | Turbo | TD22475 |
| XD3T (152A) | 2498cc | 4 Cyl. | 8 Valves | 66kW/90PS | Diesel | Turbo | TD2805 |
| XD3TE (152B) | 2498cc | 4 Cyl. | 8 Valves | 77kW/105PS | Diesel | Turbo | TD2806 |

| | | | |
|----------------|-----------------|----------------------|-----------------|
| 504 2.5 D | 08/1990→10/1999 | 505 2.5 D | 10/1985→08/1991 |
| 505 2.5 Diesel | 06/1981→12/1993 | 505 2.5 Turbo Diesel | 10/1983→12/1993 |
| 604 2.5 TD | 08/1983→12/1986 | J9 2.5 D | 07/1982→06/1987 |

| | | | | | | |
|--|---------|----------------|-----|---|---|--|
| V91151 42.52 x 8.48 x 115.92 | 0948.53 | MB | 45° | H | VAG92179 55.50 x 8.53 x 14.06 | |
| V91152 35.48 x 8.47 x 116.30 | 0949.50 | MD + MB cr | 45° | H | | |

80 **94.40**

| | | | | | | | |
|---------------------------|--------|--------|-----------------|-------------------|--------|---------------------------|----------------|
| 8140.43N | 2800cc | 4 Cyl. | 8 Valves | 107kW/146PS | Diesel | Sofim, Turbo, SOHC | TD24923 |
| 8140.43S (F28DTCR) | 2800cc | 4 Cyl. | 8 Valves | 92-94kW/125-128PS | Diesel | Sofim, Turbo, SOHC | TD17514 |

| | | | |
|---------------|----------|---------------|-----------------|
| BOXER 2.8 HDi | 10/2000→ | BOXER 2.8 HDi | 11/2000→04/2002 |
|---------------|----------|---------------|-----------------|







| | | | | | | | |
|--|------------|----------------|-----|---|---|---|--|
| V91292 40.80 x 8.00 x 120.70 | 0948.A2 | MB cr | 30° | Y | H | VAG92369 60.00 x 8.00 x 13.07 | |
| V91940 36.70 x 8.00 x 122.00 | 98 418 161 | MD + MB cr | 45° | | H | VAG92373 56.00 x 8.03 x 13.04 | |

81 **95.80**

| | | | | | | | |
|---------------------------|--------|--------|------------------|---------------------|--------|--------------------|----------------|
| F1CE0481D (F30DT) | 2999cc | 4 Cyl. | 16 Valves | 115-130kW/156-177PS | Diesel | Turbo, DOHC | TD29257 |
| F1CE0481D (FG30DT) | 2999cc | 4 Cyl. | 16 Valves | 116kW/158PS | Diesel | Turbo, DOHC | TD24697 |

| | | | |
|---------------|----------|-------------------|----------|
| BOXER 3.0 HDi | 07/2006→ | BOXER 3.0 HDi 160 | 04/2006→ |
|---------------|----------|-------------------|----------|

| | | | | | | | |
|--|-------------|----------------|-----|--|--|--|--|
| V98042 32.40 x 5.99 x 119.90 | 504 072 531 | MB cr | 30° | | | | |
| V98043 32.40 x 5.98 x 119.90 | 504 081 062 | MD + MB cr | 30° | | | | |

|  |  | ccm |  |  |  |  |
|---|---|------|--|---|---|---|
| 616.15 | 82.50 | 1582 | 4 | 8 | Petrol | 1 |
| 911.01 | 84.00 | 2179 | 6 | 12 | Petrol | 2 |
| 911.02 | 84.00 | 2179 | 6 | 12 | Petrol | 2 |
| 911.04 | 84.00 | 2179 | 6 | 12 | Petrol | 2 |
| 930.03 | 95.00 | 2993 | 6 | 12 | Petrol | 5 |
| 930.13 | 95.00 | 2993 | 6 | 12 | Petrol | 5 |
| 930.20 | 95.00 | 3164 | 6 | 12 | Petrol | 7 |
| 930.25 | 95.00 | 3164 | 6 | 12 | Petrol | 7 |
| 930.52 | 95.00 | 2993 | 6 | 12 | Petrol | 6 |
| 930.60 | 97.00 | 3299 | 6 | 12 | Petrol | 8 |
| 930.66/68 | 97.00 | 3299 | 6 | 12 | Petrol | 8 |
| M 28.11 | 97.00 | 4664 | 8 | 16 | Petrol | 10 |
| M 28.12 | 97.00 | 4664 | 8 | 16 | Petrol | 10 |
| M 28.21 | 97.00 | 4664 | 8 | 16 | Petrol | 10 |
| M 28.22 | 97.00 | 4664 | 8 | 16 | Petrol | 10 |
| M 28.41 | 100.00 | 4957 | 8 | 32 | Petrol | 18 |
| M 28.42 | 100.00 | 4957 | 8 | 32 | Petrol | 18 |
| M 28.47 | 100.00 | 4957 | 8 | 32 | Petrol | 18 |
| M 28.49 | 100.00 | 5397 | 8 | 32 | Petrol | 19 |
| M 28.50 | 100.00 | 5397 | 8 | 32 | Petrol | 19 |
| M 30.69 | 97.00 | 3299 | 6 | 12 | Petrol | 9 |
| M 44.01 | 100.00 | 2479 | 4 | 8 | Petrol | 11 |
| M 44.03 | 100.00 | 2479 | 4 | 8 | Petrol | 12 |
| M 44.05 | 100.00 | 2479 | 4 | 8 | Petrol | 12 |
| M 44.06 | 100.00 | 2479 | 4 | 8 | Petrol | 12 |
| M 44.07 | 100.00 | 2479 | 4 | 8 | Petrol | 13 |
| M 44.08 | 100.00 | 2479 | 4 | 8 | Petrol | 13 |
| M 44.09 | 100.00 | 2479 | 4 | 8 | Petrol | 11 |
| M 44.10 | 100.00 | 2479 | 4 | 8 | Petrol | 11 |
| M 44.40 | 100.00 | 2479 | 4 | 16 | Petrol | 14 |
| M 44.41 | 104.00 | 2990 | 4 | 16 | Petrol | 20 |
| M 44.43 | 104.00 | 2990 | 4 | 8 | Petrol | 21 |
| M 44.44 | 104.00 | 2990 | 4 | 8 | Petrol | 21 |
| M 64.01 | 100.00 | 3600 | 6 | 12 | Petrol | 15 |
| M 64.02 | 100.00 | 3600 | 6 | 12 | Petrol | 15 |
| M 64.03 | 100.00 | 3600 | 6 | 12 | Petrol | 15 |
| M 64.50 | 100.00 | 3600 | 6 | 12 | Petrol | 16 |
| M 64.60 | 100.00 | 3600 | 6 | 12 | Petrol | 17 |
| M02.2Y | 84.00 | 3189 | 6 | 24 | Petrol | 3 |
| W | 90.00 | 1679 | 4 | 8 | Petrol | 4 |



OE

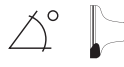



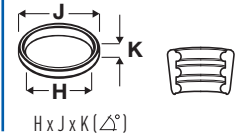

E x F x G







H x J x K (Δ°)







1  **82.50**

| | | | | | | | |
|---|----------------|---|-----------------|-----------|--------|-----------------|------------------|
| 616.15 | 1582cc | 4 Cyl. | 8 Valves | 55kW/75PS | Petrol | | TD20989 |
| 356 A 1600 S | | | | | | 01/1955→12/1959 | 356 A 1600 Super |
| 356 B 1600 Super 75 | | | | | | 01/1959→12/1963 | 356 C 1600 |
| V94263  | 616.105.402.00 |  | 45° | Y | H | | |
| 38.00 x 9.99 x 118.00 | | MB | | | | | |
| V94264  | 616.105.406.01 |  | 45° | SS | | | |
| 34.00 x 10.00 x 128.50 | | MD cr | | | | | |

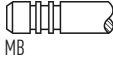

2  **84.00**

| | | | | | | | |
|--|----------------|--|------------------|-------------|--------|--|---------------|
| 911.01 | 2179cc | 6 Cyl. | 12 Valves | 114kW/155PS | Petrol | OHV | TD5411 |
| 911.02 | 2179cc | 6 Cyl. | 12 Valves | 132kW/180PS | Petrol | OHV | TD5413 |
| 911.04 | 2179cc | 6 Cyl. | 12 Valves | 114kW/155PS | Petrol | OHV | TD5412 |
| 911 2.2 E | | 09/1969→02/1972 | | 911 2.2 S | | 09/1969→02/1972 | |
| V94266  | 911.105.411.20 |  | 45° | Y | H | VAG96168B  | |
| 46.00 x 9.00 x 114.60 | | MB | | | | 51.00 x 9.02 x 13.07 | |
| V94267  | 911.105.415.20 |  | 45° | SS | H | | |
| 40.00 x 9.00 x 113.50 | | MD + MB cr | | | | | |

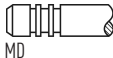



3  **84.00**

| | | | | | | | |
|---|--------------|---|------------------|---------------------|--------|-----------------|----------------|
| M02.2Y | 3189cc | V6 Cyl. | 24 Valves | 177-184kW/241-250PS | Petrol | DOHC | TD23319 |
| CAYENNE (9PA) 3.2 | | | | | | 08/2003→09/2007 | |
| V95085  | 022 109 601G |  | 45° | Y | H | | |
| 33.20 x 5.98 x 102.40 | | MB | | | | | |
| V95127  | 022 109 601H |  | 45° | Y | H | | |
| 33.20 x 5.98 x 136.35 | | MB | | | | | |
| V95086  | 022 109 611N |  | 45° | SS | H | | |
| 30.20 x 5.97 x 102.20 | | MD + MB cr | | | | | |
| V95128  | 022 109 611M |  | 45° | SS | H | | |
| 30.20 x 5.97 x 136.10 | | MD | | | | | |

4  **90.00**

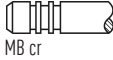
| | | | | | | | |
|---|-------------|---|-----------------|-----------|--------|--|----------------|
| W | 1679cc | 4 Cyl. | 8 Valves | 59kW/80PS | Petrol | SOHC | TD18881 |
| 914 1.7 | | | | | | 01/1969→12/1973 | |
| V94546  | 021 109 601 |  | 30° | | H | VAG96228B  | |
| 39.20 x 8.00 x 117.05 | | MB | | | | 66.50 x 9.02 x 13.05 | |

5  **95.00**

| | | | | | | | |
|---|----------------|---|------------------|-------------|--------|--|----------------|
| 930.03 | 2993cc | 6 Cyl. | 12 Valves | 132kW/180PS | Petrol | SOHC | TD28033 |
| 930.13 | 2993cc | 6 Cyl. | 12 Valves | 132kW/180PS | Petrol | SOHC | TD28034 |
| 911 3.0 SC Carrera | | | | | | 07/1977→06/1980 | |
| V94268  | 930.105.409.01 |  | 45° | Y | H | VAG96168B  | |
| 49.00 x 9.00 x 110.10 | | MB cr | | | | 51.00 x 9.02 x 13.07 | |
| V94265  | 930.105.419.08 |  | 45° | SS | H | | |
| 41.50 x 9.00 x 108.40 | | MD + MB cr | | | | | |



OE

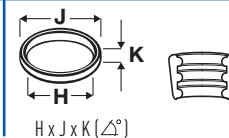
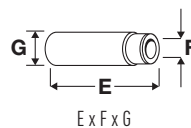

6 95.00

| 930.52 | 2993cc | 6 Cyl. | 12 Valves | 191kW/260PS | Petrol | Turbo, SOHC | TD21395 |
|--|----------------|-----------------|-----------|-------------|--------|--|---------|
| 911 3.0 Turbo | | 01/1975→12/1977 | | | | | |
| V94270 ■ 49.90 x 9.00 x 110.10 | 930.105.409.02 | MD + MB cr | 45° | SS | H | VAG96168B ■ ■ ■ 51.00 x 9.02 x 13.07 | |
| V94269 ■ 41.50 x 9.00 x 108.40 | 930.105.419.03 | ME + MB cr | 45° | SS | H | | |

7 95.00

| 930.20 | 3164cc | 6 Cyl. | 12 Valves | 170kW/231PS | Petrol | | TD2944 |
|--|----------------|-----------------|-----------|--------------------|--------|--|--------|
| 930.25 | 3164cc | 6 Cyl. | 12 Valves | 160kW/218PS | Petrol | | TD2946 |
| 911 3.2 | | 08/1986→08/1989 | | 911 3.2 Carrera | | 08/1986→08/1989 | |
| 911 3.2 Carrera Speedster | | 08/1986→08/1989 | | 911 3.2 SC Carrera | | 08/1983→08/1989 | |
| V94268 ■ 49.00 x 9.00 x 110.10 | 930.105.409.01 | MB cr | 45° | Y | H | VAG96168B ■ ■ ■ 51.00 x 9.02 x 13.07 | |
| V94265 ■ 41.50 x 9.00 x 108.40 | 930.105.419.08 | MD + MB cr | 45° | SS | H | | |

8 97.00

| 930.60 | 3299cc | 6 Cyl. | 12 Valves | 221-243kW/300-330PS | Petrol | Turbo | TD2948 |
|--|----------------|-----------------|-----------|---------------------|--------|--|--------|
| 930.66/68 | 3299cc | 6 Cyl. | 12 Valves | 221kW/301PS | Petrol | Turbo | TD2949 |
| 911 3.3 SC Turbo | | 09/1977→06/1987 | | 911 3.3 Turbo | | 06/1986→11/1990 | |
| V94270 ■ 49.90 x 9.00 x 110.10 | 930.105.409.02 | MD + MB cr | 45° | SS | H | VAG96168B ■ ■ ■ 51.00 x 9.02 x 13.07 | |
| V94265 ■ 41.50 x 9.00 x 108.40 | 930.105.419.08 | MD + MB cr | 45° | SS | H | VAG96177B ■ ■ ■ 51.00 x 9.02 x 13.06 | |
| V94269 ■ 41.50 x 9.00 x 108.40 | 930.105.419.03 | ME + MB cr | 45° | SS | H | | |

9 97.00

| M 30.69 | 3299cc | 6 Cyl. | 12 Valves | 235kW/320PS | Petrol | Turbo, SOHC | TD2934 |
|--|----------------|-----------------|-----------|-------------|--------|--|--------|
| 911 (964) 3.3 Turbo | | 08/1990→09/1993 | | | | | |
| V94270 ■ 49.90 x 9.00 x 110.10 | 930.105.409.02 | MD + MB cr | 45° | SS | H | VAG96168B ■ ■ ■ 51.00 x 9.02 x 13.07 | |
| V94265 ■ 41.50 x 9.00 x 108.40 | 930.105.419.08 | MD + MB cr | 45° | SS | H | VAG96177B ■ ■ ■ 51.00 x 9.02 x 13.06 | |



OE

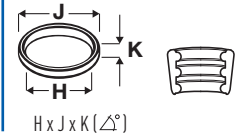
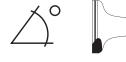

10  **97.00**

| | | | | | | | |
|---------|--------|---------|-----------|-------------|--------|------|--------|
| M 28.11 | 4664cc | V8 Cyl. | 16 Valves | 221kW/301PS | Petrol | DOHC | TD2954 |
| M 28.12 | 4664cc | V8 Cyl. | 16 Valves | 221kW/301PS | Petrol | DOHC | TD2955 |
| M 28.21 | 4664cc | V8 Cyl. | 16 Valves | 228kW/310PS | Petrol | DOHC | TD2960 |
| M 28.22 | 4664cc | V8 Cyl. | 16 Valves | 228kW/310PS | Petrol | DOHC | TD2961 |

928 4.7 S 09/1979→07/1986

V94335 
45.00 x 9.00 x 111.50

928.105.409.03

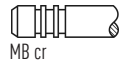

45° Y H

VAG96183B 
40.50 x 9.02 x 13.08

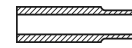

V94408 
40.00 x 9.00 x 112.30

928.105.410.04



45° ss H

11  **100.00**

| | | | | | | | |
|---------|--------|--------|----------|-------------|--------|------|--------|
| M 44.01 | 2479cc | 4 Cyl. | 8 Valves | 120kW/163PS | Petrol | SOHC | TD2975 |
| M 44.09 | 2479cc | 4 Cyl. | 8 Valves | 118kW/160PS | Petrol | SOHC | TD2983 |
| M 44.10 | 2479cc | 4 Cyl. | 8 Valves | 118kW/160PS | Petrol | SOHC | TD2984 |

924 2.5 S 10/1981→07/1988

944 2.5

06/1981→12/1990

V94335 
45.00 x 9.00 x 111.50

928.105.409.03

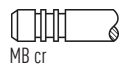

45° Y H

VAG96183B 
40.50 x 9.02 x 13.08



V94408 
40.00 x 9.00 x 112.30

928.105.410.04



45° ss H

12  **100.00**

| | | | | | | | |
|---------|--------|--------|----------|---------------------|--------|------|--------|
| M 44.03 | 2479cc | 4 Cyl. | 8 Valves | 120kW/163PS | Petrol | SOHC | TD2977 |
| M 44.05 | 2479cc | 4 Cyl. | 8 Valves | 118-120kW/160-163PS | Petrol | SOHC | TD2979 |
| M 44.06 | 2479cc | 4 Cyl. | 8 Valves | 120kW/163PS | Petrol | SOHC | TD2980 |

924 2.5 S 10/1981→12/1984

944 2.5

06/1981→12/1990

V94335 
45.00 x 9.00 x 111.50

928.105.409.03

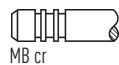

45° Y H

VAG96183B 
40.50 x 9.02 x 13.08



13  **100.00**

| | | | | | | | |
|---------|--------|--------|----------|-------------|--------|------|--------|
| M 44.07 | 2479cc | 4 Cyl. | 8 Valves | 110kW/150PS | Petrol | SOHC | TD2981 |
| M 44.08 | 2479cc | 4 Cyl. | 8 Valves | 110kW/150PS | Petrol | SOHC | TD2982 |

924 2.5 S 09/1985→07/1987

944 2.5

01/1985→07/1987

V94335 
45.00 x 9.00 x 111.50

928.105.409.03

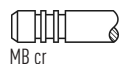

45° Y H

VAG96183B 
40.50 x 9.02 x 13.08

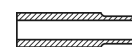

V94408 
40.00 x 9.00 x 112.30

928.105.410.04

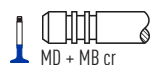

45° ss H

V94544 
40.00 x 9.00 x 112.40

928.105.410.02

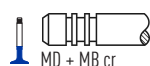

45° ss H

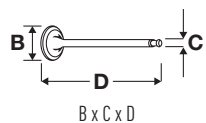

OE

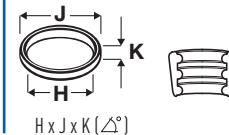
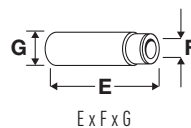
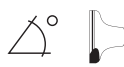

14 100.00

| M 44.40 | 2479cc | 4 Cyl. | 16 Valves | 135-140kW/184-190PS | Petrol | DOHC | TD2987 |
|--|----------------|------------|-----------|---------------------|--------|------|--------|
| 944 2.5 S | | | | 08/1986→07/1988 | | | |
| V94295 ■ 37.00 x 7.00 x 114.70 | 928.105.641.05 | MB cr | 45° | Y | H | | |
| V94296 ■ 33.00 x 7.00 x 113.60 | 928.105.642.05 | ME + MB cr | 45° | SS | H | | |

15 100.00

| M 64.01 | 3600cc | 6 Cyl. | 12 Valves | 184kW/250PS | Petrol | DOHC | TD2935 |
|--|----------------|------------|-----------|-----------------|--------|--|---------------------------------|
| M 64.02 | 3600cc | 6 Cyl. | 12 Valves | 184kW/250PS | Petrol | DOHC | TD2936 |
| M 64.03 | 3600cc | 6 Cyl. | 12 Valves | 191kW/260PS | Petrol | DOHC | TD23890 |
| 911 (964) 3.6 Carrera | | | | 12/1988→05/1994 | | | 911 (964) 3.6 Carrera 4 |
| 911 (964) 3.6 Carrera RS | | | | 06/1991→09/1993 | | | 911 Speedster (964) 3.6 Carrera |
| | | | | | | | 12/1988→05/1994 |
| | | | | | | | 08/1992→06/1994 |
| V94545 ■ 49.00 x 9.00 x 110.10 | 964.105.409.05 | MD + MB cr | 45° | SS | H | VAG96177B ■ ■ ■ 51.00 x 9.02 x 13.06 | |
| V94300 ■ 42.50 x 9.00 x 109.00 | 964.105.419.04 | MD + MB cr | 45° | SS | H | | |

16 100.00

| M 64.50 | 3600cc | 6 Cyl. | 12 Valves | 265kW/360PS | Petrol | Turbo, DOHC | TD5477 |
|--|----------------|------------|-----------|-----------------|--------|--|--------|
| 911 (964) 3.6 Turbo | | | | 01/1993→09/1993 | | | |
| V94545 ■ 49.00 x 9.00 x 110.10 | 964.105.409.05 | MD + MB cr | 45° | SS | H | VAG96177B ■ ■ ■ 51.00 x 9.02 x 13.06 | |

17 100.00

| M 64.60 | 3600cc | 6 Cyl. | 12 Valves | 298-300kW/405-408PS | Petrol | Turbo | TD5456 |
|--|----------------|------------|-----------|---------------------|--------|--|--------|
| 911 (993) 3.6 Turbo 4 | | | | 03/1995→09/1997 | | | |
| V94300 ■ 42.50 x 9.00 x 109.00 | 964.105.419.04 | MD + MB cr | 45° | SS | H | VAG96177B ■ ■ ■ 51.00 x 9.02 x 13.06 | |

18 100.00

| M 28.41 | 4957cc | V8 Cyl. | 32 Valves | 221-235kW/300-320PS | Petrol | | TD2963 |
|--|----------------|------------|-----------|---------------------|--------|--|-----------------|
| M 28.42 | 4957cc | V8 Cyl. | 32 Valves | 221-235kW/300-320PS | Petrol | | TD2964 |
| M 28.47 | 4957cc | V8 Cyl. | 32 Valves | 243kW/330PS | Petrol | | TD2969 |
| 928 5.0 GT | | | | 01/1989→07/1991 | | | 928 5.0 S4 |
| 928 5.0 S4 Cat | | | | 08/1986→07/1991 | | | 928 5.0 S, S4 |
| | | | | | | | 08/1986→07/1991 |
| V94295 ■ 37.00 x 7.00 x 114.70 | 928.105.641.05 | MB cr | 45° | Y | H | | |
| V94296 ■ 33.00 x 7.00 x 113.60 | 928.105.642.05 | ME + MB cr | 45° | SS | H | | |

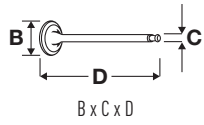

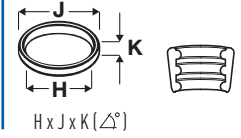
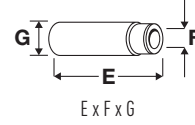
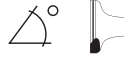

OE



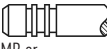

19  **100.00**

| | | | | | | | |
|----------------|--------|-----------------|------------------|---------------------|--------|--|---------------|
| M 28.49 | 5397cc | V8 Cyl. | 32 Valves | 250-257kW/340-350PS | Petrol | | TD2970 |
| M 28.50 | 5397cc | V8 Cyl. | 32 Valves | 250-257kW/340-350PS | Petrol | | TD2971 |
| 928 5.4 GTS | | 08/1991→11/1995 | | | | | |

| | | | | | | | |
|---|----------------|---|-----|----|---|--|--|
| V94295  | 928.105.641.05 |  MB cr | 45° | Y | H | | |
| 37.00 x 7.00 x 114.70 | | | | | | | |
| V94296  | 928.105.642.05 |  ME + MB cr | 45° | SS | H | | |
| 33.00 x 7.00 x 113.60 | | | | | | | |

20  **104.00**

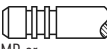





| | | | | | | | |
|----------------|--------|-----------------|------------------|-------------|--------|-------------|---------------|
| M 44.41 | 2990cc | 4 Cyl. | 16 Valves | 155kW/211PS | Petrol | DOHC | TD2988 |
| 944 3.0 S2 | | 12/1988→07/1991 | | | | | |

| | | | | | | | |
|---|----------------|---|-----|----|---|--|--|
| V94295  | 928.105.641.05 |  MB cr | 45° | Y | H | | |
| 37.00 x 7.00 x 114.70 | | | | | | | |
| V94296  | 928.105.642.05 |  ME + MB cr | 45° | SS | H | | |
| 33.00 x 7.00 x 113.60 | | | | | | | |

21  **104.00**

| | | | | | | | |
|----------------|--------|-----------------|-----------------|-------------|--------|--|---------------|
| M 44.43 | 2990cc | 4 Cyl. | 8 Valves | 176kW/239PS | Petrol | | TD2989 |
| M 44.44 | 2990cc | 4 Cyl. | 8 Valves | 176kW/239PS | Petrol | | TD2990 |
| 968 3.0 | | 06/1991→11/1995 | | | | | |

| | | | | | | | |
|---|----------------|---|-----|----|---|--|--|
| V94299  | 928.105.642.06 |  ME + MB cr | 45° | SS | H | | |
| 33.00 x 7.00 x 113.60 | | | | | | | |

|  |  | ccm |  x |  x |  |  |
|---|---|------|--|---|---|---|
| 4 G 15 | 75.50 | 1468 | 4 | 12 | Petrol | 2 |
| 4 G 92 | 81.00 | 1597 | 4 | 16 | Petrol | 3 |
| 4 G 93 (DOHC) | 81.00 | 1834 | 4 | 16 | Petrol | 4 |
| 4G13 | 71.00 | 1299 | 4 | 12 | Petrol | 1 |
| Mitsubishi G13B | 71.00 | 1299 | 4 | 12 | Petrol | 1 |
| Mitsubishi G15B | 75.50 | 1468 | 4 | 12 | Petrol | 2 |



OE

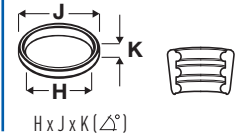
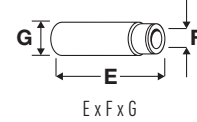

1 **71.00**

| | | | | | | | |
|------------------------|-----------------|--------|------------------|------------------|--------|-----------------|---------------|
| 4G13 | 1299cc | 4 Cyl. | 12 Valves | 50-56kW/68-76PS | Petrol | SOHC | TD3002 |
| Mitsubishi G13B | 1299cc | 4 Cyl. | 12 Valves | 55kW/75PS | Petrol | SOHC | TD3000 |
| AEROBACK 1.3 | 10/1988→12/2002 | | | PERSONA 300 313i | | 03/1996→01/2000 | |
| PERSONA 400 413 GLSi | 01/1994→01/2000 | | | SALOON 1.3 | | 01/1991→09/1993 | |
| SATRIA 1.3 | 07/1996→05/2006 | | | WIRA 1.3 | | 08/2000→ | |

V90123 ■
34.16 x 6.57 x 102.08

MD-016460

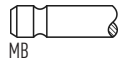

45°

H

VAG92046 ■
44.00 x 6.62 x 12.13



V90124 ■
29.97 x 6.54 x 100.97

MD-016461

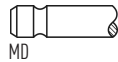

45°

VAG92047 ■
49.50 x 6.62 x 12.13



2 **75.50**

| | | | | | | | |
|------------------------|-----------------|--------|------------------|--------------------------|--------|-----------------|---------------|
| 4 G 15 | 1468cc | 4 Cyl. | 12 Valves | 55-66kW/75-90PS | Petrol | SOHC | TD3003 |
| Mitsubishi G15B | 1468cc | 4 Cyl. | 12 Valves | 55-66kW/75-90PS | Petrol | SOHC | TD3001 |
| AEROBACK 1.5 | 01/1991→09/1993 | | | JUMBUCK 1.5 | | 05/2002→ | |
| PERSONA 300 315 GLSi | 09/1996→07/2000 | | | PERSONA 400 415 GLi/GLSi | | 01/1994→07/2000 | |
| SATRIA 1.5 | 04/1996→05/2006 | | | WIRA 1.5 | | 08/2000→ | |

V90123 ■
34.16 x 6.57 x 102.08

MD-016460

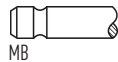

45°

H

VAG92046 ■
44.00 x 6.62 x 12.13



V90124 ■
29.97 x 6.54 x 100.97

MD-016461

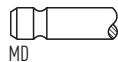

45°

VAG92047 ■
49.50 x 6.62 x 12.13



3 **81.00**

| | | | | | | | |
|----------------------|-----------------|--------|------------------|-------------------|--------|-----------------|---------------|
| 4 G 92 | 1597cc | 4 Cyl. | 16 Valves | 70-83kW/95-113PS | Petrol | SOHC | TD2999 |
| PERSONA 1.6 | 03/2008→07/2016 | | | PERSONA 300 316 | | 03/1996→07/2004 | |
| PERSONA 300 316 GLXi | 03/1996→07/2000 | | | PERSONA 400 416 | | 08/2000→02/2002 | |
| PERSONA 400 416 GLXi | 01/1994→07/2000 | | | PERSONA 400 416 i | | 12/1995→07/2000 | |
| SATRIA 1.6 | 07/1997→05/2006 | | | WIRA 1.6 | | 08/2000→02/2002 | |

VAG96288 ■ ■ ■
45.50 x 6.00 x 11.11















4 **81.00**







| | | | | | | | |
|----------------------|-----------------|--------|------------------|-------------------------|--------|-----------------|----------------|
| 4 G 93 (DOHC) | 1834cc | 4 Cyl. | 16 Valves | 85-103kW/115-140PS | Petrol | DOHC | TD18657 |
| PERSONA 300 1.8 GTi | 08/2000→07/2004 | | | PERSONA 300 318 16V GTi | | 03/1996→07/2000 | |
| PERSONA 400 1.8 | 08/2000→12/2001 | | | PERSONA 400 418 | | 05/1996→07/2000 | |
| PERSONA 400 418 GLXi | 05/1996→07/2000 | | | PUTRA 1.8 EXi | | 09/1997→11/2000 | |
| SATRIA 1.8 GTi | 08/2000→05/2006 | | | WIRA 1.8 | | 08/2000→12/2001 | |
| WIRA 1.9 16V | 01/2000→ | | | | | | |







VAG96288 ■ ■ ■
45.50 x 6.00 x 11.11















|  |  | ccm |  |  |  |  | |
|---|---|--------|--|---|---|---|----|
| 112 | | 88.00 | 2664 | 6 | 12 | Petrol | 57 |
| 140 | | 88.00 | 2664 | 6 | 12 | Petrol | 57 |
| 144.01 | | 88.00 | 2664 | 6 | 12 | Petrol | 57 |
| 688 02 | | 70.00 | 1108 | 4 | 8 | Petrol | 5 |
| 688 10 | | 70.00 | 1108 | 4 | 8 | Petrol | 5 |
| 688 711 | | 70.00 | 1108 | 4 | 8 | Petrol | 5 |
| 688 712 | | 70.00 | 1108 | 4 | 8 | Petrol | 5 |
| 688 713 | | 70.00 | 1108 | 4 | 8 | Petrol | 5 |
| 689 710 | | 65.00 | 956 | 4 | 8 | Petrol | 1 |
| 712 | | 98.00 | 3320 | 4 | 8 | Diesel | 72 |
| 712-01-03 | | 98.00 | 3320 | 4 | 8 | Diesel | 72 |
| 712-01-04 | | 98.00 | 3320 | 4 | 8 | Diesel | 72 |
| 720 | | 102.00 | 3590 | 4 | 8 | Diesel | 75 |
| 720-12 | | 102.00 | 3590 | 4 | 8 | Diesel | 75 |
| 797 | | 102.00 | 5491 | 6 | 12 | Diesel | 81 |
| 797 NFA | | 102.00 | 5491 | 6 | 12 | Diesel | 81 |
| 797-10 | | 102.00 | 5490 | 6 | 12 | Diesel | 80 |
| 797-20 | | 102.00 | 5491 | 6 | 12 | Diesel | 81 |
| 797-21 | | 102.00 | 5491 | 6 | 12 | Diesel | 81 |
| 797-26 | | 102.00 | 5491 | 6 | 12 | Diesel | 81 |
| 798 | | 102.00 | 5491 | 6 | 12 | Diesel | 81 |
| 798-10 | | 102.00 | 5491 | 6 | 12 | Diesel | 81 |
| 798-13 | | 102.00 | 5490 | 6 | 12 | Diesel | 80 |
| 798-20 | | 102.00 | 5491 | 6 | 12 | Diesel | 81 |
| 810 719 | | 73.00 | 1289 | 4 | 8 | Petrol | 9 |
| 810 725 | | 73.00 | 1289 | 4 | 8 | Petrol | 9 |
| 810 726 | | 73.00 | 1289 | 4 | 8 | Petrol | 9 |
| 810 729 | | 73.00 | 1289 | 4 | 8 | Petrol | 9 |
| 810.01 | | 73.00 | 1289 | 4 | 8 | Petrol | 9 |
| 810.02 | | 73.00 | 1289 | 4 | 8 | Petrol | 9 |
| 810.02/97 | | 73.00 | 1289 | 4 | 8 | Petrol | 9 |
| 810.03 | | 73.00 | 1289 | 4 | 8 | Petrol | 9 |
| 810.05 | | 73.00 | 1289 | 4 | 8 | Petrol | 9 |
| 810.06 | | 73.00 | 1289 | 4 | 8 | Petrol | 9 |
| 8140.07.2530 | | 93.00 | 2500 | 4 | 8 | Diesel | 62 |
| 8140.07.2585 | | 93.00 | 2500 | 4 | 8 | Diesel | 63 |
| 8140.07.2700 | | 93.00 | 2500 | 4 | 8 | Diesel | 62 |
| 8140.07.3700 | | 93.00 | 2500 | 4 | 8 | Diesel | 62 |
| 8140.21.235 IDS | | 93.00 | 2445 | 4 | 8 | Diesel | 60 |
| 8140.23.2565 | | 94.40 | 2800 | 4 | 8 | Diesel | 70 |
| 8140.23.2585 | | 94.40 | 2800 | 4 | 16 | Diesel | 70 |
| 8140.27 | | 93.00 | 2500 | 4 | 8 | Diesel | 62 |
| 8140.27.2500 | | 93.00 | 2500 | 4 | 8 | Diesel | 62 |
| 8140.27.2510 | | 93.00 | 2500 | 4 | 8 | Diesel | 62 |
| 8140.27.2512 | | 93.00 | 2500 | 4 | 8 | Diesel | 62 |
| 8140.27.2560 | | 93.00 | 2500 | 4 | 8 | Diesel | 62 |
| 8140.27.2565 | | 93.00 | 2500 | 4 | 8 | Diesel | 64 |
| 8140.27.2580 | | 93.00 | 2500 | 4 | 8 | Diesel | 62 |
| 8140.27.2582 | | 93.00 | 2500 | 4 | 8 | Diesel | 62 |
| 8140.27.2585 | | 93.00 | 2500 | 4 | 8 | Diesel | 62 |
| 8140.27.2700 | | 93.00 | 2500 | 4 | 8 | Diesel | 65 |
| 8140.43.2585 | | 94.40 | 2800 | 4 | 8 | Diesel | 70 |
| 8140.43.3700 | | 94.40 | 2800 | 4 | 8 | Diesel | 70 |
| 8140.43.C.2586 | | 94.40 | 2800 | 4 | 8 | Diesel | 70 |
| 8140.43.S.2585 | | 94.40 | 2800 | 4 | 8 | Diesel | 70 |
| 8140.43K | | 94.40 | 2800 | 4 | 8 | Diesel | 70 |
| 8140.47.2530 IDR | | 93.00 | 2500 | 4 | 8 | Diesel | 62 |
| 8140.47.2535 | | 93.00 | 2500 | 4 | 8 | Diesel | 62 |
| 8140.47.2585 | | 93.00 | 2500 | 4 | 8 | Diesel | 62 |
| 8140.47.2590 | | 93.00 | 2500 | 4 | 8 | Diesel | 62 |
| 8140.47.2700 | | 93.00 | 2500 | 4 | 8 | Diesel | 66 |
| 8140.47.2721 | | 93.00 | 2500 | 4 | 8 | Diesel | 66 |
| 8140.47.2785 | | 93.00 | 2500 | 4 | 8 | Diesel | 66 |
| 8140.61.2300 | | 93.00 | 2445 | 4 | 8 | Diesel | 60 |
| 8140.61.240 | | 93.00 | 2445 | 4 | 8 | Diesel | 60 |
| 8140.67.2510 | | 93.00 | 2500 | 4 | 8 | Diesel | 62 |







|  |  | ccm |  |  |  |  |
|---|---|------|---|---|---|---|
| 8140.67.2585 | 93.00 | 2500 | 4 | 8 | Diesel | 67 |
| 8140-27 IDS | 93.00 | 2500 | 4 | 8 | Diesel | 62 |
| 8140-47 | 93.00 | 2500 | 4 | 8 | Diesel | 62 |
| 829 710 | 88.00 | 1995 | 4 | 8 | Petrol | 53 |
| 829 730 | 88.00 | 1995 | 4 | 8 | Petrol | 53 |
| 829 731 | 88.00 | 1995 | 4 | 8 | Petrol | 53 |
| 847 700 | 76.00 | 1397 | 4 | 8 | Petrol | 13 |
| 847 701 | 76.00 | 1397 | 4 | 8 | Petrol | 13 |
| 847 720 | 76.00 | 1397 | 4 | 8 | Petrol | 13 |
| 847 722 | 76.00 | 1397 | 4 | 8 | Petrol | 13 |
| 847 725 | 76.00 | 1397 | 4 | 8 | Petrol | 14 |
| 851 700 | 88.00 | 2165 | 4 | 8 | Petrol | 55 |
| 852 | 86.00 | 2068 | 4 | 8 | Diesel | 47 |
| 852 710 | 86.00 | 2068 | 4 | 8 | Diesel | 47 |
| 852 720 | 86.00 | 2068 | 4 | 8 | Diesel | 47 |
| 852 750 | 86.00 | 2068 | 4 | 8 | Diesel | 47 |
| C1C 700 | 65.00 | 956 | 4 | 8 | Petrol | 1 |
| C1C 706 | 65.00 | 956 | 4 | 8 | Petrol | 1 |
| C1C 708 | 65.00 | 956 | 4 | 8 | Petrol | 1 |
| C1E (688.01) | 70.00 | 1108 | 4 | 8 | Petrol | 5 |
| C1E 700 | 70.00 | 1108 | 4 | 8 | Petrol | 5 |
| C1E 714 | 70.00 | 1108 | 4 | 8 | Petrol | 5 |
| C1E 715 | 70.00 | 1108 | 4 | 8 | Petrol | 5 |
| C1E 718 | 70.00 | 1108 | 4 | 8 | Petrol | 5 |
| C1E 719 | 70.00 | 1108 | 4 | 8 | Petrol | 5 |
| C1E 720 | 70.00 | 1108 | 4 | 8 | Petrol | 5 |
| C1E 726 | 70.00 | 1108 | 4 | 8 | Petrol | 5 |
| C1E 750 | 70.00 | 1108 | 4 | 8 | Petrol | 5 |
| C1E 752 | 70.00 | 1108 | 4 | 8 | Petrol | 5 |
| C1E 754 | 70.00 | 1108 | 4 | 8 | Petrol | 5 |
| C1E 756 | 70.00 | 1108 | 4 | 8 | Petrol | 5 |
| C1E 760 | 70.00 | 1108 | 4 | 8 | Petrol | 5 |
| C1E 762 | 70.00 | 1108 | 4 | 8 | Petrol | 5 |
| C1E 764 | 70.00 | 1108 | 4 | 8 | Petrol | 5 |
| C1E 792 | 70.00 | 1108 | 4 | 8 | Petrol | 5 |
| C1G 700 | 71.50 | 1237 | 4 | 8 | Petrol | 7 |
| C1G 702 | 71.50 | 1237 | 4 | 8 | Petrol | 7 |
| C1G 710 | 71.50 | 1237 | 4 | 8 | Petrol | 7 |
| C1G 720 | 71.50 | 1237 | 4 | 8 | Petrol | 7 |
| C1G 722 | 71.50 | 1237 | 4 | 8 | Petrol | 7 |
| C1G 726 | 71.50 | 1237 | 4 | 8 | Petrol | 7 |
| C1G 730 | 71.50 | 1237 | 4 | 8 | Petrol | 7 |
| C1J 700 | 76.00 | 1397 | 4 | 8 | Petrol | 13 |
| C1J 715 | 76.00 | 1397 | 4 | 8 | Petrol | 13 |
| C1J 742 | 76.00 | 1397 | 4 | 8 | Petrol | 13 |
| C1J 760 | 76.00 | 1397 | 4 | 8 | Petrol | 15 |
| C1J 764 | 76.00 | 1397 | 4 | 8 | Petrol | 13 |
| C1J 768 | 76.00 | 1397 | 4 | 8 | Petrol | 13 |
| C1J 770 | 76.00 | 1397 | 4 | 8 | Petrol | 15 |
| C1J 780 | 76.00 | 1397 | 4 | 8 | Petrol | 13 |
| C1J 782 | 76.00 | 1397 | 4 | 8 | Petrol | 14 |
| C1J 784 | 76.00 | 1397 | 4 | 8 | Petrol | 14 |
| C1J 788 | 76.00 | 1397 | 4 | 8 | Petrol | 14 |
| C1J 792 | 76.00 | 1397 | 4 | 8 | Petrol | 14 |
| C1J 796 | 76.00 | 1397 | 4 | 8 | Petrol | 14 |
| C2J 700 | 76.00 | 1397 | 4 | 8 | Petrol | 13 |
| C2J 717 | 76.00 | 1397 | 4 | 8 | Petrol | 14 |
| C2J 718 | 76.00 | 1397 | 4 | 8 | Petrol | 14 |
| C2J 720 | 76.00 | 1397 | 4 | 8 | Petrol | 14 |
| C2J 730 | 76.00 | 1397 | 4 | 8 | Petrol | 14 |
| C2J 755 | 76.00 | 1397 | 4 | 8 | Petrol | 14 |
| C2J 757 | 76.00 | 1397 | 4 | 8 | Petrol | 14 |
| C2J 760 | 76.00 | 1397 | 4 | 8 | Petrol | 13 |
| C2J 766 | 76.00 | 1397 | 4 | 8 | Petrol | 14 |
| C2J 767 | 76.00 | 1397 | 4 | 8 | Petrol | 14 |
| C2J 768 | 76.00 | 1397 | 4 | 8 | Petrol | 14 |







|  |  | ccm |  |  |  |  |
|---|---|-------|--|---|---|---|
| C2J 770 | 76.00 | 1397 | 4 | 8 | Petrol | 13 |
| C2J 772 | 76.00 | 1397 | 4 | 8 | Petrol | 13 |
| C2J 776 | 76.00 | 1397 | 4 | 8 | Petrol | 13 |
| C2J 780 | 76.00 | 1397 | 4 | 8 | Petrol | 13 |
| C2J 781 | 76.00 | 1397 | 4 | 8 | Petrol | 13 |
| C2J 782 | 76.00 | 1397 | 4 | 8 | Petrol | 13 |
| C2J 784 | 76.00 | 1397 | 4 | 8 | Petrol | 13 |
| C2J 788 | 76.00 | 1397 | 4 | 8 | Petrol | 13 |
| C2J 789 | 76.00 | 1397 | 4 | 8 | Petrol | 13 |
| C2J 798 | 76.00 | 1397 | 4 | 8 | Petrol | 13 |
| C3G 700 | 74.00 | 1239 | 4 | 8 | Petrol | 10 |
| C3G 702 | 74.00 | 1239 | 4 | 8 | Petrol | 10 |
| C3G 710 | 74.00 | 1239 | 4 | 8 | Petrol | 10 |
| C3G 712 | 74.00 | 1239 | 4 | 8 | Petrol | 10 |
| C3G 720 | 74.00 | 1239 | 4 | 8 | Petrol | 10 |
| C3J 700 | 76.00 | 1397 | 4 | 8 | Petrol | 14 |
| C3J 702 | 76.00 | 1397 | 4 | 8 | Petrol | 14 |
| C3J 710 | 76.00 | 1397 | 4 | 8 | Petrol | 14 |
| C3J 760 | 76.00 | 1397 | 4 | 8 | Petrol | 14 |
| C3J 762 | 76.00 | 1397 | 4 | 8 | Petrol | 14 |
| CG10DE | 71.00 | 998 | 4 | 16 | Petrol | 6 |
| D4D 700 | 69.00 | 999 | 4 | 16 | Petrol | 2 |
| D4D 720 | 69.00 | 999 | 4 | 16 | Petrol | 2 |
| D4F 702 | 69.00 | 1149 | 4 | 16 | Petrol | 3 |
| D4F 704 | 69.00 | 1149 | 4 | 16 | Petrol | 3 |
| D4F 706 | 69.00 | 1149 | 4 | 16 | Petrol | 3 |
| D4F 708 | 69.00 | 1149 | 4 | 16 | Petrol | 3 |
| D4F 712 | 69.00 | 1149 | 4 | 16 | Petrol | 3 |
| D4F 714 | 69.00 | 1149 | 4 | 16 | Petrol | 3 |
| D4F 716 | 69.00 | 1149 | 4 | 16 | Petrol | 3 |
| D4F 722 | 69.00 | 1149 | 4 | 16 | Petrol | 3 |
| D4F 728 | 69.00 | 1149 | 4 | 16 | Petrol | 3 |
| D4F 730 | 69.00 | 1149 | 4 | 16 | Petrol | 3 |
| D4F 732 | 69.00 | 1149 | 4 | 16 | Petrol | 3 |
| D4F 740 | 69.00 | 1149 | 4 | 16 | Petrol | 3 |
| D4F 742 | 69.00 | 1149 | 4 | 16 | Petrol | 3 |
| D4F 764 | 69.00 | 1149 | 4 | 16 | Petrol | 3 |
| D4F 772 | 69.00 | 1149 | 4 | 16 | Petrol | 3 |
| D4F 780 | 69.00 | 1149 | 4 | 16 | Petrol | 3 |
| D4F 784 | 69.00 | 1149 | 4 | 16 | Petrol | 3 |
| D4F 786 | 69.00 | 1149 | 4 | 16 | Petrol | 3 |
| D4F 790 | 69.00 | 1149 | 4 | 16 | Petrol | 3 |
| D7F 700 | 69.00 | 1149 | 4 | 8 | Petrol | 4 |
| D7F 701 | 69.00 | 1149 | 4 | 8 | Petrol | 4 |
| D7F 702 | 69.00 | 1149 | 4 | 8 | Petrol | 4 |
| D7F 703 | 69.00 | 1149 | 4 | 8 | Petrol | 4 |
| D7F 704 | 69.00 | 1149 | 4 | 8 | Petrol | 4 |
| D7F 706 | 69.00 | 1149 | 4 | 8 | Petrol | 4 |
| D7F 708 | 69.00 | 1149 | 4 | 8 | Petrol | 4 |
| D7F 710 | 69.00 | 1149 | 4 | 8 | Petrol | 4 |
| D7F 720 | 69.00 | 1149 | 4 | 8 | Petrol | 4 |
| D7F 722 | 69.00 | 1149 | 4 | 8 | Petrol | 4 |
| D7F 726 | 69.00 | 1149 | 4 | 8 | Petrol | 4 |
| D7F 730 | 69.00 | 1149 | 4 | 8 | Petrol | 4 |
| D7F 744 | 69.00 | 1149 | 4 | 8 | Petrol | 4 |
| D7F 746 | 69.00 | 1149 | 4 | 8 | Petrol | 4 |
| D7F 764 | 69.00 | 1149 | 4 | 8 | Petrol | 4 |
| D7F 766 | 69.00 | 1149 | 4 | 8 | Petrol | 4 |
| D7F 800 | 69.00 | 1149 | 4 | 8 | Petrol | 4 |
| dCi 11 B/43 | 123.00 | 11100 | 6 | 12 | Diesel | 95 |
| dCi 11C | 123.00 | 11100 | 6 | 24 | Diesel | 95 |
| dCi 11E | 123.00 | 11100 | 6 | 24 | Diesel | 95 |
| dCi 11G | 123.00 | 11100 | 6 | 24 | Diesel | 95 |
| dCi 4B | 102.00 | 4120 | 4 | 12 | Diesel | 78 |
| dCi 4C | 102.00 | 4120 | 4 | 12 | Diesel | 78 |
| dCi 6 A | 102.00 | 6177 | 6 | 24 | Diesel | 82 |







|  |  | ccm |  |  |  |  | |
|---|---|--------|---|---|---|---|-----|
| dCi 6 W | | 102.00 | 6177 | 6 | 24 | Diesel | 82 |
| DXi 11 | | 123.00 | 10800 | 6 | 24 | Diesel | 94 |
| DXi 12 | | 131.00 | 12130 | 6 | 24 | Diesel | 99 |
| DXi 13 | | 131.00 | 12800 | 6 | 24 | Diesel | 100 |
| DXi 13 440 | | 131.00 | 12800 | 6 | 24 | Diesel | 100 |
| DXi 13 460 | | 131.00 | 12800 | 6 | 24 | Diesel | 100 |
| DXi 13 480 | | 131.00 | 12800 | 6 | 24 | Diesel | 100 |
| DXi 13 500 | | 131.00 | 12800 | 6 | 24 | Diesel | 100 |
| DXi 13 520 | | 131.00 | 12800 | 6 | 24 | Diesel | 100 |
| DXi 5 | | 108.00 | 4800 | 4 | 16 | Diesel | 87 |
| DXi 7 | | 108.00 | 7200 | 6 | 24 | Diesel | 88 |
| E5F 710 | | 75.80 | 1171 | 4 | 8 | Petrol | 11 |
| E5F 716 | | 75.80 | 1171 | 4 | 8 | Petrol | 11 |
| E6J 700 | | 75.80 | 1390 | 4 | 8 | Petrol | 12 |
| E6J 701 | | 75.80 | 1390 | 4 | 8 | Petrol | 12 |
| E6J 706 | | 75.80 | 1390 | 4 | 8 | Petrol | 12 |
| E6J 712 | | 75.80 | 1390 | 4 | 8 | Petrol | 12 |
| E6J 713 | | 75.80 | 1390 | 4 | 8 | Petrol | 12 |
| E6J 718 | | 75.80 | 1390 | 4 | 8 | Petrol | 12 |
| E6J 734 | | 75.80 | 1390 | 4 | 8 | Petrol | 12 |
| E6J 738 | | 75.80 | 1390 | 4 | 8 | Petrol | 12 |
| E6J 760 | | 75.80 | 1390 | 4 | 8 | Petrol | 12 |
| E7F 700 | | 75.80 | 1171 | 4 | 8 | Petrol | 11 |
| E7F 704 | | 75.80 | 1171 | 4 | 8 | Petrol | 11 |
| E7F 706 | | 75.80 | 1171 | 4 | 8 | Petrol | 11 |
| E7F 708 | | 75.80 | 1171 | 4 | 8 | Petrol | 11 |
| E7F 730 | | 75.80 | 1171 | 4 | 8 | Petrol | 11 |
| E7F 750 | | 75.80 | 1171 | 4 | 8 | Petrol | 11 |
| E7J 601 | | 75.80 | 1390 | 4 | 8 | Petrol | 12 |
| E7J 624 | | 75.80 | 1390 | 4 | 8 | Petrol | 12 |
| E7J 626 | | 75.80 | 1390 | 4 | 8 | Petrol | 12 |
| E7J 634 | | 75.80 | 1390 | 4 | 8 | Petrol | 12 |
| E7J 635 | | 75.80 | 1390 | 4 | 8 | Petrol | 12 |
| E7J 700 | | 75.80 | 1390 | 4 | 8 | Petrol | 12 |
| E7J 706 | | 75.80 | 1390 | 4 | 8 | Petrol | 12 |
| E7J 707 | | 75.80 | 1390 | 4 | 8 | Petrol | 12 |
| E7J 710 | | 75.80 | 1390 | 4 | 8 | Petrol | 12 |
| E7J 711 | | 75.80 | 1390 | 4 | 8 | Petrol | 12 |
| E7J 718 | | 75.80 | 1390 | 4 | 8 | Petrol | 12 |
| E7J 719 | | 75.80 | 1390 | 4 | 8 | Petrol | 12 |
| E7J 720 | | 75.80 | 1390 | 4 | 8 | Petrol | 12 |
| E7J 724 | | 75.80 | 1390 | 4 | 8 | Petrol | 12 |
| E7J 726 | | 75.80 | 1390 | 4 | 8 | Petrol | 12 |
| E7J 728 | | 75.80 | 1390 | 4 | 8 | Petrol | 12 |
| E7J 742 | | 75.80 | 1390 | 4 | 8 | Petrol | 12 |
| E7J 745 | | 75.80 | 1390 | 4 | 8 | Petrol | 12 |
| E7J 754 | | 75.80 | 1390 | 4 | 8 | Petrol | 12 |
| E7J 756 | | 75.80 | 1390 | 4 | 8 | Petrol | 12 |
| E7J 757 | | 75.80 | 1390 | 4 | 8 | Petrol | 12 |
| E7J 764 | | 75.80 | 1390 | 4 | 8 | Petrol | 12 |
| E7J 770 | | 75.80 | 1390 | 4 | 8 | Petrol | 12 |
| E7J 771 | | 75.80 | 1390 | 4 | 8 | Petrol | 12 |
| E7J 773 | | 75.80 | 1390 | 4 | 8 | Petrol | 12 |
| E7J 780 | | 75.80 | 1390 | 4 | 8 | Petrol | 12 |
| F1N 720 | | 81.00 | 1721 | 4 | 8 | Petrol | 30 |
| F1N 722 | | 81.00 | 1721 | 4 | 8 | Petrol | 30 |
| F1N 724 | | 81.00 | 1721 | 4 | 8 | Petrol | 30 |
| F2N 700 | | 81.00 | 1721 | 4 | 8 | Petrol | 30 |
| F2N 704 | | 81.00 | 1721 | 4 | 8 | Petrol | 30 |
| F2N 708 | | 81.00 | 1721 | 4 | 8 | Petrol | 30 |
| F2N 710 | | 81.00 | 1721 | 4 | 8 | Petrol | 30 |
| F2N 711 | | 81.00 | 1721 | 4 | 8 | Petrol | 30 |
| F2N 712 | | 81.00 | 1721 | 4 | 8 | Petrol | 30 |
| F2N 716 | | 81.00 | 1721 | 4 | 8 | Petrol | 30 |
| F2N 720 | | 81.00 | 1721 | 4 | 8 | Petrol | 30 |
| F2N 721 | | 81.00 | 1721 | 4 | 8 | Petrol | 30 |







|  |  | ccm |  |  |  |  |
|---|---|------|--|---|---|---|
| F2N 722 | 81.00 | 1721 | 4 | 8 | Petrol | 30 |
| F2N 724 | 81.00 | 1721 | 4 | 8 | Petrol | 30 |
| F2N 726 | 81.00 | 1721 | 4 | 8 | Petrol | 30 |
| F2N 727 | 81.00 | 1721 | 4 | 8 | Petrol | 30 |
| F2N 728 | 81.00 | 1721 | 4 | 8 | Petrol | 30 |
| F2N 730 | 81.00 | 1721 | 4 | 8 | Petrol | 30 |
| F2N 732 | 81.00 | 1721 | 4 | 8 | Petrol | 30 |
| F2N 740 | 81.00 | 1721 | 4 | 8 | Petrol | 30 |
| F2N 742 | 81.00 | 1721 | 4 | 8 | Petrol | 30 |
| F2N 750 | 81.00 | 1721 | 4 | 8 | Petrol | 30 |
| F2N 752 | 81.00 | 1721 | 4 | 8 | Petrol | 30 |
| F2N 754 | 81.00 | 1721 | 4 | 8 | Petrol | 30 |
| F2N 758 | 81.00 | 1721 | 4 | 8 | Petrol | 30 |
| F2N 770 | 81.00 | 1721 | 4 | 8 | Petrol | 30 |
| F2N 783 | 81.00 | 1721 | 4 | 8 | Petrol | 30 |
| F2N 786 | 81.00 | 1721 | 4 | 8 | Petrol | 30 |
| F2N 798 | 81.00 | 1721 | 4 | 8 | Petrol | 30 |
| F3N 702 | 81.00 | 1721 | 4 | 8 | Petrol | 30 |
| F3N 716 | 81.00 | 1721 | 4 | 8 | Petrol | 30 |
| F3N 717 | 81.00 | 1721 | 4 | 8 | Petrol | 30 |
| F3N 718 | 81.00 | 1721 | 4 | 8 | Petrol | 30 |
| F3N 722 | 81.00 | 1721 | 4 | 8 | Petrol | 30 |
| F3N 723 | 81.00 | 1721 | 4 | 8 | Petrol | 30 |
| F3N 726 | 81.00 | 1721 | 4 | 8 | Petrol | 30 |
| F3N 740 | 81.00 | 1721 | 4 | 8 | Petrol | 30 |
| F3N 741 | 81.00 | 1721 | 4 | 8 | Petrol | 30 |
| F3N 742 | 81.00 | 1721 | 4 | 8 | Petrol | 30 |
| F3N 743 | 81.00 | 1721 | 4 | 8 | Petrol | 30 |
| F3N 746 | 81.00 | 1721 | 4 | 8 | Petrol | 30 |
| F3P 670 | 82.70 | 1794 | 4 | 8 | Petrol | 34 |
| F3P 674 | 82.70 | 1794 | 4 | 8 | Petrol | 34 |
| F3P 676 | 82.70 | 1794 | 4 | 8 | Petrol | 35 |
| F3P 678 | 82.70 | 1794 | 4 | 8 | Petrol | 34 |
| F3P 682 | 82.70 | 1783 | 4 | 8 | Petrol | 31 |
| F3P 700 | 82.70 | 1794 | 4 | 8 | Petrol | 36 |
| F3P 704 | 82.70 | 1794 | 4 | 8 | Petrol | 36 |
| F3P 705 | 82.70 | 1794 | 4 | 8 | Petrol | 36 |
| F3P 706 | 82.70 | 1794 | 4 | 8 | Petrol | 36 |
| F3P 707 | 82.70 | 1794 | 4 | 8 | Petrol | 36 |
| F3P 708 | 82.70 | 1794 | 4 | 8 | Petrol | 36 |
| F3P 710 | 82.70 | 1794 | 4 | 8 | Petrol | 36 |
| F3P 712 | 82.70 | 1794 | 4 | 8 | Petrol | 36 |
| F3P 714 | 82.70 | 1794 | 4 | 8 | Petrol | 36 |
| F3P 720 | 82.70 | 1794 | 4 | 8 | Petrol | 34 |
| F3P 724 | 82.70 | 1794 | 4 | 8 | Petrol | 34 |
| F3P 754 | 82.70 | 1794 | 4 | 8 | Petrol | 36 |
| F3P 755 | 82.70 | 1794 | 4 | 8 | Petrol | 36 |
| F3P 758 | 82.70 | 1794 | 4 | 8 | Petrol | 36 |
| F3P 760 | 82.70 | 1794 | 4 | 8 | Petrol | 36 |
| F3P 764 | 82.70 | 1794 | 4 | 8 | Petrol | 36 |
| F3P 765 | 82.70 | 1794 | 4 | 8 | Petrol | 36 |
| F3R 611 | 82.70 | 1998 | 4 | 8 | Petrol | 37 |
| F3R 722 | 82.70 | 1998 | 4 | 8 | Petrol | 37 |
| F3R 723 | 82.70 | 1998 | 4 | 8 | Petrol | 37 |
| F3R 728 | 82.70 | 1998 | 4 | 8 | Petrol | 38 |
| F3R 729 | 82.70 | 1998 | 4 | 8 | Petrol | 38 |
| F3R 742 | 82.70 | 1998 | 4 | 8 | Petrol | 39 |
| F3R 750 | 82.70 | 1998 | 4 | 8 | Petrol | 37 |
| F3R 751 | 82.70 | 1998 | 4 | 8 | Petrol | 39 |
| F3R 752 | 82.70 | 1998 | 4 | 8 | Petrol | 37 |
| F3R 768 | 82.70 | 1998 | 4 | 8 | Petrol | 39 |
| F3R 769 | 82.70 | 1998 | 4 | 8 | Petrol | 39 |
| F3R 791 | 82.70 | 1998 | 4 | 8 | Petrol | 37 |
| F3R 796 | 82.70 | 1998 | 4 | 8 | Petrol | 37 |
| F4P 720 | 82.70 | 1783 | 4 | 16 | Petrol | 32 |
| F4P 722 | 82.70 | 1783 | 4 | 16 | Petrol | 32 |







|  |  | ccm |  |  |  |  |
|---|---|------|---|---|---|---|
| F4P 760 | 82.70 | 1783 | 4 | 16 | Petrol | 32 |
| F4P 770 | 82.70 | 1783 | 4 | 16 | Petrol | 32 |
| F4P 771 | 82.70 | 1783 | 4 | 16 | Petrol | 32 |
| F4P 772 | 82.70 | 1783 | 4 | 16 | Petrol | 33 |
| F4P 773 | 82.70 | 1783 | 4 | 16 | Petrol | 32 |
| F4P 774 | 82.70 | 1783 | 4 | 16 | Petrol | 32 |
| F4P 775 | 82.70 | 1783 | 4 | 16 | Petrol | 32 |
| F4R 700 | 82.70 | 1998 | 4 | 16 | Petrol | 40 |
| F4R 701 | 82.70 | 1998 | 4 | 16 | Petrol | 40 |
| F4R 712 | 82.70 | 1998 | 4 | 16 | Petrol | 40 |
| F4R 713 | 82.70 | 1998 | 4 | 16 | Petrol | 40 |
| F4R 714 | 82.70 | 1998 | 4 | 16 | Petrol | 40 |
| F4R 715 | 82.70 | 1998 | 4 | 16 | Petrol | 40 |
| F4R 720 | 82.70 | 1998 | 4 | 16 | Petrol | 40 |
| F4R 722 | 82.70 | 1998 | 4 | 16 | Petrol | 40 |
| F4R 730 | 82.70 | 1998 | 4 | 16 | Petrol | 40 |
| F4R 732 | 82.70 | 1998 | 4 | 16 | Petrol | 41 |
| F4R 736 | 82.70 | 1998 | 4 | 16 | Petrol | 41 |
| F4R 738 | 82.70 | 1998 | 4 | 16 | Petrol | 40 |
| F4R 740 | 82.70 | 1998 | 4 | 16 | Petrol | 40 |
| F4R 741 | 82.70 | 1998 | 4 | 16 | Petrol | 40 |
| F4R 744 | 82.70 | 1998 | 4 | 16 | Petrol | 40 |
| F4R 746 | 82.70 | 1998 | 4 | 16 | Petrol | 40 |
| F4R 747 | 82.70 | 1998 | 4 | 16 | Petrol | 41 |
| F4R 760 | 82.70 | 1998 | 4 | 16 | Petrol | 40 |
| F4R 761 | 82.70 | 1998 | 4 | 16 | Petrol | 40 |
| F4R 762 | 82.70 | 1998 | 4 | 16 | Petrol | 40 |
| F4R 763 | 82.70 | 1998 | 4 | 16 | Petrol | 40 |
| F4R 764 | 82.70 | 1998 | 4 | 16 | Petrol | 40 |
| F4R 765 | 82.70 | 1998 | 4 | 16 | Petrol | 40 |
| F4R 766 | 82.70 | 1998 | 4 | 16 | Petrol | 40 |
| F4R 767 | 82.70 | 1998 | 4 | 16 | Petrol | 40 |
| F4R 770 | 82.70 | 1998 | 4 | 16 | Petrol | 40 |
| F4R 771 | 82.70 | 1998 | 4 | 16 | Petrol | 40 |
| F4R 774 | 82.70 | 1998 | 4 | 16 | Petrol | 41 |
| F4R 776 | 82.70 | 1998 | 4 | 16 | Petrol | 40 |
| F4R 780 | 82.70 | 1998 | 4 | 16 | Petrol | 40 |
| F4R 784 | 82.70 | 1998 | 4 | 16 | Petrol | 40 |
| F4R 786 | 82.70 | 1998 | 4 | 16 | Petrol | 40 |
| F4R 787 | 82.70 | 1998 | 4 | 16 | Petrol | 40 |
| F4R 790 | 82.70 | 1998 | 4 | 16 | Petrol | 40 |
| F4R 791 | 82.70 | 1998 | 4 | 16 | Petrol | 40 |
| F4R 792 | 82.70 | 1998 | 4 | 16 | Petrol | 40 |
| F4R 794 | 82.70 | 1998 | 4 | 16 | Petrol | 40 |
| F4R 795 | 82.70 | 1998 | 4 | 16 | Petrol | 40 |
| F4R 796 | 82.70 | 1998 | 4 | 16 | Petrol | 40 |
| F4R 797 | 82.70 | 1998 | 4 | 16 | Petrol | 40 |
| F4R 800 | 82.70 | 1998 | 4 | 16 | Petrol | 41 |
| F4R 811 | 82.70 | 1998 | 4 | 16 | Petrol | 41 |
| F4R 820 | 82.70 | 1998 | 4 | 16 | Petrol | 40 |
| F4R 830 | 82.70 | 1998 | 4 | 16 | Petrol | 40 |
| F4R 832 | 82.70 | 1998 | 4 | 16 | Petrol | 41 |
| F4R 867 | 82.70 | 1998 | 4 | 16 | Petrol | 41 |
| F4R 886 | 82.70 | 1998 | 4 | 16 | Petrol | 41 |
| F4R 887 | 82.70 | 1998 | 4 | 16 | Petrol | 41 |
| F4R 896 | 82.70 | 1998 | 4 | 16 | Petrol | 41 |
| F4R 897 | 82.70 | 1998 | 4 | 16 | Petrol | 41 |
| F4Rt 774 | 82.70 | 1998 | 4 | 16 | Petrol | 41 |
| F4Rt 811 | 82.70 | 1998 | 4 | 16 | Petrol | 40 |
| F7R 700 | 82.70 | 1998 | 4 | 16 | Petrol | 42 |
| F7R 710 | 82.70 | 1998 | 4 | 16 | Petrol | 42 |
| F7R 714 | 82.70 | 1998 | 4 | 16 | Petrol | 42 |
| F8M 700 | 78.00 | 1596 | 4 | 8 | Diesel | 17 |
| F8M 720 | 78.00 | 1596 | 4 | 8 | Diesel | 17 |
| F8M 730 | 78.00 | 1596 | 4 | 8 | Diesel | 17 |
| F8M 736 | 78.00 | 1596 | 4 | 8 | Diesel | 17 |







|  |  | ccm |  |  |  |  |
|---|---|------|--|---|---|---|
| F8M 760 | 78.00 | 1596 | 4 | 8 | Diesel | 17 |
| F8Q 600 | 80.00 | 1870 | 4 | 8 | Diesel | 23 |
| F8Q 606 | 80.00 | 1870 | 4 | 8 | Diesel | 23 |
| F8Q 610 | 80.00 | 1870 | 4 | 8 | Diesel | 23 |
| F8Q 620 | 80.00 | 1870 | 4 | 8 | Diesel | 24 |
| F8Q 622 | 80.00 | 1870 | 4 | 8 | Diesel | 23 |
| F8Q 624 | 80.00 | 1870 | 4 | 8 | Diesel | 23 |
| F8Q 630 | 80.00 | 1870 | 4 | 8 | Diesel | 25 |
| F8Q 632 | 80.00 | 1870 | 4 | 8 | Diesel | 23 |
| F8Q 640 | 80.00 | 1870 | 4 | 8 | Diesel | 24 |
| F8Q 662 | 80.00 | 1870 | 4 | 8 | Diesel | 25 |
| F8Q 678 | 80.00 | 1870 | 4 | 8 | Diesel | 23 |
| F8Q 682 | 80.00 | 1870 | 4 | 8 | Diesel | 23 |
| F8Q 706 | 80.00 | 1870 | 4 | 8 | Diesel | 23 |
| F8Q 710 | 80.00 | 1870 | 4 | 8 | Diesel | 26 |
| F8Q 714 | 80.00 | 1870 | 4 | 8 | Diesel | 23 |
| F8Q 722 | 80.00 | 1870 | 4 | 8 | Diesel | 27 |
| F8Q 724 | 80.00 | 1870 | 4 | 8 | Diesel | 23 |
| F8Q 730 | 80.00 | 1870 | 4 | 8 | Diesel | 27 |
| F8Q 732 | 80.00 | 1870 | 4 | 8 | Diesel | 23 |
| F8Q 742 | 80.00 | 1870 | 4 | 8 | Diesel | 26 |
| F8Q 764 | 80.00 | 1870 | 4 | 8 | Diesel | 23 |
| F8Q 768 | 80.00 | 1870 | 4 | 8 | Diesel | 28 |
| F8Q 774 | 80.00 | 1870 | 4 | 8 | Diesel | 23 |
| F8Q 776 | 80.00 | 1870 | 4 | 8 | Diesel | 23 |
| F8Q 784 | 80.00 | 1870 | 4 | 8 | Diesel | 28 |
| F8Q 786 | 80.00 | 1870 | 4 | 8 | Diesel | 28 |
| F8Q 790 | 80.00 | 1870 | 4 | 8 | Diesel | 25 |
| F9Q 650 | 80.00 | 1870 | 4 | 8 | Diesel | 29 |
| F9Q 664 | 80.00 | 1870 | 4 | 8 | Diesel | 29 |
| F9Q 670 | 80.00 | 1870 | 4 | 8 | Diesel | 29 |
| F9Q 674 | 80.00 | 1870 | 4 | 8 | Diesel | 29 |
| F9Q 680 | 80.00 | 1870 | 4 | 8 | Diesel | 29 |
| F9Q 710 | 80.00 | 1870 | 4 | 8 | Diesel | 29 |
| F9Q 716 | 80.00 | 1870 | 4 | 8 | Diesel | 29 |
| F9Q 717 | 80.00 | 1870 | 4 | 8 | Diesel | 29 |
| F9Q 718 | 80.00 | 1870 | 4 | 8 | Diesel | 29 |
| F9Q 722 | 80.00 | 1870 | 4 | 8 | Diesel | 29 |
| F9Q 730 | 80.00 | 1870 | 4 | 8 | Diesel | 29 |
| F9Q 731 | 80.00 | 1870 | 4 | 8 | Diesel | 29 |
| F9Q 732 | 80.00 | 1870 | 4 | 8 | Diesel | 29 |
| F9Q 733 | 80.00 | 1870 | 4 | 8 | Diesel | 29 |
| F9Q 734 | 80.00 | 1870 | 4 | 8 | Diesel | 29 |
| F9Q 736 | 80.00 | 1870 | 4 | 8 | Diesel | 29 |
| F9Q 738 | 80.00 | 1870 | 4 | 8 | Diesel | 29 |
| F9Q 740 | 80.00 | 1870 | 4 | 8 | Diesel | 29 |
| F9Q 744 | 80.00 | 1870 | 4 | 8 | Diesel | 29 |
| F9Q 746 | 80.00 | 1870 | 4 | 8 | Diesel | 29 |
| F9Q 748 | 80.00 | 1870 | 4 | 8 | Diesel | 29 |
| F9Q 750 | 80.00 | 1870 | 4 | 8 | Diesel | 29 |
| F9Q 751 | 80.00 | 1870 | 4 | 8 | Diesel | 29 |
| F9Q 752 | 80.00 | 1870 | 4 | 8 | Diesel | 29 |
| F9Q 754 | 80.00 | 1870 | 4 | 8 | Diesel | 29 |
| F9Q 756 | 80.00 | 1870 | 4 | 8 | Diesel | 29 |
| F9Q 758 | 80.00 | 1870 | 4 | 8 | Diesel | 29 |
| F9Q 759 | 80.00 | 1870 | 4 | 8 | Diesel | 29 |
| F9Q 760 | 80.00 | 1870 | 4 | 8 | Diesel | 29 |
| F9Q 762 | 80.00 | 1870 | 4 | 8 | Diesel | 29 |
| F9Q 770 | 80.00 | 1870 | 4 | 8 | Diesel | 29 |
| F9Q 772 | 80.00 | 1870 | 4 | 8 | Diesel | 29 |
| F9Q 774 | 80.00 | 1870 | 4 | 8 | Diesel | 29 |
| F9Q 780 | 80.00 | 1870 | 4 | 8 | Diesel | 29 |
| F9Q 782 | 80.00 | 1870 | 4 | 8 | Diesel | 29 |
| F9Q 790 | 80.00 | 1870 | 4 | 8 | Diesel | 29 |
| F9Q 800 | 80.00 | 1870 | 4 | 8 | Diesel | 29 |
| F9Q 803 | 80.00 | 1870 | 4 | 8 | Diesel | 29 |







|  |  | ccm |  |  |  |  |
|---|---|------|---|---|---|---|
| F9Q 804 | 80.00 | 1870 | 4 | 8 | Diesel | 29 |
| F9Q 808 | 80.00 | 1870 | 4 | 8 | Diesel | 29 |
| F9Q 812 | 80.00 | 1870 | 4 | 8 | Diesel | 29 |
| F9Q 816 | 80.00 | 1870 | 4 | 8 | Diesel | 29 |
| F9Q 818 | 80.00 | 1870 | 4 | 8 | Diesel | 29 |
| F9Q 820 | 80.00 | 1870 | 4 | 8 | Diesel | 29 |
| F9Q 826 | 80.00 | 1870 | 4 | 8 | Diesel | 29 |
| F9Q E 804 | 80.00 | 1870 | 4 | 8 | Diesel | 29 |
| F9Q EE 804 | 80.00 | 1870 | 4 | 8 | Diesel | 29 |
| F9Q J 803 | 80.00 | 1870 | 4 | 8 | Diesel | 29 |
| G8T 706 | 87.00 | 2188 | 4 | 12 | Diesel | 48 |
| G8T 714 | 87.00 | 2188 | 4 | 12 | Diesel | 49 |
| G8T 716 | 87.00 | 2188 | 4 | 12 | Diesel | 49 |
| G8T 740 | 87.00 | 2188 | 4 | 12 | Diesel | 49 |
| G8T 752 | 87.00 | 2188 | 4 | 12 | Diesel | 48 |
| G8T 760 | 87.00 | 2188 | 4 | 12 | Diesel | 49 |
| G8T 790 | 87.00 | 2188 | 4 | 12 | Diesel | 48 |
| G8T 792 | 87.00 | 2188 | 4 | 12 | Diesel | 48 |
| G8T 794 | 87.00 | 2188 | 4 | 12 | Diesel | 48 |
| G9T 600 | 87.00 | 2188 | 4 | 16 | Diesel | 50 |
| G9T 605 | 87.00 | 2188 | 4 | 16 | Diesel | 50 |
| G9T 606 | 87.00 | 2188 | 4 | 16 | Diesel | 50 |
| G9T 607 | 87.00 | 2188 | 4 | 16 | Diesel | 50 |
| G9T 642 | 87.00 | 2188 | 4 | 16 | Diesel | 50 |
| G9T 645 | 87.00 | 2188 | 4 | 16 | Diesel | 50 |
| G9T 700 | 87.00 | 2188 | 4 | 16 | Diesel | 50 |
| G9T 702 | 87.00 | 2188 | 4 | 16 | Diesel | 50 |
| G9T 703 | 87.00 | 2188 | 4 | 16 | Diesel | 50 |
| G9T 704 | 87.00 | 2188 | 4 | 16 | Diesel | 50 |
| G9T 706 | 87.00 | 2188 | 4 | 16 | Diesel | 50 |
| G9T 707 | 87.00 | 2188 | 4 | 16 | Diesel | 50 |
| G9T 710 | 87.00 | 2188 | 4 | 16 | Diesel | 50 |
| G9T 712 | 87.00 | 2188 | 4 | 16 | Diesel | 50 |
| G9T 720 | 87.00 | 2188 | 4 | 16 | Diesel | 50 |
| G9T 722 | 87.00 | 2188 | 4 | 16 | Diesel | 50 |
| G9T 742 | 87.00 | 2188 | 4 | 16 | Diesel | 50 |
| G9T 743 | 87.00 | 2188 | 4 | 16 | Diesel | 50 |
| G9T 750 | 87.00 | 2188 | 4 | 16 | Diesel | 50 |
| G9U 630 | 89.00 | 2464 | 4 | 16 | Diesel | 58 |
| G9U 632 | 89.00 | 2464 | 4 | 16 | Diesel | 58 |
| G9U 650 | 89.00 | 2464 | 4 | 16 | Diesel | 58 |
| G9U 720 | 89.00 | 2464 | 4 | 16 | Diesel | 58 |
| G9U 724 | 89.00 | 2464 | 4 | 16 | Diesel | 58 |
| G9U 730 | 89.00 | 2464 | 4 | 16 | Diesel | 58 |
| G9U 750 | 89.00 | 2464 | 4 | 16 | Diesel | 58 |
| G9U 754 | 89.00 | 2464 | 4 | 16 | Diesel | 58 |
| H4B 400 | 72.20 | 898 | 3 | 12 | Petrol | 8 |
| H4B 401 | 72.20 | 898 | 3 | 12 | Petrol | 8 |
| H4B 408 | 72.20 | 898 | 3 | 12 | Petrol | 8 |
| J5R 716 | 88.00 | 1995 | 4 | 8 | Petrol | 53 |
| J5R 718 | 88.00 | 1995 | 4 | 8 | Petrol | 53 |
| J5R 722 | 88.00 | 1995 | 4 | 8 | Petrol | 53 |
| J5R 726 | 88.00 | 1995 | 4 | 8 | Petrol | 53 |
| J5R 728 | 88.00 | 1995 | 4 | 8 | Petrol | 53 |
| J5R 800 | 88.00 | 1995 | 4 | 8 | Petrol | 53 |
| J6R 234 | 88.00 | 1995 | 4 | 8 | Petrol | 53 |
| J6R 236 | 88.00 | 1995 | 4 | 8 | Petrol | 53 |
| J6R 706 | 88.00 | 1995 | 4 | 8 | Petrol | 53 |
| J6R 707 | 88.00 | 1995 | 4 | 8 | Petrol | 53 |
| J6R 710 | 88.00 | 1995 | 4 | 8 | Petrol | 53 |
| J6R 711 | 88.00 | 1995 | 4 | 8 | Petrol | 53 |
| J6R 712 | 88.00 | 1995 | 4 | 8 | Petrol | 53 |
| J6R 713 | 88.00 | 1995 | 4 | 8 | Petrol | 53 |
| J6R 714 | 88.00 | 1995 | 4 | 8 | Petrol | 53 |
| J6R 715 | 88.00 | 1995 | 4 | 8 | Petrol | 53 |
| J6R 716 | 88.00 | 1995 | 4 | 8 | Petrol | 53 |







|  |  | ccm |  |  |  |  |
|---|---|------|--|---|---|---|
| J6R 726 | 88.00 | 1995 | 4 | 8 | Petrol | 53 |
| J6R 734 | 88.00 | 1995 | 4 | 8 | Petrol | 53 |
| J6R 758 | 88.00 | 1995 | 4 | 8 | Petrol | 53 |
| J6R 759 | 88.00 | 1995 | 4 | 8 | Petrol | 53 |
| J6R 760 | 88.00 | 1995 | 4 | 8 | Petrol | 53 |
| J6R 762 | 88.00 | 1995 | 4 | 8 | Petrol | 53 |
| J6R 763 | 88.00 | 1995 | 4 | 8 | Petrol | 53 |
| J6R 792 | 88.00 | 1995 | 4 | 8 | Petrol | 53 |
| J6R 793 | 88.00 | 1995 | 4 | 8 | Petrol | 53 |
| J7R 720 | 88.00 | 1995 | 4 | 12 | Petrol | 53 |
| J7R 721 | 88.00 | 1995 | 4 | 12 | Petrol | 53 |
| J7R 722 | 88.00 | 1995 | 4 | 8 | Petrol | 53 |
| J7R 723 | 88.00 | 1995 | 4 | 8 | Petrol | 53 |
| J7R 726 | 88.00 | 1995 | 4 | 12 | Petrol | 53 |
| J7R 732 | 88.00 | 1995 | 4 | 8 | Petrol | 53 |
| J7R 733 | 88.00 | 1995 | 4 | 8 | Petrol | 53 |
| J7R 734 | 88.00 | 1995 | 4 | 12 | Petrol | 54 |
| J7R 735 | 88.00 | 1995 | 4 | 12 | Petrol | 54 |
| J7R 738 | 88.00 | 1995 | 4 | 8 | Petrol | 53 |
| J7R 739 | 88.00 | 1995 | 4 | 8 | Petrol | 53 |
| J7R 740 | 88.00 | 1995 | 4 | 12 | Petrol | 53 |
| J7R 746 | 88.00 | 1995 | 4 | 8 | Petrol | 53 |
| J7R 747 | 88.00 | 1995 | 4 | 8 | Petrol | 53 |
| J7R 750 | 88.00 | 1995 | 4 | 8 | Petrol | 53 |
| J7R 751 | 88.00 | 1995 | 4 | 8 | Petrol | 53 |
| J7R 752 | 88.00 | 1995 | 4 | 8 | Petrol | 53 |
| J7R 754 | 88.00 | 1995 | 4 | 12 | Petrol | 53 |
| J7R 756 | 88.00 | 1995 | 4 | 8 | Petrol | 53 |
| J7R 760 | 88.00 | 1995 | 4 | 8 | Petrol | 53 |
| J7R 768 | 88.00 | 1995 | 4 | 8 | Petrol | 53 |
| J7T 600 | 88.00 | 2165 | 4 | 8 | Petrol | 55 |
| J7T 706 | 88.00 | 2165 | 4 | 8 | Petrol | 55 |
| J7T 707 | 88.00 | 2165 | 4 | 8 | Petrol | 55 |
| J7T 708 | 88.00 | 2165 | 4 | 8 | Petrol | 55 |
| J7T 714 | 88.00 | 2165 | 4 | 8 | Petrol | 55 |
| J7T 715 | 88.00 | 2165 | 4 | 8 | Petrol | 55 |
| J7T 718 | 88.00 | 2165 | 4 | 8 | Petrol | 55 |
| J7T 719 | 88.00 | 2165 | 4 | 8 | Petrol | 55 |
| J7T 730 | 88.00 | 2165 | 4 | 8 | Petrol | 55 |
| J7T 731 | 88.00 | 2165 | 4 | 8 | Petrol | 55 |
| J7T 732 | 88.00 | 2165 | 4 | 8 | Petrol | 55 |
| J7T 733 | 88.00 | 2165 | 4 | 8 | Petrol | 55 |
| J7T 734 | 88.00 | 2165 | 4 | 8 | Petrol | 55 |
| J7T 736 | 88.00 | 2165 | 4 | 8 | Petrol | 55 |
| J7T 754 | 88.00 | 2165 | 4 | 8 | Petrol | 55 |
| J7T 755 | 88.00 | 2165 | 4 | 8 | Petrol | 55 |
| J7T 756 | 88.00 | 2165 | 4 | 8 | Petrol | 55 |
| J7T 760 | 88.00 | 2165 | 4 | 12 | Petrol | 56 |
| J7T 761 | 88.00 | 2165 | 4 | 12 | Petrol | 56 |
| J7T 762 | 88.00 | 2165 | 4 | 8 | Petrol | 55 |
| J7T 763 | 88.00 | 2165 | 4 | 8 | Petrol | 55 |
| J7T 770 | 88.00 | 2165 | 4 | 8 | Petrol | 55 |
| J7T 772 | 88.00 | 2165 | 4 | 8 | Petrol | 55 |
| J7T 773 | 88.00 | 2165 | 4 | 8 | Petrol | 55 |
| J7T 776 | 88.00 | 2165 | 4 | 8 | Petrol | 55 |
| J7T 780 | 88.00 | 2165 | 4 | 8 | Petrol | 55 |
| J7T 782 | 88.00 | 2165 | 4 | 8 | Petrol | 55 |
| J7T 788 | 88.00 | 2165 | 4 | 8 | Petrol | 55 |
| J8S 232 (852.232) | 86.00 | 2068 | 4 | 8 | Diesel | 47 |
| J8S 240 | 86.00 | 2068 | 4 | 8 | Diesel | 47 |
| J8S 330 | 86.00 | 2068 | 4 | 8 | Diesel | 47 |
| J8S 600 | 86.00 | 2068 | 4 | 8 | Diesel | 47 |
| J8S 604 | 86.00 | 2068 | 4 | 8 | Diesel | 47 |
| J8S 610 | 86.00 | 2068 | 4 | 8 | Diesel | 47 |
| J8S 612 | 86.00 | 2068 | 4 | 8 | Diesel | 47 |
| J8S 620 | 86.00 | 2068 | 4 | 8 | Diesel | 47 |







|  |  | ccm |  |  |  |  | |
|---|---|-------|---|---|---|---|----|
| J8S 702 | | 86.00 | 2068 | 4 | 8 | Diesel | 47 |
| J8S 704 | | 86.00 | 2068 | 4 | 8 | Diesel | 47 |
| J8S 706 | | 86.00 | 2068 | 4 | 8 | Diesel | 47 |
| J8S 708 | | 86.00 | 2068 | 4 | 8 | Diesel | 47 |
| J8S 711 | | 86.00 | 2068 | 4 | 8 | Diesel | 47 |
| J8S 712 | | 86.00 | 2068 | 4 | 8 | Diesel | 47 |
| J8S 714 | | 86.00 | 2068 | 4 | 8 | Diesel | 47 |
| J8S 736 | | 86.00 | 2068 | 4 | 8 | Diesel | 47 |
| J8S 738 | | 86.00 | 2068 | 4 | 8 | Diesel | 47 |
| J8S 740 | | 86.00 | 2068 | 4 | 8 | Diesel | 47 |
| J8S 742 | | 86.00 | 2068 | 4 | 8 | Diesel | 47 |
| J8S 746 | | 86.00 | 2068 | 4 | 8 | Diesel | 47 |
| J8S 758 | | 86.00 | 2068 | 4 | 8 | Diesel | 47 |
| J8S 760 | | 86.00 | 2068 | 4 | 8 | Diesel | 47 |
| J8S 772 | | 86.00 | 2068 | 4 | 8 | Diesel | 47 |
| J8S 774 | | 86.00 | 2068 | 4 | 8 | Diesel | 47 |
| J8S 776 | | 86.00 | 2068 | 4 | 8 | Diesel | 47 |
| J8S 778 | | 86.00 | 2068 | 4 | 8 | Diesel | 47 |
| J8S 784 | | 86.00 | 2068 | 4 | 8 | Diesel | 47 |
| J8S 786 (KAT) | | 86.00 | 2068 | 4 | 8 | Diesel | 47 |
| J8S 788 | | 86.00 | 2068 | 4 | 8 | Diesel | 47 |
| J8S 852 | | 86.00 | 2068 | 4 | 8 | Diesel | 47 |
| J8S 890 | | 86.00 | 2068 | 4 | 8 | Diesel | 47 |
| K4J 700 | | 79.50 | 1390 | 4 | 16 | Petrol | 18 |
| K4J 710 | | 79.50 | 1390 | 4 | 16 | Petrol | 18 |
| K4J 711 | | 79.50 | 1390 | 4 | 16 | Petrol | 18 |
| K4J 712 | | 79.50 | 1390 | 4 | 16 | Petrol | 18 |
| K4J 713 | | 79.50 | 1390 | 4 | 16 | Petrol | 18 |
| K4J 714 | | 79.50 | 1390 | 4 | 16 | Petrol | 18 |
| K4J 715 | | 79.50 | 1390 | 4 | 16 | Petrol | 19 |
| K4J 730 | | 79.50 | 1390 | 4 | 16 | Petrol | 18 |
| K4J 732 | | 79.50 | 1390 | 4 | 16 | Petrol | 18 |
| K4J 740 | | 79.50 | 1390 | 4 | 16 | Petrol | 18 |
| K4J 750 | | 79.50 | 1390 | 4 | 16 | Petrol | 18 |
| K4J 770 | | 79.50 | 1390 | 4 | 16 | Petrol | 18 |
| K4J 780 | | 79.50 | 1390 | 4 | 16 | Petrol | 18 |
| K4J D 740 | | 79.50 | 1390 | 4 | 16 | Petrol | 19 |
| K4M 690 | | 79.50 | 1598 | 4 | 16 | Petrol | 21 |
| K4M 697 | | 79.50 | 1598 | 4 | 16 | Petrol | 21 |
| K4M 698 | | 79.50 | 1598 | 4 | 16 | Petrol | 21 |
| K4M 700 | | 79.50 | 1598 | 4 | 16 | Petrol | 21 |
| K4M 701 | | 79.50 | 1598 | 4 | 16 | Petrol | 21 |
| K4M 704 | | 79.50 | 1598 | 4 | 16 | Petrol | 21 |
| K4M 706 | | 79.50 | 1598 | 4 | 16 | Petrol | 21 |
| K4M 708 | | 79.50 | 1598 | 4 | 16 | Petrol | 21 |
| K4M 709 | | 79.50 | 1598 | 4 | 16 | Petrol | 21 |
| K4M 710 | | 79.50 | 1598 | 4 | 16 | Petrol | 21 |
| K4M 711 | | 79.50 | 1598 | 4 | 16 | Petrol | 21 |
| K4M 712 | | 79.50 | 1598 | 4 | 16 | Petrol | 21 |
| K4M 714 | | 79.50 | 1598 | 4 | 16 | Petrol | 21 |
| K4M 716 | | 79.50 | 1598 | 4 | 16 | Petrol | 21 |
| K4M 720 | | 79.50 | 1598 | 4 | 16 | Petrol | 21 |
| K4M 724 | | 79.50 | 1598 | 4 | 16 | Petrol | 21 |
| K4M 730 | | 79.50 | 1598 | 4 | 16 | Petrol | 21 |
| K4M 732 | | 79.50 | 1598 | 4 | 16 | Petrol | 21 |
| K4M 734 | | 79.50 | 1598 | 4 | 16 | Petrol | 21 |
| K4M 736 | | 79.50 | 1598 | 4 | 16 | Petrol | 21 |
| K4M 740 | | 79.50 | 1598 | 4 | 16 | Petrol | 21 |
| K4M 742 | | 79.50 | 1598 | 4 | 16 | Petrol | 21 |
| K4M 743 | | 79.50 | 1598 | 4 | 16 | Petrol | 21 |
| K4M 744 | | 79.50 | 1598 | 4 | 16 | Petrol | 21 |
| K4M 745 | | 79.50 | 1598 | 4 | 16 | Petrol | 21 |
| K4M 746 | | 79.50 | 1598 | 4 | 16 | Petrol | 21 |
| K4M 748 | | 79.50 | 1598 | 4 | 16 | Petrol | 21 |
| K4M 750 | | 79.50 | 1598 | 4 | 16 | Petrol | 21 |
| K4M 752 | | 79.50 | 1598 | 4 | 16 | Petrol | 21 |

|  |  | ccm |  |  |  |  |
|---|---|------------|--|---|---|---|
| K4M 753 | | 79.50 1598 | 4 | 16 | Petrol | 21 |
| K4M 754 | | 79.50 1598 | 4 | 16 | Petrol | 21 |
| K4M 760 | | 79.50 1598 | 4 | 16 | Petrol | 21 |
| K4M 761 | | 79.50 1598 | 4 | 16 | Petrol | 21 |
| K4M 762 | | 79.50 1598 | 4 | 16 | Petrol | 21 |
| K4M 764 | | 79.50 1598 | 4 | 16 | Petrol | 21 |
| K4M 768 | | 79.50 1598 | 4 | 16 | Petrol | 21 |
| K4M 776 | | 79.50 1598 | 4 | 16 | Petrol | 21 |
| K4M 782 | | 79.50 1598 | 4 | 16 | Petrol | 21 |
| K4M 788 | | 79.50 1598 | 4 | 16 | Petrol | 21 |
| K4M 790 | | 79.50 1598 | 4 | 16 | Petrol | 21 |
| K4M 791 | | 79.50 1598 | 4 | 16 | Petrol | 21 |
| K4M 792 | | 79.50 1598 | 4 | 16 | Petrol | 21 |
| K4M 794 | | 79.50 1598 | 4 | 16 | Petrol | 21 |
| K4M 800 | | 79.50 1598 | 4 | 16 | Petrol | 21 |
| K4M 801 | | 79.50 1598 | 4 | 16 | Petrol | 21 |
| K4M 804 | | 79.50 1598 | 4 | 16 | Petrol | 21 |
| K4M 812 | | 79.50 1598 | 4 | 16 | Petrol | 21 |
| K4M 813 | | 79.50 1598 | 4 | 16 | Petrol | 21 |
| K4M 824 | | 79.50 1598 | 4 | 16 | Petrol | 21 |
| K4M 854 | | 79.50 1598 | 4 | 16 | Petrol | 21 |
| K4M T 782 | | 79.50 1598 | 4 | 16 | Petrol | 21 |
| K4M W 761 | | 79.50 1598 | 4 | 16 | Petrol | 21 |
| K7J 700 | | 75.80 1390 | 4 | 8 | Petrol | 12 |
| K7J 701 | | 75.80 1390 | 4 | 8 | Petrol | 12 |
| K7J 710 | | 79.50 1390 | 4 | 8 | Petrol | 20 |
| K7J 714 | | 79.50 1390 | 4 | 8 | Petrol | 20 |
| K7M 702 | | 79.50 1598 | 4 | 8 | Petrol | 22 |
| K7M 703 | | 79.50 1598 | 4 | 8 | Petrol | 22 |
| K7M 704 | | 79.50 1598 | 4 | 8 | Petrol | 22 |
| K7M 710 | | 79.50 1598 | 4 | 8 | Petrol | 22 |
| K7M 718 | | 79.50 1598 | 4 | 8 | Petrol | 22 |
| K7M 720 | | 79.50 1598 | 4 | 8 | Petrol | 22 |
| K7M 732 | | 79.50 1598 | 4 | 8 | Petrol | 22 |
| K7M 744 | | 79.50 1598 | 4 | 8 | Petrol | 22 |
| K7M 745 | | 79.50 1598 | 4 | 8 | Petrol | 22 |
| K7M 746 | | 79.50 1598 | 4 | 8 | Petrol | 22 |
| K7M 750 | | 79.50 1598 | 4 | 8 | Petrol | 22 |
| K7M 790 | | 79.50 1598 | 4 | 8 | Petrol | 22 |
| K9K 608 | | 76.00 1461 | 4 | 8 | Diesel | 16 |
| K9K 612 | | 76.00 1461 | 4 | 8 | Diesel | 16 |
| K9K 636 | | 76.00 1461 | 4 | 8 | Diesel | 16 |
| K9K 700 | | 76.00 1461 | 4 | 8 | Diesel | 16 |
| K9K 702 | | 76.00 1461 | 4 | 8 | Diesel | 16 |
| K9K 704 | | 76.00 1461 | 4 | 8 | Diesel | 16 |
| K9K 706 | | 76.00 1461 | 4 | 8 | Diesel | 16 |
| K9K 708 | | 76.00 1461 | 4 | 8 | Diesel | 16 |
| K9K 710 | | 76.00 1461 | 4 | 8 | Diesel | 16 |
| K9K 712 | | 76.00 1461 | 4 | 8 | Diesel | 16 |
| K9K 714 | | 76.00 1461 | 4 | 8 | Diesel | 16 |
| K9K 716 | | 76.00 1461 | 4 | 8 | Diesel | 16 |
| K9K 718 | | 76.00 1461 | 4 | 8 | Diesel | 16 |
| K9K 722 | | 76.00 1461 | 4 | 8 | Diesel | 16 |
| K9K 724 | | 76.00 1461 | 4 | 8 | Diesel | 16 |
| K9K 728 | | 76.00 1461 | 4 | 8 | Diesel | 16 |
| K9K 729 | | 76.00 1461 | 4 | 8 | Diesel | 16 |
| K9K 732 | | 76.00 1461 | 4 | 8 | Diesel | 16 |
| K9K 734 | | 76.00 1461 | 4 | 8 | Diesel | 16 |
| K9K 740 | | 76.00 1461 | 4 | 8 | Diesel | 16 |
| K9K 750 | | 76.00 1461 | 4 | 8 | Diesel | 16 |
| K9K 752 | | 76.00 1461 | 4 | 8 | Diesel | 16 |
| K9K 760 | | 76.00 1461 | 4 | 8 | Diesel | 16 |
| K9K 762 | | 76.00 1461 | 4 | 8 | Diesel | 16 |
| K9K 764 | | 76.00 1461 | 4 | 8 | Diesel | 16 |
| K9K 766 | | 76.00 1461 | 4 | 8 | Diesel | 16 |
| K9K 768 | | 76.00 1461 | 4 | 8 | Diesel | 16 |

|  |  | ccm |  |  |  |  | |
|---|---|-------|---|---|---|---|----|
| K9K 770 | | 76.00 | 1461 | 4 | 8 | Diesel | 16 |
| K9K 772 | | 76.00 | 1461 | 4 | 8 | Diesel | 16 |
| K9K 780 | | 76.00 | 1461 | 4 | 8 | Diesel | 16 |
| K9K 790 | | 76.00 | 1461 | 4 | 8 | Diesel | 16 |
| K9K 792 | | 76.00 | 1461 | 4 | 8 | Diesel | 16 |
| K9K 794 | | 76.00 | 1461 | 4 | 8 | Diesel | 16 |
| K9K 796 | | 76.00 | 1461 | 4 | 8 | Diesel | 16 |
| K9K 800 | | 76.00 | 1461 | 4 | 8 | Diesel | 16 |
| K9K 802 | | 76.00 | 1461 | 4 | 8 | Diesel | 16 |
| K9K 804 | | 76.00 | 1461 | 4 | 8 | Diesel | 16 |
| K9K 806 | | 76.00 | 1461 | 4 | 8 | Diesel | 16 |
| K9K 808 | | 76.00 | 1461 | 4 | 8 | Diesel | 16 |
| K9K 812 | | 76.00 | 1461 | 4 | 8 | Diesel | 16 |
| K9K 820 | | 76.00 | 1461 | 4 | 8 | Diesel | 16 |
| K9K 830 | | 76.00 | 1461 | 4 | 8 | Diesel | 16 |
| K9K 832 | | 76.00 | 1461 | 4 | 8 | Diesel | 16 |
| K9K 834 | | 76.00 | 1461 | 4 | 8 | Diesel | 16 |
| K9K 836 | | 76.00 | 1461 | 4 | 8 | Diesel | 16 |
| K9K 837 | | 76.00 | 1461 | 4 | 8 | Diesel | 16 |
| K9K 856 | | 76.00 | 1461 | 4 | 8 | Diesel | 16 |
| K9K 896 | | 76.00 | 1461 | 4 | 8 | Diesel | 16 |
| K9K 898 | | 76.00 | 1461 | 4 | 8 | Diesel | 16 |
| K9K P 732 | | 76.00 | 1461 | 4 | 8 | Diesel | 16 |
| L7X 700 | | 87.00 | 2946 | 6 | 24 | Petrol | 51 |
| L7X 701 | | 87.00 | 2946 | 6 | 24 | Petrol | 51 |
| L7X 727 | | 87.00 | 2946 | 6 | 24 | Petrol | 51 |
| M9R 610 | | 84.00 | 1995 | 4 | 16 | Diesel | 44 |
| M9R 615 | | 84.00 | 1995 | 4 | 16 | Diesel | 44 |
| M9R 630 | | 84.00 | 1995 | 4 | 16 | Diesel | 44 |
| M9R 692 | | 84.00 | 1995 | 4 | 16 | Diesel | 44 |
| M9R 700 | | 84.00 | 1995 | 4 | 16 | Diesel | 44 |
| M9R 721 | | 84.00 | 1995 | 4 | 16 | Diesel | 44 |
| M9R 722 | | 84.00 | 1995 | 4 | 16 | Diesel | 44 |
| M9R 724 | | 84.00 | 1995 | 4 | 16 | Diesel | 44 |
| M9R 740 | | 84.00 | 1995 | 4 | 16 | Diesel | 44 |
| M9R 742 | | 84.00 | 1995 | 4 | 16 | Diesel | 44 |
| M9R 744 | | 84.00 | 1995 | 4 | 16 | Diesel | 44 |
| M9R 746 | | 84.00 | 1995 | 4 | 16 | Diesel | 44 |
| M9R 748 | | 84.00 | 1995 | 4 | 16 | Diesel | 44 |
| M9R 750 | | 84.00 | 1995 | 4 | 16 | Diesel | 44 |
| M9R 760 | | 84.00 | 1995 | 4 | 16 | Diesel | 44 |
| M9R 761 | | 84.00 | 1995 | 4 | 16 | Diesel | 44 |
| M9R 762 | | 84.00 | 1995 | 4 | 16 | Diesel | 44 |
| M9R 763 | | 84.00 | 1995 | 4 | 16 | Diesel | 44 |
| M9R 780 | | 84.00 | 1995 | 4 | 16 | Diesel | 44 |
| M9R 782 | | 84.00 | 1995 | 4 | 16 | Diesel | 44 |
| M9R 784 | | 84.00 | 1995 | 4 | 16 | Diesel | 44 |
| M9R 786 | | 84.00 | 1995 | 4 | 16 | Diesel | 44 |
| M9R 788 | | 84.00 | 1995 | 4 | 16 | Diesel | 44 |
| M9R 800 | | 84.00 | 1995 | 4 | 16 | Diesel | 44 |
| M9R 802 | | 84.00 | 1995 | 4 | 16 | Diesel | 44 |
| M9R 804 | | 84.00 | 1995 | 4 | 16 | Diesel | 44 |
| M9R 805 | | 84.00 | 1995 | 4 | 16 | Diesel | 44 |
| M9R 809 | | 84.00 | 1995 | 4 | 16 | Diesel | 44 |
| M9R 814 | | 84.00 | 1995 | 4 | 16 | Diesel | 44 |
| M9R 815 | | 84.00 | 1995 | 4 | 16 | Diesel | 44 |
| M9R 816 | | 84.00 | 1995 | 4 | 16 | Diesel | 44 |
| M9R 817 | | 84.00 | 1995 | 4 | 16 | Diesel | 44 |
| M9R 820 | | 84.00 | 1995 | 4 | 16 | Diesel | 44 |
| M9R 824 | | 84.00 | 1995 | 4 | 16 | Diesel | 44 |
| M9R 830 | | 84.00 | 1995 | 4 | 16 | Diesel | 44 |
| M9R 832 | | 84.00 | 1995 | 4 | 16 | Diesel | 44 |
| M9R 833 | | 84.00 | 1995 | 4 | 16 | Diesel | 44 |
| M9R 844 | | 84.00 | 1995 | 4 | 16 | Diesel | 44 |
| M9R 845 | | 84.00 | 1995 | 4 | 16 | Diesel | 44 |
| M9R 849 | | 84.00 | 1995 | 4 | 16 | Diesel | 44 |

|  |  | ccm |  |  |  |  |
|---|---|-------|--|---|---|---|
| M9R 855 | 84.00 | 1995 | 4 | 16 | Diesel | 44 |
| M9R 856 | 84.00 | 1995 | 4 | 16 | Diesel | 44 |
| M9R 862 | 84.00 | 1995 | 4 | 16 | Diesel | 44 |
| M9R 864 | 84.00 | 1995 | 4 | 16 | Diesel | 44 |
| M9R 865 | 84.00 | 1995 | 4 | 16 | Diesel | 44 |
| M9R 866 | 84.00 | 1995 | 4 | 16 | Diesel | 44 |
| M9R A 700 | 84.00 | 1995 | 4 | 16 | Diesel | 45 |
| M9R B 610 | 84.00 | 1995 | 4 | 16 | Diesel | 45 |
| M9R B 721 | 84.00 | 1995 | 4 | 16 | Diesel | 45 |
| M9R C 613 | 84.00 | 1995 | 4 | 16 | Diesel | 45 |
| M9R C 615 | 84.00 | 1995 | 4 | 16 | Diesel | 45 |
| M9R C 830 | 84.00 | 1995 | 4 | 16 | Diesel | 45 |
| M9R G 832 | 84.00 | 1995 | 4 | 16 | Diesel | 45 |
| M9Ra 742 | 84.00 | 1995 | 4 | 16 | Diesel | 45 |
| M9Rk 800 | 84.00 | 1995 | 4 | 16 | Diesel | 45 |
| M9Rk 802 | 84.00 | 1995 | 4 | 16 | Diesel | 45 |
| M9Rk 805 | 84.00 | 1995 | 4 | 16 | Diesel | 45 |
| M9Rk 806 | 84.00 | 1995 | 4 | 16 | Diesel | 45 |
| M9Rk 816 | 84.00 | 1995 | 4 | 16 | Diesel | 45 |
| M9T 670 | 85.00 | 2298 | 4 | 16 | Diesel | 46 |
| M9T 672 | 85.00 | 2298 | 4 | 16 | Diesel | 46 |
| M9T 676 | 85.00 | 2298 | 4 | 16 | Diesel | 46 |
| M9T 678 | 85.00 | 2298 | 4 | 16 | Diesel | 46 |
| M9T 680 | 85.00 | 2298 | 4 | 16 | Diesel | 46 |
| M9T 686 | 85.00 | 2298 | 4 | 16 | Diesel | 46 |
| M9T 690 | 85.00 | 2298 | 4 | 16 | Diesel | 46 |
| M9T 692 | 85.00 | 2298 | 4 | 16 | Diesel | 46 |
| M9T 694 | 85.00 | 2298 | 4 | 16 | Diesel | 46 |
| M9T 696 | 85.00 | 2298 | 4 | 16 | Diesel | 46 |
| M9T 698 | 85.00 | 2298 | 4 | 16 | Diesel | 46 |
| M9T 880 | 85.00 | 2298 | 4 | 16 | Diesel | 46 |
| M9T 896 | 85.00 | 2298 | 4 | 16 | Diesel | 46 |
| M9T 898 | 85.00 | 2298 | 4 | 16 | Diesel | 46 |
| MACK E.TECH A/46 | 124.00 | 12000 | 6 | 24 | Diesel | 98 |
| MACK E.TECH B/46 | 124.00 | 12000 | 6 | 24 | Diesel | 98 |
| MACK E.TECH C/46 | 124.00 | 12000 | 6 | 24 | Diesel | 98 |
| MDS 06.35.40 | 135.00 | 12024 | 6 | 12 | Diesel | 101 |
| MDS 06.35.40 H | 135.00 | 12024 | 6 | 12 | Diesel | 101 |
| MDS 06.35.40 I | 135.00 | 12024 | 6 | 12 | Diesel | 101 |
| MID 06.20.30 C | 120.00 | 8822 | 6 | 12 | Diesel | 90 |
| MID 06.20.30 G | 120.00 | 8822 | 6 | 12 | Diesel | 90 |
| MID 06.20.45 | 120.00 | 9839 | 6 | 12 | Diesel | 92 |
| MIDR 04.02.26 A/4 | 102.00 | 4118 | 4 | 8 | Diesel | 76 |
| MIDR 04.02.26 A/41 | 102.00 | 4118 | 4 | 8 | Diesel | 77 |
| MIDR 04.02.26 B/4 | 102.00 | 4118 | 4 | 8 | Diesel | 76 |
| MIDR 04.02.26 B/41 | 102.00 | 4118 | 4 | 8 | Diesel | 77 |
| MIDR 06.02.12 | 102.00 | 5491 | 6 | 12 | Diesel | 81 |
| MIDR 06.02.12 D | 102.00 | 5491 | 6 | 12 | Diesel | 81 |
| MIDR 06.02.26 | 102.00 | 6177 | 6 | 12 | Diesel | 83 |
| MIDR 06.02.26 D | 102.00 | 6177 | 6 | 12 | Diesel | 84 |
| MIDR 06.02.26 H | 102.00 | 6177 | 6 | 12 | Diesel | 84 |
| MIDR 06.02.26 I | 102.00 | 6177 | 6 | 12 | Diesel | 85 |
| MIDR 06.02.26 K | 102.00 | 6177 | 6 | 12 | Diesel | 85 |
| MIDR 06.02.26 L | 102.00 | 6177 | 6 | 12 | Diesel | 85 |
| MIDR 06.02.26 L2 | 102.00 | 6177 | 6 | 12 | Diesel | 85 |
| MIDR 06.02.26 M | 102.00 | 6177 | 6 | 12 | Diesel | 85 |
| MIDR 06.02.26 M2 | 102.00 | 6177 | 6 | 12 | Diesel | 85 |
| MIDR 06.02.26 Q | 102.00 | 6177 | 6 | 12 | Diesel | 84 |
| MIDR 06.02.26 S | 102.00 | 6177 | 6 | 12 | Diesel | 85 |
| MIDR 06.02.26 U | 102.00 | 6177 | 6 | 12 | Diesel | 84 |
| MIDR 06.02.26 U/4 | 102.00 | 6177 | 6 | 12 | Diesel | 85 |
| MIDR 06.02.26 V | 102.00 | 6177 | 6 | 12 | Diesel | 84 |
| MIDR 06.02.26 V/4 | 102.00 | 6177 | 6 | 12 | Diesel | 83 |
| MIDR 06.02.26 V/41 | 102.00 | 6177 | 6 | 12 | Diesel | 83 |
| MIDR 06.02.26 W | 102.00 | 6177 | 6 | 12 | Diesel | 84 |
| MIDR 06.02.26 W/4 | 102.00 | 6177 | 6 | 12 | Diesel | 86 |

|  |  | ccm |  |  |  |  | |
|---|---|--------|---|---|---|---|-----|
| MIDR 06.02.26 W/41 | | 102.00 | 6177 | 6 | 12 | Diesel | 85 |
| MIDR 06.02.26 X | | 102.00 | 6177 | 6 | 12 | Diesel | 84 |
| MIDR 06.02.26 Y/41 | | 102.00 | 6177 | 6 | 12 | Diesel | 86 |
| MIDR 06.20.30 A | | 120.00 | 8822 | 6 | 12 | Diesel | 90 |
| MIDR 06.20.45 | | 120.00 | 9771 | 6 | 12 | Diesel | 91 |
| MIDR 06.20.45 A | | 120.00 | 9839 | 6 | 12 | Diesel | 92 |
| MIDR 06.20.45 A2 | | 120.00 | 9839 | 6 | 12 | Diesel | 92 |
| MIDR 06.20.45 B3 | | 120.00 | 9839 | 6 | 12 | Diesel | 92 |
| MIDR 06.20.45 C | | 120.00 | 9839 | 6 | 12 | Diesel | 92 |
| MIDR 06.20.45 C/4 | | 120.00 | 9839 | 6 | 12 | Diesel | 92 |
| MIDR 06.20.45 D | | 120.00 | 9839 | 6 | 12 | Diesel | 92 |
| MIDR 06.20.45 D/41 | | 120.00 | 9839 | 6 | 12 | Diesel | 92 |
| MIDR 06.20.45 D3 | | 120.00 | 9839 | 6 | 12 | Diesel | 92 |
| MIDR 06.20.45 E | | 120.00 | 9839 | 6 | 12 | Diesel | 92 |
| MIDR 06.20.45 E2 | | 120.00 | 9839 | 6 | 12 | Diesel | 92 |
| MIDR 06.20.45 E3 | | 120.00 | 9839 | 6 | 12 | Diesel | 92 |
| MIDR 06.20.45 F3 | | 120.00 | 9839 | 6 | 12 | Diesel | 92 |
| MIDR 06.20.45 H | | 120.00 | 9839 | 6 | 12 | Diesel | 92 |
| MIDR 06.20.45 I3 | | 120.00 | 9839 | 6 | 12 | Diesel | 92 |
| MIDR 06.20.45 I41 | | 120.00 | 9839 | 6 | 12 | Diesel | 92 |
| MIDR 06.20.45 J3 | | 120.00 | 9839 | 6 | 12 | Diesel | 92 |
| MIDR 06.20.45 K | | 120.00 | 9839 | 6 | 12 | Diesel | 92 |
| MIDR 06.20.45 L | | 120.00 | 9839 | 6 | 12 | Diesel | 92 |
| MIDR 06.20.45 M | | 120.00 | 9839 | 6 | 12 | Diesel | 92 |
| MIDR 06.20.45 M3 | | 120.00 | 9839 | 6 | 12 | Diesel | 92 |
| MIDR 06.23.56 A/41 | | 123.00 | 11122 | 6 | 12 | Diesel | 96 |
| MIDR 06.23.56 B/41 | | 123.00 | 11122 | 6 | 12 | Diesel | 96 |
| MIDR 06.24.65 A/42 | | 124.00 | 11955 | 6 | 24 | Diesel | 97 |
| MIDR 06.24.65 B/42 | | 124.00 | 11955 | 6 | 24 | Diesel | 97 |
| MIDR 06.24.65 C/42 | | 124.00 | 11955 | 6 | 24 | Diesel | 97 |
| MIDR 06.35.40 | | 135.00 | 12024 | 6 | 12 | Diesel | 102 |
| MIDR 06.35.40 C | | 135.00 | 12024 | 6 | 12 | Diesel | 101 |
| MIDR 06.35.40 G | | 135.00 | 12024 | 6 | 12 | Diesel | 103 |
| MIDR 06.35.40 H | | 135.00 | 12024 | 6 | 12 | Diesel | 103 |
| MIDR 06.35.40 J/3 | | 135.00 | 12024 | 6 | 12 | Diesel | 103 |
| MIDR 06.35.40 J1 | | 135.00 | 12024 | 6 | 12 | Diesel | 103 |
| MIDR 06.35.40 L1 | | 135.00 | 12024 | 6 | 12 | Diesel | 103 |
| MIDR 06.35.40 M3 | | 135.00 | 12024 | 6 | 12 | Diesel | 102 |
| MIDR 06.35.40 N/3 | | 135.00 | 12024 | 6 | 12 | Diesel | 103 |
| MIDS 06.02.12 | | 102.00 | 5491 | 6 | 12 | Diesel | 81 |
| MIDS 06.02.12 B | | 102.00 | 5453 | 6 | 12 | Diesel | 79 |
| MIDS 06.02.12 C | | 102.00 | 5491 | 6 | 12 | Diesel | 81 |
| MIDS 06.02.12 D/3 | | 102.00 | 5491 | 6 | 12 | Diesel | 81 |
| MIDS 06.20.30 | | 120.00 | 8822 | 6 | 12 | Diesel | 90 |
| MIDS 06.20.30 N | | 120.00 | 8822 | 6 | 12 | Diesel | 90 |
| MIDS 06.20.30 N1 | | 120.00 | 8822 | 6 | 12 | Diesel | 90 |
| MIDS 06.20.30 P | | 120.00 | 8822 | 6 | 12 | Diesel | 90 |
| MIDS 06.20.45 | | 120.00 | 9839 | 6 | 12 | Diesel | 92 |
| MIDS 06.20.45 B | | 120.00 | 9839 | 6 | 12 | Diesel | 92 |
| MIDS 06.20.45 D | | 120.00 | 9839 | 6 | 12 | Diesel | 92 |
| MIDS 06.20.45 F | | 120.00 | 9839 | 6 | 12 | Diesel | 92 |
| MIDS 06.20.45 J | | 120.00 | 9839 | 6 | 12 | Diesel | 92 |
| MIDS 06.20.45 J3 | | 120.00 | 9839 | 6 | 12 | Diesel | 92 |
| MIDS 06.35.40 | | 135.00 | 12024 | 6 | 12 | Diesel | 102 |
| MIDS 06.35.40 B | | 135.00 | 12024 | 6 | 12 | Diesel | 102 |
| MIDS 06.35.40 D | | 135.00 | 12024 | 6 | 12 | Diesel | 101 |
| MIDS 06.35.40 E | | 135.00 | 12024 | 6 | 12 | Diesel | 101 |
| MIP 06.20.30 | | 120.00 | 8820 | 6 | 12 | Diesel | 89 |
| MIPR 06.20.45 A | | 120.00 | 9840 | 6 | 12 | Diesel | 93 |
| MIPR 06.20.45 A3 | | 120.00 | 9840 | 6 | 12 | Diesel | 93 |
| MIPR 06.20.45 B3 | | 120.00 | 9840 | 6 | 12 | Diesel | 93 |
| MIPR 06.20.45 C3 | | 120.00 | 9840 | 6 | 12 | Diesel | 93 |
| MIPS 06.20.30 | | 120.00 | 8820 | 6 | 12 | Diesel | 89 |
| MIPS 06.20.45 | | 120.00 | 9840 | 6 | 12 | Diesel | 93 |
| MIPS 06.20.45 A | | 120.00 | 9840 | 6 | 12 | Diesel | 93 |
| MIPS 06.20.45 B | | 120.00 | 9840 | 6 | 12 | Diesel | 93 |

|  |  | ccm |  |  |  |  | |
|---|---|--------|--|---|---|---|----|
| MIPS 06.20.45 C | | 120.00 | 9840 | 6 | 12 | Diesel | 93 |
| N7Q 700 | | 83.00 | 1948 | 4 | 16 | Petrol | 43 |
| N7Q 704 | | 83.00 | 1948 | 4 | 16 | Petrol | 43 |
| N7Q 710 | | 83.00 | 1948 | 4 | 16 | Petrol | 43 |
| N7Q 711 | | 83.00 | 1948 | 4 | 16 | Petrol | 43 |
| P9X 701 | | 87.50 | 2958 | 6 | 24 | Diesel | 52 |
| S8U 720 | | 93.00 | 2445 | 4 | 8 | Diesel | 61 |
| S8U 722 | | 93.00 | 2445 | 4 | 8 | Diesel | 61 |
| S8U 730 | | 93.00 | 2445 | 4 | 8 | Diesel | 61 |
| S8U 731 | | 93.00 | 2445 | 4 | 8 | Diesel | 61 |
| S8U 742 | | 93.00 | 2500 | 4 | 8 | Diesel | 65 |
| S8U 748 | | 93.00 | 2445 | 4 | 8 | Diesel | 61 |
| S8U 750 | | 93.00 | 2500 | 4 | 8 | Diesel | 65 |
| S8U 752 | | 93.00 | 2500 | 4 | 8 | Diesel | 65 |
| S8U 758 | | 93.00 | 2500 | 4 | 8 | Diesel | 65 |
| S8U 762 | | 93.00 | 2445 | 4 | 8 | Diesel | 61 |
| S8U 763 | | 93.00 | 2500 | 4 | 8 | Diesel | 68 |
| S8U 770 | | 93.00 | 2445 | 4 | 8 | Diesel | 60 |
| S8U 772 | | 93.00 | 2500 | 4 | 8 | Diesel | 69 |
| S8U 780 | | 93.00 | 2500 | 4 | 8 | Diesel | 65 |
| S8U 782 | | 93.00 | 2500 | 4 | 8 | Diesel | 65 |
| S9U 700 | | 93.00 | 2500 | 4 | 8 | Diesel | 65 |
| S9U 702 | | 93.00 | 2500 | 4 | 8 | Diesel | 65 |
| S9U 704 | | 93.00 | 2500 | 4 | 8 | Diesel | 65 |
| S9U 714 | | 93.00 | 2500 | 4 | 8 | Diesel | 65 |
| S9U 740 | | 93.00 | 2500 | 4 | 8 | Diesel | 65 |
| S9W 700 | | 94.40 | 2800 | 4 | 8 | Diesel | 71 |
| S9W 702 | | 94.40 | 2800 | 4 | 8 | Diesel | 70 |
| T 4.40 | | 100.00 | 3869 | 4 | 8 | Diesel | 73 |
| T 4.40 A/3 | | 100.00 | 3990 | 4 | 8 | Diesel | 74 |
| T 4.40 B/3 | | 100.00 | 3990 | 4 | 8 | Diesel | 74 |
| T 4.40 CC | | 100.00 | 3990 | 4 | 8 | Diesel | 74 |
| Z6W 700 | | 91.00 | 2849 | 6 | 12 | Petrol | 59 |
| Z6W 702 | | 91.00 | 2849 | 6 | 12 | Petrol | 59 |
| Z7V 709 | | 88.00 | 2664 | 6 | 12 | Petrol | 57 |
| Z7V 711 | | 88.00 | 2664 | 6 | 12 | Petrol | 57 |
| Z7W 700 | | 91.00 | 2849 | 6 | 12 | Petrol | 59 |
| Z7W 701 | | 91.00 | 2849 | 6 | 12 | Petrol | 59 |
| Z7W 702 | | 91.00 | 2849 | 6 | 12 | Petrol | 59 |
| Z7W 706 | | 91.00 | 2849 | 6 | 12 | Petrol | 59 |
| Z7W 707 | | 91.00 | 2849 | 6 | 12 | Petrol | 59 |
| Z7W 709 | | 91.00 | 2849 | 6 | 12 | Petrol | 59 |
| Z7W 712 | | 91.00 | 2849 | 6 | 12 | Petrol | 59 |
| Z7W 713 | | 91.00 | 2849 | 6 | 12 | Petrol | 59 |
| Z7W 717 | | 91.00 | 2849 | 6 | 12 | Petrol | 59 |



OE

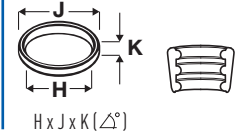
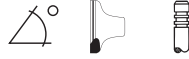

1 **65.00**

| | | | | | | |
|----------------|-------|--------|-----------------|-----------------|--------|---------------|
| 689 710 | 956cc | 4 Cyl. | 8 Valves | 31-32kW/42-44PS | Petrol | TD3017 |
| C1C 700 | 956cc | 4 Cyl. | 8 Valves | 30-32kW/41-44PS | Petrol | TD3097 |
| C1C 706 | 956cc | 4 Cyl. | 8 Valves | 27-31kW/37-42PS | Petrol | TD3098 |
| C1C 708 | 956cc | 4 Cyl. | 8 Valves | 25kW/34PS | Petrol | TD3099 |

| | | | |
|-----------|-----------------|-------------|-----------------|
| 4 1.0 | 12/1985→12/1993 | 5 1.0 | 01/1972→12/1985 |
| RAPID 1.0 | 09/1985→05/1992 | SUPER 5 1.0 | 10/1984→06/1992 |

| | | | | | | |
|----------------------|--------------|----|-----|---|----------------------|--|
| V35117 | 7701 458 180 | | 45° | H | VAG50758 | |
| 33.38 x 6.99 x 89.79 | | MB | | | 41.50 x 7.00 x 11.15 | |
| V91834 | 7701 460 690 | | 45° | | | |
| 29.00 x 7.00 x 89.00 | | MD | | | | |

2 **69.00**

| | | | | | | |
|----------------|-------|--------|------------------|-----------------|--------|----------------|
| D4D 700 | 999cc | 4 Cyl. | 16 Valves | 44-50kW/60-68PS | Petrol | TD17268 |
| D4D 720 | 999cc | 4 Cyl. | 16 Valves | 44-50kW/60-68PS | Petrol | TD17269 |

| | | | |
|------------|-----------------|--------------------|-----------------|
| KANGOO 1.0 | 01/2002→01/2007 | KANGOO Express 1.0 | 01/2002→01/2007 |
|------------|-----------------|--------------------|-----------------|

| | | | | | | |
|-----------------------|--------------|---------|-----|---|----------------------|--|
| V94705 | 8200 343 407 | | 45° | | VAG96292B | |
| 26.00 x 5.50 x 110.80 | | MB | | | 40.60 x 5.50 x 11.07 | |
| V94706 | 8200 343 412 | | 45° | H | | |
| 22.00 x 5.50 x 112.50 | | MD + MB | | | | |



OE

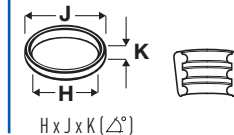
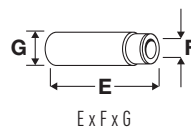

3 **69.00**

| | | | | | | |
|---------|--------|--------|-----------|-------------------|--------------|---------|
| D4F 702 | 1149cc | 4 Cyl. | 16 Valves | 55kW/75PS | Petrol | TD16272 |
| D4F 704 | 1149cc | 4 Cyl. | 16 Valves | 55kW/75PS | Petrol | TD16273 |
| D4F 706 | 1149cc | 4 Cyl. | 16 Valves | 55kW/75PS | Petrol | TD21205 |
| D4F 708 | 1149cc | 4 Cyl. | 16 Valves | 44kW/60PS | Petrol | TD19014 |
| D4F 712 | 1149cc | 4 Cyl. | 16 Valves | 50-55kW/68-75PS | Petrol | TD16186 |
| D4F 714 | 1149cc | 4 Cyl. | 16 Valves | 55kW/75PS | Petrol | TD16187 |
| D4F 716 | 1149cc | 4 Cyl. | 16 Valves | 55kW/75PS | Petrol | TD17270 |
| D4F 722 | 1149cc | 4 Cyl. | 16 Valves | 55kW/75PS | Petrol | TD19671 |
| D4F 728 | 1149cc | 4 Cyl. | 16 Valves | 54-55kW/73-75PS | Petrol | TD21206 |
| D4F 730 | 1149cc | 4 Cyl. | 16 Valves | 55kW/75PS | Petrol | TD21207 |
| D4F 732 | 1149cc | 4 Cyl. | 16 Valves | 53-55kW/72-75PS | Petrol | TD23528 |
| D4F 740 | 1149cc | 4 Cyl. | 16 Valves | 48-55kW/65-75PS | Petrol | TD18421 |
| D4F 742 | 1149cc | 4 Cyl. | 16 Valves | 55kW/75PS | Petrol | TD24895 |
| D4F 764 | 1149cc | 4 Cyl. | 16 Valves | 43-58kW/58-79PS | Petrol | TD18530 |
| D4F 772 | 1149cc | 4 Cyl. | 16 Valves | 55-56kW/75-76PS | Petrol | TD20444 |
| D4F 780 | 1149cc | 4 Cyl. | 16 Valves | 74-75kW/100-102PS | Petrol Turbo | TD20442 |
| D4F 784 | 1149cc | 4 Cyl. | 16 Valves | 74kW/101PS | Petrol | TD20813 |
| D4F 786 | 1149cc | 4 Cyl. | 16 Valves | 76kW/103PS | Petrol | TD27696 |
| D4F 790 | 1149cc | 4 Cyl. | 16 Valves | 55kW/75PS | Petrol | TD29123 |

| | | | |
|-----------------------------|-----------------|----------------------------|-----------------|
| CLIO 1.2 16V | 02/2008→ | CLIO II 1.2 16V | 06/2001→ |
| CLIO III 1.2 | 10/2005→ | CLIO III 1.2 16V | 06/2005→ |
| CLIO IV 1.2 16V | 11/2012→ | CLIO IV 1.2 LPG 16V | 11/2012→ |
| KANGOO 1.2 16V | 06/2001→ | KANGOO Express 1.2 16V | 10/2001→ |
| LOGAN II 1.2 | 11/2013→ | LOGAN II 1.2 16V | 12/2013→ |
| LOGAN II 1.2 16V LPG | 11/2013→ | MODUS / GRAND MODUS 1.2 | 12/2004→ |
| MODUS / GRAND MODUS 1.2 16V | 05/2007→ | SANDERO/STEPWAY II 1.2 16V | 12/2013→ |
| THALIA I 1.2 16V | 04/2002→ | THALIA II 1.2 16V | 09/2008→ |
| THALIA II 1.2 LPG | 01/2010→12/2013 | THALIA III 1.2 16V | 12/2013→ |
| THALIA III 1.2 LPG | 03/2014→ | TWINGO I 1.2 16V | 01/2001→06/2007 |
| TWINGO II 1.2 16V | 03/2007→ | TWINGO II 1.2 TCe 100 | 02/2011→ |
| TWINGO II 1.2 Turbo | 03/2007→ | WIND 1.2 TCe 100 | 02/2011→ |

V94705 26.00 x 5.50 x 110.80

8200 343 407

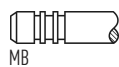

45°

VAG96292B 40.60 x 5.50 x 11.07



V94706 22.00 x 5.50 x 112.50

8200 343 412

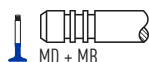

45°

H



OE

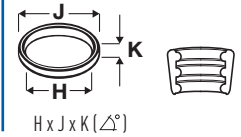
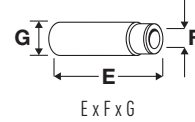
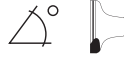

4  **69.00**

| | | | | | | | |
|---------|--------|--------|----------|-----------------|--------|------|---------|
| D7F 700 | 1149cc | 4 Cyl. | 8 Valves | 40-44kW/54-60PS | Petrol | SOHC | TD5520 |
| D7F 701 | 1149cc | 4 Cyl. | 8 Valves | 40-44kW/54-60PS | Petrol | SOHC | TD5521 |
| D7F 702 | 1149cc | 4 Cyl. | 8 Valves | 43-44kW/58-60PS | Petrol | SOHC | TD16274 |
| D7F 703 | 1149cc | 4 Cyl. | 8 Valves | 43kW/58PS | Petrol | SOHC | TD16275 |
| D7F 704 | 1149cc | 4 Cyl. | 8 Valves | 43-44kW/58-60PS | Petrol | SOHC | TD16276 |
| D7F 706 | 1149cc | 4 Cyl. | 8 Valves | 43kW/58PS | Petrol | SOHC | TD18178 |
| D7F 708 | 1149cc | 4 Cyl. | 8 Valves | 43-44kW/58-60PS | Petrol | SOHC | TD26522 |
| D7F 710 | 1149cc | 4 Cyl. | 8 Valves | 43kW/58PS | Petrol | SOHC | TD9624 |
| D7F 720 | 1149cc | 4 Cyl. | 8 Valves | 43kW/58PS | Petrol | SOHC | TD14328 |
| D7F 722 | 1149cc | 4 Cyl. | 8 Valves | 43-44kW/58-60PS | Petrol | SOHC | TD16326 |
| D7F 726 | 1149cc | 4 Cyl. | 8 Valves | 43kW/58PS | Petrol | SOHC | TD14329 |
| D7F 730 | 1149cc | 4 Cyl. | 8 Valves | 40-43kW/54-58PS | Petrol | SOHC | TD5522 |
| D7F 744 | 1149cc | 4 Cyl. | 8 Valves | 43kW/58PS | Petrol | SOHC | TD17266 |
| D7F 746 | 1149cc | 4 Cyl. | 8 Valves | 43kW/58PS | Petrol | SOHC | TD17267 |
| D7F 764 | 1149cc | 4 Cyl. | 8 Valves | 43kW/58PS | Petrol | SOHC | TD20903 |
| D7F 766 | 1149cc | 4 Cyl. | 8 Valves | 43kW/58PS | Petrol | SOHC | TD19670 |
| D7F 800 | 1149cc | 4 Cyl. | 8 Valves | 43kW/58PS | Petrol | SOHC | TD20443 |

| | | | |
|------------------|-----------------|--------------------|-----------------|
| CLIO I 1.2 | 01/1996→09/1998 | CLIO II 1.2 | 09/1998→ |
| CLIO II 1.2 LPG | 09/1998→06/2009 | CLIO III 1.2 | 05/2005→06/2009 |
| KANGOO 1.2 | 08/1997→ | KANGOO Express 1.2 | 08/1997→ |
| THALIA I 1.2 | 02/1998→10/2003 | TWINGO I 1.2 | 05/1996→06/2007 |
| TWINGO I 1.2 LPG | 10/2003→06/2007 | TWINGO II 1.2 | 03/2007→ |

V94180 
32.80 x 6.00 x 106.70

7701 469 266

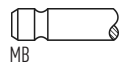

30°

H

VAG96238B 
45.00 x 6.00 x 11.07



V94181 
29.90 x 6.00 x 106.70

7701 469 269

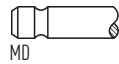

45°

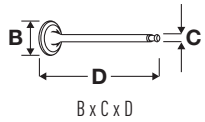

OE



MAT.

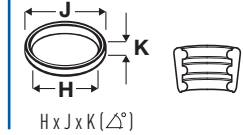
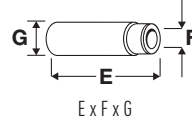
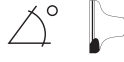

5



70.00

| | | | | | | | |
|--------------|-----------------|--------|----------|-----------------|--------|-----------------|---------|
| 688 02 | 1108cc | 4 Cyl. | 8 Valves | 41kW/56PS | Petrol | OHV | TD3012 |
| 688 10 | 1108cc | 4 Cyl. | 8 Valves | 25-39kW/34-53PS | Petrol | OHV | TD21382 |
| 688 711 | 1108cc | 4 Cyl. | 8 Valves | 25kW/34PS | Petrol | OHV | TD3014 |
| 688 712 | 1108cc | 4 Cyl. | 8 Valves | 25-35kW/34-48PS | Petrol | OHV | TD3015 |
| 688 713 | 1108cc | 4 Cyl. | 8 Valves | 33kW/45PS | Petrol | OHV | TD3013 |
| C1E (688.01) | 1108cc | 4 Cyl. | 8 Valves | 25-39kW/34-53PS | Petrol | OHV | TD22490 |
| C1E 700 | 1108cc | 4 Cyl. | 8 Valves | 35-36kW/48-49PS | Petrol | OHV | TD3100 |
| C1E 714 | 1108cc | 4 Cyl. | 8 Valves | 25-32kW/34-44PS | Petrol | OHV | TD3101 |
| C1E 715 | 1108cc | 4 Cyl. | 8 Valves | 35kW/48PS | Petrol | OHV | TD3102 |
| C1E 718 | 1108cc | 4 Cyl. | 8 Valves | 25-26kW/34-35PS | Petrol | OHV | TD3103 |
| C1E 719 | 1108cc | 4 Cyl. | 8 Valves | 25-26kW/34-35PS | Petrol | OHV | TD3104 |
| C1E 720 | 1108cc | 4 Cyl. | 8 Valves | 35kW/48PS | Petrol | OHV | TD3105 |
| C1E 726 | 1108cc | 4 Cyl. | 8 Valves | 33kW/45PS | Petrol | OHV | TD3011 |
| C1E 750 | 1108cc | 4 Cyl. | 8 Valves | 33-35kW/45-48PS | Petrol | OHV | TD3106 |
| C1E 752 | 1108cc | 4 Cyl. | 8 Valves | 33-34kW/45-46PS | Petrol | OHV | TD3107 |
| C1E 754 | 1108cc | 4 Cyl. | 8 Valves | 33-34kW/45-46PS | Petrol | OHV | TD3108 |
| C1E 756 | 1108cc | 4 Cyl. | 8 Valves | 33kW/45PS | Petrol | OHV | TD3109 |
| C1E 760 | 1108cc | 4 Cyl. | 8 Valves | 33kW/45PS | Petrol | OHV | TD3110 |
| C1E 762 | 1108cc | 4 Cyl. | 8 Valves | 33-36kW/45-49PS | Petrol | OHV | TD3111 |
| C1E 764 | 1108cc | 4 Cyl. | 8 Valves | 36kW/49PS | Petrol | OHV | TD3112 |
| C1E 792 | 1108cc | 4 Cyl. | 8 Valves | 33kW/45PS | Petrol | OHV | TD3113 |
| 4 1.1 | 10/1976→06/1990 | | | 5 1.1 | | 09/1980→12/1985 | |
| 6 1.1 | 08/1970→04/1987 | | | 8 1.1 | | 11/1962→10/1972 | |
| 9 1.1 | 09/1981→05/1987 | | | 10 1.1 | | 05/1966→10/1972 | |
| 11 1.1 | 03/1983→06/1986 | | | 19 1.1 TR | | 07/1988→04/1992 | |
| CLIO 1 1.1 | 01/1991→09/1998 | | | ESTAFETTE 1.1 | | 02/1962→12/1981 | |
| RAPID 1.1 | 07/1985→04/1995 | | | RODEO 5 1.1 | | 11/1981→12/1987 | |
| RODEO 6 1.1 | 08/1973→11/1981 | | | SUPER 5 1.1 | | 10/1984→12/1996 | |

V35117 ■
33.38 x 6.99 x 89.79

7701 458 180

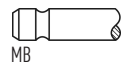

45°

H

VAG50758 ■ ■ ■
41.50 x 7.00 x 11.15



V91834 ■ ■
29.00 x 7.00 x 89.00

7701 460 690

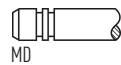

45°

6



71.00

| | | | | | | | |
|----------------------|-------------|--------|-----------|-----------|--------|-----------------|---------|
| CG10DE | 998cc | 4 Cyl. | 16 Valves | 40kW/54PS | Petrol | DOHC, Injection | TD22183 |
| V94447 ■ | 13201-99B10 | | | | | | |
| 27.50 x 5.50 x 95.70 | | | | | | | |
| V94016 ■ ■ | 13202-99B10 | | | | | | |
| 22.50 x 5.50 x 95.90 | | | | | | | |

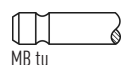

45°

Y

H

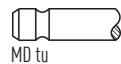

45°



OE

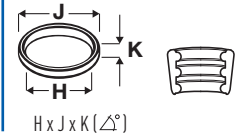
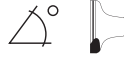

7  **71.50**

| | | | | | | | |
|----------------|-----------------|--------|-----------------|-----------------|--------|-----------------|---------------|
| C16 700 | 1237cc | 4 Cyl. | 8 Valves | 40kW/54PS | Petrol | OHV | TD3114 |
| C16 702 | 1237cc | 4 Cyl. | 8 Valves | 40-44kW/54-60PS | Petrol | OHV | TD3115 |
| C16 710 | 1237cc | 4 Cyl. | 8 Valves | 40kW/55PS | Petrol | OHV | TD3116 |
| C16 720 | 1237cc | 4 Cyl. | 8 Valves | 40kW/54PS | Petrol | OHV | TD3117 |
| C16 722 | 1237cc | 4 Cyl. | 8 Valves | 40kW/54PS | Petrol | OHV | TD3118 |
| C16 726 | 1237cc | 4 Cyl. | 8 Valves | 40kW/54PS | Petrol | OHV | TD3119 |
| C16 730 | 1237cc | 4 Cyl. | 8 Valves | 40kW/54PS | Petrol | OHV | TD3120 |
| 9 1.2 | 09/1985→12/1988 | | | 11 1.2 | | 10/1984→12/1988 | |
| 19 I 1.2 | 01/1988→12/1992 | | | 19 II 1.2 | | 03/1992→12/1995 | |
| RAPID 1.2 | 09/1991→08/1993 | | | SUPER 5 1.2 | | 01/1987→12/1996 | |

V91317 ■
34.00 x 7.00 x 91.50

7701 462 137

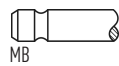

45°

H

VAG50758 ■ ■ ■
41.50 x 7.00 x 11.15



V91834 ■
29.00 x 7.00 x 89.00

7701 460 690

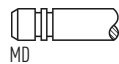

45°

8  **72.20**

| | | | | | | | |
|------------------------|-----------------|--------|------------------|---------------------------|--------|--------------------|----------------|
| H4B 400 | 898cc | 3 Cyl. | 12 Valves | 66kW/90PS | Petrol | Turbo, DOHC | TD32304 |
| H4B 401 | 898cc | 3 Cyl. | 12 Valves | 66-80kW/90-109PS | Petrol | Turbo, DOHC | TD32306 |
| H4B 408 | 898cc | 3 Cyl. | 12 Valves | 66kW/90PS | Petrol | Turbo, DOHC | TD34138 |
| CAPTUR 0.9 TCe 90 | 06/2013→ | | | CLIO IV 0.9 TCe 90 | | 11/2012→ | |
| CLIO IV 0.9 TCe 90 LPG | 06/2016→ | | | SANDERO/STEPWAY II TCe 90 | | 09/2015→ | |
| THALIA II 0.9 TCe | 11/2012→06/2014 | | | TWINGO III 0.9 TCe 90 | | 09/2014→ | |
| TWINGO III 0.9 TCe 110 | 11/2016→ | | | | | | |

V95239 ■
26.55 x 5.50 x 100.90

13201-3562R

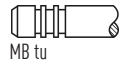

45°

H

V95240 ■
23.50 x 5.50 x 101.70

13202-5379R

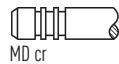

45°

9  **73.00**

| | | | | | | | |
|------------------|-----------------|--------|-----------------|-----------------|--------|-----------------|----------------|
| 810 719 | 1289cc | 4 Cyl. | 8 Valves | 33kW/45PS | Petrol | OHV | TD3035 |
| 810 725 | 1289cc | 4 Cyl. | 8 Valves | 47kW/64PS | Petrol | OHV | TD3036 |
| 810 726 | 1289cc | 4 Cyl. | 8 Valves | 31-43kW/42-58PS | Petrol | OHV | TD3037 |
| 810 729 | 1289cc | 4 Cyl. | 8 Valves | 40kW/54PS | Petrol | OHV | TD3038 |
| 810.01 | 1289cc | 4 Cyl. | 8 Valves | 26-32kW/37-44PS | Petrol | OHV | TD8555 |
| 810.02 | 1289cc | 4 Cyl. | 8 Valves | 37kW/50PS | Petrol | OHV | TD3033 |
| 810.02/97 | 1289cc | 4 Cyl. | 8 Valves | 40kW/54PS | Petrol | OHV | TD3032 |
| 810.03 | 1289cc | 4 Cyl. | 8 Valves | 35kW/48PS | Petrol | OHV | TD23613 |
| 810.05 | 1289cc | 4 Cyl. | 8 Valves | 31-45kW/42-61PS | Petrol | OHV | TD21386 |
| 810.06 | 1289cc | 4 Cyl. | 8 Valves | 44kW/60PS | Petrol | OHV | TD3034 |
| 5 1.3 | 09/1975→09/1984 | | | 10 1.3 | | 07/1969→10/1972 | |
| 12 1.3 | 10/1969→08/1980 | | | 12 1.3 TS | | 08/1972→08/1980 | |
| 15 1.3 | 03/1972→10/1980 | | | ESTAFETTE 1.3 | | 08/1969→12/1981 | |

V35117 ■
33.38 x 6.99 x 89.79

7701 458 180

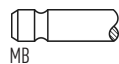

45°

H

VAG50758 ■ ■ ■
41.50 x 7.00 x 11.15



V91834 ■
29.00 x 7.00 x 89.00

7701 460 690

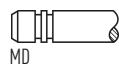

45°

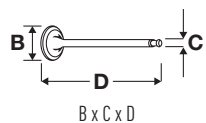

OE

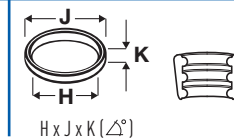
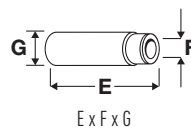

10 74.00

| | | | | | | | |
|-------------------------|------------------------------------|--------|-----------------|-----------------------------|--------|------------------------------------|----------------|
| C3G 700 | 1239cc | 4 Cyl. | 8 Valves | 40kW/55PS | Petrol | OHV | TD3172 |
| C3G 702 | 1239cc | 4 Cyl. | 8 Valves | 40kW/55PS | Petrol | OHV | TD5515 |
| C3G 710 | 1239cc | 4 Cyl. | 8 Valves | 40kW/55PS | Petrol | OHV | TD3173 |
| C3G 712 | 1239cc | 4 Cyl. | 8 Valves | 40kW/55PS | Petrol | OHV | TD16545 |
| C3G 720 | 1239cc | 4 Cyl. | 8 Valves | 40kW/54PS | Petrol | OHV | TD14314 |
| CLIO I 1.2 RAPID 1.2 | 06/1994→02/1998 09/1991→03/1998 | | | EXPRESS 1.2 TWINGO I 1.2 | | 07/1995→10/1999 03/1993→10/1996 | |

V35117 ■
33.38 x 6.99 x 89.79

7701 458 180

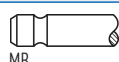

45°

H

VAG50758 ■ ■
41.50 x 7.00 x 11.15



V91834 ■
29.00 x 7.00 x 89.00

7701 460 690

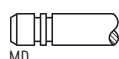

45°

11 75.80

| | | | | | | | |
|------------------------|------------------------------------|--------|-----------------|-----------------|--------|-----------------|---------------|
| E5F 710 | 1171cc | 4 Cyl. | 8 Valves | 40-44kW/55-60PS | Petrol | SOHC | TD3181 |
| E5F 716 | 1171cc | 4 Cyl. | 8 Valves | 40-44kW/55-60PS | Petrol | SOHC | TD3182 |
| E7F 700 | 1171cc | 4 Cyl. | 8 Valves | 43-44kW/58-60PS | Petrol | SOHC | TD3192 |
| E7F 704 | 1171cc | 4 Cyl. | 8 Valves | 44kW/60PS | Petrol | SOHC | TD3193 |
| E7F 706 | 1171cc | 4 Cyl. | 8 Valves | 40-43kW/54-58PS | Petrol | SOHC | TD3194 |
| E7F 708 | 1171cc | 4 Cyl. | 8 Valves | 43-48kW/58-65PS | Petrol | SOHC | TD3195 |
| E7F 730 | 1171cc | 4 Cyl. | 8 Valves | 44-46kW/60-63PS | Petrol | SOHC | TD3196 |
| E7F 750 | 1171cc | 4 Cyl. | 8 Valves | 43-44kW/58-60PS | Petrol | SOHC | TD3197 |
| 19 II 1.2 RAPID 1.2 | 05/1992→09/1994 05/1995→11/1998 | | | CLIO I 1.2 | | 05/1990→09/1998 | |

V91835 ■
37.50 x 7.00 x 107.80

7701 465 088

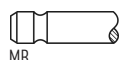

30°

H

VAG96182B ■
42.00 x 7.02 x 12.08

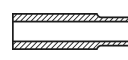

V91836 ■
33.60 x 7.00 x 107.80

7701 465 090

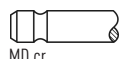

45°

VAG96172B ■
49.00 x 7.02 x 12.08



V94442 ■
33.60 x 7.00 x 107.70

7701 468 419

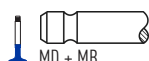

45°

H

VAG96347B ■ ■
48.50 x 7.02 x 13.07





OE

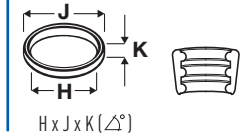
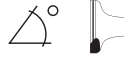

12



75.80

| | | | | | | | |
|------------------|-----------------|--------|----------|---------------------|--------|-------------------|-----------------|
| E6J 700 | 1390cc | 4 Cyl. | 8 Valves | 57-59kW/78-80PS | Petrol | SOHC | TD3183 |
| E6J 701 | 1390cc | 4 Cyl. | 8 Valves | 57-59kW/78-80PS | Petrol | SOHC | TD3184 |
| E6J 706 | 1390cc | 4 Cyl. | 8 Valves | 58-60kW/79-82PS | Petrol | SOHC | TD3185 |
| E6J 712 | 1390cc | 4 Cyl. | 8 Valves | 55-57kW/75-80PS | Petrol | SOHC | TD3186 |
| E6J 713 | 1390cc | 4 Cyl. | 8 Valves | 55-57kW/75-80PS | Petrol | SOHC | TD3187 |
| E6J 718 | 1390cc | 4 Cyl. | 8 Valves | 55-57kW/75-78PS | Petrol | SOHC, Carburettor | TD3188 |
| E6J 734 | 1390cc | 4 Cyl. | 8 Valves | 43-44kW/60-60PS | Petrol | SOHC | TD3189 |
| E6J 738 | 1390cc | 4 Cyl. | 8 Valves | 43kW/60PS | Petrol | SOHC | TD3190 |
| E6J 760 | 1390cc | 4 Cyl. | 8 Valves | 55-57kW/75-78PS | Petrol | SOHC | TD3191 |
| E7J 601 | 1390cc | 4 Cyl. | 8 Valves | 58-59kW/80-80PS | Petrol | SOHC | TD3198 |
| E7J 624 | 1390cc | 4 Cyl. | 8 Valves | 52kW/71PS | Petrol | SOHC | TD5526 |
| E7J 626 | 1390cc | 4 Cyl. | 8 Valves | 55kW/75PS | Petrol | SOHC | TD16362 |
| E7J 634 | 1390cc | 4 Cyl. | 8 Valves | 55kW/75PS | Petrol | SOHC | TD17271 |
| E7J 635 | 1390cc | 4 Cyl. | 8 Valves | 55kW/75PS | Petrol | SOHC | TD17272 |
| E7J 700 | 1390cc | 4 Cyl. | 8 Valves | 55-59kW/75-80PS | Petrol | SOHC | TD3199 |
| E7J 706 | 1390cc | 4 Cyl. | 8 Valves | 55-59kW/75-80PS | Petrol | SOHC | TD3200 |
| E7J 707 | 1390cc | 4 Cyl. | 8 Valves | 55-59kW/75-80PS | Petrol | SOHC | TD3201 |
| E7J 710 | 1390cc | 4 Cyl. | 8 Valves | 58-59kW/80-80PS | Petrol | SOHC | TD3203 |
| E7J 711 | 1390cc | 4 Cyl. | 8 Valves | 58-59kW/80-80PS | Petrol | SOHC | TD3204 |
| E7J 718 | 1390cc | 4 Cyl. | 8 Valves | 58kW/79PS | Petrol | SOHC | TD3205 |
| E7J 719 | 1390cc | 4 Cyl. | 8 Valves | 58kW/79PS | Petrol | SOHC | TD3206 |
| E7J 720 | 1390cc | 4 Cyl. | 8 Valves | 43-59kW/58-80PS | Petrol | SOHC | TD3207 |
| E7J 724 | 1390cc | 4 Cyl. | 8 Valves | 54-59kW/73-80PS | Petrol | SOHC | TD3208 |
| E7J 726 | 1390cc | 4 Cyl. | 8 Valves | 55-59kW/75-80PS | Petrol | SOHC | TD5508 |
| E7J 728 | 1390cc | 4 Cyl. | 8 Valves | 58-59kW/79-80PS | Petrol | SOHC | TD3209 |
| E7J 742 | 1390cc | 4 Cyl. | 8 Valves | 55kW/75PS | Petrol | SOHC | TD3212 |
| E7J 745 | 1390cc | 4 Cyl. | 8 Valves | 55-59kW/75-80PS | Petrol | SOHC | TD3210 |
| E7J 754 | 1390cc | 4 Cyl. | 8 Valves | 55-59kW/75-80PS | Petrol | SOHC | TD3211 |
| E7J 756 | 1390cc | 4 Cyl. | 8 Valves | 55kW/75PS | Petrol | SOHC | TD17279 |
| E7J 757 | 1390cc | 4 Cyl. | 8 Valves | 55kW/75PS | Petrol | SOHC | TD17282 |
| E7J 764 | 1390cc | 4 Cyl. | 8 Valves | 55kW/75PS | Petrol | SOHC | TD4858 |
| E7J 770 | 1390cc | 4 Cyl. | 8 Valves | 55-59kW/75-80PS | Petrol | SOHC | TD20896 |
| E7J 771 | 1390cc | 4 Cyl. | 8 Valves | 55-59kW/75-80PS | Petrol | SOHC | TD20897 |
| E7J 773 | 1390cc | 4 Cyl. | 8 Valves | 55-59kW/75-80PS | Petrol | SOHC | TD3213 |
| E7J 780 | 1390cc | 4 Cyl. | 8 Valves | 55kW/75PS | Petrol | SOHC | TD9623 |
| K7J 700 | 1390cc | 4 Cyl. | 8 Valves | 55-72kW/75-98PS | Petrol | SOHC | TD17470 |
| K7J 701 | 1390cc | 4 Cyl. | 8 Valves | 55kW/75PS | Petrol | SOHC | TD17851 |
| 19 I 1.4 | 01/1988→12/1992 | | | 19 II 1.4 | | | 01/1992→06/2001 |
| CLIO I 1.4 | 05/1990→09/1998 | | | CLIO II 1.4 | | | 09/1998→05/2005 |
| KANGOO 1.4 | 08/1997→ | | | KANGOO Express 1.4 | | | 08/1997→06/2008 |
| MEGANE I 1.4 | 09/1996→08/2003 | | | MEGANE I 1.4 e | | | 01/1996→08/2003 |
| MEGANE I 1.4 Eco | 01/1996→03/1999 | | | MEGANE Scenic 1.4 i | | | 01/1997→09/1999 |
| RAPID 1.4 | 09/1991→03/1998 | | | RAPID 1.4 RN | | | 09/1991→08/1993 |
| THALIA I 1.4 | 05/2000→ | | | THALIA II 1.4 | | | 09/2008→06/2014 |

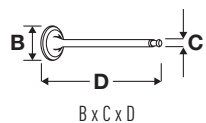

OE

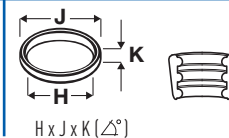
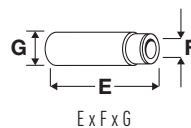

V91835 ■
37.50 x 7.00 x 107.80

7701 465 088



30°

H

VAG96182B ■
42.00 x 7.02 x 12.08

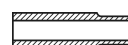

V91836 ■
33.60 x 7.00 x 107.80

7701 465 090

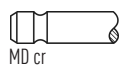

45°

VAG96172B ■
49.00 x 7.02 x 12.08

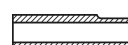

V94442 ■
33.60 x 7.00 x 107.70

7701 468 419

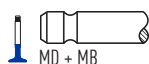

45°

VAG96347B ■ ■
48.50 x 7.02 x 13.07

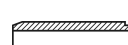

13



76.00

| | | | | | | | |
|------------------|-----------------|--------|----------|-------------------|--------|-----------------|--------|
| 847 700 | 1397cc | 4 Cyl. | 8 Valves | 35kW/48PS | Petrol | OHV | TD3067 |
| 847 701 | 1397cc | 4 Cyl. | 8 Valves | 35kW/48PS | Petrol | OHV | TD3072 |
| 847 720 | 1397cc | 4 Cyl. | 8 Valves | 47kW/64PS | Petrol | OHV | TD5054 |
| 847 722 | 1397cc | 4 Cyl. | 8 Valves | 47kW/64PS | Petrol | OHV | TD4853 |
| C1J 700 | 1397cc | 4 Cyl. | 8 Valves | 35-36kW/48-50PS | Petrol | OHV | TD3122 |
| C1J 715 | 1397cc | 4 Cyl. | 8 Valves | 44kW/60PS | Petrol | OHV | TD3123 |
| C1J 742 | 1397cc | 4 Cyl. | 8 Valves | 43-44kW/58-60PS | Petrol | OHV | TD3125 |
| C1J 764 | 1397cc | 4 Cyl. | 8 Valves | 77-87kW/105-118PS | Petrol | Turbo, OHV | TD3127 |
| C1J 768 | 1397cc | 4 Cyl. | 8 Valves | 39-44kW/53-60PS | Petrol | OHV | TD3128 |
| C1J 780 | 1397cc | 4 Cyl. | 8 Valves | 43kW/58PS | Petrol | OHV | TD3130 |
| C2J 700 | 1397cc | 4 Cyl. | 8 Valves | 52-53kW/71-72PS | Petrol | OHV | TD3137 |
| C2J 760 | 1397cc | 4 Cyl. | 8 Valves | 51kW/70PS | Petrol | OHV | TD3148 |
| C2J 770 | 1397cc | 4 Cyl. | 8 Valves | 51kW/69PS | Petrol | OHV | TD3153 |
| C2J 772 | 1397cc | 4 Cyl. | 8 Valves | 43-44kW/58-60PS | Petrol | OHV | TD3154 |
| C2J 776 | 1397cc | 4 Cyl. | 8 Valves | 50kW/68PS | Petrol | OHV | TD3155 |
| C2J 780 | 1397cc | 4 Cyl. | 8 Valves | 52-53kW/71-72PS | Petrol | OHV | TD3156 |
| C2J 781 | 1397cc | 4 Cyl. | 8 Valves | 52-53kW/71-72PS | Petrol | OHV | TD3157 |
| C2J 782 | 1397cc | 4 Cyl. | 8 Valves | 49kW/67PS | Petrol | OHV | TD3158 |
| C2J 784 | 1397cc | 4 Cyl. | 8 Valves | 44kW/60PS | Petrol | OHV | TD3161 |
| C2J 788 | 1397cc | 4 Cyl. | 8 Valves | 52-53kW/71-72PS | Petrol | OHV | TD3162 |
| C2J 789 | 1397cc | 4 Cyl. | 8 Valves | 52-53kW/71-72PS | Petrol | OHV | TD3163 |
| C2J 798 | 1397cc | 4 Cyl. | 8 Valves | 52-53kW/71-72PS | Petrol | OHV | TD3168 |
| 9 1.4 | 12/1981→12/1988 | | | 9 1.4 Turbo | | 04/1984→12/1989 | |
| 11 1.4 | 03/1983→12/1988 | | | 11 1.4 Turbo | | 02/1984→12/1986 | |
| 18 1.4 | 04/1978→07/1986 | | | 19 1.4 | | 07/1988→05/1993 | |
| 19 II 1.4 | 05/1992→09/1994 | | | 21 1.4 | | 06/1988→10/1993 | |
| FUEGO 1.4 TL/GTL | 02/1980→10/1985 | | | RAPID 1.4 | | 07/1985→08/1991 | |
| SUPER 5 1.4 | 10/1984→08/1990 | | | TRAFIC 1.4 | | 03/1980→08/1992 | |

V91317 ■
34.00 x 7.00 x 91.50

7701 462 137

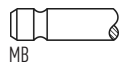

45°

H

VAG50758 ■ ■
41.50 x 7.00 x 11.15



V91834 ■
29.00 x 7.00 x 89.00

7701 460 690

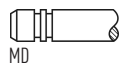

45°



OE

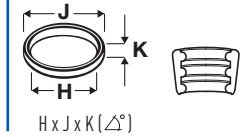
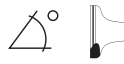

14  **76.00**

| | | | | | | | |
|-------------------|-----------------|--------|----------|-------------------|--------|-----------------|--------|
| 847 725 | 1397cc | 4 Cyl. | 8 Valves | 43-46kW/59-63PS | Petrol | OHV | TD3070 |
| C1J 782 | 1397cc | 4 Cyl. | 8 Valves | 85-88kW/115-120PS | Petrol | Turbo, OHV | TD3131 |
| C1J 784 | 1397cc | 4 Cyl. | 8 Valves | 85-88kW/115-120PS | Petrol | Turbo, OHV | TD3133 |
| C1J 788 | 1397cc | 4 Cyl. | 8 Valves | 85-88kW/115-120PS | Petrol | Turbo, OHV | TD3134 |
| C1J 792 | 1397cc | 4 Cyl. | 8 Valves | 44kW/60PS | Petrol | OHV | TD3135 |
| C1J 796 | 1397cc | 4 Cyl. | 8 Valves | 44kW/60PS | Petrol | OHV | TD3136 |
| C2J 717 | 1397cc | 4 Cyl. | 8 Valves | 53kW/72PS | Petrol | OHV | TD3141 |
| C2J 718 | 1397cc | 4 Cyl. | 8 Valves | 49-50kW/67-68PS | Petrol | OHV | TD3143 |
| C2J 720 | 1397cc | 4 Cyl. | 8 Valves | 43-49kW/58-67PS | Petrol | OHV | TD3144 |
| C2J 730 | 1397cc | 4 Cyl. | 8 Valves | 44kW/60PS | Petrol | OHV | TD3145 |
| C2J 755 | 1397cc | 4 Cyl. | 8 Valves | 53kW/72PS | Petrol | OHV | TD5445 |
| C2J 757 | 1397cc | 4 Cyl. | 8 Valves | 49-50kW/67-68PS | Petrol | OHV | TD3147 |
| C2J 766 | 1397cc | 4 Cyl. | 8 Valves | 49kW/67PS | Petrol | OHV | TD3149 |
| C2J 767 | 1397cc | 4 Cyl. | 8 Valves | 49kW/67PS | Petrol | OHV | TD3151 |
| C2J 768 | 1397cc | 4 Cyl. | 8 Valves | 49-50kW/67-68PS | Petrol | OHV | TD3152 |
| C3J 700 | 1397cc | 4 Cyl. | 8 Valves | 43-44kW/58-60PS | Petrol | OHV | TD4856 |
| C3J 702 | 1397cc | 4 Cyl. | 8 Valves | 43-44kW/58-60PS | Petrol | OHV | TD3175 |
| C3J 710 | 1397cc | 4 Cyl. | 8 Valves | 43-44kW/58-60PS | Petrol | OHV | TD3176 |
| C3J 760 | 1397cc | 4 Cyl. | 8 Valves | 43-44kW/58-60PS | Petrol | OHV | TD3179 |
| C3J 762 | 1397cc | 4 Cyl. | 8 Valves | 43-44kW/58-60PS | Petrol | OHV | TD3180 |
| 5 1.4 | 01/1982→12/1985 | | | 9 1.4 | | 09/1981→12/1988 | |
| 11 1.4 | 03/1983→12/1988 | | | 11 1.4 Turbo | | 10/1986→12/1988 | |
| 19 I 1.4 | 07/1988→04/1992 | | | 19 I 1.4 Cat | | 01/1989→04/1992 | |
| 19 II 1.4 | 04/1992→12/1995 | | | RAPID 1.4 Cat | | 08/1988→03/1998 | |
| SUPER 5 1.4 | 04/1985→10/1987 | | | SUPER 5 1.4 Cat | | 10/1985→12/1996 | |
| SUPER 5 1.4 Turbo | 04/1985→08/1990 | | | | | | |

V91317  34.00 x 7.00 x 91.50

7701 462 137

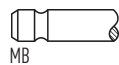

45°

H

VAG50758  41.50 x 7.00 x 11.15



V91261  29.00 x 7.00 x 89.00

7701 461 214

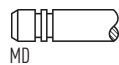

45°

V91834  29.00 x 7.00 x 89.00

7701 460 690

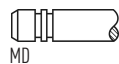

45°

15  **76.00**

| | | | | | | | |
|-------------|-----------------|--------|----------|--------------|--------|-----------------|--------|
| C1J 760 | 1397cc | 4 Cyl. | 8 Valves | 77kW/105PS | Petrol | Turbo, OHV | TD3126 |
| C1J 770 | 1397cc | 4 Cyl. | 8 Valves | 85kW/115PS | Petrol | Turbo, OHV | TD3129 |
| 9 1.4 Turbo | 04/1984→12/1986 | | | 11 1.4 Turbo | | 04/1984→12/1988 | |

V94320  34.10 x 7.00 x 90.80

7701 462 385

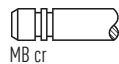

45°

H

VAG50758  41.50 x 7.00 x 11.15



V91834  29.00 x 7.00 x 89.00

7701 460 690

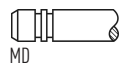

45°

16  **76.00**

| | | | | | | | |
|---------|--------|--------|----------|-----------------|--------|-------------|---------|
| K9K 608 | 1461cc | 4 Cyl. | 8 Valves | 55-66kW/75-90PS | Diesel | Turbo, SOHC | TD27682 |
| K9K 612 | 1461cc | 4 Cyl. | 8 Valves | 55-66kW/75-90PS | Diesel | Turbo, SOHC | TD27683 |
| K9K 636 | 1461cc | 4 Cyl. | 8 Valves | 81kW/110PS | Diesel | Turbo, SOHC | TD28220 |
| K9K 700 | 1461cc | 4 Cyl. | 8 Valves | 45-50kW/61-68PS | Diesel | Turbo, SOHC | TD16219 |
| K9K 702 | 1461cc | 4 Cyl. | 8 Valves | 45-60kW/61-82PS | Diesel | Turbo, SOHC | TD16344 |



OE

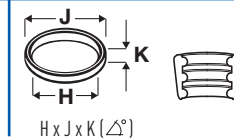
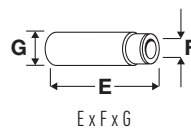

| | | | | | | | |
|--------------------------|----------|--------|----------|-------------------------|--------|-------------|---------|
| K9K 704 | 1461cc | 4 Cyl. | 8 Valves | 42-48kW/57-65PS | Diesel | Turbo, SOHC | TD16343 |
| K9K 706 | 1461cc | 4 Cyl. | 8 Valves | 48-58kW/65-79PS | Diesel | Turbo, SOHC | TD20974 |
| K9K 708 | 1461cc | 4 Cyl. | 8 Valves | 48-50kW/65-68PS | Diesel | Turbo, SOHC | TD26047 |
| K9K 710 | 1461cc | 4 Cyl. | 8 Valves | 60kW/82PS | Diesel | Turbo, SOHC | TD17488 |
| K9K 712 | 1461cc | 4 Cyl. | 8 Valves | 74kW/100PS | Diesel | Turbo, SOHC | TD18419 |
| K9K 714 | 1461cc | 4 Cyl. | 8 Valves | 47-50kW/64-68PS | Diesel | Turbo, SOHC | TD21173 |
| K9K 716 | 1461cc | 4 Cyl. | 8 Valves | 45-60kW/61-82PS | Diesel | Turbo, SOHC | TD22179 |
| K9K 718 | 1461cc | 4 Cyl. | 8 Valves | 62kW/84PS | Diesel | Turbo, SOHC | TD21171 |
| K9K 722 | 1461cc | 4 Cyl. | 8 Valves | 60-63kW/82-86PS | Diesel | Turbo, SOHC | TD16534 |
| K9K 724 | 1461cc | 4 Cyl. | 8 Valves | 63kW/86PS | Diesel | Turbo, SOHC | TD20988 |
| K9K 728 | 1461cc | 4 Cyl. | 8 Valves | 74-78kW/101-106PS | Diesel | Turbo, SOHC | TD20706 |
| K9K 729 | 1461cc | 4 Cyl. | 8 Valves | 74kW/101PS | Diesel | Turbo, SOHC | TD20707 |
| K9K 732 | 1461cc | 4 Cyl. | 8 Valves | 78kW/106PS | Diesel | Turbo, SOHC | TD20829 |
| K9K 734 | 1461cc | 4 Cyl. | 8 Valves | 74-78kW/103-106PS | Diesel | Turbo, SOHC | TD22192 |
| K9K 740 | 1461cc | 4 Cyl. | 8 Valves | 47kW/64PS | Diesel | Turbo, SOHC | TD20446 |
| K9K 750 | 1461cc | 4 Cyl. | 8 Valves | 57-65kW/78-88PS | Diesel | Turbo, SOHC | TD21133 |
| K9K 752 | 1461cc | 4 Cyl. | 8 Valves | 47-50kW/64-68PS | Diesel | Turbo, SOHC | TD21134 |
| K9K 760 | 1461cc | 4 Cyl. | 8 Valves | 50-63kW/68-86PS | Diesel | Turbo, SOHC | TD21135 |
| K9K 762 | 1461cc | 4 Cyl. | 8 Valves | 50kW/68PS | Diesel | Turbo, SOHC | TD20922 |
| K9K 764 | 1461cc | 4 Cyl. | 8 Valves | 78kW/106PS | Diesel | Turbo, SOHC | TD18538 |
| K9K 766 | 1461cc | 4 Cyl. | 8 Valves | 63kW/86PS | Diesel | Turbo, SOHC | TD18537 |
| K9K 768 | 1461cc | 4 Cyl. | 8 Valves | 48-50kW/65-68PS | Diesel | Turbo, SOHC | TD18536 |
| K9K 770 | 1461cc | 4 Cyl. | 8 Valves | 55-65kW/75-88PS | Diesel | Turbo, SOHC | TD25691 |
| K9K 772 | 1461cc | 4 Cyl. | 8 Valves | 63-76kW/86-103PS | Diesel | Turbo, SOHC | TD23549 |
| K9K 780 | 1461cc | 4 Cyl. | 8 Valves | 76-81kW/103-110PS | Diesel | Turbo, SOHC | TD20817 |
| K9K 790 | 1461cc | 4 Cyl. | 8 Valves | 48kW/65PS | Diesel | Turbo, SOHC | TD21438 |
| K9K 792 | 1461cc | 4 Cyl. | 8 Valves | 50kW/68PS | Diesel | Turbo, SOHC | TD21439 |
| K9K 794 | 1461cc | 4 Cyl. | 8 Valves | 48-50kW/65-68PS | Diesel | Turbo, SOHC | TD23795 |
| K9K 796 | 1461cc | 4 Cyl. | 8 Valves | 63kW/86PS | Diesel | Turbo, SOHC | TD26080 |
| K9K 800 | 1461cc | 4 Cyl. | 8 Valves | 50-63kW/75-86PS | Diesel | Turbo, SOHC | TD22193 |
| K9K 802 | 1461cc | 4 Cyl. | 8 Valves | 55-63kW/75-86PS | Diesel | Turbo, SOHC | TD20830 |
| K9K 804 | 1461cc | 4 Cyl. | 8 Valves | 76-80kW/103-110PS | Diesel | Turbo, SOHC | TD20831 |
| K9K 806 | 1461cc | 4 Cyl. | 8 Valves | 76kW/103PS | Diesel | Turbo, SOHC | TD20832 |
| K9K 808 | 1461cc | 4 Cyl. | 8 Valves | 55-66kW/75-90PS | Diesel | Turbo, SOHC | TD26258 |
| K9K 812 | 1461cc | 4 Cyl. | 8 Valves | 60-66kW/82-90PS | Diesel | Turbo, SOHC | TD24967 |
| K9K 820 | 1461cc | 4 Cyl. | 8 Valves | 55-63kW/75-86PS | Diesel | Turbo, SOHC | TD25692 |
| K9K 830 | 1461cc | 4 Cyl. | 8 Valves | 62-66kW/84-90PS | Diesel | Turbo, SOHC | TD25693 |
| K9K 832 | 1461cc | 4 Cyl. | 8 Valves | 78kW/106PS | Diesel | Turbo, SOHC | TD23521 |
| K9K 834 | 1461cc | 4 Cyl. | 8 Valves | 66kW/90PS | Diesel | Turbo, SOHC | TD23742 |
| K9K 836 | 1461cc | 4 Cyl. | 8 Valves | 78-81kW/106-110PS | Diesel | Turbo, SOHC | TD23743 |
| K9K 837 | 1461cc | 4 Cyl. | 8 Valves | 81kW/110PS | Diesel | Turbo, SOHC | TD26246 |
| K9K 856 | 1461cc | 4 Cyl. | 8 Valves | 80-81kW/109-110PS | Diesel | Turbo, SOHC | TD34471 |
| K9K 896 | 1461cc | 4 Cyl. | 8 Valves | 81kW/110PS | Diesel | Turbo, SOHC | TD33638 |
| K9K 898 | 1461cc | 4 Cyl. | 8 Valves | 80kW/109PS | Diesel | Turbo, SOHC | TD34473 |
| K9K P 732 | 1461cc | 4 Cyl. | 8 Valves | 78kW/106PS | Diesel | Turbo, SOHC | TD19693 |
| CAPTUR 1.5 dCi 90 | 06/2013→ | | | CLIO 1.5 dCi | | 02/2008→ | |
| CLIO II 1.5 dCi | 06/2001→ | | | CLIO III 1.5 dCi | | 05/2005→ | |
| CLIO IV 1.5 dCi 75 | 11/2012→ | | | CLIO IV 1.5 dCi 90 | | 11/2012→ | |
| DOKKER 1.5 dCi | 12/2013→ | | | DUSTER 1.5 dCi | | 02/2012→ | |
| FLUENCE 1.5 dCi | 02/2010→ | | | GRAND SCÉNIC II 1.5 dCi | | 04/2004→ | |
| GRAND SCÉNIC III 1.5 dCi | 02/2009→ | | | KANGOO 1.5 dCi | | 12/2001→ | |



OE

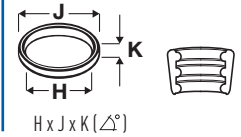
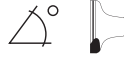

| | | | |
|-----------------------------------|-----------------|--------------------------------|----------|
| KANGOO BE BOP 1.5 dCi | 02/2009→ | KANGOO BE BOP 1.5 dCi 75 | 09/2010→ |
| KANGOO Express 1.5 dCi | 12/2001→ | KANGOO Express 1.5 dCi 75 | 09/2010→ |
| KANGOO Express 1.5 dCi 85 | 02/2008→ | KANGOO Express 1.5 dCi 90 | 06/2009→ |
| KANGOO Express 1.5 dCi 110 | 09/2010→ | KANGOO / GRAND KANGOO 1.5 dCi | 02/2008→ |
| KANGOO / GRAND KANGOO 1.5 dCi 110 | 09/2010→ | LAGUNA III 1.5 dCi | 10/2007→ |
| LODGY 1.5 dCi | 01/2015→ | LOGAN EXPRESS 1.5 dCi | 04/2007→ |
| LOGAN I 1.5 dCi | 04/2007→ | MEGANE CC 1.5 dCi | 06/2010→ |
| MEGANE II 1.5 dCi | 09/2002→12/2010 | MEGANE III 1.5 dCi | 11/2008→ |
| MODUS / GRAND MODUS 1.5 dCi | 09/2004→ | MODUS / GRAND MODUS 1.5 dCi 75 | 10/2010→ |
| MODUS / GRAND MODUS 1.5 dCi 90 | 10/2010→ | PULSE 1.5 DCI | 01/2012→ |
| SANDERO/STEPWAY I 1.5 dCi | 02/2008→11/2011 | SANDERO/STEPWAY II 1.5 dCi | 12/2013→ |
| SCALA 1.5 dCi | 01/2012→ | SCÉNIC II 1.5 dCi | 06/2003→ |
| SCÉNIC III 1.5 dCi | 02/2009→ | THALIA I 1.5 dCi | 06/2001→ |
| THALIA II 1.5 dCi | 09/2008→ | THALIA III 1.5 dCi | 12/2013→ |
| TWINGO II 1.5 dCi | 03/2007→ | TWINGO II 1.5 dCi 75 | 10/2010→ |
| TWINGO II 1.5 dCi 90 | 10/2010→ | | |

V94608 ■
33.50 x 6.00 x 100.90

7701 476 573



45° Y H

VAG96354B ■ ■ ■
40.50 x 6.00 x 12.08



V94609 ■
29.00 x 6.00 x 100.70

7701 476 572



45° H

17  **78.00**

| | | | | | | | |
|----------------|--------|-----------------|-----------------|---------------|--------|-----------------|---------------|
| F8M 700 | 1596cc | 4 Cyl. | 8 Valves | 40kW/55PS | Diesel | SOHC | TD3282 |
| F8M 720 | 1596cc | 4 Cyl. | 8 Valves | 40kW/55PS | Diesel | SOHC | TD3283 |
| F8M 730 | 1596cc | 4 Cyl. | 8 Valves | 40kW/55PS | Diesel | SOHC | TD3284 |
| F8M 736 | 1596cc | 4 Cyl. | 8 Valves | 40kW/55PS | Diesel | SOHC | TD3285 |
| F8M 760 | 1596cc | 4 Cyl. | 8 Valves | 40kW/55PS | Diesel | SOHC | TD3286 |
| 9 1.6 D | | 10/1982→12/1988 | | 11 1.6 D | | 08/1983→12/1988 | |
| RAPID 1.6 D | | 03/1986→08/1998 | | SUPER 5 1.6 D | | 10/1984→12/1996 | |

V91269 ■
36.30 x 8.00 x 111.70

7701 462 813



30° H

VAG92329B ■ ■ ■
39.00 x 8.00 x 13.07



V91267 ■
31.50 x 8.00 x 111.50

7701 462 814



45°

VAG96226B ■ ■ ■
39.00 x 8.02 x 13.13

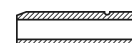



OE

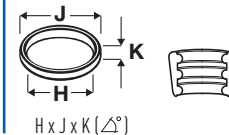
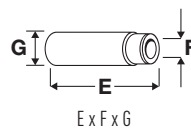

18 79.50

| | | | | | | | |
|---------|--------|--------|-----------|-----------------|--------|------|---------|
| K4J 700 | 1390cc | 4 Cyl. | 16 Valves | 70-72kW/95-98PS | Petrol | DOHC | TD16342 |
| K4J 710 | 1390cc | 4 Cyl. | 16 Valves | 72kW/98PS | Petrol | DOHC | TD19673 |
| K4J 711 | 1390cc | 4 Cyl. | 16 Valves | 72kW/98PS | Petrol | DOHC | TD19672 |
| K4J 712 | 1390cc | 4 Cyl. | 16 Valves | 70-72kW/95-98PS | Petrol | DOHC | TD14330 |
| K4J 713 | 1390cc | 4 Cyl. | 16 Valves | 70-72kW/95-98PS | Petrol | DOHC | TD14331 |
| K4J 714 | 1390cc | 4 Cyl. | 16 Valves | 70kW/95PS | Petrol | DOHC | TD16349 |
| K4J 730 | 1390cc | 4 Cyl. | 16 Valves | 72kW/98PS | Petrol | DOHC | TD16531 |
| K4J 732 | 1390cc | 4 Cyl. | 16 Valves | 60kW/82PS | Petrol | DOHC | TD20910 |
| K4J 740 | 1390cc | 4 Cyl. | 16 Valves | 72kW/98PS | Petrol | DOHC | TD21208 |
| K4J 750 | 1390cc | 4 Cyl. | 16 Valves | 70kW/95PS | Petrol | DOHC | TD13310 |
| K4J 770 | 1390cc | 4 Cyl. | 16 Valves | 72kW/98PS | Petrol | DOHC | TD18422 |
| K4J 780 | 1390cc | 4 Cyl. | 16 Valves | 72kW/98PS | Petrol | DOHC | TD18533 |

| | | | |
|-------------------------|----------|----------------------|-----------------|
| CLIO 1.4 16V | 02/2010→ | CLIO II 1.4 16V | 10/1999→ |
| CLIO III 1.4 16V | 06/2005→ | MEGANE I 1.4 16V | 03/1999→08/2003 |
| MEGANE II 1.4 | 08/2003→ | MEGANE II 1.4 16V | 11/2002→02/2008 |
| MODUS / GRAND MODUS 1.4 | 12/2004→ | SCÉNIC I MPV 1.4 16V | 09/1999→08/2003 |
| SCÉNIC II 1.4 | 06/2003→ | THALIA I 1.4 16V | 08/2000→ |

| | | | | | | | |
|-----------------------|--------------|---------|-----|----|---|----------------------|--|
| V94498 | 7701 472 124 | | 45° | Y | H | VAG96292B | |
| 32.40 x 5.50 x 109.20 | | MB | | | | 40.60 x 5.50 x 11.07 | |
| V94499 | 7701 471 379 | | 45° | | | | |
| 28.00 x 5.50 x 107.50 | | MD | | | | | |
| V94501 | 7701 472 125 | | 45° | ss | H | | |
| 28.00 x 5.50 x 107.50 | | MD + MB | | | | | |

19 79.50

| | | | | | | | |
|-----------|--------|--------|-----------|-----------------|--------|------|---------|
| K4J 715 | 1390cc | 4 Cyl. | 16 Valves | 70-72kW/95-98PS | Petrol | DOHC | TD20907 |
| K4J D 740 | 1390cc | 4 Cyl. | 16 Valves | 72kW/98PS | Petrol | DOHC | TD19686 |

| | |
|-----------|-----------------|
| 19 II 1.4 | 10/1998→06/2001 |
|-----------|-----------------|

| | | | | | | | |
|-----------------------|--------------|---------|-----|----|---|----------------------|--|
| V94498 | 7701 472 124 | | 45° | Y | H | VAG96293B | |
| 32.40 x 5.50 x 109.20 | | MB | | | | 45.00 x 5.50 x 11.06 | |
| V94499 | 7701 471 379 | | 45° | | | | |
| 28.00 x 5.50 x 107.50 | | MD | | | | | |
| V94501 | 7701 472 125 | | 45° | ss | H | | |
| 28.00 x 5.50 x 107.50 | | MD + MB | | | | | |

20 79.50

| | | | | | | | |
|---------|--------|--------|----------|-----------|--------|------|---------|
| K7J 710 | 1390cc | 4 Cyl. | 8 Valves | 55kW/75PS | Petrol | SOHC | TD18138 |
| K7J 714 | 1390cc | 4 Cyl. | 8 Valves | 53kW/72PS | Petrol | SOHC | TD23530 |

| | | | |
|-------------|----------|-----------------------|----------|
| LOGAN I 1.4 | 09/2004→ | SANDERO/STEPWAY I 1.4 | 02/2009→ |
|-------------|----------|-----------------------|----------|

| | | | | | | | |
|-----------------------|--------------|---------|-----|--|---|----------------------|--|
| V91835 | 7701 465 088 | | 30° | | H | VAG96182B | |
| 37.50 x 7.00 x 107.80 | | MB | | | | 42.00 x 7.02 x 12.08 | |
| V91836 | 7701 465 090 | | 45° | | | VAG96172B | |
| 33.60 x 7.00 x 107.80 | | MD cr | | | | 49.00 x 7.02 x 12.08 | |
| V94442 | 7701 468 419 | | 45° | | H | | |
| 33.60 x 7.00 x 107.70 | | MD + MB | | | | | |



OE

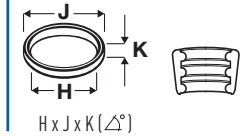
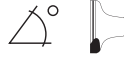

21  79.50

| | | | | | | | |
|---------|--------|--------|-----------|-------------------|--------|------|---------|
| K4M 690 | 1598cc | 4 Cyl. | 16 Valves | 76-85kW/103-116PS | Petrol | DOHC | TD22187 |
| K4M 697 | 1598cc | 4 Cyl. | 16 Valves | 77-82kW/105-112PS | Petrol | DOHC | TD23897 |
| K4M 698 | 1598cc | 4 Cyl. | 16 Valves | 77-82kW/105-112PS | Petrol | DOHC | TD23898 |
| K4M 700 | 1598cc | 4 Cyl. | 16 Valves | 79-81kW/107-110PS | Petrol | DOHC | TD13308 |
| K4M 701 | 1598cc | 4 Cyl. | 16 Valves | 79-81kW/107-110PS | Petrol | DOHC | TD13309 |
| K4M 704 | 1598cc | 4 Cyl. | 16 Valves | 79-80kW/107-109PS | Petrol | DOHC | TD16346 |
| K4M 706 | 1598cc | 4 Cyl. | 16 Valves | 69-82kW/94-112PS | Petrol | DOHC | TD21193 |
| K4M 708 | 1598cc | 4 Cyl. | 16 Valves | 75-81kW/102-110PS | Petrol | DOHC | TD16345 |
| K4M 709 | 1598cc | 4 Cyl. | 16 Valves | 75-79kW/102-107PS | Petrol | DOHC | TD21194 |
| K4M 710 | 1598cc | 4 Cyl. | 16 Valves | 76-79kW/103-107PS | Petrol | DOHC | TD16214 |
| K4M 711 | 1598cc | 4 Cyl. | 16 Valves | 79kW/107PS | Petrol | DOHC | TD16215 |
| K4M 712 | 1598cc | 4 Cyl. | 16 Valves | 79kW/107PS | Petrol | DOHC | TD21163 |
| K4M 714 | 1598cc | 4 Cyl. | 16 Valves | 79kW/107PS | Petrol | DOHC | TD21164 |
| K4M 716 | 1598cc | 4 Cyl. | 16 Valves | 82kW/112PS | Petrol | DOHC | TD21200 |
| K4M 720 | 1598cc | 4 Cyl. | 16 Valves | 79kW/107PS | Petrol | DOHC | TD16269 |
| K4M 724 | 1598cc | 4 Cyl. | 16 Valves | 79kW/107PS | Petrol | DOHC | TD16270 |
| K4M 730 | 1598cc | 4 Cyl. | 16 Valves | 70-80kW/95-109PS | Petrol | DOHC | TD21195 |
| K4M 732 | 1598cc | 4 Cyl. | 16 Valves | 66-81kW/90-110PS | Petrol | DOHC | TD20911 |
| K4M 734 | 1598cc | 4 Cyl. | 16 Valves | 58-66kW/79-90PS | Petrol | DOHC | TD20912 |
| K4M 736 | 1598cc | 4 Cyl. | 16 Valves | 79-82kW/107-112PS | Petrol | DOHC | TD21201 |
| K4M 740 | 1598cc | 4 Cyl. | 16 Valves | 79-81kW/107-110PS | Petrol | DOHC | TD18445 |
| K4M 742 | 1598cc | 4 Cyl. | 16 Valves | 66-79kW/90-107PS | Petrol | DOHC | TD20913 |
| K4M 743 | 1598cc | 4 Cyl. | 16 Valves | 66-81kW/90-110PS | Petrol | DOHC | TD20914 |
| K4M 744 | 1598cc | 4 Cyl. | 16 Valves | 55-79kW/75-107PS | Petrol | DOHC | TD19674 |
| K4M 745 | 1598cc | 4 Cyl. | 16 Valves | 79kW/107PS | Petrol | DOHC | TD19675 |
| K4M 746 | 1598cc | 4 Cyl. | 16 Valves | 79kW/107PS | Petrol | DOHC | TD20915 |
| K4M 748 | 1598cc | 4 Cyl. | 16 Valves | 79-86kW/107-117PS | Petrol | DOHC | TD11567 |
| K4M 750 | 1598cc | 4 Cyl. | 16 Valves | 70kW/95PS | Petrol | DOHC | TD17489 |
| K4M 752 | 1598cc | 4 Cyl. | 16 Valves | 70kW/95PS | Petrol | DOHC | TD16370 |
| K4M 753 | 1598cc | 4 Cyl. | 16 Valves | 70kW/95PS | Petrol | DOHC | TD17494 |
| K4M 754 | 1598cc | 4 Cyl. | 16 Valves | 98kW/133PS | Petrol | DOHC | TD21176 |
| K4M 760 | 1598cc | 4 Cyl. | 16 Valves | 81-83kW/110-113PS | Petrol | DOHC | TD16532 |
| K4M 761 | 1598cc | 4 Cyl. | 16 Valves | 81-83kW/110-113PS | Petrol | DOHC | TD18302 |
| K4M 762 | 1598cc | 4 Cyl. | 16 Valves | 77-81kW/105-110PS | Petrol | DOHC | TD21202 |
| K4M 764 | 1598cc | 4 Cyl. | 16 Valves | 82-85kW/112-116PS | Petrol | DOHC | TD20916 |
| K4M 768 | 1598cc | 4 Cyl. | 16 Valves | 75kW/102PS | Petrol | DOHC | TD21203 |
| K4M 776 | 1598cc | 4 Cyl. | 16 Valves | 79kW/107PS | Petrol | DOHC | TD26525 |
| K4M 782 | 1598cc | 4 Cyl. | 16 Valves | 83kW/113PS | Petrol | DOHC | TD18303 |
| K4M 788 | 1598cc | 4 Cyl. | 16 Valves | 77kW/105PS | Petrol | DOHC | TD21204 |
| K4M 790 | 1598cc | 4 Cyl. | 16 Valves | 82kW/112PS | Petrol | DOHC | TD18898 |
| K4M 791 | 1598cc | 4 Cyl. | 16 Valves | 82kW/112PS | Petrol | DOHC | TD18899 |
| K4M 792 | 1598cc | 4 Cyl. | 16 Valves | 65kW/88PS | Petrol | DOHC | TD20894 |
| K4M 794 | 1598cc | 4 Cyl. | 16 Valves | 65kW/88PS | Petrol | DOHC | TD20895 |
| K4M 800 | 1598cc | 4 Cyl. | 16 Valves | 82kW/112PS | Petrol | DOHC | TD18534 |
| K4M 801 | 1598cc | 4 Cyl. | 16 Valves | 82kW/112PS | Petrol | DOHC | TD18535 |
| K4M 804 | 1598cc | 4 Cyl. | 16 Valves | 65kW/88PS | Petrol | DOHC | TD18532 |
| K4M 812 | 1598cc | 4 Cyl. | 16 Valves | 82kW/112PS | Petrol | DOHC | TD21294 |
| K4M 813 | 1598cc | 4 Cyl. | 16 Valves | 82kW/112PS | Petrol | DOHC | TD26333 |

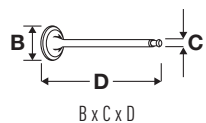

OE

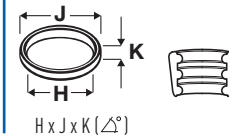
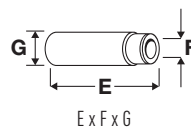

| Part No. | Capacity | Cyls | Valves | Power | Fuel | Configuration | Part No. |
|------------------------|----------|-----------------|------------------|---------------------------|--------|-----------------|----------------|
| K4M 824 | 1598cc | 4 Cyl. | 16 Valves | 81kW/110PS | Petrol | DOHC | TD20814 |
| K4M 854 | 1598cc | 4 Cyl. | 16 Valves | 98kW/133PS | Petrol | DOHC | TD21229 |
| K4M T 782 | 1598cc | 4 Cyl. | 16 Valves | 83kW/113PS | Petrol | DOHC | TD20824 |
| K4M W 761 | 1598cc | 4 Cyl. | 16 Valves | 83kW/113PS | Petrol | DOHC | TD20827 |
| 19 II 1.6 | | 10/1997→06/2001 | | CLIO 1.6 16V | | 02/2008→ | |
| CLIO II 1.6 | | 05/2000→ | | CLIO II 1.6 16V | | 09/1998→ | |
| CLIO III 1.6 16V | | 06/2005→ | | DUSTER 1.6 | | 10/2011→ | |
| DUSTER 1.6 16V | | 01/2011→ | | GRAND SCÉNIC II 1.6 | | 04/2004→ | |
| KANGOO 1.6 | | 09/2006→ | | KANGOO 1.6 16V | | 06/2001→ | |
| KANGOO BE BOP 1.6 16V | | 11/2013→ | | KANGOO Express 1.6 | | 02/2008→12/2009 | |
| KANGOO Express 1.6 16V | | 10/2001→ | | KANGOO / GRAND KANGOO 1.6 | | 01/2010→ | |
| LAGUNA I 1.6 16V | | 11/1997→03/2001 | | LAGUNA II 1.6 | | 03/2001→12/2007 | |
| LAGUNA II 1.6 16V | | 03/2001→ | | LAGUNA II 1.6 LPG | | 03/2001→05/2005 | |
| LAGUNA III 1.6 16V | | 10/2007→ | | LOGAN I 1.6 | | 02/2007→ | |
| MEGANE I 1.6 | | 03/1999→09/2000 | | MEGANE I 1.6 16V | | 01/1999→08/2008 | |
| MEGANE I 1.6 LPG | | 10/2000→08/2002 | | MEGANE II 1.6 | | 08/2003→ | |
| MEGANE II 1.6 16V | | 11/2002→ | | MEGANE II 1.6 LPG 16V | | 01/2006→08/2009 | |
| MEGANE Scenic 1.6 16V | | 04/1998→10/1999 | | MODUS / GRAND MODUS 1.6 | | 12/2004→ | |
| OROCH 1.6 16V | | 09/2015→ | | RAPID 1.6 | | 08/1996→11/2001 | |
| SANDERO/STEPWAY I 1.6 | | 12/2007→ | | SCÉNIC I MPV 1.6 | | 09/1999→09/2003 | |
| SCÉNIC II 1.6 | | 06/2003→ | | SCÉNIC II 1.6 16V | | 10/2005→ | |
| THALIA I 1.6 | | 01/2004→12/2008 | | THALIA I 1.6 16V | | 04/2002→ | |
| THALIA II 1.6 16V | | 09/2008→ | | TWINGO II 1.6 RS | | 05/2008→ | |
| WIND 1.6 | | 07/2010→ | | | | | |

V94498 ■
32.40 x 5.50 x 109.20

7701 472 124

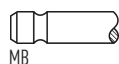

45° Y H

VAG96292B ■ ■ ■
40.60 x 5.50 x 11.07



V94499 ■
28.00 x 5.50 x 107.50

7701 471 379

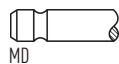

45°

V94501 ■
28.00 x 5.50 x 107.50

7701 472 125

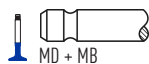

45° ss H



OE

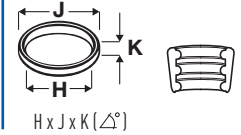
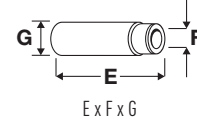

22  **79.50**

| | | | | | | | |
|----------------|--------|--------|-----------------|------------------|--------|-------------|----------------|
| K7M 702 | 1598cc | 4 Cyl. | 8 Valves | 66kW/90PS | Petrol | SOHC | TD4876 |
| K7M 703 | 1598cc | 4 Cyl. | 8 Valves | 66kW/90PS | Petrol | SOHC | TD4877 |
| K7M 704 | 1598cc | 4 Cyl. | 8 Valves | 64-66kW/87-90PS | Petrol | SOHC | TD20917 |
| K7M 710 | 1598cc | 4 Cyl. | 8 Valves | 64-76kW/87-103PS | Petrol | SOHC | TD18139 |
| K7M 718 | 1598cc | 4 Cyl. | 8 Valves | 62-66kW/84-90PS | Petrol | SOHC | TD23534 |
| K7M 720 | 1598cc | 4 Cyl. | 8 Valves | 55kW/75PS | Petrol | SOHC | TD4878 |
| K7M 732 | 1598cc | 4 Cyl. | 8 Valves | 64kW/87PS | Petrol | SOHC | TD23532 |
| K7M 744 | 1598cc | 4 Cyl. | 8 Valves | 66kW/90PS | Petrol | SOHC | TD14332 |
| K7M 745 | 1598cc | 4 Cyl. | 8 Valves | 66kW/90PS | Petrol | SOHC | TD14333 |
| K7M 746 | 1598cc | 4 Cyl. | 8 Valves | 66-73kW/90-100PS | Petrol | SOHC | TD20918 |
| K7M 750 | 1598cc | 4 Cyl. | 8 Valves | 64kW/87PS | Petrol | SOHC | TD22191 |
| K7M 790 | 1598cc | 4 Cyl. | 8 Valves | 66kW/90PS | Petrol | SOHC | TD4879 |

| | | | |
|---------------------------|-----------------|-----------------------|-----------------|
| 19 II 1.6 | 10/1996→06/2001 | CLIO II 1.6 | 09/1998→05/2005 |
| KANGOO 1.6 | 09/1999→06/2001 | KANGOO Express 1.6 | 09/1999→ |
| KANGOO / GRAND KANGOO 1.6 | 02/2008→ | LOGAN EXPRESS 1.6 | 04/2007→ |
| LOGAN I 1.6 | 09/2004→ | MEGANE I 1.6 | 02/2000→09/2000 |
| MEGANE I 1.6 e | 01/1996→08/2003 | MEGANE I 1.6 i | 01/1996→03/1999 |
| MEGANE I 1.6 LPG | 08/1995→03/1999 | MEGANE Scenic 1.6 e | 10/1996→10/1999 |
| MEGANE Scenic 1.6 i | 01/1997→09/1999 | SANDERO/STEPWAY I 1.6 | 12/2007→ |
| SANDERO/STEPWAY II 1.6 | 05/2015→ | THALIA I 1.6 | 03/1998→ |

V91835 ■
37.50 x 7.00 x 107.80

7701 465 088

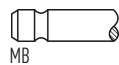

30°

H

VAG96182B ■
42.00 x 7.02 x 12.08



V91836 ■
33.60 x 7.00 x 107.80

7701 465 090

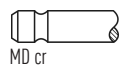

45°

VAG96172B ■
49.00 x 7.02 x 12.08

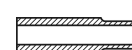

V94442 ■
33.60 x 7.00 x 107.70

7701 468 419

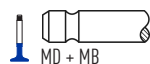

45°

H



OE

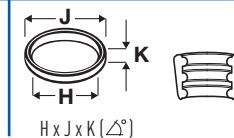
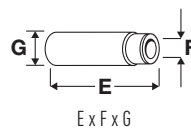

23



80.00

| | | | | | | | |
|---------|--------|--------|----------|-----------------|--------|-------------|---------|
| F8Q 600 | 1870cc | 4 Cyl. | 8 Valves | 44kW/60PS | Diesel | SOHC | TD16330 |
| F8Q 606 | 1870cc | 4 Cyl. | 8 Valves | 44kW/60PS | Diesel | SOHC | TD9690 |
| F8Q 610 | 1870cc | 4 Cyl. | 8 Valves | 66-69kW/90-94PS | Diesel | Turbo, SOHC | TD19666 |
| F8Q 622 | 1870cc | 4 Cyl. | 8 Valves | 47kW/64PS | Diesel | SOHC | TD18295 |
| F8Q 624 | 1870cc | 4 Cyl. | 8 Valves | 47kW/64PS | Diesel | SOHC | TD16348 |
| F8Q 632 | 1870cc | 4 Cyl. | 8 Valves | 47-48kW/64-65PS | Diesel | SOHC | TD17431 |
| F8Q 678 | 1870cc | 4 Cyl. | 8 Valves | 40-48kW/54-65PS | Diesel | SOHC | TD20390 |
| F8Q 682 | 1870cc | 4 Cyl. | 8 Valves | 40kW/54PS | Diesel | SOHC | TD16544 |
| F8Q 706 | 1870cc | 4 Cyl. | 8 Valves | 47-48kW/64-65PS | Diesel | SOHC | TD3287 |
| F8Q 714 | 1870cc | 4 Cyl. | 8 Valves | 47-48kW/64-65PS | Diesel | SOHC | TD3289 |
| F8Q 724 | 1870cc | 4 Cyl. | 8 Valves | 47-48kW/64-67PS | Diesel | SOHC | TD3291 |
| F8Q 732 | 1870cc | 4 Cyl. | 8 Valves | 47-48kW/64-65PS | Diesel | SOHC | TD4869 |
| F8Q 764 | 1870cc | 4 Cyl. | 8 Valves | 47kW/64PS | Diesel | SOHC | TD3297 |
| F8Q 774 | 1870cc | 4 Cyl. | 8 Valves | 47-48kW/64-67PS | Diesel | SOHC | TD3298 |
| F8Q 776 | 1870cc | 4 Cyl. | 8 Valves | 47-48kW/64-67PS | Diesel | SOHC | TD3299 |

| | | | |
|-------------------------|-----------------|----------------------|-----------------|
| 19 I 1.9 D | 01/1988→12/1992 | 19 I 1.9 DT | 09/1990→04/1992 |
| 19 II 1.9 D | 03/1992→12/1995 | CLIO I 1.9 D | 01/1991→09/1998 |
| CLIO I 1.9 RND | 04/1996→02/1998 | CLIO II 1.9 D | 02/2000→05/2001 |
| EXPRESS 1.9 D | 07/1995→10/1999 | KANGOO 1.9 RXED | 09/1999→06/2001 |
| KANGOO D 65 1.9 | 08/1997→ | KANGOO Express 1.9 D | 09/1999→06/2003 |
| KANGOO Express D 65 1.9 | 08/1997→ | MEGANE I 1.9 D | 09/1996→08/2003 |
| MEGANE I 1.9 D Eco | 01/1996→08/2003 | RAPID 1.9 D | 09/1991→03/1998 |
| TRAFIC 1.9 D | 06/1997→03/2001 | | |

V94067 ■
35.00 x 8.00 x 111.90
09/93→08/96

7701 468 035

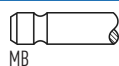

45°

H

VAG92329B ■ ■ ■
39.00 x 8.00 x 13.07

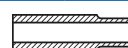

V94338 ■
35.30 x 8.00 x 110.00
09/96→

7701 471 704

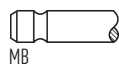

45°

H

VAG96226B ■ ■ ■
39.00 x 8.02 x 13.13



V91267 ■
31.50 x 8.00 x 111.50
→05/98

7701 462 814

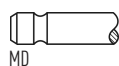

45°

V94339 ■
31.50 x 8.00 x 109.80
06/98→

7701 469 373

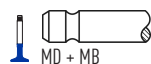

45°

ss

H



OE

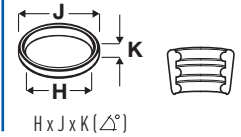
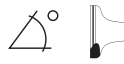

24 80.00

| | | | | | | | |
|--|--------------|-----------------|-----------------|----------------|--|-----------------|---------------|
| F8Q 620 | 1870cc | 4 Cyl. | 8 Valves | 47kW/64PS | Diesel | SOHC | TD4867 |
| F8Q 640 | 1870cc | 4 Cyl. | 8 Valves | 40kW/54PS | Diesel | SOHC | TD5510 |
| EXPRESS 1.9 D | | 07/1995→10/1997 | | MEGANE I 1.9 D | | 09/1996→08/2003 | |
| MEGANE I 1.9 D Eco | | 01/1996→08/2003 | | RAPID 1.9 D | | 09/1994→03/1998 | |
| V94067 35.00 x 8.00 x 111.90 →08/96 | 7701 468 035 | MB | 45° | H | VAG92329B 39.00 x 8.00 x 13.07 | | |
| V94338 35.30 x 8.00 x 110.00 09/96→ | 7701 471 704 | MB | 45° | H | VAG96226B 39.00 x 8.02 x 13.13 | | |
| V91267 31.50 x 8.00 x 111.50 →05/96 | 7701 462 814 | MD | 45° | | | | |
| V94339 31.50 x 8.00 x 109.80 06/98→ | 7701 469 373 | MD + MB | 45° | SS H | | | |

25 80.00

| | | | | | | | |
|--|--------------|-----------------|-----------------|-------------------------|--|-----------------|----------------|
| F8Q 630 | 1870cc | 4 Cyl. | 8 Valves | 47-48kW/64-65PS | Diesel | SOHC | TD9626 |
| F8Q 662 | 1870cc | 4 Cyl. | 8 Valves | 40-48kW/54-65PS | Diesel | SOHC | TD9625 |
| F8Q 790 | 1870cc | 4 Cyl. | 8 Valves | 47kW/64PS | Diesel | SOHC | TD18290 |
| CLIO II 1.9 D | | 09/1998→ | | KANGOO 1.9 RXED | | 09/1999→06/2001 | |
| KANGOO D 55 1.9 | | 08/1997→ | | KANGOO D 65 1.9 | | 08/1997→ | |
| KANGOO Express D 55 1.9 | | 08/1997→ | | KANGOO Express D 65 1.9 | | 08/1997→ | |
| MEGANE I 1.9 D | | 04/1999→08/2003 | | MEGANE Scenic 1.9 D | | 03/1997→09/1999 | |
| SCÉNIC I MPV 1.9 D | | 09/1999→03/2001 | | THALIA I 1.9 D | | 02/1998→05/2001 | |
| V94338 35.30 x 8.00 x 110.00 | 7701 471 704 | MB | 45° | H | VAG92329B 39.00 x 8.00 x 13.07 | | |
| V91267 31.50 x 8.00 x 111.50 →05/98 | 7701 462 814 | MD | 45° | | VAG96226B 39.00 x 8.02 x 13.13 | | |
| V94339 31.50 x 8.00 x 109.80 06/98→ | 7701 469 373 | MD + MB | 45° | SS H | | | |

26 80.00

| | | | | | | | |
|--|--------------|-----------------|-----------------|-----------------|--|-----------------|---------------|
| F8Q 710 | 1870cc | 4 Cyl. | 8 Valves | 47kW/64PS | Diesel | SOHC | TD3288 |
| F8Q 742 | 1870cc | 4 Cyl. | 8 Valves | 47-48kW/64-65PS | Diesel | SOHC | TD3295 |
| 19 I 1.9 D | | 01/1988→12/1992 | | 19 II 1.9 D | | 03/1992→12/1995 | |
| 21 1.9 D | | 03/1986→08/1994 | | | | | |
| V94067 35.00 x 8.00 x 111.90 09/93→ | 7701 468 035 | MB | 45° | H | VAG92329B 39.00 x 8.00 x 13.07 | | |
| V91267 31.50 x 8.00 x 111.50 | 7701 462 814 | MD | 45° | | VAG96226B 39.00 x 8.02 x 13.13 | | |

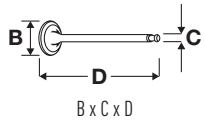

OE

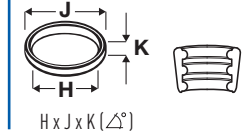
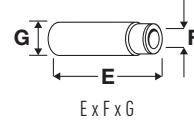
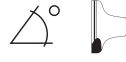

27 80.00

| | | | | | | | |
|----------------|-----------------|--------|-----------------|-----------------|-----------------|-------------|---------------|
| F8Q 722 | 1870cc | 4 Cyl. | 8 Valves | 47-48kW/64-67PS | Diesel | SOHC | TD3290 |
| F8Q 730 | 1870cc | 4 Cyl. | 8 Valves | 47-48kW/64-65PS | Diesel | SOHC | TD4868 |
| CLIO I 1.9 D | 01/1991→09/1998 | | RAPID 1.9 D | | 09/1991→03/1998 | | |

| | | | | | | |
|--------------------------------------|--------------|----|-----|---|------------------------|--|
| V94067 ■ | 7701 468 035 | | 45° | H | VAG92329B ■ ■ ■ | |
| 35.00 x 8.00 x 111.90 09/93→08/96 | | MB | | | 39.00 x 8.00 x 13.07 | |
| V94338 ■ | 7701 471 704 | | 45° | H | VAG96226B ■ ■ ■ | |
| 35.30 x 8.00 x 110.00 09/96→ | | MB | | | 39.00 x 8.02 x 13.13 | |
| V91267 ■ | 7701 462 814 | | 45° | | | |
| 31.50 x 8.00 x 111.50 | | MD | | | | |

28 80.00

| | | | | | | | |
|------------------|-----------------|--------|----------------------|------------------|-----------------|--------------------|----------------|
| F8Q 768 | 1870cc | 4 Cyl. | 8 Valves | 66-69kW/90-94PS | Diesel | Turbo, SOHC | TD19234 |
| F8Q 784 | 1870cc | 4 Cyl. | 8 Valves | 66-76kW/90-104PS | Diesel | Turbo, SOHC | TD4870 |
| F8Q 786 | 1870cc | 4 Cyl. | 8 Valves | 66kW/90PS | Diesel | Turbo, SOHC | TD16352 |
| MEGANE I 1.9 D | 04/1996→02/2001 | | MEGANE I 1.9 dT | | 01/1996→08/2003 | | |
| MEGANE I 1.9 TDI | 09/1996→08/2003 | | MEGANE Scenic 1.9 dT | | 01/1997→09/1999 | | |

| | | | | | | |
|-----------------------|--------------|---------|-----|----|------------------------|--|
| V91269 ■ | 7701 462 813 | | 30° | H | VAG92329B ■ ■ ■ | |
| 36.30 x 8.00 x 111.70 | | MB | | | 39.00 x 8.00 x 13.07 | |
| V94067 ■ | 7701 468 035 | | 45° | H | VAG96226B ■ ■ ■ | |
| 35.00 x 8.00 x 111.90 | | MB | | | 39.00 x 8.02 x 13.13 | |
| V94338 ■ | 7701 471 704 | | 45° | H | | |
| 35.30 x 8.00 x 110.00 | | MB | | | | |
| V91267 ■ | 7701 462 814 | | 45° | | | |
| 31.50 x 8.00 x 111.50 | | MD | | | | |
| V94339 ■ | 7701 469 373 | | 45° | ss | H | |
| 31.50 x 8.00 x 109.80 | | MD + MB | | | | |

29 80.00

| | | | | | | | |
|----------------|--------|--------|-----------------|-------------------|--------|--------------------|----------------|
| F9Q 650 | 1870cc | 4 Cyl. | 8 Valves | 88kW/120PS | Diesel | Turbo, SOHC | TD21223 |
| F9Q 664 | 1870cc | 4 Cyl. | 8 Valves | 66-68kW/90-92PS | Diesel | SOHC | TD19677 |
| F9Q 670 | 1870cc | 4 Cyl. | 8 Valves | 88kW/120PS | Diesel | Turbo, SOHC | TD21224 |
| F9Q 674 | 1870cc | 4 Cyl. | 8 Valves | 81-88kW/110-120PS | Diesel | Turbo, SOHC | TD21225 |
| F9Q 680 | 1870cc | 4 Cyl. | 8 Valves | 88kW/120PS | Diesel | Turbo, SOHC | TD18286 |
| F9Q 710 | 1870cc | 4 Cyl. | 8 Valves | 72kW/98PS | Diesel | Turbo, SOHC | TD16190 |
| F9Q 716 | 1870cc | 4 Cyl. | 8 Valves | 72-75kW/98-102PS | Diesel | Turbo, SOHC | TD16191 |
| F9Q 717 | 1870cc | 4 Cyl. | 8 Valves | 72-75kW/98-102PS | Diesel | Turbo, SOHC | TD21136 |
| F9Q 718 | 1870cc | 4 Cyl. | 8 Valves | 79kW/107PS | Diesel | Turbo, SOHC | TD16192 |
| F9Q 722 | 1870cc | 4 Cyl. | 8 Valves | 72kW/98PS | Diesel | Turbo, SOHC | TD16305 |
| F9Q 730 | 1870cc | 4 Cyl. | 8 Valves | 60-72kW/82-98PS | Diesel | Turbo, SOHC | TD11427 |
| F9Q 731 | 1870cc | 4 Cyl. | 8 Valves | 72kW/98PS | Diesel | Turbo, SOHC | TD16353 |
| F9Q 732 | 1870cc | 4 Cyl. | 8 Valves | 74-77kW/101-105PS | Diesel | Turbo, SOHC | TD16347 |
| F9Q 733 | 1870cc | 4 Cyl. | 8 Valves | 75-77kW/102-105PS | Diesel | Turbo, SOHC | TD16363 |
| F9Q 734 | 1870cc | 4 Cyl. | 8 Valves | 72kW/98PS | Diesel | Turbo, SOHC | TD11428 |
| F9Q 736 | 1870cc | 4 Cyl. | 8 Valves | 72kW/98PS | Diesel | Turbo, SOHC | TD16354 |
| F9Q 738 | 1870cc | 4 Cyl. | 8 Valves | 74-79kW/101-107PS | Diesel | Turbo, SOHC | TD21137 |



OE

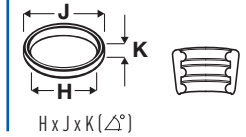

| | | | | | | | |
|------------|--------|--------|----------|-------------------|--------|-------------|---------|
| F9Q 740 | 1870cc | 4 Cyl. | 8 Valves | 75kW/102PS | Diesel | Turbo, SOHC | TD16341 |
| F9Q 744 | 1870cc | 4 Cyl. | 8 Valves | 59kW/80PS | Diesel | Turbo, SOHC | TD16361 |
| F9Q 746 | 1870cc | 4 Cyl. | 8 Valves | 75-79kW/102-107PS | Diesel | Turbo, SOHC | TD24971 |
| F9Q 748 | 1870cc | 4 Cyl. | 8 Valves | 74-79kW/101-107PS | Diesel | Turbo, SOHC | TD21138 |
| F9Q 750 | 1870cc | 4 Cyl. | 8 Valves | 85-92kW/115-125PS | Diesel | Turbo, SOHC | TD17028 |
| F9Q 751 | 1870cc | 4 Cyl. | 8 Valves | 88kW/120PS | Diesel | Turbo, SOHC | TD21226 |
| F9Q 752 | 1870cc | 4 Cyl. | 8 Valves | 74-77kW/101-105PS | Diesel | Turbo, SOHC | TD21139 |
| F9Q 754 | 1870cc | 4 Cyl. | 8 Valves | 74-79kW/101-107PS | Diesel | Turbo, SOHC | TD20841 |
| F9Q 756 | 1870cc | 4 Cyl. | 8 Valves | 88kW/120PS | Diesel | Turbo, SOHC | TD17064 |
| F9Q 758 | 1870cc | 4 Cyl. | 8 Valves | 81-96kW/110-130PS | Diesel | Turbo, SOHC | TD19678 |
| F9Q 759 | 1870cc | 4 Cyl. | 8 Valves | 85-96kW/116-130PS | Diesel | Turbo, SOHC | TD19679 |
| F9Q 760 | 1870cc | 4 Cyl. | 8 Valves | 60-75kW/82-102PS | Diesel | Turbo, SOHC | TD16529 |
| F9Q 762 | 1870cc | 4 Cyl. | 8 Valves | 60kW/82PS | Diesel | Turbo, SOHC | TD18691 |
| F9Q 770 | 1870cc | 4 Cyl. | 8 Valves | 59kW/80PS | Diesel | Turbo, SOHC | TD15688 |
| F9Q 772 | 1870cc | 4 Cyl. | 8 Valves | 60kW/82PS | Diesel | Turbo, SOHC | TD16304 |
| F9Q 774 | 1870cc | 4 Cyl. | 8 Valves | 60kW/82PS | Diesel | Turbo, SOHC | TD19370 |
| F9Q 780 | 1870cc | 4 Cyl. | 8 Valves | 59kW/80PS | Diesel | Turbo, SOHC | TD16339 |
| F9Q 782 | 1870cc | 4 Cyl. | 8 Valves | 59-62kW/80-84PS | Diesel | SOHC | TD17498 |
| F9Q 790 | 1870cc | 4 Cyl. | 8 Valves | 59-62kW/80-84PS | Diesel | Turbo, SOHC | TD16358 |
| F9Q 800 | 1870cc | 4 Cyl. | 8 Valves | 88kW/120PS | Diesel | Turbo, SOHC | TD16535 |
| F9Q 803 | 1870cc | 4 Cyl. | 8 Valves | 72-96kW/98-131PS | Diesel | Turbo, SOHC | TD20973 |
| F9Q 804 | 1870cc | 4 Cyl. | 8 Valves | 81-97kW/110-132PS | Diesel | Turbo, SOHC | TD20391 |
| F9Q 808 | 1870cc | 4 Cyl. | 8 Valves | 66-75kW/90-102PS | Diesel | Turbo, SOHC | TD21147 |
| F9Q 812 | 1870cc | 4 Cyl. | 8 Valves | 85-88kW/116-120PS | Diesel | Turbo, SOHC | TD20392 |
| F9Q 816 | 1870cc | 4 Cyl. | 8 Valves | 81-96kW/110-131PS | Diesel | Turbo, SOHC | TD22184 |
| F9Q 818 | 1870cc | 4 Cyl. | 8 Valves | 81-96kW/110-131PS | Diesel | Turbo, SOHC | TD22185 |
| F9Q 820 | 1870cc | 4 Cyl. | 8 Valves | 85-88kW/115-120PS | Diesel | Turbo, SOHC | TD18287 |
| F9Q 826 | 1870cc | 4 Cyl. | 8 Valves | 88kW/120PS | Diesel | Turbo, SOHC | TD18288 |
| F9Q E 804 | 1870cc | 4 Cyl. | 8 Valves | 81-96kW/110-131PS | Diesel | Turbo, SOHC | TD19683 |
| F9Q EE 804 | 1870cc | 4 Cyl. | 8 Valves | 81-96kW/110-131PS | Diesel | Turbo, SOHC | TD19696 |
| F9Q J 803 | 1870cc | 4 Cyl. | 8 Valves | 85-96kW/116-131PS | Diesel | Turbo, SOHC | TD19694 |

| | | | |
|--------------------------|-----------------|------------------------|-----------------|
| CLIO II 1.9 dTi | 02/2000→05/2001 | CLIO II 1.9 dTi | 12/1999→05/2005 |
| ESPACE III 1.9 dTi | 02/1999→10/2002 | ESPACE IV 1.9 dCi | 11/2002→ |
| GRAND SCÉNIC II 1.9 dCi | 04/2004→ | KANGOO 1.9 dCi | 10/2001→ |
| KANGOO 1.9 dTi | 02/2000→ | KANGOO Express 1.9 dCi | 10/2001→ |
| KANGOO Express 1.9 dTi | 02/2000→ | LAGUNA I 1.9 dCi | 09/1999→03/2001 |
| LAGUNA I 1.9 dTi | 10/1997→08/2002 | LAGUNA II 1.9 dCi | 03/2001→ |
| LAGUNA II 1.9 dCi | 06/2001→ | MASTER II 1.9 dCi 80 | 11/2001→ |
| MASTER II 1.9 dTi | 09/2000→ | MEGANE I 1.9 dCi | 03/1999→08/2003 |
| MEGANE I 1.9 DCi | 03/1999→08/2003 | MEGANE I 1.9 DTi | 02/2000→09/2000 |
| MEGANE I 1.9 dTi | 03/1997→08/2003 | MEGANE II 1.9 dCi | 11/2002→ |
| MEGANE Scenic 1.9 dTi | 04/1997→09/1999 | SCÉNIC I MPV 1.9 dCi | 09/1999→08/2003 |
| SCÉNIC I MPV 1.9 dCi RX4 | 11/2000→08/2003 | SCÉNIC I MPV 1.9 dTi | 09/1999→08/2003 |
| SCÉNIC II 1.9 D | 06/2006→ | SCÉNIC II 1.9 dCi | 06/2003→ |
| SCÉNIC II 1.9 dCi 130 | 10/2005→12/2009 | TRAFIC II 1.9 dCi | 03/2001→ |
| TRAFIC II 1.9 dCi 80 | 03/2001→ | TRAFIC II 1.9 dCi 80 | 03/2001→ |
| TRAFIC II 1.9 dCi 100 | 03/2001→ | TRAFIC II 1.9 dCi 100 | 03/2001→ |

V94190 ■
35.40 x 7.00 x 111.00

7701 476 024

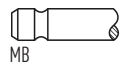

45°

H

VAG96294B ■ ■ ■
38.30 x 7.00 x 12.03

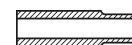

V94191 ■
32.60 x 7.00 x 110.80

7701 476 025



45°

H



OE

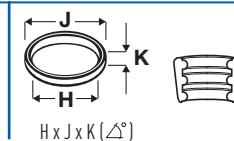
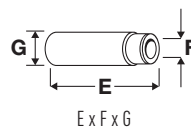

30 **81.00**

| | | | | | | | |
|--------------|-----------------|--------|----------|------------------|--------|-----------------|-----------------|
| F1N 720 | 1721cc | 4 Cyl. | 8 Valves | 50kW/68PS | Petrol | SOHC | TD3216 |
| F1N 722 | 1721cc | 4 Cyl. | 8 Valves | 50kW/68PS | Petrol | SOHC | TD3217 |
| F1N 724 | 1721cc | 4 Cyl. | 8 Valves | 50-51kW/68-69PS | Petrol | SOHC | TD3218 |
| F2N 700 | 1721cc | 4 Cyl. | 8 Valves | 59kW/80PS | Petrol | SOHC | TD3219 |
| F2N 704 | 1721cc | 4 Cyl. | 8 Valves | 59kW/80PS | Petrol | SOHC | TD3220 |
| F2N 708 | 1721cc | 4 Cyl. | 8 Valves | 65kW/88PS | Petrol | SOHC | TD3221 |
| F2N 710 | 1721cc | 4 Cyl. | 8 Valves | 65kW/88PS | Petrol | SOHC | TD3222 |
| F2N 711 | 1721cc | 4 Cyl. | 8 Valves | 65kW/88PS | Petrol | SOHC | TD3223 |
| F2N 712 | 1721cc | 4 Cyl. | 8 Valves | 55kW/75PS | Petrol | SOHC | TD3224 |
| F2N 716 | 1721cc | 4 Cyl. | 8 Valves | 56kW/76PS | Petrol | SOHC | TD3226 |
| F2N 720 | 1721cc | 4 Cyl. | 8 Valves | 65-68kW/88-92PS | Petrol | SOHC | TD4862 |
| F2N 721 | 1721cc | 4 Cyl. | 8 Valves | 68-69kW/92-94PS | Petrol | SOHC | TD3228 |
| F2N 722 | 1721cc | 4 Cyl. | 8 Valves | 66-69kW/90-94PS | Petrol | SOHC | TD3229 |
| F2N 724 | 1721cc | 4 Cyl. | 8 Valves | 55-56kW/75-76PS | Petrol | SOHC | TD3230 |
| F2N 726 | 1721cc | 4 Cyl. | 8 Valves | 68kW/92PS | Petrol | SOHC | TD3231 |
| F2N 727 | 1721cc | 4 Cyl. | 8 Valves | 68kW/92PS | Petrol | SOHC | TD3232 |
| F2N 728 | 1721cc | 4 Cyl. | 8 Valves | 55kW/75PS | Petrol | SOHC | TD3233 |
| F2N 730 | 1721cc | 4 Cyl. | 8 Valves | 54-55kW/73-75PS | Petrol | SOHC | TD3234 |
| F2N 732 | 1721cc | 4 Cyl. | 8 Valves | 64kW/87PS | Petrol | SOHC | TD3235 |
| F2N 740 | 1721cc | 4 Cyl. | 8 Valves | 64-66kW/87-90PS | Petrol | SOHC | TD3236 |
| F2N 742 | 1721cc | 4 Cyl. | 8 Valves | 64-66kW/87-90PS | Petrol | SOHC | TD4861 |
| F2N 750 | 1721cc | 4 Cyl. | 8 Valves | 54kW/73PS | Petrol | SOHC | TD3238 |
| F2N 752 | 1721cc | 4 Cyl. | 8 Valves | 64kW/87PS | Petrol | SOHC | TD3239 |
| F2N 754 | 1721cc | 4 Cyl. | 8 Valves | 65kW/88PS | Petrol | SOHC | TD3240 |
| F2N 758 | 1721cc | 4 Cyl. | 8 Valves | 56-66kW/76-90PS | Petrol | SOHC | TD3241 |
| F2N 770 | 1721cc | 4 Cyl. | 8 Valves | 66-68kW/90-92PS | Petrol | SOHC | TD3242 |
| F2N 783 | 1721cc | 4 Cyl. | 8 Valves | 65kW/88PS | Petrol | SOHC | TD3243 |
| F2N 786 | 1721cc | 4 Cyl. | 8 Valves | 59kW/80PS | Petrol | SOHC | TD3244 |
| F2N 798 | 1721cc | 4 Cyl. | 8 Valves | 65kW/88PS | Petrol | SOHC | TD3247 |
| F3N 702 | 1721cc | 4 Cyl. | 8 Valves | 68-69kW/92-94PS | Petrol | SOHC | TD3249 |
| F3N 716 | 1721cc | 4 Cyl. | 8 Valves | 54-55kW/73-75PS | Petrol | SOHC | TD3251 |
| F3N 717 | 1721cc | 4 Cyl. | 8 Valves | 54-55kW/73-75PS | Petrol | SOHC | TD3252 |
| F3N 718 | 1721cc | 4 Cyl. | 8 Valves | 54-55kW/73-75PS | Petrol | SOHC | TD4863 |
| F3N 722 | 1721cc | 4 Cyl. | 8 Valves | 66-70kW/90-95PS | Petrol | SOHC | TD3254 |
| F3N 723 | 1721cc | 4 Cyl. | 8 Valves | 66-70kW/90-95PS | Petrol | SOHC | TD3255 |
| F3N 726 | 1721cc | 4 Cyl. | 8 Valves | 54kW/73PS | Petrol | SOHC | TD3256 |
| F3N 740 | 1721cc | 4 Cyl. | 8 Valves | 54-55kW/73-75PS | Petrol | SOHC | TD3257 |
| F3N 741 | 1721cc | 4 Cyl. | 8 Valves | 54-55kW/73-75PS | Petrol | SOHC | TD3258 |
| F3N 742 | 1721cc | 4 Cyl. | 8 Valves | 66-70kW/90-95PS | Petrol | SOHC | TD3259 |
| F3N 743 | 1721cc | 4 Cyl. | 8 Valves | 66kW/90PS | Petrol | SOHC, Injection | TD3260 |
| F3N 746 | 1721cc | 4 Cyl. | 8 Valves | 66-80kW/90-109PS | Petrol | SOHC | TD3261 |
| 9 1.7 | 09/1984→12/1989 | | | 11 1.7 | | | 10/1983→12/1988 |
| 19 1.7 | 07/1988→12/1992 | | | 19 II 1.7 | | | 04/1992→12/1995 |
| 21 1.7 | 03/1986→04/1995 | | | 21 1.7 Cat | | | 05/1988→06/1993 |
| ALLIANCE 1.7 | 09/1983→12/1986 | | | CLIO I 1.7 | | | 01/1991→12/1993 |
| SUPER 5 1.7 | 10/1986→03/1995 | | | SUPER 5 1.7 i | | | 10/1986→08/1991 |
| TRAFIC 1.7 | 06/1986→08/1994 | | | | | | |



OE

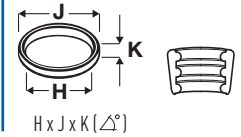
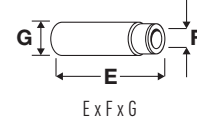
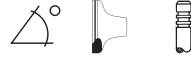

V91268 ■
38.10 x 8.00 x 111.50

7701 463 081

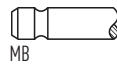

30°

H

V91319 ■
32.50 x 8.00 x 111.50

7701 463 082

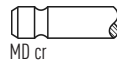

45°

31 **82.70**

| | | | | | | | |
|----------------|-----------------|--------|-----------------|------------|--------|------------------------|---------------|
| F3P 682 | 1783cc | 4 Cyl. | 8 Valves | 79kW/107PS | Petrol | SOHC, Injection | TD5483 |
| 19 II 1.8 | 05/1994→06/1996 | | | | | | |

V94038 ■
40.20 x 8.00 x 107.00

7701 466 606

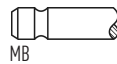

45°

H

VAG96057B ■ ■ ■
37.70 x 8.03 x 13.08



V94039 ■
32.60 x 8.00 x 107.00

7701 466 607



45°

H

32 **82.70**

| | | | | | | | |
|----------------------|-----------------|--------|-------------------|-------------------|-----------------|-------------|----------------|
| F4P 720 | 1783cc | 4 Cyl. | 16 Valves | 85kW/115PS | Petrol | DOHC | TD16220 |
| F4P 722 | 1783cc | 4 Cyl. | 16 Valves | 85kW/115PS | Petrol | DOHC | TD16221 |
| F4P 760 | 1783cc | 4 Cyl. | 16 Valves | 88kW/120PS | Petrol | DOHC | TD16189 |
| F4P 770 | 1783cc | 4 Cyl. | 16 Valves | 85-89kW/116-121PS | Petrol | DOHC | TD16216 |
| F4P 771 | 1783cc | 4 Cyl. | 16 Valves | 85-89kW/116-121PS | Petrol | DOHC | TD18272 |
| F4P 773 | 1783cc | 4 Cyl. | 16 Valves | 85-89kW/116-121PS | Petrol | DOHC | TD16217 |
| F4P 774 | 1783cc | 4 Cyl. | 16 Valves | 85-89kW/116-121PS | Petrol | DOHC | TD18273 |
| F4P 775 | 1783cc | 4 Cyl. | 16 Valves | 85-89kW/116-121PS | Petrol | DOHC | TD18274 |
| LAGUNA I 1.8 16V | 04/1998→03/2001 | | LAGUNA II 1.8 16V | | 03/2001→ | | |
| MEGANE I 1.8 16V | 01/2001→08/2003 | | SCÉNIC I MPV 1.8 | | 07/2000→04/2001 | | |
| SCÉNIC I MPV 1.8 16V | 01/2001→08/2003 | | | | | | |

V94606 ■
33.60 x 5.50 x 110.00

7701 474 287

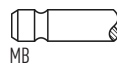

45°

H

VAG96292B ■ ■ ■
40.60 x 5.50 x 11.07



V94607 ■
29.00 x 5.50 x 108.90

7701 474 286



45°

H

33 **82.70**

| | | | | | | | |
|-------------------|----------|--------|------------------|------------|--------|-------------|----------------|
| F4P 772 | 1783cc | 4 Cyl. | 16 Valves | 89kW/121PS | Petrol | DOHC | TD21211 |
| LAGUNA II 1.8 16V | 03/2001→ | | | | | | |

V94606 ■
33.60 x 5.50 x 110.00

7701 474 287

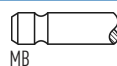

45°

H

VAG96292B
40.60 x 5.50 x 11.07



V94607 ■
29.00 x 5.50 x 108.90

7701 474 286

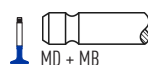

45°

H

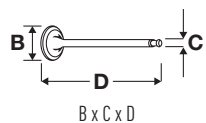

OE

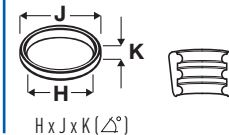
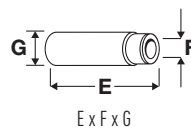

34 82.70

| | | | | | | | |
|---------|--------|--------|----------|-----------------|--------|-----------------|---------|
| F3P 670 | 1794cc | 4 Cyl. | 8 Valves | 66kW/90PS | Petrol | SOHC | TD5541 |
| F3P 674 | 1794cc | 4 Cyl. | 8 Valves | 69kW/94PS | Petrol | SOHC, Injection | TD18885 |
| F3P 678 | 1794cc | 4 Cyl. | 8 Valves | 66-70kW/90-95PS | Petrol | SOHC | TD5542 |
| F3P 720 | 1794cc | 4 Cyl. | 8 Valves | 66-69kW/90-94PS | Petrol | SOHC | TD3270 |
| F3P 724 | 1794cc | 4 Cyl. | 8 Valves | 66-69kW/90-94PS | Petrol | SOHC | TD3271 |

LAGUNA I 1.8 11/1993→03/2001

| | | | | | | |
|--|--------------|---------|-----|---|--|--|
| V94038 ■ 40.20 x 8.00 x 107.00 →12/96 | 7701 466 606 | MB | 45° | H | VAG96057B ■ ■ ■ 37.70 x 8.03 x 13.08 | |
| V94573 ■ 40.00 x 8.00 x 115.50 01/97→ | 7701 471 713 | MB | 45° | H | | |
| V94039 ■ 32.60 x 8.00 x 107.00 →12/96 | 7701 466 607 | MD + MB | 45° | H | | |
| V94574 ■ 32.80 x 8.00 x 115.30 01/97→ | 7701 471 714 | MD + MB | 45° | H | | |

35 82.70

| | | | | | | | |
|---------|--------|--------|----------|-----------------|--------|------|---------|
| F3P 676 | 1794cc | 4 Cyl. | 8 Valves | 69-70kW/94-95PS | Petrol | SOHC | TD20049 |
|---------|--------|--------|----------|-----------------|--------|------|---------|

LAGUNA I 1.8 06/1995→06/1998

| | | | | | | |
|--|--------------|---------|-----|------|--|--|
| V94616 ■ 40.00 x 8.00 x 115.50 | 7701 471 711 | MD + MB | 45° | H | VAG96057B ■ ■ ■ 37.70 x 8.03 x 13.08 | |
| V94189 ■ 32.60 x 8.00 x 115.40 | 7701 471 712 | MD + MB | 45° | SS H | | |



OE

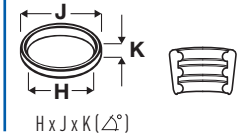
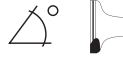

36



82.70

| | | | | | | | |
|------------------------|------------------------------------|--------|----------|-----------------------------|--------|------------------------------------|--------|
| F3P 700 | 1794cc | 4 Cyl. | 8 Valves | 79-81kW/107-110PS | Petrol | SOHC | TD3262 |
| F3P 704 | 1794cc | 4 Cyl. | 8 Valves | 65-66kW/88-90PS | Petrol | SOHC | TD5488 |
| F3P 705 | 1794cc | 4 Cyl. | 8 Valves | 65-66kW/88-90PS | Petrol | SOHC | TD3263 |
| F3P 706 | 1794cc | 4 Cyl. | 8 Valves | 65-79kW/88-107PS | Petrol | SOHC | TD3264 |
| F3P 707 | 1794cc | 4 Cyl. | 8 Valves | 65-66kW/88-90PS | Petrol | SOHC | TD3265 |
| F3P 708 | 1794cc | 4 Cyl. | 8 Valves | 65-66kW/88-90PS | Petrol | SOHC | TD3266 |
| F3P 710 | 1794cc | 4 Cyl. | 8 Valves | 65-70kW/88-95PS | Petrol | SOHC | TD3267 |
| F3P 712 | 1794cc | 4 Cyl. | 8 Valves | 66-80kW/90-109PS | Petrol | SOHC | TD3268 |
| F3P 714 | 1794cc | 4 Cyl. | 8 Valves | 65-70kW/88-95PS | Petrol | SOHC | TD3269 |
| F3P 754 | 1794cc | 4 Cyl. | 8 Valves | 66kW/90PS | Petrol | SOHC | TD5523 |
| F3P 755 | 1794cc | 4 Cyl. | 8 Valves | 66kW/90PS | Petrol | SOHC, Injection | TD3272 |
| F3P 758 | 1794cc | 4 Cyl. | 8 Valves | 79-80kW/107-109PS | Petrol | SOHC | TD3273 |
| F3P 760 | 1794cc | 4 Cyl. | 8 Valves | 65-66kW/88-90PS | Petrol | SOHC | TD3274 |
| F3P 764 | 1794cc | 4 Cyl. | 8 Valves | 79kW/107PS | Petrol | SOHC | TD9554 |
| F3P 765 | 1794cc | 4 Cyl. | 8 Valves | 67-79kW/91-107PS | Petrol | SOHC | TD5494 |
| 19 I 1.8 CLIO I 1.8 | 05/1992→09/1994 08/1990→09/1998 | | | 19 II 1.8 CLIO I 1.8 Rsi | | 04/1992→06/1996 01/1993→09/1998 | |

V94038 ■
40.20 x 8.00 x 107.00

7701 466 606

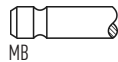

45°

H

VAG96057B ■ ■ ■
37.70 x 8.03 x 13.08



V94039 ■
32.60 x 8.00 x 107.00

7701 466 607

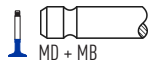

45°

H

37



82.70

| | | | | | | | |
|---|---|--------|----------|-------------------------------------|--------|------------------------------------|---------|
| F3R 611 | 1998cc | 4 Cyl. | 8 Valves | 80-85kW/109-116PS | Petrol | SOHC | TD20904 |
| F3R 722 | 1998cc | 4 Cyl. | 8 Valves | 83-84kW/113-114PS | Petrol | SOHC | TD3275 |
| F3R 723 | 1998cc | 4 Cyl. | 8 Valves | 83-84kW/113-114PS | Petrol | SOHC | TD3276 |
| F3R 750 | 1998cc | 4 Cyl. | 8 Valves | 80-85kW/109-115PS | Petrol | SOHC | TD4865 |
| F3R 752 | 1998cc | 4 Cyl. | 8 Valves | 80-85kW/109-115PS | Petrol | SOHC | TD20052 |
| F3R 791 | 1998cc | 4 Cyl. | 8 Valves | 80-85kW/109-115PS | Petrol | SOHC | TD16350 |
| F3R 796 | 1998cc | 4 Cyl. | 8 Valves | 80-85kW/109-115PS | Petrol | SOHC | TD16351 |
| LAGUNA I 2.0 MEGANE I 2.0 i MEGANE Scenic 2.0 RXE | 11/1993→03/2001 01/1996→08/2003 05/1997→10/1999 | | | MEGANE I 2.0 MEGANE Scenic 2.0 i | | 04/1997→08/2003 01/1997→09/1999 | |

V94038 ■
40.20 x 8.00 x 107.00

7701 466 606

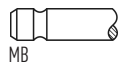

45°

H

VAG96057B ■ ■ ■
37.70 x 8.03 x 13.08



V94039 ■
32.60 x 8.00 x 107.00

7701 466 607

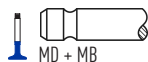

45°

H

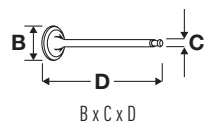

OE

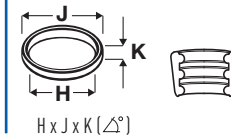
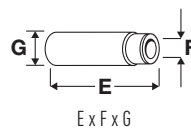

38 82.70

| | | | | | | | |
|-----------------------|-----------------|--------------|----------|-----------------|--------|------|---------|
| F3R 728 | 1998cc | 4 Cyl. | 8 Valves | 84kW/114PS | Petrol | SOHC | TD16177 |
| F3R 729 | 1998cc | 4 Cyl. | 8 Valves | 84kW/114PS | Petrol | SOHC | TD16178 |
| ESPACE III 2.0 | 11/1996→10/2000 | LAGUNA I 2.0 | | 10/1998→01/2001 | | | |
| V94188 | 7701 471 170 | | 45° | | | | |
| 40.00 x 8.00 x 115.55 | | MD | | | | | |
| V94614 | 7438 610 036 | | 45° | H | | | |
| 31.00 x 7.00 x 104.20 | | MB | | | | | |
| 01/98→ | | | | | | | |
| V94189 | 7701 471 712 | | 45° | ss | H | | |
| 32.60 x 8.00 x 115.40 | | MD + MB | | | | | |
| V94615 | 7438 610 034 | | 45° | | | | |
| 27.00 x 7.00 x 103.20 | | MD cr | | | | | |
| 01/98→ | | | | | | | |

39 82.70

| | | | | | | | |
|-----------------------|-----------------|----------------|----------|-------------------|--------|------|---------|
| F3R 742 | 1998cc | 4 Cyl. | 8 Valves | 84kW/114PS | Petrol | SOHC | TD16372 |
| F3R 751 | 1998cc | 4 Cyl. | 8 Valves | 80-85kW/109-115PS | Petrol | SOHC | TD16357 |
| F3R 768 | 1998cc | 4 Cyl. | 8 Valves | 84kW/114PS | Petrol | SOHC | TD16373 |
| F3R 769 | 1998cc | 4 Cyl. | 8 Valves | 84kW/114PS | Petrol | SOHC | TD16374 |
| ESPACE III 2.0 | 11/1996→10/2000 | LAGUNA I 2.0 | | 06/1995→02/2001 | | | |
| MEGANE I 2.0 | 05/1998→05/2001 | MEGANE I 2.0 i | | 01/1996→08/2003 | | | |
| MEGANE Scenic 2.0 i | 01/1997→09/1999 | | | | | | |
| V94038 | 7701 466 606 | | 45° | H | | | |
| 40.20 x 8.00 x 107.00 | | MB | | | | | |
| →12/96 | | | | | | | |
| V94573 | 7701 471 713 | | 45° | H | | | |
| 40.00 x 8.00 x 115.50 | | MB | | | | | |
| 01/97→ | | | | | | | |
| V94039 | 7701 466 607 | | 45° | H | | | |
| 32.60 x 8.00 x 107.00 | | MD + MB | | | | | |
| →12/96 | | | | | | | |
| V94574 | 7701 471 714 | | 45° | H | | | |
| 32.80 x 8.00 x 115.30 | | MD + MB | | | | | |
| 01/97→ | | | | | | | |

40 82.70

| | | | | | | | |
|---------|--------|--------|-----------|---------------------|--------|------|---------|
| F4R 700 | 1998cc | 4 Cyl. | 16 Valves | 103kW/140PS | Petrol | DOHC | TD16306 |
| F4R 701 | 1998cc | 4 Cyl. | 16 Valves | 103kW/140PS | Petrol | DOHC | TD16307 |
| F4R 712 | 1998cc | 4 Cyl. | 16 Valves | 99kW/135PS | Petrol | DOHC | TD18276 |
| F4R 713 | 1998cc | 4 Cyl. | 16 Valves | 95-99kW/129-135PS | Petrol | DOHC | TD18278 |
| F4R 714 | 1998cc | 4 Cyl. | 16 Valves | 98-99kW/133-135PS | Petrol | DOHC | TD18279 |
| F4R 715 | 1998cc | 4 Cyl. | 16 Valves | 98-99kW/133-135PS | Petrol | DOHC | TD18280 |
| F4R 720 | 1998cc | 4 Cyl. | 16 Valves | 88kW/120PS | Petrol | DOHC | TD16359 |
| F4R 722 | 1998cc | 4 Cyl. | 16 Valves | 88kW/120PS | Petrol | DOHC | TD16360 |
| F4R 730 | 1998cc | 4 Cyl. | 16 Valves | 124-126kW/169-172PS | Petrol | DOHC | TD14334 |
| F4R 738 | 1998cc | 4 Cyl. | 16 Valves | 124-132kW/168-180PS | Petrol | DOHC | TD19676 |
| F4R 740 | 1998cc | 4 Cyl. | 16 Valves | 99-103kW/135-140PS | Petrol | DOHC | TD16355 |
| F4R 741 | 1998cc | 4 Cyl. | 16 Valves | 99-103kW/135-140PS | Petrol | DOHC | TD16356 |



OE

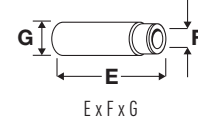

| | | | | | | | |
|----------|--------|--------|-----------|---------------------|--------|-------------|---------|
| F4R 744 | 1998cc | 4 Cyl. | 16 Valves | 99-103kW/135-140PS | Petrol | DOHC | TD16340 |
| F4R 746 | 1998cc | 4 Cyl. | 16 Valves | 102-103kW/139-140PS | Petrol | DOHC | TD21214 |
| F4R 760 | 1998cc | 4 Cyl. | 16 Valves | 120kW/163PS | Petrol | Turbo, DOHC | TD16478 |
| F4R 761 | 1998cc | 4 Cyl. | 16 Valves | 120kW/163PS | Petrol | Turbo, DOHC | TD16480 |
| F4R 762 | 1998cc | 4 Cyl. | 16 Valves | 120kW/163PS | Petrol | Turbo, DOHC | TD16286 |
| F4R 763 | 1998cc | 4 Cyl. | 16 Valves | 120kW/163PS | Petrol | Turbo, DOHC | TD16376 |
| F4R 764 | 1998cc | 4 Cyl. | 16 Valves | 120kW/163PS | Petrol | Turbo, DOHC | TD18281 |
| F4R 765 | 1998cc | 4 Cyl. | 16 Valves | 120kW/163PS | Petrol | Turbo, DOHC | TD18282 |
| F4R 766 | 1998cc | 4 Cyl. | 16 Valves | 125kW/170PS | Petrol | Turbo, DOHC | TD19668 |
| F4R 767 | 1998cc | 4 Cyl. | 16 Valves | 125kW/170PS | Petrol | Turbo, DOHC | TD19669 |
| F4R 770 | 1998cc | 4 Cyl. | 16 Valves | 99-103kW/135-140PS | Petrol | DOHC | TD16533 |
| F4R 771 | 1998cc | 4 Cyl. | 16 Valves | 99-103kW/135-140PS | Petrol | DOHC | TD18301 |
| F4R 776 | 1998cc | 4 Cyl. | 16 Valves | 120kW/163PS | Petrol | Turbo, DOHC | TD19695 |
| F4R 780 | 1998cc | 4 Cyl. | 16 Valves | 103kW/140PS | Petrol | DOHC | TD16475 |
| F4R 784 | 1998cc | 4 Cyl. | 16 Valves | 125kW/170PS | Petrol | Turbo, DOHC | TD21216 |
| F4R 786 | 1998cc | 4 Cyl. | 16 Valves | 120-125kW/163-170PS | Petrol | Turbo, DOHC | TD18283 |
| F4R 787 | 1998cc | 4 Cyl. | 16 Valves | 120-125kW/163-170PS | Petrol | Turbo, DOHC | TD18284 |
| F4R 790 | 1998cc | 4 Cyl. | 16 Valves | 98-100kW/133-136PS | Petrol | DOHC | TD17057 |
| F4R 791 | 1998cc | 4 Cyl. | 16 Valves | 100kW/136PS | Petrol | DOHC | TD17058 |
| F4R 792 | 1998cc | 4 Cyl. | 16 Valves | 100kW/136PS | Petrol | DOHC | TD21197 |
| F4R 794 | 1998cc | 4 Cyl. | 16 Valves | 120kW/163PS | Petrol | Turbo, DOHC | TD17059 |
| F4R 795 | 1998cc | 4 Cyl. | 16 Valves | 120kW/163PS | Petrol | Turbo, DOHC | TD17060 |
| F4R 796 | 1998cc | 4 Cyl. | 16 Valves | 120-125kW/163-170PS | Petrol | Turbo, DOHC | TD23108 |
| F4R 797 | 1998cc | 4 Cyl. | 16 Valves | 120-125kW/163-170PS | Petrol | Turbo, DOHC | TD17061 |
| F4R 820 | 1998cc | 4 Cyl. | 16 Valves | 86kW/117PS | Petrol | DOHC | TD19712 |
| F4R 830 | 1998cc | 4 Cyl. | 16 Valves | 145-148kW/197-200PS | Petrol | DOHC | TD20836 |
| F4Rt 811 | 1998cc | 4 Cyl. | 16 Valves | 125kW/170PS | Petrol | Turbo, DOHC | TD20816 |

| | | | |
|-------------------------|-----------------|--------------------------|-----------------|
| AVANTIME 2.0 16V Turbo | 11/2001→05/2003 | CLIO II 2.0 16V | 02/2000→ |
| CLIO III 2.0 16V | 02/2006→ | ESPACE III 2.0 | 09/2001→10/2002 |
| ESPACE III 2.0 16V | 10/1998→10/2002 | ESPACE IV 2.0 | 11/2002→ |
| ESPACE IV 2.0 Turbo | 11/2002→ | GRAND SCÉNIC II 2.0 | 04/2004→ |
| LAGUNA 2.0 16V Turbo | 09/2008→ | LAGUNA I 2.0 | 09/1999→02/2001 |
| LAGUNA I 2.0 16V | 09/1999→03/2001 | LAGUNA II 2.0 | 09/2002→05/2005 |
| LAGUNA II 2.0 16V | 08/2002→ | LAGUNA II 2.0 16V Turbo | 01/2003→ |
| MEGANE I 2.0 16V | 01/2002→08/2003 | MEGANE II 2.0 | 08/2003→ |
| MEGANE II 2.0 16V | 11/2002→02/2008 | MEGANE II 2.0 16V Turbo | 05/2004→03/2009 |
| SCÉNIC I MPV 2.0 16V | 09/1999→08/2003 | SCÉNIC I MPV 2.0 16V RX4 | 06/2000→08/2003 |
| SCÉNIC II 2.0 | 06/2003→ | SCÉNIC II 2.0 16V Turbo | 05/2004→ |
| TRAFIC II 2.0 | 03/2001→ | TRAFIC II 2.0 16V | 08/2006→ |
| VEL SATIS 2.0 16V Turbo | 06/2002→ | VEL SATIS 2.0 16 V Turbo | 04/2004→ |

V94606 □
33.60 x 5.50 x 110.00

7701 474 287



45°

H

VAG96292B □ □ □
40.60 x 5.50 x 11.07



V94607 □
29.00 x 5.50 x 108.90

7701 474 286



45°

H

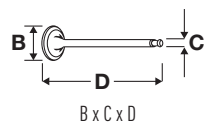

OE

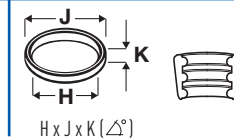
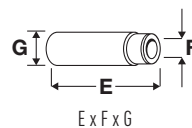

41 82.70

| | | | | | | | |
|----------|--------|--------|-----------|---------------------|--------|-------------|---------|
| F4R 732 | 1998cc | 4 Cyl. | 16 Valves | 124kW/169PS | Petrol | DOHC | TD21212 |
| F4R 736 | 1998cc | 4 Cyl. | 16 Valves | 124-126kW/169-172PS | Petrol | DOHC | TD21213 |
| F4R 747 | 1998cc | 4 Cyl. | 16 Valves | 103kW/140PS | Petrol | DOHC | TD21215 |
| F4R 774 | 1998cc | 4 Cyl. | 16 Valves | 165-169kW/224-230PS | Petrol | Turbo, DOHC | TD20906 |
| F4R 800 | 1998cc | 4 Cyl. | 16 Valves | 150kW/204PS | Petrol | Turbo, DOHC | TD22188 |
| F4R 811 | 1998cc | 4 Cyl. | 16 Valves | 125kW/170PS | Petrol | Turbo, DOHC | TD22189 |
| F4R 832 | 1998cc | 4 Cyl. | 16 Valves | 145-148kW/197-201PS | Petrol | DOHC | TD23547 |
| F4R 867 | 1998cc | 4 Cyl. | 16 Valves | 108kW/147PS | Petrol | DOHC | TD21217 |
| F4R 886 | 1998cc | 4 Cyl. | 16 Valves | 150kW/204PS | Petrol | Turbo, DOHC | TD21218 |
| F4R 887 | 1998cc | 4 Cyl. | 16 Valves | 150kW/204PS | Petrol | Turbo, DOHC | TD21219 |
| F4R 896 | 1998cc | 4 Cyl. | 16 Valves | 125kW/170PS | Petrol | Turbo, DOHC | TD23891 |
| F4R 897 | 1998cc | 4 Cyl. | 16 Valves | 125kW/170PS | Petrol | Turbo, DOHC | TD21220 |
| F4Rt 774 | 1998cc | 4 Cyl. | 16 Valves | 165kW/224PS | Petrol | Turbo, DOHC | TD21108 |

| | | | |
|----------------------|-----------------|--------------------------|-----------------|
| CLIO II 2.0 16V | 02/2000→ | ESPACE IV 2.0 | 04/2005→ |
| LAGUNA 2.0 16V Turbo | 09/2008→ | LAGUNA 2.0 GT | 09/2008→ |
| LAGUNA II 2.0 16V | 01/2005→ | LAGUNA III 2.0 16V Turbo | 10/2007→ |
| LAGUNA III 2.0 GT | 03/2008→ | MEGANE I 2.0 RT | 03/2001→08/2003 |
| MEGANE II 2.0 | 08/2006→02/2008 | MEGANE II 2.0 Renault | 05/2004→10/2009 |
| SCÉNIC I MPV 2.0 16V | 09/1999→08/2003 | VEL SATIS 2.0 Turbo | 04/2005→ |

V94606 ■
33.60 x 5.50 x 110.00

7701 474 287

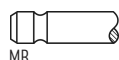

45°

H

VAG96292B
40.60 x 5.50 x 11.07



V94607 ■
29.00 x 5.50 x 108.90

7701 474 286

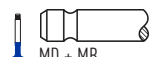

45°

H

42 82.70

| | | | | | | | |
|---------|--------|--------|-----------|---------------------|--------|------|---------|
| F7R 700 | 1998cc | 4 Cyl. | 16 Valves | 108-110kW/147-150PS | Petrol | DOHC | TD3281 |
| F7R 710 | 1998cc | 4 Cyl. | 16 Valves | 108-110kW/147-150PS | Petrol | DOHC | TD4866 |
| F7R 714 | 1998cc | 4 Cyl. | 16 Valves | 108-110kW/147-150PS | Petrol | DOHC | TD16278 |

| | | | |
|------------------|-----------------|----------------------|-----------------|
| CLIO I Williams | 01/1994→09/1998 | MEGANE I 2.0 16V | 03/1996→08/2003 |
| SPORT SPIDER 2.0 | 12/1995→08/1996 | SPORT SPIDER 2.0 16V | 03/1995→10/1999 |

V94436 ■
33.00 x 7.00 x 107.20

7700 865 550

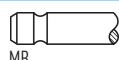

45°

Y

H

VAG96163B ■ ■
39.00 x 7.02 x 12.08

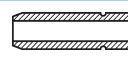

V94440 ■
28.30 x 7.00 x 108.60

7700 865 551

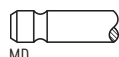

45°

H

43 83.00

| | | | | | | | |
|---------|--------|--------|-----------|-------------|--------|------|--------|
| N7Q 700 | 1948cc | 4 Cyl. | 16 Valves | 102kW/139PS | Petrol | DOHC | TD5529 |
| N7Q 704 | 1948cc | 4 Cyl. | 16 Valves | 102kW/139PS | Petrol | DOHC | TD5530 |
| N7Q 710 | 1948cc | 4 Cyl. | 16 Valves | 100kW/136PS | Petrol | DOHC | TD5547 |
| N7Q 711 | 1948cc | 4 Cyl. | 16 Valves | 100kW/136PS | Petrol | DOHC | TD5548 |

| | | | |
|--------------------|-----------------|------------------|-----------------|
| LAGUNA I 2.0 | 06/1995→02/2001 | LAGUNA I 2.0 16V | 06/1995→03/2001 |
| SAFRANE II 2.0 16V | 07/1996→12/2000 | | |

V94315 ■
31.00 x 7.00 x 104.10

1397641-0

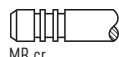

45°

H

VAG96158 ■ ■
45.00 x 7.02 x 12.08

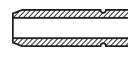

V94044 ■
27.00 x 7.00 x 103.30

7438 610 008

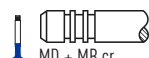

45°

H

V94314 ■
27.00 x 7.00 x 103.30

7438 610 034

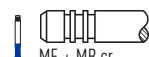

45°

SS

H

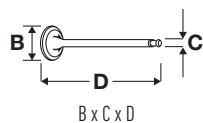

OE

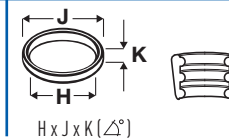
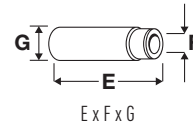

44



84.00

| | | | | | | | |
|---------|--------|--------|-----------|---------------------|--------|-------------|---------|
| M9R 610 | 1995cc | 4 Cyl. | 16 Valves | 118-120kW/160-163PS | Diesel | Turbo, DOHC | TD23557 |
| M9R 615 | 1995cc | 4 Cyl. | 16 Valves | 110kW/150PS | Diesel | Turbo, DOHC | TD23559 |
| M9R 630 | 1995cc | 4 Cyl. | 16 Valves | 66-84kW/90-114PS | Diesel | Turbo, DOHC | TD26729 |
| M9R 692 | 1995cc | 4 Cyl. | 16 Valves | 84kW/114PS | Diesel | Turbo, DOHC | TD26569 |
| M9R 700 | 1995cc | 4 Cyl. | 16 Valves | 110kW/150PS | Diesel | Turbo, DOHC | TD20708 |
| M9R 721 | 1995cc | 4 Cyl. | 16 Valves | 110kW/150PS | Diesel | Turbo, DOHC | TD23502 |
| M9R 722 | 1995cc | 4 Cyl. | 16 Valves | 110kW/150PS | Diesel | Turbo, DOHC | TD23503 |
| M9R 724 | 1995cc | 4 Cyl. | 16 Valves | 127kW/173PS | Diesel | Turbo, DOHC | TD22195 |
| M9R 740 | 1995cc | 4 Cyl. | 16 Valves | 96-110kW/131-150PS | Diesel | Turbo, DOHC | TD19680 |
| M9R 742 | 1995cc | 4 Cyl. | 16 Valves | 96-110kW/131-150PS | Diesel | Turbo, DOHC | TD23504 |
| M9R 744 | 1995cc | 4 Cyl. | 16 Valves | 96-110kW/131-150PS | Diesel | Turbo, DOHC | TD23505 |
| M9R 746 | 1995cc | 4 Cyl. | 16 Valves | 110kW/150PS | Diesel | Turbo, DOHC | TD23506 |
| M9R 748 | 1995cc | 4 Cyl. | 16 Valves | 110kW/150PS | Diesel | Turbo, DOHC | TD23507 |
| M9R 750 | 1995cc | 4 Cyl. | 16 Valves | 96-110kW/131-150PS | Diesel | Turbo, DOHC | TD23508 |
| M9R 760 | 1995cc | 4 Cyl. | 16 Valves | 96-127kW/131-173PS | Diesel | Turbo, DOHC | TD19681 |
| M9R 761 | 1995cc | 4 Cyl. | 16 Valves | 96-127kW/131-173PS | Diesel | Turbo, DOHC | TD23899 |
| M9R 762 | 1995cc | 4 Cyl. | 16 Valves | 96-127kW/131-173PS | Diesel | Turbo, DOHC | TD23900 |
| M9R 763 | 1995cc | 4 Cyl. | 16 Valves | 96-127kW/131-173PS | Diesel | Turbo, DOHC | TD23901 |
| M9R 780 | 1995cc | 4 Cyl. | 16 Valves | 66-84kW/90-114PS | Diesel | Turbo, DOHC | TD19714 |
| M9R 782 | 1995cc | 4 Cyl. | 16 Valves | 66-84kW/90-114PS | Diesel | Turbo, DOHC | TD23109 |
| M9R 784 | 1995cc | 4 Cyl. | 16 Valves | 84kW/114PS | Diesel | Turbo, DOHC | TD25141 |
| M9R 786 | 1995cc | 4 Cyl. | 16 Valves | 66-84kW/90-114PS | Diesel | Turbo, DOHC | TD24966 |
| M9R 788 | 1995cc | 4 Cyl. | 16 Valves | 84kW/114PS | Diesel | Turbo, DOHC | TD25142 |
| M9R 800 | 1995cc | 4 Cyl. | 16 Valves | 127kW/173PS | Diesel | Turbo, DOHC | TD22196 |
| M9R 802 | 1995cc | 4 Cyl. | 16 Valves | 96-110kW/131-150PS | Diesel | Turbo, DOHC | TD22197 |
| M9R 804 | 1995cc | 4 Cyl. | 16 Valves | 127kW/173PS | Diesel | Turbo, DOHC | TD26134 |
| M9R 805 | 1995cc | 4 Cyl. | 16 Valves | 110kW/150PS | Diesel | Turbo, DOHC | TD26244 |
| M9R 809 | 1995cc | 4 Cyl. | 16 Valves | 127kW/173PS | Diesel | Turbo, DOHC | TD22198 |
| M9R 814 | 1995cc | 4 Cyl. | 16 Valves | 96-110kW/131-150PS | Diesel | Turbo, DOHC | TD26247 |
| M9R 815 | 1995cc | 4 Cyl. | 16 Valves | 110-127kW/150-173PS | Diesel | Turbo, DOHC | TD26531 |
| M9R 816 | 1995cc | 4 Cyl. | 16 Valves | 127-132kW/173-180PS | Diesel | Turbo, DOHC | TD22199 |
| M9R 817 | 1995cc | 4 Cyl. | 16 Valves | 127kW/173PS | Diesel | Turbo, DOHC | TD26135 |
| M9R 820 | 1995cc | 4 Cyl. | 16 Valves | 131kW/178PS | Diesel | Turbo, DOHC | TD26532 |
| M9R 824 | 1995cc | 4 Cyl. | 16 Valves | 110kW/150PS | Diesel | Turbo, DOHC | TD26073 |
| M9R 830 | 1995cc | 4 Cyl. | 16 Valves | 127-130kW/173-177PS | Diesel | Turbo, DOHC | TD22206 |
| M9R 832 | 1995cc | 4 Cyl. | 16 Valves | 110kW/150PS | Diesel | Turbo, DOHC | TD22207 |
| M9R 833 | 1995cc | 4 Cyl. | 16 Valves | 110kW/150PS | Diesel | Turbo, DOHC | TD26252 |
| M9R 844 | 1995cc | 4 Cyl. | 16 Valves | 127kW/173PS | Diesel | Turbo, DOHC | TD26533 |
| M9R 845 | 1995cc | 4 Cyl. | 16 Valves | 110kW/150PS | Diesel | Turbo, DOHC | TD26254 |
| M9R 849 | 1995cc | 4 Cyl. | 16 Valves | 110-127kW/150-173PS | Diesel | Turbo, DOHC | TD26253 |
| M9R 855 | 1995cc | 4 Cyl. | 16 Valves | 110kW/150PS | Diesel | Turbo, DOHC | TD26248 |
| M9R 856 | 1995cc | 4 Cyl. | 16 Valves | 110kW/150PS | Diesel | Turbo, DOHC | TD26249 |
| M9R 862 | 1995cc | 4 Cyl. | 16 Valves | 110kW/150PS | Diesel | Turbo, DOHC | TD26255 |
| M9R 864 | 1995cc | 4 Cyl. | 16 Valves | 127kW/173PS | Diesel | Turbo, DOHC | TD26256 |
| M9R 865 | 1995cc | 4 Cyl. | 16 Valves | 110kW/150PS | Diesel | Turbo, DOHC | TD26250 |
| M9R 866 | 1995cc | 4 Cyl. | 16 Valves | 110kW/150PS | Diesel | Turbo, DOHC | TD26251 |

ESPACE IV 2.0 dCi

01/2006→

GRAND SCÉNIC II 2.0 dCi

09/2005→

GRAND SCÉNIC III 2.0 dCi

02/2009→

KOLEOS I 2.0 dCi

09/2008→



OE

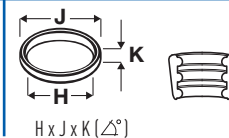
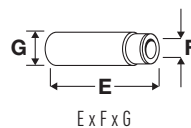
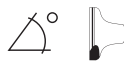

| | | | |
|-----------------------|----------|-----------------------|----------|
| LAGUNA 2.0 dCi | 09/2008→ | LAGUNA 2.0 dCi GT | 09/2008→ |
| LAGUNA II 2.0 dCi | 08/2005→ | LAGUNA III 2.0 dCi | 10/2007→ |
| LAGUNA III 2.0 dCi GT | 03/2008→ | LATITUDE 2.0 dCi 150 | 02/2011→ |
| LATITUDE 2.0 dCi 175 | 05/2011→ | MEGANE CC 2.0 dCi | 06/2010→ |
| MEGANE II 2.0 dCi | 09/2005→ | MEGANE III 2.0 dCi | 04/2009→ |
| SCÉNIC II 2.0 dCi | 09/2005→ | SCÉNIC III 2.0 dCi | 02/2009→ |
| TRAFIC II 2.0 dCi 90 | 08/2006→ | TRAFIC II 2.0 dCi 115 | 08/2006→ |
| VEL SATIS 2.0 dCi | 08/2005→ | | |

V95001 ■
27.70 x 5.98 x 103.90

7701 476 596

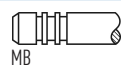

45° Y

H

VAG96383B ■ ■ ■
42.40 x 6.00 x 11.07



V95002 ■
26.00 x 5.97 x 103.75

7701 476 595



45°

H

45



84.00

| | | | | | | | |
|-----------|--------|--------|-----------|--------------------|--------|-------------|---------|
| M9R A 700 | 1995cc | 4 Cyl. | 16 Valves | 110kW/150PS | Diesel | Turbo, DOHC | TD19684 |
| M9R B 610 | 1995cc | 4 Cyl. | 16 Valves | 118kW/160PS | Diesel | Turbo, DOHC | TD23556 |
| M9R B 721 | 1995cc | 4 Cyl. | 16 Valves | 110kW/150PS | Diesel | Turbo, DOHC | TD19685 |
| M9R C 613 | 1995cc | 4 Cyl. | 16 Valves | 110kW/150PS | Diesel | Turbo, DOHC | TD23570 |
| M9R C 615 | 1995cc | 4 Cyl. | 16 Valves | 110kW/150PS | Diesel | Turbo, DOHC | TD23558 |
| M9R C 830 | 1995cc | 4 Cyl. | 16 Valves | 110kW/150PS | Diesel | Turbo, DOHC | TD20968 |
| M9R G 832 | 1995cc | 4 Cyl. | 16 Valves | 110kW/150PS | Diesel | Turbo, DOHC | TD20966 |
| M9Ra 742 | 1995cc | 4 Cyl. | 16 Valves | 96-110kW/131-150PS | Diesel | DOHC | TD20818 |
| M9Rk 800 | 1995cc | 4 Cyl. | 16 Valves | 127kW/173PS | Diesel | DOHC | TD20821 |
| M9Rk 802 | 1995cc | 4 Cyl. | 16 Valves | 96-110kW/131-150PS | Diesel | DOHC | TD20819 |
| M9Rk 805 | 1995cc | 4 Cyl. | 16 Valves | 110kW/150PS | Diesel | DOHC | TD20820 |
| M9Rk 806 | 1995cc | 4 Cyl. | 16 Valves | 127kW/173PS | Diesel | Turbo, DOHC | TD23055 |
| M9Rk 816 | 1995cc | 4 Cyl. | 16 Valves | 131kW/178PS | Diesel | Turbo, DOHC | TD23056 |

V95002 ■
26.00 x 5.97 x 103.75

7701 476 595

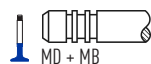

45°

H

VAG96383B ■ ■ ■
42.40 x 6.00 x 11.07



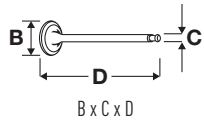

OE



MAT.

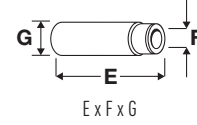

E x F x G

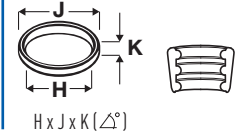

H x J x K (Δ°)

46



85.00

| | | | | | | | |
|----------------------------|----------|--------|------------------|----------------------------|----------|--------------------|----------------|
| M9T 670 | 2298cc | 4 Cyl. | 16 Valves | 74-92kW/101-125PS | Diesel | Turbo, DOHC | TD24269 |
| M9T 672 | 2298cc | 4 Cyl. | 16 Valves | 74-92kW/101-125PS | Diesel | Turbo, DOHC | TD25154 |
| M9T 676 | 2298cc | 4 Cyl. | 16 Valves | 74-92kW/101-125PS | Diesel | Turbo, DOHC | TD24268 |
| M9T 678 | 2298cc | 4 Cyl. | 16 Valves | 107kW/146PS | Diesel | Turbo, DOHC | TD25158 |
| M9T 680 | 2298cc | 4 Cyl. | 16 Valves | 107kW/146PS | Diesel | Turbo, DOHC | TD24295 |
| M9T 686 | 2298cc | 4 Cyl. | 16 Valves | 92kW/125PS | Diesel | Turbo, DOHC | TD25151 |
| M9T 690 | 2298cc | 4 Cyl. | 16 Valves | 74-92kW/101-125PS | Diesel | Turbo, DOHC | TD24270 |
| M9T 692 | 2298cc | 4 Cyl. | 16 Valves | 74-96kW/101-130PS | Diesel | Turbo, DOHC | TD24271 |
| M9T 694 | 2298cc | 4 Cyl. | 16 Valves | 107-110kW/146-150PS | Diesel | Turbo, DOHC | TD24272 |
| M9T 696 | 2298cc | 4 Cyl. | 16 Valves | 92-110kW/125-150PS | Diesel | Turbo, DOHC | TD25150 |
| M9T 698 | 2298cc | 4 Cyl. | 16 Valves | 92-110kW/125-150PS | Diesel | Turbo, DOHC | TD24273 |
| M9T 880 | 2298cc | 4 Cyl. | 16 Valves | 110kW/150PS | Diesel | Turbo, DOHC | TD29756 |
| M9T 896 | 2298cc | 4 Cyl. | 16 Valves | 92-107kW/125-146PS | Diesel | Turbo, DOHC | TD29759 |
| M9T 898 | 2298cc | 4 Cyl. | 16 Valves | 110kW/150PS | Diesel | Turbo, DOHC | TD29757 |
| MASTER III 2.3 dCi 100 | 02/2010→ | | | MASTER III 2.3 dCi 100 RWD | 02/2010→ | | |
| MASTER III 2.3 dCi 125 | 02/2010→ | | | MASTER III 2.3 dCi 125 RWD | 02/2010→ | | |
| MASTER III 2.3 dCi 130 | 06/2016→ | | | MASTER III 2.3 dCi 145 | 02/2010→ | | |
| MASTER III 2.3 dCi 145 RWD | 02/2010→ | | | MASTER III 2.3 dCi 150 | 10/2012→ | | |
| MASTER III 2.3 dCi 150 RWD | 03/2013→ | | | | | | |

V95001 ■
27.70 x 5.98 x 103.90

7701 476 596

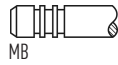

MB

45°

Y

H

V95002 ■
26.00 x 5.97 x 103.75

7701 476 595



MD + MB

45°

H

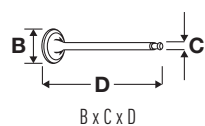

OE

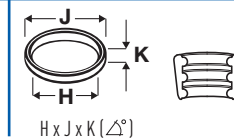
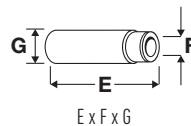

47 **86.00**

| | | | | | | | |
|-------------------|-----------------|--------|----------|----------------------|--------|-----------------|---------|
| 852 | 2068cc | 4 Cyl. | 8 Valves | 47kW/64PS | Diesel | SOHC | TD3077 |
| 852 710 | 2068cc | 4 Cyl. | 8 Valves | 49kW/67PS | Diesel | SOHC | TD3078 |
| 852 720 | 2068cc | 4 Cyl. | 8 Valves | 43-44kW/58-60PS | Diesel | SOHC | TD3079 |
| 852 750 | 2068cc | 4 Cyl. | 8 Valves | 43-44kW/58-60PS | Diesel | SOHC | TD3080 |
| J8S 232 (852.232) | 2068cc | 4 Cyl. | 8 Valves | 43kW/60PS | Diesel | SOHC | TD3384 |
| J8S 240 | 2068cc | 4 Cyl. | 8 Valves | 65kW/88PS | Diesel | Turbo, SOHC | TD3386 |
| J8S 330 | 2068cc | 4 Cyl. | 8 Valves | 44-46kW/60-63PS | Diesel | SOHC | TD3387 |
| J8S 600 | 2068cc | 4 Cyl. | 8 Valves | 53kW/72PS | Diesel | SOHC | TD3388 |
| J8S 604 | 2068cc | 4 Cyl. | 8 Valves | 65kW/88PS | Diesel | Turbo, SOHC | TD3389 |
| J8S 610 | 2068cc | 4 Cyl. | 8 Valves | 65kW/88PS | Diesel | Turbo, SOHC | TD3390 |
| J8S 612 | 2068cc | 4 Cyl. | 8 Valves | 66kW/90PS | Diesel | Turbo, SOHC | TD5525 |
| J8S 620 | 2068cc | 4 Cyl. | 8 Valves | 47kW/64PS | Diesel | SOHC | TD5564 |
| J8S 702 | 2068cc | 4 Cyl. | 8 Valves | 63kW/86PS | Diesel | Turbo, SOHC | TD3382 |
| J8S 704 | 2068cc | 4 Cyl. | 8 Valves | 48-50kW/65-68PS | Diesel | SOHC | TD3391 |
| J8S 706 | 2068cc | 4 Cyl. | 8 Valves | 46kW/63PS | Diesel | SOHC | TD3392 |
| J8S 708 | 2068cc | 4 Cyl. | 8 Valves | 63kW/86PS | Diesel | Turbo, SOHC | TD3393 |
| J8S 711 | 2068cc | 4 Cyl. | 8 Valves | 49-53kW/67-72PS | Diesel | SOHC | TD5431 |
| J8S 712 | 2068cc | 4 Cyl. | 8 Valves | 65kW/88PS | Diesel | Turbo, SOHC | TD3394 |
| J8S 714 | 2068cc | 4 Cyl. | 8 Valves | 65kW/88PS | Diesel | Turbo, SOHC | TD3395 |
| J8S 736 | 2068cc | 4 Cyl. | 8 Valves | 51kW/69PS | Diesel | SOHC | TD3396 |
| J8S 738 | 2068cc | 4 Cyl. | 8 Valves | 63kW/86PS | Diesel | Turbo, SOHC | TD3397 |
| J8S 740 | 2068cc | 4 Cyl. | 8 Valves | 53kW/72PS | Diesel | SOHC | TD3398 |
| J8S 742 | 2068cc | 4 Cyl. | 8 Valves | 65kW/88PS | Diesel | Turbo, SOHC | TD3399 |
| J8S 746 | 2068cc | 4 Cyl. | 8 Valves | 65kW/88PS | Diesel | Turbo, SOHC | TD3400 |
| J8S 758 | 2068cc | 4 Cyl. | 8 Valves | 47kW/64PS | Diesel | SOHC | TD5565 |
| J8S 760 | 2068cc | 4 Cyl. | 8 Valves | 65-66kW/88-90PS | Diesel | Turbo, SOHC | TD3401 |
| J8S 772 | 2068cc | 4 Cyl. | 8 Valves | 65kW/88PS | Diesel | Turbo, SOHC | TD3402 |
| J8S 774 | 2068cc | 4 Cyl. | 8 Valves | 65kW/88PS | Diesel | Turbo, SOHC | TD3403 |
| J8S 776 | 2068cc | 4 Cyl. | 8 Valves | 65kW/88PS | Diesel | Turbo, SOHC | TD3404 |
| J8S 778 | 2068cc | 4 Cyl. | 8 Valves | 65kW/88PS | Diesel | Turbo, SOHC | TD3405 |
| J8S 784 | 2068cc | 4 Cyl. | 8 Valves | 51kW/69PS | Diesel | SOHC | TD3406 |
| J8S 786 (KAT) | 2068cc | 4 Cyl. | 8 Valves | 65kW/88PS | Diesel | Turbo, SOHC | TD3407 |
| J8S 788 | 2068cc | 4 Cyl. | 8 Valves | 65kW/88PS | Diesel | Turbo, SOHC | TD3408 |
| J8S 852 | 2068cc | 4 Cyl. | 8 Valves | 63kW/85PS | Diesel | SOHC | TD3081 |
| J8S 890 | 2068cc | 4 Cyl. | 8 Valves | 65kW/88PS | Diesel | Turbo, SOHC | TD21258 |
| 18 2.1 Diesel | 05/1979→07/1986 | | | 18 2.1 TD | | 11/1981→07/1986 | |
| 20 2.1 Diesel | 10/1980→12/1983 | | | 20 2.1 TD | | 01/1982→12/1983 | |
| 21 2.1 D | 03/1986→09/1995 | | | 21 2.1 TD | | 04/1986→06/1989 | |
| 21 2.1 Turbo-D | 03/1986→06/1994 | | | 25 2.1 Diesel | | 04/1984→12/1992 | |
| 25 2.1 Turbo-D | 04/1984→12/1992 | | | 30 2.1 Turbo-D | | 02/1982→03/1986 | |
| ESPACE I 2.1 TD | 10/1984→12/1990 | | | ESPACE II 2.1 RTDT | | 01/1991→05/1992 | |
| ESPACE II 2.1 TD | 01/1991→10/1996 | | | FUEGO 2.1 TD | | 08/1982→10/1985 | |
| MASTER I 2.1 D | 11/1989→04/1995 | | | MASTER I 28-35 2.1 D | | 08/1980→07/1998 | |
| SAFRANE I 2.1 dT | 11/1993→07/1996 | | | TRAFIC 2.1 D | | 03/1980→04/1998 | |
| TRAFIC 2.1 D RWD | 05/1989→10/1997 | | | | | | |

V91264 ■
40.50 x 8.00 x 111.50

7701 461 338

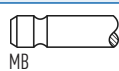

45°

H

V91265 ■
33.50 x 8.00 x 111.50

7701 461 339

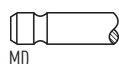

45°



OE





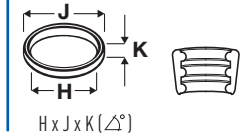
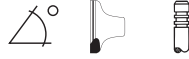

MAT.



48  **87.00**

| | | | | | | | |
|---------|--------|--------|-----------|-----------|--------|------|---------|
| G8T 706 | 2188cc | 4 Cyl. | 12 Valves | 61kW/83PS | Diesel | SOHC | TD3301 |
| G8T 752 | 2188cc | 4 Cyl. | 12 Valves | 61kW/83PS | Diesel | SOHC | TD4872 |
| G8T 790 | 2188cc | 4 Cyl. | 12 Valves | 61kW/83PS | Diesel | SOHC | TD4873 |
| G8T 792 | 2188cc | 4 Cyl. | 12 Valves | 61kW/83PS | Diesel | SOHC | TD18886 |
| G8T 794 | 2188cc | 4 Cyl. | 12 Valves | 61kW/83PS | Diesel | SOHC | TD4874 |





LAGUNA I 2.2 D 11/1993→03/2001

| | | | | |
|---|--------------|---|-----|---|
| V94337  | 7701 469 684 |  | 45° | H |
| 32.10 x 7.00 x 117.60 | | MB | | |
| V94319  | 7701 468 170 |  | 45° | |
| 31.10 x 7.00 x 117.60 | | MD cr | | |

49  **87.00**

| | | | | | | | |
|---------|--------|--------|-----------|------------|--------|-------------|---------|
| G8T 714 | 2188cc | 4 Cyl. | 12 Valves | 83kW/113PS | Diesel | Turbo, SOHC | TD16308 |
| G8T 716 | 2188cc | 4 Cyl. | 12 Valves | 83kW/113PS | Diesel | Turbo, SOHC | TD16309 |
| G8T 740 | 2188cc | 4 Cyl. | 12 Valves | 83kW/113PS | Diesel | Turbo, SOHC | TD3300 |
| G8T 760 | 2188cc | 4 Cyl. | 12 Valves | 83kW/113PS | Diesel | Turbo, SOHC | TD4871 |

ESPACE III 2.2 12V TD 11/1996→10/2000 ESPACE III 2.2 D 11/1997→01/2000
LAGUNA I 2.2 dT 03/1996→03/2001 SAFRANE II 2.2 dT 07/1996→12/2000

| | | | | | |
|---|--------------|---|-----|----|---|
| V94562  | 7700 859 517 |  | 45° | SS | H |
| 32.10 x 7.00 x 117.60 | | MD + MB cr | | | |
| V94319  | 7701 468 170 |  | 45° | | |
| 31.10 x 7.00 x 117.60 | | MD cr | | | |

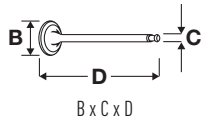

OE

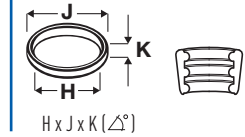
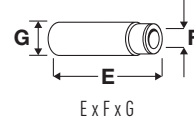

50 87.00

| | | | | | | | |
|----------------------|-----------------|--------|-----------|---------------------|--------|-----------------|---------|
| G9T 600 | 2188cc | 4 Cyl. | 16 Valves | 83-102kW/113-139PS | Diesel | Turbo, DOHC | TD19667 |
| G9T 605 | 2188cc | 4 Cyl. | 16 Valves | 102kW/139PS | Diesel | Turbo, DOHC | TD19682 |
| G9T 606 | 2188cc | 4 Cyl. | 16 Valves | 78-102kW/106-139PS | Diesel | Turbo, DOHC | TD21209 |
| G9T 607 | 2188cc | 4 Cyl. | 16 Valves | 102-110kW/139-150PS | Diesel | Turbo, DOHC | TD23896 |
| G9T 642 | 2188cc | 4 Cyl. | 16 Valves | 95-110kW/129-150PS | Diesel | Turbo, DOHC | TD23177 |
| G9T 645 | 2188cc | 4 Cyl. | 16 Valves | 102kW/139PS | Diesel | Turbo, DOHC | TD21198 |
| G9T 700 | 2188cc | 4 Cyl. | 16 Valves | 83-110kW/113-150PS | Diesel | Turbo, DOHC | TD20978 |
| G9T 702 | 2188cc | 4 Cyl. | 16 Valves | 83-110kW/113-150PS | Diesel | Turbo, DOHC | TD16288 |
| G9T 703 | 2188cc | 4 Cyl. | 16 Valves | 110kW/150PS | Diesel | Turbo, DOHC | TD16377 |
| G9T 704 | 2188cc | 4 Cyl. | 16 Valves | 110kW/150PS | Diesel | Turbo, DOHC | TD20975 |
| G9T 706 | 2188cc | 4 Cyl. | 16 Valves | 102-110kW/139-150PS | Diesel | Turbo, DOHC | TD20976 |
| G9T 707 | 2188cc | 4 Cyl. | 16 Valves | 102-110kW/139-150PS | Diesel | Turbo, DOHC | TD20977 |
| G9T 710 | 2188cc | 4 Cyl. | 16 Valves | 85-95kW/115-130PS | Diesel | Turbo, DOHC | TD16310 |
| G9T 712 | 2188cc | 4 Cyl. | 16 Valves | 110kW/150PS | Diesel | Turbo, DOHC | TD18298 |
| G9T 720 | 2188cc | 4 Cyl. | 16 Valves | 66kW/90PS | Diesel | Turbo, DOHC | TD14928 |
| G9T 722 | 2188cc | 4 Cyl. | 16 Valves | 66kW/90PS | Diesel | Turbo, DOHC | TD16302 |
| G9T 742 | 2188cc | 4 Cyl. | 16 Valves | 110kW/150PS | Diesel | Turbo, DOHC | TD17062 |
| G9T 743 | 2188cc | 4 Cyl. | 16 Valves | 110kW/150PS | Diesel | Turbo, DOHC | TD17063 |
| G9T 750 | 2188cc | 4 Cyl. | 16 Valves | 66kW/90PS | Diesel | Turbo, DOHC | TD19088 |
| AVANTIME 2.2 dCi | 05/2002→05/2003 | | | ESPACE III 2.2 dCi | | 07/2000→10/2002 | |
| ESPACE IV 2.2 dCi | 11/2002→ | | | LAGUNA II 2.2 dCi | | 10/2001→ | |
| MASTER II 2.2 dCi 90 | 09/2000→ | | | VEL SATIS 2.2 dCi | | 06/2002→ | |

V94513
30.70 x 6.00 x 123.10

7701 472 669

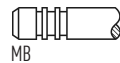

45°

H

VAG96361B
50.00 x 6.00 x 11.05



V94514
29.50 x 6.00 x 122.90

7701 472 670

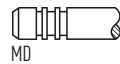

45°

51 87.00

| | | | | | | | |
|-------------------|-----------------|---------|-----------|---------------------|--------|-----------------|---------|
| L7X 700 | 2946cc | V6 Cyl. | 24 Valves | 140-142kW/190-194PS | Petrol | DOHC | TD16207 |
| L7X 701 | 2946cc | V6 Cyl. | 24 Valves | 140-142kW/190-194PS | Petrol | DOHC | TD16208 |
| L7X 727 | 2946cc | V6 Cyl. | 24 Valves | 140kW/190PS | Petrol | DOHC | TD16311 |
| ESPACE III 3.0 V6 | 10/1998→10/2002 | | | LAGUNA I 3.0 | | 03/1997→08/2002 | |

V94173
33.80 x 6.00 x 108.40

96 219 217

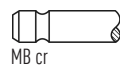

45°

Y

H

52 87.50

| | | | | | | | |
|-------------------|----------|---------|-----------|---------------------|--------|----------|---------|
| P9X 701 | 2958cc | V6 Cyl. | 24 Valves | 120-130kW/163-177PS | Diesel | DOHC | TD16289 |
| ESPACE IV 3.0 dCi | 11/2002→ | | | VEL SATIS 3.0 dCi | | 06/2002→ | |

V94513
30.70 x 6.00 x 123.10

7701 472 669

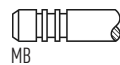

45°

H

VAG96295
42.00 x 6.01 x 11.04



V94514
29.50 x 6.00 x 122.90

7701 472 670

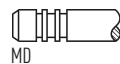

45°

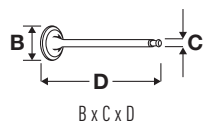

OE

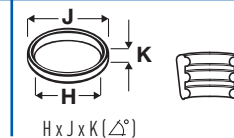
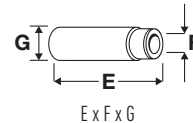

53



88.00

| | | | | | | | |
|---------|--------|--------|-----------|--------------------|--------|-------------|---------|
| 829 710 | 1995cc | 4 Cyl. | 8 Valves | 81kW/110PS | Petrol | SOHC | TD3044 |
| 829 730 | 1995cc | 4 Cyl. | 8 Valves | 59kW/80PS | Petrol | SOHC | TD3045 |
| 829 731 | 1995cc | 4 Cyl. | 8 Valves | 57-59kW/78-82PS | Petrol | SOHC | TD3046 |
| J5R 716 | 1995cc | 4 Cyl. | 8 Valves | 59-62kW/80-84PS | Petrol | SOHC | TD3302 |
| J5R 718 | 1995cc | 4 Cyl. | 8 Valves | 57-60kW/78-82PS | Petrol | SOHC | TD3303 |
| J5R 722 | 1995cc | 4 Cyl. | 8 Valves | 59kW/80PS | Petrol | SOHC | TD3304 |
| J5R 726 | 1995cc | 4 Cyl. | 8 Valves | 59kW/80PS | Petrol | SOHC | TD3305 |
| J5R 728 | 1995cc | 4 Cyl. | 8 Valves | 58-60kW/79-82PS | Petrol | SOHC | TD3306 |
| J5R 800 | 1995cc | 4 Cyl. | 8 Valves | 61-63kW/85-86PS | Petrol | SOHC | TD21103 |
| J6R 234 | 1995cc | 4 Cyl. | 8 Valves | 79-81kW/107-110PS | Petrol | SOHC | TD3308 |
| J6R 236 | 1995cc | 4 Cyl. | 8 Valves | 80kW/108PS | Petrol | SOHC | TD3309 |
| J6R 706 | 1995cc | 4 Cyl. | 8 Valves | 74kW/101PS | Petrol | SOHC | TD3310 |
| J6R 707 | 1995cc | 4 Cyl. | 8 Valves | 74kW/101PS | Petrol | SOHC | TD3311 |
| J6R 710 | 1995cc | 4 Cyl. | 8 Valves | 81kW/110PS | Petrol | SOHC | TD3312 |
| J6R 711 | 1995cc | 4 Cyl. | 8 Valves | 77-79kW/105-107PS | Petrol | SOHC | TD5063 |
| J6R 712 | 1995cc | 4 Cyl. | 8 Valves | 81kW/110PS | Petrol | SOHC | TD3314 |
| J6R 713 | 1995cc | 4 Cyl. | 8 Valves | 81kW/110PS | Petrol | SOHC | TD3315 |
| J6R 714 | 1995cc | 4 Cyl. | 8 Valves | 75-77kW/102-105PS | Petrol | SOHC | TD5062 |
| J6R 715 | 1995cc | 4 Cyl. | 8 Valves | 81kW/110PS | Petrol | SOHC | TD3319 |
| J6R 716 | 1995cc | 4 Cyl. | 8 Valves | 77kW/105PS | Petrol | SOHC | TD5064 |
| J6R 726 | 1995cc | 4 Cyl. | 8 Valves | 81kW/110PS | Petrol | SOHC | TD3322 |
| J6R 734 | 1995cc | 4 Cyl. | 8 Valves | 74kW/101PS | Petrol | SOHC | TD3323 |
| J6R 758 | 1995cc | 4 Cyl. | 8 Valves | 75-78kW/102-106PS | Petrol | SOHC | TD3324 |
| J6R 759 | 1995cc | 4 Cyl. | 8 Valves | 75kW/102PS | Petrol | SOHC | TD3325 |
| J6R 760 | 1995cc | 4 Cyl. | 8 Valves | 74kW/101PS | Petrol | SOHC | TD3326 |
| J6R 762 | 1995cc | 4 Cyl. | 8 Valves | 74kW/101PS | Petrol | SOHC | TD3327 |
| J6R 763 | 1995cc | 4 Cyl. | 8 Valves | 74kW/101PS | Petrol | SOHC | TD3328 |
| J6R 792 | 1995cc | 4 Cyl. | 8 Valves | 75kW/102PS | Petrol | SOHC | TD3329 |
| J6R 793 | 1995cc | 4 Cyl. | 8 Valves | 75kW/102PS | Petrol | SOHC | TD3330 |
| J7R 720 | 1995cc | 4 Cyl. | 12 Valves | 103kW/140PS | Petrol | SOHC | TD3333 |
| J7R 721 | 1995cc | 4 Cyl. | 12 Valves | 103kW/140PS | Petrol | SOHC | TD3334 |
| J7R 722 | 1995cc | 4 Cyl. | 8 Valves | 88kW/120PS | Petrol | SOHC | TD3335 |
| J7R 723 | 1995cc | 4 Cyl. | 8 Valves | 88kW/120PS | Petrol | SOHC | TD3336 |
| J7R 726 | 1995cc | 4 Cyl. | 12 Valves | 99-100kW/135-136PS | Petrol | SOHC | TD3337 |
| J7R 732 | 1995cc | 4 Cyl. | 8 Valves | 77kW/105PS | Petrol | SOHC | TD3338 |
| J7R 733 | 1995cc | 4 Cyl. | 8 Valves | 77kW/105PS | Petrol | SOHC | TD3339 |
| J7R 738 | 1995cc | 4 Cyl. | 8 Valves | 97-99kW/135-135PS | Petrol | SOHC | TD3342 |
| J7R 739 | 1995cc | 4 Cyl. | 8 Valves | 97-99kW/135-135PS | Petrol | SOHC | TD3343 |
| J7R 740 | 1995cc | 4 Cyl. | 12 Valves | 99-100kW/134-136PS | Petrol | SOHC | TD3344 |
| J7R 746 | 1995cc | 4 Cyl. | 8 Valves | 88kW/120PS | Petrol | SOHC | TD3345 |
| J7R 747 | 1995cc | 4 Cyl. | 8 Valves | 88kW/120PS | Petrol | SOHC | TD3346 |
| J7R 750 | 1995cc | 4 Cyl. | 8 Valves | 85-86kW/116-117PS | Petrol | SOHC | TD3347 |
| J7R 751 | 1995cc | 4 Cyl. | 8 Valves | 85-86kW/116-117PS | Petrol | SOHC | TD3348 |
| J7R 752 | 1995cc | 4 Cyl. | 8 Valves | 129kW/175PS | Petrol | Turbo, SOHC | TD3349 |
| J7R 754 | 1995cc | 4 Cyl. | 12 Valves | 98-100kW/133-136PS | Petrol | SOHC | TD3350 |
| J7R 756 | 1995cc | 4 Cyl. | 8 Valves | 119kW/162PS | Petrol | Turbo, SOHC | TD3351 |
| J7R 760 | 1995cc | 4 Cyl. | 8 Valves | 87-88kW/118-120PS | Petrol | SOHC | TD3352 |
| J7R 768 | 1995cc | 4 Cyl. | 8 Valves | 76kW/103PS | Petrol | SOHC | TD3353 |



OE

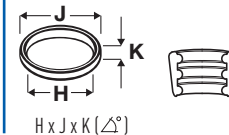
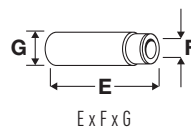
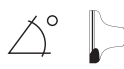

| | | | |
|----------------|-----------------|--------------------|-----------------|
| 18 2.0 | 10/1981→12/1986 | 21 2.0 | 03/1986→06/1994 |
| 21 2.0 Turbo | 04/1987→10/1993 | 21 2.0 TXi | 07/1989→08/1994 |
| 25 2.0 | 04/1984→12/1993 | 25 2.0 12V | 06/1988→12/1993 |
| ESPACE I 2.0 | 07/1984→12/1990 | ESPACE I 2.0 i | 03/1988→12/1992 |
| ESPACE II 2.0 | 01/1991→10/1996 | FUEGO 2.0 TX/GTX | 10/1980→11/1986 |
| MASTER I 2.0 | 07/1980→12/1995 | MASTER I 28-35 2.0 | 08/1980→07/1998 |
| SAFRANE I 2.0 | 11/1992→07/1996 | TRAFIC 2.0 | 03/1980→12/1991 |
| TRAFIC 2.0 RWD | 05/1989→10/1997 | | |

V90371 ■
44.00 x 8.00 x 112.00

7701 460 147

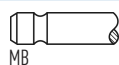

30°

H

VAG92337 ■ ■ ■
51.00 x 8.00 x 13.30

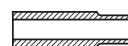

V91263 ■
38.50 x 8.00 x 111.50

7701 460 148

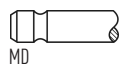

45°

54



88.00

| | | | | | | | |
|-------------------|--------|-----------------|------------------|-------------------|--------|-------------|---------------|
| J7R 734 | 1995cc | 4 Cyl. | 12 Valves | 97-99kW/132-135PS | Petrol | SOHC | TD3340 |
| J7R 735 | 1995cc | 4 Cyl. | 12 Valves | 97-99kW/132-135PS | Petrol | SOHC | TD3341 |
| SAFRANE I 2.0 12V | | 04/1992→07/1996 | | | | | |

V94552 ■
40.15 x 7.00 x 112.00

7701 465 497

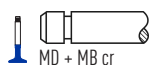

45°

ss

H



OE

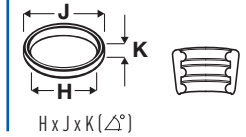

55



88.00

| | | | | | | | |
|-----------------|--------|-----------------|----------|-------------------|--------|-----------------|---------|
| J7T 700 | 2165cc | 4 Cyl. | 8 Valves | 85kW/116PS | Petrol | SOHC | TD3076 |
| J7T 600 | 2165cc | 4 Cyl. | 8 Valves | 74kW/101PS | Petrol | SOHC | TD5563 |
| J7T 706 | 2165cc | 4 Cyl. | 8 Valves | 89kW/121PS | Petrol | SOHC | TD3355 |
| J7T 707 | 2165cc | 4 Cyl. | 8 Valves | 89kW/121PS | Petrol | SOHC | TD3356 |
| J7T 708 | 2165cc | 4 Cyl. | 8 Valves | 76-79kW/103-107PS | Petrol | SOHC | TD3357 |
| J7T 714 | 2165cc | 4 Cyl. | 8 Valves | 89-91kW/121-124PS | Petrol | SOHC | TD3358 |
| J7T 715 | 2165cc | 4 Cyl. | 8 Valves | 89-91kW/121-124PS | Petrol | SOHC | TD3359 |
| J7T 718 | 2165cc | 4 Cyl. | 8 Valves | 76-85kW/103-116PS | Petrol | SOHC | TD3360 |
| J7T 719 | 2165cc | 4 Cyl. | 8 Valves | 77kW/105PS | Petrol | SOHC | TD3362 |
| J7T 730 | 2165cc | 4 Cyl. | 8 Valves | 88-91kW/120-124PS | Petrol | SOHC | TD3364 |
| J7T 731 | 2165cc | 4 Cyl. | 8 Valves | 88-91kW/120-124PS | Petrol | SOHC | TD3365 |
| J7T 732 | 2165cc | 4 Cyl. | 8 Valves | 76-79kW/104-107PS | Petrol | SOHC | TD3366 |
| J7T 733 | 2165cc | 4 Cyl. | 8 Valves | 79kW/107PS | Petrol | SOHC | TD3367 |
| J7T 734 | 2165cc | 4 Cyl. | 8 Valves | 75-80kW/102-109PS | Petrol | SOHC | TD3368 |
| J7T 736 | 2165cc | 4 Cyl. | 8 Valves | 79kW/107PS | Petrol | SOHC | TD3369 |
| J7T 754 | 2165cc | 4 Cyl. | 8 Valves | 79kW/107PS | Petrol | SOHC | TD3370 |
| J7T 755 | 2165cc | 4 Cyl. | 8 Valves | 79-81kW/107-110PS | Petrol | SOHC | TD3371 |
| J7T 756 | 2165cc | 4 Cyl. | 8 Valves | 79-81kW/107-110PS | Petrol | SOHC | TD3372 |
| J7T 762 | 2165cc | 4 Cyl. | 8 Valves | 79-81kW/107-110PS | Petrol | SOHC | TD3375 |
| J7T 763 | 2165cc | 4 Cyl. | 8 Valves | 79-81kW/107-110PS | Petrol | SOHC, Injection | TD3376 |
| J7T 770 | 2165cc | 4 Cyl. | 8 Valves | 79-81kW/107-110PS | Petrol | SOHC | TD3377 |
| J7T 772 | 2165cc | 4 Cyl. | 8 Valves | 79-81kW/107-110PS | Petrol | SOHC | TD3378 |
| J7T 773 | 2165cc | 4 Cyl. | 8 Valves | 79-81kW/108-110PS | Petrol | SOHC | TD5524 |
| J7T 776 | 2165cc | 4 Cyl. | 8 Valves | 79-81kW/107-110PS | Petrol | SOHC | TD3379 |
| J7T 780 | 2165cc | 4 Cyl. | 8 Valves | 70kW/95PS | Petrol | SOHC | TD3380 |
| J7T 782 | 2165cc | 4 Cyl. | 8 Valves | 67-69kW/91-94PS | Petrol | SOHC | TD3381 |
| J7T 788 | 2165cc | 4 Cyl. | 8 Valves | 67-71kW/91-97PS | Petrol | SOHC | TD12736 |
| 18 2.2 i | | 06/1984→07/1986 | | 20 2.2 | | 10/1980→12/1983 | |
| 21 2.2 | | 04/1986→07/1997 | | 25 2.2 | | 04/1984→12/1992 | |
| ESPACE I 2.2 | | 07/1986→12/1990 | | ESPACE II 2.2 | | 01/1991→12/1996 | |
| FUEGO 2.2 | | 11/1984→06/1988 | | MASTER I 2.2 | | 08/1993→02/1998 | |
| MASTER I 30 2.2 | | 08/1980→07/1998 | | SAFRANE I 2.2 | | 04/1992→07/1996 | |
| TRAFIC 2.2 | | 05/1989→04/1998 | | | | | |

V90371 ■
44.00 x 8.00 x 112.00

7701 460 147

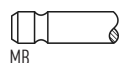

30°

H

VAG92337 ■ ■ ■
51.00 x 8.00 x 13.30

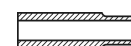

V91263 ■
38.50 x 8.00 x 111.50

7701 460 148

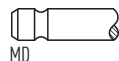

45°

56



88.00

| | | | | | | | |
|---------|--------|--------|-----------|-------------|--------|------|--------|
| J7T 760 | 2165cc | 4 Cyl. | 12 Valves | 101kW/137PS | Petrol | SOHC | TD3373 |
| J7T 761 | 2165cc | 4 Cyl. | 12 Valves | 101kW/137PS | Petrol | SOHC | TD3374 |

SAFRANE I 2.2

04/1992→07/1996

V94552 ■
40.15 x 7.00 x 112.00

7701 465 497



45°

ss

H

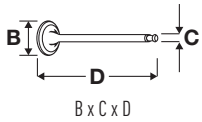

OE

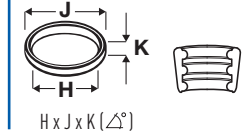
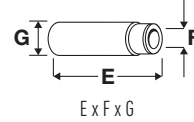
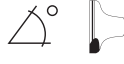

57 **88.00**

| | | | | | | | |
|---------|--------|---------|-----------|-------------------|--------|------|---------|
| 112 | 2664cc | V6 Cyl. | 12 Valves | 92-96kW/125-131PS | Petrol | SOHC | TD3410 |
| 140 | 2664cc | V6 Cyl. | 12 Valves | 105kW/143PS | Petrol | SOHC | TD3411 |
| 144.01 | 2664cc | V6 Cyl. | 12 Valves | 85-96kW/116-131PS | Petrol | SOHC | TD22488 |
| Z7V 709 | 2664cc | V6 Cyl. | 12 Valves | 104kW/141PS | Petrol | SOHC | TD3442 |
| Z7V 711 | 2664cc | V6 Cyl. | 12 Valves | 104kW/141PS | Petrol | SOHC | TD3443 |

| | | | |
|-----------|-----------------|--------|-----------------|
| 25 2.7 V6 | 04/1984→08/1989 | 30 2.6 | 02/1975→08/1978 |
| 30 2.6 TX | 10/1978→12/1983 | | |

| | | | | | | |
|-----------------------|--------------|----|-----|---|----------------------|--|
| V90371 | 7701 460 147 | | 30° | H | VAG92337 | |
| 44.00 x 8.00 x 112.00 | | MB | | | 51.00 x 8.00 x 13.30 | |
| V91263 | 7701 460 148 | | 45° | | | |
| 38.50 x 8.00 x 111.50 | | MD | | | | |

58 **89.00**

| | | | | | | | |
|---------|--------|--------|-----------|--------------------|--------|-------------|---------|
| G9U 630 | 2464cc | 4 Cyl. | 16 Valves | 84-107kW/114-146PS | Diesel | Turbo, DOHC | TD19713 |
| G9U 632 | 2464cc | 4 Cyl. | 16 Valves | 88-107kW/120-146PS | Diesel | Turbo, DOHC | TD21013 |
| G9U 650 | 2464cc | 4 Cyl. | 16 Valves | 74-88kW/101-120PS | Diesel | Turbo, DOHC | TD21011 |
| G9U 720 | 2464cc | 4 Cyl. | 16 Valves | 84kW/115PS | Diesel | Turbo, DOHC | TD16303 |
| G9U 724 | 2464cc | 4 Cyl. | 16 Valves | 84-85kW/115-116PS | Diesel | Turbo, DOHC | TD19366 |
| G9U 730 | 2464cc | 4 Cyl. | 16 Valves | 99kW/135PS | Diesel | Turbo, DOHC | TD18275 |
| G9U 750 | 2464cc | 4 Cyl. | 16 Valves | 84kW/115PS | Diesel | Turbo, DOHC | TD19359 |
| G9U 754 | 2464cc | 4 Cyl. | 16 Valves | 73-85kW/99-115PS | Diesel | Turbo, DOHC | TD19085 |

| | | | |
|-----------------------|----------|-----------------------|-----------------|
| MASTER II 2.5 dCi | 10/2004→ | MASTER II 2.5 dCi 100 | 10/2003→ |
| MASTER II 2.5 dCi 120 | 10/2001→ | TRAFIC II 2.5 dCi | 08/2007→ |
| TRAFIC II 2.5 dCi 115 | 02/2008→ | TRAFIC II 2.5 dCi 135 | 03/2001→ |
| TRAFIC II 2.5 dCi 145 | 08/2006→ | TRAFIC II 2.5 DTi | 03/2003→07/2003 |

| | | | | | | |
|-----------------------|--------------|----|-----|---|----------------------|--|
| V94513 | 7701 472 669 | | 45° | H | VAG96361B | |
| 30.70 x 6.00 x 123.10 | | MB | | | 50.00 x 6.00 x 11.05 | |
| V94514 | 7701 472 670 | | 45° | | | |
| 29.50 x 6.00 x 122.90 | | MD | | | | |

59 **91.00**

| | | | | | | | |
|---------|--------|---------|-----------|---------------------|--------|------|---------|
| Z6W 700 | 2849cc | V6 Cyl. | 12 Valves | 116kW/158PS | Petrol | SOHC | TD3435 |
| Z6W 702 | 2849cc | V6 Cyl. | 12 Valves | 116kW/158PS | Petrol | SOHC | TD3436 |
| Z7W 700 | 2849cc | V6 Cyl. | 12 Valves | 115kW/156PS | Petrol | SOHC | TD3444 |
| Z7W 701 | 2849cc | V6 Cyl. | 12 Valves | 115kW/156PS | Petrol | SOHC | TD3445 |
| Z7W 702 | 2849cc | V6 Cyl. | 12 Valves | 100kW/136PS | Petrol | SOHC | TD3446 |
| Z7W 706 | 2849cc | V6 Cyl. | 12 Valves | 110-112kW/150-153PS | Petrol | SOHC | TD3447 |
| Z7W 707 | 2849cc | V6 Cyl. | 12 Valves | 110-112kW/150-153PS | Petrol | SOHC | TD3448 |
| Z7W 709 | 2849cc | V6 Cyl. | 12 Valves | 110kW/150PS | Petrol | SOHC | TD3449 |
| Z7W 712 | 2849cc | V6 Cyl. | 12 Valves | 110kW/150PS | Petrol | SOHC | TD3450 |
| Z7W 713 | 2849cc | V6 Cyl. | 12 Valves | 110kW/150PS | Petrol | SOHC | TD3451 |
| Z7W 717 | 2849cc | V6 Cyl. | 12 Valves | 110kW/150PS | Petrol | SOHC | TD17866 |

| | | | |
|-----------|-----------------|------------------|-----------------|
| 25 2.8 V6 | 06/1986→12/1992 | ESPACE II 2.8 V6 | 01/1991→10/1996 |
|-----------|-----------------|------------------|-----------------|

| | | | | | | |
|-----------------------|--------------|----|-----|---|----------------------|--|
| V90371 | 7701 460 147 | | 30° | H | VAG92337 | |
| 44.00 x 8.00 x 112.00 | | MB | | | 51.00 x 8.00 x 13.30 | |
| V91263 | 7701 460 148 | | 45° | | | |
| 38.50 x 8.00 x 111.50 | | MD | | | | |



OE

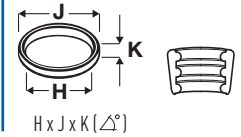
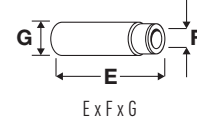

60  **93.00**

| | | | | | | | |
|------------------------|--------|-----------------|-----------------|----------------------|--------|---------------------|----------------|
| 8140.21.235 IDS | 2445cc | 4 Cyl. | 8 Valves | 68-71kW/92-96PS | Diesel | Turbo | TD3418 |
| 8140.61.2300 | 2445cc | 4 Cyl. | 8 Valves | 52kW/71PS | Diesel | | TD3429 |
| 8140.61.240 | 2445cc | 4 Cyl. | 8 Valves | 51kW/69PS | Diesel | Sofim, Turbo | TD12871 |
| S8U 770 | 2445cc | 4 Cyl. | 8 Valves | 59kW/80PS | Diesel | Turbo, SOHC | TD13409 |
| MASTER I 28-35 2.4 D | | 08/1980→08/1989 | | MASTER I 28-35 2.5 D | | 09/1980→07/1998 | |
| MASTER II 2.5 D | | 07/1998→01/2001 | | TRAFIC 2.5 D | | 03/1980→03/2001 | |

V91292 
40.80 x 8.00 x 120.70

7701 463 603

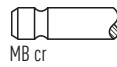

30° Y H

VAG92369 
60.00 x 8.00 x 13.07



V91293 
34.50 x 8.00 x 122.00

7701 203 675

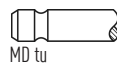

45°

VAG92373 
56.00 x 8.03 x 13.04

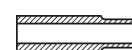

61  **93.00**

| | | | | | | | |
|----------------------|--------|-----------------|-----------------|----------------------|--------|--------------------|----------------|
| S8U 720 | 2445cc | 4 Cyl. | 8 Valves | 51kW/69PS | Diesel | SOHC | TD3413 |
| S8U 722 | 2445cc | 4 Cyl. | 8 Valves | 51kW/69PS | Diesel | SOHC | TD3414 |
| S8U 730 | 2445cc | 4 Cyl. | 8 Valves | 52kW/71PS | Diesel | SOHC | TD12873 |
| S8U 731 | 2445cc | 4 Cyl. | 8 Valves | 50-53kW/68-72PS | Diesel | SOHC | TD12730 |
| S8U 748 | 2445cc | 4 Cyl. | 8 Valves | 55kW/75PS | Diesel | SOHC | TD12735 |
| S8U 762 | 2445cc | 4 Cyl. | 8 Valves | 83kW/113PS | Diesel | Turbo, SOHC | TD3415 |
| MASTER I 2.4 D | | 07/1980→02/1998 | | MASTER I 28-35 2.4 D | | 08/1980→08/1989 | |
| MASTER I 28-35 2.5 D | | 09/1980→07/1998 | | SAFRANE I 2.5 dT | | 12/1992→07/1996 | |
| TRAFIC 2.5 D | | 03/1980→03/2001 | | | | | |

V91292 
40.80 x 8.00 x 120.70

7701 463 603

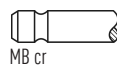

30° Y H

VAG92369 
60.00 x 8.00 x 13.07



V91293 
34.50 x 8.00 x 122.00

7701 203 675

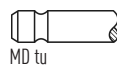

45°

VAG92373 
56.00 x 8.03 x 13.04

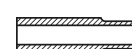

V91294 
34.50 x 8.00 x 122.00

7701 467 249

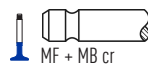

45°

H

V91940 
36.70 x 8.00 x 122.00

7701 467 249

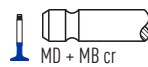

45°

H

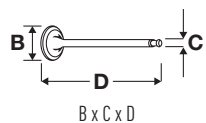

OE

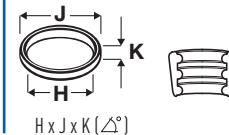
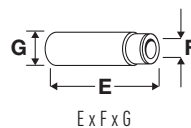

62 93.00

| | | | | | | | |
|----------------------|--------|-----------------|-----------------|-----------------------|--------|---------------------|---------|
| 8140.07.2530 | 2500cc | 4 Cyl. | 8 Valves | 56kW/76PS | Diesel | | TD3417 |
| 8140.07.2700 | 2500cc | 4 Cyl. | 8 Valves | 55kW/75PS | Diesel | | TD22385 |
| 8140.07.3700 | 2500cc | 4 Cyl. | 8 Valves | 55kW/75PS | Diesel | Turbo | TD22386 |
| 8140.27 | 2500cc | 4 Cyl. | 8 Valves | 78kW/106PS | Diesel | Sofim, Turbo | TD8529 |
| 8140.27.2500 | 2500cc | 4 Cyl. | 8 Valves | 69kW/94PS | Diesel | Turbo | TD3419 |
| 8140.27.2510 | 2500cc | 4 Cyl. | 8 Valves | 69kW/94PS | Diesel | Sofim, Turbo | TD3420 |
| 8140.27.2512 | 2500cc | 4 Cyl. | 8 Valves | 69kW/94PS | Diesel | Turbo | TD3421 |
| 8140.27.2560 | 2500cc | 4 Cyl. | 8 Valves | 69kW/94PS | Diesel | | TD8623 |
| 8140.27.2580 | 2500cc | 4 Cyl. | 8 Valves | 72kW/98PS | Diesel | Sofim, Turbo | TD3423 |
| 8140.27.2582 | 2500cc | 4 Cyl. | 8 Valves | 92kW/125PS | Diesel | Turbo | TD3424 |
| 8140.27.2585 | 2500cc | 4 Cyl. | 8 Valves | 78kW/106PS | Diesel | Turbo | TD12195 |
| 8140.47.2530 IDR | 2500cc | 4 Cyl. | 8 Valves | 85kW/116PS | Diesel | Sofim, Turbo | TD3425 |
| 8140.47.2535 | 2500cc | 4 Cyl. | 8 Valves | 85kW/116PS | Diesel | Turbo | TD3426 |
| 8140.47.2585 | 2500cc | 4 Cyl. | 8 Valves | 85kW/116PS | Diesel | Turbo | TD3428 |
| 8140.47.2590 | 2500cc | 4 Cyl. | 8 Valves | 85kW/116PS | Diesel | Turbo | TD12199 |
| 8140.67.2510 | 2500cc | 4 Cyl. | 8 Valves | 55kW/75PS | Diesel | | TD3432 |
| 8140-27 IDS | 2500cc | 4 Cyl. | 8 Valves | 78kW/106PS | Diesel | Turbo | TD8530 |
| 8140-47 | 2500cc | 4 Cyl. | 8 Valves | 85kW/116PS | Diesel | Turbo | TD8533 |
| MASTER I 28-35 2.5 D | | 08/1989→07/1998 | | MASTER I 28-35 2.5 TD | | 08/1989→07/1998 | |
| MASTER I 28-35 2.5 D | | 08/1989→07/1998 | | MASTER I 35 2.5 TD | | 08/1989→07/1998 | |

V91292
40.80 x 8.00 x 120.70

7701 463 603



30° Y H

VAG92369
60.00 x 8.00 x 13.07



V91293
34.50 x 8.00 x 122.00

7701 203 675

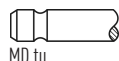

45°

VAG92373
56.00 x 8.03 x 13.04

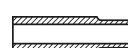

63 93.00

| | | | | | | | |
|--|-----------|--------|-----------------|-----------|---|--|---------|
| 8140.07.2585 | 2500cc | 4 Cyl. | 8 Valves | 55kW/75PS | Diesel | | TD12192 |
| V91399 41.00 x 8.00 x 122.00 | 4 813 760 | | 30° | H | VAG92369 60.00 x 8.00 x 13.07 | | |
| V91400 34.50 x 8.00 x 122.00 | 7 303 309 | | 45° | H | VAG92373 56.00 x 8.03 x 13.04 | | |

64 93.00

| | | | | | | | |
|--|--------------|--------|-----------------|------------|---|--------------|---------|
| 8140.27.2565 | 2500cc | 4 Cyl. | 8 Valves | 78kW/106PS | Diesel | Sofim | TD12197 |
| V91292 40.80 x 8.00 x 120.70 | 7701 463 603 | | 30° | Y H | VAG92369 60.00 x 8.00 x 13.07 | | |
| V91399 41.00 x 8.00 x 122.00 | 4 813 760 | | 30° | H | VAG92373 56.00 x 8.03 x 13.04 | | |
| V91400 34.50 x 8.00 x 122.00 | 7 303 309 | | 45° | H | | | |
| V91994 35.80 x 8.00 x 121.90 | 99 432 837 | | 45° | | | | |

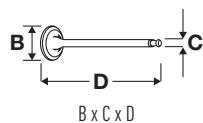
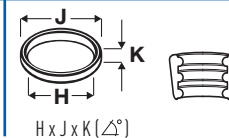
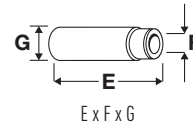

OE

65  **93.00**

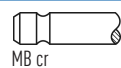
| | | | | | | | |
|--------------|--------|--------|----------|------------------|--------|-------------|---------|
| 8140.27.2700 | 2500cc | 4 Cyl. | 8 Valves | 68-76kW/92-103PS | Diesel | Turbo, SOHC | TD21392 |
| S8U 742 | 2500cc | 4 Cyl. | 8 Valves | 55kW/75PS | Diesel | SOHC | TD5442 |
| S8U 750 | 2500cc | 4 Cyl. | 8 Valves | 55kW/75PS | Diesel | SOHC | TD5566 |
| S8U 752 | 2500cc | 4 Cyl. | 8 Valves | 55kW/75PS | Diesel | SOHC | TD5567 |
| S8U 758 | 2500cc | 4 Cyl. | 8 Valves | 55-58kW/75-79PS | Diesel | SOHC | TD9689 |
| S8U 780 | 2500cc | 4 Cyl. | 8 Valves | 55kW/75PS | Diesel | SOHC | TD16328 |
| S8U 782 | 2500cc | 4 Cyl. | 8 Valves | 55kW/75PS | Diesel | SOHC | TD16329 |
| S9U 700 | 2500cc | 4 Cyl. | 8 Valves | 69kW/94PS | Diesel | Turbo, SOHC | TD12734 |
| S9U 702 | 2500cc | 4 Cyl. | 8 Valves | 69-72kW/94-98PS | Diesel | Turbo, SOHC | TD12731 |
| S9U 704 | 2500cc | 4 Cyl. | 8 Valves | 69kW/94PS | Diesel | Turbo, SOHC | TD12733 |
| S9U 714 | 2500cc | 4 Cyl. | 8 Valves | 69kW/94PS | Diesel | Turbo, SOHC | TD12732 |
| S9U 740 | 2500cc | 4 Cyl. | 8 Valves | 69kW/94PS | Diesel | Turbo, SOHC | TD12728 |

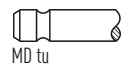
| | | | |
|----------------------|-----------------|-----------------------|-----------------|
| MASTER I 2.5 D | 07/1980→10/1989 | MASTER I 2.5 DT | 11/1989→02/1998 |
| MASTER I 28-35 2.5 D | 08/1989→07/1998 | MASTER I 28-35 2.5 TD | 08/1989→07/1998 |
| MASTER I 28-35 2.5 D | 08/1989→07/1998 | MASTER I 35 2.5 TD | 08/1989→07/1998 |
| TRAFFIC 2.5 D | 03/1989→03/2001 | | |

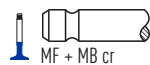
V91292  7701 463 603
 40.80 x 8.00 x 120.70

VAG92369  60.00 x 8.00 x 13.07



V91293  7701 203 675
 34.50 x 8.00 x 122.00

VAG92373  56.00 x 8.03 x 13.04

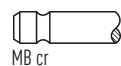
V91294  7701 467 249
 34.50 x 8.00 x 122.00

V91940  7701 467 249
 36.70 x 8.00 x 122.00

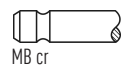
66  **93.00**

| | | | | | | | |
|--------------|--------|--------|----------|------------|--------|-------|---------|
| 8140.47.2700 | 2500cc | 4 Cyl. | 8 Valves | 85kW/116PS | Diesel | Turbo | TD22395 |
| 8140.47.2721 | 2500cc | 4 Cyl. | 8 Valves | 85kW/116PS | Diesel | Turbo | TD22396 |
| 8140.47.2785 | 2500cc | 4 Cyl. | 8 Valves | 85kW/116PS | Diesel | Turbo | TD22397 |

V91292  7701 463 603
 40.80 x 8.00 x 120.70

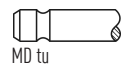
VAG92369  60.00 x 8.00 x 13.07

V91939  98 468 338
 43.50 x 8.00 x 122.00

VAG92373  56.00 x 8.03 x 13.04

V91293  7701 203 675
 34.50 x 8.00 x 122.00

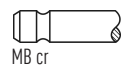
V91940  7701 467 249
 36.70 x 8.00 x 122.00

67  **93.00**

| | | | | | | | |
|--------------|--------|--------|----------|-----------|--------|-------------|---------|
| 8140.67.2585 | 2500cc | 4 Cyl. | 8 Valves | 55kW/75PS | Diesel | Turbo, SOHC | TD12193 |
|--------------|--------|--------|----------|-----------|--------|-------------|---------|

V91939  98 468 338
 43.50 x 8.00 x 122.00

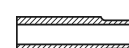
VAG92369  60.00 x 8.00 x 13.07

V91940  7701 467 249
 36.70 x 8.00 x 122.00

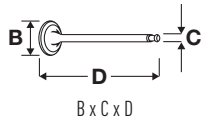
VAG92373  56.00 x 8.03 x 13.04

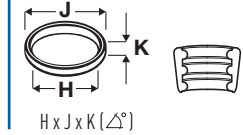
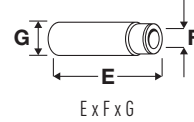
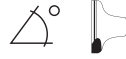

OE



68 93.00

| | | | | | | | |
|------------------|--------|-----------------|-----------------|------------|--------|--------------------|---------------|
| S8U 763 | 2500cc | 4 Cyl. | 8 Valves | 83kW/113PS | Diesel | Turbo, SOHC | TD3416 |
| SAFRANE I 2.5 dT | | 12/1992→07/1996 | | | | | |

| | | | | | | | |
|-----------------------|--------------|------------|-----|---|---|----------------------|--|
| V91292 | 7701 463 603 | | 30° | Y | H | VAG92369 | |
| 40.80 x 8.00 x 120.70 | | MB cr | | | | 60.00 x 8.00 x 13.07 | |
| V91294 | 7701 467 249 | | 45° | | H | VAG92373 | |
| 34.50 x 8.00 x 122.00 | | MF + MB cr | | | | 56.00 x 8.03 x 13.04 | |

69 93.00

| | | | | | | | |
|----------------|--------|--------|-----------------|-----------|--------|-------------|----------------|
| S8U 772 | 2500cc | 4 Cyl. | 8 Valves | 59kW/80PS | Diesel | SOHC | TD23889 |
|----------------|--------|--------|-----------------|-----------|--------|-------------|----------------|

| | | | | | | | |
|-----------------------|--------------|------------|-----|---|---|----------------------|--|
| V91292 | 7701 463 603 | | 30° | Y | H | VAG92369 | |
| 40.80 x 8.00 x 120.70 | | MB cr | | | | 60.00 x 8.00 x 13.07 | |
| V91940 | 7701 467 249 | | 45° | | H | VAG92373 | |
| 36.70 x 8.00 x 122.00 | | MD + MB cr | | | | 56.00 x 8.03 x 13.04 | |

70 94.40

| | | | | | | | |
|-----------------------|--------|-----------------|------------------|---------------------|--------|--|----------------|
| 8140.23.2565 | 2800cc | 4 Cyl. | 8 Valves | 76kW/103PS | Diesel | Sofim, Turbo, SOHC | TD17285 |
| 8140.23.2585 | 2800cc | 4 Cyl. | 16 Valves | 76kW/103PS | Diesel | Sofim, Turbo, SOHC | TD12194 |
| 8140.43.2585 | 2800cc | 4 Cyl. | 8 Valves | 90kW/122PS | Diesel | Sofim, Turbo, SOHC | TD12198 |
| 8140.43.3700 | 2800cc | 4 Cyl. | 8 Valves | 90kW/122PS | Diesel | Sofim, Turbo, SOHC | TD22394 |
| 8140.43.C.2586 | 2800cc | 4 Cyl. | 8 Valves | 78kW/106PS | Diesel | Sofim, Turbo, SOHC | TD14090 |
| 8140.43.S.2585 | 2800cc | 4 Cyl. | 8 Valves | 92-94kW/125-128PS | Diesel | Sofim, Turbo, SOHC | TD14091 |
| 8140.43K | 2800cc | 4 Cyl. | 8 Valves | 103-107kW/140-146PS | Diesel | Sofim, Turbo, SOHC, Common Rail | TD16211 |
| S9W 702 | 2800cc | 4 Cyl. | 8 Valves | 84kW/114PS | Diesel | Turbo, SOHC | TD13408 |
| MASTER II 2.8 dTI | | 07/1998→09/2004 | | | | | |

| | | | | | | | |
|-----------------------|--------------|-------|-----|---|---|----------------------|--|
| V91292 | 7701 463 603 | | 30° | Y | H | VAG92369 | |
| 40.80 x 8.00 x 120.70 | | MB cr | | | | 60.00 x 8.00 x 13.07 | |
| V91994 | 99 432 837 | | 45° | | | VAG92373 | |
| 35.80 x 8.00 x 121.90 | | MD cr | | | | 56.00 x 8.03 x 13.04 | |

71 94.40

| | | | | | | | |
|-------------------|--------|-----------------|-----------------|------------|--------|--------------------|----------------|
| S9W 700 | 2800cc | 4 Cyl. | 8 Valves | 84kW/114PS | Diesel | Turbo, SOHC | TD19362 |
| MASTER II 2.8 dTI | | 01/2002→09/2004 | | | | | |

| | | | | | | | |
|-----------------------|--------------|------------|-----|---|---|----------------------|--|
| V91292 | 7701 463 603 | | 30° | Y | H | VAG92193 | |
| 40.80 x 8.00 x 120.70 | | MB cr | | | | 56.00 x 8.04 x 13.05 | |
| V91940 | 7701 467 249 | | 45° | | H | VAG92369 | |
| 36.70 x 8.00 x 122.00 | | MD + MB cr | | | | 60.00 x 8.00 x 13.07 | |
| | | | | | | VAG92373 | |
| | | | | | | 56.00 x 8.03 x 13.04 | |
| | | | | | | VAG96190 | |
| | | | | | | 56.00 x 8.04 x 13.13 | |



OE

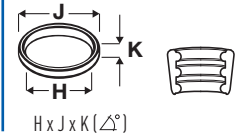

72  **98.00**

| | | | | | | | |
|-----------|--------|--------|----------|-----------|--------|--|--------|
| 712 | 3320cc | 4 Cyl. | 8 Valves | 56kW/76PS | Diesel | | TD8669 |
| 712-01-03 | 3320cc | 4 Cyl. | 8 Valves | 53kW/72PS | Diesel | | TD3019 |
| 712-01-04 | 3320cc | 4 Cyl. | 8 Valves | 54kW/73PS | Diesel | | TD3020 |

V95009 ■
45.80 x 9.96 x 140.20

5000 676 255



VAG92387 ■
86.00 x 10.00 x 16.00



V95010 ■
39.00 x 9.94 x 140.20

5000 676 257



VAG92389 ■
67.00 x 10.00 x 16.00



73  **100.00**

| | | | | | | | |
|----------|-----------------|--------|----------|------------|--------|-------|---------|
| T 4.40 | 3869cc | 4 Cyl. | 8 Valves | 82kW/112PS | Diesel | Turbo | TD13968 |
| Midliner | 09/1990→11/1992 | | | | | | |

V91249 ■
45.10 x 9.49 x 123.00

3142 L071



VAG92299 ■
58.00 x 9.55 x 15.92



VS6353 ■ [5]
40.30 x 51.30 x 7.20 (45°)

V91250 ■
45.00 x 9.49 x 123.00

3142 L072



VAG92300 ■
61.00 x 9.55 x 15.92



V91248 ■
37.40 x 9.46 x 123.50

3142 A051

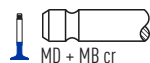

[5] Fully finished

[5] Fertigtgeschliffene

[5] Entierement finis

[5] Totalmente acabada

[5] Finite

74  **100.00**

| | | | | | | | |
|------------|-----------------|--------|----------|-------------|--------|-------|---------|
| T 4.40 A/3 | 3990cc | 4 Cyl. | 8 Valves | 88kW/120PS | Diesel | Turbo | TD13989 |
| T 4.40 B/3 | 3990cc | 4 Cyl. | 8 Valves | 102kW/139PS | Diesel | Turbo | TD13990 |
| T 4.40 CC | 3990cc | 4 Cyl. | 8 Valves | 88kW/120PS | Diesel | Turbo | TD13988 |
| Midliner | 11/1992→05/1996 | | | | | | |

V91249 ■
45.10 x 9.49 x 123.00

3142 L071



VAG92299 ■
58.00 x 9.55 x 15.92

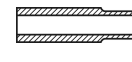

V91248 ■
37.40 x 9.46 x 123.50

3142 A051



VAG92300 ■
61.00 x 9.55 x 15.92



75  **102.00**

| | | | | | | | |
|----------|-----------------|--------|----------|-----------------|--------|-----|--------|
| 720 | 3590cc | 4 Cyl. | 8 Valves | 67-72kW/91-98PS | Diesel | | TD3022 |
| 720-12 | 3590cc | 4 Cyl. | 8 Valves | 67-72kW/90-98PS | Diesel | OHV | TD8609 |
| Midliner | 05/1984→12/1994 | | | | | | |

V95009 ■
45.80 x 9.96 x 140.20

5000 676 255



VAG92387 ■
86.00 x 10.00 x 16.00



V95010 ■
39.00 x 9.94 x 140.20

5000 676 257

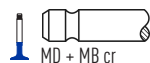

VAG92389 ■
67.00 x 10.00 x 16.00

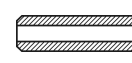

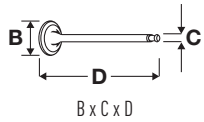

OE

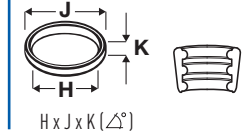
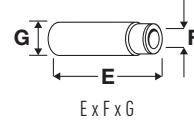
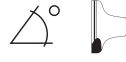

76 | 102.00

| | | | | | | | |
|-------------------|----------|--------|----------|-------------|--------|------------|---------|
| MIDR 04.02.26 A/4 | 4118cc | 4 Cyl. | 8 Valves | 100kW/136PS | Diesel | Turbo, OHV | TD14509 |
| MIDR 04.02.26 B/4 | 4118cc | 4 Cyl. | 8 Valves | 110kW/150PS | Diesel | Turbo, OHV | TD14510 |
| Midlum | 01/2000→ | | | | | | |

V94474 ■
46.60 x 10.00 x 140.10

5000 676 035



30°

H

VAG96126 ■
78.00 x 10.00 x 16.02



V94475 ■
40.65 x 10.00 x 140.20

5010 553 312



45°

H

VAG96127 ■
67.00 x 10.03 x 16.01



77 | 102.00

| | | | | | | | |
|--------------------|-----------------|--------|----------|-------------|--------|------------|---------|
| MIDR 04.02.26 A/41 | 4118cc | 4 Cyl. | 8 Valves | 100kW/136PS | Diesel | Turbo, OHV | TD12269 |
| MIDR 04.02.26 B/41 | 4118cc | 4 Cyl. | 8 Valves | 110kW/150PS | Diesel | Turbo, OHV | TD12268 |
| Midliner | 05/1996→01/2000 | | | | | | |

V91905 ■
46.50 x 9.96 x 140.00

5010 553 049

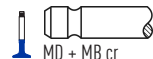

30°

H

VAG96126 ■
78.00 x 10.00 x 16.02



V91906 ■
40.60 x 10.00 x 140.20

5010 450590

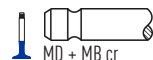

45°

H

VAG96127 ■
67.00 x 10.03 x 16.01



78 | 102.00

| | | | | | | | |
|--------|----------|--------|-----------|-------------|--------|-------|---------|
| dCi 4B | 4120cc | 4 Cyl. | 12 Valves | 112kW/152PS | Diesel | | TD17333 |
| dCi 4C | 4120cc | 4 Cyl. | 12 Valves | 128kW/174PS | Diesel | Turbo | TD17335 |
| Midlum | 01/2000→ | | | | | | |

V94622 ■
46.60 x 10.00 x 140.20

5010 450 309



30°

ss

H

V94475 ■
40.65 x 10.00 x 140.20

5010 553 312



45°

H

79 | 102.00

| | | | | | | | |
|-----------------|-----------------|--------|-----------|---------------------|--------|------------|--------|
| MIDS 06.02.12 B | 5453cc | 6 Cyl. | 12 Valves | 113-117kW/154-159PS | Diesel | Turbo, OHV | TD8608 |
| Midliner | 04/1986→09/1993 | | | | | | |

V95009 ■
45.80 x 9.96 x 140.20

5000 676 255

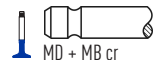

30°

Y

VAG92387 ■
86.00 x 10.00 x 16.00



V95010 ■
39.00 x 9.94 x 140.20

5000 676 257

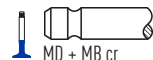

45°

H

VAG92389 ■
67.00 x 10.00 x 16.00



80 | 102.00

| | | | | | | | |
|--------|--------|--------|-----------|---------------------|--------|-------|--------|
| 797-10 | 5490cc | 6 Cyl. | 12 Valves | 98kW/133PS | Diesel | | TD8611 |
| 798-13 | 5490cc | 6 Cyl. | 12 Valves | 111-112kW/151-152PS | Diesel | Turbo | TD5861 |

V95009 ■
45.80 x 9.96 x 140.20

5000 676 255

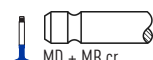

30°

Y

VAG92387 ■
86.00 x 10.00 x 16.00



V95010 ■
39.00 x 9.94 x 140.20

5000 676 257

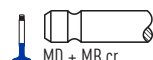

45°

H

VAG92389 ■
67.00 x 10.00 x 16.00





OE

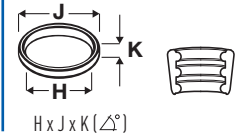
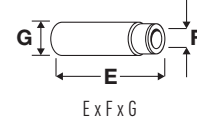
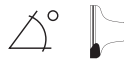

81  **102.00**

| | | | | | | | |
|-------------------|--------|-----------------|-----------|---------------------|--------|-----------------|---------|
| 797 | 5491cc | 6 Cyl. | 12 Valves | 96-97kW/130-132PS | Diesel | | TD8610 |
| 797 NFA | 5491cc | 6 Cyl. | 12 Valves | 89kW/121PS | Diesel | | TD8660 |
| 797-20 | 5491cc | 6 Cyl. | 12 Valves | 96-98kW/130-133PS | Diesel | Turbo, OHV | TD8607 |
| 797-21 | 5491cc | 6 Cyl. | 12 Valves | 76kW/103PS | Diesel | OHV | TD8658 |
| 797-26 | 5491cc | 6 Cyl. | 12 Valves | 98kW/133PS | Diesel | Turbo, OHV | TD8593 |
| 798 | 5491cc | 6 Cyl. | 12 Valves | 110kW/150PS | Diesel | Turbo | TD8613 |
| 798-10 | 5491cc | 6 Cyl. | 12 Valves | 113kW/154PS | Diesel | Turbo | TD6210 |
| 798-20 | 5491cc | 6 Cyl. | 12 Valves | 113kW/154PS | Diesel | Turbo | TD8606 |
| MIDR 06.02.12 | 5491cc | 6 Cyl. | 12 Valves | 128-134kW/173-182PS | Diesel | Turbo, OHV | TD8547 |
| MIDR 06.02.12 D | 5491cc | 6 Cyl. | 12 Valves | 127-134kW/172-182PS | Diesel | Turbo, OHV | TD8583 |
| MIDS 06.02.12 | 5491cc | 6 Cyl. | 12 Valves | 107kW/145PS | Diesel | Turbo, OHV | TD8545 |
| MIDS 06.02.12 C | 5491cc | 6 Cyl. | 12 Valves | 97-103kW/132-140PS | Diesel | Turbo, OHV | TD8615 |
| MIDS 06.02.12 D/3 | 5491cc | 6 Cyl. | 12 Valves | 110kW/150PS | Diesel | Turbo, OHV | TD14068 |
| G | | 05/1983→02/1990 | | Midliner | | 10/1982→05/1996 | |

V95009 
45.80 x 9.96 x 140.20

5000 676 255

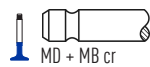

30° Y

VAG92387 
86.00 x 10.00 x 16.00



V95010 
39.00 x 9.94 x 140.20

5000 676 257







45° H









VAG92389 
67.00 x 10.00 x 16.00



82  **102.00**

| | | | | | | | |
|---|--------------|---|-----------|-------------|--------|----------|---------|
| dCi 6 A | 6177cc | 6 Cyl. | 24 Valves | 195kW/265PS | Diesel | Turbo | TD17339 |
| dCi 6 W | 6177cc | 6 Cyl. | 24 Valves | 158kW/215PS | Diesel | Turbo | TD17338 |
| Midlum | | 01/2000→ | | Premium | | 04/1996→ | |
| V94622  46.60 x 10.00 x 140.20 | 5010 450 309 |  | 30° ss H | | | | |
| V94475  40.65 x 10.00 x 140.20 | 5010 553 312 |  | 45° H | | | | |

83  **102.00**

| | | | | | | | |
|--|--------------|---|-----------|-------------|--------|---|---------|
| MIDR 06.02.26 | 6177cc | 6 Cyl. | 12 Valves | 159kW/216PS | Diesel | Turbo, OHV | TD14049 |
| MIDR 06.02.26 V/4 | 6177cc | 6 Cyl. | 12 Valves | 132kW/180PS | Diesel | Turbo, OHV | TD14508 |
| MIDR 06.02.26 V/41 | 6177cc | 6 Cyl. | 12 Valves | 132kW/180PS | Diesel | Turbo, OHV | TD12248 |
| Midliner | | 09/1987→01/2000 | | Midlum | | 01/2000→ | |
| V95009  45.80 x 9.96 x 140.20 | 5000 676 255 |  | 30° Y | | | | |
| V95010  39.00 x 9.94 x 140.20 | 5000 676 257 |  | 45° H | | | | |
| VAG92387  86.00 x 10.00 x 16.00 | | | | | |  | |
| VAG92389  67.00 x 10.00 x 16.00 | | | | | |  | |

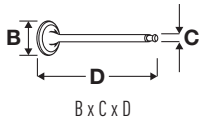

OE

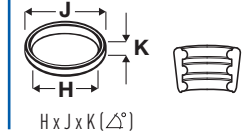
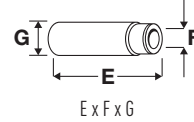

84 102.00

| | | | | | | | |
|-----------------|--------|--------|-----------|---------------------|--------|------------|--------|
| MIDR 06.02.26 D | 6177cc | 6 Cyl. | 12 Valves | 166kW/226PS | Diesel | Turbo, OHV | TD5862 |
| MIDR 06.02.26 H | 6177cc | 6 Cyl. | 12 Valves | 133-144kW/181-196PS | Diesel | Turbo, OHV | TD5645 |
| MIDR 06.02.26 Q | 6177cc | 6 Cyl. | 12 Valves | 137-140kW/186-190PS | Diesel | Turbo, OHV | TD8584 |
| MIDR 06.02.26 U | 6177cc | 6 Cyl. | 12 Valves | 110kW/150PS | Diesel | Turbo, OHV | TD8616 |
| MIDR 06.02.26 V | 6177cc | 6 Cyl. | 12 Valves | 129-132kW/175-180PS | Diesel | Turbo, OHV | TD8618 |
| MIDR 06.02.26 W | 6177cc | 6 Cyl. | 12 Valves | 151kW/205PS | Diesel | Turbo, OHV | TD8587 |
| MIDR 06.02.26 X | 6177cc | 6 Cyl. | 12 Valves | 166kW/226PS | Diesel | Turbo, OHV | TD8536 |

| | | | |
|----------|-----------------|--------|-----------------|
| C | 05/1990→10/1998 | G | 02/1990→09/1991 |
| Manager | 09/1991→10/1996 | Maxter | 10/1992→05/1995 |
| Midliner | 09/1987→01/2000 | | |

| | | | | | | |
|------------------------|--------------|------------|-----|---|-----------------------|--|
| V91905 | 5010 553 049 | | 30° | H | VAG92387 | |
| 46.50 x 9.96 x 140.00 | | MD + MB cr | | | 86.00 x 10.00 x 16.00 | |
| V95009 | 5000 676 255 | | 30° | Y | VAG92389 | |
| 45.80 x 9.96 x 140.20 | | MD + MB cr | | | 67.00 x 10.00 x 16.00 | |
| V91906 | 5010 450590 | | 45° | H | | |
| 40.60 x 10.00 x 140.20 | | MD + MB cr | | | | |
| V95010 | 5000 676 257 | | 45° | H | | |
| 39.00 x 9.94 x 140.20 | | MD + MB cr | | | | |

85 102.00

| | | | | | | | |
|--------------------|--------|--------|-----------|-------------|--------|------------|---------|
| MIDR 06.02.26 I | 6177cc | 6 Cyl. | 12 Valves | 133kW/181PS | Diesel | Turbo, OHV | TD5986 |
| MIDR 06.02.26 K | 6177cc | 6 Cyl. | 12 Valves | 155kW/211PS | Diesel | Turbo, OHV | TD7554 |
| MIDR 06.02.26 L | 6177cc | 6 Cyl. | 12 Valves | 132kW/180PS | Diesel | Turbo, OHV | TD7552 |
| MIDR 06.02.26 L2 | 6177cc | 6 Cyl. | 12 Valves | 132kW/180PS | Diesel | Turbo, OHV | TD7553 |
| MIDR 06.02.26 M | 6177cc | 6 Cyl. | 12 Valves | 155kW/211PS | Diesel | Turbo, OHV | TD7556 |
| MIDR 06.02.26 M2 | 6177cc | 6 Cyl. | 12 Valves | 155kW/211PS | Diesel | Turbo, OHV | TD7555 |
| MIDR 06.02.26 S | 6177cc | 6 Cyl. | 12 Valves | 166kW/226PS | Diesel | Turbo, OHV | TD6211 |
| MIDR 06.02.26 U/4 | 6177cc | 6 Cyl. | 12 Valves | 110kW/150PS | Diesel | Turbo, OHV | TD12208 |
| MIDR 06.02.26 W/41 | 6177cc | 6 Cyl. | 12 Valves | 154kW/210PS | Diesel | Turbo, OHV | TD8638 |

| | | | |
|----------|-----------------|--|--|
| Midliner | 05/1989→01/2000 | | |
|----------|-----------------|--|--|

| | | | | | | |
|------------------------|--------------|------------|-----|---|-----------------------|--|
| V91905 | 5010 553 049 | | 30° | H | VAG96126 | |
| 46.50 x 9.96 x 140.00 | | MD + MB cr | | | 78.00 x 10.00 x 16.02 | |
| V91906 | 5010 450590 | | 45° | H | VAG96127 | |
| 40.60 x 10.00 x 140.20 | | MD + MB cr | | | 67.00 x 10.03 x 16.01 | |

86 102.00

| | | | | | | | |
|--------------------|--------|--------|-----------|-------------|--------|------------|---------|
| MIDR 06.02.26 W/4 | 6177cc | 6 Cyl. | 12 Valves | 154kW/209PS | Diesel | Turbo, OHV | TD14511 |
| MIDR 06.02.26 Y/41 | 6177cc | 6 Cyl. | 12 Valves | 184kW/250PS | Diesel | Turbo, OHV | TD8639 |

| | | | |
|----------|-----------------|--------|----------|
| Midliner | 05/1996→01/2000 | Midlum | 01/2000→ |
| Premium | 04/1996→ | | |

| | | | | | | |
|------------------------|--------------|------------|-----|---|-----------------------|--|
| V94474 | 5000 676 035 | | 30° | H | VAG96126 | |
| 46.60 x 10.00 x 140.10 | | MD + MB cr | | | 78.00 x 10.00 x 16.02 | |
| V94475 | 5010 553 312 | | 45° | H | VAG96127 | |
| 40.65 x 10.00 x 140.20 | | MD + MB cr | | | 67.00 x 10.03 x 16.01 | |



OE

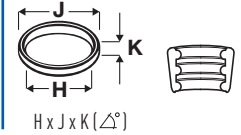
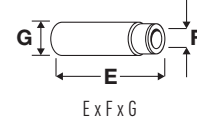

87



108.00

| | | | | | | | |
|--------|----------|--------|-----------|---------------------|--------|-------|---------|
| DXi 5 | 4800cc | 4 Cyl. | 16 Valves | 118-162kW/160-220PS | Diesel | Turbo | TD19015 |
| Midlum | 05/2006→ | | | | | | |

V95164 ■
38.20 x 7.96 x 145.80

7420 833 932

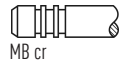

30° ss H

VAG96382 ■
58.30 x 7.50 x 13.03



V95165 ■
35.75 x 7.95 x 145.80

7420 833 936



45° H

88



108.00

| | | | | | | | |
|--------|----------|--------|-----------|---------------------|--------|----------|---------|
| DXi 7 | 7200cc | 6 Cyl. | 24 Valves | 177-247kW/240-340PS | Diesel | Turbo | TD19016 |
| Midlum | 05/2006→ | | | Premium 2 | | 10/2005→ | |

V95164 ■
38.20 x 7.96 x 145.80

7420 833 932

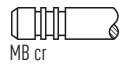

30° ss H

VAG96382 ■
58.30 x 7.50 x 13.03

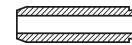

V95165 ■
35.75 x 7.95 x 145.80

7420 833 936



45° H

89



120.00

| | | | | | | | |
|---------------|--------|--------|-----------|---------------------|--------|-------|--------|
| MIP 06.20.30 | 8820cc | 6 Cyl. | 12 Valves | 141-158kW/192-215PS | Diesel | OHV | TD8627 |
| MIPS 06.20.30 | 8820cc | 6 Cyl. | 12 Valves | 166kW/225PS | Diesel | Turbo | TD8626 |

V91345 ■
54.00 x 9.00 x 163.00

5010 295 349



30° H

VAG92395 ■ ■
78.00 x 9.07 x 17.03



V91346 ■
48.00 x 9.00 x 163.50

5000 670 730



45° H

VAG92396 ■ ■
78.00 x 9.07 x 17.53

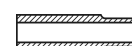

90



120.00

| | | | | | | | |
|------------------|-----------------|--------|-----------|---------------------|-----------------|------------|---------|
| MID 06.20.30 C | 8822cc | 6 Cyl. | 12 Valves | 135-141kW/184-192PS | Diesel | OHV | TD12249 |
| MID 06.20.30 G | 8822cc | 6 Cyl. | 12 Valves | 141kW/192PS | Diesel | OHV | TD8598 |
| MIDR 06.20.30 A | 8822cc | 6 Cyl. | 12 Valves | 194kW/264PS | Diesel | Turbo, OHV | TD8603 |
| MIDS 06.20.30 | 8822cc | 6 Cyl. | 12 Valves | 159-169kW/216-230PS | Diesel | Turbo, OHV | TD8595 |
| MIDS 06.20.30 N | 8822cc | 6 Cyl. | 12 Valves | 153kW/208PS | Diesel | Turbo, OHV | TD8535 |
| MIDS 06.20.30 N1 | 8822cc | 6 Cyl. | 12 Valves | 162kW/220PS | Diesel | Turbo, OHV | TD8586 |
| MIDS 06.20.30 P | 8822cc | 6 Cyl. | 12 Valves | 169-177kW/230-240PS | Diesel | Turbo, OHV | TD8590 |
| C | 12/1983→05/1991 | | | G | 11/1983→03/1993 | | |
| Manager | 09/1991→03/1993 | | | TB | 06/1980→ | | |

V91345 ■
54.00 x 9.00 x 163.00

5010 295 349



30° H

VAG92395 ■ ■
78.00 x 9.07 x 17.03



V91346 ■
48.00 x 9.00 x 163.50

5000 670 730



45° H

VAG92396 ■ ■
78.00 x 9.07 x 17.53



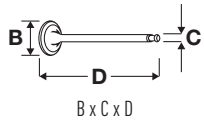

OE

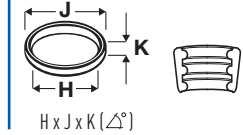
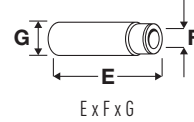
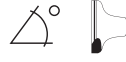

91 120.00

| | | | | | | | |
|---------------|--------|-----------------|-----------|---------------------|--------|------------|--------|
| MIDR 06.20.45 | 9771cc | 6 Cyl. | 12 Valves | 214-222kW/291-302PS | Diesel | Turbo, OHV | TD8414 |
| G | | 11/1985→12/1989 | | | | | |

| | | | | | | |
|-----------------------|--------------|------------|-----|---|----------------------|--|
| V91345 ■ | 5010 295 349 | | 30° | H | VAG92395 ■■ | |
| 54.00 x 9.00 x 163.00 | | MD + MB cr | | | 78.00 x 9.07 x 17.03 | |
| V91346 ■ | 5000 670 730 | | 45° | H | VAG92396 ■■ | |
| 48.00 x 9.00 x 163.50 | | MD + MB cr | | | 78.00 x 9.07 x 17.53 | |

92 120.00

| | | | | | | | |
|--------------------|--------|--------|-----------|---------------------|--------|------------|---------|
| MID 06.20.45 | 9839cc | 6 Cyl. | 12 Valves | 152kW/207PS | Diesel | OHV | TD8534 |
| MIDR 06.20.45 A | 9839cc | 6 Cyl. | 12 Valves | 192kW/260PS | Diesel | Turbo, OHV | TD8591 |
| MIDR 06.20.45 A2 | 9839cc | 6 Cyl. | 12 Valves | 202kW/275PS | Diesel | Turbo, OHV | TD8579 |
| MIDR 06.20.45 B3 | 9839cc | 6 Cyl. | 12 Valves | 195kW/265PS | Diesel | Turbo, OHV | TD8592 |
| MIDR 06.20.45 C | 9839cc | 6 Cyl. | 12 Valves | 206-210kW/280-285PS | Diesel | Turbo, OHV | TD8580 |
| MIDR 06.20.45 C/4 | 9839cc | 6 Cyl. | 12 Valves | 188kW/256PS | Diesel | Turbo, OHV | TD17421 |
| MIDR 06.20.45 D | 9839cc | 6 Cyl. | 12 Valves | 210-222kW/286-302PS | Diesel | Turbo, OHV | TD8538 |
| MIDR 06.20.45 D/41 | 9839cc | 6 Cyl. | 12 Valves | 219kW/298PS | Diesel | Turbo, OHV | TD8641 |
| MIDR 06.20.45 D3 | 9839cc | 6 Cyl. | 12 Valves | 222kW/302PS | Diesel | Turbo, OHV | TD8539 |
| MIDR 06.20.45 E | 9839cc | 6 Cyl. | 12 Valves | 240-249kW/326-339PS | Diesel | Turbo, OHV | TD5860 |
| MIDR 06.20.45 E2 | 9839cc | 6 Cyl. | 12 Valves | 249kW/339PS | Diesel | Turbo, OHV | TD8540 |
| MIDR 06.20.45 E3 | 9839cc | 6 Cyl. | 12 Valves | 249kW/339PS | Diesel | Turbo, OHV | TD8541 |
| MIDR 06.20.45 F3 | 9839cc | 6 Cyl. | 12 Valves | 144kW/196PS | Diesel | Turbo, OHV | TD8646 |
| MIDR 06.20.45 H | 9839cc | 6 Cyl. | 12 Valves | 227-240kW/310-326PS | Diesel | Turbo, OHV | TD6209 |
| MIDR 06.20.45 I3 | 9839cc | 6 Cyl. | 12 Valves | 191kW/260PS | Diesel | Turbo, OHV | TD12190 |
| MIDR 06.20.45 I41 | 9839cc | 6 Cyl. | 12 Valves | 188kW/256PS | Diesel | Turbo, OHV | TD12191 |
| MIDR 06.20.45 J3 | 9839cc | 6 Cyl. | 12 Valves | 222kW/302PS | Diesel | Turbo, OHV | TD12204 |
| MIDR 06.20.45 K | 9839cc | 6 Cyl. | 12 Valves | 177kW/241PS | Diesel | Turbo, OHV | TD7550 |
| MIDR 06.20.45 L | 9839cc | 6 Cyl. | 12 Valves | 177-187kW/241-254PS | Diesel | Turbo, OHV | TD7551 |
| MIDR 06.20.45 M | 9839cc | 6 Cyl. | 12 Valves | 236kW/320PS | Diesel | Turbo, OHV | TD8581 |
| MIDR 06.20.45 M3 | 9839cc | 6 Cyl. | 12 Valves | 250kW/340PS | Diesel | Turbo, OHV | TD8582 |
| MIDS 06.20.45 | 9839cc | 6 Cyl. | 12 Valves | 192-202kW/261-275PS | Diesel | Turbo, OHV | TD8633 |
| MIDS 06.20.45 B | 9839cc | 6 Cyl. | 12 Valves | 192-202kW/260-275PS | Diesel | Turbo, OHV | TD8537 |
| MIDS 06.20.45 D | 9839cc | 6 Cyl. | 12 Valves | 129kW/175PS | Diesel | Turbo, OHV | TD8647 |
| MIDS 06.20.45 F | 9839cc | 6 Cyl. | 12 Valves | 144kW/196PS | Diesel | Turbo, OHV | TD8648 |
| MIDS 06.20.45 J | 9839cc | 6 Cyl. | 12 Valves | 161kW/219PS | Diesel | Turbo, OHV | TD8588 |
| MIDS 06.20.45 J3 | 9839cc | 6 Cyl. | 12 Valves | 168kW/228PS | Diesel | Turbo, OHV | TD8589 |

| | | | |
|---------|-----------------|--------|-----------------|
| Agora | 01/1996→ | C | 10/1982→10/1998 |
| FR1 | 01/1983→ | G | 10/1982→09/1991 |
| Kerax | 06/1997→ | Major | 05/1991→10/1996 |
| Manager | 09/1991→10/1996 | Maxter | 10/1992→06/1997 |
| Premium | 04/1996→ | R | 01/1987→ |

| | | | | | | |
|-----------------------|--------------|------------|-----|---|----------------------|--|
| V91345 ■ | 5010 295 349 | | 30° | H | VAG92395 ■■ | |
| 54.00 x 9.00 x 163.00 | | MD + MB cr | | | 78.00 x 9.07 x 17.03 | |
| V91346 ■ | 5000 670 730 | | 45° | H | VAG92396 ■■ | |
| 48.00 x 9.00 x 163.50 | | MD + MB cr | | | 78.00 x 9.07 x 17.53 | |





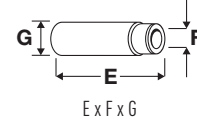







OE











93  **120.00**

| | | | | | | | |
|------------------|--------|--------|-----------|---------------------|--------|-------|--------|
| MIPR 06.20.45 A | 9840cc | 6 Cyl. | 12 Valves | 210kW/286PS | Diesel | Turbo | TD8634 |
| MIPR 06.20.45 A3 | 9840cc | 6 Cyl. | 12 Valves | 222kW/302PS | Diesel | Turbo | TD8635 |
| MIPR 06.20.45 B3 | 9840cc | 6 Cyl. | 12 Valves | 186kW/253PS | Diesel | | TD8628 |
| MIPR 06.20.45 C3 | 9840cc | 6 Cyl. | 12 Valves | 152kW/206PS | Diesel | | TD8629 |
| MIPS 06.20.45 | 9840cc | 6 Cyl. | 12 Valves | 137-186kW/186-253PS | Diesel | Turbo | TD8630 |
| MIPS 06.20.45 A | 9840cc | 6 Cyl. | 12 Valves | 129kW/175PS | Diesel | Turbo | TD8631 |
| MIPS 06.20.45 B | 9840cc | 6 Cyl. | 12 Valves | 176-186kW/240-253PS | Diesel | Turbo | TD8636 |
| MIPS 06.20.45 C | 9840cc | 6 Cyl. | 12 Valves | 144kW/196PS | Diesel | Turbo | TD8632 |

| | | | | | | | |
|---|-----------------|---|-----|---|---|---|--|
| PR | 01/1987→12/1990 | | | | | | |
| V91345  | 5010 295 349 |   | 30° | H | VAG92395  |  | |
| 54.00 x 9.00 x 163.00 | | MD + MB cr | | | 78.00 x 9.07 x 17.03 | | |
| V91346  | 5000 670 730 |   | 45° | H | VAG92396  |  | |
| 48.00 x 9.00 x 163.50 | | MD + MB cr | | | 78.00 x 9.07 x 17.53 | | |

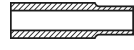



94  **123.00**

| | | | | | | | |
|---------------|---------|--------|-----------|---------------------|--------|--|---------|
| DXi 11 | 10800cc | 6 Cyl. | 24 Valves | 243-339kW/330-460PS | Diesel | | TD19017 |
|---------------|---------|--------|-----------|---------------------|--------|--|---------|

| | | | | | | | |
|---|--------------|---|-----------|----------|---|---|---|
| Kerax | 10/2005→ | | Premium 2 | 10/2005→ | | | |
| V95170  | 7420 540 017 |   | 30° | SS | H | VAG96308  |  |
| 40.00 x 7.97 x 191.85 | | MD + MB cr | | | | 83.20 x 8.02 x 15.00 | |
| V95171  | 7420 564 020 |   | 30° | SS | H | | |
| 37.90 x 7.96 x 192.70 | | MD + MB cr | | | | | |





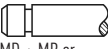





95  **123.00**

| | | | | | | | |
|--------------------|---------|--------|-----------|---------------------|--------|------------|---------|
| dCi 11 B/43 | 11100cc | 6 Cyl. | 12 Valves | 303kW/412PS | Diesel | Turbo, OHV | TD14848 |
| dCi 11C | 11100cc | 6 Cyl. | 24 Valves | 303kW/412PS | Diesel | Turbo | TD16880 |
| dCi 11E | 11100cc | 6 Cyl. | 24 Valves | 266kW/362PS | Diesel | Turbo | TD16879 |
| dCi 11G | 11100cc | 6 Cyl. | 24 Valves | 230-236kW/313-321PS | Diesel | Turbo | TD16878 |

| | | | | | | | |
|---|--------------|---|-----------|-----------------|---|--|--|
| ILIADE | 03/2006→ | | Kerax | 01/2001→ | | | |
| Premium | 08/2000→ | | Premium 2 | 01/2006→05/2008 | | | |
| V94620  | 5010 359 501 |   | 30° | SS | H | | |
| 42.00 x 8.00 x 185.50 | | MD + MB cr | | | | | |
| V94621  | 5010 412 164 |   | 45° | SS | H | | |
| 38.00 x 8.00 x 185.50 | | MD + MB cr | | | | | |

96  **123.00**

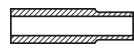
| | | | | | | | |
|---------------------------|---------|--------|-----------|-------------|--------|------------|---------|
| MIDR 06.23.56 A/41 | 11122cc | 6 Cyl. | 12 Valves | 280kW/381PS | Diesel | Turbo, OHV | TD8643 |
| MIDR 06.23.56 B/41 | 11122cc | 6 Cyl. | 12 Valves | 288kW/392PS | Diesel | Turbo, OHV | TD12207 |

| | | | | | | | |
|---|--------------|---|-----------|-----------------|---|---|--|
| Iliade | 01/1997→ | | Kerax | 06/1997→ | | | |
| Premium | 04/1996→ | | Premium 2 | 10/2005→08/2007 | | | |
| V91345  | 5010 295 349 |   | 30° | H | VAG92395  |  | |
| 54.00 x 9.00 x 163.00 | | MD + MB cr | | | 78.00 x 9.07 x 17.03 | | |
| V91346  | 5000 670 730 |   | 45° | H | VAG92396  |  | |
| 48.00 x 9.00 x 163.50 | | MD + MB cr | | | 78.00 x 9.07 x 17.53 | | |
| | | | | | VAG96131  |  | |
| | | | | | 78.00 x 9.07 x 17.52 | | |

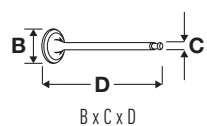

OE

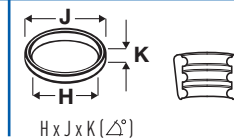
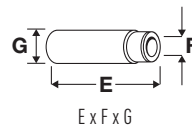

97 124.00

| | | | | | | | |
|--------------------|---------|--------|-----------|-------------|--------|------------|---------|
| MIDR 06.24.65 A/42 | 11955cc | 6 Cyl. | 24 Valves | 287kW/390PS | Diesel | Turbo, OHV | TD12148 |
| MIDR 06.24.65 B/42 | 11955cc | 6 Cyl. | 24 Valves | 316kW/430PS | Diesel | Turbo, OHV | TD12188 |
| MIDR 06.24.65 C/42 | 11955cc | 6 Cyl. | 24 Valves | 346kW/471PS | Diesel | Turbo, OHV | TD12189 |

Magnum 09/1996→

V94627
39.95 x 9.50 x 175.00

5010 284 468



30°

H

98 124.00

| | | | | | | | |
|------------------|---------|--------|-----------|---------------------|--------|-------|---------|
| MACK E.TECH A/46 | 12000cc | 6 Cyl. | 24 Valves | 295kW/401PS | Diesel | Turbo | TD14770 |
| MACK E.TECH B/46 | 12000cc | 6 Cyl. | 24 Valves | 324kW/441PS | Diesel | Turbo | TD14771 |
| MACK E.TECH C/46 | 12000cc | 6 Cyl. | 24 Valves | 347-353kW/472-480PS | Diesel | Turbo | TD14772 |

Magnum 05/2000→

V94630
43.00 x 9.50 x 179.30

5010 284 847

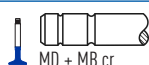

20°

ss

H

V94631
39.90 x 9.50 x 177.50

5010 284 848



30°

H

99 131.00

| | | | | | | | |
|--------|---------|--------|-----------|---------------------|--------|------------|---------|
| DXi 12 | 12130cc | 6 Cyl. | 24 Valves | 324-353kW/441-480PS | Diesel | DXi, Turbo | TD19083 |
|--------|---------|--------|-----------|---------------------|--------|------------|---------|

Magnum 10/2004→04/2006

V98089
40.00 x 7.95 x 191.80

20459326

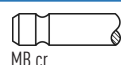

30°

VAG96308
83.20 x 8.02 x 15.00

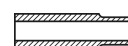

V94021
40.10 x 7.96 x 191.70

20441945

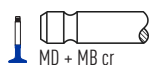

45°

H

100 131.00

| | | | | | | | |
|------------|---------|--------|-----------|---------------------|--------|-----------------|---------|
| DXi 13 | 12800cc | 6 Cyl. | 24 Valves | 323-382kW/440-520PS | Diesel | DXi, Turbo, OHV | TD19084 |
| DXi 13 440 | 12800cc | 6 Cyl. | 24 Valves | 323kW/440PS | Diesel | DXi, Turbo, OHV | TD29092 |
| DXi 13 460 | 12800cc | 6 Cyl. | 24 Valves | 338kW/460PS | Diesel | DXi, Turbo, OHV | TD29093 |
| DXi 13 480 | 12800cc | 6 Cyl. | 24 Valves | 353kW/480PS | Diesel | DXi, Turbo, OHV | TD29094 |
| DXi 13 500 | 12800cc | 6 Cyl. | 24 Valves | 368kW/500PS | Diesel | DXi, Turbo, OHV | TD29095 |
| DXi 13 520 | 12800cc | 6 Cyl. | 24 Valves | 382kW/520PS | Diesel | DXi, Turbo, OHV | TD29096 |

Kerax 05/2006→

Magnum

05/2006→

V95160
42.00 x 7.97 x 192.00

20561995

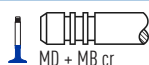

25°

ss

H

VAG96308
83.20 x 8.02 x 15.00

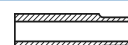

V95161
40.00 x 7.96 x 191.60

20768506

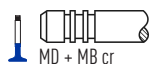

39°

ss

H



OE

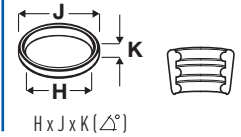
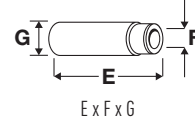
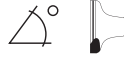

101 **135.00**

| | | | | | | | |
|-----------------|---------|--------|-----------|---------------------|--------|-------|--------|
| MDS 06.35.40 | 12024cc | 6 Cyl. | 12 Valves | 177-208kW/241-283PS | Diesel | Turbo | TD8668 |
| MDS 06.35.40 H | 12024cc | 6 Cyl. | 12 Valves | 178kW/242PS | Diesel | Turbo | TD8596 |
| MDS 06.35.40 I | 12024cc | 6 Cyl. | 12 Valves | 196kW/266PS | Diesel | Turbo | TD8601 |
| MIDR 06.35.40 C | 12024cc | 6 Cyl. | 12 Valves | 224-228kW/305-310PS | Diesel | Turbo | TD8645 |
| MIDS 06.35.40 D | 12024cc | 6 Cyl. | 12 Valves | 208kW/283PS | Diesel | Turbo | TD8542 |
| MIDS 06.35.40 E | 12024cc | 6 Cyl. | 12 Valves | 195kW/265PS | Diesel | Turbo | TD8597 |

| | | | |
|---|-----------------|---|-----------------|
| C | 04/1986→10/1992 | R | 10/1980→03/1989 |
|---|-----------------|---|-----------------|

V91872
54.00 x 12.00 x 189.00

5000 678 287

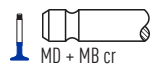

45°

H

VAG96129
105.00 x 12.03 x 20.03

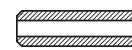

102 **135.00**

| | | | | | | | |
|------------------|---------|--------|-----------|---------------------|--------|------------|---------|
| MIDR 06.35.40 | 12024cc | 6 Cyl. | 12 Valves | 206-226kW/280-307PS | Diesel | Turbo, OHV | TD19965 |
| MIDR 06.35.40 M3 | 12024cc | 6 Cyl. | 12 Valves | 236kW/321PS | Diesel | Turbo, OHV | TD8543 |
| MIDS 06.35.40 | 12024cc | 6 Cyl. | 12 Valves | 206kW/280PS | Diesel | Turbo, OHV | TD29112 |
| MIDS 06.35.40 B | 12024cc | 6 Cyl. | 12 Valves | 225kW/306PS | Diesel | Turbo, OHV | TD29113 |

| | | | |
|---|-----------------|-----|-----------------|
| C | 10/1992→10/1998 | TBH | 01/1977→06/1980 |
|---|-----------------|-----|-----------------|

V91872
54.00 x 12.00 x 189.00

5000 678 287



45°

H

VAG96129
105.00 x 12.03 x 20.03



103 **135.00**

| | | | | | | | |
|-------------------|---------|--------|-----------|---------------------|--------|------------|---------|
| MIDR 06.35.40 G | 12024cc | 6 Cyl. | 12 Valves | 243-259kW/330-352PS | Diesel | Turbo, OHV | TD12202 |
| MIDR 06.35.40 H | 12024cc | 6 Cyl. | 12 Valves | 264-279kW/359-380PS | Diesel | Turbo, OHV | TD8516 |
| MIDR 06.35.40 J/3 | 12024cc | 6 Cyl. | 12 Valves | 305kW/415PS | Diesel | Turbo, OHV | TD8519 |
| MIDR 06.35.40 J1 | 12024cc | 6 Cyl. | 12 Valves | 314kW/427PS | Diesel | Turbo, OHV | TD8653 |
| MIDR 06.35.40 L1 | 12024cc | 6 Cyl. | 12 Valves | 283kW/385PS | Diesel | Turbo, OHV | TD8517 |
| MIDR 06.35.40 N/3 | 12024cc | 6 Cyl. | 12 Valves | 283kW/385PS | Diesel | Turbo, OHV | TD8518 |

| | | | |
|-------|-----------------|--------|-----------------|
| C | 02/1988→10/1998 | Magnum | 09/1990→12/1996 |
| Major | 05/1991→10/1996 | R | 03/1986→05/1991 |

V95207
60.00 x 11.99 x 204.40

5000 678 873

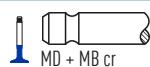

30°

H

VAG96129
105.00 x 12.03 x 20.03









V95208
52.00 x 11.96 x 205.10

5000 678 652



30°

H

|  |  | ccm |  |  |  |  |
|---|---|------|--|---|---|---|
| 11 D | 88.86 | 3528 | 8 | 16 | Petrol | 22 |
| 11 K2A | 75.00 | 1119 | 4 | 8 | Petrol | 2 |
| 11 K2D | 75.00 | 1119 | 4 | 8 | Petrol | 2 |
| 11 K4F | 75.00 | 1119 | 4 | 16 | Petrol | 3 |
| 14 K2A | 75.00 | 1396 | 4 | 8 | Petrol | 4 |
| 14 K2D | 75.00 | 1396 | 4 | 8 | Petrol | 4 |
| 14 K2F | 75.00 | 1396 | 4 | 8 | Petrol | 4 |
| 14 K4C | 75.00 | 1396 | 4 | 16 | Petrol | 5 |
| 14 K4D | 75.00 | 1396 | 4 | 16 | Petrol | 5 |
| 14 K4F | 75.00 | 1396 | 4 | 16 | Petrol | 5 |
| 14 K4M | 75.00 | 1396 | 4 | 16 | Petrol | 5 |
| 16 K4F | 80.00 | 1588 | 4 | 16 | Petrol | 10 |
| 18 K4F | 80.00 | 1796 | 4 | 16 | Petrol | 12 |
| 18 K4F | 80.00 | 1796 | 4 | 16 | Petrol | 12 |
| 18 K4K (VVC) | 80.00 | 1796 | 4 | 16 | Petrol | 13 |
| 20 K4F | 80.00 | 1997 | 6 | 24 | Petrol | 14 |
| 20 T2N (L Series) | 84.45 | 1994 | 4 | 8 | Diesel | 18 |
| 20 T2R (L Series) | 84.45 | 1994 | 4 | 8 | Diesel | 18 |
| 20 T4G | 84.45 | 1994 | 4 | 16 | Petrol | 19 |
| 20 T4H | 84.45 | 1994 | 4 | 16 | Petrol | 19 |
| 204 D2 | 84.00 | 1950 | 4 | 16 | Diesel | 17 |
| 25 6T (BMW) | 80.00 | 2497 | 6 | 12 | Diesel | 15 |
| 25 K4F | 80.00 | 2497 | 6 | 24 | Petrol | 16 |
| D 16 A7 | 75.00 | 1590 | 4 | 16 | Petrol | 6 |
| D 16 A8 | 75.00 | 1590 | 4 | 16 | Petrol | 7 |
| D 16 A9 | 75.00 | 1590 | 4 | 16 | Petrol | 7 |
| D 16 Y2 | 75.00 | 1590 | 4 | 16 | Petrol | 8 |
| D 16 Z2 | 75.00 | 1590 | 4 | 16 | Petrol | 6 |
| EV 2 | 74.00 | 1342 | 4 | 12 | Petrol | 1 |
| F 18 A3 | 85.00 | 1850 | 4 | 16 | Petrol | 20 |
| F 20 Z1 | 85.00 | 1997 | 4 | 16 | Petrol | 21 |
| F 20 Z2 | 85.00 | 1997 | 4 | 16 | Petrol | 21 |
| M 47 R | 84.00 | 1950 | 4 | 16 | Diesel | 17 |
| TUD5 | 77.00 | 1527 | 4 | 8 | Diesel | 9 |
| VM-HR 492.4 | 92.00 | 2393 | 4 | 8 | Diesel | 23 |
| XUD 7TE | 80.00 | 1769 | 4 | 8 | Diesel | 11 |



OE

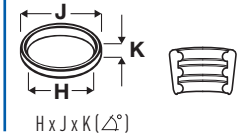
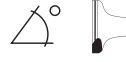

1



74.00

| | | | | | | | |
|-----------|-----------------|--------|-----------|-----------|--------|------|--------|
| EV 2 | 1342cc | 4 Cyl. | 12 Valves | 54kW/73PS | Petrol | SOHC | TD4883 |
| 200 213 S | 09/1985→09/1989 | | | | | | |

V90935 32.00 x 6.56 x 113.75

14721-PE0-000

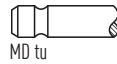

45°

VAG92210 55.00 x 6.52 x 12.09

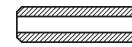

2



75.00

| | | | | | | | |
|---------|-----------------|--------|----------|-----------------------|--------|-----------------|--------|
| 11 K2A | 1119cc | 4 Cyl. | 8 Valves | 44kW/60PS | Petrol | SOHC | TD9488 |
| 11 K2D | 1119cc | 4 Cyl. | 8 Valves | 44kW/60PS | Petrol | SOHC | TD4884 |
| 100 111 | 04/1994→10/1997 | | | 100 / METRO 111 C/L/S | | 03/1990→12/1998 | |
| 200 211 | 01/1998→03/2000 | | | | | | |

V91175 33.85 x 6.97 x 90.48

WAM4002

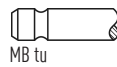

45°

VAG92294 32.00 x 6.50 x 12.04



V94052 31.30 x 6.97 x 90.95

WAM4003

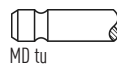

45°

SS

3



75.00

| | | | | | | | |
|--------|-----------------|--------|-----------|------------|--------|-----------------|---------|
| 11 K4F | 1119cc | 4 Cyl. | 16 Valves | 55kW/75PS | Petrol | DOHC | TD18365 |
| 25 1.1 | 09/1999→06/2001 | | | 25 1.1 16V | | 01/2004→05/2005 | |

V91209 27.80 x 5.97 x 89.60

LGH10029

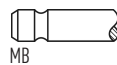

45°

H

VAG92309 30.00 x 6.00 x 9.90

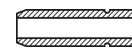

V94053 24.30 x 5.96 x 90.00

LGH100820

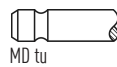

45°

SS

VAG92316 30.00 x 6.01 x 10.14

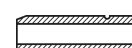

4



75.00

| | | | | | | | |
|---------|-----------------|--------|----------|-------------------------|--------|-----------------|--------|
| 14 K2A | 1396cc | 4 Cyl. | 8 Valves | 55kW/75PS | Petrol | SOHC | TD3477 |
| 14 K2D | 1396cc | 4 Cyl. | 8 Valves | 55kW/75PS | Petrol | SOHC | TD3478 |
| 14 K2F | 1396cc | 4 Cyl. | 8 Valves | 55kW/75PS | Petrol | SOHC | TD9499 |
| 100 114 | 04/1994→10/1997 | | | 100 / METRO 114 S/L/GTA | | 03/1990→12/1998 | |
| 200 214 | 09/1993→10/1995 | | | 200 214 i | | 11/1995→03/2000 | |
| 400 414 | 03/1996→12/1999 | | | | | | |

V91175 33.85 x 6.97 x 90.48

WAM4002

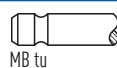

45°

VAG92294 32.00 x 6.50 x 12.04

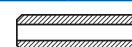

V94052 31.30 x 6.97 x 90.95

WAM4003

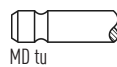

45°

SS

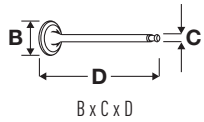

OE



MAT.

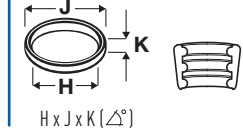
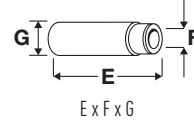

5 75.00

| | | | | | | | |
|---------------|--------|--------|------------------|-----------------|--------|------------------------|----------------|
| 14 K4C | 1396cc | 4 Cyl. | 16 Valves | 66-70kW/90-95PS | Petrol | DOHC | TD3480 |
| 14 K4D | 1396cc | 4 Cyl. | 16 Valves | 66kW/90PS | Petrol | DOHC, Injection | TD3488 |
| 14 K4F | 1396cc | 4 Cyl. | 16 Valves | 76kW/103PS | Petrol | DOHC | TD3481 |
| 14 K4M | 1396cc | 4 Cyl. | 16 Valves | 62kW/84PS | Petrol | DOHC | TD18231 |

| | | | |
|-------------------------|-----------------|--------------------------------|-----------------|
| 25 1.4 16V | 10/1999→05/2005 | 45 1.4 | 02/2000→05/2005 |
| 100 114 | 03/1997→10/1998 | 100 / METRO 114 GSi | 10/1994→10/1995 |
| 100 / METRO 114 GTI 16V | 03/1990→12/1998 | 100 / METRO 114 GTI/GT 16V Cat | 03/1990→12/1998 |
| 200 1.4 | 01/1996→12/1997 | 200 214 1.4 | 04/1990→11/1999 |
| 200 214 1.4i 16V | 01/1993→11/1999 | 200 214 GSi/Si | 01/1990→10/1995 |
| 200 214 Si | 11/1995→03/2000 | 200 214 Si/Gsi | 10/1989→10/1995 |
| 400 414 | 01/1993→04/1995 | 400 414 GSi/Si | 04/1990→04/1995 |
| 400 414 GSi/Si Cat | 10/1992→04/1995 | 400 414 Si | 05/1995→03/2000 |
| STREETWISE 1.4 | 08/2003→05/2005 | | |

| | | | | | | |
|----------------------|-----------|-------|-----|----|----------------------|--|
| V91209 ■ | LGH10029 | | 45° | H | VAG92309 ■■ | |
| 27.80 x 5.97 x 89.60 | | MB | | | 30.00 x 6.00 x 9.90 | |
| V94053 ■ | LGH100820 | | 45° | SS | VAG92316 ■■ | |
| 24.30 x 5.96 x 90.00 | | MD tu | | | 30.00 x 6.01 x 10.14 | |

6 75.00

| | | | | | | | |
|----------------|--------|--------|------------------|------------|--------|-------------|----------------|
| D 16 A7 | 1590cc | 4 Cyl. | 16 Valves | 85kW/116PS | Petrol | SOHC | TD18331 |
| D 16 Z2 | 1590cc | 4 Cyl. | 16 Valves | 82kW/112PS | Petrol | SOHC | TD3467 |

| | | | |
|-----------------|-----------------|-------------|-----------------|
| 200 216 1.6 | 04/1990→02/1996 | 200 216 GSi | 10/1989→10/1995 |
| 400 1.6 i | 05/1994→11/1998 | 400 416 GSi | 04/1990→04/1995 |
| 400 416 GSi/GSE | 04/1990→04/1995 | | |

| | | | | | | |
|-----------------------|---------------|----|-----|--|----------------------|--|
| V91731 ■ | 14721-PM3-000 | | 45° | | VAG92397 ■ | |
| 25.10 x 5.46 x 118.80 | | MD | | | 47.50 x 5.53 x 11.06 | |

7 75.00

| | | | | | | | |
|----------------|--------|--------|------------------|------------|--------|-------------|----------------|
| D 16 A8 | 1590cc | 4 Cyl. | 16 Valves | 90kW/122PS | Petrol | DOHC | TD4881 |
| D 16 A9 | 1590cc | 4 Cyl. | 16 Valves | 96kW/131PS | Petrol | DOHC | TD18330 |

| | | | |
|-------------|-----------------|-----------------|-----------------|
| 200 216 | 10/1992→06/1999 | 200 216 1.6i | 01/1992→11/1999 |
| 200 216 GTi | 09/1990→10/1995 | 400 1.6 i | 05/1994→11/1998 |
| 400 416 GTi | 04/1990→04/1995 | 400 416 GTi/GTE | 04/1990→04/1995 |

| | | | | | | |
|-----------------------|---------------|----|-----|--|--|--|
| V91733 ■ | 14721-PG6-000 | | 45° | | | |
| 27.10 x 6.56 x 104.60 | | MD | | | | |

8 75.00

| | | | | | | | |
|----------------|-----------------|--------|------------------|------------|--------|-------------|---------------|
| D 16 Y2 | 1590cc | 4 Cyl. | 16 Valves | 83kW/113PS | Petrol | SOHC | TD9498 |
| 400 416 Si | 05/1995→03/2000 | | | | | | |

| | | | | | | |
|-----------------------|-----------|-------|-----|--|----------------------|--|
| V94099 ■ | LGH101310 | | 45° | | VAG92397 ■ | |
| 30.00 x 5.50 x 118.60 | | MB tu | | | 47.50 x 5.53 x 11.06 | |
| V94100 ■ | LGH101330 | | 45° | | | |
| 26.00 x 5.50 x 116.00 | | MD tu | | | | |



OE

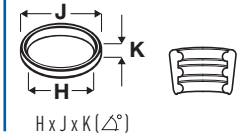
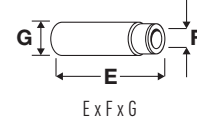

9 **77.00**

| TUD5 | 1527cc | 4 Cyl. | 8 Valves | 42kW/57PS | Diesel | SOHC | TD3490 |
|-----------------------|-----------------|--------|----------|-----------|----------------------|------|--------|
| 100 / METRO 115 D | 12/1994→12/1998 | | | | | | |
| V94171 | 0948.A8 | | 45° | H | VAG96049B | | |
| 37.00 x 7.00 x 108.50 | | MB | | | 40.20 x 7.02 x 13.08 | | |
| V94172 | 0949.80 | | 45° | | | | |
| 31.55 x 7.00 x 108.20 | | MD | | | | | |

10 **80.00**

| 16 K4F | 1588cc | 4 Cyl. | 16 Valves | 80-86kW/109-117PS | Petrol | DOHC | TD9358 |
|----------------------|-----------------|--------|-----------|-------------------|----------------------|-----------------|--------|
| 25 1.6 16V | 10/1999→05/2005 | | | 45 1.6 | | 02/2000→05/2005 | |
| 200 216 | 01/1996→12/1997 | | | 200 216 1.6i 16V | | 01/1996→11/1999 | |
| 200 216 Si | 11/1995→03/2000 | | | 400 416 Si | | 05/1995→03/2000 | |
| COUPE 1.6 16 V | 03/1996→11/1999 | | | STREETWISE 1.6 | | 01/2004→05/2005 | |
| V91209 | LGH10029 | | 45° | H | VAG92309 | | |
| 27.80 x 5.97 x 89.60 | | MB | | | 30.00 x 6.00 x 9.90 | | |
| V94053 | LGH100820 | | 45° | SS | VAG92316 | | |
| 24.30 x 5.96 x 90.00 | | MD tu | | | 30.00 x 6.01 x 10.14 | | |

11 **80.00**

| XUD 7TE | 1769cc | 4 Cyl. | 8 Valves | 64-65kW/87-88PS | Diesel | Turbo, SOHC | TD3504 |
|-----------------------|-----------------|--------|----------|-----------------|----------------------|-----------------|--------|
| 200 218 Td | 03/1998→11/2000 | | | 200 218 TD | | 09/1991→10/1995 | |
| 400 1.8 TD | 09/1993→11/1998 | | | 400 418 TD | | 09/1991→04/1995 | |
| V91144 | 0948.63 | | 45° | H | VAG92288B | | |
| 38.50 x 8.00 x 112.50 | | MB | | | 52.00 x 8.03 x 14.28 | | |
| V91145 | 0949.47 | | 45° | | | | |
| 33.00 x 8.00 x 112.00 | | MD cr | | | | | |
| V94024 | 0949.64 | | 45° | | | | |
| 33.00 x 8.00 x 112.00 | | MD | | | | | |

12 **80.00**

| 18 K4F | 1796cc | 4 Cyl. | 16 Valves | 88kW/120PS | Petrol | DOHC | TD11607 |
|----------------------|-----------------|--------|-----------|------------|----------------------|-----------------|---------|
| 25 1.8 16V | 10/1999→05/2005 | | | 45 1.8 | | 02/2000→05/2005 | |
| 75 1.8 | 02/1999→05/2005 | | | 200 218 Si | | 08/1999→03/2000 | |
| STREETWISE 1.8 | 08/2003→05/2005 | | | | | | |
| V91209 | LGH10029 | | 45° | H | VAG92309 | | |
| 27.80 x 5.97 x 89.60 | | MB | | | 30.00 x 6.00 x 9.90 | | |
| V94053 | LGH100820 | | 45° | SS | VAG92316 | | |
| 24.30 x 5.96 x 90.00 | | MD tu | | | 30.00 x 6.01 x 10.14 | | |

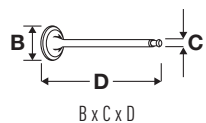

OE

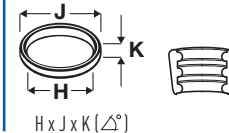
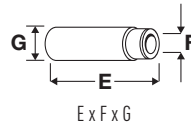
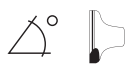

13 80.00

| 18 K4K (VVC) | 1796cc | 4 Cyl. | 16 Valves | 107-110kW/146-150PS | Petrol | DOHC | TD3500 |
|----------------------|-----------------|--------|-----------|---------------------|---------------------|-----------------|--------|
| 25 1.8 16V | 02/2000→05/2005 | | | 200 218 K Vi | | 11/1995→03/2000 | |
| 400 1.8 i | 06/1996→11/1998 | | | COUPE 1.8 16 V | | 03/1996→11/1999 | |
| V94101 | LGH10064 | | 45° | H | VAG96058 | | |
| 31.60 x 6.00 x 89.60 | | MB tu | | | 30.00 x 6.01 x 9.88 | | |
| V94102 | LGH10065 | | 45° | | | | |
| 27.40 x 6.00 x 90.00 | | MD tu | | | | | |
| →12/99 | | | | | | | |
| V94342 | LGH101360 | | 45° | | | | |
| 27.50 x 6.00 x 90.10 | | MD tu | | | | | |
| 01/00→ | | | | | | | |

14 80.00

| 20 K4F | 1997cc | V6 Cyl. | 24 Valves | 110kW/150PS | Petrol | DOHC | TD18238 |
|----------------------|-----------------|---------|-----------|-------------|---------------------|-----------------|---------|
| 45 2.0 V6 | 02/2000→05/2005 | | | 75 2.0 V6 | | 02/1999→05/2005 | |
| V94101 | LGH10064 | | 45° | H | VAG96058 | | |
| 31.60 x 6.00 x 89.60 | | MB tu | | | 30.00 x 6.01 x 9.88 | | |
| V94342 | LGH101360 | | 45° | | | | |
| 27.50 x 6.00 x 90.10 | | MD tu | | | | | |

15 80.00

| 25 6T (BMW) | 2497cc | 6 Cyl. | 12 Valves | 100kW/136PS | Diesel | SOHC | TD9485 |
|-----------------------|-----------------|------------|-----------|-------------|--------|----------------------|--------|
| V94555 | 11 34 2 244 815 | | 45° | ss | H | VAG96148B | |
| 30.90 x 6.00 x 103.50 | | MD + MB cr | | | | 39.50 x 6.00 x 12.57 | |

16 80.00

| 25 K4F | 2497cc | V6 Cyl. | 24 Valves | 129-130kW/175-177PS | Petrol | DOHC | TD9492 |
|----------------------|-----------------|---------|-----------|---------------------|---------------------|-----------------|--------|
| 75 2.5 V6 | 10/2001→05/2005 | | | 800 2.5 | | 02/1996→10/1998 | |
| 800 2.5 Si | 02/1996→10/1998 | | | 800 825 Si | | 04/1996→02/1999 | |
| 800 825 Si Lux | 04/1996→02/1999 | | | | | | |
| V94101 | LGH10064 | | 45° | H | VAG96058 | | |
| 31.60 x 6.00 x 89.60 | | MB tu | | | 30.00 x 6.01 x 9.88 | | |
| V94342 | LGH101360 | | 45° | | | | |
| 27.50 x 6.00 x 90.10 | | MD tu | | | | | |

17 84.00

| 204 D2 | 1950cc | 4 Cyl. | 16 Valves | 85-96kW/116-131PS | Diesel | | TD18240 |
|----------------------|-----------------|------------|-----------|-------------------|----------------------|-----------------|---------|
| M 47 R | 1950cc | 4 Cyl. | 16 Valves | 85kW/116PS | Diesel | Turbo | TD11609 |
| 75 2.0 CDT | 02/1999→05/2005 | | | 75 2.0 CDTi | | 02/2003→05/2005 | |
| V94086 | 11 34 2 247 077 | | 45° | H | VAG96266B | | |
| 26.00 x 6.00 x 99.90 | | MF + MB cr | | | 39.00 x 6.00 x 11.54 | | |
| V94086 | 11 34 2 247 077 | | 45° | H | | | |
| 26.00 x 6.00 x 99.90 | | cr | | | | | |



OE

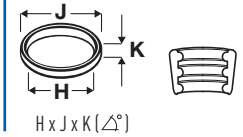
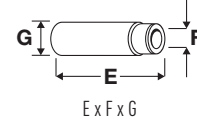

18  **84.45**

| | | | | | | | |
|--------------------------|--------|-----------------|-----------------|-------------------|--------|--------------------|---------------|
| 20 T2N (L Series) | 1994cc | 4 Cyl. | 8 Valves | 74-83kW/101-113PS | Diesel | Turbo, SOHC | TD9496 |
| 20 T2R (L Series) | 1994cc | 4 Cyl. | 8 Valves | 63kW/86PS | Diesel | Turbo, SOHC | TD9497 |
| 25 2.0 iDT | | 10/1999→05/2005 | | 45 2.0 iDT | | 02/2000→05/2005 | |
| 200 220 D/SD | | 11/1995→03/2000 | | 200 220 SDi | | 11/1995→03/2000 | |
| 400 420 D | | 11/1995→03/2000 | | 400 420 Di | | 05/1995→03/2000 | |
| 600 620 Sdi | | 12/1994→02/1999 | | STREETWISE 2.0 TD | | 08/2003→05/2005 | |

V94018 ■
37.20 x 6.92 x 87.00

LGH100990

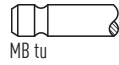

45°

VAG92511 ■■■
28.30 x 6.96 x 12.05



V94019 ■
32.60 x 6.91 x 87.00

LGH100980

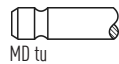

45°

19  **84.45**

| | | | | | | | |
|--------------------------|--------|-----------------|------------------|---------------------|--------|--------------------|---------------|
| 20 T4G | 1994cc | 4 Cyl. | 16 Valves | 132-147kW/180-200PS | Petrol | Turbo, DOHC | TD4885 |
| 20 T4H | 1994cc | 4 Cyl. | 16 Valves | 100-132kW/136-179PS | Petrol | Turbo, DOHC | TD3479 |
| 200 220 GSi | | 05/1994→06/1999 | | 200 220 GTi | | 01/1993→10/1995 | |
| 200 220 Turbo | | 10/1992→06/1999 | | 400 2.0 i | | 05/1994→11/1998 | |
| 400 420 GSi/SLI/GTI/Vite | | 01/1993→04/1995 | | 400 420 Si Lux | | 12/1995→03/2000 | |
| 400 420 Turbo | | 01/1993→04/1995 | | 600 620 Ti Vitesse | | 07/1994→02/1999 | |
| 800 2.0 | | 08/1987→09/1988 | | 800 820 | | 04/1994→02/1999 | |
| 800 820 I/Si | | 01/1992→02/1999 | | | | | |

V91217 ■
32.10 x 7.10 x 110.80

LGH101060

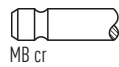

45°

H

V94026 ■
29.40 x 7.08 x 111.00

LGH101000

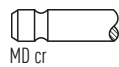

45°

20  **85.00**

| | | | | | | | |
|----------------|--------|-----------------|------------------|------------|--------|-------------|---------------|
| F 18 A3 | 1850cc | 4 Cyl. | 16 Valves | 85kW/115PS | Petrol | SOHC | TD9491 |
| 600 618 i/Si | | 03/1996→02/1999 | | | | | |

V94096 ■
29.00 x 5.50 x 123.40

14721-PT6-A00

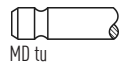

45°

VAG92397 ■
47.50 x 5.53 x 11.06



21  **85.00**

| | | | | | | | |
|----------------|--------|-----------------|------------------|------------|--------|-----------------|---------------|
| F 20 Z1 | 1997cc | 4 Cyl. | 16 Valves | 96kW/131PS | Petrol | | TD3470 |
| F 20 Z2 | 1997cc | 4 Cyl. | 16 Valves | 85kW/115PS | Petrol | | TD4882 |
| 600 620 i | | 08/1993→06/1996 | | 600 620 Si | | 08/1993→02/1999 | |

V91731 ■
25.10 x 5.46 x 118.80

14721-PM3-000

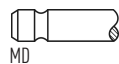

45°

VAG92397 ■
47.50 x 5.53 x 11.06

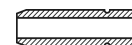

22  **88.86**

| | | | | | | | |
|-------------|--------|---------|------------------|------------|--------|--|---------------|
| 11 D | 3528cc | V8 Cyl. | 16 Valves | 93kW/126PS | Petrol | | TD3494 |
|-------------|--------|---------|------------------|------------|--------|--|---------------|

V34939 ■
40.00 x 8.67 x 116.97

614088

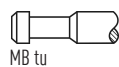

45°

H

VAG50919 ■■■
65.90 x 8.73 x 15.14

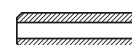

V34940 ■
34.48 x 8.65 x 116.95

614089

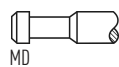

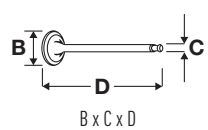

45°



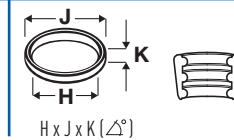
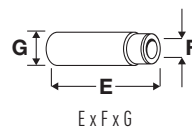





OE



23  **92.00**

| | | | | | | | |
|--|------------|--|----------|------------|--------|-------------|--------|
| VM-HR 492.4 | 2393cc | 4 Cyl. | 8 Valves | 89kW/121PS | Diesel | Turbo, SOHC | TD3503 |
| V91437  40.00 x 8.00 x 121.00 | 605 07 189 |  MD cr | 35° | | | | |



|  |  | ccm |  |  |  |  |
|---|---|------|---|---|---|---|
| A16 LET | 79.00 | 1598 | 4 | 16 | Petrol | 1 |
| A20 DTH | 83.00 | 1956 | 4 | 16 | Diesel | 8 |
| A20 NHT | 86.00 | 1998 | 4 | 16 | Petrol | 11 |
| B205E | 90.00 | 1985 | 4 | 16 | Petrol | 13 |
| B207E | 86.00 | 1998 | 4 | 16 | Petrol | 11 |
| B207L | 86.00 | 1998 | 4 | 16 | Petrol | 11 |
| B207R | 86.00 | 1998 | 4 | 16 | Petrol | 11 |
| B235L | 90.00 | 2290 | 4 | 16 | Petrol | 14 |
| B235R | 90.00 | 2290 | 4 | 16 | Petrol | 14 |
| B258I | 81.60 | 2498 | 6 | 24 | Petrol | 3 |
| B308I | 86.00 | 2962 | 6 | 24 | Petrol | 12 |
| D223L | 84.00 | 2171 | 4 | 16 | Diesel | 9 |
| X22 DTH | 84.00 | 2171 | 4 | 16 | Diesel | 10 |
| Y22 DTH | 84.00 | 2171 | 4 | 16 | Diesel | 10 |
| Z18XE | 80.50 | 1796 | 4 | 16 | Petrol | 2 |
| Z19 DTJ | 82.00 | 1910 | 4 | 16 | Diesel | 4 |
| Z19 DTR | 82.00 | 1910 | 4 | 16 | Diesel | 5 |
| Z19DT | 82.00 | 1910 | 4 | 8 | Diesel | 6 |
| Z19DTH | 82.00 | 1910 | 4 | 16 | Diesel | 7 |



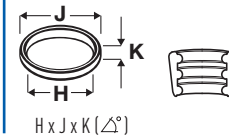
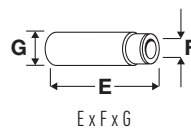

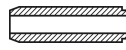
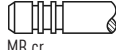

OE

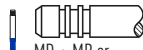

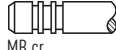

1  **79.00**

| A16 LET | 1598cc | 4 Cyl. | 16 Valves | 132kW/180PS | Petrol | Turbo, DOHC | TD24444 |
|-----------------------|----------|---|-----------|-------------|---------|----------------------|---|
| 9-5 1.6 Turbo | | | | | | | 05/2010→01/2012 |
| V98024 ■ | 55557741 |  | 45° | | | VAG96346 ■ ■ |  |
| 31.00 x 5.00 x 114.00 | | MB cr | | | | 37.00 x 4.99 x 10.04 | |
| V98077 ■ [3] | 55557862 |  | 45° | | | | |
| 31.20 x 5.00 x 117.20 | | MB cr | | | | | |
| V98025 ■ | 24405815 |  | 45° | | | | |
| 27.50 x 5.00 x 113.20 | | MD + MB cr | | | | | |
| V98078 ■ [3] | 55558728 |  | 45° | SS | | | |
| 27.50 x 5.00 x 116.20 | | MD + MB cr | | | | | |
| [3] LPG | [3] LPG | | [3] LPG | | [3] LPG | | [3] LPG |

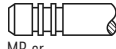

2  **80.50**

| Z18XE | 1796cc | 4 Cyl. | 16 Valves | 90kW/122PS | Petrol | DOHC | TD18079 |
|-----------------------|----------|---|-----------|------------|--------|----------------------|---|
| 9-3 1.8 i | | | | | | | 01/2004→02/2015 |
| V94249 ■ | 90536095 |  | 45° | H | | VAG96076 ■ |  |
| 31.20 x 5.00 x 101.40 | | MB cr | | | | 39.00 x 5.00 x 10.04 | |
| V94250 ■ | 90536164 |  | 45° | SS | | VAG96077 ■ |  |
| 27.50 x 5.00 x 100.80 | | MD cr | | | | 39.00 x 5.00 x 10.04 | |

3  **81.60**

| B258I | 2498cc | V6 Cyl. | 24 Valves | 125-127kW/170-173PS | Petrol | DOHC | TD3526 |
|-----------------------|-----------|---|-----------|---------------------|--------|----------------------|---|
| 900 II 2.5 | | | | | | | 12/1993→12/1997 |
| V91997 ■ | 45 00 849 |  | 45° | H | | VAG96028 ■ ■ |  |
| 32.10 x 5.97 x 102.10 | | MB cr | | | | 45.00 x 5.99 x 10.05 | |
| V91998 ■ | 45 00 864 |  | 45° | SS | | | |
| 29.10 x 5.96 x 92.25 | | MD cr | | | | | |

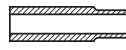
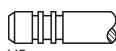
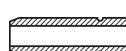
4  **82.00**

| Z19 DTJ | 1910cc | 4 Cyl. | 16 Valves | 88kW/120PS | Diesel | Turbo, DOHC | TD24819 |
|-----------------------|------------|---|-----------|------------|--------|----------------------|---|
| V94588 ■ | 46 802 049 |  | 45° | Y | H | VAG96291 ■ ■ |  |
| 27.90 x 6.00 x 114.00 | | MB cr | | | | 42.00 x 6.00 x 11.05 | |
| Eng.→17180894 | | | | | | Eng.→17180894 | |
| V98005 ■ | 55207517 |  | 45° | | | VAG96360 ■ ■ |  |
| 28.00 x 5.00 x 114.40 | | MB cr | | | | 46.70 x 5.00 x 10.03 | |
| Eng.17180895→ | | | | | | Eng.17180895→ | |
| V94589 ■ | 46 787 902 |  | 45° | | H | | |
| 25.80 x 6.00 x 114.30 | | MD + MB cr | | | | | |
| Eng.→17180894 | | | | | | | |
| V98006 ■ | 55207955 |  | 45° | | | | |
| 24.50 x 5.00 x 114.40 | | MD + MB cr | | | | | |
| Eng.17180895→ | | | | | | | |



OE

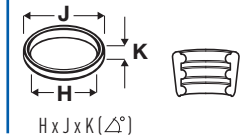
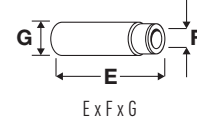

5

82.00

| Z19 DTR | 1910cc | 4 Cyl. | 16 Valves | 129-132kW/175-180PS | Diesel | Turbo, DOHC | TD23523 |
|-----------------------|------------|------------|-----------|---------------------|--------|----------------------|-----------------|
| 9-3 1.9 TiD | | | | 12/2007→02/2015 | | 9-3X 1.9 TiD | 02/2009→12/2012 |
| 9-5 1.9 TiD | | | | 01/2007→12/2009 | | | |
| V94588 | 46 802 049 | | 45° | Y | H | VAG96291 | |
| 27.90 x 6.00 x 114.00 | | MB cr | | | | 42.00 x 6.00 x 11.05 | |
| V94589 | 46 787 902 | | 45° | | H | | |
| 25.80 x 6.00 x 114.30 | | MD + MB cr | | | | | |

6

82.00

| Z19DT | 1910cc | 4 Cyl. | 8 Valves | 88kW/120PS | Diesel | Turbo, SOHC | TD18086 |
|-----------------------|------------|------------|----------|-----------------|--------|----------------------|---------|
| 9-3 1.9 TiD | | | | 09/2004→02/2015 | | | |
| V94470 | 46 750 859 | | 45° | | H | VAG96124 | |
| 35.30 x 8.00 x 115.00 | | MD + MB cr | | | | 42.90 x 8.02 x 14.06 | |
| V94065 | 608 14 604 | | 45° | | | VAG96203 | |
| 34.50 x 8.00 x 115.00 | | MD cr | | | | 43.00 x 8.03 x 14.08 | |
| V94471 | 46 783 962 | | 45° | | H | VAG96210 | |
| 34.50 x 8.00 x 115.00 | | MD + MB cr | | | | 43.00 x 8.04 x 14.04 | |

7

82.00

| Z19DTH | 1910cc | 4 Cyl. | 16 Valves | 110kW/150PS | Diesel | Turbo, DOHC | TD18084 |
|---------------------------------|------------|------------|-----------|-----------------|--------|--------------------------------|-----------------|
| 9-3 1.9 TiD | | | | 09/2004→02/2015 | | 9-5 1.9 TiD | 01/2006→12/2009 |
| V94588 | 46 802 049 | | 45° | Y | H | VAG96291 | |
| 27.90 x 6.00 x 114.00 →06/06 | | MB cr | | | | 42.00 x 6.00 x 11.05 →06/06 | |
| V98005 | 55207517 | | 45° | | | VAG96360 | |
| 28.00 x 5.00 x 114.40 07/06→ | | MB cr | | | | 46.70 x 5.00 x 10.03 07/06→ | |
| V94589 | 46 787 902 | | 45° | | H | | |
| 25.80 x 6.00 x 114.30 →06/06 | | MD + MB cr | | | | | |
| V98006 | 55207955 | | 45° | | | | |
| 24.50 x 5.00 x 114.40 07/06→ | | MD + MB cr | | | | | |

8

83.00

| A20 DTH | 1956cc | 4 Cyl. | 16 Valves | 118kW/160PS | Diesel | Turbo, DOHC | TD24003 |
|-----------------------|----------|------------|-----------|-----------------|--------|----------------------|---------|
| 9-5 2.0 TiD | | | | 05/2010→01/2012 | | | |
| V98005 | 55207517 | | 45° | | | VAG96360 | |
| 28.00 x 5.00 x 114.40 | | MB cr | | | | 46.70 x 5.00 x 10.03 | |
| V98006 | 55207955 | | 45° | | | | |
| 24.50 x 5.00 x 114.40 | | MD + MB cr | | | | | |

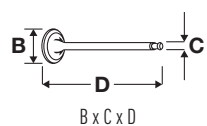

OE

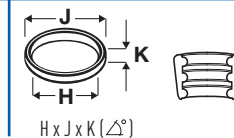
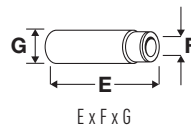

9 **84.00**

| | | | | | | | |
|----------------------|-----------------|------------|------------------|-------------------|----------------------|--------------------|----------------|
| D223L | 2171cc | 4 Cyl. | 16 Valves | 85-92kW/115-125PS | Diesel | Turbo, SOHC | TD18087 |
| 9-3 2.2 TiD | 02/1998→02/2015 | | | 9-5 2.2 TiD | 03/2002→12/2009 | | |
| V94355 | 90502316 | | 45° | H | VAG96028 | | |
| 29.00 x 6.00 x 97.00 | | MD + MB cr | | | 45.00 x 5.99 x 10.05 | | |
| V94356 | 90502323 | | 45° | SS H | | | |
| 26.20 x 6.00 x 97.00 | | MD + MB cr | | | | | |

10 **84.00**

| | | | | | | | |
|----------------------|-----------------|------------|------------------|-------------------|----------------------|--------------------|----------------|
| X22 DTH | 2171cc | 4 Cyl. | 16 Valves | 85kW/115PS | Diesel | Turbo, SOHC | TD9750 |
| Y22 DTH | 2171cc | 4 Cyl. | 16 Valves | 85-88kW/116-120PS | Diesel | Turbo, SOHC | TD19130 |
| 9-3 2.2 TiD | 02/1998→11/2000 | | | | | | |
| V94097 | 90502319 | | 45° | SS H | VAG96028 | | |
| 29.00 x 6.00 x 97.20 | | MD + MB cr | | | 45.00 x 5.99 x 10.05 | | |
| V94098 | 90 502 326 | | 45° | SS H | | | |
| 26.00 x 6.00 x 97.00 | | MD + MB cr | | | | | |

11 **86.00**

| | | | | | | | |
|---------------------------|-----------------|------------|------------------|---------------------|-----------------|--------------------|----------------|
| A20 NHT | 1998cc | 4 Cyl. | 16 Valves | 162kW/220PS | Petrol | Turbo, DOHC | TD24002 |
| B207E | 1998cc | 4 Cyl. | 16 Valves | 110kW/150PS | Petrol | Turbo, DOHC | TD18081 |
| B207L | 1998cc | 4 Cyl. | 16 Valves | 129-143kW/175-194PS | Petrol | Turbo, DOHC | TD18082 |
| B207R | 1998cc | 4 Cyl. | 16 Valves | 145-185kW/197-252PS | Petrol | Turbo, DOHC | TD18083 |
| 9-3 1.8t | 09/2002→02/2015 | | | 9-3 1.8t BioPower | 01/2007→02/2015 | | |
| 9-3 1.8t 2.0 | 03/2005→02/2015 | | | 9-3 2.0 | 09/2002→02/2015 | | |
| 9-3 2.0 t | 09/2002→02/2015 | | | 9-3 2.0 t BioPower | 09/2002→02/2015 | | |
| 9-3 2.0 t Bio XWD | 06/2008→02/2015 | | | 9-3 2.0 Turbo | 01/2008→02/2015 | | |
| 9-3 2.0 Turbo Performance | 04/2004→02/2015 | | | 9-3X 2.0 | 09/2009→12/2012 | | |
| 9-3X 2.0 t | 02/2009→12/2012 | | | 9-3X 2.0 t BioPower | 02/2009→12/2012 | | |
| 9-5 2.0 t BioPower | 05/2010→01/2012 | | | 9-5 2.0 Turbo | 05/2010→01/2012 | | |
| V94962 | 12575793 | | 45° | H | | | |
| 35.15 x 6.00 x 102.20 | | MB cr | | | | | |
| V94963 | 24454518 | | 45° | SS H | | | |
| 30.10 x 6.00 x 100.90 | | MD + MB cr | | | | | |

12 **86.00**

| | | | | | | | |
|------------------------|-----------------|---------|------------------|------------------------|----------------------|-------------|---------------|
| B3081 | 2962cc | V6 Cyl. | 24 Valves | 155kW/211PS | Petrol | DOHC | TD5373 |
| 9000 3.0 -24 V6 CD/CDE | 07/1994→12/1998 | | | 9000 3.0 -24 V6 CS/CSE | 07/1994→12/1998 | | |
| V91997 | 45 00 849 | | 45° | H | VAG96029 | | |
| 32.10 x 5.97 x 102.10 | | MB cr | | | 35.00 x 5.99 x 10.05 | | |
| V91998 | 45 00 864 | | 45° | SS | VAG96028 | | |
| 29.10 x 5.96 x 92.25 | | MD cr | | | 45.00 x 5.99 x 10.05 | | |

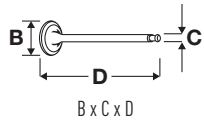

OE

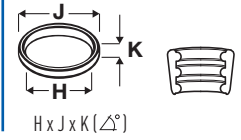
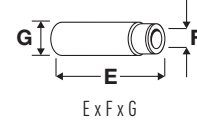
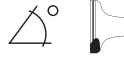

13



90.00

| | | | | | | | |
|--------------------|--------|-----------------|------------------|---------------------|--------|--------------------|---------------|
| B205E | 1985cc | 4 Cyl. | 16 Valves | 110-141kW/150-192PS | Petrol | Turbo, DOHC | TD9447 |
| 9-3 2.0 Turbo | | 02/1998→08/2003 | | 9-5 2.0 t | | 09/1997→12/2009 | |
| 9-5 2.0 t Biopower | | 09/2005→12/2009 | | 9-5 2.0 t BioPower | | 01/2005→12/2009 | |
| 9-5 2.0 Turbo SE | | 10/1998→07/2000 | | | | | |

V94363
33.00 x 5.00 x 107.50

91 85 851

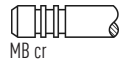

MB cr

45° Y H

VAG96113
42.80 x 5.00 x 12.00



V94364
29.00 x 5.00 x 108.00

93 99 965

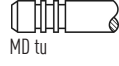

MD tu

45° ss

14



90.00

| | | | | | | | |
|--------------------|--------|-----------------|------------------|---------------------|--------|--------------------|----------------|
| B235L | 2290cc | 4 Cyl. | 16 Valves | 149-184kW/203-250PS | Petrol | Turbo, DOHC | TD18090 |
| B235R | 2290cc | 4 Cyl. | 16 Valves | 152-224kW/207-305PS | Petrol | Turbo, DOHC | TD18089 |
| 9-3 2.3 | | 09/1999→01/2002 | | 9-3 2.3 Turbo | | 10/1998→08/2003 | |
| 9-5 2.3 | | 09/1999→12/2009 | | 9-5 2.3 t | | 09/2003→12/2005 | |
| 9-5 2.3 t BioPower | | 11/2006→12/2009 | | 9-5 2.3 Turbo | | 10/1999→12/2009 | |

V94363
33.00 x 5.00 x 107.50

91 85 851

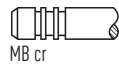

MB cr

45° Y H

VAG96113
42.80 x 5.00 x 12.00







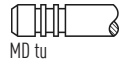

V94364
29.00 x 5.00 x 108.00







93 99 965









MD tu

45° ss

|  |  | ccm |  |  |  |  | |
|---|---|--------|--|---|---|---|----|
| D 10-R 01 | | 127.00 | 10260 | 6 | 12 | Diesel | 3 |
| D 11 R 23 | | 127.00 | 11022 | 6 | 12 | Diesel | 8 |
| DC 11.01 | | 127.00 | 10600 | 6 | 24 | Diesel | 4 |
| DC 11.02 | | 127.00 | 10600 | 6 | 24 | Diesel | 4 |
| DC 11.03 | | 127.00 | 10600 | 6 | 24 | Diesel | 4 |
| DC 11.04 | | 127.00 | 10600 | 6 | 24 | Diesel | 4 |
| DC 11.07 | | 127.00 | 10600 | 6 | 24 | Diesel | 4 |
| DC 11.08 | | 127.00 | 10600 | 6 | 24 | Diesel | 4 |
| DC 11.09 | | 127.00 | 10600 | 6 | 24 | Diesel | 4 |
| DC 12.01 | | 127.00 | 11700 | 6 | 24 | Diesel | 10 |
| DC 12.02 | | 127.00 | 11700 | 6 | 24 | Diesel | 10 |
| DC 12.03 | | 127.00 | 11700 | 6 | 24 | Diesel | 10 |
| DC 12.06 | | 127.00 | 11700 | 6 | 24 | Diesel | 10 |
| DC 12.09 | | 127.00 | 11700 | 6 | 24 | Diesel | 10 |
| DC 12.10 | | 127.00 | 11700 | 6 | 24 | Diesel | 10 |
| DC 12.13 | | 127.00 | 11700 | 6 | 24 | Diesel | 10 |
| DC 12.14 | | 127.00 | 11716 | 6 | 24 | Diesel | 11 |
| DC 12.15 | | 127.00 | 11716 | 6 | 24 | Diesel | 11 |
| DC 12.17 | | 127.00 | 11716 | 6 | 24 | Diesel | 11 |
| DC 12.18 | | 127.00 | 11716 | 6 | 24 | Diesel | 11 |
| DC 12.22 | | 127.00 | 11716 | 6 | 24 | Diesel | 11 |
| DC 12.23 | | 127.00 | 11716 | 6 | 24 | Diesel | 11 |
| DC 12.24 | | 127.00 | 11716 | 6 | 24 | Diesel | 11 |
| DC 12.26 | | 127.00 | 11716 | 6 | 24 | Diesel | 11 |
| DC 13.05 | | 130.00 | 12742 | 6 | 24 | Diesel | 21 |
| DC 13.06 | | 130.00 | 12742 | 6 | 24 | Diesel | 21 |
| DC 13.07 | | 130.00 | 12742 | 6 | 24 | Diesel | 21 |
| DC 13.10 | | 130.00 | 12742 | 6 | 24 | Diesel | 21 |
| DC 16.01 | | 127.00 | 15600 | 8 | 32 | Diesel | 19 |
| DC 16.02 | | 127.00 | 15600 | 8 | 32 | Diesel | 19 |
| DC 16.03 | | 127.00 | 15600 | 8 | 32 | Diesel | 19 |
| DC 16.04 | | 127.00 | 15600 | 8 | 32 | Diesel | 19 |
| DC 16.05 | | 127.00 | 15600 | 8 | 32 | Diesel | 19 |
| DC 16.06 | | 127.00 | 15600 | 8 | 32 | Diesel | 19 |
| DC 16.08 | | 127.00 | 15600 | 8 | 32 | Diesel | 19 |
| DC 16.09 | | 127.00 | 15600 | 8 | 32 | Diesel | 19 |
| DC 16.101 | | 130.00 | 16352 | 8 | 32 | Diesel | 22 |
| DC 16.102 | | 130.00 | 16352 | 8 | 32 | Diesel | 22 |
| DC 16.103 | | 130.00 | 16352 | 8 | 32 | Diesel | 22 |
| DC 16.17 | | 127.00 | 15600 | 8 | 32 | Diesel | 19 |
| DC 16.18 | | 127.00 | 15600 | 8 | 32 | Diesel | 19 |
| DC 16.19 | | 127.00 | 15600 | 8 | 32 | Diesel | 19 |
| DC 16.21 | | 130.00 | 16352 | 8 | 32 | Diesel | 22 |
| DC 16.22 | | 127.00 | 15600 | 8 | 32 | Diesel | 19 |
| DC 9.01 | | 115.00 | 9000 | 6 | 12 | Diesel | 1 |
| DC 9.02 | | 115.00 | 9000 | 6 | 12 | Diesel | 1 |
| DC 9.03 | | 115.00 | 9000 | 6 | 12 | Diesel | 1 |
| DC 9.04 | | 115.00 | 9000 | 6 | 12 | Diesel | 1 |
| DC 9.05 | | 115.00 | 9000 | 6 | 12 | Diesel | 1 |
| DC 9.06 | | 115.00 | 9000 | 6 | 12 | Diesel | 1 |
| DC 9.11 | | 127.00 | 8867 | 5 | 20 | Diesel | 2 |
| DC 9.12 | | 127.00 | 8867 | 5 | 20 | Diesel | 2 |
| DC 9.13 | | 127.00 | 8867 | 5 | 20 | Diesel | 2 |
| DC 9.16 | | 127.00 | 8867 | 5 | 20 | Diesel | 2 |
| DC 9.17 | | 127.00 | 8867 | 5 | 20 | Diesel | 2 |
| DC 9.18 | | 127.00 | 8867 | 5 | 20 | Diesel | 2 |
| DC 9.22 | | 130.00 | 9300 | 5 | 20 | Diesel | 20 |
| DC 9.29 | | 130.00 | 9300 | 5 | 20 | Diesel | 20 |
| DC 9.30 | | 130.00 | 9300 | 5 | 20 | Diesel | 20 |
| DC 9.32 | | 130.00 | 9300 | 5 | 20 | Diesel | 20 |
| DC 9.35 | | 130.00 | 9300 | 5 | 20 | Diesel | 20 |
| DC 9.36 | | 130.00 | 9300 | 5 | 20 | Diesel | 20 |
| DN 11.01 | | 127.00 | 11020 | 6 | 12 | Diesel | 6 |
| DN 11.01 B10 | | 127.00 | 11022 | 6 | 12 | Diesel | 8 |
| DN 11.01 C 09 | | 127.00 | 11020 | 6 | 12 | Diesel | 6 |
| DN 11.04 B10 | | 127.00 | 11022 | 6 | 12 | Diesel | 8 |

|  |  | ccm |  |  |  |  | |
|---|---|--------|---|---|---|---|----|
| DN 11.04 C 01 | | 127.00 | 11022 | 6 | 12 | Diesel | 8 |
| DN 11.06 | | 127.00 | 11020 | 6 | 12 | Diesel | 6 |
| DN 11.06 B | | 127.00 | 11020 | 6 | 12 | Diesel | 6 |
| DN 11.06 C | | 127.00 | 11020 | 6 | 12 | Diesel | 6 |
| DN 11.07 | | 127.00 | 11022 | 6 | 12 | Diesel | 8 |
| DN 11.08 | | 127.00 | 11022 | 6 | 12 | Diesel | 8 |
| DN 11.08 B01 | | 127.00 | 11020 | 6 | 12 | Diesel | 6 |
| DS 11 | | 127.00 | 11022 | 6 | 12 | Diesel | 8 |
| DS 11 / D11 | | 127.00 | 11022 | 6 | 12 | Diesel | 9 |
| DS 11.01 | | 127.00 | 11022 | 6 | 12 | Diesel | 9 |
| DS 11.01 B 06 | | 127.00 | 11000 | 6 | 12 | Diesel | 5 |
| DS 11.02 | | 127.00 | 11022 | 6 | 12 | Diesel | 8 |
| DS 11.14 | | 127.00 | 11022 | 6 | 12 | Diesel | 8 |
| DS 11.15 | | 127.00 | 11022 | 6 | 12 | Diesel | 8 |
| DS 11.15 B | | 127.00 | 11022 | 6 | 12 | Diesel | 8 |
| DS 11.18 | | 127.00 | 11022 | 6 | 12 | Diesel | 9 |
| DS 11.22 | | 127.00 | 11022 | 6 | 12 | Diesel | 8 |
| DS 11.23 | | 127.00 | 11022 | 6 | 12 | Diesel | 8 |
| DS 11.25 | | 127.00 | 11022 | 6 | 12 | Diesel | 8 |
| DS 11.34 | | 127.00 | 11020 | 6 | 12 | Diesel | 6 |
| DS 11.34 B | | 127.00 | 11020 | 6 | 12 | Diesel | 6 |
| DS 11.34 B0 6 | | 127.00 | 11020 | 6 | 12 | Diesel | 6 |
| DS 11.34 C | | 127.00 | 11020 | 6 | 12 | Diesel | 6 |
| DS 11.71 | | 127.00 | 11020 | 6 | 12 | Diesel | 6 |
| DS 11.71 C | | 127.00 | 11020 | 6 | 12 | Diesel | 6 |
| DS 11.72 | | 127.00 | 11022 | 6 | 12 | Diesel | 8 |
| DS 11.73 | | 127.00 | 11020 | 6 | 12 | Diesel | 6 |
| DS 11.73 B | | 127.00 | 11020 | 6 | 12 | Diesel | 6 |
| DS 11.74 | | 127.00 | 11020 | 6 | 12 | Diesel | 6 |
| DS 11.74 C | | 127.00 | 11020 | 6 | 12 | Diesel | 6 |
| DS 11.75 | | 127.00 | 11020 | 6 | 12 | Diesel | 7 |
| DS 11.78 | | 127.00 | 11020 | 6 | 12 | Diesel | 6 |
| DS 14 | | 127.00 | 14181 | 8 | 16 | Diesel | 12 |
| DS 14 LB 05 | | 127.00 | 14200 | 8 | 16 | Diesel | 17 |
| DS 14 LB 08 | | 127.00 | 14200 | 8 | 16 | Diesel | 18 |
| DS 14.01 | | 127.00 | 14190 | 8 | 16 | Diesel | 15 |
| DS 14.01 L 01 | | 127.00 | 14200 | 8 | 16 | Diesel | 18 |
| DS 14.02 | | 127.00 | 14190 | 8 | 16 | Diesel | 15 |
| DS 14.06 | | 127.00 | 14190 | 8 | 16 | Diesel | 15 |
| DS 14.06 L01/L02/L03 | | 127.00 | 14200 | 8 | 16 | Diesel | 17 |
| DS 14.07 | | 127.00 | 14190 | 8 | 16 | Diesel | 16 |
| DSC 11.01 | | 127.00 | 11020 | 6 | 12 | Diesel | 6 |
| DSC 11.01 B | | 127.00 | 11022 | 6 | 12 | Diesel | 8 |
| DSC 11.02 | | 127.00 | 11022 | 6 | 12 | Diesel | 8 |
| DSC 11.03 | | 127.00 | 11020 | 6 | 12 | Diesel | 6 |
| DSC 11.04 | | 127.00 | 11020 | 6 | 12 | Diesel | 6 |
| DSC 11.04 C | | 127.00 | 11020 | 6 | 12 | Diesel | 6 |
| DSC 11.06 | | 127.00 | 11020 | 6 | 12 | Diesel | 6 |
| DSC 11.08 | | 127.00 | 11020 | 6 | 12 | Diesel | 6 |
| DSC 11.08 B | | 127.00 | 11020 | 6 | 12 | Diesel | 6 |
| DSC 11.08 C | | 127.00 | 11020 | 6 | 12 | Diesel | 6 |
| DSC 11.10 | | 127.00 | 11020 | 6 | 12 | Diesel | 6 |
| DSC 11.12 | | 127.00 | 11020 | 6 | 12 | Diesel | 6 |
| DSC 11.13 | | 127.00 | 11020 | 6 | 12 | Diesel | 6 |
| DSC 11.13 B | | 127.00 | 11020 | 6 | 12 | Diesel | 6 |
| DSC 11.16 | | 127.00 | 11020 | 6 | 12 | Diesel | 6 |
| DSC 11.16 B | | 127.00 | 11020 | 6 | 12 | Diesel | 6 |
| DSC 11.17 | | 127.00 | 11020 | 6 | 12 | Diesel | 6 |
| DSC 11.17 B | | 127.00 | 11020 | 6 | 12 | Diesel | 6 |
| DSC 11.18 | | 127.00 | 11020 | 6 | 12 | Diesel | 6 |
| DSC 11.18 B | | 127.00 | 11020 | 6 | 12 | Diesel | 6 |
| DSC 11.18 B0 1 | | 127.00 | 11020 | 6 | 12 | Diesel | 6 |
| DSC 11.18 L01 | | 127.00 | 11020 | 6 | 12 | Diesel | 6 |
| DSC 11.21 | | 127.00 | 11020 | 6 | 12 | Diesel | 6 |
| DSC 11.22 | | 127.00 | 11020 | 6 | 12 | Diesel | 6 |
| DSC 11.23 | | 127.00 | 11020 | 6 | 12 | Diesel | 6 |

|  |  | ccm |  |  |  |  | |
|---|---|--------|--|---|---|---|----|
| DSC 11.24 | | 127.00 | 11020 | 6 | 12 | Diesel | 6 |
| DSC 11.27 C | | 127.00 | 11020 | 6 | 12 | Diesel | 6 |
| DSC 11.27 C02 | | 127.00 | 11020 | 6 | 12 | Diesel | 6 |
| DSC 11.30 | | 127.00 | 11020 | 6 | 12 | Diesel | 6 |
| DSC 11.32 | | 127.00 | 11020 | 6 | 12 | Diesel | 6 |
| DSC 11.33 | | 127.00 | 11020 | 6 | 12 | Diesel | 6 |
| DSC 11.35 | | 127.00 | 11020 | 6 | 12 | Diesel | 6 |
| DSC 11.36 | | 127.00 | 11020 | 6 | 12 | Diesel | 6 |
| DSC 11.39 | | 127.00 | 11020 | 6 | 12 | Diesel | 6 |
| DSC 11.70 | | 127.00 | 11020 | 6 | 12 | Diesel | 6 |
| DSC 11.71 | | 127.00 | 11020 | 6 | 12 | Diesel | 6 |
| DSC 11.74 | | 127.00 | 11020 | 6 | 12 | Diesel | 6 |
| DSC 11.75 | | 127.00 | 11020 | 6 | 12 | Diesel | 6 |
| DSC 11.79 | | 127.00 | 11000 | 6 | 12 | Diesel | 5 |
| DSC 11.81 | | 127.00 | 11020 | 6 | 12 | Diesel | 6 |
| DSC 12.01 | | 127.00 | 11700 | 6 | 24 | Diesel | 10 |
| DSC 12.02 | | 127.00 | 11700 | 6 | 24 | Diesel | 10 |
| DSC 12.03 | | 127.00 | 11700 | 6 | 24 | Diesel | 10 |
| DSC 12.05 | | 127.00 | 11700 | 6 | 24 | Diesel | 10 |
| DSC 12.06 | | 127.00 | 11700 | 6 | 24 | Diesel | 10 |
| DSC 14.01 | | 127.00 | 14190 | 8 | 16 | Diesel | 15 |
| DSC 14.02 | | 127.00 | 14190 | 8 | 16 | Diesel | 15 |
| DSC 14.03 | | 127.00 | 14190 | 8 | 16 | Diesel | 15 |
| DSC 14.03 L07 | | 127.00 | 14188 | 8 | 16 | Diesel | 14 |
| DSC 14.04 | | 127.00 | 14190 | 8 | 16 | Diesel | 15 |
| DSC 14.05 | | 127.00 | 14190 | 8 | 16 | Diesel | 15 |
| DSC 14.06 | | 127.00 | 14190 | 8 | 16 | Diesel | 15 |
| DSC 14.07 L 01 | | 127.00 | 14200 | 8 | 16 | Diesel | 17 |
| DSC 14.08 | | 127.00 | 14190 | 8 | 16 | Diesel | 15 |
| DSC 14.09 | | 127.00 | 14190 | 8 | 16 | Diesel | 15 |
| DSC 14.10 | | 127.00 | 14190 | 8 | 16 | Diesel | 15 |
| DSC 14.13 | | 127.00 | 14200 | 8 | 16 | Diesel | 17 |
| DSC 14.15 | | 127.00 | 14200 | 8 | 16 | Diesel | 17 |
| DSC 9.11 | | 115.00 | 9000 | 6 | 12 | Diesel | 1 |
| DSC 9.12 | | 115.00 | 9000 | 6 | 12 | Diesel | 1 |
| DSC 9.13 | | 115.00 | 9000 | 6 | 12 | Diesel | 1 |
| DSC 9.15 | | 115.00 | 9000 | 6 | 12 | Diesel | 1 |
| DSI 14.47 | | 127.00 | 14181 | 8 | 16 | Diesel | 13 |
| DSI 14.50 | | 127.00 | 14181 | 8 | 16 | Diesel | 13 |
| DSI 14.60 | | 127.00 | 14181 | 8 | 16 | Diesel | 13 |
| DSI 14.61 | | 127.00 | 14181 | 8 | 16 | Diesel | 13 |
| DSI 14.63 | | 127.00 | 14181 | 8 | 16 | Diesel | 13 |
| DT 12.02 | | 127.00 | 11716 | 6 | 24 | Diesel | 11 |
| DT 12.03 | | 127.00 | 11716 | 6 | 24 | Diesel | 11 |
| DT 12.06 | | 127.00 | 11716 | 6 | 24 | Diesel | 11 |
| DT 12.08 | | 127.00 | 11716 | 6 | 24 | Diesel | 11 |
| DT 12.10 | | 127.00 | 11716 | 6 | 24 | Diesel | 11 |
| DT 12.11 | | 127.00 | 11716 | 6 | 24 | Diesel | 11 |
| DT 12.12 | | 127.00 | 11716 | 6 | 24 | Diesel | 11 |
| DT 12.17 | | 127.00 | 11716 | 6 | 24 | Diesel | 11 |
| DT 12.18 | | 127.00 | 11716 | 6 | 24 | Diesel | 11 |



OE

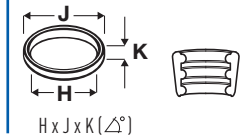
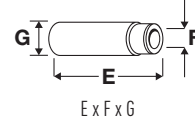
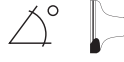

1



115.00

| | | | | | | | |
|----------|--------|--------|-----------|-------------|--------|------------|---------|
| DC 9.01 | 9000cc | 6 Cyl. | 12 Valves | 169kW/230PS | Diesel | Turbo, OHV | TD15408 |
| DC 9.02 | 9000cc | 6 Cyl. | 12 Valves | 191kW/260PS | Diesel | Turbo, OHV | TD15411 |
| DC 9.03 | 9000cc | 6 Cyl. | 12 Valves | 221kW/300PS | Diesel | Turbo, OHV | TD15413 |
| DC 9.04 | 9000cc | 6 Cyl. | 12 Valves | 169kW/230PS | Diesel | Turbo, OHV | TD15410 |
| DC 9.05 | 9000cc | 6 Cyl. | 12 Valves | 191kW/260PS | Diesel | Turbo, OHV | TD15412 |
| DC 9.06 | 9000cc | 6 Cyl. | 12 Valves | 221kW/300PS | Diesel | Turbo, OHV | TD15414 |
| DSC 9.11 | 9000cc | 6 Cyl. | 12 Valves | 162kW/220PS | Diesel | Turbo, OHV | TD8854 |
| DSC 9.12 | 9000cc | 6 Cyl. | 12 Valves | 191kW/260PS | Diesel | Turbo, OHV | TD8855 |
| DSC 9.13 | 9000cc | 6 Cyl. | 12 Valves | 228kW/310PS | Diesel | Turbo, OHV | TD8853 |
| DSC 9.15 | 9000cc | 6 Cyl. | 12 Valves | 228kW/310PS | Diesel | Turbo, OHV | TD12608 |

| | | | |
|----------------|-----------------|----------------|-----------------|
| 3 - series | 01/1990→12/1998 | 4 - series | 08/1996→ |
| 4 - series bus | 01/1999→ | F - series bus | 01/1999→04/2000 |

| | | | | |
|----------|---------|------------|-----|----|
| V95168 ■ | 1386647 | MD + MB cr | 36° | H |
| V95169 ■ | 1386648 | MD cr | 45° | SS |

2



127.00

| | | | | | | | |
|---------|--------|--------|-----------|-------------|--------|------------|---------|
| DC 9.11 | 8867cc | 5 Cyl. | 20 Valves | 228kW/310PS | Diesel | Turbo, OHV | TD18048 |
| DC 9.12 | 8867cc | 5 Cyl. | 20 Valves | 198kW/270PS | Diesel | Turbo, OHV | TD18047 |
| DC 9.13 | 8867cc | 5 Cyl. | 20 Valves | 169kW/230PS | Diesel | Turbo, OHV | TD18045 |
| DC 9.16 | 8867cc | 5 Cyl. | 20 Valves | 169kW/230PS | Diesel | Turbo, OHV | TD18641 |
| DC 9.17 | 8867cc | 5 Cyl. | 20 Valves | 198kW/270PS | Diesel | Turbo, OHV | TD18642 |
| DC 9.18 | 8867cc | 5 Cyl. | 20 Valves | 228kW/310PS | Diesel | Turbo, OHV | TD18643 |

| | | | |
|------------------|----------|----------------|----------|
| F - series bus | 12/2009→ | K - series | 01/2009→ |
| K - series bus | 10/2006→ | N - series bus | 02/2007→ |
| OMNICITY | 07/2008→ | OMNILINK | 09/2006→ |
| P,G,R,T - series | 04/2004→ | | |

| | | | | |
|----------|---------|------------|-----|----|
| V95168 ■ | 1386647 | MD + MB cr | 36° | H |
| V95169 ■ | 1386648 | MD cr | 45° | SS |

3



127.00

| | | | | | | | |
|-----------|---------|--------|-----------|---------------------|--------|-----|--------|
| D 10-R 01 | 10260cc | 6 Cyl. | 12 Valves | 121-151kW/165-205PS | Diesel | OHV | TD5877 |
|-----------|---------|--------|-----------|---------------------|--------|-----|--------|

| | | | | |
|--------------|-----------|------------|-----|----|
| V91200 ■ | 136 08 36 | MD + MB cr | 20° | SS |
| V91202 ■ [1] | 139 75 21 | MD cr | 45° | SS |

| | | |
|------------|-----------------------|--|
| VAG92166 ■ | 80.00 x 11.02 x 18.03 | |
| VAG92167 ■ | 73.00 x 11.02 x 18.03 | |

[1] Not for engines with increased exhaust brake capacity [1] Nicht für Motoren mit erhöhter Abgasbremsleistung [1] Pas pour moteur avec capacité frein moteur élevée [1] No para motores con elevada potencia de frenado del gas de escape [1] Non per motori con potenza motore aumentata

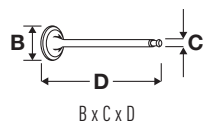

OE

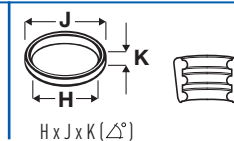
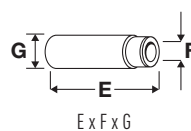

4 127.00

| | | | | | | | |
|----------|---------|--------|-----------|-------------|--------|------------|---------|
| DC 11.01 | 10600cc | 6 Cyl. | 24 Valves | 250kW/340PS | Diesel | Turbo, OHV | TD12769 |
| DC 11.02 | 10600cc | 6 Cyl. | 24 Valves | 280kW/380PS | Diesel | Turbo, OHV | TD12772 |
| DC 11.03 | 10600cc | 6 Cyl. | 24 Valves | 250kW/340PS | Diesel | Turbo, OHV | TD15415 |
| DC 11.04 | 10600cc | 6 Cyl. | 24 Valves | 280kW/381PS | Diesel | Turbo, OHV | TD15416 |
| DC 11.07 | 10600cc | 6 Cyl. | 24 Valves | 243kW/330PS | Diesel | Turbo, OHV | TD21005 |
| DC 11.08 | 10600cc | 6 Cyl. | 24 Valves | 250kW/340PS | Diesel | Turbo, OHV | TD17451 |
| DC 11.09 | 10600cc | 6 Cyl. | 24 Valves | 279kW/380PS | Diesel | Turbo, OHV | TD17452 |

4 - series 05/1996→ K - series bus 03/2010→
 P.G.R.T - series 03/2004→

| | | | | | | |
|-----------------------|-----------|------------|-----|----|-----------------------|--|
| V94444 ■ | 133 32 30 | | 20° | H | VAG96314 ■ ■ | |
| 44.10 x 9.95 x 171.40 | | MD + MB cr | | | 73.00 x 10.00 x 16.00 | |
| V94445 ■ | 132 85 37 | | 45° | SS | | |
| 41.00 x 9.94 x 171.50 | | MD + MB cr | | | | |

5 127.00

| | | | | | | | |
|---------------|---------|--------|-----------|-------------|--------|------------|---------|
| DS 11.01 B 06 | 11000cc | 6 Cyl. | 12 Valves | 202kW/275PS | Diesel | Turbo, OHV | TD8799 |
| DSC 11.79 | 11000cc | 6 Cyl. | 12 Valves | 250kW/340PS | Diesel | Turbo, OHV | TD12768 |

4 - series 05/1996→

| | | | | | | |
|------------------------|-----------|------------|-----|----|-----------------------|--|
| V91200 ■ | 136 08 36 | | 20° | SS | VAG92166 ■ | |
| 54.20 x 10.95 x 162.70 | | MD + MB cr | | | 80.00 x 11.02 x 18.03 | |
| V91201 ■ | 352211 | | 20° | | VAG92167 ■ | |
| 54.20 x 10.95 x 162.70 | | MD + MB cr | | | 73.00 x 11.02 x 18.03 | |
| V34963 ■ | 232018 | | 45° | SS | | |
| 45.11 x 10.94 x 162.51 | | MD cr | | | | |
| V91202 ■ [1] | 139 75 21 | | 45° | SS | | |
| 44.75 x 10.94 x 162.70 | | MD cr | | | | |

[1] Not for engines with increased exhaust brake capacity [1] Nicht für Motoren mit erhöhter Abgasbremsleistung [1] Pas pour moteurs avec capacité frein moteur élevée [1] No para motores con elevada potencia de frenado del ga [1] Non per motori con potenza motore aumentata s de escape

6 127.00

| | | | | | | | |
|---------------|---------|--------|-----------|---------------------|--------|------------|--------|
| DN 11.01 | 11020cc | 6 Cyl. | 12 Valves | 149-153kW/203-208PS | Diesel | OHV | TD8806 |
| DN 11.01 C 09 | 11020cc | 6 Cyl. | 12 Valves | 158kW/215PS | Diesel | OHV | TD8836 |
| DN 11.06 | 11020cc | 6 Cyl. | 12 Valves | 134kW/182PS | Diesel | OHV | TD8875 |
| DN 11.06 B | 11020cc | 6 Cyl. | 12 Valves | 143kW/195PS | Diesel | OHV | TD8800 |
| DN 11.06 C | 11020cc | 6 Cyl. | 12 Valves | 143-149kW/194-203PS | Diesel | OHV | TD8817 |
| DN 11.08 B01 | 11020cc | 6 Cyl. | 12 Valves | 149kW/203PS | Diesel | OHV | TD8889 |
| DS 11.34 | 11020cc | 6 Cyl. | 12 Valves | 228kW/310PS | Diesel | Turbo, OHV | TD8869 |
| DS 11.34 B | 11020cc | 6 Cyl. | 12 Valves | 228kW/310PS | Diesel | Turbo, OHV | TD8818 |
| DS 11.34 B0 6 | 11020cc | 6 Cyl. | 12 Valves | 230kW/313PS | Diesel | Turbo, OHV | TD8830 |
| DS 11.34 C | 11020cc | 6 Cyl. | 12 Valves | 228kW/310PS | Diesel | Turbo, OHV | TD8866 |
| DS 11.71 | 11020cc | 6 Cyl. | 12 Valves | 189kW/257PS | Diesel | Turbo, OHV | TD8873 |
| DS 11.71 C | 11020cc | 6 Cyl. | 12 Valves | 189kW/257PS | Diesel | Turbo, OHV | TD5878 |
| DS 11.73 | 11020cc | 6 Cyl. | 12 Valves | 228-230kW/310-313PS | Diesel | Turbo, OHV | TD8859 |
| DS 11.73 B | 11020cc | 6 Cyl. | 12 Valves | 230kW/313PS | Diesel | Turbo, OHV | TD8819 |
| DS 11.74 | 11020cc | 6 Cyl. | 12 Valves | 194kW/257PS | Diesel | Turbo, OHV | TD8820 |
| DS 11.74 C | 11020cc | 6 Cyl. | 12 Valves | 189kW/257PS | Diesel | Turbo, OHV | TD6226 |
| DS 11.78 | 11020cc | 6 Cyl. | 12 Valves | 162kW/220PS | Diesel | Turbo, OHV | TD8822 |
| DSC 11.01 | 11020cc | 6 Cyl. | 12 Valves | 230kW/313PS | Diesel | Turbo, OHV | TD8811 |



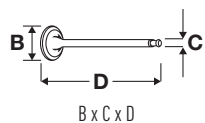

OE

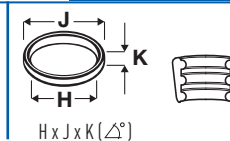
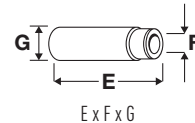
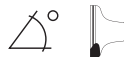

| | | | | | | | |
|----------------|---------|--------|-----------|---------------------|--------|------------|---------|
| DSC 11.03 | 11020cc | 6 Cyl. | 12 Valves | 254kW/345PS | Diesel | Turbo, OHV | TD8862 |
| DSC 11.04 | 11020cc | 6 Cyl. | 12 Valves | 189-245kW/257-333PS | Diesel | Turbo, OHV | TD8868 |
| DSC 11.04 C | 11020cc | 6 Cyl. | 12 Valves | 189kW/257PS | Diesel | Turbo, OHV | TD5879 |
| DSC 11.06 | 11020cc | 6 Cyl. | 12 Valves | 229kW/311PS | Diesel | Turbo, OHV | TD8863 |
| DSC 11.08 | 11020cc | 6 Cyl. | 12 Valves | 228-280kW/310-381PS | Diesel | Turbo, OHV | TD8823 |
| DSC 11.08 B | 11020cc | 6 Cyl. | 12 Valves | 228kW/310PS | Diesel | Turbo, OHV | TD8828 |
| DSC 11.08 C | 11020cc | 6 Cyl. | 12 Valves | 228kW/310PS | Diesel | Turbo, OHV | TD8867 |
| DSC 11.10 | 11020cc | 6 Cyl. | 12 Valves | 250kW/340PS | Diesel | Turbo, OHV | TD8877 |
| DSC 11.12 | 11020cc | 6 Cyl. | 12 Valves | 254kW/345PS | Diesel | Turbo, OHV | TD8861 |
| DSC 11.13 | 11020cc | 6 Cyl. | 12 Valves | 267kW/363PS | Diesel | Turbo, OHV | TD8878 |
| DSC 11.13 B | 11020cc | 6 Cyl. | 12 Valves | 267kW/363PS | Diesel | Turbo, OHV | TD8824 |
| DSC 11.16 | 11020cc | 6 Cyl. | 12 Valves | 239kW/325PS | Diesel | Turbo, OHV | TD8879 |
| DSC 11.16 B | 11020cc | 6 Cyl. | 12 Valves | 239kW/325PS | Diesel | Turbo, OHV | TD8825 |
| DSC 11.17 | 11020cc | 6 Cyl. | 12 Valves | 237kW/322PS | Diesel | Turbo, OHV | TD8880 |
| DSC 11.17 B | 11020cc | 6 Cyl. | 12 Valves | 235kW/320PS | Diesel | Turbo, OHV | TD8829 |
| DSC 11.18 | 11020cc | 6 Cyl. | 12 Valves | 267kW/363PS | Diesel | Turbo, OHV | TD8826 |
| DSC 11.18 B | 11020cc | 6 Cyl. | 12 Valves | 267kW/363PS | Diesel | Turbo, OHV | TD8827 |
| DSC 11.18 B0 1 | 11020cc | 6 Cyl. | 12 Valves | 265kW/360PS | Diesel | Turbo, OHV | TD8831 |
| DSC 11.18 L01 | 11020cc | 6 Cyl. | 12 Valves | 267kW/360PS | Diesel | Turbo, OHV | TD8891 |
| DSC 11.21 | 11020cc | 6 Cyl. | 12 Valves | 235-266kW/320-362PS | Diesel | Turbo, OHV | TD8812 |
| DSC 11.22 | 11020cc | 6 Cyl. | 12 Valves | 280kW/381PS | Diesel | Turbo, OHV | TD8813 |
| DSC 11.23 | 11020cc | 6 Cyl. | 12 Valves | 266kW/362PS | Diesel | Turbo, OHV | TD8814 |
| DSC 11.24 | 11020cc | 6 Cyl. | 12 Valves | 191kW/260PS | Diesel | Turbo, OHV | TD8870 |
| DSC 11.27 C | 11020cc | 6 Cyl. | 12 Valves | 189kW/257PS | Diesel | Turbo, OHV | TD6227 |
| DSC 11.27 C02 | 11020cc | 6 Cyl. | 12 Valves | 180-200kW/245-272PS | Diesel | Turbo, OHV | TD8871 |
| DSC 11.30 | 11020cc | 6 Cyl. | 12 Valves | 265-280kW/360-381PS | Diesel | Turbo, OHV | TD8881 |
| DSC 11.32 | 11020cc | 6 Cyl. | 12 Valves | 235kW/320PS | Diesel | Turbo, OHV | TD8887 |
| DSC 11.33 | 11020cc | 6 Cyl. | 12 Valves | 266kW/362PS | Diesel | Turbo, OHV | TD8888 |
| DSC 11.35 | 11020cc | 6 Cyl. | 12 Valves | 235-266kW/320-362PS | Diesel | Turbo, OHV | TD8815 |
| DSC 11.36 | 11020cc | 6 Cyl. | 12 Valves | 235-266kW/320-362PS | Diesel | Turbo, OHV | TD8816 |
| DSC 11.39 | 11020cc | 6 Cyl. | 12 Valves | 258kW/351PS | Diesel | Turbo, OHV | TD8882 |
| DSC 11.70 | 11020cc | 6 Cyl. | 12 Valves | 280kW/381PS | Diesel | Turbo, OHV | TD8884 |
| DSC 11.71 | 11020cc | 6 Cyl. | 12 Valves | 235-266kW/320-362PS | Diesel | Turbo, OHV | TD8872 |
| DSC 11.74 | 11020cc | 6 Cyl. | 12 Valves | 235-266kW/320-362PS | Diesel | Turbo, OHV | TD22369 |
| DSC 11.75 | 11020cc | 6 Cyl. | 12 Valves | 235-266kW/320-362PS | Diesel | Turbo, OHV | TD22370 |
| DSC 11.81 | 11020cc | 6 Cyl. | 12 Valves | 250-305kW/340-415PS | Diesel | Turbo, OHV | TD17286 |

| | | | |
|----------------|-----------------|------------|-----------------|
| 2 - series | 01/1981→06/1989 | 3 - series | 05/1988→12/1998 |
| 3 - series bus | 01/1988→ | 4 - series | 01/2004→ |
| Cityliner | 09/1990→ | Jetliner | 09/1990→ |
| K - series bus | 03/1991→08/1999 | Skyliner | 09/1990→ |
| Spaceliner | 09/1990→ | Transliner | 09/1990→ |

V91200 ■ 136 08 36
54.20 x 10.95 x 162.70

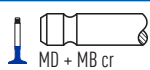

20° SS

V91201 ■ 352211
54.20 x 10.95 x 162.70

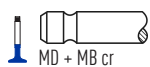

20°

V34963 ■ 232018
45.11 x 10.94 x 162.51

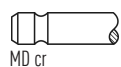

45° SS

V91202 ■ [1] 139 75 21
44.75 x 10.94 x 162.70

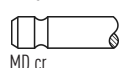

45° SS

VAG92166 ■ 80.00 x 11.02 x 18.03



VAG92167 ■ 73.00 x 11.02 x 18.03



[1] Not for engines with increased exhaust brake capacity [1] Nicht für Motoren mit erhöhter Abgasbremsleistung [1] Pas pour moteur avec capacité frein moteur élevée [1] No para motores con elevada potencia de frenado del gas de escape [1] Non per motori con potenza motore aumentata

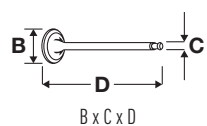

OE

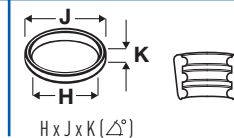
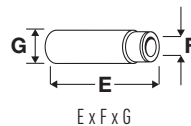

7 **127.00**

| DS 11.75 | 11020cc | 6 Cyl. | 12 Valves | 228-230kW/310-313PS | Diesel | Turbo, OHV | TD8821 |
|------------------------|-----------|-----------------|-----------|---------------------|-----------------------|------------|---|
| 3 - series | | 01/1990→12/1991 | | | | | |
| V91200 ■ | 136 08 36 | MD + MB cr | 20° | SS | VAG92166 ■ | | VS6103 ■ [5] 47.50 x 56.03 x 7.65 (30°) |
| 54.20 x 10.95 x 162.70 | | | | | 80.00 x 11.02 x 18.03 | | |
| V91201 ■ | 352211 | MD + MB cr | 20° | | VAG92167 ■ | | |
| 54.20 x 10.95 x 162.70 | | | | | 73.00 x 11.02 x 18.03 | | |
| V34963 ■ | 232018 | MD cr | 45° | SS | | | |
| 45.11 x 10.94 x 162.51 | | | | | | | |
| V91202 ■ [1] | 139 75 21 | MD cr | 45° | SS | | | |
| 44.75 x 10.94 x 162.70 | | | | | | | |

[1] Not for engines with increased exhaust brake capacity [1] Nicht für Motoren mit erhöhter Abgasbremsleistung [1] Pas pour moteur avec capacité frein moteur élevée [1] No para motores con elevada potencia de frenado del gas de escape [1] Non per motori con potenza motore aumentata s de escape
 [5] Fully finished [5] Fertigeschliffene [5] Entièrement finis [5] Totalmente acabada [5] Finite

8 **127.00**

| D 11 R 23 | 11022cc | 6 Cyl. | 12 Valves | 143kW/195PS | Diesel | OHV | TD8805 |
|----------------------|---------|--------|-----------|---------------------|--------|------------|--------|
| DN 11.01 B10 | 11022cc | 6 Cyl. | 12 Valves | 155kW/211PS | Diesel | OHV | TD5872 |
| DN 11.04 B10 | 11022cc | 6 Cyl. | 12 Valves | 155kW/211PS | Diesel | OHV | TD6220 |
| DN 11.04 C 01 | 11022cc | 6 Cyl. | 12 Valves | 158kW/215PS | Diesel | Turbo, OHV | TD8837 |
| DN 11.07 | 11022cc | 6 Cyl. | 12 Valves | 139kW/189PS | Diesel | OHV | TD8808 |
| DN 11.08 | 11022cc | 6 Cyl. | 12 Valves | 150kW/204PS | Diesel | OHV | TD8886 |
| DS 11 | 11022cc | 6 Cyl. | 12 Valves | 184-202kW/250-275PS | Diesel | Turbo, OHV | TD8798 |
| DS 11.02 | 11022cc | 6 Cyl. | 12 Valves | 206-245kW/280-333PS | Diesel | Turbo, OHV | TD8864 |
| DS 11.14 | 11022cc | 6 Cyl. | 12 Valves | 206-245kW/280-333PS | Diesel | Turbo, OHV | TD6222 |
| DS 11.15 | 11022cc | 6 Cyl. | 12 Valves | 224-245kW/305-333PS | Diesel | Turbo, OHV | TD8803 |
| DS 11.15 B | 11022cc | 6 Cyl. | 12 Valves | 224kW/305PS | Diesel | Turbo, OHV | TD8801 |
| DS 11.22 | 11022cc | 6 Cyl. | 12 Valves | 280kW/381PS | Diesel | Turbo, OHV | TD7436 |
| DS 11.23 | 11022cc | 6 Cyl. | 12 Valves | 266kW/362PS | Diesel | Turbo, OHV | TD7180 |
| DS 11.25 | 11022cc | 6 Cyl. | 12 Valves | 185-189kW/252-260PS | Diesel | Turbo, OHV | TD8856 |
| DS 11.72 | 11022cc | 6 Cyl. | 12 Valves | 230kW/313PS | Diesel | Turbo, OHV | TD8858 |
| DSC 11.01 B | 11022cc | 6 Cyl. | 12 Valves | 254kW/345PS | Diesel | Turbo, OHV | TD8802 |
| DSC 11.02 | 11022cc | 6 Cyl. | 12 Valves | 267kW/363PS | Diesel | Turbo, OHV | TD8860 |

| | | | | | | | |
|------------------------|-----------|-----------------|-----|----|-----------------------|--|--|
| 2 - series | | 01/1981→08/1991 | | | | | |
| V91200 ■ | 136 08 36 | MD + MB cr | 20° | SS | VAG92166 ■ | | |
| 54.20 x 10.95 x 162.70 | | | | | 80.00 x 11.02 x 18.03 | | |
| V91201 ■ | 352211 | MD + MB cr | 20° | | VAG92167 ■ | | |
| 54.20 x 10.95 x 162.70 | | | | | 73.00 x 11.02 x 18.03 | | |
| V34963 ■ | 232018 | MD cr | 45° | SS | | | |
| 45.11 x 10.94 x 162.51 | | | | | | | |
| V91202 ■ [1] | 139 75 21 | MD cr | 45° | SS | | | |
| 44.75 x 10.94 x 162.70 | | | | | | | |

[1] Not for engines with increased exhaust brake capacity [1] Nicht für Motoren mit erhöhter Abgasbremsleistung [1] Pas pour moteur avec capacité frein moteur élevée [1] No para motores con elevada potencia de frenado del gas de escape [1] Non per motori con potenza motore aumentata s de escape



OE

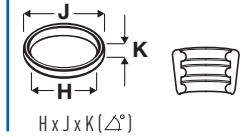
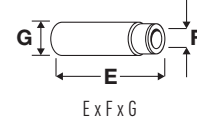

9



127.00

| | | | | | | | |
|-------------|---------|--------|-----------|---------------------|--------|------------|--------|
| DS 11 / D11 | 11022cc | 6 Cyl. | 12 Valves | 140-149kW/190-203PS | Diesel | OHV | TD8794 |
| DS 11.01 | 11022cc | 6 Cyl. | 12 Valves | 184-202kW/250-275PS | Diesel | Turbo, OHV | TD5874 |
| DS 11.18 | 11022cc | 6 Cyl. | 12 Valves | 254kW/345PS | Diesel | Turbo, OHV | TD8857 |

V91200 ■ 136 08 36

54.20 x 10.95 x 162.70



20° SS

V91201 ■ 352211

54.20 x 10.95 x 162.70



20°

V34963 ■ 232018

45.11 x 10.94 x 162.51

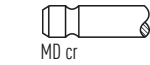

45° SS

V91202 ■ [1] 139 75 21

44.75 x 10.94 x 162.70

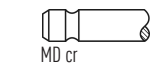

45° SS

VAG92166 ■ 80.00 x 11.02 x 18.03



VAG92167 ■ 73.00 x 11.02 x 18.03



VS6103 ■ [5] 47.50 x 56.03 x 7.65 (30°)
→12/73

[1] Not for engines with increased exhaust brake capacity [1] Nicht für Motoren mit erhöhter Abgasbremsleistung [1] Pas pour moteur avec capacité frein moteur élevée [1] No para motores con elevada potencia de frenado del gas de escape [1] Non per motori con potenza motore aumentata
[5] Fully finished [5] Fertigggeschliffene [5] Entièrement finis [5] Totalmente acabada [5] Finite

10



127.00

| | | | | | | | |
|-----------|---------|--------|-----------|---------------------|--------|------------|---------|
| DC 12.01 | 11700cc | 6 Cyl. | 24 Valves | 309kW/420PS | Diesel | Turbo, OHV | TD15418 |
| DC 12.02 | 11700cc | 6 Cyl. | 24 Valves | 265kW/360PS | Diesel | Turbo, OHV | TD21080 |
| DC 12.03 | 11700cc | 6 Cyl. | 24 Valves | 308kW/420PS | Diesel | Turbo, OHV | TD16852 |
| DC 12.06 | 11700cc | 6 Cyl. | 24 Valves | 309kW/420PS | Diesel | Turbo, OHV | TD20875 |
| DC 12.09 | 11700cc | 6 Cyl. | 24 Valves | 309kW/420PS | Diesel | Turbo, OHV | TD22367 |
| DC 12.10 | 11700cc | 6 Cyl. | 24 Valves | 250kW/340PS | Diesel | Turbo, OHV | TD18644 |
| DC 12.13 | 11700cc | 6 Cyl. | 24 Valves | 280kW/380PS | Diesel | Turbo, OHV | TD18645 |
| DSC 12.01 | 11700cc | 6 Cyl. | 24 Valves | 294kW/400PS | Diesel | Turbo, OHV | TD8892 |
| DSC 12.02 | 11700cc | 6 Cyl. | 24 Valves | 265kW/360PS | Diesel | Turbo, OHV | TD8893 |
| DSC 12.03 | 11700cc | 6 Cyl. | 24 Valves | 265-325kW/360-442PS | Diesel | Turbo, OHV | TD22371 |
| DSC 12.05 | 11700cc | 6 Cyl. | 24 Valves | 309kW/420PS | Diesel | Turbo, OHV | TD12870 |
| DSC 12.06 | 11700cc | 6 Cyl. | 24 Valves | 309kW/420PS | Diesel | Turbo, OHV | TD22372 |

4 - series
K - series bus

05/1995→
04/1999→

IRIZAR CENTURY
P,G,R,T - series

09/2006→
03/2004→

V94444 ■ 133 32 30

44.10 x 9.95 x 171.40



20° H

VAG96314 ■ ■ 73.00 x 10.00 x 16.00



V94445 ■ 132 85 37

41.00 x 9.94 x 171.50



45° SS H

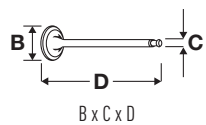

OE

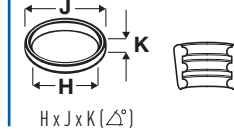
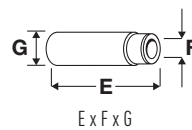

11 **127.00**

| | | | | | | | |
|----------|---------|--------|-----------|-------------|--------|------------|---------|
| DC 12.14 | 11716cc | 6 Cyl. | 24 Valves | 309kW/420PS | Diesel | Turbo, OHV | TD17453 |
| DC 12.15 | 11716cc | 6 Cyl. | 24 Valves | 309kW/420PS | Diesel | Turbo, OHV | TD18647 |
| DC 12.17 | 11716cc | 6 Cyl. | 24 Valves | 279kW/379PS | Diesel | Turbo, OHV | TD20873 |
| DC 12.18 | 11716cc | 6 Cyl. | 24 Valves | 279kW/379PS | Diesel | Turbo, OHV | TD20874 |
| DC 12.22 | 11716cc | 6 Cyl. | 24 Valves | 309kW/420PS | Diesel | Turbo, OHV | TD23694 |
| DC 12.23 | 11716cc | 6 Cyl. | 24 Valves | 309kW/420PS | Diesel | Turbo, OHV | TD23698 |
| DC 12.24 | 11716cc | 6 Cyl. | 24 Valves | 280kW/381PS | Diesel | Turbo, OHV | TD23699 |
| DC 12.26 | 11716cc | 6 Cyl. | 24 Valves | 250kW/340PS | Diesel | Turbo, OHV | TD23700 |
| DT 12.02 | 11716cc | 6 Cyl. | 24 Valves | 345kW/470PS | Diesel | Turbo, OHV | TD16495 |
| DT 12.03 | 11716cc | 6 Cyl. | 24 Valves | 345kW/470PS | Diesel | Turbo, OHV | TD18648 |
| DT 12.06 | 11716cc | 6 Cyl. | 24 Valves | 345kW/470PS | Diesel | Turbo, OHV | TD17455 |
| DT 12.08 | 11716cc | 6 Cyl. | 24 Valves | 324kW/440PS | Diesel | Turbo, OHV | TD16716 |
| DT 12.10 | 11716cc | 6 Cyl. | 24 Valves | 324kW/441PS | Diesel | Turbo, OHV | TD29079 |
| DT 12.11 | 11716cc | 6 Cyl. | 24 Valves | 309kW/420PS | Diesel | Turbo, OHV | TD17454 |
| DT 12.12 | 11716cc | 6 Cyl. | 24 Valves | 309kW/420PS | Diesel | Turbo, OHV | TD18646 |
| DT 12.17 | 11716cc | 6 Cyl. | 24 Valves | 353kW/480PS | Diesel | Turbo, OHV | TD20878 |
| DT 12.18 | 11716cc | 6 Cyl. | 24 Valves | 324kW/440PS | Diesel | Turbo, OHV | TD20877 |

4 - series 01/2000→ IRIZAR CENTURY 09/2006→
 IRIZAR PB 09/2006→ K - series bus 06/2007→
 P.G.R.T - series 03/2004→

| | | | | | | |
|--|-----------|----------------|-----|------|--|---------------------------|
| V94444 44.10 x 9.95 x 171.40 | 133 32 30 | MD + MB cr | 20° | H | VAG96314 73.00 x 10.00 x 16.00 | 73.00 x 10.00 x 16.00 |
| V94445 41.00 x 9.94 x 171.50 | 132 85 37 | MD + MB cr | 45° | SS H | | |

12 **127.00**

| | | | | | | | |
|---|-----------|----------------|-----------|-------------|--|---------------------------|---|
| DS 14 | 14181cc | V8 Cyl. | 16 Valves | 257kW/350PS | Diesel | Turbo, OHV | TD8835 |
| V91200 54.20 x 10.95 x 162.70 | 136 08 36 | MD + MB cr | 20° | SS | VAG92166 80.00 x 11.02 x 18.03 | 80.00 x 11.02 x 18.03 | VS6103 [5] 47.50 x 56.03 x 7.65 (30°) →12/81 |
| V91201 54.20 x 10.95 x 162.70 | 352211 | MD + MB cr | 20° | | VAG92167 73.00 x 11.02 x 18.03 | 73.00 x 11.02 x 18.03 | |
| V34963 45.11 x 10.94 x 162.51 | 232018 | MD cr | 45° | SS | | | |
| V91202 [1] 44.75 x 10.94 x 162.70 | 139 75 21 | MD cr | 45° | SS | | | |

[1] Not for engines with increased exhaust brake capacity [1] Nicht für Motoren mit erhöhter Abgasbremsleistung [1] Pas pour moteur avec capacité frein moteur élevée [1] No para motores con elevada potencia de frenado del gas de escape [1] Non per motori con potenza motore aumentata
 [5] Fully finished [5] Fertigggeschliffene [5] Entierement finis [5] Totalmente acabada [5] Finite



OE

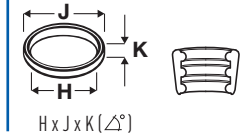
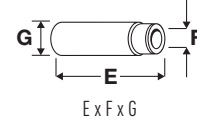

13  **127.00**

| | | | | | | | |
|-----------|---------|---------|-----------|-------------|--------|-------|---------|
| DSI 14.47 | 14181cc | V8 Cyl. | 16 Valves | 341kW/464PS | Diesel | Turbo | TD19149 |
| DSI 14.50 | 14181cc | V8 Cyl. | 16 Valves | 341kW/464PS | Diesel | Turbo | TD19150 |
| DSI 14.60 | 14181cc | V8 Cyl. | 16 Valves | 341kW/464PS | Diesel | Turbo | TD19151 |
| DSI 14.61 | 14181cc | V8 Cyl. | 16 Valves | 341kW/464PS | Diesel | Turbo | TD19152 |
| DSI 14.63 | 14181cc | V8 Cyl. | 16 Valves | 341kW/464PS | Diesel | Turbo | TD19153 |

V91200 ■
54.20 x 10.95 x 162.70

136 08 36



20° SS

VAG92166 ■
80.00 x 11.02 x 18.03



V91201 ■
54.20 x 10.95 x 162.70

352211



20°

VAG92167 ■
73.00 x 11.02 x 18.03



V34963 ■
45.11 x 10.94 x 162.51

232018

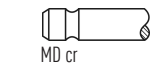

45° SS

V91202 ■ [1]
44.75 x 10.94 x 162.70

139 75 21

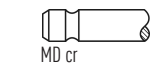

45° SS

[1] Not for engines with increased exhaust brake capacity [1] Nicht für Motoren mit erhöhter Abgasbremsleistung [1] Pas pour moteur avec capacité frein moteur élevée [1] No para motores con elevada potencia de frenado del gas de escape [1] Non per motori con potenza motore aumentata

14  **127.00**

| | | | | | | | |
|---------------|---------|---------|-----------|-------------|--------|------------|--------|
| DSC 14.03 L07 | 14188cc | V8 Cyl. | 16 Valves | 331kW/450PS | Diesel | Turbo, OHV | TD8913 |
|---------------|---------|---------|-----------|-------------|--------|------------|--------|

V91200 ■
54.20 x 10.95 x 162.70

136 08 36



20° SS

VAG92166 ■
80.00 x 11.02 x 18.03



V91201 ■
54.20 x 10.95 x 162.70

352211



20°

VAG92167 ■
73.00 x 11.02 x 18.03

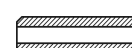

V34963 ■
45.11 x 10.94 x 162.51

232018

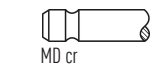

45° SS

V91202 ■ [1]
44.75 x 10.94 x 162.70

139 75 21

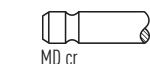

45° SS

[1] Not for engines with increased exhaust brake capacity [1] Nicht für Motoren mit erhöhter Abgasbremsleistung [1] Pas pour moteur avec capacité frein moteur élevée [1] No para motores con elevada potencia de frenado del gas de escape [1] Non per motori con potenza motore aumentata



OE

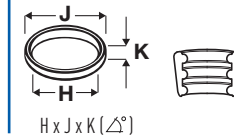
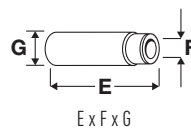
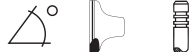

15 **127.00**

| | | | | | | | |
|-----------|---------|---------|-----------|---------------------|--------|------------|---------|
| DS 14.01 | 14190cc | V8 Cyl. | 16 Valves | 283-293kW/385-398PS | Diesel | Turbo | TD8902 |
| DS 14.02 | 14190cc | V8 Cyl. | 16 Valves | 309-320kW/420-435PS | Diesel | Turbo | TD22368 |
| DS 14.06 | 14190cc | V8 Cyl. | 16 Valves | 285-291kW/388-396PS | Diesel | Turbo | TD8896 |
| DSC 14.01 | 14190cc | V8 Cyl. | 16 Valves | 309kW/420PS | Diesel | Turbo, OHV | TD8898 |
| DSC 14.02 | 14190cc | V8 Cyl. | 16 Valves | 301kW/409PS | Diesel | Turbo, OHV | TD8899 |
| DSC 14.03 | 14190cc | V8 Cyl. | 16 Valves | 331kW/450PS | Diesel | Turbo, OHV | TD8906 |
| DSC 14.04 | 14190cc | V8 Cyl. | 16 Valves | 346kW/470PS | Diesel | Turbo, OHV | TD8907 |
| DSC 14.05 | 14190cc | V8 Cyl. | 16 Valves | 318kW/432PS | Diesel | Turbo, OHV | TD8900 |
| DSC 14.06 | 14190cc | V8 Cyl. | 16 Valves | 297-309kW/404-420PS | Diesel | Turbo, OHV | TD8901 |
| DSC 14.08 | 14190cc | V8 Cyl. | 16 Valves | 309-331kW/420-450PS | Diesel | Turbo, OHV | TD8908 |
| DSC 14.09 | 14190cc | V8 Cyl. | 16 Valves | 368kW/500PS | Diesel | Turbo, OHV | TD8909 |
| DSC 14.10 | 14190cc | V8 Cyl. | 16 Valves | 333-346kW/453-471PS | Diesel | Turbo, OHV | TD8910 |

2 - series 05/1980→03/1988 3 - series 01/1988→12/1996

| | | | | | |
|------------------------|-----------|--|------------|-----|----|
| V91200 | 136 08 36 | | | 20° | SS |
| 54.20 x 10.95 x 162.70 | | | MD + MB cr | | |
| V91201 | 352211 | | | 20° | |
| 54.20 x 10.95 x 162.70 | | | MD + MB cr | | |
| V34963 | 232018 | | | 45° | SS |
| 45.11 x 10.94 x 162.51 | | | MD cr | | |
| V91202 [1] | 139 75 21 | | | 45° | SS |
| 44.75 x 10.94 x 162.70 | | | MD cr | | |

| | | |
|-----------------|-----------------------|--|
| VAG92166 | 80.00 x 11.02 x 18.03 | |
| VAG92167 | 73.00 x 11.02 x 18.03 | |

[1] Not for engines with increased exhaust brake capacity [1] Nicht für Motoren mit erhöhter Abgasbremsleistung [1] Pas pour moteur avec capacité frein moteur élevée [1] No para motores con elevada potencia de frenado del gas de escape [1] Non per motori con potenza motore aumentata

16 **127.00**

| | | | | | | | |
|------------------------|-----------|---------|------------|-------------|--------|-------|--------|
| DS 14.07 | 14190cc | V8 Cyl. | 16 Valves | 293kW/398PS | Diesel | Turbo | TD8897 |
| V91200 | 136 08 36 | | | 20° | SS | | |
| 54.20 x 10.95 x 162.70 | | | MD + MB cr | | | | |
| V91201 | 352211 | | | 20° | | | |
| 54.20 x 10.95 x 162.70 | | | MD + MB cr | | | | |
| V34963 | 232018 | | | 45° | SS | | |
| 45.11 x 10.94 x 162.51 | | | MD cr | | | | |
| V91202 [1] | 139 75 21 | | | 45° | SS | | |
| 44.75 x 10.94 x 162.70 | | | MD cr | | | | |

| | | |
|-----------------|-----------------------|--|
| VAG92166 | 80.00 x 11.02 x 18.03 | |
| VAG92167 | 73.00 x 11.02 x 18.03 | |

VS6103 [5]
47.50 x 56.03 x 7.65 (30°)
→12/81

[1] Not for engines with increased exhaust brake capacity [1] Nicht für Motoren mit erhöhter Abgasbremsleistung [1] Pas pour moteur avec capacité frein moteur élevée [1] No para motores con elevada potencia de frenado del gas de escape [1] Non per motori con potenza motore aumentata

[5] Fully finished [5] Fertiggeschliffene [5] Entièrement finis [5] Totalmente acabada [5] Finite



OE

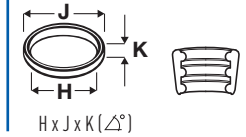

17 **127.00**

| | | | | | | | |
|-----------------------------|---------|---------|------------------|-------------|--------|-------------------|---------------|
| DS 14 LB 05 | 14200cc | V8 Cyl. | 16 Valves | 257kW/350PS | Diesel | Turbo | TD8894 |
| DS 14.06 LD1/LD2/LD3 | 14200cc | V8 Cyl. | 16 Valves | 290kW/394PS | Diesel | Turbo | TD8904 |
| DSC 14.07 L 01 | 14200cc | V8 Cyl. | 16 Valves | 298kW/405PS | Diesel | Turbo, OHV | TD8905 |
| DSC 14.13 | 14200cc | V8 Cyl. | 16 Valves | 390kW/530PS | Diesel | Turbo, OHV | TD8911 |
| DSC 14.15 | 14200cc | V8 Cyl. | 16 Valves | 338kW/460PS | Diesel | Turbo, OHV | TD8914 |

4 - series 09/1995→ L - series 08/1975→08/1978

| | | | | | | |
|---|-----------|------------|-----|----|--|--|
| V91200 ■ 54.20 x 10.95 x 162.70 | 136 08 36 | MD + MB cr | 20° | SS | VAG92166 ■ 80.00 x 11.02 x 18.03 | |
| V91201 ■ 54.20 x 10.95 x 162.70 | 352211 | MD + MB cr | 20° | | VAG92167 ■ 73.00 x 11.02 x 18.03 | |
| V34963 ■ 45.11 x 10.94 x 162.51 | 232018 | MD cr | 45° | SS | | |
| V91202 ■ [1] 44.75 x 10.94 x 162.70 | 139 75 21 | MD cr | 45° | SS | | |

[1] Not for engines with increased exhaust brake capacity [1] Nicht für Motoren mit erhöhter Abgasbremsleistung [1] Pas pour moteur avec capacité frein moteur élevée [1] No para motores con elevada potencia de frenado del gas de escape [1] Non per motori con potenza motore aumentata

18 **127.00**

| | | | | | | | |
|----------------------|---------|---------|------------------|-------------|--------|--------------|---------------|
| DS 14 LB 08 | 14200cc | V8 Cyl. | 16 Valves | 276kW/375PS | Diesel | Turbo | TD8895 |
| DS 14.01 L 01 | 14200cc | V8 Cyl. | 16 Valves | 276kW/375PS | Diesel | Turbo | TD8903 |

L - series 06/1978→12/1981

| | | | | | | | |
|---|-----------|------------|-----|----|--|--|---|
| V91200 ■ 54.20 x 10.95 x 162.70 | 136 08 36 | MD + MB cr | 20° | SS | VAG92166 ■ 80.00 x 11.02 x 18.03 | | VS6103 ■ [5] 47.50 x 56.03 x 7.65 (30°) →12/81 |
| V91201 ■ 54.20 x 10.95 x 162.70 | 352211 | MD + MB cr | 20° | | VAG92167 ■ 73.00 x 11.02 x 18.03 | | |
| V34963 ■ 45.11 x 10.94 x 162.51 | 232018 | MD cr | 45° | SS | | | |
| V91202 ■ [1] 44.75 x 10.94 x 162.70 | 139 75 21 | MD cr | 45° | SS | | | |

[1] Not for engines with increased exhaust brake capacity [1] Nicht für Motoren mit erhöhter Abgasbremsleistung [1] Pas pour moteur avec capacité frein moteur élevée [1] No para motores con elevada potencia de frenado del gas de escape [1] Non per motori con potenza motore aumentata
[5] Fully finished [5] Fertigeschliffene [5] Entièrement finis [5] Totalmente acabada [5] Finite



OE

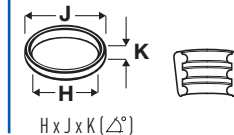
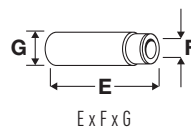

19 **127.00**

| | | | | | | | |
|----------|---------|---------|-----------|-------------|--------|-------|---------|
| DC 16.01 | 15600cc | V8 Cyl. | 32 Valves | 426kW/580PS | Diesel | Turbo | TD15429 |
| DC 16.02 | 15600cc | V8 Cyl. | 32 Valves | 353kW/480PS | Diesel | Turbo | TD15428 |
| DC 16.03 | 15600cc | V8 Cyl. | 32 Valves | 426kW/580PS | Diesel | Turbo | TD17458 |
| DC 16.04 | 15600cc | V8 Cyl. | 32 Valves | 368kW/500PS | Diesel | Turbo | TD17457 |
| DC 16.05 | 15600cc | V8 Cyl. | 32 Valves | 412kW/560PS | Diesel | Turbo | TD18649 |
| DC 16.06 | 15600cc | V8 Cyl. | 32 Valves | 368kW/500PS | Diesel | Turbo | TD18650 |
| DC 16.08 | 15600cc | V8 Cyl. | 32 Valves | 456kW/620PS | Diesel | Turbo | TD18652 |
| DC 16.09 | 15600cc | V8 Cyl. | 32 Valves | 368kW/500PS | Diesel | Turbo | TD18651 |
| DC 16.17 | 15600cc | V8 Cyl. | 32 Valves | 456kW/620PS | Diesel | Turbo | TD20881 |
| DC 16.18 | 15600cc | V8 Cyl. | 32 Valves | 412kW/560PS | Diesel | Turbo | TD20880 |
| DC 16.19 | 15600cc | V8 Cyl. | 32 Valves | 368kW/500PS | Diesel | Turbo | TD20879 |
| DC 16.22 | 15600cc | V8 Cyl. | 32 Valves | 368kW/500PS | Diesel | Turbo | TD28138 |

| | | | |
|---|------------|------------------|--|
| 4 - series | 01/2000→ | P.G.R.T - series | 03/2004→ |
| V94444 133 32 30 44.10 x 9.95 x 171.40 | MD + MB cr | 20° H | VAG96314 73.00 x 10.00 x 16.00 |
| V94445 132 85 37 41.00 x 9.94 x 171.50 | MD + MB cr | 45° SS H | |

20 **130.00**

| | | | | | | | |
|---------|--------|--------|-----------|-------------|--------|------------|---------|
| DC 9.22 | 9300cc | 5 Cyl. | 20 Valves | 235kW/320PS | Diesel | Turbo, OHV | TD20871 |
| DC 9.29 | 9300cc | 5 Cyl. | 20 Valves | 206kW/280PS | Diesel | Turbo, OHV | TD20870 |
| DC 9.30 | 9300cc | 5 Cyl. | 20 Valves | 169kW/230PS | Diesel | Turbo, OHV | TD20847 |
| DC 9.32 | 9300cc | 5 Cyl. | 20 Valves | 235kW/320PS | Diesel | Turbo, OHV | TD20872 |
| DC 9.35 | 9300cc | 5 Cyl. | 20 Valves | 169kW/230PS | Diesel | Turbo, OHV | TD20848 |
| DC 9.36 | 9300cc | 5 Cyl. | 20 Valves | 206kW/280PS | Diesel | Turbo, OHV | TD20869 |

| | | | |
|------------------|----------|----------------|----------|
| ENVIRO | 02/2017→ | IRIZAR | 02/2010→ |
| K - series | 01/2009→ | K - series bus | 02/2008→ |
| OMNICITY | 07/2008→ | OMNILINK | 07/2008→ |
| P.G.R.T - series | 04/2004→ | | |

| | | | |
|---|------------|----------|--|
| V95112 1854798 44.00 x 9.94 x 171.25 | MD + MB cr | 20° SS H | VAG96314 73.00 x 10.00 x 16.00 |
| V95113 1778492 41.00 x 9.93 x 171.45 | MD + MB cr | 45° SS H | |

21 **130.00**

| | | | | | | | |
|----------|---------|--------|-----------|-------------|--------|------------|---------|
| DC 13.05 | 12742cc | 6 Cyl. | 24 Valves | 294kW/400PS | Diesel | Turbo, OHV | TD20882 |
| DC 13.06 | 12742cc | 6 Cyl. | 24 Valves | 265kW/360PS | Diesel | Turbo, OHV | TD20887 |
| DC 13.07 | 12742cc | 6 Cyl. | 24 Valves | 353kW/480PS | Diesel | Turbo, OHV | TD20886 |
| DC 13.10 | 12742cc | 6 Cyl. | 24 Valves | 324kW/441PS | Diesel | Turbo, OHV | TD20884 |

| | | | |
|------------------|----------|-------------|-----------------|
| IRIZAR CENTURY | 07/2009→ | IRIZAR PB | 01/2007→05/2010 |
| K - series bus | 09/2009→ | OMNIEXPRESS | |
| P.G.R.T - series | 04/2004→ | | |

| | | | |
|---|------------|----------|--|
| V95112 1854798 44.00 x 9.94 x 171.25 | MD + MB cr | 20° SS H | VAG96314 73.00 x 10.00 x 16.00 |
| V95113 1778492 41.00 x 9.93 x 171.45 | MD + MB cr | 45° SS H | |

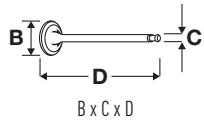

OE

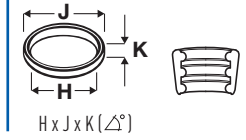
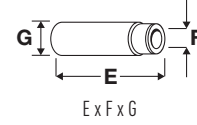
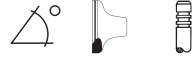







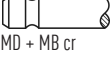

22

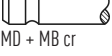













130.00







| | | | | | | | |
|-----------|---------|---------|-----------|---------------------|--------|-------|---------|
| DC 16.101 | 16352cc | V8 Cyl. | 32 Valves | 382kW/520PS | Diesel | Turbo | TD29011 |
| DC 16.102 | 16352cc | V8 Cyl. | 32 Valves | 426-427kW/579-581PS | Diesel | Turbo | TD29012 |
| DC 16.103 | 16352cc | V8 Cyl. | 32 Valves | 537kW/730PS | Diesel | Turbo | TD29015 |
| DC 16.21 | 16352cc | V8 Cyl. | 32 Valves | 537kW/730PS | Diesel | Turbo | TD23988 |

| L,P,G,R,S - series | 08/2016→ | | | | P,G,R,T - series | 04/2010→ |
|--|-----------|---|-----|------|--|---|
| V94444 ■ 44.10 x 9.95 x 171.40 | 133 32 30 |   MD + MB cr | 20° | H | VAG96314 ■■■ 73.00 x 10.00 x 16.00 |  |
| V94445 ■ 41.00 x 9.94 x 171.50 | 132 85 37 |   MD + MB cr | 45° | SS H | | |

|  |  | ccm |  |  |  |  |
|---|---|------|--|---|---|---|
| 021 A.1000 | 75.00 | 1193 | 4 | 8 | Petrol | 13 |
| 021 A.2000 | 83.00 | 1461 | 4 | 8 | Petrol | 66 |
| 08 NCA | 65.00 | 843 | 4 | 8 | Petrol | 1 |
| 09 NCA | 65.00 | 903 | 4 | 8 | Petrol | 2 |
| 100 GL.3000 | 65.00 | 903 | 4 | 8 | Petrol | 2 |
| 146 A.000 | 65.00 | 903 | 4 | 8 | Petrol | 3 |
| 1F | 81.00 | 1595 | 4 | 8 | Petrol | 45 |
| 1W | 75.00 | 1398 | 4 | 8 | Diesel | 18 |
| 1Y | 79.50 | 1896 | 4 | 8 | Diesel | 35 |
| 1Z | 79.50 | 1896 | 4 | 8 | Diesel | 36 |
| 2E | 82.50 | 1984 | 4 | 8 | Petrol | 60 |
| 2G | 75.00 | 1272 | 4 | 8 | Petrol | 14 |
| 8144.61 | 93.00 | 2445 | 4 | 8 | Diesel | 67 |
| A112 A5.000;M020.AA.09 | 65.00 | 903 | 4 | 8 | Petrol | 4 |
| AAU | 75.00 | 1043 | 4 | 8 | Petrol | 12 |
| AAV | 75.00 | 1272 | 4 | 8 | Petrol | 15 |
| AAZ | 79.50 | 1896 | 4 | 8 | Diesel | 37 |
| ABD | 75.00 | 1390 | 4 | 8 | Petrol | 17 |
| ABF | 82.50 | 1984 | 4 | 16 | Petrol | 61 |
| ABN | 81.00 | 1595 | 4 | 8 | Petrol | 45 |
| ABS | 81.00 | 1781 | 4 | 8 | Petrol | 50 |
| ABU | 76.50 | 1598 | 4 | 8 | Petrol | 25 |
| ACC | 81.00 | 1781 | 4 | 8 | Petrol | 50 |
| ADY | 82.50 | 1984 | 4 | 8 | Petrol | 62 |
| ADZ | 81.00 | 1781 | 4 | 8 | Petrol | 51 |
| AEE | 76.50 | 1598 | 4 | 8 | Petrol | 26 |
| AEF | 79.50 | 1896 | 4 | 8 | Diesel | 38 |
| AEH | 81.00 | 1595 | 4 | 8 | Petrol | 46 |
| AER | 67.10 | 999 | 4 | 8 | Petrol | 5 |
| AEX | 76.50 | 1390 | 4 | 8 | Petrol | 21 |
| AEY | 79.50 | 1896 | 4 | 8 | Diesel | 39 |
| AFH | 76.50 | 1390 | 4 | 16 | Petrol | 22 |
| AFK | 76.50 | 1390 | 4 | 16 | Petrol | 23 |
| AFN | 79.50 | 1896 | 4 | 8 | Diesel | 40 |
| AFT | 81.00 | 1595 | 4 | 8 | Petrol | 46 |
| AGG | 82.50 | 1984 | 4 | 8 | Petrol | 62 |
| AGN | 81.00 | 1781 | 4 | 20 | Petrol | 52 |
| AGP | 79.50 | 1896 | 4 | 8 | Diesel | 41 |
| AGR | 79.50 | 1896 | 4 | 8 | Diesel | 40 |
| AGZ | 81.00 | 2324 | 5 | 10 | Petrol | 58 |
| AHB | 79.50 | 1716 | 4 | 8 | Diesel | 34 |
| AHF | 79.50 | 1896 | 4 | 8 | Diesel | 40 |
| AHT | 72.00 | 997 | 4 | 8 | Petrol | 9 |
| AHU | 79.50 | 1896 | 4 | 8 | Diesel | 40 |
| AHW | 76.50 | 1390 | 4 | 16 | Petrol | 23 |
| AJH | 81.00 | 1781 | 4 | 20 | Petrol | 53 |
| AJQ | 81.00 | 1781 | 4 | 20 | Petrol | 53 |
| AKK | 76.50 | 1390 | 4 | 8 | Petrol | 24 |
| AKL | 81.00 | 1595 | 4 | 8 | Petrol | 46 |
| AKU | 79.50 | 1716 | 4 | 8 | Diesel | 34 |
| AKV | 76.50 | 1390 | 4 | 8 | Petrol | 21 |
| ALD | 67.10 | 999 | 4 | 8 | Petrol | 6 |
| ALH | 79.50 | 1896 | 4 | 8 | Diesel | 40 |
| ALL | 67.10 | 999 | 4 | 8 | Petrol | 5 |
| ALM | 76.50 | 1598 | 4 | 8 | Petrol | 26 |
| ALZ | 81.00 | 1595 | 4 | 8 | Petrol | 47 |
| AMF | 79.50 | 1422 | 3 | 6 | Diesel | 31 |
| AMK | 81.00 | 1781 | 4 | 20 | Petrol | 53 |
| ANM | 76.50 | 1390 | 4 | 16 | Petrol | 23 |
| ANU | 79.50 | 1896 | 4 | 8 | Diesel | 42 |
| ANV | 67.10 | 999 | 4 | 8 | Petrol | 6 |
| ANW | 76.50 | 1390 | 4 | 8 | Petrol | 24 |
| ANX | 76.50 | 1390 | 4 | 8 | Petrol | 21 |
| APE | 76.50 | 1390 | 4 | 16 | Petrol | 23 |
| APF | 81.00 | 1595 | 4 | 8 | Petrol | 46 |
| APG | 81.00 | 1781 | 4 | 20 | Petrol | 52 |

|  |  | ccm |  |  |  |  |
|---|---|------|---|---|---|---|
| APP | 81.00 | 1781 | 4 | 20 | Petrol | 53 |
| APQ | 76.50 | 1390 | 4 | 8 | Petrol | 21 |
| AQM | 79.50 | 1896 | 4 | 8 | Diesel | 41 |
| AQQ | 76.50 | 1390 | 4 | 16 | Petrol | 23 |
| AQX | 81.00 | 1781 | 4 | 20 | Petrol | 53 |
| ARL | 79.50 | 1896 | 4 | 8 | Diesel | 42 |
| ARY | 81.00 | 1781 | 4 | 20 | Petrol | 53 |
| ASK | 79.50 | 1896 | 4 | 8 | Diesel | 43 |
| ASV | 79.50 | 1896 | 4 | 8 | Diesel | 40 |
| ASY | 79.50 | 1896 | 4 | 8 | Diesel | 41 |
| ASZ | 79.50 | 1896 | 4 | 8 | Diesel | 42 |
| ATD | 79.50 | 1896 | 4 | 8 | Diesel | 42 |
| ATM | 82.50 | 1984 | 4 | 8 | Petrol | 62 |
| ATN | 76.50 | 1598 | 4 | 16 | Petrol | 27 |
| AUA | 76.50 | 1390 | 4 | 16 | Petrol | 23 |
| AUB | 76.50 | 1390 | 4 | 16 | Petrol | 23 |
| AUC | 67.10 | 999 | 4 | 8 | Petrol | 6 |
| AUD | 76.50 | 1390 | 4 | 8 | Petrol | 24 |
| AUQ | 81.00 | 1781 | 4 | 20 | Petrol | 53 |
| AUR | 81.00 | 1595 | 4 | 8 | Petrol | 48 |
| AUS | 76.50 | 1598 | 4 | 16 | Petrol | 27 |
| AUY | 79.50 | 1896 | 4 | 8 | Diesel | 42 |
| AVG | 79.50 | 1896 | 4 | 8 | Diesel | 40 |
| AWC | 81.00 | 1781 | 4 | 20 | Petrol | 53 |
| AXP | 76.50 | 1390 | 4 | 16 | Petrol | 23 |
| AXR | 79.50 | 1896 | 4 | 8 | Diesel | 44 |
| AYP | 81.00 | 1781 | 4 | 20 | Petrol | 53 |
| AYQ | 79.50 | 1896 | 4 | 8 | Diesel | 41 |
| AZD | 76.50 | 1598 | 4 | 16 | Petrol | 27 |
| AZL | 82.50 | 1984 | 4 | 8 | Petrol | 62 |
| AZQ | 76.50 | 1198 | 3 | 12 | Petrol | 19 |
| AZV | 81.00 | 1968 | 4 | 16 | Diesel | 55 |
| BAH | 76.50 | 1598 | 4 | 8 | Petrol | 28 |
| BAM | 81.00 | 1781 | 4 | 20 | Petrol | 53 |
| BBM | 76.50 | 1198 | 3 | 6 | Petrol | 20 |
| BBU | 81.00 | 1781 | 4 | 20 | Petrol | 53 |
| BBX | 82.50 | 1984 | 4 | 8 | Petrol | 62 |
| BBY | 76.50 | 1390 | 4 | 16 | Petrol | 23 |
| BBZ | 76.50 | 1390 | 4 | 16 | Petrol | 23 |
| BCA | 76.50 | 1390 | 4 | 16 | Petrol | 23 |
| BCB | 76.50 | 1598 | 4 | 16 | Petrol | 27 |
| BFQ | 81.00 | 1595 | 4 | 8 | Petrol | 47 |
| BGU | 81.00 | 1595 | 4 | 8 | Petrol | 47 |
| BJB | 79.50 | 1896 | 4 | 8 | Diesel | 44 |
| BJX | 81.00 | 1781 | 4 | 20 | Petrol | 53 |
| BKC | 79.50 | 1896 | 4 | 8 | Diesel | 44 |
| BKD | 81.00 | 1968 | 4 | 16 | Diesel | 55 |
| BKY | 76.50 | 1390 | 4 | 16 | Petrol | 23 |
| BLR | 82.50 | 1984 | 4 | 16 | Petrol | 63 |
| BLS | 79.50 | 1896 | 4 | 8 | Diesel | 44 |
| BLT | 79.50 | 1896 | 4 | 8 | Diesel | 42 |
| BLY | 82.50 | 1984 | 4 | 16 | Petrol | 63 |
| BME | 76.50 | 1198 | 3 | 12 | Petrol | 19 |
| BMM | 81.00 | 1968 | 4 | 8 | Diesel | 56 |
| BMN | 81.00 | 1968 | 4 | 16 | Diesel | 55 |
| BMS | 79.50 | 1422 | 3 | 6 | Diesel | 32 |
| BMT | 79.50 | 1896 | 4 | 8 | Diesel | 44 |
| BNM | 79.50 | 1422 | 3 | 6 | Diesel | 32 |
| BNV | 79.50 | 1422 | 3 | 6 | Diesel | 32 |
| BPX | 79.50 | 1896 | 4 | 8 | Diesel | 42 |
| BRT | 81.00 | 1968 | 4 | 8 | Diesel | 56 |
| BSE | 81.00 | 1595 | 4 | 8 | Petrol | 47 |
| BSF | 81.00 | 1595 | 4 | 8 | Petrol | 47 |
| BTB | 79.50 | 1896 | 4 | 8 | Diesel | 42 |
| BTS | 76.50 | 1598 | 4 | 16 | Petrol | 27 |
| BUK | 79.50 | 1896 | 4 | 8 | Diesel | 42 |

| |  |  | ccm |  |  |  |  | |
|------|---|---|-------|--|---|---|---|----|
| BVK | | | 79.50 | 1896 | 4 | 8 | Diesel | 42 |
| BVY | | | 82.50 | 1984 | 4 | 16 | Petrol | 63 |
| BVZ | | | 82.50 | 1984 | 4 | 16 | Petrol | 63 |
| BWA | | | 82.50 | 1984 | 4 | 16 | Petrol | 64 |
| BWE | | | 82.50 | 1984 | 4 | 16 | Petrol | 64 |
| BXE | | | 79.50 | 1896 | 4 | 8 | Diesel | 44 |
| BXF | | | 79.50 | 1896 | 4 | 8 | Diesel | 44 |
| BXJ | | | 79.50 | 1896 | 4 | 8 | Diesel | 44 |
| BXV | | | 76.50 | 1198 | 3 | 12 | Petrol | 19 |
| BXW | | | 76.50 | 1390 | 4 | 16 | Petrol | 23 |
| BYT | | | 82.50 | 1798 | 4 | 16 | Petrol | 59 |
| BZB | | | 82.50 | 1798 | 4 | 16 | Petrol | 59 |
| BZG | | | 76.50 | 1198 | 3 | 12 | Petrol | 19 |
| CAGA | | | 81.00 | 1968 | 4 | 16 | Diesel | 57 |
| CAGC | | | 81.00 | 1968 | 4 | 16 | Diesel | 57 |
| CAHA | | | 81.00 | 1968 | 4 | 16 | Diesel | 57 |
| CAVA | | | 76.50 | 1390 | 4 | 16 | Petrol | 23 |
| CAVE | | | 76.50 | 1390 | 4 | 16 | Petrol | 23 |
| CAVF | | | 76.50 | 1390 | 4 | 16 | Petrol | 23 |
| CAXA | | | 76.50 | 1390 | 4 | 16 | Petrol | 23 |
| CAXC | | | 76.50 | 1390 | 4 | 16 | Petrol | 23 |
| CAYA | | | 79.50 | 1598 | 4 | 16 | Diesel | 33 |
| CAYB | | | 79.50 | 1598 | 4 | 16 | Diesel | 33 |
| CAYC | | | 79.50 | 1598 | 4 | 16 | Diesel | 33 |
| CBDB | | | 81.00 | 1968 | 4 | 16 | Diesel | 57 |
| CBZA | | | 71.00 | 1197 | 4 | 8 | Petrol | 7 |
| CBZB | | | 71.00 | 1197 | 4 | 8 | Petrol | 7 |
| CCSA | | | 81.00 | 1595 | 4 | 8 | Petrol | 47 |
| CCZA | | | 82.50 | 1984 | 4 | 16 | Petrol | 64 |
| CCZB | | | 82.50 | 1984 | 4 | 16 | Petrol | 65 |
| CDAA | | | 82.50 | 1798 | 4 | 16 | Petrol | 59 |
| CDHA | | | 82.50 | 1798 | 4 | 16 | Petrol | 59 |
| CDHB | | | 82.50 | 1798 | 4 | 16 | Petrol | 59 |
| CDLA | | | 82.50 | 1984 | 4 | 16 | Petrol | 65 |
| CDND | | | 82.50 | 1984 | 4 | 16 | Petrol | 65 |
| CEGA | | | 81.00 | 1968 | 4 | 16 | Diesel | 57 |
| CFFA | | | 81.00 | 1968 | 4 | 16 | Diesel | 57 |
| CFFB | | | 81.00 | 1968 | 4 | 16 | Diesel | 57 |
| CFFE | | | 81.00 | 1968 | 4 | 16 | Diesel | 57 |
| CFGB | | | 81.00 | 1968 | 4 | 16 | Diesel | 57 |
| CFGC | | | 81.00 | 1968 | 4 | 16 | Diesel | 57 |
| CFHC | | | 81.00 | 1968 | 4 | 16 | Diesel | 57 |
| CFHD | | | 81.00 | 1968 | 4 | 16 | Diesel | 57 |
| CFJA | | | 81.00 | 1968 | 4 | 16 | Diesel | 57 |
| CFWA | | | 79.50 | 1199 | 3 | 12 | Diesel | 30 |
| CGGB | | | 76.50 | 1390 | 4 | 16 | Petrol | 23 |
| CGLB | | | 81.00 | 1968 | 4 | 16 | Diesel | 57 |
| CGPA | | | 76.50 | 1198 | 3 | 12 | Petrol | 19 |
| CGPB | | | 76.50 | 1198 | 3 | 12 | Petrol | 19 |
| CHFA | | | 76.50 | 1198 | 3 | 6 | Petrol | 20 |
| CHGA | | | 81.00 | 1595 | 4 | 8 | Petrol | 47 |
| CHPA | | | 74.50 | 1395 | 4 | 16 | Petrol | 11 |
| CHYA | | | 74.50 | 999 | 3 | 12 | Petrol | 10 |
| CHYB | | | 74.50 | 999 | 3 | 12 | Petrol | 10 |
| CJCA | | | 81.00 | 1968 | 4 | 16 | Diesel | 57 |
| CJCC | | | 81.00 | 1968 | 4 | 16 | Diesel | 57 |
| CJZA | | | 71.00 | 1197 | 4 | 16 | Petrol | 8 |
| CJZB | | | 71.00 | 1197 | 4 | 16 | Petrol | 8 |
| CKFC | | | 81.00 | 1968 | 4 | 16 | Diesel | 57 |
| CLCB | | | 81.00 | 1968 | 4 | 16 | Diesel | 57 |
| CLHA | | | 79.50 | 1598 | 4 | 16 | Diesel | 33 |
| CLHB | | | 79.50 | 1598 | 4 | 16 | Diesel | 33 |
| CLNA | | | 79.50 | 1598 | 4 | 16 | Diesel | 33 |
| CMBA | | | 74.50 | 1395 | 4 | 16 | Petrol | 11 |
| CMXA | | | 81.00 | 1595 | 4 | 8 | Petrol | 47 |
| CNKA | | | 76.50 | 1598 | 4 | 16 | Petrol | 29 |

| |  |  | ccm |  |  |  |  | |
|------|---|---|-------|---|---|---|---|----|
| CPTA | | | 74.50 | 1395 | 4 | 16 | Petrol | 11 |
| CPWA | | | 74.50 | 1395 | 4 | 16 | Petrol | 11 |
| CRBC | | | 81.00 | 1968 | 4 | 16 | Diesel | 57 |
| CRKB | | | 79.50 | 1598 | 4 | 16 | Diesel | 33 |
| CRLB | | | 81.00 | 1968 | 4 | 16 | Diesel | 57 |
| CRMB | | | 81.00 | 1968 | 4 | 16 | Diesel | 57 |
| CRVA | | | 81.00 | 1968 | 4 | 16 | Diesel | 57 |
| CRVC | | | 81.00 | 1968 | 4 | 16 | Diesel | 57 |
| CUNA | | | 81.00 | 1968 | 4 | 16 | Diesel | 57 |
| CUPA | | | 81.00 | 1968 | 4 | 16 | Diesel | 57 |
| CUVA | | | 81.00 | 1968 | 4 | 16 | Diesel | 57 |
| CUVC | | | 81.00 | 1968 | 4 | 16 | Diesel | 57 |
| CUWA | | | 81.00 | 1968 | 4 | 16 | Diesel | 57 |
| CXSA | | | 74.50 | 1395 | 4 | 16 | Petrol | 11 |
| CYVA | | | 71.00 | 1197 | 4 | 16 | Petrol | 8 |
| CYVB | | | 71.00 | 1197 | 4 | 16 | Petrol | 8 |
| CZCA | | | 74.50 | 1395 | 4 | 16 | Petrol | 11 |
| CZDA | | | 74.50 | 1395 | 4 | 16 | Petrol | 11 |
| CZEA | | | 74.50 | 1395 | 4 | 16 | Petrol | 11 |
| DH | | | 94.00 | 1915 | 4 | 8 | Petrol | 68 |
| EZ | | | 81.00 | 1595 | 4 | 8 | Petrol | 49 |
| KR | | | 81.00 | 1781 | 4 | 16 | Petrol | 54 |
| MN | | | 75.00 | 1272 | 4 | 8 | Diesel | 16 |
| PL | | | 81.00 | 1781 | 4 | 16 | Petrol | 54 |
| RP | | | 81.00 | 1781 | 4 | 8 | Petrol | 50 |

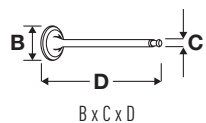

OE

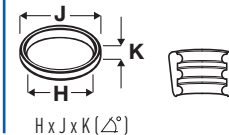
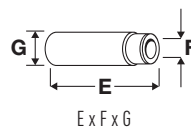

1 65.00

| | | | | | | | |
|---------------|-------|-----------------|-----------------|-----------|--------|------------|---------------|
| 08 NCA | 843cc | 4 Cyl. | 8 Valves | 25kW/34PS | Petrol | OHV | TD3556 |
| MARBELLA 0.8 | | 08/1986→12/1993 | | | | | |

V34457 ■
29.10 x 7.02 x 95.65

4 265 695

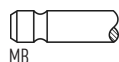

45°

H

2 65.00

| | | | | | | | |
|--------------------|-------|--------|-----------------|-----------------|--------|------------|---------------|
| 09 NCA | 903cc | 4 Cyl. | 8 Valves | 29kW/40PS | Petrol | OHV | TD3557 |
| 100 GL.3000 | 903cc | 4 Cyl. | 8 Valves | 31-33kW/42-45PS | Petrol | OHV | TD3558 |

| | | | |
|--------------|-----------------|-------------|-----------------|
| FURA 0.9 | 01/1982→12/1986 | IBIZA I 0.9 | 08/1990→05/1993 |
| MARBELLA 0.9 | 01/1987→12/1993 | PANDA 0.9 | 10/1980→12/1986 |
| TERRA 0.9 | 01/1987→12/1996 | | |

V34457 ■
29.10 x 7.02 x 95.65

4 265 695

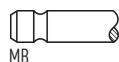

45°

H

VAG92364 ■ ■ ■
42.50 x 7.00 x 13.07

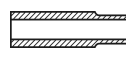

V91282 ■
26.00 x 7.00 x 95.50

7 783 841

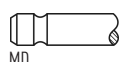

45°

3 65.00

| | | | | | | | |
|------------------|-------|-----------------|-----------------|-----------------|--------|------------|---------------|
| 146 A.000 | 903cc | 4 Cyl. | 8 Valves | 29-32kW/40-43PS | Petrol | OHV | TD9377 |
| IBIZA I 0.9 | | 08/1986→05/1993 | | | | | |

V91282 ■
26.00 x 7.00 x 95.50

7 783 841

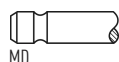

45°

VAG92364 ■ ■ ■
42.50 x 7.00 x 13.07

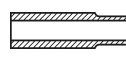

4 65.00

| | | | | | | | |
|-------------------------------|-------|-----------------|-----------------|-----------------|--------|------------|----------------|
| A112 A5.000;M020.AA.09 | 903cc | 4 Cyl. | 8 Valves | 29-33kW/40-45PS | Petrol | OHV | TD20969 |
| 127 0.9 | | 04/1972→12/1982 | | | | | |

V34457 ■
29.10 x 7.02 x 95.65

4 265 695

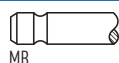

45°

H

VAG92364 ■ ■ ■
42.50 x 7.00 x 13.07

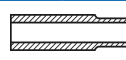

5 67.10

| | | | | | | | |
|------------|-------|--------|-----------------|-----------|--------|-------------|----------------|
| AER | 999cc | 4 Cyl. | 8 Valves | 37kW/50PS | Petrol | SOHC | TD5533 |
| ALL | 999cc | 4 Cyl. | 8 Valves | 37kW/50PS | Petrol | SOHC | TD13891 |

| | | | |
|----------------|-----------------|---------------|-----------------|
| AROSA 1.0 | 05/1997→06/2004 | CORDOBA 1.0 i | 09/1996→10/2002 |
| IBIZA II 1.0 i | 09/1996→02/2002 | | |

V94149 ■
31.00 x 7.00 x 94.70

030 109 601AG

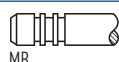

45°

H

VAG96041B ■ ■ ■
36.50 x 7.00 x 12.08

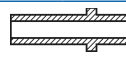

V94197 ■
26.00 x 7.00 x 94.40

030 109 611N

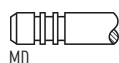

45°

VAG96062B ■ ■ ■
33.00 x 7.02 x 15.00

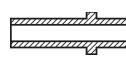



OE

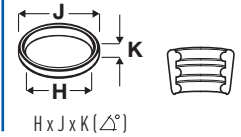
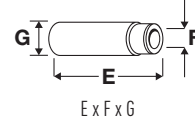
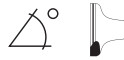

6



67.10

| | | | | | | | |
|----------------|-------|-----------------|----------|-------------|--------|-----------------|---------|
| ALD | 999cc | 4 Cyl. | 8 Valves | 37kW/50PS | Petrol | SOHC | TD13890 |
| ANV | 999cc | 4 Cyl. | 8 Valves | 37kW/50PS | Petrol | SOHC | TD13888 |
| AUC | 999cc | 4 Cyl. | 8 Valves | 37kW/50PS | Petrol | SOHC | TD16138 |
| AROSA 1.0 | | 05/1997→06/2004 | | CORDOBA 1.0 | | 06/1999→10/2002 | |
| IBIZA II 1.0 i | | 09/1996→02/2002 | | | | | |

V94644 ■
31.00 x 6.00 x 99.00

030 109 601AK

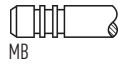

45°

H

VAG96073B ■ ■ ■
36.00 x 6.02 x 11.06



V94645 ■
26.00 x 6.00 x 98.95

030 109 611S



45°

ss

H

7



71.00

| | | | | | | | |
|-------------------|--------|----------|----------|------------------|--------|------------------------|---------|
| CBZA | 1197cc | 4 Cyl. | 8 Valves | 63kW/86PS | Petrol | Turbo, SOHC, Injection | TD23927 |
| CBZB | 1197cc | 4 Cyl. | 8 Valves | 77kW/105PS | Petrol | Turbo, SOHC, Injection | TD23908 |
| ALTEA 1.2 TSI | | 04/2010→ | | ALTEA XL 1.2 TSI | | 04/2010→ | |
| IBIZA IV 1.2 TSI | | 09/2010→ | | LEON 1.2 TSI | | 02/2010→12/2012 | |
| TOLEDO IV 1.2 TSI | | 07/2012→ | | | | | |

V95149 ■
35.45 x 5.98 x 98.70

03F 109 601A

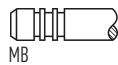

45°

Y

VAG96073B ■ ■ ■
36.00 x 6.02 x 11.06



V95150 ■
30.00 x 5.95 x 98.40

03F 109 611C



45°

ss

H

8



71.00

| | | | | | | | |
|--------------|--------|----------|-----------|------------|--------|------------------------|---------|
| CJZA | 1197cc | 4 Cyl. | 16 Valves | 77kW/105PS | Petrol | Turbo, DOHC, Injection | TD27252 |
| CJZB | 1197cc | 4 Cyl. | 16 Valves | 63kW/86PS | Petrol | Turbo, DOHC, Injection | TD27251 |
| CYVA | 1197cc | 4 Cyl. | 16 Valves | 63kW/86PS | Petrol | Turbo, DOHC, Injection | TD30802 |
| CYVB | 1197cc | 4 Cyl. | 16 Valves | 81kW/110PS | Petrol | Turbo, DOHC, Injection | TD29200 |
| LEON 1.2 TSI | | 12/2012→ | | | | | |

V80012 ■
26.50 x 5.00 x 110.25

04E 109 601A



45°

V80013 ■
23.50 x 5.00 x 110.09

04E 109 611K



30°

ss

9



72.00

| | | | | | | | |
|-----------|-------|-----------------|----------|-----------|--------|-----|---------|
| AHT | 997cc | 4 Cyl. | 8 Valves | 37kW/50PS | Petrol | OHV | TD13889 |
| AROSA 1.0 | | 10/1998→01/2001 | | | | | |

V94418 ■
34.00 x 7.00 x 101.40

047 198 601D

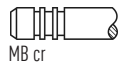

45°

Y

H

VAG96041B ■ ■ ■
36.50 x 7.00 x 12.08

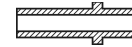

V94419 ■
30.00 x 7.00 x 101.40

047 109 611D



45°

ss

H

VAG96062B ■ ■ ■
33.00 x 7.02 x 15.00



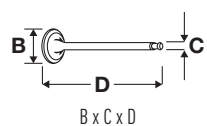

OE

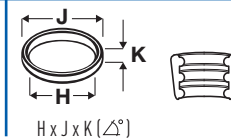
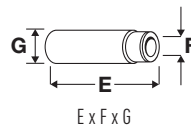

10 74.50

| | | | | | | | |
|--------------|----------|--------|-----------|-------------|--------|----------|---------|
| CHYA | 999cc | 3 Cyl. | 12 Valves | 44kW/60PS | Petrol | DOHC | TD26310 |
| CHYB | 999cc | 3 Cyl. | 12 Valves | 55kW/75PS | Petrol | DOHC | TD26311 |
| IBIZA IV 1.0 | 05/2015→ | | | IBIZA V 1.0 | | 01/2017→ | |
| Mii 1.0 | 10/2011→ | | | | | | |

V95237
29.50 x 5.00 x 110.23

04E 109 601

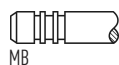

45°

H

V95238
26.90 x 5.00 x 110.30

04E 109 611L

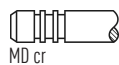

30°

11 74.50

| | | | | | | | |
|------------------|----------|--------|-----------|-------------------|--------|------------------------|---------|
| CHPA | 1395cc | 4 Cyl. | 16 Valves | 103kW/140PS | Petrol | Turbo, DOHC, Injection | TD27254 |
| CMBA | 1395cc | 4 Cyl. | 16 Valves | 90kW/122PS | Petrol | Turbo, DOHC, Injection | TD27253 |
| CPTA | 1395cc | 4 Cyl. | 16 Valves | 103kW/140PS | Petrol | Turbo, DOHC, Injection | TD27255 |
| CPWA | 1395cc | 4 Cyl. | 16 Valves | 81kW/110PS | Petrol | Turbo, DOHC, Injection | TD28854 |
| CXSA | 1395cc | 4 Cyl. | 16 Valves | 90kW/122PS | Petrol | Turbo, DOHC, Injection | TD28124 |
| CZCA | 1395cc | 4 Cyl. | 16 Valves | 92kW/125PS | Petrol | Turbo, DOHC, Injection | TD29306 |
| CZDA | 1395cc | 4 Cyl. | 16 Valves | 110kW/150PS | Petrol | Turbo, DOHC, Injection | TD32104 |
| CZEA | 1395cc | 4 Cyl. | 16 Valves | 110kW/150PS | Petrol | Turbo, DOHC, Injection | TD29307 |
| ALHAMBRA 1.4 TSI | 05/2015→ | | | ATECA 1.4 TSI | | 06/2016→ | |
| IBIZA IV 1.4 TSI | 10/2013→ | | | LEON 1.4 TGI | | 02/2013→ | |
| LEON 1.4 TSI | 09/2012→ | | | TOLEDO IV 1.4 TSI | | 05/2015→ | |

V95192
28.45 x 4.70 x 110.30

04E 109 601B

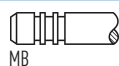

45°

Y

H

V95193
25.00 x 4.97 x 110.15

04E 109 611J



30°

ss

H

12 75.00

| | | | | | | | |
|--------------|-----------------|--------|----------|-----------|--------|------|--------|
| AAU | 1043cc | 4 Cyl. | 8 Valves | 33kW/45PS | Petrol | SOHC | TD4892 |
| IBIZA II 1.0 | 03/1993→09/1996 | | | | | | |

V94305
32.00 x 8.00 x 99.30

030 109 601E

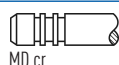

45°

ss

VAG92061B
36.70 x 8.00 x 12.08

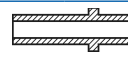

V94715
32.00 x 6.90 x 99.00
08/94→

030 109 601N

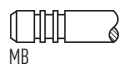

45°

Y

H

VAG96161B
36.50 x 7.00 x 11.80



V91473
29.00 x 7.95 x 99.10

030 109 611A



45°

ss

H

13 75.00

| | | | | | | | |
|-------------|-----------------|--------|----------|-----------------|--------|-----------------|--------|
| 021 A.1000 | 1193cc | 4 Cyl. | 8 Valves | 44-47kW/60-63PS | Petrol | SOHC | TD3553 |
| IBIZA I 1.2 | 11/1984→12/1993 | | | MALAGA 1.2 | | 11/1984→12/1993 | |
| RONDA 1.2 | 10/1984→12/1986 | | | | | | |

V91639
32.00 x 7.00 x 103.00

3940 3030



45°





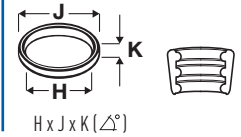
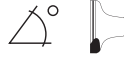

H





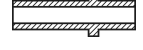
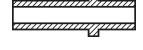

OE



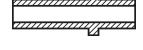
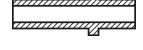

14  **75.00**

| 2G | 1272cc | 4 Cyl. | 8 Valves | 40kW/54PS | Petrol | SOHC | TD3571 |
|---|--------------|---|----------|----------------|--------|--|---|
| CORDOBA 1.3 | | 02/1993→08/1994 | | IBIZA II 1.3 i | | 03/1993→08/1999 | |
| V91332  | 030 109 601F |  | 45° | | | VAG92061B  |  |
| 36.10 x 7.97 x 99.30 | | MD | | | | 36.70 x 8.00 x 12.08 | |
| V94580  | 030 109 601C |  | 45° | H | | | |
| 36.00 x 7.97 x 98.85 | | MB | | | | | |
| V91473  | 030 109 611A |  | 45° | SS | H | | |
| 29.00 x 7.95 x 99.10 | | MD + MB | | | | | |







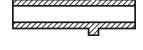
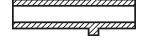





15  **75.00**

| AAV | 1272cc | 4 Cyl. | 8 Valves | 40kW/54PS | Petrol | SOHC | TD4893 |
|---|--------------|--|----------|----------------|--------|--|---|
| CORDOBA 1.3 | | 02/1993→08/1994 | | IBIZA II 1.3 i | | 03/1993→08/1999 | |
| V91332  | 030 109 601F |  | 45° | | | VAG92061B  |  |
| 36.10 x 7.97 x 99.30 | | MD | | | | 36.70 x 8.00 x 12.08 | |
| V91473  | 030 109 611A |  | 45° | SS | H | | |
| 29.00 x 7.95 x 99.10 | | MD + MB | | | | | |



16  **75.00**

| MN | 1272cc | 4 Cyl. | 8 Valves | 33kW/45PS | Diesel | SOHC | TD9401 |
|---|--------------|---|----------|-----------|--------|--|---|
| TERRA 1.3 D | | 03/1990→12/1994 | | | | | |
| V91473  | 030 109 611A |  | 45° | SS | H | VAG92061B  |  |
| 29.00 x 7.95 x 99.10 | | MD + MB | | | | 36.70 x 8.00 x 12.08 | |

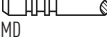
17  **75.00**

| ABD | 1390cc | 4 Cyl. | 8 Valves | 44kW/60PS | Petrol | SOHC | TD3574 |
|---|--------------|---|----------|----------------|--------|--|---|
| CORDOBA 1.4 i | | 06/1994→10/2002 | | IBIZA II 1.4 i | | 09/1993→02/2002 | |
| V91332  | 030 109 601F |  | 45° | | | VAG92061B  |  |
| 36.10 x 7.97 x 99.30 | | MD | | | | 36.70 x 8.00 x 12.08 | |
| V94305  | 030 109 601E |  | 45° | SS | | VAG96161B  |  |
| 32.00 x 8.00 x 99.30 | | MD cr | | | | 36.50 x 7.00 x 11.80 | |
| V94308  | 030 109 601G |  | 45° | Y | H | | |
| 34.00 x 7.00 x 99.10 | | MB | | | | | |
| V91473  | 030 109 611A |  | 45° | SS | H | | |
| 29.00 x 7.95 x 99.10 | | MD + MB | | | | | |
| V94309  | 030 109 611D |  | 45° | | | | |
| 29.00 x 7.00 x 99.00 | | MD | | | | | |

18  **75.00**

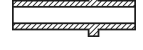
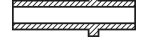
| 1W | 1398cc | 4 Cyl. | 8 Valves | 35kW/48PS | Diesel | SOHC | TD9402 |
|---|--------------|---|----------|-----------|--------|--|---|
| TERRA 1.4 D | | 10/1990→12/1995 | | | | | |
| V91473  | 030 109 611A |  | 45° | SS | H | VAG92061B  |  |
| 29.00 x 7.95 x 99.10 | | MD + MB | | | | 36.70 x 8.00 x 12.08 | |



OE

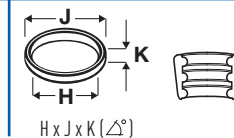
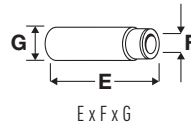

19 76.50

| | | | | | | | |
|------|--------|--------|-----------|-----------|--------|------|---------|
| AZQ | 1198cc | 3 Cyl. | 12 Valves | 47kW/64PS | Petrol | DOHC | TD16459 |
| BME | 1198cc | 3 Cyl. | 12 Valves | 47kW/64PS | Petrol | DOHC | TD20510 |
| BXV | 1198cc | 3 Cyl. | 12 Valves | 51kW/70PS | Petrol | DOHC | TD19426 |
| BZG | 1198cc | 3 Cyl. | 12 Valves | 51kW/70PS | Petrol | DOHC | TD20839 |
| CGPA | 1198cc | 3 Cyl. | 12 Valves | 51kW/70PS | Petrol | DOHC | TD23138 |
| CGPB | 1198cc | 3 Cyl. | 12 Valves | 44kW/60PS | Petrol | DOHC | TD23097 |

| | | | |
|---------------|-----------------|-------------------|-----------------|
| CORDOBA 1.2 | 10/2002→06/2006 | CORDOBA 1.2 12V | 05/2006→11/2009 |
| IBIZA III 1.2 | 02/2002→06/2006 | IBIZA III 1.2 12V | 05/2006→11/2009 |
| IBIZA IV 1.2 | 03/2008→ | | |

V94116 ■
29.50 x 6.00 x 100.90

036 109 601S



45° Y H

VAG96073B ■ ■ ■
36.00 x 6.02 x 11.06

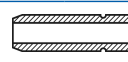

V94117 ■
26.00 x 6.00 x 100.50

036 109 611K

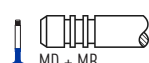

45°

20 76.50

| | | | | | | | |
|------|--------|--------|----------|-----------|--------|------|---------|
| BBM | 1198cc | 3 Cyl. | 6 Valves | 44kW/60PS | Petrol | SOHC | TD21594 |
| CHFA | 1198cc | 3 Cyl. | 6 Valves | 44kW/60PS | Petrol | SOHC | TD23098 |

| | | | |
|---------------|-----------------|--|--|
| IBIZA III 1.2 | 06/2007→05/2008 | | |
|---------------|-----------------|--|--|

V94646 ■
34.50 x 6.00 x 99.10

032 109 601M



45° Y H

VAG96073B ■ ■ ■
36.00 x 6.02 x 11.06

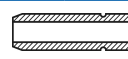

V94405 ■
28.00 x 6.00 x 99.10

030 109 611T

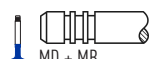

45° ss H

21 76.50

| | | | | | | | |
|-----|--------|--------|----------|-----------|--------|------|---------|
| AEX | 1390cc | 4 Cyl. | 8 Valves | 44kW/60PS | Petrol | SOHC | TD5532 |
| AKV | 1390cc | 4 Cyl. | 8 Valves | 44kW/60PS | Petrol | SOHC | TD12513 |
| ANX | 1390cc | 4 Cyl. | 8 Valves | 40kW/54PS | Petrol | SOHC | TD12514 |
| APQ | 1390cc | 4 Cyl. | 8 Valves | 44kW/60PS | Petrol | SOHC | TD12515 |

| | | | |
|----------------|-----------------|--------------|-----------------|
| AROSA 1.4 | 05/1997→06/2004 | CORDOBA 1.4 | 12/1997→04/1999 |
| CORDOBA 1.4 i | 06/1994→12/2002 | IBIZA II 1.4 | 12/1997→04/1999 |
| IBIZA II 1.4 i | 09/1993→02/2002 | INCA 1.4 i | 11/1995→06/2003 |

V94114 ■
35.60 x 7.00 x 94.70

030 109 601AH



45° H

VAG96062B ■ ■ ■
33.00 x 7.02 x 15.00

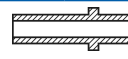

V94115 ■
29.00 x 7.00 x 95.00

032 109 611G

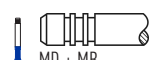

45° H

22 76.50

| | | | | | | | |
|-----|--------|--------|-----------|------------|--------|------|--------|
| AFH | 1390cc | 4 Cyl. | 16 Valves | 74kW/101PS | Petrol | DOHC | TD5534 |
|-----|--------|--------|-----------|------------|--------|------|--------|

| | | | |
|-------------------|-----------------|--------------------|-----------------|
| CORDOBA 1.4 i 16V | 09/1996→10/2002 | IBIZA II 1.4 i 16V | 06/1997→02/2002 |
|-------------------|-----------------|--------------------|-----------------|

V94247 ■
29.50 x 6.00 x 97.90

036 109 601P



45° Y H

VAG96073B ■ ■ ■
36.00 x 6.02 x 11.06



V94248 ■
26.00 x 6.00 x 97.30

036 109 611L

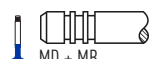

45° H

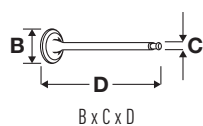

OE

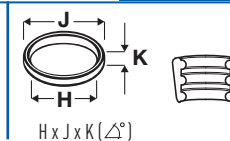
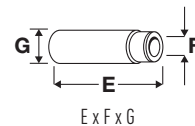

23  **76.50**

| | | | | | | | |
|------------------------|-----------------|--------|-----------|--------------------|-----------------|------------------------|---------|
| AFK | 1390cc | 4 Cyl. | 16 Valves | 74kW/101PS | Petrol | DOHC | TD13893 |
| AHW | 1390cc | 4 Cyl. | 16 Valves | 55kW/75PS | Petrol | DOHC | TD15529 |
| ANM | 1390cc | 4 Cyl. | 16 Valves | 74kW/101PS | Petrol | DOHC | TD13894 |
| APE | 1390cc | 4 Cyl. | 16 Valves | 55kW/75PS | Petrol | DOHC | TD13268 |
| AQQ | 1390cc | 4 Cyl. | 16 Valves | 74kW/100PS | Petrol | DOHC | TD15528 |
| AUA | 1390cc | 4 Cyl. | 16 Valves | 55kW/75PS | Petrol | DOHC | TD16197 |
| AUB | 1390cc | 4 Cyl. | 16 Valves | 74kW/100PS | Petrol | DOHC | TD16140 |
| AXP | 1390cc | 4 Cyl. | 16 Valves | 55kW/75PS | Petrol | DOHC | TD16134 |
| BBY | 1390cc | 4 Cyl. | 16 Valves | 55kW/75PS | Petrol | DOHC | TD16460 |
| BBZ | 1390cc | 4 Cyl. | 16 Valves | 74kW/100PS | Petrol | DOHC | TD16541 |
| BCA | 1390cc | 4 Cyl. | 16 Valves | 55kW/75PS | Petrol | DOHC | TD16434 |
| BKY | 1390cc | 4 Cyl. | 16 Valves | 55kW/75PS | Petrol | DOHC | TD18750 |
| BXW | 1390cc | 4 Cyl. | 16 Valves | 63kW/86PS | Petrol | DOHC | TD19427 |
| CAVA | 1390cc | 4 Cyl. | 16 Valves | 110kW/150PS | Petrol | Turbo, DOHC, Injection | TD24449 |
| CAVE | 1390cc | 4 Cyl. | 16 Valves | 132kW/180PS | Petrol | Turbo, DOHC, Injection | TD23095 |
| CAVF | 1390cc | 4 Cyl. | 16 Valves | 110kW/150PS | Petrol | Turbo, DOHC, Injection | TD23096 |
| CAXA | 1390cc | 4 Cyl. | 16 Valves | 90kW/122PS | Petrol | Turbo, DOHC, Injection | TD27223 |
| CAXC | 1390cc | 4 Cyl. | 16 Valves | 92kW/125PS | Petrol | Turbo, DOHC, Injection | TD20488 |
| CGGB | 1390cc | 4 Cyl. | 16 Valves | 63kW/85PS | Petrol | DOHC | TD23136 |
| ALHAMBRA 1.4 TSI | 06/2010→ | | | ALTEA 1.4 16V | 05/2006→ | | |
| ALTEA 1.4 TSI | 11/2007→ | | | ALTEA XL 1.4 16V | 10/2006→ | | |
| ALTEA XL 1.4 TSI | 11/2007→ | | | AROSA 1.4 16V | 01/2000→06/2004 | | |
| CORDOBA 1.4 16V | 06/1999→11/2009 | | | IBIZA II 1.4 16V | 05/2000→02/2002 | | |
| IBIZA II 1.4 i 16V | 06/1997→02/2002 | | | IBIZA III 1.4 16V | 02/2002→11/2009 | | |
| IBIZA IV 1.4 | 03/2008→ | | | IBIZA IV 1.4 TSI | 06/2009→ | | |
| IBIZA IV 1.4 TSI Cupra | 06/2009→ | | | INCA 1.4 16V | 04/2000→06/2003 | | |
| LEON 1.4 16V | 11/1999→12/2012 | | | LEON 1.4 TSI | 11/2007→12/2012 | | |
| TOLEDO II 1.4 16V | 01/2000→05/2002 | | | TOLEDO III 1.4 16V | 05/2006→05/2009 | | |
| TOLEDO III 1.4 TSI | 11/2007→05/2009 | | | TOLEDO IV 1.4 TSI | 07/2012→ | | |

V94116 
29.50 x 6.00 x 100.90

036 109 601S

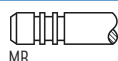

45° Y H

VAG96073B 
36.00 x 6.02 x 11.06

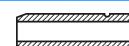

V94117 
26.00 x 6.00 x 100.50

036 109 611K

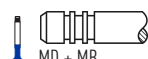

45°

24  **76.50**

| | | | | | | | |
|----------------|-----------------|--------|----------|-------------|-----------------|------|---------|
| AKK | 1390cc | 4 Cyl. | 8 Valves | 44kW/60PS | Petrol | SOHC | TD13892 |
| ANW | 1390cc | 4 Cyl. | 8 Valves | 44kW/60PS | Petrol | SOHC | TD13274 |
| AUD | 1390cc | 4 Cyl. | 8 Valves | 44kW/60PS | Petrol | SOHC | TD16139 |
| AROSA 1.4 | 05/1997→06/2004 | | | CORDOBA 1.4 | 06/1999→12/2002 | | |
| IBIZA II 1.4 i | 09/1993→02/2002 | | | INCA 1.4 i | 11/1995→06/2003 | | |

V94404 
33.50 x 6.00 x 99.10

030 109 601AL

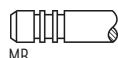

45° H

VAG96073B 
36.00 x 6.02 x 11.06

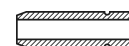

V94405 
28.00 x 6.00 x 99.10

030 109 611T

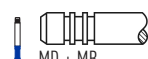

45° ss H

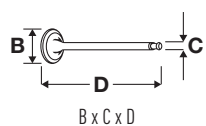

OE

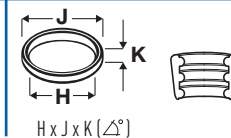
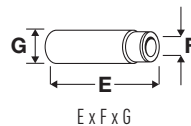
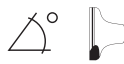

25 76.50

| | | | | | | | |
|----------------|-----------------|--------|-----------------|-----------|-----------------|-------------|---------------|
| ABU | 1598cc | 4 Cyl. | 8 Valves | 55kW/75PS | Petrol | SOHC | TD4897 |
| CORDOBA 1.6 | 06/1999→12/2002 | | CORDOBA 1.6 i | | 02/1993→10/2002 | | |
| IBIZA II 1.6 i | 03/1993→02/2002 | | | | | | |

| | | | | | | |
|----------------------|---------------|---------|-----|---|----------------------|--|
| V94114 | 030 109 601AH | | 45° | H | VAG96041B | |
| 35.60 x 7.00 x 94.70 | | MB cr | | | 36.50 x 7.00 x 12.08 | |
| V94115 | 032 109 611G | | 45° | H | VAG96161B | |
| 29.00 x 7.00 x 95.00 | | MD + MB | | | 36.50 x 7.00 x 11.80 | |

26 76.50

| | | | | | | | |
|----------------|-----------------|--------|-----------------|-----------|-----------------|-------------|----------------|
| AEE | 1598cc | 4 Cyl. | 8 Valves | 55kW/75PS | Petrol | SOHC | TD10867 |
| ALM | 1598cc | 4 Cyl. | 8 Valves | 55kW/75PS | Petrol | SOHC | TD12949 |
| CORDOBA 1.6 | 06/1999→12/2002 | | CORDOBA 1.6 i | | 02/1993→12/2002 | | |
| IBIZA II 1.6 i | 03/1993→02/2002 | | INCA 1.6 i | | 06/1997→09/2000 | | |

| | | | | | | |
|----------------------|---------------|---------|-----|---|----------------------|--|
| V94114 | 030 109 601AH | | 45° | H | VAG96062B | |
| 35.60 x 7.00 x 94.70 | | MB cr | | | 33.00 x 7.02 x 15.00 | |
| V94115 | 032 109 611G | | 45° | H | | |
| 29.00 x 7.00 x 95.00 | | MD + MB | | | | |

27 76.50

| | | | | | | | |
|-------------------|-----------------|--------|-------------------|------------|-----------------|-------------|----------------|
| ATN | 1598cc | 4 Cyl. | 16 Valves | 77kW/105PS | Petrol | DOHC | TD15531 |
| AUS | 1598cc | 4 Cyl. | 16 Valves | 77kW/105PS | Petrol | DOHC | TD15788 |
| AZD | 1598cc | 4 Cyl. | 16 Valves | 77kW/105PS | Petrol | DOHC | TD16131 |
| BCB | 1598cc | 4 Cyl. | 16 Valves | 77kW/105PS | Petrol | DOHC | TD16435 |
| BTS | 1598cc | 4 Cyl. | 16 Valves | 77kW/105PS | Petrol | DOHC | TD19428 |
| CORDOBA 1.6 16V | 11/2006→11/2009 | | IBIZA III 1.6 16V | | 11/2006→11/2009 | | |
| IBIZA IV 1.6 | 05/2008→ | | LEON 1.6 16 V | | 09/2000→06/2006 | | |
| TOLEDO II 1.6 16V | 06/2000→05/2006 | | | | | | |

| | | | | | | | |
|-----------------------|--------------|---------|-----|---|---|----------------------|--|
| V94116 | 036 109 601S | | 45° | Y | H | VAG96073B | |
| 29.50 x 6.00 x 100.90 | | MB | | | | 36.00 x 6.02 x 11.06 | |
| V94117 | 036 109 611K | | 45° | | | | |
| 26.00 x 6.00 x 100.50 | | MD + MB | | | | | |

28 76.50

| | | | | | | | |
|--------------|-----------------|--------|-----------------|-------------------|-----------------|-------------|----------------|
| BAH | 1598cc | 4 Cyl. | 8 Valves | 74-75kW/101-102PS | Petrol | SOHC | TD17340 |
| CORDOBA 1.6 | 04/2003→11/2009 | | IBIZA III 1.6 | | 02/2003→11/2009 | | |
| IBIZA IV 1.6 | 09/2008→ | | | | | | |

| | | | | | | | |
|----------------------|--------------|---------|-----|----|---|----------------------|--|
| V94646 | 032 109 601M | | 45° | Y | H | VAG96073B | |
| 34.50 x 6.00 x 99.10 | | MB | | | | 36.00 x 6.02 x 11.06 | |
| V94405 | 030 109 611T | | 45° | ss | H | | |
| 28.00 x 6.00 x 99.10 | | MD + MB | | | | | |



OE

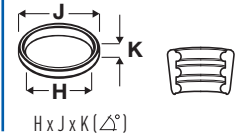
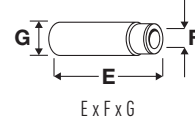
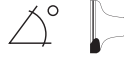

29 **76.50**

| | | | | | | | |
|------------------|--------|----------|------------------|-----------|--------|-------------|----------------|
| CNKA | 1598cc | 4 Cyl. | 16 Valves | 60kW/81PS | Petrol | DOHC | TD25408 |
| IBIZA IV 1.6 LPG | | 05/2011→ | | | | | |

| | | | | | |
|-----------------------|--------------|---------------|-----|----|--|
| V80010 | 03C 109 601L | | 45° | SS | |
| 29.50 x 6.00 x 100.60 | | MB tu | | | |
| V80011 | 03C 109 611Q | | 45° | SS | |
| 26.00 x 6.00 x 100.60 | | ME + MB tu Na | | | |

30 **79.50**

| | | | | | | | |
|------------------|--------|----------|------------------|-----------|--------|--------------------|----------------|
| CFWA | 1199cc | 3 Cyl. | 12 Valves | 55kW/75PS | Diesel | Turbo, DOHC | TD23935 |
| IBIZA IV 1.2 TDI | | 04/2010→ | | | | | |

| | | | | | | | |
|----------------------|--------------|---------|-----|----|---|----------------------|--|
| V95125 | 03L 109 601A | | 45° | Y | H | VAG96388B | |
| 26.60 x 5.97 x 99.30 | | MD + MB | | | | 36.00 x 6.00 x 10.06 | |
| V95126 | 03L 109 611A | | 45° | SS | H | | |
| 24.50 x 5.97 x 99.00 | | MD | | | | | |

31 **79.50**

| | | | | | | | |
|-------------------|--------|-----------------|-----------------|-----------------|--------|--------------------|----------------|
| AMF | 1422cc | 3 Cyl. | 6 Valves | 55kW/75PS | Diesel | Turbo, SOHC | TD13895 |
| AROSA 1.4 TDI | | 01/2000→06/2004 | | CORDOBA 1.4 TDI | | 10/2002→12/2005 | |
| IBIZA III 1.4 TDI | | 05/2002→12/2005 | | | | | |

| | | | | | | | |
|----------------------|--------------|---------|-----|----|---|----------------------|--|
| V94147 | 038 109 601B | | 45° | | H | VAG96041B | |
| 35.90 x 7.00 x 89.90 | | MB | | | | 36.50 x 7.00 x 12.08 | |
| V94649 | 038 109 601E | | 45° | Y | H | | |
| 36.00 x 7.00 x 89.40 | | MB | | | | | |
| V94148 | 038 109 611F | | 45° | SS | H | | |
| 31.50 x 7.00 x 90.00 | | MD + MB | | | | | |
| V94650 | 038 109 611E | | 45° | SS | H | | |
| 31.40 x 7.00 x 89.00 | | MD + MB | | | | | |

32 **79.50**

| | | | | | | | |
|------------------|--------|-----------------|-----------------|-------------------|--------|--------------------|----------------|
| BMS | 1422cc | 3 Cyl. | 6 Valves | 59kW/80PS | Diesel | Turbo, SOHC | TD18727 |
| BNM | 1422cc | 3 Cyl. | 6 Valves | 51kW/70PS | Diesel | Turbo, SOHC | TD18726 |
| BNV | 1422cc | 3 Cyl. | 6 Valves | 59kW/80PS | Diesel | Turbo, SOHC | TD18738 |
| CORDOBA 1.4 TDI | | 05/2005→11/2009 | | IBIZA III 1.4 TDI | | 05/2005→11/2009 | |
| IBIZA IV 1.4 TDI | | 07/2008→06/2010 | | | | | |

| | | | | | | | |
|----------------------|--------------|---------|-----|----|---|----------------------|--|
| V94649 | 038 109 601E | | 45° | Y | H | VAG96041B | |
| 36.00 x 7.00 x 89.40 | | MB | | | | 36.50 x 7.00 x 12.08 | |
| V94650 | 038 109 611E | | 45° | SS | H | | |
| 31.40 x 7.00 x 89.00 | | MD + MB | | | | | |

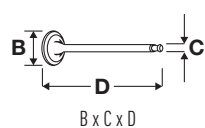

OE

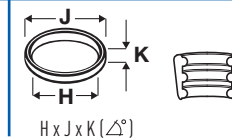
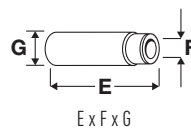

33 **79.50**

| | | | | | | | |
|-------------|--------|--------|------------------|------------|--------|--------------------|----------------|
| CAYA | 1598cc | 4 Cyl. | 16 Valves | 55kW/75PS | Diesel | Turbo, DOHC | TD25762 |
| CAYB | 1598cc | 4 Cyl. | 16 Valves | 66kW/90PS | Diesel | Turbo, DOHC | TD22670 |
| CAVC | 1598cc | 4 Cyl. | 16 Valves | 77kW/105PS | Diesel | Turbo, DOHC | TD22671 |
| CLHA | 1598cc | 4 Cyl. | 16 Valves | 77kW/105PS | Diesel | Turbo, DOHC | TD27258 |
| CLHB | 1598cc | 4 Cyl. | 16 Valves | 66kW/90PS | Diesel | Turbo, DOHC | TD27263 |
| CLNA | 1598cc | 4 Cyl. | 16 Valves | 77kW/105PS | Diesel | Turbo, DOHC | TD23934 |
| CRKB | 1598cc | 4 Cyl. | 16 Valves | 81kW/110PS | Diesel | Turbo, DOHC | TD27958 |

| | | | |
|-------------------|----------|------------------|----------|
| ALTEA 1.6 TDI | 10/2009→ | ALTEA XL 1.6 TDI | 10/2009→ |
| IBIZA IV 1.6 TDI | 05/2009→ | LEON 1.6 TDI | 02/2010→ |
| TOLEDO IV 1.6 TDI | 07/2012→ | | |

V95125 03L 109 601A
26.60 x 5.97 x 99.30

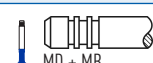

45° Y H

VAG96388B 36.00 x 6.00 x 10.06



V95126 03L 109 611A
24.50 x 5.97 x 99.00

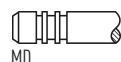

45° ss H

34 **79.50**

| | | | | | | | |
|------------|--------|--------|-----------------|-----------|--------|-------------|----------------|
| AHB | 1716cc | 4 Cyl. | 8 Valves | 42kW/57PS | Diesel | SOHC | TD9403 |
| AKU | 1716cc | 4 Cyl. | 8 Valves | 44kW/60PS | Diesel | SOHC | TD13896 |

| | | | |
|---------------|-----------------|------------|-----------------|
| AROSA 1.7 SDI | 08/1997→06/2004 | INCA 1.7 D | 09/1996→06/2003 |
|---------------|-----------------|------------|-----------------|

V94112 028 109 601J
36.00 x 7.00 x 96.50

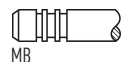

45° Y H

VAG96041B 36.50 x 7.00 x 12.08

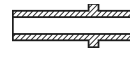

V94113 028 109 611K
31.50 x 7.00 x 96.30

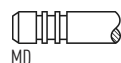

45°

35 **79.50**

| | | | | | | | |
|-----------|--------|--------|-----------------|-----------------|--------|-------------|---------------|
| 1Y | 1896cc | 4 Cyl. | 8 Valves | 47-50kW/64-68PS | Diesel | SOHC | TD4891 |
|-----------|--------|--------|-----------------|-----------------|--------|-------------|---------------|

| | | | |
|---------------|-----------------|----------------|-----------------|
| CORDOBA 1.9 D | 02/1993→08/1996 | IBIZA II 1.9 D | 04/1993→08/1996 |
| INCA 1.9 D | 11/1995→06/2003 | TOLEDO I 1.9 D | 05/1991→03/1999 |

V91337 069 109 601F
36.10 x 7.97 x 95.10
Eng.→580.000



45° H

VAG92061B 36.70 x 8.00 x 12.08
Eng.→580.000

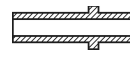

V94108 028 109 601C
36.00 x 7.00 x 95.50
Eng.580.001→

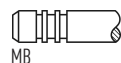

45° Y H

VAG96041B 36.50 x 7.00 x 12.08
Eng.580.001→

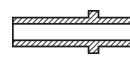

V94414 028 109 601C
36.00 x 7.00 x 95.50
Eng.580.001→

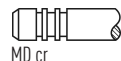

45°

V91334 074 109 611
31.30 x 7.95 x 95.10
Eng.→580.000



45° ss H

V94109 028 109 611E
31.10 x 7.00 x 95.60
Eng.580.001→



45° H



OE

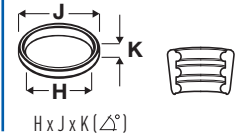
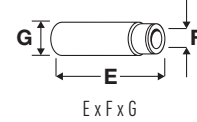

36 **79.50**

| 1Z | 1896cc | 4 Cyl. | 8 Valves | 66kW/90PS | Diesel | Turbo, SOHC | TD5527 |
|----------------------|--------------|-----------------|----------|----------------------|--------|-----------------|--------|
| ALHAMBRA 1.9 TDI | | 04/1996→03/2010 | | CORDOBA 1.9 TDI | | 08/1996→12/2002 | |
| IBIZA II 1.9 TDI | | 08/1996→02/2002 | | TOLEDO I 1.9 TDI | | 08/1995→03/1999 | |
| V94010 | 028 109 601H | | 45° Y H | VAG92061B | | | |
| 36.00 x 8.00 x 96.80 | | MB | | 36.70 x 8.00 x 12.08 | | | |
| V94011 | 046 109 611F | | 45° SS | | | | |
| 31.50 x 7.95 x 96.85 | | MD + MB | | | | | |

37 **79.50**

| AAZ | 1896cc | 4 Cyl. | 8 Valves | 55kW/75PS | Diesel | Turbo, SOHC | TD4894 |
|-------------------------------------|--------------|-----------------|----------|-------------------------------------|--------|-----------------|--------|
| CORDOBA 1.9 TD | | 02/1993→08/1996 | | IBIZA II 1.9 TD | | 03/1993→08/1996 | |
| TOLEDO I 1.9 TD | | 05/1991→03/1999 | | | | | |
| V91336 | 069 109 601H | | 45° | VAG92061B | | | |
| 36.10 x 7.97 x 95.00 Eng.→678000 | | MD | | 36.70 x 8.00 x 12.08 Eng.→678000 | | | |
| V94108 | 028 109 601C | | 45° Y H | VAG96041B | | | |
| 36.00 x 7.00 x 95.50 Eng.678001→ | | MB | | 36.50 x 7.00 x 12.08 Eng.678001→ | | | |
| V94414 | 028 109 601C | | 45° | | | | |
| 36.00 x 7.00 x 95.50 Eng.678001→ | | MD cr | | | | | |
| V91334 | 074 109 611 | | 45° SS H | | | | |
| 31.30 x 7.95 x 95.10 Eng.→678000 | | ME + MB | | | | | |
| V94109 | 028 109 611E | | 45° H | | | | |
| 31.10 x 7.00 x 95.60 Eng.678001→ | | MD + MB | | | | | |

38 **79.50**

| AEF | 1896cc | 4 Cyl. | 8 Valves | 47kW/64PS | Diesel | SOHC | TD9373 |
|-------------------------------------|--------------|---------|----------|-------------------------------------|--------|------|--------|
| V91337 | 069 109 601F | | 45° H | VAG92061B | | | |
| 36.10 x 7.97 x 95.10 Eng.→007000 | | MB | | 36.70 x 8.00 x 12.08 Eng.→007000 | | | |
| V94108 | 028 109 601C | | 45° Y H | VAG96041B | | | |
| 36.00 x 7.00 x 95.50 Eng.007001→ | | MB | | 36.50 x 7.00 x 12.08 Eng.007001→ | | | |
| V94414 | 028 109 601C | | 45° | | | | |
| 36.00 x 7.00 x 95.50 Eng.007001→ | | MD cr | | | | | |
| V91334 | 074 109 611 | | 45° SS H | | | | |
| 31.30 x 7.95 x 95.10 Eng.→007000 | | ME + MB | | | | | |
| V94109 | 028 109 611E | | 45° H | | | | |
| 31.10 x 7.00 x 95.60 Eng.007001→ | | MD + MB | | | | | |



OE

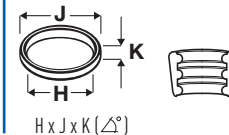
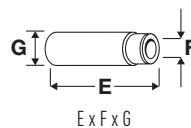

39 79.50

| AEY | 1896cc | 4 Cyl. | 8 Valves | 47kW/64PS | Diesel | SOHC | TD5535 |
|-------------------------------------|--------------|-----------------|----------|------------------|-------------------------------------|------------------|--------|
| CORDOBA 1.9 SDI | | 08/1996→06/1999 | | IBIZA II 1.9 SDI | | 08/1996→08/1999 | |
| INCA 1.9 SDI | | 11/1995→06/2003 | | | | | |
| V94409 | 028 109 601G | | 45° | H | VAG92061B | | |
| 36.00 x 8.00 x 96.30 Eng.→002000 | | MD + MB | | | 36.70 x 8.00 x 12.08 Eng.→002000 | | |
| V94112 | 028 109 601J | | 45° | Y | H | VAG96041B | |
| 36.00 x 7.00 x 96.50 Eng.002001→ | | MB | | | 36.50 x 7.00 x 12.08 Eng.002001→ | | |
| V94410 | 028 109 611J | | 45° | ss | H | | |
| 31.50 x 8.00 x 96.40 Eng.→002000 | | MD + MB | | | | | |
| V94113 | 028 109 611K | | 45° | | | | |
| 31.50 x 7.00 x 96.30 Eng.002001→ | | MD | | | | | |

40 79.50

| AFN | 1896cc | 4 Cyl. | 8 Valves | 81kW/110PS | Diesel | Turbo, SOHC | TD5531 |
|-------------------|--------|-----------------|----------|------------------|--------|-----------------|---------|
| AGR | 1896cc | 4 Cyl. | 8 Valves | 66kW/90PS | Diesel | Turbo, SOHC | TD13278 |
| AHF | 1896cc | 4 Cyl. | 8 Valves | 81kW/110PS | Diesel | Turbo, SOHC | TD12512 |
| AHU | 1896cc | 4 Cyl. | 8 Valves | 66kW/90PS | Diesel | Turbo, SOHC | TD5528 |
| ALH | 1896cc | 4 Cyl. | 8 Valves | 66kW/90PS | Diesel | Turbo, SOHC | TD13272 |
| ASV | 1896cc | 4 Cyl. | 8 Valves | 81kW/110PS | Diesel | Turbo, SOHC | TD13273 |
| AVG | 1896cc | 4 Cyl. | 8 Valves | 81kW/110PS | Diesel | Turbo, SOHC | TD23884 |
| ALHAMBRA 1.9 TDI | | 04/1996→03/2010 | | CORDOBA 1.9 TDI | | 08/1996→12/2002 | |
| IBIZA II 1.9 TDI | | 08/1996→02/2002 | | INCA 1.9 TDI | | 09/1996→06/2003 | |
| LEON 1.9 TDI | | 11/1999→06/2006 | | TOLEDO I 1.9 TDI | | 08/1995→03/1999 | |
| TOLEDO II 1.9 TDI | | 10/1998→07/2004 | | | | | |

| | | | | | | | |
|----------------------|--------------|---------|-----|---|---|----------------------|--|
| V94084 | 028 109 601D | | 45° | Y | H | VAG96041B | |
| 35.90 x 7.00 x 96.80 | | MB | | | | 36.50 x 7.00 x 12.08 | |
| V94085 | 028 109 611G | | 45° | | H | | |
| 31.40 x 7.00 x 96.90 | | MD + MB | | | | | |

41 79.50

| AGP | 1896cc | 4 Cyl. | 8 Valves | 50kW/68PS | Diesel | SOHC | TD14808 |
|-------------------|--------|-----------------|----------|------------------|--------|-----------------|---------|
| AQM | 1896cc | 4 Cyl. | 8 Valves | 50kW/68PS | Diesel | SOHC | TD13271 |
| ASY | 1896cc | 4 Cyl. | 8 Valves | 47kW/64PS | Diesel | SOHC | TD16461 |
| AYQ | 1896cc | 4 Cyl. | 8 Valves | 47kW/64PS | Diesel | SOHC | TD16198 |
| CORDOBA 1.9 SDI | | 06/1999→11/2009 | | IBIZA II 1.9 SDI | | 08/1999→02/2002 | |
| IBIZA III 1.9 SDI | | 02/2002→12/2005 | | INCA 1.9 SDI | | 11/1995→06/2003 | |
| LEON 1.9 SDI | | 11/1999→06/2006 | | | | | |

| | | | | | | | |
|----------------------|--------------|----|-----|---|---|----------------------|--|
| V94112 | 028 109 601J | | 45° | Y | H | VAG96041B | |
| 36.00 x 7.00 x 96.50 | | MB | | | | 36.50 x 7.00 x 12.08 | |
| V94113 | 028 109 611K | | 45° | | | | |
| 31.50 x 7.00 x 96.30 | | MD | | | | | |

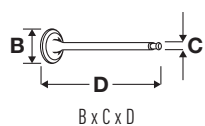
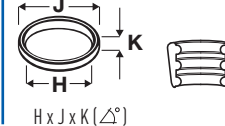
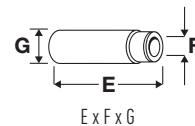
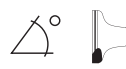
OE

42 **79.50**

| | | | | | | | |
|-----|--------|--------|----------|-------------|--------|-------------|---------|
| ANU | 1896cc | 4 Cyl. | 8 Valves | 66kW/90PS | Diesel | Turbo, SOHC | TD14911 |
| ARL | 1896cc | 4 Cyl. | 8 Valves | 110kW/150PS | Diesel | Turbo, SOHC | TD15768 |
| ASZ | 1896cc | 4 Cyl. | 8 Valves | 96kW/130PS | Diesel | Turbo, SOHC | TD16463 |
| ATD | 1896cc | 4 Cyl. | 8 Valves | 74kW/100PS | Diesel | Turbo, SOHC | TD16462 |
| AUY | 1896cc | 4 Cyl. | 8 Valves | 85kW/115PS | Diesel | Turbo, SOHC | TD14912 |
| BLT | 1896cc | 4 Cyl. | 8 Valves | 96kW/131PS | Diesel | Turbo, SOHC | TD20516 |
| BPX | 1896cc | 4 Cyl. | 8 Valves | 118kW/160PS | Diesel | Turbo, SOHC | TD17640 |
| BTB | 1896cc | 4 Cyl. | 8 Valves | 110kW/150PS | Diesel | Turbo, SOHC | TD20625 |
| BUK | 1896cc | 4 Cyl. | 8 Valves | 118kW/160PS | Diesel | Turbo, SOHC | TD22667 |
| BVK | 1896cc | 4 Cyl. | 8 Valves | 85kW/115PS | Diesel | Turbo, SOHC | TD20515 |

| | | | |
|-------------------|-----------------|---------------------------|-----------------|
| ALHAMBRA 1.9 TDI | 04/1996→03/2010 | CORDOBA 1.9 TDI | 09/2002→11/2009 |
| IBIZA III 1.9 TDI | 02/2002→11/2009 | IBIZA III 1.9 TDI Cupra R | 03/2004→02/2008 |
| LEON 1.9 TDI | 09/2000→06/2006 | TOLEDO II 1.9 TDI | 10/2000→05/2006 |

| | | | | | | |
|------------------------------|--------------|--|-----|------|----------------------------|--|
| V94147 MB | 038 109 601B | | 45° | H | VAG96041B MB | |
| 35.90 x 7.00 x 89.90 | | | | | 36.50 x 7.00 x 12.08 | |
| V94148 MD + MB | 038 109 611F | | 45° | SS H | | |
| 31.50 x 7.00 x 90.00 | | | | | | |

43 **79.50**

| | | | | | | | |
|-----------------|-----------------|------------------|-----------------|------------|--------|-------------|---------|
| ASK | 1896cc | 4 Cyl. | 8 Valves | 81kW/110PS | Diesel | Turbo, SOHC | TD13277 |
| CORDOBA 1.9 TDI | 06/1999→12/2002 | IBIZA II 1.9 TDI | 02/1997→02/2002 | | | | |

| | | | | | | |
|------------------------------|--------------|--|-----|-----|----------------------------|--|
| V94084 MB | 028 109 601D | | 45° | Y H | VAG96041B MB | |
| 35.90 x 7.00 x 96.80 | | | | | 36.50 x 7.00 x 12.08 | |
| V94112 MB | 028 109 601J | | 45° | Y H | | |
| 36.00 x 7.00 x 96.50 | | | | | | |
| V94085 MD + MB | 028 109 611G | | 45° | H | | |
| 31.40 x 7.00 x 96.90 | | | | | | |

44 **79.50**

| | | | | | | | |
|-----|--------|--------|----------|------------|--------|-------------|---------|
| AXR | 1896cc | 4 Cyl. | 8 Valves | 74kW/100PS | Diesel | Turbo, SOHC | TD18739 |
| BJB | 1896cc | 4 Cyl. | 8 Valves | 77kW/105PS | Diesel | Turbo, SOHC | TD17356 |
| BKC | 1896cc | 4 Cyl. | 8 Valves | 77kW/105PS | Diesel | Turbo, SOHC | TD17355 |
| BLS | 1896cc | 4 Cyl. | 8 Valves | 77kW/105PS | Diesel | Turbo, SOHC | TD18268 |
| BMT | 1896cc | 4 Cyl. | 8 Valves | 74kW/101PS | Diesel | Turbo, SOHC | TD20495 |
| BXE | 1896cc | 4 Cyl. | 8 Valves | 77kW/105PS | Diesel | Turbo, SOHC | TD19819 |
| BXF | 1896cc | 4 Cyl. | 8 Valves | 66kW/90PS | Diesel | Turbo, SOHC | TD20866 |
| BXJ | 1896cc | 4 Cyl. | 8 Valves | 66kW/90PS | Diesel | Turbo, SOHC | TD20840 |

| | | | |
|-------------------|-----------------|--------------------|-----------------|
| ALTEA 1.9 TDI | 04/2004→ | ALTEA XL 1.9 TDI | 10/2006→ |
| CORDOBA 1.9 TDI | 09/2002→11/2009 | IBIZA III 1.9 TDI | 02/2002→11/2009 |
| IBIZA IV 1.9 TDI | 03/2008→06/2010 | LEON 1.9 TDI | 07/2005→12/2010 |
| TOLEDO II 1.9 TDI | 08/2005→05/2006 | TOLEDO III 1.9 TDI | 10/2004→05/2009 |

| | | | | | | |
|------------------------------|--------------|--|-----|------|----------------------------|--|
| V94649 MB | 038 109 601E | | 45° | Y H | VAG96041B MB | |
| 36.00 x 7.00 x 89.40 | | | | | 36.50 x 7.00 x 12.08 | |
| V94650 MD + MB | 038 109 611E | | 45° | SS H | | |
| 31.40 x 7.00 x 89.00 | | | | | | |

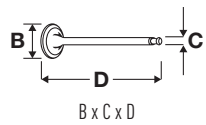

OE

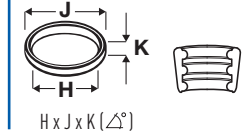
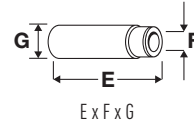
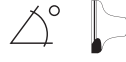

45 81.00

| | | | | | | | |
|---------------|-----------------|--------|----------|-----------------|--------|-----------------|---------|
| 1F | 1595cc | 4 Cyl. | 8 Valves | 52-55kW/71-75PS | Petrol | SOHC | TD4890 |
| ABN | 1595cc | 4 Cyl. | 8 Valves | 54-55kW/73-75PS | Petrol | SOHC | TD17897 |
| CORDOBA 1.6 i | 05/1994→06/1999 | | | IBIZA II 1.6 i | | 09/1994→06/1999 | |
| INCA 1.6 i | 11/1995→05/1998 | | | TOLEDO I 1.6 i | | 05/1991→03/1999 | |

V91338
 38.10 x 7.97 x 91.90

035 109 601K

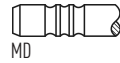

45°

VAG92061B
 36.70 x 8.00 x 12.08

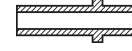

V91340
 33.30 x 7.95 x 91.20

048 109 611A



45°

H

46 81.00

| | | | | | | | |
|---------------|-----------------|--------|----------|-------------------|--------|-----------------|---------|
| AEH | 1595cc | 4 Cyl. | 8 Valves | 74kW/101PS | Petrol | SOHC | TD12488 |
| AFT | 1595cc | 4 Cyl. | 8 Valves | 74kW/101PS | Petrol | SOHC | TD5536 |
| AKL | 1595cc | 4 Cyl. | 8 Valves | 74-76kW/101-103PS | Petrol | SOHC | TD12509 |
| APF | 1595cc | 4 Cyl. | 8 Valves | 74kW/100PS | Petrol | SOHC | TD13269 |
| CORDOBA 1.6 | 06/1999→12/2002 | | | CORDOBA 1.6 i | | 07/1996→12/2002 | |
| IBIZA II 1.6 | 10/1999→02/2002 | | | IBIZA II 1.6 i | | 04/1996→02/2002 | |
| LEON 1.6 | 11/1999→06/2006 | | | TOLEDO I 1.6 i | | 11/1996→03/1999 | |
| TOLEDO II 1.6 | 10/1998→07/2004 | | | | | | |

V94079
 39.40 x 7.00 x 92.10

078 109 601B



45°

H

VAG96041B
 36.50 x 7.00 x 12.08

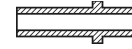

V94080
 32.80 x 7.00 x 91.20

048 109 611B



45°

H

47 81.00

| | | | | | | | |
|----------------|-----------------|--------|----------|------------------|--------|-----------------|---------|
| ALZ | 1595cc | 4 Cyl. | 8 Valves | 75kW/102PS | Petrol | SOHC | TD22242 |
| BFQ | 1595cc | 4 Cyl. | 8 Valves | 75kW/102PS | Petrol | SOHC | TD20621 |
| BGU | 1595cc | 4 Cyl. | 8 Valves | 75kW/102PS | Petrol | SOHC | TD17352 |
| BSE | 1595cc | 4 Cyl. | 8 Valves | 75kW/102PS | Petrol | SOHC | TD18245 |
| BSF | 1595cc | 4 Cyl. | 8 Valves | 75kW/102PS | Petrol | SOHC | TD18246 |
| CCSA | 1595cc | 4 Cyl. | 8 Valves | 75kW/102PS | Petrol | SOHC | TD20710 |
| CHGA | 1595cc | 4 Cyl. | 8 Valves | 75kW/102PS | Petrol | SOHC | TD22676 |
| CMXA | 1595cc | 4 Cyl. | 8 Valves | 75kW/102PS | Petrol | SOHC | TD24325 |
| ALTEA 1.6 | 03/2004→ | | | ALTEA 1.6 LPG | | 09/2009→ | |
| ALTEA XL 1.6 | 10/2006→ | | | ALTEA XL 1.6 LPG | | 09/2009→ | |
| EXEO 1.6 | 03/2009→09/2010 | | | LEON 1.6 | | 07/2005→12/2012 | |
| LEON 1.6 LPG | 12/2009→12/2012 | | | TOLEDO II 1.6 | | 08/2005→05/2006 | |
| TOLEDO III 1.6 | 10/2004→05/2009 | | | | | | |

V94424
 39.50 x 6.00 x 94.00

06B 109 601D



45°

Y

H

VAG96353B
 36.50 x 6.02 x 12.08



V94425
 32.90 x 6.00 x 93.90

06B 109 611C



45°

SS



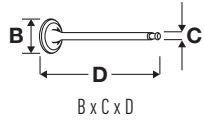

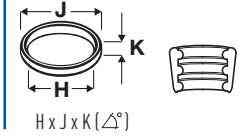
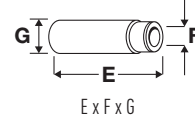
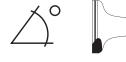

H



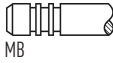

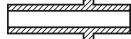



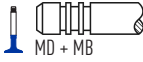

OE

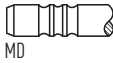



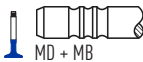

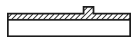
48  **81.00**

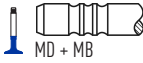
| AUR | 1595cc | 4 Cyl. | 8 Valves | 74kW/101PS | Petrol | SOHC | TD16200 |
|---|--------------|---|----------|----------------|--------|--|---|
| CORDOBA 1.6 | | 06/1999→12/2002 | | IBIZA II 1.6 i | | 04/1996→02/2002 | |
| V94079  | 078 109 601B |  | 45° | H | | VAG96041B  |  |
| 39.40 x 7.00 x 92.10 | | MB | | | | 36.50 x 7.00 x 12.08 | |
| V94080  | 048 109 611B |  | 45° | H | | | |
| 32.80 x 7.00 x 91.20 | | MD + MB | | | | | |
| V94303  | 078 109 611C |  | 45° | ss | H | | |
| 32.90 x 7.00 x 91.20 | | MD + MB | | | | | |



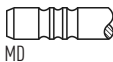

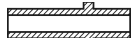



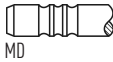

49  **81.00**

| EZ | 1595cc | 4 Cyl. | 8 Valves | 52-54kW/71-73PS | Petrol | SOHC | TD4899 |
|---|--------------|---|----------|-----------------|--------|--|---|
| TOLEDO I 1.6 i | | 05/1991→03/1999 | | | | | |
| V91338  | 035 109 601K |  | 45° | | | VAG92061B  |  |
| 38.10 x 7.97 x 91.90 | | MD | | | | 36.70 x 8.00 x 12.08 | |
| V91030  | 035 109 611F |  | 45° | ss | H | VAG92105B  |  |
| 33.30 x 7.95 x 98.60 | | MD + MB | | | | 42.30 x 7.99 x 12.08 | |
| V91340  | 048 109 611A |  | 45° | | H | | |
| 33.30 x 7.95 x 91.20 | | MD + MB | | | | | |

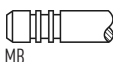
50  **81.00**

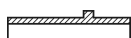
| ABS | 1781cc | 4 Cyl. | 8 Valves | 66kW/90PS | Petrol | SOHC | TD3576 |
|---|--------------|---|----------|----------------|--------|--|---|
| CORDOBA 1.8 i | | 02/1993→09/2002 | | IBIZA II 1.8 i | | 03/1993→08/1999 | |
| TOLEDO I 1.8 i | | 05/1991→12/1996 | | | | | |
| V91338  | 035 109 601K |  | 45° | | | VAG92061B  |  |
| 38.10 x 7.97 x 91.90 | | MD | | | | 36.70 x 8.00 x 12.08 | |
| V91340  | 048 109 611A |  | 45° | | H | | |
| 33.30 x 7.95 x 91.20 | | MD + MB | | | | | |

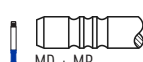
51  **81.00**

| ADZ | 1781cc | 4 Cyl. | 8 Valves | 66kW/90PS | Petrol | SOHC | TD9384 |
|---|--------------|---|----------|----------------|--------|--|---|
| CORDOBA 1.8 i | | 02/1993→09/2002 | | IBIZA II 1.8 i | | 03/1993→08/1999 | |
| TOLEDO I 1.8 i | | 11/1993→12/1996 | | | | | |
| V91338  | 035 109 601K |  | 45° | | | VAG92061B  |  |
| 38.10 x 7.97 x 91.90 Eng.→408197 | | MD | | | | 36.70 x 8.00 x 12.08 Eng.→408197 | |
| V94450  | 048 109 601E |  | 45° | Y | H | VAG96041B  |  |
| 37.80 x 7.00 x 91.80 Eng.408198→ | | MB | | | | 36.50 x 7.00 x 12.08 Eng.408198→ | |
| V91340  | 048 109 611A |  | 45° | | H | | |
| 33.30 x 7.95 x 91.20 Eng.→408197 | | MD + MB | | | | | |
| V94080  | 048 109 611B |  | 45° | | H | | |
| 32.80 x 7.00 x 91.20 Eng.408198→ | | MD + MB | | | | | |

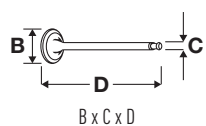

OE

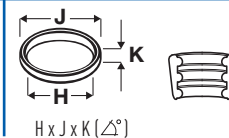
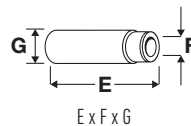

52 81.00

| | | | | | | | |
|-----------------------|-----------------|------------|-------------------|------------|-----------------|------------------------|---------|
| AGN | 1781cc | 4 Cyl. | 20 Valves | 92kW/125PS | Petrol | DOHC | TD12510 |
| APG | 1781cc | 4 Cyl. | 20 Valves | 92kW/125PS | Petrol | DOHC | TD15530 |
| LEON 1.8 20V | 11/1999→06/2006 | | TOLEDO II 1.8 20V | | 10/1998→07/2004 | | |
| V94081 ■ | 058 109 601C | | 45° | Y | H | VAG96073B ■ ■ ■ | |
| 26.90 x 6.00 x 105.10 | | MB | | | | 36.00 x 6.02 x 11.06 | |
| V94083 ■ | 058 109 611M | | 45° | | H | | |
| 29.90 x 6.00 x 103.90 | | MD + MB cr | | | | | |

53 81.00

| | | | | | | | |
|--------------------------|-----------------|--------|-------------------------|-------------|-----------------|-------------|---------|
| AJH | 1781cc | 4 Cyl. | 20 Valves | 110kW/150PS | Petrol | Turbo, DOHC | TD17899 |
| AJQ | 1781cc | 4 Cyl. | 20 Valves | 132kW/180PS | Petrol | Turbo, DOHC | TD16199 |
| AMK | 1781cc | 4 Cyl. | 20 Valves | 154kW/209PS | Petrol | Turbo, DOHC | TD16436 |
| APP | 1781cc | 4 Cyl. | 20 Valves | 132kW/180PS | Petrol | Turbo, DOHC | TD13270 |
| AQX | 1781cc | 4 Cyl. | 20 Valves | 115kW/156PS | Petrol | Turbo, DOHC | TD13275 |
| ARY | 1781cc | 4 Cyl. | 20 Valves | 132kW/180PS | Petrol | Turbo, DOHC | TD16136 |
| AUQ | 1781cc | 4 Cyl. | 20 Valves | 132kW/180PS | Petrol | Turbo, DOHC | TD16135 |
| AWC | 1781cc | 4 Cyl. | 20 Valves | 110kW/150PS | Petrol | Turbo, DOHC | TD14909 |
| AYP | 1781cc | 4 Cyl. | 20 Valves | 115kW/156PS | Petrol | Turbo, DOHC | TD16201 |
| BAM | 1781cc | 4 Cyl. | 20 Valves | 165kW/225PS | Petrol | Turbo, DOHC | TD17347 |
| BBU | 1781cc | 4 Cyl. | 20 Valves | 132kW/180PS | Petrol | Turbo, DOHC | TD17365 |
| BJX | 1781cc | 4 Cyl. | 20 Valves | 110kW/150PS | Petrol | Turbo, DOHC | TD17320 |
| ALHAMBRA 1.8 T 20V | 10/1997→03/2010 | | CORDOBA 1.8 T 20V Cupra | | 07/2000→10/2002 | | |
| IBIZA II 1.8 T 20V Cupra | 07/2000→02/2002 | | IBIZA III 1.8 T Cupra R | | 01/2004→02/2008 | | |
| IBIZA III 1.8 T FR | 12/2003→05/2008 | | LEON 1.8 20V T | | 11/1999→06/2006 | | |
| LEON 1.8 20V T 4 | 11/1999→06/2006 | | LEON 1.8 T Cupra R | | 02/2002→06/2006 | | |
| LEON 1.8 Turbo | 05/2002→05/2003 | | TOLEDO II 1.8 20VT | | 09/2000→07/2004 | | |

| | | | | | | | |
|-----------------------|--------------|------------|-----|----|---|------------------------|--|
| V94081 ■ | 058 109 601C | | 45° | Y | H | VAG96073B ■ ■ ■ | |
| 26.90 x 6.00 x 105.10 | | MB | | | | 36.00 x 6.02 x 11.06 | |
| V94082 ■ | 058 109 611E | | 45° | SS | H | | |
| 29.90 x 6.00 x 103.90 | | MD + MB cr | | | | | |

54 81.00

| | | | | | | | |
|----------------------|-----------------|------------|-----------------|--------------------|-----------------|------------------------|--------|
| KR | 1781cc | 4 Cyl. | 16 Valves | 98-102kW/133-139PS | Petrol | DOHC | TD3591 |
| PL | 1781cc | 4 Cyl. | 16 Valves | 92kW/125PS | Petrol | DOHC | TD3595 |
| TOLEDO I 1.8 16V | 05/1991→03/1999 | | TOLEDO I 1.8 GT | | 05/1991→11/1992 | | |
| V91416 ■ | 027 109 601C | | 45° | | H | VAG92382B ■ ■ ■ | |
| 32.10 x 6.97 x 95.50 | | MB | | | | 38.00 x 7.00 x 12.05 | |
| V91372 ■ | 027 109 611D | | 45° | | H | | |
| 28.10 x 6.95 x 98.20 | | MD + MB cr | | | | | |

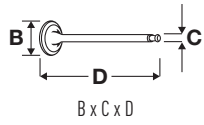

OE

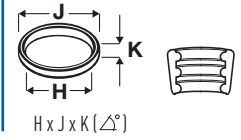
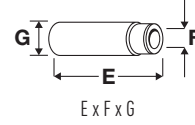
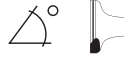

55



81.00

| | | | | | | | |
|--------------------|--------|-----------------|------------------|------------------------|--------|--------------------|----------------|
| AZV | 1968cc | 4 Cyl. | 16 Valves | 100kW/136PS | Diesel | Turbo, DOHC | TD18247 |
| BKD | 1968cc | 4 Cyl. | 16 Valves | 103kW/140PS | Diesel | Turbo, DOHC | TD17357 |
| BMN | 1968cc | 4 Cyl. | 16 Valves | 125kW/170PS | Diesel | Turbo, DOHC | TD18977 |
| ALTEA 2.0 TDI | | 03/2004→ | | ALTEA 2.0 TDI 16V | | 03/2004→ | |
| ALTEA XL 2.0 TDI | | 11/2006→ | | ALTEA XL 2.0 TDI 16V | | 10/2006→ | |
| LEON 2.0 TDI | | 07/2005→12/2012 | | LEON 2.0 TDI 16V | | 07/2005→12/2012 | |
| TOLEDO III 2.0 TDI | | 09/2004→05/2009 | | TOLEDO III 2.0 TDI 16V | | 04/2004→05/2009 | |

V94697 ■
29.20 x 6.00 x 87.80

03G 109 601B

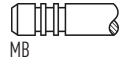

MB

45° Y H

VAG96237B ■ ■ ■
42.00 x 6.02 x 10.07



V98007 ■
29.20 x 6.00 x 88.45

03G 109 601A

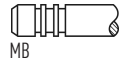

MB

45°

V94698 ■
25.50 x 6.00 x 88.10

03G 109 611B



MD + MB

45° ss H

V98097 ■
25.40 x 6.00 x 87.50

03G 109 611D



MD + MB

45°

56



81.00

| | | | | | | | |
|--------------------|--------|-----------------|-----------------|---------------|--------|--------------------|----------------|
| BMM | 1968cc | 4 Cyl. | 8 Valves | 103kW/140PS | Diesel | Turbo, SOHC | TD18269 |
| BRT | 1968cc | 4 Cyl. | 8 Valves | 103kW/140PS | Diesel | Turbo, SOHC | TD19388 |
| ALHAMBRA 2.0 TDI | | 11/2005→03/2010 | | ALTEA 2.0 TDI | | 11/2005→ | |
| ALTEA XL 2.0 TDI | | 10/2006→ | | LEON 2.0 TDI | | 10/2005→10/2010 | |
| TOLEDO III 2.0 TDI | | 11/2005→05/2009 | | | | | |

V94649 ■
36.00 x 7.00 x 89.40

038 109 601E

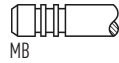

MB

45° Y H

VAG96041B ■ ■ ■
36.50 x 7.00 x 12.08



V94650 ■
31.40 x 7.00 x 89.00

038 109 611E



MD + MB

45° ss H

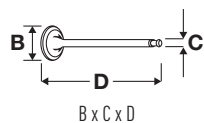

OE

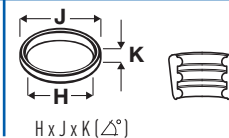
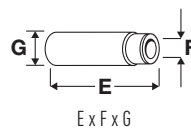

57



81.00

| | | | | | | | |
|----------------------|-----------------|--------|-----------|------------------|--------|-----------------|---------|
| CAGA | 1968cc | 4 Cyl. | 16 Valves | 105kW/143PS | Diesel | Turbo, DOHC | TD22243 |
| CAGC | 1968cc | 4 Cyl. | 16 Valves | 88kW/120PS | Diesel | Turbo, DOHC | TD22669 |
| CAHA | 1968cc | 4 Cyl. | 16 Valves | 125kW/170PS | Diesel | Turbo, DOHC | TD22244 |
| CBDB | 1968cc | 4 Cyl. | 16 Valves | 103kW/140PS | Diesel | Turbo, DOHC | TD24327 |
| CEGA | 1968cc | 4 Cyl. | 16 Valves | 125kW/170PS | Diesel | Turbo, DOHC | TD22674 |
| CFFA | 1968cc | 4 Cyl. | 16 Valves | 100kW/136PS | Diesel | Turbo, DOHC | TD25404 |
| CFFB | 1968cc | 4 Cyl. | 16 Valves | 103kW/140PS | Diesel | Turbo, DOHC | TD24450 |
| CFFE | 1968cc | 4 Cyl. | 16 Valves | 85kW/116PS | Diesel | Turbo, DOHC | TD25403 |
| CFGB | 1968cc | 4 Cyl. | 16 Valves | 125kW/170PS | Diesel | Turbo, DOHC | TD24451 |
| CFGC | 1968cc | 4 Cyl. | 16 Valves | 130kW/177PS | Diesel | Turbo, DOHC | TD27529 |
| CFHC | 1968cc | 4 Cyl. | 16 Valves | 103kW/140PS | Diesel | Turbo, DOHC | TD24326 |
| CFHD | 1968cc | 4 Cyl. | 16 Valves | 105kW/143PS | Diesel | Turbo, DOHC | TD23582 |
| CFJA | 1968cc | 4 Cyl. | 16 Valves | 125kW/170PS | Diesel | Turbo, DOHC | TD24333 |
| CGLB | 1968cc | 4 Cyl. | 16 Valves | 125kW/170PS | Diesel | Turbo, DOHC | TD26498 |
| CJCA | 1968cc | 4 Cyl. | 16 Valves | 105kW/143PS | Diesel | Turbo, DOHC | TD26497 |
| CJCC | 1968cc | 4 Cyl. | 16 Valves | 88kW/120PS | Diesel | Turbo, DOHC | TD27013 |
| CKFC | 1968cc | 4 Cyl. | 16 Valves | 110kW/150PS | Diesel | Turbo, DOHC | TD27260 |
| CLCB | 1968cc | 4 Cyl. | 16 Valves | 103kW/140PS | Diesel | Turbo, DOHC | TD25102 |
| CRBC | 1968cc | 4 Cyl. | 16 Valves | 110kW/150PS | Diesel | Turbo, DOHC | TD29194 |
| CRLB | 1968cc | 4 Cyl. | 16 Valves | 110kW/150PS | Diesel | Turbo, DOHC | TD29192 |
| CRMB | 1968cc | 4 Cyl. | 16 Valves | 110kW/150PS | Diesel | Turbo, DOHC | TD27261 |
| CRVA | 1968cc | 4 Cyl. | 16 Valves | 81kW/110PS | Diesel | Turbo, DOHC | TD27960 |
| CRVC | 1968cc | 4 Cyl. | 16 Valves | 105kW/143PS | Diesel | Turbo, DOHC | TD27959 |
| CUNA | 1968cc | 4 Cyl. | 16 Valves | 135kW/184PS | Diesel | Turbo, DOHC | TD28019 |
| CUPA | 1968cc | 4 Cyl. | 16 Valves | 135kW/184PS | Diesel | Turbo, DOHC | TD27262 |
| CUVA | 1968cc | 4 Cyl. | 16 Valves | 85kW/115PS | Diesel | Turbo, DOHC | TD33096 |
| CUVC | 1968cc | 4 Cyl. | 16 Valves | 110kW/150PS | Diesel | Turbo, DOHC | TD31428 |
| CUWA | 1968cc | 4 Cyl. | 16 Valves | 135kW/184PS | Diesel | Turbo, DOHC | TD31429 |
| ALHAMBRA 2.0 TDI | 06/2010→ | | | ALTEA 2.0 TDI | | 03/2006→ | |
| ALTEA 2.0 TDI 16V | 03/2004→ | | | ALTEA XL 2.0 TDI | | 06/2007→ | |
| ALTEA XL 2.0 TDI 16V | 10/2006→ | | | ATECA 2.0 TDI | | 10/2016→ | |
| EXEO 2.0 TDI | 12/2008→ | | | IBIZA IV 2.0 TDI | | 01/2010→ | |
| LEON 2.0 TDI | 05/2006→ | | | LEON 2.0 TDI 16V | | 07/2005→12/2012 | |
| TOLEDO III 2.0 TDI | 01/2006→05/2009 | | | | | | |

V95099 ■
28.10 x 5.97 x 99.30

03L 109 601

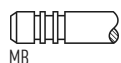

45°

H

VAG96237B ■ ■ ■
42.00 x 6.02 x 10.07



V95114 ■
26.00 x 5.97 x 99.10

03L 109 611

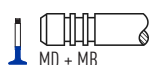

45°

SS

H

58



81.00

| | | | | | | | |
|------------------|-----------------|----------|-----------|-------------|--------|------|---------|
| AGZ | 2324cc | VR5 Cyl. | 10 Valves | 110kW/150PS | Petrol | DOHC | TD12511 |
| TOLEDO II 2.3 V5 | 10/1998→11/2000 | | | | | | |

V94374 ■
39.00 x 7.00 x 106.00

021 109 601L

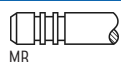

45°

H

VAG96157B ■ ■ ■
38.00 x 7.00 x 12.00

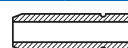

V94306 ■
34.20 x 7.00 x 107.00

021 109 611D

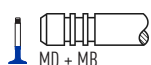

45°

SS

H





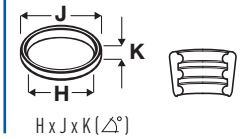





OE



59  **82.50**





| | | | | | | | |
|------|--------|--------|-----------|-------------|--------|------------------------|---------|
| BYT | 1798cc | 4 Cyl. | 16 Valves | 118kW/160PS | Petrol | Turbo, DOHC, Injection | TD19901 |
| BZB | 1798cc | 4 Cyl. | 16 Valves | 118kW/160PS | Petrol | Turbo, DOHC, Injection | TD19902 |
| CDAA | 1798cc | 4 Cyl. | 16 Valves | 118kW/160PS | Petrol | Turbo, DOHC, Injection | TD21590 |
| CDHA | 1798cc | 4 Cyl. | 16 Valves | 88kW/120PS | Petrol | Turbo, DOHC, Injection | TD24317 |
| CDHB | 1798cc | 4 Cyl. | 16 Valves | 118kW/160PS | Petrol | Turbo, DOHC, Injection | TD24319 |

| | | | | |
|-------------------|-----------------|--|---------------------|-----------------|
| ALHAMBRA 1.8 TSI | 11/2012→ | | ALTEA 1.8 TFSI | 01/2007→ |
| ALTEA XL 1.8 TFSI | 01/2007→ | | EXEO 1.8 TSI | 05/2010→ |
| LEON 1.8 TSI | 06/2007→12/2012 | | TOLEDO III 1.8 TFSI | 01/2007→05/2009 |

| | | | | | | |
|---|--------------|---|-----|---|---|---|
| V95098  33.80 x 5.98 x 103.95 | 06D 109 601M |  MB | 45° | H | VAG96073B  36.00 x 6.02 x 11.06 |  |
| V94692  28.00 x 6.00 x 101.80 | 06D 109 611L |  MD + MB cr | 45° | H | | |
| V95152  28.10 x 5.97 x 101.90 | 06D 109 611L |  MD + MB cr | 45° | H | | |



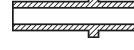

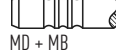
60  **82.50**

| | | | | | | | |
|----------------|-----------------|--------|----------------|-----------------|--------|------|--------|
| 2E | 1984cc | 4 Cyl. | 8 Valves | 85kW/115PS | Petrol | SOHC | TD3570 |
| CORDOBA 2.0 i | 02/1993→06/1999 | | IBIZA II 2.0 i | 03/1993→08/1999 | | | |
| TOLEDO I 2.0 i | 05/1991→03/1999 | | | | | | |

| | | | | | | |
|--|--------------|--|-----|---|---|---|
| V91407  39.60 x 7.97 x 91.90 | 048 109 601A |  MD | 45° | | VAG92061B  36.70 x 8.00 x 12.08 |  |
| V91340  33.30 x 7.95 x 91.20 | 048 109 611A |  MD + MB | 45° | H | | |

61  **82.50**

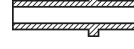



| | | | | | | | |
|--------------------|-----------------|--------|--------------------|-----------------|--------|------|--------|
| ABF | 1984cc | 4 Cyl. | 16 Valves | 110kW/150PS | Petrol | DOHC | TD4895 |
| CORDOBA 2.0 i 16V | 08/1996→06/1999 | | IBIZA II 2.0 i 16V | 08/1996→08/1999 | | | |
| TOLEDO I 2.0 i 16V | 11/1993→03/1999 | | | | | | |

| | | | | | | | |
|--|--------------|--|-----|---|---|---|---|
| V94110  32.00 x 7.00 x 95.50 | 051 109 601B |  MB | 45° | Y | H | VAG96041B  36.50 x 7.00 x 12.08 |  |
| V94111  27.00 x 7.00 x 97.95 | 051 109 611B |  MD + MB | 45° | | H | | |

62  **82.50**

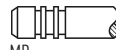
| | | | | | | | |
|-----|--------|--------|----------|-------------------|--------|------|---------|
| ADY | 1984cc | 4 Cyl. | 8 Valves | 85kW/115PS | Petrol | SOHC | TD9386 |
| AGG | 1984cc | 4 Cyl. | 8 Valves | 85kW/115PS | Petrol | SOHC | TD5537 |
| ATM | 1984cc | 4 Cyl. | 8 Valves | 85kW/115PS | Petrol | SOHC | TD14908 |
| AZL | 1984cc | 4 Cyl. | 8 Valves | 85kW/115PS | Petrol | SOHC | TD17901 |
| BBX | 1984cc | 4 Cyl. | 8 Valves | 85-86kW/115-117PS | Petrol | SOHC | TD18446 |

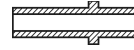
| | | | | |
|----------------|-----------------|--|----------------|-----------------|
| ALHAMBRA 2.0 i | 04/1996→03/2010 | | CORDOBA 2.0 | 09/2002→11/2009 |
| CORDOBA 2.0 i | 02/1993→06/1999 | | IBIZA II 2.0 i | 03/1993→08/1999 |
| IBIZA III 2.0 | 04/2002→11/2009 | | TOLEDO I 2.0 i | 05/1991→03/1999 |

| | | | | | | | |
|--|--------------|--|-----|--|---|---|---|
| V94079  39.40 x 7.00 x 92.10 | 078 109 601B |  MB | 45° | | H | VAG96041B  36.50 x 7.00 x 12.08 |  |
| V94080  32.80 x 7.00 x 91.20 | 048 109 611B |  MD + MB | 45° | | H | | |

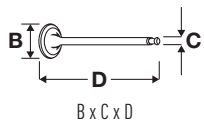

OE

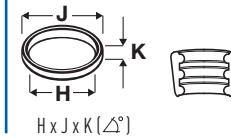
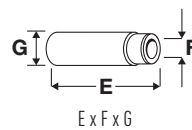

63 | 82.50

| | | | | | | | |
|-------------------------------|--------|------------------------------------|------------------|--|--------|------------------------------------|----------------|
| BLR | 1984cc | 4 Cyl. | 16 Valves | 110kW/150PS | Petrol | DOHC, Injection | TD17353 |
| BLY | 1984cc | 4 Cyl. | 16 Valves | 110kW/150PS | Petrol | DOHC, Injection | TD17354 |
| BVY | 1984cc | 4 Cyl. | 16 Valves | 110kW/150PS | Petrol | DOHC, Injection | TD18266 |
| BVZ | 1984cc | 4 Cyl. | 16 Valves | 110kW/150PS | Petrol | DOHC, Injection | TD18267 |
| ALTEA 2.0 FSI LEON 2.0 FSI | | 05/2004→03/2009 07/2005→05/2010 | | ALTEA XL 2.0 FSI TOLEDO III 2.0 FSI | | 10/2006→03/2009 10/2004→05/2009 | |

| | | | | | | | |
|-----------------------|--------------|------------|-----|---|---|----------------------|--|
| V94691 | 06E 109 601E | | 45° | Y | H | VAG96073B | |
| 33.85 x 6.00 x 103.90 | | MB | | | | 36.00 x 6.02 x 11.06 | |
| V94692 | 06D 109 611L | | 45° | | H | | |
| 28.00 x 6.00 x 101.80 | | MD + MB cr | | | | | |
| V95152 | 06D 109 611L | | 45° | | H | | |
| 28.10 x 5.97 x 101.90 | | MD + MB cr | | | | | |

64 | 82.50

| | | | | | | | |
|--|--------|--|------------------|--|--------|--|----------------|
| BWA | 1984cc | 4 Cyl. | 16 Valves | 147kW/200PS | Petrol | Turbo, DOHC, Injection | TD19424 |
| BWE | 1984cc | 4 Cyl. | 16 Valves | 147kW/200PS | Petrol | Turbo, DOHC, Injection | TD22246 |
| CCZA | 1984cc | 4 Cyl. | 16 Valves | 147kW/200PS | Petrol | Turbo, DOHC, Injection | TD24656 |
| ALHAMBRA 2.0 TSI ALTEA XL 2.0 TFSI LEON 2.0 TFSI | | 11/2010→ 10/2006→05/2009 05/2005→03/2009 | | ALTEA 2.0 TFSI EXEO 2.0 TFSI TOLEDO III 2.0 TFSI | | 04/2006→05/2009 03/2009→ 11/2005→05/2009 | |

| | | | | | | | |
|-----------------------|--------------|------------|-----|--|---|----------------------|--|
| V95098 | 06D 109 601M | | 45° | | H | VAG96073B | |
| 33.80 x 5.98 x 103.95 | | MB | | | | 36.00 x 6.02 x 11.06 | |
| V94692 | 06D 109 611L | | 45° | | H | | |
| 28.00 x 6.00 x 101.80 | | MD + MB cr | | | | | |
| V95152 | 06D 109 611L | | 45° | | H | | |
| 28.10 x 5.97 x 101.90 | | MD + MB cr | | | | | |

65 | 82.50

| | | | | | | | |
|---------------------------------------|--------|-----------------------------|------------------|--------------------------------|--------|-------------------------------|----------------|
| CCZB | 1984cc | 4 Cyl. | 16 Valves | 155kW/211PS | Petrol | Turbo, DOHC, Injection | TD22672 |
| CDLA | 1984cc | 4 Cyl. | 16 Valves | 195kW/265PS | Petrol | Turbo, DOHC, Injection | TD22673 |
| CDND | 1984cc | 4 Cyl. | 16 Valves | 155kW/211PS | Petrol | Turbo, DOHC, Injection | TD24320 |
| ALTEA XL 2.0 TFSI LEON 2.0 Cupra R | | 05/2009→ 09/2009→12/2012 | | EXEO 2.0 TFSI LEON 2.0 TFSI | | 05/2010→ 06/2009→12/2012 | |

| | | | | | | | |
|-----------------------|--------------|----|-----|--|---|----------------------|--|
| V95098 | 06D 109 601M | | 45° | | H | VAG96073B | |
| 33.80 x 5.98 x 103.95 | | MB | | | | 36.00 x 6.02 x 11.06 | |

66 | 83.00

| | | | | | | | |
|-------------------------------|--------|------------------------------------|-----------------|-------------------------|--------|------------------------------------|---------------|
| 021 A.2000 | 1461cc | 4 Cyl. | 8 Valves | 63-66kW/85-90PS | Petrol | SOHC | TD3554 |
| IBIZA 1.5 MALAGA 1.5 i Cat | | 11/1984→05/1993 10/1986→12/1993 | | MALAGA 1.5 RONDA 1.5 | | 05/1985→12/1993 09/1984→12/1986 | |

| | | | | | | | |
|-----------------------|-----------|-------|-----|--|--|--|--|
| V91391 | 3940 2840 | | 45° | | | | |
| 30.00 x 7.00 x 103.00 | | MD cr | | | | | |

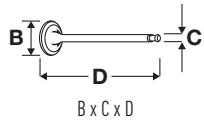

OE

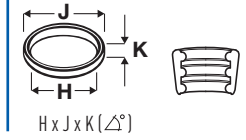
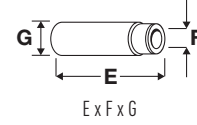
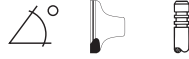

67  **93.00**

| | | | | | | | |
|----------------|--------|-----------------|----------|-----------------|--------|------|--------|
| 8144.61 | 2445cc | 4 Cyl. | 8 Valves | 52-55kW/72-75PS | Diesel | SOHC | TD3597 |
| 131 2.4 Diesel | | 06/1978→12/1986 | | | | | |

V91292 ■
40.80 x 8.00 x 120.70

4757358

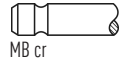

30° Y H

VAG92193 ■
56.00 x 8.04 x 13.05



VAG92373 ■
56.00 x 8.03 x 13.04



VAG92369 ■
60.00 x 8.00 x 13.07



68  **94.00**

| | | | | | | | |
|----|--------|--------|----------|-----------------|--------|-----|--------|
| DH | 1915cc | 4 Cyl. | 8 Valves | 60-63kW/82-86PS | Petrol | OHV | TD3580 |
|----|--------|--------|----------|-----------------|--------|-----|--------|

V94549 ■
39.90 x 8.00 x 122.40

025 109 601C

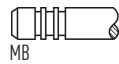

45° Y H

VAG96228B ■
66.50 x 9.02 x 13.05













V94548 ■
33.85 x 9.00 x 122.65







025 109 612A



45° SS H

| |  | ccm |  |  |  |  |
|------|---|------|--|---|---|---|
| 136B | 75.50 | 1289 | 4 | 8 | Petrol | 5 |
| ADR | 81.00 | 1781 | 4 | 20 | Petrol | 28 |
| AEE | 76.50 | 1598 | 4 | 8 | Petrol | 11 |
| AEF | 79.50 | 1896 | 4 | 8 | Diesel | 19 |
| AEG | 82.50 | 1984 | 4 | 8 | Petrol | 34 |
| AEH | 81.00 | 1595 | 4 | 8 | Petrol | 26 |
| AEY | 79.50 | 1896 | 4 | 8 | Diesel | 20 |
| AGN | 81.00 | 1781 | 4 | 20 | Petrol | 28 |
| AGP | 79.50 | 1896 | 4 | 8 | Diesel | 21 |
| AGR | 79.50 | 1896 | 4 | 8 | Diesel | 22 |
| AGU | 81.00 | 1781 | 4 | 20 | Petrol | 29 |
| AHF | 79.50 | 1896 | 4 | 8 | Diesel | 22 |
| AKL | 81.00 | 1595 | 4 | 8 | Petrol | 26 |
| ALH | 79.50 | 1896 | 4 | 8 | Diesel | 22 |
| AME | 75.50 | 1397 | 4 | 8 | Petrol | 7 |
| AMF | 79.50 | 1422 | 3 | 6 | Diesel | 16 |
| AMG | 75.50 | 1289 | 4 | 8 | Petrol | 5 |
| AMH | 75.50 | 1289 | 4 | 8 | Petrol | 5 |
| AMJ | 75.50 | 1289 | 4 | 8 | Petrol | 6 |
| AMX | 82.50 | 2771 | 6 | 30 | Petrol | 38 |
| APK | 82.50 | 1984 | 4 | 8 | Petrol | 34 |
| AQM | 79.50 | 1896 | 4 | 8 | Diesel | 21 |
| AQW | 75.50 | 1397 | 4 | 8 | Petrol | 7 |
| AQY | 82.50 | 1984 | 4 | 8 | Petrol | 34 |
| ARX | 81.00 | 1781 | 4 | 20 | Petrol | 29 |
| ARZ | 81.00 | 1781 | 4 | 20 | Petrol | 29 |
| ASV | 79.50 | 1896 | 4 | 8 | Diesel | 22 |
| ASY | 79.50 | 1896 | 4 | 8 | Diesel | 21 |
| ASZ | 79.50 | 1896 | 4 | 8 | Diesel | 23 |
| ATD | 79.50 | 1896 | 4 | 8 | Diesel | 23 |
| ATZ | 75.50 | 1397 | 4 | 8 | Petrol | 7 |
| AUA | 76.50 | 1390 | 4 | 16 | Petrol | 10 |
| AUB | 76.50 | 1390 | 4 | 16 | Petrol | 10 |
| AUM | 81.00 | 1781 | 4 | 20 | Petrol | 29 |
| AUQ | 81.00 | 1781 | 4 | 20 | Petrol | 29 |
| AVB | 79.50 | 1896 | 4 | 8 | Diesel | 23 |
| AVF | 79.50 | 1896 | 4 | 8 | Diesel | 23 |
| AVU | 81.00 | 1595 | 4 | 8 | Petrol | 27 |
| AWT | 81.00 | 1781 | 4 | 20 | Petrol | 29 |
| AWX | 79.50 | 1896 | 4 | 8 | Diesel | 23 |
| AWY | 76.50 | 1198 | 3 | 6 | Petrol | 8 |
| AXP | 76.50 | 1390 | 4 | 16 | Petrol | 10 |
| AXR | 79.50 | 1896 | 4 | 8 | Diesel | 24 |
| AYM | 78.30 | 2496 | 6 | 24 | Diesel | 13 |
| AZE | 75.50 | 1397 | 4 | 8 | Petrol | 7 |
| AZF | 75.50 | 1397 | 4 | 8 | Petrol | 7 |
| AZH | 82.50 | 1984 | 4 | 8 | Petrol | 34 |
| AZJ | 82.50 | 1984 | 4 | 8 | Petrol | 35 |
| AZL | 82.50 | 1984 | 4 | 8 | Petrol | 34 |
| AZM | 82.50 | 1984 | 4 | 8 | Petrol | 34 |
| AZQ | 76.50 | 1198 | 3 | 12 | Petrol | 9 |
| AZV | 81.00 | 1968 | 4 | 16 | Diesel | 30 |
| BBG | 82.50 | 2771 | 6 | 30 | Petrol | 38 |
| BBM | 76.50 | 1198 | 3 | 6 | Petrol | 8 |
| BBY | 76.50 | 1390 | 4 | 16 | Petrol | 10 |
| BBZ | 76.50 | 1390 | 4 | 16 | Petrol | 10 |
| BCA | 76.50 | 1390 | 4 | 16 | Petrol | 10 |
| BDG | 78.30 | 2496 | 6 | 24 | Diesel | 14 |
| BFQ | 81.00 | 1595 | 4 | 8 | Petrol | 27 |
| BGU | 81.00 | 1595 | 4 | 8 | Petrol | 27 |
| BJB | 79.50 | 1896 | 4 | 8 | Diesel | 24 |
| BKC | 79.50 | 1896 | 4 | 8 | Diesel | 24 |
| BKD | 81.00 | 1968 | 4 | 16 | Diesel | 30 |
| BKY | 76.50 | 1390 | 4 | 16 | Petrol | 10 |
| BLF | 76.50 | 1598 | 4 | 16 | Petrol | 12 |
| BLR | 82.50 | 1984 | 4 | 16 | Petrol | 36 |

|  |  | ccm |  |  |  |  |
|---|---|------|---|---|---|---|
| BLS | 79.50 | 1896 | 4 | 8 | Diesel | 24 |
| BLT | 79.50 | 1896 | 4 | 8 | Diesel | 23 |
| BLX | 82.50 | 1984 | 4 | 16 | Petrol | 36 |
| BLY | 82.50 | 1984 | 4 | 16 | Petrol | 36 |
| BMD | 76.50 | 1198 | 3 | 6 | Petrol | 8 |
| BME | 76.50 | 1198 | 3 | 12 | Petrol | 9 |
| BMM | 81.00 | 1968 | 4 | 8 | Diesel | 31 |
| BMN | 81.00 | 1968 | 4 | 16 | Diesel | 30 |
| BMP | 81.00 | 1968 | 4 | 8 | Diesel | 31 |
| BMS | 79.50 | 1422 | 3 | 6 | Diesel | 17 |
| BNM | 79.50 | 1422 | 3 | 6 | Diesel | 17 |
| BNV | 79.50 | 1422 | 3 | 6 | Diesel | 17 |
| BSE | 81.00 | 1595 | 4 | 8 | Petrol | 27 |
| BSF | 81.00 | 1595 | 4 | 8 | Petrol | 27 |
| BSS | 81.00 | 1968 | 4 | 8 | Diesel | 31 |
| BSV | 79.50 | 1896 | 4 | 8 | Diesel | 24 |
| BSW | 79.50 | 1896 | 4 | 8 | Diesel | 25 |
| BTS | 76.50 | 1598 | 4 | 16 | Petrol | 12 |
| BUD | 76.50 | 1390 | 4 | 16 | Petrol | 10 |
| BVX | 82.50 | 1984 | 4 | 16 | Petrol | 36 |
| BVY | 82.50 | 1984 | 4 | 16 | Petrol | 36 |
| BVZ | 82.50 | 1984 | 4 | 16 | Petrol | 36 |
| BWA | 82.50 | 1984 | 4 | 16 | Petrol | 37 |
| BXE | 79.50 | 1896 | 4 | 8 | Diesel | 24 |
| BXW | 76.50 | 1390 | 4 | 16 | Petrol | 10 |
| BZB | 82.50 | 1798 | 4 | 16 | Petrol | 33 |
| BZG | 76.50 | 1198 | 3 | 12 | Petrol | 9 |
| CAVE | 76.50 | 1390 | 4 | 16 | Petrol | 10 |
| CAXA | 76.50 | 1390 | 4 | 16 | Petrol | 10 |
| CAXC | 76.50 | 1390 | 4 | 16 | Petrol | 10 |
| CAYA | 79.50 | 1598 | 4 | 16 | Diesel | 18 |
| CAYB | 79.50 | 1598 | 4 | 16 | Diesel | 18 |
| CAYC | 79.50 | 1598 | 4 | 16 | Diesel | 18 |
| CBBB | 81.00 | 1968 | 4 | 16 | Diesel | 32 |
| CBDB | 81.00 | 1968 | 4 | 16 | Diesel | 32 |
| CBZA | 71.00 | 1197 | 4 | 8 | Petrol | 1 |
| CBZB | 71.00 | 1197 | 4 | 8 | Petrol | 1 |
| CCSA | 81.00 | 1595 | 4 | 8 | Petrol | 27 |
| CCZA | 82.50 | 1984 | 4 | 16 | Petrol | 37 |
| CDAA | 82.50 | 1798 | 4 | 16 | Petrol | 33 |
| CDAB | 82.50 | 1798 | 4 | 16 | Petrol | 33 |
| CDVA | 89.00 | 3597 | 6 | 24 | Petrol | 39 |
| CEGA | 81.00 | 1968 | 4 | 16 | Diesel | 32 |
| CEVA | 76.50 | 1198 | 3 | 12 | Petrol | 9 |
| CFFB | 81.00 | 1968 | 4 | 16 | Diesel | 32 |
| CFGB | 81.00 | 1968 | 4 | 16 | Diesel | 32 |
| CFHA | 81.00 | 1968 | 4 | 16 | Diesel | 32 |
| CFHC | 81.00 | 1968 | 4 | 16 | Diesel | 32 |
| CFHF | 81.00 | 1968 | 4 | 16 | Diesel | 32 |
| CFJA | 81.00 | 1968 | 4 | 16 | Diesel | 32 |
| CFWA | 79.50 | 1199 | 3 | 12 | Diesel | 15 |
| CGGA | 76.50 | 1390 | 4 | 16 | Petrol | 10 |
| CGGB | 76.50 | 1390 | 4 | 16 | Petrol | 10 |
| CGPA | 76.50 | 1198 | 3 | 12 | Petrol | 9 |
| CGPB | 76.50 | 1198 | 3 | 12 | Petrol | 9 |
| CHFA | 76.50 | 1198 | 3 | 6 | Petrol | 8 |
| CHGA | 81.00 | 1595 | 4 | 8 | Petrol | 27 |
| CHPA | 74.50 | 1395 | 4 | 16 | Petrol | 4 |
| CHPB | 74.50 | 1395 | 4 | 16 | Petrol | 4 |
| CHTA | 76.50 | 1198 | 3 | 12 | Petrol | 9 |
| CHYA | 74.50 | 999 | 3 | 12 | Petrol | 3 |
| CHYB | 74.50 | 999 | 3 | 12 | Petrol | 3 |
| CJZA | 71.00 | 1197 | 4 | 16 | Petrol | 2 |
| CJZB | 71.00 | 1197 | 4 | 16 | Petrol | 2 |
| CKFB | 81.00 | 1968 | 4 | 16 | Diesel | 32 |
| CKFC | 81.00 | 1968 | 4 | 16 | Diesel | 32 |

|  |  | ccm |  |  |  |  |
|---|---|------|--|---|---|---|
| CLCA | 81.00 | 1968 | 4 | 16 | Diesel | 32 |
| CLCB | 81.00 | 1968 | 4 | 16 | Diesel | 32 |
| CLHA | 79.50 | 1598 | 4 | 16 | Diesel | 18 |
| CLHB | 79.50 | 1598 | 4 | 16 | Diesel | 18 |
| CLJA | 81.00 | 1968 | 4 | 16 | Diesel | 32 |
| CLNA | 79.50 | 1598 | 4 | 16 | Diesel | 18 |
| CMXA | 81.00 | 1595 | 4 | 8 | Petrol | 27 |
| CPWA | 74.50 | 1395 | 4 | 16 | Petrol | 4 |
| CRKB | 79.50 | 1598 | 4 | 16 | Diesel | 18 |
| CRLB | 81.00 | 1968 | 4 | 16 | Diesel | 32 |
| CRMB | 81.00 | 1968 | 4 | 16 | Diesel | 32 |
| CRVC | 81.00 | 1968 | 4 | 16 | Diesel | 32 |
| CUNA | 81.00 | 1968 | 4 | 16 | Diesel | 32 |
| CUPA | 81.00 | 1968 | 4 | 16 | Diesel | 32 |
| CUUB | 81.00 | 1968 | 4 | 16 | Diesel | 32 |
| CYVA | 71.00 | 1197 | 4 | 16 | Petrol | 2 |
| CYVB | 71.00 | 1197 | 4 | 16 | Petrol | 2 |
| CZCA | 74.50 | 1395 | 4 | 16 | Petrol | 4 |
| CZDA | 74.50 | 1395 | 4 | 16 | Petrol | 4 |
| CZEA | 74.50 | 1395 | 4 | 16 | Petrol | 4 |
| DFEA | 81.00 | 1968 | 4 | 16 | Diesel | 32 |
| DFGA | 81.00 | 1968 | 4 | 16 | Diesel | 32 |

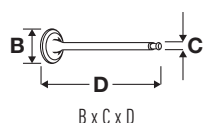
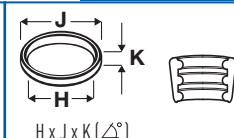
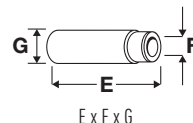
OE

1  **71.00**

| | | | | | | | |
|------------------|-----------------|--------|--------------------|-----------------|--------|-------------------------------|----------------|
| CBZA | 1197cc | 4 Cyl. | 8 Valves | 63kW/86PS | Petrol | Turbo, SOHC, Injection | TD23928 |
| CBZB | 1197cc | 4 Cyl. | 8 Valves | 77kW/105PS | Petrol | Turbo, SOHC, Injection | TD23583 |
| FABIA II 1.2 TSI | 03/2010→12/2014 | | OCTAVIA II 1.2 TSI | 02/2010→06/2013 | | | |
| RAPID 1.2 TSI | 07/2012→ | | ROOMSTER 1.2 TSI | 03/2010→05/2015 | | | |
| YETI 1.2 TSI | 09/2009→05/2015 | | | | | | |

V95149 
 35.45 x 5.98 x 98.70

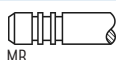
03F 109 601A



45°

Y

VAG96073B  
 36.00 x 6.02 x 11.06

V95150 
 30.00 x 5.95 x 98.40

03F 109 611C

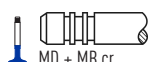

45°

ss

H

2  **71.00**

| | | | | | | | |
|---------------------|----------|--------|------------------|-----------------|--------|-------------------------------|----------------|
| CJZA | 1197cc | 4 Cyl. | 16 Valves | 77kW/105PS | Petrol | Turbo, DOHC, Injection | TD27806 |
| CJZB | 1197cc | 4 Cyl. | 16 Valves | 63kW/86PS | Petrol | Turbo, DOHC, Injection | TD27805 |
| CYVA | 1197cc | 4 Cyl. | 16 Valves | 63kW/86PS | Petrol | Turbo, DOHC, Injection | TD34747 |
| CYVB | 1197cc | 4 Cyl. | 16 Valves | 81kW/110PS | Petrol | Turbo, DOHC, Injection | TD31355 |
| OCTAVIA III 1.2 TSI | 11/2012→ | | YETI 1.2 TSI | 05/2015→12/2017 | | | |

V80012 
 26.50 x 5.00 x 110.25

04E 109 601A

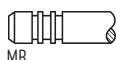

45°

V80013 
 23.50 x 5.00 x 110.09

04E 109 611K



30°

ss

3  **74.50**

| | | | | | | | |
|-------------|----------|--------|------------------|-----------|--------|-------------|----------------|
| CHYA | 999cc | 3 Cyl. | 12 Valves | 44kW/60PS | Petrol | DOHC | TD26323 |
| CHYB | 999cc | 3 Cyl. | 12 Valves | 55kW/75PS | Petrol | DOHC | TD26325 |
| CITIGO 1.0 | 10/2011→ | | FABIA III 1.0 | 08/2014→ | | | |

V95237 
 29.50 x 5.00 x 110.23

04E 109 601

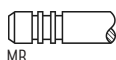

45°

H

V95238 
 26.90 x 5.00 x 110.30

04E 109 611L

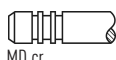

30°

4  **74.50**

| | | | | | | | |
|-------------|--------|--------|------------------|-------------|--------|-------------------------------|----------------|
| CHPA | 1395cc | 4 Cyl. | 16 Valves | 103kW/140PS | Petrol | Turbo, DOHC, Injection | TD27808 |
| CHPB | 1395cc | 4 Cyl. | 16 Valves | 110kW/150PS | Petrol | Turbo, DOHC, Injection | TD31358 |
| CPWA | 1395cc | 4 Cyl. | 16 Valves | 81kW/110PS | Petrol | Turbo, DOHC, Injection | TD29519 |
| CZCA | 1395cc | 4 Cyl. | 16 Valves | 92kW/125PS | Petrol | Turbo, DOHC, Injection | TD31360 |
| CZDA | 1395cc | 4 Cyl. | 16 Valves | 110kW/150PS | Petrol | Turbo, DOHC, Injection | TD31357 |
| CZEA | 1395cc | 4 Cyl. | 16 Valves | 110kW/150PS | Petrol | Turbo, DOHC, Injection | TD31648 |

 KODIAQ 1.4 TSI
 OCTAVIA III 1.4 TSI G-TEC
 SUPERB III 1.4 TSI

 10/2016→
 11/2013→
 03/2015→

 OCTAVIA III 1.4 TSI
 RAPID 1.4 TSI
 YETI 1.4 TSI

 11/2012→
 05/2015→
 05/2015→12/2017

V95192 
 28.45 x 4.70 x 110.30

04E 109 601B

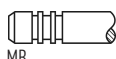

45°

Y

H

V95193 
 25.00 x 4.97 x 110.15

04E 109 611J

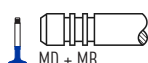

30°

ss

H

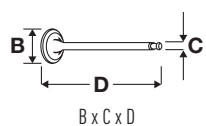

OE

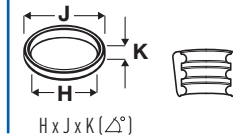
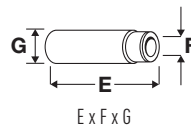

5 75.50

| | | | | | | |
|------------------|-----------------|--------|-------------------|-----------------|--------|----------------|
| 136B | 1289cc | 4 Cyl. | 8 Valves | 50kW/68PS | Petrol | TD13390 |
| AMG | 1289cc | 4 Cyl. | 8 Valves | 40kW/54PS | Petrol | TD13828 |
| AMH | 1289cc | 4 Cyl. | 8 Valves | 50kW/68PS | Petrol | TD13829 |
| FAVORIT 1.3 | 12/1992→06/1997 | | FELICIA I 1.3 | 10/1994→04/2002 | | |
| FELICIA I 1.3 LX | 08/1995→03/1998 | | FELICIA I 1.3 LXI | 08/1995→03/1998 | | |
| FELICIA II 1.3 | 01/1998→06/2001 | | | | | |

| | | | | | | |
|-----------------------|--------------|------------|-----|----|---|--|
| V94418 ■ | 047 198 601D | | 45° | Y | H | |
| 34.00 x 7.00 x 101.40 | | MB cr | | | | |
| V94419 ■ | 047 109 611D | | 45° | ss | H | |
| 30.00 x 7.00 x 101.40 | | MD + MB cr | | | | |

6 75.50

| | | | | | | |
|---------------|-----------------|--------|-----------------|-----------------|--------|----------------|
| AMJ | 1289cc | 4 Cyl. | 8 Valves | 43kW/58PS | Petrol | TD13849 |
| FELICIA I 1.3 | 10/1994→04/2002 | | FELICIA II 1.3 | 01/1998→06/2001 | | |

| | | | | | | |
|-----------------------|--------------|-------|-----|---|---|--|
| V94418 ■ | 047 198 601D | | 45° | Y | H | |
| 34.00 x 7.00 x 101.40 | | MB cr | | | | |

7 75.50

| | | | | | | | |
|-------------|-----------------|--------|-----------------|-----------|--------|------------|----------------|
| AME | 1397cc | 4 Cyl. | 8 Valves | 50kW/68PS | Petrol | OHV | TD15373 |
| AQW | 1397cc | 4 Cyl. | 8 Valves | 50kW/68PS | Petrol | OHV | TD16240 |
| ATZ | 1397cc | 4 Cyl. | 8 Valves | 50kW/68PS | Petrol | OHV | TD15372 |
| AZE | 1397cc | 4 Cyl. | 8 Valves | 44kW/60PS | Petrol | OHV | TD16049 |
| AZF | 1397cc | 4 Cyl. | 8 Valves | 44kW/60PS | Petrol | OHV | TD16239 |
| FABIA I 1.4 | 08/1999→05/2003 | | | | | | |

| | | | | | | | |
|-----------------------|--------------|------------|-----|----|---|------------------------|--|
| V94418 ■ | 047 198 601D | | 45° | Y | H | VAG96062B ■ ■ ■ | |
| 34.00 x 7.00 x 101.40 | | MB cr | | | | 33.00 x 7.02 x 15.00 | |
| V94419 ■ | 047 109 611D | | 45° | ss | H | | |
| 30.00 x 7.00 x 101.40 | | MD + MB cr | | | | | |

8 76.50

| | | | | | | | |
|-------------|-----------------|--------|-----------------|-----------------|--------|-------------|----------------|
| AWY | 1198cc | 3 Cyl. | 6 Valves | 40kW/54PS | Petrol | SOHC | TD16524 |
| BBM | 1198cc | 3 Cyl. | 6 Valves | 44kW/60PS | Petrol | SOHC | TD20009 |
| BMD | 1198cc | 3 Cyl. | 6 Valves | 40kW/54PS | Petrol | SOHC | TD18835 |
| CHFA | 1198cc | 3 Cyl. | 6 Valves | 44kW/60PS | Petrol | SOHC | TD23439 |
| FABIA I 1.2 | 07/2001→12/2007 | | FABIA II 1.2 | 12/2006→12/2014 | | | |

| | | | | | | | |
|----------------------|--------------|---------|-----|----|---|------------------------|--|
| V94646 ■ | 032 109 601M | | 45° | Y | H | VAG96073B ■ ■ ■ | |
| 34.50 x 6.00 x 99.10 | | MB | | | | 36.00 x 6.02 x 11.06 | |
| V94405 ■ | 030 109 611T | | 45° | ss | H | | |
| 28.00 x 6.00 x 99.10 | | MD + MB | | | | | |

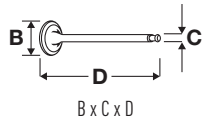

OE

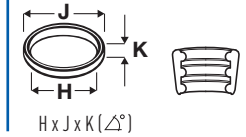

9 **76.50**

| | | | | | | | |
|------------------|--------|-----------------|-----------|--------------|--------|-----------------|---------|
| AZQ | 1198cc | 3 Cyl. | 12 Valves | 47kW/64PS | Petrol | DOHC | TD17070 |
| BME | 1198cc | 3 Cyl. | 12 Valves | 47kW/64PS | Petrol | DOHC | TD18836 |
| BZG | 1198cc | 3 Cyl. | 12 Valves | 51kW/70PS | Petrol | DOHC | TD20010 |
| CEVA | 1198cc | 3 Cyl. | 12 Valves | 51kW/70PS | Petrol | DOHC | TD20919 |
| CGPA | 1198cc | 3 Cyl. | 12 Valves | 51kW/70PS | Petrol | DOHC | TD23524 |
| CGPB | 1198cc | 3 Cyl. | 12 Valves | 44kW/60PS | Petrol | DOHC | TD24978 |
| CHTA | 1198cc | 3 Cyl. | 12 Valves | 51kW/70PS | Petrol | DOHC | TD24979 |
| FABIA I 1.2 | | 01/2003→03/2008 | | FABIA II 1.2 | | 01/2007→12/2014 | |
| FABIA II 1.2 12V | | 11/2011→12/2014 | | ROOMSTER 1.2 | | 05/2006→05/2015 | |

V94116
 29.50 x 6.00 x 100.90

036 109 601S

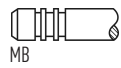

45° Y H

VAG96073B
 36.00 x 6.02 x 11.06



V94117
 26.00 x 6.00 x 100.50

036 109 611K



45°

10 **76.50**

| | | | | | | | |
|--------------------|--------|-----------------|-----------|---------------------|--------|------------------------|---------|
| AUA | 1390cc | 4 Cyl. | 16 Valves | 55kW/75PS | Petrol | DOHC | TD15374 |
| AUB | 1390cc | 4 Cyl. | 16 Valves | 74kW/100PS | Petrol | DOHC | TD15375 |
| AXP | 1390cc | 4 Cyl. | 16 Valves | 55kW/75PS | Petrol | DOHC | TD16050 |
| BBY | 1390cc | 4 Cyl. | 16 Valves | 55kW/75PS | Petrol | DOHC | TD17471 |
| BBZ | 1390cc | 4 Cyl. | 16 Valves | 74kW/100PS | Petrol | DOHC | TD17472 |
| BCA | 1390cc | 4 Cyl. | 16 Valves | 55kW/75PS | Petrol | DOHC | TD17495 |
| BKY | 1390cc | 4 Cyl. | 16 Valves | 55kW/75PS | Petrol | DOHC | TD18696 |
| BUD | 1390cc | 4 Cyl. | 16 Valves | 59kW/80PS | Petrol | DOHC | TD20190 |
| BXW | 1390cc | 4 Cyl. | 16 Valves | 63kW/86PS | Petrol | DOHC | TD19089 |
| CAVE | 1390cc | 4 Cyl. | 16 Valves | 132kW/180PS | Petrol | Turbo, DOHC, Injection | TD24217 |
| CAXA | 1390cc | 4 Cyl. | 16 Valves | 90kW/122PS | Petrol | Turbo, DOHC, Injection | TD21592 |
| CAXC | 1390cc | 4 Cyl. | 16 Valves | 92kW/125PS | Petrol | Turbo, DOHC, Injection | TD22677 |
| CGGA | 1390cc | 4 Cyl. | 16 Valves | 59kW/80PS | Petrol | DOHC | TD24838 |
| CGGB | 1390cc | 4 Cyl. | 16 Valves | 63kW/85PS | Petrol | DOHC | TD24980 |
| FABIA I 1.4 | | 02/2006→10/2006 | | FABIA I 1.4 16V | | 10/1999→03/2008 | |
| FABIA II 1.4 | | 01/2007→12/2014 | | FABIA II 1.4 TSI RS | | 05/2010→12/2014 | |
| OCTAVIA I 1.4 16V | | 08/2000→12/2010 | | OCTAVIA II 1.4 | | 05/2004→06/2013 | |
| OCTAVIA II 1.4 TSI | | 11/2008→06/2013 | | RAPID 1.4 TSI | | 07/2012→ | |
| ROOMSTER 1.4 | | 09/2006→05/2015 | | SUPERB II 1.4 TSI | | 07/2008→05/2015 | |
| YETI 1.4 TSI | | 06/2010→05/2015 | | | | | |

V94116
 29.50 x 6.00 x 100.90

036 109 601S

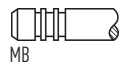

45° Y H

VAG96073B
 36.00 x 6.02 x 11.06

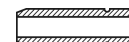

V94117
 26.00 x 6.00 x 100.50

036 109 611K



45°



OE

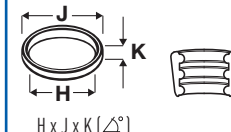
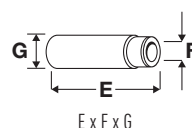

11 76.50

| AEE | 1598cc | 4 Cyl. | 8 Valves | 55kW/75PS | Petrol | SOHC | TD13394 |
|------------------|-----------------|--------|----------|-------------------|--------|-----------------|---------|
| FELICIA I 1.6 | 06/1997→04/2002 | | | FELICIA I 1.6 GLX | | 08/1995→03/1998 | |
| FELICIA I 1.6 LX | 08/1995→03/1998 | | | FELICIA II 1.6 | | 01/1998→06/2001 | |
| OCTAVIA I 1.6 | 09/1996→09/2004 | | | | | | |

V94114 35.60 x 7.00 x 94.70

030 109 601AH



45°

H

VAG96062B 33.00 x 7.02 x 15.00

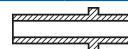

V94115 29.00 x 7.00 x 95.00

032 109 611G

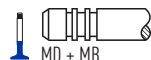

45°

H

12 76.50

| BLF | 1598cc | 4 Cyl. | 16 Valves | 85kW/115PS | Petrol | DOHC, Injection | TD17501 |
|--------------|-----------------|--------|-----------|--------------------|--------|-----------------|---------|
| BTS | 1598cc | 4 Cyl. | 16 Valves | 77kW/105PS | Petrol | DOHC | TD19090 |
| FABIA II 1.6 | 04/2007→12/2014 | | | OCTAVIA II 1.6 FSI | | 02/2004→10/2008 | |
| ROOMSTER 1.6 | 09/2006→05/2015 | | | | | | |

V94116 29.50 x 6.00 x 100.90

036 109 601S

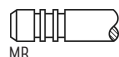

45°

Y

H

VAG96073B 36.00 x 6.02 x 11.06



V94117 26.00 x 6.00 x 100.50

036 109 611K

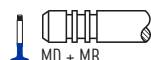

45°

13 78.30

| AYM | 2496cc | V6 Cyl. | 24 Valves | 114kW/155PS | Diesel | Turbo, DOHC | TD16404 |
|------------------|-----------------|---------|-----------|-------------|--------|-------------|---------|
| SUPERB I 2.5 TDI | 12/2001→08/2003 | | | | | | |

V94653 27.10 x 6.00 x 100.50

059 109 601B

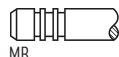

45°

H

VAG96237B 42.00 x 6.02 x 10.07



V94423 24.10 x 6.00 x 100.50

059 109 611B

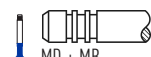

45°

SS

H

VAG96265B 42.00 x 5.98 x 10.21

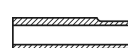

14 78.30

| BDG | 2496cc | V6 Cyl. | 24 Valves | 120kW/163PS | Diesel | Turbo, DOHC | TD17350 |
|------------------|-----------------|---------|-----------|-------------|--------|-------------|---------|
| SUPERB I 2.5 TDI | 06/2003→03/2008 | | | | | | |

V98008 27.20 x 6.00 x 100.60

059 109 601F

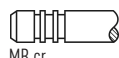

45°

VAG96237B 42.00 x 6.02 x 10.07



V98009 24.10 x 6.00 x 100.70

059 109 611G

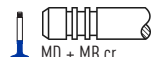

45°

SS

H

VAG96265B 42.00 x 5.98 x 10.21

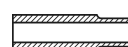

15 79.50

| CFWA | 1199cc | 3 Cyl. | 12 Valves | 55kW/75PS | Diesel | Turbo, DOHC | TD24261 |
|------------------|-----------------|--------|-----------|------------------|--------|-----------------|---------|
| FABIA II 1.2 TDI | 05/2010→12/2014 | | | ROOMSTER 1.2 TDI | | 03/2010→05/2015 | |

V95125 26.60 x 5.97 x 99.30

03L 109 601A

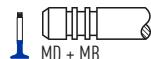

45°

Y

H

VAG96388B 36.00 x 6.00 x 10.06



V95126 24.50 x 5.97 x 99.00

03L 109 611A

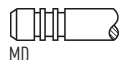

45°

SS

H

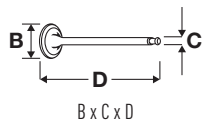

OE

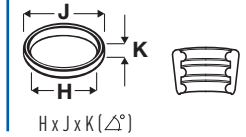
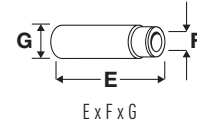
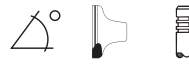

16



79.50

| AMF | 1422cc | 3 Cyl. | 6 Valves | 55kW/75PS | Diesel | Turbo, SOHC | TD17348 |
|----------------------|--------------|-----------------|----------|-----------|--|-------------|---------|
| FABIA I 1.4 TDI | | 04/2003→03/2008 | | | | | |
| V94147 ■ | 038 109 601B | | 45° | H | VAG96041B ■ ■ ■ 36.50 x 7.00 x 12.08 | | |
| 35.90 x 7.00 x 89.90 | | MB | | | | | |
| V94649 ■ | 038 109 601E | | 45° | Y | H | | |
| 36.00 x 7.00 x 89.40 | | MB | | | | | |
| V94148 ■ | 038 109 611F | | 45° | SS | H | | |
| 31.50 x 7.00 x 90.00 | | MD + MB | | | | | |
| V94650 ■ | 038 109 611E | | 45° | SS | H | | |
| 31.40 x 7.00 x 89.00 | | MD + MB | | | | | |

17



79.50

| BMS | 1422cc | 3 Cyl. | 6 Valves | 59kW/80PS | Diesel | Turbo, SOHC | TD19092 |
|----------------------|--------------|-----------------|----------|------------------|--------|--|---------|
| FABIA I 1.4 TDI | | 10/2005→03/2008 | | FABIA II 1.4 TDI | | 01/2007→03/2010 | |
| ROOMSTER 1.4 TDI | | 07/2006→03/2010 | | | | | |
| V94649 ■ | 038 109 601E | | 45° | Y | H | VAG96041B ■ ■ ■ 36.50 x 7.00 x 12.08 | |
| 36.00 x 7.00 x 89.40 | | MB | | | | | |
| V94650 ■ | 038 109 611E | | 45° | SS | H | | |
| 31.40 x 7.00 x 89.00 | | MD + MB | | | | | |

18



79.50

| CAYA | 1598cc | 4 Cyl. | 16 Valves | 55kW/75PS | Diesel | Turbo, DOHC | TD24216 |
|----------------------|--------------|-----------------|-----------|--------------------|--------|--|---------|
| CAYB | 1598cc | 4 Cyl. | 16 Valves | 66kW/90PS | Diesel | Turbo, DOHC | TD23929 |
| CAYC | 1598cc | 4 Cyl. | 16 Valves | 77kW/105PS | Diesel | Turbo, DOHC | TD22678 |
| CLHA | 1598cc | 4 Cyl. | 16 Valves | 77kW/105PS | Diesel | Turbo, DOHC | TD27810 |
| CLHB | 1598cc | 4 Cyl. | 16 Valves | 66kW/90PS | Diesel | Turbo, DOHC | TD27972 |
| CLNA | 1598cc | 4 Cyl. | 16 Valves | 77kW/105PS | Diesel | Turbo, DOHC | TD25764 |
| CRKB | 1598cc | 4 Cyl. | 16 Valves | 81kW/110PS | Diesel | Turbo, DOHC | TD28543 |
| FABIA II 1.6 TDI | | 03/2010→12/2014 | | OCTAVIA II 1.6 TDI | | 06/2009→04/2013 | |
| OCTAVIA III 1.6 TDI | | 11/2012→ | | RAPID 1.6 TDI | | 10/2011→ | |
| ROOMSTER 1.6 TDI | | 03/2010→05/2015 | | SUPERB II 1.6 TDI | | 09/2010→05/2015 | |
| YETI 1.6 TDI | | 11/2010→05/2015 | | | | | |
| V95125 ■ | 03L 109 601A | | 45° | Y | H | VAG96388B ■ ■ ■ 36.00 x 6.00 x 10.06 | |
| 26.60 x 5.97 x 99.30 | | MD + MB | | | | | |
| V95126 ■ | 03L 109 611A | | 45° | SS | H | | |
| 24.50 x 5.97 x 99.00 | | MD | | | | | |

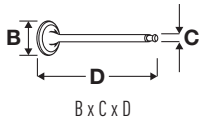

OE

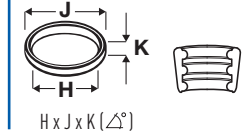
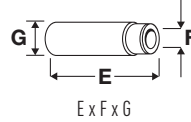
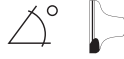

19 **79.50**

| AEF | 1896cc | 4 Cyl. | 8 Valves | 47kW/64PS | Diesel | SOHC | TD13395 |
|-------------------------------------|-----------------|---------|------------------|-----------|-------------------------------------|------------------------|---------|
| FELICIA I 1.9 D | 10/1995→04/2002 | | FELICIA II 1.9 D | | 01/1998→06/2001 | | |
| V91337 ■ | 069 109 601F | | 45° | H | VAG92061B ■ ■ ■ | | |
| 36.10 x 7.97 x 95.10 Eng.→007000 | | MB | | | 36.70 x 8.00 x 12.08 Eng.→007000 | | |
| V94108 ■ | 028 109 601C | | 45° | Y | H | VAG96041B ■ ■ ■ | |
| 36.00 x 7.00 x 95.50 Eng.007001→ | | MB | | | 36.50 x 7.00 x 12.08 Eng.007001→ | | |
| V94414 ■ | 028 109 601C | | 45° | | | | |
| 36.00 x 7.00 x 95.50 Eng.007001→ | | MD cr | | | | | |
| V91334 ■ | 074 109 611 | | 45° | ss | H | | |
| 31.30 x 7.95 x 95.10 Eng.→007000 | | ME + MB | | | | | |
| V94109 ■ | 028 109 611E | | 45° | | H | | |
| 31.10 x 7.00 x 95.60 Eng.007001→ | | MD + MB | | | | | |

20 **79.50**

| AEY | 1896cc | 4 Cyl. | 8 Valves | 47kW/64PS | Diesel | SOHC | TD18729 |
|-------------------------------------|--------------|---------|----------|-----------|-------------------------------------|------------------------|---------|
| V94409 ■ | 028 109 601G | | 45° | H | VAG92061B ■ ■ ■ | | |
| 36.00 x 8.00 x 96.30 Eng.→002000 | | MD + MB | | | 36.70 x 8.00 x 12.08 Eng.→002000 | | |
| V94112 ■ | 028 109 601J | | 45° | Y | H | VAG96041B ■ ■ ■ | |
| 36.00 x 7.00 x 96.50 Eng.002001→ | | MB | | | 36.50 x 7.00 x 12.08 Eng.002001→ | | |
| V94410 ■ | 028 109 611J | | 45° | ss | H | | |
| 31.50 x 8.00 x 96.40 Eng.→002000 | | MD + MB | | | | | |
| V94113 ■ | 028 109 611K | | 45° | | | | |
| 31.50 x 7.00 x 96.30 Eng.002001→ | | MD | | | | | |

21 **79.50**

| AGP | 1896cc | 4 Cyl. | 8 Valves | 50kW/68PS | Diesel | SOHC | TD16424 |
|----------------------|-----------------|--------|-------------------|-----------|----------------------|------------------------|---------|
| AQM | 1896cc | 4 Cyl. | 8 Valves | 50kW/68PS | Diesel | SOHC | TD16089 |
| ASY | 1896cc | 4 Cyl. | 8 Valves | 47kW/64PS | Diesel | SOHC | TD15376 |
| FABIA I 1.9 SDI | 11/1999→03/2008 | | OCTAVIA I 1.9 SDI | | 06/1997→12/2003 | | |
| V94112 ■ | 028 109 601J | | 45° | Y | H | VAG96041B ■ ■ ■ | |
| 36.00 x 7.00 x 96.50 | | MB | | | 36.50 x 7.00 x 12.08 | | |
| V94113 ■ | 028 109 611K | | 45° | | | | |
| 31.50 x 7.00 x 96.30 | | MD | | | | | |

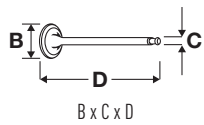

OE

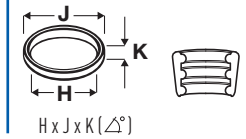
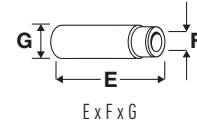

22 **79.50**

| | | | | | | | |
|-----|--------|--------|----------|------------|--------|-------------|---------|
| AGR | 1896cc | 4 Cyl. | 8 Valves | 66kW/90PS | Diesel | Turbo, SOHC | TD17905 |
| AHF | 1896cc | 4 Cyl. | 8 Valves | 81kW/110PS | Diesel | Turbo, SOHC | TD17910 |
| ALH | 1896cc | 4 Cyl. | 8 Valves | 66kW/90PS | Diesel | Turbo, SOHC | TD16090 |
| ASV | 1896cc | 4 Cyl. | 8 Valves | 81kW/110PS | Diesel | Turbo, SOHC | TD16091 |

OCTAVIA I 1.9 TDI 09/1996→03/2010

V94084
35.90 x 7.00 x 96.80

028 109 601D

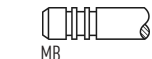

45° Y H

VAG96041B
36.50 x 7.00 x 12.08

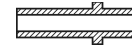

V94085
31.40 x 7.00 x 96.90

028 109 611G

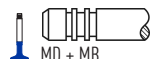

45° H

23 **79.50**

| | | | | | | | |
|-----|--------|--------|----------|------------|--------|-------------|---------|
| ASZ | 1896cc | 4 Cyl. | 8 Valves | 96kW/130PS | Diesel | Turbo, SOHC | TD17036 |
| ATD | 1896cc | 4 Cyl. | 8 Valves | 74kW/100PS | Diesel | Turbo, SOHC | TD15377 |
| AVB | 1896cc | 4 Cyl. | 8 Valves | 74kW/101PS | Diesel | Turbo, SOHC | TD17037 |
| AVF | 1896cc | 4 Cyl. | 8 Valves | 96kW/130PS | Diesel | Turbo, SOHC | TD18239 |
| AWX | 1896cc | 4 Cyl. | 8 Valves | 96kW/130PS | Diesel | Turbo, SOHC | TD16403 |
| BLT | 1896cc | 4 Cyl. | 8 Valves | 96kW/130PS | Diesel | Turbo, SOHC | TD20517 |

FABIA I 1.9 TDI 01/2000→03/2008
OCTAVIA I 1.9 TDI 09/2000→01/2006
FABIA I 1.9 TDI RS 06/2003→03/2008
SUPERB I 1.9 TDI 12/2001→03/2008

V94147
35.90 x 7.00 x 89.90

038 109 601B

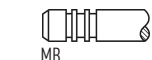

45° H

VAG96041B
36.50 x 7.00 x 12.08



V94148
31.50 x 7.00 x 90.00

038 109 611F

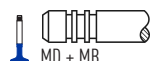

45° ss H

24 **79.50**

| | | | | | | | |
|-----|--------|--------|----------|------------|--------|-------------|---------|
| AXR | 1896cc | 4 Cyl. | 8 Valves | 74kW/100PS | Diesel | Turbo, SOHC | TD20195 |
| BJB | 1896cc | 4 Cyl. | 8 Valves | 77kW/105PS | Diesel | Turbo, SOHC | TD17499 |
| BKC | 1896cc | 4 Cyl. | 8 Valves | 77kW/105PS | Diesel | Turbo, SOHC | TD17497 |
| BLS | 1896cc | 4 Cyl. | 8 Valves | 77kW/105PS | Diesel | Turbo, SOHC | TD19091 |
| BSV | 1896cc | 4 Cyl. | 8 Valves | 77kW/105PS | Diesel | Turbo, SOHC | TD20206 |
| BXE | 1896cc | 4 Cyl. | 8 Valves | 77kW/105PS | Diesel | Turbo, SOHC | TD20513 |

FABIA I 1.9 TDI 01/2000→03/2008
OCTAVIA I 1.9 TDI 08/2000→12/2010
ROOMSTER 1.9 TDI 03/2006→03/2010
SUPERB II 1.9 TDI 03/2008→11/2010
FABIA II 1.9 TDI 04/2007→03/2010
OCTAVIA II 1.9 TDI 06/2004→12/2010
SUPERB I 1.9 TDI 10/2005→05/2007

V94649
36.00 x 7.00 x 89.40

038 109 601E

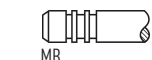

45° Y H

VAG96041B
36.50 x 7.00 x 12.08

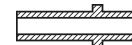

V94650
31.40 x 7.00 x 89.00

038 109 611E

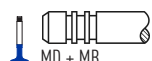

45° ss H

25 **79.50**

| | | | | | | | |
|-----|--------|--------|----------|------------|--------|-------------|---------|
| BSW | 1896cc | 4 Cyl. | 8 Valves | 77kW/105PS | Diesel | Turbo, SOHC | TD20004 |
|-----|--------|--------|----------|------------|--------|-------------|---------|

FABIA II 1.9 TDI 04/2007→03/2010
ROOMSTER 1.9 TDI 09/2006→03/2010

V94147
35.90 x 7.00 x 89.90

038 109 601B



45° H

VAG96041B
36.50 x 7.00 x 12.08



V94650
31.40 x 7.00 x 89.00

038 109 611E

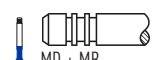

45° ss H

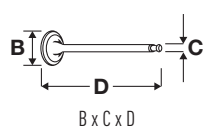

OE

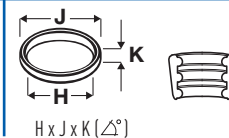
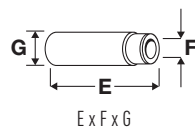
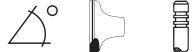

26 81.00

| | | | | | | | |
|------------|--------|--------|-----------------|------------|--------|-------------|----------------|
| AEH | 1595cc | 4 Cyl. | 8 Valves | 74kW/101PS | Petrol | SOHC | TD12950 |
| AKL | 1595cc | 4 Cyl. | 8 Valves | 74kW/101PS | Petrol | SOHC | TD12951 |

| | | | | | | | |
|----------------------|--------------|-----------------|-----|---|------------------------|--|--|
| OCTAVIA I 1.6 | | 02/1997→12/2007 | | | | | |
| V94079 ■ | 078 109 601B | | 45° | H | VAG96041B ■ ■ ■ | | |
| 39.40 x 7.00 x 92.10 | | MB | | | 36.50 x 7.00 x 12.08 | | |
| V94080 ■ | 048 109 611B | | 45° | H | | | |
| 32.80 x 7.00 x 91.20 | | MD + MB | | | | | |

27 81.00

| | | | | | | | |
|-------------|--------|--------|-----------------|------------|--------|-------------|----------------|
| AVU | 1595cc | 4 Cyl. | 8 Valves | 75kW/102PS | Petrol | SOHC | TD16068 |
| BFQ | 1595cc | 4 Cyl. | 8 Valves | 75kW/102PS | Petrol | SOHC | TD17912 |
| BGU | 1595cc | 4 Cyl. | 8 Valves | 75kW/102PS | Petrol | SOHC | TD17496 |
| BSE | 1595cc | 4 Cyl. | 8 Valves | 75kW/102PS | Petrol | SOHC | TD20898 |
| BSF | 1595cc | 4 Cyl. | 8 Valves | 75kW/102PS | Petrol | SOHC | TD20899 |
| CCSA | 1595cc | 4 Cyl. | 8 Valves | 75kW/102PS | Petrol | SOHC | TD20900 |
| CHGA | 1595cc | 4 Cyl. | 8 Valves | 75kW/102PS | Petrol | SOHC | TD22691 |
| CMXA | 1595cc | 4 Cyl. | 8 Valves | 75kW/102PS | Petrol | SOHC | TD24599 |

| | | | | | | | |
|----------------------|--------------|-----------------|-----|----------------|---|------------------------|--|
| OCTAVIA I 1.6 | | 09/2000→12/2010 | | OCTAVIA II 1.6 | | 06/2004→06/2013 | |
| OCTAVIA II 1.6 LPG | | 08/2009→11/2012 | | | | | |
| V94424 ■ | 06B 109 601D | | 45° | Y | H | VAG96353B ■ ■ ■ | |
| 39.50 x 6.00 x 94.00 | | MB | | | | 36.50 x 6.02 x 12.08 | |
| V94425 ■ | 06B 109 611C | | 45° | SS | H | | |
| 32.90 x 6.00 x 93.90 | | MD + MB | | | | | |

28 81.00

| | | | | | | | |
|------------|--------|--------|------------------|------------|--------|-------------|----------------|
| ADR | 1781cc | 4 Cyl. | 20 Valves | 92kW/125PS | Petrol | DOHC | TD20805 |
| AGN | 1781cc | 4 Cyl. | 20 Valves | 92kW/125PS | Petrol | DOHC | TD17903 |

| | | | | | | | |
|-----------------------|--------------|-----------------|-----|-------------------|---|------------------------|--|
| OCTAVIA I 1.8 | | 09/1996→07/2000 | | OCTAVIA I 1.8 20V | | 07/1998→07/2000 | |
| V94081 ■ | 058 109 601C | | 45° | Y | H | VAG96073B ■ ■ ■ | |
| 26.90 x 6.00 x 105.10 | | MB | | | | 36.00 x 6.02 x 11.06 | |
| V94083 ■ | 058 109 611M | | 45° | | H | | |
| 29.90 x 6.00 x 103.90 | | MD + MB cr | | | | | |

29 81.00

| | | | | | | | |
|------------|--------|--------|------------------|-------------|--------|--------------------|----------------|
| AGU | 1781cc | 4 Cyl. | 20 Valves | 110kW/150PS | Petrol | Turbo, DOHC | TD13396 |
| ARX | 1781cc | 4 Cyl. | 20 Valves | 110kW/150PS | Petrol | Turbo, DOHC | TD16069 |
| ARZ | 1781cc | 4 Cyl. | 20 Valves | 110kW/150PS | Petrol | Turbo, DOHC | TD16030 |
| AUM | 1781cc | 4 Cyl. | 20 Valves | 110kW/150PS | Petrol | Turbo, DOHC | TD16070 |
| AUQ | 1781cc | 4 Cyl. | 20 Valves | 132kW/180PS | Petrol | Turbo, DOHC | TD16279 |
| AWT | 1781cc | 4 Cyl. | 20 Valves | 110kW/150PS | Petrol | Turbo, DOHC | TD16365 |

| | | | | | | | |
|-----------------------|--------------|-----------------|-----|--------------------|---|------------------------|--|
| OCTAVIA I 1.8 T | | 08/1997→12/2010 | | OCTAVIA I RS 1.8 T | | 05/2001→01/2006 | |
| SUPERB I 1.8 T | | 12/2001→03/2008 | | | | | |
| V94081 ■ | 058 109 601C | | 45° | Y | H | VAG96073B ■ ■ ■ | |
| 26.90 x 6.00 x 105.10 | | MB | | | | 36.00 x 6.02 x 11.06 | |
| V94082 ■ | 058 109 611E | | 45° | SS | H | | |
| 29.90 x 6.00 x 103.90 | | MD + MB cr | | | | | |



OE

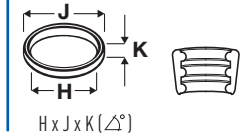
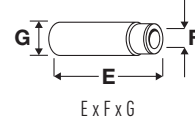
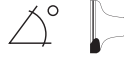

30



81.00

| | | | | | | | |
|-----|--------|--------|-----------|-------------|--------|-------------|---------|
| AZV | 1968cc | 4 Cyl. | 16 Valves | 100kW/136PS | Diesel | Turbo, DOHC | TD20909 |
| BKD | 1968cc | 4 Cyl. | 16 Valves | 103kW/140PS | Diesel | Turbo, DOHC | TD17500 |
| BMN | 1968cc | 4 Cyl. | 16 Valves | 125kW/170PS | Diesel | Turbo, DOHC | TD20735 |

| | | | |
|-----------------------|-----------------|------------------------|-----------------|
| OCTAVIA II 2.0 TDI | 02/2004→05/2010 | OCTAVIA II 2.0 TDI 16V | 02/2004→05/2013 |
| OCTAVIA II 2.0 TDI RS | 04/2006→02/2013 | SUPERB II 2.0 TDI 16V | 01/2009→05/2015 |

| | | | | | | | |
|----------------------|--------------|---------|-----|----|---|----------------------|--|
| V94697 | 03G 109 601B | | 45° | Y | H | VAG96237B | |
| 29.20 x 6.00 x 87.80 | | MB | | | | 42.00 x 6.02 x 10.07 | |
| V98007 | 03G 109 601A | | 45° | | | | |
| 29.20 x 6.00 x 88.45 | | MB | | | | | |
| V94698 | 03G 109 611B | | 45° | SS | H | | |
| 25.50 x 6.00 x 88.10 | | MD + MB | | | | | |
| V98097 | 03G 109 611D | | 45° | | | | |
| 25.40 x 6.00 x 87.50 | | MD + MB | | | | | |

31



81.00

| | | | | | | | |
|-----|--------|--------|----------|-------------|--------|-------------|---------|
| BMM | 1968cc | 4 Cyl. | 8 Valves | 103kW/140PS | Diesel | Turbo, SOHC | TD19315 |
| BMP | 1968cc | 4 Cyl. | 8 Valves | 103kW/140PS | Diesel | Turbo, SOHC | TD20945 |
| BSS | 1968cc | 4 Cyl. | 8 Valves | 103kW/140PS | Diesel | Turbo, SOHC | TD19317 |

| | | | |
|--------------------|-----------------|------------------|-----------------|
| OCTAVIA II 2.0 TDI | 11/2005→05/2010 | SUPERB I 2.0 TDI | 10/2005→03/2008 |
| SUPERB II 2.0 TDI | 03/2008→05/2010 | | |

| | | | | | | | |
|----------------------|--------------|---------|-----|----|---|----------------------|--|
| V94649 | 038 109 601E | | 45° | Y | H | VAG96041B | |
| 36.00 x 7.00 x 89.40 | | MB | | | | 36.50 x 7.00 x 12.08 | |
| V94650 | 038 109 611E | | 45° | SS | H | | |
| 31.40 x 7.00 x 89.00 | | MD + MB | | | | | |



OE

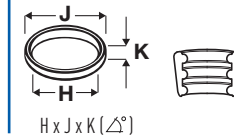
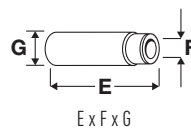

32 **81.00**

| | | | | | | | |
|------|--------|--------|-----------|-------------|--------|-------------|---------|
| CBBB | 1968cc | 4 Cyl. | 16 Valves | 125kW/170PS | Diesel | Turbo, DOHC | TD20944 |
| CBDB | 1968cc | 4 Cyl. | 16 Valves | 103kW/140PS | Diesel | Turbo, DOHC | TD23586 |
| CEGA | 1968cc | 4 Cyl. | 16 Valves | 125kW/170PS | Diesel | Turbo, DOHC | TD20905 |
| CFFB | 1968cc | 4 Cyl. | 16 Valves | 103kW/140PS | Diesel | Turbo, DOHC | TD23589 |
| CFGB | 1968cc | 4 Cyl. | 16 Valves | 125kW/170PS | Diesel | Turbo, DOHC | TD23591 |
| CFHA | 1968cc | 4 Cyl. | 16 Valves | 81kW/110PS | Diesel | Turbo, DOHC | TD23584 |
| CFHC | 1968cc | 4 Cyl. | 16 Valves | 103kW/140PS | Diesel | Turbo, DOHC | TD23587 |
| CFHF | 1968cc | 4 Cyl. | 16 Valves | 81kW/110PS | Diesel | Turbo, DOHC | TD23585 |
| CFJA | 1968cc | 4 Cyl. | 16 Valves | 125kW/170PS | Diesel | Turbo, DOHC | TD23588 |
| CKFB | 1968cc | 4 Cyl. | 16 Valves | 105kW/143PS | Diesel | Turbo, DOHC | TD27971 |
| CKFC | 1968cc | 4 Cyl. | 16 Valves | 110kW/150PS | Diesel | Turbo, DOHC | TD27811 |
| CLCA | 1968cc | 4 Cyl. | 16 Valves | 81kW/110PS | Diesel | Turbo, DOHC | TD24839 |
| CLCB | 1968cc | 4 Cyl. | 16 Valves | 103kW/140PS | Diesel | Turbo, DOHC | TD24598 |
| CLJA | 1968cc | 4 Cyl. | 16 Valves | 103kW/140PS | Diesel | Turbo, DOHC | TD23590 |
| CRLB | 1968cc | 4 Cyl. | 16 Valves | 110kW/150PS | Diesel | Turbo, DOHC | TD31653 |
| CRMB | 1968cc | 4 Cyl. | 16 Valves | 110kW/150PS | Diesel | Turbo, DOHC | TD30582 |
| CRVC | 1968cc | 4 Cyl. | 16 Valves | 105kW/143PS | Diesel | Turbo, DOHC | TD27970 |
| CUNA | 1968cc | 4 Cyl. | 16 Valves | 135kW/184PS | Diesel | Turbo, DOHC | TD29186 |
| CUPA | 1968cc | 4 Cyl. | 16 Valves | 135kW/184PS | Diesel | Turbo, DOHC | TD28040 |
| CUUB | 1968cc | 4 Cyl. | 16 Valves | 110kW/150PS | Diesel | Turbo, DOHC | TD31364 |
| DFEA | 1968cc | 4 Cyl. | 16 Valves | 110kW/150PS | Diesel | Turbo, DOHC | TD31654 |
| DFGA | 1968cc | 4 Cyl. | 16 Valves | 110kW/150PS | Diesel | Turbo, DOHC | TD33915 |

| | | | |
|------------------------------|-----------------|------------------------|-----------------|
| KODIAQ 2.0 TDI | 10/2016→ | OCTAVIA II 2.0 TDI | 03/2010→06/2013 |
| OCTAVIA II 2.0 TDI 16V | 02/2004→05/2013 | OCTAVIA II 2.0 TDI RS | 04/2006→02/2013 |
| OCTAVIA III 2.0 TDI | 11/2012→ | OCTAVIA III 2.0 TDI RS | 05/2013→ |
| OCTAVIA III 2.0 TDI / TDI RS | 09/2014→ | SUPERB II 2.0 TDI | 07/2008→05/2015 |
| SUPERB II 2.0 TDI 16V | 01/2009→05/2015 | SUPERB III 2.0 TDI | 03/2015→ |
| YETI 2.0 TDI | 05/2009→12/2017 | | |

V95099 03L 109 601
28.10 x 5.97 x 99.30

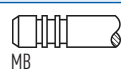

VAG96237B
42.00 x 6.02 x 10.07



V95114 03L 109 611
26.00 x 5.97 x 99.10

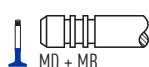

33 **82.50**

| | | | | | | | |
|------|--------|--------|-----------|-------------|--------|------------------------|---------|
| BZB | 1798cc | 4 Cyl. | 16 Valves | 118kW/160PS | Petrol | Turbo, DOHC, Injection | TD20902 |
| CDAA | 1798cc | 4 Cyl. | 16 Valves | 118kW/160PS | Petrol | Turbo, DOHC, Injection | TD20943 |
| CDAB | 1798cc | 4 Cyl. | 16 Valves | 112kW/152PS | Petrol | Turbo, DOHC, Injection | TD24597 |

| | | | |
|--------------------|-----------------|-------------------|-----------------|
| OCTAVIA II 1.8 TSI | 06/2007→06/2013 | SUPERB II 1.8 TSI | 03/2008→05/2015 |
| YETI 1.8 TSI | 05/2009→12/2017 | | |

V95098 06D 109 601M
33.80 x 5.98 x 103.95

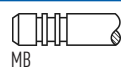

VAG96073B
36.00 x 6.02 x 11.06



V94692 06D 109 611L
28.00 x 6.00 x 101.80



V95152 06D 109 611L
28.10 x 5.97 x 101.90

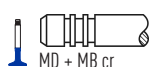



OE

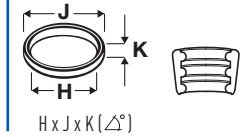
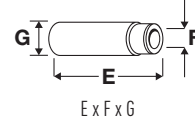
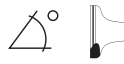

34



82.50

| | | | | | | | |
|--------------|--------|-----------------|----------|---------------|--------|-----------------|---------|
| AEG | 1984cc | 4 Cyl. | 8 Valves | 85kW/116PS | Petrol | SOHC | TD16280 |
| APK | 1984cc | 4 Cyl. | 8 Valves | 85kW/116PS | Petrol | SOHC | TD16031 |
| AQY | 1984cc | 4 Cyl. | 8 Valves | 85kW/116PS | Petrol | SOHC | TD13869 |
| AZH | 1984cc | 4 Cyl. | 8 Valves | 85kW/116PS | Petrol | SOHC | TD16092 |
| AZL | 1984cc | 4 Cyl. | 8 Valves | 85kW/116PS | Petrol | SOHC | TD16241 |
| AZM | 1984cc | 4 Cyl. | 8 Valves | 85kW/115PS | Petrol | SOHC | TD16366 |
| FABIA I 2.0 | | 12/1999→03/2008 | | OCTAVIA I 2.0 | | 04/1999→05/2007 | |
| SUPERB I 2.0 | | 12/2001→03/2008 | | | | | |

V94079 ■
39.40 x 7.00 x 92.10

078 109 601B

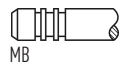

45°

H

VAG96041B ■ ■ ■
36.50 x 7.00 x 12.08



V94080 ■
32.80 x 7.00 x 91.20

048 109 611B



45°

H

35



82.50

| | | | | | | | |
|---------------|--------|-----------------|----------|------------|--------|------|---------|
| AZJ | 1984cc | 4 Cyl. | 8 Valves | 85kW/116PS | Petrol | SOHC | TD17466 |
| OCTAVIA I 2.0 | | 04/1999→05/2007 | | | | | |

V94079 ■
39.40 x 7.00 x 92.10

078 109 601B

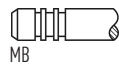

45°

H

VAG96041B ■ ■ ■
36.50 x 7.00 x 12.08

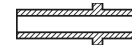

V94080 ■
32.80 x 7.00 x 91.20

048 109 611B



45°

H

V94303 ■
32.90 x 7.00 x 91.20

078 109 611C



45°

SS

H

36



82.50

| | | | | | | | |
|--------------------|--------|-----------------|-----------|-------------|--------|-----------------|---------|
| BLR | 1984cc | 4 Cyl. | 16 Valves | 110kW/150PS | Petrol | DOHC, Injection | TD18102 |
| BLX | 1984cc | 4 Cyl. | 16 Valves | 110kW/150PS | Petrol | DOHC, Injection | TD20393 |
| BLY | 1984cc | 4 Cyl. | 16 Valves | 110kW/150PS | Petrol | DOHC, Injection | TD18101 |
| BVX | 1984cc | 4 Cyl. | 16 Valves | 110kW/150PS | Petrol | DOHC, Injection | TD20394 |
| BVY | 1984cc | 4 Cyl. | 16 Valves | 110kW/150PS | Petrol | DOHC, Injection | TD20518 |
| BVZ | 1984cc | 4 Cyl. | 16 Valves | 110kW/150PS | Petrol | DOHC, Injection | TD20519 |
| OCTAVIA II 2.0 FSI | | 11/2004→10/2008 | | | | | |

V94691 ■
33.85 x 6.00 x 103.90

06E 109 601E

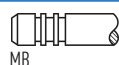

45°

Y

H

VAG96073B ■ ■ ■
36.00 x 6.02 x 11.06

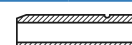

V94692 ■
28.00 x 6.00 x 101.80

06D 109 611L



45°

H

V95152 ■
28.10 x 5.97 x 101.90

06D 109 611L



45°

H



OE

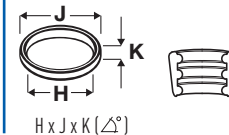
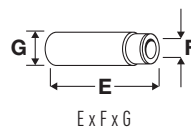
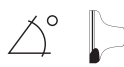

37 82.50







| BWA | 1984cc | 4 Cyl. | 16 Valves | 147kW/200PS | Petrol | Turbo, DOHC, Injection | TD20395 |
|-----------------------|--------------|-----------------|-----------|-------------------|----------------------|------------------------|---------|
| CCZA | 1984cc | 4 Cyl. | 16 Valves | 147kW/200PS | Petrol | Turbo, DOHC, Injection | TD22171 |
| OCTAVIA II 2.0 RS | | 10/2005→02/2013 | | SUPERB II 2.0 TSI | | 05/2010→05/2015 | |
| V95098 | 06D 109 601M | | 45° | H | VAG96073B | | |
| 33.80 x 5.98 x 103.95 | | MB | | | 36.00 x 6.02 x 11.06 | | |
| V94692 | 06D 109 611L | | 45° | H | | | |
| 28.00 x 6.00 x 101.80 | | MD + MB cr | | | | | |
| V95152 | 06D 109 611L | | 45° | H | | | |
| 28.10 x 5.97 x 101.90 | | MD + MB cr | | | | | |

38 82.50

| AMX | 2771cc | V6 Cyl. | 30 Valves | 142kW/193PS | Petrol | DOHC | TD16367 |
|-----------------------|--------------|-----------------|-----------|-------------|--------|----------------------|---------|
| BBG | 2771cc | V6 Cyl. | 30 Valves | 140kW/190PS | Petrol | DOHC | TD18754 |
| SUPERB I 2.8 V6 | | 12/2001→03/2008 | | | | | |
| V94081 | 058 109 601C | | 45° | Y | H | VAG96073B | |
| 26.90 x 6.00 x 105.10 | | MB | | | | 36.00 x 6.02 x 11.06 | |
| V94083 | 058 109 611M | | 45° | | H | | |
| 29.90 x 6.00 x 103.90 | | MD + MB cr | | | | | |

39 89.00

| CDVA | 3597cc | VR6 Cyl. | 24 Valves | 191kW/260PS | Petrol | DOHC, Injection | TD22679 |
|-----------------------|--------------|-----------------|-----------|------------------|--------|-----------------|---------|
| SUPERB II 3.6 FSI | | 11/2008→05/2015 | | SUPERB II 3.6 V6 | | 10/2009→05/2015 | |
| V95085 | 022 109 601G | | 45° | Y | H | | |
| 33.20 x 5.98 x 102.40 | | MB | | | | | |
| V95127 | 022 109 601H | | 45° | Y | H | | |
| 33.20 x 5.98 x 136.35 | | MB | | | | | |
| V95086 | 022 109 611N | | 45° | SS | H | | |
| 30.20 x 5.97 x 102.20 | | MD + MB cr | | | | | |
| V95128 | 022 109 611M | | 45° | SS | H | | |
| 30.20 x 5.97 x 136.10 | | MD | | | | | |

|  |  | ccm |  |  |  |  |
|---|---|------|---|---|---|---|
| M 132.910 | 72.00 | 999 | 3 | 12 | Petrol | 3 |
| M 132.930 | 72.00 | 999 | 3 | 12 | Petrol | 3 |
| M 134.910 | 75.00 | 1124 | 3 | 12 | Petrol | 4 |
| M 134.911 | 75.00 | 1124 | 3 | 12 | Petrol | 4 |
| M 135.930 | 75.00 | 1332 | 4 | 16 | Petrol | 5 |
| M 135.950 | 75.00 | 1499 | 4 | 16 | Petrol | 6 |
| M 160 E6AL B03 | 63.50 | 599 | 3 | 6 | Petrol | 1 |
| M 160 E6AL B04 | 63.50 | 599 | 3 | 6 | Petrol | 1 |
| M 160 E6AL B05 | 63.50 | 599 | 3 | 6 | Petrol | 1 |
| M 160.910 | 63.50 | 599 | 3 | 6 | Petrol | 1 |
| M 160.921 | 66.50 | 698 | 3 | 6 | Petrol | 2 |
| M 160.922 | 66.50 | 698 | 3 | 6 | Petrol | 2 |
| OM 639.939 | 83.00 | 1493 | 3 | 12 | Diesel | 7 |

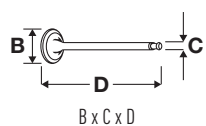

OE

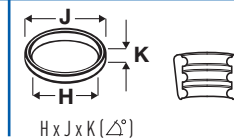
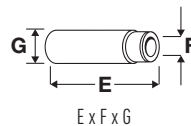

1 63.50

| | | | | | | | |
|-----------------------|-----------------|--------|-----------------|-----------------|--------|--------------------|---------|
| M 160 E6AL B03 | 599cc | 3 Cyl. | 6 Valves | 40kW/55PS | Petrol | Turbo, SOHC | TD22902 |
| M 160 E6AL B04 | 599cc | 3 Cyl. | 6 Valves | 33kW/45PS | Petrol | SOHC | TD22903 |
| M 160 E6AL B05 | 599cc | 3 Cyl. | 6 Valves | 45kW/61PS | Petrol | SOHC | TD22901 |
| M 160.910 | 599cc | 3 Cyl. | 6 Valves | 33-55kW/45-75PS | Petrol | SOHC | TD26102 |
| CABRIO 0.6 | 03/2000→01/2004 | | | CITY-COUPE 0.6 | | 07/1998→01/2004 | |
| CROSSBLADE 0.6 | 06/2002→12/2003 | | | FORTWO 0.6 | | 01/2004→02/2007 | |
| FORTWO 0.6 Brabus | 01/2004→12/2006 | | | | | | |

| | | | | | | | |
|----------------------|---------------|-------|-----|----|----------------------|--|--|
| V94803 | 160 053 00 01 | | 45° | H | VAG96310 | | |
| 30.00 x 6.00 x 89.35 | | MB cr | | | 34.50 x 6.00 x 12.56 | | |
| V94804 | 160 050 00 27 | | 45° | SS | | | |
| 25.00 x 6.00 x 89.20 | | MD cr | | | | | |

2 66.50

| | | | | | | | |
|------------------|-----------------|--------|-----------------|-----------------|--------|--------------|---------|
| M 160.921 | 698cc | 3 Cyl. | 6 Valves | 45-60kW/61-82PS | Petrol | Turbo | TD22100 |
| M 160.922 | 698cc | 3 Cyl. | 6 Valves | 45-60kW/61-82PS | Petrol | Turbo | TD26301 |
| ROADSTER 0.7 | 04/2003→11/2005 | | | | | | |

| | | | | | | | |
|----------------------|---------------|-------|-----|----|----------------------|--|--|
| V94803 | 160 053 00 01 | | 45° | H | VAG96310 | | |
| 30.00 x 6.00 x 89.35 | | MB cr | | | 34.50 x 6.00 x 12.56 | | |
| V94804 | 160 050 00 27 | | 45° | SS | | | |
| 25.00 x 6.00 x 89.20 | | MD cr | | | | | |

3 72.00

| | | | | | | | |
|------------------|----------|--------|------------------|-------------------------|--------|--------------------|---------|
| M 132.910 | 999cc | 3 Cyl. | 12 Valves | 45-52kW/61-71PS | Petrol | DOHC | TD20948 |
| M 132.930 | 999cc | 3 Cyl. | 12 Valves | 62-75kW/84-102PS | Petrol | Turbo, DOHC | TD20947 |
| FORTWO 1.0 | 01/2007→ | | | FORTWO 1.0 Brabus | | 01/2008→ | |
| FORTWO 1.0 Turbo | 01/2007→ | | | FORTWO 1.0 Turbo Brabus | | 07/2010→ | |

| | | | | | | | |
|----------------------|---------------|-------|-----|---|--|--|--|
| V95196 | 132 053 00 01 | | 45° | H | | | |
| 28.05 x 4.97 x 85.55 | | MB tu | | | | | |
| V95197 | 132 053 00 05 | | 45° | | | | |
| 25.00 x 4.96 x 86.90 | | MD tu | | | | | |

4 75.00

| | | | | | | | |
|------------------|-----------------|--------|------------------|-----------|--------|-------------|---------|
| M 134.910 | 1124cc | 3 Cyl. | 12 Valves | 55kW/75PS | Petrol | DOHC | TD25557 |
| M 134.911 | 1124cc | 3 Cyl. | 12 Valves | 47kW/64PS | Petrol | DOHC | TD25556 |
| FORFOUR 1.1 | 01/2004→06/2006 | | | | | | |

| | | | | | | | |
|----------------------|---------------|-------|-----|--|--|--|--|
| V98083 | 135 053 00 01 | | 45° | | | | |
| 30.40 x 5.00 x 89.60 | | MB tu | | | | | |
| V98084 | 135 053 00 05 | | 45° | | | | |
| 25.40 x 5.00 x 90.90 | | MD tu | | | | | |



OE

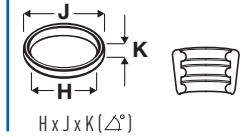
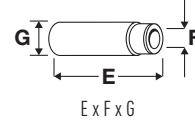
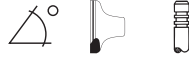

5



75.00

| | | | | | | | |
|-------------|--------|-----------------|-----------|-----------|--------|-------------|---------|
| M 135.930 | 1332cc | 4 Cyl. | 16 Valves | 70kW/95PS | Petrol | Turbo, DOHC | TD25844 |
| FORFOUR 1.3 | | 01/2004→06/2006 | | | | | |

V98083 ■ 135 053 00 01  45°
30.40 x 5.00 x 89.60 MB tu

V98084 ■ 135 053 00 05  45°
25.40 x 5.00 x 90.90 MD tu

6



75.00

| | | | | | | | |
|-------------|--------|-----------------|-----------|-------------------|--------|------|---------|
| M 135.950 | 1499cc | 4 Cyl. | 16 Valves | 80-90kW/109-122PS | Petrol | DOHC | TD22717 |
| FORFOUR 1.5 | | 01/2004→06/2006 | | | | | |

V98083 ■ 135 053 00 01  45°
30.40 x 5.00 x 89.60 MB tu

V98084 ■ 135 053 00 05  45°
25.40 x 5.00 x 90.90 MD tu

7



83.00







| | | | | | | | |
|-----------------|--------|-----------------|-----------|-----------------|--------|-------------|---------|
| OM 639.939 | 1493cc | 3 Cyl. | 12 Valves | 50-70kW/58-95PS | Diesel | Turbo, DOHC | TD23800 |
| FORFOUR 1.5 CDI | | 09/2004→06/2006 | | | | | |

V98071 ■ 642 053 04 01  45°
28.50 x 6.00 x 102.30 MB cr

V98072 ■ 642 050 05 27  45°
25.40 x 6.00 x 102.30 MD cr

VAG96371 ■ ■ ■
34.50 x 6.00 x 11.55



|  |  | ccm |  |  |  |  |
|---|---|------|--|---|---|---|
| M 104.942 | 89.90 | 2799 | 6 | 24 | Petrol | 3 |
| M 104.945 | 89.90 | 2799 | 6 | 24 | Petrol | 3 |
| M 104.992 | 89.90 | 3199 | 6 | 24 | Petrol | 4 |
| M 104.995 | 89.90 | 3199 | 6 | 24 | Petrol | 4 |
| M 111.970 | 90.90 | 2295 | 4 | 16 | Petrol | 5 |
| M 111.974 | 90.90 | 2295 | 4 | 16 | Petrol | 5 |
| MB-OM 661 | 89.00 | 2299 | 4 | 8 | Diesel | 1 |
| OM 601.940 | 89.00 | 2299 | 4 | 8 | Diesel | 1 |
| OM 602.940 | 89.00 | 2874 | 5 | 10 | Diesel | 2 |
| OM 602.980 | 89.00 | 2874 | 5 | 10 | Diesel | 2 |
| XD3P | 94.00 | 2497 | 4 | 8 | Diesel | 6 |



OE

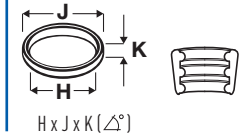
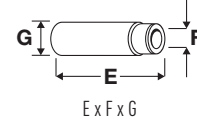

1 **89.00**

| | | | | | | | |
|-------------------|--------|-----------------|-----------------|-----------------|--------|-----------------|---------------|
| MB-OM 661 | 2299cc | 4 Cyl. | 8 Valves | 59kW/80PS | Diesel | SOHC | TD9356 |
| OM 601.940 | 2299cc | 4 Cyl. | 8 Valves | 57-59kW/77-80PS | Diesel | SOHC | TD3612 |
| KORANDO 2.3 D | | 12/1996→06/1998 | | MUSSO 2.3 D | | 10/1995→04/1999 | |

| | | | | | | |
|-----------------------|---------------|------------|-----|---|----------------------|--|
| V91181 ■ | 601 053 17 01 | | 45° | H | VAG92297 ■ | |
| 38.10 x 7.97 x 106.50 | | MB tu | | | 39.50 x 8.00 x 14.05 | |
| V91182 ■ | 601 050 25 27 | | 45° | H | VAG96214 ■ | |
| 35.10 x 8.96 x 106.50 | | MF + MB cr | | | 39.50 x 8.02 x 14.25 | |
| | | | | | VAG92298 ■ | |
| | | | | | 37.50 x 9.00 x 14.05 | |
| | | | | | VAG96204 ■ | |
| | | | | | 37.50 x 9.02 x 14.25 | |

2 **89.00**

| | | | | | | | |
|-------------------|--------|-----------------|------------------|-------------------|--------|--------------------|----------------|
| OM 602.940 | 2874cc | 5 Cyl. | 10 Valves | 70kW/95PS | Diesel | SOHC | TD3613 |
| OM 602.980 | 2874cc | 5 Cyl. | 10 Valves | 75-90kW/102-122PS | Diesel | Turbo, SOHC | TD19846 |
| ISTANA 2.9 D | | 10/1992→11/2003 | | ISTANA 2.9 TD | | 10/1992→05/1995 | |

| | | | | | | |
|-----------------------|---------------|------------|-----|---|----------------------|--|
| V91181 ■ | 601 053 17 01 | | 45° | H | VAG92297 ■ | |
| 38.10 x 7.97 x 106.50 | | MB tu | | | 39.50 x 8.00 x 14.05 | |
| V91182 ■ | 601 050 25 27 | | 45° | H | VAG96214 ■ | |
| 35.10 x 8.96 x 106.50 | | MF + MB cr | | | 39.50 x 8.02 x 14.25 | |
| | | | | | VAG92298 ■ | |
| | | | | | 37.50 x 9.00 x 14.05 | |
| | | | | | VAG96204 ■ | |
| | | | | | 37.50 x 9.02 x 14.25 | |

3 **89.90**

| | | | | | | | |
|------------------|--------|----------|------------------|---------------------|--------|-------------|----------------|
| M 104.942 | 2799cc | 6 Cyl. | 24 Valves | 142-145kW/193-197PS | Petrol | DOHC | TD20447 |
| M 104.945 | 2799cc | 6 Cyl. | 24 Valves | 142kW/193PS | Petrol | DOHC | TD19845 |
| CHAIRMAN 2.8 | | 08/1999→ | | | | | |

| | | | | | | |
|-----------------------|--------------|-------|-----|----|----------------------|--|
| V94370 ■ | 111 053 1101 | | 45° | H | VAG96149 ■ ■ | |
| 35.00 x 7.00 x 101.50 | | MB tu | | | 37.50 x 7.02 x 12.59 | |
| V94371 ■ | 611 050 0127 | | 45° | SS | VAG96178 ■ ■ | |
| 31.00 x 7.00 x 103.50 | | MD tu | | | 37.50 x 7.02 x 12.76 | |

4 **89.90**

| | | | | | | | |
|------------------|--------|-----------------|------------------|---------------------|--------|-----------------|---------------|
| M 104.992 | 3199cc | 6 Cyl. | 24 Valves | 162kW/220PS | Petrol | DOHC | TD9357 |
| M 104.995 | 3199cc | 6 Cyl. | 24 Valves | 154-156kW/209-212PS | Petrol | DOHC | TD9374 |
| CHAIRMAN 3.2 | | 07/1997→ | | KORANDO 3.2 | | 12/1996→11/2006 | |
| MUSSO 3.2 | | 06/1996→09/2004 | | | | | |

| | | | | | | |
|-----------------------|--------------|-------|-----|----|----------------------|--|
| V94370 ■ | 111 053 1101 | | 45° | H | VAG96149 ■ ■ | |
| 35.00 x 7.00 x 101.50 | | MB tu | | | 37.50 x 7.02 x 12.59 | |
| V94371 ■ | 611 050 0127 | | 45° | SS | VAG96178 ■ ■ | |
| 31.00 x 7.00 x 103.50 | | MD tu | | | 37.50 x 7.02 x 12.76 | |

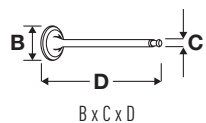

OE

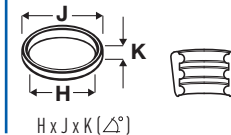
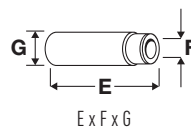

5 90.90







| | | | | | | | |
|--------------|-----------------|--------|-----------|---------------------|--------|------|-----------------|
| M 111.970 | 2295cc | 4 Cyl. | 16 Valves | 103-110kW/140-150PS | Petrol | DOHC | TD5544 |
| M 111.974 | 2295cc | 4 Cyl. | 16 Valves | 110kW/150PS | Petrol | DOHC | TD19459 |
| CHAIRMAN 2.3 | 07/1997→ | | | KORANDO 2.3 | | | 05/1997→02/2000 |
| MUSSO 2.3 | 10/1996→11/2002 | | | | | | |

| | | | | | | |
|-----------------------|--------------|-------|-----|----|----------------------|--|
| V94370 | 111 053 1101 | | 45° | H | VAG96149 | |
| 35.00 x 7.00 x 101.50 | | MB tu | | | 37.50 x 7.02 x 12.59 | |
| V94371 | 611 050 0127 | | 45° | SS | VAG96178 | |
| 31.00 x 7.00 x 103.50 | | MD tu | | | 37.50 x 7.02 x 12.76 | |

6 94.00

| | | | | | | | |
|---------------|-----------------|--------|----------|-----------------|--------|------|---------|
| XD3P | 2497cc | 4 Cyl. | 8 Valves | 53-58kW/72-79PS | Diesel | SOHC | TD19458 |
| KORANDO 2.5 D | 06/1993→05/1997 | | | | | | |

| | | | | | | |
|-----------------------|---------|------------|-----|---|----------------------|--|
| V91151 | 0948.53 | | 45° | H | VAG92179 | |
| 42.52 x 8.48 x 115.92 | | MB | | | 55.50 x 8.53 x 14.06 | |
| V91152 | 0949.50 | | 45° | H | | |
| 35.48 x 8.47 x 116.30 | | MD + MB cr | | | | |

|  |  | ccm |  |  |  |  |
|---|---|------|---|---|---|---|
| 1KR-FE | 71.00 | 998 | 3 | 12 | Petrol | 2 |
| 1ND-TV | 73.00 | 1364 | 4 | 8 | Diesel | 4 |
| 1NR-FE | 72.50 | 1329 | 4 | 16 | Petrol | 3 |
| 1NZ-FE | 75.00 | 1496 | 4 | 16 | Petrol | 8 |
| EF13 | 74.00 | 1298 | 4 | 8 | Petrol | 5 |
| EJ16 | 87.90 | 1597 | 4 | 16 | Petrol | 11 |
| EJ20 | 92.00 | 1994 | 4 | 16 | Petrol | 12 |
| EJ20J | 92.00 | 1994 | 4 | 16 | Petrol | 13 |
| G13B | 74.00 | 1299 | 4 | 8 | Petrol | 6 |
| G13BB | 74.00 | 1299 | 4 | 16 | Petrol | 7 |
| M13A | 78.00 | 1328 | 4 | 16 | Petrol | 9 |
| Z 13 DT | 69.60 | 1248 | 4 | 16 | Diesel | 1 |
| Z 22 XE | 86.00 | 2198 | 4 | 16 | Petrol | 10 |

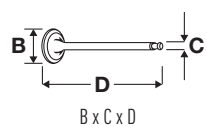

OE

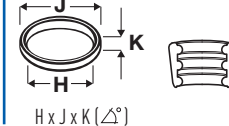
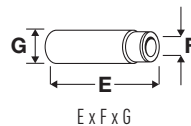
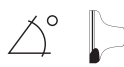

1 69.60

| Z 13 DT | 1248cc | 4 Cyl. | 16 Valves | 51kW/70PS | Diesel | Turbo, DOHC | TD21369 |
|--|-------------|--------|-----------|-----------|---|-------------|---------|
| V95015 ■ 21.85 x 6.00 x 109.20 | 12911-85E00 | | 45° Y | H | VAG96359 ■ ■ ■ 43.28 x 6.00 x 10.25 | | |
| V95016 ■ 21.80 x 6.00 x 109.20 | 12915-85E00 | | 45° | H | | | |

2 71.00

| 1KR-FE | 998cc | 3 Cyl. | 12 Valves | 50-51kW/68-70PS | Petrol | DOHC | TD26119 |
|---|-------------|--------|-----------|-----------------|--|----------|---------|
| JUSTY 1.0 | 11/2016→ | | | JUSTY IV 1.0 | | 01/2007→ | |
| V94969 ■ 27.65 x 4.98 x 88.35 | 13711-40040 | | 45° | H | VAG96067 ■ ■ ■ 34.50 x 5.00 x 9.70 | | |
| V94970 ■ 23.70 x 4.98 x 89.10 | 13715-40040 | | 45° | | | | |

3 72.50

| 1NR-FE | 1329cc | 4 Cyl. | 16 Valves | 69-74kW/94-101PS | Petrol | DOHC | TD25015 |
|--|-------------|--------|-----------|------------------|---|------|---------|
| TREZIA 1.3 | 11/2010→ | | | | | | |
| V95143 ■ 28.90 x 5.48 x 103.35 | 13711-47010 | | 45° | H | VAG96381 ■ ■ ■ 43.60 x 5.50 x 10.34 | | |
| V95144 ■ 24.20 x 5.47 x 104.55 | 13715-47010 | | 45° | | | | |

4 73.00

| 1ND-TV | 1364cc | 4 Cyl. | 8 Valves | 55-66kW/75-90PS | Diesel | Turbo, SOHC | TD25016 |
|--|-------------|--------|----------|-----------------|---|-------------|---------|
| TREZIA 1.4 D | 03/2011→ | | | | | | |
| V94670 ■ 30.70 x 6.00 x 100.00 | 13711-33031 | | 45° | H | VAG96357 ■ ■ ■ 40.60 x 6.00 x 11.04 | | |
| V94671 ■ 28.00 x 6.00 x 99.70 | 13715-33040 | | 45° | | | | |

5 74.00

| EF13 | 1298cc | 4 Cyl. | 8 Valves | 50kW/68PS | Petrol | SOHC | TD9008 |
|--|-----------------|--------|----------|-----------|--------|------|--------|
| JUSTY II 1.3 GX | 10/1995→11/2003 | | | | | | |
| V91157 ■ 30.05 x 6.97 x 114.56 | 12915-82000 | | 45° | SS | | | |

6 74.00

| G13B | 1299cc | 4 Cyl. | 8 Valves | 50kW/68PS | Petrol | SOHC, Injection | TD19194 |
|---|-------------|--------|----------|-----------|---|-----------------|---------|
| V94130 ■ 29.20 x 5.50 x 92.20 | 12991-71C00 | | 45° | H | VAG96065 ■ ■ ■ 32.00 x 5.50 x 11.10 | | |
| V94125 ■ 25.00 x 5.50 x 79.80 | 12915-71C50 | | 45° | SS | | | |

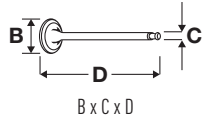

OE

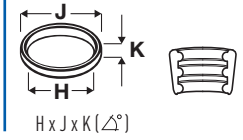
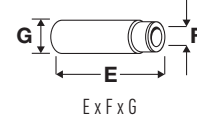





7  **74.00**

| | | | | | | | |
|--------------|-----------------|--------|------------------|-----------------|--------|-------------|----------------|
| G13BB | 1299cc | 4 Cyl. | 16 Valves | 62-63kW/84-86PS | Petrol | SOHC | TD18569 |
| JUSTY II 1.3 | 04/2001→11/2003 | | | | | | |

| | | | | | | |
|---|-------------|---|-----|----|---|---|
| V94125  | 12915-71C50 |  MD + MB tu | 45° | SS | VAG96065  |  |
| 25.00 x 5.50 x 79.80 | | | | | 32.00 x 5.50 x 11.10 | |

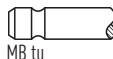

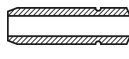

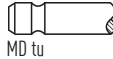

8  **75.00**

| | | | | | | | |
|---------------|----------|--------|------------------|-------------------|--------|-------------|----------------|
| 1N1-FE | 1496cc | 4 Cyl. | 16 Valves | 76-80kW/103-109PS | Petrol | DOHC | TD30984 |
| TREZIA 1.5 | 03/2011→ | | | | | | |

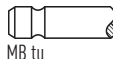
| | | | | | | |
|---|-------------|--|-----|---|---|---|
| V94134  | 13711-21010 |  MB tu | 45° | H | VAG96067  |  |
| 30.50 x 4.97 x 89.20 | | | | | 34.50 x 5.00 x 9.70 | |
| V94135  | 13715-21010 |  MD tu | 45° | | | |
| 25.40 x 4.98 x 88.00 | | | | | | |

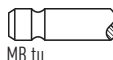

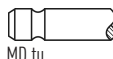

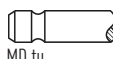

9  **78.00**

| | | | | | | | |
|---------------|----------|--------|------------------|-----------------|--------|-------------|----------------|
| M13A | 1328cc | 4 Cyl. | 16 Valves | 60-69kW/82-94PS | Petrol | DOHC | TD24894 |
| JUSTY III 1.3 | 09/2003→ | | | | | | |

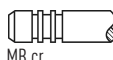
| | | | | | | |
|---|-------------|--|-----|----|--|--|
| V95007  | 12911-69G00 |  MB tu | 45° | H | | |
| 30.00 x 6.00 x 100.80 →12/03 | | | | | | |
| V95141  | 12911-54G00 |  MB tu | 45° | H | | |
| 30.00 x 5.47 x 100.75 01/04→ | | | | | | |
| V95008  | 12915-69G50 |  MD tu | 45° | SS | | |
| 25.00 x 6.00 x 99.10 →12/03 | | | | | | |
| V95142  | 12915-54G00 |  MD tu | 45° | SS | | |
| 25.00 x 5.44 x 99.00 01/04→ | | | | | | |

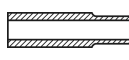

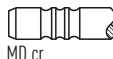
10  **86.00**

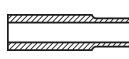
| | | | | | | | |
|----------------|--------|--------|------------------|---------------------|--------|--------------------------------|----------------|
| Z 22 XE | 2198cc | 4 Cyl. | 16 Valves | 106-108kW/144-147PS | Petrol | ECOTEC, DOHC, Injection | TD21370 |
|----------------|--------|--------|------------------|---------------------|--------|--------------------------------|----------------|

| | | | | | | |
|---|----------|--|-----|----|---|---|
| V91997  | 90412277 |  MB cr | 45° | H | VAG96029  |  |
| 32.10 x 5.97 x 102.10 | | | | | 35.00 x 5.99 x 10.05 | |
| V91998  | 90410813 |  MD cr | 45° | SS | VAG96028  |  |
| 29.10 x 5.96 x 92.25 | | | | | 45.00 x 5.99 x 10.05 | |

11  **87.90**

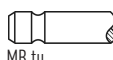
| | | | | | | | |
|--------------|-----------------|--------|------------------|-----------------|-----------------|-------------|---------------|
| EJ16 | 1597cc | 4 Cyl. | 16 Valves | 66-70kW/90-95PS | Petrol | SOHC | TD3634 |
| IMPREZA 1.6 | 06/2001→09/2006 | | IMPREZA 1.6 i | | 08/1992→12/2000 | | |
| LEGACY I 1.6 | 05/1989→12/1993 | | LEGACY I 1.6 GL | | 05/1989→12/1993 | | |

| | | | | | | |
|---|------------|--|-----|---|---|---|
| V94120  | 13201AA420 |  MB tu | 45° | H | VAG96064  |  |
| 32.50 x 5.90 x 120.60 | | | | | 52.50 x 6.02 x 11.07 | |

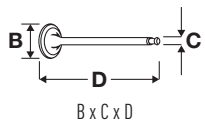

OE



MAT.

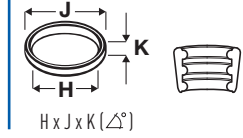
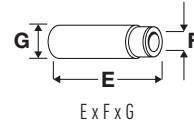
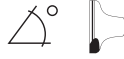

12 92.00







| | | | | | | | |
|-------------|--------|-----------------|-----------|--------------------|--------|------|--------|
| EJ20 | 1994cc | 4 Cyl. | 16 Valves | 82-130kW/112-177PS | Petrol | DOHC | TD3640 |
| IMPREZA 2.0 | | 08/2008→03/2011 | | | | | |

| | | | | | | |
|-----------------------|------------|-------|-----|----|----------------------|--|
| V94122 | 13201AA430 | | 45° | SS | VAG96064 | |
| 34.00 x 5.90 x 120.60 | | MB tu | | | 52.50 x 6.02 x 11.07 | |

13 92.00

| | | | | | | | |
|-------|--------|--------|-----------|------------|--------|------|---------|
| EJ20J | 1994cc | 4 Cyl. | 16 Valves | 92kW/125PS | Petrol | SOHC | TD18955 |
|-------|--------|--------|-----------|------------|--------|------|---------|

| | | | | | | |
|-----------------------|------------|------------|-----|---|----------------------|--|
| V94118 | 13201AA351 | | 45° | H | VAG96064 | |
| 34.00 x 5.90 x 120.60 | | MB tu | | | 52.50 x 6.02 x 11.07 | |
| V94119 | 13202AA361 | | 45° | H | | |
| 30.00 x 5.90 x 121.70 | | MD + MB tu | | | | |

|  |  | ccm |  |  |  |  |
|---|---|------|---|---|---|---|
| 8HY | 73.70 | 1398 | 4 | 16 | Diesel | 9 |
| 9HX | 75.00 | 1560 | 4 | 16 | Diesel | 13 |
| C 14 SE | 77.60 | 1389 | 4 | 8 | Petrol | 16 |
| D13A | 69.60 | 1248 | 4 | 16 | Diesel | 4 |
| D19AA | 82.00 | 1910 | 4 | 8 | Diesel | 19 |
| DW10ATED4 (RHW) | 85.00 | 1997 | 4 | 16 | Diesel | 24 |
| F10A | 65.50 | 970 | 4 | 8 | Petrol | 1 |
| F10D | 68.50 | 1061 | 4 | 16 | Petrol | 3 |
| F10DN | 68.50 | 1061 | 4 | 16 | Petrol | 3 |
| F8B | 68.50 | 796 | 3 | 6 | Petrol | 2 |
| G10 | 74.00 | 993 | 3 | 6 | Petrol | 10 |
| G10A | 74.00 | 993 | 3 | 6 | Petrol | 10 |
| G13A | 74.00 | 1324 | 4 | 8 | Petrol | 12 |
| G13B | 74.00 | 1299 | 4 | 16 | Petrol | 11 |
| G13BB | 74.00 | 1299 | 4 | 16 | Petrol | 11 |
| G16B | 75.00 | 1590 | 4 | 16 | Petrol | 14 |
| J20A | 84.00 | 1995 | 4 | 16 | Petrol | 23 |
| K10B | 73.00 | 998 | 3 | 12 | Petrol | 6 |
| K9K 266 | 76.00 | 1461 | 4 | 8 | Diesel | 15 |
| K9K 700 | 76.00 | 1461 | 4 | 8 | Diesel | 15 |
| M13A | 78.00 | 1328 | 4 | 16 | Petrol | 17 |
| M16A | 78.00 | 1586 | 4 | 16 | Petrol | 18 |
| RF | 86.00 | 1998 | 4 | 8 | Diesel | 26 |
| RHZ | 85.00 | 1997 | 4 | 8 | Diesel | 25 |
| XUD9 | 83.00 | 1905 | 4 | 8 | Diesel | 20 |
| XUD9A | 83.00 | 1905 | 4 | 8 | Diesel | 21 |
| XUD9SD | 83.00 | 1905 | 4 | 8 | Diesel | 22 |
| Z 10 XEP | 73.40 | 998 | 3 | 12 | Petrol | 7 |
| Z 12 XEP | 73.40 | 1229 | 4 | 16 | Petrol | 8 |
| Z 13 DT | 69.60 | 1248 | 4 | 16 | Diesel | 5 |
| Z 13 DTJ | 69.60 | 1248 | 4 | 16 | Diesel | 5 |

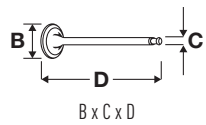

OE

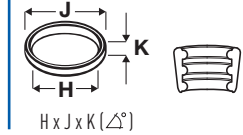
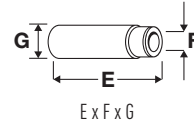
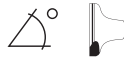

1 65.50

| F10A | 970cc | 4 Cyl. | 8 Valves | 29-40kW/39-54PS | Petrol | SOHC | TD3650 |
|-----------------|-------|--------|----------|-----------------|--------|------|-----------------|
| CARRY 1.0 | | | | SAMURAI 1.0 | | | 11/1988→12/2004 |
| SC100 1.0 | | | | SIERRA 1.0 | | | 09/1981→12/1988 |
| SIERRA II 1.0 | | | | SJ 410 1.0 | | | 09/1981→12/1988 |
| SUPER CARRY 1.0 | | | | | | | |

V91253 ■
31.70 x 6.98 x 110.00

12911-78101

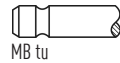

45°

H

V91254 ■
27.65 x 6.97 x 109.85

12915-84000

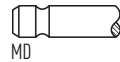

45°

2 68.50

| F8B | 796cc | 3 Cyl. | 6 Valves | 25-30kW/34-41PS | Petrol | SOHC | TD3655 |
|------------|-------|--------|----------|-----------------|--------|------|-----------------|
| ALTO 0.8 | | | | HATCH 0.8 | | | 11/1980→12/1985 |
| MARUTI 800 | | | | | | | |

V94368 ■
35.70 x 5.50 x 110.50

12911-78B00

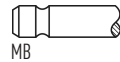

45°

H

V94369 ■
31.80 x 5.50 x 110.20

96352793

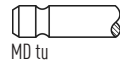

45°

st

3 68.50

| F10D | 1061cc | 4 Cyl. | 16 Valves | 46kW/63PS | Petrol | | TD24250 |
|----------|--------|--------|-----------|-----------|--------|--|-----------------|
| F10DN | 1061cc | 4 Cyl. | 16 Valves | 46kW/63PS | Petrol | | TD22103 |
| ALTO 1.1 | | | | | | | 09/2004→12/2008 |

V98087 ■
26.70 x 5.47 x 90.50

12911-M84420

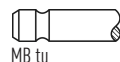

45°

4 69.60

| D13A | 1248cc | 4 Cyl. | 16 Valves | 55kW/75PS | Diesel | Turbo, DOHC | TD21664 |
|-------------------|--------|--------|-----------|--------------------|--------|-------------|----------|
| SPLASH 1.3 CDTi | | | | SWIFT III 1.3 DDiS | | | 01/2008→ |
| SWIFT IV 1.3 DDiS | | | | | | | 10/2010→ |

V95182 ■
21.85 x 5.98 x 109.25

12911-68L10-000

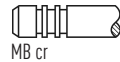

45°

H

VAG96359 ■ ■
43.28 x 6.00 x 10.25

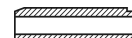

V95183 ■
22.50 x 5.99 x 109.20

12915-68L10-000



45°

ss

H

5 69.60

| Z 13 DT | 1248cc | 4 Cyl. | 16 Valves | 51kW/69PS | Diesel | Turbo, DOHC | TD18265 |
|--------------------|--------|--------|-----------|-------------------|--------|-------------|----------|
| Z 13 DTJ | 1248cc | 4 Cyl. | 16 Valves | 55kW/75PS | Diesel | Turbo, DOHC | TD21665 |
| IGNIS II 1.3 DDiS | | | | SPLASH 1.3 CDTi | | | 01/2008→ |
| SWIFT III 1.3 DDiS | | | | WAGON R+ 1.3 DDiS | | | 09/2003→ |

V95015 ■
21.85 x 6.00 x 109.20

12911-85E00

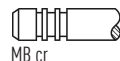

45°

Y

H

VAG96359 ■ ■
43.28 x 6.00 x 10.25



V95016 ■
21.80 x 6.00 x 109.20

12915-85E00



45°



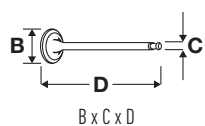

H

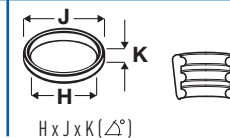
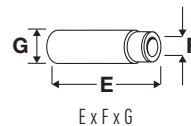
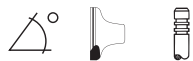





OE

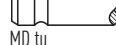



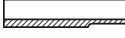

6  **73.00**

| | | | | | | | |
|---|------------------|---|-----------|-----------------|---|----------------------|----------------|
| K10B | 998cc | 3 Cyl. | 12 Valves | 48-50kW/65-68PS | Petrol | DOHC | TD21662 |
| ALTO 1.0 | 01/2009→ | | | CELERIO 1.0 | | 03/2014→ | |
| KARIMUN WAGON R 1.0 | 09/2013→ | | | SPLASH 1.0 | | 01/2008→ | |
| V95224  | 12911-51K00 |  | 45° | H | VAG96385  | 34.00 x 5.51 x 10.59 | |
| 27.50 x 5.47 x 87.50 | | MB tu | | | | | |
| V95225  | 12915-M68K00-000 |  | 45° | | | | |
| 22.95 x 5.46 x 87.05 | | MD tu | | | | | |



7  **73.40**

| | | | | | | | |
|---|-----------------|---|-----------|-----------|---|----------------------|----------------|
| Z 10 XEP | 998cc | 3 Cyl. | 12 Valves | 44kW/60PS | Petrol | DOHC | TD27099 |
| WAGON R 1.0 | 06/2004→08/2005 | | | | | | |
| V94245  | 90529527 |  | 45° | H | VAG96077  | 39.00 x 5.00 x 10.04 | |
| 28.00 x 5.00 x 93.90 | | MB cr | | | | | |
| V94246  | 90529529 |  | 45° | | | | |
| 25.00 x 5.00 x 93.90 | | MD cr | | | | | |

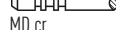

8  **73.40**

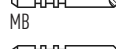
| | | | | | | | |
|---|-----------------|---|-----------|-----------|---|----------------------|----------------|
| Z 12 XEP | 1229cc | 4 Cyl. | 16 Valves | 59kW/80PS | Petrol | DOHC | TD19903 |
| WAGON R 1.2 | 06/2004→08/2005 | | | | | | |
| V94245  | 90529527 |  | 45° | H | VAG96077  | 39.00 x 5.00 x 10.04 | |
| 28.00 x 5.00 x 93.90 | | MB cr | | | | | |
| V94246  | 90529529 |  | 45° | | | | |
| 25.00 x 5.00 x 93.90 | | MD cr | | | | | |

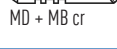
9  **73.70**

| | | | | | | | |
|---|----------|---|-----------|-----------|--------|---|---------------------|
| 8HY | 1398cc | 4 Cyl. | 16 Valves | 66kW/90PS | Diesel | | TD18220 |
| LIANA 1.4 DDiS | 04/2004→ | | | | | | |
| V94603  | 0948.C4 |  | 45° | Y | H | VAG96364  | 34.20 x 5.50 x 9.53 |
| 24.30 x 5.50 x 96.40 | | MB | | | | | |
| V94604  | 0949.C1 |  | 45° | SS | H | | |
| 22.35 x 5.50 x 96.60 | | MD + MB cr | | | | | |

10  **74.00**

| | | | | | | | |
|---|-----------------|---|----------|-----------------|--------|-----------------|----------------|
| G10 | 993cc | 3 Cyl. | 6 Valves | 36-52kW/48-70PS | Petrol | | TD18370 |
| G10A | 993cc | 3 Cyl. | 6 Valves | 37-41kW/50-56PS | Petrol | | TD3658 |
| FORSA 1.0 | 09/1984→12/1988 | | | LJ 81 1.0 | | 09/1980→12/1981 | |
| SWIFT I 1.0 | 10/1983→03/1989 | | | SWIFT II 1.0 | | 03/1989→05/2001 | |
| SWIFT II 1.0 i | 03/1989→12/2005 | | | WAGON R 1.0 | | 07/2003→08/2005 | |
| V91157  | 12915-82000 |  | 45° | SS | | | |
| 30.05 x 6.97 x 114.56 | | MD tu | | | | | |

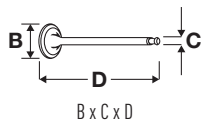

OE

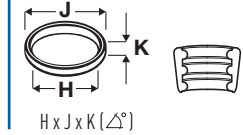
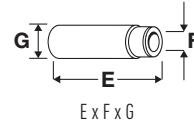
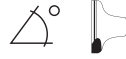

11 74.00

| Part No. | Capacity | Cyls | Valves | Power | Fuel | Configuration | Code |
|---------------------|-----------------|--------|-----------|------------------|--------|---------------|-----------------|
| G13B | 1299cc | 4 Cyl. | 16 Valves | 44-74kW/60-101PS | Petrol | SOHC | TD4915 |
| G13BB | 1299cc | 4 Cyl. | 16 Valves | 56-63kW/76-86PS | Petrol | SOHC | TD11288 |
| ALTO 1.3 | 10/1998→09/2000 | | | BALENO 1.3 16V | | | 03/1997→05/2002 |
| BALENO 1.3 i 16V | 07/1995→05/2002 | | | CARRY 1.3 | | | 02/1999→ |
| CARRY 1.3 16 V | 03/2000→ | | | FARMWORKER 1.3 | | | 01/2011→ |
| GRAND VITARA II 1.3 | 05/2005→07/2006 | | | JIMNY 1.3 | | | 09/1998→08/2000 |
| JIMNY 1.3 16V | 09/1998→ | | | SAMURAI 1.3 | | | 11/1988→12/2004 |
| SJ 413 1.3 | 09/1984→08/1990 | | | SWIFT 1.3 i | | | 01/1992→10/1996 |
| SWIFT I 1.3 GTi/GXi | 08/1985→03/1989 | | | SWIFT II 1.3 | | | 03/1989→12/2003 |
| SWIFT II 1.3 GTi | 03/1989→05/2001 | | | WAGON R+ 1.3 | | | 04/1999→ |

V94130 ■
29.20 x 5.50 x 92.20

12991-71C00

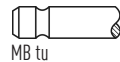

45°

H

VAG96065 ■ ■ ■
32.00 x 5.50 x 11.10

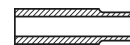

V94125 ■
25.00 x 5.50 x 79.80

12915-71C50



45°

SS

12 74.00

| Part No. | Capacity | Cyls | Valves | Power | Fuel | Configuration | Code |
|--------------|-----------------|--------|----------|-----------------|--------|---------------|-----------------|
| G13A | 1324cc | 4 Cyl. | 8 Valves | 44-54kW/60-73PS | Petrol | SOHC | TD3659 |
| SAMURAI 1.3 | 11/1988→12/2004 | | | SIERRA 1.3 | | | 09/1984→03/1990 |
| SJ 413 1.3 | 09/1984→08/1990 | | | SWIFT I 1.3 | | | 10/1984→03/1989 |
| SWIFT II 1.3 | 03/1989→05/2001 | | | VITARA 1.3 | | | 09/1988→12/1989 |

V91157 ■
30.05 x 6.97 x 114.56

12915-82000

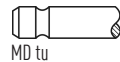

45°

SS

13 75.00

| Part No. | Capacity | Cyls | Valves | Power | Fuel | Configuration | Code |
|--------------|----------|--------|-----------|-----------|--------|---------------|---------|
| 9HX | 1560cc | 4 Cyl. | 16 Valves | 66kW/90PS | Diesel | Turbo, DOHC | TD21659 |
| SX4 1.6 DDIS | 04/2007→ | | | | | | |

V94960 ■
25.60 x 5.50 x 96.35

0948.C7

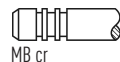

45°

H

VAG96364 ■ ■ ■
34.20 x 5.50 x 9.53



V94961 ■
23.40 x 5.50 x 96.50

0949.C3



45°

SS

H

14 75.00

| Part No. | Capacity | Cyls | Valves | Power | Fuel | Configuration | Code |
|------------------|-----------------|--------|-----------|--------------------|--------|---------------|-----------------|
| G16B | 1590cc | 4 Cyl. | 16 Valves | 68-73kW/92-99PS | Petrol | SOHC | TD4917 |
| ALTO 1.6 | 10/1998→09/2000 | | | BALENO 1.6 | | | 09/1997→12/2000 |
| BALENO 1.6 i 16V | 07/1995→05/2002 | | | GRAND VITARA I 1.6 | | | 03/1998→09/2005 |
| SWIFT II 1.6 | 03/1989→10/1996 | | | SWIFT II 1.6 i | | | 01/1990→05/2001 |
| VITARA 1.6 | 02/1991→03/1998 | | | VITARA 1.6 16V | | | 10/1999→10/2002 |
| VITARA 1.6 i 16V | 01/1990→03/1999 | | | X-90 1.6 i 16V | | | 09/1995→12/1997 |

V94130 ■
29.20 x 5.50 x 92.20

12991-71C00

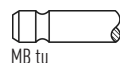

45°

H

VAG96065 ■ ■ ■
32.00 x 5.50 x 11.10

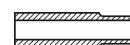

V94125 ■
25.00 x 5.50 x 79.80

12915-71C50



45°

SS



OE

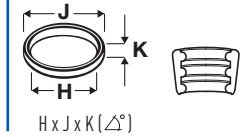
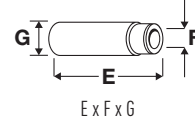
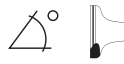

15 **76.00**

| | | | | | | | |
|----------------|--------|----------|-----------------|-----------------|--------|--------------------|----------------|
| K9K 266 | 1461cc | 4 Cyl. | 8 Valves | 63kW/86PS | Diesel | Turbo, SOHC | TD24900 |
| K9K 700 | 1461cc | 4 Cyl. | 8 Valves | 48-50kW/65-68PS | Diesel | Turbo, SOHC | TD21367 |
| JIMNY 1.5 DDiS | | 12/2003→ | | | | | |

| | | | | | | | |
|-----------------------|-------------|---------|-----|---|---|----------------------|--|
| V94608 | 13201-BN700 | | 45° | Y | H | VAG96354B | |
| 33.50 x 6.00 x 100.90 | | MB | | | | 40.50 x 6.00 x 12.08 | |
| V94609 | 13202-BN700 | | 45° | | H | | |
| 29.00 x 6.00 x 100.70 | | MD + MB | | | | | |

16 **77.60**

| | | | | | | | |
|----------------|--------|-----------------|-----------------|-----------------|--------|-------------|----------------|
| C 14 SE | 1389cc | 4 Cyl. | 8 Valves | 60-63kW/82-86PS | Petrol | SOHC | TD26149 |
| FUN 1.4 | | 02/2004→12/2012 | | | | | |

| | | | | | | | |
|-----------------------|----------|-------|-----|--|---|----------------------|--|
| V91959 | 90409992 | | 45° | | H | VAG96022 | |
| 38.00 x 7.00 x 104.60 | | MB cr | | | | 45.80 x 7.02 x 11.04 | |
| V91960 | 90409996 | | 45° | | | | |
| 31.00 x 7.00 x 104.60 | | MD | | | | | |

17 **78.00**

| | | | | | | | |
|--------------------|-----------------|--------|---------------------|-----------------|-----------------|-------------|----------------|
| M13A | 1328cc | 4 Cyl. | 16 Valves | 59-69kW/80-94PS | Petrol | DOHC | TD17430 |
| GRAND VITARA I 1.3 | 03/1998→07/2003 | | GRAND VITARA II 1.3 | | 08/2006→02/2015 | | |
| IGNIS I 1.3 | 10/2000→09/2003 | | IGNIS II 1.3 | | 09/2003→ | | |
| JIMNY 1.3 | 09/2000→ | | JIMNY 1.3 16V | | 02/2001→ | | |
| LIANA 1.3 | 07/2001→ | | SOLIO 1.3 | | 04/2004→05/2008 | | |
| SWIFT III 1.3 | 02/2005→ | | WAGON R+ 1.3 | | 08/2001→ | | |

| | | | | | | | |
|---------------------------------|-------------|-------|-----|----|---|----------------------|--|
| V95007 | 12911-69G00 | | 45° | | H | VAG96391 | |
| 30.00 x 6.00 x 100.80 →12/03 | | MB tu | | | | 40.00 x 5.50 x 10.57 | |
| V95141 | 12911-54G00 | | 45° | | H | | |
| 30.00 x 5.47 x 100.75 01/04→ | | MB tu | | | | | |
| V95008 | 12915-69G50 | | 45° | SS | | | |
| 25.00 x 6.00 x 99.10 →12/03 | | MD tu | | | | | |
| V95142 | 12915-54G00 | | 45° | SS | | | |
| 25.00 x 5.44 x 99.00 01/04→ | | MD tu | | | | | |

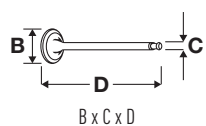

OE

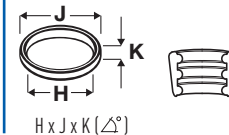
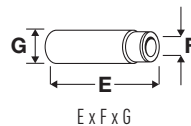
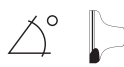

18 78.00

| M16A | 1586cc | 4 Cyl. | 16 Valves | 73-104kW/99-142PS | Petrol | DOHC | TD18221 |
|---------------------|----------|--------|-----------|-------------------|--------|----------|---------|
| GRAND VITARA II 1.6 | 04/2005→ | | | JIMNY 1.6 VVT | | 05/2004→ | |
| LIANA 1.6 | 06/2001→ | | | LIANA 1.6 i | | 04/2002→ | |
| SWIFT III 1.6 | 05/2006→ | | | SWIFT IV 1.6 | | 01/2012→ | |
| SX4 1.6 | 06/2006→ | | | SX4 1.6 VVT | | 06/2006→ | |
| VITARA 1.6 | 02/2015→ | | | | | | |

| | | | | | | |
|--|-------------|-------|-----|----|---|--|
| V95007 ■ 30.00 x 6.00 x 100.80 →12/03 | 12911-69G00 | MB tu | 45° | H | VAG96391 ■ ■ ■ 40.00 x 5.50 x 10.57 | |
| V95141 ■ 30.00 x 5.47 x 100.75 01/04→ | 12911-54G00 | MB tu | 45° | H | | |
| V95008 ■ 25.00 x 6.00 x 99.10 →12/03 | 12915-69G50 | MD tu | 45° | SS | | |
| V95142 ■ 25.00 x 5.44 x 99.00 01/04→ | 12915-54G00 | MD tu | 45° | SS | | |

19 82.00

| D19AA | 1910cc | 4 Cyl. | 8 Valves | 88kW/120PS | Diesel | Turbo, SOHC | TD20931 |
|--------------|----------|--------|----------|------------|--------|-------------|---------|
| SX4 1.9 DDiS | 06/2006→ | | | | | | |

| | | | | | | |
|--|------------|------------|-----|---|---|--|
| V94470 ■ 35.30 x 8.00 x 115.00 | 46 750 859 | MD + MB cr | 45° | H | VAG96124 ■ ■ ■ 42.90 x 8.02 x 14.06 | |
| V94471 ■ 34.50 x 8.00 x 115.00 | 46 783 962 | MD + MB cr | 45° | H | VAG96203 ■ ■ ■ 43.00 x 8.03 x 14.08 | |
| | | | | | VAG96210 ■ ■ ■ 43.00 x 8.04 x 14.04 | |

20 83.00

| XUD9 | 1905cc | 4 Cyl. | 8 Valves | 46-50kW/63-68PS | Diesel | Turbo, SOHC | TD16375 |
|----------------|-----------------|--------|----------|-----------------|--------|-------------|---------|
| SAMURAI 1.9 TD | 11/1998→12/2004 | | | | | | |

| | | | | | | |
|--|---------|-------|-----|---|--|--|
| V91144 ■ 38.50 x 8.00 x 112.50 | 0948.63 | MB | 45° | H | VAG92288B ■ ■ ■ 52.00 x 8.03 x 14.28 | |
| V91145 ■ 33.00 x 8.00 x 112.00 | 0949.47 | MD cr | 45° | | VAG92465B ■ ■ ■ 52.00 x 8.03 x 14.07 | |



OE

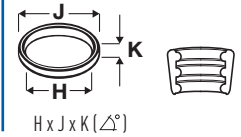
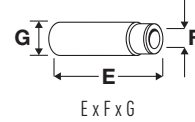
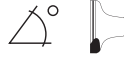

21



83.00

| XUD9A | 1905cc | 4 Cyl. | 8 Valves | 50kW/68PS | Diesel | SOHC | TD5443 |
|---------------------------------|---------|-----------------|----------|-----------|------------------------|------|--------|
| VITARA 1.9 D | | 01/1995→03/1998 | | | | | |
| V91143 ■ | 0948.49 | | 30° | H | VAG92288B ■ ■ ■ | | |
| 38.00 x 8.00 x 112.40 →01/86 | | | | | | | |
| V91144 ■ | 0948.63 | | 45° | H | VAG92331B ■ ■ ■ | | |
| 38.50 x 8.00 x 112.50 01/86→ | | | | | | | |
| V91145 ■ | 0949.47 | | 45° | | VAG92465B ■ ■ ■ | | |
| 33.00 x 8.00 x 112.00 | | | | | | | |
| V94024 ■ | 0949.64 | | 45° | | | | |
| 33.00 x 8.00 x 112.00 | | | | | | | |

22



83.00

| XUD9SD | 1905cc | 4 Cyl. | 8 Valves | 55kW/75PS | Diesel | Turbo, SOHC | TD22439 |
|-----------------------|---------|----------------------|----------|-----------|------------------------|-------------|---------|
| VITARA 1.9 D | | 08/1996→03/1999 | | | | | |
| V91144 ■ | 0948.63 | | 45° | H | VAG92288B ■ ■ ■ | | |
| 38.50 x 8.00 x 112.50 | | | | | | | |
| V91145 ■ | 0949.47 | | 45° | | VAG92331B ■ ■ ■ | | |
| 33.00 x 8.00 x 112.00 | | | | | | | |
| | | | | | VAG92465B ■ ■ ■ | | |
| | | 52.00 x 8.03 x 14.07 | | | | | |

23



84.00

| J20A | 1995cc | 4 Cyl. | 16 Valves | 94-108kW/128-147PS | Petrol | DOHC | TD18366 |
|----------------------|-------------|-----------------|-----------|---------------------|--------|-----------------|---------|
| GRAND VITARA I 2.0 | | 03/1998→08/2005 | | GRAND VITARA II 2.0 | | 10/2005→ | |
| LIANA 2.0 | | 09/2001→03/2004 | | SX4 2.0 | | 06/2006→ | |
| VITARA 2.0 | | 10/2016→ | | VITARA 2.0 16V | | 12/1996→03/1999 | |
| V94129 ■ | 12915-86F50 | | 45° | | | | |
| 28.00 x 5.95 x 85.90 | | | | | | | |

24



85.00

| DW10ATED4 (RHW) | 1997cc | 4 Cyl. | 16 Valves | 80kW/109PS | Diesel | Turbo, DOHC | TD18270 |
|--------------------------------|---------|-----------------|-----------|-------------------------|--------|-----------------------|---------|
| GRAND VITARA I 2.0 HDi 110 16V | | 07/2001→09/2005 | | GRAND VITARA II 2.0 HDi | | 01/2006→02/2015 | |
| V94486 ■ | 0948.C0 | | 45° | Y | H | VAG96119 ■ ■ ■ | |
| 29.90 x 6.00 x 106.20 | | | | | | | |
| V94487 ■ | 0949.A9 | | 45° | SS | H | | |
| 25.00 x 6.00 x 106.10 | | | | | | | |



OE

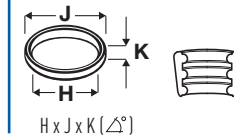
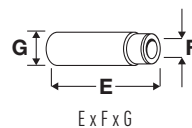



25  **85.00**





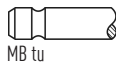

| | | | | | | | |
|----------------------------|--------|-----------------|-----------------|------------|--------|--------------------|----------------|
| RHZ | 1997cc | 4 Cyl. | 8 Valves | 80kW/109PS | Diesel | Turbo, SOHC | TD19715 |
| GRAND VITARA I 2.0 HDI 110 | | 07/2001→09/2005 | | | | | |

| | | | | | | | |
|---|---------|---|-----|---|--|---|--|
| V94178  | 0948.95 |  MB cr | 45° | H | VAG96119  |  | |
| 35.60 x 6.00 x 107.10 | | | | | 41.50 x 6.03 x 10.54 | | |
| V94179  | 0949.96 |  MD + MB cr | 45° | H | | | |
| 33.80 x 6.00 x 107.10 | | | | | | | |

26  **86.00**

| | | | | | | | |
|---------------------------|--------|-----------------|-----------------|-----------------|--------|-------------------|---------------|
| RF | 1998cc | 4 Cyl. | 8 Valves | 52-68kW/71-92PS | Diesel | Turbo, OHV | TD5444 |
| GRAND VITARA I 2.0 TD | | 03/1998→07/2003 | | VITARA 2.0 TD | | 12/1994→03/1998 | |
| VITARA 2.0 TD Intercooler | | 12/1995→03/1998 | | | | | |

| | | | | | | | |
|---|-------------|---|-----|---|--|--|--|
| V94510  | 12911-78E00 |  MB tu | 30° | H | | | |
| 39.30 x 8.00 x 106.80 | | | | | | | |
| V94511  | 12915-78E00 |  MD + MB tu | 45° | H | | | |
| 35.10 x 8.00 x 106.70 | | | | | | | |

|  |  | ccm |  |  |  |  |
|---|---|------|---|---|---|---|
| 1AD-FTV | 86.00 | 1998 | 4 | 16 | Diesel | 27 |
| 1AZ-FE | 86.00 | 1998 | 4 | 16 | Petrol | 28 |
| 1AZ-FSE | 86.00 | 1998 | 4 | 16 | Petrol | 28 |
| 1C | 83.00 | 1839 | 4 | 8 | Diesel | 23 |
| 1CD-FTV | 82.20 | 1995 | 4 | 16 | Diesel | 22 |
| 1C-L | 83.00 | 1839 | 4 | 8 | Diesel | 24 |
| 1C-TL | 83.00 | 1839 | 4 | 8 | Diesel | 24 |
| 1E | 70.50 | 999 | 4 | 12 | Petrol | 2 |
| 1E-L | 70.50 | 999 | 4 | 12 | Petrol | 2 |
| 1HD-T | 94.00 | 4164 | 6 | 12 | Diesel | 37 |
| 1H-Z | 94.00 | 4164 | 6 | 12 | Diesel | 37 |
| 1KD-FTV | 96.00 | 2982 | 4 | 16 | Diesel | 39 |
| 1KR-FE | 71.00 | 998 | 3 | 12 | Petrol | 3 |
| 1KZ-T | 96.00 | 2982 | 4 | 8 | Diesel | 40 |
| 1KZ-TE | 96.00 | 2982 | 4 | 8 | Diesel | 41 |
| 1ND-TV | 73.00 | 1364 | 4 | 8 | Diesel | 7 |
| 1NR-FE | 72.50 | 1329 | 4 | 16 | Petrol | 5 |
| 1NZ-FE | 75.00 | 1497 | 4 | 16 | Petrol | 11 |
| 1NZ-FNE | 75.00 | 1497 | 4 | 16 | Petrol | 12 |
| 1NZ-FXE | 75.00 | 1497 | 4 | 16 | Petrol | 11 |
| 1SZ-FE | 69.00 | 998 | 4 | 16 | Petrol | 1 |
| 1WZ | 82.20 | 1867 | 4 | 8 | Diesel | 21 |
| 1ZR-FE | 80.50 | 1598 | 4 | 16 | Petrol | 16 |
| 1ZZ-FE | 79.00 | 1794 | 4 | 16 | Petrol | 15 |
| 2AD-FHV | 86.00 | 2231 | 4 | 16 | Diesel | 32 |
| 2AD-FTV | 86.00 | 2231 | 4 | 16 | Diesel | 32 |
| 2C | 86.00 | 1975 | 4 | 8 | Diesel | 25 |
| 2C-T | 86.00 | 1975 | 4 | 8 | Diesel | 26 |
| 2E | 73.00 | 1296 | 4 | 12 | Petrol | 6 |
| 2E-E | 73.00 | 1296 | 4 | 12 | Petrol | 6 |
| 2E-L | 73.00 | 1296 | 4 | 12 | Petrol | 6 |
| 2E-LC | 73.00 | 1296 | 4 | 12 | Petrol | 6 |
| 2KD-FTV | 92.00 | 2494 | 4 | 16 | Diesel | 36 |
| 2L | 92.00 | 2446 | 4 | 8 | Diesel | 34 |
| 2L-T | 92.00 | 2446 | 4 | 8 | Diesel | 34 |
| 2L-TII | 92.00 | 2446 | 4 | 8 | Diesel | 35 |
| 2NZ-FE | 75.00 | 1299 | 4 | 16 | Petrol | 10 |
| 2SZ-FE | 72.00 | 1298 | 4 | 16 | Petrol | 4 |
| 2WZ-TV | 73.70 | 1398 | 4 | 8 | Diesel | 8 |
| 2ZZ-GE | 82.00 | 1796 | 4 | 16 | Petrol | 20 |
| 3C-TE | 86.00 | 2184 | 4 | 8 | Diesel | 31 |
| 3L | 96.00 | 2779 | 4 | 8 | Diesel | 38 |
| 3S-FE | 86.00 | 1998 | 4 | 16 | Petrol | 29 |
| 3S-GE | 86.00 | 1998 | 4 | 16 | Petrol | 30 |
| 3S-GTE | 86.00 | 1998 | 4 | 16 | Petrol | 30 |
| 3ZZ-FE | 79.00 | 1598 | 4 | 16 | Petrol | 14 |
| 4A-F | 81.00 | 1587 | 4 | 16 | Petrol | 17 |
| 4A-FE | 81.00 | 1587 | 4 | 16 | Petrol | 18 |
| 4ZZ-FE | 79.00 | 1398 | 4 | 16 | Petrol | 13 |
| 5E-FE | 74.00 | 1497 | 4 | 16 | Petrol | 9 |
| 7A-FE | 81.00 | 1762 | 4 | 16 | Petrol | 19 |
| L | 90.00 | 2188 | 4 | 8 | Diesel | 33 |

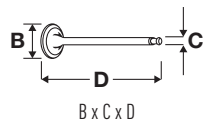

OE

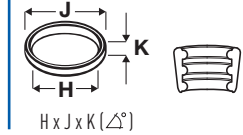
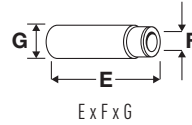
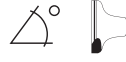

1 69.00

| | | | | | | | |
|---------------|-----------------|--------|------------------|-----------------|--------|-------------|----------------|
| 1SZ-FE | 998cc | 4 Cyl. | 16 Valves | 48-50kW/65-68PS | Petrol | DOHC | TD11808 |
| ECHO 1.0 | 03/1999→08/2005 | | PLATZ 1.0 | 04/1999→08/2005 | | | |
| YARIS 1.0 | 04/1999→09/2005 | | | | | | |

| | | | | | | |
|----------------------|-------------|-------|-----|---|---------------------|--|
| V94132 | 13711-23030 | | 45° | H | VAG96067 | |
| 26.00 x 5.00 x 88.20 | | MB tu | | | 34.50 x 5.00 x 9.70 | |
| V94133 | 13715-23030 | | 45° | | | |
| 22.60 x 5.00 x 89.10 | | MD tu | | | | |

2 70.50

| | | | | | | | |
|-------------|-----------------|--------|------------------|-----------|--------|-------------|---------------|
| 1E | 999cc | 4 Cyl. | 12 Valves | 40kW/54PS | Petrol | SOHC | TD3718 |
| 1E-L | 999cc | 4 Cyl. | 12 Valves | 40kW/54PS | Petrol | SOHC | TD3719 |
| STARLET 1.0 | 10/1984→12/1992 | | | | | | |

| | | | | | | |
|----------------------|-------------|-------|-----|---|----------------------|--|
| V91244 | 13711-10020 | | 45° | H | VAG92325 | |
| 30.10 x 5.99 x 92.30 | | MB tu | | | 40.50 x 6.00 x 11.04 | |
| V91245 | 13712-10010 | | 45° | H | | |
| 21.00 x 5.99 x 98.50 | | MB tu | | | | |
| V91246 | 13715-10030 | | 45° | | | |
| 31.10 x 5.98 x 92.30 | | MD tu | | | | |

3 71.00

| | | | | | | | |
|------------------|----------|--------|------------------|-----------------|--------|-------------|----------------|
| 1KR-FE | 998cc | 3 Cyl. | 12 Valves | 48-52kW/65-71PS | Petrol | DOHC | TD18481 |
| AYGO 1.0 | 07/2005→ | | AYGO 1.0 GPL | 07/2005→ | | | |
| IQ 1.0 | 01/2009→ | | PASSO 1.0 | 06/2005→ | | | |
| TANK / ROOMY 1.0 | 11/2016→ | | VIOS/YARIS 1.0 | 08/2007→ | | | |
| YARIS 1.0 | 12/2010→ | | YARIS 1.0 GPL | 01/2006→ | | | |
| YARIS 1.0 VWT-i | 01/2005→ | | | | | | |

| | | | | | | |
|----------------------|-------------|----|-----|---|---------------------|--|
| V94969 | 13711-40040 | | 45° | H | VAG96067 | |
| 27.65 x 4.98 x 88.35 | | MB | | | 34.50 x 5.00 x 9.70 | |
| V94970 | 13715-40040 | | 45° | | | |
| 23.70 x 4.98 x 89.10 | | MD | | | | |

4 72.00

| | | | | | | | |
|-----------------|-----------------|--------|------------------|-----------------|--------|-------------|----------------|
| 2SZ-FE | 1298cc | 4 Cyl. | 16 Valves | 57-64kW/76-87PS | Petrol | DOHC | TD17287 |
| ECHO 1.3 | 04/2003→08/2005 | | RACTIS 1.3 | 09/2005→08/2010 | | | |
| VIOS/YARIS 1.3 | 08/2007→ | | YARIS 1.3 | 08/1999→ | | | |
| YARIS 1.3 VWT-i | 01/2005→ | | | | | | |

| | | | | | | |
|----------------------|-------------|-------|-----|---|---------------------|--|
| V94132 | 13711-23030 | | 45° | H | VAG96067 | |
| 26.00 x 5.00 x 88.20 | | MB tu | | | 34.50 x 5.00 x 9.70 | |
| V94133 | 13715-23030 | | 45° | | | |
| 22.60 x 5.00 x 89.10 | | MD tu | | | | |

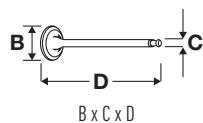

OE

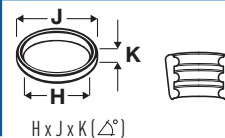
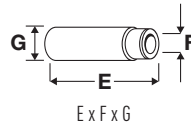

5 **72.50**

| 1NR-FE | 1329cc | 4 Cyl. | 16 Valves | 62-74kW/84-101PS | Petrol | DOHC | TD21740 |
|------------------|--------|--------|-----------|--------------------|--------|-----------------|---------|
| AURIS 1.3 | | | | AURIS 1.33-VVTi | | 05/2009→09/2012 | |
| COROLLA 1.3 | | | | COROLLA 1.33 | | 01/2007→ | |
| ETIOS 1.3 | | | | IQ 1.33 | | 01/2009→ | |
| PASSO 1.3 | | | | PORTE II 1.3 | | 08/2012→ | |
| SPADE 1.3 | | | | URBAN CRUISER 1.33 | | 01/2009→ | |
| VERSO S 1.33 | | | | YARIS 1.3 | | 12/2010→ | |
| YARIS 1.33 VVT-i | | | | | | | |

V95143
28.90 x 5.48 x 103.35

13711-47010

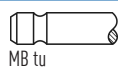

45°

H

VAG96381
43.60 x 5.50 x 10.34



V95144
24.20 x 5.47 x 104.55

13715-47010

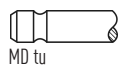

45°

6 **73.00**

| 2E | 1296cc | 4 Cyl. | 12 Valves | 48-60kW/65-82PS | Petrol | SOHC | TD4935 |
|---------------------|--------|--------|-----------|-----------------|--------|-----------------|--------|
| 2E-E | 1296cc | 4 Cyl. | 12 Valves | 55kW/75PS | Petrol | SOHC | TD4936 |
| 2E-L | 1296cc | 4 Cyl. | 12 Valves | 55-60kW/75-82PS | Petrol | SOHC | TD4937 |
| 2E-LC | 1296cc | 4 Cyl. | 12 Valves | 52-55kW/71-75PS | Petrol | SOHC | TD3756 |
| CONQUEST 1.3 | | | | COROLLA 1.3 | | 08/1983→10/2001 | |
| COROLLA 1.3 12V | | | | COROLLA 1.3 i | | 08/1987→12/1992 | |
| COROLLA FX 1.3 | | | | SPRINTER 1.3 | | 06/1983→04/1992 | |
| STARLET 1.3 | | | | STARLET 1.3 12V | | 12/1989→12/1992 | |
| STARLET 1.3 12V Cat | | | | STARLET 1.3 XL | | 12/1989→12/1991 | |
| TAZZ 1.3 | | | | TERCEL 1.3 12V | | 05/1986→06/1999 | |

V91244
30.10 x 5.99 x 92.30

13711-10020

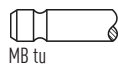

45°

H

VAG92325
40.50 x 6.00 x 11.04

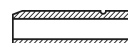

V91245
21.00 x 5.99 x 98.50

13712-10010

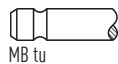

45°

H

V91246
31.10 x 5.98 x 92.30

13715-10030

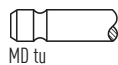

45°

7 **73.00**

| 1ND-TV | 1364cc | 4 Cyl. | 8 Valves | 50-66kW/68-90PS | Diesel | Turbo, SOHC | TD16378 |
|---------------------------|--------|--------|----------|------------------------|--------|-----------------|---------|
| AURIS 1.4 D-4D | | | | AURIS VAN 1.4 D-4D | | 03/2013→ | |
| COROLLA 1.4 D | | | | COROLLA 1.4 D4-D | | 07/2004→02/2007 | |
| COROLLA 1.4 D-4D | | | | ECHO 1.4 D | | 01/2000→03/2003 | |
| ETIOS 1.4 D-4D | | | | IQ 1.4 D-4D | | 01/2009→ | |
| PROBOX / SUCCEED 1.4 D-4D | | | | URBAN CRUISER 1.4 D-4D | | 01/2009→04/2014 | |
| VERSO S 1.4 D4-D | | | | YARIS 1.4 D | | 09/2011→ | |
| YARIS 1.4 D-4D | | | | YARIS VERSO 1.4 D-4D | | 12/2001→09/2005 | |

V94670
30.70 x 6.00 x 100.00

13711-33030

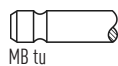

45°

H

VAG96357
40.60 x 6.00 x 11.04

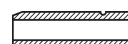

V94671
28.00 x 6.00 x 99.70

13715-33040

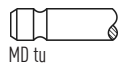

45°

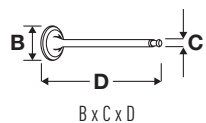

OE

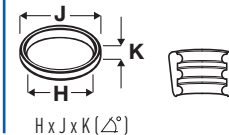
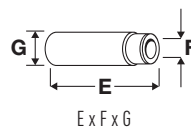

8 73.70

| 2WZ-TV | 1398cc | 4 Cyl. | 8 Valves | 40kW/54PS | Diesel | Turbo, SOHC | TD24605 |
|--------|--------|--------|----------|-----------|--------|-------------|---------|
|--------|--------|--------|----------|-----------|--------|-------------|---------|

AYGO 1.4 HDi 07/2005→08/2010

| | | | | | |
|---|------------|--|---------|--|--|
| V94601 ■ 32.80 x 5.50 x 97.30 | Y4011-2111 | | 45° Y H | VAG96364 ■ ■ ■ 34.20 x 5.50 x 9.53 | |
| V94602 ■ 30.30 x 5.50 x 97.30 | Y4011-2121 | | 45° H | | |

9 74.00

| 5E-FE | 1497cc | 4 Cyl. | 16 Valves | 66-92kW/90-125PS | Petrol | DOHC | TD3839 |
|-------|--------|--------|-----------|------------------|--------|------|--------|
|-------|--------|--------|-----------|------------------|--------|------|--------|

| | | | |
|-------------|-----------------|-------------|-----------------|
| CALDINA 1.5 | 11/1992→05/2002 | COROLLA 1.5 | 11/1989→04/1992 |
| CORSA 1.5 | 09/1990→09/1999 | PASEO 1.5 | 06/1988→06/1999 |
| RAUM 1.5 | 05/1993→04/2003 | TERCEL 1.5 | 09/1990→09/1999 |

| | | | | | |
|---|-------------|--|-----|--|--|
| V94568 ■ 24.50 x 6.00 x 94.00 | 13715-11030 | | 45° | | |
|---|-------------|--|-----|--|--|

10 75.00

| 2NZ-FE | 1299cc | 4 Cyl. | 16 Valves | 57-66kW/78-90PS | Petrol | DOHC | TD13088 |
|--------|--------|--------|-----------|-----------------|--------|------|---------|
|--------|--------|--------|-----------|-----------------|--------|------|---------|

| | | | |
|-------------------|-----------------|---------------------------|-----------------|
| bB I 1.3 | 01/2000→11/2005 | COROLLA 1.3 | 08/2000→05/2004 |
| COROLLA 1.3 VVT-i | 03/2008→ | ECHO 1.3 | 08/1999→08/2005 |
| IST 1.3 VVTi | 05/2002→07/2007 | PLATZ 1.3 | 08/1999→08/2005 |
| PORTE 1.3 VVTi | 07/2004→07/2012 | PROBOX / SUCCEED 1.3 VVTi | 07/2002→08/2014 |
| VIOS/YARIS 1.3 | 08/2005→ | WILL CYPHA 1.3 VVTi | 05/2001→07/2005 |
| WILL Vi 1.3 | 01/2000→12/2001 | YARIS 1.3 | 09/1999→ |
| YARIS 1.3 VVT-i | 01/2005→ | YARIS VERSO 1.3 | 08/1999→09/2005 |

| | | | | | |
|---|-------------|--|-------|--|--|
| V94134 ■ 30.50 x 4.97 x 89.20 | 13711-21010 | | 45° H | VAG96067 ■ ■ ■ 34.50 x 5.00 x 9.70 | |
| V94135 ■ 25.40 x 4.98 x 88.00 | 13715-21010 | | 45° | | |

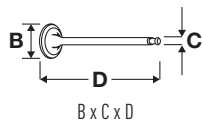
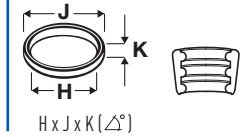
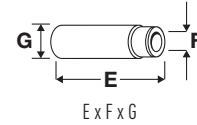
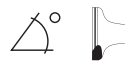
OE

11 **75.00**

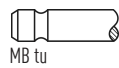
| 1N1-FE | 1497cc | 4 Cyl. | 16 Valves | 76-110kW/103-150PS | Petrol | DOHC | TD15499 |
|------------------------|--------|-----------------|-----------|-----------------------------|--------|-----------------|---------|
| 1N1-FXE | 1497cc | 4 Cyl. | 16 Valves | 43-74kW/58-101PS | Petrol | DOHC | TD15589 |
| ALLION I 1.5 | | 06/2001→04/2005 | | ALLION II 1.5 | | 07/2007→ | |
| AQUA 1.5 | | 12/2011→ | | AURIS 1.5 | | 09/2009→ | |
| bB I 1.5 | | 03/2000→12/2005 | | COROLLA 1.5 | | 09/1999→ | |
| COROLLA 1.5 G | | 11/2001→05/2004 | | COROLLA RUMION 1.5 | | 09/2007→ | |
| ECHO 1.5 | | 08/1999→01/2006 | | IST 1.5 VWTi | | 05/2002→07/2007 | |
| PLATZ 1.5 | | 04/1999→08/2005 | | PORTE 1.5 | | 07/2004→07/2012 | |
| PORTE 1.5 VWTi | | 07/2004→07/2012 | | PORTE II 1.5 | | 08/2012→ | |
| PREMIO 1.5 | | 12/2001→ | | PRIUS 1.5 | | 12/1997→03/2009 | |
| PRIUS C 1.5 | | 09/2011→ | | PROBOX / SUCCEED 1.5 VWTi | | 07/2002→ | |
| RACTIS 1.5 | | 09/2005→08/2010 | | RAUM 1.5 | | 05/2003→ | |
| SIENTA 1.5 | | 05/2003→ | | SPADE 1.5 | | 08/2012→ | |
| URBAN CRUISER 1.5 VWTi | | 07/2007→ | | VERSO S 1.5 | | 11/2010→10/2016 | |
| VIOS / SOLUNA VIOS 1.5 | | 07/2002→08/2013 | | VIOS / SOLUNA VIOS 1.5 VWTi | | 07/2002→01/2008 | |
| VIOS/YARIS 1.5 | | 08/2007→ | | WILL CYPHA 1.5 VWTi | | 05/2001→07/2005 | |
| WILL VS 1.5 VWTi | | 03/2001→04/2004 | | YARIS 1.5 | | 03/2000→ | |
| YARIS VERSO 1.5 | | 01/2000→09/2005 | | | | | |

V94134 13711-21010
 30.50 x 4.97 x 89.20

45°

H

VAG96067
 34.50 x 5.00 x 9.70

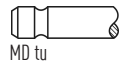
V94135 13715-21010
 25.40 x 4.98 x 88.00

45°

12 **75.00**

| 1N1-FNE | 1497cc | 4 Cyl. | 16 Valves | 68kW/92PS | Petrol | DOHC | TD25278 |
|-------------------------------|--------|-----------------|-----------|-----------|--------|------|---------|
| PROBOX / SUCCEED 1.5 VWTi CNG | | 07/2002→08/2014 | | | | | |

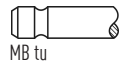
V94134 13711-21010
 30.50 x 4.97 x 89.20

45°

H

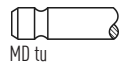
V94135 13715-21010
 25.40 x 4.98 x 88.00

45°

13 **79.00**

| 4ZZ-FE | 1398cc | 4 Cyl. | 16 Valves | 71-74kW/97-101PS | Petrol | DOHC | TD14228 |
|-------------------|--------|-----------------|-----------|------------------|--------|-----------------|---------|
| AURIS 1.4 | | 03/2007→09/2012 | | CARRI 1.4 | | 01/2002→07/2006 | |
| COROLLA 1.4 | | 02/2000→01/2002 | | COROLLA 1.4 16V | | 02/2000→11/2001 | |
| COROLLA 1.4 VWT-i | | 01/2002→ | | | | | |

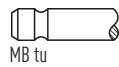
V94142 13711-0D020
 31.00 x 5.50 x 88.70

45°

H

VAG96072
 34.50 x 5.50 x 10.30

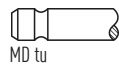
V94143 13715-22040
 26.00 x 5.50 x 88.70

45°

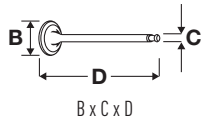

OE

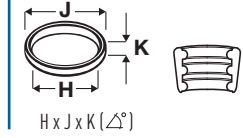
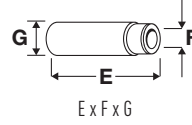
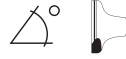

14  **79.00**

| 3ZZ-FE | 1598cc | 4 Cyl. | 16 Valves | 80-81kW/109-110PS | Petrol | DOHC | TD14229 |
|-------------------|--------|--------|-----------|-------------------|--------|-------------------|-----------------|
| AVENSIS 1.6 | | | | 07/2000→02/2003 | | AVENSIS 1.6 VVT-i | 10/2000→11/2008 |
| CONQUEST 1.6 | | | | 01/1996→12/1999 | | COROLLA 1.6 | 02/2000→03/2009 |
| COROLLA 1.6 16V | | | | 02/2000→11/2001 | | COROLLA 1.6 VVTi | 12/2007→ |
| COROLLA 1.6 VVT-i | | | | 10/2001→ | | | |

V94142  **31.00** x 5.50 x 88.70

13711-0D020

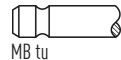

45°

H

VAG96110  **34.50** x 5.50 x 10.36



V94143  **26.00** x 5.50 x 88.70

13715-22040

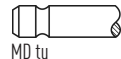

45°

15  **79.00**

| 1ZZ-FE | 1794cc | 4 Cyl. | 16 Valves | 89-107kW/121-146PS | Petrol | DOHC | TD13368 |
|-----------------------|--------|--------|-----------|--------------------|--------|---------------------|-----------------|
| ALLION I 1.8 | | | | 06/2001→06/2007 | | AVENSIS 1.8 | 10/2000→11/2008 |
| AVENSIS 1.8 VVT-i | | | | 10/2000→02/2003 | | CALDINA 1.8 | 09/2002→06/2007 |
| CELICA 1.8 | | | | 09/1999→09/2005 | | CELICA 1.8 16V VT-i | 08/1999→07/2005 |
| COROLLA 1.8 | | | | 09/1997→ | | COROLLA 1.8 CNG | 02/2010→06/2011 |
| COROLLA 1.8 VVTi | | | | 07/2001→ | | COROLLA 1.8 VVT-i | 01/2002→05/2004 |
| ISIS 1.8 VVTi | | | | 07/2004→ | | LITEACE 1.8 | 10/1997→08/2001 |
| MATRIX 1.8 | | | | 01/2002→12/2007 | | MATRIX 1.8 VVTi | 01/2002→12/2005 |
| MR 2 III 1.8 16V VT-i | | | | 10/1999→06/2007 | | OPA 1.8 | 04/2000→08/2003 |
| PREMIO 1.8 | | | | 12/2001→06/2007 | | RAV 4 II 1.8 | 08/2000→11/2005 |
| VISTA 1.8 | | | | 06/1998→08/2003 | | WILL VS 1.8 VVTi | 03/2001→04/2004 |
| WISH 1.8 Hi | | | | 04/2003→03/2009 | | YARIS 1.8 VVTi | 11/2005→ |

V80018  **32.00** x 5.50 x 88.70

13711-22030

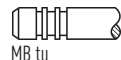

45°

VAG96110  **34.50** x 5.50 x 10.36



V80019  **27.50** x 5.50 x 88.70

13715-22030

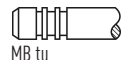

45°

16  **80.50**

| 1ZR-FE | 1598cc | 4 Cyl. | 16 Valves | 90-97kW/122-132PS | Petrol | DOHC | TD20925 |
|------------------|--------|--------|-----------|-------------------|--------|-------------|----------|
| AURIS 1.6 | | | | 03/2007→09/2012 | | COROLLA 1.6 | 01/2009→ |
| COROLLA 1.6 VVTi | | | | 10/2006→ | | | |

V95051  **32.00** x 5.50 x 109.45

13711-37020

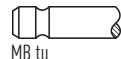

45°

H

VAG96110  **34.50** x 5.50 x 10.36



V95052  **27.50** x 5.50 x 108.25

13715-37030

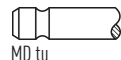

45°

17  **81.00**

| 4A-F | 1587cc | 4 Cyl. | 16 Valves | 66-79kW/90-107PS | Petrol | DOHC | TD3818 |
|----------------|--------|--------|-----------|------------------|--------|--------------------|-----------------|
| CARINA II 1.6 | | | | 12/1987→08/1990 | | COROLLA 1.6 | 05/1987→12/1997 |
| COROLLA 1.6 GL | | | | 10/1987→08/1990 | | COROLLA 1.6 XL | 09/1989→04/1992 |
| CORONA 1.6 | | | | 12/1987→12/1992 | | SPRINTER CARIB 1.6 | 11/1987→05/1992 |

V94569  **24.50** x 6.00 x 92.00

13715-15030

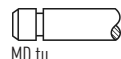

45°

VAG96068  **38.50** x 6.03 x 11.06





OE



MAT.

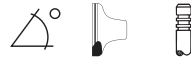

E x F x G

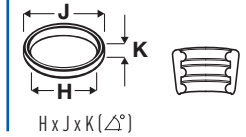

H x J x K (△°)

18



81.00

| 4A-FE | 1587cc | 4 Cyl. | 16 Valves | 66-136kW/90-185PS | Petrol | DOHC | TD3820 |
|----------------------|-----------------|--------|-----------|-------------------|--------|-----------------|--------|
| AVENSIS 1.6 | 09/1997→10/2000 | | | CALDINA 1.6 | | 02/1992→09/1997 | |
| CARIBE 1.6 | 09/1994→08/2003 | | | CARINA E 1.6 | | 04/1992→09/1997 | |
| CARINA E 1.6 16V | 12/1994→09/1997 | | | CARINA E 1.6 GLI | | 04/1992→09/1997 | |
| CARINA E 1.6 i | 02/1995→09/1997 | | | CARINA II 1.6 | | 12/1987→06/1992 | |
| CARINA II 1.6 GX | 12/1987→03/1992 | | | CELICA 1.6 | | 10/1989→11/1993 | |
| CONQUEST 1.6 | 01/1995→12/1995 | | | COROLLA 1.6 | | 04/1988→02/2000 | |
| COROLLA 1.6 GLI | 07/1992→04/1997 | | | COROLLA 1.6 i | | 10/1987→11/1999 | |
| COROLLA 1.6 Si | 07/1992→04/1997 | | | COROLLA 1.6 XLI | | 08/1989→07/1995 | |
| COROLLA LEVIN 1.6 GT | 06/1991→08/1997 | | | CORONA 1.6 | | 06/1989→11/2001 | |
| CURREN 1.6 | 09/1989→10/1993 | | | SPRINTER 1.6 | | 08/1987→12/2000 | |
| SPRINTER CARIB 1.6 | 11/1987→05/2002 | | | TAZZ 1.6 | | 04/1996→07/2006 | |

V94144 ■

30.90 x 6.00 x 87.50

13711-15090

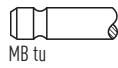

45°

H

VAG96068 ■ ■ ■

38.50 x 6.03 x 11.06



V94137 ■

24.50 x 6.00 x 87.90

13715-16060

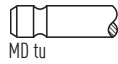

45°

19



81.00

| 7A-FE | 1762cc | 4 Cyl. | 16 Valves | 78-106kW/106-144PS | Petrol | DOHC | TD3854 |
|--------------------|-----------------|--------|-----------|--------------------|--------|-----------------|--------|
| ASCENT 1.8 | 06/2001→10/2003 | | | AVENSIS 1.8 | | 09/1997→10/2000 | |
| CALDINA 1.8 | 02/1992→08/2002 | | | CARIBE 1.8 | | 09/1994→08/2003 | |
| CARINA 1.8 | 08/1996→08/2001 | | | CARINA E 1.8 | | 04/1992→09/1997 | |
| CARINA E 1.8 GL | 10/1994→09/1997 | | | CARINA E 1.8 i | | 02/1995→09/1997 | |
| CARINA E 1.8 i 16V | 01/1995→09/1997 | | | CELICA 1.8 | | 11/1993→12/1997 | |
| CELICA 1.8 i 16V | 11/1993→11/1999 | | | CHASER 1.8 | | 10/1993→08/1996 | |
| COROLLA 1.8 | 05/1992→06/2002 | | | COROLLA 1.8 16V | | 09/1995→04/1997 | |
| COROLLA 1.8 EFi | 10/1992→08/1994 | | | COROLLA 1.8 GT | | 11/1992→05/1995 | |
| COROLLA 1.8 GTi | 11/1992→04/1995 | | | COROLLA 1.8 i | | 11/1992→09/1994 | |
| COROLLA 1.8 XL | 09/1992→11/1993 | | | CORONA 1.8 | | 02/1992→09/1997 | |
| CORONA 1.8 i 16V | 01/1996→11/2001 | | | CURREN 1.8 | | 11/1993→10/1998 | |
| PREMIO 1.8 | 12/2001→05/2007 | | | SPRINTER 1.8 | | 11/1992→04/1997 | |
| SPRINTER CARIB 1.8 | 11/1992→10/2001 | | | | | | |

V94144 ■

30.90 x 6.00 x 87.50

13711-15090

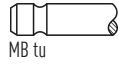

45°

H

VAG96068 ■ ■ ■

38.50 x 6.03 x 11.06



V94137 ■

24.50 x 6.00 x 87.90

13715-16060

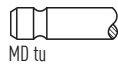

45°

20



82.00

| ZZZ-GE | 1796cc | 4 Cyl. | 16 Valves | 122-165kW/166-224PS | Petrol | DOHC | TD13369 |
|----------------|-----------------|--------|-----------|----------------------|--------|-----------------|---------|
| CELICA 1.8 16V | 08/1999→09/2005 | | | CELICA 1.8 16V TS | | 08/1999→09/2005 | |
| COROLLA 1.8 | 03/2001→12/2006 | | | COROLLA 1.8 VTL-i TS | | 01/2001→02/2007 | |
| MATRIX 1.8 | 01/2002→12/2006 | | | | | | |

V94142 ■

31.00 x 5.50 x 88.70

13711-0D020

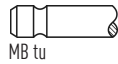

45°

H

VAG96110 ■ ■ ■

34.50 x 5.50 x 10.36

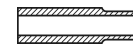

V94143 ■

26.00 x 5.50 x 88.70

13715-22040

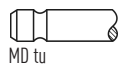

45°



OE

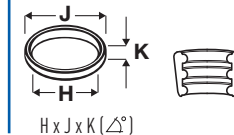
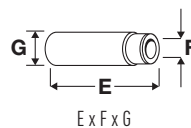
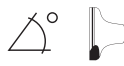

21 82.20

| 1WZ | 1867cc | 4 Cyl. | 8 Valves | 51kW/69PS | Diesel | SOHC | TD14769 |
|-----------------------|---------|-----------------|----------|-----------|--------|------|---------|
| COROLLA 1.9 D | | 02/2000→01/2002 | | | | | |
| V91144 ■ | 0948.63 | | 45° | H | | | |
| 38.50 x 8.00 x 112.50 | | MB | | | | | |
| V91145 ■ | 0949.47 | | 45° | | | | |
| 33.00 x 8.00 x 112.00 | | MD cr | | | | | |

22 82.20

| 1CD-FTV | 1995cc | 4 Cyl. | 16 Valves | 66-85kW/90-116PS | Diesel | Turbo, DOHC | TD15191 |
|-----------------------|-----------------|--------|-----------|------------------|-----------------|-------------|---------|
| AVENSIS 2.0 D | 09/2002→02/2003 | | | AVENSIS 2.0 D-4D | 10/1999→11/2008 | | |
| AVENSIS VERSO 2.0 D | 08/2001→08/2005 | | | COROLLA 2.0 D-4D | 04/1997→03/2009 | | |
| CORONA 2.0 D | 01/2000→09/2003 | | | PREVIA 2.0 D-4D | 03/2001→01/2006 | | |
| RAV 4 II 2.0 D | 05/2001→11/2005 | | | | | | |
| V94454 ■ | 13711-27010 | | 45° | | | | |
| 28.00 x 6.00 x 102.50 | | MD tu | | | | | |
| V94455 ■ | 13715-27010 | | 45° | | | | |
| 24.00 x 6.00 x 102.00 | | MD tu | | | | | |

23 83.00

| 1C | 1839cc | 4 Cyl. | 8 Valves | 41-49kW/56-67PS | Diesel | SOHC | TD3715 |
|-----------------------|-----------------|--------|----------|----------------------|----------------------|------|--------|
| CARINA 1.8 D | 04/1982→09/1983 | | | COROLLA 1.8 D | 01/1983→06/1993 | | |
| COROLLA FX 1.8 D | 01/1985→05/1988 | | | LITEACE 1.8 D | 10/1982→08/1988 | | |
| SPRINTER 1.8 D | 05/1987→05/1991 | | | SPRINTER CARIB 1.8 D | 11/1987→07/1991 | | |
| V91466 ■ | 13711-64010 | | 45° | H | VAG92093 ■ ■ | | |
| 38.50 x 8.00 x 106.50 | | MB | | | 50.00 x 8.04 x 13.06 | | |
| V94459 ■ | 13711-64030 | | 45° | | | | |
| 38.50 x 8.00 x 105.70 | | MD tu | | | | | |
| V94460 ■ | 13715-64040 | | 45° | | | | |
| 32.50 x 8.00 x 105.30 | | MD tu | | | | | |

24 83.00

| 1C-L | 1839cc | 4 Cyl. | 8 Valves | 47kW/64PS | Diesel | SOHC | TD3716 |
|-----------------------|-----------------|--------|----------|---------------|----------------------|-------------|--------|
| 1C-TL | 1839cc | 4 Cyl. | 8 Valves | 54kW/73PS | Diesel | Turbo, SOHC | TD3717 |
| CAMRY 1.8 Turbo-D | 01/1983→07/1988 | | | COROLLA 1.8 D | 06/1983→06/1989 | | |
| COROLLA FX 1.8 D | 08/1985→08/1987 | | | | | | |
| V94459 ■ | 13711-64030 | | 45° | | VAG92093 ■ ■ | | |
| 38.50 x 8.00 x 105.70 | | MD tu | | | 50.00 x 8.04 x 13.06 | | |
| V94460 ■ | 13715-64040 | | 45° | | | | |
| 32.50 x 8.00 x 105.30 | | MD tu | | | | | |

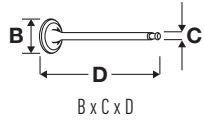

OE

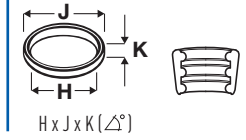
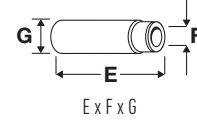

25 **86.00**

| 2C | 1975cc | 4 Cyl. | 8 Valves | 49-56kW/67-76PS | Diesel | SOHC | TD3747 |
|-----------------|-----------------|--------|----------|-----------------------|--------|-----------------|--------|
| CALDINA 2.0 TD | 11/1992→04/1998 | | | CARINA E 2.0 D | | 04/1992→01/1996 | |
| CARINA II 2.0 D | 03/1988→06/1992 | | | COROLLA 2.0 D | | 07/1992→04/1997 | |
| CORONA 2.0 D | 12/1987→01/1996 | | | DELIBOY 2.0 D | | 10/1989→10/1995 | |
| LITEACE 2.0 D | 10/1985→05/1994 | | | MASTER ACE SURF 2.0 D | | 02/1985→10/1993 | |
| MODELL F 2.0 D | 04/1985→08/1988 | | | SPRINTER 2.0 D | | 06/1991→11/2000 | |
| TOWN ACE 2.0 D | 01/1992→04/1995 | | | | | | |

| | | | | | | |
|-----------------------|-------------|-------|-----|---|----------------------|--|
| V91466 | 13711-64010 | | 45° | H | VAG92093 | |
| 38.50 x 8.00 x 106.50 | | MB | | | 50.00 x 8.04 x 13.06 | |
| V94459 | 13711-64030 | | 45° | | | |
| 38.50 x 8.00 x 105.70 | | MD tu | | | | |
| V94460 | 13715-64040 | | 45° | | | |
| 32.50 x 8.00 x 105.30 | | MD tu | | | | |

26 **86.00**

| 2C-T | 1975cc | 4 Cyl. | 8 Valves | 61-67kW/83-91PS | Diesel | Turbo, SOHC | TD3749 |
|------------------------|-----------------|--------|----------|----------------------|--------|-----------------|--------|
| AVENSIS 2.0 D | 10/1997→05/1998 | | | CALDINA 2.0 TD | | 01/1996→08/1997 | |
| CAMRY 2.0 TD | 08/1996→09/1999 | | | CAMRY 2.0 Turbo-D | | 10/1986→05/1991 | |
| CARINA 2.0 TD | 08/1996→08/2001 | | | CARINA E 2.0 TD | | 01/1996→09/1997 | |
| CORONA 2.0 D | 06/1997→02/2000 | | | CORONA 2.0 TD | | 07/1994→12/1997 | |
| MASTER ACE SURF 2.0 TD | 02/1985→12/1996 | | | SCEPTER 2.0 TD | | 11/1992→09/1996 | |
| TOWN ACE 2.0 TD | 04/1985→12/1991 | | | VISTA 2.0 TD | | 11/1988→06/1991 | |
| VISTA / CAMRY 2.0 D | 07/1990→06/1994 | | | VISTA / CAMRY 2.0 TD | | 07/1990→12/1994 | |

| | | | | | | |
|-----------------------|-------------|-------|-----|--|----------------------|--|
| V94459 | 13711-64030 | | 45° | | VAG96107 | |
| 38.50 x 8.00 x 105.70 | | MD tu | | | 46.00 x 8.00 x 13.00 | |
| V94460 | 13715-64040 | | 45° | | VAG96108 | |
| 32.50 x 8.00 x 105.30 | | MD tu | | | 50.00 x 8.00 x 13.00 | |

27 **86.00**

| 1AD-FTV | 1998cc | 4 Cyl. | 16 Valves | 91-93kW/124-126PS | Diesel | Turbo, DOHC | TD20923 |
|------------------|----------|--------|-----------|-------------------|--------|-------------|---------|
| AURIS 2.0 D-4D | 03/2007→ | | | AVENSIS 2.0 D-4D | | 03/2006→ | |
| COROLLA 2.0 D-4D | 01/2007→ | | | RAV 4 IV 2.0 D | | 12/2012→ | |
| VERSO 2.0 D-4D | 04/2009→ | | | | | | |

| | | | | | | |
|-----------------------|-------------|------------|-----|---|----------------------|--|
| V95053 | 13711-0R010 | | 45° | H | VAG96357 | |
| 30.20 x 6.00 x 104.35 | | MB tu | | | 40.60 x 6.00 x 11.04 | |
| V95054 | 13715-0R010 | | 45° | H | | |
| 27.00 x 6.00 x 104.00 | | MD + MB tu | | | | |

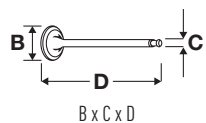

OE



MAT.

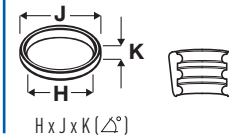
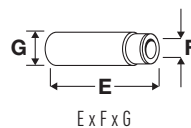
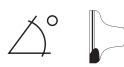

28 86.00

| 1AZ-FE | 1998cc | 4 Cyl. | 16 Valves | 100-114kW/136-155PS | Petrol | DOHC | TD14870 |
|-------------------|-----------------|--------|-----------|---------------------|--------|-----------------|---------|
| 1AZ-FSE | 1998cc | 4 Cyl. | 16 Valves | 108-132kW/147-179PS | Petrol | DOHC, Injection | TD15108 |
| ALLION 1.2.0 | 06/2001→06/2007 | | | AURION 2.0 | | 03/2006→07/2009 | |
| AVENSIS 2.0 | 10/2000→04/2011 | | | AVENSIS 2.0 VVTi | | 04/2003→11/2008 | |
| AVENSIS 2.0 VVT-i | 10/2000→02/2003 | | | AVENSIS VERSO 2.0 | | 08/2001→11/2009 | |
| CALDINA 2.0 | 09/2002→06/2007 | | | CAMRY 2.0 | | 08/2001→ | |
| GAIA 2.0 VVTi | 05/1998→10/2003 | | | ISIS 2.0 VVTi | | 07/2004→ | |
| NOAH/VOXY 2.0 | 12/2001→06/2007 | | | OPA 2.0 | | 08/2000→04/2005 | |
| PREMIO 2.0 | 12/2001→06/2007 | | | RAV 4 II 2.0 | | 06/2000→11/2005 | |
| RAV 4 III 2.0 | 03/2006→ | | | VISTA 2.0 | | 06/1998→08/2003 | |
| WISH 2.0 | 12/2003→12/2007 | | | WISH 2.0 Zi | | 04/2003→03/2009 | |

V94456 13711-28010 45° Y H

V94457 13715-28010 45°

29 86.00

| 3S-FE | 1998cc | 4 Cyl. | 16 Valves | 86-125kW/117-170PS | Petrol | DOHC | TD3798 |
|-------------------|-----------------|--------|-----------|--------------------|--------|-----------------|--------|
| AVENSIS 2.0 | 09/1997→10/2000 | | | CALDINA 2.0 | | 02/1992→09/2002 | |
| CAMRY 2.0 | 03/1983→09/1997 | | | CARINA E 2.0 | | 01/1993→09/1997 | |
| CARINA E 2.0 GLI | 04/1992→09/1997 | | | CARINA E 2.0 i | | 12/1992→09/1997 | |
| CARINA ED 2.0 | 08/1985→12/1998 | | | CARINA II 2.0 | | 12/1987→04/1992 | |
| CARINA II 2.0 GLI | 12/1987→03/1992 | | | CARINA II 2.0 GLi | | 12/1987→03/1992 | |
| CELICA 2.0 | 09/1986→08/1989 | | | CELICA 2.0 i 16V | | 09/1993→12/1997 | |
| CORONA 2.0 | 12/1987→09/2002 | | | CORONA 2.0 EZ | | 12/1987→01/1992 | |
| CORONA EXIV 2.0 | 09/1989→09/1993 | | | CURREN 2.0 | | 02/1994→07/1998 | |
| GAIA 2.0 VVTi | 05/1998→03/2001 | | | LITEACE 2.0 | | 01/1998→08/2002 | |
| MR 2 II 2.0 | 12/1989→08/1992 | | | NADIA 2.0 | | 04/1998→08/2003 | |
| PICNIC 2.0 | 05/1996→12/2001 | | | PICNIC 2.0 16V | | 05/1996→12/2001 | |
| PREVIA 2.0 | 10/2000→08/2003 | | | RAV 4 I 2.0 | | 01/1994→09/2000 | |
| SCEPTER 2.0 | 11/1992→09/1996 | | | TOWN ACE 2.0 | | 10/1996→10/2001 | |
| VISTA 2.0 | 08/1986→04/2002 | | | VISTA / CAMRY 2.0 | | 01/1994→06/1998 | |

V94138 13711-74101 45°

V94139 13715-74100 45° SS

VAG96069 38.50 x 6.02 x 11.04

VAG96070 40.50 x 6.02 x 11.06

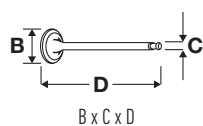
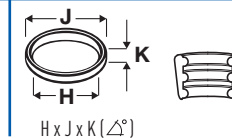
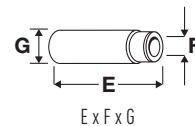

OE

30

86.00

| 3S-GE | 1998cc | 4 Cyl. | 16 Valves | 103-154kW/140-209PS | Petrol | DOHC | TD3802 |
|--------------------|-----------------|--------|-----------|-----------------------|--------|-----------------|--------|
| 3S-GTE | 1998cc | 4 Cyl. | 16 Valves | 136-195kW/185-265PS | Petrol | Turbo, DOHC | TD3797 |
| ALTEZZA 2.0 VVTi | 02/1999→07/2005 | | | ALTEZZA GITA 2.0 VVTi | | 02/1999→06/2005 | |
| CALDINA 2.0 | 07/1994→06/2007 | | | CAMRY 2.0 | | 10/1986→07/1990 | |
| CARINA E 2.0 GTi | 04/1992→02/1994 | | | CARINA E 2.0 GTi 16V | | 03/1994→09/1997 | |
| CARINA ED 2.0 | 09/1989→12/1998 | | | CELICA 2.0 | | 01/1987→11/1993 | |
| CELICA 2.0 GTi | 10/1989→08/1999 | | | CELICA 2.0 i 16V | | 11/1993→11/1999 | |
| CELICA 2.0 i Turbo | 02/1994→11/1999 | | | CELICA 2.0 Turbo | | 03/1988→11/1993 | |
| CELICA GT-FOUR 2.0 | 02/1994→08/1999 | | | CORONA 2.0 | | 11/1987→09/1993 | |
| CORONA 2.0 GTi | 09/1989→09/1995 | | | CORONA EXIV 2.0 | | 09/1989→09/1993 | |
| CORONA GT-R 2.0 | 12/1987→02/1992 | | | CURREN 2.0 | | 09/1989→10/1998 | |
| CURREN 2.0 Turbo | 09/1989→10/1993 | | | MR 2 II 2.0 | | 12/1989→07/1999 | |
| MR 2 II 2.0 16V | 12/1989→11/1999 | | | MR 2 II 2.0 Turbo | | 12/1989→07/1999 | |
| RAV 4 I 2.0 | 01/1994→09/1999 | | | VISTA 2.0 | | 08/1988→06/1990 | |
| VISTA / CAMRY 2.0 | 07/1990→06/1994 | | | | | | |

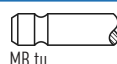
V95055 ■
 33.50 x 5.97 x 100.50

13711-88362



45°

H

V95056 ■
 29.00 x 5.97 x 99.55

13715-88361

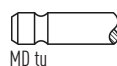

45°

SS

31

86.00

| 3C-TE | 2184cc | 4 Cyl. | 8 Valves | 66-77kW/90-105PS | Diesel | Turbo, SOHC | TD12628 |
|------------------------------|-----------------|--------|----------|------------------|--------|-----------------|---------|
| AVENSIS 2.2 TD | 04/2005→11/2008 | | | CALDINA 2.2 TD | | 08/1997→09/2002 | |
| COROLLA 2.2 TD | 04/1998→10/2001 | | | CORONA 2.2 TD | | 01/1998→05/2001 | |
| CRESTA 2.2 TD | 10/1996→09/2001 | | | DELIBOY 2.2 D | | 10/1994→10/1995 | |
| ESTIMA EMINA / LUCIDA 2.2 TD | 01/1992→12/1999 | | | GAIA 2.2 TD | | 10/1998→10/2003 | |
| LITEACE 2.2 D | 02/1995→08/1997 | | | PICNIC 2.2 D | | 08/1997→12/2001 | |
| PREVIA 2.2 TD | 05/1990→08/2000 | | | SPRINTER 2.2 TD | | 04/1995→11/2002 | |

V94459 ■
 38.50 x 8.00 x 105.70

13711-64030

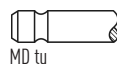

45°

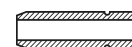
VAG96107 ■
 46.00 x 8.00 x 13.00

V94460 ■
 32.50 x 8.00 x 105.30

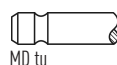
13715-64040

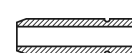

45°

VAG96108 ■
 50.00 x 8.00 x 13.00

32

86.00

| 2AD-FHV | 2231cc | 4 Cyl. | 16 Valves | 110-130kW/150-177PS | Diesel | Turbo, DOHC | TD18483 |
|-------------------|-----------------|--------|-----------|---------------------|--------|-------------|---------|
| 2AD-FTV | 2231cc | 4 Cyl. | 16 Valves | 100-110kW/136-150PS | Diesel | Turbo, DOHC | TD18485 |
| AURIS 2.2 D | 03/2007→09/2012 | | | AVENSIS 2.2 D-4D | | 10/2005→ | |
| AVENSIS 2.2 D-CAT | 07/2005→11/2008 | | | COROLLA 2.2 D-4D | | 10/2005→ | |
| RAV 4 III 2.2 D | 03/2006→ | | | RAV 4 IV 2.2 D | | 12/2012→ | |
| VERSO 2.2 D-4D | 04/2009→ | | | VERSO 2.2 D-CAT | | 04/2009→ | |

V95053 ■
 30.20 x 6.00 x 104.35

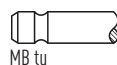
13711-0R010



45°

H

VAG96357 ■ ■ ■
 40.60 x 6.00 x 11.04

V95054 ■
 27.00 x 6.00 x 104.00

13715-0R010

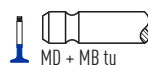

45°

H

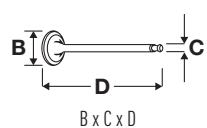

OE

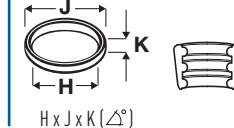
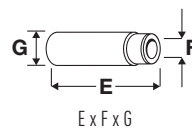

33 **90.00**

| L | 2188cc | 4 Cyl. | 8 Valves | 46-53kW/63-72PS | Diesel | SOHC | TD4955 |
|----------------------|-----------------|--------|----------|-----------------|--------|-----------------|--------|
| BLIZZARD 2.2 D | 03/1982→12/1983 | | | CRESSIDA 2.2 D | | 09/1980→03/1985 | |
| CROWN 2.2 D | 04/1980→07/1983 | | | HIACE 2.2 D | | 01/1979→07/1985 | |
| HIACE I 2.2 D | 01/1979→03/1983 | | | HIACE II 2.2 D | | 12/1982→11/1989 | |
| HILUX III 2.2 D | 05/1979→03/1984 | | | HILUX IV 2.2 D | | 08/1983→08/1984 | |
| MARK II 2.2 DX | 08/1980→10/1983 | | | PICKUP 2.2 D | | 09/1980→12/1983 | |
| QUICK DELIVERY 2.2 D | 05/1982→06/1985 | | | TOWN ACE 2.2 D | | 04/1985→12/1991 | |

V90283 13711-54010

42.70 x 8.49 x 123.00

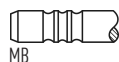

45°

H

VAG92282 **61.00 x 8.50 x 14.00**



V90284 13715-54020

35.10 x 8.47 x 122.80

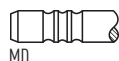

45°

34 **92.00**

| 2L | 2446cc | 4 Cyl. | 8 Valves | 53-63kW/72-86PS | Diesel | SOHC | TD4938 |
|--------------------|-----------------|--------|----------|----------------------|--------|-----------------|--------|
| 2L-T | 2446cc | 4 Cyl. | 8 Valves | 63-92kW/85-125PS | Diesel | Turbo, SOHC | TD3767 |
| 4 RUNNER 2.4 D | 07/1984→12/2001 | | | CHASER 2.4 D | | 10/1992→08/1996 | |
| CHASER 2.4 TD | 08/1988→10/1992 | | | CRESSIDA 2.4 TD | | 01/1985→10/1988 | |
| CRESTA 2.4 D | 09/1988→10/1996 | | | CRESTA 2.4 TD | | 09/1988→09/1996 | |
| DYNA 2.4 D | 08/1977→07/2001 | | | DYNA 100 2.4 D | | 05/1995→07/2001 | |
| DYNA 150 2.4 D | 08/1985→07/2001 | | | HIACE II 2.4 D | | 04/1984→11/1989 | |
| HIACE III 2.4 D | 08/1987→12/2004 | | | HIACE IV 2.4 D | | 08/1995→08/2006 | |
| HIACE IV 2.4 TD | 08/1995→08/2006 | | | HILUX 2.4 D | | 01/1984→08/1988 | |
| HILUX 2.4 TD | 08/1988→07/2001 | | | HILUX IV 2.4 D | | 08/1983→07/1988 | |
| HILUX V 2.4 D | 09/1988→12/1997 | | | HILUX VI 2.4 D | | 08/1997→02/2006 | |
| HILUX VI 2.4 TD | 08/1998→01/2002 | | | MARK II 2.4 D | | 04/1988→09/1996 | |
| INNOVA I 2.4 D | 08/2004→ | | | KIJANG 2.4 D | | 01/1995→12/2000 | |
| LAND CRUISER 2.4 D | 11/1984→10/1985 | | | LAND CRUISER 2.4 TD | | 10/1985→05/1996 | |
| QUALIS 2.4 D | 01/1999→10/2004 | | | QUICK DELIVERY 2.4 D | | 08/1985→04/1995 | |
| STALLION 2.4 D | 08/1999→05/2005 | | | TOWN ACE 2.4 D | | 04/1985→12/1991 | |
| TOYACE 2.4 D | 01/1983→06/1985 | | | TUV 2.4 D | | 12/1996→12/2004 | |

V90283 13711-54010

42.70 x 8.49 x 123.00
→12/89

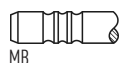

45°

H

VAG92282 **61.00 x 8.50 x 14.00**
→12/89



V91720 13711-54020

42.50 x 7.99 x 103.55
01/90→

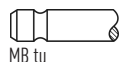

45°

H

VAG92406 **40.00 x 8.00 x 13.05**
01/90→

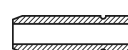

V90284 13715-54020

35.10 x 8.47 x 122.80
→12/89

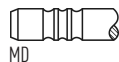

45°

V91721 13715-17010

36.00 x 7.97 x 103.40
01/90→

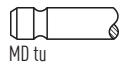

45°

V94581 13715-54040

36.00 x 8.00 x 103.30
01/90→

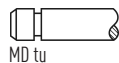

45°



OE

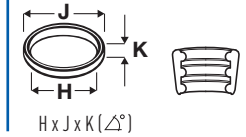

35



92.00

| 2L-TII | 2446cc | 4 Cyl. | 8 Valves | 60-71kW/82-97PS | Diesel | Turbo, SOHC | TD21259 |
|-----------------------|-------------|--------|----------|-----------------|----------------------|-----------------|---------|
| BLIZZARD 2.5 TD | | | | CHASER 2.4 TD | | 10/1992→08/1996 | |
| CRESSIDA 2.4 TD | | | | MARK II 2.4 D | | 11/1984→03/1988 | |
| MARK II 2.4 TD | | | | | | | |
| V91720 | 13711-54020 | | 45° | H | VAG92406 | | |
| 42.50 x 7.99 x 103.55 | | | | | 40.00 x 8.00 x 13.05 | | |
| V91721 | 13715-17010 | | 45° | | | | |
| 36.00 x 7.97 x 103.40 | | | | | | | |
| V94581 | 13715-54040 | | 45° | | | | |
| 36.00 x 8.00 x 103.30 | | | | | | | |

36



92.00

| 2KD-FTV | 2494cc | 4 Cyl. | 16 Valves | 65-108kW/88-147PS | Diesel | Turbo, DOHC | TD16332 |
|-----------------------------|-------------|--------|-----------|--------------------|----------------------|-----------------|---------|
| DYNA 2.5 D4d | | | | FORTUNER 2.5 D-4D | | 01/2009→05/2015 | |
| HIACE / COMMUTER V 2.5 D-4D | | | | HIACE III 2.5 D-4D | | 08/2001→08/2004 | |
| HIACE IV 2.5 D-4D | | | | HIACE V 2.5 D-4D | | 09/2006→ | |
| HILUX VI 2.5 D-4D | | | | HILUX VII 2.5 D | | 10/2005→ | |
| HILUX VII 2.5 D-4D | | | | HILUX VIII 2.5 D | | 05/2015→ | |
| INNOVA I 2.5 D | | | | REGIUSACE 2.5 D-4D | | 08/2004→ | |
| V95145 | 13711-0L010 | | 45° | H | VAG96357 | | |
| 30.45 x 5.98 x 105.60 | | | | | 40.60 x 6.00 x 11.04 | | |
| V95146 | 13715-30040 | | 45° | | | | |
| 26.55 x 5.97 x 105.75 | | | | | | | |

37



94.00

| 1HD-T | 4164cc | 6 Cyl. | 12 Valves | 118-123kW/160-167PS | Diesel | Turbo, SOHC | TD3725 |
|------------------------|-------------|--------|-----------|-------------------------|----------------------|-----------------|--------|
| 1H-Z | 4164cc | 6 Cyl. | 12 Valves | 59-123kW/80-167PS | Diesel | SOHC | TD3726 |
| COASTER 4.2 D | | | | COASTER 4.2 TD | | 01/1990→01/1993 | |
| LAND CRUISER 4.2 D | | | | LAND CRUISER 80 4.2 D | | 01/1990→12/1997 | |
| LAND CRUISER 80 4.2 TD | | | | LAND CRUISER 90 4.2 D | | 08/1999→08/2001 | |
| LAND CRUISER 100 4.2 D | | | | LAND CRUISER 200 4.2 TD | | 05/2015→ | |
| V91720 | 13711-54020 | | 45° | H | VAG92406 | | |
| 42.50 x 7.99 x 103.55 | | | | | 40.00 x 8.00 x 13.05 | | |
| V91721 | 13715-17010 | | 45° | | | | |
| 36.00 x 7.97 x 103.40 | | | | | | | |

38



96.00

| 3L | 2779cc | 4 Cyl. | 8 Valves | 58-66kW/79-90PS | Diesel | SOHC | TD3796 |
|-----------------------|-------------|--------|----------|----------------------|----------------------|-----------------|--------|
| 4 RUNNER 2.8 D | | | | DYNA 150 2.8 D | | 08/1988→08/1998 | |
| HIACE III 2.8 D | | | | HILUX 2.8 D | | 10/1988→08/1998 | |
| HILUX V 2.8 D | | | | HILUX VI 2.8 D | | 08/1997→07/2005 | |
| LAND CRUISER 2.7 TD | | | | QUICK DELIVERY 2.8 D | | 05/1995→04/1999 | |
| TOWN ACE 2.8 D | | | | TOYOACE 2.8 D | | 08/1988→04/1995 | |
| V91720 | 13711-54020 | | 45° | H | VAG92406 | | |
| 42.50 x 7.99 x 103.55 | | | | | 40.00 x 8.00 x 13.05 | | |
| V91721 | 13715-17010 | | 45° | | | | |
| 36.00 x 7.97 x 103.40 | | | | | | | |
| V94581 | 13715-54040 | | 45° | | | | |
| 36.00 x 8.00 x 103.30 | | | | | | | |



OE

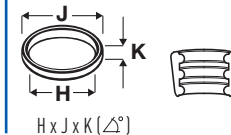
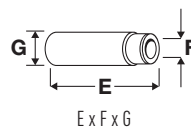
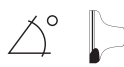

39 96.00

| 1KD-FTV | 2982cc | 4 Cyl. | 16 Valves | 75-150kW/102-204PS | Diesel | Turbo, DOHC | TD15208 |
|----------------------------|----------|--------|-----------|-----------------------------|--------|-----------------|---------|
| DYNA 3.0 D4d | 08/2001→ | | | FORTUNER 3.0 D | | 06/2004→05/2015 | |
| FORTUNER 3.0 Tdi | 12/2013→ | | | HIACE / COMMUTER V 3.0 D | | 08/2004→ | |
| HIACE V 3.0 D | 01/2005→ | | | HILUX 3.0 D | | 02/2005→ | |
| HILUX VII 3.0 D | 11/2004→ | | | HILUX VII 3.0 D-4D | | 12/2007→ | |
| HILUX VII 3.0 Tdi | 06/2013→ | | | HILUX VIII 3.0 D | | 08/2015→ | |
| LAND CRUISER 90 3.0 D-4D | 02/2000→ | | | LAND CRUISER PRADO 3.0 D-4D | | 09/2002→ | |
| LAND CRUISER PRADO 3.0 TDi | 08/2009→ | | | REGIUSACE 3.0 D-4D | | 08/2004→ | |
| TOYO ACE 3.0 DiD | 06/2011→ | | | | | | |

V95057 13711-30030
32.25 x 5.98 x 105.50

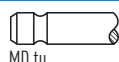

45°

VAG96357
40.60 x 6.00 x 11.04



V95058 13715-30030
27.80 x 5.97 x 105.30

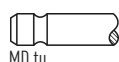

45°

40 96.00

| 1KZ-T | 2982cc | 4 Cyl. | 8 Valves | 87-92kW/118-125PS | Diesel | Turbo, SOHC | TD3728 |
|----------------------|-----------------|--------|----------|------------------------|--------|-----------------|--------|
| 4 RUNNER 3.0 Turbo-D | 10/1993→11/2002 | | | HIACE III 3.0 TD | | 08/1996→06/1999 | |
| HILUX 3.0 D | 08/1997→08/2005 | | | HILUX 3.0 TDiC | | 08/1993→07/1997 | |
| HILUX V 3.0 D | 08/1993→11/1995 | | | HILUX VI 3.0 TD | | 01/2000→04/2005 | |
| LAND CRUISER 3.0 TD | 05/1993→05/1996 | | | LAND CRUISER 80 3.0 TD | | 01/1990→09/1991 | |

V95147 13711-54040
42.50 x 7.99 x 104.30

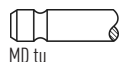

45°

V95148 13715-67040
37.00 x 7.98 x 104.25

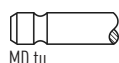

45° SS

41 96.00

| 1KZ-TE | 2982cc | 4 Cyl. | 8 Valves | 85-103kW/116-140PS | Diesel | Turbo, SOHC | TD9479 |
|-----------------------------|-----------------|--------|----------|--------------------------|--------|-----------------|--------|
| 4 RUNNER 3.0 TDi | 09/2000→07/2002 | | | 4 RUNNER 3.0 Turbo-D | | 08/1993→03/1996 | |
| GRANVIA 3.0 TD | 08/1995→12/2002 | | | GRANVIA 3.0 TDi | | 08/1995→12/2004 | |
| HIACE III 3.0 TD | 08/1993→08/2004 | | | HILUX 3.0 TDiC | | 08/1993→07/1997 | |
| HILUX V 3.0 D | 08/1993→11/1995 | | | HILUX VI 3.0 TD | | 08/1997→06/2005 | |
| LAND CRUISER 90 3.0 TD | 04/1995→12/2002 | | | LAND CRUISER PRADO 3.0 D | | 02/2003→07/2009 | |
| LAND CRUISER PRADO 3.0 D-4D | 09/2002→07/2009 | | | | | | |

V91720 13711-54020
42.50 x 7.99 x 103.55

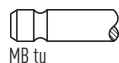

45°

H

V95147 13711-54040
42.50 x 7.99 x 104.30

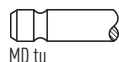

45°

V94458 13715-67020
37.00 x 8.00 x 103.50

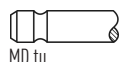





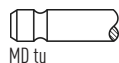







45°







V95148 13715-67040
37.00 x 7.98 x 104.25









45° SS

|  |  | ccm |  |  |  |  | |
|---|---|-------|---|---|---|---|----|
| 12 NV | | 77.80 | 1196 | 4 | 8 | Petrol | 25 |
| 12 ST | | 77.80 | 1196 | 4 | 8 | Petrol | 25 |
| 13 N | | 75.00 | 1297 | 4 | 8 | Petrol | 17 |
| 13 NB | | 75.00 | 1297 | 4 | 8 | Petrol | 17 |
| 13 S | | 75.00 | 1297 | 4 | 8 | Petrol | 17 |
| 13 SB | | 75.00 | 1297 | 4 | 8 | Petrol | 17 |
| 14 NV | | 77.60 | 1389 | 4 | 8 | Petrol | 20 |
| 15 D | | 76.00 | 1488 | 4 | 8 | Diesel | 18 |
| 15 DT | | 76.00 | 1488 | 4 | 8 | Diesel | 19 |
| 15 DT (T4EC1) | | 76.00 | 1488 | 4 | 8 | Diesel | 19 |
| 16 D | | 80.00 | 1598 | 4 | 8 | Diesel | 37 |
| 16 DA | | 80.00 | 1598 | 4 | 8 | Diesel | 37 |
| 16 N | | 80.00 | 1598 | 4 | 8 | Petrol | 38 |
| 16 S | | 85.00 | 1598 | 4 | 8 | Petrol | 61 |
| 16 SH | | 80.00 | 1598 | 4 | 8 | Petrol | 38 |
| 16 SV | | 79.00 | 1598 | 4 | 8 | Petrol | 26 |
| 17 D | | 82.50 | 1699 | 4 | 8 | Diesel | 49 |
| 17 D (4EE1) | | 79.00 | 1686 | 4 | 8 | Diesel | 33 |
| 17 DR | | 82.50 | 1699 | 4 | 8 | Diesel | 49 |
| 17 DT (TC4EE1) | | 79.00 | 1686 | 4 | 8 | Diesel | 34 |
| 18 NV | | 84.80 | 1796 | 4 | 8 | Petrol | 58 |
| 18 SE | | 84.80 | 1796 | 4 | 8 | Petrol | 59 |
| 18 SEH | | 84.80 | 1796 | 4 | 8 | Petrol | 59 |
| 18 SV | | 84.80 | 1796 | 4 | 8 | Petrol | 59 |
| 20 NE | | 86.00 | 1998 | 4 | 8 | Petrol | 63 |
| 20 NEJ | | 86.00 | 1998 | 4 | 8 | Petrol | 64 |
| 20 SE | | 86.00 | 1998 | 4 | 8 | Petrol | 65 |
| 20 SEH | | 86.00 | 1998 | 4 | 8 | Petrol | 63 |
| 20 XE | | 86.00 | 1998 | 4 | 16 | Petrol | 66 |
| 23 DTR | | 92.00 | 2260 | 4 | 8 | Diesel | 79 |
| 23 YDT | | 92.00 | 2260 | 4 | 8 | Diesel | 79 |
| 25TDS (VM41B) | | 92.00 | 2499 | 4 | 8 | Diesel | 80 |
| 4 JG2TC | | 95.40 | 3059 | 4 | 8 | Diesel | 85 |
| 6 VD1 | | 93.40 | 3165 | 6 | 24 | Petrol | 82 |
| 843 A1.000 | | 72.00 | 1368 | 4 | 16 | Petrol | 5 |
| A 10 XEP | | 73.40 | 998 | 3 | 12 | Petrol | 11 |
| A 12 XEL | | 73.40 | 1229 | 4 | 16 | Petrol | 12 |
| A 12 XER | | 73.40 | 1229 | 4 | 16 | Petrol | 13 |
| A 13 DTC | | 69.60 | 1248 | 4 | 16 | Diesel | 2 |
| A 13 DTE | | 69.60 | 1248 | 4 | 16 | Diesel | 2 |
| A 13 DTR | | 69.60 | 1248 | 4 | 16 | Diesel | 2 |
| A 13 FD | | 69.60 | 1248 | 4 | 16 | Diesel | 2 |
| A 14 FP | | 72.00 | 1368 | 4 | 16 | Petrol | 6 |
| A 14 NEL | | 72.50 | 1364 | 4 | 16 | Petrol | 9 |
| A 14 NET | | 72.50 | 1364 | 4 | 16 | Petrol | 9 |
| A 14 XEL | | 73.40 | 1398 | 4 | 16 | Petrol | 15 |
| A 14 XER | | 73.40 | 1398 | 4 | 16 | Petrol | 15 |
| A 16 LET | | 79.00 | 1598 | 4 | 16 | Petrol | 27 |
| A 16 XER | | 79.00 | 1598 | 4 | 16 | Petrol | 27 |
| A 17 DT | | 79.00 | 1686 | 4 | 16 | Diesel | 35 |
| A 17 DTC | | 79.00 | 1686 | 4 | 16 | Diesel | 35 |
| A 17 DTE | | 79.00 | 1686 | 4 | 16 | Diesel | 35 |
| A 17 DTJ | | 79.00 | 1686 | 4 | 16 | Diesel | 35 |
| A 17 DTL | | 79.00 | 1686 | 4 | 16 | Diesel | 35 |
| A 17 DTR | | 79.00 | 1686 | 4 | 16 | Diesel | 35 |
| A 17 DTS | | 79.00 | 1686 | 4 | 16 | Diesel | 35 |
| A 18 XEL | | 80.50 | 1796 | 4 | 16 | Petrol | 42 |
| A 18 XER | | 80.50 | 1796 | 4 | 16 | Petrol | 43 |
| A 20 DTC | | 83.00 | 1956 | 4 | 16 | Diesel | 52 |
| A 20 DTH | | 83.00 | 1956 | 4 | 16 | Diesel | 52 |
| A 20 DTJ | | 83.00 | 1956 | 4 | 16 | Diesel | 52 |
| A 20 NHT | | 86.00 | 1998 | 4 | 16 | Petrol | 67 |
| B 12 XHT (EB2DTS) | | 75.00 | 1199 | 3 | 12 | Petrol | 16 |
| C 12 NZ | | 72.00 | 1195 | 4 | 8 | Petrol | 4 |
| C 13 N | | 75.00 | 1297 | 4 | 8 | Petrol | 17 |
| C 14 NZ | | 77.60 | 1389 | 4 | 8 | Petrol | 20 |

|  |  | ccm |  |  |  |  |
|---|---|------|--|---|---|---|
| C 14 SE | 77.60 | 1389 | 4 | 8 | Petrol | 21 |
| C 14 SEL | 77.60 | 1389 | 4 | 16 | Petrol | 22 |
| C 16 LZ | 79.00 | 1598 | 4 | 8 | Petrol | 26 |
| C 16 NZ | 79.00 | 1598 | 4 | 8 | Petrol | 26 |
| C 16 SE | 79.00 | 1598 | 4 | 8 | Petrol | 26 |
| C 16 SEL | 79.00 | 1598 | 4 | 16 | Petrol | 28 |
| C 16 XE | 79.00 | 1598 | 4 | 16 | Petrol | 29 |
| C 18 NE | 84.80 | 1796 | 4 | 8 | Petrol | 60 |
| C 18 NZ | 84.80 | 1796 | 4 | 8 | Petrol | 59 |
| C 18 XE | 81.60 | 1799 | 4 | 16 | Petrol | 45 |
| C 18 XEL | 81.60 | 1799 | 4 | 16 | Petrol | 45 |
| C 20 LET | 86.00 | 1998 | 4 | 16 | Petrol | 68 |
| C 20 NE | 86.00 | 1998 | 4 | 8 | Petrol | 65 |
| C 20 NEF | 86.00 | 1998 | 4 | 8 | Petrol | 65 |
| C 20 NEJ | 86.00 | 1998 | 4 | 8 | Petrol | 65 |
| C 20 XE | 86.00 | 1998 | 4 | 16 | Petrol | 68 |
| C 22 SEL | 86.00 | 2198 | 4 | 16 | Petrol | 70 |
| C 223 | 88.00 | 2238 | 4 | 8 | Diesel | 76 |
| C 25 XE | 81.60 | 2498 | 6 | 24 | Petrol | 46 |
| E 16 NZ | 79.00 | 1598 | 4 | 8 | Petrol | 26 |
| E 16 SE | 79.00 | 1598 | 4 | 8 | Petrol | 26 |
| E 18 NV | 84.80 | 1796 | 4 | 8 | Petrol | 59 |
| E 18 NVR | 84.80 | 1796 | 4 | 8 | Petrol | 59 |
| F 10 A | 65.50 | 970 | 4 | 8 | Petrol | 1 |
| F4R 720 | 82.70 | 1998 | 4 | 16 | Petrol | 51 |
| F4R 820 | 82.70 | 1998 | 4 | 16 | Petrol | 51 |
| F8Q 600 | 80.00 | 1870 | 4 | 8 | Diesel | 39 |
| F8Q 606 | 80.00 | 1870 | 4 | 8 | Diesel | 39 |
| F9Q 760 | 80.00 | 1870 | 4 | 8 | Diesel | 40 |
| F9Q 762 | 80.00 | 1870 | 4 | 8 | Diesel | 40 |
| F9Q 770 | 80.00 | 1870 | 4 | 8 | Diesel | 40 |
| F9Q 772 | 80.00 | 1870 | 4 | 8 | Diesel | 40 |
| F9Q 774 | 80.00 | 1870 | 4 | 8 | Diesel | 40 |
| G9T 720 | 87.00 | 2188 | 4 | 16 | Diesel | 73 |
| G9T 722 | 87.00 | 2188 | 4 | 16 | Diesel | 73 |
| G9T 750 | 87.00 | 2188 | 4 | 16 | Diesel | 73 |
| G9U 630 | 89.00 | 2464 | 4 | 16 | Diesel | 78 |
| G9U 632 | 89.00 | 2464 | 4 | 16 | Diesel | 78 |
| G9U 650 | 89.00 | 2464 | 4 | 16 | Diesel | 78 |
| G9U 720 | 89.00 | 2464 | 4 | 16 | Diesel | 78 |
| G9U 724 | 89.00 | 2464 | 4 | 16 | Diesel | 78 |
| G9U 730 | 89.00 | 2464 | 4 | 16 | Diesel | 78 |
| G9U 750 | 89.00 | 2464 | 4 | 16 | Diesel | 78 |
| G9U 754 | 89.00 | 2464 | 4 | 16 | Diesel | 78 |
| K10B | 73.00 | 996 | 3 | 12 | Petrol | 10 |
| M9R 630 | 84.00 | 1995 | 4 | 16 | Diesel | 55 |
| M9R 780 | 84.00 | 1995 | 4 | 16 | Diesel | 55 |
| M9R 782 | 84.00 | 1995 | 4 | 16 | Diesel | 55 |
| M9R 784 | 84.00 | 1995 | 4 | 16 | Diesel | 55 |
| M9R 786 | 84.00 | 1995 | 4 | 16 | Diesel | 55 |
| M9R 788 | 84.00 | 1995 | 4 | 16 | Diesel | 55 |
| M9T 670 | 85.00 | 2298 | 4 | 16 | Diesel | 62 |
| M9T 672 | 85.00 | 2298 | 4 | 16 | Diesel | 62 |
| M9T 676 | 85.00 | 2298 | 4 | 16 | Diesel | 62 |
| M9T 678 | 85.00 | 2298 | 4 | 16 | Diesel | 62 |
| M9T 680 | 85.00 | 2298 | 4 | 16 | Diesel | 62 |
| M9T 686 | 85.00 | 2298 | 4 | 16 | Diesel | 62 |
| M9T 690 | 85.00 | 2298 | 4 | 16 | Diesel | 62 |
| M9T 692 | 85.00 | 2298 | 4 | 16 | Diesel | 62 |
| M9T 694 | 85.00 | 2298 | 4 | 16 | Diesel | 62 |
| M9T 696 | 85.00 | 2298 | 4 | 16 | Diesel | 62 |
| M9T 698 | 85.00 | 2298 | 4 | 16 | Diesel | 62 |
| M9T 880 | 85.00 | 2298 | 4 | 16 | Diesel | 62 |
| M9T 898 | 85.00 | 2298 | 4 | 16 | Diesel | 62 |
| S 18 NV | 84.80 | 1796 | 4 | 8 | Petrol | 59 |
| S8U 758 | 93.00 | 2500 | 4 | 8 | Diesel | 81 |

|  |  | ccm |  |  |  |  |
|---|---|------|---|---|---|---|
| S8U 770 | 93.00 | 2500 | 4 | 8 | Diesel | 81 |
| S8U 772 | 93.00 | 2500 | 4 | 8 | Diesel | 81 |
| S8U 780 | 93.00 | 2500 | 4 | 8 | Diesel | 81 |
| S8U 782 | 93.00 | 2500 | 4 | 8 | Diesel | 81 |
| S9W 700 | 94.40 | 2800 | 4 | 8 | Diesel | 83 |
| S9W 702 | 94.40 | 2800 | 4 | 8 | Diesel | 84 |
| X 10 XE | 72.50 | 973 | 3 | 12 | Petrol | 7 |
| X 12 SZ | 72.00 | 1195 | 4 | 8 | Petrol | 4 |
| X 12 XE | 72.50 | 1199 | 4 | 16 | Petrol | 8 |
| X 14 SZ | 77.60 | 1389 | 4 | 8 | Petrol | 21 |
| X 14 XE | 77.60 | 1389 | 4 | 16 | Petrol | 23 |
| X 15 DT (T4EC1) | 76.00 | 1488 | 4 | 8 | Diesel | 19 |
| X 16 SZ | 79.00 | 1598 | 4 | 8 | Petrol | 26 |
| X 16 SZR | 79.00 | 1598 | 4 | 8 | Petrol | 30 |
| X 16 XE | 79.00 | 1598 | 4 | 16 | Petrol | 29 |
| X 16 XEL | 79.00 | 1598 | 4 | 16 | Petrol | 29 |
| X 17 D (4EE1) | 79.00 | 1686 | 4 | 8 | Diesel | 33 |
| X 17 DT (TC4EE1) | 79.00 | 1686 | 4 | 8 | Diesel | 34 |
| X 17 DTL | 82.50 | 1699 | 4 | 8 | Diesel | 50 |
| X 18 XE | 81.60 | 1799 | 4 | 16 | Petrol | 45 |
| X 18 XE1 | 80.50 | 1796 | 4 | 16 | Petrol | 44 |
| X 20 DTH | 84.00 | 1995 | 4 | 16 | Diesel | 56 |
| X 20 DTL | 84.00 | 1995 | 4 | 16 | Diesel | 56 |
| X 20 SE | 86.00 | 1998 | 4 | 8 | Petrol | 65 |
| X 20 XER | 86.00 | 1998 | 4 | 16 | Petrol | 69 |
| X 20 XEV | 86.00 | 1998 | 4 | 16 | Petrol | 69 |
| X 22 DTH | 84.00 | 2171 | 4 | 16 | Diesel | 57 |
| X 22 SE | 86.00 | 2198 | 4 | 16 | Petrol | 70 |
| X 22 XE | 86.00 | 2198 | 4 | 16 | Petrol | 70 |
| X 25 DT | 80.00 | 2497 | 6 | 12 | Diesel | 41 |
| X 25 TD | 80.00 | 2497 | 6 | 12 | Diesel | 41 |
| X 25 XE | 81.60 | 2498 | 6 | 24 | Petrol | 46 |
| X 30 XE | 86.00 | 2962 | 6 | 24 | Petrol | 72 |
| Y 13 DT | 69.60 | 1248 | 4 | 16 | Diesel | 3 |
| Y 16 XE | 79.00 | 1598 | 4 | 16 | Petrol | 28 |
| Y 17 DT | 79.00 | 1686 | 4 | 16 | Diesel | 36 |
| Y 17 DTL | 79.00 | 1686 | 4 | 16 | Diesel | 36 |
| Y 20 DTH | 84.00 | 1995 | 4 | 16 | Diesel | 56 |
| Y 20 DTL | 84.00 | 1995 | 4 | 16 | Diesel | 56 |
| Y 22 DTH | 84.00 | 2171 | 4 | 16 | Diesel | 57 |
| Y 22 DTR | 84.00 | 2171 | 4 | 16 | Diesel | 57 |
| Y 22 SE | 86.00 | 2198 | 4 | 16 | Petrol | 70 |
| Y 22 XE | 86.00 | 2198 | 4 | 16 | Petrol | 70 |
| Y 26 SE | 83.20 | 2597 | 6 | 24 | Petrol | 54 |
| Y 32 SE | 87.50 | 3175 | 6 | 24 | Petrol | 75 |
| Z 10 XE | 72.50 | 973 | 3 | 12 | Petrol | 7 |
| Z 10 XEP | 73.40 | 998 | 3 | 12 | Petrol | 11 |
| Z 12 XE | 72.50 | 1199 | 4 | 16 | Petrol | 8 |
| Z 12 XEP | 73.40 | 1229 | 4 | 16 | Petrol | 13 |
| Z 13 DT | 69.60 | 1248 | 4 | 16 | Diesel | 3 |
| Z 13 DTE | 69.60 | 1248 | 4 | 16 | Diesel | 2 |
| Z 13 DTH | 69.60 | 1248 | 4 | 16 | Diesel | 3 |
| Z 13 DTJ | 69.60 | 1248 | 4 | 16 | Diesel | 3 |
| Z 13 DTR | 69.60 | 1248 | 4 | 16 | Diesel | 3 |
| Z 14 XE | 77.60 | 1389 | 4 | 16 | Petrol | 24 |
| Z 14 XEL | 73.40 | 1364 | 4 | 16 | Petrol | 14 |
| Z 14 XEP | 73.40 | 1364 | 4 | 16 | Petrol | 14 |
| Z 16 LEL | 79.00 | 1598 | 4 | 16 | Petrol | 31 |
| Z 16 LER | 79.00 | 1598 | 4 | 16 | Petrol | 31 |
| Z 16 LET | 79.00 | 1598 | 4 | 16 | Petrol | 31 |
| Z 16 SE | 79.00 | 1598 | 4 | 8 | Petrol | 30 |
| Z 16 XE | 79.00 | 1598 | 4 | 16 | Petrol | 28 |
| Z 16 XE1 | 79.00 | 1598 | 4 | 16 | Petrol | 32 |
| Z 16 XEP | 79.00 | 1598 | 4 | 16 | Petrol | 32 |
| Z 16 XER | 79.00 | 1598 | 4 | 16 | Petrol | 32 |
| Z 17 DTH | 79.00 | 1686 | 4 | 16 | Diesel | 36 |

|  |  | ccm |  |  |  |  |
|---|---|------|--|---|---|---|
| Z 17 DTJ | 79.00 | 1686 | 4 | 16 | Diesel | 35 |
| Z 17 DTL | 79.00 | 1686 | 4 | 16 | Diesel | 36 |
| Z 17 DTR | 79.00 | 1686 | 4 | 16 | Diesel | 35 |
| Z 18 XE | 80.50 | 1796 | 4 | 16 | Petrol | 44 |
| Z 18 XEL | 80.50 | 1796 | 4 | 16 | Petrol | 44 |
| Z 18 XEP | 80.50 | 1796 | 4 | 16 | Petrol | 42 |
| Z 18 XER | 80.50 | 1796 | 4 | 16 | Petrol | 43 |
| Z 19 DT | 82.00 | 1910 | 4 | 8 | Diesel | 47 |
| Z 19 DTH | 82.00 | 1910 | 4 | 16 | Diesel | 48 |
| Z 19 DTJ | 82.00 | 1910 | 4 | 16 | Diesel | 48 |
| Z 19 DTL | 82.00 | 1910 | 4 | 8 | Diesel | 47 |
| Z 20 DM | 83.00 | 1991 | 4 | 16 | Diesel | 53 |
| Z 20 DMH | 83.00 | 1991 | 4 | 16 | Diesel | 53 |
| Z 20 LEH | 86.00 | 1998 | 4 | 16 | Petrol | 69 |
| Z 20 LEL | 86.00 | 1998 | 4 | 16 | Petrol | 69 |
| Z 20 LER | 86.00 | 1998 | 4 | 16 | Petrol | 69 |
| Z 20 LET | 86.00 | 1998 | 4 | 16 | Petrol | 69 |
| Z 20 NET | 86.00 | 1998 | 4 | 16 | Petrol | 67 |
| Z 22 SE | 86.00 | 2198 | 4 | 16 | Petrol | 71 |
| Z 22 XE | 86.00 | 2198 | 4 | 16 | Petrol | 70 |
| Z 22 YH | 86.00 | 2198 | 4 | 16 | Petrol | 71 |
| Z 24 XED | 87.50 | 2405 | 4 | 16 | Petrol | 74 |
| Z 32 SE | 88.50 | 3175 | 6 | 24 | Petrol | 77 |



OE

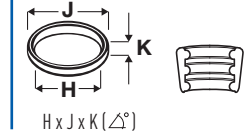
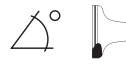

1

65.50

| | | | | | | | |
|---------------|-------|-----------------|-----------------|-----------|--------|-------------|----------------|
| F 10 A | 970cc | 4 Cyl. | 8 Valves | 34kW/46PS | Petrol | SOHC | TD29536 |
| RASCAL 1.0 | | 07/1986→08/1993 | | | | | |

| | | | | | | | |
|-----------------------|-------------|-------|-----|---|--|--|--|
| V91253 | 12911-78101 | | 45° | H | | | |
| 31.70 x 6.98 x 110.00 | | MB tu | | | | | |
| V91254 | 12915-84000 | | 45° | | | | |
| 27.65 x 6.97 x 109.85 | | MD | | | | | |

2

69.60

| | | | | | | | |
|-----------------|--------|--------|------------------|-----------------|--------|--------------------|----------------|
| A 13 DTC | 1248cc | 4 Cyl. | 16 Valves | 55kW/75PS | Diesel | Turbo, DOHC | TD24745 |
| A 13 DTE | 1248cc | 4 Cyl. | 16 Valves | 70kW/95PS | Diesel | Turbo, DOHC | TD24232 |
| A 13 DTR | 1248cc | 4 Cyl. | 16 Valves | 70kW/95PS | Diesel | Turbo, DOHC | TD28000 |
| A 13 FD | 1248cc | 4 Cyl. | 16 Valves | 55-66kW/75-90PS | Diesel | Turbo, DOHC | TD26203 |
| Z 13 DTE | 1248cc | 4 Cyl. | 16 Valves | 70kW/95PS | Diesel | Turbo, DOHC | TD24377 |

| | | | |
|---------------------------|-----------------|------------------------------|----------|
| ASTRA Mk VI (J) 1.3 CDTi | 12/2009→ | ASTRA Mk VI (J) 1.3 CDTi | 10/2010→ |
| COMBO Mk III (D) 1.3 CDTi | 11/2011→ | COMBO Mk III (D) 1.3 CDTi | 02/2012→ |
| CORSA Mk III (D) 1.3 CDTi | 07/2006→08/2014 | CORSAVAN Mk III (D) 1.3 CDTi | 07/2006→ |
| MERIVA Mk II (B) 1.3 CDTi | 06/2010→ | MERIVA Mk II (B) 1.3 CDTi | 06/2010→ |

| | | | | | | | |
|-----------------------|----------|------------|-----|----|----------------------|--|--|
| V95182 | 55204574 | | 45° | H | VAG96359 | | |
| 21.85 x 5.98 x 109.25 | | MB cr | | | 43.28 x 6.00 x 10.25 | | |
| V95183 | 55223836 | | 45° | ss | H | | |
| 22.50 x 5.99 x 109.20 | | MD + MB cr | | | | | |

3

69.60

| | | | | | | | |
|-----------------|--------|--------|------------------|------------------|--------|--------------------|----------------|
| Y 13 DT | 1248cc | 4 Cyl. | 16 Valves | 51kW/69PS | Diesel | Turbo, DOHC | TD23798 |
| Z 13 DT | 1248cc | 4 Cyl. | 16 Valves | 51-52kW/70-71PS | Diesel | Turbo, DOHC | TD18361 |
| Z 13 DTH | 1248cc | 4 Cyl. | 16 Valves | 66-74kW/90-101PS | Diesel | Turbo, DOHC | TD18654 |
| Z 13 DTJ | 1248cc | 4 Cyl. | 16 Valves | 51-55kW/69-75PS | Diesel | Turbo, DOHC | TD19348 |
| Z 13 DTR | 1248cc | 4 Cyl. | 16 Valves | 70kW/95PS | Diesel | Turbo, DOHC | TD25258 |

| | | | |
|---------------------------------|-----------------|-----------------------------------|-----------------|
| AGILA Mk II (B) 1.3 CDTi | 01/2008→11/2014 | ASTRA Mk V (H) 1.3 CDTi | 08/2004→11/2010 |
| ASTRA Mk V (H) 1.3 CDTi | 01/2004→05/2009 | ASTRAVAN Mk V (H) 1.3 CDTi | 08/2005→ |
| COMBO Mk II (C) 1.3 CDTi 16V | 09/2004→02/2012 | COMBO TOUR Mk II (C) 1.3 CDTi 16V | 09/2004→02/2012 |
| CORSA Mk II (C) 1.3 CDTi 16V | 08/2000→09/2006 | CORSA Mk III (D) 1.3 CDTi | 07/2006→08/2014 |
| CORSAVAN Mk II (C) 1.3 CDTi 16V | 04/2004→06/2006 | CORSAVAN Mk III (D) 1.3 CDTi | 07/2006→ |
| MERIVA Mk I (A) 1.3 CDTi | 01/2003→06/2010 | TIGRA 1.3 CDTi | 06/2004→08/2009 |

| | | | | | | | |
|-----------------------|----------|------------|-----|---|---|----------------------|--|
| V95015 | 93177676 | | 45° | Y | H | VAG96359 | |
| 21.85 x 6.00 x 109.20 | | MB cr | | | | 43.28 x 6.00 x 10.25 | |
| V95016 | 93190438 | | 45° | | H | | |
| 21.80 x 6.00 x 109.20 | | MD + MB cr | | | | | |

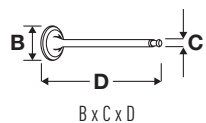

OE

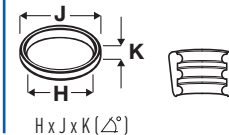
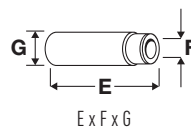

4 72.00

| | | | | | | | |
|--------------------------------|------------------------------------|--------|-----------------|----------------------|--------|------------------------|----------------|
| C 12 NZ | 1195cc | 4 Cyl. | 8 Valves | 33kW/45PS | Petrol | SOHC, Injection | TD17553 |
| X 12 SZ | 1195cc | 4 Cyl. | 8 Valves | 33kW/45PS | Petrol | SOHC, Injection | TD17552 |
| COMBO Mk I (B) 1.2 NOVA 1.2 | 07/1994→10/2001 09/1989→03/1993 | | | CORSA Mk I (B) 1.2 i | | 03/1993→09/2000 | |

| | | | | | | | |
|-----------------------|----------|-------|-----|---|----------------------|--|--|
| V91211 | 90323519 | | 45° | H | VAG96022 | | |
| 33.10 x 7.00 x 104.50 | | MB | | | 45.80 x 7.02 x 11.04 | | |
| V91212 | 90323524 | | 45° | | | | |
| 29.10 x 6.99 x 104.60 | | MD cr | | | | | |

5 72.00

| | | | | | | | |
|-------------------|--------|--------|------------------|-----------|--------|-------------|----------------|
| 843 A1.000 | 1368cc | 4 Cyl. | 16 Valves | 70kW/95PS | Petrol | DOHC | TD26415 |
|-------------------|--------|--------|------------------|-----------|--------|-------------|----------------|

| | | | | | | | |
|-------------------------------------|------------|-------|-----|---|-------------------------------------|--|--|
| V94029 | 46 403 681 | | 45° | H | VAG96272 | | |
| 26.90 x 6.00 x 95.20 Eng.→984712 | | MB | | | 39.70 x 6.02 x 10.03 Eng.984713→ | | |
| V98026 | 55 185 028 | | 45° | | | | |
| 26.80 x 6.00 x 95.20 Eng.984713→ | | MB cr | | | | | |
| V94030 | 46 471 639 | | 45° | | | | |
| 22.50 x 6.00 x 96.20 Eng.→984712 | | MD cr | | | | | |
| V98027 | 55 185 080 | | 45° | | | | |
| 22.45 x 5.97 x 94.70 Eng.984713→ | | MD cr | | | | | |

6 72.00

| | | | | | | | |
|----------------|--------|--------|------------------|-----------|--------|-------------|----------------|
| A 14 FP | 1368cc | 4 Cyl. | 16 Valves | 70kW/95PS | Petrol | DOHC | TD26198 |
|----------------|--------|--------|------------------|-----------|--------|-------------|----------------|

| | | | | | | | |
|-------------------------------------|------------|-------|-----|---|----------------------|--|--|
| COMBO Mk III (D) 1.4 | 11/2011→ | | | | | | |
| V94029 | 46 403 681 | | 45° | H | VAG96272 | | |
| 26.90 x 6.00 x 95.20 Eng.→984712 | | MB | | | 39.70 x 6.02 x 10.03 | | |
| V98026 | 55 185 028 | | 45° | | | | |
| 26.80 x 6.00 x 95.20 Eng.984713→ | | MB cr | | | | | |
| V94030 | 46 471 639 | | 45° | | | | |
| 22.50 x 6.00 x 96.20 Eng.→984712 | | MD cr | | | | | |
| V98027 | 55 185 080 | | 45° | | | | |
| 22.45 x 5.97 x 94.70 Eng.984713→ | | MD cr | | | | | |





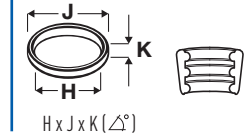
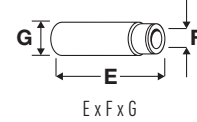



OE





7  **72.50**

| | | | | | | | |
|-------------------------|-------|-----------------|------------------|--------------------------|--------|------------------------|----------------|
| X 10 XE | 973cc | 3 Cyl. | 12 Valves | 40kW/54PS | Petrol | DOHC, Injection | TD17619 |
| Z 10 XE | 973cc | 3 Cyl. | 12 Valves | 43kW/58PS | Petrol | DOHC, Injection | TD17630 |
| AGILA Mk I (A) 1.0 12V | | 09/2000→08/2005 | | CORSA Mk I (B) 1.0 i 12V | | 11/1996→09/2000 | |
| CORSA Mk II (C) 1.0 12V | | 09/2000→10/2003 | | | | | |

| | | | | | | |
|---|----------|---|-----|---|---|---|
| V94245  | 90529527 |  | 45° | H | VAG96077  |  |
| 28.00 x 5.00 x 93.90 | | MB cr | | | 39.00 x 5.00 x 10.04 | |
| V94246  | 90529529 |  | 45° | | | |
| 25.00 x 5.00 x 93.90 | | MD cr | | | | |



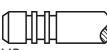

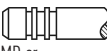
8  **72.50**

| | | | | | | | |
|----------------------------|--------|-----------------|------------------|-------------------------|--------|------------------------|----------------|
| X 12 XE | 1199cc | 4 Cyl. | 16 Valves | 48kW/65PS | Petrol | DOHC, Injection | TD17620 |
| Z 12 XE | 1199cc | 4 Cyl. | 16 Valves | 55kW/75PS | Petrol | DOHC, Injection | TD17935 |
| AGILA Mk I (A) 1.2 16V | | 09/2000→03/2008 | | ASTRA Mk IV (G) 1.2 16V | | 02/1998→05/2005 | |
| CORSA Mk I (B) 1.2 i 16V | | 03/1998→09/2000 | | CORSA Mk II (C) 1.2 16V | | 09/2000→10/2006 | |
| CORSAVAN Mk II (C) 1.2 16V | | 09/2000→06/2006 | | | | | |

| | | | | | | |
|---|----------|---|-----|---|---|--|
| V94245  | 90529527 |  | 45° | H | VAG96077  |  |
| 28.00 x 5.00 x 93.90 | | MB cr | | | 39.00 x 5.00 x 10.04 | |
| V94246  | 90529529 |  | 45° | | | |
| 25.00 x 5.00 x 93.90 | | MD cr | | | | |

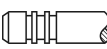

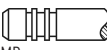

9  **72.50**

| | | | | | | | |
|------------------------------|--------|-----------------|------------------|----------------------------------|--------|-------------------------------|----------------|
| A 14 NEL | 1364cc | 4 Cyl. | 16 Valves | 88kW/120PS | Petrol | DOHC, Injection | TD24744 |
| A 14 NET | 1364cc | 4 Cyl. | 16 Valves | 103kW/140PS | Petrol | Turbo, DOHC, Injection | TD24731 |
| ASTRA Mk VI (J) 1.4 Turbo | | 12/2009→ | | ASTRA Mk VI (J) GTC 1.4 | | 10/2011→ | |
| CASCADA 1.4 | | 02/2013→ | | CORSA Mk III (D) 1.4 | | 07/2012→08/2014 | |
| INSIGNIA Mk I (A) 1.4 | | 04/2011→05/2017 | | INSIGNIA Mk I (A) 1.4 LPG | | 07/2012→05/2017 | |
| INSIGNIA Mk I (A) Tourer 1.4 | | 04/2011→05/2017 | | INSIGNIA Mk I (A) Tourer 1.4 LPG | | 07/2012→05/2017 | |
| MERIVA Mk II (B) 1.4 | | 06/2010→ | | MERIVA Mk II (B) 1.4 LPG | | 06/2011→ | |
| MOKKA / MOKKA X 1.4 | | 06/2012→ | | ZAFIRA Mk III 1.4 | | 10/2011→ | |
| ZAFIRA Mk III 1.4 LPG | | 10/2011→ | | | | | |

| | | | | | | |
|---|----------|---|-----|---|---|---|
| V94245  | 90529527 |  | 45° | H | VAG96077  |  |
| 28.00 x 5.00 x 93.90 | | MB cr | | | 39.00 x 5.00 x 10.04 | |
| V94246  | 90529529 |  | 45° | | | |
| 25.00 x 5.00 x 93.90 | | MD cr | | | | |

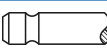
10  **73.00**

| | | | | | | | |
|-------------------------|-------|-----------------|------------------|-----------------------|--------|-----------------|----------------|
| K10B | 996cc | 3 Cyl. | 12 Valves | 48-50kW/65-68PS | Petrol | DOHC | TD24738 |
| AGILA Mk II (B) 1.0 12V | | 01/2008→11/2014 | | AGILA Mk II (B) 1.0 i | | 08/2011→11/2014 | |

| | | | | | | |
|---|----------|---|-----|---|---|---|
| V95224  | 93193754 |  | 45° | H | VAG96385  |  |
| 27.50 x 5.47 x 87.50 | | MB tu | | | 34.00 x 5.51 x 10.59 | |
| V95225  | 93193762 |  | 45° | | | |
| 22.95 x 5.46 x 87.05 | | MD tu | | | | |

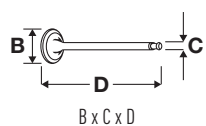

OE

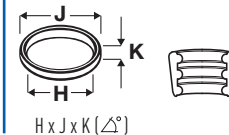

11 73.40

| | | | | | | | |
|------------------------|-----------------|--------|------------------|----------------------------|-----------------------|------------------------|----------------|
| A 10 XEP | 998cc | 3 Cyl. | 12 Valves | 44-48kW/60-65PS | Petrol | DOHC, Injection | TD24906 |
| Z 10 XEP | 998cc | 3 Cyl. | 12 Valves | 44kW/60PS | Petrol | DOHC, Injection | TD19349 |
| AGILA Mk I (A) 1.0 12V | 02/2000→11/2006 | | | CORSA Mk II (C) 1.0 12V | | 11/2003→10/2006 | |
| CORSA Mk III (D) 1.0 | 11/2006→08/2014 | | | CORSA Mk III (D) 1.0 i 12V | | 06/2010→08/2014 | |
| V94245 ■ | 90529527 | | 45° | H | VAG96077 ■ ■ ■ | | |
| 28.00 x 5.00 x 93.90 | | MB cr | | | 39.00 x 5.00 x 10.04 | | |
| V94246 ■ | 90529529 | | 45° | | | | |
| 25.00 x 5.00 x 93.90 | | MD cr | | | | | |

12 73.40

| | | | | | | | |
|-------------------------|----------|--------|------------------|----------------------|-----------------------|------------------------|----------------|
| A 12 XEL | 1229cc | 4 Cyl. | 16 Valves | 51kW/69PS | Petrol | DOHC, Injection | TD24747 |
| ADAM 1.2 | 10/2012→ | | | CORSA Mk III (D) 1.2 | | 06/2010→08/2014 | |
| CORSAVAN Mk III (D) 1.2 | 01/2010→ | | | | | | |
| V94245 ■ | 90529527 | | 45° | H | VAG96077 ■ ■ ■ | | |
| 28.00 x 5.00 x 93.90 | | MB cr | | | 39.00 x 5.00 x 10.04 | | |
| Eng.→19RN1913 | | | | | | | |
| V94246 ■ | 90529529 | | 45° | | | | |
| 25.00 x 5.00 x 93.90 | | MD cr | | | | | |
| Eng.→19RN1913 | | | | | | | |

13 73.40

| | | | | | | | |
|--------------------------|-----------------|--------|------------------|----------------------------|-----------------------|------------------------|----------------|
| A 12 XER | 1229cc | 4 Cyl. | 16 Valves | 61-63kW/83-86PS | Petrol | DOHC, Injection | TD24752 |
| Z 12 XEP | 1229cc | 4 Cyl. | 16 Valves | 59kW/80PS | Petrol | DOHC, Injection | TD19350 |
| AGILA Mk I (A) 1.2 16V | 07/2004→11/2006 | | | CORSA Mk II (C) 1.2 | | 07/2004→10/2006 | |
| CORSA Mk III (D) 1.2 | 11/2006→08/2014 | | | CORSA Mk III (D) 1.2 i 16V | | 11/2006→08/2014 | |
| CORSA Mk III (D) 1.2 LPG | 09/2009→08/2014 | | | CORSAVAN Mk III (D) 1.2 | | 07/2009→ | |
| V94245 ■ | 90529527 | | 45° | H | VAG96077 ■ ■ ■ | | |
| 28.00 x 5.00 x 93.90 | | MB cr | | | 39.00 x 5.00 x 10.04 | | |
| V94246 ■ | 90529529 | | 45° | | | | |
| 25.00 x 5.00 x 93.90 | | MD cr | | | | | |

14 73.40

| | | | | | | | |
|--------------------------|-----------------|--------|------------------|---------------------------|-----------------------|------------------------|----------------|
| Z 14 XEL | 1364cc | 4 Cyl. | 16 Valves | 55-59kW/75-80PS | Petrol | DOHC, Injection | TD25529 |
| Z 14 XEP | 1364cc | 4 Cyl. | 16 Valves | 66kW/90PS | Petrol | DOHC, Injection | TD18228 |
| ASTRA Mk V (H) 1.4 | 01/2004→11/2010 | | | ASTRA Mk V (H) 1.4 i 16V | | 03/2005→11/2010 | |
| ASTRAVAN Mk V (H) 1.4 i | 03/2005→ | | | COMBO Mk II (C) 1.4 i 16V | | 01/2004→11/2011 | |
| COMBO TOUR Mk II (C) 1.4 | 10/2004→09/2010 | | | CORSA Mk II (C) 1.4 | | 06/2003→10/2006 | |
| CORSA Mk III (D) 1.4 | 07/2006→08/2014 | | | CORSA Mk III (D) 1.4 LPG | | 07/2006→08/2014 | |
| CORSAVAN Mk II (C) 1.4 | 11/2003→06/2006 | | | MERIVA Mk I (A) 1.4 16V | | 01/2003→06/2010 | |
| TIGRA 1.4 | 06/2004→08/2009 | | | | | | |
| V94245 ■ | 90529527 | | 45° | H | VAG96077 ■ ■ ■ | | |
| 28.00 x 5.00 x 93.90 | | MB cr | | | 39.00 x 5.00 x 10.04 | | |
| V94246 ■ | 90529529 | | 45° | | | | |
| 25.00 x 5.00 x 93.90 | | MD cr | | | | | |

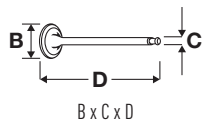

OE

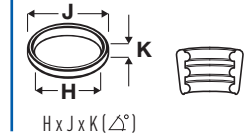
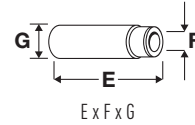
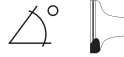

15



73.40

| | | | | | | | |
|----------------------|-----------------|--------|-----------|--------------------------|--------|-----------------|---------|
| A 14 XEL | 1398cc | 4 Cyl. | 16 Valves | 64kW/87PS | Petrol | DOHC, Injection | TD24743 |
| A 14 XER | 1398cc | 4 Cyl. | 16 Valves | 74kW/101PS | Petrol | DOHC, Injection | TD24542 |
| ADAM 1.4 | 10/2012→ | | | ADAM 1.4 LPG | | 07/2013→ | |
| ASTRA Mk VI (J) 1.4 | 12/2009→ | | | ASTRA Mk VI (J) GTC 1.4 | | 10/2011→ | |
| CORSA Mk III (D) 1.4 | 09/2009→08/2014 | | | CORSA Mk III (D) 1.4 LPG | | 09/2009→08/2014 | |
| MERIVA Mk II (B) 1.4 | 06/2010→ | | | | | | |

V94245 ■
28.00 x 5.00 x 93.90

90529527

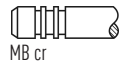

45°

H

VAG96077 ■ ■ ■
39.00 x 5.00 x 10.04



V94246 ■
25.00 x 5.00 x 93.90

90529529

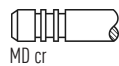

45°

16



75.00

| | | | | | | | |
|-------------------|----------|--------|-----------|-------------------|--------|------------------------|---------|
| B 12 XHT (EB2DTS) | 1199cc | 3 Cyl. | 12 Valves | 81-96kW/110-131PS | Petrol | Turbo, DOHC, Injection | TD34732 |
| CROSSLAND X 1.2 | 03/2017→ | | | GRANDLAND X 1.2 | | 06/2017→ | |

V80020 ■
26.42 x 5.00 x 93.50

98 019 609 80

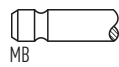

45°

V80021 ■
23.78 x 5.00 x 92.91

98 076 459 80



45°

SS

17



75.00

| | | | | | | | |
|--------|--------|--------|----------|-----------------|--------|------|---------|
| 13 N | 1297cc | 4 Cyl. | 8 Valves | 39-44kW/53-60PS | Petrol | SOHC | TD17558 |
| 13 NB | 1297cc | 4 Cyl. | 8 Valves | 44kW/60PS | Petrol | SOHC | TD17560 |
| 13 S | 1297cc | 4 Cyl. | 8 Valves | 42-55kW/57-75PS | Petrol | SOHC | TD17561 |
| 13 SB | 1297cc | 4 Cyl. | 8 Valves | 51kW/69PS | Petrol | SOHC | TD17600 |
| C 13 N | 1297cc | 4 Cyl. | 8 Valves | 44kW/60PS | Petrol | SOHC | TD18673 |

| | | | | | | | |
|----------------------|-----------------|--|--|-----------------------|--|-----------------|--|
| ASTRA 1.3 | 09/1980→08/1984 | | | ASTRA 1.3 S | | 09/1979→08/1984 | |
| ASTRA Mk II 1.3 | 09/1984→08/1991 | | | ASTRA Mk II 1.3 i Cat | | 09/1985→08/1991 | |
| ASTRAMAX 1.3 N | 08/1985→12/1989 | | | ASTRAMAX 1.3 S | | 08/1985→12/1989 | |
| CAVALIER 1300 | 08/1977→08/1981 | | | CAVALIER Mk II 1.3 | | 09/1981→08/1988 | |
| CAVALIER Mk II 1.3 N | 09/1981→08/1988 | | | CAVALIER Mk II 1.3 S | | 09/1981→08/1988 | |
| CHEVETTE 1.2 | 09/1974→12/1985 | | | CHEVETTE 1300 | | 09/1974→12/1985 | |
| NOVA 1.3 i | 09/1985→10/1989 | | | NOVA 1.3 i Cat | | 09/1989→03/1993 | |
| NOVA 1.3 S | 09/1982→10/1989 | | | | | | |

V90107 ■
33.02 x 7.01 x 104.90

90106098

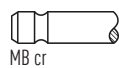

45°

H

VAG96022 ■ ■ ■
45.80 x 7.02 x 11.04



V90108 ■
29.00 x 6.99 x 104.60

90106086

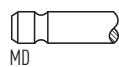

45°

VAG96026 ■ ■ ■
43.00 x 7.02 x 11.04



18



76.00

| | | | | | | | |
|----------------------|-----------------|--------|----------|-------------------------|--------|-----------------|---------|
| 15 D | 1488cc | 4 Cyl. | 8 Valves | 37kW/50PS | Diesel | SOHC | TD21906 |
| CORSA Mk I (B) 1.5 D | 12/1992→12/1996 | | | CORSAVAN Mk I (B) 1.5 D | | 08/1994→12/1995 | |
| NOVA 1.5 D | 09/1987→03/1993 | | | NOVAVAN 1.5 D | | 01/1991→10/1994 | |

V91230 ■
34.70 x 6.99 x 104.00

94326843

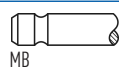

45°

H

VAG92321 ■ ■ ■
43.00 x 7.00 x 11.56

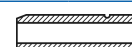

V91231 ■
30.70 x 6.98 x 104.00

94110017

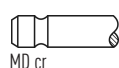

45°

st



OE

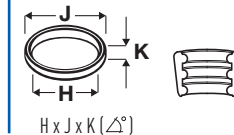
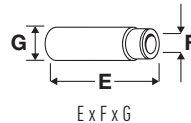

19 76.00

| | | | | | | | |
|-----------------------------------|------------------------------------|--------|-----------------|-----------------------|--------|--------------------|----------------|
| 15 DT | 1488cc | 4 Cyl. | 8 Valves | 53kW/73PS | Diesel | Turbo, SOHC | TD17578 |
| 15 DT (T4EC1) | 1488cc | 4 Cyl. | 8 Valves | 49-53kW/67-72PS | Diesel | Turbo, SOHC | TD18227 |
| X 15 DT (T4EC1) | 1488cc | 4 Cyl. | 8 Valves | 49kW/67PS | Diesel | Turbo, SOHC | TD22871 |
| ASTRA Mk II 1.5 DT NOVA 1.5 TD | 01/1987→08/1991 01/1990→03/1993 | | | CORSA Mk I (B) 1.5 TD | | 03/1993→10/1996 | |

V91230
34.70 x 6.99 x 104.00

94326843

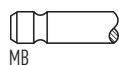

45°

H

VAG92321
43.00 x 7.00 x 11.56



V91232
30.70 x 6.98 x 104.15

97037591

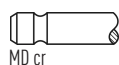

45°

ss

st

20 77.60

| | | | | | | | |
|--|--|--------|-----------------|--|--------|---|----------------|
| 14 NV | 1389cc | 4 Cyl. | 8 Valves | 53-55kW/72-75PS | Petrol | SOHC, Carburettor | TD17562 |
| C 14 NZ | 1389cc | 4 Cyl. | 8 Valves | 44kW/60PS | Petrol | SOHC, Injection | TD17581 |
| ASTRA Mk II 1.4 i ASTRA Mk III (F) 1.4 i ASTRAMAX 1.4 i ASTRAVAN Mk III (F) 1.4 i COMBO Mk I (B) 1.4 CORSAVAN Mk I (B) 1.4 i NOVA 1.4 i NOVAVAN 1.4 | 01/1990→12/1991 09/1991→09/1998 08/1991→07/1994 01/1991→10/1994 07/1994→10/2001 01/1994→09/2000 01/1990→03/1993 11/1990→03/1993 | | | ASTRA Mk II 1.4 S ASTRA Mk III (F) 1.4 S ASTRAMAX 1.4 S CAVALIER Mk III 1.4 S CORSA Mk I (B) 1.4 i NOVA 1.4 NOVA 1.4 S | | 01/1989→12/1991 09/1991→02/1998 07/1989→08/1991 09/1988→11/1995 03/1993→09/2000 10/1990→08/1992 01/1990→03/1993 | |

V91211
33.10 x 7.00 x 104.50

90323519

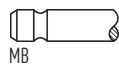

45°

H

VAG96022
45.80 x 7.02 x 11.04



V91212
29.10 x 6.99 x 104.60

90323524

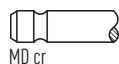

45°

21 77.60

| | | | | | | | |
|--|---|--------|-----------------|--|--------|---|----------------|
| C 14 SE | 1389cc | 4 Cyl. | 8 Valves | 60kW/82PS | Petrol | SOHC, Injection | TD17582 |
| X 14 SZ | 1389cc | 4 Cyl. | 8 Valves | 40-44kW/54-60PS | Petrol | SOHC, Injection | TD17621 |
| ASTRA Mk III (F) 1.4 i CORSA Mk I (B) 1.4 i NOVA 1.4 | 03/1991→03/2001 03/1993→09/2000 09/1990→08/1992 | | | COMBO Mk I (B) 1.4 CORSA Mk I (B) 1.4 i S NOVA 1.4 i S | | 07/1994→10/2001 03/1993→09/2000 09/1991→03/1993 | |

V91959
38.00 x 7.00 x 104.60

90409992

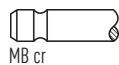

45°

H

VAG96022
45.80 x 7.02 x 11.04



V91960
31.00 x 7.00 x 104.60

90409996

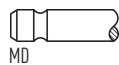

45°

22 77.60

| | | | | | | | |
|--------------------------|-----------------|--------|------------------|-----------|--------|------------------------|----------------|
| C 14 SEL | 1389cc | 4 Cyl. | 16 Valves | 63kW/86PS | Petrol | DOHC, Injection | TD12363 |
| CORSA Mk I (B) 1.4 i 16V | 08/1997→09/2000 | | | | | | |

V91995
31.10 x 6.00 x 103.10

90412912

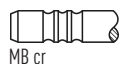

45°

H

VAG96028
45.00 x 5.99 x 10.05

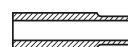

V91996
27.60 x 6.00 x 102.20

90412974



45°

ss



OE

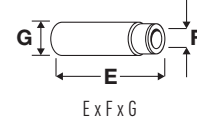



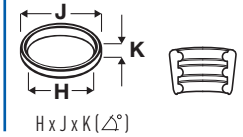





E x F x G

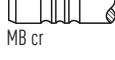

H x J x K (Δ°)

23  **77.60**

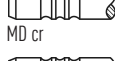





| X 14 XE | 1389cc | 4 Cyl. | 16 Valves | 66kW/90PS | Petrol | DOHC, Injection | TD17589 |
|----------------------------|--------|--------|-----------|-----------------|--------|-------------------------|-----------------|
| ASTRA Mk III (F) 1.4 i 16V | | | | 01/1996→03/2001 | | ASTRA Mk IV (G) 1.4 16V | 02/1998→05/2005 |
| ASTRAVAN Mk IV (G) 1.4 16V | | | | 09/2000→05/2005 | | COMBO Mk I (B) 1.4 16V | 08/1999→10/2001 |
| CORSA Mk I (B) 1.4 i 16V | | | | 09/1994→09/2000 | | TIGRA Mk I 1.4 16V | 07/1994→12/2000 |

| | | | | | | |
|--|----------|--|-----|----|---|---|
| V91995  31.10 x 6.00 x 103.10 | 90412912 |  MB cr | 45° | H | VAG96028  45.00 x 5.99 x 10.05 |  |
| V94050  [2] 31.10 x 5.97 x 102.90 | |  MB cr | 45° | H | | |
| V91996  27.60 x 6.00 x 102.20 | 90412974 |  MD cr | 45° | SS | | |
| V94051  [2] 27.60 x 5.95 x 101.95 | |  MD cr | 45° | SS | | |

[2] Service valve, for use on re-surfaced cylinder head only [2] Reparatur-Ventil, nur bei geplanten Zylinderkopfverarbeiten [2] Soupape de réparation, pour utilisation uniquement sur une culasse ré-usinée [2] Válvula de servicio, para uso solamente en culatas rebajadas [2] Ricambio valvola per uso su testate cilindro spianate

24  **77.60**

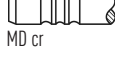
| Z 14 XE | 1389cc | 4 Cyl. | 16 Valves | 66kW/90PS | Petrol | DOHC, Injection | TD17631 |
|-------------------------|--------|--------|-----------|-----------------|--------|----------------------------|-----------------|
| ASTRA Mk IV (G) 1.4 16V | | | | 02/1998→05/2005 | | ASTRAVAN Mk IV (G) 1.4 16V | 09/2000→05/2005 |
| COMBO Mk II (C) 1.4 16V | | | | 10/2001→05/2007 | | CORSA Mk II (C) 1.4 16V | 09/2000→10/2006 |

| | | | | | | |
|--|----------|--|-----|----|---|---|
| V91995  31.10 x 6.00 x 103.10 | 90412912 |  MB cr | 45° | H | VAG96137  45.00 x 6.02 x 10.05 |  |
| V91996  27.60 x 6.00 x 102.20 | 90412974 |  MD cr | 45° | SS | VAG96151  45.00 x 6.02 x 10.09 |  |

25  **77.80**

| 12 NV | 119cc | 4 Cyl. | 8 Valves | 38kW/52PS | Petrol | SOHC, Carburettor | TD22840 |
|-------------|-------|--------|----------|-----------------|--------|-------------------|-----------------|
| 12 ST | 119cc | 4 Cyl. | 8 Valves | 40-43kW/54-58PS | Petrol | SOHC | TD17599 |
| NOVA 1.2 N | | | | 01/1990→03/1993 | | NOVA 1.2 S | 09/1982→02/1990 |
| NOVAVAN 1.2 | | | | 01/1990→10/1994 | | | |

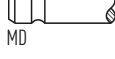
| | | | | | | |
|--|----------|--|-----|---|---|---|
| V90107  33.02 x 7.01 x 104.90 | 90106098 |  MB cr | 45° | H | VAG96022  45.80 x 7.02 x 11.04 |  |
| V90108  29.00 x 6.99 x 104.60 | 90106086 |  MD | 45° | | VAG96026  43.00 x 7.02 x 11.04 |  |

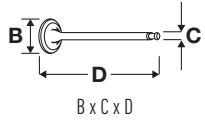

OE

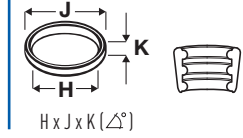
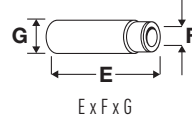
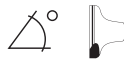

26  **79.00**

| | | | | | | | |
|----------------|--------|--------|-----------------|------------------|--------|--------------------------|----------------|
| 16 SV | 1598cc | 4 Cyl. | 8 Valves | 60kW/82PS | Petrol | SOHC, Carburettor | TD17565 |
| C 16 LZ | 1598cc | 4 Cyl. | 8 Valves | 55kW/75PS | Petrol | SOHC, Injection | TD21362 |
| C 16 NZ | 1598cc | 4 Cyl. | 8 Valves | 55-61kW/75-83PS | Petrol | SOHC, Injection | TD17583 |
| C 16 SE | 1598cc | 4 Cyl. | 8 Valves | 74kW/101PS | Petrol | SOHC, Injection | TD17608 |
| E 16 NZ | 1598cc | 4 Cyl. | 8 Valves | 55-61kW/75-83PS | Petrol | SOHC, Injection | TD17618 |
| E 16 SE | 1598cc | 4 Cyl. | 8 Valves | 60-74kW/81-101PS | Petrol | SOHC, Injection | TD17586 |
| X 16 SZ | 1598cc | 4 Cyl. | 8 Valves | 52kW/71PS | Petrol | SOHC, Injection | TD17622 |

| | | | |
|---------------------------|-----------------|-------------------------|-----------------|
| ASTRA Mk II 1.6 | 09/1984→08/1991 | ASTRA Mk II 1.6 i | 01/1987→12/1991 |
| ASTRA Mk II 1.6 S | 01/1989→12/1991 | ASTRA Mk III (F) 1.6 | 03/1994→08/1995 |
| ASTRA Mk III (F) 1.6 i | 09/1991→12/1998 | ASTRA Mk III (F) 1.6 Si | 03/1991→12/1994 |
| ASTRAMAX 1.6 | 09/1985→12/1991 | ASTRAMAX 1.6 i | 08/1991→10/1994 |
| ASTRAVAN Mk III (F) 1.6 i | 01/1991→08/1998 | CAVALIER Mk II 1.6 i | 08/1986→08/1988 |
| CAVALIER Mk II 1.6 i Cat | 08/1986→08/1988 | CAVALIER Mk III 1.6 | 09/1988→05/1993 |
| CAVALIER Mk III 1.6 i | 09/1988→11/1995 | NOVA 1.6 | 09/1988→08/1990 |
| NOVA 1.6 GSI | 05/1988→03/1992 | NOVA 1.6 GSI Cat | 02/1992→03/1993 |

V91137 
37.92 x 7.00 x 101.00

90295011

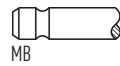

45°

H

VAG96022 
45.80 x 7.02 x 11.04



V91138 
30.87 x 6.98 x 101.08

90295015

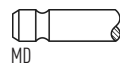

45°

27  **79.00**

| | | | | | | | |
|-----------------|--------|--------|------------------|-------------|--------|-------------------------------|----------------|
| A 16 LET | 1598cc | 4 Cyl. | 16 Valves | 132kW/180PS | Petrol | Turbo, DOHC, Injection | TD22590 |
| A 16 XER | 1598cc | 4 Cyl. | 16 Valves | 85kW/116PS | Petrol | DOHC, Injection | TD22588 |

| | | | |
|-----------------------------|-----------------|------------------------------------|-----------------|
| ASTRA Mk V (H) 1.6 | 08/2004→03/2009 | ASTRA Mk VI (J) 1.6 | 12/2009→ |
| ASTRA Mk VI (J) 1.6 Turbo | 12/2009→ | ASTRA Mk VI (J) GTC 1.6 | 10/2011→ |
| INSIGNIA Mk I (A) 1.6 Turbo | 01/2009→05/2017 | INSIGNIA Mk I (A) Tourer 1.6 Turbo | 01/2009→05/2017 |
| MOKKA / MOKKA X 1.6 | 06/2012→ | ZAFIRA Mk II (B) 1.6 | 12/2007→11/2014 |

V98024 
31.00 x 5.00 x 114.00

55557741

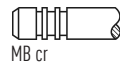

45°

VAG96346 
37.00 x 4.99 x 10.04



V98077  [3]
31.20 x 5.00 x 117.20

55557862

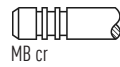

45°

V98025 
27.50 x 5.00 x 113.20

24405815



45°

V98078  [3]
27.50 x 5.00 x 116.20

55558728



45°

SS

[3] LPG

[3] LPG

[3] LPG

[3] LPG

[3] LPG

28  **79.00**

| | | | | | | | |
|-----------------|--------|--------|------------------|------------------|--------|------------------------|----------------|
| C 16 SEL | 1598cc | 4 Cyl. | 16 Valves | 74kW/100PS | Petrol | DOHC, Injection | TD25534 |
| Y 16 XE | 1598cc | 4 Cyl. | 16 Valves | 74kW/101PS | Petrol | DOHC, Injection | TD22874 |
| Z 16 XE | 1598cc | 4 Cyl. | 16 Valves | 63-74kW/85-101PS | Petrol | DOHC, Injection | TD17937 |

| | | | |
|---------------------------|-----------------|--------------------------|-----------------|
| ASTRA Mk IV (G) 1.6 | 09/1999→08/2004 | ASTRA Mk IV (G) 1.6 16V | 02/1998→10/2005 |
| ASTRAVAN Mk IV (G) 1.6 | 07/2000→08/2005 | CORSA Mk I (B) 1.6 i 16V | 08/1997→09/2000 |
| MERIVA Mk I (A) 1.6 i 16V | 01/2003→09/2005 | VECTRA (B) 1.6 i 16V | 08/1995→10/2001 |
| ZAFIRA Mk I (A) 1.6 | 11/1998→08/2005 | ZAFIRA Mk I (A) 1.6 16V | 04/1999→08/2005 |

V91995 
31.10 x 6.00 x 103.10

90412912

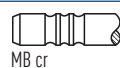

45°

H

VAG96028 
45.00 x 5.99 x 10.05

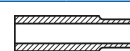

V91996 
27.60 x 6.00 x 102.20

90412974

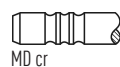

45°

SS



OE



MAT.

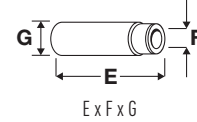

E x F x G

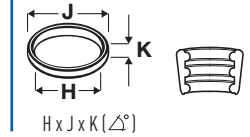

H x J x K (∠°)

29  79.00

| Model | Capacity | Cyls | Valves | Power | Fuel | Engine Type | Part No. |
|----------------------------|----------|--------|-----------|-------------------|--------|----------------------------|-----------------|
| C 16 XE | 1598cc | 4 Cyl. | 16 Valves | 78-80kW/106-109PS | Petrol | DOHC, Injection | TD17609 |
| X 16 XE | 1598cc | 4 Cyl. | 16 Valves | 78-80kW/106-109PS | Petrol | DOHC, Injection | TD17624 |
| X 16 XEL | 1598cc | 4 Cyl. | 16 Valves | 74kW/101PS | Petrol | DOHC, Injection | TD17590 |
| ASTRA Mk III (F) 1.6 i 16V | | | | 01/1994→09/1998 | | ASTRA Mk IV (G) 1.6 | 09/1999→08/2004 |
| ASTRA Mk IV (G) 1.6 16V | | | | 02/1998→05/2005 | | CORSA Mk I (B) 1.6 GSI 16V | 03/1993→09/2000 |
| CORSA Mk I (B) 1.6 i 16V | | | | 09/1994→09/2000 | | TIGRA Mk I 1.6 16V | 07/1994→12/2000 |
| VECTRA (B) 1.6 i 16V | | | | 08/1995→10/2001 | | ZAFIRA Mk I (A) 1.6 | 11/1998→08/2005 |
| ZAFIRA Mk I (A) 1.6 16V | | | | 04/1999→08/2005 | | | |

V91995  90412912
31.10 x 6.00 x 103.10

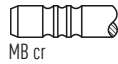

45°

H

VAG96028  45.00 x 5.99 x 10.05

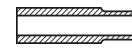

V94050  [2]
31.10 x 5.97 x 102.90

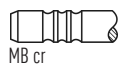

45°

H

V91996  90412974
27.60 x 6.00 x 102.20

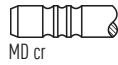

45°

SS

V94051  [2]
27.60 x 5.95 x 101.95

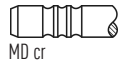

45°

SS

[2] Service valve, for use on re-surfaced cylinder head only [2] Reparatur-Ventil, nur bei geplanten Zylinderkopfverwen den [2] Soupape de réparation, pour utilisation uniquement sur une culasse ré-usinée [2] Válvula de servicio, para uso solamente en culatas rebaj adas. [2] Ricambio valvula per uso su testate cilindro spianate

30  79.00

| Model | Capacity | Cyls | Valves | Power | Fuel | Engine Type | Part No. |
|--------------------------|----------|--------|----------|-----------------|--------|---------------------|-----------------|
| X 16 SZR | 1598cc | 4 Cyl. | 8 Valves | 55kW/75PS | Petrol | SOHC, Injection | TD17623 |
| Z 16 SE | 1598cc | 4 Cyl. | 8 Valves | 62-64kW/84-87PS | Petrol | SOHC, Injection | TD17632 |
| ASTRA Mk III (F) 1.6 i | | | | 03/1992→03/2001 | | ASTRA Mk IV (G) 1.6 | 02/1998→05/2005 |
| ASTRAVAN Mk IV (G) 1.6 i | | | | 08/1998→08/2006 | | COMBO Mk II (C) 1.6 | 09/2001→11/2011 |
| COMBO TOUR Mk II (C) 1.6 | | | | 10/2001→06/2004 | | CORSA Mk II (C) 1.6 | 08/2000→10/2004 |
| MERIVA Mk I (A) 1.6 i | | | | 01/2003→06/2010 | | VECTRA (B) 1.6 i | 08/1995→10/2001 |

V91137  90295011
37.92 x 7.00 x 101.00

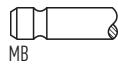

45°

H

VAG96022  45.80 x 7.02 x 11.04

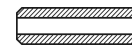

V94353  09117912
31.00 x 7.00 x 101.00

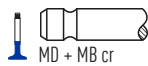

45°

H

31  79.00

| Model | Capacity | Cyls | Valves | Power | Fuel | Engine Type | Part No. |
|--------------------------|----------|--------|-----------|---------------------|--------|---------------------------|-----------------|
| Z 16 LEL | 1598cc | 4 Cyl. | 16 Valves | 110kW/150PS | Petrol | Turbo, DOHC, Injection | TD24910 |
| Z 16 LER | 1598cc | 4 Cyl. | 16 Valves | 141-150kW/192-204PS | Petrol | Turbo, DOHC, Injection | TD20164 |
| Z 16 LET | 1598cc | 4 Cyl. | 16 Valves | 132kW/180PS | Petrol | Turbo, DOHC, Injection | TD19347 |
| ASTRA Mk V (H) 1.6 | | | | 08/2004→11/2010 | | ASTRA Mk V (H) 1.6 Turbo | 09/2006→09/2009 |
| CORSA Mk III (D) 1.6 VXR | | | | 06/2011→08/2014 | | MERIVA Mk I (A) 1.6 Turbo | 05/2006→06/2010 |

V98024  55557741
31.00 x 5.00 x 114.00

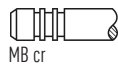

45°

VAG96346  37.00 x 4.99 x 10.04



V98025  24405815
27.50 x 5.00 x 113.20



45°

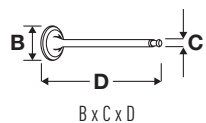

OE

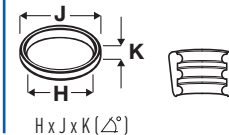
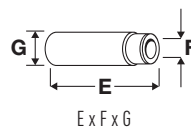

32 79.00

| | | | | | | | |
|-----------------------|-----------------|--------|------------------|---------------------------|--------|------------------------|----------------|
| Z 16 XE1 | 1598cc | 4 Cyl. | 16 Valves | 77kW/105PS | Petrol | DOHC, Injection | TD21875 |
| Z 16 XEP | 1598cc | 4 Cyl. | 16 Valves | 74-77kW/101-105PS | Petrol | DOHC, Injection | TD17939 |
| Z 16 XER | 1598cc | 4 Cyl. | 16 Valves | 85kW/116PS | Petrol | DOHC, Injection | TD21873 |
| ASTRA Mk IV (G) 1.6 | 12/2002→05/2005 | | | ASTRA Mk IV (G) 1.6 16V | | 09/1998→10/2005 | |
| ASTRA Mk V (H) 1.6 | 01/2004→11/2010 | | | ASTRA Mk V (H) 1.6 i 16V | | 10/2006→11/2010 | |
| ASTRAVAN Mk V (H) 1.6 | 03/2005→ | | | MERIVA Mk I (A) 1.6 i 16V | | 05/2003→06/2010 | |
| VECTRA Mk II (C) 1.6 | 09/2006→07/2008 | | | ZAFIRA Mk II (B) 1.6 | | 07/2005→11/2014 | |

V98077 [3]
31.20 x 5.00 x 117.20

55557862

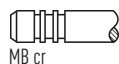

45°

VAG96346 [3]
37.00 x 4.99 x 10.04



V98078 [3]
27.50 x 5.00 x 116.20

55558728

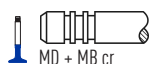

45°

ss

[3] LPG

[3] LPG

[3] LPG

[3] LPG

[3] LPG

33 79.00

| | | | | | | | |
|-------------------------|-----------------|--------|-----------------|----------------------|--------|-----------------|----------------|
| 17 D (4EE1) | 1686cc | 4 Cyl. | 8 Valves | 44kW/60PS | Diesel | SOHC | TD22845 |
| X 17 D (4EE1) | 1686cc | 4 Cyl. | 8 Valves | 44kW/60PS | Diesel | SOHC | TD22872 |
| COMBO Mk I (B) 1.7 D | 07/1994→10/2001 | | | CORSA Mk I (B) 1.7 D | | 02/1996→09/2000 | |
| CORSAVAN Mk I (B) 1.7 D | 01/1994→09/2000 | | | | | | |

V91230 [3]
34.70 x 6.99 x 104.00

94326843

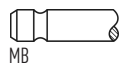

45°

H

VAG92321 [3]
43.00 x 7.00 x 11.56



V91231 [3]
30.70 x 6.98 x 104.00

94110017

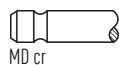

45°

st

34 79.00

| | | | | | | | |
|-------------------------|-----------------|--------|-----------------|------------------------|--------|--------------------|----------------|
| 17 DT (TC4EE1) | 1686cc | 4 Cyl. | 8 Valves | 60kW/82PS | Diesel | Turbo, SOHC | TD22846 |
| X 17 DT (TC4EE1) | 1686cc | 4 Cyl. | 8 Valves | 60kW/82PS | Diesel | Turbo, SOHC | TD22873 |
| ASTRA Mk III (F) 1.7 TD | 12/1991→09/1998 | | | CAVALIER Mk III 1.7 TD | | 09/1988→11/1995 | |
| VECTRA (B) 1.7 TD | 10/1995→11/1996 | | | | | | |

V91230 [3]
34.70 x 6.99 x 104.00

94326843

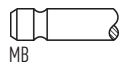

45°

H

VAG92321 [3]
43.00 x 7.00 x 11.56



V91232 [3]
30.70 x 6.98 x 104.15

97037591

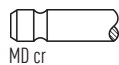

45°

ss

st



OE

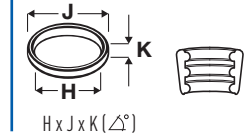
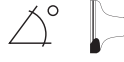

35  **79.00**

| | | | | | | | |
|------------------------------|-----------------|--------|------------------|----------------------------|-----------------|--------------------|----------------|
| A 17 DT | 1686cc | 4 Cyl. | 16 Valves | 74kW/101PS | Diesel | Turbo, DOHC | TD24746 |
| A 17 DTC | 1686cc | 4 Cyl. | 16 Valves | 81kW/110PS | Diesel | Turbo, DOHC | TD25259 |
| A 17 DTE | 1686cc | 4 Cyl. | 16 Valves | 81kW/110PS | Diesel | Turbo, DOHC | TD25742 |
| A 17 DTJ | 1686cc | 4 Cyl. | 16 Valves | 81kW/110PS | Diesel | Turbo, DOHC | TD24659 |
| A 17 DTL | 1686cc | 4 Cyl. | 16 Valves | 74kW/101PS | Diesel | Turbo, DOHC | TD25741 |
| A 17 DTR | 1686cc | 4 Cyl. | 16 Valves | 92kW/125PS | Diesel | Turbo, DOHC | TD20165 |
| A 17 DTS | 1686cc | 4 Cyl. | 16 Valves | 96kW/131PS | Diesel | Turbo, DOHC | TD24732 |
| Z 17 DTJ | 1686cc | 4 Cyl. | 16 Valves | 81kW/110PS | Diesel | Turbo, DOHC | TD24045 |
| Z 17 DTR | 1686cc | 4 Cyl. | 16 Valves | 92kW/125PS | Diesel | Turbo, DOHC | TD21871 |
| ASTRA Mk V (H) 1.7 CDTi | 02/2007→10/2010 | | | ASTRA Mk V (H) 1.7 CDTi | 01/2004→10/2012 | | |
| ASTRA Mk VI (J) 1.7 CDTi | 12/2009→ | | | ASTRA Mk VI (J) 1.7 CDTi | 10/2010→ | | |
| ASTRA Mk VI (J) GTC 1.7 CDTi | 10/2011→ | | | ASTRAVAN Mk V (H) 1.7 CDTi | 06/2011→ | | |
| CORSA Mk III (D) 1.7 CDTi | 11/2006→08/2014 | | | MERIVA Mk I (A) 1.7 CDTi | 08/2006→05/2010 | | |
| MERIVA Mk II (B) 1.7 CDTi | 06/2010→ | | | MERIVA Mk II (B) 1.7 CDTi | 06/2010→ | | |
| MOKKA / MOKKA X 1.7 CDTi | 06/2012→ | | | ZAFIRA Mk II (B) 1.7 CDTi | 01/2008→11/2014 | | |

V95186 
27.50 x 5.97 x 102.50

97385841

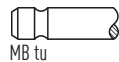

45°

H

VAG96291 
42.00 x 6.00 x 11.05

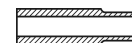

V95157 
25.45 x 5.96 x 102.20

97385842

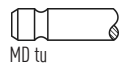

MD tu

36  **79.00**

| | | | | | | | |
|---------------------------------|-----------------|--------|------------------|-----------------------------------|-----------------|--------------------|----------------|
| Y 17 DT | 1686cc | 4 Cyl. | 16 Valves | 55kW/75PS | Diesel | Turbo, DOHC | TD18380 |
| Y 17 DTL | 1686cc | 4 Cyl. | 16 Valves | 48kW/65PS | Diesel | DOHC | TD18381 |
| Z 17 DTH | 1686cc | 4 Cyl. | 16 Valves | 74kW/100PS | Diesel | Turbo, DOHC | TD17941 |
| Z 17 DTL | 1686cc | 4 Cyl. | 16 Valves | 59kW/80PS | Diesel | Turbo, DOHC | TD17945 |
| ASTRA Mk IV (G) 1.7 CDTi 16V | 04/2003→05/2005 | | | ASTRA Mk IV (G) 1.7 DTi 16V | 02/2000→05/2005 | | |
| ASTRA Mk V (H) 1.7 CDTi | 01/2004→05/2009 | | | ASTRA Mk V (H) 1.7 CDTi | 08/2004→11/2010 | | |
| ASTRAVAN Mk IV (G) 1.7 CDTi | 04/2004→08/2006 | | | ASTRAVAN Mk IV (G) 1.7 DTi 16V | 04/2001→08/2006 | | |
| ASTRAVAN Mk V (H) 1.7 CDTi | 03/2005→07/2006 | | | ASTRAVAN Mk V (H) 1.7 CDTi | 03/2005→11/2011 | | |
| COMBO Mk II (C) 1.7 CDTi 16V | 12/2004→11/2011 | | | COMBO Mk II (C) 1.7 DI 16V | 09/2001→11/2011 | | |
| COMBO Mk II (C) 1.7 DTi 16V | 10/2001→11/2011 | | | COMBO TOUR Mk II (C) 1.7 CDTi 16V | 12/2004→09/2010 | | |
| COMBO TOUR Mk II (C) 1.7 DI 16V | 09/2001→06/2004 | | | COMBO TOUR Mk II (C) 1.7 DTi 16V | 10/2001→02/2012 | | |
| CORSA Mk II (C) 1.7 CDTi 16V | 08/2000→09/2006 | | | CORSA Mk II (C) 1.7 DI 16V | 08/2000→09/2006 | | |
| CORSA Mk II (C) 1.7 DTi 16V | 08/2000→09/2006 | | | CORSAVAN Mk II (C) 1.7 DI 16V | 09/2000→06/2006 | | |
| CORSAVAN Mk II (C) 1.7 DTi 16V | 09/2000→06/2006 | | | MERIVA Mk I (A) 1.7 CDTi | 09/2003→06/2010 | | |
| MERIVA Mk I (A) 1.7 DTi | 06/2003→06/2010 | | | | | | |

V94426 
27.50 x 6.00 x 98.40

97185860

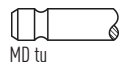

45°

VAG96291 
42.00 x 6.00 x 11.05

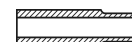

V94427 
26.50 x 6.00 x 98.10

97358650

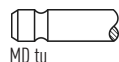

45°

SS



OE

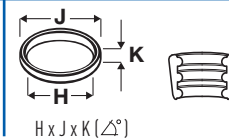
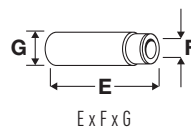

37 80.00

| | | | | | | | |
|----------------------|-----------------|--------|----------------------|-----------|-----------------|-------------|----------------|
| 16 D | 1598cc | 4 Cyl. | 8 Valves | 40kW/54PS | Diesel | SOHC | TD17563 |
| 16 DA | 1598cc | 4 Cyl. | 8 Valves | 40kW/54PS | Diesel | SOHC | TD17601 |
| ASTRA 1.6 D | 02/1982→08/1986 | | ASTRA Mk II 1.6 D | | 09/1984→08/1991 | | |
| ASTRAMAX 1.6 D | 05/1986→06/1990 | | CAVALIER Mk II 1.6 D | | 03/1982→08/1988 | | |
| CAVALIER Mk II 1600D | 03/1982→08/1988 | | | | | | |

V90230 ■
36.10 x 7.98 x 123.40

90009534

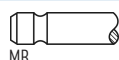

45°

H

VAG96021 ■ ■ ■
50.00 x 8.00 x 12.02

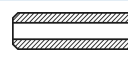

V90231 ■
32.10 x 7.97 x 123.40

90499097



45°

38 80.00

| | | | | | | | |
|----------------------|-----------------|--------|----------------------|-----------------|-----------------|-------------|----------------|
| 16 N | 1598cc | 4 Cyl. | 8 Valves | 51-55kW/69-75PS | Petrol | SOHC | TD17602 |
| 16 SH | 1598cc | 4 Cyl. | 8 Valves | 66kW/90PS | Petrol | SOHC | TD17564 |
| ASTRA 1.6 S | 09/1981→08/1986 | | ASTRA Mk II 1.6 | | 09/1985→08/1991 | | |
| ASTRA Mk II 1.6 S | 09/1984→08/1986 | | CAVALIER Mk II 1.6 | | 10/1983→08/1988 | | |
| CAVALIER Mk II 1.6 N | 09/1981→08/1988 | | CAVALIER Mk II 1.6 S | | 09/1981→08/1988 | | |

V90166 ■
35.00 x 7.98 x 105.99

90106792

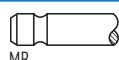

45°

H

VAG96023 ■ ■ ■
43.00 x 8.02 x 12.02



39 80.00

| | | | | | | | |
|----------------|-----------------|--------|-----------------|-----------|--------|-------------|----------------|
| F8Q 600 | 1870cc | 4 Cyl. | 8 Valves | 44kW/60PS | Diesel | SOHC | TD21360 |
| F8Q 606 | 1870cc | 4 Cyl. | 8 Valves | 44kW/60PS | Diesel | SOHC | TD21358 |
| ARENA 1.9 D | 03/1998→08/2001 | | | | | | |

V94338 ■
35.30 x 8.00 x 110.00

7701 471 704

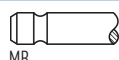

45°

H

VAG92329B ■ ■ ■
39.00 x 8.00 x 13.07

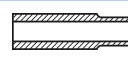

V94339 ■
31.50 x 8.00 x 109.80

7701 469 373

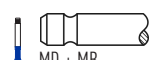

45°

ss

H

VAG96226B ■ ■ ■
39.00 x 8.02 x 13.13



40 80.00

| | | | | | | | |
|-------------------------|-----------------|--------|-----------------|-----------------|-----------------|--------------------|----------------|
| F9Q 760 | 1870cc | 4 Cyl. | 8 Valves | 74kW/101PS | Diesel | Turbo, SOHC | TD19375 |
| F9Q 762 | 1870cc | 4 Cyl. | 8 Valves | 59-60kW/80-82PS | Diesel | Turbo, SOHC | TD21148 |
| F9Q 770 | 1870cc | 4 Cyl. | 8 Valves | 59kW/80PS | Diesel | Turbo, SOHC | TD19351 |
| F9Q 772 | 1870cc | 4 Cyl. | 8 Valves | 60kW/82PS | Diesel | Turbo, SOHC | TD19363 |
| F9Q 774 | 1870cc | 4 Cyl. | 8 Valves | 60kW/82PS | Diesel | Turbo, SOHC | TD19352 |
| MOVANO Mk I (A) 1.9 DTI | 09/2000→05/2010 | | VIVARO 1.9 DI | | 08/2001→07/2014 | | |
| VIVARO 1.9 DTI | 08/2001→12/2006 | | | | | | |

V94190 ■
35.40 x 7.00 x 111.00

44 15 921

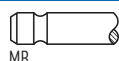

45°

H

VAG96294B ■ ■ ■
38.30 x 7.00 x 12.03

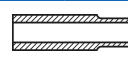

V94191 ■
32.60 x 7.00 x 110.80

44 15 922

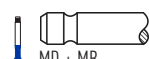

45°

H



OE

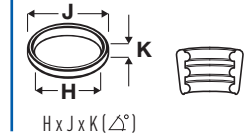
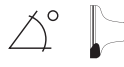

41  **80.00**

| | | | | | | | |
|------------------|-----------------|--------|------------------|------------|--------|--------------------|----------------|
| X 25 DT | 2497cc | 6 Cyl. | 12 Valves | 96kW/131PS | Diesel | Turbo, SOHC | TD17595 |
| X 25 TD | 2497cc | 6 Cyl. | 12 Valves | 96kW/131PS | Diesel | Turbo, SOHC | TD17920 |
| OMEGA (B) 2.5 TD | 04/1994→07/2001 | | | | | | |

V94555  90511374  45° ss H

42  **80.50**

| | | | | | | | |
|----------------------|-----------------|--------|-------------------|-------------------|--------|------------------------|----------------|
| A 18 XEL | 1796cc | 4 Cyl. | 16 Valves | 85-88kW/116-120PS | Petrol | DOHC, Injection | TD25706 |
| Z 18 XEP | 1796cc | 4 Cyl. | 16 Valves | 103kW/140PS | Petrol | DOHC, Injection | TD18837 |
| ZAFIRA Mk II (B) 1.8 | 04/2013→11/2014 | | ZAFIRA Mk III 1.8 | 10/2011→ | | | |

V98024  55557741  45°

VAG96346  37.00 x 4.99 x 10.04

V98025  24405815  45°

43  **80.50**

| | | | | | | | |
|-----------------|--------|--------|------------------|-------------|--------|------------------------|----------------|
| A 18 XER | 1796cc | 4 Cyl. | 16 Valves | 103kW/140PS | Petrol | DOHC, Injection | TD22592 |
| Z 18 XER | 1796cc | 4 Cyl. | 16 Valves | 103kW/140PS | Petrol | DOHC, Injection | TD18838 |

| | | | |
|--------------------------|-----------------|------------------------------|-----------------|
| ASTRA Mk V (H) 1.8 | 01/2004→11/2010 | ASTRA Mk V (H) 1.8 i 16V | 03/2007→11/2010 |
| INSIGNIA Mk I (A) 1.8 | 07/2008→05/2017 | INSIGNIA Mk I (A) Tourer 1.8 | 07/2008→05/2017 |
| SIGNUM 1.8 | 08/2005→05/2008 | VECTRA Mk II (C) 1.8 | 01/2006→07/2008 |
| VECTRA Mk II (C) GTS 1.8 | 01/2006→07/2008 | ZAFIRA Mk II (B) 1.8 | 04/2005→11/2014 |
| ZAFIRA Mk III 1.8 | 10/2011→ | | |

V80016  [3] 55572520  45° ss

VAG96346  37.00 x 4.99 x 10.04

V98024  55557741  45°

V80017  [3] 55572521  45° ss

V98025  24405815  45°

[3] LPG

[3] LPG

[3] LPG



[3] LPG

[3] LPG

44  **80.50**

| | | | | | | | |
|-----------------|--------|--------|------------------|-------------------|--------|------------------------|----------------|
| X 18 XE1 | 1796cc | 4 Cyl. | 16 Valves | 85kW/116PS | Petrol | DOHC, Injection | TD17626 |
| Z 18 XE | 1796cc | 4 Cyl. | 16 Valves | 87-92kW/118-125PS | Petrol | DOHC, Injection | TD17633 |
| Z 18 XEL | 1796cc | 4 Cyl. | 16 Valves | 81-85kW/110-116PS | Petrol | DOHC, Injection | TD17987 |

| | | | |
|--------------------------|-----------------|------------------------------|-----------------|
| ASTRA Mk IV (G) 1.8 16V | 02/1998→10/2005 | ASTRA Mk V (H) 1.8 | 01/2004→11/2010 |
| CORSA Mk II (C) 1.8 16V | 08/2000→09/2006 | MERIVA Mk I (A) 1.8 i 16V | 05/2003→06/2010 |
| SIGNUM 1.8 | 06/2003→07/2005 | TIGRA 1.8 | 06/2004→08/2009 |
| VECTRA (B) 1.8 | 09/2000→07/2003 | VECTRA (B) 1.8 i 16V | 10/1995→07/2003 |
| VECTRA Mk II (C) 1.8 16V | 04/2002→07/2008 | VECTRA Mk II (C) GTS 1.8 16V | 08/2002→07/2008 |
| ZAFIRA Mk I (A) 1.8 | 09/2000→08/2005 | ZAFIRA Mk I (A) 1.8 16V | 05/1999→08/2005 |

V94249  90536095  45° H

VAG96076  39.00 x 5.00 x 10.04

V94250  90536164  45° ss

VAG96077  39.00 x 5.00 x 10.04



OE

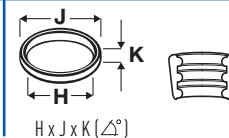
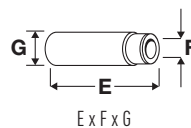
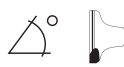

45 81.60

| | | | | | | | |
|----------------------------|-----------------|--------|------------------|--------------------------|--------|------------------------|----------------|
| C 18 XE | 1799cc | 4 Cyl. | 16 Valves | 92kW/125PS | Petrol | DOHC, Injection | TD17611 |
| C 18 XEL | 1799cc | 4 Cyl. | 16 Valves | 85kW/116PS | Petrol | DOHC, Injection | TD17636 |
| X 18 XE | 1799cc | 4 Cyl. | 16 Valves | 85kW/116PS | Petrol | DOHC, Injection | TD17625 |
| ASTRA Mk III (F) 1.8 | 09/1994→08/1996 | | | ASTRA Mk III (F) 1.8 16V | | 11/1994→03/2001 | |
| ASTRA Mk III (F) 1.8 i 16V | 06/1993→02/1998 | | | VECTRA (B) 1.8 i 16V | | 09/1995→09/2000 | |

| | | | | | | |
|-----------------------|----------|-------|-----|----|----------------------|--|
| V91997 | 90412277 | | 45° | H | VAG96028 | |
| 32.10 x 5.97 x 102.10 | | MB cr | | | 45.00 x 5.99 x 10.05 | |
| V91998 | 90410813 | | 45° | ss | | |
| 29.10 x 5.96 x 92.25 | | MD cr | | | | |

46 81.60

| | | | | | | | |
|---------------------|-----------------|---------|------------------|------------------------|--------|------------------------|----------------|
| C 25 XE | 2498cc | V6 Cyl. | 24 Valves | 125kW/170PS | Petrol | DOHC, Injection | TD17635 |
| X 25 XE | 2498cc | V6 Cyl. | 24 Valves | 125-143kW/170-194PS | Petrol | DOHC, Injection | TD17634 |
| CALIBRA 2.5 i V6 | 04/1993→07/1997 | | | CAVALIER Mk III 2.5 V6 | | 08/1988→06/1994 | |
| OMEGA (B) 2.5 V6 | 03/1994→09/2000 | | | VECTRA (B) 2.5 i GSi | | 03/1998→07/2000 | |
| VECTRA (B) 2.5 i V6 | 09/1995→08/2000 | | | | | | |

| | | | | | | |
|-----------------------|----------|-------|-----|----|----------------------|--|
| V91997 | 90412277 | | 45° | H | VAG96028 | |
| 32.10 x 5.97 x 102.10 | | MB cr | | | 45.00 x 5.99 x 10.05 | |
| V91998 | 90410813 | | 45° | ss | | |
| 29.10 x 5.96 x 92.25 | | MD cr | | | | |

47 82.00

| | | | | | | | |
|-------------------------------|-----------------|--------|-----------------|---------------------------|--------|--------------------|----------------|
| Z 19 DT | 1910cc | 4 Cyl. | 8 Valves | 88kW/120PS | Diesel | Turbo, SOHC | TD18659 |
| Z 19 DTL | 1910cc | 4 Cyl. | 8 Valves | 74kW/100PS | Diesel | Turbo, SOHC | TD20149 |
| ASTRA Mk V (H) 1.9 CDTi | 08/2004→11/2010 | | | ASTRA Mk V (H) 1.9 CDTi | | 01/2004→05/2009 | |
| ASTRAVAN Mk V (H) 1.9 CDTi | 03/2005→11/2011 | | | SIGNUM 1.9 CDTi | | 04/2004→03/2008 | |
| SIGNUM 1.9 Turbo | 01/2005→05/2008 | | | VECTRA Mk II (C) 1.9 CDTi | | 04/2002→09/2008 | |
| VECTRA Mk II (C) GTS 1.9 CDTi | 08/2002→07/2008 | | | ZAFIRA Mk II (B) 1.9 CDTi | | 07/2005→11/2014 | |

| | | | | | | |
|-----------------------|------------|------------|-----|---|----------------------|--|
| V94470 | 46 750 859 | | 45° | H | VAG96124 | |
| 35.30 x 8.00 x 115.00 | | MD + MB cr | | | 42.90 x 8.02 x 14.06 | |
| V94065 | 608 14 604 | | 45° | | VAG96203 | |
| 34.50 x 8.00 x 115.00 | | MD cr | | | 43.00 x 8.03 x 14.08 | |
| V94471 | 46 783 962 | | 45° | H | VAG96210 | |
| 34.50 x 8.00 x 115.00 | | MD + MB cr | | | 43.00 x 8.04 x 14.04 | |



OE



MAT.

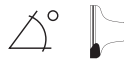

E x F x G

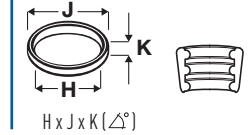

H x J x K (Δ°)

48  **82.00**

| | | | | | | | |
|-----------------------------------|-----------------|--------|------------------|-------------------------------|--------|--------------------|----------------|
| Z 19 DTH | 1910cc | 4 Cyl. | 16 Valves | 110kW/150PS | Diesel | Turbo, DOHC | TD18016 |
| Z 19 DTJ | 1910cc | 4 Cyl. | 16 Valves | 88kW/120PS | Diesel | Turbo, DOHC | TD18017 |
| ASTRA Mk V (H) 1.9 CDTi | 08/2004→11/2010 | | | ASTRA Mk V (H) 1.9 CDTi | | 01/2004→05/2009 | |
| ASTRA Mk V (H) 1.9 CDTi 16V | 01/2004→05/2009 | | | ASTRAVAN Mk V (H) 1.9 CDTi | | 03/2005→11/2011 | |
| SIGNUM 1.9 CDTi 16V | 04/2004→03/2008 | | | VECTRA Mk II (C) 1.9 CDTi 16V | | 04/2004→05/2009 | |
| VECTRA Mk II (C) GTS 1.9 CDTi 16V | 04/2004→07/2008 | | | ZAFIRA Mk II (B) 1.9 CDTi | | 07/2005→11/2014 | |

V94588 
27.90 x 6.00 x 114.00
Eng.→17180894

93185523

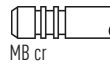

MB cr

45° Y H

VAG96291 
42.00 x 6.00 x 11.05
Eng.→17180894

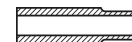

V98005 
28.00 x 5.00 x 114.40
Eng.17180895→

55206431

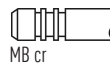

MB cr

45°

VAG96360 
46.70 x 5.00 x 10.03
Eng.17180895→

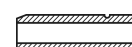

V94589 
25.80 x 6.00 x 114.30
Eng.→17180894

46 787 902



MD + MB cr

45° H

V98006 
24.50 x 5.00 x 114.40
Eng.17180895→

55205183



MD + MB cr

45°

49  **82.50**

| | | | | | | | |
|-----------------------|-----------------|--------|-----------------|---------------------------|--------|-----------------|----------------|
| 17 D | 1699cc | 4 Cyl. | 8 Valves | 42kW/57PS | Diesel | SOHC | TD17566 |
| 17 DR | 1699cc | 4 Cyl. | 8 Valves | 42-44kW/57-60PS | Diesel | SOHC | TD17567 |
| ASTRA Mk II 1.7 D | 01/1989→12/1991 | | | ASTRA Mk III (F) 1.7 D | | 03/1991→09/1998 | |
| ASTRAMAX 1.7 D | 09/1985→07/1994 | | | ASTRAVAN Mk III (F) 1.7 D | | 01/1991→08/1994 | |
| CAVALIER Mk III 1.7 D | 09/1988→11/1995 | | | | | | |

V90230 
36.10 x 7.98 x 123.40

90009534

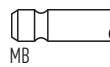

MB

45° H

VAG96021 
50.00 x 8.00 x 12.02



V90231 
32.10 x 7.97 x 123.40

90499097

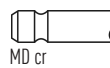

MD cr

45°

50  **82.50**

| | | | | | | | |
|----------------------------|-----------------|--------|-----------------|---------------------------|--------|--------------------|----------------|
| X 17 DTL | 1699cc | 4 Cyl. | 8 Valves | 50kW/68PS | Diesel | Turbo, SOHC | TD17591 |
| ASTRA Mk III (F) 1.7 TD | 01/1994→09/1998 | | | ASTRA Mk IV (G) 1.7 TD | | 02/1998→08/2000 | |
| ASTRAVAN Mk III (F) 1.7 TD | 01/1994→08/1998 | | | ASTRAVAN Mk IV (G) 1.7 TD | | 08/1998→08/2006 | |

V90230 
36.10 x 7.98 x 123.40

90009534

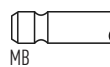

MB

45° H

VAG96021 
50.00 x 8.00 x 12.02



V91987 
32.10 x 7.97 x 123.20

90499097



MD + MB cr

45° H

51  **82.70**

| | | | | | | | |
|----------------|-----------------|--------|------------------|--------------------|--------|-----------------|----------------|
| F4R 720 | 1998cc | 4 Cyl. | 16 Valves | 88kW/120PS | Petrol | DOHC | TD19216 |
| F4R 820 | 1998cc | 4 Cyl. | 16 Valves | 86kW/117PS | Petrol | DOHC | TD21905 |
| VIVARO 2.0 16V | 08/2001→07/2014 | | | VIVARO 2.0 ECOTECH | | 08/2006→07/2014 | |

V94606 
33.60 x 5.50 x 110.00

4411048



MB

45° H

VAG96292B 
40.60 x 5.50 x 11.07



V94607 
29.00 x 5.50 x 108.90

93160646

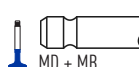

MD + MB

45° H

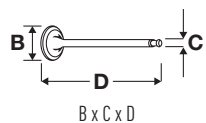

OE

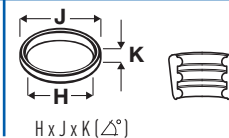
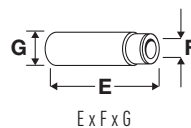
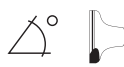

52 83.00

| | | | | | | | |
|-----------------|--------|--------|------------------|---------------------|--------|--------------------|----------------|
| A 20 DTC | 1956cc | 4 Cyl. | 16 Valves | 81kW/110PS | Diesel | Turbo, DOHC | TD22598 |
| A 20 DTH | 1956cc | 4 Cyl. | 16 Valves | 118-121kW/160-165PS | Diesel | Turbo, DOHC | TD22603 |
| A 20 DTJ | 1956cc | 4 Cyl. | 16 Valves | 96kW/131PS | Diesel | Turbo, DOHC | TD22600 |

| | | | |
|-----------------------------------|-----------------|------------------------------|-----------------|
| ASTRA Mk VI (J) 2.0 CDTi | 12/2009→ | ASTRA Mk VI (J) GTC 2.0 CDTi | 10/2011→ |
| CASCADE 2.0 CDTi | 02/2013→ | INSIGNIA Mk I (A) 2.0 CDTi | 07/2008→05/2017 |
| INSIGNIA Mk I (A) Tourer 2.0 CDTi | 07/2008→05/2017 | ZAFIRA Mk III 2.0 CDTi | 10/2011→ |

V98005 ■
28.00 x 5.00 x 114.40

55206431

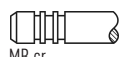

45°

VAG96360 ■ ■ ■
46.70 x 5.00 x 10.03

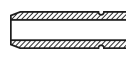

V98006 ■
24.50 x 5.00 x 114.40

55205183

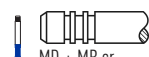

45°

53 83.00

| | | | | | | | |
|-----------------|--------|--------|------------------|-------------|--------|--------------------|----------------|
| Z 20 DM | 1991cc | 4 Cyl. | 16 Valves | 93kW/126PS | Diesel | Turbo, DOHC | TD24741 |
| Z 20 DMH | 1991cc | 4 Cyl. | 16 Valves | 110kW/150PS | Diesel | DOHC | TD19219 |

| | | | |
|-----------------|-----------------|-----------------|-----------------|
| ANTARA 2.0 CDTi | 08/2006→04/2015 | ANTARA 2.0 CDTi | 08/2006→04/2015 |
|-----------------|-----------------|-----------------|-----------------|

V95187 ■
28.50 x 5.95 x 95.70

96440147

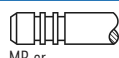

H

V95188 ■
24.50 x 5.92 x 95.75

93743882

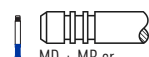

45°

H

54 83.20

| | | | | | | | |
|------------------|-----------------|---------------------|------------------|---------------------|--------|------------------------|----------------|
| Y 26 SE | 2597cc | V6 Cyl. | 24 Valves | 125-132kW/170-180PS | Petrol | DOHC, Injection | TD18888 |
| OMEGA (B) 2.6 V6 | 08/2000→07/2003 | VECTRA (B) 2.6 i V6 | 09/2000→07/2003 | | | | |

V91997 ■
32.10 x 5.97 x 102.10

90412277



45°

H

VAG96137 ■ ■ ■
45.00 x 6.02 x 10.05

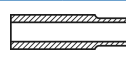

V91998 ■
29.10 x 5.96 x 92.25

90410813

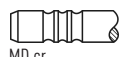

45°

SS

55 84.00

| | | | | | | | |
|----------------|--------|--------|------------------|------------------|--------|--------------------|----------------|
| M9R 630 | 1995cc | 4 Cyl. | 16 Valves | 66-84kW/90-114PS | Diesel | Turbo, DOHC | TD25645 |
| M9R 780 | 1995cc | 4 Cyl. | 16 Valves | 66-84kW/90-114PS | Diesel | Turbo, DOHC | TD20889 |
| M9R 782 | 1995cc | 4 Cyl. | 16 Valves | 66-84kW/90-114PS | Diesel | Turbo, DOHC | TD21889 |
| M9R 784 | 1995cc | 4 Cyl. | 16 Valves | 84kW/114PS | Diesel | Turbo, DOHC | TD21904 |
| M9R 786 | 1995cc | 4 Cyl. | 16 Valves | 66-84kW/90-114PS | Diesel | Turbo, DOHC | TD25647 |
| M9R 788 | 1995cc | 4 Cyl. | 16 Valves | 84kW/114PS | Diesel | Turbo, DOHC | TD25644 |

| | |
|-----------------|-----------------|
| VIVARO 2.0 CDTi | 01/2006→07/2014 |
|-----------------|-----------------|

V95001 ■
27.70 x 5.98 x 103.90

93161682

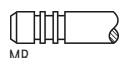

45°

Y

H

VAG96383B ■ ■ ■
42.40 x 6.00 x 11.07



V95002 ■
26.00 x 5.97 x 103.75

93161681

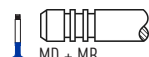

45°

H



OE

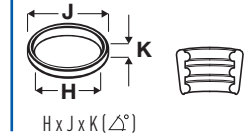
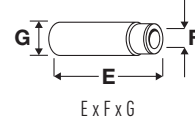
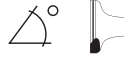

56



84.00

| | | | | | | | |
|------------------------------|-----------------|--------|------------------|----------------------------------|-----------------|--------------------|----------------|
| X 20 DTH | 1995cc | 4 Cyl. | 16 Valves | 74kW/101PS | Diesel | Turbo, SOHC | TD17592 |
| X 20 DTL | 1995cc | 4 Cyl. | 16 Valves | 60kW/82PS | Diesel | Turbo, SOHC | TD17627 |
| Y 20 DTH | 1995cc | 4 Cyl. | 16 Valves | 74kW/101PS | Diesel | Turbo, SOHC | TD17924 |
| Y 20 DTL | 1995cc | 4 Cyl. | 16 Valves | 60kW/82PS | Diesel | Turbo, SOHC | TD17926 |
| ASTRA Mk IV (G) 2.0 DI | 02/1998→05/2005 | | | ASTRA Mk IV (G) 2.0 DTi 16V | 02/1998→05/2005 | | |
| ASTRAVAN Mk IV (G) 2.0 DI | 08/1998→08/2006 | | | ASTRAVAN Mk IV (G) 2.0 DTi | 04/2004→08/2006 | | |
| OMEGA (B) 2.0 DTi 16V | 01/1998→09/2000 | | | SIGNUM 2.0 DTi | 05/2003→05/2008 | | |
| VECTRA (B) 2.0 Di 16V | 08/1995→10/2001 | | | VECTRA (B) 2.0 DTi 16V | 08/1995→10/2001 | | |
| VECTRA (B) 2.0 DTi 16V | 08/1995→10/2001 | | | VECTRA (B) 2.0 DTi 16V | 06/1997→10/2001 | | |
| VECTRA Mk II (C) 2.0 DTi 16V | 04/2002→10/2008 | | | VECTRA Mk II (C) GTS 2.0 DTi 16V | 08/2002→07/2008 | | |
| ZAFIRA Mk I (A) 2.0 DI 16V | 10/1999→08/2005 | | | ZAFIRA Mk I (A) 2.0 DTi 16V | 04/1999→08/2005 | | |

V94097 ■

29.00 x 6.00 x 97.20

90502319



45° SS H

VAG96028 ■ ■ ■

45.00 x 5.99 x 10.05



V94355 ■

29.00 x 6.00 x 97.00

90502316



45° H

V94098 ■

26.00 x 6.00 x 97.00

90502326



45° SS H

V94356 ■

26.20 x 6.00 x 97.00

90502323



45° SS H

57



84.00

| | | | | | | | |
|------------------------------|-----------------|--------|------------------|----------------------------------|-----------------|--------------------|----------------|
| X 22 DTH | 2171cc | 4 Cyl. | 16 Valves | 85kW/116PS | Diesel | Turbo, SOHC | TD17916 |
| Y 22 DTH | 2171cc | 4 Cyl. | 16 Valves | 85-88kW/116-120PS | Diesel | Turbo, SOHC | TD17928 |
| Y 22 DTR | 2171cc | 4 Cyl. | 16 Valves | 92kW/125PS | Diesel | Turbo, SOHC | TD17629 |
| ASTRA Mk IV (G) 2.2 DTi | 09/2002→05/2005 | | | FRONTERA Mk II (B) 2.2 DTi | 10/1998→09/2004 | | |
| OMEGA (B) 2.2 DTi 16V | 08/2000→07/2003 | | | SIGNUM 2.2 DTi | 05/2003→05/2008 | | |
| SINTRA 2.2 DTi | 07/1997→04/1999 | | | VECTRA (B) 2.2 DTi 16V | 08/1995→10/2001 | | |
| VECTRA Mk II (C) 2.2 DTi 16V | 04/2002→10/2008 | | | VECTRA Mk II (C) GTS 2.2 DTi 16V | 08/2002→07/2008 | | |
| ZAFIRA Mk I (A) 2.2 D | 06/2001→06/2005 | | | | | | |

V94097 ■

29.00 x 6.00 x 97.20

90502319



45° SS H

VAG96028 ■ ■ ■

45.00 x 5.99 x 10.05



V94355 ■

29.00 x 6.00 x 97.00

90502316



45° H

V94098 ■

26.00 x 6.00 x 97.00

90502326



45° SS H

V94356 ■

26.20 x 6.00 x 97.00

90502323



45° SS H

58



84.80

| | | | | | | | |
|----------------------|-----------------|--------|-----------------|-----------|--------|--------------------------|----------------|
| 18 NV | 1796cc | 4 Cyl. | 8 Valves | 60kW/82PS | Petrol | SOHC, Carburettor | TD17569 |
| CARLTON Mk III 1.8 N | 09/1986→08/1987 | | | | | | |

V91148 ■

41.80 x 7.00 x 103.80

90295019

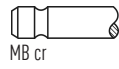

45° H

VAG96022 ■ ■ ■

45.80 x 7.02 x 11.04

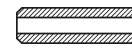

V91149 ■

36.57 x 6.97 x 103.63

90323757

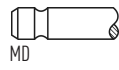

45°

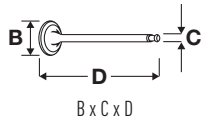

OE

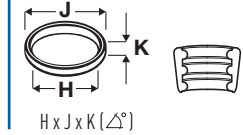
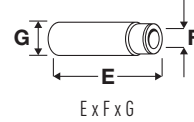
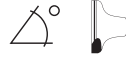

59 84.80

| | | | | | | | |
|-----------------|--------|--------|-----------------|-------------------|--------|--------------------------|----------------|
| 18 SE | 1796cc | 4 Cyl. | 8 Valves | 82-85kW/112-116PS | Petrol | SOHC, Injection | TD17604 |
| 18 SEH | 1796cc | 4 Cyl. | 8 Valves | 85kW/115PS | Petrol | SOHC, Injection | TD17570 |
| 18 SV | 1796cc | 4 Cyl. | 8 Valves | 66kW/90PS | Petrol | SOHC, Carburettor | TD17571 |
| C 18 NZ | 1796cc | 4 Cyl. | 8 Valves | 66kW/90PS | Petrol | SOHC, Injection | TD17610 |
| E 18 NV | 1796cc | 4 Cyl. | 8 Valves | 62kW/84PS | Petrol | SOHC, Carburettor | TD17587 |
| E 18 NVR | 1796cc | 4 Cyl. | 8 Valves | 65kW/88PS | Petrol | SOHC, Carburettor | TD17588 |
| S 18 NV | 1796cc | 4 Cyl. | 8 Valves | 62-74kW/84-101PS | Petrol | SOHC, Carburettor | TD21884 |

| | | | |
|----------------------------|-----------------|------------------------|-----------------|
| ASTRA Mk II 1.8 | 01/1986→12/1990 | ASTRA Mk II 1.8 GTE | 09/1984→08/1991 |
| ASTRA Mk II 1.8 i | 09/1985→08/1991 | ASTRA Mk III (F) 1.8 i | 09/1991→09/1998 |
| ASTRA Mk III (F) 1.8 i 16V | 09/1995→02/1998 | CARLTON Mk III 1.8 | 09/1987→03/1994 |
| CARLTON Mk III 1.8 i | 09/1986→03/1994 | CARLTON Mk III 1.8 S | 09/1986→03/1994 |
| CAVALIER Mk II 1.8 | 08/1986→08/1988 | CAVALIER Mk II 1.8 i | 09/1981→08/1988 |
| CAVALIER Mk II 1800i | 03/1985→10/1988 | CAVALIER Mk III 1.8 | 09/1988→08/1995 |
| CAVALIER Mk III 1.8 i Cat | 03/1990→11/1995 | | |

| | | | | | | |
|-----------------------|----------|-------|-----|---|----------------------|--|
| V91148 ■ | 90295019 | | 45° | H | VAG96022 ■■ ■ | |
| 41.80 x 7.00 x 103.80 | | MB cr | | | 45.80 x 7.02 x 11.04 | |
| V91149 ■ | 90323757 | | 45° | | | |
| 36.57 x 6.97 x 103.63 | | MD | | | | |
| 01/86→12/88 | | | | | | |
| V91150 ■ | 90220112 | | 45° | | | |
| 36.47 x 6.97 x 103.67 | | MD cr | | | | |
| 01/89→ | | | | | | |

60 84.80

| | | | | | | | |
|----------------|--------|--------|-----------------|------------|--------|------------------------|----------------|
| C 18 NE | 1796cc | 4 Cyl. | 8 Valves | 74kW/100PS | Petrol | SOHC, Injection | TD22865 |
|----------------|--------|--------|-----------------|------------|--------|------------------------|----------------|

| | | | |
|-------------------|-----------------|--------------------------|-----------------|
| ASTRA Mk II 1.8 i | 10/1985→08/1986 | CAVALIER Mk II 1.8 i Cat | 01/1985→08/1986 |
|-------------------|-----------------|--------------------------|-----------------|

| | | | | | | |
|-----------------------|----------|-------|-----|---|----------------------|--|
| V91148 ■ | 90295019 | | 45° | H | VAG96022 ■■ ■ | |
| 41.80 x 7.00 x 103.80 | | MB cr | | | 45.80 x 7.02 x 11.04 | |
| V91150 ■ | 90220112 | | 45° | | | |
| 36.47 x 6.97 x 103.67 | | MD cr | | | | |

61 85.00

| | | | | | | | |
|-------------|--------|--------|-----------------|-----------------|--------|------------|----------------|
| 16 S | 1598cc | 4 Cyl. | 8 Valves | 55-66kW/75-90PS | Petrol | CIH | TD22382 |
|-------------|--------|--------|-----------------|-----------------|--------|------------|----------------|

| | | | |
|-------------|-----------------|-------------------|-----------------|
| ASTRA 1.6 S | 09/1981→08/1986 | ASTRA Mk II 1.6 S | 09/1984→08/1986 |
|-------------|-----------------|-------------------|-----------------|

| | | | | | | |
|-----------------------|----------|----|-----|---|----------------------|--|
| V90166 ■ | 90106792 | | 45° | H | VAG96023 ■■ ■ | |
| 35.00 x 7.98 x 105.99 | | MB | | | 43.00 x 8.02 x 12.02 | |



OE

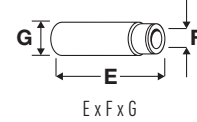

62  **85.00**

| | | | | | | | |
|-------------------------------|----------|--------|-----------|-----------------------------------|----------|-------------|---------|
| M9T 670 | 2298cc | 4 Cyl. | 16 Valves | 74-92kW/101-125PS | Diesel | Turbo, DOHC | TD24749 |
| M9T 672 | 2298cc | 4 Cyl. | 16 Valves | 74-92kW/101-125PS | Diesel | Turbo, DOHC | TD25155 |
| M9T 676 | 2298cc | 4 Cyl. | 16 Valves | 74-92kW/101-125PS | Diesel | Turbo, DOHC | TD24748 |
| M9T 678 | 2298cc | 4 Cyl. | 16 Valves | 107kW/146PS | Diesel | Turbo, DOHC | TD25156 |
| M9T 680 | 2298cc | 4 Cyl. | 16 Valves | 92-107kW/125-146PS | Diesel | Turbo, DOHC | TD25138 |
| M9T 686 | 2298cc | 4 Cyl. | 16 Valves | 92kW/125PS | Diesel | Turbo, DOHC | TD25152 |
| M9T 690 | 2298cc | 4 Cyl. | 16 Valves | 74-92kW/101-125PS | Diesel | Turbo, DOHC | TD25105 |
| M9T 692 | 2298cc | 4 Cyl. | 16 Valves | 74-92kW/101-125PS | Diesel | Turbo, DOHC | TD25106 |
| M9T 694 | 2298cc | 4 Cyl. | 16 Valves | 107-110kW/146-150PS | Diesel | Turbo, DOHC | TD24750 |
| M9T 696 | 2298cc | 4 Cyl. | 16 Valves | 92-107kW/125-146PS | Diesel | Turbo, DOHC | TD25149 |
| M9T 698 | 2298cc | 4 Cyl. | 16 Valves | 92-107kW/125-146PS | Diesel | Turbo, DOHC | TD24751 |
| M9T 880 | 2298cc | 4 Cyl. | 16 Valves | 110kW/150PS | Diesel | Turbo, DOHC | TD31642 |
| M9T 898 | 2298cc | 4 Cyl. | 16 Valves | 92-110kW/125-150PS | Diesel | Turbo, DOHC | TD34462 |
| MOVANO Mk II (B) 2.3 CDTi | 05/2010→ | | | MOVANO Mk II (B) 2.3 CDTi RWD | 07/2010→ | | |
| MOVANO Mk II (B) VAN 2.3 CDTi | 05/2010→ | | | MOVANO Mk II (B) VAN 2.3 CDTi RWD | 05/2010→ | | |

V95001 
27.70 x 5.98 x 103.90

93161682



45° Y H

VAG96383B 
42.40 x 6.00 x 11.07

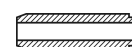

V95002 
26.00 x 5.97 x 103.75

93161681

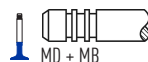

45° H

63  **86.00**

| | | | | | | | |
|-----------------------|-----------------|--------|----------|----------------------------|-----------------|-----------------|---------|
| 20 NE | 1998cc | 4 Cyl. | 8 Valves | 85kW/116PS | Petrol | SOHC, Injection | TD17637 |
| 20 SEH | 1998cc | 4 Cyl. | 8 Valves | 95kW/129PS | Petrol | SOHC, Injection | TD17574 |
| ASTRA Mk II 2.0 | 09/1986→08/1991 | | | ASTRA Mk II 2.0 GTE | 09/1986→08/1991 | | |
| ASTRA Mk II 2.0 i | 01/1987→12/1991 | | | CAVALIER Mk II 2.0 | 09/1987→08/1988 | | |
| CAVALIER Mk II 2.0 i | 09/1986→08/1988 | | | CAVALIER Mk II 2.0 SRi 130 | 03/1987→08/1988 | | |
| CAVALIER Mk III 2.0 i | 09/1988→10/1992 | | | CAVALIER Mk III 2.0 SRi | 09/1988→09/1992 | | |

V91148 
41.80 x 7.00 x 103.80

90295019

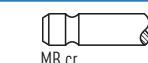

45° H

VAG96022 
45.80 x 7.02 x 11.04



V91149 
36.57 x 6.97 x 103.63
Eng.→J1216862

90323757

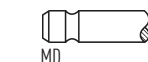

45°

V91150 
36.47 x 6.97 x 103.67
Eng.J1216863→

90220112

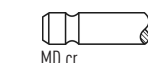

45°

64  **86.00**

| | | | | | | | |
|--------|--------|--------|----------|------------|--------|-----------------|---------|
| 20 NEJ | 1998cc | 4 Cyl. | 8 Valves | 82kW/112PS | Petrol | SOHC, Injection | TD25533 |
|--------|--------|--------|----------|------------|--------|-----------------|---------|

V91148 
41.80 x 7.00 x 103.80

90295019

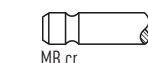

45° H

VAG96022 
45.80 x 7.02 x 11.04



V91149 
36.57 x 6.97 x 103.63

90323757

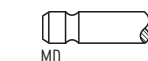

45°



OE

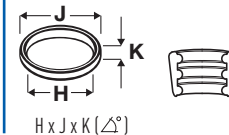
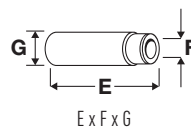
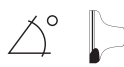

65 86.00

| | | | | | | | |
|---------------------------|-----------------|--------|-----------------|------------------------|--------|------------------------|----------------|
| 20 SE | 1998cc | 4 Cyl. | 8 Valves | 85-90kW/116-122PS | Petrol | SOHC, Injection | TD17573 |
| C 20 NE | 1998cc | 4 Cyl. | 8 Valves | 85kW/115PS | Petrol | SOHC, Injection | TD17584 |
| C 20 NEF | 1998cc | 4 Cyl. | 8 Valves | 74kW/100PS | Petrol | SOHC, Injection | TD22866 |
| C 20 NEJ | 1998cc | 4 Cyl. | 8 Valves | 73-74kW/99-100PS | Petrol | SOHC, Injection | TD22867 |
| X 20 SE | 1998cc | 4 Cyl. | 8 Valves | 85kW/116PS | Petrol | SOHC, Injection | TD17593 |
| ASTRA Mk II 2.0 i Cat | 01/1991→08/1993 | | | ASTRA Mk III (F) 2.0 i | | 09/1991→09/1998 | |
| CALIBRA 2.0 i | 06/1990→07/1997 | | | CARLTON Mk II 2.0 S | | 10/1978→08/1986 | |
| CARLTON Mk III 2.0 | 09/1986→03/1994 | | | CARLTON Mk III 2.0 i | | 09/1986→03/1994 | |
| CAVALIER Mk II 2.0 i Cat | 09/1986→08/1988 | | | CAVALIER Mk II 2000i | | 09/1986→08/1988 | |
| CAVALIER Mk III 2.0 i Cat | 09/1990→11/1995 | | | FRONTERA Mk I (A) 2.0 | | 04/1995→08/1998 | |
| FRONTERA Mk I (A) 2.0 i | 03/1992→10/1998 | | | OMEGA (B) 2.0 | | 03/1994→09/1999 | |

V91148
41.80 x 7.00 x 103.80

90295019

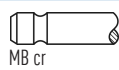

45°

H

VAG96022
45.80 x 7.02 x 11.04



V91150
36.47 x 6.97 x 103.67

90220112

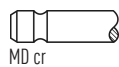

45°

66 86.00

| | | | | | | | |
|-------------------------|-----------------|--------|------------------|-------------------------|--------|------------------------|----------------|
| 20 XE | 1998cc | 4 Cyl. | 16 Valves | 115kW/156PS | Petrol | DOHC, Injection | TD17605 |
| ASTRA Mk II 2.0 GTE 16V | 05/1988→08/1991 | | | CAVALIER Mk III 2.0 GSi | | 09/1989→08/1992 | |

V91429
33.00 x 7.00 x 104.90

90322694

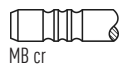

45°

H

VAG96022
45.80 x 7.02 x 11.04



V91430
29.10 x 6.96 x 104.90

90322697



45°

SS

H

67 86.00

| | | | | | | | |
|------------------------------------|-----------------|--------|------------------|------------------------------------|--------|-------------------------------|----------------|
| A 20 NHT | 1998cc | 4 Cyl. | 16 Valves | 162-184kW/220-250PS | Petrol | Turbo, DOHC, Injection | TD22594 |
| Z 20 NET | 1998cc | 4 Cyl. | 16 Valves | 129kW/175PS | Petrol | Turbo, DOHC, Injection | TD20350 |
| INSIGNIA Mk I (A) 2.0 Turbo | 07/2008→05/2017 | | | INSIGNIA Mk I (A) Tourer 2.0 Turbo | | 07/2008→05/2017 | |
| SIGNUM 2.0 i Turbo | 03/2003→10/2008 | | | VECTRA Mk II (C) 2.0 16V Turbo | | 01/2000→10/2008 | |
| VECTRA Mk II (C) GTS 2.0 16V Turbo | 03/2003→07/2008 | | | | | | |

V94962
35.15 x 6.00 x 102.20

12575793

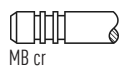

45°

H

V94963
30.10 x 6.00 x 100.90

24454518



45°

SS

H

68 86.00

| | | | | | | | |
|---------------------------|-----------------|--------|------------------|-----------------------------|--------|-------------------------------|----------------|
| C 20 LET | 1998cc | 4 Cyl. | 16 Valves | 150kW/204PS | Petrol | Turbo, DOHC, Injection | TD17612 |
| C 20 XE | 1998cc | 4 Cyl. | 16 Valves | 110kW/150PS | Petrol | DOHC, Injection | TD17585 |
| ASTRA Mk II 1.9 | 03/1988→08/1991 | | | ASTRA Mk III (F) 2.0 i 16V | | 09/1991→02/1998 | |
| CALIBRA 2.0 i 16V | 06/1990→02/1994 | | | CALIBRA 2.0 i Turbo | | 03/1992→07/1997 | |
| CAVALIER Mk III 2.0 i 16V | 09/1988→11/1995 | | | CAVALIER Mk III 2.0 i Turbo | | 06/1992→11/1994 | |

V91429
33.00 x 7.00 x 104.90

90322694

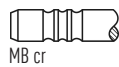

45°

H

V91430
29.10 x 6.96 x 104.90

90322697



45°

SS

H



OE

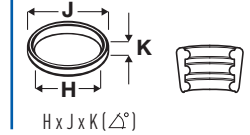
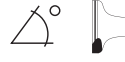

69  **86.00**

| | | | | | | | |
|-------------------------------|-----------------|--------|------------------|-------------------------------|-----------------|-------------------------------|----------------|
| X 20 XER | 1998cc | 4 Cyl. | 16 Valves | 118kW/160PS | Petrol | DOHC, Injection | TD21880 |
| X 20 XEV | 1998cc | 4 Cyl. | 16 Valves | 100kW/136PS | Petrol | DOHC, Injection | TD17594 |
| Z 20 LEH | 1998cc | 4 Cyl. | 16 Valves | 176-177kW/240-241PS | Petrol | Turbo, DOHC, Injection | TD20353 |
| Z 20 LEL | 1998cc | 4 Cyl. | 16 Valves | 125kW/170PS | Petrol | Turbo, DOHC, Injection | TD18019 |
| Z 20 LER | 1998cc | 4 Cyl. | 16 Valves | 147kW/200PS | Petrol | Turbo, DOHC, Injection | TD20352 |
| Z 20 LET | 1998cc | 4 Cyl. | 16 Valves | 140-162kW/190-220PS | Petrol | Turbo, DOHC, Injection | TD17944 |
| ASTRA Mk III (F) 2.0 i 16V | 01/1994→09/1998 | | | ASTRA Mk IV (G) 2.0 | 10/1999→10/2005 | | |
| ASTRA Mk IV (G) 2.0 16V | 02/1998→05/2005 | | | ASTRA Mk IV (G) 2.0 16V Turbo | 09/2000→08/2005 | | |
| ASTRA Mk IV (G) 2.0 SRI Turbo | 11/2001→05/2005 | | | ASTRA Mk IV (G) 2.0 Turbo | 03/2002→10/2005 | | |
| ASTRA Mk V (H) 2.0 | 02/2006→11/2010 | | | ASTRA Mk V (H) 2.0 Turbo | 01/2004→11/2010 | | |
| ASTRA Mk V (H) 2.0 VXR | 02/2009→11/2010 | | | CALIBRA 2.0 i 16V | 06/1990→07/1997 | | |
| CAVALIER Mk III 2.0 i 16V | 09/1993→11/1995 | | | CAVALIER Mk III 2.0 SRi 16V | 09/1993→11/1995 | | |
| OMEGA (B) 2.0 16V | 03/1994→07/2001 | | | VECTRA (B) 2.0 i 16V | 10/1995→01/2001 | | |
| VX220 2.0 i Turbo | 03/2001→07/2005 | | | ZAFIRA Mk I (A) 2.0 | 06/2002→06/2005 | | |
| ZAFIRA Mk I (A) 2.0 GSI Turbo | 09/2001→06/2005 | | | ZAFIRA Mk II (B) 2.0 | 07/2005→11/2014 | | |

V91997  32.10 x 5.97 x 102.10

90412277

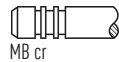

45°

H

VAG96029  35.00 x 5.99 x 10.05



V91998  29.10 x 5.96 x 92.25

90410813

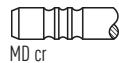

45°

SS

VAG96028  45.00 x 5.99 x 10.05

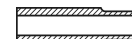

70  **86.00**

| | | | | | | | |
|-------------------------|-----------------|--------|------------------|--------------------------|-----------------|------------------------|----------------|
| C 22 SEL | 2198cc | 4 Cyl. | 16 Valves | 102-106kW/139-144PS | Petrol | DOHC, Injection | TD22204 |
| X 22 SE | 2198cc | 4 Cyl. | 16 Valves | 100-104kW/136-141PS | Petrol | DOHC, Injection | TD17918 |
| X 22 XE | 2198cc | 4 Cyl. | 16 Valves | 100-104kW/136-141PS | Petrol | DOHC, Injection | TD17628 |
| Y 22 SE | 2198cc | 4 Cyl. | 16 Valves | 100kW/136PS | Petrol | DOHC, Injection | TD17930 |
| Y 22 XE | 2198cc | 4 Cyl. | 16 Valves | 106-108kW/144-147PS | Petrol | DOHC, Injection | TD17933 |
| Z 22 XE | 2198cc | 4 Cyl. | 16 Valves | 106kW/144PS | Petrol | DOHC, Injection | TD22877 |
| FRONTERA Mk I (A) 2.2 i | 03/1995→10/1998 | | | FRONTERA Mk II (B) 2.2 i | 10/1998→10/2004 | | |
| OMEGA (B) 2.2 16V | 01/1994→06/2003 | | | SINTRA 2.2 i 16 V | 11/1996→04/1999 | | |

V91997  32.10 x 5.97 x 102.10

90412277

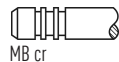

45°

H

VAG96029  35.00 x 5.99 x 10.05



V91998  29.10 x 5.96 x 92.25

90410813



45°

SS

VAG96028  45.00 x 5.99 x 10.05

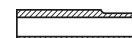

71  **86.00**

| | | | | | | | |
|------------------------------|-----------------|--------|------------------|---------------------------------|-----------------|------------------------|----------------|
| Z 22 SE | 2198cc | 4 Cyl. | 16 Valves | 106-108kW/144-147PS | Petrol | DOHC, Injection | TD17683 |
| Z 22 YH | 2198cc | 4 Cyl. | 16 Valves | 100-114kW/136-155PS | Petrol | DOHC, Injection | TD18021 |
| ASTRA Mk IV (G) 2.2 16V | 03/2000→10/2005 | | | SIGNUM 2.2 i | 05/2003→05/2008 | | |
| SPEEDSTER 2.2 | 03/2001→09/2006 | | | VECTRA (B) 2.2 i 16V | 08/1995→07/2003 | | |
| VECTRA Mk II (C) 2.2 16V | 01/2002→10/2008 | | | VECTRA Mk II (C) 2.2 direct | 01/2002→10/2008 | | |
| VECTRA Mk II (C) GTS 2.2 16V | 08/2002→07/2008 | | | VECTRA Mk II (C) GTS 2.2 direct | 10/2003→08/2005 | | |
| VX220 2.2 i | 09/2000→07/2005 | | | ZAFIRA Mk I (A) 2.2 16V | 11/1998→08/2004 | | |
| ZAFIRA Mk II (B) 2.2 | 07/2005→11/2014 | | | | | | |

V94962  35.15 x 6.00 x 102.20

12575793

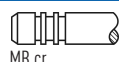

45°

H

V94963  30.10 x 6.00 x 100.90

24454518

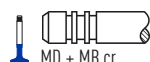

45°

SS

H



OE

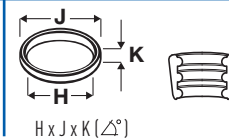
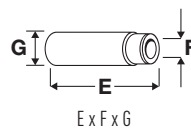

72 86.00

| X 30 XE | 2962cc | V6 Cyl. | 24 Valves | 148-155kW/201-211PS | Petrol | DOHC, Injection | TD19222 |
|-----------------------|----------|-----------------|-----------|---------------------|----------------------|-----------------|---------|
| OMEGA (B) 3.0 V6 | | 04/1994→07/2000 | | SINTRA 3.0 i | | 11/1996→04/1999 | |
| V91997 | 90412277 | | 45° | H | VAG96137 | | |
| 32.10 x 5.97 x 102.10 | | MB cr | | | 45.00 x 6.02 x 10.05 | | |
| V94542 | 90410816 | | 45° | ss H | | | |
| 29.00 x 6.00 x 92.25 | | MD + MB cr | | | | | |

73 87.00

| G9T 720 | 2188cc | 4 Cyl. | 16 Valves | 66kW/90PS | Diesel | Turbo, DOHC | TD19353 |
|-------------------------|--------------|-----------------|-----------|-----------|----------------------|-------------|---------|
| G9T 722 | 2188cc | 4 Cyl. | 16 Valves | 66kW/90PS | Diesel | Turbo, DOHC | TD19356 |
| G9T 750 | 2188cc | 4 Cyl. | 16 Valves | 66kW/90PS | Diesel | Turbo, DOHC | TD19355 |
| MOVANO Mk I (A) 2.2 DTI | | 09/2000→05/2010 | | | | | |
| V94513 | 7701 472 669 | | 45° | H | VAG96361B | | |
| 30.70 x 6.00 x 123.10 | | MB | | | 50.00 x 6.00 x 11.05 | | |
| V94514 | 7701 472 670 | | 45° | | | | |
| 29.50 x 6.00 x 122.90 | | MD | | | | | |

74 87.50

| Z 24 XED | 2405cc | 4 Cyl. | 16 Valves | 103kW/140PS | Petrol | DOHC, Injection | TD19221 |
|-----------------------|----------|-----------------|-----------|-------------|----------------------|-----------------|---------|
| ANTARA 2.4 | | 08/2006→04/2015 | | | | | |
| V91997 | 90412277 | | 45° | H | VAG96028 | | |
| 32.10 x 5.97 x 102.10 | | MB cr | | | 45.00 x 5.99 x 10.05 | | |
| V91998 | 90410813 | | 45° | ss | | | |
| 29.10 x 5.96 x 92.25 | | MD cr | | | | | |

75 87.50

| Y 32 SE | 3175cc | V6 Cyl. | 24 Valves | 160kW/218PS | Petrol | DOHC, Injection | TD18887 |
|-----------------------|----------|-----------------|-----------|-------------|----------------------|-----------------|---------|
| OMEGA (B) 3.2 V6 | | 02/2001→07/2003 | | | | | |
| V91997 | 90412277 | | 45° | H | VAG96028 | | |
| 32.10 x 5.97 x 102.10 | | MB cr | | | 45.00 x 5.99 x 10.05 | | |
| V91998 | 90410813 | | 45° | ss | | | |
| 29.10 x 5.96 x 92.25 | | MD cr | | | | | |

76 88.00

| C 223 | 2238cc | 4 Cyl. | 8 Valves | 39-54kW/53-73PS | Diesel | OHV | TD22879 |
|-----------------------|---------------|-----------------|----------|-----------------|----------------------|-----|---------|
| BRAVA 2.2 D | | 12/1988→09/1996 | | | | | |
| V91498 | 5-12552-034-2 | | 45° | st | VAG92372 | | |
| 34.10 x 7.94 x 115.80 | | MD tu | | | 50.00 x 8.00 x 14.03 | | |



OE

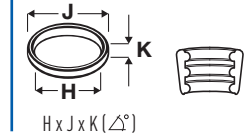
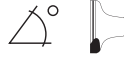

77  **88.50**

| | | | | | | | |
|-----------------------------|--------|-----------------|-----------|-------------------------|--------|-----------------|---------|
| Z 32 SE | 3175cc | V6 Cyl. | 24 Valves | 155kW/211PS | Petrol | DOHC, Injection | TD19217 |
| SIGNUM 3.2 V6 | | 05/2003→05/2008 | | VECTRA Mk II (C) 3.2 V6 | | 06/2003→07/2008 | |
| VECTRA Mk II (C) GTS 3.2 V6 | | 08/2002→07/2008 | | | | | |

V91997 
32.10 x 5.97 x 102.10

90412277

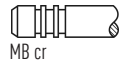

45°

H

VAG96028 
45.00 x 5.99 x 10.05



V91998 
29.10 x 5.96 x 92.25

90410813

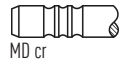

45°

SS

78  **89.00**

| | | | | | | | |
|--------------------------|--------|-----------------|-----------|-------------------------|--------|-----------------|---------|
| G9U 630 | 2464cc | 4 Cyl. | 16 Valves | 84-107kW/114-146PS | Diesel | Turbo, DOHC | TD21903 |
| G9U 632 | 2464cc | 4 Cyl. | 16 Valves | 88-107kW/120-146PS | Diesel | Turbo, DOHC | TD24755 |
| G9U 650 | 2464cc | 4 Cyl. | 16 Valves | 74-107kW/101-146PS | Diesel | Turbo, DOHC | TD24737 |
| G9U 720 | 2464cc | 4 Cyl. | 16 Valves | 84-85kW/115-116PS | Diesel | Turbo, DOHC | TD19358 |
| G9U 724 | 2464cc | 4 Cyl. | 16 Valves | 84kW/115PS | Diesel | Turbo, DOHC | TD19368 |
| G9U 730 | 2464cc | 4 Cyl. | 16 Valves | 99kW/135PS | Diesel | Turbo, DOHC | TD18701 |
| G9U 750 | 2464cc | 4 Cyl. | 16 Valves | 84kW/115PS | Diesel | Turbo, DOHC | TD19365 |
| G9U 754 | 2464cc | 4 Cyl. | 16 Valves | 73-84kW/99-115PS | Diesel | Turbo, DOHC | TD19369 |
| MOVANO Mk I (A) 2.5 CDTI | | 10/2001→12/2010 | | MOVANO Mk I (A) 2.5 DTI | | 10/2001→05/2010 | |
| VIVARO 2.5 CDTI | | 04/2003→07/2014 | | VIVARO 2.5 DTI | | 07/2003→07/2014 | |

V94513 
30.70 x 6.00 x 123.10

7701 472 669

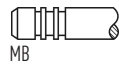

45°

H

VAG96361B 
50.00 x 6.00 x 11.05



V94514 
29.50 x 6.00 x 122.90

7701 472 670

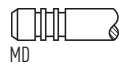

45°

79  **92.00**

| | | | | | | | |
|--------------------------|--------|-----------------|----------|-----------------------|--------|-----------------|---------|
| 23 DTR | 2260cc | 4 Cyl. | 8 Valves | 74kW/100PS | Diesel | Turbo, SOHC | TD17576 |
| 23 YDT | 2260cc | 4 Cyl. | 8 Valves | 66kW/90PS | Diesel | Turbo, SOHC | TD17579 |
| CARLTON Mk III 2.2 TD | | 09/1986→08/1988 | | CARLTON Mk III 2.3 TD | | 08/1988→03/1994 | |
| FRONTERA Mk I (A) 2.3 TD | | 09/1991→06/1998 | | | | | |

V91433 
42.10 x 8.01 x 127.20

90298607

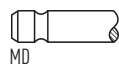

45°

80  **92.00**

| | | | | | | | |
|---------------------------|--------|-----------------|----------|------------|--------|------------|---------|
| 25TDS (VM41B) | 2499cc | 4 Cyl. | 8 Valves | 85kW/115PS | Diesel | Turbo, OHV | TD22850 |
| FRONTERA Mk I (A) 2.5 TDS | | 11/1991→10/1998 | | | | | |

V91437 
40.00 x 8.00 x 121.00

605 07 189

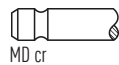

35°

VAG96187 
55.00 x 8.02 x 14.06

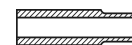

V91438 
34.00 x 8.00 x 121.00

605 07 190

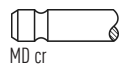

45°

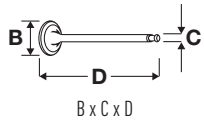

OE

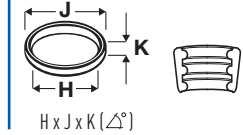
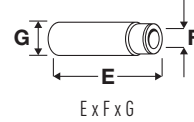
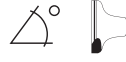

81 93.00

| | | | | | | | |
|----------------|--------|--------|-----------------|-----------------|--------|--------------------|----------------|
| S8U 758 | 2500cc | 4 Cyl. | 8 Valves | 55-58kW/75-79PS | Diesel | SOHC | TD22883 |
| S8U 770 | 2500cc | 4 Cyl. | 8 Valves | 59kW/80PS | Diesel | Turbo, SOHC | TD19357 |
| S8U 772 | 2500cc | 4 Cyl. | 8 Valves | 59kW/80PS | Diesel | SOHC | TD19364 |
| S8U 780 | 2500cc | 4 Cyl. | 8 Valves | 55kW/75PS | Diesel | SOHC | TD22884 |
| S8U 782 | 2500cc | 4 Cyl. | 8 Valves | 55kW/75PS | Diesel | SOHC | TD22885 |

ARENA 2.5 D 03/1998→08/2001 MOVANO Mk I (A) 2.5 D 10/1998→08/2002

| | | | | | | | |
|-----------------------|--------------|------------|-----|---|---|----------------------|--|
| V91292 | 0948.A2 | | 30° | Y | H | VAG92369 | |
| 40.80 x 8.00 x 120.70 | | MB cr | | | | 60.00 x 8.00 x 13.07 | |
| V91940 | 7701 467 249 | | 45° | | H | VAG92373 | |
| 36.70 x 8.00 x 122.00 | | MD + MB cr | | | | 56.00 x 8.03 x 13.04 | |

82 93.40

| | | | | | | | |
|--------------|--------|---------|------------------|---------------------|--------|-------------|----------------|
| 6 VD1 | 3165cc | V6 Cyl. | 24 Valves | 130-151kW/177-205PS | Petrol | DOHC | TD22861 |
|--------------|--------|---------|------------------|---------------------|--------|-------------|----------------|

FRONTERA Mk II (B) 3.2 i 10/1998→10/2004 MONTEREY 3.2 06/1992→07/1998

| | | | | | | | |
|-----------------------|----------|-------|-----|--|--|--|--|
| V94344 | 97131962 | | 45° | | | | |
| 29.00 x 6.00 x 103.50 | | MD tu | | | | | |

83 94.40

| | | | | | | | |
|----------------|--------|--------|-----------------|------------|--------|--------------------|----------------|
| S9W 700 | 2800cc | 4 Cyl. | 8 Valves | 84kW/114PS | Diesel | Turbo, SOHC | TD21150 |
|----------------|--------|--------|-----------------|------------|--------|--------------------|----------------|

| | | | | | | | |
|-----------------------|--------------|------------|-----|---|---|----------------------|--|
| V91292 | 0948.A2 | | 30° | Y | H | VAG92193 | |
| 40.80 x 8.00 x 120.70 | | MB cr | | | | 56.00 x 8.04 x 13.05 | |
| V91940 | 7701 467 249 | | 45° | | H | VAG92369 | |
| 36.70 x 8.00 x 122.00 | | MD + MB cr | | | | 60.00 x 8.00 x 13.07 | |
| | | | | | | VAG92373 | |
| | | | | | | 56.00 x 8.03 x 13.04 | |
| | | | | | | VAG96190 | |
| | | | | | | 56.00 x 8.04 x 13.13 | |

84 94.40

| | | | | | | | |
|----------------|--------|--------|-----------------|------------|--------|--------------------|----------------|
| S9W 702 | 2800cc | 4 Cyl. | 8 Valves | 84kW/114PS | Diesel | Turbo, SOHC | TD19361 |
|----------------|--------|--------|-----------------|------------|--------|--------------------|----------------|

MOVANO Mk I (A) 2.8 DTI 10/1998→10/2001 MOVANO Mk I (A) 2.8 TDI 10/1998→10/2001







| | | | | | | | |
|-----------------------|--------------|------------|-----|---|---|----------------------|--|
| V91292 | 0948.A2 | | 30° | Y | H | VAG92369 | |
| 40.80 x 8.00 x 120.70 | | MB cr | | | | 60.00 x 8.00 x 13.07 | |
| V91940 | 7701 467 249 | | 45° | | H | | |
| 36.70 x 8.00 x 122.00 | | MD + MB cr | | | | | |







85 95.40







| | | | | | | | |
|----------------|--------|--------|-----------------|------------|--------|--------------------|----------------|
| 4 JG2TC | 3059cc | 4 Cyl. | 8 Valves | 84kW/114PS | Diesel | Turbo, SOHC | TD22854 |
|----------------|--------|--------|-----------------|------------|--------|--------------------|----------------|







MONTEREY 3.1 TD 09/1991→07/1998







| | | | | | | | |
|-----------------------|----------|-------|-----|--|----|--|--|
| V94662 | 94363134 | | 45° | | st | | |
| 40.10 x 8.00 x 117.50 | | MD tu | | | | | |
| V94663 | 97043861 | | 45° | | st | | |
| 35.70 x 8.00 x 117.50 | | MD tu | | | | | |







|  |  | ccm |  |  |  |  | |
|---|---|-------|---|---|---|---|----|
| B 130 | | 73.00 | 1289 | 4 | 8 | Petrol | 1 |
| B 14.3 E | | 76.00 | 1397 | 4 | 8 | Petrol | 4 |
| B 14.4 S | | 76.00 | 1397 | 4 | 8 | Petrol | 4 |
| B 17 2 K | | 81.00 | 1721 | 4 | 8 | Petrol | 13 |
| B 18 E | | 81.00 | 1721 | 4 | 8 | Petrol | 13 |
| B 18 EP | | 81.00 | 1721 | 4 | 8 | Petrol | 13 |
| B 18 F | | 81.00 | 1721 | 4 | 8 | Petrol | 13 |
| B 18 FP | | 81.00 | 1721 | 4 | 8 | Petrol | 13 |
| B 18 FT | | 81.00 | 1721 | 4 | 8 | Petrol | 13 |
| B 18 U | | 82.70 | 1794 | 4 | 8 | Petrol | 25 |
| B 19 A | | 88.90 | 1986 | 4 | 8 | Petrol | 42 |
| B 19 E | | 88.90 | 1986 | 4 | 8 | Petrol | 42 |
| B 19 ET | | 88.90 | 1986 | 4 | 8 | Petrol | 42 |
| B 19 K | | 88.90 | 1986 | 4 | 8 | Petrol | 43 |
| B 20 A | | 88.90 | 1998 | 4 | 8 | Petrol | 44 |
| B 20 B | | 88.90 | 1998 | 4 | 8 | Petrol | 44 |
| B 20 F | | 88.90 | 1998 | 4 | 8 | Petrol | 45 |
| B 20 F | | 82.70 | 1998 | 4 | 8 | Petrol | 26 |
| B 200 E | | 88.90 | 1986 | 4 | 8 | Petrol | 42 |
| B 200 EA | | 88.90 | 1986 | 4 | 8 | Petrol | 42 |
| B 200 ET | | 88.90 | 1986 | 4 | 8 | Petrol | 42 |
| B 200 F | | 88.90 | 1986 | 4 | 8 | Petrol | 42 |
| B 200 FT | | 88.90 | 1986 | 4 | 8 | Petrol | 42 |
| B 200 G | | 88.90 | 1986 | 4 | 8 | Petrol | 42 |
| B 200 K | | 88.90 | 1986 | 4 | 8 | Petrol | 42 |
| B 21 A | | 92.00 | 2127 | 4 | 8 | Petrol | 48 |
| B 21 E | | 92.00 | 2127 | 4 | 8 | Petrol | 48 |
| B 21 ET | | 92.00 | 2127 | 4 | 8 | Petrol | 48 |
| B 21 F | | 92.00 | 2127 | 4 | 8 | Petrol | 48 |
| B 23 A | | 96.00 | 2316 | 4 | 8 | Petrol | 50 |
| B 23 E | | 96.00 | 2316 | 4 | 8 | Petrol | 50 |
| B 23 ET | | 96.00 | 2315 | 4 | 8 | Petrol | 49 |
| B 230 E | | 96.00 | 2316 | 4 | 8 | Petrol | 50 |
| B 230 ET | | 96.00 | 2316 | 4 | 8 | Petrol | 50 |
| B 230 F | | 96.00 | 2316 | 4 | 8 | Petrol | 50 |
| B 230 FB | | 96.00 | 2316 | 4 | 8 | Petrol | 50 |
| B 230 FD | | 96.00 | 2316 | 4 | 8 | Petrol | 50 |
| B 230 FK | | 96.00 | 2316 | 4 | 8 | Petrol | 50 |
| B 230 FT | | 96.00 | 2316 | 4 | 8 | Petrol | 50 |
| B 230 FT+ | | 96.00 | 2316 | 4 | 8 | Petrol | 50 |
| B 230 G | | 96.00 | 2316 | 4 | 8 | Petrol | 50 |
| B 230 GT | | 96.00 | 2316 | 4 | 8 | Petrol | 50 |
| B 234 F | | 96.00 | 2316 | 4 | 16 | Petrol | 51 |
| B 27 A | | 88.00 | 2664 | 6 | 12 | Petrol | 41 |
| B 27 E | | 88.00 | 2664 | 6 | 12 | Petrol | 41 |
| B 27 F | | 88.00 | 2664 | 6 | 12 | Petrol | 41 |
| B 28 A | | 91.00 | 2849 | 6 | 12 | Petrol | 46 |
| B 28 E | | 91.00 | 2849 | 6 | 12 | Petrol | 46 |
| B 28 F | | 91.00 | 2849 | 6 | 12 | Petrol | 46 |
| B 280 E | | 91.00 | 2849 | 6 | 12 | Petrol | 47 |
| B 4164 S | | 81.00 | 1587 | 4 | 16 | Petrol | 12 |
| B 4164 S2 | | 81.00 | 1587 | 4 | 16 | Petrol | 12 |
| B 4164 S3 | | 79.00 | 1596 | 4 | 16 | Petrol | 7 |
| B 4184 S | | 83.00 | 1783 | 4 | 16 | Petrol | 28 |
| B 4184 S11 | | 83.00 | 1798 | 4 | 16 | Petrol | 30 |
| B 4184 S2 | | 83.00 | 1783 | 4 | 16 | Petrol | 29 |
| B 4184 S3 | | 83.00 | 1731 | 4 | 16 | Petrol | 27 |
| B 4184 S9 | | 83.00 | 1783 | 4 | 16 | Petrol | 28 |
| B 4184 SJ | | 81.00 | 1834 | 4 | 16 | Petrol | 14 |
| B 4184 SM | | 81.00 | 1834 | 4 | 16 | Petrol | 14 |
| B 4194 T | | 81.00 | 1855 | 4 | 16 | Petrol | 15 |
| B 4194 T2 | | 81.00 | 1855 | 4 | 16 | Petrol | 15 |
| B 4204 S | | 83.00 | 1948 | 4 | 16 | Petrol | 31 |
| B 4204 S2 | | 83.00 | 1948 | 4 | 16 | Petrol | 31 |
| B 4204 S3 | | 87.50 | 1999 | 4 | 16 | Petrol | 40 |
| B 4204 T | | 83.00 | 1948 | 4 | 16 | Petrol | 31 |

|  |  | ccm |  |  |  |  |
|---|---|------|--|---|---|---|
| B 4204 T2 | 83.00 | 1948 | 4 | 16 | Petrol | 31 |
| B 4204 T3 | 83.00 | 1948 | 4 | 16 | Petrol | 31 |
| B 4204 T5 | 83.00 | 1948 | 4 | 16 | Petrol | 31 |
| B 5204 F | 81.00 | 1984 | 5 | 20 | Petrol | 16 |
| B 5204 T | 81.00 | 1984 | 5 | 20 | Petrol | 16 |
| B 5204 T2 | 81.00 | 1984 | 5 | 20 | Petrol | 16 |
| B 5204 T3 | 81.00 | 1984 | 5 | 20 | Petrol | 16 |
| B 5204 T4 | 81.00 | 1984 | 5 | 20 | Petrol | 16 |
| B 5204 T5 | 81.00 | 1984 | 5 | 20 | Petrol | 17 |
| B 5234 FT | 81.00 | 2319 | 5 | 20 | Petrol | 18 |
| B 5234 T2 | 81.00 | 2319 | 5 | 20 | Petrol | 18 |
| B 5234 T3 | 81.00 | 2319 | 5 | 20 | Petrol | 19 |
| B 5234 T4 | 81.00 | 2319 | 5 | 20 | Petrol | 18 |
| B 5234 T5 | 81.00 | 2319 | 5 | 20 | Petrol | 18 |
| B 5234 T6 | 81.00 | 2319 | 5 | 20 | Petrol | 18 |
| B 5234 T7 | 81.00 | 2319 | 5 | 20 | Petrol | 18 |
| B 5234 T8 | 81.00 | 2319 | 5 | 20 | Petrol | 18 |
| B 5234 T9 | 81.00 | 2319 | 5 | 20 | Petrol | 18 |
| B 5244 S | 83.00 | 2435 | 5 | 20 | Petrol | 32 |
| B 5244 S2 | 83.00 | 2435 | 5 | 20 | Petrol | 33 |
| B 5244 S4 | 83.00 | 2435 | 5 | 20 | Petrol | 33 |
| B 5244 S5 | 83.00 | 2435 | 5 | 20 | Petrol | 34 |
| B 5244 SG | 83.00 | 2435 | 5 | 20 | Petrol | 34 |
| B 5244 SG2 | 83.00 | 2435 | 5 | 20 | Petrol | 34 |
| B 5244 T | 83.00 | 2435 | 5 | 20 | Petrol | 34 |
| B 5244 T3 | 83.00 | 2435 | 5 | 20 | Petrol | 34 |
| B 5244 T5 | 81.00 | 2401 | 5 | 20 | Petrol | 21 |
| B 5244 T7 | 83.00 | 2435 | 5 | 20 | Petrol | 33 |
| B 5254 F | 83.00 | 2435 | 5 | 20 | Petrol | 33 |
| B 5254 S | 83.00 | 2435 | 5 | 20 | Petrol | 33 |
| B 5254 T | 83.00 | 2435 | 5 | 20 | Petrol | 33 |
| B 5254 T2 | 83.00 | 2521 | 5 | 20 | Petrol | 35 |
| B 5254 T3 | 83.00 | 2521 | 5 | 20 | Petrol | 36 |
| B 5254 T4 | 83.00 | 2521 | 5 | 20 | Petrol | 35 |
| B 5254 T6 | 83.00 | 2521 | 5 | 20 | Petrol | 35 |
| B 5254 T7 | 83.00 | 2521 | 5 | 20 | Petrol | 36 |
| B 6254 F | 81.00 | 2473 | 6 | 24 | Petrol | 23 |
| B 6254 S | 81.00 | 2473 | 6 | 24 | Petrol | 23 |
| B 6284 T | 81.00 | 2783 | 6 | 24 | Petrol | 24 |
| B 6294 S | 83.00 | 2922 | 6 | 24 | Petrol | 37 |
| B 6294 S2 | 83.00 | 2922 | 6 | 24 | Petrol | 37 |
| B 6294 T | 83.00 | 2922 | 6 | 24 | Petrol | 37 |
| B 6304 F | 83.00 | 2922 | 6 | 24 | Petrol | 38 |
| B 6304 G | 83.00 | 2922 | 6 | 24 | Petrol | 38 |
| B 6304 S | 83.00 | 2922 | 6 | 24 | Petrol | 38 |
| B 6304 S2 | 83.00 | 2922 | 6 | 24 | Petrol | 38 |
| B 6304 S3 | 83.00 | 2922 | 6 | 24 | Petrol | 38 |
| D 16 | 78.00 | 1596 | 4 | 8 | Diesel | 6 |
| D 19 T | 80.00 | 1870 | 4 | 8 | Diesel | 8 |
| D 24 | 76.50 | 2383 | 6 | 12 | Diesel | 5 |
| D 24 T | 76.50 | 2383 | 6 | 12 | Diesel | 5 |
| D 24 TIC | 76.50 | 2383 | 6 | 12 | Diesel | 5 |
| D 4162 T | 75.00 | 1560 | 4 | 8 | Diesel | 2 |
| D 4164 T | 75.00 | 1560 | 4 | 16 | Diesel | 3 |
| D 4192 T | 80.00 | 1870 | 4 | 8 | Diesel | 9 |
| D 4192 T2 | 80.00 | 1870 | 4 | 8 | Diesel | 10 |
| D 4192 T3 | 80.00 | 1870 | 4 | 8 | Diesel | 10 |
| D 4192 T4 | 80.00 | 1870 | 4 | 8 | Diesel | 10 |
| D 4204 T | 85.00 | 1997 | 4 | 16 | Diesel | 39 |
| D 4204 T2 | 85.00 | 1997 | 4 | 16 | Diesel | 39 |
| D 5244 T | 81.00 | 2400 | 5 | 20 | Diesel | 20 |
| D 5244 T2 | 81.00 | 2400 | 5 | 20 | Diesel | 20 |
| D 5244 T4 | 81.00 | 2400 | 5 | 20 | Diesel | 20 |
| D 5244 T5 | 81.00 | 2400 | 5 | 20 | Diesel | 20 |
| D 5244 T8 | 81.00 | 2400 | 5 | 20 | Diesel | 20 |
| D 5252 T | 81.00 | 2461 | 5 | 10 | Diesel | 22 |

|  |  | ccm |  |  |  |  |
|---|---|-------|---|---|---|---|
| D10A320 | 120.65 | 9600 | 6 | 12 | Diesel | 64 |
| D10A360 | 120.65 | 9600 | 6 | 12 | Diesel | 64 |
| D10B320 | 120.65 | 9600 | 6 | 12 | Diesel | 64 |
| D10B360 | 120.65 | 9600 | 6 | 12 | Diesel | 64 |
| D12A340 | 131.00 | 12100 | 6 | 24 | Diesel | 67 |
| D12A380 | 131.00 | 12100 | 6 | 24 | Diesel | 67 |
| D12A420 | 131.00 | 12100 | 6 | 24 | Diesel | 67 |
| D12C340 | 131.00 | 12100 | 6 | 24 | Diesel | 68 |
| D12C380 | 131.00 | 12100 | 6 | 24 | Diesel | 68 |
| D12C420 | 131.00 | 12100 | 6 | 24 | Diesel | 68 |
| D12C460 | 131.00 | 12100 | 6 | 24 | Diesel | 68 |
| D12D340 | 131.00 | 12100 | 6 | 24 | Diesel | 68 |
| D12D380 | 131.00 | 12100 | 6 | 24 | Diesel | 68 |
| D12D420 | 131.00 | 12100 | 6 | 24 | Diesel | 68 |
| D12D460 | 131.00 | 12100 | 6 | 24 | Diesel | 68 |
| D12D500 | 131.00 | 12100 | 6 | 24 | Diesel | 68 |
| D13A360 | 131.00 | 12800 | 6 | 24 | Diesel | 69 |
| D13A400 | 131.00 | 12800 | 6 | 24 | Diesel | 69 |
| D13A440 | 131.00 | 12800 | 6 | 24 | Diesel | 69 |
| D13A480 | 131.00 | 12800 | 6 | 24 | Diesel | 69 |
| D13A520 | 131.00 | 12800 | 6 | 24 | Diesel | 69 |
| D13B360 | 131.00 | 12800 | 6 | 24 | Diesel | 69 |
| D13B400 | 131.00 | 12800 | 6 | 24 | Diesel | 69 |
| D13B440 | 131.00 | 12800 | 6 | 24 | Diesel | 69 |
| D13B500 | 131.00 | 12800 | 6 | 24 | Diesel | 69 |
| D13C380 | 131.00 | 12800 | 6 | 24 | Diesel | 69 |
| D13C420 | 131.00 | 12800 | 6 | 24 | Diesel | 69 |
| D13C460 | 131.00 | 12800 | 6 | 24 | Diesel | 69 |
| D13C500 | 131.00 | 12800 | 6 | 24 | Diesel | 69 |
| D13C540 | 131.00 | 12800 | 6 | 24 | Diesel | 69 |
| D16C550 | 144.00 | 16120 | 6 | 24 | Diesel | 70 |
| D16C610 | 144.00 | 16120 | 6 | 24 | Diesel | 70 |
| D60A | 98.43 | 5480 | 6 | 12 | Diesel | 52 |
| D70A | 104.775 | 6700 | 6 | 12 | Diesel | 54 |
| D70B | 104.775 | 6700 | 6 | 12 | Diesel | 54 |
| D7A230 | 104.775 | 6700 | 6 | 12 | Diesel | 55 |
| D7A260 | 104.775 | 6700 | 6 | 12 | Diesel | 55 |
| D7A285 | 104.775 | 6700 | 6 | 12 | Diesel | 55 |
| D7B230 | 104.775 | 6700 | 6 | 12 | Diesel | 55 |
| D7B260 | 104.775 | 6700 | 6 | 12 | Diesel | 55 |
| D7C215 | 107.00 | 7300 | 6 | 12 | Diesel | 60 |
| D7C250 | 107.00 | 7300 | 6 | 12 | Diesel | 60 |
| D7C290 | 107.00 | 7300 | 6 | 12 | Diesel | 60 |
| D7C310 | 107.00 | 7300 | 6 | 12 | Diesel | 60 |
| D7E240 | 108.00 | 7100 | 6 | 24 | Diesel | 61 |
| D7E280 | 108.00 | 7100 | 6 | 24 | Diesel | 61 |
| D7E290 | 108.00 | 7100 | 6 | 24 | Diesel | 61 |
| D7E320 | 108.00 | 7100 | 6 | 24 | Diesel | 61 |
| D9A260 | 120.00 | 9364 | 6 | 24 | Diesel | 62 |
| D9A300 | 120.00 | 9364 | 6 | 24 | Diesel | 62 |
| D9A340 | 120.00 | 9364 | 6 | 24 | Diesel | 62 |
| D9A380 | 120.00 | 9364 | 6 | 24 | Diesel | 62 |
| D9B260 | 120.00 | 9364 | 6 | 24 | Diesel | 63 |
| D9B300 | 120.00 | 9364 | 6 | 24 | Diesel | 63 |
| D9B310 | 120.00 | 9364 | 6 | 24 | Diesel | 63 |
| D9B340 | 120.00 | 9364 | 6 | 24 | Diesel | 63 |
| D9B360 | 120.00 | 9364 | 6 | 24 | Diesel | 63 |
| D9B380 | 120.00 | 9364 | 6 | 24 | Diesel | 63 |
| F8Q 768 | 80.00 | 1870 | 4 | 8 | Diesel | 11 |
| HD100D | 120.65 | 9600 | 6 | 12 | Diesel | 64 |
| TD100A | 120.65 | 9600 | 6 | 12 | Diesel | 64 |
| TD100B | 120.65 | 9600 | 6 | 12 | Diesel | 64 |
| TD100BG | 120.65 | 9600 | 6 | 12 | Diesel | 64 |
| TD100C | 120.65 | 9600 | 6 | 12 | Diesel | 64 |
| TD100CHC | 120.65 | 9600 | 6 | 12 | Diesel | 64 |
| TD100F | 120.65 | 9600 | 6 | 12 | Diesel | 64 |

|  |  | ccm |  |  |  |  |
|---|---|-------|--|---|---|---|
| TD100G | 120.65 | 9600 | 6 | 12 | Diesel | 64 |
| TD100GA | 120.65 | 9600 | 6 | 12 | Diesel | 64 |
| TD101F | 120.65 | 9600 | 6 | 12 | Diesel | 64 |
| TD101FA | 120.65 | 9600 | 6 | 12 | Diesel | 64 |
| TD101FC | 120.65 | 9600 | 6 | 12 | Diesel | 64 |
| TD101FD | 120.65 | 9600 | 6 | 12 | Diesel | 64 |
| TD101G | 120.65 | 9600 | 6 | 12 | Diesel | 64 |
| TD101GA | 120.65 | 9600 | 6 | 12 | Diesel | 64 |
| TD101GB | 120.65 | 9600 | 6 | 12 | Diesel | 64 |
| TD101GE | 120.65 | 9600 | 6 | 12 | Diesel | 64 |
| TD102F | 120.65 | 9600 | 6 | 12 | Diesel | 64 |
| TD102FAQ | 120.65 | 9600 | 6 | 12 | Diesel | 64 |
| TD102FBQ | 120.65 | 9600 | 6 | 12 | Diesel | 64 |
| TD102FCQ | 120.65 | 9600 | 6 | 12 | Diesel | 64 |
| TD102FD | 120.65 | 9600 | 6 | 12 | Diesel | 64 |
| TD102FDQ | 120.65 | 9600 | 6 | 12 | Diesel | 64 |
| TD102FEQ | 120.65 | 9600 | 6 | 12 | Diesel | 64 |
| TD102FF | 120.65 | 9600 | 6 | 12 | Diesel | 64 |
| TD102FGQ | 120.65 | 9600 | 6 | 12 | Diesel | 64 |
| TD102FH | 120.65 | 9600 | 6 | 12 | Diesel | 64 |
| TD102FL | 120.65 | 9600 | 6 | 12 | Diesel | 64 |
| TD102FM | 120.65 | 9600 | 6 | 12 | Diesel | 64 |
| TD102FS | 120.65 | 9600 | 6 | 12 | Diesel | 64 |
| TD102FT | 120.65 | 9600 | 6 | 12 | Diesel | 64 |
| TD103E | 120.65 | 9600 | 6 | 12 | Diesel | 64 |
| TD103EA | 120.65 | 9600 | 6 | 12 | Diesel | 64 |
| TD103ES | 120.65 | 9600 | 6 | 12 | Diesel | 64 |
| TD103KBE | 120.65 | 9600 | 6 | 12 | Diesel | 64 |
| TD103KF | 120.65 | 9600 | 6 | 12 | Diesel | 64 |
| TD120A | 130.175 | 11980 | 6 | 12 | Diesel | 65 |
| TD120C | 130.175 | 11980 | 6 | 12 | Diesel | 65 |
| TD120D | 130.175 | 11980 | 6 | 12 | Diesel | 65 |
| TD120E | 130.175 | 11980 | 6 | 12 | Diesel | 65 |
| TD120F | 130.175 | 11980 | 6 | 12 | Diesel | 65 |
| TD120FA | 130.175 | 11980 | 6 | 12 | Diesel | 66 |
| TD120FB | 130.175 | 11980 | 6 | 12 | Diesel | 66 |
| TD120FC | 130.175 | 11980 | 6 | 12 | Diesel | 65 |
| TD120FTQ | 130.175 | 11980 | 6 | 12 | Diesel | 66 |
| TD120G | 130.175 | 11980 | 6 | 12 | Diesel | 65 |
| TD120GA | 130.175 | 11980 | 6 | 12 | Diesel | 65 |
| TD121F | 130.175 | 11980 | 6 | 12 | Diesel | 65 |
| TD121FA | 130.175 | 11980 | 6 | 12 | Diesel | 66 |
| TD121FB | 130.175 | 11980 | 6 | 12 | Diesel | 66 |
| TD121FC | 130.175 | 11980 | 6 | 12 | Diesel | 66 |
| TD121FD | 130.175 | 11980 | 6 | 12 | Diesel | 65 |
| TD121FE | 130.175 | 11980 | 6 | 12 | Diesel | 66 |
| TD121FF | 130.175 | 11980 | 6 | 12 | Diesel | 66 |
| TD121FG | 130.175 | 11980 | 6 | 12 | Diesel | 66 |
| TD121FH | 130.175 | 11980 | 6 | 12 | Diesel | 66 |
| TD121FK | 130.175 | 11980 | 6 | 12 | Diesel | 66 |
| TD121G | 130.175 | 11980 | 6 | 12 | Diesel | 65 |
| TD121GD | 130.175 | 11980 | 6 | 12 | Diesel | 65 |
| TD122 | 130.175 | 11980 | 6 | 12 | Diesel | 65 |
| TD122ED | 130.175 | 11980 | 6 | 12 | Diesel | 66 |
| TD122F | 130.175 | 11980 | 6 | 12 | Diesel | 65 |
| TD122FA | 130.175 | 11980 | 6 | 12 | Diesel | 65 |
| TD122FAQ | 130.175 | 11980 | 6 | 12 | Diesel | 66 |
| TD122FBQ | 130.175 | 11980 | 6 | 12 | Diesel | 66 |
| TD122FCQ | 130.175 | 11980 | 6 | 12 | Diesel | 66 |
| TD122FH | 130.175 | 11980 | 6 | 12 | Diesel | 65 |
| TD122FK | 130.175 | 11980 | 6 | 12 | Diesel | 65 |
| TD122FKQ | 130.175 | 11980 | 6 | 12 | Diesel | 66 |
| TD122FL | 130.175 | 11980 | 6 | 12 | Diesel | 65 |
| TD122FR | 130.175 | 11980 | 6 | 12 | Diesel | 65 |
| TD122FS | 130.175 | 11980 | 6 | 12 | Diesel | 65 |
| TD122FTO | 130.175 | 11980 | 6 | 12 | Diesel | 66 |

|  |  | ccm |  |  |  |  |
|---|---|-------|---|---|---|---|
| TD122KBE | 130.175 | 11980 | 6 | 12 | Diesel | 66 |
| TD122KE | 130.175 | 11980 | 6 | 12 | Diesel | 66 |
| TD122KHD | 130.175 | 11980 | 6 | 12 | Diesel | 66 |
| TD123E | 130.175 | 11980 | 6 | 12 | Diesel | 65 |
| TD123EA | 130.175 | 11980 | 6 | 12 | Diesel | 66 |
| TD123EB | 130.175 | 11980 | 6 | 12 | Diesel | 66 |
| TD123EC | 130.175 | 11980 | 6 | 12 | Diesel | 66 |
| TD123ED | 130.175 | 11980 | 6 | 12 | Diesel | 66 |
| TD123ES | 130.175 | 11980 | 6 | 12 | Diesel | 65 |
| TD60A | 98.43 | 5480 | 6 | 12 | Diesel | 52 |
| TD60B | 98.43 | 5480 | 6 | 12 | Diesel | 52 |
| TD60C | 98.43 | 5480 | 6 | 12 | Diesel | 52 |
| TD60D | 98.43 | 5480 | 6 | 12 | Diesel | 53 |
| TD60DG | 98.43 | 5480 | 6 | 12 | Diesel | 53 |
| TD61F | 98.43 | 5480 | 6 | 12 | Diesel | 52 |
| TD61FB | 98.43 | 5480 | 6 | 12 | Diesel | 53 |
| TD61G | 98.43 | 5480 | 6 | 12 | Diesel | 52 |
| TD61GA | 98.43 | 5480 | 6 | 12 | Diesel | 52 |
| TD61GB | 98.43 | 5480 | 6 | 12 | Diesel | 52 |
| TD61GC | 98.43 | 5480 | 6 | 12 | Diesel | 52 |
| TD61GE | 98.43 | 5480 | 6 | 12 | Diesel | 53 |
| TD61GS | 98.43 | 5480 | 6 | 12 | Diesel | 52 |
| TD63E | 98.43 | 5480 | 6 | 12 | Diesel | 52 |
| TD63ES | 98.43 | 5480 | 6 | 12 | Diesel | 52 |
| TD70A | 104.775 | 6700 | 6 | 12 | Diesel | 54 |
| TD70B | 104.775 | 6700 | 6 | 12 | Diesel | 54 |
| TD70C | 104.775 | 6700 | 6 | 12 | Diesel | 56 |
| TD70D | 104.775 | 6700 | 6 | 12 | Diesel | 56 |
| TD70E | 104.775 | 6700 | 6 | 12 | Diesel | 54 |
| TD70ES | 104.775 | 6700 | 6 | 12 | Diesel | 56 |
| TD70F | 104.775 | 6700 | 6 | 12 | Diesel | 54 |
| TD70FS | 104.775 | 6700 | 6 | 12 | Diesel | 54 |
| TD70G | 104.775 | 6700 | 6 | 12 | Diesel | 54 |
| TD70H | 104.775 | 6700 | 6 | 12 | Diesel | 54 |
| TD70HA | 104.775 | 6700 | 6 | 12 | Diesel | 54 |
| TD71A | 104.775 | 6700 | 6 | 12 | Diesel | 56 |
| TD71ACE | 104.775 | 6700 | 6 | 12 | Diesel | 56 |
| TD71AG | 104.775 | 6700 | 6 | 12 | Diesel | 56 |
| TD71AGP | 104.775 | 6700 | 6 | 12 | Diesel | 56 |
| TD71AP | 104.775 | 6700 | 6 | 12 | Diesel | 56 |
| TD71APB | 104.775 | 6700 | 6 | 12 | Diesel | 56 |
| TD71AW | 104.775 | 6700 | 6 | 12 | Diesel | 56 |
| TD71F | 104.775 | 6700 | 6 | 12 | Diesel | 54 |
| TD71FA | 104.775 | 6730 | 6 | 12 | Diesel | 58 |
| TD71FC | 104.775 | 6730 | 6 | 12 | Diesel | 58 |
| TD71FD | 104.775 | 6725 | 6 | 12 | Diesel | 57 |
| TD71FQ | 104.775 | 6700 | 6 | 12 | Diesel | 54 |
| TD71FS | 104.775 | 6730 | 6 | 12 | Diesel | 59 |
| TD71FSQ | 104.775 | 6730 | 6 | 12 | Diesel | 59 |
| TD73E | 104.775 | 6700 | 6 | 12 | Diesel | 55 |
| TD73ES | 104.775 | 6700 | 6 | 12 | Diesel | 55 |
| THD100A | 120.65 | 9600 | 6 | 12 | Diesel | 64 |
| THD100D | 120.65 | 9600 | 6 | 12 | Diesel | 64 |
| THD100DA | 120.65 | 9600 | 6 | 12 | Diesel | 64 |
| THD100DB | 120.65 | 9600 | 6 | 12 | Diesel | 64 |
| THD100DC | 120.65 | 9600 | 6 | 12 | Diesel | 64 |
| THD100DD | 120.65 | 9600 | 6 | 12 | Diesel | 64 |
| THD100E | 120.65 | 9600 | 6 | 12 | Diesel | 64 |
| THD100EA | 120.65 | 9600 | 6 | 12 | Diesel | 64 |
| THD100EB | 120.65 | 9600 | 6 | 12 | Diesel | 64 |
| THD100EC | 120.65 | 9600 | 6 | 12 | Diesel | 64 |
| THD100ED | 120.65 | 9600 | 6 | 12 | Diesel | 64 |
| THD100EE | 120.65 | 9600 | 6 | 12 | Diesel | 64 |
| THD100EK | 120.65 | 9600 | 6 | 12 | Diesel | 64 |
| THD101B | 120.65 | 9600 | 6 | 12 | Diesel | 64 |
| THD101GB | 120.65 | 9600 | 6 | 12 | Diesel | 64 |

|  |  | ccm |  |  |  |  |
|---|---|------|--|---|---|---|
| THD101GC | 120.65 | 9600 | 6 | 12 | Diesel | 64 |
| THD101GD | 120.65 | 9600 | 6 | 12 | Diesel | 64 |
| THD101KB | 120.65 | 9600 | 6 | 12 | Diesel | 64 |
| THD101KC | 120.65 | 9600 | 6 | 12 | Diesel | 64 |
| THD101KE | 120.65 | 9600 | 6 | 12 | Diesel | 64 |
| THD102KA | 120.65 | 9600 | 6 | 12 | Diesel | 64 |
| THD102KB | 120.65 | 9600 | 6 | 12 | Diesel | 64 |
| THD102KD | 120.65 | 9600 | 6 | 12 | Diesel | 64 |
| THD102KE | 120.65 | 9600 | 6 | 12 | Diesel | 64 |
| THD102KF | 120.65 | 9600 | 6 | 12 | Diesel | 64 |
| THD102KJ | 120.65 | 9600 | 6 | 12 | Diesel | 64 |
| THD103E | 120.65 | 9600 | 6 | 12 | Diesel | 64 |
| THD103ES | 120.65 | 9600 | 6 | 12 | Diesel | 64 |
| THD103KB | 120.65 | 9600 | 6 | 12 | Diesel | 64 |
| THD103KD | 120.65 | 9600 | 6 | 12 | Diesel | 64 |
| THD103KF | 120.65 | 9600 | 6 | 12 | Diesel | 64 |



OE

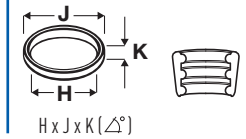
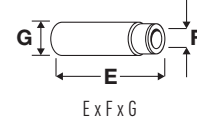
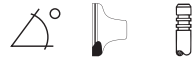

1 **73.00**

| B 130 | 1289cc | 4 Cyl. | 8 Valves | 42kW/57PS | Petrol | SOHC | TD3904 |
|----------------------|--------------|-----------------|----------|-----------|----------------------|------|--------|
| 66 GL 1.3 | | 08/1975→11/1979 | | | | | |
| V35117 | 7701 458 180 | | 45° | H | VAG50758 | | |
| 33.38 x 6.99 x 89.79 | | MB | | | 41.50 x 7.00 x 11.15 | | |
| V91261 | 7701 461 214 | | 45° | | | | |
| 29.00 x 7.00 x 89.00 | | MD | | | | | |
| V91834 | 7701 460 690 | | 45° | | | | |
| 29.00 x 7.00 x 89.00 | | MD | | | | | |

2 **75.00**

| D 4162 T | 1560cc | 4 Cyl. | 8 Valves | 84kW/114PS | Diesel | Turbo, DOHC | TD23981 |
|----------------------|----------|-----------------|----------|------------------|--------|---------------------|---------|
| C30 1.6 D2 | | 10/2010→12/2012 | | S40 II 1.6 D2 | | 10/2010→12/2012 | |
| S60 II DRIVE / D2 | | 01/2011→12/2015 | | S80 II 1.6 | | 06/2011→ | |
| V40 D2 | | 03/2012→ | | V50 1.6 D2 | | 01/2010→12/2012 | |
| V60 1.6 | | 02/2011→12/2015 | | V70 III 1.6 / D2 | | 04/2011→12/2015 | |
| V95137 | 31330181 | | 45° | Y | H | VAG96364 | |
| 30.15 x 5.48 x 95.55 | | MB cr | | | | 34.20 x 5.50 x 9.53 | |
| V95138 | 31330182 | | 45° | SS | H | | |
| 27.50 x 5.47 x 95.45 | | MD + MB cr | | | | | |

3 **75.00**

| D 4164 T | 1560cc | 4 Cyl. | 16 Valves | 80-81kW/109-110PS | Diesel | Turbo, DOHC | TD20849 |
|----------------------|----------|-----------------|-----------|-------------------|---------------------|-----------------|---------|
| C30 1.6 D | | 10/2006→12/2012 | | S40 II 1.6 D | | 01/2005→12/2012 | |
| S80 II 1.6 D | | 01/2010→12/2011 | | V50 1.6 D | | 01/2005→12/2011 | |
| V70 III 1.6 D | | 07/2009→12/2011 | | | | | |
| V94960 | 30711498 | | 45° | H | VAG96364 | | |
| 25.60 x 5.50 x 96.35 | | MB cr | | | 34.20 x 5.50 x 9.53 | | |
| V94961 | 30711497 | | 45° | SS | H | | |
| 23.40 x 5.50 x 96.50 | | MD + MB cr | | | | | |

4 **76.00**

| B 14.3 E | 1397cc | 4 Cyl. | 8 Valves | 46-53kW/63-72PS | Petrol | | TD3988 |
|----------------------|--------------|-----------------|----------|-----------------|----------------------|--|--------|
| B 14.4 S | 1397cc | 4 Cyl. | 8 Valves | 50-53kW/68-72PS | Petrol | | TD5142 |
| 340-360 1.4 | | 08/1975→12/1988 | | | | | |
| V35117 | 7701 458 180 | | 45° | H | VAG50758 | | |
| 33.38 x 6.99 x 89.79 | | MB | | | 41.50 x 7.00 x 11.15 | | |
| V91834 | 7701 460 690 | | 45° | | | | |
| 29.00 x 7.00 x 89.00 | | MD | | | | | |

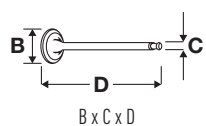

OE

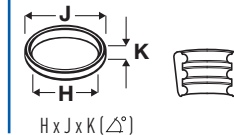
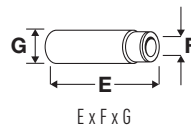
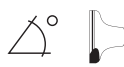

5 76.50

| D 24 | 2383cc | 6 Cyl. | 12 Valves | 58-61kW/79-83PS | Diesel | SOHC | TD3984 |
|------------------------|-----------------|--------|-----------|----------------------|--------|-----------------|--------|
| D 24 T | 2383cc | 6 Cyl. | 12 Valves | 79-83kW/107-113PS | Diesel | Turbo, SOHC | TD3985 |
| D 24 TIC | 2383cc | 6 Cyl. | 12 Valves | 85-95kW/115-130PS | Diesel | Turbo, SOHC | TD3986 |
| 240 2.4 D | 09/1981→12/1984 | | | 240 2.4 Diesel | | 08/1978→08/1993 | |
| 260 2.4 D | 09/1979→12/1981 | | | 740 2.4 Diesel | | 08/1984→07/1992 | |
| 740 2.4 TD | 08/1984→12/1990 | | | 740 2.4 Turbo-Diesel | | 09/1985→07/1992 | |
| 760 2.4 D | 01/1982→07/1992 | | | 760 2.4 TD | | 04/1983→07/1992 | |
| 760 2.4 Turbo Diesel | 08/1982→07/1992 | | | 780 2.4 D | | 04/1986→07/1990 | |
| 940 2.4 D | 08/1990→07/1995 | | | 940 2.4 TD | | 05/1991→03/1995 | |
| 940 2.4 TD Intercooler | 08/1990→12/1994 | | | 940 2.4 Turbo Diesel | | 08/1990→12/1994 | |
| 940 II 2.4 TD | 08/1994→10/1998 | | | 960 2.4 TD | | 09/1991→07/1994 | |
| 960 2.4 Tdi | 09/1990→08/1993 | | | | | | |

V90321 ■
36.13 x 7.96 x 104.63

069 109 601D

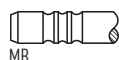

MB

45°

H

VAG92061B ■ ■ ■
36.70 x 8.00 x 12.08

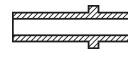

V90180 ■
31.32 x 7.94 x 104.60

068 109 611C

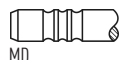

MD

45°

V91174 ■
31.00 x 7.95 x 104.60

068 109 611D

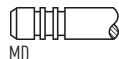

MD

45°

SS

6 78.00

| D 16 | 1596cc | 4 Cyl. | 8 Valves | 40kW/54PS | Diesel | SOHC | TD3981 |
|--|-----------------|--------|----------|-----------|--|------|--------|
| 340-360 1.6 Diesel | 08/1984→07/1991 | | | | | | |
| V91269 ■ 36.30 x 8.00 x 111.70 | 7701 462 813 | | 30° | H | VAG92329B ■ ■ ■ 39.00 x 8.00 x 13.07 | | |
| V91267 ■ 31.50 x 8.00 x 111.50 | 7701 462 814 | | 45° | | VAG96226B ■ ■ ■ 39.00 x 8.02 x 13.13 | | |

7 79.00

| B 4164 S3 | 1596cc | 4 Cyl. | 16 Valves | 74kW/101PS | Petrol | DOHC | TD18513 |
|--|-----------------|--------|-----------|------------|---|-----------------|---------|
| C30 1.6 | 10/2006→12/2012 | | | S40 II 1.6 | | 01/2005→12/2012 | |
| V50 1.6 | 01/2005→12/2012 | | | | | | |
| V95013 ■ 30.10 x 6.00 x 99.00 | 1320927 | | 45° | H | VAG92325 ■ ■ ■ 40.50 x 6.00 x 11.04 | | |
| V95014 ■ 24.10 x 6.00 x 101.45 | 1113189 | | 45° | | | | |

8 80.00

| D 19 T | 1870cc | 4 Cyl. | 8 Valves | 66kW/90PS | Diesel | Turbo, SOHC | TD5044 |
|---|-----------------|--------|----------|------------------------|--|-----------------|--------|
| 440 K 1.9 Turbo-Diesel | 07/1994→12/1996 | | | 460 L 1.9 Turbo-Diesel | | 07/1994→07/1996 | |
| V94067 ■ 35.00 x 8.00 x 111.90 Eng.930901→ | 7701 468 035 | | 45° | H | VAG92329B ■ ■ ■ 39.00 x 8.00 x 13.07 | | |
| | | | | | VAG96226B ■ ■ ■ 39.00 x 8.02 x 13.13 | | |



OE

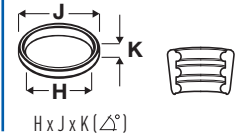
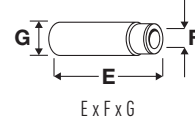

9

80.00

| | | | | | | | |
|-----------------|-----------------|--------|------------|-----------|-----------------|-------------|--------|
| D 4192 T | 1870cc | 4 Cyl. | 8 Valves | 66kW/90PS | Diesel | Turbo, SOHC | TD5550 |
| S40 I 1.9 TD | 07/1995→08/1999 | | V40 1.9 TD | | 07/1995→08/1999 | | |

| | | | | | | | |
|-----------------------|--------------|----|-----|--|----------------------|--|--|
| V91267 | 7701 462 814 | | 45° | | VAG92329B | | |
| 31.50 x 8.00 x 111.50 | | MD | | | 39.00 x 8.00 x 13.07 | | |
| | | | | | VAG96226B | | |
| | | | | | 39.00 x 8.02 x 13.13 | | |

10

80.00

| | | | | | | | |
|------------------|-----------------|--------|------------|------------|-----------------|-------------|---------|
| D 4192 T2 | 1870cc | 4 Cyl. | 8 Valves | 70kW/95PS | Diesel | Turbo, SOHC | TD13728 |
| D 4192 T3 | 1870cc | 4 Cyl. | 8 Valves | 85kW/116PS | Diesel | Turbo, SOHC | TD17997 |
| D 4192 T4 | 1870cc | 4 Cyl. | 8 Valves | 75kW/102PS | Diesel | Turbo, SOHC | TD17996 |
| S40 I 1.9 DI | 03/1999→12/2003 | | V40 1.9 DI | | 03/1999→06/2004 | | |

| | | | | | | | |
|-----------------------|--------------|---------|-----|---|----------------------|--|--|
| V94190 | 7701 476 024 | | 45° | H | VAG96294B | | |
| 35.40 x 7.00 x 111.00 | | MB | | | 38.30 x 7.00 x 12.03 | | |
| V94191 | 7701 476 025 | | 45° | H | | | |
| 32.60 x 7.00 x 110.80 | | MD + MB | | | | | |

11

80.00

| | | | | | | | |
|-----------------------|--------------|--------|----------|-----------------|----------------------|-------------|---------|
| F8Q 768 | 1870cc | 4 Cyl. | 8 Valves | 66-69kW/90-94PS | Diesel | Turbo, SOHC | TD19235 |
| V91269 | 7701 462 813 | | 30° | H | VAG92329B | | |
| 36.30 x 8.00 x 111.70 | | MB | | | 39.00 x 8.00 x 13.07 | | |
| V94067 | 7701 468 035 | | 45° | H | VAG96226B | | |
| 35.00 x 8.00 x 111.90 | | MB | | | 39.00 x 8.02 x 13.13 | | |

| | | | | | | | |
|-----------------------|--------------|---------|-----|----|---|--|--|
| V94338 | 7701 471 704 | | 45° | H | | | |
| 35.30 x 8.00 x 110.00 | | MB | | | | | |
| V91267 | 7701 462 814 | | 45° | | | | |
| 31.50 x 8.00 x 111.50 | | MD | | | | | |
| V94339 | 7701 469 373 | | 45° | SS | H | | |
| 31.50 x 8.00 x 109.80 | | MD + MB | | | | | |

12

81.00

| | | | | | | | |
|------------------|-----------------|--------|-----------|------------|-----------------|------|---------|
| B 4164 S | 1587cc | 4 Cyl. | 16 Valves | 77kW/105PS | Petrol | DOHC | TD5549 |
| B 4164 S2 | 1587cc | 4 Cyl. | 16 Valves | 80kW/109PS | Petrol | DOHC | TD13708 |
| S40 I 1.6 | 09/1995→12/2003 | | V40 1.6 | | 12/1995→06/2004 | | |

| | | | | | | | |
|-----------------------|-----------|------------|-----|----|----------------------|--|--|
| V94315 | 1397641-0 | | 45° | H | VAG96158 | | |
| 31.00 x 7.00 x 104.10 | | MB cr | | | 45.00 x 7.02 x 12.08 | | |
| V94314 | 1366490 | | 45° | SS | H | | |
| 27.00 x 7.00 x 103.30 | | ME + MB cr | | | | | |

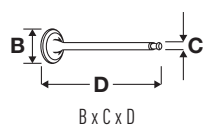

OE

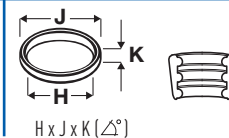
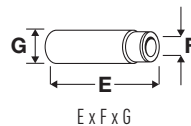

13 **81.00**

| | | | | | | | |
|-----------------|-----------------|--------|-----------------|-------------------|--------|--------------------|---------------|
| B 17 2 K | 1721cc | 4 Cyl. | 8 Valves | 59kW/80PS | Petrol | SOHC | TD3991 |
| B 18 E | 1721cc | 4 Cyl. | 8 Valves | 78-80kW/106-109PS | Petrol | SOHC | TD3907 |
| B 18 EP | 1721cc | 4 Cyl. | 8 Valves | 75-78kW/102-106PS | Petrol | SOHC | TD3908 |
| B 18 F | 1721cc | 4 Cyl. | 8 Valves | 70-75kW/95-102PS | Petrol | SOHC | TD3909 |
| B 18 FP | 1721cc | 4 Cyl. | 8 Valves | 75kW/102PS | Petrol | SOHC | TD3910 |
| B 18 FT | 1721cc | 4 Cyl. | 8 Valves | 88-90kW/120-122PS | Petrol | Turbo, SOHC | TD3911 |
| 340-360 1.7 | 08/1985→07/1991 | | | 440 K 1.7 | | 08/1988→12/1996 | |
| 440 K 1.7 Turbo | 08/1988→12/1996 | | | 460 L 1.7 | | 08/1989→07/1992 | |
| 460 L 1.7 Turbo | 08/1989→07/1996 | | | 480 E 1.7 | | 04/1986→07/1996 | |
| 480 E 1.7 Turbo | 08/1987→07/1996 | | | | | | |

V91268
38.10 x 8.00 x 111.50

3342278

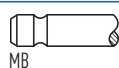

30°

H

VAG96057B
37.70 x 8.03 x 13.08

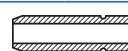

V91319
32.50 x 8.00 x 111.50

7701 463 082

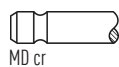

45°

14 **81.00**

| | | | | | | | |
|------------------|-----------------|--------|------------------|------------|--------|------------------------|----------------|
| B 4184 SJ | 1834cc | 4 Cyl. | 16 Valves | 90kW/122PS | Petrol | DOHC | TD18000 |
| B 4184 SM | 1834cc | 4 Cyl. | 16 Valves | 92kW/125PS | Petrol | DOHC, Injection | TD12329 |
| S40 I 1.8 i | 03/1998→12/2003 | | | V40 1.8 i | | 03/1998→06/2004 | |

V94315
31.00 x 7.00 x 104.10

1397641-0

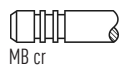

45°

H

VAG96158
45.00 x 7.02 x 12.08



V94044
27.00 x 7.00 x 103.30

1366882-7



45°

H

V94314
27.00 x 7.00 x 103.30

1366490



45°

ss

H

15 **81.00**

| | | | | | | | |
|------------------|-----------------|--------|------------------|-------------|--------|--------------------|----------------|
| B 4194 T | 1855cc | 4 Cyl. | 16 Valves | 147kW/200PS | Petrol | Turbo, DOHC | TD18003 |
| B 4194 T2 | 1855cc | 4 Cyl. | 16 Valves | 147kW/200PS | Petrol | Turbo, DOHC | TD18004 |
| S40 I 1.9 T4 | 05/1997→07/2000 | | | V40 1.9 T4 | | 05/1997→07/2000 | |

V94315
31.00 x 7.00 x 104.10

1397641-0

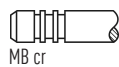

45°

H

VAG96158
45.00 x 7.02 x 12.08



V94044
27.00 x 7.00 x 103.30

1366882-7



45°

H

V94314
27.00 x 7.00 x 103.30

1366490



45°

ss

H



OE

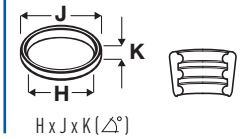

16 **81.00**

| | | | | | | | |
|------------------|-----------------|--------|------------------|-----------------|--------|--------------------|----------------|
| B 5204 F | 1984cc | 5 Cyl. | 20 Valves | 105kW/143PS | Petrol | DOHC | TD3971 |
| B 5204 T | 1984cc | 5 Cyl. | 20 Valves | 155kW/211PS | Petrol | Turbo, DOHC | TD9893 |
| B 5204 T2 | 1984cc | 5 Cyl. | 20 Valves | 132kW/180PS | Petrol | Turbo, DOHC | TD5554 |
| B 5204 T3 | 1984cc | 5 Cyl. | 20 Valves | 166kW/226PS | Petrol | Turbo, DOHC | TD5553 |
| B 5204 T4 | 1984cc | 5 Cyl. | 20 Valves | 120kW/163PS | Petrol | Turbo, DOHC | TD11553 |
| 850 2.0 | 06/1991→12/1996 | | | 850 2.0 Turbo | | 02/1993→10/1997 | |
| C70 I 2.0 | 03/1997→10/2005 | | | C70 I 2.0 T | | 03/1997→10/2005 | |
| S70 2.0 | 01/1997→11/2000 | | | S70 2.0 Turbo | | 01/1997→11/2000 | |
| S80 I 2.0 | 06/1998→07/2006 | | | S80 I 2.0 T | | 06/1998→07/2006 | |
| V70 I 2.0 | 12/1995→12/2000 | | | V70 I 2.0 Turbo | | 12/1995→12/2000 | |
| XC70 2.0 T5 | 10/1997→03/1999 | | | | | | |

V94315
31.00 x 7.00 x 104.10

1397641-0



45°

H

VAG96158
45.00 x 7.02 x 12.08



V94044
27.00 x 7.00 x 103.30

1366882-7



45°

H

V94314
27.00 x 7.00 x 103.30

1366490



45°

SS

H

17 **81.00**

| | | | | | | | |
|------------------|-----------------|--------|------------------|-------------|--------|--------------------|----------------|
| B 5204 T5 | 1984cc | 5 Cyl. | 20 Valves | 132kW/180PS | Petrol | Turbo, DOHC | TD18006 |
| S60 I 2.0 T | 07/2000→04/2010 | | | S80 I 2.0 T | | 12/1999→07/2006 | |
| V70 II 2.0 T | 11/1999→08/2007 | | | | | | |

V95049
31.00 x 6.00 x 104.25

9454607



45°

H

V95050
27.00 x 6.00 x 103.35

9454610



45°

H

18 **81.00**

| | | | | | | | |
|------------------|--------|--------|------------------|---------------------|--------|--------------------|----------------|
| B 5234 FT | 2319cc | 5 Cyl. | 20 Valves | 166-170kW/225-231PS | Petrol | Turbo, DOHC | TD3973 |
| B 5234 T2 | 2319cc | 5 Cyl. | 20 Valves | 176kW/239PS | Petrol | Turbo, DOHC | TD19341 |
| B 5234 T4 | 2319cc | 5 Cyl. | 20 Valves | 176-184kW/239-250PS | Petrol | Turbo, DOHC | TD17848 |
| B 5234 T5 | 2319cc | 5 Cyl. | 20 Valves | 177-179kW/241-243PS | Petrol | Turbo, DOHC | TD19264 |
| B 5234 T6 | 2319cc | 5 Cyl. | 20 Valves | 184kW/250PS | Petrol | Turbo, DOHC | TD19265 |
| B 5234 T7 | 2319cc | 5 Cyl. | 20 Valves | 195kW/265PS | Petrol | Turbo, DOHC | TD19340 |
| B 5234 T8 | 2319cc | 5 Cyl. | 20 Valves | 195kW/265PS | Petrol | Turbo, DOHC | TD19343 |
| B 5234 T9 | 2319cc | 5 Cyl. | 20 Valves | 180kW/245PS | Petrol | Turbo, DOHC | TD19284 |

850 2.3
850 2.3 T5 R
850 2.3 Turbo
C70 I 2.3 T5
S70 2.3
S80 I 2.3 R
V70 I 2.3 T

09/1993→12/1994
04/1996→10/1996
09/1993→12/1994
07/2002→10/2005
04/1999→09/2000
04/2000→08/2005
04/1997→03/2000

850 2.3 T5
850 2.3 T5-R
850 2.3 Turbo R
S60 I 2.3 T5
S70 2.3 T5
V70 I 2.3
V70 II 2.3

02/1993→12/1996
08/1995→12/1996
09/1994→10/1997
07/2000→09/2002
07/1997→09/2000
12/1998→02/2000
10/2000→09/2004

V94315
31.00 x 7.00 x 104.10

1397641-0



45°

H

VAG96158
45.00 x 7.02 x 12.08



V94044
27.00 x 7.00 x 103.30

1366882-7



45°

H

V94314
27.00 x 7.00 x 103.30

1366490



45°

SS

H

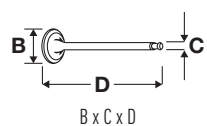

OE



MAT.

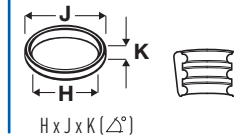
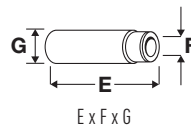
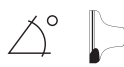

19 81.00

| B 5234 T3 | 2319cc | 5 Cyl. | 20 Valves | 147-184kW/239-250PS | Petrol | Turbo, DOHC | TD5401 |
|---------------|-----------------|--------|-----------|---------------------|--------|-----------------|--------|
| C70 I 2.3 | 09/2002→12/2003 | | | C70 I 2.3 T5 | | 03/1998→10/2005 | |
| C70 I 2.3 T-5 | 03/1997→09/2002 | | | S60 I 2.3 T5 | | 09/2000→12/2004 | |
| S60 I T5 | 07/2000→04/2010 | | | S70 2.3 | | 11/1996→11/2000 | |
| S70 2.3 T5 | 11/1996→09/1998 | | | S70 2.3 T-5 | | 01/1997→11/2000 | |
| V70 I 2.3 | 11/1996→11/2000 | | | V70 I 2.3 T-5 | | 11/1996→12/2000 | |
| V70 II 2.3 | 03/2002→12/2004 | | | V70 II 2.3 T5 | | 11/1999→12/2004 | |

V95049 ■ 9454607  45° H

31.00 x 6.00 x 104.25

MB cr

V95050 ■ 9454610  45° H

27.00 x 6.00 x 103.35

MD + MB tu

20 81.00

| D 5244 T | 2400cc | 5 Cyl. | 20 Valves | 120kW/163PS | Diesel | Turbo, DOHC | TD16325 |
|-----------|--------|--------|-----------|--------------------|--------|-------------|---------|
| D 5244 T2 | 2400cc | 5 Cyl. | 20 Valves | 96-120kW/131-163PS | Diesel | Turbo, DOHC | TD17990 |
| D 5244 T4 | 2400cc | 5 Cyl. | 20 Valves | 136kW/185PS | Diesel | Turbo, DOHC | TD20081 |
| D 5244 T5 | 2400cc | 5 Cyl. | 20 Valves | 120kW/163PS | Diesel | Turbo, DOHC | TD20833 |
| D 5244 T8 | 2400cc | 5 Cyl. | 20 Valves | 132kW/180PS | Diesel | Turbo, DOHC | TD19660 |

| | | | | | | | |
|----------------------|-----------------|--|--|----------------|--|-----------------|--|
| C30 D5 | 10/2006→12/2012 | | | C70 II D5 | | 03/2006→06/2013 | |
| S40 II 2.4 D5 | 03/2006→12/2010 | | | S60 I 2.4 D | | 05/2001→04/2010 | |
| S60 I 2.4 D5 | 01/2001→04/2010 | | | S80 I 2.4 D | | 10/2001→07/2006 | |
| S80 I 2.4 D5 | 08/2001→07/2006 | | | S80 II 2.4 D | | 03/2006→ | |
| S80 II D5 | 03/2006→ | | | V50 2.4 D5 | | 03/2006→12/2010 | |
| V70 II 2.4 D | 07/2001→08/2007 | | | V70 II 2.4 D5 | | 01/2001→12/2008 | |
| V70 III 2.4 D | 04/2007→12/2010 | | | V70 III D5 | | 04/2007→12/2009 | |
| XC60 2.4 D / D3 / D4 | 05/2008→02/2017 | | | XC60 D5 | | 05/2008→12/2009 | |
| XC70 2.4 D5 | 12/2005→08/2007 | | | XC70 2.4 D5 XC | | 09/2002→08/2007 | |
| XC70 II 2.4 D / D4 | 08/2007→ | | | XC70 II D5 | | 04/2007→12/2009 | |
| XC90 I D3 / D5 | 04/2009→12/2014 | | | XC90 I D5 | | 10/2002→12/2010 | |

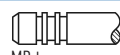
V98093 ■ 8631650  45°

28.80 x 6.00 x 98.10

MB tu

VAG96372 ■ ■ 39.50 x 6.00 x 11.52



V98094 ■ 8631651  45° ss

26.20 x 6.00 x 97.80

MD + MB tu

21 81.00

| B 5244 T5 | 2401cc | 5 Cyl. | 20 Valves | 191kW/260PS | Petrol | Turbo, DOHC | TD18547 |
|--------------|-----------------|--------|-----------|---------------|--------|-----------------|---------|
| C70 I 2.4 | 09/2004→10/2005 | | | S60 I 2.4 | | 02/2004→04/2010 | |
| S60 I 2.4 T5 | 04/2004→04/2010 | | | V70 II 2.4 T5 | | 04/2004→08/2007 | |

V95049 ■ 9454607  45° H

31.00 x 6.00 x 104.25

MB cr

V95050 ■ 9454610  45° H

27.00 x 6.00 x 103.35

MD + MB tu



OE

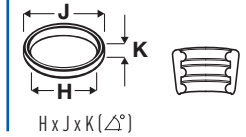
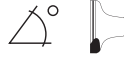

22 **81.00**

| | | | | | | | |
|-----------------|--------|-----------------|------------------|---------------|--------|--------------------|---------------|
| D 5252 T | 2461cc | 5 Cyl. | 10 Valves | 103kW/140PS | Diesel | Turbo, SOHC | TD5145 |
| 850 2.5 TDI | | 08/1995→12/1996 | | S70 2.5 TDi | | 10/1999→09/2000 | |
| S70 2.5 TDI | | 01/1997→11/2000 | | S80 I 2.5 TDI | | 01/1999→07/2006 | |
| V70 I 2.5 TDi | | 11/1996→02/2000 | | V70 I 2.5 TDI | | 12/1995→12/2000 | |
| V70 II 2.5 TDI | | 11/1999→08/2007 | | | | | |

| | | | | | | | |
|----------------------|--------------|---------|-----|----|---|----------------------|--|
| V94010 | 028 109 601H | | 45° | Y | H | VAG92061B | |
| 36.00 x 8.00 x 96.80 | | MB | | | | 36.70 x 8.00 x 12.08 | |
| V94150 | 918 6565 | | 45° | SS | | | |
| 36.00 x 8.00 x 96.80 | | MD | | | | | |
| V94011 | 046 109 611F | | 45° | SS | | | |
| 31.50 x 7.95 x 96.85 | | MD + MB | | | | | |

23 **81.00**

| | | | | | | | |
|-----------------|--------|-----------------|------------------|-------------|--------|------------------------|---------------|
| B 6254 F | 2473cc | 6 Cyl. | 24 Valves | 125kW/170PS | Petrol | DOHC, Injection | TD3976 |
| B 6254 S | 2473cc | 6 Cyl. | 24 Valves | 125kW/170PS | Petrol | DOHC | TD5154 |
| 960 II 2.5 | | 07/1994→12/1996 | | | | | |

| | | | | | | | |
|-----------------------|-----------|------------|-----|----|---|----------------------|--|
| V94315 | 1397641-0 | | 45° | | H | VAG96158 | |
| 31.00 x 7.00 x 104.10 | | MB cr | | | | 45.00 x 7.02 x 12.08 | |
| V94044 | 1366882-7 | | 45° | | H | | |
| 27.00 x 7.00 x 103.30 | | MD + MB cr | | | | | |
| V94314 | 1366490 | | 45° | SS | H | | |
| 27.00 x 7.00 x 103.30 | | ME + MB cr | | | | | |

24 **81.00**

| | | | | | | | |
|-----------------|--------|-----------------|------------------|---------------|--------|--------------------|---------------|
| B 6284 T | 2783cc | 6 Cyl. | 24 Valves | 200kW/272PS | Petrol | Turbo, DOHC | TD9828 |
| S80 I 2.8 T6 | | 05/1998→07/2006 | | XC90 I 2.8 T6 | | 09/2003→11/2008 | |

| | | | | | | | |
|-----------------------|---------|------------|-----|--|---|--|--|
| V95049 | 9454607 | | 45° | | H | | |
| 31.00 x 6.00 x 104.25 | | MB cr | | | | | |
| V95050 | 9454610 | | 45° | | H | | |
| 27.00 x 6.00 x 103.35 | | MD + MB tu | | | | | |

25 **82.70**

| | | | | | | | |
|---------------|--------|-----------------|-----------------|-----------|--------|-----------------|---------------|
| B 18 U | 1794cc | 4 Cyl. | 8 Valves | 66kW/90PS | Petrol | | TD3914 |
| 440 K 1.8 | | 08/1991→12/1996 | | 460 L 1.8 | | 08/1991→07/1996 | |

| | | | | | | | |
|-----------------------|--------------|---------|-----|--|---|----------------------|--|
| V94038 | 7701 466 606 | | 45° | | H | VAG96057B | |
| 40.20 x 8.00 x 107.00 | | MB | | | | 37.70 x 8.03 x 13.08 | |
| V94039 | 7701 466 607 | | 45° | | H | | |
| 32.60 x 8.00 x 107.00 | | MD + MB | | | | | |

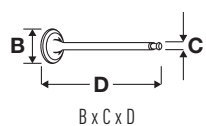

OE

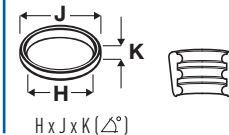
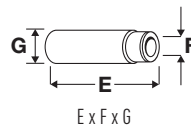
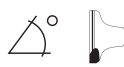

26 **82.70**

| | | | | | | | |
|---------------|--------|-----------------|-----------------|-------------------|--------|-----------------|---------------|
| B 20 F | 1998cc | 4 Cyl. | 8 Valves | 80-85kW/108-115PS | Petrol | SOHC | TD3924 |
| 440 K 2.0 | | 08/1992→07/1996 | | 460 L 2.0 | | 08/1992→07/1996 | |
| 480 E 2.0 | | 08/1992→09/1995 | | | | | |

| | | | | | | |
|-----------------------|--------------|---------|-----|---|----------------------|--|
| V94038 | 7701 466 606 | | 45° | H | VAG96057B | |
| 40.20 x 8.00 x 107.00 | | MB | | | 37.70 x 8.03 x 13.08 | |
| V94039 | 7701 466 607 | | 45° | H | | |
| 32.60 x 8.00 x 107.00 | | MD + MB | | | | |

27 **83.00**

| | | | | | | | |
|------------------|--------|-----------------|------------------|------------|--------|-----------------|----------------|
| B 4184 S3 | 1731cc | 4 Cyl. | 16 Valves | 85kW/116PS | Petrol | | TD13748 |
| S40 I 1.8 | | 07/1995→08/1999 | | V40 1.8 | | 07/1995→08/1999 | |

| | | | | | | |
|-----------------------|-----------|------------|-----|------|----------------------|--|
| V94315 | 1397641-0 | | 45° | H | VAG96158 | |
| 31.00 x 7.00 x 104.10 | | MB cr | | | 45.00 x 7.02 x 12.08 | |
| V94044 | 1366882-7 | | 45° | H | | |
| 27.00 x 7.00 x 103.30 | | MD + MB cr | | | | |
| V94314 | 1366490 | | 45° | ss H | | |
| 27.00 x 7.00 x 103.30 | | ME + MB cr | | | | |

28 **83.00**

| | | | | | | | |
|------------------|--------|-----------------|------------------|-------------------|--------|-----------------|----------------|
| B 4184 S | 1783cc | 4 Cyl. | 16 Valves | 85kW/115PS | Petrol | DOHC | TD5152 |
| B 4184 S9 | 1783cc | 4 Cyl. | 16 Valves | 88-90kW/120-122PS | Petrol | DOHC | TD17998 |
| S40 I 1.8 | | 07/1995→12/2003 | | S40 I 1.8 LPG | | 03/1999→ | |
| V40 1.8 | | 07/1995→06/2004 | | V40 1.8 Bi-Fuel | | 11/1999→08/2003 | |
| V40 1.8 LPG | | 03/1999→ | | | | | |

| | | | | | | |
|-----------------------|-----------|------------|-----|------|----------------------|--|
| V94315 | 1397641-0 | | 45° | H | VAG96158 | |
| 31.00 x 7.00 x 104.10 | | MB cr | | | 45.00 x 7.02 x 12.08 | |
| V94044 | 1366882-7 | | 45° | H | | |
| 27.00 x 7.00 x 103.30 | | MD + MB cr | | | | |
| V94314 | 1366490 | | 45° | ss H | | |
| 27.00 x 7.00 x 103.30 | | ME + MB cr | | | | |



OE

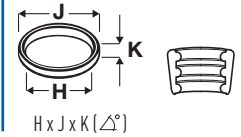
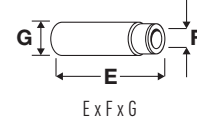
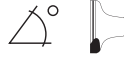

29



83.00

| B 4184 S2 | 1783cc | 4 Cyl. | 16 Valves | 85-90kW/116-122PS | Petrol | DOHC | TD13729 |
|---|------------------------------------|--------|-----------|-------------------|--------|--|---------|
| S40 I 1.8 V40 1.8 Blu-Fuel | 03/1999→12/2003 06/2001→08/2003 | | | V40 1.8 | | 03/1999→06/2004 | |
| V94315 ■ 31.00 x 7.00 x 104.10 Eng.->1818169 | 1397641-0 | | 45° | H | | VAG96158 ■ ■ ■ 45.00 x 7.02 x 12.08 Eng.->1818169 | |
| V95049 ■ 31.00 x 6.00 x 104.25 Eng.1818170→ | 9454607 | | 45° | H | | | |
| V94044 ■ 27.00 x 7.00 x 103.30 Eng.->1818169 | 1366882-7 | | 45° | H | | | |
| V94314 ■ 27.00 x 7.00 x 103.30 Eng.->1818169 | 1366490 | | 45° | SS | H | | |
| V95050 ■ 27.00 x 6.00 x 103.35 Eng.1818170→ | 9454610 | | 45° | H | | | |

30



83.00

| B 4184 S11 | 1798cc | 4 Cyl. | 16 Valves | 92kW/125PS | Petrol | DOHC | TD18022 |
|--|------------------------------------|--------|-----------|------------|--------|---|---------|
| C30 1.8 V50 1.8 | 10/2006→12/2012 04/2004→12/2010 | | | S40 II 1.8 | | 04/2004→12/2010 | |
| V94693 ■ 32.50 x 5.50 x 103.40 | 8694781 | | 45° | H | | VAG96367 ■ ■ ■ 39.00 x 5.50 x 11.05 | |
| V94694 ■ 28.00 x 5.50 x 104.60 | 8694780 | | 45° | | | | |

31



83.00

| B 4204 S | 1948cc | 4 Cyl. | 16 Valves | 100-103kW/136-140PS | Petrol | Turbo, DOHC | TD5153 |
|---|--|--------|-----------|--|--------|--|---------|
| B 4204 S2 | 1948cc | 4 Cyl. | 16 Valves | 100kW/136PS | Petrol | DOHC | TD17999 |
| B 4204 T | 1948cc | 4 Cyl. | 16 Valves | 118-119kW/160-162PS | Petrol | Turbo, DOHC | TD11287 |
| B 4204 T2 | 1948cc | 4 Cyl. | 16 Valves | 118-121kW/160-165PS | Petrol | Turbo, DOHC | TD18005 |
| B 4204 T3 | 1948cc | 4 Cyl. | 16 Valves | 120-121kW/163-165PS | Petrol | Turbo, DOHC | TD18001 |
| B 4204 T5 | 1948cc | 4 Cyl. | 16 Valves | 147kW/200PS | Petrol | Turbo, DOHC | TD18002 |
| C30 2.0 S40 I 2.0 T V40 2.0 V40 2.0 T4 | 10/2007→12/2013 10/1997→12/2003 07/1995→06/2004 07/2000→06/2004 | | | S40 I 2.0 S40 I 2.0 T4 V40 2.0 T | | 07/1995→12/2003 07/2000→12/2003 10/1997→ | |
| V94315 ■ 31.00 x 7.00 x 104.10 | 1397641-0 | | 45° | H | | VAG96158 ■ ■ ■ 45.00 x 7.02 x 12.08 | |
| V94044 ■ 27.00 x 7.00 x 103.30 | 1366882-7 | | 45° | H | | | |
| V94314 ■ 27.00 x 7.00 x 103.30 | 1366490 | | 45° | SS | H | | |

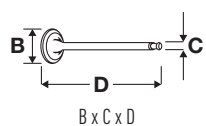

OE

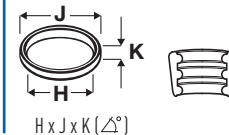
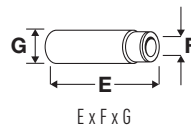
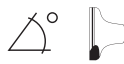

32  **83.00**

| B 5244 S | 2435cc | 5 Cyl. | 20 Valves | 125kW/170PS | Petrol | DOHC | TD11552 |
|------------|-----------------|--------|-----------|-------------|--------|-----------------|---------|
| C70 I 2.4 | 05/1999→09/2002 | | | S60 I 2.4 | | 11/2000→04/2010 | |
| S70 2.4 | 01/1997→11/2000 | | | S80 I 2.4 | | 01/1999→07/2006 | |
| V40 2.4 | 10/2013→ | | | V70 I 2.4 | | 12/1995→05/2000 | |
| V70 II 2.4 | 03/2000→08/2007 | | | | | | |

V94315 
31.00 x 7.00 x 104.10
Eng.→1817725

1397641-0

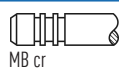

45°

H

VAG96158 
45.00 x 7.02 x 12.08
Eng.→1817725

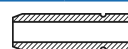

V95049 
31.00 x 6.00 x 104.25
Eng.1817726→

9454607

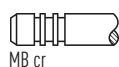

45°

H

V94044 
27.00 x 7.00 x 103.30
Eng.→1817725

1366882-7

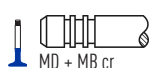

45°

H

V94314 
27.00 x 7.00 x 103.30
Eng.→1817725

1366490



45°

ss

H

V95050 
27.00 x 6.00 x 103.35
Eng.1817726→

9454610



45°

H

33  **83.00**

| B 5244 S2 | 2435cc | 5 Cyl. | 20 Valves | 103kW/140PS | Petrol | DOHC | TD9847 |
|-------------|-----------------|--------|-----------|---------------------|--------|-----------------|---------|
| B 5244 S4 | 2435cc | 5 Cyl. | 20 Valves | 125kW/170PS | Petrol | DOHC | TD19285 |
| B 5244 T7 | 2435cc | 5 Cyl. | 20 Valves | 147kW/200PS | Petrol | Turbo, DOHC | TD18251 |
| B 5254 F | 2435cc | 5 Cyl. | 20 Valves | 121-125kW/165-170PS | Petrol | DOHC, Injection | TD19266 |
| B 5254 S | 2435cc | 5 Cyl. | 20 Valves | 121-125kW/165-170PS | Petrol | DOHC | TD5147 |
| B 5254 T | 2435cc | 5 Cyl. | 20 Valves | 142kW/193PS | Petrol | Turbo, DOHC | TD9366 |
| 850 2.4 | 08/1991→12/1996 | | | 850 2.4 GLE | | 09/1993→10/1997 | |
| C30 2.4 i | 10/2006→12/2012 | | | C70 I 2.4 | | 06/1998→10/2005 | |
| C70 I 2.4 T | 03/1997→10/2005 | | | C70 II 2.4 i | | 03/2006→10/2009 | |
| S40 II 2.4 | 01/2004→12/2012 | | | S60 I 2.4 | | 07/2000→04/2010 | |
| S70 2.4 | 01/1997→11/2000 | | | S70 2.4 Blu-Fuel | | 07/1997→09/2000 | |
| S70 2.4 T5 | 11/1996→04/1999 | | | S70 2.4 Turbo | | 01/1997→11/2000 | |
| S80 I 2.4 | 01/1999→07/2006 | | | V50 2.4 | | 04/2004→12/2010 | |
| V70 I 2.4 | 12/1995→12/2000 | | | V70 I 2.4 Turbo | | 04/1996→12/2000 | |
| V70 II 2.4 | 03/2000→08/2007 | | | XC70 2.4 T XC | | 11/1997→09/2002 | |

V94315 
31.00 x 7.00 x 104.10

1397641-0

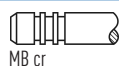

45°

H

VAG96158 
45.00 x 7.02 x 12.08



V94044 
27.00 x 7.00 x 103.30

1366882-7



45°

H

V94314 
27.00 x 7.00 x 103.30

1366490



45°

ss

H



OE

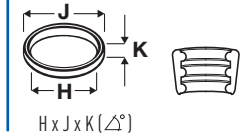
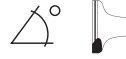

34 **83.00**

| | | | | | | | |
|-------------------|-----------------|--------|------------------|-----------------|--------|--------------------|----------------|
| B 5244 S5 | 2435cc | 5 Cyl. | 20 Valves | 103kW/140PS | Petrol | DOHC | TD18249 |
| B 5244 S6 | 2435cc | 5 Cyl. | 20 Valves | 103kW/140PS | Petrol | DOHC | TD12328 |
| B 5244 S62 | 2435cc | 5 Cyl. | 20 Valves | 103kW/140PS | Petrol | DOHC | TD17992 |
| B 5244 T | 2435cc | 5 Cyl. | 20 Valves | 142kW/193PS | Petrol | Turbo, DOHC | TD17995 |
| B 5244 T3 | 2435cc | 5 Cyl. | 20 Valves | 147kW/200PS | Petrol | Turbo, DOHC | TD15008 |
| C70 I 2.4 T | 03/1997→10/2005 | | | C70 II 2.4 | | 03/2006→10/2009 | |
| S40 II 2.4 | 01/2004→12/2010 | | | S60 I 2.4 | | 07/2001→04/2010 | |
| S60 I 2.4 T | 07/2000→04/2010 | | | S70 2.4 | | 07/1999→11/2000 | |
| S70 2.4 Blu-Fuel | 07/1997→09/2000 | | | S70 2.4 Turbo | | 01/1997→11/2000 | |
| S80 I 2.4 | 09/2001→07/2006 | | | S80 I 2.4 T | | 06/2000→07/2006 | |
| S80 I 2.4 T5 | 04/2000→09/2003 | | | V50 2.4 | | 04/2004→12/2010 | |
| V70 I 2.4 | 03/1999→12/2000 | | | V70 I 2.4 Turbo | | 04/1996→12/2000 | |
| V70 II 2.4 | 09/2001→08/2007 | | | V70 II 2.4 T | | 11/1999→08/2003 | |
| XC70 2.4 T XC | 03/2000→09/2002 | | | | | | |

| | | | | |
|-----------------------|---------|------------|-----|---|
| V95049 | 9454607 | | 45° | H |
| 31.00 x 6.00 x 104.25 | | MB cr | | |
| V95050 | 9454610 | | 45° | H |
| 27.00 x 6.00 x 103.35 | | MD + MB tu | | |

35 **83.00**

| | | | | | | | |
|------------------|-----------------|--------|------------------|---------------------|--------|--------------------|----------------|
| B 5254 T2 | 2521cc | 5 Cyl. | 20 Valves | 154-162kW/209-220PS | Petrol | Turbo, DOHC | TD17991 |
| B 5254 T4 | 2521cc | 5 Cyl. | 20 Valves | 220-224kW/299-305PS | Petrol | Turbo, DOHC | TD18248 |
| B 5254 T6 | 2521cc | 5 Cyl. | 20 Valves | 147kW/200PS | Petrol | Turbo, DOHC | TD20985 |
| S60 I 2.5 T | 07/2002→04/2010 | | | S60 I R 2.5 T | | 01/2003→04/2010 | |
| S80 I 2.5 T | 03/2003→07/2006 | | | S80 II 2.5 T | | 03/2006→12/2011 | |
| V70 II 2.5 | 09/2002→08/2007 | | | V70 II 2.5 R | | 12/2002→08/2007 | |
| V70 II 2.5 T | 07/2001→08/2007 | | | V70 II R 2.5 T | | 03/2003→08/2007 | |
| V70 III 2.5 T | 08/2007→12/2009 | | | XC70 2.5 T XC | | 08/2002→08/2007 | |
| XC90 I 2.5 T | 10/2002→09/2014 | | | | | | |

| | | | | |
|-----------------------|-----------|------------|-----|------|
| V94315 | 1397641-0 | | 45° | H |
| 31.00 x 7.00 x 104.10 | | MB cr | | |
| V94044 | 1366882-7 | | 45° | H |
| 27.00 x 7.00 x 103.30 | | MD + MB cr | | |
| V94314 | 1366490 | | 45° | ss H |
| 27.00 x 7.00 x 103.30 | | ME + MB cr | | |

| | | |
|-----------------|----------------------|--|
| VAG96158 | 45.00 x 7.02 x 12.08 | |
|-----------------|----------------------|--|

36 **83.00**

| | | | | | | | |
|------------------|-----------------|--------|------------------|-------------|--------|--------------------|----------------|
| B 5254 T3 | 2521cc | 5 Cyl. | 20 Valves | 162kW/220PS | Petrol | Turbo, DOHC | TD18250 |
| B 5254 T7 | 2521cc | 5 Cyl. | 20 Valves | 169kW/230PS | Petrol | Turbo, DOHC | TD20963 |
| C30 T5 | 10/2006→12/2012 | | | C70 II T5 | | 03/2006→10/2009 | |
| S40 II T5 | 01/2004→12/2012 | | | V50 T5 | | 04/2004→12/2012 | |

| | | | | |
|-----------------------|---------|------------|-----|---|
| V95049 | 9454607 | | 45° | H |
| 31.00 x 6.00 x 104.25 | | MB cr | | |
| V95050 | 9454610 | | 45° | H |
| 27.00 x 6.00 x 103.35 | | MD + MB tu | | |

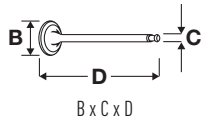

OE

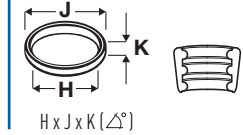
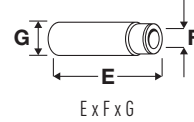
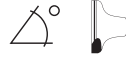

37 83.00

| | | | | | | | |
|------------------|-----------------|--------|------------------|-------------|-----------------|--|----------------|
| B 6294 S | 2922cc | 6 Cyl. | 24 Valves | 147kW/200PS | Petrol | | TD13668 |
| B 6294 S2 | 2922cc | 6 Cyl. | 24 Valves | 144kW/196PS | Petrol | | TD17993 |
| B 6294 T | 2922cc | 6 Cyl. | 24 Valves | 200kW/272PS | Petrol | | TD17994 |
| S80 I 2.9 | 03/1999→07/2006 | | | S80 I 3.0 | 06/2001→07/2006 | | |
| S80 I 3.0 T6 | 06/2001→07/2006 | | | XC90 I T6 | 10/2002→12/2006 | | |

V95049 ■
31.00 x 6.00 x 104.25

9454607

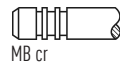

45°

H

MB cr

V95050 ■
27.00 x 6.00 x 103.35

9454610



45°

H

MD + MB tu

38 83.00

| | | | | | | | |
|------------------|-----------------|--------|------------------|---------------------|-----------------|-------------|---------------|
| B 6304 F | 2922cc | 6 Cyl. | 24 Valves | 150-152kW/204-207PS | Petrol | DOHC | TD5042 |
| B 6304 G | 2922cc | 6 Cyl. | 24 Valves | 150kW/204PS | Petrol | DOHC | TD5402 |
| B 6304 S | 2922cc | 6 Cyl. | 24 Valves | 150kW/204PS | Petrol | DOHC | TD5555 |
| B 6304 S2 | 2922cc | 6 Cyl. | 24 Valves | 132-135kW/180-184PS | Petrol | DOHC | TD5155 |
| B 6304 S3 | 2922cc | 6 Cyl. | 24 Valves | 150kW/204PS | Petrol | DOHC | TD9827 |
| 960 2.9 | 08/1990→07/1994 | | | 960 II 2.9 | 07/1994→12/1996 | | |
| S80 I 2.9 | 05/1998→07/2006 | | | S90 2.9 | 11/1996→12/1998 | | |
| V90 2.9 | 01/1997→12/1998 | | | | | | |

V94315 ■
31.00 x 7.00 x 104.10

1397641-0

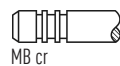

45°

H

MB cr

VAG96158 ■ ■
45.00 x 7.02 x 12.08

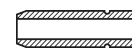

V94044 ■
27.00 x 7.00 x 103.30

1366882-7



45°

H

MD + MB cr

V94314 ■
27.00 x 7.00 x 103.30

1366490



45°

ss

H

ME + MB cr

39 85.00

| | | | | | | | |
|------------------|-----------------|--------|------------------|-------------------|-----------------|--------------------|----------------|
| D 4204 T | 1997cc | 4 Cyl. | 16 Valves | 100kW/136PS | Diesel | Turbo, DOHC | TD18993 |
| D 4204 T2 | 1997cc | 4 Cyl. | 16 Valves | 96-98kW/131-133PS | Diesel | Turbo, DOHC | TD21826 |
| C30 2.0 D | 10/2006→12/2012 | | | C70 II 2.0 D | 01/2008→10/2009 | | |
| S40 I 2.0 D | 12/2002→06/2004 | | | S40 II 2.0 CDI | 07/2005→12/2006 | | |
| S40 II 2.0 D | 01/2004→12/2010 | | | S40 II 2.0 D4 | 07/2005→12/2006 | | |
| S80 II 2.0 TDi | 02/2008→03/2011 | | | V40 2.0 D | 12/2002→06/2004 | | |
| V50 2.0 CDI | 12/2003→12/2006 | | | V50 2.0 D | 04/2004→12/2010 | | |
| V70 III 2.0 D | 10/2007→12/2015 | | | | | | |

V94490 ■
29.80 x 6.00 x 105.00

8653745

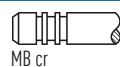

45°

Y

H

MB cr

VAG96119 ■ ■
41.50 x 6.03 x 10.54



V94491 ■
25.00 x 6.00 x 105.00

8659744



45°

ss

H

MD + MB cr

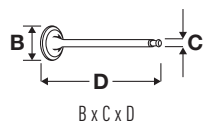

OE

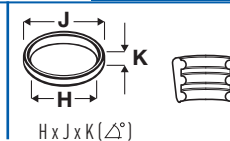
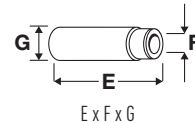

40  87.50

| | | | | | | | |
|------------------|--------|--------|------------------|-------------|--------|-------------|-----------------|
| B 4204 S3 | 1999cc | 4 Cyl. | 16 Valves | 107kW/146PS | Petrol | DOHC | TD19659 |
| C30 2.0 | | | | S40 II 2.0 | | | 10/2006→12/2012 |
| S80 II 2.0 | | | | V50 2.0 | | | 10/2006→12/2012 |
| V70 III 2.0 | | | | | | | 10/2007→12/2011 |

V98032  1324132
35.00 x 5.50 x 103.40



VAG96367  
39.00 x 5.50 x 11.05



V98033  1324131
30.00 x 5.50 x 104.60

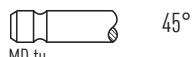

41  88.00

| | | | | | | | |
|---------------|--------|---------|------------------|---------------------|--------|-------------|-----------------|
| B 27 A | 2664cc | V6 Cyl. | 12 Valves | 92-93kW/125-126PS | Petrol | SOHC | TD3958 |
| B 27 E | 2664cc | V6 Cyl. | 12 Valves | 103-109kW/140-148PS | Petrol | SOHC | TD3959 |
| B 27 F | 2664cc | V6 Cyl. | 12 Valves | 109kW/148PS | Petrol | SOHC | TD3960 |
| 240 2.7 GLT6 | | | | 260 2.7 | | | 08/1979→07/1980 |

V90371  7701 460 147
44.00 x 8.00 x 112.00

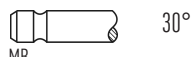

VAG92337  
51.00 x 8.00 x 13.30



42  88.90

| | | | | | | | |
|-----------------|--------|--------|-----------------|---------------------|--------|--------------|-----------------|
| B 19 A | 1986cc | 4 Cyl. | 8 Valves | 65-71kW/88-97PS | Petrol | | TD3915 |
| B 19 E | 1986cc | 4 Cyl. | 8 Valves | 74-86kW/101-117PS | Petrol | | TD3916 |
| B 19 ET | 1986cc | 4 Cyl. | 8 Valves | 100-110kW/136-150PS | Petrol | Turbo | TD3917 |
| B 200 E | 1986cc | 4 Cyl. | 8 Valves | 82-89kW/112-121PS | Petrol | | TD3925 |
| B 200 EA | 1986cc | 4 Cyl. | 8 Valves | 81-82kW/110-112PS | Petrol | | TD5150 |
| B 200 ET | 1986cc | 4 Cyl. | 8 Valves | 115-121kW/156-165PS | Petrol | Turbo | TD3926 |
| B 200 F | 1986cc | 4 Cyl. | 8 Valves | 80-82kW/109-112PS | Petrol | | TD3927 |
| B 200 FT | 1986cc | 4 Cyl. | 8 Valves | 105-114kW/143-155PS | Petrol | Turbo | TD3928 |
| B 200 G | 1986cc | 4 Cyl. | 8 Valves | 80-89kW/109-121PS | Petrol | | TD3929 |
| B 200 K | 1986cc | 4 Cyl. | 8 Valves | 70-77kW/95-105PS | Petrol | | TD3930 |
| 240 2.0 | | | | 240 2.0 T | | | 08/1983→05/1993 |
| 340-360 2.0 | | | | 740 2.0 | | | 12/1983→08/1992 |
| 740 2.0 GLE | | | | 740 2.0 Turbo | | | 05/1985→08/1991 |
| 940 2.0 | | | | 940 2.0 Turbo | | | 08/1990→07/1995 |
| 940 II 2.0 | | | | 940 II 2.0 Turbo | | | 04/1996→10/1998 |
| 960 2.0 | | | | | | | 09/1990→09/1993 |

V35039  463395-4
44.15 x 7.97 x 110.74

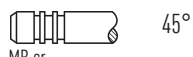

VAG50986 
59.20 x 8.02 x 13.51



V35040  463526-4
35.15 x 7.94 x 110.90

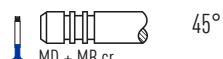

VAG92234 
52.00 x 8.02 x 13.52



43  88.90

| | | | | | | | |
|---------------|--------|--------|-----------------|------------------|--------|-------------|-----------------|
| B 19 K | 1986cc | 4 Cyl. | 8 Valves | 71-74kW/97-101PS | Petrol | SOHC | TD19335 |
| 240 2.0 | | | | | | | 09/1978→12/1984 |

V35039  463395-4
44.15 x 7.97 x 110.74

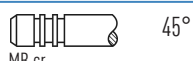

VAG92234 
52.00 x 8.02 x 13.52



V35040  463526-4
35.15 x 7.94 x 110.90

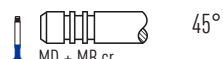



OE

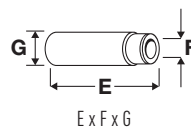

E x F x G

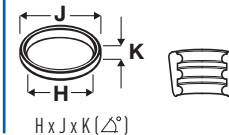

H x J x K (Δ°)

44 **88.90**

| | | | | | | |
|--------------------|--------|-----------------|-----------------|-------------------|--------|-----------------|
| B 20 A | 1998cc | 4 Cyl. | 8 Valves | 60kW/82PS | Petrol | TD3919 |
| B 20 B | 1998cc | 4 Cyl. | 8 Valves | 73-74kW/100-101PS | Petrol | TD3920 |
| 140 2.0 | | 08/1968→07/1974 | | 140 2.0 S | | 08/1968→07/1974 |
| 240 2.0 | | 08/1974→07/1976 | | P 121 2.0 | | 11/1968→05/1971 |
| P 122 S AMAZON 2.0 | | 11/1968→05/1971 | | | | |

| | | | | | | | |
|---------------|-----------------------|----------|------------|-----|---|-----------------|----------------------|
| V35039 | 44.15 x 7.97 x 110.74 | 463395-4 | MB cr | 45° | H | VAG50986 | 59.20 x 8.02 x 13.51 |
| V35040 | 35.15 x 7.94 x 110.90 | 463526-4 | MD + MB cr | 45° | H | VAG92234 | 52.00 x 8.02 x 13.52 |

45 **88.90**

| | | | | | | |
|---------------|--------|-----------------|-----------------|------------|--------|----------------|
| B 20 F | 1998cc | 4 Cyl. | 8 Valves | 85kW/116PS | Petrol | TD15068 |
| 140 2.0 S | | 09/1972→08/1975 | | | | |

| | | | | | | | |
|---------------|-----------------------|--------------|---------|-----|---|------------------|----------------------|
| V94038 | 40.20 x 8.00 x 107.00 | 7701 466 606 | MB | 45° | H | VAG96057B | 37.70 x 8.03 x 13.08 |
| V94039 | 32.60 x 8.00 x 107.00 | 7701 466 607 | MD + MB | 45° | H | | |

46 **91.00**

| | | | | | | |
|---------------|--------|-----------------|------------------|---------------------|--------|-----------------|
| B 28 A | 2849cc | V6 Cyl. | 12 Valves | 95-97kW/129-132PS | Petrol | TD3962 |
| B 28 E | 2849cc | V6 Cyl. | 12 Valves | 114-125kW/155-170PS | Petrol | TD3963 |
| B 28 F | 2849cc | V6 Cyl. | 12 Valves | 114kW/155PS | Petrol | TD3964 |
| 240 2.8 | | 10/1980→09/1984 | | 260 2.8 | | 09/1979→07/1982 |
| 760 2.8 | | 08/1981→08/1990 | | | | |

| | | | | | | | |
|---------------|-----------------------|--------------|----|-----|---|-----------------|----------------------|
| V90371 | 44.00 x 8.00 x 112.00 | 7701 460 147 | MB | 30° | H | VAG92337 | 51.00 x 8.00 x 13.30 |
| V91263 | 38.50 x 8.00 x 111.50 | 7701 460 148 | MD | 45° | | | |

47 **91.00**

| | | | | | | | |
|----------------|--------|-----------------|------------------|---------------------|--------|-----------------|---------------|
| B 280 E | 2849cc | V6 Cyl. | 12 Valves | 108-125kW/147-170PS | Petrol | SOHC | TD3965 |
| 760 2.8 | | 08/1981→08/1990 | | 780 2.9 | | 08/1986→07/1987 | |

| | | | | | | | |
|---------------|-----------------------|--------------|----|-----|---|------------------|----------------------|
| V90371 | 44.00 x 8.00 x 112.00 | 7701 460 147 | MB | 30° | H | VAG96056B | 45.00 x 8.03 x 13.07 |
| | | | | | | VAG92337 | 51.00 x 8.00 x 13.30 |



OE

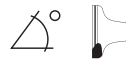

E x F x G

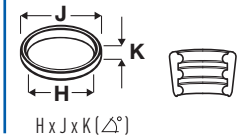

H x J x K (45°)

48  **92.00**

| | | | | | | | |
|----------------|-----------------|--------|-----------------|---------------------|--------|-----------------|---------------|
| B 21 A | 2127cc | 4 Cyl. | 8 Valves | 71-80kW/97-108PS | Petrol | | TD3934 |
| B 21 E | 2127cc | 4 Cyl. | 8 Valves | 86-91kW/117-124PS | Petrol | | TD3935 |
| B 21 ET | 2127cc | 4 Cyl. | 8 Valves | 114-115kW/155-156PS | Petrol | Turbo | TD3936 |
| B 21 F | 2127cc | 4 Cyl. | 8 Valves | 80kW/109PS | Petrol | | TD3937 |
| 240 2.1 | 08/1974→12/1985 | | | 240 2.1 Turbo | | 08/1980→07/1985 | |
| 260 2.1 | 09/1979→12/1980 | | | 340-360 2.1 | | 08/1981→07/1982 | |

V35039 
44.15 x 7.97 x 110.74

463395-4



45°

H

VAG50986 
59.20 x 8.02 x 13.51



V35040 
35.15 x 7.94 x 110.90

463526-4



45°

H

VAG92234 
52.00 x 8.02 x 13.52



49  **96.00**

| | | | | | | | |
|----------------|-----------------|--------|-----------------|---------------|--------|--------------------|---------------|
| B 23 ET | 2315cc | 4 Cyl. | 8 Valves | 127kW/173PS | Petrol | Turbo, SOHC | TD3943 |
| 760 2.3 | 01/1984→03/1986 | | | 760 2.3 Turbo | | 08/1982→07/1984 | |

V35039 
44.15 x 7.97 x 110.74

463395-4

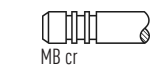

45°

H

VAG50986 
59.20 x 8.02 x 13.51



V35040 
35.15 x 7.94 x 110.90

463526-4



45°

H

VAG92234 
52.00 x 8.02 x 13.52



50  **96.00**

| | | | | | | | |
|------------------|--------|--------|-----------------|---------------------|--------|--------------|---------------|
| B 23 A | 2316cc | 4 Cyl. | 8 Valves | 78-84kW/106-114PS | Petrol | | TD3941 |
| B 23 E | 2316cc | 4 Cyl. | 8 Valves | 91-103kW/124-140PS | Petrol | | TD3942 |
| B 230 E | 2316cc | 4 Cyl. | 8 Valves | 89-98kW/121-133PS | Petrol | | TD5038 |
| B 230 ET | 2316cc | 4 Cyl. | 8 Valves | 130-134kW/177-182PS | Petrol | Turbo | TD3947 |
| B 230 F | 2316cc | 4 Cyl. | 8 Valves | 81-100kW/110-136PS | Petrol | | TD3948 |
| B 230 FB | 2316cc | 4 Cyl. | 8 Valves | 96kW/131PS | Petrol | | TD5157 |
| B 230 FD | 2316cc | 4 Cyl. | 8 Valves | 85-96kW/116-131PS | Petrol | | TD3949 |
| B 230 FK | 2316cc | 4 Cyl. | 8 Valves | 99kW/135PS | Petrol | Turbo | TD5156 |
| B 230 FT | 2316cc | 4 Cyl. | 8 Valves | 115-151kW/156-205PS | Petrol | Turbo | TD3950 |
| B 230 FT+ | 2316cc | 4 Cyl. | 8 Valves | 140kW/190PS | Petrol | Turbo | TD5361 |
| B 230 G | 2316cc | 4 Cyl. | 8 Valves | 90-96kW/122-131PS | Petrol | | TD3951 |
| B 230 GT | 2316cc | 4 Cyl. | 8 Valves | 121-125kW/165-170PS | Petrol | Turbo | TD5039 |

| | | | | | | | |
|------------------|-----------------|--|--|---------------|--|-----------------|--|
| 240 2.3 | 08/1978→12/1989 | | | 240 2.3 Cat | | 08/1991→07/1992 | |
| 240 2.3 i Cat | 08/1986→07/1993 | | | 740 2.3 | | 08/1983→12/1992 | |
| 740 2.3 GL | 08/1984→08/1987 | | | 740 2.3 GLE | | 08/1984→08/1987 | |
| 740 2.3 Turbo | 08/1985→08/1991 | | | 760 2.3 | | 09/1983→07/1992 | |
| 760 2.3 Turbo | 08/1984→08/1990 | | | 780 2.3 | | 09/1988→07/1990 | |
| 940 2.3 | 08/1990→03/1995 | | | 940 2.3 Turbo | | 08/1990→07/1994 | |
| 940 II 2.3 | 08/1994→10/1998 | | | 940 II 2.3 ti | | 01/1995→10/1998 | |
| 940 II 2.3 Turbo | 08/1994→12/1998 | | | 960 2.3 Turbo | | 09/1990→08/1993 | |

V35039 
44.15 x 7.97 x 110.74

463395-4



45°

H

VAG50986 
59.20 x 8.02 x 13.51

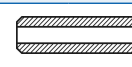

V35040 
35.15 x 7.94 x 110.90

463526-4

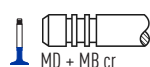

45°

H

VAG92234 
52.00 x 8.02 x 13.52

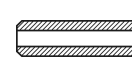



OE

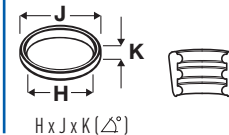
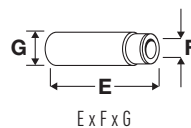
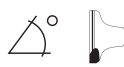

51 **96.00**

| | | | | | | | |
|-----------------------|-----------|-----------------|------------------|----------------------|--------|-----------------|---------------|
| B 234 F | 2316cc | 4 Cyl. | 16 Valves | 111-117kW/151-159PS | Petrol | SOHC | TD3956 |
| 740 2.3 | | 08/1987→08/1992 | | 940 2.3 | | 08/1990→07/1991 | |
| V94274 | 1317792-8 | | 45° | VAG96037 | | | |
| 31.50 x 7.00 x 122.30 | | MD cr | | 55.00 x 7.00 x 12.10 | | | |

52 **98.43**

| | | | | | | | |
|---------------|--------|-----------------|------------------|---------------------|--------|-----------------|---------------|
| D60A | 5480cc | 6 Cyl. | 12 Valves | 88kW/120PS | Diesel | | TD9146 |
| TD60A | 5480cc | 6 Cyl. | 12 Valves | 132kW/180PS | Diesel | Turbo | TD9095 |
| TD60B | 5480cc | 6 Cyl. | 12 Valves | 128-132kW/174-180PS | Diesel | Turbo | TD9096 |
| TD60C | 5480cc | 6 Cyl. | 12 Valves | 108-113kW/147-154PS | Diesel | Turbo | TD9147 |
| TD61F | 5480cc | 6 Cyl. | 12 Valves | 150-152kW/204-207PS | Diesel | Turbo | TD9225 |
| TD61G | 5480cc | 6 Cyl. | 12 Valves | 108-152kW/147-207PS | Diesel | Turbo | TD9221 |
| TD61GA | 5480cc | 6 Cyl. | 12 Valves | 112kW/152PS | Diesel | Turbo | TD9222 |
| TD61GB | 5480cc | 6 Cyl. | 12 Valves | 131-132kW/179-180PS | Diesel | Turbo | TD6249 |
| TD61GC | 5480cc | 6 Cyl. | 12 Valves | 132kW/180PS | Diesel | Turbo | TD9226 |
| TD61GS | 5480cc | 6 Cyl. | 12 Valves | 131-132kW/179-180PS | Diesel | Turbo | TD5902 |
| TD63E | 5480cc | 6 Cyl. | 12 Valves | 132kW/180PS | Diesel | Turbo | TD9223 |
| TD63ES | 5480cc | 6 Cyl. | 12 Valves | 154kW/210PS | Diesel | Turbo | TD9224 |
| B 6 | | 11/1991→ | | F 6 | | 03/1975→10/1986 | |
| FL 6 | | 09/1985→03/2000 | | | | | |

| | | | | | | | |
|-----------------------|----------|------------|-----|----|---|----------------------|--|
| V91204 | 465548-6 | | 30° | Y | H | VAG92096 | |
| 41.00 x 7.96 x 145.40 | | MB cr | | | | 64.50 x 8.02 x 12.08 | |
| V90182 | 465549-4 | | 45° | SS | H | | |
| 36.98 x 7.94 x 145.41 | | MD + MB cr | | | | | |

53 **98.43**

| | | | | | | | |
|---------------|--------|--------|------------------|---------------------|--------|--------------|----------------|
| TD60D | 5480cc | 6 Cyl. | 12 Valves | 108-113kW/147-154PS | Diesel | Turbo | TD23336 |
| TD60DG | 5480cc | 6 Cyl. | 12 Valves | 108-113kW/147-154PS | Diesel | Turbo | TD23337 |
| TD61FB | 5480cc | 6 Cyl. | 12 Valves | 153kW/206PS | Diesel | Turbo | TD9211 |
| TD61GE | 5480cc | 6 Cyl. | 12 Valves | 130kW/175PS | Diesel | Turbo | TD9210 |

| | | | | | | | |
|-----------------------|----------|------------|-----|----|---|----------------------|--|
| V91204 | 465548-6 | | 30° | Y | H | VAG96185 | |
| 41.00 x 7.96 x 145.40 | | MB cr | | | | 64.50 x 8.02 x 16.02 | |
| V90182 | 465549-4 | | 45° | SS | H | | |
| 36.98 x 7.94 x 145.41 | | MD + MB cr | | | | | |



OE

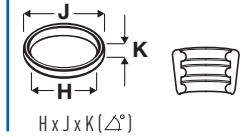
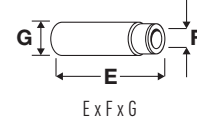

54



104.775

| | | | | | | | |
|--------|--------|--------|-----------|---------------------|--------|-------------|--------|
| D70A | 6700cc | 6 Cyl. | 12 Valves | 106kW/144PS | Diesel | SOHC | TD9128 |
| D70B | 6700cc | 6 Cyl. | 12 Valves | 110kW/150PS | Diesel | SOHC | TD9129 |
| TD70A | 6700cc | 6 Cyl. | 12 Valves | 136kW/185PS | Diesel | Turbo, SOHC | TD9131 |
| TD70B | 6700cc | 6 Cyl. | 12 Valves | 152kW/207PS | Diesel | Turbo, SOHC | TD9132 |
| TD70E | 6700cc | 6 Cyl. | 12 Valves | 154kW/210PS | Diesel | Turbo, SOHC | TD9133 |
| TD70F | 6700cc | 6 Cyl. | 12 Valves | 157-180kW/214-245PS | Diesel | Turbo, SOHC | TD9148 |
| TD70FS | 6700cc | 6 Cyl. | 12 Valves | 157-180kW/214-245PS | Diesel | Turbo, SOHC | TD9150 |
| TD70G | 6700cc | 6 Cyl. | 12 Valves | 147-180kW/200-245PS | Diesel | Turbo, SOHC | TD9151 |
| TD70H | 6700cc | 6 Cyl. | 12 Valves | 157kW/213PS | Diesel | Turbo, SOHC | TD9097 |
| TD70HA | 6700cc | 6 Cyl. | 12 Valves | 143kW/194PS | Diesel | Turbo, SOHC | TD9130 |
| TD71F | 6700cc | 6 Cyl. | 12 Valves | 169-180kW/220-245PS | Diesel | Turbo, SOHC | TD5903 |
| TD71FQ | 6700cc | 6 Cyl. | 12 Valves | 169-173kW/220-235PS | Diesel | Turbo, SOHC | TD6250 |

F 7

08/1978→12/1985

F 80

08/1965→12/1974

FL 7

09/1985→09/1998

V90169 ■
43.26 x 10.98 x 148.70

466379-5



30°

VAG92080 ■ ■ ■
66.00 x 11.06 x 18.00

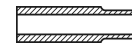

VS6049 ■ [5]
37.50 x 46.10 x 6.17 (30°)

V91205 ■
37.10 x 10.96 x 148.85

421680



45°

H

[5] Fully finished

[5] Fertigggeschliffene

[5] Entièrement finis

[5] Totalmente acabada

[5] Finite

55



104.775

| | | | | | | | |
|--------|--------|--------|-----------|-------------|--------|-------------|---------|
| D7A230 | 6700cc | 6 Cyl. | 12 Valves | 169kW/230PS | Diesel | Turbo, SOHC | TD29201 |
| D7A260 | 6700cc | 6 Cyl. | 12 Valves | 191kW/260PS | Diesel | Turbo, SOHC | TD29199 |
| D7A285 | 6700cc | 6 Cyl. | 12 Valves | 210kW/286PS | Diesel | Turbo, SOHC | TD9229 |
| D7B230 | 6700cc | 6 Cyl. | 12 Valves | 169kW/230PS | Diesel | Turbo, SOHC | TD9242 |
| D7B260 | 6700cc | 6 Cyl. | 12 Valves | 191kW/260PS | Diesel | Turbo, SOHC | TD9243 |
| TD73E | 6700cc | 6 Cyl. | 12 Valves | 169kW/230PS | Diesel | Turbo, SOHC | TD9233 |
| TD73ES | 6700cc | 6 Cyl. | 12 Valves | 191kW/260PS | Diesel | Turbo, SOHC | TD9236 |

FL 7

09/1985→09/1998

FS 7

09/1994→03/1996

V98095 ■
43.00 x 7.97 x 149.55

3978768



30°

VAG96185 ■ ■ ■
64.50 x 8.02 x 16.02

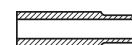

V98096 ■
39.00 x 8.00 x 149.70

3978766



45°

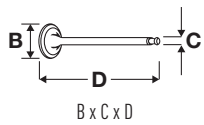

OE

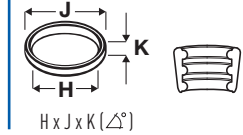
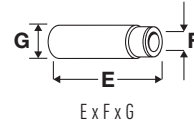

56 104.775

| | | | | | | | |
|----------------|--------|--------|------------------|---------------------|--------|--------------------|----------------|
| TD70C | 6700cc | 6 Cyl. | 12 Valves | 149-152kW/202-207PS | Diesel | Turbo, SOHC | TD9208 |
| TD70D | 6700cc | 6 Cyl. | 12 Valves | 121kW/165PS | Diesel | Turbo, SOHC | TD9209 |
| TD70ES | 6700cc | 6 Cyl. | 12 Valves | 155-166kW/211-226PS | Diesel | Turbo, SOHC | TD9250 |
| TD71A | 6700cc | 6 Cyl. | 12 Valves | 169kW/220PS | Diesel | Turbo, SOHC | TD23335 |
| TD71ACE | 6700cc | 6 Cyl. | 12 Valves | 169kW/220PS | Diesel | Turbo, SOHC | TD23334 |
| TD71AG | 6700cc | 6 Cyl. | 12 Valves | 169kW/220PS | Diesel | Turbo, SOHC | TD23333 |
| TD71AGP | 6700cc | 6 Cyl. | 12 Valves | 169kW/220PS | Diesel | Turbo, SOHC | TD23332 |
| TD71AP | 6700cc | 6 Cyl. | 12 Valves | 169kW/220PS | Diesel | Turbo, SOHC | TD23331 |
| TD71APB | 6700cc | 6 Cyl. | 12 Valves | 169kW/220PS | Diesel | Turbo, SOHC | TD23330 |
| TD71AW | 6700cc | 6 Cyl. | 12 Valves | 169kW/220PS | Diesel | Turbo, SOHC | TD23329 |

N 7 01/1973→09/1980

| | | | | | | |
|---|-------------------------|-----------------------|------------------------|------------|--|---|
| V90169 ■ 43.26 x 10.98 x 148.70 | 466379-5 | MB cr | 30° | H | VAG92080 ■ ■ ■ 66.00 x 11.06 x 18.00 | VS6049 [5] 37.50 x 46.10 x 6.17 (30°) |
| V91205 ■ 37.10 x 10.96 x 148.85 | 421680 | ME + MB cr | 45° | | | |
| [5] Fully finished | [5] Fertigggeschliffene | [5] Entierement finis | [5] Totalmente acabada | [5] Finite | | |

57 104.775

| | | | | | | | |
|---|-------------------------|-----------------------|------------------------|-------------|--|---|---------------|
| TD71FD | 6725cc | 6 Cyl. | 12 Valves | 180kW/245PS | Diesel | Turbo, SOHC | TD9232 |
| V90169 ■ 43.26 x 10.98 x 148.70 | 466379-5 | MB cr | 30° | H | VAG92080 ■ ■ ■ 66.00 x 11.06 x 18.00 | VS6049 ■ [5] 37.50 x 46.10 x 6.17 (30°) | |
| V91205 ■ 37.10 x 10.96 x 148.85 | 421680 | ME + MB cr | 45° | | | | |
| [5] Fully finished | [5] Fertigggeschliffene | [5] Entierement finis | [5] Totalmente acabada | [5] Finite | | | |

58 104.775

| | | | | | | | |
|---|-------------------------|-----------------------|------------------------|-------------|--|---|---------------|
| TD71FA | 6730cc | 6 Cyl. | 12 Valves | 173kW/236PS | Diesel | Turbo, SOHC | TD9212 |
| TD71FC | 6730cc | 6 Cyl. | 12 Valves | 173kW/236PS | Diesel | Turbo, SOHC | TD9213 |
| V90169 ■ 43.26 x 10.98 x 148.70 | 466379-5 | MB cr | 30° | H | VAG92080 ■ ■ ■ 66.00 x 11.06 x 18.00 | VS6049 [5] 37.50 x 46.10 x 6.17 (30°) | |
| V91205 ■ 37.10 x 10.96 x 148.85 | 421680 | ME + MB cr | 45° | | | | |
| [5] Fully finished | [5] Fertigggeschliffene | [5] Entierement finis | [5] Totalmente acabada | [5] Finite | | | |

59 104.775

| | | | | | | | |
|---|-------------------------|-----------------------|------------------------|---------------------|--|---|---------------|
| TD71FS | 6730cc | 6 Cyl. | 12 Valves | 178-184kW/242-250PS | Diesel | Turbo, SOHC | TD5904 |
| TD71FSQ | 6730cc | 6 Cyl. | 12 Valves | 169-184kW/230-250PS | Diesel | Turbo, SOHC | TD6251 |
| V90169 ■ 43.26 x 10.98 x 148.70 | 466379-5 | MB cr | 30° | H | VAG92080 ■ ■ ■ 66.00 x 11.06 x 18.00 | VS6049 ■ [5] 37.50 x 46.10 x 6.17 (30°) | |
| V91205 ■ 37.10 x 10.96 x 148.85 | 421680 | ME + MB cr | 45° | | | | |
| [5] Fully finished | [5] Fertigggeschliffene | [5] Entierement finis | [5] Totalmente acabada | [5] Finite | | | |



OE

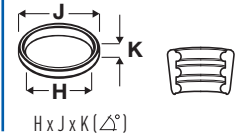
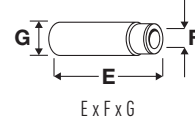
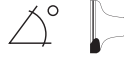

60  **107.00**

| | | | | | | | |
|--------|--------|--------|-----------|-------------|--------|-------|---------|
| D7C215 | 7300cc | 6 Cyl. | 12 Valves | 158kW/215PS | Diesel | Turbo | TD18725 |
| D7C250 | 7300cc | 6 Cyl. | 12 Valves | 184kW/250PS | Diesel | Turbo | TD11770 |
| D7C290 | 7300cc | 6 Cyl. | 12 Valves | 213kW/290PS | Diesel | Turbo | TD11771 |
| D7C310 | 7300cc | 6 Cyl. | 12 Valves | 228kW/310PS | Diesel | Turbo | TD16726 |





FM 7 08/1998→12/2001

| | | | | | | | | |
|--|---------|---|-----|--|--|--|---|--|
| V98095  | 3978768 |  | 30° | | | VAG96185  |  | |
| 43.00 x 7.97 x 149.55 | | | | | | 64.50 x 8.02 x 16.02 | | |
| V98096  | 3978766 |  | 45° | | | | | |
| 39.00 x 8.00 x 149.70 | | | | | | | | |

61  **108.00**

| | | | | | | | |
|--------|--------|--------|-----------|-------------|--------|------------|---------|
| D7E240 | 7100cc | 6 Cyl. | 24 Valves | 177kW/240PS | Diesel | Turbo, OHV | TD18965 |
| D7E280 | 7100cc | 6 Cyl. | 24 Valves | 206kW/280PS | Diesel | Turbo, OHV | TD18964 |
| D7E290 | 7100cc | 6 Cyl. | 24 Valves | 213kW/290PS | Diesel | Turbo, OHV | TD20460 |
| D7E320 | 7100cc | 6 Cyl. | 24 Valves | 235kW/320PS | Diesel | Turbo, OHV | TD18963 |

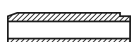







| | | | |
|----------|----------|---------|----------|
| 8700 | 01/1999→ | B 7 | 01/1998→ |
| CENTRO | 01/1998→ | ELITE 2 | 05/2003→ |
| FE | 05/2006→ | FE II | 05/2012→ |
| FL II | 05/2006→ | FL III | 05/2013→ |
| PHÖNIX 2 | 01/2003→ | | |

| | | | | | | | | |
|--|----------|---|-----|----|---|--|---|--|
| V95164  | 20833932 |  | 30° | ss | H | VAG96382  |  | |
| 38.20 x 7.96 x 145.80 | | | | | | 58.30 x 7.50 x 13.03 | | |
| V95165  | 20833936 |  | 45° | | H | | | |
| 35.75 x 7.95 x 145.80 | | | | | | | | |

62  **120.00**

| | | | | | | | |
|--------|--------|--------|-----------|---------------------|--------|-------------|---------|
| D9A260 | 9364cc | 6 Cyl. | 24 Valves | 191kW/260PS | Diesel | Turbo, SOHC | TD16780 |
| D9A300 | 9364cc | 6 Cyl. | 24 Valves | 221-224kW/300-305PS | Diesel | Turbo, SOHC | TD16781 |
| D9A340 | 9364cc | 6 Cyl. | 24 Valves | 250-251kW/340-341PS | Diesel | Turbo, SOHC | TD16782 |
| D9A380 | 9364cc | 6 Cyl. | 24 Valves | 279kW/380PS | Diesel | Turbo, SOHC | TD16783 |

A-Series 01/2005→ FM 09/2005→
FM 9 12/2001→09/2005

| | | | | | | | | |
|--|----------|---|-----|----|---|--|---|--|
| V95089  | 20528113 |  | 30° | ss | H | VAG96308  |  | |
| 38.00 x 7.97 x 192.00 | | | | | | 83.20 x 8.02 x 15.00 | | |
| V98091  | 20450002 |  | 30° | | | | | |
| 38.00 x 7.95 x 191.75 | | | | | | | | |
| V95214  | 20570965 |  | 30° | ss | H | | | |
| 38.00 x 7.96 x 191.70 | | | | | | | | |



OE



MAT.

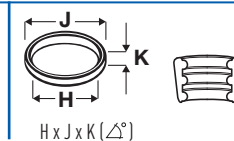
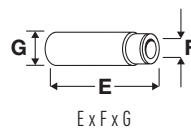

63 **120.00**

| | | | | | | | |
|---------------|-----------------|--------|------------------|---------------------|--------|--------------------|----------------|
| D9B260 | 9364cc | 6 Cyl. | 24 Valves | 191-194kW/260-264PS | Diesel | Turbo, SOHC | TD21048 |
| D9B300 | 9364cc | 6 Cyl. | 24 Valves | 221kW/300PS | Diesel | Turbo, SOHC | TD18978 |
| D9B310 | 9364cc | 6 Cyl. | 24 Valves | 228kW/310PS | Diesel | Turbo, SOHC | TD21049 |
| D9B340 | 9364cc | 6 Cyl. | 24 Valves | 250kW/340PS | Diesel | Turbo, SOHC | TD18979 |
| D9B360 | 9364cc | 6 Cyl. | 24 Valves | 265kW/360PS | Diesel | Turbo, SOHC | TD21050 |
| D9B380 | 9364cc | 6 Cyl. | 24 Valves | 280kW/380PS | Diesel | Turbo, SOHC | TD18980 |
| 7700 | 06/2006→ | | | 8500 | | 01/1999→ | |
| B 9 | 09/2005→ | | | FM | | 09/2005→ | |
| FM 9 | 12/2001→09/2005 | | | OLYMPUS | | 11/2006→ | |

V95089
 38.00 x 7.97 x 192.00

20528113

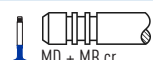

MD + MB cr

30° SS H

VAG96308
 83.20 x 8.02 x 15.00

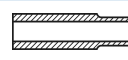

V95090
 36.00 x 7.96 x 192.70

20564039

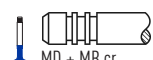

MD + MB cr

30° SS H

64 **120.65**

| | | | | | | | |
|-----------------|--------|--------|------------------|---------------------|--------|-------------------|----------------|
| D10A320 | 9600cc | 6 Cyl. | 12 Valves | 235kW/320PS | Diesel | OHV | TD9263 |
| D10A360 | 9600cc | 6 Cyl. | 12 Valves | 265kW/360PS | Diesel | OHV | TD12047 |
| D10B320 | 9600cc | 6 Cyl. | 12 Valves | 235kW/320PS | Diesel | Turbo, OHV | TD16235 |
| D10B360 | 9600cc | 6 Cyl. | 12 Valves | 265kW/360PS | Diesel | Turbo, OHV | TD16236 |
| HD100D | 9600cc | 6 Cyl. | 12 Valves | 125-132kW/170-180PS | Diesel | OHV | TD9135 |
| TD100A | 9600cc | 6 Cyl. | 12 Valves | 176-190kW/239-258PS | Diesel | Turbo, OHV | TD9152 |
| TD100B | 9600cc | 6 Cyl. | 12 Valves | 206-220kW/280-299PS | Diesel | Turbo, OHV | TD9153 |
| TD100BG | 9600cc | 6 Cyl. | 12 Valves | 207kW/282PS | Diesel | Turbo, OHV | TD21337 |
| TD100C | 9600cc | 6 Cyl. | 12 Valves | 189kW/257PS | Diesel | Turbo, OHV | TD9251 |
| TD100CHC | 9600cc | 6 Cyl. | 12 Valves | 200kW/272PS | Diesel | Turbo, OHV | TD21338 |
| TD100F | 9600cc | 6 Cyl. | 12 Valves | 200kW/272PS | Diesel | Turbo, OHV | TD21339 |
| TD100G | 9600cc | 6 Cyl. | 12 Valves | 192-202kW/261-275PS | Diesel | Turbo, OHV | TD9154 |
| TD100GA | 9600cc | 6 Cyl. | 12 Valves | 200kW/272PS | Diesel | Turbo, OHV | TD9155 |
| TD101F | 9600cc | 6 Cyl. | 12 Valves | 215-220kW/292-299PS | Diesel | Turbo, OHV | TD9156 |
| TD101FA | 9600cc | 6 Cyl. | 12 Valves | 220kW/299PS | Diesel | Turbo, OHV | TD9157 |
| TD101FC | 9600cc | 6 Cyl. | 12 Valves | 221kW/301PS | Diesel | Turbo, OHV | TD9237 |
| TD101FD | 9600cc | 6 Cyl. | 12 Valves | 220-222kW/299-302PS | Diesel | Turbo, OHV | TD9238 |
| TD101G | 9600cc | 6 Cyl. | 12 Valves | 192-202kW/261-275PS | Diesel | Turbo, OHV | TD9158 |
| TD101GA | 9600cc | 6 Cyl. | 12 Valves | 200kW/272PS | Diesel | Turbo, OHV | TD9159 |
| TD101GB | 9600cc | 6 Cyl. | 12 Valves | 185-200kW/252-272PS | Diesel | Turbo, OHV | TD9252 |
| TD101GE | 9600cc | 6 Cyl. | 12 Valves | 200kW/272PS | Diesel | Turbo, OHV | TD21340 |
| TD102F | 9600cc | 6 Cyl. | 12 Valves | 230-234kW/313-318PS | Diesel | Turbo, OHV | TD9160 |
| TD102FAQ | 9600cc | 6 Cyl. | 12 Valves | 221kW/301PS | Diesel | Turbo, OHV | TD9161 |
| TD102FBQ | 9600cc | 6 Cyl. | 12 Valves | 228kW/310PS | Diesel | Turbo, OHV | TD9162 |
| TD102FCQ | 9600cc | 6 Cyl. | 12 Valves | 220kW/299PS | Diesel | Turbo, OHV | TD9163 |
| TD102FD | 9600cc | 6 Cyl. | 12 Valves | 234kW/318PS | Diesel | Turbo, OHV | TD21341 |
| TD102FDQ | 9600cc | 6 Cyl. | 12 Valves | 232-234kW/316-318PS | Diesel | Turbo, OHV | TD9164 |
| TD102FEQ | 9600cc | 6 Cyl. | 12 Valves | 191kW/260PS | Diesel | Turbo, OHV | TD9165 |
| TD102FF | 9600cc | 6 Cyl. | 12 Valves | 230-234kW/313-318PS | Diesel | Turbo, OHV | TD9166 |
| TD102FGQ | 9600cc | 6 Cyl. | 12 Valves | 205kW/279PS | Diesel | Turbo, OHV | TD9167 |
| TD102FH | 9600cc | 6 Cyl. | 12 Valves | 210-234kW/286-318PS | Diesel | Turbo, OHV | TD9168 |
| TD102FL | 9600cc | 6 Cyl. | 12 Valves | 234kW/318PS | Diesel | Turbo, OHV | TD9169 |
| TD102FM | 9600cc | 6 Cyl. | 12 Valves | 230-252kW/313-343PS | Diesel | Turbo, OHV | TD9170 |

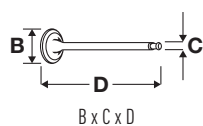

OE

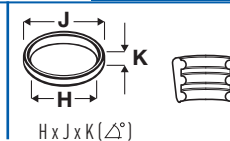
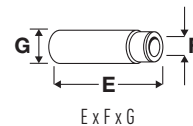

| | | | | | | | |
|----------|--------|--------|-----------|---------------------|--------|------------|---------|
| TD102FS | 9600cc | 6 Cyl. | 12 Valves | 250kW/340PS | Diesel | Turbo, OHV | TD9264 |
| TD102FT | 9600cc | 6 Cyl. | 12 Valves | 228kW/310PS | Diesel | Turbo, OHV | TD9262 |
| TD103E | 9600cc | 6 Cyl. | 12 Valves | 210-235kW/286-320PS | Diesel | Turbo, OHV | TD5900 |
| TD103EA | 9600cc | 6 Cyl. | 12 Valves | 235kW/320PS | Diesel | Turbo, OHV | TD21342 |
| TD103ES | 9600cc | 6 Cyl. | 12 Valves | 210-235kW/286-320PS | Diesel | Turbo, OHV | TD6247 |
| TD103KBE | 9600cc | 6 Cyl. | 12 Valves | 210-235kW/286-320PS | Diesel | Turbo, OHV | TD19062 |
| TD103KF | 9600cc | 6 Cyl. | 12 Valves | 210-235kW/286-320PS | Diesel | Turbo, OHV | TD19063 |
| THD100A | 9600cc | 6 Cyl. | 12 Valves | 139-191kW/200-260PS | Diesel | Turbo, OHV | TD9136 |
| THD100D | 9600cc | 6 Cyl. | 12 Valves | 155-177kW/211-241PS | Diesel | Turbo, OHV | TD9119 |
| THD100DA | 9600cc | 6 Cyl. | 12 Valves | 133kW/181PS | Diesel | Turbo, OHV | TD9103 |
| THD100DB | 9600cc | 6 Cyl. | 12 Valves | 160-203kW/218-276PS | Diesel | Turbo, OHV | TD9120 |
| THD100DC | 9600cc | 6 Cyl. | 12 Valves | 160-203kW/218-276PS | Diesel | Turbo, OHV | TD9104 |
| THD100DD | 9600cc | 6 Cyl. | 12 Valves | 203kW/276PS | Diesel | Turbo, OHV | TD9105 |
| THD100E | 9600cc | 6 Cyl. | 12 Valves | 160-203kW/218-276PS | Diesel | Turbo, OHV | TD9137 |
| THD100EA | 9600cc | 6 Cyl. | 12 Valves | 133-180kW/180-245PS | Diesel | Turbo, OHV | TD9106 |
| THD100EB | 9600cc | 6 Cyl. | 12 Valves | 160-203kW/218-276PS | Diesel | Turbo, OHV | TD9107 |
| THD100EC | 9600cc | 6 Cyl. | 12 Valves | 160-203kW/218-276PS | Diesel | Turbo, OHV | TD9108 |
| THD100ED | 9600cc | 6 Cyl. | 12 Valves | 160-203kW/218-276PS | Diesel | Turbo, OHV | TD9109 |
| THD100EE | 9600cc | 6 Cyl. | 12 Valves | 212kW/288PS | Diesel | Turbo, OHV | TD9110 |
| THD100EK | 9600cc | 6 Cyl. | 12 Valves | 179kW/243PS | Diesel | Turbo, OHV | TD9111 |
| THD101B | 9600cc | 6 Cyl. | 12 Valves | 169-191kW/230-260PS | Diesel | Turbo, OHV | TD23324 |
| THD101GB | 9600cc | 6 Cyl. | 12 Valves | 160kW/218PS | Diesel | Turbo, OHV | TD9112 |
| THD101GC | 9600cc | 6 Cyl. | 12 Valves | 180kW/245PS | Diesel | Turbo, OHV | TD9113 |
| THD101GD | 9600cc | 6 Cyl. | 12 Valves | 160-203kW/218-276PS | Diesel | Turbo, OHV | TD9114 |
| THD101KB | 9600cc | 6 Cyl. | 12 Valves | 210kW/286PS | Diesel | Turbo, OHV | TD9115 |
| THD101KC | 9600cc | 6 Cyl. | 12 Valves | 228kW/310PS | Diesel | Turbo, OHV | TD9116 |
| THD101KE | 9600cc | 6 Cyl. | 12 Valves | 235kW/320PS | Diesel | Turbo, OHV | TD9117 |
| THD102KA | 9600cc | 6 Cyl. | 12 Valves | 210kW/286PS | Diesel | Turbo, OHV | TD23325 |
| THD102KB | 9600cc | 6 Cyl. | 12 Valves | 210kW/286PS | Diesel | Turbo, OHV | TD23326 |
| THD102KD | 9600cc | 6 Cyl. | 12 Valves | 252kW/343PS | Diesel | Turbo, OHV | TD9118 |
| THD102KE | 9600cc | 6 Cyl. | 12 Valves | 235kW/320PS | Diesel | Turbo, OHV | TD26266 |
| THD102KF | 9600cc | 6 Cyl. | 12 Valves | 180-210kW/245-286PS | Diesel | Turbo, OHV | TD9121 |
| THD102KJ | 9600cc | 6 Cyl. | 12 Valves | 158kW/215PS | Diesel | Turbo, OHV | TD9138 |
| THD103E | 9600cc | 6 Cyl. | 12 Valves | 235kW/320PS | Diesel | Turbo, OHV | TD23327 |
| THD103ES | 9600cc | 6 Cyl. | 12 Valves | 235kW/320PS | Diesel | Turbo, OHV | TD23328 |
| THD103KB | 9600cc | 6 Cyl. | 12 Valves | 210kW/286PS | Diesel | Turbo, OHV | TD9098 |
| THD103KD | 9600cc | 6 Cyl. | 12 Valves | 250kW/340PS | Diesel | Turbo, OHV | TD9099 |
| THD103KF | 9600cc | 6 Cyl. | 12 Valves | 180kW/245PS | Diesel | Turbo, OHV | TD9100 |

B 10

F 80

FM 10

08/1965→06/1977

04/1999→09/2003

F 10

FL 10

N 10

08/1977→12/1994

09/1985→09/1998

01/1973→12/1998

V91206 ■
50.15 x 11.00 x 167.40

467502-1

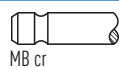

30°

H

VAG50965 ■
82.00 x 11.06 x 18.00



VS6107 ■ [5]
44.35 x 54.06 x 6.68 (30°)

V91207 ■
46.10 x 11.00 x 167.40

467855-3

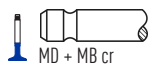

45°

H

VAG50964 ■
66.00 x 11.06 x 18.04

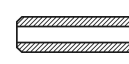

[5] Fully finished

[5] Fertiggeschliffene

[5] Entièrement finis

[5] Totalmente acabada

[5] Finite



OE

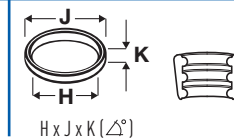
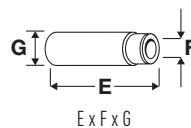

65



130.175

| | | | | | | | |
|---------|---------|--------|-----------|---------------------|--------|------------|--------|
| TD120A | 11980cc | 6 Cyl. | 12 Valves | 243kW/330PS | Diesel | Turbo, OHV | TD9206 |
| TD120C | 11980cc | 6 Cyl. | 12 Valves | 260kW/354PS | Diesel | Turbo, OHV | TD9171 |
| TD120D | 11980cc | 6 Cyl. | 12 Valves | 273kW/371PS | Diesel | Turbo, OHV | TD9172 |
| TD120E | 11980cc | 6 Cyl. | 12 Valves | 225-273kW/306-371PS | Diesel | Turbo, OHV | TD9173 |
| TD120F | 11980cc | 6 Cyl. | 12 Valves | 265kW/360PS | Diesel | Turbo, OHV | TD9174 |
| TD120FC | 11980cc | 6 Cyl. | 12 Valves | 265kW/360PS | Diesel | Turbo, OHV | TD9175 |
| TD120G | 11980cc | 6 Cyl. | 12 Valves | 226-243kW/307-330PS | Diesel | Turbo, OHV | TD9177 |
| TD120GA | 11980cc | 6 Cyl. | 12 Valves | 227kW/308PS | Diesel | Turbo, OHV | TD9178 |
| TD121F | 11980cc | 6 Cyl. | 12 Valves | 272-283kW/370-385PS | Diesel | Turbo, OHV | TD9179 |
| TD121FD | 11980cc | 6 Cyl. | 12 Valves | 283kW/385PS | Diesel | Turbo, OHV | TD9180 |
| TD121G | 11980cc | 6 Cyl. | 12 Valves | 235-243kW/320-330PS | Diesel | Turbo, OHV | TD9183 |
| TD121GD | 11980cc | 6 Cyl. | 12 Valves | 243kW/330PS | Diesel | Turbo, OHV | TD9143 |
| TD122 | 11980cc | 6 Cyl. | 12 Valves | 309kW/420PS | Diesel | Turbo, OHV | TD9184 |
| TD122F | 11980cc | 6 Cyl. | 12 Valves | 257-262kW/350-356PS | Diesel | Turbo, OHV | TD9186 |
| TD122FA | 11980cc | 6 Cyl. | 12 Valves | 272kW/370PS | Diesel | Turbo, OHV | TD9187 |
| TD122FH | 11980cc | 6 Cyl. | 12 Valves | 262kW/356PS | Diesel | Turbo, OHV | TD9122 |
| TD122FK | 11980cc | 6 Cyl. | 12 Valves | 287-291kW/390-396PS | Diesel | Turbo, OHV | TD9191 |
| TD122FL | 11980cc | 6 Cyl. | 12 Valves | 291kW/396PS | Diesel | Turbo, OHV | TD9123 |
| TD122FR | 11980cc | 6 Cyl. | 12 Valves | 262-291kW/356-396PS | Diesel | Turbo, OHV | TD9193 |
| TD122FS | 11980cc | 6 Cyl. | 12 Valves | 287-291kW/395-396PS | Diesel | Turbo, OHV | TD9194 |
| TD123E | 11980cc | 6 Cyl. | 12 Valves | 262-265kW/356-360PS | Diesel | Turbo, OHV | TD9124 |
| TD123ES | 11980cc | 6 Cyl. | 12 Valves | 298kW/405PS | Diesel | Turbo, OHV | TD9125 |

B 12
F 80

01/1992→
10/1970→06/1977

F 12

08/1977→12/1994

V34949 ■
54.10 x 11.00 x 167.49

468302-5

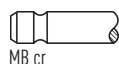

30°

H

VAG50965 ■
82.00 x 11.06 x 18.00



VS6337 ■ [5]
44.95 x 56.60 x 9.45 (45°)

V34950 ■
50.10 x 10.98 x 167.40

468303-3

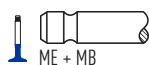

45°

H

VAG50964 ■
66.00 x 11.06 x 18.04



[5] Fully finished

[5] Fertiggeschliffene

[5] Entierement finis

[5] Totalmente acabada

[5] Finite



OE

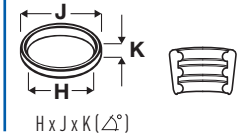
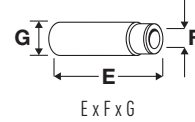
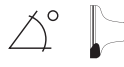

66



130.175

| | | | | | | | |
|----------|---------|--------|-----------|---------------------|--------|------------|---------|
| TD120FA | 11980cc | 6 Cyl. | 12 Valves | 213kW/290PS | Diesel | Turbo, OHV | TD9254 |
| TD120FB | 11980cc | 6 Cyl. | 12 Valves | 226-265kW/307-360PS | Diesel | Turbo, OHV | TD9255 |
| TD120FTQ | 11980cc | 6 Cyl. | 12 Valves | 220kW/299PS | Diesel | Turbo, OHV | TD9176 |
| TD121FA | 11980cc | 6 Cyl. | 12 Valves | 206kW/280PS | Diesel | Turbo, OHV | TD9256 |
| TD121FB | 11980cc | 6 Cyl. | 12 Valves | 210kW/285PS | Diesel | Turbo, OHV | TD9257 |
| TD121FC | 11980cc | 6 Cyl. | 12 Valves | 232kW/315PS | Diesel | Turbo, OHV | TD9258 |
| TD121FE | 11980cc | 6 Cyl. | 12 Valves | 257kW/350PS | Diesel | Turbo, OHV | TD9259 |
| TD121FF | 11980cc | 6 Cyl. | 12 Valves | 272kW/370PS | Diesel | Turbo, OHV | TD9260 |
| TD121FG | 11980cc | 6 Cyl. | 12 Valves | 280kW/380PS | Diesel | Turbo, OHV | TD9261 |
| TD121FH | 11980cc | 6 Cyl. | 12 Valves | 232kW/315PS | Diesel | Turbo, OHV | TD9181 |
| TD121FK | 11980cc | 6 Cyl. | 12 Valves | 280kW/381PS | Diesel | Turbo, OHV | TD9182 |
| TD122ED | 11980cc | 6 Cyl. | 12 Valves | 300-310kW/408-422PS | Diesel | Turbo, OHV | TD9185 |
| TD122FAQ | 11980cc | 6 Cyl. | 12 Valves | 287kW/390PS | Diesel | Turbo, OHV | TD9188 |
| TD122FBQ | 11980cc | 6 Cyl. | 12 Valves | 287kW/390PS | Diesel | Turbo, OHV | TD9189 |
| TD122FCQ | 11980cc | 6 Cyl. | 12 Valves | 287kW/390PS | Diesel | Turbo, OHV | TD9190 |
| TD122FKQ | 11980cc | 6 Cyl. | 12 Valves | 254kW/345PS | Diesel | Turbo, OHV | TD9192 |
| TD122FTO | 11980cc | 6 Cyl. | 12 Valves | 221kW/300PS | Diesel | Turbo, OHV | TD9195 |
| TD122KBE | 11980cc | 6 Cyl. | 12 Valves | 226-265kW/307-360PS | Diesel | Turbo, OHV | TD23340 |
| TD122KE | 11980cc | 6 Cyl. | 12 Valves | 290kW/394PS | Diesel | Turbo, OHV | TD23339 |
| TD122KHD | 11980cc | 6 Cyl. | 12 Valves | 272kW/370PS | Diesel | Turbo, OHV | TD23338 |
| TD123EA | 11980cc | 6 Cyl. | 12 Valves | 224kW/305PS | Diesel | Turbo, OHV | TD9196 |
| TD123EB | 11980cc | 6 Cyl. | 12 Valves | 246kW/335PS | Diesel | Turbo, OHV | TD9197 |
| TD123EC | 11980cc | 6 Cyl. | 12 Valves | 270kW/367PS | Diesel | Turbo, OHV | TD9198 |
| TD123ED | 11980cc | 6 Cyl. | 12 Valves | 301kW/410PS | Diesel | Turbo, OHV | TD9199 |

V34949 ■
54.10 x 11.00 x 167.49

468302-5

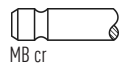

30°

H

VAG50965 ■
82.00 x 11.06 x 18.00



V34950 ■
50.10 x 10.98 x 167.40

468303-3

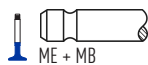

45°

H

VAG50964 ■
66.00 x 11.06 x 18.04



67



131.00

| | | | | | | | |
|---------|---------|--------|-----------|-------------|--------|-------------|---------|
| D12A340 | 12100cc | 6 Cyl. | 24 Valves | 250kW/340PS | Diesel | Turbo, SOHC | TD11727 |
| D12A380 | 12100cc | 6 Cyl. | 24 Valves | 279kW/380PS | Diesel | Turbo, SOHC | TD9215 |
| D12A420 | 12100cc | 6 Cyl. | 24 Valves | 309kW/420PS | Diesel | Turbo, SOHC | TD9216 |

A-Series
FH 12

01/2003→
08/1993→

B 12
FL 12

01/1992→
09/1995→09/1998

V94020 ■
40.10 x 7.98 x 192.00

1547492

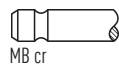

30°

H

VAG96308 ■ ■
83.20 x 8.02 x 15.00



V94021 ■
40.10 x 7.96 x 191.70

20441945

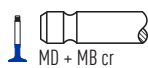

45°

H

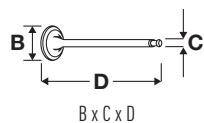

OE

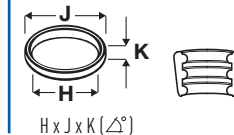
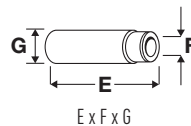

68  **131.00**

| | | | | | | | |
|----------|----------|--------|-----------|-------------|--------|-----------------|---------|
| D12C340 | 12100cc | 6 Cyl. | 24 Valves | 250kW/340PS | Diesel | Turbo, SOHC | TD11731 |
| D12C380 | 12100cc | 6 Cyl. | 24 Valves | 279kW/380PS | Diesel | Turbo, SOHC | TD11728 |
| D12C420 | 12100cc | 6 Cyl. | 24 Valves | 309kW/420PS | Diesel | Turbo, SOHC | TD11729 |
| D12C460 | 12100cc | 6 Cyl. | 24 Valves | 338kW/460PS | Diesel | Turbo, SOHC | TD11730 |
| D12D340 | 12100cc | 6 Cyl. | 24 Valves | 250kW/340PS | Diesel | Turbo, SOHC | TD16784 |
| D12D380 | 12100cc | 6 Cyl. | 24 Valves | 279kW/379PS | Diesel | Turbo, SOHC | TD16785 |
| D12D420 | 12100cc | 6 Cyl. | 24 Valves | 309kW/420PS | Diesel | Turbo, SOHC | TD16786 |
| D12D460 | 12100cc | 6 Cyl. | 24 Valves | 338kW/460PS | Diesel | Turbo, SOHC | TD16787 |
| D12D500 | 12100cc | 6 Cyl. | 24 Valves | 368kW/500PS | Diesel | Turbo, SOHC | TD16508 |
| A-Series | 01/2003→ | | | B 12 | | 02/2006→ | |
| FH 12 | 08/1993→ | | | FM 12 | | 08/1998→09/2005 | |
| NH 12 | 05/1998→ | | | | | | |

V98089 
40.00 x 7.95 x 191.80

20459326

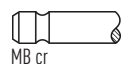

30°

VAG96308 
83.20 x 8.02 x 15.00

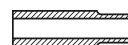

V94021 
40.10 x 7.96 x 191.70

20441945

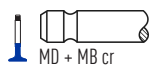

45°

H

69  **131.00**

| | | | | | | | |
|---------|----------|--------|-----------|---------------------|--------|-------------|---------|
| D13A360 | 12800cc | 6 Cyl. | 24 Valves | 264kW/360PS | Diesel | Turbo, SOHC | TD18826 |
| D13A400 | 12800cc | 6 Cyl. | 24 Valves | 294kW/400PS | Diesel | Turbo, SOHC | TD18827 |
| D13A440 | 12800cc | 6 Cyl. | 24 Valves | 324kW/440PS | Diesel | Turbo, SOHC | TD18828 |
| D13A480 | 12800cc | 6 Cyl. | 24 Valves | 353kW/480PS | Diesel | Turbo, SOHC | TD18829 |
| D13A520 | 12800cc | 6 Cyl. | 24 Valves | 382kW/520PS | Diesel | Turbo, SOHC | TD18830 |
| D13B360 | 12800cc | 6 Cyl. | 24 Valves | 264kW/360PS | Diesel | Turbo, SOHC | TD20776 |
| D13B400 | 12800cc | 6 Cyl. | 24 Valves | 294kW/400PS | Diesel | Turbo, SOHC | TD20777 |
| D13B440 | 12800cc | 6 Cyl. | 24 Valves | 324kW/440PS | Diesel | Turbo, SOHC | TD20778 |
| D13B500 | 12800cc | 6 Cyl. | 24 Valves | 368kW/500PS | Diesel | Turbo, SOHC | TD20779 |
| D13C380 | 12800cc | 6 Cyl. | 24 Valves | 280-285kW/380-388PS | Diesel | Turbo, SOHC | TD22378 |
| D13C420 | 12800cc | 6 Cyl. | 24 Valves | 309kW/420PS | Diesel | Turbo, SOHC | TD22150 |
| D13C460 | 12800cc | 6 Cyl. | 24 Valves | 338-343kW/460-466PS | Diesel | Turbo, SOHC | TD22151 |
| D13C500 | 12800cc | 6 Cyl. | 24 Valves | 368kW/500PS | Diesel | Turbo, SOHC | TD22152 |
| D13C540 | 12800cc | 6 Cyl. | 24 Valves | 397kW/540PS | Diesel | Turbo, SOHC | TD22153 |
| 9700 | 01/2009→ | | | 9900 | | 01/2009→ | |
| FH | 09/2005→ | | | FH II | | 01/2012→ | |
| FM | 09/2005→ | | | FMX | | 04/2010→ | |
| FMX II | 09/2013→ | | | VA | | 08/2016→ | |
| VH | 08/2016→ | | | VNL | | 08/2016→ | |
| VNM | 08/2016→ | | | | | | |

V95160 
42.00 x 7.97 x 192.00

20561995

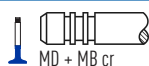

25°

ss

H

VAG96308 
83.20 x 8.02 x 15.00

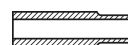

V95161 
40.00 x 7.96 x 191.60

20768506



39°

ss

H

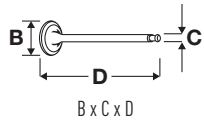

OE



MAT.

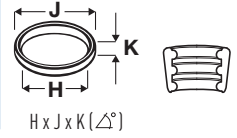
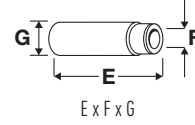
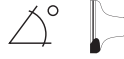

70



144.00

| | | | | | | | |
|----------------|----------|--------|------------------|-------------|-----------------|-------------------|----------------|
| D16C550 | 16120cc | 6 Cyl. | 24 Valves | 404kW/549PS | Diesel | Turbo, OHV | TD17170 |
| D16C610 | 16120cc | 6 Cyl. | 24 Valves | 449kW/610PS | Diesel | Turbo, OHV | TD17171 |
| FH 16 | 01/2003→ | | | VT | 01/2005→12/2007 | | |

V95166 ■
49.00 x 9.96 x 192.90

20739057

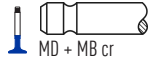

20°

H

VAG96350 ■ ■ ■
83.40 x 10.02 x 16.00







V95167 ■
46.00 x 9.93 x 191.40

20513284









45°

H





| |  | ccm |  |  |  |  |
|-----|---|------|--|---|---|---|
| 1E | 76.50 | 2383 | 6 | 12 | Petrol | 50 |
| 1F | 81.00 | 1595 | 4 | 8 | Petrol | 84 |
| 1G | 76.50 | 2383 | 6 | 12 | Diesel | 51 |
| 1H | 81.00 | 1781 | 4 | 8 | Petrol | 91 |
| 1P | 81.00 | 1781 | 4 | 8 | Petrol | 91 |
| 1S | 76.50 | 2383 | 6 | 12 | Diesel | 52 |
| 1V | 76.50 | 1589 | 4 | 8 | Diesel | 40 |
| 1W | 75.00 | 1398 | 4 | 8 | Diesel | 20 |
| 1X | 79.50 | 1896 | 4 | 8 | Diesel | 67 |
| 1Y | 79.50 | 1896 | 4 | 8 | Diesel | 68 |
| 1Z | 79.50 | 1896 | 4 | 8 | Diesel | 69 |
| 2E | 82.50 | 1984 | 4 | 8 | Petrol | 125 |
| 2G | 75.00 | 1272 | 4 | 8 | Petrol | 13 |
| 2H | 81.00 | 1781 | 4 | 8 | Petrol | 91 |
| 2L | 92.00 | 2446 | 4 | 8 | Diesel | 150 |
| 3F | 75.00 | 1272 | 4 | 8 | Petrol | 14 |
| 9A | 82.50 | 1984 | 4 | 16 | Petrol | 126 |
| AAA | 81.00 | 2792 | 6 | 12 | Petrol | 119 |
| AAB | 79.50 | 2370 | 5 | 10 | Diesel | 83 |
| AAC | 81.00 | 1968 | 4 | 8 | Petrol | 106 |
| AAF | 81.00 | 2461 | 5 | 10 | Petrol | 114 |
| AAK | 75.00 | 1043 | 4 | 8 | Petrol | 8 |
| AAM | 81.00 | 1781 | 4 | 8 | Petrol | 92 |
| AAU | 75.00 | 1043 | 4 | 8 | Petrol | 9 |
| AAV | 75.00 | 1272 | 4 | 8 | Petrol | 14 |
| AAZ | 79.50 | 1896 | 4 | 8 | Diesel | 70 |
| ABD | 75.00 | 1390 | 4 | 8 | Petrol | 19 |
| ABF | 82.50 | 1984 | 4 | 16 | Petrol | 127 |
| ABL | 79.50 | 1896 | 4 | 8 | Diesel | 71 |
| ABN | 81.00 | 1595 | 4 | 8 | Petrol | 84 |
| ABS | 81.00 | 1781 | 4 | 8 | Petrol | 93 |
| ABU | 76.50 | 1598 | 4 | 8 | Petrol | 42 |
| ABV | 82.00 | 2861 | 6 | 12 | Petrol | 123 |
| ACC | 81.00 | 1781 | 4 | 8 | Petrol | 93 |
| ACK | 82.50 | 2771 | 6 | 30 | Petrol | 138 |
| ACL | 76.50 | 2383 | 6 | 12 | Diesel | 53 |
| ACM | 75.00 | 1043 | 4 | 8 | Petrol | 8 |
| ACT | 76.50 | 2383 | 6 | 12 | Diesel | 52 |
| ACU | 81.00 | 2461 | 5 | 10 | Petrol | 114 |
| ACV | 81.00 | 2461 | 5 | 10 | Diesel | 115 |
| AD | 85.50 | 1584 | 4 | 8 | Petrol | 146 |
| ADD | 81.00 | 1781 | 4 | 8 | Petrol | 93 |
| ADP | 81.00 | 1595 | 4 | 8 | Petrol | 85 |
| ADR | 81.00 | 1781 | 4 | 20 | Petrol | 94 |
| ADX | 76.50 | 1296 | 4 | 8 | Petrol | 23 |
| ADY | 82.50 | 1984 | 4 | 8 | Petrol | 128 |
| ADZ | 81.00 | 1781 | 4 | 8 | Petrol | 92 |
| AE | 85.50 | 1584 | 4 | 8 | Petrol | 146 |
| AEA | 76.50 | 1598 | 4 | 8 | Petrol | 43 |
| AEB | 81.00 | 1781 | 4 | 20 | Petrol | 95 |
| AEE | 76.50 | 1598 | 4 | 8 | Petrol | 44 |
| AEF | 79.50 | 1896 | 4 | 8 | Diesel | 72 |
| AEG | 82.50 | 1984 | 4 | 8 | Petrol | 128 |
| AEH | 81.00 | 1595 | 4 | 8 | Petrol | 85 |
| AEK | 81.00 | 1595 | 4 | 8 | Petrol | 86 |
| AEN | 81.00 | 2461 | 5 | 10 | Petrol | 114 |
| AEP | 82.50 | 1984 | 4 | 8 | Petrol | 129 |
| AER | 67.10 | 999 | 4 | 8 | Petrol | 1 |
| AES | 81.00 | 2792 | 6 | 12 | Petrol | 120 |
| AET | 81.00 | 2461 | 5 | 10 | Petrol | 114 |
| AEU | 81.00 | 2461 | 5 | 10 | Petrol | 114 |
| AEV | 75.00 | 1043 | 4 | 8 | Petrol | 10 |
| AEX | 76.50 | 1390 | 4 | 8 | Petrol | 24 |
| AEY | 79.50 | 1896 | 4 | 8 | Diesel | 73 |
| AFB | 78.30 | 2496 | 6 | 24 | Diesel | 59 |
| AFH | 76.50 | 1390 | 4 | 16 | Petrol | 25 |







Engine Index • Indice des moteurs • Indice de motores
 Indice per motore • Motorverzeichnis













| |  |  | ccm |  |  |  |  | |
|-----|---|---|-------|---|---|---|---|-----|
| AFK | | | 76.50 | 1390 | 4 | 16 | Petrol | 26 |
| AFN | | | 79.50 | 1896 | 4 | 8 | Diesel | 74 |
| AFT | | | 81.00 | 1595 | 4 | 8 | Petrol | 85 |
| AFY | | | 81.00 | 1781 | 4 | 20 | Petrol | 94 |
| AGD | | | 79.50 | 1896 | 4 | 8 | Diesel | 75 |
| AGE | | | 82.50 | 2771 | 6 | 30 | Petrol | 138 |
| AGG | | | 82.50 | 1984 | 4 | 8 | Petrol | 128 |
| AGK | | | 93.00 | 2799 | 4 | 12 | Diesel | 152 |
| AGN | | | 81.00 | 1781 | 4 | 20 | Petrol | 94 |
| AGP | | | 79.50 | 1896 | 4 | 8 | Diesel | 76 |
| AGR | | | 79.50 | 1896 | 4 | 8 | Diesel | 74 |
| AGU | | | 81.00 | 1781 | 4 | 20 | Petrol | 95 |
| AGX | | | 81.00 | 2461 | 5 | 10 | Diesel | 115 |
| AGZ | | | 81.00 | 2324 | 5 | 10 | Petrol | 113 |
| AHB | | | 79.50 | 1716 | 4 | 8 | Diesel | 65 |
| AHD | | | 81.00 | 2461 | 5 | 10 | Diesel | 115 |
| AHF | | | 79.50 | 1896 | 4 | 8 | Diesel | 74 |
| AHG | | | 79.50 | 1716 | 4 | 8 | Diesel | 65 |
| AHH | | | 79.50 | 1896 | 4 | 8 | Diesel | 74 |
| AHL | | | 81.00 | 1595 | 4 | 8 | Petrol | 85 |
| AHS | | | 76.50 | 1588 | 4 | 8 | Petrol | 33 |
| AHT | | | 72.00 | 997 | 4 | 8 | Petrol | 5 |
| AHU | | | 79.50 | 1896 | 4 | 8 | Diesel | 74 |
| AHW | | | 76.50 | 1390 | 4 | 16 | Petrol | 26 |
| AHY | | | 81.00 | 2461 | 5 | 10 | Diesel | 115 |
| AJA | | | 79.50 | 2370 | 5 | 10 | Diesel | 83 |
| AJH | | | 81.00 | 1781 | 4 | 20 | Petrol | 95 |
| AJM | | | 79.50 | 1896 | 4 | 8 | Diesel | 77 |
| AJS | | | 81.00 | 4921 | 10 | 20 | Diesel | 121 |
| AJT | | | 81.00 | 2461 | 5 | 10 | Diesel | 115 |
| AJV | | | 76.50 | 1598 | 4 | 16 | Petrol | 45 |
| AKK | | | 76.50 | 1390 | 4 | 8 | Petrol | 27 |
| AKL | | | 81.00 | 1595 | 4 | 8 | Petrol | 85 |
| AKN | | | 78.30 | 2496 | 6 | 24 | Diesel | 59 |
| AKP | | | 76.50 | 1390 | 4 | 8 | Petrol | 27 |
| AKQ | | | 76.50 | 1390 | 4 | 16 | Petrol | 26 |
| AKR | | | 82.50 | 1984 | 4 | 8 | Petrol | 130 |
| AKS | | | 81.00 | 1595 | 4 | 8 | Petrol | 85 |
| AKU | | | 79.50 | 1716 | 4 | 8 | Diesel | 65 |
| AKV | | | 76.50 | 1390 | 4 | 8 | Petrol | 24 |
| AKW | | | 79.50 | 1716 | 4 | 8 | Diesel | 65 |
| ALD | | | 67.10 | 999 | 4 | 8 | Petrol | 2 |
| ALE | | | 79.50 | 1896 | 4 | 8 | Diesel | 74 |
| ALG | | | 82.50 | 2771 | 6 | 30 | Petrol | 138 |
| ALH | | | 79.50 | 1896 | 4 | 8 | Diesel | 74 |
| ALL | | | 67.10 | 999 | 4 | 8 | Petrol | 1 |
| ALM | | | 76.50 | 1598 | 4 | 8 | Petrol | 44 |
| ALT | | | 82.50 | 1984 | 4 | 20 | Petrol | 131 |
| ALZ | | | 81.00 | 1595 | 4 | 8 | Petrol | 87 |
| AMF | | | 79.50 | 1422 | 3 | 6 | Diesel | 62 |
| AMX | | | 82.50 | 2771 | 6 | 30 | Petrol | 138 |
| AMY | | | 81.00 | 2792 | 6 | 12 | Petrol | 119 |
| ANA | | | 81.00 | 1595 | 4 | 8 | Petrol | 85 |
| ANB | | | 81.00 | 1781 | 4 | 20 | Petrol | 95 |
| ANJ | | | 81.00 | 2461 | 5 | 10 | Diesel | 115 |
| ANM | | | 76.50 | 1390 | 4 | 16 | Petrol | 26 |
| ANN | | | 81.00 | 1781 | 4 | 8 | Petrol | 96 |
| ANP | | | 81.00 | 1781 | 4 | 8 | Petrol | 96 |
| ANU | | | 79.50 | 1896 | 4 | 8 | Diesel | 77 |
| ANV | | | 67.10 | 999 | 4 | 8 | Petrol | 2 |
| ANW | | | 76.50 | 1390 | 4 | 8 | Petrol | 27 |
| ANX | | | 76.50 | 1390 | 4 | 8 | Petrol | 24 |
| AP | | | 93.00 | 1795 | 4 | 8 | Petrol | 151 |
| APA | | | 81.00 | 2461 | 5 | 10 | Diesel | 115 |
| APE | | | 76.50 | 1390 | 4 | 16 | Petrol | 26 |
| APF | | | 81.00 | 1595 | 4 | 8 | Petrol | 85 |















| |  | ccm |  |  |  |  |
|-----|---|------|--|---|---|---|
| APH | 81.00 | 1781 | 4 | 20 | Petrol | 95 |
| APK | 82.50 | 1984 | 4 | 8 | Petrol | 128 |
| APL | 81.00 | 2461 | 5 | 10 | Petrol | 114 |
| APQ | 76.50 | 1390 | 4 | 8 | Petrol | 24 |
| APR | 82.50 | 2771 | 6 | 30 | Petrol | 138 |
| APT | 81.00 | 1781 | 4 | 20 | Petrol | 94 |
| APU | 81.00 | 1781 | 4 | 20 | Petrol | 95 |
| AQA | 81.00 | 1781 | 4 | 20 | Petrol | 95 |
| AQD | 82.50 | 2771 | 6 | 30 | Petrol | 138 |
| AQM | 79.50 | 1896 | 4 | 8 | Diesel | 76 |
| AQQ | 76.50 | 1390 | 4 | 16 | Petrol | 26 |
| AQY | 82.50 | 1984 | 4 | 8 | Petrol | 128 |
| ARC | 76.50 | 1598 | 4 | 16 | Petrol | 46 |
| ARG | 81.00 | 1781 | 4 | 20 | Petrol | 94 |
| ARL | 79.50 | 1896 | 4 | 8 | Diesel | 77 |
| ARM | 81.00 | 1595 | 4 | 8 | Petrol | 85 |
| ARR | 76.50 | 1390 | 4 | 16 | Petrol | 28 |
| ARX | 81.00 | 1781 | 4 | 20 | Petrol | 95 |
| ARZ | 81.00 | 1781 | 4 | 20 | Petrol | 95 |
| AS | 85.50 | 1584 | 4 | 8 | Petrol | 146 |
| ASV | 79.50 | 1896 | 4 | 8 | Diesel | 74 |
| ASX | 79.50 | 1896 | 4 | 8 | Diesel | 76 |
| ASY | 79.50 | 1896 | 4 | 8 | Diesel | 76 |
| ASZ | 79.50 | 1896 | 4 | 8 | Diesel | 77 |
| ATA | 93.00 | 2799 | 4 | 12 | Diesel | 152 |
| ATD | 79.50 | 1896 | 4 | 8 | Diesel | 77 |
| ATJ | 79.50 | 1896 | 4 | 8 | Diesel | 77 |
| ATL | 79.50 | 1422 | 3 | 6 | Diesel | 63 |
| ATM | 82.50 | 1984 | 4 | 8 | Petrol | 128 |
| ATN | 76.50 | 1598 | 4 | 16 | Petrol | 46 |
| ATQ | 82.50 | 2771 | 6 | 30 | Petrol | 138 |
| ATU | 82.50 | 1984 | 4 | 8 | Petrol | 130 |
| ATX | 82.50 | 2771 | 6 | 30 | Petrol | 138 |
| AUA | 76.50 | 1390 | 4 | 16 | Petrol | 26 |
| AUB | 76.50 | 1390 | 4 | 16 | Petrol | 26 |
| AUC | 67.10 | 999 | 4 | 8 | Petrol | 2 |
| AUD | 76.50 | 1390 | 4 | 8 | Petrol | 27 |
| AUF | 81.00 | 2461 | 5 | 10 | Diesel | 116 |
| AUH | 93.00 | 2799 | 4 | 12 | Diesel | 152 |
| AUM | 81.00 | 1781 | 4 | 20 | Petrol | 95 |
| AUQ | 81.00 | 1781 | 4 | 20 | Petrol | 95 |
| AUR | 81.00 | 1595 | 4 | 8 | Petrol | 88 |
| AUS | 76.50 | 1598 | 4 | 16 | Petrol | 46 |
| AUY | 79.50 | 1896 | 4 | 8 | Diesel | 77 |
| AVB | 79.50 | 1896 | 4 | 8 | Diesel | 77 |
| AVC | 81.00 | 1781 | 4 | 20 | Petrol | 95 |
| AVF | 79.50 | 1896 | 4 | 8 | Diesel | 77 |
| AVG | 79.50 | 1896 | 4 | 8 | Diesel | 74 |
| AVH | 82.50 | 1984 | 4 | 8 | Petrol | 130 |
| AVQ | 79.50 | 1896 | 4 | 8 | Diesel | 78 |
| AVR | 81.00 | 2461 | 5 | 10 | Diesel | 116 |
| AVT | 81.00 | 2461 | 5 | 10 | Petrol | 114 |
| AVU | 81.00 | 1595 | 4 | 8 | Petrol | 87 |
| AVY | 76.50 | 1598 | 4 | 16 | Petrol | 46 |
| AWC | 81.00 | 1781 | 4 | 20 | Petrol | 95 |
| AWF | 82.50 | 1984 | 4 | 8 | Petrol | 130 |
| AWG | 82.50 | 1984 | 4 | 8 | Petrol | 130 |
| AWH | 81.00 | 1595 | 4 | 8 | Petrol | 85 |
| AWP | 81.00 | 1781 | 4 | 20 | Petrol | 95 |
| AWT | 81.00 | 1781 | 4 | 20 | Petrol | 95 |
| AWU | 81.00 | 1781 | 4 | 20 | Petrol | 95 |
| AWV | 81.00 | 1781 | 4 | 20 | Petrol | 95 |
| AWX | 79.50 | 1896 | 4 | 8 | Diesel | 77 |
| AWY | 76.50 | 1198 | 3 | 6 | Petrol | 21 |
| AXA | 82.50 | 1984 | 4 | 8 | Petrol | 130 |
| AXB | 79.50 | 1896 | 4 | 8 | Diesel | 77 |





|  |  | ccm |  |  |  |  | |
|---|---|-------|---|---|---|---|-----|
| AXC | | 79.50 | 1896 | 4 | 8 | Diesel | 77 |
| AXD | | 81.00 | 2461 | 5 | 10 | Diesel | 117 |
| AXE | | 81.00 | 2461 | 5 | 10 | Diesel | 117 |
| AXG | | 81.00 | 2461 | 5 | 10 | Diesel | 115 |
| AXL | | 81.00 | 2461 | 5 | 10 | Diesel | 115 |
| AXP | | 76.50 | 1390 | 4 | 16 | Petrol | 26 |
| AXR | | 79.50 | 1896 | 4 | 8 | Diesel | 78 |
| AXU | | 76.50 | 1390 | 4 | 16 | Petrol | 26 |
| AXW | | 82.50 | 1984 | 4 | 16 | Petrol | 132 |
| AXX | | 82.50 | 1984 | 4 | 16 | Petrol | 133 |
| AXZ | | 86.00 | 3168 | 6 | 24 | Petrol | 147 |
| AYC | | 81.00 | 2461 | 5 | 10 | Diesel | 116 |
| AYD | | 81.00 | 1595 | 4 | 8 | Petrol | 87 |
| AYH | | 81.00 | 4921 | 10 | 20 | Diesel | 121 |
| AYQ | | 79.50 | 1896 | 4 | 8 | Diesel | 76 |
| AYT | | 84.00 | 3189 | 6 | 24 | Petrol | 142 |
| AYY | | 81.00 | 2461 | 5 | 10 | Diesel | 115 |
| AZD | | 76.50 | 1598 | 4 | 16 | Petrol | 46 |
| AZG | | 82.50 | 1984 | 4 | 8 | Petrol | 130 |
| AZH | | 82.50 | 1984 | 4 | 8 | Petrol | 128 |
| AZJ | | 82.50 | 1984 | 4 | 8 | Petrol | 130 |
| AZM | | 82.50 | 1984 | 4 | 8 | Petrol | 128 |
| AZQ | | 76.50 | 1198 | 3 | 12 | Petrol | 22 |
| AZV | | 81.00 | 1968 | 4 | 16 | Diesel | 107 |
| AZZ | | 84.00 | 3189 | 6 | 24 | Petrol | 142 |
| BAA | | 84.00 | 3189 | 6 | 24 | Petrol | 142 |
| BAC | | 81.00 | 2461 | 5 | 10 | Diesel | 117 |
| BAD | | 76.50 | 1598 | 4 | 16 | Petrol | 46 |
| BAF | | 81.00 | 1781 | 4 | 20 | Petrol | 95 |
| BAG | | 76.50 | 1598 | 4 | 16 | Petrol | 46 |
| BAH | | 76.50 | 1598 | 4 | 8 | Petrol | 47 |
| BAR | | 84.50 | 4163 | 8 | 32 | Petrol | 145 |
| BAU | | 78.30 | 2496 | 6 | 24 | Diesel | 60 |
| BAY | | 79.50 | 1422 | 3 | 6 | Diesel | 63 |
| BBE | | 81.00 | 2461 | 5 | 10 | Diesel | 115 |
| BBF | | 81.00 | 2461 | 5 | 10 | Diesel | 115 |
| BBG | | 82.50 | 2771 | 6 | 30 | Petrol | 138 |
| BBM | | 76.50 | 1198 | 3 | 6 | Petrol | 21 |
| BBU | | 81.00 | 1781 | 4 | 20 | Petrol | 95 |
| BBX | | 82.50 | 1984 | 4 | 8 | Petrol | 128 |
| BBY | | 76.50 | 1390 | 4 | 16 | Petrol | 26 |
| BBZ | | 76.50 | 1390 | 4 | 16 | Petrol | 26 |
| BCA | | 76.50 | 1390 | 4 | 16 | Petrol | 26 |
| BCB | | 76.50 | 1598 | 4 | 16 | Petrol | 46 |
| BCQ | | 93.00 | 2799 | 4 | 12 | Diesel | 152 |
| BDC | | 82.50 | 1984 | 4 | 8 | Petrol | 130 |
| BDG | | 78.30 | 2496 | 6 | 24 | Diesel | 60 |
| BDH | | 78.30 | 2496 | 6 | 24 | Diesel | 60 |
| BDJ | | 81.00 | 1968 | 4 | 8 | Diesel | 108 |
| BDK | | 81.00 | 1968 | 4 | 8 | Diesel | 108 |
| BDL | | 84.00 | 3189 | 6 | 24 | Petrol | 142 |
| BEJ | | 82.50 | 1984 | 4 | 8 | Petrol | 130 |
| BER | | 82.50 | 1984 | 4 | 8 | Petrol | 130 |
| BEV | | 82.50 | 1984 | 4 | 8 | Petrol | 130 |
| BEW | | 79.50 | 1896 | 4 | 8 | Diesel | 79 |
| BFH | | 84.00 | 3189 | 6 | 24 | Petrol | 142 |
| BFQ | | 81.00 | 1595 | 4 | 8 | Petrol | 87 |
| BFS | | 81.00 | 1595 | 4 | 8 | Petrol | 87 |
| BGD | | 82.50 | 1984 | 4 | 8 | Petrol | 130 |
| BGG | | 79.50 | 1896 | 4 | 8 | Diesel | 80 |
| BGP | | 82.50 | 2480 | 5 | 20 | Petrol | 137 |
| BGU | | 82.50 | 2480 | 5 | 20 | Petrol | 137 |
| BGU | | 81.00 | 1595 | 4 | 8 | Petrol | 87 |
| BGW | | 81.00 | 1968 | 4 | 8 | Diesel | 108 |
| BHK | | 89.00 | 3597 | 6 | 24 | Petrol | 148 |
| BHP | | 82.50 | 1984 | 4 | 8 | Petrol | 130 |

| |  | ccm |  |  |  |  |
|-----|---|------|--|---|---|---|
| BHW | 81.00 | 1968 | 4 | 8 | Diesel | 108 |
| BJB | 79.50 | 1896 | 4 | 8 | Diesel | 78 |
| BJJ | 81.00 | 2461 | 5 | 10 | Diesel | 116 |
| BJK | 81.00 | 2461 | 5 | 10 | Diesel | 116 |
| BJL | 81.00 | 2461 | 5 | 10 | Diesel | 116 |
| BJX | 81.00 | 1781 | 4 | 20 | Petrol | 95 |
| BKC | 79.50 | 1896 | 4 | 8 | Diesel | 78 |
| BKD | 81.00 | 1968 | 4 | 16 | Diesel | 107 |
| BKF | 81.00 | 1781 | 4 | 20 | Petrol | 95 |
| BKG | 76.50 | 1390 | 4 | 16 | Petrol | 26 |
| BKJ | 84.00 | 3189 | 6 | 24 | Petrol | 142 |
| BKK | 84.00 | 3189 | 6 | 24 | Petrol | 142 |
| BKL | 84.00 | 3189 | 6 | 24 | Petrol | 142 |
| BKP | 81.00 | 1968 | 4 | 16 | Diesel | 107 |
| BKS | 83.00 | 2967 | 6 | 24 | Diesel | 139 |
| BKY | 76.50 | 1390 | 4 | 16 | Petrol | 26 |
| BLE | 81.00 | 4921 | 10 | 20 | Diesel | 122 |
| BLF | 76.50 | 1598 | 4 | 16 | Petrol | 46 |
| BLG | 76.50 | 1390 | 4 | 16 | Petrol | 26 |
| BLM | 76.50 | 1390 | 4 | 8 | Petrol | 29 |
| BLN | 76.50 | 1390 | 4 | 16 | Petrol | 26 |
| BLP | 76.50 | 1598 | 4 | 16 | Petrol | 46 |
| BLR | 82.50 | 1984 | 4 | 16 | Petrol | 132 |
| BLS | 79.50 | 1896 | 4 | 8 | Diesel | 78 |
| BLT | 79.50 | 1896 | 4 | 8 | Diesel | 77 |
| BLV | 89.00 | 3597 | 6 | 24 | Petrol | 148 |
| BLX | 82.50 | 1984 | 4 | 16 | Petrol | 132 |
| BLY | 82.50 | 1984 | 4 | 16 | Petrol | 132 |
| BMA | 81.00 | 1968 | 4 | 16 | Diesel | 107 |
| BMD | 76.50 | 1198 | 3 | 6 | Petrol | 21 |
| BME | 76.50 | 1198 | 3 | 12 | Petrol | 22 |
| BMK | 83.00 | 2967 | 6 | 24 | Diesel | 139 |
| BML | 84.00 | 3189 | 6 | 24 | Petrol | 142 |
| BMM | 81.00 | 1968 | 4 | 8 | Diesel | 108 |
| BMN | 81.00 | 1968 | 4 | 16 | Diesel | 107 |
| BMP | 81.00 | 1968 | 4 | 8 | Diesel | 108 |
| BMR | 81.00 | 1968 | 4 | 16 | Diesel | 107 |
| BMS | 79.50 | 1422 | 3 | 6 | Diesel | 63 |
| BMT | 79.50 | 1896 | 4 | 8 | Diesel | 78 |
| BMV | 84.00 | 3189 | 6 | 24 | Petrol | 142 |
| BMX | 84.00 | 3189 | 6 | 24 | Petrol | 142 |
| BMY | 76.50 | 1390 | 4 | 16 | Petrol | 26 |
| BNM | 79.50 | 1422 | 3 | 6 | Diesel | 63 |
| BNU | 81.00 | 1781 | 4 | 20 | Petrol | 95 |
| BNV | 79.50 | 1422 | 3 | 6 | Diesel | 63 |
| BNZ | 81.00 | 2461 | 5 | 10 | Diesel | 118 |
| BPC | 81.00 | 2461 | 5 | 10 | Diesel | 118 |
| BPE | 81.00 | 2461 | 5 | 10 | Diesel | 118 |
| BPF | 84.00 | 3189 | 6 | 24 | Petrol | 142 |
| BPR | 82.50 | 2480 | 5 | 20 | Petrol | 137 |
| BPS | 82.50 | 2480 | 5 | 20 | Petrol | 137 |
| BPY | 82.50 | 1984 | 4 | 16 | Petrol | 133 |
| BRJ | 84.00 | 3189 | 6 | 24 | Petrol | 142 |
| BRK | 84.00 | 3189 | 6 | 24 | Petrol | 142 |
| BRR | 79.50 | 1896 | 4 | 8 | Diesel | 78 |
| BRS | 79.50 | 1896 | 4 | 8 | Diesel | 78 |
| BRT | 81.00 | 1968 | 4 | 8 | Diesel | 108 |
| BRU | 79.50 | 1896 | 4 | 8 | Diesel | 78 |
| BSE | 81.00 | 1595 | 4 | 8 | Petrol | 87 |
| BSF | 81.00 | 1595 | 4 | 8 | Petrol | 87 |
| BSP | 83.00 | 2967 | 6 | 24 | Diesel | 139 |
| BST | 81.00 | 1968 | 4 | 8 | Diesel | 108 |
| BSU | 79.50 | 1896 | 4 | 8 | Diesel | 78 |
| BSV | 76.50 | 1423 | 4 | 8 | Petrol | 32 |
| BSW | 79.50 | 1896 | 4 | 8 | Diesel | 81 |
| BTB | 79.50 | 1896 | 4 | 8 | Diesel | 77 |

|  |  | ccm |  |  |  |  |
|---|---|------|---|---|---|---|
| BTK | 82.50 | 2480 | 5 | 20 | Petrol | 137 |
| BTS | 76.50 | 1598 | 4 | 16 | Petrol | 46 |
| BUB | 84.00 | 3189 | 6 | 24 | Petrol | 142 |
| BUD | 76.50 | 1390 | 4 | 16 | Petrol | 26 |
| BUK | 79.50 | 1896 | 4 | 8 | Diesel | 77 |
| BUN | 83.00 | 2967 | 6 | 24 | Diesel | 139 |
| BUZ | 81.00 | 1968 | 4 | 16 | Diesel | 107 |
| BVE | 81.00 | 1968 | 4 | 16 | Diesel | 107 |
| BVH | 81.00 | 1968 | 4 | 8 | Diesel | 108 |
| BVK | 79.50 | 1896 | 4 | 8 | Diesel | 77 |
| BVX | 82.50 | 1984 | 4 | 16 | Petrol | 132 |
| BVY | 82.50 | 1984 | 4 | 16 | Petrol | 132 |
| BVZ | 82.50 | 1984 | 4 | 16 | Petrol | 132 |
| BWA | 82.50 | 1984 | 4 | 16 | Petrol | 133 |
| BWB | 79.50 | 1422 | 3 | 6 | Diesel | 63 |
| BWK | 76.50 | 1390 | 4 | 16 | Petrol | 26 |
| BWS | 89.00 | 3597 | 6 | 24 | Petrol | 148 |
| BWV | 81.00 | 1968 | 4 | 16 | Diesel | 107 |
| BXE | 79.50 | 1896 | 4 | 8 | Diesel | 78 |
| BXF | 79.50 | 1896 | 4 | 8 | Diesel | 78 |
| BXJ | 79.50 | 1896 | 4 | 8 | Diesel | 78 |
| BYD | 82.50 | 1984 | 4 | 16 | Petrol | 134 |
| BZB | 82.50 | 1798 | 4 | 16 | Petrol | 124 |
| BZG | 76.50 | 1198 | 3 | 12 | Petrol | 22 |
| CA | 90.00 | 1679 | 4 | 8 | Petrol | 149 |
| CAAA | 81.00 | 1968 | 4 | 16 | Diesel | 109 |
| CAAB | 81.00 | 1968 | 4 | 16 | Diesel | 109 |
| CAAC | 81.00 | 1968 | 4 | 16 | Diesel | 109 |
| CAAD | 81.00 | 1968 | 4 | 16 | Diesel | 109 |
| CAAE | 81.00 | 1968 | 4 | 16 | Diesel | 109 |
| CARA | 83.00 | 2967 | 6 | 24 | Diesel | 139 |
| CASA | 83.00 | 2967 | 6 | 24 | Diesel | 139 |
| CASB | 83.00 | 2967 | 6 | 24 | Diesel | 139 |
| CASC | 83.00 | 2967 | 6 | 24 | Diesel | 139 |
| CASD | 83.00 | 2967 | 6 | 24 | Diesel | 139 |
| CATA | 83.00 | 2967 | 6 | 24 | Diesel | 139 |
| CAVA | 76.50 | 1390 | 4 | 16 | Petrol | 26 |
| CAVB | 76.50 | 1390 | 4 | 16 | Petrol | 26 |
| CAVC | 76.50 | 1390 | 4 | 16 | Petrol | 26 |
| CAVD | 76.50 | 1390 | 4 | 16 | Petrol | 26 |
| CAVE | 76.50 | 1390 | 4 | 16 | Petrol | 26 |
| CAWA | 82.50 | 1984 | 4 | 16 | Petrol | 133 |
| CAWB | 82.50 | 1984 | 4 | 16 | Petrol | 133 |
| CAXA | 76.50 | 1390 | 4 | 16 | Petrol | 26 |
| CAYA | 79.50 | 1598 | 4 | 16 | Diesel | 64 |
| CAYB | 79.50 | 1598 | 4 | 16 | Diesel | 64 |
| CAYC | 79.50 | 1598 | 4 | 16 | Diesel | 64 |
| CAYD | 79.50 | 1598 | 4 | 16 | Diesel | 64 |
| CAYE | 79.50 | 1598 | 4 | 16 | Diesel | 64 |
| CB | 90.00 | 1679 | 4 | 8 | Petrol | 149 |
| CBAA | 81.00 | 1968 | 4 | 16 | Diesel | 109 |
| CBAB | 81.00 | 1968 | 4 | 16 | Diesel | 109 |
| CBAC | 81.00 | 1968 | 4 | 16 | Diesel | 109 |
| CBBA | 81.00 | 1968 | 4 | 16 | Diesel | 109 |
| CBBB | 81.00 | 1968 | 4 | 16 | Diesel | 109 |
| CBDA | 81.00 | 1968 | 4 | 16 | Diesel | 109 |
| CBDB | 81.00 | 1968 | 4 | 16 | Diesel | 109 |
| CBDC | 81.00 | 1968 | 4 | 16 | Diesel | 109 |
| CBEA | 81.00 | 1968 | 4 | 16 | Diesel | 109 |
| CBFA | 82.50 | 1984 | 4 | 16 | Petrol | 133 |
| CBPA | 82.50 | 1984 | 4 | 8 | Petrol | 130 |
| CBRA | 84.00 | 3189 | 6 | 24 | Petrol | 142 |
| CBTA | 82.50 | 2480 | 5 | 20 | Petrol | 137 |
| CBUA | 82.50 | 2480 | 5 | 20 | Petrol | 137 |
| CBWA | 81.00 | 4921 | 10 | 20 | Diesel | 122 |
| CBZA | 71.00 | 1197 | 4 | 8 | Petrol | 3 |







|  |  | ccm |  |  |  |  | |
|---|---|-------|--|---|---|---|-----|
| CBZB | | 71.00 | 1197 | 4 | 8 | Petrol | 3 |
| CBZC | | 71.00 | 1197 | 4 | 8 | Petrol | 3 |
| CCCA | | 82.50 | 2480 | 5 | 20 | Petrol | 137 |
| CCHA | | 81.00 | 1968 | 4 | 16 | Diesel | 109 |
| CCHB | | 81.00 | 1968 | 4 | 16 | Diesel | 109 |
| CCRA | | 76.50 | 1598 | 4 | 8 | Petrol | 48 |
| CCSA | | 81.00 | 1595 | 4 | 8 | Petrol | 87 |
| CCTA | | 82.50 | 1984 | 4 | 16 | Petrol | 133 |
| CCTB | | 82.50 | 1984 | 4 | 16 | Petrol | 133 |
| CCZA | | 82.50 | 1984 | 4 | 16 | Petrol | 133 |
| CCZB | | 82.50 | 1984 | 4 | 16 | Petrol | 134 |
| CCZC | | 82.50 | 1984 | 4 | 16 | Petrol | 133 |
| CCZD | | 82.50 | 1984 | 4 | 16 | Petrol | 133 |
| CDAA | | 82.50 | 1798 | 4 | 16 | Petrol | 124 |
| CDAB | | 82.50 | 1798 | 4 | 16 | Petrol | 124 |
| CDBA | | 81.00 | 1968 | 4 | 16 | Diesel | 109 |
| CDCA | | 81.00 | 1968 | 4 | 16 | Diesel | 109 |
| CDGA | | 76.50 | 1390 | 4 | 16 | Petrol | 30 |
| CDLA | | 82.50 | 1984 | 4 | 16 | Petrol | 134 |
| CDLC | | 82.50 | 1984 | 4 | 16 | Petrol | 134 |
| CDLF | | 82.50 | 1984 | 4 | 16 | Petrol | 134 |
| CDLJ | | 82.50 | 1984 | 4 | 16 | Petrol | 134 |
| CDVA | | 89.00 | 3597 | 6 | 24 | Petrol | 148 |
| CEBA | | 81.00 | 2461 | 5 | 10 | Diesel | 116 |
| CEBB | | 81.00 | 2461 | 5 | 10 | Diesel | 116 |
| CECA | | 81.00 | 2461 | 5 | 10 | Diesel | 116 |
| CEGA | | 81.00 | 1968 | 4 | 16 | Diesel | 109 |
| CEXA | | 83.00 | 2967 | 6 | 24 | Diesel | 139 |
| CEXB | | 83.00 | 2967 | 6 | 24 | Diesel | 139 |
| CEZA | | 83.00 | 2967 | 6 | 24 | Diesel | 139 |
| CFCA | | 81.00 | 1968 | 4 | 16 | Diesel | 109 |
| CFEA | | 82.50 | 1984 | 4 | 8 | Petrol | 135 |
| CFFA | | 81.00 | 1968 | 4 | 16 | Diesel | 109 |
| CFFB | | 81.00 | 1968 | 4 | 16 | Diesel | 109 |
| CFFD | | 81.00 | 1968 | 4 | 16 | Diesel | 109 |
| CFFE | | 81.00 | 1968 | 4 | 16 | Diesel | 109 |
| CFGB | | 81.00 | 1968 | 4 | 16 | Diesel | 109 |
| CFGC | | 81.00 | 1968 | 4 | 16 | Diesel | 109 |
| CFHB | | 81.00 | 1968 | 4 | 16 | Diesel | 109 |
| CFHC | | 81.00 | 1968 | 4 | 16 | Diesel | 109 |
| CFHE | | 81.00 | 1968 | 4 | 16 | Diesel | 109 |
| CFHF | | 81.00 | 1968 | 4 | 16 | Diesel | 109 |
| CFJA | | 81.00 | 1968 | 4 | 16 | Diesel | 109 |
| CFJB | | 81.00 | 1968 | 4 | 16 | Diesel | 109 |
| CFLA | | 84.00 | 3189 | 6 | 24 | Petrol | 142 |
| CFPA | | 82.50 | 1984 | 4 | 16 | Petrol | 133 |
| CFWA | | 79.50 | 1199 | 3 | 12 | Diesel | 61 |
| CFZA | | 76.50 | 1598 | 4 | 8 | Petrol | 48 |
| CGEA | | 84.50 | 2995 | 6 | 24 | Petrol | 143 |
| CGGA | | 76.50 | 1390 | 4 | 16 | Petrol | 26 |
| CGGB | | 76.50 | 1390 | 4 | 16 | Petrol | 31 |
| CGPA | | 76.50 | 1198 | 3 | 12 | Petrol | 22 |
| CGPB | | 76.50 | 1198 | 3 | 12 | Petrol | 22 |
| CGYA | | 82.50 | 1798 | 4 | 16 | Petrol | 124 |
| CHFA | | 76.50 | 1198 | 3 | 6 | Petrol | 21 |
| CHFB | | 76.50 | 1198 | 3 | 6 | Petrol | 21 |
| CHGA | | 81.00 | 1595 | 4 | 8 | Petrol | 87 |
| CHNA | | 89.00 | 3597 | 6 | 24 | Petrol | 148 |
| CHPA | | 74.50 | 1395 | 4 | 16 | Petrol | 7 |
| CHPB | | 74.50 | 1395 | 4 | 16 | Petrol | 7 |
| CHYA | | 74.50 | 999 | 3 | 12 | Petrol | 6 |
| CHYB | | 74.50 | 999 | 3 | 12 | Petrol | 6 |
| CJ | | 94.00 | 1970 | 4 | 8 | Petrol | 154 |
| CJAA | | 81.00 | 1968 | 4 | 16 | Diesel | 109 |
| CJGD | | 83.00 | 2967 | 6 | 24 | Diesel | 140 |
| CJKA | | 82.50 | 1984 | 4 | 16 | Petrol | 134 |

|  |  | ccm |  |  |  |  |
|---|---|------|---|---|---|---|
| CJKB | 82.50 | 1984 | 4 | 16 | Petrol | 133 |
| CJMA | 83.00 | 2967 | 6 | 24 | Diesel | 140 |
| CJTA | 84.50 | 2995 | 6 | 24 | Petrol | 144 |
| CJZA | 71.00 | 1197 | 4 | 16 | Petrol | 4 |
| CJZB | 71.00 | 1197 | 4 | 16 | Petrol | 4 |
| CKDA | 83.00 | 4134 | 8 | 32 | Diesel | 141 |
| CKFC | 81.00 | 1968 | 4 | 16 | Diesel | 109 |
| CKMA | 76.50 | 1390 | 4 | 16 | Petrol | 30 |
| CKRA | 81.00 | 1968 | 4 | 16 | Diesel | 109 |
| CKTB | 81.00 | 1968 | 4 | 16 | Diesel | 109 |
| CKTC | 81.00 | 1968 | 4 | 16 | Diesel | 109 |
| CKUB | 81.00 | 1968 | 4 | 16 | Diesel | 109 |
| CKUC | 81.00 | 1968 | 4 | 16 | Diesel | 109 |
| CLCA | 81.00 | 1968 | 4 | 16 | Diesel | 109 |
| CLCB | 81.00 | 1968 | 4 | 16 | Diesel | 109 |
| CLHA | 79.50 | 1598 | 4 | 16 | Diesel | 64 |
| CLHB | 79.50 | 1598 | 4 | 16 | Diesel | 64 |
| CLJA | 81.00 | 1968 | 4 | 16 | Diesel | 109 |
| CLLA | 81.00 | 1968 | 4 | 16 | Diesel | 109 |
| CLNA | 79.50 | 1598 | 4 | 16 | Diesel | 64 |
| CMAA | 76.50 | 1390 | 4 | 16 | Petrol | 30 |
| CMBA | 74.50 | 1395 | 4 | 16 | Petrol | 7 |
| CMXA | 81.00 | 1595 | 4 | 8 | Petrol | 87 |
| CNEA | 81.00 | 1968 | 4 | 16 | Diesel | 109 |
| CNFA | 81.00 | 1968 | 4 | 16 | Diesel | 109 |
| CNFB | 81.00 | 1968 | 4 | 16 | Diesel | 109 |
| CNKA | 76.50 | 1598 | 4 | 16 | Petrol | 49 |
| CNLA | 74.50 | 1395 | 4 | 16 | Petrol | 7 |
| CNRB | 83.00 | 2967 | 6 | 24 | Diesel | 140 |
| CNWA | 76.50 | 1390 | 4 | 16 | Petrol | 28 |
| CP | 76.50 | 2383 | 6 | 12 | Diesel | 54 |
| CPTA | 74.50 | 1395 | 4 | 16 | Petrol | 7 |
| CPVA | 74.50 | 1395 | 4 | 16 | Petrol | 7 |
| CPWA | 74.50 | 1395 | 4 | 16 | Petrol | 7 |
| CR | 76.50 | 1588 | 4 | 8 | Diesel | 34 |
| CRBB | 81.00 | 1968 | 4 | 16 | Diesel | 109 |
| CRBC | 81.00 | 1968 | 4 | 16 | Diesel | 109 |
| CRCA | 83.00 | 2967 | 6 | 24 | Diesel | 140 |
| CRFC | 81.00 | 1968 | 4 | 16 | Diesel | 109 |
| CRJA | 74.50 | 1395 | 4 | 16 | Petrol | 7 |
| CRKA | 79.50 | 1598 | 4 | 16 | Diesel | 64 |
| CRKB | 79.50 | 1598 | 4 | 16 | Diesel | 64 |
| CRLB | 81.00 | 1968 | 4 | 16 | Diesel | 109 |
| CRMB | 81.00 | 1968 | 4 | 16 | Diesel | 109 |
| CRUA | 81.00 | 1968 | 4 | 16 | Diesel | 109 |
| CRVA | 81.00 | 1968 | 4 | 16 | Diesel | 109 |
| CRVC | 81.00 | 1968 | 4 | 16 | Diesel | 109 |
| CRZA | 82.50 | 1984 | 4 | 16 | Petrol | 136 |
| CS | 76.50 | 1588 | 4 | 8 | Diesel | 35 |
| CSHA | 81.00 | 1968 | 4 | 16 | Diesel | 109 |
| CT | 85.50 | 1584 | 4 | 8 | Petrol | 146 |
| CTHD | 76.50 | 1390 | 4 | 16 | Petrol | 28 |
| CTKA | 76.50 | 1390 | 4 | 16 | Petrol | 28 |
| CU | 94.00 | 1970 | 4 | 8 | Petrol | 154 |
| CUKA | 74.50 | 1395 | 4 | 16 | Petrol | 7 |
| CUKB | 74.50 | 1395 | 4 | 16 | Petrol | 7 |
| CUNA | 81.00 | 1968 | 4 | 16 | Diesel | 109 |
| CUPA | 81.00 | 1968 | 4 | 16 | Diesel | 109 |
| CUUB | 81.00 | 1968 | 4 | 16 | Diesel | 109 |
| CUVA | 81.00 | 1968 | 4 | 16 | Diesel | 109 |
| CUVC | 81.00 | 1968 | 4 | 16 | Diesel | 109 |
| CUWA | 81.00 | 1968 | 4 | 16 | Diesel | 109 |
| CV | 94.00 | 1970 | 4 | 8 | Petrol | 154 |
| CXSA | 74.50 | 1395 | 4 | 16 | Petrol | 7 |
| CXSB | 74.50 | 1395 | 4 | 16 | Petrol | 7 |
| CXXA | 79.50 | 1598 | 4 | 16 | Diesel | 64 |

| |  | ccm |  |  |  |  | |
|------|---|-------|--|---|---|---|-----|
| CXXB | | 79.50 | 1598 | 4 | 16 | Diesel | 64 |
| CY | | 76.50 | 1588 | 4 | 8 | Diesel | 36 |
| CYKB | | 81.00 | 1968 | 4 | 16 | Diesel | 109 |
| CYVA | | 71.00 | 1197 | 4 | 16 | Petrol | 4 |
| CYVB | | 71.00 | 1197 | 4 | 16 | Petrol | 4 |
| CZCA | | 74.50 | 1395 | 4 | 16 | Petrol | 7 |
| CZDA | | 74.50 | 1395 | 4 | 16 | Petrol | 7 |
| CZEA | | 74.50 | 1395 | 4 | 16 | Petrol | 7 |
| DCXA | | 79.50 | 1598 | 4 | 16 | Diesel | 64 |
| DFEA | | 81.00 | 1968 | 4 | 16 | Diesel | 109 |
| DFEB | | 81.00 | 1968 | 4 | 16 | Diesel | 109 |
| DFGA | | 81.00 | 1968 | 4 | 16 | Diesel | 109 |
| DFGB | | 81.00 | 1968 | 4 | 16 | Diesel | 109 |
| DFHA | | 81.00 | 1968 | 4 | 16 | Diesel | 109 |
| DG | | 94.00 | 1913 | 4 | 8 | Petrol | 153 |
| DGDB | | 79.50 | 1598 | 4 | 16 | Diesel | 64 |
| DH | | 94.00 | 1913 | 4 | 8 | Petrol | 153 |
| DJ | | 94.00 | 2110 | 4 | 8 | Petrol | 155 |
| DL | | 76.50 | 2383 | 6 | 12 | Petrol | 55 |
| DS | | 81.00 | 1781 | 4 | 8 | Petrol | 97 |
| DTA | | 81.00 | 1595 | 4 | 8 | Petrol | 89 |
| DV | | 76.50 | 2383 | 6 | 12 | Diesel | 56 |
| DW | | 76.50 | 2383 | 6 | 12 | Diesel | 57 |
| DX | | 81.00 | 1781 | 4 | 8 | Petrol | 98 |
| DZ | | 81.00 | 1781 | 4 | 8 | Petrol | 93 |
| EV | | 81.00 | 1781 | 4 | 8 | Petrol | 91 |
| EW | | 81.00 | 1595 | 4 | 8 | Petrol | 90 |
| EX | | 81.00 | 1781 | 4 | 8 | Petrol | 99 |
| EZ | | 81.00 | 1595 | 4 | 8 | Petrol | 90 |
| GD | | 94.00 | 1970 | 4 | 8 | Petrol | 154 |
| GE | | 94.00 | 1970 | 4 | 8 | Petrol | 154 |
| GK | | 75.00 | 1272 | 4 | 8 | Petrol | 15 |
| GL | | 75.00 | 1043 | 4 | 8 | Petrol | 11 |
| GU | | 81.00 | 1781 | 4 | 8 | Petrol | 93 |
| GW | | 94.00 | 1913 | 4 | 8 | Petrol | 153 |
| GX | | 81.00 | 1781 | 4 | 8 | Petrol | 93 |
| GZ | | 81.00 | 1781 | 4 | 8 | Petrol | 93 |
| HK | | 75.00 | 1272 | 4 | 8 | Petrol | 15 |
| HN | | 81.00 | 1595 | 4 | 8 | Petrol | 90 |
| HP | | 81.00 | 1994 | 5 | 10 | Petrol | 110 |
| HS | | 76.50 | 2384 | 6 | 12 | Petrol | 58 |
| HT | | 81.00 | 1781 | 4 | 8 | Petrol | 91 |
| HV | | 81.00 | 1781 | 4 | 8 | Petrol | 93 |
| HY | | 81.00 | 2226 | 5 | 10 | Petrol | 112 |
| HZ | | 75.00 | 1043 | 4 | 8 | Petrol | 12 |
| JH | | 81.00 | 1781 | 4 | 8 | Petrol | 100 |
| JJ | | 81.00 | 1781 | 4 | 8 | Petrol | 101 |
| JK | | 76.50 | 1588 | 4 | 8 | Diesel | 37 |
| JN | | 81.00 | 1781 | 4 | 8 | Petrol | 97 |
| JP | | 76.50 | 1588 | 4 | 8 | Diesel | 37 |
| JR | | 76.50 | 1588 | 4 | 8 | Diesel | 38 |
| JS | | 81.00 | 1994 | 5 | 10 | Petrol | 111 |
| JT | | 81.00 | 2226 | 5 | 10 | Petrol | 112 |
| JU | | 81.00 | 1595 | 4 | 8 | Petrol | 90 |
| JV | | 81.00 | 1781 | 4 | 8 | Petrol | 102 |
| JX | | 76.50 | 1589 | 4 | 8 | Diesel | 41 |
| KR | | 81.00 | 1781 | 4 | 16 | Petrol | 103 |
| KT | | 81.00 | 1781 | 4 | 8 | Petrol | 104 |
| KV | | 81.00 | 2226 | 5 | 10 | Petrol | 112 |
| KX | | 81.00 | 2226 | 5 | 10 | Petrol | 112 |
| KY | | 79.50 | 1716 | 4 | 8 | Diesel | 66 |
| ME | | 76.50 | 1588 | 4 | 8 | Diesel | 39 |
| MF | | 76.50 | 1588 | 4 | 8 | Diesel | 38 |
| MH | | 75.00 | 1272 | 4 | 8 | Petrol | 14 |
| MN | | 75.00 | 1272 | 4 | 8 | Diesel | 16 |
| MV | | 94.00 | 2110 | 4 | 8 | Petrol | 155 |

Engine Index • Indice des moteurs • Indice de motores
 Indice per motore • Motorverzeichnis

VW

| |  |  | ccm |  |  |  |  | |
|-----------|---|---|-------|---|---|---|---|------------|
| NU | | | 75.00 | 1272 | 4 | 8 | Petrol | 17 |
| NZ | | | 75.00 | 1272 | 4 | 8 | Petrol | 18 |
| PB | | | 81.00 | 1781 | 4 | 8 | Petrol | 105 |
| PD | | | 81.00 | 1781 | 4 | 8 | Petrol | 93 |
| PF | | | 81.00 | 1781 | 4 | 8 | Petrol | 105 |
| PG | | | 81.00 | 1781 | 4 | 8 | Petrol | 91 |
| PL | | | 81.00 | 1781 | 4 | 16 | Petrol | 103 |
| PN | | | 81.00 | 1595 | 4 | 8 | Petrol | 84 |
| PP | | | 81.00 | 1595 | 4 | 8 | Petrol | 89 |
| PY | | | 75.00 | 1272 | 4 | 8 | Petrol | 14 |
| RA | | | 76.50 | 1588 | 4 | 8 | Diesel | 38 |
| RD | | | 81.00 | 1781 | 4 | 8 | Petrol | 91 |
| RE | | | 81.00 | 1595 | 4 | 8 | Petrol | 84 |
| RF | | | 81.00 | 1595 | 4 | 8 | Petrol | 84 |
| RG | | | 81.00 | 1781 | 4 | 8 | Petrol | 91 |
| RH | | | 81.00 | 1781 | 4 | 8 | Petrol | 97 |
| RL | | | 81.00 | 1595 | 4 | 8 | Petrol | 84 |
| RM | | | 81.00 | 1781 | 4 | 8 | Petrol | 93 |
| RP | | | 81.00 | 1781 | 4 | 8 | Petrol | 93 |
| RV | | | 81.00 | 1781 | 4 | 8 | Petrol | 105 |
| SB | | | 76.50 | 1588 | 4 | 8 | Diesel | 38 |
| SR | | | 94.00 | 2110 | 4 | 8 | Petrol | 155 |
| V | | | 90.00 | 1679 | 4 | 8 | Petrol | 149 |
| W | | | 90.00 | 1679 | 4 | 8 | Petrol | 149 |
| WN | | | 79.50 | 1921 | 5 | 10 | Petrol | 82 |
| Z | | | 90.00 | 1679 | 4 | 8 | Petrol | 149 |

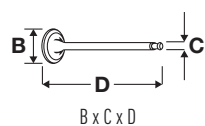

OE

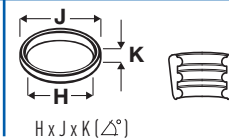
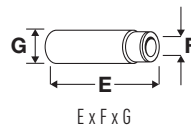

1 67.10

| | | | | | | | |
|------------------|-----------------|--------|-------------|-----------------|--------|------|---------|
| AER | 999cc | 4 Cyl. | 8 Valves | 37kW/50PS | Petrol | SOHC | TD9519 |
| ALL | 999cc | 4 Cyl. | 8 Valves | 37kW/50PS | Petrol | SOHC | TD10609 |
| LUPU 1.0 | 09/1998→07/2005 | | POLO 50 1.0 | 09/1996→10/1999 | | | |
| POLO CLASSIC 1.0 | 08/1996→12/2001 | | VOYAGE 1.0 | 08/1996→12/2001 | | | |

| | | | | | | |
|---------------------------------------|---------------|--------|-----|---|--|--------------------------|
| V94149 31.00 x 7.00 x 94.70 | 030 109 601AG | MB | 45° | H | VAG96041B 36.50 x 7.00 x 12.08 | 36.50 x 7.00 x 12.08 |
| V94197 26.00 x 7.00 x 94.40 | 030 109 611N | MD | 45° | | VAG96062B 33.00 x 7.02 x 15.00 | 33.00 x 7.02 x 15.00 |

2 67.10

| | | | | | | | |
|----------|-----------------|--------|----------|-----------------|--------|------|---------|
| ALD | 999cc | 4 Cyl. | 8 Valves | 37kW/50PS | Petrol | SOHC | TD11468 |
| ANV | 999cc | 4 Cyl. | 8 Valves | 37kW/50PS | Petrol | SOHC | TD11469 |
| AUC | 999cc | 4 Cyl. | 8 Valves | 37kW/50PS | Petrol | SOHC | TD15491 |
| LUPU 1.0 | 09/1998→07/2005 | | POLO 1.0 | 05/1999→05/2002 | | | |

| | | | | | | |
|---------------------------------------|---------------|-------------|-----|------|--|--------------------------|
| V94644 31.00 x 6.00 x 99.00 | 030 109 601AK | MB | 45° | H | VAG96073B 36.00 x 6.02 x 11.06 | 36.00 x 6.02 x 11.06 |
| V94645 26.00 x 6.00 x 98.95 | 030 109 611S | MD + MB | 45° | SS H | | |

3 71.00

| | | | | | | | |
|------------------|-----------------|--------|-------------------|-----------------|--------|------------------------|---------|
| CBZA | 1197cc | 4 Cyl. | 8 Valves | 63kW/86PS | Petrol | Turbo, SOHC, Injection | TD24312 |
| CBZB | 1197cc | 4 Cyl. | 8 Valves | 77kW/105PS | Petrol | Turbo, SOHC, Injection | TD23520 |
| CBZC | 1197cc | 4 Cyl. | 8 Valves | 66kW/90PS | Petrol | Turbo, SOHC, Injection | TD25703 |
| BEETLE 1.2 TSI | 07/2011→ | | CADDY III 1.2 TSI | 09/2010→05/2015 | | | |
| GOLF VI 1.2 TSI | 11/2008→ | | GOLF PLUS 1.2 TSI | 11/2009→12/2013 | | | |
| JETTA IV 1.2 TSI | 10/2010→ | | POLO 1.2 TSI | 11/2009→ | | | |
| TOURAN 1.2 TSI | 05/2010→05/2015 | | VENTO 1.2 | 01/2010→ | | | |

| | | | | | | |
|---------------------------------------|--------------|----------------|-----|------|--|--------------------------|
| V95149 35.45 x 5.98 x 98.70 | 03F 109 601A | MB | 45° | Y | VAG96073B 36.00 x 6.02 x 11.06 | 36.00 x 6.02 x 11.06 |
| V95150 30.00 x 5.95 x 98.40 | 03F 109 611C | MD + MB cr | 45° | SS H | | |

4 71.00

| | | | | | | | |
|----------------|----------|--------|------------------|------------|--------|------------------------|---------|
| CJZA | 1197cc | 4 Cyl. | 16 Valves | 77kW/105PS | Petrol | Turbo, DOHC, Injection | TD27189 |
| CJZB | 1197cc | 4 Cyl. | 16 Valves | 63kW/86PS | Petrol | Turbo, DOHC, Injection | TD27190 |
| CYVA | 1197cc | 4 Cyl. | 16 Valves | 63kW/86PS | Petrol | Turbo, DOHC, Injection | TD29246 |
| CYVB | 1197cc | 4 Cyl. | 16 Valves | 81kW/110PS | Petrol | Turbo, DOHC, Injection | TD29245 |
| GOLF 1.2 TSI | 04/2014→ | | GOLF VII 1.2 TSI | 08/2012→ | | | |
| TOURAN 1.2 TSI | 05/2015→ | | | | | | |

| | | | | | | |
|--|--------------|----------------|-----|----|--|--|
| V80012 26.50 x 5.00 x 110.25 | 04E 109 601A | MB | 45° | | | |
| V80013 23.50 x 5.00 x 110.09 | 04E 109 611K | ME + MB cr | 30° | SS | | |



OE

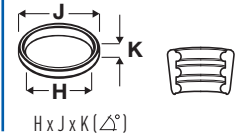
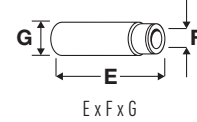

5 **72.00**

| | | | | | | | |
|-----------------------|-----------------|------------|-----------------|-----------|--------|----------------------|----------------|
| AHT | 997cc | 4 Cyl. | 8 Valves | 37kW/50PS | Petrol | OHV | TD11467 |
| LUPD 1.0 | 10/1998→05/2000 | | | | | | |
| V94418 | 047 198 601D | | 45° | Y | H | VAG96041B | |
| 34.00 x 7.00 x 101.40 | | MB cr | | | | 36.50 x 7.00 x 12.08 | |
| V94419 | 047 109 611D | | 45° | ss | H | VAG96062B | |
| 30.00 x 7.00 x 101.40 | | MD + MB cr | | | | 33.00 x 7.02 x 15.00 | |

6 **74.50**

| | | | | | | | |
|-----------------------|--------------|--------|------------------|-----------|----------|-------------|----------------|
| CHYA | 999cc | 3 Cyl. | 12 Valves | 44kW/60PS | Petrol | DOHC | TD26238 |
| CHYB | 999cc | 3 Cyl. | 12 Valves | 55kW/75PS | Petrol | DOHC | TD26239 |
| LOAD UP 1.0 | 12/2014→ | | | POLO 1.0 | 01/2014→ | | |
| UP 1.0 | 08/2011→ | | | | | | |
| V95237 | 04E 109 601 | | 45° | | H | | |
| 29.50 x 5.00 x 110.23 | | MB | | | | | |
| V95238 | 04E 109 611L | | 30° | | | | |
| 26.90 x 5.00 x 110.30 | | MD cr | | | | | |

7 **74.50**

| | | | | | | | |
|--------------------------|-----------------|--------|------------------|-----------------------|-----------------|-------------------------------|----------------|
| CHPA | 1395cc | 4 Cyl. | 16 Valves | 103kW/140PS | Petrol | Turbo, DOHC, Injection | TD27194 |
| CHPB | 1395cc | 4 Cyl. | 16 Valves | 110kW/150PS | Petrol | Turbo, DOHC, Injection | TD27858 |
| CMBA | 1395cc | 4 Cyl. | 16 Valves | 90kW/122PS | Petrol | Turbo, DOHC, Injection | TD27191 |
| CNLA | 1395cc | 4 Cyl. | 16 Valves | 110kW/150PS | Petrol | Turbo, DOHC, Injection | TD26572 |
| CPTA | 1395cc | 4 Cyl. | 16 Valves | 103kW/140PS | Petrol | Turbo, DOHC, Injection | TD26902 |
| CPVA | 1395cc | 4 Cyl. | 16 Valves | 90kW/122PS | Petrol | Turbo, DOHC, Injection | TD27201 |
| CPWA | 1395cc | 4 Cyl. | 16 Valves | 81kW/110PS | Petrol | Turbo, DOHC, Injection | TD28099 |
| CRJA | 1395cc | 4 Cyl. | 16 Valves | 110kW/150PS | Petrol | Turbo, DOHC, Injection | TD26924 |
| CUKA | 1395cc | 4 Cyl. | 16 Valves | 90kW/122PS | Petrol | Turbo, DOHC, Injection | TD27192 |
| CUKB | 1395cc | 4 Cyl. | 16 Valves | 110kW/150PS | Petrol | Turbo, DOHC, Injection | TD29283 |
| CXSA | 1395cc | 4 Cyl. | 16 Valves | 90kW/122PS | Petrol | Turbo, DOHC, Injection | TD27193 |
| CXSB | 1395cc | 4 Cyl. | 16 Valves | 92kW/125PS | Petrol | Turbo, DOHC, Injection | TD27857 |
| CZCA | 1395cc | 4 Cyl. | 16 Valves | 92kW/125PS | Petrol | Turbo, DOHC, Injection | TD29248 |
| CZDA | 1395cc | 4 Cyl. | 16 Valves | 110kW/150PS | Petrol | Turbo, DOHC, Injection | TD29249 |
| CZEA | 1395cc | 4 Cyl. | 16 Valves | 110kW/150PS | Petrol | Turbo, DOHC, Injection | TD29242 |
| BEETLE 1.4 TSI | 12/2014→ | | | CADDY Box 1.4 TGI CNG | 06/2015→ | | |
| CADDY Estate 1.4 TGI CNG | 06/2015→ | | | CADDY IV 1.4 TGI CNG | 06/2015→ | | |
| CC 1.4 TSI | 05/2015→12/2016 | | | GOLF 1.4 TSI | 02/2014→ | | |
| GOLF VI 1.4 TSI | 11/2013→ | | | GOLF VII 1.4 GTE | 05/2014→ | | |
| GOLF VII 1.4 TGI CNG | 06/2013→ | | | GOLF VII 1.4 TSI | 08/2012→ | | |
| JETTA IV 1.4 TSI | 04/2011→ | | | PASSAT 1.4 TSI | 11/2014→ | | |
| POLO 1.4 TSI | 10/2012→ | | | SCIROCCO 1.4 TSI | 11/2013→11/2017 | | |
| SHARAN 1.4 TSI | 05/2015→ | | | TIGUAN 1.4 TSI | 05/2015→ | | |
| TOURAN 1.4 TSI | 05/2015→ | | | | | | |

| | | | | | | | |
|-----------------------|--------------|---------|-----|----|---|--|--|
| V95192 | 04E 109 601B | | 45° | Y | H | | |
| 28.45 x 4.70 x 110.30 | | MB | | | | | |
| V95193 | 04E 109 611J | | 30° | ss | H | | |
| 25.00 x 4.97 x 110.15 | | MD + MB | | | | | |

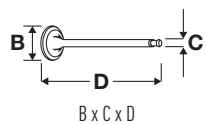

OE

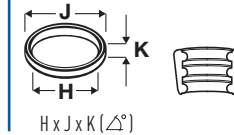
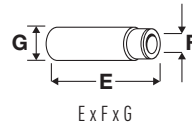
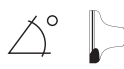

8 **75.00**

| AAK | 1043cc | 4 Cyl. | 8 Valves | 33kW/45PS | Petrol | SOHC | TD4003 |
|----------------------|-----------------|---------|------------------|-----------|----------------------|------|--------|
| ACM | 1043cc | 4 Cyl. | 8 Valves | 33kW/45PS | Petrol | SOHC | TD4013 |
| POLO 1.0 Cat | 08/1989→09/1994 | | POLO CLASSIC 1.0 | | 01/1985→09/1994 | | |
| V91332 | 030 109 601F | | 45° | | VAG92061B | | |
| 36.10 x 7.97 x 99.30 | | MD | | | 36.70 x 8.00 x 12.08 | | |
| V94305 | 030 109 601E | | 45° | SS | | | |
| 32.00 x 8.00 x 99.30 | | MD cr | | | | | |
| V91473 | 030 109 611A | | 45° | SS | H | | |
| 29.00 x 7.95 x 99.10 | | MD + MB | | | | | |

9 **75.00**

| AAU | 1043cc | 4 Cyl. | 8 Valves | 33kW/45PS | Petrol | SOHC | TD4971 |
|----------------------|-----------------|---------|--------------|-----------|-----------------|----------------------|--------|
| POLO 1.0 | 08/1992→07/1994 | | POLO 1.0 Cat | | 08/1989→09/1994 | | |
| POLO CLASSIC 1.0 | 01/1985→09/1994 | | | | | | |
| V94305 | 030 109 601E | | 45° | SS | | VAG92061B | |
| 32.00 x 8.00 x 99.30 | | MD cr | | | | 36.70 x 8.00 x 12.08 | |
| V94715 | 030 109 601N | | 45° | Y | H | VAG96161B | |
| 32.00 x 6.90 x 99.00 | | MB | | | | 36.50 x 7.00 x 11.80 | |
| 08/94→ | | | | | | | |
| V91473 | 030 109 611A | | 45° | SS | H | | |
| 29.00 x 7.95 x 99.10 | | MD + MB | | | | | |

10 **75.00**

| AEV | 1043cc | 4 Cyl. | 8 Valves | 33kW/45PS | Petrol | SOHC | TD4021 |
|----------------------|-----------------|--------|-------------|-----------|-----------------|----------------------|--------|
| POLO 1.0 | 10/1994→12/1999 | | POLO 45 1.0 | | 10/1994→09/1996 | | |
| V94308 | 030 109 601G | | 45° | Y | H | VAG96161B | |
| 34.00 x 7.00 x 99.10 | | MB | | | | 36.50 x 7.00 x 11.80 | |
| V94715 | 030 109 601N | | 45° | Y | H | | |
| 32.00 x 6.90 x 99.00 | | MB | | | | | |
| V94309 | 030 109 611D | | 45° | | | | |
| 29.00 x 7.00 x 99.00 | | MD | | | | | |

11 **75.00**

| GL | 1043cc | 4 Cyl. | 8 Valves | 29kW/40PS | Petrol | SOHC | TD5006 |
|-----------------------|-----------------|--------|----------|-----------|----------------------|------|--------|
| DERBY 1.0 | 10/1981→12/1984 | | POLO 1.0 | | 10/1981→10/1986 | | |
| POLO CLASSIC 1.0 | 01/1985→10/1986 | | | | | | |
| V90327 | 036 109 611 | | 45° | | VAG92105B | | |
| 28.14 x 7.95 x 110.00 | | MD | | | 42.30 x 7.99 x 12.08 | | |

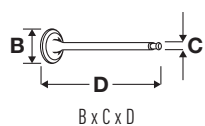

OE

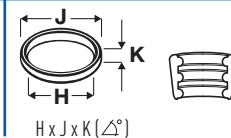
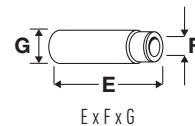

12 **75.00**

| HZ | 1043cc | 4 Cyl. | 8 Valves | 33-37kW/45-50PS | Petrol | SOHC | TD5012 |
|------------------|--------|--------|----------|-----------------|--------|------|-----------------|
| GOLF II 1.0 | | | | | | | 08/1985→10/1991 |
| POLO CLASSIC 1.0 | | | | | | | 01/1985→09/1994 |
| | | | | POLO 1.0 | | | 08/1985→01/1992 |

| | | | | | | | |
|----------------------|--------------|---------|-----|----|---|----------------------|--|
| V91332 | 030 109 601F | | 45° | | | VAG92061B | |
| 36.10 x 7.97 x 99.30 | | MD | | | | 36.70 x 8.00 x 12.08 | |
| V94580 | 030 109 601C | | 45° | H | | | |
| 36.00 x 7.97 x 98.85 | | MB | | | | | |
| V91473 | 030 109 611A | | 45° | SS | H | | |
| 29.00 x 7.95 x 99.10 | | MD + MB | | | | | |

13 **75.00**

| 2G | 1272cc | 4 Cyl. | 8 Valves | 40kW/54PS | Petrol | SOHC | TD4964 |
|------------------|--------|--------|----------|--------------|--------|------|-----------------|
| GOLF II 1.3 Cat | | | | | | | 06/1986→12/1992 |
| JETTA II 1.3 Cat | | | | | | | 06/1987→12/1991 |
| | | | | GOLF III 1.3 | | | 08/1991→07/1992 |
| | | | | POLO 1.3 Cat | | | 07/1987→09/1994 |

| | | | | | | | |
|----------------------|--------------|---------|-----|----|---|----------------------|--|
| V91332 | 030 109 601F | | 45° | | | VAG92061B | |
| 36.10 x 7.97 x 99.30 | | MD | | | | 36.70 x 8.00 x 12.08 | |
| V94580 | 030 109 601C | | 45° | H | | | |
| 36.00 x 7.97 x 98.85 | | MB | | | | | |
| V91473 | 030 109 611A | | 45° | SS | H | | |
| 29.00 x 7.95 x 99.10 | | MD + MB | | | | | |

14 **75.00**

| 3F | 1272cc | 4 Cyl. | 8 Valves | 55-57kW/75-78PS | Petrol | SOHC | TD4968 |
|----------------------|--------|--------|----------|-------------------|--------|--------------------|-----------------|
| AAV | 1272cc | 4 Cyl. | 8 Valves | 40kW/55PS | Petrol | SOHC | TD5159 |
| MH | 1272cc | 4 Cyl. | 8 Valves | 40kW/55PS | Petrol | SOHC | TD4131 |
| PY | 1272cc | 4 Cyl. | 8 Valves | 83-85kW/113-115PS | Petrol | Supercharged, SOHC | TD5023 |
| GOLF II 1.3 | | | | | | | 08/1983→06/1987 |
| JETTA II 1.3 | | | | | | | 01/1984→06/1987 |
| POLO 1.3 | | | | | | | 08/1983→09/1994 |
| POLO 1.3 G40 | | | | | | | 01/1987→09/1994 |
| POLO CLASSIC 1.3 Cat | | | | | | | 07/1987→09/1994 |
| | | | | GOLF II 1.3 Cat | | | 06/1986→12/1992 |
| | | | | JETTA II 1.3 Cat | | | 06/1987→12/1991 |
| | | | | POLO 1.3 Cat | | | 07/1987→09/1994 |
| | | | | POLO CLASSIC 1.3 | | | 01/1985→07/1987 |

| | | | | | | | |
|----------------------|--------------|---------|-----|----|---|----------------------|--|
| V91332 | 030 109 601F | | 45° | | | VAG92061B | |
| 36.10 x 7.97 x 99.30 | | MD | | | | 36.70 x 8.00 x 12.08 | |
| V94305 | 030 109 601E | | 45° | SS | | | |
| 32.00 x 8.00 x 99.30 | | MD cr | | | | | |
| V91473 | 030 109 611A | | 45° | SS | H | | |
| 29.00 x 7.95 x 99.10 | | MD + MB | | | | | |

15 **75.00**

| GK | 1272cc | 4 Cyl. | 8 Valves | 55kW/75PS | Petrol | SOHC | TD4094 |
|--------------|--------|--------|----------|------------------|--------|------|-----------------|
| HK | 1272cc | 4 Cyl. | 8 Valves | 40kW/55PS | Petrol | SOHC | TD5011 |
| DERBY 1.3 | | | | | | | 09/1982→12/1984 |
| GOLF II 1.3 | | | | | | | 08/1983→06/1987 |
| POLO 1.3 | | | | | | | 09/1982→09/1989 |
| SCIROCCO 1.3 | | | | | | | 08/1983→07/1984 |
| | | | | GOLF I 1.3 | | | 08/1983→07/1986 |
| | | | | JETTA II 1.3 | | | 01/1984→06/1987 |
| | | | | POLO CLASSIC 1.3 | | | 01/1985→07/1987 |

| | | | | | | | |
|-----------------------|-------------|----|-----|--|--|----------------------|--|
| V90327 | 036 109 611 | | 45° | | | VAG92105B | |
| 28.14 x 7.95 x 110.00 | | MD | | | | 42.30 x 7.99 x 12.08 | |

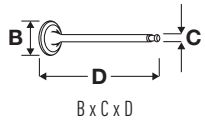

OE

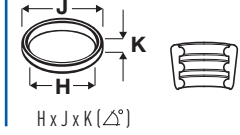
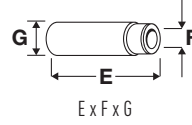
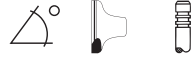

16 **75.00**

| MN | 1272cc | 4 Cyl. | 8 Valves | 33kW/44PS | Diesel | SOHC | TD4132 |
|---------------------------------------|-----------------|-------------|----------------|--|--------|-----------------|--------|
| POLO 1.3 D | 08/1986→08/1990 | | | POLO CLASSIC 1.3 D | | 08/1986→12/1988 | |
| V91473 29.00 x 7.95 x 99.10 | 030 109 611A | MD + MB | 45° ss H | VAG92061B 36.70 x 8.00 x 12.08 | | | |

17 **75.00**

| NU | 1272cc | 4 Cyl. | 8 Valves | 37kW/50PS | Petrol | SOHC | TD4135 |
|---------------------------------------|-----------------|-------------|----------------|--|--------|------|--------|
| GOLF II 1.3 | 08/1985→12/1987 | | | | | | |
| V91332 36.10 x 7.97 x 99.30 | 030 109 601F | MD | 45° | VAG92061B 36.70 x 8.00 x 12.08 | | | |
| V91473 29.00 x 7.95 x 99.10 | 030 109 611A | MD + MB | 45° ss H | | | | |

18 **75.00**

| NZ | 1272cc | 4 Cyl. | 8 Valves | 40kW/55PS | Petrol | SOHC | TD4136 |
|---------------------------------------|-----------------|-------------|----------------|--|--------|-----------------|--------|
| GOLF II 1.3 Cat | 06/1986→12/1992 | | | JETTA II 1.3 Cat | | 06/1987→12/1991 | |
| POLO 1.3 Cat | 07/1987→09/1994 | | | POLO CLASSIC 1.3 Cat | | 07/1987→09/1994 | |
| V91332 36.10 x 7.97 x 99.30 | 030 109 601F | MD | 45° | VAG92061B 36.70 x 8.00 x 12.08 | | | |
| V94305 32.00 x 8.00 x 99.30 | 030 109 601E | MD cr | 45° ss | | | | |
| V94580 36.00 x 7.97 x 98.85 | 030 109 601C | MB | 45° H | | | | |
| V91473 29.00 x 7.95 x 99.10 | 030 109 611A | MD + MB | 45° ss H | | | | |

19 **75.00**

| ABD | 1390cc | 4 Cyl. | 8 Valves | 40-44kW/55-60PS | Petrol | SOHC | TD4973 |
|---------------------------------------|-----------------|-------------|----------------|--|--------|-----------------|--------|
| GOLF III 1.4 | 10/1991→04/1999 | | | VENTO 1.4 | | 11/1991→09/1998 | |
| V91332 36.10 x 7.97 x 99.30 | 030 109 601F | MD | 45° | VAG92061B 36.70 x 8.00 x 12.08 | | | |
| V94305 32.00 x 8.00 x 99.30 | 030 109 601E | MD cr | 45° ss | VAG96161B 36.50 x 7.00 x 11.80 | | | |
| V94308 34.00 x 7.00 x 99.10 | 030 109 601G | MB | 45° Y H | | | | |
| V91473 29.00 x 7.95 x 99.10 | 030 109 611A | MD + MB | 45° ss H | | | | |
| V94309 29.00 x 7.00 x 99.00 | 030 109 611D | MD | 45° | | | | |

20 **75.00**

| 1W | 1398cc | 4 Cyl. | 8 Valves | 35kW/48PS | Diesel | SOHC | TD4959 |
|---------------------------------------|-----------------|-------------|----------------|--|--------|-----------------|--------|
| POLO 1.4 D | 08/1990→09/1994 | | | POLO CLASSIC 1.4 D | | 10/1990→09/1994 | |
| V91473 29.00 x 7.95 x 99.10 | 030 109 611A | MD + MB | 45° ss H | VAG92061B 36.70 x 8.00 x 12.08 | | | |



OE

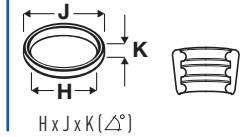
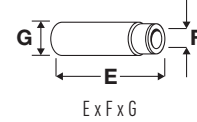

21 **76.50**

| | | | | | | | |
|------|--------|--------|----------|-----------|--------|------|---------|
| AWY | 1198cc | 3 Cyl. | 6 Valves | 40kW/54PS | Petrol | SOHC | TD16334 |
| BBM | 1198cc | 3 Cyl. | 6 Valves | 44kW/60PS | Petrol | SOHC | TD20142 |
| BMD | 1198cc | 3 Cyl. | 6 Valves | 40kW/54PS | Petrol | SOHC | TD18155 |
| CHFA | 1198cc | 3 Cyl. | 6 Valves | 44kW/60PS | Petrol | SOHC | TD23101 |
| CHFB | 1198cc | 3 Cyl. | 6 Valves | 40kW/54PS | Petrol | SOHC | TD24054 |

| | | | |
|----------------------|--------------|----------|----------------------|
| FOX 1.2 | 04/2005→ | POLO 1.2 | 01/2002→11/2009 |
| V94646 | 032 109 601M | MB | 45° Y H |
| 34.50 x 6.00 x 99.10 | | | |
| V94405 | 030 109 611T | MD + MB | 45° ss H |
| 28.00 x 6.00 x 99.10 | | | |
| VAG96073B | | | 36.00 x 6.02 x 11.06 |

22 **76.50**

| | | | | | | | |
|------|--------|--------|-----------|-----------|--------|------|---------|
| AZQ | 1198cc | 3 Cyl. | 12 Valves | 47kW/64PS | Petrol | DOHC | TD16333 |
| BME | 1198cc | 3 Cyl. | 12 Valves | 47kW/64PS | Petrol | DOHC | TD18156 |
| BZG | 1198cc | 3 Cyl. | 12 Valves | 51kW/69PS | Petrol | DOHC | TD20141 |
| CGPA | 1198cc | 3 Cyl. | 12 Valves | 51kW/70PS | Petrol | DOHC | TD23102 |
| CGPB | 1198cc | 3 Cyl. | 12 Valves | 44kW/60PS | Petrol | DOHC | TD23100 |

| | | | |
|-----------------------|--------------|--------------|----------------------|
| POLO 1.2 | 06/2009→ | POLO 1.2 12V | 10/2001→11/2009 |
| V94116 | 036 109 601S | MB | 45° Y H |
| 29.50 x 6.00 x 100.90 | | | |
| V94117 | 036 109 611K | MD + MB | 45° |
| 26.00 x 6.00 x 100.50 | | | |
| VAG96073B | | | 36.00 x 6.02 x 11.06 |

23 **76.50**

| | | | | | | | |
|-----|--------|--------|----------|-----------|--------|------|--------|
| ADX | 1296cc | 4 Cyl. | 8 Valves | 40kW/55PS | Petrol | SOHC | TD4017 |
|-----|--------|--------|----------|-----------|--------|------|--------|

| | | | |
|----------------------|-----------------|---------|----------------------|
| POLO 55 1.3 | 10/1994→07/1995 | | |
| V94115 | 032 109 611G | MD + MB | 45° H |
| 29.00 x 7.00 x 95.00 | | | |
| VAG96062B | | | 33.00 x 7.02 x 15.00 |

24 **76.50**

| | | | | | | | |
|-----|--------|--------|----------|-----------------|--------|------|---------|
| AEX | 1390cc | 4 Cyl. | 8 Valves | 40-44kW/55-60PS | Petrol | SOHC | TD4984 |
| AKV | 1390cc | 4 Cyl. | 8 Valves | 44kW/60PS | Petrol | SOHC | TD9688 |
| ANX | 1390cc | 4 Cyl. | 8 Valves | 40kW/54PS | Petrol | SOHC | TD15613 |
| APQ | 1390cc | 4 Cyl. | 8 Valves | 44kW/60PS | Petrol | SOHC | TD15614 |

| | | | |
|---------------------|-----------------|---------------------|-----------------|
| CADDY II 1.4 | 11/1995→01/2004 | CADDY II 60 1.4 | 11/1995→01/2004 |
| GOLF III 1.4 | 10/1991→04/1999 | POLO 1.4 | 05/1997→09/2001 |
| POLO 55 1.4 | 08/1995→10/1999 | POLO 60 1.4 | 07/1995→10/1999 |
| POLO CLASSIC 54 1.4 | 01/1998→08/1999 | POLO CLASSIC 60 1.4 | 12/1995→09/2001 |
| VENTO 1.4 | 11/1991→09/1998 | | |

| | | | |
|----------------------|---------------|---------|----------------------|
| V94114 | 030 109 601AH | MB cr | 45° H |
| 35.60 x 7.00 x 94.70 | | | |
| V94115 | 032 109 611G | MD + MB | 45° H |
| 29.00 x 7.00 x 95.00 | | | |
| VAG96062B | | | 33.00 x 7.02 x 15.00 |

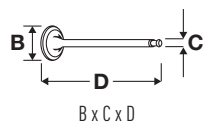

OE

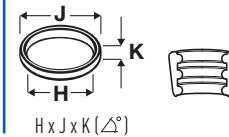
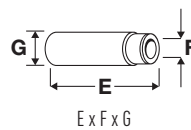

25



76.50

| | | | | | | | |
|------------------|--------|-----------------|-----------|------------|--------|------|--------|
| AFH | 1390cc | 4 Cyl. | 16 Valves | 74kW/100PS | Petrol | DOHC | TD4986 |
| POLO 100 1.4 16V | | 04/1996→10/1999 | | | | | |

V94247 ■
29.50 x 6.00 x 97.90

036 109 601P

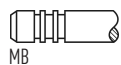

45°

Y

H

VAG96073B ■ ■ ■
36.00 x 6.02 x 11.06



V94248 ■
26.00 x 6.00 x 97.30

036 109 611L



45°

H

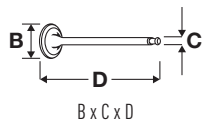

OE

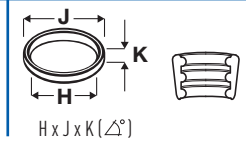
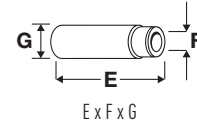

26  76.50

| | | | | | | | |
|-------------------|-----------------|--------|-----------|-------------------------|-----------------|------------------------|---------|
| AFK | 1390cc | 4 Cyl. | 16 Valves | 74kW/101PS | Petrol | DOHC | TD12028 |
| AHW | 1390cc | 4 Cyl. | 16 Valves | 55kW/75PS | Petrol | DOHC | TD9453 |
| AKQ | 1390cc | 4 Cyl. | 16 Valves | 55kW/75PS | Petrol | DOHC | TD9454 |
| ANM | 1390cc | 4 Cyl. | 16 Valves | 74kW/101PS | Petrol | DOHC | TD13470 |
| APE | 1390cc | 4 Cyl. | 16 Valves | 55kW/75PS | Petrol | DOHC | TD13468 |
| AQQ | 1390cc | 4 Cyl. | 16 Valves | 74kW/101PS | Petrol | DOHC | TD13469 |
| AUA | 1390cc | 4 Cyl. | 16 Valves | 55kW/75PS | Petrol | DOHC | TD13771 |
| AUB | 1390cc | 4 Cyl. | 16 Valves | 74kW/101PS | Petrol | DOHC | TD13772 |
| AXP | 1390cc | 4 Cyl. | 16 Valves | 55kW/75PS | Petrol | DOHC | TD15474 |
| AXU | 1390cc | 4 Cyl. | 16 Valves | 63kW/86PS | Petrol | DOHC, Injection | TD16430 |
| BBY | 1390cc | 4 Cyl. | 16 Valves | 55kW/75PS | Petrol | DOHC | TD16335 |
| BBZ | 1390cc | 4 Cyl. | 16 Valves | 74kW/101PS | Petrol | DOHC | TD16540 |
| BCA | 1390cc | 4 Cyl. | 16 Valves | 55kW/75PS | Petrol | DOHC | TD16386 |
| BKG | 1390cc | 4 Cyl. | 16 Valves | 66kW/90PS | Petrol | DOHC, Injection | TD17181 |
| BKY | 1390cc | 4 Cyl. | 16 Valves | 55kW/75PS | Petrol | DOHC | TD18154 |
| BLG | 1390cc | 4 Cyl. | 16 Valves | 125kW/170PS | Petrol | Turbo, DOHC, Injection | TD18470 |
| BLN | 1390cc | 4 Cyl. | 16 Valves | 66kW/90PS | Petrol | DOHC, Injection | TD18911 |
| BMY | 1390cc | 4 Cyl. | 16 Valves | 103kW/140PS | Petrol | Turbo, DOHC, Injection | TD18910 |
| BUD | 1390cc | 4 Cyl. | 16 Valves | 59kW/80PS | Petrol | DOHC | TD18909 |
| BWK | 1390cc | 4 Cyl. | 16 Valves | 110kW/150PS | Petrol | Turbo, DOHC, Injection | TD20734 |
| CAVA | 1390cc | 4 Cyl. | 16 Valves | 110kW/150PS | Petrol | Turbo, DOHC, Injection | TD22452 |
| CAVB | 1390cc | 4 Cyl. | 16 Valves | 125kW/170PS | Petrol | Turbo, DOHC, Injection | TD22173 |
| CAVC | 1390cc | 4 Cyl. | 16 Valves | 103kW/140PS | Petrol | Turbo, DOHC, Injection | TD22174 |
| CAVD | 1390cc | 4 Cyl. | 16 Valves | 118kW/160PS | Petrol | Turbo, DOHC, Injection | TD20792 |
| CAVE | 1390cc | 4 Cyl. | 16 Valves | 132kW/180PS | Petrol | Turbo, DOHC, Injection | TD24000 |
| CAXA | 1390cc | 4 Cyl. | 16 Valves | 90kW/122PS | Petrol | Turbo, DOHC, Injection | TD20606 |
| CGGA | 1390cc | 4 Cyl. | 16 Valves | 59kW/80PS | Petrol | DOHC | TD20791 |
| BEETLE 1.4 TSI | 10/2011→ | | | BORA 1.4 16V | 03/2000→05/2005 | | |
| CADDY II 1.4 | 08/2000→01/2004 | | | CADDY II 1.4 16V | 08/2000→01/2004 | | |
| CADDY III 1.4 | 03/2004→08/2010 | | | EOS 1.4 TSI | 11/2007→08/2015 | | |
| GOLF IV 1.4 16V | 08/1997→06/2006 | | | GOLF V 1.4 | 06/2007→07/2009 | | |
| GOLF V 1.4 16V | 10/2003→11/2008 | | | GOLF V 1.4 FSI | 10/2003→07/2006 | | |
| GOLF V 1.4 TSI | 11/2005→07/2009 | | | GOLF VI 1.4 | 10/2008→07/2013 | | |
| GOLF VI 1.4 TSI | 10/2008→ | | | GOLF PLUS 1.4 16V | 01/2005→12/2013 | | |
| GOLF PLUS 1.4 FSI | 07/2005→11/2006 | | | GOLF PLUS 1.4 TSI | 05/2006→12/2013 | | |
| JETTA III 1.4 TSI | 07/2006→10/2010 | | | JETTA IV 1.4 TSI | 04/2011→ | | |
| LUPO 1.4 16V | 09/1998→07/2005 | | | NEW BEETLE 1.4 | 11/2001→09/2010 | | |
| PASSAT 1.4 TSI | 05/2007→12/2014 | | | POLO 1.4 | 07/2003→ | | |
| POLO 1.4 16V | 10/1999→11/2009 | | | POLO 1.4 FSI | 02/2002→07/2006 | | |
| POLO 1.4 GTI | 05/2010→ | | | POLO CLASSIC 75 1.4 16V | 10/1999→09/2001 | | |
| SCIROCCO 1.4 TSI | 05/2008→11/2017 | | | SHARAN 1.4 TSI | 05/2010→ | | |
| TIGUAN 1.4 TSI | 09/2007→ | | | TOURAN 1.4 FSI | 11/2006→05/2010 | | |
| TOURAN 1.4 TSI | 02/2006→05/2015 | | | | | | |

V94116 
29.50 x 6.00 x 100.90

036 109 601S

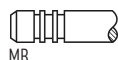

45° Y H

VAG96073B 
36.00 x 6.02 x 111.06



V94117 
26.00 x 6.00 x 100.50

036 109 611K

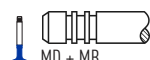

45°



OE

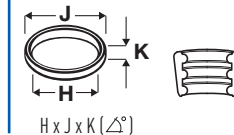

27 **76.50**

| | | | | | | | |
|---------------------|-----------------|--------|-----------------|-----------------|-----------------|-------------|----------------|
| AKK | 1390cc | 4 Cyl. | 8 Valves | 44kW/60PS | Petrol | SOHC | TD13768 |
| AKP | 1390cc | 4 Cyl. | 8 Valves | 40kW/54PS | Petrol | SOHC | TD14168 |
| ANW | 1390cc | 4 Cyl. | 8 Valves | 44kW/60PS | Petrol | SOHC | TD15568 |
| AUD | 1390cc | 4 Cyl. | 8 Valves | 44kW/60PS | Petrol | SOHC | TD13770 |
| CADDY II 1.4 | 11/1995→01/2004 | | | CADDY II 60 1.4 | 11/1995→01/2004 | | |
| LUPO 1.4 | 10/2000→07/2005 | | | POLO 1.4 | 05/1997→09/2001 | | |
| POLO CLASSIC 60 1.4 | 12/1995→09/2001 | | | | | | |

V94404
33.50 x 6.00 x 99.10

030 109 601AL



VAG96073B
36.00 x 6.02 x 11.06

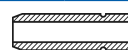

V94405
28.00 x 6.00 x 99.10

030 109 611T

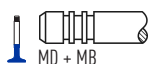

28 **76.50**

| | | | | | | | |
|-------------------|-----------------|--------|------------------|------------------|-----------------|-------------------------------|----------------|
| ARR | 1390cc | 4 Cyl. | 16 Valves | 77kW/105PS | Petrol | DOHC, Injection | TD15492 |
| CNWA | 1390cc | 4 Cyl. | 16 Valves | 118kW/160PS | Petrol | Turbo, DOHC, Injection | TD24834 |
| CTHD | 1390cc | 4 Cyl. | 16 Valves | 118kW/160PS | Petrol | Turbo, DOHC, Injection | TD26574 |
| CTKA | 1390cc | 4 Cyl. | 16 Valves | 118kW/160PS | Petrol | Turbo, DOHC, Injection | TD26695 |
| BEETLE 1.4 TSI | 10/2011→ | | | CC 1.4 TSI | 11/2011→12/2016 | | |
| EOS 1.4 TSI | 05/2008→08/2015 | | | GOLF VI 1.4 TSI | 10/2008→ | | |
| GOLF PLUS 1.4 TSI | 06/2008→12/2013 | | | JETTA IV 1.4 TSI | 04/2011→ | | |
| LUPO 1.4 FSI | 02/2001→07/2005 | | | PASSAT 1.4 TSI | 11/2012→12/2014 | | |
| SCIROCCO 1.4 TSI | 05/2008→11/2017 | | | TIGUAN 1.4 TSI | 05/2011→ | | |

V94647
29.55 x 6.00 x 100.90

036 109 601AD

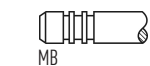

VAG96073B
36.00 x 6.02 x 11.06



V94117
26.00 x 6.00 x 100.50

036 109 611K

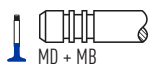

29 **76.50**

| | | | | | | | |
|------------|-----------------|--------|-----------------|-----------|--------|-------------|----------------|
| BLM | 1390cc | 4 Cyl. | 8 Valves | 61kW/83PS | Petrol | SOHC | TD21076 |
| POLO 1.4 | 08/2002→11/2009 | | | | | | |

V94646
34.50 x 6.00 x 99.10

032 109 601M



VAG96073B
36.00 x 6.02 x 11.06



V94405
28.00 x 6.00 x 99.10

030 109 611T

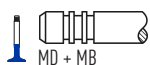

30 **76.50**

| | | | | | | | |
|-------------------|-----------------|--------|------------------|----------------|-----------------|-------------------------------|----------------|
| CDGA | 1390cc | 4 Cyl. | 16 Valves | 110kW/150PS | Petrol | Turbo, DOHC, Injection | TD22222 |
| CKMA | 1390cc | 4 Cyl. | 16 Valves | 118kW/160PS | Petrol | Turbo, DOHC, Injection | TD25401 |
| CMAA | 1390cc | 4 Cyl. | 16 Valves | 60kW/82PS | Petrol | DOHC | TD25705 |
| CC 1.4 TSI | 11/2011→12/2016 | | | PASSAT 1.4 TSI | 01/2009→12/2014 | | |
| PASSAT CC 1.4 TSI | 01/2011→01/2012 | | | POLO 1.4 | 03/2010→01/2011 | | |
| TOURAN 1.4 TSI | 05/2009→05/2015 | | | | | | |

V80010
29.50 x 6.00 x 100.60

03C 109 601L



V80011
26.00 x 6.00 x 100.60

03C 109 611Q

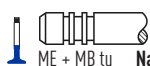





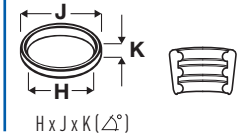
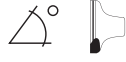











OE







31  **76.50**

| CGGB | 1390cc | 4 Cyl. | 16 Valves | 63kW/85PS | Petrol | DOHC | TD23103 |
|---|--------------|---|-----------|-----------|--------|--|---------|
| POLO 1.4 | | 03/2009→05/2014 | | | | | |
| V80010  | 03C 109 601L |  | 45° | ss | | VAG96073B  | |
| 29.50 x 6.00 x 100.60 | | MB tu | | | | 36.00 x 6.02 x 11.06 | |
| V94116  | 036 109 601S |  | 45° | Y | H | | |
| 29.50 x 6.00 x 100.90 | | MB | | | | | |
| V80011  | 03C 109 611Q |  | 45° | ss | | | |
| 26.00 x 6.00 x 100.60 | | ME + MB tu Na | | | | | |
| V94117  | 036 109 611K |  | 45° | | | | |
| 26.00 x 6.00 x 100.50 | | MD + MB | | | | | |





32  **76.50**

| BSV | 1423cc | 4 Cyl. | 8 Valves | 54kW/73PS | Petrol | SOHC | TD26799 |
|---|--------------|---|----------|-----------|--------|---|---------|
| CITYGOLF 1.4 | | 02/2002→08/2009 | | | | | |
| V94649  | 038 109 601E |  | 45° | Y | H | VAG96041B  | |
| 36.00 x 7.00 x 89.40 | | MB | | | | 36.50 x 7.00 x 12.08 | |
| V94650  | 038 109 611E |  | 45° | ss | H | | |
| 31.40 x 7.00 x 89.00 | | MD + MB | | | | | |





33  **76.50**

| AHS | 1588cc | 4 Cyl. | 8 Valves | 55kW/75PS | Petrol | SOHC | TD12992 |
|---|---------------|---|----------|-----------|--------|--|---------|
| POLO 75 1.6 | | 10/1994→10/1999 | | | | | |
| V94114  | 030 109 601AH |  | 45° | | H | VAG96062B  | |
| 35.60 x 7.00 x 94.70 | | MB cr | | | | 33.00 x 7.02 x 15.00 | |
| V94115  | 032 109 611G |  | 45° | | H | | |
| 29.00 x 7.00 x 95.00 | | MD + MB | | | | | |

34  **76.50**

| CR | 1588cc | 4 Cyl. | 8 Valves | 39-40kW/52-54PS | Diesel | SOHC | TD4992 |
|---|--------------|---|----------|-----------------|--------|--|--------|
| GOLF I 1.6 D | | 08/1980→07/1983 | | JETTA I 1.6 D | | 08/1980→12/1984 | |
| PASSAT 1.6 D | | 02/1979→03/1988 | | SANTANA 1.6 D | | 08/1981→12/1984 | |
| V90179  | 068 109 601C |  | 45° | | H | VAG92061B  | |
| 34.00 x 7.97 x 104.80 | | MB | | | | 36.70 x 8.00 x 12.08 | |
| V90180  | 068 109 611C |  | 45° | | | | |
| 31.32 x 7.94 x 104.60 | | MD | | | | | |

35  **76.50**

| CS | 1588cc | 4 Cyl. | 8 Valves | 37kW/50PS | Diesel | SOHC | TD4048 |
|---|--------------|---|----------|-----------|--------|--|--------|
| TRANSPORTER III 1.6 D | | 01/1981→07/1987 | | | | | |
| V90179  | 068 109 601C |  | 45° | | H | VAG92061B  | |
| 34.00 x 7.97 x 104.80 | | MB | | | | 36.70 x 8.00 x 12.08 | |
| Ch.F24-B-152582→ | | | | | | | |
| V90180  | 068 109 611C |  | 45° | | | | |
| 31.32 x 7.94 x 104.60 | | MD | | | | | |
| Ch.F24-B-152582→ | | | | | | | |



OE

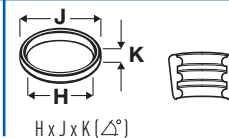
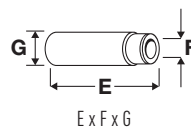

36 **76.50**

| CY | 1588cc | 4 Cyl. | 8 Valves | 51kW/70PS | Diesel | Turbo, SOHC | TD4052 |
|-----------------------|-----------------|---------|----------|----------------|--------|----------------------|--------|
| GOLF I 1.6 TD | 03/1982→07/1983 | | | JETTA I 1.6 TD | | 03/1982→02/1984 | |
| PASSAT 1.6 TD | 04/1982→03/1988 | | | SANTANA 1.6 TD | | 12/1981→12/1984 | |
| V91173 | 068 109 601D | | 45° | | | VAG92061B | |
| 34.00 x 7.97 x 104.80 | | MD | | | | 36.70 x 8.00 x 12.08 | |
| V91367 | 068 109 601N | | 45° | ss | H | | |
| 34.10 x 7.97 x 95.10 | | MD + MB | | | | | |
| V91174 | 068 109 611D | | 45° | ss | | | |
| 31.00 x 7.95 x 104.60 | | MD | | | | | |
| V91368 | 068 109 611L | | 45° | | H | | |
| 31.30 x 7.95 x 95.00 | | MD + MB | | | | | |
| V91409 | 068 109 611L | | 45° | | H | | |
| 31.30 x 7.95 x 95.10 | | MD + MB | | | | | |

37 **76.50**

| JK | 1588cc | 4 Cyl. | 8 Valves | 39-40kW/52-54PS | Diesel | SOHC | TD5013 |
|----------------------|-----------------|---------|----------|-----------------|--------|----------------------|--------|
| CADDY I 1.6 D | 08/1982→07/1992 | | | GOLF I 1.6 D | | 08/1980→07/1983 | |
| GOLF II 1.6 D | 08/1983→10/1991 | | | JETTA I 1.6 D | | 08/1980→12/1984 | |
| JETTA II 1.6 D | 01/1984→10/1991 | | | PASSAT 1.6 D | | 08/1980→03/1988 | |
| SANTANA 1.6 D | 08/1981→12/1984 | | | | | | |
| V91335 | 068 109 601L | | 45° | H | | VAG92061B | |
| 34.10 x 7.97 x 95.00 | | MB | | | | 36.70 x 8.00 x 12.08 | |
| V91368 | 068 109 611L | | 45° | | H | | |
| 31.30 x 7.95 x 95.00 | | MD + MB | | | | | |

38 **76.50**

| JR | 1588cc | 4 Cyl. | 8 Valves | 51kW/70PS | Diesel | Turbo, SOHC | TD4121 |
|----------------------|-----------------|---------|----------|-----------------|--------|----------------------|--------|
| MF | 1588cc | 4 Cyl. | 8 Valves | 51kW/70PS | Diesel | Turbo, SOHC | TD4130 |
| RA | 1588cc | 4 Cyl. | 8 Valves | 59kW/80PS | Diesel | Turbo, SOHC | TD5024 |
| SB | 1588cc | 4 Cyl. | 8 Valves | 59kW/80PS | Diesel | Turbo, SOHC | TD5028 |
| GOLF II 1.6 TD | 08/1983→10/1991 | | | JETTA II 1.6 TD | | 01/1984→10/1991 | |
| PASSAT 1.6 TD | 05/1986→09/1993 | | | SAVEIRO I 1.6 D | | 08/1991→07/1996 | |
| V91367 | 068 109 601N | | 45° | ss | H | VAG92061B | |
| 34.10 x 7.97 x 95.10 | | MD + MB | | | | 36.70 x 8.00 x 12.08 | |
| V91368 | 068 109 611L | | 45° | | H | | |
| 31.30 x 7.95 x 95.00 | | MD + MB | | | | | |
| V91409 | 068 109 611L | | 45° | | H | | |
| 31.30 x 7.95 x 95.10 | | MD + MB | | | | | |



OE

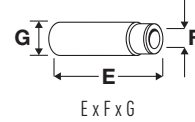
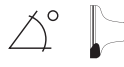



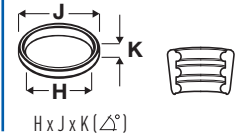

E x F x G



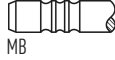
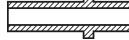

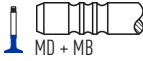



H x J x K (45°)



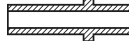

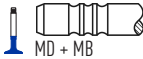
39  **76.50**

| ME | 1588cc | 4 Cyl. | 8 Valves | 40kW/55PS | Diesel | SOHC | TD4129 |
|--|--------------|---|----------|-----------|--------|---|----------------------|
| CADDY I 1.6 D | | | | | | | 08/1982→07/1992 |
| JETTA II 1.6 D | | | | | | | 01/1984→10/1991 |
| GOLF II 1.6 D | | | | | | | |
| V91335  | 068 109 601L |  | 45° | H | | VAG92061B  | 36.70 x 8.00 x 12.08 |
| 34.10 x 7.97 x 95.00 | | MB | | | | | |
| V91367  | 068 109 601N |  | 45° | SS | H | | |
| 34.10 x 7.97 x 95.10 | | MD + MB | | | | | |
| V91368  | 068 109 611L |  | 45° | H | | | |
| 31.30 x 7.95 x 95.00 | | MD + MB | | | | | |



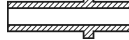

40  **76.50**

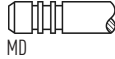
| 1V | 1589cc | 4 Cyl. | 8 Valves | 44kW/60PS | Diesel | Turbo, SOHC | TD3996 |
|--|--------------|---|----------|-----------|--------|---|----------------------|
| GOLF II 1.6 TD | | | | | | | 08/1989→10/1991 |
| JETTA II 1.6 TD | | | | | | | 01/1990→10/1991 |
| V91367  | 068 109 601N |  | 45° | SS | H | VAG92061B  | 36.70 x 8.00 x 12.08 |
| 34.10 x 7.97 x 95.10 | | MD + MB | | | | | |
| V91368  | 068 109 611L |  | 45° | H | | | |
| 31.30 x 7.95 x 95.00 | | MD + MB | | | | | |
| V91409  | 068 109 611L |  | 45° | H | | | |
| 31.30 x 7.95 x 95.10 | | MD + MB | | | | | |

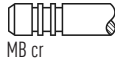
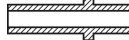

41  **76.50**

| JX | 1589cc | 4 Cyl. | 8 Valves | 51kW/69PS | Diesel | Turbo, SOHC | TD5018 |
|--|--------------|---|----------|-----------|--------|---|----------------------|
| TRANSPORTER III 1.6 TD | | | | | | | 08/1984→07/1992 |
| V91173  | 068 109 601D |  | 45° | | | VAG92061B  | 36.70 x 8.00 x 12.08 |
| 34.00 x 7.97 x 104.80 | | MD | | | | | |
| V91174  | 068 109 611D |  | 45° | SS | | | |
| 31.00 x 7.95 x 104.60 | | MD | | | | | |

42  **76.50**

| ABU | 1598cc | 4 Cyl. | 8 Valves | 55kW/75PS | Petrol | SOHC | TD4976 |
|--|---------------|---|----------|-----------|--------|---|----------------------|
| GOLF III 1.6 | | | | | | | 09/1992→08/1997 |
| VENTO 1.6 | | | | | | | 09/1992→09/1998 |
| V94114  | 030 109 601AH |  | 45° | H | | VAG96041B  | 36.50 x 7.00 x 12.08 |
| 35.60 x 7.00 x 94.70 | | MB cr | | | | | |
| V94115  | 032 109 611G |  | 45° | H | | VAG96161B  | 36.50 x 7.00 x 11.80 |
| 29.00 x 7.00 x 95.00 | | MD + MB | | | | | |

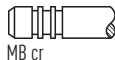
43  **76.50**

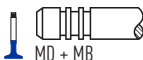
| AEA | 1598cc | 4 Cyl. | 8 Valves | 55kW/75PS | Petrol | SOHC | TD4019 |
|--|---------------|---|----------|-----------|--------|---|----------------------|
| GOLF III 1.6 | | | | | | | 09/1992→08/1997 |
| POLO 75 1.6 | | | | | | | 10/1994→10/1999 |
| POLO 1.6 | | | | | | | 09/1994→12/1995 |
| VENTO 1.6 | | | | | | | 09/1992→09/1998 |
| V94114  | 030 109 601AH |  | 45° | H | | VAG96041B  | 36.50 x 7.00 x 12.08 |
| 35.60 x 7.00 x 94.70 | | MB cr | | | | | |
| V94115  | 032 109 611G |  | 45° | H | | | |
| 29.00 x 7.00 x 95.00 | | MD + MB | | | | | |



OE

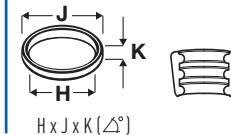
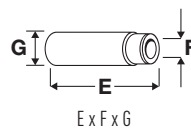

44 76.50

| | | | | | | | |
|--------------|-----------------|--------|----------|---------------------|--------|-----------------|---------|
| AEE | 1598cc | 4 Cyl. | 8 Valves | 55kW/75PS | Petrol | SOHC | TD4981 |
| ALM | 1598cc | 4 Cyl. | 8 Valves | 55kW/75PS | Petrol | SOHC | TD15610 |
| CADDY II 1.6 | 06/1996→12/2000 | | | CADDY II 75 1.6 | | 11/1995→09/2000 | |
| GOLF III 1.6 | 09/1992→08/1997 | | | POLO 1.6 | | 05/1997→09/2001 | |
| POLO 75 1.6 | 10/1994→10/1999 | | | POLO CLASSIC 75 1.6 | | 11/1995→09/2001 | |
| VENTO 1.6 | 09/1992→09/1998 | | | | | | |

V94114
35.60 x 7.00 x 94.70

030 109 601AH

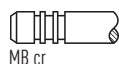

45°

H

VAG96062B
33.00 x 7.02 x 15.00



V94115
29.00 x 7.00 x 95.00

032 109 611G

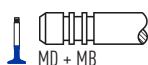

45°

H

45 76.50

| | | | | | | | |
|----------------------|-----------------|--------|-----------|------------|--------|------|---------|
| AJV | 1598cc | 4 Cyl. | 16 Valves | 88kW/120PS | Petrol | DOHC | TD11247 |
| POLO 120 1.6 16V GTI | 09/1998→10/1999 | | | | | | |

V94116
29.50 x 6.00 x 100.90

036 109 601S

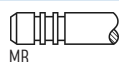

45°

Y

H

VAG96073B
36.00 x 6.02 x 11.06

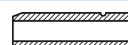

V94647
29.55 x 6.00 x 100.90

036 109 601AD

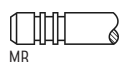

45°

Y

H

V94117
26.00 x 6.00 x 100.50

036 109 611K

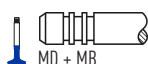

45°

46 76.50

| | | | | | | | |
|-------------------|-----------------|--------|-----------|-------------------|--------|-----------------|---------|
| ARC | 1598cc | 4 Cyl. | 16 Valves | 92kW/125PS | Petrol | DOHC | TD14169 |
| ATN | 1598cc | 4 Cyl. | 16 Valves | 77kW/105PS | Petrol | DOHC | TD15476 |
| AUS | 1598cc | 4 Cyl. | 16 Valves | 77kW/105PS | Petrol | DOHC | TD15477 |
| AVY | 1598cc | 4 Cyl. | 16 Valves | 92kW/125PS | Petrol | DOHC | TD15493 |
| AZD | 1598cc | 4 Cyl. | 16 Valves | 77kW/105PS | Petrol | DOHC | TD15478 |
| BAD | 1598cc | 4 Cyl. | 16 Valves | 81kW/110PS | Petrol | DOHC, Injection | TD16388 |
| BAG | 1598cc | 4 Cyl. | 16 Valves | 85kW/115PS | Petrol | DOHC, Injection | TD17048 |
| BCB | 1598cc | 4 Cyl. | 16 Valves | 77kW/105PS | Petrol | DOHC | TD16387 |
| BLF | 1598cc | 4 Cyl. | 16 Valves | 85kW/115PS | Petrol | DOHC, Injection | TD18100 |
| BLP | 1598cc | 4 Cyl. | 16 Valves | 85kW/115PS | Petrol | DOHC, Injection | TD18202 |
| BTS | 1598cc | 4 Cyl. | 16 Valves | 77kW/105PS | Petrol | DOHC | TD19093 |
| BORA 1.6 16V | 02/2000→05/2005 | | | BORA 1.6 FSI | | 01/2002→05/2005 | |
| EOS 1.6 FSI | 06/2006→05/2008 | | | GOLF IV 1.6 16V | | 02/2000→06/2006 | |
| GOLF IV 1.6 FSI | 10/2003→07/2004 | | | GOLF IV 1.6 FSI | | 01/2002→06/2006 | |
| GOLF V 1.6 FSI | 10/2003→07/2008 | | | GOLF PLUS 1.6 FSI | | 01/2005→05/2008 | |
| JETTA III 1.6 FSI | 09/2005→10/2010 | | | LUPO 1.6 GTI | | 09/2000→07/2005 | |
| PASSAT 1.6 FSI | 03/2005→06/2008 | | | POLO 1.6 | | 01/2007→12/2010 | |
| POLO 1.6 16V | 05/2006→11/2009 | | | POLO 1.6 16V GTI | | 10/1999→09/2001 | |
| TOURAN 1.6 FSI | 02/2003→01/2007 | | | | | | |

V94116
29.50 x 6.00 x 100.90

036 109 601S

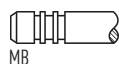

45°

Y

H

VAG96073B
36.00 x 6.02 x 11.06

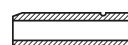

V94117
26.00 x 6.00 x 100.50

036 109 611K

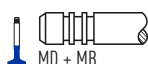

45°



OE

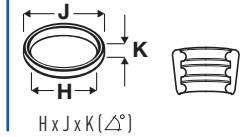
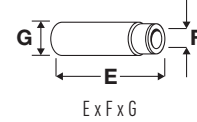



47  **76.50**

| | | | | | | | |
|----------------------------|----------|--------|-----------------|------------------|--------|-----------------|----------------|
| BAH | 1598cc | 4 Cyl. | 8 Valves | 74kW/101PS | Petrol | SOHC | TD20801 |
| FOX 1.6 | 10/2003→ | | | GOLF IV 1.6 | | 02/2001→06/2005 | |
| POLO 1.6 | 08/2002→ | | | POLO CLASSIC 1.6 | | 11/2002→07/2006 | |
| SPACEFOX / SPACE CROSS 1.6 | 03/2006→ | | | | | | |

V94646  032 109 601M
34.50 x 6.00 x 99.10



45° Y H

VAG96073B  
36.00 x 6.02 x 11.06



V94405  030 109 611T
28.00 x 6.00 x 99.10



45° ss H

48  **76.50**

| | | | | | | | |
|--------------------------------|----------|--------|-----------------|----------------------------|--------|-----------------|----------------|
| CCRA | 1598cc | 4 Cyl. | 8 Valves | 74-77kW/101-105PS | Petrol | SOHC | TD20810 |
| CFZA | 1598cc | 4 Cyl. | 8 Valves | 74-75kW/101-102PS | Petrol | SOHC | TD24043 |
| FOX 1.6 | 10/2003→ | | | FOX 1.6 Rock in Rio | | 08/2008→ | |
| GOLF 1.6 | 05/2008→ | | | GOL V 1.6 | | 07/2008→ | |
| GOL VI 1.6 | 08/2016→ | | | LUPU 1.6 | | 01/2004→12/2009 | |
| POLO 1.6 | 09/2002→ | | | SAVEIRO V 1.6 | | 09/2009→ | |
| SAVEIRO V 1.6 Cross | 09/2009→ | | | SPACEFOX / SPACE CROSS 1.6 | | 03/2006→ | |
| SPACEFOX / SPACE CROSS 1.6 MSI | 10/2015→ | | | VOYAGE 1.6 | | 07/2008→ | |
| VOYAGE 1.6 CL | 10/2008→ | | | | | | |

V94646  032 109 601M
34.50 x 6.00 x 99.10



45° Y H

V94405  030 109 611T
28.00 x 6.00 x 99.10



45° ss H

49  **76.50**

| | | | | | | | |
|-------------|----------|--------|------------------|-----------|--------|-------------|----------------|
| CNKA | 1598cc | 4 Cyl. | 16 Valves | 60kW/82PS | Petrol | DOHC | TD25189 |
| POLO 1.6 | 01/2011→ | | | | | | |

V80010  03C 109 601L
29.50 x 6.00 x 100.60



45° ss

V80011  03C 109 611Q
26.00 x 6.00 x 100.60



45° ss

50  **76.50**

| | | | | | | | |
|----------------|-----------------|--------|------------------|------------------|--------|-----------------|---------------|
| 1E | 2383cc | 6 Cyl. | 12 Valves | 69-70kW/94-95PS | Petrol | SOHC | TD4956 |
| LT 28-35 I 2.4 | 08/1992→07/1994 | | | LT 28-35 I 2.4 i | | 08/1989→06/1996 | |
| LT 40-55 I 2.4 | 08/1988→07/1989 | | | LT 40-55 I 2.4 i | | 01/1993→06/1996 | |

V91337  069 109 601F
36.10 x 7.97 x 95.10



45° H

VAG92061B  
36.70 x 8.00 x 12.08

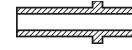

V91334  074 109 611
31.30 x 7.95 x 95.10



45° ss H

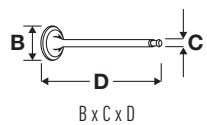

OE

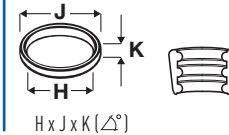
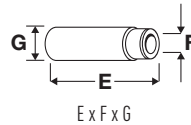
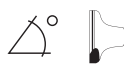

51 **76.50**

| 1G | 2383cc | 6 Cyl. | 12 Valves | 68kW/93PS | Diesel | Turbo, SOHC | TD3993 |
|---|--------------|-----------------|-----------|-------------------|--------|-----------------|--------|
| LT 28-35 I 2.4 TD | | 08/1988→08/1992 | | LT 40-55 I 2.4 TD | | 08/1988→08/1992 | |
| V91336 36.10 x 7.97 x 95.00 08/89→ | 069 109 601H | MD | 45° | | | | |
| V91409 31.30 x 7.95 x 95.10 | 068 109 611L | MD + MB | 45° | H | | | |
| V91368 31.30 x 7.95 x 95.00 08/89→ | 068 109 611L | MD + MB | 45° | H | | | |

52 **76.50**

| 1S | 2383cc | 6 Cyl. | 12 Valves | 51kW/70PS | Diesel | SOHC | TD4958 |
|---------------------------------------|--------------|-----------------|-----------|------------------|--------|-----------------|--------|
| ACT | 2383cc | 6 Cyl. | 12 Valves | 51kW/70PS | Diesel | SOHC | TD4014 |
| LT 28-35 I 2.4 D | | 08/1989→06/1996 | | LT 40-55 I 2.4 D | | 07/1990→06/1996 | |
| V91337 36.10 x 7.97 x 95.10 | 069 109 601F | MB | 45° | H | | | |
| V91368 31.30 x 7.95 x 95.00 | 068 109 611L | MD + MB | 45° | H | | | |

53 **76.50**

| ACL | 2383cc | 6 Cyl. | 12 Valves | 70kW/95PS | Diesel | Turbo, SOHC | TD4012 |
|---------------------------------------|--------------|-----------------|-----------|-------------------|--------|-----------------|--------|
| LT 28-35 I 2.4 TD | | 06/1992→06/1996 | | LT 40-55 I 2.4 TD | | 06/1992→06/1996 | |
| V91336 36.10 x 7.97 x 95.00 | 069 109 601H | MD | 45° | | | | |
| V91368 31.30 x 7.95 x 95.00 | 068 109 611L | MD + MB | 45° | H | | | |
| V91409 31.30 x 7.95 x 95.10 | 068 109 611L | MD + MB | 45° | H | | | |

54 **76.50**

| CP | 2383cc | 6 Cyl. | 12 Valves | 55kW/75PS | Diesel | SOHC | TD4047 |
|--|--------------|-----------------|-----------|------------------|--------|-----------------|--------|
| LT 28-35 I 2.4 D | | 12/1978→07/1992 | | LT 40-55 I 2.4 D | | 12/1978→07/1992 | |
| V90321 36.13 x 7.96 x 104.63 | 069 109 601D | MB | 45° | H | | | |
| V90180 31.32 x 7.94 x 104.60 | 068 109 611C | MD | 45° | | | | |
| V91174 31.00 x 7.95 x 104.60 | 068 109 611D | MD | 45° | SS | | | |

55 **76.50**

| DL | 2383cc | 6 Cyl. | 12 Valves | 66kW/90PS | Petrol | SOHC | TD4995 |
|---------------------------------------|--------------|-----------------|-----------|----------------|--------|-----------------|--------|
| LT 28-35 I 2.4 | | 12/1982→07/1992 | | LT 40-55 I 2.4 | | 12/1982→07/1992 | |
| V91337 36.10 x 7.97 x 95.10 | 069 109 601F | MB | 45° | H | | | |





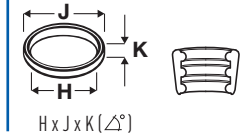
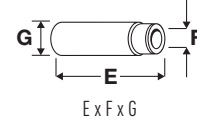
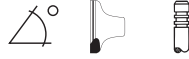

OE



56





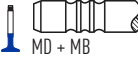



76.50

| DV | 2383cc | 6 Cyl. | 12 Valves | 75-80kW/102-109PS | Diesel | Turbo, SOHC | TD401 |
|--|--------------|--|-----------|-------------------|--------|---|-------|
| LT 28-35 I 2.4 TD | | 12/1982→09/1993 | | LT 40-55 I 2.4 TD | | 08/1978→09/1993 | |
| V90321 ■ 36.13 x 7.96 x 104.63 | 069 109 601D |  MB | 45° | H | |  VAG92061B ■ ■ ■ 36.70 x 8.00 x 12.08 | |
| V91336 ■ 36.10 x 7.97 x 95.00 | 069 109 601H |  MD | 45° | | | | |
| V91174 ■ 31.00 x 7.95 x 104.60 | 068 109 611D |  MD | 45° | SS | | | |
| V91368 ■ 31.30 x 7.95 x 95.00 | 068 109 611L |  MD + MB | 45° | H | | | |
| V91409 ■ 31.30 x 7.95 x 95.10 | 068 109 611L |  MD + MB | 45° | H | | | |

57

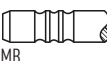



76.50

| DW | 2383cc | 6 Cyl. | 12 Valves | 55-57kW/75-78PS | Diesel | SOHC | TD4062 |
|---|--------------|--|-----------|------------------|--------|---|--------|
| LT 28-35 I 2.4 D | | 12/1978→07/1992 | | LT 40-55 I 2.4 D | | 12/1978→07/1992 | |
| V90321 ■ 36.13 x 7.96 x 104.63 08/81→07/89 | 069 109 601D |  MB | 45° | H | |  VAG92061B ■ ■ ■ 36.70 x 8.00 x 12.08 | |
| V91337 ■ 36.10 x 7.97 x 95.10 08/89→ | 069 109 601F |  MB | 45° | H | | | |
| V90180 ■ 31.32 x 7.94 x 104.60 08/81→07/89 | 068 109 611C |  MD | 45° | | | | |
| V91174 ■ 31.00 x 7.95 x 104.60 08/81→07/89 | 068 109 611D |  MD | 45° | SS | | | |
| V91368 ■ 31.30 x 7.95 x 95.00 08/89→ | 068 109 611L |  MD + MB | 45° | H | | | |

58



76.50



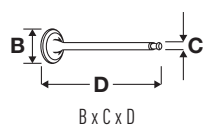

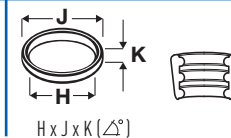
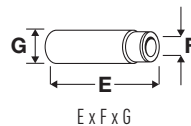

| HS | 2384cc | 6 Cyl. | 12 Valves | 62kW/82PS | Petrol | SOHC | TD4108 |
|---|--------------|---|-----------|-----------|--------|---|--------|
| V91332 ■ 36.10 x 7.97 x 99.30 | 030 109 601F |  MD | 45° | | |  VAG92061B ■ ■ ■ 36.70 x 8.00 x 12.08 | |
| V94580 ■ 36.00 x 7.97 x 98.85 | 030 109 601C |  MB | 45° | H | | | |



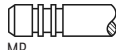





OE



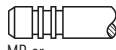



59  **78.30**

| | | | | | | | |
|---|--------------|---|------------------|------------------------|--------|--|---|
| AFB | 2496cc | V6 Cyl. | 24 Valves | 110kW/150PS | Diesel | Turbo, DOHC | TD11499 |
| AKN | 2496cc | V6 Cyl. | 24 Valves | 110kW/150PS | Diesel | Turbo, DOHC | TD11498 |
| PASSAT 2.5 TDI | | 07/1998→05/2005 | | PASSAT 2.5 TDI/4motion | | 12/1998→11/2000 | |
| V94653  | 059 109 601B |  | 45° | H | | VAG96237B  |  |
| 27.10 x 6.00 x 100.50 | | MB | | | | 42.00 x 6.02 x 10.07 | |
| V94423  | 059 109 611B |  | 45° | ss | H | VAG96265B  |  |
| 24.10 x 6.00 x 100.50 | | MD + MB | | | | 42.00 x 5.98 x 10.21 | |







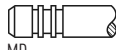

60  **78.30**

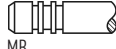
| | | | | | | | |
|---|--------------|---|------------------|-------------|--------|--|---|
| BAU | 2496cc | V6 Cyl. | 24 Valves | 132kW/180PS | Diesel | Turbo, DOHC | TD17046 |
| BDG | 2496cc | V6 Cyl. | 24 Valves | 120kW/163PS | Diesel | Turbo, DOHC | TD16985 |
| BDH | 2496cc | V6 Cyl. | 24 Valves | 132kW/180PS | Diesel | Turbo, DOHC | TD17047 |
| PASSAT 2.5 TDI | | 01/2003→05/2005 | | | | | |
| V98008  | 059 109 601F |  | 45° | | | VAG96237B  |  |
| 27.20 x 6.00 x 100.60 | | MB cr | | | | 42.00 x 6.02 x 10.07 | |
| V98009  | 059 109 611G |  | 45° | ss | | VAG96265B  |  |
| 24.10 x 6.00 x 100.70 | | MD + MB cr | | | | 42.00 x 5.98 x 10.21 | |

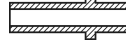
61  **79.50**

| | | | | | | | |
|---|--------------|---|------------------|-----------|--------|--|---|
| CFWA | 1199cc | 3 Cyl. | 12 Valves | 55kW/75PS | Diesel | Turbo, DOHC | TD23610 |
| POLO 1.2 TDI | | 10/2009→ | | | | | |
| V95125  | 03L 109 601A |  | 45° | Y | H | VAG96388B  |  |
| 26.60 x 5.97 x 99.30 | | MD + MB | | | | 36.00 x 6.00 x 10.06 | |
| V95126  | 03L 109 611A |  | 45° | ss | H | | |
| 24.50 x 5.97 x 99.00 | | MD | | | | | |

62  **79.50**

| | | | | | | | |
|---|--------------|---|-----------------|--------------|--------|--|---|
| AMF | 1422cc | 3 Cyl. | 6 Valves | 55kW/75PS | Diesel | Turbo, SOHC | TD12589 |
| Lupo 1.4 TDI | | 01/1999→07/2005 | | POLO 1.4 TDI | | 10/1999→06/2005 | |
| V94147  | 038 109 601B |  | 45° | | H | VAG96041B  |  |
| 35.90 x 7.00 x 89.90 | | MB | | | | 36.50 x 7.00 x 12.08 | |
| V94649  | 038 109 601E |  | 45° | Y | H | | |
| 36.00 x 7.00 x 89.40 | | MB | | | | | |
| V94148  | 038 109 611F |  | 45° | ss | H | | |
| 31.50 x 7.00 x 90.00 | | MD + MB | | | | | |
| V94650  | 038 109 611E |  | 45° | ss | H | | |
| 31.40 x 7.00 x 89.00 | | MD + MB | | | | | |





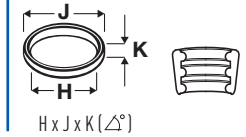
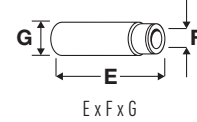



OE



63  **79.50**

| | | | | | | | |
|-----|--------|--------|----------|-----------|--------|-------------|---------|
| ATL | 1422cc | 3 Cyl. | 6 Valves | 66kW/90PS | Diesel | Turbo, SOHC | TD21352 |
| BAY | 1422cc | 3 Cyl. | 6 Valves | 55kW/75PS | Diesel | Turbo, SOHC | TD16336 |
| BMS | 1422cc | 3 Cyl. | 6 Valves | 59kW/80PS | Diesel | Turbo, SOHC | TD18157 |
| BNM | 1422cc | 3 Cyl. | 6 Valves | 51kW/70PS | Diesel | Turbo, SOHC | TD18159 |
| BNV | 1422cc | 3 Cyl. | 6 Valves | 59kW/80PS | Diesel | Turbo, SOHC | TD18158 |
| BWB | 1422cc | 3 Cyl. | 6 Valves | 51kW/70PS | Diesel | Turbo, SOHC | TD20514 |





| | | | |
|--------------|-----------------|--------------|----------|
| FOX 1.4 TDI | 04/2005→ | POLO 1.4 TDI | 10/2001→ |
| POLO 1.4 TDi | 01/2000→10/2000 | | |

| | | | | | | | |
|---|--------------|---|-----|----|---|--|---|
| V94649  | 038 109 601E |  | 45° | Y | H | VAG96041B  |  |
| 36.00 x 7.00 x 89.40 | | MB | | | | 36.50 x 7.00 x 12.08 | |
| V94650  | 038 109 611E |  | 45° | SS | H | | |
| 31.40 x 7.00 x 89.00 | | MD + MB | | | | | |

64  **79.50**

| | | | | | | | |
|------|--------|--------|-----------|------------|--------|-------------|---------|
| CAYA | 1598cc | 4 Cyl. | 16 Valves | 55kW/75PS | Diesel | Turbo, DOHC | TD23105 |
| CAYB | 1598cc | 4 Cyl. | 16 Valves | 66kW/90PS | Diesel | Turbo, DOHC | TD22638 |
| CAYC | 1598cc | 4 Cyl. | 16 Valves | 77kW/105PS | Diesel | Turbo, DOHC | TD22639 |
| CAYD | 1598cc | 4 Cyl. | 16 Valves | 75kW/102PS | Diesel | Turbo, DOHC | TD24364 |
| CAYE | 1598cc | 4 Cyl. | 16 Valves | 55kW/75PS | Diesel | Turbo, DOHC | TD24365 |
| CLHA | 1598cc | 4 Cyl. | 16 Valves | 77kW/105PS | Diesel | Turbo, DOHC | TD27195 |
| CLHB | 1598cc | 4 Cyl. | 16 Valves | 66kW/90PS | Diesel | Turbo, DOHC | TD27961 |
| CLNA | 1598cc | 4 Cyl. | 16 Valves | 77kW/105PS | Diesel | Turbo, DOHC | TD25704 |
| CRKA | 1598cc | 4 Cyl. | 16 Valves | 66kW/90PS | Diesel | Turbo, DOHC | TD27962 |
| CRKB | 1598cc | 4 Cyl. | 16 Valves | 81kW/110PS | Diesel | Turbo, DOHC | TD27963 |
| CXXA | 1598cc | 4 Cyl. | 16 Valves | 66kW/90PS | Diesel | Turbo, DOHC | TD28095 |
| CXXB | 1598cc | 4 Cyl. | 16 Valves | 81kW/110PS | Diesel | Turbo, DOHC | TD28098 |
| DCXA | 1598cc | 4 Cyl. | 16 Valves | 88kW/120PS | Diesel | Turbo, DOHC | TD29841 |
| DGDB | 1598cc | 4 Cyl. | 16 Valves | 85kW/115PS | Diesel | Turbo, DOHC | TD33683 |

| | | | |
|-------------------|-----------------|-------------------|-----------------|
| BEETLE 1.6 TDI | 10/2011→ | CADDY III 1.6 TDI | 08/2010→05/2015 |
| CADDY IV 1.6 TDI | 05/2015→ | GOLF 1.6 TDI | 02/2014→ |
| GOLF VI 1.6 TDI | 02/2009→ | GOLF VII 1.6 TDI | 08/2012→ |
| GOLF PLUS 1.6 TDI | 02/2009→12/2013 | JETTA III 1.6 TDI | 06/2009→10/2010 |
| JETTA IV 1.6 TDI | 04/2010→07/2014 | PASSAT 1.6 TDI | 08/2009→ |
| POLO 1.6 TDI | 06/2009→ | TIGUAN 1.6 TDI | 05/2016→ |
| TOURAN 1.6 TDI | 05/2010→05/2016 | | |

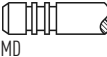
| | | | | | | | |
|---|--------------|---|-----|----|---|--|---|
| V95125  | 03L 109 601A |  | 45° | Y | H | VAG96388B  |  |
| 26.60 x 5.97 x 99.30 | | MD + MB | | | | 36.00 x 6.00 x 10.06 | |
| V95126  | 03L 109 611A |  | 45° | SS | H | | |
| 24.50 x 5.97 x 99.00 | | MD | | | | | |





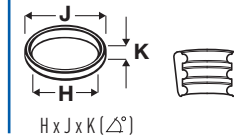

OE



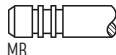





65  **79.50**

| | | | | | | | |
|-------------------------|-----------------|--------|-----------------|-----------------|-----------------|-------------|----------------|
| AHB | 1716cc | 4 Cyl. | 8 Valves | 42kW/57PS | Diesel | SOHC | TD15028 |
| AHG | 1716cc | 4 Cyl. | 8 Valves | 42-44kW/57-60PS | Diesel | SOHC | TD11207 |
| AKU | 1716cc | 4 Cyl. | 8 Valves | 44kW/60PS | Diesel | SOHC | TD9513 |
| AKW | 1716cc | 4 Cyl. | 8 Valves | 42kW/57PS | Diesel | SOHC | TD9687 |
| CADDY II 1.7 SDI | 07/1996→09/2000 | | | LUPO 1.7 SDI | 09/1998→07/2005 | | |
| POLO 1.7 SDI | 04/1997→09/2001 | | | POLO 60 1.7 SDI | 08/1997→10/1999 | | |
| POLO CLASSIC 57 1.7 SDI | 07/1997→09/2001 | | | | | | |

| | | | | | | | |
|---|--------------|---|-----|---|---|--|--|
| V94112  | 028 109 601J |  | 45° | Y | H | VAG96041B  | |
| 36.00 x 7.00 x 96.50 | | MB | | | | 36.50 x 7.00 x 12.08 | |
| V94113  | 028 109 611K |  | 45° | | | | |
| 31.50 x 7.00 x 96.30 | | MD | | | | | |



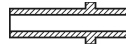

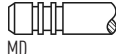
66  **79.50**

| | | | | | | | |
|-----------------------|-----------------|--------|-----------------|-----------|--------|-------------|---------------|
| KY | 1716cc | 4 Cyl. | 8 Valves | 42kW/57PS | Diesel | SOHC | TD4126 |
| TRANSPORTER III 1.7 D | 08/1985→07/1992 | | | | | | |

| | | | | | | | |
|---|--------------|---|-----|----|---|--|--|
| V90179  | 068 109 601C |  | 45° | | H | VAG92061B  | |
| 34.00 x 7.97 x 104.80 →12/87 | | MB | | | | 36.70 x 8.00 x 12.08 | |
| V90321  | 069 109 601D |  | 45° | | H | VAG92105B  | |
| 36.13 x 7.96 x 104.63 01/88→ | | MB | | | | 42.30 x 7.99 x 12.08 | |
| V91174  | 068 109 611D |  | 45° | ss | | | |
| 31.00 x 7.95 x 104.60 | | MD | | | | | |

67  **79.50**

| | | | | | | | |
|----------------------|-----------------|--------|-----------------|-----------------|--------|-------------|---------------|
| 1X | 1896cc | 4 Cyl. | 8 Valves | 44-45kW/60-61PS | Diesel | SOHC | TD3997 |
| TRANSPORTER IV 1.9 D | 07/1990→12/1995 | | | | | | |

| | | | | | | | |
|---|--------------|---|-----|----|---|--|--|
| V91337  | 069 109 601F |  | 45° | | H | VAG92061B  | |
| 36.10 x 7.97 x 95.10 | | MB | | | | 36.70 x 8.00 x 12.08 | |
| V91334  | 074 109 611 |  | 45° | ss | H | | |
| 31.30 x 7.95 x 95.10 | | ME + MB | | | | | |



OE

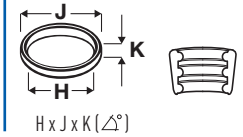
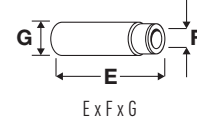

68



79.50

| 1Y | 1896cc | 4 Cyl. | 8 Valves | 47-50kW/64-68PS | Diesel | SOHC | TD4960 |
|------------------|--------|-----------------|----------|-----------------------|--------|-----------------|--------|
| CADDY 1.9 D | | 10/2005→06/2009 | | CADDY II 1.9 D | | 11/1995→01/2004 | |
| CADDY III 1.9 D | | 10/2005→06/2009 | | GOLF III 1.9 D | | 11/1991→04/1999 | |
| GOL III 1.9 D | | 06/2002→06/2005 | | PARATI III 1.9 D | | 08/2002→ | |
| PASSAT 1.9 D | | 05/1989→10/1993 | | POLO CLASSIC 64 1,9 D | | 01/1996→10/1996 | |
| SAVEIRO II 1.9 D | | 02/1998→02/2002 | | VENTO 1.9 D | | 11/1991→09/1998 | |
| VOYAGE 1.9 D | | 06/1996→09/2001 | | | | | |

V91337 ■
36.10 x 7.97 x 95.10
Eng.→580.000

069 109 601F



45°

H

VAG92061B ■ ■ ■
36.70 x 8.00 x 12.08
Eng.→580.000

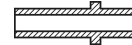

V94108 ■
36.00 x 7.00 x 95.50
Eng.580.001→

028 109 601B

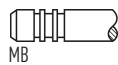

45°

Y

H

VAG96041B ■ ■ ■
36.50 x 7.00 x 12.08
Eng.580.001→



V94414 ■
36.00 x 7.00 x 95.50
Eng.580.001→

028 109 601C

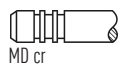

45°

V91334 ■
31.30 x 7.95 x 95.10
Eng.→580.000

074 109 611



45°

SS

H

V94109 ■
31.10 x 7.00 x 95.60
Eng.580.001→

028 109 611E



45°

H

69



79.50

| 1Z | 1896cc | 4 Cyl. | 8 Valves | 66kW/90PS | Diesel | Turbo, SOHC | TD4961 |
|------------------|--------|-----------------|----------|------------------|--------|-----------------|--------|
| CADDY II 1.9 TDI | | 09/1996→01/2004 | | GOLF III 1.9 TDI | | 09/1993→04/1999 | |
| PASSAT 1.9 TDI | | 10/1993→05/1997 | | SHARAN 1.9 TDI | | 09/1995→03/2010 | |
| VENTO 1.9 TDI | | 09/1993→09/1998 | | VOYAGE 1.9 TDI | | 09/1999→09/2001 | |

V94010 ■
36.00 x 8.00 x 96.80

028 109 601H

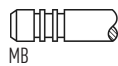

45°

Y

H

VAG92061B ■ ■ ■
36.70 x 8.00 x 12.08



V94011 ■
31.50 x 7.95 x 96.85

046 109 611F



45°

SS

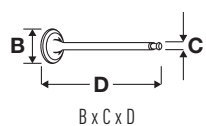



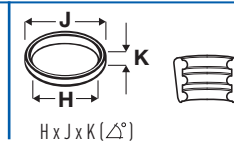
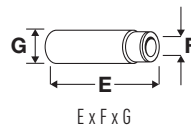







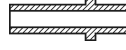

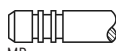
OE

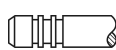

70  **79.50**

| AAZ | 1896cc | 4 Cyl. | 8 Valves | 55kW/75PS | Diesel | Turbo, SOHC | TD4972 |
|-----------------|--------|-----------------|----------|---------------------|--------|-----------------|--------|
| GOLF III 1.9 TD | | 07/1993→04/1999 | | GOLF III 1.9 TD,GTD | | 11/1991→08/1997 | |
| GOLF IV 1.9 TD | | 10/1997→09/1999 | | PASSAT 1.9 TD | | 03/1991→05/1997 | |
| VENTO 1.9 TD | | 11/1991→09/1998 | | | | | |

| | | | | | | | |
|--|--------------|---|-----|----|---|---|---|
| V91336  36.10 x 7.97 x 95.00 Eng.→678000 | 069 109 601H |  MD | 45° | | | VAG92061B  36.70 x 8.00 x 12.08 Eng.→678000 |  |
| V94108  36.00 x 7.00 x 95.50 Eng.678001→ | 028 109 601B |  MB | 45° | Y | H | VAG96041B  36.50 x 7.00 x 12.08 Eng.678001→ |  |
| V94414  36.00 x 7.00 x 95.50 Eng.678001→ | 028 109 601C |  MD cr | 45° | | | | |
| V91334  31.30 x 7.95 x 95.10 Eng.→678000 | 074 109 611 |  ME + MB | 45° | ss | H | | |
| V94109  31.10 x 7.00 x 95.60 Eng.678001→ | 028 109 611E |  MD + MB | 45° | | H | | |





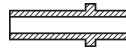





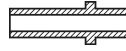

71  **79.50**

| ABL | 1896cc | 4 Cyl. | 8 Valves | 50kW/68PS | Diesel | Turbo, SOHC | TD4009 |
|-----------------------|--------|-----------------|----------|-----------|--------|-------------|--------|
| TRANSPORTER IV 1.9 TD | | 10/1992→04/2003 | | | | | |

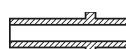
| | | | | | | | |
|---|--------------|--|-----|----|---|--|---|
| V91336  36.10 x 7.97 x 95.00 | 069 109 601H |  MD | 45° | | | VAG92061B  36.70 x 8.00 x 12.08 |  |
| V91334  31.30 x 7.95 x 95.10 | 074 109 611 |  ME + MB | 45° | ss | H | | |

72  **79.50**

| AEF | 1896cc | 4 Cyl. | 8 Valves | 47kW/64PS | Diesel | SOHC | TD4020 |
|----------------|--------|-----------------|----------|------------|--------|-----------------|--------|
| CADDY II 1.9 D | | 06/1996→12/2000 | | POLO 1.9 D | | 10/1994→09/2001 | |
| POLO 64 1.9 D | | 10/1994→10/1999 | | | | | |







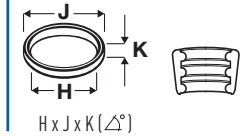
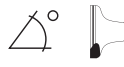

| | | | | | | | |
|--|--------------|--|-----|----|---|---|---|
| V91337  36.10 x 7.97 x 95.10 Eng.→007000 | 069 109 601F |  MB | 45° | | H | VAG92061B  36.70 x 8.00 x 12.08 Eng.→007000 |  |
| V94108  36.00 x 7.00 x 95.50 Eng.007001→ | 028 109 601B |  MB | 45° | Y | H | VAG96041B  36.50 x 7.00 x 12.08 Eng.007001→ |  |
| V94414  36.00 x 7.00 x 95.50 Eng.007001→ | 028 109 601C |  MD cr | 45° | | | | |
| V91334  31.30 x 7.95 x 95.10 Eng.→007000 | 074 109 611 |  ME + MB | 45° | ss | H | | |
| V94109  31.10 x 7.00 x 95.60 Eng.007001→ | 028 109 611E |  MD + MB | 45° | | H | | |



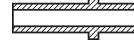

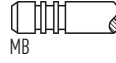
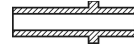

OE







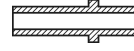

73  **79.50**

| AEY | 1896cc | 4 Cyl. | 8 Valves | 47-48kW/64-65PS | Diesel | SOHC | TD4985 |
|--|--------------|--|----------|----------------------|--------|---|--------|
| CADDY II 1.9 SDI | | 11/1995→01/2004 | | GOLF III 1.9 SDI | | 07/1995→04/1999 | |
| POLO 1.9 SDI | | 06/1997→09/2001 | | POLO CLASSIC 1.9 SDI | | 06/1996→09/2001 | |
| POLO CLASSIC 64 1.9 SDI | | 12/1995→08/1999 | | VENTO 1.9 SDI | | 04/1997→09/1998 | |
| V94409  36.00 x 8.00 x 96.30 Eng.→002000 | 028 109 601G |  MD + MB | 45° | H | |  | |
| V94112  36.00 x 7.00 x 96.50 Eng.002001→ | 028 109 601J |  MB | 45° | Y | H |  | |
| V94410  31.50 x 8.00 x 96.40 Eng.→002000 | 028 109 611J |  MD + MB | 45° | ss | H | | |
| V94113  31.50 x 7.00 x 96.30 Eng.002001→ | 028 109 611K |  MD | 45° | | | | |

74  **79.50**

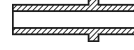
| AFN | 1896cc | 4 Cyl. | 8 Valves | 81kW/110PS | Diesel | Turbo, SOHC | TD4987 |
|---|--------------|--|----------|-------------------------|--------|---|---------|
| AGR | 1896cc | 4 Cyl. | 8 Valves | 66kW/90PS | Diesel | Turbo, SOHC | TD9364 |
| AHF | 1896cc | 4 Cyl. | 8 Valves | 81kW/110PS | Diesel | Turbo, SOHC | TD9788 |
| AHH | 1896cc | 4 Cyl. | 8 Valves | 66kW/90PS | Diesel | Turbo, SOHC | TD10927 |
| AHU | 1896cc | 4 Cyl. | 8 Valves | 66-67kW/90-91PS | Diesel | Turbo, SOHC | TD4990 |
| ALE | 1896cc | 4 Cyl. | 8 Valves | 66kW/90PS | Diesel | Turbo, SOHC | TD9512 |
| ALH | 1896cc | 4 Cyl. | 8 Valves | 66-67kW/90-91PS | Diesel | Turbo, SOHC | TD9455 |
| ASV | 1896cc | 4 Cyl. | 8 Valves | 81kW/110PS | Diesel | Turbo, SOHC | TD13773 |
| AVG | 1896cc | 4 Cyl. | 8 Valves | 81kW/110PS | Diesel | Turbo, SOHC | TD14988 |
| BORA 1.9 TDI | | 10/1998→05/2005 | | CADDY II 1.9 TDI | | 09/1996→01/2004 | |
| GOLF III 1.9 TDI | | 09/1993→04/1999 | | GOLF IV 1.9 TDI | | 08/1997→05/2006 | |
| NEW BEETLE 1.9 TDI | | 01/1998→12/2004 | | PASSAT 1.9 TDI | | 10/1993→11/2000 | |
| PASSAT 1.9 TDI/4motion | | 10/1996→11/2000 | | POLO 1.9 TDI | | 05/1997→09/2001 | |
| POLO CLASSIC 1.9 TDI | | 01/1997→08/1999 | | POLO CLASSIC 90 1.9 TDI | | 09/1996→09/2001 | |
| POLO CLASSIC 110 1.9 TDI | | 06/1998→01/2002 | | SHARAN 1.9 TDI | | 09/1995→03/2010 | |
| VENTO 1.9 TDI | | 09/1993→09/1998 | | | | | |
| V94084  35.90 x 7.00 x 96.80 | 028 109 601D |  MB | 45° | Y | H |  | |
| V94085  31.40 x 7.00 x 96.90 | 028 109 611G |  MD + MB | 45° | | H | | |

75  **79.50**

| AGD | 1896cc | 4 Cyl. | 8 Valves | 47kW/64PS | Diesel | SOHC | TD9372 |
|---|--------------|--|----------|-----------------|--------|---|--------|
| POLO 1.9 SDI | | 07/1996→09/2001 | | POLO 64 1.9 SDI | | 07/1996→10/1999 | |
| V91337  36.10 x 7.97 x 95.10 | 069 109 601F |  MB | 45° | H | |  | |
| V91334  31.30 x 7.95 x 95.10 | 074 109 611 |  ME + MB | 45° | ss | H | | |
| V91368  31.30 x 7.95 x 95.00 | 068 109 611L |  MD + MB | 45° | H | | | |

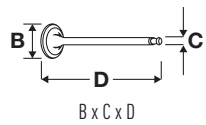

OE

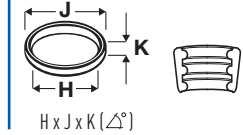
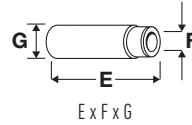
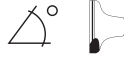

76 **79.50**

| | | | | | | | |
|--------------------------------|-----------------|--------|-------------------------|-----------------|--------|-------------|----------------|
| AGP | 1896cc | 4 Cyl. | 8 Valves | 50kW/68PS | Diesel | SOHC | TD9452 |
| AQM | 1896cc | 4 Cyl. | 8 Valves | 50kW/68PS | Diesel | SOHC | TD11351 |
| ASX | 1896cc | 4 Cyl. | 8 Valves | 47kW/64PS | Diesel | SOHC | TD15495 |
| ASY | 1896cc | 4 Cyl. | 8 Valves | 47kW/64PS | Diesel | SOHC | TD16338 |
| AYQ | 1896cc | 4 Cyl. | 8 Valves | 47kW/64PS | Diesel | SOHC | TD16863 |
| BORA 1.9 SDI | 10/1998→05/2005 | | CADDY II 1.9 SDI | 11/1995→01/2004 | | | |
| FOX 1.9 D | 12/2007→ | | GOLF IV 1.9 SDI | 08/1997→06/2006 | | | |
| POLO 1.9 SDI | 08/1999→ | | POLO CLASSIC 68 1.9 SDI | 08/1999→01/2002 | | | |
| SPACEFOX / SPACE CROSS 1.9 SDI | 11/2007→11/2010 | | | | | | |

V94112
36.00 x 7.00 x 96.50

028 109 601J

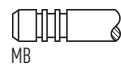

45°

Y

H

VAG96041B
36.50 x 7.00 x 12.08



V94113
31.50 x 7.00 x 96.30

028 109 611K

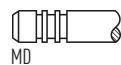

45°

77 **79.50**

| | | | | | | | |
|-----------------------|-----------------|--------|--------------------|-----------------|--------|--------------------|----------------|
| AJM | 1896cc | 4 Cyl. | 8 Valves | 85kW/115PS | Diesel | Turbo, SOHC | TD12588 |
| ANU | 1896cc | 4 Cyl. | 8 Valves | 66kW/90PS | Diesel | Turbo, SOHC | TD13443 |
| ARL | 1896cc | 4 Cyl. | 8 Valves | 110kW/150PS | Diesel | Turbo, SOHC | TD15484 |
| ASZ | 1896cc | 4 Cyl. | 8 Valves | 96kW/130PS | Diesel | Turbo, SOHC | TD16231 |
| ATD | 1896cc | 4 Cyl. | 8 Valves | 74kW/101PS | Diesel | Turbo, SOHC | TD15473 |
| ATJ | 1896cc | 4 Cyl. | 8 Valves | 85kW/115PS | Diesel | Turbo, SOHC | TD16258 |
| AUY | 1896cc | 4 Cyl. | 8 Valves | 85kW/115PS | Diesel | Turbo, SOHC | TD14915 |
| AVB | 1896cc | 4 Cyl. | 8 Valves | 74kW/101PS | Diesel | Turbo, SOHC | TD15152 |
| AVF | 1896cc | 4 Cyl. | 8 Valves | 96kW/130PS | Diesel | Turbo, SOHC | TD15153 |
| AWX | 1896cc | 4 Cyl. | 8 Valves | 96kW/130PS | Diesel | Turbo, SOHC | TD15154 |
| AXB | 1896cc | 4 Cyl. | 8 Valves | 77kW/105PS | Diesel | Turbo, SOHC | TD16867 |
| AXC | 1896cc | 4 Cyl. | 8 Valves | 63kW/85PS | Diesel | Turbo, SOHC | TD16881 |
| BLT | 1896cc | 4 Cyl. | 8 Valves | 96kW/130PS | Diesel | Turbo, SOHC | TD17467 |
| BTB | 1896cc | 4 Cyl. | 8 Valves | 110kW/150PS | Diesel | Turbo, SOHC | TD18232 |
| BUK | 1896cc | 4 Cyl. | 8 Valves | 118kW/160PS | Diesel | Turbo, SOHC | TD29051 |
| BVK | 1896cc | 4 Cyl. | 8 Valves | 85kW/115PS | Diesel | Turbo, SOHC | TD20489 |
| BORA 1.9 TDI | 12/1998→05/2005 | | GOLF IV 1.9 TDI | 12/1998→06/2006 | | | |
| MULTIVAN V 1.9 TDI | 04/2003→11/2009 | | NEW BEETLE 1.9 TDI | 02/2001→09/2010 | | | |
| PASSAT 1.9 TDI | 08/1998→05/2005 | | POLO 1.9 TDI | 10/2001→12/2010 | | | |
| POLO 1.9 TDi | 09/2002→ | | SHARAN 1.9 TDI | 09/1995→03/2010 | | | |
| TRANSPORTER V 1.9 TDI | 04/2003→11/2009 | | | | | | |

V94147
35.90 x 7.00 x 89.90

038 109 601B

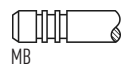

45°

H

VAG96041B
36.50 x 7.00 x 12.08



V94148
31.50 x 7.00 x 90.00

038 109 611F

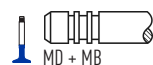

45°

SS

H

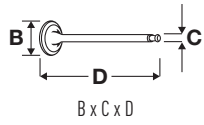

OE

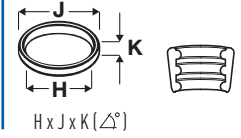
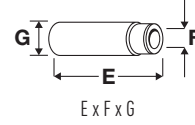
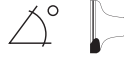

78



79.50

| | | | | | | | |
|--------------------|-----------------|--------|----------|-----------------------|--------|-----------------|---------|
| AVQ | 1896cc | 4 Cyl. | 8 Valves | 74kW/100PS | Diesel | Turbo, SOHC | TD16861 |
| AXR | 1896cc | 4 Cyl. | 8 Valves | 74kW/100PS | Diesel | Turbo, SOHC | TD16337 |
| BJB | 1896cc | 4 Cyl. | 8 Valves | 77kW/105PS | Diesel | Turbo, SOHC | TD17078 |
| BKC | 1896cc | 4 Cyl. | 8 Valves | 77kW/105PS | Diesel | Turbo, SOHC | TD17079 |
| BLS | 1896cc | 4 Cyl. | 8 Valves | 77kW/105PS | Diesel | Turbo, SOHC | TD18224 |
| BMT | 1896cc | 4 Cyl. | 8 Valves | 74kW/101PS | Diesel | Turbo, SOHC | TD20494 |
| BRR | 1896cc | 4 Cyl. | 8 Valves | 62kW/84PS | Diesel | Turbo, SOHC | TD20159 |
| BRS | 1896cc | 4 Cyl. | 8 Valves | 75kW/102PS | Diesel | Turbo, SOHC | TD18994 |
| BRU | 1896cc | 4 Cyl. | 8 Valves | 66kW/90PS | Diesel | Turbo, SOHC | TD17468 |
| BSU | 1896cc | 4 Cyl. | 8 Valves | 55kW/75PS | Diesel | Turbo, SOHC | TD18755 |
| BXE | 1896cc | 4 Cyl. | 8 Valves | 77kW/105PS | Diesel | Turbo, SOHC | TD18908 |
| BXF | 1896cc | 4 Cyl. | 8 Valves | 66kW/90PS | Diesel | Turbo, SOHC | TD18907 |
| BXJ | 1896cc | 4 Cyl. | 8 Valves | 66kW/90PS | Diesel | Turbo, SOHC | TD20493 |
| BORA 1.9 TDI | 09/2000→05/2005 | | | CADDY III 1.9 TDI | | 04/2004→08/2010 | |
| GOLF IV 1.9 TDI | 09/2000→06/2006 | | | GOLF V 1.9 TDI | | 10/2003→07/2009 | |
| GOLF PLUS 1.9 TDI | 01/2005→01/2009 | | | JETTA III 1.9 TDI | | 08/2005→10/2010 | |
| MULTIVAN V 1.9 TDI | 01/2006→11/2009 | | | NEW BEETLE 1.9 TDI | | 06/2003→09/2010 | |
| PASSAT 1.9 TDI | 03/2005→11/2008 | | | POLO 1.9 TDI | | 10/2001→11/2009 | |
| TOURAN 1.9 TDI | 02/2003→05/2010 | | | TRANSPORTER V 1.9 TDI | | 01/2006→11/2009 | |

V94649 ■
36.00 x 7.00 x 89.40

038 109 601E



45° Y H

VAG96041B ■ ■ ■
36.50 x 7.00 x 12.08

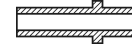

V94650 ■
31.40 x 7.00 x 89.00

038 109 611E



45° ss H

79



79.50

| | | | | | | | |
|--------------------|-----------------|--------|----------|------------|-----------------|-------------|----------------------|
| BEW | 1896cc | 4 Cyl. | 8 Valves | 74kW/101PS | Diesel | Turbo, SOHC | TD19255 |
| NEW BEETLE 1.9 TDI | 02/2001→09/2010 | | | | | | |
| V95087 ■ | 038 109 601F | | 45° | H | VAG96041B ■ ■ ■ | | 36.50 x 7.00 x 12.08 |
| V95088 ■ | 038 109 611G | | 45° | ss H | | | |

80



79.50

| | | | | | | | |
|---------------|-----------------|--------|----------|------------------|-----------------|----------|----------------------|
| BGG | 1896cc | 4 Cyl. | 8 Valves | 47kW/64PS | Diesel | SOHC | TD21349 |
| GOL III 1.9 D | 06/2002→06/2005 | | | PARATI III 1.9 D | | 08/2002→ | |
| POINTER 1.9 D | 12/2005→ | | | | | | |
| V94108 ■ | 028 109 601B | | 45° | Y H | VAG96041B ■ ■ ■ | | 36.50 x 7.00 x 12.08 |
| V94414 ■ | 028 109 601C | | 45° | | | | |
| V94109 ■ | 028 109 611E | | 45° | H | | | |



OE

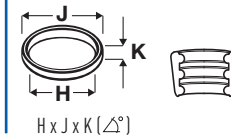
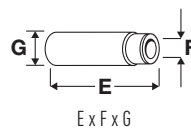

81 **79.50**

| BSW | 1896cc | 4 Cyl. | 8 Valves | 77kW/105PS | Diesel | Turbo, SOHC | TD18771 |
|----------------------|--------------|-----------------|----------|------------|----------------------|-------------|---------|
| NEW BEETLE 1.9 TDI | | 07/2005→09/2010 | | | | | |
| V94147 | 038 109 601B | | 45° | H | VAG96041B | | |
| 35.90 x 7.00 x 89.90 | | MB | | | 36.50 x 7.00 x 12.08 | | |
| V94650 | 038 109 611E | | 45° | SS H | | | |
| 31.40 x 7.00 x 89.00 | | MD + MB | | | | | |

82 **79.50**

| WN | 1921cc | 5 Cyl. | 10 Valves | 85kW/115PS | Petrol | SOHC | TD5031 |
|----------------------|--------------|-----------------|-----------|-------------|----------------------|-----------------|--------|
| PASSAT 1.9 | | 01/1981→07/1983 | | SANTANA 1.9 | | 08/1981→07/1983 | |
| V91030 | 035 109 611F | | 45° | SS H | VAG92061B | | |
| 33.30 x 7.95 x 98.60 | | MD + MB | | | 36.70 x 8.00 x 12.08 | | |
| | | | | | VAG92105B | | |
| | | | | | 42.30 x 7.99 x 12.08 | | |

83 **79.50**

| AAB | 2370cc | 5 Cyl. | 10 Valves | 57kW/78PS | Diesel | SOHC | TD4000 |
|----------------------|--------------|-----------------|-----------|-----------|----------------------|------|--------|
| TRANSPORTER IV 2.4 D | | 07/1990→04/2003 | | | | | |
| V91337 | 069 109 601F | | 45° | H | VAG92061B | | |
| 36.10 x 7.97 x 95.10 | | MB | | | 36.70 x 8.00 x 12.08 | | |
| V91334 | 074 109 611 | | 45° | SS H | | | |
| 31.30 x 7.95 x 95.10 | | ME + MB | | | | | |

84 **81.00**

| 1F | 1595cc | 4 Cyl. | 8 Valves | 53kW/72PS | Petrol | SOHC | TD4957 |
|----------------------|-----------------|---------|----------|-----------------|----------------------|------|--------|
| ABN | 1595cc | 4 Cyl. | 8 Valves | 54-55kW/73-75PS | Petrol | SOHC | TD4974 |
| PN | 1595cc | 4 Cyl. | 8 Valves | 51kW/70PS | Petrol | SOHC | TD4141 |
| RE | 1595cc | 4 Cyl. | 8 Valves | 53kW/72PS | Petrol | SOHC | TD4145 |
| RF | 1595cc | 4 Cyl. | 8 Valves | 53kW/72PS | Petrol | SOHC | TD5025 |
| RL | 1595cc | 4 Cyl. | 8 Valves | 53kW/72PS | Petrol | SOHC | TD4148 |
| CADDY II 1.6 | 11/1995→05/1997 | | | CADDY II 75 1.6 | 11/1995→05/1997 | | |
| GOLF I 1.6 | 04/1986→02/1990 | | | GOLF II 1.6 | 08/1983→12/1992 | | |
| JETTA II 1.6 | 01/1984→07/1992 | | | PASSAT 1.6 | 01/1985→07/1991 | | |
| POLO CLASSIC 75 1.6 | 11/1995→09/1997 | | | SAVEIRO I 1.6 | 08/1990→07/1996 | | |
| SAVEIRO II 1.6 | 07/1997→02/2002 | | | SCIROCCO 1.6 | 04/1986→07/1990 | | |
| V91338 | 035 109 601K | | 45° | | VAG92061B | | |
| 38.10 x 7.97 x 91.90 | | MD | | | 36.70 x 8.00 x 12.08 | | |
| V91340 | 048 109 611A | | 45° | H | | | |
| 33.30 x 7.95 x 91.20 | | MD + MB | | | | | |



OE

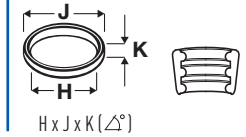
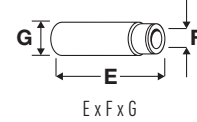

85



81.00

| | | | | | | | |
|----------------------|-----------------|--------|----------|-------------------|--------|-----------------|---------|
| ADP | 1595cc | 4 Cyl. | 8 Valves | 74kW/101PS | Petrol | SOHC | TD16253 |
| AEH | 1595cc | 4 Cyl. | 8 Valves | 74kW/100PS | Petrol | SOHC | TD9450 |
| AFT | 1595cc | 4 Cyl. | 8 Valves | 74kW/101PS | Petrol | SOHC | TD4988 |
| AHL | 1595cc | 4 Cyl. | 8 Valves | 74kW/101PS | Petrol | SOHC | TD5556 |
| AKL | 1595cc | 4 Cyl. | 8 Valves | 74-76kW/100-103PS | Petrol | SOHC | TD9451 |
| AKS | 1595cc | 4 Cyl. | 8 Valves | 74kW/101PS | Petrol | SOHC | TD9991 |
| ANA | 1595cc | 4 Cyl. | 8 Valves | 74kW/101PS | Petrol | SOHC | TD16254 |
| APF | 1595cc | 4 Cyl. | 8 Valves | 74kW/101PS | Petrol | SOHC | TD12848 |
| ARM | 1595cc | 4 Cyl. | 8 Valves | 74kW/101PS | Petrol | SOHC | TD16255 |
| AWH | 1595cc | 4 Cyl. | 8 Valves | 74kW/101PS | Petrol | SOHC | TD15465 |
| BORA 1.6 | 10/1998→05/2005 | | | GOLF III 1.6 | | 07/1994→04/1999 | |
| GOLF IV 1.6 | 08/1997→05/2004 | | | NEW BEETLE 1.6 | | 10/1999→09/2000 | |
| PASSAT 1.6 | 07/1994→11/2000 | | | POLO 1.6 | | 05/1997→10/2004 | |
| POLO CLASSIC 100 1.6 | 12/1995→09/2001 | | | VENTO 1.6 | | 10/1994→09/1998 | |

V94079 39.40 x 7.00 x 92.10

078 109 601B

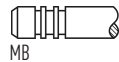

45°

H

VAG96041B 36.50 x 7.00 x 12.08

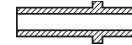

V94080 32.80 x 7.00 x 91.20

048 109 611B



45°

H

86



81.00

| | | | | | | | |
|--------------|-----------------|--------|----------|------------|--------|-----------------|--------|
| AEK | 1595cc | 4 Cyl. | 8 Valves | 74kW/101PS | Petrol | SOHC | TD4982 |
| GOLF III 1.6 | 07/1994→04/1999 | | | PASSAT 1.6 | | 07/1994→08/1996 | |
| VENTO 1.6 | 10/1994→09/1998 | | | | | | |

V91407 39.60 x 7.97 x 91.90
Eng.->000813

048 109 601A

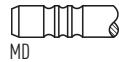

45°

VAG92061B 36.70 x 8.00 x 12.08
Eng.->000813



V94079 39.40 x 7.00 x 92.10
Eng.000814→

078 109 601B

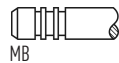

45°

H

VAG96041B 36.50 x 7.00 x 12.08
Eng.000814→



V91340 33.30 x 7.95 x 91.20
Eng.->000813

048 109 611A

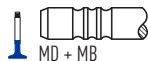

45°

H

V94080 32.80 x 7.00 x 91.20
Eng.000814→

048 109 611B



45°

H



OE

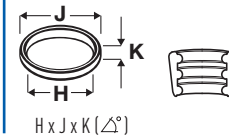
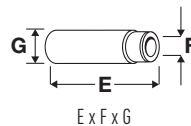

87 **81.00**

| | | | | | | | |
|------|--------|--------|----------|------------|--------|------|---------|
| ALZ | 1595cc | 4 Cyl. | 8 Valves | 75kW/102PS | Petrol | SOHC | TD15148 |
| AVU | 1595cc | 4 Cyl. | 8 Valves | 75kW/102PS | Petrol | SOHC | TD15475 |
| AYD | 1595cc | 4 Cyl. | 8 Valves | 75kW/102PS | Petrol | SOHC | TD15466 |
| BFQ | 1595cc | 4 Cyl. | 8 Valves | 75kW/102PS | Petrol | SOHC | TD18137 |
| BFS | 1595cc | 4 Cyl. | 8 Valves | 75kW/102PS | Petrol | SOHC | TD16743 |
| BGU | 1595cc | 4 Cyl. | 8 Valves | 75kW/102PS | Petrol | SOHC | TD17067 |
| BSE | 1595cc | 4 Cyl. | 8 Valves | 75kW/102PS | Petrol | SOHC | TD18222 |
| BSF | 1595cc | 4 Cyl. | 8 Valves | 75kW/102PS | Petrol | SOHC | TD18223 |
| CCSA | 1595cc | 4 Cyl. | 8 Valves | 75kW/102PS | Petrol | SOHC | TD20780 |
| CHGA | 1595cc | 4 Cyl. | 8 Valves | 75kW/102PS | Petrol | SOHC | TD22180 |
| CMXA | 1595cc | 4 Cyl. | 8 Valves | 75kW/102PS | Petrol | SOHC | TD24313 |

| | | | |
|---------------|-----------------|----------------|-----------------|
| BORA 1.6 | 08/2000→05/2005 | CADDY III 1.6 | 04/2004→05/2015 |
| GOLF IV 1.6 | 08/2000→06/2006 | GOLF V 1.6 | 01/2004→07/2009 |
| GOLF VI 1.6 | 10/2008→07/2013 | GOLF PLUS 1.6 | 05/2005→12/2013 |
| JETTA III 1.6 | 10/2005→10/2010 | NEW BEETLE 1.6 | 06/2000→09/2010 |
| PASSAT 1.6 | 11/2000→11/2010 | TOURAN 1.6 | 07/2003→05/2010 |

V94424
 39.50 x 6.00 x 94.00

06B 109 601D

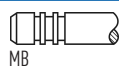

45° Y H

VAG96353B
 36.50 x 6.02 x 12.08



V94425
 32.90 x 6.00 x 93.90

06B 109 611C

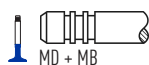

45° ss H

88 **81.00**

| | | | | | | | |
|----------|-----------------|----------------------|-----------------|------------|--------|------|---------|
| AUR | 1595cc | 4 Cyl. | 8 Valves | 74kW/101PS | Petrol | SOHC | TD15611 |
| POLO 1.6 | 05/1997→09/2001 | POLO CLASSIC 100 1.6 | 12/1995→09/2001 | | | | |

V94079
 39.40 x 7.00 x 92.10

078 109 601B

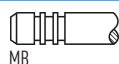

45° H

VAG96041B
 36.50 x 7.00 x 12.08

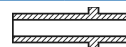

V94080
 32.80 x 7.00 x 91.20

048 109 611B



45° H

V94303
 32.90 x 7.00 x 91.20

078 109 611C



45° ss H

89 **81.00**

| | | | | | | | |
|-----|--------|--------|----------|-----------------|--------|------|---------|
| DTA | 1595cc | 4 Cyl. | 8 Valves | 51-55kW/69-75PS | Petrol | SOHC | TD22644 |
| PP | 1595cc | 4 Cyl. | 8 Valves | 51kW/70PS | Petrol | SOHC | TD5022 |

| | |
|------------|-----------------|
| PASSAT 1.6 | 08/1987→03/1988 |
|------------|-----------------|

V91338
 38.10 x 7.97 x 91.90

035 109 601K

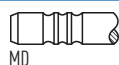

45°

VAG92061B
 36.70 x 8.00 x 12.08

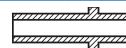

V91340
 33.30 x 7.95 x 91.20

048 109 611A



45° H

VAG92105B
 42.30 x 7.99 x 12.08



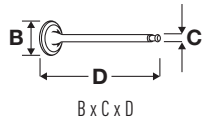

OE

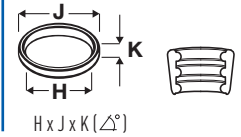
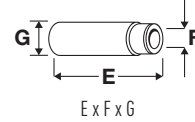

90  **81.00**

| | | | | | | | |
|-----------|--------|--------|-----------------|-----------------|--------|-------------|----------------|
| EW | 1595cc | 4 Cyl. | 8 Valves | 55kW/75PS | Petrol | SOHC | TD4070 |
| EZ | 1595cc | 4 Cyl. | 8 Valves | 53kW/72PS | Petrol | SOHC | TD4074 |
| HN | 1595cc | 4 Cyl. | 8 Valves | 53-55kW/72-75PS | Petrol | SOHC | TD4107 |
| JU | 1595cc | 4 Cyl. | 8 Valves | 55kW/75PS | Petrol | SOHC | TD12532 |

| | | | |
|----------------|-----------------|---------------|-----------------|
| CADDY I 1.6 | 01/1983→07/1992 | GOLF I 1.6 | 01/1983→04/1992 |
| GOLF II 1.6 | 08/1983→07/1992 | JETTA I 1.6 | 08/1982→07/1983 |
| JETTA II 1.6 | 01/1984→07/1992 | KOMBI 1.6 | 08/1992→07/2000 |
| PASSAT 1.6 | 04/1988→07/1991 | SAVEIRO I 1.6 | 08/1990→07/1996 |
| SAVEIRO II 1.6 | 07/1997→02/2002 | SCIROCCO 1.6 | 01/1983→12/1989 |

V91338 
38.10 x 7.97 x 91.90

035 109 601K



45°

VAG92061B 
36.70 x 8.00 x 12.08

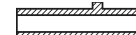

V91030 
33.30 x 7.95 x 98.60

035 109 611F



45°

SS H

VAG92105B 
42.30 x 7.99 x 12.08

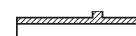

V91340 
33.30 x 7.95 x 91.20

048 109 611A

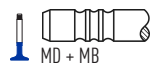

45°

H

91  **81.00**

| | | | | | | | |
|-----------|--------|--------|-----------------|---------------------|--------|---------------------------|---------------|
| 1H | 1781cc | 4 Cyl. | 8 Valves | 118kW/160PS | Petrol | Supercharged, SOHC | TD3994 |
| 1P | 1781cc | 4 Cyl. | 8 Valves | 72kW/98PS | Petrol | SOHC | TD3995 |
| 2H | 1781cc | 4 Cyl. | 8 Valves | 72kW/98PS | Petrol | SOHC | TD4965 |
| EV | 1781cc | 4 Cyl. | 8 Valves | 82kW/112PS | Petrol | SOHC | TD4069 |
| HT | 1781cc | 4 Cyl. | 8 Valves | 74-77kW/100-104PS | Petrol | SOHC | TD4109 |
| PG | 1781cc | 4 Cyl. | 8 Valves | 110-118kW/150-160PS | Petrol | Supercharged, SOHC | TD4140 |
| RD | 1781cc | 4 Cyl. | 8 Valves | 79kW/107PS | Petrol | SOHC | TD4143 |
| RG | 1781cc | 4 Cyl. | 8 Valves | 79kW/105PS | Petrol | SOHC, K-Jetronic | TD4146 |

| | | | |
|-----------------|-----------------|---------------------|-----------------|
| CORRADO 1.8 G60 | 09/1988→09/1993 | FOX 1.8 | 10/1990→12/1993 |
| GOLF I 1.8 | 08/1982→03/1993 | GOLF II 1.8 | 08/1988→07/1991 |
| GOLF II 1.8 GTI | 08/1983→10/1991 | GOLF II 1.8 GTI G60 | 08/1988→12/1991 |
| JETTA II 1.8 | 01/1984→12/1992 | PASSAT 1.8 G60 | 08/1988→05/1997 |
| SCIROCCO 1.8 | 08/1982→12/1989 | | |

V91407 
39.60 x 7.97 x 91.90

048 109 601A

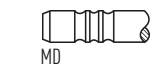

45°

VAG92061B 
36.70 x 8.00 x 12.08



V91340 
33.30 x 7.95 x 91.20

048 109 611A



45°

H



OE

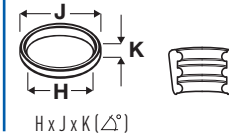
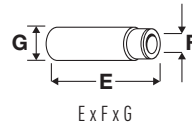
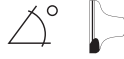

92  **81.00**

| | | | | | | | |
|---------------------|-----------------|--------|-----------------|-------------|--------|-----------------|---------------|
| AAM | 1781cc | 4 Cyl. | 8 Valves | 55kW/75PS | Petrol | SOHC | TD4004 |
| ADZ | 1781cc | 4 Cyl. | 8 Valves | 66kW/90PS | Petrol | SOHC | TD4980 |
| GOLF III 1.8 | 08/1991→04/1999 | | | GOLF IV 1.8 | | 06/1998→06/2002 | |
| PASSAT 1.8 | 02/1988→05/1997 | | | POLO 1.8 | | 01/1995→09/2001 | |
| POLO CLASSIC 90 1.8 | 01/1997→09/2001 | | | VENTO 1.8 | | 11/1991→09/1998 | |

V91338 
38.10 x 7.97 x 91.90
Eng.→408197

035 109 601K

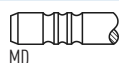

45°

VAG92061B 
36.70 x 8.00 x 12.08
Eng.→408197

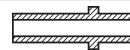

V94450 
37.80 x 7.00 x 91.80
Eng.408198→

048 109 601E

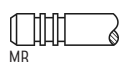

45°

Y

H

VAG96041B 
36.50 x 7.00 x 12.08
Eng.408198→



V91340 
33.30 x 7.95 x 91.20
Eng.→408197

048 109 611A

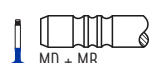

45°

H

V94080 
32.80 x 7.00 x 91.20
Eng.408198→

048 109 611B

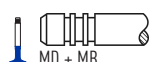

45°

H

93  **81.00**

| | | | | | | | |
|------------|--------|--------|-----------------|------------------|--------|-------------|----------------|
| ABS | 1781cc | 4 Cyl. | 8 Valves | 66kW/90PS | Petrol | SOHC | TD4975 |
| ACC | 1781cc | 4 Cyl. | 8 Valves | 66-67kW/90-91PS | Petrol | SOHC | TD4011 |
| ADD | 1781cc | 4 Cyl. | 8 Valves | 63-75kW/86-102PS | Petrol | SOHC | TD15496 |
| DZ | 1781cc | 4 Cyl. | 8 Valves | 82kW/112PS | Petrol | SOHC | TD4998 |
| GU | 1781cc | 4 Cyl. | 8 Valves | 66kW/90PS | Petrol | SOHC | TD5007 |
| GX | 1781cc | 4 Cyl. | 8 Valves | 66kW/90PS | Petrol | SOHC | TD4100 |
| GZ | 1781cc | 4 Cyl. | 8 Valves | 82kW/112PS | Petrol | SOHC | TD4102 |
| HV | 1781cc | 4 Cyl. | 8 Valves | 66kW/90PS | Petrol | SOHC | TD4111 |
| PD | 1781cc | 4 Cyl. | 8 Valves | 49kW/67PS | Petrol | SOHC | TD4138 |
| RM | 1781cc | 4 Cyl. | 8 Valves | 64kW/87PS | Petrol | SOHC | TD4149 |
| RP | 1781cc | 4 Cyl. | 8 Valves | 66kW/90PS | Petrol | SOHC | TD5027 |

| | | | | | | | |
|------------------------|-----------------|--|--|--------------------|--|-----------------|--|
| CADDY 1.8 | 09/2002→09/2005 | | | DERBY 1.8 | | 09/1994→12/2009 | |
| GOLF II 1.8 | 08/1984→10/1991 | | | GOLF II 1.8 GTI | | 08/1983→10/1991 | |
| GOLF II 1.8 i | 08/1987→07/1991 | | | GOLF II 1.8 i Cat | | 08/1987→10/1991 | |
| GOLF III 1.8 | 08/1991→04/1999 | | | GOLF IV 1.8 | | 10/1997→09/1999 | |
| GOL I 1.8 | 05/1984→09/1994 | | | JETTA II 1.8 | | 01/1984→10/1991 | |
| JETTA II 1.8 Cat | 08/1987→10/1991 | | | LOGUS 1.8 | | 10/1993→09/1994 | |
| PARATI I 1.8 | 08/1991→07/1994 | | | PASSAT 1.8 | | 12/1983→05/1997 | |
| POINTER 1.8 | 10/1993→09/1994 | | | POLO 1.8 | | 10/2005→12/2008 | |
| POLO CLASSIC 90 1.8 | 01/1997→09/2001 | | | TRANSPORTER IV 1.8 | | 12/1990→07/1992 | |
| VAN Mini Passenger 1.8 | 09/2007→12/2009 | | | VENTO 1.8 | | 11/1991→09/1998 | |
| VOYAGE 1.8 | 05/1984→09/1988 | | | | | | |

V91338 
38.10 x 7.97 x 91.90

035 109 601K

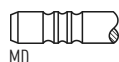

45°

VAG92061B 
36.70 x 8.00 x 12.08

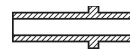

V91340 
33.30 x 7.95 x 91.20

048 109 611A

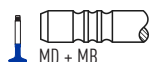

45°

H



OE

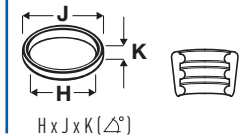

94  **81.00**

| | | | | | | | |
|-----|--------|--------|-----------|------------|--------|------|---------|
| ADR | 1781cc | 4 Cyl. | 20 Valves | 92kW/125PS | Petrol | DOHC | TD5557 |
| AFY | 1781cc | 4 Cyl. | 20 Valves | 85kW/115PS | Petrol | DOHC | TD16244 |
| AGN | 1781cc | 4 Cyl. | 20 Valves | 92kW/125PS | Petrol | DOHC | TD9363 |
| APT | 1781cc | 4 Cyl. | 20 Valves | 92kW/125PS | Petrol | DOHC | TD11497 |
| ARG | 1781cc | 4 Cyl. | 20 Valves | 92kW/125PS | Petrol | DOHC | TD16237 |

| | | | |
|--------------------|-----------------|--------------|-----------------|
| BORA 1.8 | 10/1998→05/2005 | CITYGOLF 1.8 | 06/1996→12/1999 |
| GOLF IV 1.8 | 08/1997→06/2006 | PASSAT 1.8 | 10/1996→03/2005 |
| PASSAT 1.8/4motion | 10/1996→11/2000 | | |

V94081 
26.90 x 6.00 x 105.10

058 109 601C



45° Y H

VAG96073B 
36.00 x 6.02 x 11.06

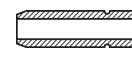

V94083 
29.90 x 6.00 x 103.90

058 109 611M

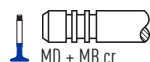

45° H

95  **81.00**

| | | | | | | | |
|-----|--------|--------|-----------|---------------------|--------|-------------|---------|
| AEB | 1781cc | 4 Cyl. | 20 Valves | 110-112kW/150-152PS | Petrol | Turbo, DOHC | TD5558 |
| AGU | 1781cc | 4 Cyl. | 20 Valves | 110kW/150PS | Petrol | Turbo, DOHC | TD9456 |
| AJH | 1781cc | 4 Cyl. | 20 Valves | 110kW/150PS | Petrol | Turbo, DOHC | TD10887 |
| ANB | 1781cc | 4 Cyl. | 20 Valves | 110kW/150PS | Petrol | Turbo, DOHC | TD16256 |
| APH | 1781cc | 4 Cyl. | 20 Valves | 110kW/150PS | Petrol | Turbo, DOHC | TD13441 |
| APU | 1781cc | 4 Cyl. | 20 Valves | 110kW/150PS | Petrol | Turbo, DOHC | TD16257 |
| AQA | 1781cc | 4 Cyl. | 20 Valves | 110kW/150PS | Petrol | Turbo, DOHC | TD22620 |
| ARX | 1781cc | 4 Cyl. | 20 Valves | 110kW/150PS | Petrol | Turbo, DOHC | TD15485 |
| ARZ | 1781cc | 4 Cyl. | 20 Valves | 110kW/150PS | Petrol | Turbo, DOHC | TD16385 |
| AUM | 1781cc | 4 Cyl. | 20 Valves | 110kW/150PS | Petrol | Turbo, DOHC | TD15486 |
| AUQ | 1781cc | 4 Cyl. | 20 Valves | 132-142kW/180-193PS | Petrol | Turbo, DOHC | TD16420 |
| AVC | 1781cc | 4 Cyl. | 20 Valves | 110kW/150PS | Petrol | Turbo, DOHC | TD15467 |
| AWC | 1781cc | 4 Cyl. | 20 Valves | 110kW/150PS | Petrol | Turbo, DOHC | TD14914 |
| AWP | 1781cc | 4 Cyl. | 20 Valves | 132kW/180PS | Petrol | Turbo, DOHC | TD19253 |
| AWT | 1781cc | 4 Cyl. | 20 Valves | 110kW/150PS | Petrol | Turbo, DOHC | TD15149 |
| AWU | 1781cc | 4 Cyl. | 20 Valves | 110kW/150PS | Petrol | Turbo, DOHC | TD15468 |
| AWV | 1781cc | 4 Cyl. | 20 Valves | 110kW/150PS | Petrol | Turbo, DOHC | TD15469 |
| BAF | 1781cc | 4 Cyl. | 20 Valves | 92kW/125PS | Petrol | DOHC | TD19143 |
| BBU | 1781cc | 4 Cyl. | 20 Valves | 132kW/180PS | Petrol | Turbo, DOHC | TD20512 |
| BJX | 1781cc | 4 Cyl. | 20 Valves | 110kW/150PS | Petrol | Turbo, DOHC | TD18799 |
| BKF | 1781cc | 4 Cyl. | 20 Valves | 110kW/150PS | Petrol | Turbo, DOHC | TD21071 |
| BNU | 1781cc | 4 Cyl. | 20 Valves | 132kW/180PS | Petrol | Turbo, DOHC | TD21072 |

| | | | |
|--------------------------|-----------------|------------------|-----------------|
| BORA 1.8 | 10/1998→05/2005 | BORA 1.8 T | 05/2000→05/2005 |
| GOLF 1.8 GTI | 04/2007→05/2008 | GOLF IV 1.8 | 08/1997→06/2005 |
| GOLF IV 1.8 T | 08/1997→06/2006 | GOLF V 1.8 GTI | 08/2001→06/2005 |
| GOLF V 1.8 GTI | 04/2007→05/2008 | NEW BEETLE 1.8 T | 10/1999→09/2010 |
| PASSAT 1.8 | 09/1998→12/2001 | PASSAT 1.8 T | 10/1996→11/2000 |
| PASSAT 1.8 T 20V | 11/2000→05/2005 | POLO 1.8 GTI | 09/2005→11/2009 |
| POLO 1.8 GTi Cup Edition | 05/2006→11/2009 | SHARAN 1.8 T 20V | 09/1997→03/2010 |

V94081 
26.90 x 6.00 x 105.10

058 109 601C



45° Y H

VAG96073B 
36.00 x 6.02 x 11.06

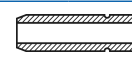

V94082 
29.90 x 6.00 x 103.90

058 109 611E

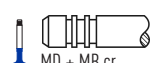

45° ss H

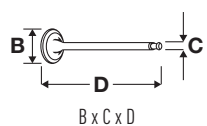

OE

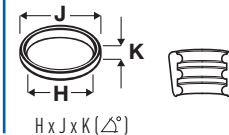
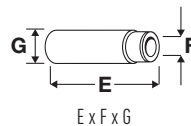

96 **81.00**

| | | | | | | | |
|----------------------|-----------------|---------|-----------------|-------------|-----------------|----------------------|----------------|
| ANN | 1781cc | 4 Cyl. | 8 Valves | 55kW/75PS | Petrol | SOHC | TD10847 |
| ANP | 1781cc | 4 Cyl. | 8 Valves | 66kW/90PS | Petrol | SOHC | TD10848 |
| GOLF III 1.8 | 07/1993→04/1999 | | | GOLF IV 1.8 | 06/1998→06/2002 | | |
| V94450 | 048 109 601E | | 45° | Y | H | VAG96041B | |
| 37.80 x 7.00 x 91.80 | | MB | | | | 36.50 x 7.00 x 12.08 | |
| V94080 | 048 109 611B | | 45° | | H | | |
| 32.80 x 7.00 x 91.20 | | MD + MB | | | | | |

97 **81.00**

| | | | | | | | |
|----------------------|-----------------|---------|-----------------|------------------|-----------------|----------------------|---------------|
| DS | 1781cc | 4 Cyl. | 8 Valves | 66kW/90PS | Petrol | SOHC | TD4996 |
| JN | 1781cc | 4 Cyl. | 8 Valves | 66-76kW/90-103PS | Petrol | SOHC | TD5014 |
| RH | 1781cc | 4 Cyl. | 8 Valves | 62kW/84PS | Petrol | SOHC | TD5026 |
| FOX 1.8 | 09/1986→12/1990 | | | GOLF II 1.8 | 08/1986→01/1990 | | |
| JETTA II 1.8 | 08/1986→01/1990 | | | PASSAT 1.8 | 01/1983→03/1988 | | |
| SANTANA 1.8 | 01/1983→12/1985 | | | SANTANA 1.8 GL | 05/1991→07/1994 | | |
| V91338 | 035 109 601K | | 45° | | | VAG92061B | |
| 38.10 x 7.97 x 91.90 | | MD | | | | 36.70 x 8.00 x 12.08 | |
| V91340 | 048 109 611A | | 45° | | H | VAG92105B | |
| 33.30 x 7.95 x 91.20 | | MD + MB | | | | 42.30 x 7.99 x 12.08 | |

98 **81.00**

| | | | | | | | |
|----------------------|-----------------|---------|-----------------|----------------|-----------------|----------------------|---------------|
| DX | 1781cc | 4 Cyl. | 8 Valves | 82kW/112PS | Petrol | SOHC | TD4063 |
| GOLF I 1.8 | 08/1982→12/1992 | | | GOLF I 1.8 GTI | 08/1982→12/1983 | | |
| GOLF II 1.8 GTI | 08/1983→10/1991 | | | JETTA I 1.8 | 08/1982→02/1984 | | |
| SCIROCCO 1.8 | 08/1982→12/1989 | | | | | | |
| V91407 | 048 109 601A | | 45° | | | VAG92061B | |
| 39.60 x 7.97 x 91.90 | | MD | | | | 36.70 x 8.00 x 12.08 | |
| V94304 | 026 109 601 | | 45° | Y | H | VAG92105B | |
| 40.00 x 8.00 x 98.70 | | MB | | | | 42.30 x 7.99 x 12.08 | |
| V91030 | 035 109 611F | | 45° | ss | H | | |
| 33.30 x 7.95 x 98.60 | | MD + MB | | | | | |
| V91340 | 048 109 611A | | 45° | | H | | |
| 33.30 x 7.95 x 91.20 | | MD + MB | | | | | |

99 **81.00**

| | | | | | | | |
|----------------------|-----------------|---------|-----------------|--------------|-----------------|----------------------|---------------|
| EX | 1781cc | 4 Cyl. | 8 Valves | 66kW/90PS | Petrol | SOHC | TD5000 |
| GOLF I 1.8 | 08/1983→09/1992 | | | SCIROCCO 1.8 | 08/1983→07/1992 | | |
| V91030 | 035 109 611F | | 45° | ss | H | VAG92061B | |
| 33.30 x 7.95 x 98.60 | | MD + MB | | | | 36.70 x 8.00 x 12.08 | |
| | | | | | | VAG92105B | |
| | | | | | | 42.30 x 7.99 x 12.08 | |

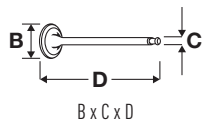

OE

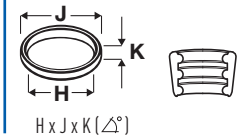
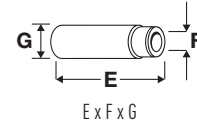

100 **81.00**

| | | | | | | | |
|--------------|-----------------|--------|-----------------|------------------|--------|-----------------|---------------|
| JH | 1781cc | 4 Cyl. | 8 Valves | 66-75kW/90-102PS | Petrol | SOHC | TD4117 |
| CADDY I 1.8 | 08/1985→07/1992 | | | GOLF I 1.8 | | 09/1982→04/1993 | |
| JETTA I 1.8 | 09/1983→02/1984 | | | PARATI I 1.8 | | 08/1987→07/1994 | |
| SCIROCCO 1.8 | 11/1985→07/1992 | | | | | | |

V91338
38.10 x 7.97 x 91.90

035 109 601K

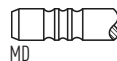

45°

VAG92105B
42.30 x 7.99 x 12.08

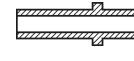

V91340
33.30 x 7.95 x 91.20

048 109 611A

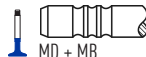

45°

H

101 **81.00**

| | | | | | | | |
|----------------|-----------------|--------|-----------------|-------------|--------|-----------------|---------------|
| JJ | 1781cc | 4 Cyl. | 8 Valves | 82kW/112PS | Petrol | SOHC | TD4118 |
| GOLF I 1.8 GTI | 08/1982→12/1983 | | | JETTA I 1.8 | | 08/1982→02/1984 | |
| SCIROCCO 1.8 | 08/1982→12/1989 | | | | | | |

V94304
40.00 x 8.00 x 98.70

026 109 601

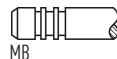

45°

Y

H

VAG92105B
42.30 x 7.99 x 12.08

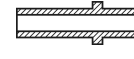

102 **81.00**

| | | | | | | | |
|------------|-----------------|--------|-----------------|-------------|--------|-----------------|---------------|
| JV | 1781cc | 4 Cyl. | 8 Valves | 66kW/90PS | Petrol | SOHC | TD5017 |
| PASSAT 1.8 | 01/1983→03/1988 | | | SANTANA 1.8 | | 01/1995→12/1999 | |

V91338
38.10 x 7.97 x 91.90

035 109 601K

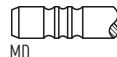

45°

VAG92061B
36.70 x 8.00 x 12.08

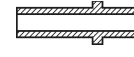

V91030
33.30 x 7.95 x 98.60

035 109 611F

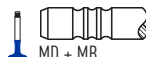

45°

SS

H

VAG92105B
42.30 x 7.99 x 12.08

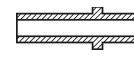

V91340
33.30 x 7.95 x 91.20

048 109 611A

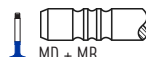

45°

H

103 **81.00**

| | | | | | | | |
|---------------------|-----------------|--------|------------------|---------------------|--------|-----------------|---------------|
| KR | 1781cc | 4 Cyl. | 16 Valves | 100-102kW/136-140PS | Petrol | DOHC | TD5019 |
| PL | 1781cc | 4 Cyl. | 16 Valves | 92-95kW/125-129PS | Petrol | DOHC | TD5021 |
| CORRADO 1.8 16V | 04/1989→07/1992 | | | GOLF II 1.8 16V | | 09/1986→12/1989 | |
| GOLF II 1.8 GTI 16V | 02/1986→10/1991 | | | JETTA II 1.8 16V | | 08/1986→10/1991 | |
| PASSAT 1.8 | 08/1991→09/1993 | | | PASSAT 1.8 16V | | 04/1988→12/1989 | |
| PASSAT 1.8 GL | 08/1991→09/1993 | | | SCIROCCO 1.8 16V | | 09/1985→07/1992 | |

V91416
32.10 x 6.97 x 95.50

027 109 601C

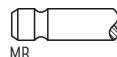

45°

H

VAG92382B
38.00 x 7.00 x 12.05



V91372
28.10 x 6.95 x 98.20

027 109 611D

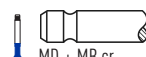

45°

H

104 **81.00**

| | | | | | | | |
|------------|-----------------|--------|-----------------|------------|--------|-------------|---------------|
| KT | 1781cc | 4 Cyl. | 8 Valves | 82kW/112PS | Petrol | SOHC | TD4124 |
| GOLF I 1.8 | 08/1982→12/1989 | | | | | | |

V91407
39.60 x 7.97 x 91.90

048 109 601A

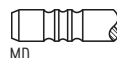

45°

VAG92105B
42.30 x 7.99 x 12.08

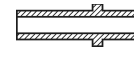

V91340
33.30 x 7.95 x 91.20

048 109 611A

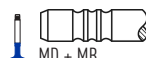

45°

H

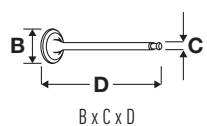

OE

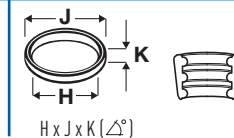
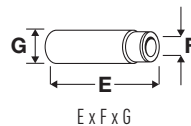

105 **81.00**

| | | | | | | | |
|-----------------|-----------------|--------|-----------------|---------------------|-----------------|-------------|---------------|
| PB | 1781cc | 4 Cyl. | 8 Valves | 82kW/112PS | Petrol | SOHC | TD9367 |
| PF | 1781cc | 4 Cyl. | 8 Valves | 75-79kW/102-107PS | Petrol | SOHC | TD4139 |
| RV | 1781cc | 4 Cyl. | 8 Valves | 75-77kW/102-105PS | Petrol | SOHC | TD4151 |
| GOLF I 1.8 | 08/1982→12/1989 | | | GOLF II 1.8 | 09/1987→12/1992 | | |
| GOLF II 1.8 GTI | 08/1983→10/1991 | | | GOLF II 1.8 GTI Cat | 01/1987→10/1991 | | |
| JETTA II 1.8 | 01/1984→12/1992 | | | JETTA II 1.8 Cat | 01/1987→10/1991 | | |
| PASSAT 1.8 | 04/1988→07/1993 | | | SCIROCCO 1.8 | 08/1982→12/1989 | | |

| | | | | | | | |
|----------------------|--------------|---------|-----|---|--|----------------------|--|
| V91407 | 048 109 601A | | 45° | | | VAG92061B | |
| 39.60 x 7.97 x 91.90 | | MD | | | | 36.70 x 8.00 x 12.08 | |
| V91340 | 048 109 611A | | 45° | H | | VAG92105B | |
| 33.30 x 7.95 x 91.20 | | MD + MB | | | | 42.30 x 7.99 x 12.08 | |

106 **81.00**

| | | | | | | | |
|--------------------|-----------------|--------|-----------------|--------------|-----------------|-------------|---------------|
| AAC | 1968cc | 4 Cyl. | 8 Valves | 62kW/84PS | Petrol | SOHC | TD4001 |
| TRANSPORTER IV 2.0 | 07/1990→04/2003 | | | VENTO 2.0 GL | 11/1991→07/1998 | | |

| | | | | | | | |
|----------------------|--------------|---------|-----|---|--|----------------------|--|
| V91407 | 048 109 601A | | 45° | | | VAG92061B | |
| 39.60 x 7.97 x 91.90 | | MD | | | | 36.70 x 8.00 x 12.08 | |
| V91340 | 048 109 611A | | 45° | H | | | |
| 33.30 x 7.95 x 91.20 | | MD + MB | | | | | |

107 **81.00**

| | | | | | | | |
|------------|--------|--------|------------------|-------------|--------|--------------------|----------------|
| AZV | 1968cc | 4 Cyl. | 16 Valves | 100kW/136PS | Diesel | Turbo, DOHC | TD16862 |
| BKD | 1968cc | 4 Cyl. | 16 Valves | 103kW/140PS | Diesel | Turbo, DOHC | TD17080 |
| BKP | 1968cc | 4 Cyl. | 16 Valves | 103kW/140PS | Diesel | Turbo, DOHC | TD18135 |
| BMA | 1968cc | 4 Cyl. | 16 Valves | 100kW/136PS | Diesel | Turbo, DOHC | TD18225 |
| BMN | 1968cc | 4 Cyl. | 16 Valves | 125kW/170PS | Diesel | Turbo, DOHC | TD18471 |
| BMR | 1968cc | 4 Cyl. | 16 Valves | 125kW/170PS | Diesel | Turbo, DOHC | TD18188 |
| BUZ | 1968cc | 4 Cyl. | 16 Valves | 120kW/163PS | Diesel | Turbo, DOHC | TD20499 |
| BVE | 1968cc | 4 Cyl. | 16 Valves | 90kW/122PS | Diesel | Turbo, DOHC | TD18543 |
| BWV | 1968cc | 4 Cyl. | 16 Valves | 88kW/120PS | Diesel | Turbo, DOHC | TD20498 |

| | | | | | | | |
|-------------------|-----------------|--|--|-----------------------|-----------------|--|--|
| GOLF V 2.0 TDI | 10/2003→07/2009 | | | GOLF V 2.0 TDI 16V | 10/2003→07/2009 | | |
| GOLF PLUS 2.0 TDI | 05/2005→12/2013 | | | GOLF PLUS 2.0 TDI 16V | 01/2005→12/2013 | | |
| JETTA III 2.0 TDI | 09/2005→10/2010 | | | JETTA III 2.0 TDI 16V | 08/2005→10/2010 | | |
| PASSAT 2.0 TDI | 03/2005→11/2010 | | | PASSAT 2.0 TDI 16V | 03/2005→11/2010 | | |
| TOURAN 2.0 TDI | 02/2003→05/2010 | | | TOURAN 2.0 TDI 16V | 08/2003→05/2010 | | |

| | | | | | | | |
|----------------------|--------------|---------|-----|----|---|----------------------|--|
| V94697 | 03G 109 601B | | 45° | Y | H | VAG96237B | |
| 29.20 x 6.00 x 87.80 | | MB | | | | 42.00 x 6.02 x 10.07 | |
| V98007 | 03G 109 601A | | 45° | | | | |
| 29.20 x 6.00 x 88.45 | | MB | | | | | |
| V94698 | 03G 109 611B | | 45° | ss | H | | |
| 25.50 x 6.00 x 88.10 | | MD + MB | | | | | |
| V98097 | 03G 109 611D | | 45° | | | | |
| 25.40 x 6.00 x 87.50 | | MD + MB | | | | | |



OE

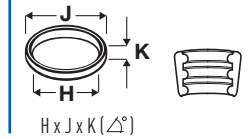
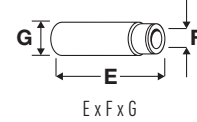

108



81.00

| | | | | | | | |
|-------------------|-----------------|--------|----------|-------------------|-----------------|-------------|---------|
| BDJ | 1968cc | 4 Cyl. | 8 Valves | 51kW/70PS | Diesel | SOHC | TD17358 |
| BDK | 1968cc | 4 Cyl. | 8 Valves | 55kW/75PS | Diesel | SOHC | TD17359 |
| BGW | 1968cc | 4 Cyl. | 8 Valves | 100kW/136PS | Diesel | Turbo, SOHC | TD18539 |
| BHW | 1968cc | 4 Cyl. | 8 Valves | 100kW/136PS | Diesel | SOHC | TD22177 |
| BMM | 1968cc | 4 Cyl. | 8 Valves | 103kW/140PS | Diesel | Turbo, SOHC | TD18482 |
| BMP | 1968cc | 4 Cyl. | 8 Valves | 103kW/140PS | Diesel | Turbo, SOHC | TD18136 |
| BRT | 1968cc | 4 Cyl. | 8 Valves | 103kW/140PS | Diesel | Turbo, SOHC | TD19105 |
| BST | 1968cc | 4 Cyl. | 8 Valves | 51kW/70PS | Diesel | SOHC | TD20501 |
| BVH | 1968cc | 4 Cyl. | 8 Valves | 100kW/136PS | Diesel | Turbo, SOHC | TD20520 |
| CADDY III 2.0 SDI | 03/2004→08/2010 | | | CADDY III 2.0 TDI | 09/2007→08/2010 | | |
| EOS 2.0 TDI | 06/2006→05/2008 | | | GOLF V 2.0 SDI | 01/2004→11/2008 | | |
| GOLF V 2.0 TDI | 08/2004→07/2009 | | | GOLF PLUS 2.0 TDI | 12/2005→05/2011 | | |
| JETTA III 2.0 TDI | 10/2005→10/2010 | | | PASSAT 2.0 TDI | 12/2003→05/2009 | | |
| SHARAN 2.0 TDI | 11/2005→03/2010 | | | TOURAN 2.0 TDI | 12/2005→05/2010 | | |

V94649 ■
36.00 x 7.00 x 89.40

038 109 601E



45° Y H

VAG96041B ■ ■ ■
36.50 x 7.00 x 12.08

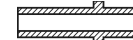

V94650 ■
31.40 x 7.00 x 89.00

038 109 611E



45° SS H

109



81.00

| | | | | | | | |
|------|--------|--------|-----------|-------------|--------|-------------|---------|
| CAAA | 1968cc | 4 Cyl. | 16 Valves | 62kW/84PS | Diesel | Turbo, DOHC | TD23411 |
| CAAB | 1968cc | 4 Cyl. | 16 Valves | 75kW/102PS | Diesel | Turbo, DOHC | TD23412 |
| CAAC | 1968cc | 4 Cyl. | 16 Valves | 103kW/140PS | Diesel | Turbo, DOHC | TD23414 |
| CAAD | 1968cc | 4 Cyl. | 16 Valves | 84kW/114PS | Diesel | Turbo, DOHC | TD26334 |
| CAAE | 1968cc | 4 Cyl. | 16 Valves | 100kW/136PS | Diesel | Turbo, DOHC | TD24473 |
| CBAA | 1968cc | 4 Cyl. | 16 Valves | 100kW/136PS | Diesel | Turbo, DOHC | TD20798 |
| CBAB | 1968cc | 4 Cyl. | 16 Valves | 103kW/140PS | Diesel | Turbo, DOHC | TD20799 |
| CBAC | 1968cc | 4 Cyl. | 16 Valves | 105kW/143PS | Diesel | Turbo, DOHC | TD20800 |
| CBBA | 1968cc | 4 Cyl. | 16 Valves | 120kW/163PS | Diesel | Turbo, DOHC | TD21661 |
| CBBB | 1968cc | 4 Cyl. | 16 Valves | 125kW/170PS | Diesel | Turbo, DOHC | TD20949 |
| CBDA | 1968cc | 4 Cyl. | 16 Valves | 100kW/136PS | Diesel | Turbo, DOHC | TD22715 |
| CBDB | 1968cc | 4 Cyl. | 16 Valves | 103kW/140PS | Diesel | Turbo, DOHC | TD21070 |
| CBDC | 1968cc | 4 Cyl. | 16 Valves | 81kW/110PS | Diesel | Turbo, DOHC | TD21109 |
| CBEA | 1968cc | 4 Cyl. | 16 Valves | 103kW/140PS | Diesel | Turbo, DOHC | TD22176 |
| CCHA | 1968cc | 4 Cyl. | 16 Valves | 103kW/140PS | Diesel | Turbo, DOHC | TD24471 |
| CCHB | 1968cc | 4 Cyl. | 16 Valves | 100kW/136PS | Diesel | Turbo, DOHC | TD24474 |
| CBDA | 1968cc | 4 Cyl. | 16 Valves | 90kW/122PS | Diesel | Turbo, DOHC | TD24402 |
| CDCA | 1968cc | 4 Cyl. | 16 Valves | 120kW/163PS | Diesel | Turbo, DOHC | TD24403 |
| CEGA | 1968cc | 4 Cyl. | 16 Valves | 125kW/170PS | Diesel | Turbo, DOHC | TD24125 |
| CFCA | 1968cc | 4 Cyl. | 16 Valves | 132kW/180PS | Diesel | Turbo, DOHC | TD23421 |
| CFFA | 1968cc | 4 Cyl. | 16 Valves | 100kW/136PS | Diesel | Turbo, DOHC | TD23312 |
| CFFB | 1968cc | 4 Cyl. | 16 Valves | 103kW/140PS | Diesel | Turbo, DOHC | TD23178 |
| CFFD | 1968cc | 4 Cyl. | 16 Valves | 81kW/110PS | Diesel | Turbo, DOHC | TD24215 |
| CFFE | 1968cc | 4 Cyl. | 16 Valves | 85kW/115PS | Diesel | Turbo, DOHC | TD25739 |
| CFGB | 1968cc | 4 Cyl. | 16 Valves | 125kW/170PS | Diesel | Turbo, DOHC | TD23180 |
| CFGC | 1968cc | 4 Cyl. | 16 Valves | 130kW/177PS | Diesel | Turbo, DOHC | TD26990 |
| CFHB | 1968cc | 4 Cyl. | 16 Valves | 100kW/136PS | Diesel | Turbo, DOHC | TD24314 |
| CFHC | 1968cc | 4 Cyl. | 16 Valves | 103kW/140PS | Diesel | Turbo, DOHC | TD24315 |



OE

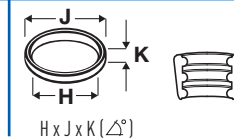
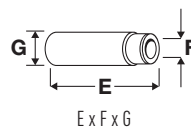

| | | | | | | | |
|------|--------|--------|-----------|---------------------|--------|-------------|---------|
| CFHE | 1968cc | 4 Cyl. | 16 Valves | 62kW/85PS | Diesel | Turbo, DOHC | TD25438 |
| CFHF | 1968cc | 4 Cyl. | 16 Valves | 81kW/110PS | Diesel | Turbo, DOHC | TD24366 |
| CFJA | 1968cc | 4 Cyl. | 16 Valves | 125kW/170PS | Diesel | Turbo, DOHC | TD24994 |
| CFJB | 1968cc | 4 Cyl. | 16 Valves | 130kW/177PS | Diesel | Turbo, DOHC | TD27973 |
| CJAA | 1968cc | 4 Cyl. | 16 Valves | 103-104kW/140-141PS | Diesel | Turbo, DOHC | TD23179 |
| CKFC | 1968cc | 4 Cyl. | 16 Valves | 110kW/150PS | Diesel | Turbo, DOHC | TD27197 |
| CKRA | 1968cc | 4 Cyl. | 16 Valves | 103kW/140PS | Diesel | Turbo, DOHC | TD31393 |
| CKTB | 1968cc | 4 Cyl. | 16 Valves | 80kW/109PS | Diesel | Turbo, DOHC | TD25415 |
| CKTC | 1968cc | 4 Cyl. | 16 Valves | 100kW/136PS | Diesel | Turbo, DOHC | TD25416 |
| CKUB | 1968cc | 4 Cyl. | 16 Valves | 120kW/163PS | Diesel | Turbo, DOHC | TD25417 |
| CKUC | 1968cc | 4 Cyl. | 16 Valves | 105kW/142PS | Diesel | Turbo, DOHC | TD25418 |
| CLCA | 1968cc | 4 Cyl. | 16 Valves | 81kW/110PS | Diesel | Turbo, DOHC | TD24835 |
| CLCB | 1968cc | 4 Cyl. | 16 Valves | 103kW/140PS | Diesel | Turbo, DOHC | TD24600 |
| CLJA | 1968cc | 4 Cyl. | 16 Valves | 103kW/140PS | Diesel | Turbo, DOHC | TD24963 |
| CLLA | 1968cc | 4 Cyl. | 16 Valves | 125kW/170PS | Diesel | Turbo, DOHC | TD24441 |
| CNEA | 1968cc | 4 Cyl. | 16 Valves | 132kW/180PS | Diesel | Turbo, DOHC | TD26330 |
| CNFA | 1968cc | 4 Cyl. | 16 Valves | 90kW/122PS | Diesel | Turbo, DOHC | TD26995 |
| CNFB | 1968cc | 4 Cyl. | 16 Valves | 103kW/140PS | Diesel | Turbo, DOHC | TD26996 |
| CRBB | 1968cc | 4 Cyl. | 16 Valves | 105kW/143PS | Diesel | Turbo, DOHC | TD27964 |
| CRBC | 1968cc | 4 Cyl. | 16 Valves | 110kW/150PS | Diesel | Turbo, DOHC | TD27202 |
| CRFC | 1968cc | 4 Cyl. | 16 Valves | 105kW/143PS | Diesel | Turbo, DOHC | TD32975 |
| CRLB | 1968cc | 4 Cyl. | 16 Valves | 110kW/150PS | Diesel | Turbo, DOHC | TD27196 |
| CRMB | 1968cc | 4 Cyl. | 16 Valves | 110kW/150PS | Diesel | Turbo, DOHC | TD27198 |
| CRUA | 1968cc | 4 Cyl. | 16 Valves | 110kW/150PS | Diesel | Turbo, DOHC | TD31407 |
| CRVA | 1968cc | 4 Cyl. | 16 Valves | 81kW/110PS | Diesel | Turbo, DOHC | TD27965 |
| CRVC | 1968cc | 4 Cyl. | 16 Valves | 105kW/143PS | Diesel | Turbo, DOHC | TD29264 |
| CSHA | 1968cc | 4 Cyl. | 16 Valves | 132kW/180PS | Diesel | Turbo, DOHC | TD26331 |
| CUNA | 1968cc | 4 Cyl. | 16 Valves | 135kW/184PS | Diesel | Turbo, DOHC | TD27978 |
| CUPA | 1968cc | 4 Cyl. | 16 Valves | 135kW/184PS | Diesel | Turbo, DOHC | TD32773 |
| CUUB | 1968cc | 4 Cyl. | 16 Valves | 110kW/150PS | Diesel | Turbo, DOHC | TD28213 |
| CUVA | 1968cc | 4 Cyl. | 16 Valves | 85kW/115PS | Diesel | Turbo, DOHC | TD31371 |
| CUVC | 1968cc | 4 Cyl. | 16 Valves | 110kW/150PS | Diesel | Turbo, DOHC | TD30995 |
| CUWA | 1968cc | 4 Cyl. | 16 Valves | 135kW/184PS | Diesel | Turbo, DOHC | TD30937 |
| CYKB | 1968cc | 4 Cyl. | 16 Valves | 81kW/110PS | Diesel | Turbo, DOHC | TD32295 |
| DFA | 1968cc | 4 Cyl. | 16 Valves | 110kW/150PS | Diesel | Turbo, DOHC | TD31777 |
| DFEB | 1968cc | 4 Cyl. | 16 Valves | 81kW/110PS | Diesel | Turbo, DOHC | TD33492 |
| DFGA | 1968cc | 4 Cyl. | 16 Valves | 110kW/150PS | Diesel | Turbo, DOHC | TD32774 |
| DFGB | 1968cc | 4 Cyl. | 16 Valves | 81kW/110PS | Diesel | Turbo, DOHC | TD33493 |
| DFHA | 1968cc | 4 Cyl. | 16 Valves | 140kW/190PS | Diesel | Turbo, DOHC | TD32468 |

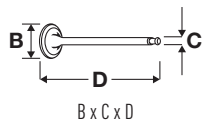

| | | | |
|-----------------------|-----------------|-----------------------|-----------------|
| AMAROK 2.0 BiTDI | 09/2010→ | AMAROK 2.0 TDI | 09/2010→ |
| ARTEON 2.0 TDI | 04/2017→ | BEETLE 2.0 TDI | 04/2011→ |
| CADDY Box 2.0 TDI | 05/2015→ | CADDY Estate 2.0 TDI | 05/2015→ |
| CADDY III 2.0 TDI | 08/2010→05/2015 | CADDY III 2.0 TDI 16V | 11/2010→05/2015 |
| CADDY IV 2.0 TDI | 05/2015→ | CC 2.0 TDI | 11/2011→12/2016 |
| CRAFTER 30-35 2.0 TDI | 05/2011→12/2016 | CRAFTER 30-50 2.0 TDI | 05/2011→12/2016 |
| EOS 2.0 TDI | 11/2010→08/2015 | EOS 2.0 TDI 16V | 05/2008→08/2015 |
| GOLF 2.0 TDI | 02/2014→ | GOLF V 2.0 TDI 16V | 06/2007→07/2009 |
| GOLF VI 2.0 TDI | 10/2008→ | GOLF VII 2.0 GTD | 04/2013→ |
| GOLF VII 2.0 TDI | 08/2012→ | GOLF PLUS 2.0 TDI | 05/2005→12/2013 |
| GOLF PLUS 2.0 TDI 16V | 01/2005→12/2013 | JETTA III 2.0 TDI | 09/2005→10/2010 |
| JETTA III 2.0 TDI 16V | 08/2005→10/2010 | JETTA IV 2.0 TDI | 10/2010→ |
| MULTIVAN V 2.0 BiTDI | 09/2009→08/2015 | MULTIVAN V 2.0 TDI | 09/2009→08/2015 |
| MULTIVAN VI 2.0 TDI | 04/2015→ | PASSAT 2.0 BlueTDI | 01/2009→11/2010 |

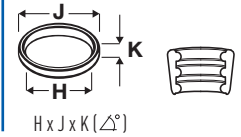
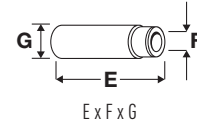

OE



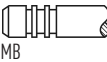

| | | | |
|-------------------------|-----------------|-----------------------|-----------------|
| PASSAT 2.0 TDI | 03/2005→ | PASSAT 2.0 TDI 16V | 03/2005→11/2010 |
| PASSAT CC 2.0 BlueTDI | 05/2009→11/2010 | PASSAT CC 2.0 TDI | 05/2008→01/2012 |
| SCIROCCO 2.0 TDI | 08/2008→11/2017 | SHARAN 2.0 TDI | 05/2010→ |
| TIGUAN 2.0 TDI | 09/2007→ | TOURAN 2.0 TDI | 05/2010→ |
| TRANSPORTER V 2.0 BiTDI | 09/2009→08/2015 | TRANSPORTER V 2.0 TDI | 09/2009→08/2015 |
| TRANSPORTER VI 2.0 TDI | 04/2015→ | | |

| | | | | | | |
|---|-------------|---|-----|------|--|---|
| V95099 ■ 28.10 x 5.97 x 99.30 | 03L 109 601 |  | 45° | H | VAG96237B ■ ■ ■ 42.00 x 6.02 x 10.07 |  |
| V95114 ■ 26.00 x 5.97 x 99.10 | 03L 109 611 |  | 45° | SS H | | |

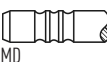
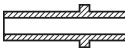
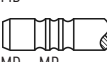
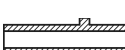
110  **81.00**

| HP | 1994cc | 5 Cyl. | 10 Valves | 85kW/115PS | Petrol | SOHC | TD16429 |
|---|--------------|---|-----------|-------------|--------|--|---|
| PASSAT 2.0 | | 08/1983→03/1988 | | SANTANA 2.0 | | 08/1983→12/1984 | |
| V91338 ■ 38.10 x 7.97 x 91.90 | 035 109 601K |  | 45° | | | VAG92061B ■ ■ ■ 36.70 x 8.00 x 12.08 |  |
| V91340 ■ 33.30 x 7.95 x 91.20 | 048 109 611A |  | 45° | H | | VAG92105B ■ ■ ■ 42.30 x 7.99 x 12.08 |  |

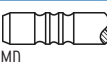
111  **81.00**

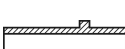
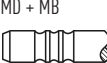
| JS | 1994cc | 5 Cyl. | 10 Valves | 85kW/115PS | Petrol | SOHC | TD5015 |
|---|--------------|---|-----------|-------------|--------|--|---|
| PASSAT 2.0 | | 08/1983→03/1988 | | SANTANA 2.0 | | 08/1983→12/1984 | |
| V91338 ■ 38.10 x 7.97 x 91.90 | 035 109 601K |  | 45° | | | VAG92061B ■ ■ ■ 36.70 x 8.00 x 12.08 |  |
| V91030 ■ 33.30 x 7.95 x 98.60 | 035 109 611F |  | 45° | SS H | | VAG92105B ■ ■ ■ 42.30 x 7.99 x 12.08 |  |
| V91340 ■ 33.30 x 7.95 x 91.20 | 048 109 611A |  | 45° | H | | | |

112  **81.00**

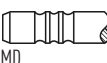
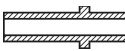
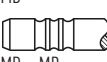
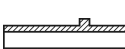
| HY | 2226cc | 5 Cyl. | 10 Valves | 100kW/136PS | Petrol | SOHC | TD21344 |
|---|--------------|---|-----------|-------------------|--------|--|---|
| JT | 2226cc | 5 Cyl. | 10 Valves | 82-88kW/112-120PS | Petrol | SOHC | TD5016 |
| KV | 2226cc | 5 Cyl. | 10 Valves | 100kW/136PS | Petrol | SOHC | TD4125 |
| KX | 2226cc | 5 Cyl. | 10 Valves | 82-85kW/112-116PS | Petrol | SOHC | TD5020 |
| PASSAT 2.2 | | 08/1984→12/1988 | | SANTANA 2.2 | | 09/1984→12/1985 | |
| V91338 ■ 38.10 x 7.97 x 91.90 | 035 109 601K |  | 45° | | | VAG92061B ■ ■ ■ 36.70 x 8.00 x 12.08 |  |
| V91340 ■ 33.30 x 7.95 x 91.20 | 048 109 611A |  | 45° | H | | VAG92105B ■ ■ ■ 42.30 x 7.99 x 12.08 |  |

113  **81.00**

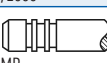
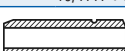
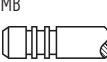
| AGZ | 2324cc | VR5 Cyl. | 10 Valves | 110kW/150PS | Petrol | DOHC | TD5559 |
|--|--------------|---|-----------|------------------------|--------|--|---|
| BORA 2.3 V5 | | 10/1998→10/2000 | | GOLF IV 2.3 V5 | | 08/1997→06/2006 | |
| PASSAT 2.3 VR5 | | 10/1996→11/2000 | | PASSAT 2.3 VR5/4motion | | 10/1997→11/2000 | |
| V94374 ■ 39.00 x 7.00 x 106.00 | 021 109 601L |  | 45° | H | | VAG96157B ■ ■ ■ 38.00 x 7.00 x 12.00 |  |
| V94306 ■ 34.20 x 7.00 x 107.00 | 021 109 611D |  | 45° | SS H | | | |

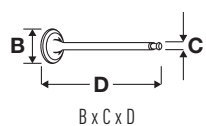

OE

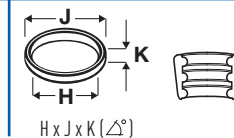
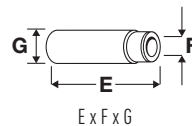

114 **81.00**

| | | | | | | | |
|-----|--------|--------|-----------|-------------------|--------|------|---------|
| AAF | 2461cc | 5 Cyl. | 10 Valves | 80-81kW/108-110PS | Petrol | SOHC | TD4002 |
| ACU | 2461cc | 5 Cyl. | 10 Valves | 80-81kW/108-110PS | Petrol | SOHC | TD4015 |
| AEN | 2461cc | 5 Cyl. | 10 Valves | 81kW/110PS | Petrol | SOHC | TD9347 |
| AET | 2461cc | 5 Cyl. | 10 Valves | 81-85kW/110-115PS | Petrol | SOHC | TD4983 |
| AEU | 2461cc | 5 Cyl. | 10 Valves | 81kW/110PS | Petrol | SOHC | TD9344 |
| APL | 2461cc | 5 Cyl. | 10 Valves | 85kW/115PS | Petrol | SOHC | TD15288 |
| AVT | 2461cc | 5 Cyl. | 10 Valves | 85kW/115PS | Petrol | SOHC | TD15370 |

TRANSPORTER IV 2.5 11/1990→04/2003

V91407
39.60 x 7.97 x 91.90

048 109 601A



45°

VAG92061B
36.70 x 8.00 x 12.08



V91340
33.30 x 7.95 x 91.20

048 109 611A



45°

H

115 **81.00**

| | | | | | | | |
|-----|--------|--------|-----------|-------------|--------|-------|---------|
| ACV | 2461cc | 5 Cyl. | 10 Valves | 75kW/102PS | Diesel | Turbo | TD4978 |
| AGX | 2461cc | 5 Cyl. | 10 Valves | 55kW/75PS | Diesel | Turbo | TD9295 |
| AHD | 2461cc | 5 Cyl. | 10 Valves | 75kW/102PS | Diesel | Turbo | TD9294 |
| AHY | 2461cc | 5 Cyl. | 10 Valves | 111kW/151PS | Diesel | Turbo | TD10748 |
| AJT | 2461cc | 5 Cyl. | 10 Valves | 65kW/88PS | Diesel | Turbo | TD10747 |
| ANJ | 2461cc | 5 Cyl. | 10 Valves | 80kW/109PS | Diesel | Turbo | TD13446 |
| APA | 2461cc | 5 Cyl. | 10 Valves | 66kW/90PS | Diesel | Turbo | TD13445 |
| AXG | 2461cc | 5 Cyl. | 10 Valves | 111kW/151PS | Diesel | Turbo | TD17505 |
| AXL | 2461cc | 5 Cyl. | 10 Valves | 75kW/102PS | Diesel | Turbo | TD18687 |
| AYY | 2461cc | 5 Cyl. | 10 Valves | 65kW/88PS | Diesel | Turbo | TD17503 |
| BBE | 2461cc | 5 Cyl. | 10 Valves | 61kW/83PS | Diesel | | TD16451 |
| BBF | 2461cc | 5 Cyl. | 10 Valves | 70kW/95PS | Diesel | | TD16452 |

LT 28-35 II 2.5 SDI 07/1996→07/2006 LT 28-35 II 2.5 TDI 05/1996→07/2006
 LT 28-46 II 2.5 SDI 09/1996→07/2006 LT 28-46 II 2.5 TDI 05/1996→07/2006
 TRANSPORTER IV 2.5 TDI 09/1995→04/2003

V94010
36.00 x 8.00 x 96.80

028 109 601H

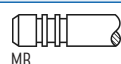

45°

Y

H

VAG92061B
36.70 x 8.00 x 12.08



V94011
31.50 x 7.95 x 96.85

046 109 611F

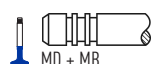

45°

SS



OE

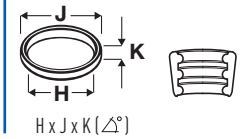
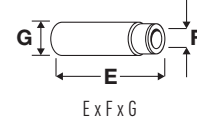

116  **81.00**

| | | | | | | | |
|------------------------|-----------------|--------|-----------|-----------------------|-----------------|-------------|---------|
| AUF | 2461cc | 5 Cyl. | 10 Valves | 75kW/102PS | Diesel | Turbo, SOHC | TD16857 |
| AVR | 2461cc | 5 Cyl. | 10 Valves | 80kW/109PS | Diesel | Turbo, SOHC | TD15497 |
| AYC | 2461cc | 5 Cyl. | 10 Valves | 75kW/102PS | Diesel | Turbo, SOHC | TD17504 |
| BJJ | 2461cc | 5 Cyl. | 10 Valves | 65kW/88PS | Diesel | Turbo, SOHC | TD18891 |
| BJK | 2461cc | 5 Cyl. | 10 Valves | 80kW/109PS | Diesel | Turbo, SOHC | TD18892 |
| BJL | 2461cc | 5 Cyl. | 10 Valves | 100kW/136PS | Diesel | Turbo, SOHC | TD18893 |
| CEBA | 2461cc | 5 Cyl. | 10 Valves | 65kW/88PS | Diesel | Turbo, SOHC | TD24719 |
| CEBB | 2461cc | 5 Cyl. | 10 Valves | 80kW/109PS | Diesel | Turbo, SOHC | TD24720 |
| CECA | 2461cc | 5 Cyl. | 10 Valves | 100kW/136PS | Diesel | Turbo, SOHC | TD24721 |
| CRAFTER 30-35 2.5 TDI | 04/2006→05/2013 | | | CRAFTER 30-50 2.5 TDI | 04/2006→05/2013 | | |
| LT 28-35 II 2.5 TDI | 05/1999→07/2006 | | | LT 28-46 II 2.5 TDI | 05/1999→07/2006 | | |
| TRANSPORTER IV 2.5 TDI | 09/1995→04/2003 | | | | | | |

V94010 
36.00 x 8.00 x 96.80

028 109 601H

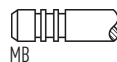

45° Y H

VAG92061B 
36.70 x 8.00 x 12.08

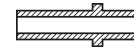

V94547 
35.95 x 8.00 x 96.85

046 109 601J

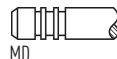

45° SS

V94011 
31.50 x 7.95 x 96.85

046 109 611F

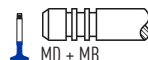

45° SS

117  **81.00**

| | | | | | | | |
|-----------------------|-----------------|--------|-----------|--------------------|-----------------|-------------|---------|
| AXD | 2461cc | 5 Cyl. | 10 Valves | 96kW/130PS | Diesel | Turbo, SOHC | TD16868 |
| AXE | 2461cc | 5 Cyl. | 10 Valves | 128kW/174PS | Diesel | Turbo, SOHC | TD16869 |
| BAC | 2461cc | 5 Cyl. | 10 Valves | 128kW/174PS | Diesel | Turbo, SOHC | TD16855 |
| MULTIVAN V 2.5 TDI | 04/2003→11/2009 | | | TOUAREG 2.5 R5 TDI | 01/2003→05/2010 | | |
| TRANSPORTER V 2.5 TDI | 04/2003→11/2009 | | | | | | |

V94147 
35.90 x 7.00 x 89.90

038 109 601B

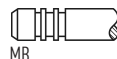

45° H

VAG96041B 
36.50 x 7.00 x 12.08

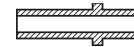

V94148 
31.50 x 7.00 x 90.00

038 109 611F

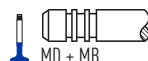

45° SS H

V94415 
31.40 x 7.00 x 89.50

038 109 611F

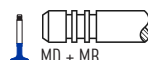

45° SS H

118  **81.00**

| | | | | | | | |
|-----------------------|-----------------|--------|-----------|--------------------|-----------------|-------------|---------|
| BNZ | 2461cc | 5 Cyl. | 10 Valves | 96kW/130PS | Diesel | Turbo, SOHC | TD20398 |
| BPC | 2461cc | 5 Cyl. | 10 Valves | 128kW/174PS | Diesel | Turbo, SOHC | TD20397 |
| BPE | 2461cc | 5 Cyl. | 10 Valves | 128kW/174PS | Diesel | Turbo, SOHC | TD20508 |
| MULTIVAN V 2.5 TDI | 04/2003→11/2009 | | | TOUAREG 2.5 R5 TDI | 01/2003→05/2010 | | |
| TRANSPORTER V 2.5 TDI | 04/2003→11/2009 | | | | | | |

V94649 
36.00 x 7.00 x 89.40

038 109 601E

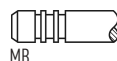

45° Y H

VAG96041B 
36.50 x 7.00 x 12.08

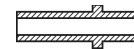

V94650 
31.40 x 7.00 x 89.00

038 109 611E

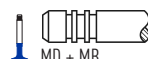

45° SS H

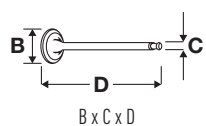

OE

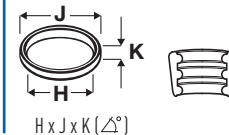
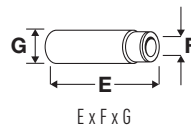
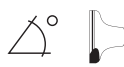

119 **81.00**

| | | | | | | | |
|------------------|-----------------|----------|------------------|---------------------|-----------------|-------------|----------------|
| AAA | 2792cc | VR6 Cyl. | 12 Valves | 120-128kW/163-174PS | Petrol | DOHC | TD3999 |
| AMY | 2792cc | VR6 Cyl. | 12 Valves | 128kW/174PS | Petrol | DOHC | TD17199 |
| BORA 2.8 VR6 | 08/2002→07/2005 | | | CORRADO 2.8 VR6 | 09/1991→12/1995 | | |
| GOLF III 2.8 VR6 | 01/1992→09/1997 | | | JETTA III 2.8 VR6 | 10/2009→10/2010 | | |
| PASSAT 2.8 VR6 | 06/1991→05/1997 | | | SHARAN 2.8 VR6 | 09/1995→04/2000 | | |
| VENTO 2.8 VR6 | 01/1992→09/1998 | | | | | | |

| | | | | | | |
|-----------------------|--------------|---------|-----|------|----------------------|--|
| V94145 | 021 109 601K | | 45° | H | VAG96041B | |
| 39.10 x 7.00 x 106.00 | | MB | | | 36.50 x 7.00 x 12.08 | |
| V94374 | 021 109 601L | | 45° | H | VAG96157B | |
| 39.00 x 7.00 x 106.00 | | MB | | | 38.00 x 7.00 x 12.00 | |
| V94146 | 021 109 611F | | 45° | SS H | | |
| 34.10 x 7.00 x 107.00 | | MD + MB | | | | |

120 **81.00**

| | | | | | | | |
|-------------------------|-----------------|----------|------------------|------------------------|-----------------|-------------|---------------|
| AES | 2792cc | VR6 Cyl. | 12 Valves | 103kW/140PS | Petrol | DOHC | TD9346 |
| TRANSPORTER IV 2.8 | 05/1996→05/2000 | | | TRANSPORTER IV 2.8 VR6 | 01/1996→05/2000 | | |
| TRANSPORTER IV 2.8 VR 6 | 11/1995→04/2000 | | | | | | |

| | | | | | | |
|-----------------------|--------------|----|-----|---|----------------------|--|
| V94374 | 021 109 601L | | 45° | H | VAG96157B | |
| 39.00 x 7.00 x 106.00 | | MB | | | 38.00 x 7.00 x 12.00 | |

121 **81.00**

| | | | | | | | |
|---------------------|-----------------|----------|------------------|---------------------|-----------------|--------------|----------------|
| AJS | 4921cc | V10 Cyl. | 20 Valves | 230kW/313PS | Diesel | Turbo | TD16530 |
| AYH | 4921cc | V10 Cyl. | 20 Valves | 230kW/313PS | Diesel | Turbo | TD17043 |
| PHAETON 5.0 V10 TDI | 11/2002→10/2006 | | | TOUAREG 5.0 V10 TDI | 10/2002→05/2010 | | |

| | | | | | | |
|----------------------|--------------|---------|-----|------|----------------------|--|
| V94147 | 038 109 601B | | 45° | H | VAG96041B | |
| 35.90 x 7.00 x 89.90 | | MB | | | 36.50 x 7.00 x 12.08 | |
| V94148 | 038 109 611F | | 45° | SS H | | |
| 31.50 x 7.00 x 90.00 | | MD + MB | | | | |
| V94415 | 038 109 611F | | 45° | SS H | | |
| 31.40 x 7.00 x 89.50 | | MD + MB | | | | |

122 **81.00**

| | | | | | | | |
|---------------------|-----------------|----------|------------------|---------------------|-----------------|--------------------|----------------|
| BLE | 4921cc | V10 Cyl. | 20 Valves | 230kW/313PS | Diesel | Turbo, DOHC | TD20527 |
| CBWA | 4921cc | V10 Cyl. | 20 Valves | 230-257kW/313-350PS | Diesel | Turbo, DOHC | TD21348 |
| TOUAREG 5.0 V10 TDI | 10/2002→05/2010 | | | TOUAREG 5.0 R50 TDI | 08/2007→05/2010 | | |

| | | | | | | |
|----------------------|--------------|---------|-----|------|----------------------|--|
| V94649 | 038 109 601E | | 45° | Y H | VAG96041B | |
| 36.00 x 7.00 x 89.40 | | MB | | | 36.50 x 7.00 x 12.08 | |
| V94650 | 038 109 611E | | 45° | SS H | | |
| 31.40 x 7.00 x 89.00 | | MD + MB | | | | |

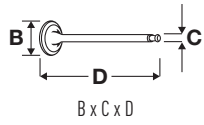

OE

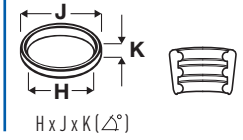
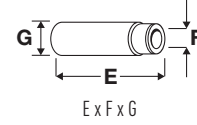
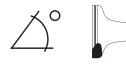

123 **82.00**

| ABV | 2861cc | VR6 Cyl. | 12 Valves | 135-140kW/184-190PS | Petrol | DOHC | TD4977 |
|-----------------------|-----------------|----------|-----------|---------------------|--------|------------------|----------------------|
| CORRADO 2.9 VR6 | 08/1991→12/1995 | | | GOLF III 2.9 VR6 | | 10/1994→04/1999 | |
| PASSAT 2.9 VR6 | 01/1994→05/1997 | | | | | | |
| V94145 | 021 109 601K | | 45° | H | | VAG96157B | 38.00 x 7.00 x 12.00 |
| 39.10 x 7.00 x 106.00 | | | | | | | |
| V94306 | 021 109 611D | | 45° | SS | H | | |
| 34.20 x 7.00 x 107.00 | | | | | | | |

124 **82.50**

| BZB | 1798cc | 4 Cyl. | 16 Valves | 118kW/160PS | Petrol | Turbo, DOHC, Injection | TD20793 |
|-----------------------|-----------------|--------|-----------|-------------------|--------|------------------------|----------------------|
| CDAA | 1798cc | 4 Cyl. | 16 Valves | 118kW/160PS | Petrol | Turbo, DOHC, Injection | TD22641 |
| CDAB | 1798cc | 4 Cyl. | 16 Valves | 112kW/152PS | Petrol | Turbo, DOHC, Injection | TD23735 |
| CGYA | 1798cc | 4 Cyl. | 16 Valves | 112kW/152PS | Petrol | Turbo, DOHC, Injection | TD23736 |
| CC 1.8 TSI | 11/2011→12/2016 | | | GOLF VI 1.8 TSI | | 06/2009→01/2011 | |
| PASSAT 1.8 TSI | 05/2007→12/2014 | | | PASSAT CC 1.8 TSI | | 06/2008→01/2012 | |
| SHARAN 1.8 TSI | 11/2011→ | | | | | | |
| V95098 | 06D 109 601M | | 45° | H | | VAG96073B | 36.00 x 6.02 x 11.06 |
| 33.80 x 5.98 x 103.95 | | | | | | | |
| V94692 | 06D 109 611L | | 45° | H | | | |
| 28.00 x 6.00 x 101.80 | | | | | | | |
| V95152 | 06D 109 611L | | 45° | H | | | |
| 28.10 x 5.97 x 101.90 | | | | | | | |

125 **82.50**

| 2E | 1984cc | 4 Cyl. | 8 Valves | 85kW/115PS | Petrol | SOHC | TD4963 |
|----------------------|-----------------|--------|----------|--------------|--------|------------------|----------------------|
| CORRADO 2.0 i | 04/1993→12/1995 | | | GOLF III 2.0 | | 11/1991→04/1999 | |
| PASSAT 2.0 | 02/1990→05/1997 | | | VENTO 2.0 | | 11/1991→09/1998 | |
| V91407 | 048 109 601A | | 45° | H | | VAG92061B | 36.70 x 8.00 x 12.08 |
| 39.60 x 7.97 x 91.90 | | | | | | | |
| V91340 | 048 109 611A | | 45° | H | | | |
| 33.30 x 7.95 x 91.20 | | | | | | | |

126 **82.50**

| 9A | 1984cc | 4 Cyl. | 16 Valves | 100kW/136PS | Petrol | DOHC | TD3998 |
|----------------------|-----------------|--------|-----------|-----------------|--------|------------------|----------------------|
| CORRADO 2.0 i 16V | 08/1991→12/1995 | | | GOLF II 2.0 GTI | | 09/1989→12/1992 | |
| JETTA II 2.0 | 08/1989→07/1992 | | | PASSAT 2.0 16V | | 08/1988→09/1993 | |
| V91416 | 027 109 601C | | 45° | H | | VAG96157B | 38.00 x 7.00 x 12.00 |
| 32.10 x 6.97 x 95.50 | | | | | | | |
| V91372 | 027 109 611D | | 45° | H | | | |
| 28.10 x 6.95 x 98.20 | | | | | | | |



OE

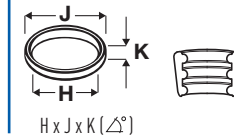
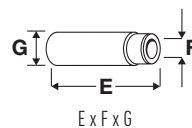

127 **82.50**

| ABF | 1984cc | 4 Cyl. | 16 Valves | 110kW/150PS | Petrol | DOHC | TD4007 |
|----------------------|--------------|---------|-----------|----------------|----------------------|------|-----------------|
| GOLF III 2.0 GTI 16V | | | | PASSAT 2.0 16V | | | 01/1994→05/1997 |
| V94110 | 051 109 601B | | 45° Y | H | VAG96041B | | |
| 32.00 x 7.00 x 95.50 | | MB | | | 36.50 x 7.00 x 12.08 | | |
| V94111 | 051 109 611B | | 45° | H | | | |
| 27.00 x 7.00 x 97.95 | | MD + MB | | | | | |

128 **82.50**

| ADY | 1984cc | 4 Cyl. | 8 Valves | 85kW/115PS | Petrol | SOHC | TD4979 |
|----------------------|--------------|---------|----------|---------------|----------------------|------|-----------------|
| AEG | 1984cc | 4 Cyl. | 8 Valves | 85kW/115PS | Petrol | SOHC | TD13442 |
| AGG | 1984cc | 4 Cyl. | 8 Valves | 85kW/115PS | Petrol | SOHC | TD4989 |
| APK | 1984cc | 4 Cyl. | 8 Valves | 85kW/116PS | Petrol | SOHC | TD11927 |
| AQY | 1984cc | 4 Cyl. | 8 Valves | 85kW/115PS | Petrol | SOHC | TD10607 |
| ATM | 1984cc | 4 Cyl. | 8 Valves | 85kW/115PS | Petrol | SOHC | TD14913 |
| AZH | 1984cc | 4 Cyl. | 8 Valves | 85kW/115PS | Petrol | SOHC | TD15479 |
| AZM | 1984cc | 4 Cyl. | 8 Valves | 85kW/116PS | Petrol | SOHC | TD15150 |
| BBX | 1984cc | 4 Cyl. | 8 Valves | 85kW/115PS | Petrol | SOHC | TD21077 |
| BORA 2.0 | | | | CORRADO 2.0 i | | | 04/1993→12/1995 |
| GOLF III 2.0 | | | | GOLF IV 2.0 | | | 06/1998→06/2006 |
| NEW BEETLE 2.0 | | | | PASSAT 2.0 | | | 02/1990→05/2005 |
| POLO 2.0 | | | | SHARAN 2.0 | | | 09/1995→03/2010 |
| SHARAN 2.0 LPG | | | | VENTO 2.0 | | | 11/1991→09/1998 |
| V94079 | 078 109 601B | | 45° | H | VAG96041B | | |
| 39.40 x 7.00 x 92.10 | | MB | | | 36.50 x 7.00 x 12.08 | | |
| V94080 | 048 109 611B | | 45° | H | | | |
| 32.80 x 7.00 x 91.20 | | MD + MB | | | | | |

129 **82.50**

| AEP | 1984cc | 4 Cyl. | 8 Valves | 79kW/107PS | Petrol | SOHC | TD11448 |
|----------------------|--------------|---------|----------|-----------------|----------------------|------|-----------------|
| GOLF III 2.0 | | | | GOLF III 2.0 GL | | | 08/1995→09/1997 |
| PASSAT 2.0 | | | | VENTO 2.0 GL | | | 05/1996→12/1997 |
| V91338 | 035 109 601K | | 45° | | VAG92061B | | |
| 38.10 x 7.97 x 91.90 | | MD | | | 36.70 x 8.00 x 12.08 | | |
| V91340 | 048 109 611A | | 45° | H | | | |
| 33.30 x 7.95 x 91.20 | | MD + MB | | | | | |



OE

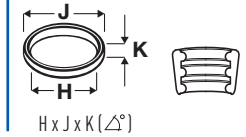
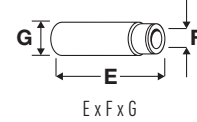

130  **82.50**

| | | | | | | | |
|----------------|-----------------|--------|----------|-------------------|--------|-----------------|---------|
| AKR | 1984cc | 4 Cyl. | 8 Valves | 85kW/115PS | Petrol | SOHC | TD11354 |
| ATU | 1984cc | 4 Cyl. | 8 Valves | 85kW/116PS | Petrol | SOHC | TD15490 |
| AVH | 1984cc | 4 Cyl. | 8 Valves | 85-86kW/115-117PS | Petrol | SOHC | TD19258 |
| AWF | 1984cc | 4 Cyl. | 8 Valves | 85kW/115PS | Petrol | SOHC | TD15488 |
| AWG | 1984cc | 4 Cyl. | 8 Valves | 85kW/116PS | Petrol | SOHC | TD15489 |
| AXA | 1984cc | 4 Cyl. | 8 Valves | 85kW/115PS | Petrol | SOHC | TD16866 |
| AZG | 1984cc | 4 Cyl. | 8 Valves | 85kW/115PS | Petrol | SOHC | TD15470 |
| AZJ | 1984cc | 4 Cyl. | 8 Valves | 85kW/115PS | Petrol | SOHC | TD16419 |
| BDC | 1984cc | 4 Cyl. | 8 Valves | 85kW/115PS | Petrol | SOHC | TD16744 |
| BEJ | 1984cc | 4 Cyl. | 8 Valves | 85kW/115PS | Petrol | SOHC | TD21073 |
| BER | 1984cc | 4 Cyl. | 8 Valves | 85kW/116PS | Petrol | SOHC | TD18049 |
| BEV | 1984cc | 4 Cyl. | 8 Valves | 85-86kW/116-117PS | Petrol | SOHC | TD19254 |
| BGD | 1984cc | 4 Cyl. | 8 Valves | 85kW/115PS | Petrol | SOHC | TD16745 |
| BHP | 1984cc | 4 Cyl. | 8 Valves | 85kW/115PS | Petrol | SOHC | TD21074 |
| CBPA | 1984cc | 4 Cyl. | 8 Valves | 85-86kW/115-117PS | Petrol | SOHC | TD21075 |
| BORA 2.0 | 10/1998→05/2005 | | | CITYGOLF 2.0 | | 09/2006→12/2010 | |
| GOLF III 2.0 | 11/1991→04/1999 | | | GOLF IV 2.0 | | 06/1998→06/2006 | |
| GOLF V 2.0 | 08/2006→11/2008 | | | GOLF V 2.0 GTI | | 09/2005→02/2009 | |
| GOLF VI 2.0 | 09/2009→12/2012 | | | GOLF VII 2.0 | | 07/2013→ | |
| JETTA CITY 2.0 | 09/2006→12/2009 | | | JETTA III 2.0 | | 09/2005→12/2009 | |
| JETTA IV 2.0 | 06/2010→ | | | MULTIVAN V 2.0 | | 11/2003→08/2015 | |
| NEW BEETLE 2.0 | 01/1998→10/2010 | | | TRANSPORTER V 2.0 | | 11/2003→08/2015 | |
| VENTO 2.0 | 11/1991→09/1998 | | | | | | |

V94079  078 109 601B
39.40 x 7.00 x 92.10



45° H

VAG96041B  
36.50 x 7.00 x 12.08

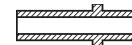

V94080  048 109 611B
32.80 x 7.00 x 91.20



45° H

V94303  078 109 611C
32.90 x 7.00 x 91.20



45° ss H



131  **82.50**

| | | | | | | | |
|------------|-----------------|--------|-----------|------------|--------|------|---------|
| ALT | 1984cc | 4 Cyl. | 20 Valves | 96kW/130PS | Petrol | DOHC | TD17040 |
| PASSAT 2.0 | 11/2001→05/2005 | | | | | | |

V94081  058 109 601C
26.90 x 6.00 x 105.10



45° Y H

VAG96073B  
36.00 x 6.02 x 11.06

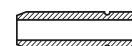

V94083  058 109 611M
29.90 x 6.00 x 103.90



45° H

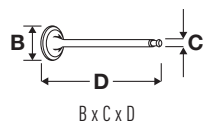

OE

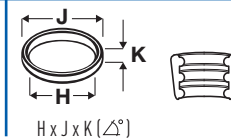
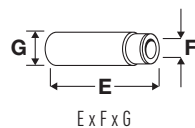

132 **82.50**

| | | | | | | | |
|------------|--------|--------|------------------|-------------|--------|------------------------|----------------|
| AXW | 1984cc | 4 Cyl. | 16 Valves | 110kW/150PS | Petrol | DOHC, Injection | TD17081 |
| BLR | 1984cc | 4 Cyl. | 16 Valves | 110kW/150PS | Petrol | DOHC, Injection | TD18134 |
| BLX | 1984cc | 4 Cyl. | 16 Valves | 110kW/150PS | Petrol | DOHC, Injection | TD17985 |
| BLY | 1984cc | 4 Cyl. | 16 Valves | 110kW/150PS | Petrol | DOHC, Injection | TD17986 |
| BVX | 1984cc | 4 Cyl. | 16 Valves | 110kW/150PS | Petrol | DOHC, Injection | TD18912 |
| BVY | 1984cc | 4 Cyl. | 16 Valves | 110kW/150PS | Petrol | DOHC, Injection | TD18468 |
| BVZ | 1984cc | 4 Cyl. | 16 Valves | 110kW/150PS | Petrol | DOHC, Injection | TD18469 |

| | | | |
|-------------------|-----------------|-------------------|-----------------|
| EOS 2.0 FSI | 03/2006→05/2008 | GOLF V 2.0 FSI | 01/2004→11/2008 |
| GOLF PLUS 2.0 FSI | 05/2005→06/2008 | JETTA III 2.0 FSI | 08/2005→10/2010 |
| PASSAT 2.0 FSI | 03/2005→11/2010 | TOURAN 2.0 FSI | 10/2003→01/2007 |

V94691
33.85 x 6.00 x 103.90

06E 109 601E

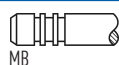

45° Y H

VAG96073B
36.00 x 6.02 x 11.06

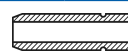

V94692
28.00 x 6.00 x 101.80

06D 109 611L



45° H

V95152
28.10 x 5.97 x 101.90

06D 109 611L



45° H

133 **82.50**

| | | | | | | | |
|-------------|--------|--------|------------------|-------------|--------|-------------------------------|----------------|
| AXX | 1984cc | 4 Cyl. | 16 Valves | 147kW/200PS | Petrol | Turbo, DOHC, Injection | TD18540 |
| BPY | 1984cc | 4 Cyl. | 16 Valves | 147kW/200PS | Petrol | Turbo, DOHC, Injection | TD18883 |
| BWA | 1984cc | 4 Cyl. | 16 Valves | 147kW/200PS | Petrol | Turbo, DOHC, Injection | TD18541 |
| CAWA | 1984cc | 4 Cyl. | 16 Valves | 125kW/170PS | Petrol | Turbo, DOHC, Injection | TD20733 |
| CAWB | 1984cc | 4 Cyl. | 16 Valves | 147kW/200PS | Petrol | Turbo, DOHC, Injection | TD20732 |
| CBFA | 1984cc | 4 Cyl. | 16 Valves | 147kW/200PS | Petrol | Turbo, DOHC, Injection | TD20797 |
| CCTA | 1984cc | 4 Cyl. | 16 Valves | 147kW/200PS | Petrol | Turbo, DOHC, Injection | TD20795 |
| CCTB | 1984cc | 4 Cyl. | 16 Valves | 125kW/170PS | Petrol | Turbo, DOHC, Injection | TD20796 |
| CCZA | 1984cc | 4 Cyl. | 16 Valves | 147kW/200PS | Petrol | Turbo, DOHC, Injection | TD22172 |
| CCZC | 1984cc | 4 Cyl. | 16 Valves | 125kW/170PS | Petrol | Turbo, DOHC, Injection | TD24964 |
| CCZD | 1984cc | 4 Cyl. | 16 Valves | 132kW/180PS | Petrol | Turbo, DOHC, Injection | TD25421 |
| CFPA | 1984cc | 4 Cyl. | 16 Valves | 118kW/160PS | Petrol | Turbo, DOHC, Injection | TD25736 |
| CJKB | 1984cc | 4 Cyl. | 16 Valves | 110kW/150PS | Petrol | DOHC, Injection | TD26535 |

| | | | |
|------------------------|-----------------|-----------------------|-----------------|
| AMAROK 2.0 TSI | 12/2010→ | BEETLE 2.0 TSI | 04/2011→ |
| CC 2.0 TSI | 11/2011→12/2016 | EOS 2.0 TFSI | 03/2006→08/2015 |
| GOLF V 2.0 | 06/2007→07/2009 | GOLF V 2.0 GTI | 10/2004→02/2009 |
| GOLF VI 2.0 GTi | 06/2009→11/2013 | GOLF VI 2.0 TSI | 07/2009→07/2013 |
| JETTA III 2.0 TFSI | 10/2005→10/2010 | JETTA IV 2.0 | 12/2010→ |
| JETTA IV 2.0 TSI | 12/2010→ | MULTIVAN V 2.0 TSI | 07/2012→08/2015 |
| MULTIVAN VI 2.0 TSI | 04/2015→ | PASSAT 2.0 FSI | 07/2005→11/2010 |
| PASSAT CC 2.0 TSI | 06/2008→01/2012 | SCIROCCO 2.0 TSI | 05/2008→11/2009 |
| SHARAN 2.0 TSI | 12/2010→ | TIGUAN 2.0 TFSI | 09/2007→ |
| TIGUAN 2.0 TSI | 05/2011→ | TRANSPORTER V 2.0 TSI | 07/2012→08/2015 |
| TRANSPORTER VI 2.0 TSI | 04/2015→ | | |

V95098
33.80 x 5.98 x 103.95

06D 109 601M

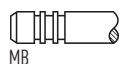

45° H

VAG96073B
36.00 x 6.02 x 11.06



V94692
28.00 x 6.00 x 101.80

06D 109 611L

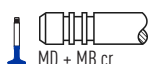

45° H

V95152
28.10 x 5.97 x 101.90

06D 109 611L

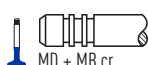

45° H



OE

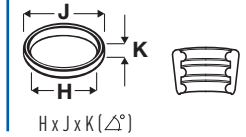
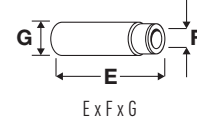

134 **82.50**

| | | | | | | | |
|-----------------------|--------|-----------------|------------------|------------------------|--------|-------------------------------|----------------|
| BYD | 1984cc | 4 Cyl. | 16 Valves | 169kW/230PS | Petrol | Turbo, DOHC, Injection | TD19430 |
| CCZB | 1984cc | 4 Cyl. | 16 Valves | 155kW/211PS | Petrol | Turbo, DOHC, Injection | TD22181 |
| CDLA | 1984cc | 4 Cyl. | 16 Valves | 195kW/265PS | Petrol | Turbo, DOHC, Injection | TD22642 |
| CDLC | 1984cc | 4 Cyl. | 16 Valves | 188kW/256PS | Petrol | Turbo, DOHC, Injection | TD22469 |
| CDLF | 1984cc | 4 Cyl. | 16 Valves | 199kW/270PS | Petrol | Turbo, DOHC, Injection | TD23525 |
| CDLJ | 1984cc | 4 Cyl. | 16 Valves | 162kW/220PS | Petrol | Turbo, DOHC, Injection | TD27543 |
| CJKA | 1984cc | 4 Cyl. | 16 Valves | 150kW/204PS | Petrol | Turbo, DOHC, Injection | TD26335 |
| CC 2.0 TSI | | 11/2011→12/2016 | | EOS 2.0 TSI | | 11/2009→08/2015 | |
| GOLF V 2.0 GTI | | 09/2006→12/2008 | | GOLF VI 2.0 GTI | | 11/2011→ | |
| GOLF VI 2.0 GTi | | 04/2009→11/2012 | | GOLF VI 2.0 R | | 11/2009→ | |
| MULTIVAN V 2.0 TSI | | 05/2011→08/2015 | | MULTIVAN VI 2.0 TSI | | 04/2015→ | |
| PASSAT 2.0 TSI | | 11/2010→12/2014 | | PASSAT CC 2.0 TSI | | 11/2010→01/2012 | |
| POLO 2.0 R WRC | | 08/2013→ | | SCIROCCO 2.0 R | | 11/2009→11/2017 | |
| SCIROCCO 2.0 TSI | | 11/2009→11/2017 | | TIGUAN 2.0 TSI | | 05/2011→ | |
| TRANSPORTER V 2.0 TSI | | 05/2011→08/2015 | | TRANSPORTER VI 2.0 TSI | | 04/2015→ | |

V95098
33.80 x 5.98 x 103.95

06D 109 601M

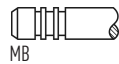

45°

H

VAG96073B
36.00 x 6.02 x 11.06



V80028
28.00 x 6.00 x 101.90

06D 109 611H



45°

SS

135 **82.50**

| | | | | | | | |
|-------------|--------|----------|-----------------|-------------------|--------|-----------------|----------------|
| CFEA | 1984cc | 4 Cyl. | 8 Valves | 85-88kW/116-120PS | Petrol | | TD27391 |
| GOLF 2.0 | | 06/2008→ | | GOLF VI 2.0 | | 10/2008→11/2013 | |
| POLO 2.0 | | 09/2002→ | | | | | |

V95099
28.10 x 5.97 x 99.30

03L 109 601

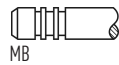

45°

H

VAG96237B
42.00 x 6.02 x 10.07



V95114
26.00 x 5.97 x 99.10

03L 109 611



45°

SS

H

136 **82.50**

| | | | | | | | |
|--------------|--------|-----------------|------------------|---------------------|--------|-------------------------------|----------------|
| CRZA | 1984cc | 4 Cyl. | 16 Valves | 188-191kW/256-260PS | Petrol | Turbo, DOHC, Injection | TD27628 |
| GOLF VI 2.0 | | 09/2011→11/2013 | | GOLF VI 2.0 R | | 11/2009→11/2013 | |
| GOLF VII 2.0 | | 09/2012→ | | | | | |

V95098
33.80 x 5.98 x 103.95

06D 109 601M

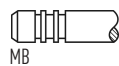

45°

H

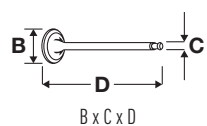

OE

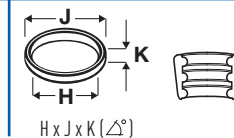
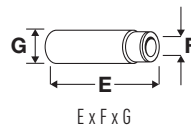

137 **82.50**

| | | | | | | | |
|-------------|--------|--------|------------------|---------------------|--------|-------------|----------------|
| BGP | 2480cc | 5 Cyl. | 20 Valves | 110-112kW/150-152PS | Petrol | DOHC | TD20522 |
| BGQ | 2480cc | 5 Cyl. | 20 Valves | 110-112kW/150-152PS | Petrol | DOHC | TD20673 |
| BPR | 2480cc | 5 Cyl. | 20 Valves | 110kW/150PS | Petrol | DOHC | TD19260 |
| BPS | 2480cc | 5 Cyl. | 20 Valves | 110kW/150PS | Petrol | DOHC | TD19261 |
| BTK | 2480cc | 5 Cyl. | 20 Valves | 110-112kW/150-152PS | Petrol | DOHC | TD20521 |
| CBTA | 2480cc | 5 Cyl. | 20 Valves | 112-127kW/152-173PS | Petrol | DOHC | TD20855 |
| CBUA | 2480cc | 5 Cyl. | 20 Valves | 112-127kW/152-173PS | Petrol | DOHC | TD22542 |
| CCCA | 2480cc | 5 Cyl. | 20 Valves | 125kW/170PS | Petrol | DOHC | TD22640 |

| | | | |
|-------------------|-----------------|----------------|-----------------|
| BEETLE 2.5 | 04/2011→ | GOLF V 2.5 | 06/2005→07/2009 |
| GOLF V RABBIT 2.5 | 05/2007→11/2008 | GOLF VI 2.5 | 07/2009→11/2013 |
| GOLF VII 2.5 | 09/2012→ | JETTA III 2.5 | 09/2005→10/2010 |
| JETTA IV 2.5 | 04/2010→ | NEW BEETLE 2.5 | 07/2005→09/2010 |
| PASSAT 2.5 | 01/2011→ | | |

V94692
28.00 x 6.00 x 101.80

06D 109 611L



45°

H

VAG96073B
36.00 x 6.02 x 11.06



V95152
28.10 x 5.97 x 101.90

06D 109 611L



45°

H

138 **82.50**

| | | | | | | | |
|------------|--------|---------|------------------|-------------|--------|-------------|----------------|
| ACK | 2771cc | V6 Cyl. | 30 Valves | 142kW/193PS | Petrol | DOHC | TD5560 |
| AGE | 2771cc | V6 Cyl. | 30 Valves | 132kW/180PS | Petrol | DOHC | TD16251 |
| ALG | 2771cc | V6 Cyl. | 30 Valves | 142kW/193PS | Petrol | DOHC | TD16260 |
| AMX | 2771cc | V6 Cyl. | 30 Valves | 142kW/193PS | Petrol | DOHC | TD15155 |
| APR | 2771cc | V6 Cyl. | 30 Valves | 142kW/193PS | Petrol | DOHC | TD15808 |
| AQD | 2771cc | V6 Cyl. | 30 Valves | 142kW/193PS | Petrol | DOHC | TD16259 |
| ATQ | 2771cc | V6 Cyl. | 30 Valves | 142kW/193PS | Petrol | DOHC | TD16422 |
| ATX | 2771cc | V6 Cyl. | 30 Valves | 140kW/190PS | Petrol | DOHC | TD16252 |
| BBG | 2771cc | V6 Cyl. | 30 Valves | 140kW/190PS | Petrol | DOHC | TD17913 |

| | | | |
|-----------------------|-----------------|---------------|-----------------|
| PASSAT 2.8 | 05/1997→08/2005 | PASSAT 2.8 V6 | 08/1996→11/2000 |
| PASSAT 2.8 V6/4motion | 10/1996→11/2000 | | |

V94081
26.90 x 6.00 x 105.10

058 109 601C



45°

Y

H

VAG96073B
36.00 x 6.02 x 11.06

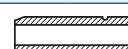

V94083
29.90 x 6.00 x 103.90

058 109 611M



45°

H



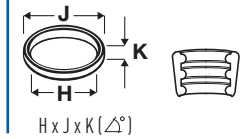
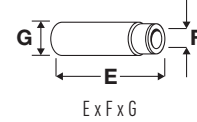

OE





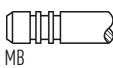

139  **83.00**

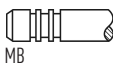

| | | | | | | | |
|--------------------|--------|-----------------|-----------|--------------------|--------|-------------|---------|
| BKS | 2967cc | V6 Cyl. | 24 Valves | 165kW/224PS | Diesel | Turbo, DOHC | TD18031 |
| BMK | 2967cc | V6 Cyl. | 24 Valves | 165kW/224PS | Diesel | Turbo, DOHC | TD18023 |
| BSP | 2967cc | V6 Cyl. | 24 Valves | 165kW/225PS | Diesel | Turbo, DOHC | TD20533 |
| BUN | 2967cc | V6 Cyl. | 24 Valves | 155kW/211PS | Diesel | Turbo, DOHC | TD21182 |
| CARA | 2967cc | V6 Cyl. | 24 Valves | 171kW/233PS | Diesel | Turbo, DOHC | TD22390 |
| CASA | 2967cc | V6 Cyl. | 24 Valves | 176kW/240PS | Diesel | Turbo, DOHC | TD20865 |
| CASB | 2967cc | V6 Cyl. | 24 Valves | 155kW/211PS | Diesel | Turbo, DOHC | TD22636 |
| CASC | 2967cc | V6 Cyl. | 24 Valves | 176kW/240PS | Diesel | Turbo, DOHC | TD22560 |
| CASD | 2967cc | V6 Cyl. | 24 Valves | 150kW/204PS | Diesel | Turbo, DOHC | TD24893 |
| CATA | 2967cc | V6 Cyl. | 24 Valves | 165kW/224PS | Diesel | Turbo, DOHC | TD22637 |
| CEXA | 2967cc | V6 Cyl. | 24 Valves | 176kW/240PS | Diesel | Turbo, DOHC | TD22389 |
| CEXB | 2967cc | V6 Cyl. | 24 Valves | 180kW/245PS | Diesel | Turbo, DOHC | TD28876 |
| CEZA | 2967cc | V6 Cyl. | 24 Valves | 195kW/265PS | Diesel | Turbo, DOHC | TD22561 |
| PHAETON 3.0 V6 TDI | | 09/2004→03/2016 | | TOUAREG 3.0 V6 TDI | | 11/2004→ | |
| TOUAREG 3.0 TDI | | 04/2006→05/2010 | | | | | |

| | | | | |
|---|--------------|---|-----|----|
| V98010  | 059 109 601G |  | 45° | |
| 28.80 x 6.00 x 99.50 | | MB | | |
| V98011  | 059 109 611M |  | 45° | SS |
| 26.80 x 6.00 x 99.50 | | MD + MB | | |

140  **83.00**

| | | | | | | | |
|---|--------------|---|-----------|-------------|--|---|---------|
| CJGD | 2967cc | V6 Cyl. | 24 Valves | 180kW/245PS | Diesel | Turbo, DOHC | TD24926 |
| CJMA | 2967cc | V6 Cyl. | 24 Valves | 150kW/204PS | Diesel | Turbo, DOHC | TD24892 |
| CNRB | 2967cc | V6 Cyl. | 24 Valves | 176kW/240PS | Diesel | Turbo, DOHC | TD24886 |
| CRCA | 2967cc | V6 Cyl. | 24 Valves | 180kW/245PS | Diesel | Turbo, DOHC | TD27356 |
| TOUAREG 3.0 V6 TDI | | 01/2010→ | | | | | |
| V98010  | 059 109 601G |  | 45° | | VAG96237B  |  | |
| 28.80 x 6.00 x 99.50 | | MB | | | 42.00 x 6.02 x 10.07 | | |
| V95114  | 03L 109 611 |  | 45° | SS | H | | |
| 26.00 x 5.97 x 99.10 | | MD + MB | | | | | |

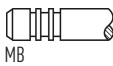
141  **83.00**

| | | | | | | | |
|---|--------------|---|-----------|-------------|--------|-------------|---------|
| CKDA | 4134cc | V8 Cyl. | 32 Valves | 250kW/340PS | Diesel | Turbo, DOHC | TD23926 |
| TOUAREG 4.2 V8 TDI | | 01/2010→ | | | | | |
| V98010  | 059 109 601G |  | 45° | | | | |
| 28.80 x 6.00 x 99.50 | | MB | | | | | |
| V98011  | 059 109 611M |  | 45° | SS | | | |
| 26.80 x 6.00 x 99.50 | | MD + MB | | | | | |

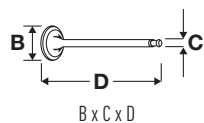



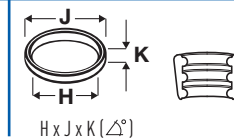
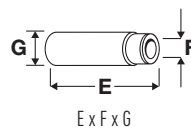





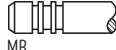

OE



142  **84.00**





| | | | | | | | |
|------|--------|----------|-----------|---------------------|--------|------|---------|
| AYT | 3189cc | VR6 Cyl. | 24 Valves | 177kW/241PS | Petrol | DOHC | TD16481 |
| AZZ | 3189cc | V6 Cyl. | 24 Valves | 162kW/220PS | Petrol | DOHC | TD17041 |
| BAA | 3189cc | VR6 Cyl. | 24 Valves | 162kW/220PS | Petrol | DOHC | TD20531 |
| BDL | 3189cc | VR6 Cyl. | 24 Valves | 170kW/231PS | Petrol | DOHC | TD16870 |
| BFH | 3189cc | VR6 Cyl. | 24 Valves | 177kW/241PS | Petrol | DOHC | TD16526 |
| BKJ | 3189cc | V6 Cyl. | 24 Valves | 162kW/220PS | Petrol | DOHC | TD17042 |
| BKK | 3189cc | V6 Cyl. | 24 Valves | 173kW/235PS | Petrol | DOHC | TD17186 |
| BKL | 3189cc | VR6 Cyl. | 24 Valves | 177kW/241PS | Petrol | DOHC | TD18024 |
| BML | 3189cc | VR6 Cyl. | 24 Valves | 177kW/241PS | Petrol | DOHC | TD20523 |
| BMV | 3189cc | VR6 Cyl. | 24 Valves | 162-177kW/220-241PS | Petrol | DOHC | TD20525 |
| BMX | 3189cc | VR6 Cyl. | 24 Valves | 162kW/220PS | Petrol | DOHC | TD19256 |
| BPF | 3189cc | VR6 Cyl. | 24 Valves | 184kW/250PS | Petrol | DOHC | TD20524 |
| BRJ | 3189cc | VR6 Cyl. | 24 Valves | 162kW/220PS | Petrol | DOHC | TD20526 |
| BRK | 3189cc | VR6 Cyl. | 24 Valves | 177kW/241PS | Petrol | DOHC | TD18025 |
| BUB | 3189cc | VR6 Cyl. | 24 Valves | 184kW/250PS | Petrol | DOHC | TD18472 |
| CBRA | 3189cc | VR6 Cyl. | 24 Valves | 184kW/250PS | Petrol | DOHC | TD22178 |
| CFLA | 3189cc | V6 Cyl. | 24 Valves | 173kW/235PS | Petrol | DOHC | TD20920 |

| | | | |
|----------------------|-----------------|-------------------|-----------------|
| EOS 3.2 V6 | 06/2006→05/2009 | GOLF IV 3.2 R32 | 09/2002→06/2005 |
| GOLF V 3.2 | 09/2005→11/2008 | GOLF V 3.2 R32 | 11/2005→11/2008 |
| MULTIVAN V 3.2 V6 | 02/2004→11/2009 | PHAETON 3.2 V6 | 04/2002→11/2008 |
| TOUAREG 3.2 V6 | 10/2002→11/2006 | TRANSPORTER V 3.2 | 11/2003→11/2009 |
| TRANSPORTER V 3.2 V6 | 04/2003→11/2009 | | |

| | | | | | | | |
|---|--------------|---|-----|----|---|--|---|
| V95085  | 022 109 601G |  | 45° | Y | H | VAG96389B  |  |
| 33.20 x 5.98 x 102.40 | | MB | | | | 44.00 x 6.00 x 10.06 | |
| V95127  | 022 109 601H |  | 45° | Y | H | VAG96390B  |  |
| 33.20 x 5.98 x 136.35 | | MB | | | | 65.00 x 6.00 x 10.06 | |
| V95086  | 022 109 611N |  | 45° | SS | H | | |
| 30.20 x 5.97 x 102.20 | | MD + MB cr | | | | | |
| V95128  | 022 109 611M |  | 45° | SS | H | | |
| 30.20 x 5.97 x 136.10 | | MD | | | | | |

143  **84.50**

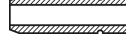
| | | | | | | | |
|--------------------|----------|---------|-----------|-------------|--------|------------------------|---------|
| CGEA | 2995cc | V6 Cyl. | 24 Valves | 245kW/333PS | Petrol | Turbo, DOHC, Injection | TD23931 |
| TOUAREG 3.0 V6 TSI | 04/2010→ | | | | | | |

| | | | | | | | |
|---|--------------|---|-----|----|---|--|---|
| V95098  | 06D 109 601M |  | 45° | | H | VAG96073B  |  |
| 33.80 x 5.98 x 103.95 | | MB | | | | 36.00 x 6.02 x 11.06 | |
| V80024  | 079 109 611D |  | 45° | SS | | | |
| 28.00 x 6.00 x 101.90 | | ME + MB cr Na | | | | | |

144  **84.50**

| | | | | | | | |
|--------------------|----------|---------|-----------|-------------|--------|-------------------------------|---------|
| CJTA | 2995cc | V6 Cyl. | 24 Valves | 213kW/290PS | Petrol | Supercharged, DOHC, Injection | TD24888 |
| TOUAREG 3.0 V6 TSI | 08/2010→ | | | | | | |

| | | | | | | | |
|---|--------------|---|-----|----|--|--|---|
| V80024  | 079 109 611D |  | 45° | SS | | VAG96073B  |  |
| 28.00 x 6.00 x 101.90 | | ME + MB cr Na | | | | 36.00 x 6.02 x 11.06 | |



OE

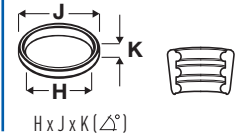
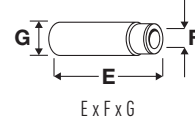

145 **84.50**

| | | | | | | | |
|-----------------------|--------------|-----------------|------------------|---------------------|--------|------------------------|----------------|
| BAR | 4163cc | V8 Cyl. | 32 Valves | 231-257kW/314-350PS | Petrol | DOHC, Injection | TD20207 |
| TOUAREG 4.2 FSI | | 09/2007→12/2009 | | TOUAREG 4.2 V8 FSI | | 06/2006→05/2010 | |
| V94691 | 06E 109 601E | | 45° | Y | H | VAG96073B | |
| 33.85 x 6.00 x 103.90 | | MB | | | | 36.00 x 6.02 x 11.06 | |

146 **85.50**

| | | | | | | | |
|-----------------------|-----------------|------------|-----------------|----------------------|--------|-----------------|---------------|
| AD | 1584cc | 4 Cyl. | 8 Valves | 35-37kW/48-50PS | Petrol | OHV | TD4016 |
| AE | 1584cc | 4 Cyl. | 8 Valves | 35-37kW/48-50PS | Petrol | OHV | TD5133 |
| AS | 1584cc | 4 Cyl. | 8 Valves | 37kW/50PS | Petrol | OHV | TD4030 |
| CT | 1584cc | 4 Cyl. | 8 Valves | 37-49kW/50-67PS | Petrol | OHV | TD4049 |
| KAEFER 1302 1.6 | 01/1970→07/1974 | | | KAEFER 1302,1303 1.6 | | 07/1970→06/1979 | |
| KAEFER 1303 1.6 | 08/1970→12/1979 | | | KAEFER 1303 LS,S 1.6 | | 08/1972→12/1979 | |
| KAEFER 1500 1.6 | 07/1970→01/1973 | | | KARMANN GHIA 1600 | | 01/1970→07/1974 | |
| KOMBI 1.6 | 05/1995→12/2011 | | | TRANSPORTER II 1.6 | | 08/1968→07/1979 | |
| TRANSPORTER III 1.6 | 05/1979→12/1982 | | | | | | |
| V33815 | 311 109 601 | | 45° | | H | | |
| 35.61 x 7.95 x 111.96 | | MB | | | | | |
| V94411 | 043 109 612 | | 45° | SS | H | | |
| 32.00 x 9.00 x 111.80 | | MD + MB cr | | | | | |

147 **86.00**

| | | | | | | | |
|-----------------------|--------------|-----------------|------------------|-------------|--------|------------------------|----------------|
| AXZ | 3168cc | VR6 Cyl. | 24 Valves | 184kW/250PS | Petrol | DOHC, Injection | TD18187 |
| PASSAT 3.2 FSI | | 11/2005→11/2010 | | | | | |
| V95085 | 022 109 601G | | 45° | Y | H | VAG96389B | |
| 33.20 x 5.98 x 102.40 | | MB | | | | 44.00 x 6.00 x 10.06 | |
| V95127 | 022 109 601H | | 45° | Y | H | VAG96390B | |
| 33.20 x 5.98 x 136.35 | | MB | | | | 65.00 x 6.00 x 10.06 | |
| V95086 | 022 109 611N | | 45° | SS | H | | |
| 30.20 x 5.97 x 102.20 | | MD + MB cr | | | | | |
| V95128 | 022 109 611M | | 45° | SS | H | | |
| 30.20 x 5.97 x 136.10 | | MD | | | | | |

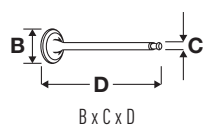

OE

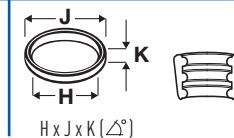
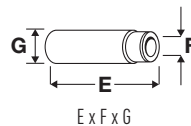

148 **89.00**

| | | | | | | | |
|-------------|--------|----------|------------------|-------------|--------|------------------------|----------------|
| BHK | 3597cc | V6 Cyl. | 24 Valves | 206kW/280PS | Petrol | DOHC, Injection | TD18998 |
| BLV | 3597cc | VR6 Cyl. | 24 Valves | 206kW/280PS | Petrol | DOHC, Injection | TD19259 |
| BWS | 3597cc | VR6 Cyl. | 24 Valves | 220kW/300PS | Petrol | DOHC, Injection | TD19820 |
| CDVA | 3597cc | V6 Cyl. | 24 Valves | 191kW/260PS | Petrol | DOHC | TD22643 |
| CHNA | 3597cc | VR6 Cyl. | 24 Valves | 206kW/280PS | Petrol | DOHC | TD22388 |

| | | | |
|--------------------|-----------------|----------------|-----------------|
| CC 3.6 FSI | 11/2011→12/2016 | EOS 3.6 V6 | 05/2009→11/2010 |
| PASSAT 3.6 FSI | 06/2005→12/2014 | PASSAT 3.6 R36 | 04/2007→11/2010 |
| PASSAT CC 3.6 FSI | 06/2008→01/2012 | PHAETON 3.6 V6 | 11/2008→03/2016 |
| TOUAREG 3.6 V6 FSI | 10/2005→05/2010 | | |

| | | | | | | | |
|-----------------------|--------------|------------|-----|----|---|----------------------|--|
| V95085 | 022 109 601G | | 45° | Y | H | VAG96389B | |
| 33.20 x 5.98 x 102.40 | | MB | | | | 44.00 x 6.00 x 10.06 | |
| V95127 | 022 109 601H | | 45° | Y | H | VAG96390B | |
| 33.20 x 5.98 x 136.35 | | MB | | | | 65.00 x 6.00 x 10.06 | |
| V95086 | 022 109 611N | | 45° | SS | H | | |
| 30.20 x 5.97 x 102.20 | | MD + MB cr | | | | | |
| V95128 | 022 109 611M | | 45° | SS | H | | |
| 30.20 x 5.97 x 136.10 | | MD | | | | | |

149 **90.00**

| | | | | | | | |
|-----------|--------|--------|-----------------|-----------------|--------|--|---------------|
| CA | 1679cc | 4 Cyl. | 8 Valves | 49kW/66PS | Petrol | | TD4040 |
| CB | 1679cc | 4 Cyl. | 8 Valves | 49kW/67PS | Petrol | | TD5149 |
| V | 1679cc | 4 Cyl. | 8 Valves | 50kW/68PS | Petrol | | TD5120 |
| W | 1679cc | 4 Cyl. | 8 Valves | 59-63kW/80-86PS | Petrol | | TD4170 |
| Z | 1679cc | 4 Cyl. | 8 Valves | 50kW/68PS | Petrol | | TD4179 |

| | | | |
|--------------------|-----------------|---------|-----------------|
| 411,412 1.7 | 07/1968→08/1973 | 412 1.7 | 01/1972→12/1973 |
| TRANSPORTER II 1.7 | 08/1971→12/1973 | | |

| | | | | | | | |
|-----------------------|-------------|----|-----|--|---|--|--|
| V94546 | 021 109 601 | | 30° | | H | | |
| 39.20 x 8.00 x 117.05 | | MB | | | | | |

150 **92.00**

| | | | | | | | |
|------------|-----------------|--------|-----------------|-----------------|--------|-------------|---------------|
| 2L | 2446cc | 4 Cyl. | 8 Valves | 58-61kW/79-83PS | Diesel | SOHC | TD4966 |
| TARO 2.4 D | 04/1989→03/1997 | | | | | | |



| | | | | | | | |
|-----------------------|-------------|-------|-----|--|---|----------------------|--|
| V90283 | 13711-54010 | | 45° | | H | VAG92282 | |
| 42.70 x 8.49 x 123.00 | | MB | | | | 61.00 x 8.50 x 14.00 | |
| V91720 | 13711-54020 | | 45° | | H | VAG92406 | |
| 42.50 x 7.99 x 103.55 | | MB tu | | | | 40.00 x 8.00 x 13.05 | |
| V90284 | 13715-54020 | | 45° | | | | |
| 35.10 x 8.47 x 122.80 | | MD | | | | | |
| V91721 | 13715-17010 | | 45° | | | | |
| 36.00 x 7.97 x 103.40 | | MD tu | | | | | |
| V94581 | 13715-54040 | | 45° | | | | |
| 36.00 x 8.00 x 103.30 | | MD tu | | | | | |



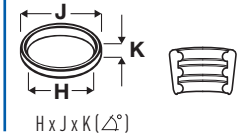
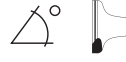



OE





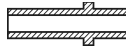

151  **93.00**

| | | | | | | | |
|---|-------------|---|----------|-----------|--------|-----|--------|
| AP | 1795cc | 4 Cyl. | 8 Valves | 50kW/68PS | Petrol | OHV | TD4991 |
| TRANSPORTER II 1.8 | | 11/1973→07/1975 | | | | | |
| V94546  | 021 109 601 |  | 30° | H | | | |
| 39.20 x 8.00 x 117.05 | | MB | | | | | |



152  **93.00**

| | | | | | | | |
|---|--------------|---|-----------|---------------------|--------|---|---------|
| AGK | 2799cc | 4 Cyl. | 12 Valves | 92kW/125PS | Diesel | Turbo | TD9522 |
| ATA | 2799cc | 4 Cyl. | 12 Valves | 96kW/130PS | Diesel | Turbo | TD13444 |
| AUH | 2799cc | 4 Cyl. | 12 Valves | 116kW/158PS | Diesel | Turbo | TD16450 |
| BCQ | 2799cc | 4 Cyl. | 12 Valves | 116kW/158PS | Diesel | Turbo | TD20509 |
| LT 28-35 II 2.8 TDI | | 07/1997→06/2006 | | LT 28-46 II 2.8 TDI | | 07/1997→07/2006 | |
| V80022  | 062 109 601 |  | 30° | | |  | |
| 33.00 x 7.00 x 105.10 | | MB cr | | | | | |
| V80023  | 062 109 611A |  | 45° | SS | | | |
| 39.70 x 7.00 x 105.10 | | ME + MB cr | | | | | |



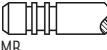

153  **94.00**





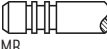

| | | | | | | | |
|---|--------------|---|----------|-----------------|--------|---|--------|
| DG | 1913cc | 4 Cyl. | 8 Valves | 57kW/78PS | Petrol | OHV | TD4993 |
| DH | 1913cc | 4 Cyl. | 8 Valves | 61-62kW/83-84PS | Petrol | OHV | TD4994 |
| GW | 1913cc | 4 Cyl. | 8 Valves | 66kW/90PS | Petrol | OHV | TD4099 |
| TRANSPORTER III 1.9 | | 08/1982→07/1992 | | | | | |
| V94549  | 025 109 601C |  | 45° | Y | H |  | |
| 39.90 x 8.00 x 122.40 | | MB | | | | | |
| V94548  | 025 109 612A |  | 45° | SS | H | | |
| 33.85 x 9.00 x 122.65 | | MD + MB cr | | | | | |

154  **94.00**

| | | | | | | | |
|---|-------------|---|----------|---------------------|--------|---|--------|
| CJ | 1970cc | 4 Cyl. | 8 Valves | 51kW/70PS | Petrol | OHV | TD4045 |
| CU | 1970cc | 4 Cyl. | 8 Valves | 51kW/70PS | Petrol | OHV | TD4050 |
| CV | 1970cc | 4 Cyl. | 8 Valves | 51kW/70PS | Petrol | OHV | TD4051 |
| GD | 1970cc | 4 Cyl. | 8 Valves | 51kW/70PS | Petrol | OHV | TD4091 |
| GE | 1970cc | 4 Cyl. | 8 Valves | 51kW/70PS | Petrol | OHV | TD5005 |
| TRANSPORTER II 2.0 | | 08/1975→07/1979 | | TRANSPORTER III 2.0 | | 05/1979→04/1986 | |
| V94546  | 021 109 601 |  | 30° | H | |  | |
| 39.20 x 8.00 x 117.05 | | MB | | | | | |
| | | | | | | | |

155  **94.00**

| | | | | | | | |
|---|--------------|---|----------|-------------------------|--------|---|--------|
| DJ | 2110cc | 4 Cyl. | 8 Valves | 82kW/112PS | Petrol | | TD4059 |
| MV | 2110cc | 4 Cyl. | 8 Valves | 67-71kW/91-97PS | Petrol | | TD4133 |
| SR | 2110cc | 4 Cyl. | 8 Valves | 64kW/87PS | Petrol | | TD4153 |
| TRANSPORTER III 2.1 | | 08/1984→07/1992 | | TRANSPORTER III 2.1 Cat | | 06/1989→07/1992 | |
| V94549  | 025 109 601C |  | 45° | Y | H |  | |
| 39.90 x 8.00 x 122.40 | | MB | | | | | |
| V94548  | 025 109 612A |  | 45° | SS | H | | |
| 33.85 x 9.00 x 122.65 | | MD + MB cr | | | | | |

|  |  | ccm |  |  |  |  |
|---|---|------|--|---|---|---|
| 128 A.000 | 80.00 | 1116 | 4 | 8 | Petrol | 3 |
| 128 A.064 | 80.00 | 1116 | 4 | 8 | Petrol | 3 |
| 128 AC5.000 | 80.00 | 1116 | 4 | 8 | Petrol | 3 |
| 128 AR.000 | 86.00 | 1290 | 4 | 8 | Petrol | 5 |
| 138 B.0000 | 80.00 | 1116 | 4 | 8 | Petrol | 3 |
| 160 A1.000 | 80.50 | 1372 | 4 | 8 | Petrol | 4 |
| 188 A4.000 | 70.80 | 1242 | 4 | 8 | Petrol | 1 |
| TU1JP | 72.00 | 1124 | 4 | 8 | Petrol | 2 |



OE

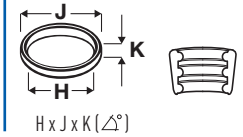
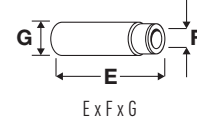

1  **70.80**

| | | | | | | | |
|------------|----------|--------|----------|-----------|--------|------|---------|
| 188 A4.000 | 1242cc | 4 Cyl. | 8 Valves | 44kW/60PS | Petrol | SOHC | TD24580 |
| 10 1.2 60 | 10/2005→ | | | | | | |

V91929 
31.50 x 7.00 x 97.00
Eng.→2533527

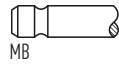

45°

H

VAG92364 
42.50 x 7.00 x 13.07



V98020 
31.90 x 5.00 x 98.40
Eng.2533528→

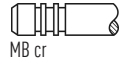

45°

VAG96273 
40.00 x 7.02 x 13.06



V91289 
27.50 x 7.00 x 97.50
Eng.→2533527

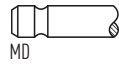

45°

V98021 
27.30 x 5.00 x 98.70
Eng.2533528→



45°

2  **72.00**

| | | | | | | | |
|-----------|-----------------|--------|----------|-----------|--------|------|---------|
| TU1JP | 1124cc | 4 Cyl. | 8 Valves | 44kW/60PS | Petrol | SOHC | TD26420 |
| KORAL 1.1 | 10/2002→11/2008 | | | | | | |

V91271 
37.00 x 7.00 x 112.50

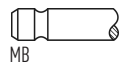

30°

H

VAG92401 
47.50 x 7.01 x 13.06

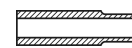

V91273 
29.50 x 7.00 x 112.50

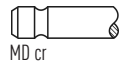

45°

VAG96132 
47.60 x 7.03 x 13.11

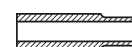

3  **80.00**

| | | | | | | | |
|-------------|-----------------|--------|----------|-----------------|-----------------|------|---------|
| 128 A.000 | 1116cc | 4 Cyl. | 8 Valves | 37-47kW/50-64PS | Petrol | SOHC | TD4183 |
| 128 A.064 | 1116cc | 4 Cyl. | 8 Valves | 40-45kW/54-61PS | Petrol | SOHC | TD9409 |
| 128 AC5.000 | 1116cc | 4 Cyl. | 8 Valves | 47kW/64PS | Petrol | SOHC | TD5045 |
| 138 B.0000 | 1116cc | 4 Cyl. | 8 Valves | 44kW/60PS | Petrol | SOHC | TD21703 |
| 101 1.1 | 06/1973→12/1993 | | | 101 1.1 Super | 07/1979→09/1981 | | |
| KORAL 1.1 | 10/2002→11/2008 | | | YUGO 1.1 | 08/1989→11/2008 | | |
| YUGO 55 | 04/1980→06/1995 | | | | | | |

V91713 
31.00 x 8.00 x 109.00

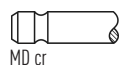

45°

4  **80.50**

| | | | | | | | |
|------------|-----------------|--------|----------|--------------|-----------------|------|---------|
| 160 A1.000 | 1372cc | 4 Cyl. | 8 Valves | 52kW/71PS | Petrol | SOHC | TD21694 |
| YUGO 1.4 | 10/1988→06/1995 | | | YUGO 1.4 Cat | 10/1988→11/2008 | | |

V91300 
37.50 x 8.00 x 108.50

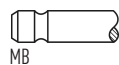

45°

H

V91713 
31.00 x 8.00 x 109.00

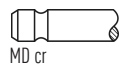

45°

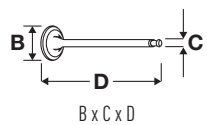

OE

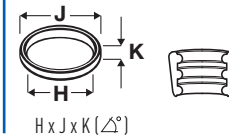
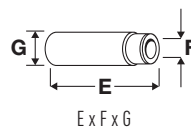

5



86.00

| | | | | | | | |
|------------|-----------------|--------|----------|-----------------|--------|------|---------|
| 128 AR.000 | 1290cc | 4 Cyl. | 8 Valves | 48-49kW/65-67PS | Petrol | SOHC | TD18319 |
| 101 1.3 | 10/1981→12/1993 | | | | | | |

V91713
31.00 x 8.00 x 109.00

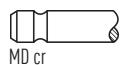















45°















VAG92366
46.50 x 8.00 x 14.10



NUMERICAL PARTS LIST

Numerische Teilenummernliste • Elenco riferimenti
Liste des références produits















|  |  |  |  |  |  |  |  |  |  |  |  |  |  |  |
|---|---|---|---|---|---|---|---|--|---|---|---|---|---|---|
| V3085 | LAND ROVER | 370 | 19 | | V34950 | VOLVO | 871 | 66 | | V80011 | VW | 897 | 49 | |
| V3195 | LAND ROVER | 370 | 18 | | V34963 | SCANIA | 734 | 5 | | V80012 | AUDI | 46 | 2 | |
| V3251 | ALFA ROMEO | 25 | 8 | | V34963 | SCANIA | 734 | 6 | | V80012 | SEAT | 749 | 8 | |
| V3251 | PERKINS | 611 | 1 | | V34963 | SCANIA | 736 | 7 | | V80012 | SKODA | 771 | 2 | |
| V3251 | PERKINS | 611 | 2 | | V34963 | SCANIA | 736 | 8 | | V80012 | VW | 884 | 4 | |
| V33815 | VW | 931 | 146 | | V34963 | SCANIA | 737 | 9 | | V80013 | AUDI | 46 | 2 | |
| V33981 | BEDFORD | 88 | 8 | | V34963 | SCANIA | 738 | 12 | | V80013 | SEAT | 749 | 8 | |
| V33981 | BEDFORD | 88 | 9 | | V34963 | SCANIA | 739 | 13 | | V80013 | SKODA | 771 | 2 | |
| V33987 | BEDFORD | 88 | 8 | | V34963 | SCANIA | 739 | 14 | | V80013 | VW | 884 | 4 | |
| V33987 | BEDFORD | 88 | 9 | | V34963 | SCANIA | 740 | 15 | | V80016 | CHEVROLET | 123 | 30 | |
| V34025 | PERKINS | 612 | 11 | | V34963 | SCANIA | 740 | 16 | | V80016 | OPEL | 596 | 42 | |
| V34025 | PERKINS | 613 | 13 | | V34963 | SCANIA | 741 | 17 | | V80016 | VAUXHALL | 831 | 43 | |
| V34274 | AUSTIN MORRIS | 82 | 3 | | V34963 | SCANIA | 741 | 18 | | V80017 | CHEVROLET | 123 | 30 | |
| V34335 | BMW | 96 | 15 | | V35018 | MERCEDES-BENZ | 478 | 82 | | V80017 | OPEL | 596 | 42 | |
| V34352 | AUSTIN MORRIS | 82 | 4 | | V35018 | MERCEDES-BENZ | 478 | 83 | | V80017 | VAUXHALL | 831 | 43 | |
| V34365 | LAND ROVER | 370 | 18 | | V35018 | MERCEDES-BENZ | 478 | 84 | | V80018 | LOTUS | 374 | 1 | |
| V34401 | AUSTIN MORRIS | 82 | 4 | | V35018 | MERCEDES-BENZ | 479 | 85 | | V80018 | TOYOTA | 806 | 15 | |
| V34457 | AUTOBIANCHI | 84 | 1 | | V35018 | MERCEDES-BENZ | 479 | 86 | | V80019 | LOTUS | 374 | 1 | |
| V34457 | AUTOBIANCHI | 84 | 2 | | V35018 | MERCEDES-BENZ | 479 | 87 | | V80019 | TOYOTA | 806 | 15 | |
| V34457 | FIAT | 194 | 1 | | V35018 | MERCEDES-BENZ | 479 | 88 | | V80020 | CITROËN | 136 | 9 | |
| V34457 | FIAT | 194 | 2 | | V35018 | MERCEDES-BENZ | 480 | 89 | | V80020 | OPEL | 587 | 14 | |
| V34457 | FIAT | 194 | 4 | | V35039 | VOLVO | 861 | 42 | | V80020 | PEUGEOT | 622 | 9 | |
| V34457 | FIAT | 195 | 7 | | V35039 | VOLVO | 861 | 43 | | V80020 | VAUXHALL | 823 | 16 | |
| V34457 | LANCIA | 350 | 1 | | V35039 | VOLVO | 862 | 44 | | V80021 | CITROËN | 136 | 9 | |
| V34457 | LANCIA | 350 | 2 | | V35039 | VOLVO | 863 | 48 | | V80021 | OPEL | 587 | 14 | |
| V34457 | SEAT | 748 | 1 | | V35039 | VOLVO | 863 | 49 | | V80021 | PEUGEOT | 622 | 9 | |
| V34457 | SEAT | 748 | 2 | | V35039 | VOLVO | 863 | 50 | | V80021 | VAUXHALL | 823 | 16 | |
| V34457 | SEAT | 748 | 4 | | V35040 | VOLVO | 861 | 42 | | V80022 | VW | 933 | 152 | |
| V34459 | CITROËN | 148 | 41 | | V35040 | VOLVO | 861 | 43 | | V80023 | VW | 933 | 152 | |
| V34459 | CITROËN | 155 | 67 | | V35040 | VOLVO | 862 | 44 | | V80024 | AUDI | 78 | 102 | |
| V34459 | FIAT | 223 | 100 | | V35040 | VOLVO | 863 | 48 | | V80024 | VW | 930 | 143 | |
| V34459 | PEUGEOT | 635 | 40 | | V35040 | VOLVO | 863 | 49 | | V80024 | VW | 930 | 144 | |
| V34459 | PEUGEOT | 635 | 41 | | V35040 | VOLVO | 863 | 50 | | V80025 | BMW | 106 | 39 | |
| V34459 | PEUGEOT | 642 | 68 | | V35042 | PERKINS | 612 | 9 | | V80025 | BMW | 109 | 45 | |
| V34460 | CITROËN | 148 | 41 | | V35042 | PERKINS | 612 | 10 | | V80028 | AUDI | 70 | 78 | |
| V34460 | CITROËN | 155 | 67 | | V35042 | PERKINS | 612 | 11 | | V80028 | AUDI | 71 | 81 | |
| V34460 | FIAT | 223 | 100 | | V35042 | PERKINS | 613 | 12 | | V80028 | AUDI | 77 | 96 | |
| V34460 | PEUGEOT | 635 | 40 | | V35117 | DACIA | 158 | 3 | | V80028 | AUDI | 77 | 97 | |
| V34460 | PEUGEOT | 635 | 41 | | V35117 | RENAULT | 669 | 1 | | V80028 | AUDI | 77 | 98 | |
| V34460 | PEUGEOT | 642 | 68 | | V35117 | RENAULT | 672 | 5 | | V80028 | AUDI | 77 | 99 | |
| V34499 | FORD | 262 | 75 | | V35117 | RENAULT | 673 | 9 | | V80028 | AUDI | 78 | 101 | |
| V34499 | FORD | 267 | 87 | | V35117 | RENAULT | 674 | 10 | | V80028 | AUDI | 78 | 103 | |
| V34499 | FORD | 267 | 89 | | V35117 | VOLVO | 849 | 1 | | V80028 | AUDI | 79 | 106 | |
| V34501 | FORD | 267 | 87 | | V35117 | VOLVO | 849 | 4 | | V80028 | VW | 927 | 134 | |
| V34501 | FORD | 267 | 89 | | V35122 | FORD | 265 | 82 | | V90048 | MERCEDES-BENZ | 521 | 152 | |
| V34509 | FORD | 265 | 83 | | V35122 | FORD | 267 | 87 | | V90048 | MERCEDES-BENZ | 522 | 154 | |
| V34524 | FORD | 253 | 51 | | V35122 | FORD | 267 | 88 | | V90050 | DEUTZ/KHD | 177 | 9 | |
| V34525 | FORD | 253 | 51 | | V35122 | FORD | 267 | 89 | | V90050 | DEUTZ/KHD | 177 | 11 | |
| V34631 | LADA | 344 | 1 | | V35122 | FORD | 268 | 90 | | V90050 | DEUTZ/KHD | 178 | 13 | |
| V34631 | LADA | 344 | 2 | | V35264 | FORD | 269 | 94 | | V90050 | DEUTZ/KHD | 178 | 15 | |
| V34631 | LADA | 344 | 3 | | V80000 | BMW | 95 | 12 | | V90050 | DEUTZ/KHD | 178 | 17 | |
| V34631 | LADA | 344 | 4 | | V80001 | BMW | 95 | 12 | | V90050 | DEUTZ/KHD | 179 | 21 | |
| V34631 | LADA | 344 | 5 | | V80002 | BMW | 113 | 60 | | V90050 | DEUTZ/KHD | 179 | 22 | |
| V34631 | LADA | 345 | 6 | | V80003 | BMW | 113 | 60 | | V90050 | DEUTZ/KHD | 180 | 23 | |
| V34632 | LADA | 344 | 1 | | V80004 | MERCEDES-BENZ | 446 | 15 | | V90050 | DEUTZ/KHD | 180 | 24 | |
| V34632 | LADA | 344 | 2 | | V80005 | MERCEDES-BENZ | 446 | 15 | | V90050 | DEUTZ/KHD | 180 | 25 | |
| V34632 | LADA | 344 | 3 | | V80006 | MERCEDES-BENZ | 483 | 97 | | V90050 | DEUTZ/KHD | 181 | 27 | |
| V34632 | LADA | 344 | 4 | | V80006 | MERCEDES-BENZ | 484 | 99 | | V90050 | DEUTZ/KHD | 181 | 28 | |
| V34632 | LADA | 344 | 5 | | V80006 | MERCEDES-BENZ | 484 | 100 | | V90050 | DEUTZ/KHD | 181 | 30 | |
| V34632 | LADA | 345 | 6 | | V80007 | MERCEDES-BENZ | 483 | 97 | | V90050 | DEUTZ/KHD | 182 | 31 | |
| V34789 | PERKINS | 612 | 11 | | V80007 | MERCEDES-BENZ | 484 | 100 | | V90050 | DEUTZ/KHD | 182 | 33 | |
| V34789 | PERKINS | 613 | 13 | | V80008 | MERCEDES-BENZ | 449 | 25 | | V90050 | DEUTZ/KHD | 183 | 34 | |
| V34858 | AUSTIN MORRIS | 82 | 1 | | V80008 | MERCEDES-BENZ | 450 | 28 | | V90050 | IVECO | 312 | 27 | |
| V34859 | AUSTIN MORRIS | 82 | 1 | | V80009 | MERCEDES-BENZ | 449 | 25 | | V90050 | IVECO | 313 | 29 | |
| V34939 | LAND ROVER | 369 | 15 | | V80009 | MERCEDES-BENZ | 450 | 28 | | V90051 | DEUTZ/KHD | 177 | 9 | |
| V34939 | ROVER | 723 | 22 | | V80010 | SEAT | 755 | 29 | | V90051 | DEUTZ/KHD | 177 | 11 | |
| V34940 | LAND ROVER | 369 | 15 | | V80010 | VW | 892 | 30 | | V90051 | DEUTZ/KHD | 178 | 13 | |
| V34940 | LAND ROVER | 370 | 16 | | V80010 | VW | 893 | 31 | | V90051 | DEUTZ/KHD | 178 | 15 | |
| V34940 | ROVER | 723 | 22 | | V80010 | VW | 897 | 49 | | V90051 | DEUTZ/KHD | 178 | 17 | |
| V34949 | VOLVO | 870 | 65 | | V80011 | SEAT | 755 | 29 | | V90051 | DEUTZ/KHD | 179 | 18 | |
| V34949 | VOLVO | 871 | 66 | | V80011 | VW | 892 | 30 | | V90051 | DEUTZ/KHD | 179 | 19 | |
| V34950 | VOLVO | 870 | 65 | | V80011 | VW | 893 | 31 | | V90051 | DEUTZ/KHD | 179 | 20 | |













|  |  |  |  |  |  |  |  |  |  |  |  |  |  |  |
|---|---|---|---|---|---|---|---|---|---|---|---|---|---|---|
| V90051 | DEUTZ/KHD | 179 | 21 | V90132 | FORD | 249 | 41 | V90233 | FORD | 271 | 100 | | | |
| V90051 | DEUTZ/KHD | 179 | 22 | V90132 | FORD | 250 | 43 | V90233 | FORD | 271 | 101 | | | |
| V90051 | DEUTZ/KHD | 180 | 23 | V90132 | FORD | 250 | 45 | V90283 | TOYOTA | 812 | 33 | | | |
| V90051 | DEUTZ/KHD | 180 | 24 | V90134V1 | FORD | 246 | 31 | V90283 | TOYOTA | 812 | 34 | | | |
| V90051 | DEUTZ/KHD | 180 | 25 | V90134V1 | FORD | 249 | 41 | V90283 | VW | 932 | 150 | | | |
| V90051 | DEUTZ/KHD | 180 | 26 | V90134V1 | FORD | 250 | 42 | V90284 | TOYOTA | 812 | 33 | | | |
| V90051 | DEUTZ/KHD | 181 | 27 | V90134V1 | FORD | 250 | 43 | V90284 | TOYOTA | 812 | 34 | | | |
| V90051 | DEUTZ/KHD | 181 | 28 | V90134V1 | FORD | 250 | 44 | V90284 | VW | 932 | 150 | | | |
| V90051 | DEUTZ/KHD | 181 | 30 | V90134V1 | FORD | 250 | 45 | V90302 | JAGUAR | 334 | 12 | | | |
| V90051 | DEUTZ/KHD | 182 | 31 | V90134V1 | FORD | 251 | 46 | V90303 | JAGUAR | 334 | 11 | | | |
| V90051 | DEUTZ/KHD | 182 | 32 | V90152 | FORD | 253 | 53 | V90303 | JAGUAR | 334 | 12 | | | |
| V90051 | DEUTZ/KHD | 182 | 33 | V90152 | FORD | 253 | 54 | V90304 | JAGUAR | 333 | 6 | | | |
| V90051 | DEUTZ/KHD | 183 | 34 | V90152 | FORD | 265 | 83 | V90304 | JAGUAR | 333 | 7 | | | |
| V90051 | IVECO | 312 | 27 | V90165 | FORD | 240 | 15 | V90307 | JAGUAR | 333 | 6 | | | |
| V90051 | IVECO | 313 | 29 | V90165 | FORD | 240 | 16 | V90307 | JAGUAR | 333 | 7 | | | |
| V90053 | MERCEDES-BENZ | 519 | 148 | V90165 | FORD | 240 | 18 | V90308 | JAGUAR | 334 | 11 | | | |
| V90053 | MERCEDES-BENZ | 522 | 153 | V90166 | CHEVROLET | 122 | 27 | V90312 | DEUTZ/KHD | 177 | 8 | | | |
| V90107 | BEDFORD | 87 | 2 | V90166 | OPEL | 595 | 37 | V90312 | DEUTZ/KHD | 177 | 10 | | | |
| V90107 | OPEL | 588 | 15 | V90166 | VAUXHALL | 830 | 38 | V90312 | DEUTZ/KHD | 177 | 12 | | | |
| V90107 | OPEL | 588 | 16 | V90166 | VAUXHALL | 836 | 61 | V90312 | DEUTZ/KHD | 178 | 14 | | | |
| V90107 | OPEL | 590 | 24 | V90169 | VOLVO | 865 | 54 | V90312 | DEUTZ/KHD | 178 | 16 | | | |
| V90107 | VAUXHALL | 823 | 17 | V90169 | VOLVO | 866 | 56 | V90321 | AUDI | 48 | 12 | | | |
| V90107 | VAUXHALL | 825 | 25 | V90169 | VOLVO | 866 | 57 | V90321 | AUDI | 48 | 13 | | | |
| V90108 | BEDFORD | 87 | 2 | V90169 | VOLVO | 866 | 58 | V90321 | VOLVO | 850 | 5 | | | |
| V90108 | OPEL | 588 | 15 | V90169 | VOLVO | 866 | 59 | V90321 | VW | 898 | 54 | | | |
| V90108 | OPEL | 588 | 16 | V90178 | FORD | 262 | 75 | V90321 | VW | 899 | 56 | | | |
| V90108 | OPEL | 590 | 24 | V90178 | FORD | 265 | 82 | V90321 | VW | 899 | 57 | | | |
| V90108 | VAUXHALL | 823 | 17 | V90178 | FORD | 267 | 87 | V90321 | VW | 902 | 66 | | | |
| V90108 | VAUXHALL | 825 | 25 | V90178 | FORD | 267 | 88 | V90327 | FORD | 242 | 21 | | | |
| V90114 | DEUTZ/KHD | 177 | 9 | V90178 | FORD | 267 | 89 | V90327 | VW | 886 | 11 | | | |
| V90114 | DEUTZ/KHD | 177 | 11 | V90178 | FORD | 268 | 90 | V90327 | VW | 887 | 15 | | | |
| V90114 | DEUTZ/KHD | 178 | 13 | V90179 | AUDI | 47 | 6 | V90351 | FORD | 270 | 96 | | | |
| V90114 | DEUTZ/KHD | 178 | 15 | V90179 | VW | 893 | 34 | V90351 | PEUGEOT | 642 | 67 | | | |
| V90114 | DEUTZ/KHD | 178 | 17 | V90179 | VW | 893 | 35 | V90351 | PEUGEOT | 643 | 72 | | | |
| V90114 | DEUTZ/KHD | 179 | 18 | V90179 | VW | 902 | 66 | V90351 | PEUGEOT | 644 | 78 | | | |
| V90114 | DEUTZ/KHD | 179 | 19 | V90180 | AUDI | 47 | 6 | V90357 | AUSTIN MORRIS | 82 | 3 | | | |
| V90114 | DEUTZ/KHD | 179 | 20 | V90180 | AUDI | 48 | 12 | V90363 | NISSAN | 571 | 17 | | | |
| V90114 | DEUTZ/KHD | 179 | 21 | V90180 | VOLVO | 850 | 5 | V90371 | CITROËN | 155 | 68 | | | |
| V90114 | DEUTZ/KHD | 179 | 22 | V90180 | VW | 893 | 34 | V90371 | CITROËN | 155 | 69 | | | |
| V90114 | DEUTZ/KHD | 180 | 23 | V90180 | VW | 893 | 35 | V90371 | JEEP | 336 | 3 | | | |
| V90114 | DEUTZ/KHD | 180 | 24 | V90180 | VW | 898 | 54 | V90371 | PEUGEOT | 642 | 69 | | | |
| V90114 | DEUTZ/KHD | 180 | 25 | V90180 | VW | 899 | 57 | V90371 | PEUGEOT | 643 | 70 | | | |
| V90114 | DEUTZ/KHD | 180 | 26 | V90182 | VOLVO | 864 | 52 | V90371 | PEUGEOT | 643 | 71 | | | |
| V90114 | DEUTZ/KHD | 181 | 27 | V90182 | VOLVO | 864 | 53 | V90371 | PEUGEOT | 643 | 73 | | | |
| V90114 | DEUTZ/KHD | 181 | 28 | V90193 | AUSTIN MORRIS | 82 | 3 | V90371 | RENAULT | 701 | 53 | | | |
| V90114 | DEUTZ/KHD | 181 | 30 | V90194 | AUSTIN MORRIS | 82 | 3 | V90371 | RENAULT | 703 | 55 | | | |
| V90114 | DEUTZ/KHD | 182 | 31 | V90225 | MERCEDES-BENZ | 478 | 82 | V90371 | RENAULT | 704 | 57 | | | |
| V90114 | DEUTZ/KHD | 182 | 32 | V90225 | MERCEDES-BENZ | 478 | 83 | V90371 | RENAULT | 704 | 59 | | | |
| V90114 | DEUTZ/KHD | 182 | 33 | V90225 | MERCEDES-BENZ | 478 | 84 | V90371 | VOLVO | 861 | 41 | | | |
| V90114 | DEUTZ/KHD | 183 | 34 | V90225 | MERCEDES-BENZ | 479 | 85 | V90371 | VOLVO | 862 | 46 | | | |
| V90114 | IVECO | 312 | 27 | V90225 | MERCEDES-BENZ | 479 | 86 | V90371 | VOLVO | 862 | 47 | | | |
| V90114 | IVECO | 313 | 29 | V90225 | MERCEDES-BENZ | 479 | 87 | V90388 | ALFA ROMEO | 25 | 6 | | | |
| V90123 | HYUNDAI | 280 | 4 | V90225 | MERCEDES-BENZ | 479 | 88 | V90388 | ALFA ROMEO | 25 | 7 | | | |
| V90123 | HYUNDAI | 282 | 9 | V90225 | MERCEDES-BENZ | 480 | 89 | V90388 | ALFA ROMEO | 26 | 13 | | | |
| V90123 | DAEWOO | 552 | 1 | V90230 | BEDFORD | 87 | 5 | V90388 | ALFA ROMEO | 26 | 14 | | | |
| V90123 | DAEWOO | 552 | 3 | V90230 | BEDFORD | 88 | 6 | V90397 | LANCIA | 364 | 55 | | | |
| V90123 | DAEWOO | 552 | 4 | V90230 | OPEL | 595 | 36 | V90398 | AUTOBIANCHI | 85 | 6 | | | |
| V90123 | DAEWOO | 553 | 8 | V90230 | OPEL | 598 | 48 | V90398 | AUTOBIANCHI | 85 | 7 | | | |
| V90123 | DAEWOO | 554 | 9 | V90230 | OPEL | 599 | 49 | V90398 | AUTOBIANCHI | 85 | 8 | | | |
| V90123 | PROTON | 653 | 1 | V90230 | VAUXHALL | 830 | 37 | V90398 | FIAT | 202 | 30 | | | |
| V90123 | PROTON | 653 | 2 | V90230 | VAUXHALL | 833 | 49 | V90398 | FIAT | 202 | 31 | | | |
| V90124 | HYUNDAI | 280 | 4 | V90230 | VAUXHALL | 833 | 50 | V90398 | FIAT | 202 | 32 | | | |
| V90124 | HYUNDAI | 282 | 9 | V90231 | BEDFORD | 87 | 5 | V90398 | FIAT | 203 | 34 | | | |
| V90124 | DAEWOO | 552 | 1 | V90231 | BEDFORD | 88 | 6 | V90398 | LANCIA | 353 | 16 | | | |
| V90124 | DAEWOO | 552 | 3 | V90231 | OPEL | 595 | 36 | V90398 | LANCIA | 354 | 17 | | | |
| V90124 | DAEWOO | 552 | 4 | V90231 | OPEL | 598 | 48 | V90398 | LANCIA | 354 | 18 | | | |
| V90124 | DAEWOO | 553 | 8 | V90231 | VAUXHALL | 830 | 37 | V90399 | AUTOBIANCHI | 85 | 6 | | | |
| V90124 | DAEWOO | 554 | 9 | V90231 | VAUXHALL | 833 | 49 | V90399 | AUTOBIANCHI | 85 | 7 | | | |
| V90124 | PROTON | 653 | 1 | V90232 | FORD | 271 | 99 | V90399 | AUTOBIANCHI | 85 | 8 | | | |
| V90124 | PROTON | 653 | 2 | V90232 | FORD | 271 | 100 | V90399 | FIAT | 194 | 3 | | | |
| V90132 | FORD | 246 | 31 | V90232 | FORD | 271 | 101 | V90399 | FIAT | 202 | 30 | | | |
| V90132 | FORD | 249 | 40 | V90233 | FORD | 271 | 99 | V90399 | FIAT | 202 | 31 | | | |



NUMERICAL PARTS LIST

Nummerische Teilenummernliste • Elenco riferimenti
Liste des références produits















|  |  |  |  |  |  |  |  |  |  |  |  |  |  |  |
|---|---|---|---|---|---|---|---|--|---|---|---|---|---|---|
| V90399 | FIAT | 202 | 32 | | V91030 | VW | | 914 | 98 | V91133 | MERCEDES-BENZ | | 533 | 168 |
| V90399 | FIAT | 203 | 34 | | V91030 | VW | | 914 | 99 | V91133 | MERCEDES-BENZ | | 534 | 169 |
| V90399 | LANCIA | 353 | 16 | | V91030 | VW | | 915 | 102 | V91133 | MERCEDES-BENZ | | 534 | 170 |
| V90399 | LANCIA | 354 | 17 | | V91030 | VW | | 919 | 111 | V91133 | MERCEDES-BENZ | | 534 | 171 |
| V90399 | LANCIA | 354 | 18 | | V91058 | JAGUAR | | 333 | 8 | V91133 | MERCEDES-BENZ | | 535 | 172 |
| V90418 | DEUTZ/KHD | 184 | 40 | | V91058 | JAGUAR | | 333 | 9 | V91133 | MERCEDES-BENZ | | 535 | 173 |
| V90418 | DEUTZ/KHD | 184 | 41 | | V91058 | JAGUAR | | 333 | 10 | V91133 | MERCEDES-BENZ | | 535 | 174 |
| V90418 | DEUTZ/KHD | 184 | 42 | | V91131 | MERCEDES-BENZ | | 488 | 110 | V91133 | MERCEDES-BENZ | | 536 | 175 |
| V90418 | DEUTZ/KHD | 185 | 43 | | V91131 | MERCEDES-BENZ | | 493 | 115 | V91133 | MERCEDES-BENZ | | 539 | 179 |
| V90418 | DEUTZ/KHD | 185 | 44 | | V91131 | MERCEDES-BENZ | | 495 | 120 | V91133 | MERCEDES-BENZ | | 540 | 180 |
| V90418 | DEUTZ/KHD | 185 | 45 | | V91131 | MERCEDES-BENZ | | 497 | 122 | V91133 | MERCEDES-BENZ | | 542 | 183 |
| V90418 | DEUTZ/KHD | 185 | 46 | | V91131 | MERCEDES-BENZ | | 502 | 123 | V91137 | BEDFORD | | 87 | 4 |
| V90418 | DEUTZ/KHD | 185 | 47 | | V91131 | MERCEDES-BENZ | | 503 | 124 | V91137 | CHEVROLET | | 120 | 18 |
| V90418 | DEUTZ/KHD | 185 | 48 | | V91131 | MERCEDES-BENZ | | 503 | 125 | V91137 | CHEVROLET | | 121 | 22 |
| V90418 | DEUTZ/KHD | 186 | 49 | | V91132 | MERCEDES-BENZ | | 511 | 132 | V91137 | DAEWOO | | 163 | 6 |
| V90418 | DEUTZ/KHD | 186 | 50 | | V91132 | MERCEDES-BENZ | | 511 | 133 | V91137 | OPEL | | 591 | 25 |
| V90418 | DEUTZ/KHD | 186 | 51 | | V91132 | MERCEDES-BENZ | | 512 | 134 | V91137 | OPEL | | 592 | 29 |
| V90418 | DEUTZ/KHD | 186 | 52 | | V91132 | MERCEDES-BENZ | | 513 | 136 | V91137 | VAUXHALL | | 826 | 26 |
| V90418 | DEUTZ/KHD | 187 | 53 | | V91132 | MERCEDES-BENZ | | 513 | 137 | V91137 | VAUXHALL | | 827 | 30 |
| V90418 | DEUTZ/KHD | 187 | 54 | | V91132 | MERCEDES-BENZ | | 514 | 138 | V91138 | BEDFORD | | 87 | 4 |
| V90418 | DEUTZ/KHD | 187 | 55 | | V91132 | MERCEDES-BENZ | | 514 | 139 | V91138 | CHEVROLET | | 120 | 18 |
| V90418 | DEUTZ/KHD | 187 | 56 | | V91132 | MERCEDES-BENZ | | 515 | 140 | V91138 | DAEWOO | | 163 | 6 |
| V90418 | DEUTZ/KHD | 188 | 57 | | V91132 | MERCEDES-BENZ | | 515 | 141 | V91138 | OPEL | | 591 | 25 |
| V90418 | IVECO | 323 | 56 | | V91132 | MERCEDES-BENZ | | 516 | 142 | V91138 | VAUXHALL | | 826 | 26 |
| V90418 | IVECO | 324 | 59 | | V91132 | MERCEDES-BENZ | | 517 | 143 | V91142 | AUSTIN MORRIS | | 82 | 2 |
| V90418 | IVECO | 325 | 61 | | V91132 | MERCEDES-BENZ | | 517 | 144 | V91143 | CITROËN | | 143 | 27 |
| V90418 | IVECO | 325 | 62 | | V91132 | MERCEDES-BENZ | | 518 | 145 | V91143 | CITROËN | | 147 | 38 |
| V90418 | IVECO | 325 | 63 | | V91132 | MERCEDES-BENZ | | 518 | 146 | V91143 | LADA | | 345 | 8 |
| V90432 | MWM | 559 | 1 | | V91132 | MERCEDES-BENZ | | 518 | 147 | V91143 | PEUGEOT | | 629 | 26 |
| V90432 | MWM | 559 | 2 | | V91132 | MERCEDES-BENZ | | 519 | 149 | V91143 | PEUGEOT | | 634 | 38 |
| V90432 | MWM | 559 | 3 | | V91132 | MERCEDES-BENZ | | 520 | 150 | V91143 | SUZUKI | | 799 | 21 |
| V90432 | MWM | 559 | 4 | | V91132 | MERCEDES-BENZ | | 520 | 151 | V91144 | CITROËN | | 143 | 27 |
| V90432 | MWM | 559 | 5 | | V91132 | MERCEDES-BENZ | | 523 | 155 | V91144 | CITROËN | | 144 | 28 |
| V90432 | MWM | 560 | 6 | | V91132 | MERCEDES-BENZ | | 523 | 156 | V91144 | CITROËN | | 144 | 30 |
| V90432 | MWM | 560 | 7 | | V91132 | MERCEDES-BENZ | | 525 | 157 | V91144 | CITROËN | | 147 | 38 |
| V90432 | MWM | 560 | 8 | | V91132 | MERCEDES-BENZ | | 529 | 164 | V91144 | CITROËN | | 147 | 39 |
| V90933 | FORD | 264 | 78 | | V91132 | MERCEDES-BENZ | | 530 | 165 | V91144 | CITROËN | | 148 | 40 |
| V90935 | HONDA | 273 | 4 | | V91132 | MERCEDES-BENZ | | 530 | 166 | V91144 | FIAT | | 212 | 60 |
| V90935 | HONDA | 273 | 5 | | V91132 | MERCEDES-BENZ | | 533 | 167 | V91144 | FIAT | | 215 | 66 |
| V90935 | ROVER | 719 | 1 | | V91132 | MERCEDES-BENZ | | 533 | 168 | V91144 | FIAT | | 215 | 66 |
| V91020 | MERCEDES-BENZ | 511 | 132 | | V91132 | MERCEDES-BENZ | | 534 | 169 | V91144 | HONDA | | 276 | 16 |
| V91020 | MERCEDES-BENZ | 511 | 133 | | V91132 | MERCEDES-BENZ | | 534 | 170 | V91144 | HYUNDAI | | 284 | 20 |
| V91020 | MERCEDES-BENZ | 512 | 134 | | V91132 | MERCEDES-BENZ | | 534 | 171 | V91144 | LADA | | 345 | 8 |
| V91020 | MERCEDES-BENZ | 513 | 136 | | V91132 | MERCEDES-BENZ | | 535 | 172 | V91144 | LADA | | 345 | 9 |
| V91020 | MERCEDES-BENZ | 513 | 137 | | V91132 | MERCEDES-BENZ | | 535 | 173 | V91144 | PEUGEOT | | 629 | 26 |
| V91020 | MERCEDES-BENZ | 514 | 138 | | V91132 | MERCEDES-BENZ | | 535 | 174 | V91144 | PEUGEOT | | 630 | 27 |
| V91020 | MERCEDES-BENZ | 514 | 139 | | V91132 | MERCEDES-BENZ | | 536 | 175 | V91144 | PEUGEOT | | 630 | 29 |
| V91020 | MERCEDES-BENZ | 515 | 140 | | V91132 | MERCEDES-BENZ | | 539 | 179 | V91144 | PEUGEOT | | 634 | 38 |
| V91020 | MERCEDES-BENZ | 516 | 142 | | V91132 | MERCEDES-BENZ | | 540 | 180 | V91144 | PEUGEOT | | 634 | 39 |
| V91020 | MERCEDES-BENZ | 517 | 143 | | V91132 | MERCEDES-BENZ | | 542 | 183 | V91144 | ROVER | | 721 | 11 |
| V91020 | MERCEDES-BENZ | 517 | 144 | | V91133 | MERCEDES-BENZ | | 511 | 132 | V91144 | SUZUKI | | 798 | 20 |
| V91020 | MERCEDES-BENZ | 519 | 149 | | V91133 | MERCEDES-BENZ | | 511 | 133 | V91144 | SUZUKI | | 799 | 21 |
| V91020 | MERCEDES-BENZ | 520 | 150 | | V91133 | MERCEDES-BENZ | | 512 | 134 | V91144 | SUZUKI | | 799 | 22 |
| V91020 | MERCEDES-BENZ | 529 | 164 | | V91133 | MERCEDES-BENZ | | 513 | 136 | V91144 | TOYOTA | | 808 | 21 |
| V91020 | MERCEDES-BENZ | 530 | 165 | | V91133 | MERCEDES-BENZ | | 513 | 137 | V91145 | CITROËN | | 143 | 27 |
| V91020 | MERCEDES-BENZ | 533 | 168 | | V91133 | MERCEDES-BENZ | | 514 | 138 | V91145 | CITROËN | | 144 | 28 |
| V91020 | MERCEDES-BENZ | 534 | 169 | | V91133 | MERCEDES-BENZ | | 514 | 139 | V91145 | CITROËN | | 144 | 30 |
| V91020 | MERCEDES-BENZ | 534 | 170 | | V91133 | MERCEDES-BENZ | | 515 | 140 | V91145 | CITROËN | | 147 | 38 |
| V91020 | MERCEDES-BENZ | 534 | 171 | | V91133 | MERCEDES-BENZ | | 516 | 142 | V91145 | CITROËN | | 147 | 39 |
| V91020 | MERCEDES-BENZ | 535 | 172 | | V91133 | MERCEDES-BENZ | | 517 | 143 | V91145 | CITROËN | | 148 | 40 |
| V91030 | AUDI | 53 | 27 | | V91133 | MERCEDES-BENZ | | 517 | 144 | V91145 | FIAT | | 212 | 60 |
| V91030 | AUDI | 53 | 28 | | V91133 | MERCEDES-BENZ | | 518 | 145 | V91145 | FIAT | | 214 | 65 |
| V91030 | AUDI | 53 | 29 | | V91133 | MERCEDES-BENZ | | 518 | 146 | V91145 | FIAT | | 215 | 66 |
| V91030 | AUDI | 55 | 35 | | V91133 | MERCEDES-BENZ | | 519 | 149 | V91145 | HONDA | | 276 | 16 |
| V91030 | AUDI | 57 | 40 | | V91133 | MERCEDES-BENZ | | 520 | 150 | V91145 | HYUNDAI | | 284 | 20 |
| V91030 | AUDI | 58 | 42 | | V91133 | MERCEDES-BENZ | | 520 | 151 | V91145 | LADA | | 345 | 8 |
| V91030 | AUDI | 61 | 50 | | V91133 | MERCEDES-BENZ | | 523 | 155 | V91145 | LADA | | 345 | 9 |
| V91030 | AUDI | 64 | 60 | | V91133 | MERCEDES-BENZ | | 523 | 156 | V91145 | PEUGEOT | | 629 | 26 |
| V91030 | HONDA | 276 | 17 | | V91133 | MERCEDES-BENZ | | 529 | 164 | V91145 | PEUGEOT | | 630 | 27 |
| V91030 | SEAT | 761 | 49 | | V91133 | MERCEDES-BENZ | | 530 | 165 | V91145 | PEUGEOT | | 630 | 29 |
| V91030 | VW | 908 | 82 | | V91133 | MERCEDES-BENZ | | 530 | 166 | V91145 | PEUGEOT | | 634 | 38 |
| V91030 | VW | 911 | 90 | | V91133 | MERCEDES-BENZ | | 533 | 167 | V91145 | PEUGEOT | | 634 | 39 |













|  |  |  |  | 9 |  |  |  |  | 9 |  |  |  |  | 9 |
|---|---|---|---|----|---|---|---|---|-----|---|---|---|---|----|
| V91145 | ROVER | | 721 | 11 | V91162 | FORD | | 241 | 19 | V91197 | NISSAN | | 567 | 1 |
| V91145 | SUZUKI | | 798 | 20 | V91168 | FORD | | 257 | 61 | V91197 | NISSAN | | 568 | 6 |
| V91145 | SUZUKI | | 799 | 21 | V91168 | MAZDA | | 408 | 13 | V91198 | FORD | | 249 | 39 |
| V91145 | SUZUKI | | 799 | 22 | V91169 | LAND ROVER | | 371 | 23 | V91198 | FORD | | 264 | 77 |
| V91145 | TOYOTA | | 808 | 21 | V91170 | LAND ROVER | | 371 | 23 | V91199 | FORD | | 249 | 39 |
| V91146 | FORD | | 246 | 32 | V91171 | KIA | | 341 | 15 | V91199 | FORD | | 264 | 77 |
| V91147 | FORD | | 246 | 32 | V91171 | MAZDA | | 409 | 16 | V91200 | SCANIA | | 733 | 3 |
| V91148 | CHEVROLET | | 124 | 35 | V91171 | MAZDA | | 409 | 18 | V91200 | SCANIA | | 734 | 5 |
| V91148 | DAEWOO | | 164 | 12 | V91172 | KIA | | 341 | 15 | V91200 | SCANIA | | 734 | 6 |
| V91148 | DAEWOO | | 164 | 13 | V91172 | MAZDA | | 409 | 16 | V91200 | SCANIA | | 736 | 7 |
| V91148 | DAEWOO | | 164 | 14 | V91172 | MAZDA | | 409 | 18 | V91200 | SCANIA | | 736 | 8 |
| V91148 | OPEL | | 601 | 58 | V91173 | AUDI | | 47 | 7 | V91200 | SCANIA | | 737 | 9 |
| V91148 | OPEL | | 601 | 59 | V91173 | VW | | 894 | 36 | V91200 | SCANIA | | 738 | 12 |
| V91148 | OPEL | | 602 | 60 | V91173 | VW | | 895 | 41 | V91200 | SCANIA | | 739 | 13 |
| V91148 | OPEL | | 603 | 63 | V91174 | AUDI | | 47 | 7 | V91200 | SCANIA | | 739 | 14 |
| V91148 | OPEL | | 603 | 64 | V91174 | AUDI | | 48 | 13 | V91200 | SCANIA | | 740 | 15 |
| V91148 | OPEL | | 603 | 65 | V91174 | VOLVO | | 850 | 5 | V91200 | SCANIA | | 740 | 16 |
| V91148 | VAUXHALL | | 835 | 58 | V91174 | VW | | 894 | 36 | V91200 | SCANIA | | 741 | 17 |
| V91148 | VAUXHALL | | 836 | 59 | V91174 | VW | | 895 | 41 | V91200 | SCANIA | | 741 | 18 |
| V91148 | VAUXHALL | | 836 | 60 | V91174 | VW | | 898 | 54 | V91201 | SCANIA | | 734 | 5 |
| V91148 | VAUXHALL | | 837 | 63 | V91174 | VW | | 899 | 56 | V91201 | SCANIA | | 734 | 6 |
| V91148 | VAUXHALL | | 837 | 64 | V91174 | VW | | 899 | 57 | V91201 | SCANIA | | 736 | 7 |
| V91148 | VAUXHALL | | 838 | 65 | V91174 | VW | | 902 | 66 | V91201 | SCANIA | | 736 | 8 |
| V91149 | CHEVROLET | | 124 | 35 | V91175 | ROVER | | 719 | 2 | V91201 | SCANIA | | 737 | 9 |
| V91149 | DAEWOO | | 164 | 13 | V91175 | ROVER | | 719 | 4 | V91201 | SCANIA | | 738 | 12 |
| V91149 | OPEL | | 601 | 58 | V91181 | MERCEDES-BENZ | | 459 | 44 | V91201 | SCANIA | | 739 | 13 |
| V91149 | OPEL | | 601 | 59 | V91181 | MERCEDES-BENZ | | 460 | 47 | V91201 | SCANIA | | 739 | 14 |
| V91149 | OPEL | | 603 | 63 | V91181 | MERCEDES-BENZ | | 461 | 48 | V91201 | SCANIA | | 740 | 15 |
| V91149 | OPEL | | 603 | 64 | V91181 | MERCEDES-BENZ | | 462 | 50 | V91201 | SCANIA | | 740 | 16 |
| V91149 | VAUXHALL | | 835 | 58 | V91181 | MERCEDES-BENZ | | 469 | 66 | V91201 | SCANIA | | 741 | 17 |
| V91149 | VAUXHALL | | 836 | 59 | V91181 | MERCEDES-BENZ | | 470 | 67 | V91201 | SCANIA | | 741 | 18 |
| V91149 | VAUXHALL | | 837 | 63 | V91181 | MERCEDES-BENZ | | 471 | 68 | V91202 | SCANIA | | 733 | 3 |
| V91149 | VAUXHALL | | 837 | 64 | V91181 | SSANGYONG | | 787 | 1 | V91202 | SCANIA | | 734 | 5 |
| V91150 | DAEWOO | | 164 | 12 | V91181 | SSANGYONG | | 787 | 2 | V91202 | SCANIA | | 734 | 6 |
| V91150 | DAEWOO | | 164 | 13 | V91182 | MERCEDES-BENZ | | 459 | 44 | V91202 | SCANIA | | 736 | 7 |
| V91150 | DAEWOO | | 164 | 14 | V91182 | MERCEDES-BENZ | | 460 | 47 | V91202 | SCANIA | | 736 | 8 |
| V91150 | OPEL | | 601 | 59 | V91182 | MERCEDES-BENZ | | 461 | 48 | V91202 | SCANIA | | 737 | 9 |
| V91150 | OPEL | | 602 | 60 | V91182 | MERCEDES-BENZ | | 462 | 50 | V91202 | SCANIA | | 738 | 12 |
| V91150 | OPEL | | 603 | 63 | V91182 | MERCEDES-BENZ | | 469 | 66 | V91202 | SCANIA | | 739 | 13 |
| V91150 | OPEL | | 603 | 65 | V91182 | MERCEDES-BENZ | | 470 | 67 | V91202 | SCANIA | | 739 | 14 |
| V91150 | VAUXHALL | | 836 | 59 | V91182 | MERCEDES-BENZ | | 471 | 68 | V91202 | SCANIA | | 740 | 15 |
| V91150 | VAUXHALL | | 836 | 60 | V91182 | SSANGYONG | | 787 | 1 | V91202 | SCANIA | | 740 | 16 |
| V91150 | VAUXHALL | | 837 | 63 | V91182 | SSANGYONG | | 787 | 2 | V91202 | SCANIA | | 741 | 17 |
| V91150 | VAUXHALL | | 838 | 65 | V91183 | PERKINS | | 612 | 8 | V91202 | SCANIA | | 741 | 18 |
| V91151 | DAF | | 168 | 2 | V91184 | PERKINS | | 612 | 8 | V91204 | VOLVO | | 864 | 52 |
| V91151 | DAF | | 168 | 3 | V91184 | PERKINS | | 613 | 12 | V91204 | VOLVO | | 864 | 53 |
| V91151 | FORD | | 271 | 97 | V91187 | BMW | | 102 | 30 | V91205 | VOLVO | | 865 | 54 |
| V91151 | PEUGEOT | | 645 | 79 | V91188 | BMW | | 102 | 30 | V91205 | VOLVO | | 866 | 56 |
| V91151 | SSANGYONG | | 788 | 6 | V91189 | BMW | | 92 | 4 | V91205 | VOLVO | | 866 | 57 |
| V91152 | DAF | | 168 | 2 | V91189 | BMW | | 94 | 8 | V91205 | VOLVO | | 866 | 58 |
| V91152 | DAF | | 168 | 3 | V91189 | BMW | | 104 | 34 | V91205 | VOLVO | | 866 | 59 |
| V91152 | FORD | | 271 | 97 | V91190 | BMW | | 92 | 4 | V91206 | VOLVO | | 868 | 64 |
| V91152 | PEUGEOT | | 645 | 79 | V91190 | BMW | | 94 | 8 | V91207 | VOLVO | | 868 | 64 |
| V91152 | SSANGYONG | | 788 | 6 | V91190 | BMW | | 104 | 34 | V91209 | LAND ROVER | | 367 | 1 |
| V91157 | SUBARU | | 790 | 5 | V91191 | MERCEDES-BENZ | | 493 | 115 | V91209 | LOTUS | | 374 | 2 |
| V91157 | SUZUKI | | 795 | 10 | V91191 | MERCEDES-BENZ | | 495 | 120 | V91209 | MG | | 545 | 1 |
| V91157 | SUZUKI | | 796 | 12 | V91191 | MERCEDES-BENZ | | 497 | 122 | V91209 | MG | | 545 | 2 |
| V91158 | FORD | | 236 | 1 | V91191 | MERCEDES-BENZ | | 502 | 123 | V91209 | MG | | 545 | 3 |
| V91158 | FORD | | 236 | 2 | V91192 | MERCEDES-BENZ | | 490 | 113 | V91209 | ROVER | | 719 | 3 |
| V91158 | FORD | | 236 | 4 | V91192 | MERCEDES-BENZ | | 490 | 114 | V91209 | ROVER | | 720 | 5 |
| V91159 | FORD | | 236 | 1 | V91192 | MERCEDES-BENZ | | 493 | 115 | V91209 | ROVER | | 721 | 10 |
| V91159 | FORD | | 236 | 2 | V91192 | MERCEDES-BENZ | | 494 | 116 | V91209 | ROVER | | 721 | 12 |
| V91159 | FORD | | 236 | 3 | V91192 | MERCEDES-BENZ | | 494 | 117 | V91211 | BEDFORD | | 87 | 3 |
| V91159 | FORD | | 236 | 4 | V91192 | MERCEDES-BENZ | | 495 | 118 | V91211 | CHEVROLET | | 119 | 11 |
| V91159 | FORD | | 240 | 14 | V91192 | MERCEDES-BENZ | | 495 | 119 | V91211 | OPEL | | 584 | 3 |
| V91159 | FORD | | 240 | 17 | V91192 | MERCEDES-BENZ | | 495 | 120 | V91211 | OPEL | | 589 | 19 |
| V91159 | FORD | | 241 | 19 | V91192 | MERCEDES-BENZ | | 497 | 121 | V91211 | VAUXHALL | | 820 | 4 |
| V91160 | FORD | | 270 | 95 | V91192 | MERCEDES-BENZ | | 497 | 122 | V91211 | VAUXHALL | | 824 | 20 |
| V91161 | FORD | | 270 | 95 | V91192 | MERCEDES-BENZ | | 502 | 123 | V91212 | BEDFORD | | 87 | 3 |
| V91162 | FORD | | 236 | 3 | V91192 | MERCEDES-BENZ | | 503 | 125 | V91212 | CHEVROLET | | 119 | 11 |
| V91162 | FORD | | 240 | 14 | V91195 | NISSAN | | 567 | 1 | V91212 | OPEL | | 584 | 3 |
| V91162 | FORD | | 240 | 17 | V91195 | NISSAN | | 568 | 6 | V91212 | OPEL | | 589 | 19 |



NUMERICAL PARTS LIST

Nummerische Teilenummernliste • Elenco riferimenti
Liste des références produits













|  |  |  |  |  |  |  |  |  |  |  |  |  |  |  |
|---|---|---|---|---|---|---|---|--|---|---|---|---|---|---|
| V91212 | VAUXHALL | 820 | 4 | | V91254 | VAUXHALL | 819 | 1 | | V91275 | PEUGEOT | 633 | 36 | |
| V91212 | VAUXHALL | 824 | 20 | | V91255 | LAND ROVER | 371 | 21 | | V91277 | CITROËN | 145 | 33 | |
| V91217 | LAND ROVER | 369 | 12 | | V91256 | LAND ROVER | 371 | 21 | | V91277 | CITROËN | 145 | 34 | |
| V91217 | ROVER | 723 | 19 | | V91261 | DACIA | 158 | 3 | | V91277 | CITROËN | 146 | 36 | |
| V91221 | FORD | 270 | 95 | | V91261 | RENAULT | 677 | 14 | | V91277 | FIAT | 214 | 64 | |
| V91230 | ISUZU | 290 | 1 | | V91261 | VOLVO | 849 | 1 | | V91277 | PEUGEOT | 631 | 33 | |
| V91230 | ISUZU | 290 | 2 | | V91263 | CITROËN | 155 | 68 | | V91277 | PEUGEOT | 632 | 34 | |
| V91230 | ISUZU | 290 | 3 | | V91263 | CITROËN | 155 | 69 | | V91277 | PEUGEOT | 633 | 36 | |
| V91230 | MAZDA | 408 | 12 | | V91263 | JEEP | 336 | 3 | | V91279 | CITROËN | 145 | 32 | |
| V91230 | OPEL | 588 | 17 | | V91263 | PEUGEOT | 642 | 69 | | V91279 | CITROËN | 145 | 33 | |
| V91230 | OPEL | 588 | 18 | | V91263 | PEUGEOT | 643 | 70 | | V91279 | PEUGEOT | 631 | 31 | |
| V91230 | OPEL | 593 | 32 | | V91263 | PEUGEOT | 643 | 71 | | V91279 | PEUGEOT | 631 | 32 | |
| V91230 | OPEL | 593 | 33 | | V91263 | RENAULT | 701 | 53 | | V91279 | PEUGEOT | 631 | 33 | |
| V91230 | VAUXHALL | 823 | 18 | | V91263 | RENAULT | 703 | 55 | | V91280 | CITROËN | 145 | 32 | |
| V91230 | VAUXHALL | 824 | 19 | | V91263 | RENAULT | 704 | 57 | | V91280 | CITROËN | 145 | 33 | |
| V91230 | VAUXHALL | 828 | 33 | | V91263 | RENAULT | 704 | 59 | | V91280 | PEUGEOT | 631 | 31 | |
| V91230 | VAUXHALL | 828 | 34 | | V91263 | VOLVO | 862 | 46 | | V91280 | PEUGEOT | 631 | 32 | |
| V91231 | ISUZU | 290 | 1 | | V91264 | CHRYSLER | 128 | 6 | | V91280 | PEUGEOT | 631 | 33 | |
| V91231 | ISUZU | 290 | 3 | | V91264 | JEEP | 336 | 2 | | V91282 | AUTOBIANCHI | 84 | 1 | |
| V91231 | OPEL | 588 | 17 | | V91264 | RENAULT | 698 | 47 | | V91282 | FIAT | 194 | 1 | |
| V91231 | OPEL | 593 | 32 | | V91265 | CHRYSLER | 128 | 6 | | V91282 | FIAT | 194 | 2 | |
| V91231 | VAUXHALL | 823 | 18 | | V91265 | JEEP | 336 | 2 | | V91282 | FIAT | 194 | 4 | |
| V91231 | VAUXHALL | 828 | 33 | | V91265 | RENAULT | 698 | 47 | | V91282 | FIAT | 195 | 6 | |
| V91232 | ISUZU | 290 | 2 | | V91267 | RENAULT | 679 | 17 | | V91282 | FIAT | 195 | 7 | |
| V91232 | MAZDA | 408 | 12 | | V91267 | RENAULT | 684 | 23 | | V91282 | LANCIA | 350 | 1 | |
| V91232 | OPEL | 588 | 18 | | V91267 | RENAULT | 685 | 24 | | V91282 | SEAT | 748 | 2 | |
| V91232 | OPEL | 593 | 33 | | V91267 | RENAULT | 685 | 25 | | V91282 | SEAT | 748 | 3 | |
| V91232 | VAUXHALL | 824 | 19 | | V91267 | RENAULT | 685 | 26 | | V91285 | IVECO | 330 | 70 | |
| V91232 | VAUXHALL | 828 | 34 | | V91267 | RENAULT | 686 | 27 | | V91285 | IVECO | 330 | 71 | |
| V91239 | FORD | 268 | 91 | | V91267 | RENAULT | 686 | 28 | | V91285 | IVECO | 330 | 72 | |
| V91239 | HYUNDAI | 287 | 29 | | V91267 | VOLVO | 850 | 6 | | V91288 | AUTOBIANCHI | 84 | 3 | |
| V91239 | HYUNDAI | 287 | 30 | | V91267 | VOLVO | 851 | 9 | | V91288 | AUTOBIANCHI | 84 | 4 | |
| V91239 | KIA | 342 | 19 | | V91267 | VOLVO | 851 | 11 | | V91288 | AUTOBIANCHI | 84 | 5 | |
| V91239 | MINIBUS | 556 | 18 | | V91268 | RENAULT | 688 | 30 | | V91288 | FIAT | 196 | 12 | |
| V91239 | MINIBUS | 556 | 21 | | V91268 | VOLVO | 852 | 13 | | V91288 | FIAT | 197 | 13 | |
| V91239 | MINIBUS | 557 | 22 | | V91269 | RENAULT | 679 | 17 | | V91288 | FIAT | 197 | 15 | |
| V91240 | LAND ROVER | 370 | 20 | | V91269 | RENAULT | 686 | 28 | | V91288 | FIAT | 198 | 17 | |
| V91241 | LAND ROVER | 370 | 20 | | V91269 | VOLVO | 850 | 6 | | V91288 | LANCIA | 350 | 5 | |
| V91241 | LAND ROVER | 371 | 22 | | V91269 | VOLVO | 851 | 11 | | V91288 | LANCIA | 351 | 6 | |
| V91243 | NISSAN | 569 | 12 | | V91270 | CITROËN | 134 | 1 | | V91288 | LANCIA | 352 | 12 | |
| V91243 | NISSAN | 571 | 18 | | V91270 | PEUGEOT | 620 | 2 | | V91289 | AUTOBIANCHI | 84 | 3 | |
| V91244 | TOYOTA | 802 | 2 | | V91271 | CITROËN | 134 | 3 | | V91289 | AUTOBIANCHI | 84 | 4 | |
| V91244 | TOYOTA | 803 | 6 | | V91271 | CITROËN | 136 | 11 | | V91289 | AUTOBIANCHI | 84 | 5 | |
| V91245 | TOYOTA | 802 | 2 | | V91271 | CITROËN | 137 | 13 | | V91289 | FIAT | 196 | 11 | |
| V91245 | TOYOTA | 803 | 6 | | V91271 | CITROËN | 138 | 14 | | V91289 | FIAT | 196 | 12 | |
| V91246 | TOYOTA | 802 | 2 | | V91271 | CITROËN | 138 | 15 | | V91289 | FIAT | 197 | 13 | |
| V91246 | TOYOTA | 803 | 6 | | V91271 | FIAT | 201 | 27 | | V91289 | FIAT | 197 | 14 | |
| V91247 | PERKINS | 613 | 15 | | V91271 | PEUGEOT | 620 | 4 | | V91289 | FIAT | 197 | 15 | |
| V91247 | PERKINS | 614 | 17 | | V91271 | PEUGEOT | 623 | 12 | | V91289 | FIAT | 198 | 17 | |
| V91248 | PERKINS | 612 | 9 | | V91271 | PEUGEOT | 624 | 13 | | V91289 | FIAT | 198 | 18 | |
| V91248 | PERKINS | 612 | 10 | | V91271 | ZASTAVA | 935 | 2 | | V91289 | FIAT | 199 | 20 | |
| V91248 | PERKINS | 613 | 15 | | V91272 | CITROËN | 134 | 1 | | V91289 | LANCIA | 350 | 5 | |
| V91248 | PERKINS | 614 | 16 | | V91272 | PEUGEOT | 620 | 2 | | V91289 | LANCIA | 351 | 6 | |
| V91248 | PERKINS | 614 | 17 | | V91273 | CITROËN | 134 | 3 | | V91289 | LANCIA | 351 | 7 | |
| V91248 | PERKINS | 614 | 18 | | V91273 | CITROËN | 135 | 4 | | V91289 | LANCIA | 352 | 10 | |
| V91248 | PERKINS | 614 | 19 | | V91273 | CITROËN | 136 | 11 | | V91289 | LANCIA | 352 | 12 | |
| V91248 | RENAULT | 709 | 73 | | V91273 | CITROËN | 137 | 12 | | V91289 | ZASTAVA | 935 | 1 | |
| V91248 | RENAULT | 709 | 74 | | V91273 | CITROËN | 137 | 13 | | V91290 | ALFA ROMEO | 35 | 42 | |
| V91249 | PERKINS | 614 | 16 | | V91273 | CITROËN | 138 | 14 | | V91290 | FIAT | 215 | 69 | |
| V91249 | PERKINS | 614 | 18 | | V91273 | CITROËN | 138 | 15 | | V91290 | FIAT | 216 | 71 | |
| V91249 | PERKINS | 614 | 19 | | V91273 | FIAT | 201 | 27 | | V91290 | FIAT | 217 | 73 | |
| V91249 | RENAULT | 709 | 73 | | V91273 | PEUGEOT | 620 | 4 | | V91290 | LANCIA | 359 | 38 | |
| V91249 | RENAULT | 709 | 74 | | V91273 | PEUGEOT | 621 | 5 | | V91290 | LANCIA | 360 | 39 | |
| V91250 | PERKINS | 614 | 16 | | V91273 | PEUGEOT | 623 | 12 | | V91290 | LANCIA | 360 | 41 | |
| V91250 | PERKINS | 614 | 18 | | V91273 | PEUGEOT | 624 | 13 | | V91290 | LANCIA | 361 | 42 | |
| V91250 | PERKINS | 614 | 19 | | V91273 | ZASTAVA | 935 | 2 | | V91291 | ALFA ROMEO | 32 | 32 | |
| V91250 | RENAULT | 709 | 73 | | V91275 | CITROËN | 145 | 33 | | V91291 | ALFA ROMEO | 32 | 33 | |
| V91253 | BEDFORD | 87 | 1 | | V91275 | CITROËN | 145 | 34 | | V91291 | FIAT | 214 | 63 | |
| V91253 | SUZUKI | 794 | 1 | | V91275 | CITROËN | 146 | 36 | | V91291 | LANCIA | 358 | 33 | |
| V91253 | VAUXHALL | 819 | 1 | | V91275 | FIAT | 214 | 64 | | V91291 | LANCIA | 358 | 35 | |
| V91254 | BEDFORD | 87 | 1 | | V91275 | PEUGEOT | 631 | 33 | | V91292 | ALFA ROMEO | 38 | 55 | |
| V91254 | SUZUKI | 794 | 1 | | V91275 | PEUGEOT | 632 | 34 | | V91292 | ALFA ROMEO | 38 | 56 | |













|  |   |  | 9 |  |   |  | 9 |  |   |  | 9 |
|---|---|---|-----|---|---|---|----|---|---|---|-----|
| V91292 | CITROËN | 156 | 73 | V91301 | IVECO | 317 | 42 | V91334 | VW | 904 | 71 |
| V91292 | FIAT | 224 | 103 | V91301 | IVECO | 318 | 43 | V91334 | VW | 904 | 72 |
| V91292 | FIAT | 225 | 104 | V91301 | IVECO | 318 | 44 | V91334 | VW | 905 | 75 |
| V91292 | FIAT | 225 | 105 | V91301 | IVECO | 319 | 45 | V91334 | VW | 908 | 83 |
| V91292 | FIAT | 225 | 106 | V91301 | IVECO | 320 | 46 | V91335 | AUDI | 47 | 8 |
| V91292 | FORD | 267 | 87 | V91301 | IVECO | 320 | 47 | V91335 | VW | 894 | 37 |
| V91292 | IVECO | 301 | 2 | V91301 | IVECO | 320 | 48 | V91335 | VW | 895 | 39 |
| V91292 | IVECO | 301 | 3 | V91302 | IVECO | 315 | 36 | V91336 | AUDI | 49 | 14 |
| V91292 | IVECO | 303 | 6 | V91302 | IVECO | 316 | 40 | V91336 | AUDI | 51 | 22 |
| V91292 | IVECO | 304 | 7 | V91302 | IVECO | 317 | 41 | V91336 | SEAT | 757 | 37 |
| V91292 | IVECO | 305 | 8 | V91302 | IVECO | 317 | 42 | V91336 | VW | 898 | 51 |
| V91292 | IVECO | 306 | 9 | V91302 | IVECO | 318 | 43 | V91336 | VW | 898 | 53 |
| V91292 | IVECO | 306 | 10 | V91302 | IVECO | 318 | 44 | V91336 | VW | 899 | 56 |
| V91292 | IVECO | 306 | 12 | V91302 | IVECO | 319 | 45 | V91336 | VW | 904 | 70 |
| V91292 | LANCIA | 365 | 60 | V91302 | IVECO | 320 | 46 | V91336 | VW | 904 | 71 |
| V91292 | LANCIA | 365 | 61 | V91302 | IVECO | 320 | 47 | V91337 | AUDI | 50 | 20 |
| V91292 | OPEL | 608 | 81 | V91302 | IVECO | 320 | 48 | V91337 | AUDI | 53 | 30 |
| V91292 | OPEL | 608 | 83 | V91304 | IVECO | 315 | 36 | V91337 | SEAT | 756 | 35 |
| V91292 | OPEL | 608 | 84 | V91304 | IVECO | 317 | 41 | V91337 | SEAT | 757 | 38 |
| V91292 | PEUGEOT | 645 | 80 | V91304 | IVECO | 317 | 42 | V91337 | SKODA | 776 | 19 |
| V91292 | RENAULT | 705 | 60 | V91304 | IVECO | 318 | 43 | V91337 | VW | 897 | 50 |
| V91292 | RENAULT | 705 | 61 | V91304 | IVECO | 319 | 45 | V91337 | VW | 898 | 52 |
| V91292 | RENAULT | 706 | 62 | V91304 | IVECO | 320 | 46 | V91337 | VW | 898 | 55 |
| V91292 | RENAULT | 706 | 64 | V91304 | IVECO | 320 | 47 | V91337 | VW | 899 | 57 |
| V91292 | RENAULT | 707 | 65 | V91305 | FIAT | 203 | 37 | V91337 | VW | 902 | 67 |
| V91292 | RENAULT | 707 | 66 | V91305 | FIAT | 215 | 69 | V91337 | VW | 903 | 68 |
| V91292 | RENAULT | 708 | 68 | V91305 | LANCIA | 360 | 39 | V91337 | VW | 904 | 72 |
| V91292 | RENAULT | 708 | 69 | V91306 | CITROËN | 154 | 64 | V91337 | VW | 905 | 75 |
| V91292 | RENAULT | 708 | 70 | V91306 | FIAT | 222 | 96 | V91337 | VW | 908 | 83 |
| V91292 | RENAULT | 708 | 71 | V91306 | LANCIA | 364 | 58 | V91338 | AUDI | 54 | 32 |
| V91292 | SEAT | 767 | 67 | V91308 | ALFA ROMEO | 33 | 36 | V91338 | AUDI | 55 | 35 |
| V91292 | VAUXHALL | 842 | 81 | V91308 | ALFA ROMEO | 34 | 39 | V91338 | AUDI | 55 | 37 |
| V91292 | VAUXHALL | 842 | 83 | V91308 | ALFA ROMEO | 34 | 40 | V91338 | AUDI | 58 | 41 |
| V91292 | VAUXHALL | 842 | 84 | V91308 | ALFA ROMEO | 34 | 41 | V91338 | AUDI | 58 | 42 |
| V91293 | ALFA ROMEO | 38 | 55 | V91308 | ALFA ROMEO | 35 | 43 | V91338 | AUDI | 61 | 49 |
| V91293 | ALFA ROMEO | 38 | 56 | V91310 | IVECO | 328 | 67 | V91338 | AUDI | 61 | 50 |
| V91293 | FIAT | 224 | 103 | V91310 | IVECO | 329 | 68 | V91338 | AUDI | 62 | 53 |
| V91293 | FIAT | 225 | 104 | V91311 | IVECO | 328 | 67 | V91338 | AUDI | 62 | 54 |
| V91293 | IVECO | 301 | 2 | V91311 | IVECO | 329 | 68 | V91338 | AUDI | 63 | 58 |
| V91293 | IVECO | 301 | 3 | V91317 | RENAULT | 673 | 7 | V91338 | AUDI | 63 | 59 |
| V91293 | IVECO | 303 | 6 | V91317 | RENAULT | 676 | 13 | V91338 | AUDI | 64 | 60 |
| V91293 | IVECO | 304 | 7 | V91317 | RENAULT | 677 | 14 | V91338 | HONDA | 276 | 17 |
| V91293 | IVECO | 305 | 8 | V91319 | RENAULT | 688 | 30 | V91338 | NISSAN | 573 | 26 |
| V91293 | IVECO | 306 | 9 | V91319 | VOLVO | 852 | 13 | V91338 | SEAT | 760 | 45 |
| V91293 | LANCIA | 365 | 60 | V91321 | ALFA ROMEO | 32 | 32 | V91338 | SEAT | 761 | 49 |
| V91293 | LANCIA | 365 | 61 | V91321 | ALFA ROMEO | 32 | 33 | V91338 | SEAT | 761 | 51 |
| V91293 | RENAULT | 705 | 60 | V91321 | FIAT | 214 | 63 | V91338 | SEAT | 761 | 50 |
| V91293 | RENAULT | 705 | 61 | V91321 | LANCIA | 358 | 33 | V91338 | VW | 908 | 84 |
| V91293 | RENAULT | 706 | 62 | V91321 | LANCIA | 358 | 35 | V91338 | VW | 910 | 89 |
| V91293 | RENAULT | 707 | 65 | V91332 | SEAT | 751 | 14 | V91338 | VW | 911 | 90 |
| V91293 | RENAULT | 707 | 66 | V91332 | SEAT | 751 | 15 | V91338 | VW | 912 | 92 |
| V91294 | ALFA ROMEO | 38 | 55 | V91332 | SEAT | 751 | 17 | V91338 | VW | 912 | 93 |
| V91294 | ALFA ROMEO | 38 | 56 | V91332 | VW | 886 | 8 | V91338 | VW | 914 | 97 |
| V91294 | FIAT | 224 | 103 | V91332 | VW | 887 | 12 | V91338 | VW | 915 | 100 |
| V91294 | FIAT | 225 | 104 | V91332 | VW | 887 | 13 | V91338 | VW | 915 | 102 |
| V91294 | IVECO | 301 | 2 | V91332 | VW | 887 | 14 | V91338 | VW | 919 | 110 |
| V91294 | IVECO | 303 | 6 | V91332 | VW | 888 | 17 | V91338 | VW | 919 | 111 |
| V91294 | IVECO | 306 | 10 | V91332 | VW | 888 | 18 | V91338 | VW | 919 | 112 |
| V91294 | LANCIA | 365 | 60 | V91332 | VW | 888 | 19 | V91338 | VW | 924 | 129 |
| V91294 | LANCIA | 365 | 61 | V91332 | VW | 899 | 58 | V91340 | AUDI | 54 | 31 |
| V91294 | RENAULT | 705 | 61 | V91334 | AUDI | 50 | 20 | V91340 | AUDI | 54 | 32 |
| V91294 | RENAULT | 707 | 65 | V91334 | AUDI | 51 | 22 | V91340 | AUDI | 55 | 35 |
| V91294 | RENAULT | 708 | 68 | V91334 | AUDI | 53 | 30 | V91340 | AUDI | 55 | 36 |
| V91300 | FIAT | 205 | 43 | V91334 | AUDI | 65 | 65 | V91340 | AUDI | 55 | 37 |
| V91300 | FIAT | 222 | 95 | V91334 | SEAT | 756 | 35 | V91340 | AUDI | 58 | 41 |
| V91300 | FIAT | 223 | 98 | V91334 | SEAT | 757 | 37 | V91340 | AUDI | 58 | 42 |
| V91300 | LANCIA | 354 | 20 | V91334 | SEAT | 757 | 38 | V91340 | AUDI | 58 | 43 |
| V91300 | LANCIA | 364 | 57 | V91334 | SKODA | 776 | 19 | V91340 | AUDI | 61 | 49 |
| V91300 | PEUGEOT | 641 | 64 | V91334 | VW | 897 | 50 | V91340 | AUDI | 61 | 50 |
| V91300 | ZASTAVA | 935 | 4 | V91334 | VW | 902 | 67 | V91340 | AUDI | 62 | 52 |
| V91301 | IVECO | 315 | 36 | V91334 | VW | 903 | 68 | V91340 | AUDI | 62 | 53 |
| V91301 | IVECO | 317 | 41 | V91334 | VW | 904 | 70 | V91340 | AUDI | 62 | 54 |



NUMERICAL PARTS LIST

Numerische Teilenummernliste • Elenco riferimenti
Liste des références produits













|  |  |  |  | 9 |  |  |  |  | 9 |  |  |  |  | 9 |
|---|---|---|---|-----|---|---|---|--|-----|---|---|---|---|-----|
| V91340 | AUDI | | 63 | 58 | V91368 | VW | | 895 | 40 | V91416 | AUDI | | 63 | 56 |
| V91340 | AUDI | | 63 | 59 | V91368 | VW | | 898 | 51 | V91416 | AUDI | | 64 | 61 |
| V91340 | AUDI | | 64 | 60 | V91368 | VW | | 898 | 52 | V91416 | AUDI | | 66 | 67 |
| V91340 | AUDI | | 66 | 70 | V91368 | VW | | 898 | 53 | V91416 | AUDI | | 67 | 72 |
| V91340 | AUDI | | 67 | 71 | V91368 | VW | | 899 | 56 | V91416 | AUDI | | 70 | 79 |
| V91340 | AUDI | | 71 | 80 | V91368 | VW | | 899 | 57 | V91416 | AUDI | | 79 | 104 |
| V91340 | AUDI | | 72 | 83 | V91368 | VW | | 905 | 75 | V91416 | SEAT | | 762 | 54 |
| V91340 | AUDI | | 72 | 84 | V91372 | AUDI | | 61 | 51 | V91416 | VW | | 915 | 103 |
| V91340 | AUDI | | 72 | 85 | V91372 | AUDI | | 62 | 55 | V91416 | VW | | 923 | 126 |
| V91340 | HONDA | | 276 | 17 | V91372 | AUDI | | 63 | 56 | V91418 | BMW | | 96 | 16 |
| V91340 | NISSAN | | 573 | 26 | V91372 | AUDI | | 66 | 67 | V91418 | BMW | | 97 | 19 |
| V91340 | SEAT | | 760 | 45 | V91372 | AUDI | | 67 | 72 | V91418 | BMW | | 110 | 51 |
| V91340 | SEAT | | 761 | 49 | V91372 | AUDI | | 70 | 79 | V91420 | BMW | | 93 | 5 |
| V91340 | SEAT | | 761 | 50 | V91372 | AUDI | | 79 | 104 | V91428 | FORD | | 256 | 59 |
| V91340 | SEAT | | 761 | 51 | V91372 | SEAT | | 762 | 54 | V91428 | FORD | | 256 | 60 |
| V91340 | SEAT | | 765 | 60 | V91372 | VW | | 915 | 103 | V91428 | FORD | | 257 | 61 |
| V91340 | VW | | 908 | 84 | V91372 | VW | | 923 | 126 | V91428 | MAZDA | | 408 | 13 |
| V91340 | VW | | 909 | 86 | V91374 | MAN | | 384 | 1 | V91429 | CHEVROLET | | 125 | 37 |
| V91340 | VW | | 910 | 89 | V91374 | MAN | | 384 | 2 | V91429 | LADA | | 346 | 10 |
| V91340 | VW | | 911 | 90 | V91374 | MAN | | 384 | 3 | V91429 | OPEL | | 604 | 66 |
| V91340 | VW | | 911 | 91 | V91374 | MAN | | 386 | 5 | V91429 | OPEL | | 604 | 68 |
| V91340 | VW | | 912 | 92 | V91374 | MAN | | 387 | 6 | V91429 | VAUXHALL | | 838 | 66 |
| V91340 | VW | | 912 | 93 | V91374 | MAN | | 387 | 7 | V91429 | VAUXHALL | | 838 | 68 |
| V91340 | VW | | 914 | 97 | V91385 | DAF | | 168 | 4 | V91430 | CHEVROLET | | 125 | 37 |
| V91340 | VW | | 914 | 98 | V91391 | SEAT | | 766 | 66 | V91430 | LADA | | 346 | 10 |
| V91340 | VW | | 915 | 100 | V91392 | FIAT | | 213 | 61 | V91430 | OPEL | | 604 | 66 |
| V91340 | VW | | 915 | 102 | V91392 | FIAT | | 213 | 62 | V91430 | OPEL | | 604 | 68 |
| V91340 | VW | | 915 | 104 | V91392 | FIAT | | 214 | 63 | V91430 | VAUXHALL | | 838 | 66 |
| V91340 | VW | | 916 | 105 | V91392 | LANCIA | | 358 | 33 | V91430 | VAUXHALL | | 838 | 68 |
| V91340 | VW | | 916 | 106 | V91392 | LANCIA | | 358 | 34 | V91433 | OPEL | | 607 | 79 |
| V91340 | VW | | 919 | 110 | V91392 | LANCIA | | 358 | 35 | V91433 | VAUXHALL | | 841 | 79 |
| V91340 | VW | | 919 | 111 | V91399 | IVECO | | 301 | 4 | V91437 | ALFA ROMEO | | 36 | 49 |
| V91340 | VW | | 919 | 112 | V91399 | IVECO | | 302 | 5 | V91437 | ALFA ROMEO | | 37 | 51 |
| V91340 | VW | | 920 | 114 | V91399 | IVECO | | 306 | 9 | V91437 | ALFA ROMEO | | 37 | 52 |
| V91340 | VW | | 923 | 125 | V91399 | RENAULT | | 706 | 63 | V91437 | ALFA ROMEO | | 37 | 53 |
| V91340 | VW | | 924 | 129 | V91399 | RENAULT | | 706 | 64 | V91437 | ALFA ROMEO | | 37 | 54 |
| V91345 | RENAULT | | 713 | 89 | V91400 | IVECO | | 301 | 4 | V91437 | CHRYSLER | | 128 | 9 |
| V91345 | RENAULT | | 713 | 90 | V91400 | IVECO | | 302 | 5 | V91437 | CHRYSLER | | 129 | 11 |
| V91345 | RENAULT | | 714 | 91 | V91400 | IVECO | | 306 | 9 | V91437 | FORD | | 269 | 92 |
| V91345 | RENAULT | | 714 | 92 | V91400 | RENAULT | | 706 | 63 | V91437 | JEEP | | 336 | 4 |
| V91345 | RENAULT | | 715 | 93 | V91400 | RENAULT | | 706 | 64 | V91437 | OPEL | | 607 | 80 |
| V91345 | RENAULT | | 715 | 96 | V91407 | AUDI | | 54 | 31 | V91437 | ROVER | | 724 | 23 |
| V91346 | RENAULT | | 713 | 89 | V91407 | AUDI | | 58 | 43 | V91437 | VAUXHALL | | 841 | 80 |
| V91346 | RENAULT | | 713 | 90 | V91407 | AUDI | | 62 | 52 | V91438 | ALFA ROMEO | | 36 | 49 |
| V91346 | RENAULT | | 714 | 91 | V91407 | AUDI | | 66 | 70 | V91438 | ALFA ROMEO | | 37 | 51 |
| V91346 | RENAULT | | 714 | 92 | V91407 | AUDI | | 67 | 71 | V91438 | ALFA ROMEO | | 37 | 52 |
| V91346 | RENAULT | | 715 | 93 | V91407 | AUDI | | 71 | 80 | V91438 | ALFA ROMEO | | 37 | 53 |
| V91346 | RENAULT | | 715 | 96 | V91407 | AUDI | | 72 | 83 | V91438 | ALFA ROMEO | | 37 | 54 |
| V91356 | FORD | | 252 | 49 | V91407 | AUDI | | 72 | 84 | V91438 | CHRYSLER | | 128 | 9 |
| V91356 | FORD | | 252 | 50 | V91407 | AUDI | | 72 | 85 | V91438 | CHRYSLER | | 129 | 11 |
| V91356 | FORD | | 259 | 66 | V91407 | SEAT | | 765 | 60 | V91438 | FORD | | 269 | 92 |
| V91356 | FORD | | 262 | 73 | V91407 | VW | | 909 | 86 | V91438 | JEEP | | 336 | 4 |
| V91361 | MERCEDES-BENZ | | 488 | 110 | V91407 | VW | | 911 | 91 | V91438 | OPEL | | 607 | 80 |
| V91361 | MERCEDES-BENZ | | 490 | 114 | V91407 | VW | | 914 | 98 | V91438 | VAUXHALL | | 841 | 80 |
| V91361 | MERCEDES-BENZ | | 494 | 116 | V91407 | VW | | 915 | 104 | V91441 | MERCEDES-BENZ | | 467 | 63 |
| V91361 | MERCEDES-BENZ | | 494 | 117 | V91407 | VW | | 916 | 105 | V91441 | MERCEDES-BENZ | | 468 | 64 |
| V91361 | MERCEDES-BENZ | | 495 | 118 | V91407 | VW | | 916 | 106 | V91441 | MERCEDES-BENZ | | 485 | 102 |
| V91361 | MERCEDES-BENZ | | 497 | 121 | V91407 | VW | | 920 | 114 | V91445 | MERCEDES-BENZ | | 485 | 102 |
| V91367 | AUDI | | 47 | 7 | V91407 | VW | | 923 | 125 | V91445 | MERCEDES-BENZ | | 485 | 103 |
| V91367 | AUDI | | 48 | 9 | V91409 | AUDI | | 47 | 7 | V91456 | NISSAN | | 572 | 23 |
| V91367 | VW | | 894 | 36 | V91409 | AUDI | | 48 | 9 | V91466 | TOYOTA | | 808 | 23 |
| V91367 | VW | | 894 | 38 | V91409 | AUDI | | 49 | 14 | V91466 | TOYOTA | | 809 | 25 |
| V91367 | VW | | 895 | 39 | V91409 | VW | | 894 | 36 | V91469 | CITROËN | | 146 | 37 |
| V91367 | VW | | 895 | 40 | V91409 | VW | | 894 | 38 | V91469 | PEUGEOT | | 633 | 37 |
| V91368 | AUDI | | 47 | 7 | V91409 | VW | | 895 | 40 | V91469 | PEUGEOT | | 640 | 60 |
| V91368 | AUDI | | 47 | 8 | V91409 | VW | | 898 | 51 | V91470 | CITROËN | | 146 | 37 |
| V91368 | AUDI | | 48 | 9 | V91409 | VW | | 898 | 53 | V91470 | PEUGEOT | | 633 | 37 |
| V91368 | AUDI | | 49 | 14 | V91409 | VW | | 899 | 56 | V91470 | PEUGEOT | | 640 | 60 |
| V91368 | VW | | 894 | 36 | V91410 | BMW | | 103 | 31 | V91473 | SEAT | | 750 | 12 |
| V91368 | VW | | 894 | 37 | V91411 | BMW | | 103 | 31 | V91473 | SEAT | | 751 | 14 |
| V91368 | VW | | 894 | 38 | V91416 | AUDI | | 61 | 51 | V91473 | SEAT | | 751 | 15 |
| V91368 | VW | | 895 | 39 | V91416 | AUDI | | 62 | 55 | V91473 | SEAT | | 751 | 16 |













|  |  |  |  | 9 |  |  |  |  | 9 |  |  |  |  | 9 |
|---|---|---|---|---|---|---|---|---|---|---|---|---|---|---|
| V91473 | SEAT | 751 | 17 | | V91676 | IVECO | 314 | 31 | | V91731 | HONDA | 274 | 10 | |
| V91473 | SEAT | 751 | 18 | | V91676 | IVECO | 314 | 32 | | V91731 | HONDA | 275 | 12 | |
| V91473 | VW | 886 | 8 | | V91676 | IVECO | 314 | 33 | | V91731 | HONDA | 277 | 22 | |
| V91473 | VW | 886 | 9 | | V91676 | IVECO | 315 | 37 | | V91731 | HONDA | 277 | 23 | |
| V91473 | VW | 887 | 12 | | V91676 | IVECO | 316 | 38 | | V91731 | HONDA | 278 | 27 | |
| V91473 | VW | 887 | 13 | | V91677 | IVECO | 311 | 23 | | V91731 | HONDA | 278 | 28 | |
| V91473 | VW | 887 | 14 | | V91677 | IVECO | 313 | 30 | | V91731 | ROVER | 720 | 6 | |
| V91473 | VW | 888 | 16 | | V91677 | IVECO | 314 | 31 | | V91731 | ROVER | 723 | 21 | |
| V91473 | VW | 888 | 17 | | V91677 | IVECO | 314 | 32 | | V91733 | HONDA | 275 | 11 | |
| V91473 | VW | 888 | 18 | | V91677 | IVECO | 314 | 33 | | V91733 | ROVER | 720 | 7 | |
| V91473 | VW | 888 | 19 | | V91677 | IVECO | 316 | 38 | | V91739 | FIAT | 195 | 8 | |
| V91473 | VW | 888 | 20 | | V91679 | IVECO | 315 | 36 | | V91739 | FIAT | 201 | 26 | |
| V91485 | LAND ROVER | 372 | 25 | | V91679 | IVECO | 316 | 40 | | V91739 | FIAT | 203 | 35 | |
| V91485 | LAND ROVER | 372 | 26 | | V91679 | IVECO | 317 | 41 | | V91739 | FIAT | 204 | 41 | |
| V91485 | LAND ROVER | 372 | 27 | | V91679 | IVECO | 317 | 42 | | V91755 | DAF | 170 | 8 | |
| V91486 | LAND ROVER | 372 | 25 | | V91679 | IVECO | 319 | 45 | | V91755 | DAF | 170 | 9 | |
| V91486 | LAND ROVER | 372 | 26 | | V91679 | IVECO | 320 | 46 | | V91756 | DAF | 170 | 8 | |
| V91486 | LAND ROVER | 372 | 27 | | V91680 | IVECO | 322 | 50 | | V91756 | DAF | 170 | 9 | |
| V91493 | NISSAN | 578 | 42 | | V91681 | IVECO | 322 | 50 | | V91757 | DAF | 169 | 6 | |
| V91493 | NISSAN | 579 | 43 | | V91688 | IVECO | 327 | 66 | | V91758 | DAF | 169 | 6 | |
| V91493 | NISSAN | 579 | 44 | | V91688 | IVECO | 329 | 69 | | V91762 | FIAT | 221 | 93 | |
| V91498 | BEDFORD | 88 | 7 | | V91689 | IVECO | 327 | 66 | | V91762 | FIAT | 222 | 94 | |
| V91498 | ISUZU | 290 | 4 | | V91689 | IVECO | 329 | 69 | | V91762 | FIAT | 222 | 95 | |
| V91498 | ISUZU | 291 | 6 | | V91693 | IVECO | 322 | 51 | | V91762 | LANCIA | 364 | 55 | |
| V91498 | OPEL | 606 | 76 | | V91693 | IVECO | 322 | 53 | | V91762 | PEUGEOT | 641 | 64 | |
| V91498 | VAUXHALL | 840 | 76 | | V91693 | IVECO | 323 | 54 | | V91767 | FIAT | 213 | 61 | |
| V91630 | ALFA ROMEO | 26 | 10 | | V91693 | IVECO | 323 | 55 | | V91767 | FIAT | 213 | 62 | |
| V91630 | ALFA ROMEO | 26 | 11 | | V91694 | IVECO | 322 | 51 | | V91767 | LANCIA | 358 | 34 | |
| V91630 | ALFA ROMEO | 26 | 12 | | V91694 | IVECO | 322 | 53 | | V91771 | MAN | 384 | 1 | |
| V91630 | ALFA ROMEO | 34 | 37 | | V91694 | IVECO | 323 | 54 | | V91771 | MAN | 384 | 2 | |
| V91630 | ALFA ROMEO | 34 | 38 | | V91694 | IVECO | 323 | 55 | | V91771 | MAN | 384 | 3 | |
| V91630 | ALFA ROMEO | 36 | 47 | | V91709 | FIAT | 226 | 108 | | V91771 | MAN | 386 | 5 | |
| V91633 | FIAT | 195 | 8 | | V91709 | IVECO | 309 | 15 | | V91771 | MAN | 387 | 6 | |
| V91636 | FIAT | 203 | 37 | | V91709 | IVECO | 310 | 18 | | V91771 | MAN | 387 | 7 | |
| V91636 | FIAT | 216 | 72 | | V91709 | IVECO | 311 | 22 | | V91810 | FORD | 253 | 53 | |
| V91636 | FIAT | 217 | 73 | | V91709 | IVECO | 313 | 30 | | V91810 | FORD | 253 | 54 | |
| V91636 | LANCIA | 359 | 38 | | V91709 | IVECO | 314 | 31 | | V91821 | FORD | 256 | 60 | |
| V91636 | LANCIA | 360 | 41 | | V91712 | FIAT | 195 | 8 | | V91821 | FORD | 257 | 61 | |
| V91638 | FIAT | 216 | 70 | | V91712 | FIAT | 203 | 35 | | V91821 | MAZDA | 408 | 13 | |
| V91638 | FIAT | 216 | 71 | | V91712 | FIAT | 203 | 36 | | V91834 | DACIA | 158 | 3 | |
| V91638 | FIAT | 217 | 74 | | V91712 | FIAT | 204 | 41 | | V91834 | RENAULT | 669 | 1 | |
| V91638 | LANCIA | 361 | 43 | | V91713 | CITROËN | 154 | 64 | | V91834 | RENAULT | 672 | 5 | |
| V91639 | SEAT | 750 | 13 | | V91713 | FIAT | 194 | 5 | | V91834 | RENAULT | 673 | 7 | |
| V91653 | FIAT | 202 | 33 | | V91713 | FIAT | 205 | 42 | | V91834 | RENAULT | 673 | 9 | |
| V91666 | IVECO | 315 | 34 | | V91713 | FIAT | 205 | 43 | | V91834 | RENAULT | 674 | 10 | |
| V91666 | IVECO | 315 | 35 | | V91713 | FIAT | 220 | 86 | | V91834 | RENAULT | 676 | 13 | |
| V91666 | IVECO | 316 | 39 | | V91713 | FIAT | 221 | 92 | | V91834 | RENAULT | 677 | 14 | |
| V91667 | FIAT | 226 | 108 | | V91713 | FIAT | 222 | 96 | | V91834 | RENAULT | 677 | 15 | |
| V91667 | FIAT | 226 | 109 | | V91713 | FIAT | 223 | 98 | | V91834 | VOLVO | 849 | 1 | |
| V91667 | IVECO | 309 | 15 | | V91713 | LANCIA | 354 | 20 | | V91834 | VOLVO | 849 | 4 | |
| V91667 | IVECO | 310 | 16 | | V91713 | LANCIA | 363 | 54 | | V91835 | DACIA | 159 | 5 | |
| V91667 | IVECO | 310 | 17 | | V91713 | LANCIA | 364 | 57 | | V91835 | DACIA | 160 | 7 | |
| V91667 | IVECO | 310 | 18 | | V91713 | LANCIA | 364 | 58 | | V91835 | NISSAN | 570 | 15 | |
| V91667 | IVECO | 310 | 19 | | V91713 | ZASTAVA | 935 | 3 | | V91835 | RENAULT | 674 | 11 | |
| V91667 | IVECO | 311 | 20 | | V91713 | ZASTAVA | 935 | 4 | | V91835 | RENAULT | 675 | 12 | |
| V91667 | IVECO | 311 | 21 | | V91713 | ZASTAVA | 936 | 5 | | V91835 | RENAULT | 680 | 20 | |
| V91667 | IVECO | 311 | 22 | | V91720 | TOYOTA | 812 | 34 | | V91835 | RENAULT | 683 | 22 | |
| V91667 | IVECO | 312 | 24 | | V91720 | TOYOTA | 813 | 35 | | V91836 | DACIA | 159 | 5 | |
| V91667 | IVECO | 312 | 25 | | V91720 | TOYOTA | 813 | 37 | | V91836 | DACIA | 160 | 7 | |
| V91667 | IVECO | 315 | 34 | | V91720 | TOYOTA | 813 | 38 | | V91836 | NISSAN | 570 | 15 | |
| V91667 | IVECO | 315 | 35 | | V91720 | TOYOTA | 814 | 41 | | V91836 | RENAULT | 674 | 11 | |
| V91667 | IVECO | 315 | 37 | | V91720 | VW | 932 | 150 | | V91836 | RENAULT | 675 | 12 | |
| V91667 | IVECO | 316 | 39 | | V91721 | TOYOTA | 812 | 34 | | V91836 | RENAULT | 680 | 20 | |
| V91676 | FIAT | 226 | 109 | | V91721 | TOYOTA | 813 | 35 | | V91836 | RENAULT | 683 | 22 | |
| V91676 | IVECO | 309 | 15 | | V91721 | TOYOTA | 813 | 37 | | V91872 | RENAULT | 717 | 101 | |
| V91676 | IVECO | 310 | 17 | | V91721 | TOYOTA | 813 | 38 | | V91872 | RENAULT | 717 | 102 | |
| V91676 | IVECO | 310 | 18 | | V91721 | VW | 932 | 150 | | V91898 | FORD | 245 | 29 | |
| V91676 | IVECO | 311 | 20 | | V91731 | HONDA | 273 | 1 | | V91898 | FORD | 245 | 30 | |
| V91676 | IVECO | 311 | 21 | | V91731 | HONDA | 273 | 2 | | V91905 | RENAULT | 710 | 77 | |
| V91676 | IVECO | 311 | 22 | | V91731 | HONDA | 273 | 3 | | V91905 | RENAULT | 712 | 84 | |
| V91676 | IVECO | 311 | 23 | | V91731 | HONDA | 273 | 6 | | V91905 | RENAULT | 712 | 85 | |
| V91676 | IVECO | 313 | 30 | | V91731 | HONDA | 274 | 8 | | V91906 | RENAULT | 710 | 77 | |



NUMERICAL PARTS LIST

Numerische Teilenummernliste • Elenco riferimenti
Liste des références produits













|  |  |  |  | 9 |  |  |  |  | 9 |  |  |  |  | 9 |
|---|---|---|---|-----|---|---|---|--|-----|---|---|---|---|-----|
| V91906 | RENAULT | | 712 | 84 | V91939 | IVECO | | 305 | 8 | V91991 | FORD | | 245 | 30 |
| V91906 | RENAULT | | 712 | 85 | V91939 | IVECO | | 306 | 11 | V91992 | FORD | | 250 | 42 |
| V91925 | BMW | | 97 | 20 | V91939 | IVECO | | 308 | 13 | V91992 | FORD | | 250 | 44 |
| V91925 | BMW | | 103 | 31 | V91939 | RENAULT | | 707 | 66 | V91992 | FORD | | 251 | 46 |
| V91925 | BMW | | 104 | 32 | V91939 | RENAULT | | 707 | 67 | V91993 | FORD | | 256 | 59 |
| V91925 | BMW | | 105 | 35 | V91940 | CITROËN | | 156 | 73 | V91993 | FORD | | 257 | 61 |
| V91925 | BMW | | 105 | 37 | V91940 | FIAT | | 226 | 107 | V91993 | MAZDA | | 408 | 13 |
| V91925 | BMW | | 106 | 38 | V91940 | IVECO | | 305 | 8 | V91994 | FIAT | | 225 | 105 |
| V91925 | BMW | | 111 | 54 | V91940 | IVECO | | 306 | 9 | V91994 | FIAT | | 225 | 106 |
| V91926 | BMW | | 97 | 20 | V91940 | IVECO | | 306 | 11 | V91994 | FIAT | | 226 | 107 |
| V91926 | BMW | | 103 | 31 | V91940 | IVECO | | 308 | 13 | V91994 | IVECO | | 305 | 8 |
| V91926 | BMW | | 104 | 32 | V91940 | OPEL | | 608 | 81 | V91994 | IVECO | | 306 | 9 |
| V91926 | BMW | | 105 | 35 | V91940 | OPEL | | 608 | 83 | V91994 | IVECO | | 306 | 12 |
| V91926 | BMW | | 105 | 37 | V91940 | OPEL | | 608 | 84 | V91994 | RENAULT | | 706 | 64 |
| V91926 | BMW | | 106 | 38 | V91940 | PEUGEOT | | 645 | 80 | V91994 | RENAULT | | 708 | 70 |
| V91926 | BMW | | 111 | 54 | V91940 | RENAULT | | 705 | 61 | V91995 | CHEVROLET | | 119 | 12 |
| V91927 | FIAT | | 206 | 46 | V91940 | RENAULT | | 707 | 65 | V91995 | CHEVROLET | | 119 | 13 |
| V91927 | LANCIA | | 355 | 22 | V91940 | RENAULT | | 707 | 66 | V91995 | CHEVROLET | | 121 | 20 |
| V91928 | FIAT | | 206 | 46 | V91940 | RENAULT | | 707 | 67 | V91995 | CHEVROLET | | 121 | 23 |
| V91928 | LANCIA | | 355 | 22 | V91940 | RENAULT | | 708 | 69 | V91995 | OPEL | | 589 | 21 |
| V91929 | AUTOBIANCHI | | 84 | 3 | V91940 | RENAULT | | 708 | 71 | V91995 | OPEL | | 590 | 22 |
| V91929 | FIAT | | 196 | 11 | V91940 | VAUXHALL | | 842 | 81 | V91995 | OPEL | | 590 | 23 |
| V91929 | FIAT | | 197 | 14 | V91940 | VAUXHALL | | 842 | 83 | V91995 | OPEL | | 592 | 27 |
| V91929 | FIAT | | 198 | 18 | V91940 | VAUXHALL | | 842 | 84 | V91995 | OPEL | | 592 | 28 |
| V91929 | FIAT | | 199 | 20 | V91942 | IVECO | | 323 | 57 | V91995 | VAUXHALL | | 824 | 22 |
| V91929 | LANCIA | | 351 | 7 | V91942 | IVECO | | 324 | 58 | V91995 | VAUXHALL | | 825 | 23 |
| V91929 | LANCIA | | 352 | 10 | V91947 | IVECO | | 330 | 70 | V91995 | VAUXHALL | | 825 | 24 |
| V91929 | ZASTAVA | | 935 | 1 | V91947 | IVECO | | 330 | 71 | V91995 | VAUXHALL | | 826 | 28 |
| V91931 | ALFA ROMEO | | 27 | 16 | V91947 | IVECO | | 330 | 72 | V91995 | VAUXHALL | | 827 | 29 |
| V91931 | ALFA ROMEO | | 27 | 18 | V91949 | FIAT | | 206 | 44 | V91996 | CHEVROLET | | 119 | 12 |
| V91931 | FIAT | | 211 | 55 | V91949 | FIAT | | 223 | 97 | V91996 | CHEVROLET | | 119 | 13 |
| V91931 | LANCIA | | 356 | 28 | V91949 | LANCIA | | 354 | 21 | V91996 | CHEVROLET | | 121 | 20 |
| V91932 | ALFA ROMEO | | 27 | 16 | V91949 | LANCIA | | 364 | 56 | V91996 | CHEVROLET | | 121 | 23 |
| V91932 | ALFA ROMEO | | 27 | 18 | V91950 | FIAT | | 206 | 44 | V91996 | OPEL | | 589 | 21 |
| V91932 | FIAT | | 211 | 55 | V91950 | FIAT | | 223 | 97 | V91996 | OPEL | | 590 | 22 |
| V91932 | LANCIA | | 356 | 28 | V91950 | LANCIA | | 354 | 21 | V91996 | OPEL | | 590 | 23 |
| V91933 | ALFA ROMEO | | 27 | 17 | V91950 | LANCIA | | 364 | 56 | V91996 | OPEL | | 592 | 27 |
| V91933 | ALFA ROMEO | | 28 | 19 | V91955 | BMW | | 96 | 16 | V91996 | OPEL | | 592 | 28 |
| V91933 | ALFA ROMEO | | 33 | 35 | V91955 | BMW | | 97 | 19 | V91996 | VAUXHALL | | 824 | 22 |
| V91933 | FIAT | | 207 | 47 | V91955 | BMW | | 110 | 51 | V91996 | VAUXHALL | | 825 | 23 |
| V91933 | FIAT | | 211 | 56 | V91958 | MERCEDES-BENZ | | 467 | 63 | V91996 | VAUXHALL | | 825 | 24 |
| V91933 | FIAT | | 215 | 68 | V91958 | MERCEDES-BENZ | | 468 | 64 | V91996 | VAUXHALL | | 826 | 28 |
| V91933 | LANCIA | | 355 | 23 | V91958 | MERCEDES-BENZ | | 485 | 102 | V91996 | VAUXHALL | | 827 | 29 |
| V91933 | LANCIA | | 357 | 29 | V91958 | MERCEDES-BENZ | | 485 | 103 | V91997 | CHEVROLET | | 123 | 32 |
| V91933 | LANCIA | | 359 | 37 | V91959 | OPEL | | 589 | 20 | V91997 | CHEVROLET | | 124 | 36 |
| V91934 | ALFA ROMEO | | 27 | 17 | V91959 | SUZUKI | | 797 | 16 | V91997 | CHEVROLET | | 125 | 38 |
| V91934 | ALFA ROMEO | | 28 | 19 | V91959 | VAUXHALL | | 824 | 21 | V91997 | CHEVROLET | | 125 | 40 |
| V91934 | ALFA ROMEO | | 33 | 35 | V91960 | OPEL | | 589 | 20 | V91997 | DAEWOO | | 165 | 15 |
| V91934 | FIAT | | 207 | 47 | V91960 | SUZUKI | | 797 | 16 | V91997 | DAEWOO | | 165 | 16 |
| V91934 | FIAT | | 211 | 56 | V91960 | VAUXHALL | | 824 | 21 | V91997 | DAEWOO | | 165 | 17 |
| V91934 | FIAT | | 215 | 68 | V91970 | CITROËN | | 152 | 55 | V91997 | ISUZU | | 290 | 5 |
| V91934 | LANCIA | | 355 | 23 | V91970 | CITROËN | | 154 | 60 | V91997 | LOTUS | | 374 | 4 |
| V91934 | LANCIA | | 357 | 29 | V91970 | FIAT | | 220 | 87 | V91997 | OPEL | | 597 | 44 |
| V91934 | LANCIA | | 359 | 37 | V91970 | FIAT | | 223 | 99 | V91997 | OPEL | | 597 | 45 |
| V91935 | ALFA ROMEO | | 35 | 44 | V91970 | PEUGEOT | | 639 | 55 | V91997 | OPEL | | 599 | 53 |
| V91935 | FIAT | | 216 | 70 | V91971 | CITROËN | | 153 | 56 | V91997 | OPEL | | 602 | 61 |
| V91935 | FIAT | | 217 | 74 | V91971 | FIAT | | 220 | 89 | V91997 | OPEL | | 605 | 69 |
| V91935 | FIAT | | 217 | 75 | V91971 | LANCIA | | 363 | 53 | V91997 | OPEL | | 605 | 70 |
| V91935 | LANCIA | | 360 | 40 | V91971 | PEUGEOT | | 639 | 56 | V91997 | OPEL | | 606 | 72 |
| V91935 | LANCIA | | 361 | 43 | V91972 | CITROËN | | 152 | 55 | V91997 | OPEL | | 606 | 74 |
| V91936 | ALFA ROMEO | | 35 | 44 | V91972 | CITROËN | | 153 | 56 | V91997 | OPEL | | 606 | 75 |
| V91936 | FIAT | | 217 | 75 | V91972 | CITROËN | | 154 | 60 | V91997 | OPEL | | 607 | 77 |
| V91936 | LANCIA | | 360 | 40 | V91972 | FIAT | | 220 | 87 | V91997 | SAAB | | 726 | 3 |
| V91937 | FIAT | | 207 | 48 | V91972 | FIAT | | 220 | 89 | V91997 | SAAB | | 728 | 12 |
| V91937 | FIAT | | 209 | 51 | V91972 | FIAT | | 223 | 99 | V91997 | SUBARU | | 791 | 10 |
| V91937 | FIAT | | 211 | 57 | V91972 | LANCIA | | 363 | 53 | V91997 | VAUXHALL | | 832 | 45 |
| V91937 | LANCIA | | 357 | 30 | V91972 | PEUGEOT | | 639 | 55 | V91997 | VAUXHALL | | 832 | 46 |
| V91938 | FIAT | | 207 | 48 | V91972 | PEUGEOT | | 639 | 56 | V91997 | VAUXHALL | | 834 | 54 |
| V91938 | FIAT | | 209 | 51 | V91987 | OPEL | | 599 | 49 | V91997 | VAUXHALL | | 839 | 69 |
| V91938 | FIAT | | 211 | 57 | V91987 | VAUXHALL | | 833 | 50 | V91997 | VAUXHALL | | 839 | 70 |
| V91938 | LANCIA | | 357 | 30 | V91988 | LAND ROVER | | 371 | 22 | V91997 | VAUXHALL | | 840 | 72 |
| V91939 | FIAT | | 226 | 107 | V91991 | FORD | | 245 | 29 | V91997 | VAUXHALL | | 840 | 74 |













|  |  |  |  | 9 |  |  |  |  | 9 |  |  |  |  | 9 |
|---|---|---|---|---|---|---|---|---|---|---|---|---|---|---|
| V91997 | VAUXHALL | 840 | 75 | | V94019 | ROVER | 723 | 18 | | V94050 | VAUXHALL | 825 | 23 | |
| V91997 | VAUXHALL | 841 | 77 | | V94020 | VOLVO | 871 | 67 | | V94050 | VAUXHALL | 827 | 29 | |
| V91998 | CHEVROLET | 123 | 32 | | V94021 | RENAULT | 716 | 99 | | V94051 | CHEVROLET | 119 | 12 | |
| V91998 | CHEVROLET | 124 | 36 | | V94021 | VOLVO | 871 | 67 | | V94051 | CHEVROLET | 121 | 20 | |
| V91998 | CHEVROLET | 125 | 38 | | V94021 | VOLVO | 872 | 68 | | V94051 | OPEL | 590 | 22 | |
| V91998 | CHEVROLET | 125 | 40 | | V94024 | CITROËN | 143 | 27 | | V94051 | OPEL | 592 | 28 | |
| V91998 | DAEWOO | 165 | 15 | | V94024 | CITROËN | 144 | 28 | | V94051 | VAUXHALL | 825 | 23 | |
| V91998 | DAEWOO | 165 | 16 | | V94024 | CITROËN | 147 | 38 | | V94051 | VAUXHALL | 827 | 29 | |
| V91998 | DAEWOO | 165 | 17 | | V94024 | FIAT | 215 | 66 | | V94052 | ROVER | 719 | 2 | |
| V91998 | ISUZU | 290 | 5 | | V94024 | HONDA | 276 | 16 | | V94052 | ROVER | 719 | 4 | |
| V91998 | LOTUS | 374 | 4 | | V94024 | HYUNDAI | 284 | 20 | | V94053 | LAND ROVER | 367 | 1 | |
| V91998 | OPEL | 597 | 44 | | V94024 | LADA | 345 | 8 | | V94053 | LOTUS | 374 | 2 | |
| V91998 | OPEL | 597 | 45 | | V94024 | PEUGEOT | 629 | 26 | | V94053 | MG | 545 | 1 | |
| V91998 | OPEL | 599 | 53 | | V94024 | PEUGEOT | 630 | 27 | | V94053 | MG | 545 | 2 | |
| V91998 | OPEL | 602 | 61 | | V94024 | PEUGEOT | 634 | 38 | | V94053 | MG | 545 | 3 | |
| V91998 | OPEL | 605 | 69 | | V94024 | ROVER | 721 | 11 | | V94053 | ROVER | 719 | 3 | |
| V91998 | OPEL | 605 | 70 | | V94024 | SUZUKI | 799 | 21 | | V94053 | ROVER | 720 | 5 | |
| V91998 | OPEL | 606 | 74 | | V94026 | LAND ROVER | 369 | 12 | | V94053 | ROVER | 721 | 10 | |
| V91998 | OPEL | 606 | 75 | | V94026 | ROVER | 723 | 19 | | V94053 | ROVER | 721 | 12 | |
| V91998 | OPEL | 607 | 77 | | V94029 | FIAT | 198 | 19 | | V94054 | IVECO | 321 | 49 | |
| V91998 | SAAB | 726 | 3 | | V94029 | FIAT | 199 | 21 | | V94054 | MERCEDES-BENZ | 502 | 123 | |
| V91998 | SAAB | 728 | 12 | | V94029 | FIAT | 200 | 22 | | V94055 | IVECO | 321 | 49 | |
| V91998 | SUBARU | 791 | 10 | | V94029 | LANCIA | 351 | 9 | | V94055 | MERCEDES-BENZ | 502 | 123 | |
| V91998 | VAUXHALL | 832 | 45 | | V94029 | LANCIA | 352 | 11 | | V94056 | FORD | 238 | 9 | |
| V91998 | VAUXHALL | 832 | 46 | | V94029 | LANCIA | 353 | 13 | | V94056 | MAZDA | 406 | 2 | |
| V91998 | VAUXHALL | 834 | 54 | | V94029 | OPEL | 585 | 4 | | V94057 | FORD | 238 | 9 | |
| V91998 | VAUXHALL | 839 | 69 | | V94029 | VAUXHALL | 820 | 5 | | V94057 | MAZDA | 406 | 2 | |
| V91998 | VAUXHALL | 839 | 70 | | V94029 | VAUXHALL | 820 | 6 | | V94058 | FORD | 244 | 25 | |
| V91998 | VAUXHALL | 840 | 74 | | V94030 | VAUXHALL | 198 | 19 | | V94058 | FORD | 244 | 26 | |
| V91998 | VAUXHALL | 840 | 75 | | V94030 | FIAT | 199 | 21 | | V94058 | FORD | 244 | 27 | |
| V91998 | VAUXHALL | 841 | 77 | | V94030 | FIAT | 200 | 22 | | V94059 | FORD | 244 | 25 | |
| V94001 | FORD | 238 | 9 | | V94030 | LANCIA | 351 | 9 | | V94059 | FORD | 244 | 26 | |
| V94001 | MAZDA | 406 | 2 | | V94030 | LANCIA | 352 | 11 | | V94059 | FORD | 244 | 27 | |
| V94003 | FORD | 244 | 25 | | V94030 | LANCIA | 353 | 13 | | V94061 | FORD | 251 | 47 | |
| V94006 | FORD | 262 | 74 | | V94030 | OPEL | 585 | 4 | | V94062 | CITROËN | 156 | 70 | |
| V94007 | FORD | 262 | 74 | | V94030 | VAUXHALL | 820 | 5 | | V94062 | CITROËN | 156 | 71 | |
| V94008 | BMW | 93 | 5 | | V94030 | VAUXHALL | 820 | 6 | | V94062 | DAF | 168 | 1 | |
| V94008 | BMW | 93 | 6 | | V94033 | FORD | 270 | 95 | | V94062 | FIAT | 224 | 102 | |
| V94008 | BMW | 93 | 7 | | V94038 | RENAULT | 689 | 31 | | V94062 | PEUGEOT | 644 | 75 | |
| V94009 | BMW | 93 | 5 | | V94038 | RENAULT | 690 | 34 | | V94062 | PEUGEOT | 644 | 76 | |
| V94009 | BMW | 93 | 6 | | V94038 | RENAULT | 691 | 36 | | V94063 | CITROËN | 156 | 70 | |
| V94009 | BMW | 93 | 7 | | V94038 | RENAULT | 691 | 37 | | V94063 | CITROËN | 156 | 71 | |
| V94010 | AUDI | 51 | 21 | | V94038 | RENAULT | 692 | 39 | | V94063 | DAF | 168 | 1 | |
| V94010 | AUDI | 65 | 65 | | V94038 | VOLVO | 855 | 25 | | V94063 | FIAT | 224 | 102 | |
| V94010 | FORD | 248 | 36 | | V94038 | VOLVO | 856 | 26 | | V94063 | PEUGEOT | 644 | 75 | |
| V94010 | SEAT | 757 | 36 | | V94038 | VOLVO | 862 | 45 | | V94063 | PEUGEOT | 644 | 76 | |
| V94010 | VOLVO | 855 | 22 | | V94039 | RENAULT | 689 | 31 | | V94064 | ALFA ROMEO | 29 | 22 | |
| V94010 | VW | 903 | 69 | | V94039 | RENAULT | 690 | 34 | | V94064 | ALFA ROMEO | 31 | 28 | |
| V94010 | VW | 920 | 115 | | V94039 | RENAULT | 691 | 36 | | V94064 | ALFA ROMEO | 31 | 29 | |
| V94010 | VW | 921 | 116 | | V94039 | RENAULT | 691 | 37 | | V94064 | ALFA ROMEO | 31 | 29 | |
| V94011 | AUDI | 51 | 21 | | V94039 | RENAULT | 692 | 39 | | V94064 | FIAT | 208 | 49 | |
| V94011 | AUDI | 65 | 65 | | V94039 | VOLVO | 855 | 25 | | V94064 | FIAT | 212 | 58 | |
| V94011 | FORD | 248 | 36 | | V94039 | VOLVO | 856 | 26 | | V94064 | LANCIA | 356 | 26 | |
| V94011 | SEAT | 757 | 36 | | V94039 | VOLVO | 856 | 26 | | V94064 | LANCIA | 357 | 31 | |
| V94011 | VOLVO | 855 | 22 | | V94039 | VOLVO | 862 | 45 | | V94065 | ALFA ROMEO | 29 | 22 | |
| V94011 | VW | 903 | 69 | | V94044 | RENAULT | 694 | 43 | | V94065 | ALFA ROMEO | 29 | 23 | |
| V94011 | VW | 920 | 115 | | V94044 | VOLVO | 852 | 14 | | V94065 | ALFA ROMEO | 30 | 27 | |
| V94011 | VW | 921 | 116 | | V94044 | VOLVO | 852 | 15 | | V94065 | ALFA ROMEO | 31 | 28 | |
| V94016 | NISSAN | 567 | 5 | | V94044 | VOLVO | 853 | 16 | | V94065 | ALFA ROMEO | 31 | 29 | |
| V94016 | NISSAN | 568 | 8 | | V94044 | VOLVO | 853 | 18 | | V94065 | FIAT | 208 | 49 | |
| V94016 | NISSAN | 568 | 9 | | V94044 | VOLVO | 855 | 23 | | V94065 | FIAT | 212 | 58 | |
| V94016 | RENAULT | 672 | 6 | | V94044 | VOLVO | 856 | 28 | | V94065 | LANCIA | 356 | 26 | |
| V94017 | CITROËN | 148 | 40 | | V94044 | VOLVO | 856 | 28 | | V94065 | LANCIA | 357 | 31 | |
| V94017 | FIAT | 214 | 65 | | V94044 | VOLVO | 857 | 29 | | V94065 | OPEL | 598 | 46 | |
| V94017 | PEUGEOT | 634 | 39 | | V94044 | VOLVO | 857 | 31 | | V94065 | SAAB | 727 | 6 | |
| V94018 | HONDA | 277 | 20 | | V94044 | VOLVO | 858 | 32 | | V94065 | VAUXHALL | 832 | 47 | |
| V94018 | LAND ROVER | 369 | 11 | | V94044 | VOLVO | 858 | 33 | | V94067 | RENAULT | 684 | 23 | |
| V94018 | MG | 546 | 8 | | V94044 | VOLVO | 859 | 35 | | V94067 | RENAULT | 685 | 24 | |
| V94018 | ROVER | 723 | 18 | | V94044 | VOLVO | 860 | 38 | | V94067 | RENAULT | 685 | 26 | |
| V94019 | HONDA | 277 | 20 | | V94044 | VOLVO | 860 | 38 | | V94067 | RENAULT | 686 | 27 | |
| V94019 | LAND ROVER | 369 | 11 | | V94050 | CHEVROLET | 119 | 12 | | V94067 | RENAULT | 686 | 28 | |
| V94019 | MG | 546 | 8 | | V94050 | CHEVROLET | 121 | 20 | | V94067 | VOLVO | 850 | 8 | |
| | | | | | V94050 | OPEL | 590 | 22 | | V94067 | VOLVO | 851 | 11 | |
| | | | | | V94050 | OPEL | 592 | 28 | | | | | | |



NUMERICAL PARTS LIST

Nummerische Teilenummernliste • Elenco riferimenti
Liste des références produits















|  |  |  |  | 9 |  |  |  |  | 9 |  |  |  |  | 9 |
|---|---|---|---|-----|---|---|---|--|-----|---|---|---|---|-----|
| V94072 | FORD | | 245 | 29 | V94083 | SEAT | | 762 | 52 | V94097 | SAAB | | 728 | 10 |
| V94072 | FORD | | 248 | 35 | V94083 | SKODA | | 778 | 28 | V94097 | VAUXHALL | | 835 | 56 |
| V94073 | FORD | | 245 | 29 | V94083 | SKODA | | 782 | 38 | V94097 | VAUXHALL | | 835 | 57 |
| V94073 | FORD | | 248 | 35 | V94083 | VW | | 913 | 94 | V94098 | CHEVROLET | | 124 | 34 |
| V94074 | FORD | | 252 | 49 | V94083 | VW | | 925 | 131 | V94098 | OPEL | | 600 | 55 |
| V94074 | FORD | | 259 | 65 | V94083 | VW | | 928 | 138 | V94098 | OPEL | | 600 | 56 |
| V94074 | FORD | | 259 | 66 | V94084 | AUDI | | 51 | 23 | V94098 | OPEL | | 601 | 57 |
| V94075 | FORD | | 252 | 49 | V94084 | AUDI | | 52 | 24 | V94098 | SAAB | | 728 | 10 |
| V94075 | FORD | | 252 | 50 | V94084 | FORD | | 248 | 37 | V94098 | VAUXHALL | | 835 | 56 |
| V94075 | FORD | | 259 | 66 | V94084 | SEAT | | 758 | 40 | V94098 | VAUXHALL | | 835 | 57 |
| V94075 | FORD | | 262 | 73 | V94084 | SEAT | | 759 | 43 | V94099 | HONDA | | 274 | 7 |
| V94076 | FORD | | 252 | 49 | V94084 | SKODA | | 777 | 22 | V94099 | HONDA | | 274 | 9 |
| V94076 | FORD | | 259 | 65 | V94084 | VW | | 905 | 74 | V94099 | HONDA | | 275 | 13 |
| V94076 | FORD | | 259 | 66 | V94085 | AUDI | | 51 | 23 | V94099 | HONDA | | 275 | 14 |
| V94079 | AUDI | | 54 | 33 | V94085 | AUDI | | 52 | 24 | V94099 | ROVER | | 720 | 8 |
| V94079 | AUDI | | 68 | 76 | V94085 | FORD | | 248 | 37 | V94100 | HONDA | | 274 | 7 |
| V94079 | AUDI | | 72 | 83 | V94085 | SEAT | | 758 | 40 | V94100 | ROVER | | 720 | 8 |
| V94079 | SEAT | | 760 | 46 | V94085 | SEAT | | 759 | 43 | V94101 | LAND ROVER | | 367 | 3 |
| V94079 | SEAT | | 761 | 48 | V94085 | SKODA | | 777 | 22 | V94101 | LOTUS | | 374 | 3 |
| V94079 | SEAT | | 765 | 62 | V94085 | VW | | 905 | 74 | V94101 | MG | | 545 | 4 |
| V94079 | SKODA | | 778 | 26 | V94086 | BMW | | 94 | 11 | V94101 | MG | | 546 | 5 |
| V94079 | SKODA | | 781 | 34 | V94086 | BMW | | 94 | 11 | V94101 | MG | | 546 | 6 |
| V94079 | SKODA | | 781 | 35 | V94086 | BMW | | 98 | 23 | V94101 | ROVER | | 722 | 13 |
| V94079 | VW | | 909 | 85 | V94086 | BMW | | 98 | 23 | V94101 | ROVER | | 722 | 14 |
| V94079 | VW | | 909 | 86 | V94086 | BMW | | 100 | 25 | V94101 | ROVER | | 722 | 16 |
| V94079 | VW | | 910 | 88 | V94086 | BMW | | 100 | 25 | V94102 | LOTUS | | 374 | 3 |
| V94079 | VW | | 924 | 128 | V94086 | BMW | | 104 | 33 | V94102 | MG | | 545 | 4 |
| V94079 | VW | | 925 | 130 | V94086 | BMW | | 104 | 33 | V94102 | ROVER | | 722 | 13 |
| V94080 | AUDI | | 54 | 33 | V94086 | BMW | | 105 | 36 | V94108 | AUDI | | 50 | 20 |
| V94080 | AUDI | | 68 | 76 | V94086 | BMW | | 105 | 36 | V94108 | AUDI | | 51 | 22 |
| V94080 | SEAT | | 760 | 46 | V94086 | BMW | | 108 | 42 | V94108 | SEAT | | 756 | 35 |
| V94080 | SEAT | | 761 | 48 | V94086 | BMW | | 108 | 42 | V94108 | SEAT | | 757 | 37 |
| V94080 | SEAT | | 761 | 51 | V94086 | BMW | | 108 | 43 | V94108 | SEAT | | 757 | 38 |
| V94080 | SEAT | | 765 | 62 | V94086 | BMW | | 110 | 50 | V94108 | SKODA | | 776 | 19 |
| V94080 | SKODA | | 778 | 26 | V94086 | BMW | | 110 | 50 | V94108 | VW | | 903 | 68 |
| V94080 | SKODA | | 781 | 34 | V94086 | LAND ROVER | | 368 | 6 | V94108 | VW | | 904 | 70 |
| V94080 | SKODA | | 781 | 35 | V94086 | LAND ROVER | | 368 | 6 | V94108 | VW | | 904 | 72 |
| V94080 | VW | | 909 | 85 | V94086 | LAND ROVER | | 368 | 7 | V94108 | VW | | 907 | 80 |
| V94080 | VW | | 909 | 86 | V94086 | LAND ROVER | | 368 | 7 | V94109 | AUDI | | 50 | 20 |
| V94080 | VW | | 910 | 88 | V94086 | MG | | 546 | 7 | V94109 | AUDI | | 51 | 22 |
| V94080 | VW | | 912 | 92 | V94086 | MG | | 546 | 7 | V94109 | SEAT | | 756 | 35 |
| V94080 | VW | | 914 | 96 | V94086 | ROVER | | 722 | 17 | V94109 | SEAT | | 757 | 37 |
| V94080 | VW | | 924 | 128 | V94086 | ROVER | | 722 | 17 | V94109 | SEAT | | 757 | 38 |
| V94080 | VW | | 925 | 130 | V94087 | BMW | | 96 | 17 | V94109 | SKODA | | 776 | 19 |
| V94081 | AUDI | | 56 | 38 | V94087 | BMW | | 97 | 21 | V94109 | VW | | 903 | 68 |
| V94081 | AUDI | | 57 | 39 | V94087 | BMW | | 111 | 53 | V94109 | VW | | 904 | 70 |
| V94081 | AUDI | | 64 | 62 | V94087 | BMW | | 112 | 56 | V94109 | VW | | 904 | 72 |
| V94081 | AUDI | | 64 | 63 | V94087 | BMW | | 113 | 58 | V94109 | VW | | 907 | 80 |
| V94081 | AUDI | | 65 | 66 | V94088 | BMW | | 96 | 17 | V94110 | AUDI | | 63 | 57 |
| V94081 | AUDI | | 67 | 74 | V94088 | BMW | | 97 | 21 | V94110 | AUDI | | 67 | 73 |
| V94081 | AUDI | | 73 | 86 | V94088 | BMW | | 111 | 53 | V94110 | AUDI | | 79 | 105 |
| V94081 | AUDI | | 73 | 87 | V94088 | BMW | | 112 | 56 | V94110 | SEAT | | 765 | 61 |
| V94081 | SEAT | | 762 | 52 | V94088 | BMW | | 113 | 58 | V94110 | VW | | 924 | 127 |
| V94081 | SEAT | | 762 | 53 | V94089 | BMW | | 94 | 9 | V94111 | AUDI | | 67 | 73 |
| V94081 | SKODA | | 778 | 28 | V94090 | BMW | | 94 | 9 | V94111 | AUDI | | 79 | 105 |
| V94081 | SKODA | | 778 | 29 | V94091 | BMW | | 113 | 59 | V94111 | SEAT | | 765 | 61 |
| V94081 | SKODA | | 782 | 38 | V94091 | BMW | | 114 | 63 | V94111 | VW | | 924 | 127 |
| V94081 | VW | | 913 | 94 | V94091 | BMW | | 115 | 65 | V94112 | SEAT | | 756 | 34 |
| V94081 | VW | | 913 | 95 | V94091 | LAND ROVER | | 371 | 24 | V94112 | SEAT | | 758 | 39 |
| V94081 | VW | | 925 | 131 | V94092 | BMW | | 113 | 59 | V94112 | SEAT | | 758 | 41 |
| V94081 | VW | | 928 | 138 | V94092 | BMW | | 114 | 63 | V94112 | SEAT | | 759 | 43 |
| V94082 | AUDI | | 57 | 39 | V94092 | BMW | | 115 | 65 | V94112 | SKODA | | 776 | 20 |
| V94082 | AUDI | | 64 | 62 | V94092 | LAND ROVER | | 371 | 24 | V94112 | SKODA | | 776 | 21 |
| V94082 | AUDI | | 65 | 66 | V94093 | HONDA | | 277 | 19 | V94112 | VW | | 902 | 65 |
| V94082 | SEAT | | 762 | 53 | V94094 | HONDA | | 277 | 19 | V94112 | VW | | 905 | 73 |
| V94082 | SKODA | | 778 | 29 | V94096 | HONDA | | 277 | 21 | V94112 | VW | | 906 | 76 |
| V94082 | VW | | 913 | 95 | V94096 | HONDA | | 278 | 24 | V94113 | SEAT | | 756 | 34 |
| V94083 | AUDI | | 56 | 38 | V94096 | ROVER | | 723 | 20 | V94113 | SEAT | | 758 | 39 |
| V94083 | AUDI | | 64 | 63 | V94097 | CHEVROLET | | 124 | 34 | V94113 | SEAT | | 758 | 41 |
| V94083 | AUDI | | 67 | 74 | V94097 | OPEL | | 600 | 55 | V94113 | SKODA | | 776 | 20 |
| V94083 | AUDI | | 73 | 86 | V94097 | OPEL | | 600 | 56 | V94113 | SKODA | | 776 | 21 |
| V94083 | AUDI | | 73 | 87 | V94097 | OPEL | | 601 | 57 | V94113 | VW | | 902 | 65 |















|  |  |  |  | 9 |  |  |  |  | 9 |  |  |  |  | 9 |
|---|---|---|---|----|---|---|---|---|-----|---|---|---|---|----|
| V94113 | VW | | 905 | 73 | V94135 | TOYOTA | | 805 | 11 | V94169 | CITROËN | | 154 | 61 |
| V94113 | VW | | 906 | 76 | V94135 | TOYOTA | | 805 | 12 | V94169 | FIAT | | 219 | 83 |
| V94114 | SEAT | | 752 | 21 | V94137 | CHEVROLET | | 123 | 31 | V94169 | LANCIA | | 362 | 49 |
| V94114 | SEAT | | 754 | 25 | V94137 | TOYOTA | | 807 | 18 | V94169 | PEUGEOT | | 638 | 51 |
| V94114 | SEAT | | 754 | 26 | V94137 | TOYOTA | | 807 | 19 | V94169 | PEUGEOT | | 641 | 61 |
| V94114 | SKODA | | 774 | 11 | V94138 | DAIHATSU | | 173 | 4 | V94170 | CITROËN | | 151 | 51 |
| V94114 | VW | | 889 | 24 | V94138 | TOYOTA | | 810 | 29 | V94170 | CITROËN | | 154 | 61 |
| V94114 | VW | | 893 | 33 | V94139 | DAIHATSU | | 173 | 4 | V94170 | FIAT | | 219 | 83 |
| V94114 | VW | | 895 | 42 | V94139 | TOYOTA | | 810 | 29 | V94170 | LANCIA | | 362 | 49 |
| V94114 | VW | | 895 | 43 | V94142 | CHEVROLET | | 122 | 26 | V94170 | PEUGEOT | | 638 | 51 |
| V94114 | VW | | 896 | 44 | V94142 | TOYOTA | | 805 | 13 | V94170 | PEUGEOT | | 641 | 61 |
| V94115 | SEAT | | 752 | 21 | V94142 | TOYOTA | | 806 | 14 | V94171 | CITROËN | | 141 | 20 |
| V94115 | SEAT | | 754 | 25 | V94142 | TOYOTA | | 807 | 20 | V94171 | NISSAN | | 571 | 19 |
| V94115 | SEAT | | 754 | 26 | V94143 | CHEVROLET | | 122 | 26 | V94171 | PEUGEOT | | 627 | 18 |
| V94115 | SKODA | | 774 | 11 | V94143 | TOYOTA | | 805 | 13 | V94171 | ROVER | | 721 | 9 |
| V94115 | VW | | 889 | 23 | V94143 | TOYOTA | | 806 | 14 | V94172 | CITROËN | | 141 | 20 |
| V94115 | VW | | 889 | 24 | V94143 | TOYOTA | | 807 | 20 | V94172 | NISSAN | | 571 | 19 |
| V94115 | VW | | 893 | 33 | V94144 | CHEVROLET | | 123 | 31 | V94172 | PEUGEOT | | 627 | 18 |
| V94115 | VW | | 895 | 42 | V94144 | TOYOTA | | 807 | 18 | V94172 | ROVER | | 721 | 9 |
| V94115 | VW | | 895 | 43 | V94144 | TOYOTA | | 807 | 19 | V94173 | CITROËN | | 155 | 66 |
| V94115 | VW | | 896 | 44 | V94145 | FORD | | 253 | 52 | V94173 | PEUGEOT | | 642 | 66 |
| V94116 | AUDI | | 47 | 5 | V94145 | MERCEDES-BENZ | | 445 | 11 | V94173 | RENAULT | | 700 | 51 |
| V94116 | AUDI | | 48 | 10 | V94145 | VW | | 922 | 119 | V94175 | CITROËN | | 146 | 35 |
| V94116 | SEAT | | 752 | 19 | V94145 | VW | | 923 | 123 | V94175 | CITROËN | | 153 | 58 |
| V94116 | SEAT | | 753 | 23 | V94146 | FORD | | 253 | 52 | V94175 | FIAT | | 220 | 88 |
| V94116 | SEAT | | 754 | 27 | V94146 | VW | | 922 | 119 | V94175 | LANCIA | | 363 | 52 |
| V94116 | SKODA | | 773 | 9 | V94147 | AUDI | | 49 | 17 | V94175 | PEUGEOT | | 632 | 35 |
| V94116 | SKODA | | 773 | 10 | V94147 | AUDI | | 52 | 25 | V94175 | PEUGEOT | | 640 | 58 |
| V94116 | SKODA | | 774 | 12 | V94147 | FORD | | 248 | 38 | V94176 | CITROËN | | 146 | 35 |
| V94116 | VW | | 889 | 22 | V94147 | SEAT | | 755 | 31 | V94176 | CITROËN | | 153 | 58 |
| V94116 | VW | | 891 | 26 | V94147 | SEAT | | 759 | 42 | V94176 | FIAT | | 220 | 88 |
| V94116 | VW | | 893 | 31 | V94147 | SKODA | | 775 | 16 | V94176 | LANCIA | | 363 | 52 |
| V94116 | VW | | 896 | 45 | V94147 | SKODA | | 777 | 23 | V94176 | PEUGEOT | | 632 | 35 |
| V94116 | VW | | 896 | 46 | V94147 | SKODA | | 777 | 25 | V94176 | PEUGEOT | | 640 | 58 |
| V94117 | AUDI | | 47 | 5 | V94147 | VW | | 900 | 62 | V94178 | CITROËN | | 149 | 44 |
| V94117 | AUDI | | 48 | 10 | V94147 | VW | | 906 | 77 | V94178 | CITROËN | | 152 | 54 |
| V94117 | SEAT | | 752 | 19 | V94147 | VW | | 908 | 81 | V94178 | FIAT | | 218 | 76 |
| V94117 | SEAT | | 753 | 23 | V94147 | VW | | 921 | 117 | V94178 | LANCIA | | 362 | 48 |
| V94117 | SEAT | | 754 | 27 | V94147 | VW | | 922 | 121 | V94178 | PEUGEOT | | 636 | 44 |
| V94117 | SKODA | | 773 | 9 | V94148 | AUDI | | 49 | 17 | V94178 | PEUGEOT | | 639 | 54 |
| V94117 | SKODA | | 773 | 10 | V94148 | AUDI | | 52 | 25 | V94178 | SUZUKI | | 800 | 25 |
| V94117 | SKODA | | 774 | 12 | V94148 | FORD | | 248 | 38 | V94179 | CITROËN | | 149 | 44 |
| V94117 | VW | | 889 | 22 | V94148 | SEAT | | 755 | 31 | V94179 | CITROËN | | 152 | 54 |
| V94117 | VW | | 891 | 26 | V94148 | SEAT | | 759 | 42 | V94179 | FIAT | | 218 | 76 |
| V94117 | VW | | 892 | 28 | V94148 | SKODA | | 775 | 16 | V94179 | LANCIA | | 362 | 48 |
| V94117 | VW | | 893 | 31 | V94148 | SKODA | | 777 | 23 | V94179 | PEUGEOT | | 636 | 44 |
| V94117 | VW | | 896 | 45 | V94148 | VW | | 900 | 62 | V94179 | PEUGEOT | | 639 | 54 |
| V94117 | VW | | 896 | 46 | V94148 | VW | | 906 | 77 | V94179 | SUZUKI | | 800 | 25 |
| V94118 | SUBARU | | 792 | 13 | V94148 | VW | | 921 | 117 | V94180 | NISSAN | | 567 | 3 |
| V94119 | SUBARU | | 792 | 13 | V94148 | VW | | 922 | 121 | V94180 | RENAULT | | 671 | 4 |
| V94120 | SUBARU | | 791 | 11 | V94149 | SEAT | | 748 | 5 | V94181 | NISSAN | | 567 | 3 |
| V94122 | SUBARU | | 792 | 12 | V94149 | VW | | 884 | 1 | V94181 | RENAULT | | 671 | 4 |
| V94125 | SUBARU | | 790 | 6 | V94150 | VOLVO | | 855 | 22 | V94188 | RENAULT | | 692 | 38 |
| V94125 | SUBARU | | 791 | 7 | V94155 | CITROËN | | 143 | 25 | V94189 | RENAULT | | 690 | 35 |
| V94125 | SUZUKI | | 796 | 11 | V94155 | CITROËN | | 143 | 26 | V94189 | RENAULT | | 692 | 38 |
| V94125 | SUZUKI | | 796 | 14 | V94155 | PEUGEOT | | 622 | 10 | V94190 | MITSUBISHI | | 554 | 13 |
| V94129 | SUZUKI | | 799 | 23 | V94155 | PEUGEOT | | 624 | 14 | V94190 | NISSAN | | 573 | 25 |
| V94130 | SUBARU | | 790 | 6 | V94155 | PEUGEOT | | 628 | 23 | V94190 | OPEL | | 595 | 39 |
| V94130 | SUZUKI | | 796 | 11 | V94156 | CITROËN | | 143 | 25 | V94190 | RENAULT | | 686 | 29 |
| V94130 | SUZUKI | | 796 | 14 | V94156 | CITROËN | | 143 | 26 | V94190 | VAUXHALL | | 830 | 40 |
| V94132 | DAIHATSU | | 173 | 2 | V94156 | PEUGEOT | | 622 | 10 | V94190 | VOLVO | | 851 | 10 |
| V94132 | TOYOTA | | 802 | 1 | V94156 | PEUGEOT | | 624 | 14 | V94191 | MITSUBISHI | | 554 | 13 |
| V94132 | TOYOTA | | 802 | 4 | V94156 | PEUGEOT | | 628 | 23 | V94191 | NISSAN | | 573 | 25 |
| V94133 | DAIHATSU | | 173 | 2 | V94157 | CITROËN | | 143 | 26 | V94191 | OPEL | | 595 | 39 |
| V94133 | TOYOTA | | 802 | 1 | V94157 | PEUGEOT | | 628 | 23 | V94191 | RENAULT | | 686 | 29 |
| V94133 | TOYOTA | | 802 | 4 | V94167 | CITROËN | | 146 | 35 | V94191 | VAUXHALL | | 830 | 40 |
| V94134 | SUBARU | | 791 | 8 | V94167 | CITROËN | | 153 | 59 | V94191 | VOLVO | | 851 | 10 |
| V94134 | TOYOTA | | 804 | 10 | V94167 | PEUGEOT | | 632 | 35 | V94194 | NISSAN | | 576 | 35 |
| V94134 | TOYOTA | | 805 | 11 | V94167 | PEUGEOT | | 640 | 59 | V94195 | NISSAN | | 576 | 35 |
| V94134 | TOYOTA | | 805 | 12 | V94168 | CITROËN | | 153 | 59 | V94197 | SEAT | | 748 | 5 |
| V94135 | SUBARU | | 791 | 8 | V94168 | PEUGEOT | | 640 | 59 | V94197 | VW | | 884 | 1 |
| V94135 | TOYOTA | | 804 | 10 | V94169 | CITROËN | | 151 | 51 | V94198 | CITROËN | | 155 | 65 |



NUMERICAL PARTS LIST

Numerische Teilenummernliste • Elenco riferimenti
Liste des références produits













|  |  |  |  |  |  |  |  |  |  |  |  |  |  |  |
|---|---|---|---|---|---|---|---|--|---|---|---|---|---|---|
| V94198 | LANCIA | 365 | 59 | | V94245 | SUZUKI | | 795 | 8 | V94265 | PORSCHE | | 648 | 7 |
| V94198 | PEUGEOT | 641 | 65 | | V94245 | VAUXHALL | | 821 | 7 | V94265 | PORSCHE | | 648 | 8 |
| V94198 | PEUGEOT | 643 | 74 | | V94245 | VAUXHALL | | 821 | 8 | V94265 | PORSCHE | | 648 | 9 |
| V94199 | CITROËN | 155 | 65 | | V94245 | VAUXHALL | | 821 | 9 | V94266 | PORSCHE | | 647 | 2 |
| V94199 | LANCIA | 365 | 59 | | V94245 | VAUXHALL | | 822 | 11 | V94267 | PORSCHE | | 647 | 2 |
| V94199 | PEUGEOT | 641 | 65 | | V94245 | VAUXHALL | | 822 | 12 | V94268 | PORSCHE | | 647 | 5 |
| V94199 | PEUGEOT | 643 | 74 | | V94245 | VAUXHALL | | 822 | 13 | V94268 | PORSCHE | | 648 | 7 |
| V94200 | CITROËN | 151 | 49 | | V94245 | VAUXHALL | | 822 | 14 | V94269 | PORSCHE | | 648 | 6 |
| V94200 | FIAT | 218 | 79 | | V94245 | VAUXHALL | | 823 | 15 | V94269 | PORSCHE | | 648 | 8 |
| V94200 | LANCIA | 362 | 45 | | V94246 | CHEVROLET | | 118 | 6 | V94270 | PORSCHE | | 648 | 6 |
| V94200 | PEUGEOT | 638 | 49 | | V94246 | CHEVROLET | | 118 | 7 | V94270 | PORSCHE | | 648 | 8 |
| V94201 | CITROËN | 151 | 49 | | V94246 | CHEVROLET | | 118 | 8 | V94270 | PORSCHE | | 648 | 9 |
| V94201 | FIAT | 218 | 79 | | V94246 | CHEVROLET | | 118 | 9 | V94274 | VOLVO | | 864 | 51 |
| V94201 | LANCIA | 362 | 45 | | V94246 | OPEL | | 585 | 5 | V94275 | BMW | | 115 | 67 |
| V94201 | PEUGEOT | 638 | 49 | | V94246 | OPEL | | 585 | 6 | V94275 | BMW | | 115 | 68 |
| V94202 | CITROËN | 135 | 4 | | V94246 | OPEL | | 586 | 7 | V94276 | BMW | | 115 | 67 |
| V94202 | CITROËN | 136 | 11 | | V94246 | OPEL | | 586 | 9 | V94276 | BMW | | 115 | 68 |
| V94202 | CITROËN | 137 | 12 | | V94246 | OPEL | | 586 | 10 | V94278 | MERCEDES-BENZ | | 459 | 45 |
| V94202 | CITROËN | 137 | 13 | | V94246 | OPEL | | 587 | 11 | V94278 | MERCEDES-BENZ | | 461 | 49 |
| V94202 | CITROËN | 138 | 15 | | V94246 | OPEL | | 587 | 12 | V94278 | MERCEDES-BENZ | | 462 | 51 |
| V94202 | PEUGEOT | 621 | 5 | | V94246 | OPEL | | 587 | 13 | V94278 | MERCEDES-BENZ | | 468 | 65 |
| V94202 | PEUGEOT | 623 | 12 | | V94246 | SUZUKI | | 795 | 7 | V94279 | MERCEDES-BENZ | | 459 | 45 |
| V94202 | PEUGEOT | 624 | 13 | | V94246 | SUZUKI | | 795 | 8 | V94279 | MERCEDES-BENZ | | 461 | 49 |
| V94203 | PEUGEOT | 629 | 24 | | V94246 | VAUXHALL | | 821 | 7 | V94279 | MERCEDES-BENZ | | 462 | 51 |
| V94204 | CITROËN | 142 | 24 | | V94246 | VAUXHALL | | 821 | 8 | V94279 | MERCEDES-BENZ | | 468 | 65 |
| V94204 | PEUGEOT | 629 | 24 | | V94246 | VAUXHALL | | 821 | 9 | V94280 | MERCEDES-BENZ | | 459 | 45 |
| V94204 | PEUGEOT | 629 | 25 | | V94246 | VAUXHALL | | 822 | 11 | V94280 | MERCEDES-BENZ | | 461 | 49 |
| V94211 | ALFA ROMEO | 36 | 50 | | V94246 | VAUXHALL | | 822 | 12 | V94280 | MERCEDES-BENZ | | 462 | 51 |
| V94214 | FORD | 247 | 33 | | V94246 | VAUXHALL | | 822 | 13 | V94280 | MERCEDES-BENZ | | 468 | 65 |
| V94215 | FORD | 244 | 25 | | V94246 | VAUXHALL | | 822 | 14 | V94284 | MERCEDES-BENZ | | 448 | 22 |
| V94215 | FORD | 244 | 26 | | V94246 | VAUXHALL | | 823 | 15 | V94285 | MERCEDES-BENZ | | 448 | 22 |
| V94215 | FORD | 244 | 27 | | V94247 | SEAT | | 752 | 22 | V94288 | MERCEDES-BENZ | | 471 | 69 |
| V94215 | FORD | 247 | 33 | | V94247 | VW | | 890 | 25 | V94288 | MERCEDES-BENZ | | 471 | 70 |
| V94217 | CITROËN | 146 | 35 | | V94248 | SEAT | | 752 | 22 | V94288 | MERCEDES-BENZ | | 474 | 77 |
| V94217 | CITROËN | 153 | 57 | | V94248 | VW | | 890 | 25 | V94289 | MERCEDES-BENZ | | 474 | 77 |
| V94217 | CITROËN | 153 | 58 | | V94249 | CHEVROLET | | 123 | 29 | V94290 | MERCEDES-BENZ | | 459 | 45 |
| V94217 | PEUGEOT | 632 | 35 | | V94249 | OPEL | | 597 | 43 | V94290 | MERCEDES-BENZ | | 461 | 49 |
| V94217 | PEUGEOT | 640 | 57 | | V94249 | SAAB | | 726 | 2 | V94290 | MERCEDES-BENZ | | 462 | 51 |
| V94217 | PEUGEOT | 640 | 58 | | V94249 | VAUXHALL | | 831 | 44 | V94290 | MERCEDES-BENZ | | 468 | 65 |
| V94218 | IVECO | 322 | 52 | | V94250 | CHEVROLET | | 123 | 29 | V94291 | MERCEDES-BENZ | | 459 | 45 |
| V94219 | IVECO | 322 | 52 | | V94250 | OPEL | | 597 | 43 | V94291 | MERCEDES-BENZ | | 461 | 49 |
| V94220 | IVECO | 325 | 60 | | V94250 | SAAB | | 726 | 2 | V94291 | MERCEDES-BENZ | | 462 | 51 |
| V94221 | IVECO | 325 | 60 | | V94250 | VAUXHALL | | 831 | 44 | V94291 | MERCEDES-BENZ | | 468 | 65 |
| V94222 | IVECO | 328 | 67 | | V94257 | MERCEDES-BENZ | | 480 | 91 | V94295 | PORSCHE | | 650 | 14 |
| V94222 | IVECO | 329 | 68 | | V94257 | MERCEDES-BENZ | | 481 | 92 | V94295 | PORSCHE | | 650 | 18 |
| V94223 | FORD | 251 | 48 | | V94257 | MERCEDES-BENZ | | 481 | 93 | V94295 | PORSCHE | | 651 | 19 |
| V94223 | FORD | 252 | 49 | | V94257 | MERCEDES-BENZ | | 482 | 95 | V94295 | PORSCHE | | 651 | 20 |
| V94223 | FORD | 259 | 65 | | V94257 | MERCEDES-BENZ | | 486 | 106 | V94296 | PORSCHE | | 650 | 14 |
| V94223 | FORD | 259 | 66 | | V94257 | MERCEDES-BENZ | | 487 | 108 | V94296 | PORSCHE | | 650 | 18 |
| V94225 | FORD | 251 | 48 | | V94258 | MWM | | 561 | 13 | V94296 | PORSCHE | | 651 | 19 |
| V94225 | FORD | 252 | 49 | | V94258 | MWM | | 561 | 14 | V94296 | PORSCHE | | 651 | 20 |
| V94225 | FORD | 259 | 65 | | V94258 | MWM | | 561 | 15 | V94299 | PORSCHE | | 651 | 21 |
| V94225 | FORD | 259 | 66 | | V94258 | MWM | | 561 | 16 | V94300 | PORSCHE | | 650 | 15 |
| V94229 | CITROËN | 146 | 35 | | V94258 | MWM | | 562 | 18 | V94300 | PORSCHE | | 650 | 17 |
| V94229 | CITROËN | 153 | 57 | | V94258 | MWM | | 562 | 20 | V94303 | AUDI | | 68 | 76 |
| V94229 | CITROËN | 153 | 58 | | V94258 | MWM | | 563 | 23 | V94303 | AUDI | | 72 | 83 |
| V94229 | PEUGEOT | 632 | 35 | | V94258 | MWM | | 563 | 27 | V94303 | SEAT | | 761 | 48 |
| V94229 | PEUGEOT | 640 | 57 | | V94260 | MWM | | 563 | 25 | V94303 | SKODA | | 781 | 35 |
| V94229 | PEUGEOT | 640 | 58 | | V94260 | MWM | | 564 | 29 | V94303 | VW | | 910 | 88 |
| V94245 | CHEVROLET | 118 | 6 | | V94261 | MWM | | 561 | 13 | V94303 | VW | | 925 | 130 |
| V94245 | CHEVROLET | 118 | 7 | | V94261 | MWM | | 561 | 14 | V94304 | VW | | 914 | 98 |
| V94245 | CHEVROLET | 118 | 8 | | V94261 | MWM | | 561 | 15 | V94304 | VW | | 915 | 101 |
| V94245 | CHEVROLET | 118 | 9 | | V94261 | MWM | | 561 | 16 | V94305 | SEAT | | 750 | 12 |
| V94245 | OPEL | 585 | 5 | | V94261 | MWM | | 562 | 18 | V94305 | SEAT | | 751 | 17 |
| V94245 | OPEL | 585 | 6 | | V94261 | MWM | | 562 | 20 | V94305 | VW | | 886 | 8 |
| V94245 | OPEL | 586 | 7 | | V94261 | MWM | | 563 | 23 | V94305 | VW | | 886 | 9 |
| V94245 | OPEL | 586 | 9 | | V94261 | MWM | | 563 | 25 | V94305 | VW | | 887 | 14 |
| V94245 | OPEL | 586 | 10 | | V94261 | MWM | | 563 | 27 | V94305 | VW | | 888 | 18 |
| V94245 | OPEL | 587 | 11 | | V94261 | MWM | | 564 | 29 | V94305 | VW | | 888 | 19 |
| V94245 | OPEL | 587 | 12 | | V94263 | PORSCHE | | 647 | 1 | V94306 | MERCEDES-BENZ | | 445 | 11 |
| V94245 | OPEL | 587 | 13 | | V94264 | PORSCHE | | 647 | 1 | V94306 | SEAT | | 764 | 58 |
| V94245 | SUZUKI | 795 | 7 | | V94265 | PORSCHE | | 647 | 5 | V94306 | VW | | 919 | 113 |









|  |  |  |  |  |  |  |  |  |  |  |  |  |  |  |
|---|---|---|---|---|---|---|---|---|---|---|---|---|---|---|
| V94306 | VW | | 923 | 123 | V94332 | MERCEDES-BENZ | | 513 | 137 | V94350 | MINI | | 549 | 7 |
| V94308 | SEAT | | 751 | 17 | V94332 | MERCEDES-BENZ | | 514 | 138 | V94352 | FORD | | 271 | 98 |
| V94308 | VW | | 886 | 10 | V94332 | MERCEDES-BENZ | | 514 | 139 | V94352 | ISUZU | | 291 | 9 |
| V94308 | VW | | 888 | 19 | V94332 | MERCEDES-BENZ | | 515 | 140 | V94353 | CHEVROLET | | 121 | 22 |
| V94309 | SEAT | | 751 | 17 | V94332 | MERCEDES-BENZ | | 515 | 141 | V94353 | OPEL | | 592 | 29 |
| V94309 | VW | | 886 | 10 | V94332 | MERCEDES-BENZ | | 516 | 142 | V94353 | VAUXHALL | | 827 | 30 |
| V94309 | VW | | 888 | 19 | V94332 | MERCEDES-BENZ | | 517 | 143 | V94355 | OPEL | | 600 | 55 |
| V94314 | RENAULT | | 694 | 43 | V94332 | MERCEDES-BENZ | | 517 | 144 | V94355 | OPEL | | 600 | 56 |
| V94314 | VOLVO | | 851 | 12 | V94332 | MERCEDES-BENZ | | 518 | 145 | V94355 | OPEL | | 601 | 57 |
| V94314 | VOLVO | | 852 | 14 | V94332 | MERCEDES-BENZ | | 518 | 146 | V94355 | SAAB | | 728 | 9 |
| V94314 | VOLVO | | 852 | 15 | V94332 | MERCEDES-BENZ | | 518 | 147 | V94355 | VAUXHALL | | 835 | 56 |
| V94314 | VOLVO | | 853 | 16 | V94332 | MERCEDES-BENZ | | 519 | 149 | V94355 | VAUXHALL | | 835 | 57 |
| V94314 | VOLVO | | 853 | 18 | V94332 | MERCEDES-BENZ | | 520 | 150 | V94356 | OPEL | | 600 | 55 |
| V94314 | VOLVO | | 855 | 23 | V94332 | MERCEDES-BENZ | | 520 | 151 | V94356 | OPEL | | 600 | 56 |
| V94314 | VOLVO | | 856 | 27 | V94332 | MERCEDES-BENZ | | 523 | 155 | V94356 | OPEL | | 601 | 57 |
| V94314 | VOLVO | | 856 | 28 | V94332 | MERCEDES-BENZ | | 523 | 156 | V94356 | SAAB | | 728 | 9 |
| V94314 | VOLVO | | 857 | 29 | V94332 | MERCEDES-BENZ | | 525 | 157 | V94356 | VAUXHALL | | 835 | 56 |
| V94314 | VOLVO | | 857 | 31 | V94332 | MERCEDES-BENZ | | 529 | 164 | V94356 | VAUXHALL | | 835 | 57 |
| V94314 | VOLVO | | 858 | 32 | V94332 | MERCEDES-BENZ | | 530 | 165 | V94359 | LAND ROVER | | 368 | 10 |
| V94314 | VOLVO | | 858 | 33 | V94332 | MERCEDES-BENZ | | 530 | 166 | V94360 | LAND ROVER | | 368 | 10 |
| V94314 | VOLVO | | 859 | 35 | V94332 | MERCEDES-BENZ | | 533 | 167 | V94363 | SAAB | | 729 | 13 |
| V94314 | VOLVO | | 860 | 38 | V94332 | MERCEDES-BENZ | | 533 | 168 | V94363 | SAAB | | 729 | 14 |
| V94315 | RENAULT | | 694 | 43 | V94332 | MERCEDES-BENZ | | 534 | 169 | V94364 | SAAB | | 729 | 13 |
| V94315 | VOLVO | | 851 | 12 | V94332 | MERCEDES-BENZ | | 534 | 170 | V94364 | SAAB | | 729 | 14 |
| V94315 | VOLVO | | 852 | 14 | V94332 | MERCEDES-BENZ | | 534 | 171 | V94366 | CHEVROLET | | 120 | 19 |
| V94315 | VOLVO | | 852 | 15 | V94332 | MERCEDES-BENZ | | 535 | 172 | V94366 | DAEWOO | | 162 | 5 |
| V94315 | VOLVO | | 853 | 16 | V94332 | MERCEDES-BENZ | | 535 | 173 | V94366 | DAEWOO | | 163 | 9 |
| V94315 | VOLVO | | 853 | 18 | V94332 | MERCEDES-BENZ | | 535 | 174 | V94367 | CHEVROLET | | 120 | 19 |
| V94315 | VOLVO | | 855 | 23 | V94332 | MERCEDES-BENZ | | 536 | 175 | V94367 | DAEWOO | | 162 | 5 |
| V94315 | VOLVO | | 856 | 27 | V94332 | MERCEDES-BENZ | | 539 | 179 | V94367 | DAEWOO | | 163 | 9 |
| V94315 | VOLVO | | 856 | 28 | V94332 | MERCEDES-BENZ | | 540 | 180 | V94368 | CHEVROLET | | 117 | 1 |
| V94315 | VOLVO | | 857 | 29 | V94332 | MERCEDES-BENZ | | 542 | 183 | V94368 | CHEVROLET | | 117 | 2 |
| V94315 | VOLVO | | 857 | 31 | V94333 | MERCEDES-BENZ | | 467 | 62 | V94368 | CHEVROLET | | 117 | 5 |
| V94315 | VOLVO | | 858 | 32 | V94333 | MERCEDES-BENZ | | 481 | 92 | V94368 | DAEWOO | | 162 | 1 |
| V94315 | VOLVO | | 858 | 33 | V94335 | PORSCHE | | 649 | 10 | V94368 | DAEWOO | | 162 | 2 |
| V94315 | VOLVO | | 859 | 35 | V94335 | PORSCHE | | 649 | 11 | V94368 | SUZUKI | | 794 | 2 |
| V94315 | VOLVO | | 860 | 38 | V94335 | PORSCHE | | 649 | 12 | V94369 | CHEVROLET | | 117 | 1 |
| V94316 | MERCEDES-BENZ | | 525 | 158 | V94335 | PORSCHE | | 649 | 13 | V94369 | CHEVROLET | | 117 | 2 |
| V94316 | MERCEDES-BENZ | | 526 | 159 | V94337 | RENAULT | | 699 | 48 | V94369 | CHEVROLET | | 117 | 5 |
| V94316 | MERCEDES-BENZ | | 528 | 161 | V94338 | DACIA | | 160 | 8 | V94369 | DAEWOO | | 162 | 1 |
| V94316 | MERCEDES-BENZ | | 529 | 163 | V94338 | MITSUBISHI | | 554 | 12 | V94369 | DAEWOO | | 162 | 2 |
| V94316 | MERCEDES-BENZ | | 536 | 176 | V94338 | OPEL | | 595 | 38 | V94369 | SUZUKI | | 794 | 2 |
| V94316 | MERCEDES-BENZ | | 538 | 178 | V94338 | RENAULT | | 684 | 23 | V94370 | DAEWOO | | 165 | 18 |
| V94316 | MERCEDES-BENZ | | 541 | 181 | V94338 | RENAULT | | 685 | 24 | V94370 | DAEWOO | | 166 | 19 |
| V94317 | MERCEDES-BENZ | | 525 | 158 | V94338 | RENAULT | | 685 | 25 | V94370 | DAEWOO | | 166 | 20 |
| V94317 | MERCEDES-BENZ | | 526 | 159 | V94338 | RENAULT | | 686 | 27 | V94370 | MERCEDES-BENZ | | 471 | 69 |
| V94317 | MERCEDES-BENZ | | 528 | 161 | V94338 | RENAULT | | 686 | 28 | V94370 | MERCEDES-BENZ | | 471 | 70 |
| V94317 | MERCEDES-BENZ | | 529 | 163 | V94338 | VAUXHALL | | 830 | 39 | V94370 | MERCEDES-BENZ | | 472 | 71 |
| V94317 | MERCEDES-BENZ | | 536 | 176 | V94338 | VOLVO | | 851 | 11 | V94370 | MERCEDES-BENZ | | 472 | 72 |
| V94317 | MERCEDES-BENZ | | 538 | 178 | V94339 | DACIA | | 160 | 8 | V94370 | MERCEDES-BENZ | | 473 | 73 |
| V94317 | MERCEDES-BENZ | | 541 | 181 | V94339 | OPEL | | 595 | 38 | V94370 | MERCEDES-BENZ | | 474 | 75 |
| V94319 | RENAULT | | 699 | 48 | V94339 | RENAULT | | 684 | 23 | V94370 | MERCEDES-BENZ | | 475 | 78 |
| V94319 | RENAULT | | 699 | 49 | V94339 | RENAULT | | 685 | 24 | V94370 | MERCEDES-BENZ | | 477 | 81 |
| V94320 | RENAULT | | 677 | 15 | V94339 | RENAULT | | 685 | 25 | V94370 | MERCEDES-BENZ | | 480 | 90 |
| V94321 | FORD | | 257 | 61 | V94339 | RENAULT | | 686 | 28 | V94370 | SSANGYONG | | 787 | 3 |
| V94321 | MAZDA | | 408 | 13 | V94339 | VAUXHALL | | 830 | 39 | V94370 | SSANGYONG | | 787 | 4 |
| V94322 | FORD | | 257 | 61 | V94339 | VOLVO | | 851 | 11 | V94370 | SSANGYONG | | 788 | 5 |
| V94322 | MAZDA | | 408 | 13 | V94340 | NISSAN | | 575 | 31 | V94371 | DAEWOO | | 165 | 18 |
| V94326 | NISSAN | | 576 | 33 | V94342 | LAND ROVER | | 367 | 3 | V94371 | DAEWOO | | 166 | 19 |
| V94328 | FORD | | 268 | 91 | V94342 | LOTUS | | 374 | 3 | V94371 | DAEWOO | | 166 | 20 |
| V94328 | HYUNDAI | | 287 | 29 | V94342 | MG | | 545 | 4 | V94371 | MERCEDES-BENZ | | 471 | 69 |
| V94328 | HYUNDAI | | 287 | 30 | V94342 | MG | | 546 | 5 | V94371 | MERCEDES-BENZ | | 471 | 70 |
| V94328 | KIA | | 342 | 19 | V94342 | MG | | 546 | 6 | V94371 | MERCEDES-BENZ | | 472 | 71 |
| V94328 | MITSUBISHI | | 556 | 18 | V94342 | ROVER | | 722 | 13 | V94371 | MERCEDES-BENZ | | 472 | 72 |
| V94328 | MITSUBISHI | | 556 | 21 | V94342 | ROVER | | 722 | 14 | V94371 | MERCEDES-BENZ | | 473 | 73 |
| V94328 | MITSUBISHI | | 557 | 22 | V94342 | ROVER | | 722 | 16 | V94371 | MERCEDES-BENZ | | 474 | 75 |
| V94329 | NISSAN | | 576 | 33 | V94344 | ISUZU | | 291 | 7 | V94371 | MERCEDES-BENZ | | 475 | 78 |
| V94330 | NISSAN | | 576 | 33 | V94344 | OPEL | | 608 | 82 | V94371 | MERCEDES-BENZ | | 477 | 81 |
| V94332 | MERCEDES-BENZ | | 511 | 132 | V94344 | VAUXHALL | | 842 | 82 | V94371 | MERCEDES-BENZ | | 480 | 90 |
| V94332 | MERCEDES-BENZ | | 511 | 133 | V94349 | CHRYSLER | | 127 | 3 | V94371 | SSANGYONG | | 787 | 3 |
| V94332 | MERCEDES-BENZ | | 512 | 134 | V94349 | MINI | | 549 | 7 | V94371 | SSANGYONG | | 787 | 4 |
| V94332 | MERCEDES-BENZ | | 513 | 136 | V94350 | CHRYSLER | | 127 | 3 | V94371 | SSANGYONG | | 788 | 5 |



NUMERICAL PARTS LIST

Nummerische Teilenummernliste • Elenco riferimenti
Liste des références produits













|  |  |  |  | 9 |  |  |  |  | 9 |  |  |  |  | 9 |
|---|---|---|---|-----|---|---|---|--|-----|---|---|---|---|----|
| V94374 | FORD | | 253 | 52 | V94403 | BMW | | 110 | 52 | V94431 | NISSAN | | 576 | 34 |
| V94374 | SEAT | | 764 | 58 | V94403 | BMW | | 114 | 61 | V94432 | NISSAN | | 569 | 13 |
| V94374 | VW | | 919 | 113 | V94403 | BMW | | 114 | 64 | V94432 | NISSAN | | 571 | 18 |
| V94374 | VW | | 922 | 119 | V94403 | BMW | | 115 | 66 | V94432 | NISSAN | | 573 | 24 |
| V94374 | VW | | 922 | 120 | V94404 | SEAT | | 753 | 24 | V94433 | NISSAN | | 577 | 39 |
| V94376 | MERCEDES-BENZ | | 486 | 104 | V94404 | VW | | 892 | 27 | V94434 | NISSAN | | 573 | 24 |
| V94376 | MERCEDES-BENZ | | 486 | 105 | V94405 | AUDI | | 48 | 11 | V94435 | NISSAN | | 569 | 12 |
| V94377 | DAEWOO | | 166 | 19 | V94405 | SEAT | | 752 | 20 | V94435 | NISSAN | | 569 | 13 |
| V94377 | MERCEDES-BENZ | | 471 | 70 | V94405 | SEAT | | 753 | 24 | V94435 | NISSAN | | 569 | 14 |
| V94377 | MERCEDES-BENZ | | 472 | 71 | V94405 | SEAT | | 754 | 28 | V94435 | NISSAN | | 571 | 18 |
| V94377 | MERCEDES-BENZ | | 473 | 73 | V94405 | SKODA | | 772 | 8 | V94436 | RENAULT | | 694 | 42 |
| V94377 | MERCEDES-BENZ | | 474 | 75 | V94405 | VW | | 889 | 21 | V94437 | NISSAN | | 569 | 12 |
| V94377 | MERCEDES-BENZ | | 475 | 78 | V94405 | VW | | 892 | 27 | V94437 | NISSAN | | 569 | 14 |
| V94377 | MERCEDES-BENZ | | 480 | 90 | V94405 | VW | | 892 | 29 | V94440 | RENAULT | | 694 | 42 |
| V94378 | FORD | | 261 | 72 | V94405 | VW | | 897 | 47 | V94441 | NISSAN | | 575 | 31 |
| V94378 | FORD | | 262 | 76 | V94405 | VW | | 897 | 48 | V94442 | DACIA | | 159 | 5 |
| V94378 | FORD | | 266 | 85 | V94408 | PORSCHE | | 649 | 10 | V94442 | DACIA | | 160 | 7 |
| V94378 | FORD | | 266 | 86 | V94408 | PORSCHE | | 649 | 11 | V94442 | NISSAN | | 570 | 15 |
| V94378 | JAGUAR | | 332 | 4 | V94408 | PORSCHE | | 649 | 13 | V94442 | RENAULT | | 674 | 11 |
| V94378 | JAGUAR | | 332 | 5 | V94409 | SEAT | | 758 | 39 | V94442 | RENAULT | | 675 | 12 |
| V94378 | LAND ROVER | | 369 | 14 | V94409 | SKODA | | 776 | 20 | V94442 | RENAULT | | 680 | 20 |
| V94378 | LAND ROVER | | 370 | 17 | V94409 | VW | | 905 | 73 | V94442 | RENAULT | | 683 | 22 |
| V94379 | FORD | | 261 | 72 | V94410 | SEAT | | 758 | 39 | V94444 | SCANIA | | 734 | 4 |
| V94379 | JAGUAR | | 332 | 4 | V94410 | SKODA | | 776 | 20 | V94444 | SCANIA | | 737 | 10 |
| V94379 | JAGUAR | | 332 | 5 | V94410 | VW | | 905 | 73 | V94444 | SCANIA | | 738 | 11 |
| V94380 | FORD | | 266 | 84 | V94411 | VW | | 931 | 146 | V94444 | SCANIA | | 742 | 19 |
| V94381 | FORD | | 266 | 84 | V94414 | AUDI | | 50 | 20 | V94444 | SCANIA | | 743 | 22 |
| V94386 | FORD | | 253 | 55 | V94414 | AUDI | | 51 | 22 | V94445 | SCANIA | | 734 | 4 |
| V94390 | MERCEDES-BENZ | | 473 | 74 | V94414 | SEAT | | 756 | 35 | V94445 | SCANIA | | 737 | 10 |
| V94390 | MERCEDES-BENZ | | 474 | 76 | V94414 | SEAT | | 757 | 37 | V94445 | SCANIA | | 738 | 11 |
| V94390 | MERCEDES-BENZ | | 476 | 79 | V94414 | SEAT | | 757 | 38 | V94445 | SCANIA | | 742 | 19 |
| V94390 | MERCEDES-BENZ | | 476 | 80 | V94414 | SKODA | | 776 | 19 | V94445 | SCANIA | | 743 | 22 |
| V94391 | MERCEDES-BENZ | | 473 | 74 | V94414 | VW | | 903 | 68 | V94446 | HYUNDAI | | 284 | 18 |
| V94391 | MERCEDES-BENZ | | 474 | 76 | V94414 | VW | | 904 | 70 | V94446 | HYUNDAI | | 284 | 18 |
| V94391 | MERCEDES-BENZ | | 476 | 79 | V94414 | VW | | 904 | 72 | V94447 | NISSAN | | 555 | 16 |
| V94391 | MERCEDES-BENZ | | 476 | 80 | V94414 | VW | | 907 | 80 | V94447 | NISSAN | | 567 | 5 |
| V94393 | MERCEDES-BENZ | | 487 | 109 | V94415 | FORD | | 248 | 38 | V94447 | NISSAN | | 568 | 8 |
| V94393 | MERCEDES-BENZ | | 488 | 111 | V94415 | VW | | 921 | 117 | V94447 | NISSAN | | 568 | 9 |
| V94393 | MERCEDES-BENZ | | 489 | 112 | V94415 | VW | | 922 | 121 | V94447 | RENAULT | | 672 | 6 |
| V94394 | MERCEDES-BENZ | | 443 | 4 | V94418 | SEAT | | 749 | 9 | V94448 | NISSAN | | 577 | 38 |
| V94394 | MERCEDES-BENZ | | 443 | 5 | V94418 | SKODA | | 772 | 5 | V94449 | NISSAN | | 577 | 38 |
| V94395 | MERCEDES-BENZ | | 443 | 4 | V94418 | SKODA | | 772 | 6 | V94450 | SEAT | | 761 | 51 |
| V94395 | MERCEDES-BENZ | | 443 | 5 | V94418 | SKODA | | 772 | 7 | V94450 | VW | | 912 | 92 |
| V94396 | MERCEDES-BENZ | | 449 | 24 | V94418 | VW | | 885 | 5 | V94450 | VW | | 914 | 96 |
| V94396 | MERCEDES-BENZ | | 449 | 26 | V94419 | SEAT | | 749 | 9 | V94451 | HYUNDAI | | 284 | 18 |
| V94396 | MERCEDES-BENZ | | 451 | 30 | V94419 | SKODA | | 772 | 5 | V94451 | HYUNDAI | | 284 | 18 |
| V94396 | MERCEDES-BENZ | | 454 | 33 | V94419 | SKODA | | 772 | 7 | V94452 | NISSAN | | 555 | 16 |
| V94396 | MERCEDES-BENZ | | 455 | 34 | V94419 | VW | | 885 | 5 | V94452 | NISSAN | | 576 | 33 |
| V94397 | MERCEDES-BENZ | | 449 | 24 | V94423 | AUDI | | 49 | 15 | V94454 | TOYOTA | | 808 | 22 |
| V94397 | MERCEDES-BENZ | | 449 | 26 | V94423 | SKODA | | 774 | 13 | V94455 | TOYOTA | | 808 | 22 |
| V94397 | MERCEDES-BENZ | | 454 | 33 | V94423 | VW | | 900 | 59 | V94456 | TOYOTA | | 810 | 28 |
| V94397 | MERCEDES-BENZ | | 455 | 34 | V94424 | AUDI | | 55 | 34 | V94457 | TOYOTA | | 810 | 28 |
| V94398 | MERCEDES-BENZ | | 464 | 53 | V94424 | SEAT | | 760 | 47 | V94458 | TOYOTA | | 814 | 41 |
| V94398 | MERCEDES-BENZ | | 465 | 55 | V94424 | SKODA | | 778 | 27 | V94459 | TOYOTA | | 808 | 24 |
| V94398 | MERCEDES-BENZ | | 465 | 57 | V94424 | VW | | 910 | 87 | V94459 | TOYOTA | | 809 | 25 |
| V94398 | MERCEDES-BENZ | | 466 | 59 | V94425 | AUDI | | 55 | 34 | V94459 | TOYOTA | | 809 | 26 |
| V94398 | MERCEDES-BENZ | | 467 | 61 | V94425 | SEAT | | 760 | 47 | V94459 | TOYOTA | | 811 | 31 |
| V94399 | MERCEDES-BENZ | | 464 | 53 | V94425 | SKODA | | 778 | 27 | V94460 | TOYOTA | | 808 | 23 |
| V94399 | MERCEDES-BENZ | | 465 | 55 | V94425 | VW | | 910 | 87 | V94460 | TOYOTA | | 808 | 24 |
| V94399 | MERCEDES-BENZ | | 465 | 57 | V94426 | CHEVROLET | | 122 | 25 | V94460 | TOYOTA | | 809 | 25 |
| V94399 | MERCEDES-BENZ | | 466 | 59 | V94426 | HONDA | | 276 | 15 | V94460 | TOYOTA | | 809 | 26 |
| V94399 | MERCEDES-BENZ | | 467 | 61 | V94426 | OPEL | | 594 | 35 | V94461 | TOYOTA | | 811 | 31 |
| V94400 | MERCEDES-BENZ | | 444 | 6 | V94426 | VAUXHALL | | 829 | 36 | V94461 | HYUNDAI | | 280 | 1 |
| V94401 | MERCEDES-BENZ | | 444 | 6 | V94427 | CHEVROLET | | 122 | 25 | V94462 | HYUNDAI | | 280 | 1 |
| V94402 | BMW | | 97 | 22 | V94427 | HONDA | | 276 | 15 | V94463 | HYUNDAI | | 285 | 22 |
| V94402 | BMW | | 100 | 26 | V94427 | OPEL | | 594 | 35 | V94464 | HYUNDAI | | 285 | 22 |
| V94402 | BMW | | 101 | 28 | V94427 | VAUXHALL | | 829 | 36 | V94468 | FIAT | | 206 | 44 |
| V94403 | BMW | | 96 | 18 | V94428 | HYUNDAI | | 288 | 32 | V94468 | FIAT | | 223 | 97 |
| V94403 | BMW | | 97 | 22 | V94428 | KIA | | 342 | 20 | V94468 | LANCIA | | 354 | 21 |
| V94403 | BMW | | 100 | 26 | V94429 | HYUNDAI | | 288 | 32 | V94468 | LANCIA | | 364 | 56 |
| V94403 | BMW | | 101 | 28 | V94429 | KIA | | 342 | 20 | V94469 | NISSAN | | 575 | 31 |
| V94403 | BMW | | 110 | 49 | V94430 | NISSAN | | 576 | 34 | V94470 | ALFA ROMEO | | 28 | 20 |
| | | | | | | | | | | V94470 | ALFA ROMEO | | 29 | 22 |









|    9 | | | |    9 | | | |    9 | | | |
|---|---------------|-----|----|---|----------|-----|----|---|---------------|-----|-----|
| V94470 | ALFA ROMEO | 29 | 23 | V94490 | FORD | 260 | 67 | V94517 | PERKINS | 611 | 4 |
| V94470 | ALFA ROMEO | 30 | 25 | V94490 | FORD | 261 | 69 | V94517 | PERKINS | 611 | 5 |
| V94470 | ALFA ROMEO | 30 | 27 | V94490 | LANCIA | 362 | 46 | V94517 | PERKINS | 611 | 6 |
| V94470 | ALFA ROMEO | 31 | 28 | V94490 | LANCIA | 362 | 47 | V94517 | PERKINS | 612 | 7 |
| V94470 | ALFA ROMEO | 31 | 29 | V94490 | LANCIA | 363 | 51 | V94518 | PERKINS | 611 | 3 |
| V94470 | FIAT | 207 | 48 | V94490 | PEUGEOT | 637 | 46 | V94518 | PERKINS | 611 | 4 |
| V94470 | FIAT | 208 | 49 | V94490 | PEUGEOT | 638 | 52 | V94518 | PERKINS | 611 | 5 |
| V94470 | FIAT | 209 | 50 | V94490 | VOLVO | 860 | 39 | V94518 | PERKINS | 611 | 6 |
| V94470 | FIAT | 212 | 58 | V94491 | CITROËN | 149 | 43 | V94518 | PERKINS | 612 | 7 |
| V94470 | LANCIA | 355 | 24 | V94491 | CITROËN | 150 | 46 | V94519 | PERKINS | 613 | 12 |
| V94470 | LANCIA | 356 | 26 | V94491 | CITROËN | 150 | 48 | V94519 | PERKINS | 613 | 13 |
| V94470 | LANCIA | 357 | 31 | V94491 | CITROËN | 152 | 53 | V94519 | PERKINS | 613 | 14 |
| V94470 | OPEL | 598 | 46 | V94491 | FIAT | 218 | 78 | V94519 | PERKINS | 615 | 20 |
| V94470 | SAAB | 727 | 6 | V94491 | FIAT | 219 | 80 | V94521 | BMW | 114 | 62 |
| V94470 | SUZUKI | 798 | 19 | V94491 | FIAT | 219 | 81 | V94529 | DEUTZ/KHD | 176 | 1 |
| V94470 | VAUXHALL | 832 | 47 | V94491 | FIAT | 219 | 82 | V94529 | DEUTZ/KHD | 176 | 2 |
| V94471 | ALFA ROMEO | 28 | 20 | V94491 | FIAT | 220 | 85 | V94529 | DEUTZ/KHD | 176 | 3 |
| V94471 | ALFA ROMEO | 29 | 22 | V94491 | FORD | 260 | 67 | V94529 | DEUTZ/KHD | 176 | 4 |
| V94471 | ALFA ROMEO | 29 | 23 | V94491 | FORD | 260 | 68 | V94529 | DEUTZ/KHD | 176 | 5 |
| V94471 | ALFA ROMEO | 30 | 25 | V94491 | FORD | 261 | 69 | V94529 | DEUTZ/KHD | 176 | 6 |
| V94471 | ALFA ROMEO | 30 | 27 | V94491 | FORD | 261 | 70 | V94529 | DEUTZ/KHD | 176 | 7 |
| V94471 | ALFA ROMEO | 31 | 28 | V94491 | LANCIA | 362 | 46 | V94530 | DEUTZ/KHD | 177 | 9 |
| V94471 | ALFA ROMEO | 31 | 29 | V94491 | LANCIA | 362 | 47 | V94530 | DEUTZ/KHD | 177 | 11 |
| V94471 | FIAT | 207 | 48 | V94491 | LANCIA | 363 | 51 | V94530 | DEUTZ/KHD | 178 | 13 |
| V94471 | FIAT | 208 | 49 | V94491 | PEUGEOT | 636 | 43 | V94530 | DEUTZ/KHD | 178 | 15 |
| V94471 | FIAT | 209 | 50 | V94491 | PEUGEOT | 637 | 46 | V94530 | DEUTZ/KHD | 178 | 17 |
| V94471 | FIAT | 212 | 58 | V94491 | PEUGEOT | 637 | 47 | V94532 | MERCEDES-BENZ | 481 | 94 |
| V94471 | LANCIA | 355 | 24 | V94491 | PEUGEOT | 638 | 52 | V94532 | MERCEDES-BENZ | 487 | 107 |
| V94471 | LANCIA | 356 | 26 | V94491 | VOLVO | 860 | 39 | V94536 | MERCEDES-BENZ | 444 | 7 |
| V94471 | LANCIA | 357 | 31 | V94492 | CITROËN | 144 | 31 | V94536 | MERCEDES-BENZ | 444 | 8 |
| V94471 | OPEL | 598 | 46 | V94492 | PEUGEOT | 630 | 30 | V94536 | MERCEDES-BENZ | 444 | 9 |
| V94471 | SAAB | 727 | 6 | V94493 | CITROËN | 144 | 31 | V94536 | MERCEDES-BENZ | 444 | 10 |
| V94471 | SUZUKI | 798 | 19 | V94493 | PEUGEOT | 630 | 30 | V94537 | MWM | 562 | 21 |
| V94471 | VAUXHALL | 832 | 47 | V94494 | CITROËN | 151 | 50 | V94537 | MWM | 563 | 24 |
| V94474 | RENAULT | 710 | 76 | V94494 | PEUGEOT | 638 | 50 | V94537 | MWM | 564 | 28 |
| V94474 | RENAULT | 712 | 86 | V94495 | CITROËN | 151 | 50 | V94538 | MWM | 562 | 21 |
| V94475 | RENAULT | 710 | 76 | V94495 | PEUGEOT | 638 | 50 | V94538 | MWM | 563 | 24 |
| V94475 | RENAULT | 710 | 78 | V94498 | DACIA | 159 | 6 | V94538 | MWM | 564 | 28 |
| V94475 | RENAULT | 711 | 82 | V94498 | NISSAN | 572 | 22 | V94539 | MWM | 562 | 17 |
| V94475 | RENAULT | 712 | 86 | V94498 | NISSAN | 680 | 18 | V94539 | MWM | 562 | 19 |
| V94476 | NISSAN | 575 | 31 | V94498 | RENAULT | 680 | 19 | V94539 | MWM | 562 | 22 |
| V94480 | DAEWOO | 166 | 19 | V94498 | RENAULT | 681 | 21 | V94539 | MWM | 563 | 26 |
| V94480 | MERCEDES-BENZ | 471 | 70 | V94499 | DACIA | 159 | 6 | V94540 | MWM | 559 | 1 |
| V94480 | MERCEDES-BENZ | 472 | 71 | V94499 | NISSAN | 572 | 22 | V94540 | MWM | 559 | 2 |
| V94480 | MERCEDES-BENZ | 473 | 73 | V94499 | RENAULT | 680 | 18 | V94540 | MWM | 559 | 3 |
| V94480 | MERCEDES-BENZ | 474 | 75 | V94499 | RENAULT | 680 | 19 | V94540 | MWM | 559 | 4 |
| V94480 | MERCEDES-BENZ | 475 | 78 | V94499 | RENAULT | 681 | 21 | V94540 | MWM | 559 | 5 |
| V94480 | MERCEDES-BENZ | 480 | 90 | V94501 | DACIA | 159 | 6 | V94540 | MWM | 560 | 6 |
| V94486 | CITROËN | 150 | 45 | V94501 | RENAULT | 680 | 18 | V94540 | MWM | 560 | 7 |
| V94486 | FIAT | 218 | 77 | V94501 | RENAULT | 680 | 19 | V94540 | MWM | 560 | 8 |
| V94486 | FIAT | 219 | 82 | V94501 | RENAULT | 681 | 21 | V94541 | MWM | 562 | 17 |
| V94486 | LANCIA | 361 | 44 | V94510 | SUZUKI | 800 | 26 | V94541 | MWM | 562 | 19 |
| V94486 | LANCIA | 362 | 46 | V94511 | SUZUKI | 800 | 26 | V94541 | MWM | 562 | 22 |
| V94486 | PEUGEOT | 637 | 45 | V94513 | SUZUKI | 800 | 26 | V94541 | MWM | 562 | 22 |
| V94486 | SUZUKI | 799 | 24 | V94513 | NISSAN | 577 | 37 | V94541 | MWM | 563 | 26 |
| V94487 | CITROËN | 150 | 45 | V94513 | NISSAN | 578 | 40 | V94542 | OPEL | 606 | 72 |
| V94487 | FIAT | 218 | 77 | V94513 | OPEL | 606 | 73 | V94542 | VAUXHALL | 840 | 72 |
| V94487 | FIAT | 219 | 82 | V94513 | OPEL | 607 | 78 | V94544 | PORSCHE | 649 | 13 |
| V94487 | LANCIA | 361 | 44 | V94513 | RENAULT | 700 | 50 | V94545 | PORSCHE | 650 | 15 |
| V94487 | LANCIA | 362 | 46 | V94513 | RENAULT | 700 | 52 | V94545 | PORSCHE | 650 | 16 |
| V94487 | PEUGEOT | 637 | 45 | V94513 | RENAULT | 704 | 58 | V94546 | PORSCHE | 647 | 4 |
| V94487 | SUZUKI | 799 | 24 | V94513 | VAUXHALL | 840 | 73 | V94546 | VW | 932 | 149 |
| V94488 | CITROËN | 154 | 63 | V94513 | VAUXHALL | 841 | 78 | V94546 | VW | 933 | 151 |
| V94488 | PEUGEOT | 641 | 63 | V94514 | NISSAN | 577 | 37 | V94546 | VW | 933 | 154 |
| V94489 | CITROËN | 154 | 63 | V94514 | NISSAN | 578 | 40 | V94547 | AUDI | 53 | 30 |
| V94489 | PEUGEOT | 641 | 63 | V94514 | NISSAN | 578 | 40 | V94547 | AUDI | 65 | 65 |
| V94490 | CITROËN | 150 | 46 | V94514 | OPEL | 606 | 73 | V94547 | VW | 921 | 116 |
| V94490 | CITROËN | 152 | 53 | V94514 | OPEL | 607 | 78 | V94547 | VW | 921 | 116 |
| V94490 | FIAT | 218 | 78 | V94514 | RENAULT | 700 | 50 | V94548 | SEAT | 767 | 68 |
| V94490 | FIAT | 219 | 81 | V94514 | RENAULT | 700 | 52 | V94548 | VW | 933 | 153 |
| V94490 | FIAT | 219 | 82 | V94514 | RENAULT | 704 | 58 | V94548 | VW | 933 | 155 |
| V94490 | FIAT | 220 | 85 | V94514 | VAUXHALL | 840 | 73 | V94549 | SEAT | 767 | 68 |
| | | | | V94514 | VAUXHALL | 841 | 78 | V94549 | VW | 933 | 153 |
| | | | | V94517 | PERKINS | 611 | 3 | V94549 | VW | 933 | 155 |



NUMERICAL PARTS LIST

Nummerische Teilenummernliste • Elenco riferimenti
Liste des références produits















|  |  |  |  | 9 |  |  |  |  | 9 |  |  |  |  | 9 |
|---|---|---|---|----------|---|---|---|--|----------|---|---|---|---|----------|
| V94552 | RENAULT | | 702 | 54 | V94583 | MAN | | 395 | 14 | V94595 | BMW | | 103 | 31 |
| V94552 | RENAULT | | 703 | 56 | V94583 | MAN | | 395 | 15 | V94595 | BMW | | 104 | 32 |
| V94555 | BMW | | 92 | 3 | V94583 | MAN | | 395 | 16 | V94595 | BMW | | 105 | 35 |
| V94555 | BMW | | 94 | 9 | V94583 | MAN | | 395 | 17 | V94595 | BMW | | 105 | 37 |
| V94555 | BMW | | 94 | 10 | V94583 | MAN | | 395 | 18 | V94595 | BMW | | 106 | 38 |
| V94555 | LAND ROVER | | 367 | 2 | V94583 | MAN | | 396 | 19 | V94595 | BMW | | 111 | 54 |
| V94555 | OPEL | | 596 | 40 | V94583 | MAN | | 397 | 21 | V94599 | CITROËN | | 142 | 24 |
| V94555 | ROVER | | 722 | 15 | V94583 | MAN | | 398 | 22 | V94599 | PEUGEOT | | 629 | 25 |
| V94555 | VAUXHALL | | 831 | 41 | V94583 | MAN | | 401 | 24 | V94601 | CITROËN | | 135 | 6 |
| V94558 | MERCEDES-BENZ | | 519 | 148 | V94583 | MAN | | 401 | 25 | V94601 | FORD | | 239 | 11 |
| V94558 | MERCEDES-BENZ | | 522 | 153 | V94583 | MAN | | 402 | 28 | V94601 | MAZDA | | 406 | 4 |
| V94558 | MERCEDES-BENZ | | 522 | 154 | V94583 | MAN | | 402 | 29 | V94601 | PEUGEOT | | 621 | 6 |
| V94562 | RENAULT | | 699 | 49 | V94583 | MAN | | 403 | 30 | V94601 | TOYOTA | | 804 | 8 |
| V94564 | MAN | | 392 | 10 | V94583 | MAN | | 404 | 32 | V94602 | CITROËN | | 135 | 6 |
| V94564 | MAN | | 393 | 11 | V94588 | ALFA ROMEO | | 28 | 21 | V94602 | FORD | | 239 | 11 |
| V94564 | MAN | | 393 | 12 | V94588 | ALFA ROMEO | | 29 | 24 | V94602 | MAZDA | | 406 | 4 |
| V94564 | MAN | | 394 | 13 | V94588 | ALFA ROMEO | | 30 | 26 | V94602 | PEUGEOT | | 621 | 6 |
| V94564 | MAN | | 395 | 14 | V94588 | ALFA ROMEO | | 31 | 30 | V94602 | TOYOTA | | 804 | 8 |
| V94564 | MAN | | 395 | 15 | V94588 | ALFA ROMEO | | 32 | 31 | V94603 | CITROËN | | 135 | 7 |
| V94564 | MAN | | 395 | 16 | V94588 | FIAT | | 210 | 52 | V94603 | SUZUKI | | 795 | 9 |
| V94564 | MAN | | 395 | 17 | V94588 | FIAT | | 210 | 53 | V94604 | CITROËN | | 135 | 7 |
| V94564 | MAN | | 395 | 18 | V94588 | FIAT | | 210 | 54 | V94604 | SUZUKI | | 795 | 9 |
| V94564 | MAN | | 396 | 19 | V94588 | FIAT | | 212 | 59 | V94606 | NISSAN | | 574 | 27 |
| V94564 | MAN | | 397 | 21 | V94588 | LANCIA | | 356 | 27 | V94606 | OPEL | | 599 | 50 |
| V94564 | MAN | | 398 | 22 | V94588 | LANCIA | | 358 | 32 | V94606 | RENAULT | | 689 | 32 |
| V94564 | MAN | | 401 | 24 | V94588 | OPEL | | 598 | 47 | V94606 | RENAULT | | 689 | 33 |
| V94564 | MAN | | 401 | 25 | V94588 | SAAB | | 726 | 4 | V94606 | RENAULT | | 692 | 40 |
| V94564 | MAN | | 402 | 28 | V94588 | SAAB | | 727 | 5 | V94606 | RENAULT | | 694 | 41 |
| V94564 | MAN | | 402 | 29 | V94588 | SAAB | | 727 | 7 | V94606 | VAUXHALL | | 833 | 51 |
| V94564 | MAN | | 403 | 30 | V94588 | VAUXHALL | | 833 | 48 | V94607 | NISSAN | | 574 | 27 |
| V94564 | MAN | | 404 | 32 | V94589 | ALFA ROMEO | | 28 | 21 | V94607 | OPEL | | 599 | 50 |
| V94566 | CITROËN | | 156 | 71 | V94589 | ALFA ROMEO | | 29 | 24 | V94607 | RENAULT | | 689 | 32 |
| V94566 | CITROËN | | 156 | 72 | V94589 | ALFA ROMEO | | 30 | 26 | V94607 | RENAULT | | 689 | 33 |
| V94566 | DAF | | 168 | 1 | V94589 | ALFA ROMEO | | 31 | 30 | V94607 | RENAULT | | 692 | 40 |
| V94566 | PEUGEOT | | 644 | 76 | V94589 | ALFA ROMEO | | 32 | 31 | V94607 | RENAULT | | 694 | 41 |
| V94566 | PEUGEOT | | 644 | 77 | V94589 | FIAT | | 210 | 52 | V94607 | VAUXHALL | | 833 | 51 |
| V94567 | CITROËN | | 156 | 71 | V94589 | FIAT | | 210 | 53 | V94608 | DACIA | | 159 | 4 |
| V94567 | CITROËN | | 156 | 72 | V94589 | FIAT | | 210 | 54 | V94608 | MERCEDES-BENZ | | 443 | 3 |
| V94567 | DAF | | 168 | 1 | V94589 | FIAT | | 212 | 59 | V94608 | NISSAN | | 570 | 16 |
| V94567 | PEUGEOT | | 644 | 76 | V94589 | LANCIA | | 356 | 27 | V94608 | RENAULT | | 677 | 16 |
| V94567 | PEUGEOT | | 644 | 77 | V94589 | LANCIA | | 358 | 32 | V94608 | SUZUKI | | 797 | 15 |
| V94568 | TOYOTA | | 804 | 9 | V94589 | OPEL | | 598 | 47 | V94609 | DACIA | | 159 | 4 |
| V94569 | TOYOTA | | 806 | 17 | V94589 | SAAB | | 726 | 4 | V94609 | MERCEDES-BENZ | | 443 | 3 |
| V94570 | MINI | | 553 | 8 | V94589 | SAAB | | 727 | 5 | V94609 | NISSAN | | 570 | 16 |
| V94572 | KIA | | 340 | 12 | V94589 | SAAB | | 727 | 7 | V94609 | RENAULT | | 677 | 16 |
| V94572 | MAZDA | | 407 | 8 | V94589 | VAUXHALL | | 833 | 48 | V94609 | SUZUKI | | 797 | 15 |
| V94573 | RENAULT | | 690 | 34 | V94590 | ALFA ROMEO | | 28 | 20 | V94614 | RENAULT | | 692 | 38 |
| V94573 | RENAULT | | 692 | 39 | V94590 | ALFA ROMEO | | 29 | 22 | V94615 | RENAULT | | 692 | 38 |
| V94574 | RENAULT | | 690 | 34 | V94590 | ALFA ROMEO | | 31 | 29 | V94616 | RENAULT | | 690 | 35 |
| V94574 | RENAULT | | 692 | 39 | V94590 | FIAT | | 208 | 49 | V94620 | RENAULT | | 715 | 95 |
| V94575 | DEUTZ/KHD | | 176 | 1 | V94590 | FIAT | | 212 | 58 | V94621 | RENAULT | | 715 | 95 |
| V94575 | DEUTZ/KHD | | 176 | 3 | V94590 | LANCIA | | 356 | 26 | V94622 | RENAULT | | 710 | 78 |
| V94575 | DEUTZ/KHD | | 176 | 7 | V94590 | LANCIA | | 357 | 31 | V94622 | RENAULT | | 711 | 82 |
| V94577 | MERCEDES-BENZ | | 519 | 148 | V94591 | ALFA ROMEO | | 27 | 17 | V94627 | RENAULT | | 716 | 97 |
| V94577 | MERCEDES-BENZ | | 522 | 153 | V94591 | ALFA ROMEO | | 28 | 19 | V94630 | RENAULT | | 716 | 98 |
| V94580 | SEAT | | 751 | 14 | V94591 | ALFA ROMEO | | 33 | 35 | V94631 | RENAULT | | 716 | 98 |
| V94580 | VW | | 887 | 12 | V94591 | FIAT | | 207 | 47 | V94636 | CHEVROLET | | 118 | 10 |
| V94580 | VW | | 887 | 13 | V94591 | FIAT | | 215 | 68 | V94636 | DAEWOO | | 162 | 3 |
| V94580 | VW | | 888 | 18 | V94591 | LANCIA | | 355 | 23 | V94636 | DAEWOO | | 162 | 4 |
| V94580 | VW | | 899 | 58 | V94591 | LANCIA | | 359 | 37 | V94637 | CHEVROLET | | 118 | 10 |
| V94581 | TOYOTA | | 812 | 34 | V94592 | FIAT | | 224 | 101 | V94637 | DAEWOO | | 162 | 3 |
| V94581 | TOYOTA | | 813 | 35 | V94592 | IVECO | | 300 | 1 | V94637 | DAEWOO | | 162 | 4 |
| V94581 | TOYOTA | | 813 | 38 | V94593 | FIAT | | 224 | 101 | V94638 | DAF | | 171 | 10 |
| V94581 | VW | | 932 | 150 | V94593 | IVECO | | 300 | 1 | V94638 | DAF | | 171 | 12 |
| V94582 | FIAT | | 207 | 47 | V94594 | BMW | | 97 | 20 | V94638 | DAF | | 172 | 13 |
| V94582 | FIAT | | 215 | 68 | V94594 | BMW | | 103 | 31 | V94638 | DAF | | 172 | 15 |
| V94582 | LANCIA | | 355 | 23 | V94594 | BMW | | 104 | 32 | V94639 | DAF | | 171 | 10 |
| V94582 | LANCIA | | 359 | 37 | V94594 | BMW | | 105 | 35 | V94639 | DAF | | 171 | 12 |
| V94583 | MAN | | 392 | 10 | V94594 | BMW | | 105 | 37 | V94639 | DAF | | 172 | 13 |
| V94583 | MAN | | 393 | 11 | V94594 | BMW | | 106 | 38 | V94639 | DAF | | 172 | 15 |
| V94583 | MAN | | 393 | 12 | V94594 | BMW | | 111 | 54 | V94644 | SEAT | | 749 | 6 |
| V94583 | MAN | | 394 | 13 | V94595 | BMW | | 97 | 20 | V94644 | VW | | 884 | 2 |















|    9 | | | |    9 | | | |    9 | | | |
|---|----------|-----|-----|---|---------------|-----|-----|---|---------------|-----|----|
| V94645 | SEAT | 749 | 6 | V94691 | AUDI | 77 | 96 | V94750 | MERCEDES-BENZ | 460 | 46 |
| V94645 | VW | 884 | 2 | V94691 | AUDI | 77 | 97 | V94757 | DEUTZ/KHD | 181 | 29 |
| V94646 | AUDI | 48 | 11 | V94691 | AUDI | 77 | 98 | V94757 | DEUTZ/KHD | 181 | 30 |
| V94646 | SEAT | 752 | 20 | V94691 | AUDI | 77 | 99 | V94757 | DEUTZ/KHD | 182 | 33 |
| V94646 | SEAT | 754 | 28 | V94691 | AUDI | 78 | 100 | V94774 | BMW | 113 | 57 |
| V94646 | SKODA | 772 | 8 | V94691 | AUDI | 78 | 102 | V94776 | BMW | 113 | 57 |
| V94646 | VW | 889 | 21 | V94691 | AUDI | 78 | 103 | V94797 | BMW | 115 | 69 |
| V94646 | VW | 892 | 29 | V94691 | AUDI | 79 | 106 | V94800 | MAN | 400 | 23 |
| V94646 | VW | 897 | 47 | V94691 | AUDI | 79 | 107 | V94800 | MAN | 401 | 26 |
| V94646 | VW | 897 | 48 | V94691 | SEAT | 766 | 63 | V94801 | MAN | 400 | 23 |
| V94647 | VW | 892 | 28 | V94691 | SKODA | 781 | 36 | V94801 | MAN | 401 | 26 |
| V94647 | VW | 896 | 45 | V94691 | VW | 926 | 132 | V94803 | MERCEDES-BENZ | 443 | 1 |
| V94649 | AUDI | 49 | 17 | V94691 | VW | 931 | 145 | V94803 | SMART | 784 | 1 |
| V94649 | AUDI | 50 | 18 | V94692 | AUDI | 65 | 64 | V94803 | SMART | 784 | 2 |
| V94649 | AUDI | 52 | 26 | V94692 | AUDI | 66 | 68 | V94804 | MERCEDES-BENZ | 443 | 1 |
| V94649 | AUDI | 59 | 46 | V94692 | AUDI | 66 | 69 | V94804 | SMART | 784 | 1 |
| V94649 | DAIHATSU | 555 | 15 | V94692 | AUDI | 68 | 75 | V94804 | SMART | 784 | 2 |
| V94649 | SEAT | 755 | 31 | V94692 | AUDI | 69 | 77 | V94950 | LADA | 345 | 7 |
| V94649 | SEAT | 755 | 32 | V94692 | AUDI | 71 | 82 | V94951 | LADA | 345 | 7 |
| V94649 | SEAT | 759 | 44 | V94692 | AUDI | 76 | 95 | V94957 | BMW | 96 | 18 |
| V94649 | SEAT | 763 | 56 | V94692 | AUDI | 77 | 96 | V94957 | BMW | 114 | 61 |
| V94649 | SKODA | 775 | 16 | V94692 | AUDI | 77 | 99 | V94957 | BMW | 114 | 64 |
| V94649 | SKODA | 775 | 17 | V94692 | AUDI | 78 | 100 | V94957 | BMW | 115 | 66 |
| V94649 | SKODA | 777 | 24 | V94692 | AUDI | 79 | 107 | V94960 | CITROËN | 139 | 17 |
| V94649 | SKODA | 779 | 31 | V94692 | SEAT | 765 | 59 | V94960 | FIAT | 201 | 29 |
| V94649 | VW | 893 | 32 | V94692 | SEAT | 766 | 63 | V94960 | FORD | 242 | 22 |
| V94649 | VW | 900 | 62 | V94692 | SEAT | 766 | 64 | V94960 | MAZDA | 407 | 6 |
| V94649 | VW | 901 | 63 | V94692 | SKODA | 780 | 33 | V94960 | MINI | 548 | 2 |
| V94649 | VW | 907 | 78 | V94692 | SKODA | 781 | 36 | V94960 | PEUGEOT | 625 | 15 |
| V94649 | VW | 917 | 108 | V94692 | SKODA | 782 | 37 | V94960 | SUZUKI | 796 | 13 |
| V94649 | VW | 921 | 118 | V94692 | VW | 923 | 124 | V94960 | VOLVO | 849 | 3 |
| V94649 | VW | 922 | 122 | V94692 | VW | 926 | 132 | V94961 | CITROËN | 139 | 17 |
| V94650 | AUDI | 49 | 17 | V94692 | VW | 926 | 133 | V94961 | FIAT | 201 | 29 |
| V94650 | AUDI | 50 | 18 | V94692 | VW | 928 | 137 | V94961 | FORD | 242 | 22 |
| V94650 | AUDI | 52 | 26 | V94693 | FORD | 258 | 62 | V94961 | MAZDA | 407 | 6 |
| V94650 | AUDI | 59 | 46 | V94693 | MAZDA | 409 | 14 | V94961 | MINI | 548 | 2 |
| V94650 | DAIHATSU | 555 | 15 | V94693 | VOLVO | 857 | 30 | V94961 | PEUGEOT | 625 | 15 |
| V94650 | SEAT | 755 | 31 | V94694 | FORD | 258 | 62 | V94961 | SUZUKI | 796 | 13 |
| V94650 | SEAT | 755 | 32 | V94694 | FORD | 264 | 79 | V94961 | VOLVO | 849 | 3 |
| V94650 | SEAT | 759 | 44 | V94694 | MAZDA | 409 | 14 | V94962 | ALFA ROMEO | 35 | 45 |
| V94650 | SEAT | 763 | 56 | V94694 | VOLVO | 857 | 30 | V94962 | ALFA ROMEO | 35 | 46 |
| V94650 | SKODA | 775 | 16 | V94695 | FORD | 255 | 58 | V94962 | CHEVROLET | 125 | 39 |
| V94650 | SKODA | 775 | 17 | V94696 | FORD | 255 | 58 | V94962 | FIAT | 221 | 90 |
| V94650 | SKODA | 777 | 24 | V94697 | AUDI | 59 | 44 | V94962 | OPEL | 604 | 67 |
| V94650 | SKODA | 777 | 25 | V94697 | AUDI | 59 | 45 | V94962 | OPEL | 605 | 71 |
| V94650 | SKODA | 779 | 31 | V94697 | DAIHATSU | 555 | 14 | V94962 | SAAB | 728 | 11 |
| V94650 | VW | 893 | 32 | V94697 | SEAT | 763 | 55 | V94962 | VAUXHALL | 838 | 67 |
| V94650 | VW | 900 | 62 | V94697 | SKODA | 779 | 30 | V94962 | VAUXHALL | 839 | 71 |
| V94650 | VW | 901 | 63 | V94697 | VW | 916 | 107 | V94963 | ALFA ROMEO | 35 | 45 |
| V94650 | VW | 907 | 78 | V94698 | AUDI | 59 | 44 | V94963 | ALFA ROMEO | 35 | 46 |
| V94650 | VW | 908 | 81 | V94698 | DAIHATSU | 555 | 14 | V94963 | CHEVROLET | 125 | 39 |
| V94650 | VW | 917 | 108 | V94698 | SEAT | 763 | 55 | V94963 | FIAT | 221 | 90 |
| V94650 | VW | 921 | 118 | V94698 | SKODA | 779 | 30 | V94963 | OPEL | 604 | 67 |
| V94650 | VW | 922 | 122 | V94698 | VW | 916 | 107 | V94963 | OPEL | 605 | 71 |
| V94653 | AUDI | 49 | 15 | V94705 | DACIA | 158 | 1 | V94963 | SAAB | 728 | 11 |
| V94653 | SKODA | 774 | 13 | V94705 | NISSAN | 567 | 2 | V94963 | VAUXHALL | 838 | 67 |
| V94653 | VW | 900 | 59 | V94705 | RENAULT | 669 | 2 | V94963 | VAUXHALL | 839 | 71 |
| V94662 | ISUZU | 291 | 8 | V94705 | RENAULT | 670 | 3 | V94967 | DAF | 171 | 10 |
| V94662 | OPEL | 609 | 85 | V94706 | DACIA | 158 | 1 | V94967 | DAF | 171 | 12 |
| V94662 | VAUXHALL | 842 | 85 | V94706 | NISSAN | 567 | 2 | V94967 | DAF | 172 | 13 |
| V94663 | ISUZU | 291 | 8 | V94706 | RENAULT | 669 | 2 | V94967 | DAF | 172 | 15 |
| V94663 | OPEL | 609 | 85 | V94706 | RENAULT | 670 | 3 | V94968 | DAF | 171 | 10 |
| V94663 | VAUXHALL | 842 | 85 | V94715 | SEAT | 750 | 12 | V94968 | DAF | 171 | 11 |
| V94667 | DAIHATSU | 554 | 12 | V94715 | VW | 886 | 9 | V94968 | DAF | 171 | 12 |
| V94670 | MINI | 548 | 1 | V94715 | VW | 886 | 10 | V94968 | DAF | 172 | 13 |
| V94670 | SUBARU | 790 | 4 | V94723 | MWM | 560 | 9 | V94968 | DAF | 172 | 15 |
| V94670 | TOYOTA | 803 | 7 | V94723 | MWM | 560 | 10 | V94969 | CITROËN | 134 | 2 |
| V94671 | MINI | 548 | 1 | V94723 | MWM | 560 | 11 | V94969 | DAIHATSU | 173 | 1 |
| V94671 | SUBARU | 790 | 4 | V94723 | MWM | 561 | 12 | V94969 | PEUGEOT | 620 | 3 |
| V94671 | TOYOTA | 803 | 7 | V94750 | MERCEDES-BENZ | 458 | 41 | V94969 | SUBARU | 790 | 2 |
| V94691 | AUDI | 68 | 75 | V94750 | MERCEDES-BENZ | 458 | 42 | V94969 | TOYOTA | 802 | 3 |
| V94691 | AUDI | 76 | 95 | V94750 | MERCEDES-BENZ | 458 | 43 | V94970 | CITROËN | 134 | 2 |



NUMERICAL PARTS LIST

Numerische Teilenummernliste • Elenco riferimenti
Liste des références produits















|  |  |  |  |  |  |  |  |  |  |  |  |  |  |  |
|---|---|---|---|---|---|---|---|--|---|---|---|---|---|---|
| V94970 | DAIHATSU | 173 | 1 | | V95014 | MAZDA | 407 | 7 | | V95038 | CITROËN | 142 | 23 | |
| V94970 | PEUGEOT | 620 | 3 | | V95014 | MAZDA | 408 | 11 | | V95038 | MINI | 548 | 4 | |
| V94970 | SUBARU | 790 | 2 | | V95014 | VOLVO | 850 | 7 | | V95038 | MINI | 549 | 6 | |
| V94970 | TOYOTA | 802 | 3 | | V95015 | ALFA ROMEO | 24 | 2 | | V95038 | PEUGEOT | 627 | 19 | |
| V95001 | NISSAN | 574 | 28 | | V95015 | CHEVROLET | 117 | 3 | | V95038 | PEUGEOT | 628 | 21 | |
| V95001 | NISSAN | 574 | 29 | | V95015 | CHEVROLET | 117 | 4 | | V95038 | PEUGEOT | 628 | 22 | |
| V95001 | NISSAN | 575 | 32 | | V95015 | FIAT | 195 | 9 | | V95039 | FORD | 243 | 24 | |
| V95001 | OPEL | 600 | 54 | | V95015 | FORD | 236 | 5 | | V95039 | FORD | 245 | 28 | |
| V95001 | OPEL | 602 | 62 | | V95015 | FORD | 239 | 12 | | V95039 | MAZDA | 407 | 7 | |
| V95001 | RENAULT | 695 | 44 | | V95015 | LANCIA | 350 | 3 | | V95040 | BMW | 95 | 14 | |
| V95001 | RENAULT | 697 | 46 | | V95015 | OPEL | 584 | 2 | | V95040 | BMW | 99 | 24 | |
| V95001 | VAUXHALL | 834 | 55 | | V95015 | SUBARU | 790 | 1 | | V95040 | BMW | 107 | 41 | |
| V95001 | VAUXHALL | 837 | 62 | | V95015 | SUZUKI | 794 | 5 | | V95040 | BMW | 109 | 44 | |
| V95002 | NISSAN | 574 | 28 | | V95015 | VAUXHALL | 819 | 3 | | V95040 | MINI | 550 | 9 | |
| V95002 | NISSAN | 574 | 29 | | V95016 | ALFA ROMEO | 24 | 2 | | V95040 | MINI | 550 | 10 | |
| V95002 | NISSAN | 575 | 32 | | V95016 | CHEVROLET | 117 | 3 | | V95041 | BMW | 95 | 14 | |
| V95002 | OPEL | 600 | 54 | | V95016 | CHEVROLET | 117 | 4 | | V95041 | BMW | 99 | 24 | |
| V95002 | OPEL | 602 | 62 | | V95016 | FIAT | 195 | 9 | | V95041 | BMW | 107 | 41 | |
| V95002 | RENAULT | 695 | 44 | | V95016 | FORD | 236 | 5 | | V95041 | BMW | 109 | 44 | |
| V95002 | RENAULT | 696 | 45 | | V95016 | FORD | 239 | 12 | | V95041 | MINI | 550 | 9 | |
| V95002 | RENAULT | 697 | 46 | | V95016 | LANCIA | 350 | 3 | | V95041 | MINI | 550 | 10 | |
| V95002 | VAUXHALL | 834 | 55 | | V95016 | OPEL | 584 | 2 | | V95042 | BMW | 108 | 43 | |
| V95002 | VAUXHALL | 837 | 62 | | V95016 | SUBARU | 790 | 1 | | V95043 | BMW | 112 | 55 | |
| V95003 | MERCEDES-BENZ | 503 | 126 | | V95016 | SUZUKI | 794 | 5 | | V95044 | BMW | 112 | 55 | |
| V95003 | MERCEDES-BENZ | 505 | 127 | | V95016 | VAUXHALL | 819 | 3 | | V95045 | BMW | 95 | 13 | |
| V95003 | MERCEDES-BENZ | 508 | 128 | | V95017 | HYUNDAI | 281 | 5 | | V95046 | BMW | 95 | 13 | |
| V95003 | MERCEDES-BENZ | 509 | 129 | | V95017 | HYUNDAI | 282 | 10 | | V95047 | BMW | 101 | 27 | |
| V95003 | MERCEDES-BENZ | 510 | 131 | | V95018 | HYUNDAI | 281 | 5 | | V95047 | BMW | 101 | 28 | |
| V95004 | MERCEDES-BENZ | 503 | 126 | | V95018 | HYUNDAI | 282 | 10 | | V95048 | BMW | 101 | 27 | |
| V95004 | MERCEDES-BENZ | 505 | 127 | | V95019 | MINISUBISHI | 554 | 10 | | V95048 | BMW | 101 | 28 | |
| V95004 | MERCEDES-BENZ | 508 | 128 | | V95020 | MINISUBISHI | 554 | 10 | | V95048 | BMW | 106 | 39 | |
| V95004 | MERCEDES-BENZ | 509 | 129 | | V95021 | HYUNDAI | 282 | 11 | | V95048 | BMW | 109 | 45 | |
| V95004 | MERCEDES-BENZ | 509 | 130 | | V95021 | KIA | 339 | 8 | | V95049 | FORD | 258 | 63 | |
| V95004 | MERCEDES-BENZ | 510 | 131 | | V95022 | HYUNDAI | 282 | 11 | | V95049 | VOLVO | 853 | 17 | |
| V95005 | MAN | 402 | 27 | | V95022 | KIA | 339 | 8 | | V95049 | VOLVO | 854 | 19 | |
| V95005 | MAN | 403 | 31 | | V95024 | DEUTZ/KHD | 183 | 35 | | V95049 | VOLVO | 854 | 21 | |
| V95006 | MAN | 402 | 27 | | V95024 | DEUTZ/KHD | 183 | 37 | | V95049 | VOLVO | 855 | 24 | |
| V95006 | MAN | 403 | 31 | | V95029 | MAN | 386 | 4 | | V95049 | VOLVO | 857 | 29 | |
| V95007 | CHEVROLET | 120 | 17 | | V95029 | MAN | 390 | 8 | | V95049 | VOLVO | 858 | 32 | |
| V95007 | FIAT | 203 | 38 | | V95030 | MAN | 386 | 4 | | V95049 | VOLVO | 859 | 34 | |
| V95007 | SUBARU | 791 | 9 | | V95030 | MAN | 390 | 8 | | V95049 | VOLVO | 859 | 36 | |
| V95007 | SUZUKI | 797 | 17 | | V95032 | MAN | 391 | 9 | | V95049 | VOLVO | 860 | 37 | |
| V95007 | SUZUKI | 798 | 18 | | V95032 | MAN | 396 | 20 | | V95050 | FORD | 258 | 63 | |
| V95008 | CHEVROLET | 120 | 17 | | V95033 | MERCEDES-BENZ | 503 | 126 | | V95050 | VOLVO | 853 | 17 | |
| V95008 | FIAT | 203 | 38 | | V95033 | MERCEDES-BENZ | 505 | 127 | | V95050 | VOLVO | 854 | 19 | |
| V95008 | SUBARU | 791 | 9 | | V95033 | MERCEDES-BENZ | 508 | 128 | | V95050 | VOLVO | 854 | 21 | |
| V95008 | SUZUKI | 797 | 17 | | V95033 | MERCEDES-BENZ | 509 | 129 | | V95050 | VOLVO | 855 | 24 | |
| V95008 | SUZUKI | 798 | 18 | | V95033 | MERCEDES-BENZ | 510 | 131 | | V95050 | VOLVO | 857 | 29 | |
| V95009 | RENAULT | 709 | 72 | | V95034 | MAN | 391 | 9 | | V95050 | VOLVO | 858 | 32 | |
| V95009 | RENAULT | 709 | 75 | | V95034 | MAN | 396 | 20 | | V95050 | VOLVO | 859 | 34 | |
| V95009 | RENAULT | 710 | 79 | | V95035 | CITROËN | 140 | 19 | | V95050 | VOLVO | 859 | 36 | |
| V95009 | RENAULT | 710 | 80 | | V95035 | CITROËN | 141 | 21 | | V95050 | VOLVO | 860 | 37 | |
| V95009 | RENAULT | 711 | 81 | | V95035 | MINI | 548 | 3 | | V95051 | TOYOTA | 806 | 16 | |
| V95009 | RENAULT | 711 | 83 | | V95035 | MINI | 549 | 5 | | V95052 | TOYOTA | 806 | 16 | |
| V95009 | RENAULT | 712 | 84 | | V95035 | MINI | 549 | 6 | | V95053 | LEXUS | 373 | 1 | |
| V95010 | RENAULT | 709 | 72 | | V95035 | PEUGEOT | 626 | 17 | | V95053 | TOYOTA | 809 | 27 | |
| V95010 | RENAULT | 709 | 75 | | V95035 | PEUGEOT | 627 | 19 | | V95053 | TOYOTA | 811 | 32 | |
| V95010 | RENAULT | 710 | 79 | | V95035 | PEUGEOT | 627 | 20 | | V95054 | LEXUS | 373 | 1 | |
| V95010 | RENAULT | 710 | 80 | | V95036 | CITROËN | 140 | 19 | | V95054 | TOYOTA | 809 | 27 | |
| V95010 | RENAULT | 711 | 81 | | V95036 | CITROËN | 141 | 21 | | V95054 | TOYOTA | 811 | 32 | |
| V95010 | RENAULT | 711 | 83 | | V95036 | MINI | 548 | 3 | | V95055 | TOYOTA | 811 | 30 | |
| V95010 | RENAULT | 712 | 84 | | V95036 | MINI | 549 | 5 | | V95056 | TOYOTA | 811 | 30 | |
| V95011 | MERCEDES-BENZ | 455 | 35 | | V95036 | MINI | 549 | 6 | | V95057 | TOYOTA | 814 | 39 | |
| V95012 | MERCEDES-BENZ | 455 | 35 | | V95036 | PEUGEOT | 626 | 17 | | V95058 | TOYOTA | 814 | 39 | |
| V95013 | FORD | 247 | 33 | | V95036 | PEUGEOT | 627 | 19 | | V95059 | BMW | 109 | 46 | |
| V95013 | FORD | 247 | 34 | | V95036 | PEUGEOT | 627 | 20 | | V95059 | BMW | 110 | 48 | |
| V95013 | MAZDA | 408 | 11 | | V95037 | CITROËN | 142 | 23 | | V95060 | BMW | 109 | 46 | |
| V95013 | VOLVO | 850 | 7 | | V95037 | MINI | 548 | 4 | | V95060 | BMW | 109 | 47 | |
| V95014 | FORD | 243 | 24 | | V95037 | PEUGEOT | 627 | 19 | | V95060 | BMW | 110 | 48 | |
| V95014 | FORD | 244 | 27 | | V95037 | PEUGEOT | 628 | 22 | | V95061 | FORD | 242 | 20 | |
| V95014 | FORD | 247 | 33 | | V95038 | BMW | 92 | 1 | | V95062 | FORD | 242 | 20 | |
| V95014 | FORD | 247 | 34 | | V95038 | CITROËN | 141 | 22 | | V95063 | FORD | 258 | 64 | |













|  |  |  |  |  |  |  |  |  |  |  |  |  |  |  |
|---|---|---|---|---|---|---|---|---|---|---|---|---|---|---|
| V95064 | FORD | 258 | 64 | V95084 | PEUGEOT | 637 | 48 | V95112 | SCANIA | 742 | 20 | | | |
| V95065 | HONDA | 278 | 25 | V95084 | PEUGEOT | 639 | 53 | V95112 | SCANIA | 742 | 21 | | | |
| V95066 | HONDA | 278 | 25 | V95085 | AUDI | 76 | 93 | V95113 | SCANIA | 742 | 20 | | | |
| V95067 | DAF | 169 | 5 | V95085 | AUDI | 76 | 94 | V95113 | SCANIA | 742 | 21 | | | |
| V95067 | IVECO | 312 | 26 | V95085 | AUDI | 80 | 108 | V95114 | AUDI | 60 | 48 | | | |
| V95067 | IVECO | 313 | 28 | V95085 | PORSCHE | 647 | 3 | V95114 | AUDI | 75 | 90 | | | |
| V95068 | DAF | 169 | 5 | V95085 | SKODA | 782 | 39 | V95114 | SEAT | 764 | 57 | | | |
| V95068 | IVECO | 312 | 26 | V95085 | VW | 930 | 142 | V95114 | SKODA | 780 | 32 | | | |
| V95068 | IVECO | 313 | 28 | V95085 | VW | 931 | 147 | V95114 | VW | 917 | 109 | | | |
| V95069 | HYUNDAI | 280 | 2 | V95085 | VW | 932 | 148 | V95114 | VW | 927 | 135 | | | |
| V95069 | KIA | 338 | 1 | V95086 | AUDI | 76 | 93 | V95114 | VW | 929 | 140 | | | |
| V95069 | KIA | 338 | 2 | V95086 | AUDI | 76 | 94 | V95119 | NISSAN | 574 | 30 | | | |
| V95070 | HYUNDAI | 280 | 2 | V95086 | AUDI | 80 | 108 | V95120 | NISSAN | 574 | 30 | | | |
| V95070 | KIA | 338 | 1 | V95086 | PORSCHE | 647 | 3 | V95121 | MERCEDES-BENZ | 512 | 135 | | | |
| V95070 | KIA | 338 | 2 | V95086 | SKODA | 782 | 39 | V95122 | MERCEDES-BENZ | 512 | 135 | | | |
| V95071 | MERCEDES-BENZ | 456 | 37 | V95086 | VW | 930 | 142 | V95123 | MERCEDES-BENZ | 543 | 184 | | | |
| V95071 | MERCEDES-BENZ | 456 | 38 | V95086 | VW | 931 | 147 | V95124 | MERCEDES-BENZ | 543 | 184 | | | |
| V95072 | MERCEDES-BENZ | 456 | 37 | V95086 | VW | 932 | 148 | V95125 | AUDI | 50 | 19 | | | |
| V95072 | MERCEDES-BENZ | 480 | 91 | V95087 | AUDI | 59 | 47 | V95125 | SEAT | 755 | 30 | | | |
| V95072 | MERCEDES-BENZ | 482 | 95 | V95087 | VW | 907 | 79 | V95125 | SEAT | 756 | 33 | | | |
| V95073 | MERCEDES-BENZ | 464 | 54 | V95088 | AUDI | 59 | 47 | V95125 | SKODA | 774 | 15 | | | |
| V95073 | MERCEDES-BENZ | 466 | 58 | V95088 | VW | 907 | 79 | V95125 | SKODA | 775 | 18 | | | |
| V95074 | MERCEDES-BENZ | 464 | 54 | V95089 | VOLVO | 867 | 62 | V95125 | VW | 900 | 61 | | | |
| V95074 | MERCEDES-BENZ | 466 | 58 | V95089 | VOLVO | 868 | 63 | V95125 | VW | 901 | 64 | | | |
| V95075 | MERCEDES-BENZ | 445 | 14 | V95090 | VOLVO | 868 | 63 | V95126 | AUDI | 50 | 19 | | | |
| V95075 | MERCEDES-BENZ | 446 | 16 | V95093 | FORD | 245 | 28 | V95126 | SEAT | 755 | 30 | | | |
| V95075 | MERCEDES-BENZ | 447 | 17 | V95094 | HONDA | 274 | 9 | V95126 | SEAT | 756 | 33 | | | |
| V95075 | MERCEDES-BENZ | 447 | 18 | V95094 | HONDA | 276 | 18 | V95126 | SKODA | 774 | 15 | | | |
| V95076 | MERCEDES-BENZ | 445 | 14 | V95094 | HONDA | 278 | 26 | V95126 | SKODA | 775 | 18 | | | |
| V95076 | MERCEDES-BENZ | 446 | 16 | V95096 | MERCEDES-BENZ | 445 | 12 | V95126 | VW | 900 | 61 | | | |
| V95076 | MERCEDES-BENZ | 447 | 17 | V95096 | MERCEDES-BENZ | 445 | 13 | V95126 | VW | 901 | 64 | | | |
| V95076 | MERCEDES-BENZ | 447 | 18 | V95096 | MERCEDES-BENZ | 447 | 19 | V95127 | AUDI | 76 | 93 | | | |
| V95077 | HYUNDAI | 286 | 28 | V95096 | MERCEDES-BENZ | 447 | 20 | V95127 | AUDI | 76 | 94 | | | |
| V95077 | HYUNDAI | 287 | 29 | V95096 | MERCEDES-BENZ | 448 | 21 | V95127 | AUDI | 80 | 108 | | | |
| V95077 | HYUNDAI | 287 | 30 | V95096 | MERCEDES-BENZ | 455 | 36 | V95127 | PORSCHE | 647 | 3 | | | |
| V95077 | HYUNDAI | 287 | 31 | V95096 | MERCEDES-BENZ | 457 | 40 | V95127 | SKODA | 782 | 39 | | | |
| V95077 | KIA | 342 | 19 | V95096 | MERCEDES-BENZ | 458 | 41 | V95127 | VW | 930 | 142 | | | |
| V95077 | MINIBUS | 556 | 19 | V95096 | MERCEDES-BENZ | 458 | 43 | V95127 | VW | 931 | 147 | | | |
| V95077 | MITSUBISHI | 556 | 20 | V95096 | MERCEDES-BENZ | 460 | 46 | V95127 | VW | 932 | 148 | | | |
| V95077 | MITSUBISHI | 557 | 22 | V95096 | MERCEDES-BENZ | 484 | 101 | V95128 | AUDI | 76 | 93 | | | |
| V95078 | HYUNDAI | 286 | 28 | V95097 | AUDI | 65 | 64 | V95128 | AUDI | 76 | 94 | | | |
| V95078 | HYUNDAI | 287 | 29 | V95098 | AUDI | 65 | 64 | V95128 | AUDI | 80 | 108 | | | |
| V95078 | HYUNDAI | 287 | 30 | V95098 | AUDI | 66 | 68 | V95128 | PORSCHE | 647 | 3 | | | |
| V95078 | HYUNDAI | 287 | 31 | V95098 | AUDI | 66 | 69 | V95128 | SKODA | 782 | 39 | | | |
| V95078 | KIA | 342 | 19 | V95098 | AUDI | 69 | 77 | V95128 | VW | 930 | 142 | | | |
| V95078 | MITSUBISHI | 556 | 19 | V95098 | AUDI | 70 | 78 | V95128 | VW | 931 | 147 | | | |
| V95078 | MITSUBISHI | 556 | 20 | V95098 | AUDI | 71 | 81 | V95128 | VW | 932 | 148 | | | |
| V95078 | MITSUBISHI | 557 | 22 | V95098 | AUDI | 71 | 82 | V95129 | NISSAN | 577 | 36 | | | |
| V95079 | MAZDA | 408 | 10 | V95098 | AUDI | 78 | 101 | V95129 | NISSAN | 578 | 41 | | | |
| V95079 | MITSUBISHI | 554 | 11 | V95098 | SEAT | 765 | 59 | V95130 | NISSAN | 577 | 36 | | | |
| V95079 | NISSAN | 572 | 20 | V95098 | SEAT | 766 | 64 | V95130 | NISSAN | 578 | 41 | | | |
| V95079 | NISSAN | 572 | 21 | V95098 | SEAT | 766 | 65 | V95131 | NISSAN | 573 | 24 | | | |
| V95080 | MAZDA | 408 | 10 | V95098 | SKODA | 780 | 33 | V95132 | NISSAN | 573 | 24 | | | |
| V95080 | MITSUBISHI | 554 | 11 | V95098 | SKODA | 782 | 37 | V95133 | HYUNDAI | 284 | 19 | | | |
| V95080 | NISSAN | 572 | 20 | V95098 | VW | 923 | 124 | V95133 | HYUNDAI | 285 | 21 | | | |
| V95080 | NISSAN | 572 | 21 | V95098 | VW | 926 | 133 | V95133 | HYUNDAI | 286 | 25 | | | |
| V95083 | CITROËN | 150 | 47 | V95098 | VW | 927 | 134 | V95133 | KIA | 341 | 14 | | | |
| V95083 | CITROËN | 152 | 52 | V95098 | VW | 927 | 136 | V95134 | HYUNDAI | 284 | 19 | | | |
| V95083 | FIAT | 219 | 84 | V95098 | VW | 930 | 143 | V95134 | HYUNDAI | 285 | 21 | | | |
| V95083 | FORD | 261 | 71 | V95099 | AUDI | 60 | 48 | V95134 | HYUNDAI | 286 | 25 | | | |
| V95083 | JAGUAR | 332 | 3 | V95099 | SEAT | 764 | 57 | V95134 | KIA | 341 | 14 | | | |
| V95083 | LANCIA | 363 | 50 | V95099 | SKODA | 780 | 32 | V95135 | CITROËN | 144 | 29 | | | |
| V95083 | LAND ROVER | 369 | 13 | V95099 | VW | 917 | 109 | V95135 | CITROËN | 148 | 42 | | | |
| V95083 | PEUGEOT | 637 | 48 | V95099 | VW | 927 | 135 | V95135 | JAGUAR | 332 | 1 | | | |
| V95083 | PEUGEOT | 639 | 53 | V95102 | DEUTZ/KHD | 183 | 35 | V95135 | JAGUAR | 332 | 2 | | | |
| V95084 | CITROËN | 150 | 47 | V95102 | DEUTZ/KHD | 183 | 36 | V95135 | LAND ROVER | 367 | 4 | | | |
| V95084 | CITROËN | 152 | 52 | V95102 | DEUTZ/KHD | 183 | 37 | V95135 | LAND ROVER | 367 | 5 | | | |
| V95084 | FIAT | 219 | 84 | V95102 | DEUTZ/KHD | 184 | 38 | V95135 | LAND ROVER | 368 | 8 | | | |
| V95084 | FORD | 261 | 71 | V95103 | DEUTZ/KHD | 183 | 35 | V95135 | LAND ROVER | 368 | 9 | | | |
| V95084 | JAGUAR | 332 | 3 | V95103 | DEUTZ/KHD | 183 | 36 | V95135 | PEUGEOT | 630 | 28 | | | |
| V95084 | LANCIA | 363 | 50 | V95103 | DEUTZ/KHD | 183 | 37 | V95135 | PEUGEOT | 635 | 42 | | | |
| V95084 | LAND ROVER | 369 | 13 | V95103 | DEUTZ/KHD | 184 | 38 | V95136 | CITROËN | 144 | 29 | | | |



NUMERICAL PARTS LIST

Numerische Teilenummernliste • Elenco riferimenti
Liste des références produits















|  |  |  |  |  |  |  |  |  |  |  |  |  |  |  |
|---|---|---|---|---|---|---|---|--|---|---|---|---|---|---|
| V95136 | CITROËN | 148 | 42 | | V95152 | SKODA | 780 | 33 | | V95182 | CHRYSLER | 127 | 1 | |
| V95136 | JAGUAR | 332 | 1 | | V95152 | SKODA | 781 | 36 | | V95182 | FIAT | 196 | 10 | |
| V95136 | JAGUAR | 332 | 2 | | V95152 | SKODA | 782 | 37 | | V95182 | FORD | 239 | 12 | |
| V95136 | LAND ROVER | 367 | 4 | | V95152 | VW | 923 | 124 | | V95182 | LANCIA | 350 | 4 | |
| V95136 | LAND ROVER | 367 | 5 | | V95152 | VW | 926 | 132 | | V95182 | OPEL | 584 | 1 | |
| V95136 | LAND ROVER | 368 | 8 | | V95152 | VW | 926 | 133 | | V95182 | PEUGEOT | 620 | 1 | |
| V95136 | LAND ROVER | 368 | 9 | | V95152 | VW | 928 | 137 | | V95182 | SUZUKI | 794 | 4 | |
| V95136 | PEUGEOT | 630 | 28 | | V95153 | BMW | 92 | 1 | | V95182 | VAUXHALL | 819 | 2 | |
| V95136 | PEUGEOT | 635 | 42 | | V95153 | CITROËN | 141 | 22 | | V95183 | ALFA ROMEO | 24 | 1 | |
| V95137 | CITROËN | 135 | 5 | | V95153 | MINI | 549 | 6 | | V95183 | CHEVROLET | 117 | 3 | |
| V95137 | CITROËN | 140 | 18 | | V95153 | PEUGEOT | 628 | 21 | | V95183 | CHRYSLER | 127 | 1 | |
| V95137 | FIAT | 201 | 28 | | V95154 | BMW | 92 | 2 | | V95183 | FIAT | 196 | 10 | |
| V95137 | FORD | 239 | 13 | | V95154 | MINI | 549 | 8 | | V95183 | FORD | 239 | 12 | |
| V95137 | FORD | 243 | 23 | | V95155 | BMW | 102 | 29 | | V95183 | LANCIA | 350 | 4 | |
| V95137 | PEUGEOT | 621 | 7 | | V95155 | BMW | 106 | 40 | | V95183 | OPEL | 584 | 1 | |
| V95137 | PEUGEOT | 626 | 16 | | V95155 | BMW | 112 | 55 | | V95183 | PEUGEOT | 620 | 1 | |
| V95137 | VOLVO | 849 | 2 | | V95156 | FORD | 237 | 7 | | V95183 | SUZUKI | 794 | 4 | |
| V95138 | CITROËN | 135 | 5 | | V95156 | FORD | 238 | 8 | | V95183 | VAUXHALL | 819 | 2 | |
| V95138 | CITROËN | 140 | 18 | | V95157 | CHEVROLET | 122 | 24 | | V95186 | CHEVROLET | 122 | 24 | |
| V95138 | FIAT | 201 | 28 | | V95157 | OPEL | 594 | 34 | | V95186 | OPEL | 594 | 34 | |
| V95138 | FORD | 239 | 13 | | V95157 | VAUXHALL | 829 | 35 | | V95186 | VAUXHALL | 829 | 35 | |
| V95138 | FORD | 243 | 23 | | V95159 | CITROËN | 136 | 8 | | V95187 | CHEVROLET | 124 | 33 | |
| V95138 | PEUGEOT | 621 | 7 | | V95159 | PEUGEOT | 621 | 8 | | V95187 | DAEWOO | 164 | 11 | |
| V95138 | PEUGEOT | 626 | 16 | | V95160 | RENAULT | 716 | 100 | | V95187 | OPEL | 599 | 52 | |
| V95138 | VOLVO | 849 | 2 | | V95160 | VOLVO | 872 | 69 | | V95187 | VAUXHALL | 834 | 53 | |
| V95140 | FORD | 262 | 76 | | V95161 | RENAULT | 716 | 100 | | V95188 | CHEVROLET | 124 | 33 | |
| V95140 | FORD | 266 | 85 | | V95161 | VOLVO | 872 | 69 | | V95188 | DAEWOO | 164 | 11 | |
| V95140 | FORD | 266 | 86 | | V95162 | BMW | 92 | 2 | | V95188 | OPEL | 599 | 52 | |
| V95140 | LAND ROVER | 369 | 14 | | V95162 | MINI | 549 | 8 | | V95188 | VAUXHALL | 834 | 53 | |
| V95140 | LAND ROVER | 370 | 17 | | V95163 | CITROËN | 136 | 8 | | V95189 | CHEVROLET | 122 | 28 | |
| V95141 | CHEVROLET | 120 | 17 | | V95163 | PEUGEOT | 621 | 8 | | V95190 | CHEVROLET | 122 | 28 | |
| V95141 | FIAT | 203 | 38 | | V95164 | DEUTZ/KHD | 184 | 39 | | V95191 | BMW | 102 | 29 | |
| V95141 | SUBARU | 791 | 9 | | V95164 | RENAULT | 713 | 87 | | V95191 | BMW | 106 | 40 | |
| V95141 | SUZUKI | 797 | 17 | | V95164 | RENAULT | 713 | 88 | | V95191 | BMW | 112 | 55 | |
| V95141 | SUZUKI | 798 | 18 | | V95164 | VOLVO | 867 | 61 | | V95192 | AUDI | 46 | 4 | |
| V95142 | CHEVROLET | 120 | 17 | | V95165 | DEUTZ/KHD | 184 | 39 | | V95192 | SEAT | 750 | 11 | |
| V95142 | FIAT | 203 | 38 | | V95165 | RENAULT | 713 | 87 | | V95192 | SKODA | 771 | 4 | |
| V95142 | SUBARU | 791 | 9 | | V95165 | RENAULT | 713 | 88 | | V95192 | VW | 885 | 7 | |
| V95142 | SUZUKI | 797 | 17 | | V95165 | VOLVO | 867 | 61 | | V95193 | AUDI | 46 | 4 | |
| V95142 | SUZUKI | 798 | 18 | | V95166 | VOLVO | 873 | 70 | | V95193 | SEAT | 750 | 11 | |
| V95143 | DAIHATSU | 173 | 3 | | V95167 | VOLVO | 873 | 70 | | V95193 | SKODA | 771 | 4 | |
| V95143 | SUBARU | 790 | 3 | | V95168 | SCANIA | 733 | 1 | | V95193 | VW | 885 | 7 | |
| V95143 | TOYOTA | 803 | 5 | | V95168 | SCANIA | 733 | 2 | | V95194 | JEEP | 336 | 1 | |
| V95144 | DAIHATSU | 173 | 3 | | V95169 | SCANIA | 733 | 1 | | V95194 | MERCEDES-BENZ | 450 | 27 | |
| V95144 | SUBARU | 790 | 3 | | V95169 | SCANIA | 733 | 2 | | V95194 | MERCEDES-BENZ | 451 | 31 | |
| V95144 | TOYOTA | 803 | 5 | | V95170 | RENAULT | 715 | 94 | | V95195 | JEEP | 336 | 1 | |
| V95145 | TOYOTA | 813 | 36 | | V95171 | RENAULT | 715 | 94 | | V95195 | MERCEDES-BENZ | 450 | 27 | |
| V95146 | TOYOTA | 813 | 36 | | V95174 | MERCEDES-BENZ | 526 | 159 | | V95195 | MERCEDES-BENZ | 451 | 31 | |
| V95147 | TOYOTA | 814 | 40 | | V95174 | MERCEDES-BENZ | 527 | 160 | | V95196 | SMART | 784 | 3 | |
| V95147 | TOYOTA | 814 | 41 | | V95174 | MERCEDES-BENZ | 528 | 161 | | V95197 | SMART | 784 | 3 | |
| V95148 | TOYOTA | 814 | 40 | | V95174 | MERCEDES-BENZ | 529 | 162 | | V95198 | HYUNDAI | 282 | 12 | |
| V95148 | TOYOTA | 814 | 41 | | V95174 | MERCEDES-BENZ | 536 | 176 | | V95198 | HYUNDAI | 283 | 13 | |
| V95149 | AUDI | 46 | 1 | | V95174 | MERCEDES-BENZ | 537 | 177 | | V95198 | KIA | 339 | 9 | |
| V95149 | SEAT | 749 | 7 | | V95174 | MERCEDES-BENZ | 541 | 181 | | V95198 | KIA | 340 | 10 | |
| V95149 | SKODA | 771 | 1 | | V95174 | MERCEDES-BENZ | 542 | 182 | | V95199 | HYUNDAI | 282 | 12 | |
| V95149 | VW | 884 | 3 | | V95175 | MERCEDES-BENZ | 526 | 159 | | V95199 | HYUNDAI | 283 | 13 | |
| V95150 | AUDI | 46 | 1 | | V95175 | MERCEDES-BENZ | 527 | 160 | | V95199 | KIA | 339 | 9 | |
| V95150 | SEAT | 749 | 7 | | V95175 | MERCEDES-BENZ | 528 | 161 | | V95199 | KIA | 340 | 10 | |
| V95150 | SKODA | 771 | 1 | | V95175 | MERCEDES-BENZ | 529 | 162 | | V95200 | HONDA | 276 | 18 | |
| V95150 | VW | 884 | 3 | | V95175 | MERCEDES-BENZ | 536 | 176 | | V95200 | HONDA | 278 | 26 | |
| V95152 | AUDI | 65 | 64 | | V95175 | MERCEDES-BENZ | 537 | 177 | | V95201 | HYUNDAI | 284 | 17 | |
| V95152 | AUDI | 66 | 68 | | V95175 | MERCEDES-BENZ | 541 | 181 | | V95201 | HYUNDAI | 285 | 23 | |
| V95152 | AUDI | 66 | 69 | | V95175 | MERCEDES-BENZ | 542 | 182 | | V95201 | HYUNDAI | 285 | 24 | |
| V95152 | AUDI | 68 | 75 | | V95176 | MERCEDES-BENZ | 482 | 96 | | V95201 | KIA | 341 | 13 | |
| V95152 | AUDI | 69 | 77 | | V95176 | MERCEDES-BENZ | 483 | 98 | | V95201 | KIA | 341 | 16 | |
| V95152 | AUDI | 71 | 82 | | V95177 | MERCEDES-BENZ | 482 | 96 | | V95202 | HYUNDAI | 284 | 17 | |
| V95152 | AUDI | 76 | 95 | | V95177 | MERCEDES-BENZ | 483 | 98 | | V95202 | HYUNDAI | 285 | 23 | |
| V95152 | AUDI | 78 | 100 | | V95178 | FORD | 238 | 8 | | V95202 | HYUNDAI | 285 | 24 | |
| V95152 | AUDI | 79 | 107 | | V95179 | FORD | 237 | 7 | | V95202 | KIA | 341 | 13 | |
| V95152 | SEAT | 765 | 59 | | V95181 | FORD | 243 | 23 | | V95202 | KIA | 341 | 16 | |
| V95152 | SEAT | 766 | 63 | | V95182 | ALFA ROMEO | 24 | 1 | | V95203 | HYUNDAI | 280 | 3 | |
| V95152 | SEAT | 766 | 64 | | V95182 | CHEVROLET | 117 | 3 | | V95203 | KIA | 338 | 3 | |













|  |  |  |  | 9 |  |  |  |  | 9 |  |  |  |  | 9 |
|---|---|---|---|-----|---|---|---|---|-----|---|---|---|---|-----|
| V95204 | HYUNDAI | | 280 | 3 | V95236 | KIA | | 342 | 17 | V98010 | AUDI | | 75 | 90 |
| V95204 | KIA | | 338 | 3 | V95237 | AUDI | | 46 | 3 | V98010 | AUDI | | 75 | 91 |
| V95205 | IVECO | | 326 | 64 | V95237 | SEAT | | 750 | 10 | V98010 | AUDI | | 76 | 92 |
| V95205 | IVECO | | 326 | 65 | V95237 | SKODA | | 771 | 3 | V98010 | VW | | 929 | 139 |
| V95206 | IVECO | | 326 | 64 | V95237 | VW | | 885 | 6 | V98010 | VW | | 929 | 140 |
| V95206 | IVECO | | 326 | 65 | V95238 | AUDI | | 46 | 3 | V98010 | VW | | 929 | 141 |
| V95207 | RENAULT | | 717 | 103 | V95238 | SEAT | | 750 | 10 | V98011 | AUDI | | 73 | 88 |
| V95208 | RENAULT | | 717 | 103 | V95238 | SKODA | | 771 | 3 | V98011 | AUDI | | 74 | 89 |
| V95209 | DAF | | 172 | 14 | V95238 | VW | | 885 | 6 | V98011 | AUDI | | 75 | 91 |
| V95210 | DAF | | 172 | 14 | V95239 | DACIA | | 158 | 2 | V98011 | AUDI | | 76 | 92 |
| V95211 | DAF | | 169 | 7 | V95239 | RENAULT | | 673 | 8 | V98011 | VW | | 929 | 139 |
| V95212 | DAF | | 169 | 7 | V95240 | DACIA | | 158 | 2 | V98011 | VW | | 929 | 141 |
| V95213 | DAF | | 171 | 12 | V95240 | RENAULT | | 673 | 8 | V98013 | CHEVROLET | | 119 | 15 |
| V95214 | VOLVO | | 867 | 62 | V98001 | ALFA ROMEO | | 36 | 48 | V98013 | DAEWOO | | 163 | 8 |
| V95215 | MINISUBISHI | | 553 | 5 | V98002 | ALFA ROMEO | | 36 | 48 | V98014 | CHEVROLET | | 119 | 14 |
| V95215 | MINISUBISHI | | 553 | 6 | V98005 | ALFA ROMEO | | 29 | 24 | V98014 | DAEWOO | | 163 | 7 |
| V95215 | MINISUBISHI | | 553 | 7 | V98005 | ALFA ROMEO | | 30 | 26 | V98015 | CHEVROLET | | 119 | 14 |
| V95216 | MINISUBISHI | | 553 | 5 | V98005 | ALFA ROMEO | | 30 | 27 | V98015 | DAEWOO | | 163 | 7 |
| V95216 | MINISUBISHI | | 553 | 6 | V98005 | ALFA ROMEO | | 32 | 31 | V98016 | CHRYSLER | | 129 | 10 |
| V95216 | MINISUBISHI | | 553 | 7 | V98005 | ALFA ROMEO | | 33 | 34 | V98016 | CHRYSLER | | 129 | 12 |
| V95218 | CHRYSLER | | 128 | 7 | V98005 | CHRYSLER | | 127 | 5 | V98016 | JEEP | | 336 | 5 |
| V95218 | CHRYSLER | | 128 | 8 | V98005 | FIAT | | 210 | 52 | V98017 | CHRYSLER | | 129 | 10 |
| V95219 | CHRYSLER | | 128 | 7 | V98005 | FIAT | | 210 | 54 | V98017 | CHRYSLER | | 129 | 12 |
| V95219 | CHRYSLER | | 128 | 8 | V98005 | FIAT | | 212 | 59 | V98017 | JEEP | | 336 | 5 |
| V95220 | ALFA ROMEO | | 24 | 3 | V98005 | FIAT | | 215 | 67 | V98018 | FIAT | | 224 | 101 |
| V95220 | FIAT | | 200 | 23 | V98005 | LANCIA | | 355 | 25 | V98018 | IVECO | | 300 | 1 |
| V95220 | LANCIA | | 353 | 14 | V98005 | LANCIA | | 356 | 27 | V98019 | FIAT | | 224 | 101 |
| V95223 | ALFA ROMEO | | 25 | 9 | V98005 | LANCIA | | 359 | 36 | V98019 | IVECO | | 300 | 1 |
| V95223 | CHRYSLER | | 127 | 4 | V98005 | OPEL | | 598 | 47 | V98020 | FIAT | | 197 | 15 |
| V95223 | FIAT | | 204 | 40 | V98005 | OPEL | | 599 | 51 | V98020 | FIAT | | 199 | 20 |
| V95223 | LANCIA | | 354 | 19 | V98005 | SAAB | | 726 | 4 | V98020 | LANCIA | | 352 | 10 |
| V95224 | NISSAN | | 569 | 11 | V98005 | SAAB | | 727 | 7 | V98020 | ZASTAVA | | 935 | 1 |
| V95224 | OPEL | | 586 | 8 | V98005 | SAAB | | 727 | 8 | V98021 | FIAT | | 197 | 15 |
| V95224 | SUZUKI | | 795 | 6 | V98005 | VAUXHALL | | 833 | 48 | V98021 | FIAT | | 199 | 20 |
| V95224 | VAUXHALL | | 821 | 10 | V98005 | VAUXHALL | | 834 | 52 | V98021 | LANCIA | | 352 | 10 |
| V95225 | NISSAN | | 569 | 11 | V98006 | ALFA ROMEO | | 25 | 9 | V98021 | ZASTAVA | | 935 | 1 |
| V95225 | OPEL | | 586 | 8 | V98006 | ALFA ROMEO | | 29 | 24 | V98022 | ALFA ROMEO | | 25 | 5 |
| V95225 | SUZUKI | | 795 | 6 | V98006 | ALFA ROMEO | | 30 | 26 | V98022 | CHRYSLER | | 127 | 2 |
| V95225 | VAUXHALL | | 821 | 10 | V98006 | ALFA ROMEO | | 30 | 27 | V98022 | FIAT | | 198 | 16 |
| V95226 | DEUTZ/KHD | | 188 | 59 | V98006 | ALFA ROMEO | | 32 | 31 | V98022 | FIAT | | 201 | 25 |
| V95226 | DEUTZ/KHD | | 188 | 61 | V98006 | ALFA ROMEO | | 33 | 34 | V98022 | FORD | | 237 | 6 |
| V95227 | DEUTZ/KHD | | 188 | 58 | V98006 | CHRYSLER | | 127 | 4 | V98022 | LANCIA | | 351 | 8 |
| V95227 | DEUTZ/KHD | | 188 | 59 | V98006 | CHRYSLER | | 127 | 5 | V98022 | LANCIA | | 353 | 15 |
| V95227 | DEUTZ/KHD | | 188 | 60 | V98006 | FIAT | | 204 | 40 | V98023 | ALFA ROMEO | | 25 | 5 |
| V95227 | DEUTZ/KHD | | 188 | 61 | V98006 | FIAT | | 210 | 52 | V98023 | CHRYSLER | | 127 | 2 |
| V95228 | HYUNDAI | | 281 | 6 | V98006 | FIAT | | 210 | 54 | V98023 | FIAT | | 198 | 16 |
| V95228 | HYUNDAI | | 281 | 7 | V98006 | FIAT | | 212 | 59 | V98023 | FIAT | | 201 | 25 |
| V95228 | HYUNDAI | | 281 | 8 | V98006 | FIAT | | 215 | 67 | V98023 | FORD | | 237 | 6 |
| V95228 | HYUNDAI | | 283 | 14 | V98006 | LANCIA | | 354 | 19 | V98023 | LANCIA | | 351 | 8 |
| V95228 | HYUNDAI | | 283 | 15 | V98006 | LANCIA | | 355 | 25 | V98023 | LANCIA | | 353 | 15 |
| V95228 | KIA | | 338 | 4 | V98006 | LANCIA | | 356 | 27 | V98024 | ALFA ROMEO | | 27 | 15 |
| V95228 | KIA | | 338 | 5 | V98006 | LANCIA | | 359 | 36 | V98024 | CHEVROLET | | 123 | 30 |
| V95228 | KIA | | 339 | 6 | V98006 | OPEL | | 598 | 47 | V98024 | FIAT | | 206 | 45 |
| V95228 | KIA | | 340 | 11 | V98006 | OPEL | | 599 | 51 | V98024 | OPEL | | 591 | 26 |
| V95229 | HYUNDAI | | 281 | 6 | V98006 | SAAB | | 726 | 4 | V98024 | OPEL | | 593 | 30 |
| V95229 | HYUNDAI | | 281 | 7 | V98006 | SAAB | | 727 | 7 | V98024 | OPEL | | 596 | 41 |
| V95229 | HYUNDAI | | 281 | 8 | V98006 | SAAB | | 727 | 8 | V98024 | OPEL | | 596 | 42 |
| V95229 | HYUNDAI | | 283 | 14 | V98006 | VAUXHALL | | 833 | 48 | V98024 | SAAB | | 726 | 1 |
| V95229 | HYUNDAI | | 283 | 15 | V98006 | VAUXHALL | | 834 | 52 | V98024 | VAUXHALL | | 826 | 27 |
| V95229 | KIA | | 338 | 4 | V98007 | AUDI | | 59 | 44 | V98024 | VAUXHALL | | 827 | 31 |
| V95229 | KIA | | 338 | 5 | V98007 | MINISUBISHI | | 555 | 14 | V98024 | VAUXHALL | | 831 | 42 |
| V95229 | KIA | | 339 | 6 | V98007 | SEAT | | 763 | 55 | V98024 | VAUXHALL | | 831 | 43 |
| V95229 | KIA | | 340 | 11 | V98007 | SKODA | | 779 | 30 | V98025 | ALFA ROMEO | | 27 | 15 |
| V95234 | CITROËN | | 149 | 43 | V98007 | VW | | 916 | 107 | V98025 | CHEVROLET | | 123 | 30 |
| V95234 | FIAT | | 219 | 80 | V98008 | AUDI | | 49 | 16 | V98025 | FIAT | | 206 | 45 |
| V95234 | FIAT | | 219 | 81 | V98008 | SKODA | | 774 | 14 | V98025 | OPEL | | 591 | 26 |
| V95234 | FORD | | 260 | 68 | V98008 | VW | | 900 | 60 | V98025 | OPEL | | 593 | 30 |
| V95234 | FORD | | 261 | 69 | V98009 | AUDI | | 49 | 16 | V98025 | OPEL | | 596 | 41 |
| V95234 | PEUGEOT | | 636 | 43 | V98009 | SKODA | | 774 | 14 | V98025 | OPEL | | 596 | 42 |
| V95235 | HYUNDAI | | 286 | 26 | V98009 | VW | | 900 | 60 | V98025 | SAAB | | 726 | 1 |
| V95235 | KIA | | 342 | 17 | V98010 | AUDI | | 73 | 88 | V98025 | VAUXHALL | | 826 | 27 |
| V95236 | HYUNDAI | | 286 | 26 | V98010 | AUDI | | 74 | 89 | V98025 | VAUXHALL | | 827 | 31 |



NUMERICAL PARTS LIST

Numerische Teilenummernliste • Elenco riferimenti
Liste des références produits















|  |  |  |  |  |  |  |  |  |  |  |  |  |  |  |
|---|---|---|---|---|---|---|---|--|---|---|---|---|---|---|
| V98025 | VAUXHALL | 831 | 42 | | V98053 | KIA | 342 | 18 | | V98083 | SMART | 785 | 5 | |
| V98025 | VAUXHALL | 831 | 43 | | V98055 | MAN | 400 | 23 | | V98083 | SMART | 785 | 6 | |
| V98026 | ALFA ROMEO | 24 | 3 | | V98055 | MAN | 401 | 26 | | V98084 | MERCEDES-BENZ | 443 | 2 | |
| V98026 | ALFA ROMEO | 24 | 4 | | V98056 | MAN | 400 | 23 | | V98084 | SMART | 784 | 4 | |
| V98026 | FIAT | 199 | 21 | | V98056 | MAN | 401 | 26 | | V98084 | SMART | 785 | 5 | |
| V98026 | FIAT | 200 | 22 | | V98058 | MAZDA | 409 | 17 | | V98084 | SMART | 785 | 6 | |
| V98026 | FIAT | 200 | 23 | | V98059 | MAZDA | 409 | 15 | | V98087 | SUZUKI | 794 | 3 | |
| V98026 | FIAT | 200 | 24 | | V98059 | MAZDA | 409 | 17 | | V98089 | RENAULT | 716 | 99 | |
| V98026 | LANCIA | 352 | 11 | | V98060 | FORD | 269 | 93 | | V98089 | VOLVO | 872 | 68 | |
| V98026 | LANCIA | 353 | 13 | | V98060 | MAZDA | 410 | 21 | | V98091 | VOLVO | 867 | 62 | |
| V98026 | LANCIA | 353 | 14 | | V98061 | FORD | 269 | 93 | | V98093 | VOLVO | 854 | 20 | |
| V98026 | OPEL | 585 | 4 | | V98061 | MAZDA | 410 | 21 | | V98094 | VOLVO | 854 | 20 | |
| V98026 | VAUXHALL | 820 | 5 | | V98062 | MAZDA | 407 | 5 | | V98095 | VOLVO | 865 | 55 | |
| V98026 | VAUXHALL | 820 | 6 | | V98063 | MAZDA | 407 | 5 | | V98095 | VOLVO | 867 | 60 | |
| V98027 | ALFA ROMEO | 24 | 4 | | V98065 | MAZDA | 407 | 9 | | V98096 | VOLVO | 865 | 55 | |
| V98027 | FIAT | 199 | 21 | | V98066 | MERCEDES-BENZ | 457 | 39 | | V98096 | VOLVO | 867 | 60 | |
| V98027 | FIAT | 200 | 22 | | V98066 | MERCEDES-BENZ | 463 | 52 | | V98097 | AUDI | 59 | 44 | |
| V98027 | FIAT | 200 | 24 | | V98066 | MERCEDES-BENZ | 465 | 56 | | V98097 | AUDI | 59 | 45 | |
| V98027 | LANCIA | 352 | 11 | | V98066 | MERCEDES-BENZ | 466 | 60 | | V98097 | MITSUBISHI | 555 | 14 | |
| V98027 | LANCIA | 353 | 13 | | V98067 | MERCEDES-BENZ | 457 | 39 | | V98097 | SEAT | 763 | 55 | |
| V98027 | OPEL | 585 | 4 | | V98067 | MERCEDES-BENZ | 463 | 52 | | V98097 | SKODA | 779 | 30 | |
| V98027 | VAUXHALL | 820 | 5 | | V98067 | MERCEDES-BENZ | 465 | 56 | | V98097 | VW | 916 | 107 | |
| V98027 | VAUXHALL | 820 | 6 | | V98067 | MERCEDES-BENZ | 466 | 60 | | | | | | |
| V98028 | CITROËN | 154 | 62 | | V98068 | MERCEDES-BENZ | 446 | 16 | | | | | | |
| V98028 | FIAT | 221 | 91 | | V98069 | MERCEDES-BENZ | 446 | 16 | | | | | | |
| V98028 | PEUGEOT | 641 | 62 | | V98070 | MERCEDES-BENZ | 449 | 24 | | | | | | |
| V98029 | CITROËN | 154 | 62 | | V98070 | MERCEDES-BENZ | 449 | 26 | | | | | | |
| V98029 | FIAT | 221 | 91 | | V98070 | MERCEDES-BENZ | 451 | 30 | | | | | | |
| V98029 | PEUGEOT | 641 | 62 | | V98071 | MERCEDES-BENZ | 448 | 23 | | | | | | |
| V98032 | FORD | 264 | 79 | | V98071 | MERCEDES-BENZ | 451 | 29 | | | | | | |
| V98032 | FORD | 265 | 80 | | V98071 | MERCEDES-BENZ | 453 | 32 | | | | | | |
| V98032 | FORD | 265 | 81 | | V98071 | MITSUBISHI | 555 | 17 | | | | | | |
| V98032 | MAZDA | 410 | 19 | | V98071 | SMART | 785 | 7 | | | | | | |
| V98032 | MAZDA | 410 | 20 | | V98072 | MERCEDES-BENZ | 448 | 23 | | | | | | |
| V98032 | VOLVO | 861 | 40 | | V98072 | MERCEDES-BENZ | 451 | 29 | | | | | | |
| V98033 | FORD | 264 | 79 | | V98072 | MERCEDES-BENZ | 453 | 32 | | | | | | |
| V98033 | FORD | 265 | 80 | | V98072 | MITSUBISHI | 555 | 17 | | | | | | |
| V98033 | FORD | 265 | 81 | | V98072 | SMART | 785 | 7 | | | | | | |
| V98033 | MAZDA | 410 | 19 | | V98073 | MAZDA | 406 | 1 | | | | | | |
| V98033 | MAZDA | 410 | 20 | | V98073 | MITSUBISHI | 552 | 2 | | | | | | |
| V98033 | VOLVO | 861 | 40 | | V98073 | NISSAN | 567 | 4 | | | | | | |
| V98034 | FORD | 254 | 56 | | V98073 | NISSAN | 568 | 7 | | | | | | |
| V98034 | FORD | 254 | 57 | | V98073 | NISSAN | 568 | 10 | | | | | | |
| V98035 | FORD | 254 | 56 | | V98074 | MAZDA | 406 | 1 | | | | | | |
| V98035 | FORD | 254 | 57 | | V98074 | MITSUBISHI | 552 | 2 | | | | | | |
| V98036 | FORD | 239 | 10 | | V98074 | NISSAN | 567 | 4 | | | | | | |
| V98036 | MAZDA | 406 | 3 | | V98074 | NISSAN | 568 | 7 | | | | | | |
| V98037 | FORD | 239 | 10 | | V98074 | NISSAN | 568 | 10 | | | | | | |
| V98037 | MAZDA | 406 | 3 | | V98077 | CHEVROLET | 120 | 16 | | | | | | |
| V98038 | HYUNDAI | 283 | 16 | | V98077 | CHEVROLET | 121 | 21 | | | | | | |
| V98038 | HYUNDAI | 284 | 17 | | V98077 | DAEWOO | 163 | 10 | | | | | | |
| V98038 | KIA | 341 | 13 | | V98077 | FIAT | 204 | 39 | | | | | | |
| V98039 | HYUNDAI | 283 | 16 | | V98077 | OPEL | 591 | 26 | | | | | | |
| V98039 | HYUNDAI | 284 | 17 | | V98077 | OPEL | 593 | 31 | | | | | | |
| V98039 | KIA | 341 | 13 | | V98077 | SAAB | 726 | 1 | | | | | | |
| V98040 | HYUNDAI | 285 | 23 | | V98077 | VAUXHALL | 826 | 27 | | | | | | |
| V98040 | KIA | 341 | 16 | | V98077 | VAUXHALL | 828 | 32 | | | | | | |
| V98042 | CITROËN | 156 | 74 | | V98078 | CHEVROLET | 120 | 16 | | | | | | |
| V98042 | FIAT | 226 | 110 | | V98078 | CHEVROLET | 121 | 21 | | | | | | |
| V98042 | IVECO | 309 | 14 | | V98078 | DAEWOO | 163 | 10 | | | | | | |
| V98042 | MITSUBISHI | 557 | 23 | | V98078 | FIAT | 204 | 39 | | | | | | |
| V98042 | PEUGEOT | 645 | 81 | | V98078 | OPEL | 591 | 26 | | | | | | |
| V98043 | CITROËN | 156 | 74 | | V98078 | OPEL | 593 | 31 | | | | | | |
| V98043 | FIAT | 226 | 110 | | V98078 | SAAB | 726 | 1 | | | | | | |
| V98043 | IVECO | 309 | 14 | | V98078 | VAUXHALL | 826 | 27 | | | | | | |
| V98043 | MITSUBISHI | 557 | 23 | | V98078 | VAUXHALL | 828 | 32 | | | | | | |
| V98043 | PEUGEOT | 645 | 81 | | V98081 | CITROËN | 136 | 10 | | | | | | |
| V98048 | KIA | 339 | 7 | | V98081 | PEUGEOT | 622 | 11 | | | | | | |
| V98049 | KIA | 339 | 7 | | V98082 | CITROËN | 136 | 10 | | | | | | |
| V98052 | HYUNDAI | 286 | 27 | | V98082 | PEUGEOT | 622 | 11 | | | | | | |
| V98052 | KIA | 342 | 18 | | V98083 | MERCEDES-BENZ | 443 | 2 | | | | | | |
| V98053 | HYUNDAI | 286 | 27 | | V98083 | SMART | 784 | 4 | | | | | | |















|  |  |  |  |  |  |  |  |  |  |  |  |
|---|---|---|---|---|---|---|---|---|---|---|---|
| VAG330 | FORD | 271 | 99 | VAG51007 | CITROËN | 155 | 67 | VAG92061B | AUDI | 47 | 8 |
| VAG330 | FORD | 271 | 100 | VAG51007 | FIAT | 223 | 100 | VAG92061B | AUDI | 48 | 9 |
| VAG330 | FORD | 271 | 101 | VAG51007 | PEUGEOT | 635 | 40 | VAG92061B | AUDI | 48 | 12 |
| VAG474 | BEDFORD | 88 | 8 | VAG51007 | PEUGEOT | 635 | 41 | VAG92061B | AUDI | 48 | 13 |
| VAG474 | BEDFORD | 88 | 9 | VAG51007 | PEUGEOT | 642 | 68 | VAG92061B | AUDI | 49 | 14 |
| VAG50758 | DACIA | 158 | 3 | VAG51028B | MERCEDES-BENZ | 445 | 12 | VAG92061B | AUDI | 50 | 20 |
| VAG50758 | RENAULT | 669 | 1 | VAG51028B | MERCEDES-BENZ | 445 | 13 | VAG92061B | AUDI | 51 | 21 |
| VAG50758 | RENAULT | 672 | 5 | VAG51028B | MERCEDES-BENZ | 447 | 19 | VAG92061B | AUDI | 51 | 22 |
| VAG50758 | RENAULT | 673 | 7 | VAG51028B | MERCEDES-BENZ | 447 | 20 | VAG92061B | AUDI | 53 | 27 |
| VAG50758 | RENAULT | 673 | 9 | VAG51028B | MERCEDES-BENZ | 448 | 21 | VAG92061B | AUDI | 53 | 28 |
| VAG50758 | RENAULT | 674 | 10 | VAG51028B | MERCEDES-BENZ | 455 | 36 | VAG92061B | AUDI | 53 | 29 |
| VAG50758 | RENAULT | 676 | 13 | VAG51028B | MERCEDES-BENZ | 457 | 40 | VAG92061B | AUDI | 53 | 30 |
| VAG50758 | RENAULT | 677 | 14 | VAG51028B | MERCEDES-BENZ | 458 | 41 | VAG92061B | AUDI | 54 | 31 |
| VAG50758 | RENAULT | 677 | 15 | VAG51028B | MERCEDES-BENZ | 458 | 42 | VAG92061B | AUDI | 54 | 32 |
| VAG50758 | VOLVO | 849 | 1 | VAG51028B | MERCEDES-BENZ | 458 | 43 | VAG92061B | AUDI | 55 | 36 |
| VAG50758 | VOLVO | 849 | 4 | VAG51028B | MERCEDES-BENZ | 460 | 46 | VAG92061B | AUDI | 55 | 37 |
| VAG50828 | BEDFORD | 88 | 8 | VAG51028B | MERCEDES-BENZ | 484 | 101 | VAG92061B | AUDI | 58 | 41 |
| VAG50828 | BEDFORD | 88 | 9 | VAG586 | ALFA ROMEO | 25 | 8 | VAG92061B | AUDI | 58 | 42 |
| VAG50895 | ALFA ROMEO | 28 | 19 | VAG586 | PERKINS | 611 | 1 | VAG92061B | AUDI | 58 | 43 |
| VAG50895 | AUTOBIANCHI | 84 | 3 | VAG586 | PERKINS | 611 | 2 | VAG92061B | AUDI | 61 | 49 |
| VAG50895 | AUTOBIANCHI | 84 | 4 | VAG586 | PERKINS | 611 | 3 | VAG92061B | AUDI | 61 | 50 |
| VAG50895 | AUTOBIANCHI | 84 | 5 | VAG586 | PERKINS | 611 | 4 | VAG92061B | AUDI | 62 | 52 |
| VAG50895 | FIAT | 194 | 4 | VAG586 | PERKINS | 611 | 5 | VAG92061B | AUDI | 62 | 53 |
| VAG50895 | FIAT | 195 | 6 | VAG586 | PERKINS | 611 | 6 | VAG92061B | AUDI | 62 | 54 |
| VAG50895 | FIAT | 195 | 7 | VAG586 | PERKINS | 612 | 7 | VAG92061B | AUDI | 63 | 59 |
| VAG50895 | FIAT | 196 | 12 | VAG601 | PERKINS | 612 | 10 | VAG92061B | AUDI | 64 | 60 |
| VAG50895 | FIAT | 197 | 13 | VAG601 | PERKINS | 612 | 11 | VAG92061B | AUDI | 65 | 65 |
| VAG50895 | FIAT | 197 | 14 | VAG601 | PERKINS | 613 | 13 | VAG92061B | AUDI | 67 | 71 |
| VAG50895 | FIAT | 197 | 15 | VAG701 | ALFA ROMEO | 25 | 8 | VAG92061B | AUDI | 71 | 80 |
| VAG50895 | FIAT | 198 | 17 | VAG701 | PERKINS | 611 | 1 | VAG92061B | AUDI | 72 | 83 |
| VAG50895 | FIAT | 198 | 18 | VAG701 | PERKINS | 611 | 2 | VAG92061B | AUDI | 72 | 84 |
| VAG50895 | FIAT | 206 | 44 | VAG92016 | MERCEDES-BENZ | 519 | 148 | VAG92061B | AUDI | 72 | 85 |
| VAG50895 | LANCIA | 350 | 5 | VAG92016 | MERCEDES-BENZ | 522 | 153 | VAG92061B | FORD | 248 | 36 |
| VAG50895 | LANCIA | 351 | 6 | VAG92016 | MERCEDES-BENZ | 522 | 154 | VAG92061B | HONDA | 276 | 17 |
| VAG50895 | LANCIA | 351 | 7 | VAG92017 | MERCEDES-BENZ | 519 | 148 | VAG92061B | NISSAN | 573 | 26 |
| VAG50895 | LANCIA | 352 | 12 | VAG92017 | MERCEDES-BENZ | 522 | 153 | VAG92061B | SEAT | 750 | 12 |
| VAG50895 | LANCIA | 354 | 21 | VAG92017 | MERCEDES-BENZ | 522 | 154 | VAG92061B | SEAT | 751 | 14 |
| VAG50909 | AUSTIN MORRIS | 82 | 4 | VAG92044V1 | FORD | 246 | 31 | VAG92061B | SEAT | 751 | 15 |
| VAG50911 | AUSTIN MORRIS | 82 | 1 | VAG92044V1 | FORD | 246 | 32 | VAG92061B | SEAT | 751 | 16 |
| VAG50911 | AUSTIN MORRIS | 82 | 2 | VAG92044V1 | FORD | 249 | 39 | VAG92061B | SEAT | 751 | 17 |
| VAG50913 | JAGUAR | 334 | 11 | VAG92044V1 | FORD | 249 | 40 | VAG92061B | SEAT | 751 | 18 |
| VAG50913 | JAGUAR | 334 | 12 | VAG92044V1 | FORD | 249 | 41 | VAG92061B | SEAT | 756 | 35 |
| VAG50914 | JAGUAR | 333 | 9 | VAG92044V1 | FORD | 250 | 42 | VAG92061B | SEAT | 757 | 36 |
| VAG50914 | JAGUAR | 334 | 11 | VAG92044V1 | FORD | 250 | 43 | VAG92061B | SEAT | 757 | 37 |
| VAG50914 | JAGUAR | 334 | 12 | VAG92044V1 | FORD | 250 | 44 | VAG92061B | SEAT | 757 | 38 |
| VAG50919 | LAND ROVER | 369 | 15 | VAG92044V1 | FORD | 250 | 45 | VAG92061B | SEAT | 758 | 39 |
| VAG50919 | LAND ROVER | 370 | 16 | VAG92044V1 | FORD | 251 | 46 | VAG92061B | SEAT | 760 | 45 |
| VAG50919 | ROVER | 723 | 22 | VAG92044V1 | FORD | 264 | 77 | VAG92061B | SEAT | 761 | 49 |
| VAG50923 | JAGUAR | 333 | 6 | VAG92046 | HYUNDAI | 280 | 4 | VAG92061B | SEAT | 761 | 50 |
| VAG50923 | JAGUAR | 333 | 7 | VAG92046 | HYUNDAI | 282 | 9 | VAG92061B | SEAT | 761 | 51 |
| VAG50923 | JAGUAR | 333 | 8 | VAG92046 | HYUNDAI | 284 | 18 | VAG92061B | SEAT | 765 | 60 |
| VAG50923 | JAGUAR | 333 | 10 | VAG92046 | MITSUBISHI | 552 | 1 | VAG92061B | SKODA | 776 | 19 |
| VAG50924 | JAGUAR | 333 | 6 | VAG92046 | MITSUBISHI | 552 | 3 | VAG92061B | SKODA | 776 | 20 |
| VAG50924 | JAGUAR | 333 | 7 | VAG92046 | MITSUBISHI | 552 | 4 | VAG92061B | VOLVO | 850 | 5 |
| VAG50948 | LAND ROVER | 370 | 18 | VAG92046 | MITSUBISHI | 553 | 8 | VAG92061B | VOLVO | 855 | 22 |
| VAG50948 | LAND ROVER | 371 | 23 | VAG92046 | MITSUBISHI | 554 | 9 | VAG92061B | VW | 886 | 8 |
| VAG50949 | LAND ROVER | 370 | 18 | VAG92046 | MITSUBISHI | 555 | 16 | VAG92061B | VW | 886 | 9 |
| VAG50949 | LAND ROVER | 371 | 23 | VAG92046 | PROTON | 653 | 1 | VAG92061B | VW | 887 | 12 |
| VAG50963 | AUSTIN MORRIS | 82 | 4 | VAG92046 | PROTON | 653 | 2 | VAG92061B | VW | 887 | 13 |
| VAG50964 | VOLVO | 868 | 64 | VAG92047 | HYUNDAI | 280 | 4 | VAG92061B | VW | 887 | 14 |
| VAG50964 | VOLVO | 870 | 65 | VAG92047 | HYUNDAI | 282 | 9 | VAG92061B | VW | 888 | 16 |
| VAG50964 | VOLVO | 871 | 66 | VAG92047 | HYUNDAI | 284 | 18 | VAG92061B | VW | 888 | 17 |
| VAG50965 | VOLVO | 868 | 64 | VAG92047 | MITSUBISHI | 552 | 1 | VAG92061B | VW | 888 | 18 |
| VAG50965 | VOLVO | 870 | 65 | VAG92047 | MITSUBISHI | 552 | 3 | VAG92061B | VW | 888 | 19 |
| VAG50965 | VOLVO | 871 | 66 | VAG92047 | MITSUBISHI | 552 | 4 | VAG92061B | VW | 888 | 20 |
| VAG50969 | AUSTIN MORRIS | 82 | 3 | VAG92047 | MITSUBISHI | 553 | 8 | VAG92061B | VW | 893 | 34 |
| VAG50986 | VOLVO | 861 | 42 | VAG92047 | MITSUBISHI | 554 | 9 | VAG92061B | VW | 893 | 35 |
| VAG50986 | VOLVO | 862 | 44 | VAG92047 | MITSUBISHI | 555 | 16 | VAG92061B | VW | 894 | 36 |
| VAG50986 | VOLVO | 863 | 48 | VAG92047 | PROTON | 653 | 1 | VAG92061B | VW | 894 | 37 |
| VAG50986 | VOLVO | 863 | 49 | VAG92047 | PROTON | 653 | 2 | VAG92061B | VW | 894 | 38 |
| VAG50986 | VOLVO | 863 | 50 | VAG92061B | AUDI | 47 | 6 | VAG92061B | VW | 895 | 39 |
| VAG51007 | CITROËN | 148 | 41 | VAG92061B | AUDI | 47 | 7 | VAG92061B | VW | 895 | 40 |



NUMERICAL PARTS LIST

Nummerische Teilenummernliste • Elenco riferimenti
Liste des références produits















|  |  |  |  |  |  |  |  |  |  |  |  |  |  |  |
|---|---|---|---|---|---|---|---|--|---|---|---|---|---|---|
| VAG92061B | VW | | 895 | 41 | VAG92089 | MERCEDES-BENZ | | 533 | 168 | VAG92155 | DEUTZ/KHD | | 179 | 18 |
| VAG92061B | VW | | 897 | 50 | VAG92089 | MERCEDES-BENZ | | 534 | 169 | VAG92155 | DEUTZ/KHD | | 179 | 19 |
| VAG92061B | VW | | 898 | 51 | VAG92089 | MERCEDES-BENZ | | 534 | 170 | VAG92155 | DEUTZ/KHD | | 179 | 20 |
| VAG92061B | VW | | 898 | 52 | VAG92089 | MERCEDES-BENZ | | 534 | 171 | VAG92155 | DEUTZ/KHD | | 179 | 21 |
| VAG92061B | VW | | 898 | 53 | VAG92089 | MERCEDES-BENZ | | 535 | 172 | VAG92155 | DEUTZ/KHD | | 179 | 22 |
| VAG92061B | VW | | 898 | 54 | VAG92089 | MERCEDES-BENZ | | 535 | 173 | VAG92155 | DEUTZ/KHD | | 180 | 23 |
| VAG92061B | VW | | 898 | 55 | VAG92089 | MERCEDES-BENZ | | 535 | 174 | VAG92155 | DEUTZ/KHD | | 180 | 24 |
| VAG92061B | VW | | 899 | 56 | VAG92089 | MERCEDES-BENZ | | 536 | 175 | VAG92155 | DEUTZ/KHD | | 180 | 25 |
| VAG92061B | VW | | 899 | 57 | VAG92089 | MERCEDES-BENZ | | 539 | 179 | VAG92155 | DEUTZ/KHD | | 180 | 26 |
| VAG92061B | VW | | 899 | 58 | VAG92089 | MERCEDES-BENZ | | 540 | 180 | VAG92155 | DEUTZ/KHD | | 181 | 27 |
| VAG92061B | VW | | 902 | 66 | VAG92089 | MERCEDES-BENZ | | 542 | 183 | VAG92155 | DEUTZ/KHD | | 181 | 28 |
| VAG92061B | VW | | 902 | 67 | VAG92093 | TOYOTA | | 808 | 23 | VAG92155 | DEUTZ/KHD | | 181 | 29 |
| VAG92061B | VW | | 903 | 68 | VAG92093 | TOYOTA | | 808 | 24 | VAG92155 | DEUTZ/KHD | | 181 | 30 |
| VAG92061B | VW | | 903 | 69 | VAG92093 | TOYOTA | | 809 | 25 | VAG92155 | DEUTZ/KHD | | 182 | 31 |
| VAG92061B | VW | | 904 | 70 | VAG92096 | VOLVO | | 864 | 52 | VAG92155 | DEUTZ/KHD | | 182 | 32 |
| VAG92061B | VW | | 904 | 71 | VAG92105B | AUDI | | 53 | 27 | VAG92155 | DEUTZ/KHD | | 182 | 33 |
| VAG92061B | VW | | 904 | 72 | VAG92105B | AUDI | | 53 | 28 | VAG92155 | DEUTZ/KHD | | 183 | 34 |
| VAG92061B | VW | | 905 | 73 | VAG92105B | AUDI | | 54 | 32 | VAG92155 | IVECO | | 312 | 27 |
| VAG92061B | VW | | 905 | 75 | VAG92105B | AUDI | | 55 | 35 | VAG92155 | IVECO | | 313 | 29 |
| VAG92061B | VW | | 908 | 82 | VAG92105B | AUDI | | 57 | 40 | VAG92158 | LAND ROVER | | 370 | 19 |
| VAG92061B | VW | | 908 | 83 | VAG92105B | AUDI | | 58 | 41 | VAG92158 | LAND ROVER | | 371 | 21 |
| VAG92061B | VW | | 908 | 84 | VAG92105B | AUDI | | 58 | 42 | VAG92159 | LAND ROVER | | 370 | 19 |
| VAG92061B | VW | | 909 | 86 | VAG92105B | AUDI | | 58 | 43 | VAG92159 | LAND ROVER | | 371 | 21 |
| VAG92061B | VW | | 910 | 89 | VAG92105B | AUDI | | 61 | 49 | VAG92166 | SCANIA | | 733 | 3 |
| VAG92061B | VW | | 911 | 90 | VAG92105B | AUDI | | 61 | 50 | VAG92166 | SCANIA | | 734 | 5 |
| VAG92061B | VW | | 911 | 91 | VAG92105B | AUDI | | 62 | 53 | VAG92166 | SCANIA | | 734 | 6 |
| VAG92061B | VW | | 912 | 92 | VAG92105B | AUDI | | 62 | 54 | VAG92166 | SCANIA | | 736 | 7 |
| VAG92061B | VW | | 912 | 93 | VAG92105B | AUDI | | 63 | 58 | VAG92166 | SCANIA | | 736 | 8 |
| VAG92061B | VW | | 914 | 97 | VAG92105B | AUDI | | 64 | 60 | VAG92166 | SCANIA | | 737 | 9 |
| VAG92061B | VW | | 914 | 98 | VAG92105B | AUDI | | 66 | 70 | VAG92166 | SCANIA | | 738 | 12 |
| VAG92061B | VW | | 914 | 99 | VAG92105B | FORD | | 242 | 21 | VAG92166 | SCANIA | | 739 | 13 |
| VAG92061B | VW | | 915 | 102 | VAG92105B | HONDA | | 276 | 17 | VAG92166 | SCANIA | | 739 | 14 |
| VAG92061B | VW | | 916 | 105 | VAG92105B | NISSAN | | 573 | 26 | VAG92166 | SCANIA | | 740 | 15 |
| VAG92061B | VW | | 916 | 106 | VAG92105B | SEAT | | 761 | 49 | VAG92166 | SCANIA | | 740 | 16 |
| VAG92061B | VW | | 919 | 110 | VAG92105B | VW | | 886 | 11 | VAG92166 | SCANIA | | 741 | 17 |
| VAG92061B | VW | | 919 | 111 | VAG92105B | VW | | 887 | 15 | VAG92166 | SCANIA | | 741 | 18 |
| VAG92061B | VW | | 919 | 112 | VAG92105B | VW | | 902 | 66 | VAG92167 | SCANIA | | 733 | 3 |
| VAG92061B | VW | | 920 | 114 | VAG92105B | VW | | 908 | 82 | VAG92167 | SCANIA | | 734 | 5 |
| VAG92061B | VW | | 920 | 115 | VAG92105B | VW | | 910 | 89 | VAG92167 | SCANIA | | 734 | 6 |
| VAG92061B | VW | | 921 | 116 | VAG92105B | VW | | 911 | 90 | VAG92167 | SCANIA | | 736 | 7 |
| VAG92061B | VW | | 923 | 125 | VAG92105B | VW | | 914 | 97 | VAG92167 | SCANIA | | 736 | 8 |
| VAG92061B | VW | | 924 | 129 | VAG92105B | VW | | 914 | 98 | VAG92167 | SCANIA | | 737 | 9 |
| VAG92080 | VOLVO | | 865 | 54 | VAG92105B | VW | | 914 | 99 | VAG92167 | SCANIA | | 738 | 12 |
| VAG92080 | VOLVO | | 866 | 56 | VAG92105B | VW | | 915 | 100 | VAG92167 | SCANIA | | 739 | 13 |
| VAG92080 | VOLVO | | 866 | 57 | VAG92105B | VW | | 915 | 101 | VAG92167 | SCANIA | | 739 | 14 |
| VAG92080 | VOLVO | | 866 | 58 | VAG92105B | VW | | 915 | 102 | VAG92167 | SCANIA | | 740 | 15 |
| VAG92080 | VOLVO | | 866 | 59 | VAG92105B | VW | | 915 | 104 | VAG92167 | SCANIA | | 740 | 16 |
| VAG92089 | MERCEDES-BENZ | | 511 | 132 | VAG92105B | VW | | 916 | 105 | VAG92167 | SCANIA | | 741 | 17 |
| VAG92089 | MERCEDES-BENZ | | 511 | 133 | VAG92105B | VW | | 919 | 110 | VAG92167 | SCANIA | | 741 | 18 |
| VAG92089 | MERCEDES-BENZ | | 512 | 134 | VAG92105B | VW | | 919 | 111 | VAG92168B | ALFA ROMEO | | 25 | 6 |
| VAG92089 | MERCEDES-BENZ | | 513 | 136 | VAG92105B | VW | | 919 | 112 | VAG92168B | ALFA ROMEO | | 25 | 7 |
| VAG92089 | MERCEDES-BENZ | | 513 | 137 | VAG92108 | MERCEDES-BENZ | | 478 | 82 | VAG92168B | ALFA ROMEO | | 26 | 13 |
| VAG92089 | MERCEDES-BENZ | | 514 | 138 | VAG92108 | MERCEDES-BENZ | | 478 | 83 | VAG92168B | ALFA ROMEO | | 26 | 14 |
| VAG92089 | MERCEDES-BENZ | | 514 | 139 | VAG92108 | MERCEDES-BENZ | | 478 | 84 | VAG92170B | BMW | | 96 | 15 |
| VAG92089 | MERCEDES-BENZ | | 515 | 140 | VAG92108 | MERCEDES-BENZ | | 479 | 85 | VAG92170B | BMW | | 114 | 62 |
| VAG92089 | MERCEDES-BENZ | | 515 | 141 | VAG92108 | MERCEDES-BENZ | | 479 | 86 | VAG92171B | MERCEDES-BENZ | | 456 | 37 |
| VAG92089 | MERCEDES-BENZ | | 516 | 142 | VAG92108 | MERCEDES-BENZ | | 479 | 87 | VAG92171B | MERCEDES-BENZ | | 456 | 38 |
| VAG92089 | MERCEDES-BENZ | | 517 | 143 | VAG92108 | MERCEDES-BENZ | | 479 | 88 | VAG92172B | MERCEDES-BENZ | | 456 | 37 |
| VAG92089 | MERCEDES-BENZ | | 517 | 144 | VAG92108 | MERCEDES-BENZ | | 480 | 89 | VAG92172B | MERCEDES-BENZ | | 456 | 38 |
| VAG92089 | MERCEDES-BENZ | | 518 | 145 | VAG92109 | MERCEDES-BENZ | | 478 | 82 | VAG92174 | LADA | | 344 | 1 |
| VAG92089 | MERCEDES-BENZ | | 518 | 146 | VAG92109 | MERCEDES-BENZ | | 478 | 83 | VAG92174 | LADA | | 344 | 2 |
| VAG92089 | MERCEDES-BENZ | | 518 | 147 | VAG92109 | MERCEDES-BENZ | | 478 | 84 | VAG92174 | LADA | | 344 | 3 |
| VAG92089 | MERCEDES-BENZ | | 519 | 149 | VAG92109 | MERCEDES-BENZ | | 479 | 85 | VAG92174 | LADA | | 344 | 4 |
| VAG92089 | MERCEDES-BENZ | | 520 | 150 | VAG92109 | MERCEDES-BENZ | | 479 | 86 | VAG92174 | LADA | | 344 | 5 |
| VAG92089 | MERCEDES-BENZ | | 520 | 151 | VAG92109 | MERCEDES-BENZ | | 479 | 87 | VAG92174 | LADA | | 345 | 6 |
| VAG92089 | MERCEDES-BENZ | | 523 | 155 | VAG92109 | MERCEDES-BENZ | | 479 | 88 | VAG92175 | LADA | | 344 | 1 |
| VAG92089 | MERCEDES-BENZ | | 523 | 156 | VAG92109 | MERCEDES-BENZ | | 480 | 89 | VAG92175 | LADA | | 344 | 2 |
| VAG92089 | MERCEDES-BENZ | | 525 | 157 | VAG92155 | DEUTZ/KHD | | 177 | 9 | VAG92175 | LADA | | 344 | 3 |
| VAG92089 | MERCEDES-BENZ | | 529 | 164 | VAG92155 | DEUTZ/KHD | | 177 | 11 | VAG92175 | LADA | | 344 | 4 |
| VAG92089 | MERCEDES-BENZ | | 530 | 165 | VAG92155 | DEUTZ/KHD | | 178 | 13 | VAG92175 | LADA | | 344 | 5 |
| VAG92089 | MERCEDES-BENZ | | 530 | 166 | VAG92155 | DEUTZ/KHD | | 178 | 15 | VAG92175 | LADA | | 345 | 6 |
| VAG92089 | MERCEDES-BENZ | | 533 | 167 | VAG92155 | DEUTZ/KHD | | 178 | 17 | VAG92179 | DAF | | 168 | 2 |















|  |  |  |  |  |  |  |  |  |  |  |  |  |  |  |
|---|---|---|---|---|---|---|---|---|---|---|---|---|---|---|
| VAG92179 | DAF | | 168 | 3 | VAG92288B | FIAT | | 215 | 66 | VAG92303B | BMW | | 104 | 34 |
| VAG92179 | FORD | | 270 | 96 | VAG92288B | HONDA | | 276 | 16 | VAG92309 | LAND ROVER | | 367 | 1 |
| VAG92179 | FORD | | 271 | 97 | VAG92288B | HYUNDAI | | 284 | 20 | VAG92309 | LOTUS | | 374 | 2 |
| VAG92179 | PEUGEOT | | 642 | 67 | VAG92288B | LADA | | 345 | 8 | VAG92309 | MG | | 545 | 1 |
| VAG92179 | PEUGEOT | | 643 | 72 | VAG92288B | LADA | | 345 | 9 | VAG92309 | MG | | 545 | 2 |
| VAG92179 | PEUGEOT | | 644 | 78 | VAG92288B | PEUGEOT | | 629 | 26 | VAG92309 | MG | | 545 | 3 |
| VAG92179 | PEUGEOT | | 645 | 79 | VAG92288B | PEUGEOT | | 630 | 27 | VAG92309 | ROVER | | 719 | 3 |
| VAG92179 | SSANGYONG | | 788 | 6 | VAG92288B | PEUGEOT | | 634 | 38 | VAG92309 | ROVER | | 720 | 5 |
| VAG92193 | ALFA ROMEO | | 38 | 55 | VAG92288B | PEUGEOT | | 634 | 39 | VAG92309 | ROVER | | 721 | 10 |
| VAG92193 | ALFA ROMEO | | 38 | 56 | VAG92288B | ROVER | | 721 | 11 | VAG92309 | ROVER | | 721 | 12 |
| VAG92193 | FIAT | | 224 | 103 | VAG92288B | SUZUKI | | 798 | 20 | VAG92316 | LAND ROVER | | 367 | 1 |
| VAG92193 | FIAT | | 225 | 104 | VAG92288B | SUZUKI | | 799 | 21 | VAG92316 | LOTUS | | 374 | 2 |
| VAG92193 | FIAT | | 225 | 105 | VAG92288B | SUZUKI | | 799 | 22 | VAG92316 | MG | | 545 | 1 |
| VAG92193 | FIAT | | 226 | 107 | VAG92292 | KIA | | 341 | 15 | VAG92316 | MG | | 545 | 2 |
| VAG92193 | IVECO | | 301 | 2 | VAG92292 | MAZDA | | 409 | 16 | VAG92316 | MG | | 545 | 3 |
| VAG92193 | IVECO | | 301 | 3 | VAG92292 | MAZDA | | 409 | 18 | VAG92316 | ROVER | | 719 | 3 |
| VAG92193 | IVECO | | 301 | 4 | VAG92293 | KIA | | 341 | 15 | VAG92316 | ROVER | | 720 | 5 |
| VAG92193 | IVECO | | 302 | 5 | VAG92293 | MAZDA | | 409 | 16 | VAG92316 | ROVER | | 721 | 10 |
| VAG92193 | IVECO | | 303 | 6 | VAG92293 | MAZDA | | 409 | 18 | VAG92316 | ROVER | | 721 | 12 |
| VAG92193 | IVECO | | 304 | 7 | VAG92294 | ROVER | | 719 | 2 | VAG92318 | NISSAN | | 576 | 35 |
| VAG92193 | IVECO | | 305 | 8 | VAG92294 | ROVER | | 719 | 4 | VAG92320 | NISSAN | | 576 | 35 |
| VAG92193 | IVECO | | 306 | 9 | VAG92297 | MERCEDES-BENZ | | 459 | 44 | VAG92321 | ISUZU | | 290 | 1 |
| VAG92193 | IVECO | | 306 | 10 | VAG92297 | MERCEDES-BENZ | | 460 | 47 | VAG92321 | ISUZU | | 290 | 2 |
| VAG92193 | IVECO | | 306 | 11 | VAG92297 | MERCEDES-BENZ | | 461 | 48 | VAG92321 | ISUZU | | 290 | 3 |
| VAG92193 | IVECO | | 306 | 12 | VAG92297 | MERCEDES-BENZ | | 462 | 50 | VAG92321 | MAZDA | | 408 | 12 |
| VAG92193 | IVECO | | 308 | 13 | VAG92297 | MERCEDES-BENZ | | 469 | 66 | VAG92321 | OPEL | | 588 | 17 |
| VAG92193 | LANCIA | | 365 | 60 | VAG92297 | MERCEDES-BENZ | | 470 | 67 | VAG92321 | OPEL | | 588 | 18 |
| VAG92193 | LANCIA | | 365 | 61 | VAG92297 | MERCEDES-BENZ | | 471 | 68 | VAG92321 | OPEL | | 593 | 32 |
| VAG92193 | OPEL | | 608 | 83 | VAG92297 | SSANGYONG | | 787 | 1 | VAG92321 | OPEL | | 593 | 33 |
| VAG92193 | RENAULT | | 708 | 71 | VAG92297 | SSANGYONG | | 787 | 2 | VAG92321 | VAUXHALL | | 823 | 18 |
| VAG92193 | SEAT | | 767 | 67 | VAG92298 | MERCEDES-BENZ | | 459 | 44 | VAG92321 | VAUXHALL | | 824 | 19 |
| VAG92193 | VAUXHALL | | 842 | 83 | VAG92298 | MERCEDES-BENZ | | 460 | 47 | VAG92321 | VAUXHALL | | 828 | 33 |
| VAG92198 | JAGUAR | | 334 | 11 | VAG92298 | MERCEDES-BENZ | | 461 | 48 | VAG92321 | VAUXHALL | | 828 | 34 |
| VAG92198 | JAGUAR | | 334 | 12 | VAG92298 | MERCEDES-BENZ | | 462 | 50 | VAG92322 | FORD | | 268 | 91 |
| VAG92199 | JAGUAR | | 334 | 11 | VAG92298 | MERCEDES-BENZ | | 469 | 66 | VAG92322 | HYUNDAI | | 286 | 28 |
| VAG92199 | JAGUAR | | 334 | 12 | VAG92298 | MERCEDES-BENZ | | 470 | 67 | VAG92322 | HYUNDAI | | 287 | 29 |
| VAG92200B | MERCEDES-BENZ | | 445 | 12 | VAG92298 | MERCEDES-BENZ | | 471 | 68 | VAG92322 | HYUNDAI | | 287 | 30 |
| VAG92200B | MERCEDES-BENZ | | 445 | 13 | VAG92298 | SSANGYONG | | 787 | 1 | VAG92322 | HYUNDAI | | 287 | 31 |
| VAG92200B | MERCEDES-BENZ | | 447 | 19 | VAG92298 | SSANGYONG | | 787 | 2 | VAG92322 | KIA | | 342 | 19 |
| VAG92200B | MERCEDES-BENZ | | 447 | 20 | VAG92299 | PERKINS | | 612 | 8 | VAG92322 | MITSUBISHI | | 556 | 18 |
| VAG92200B | MERCEDES-BENZ | | 448 | 21 | VAG92299 | PERKINS | | 612 | 9 | VAG92322 | MITSUBISHI | | 556 | 21 |
| VAG92200B | MERCEDES-BENZ | | 455 | 36 | VAG92299 | PERKINS | | 612 | 10 | VAG92322 | MITSUBISHI | | 557 | 22 |
| VAG92200B | MERCEDES-BENZ | | 457 | 40 | VAG92299 | PERKINS | | 612 | 11 | VAG92323 | FORD | | 268 | 91 |
| VAG92200B | MERCEDES-BENZ | | 458 | 41 | VAG92299 | PERKINS | | 613 | 12 | VAG92323 | HYUNDAI | | 286 | 28 |
| VAG92200B | MERCEDES-BENZ | | 458 | 42 | VAG92299 | PERKINS | | 613 | 13 | VAG92323 | HYUNDAI | | 287 | 29 |
| VAG92200B | MERCEDES-BENZ | | 458 | 43 | VAG92299 | PERKINS | | 613 | 14 | VAG92323 | HYUNDAI | | 287 | 30 |
| VAG92200B | MERCEDES-BENZ | | 460 | 46 | VAG92299 | PERKINS | | 613 | 15 | VAG92323 | HYUNDAI | | 287 | 31 |
| VAG92200B | MERCEDES-BENZ | | 484 | 101 | VAG92299 | PERKINS | | 614 | 16 | VAG92323 | KIA | | 342 | 19 |
| VAG92210 | HONDA | | 273 | 4 | VAG92299 | PERKINS | | 614 | 17 | VAG92323 | MITSUBISHI | | 556 | 18 |
| VAG92210 | HONDA | | 273 | 5 | VAG92299 | PERKINS | | 614 | 18 | VAG92323 | MITSUBISHI | | 556 | 21 |
| VAG92210 | ROVER | | 719 | 1 | VAG92299 | PERKINS | | 614 | 19 | VAG92323 | MITSUBISHI | | 557 | 22 |
| VAG92221 | FORD | | 270 | 95 | VAG92299 | PERKINS | | 615 | 20 | VAG92324 | LAND ROVER | | 370 | 20 |
| VAG92234 | VOLVO | | 861 | 42 | VAG92299 | RENAULT | | 709 | 73 | VAG92324 | LAND ROVER | | 371 | 22 |
| VAG92234 | VOLVO | | 861 | 43 | VAG92299 | RENAULT | | 709 | 74 | VAG92325 | FORD | | 247 | 33 |
| VAG92234 | VOLVO | | 862 | 44 | VAG92300 | PERKINS | | 612 | 8 | VAG92325 | FORD | | 247 | 34 |
| VAG92234 | VOLVO | | 863 | 48 | VAG92300 | PERKINS | | 612 | 9 | VAG92325 | MAZDA | | 407 | 7 |
| VAG92234 | VOLVO | | 863 | 49 | VAG92300 | PERKINS | | 612 | 10 | VAG92325 | MAZDA | | 408 | 11 |
| VAG92234 | VOLVO | | 863 | 50 | VAG92300 | PERKINS | | 612 | 11 | VAG92325 | TOYOTA | | 802 | 2 |
| VAG92282 | TOYOTA | | 812 | 33 | VAG92300 | PERKINS | | 613 | 12 | VAG92325 | TOYOTA | | 803 | 6 |
| VAG92282 | TOYOTA | | 812 | 34 | VAG92300 | PERKINS | | 613 | 13 | VAG92325 | VOLVO | | 850 | 7 |
| VAG92282 | VW | | 932 | 150 | VAG92300 | PERKINS | | 613 | 14 | VAG92329B | DACIA | | 160 | 8 |
| VAG92284 | NISSAN | | 572 | 23 | VAG92300 | PERKINS | | 613 | 15 | VAG92329B | MITSUBISHI | | 554 | 12 |
| VAG92284 | NISSAN | | 575 | 31 | VAG92300 | PERKINS | | 614 | 16 | VAG92329B | OPEL | | 595 | 38 |
| VAG92285 | NISSAN | | 572 | 23 | VAG92300 | PERKINS | | 614 | 17 | VAG92329B | RENAULT | | 679 | 17 |
| VAG92285 | NISSAN | | 575 | 31 | VAG92300 | PERKINS | | 614 | 18 | VAG92329B | RENAULT | | 684 | 23 |
| VAG92286 | NISSAN | | 575 | 31 | VAG92300 | PERKINS | | 614 | 19 | VAG92329B | RENAULT | | 685 | 24 |
| VAG92288B | CITROËN | | 143 | 27 | VAG92300 | PERKINS | | 615 | 20 | VAG92329B | RENAULT | | 685 | 25 |
| VAG92288B | CITROËN | | 144 | 28 | VAG92300 | RENAULT | | 709 | 73 | VAG92329B | RENAULT | | 685 | 26 |
| VAG92288B | CITROËN | | 147 | 38 | VAG92300 | RENAULT | | 709 | 74 | VAG92329B | RENAULT | | 686 | 27 |
| VAG92288B | CITROËN | | 147 | 39 | VAG92303B | BMW | | 92 | 4 | VAG92329B | RENAULT | | 686 | 28 |
| VAG92288B | CITROËN | | 148 | 40 | VAG92303B | BMW | | 94 | 8 | VAG92329B | VAUXHALL | | 830 | 39 |
| VAG92288B | FIAT | | 214 | 65 | VAG92303B | BMW | | 102 | 30 | VAG92329B | VOLVO | | 850 | 6 |



NUMERICAL PARTS LIST

Nummerische Teilenummernliste • Elenco riferimenti
Liste des références produits















|  |  |  |  |  |  |  |  |  |  |  |  |  |  |  |
|---|---|---|---|---|---|---|---|--|---|---|---|---|---|---|
| VAG92329B | VOLVO | 850 | 8 | VAG92364 | FIAT | 194 | 2 | VAG92369 | LANCIA | 365 | 60 | | | |
| VAG92329B | VOLVO | 851 | 9 | VAG92364 | FIAT | 194 | 4 | VAG92369 | LANCIA | 365 | 61 | | | |
| VAG92329B | VOLVO | 851 | 11 | VAG92364 | FIAT | 195 | 6 | VAG92369 | OPEL | 608 | 81 | | | |
| VAG92331B | CITROËN | 143 | 27 | VAG92364 | FIAT | 195 | 7 | VAG92369 | OPEL | 608 | 83 | | | |
| VAG92331B | CITROËN | 147 | 38 | VAG92364 | FIAT | 196 | 12 | VAG92369 | OPEL | 608 | 84 | | | |
| VAG92331B | CITROËN | 147 | 39 | VAG92364 | FIAT | 197 | 13 | VAG92369 | PEUGEOT | 645 | 80 | | | |
| VAG92331B | CITROËN | 148 | 40 | VAG92364 | FIAT | 197 | 14 | VAG92369 | RENAULT | 705 | 60 | | | |
| VAG92331B | FIAT | 215 | 66 | VAG92364 | FIAT | 197 | 15 | VAG92369 | RENAULT | 705 | 61 | | | |
| VAG92331B | HYUNDAI | 284 | 20 | VAG92364 | FIAT | 198 | 17 | VAG92369 | RENAULT | 706 | 62 | | | |
| VAG92331B | LADA | 345 | 8 | VAG92364 | FIAT | 198 | 18 | VAG92369 | RENAULT | 706 | 63 | | | |
| VAG92331B | LADA | 345 | 9 | VAG92364 | FIAT | 199 | 20 | VAG92369 | RENAULT | 706 | 64 | | | |
| VAG92331B | PEUGEOT | 629 | 26 | VAG92364 | FIAT | 206 | 44 | VAG92369 | RENAULT | 707 | 65 | | | |
| VAG92331B | PEUGEOT | 634 | 38 | VAG92364 | FIAT | 223 | 97 | VAG92369 | RENAULT | 707 | 66 | | | |
| VAG92331B | PEUGEOT | 634 | 39 | VAG92364 | LANCIA | 350 | 1 | VAG92369 | RENAULT | 707 | 67 | | | |
| VAG92331B | SUZUKI | 799 | 21 | VAG92364 | LANCIA | 350 | 2 | VAG92369 | RENAULT | 708 | 68 | | | |
| VAG92331B | SUZUKI | 799 | 22 | VAG92364 | LANCIA | 350 | 5 | VAG92369 | RENAULT | 708 | 69 | | | |
| VAG92332B | CITROËN | 145 | 32 | VAG92364 | LANCIA | 351 | 6 | VAG92369 | RENAULT | 708 | 70 | | | |
| VAG92332B | CITROËN | 145 | 33 | VAG92364 | LANCIA | 351 | 7 | VAG92369 | RENAULT | 708 | 71 | | | |
| VAG92332B | CITROËN | 145 | 34 | VAG92364 | LANCIA | 352 | 10 | VAG92369 | SEAT | 767 | 67 | | | |
| VAG92332B | FIAT | 214 | 64 | VAG92364 | LANCIA | 352 | 12 | VAG92369 | VAUXHALL | 842 | 81 | | | |
| VAG92332B | PEUGEOT | 631 | 31 | VAG92364 | LANCIA | 354 | 21 | VAG92369 | VAUXHALL | 842 | 83 | | | |
| VAG92332B | PEUGEOT | 631 | 32 | VAG92364 | LANCIA | 364 | 56 | VAG92369 | VAUXHALL | 842 | 84 | | | |
| VAG92332B | PEUGEOT | 631 | 33 | VAG92364 | SEAT | 748 | 2 | VAG92372 | BEDFORD | 88 | 7 | | | |
| VAG92332B | PEUGEOT | 632 | 34 | VAG92364 | SEAT | 748 | 3 | VAG92372 | ISUZU | 290 | 4 | | | |
| VAG92332B | PEUGEOT | 633 | 36 | VAG92364 | SEAT | 748 | 4 | VAG92372 | ISUZU | 291 | 6 | | | |
| VAG92333B | CITROËN | 145 | 32 | VAG92364 | ZASTAVA | 935 | 1 | VAG92372 | OPEL | 606 | 76 | | | |
| VAG92333B | CITROËN | 145 | 33 | VAG92366 | ALFA ROMEO | 32 | 32 | VAG92372 | VAUXHALL | 840 | 76 | | | |
| VAG92333B | PEUGEOT | 631 | 31 | VAG92366 | CITROËN | 154 | 64 | VAG92373 | ALFA ROMEO | 38 | 55 | | | |
| VAG92333B | PEUGEOT | 631 | 32 | VAG92366 | FIAT | 205 | 42 | VAG92373 | ALFA ROMEO | 38 | 56 | | | |
| VAG92333B | PEUGEOT | 631 | 33 | VAG92366 | FIAT | 205 | 43 | VAG92373 | CITROËN | 156 | 73 | | | |
| VAG92337 | CITROËN | 155 | 68 | VAG92366 | FIAT | 213 | 61 | VAG92373 | FIAT | 224 | 103 | | | |
| VAG92337 | CITROËN | 155 | 69 | VAG92366 | FIAT | 213 | 62 | VAG92373 | FIAT | 225 | 104 | | | |
| VAG92337 | JEEP | 336 | 3 | VAG92366 | FIAT | 214 | 63 | VAG92373 | FIAT | 225 | 105 | | | |
| VAG92337 | PEUGEOT | 642 | 69 | VAG92366 | FIAT | 220 | 86 | VAG92373 | FIAT | 225 | 106 | | | |
| VAG92337 | PEUGEOT | 643 | 70 | VAG92366 | FIAT | 221 | 92 | VAG92373 | FIAT | 226 | 107 | | | |
| VAG92337 | PEUGEOT | 643 | 71 | VAG92366 | FIAT | 221 | 93 | VAG92373 | FIAT | 226 | 108 | | | |
| VAG92337 | PEUGEOT | 643 | 73 | VAG92366 | FIAT | 222 | 94 | VAG92373 | FIAT | 226 | 109 | | | |
| VAG92337 | RENAULT | 701 | 53 | VAG92366 | FIAT | 222 | 95 | VAG92373 | IVECO | 301 | 2 | | | |
| VAG92337 | RENAULT | 703 | 55 | VAG92366 | FIAT | 222 | 96 | VAG92373 | IVECO | 301 | 3 | | | |
| VAG92337 | RENAULT | 704 | 57 | VAG92366 | FIAT | 223 | 98 | VAG92373 | IVECO | 301 | 4 | | | |
| VAG92337 | RENAULT | 704 | 59 | VAG92366 | LANCIA | 354 | 20 | VAG92373 | IVECO | 302 | 5 | | | |
| VAG92337 | VOLVO | 861 | 41 | VAG92366 | LANCIA | 358 | 33 | VAG92373 | IVECO | 303 | 6 | | | |
| VAG92337 | VOLVO | 862 | 46 | VAG92366 | LANCIA | 358 | 34 | VAG92373 | IVECO | 304 | 7 | | | |
| VAG92337 | VOLVO | 862 | 47 | VAG92366 | LANCIA | 358 | 35 | VAG92373 | IVECO | 305 | 8 | | | |
| VAG92342B | MERCEDES-BENZ | 448 | 22 | VAG92366 | LANCIA | 363 | 54 | VAG92373 | IVECO | 306 | 9 | | | |
| VAG92344 | MAN | 384 | 1 | VAG92366 | LANCIA | 364 | 55 | VAG92373 | IVECO | 306 | 10 | | | |
| VAG92344 | MAN | 384 | 2 | VAG92366 | LANCIA | 364 | 57 | VAG92373 | IVECO | 306 | 11 | | | |
| VAG92344 | MAN | 384 | 3 | VAG92366 | LANCIA | 364 | 58 | VAG92373 | IVECO | 306 | 12 | | | |
| VAG92344 | MAN | 386 | 5 | VAG92366 | PEUGEOT | 641 | 64 | VAG92373 | IVECO | 308 | 13 | | | |
| VAG92344 | MAN | 387 | 6 | VAG92366 | ZASTAVA | 936 | 5 | VAG92373 | IVECO | 309 | 15 | | | |
| VAG92344 | MAN | 387 | 7 | VAG92369 | ALFA ROMEO | 38 | 55 | VAG92373 | IVECO | 310 | 16 | | | |
| VAG92345 | MAN | 384 | 1 | VAG92369 | ALFA ROMEO | 38 | 56 | VAG92373 | IVECO | 310 | 17 | | | |
| VAG92345 | MAN | 384 | 2 | VAG92369 | CITROËN | 156 | 73 | VAG92373 | IVECO | 310 | 18 | | | |
| VAG92345 | MAN | 384 | 3 | VAG92369 | FIAT | 224 | 103 | VAG92373 | IVECO | 310 | 19 | | | |
| VAG92345 | MAN | 386 | 5 | VAG92369 | FIAT | 225 | 104 | VAG92373 | IVECO | 311 | 20 | | | |
| VAG92345 | MAN | 387 | 6 | VAG92369 | FIAT | 225 | 105 | VAG92373 | IVECO | 311 | 21 | | | |
| VAG92345 | MAN | 387 | 7 | VAG92369 | FIAT | 225 | 106 | VAG92373 | IVECO | 311 | 22 | | | |
| VAG92347B | BMW | 92 | 4 | VAG92369 | FIAT | 226 | 107 | VAG92373 | IVECO | 312 | 24 | | | |
| VAG92347B | BMW | 94 | 8 | VAG92369 | IVECO | 301 | 2 | VAG92373 | IVECO | 312 | 25 | | | |
| VAG92347B | BMW | 102 | 30 | VAG92369 | IVECO | 301 | 3 | VAG92373 | IVECO | 313 | 30 | | | |
| VAG92347B | BMW | 104 | 34 | VAG92369 | IVECO | 301 | 4 | VAG92373 | IVECO | 314 | 33 | | | |
| VAG92360 | NISSAN | 569 | 12 | VAG92369 | IVECO | 302 | 5 | VAG92373 | IVECO | 315 | 34 | | | |
| VAG92360 | NISSAN | 569 | 13 | VAG92369 | IVECO | 303 | 6 | VAG92373 | IVECO | 315 | 36 | | | |
| VAG92360 | NISSAN | 569 | 14 | VAG92369 | IVECO | 304 | 7 | VAG92373 | IVECO | 315 | 37 | | | |
| VAG92360 | NISSAN | 571 | 18 | VAG92369 | IVECO | 305 | 8 | VAG92373 | IVECO | 316 | 40 | | | |
| VAG92360 | NISSAN | 573 | 24 | VAG92369 | IVECO | 306 | 9 | VAG92373 | IVECO | 317 | 42 | | | |
| VAG92364 | AUTOBIANCHI | 84 | 1 | VAG92369 | IVECO | 306 | 10 | VAG92373 | IVECO | 318 | 43 | | | |
| VAG92364 | AUTOBIANCHI | 84 | 2 | VAG92369 | IVECO | 306 | 11 | VAG92373 | IVECO | 318 | 44 | | | |
| VAG92364 | AUTOBIANCHI | 84 | 3 | VAG92369 | IVECO | 306 | 12 | VAG92373 | IVECO | 320 | 46 | | | |
| VAG92364 | AUTOBIANCHI | 84 | 4 | VAG92369 | IVECO | 308 | 13 | VAG92373 | IVECO | 320 | 47 | | | |
| VAG92364 | AUTOBIANCHI | 84 | 5 | VAG92369 | LANCIA | 353 | 16 | VAG92373 | IVECO | 320 | 48 | | | |
| VAG92364 | FIAT | 194 | 1 | VAG92369 | LANCIA | 354 | 18 | VAG92373 | LANCIA | 365 | 60 | | | |















|  |  |  |  |  |  |  |  |  |  |  |  |  |  |  |
|---|---|---|---|---|---|---|---|---|---|---|---|---|---|---|
| VAG92373 | LANCIA | 365 | 61 | VAG92397 | HONDA | 274 | 8 | VAG92444 | IVECO | 304 | 7 | | | |
| VAG92373 | OPEL | 608 | 81 | VAG92397 | HONDA | 274 | 9 | VAG92444 | IVECO | 305 | 8 | | | |
| VAG92373 | OPEL | 608 | 83 | VAG92397 | HONDA | 274 | 10 | VAG92444 | IVECO | 306 | 9 | | | |
| VAG92373 | PEUGEOT | 645 | 80 | VAG92397 | HONDA | 275 | 12 | VAG92444 | IVECO | 306 | 10 | | | |
| VAG92373 | RENAULT | 705 | 60 | VAG92397 | HONDA | 275 | 13 | VAG92444 | IVECO | 306 | 11 | | | |
| VAG92373 | RENAULT | 705 | 61 | VAG92397 | HONDA | 275 | 14 | VAG92444 | IVECO | 306 | 12 | | | |
| VAG92373 | RENAULT | 706 | 62 | VAG92397 | HONDA | 276 | 18 | VAG92444 | IVECO | 308 | 13 | | | |
| VAG92373 | RENAULT | 706 | 63 | VAG92397 | HONDA | 277 | 21 | VAG92444 | IVECO | 311 | 23 | | | |
| VAG92373 | RENAULT | 706 | 64 | VAG92397 | HONDA | 277 | 22 | VAG92444 | IVECO | 314 | 31 | | | |
| VAG92373 | RENAULT | 707 | 65 | VAG92397 | HONDA | 277 | 23 | VAG92444 | IVECO | 314 | 32 | | | |
| VAG92373 | RENAULT | 707 | 66 | VAG92397 | HONDA | 278 | 24 | VAG92444 | IVECO | 315 | 35 | | | |
| VAG92373 | RENAULT | 707 | 67 | VAG92397 | HONDA | 278 | 26 | VAG92444 | IVECO | 316 | 38 | | | |
| VAG92373 | RENAULT | 708 | 68 | VAG92397 | HONDA | 278 | 27 | VAG92444 | IVECO | 316 | 39 | | | |
| VAG92373 | RENAULT | 708 | 69 | VAG92397 | HONDA | 278 | 28 | VAG92465B | CITROËN | 147 | 38 | | | |
| VAG92373 | RENAULT | 708 | 70 | VAG92397 | ROVER | 720 | 6 | VAG92465B | CITROËN | 147 | 39 | | | |
| VAG92373 | RENAULT | 708 | 71 | VAG92397 | ROVER | 720 | 8 | VAG92465B | CITROËN | 148 | 40 | | | |
| VAG92373 | SEAT | 767 | 67 | VAG92397 | ROVER | 723 | 20 | VAG92465B | FIAT | 214 | 65 | | | |
| VAG92373 | VAUXHALL | 842 | 81 | VAG92397 | ROVER | 723 | 21 | VAG92465B | LADA | 345 | 8 | | | |
| VAG92373 | VAUXHALL | 842 | 83 | VAG92401 | CITROËN | 134 | 1 | VAG92465B | LADA | 345 | 9 | | | |
| VAG92375 | IVECO | 328 | 67 | VAG92401 | CITROËN | 134 | 3 | VAG92465B | PEUGEOT | 634 | 38 | | | |
| VAG92375 | IVECO | 329 | 68 | VAG92401 | CITROËN | 135 | 4 | VAG92465B | PEUGEOT | 634 | 39 | | | |
| VAG92378B | MERCEDES-BENZ | 467 | 63 | VAG92401 | CITROËN | 136 | 11 | VAG92465B | SUZUKI | 798 | 20 | | | |
| VAG92378B | MERCEDES-BENZ | 468 | 64 | VAG92401 | CITROËN | 137 | 12 | VAG92465B | SUZUKI | 799 | 21 | | | |
| VAG92378B | MERCEDES-BENZ | 485 | 102 | VAG92401 | CITROËN | 137 | 13 | VAG92465B | SUZUKI | 799 | 22 | | | |
| VAG92378B | MERCEDES-BENZ | 485 | 103 | VAG92401 | CITROËN | 138 | 14 | VAG92484 | DAF | 170 | 8 | | | |
| VAG92379B | MERCEDES-BENZ | 467 | 63 | VAG92401 | CITROËN | 138 | 15 | VAG92484 | DAF | 170 | 9 | | | |
| VAG92379B | MERCEDES-BENZ | 468 | 64 | VAG92401 | FIAT | 201 | 27 | VAG92492 | DEUTZ/KHD | 184 | 40 | | | |
| VAG92379B | MERCEDES-BENZ | 485 | 102 | VAG92401 | PEUGEOT | 620 | 2 | VAG92492 | DEUTZ/KHD | 184 | 41 | | | |
| VAG92379B | MERCEDES-BENZ | 485 | 103 | VAG92401 | PEUGEOT | 620 | 4 | VAG92492 | DEUTZ/KHD | 184 | 42 | | | |
| VAG92380B | MERCEDES-BENZ | 448 | 22 | VAG92401 | PEUGEOT | 621 | 5 | VAG92492 | DEUTZ/KHD | 185 | 43 | | | |
| VAG92382B | AUDI | 63 | 56 | VAG92401 | PEUGEOT | 623 | 12 | VAG92492 | DEUTZ/KHD | 185 | 44 | | | |
| VAG92382B | SEAT | 762 | 54 | VAG92401 | PEUGEOT | 624 | 13 | VAG92492 | DEUTZ/KHD | 185 | 45 | | | |
| VAG92382B | VW | 915 | 103 | VAG92401 | ZASTAVA | 935 | 2 | VAG92492 | DEUTZ/KHD | 185 | 46 | | | |
| VAG92384 | FORD | 271 | 98 | VAG92406 | TOYOTA | 812 | 34 | VAG92492 | DEUTZ/KHD | 185 | 47 | | | |
| VAG92384 | ISUZU | 291 | 9 | VAG92406 | TOYOTA | 813 | 35 | VAG92492 | DEUTZ/KHD | 185 | 48 | | | |
| VAG92384 | NISSAN | 578 | 42 | VAG92406 | TOYOTA | 813 | 37 | VAG92492 | DEUTZ/KHD | 186 | 49 | | | |
| VAG92384 | NISSAN | 579 | 43 | VAG92406 | TOYOTA | 813 | 38 | VAG92492 | DEUTZ/KHD | 186 | 50 | | | |
| VAG92384 | NISSAN | 579 | 44 | VAG92406 | VW | 932 | 150 | VAG92492 | DEUTZ/KHD | 186 | 51 | | | |
| VAG92385 | LAND ROVER | 372 | 25 | VAG92411 | MERCEDES-BENZ | 488 | 110 | VAG92492 | DEUTZ/KHD | 186 | 52 | | | |
| VAG92385 | LAND ROVER | 372 | 26 | VAG92411 | MERCEDES-BENZ | 490 | 113 | VAG92492 | DEUTZ/KHD | 187 | 53 | | | |
| VAG92385 | LAND ROVER | 372 | 27 | VAG92411 | MERCEDES-BENZ | 490 | 114 | VAG92492 | DEUTZ/KHD | 187 | 54 | | | |
| VAG92387 | RENAULT | 709 | 72 | VAG92411 | MERCEDES-BENZ | 493 | 115 | VAG92492 | DEUTZ/KHD | 187 | 55 | | | |
| VAG92387 | RENAULT | 709 | 75 | VAG92411 | MERCEDES-BENZ | 494 | 116 | VAG92492 | DEUTZ/KHD | 187 | 56 | | | |
| VAG92387 | RENAULT | 710 | 79 | VAG92411 | MERCEDES-BENZ | 494 | 117 | VAG92492 | DEUTZ/KHD | 188 | 57 | | | |
| VAG92387 | RENAULT | 710 | 80 | VAG92411 | MERCEDES-BENZ | 495 | 118 | VAG92492 | IVECO | 323 | 56 | | | |
| VAG92387 | RENAULT | 711 | 81 | VAG92411 | MERCEDES-BENZ | 495 | 119 | VAG92492 | IVECO | 324 | 59 | | | |
| VAG92387 | RENAULT | 711 | 83 | VAG92411 | MERCEDES-BENZ | 495 | 120 | VAG92492 | IVECO | 325 | 61 | | | |
| VAG92387 | RENAULT | 712 | 84 | VAG92411 | MERCEDES-BENZ | 497 | 121 | VAG92492 | IVECO | 325 | 62 | | | |
| VAG92389 | RENAULT | 709 | 72 | VAG92411 | MERCEDES-BENZ | 497 | 122 | VAG92492 | IVECO | 325 | 63 | | | |
| VAG92389 | RENAULT | 709 | 75 | VAG92411 | MERCEDES-BENZ | 502 | 123 | VAG92496 | ALFA ROMEO | 35 | 44 | | | |
| VAG92389 | RENAULT | 710 | 79 | VAG92411 | MERCEDES-BENZ | 503 | 124 | VAG92496 | FIAT | 216 | 70 | | | |
| VAG92389 | RENAULT | 710 | 80 | VAG92411 | MERCEDES-BENZ | 503 | 125 | VAG92496 | FIAT | 217 | 74 | | | |
| VAG92389 | RENAULT | 711 | 81 | VAG92412 | MERCEDES-BENZ | 488 | 110 | VAG92496 | FIAT | 217 | 75 | | | |
| VAG92389 | RENAULT | 711 | 83 | VAG92412 | MERCEDES-BENZ | 490 | 113 | VAG92496 | LANCIA | 360 | 40 | | | |
| VAG92389 | RENAULT | 712 | 84 | VAG92412 | MERCEDES-BENZ | 490 | 114 | VAG92496 | LANCIA | 361 | 43 | | | |
| VAG92395 | RENAULT | 713 | 89 | VAG92412 | MERCEDES-BENZ | 493 | 115 | VAG92497 | FIAT | 226 | 108 | | | |
| VAG92395 | RENAULT | 713 | 90 | VAG92412 | MERCEDES-BENZ | 494 | 116 | VAG92497 | FIAT | 226 | 109 | | | |
| VAG92395 | RENAULT | 714 | 91 | VAG92412 | MERCEDES-BENZ | 494 | 117 | VAG92497 | IVECO | 309 | 15 | | | |
| VAG92395 | RENAULT | 714 | 92 | VAG92412 | MERCEDES-BENZ | 495 | 118 | VAG92497 | IVECO | 310 | 16 | | | |
| VAG92395 | RENAULT | 715 | 93 | VAG92412 | MERCEDES-BENZ | 495 | 119 | VAG92497 | IVECO | 310 | 17 | | | |
| VAG92395 | RENAULT | 715 | 96 | VAG92412 | MERCEDES-BENZ | 495 | 120 | VAG92497 | IVECO | 310 | 18 | | | |
| VAG92396 | RENAULT | 713 | 89 | VAG92412 | MERCEDES-BENZ | 497 | 121 | VAG92497 | IVECO | 310 | 19 | | | |
| VAG92396 | RENAULT | 713 | 90 | VAG92412 | MERCEDES-BENZ | 497 | 122 | VAG92497 | IVECO | 311 | 20 | | | |
| VAG92396 | RENAULT | 714 | 91 | VAG92412 | MERCEDES-BENZ | 502 | 123 | VAG92497 | IVECO | 311 | 21 | | | |
| VAG92396 | RENAULT | 714 | 92 | VAG92412 | MERCEDES-BENZ | 503 | 124 | VAG92497 | IVECO | 311 | 22 | | | |
| VAG92396 | RENAULT | 715 | 93 | VAG92412 | MERCEDES-BENZ | 503 | 125 | VAG92497 | IVECO | 311 | 23 | | | |
| VAG92396 | RENAULT | 715 | 96 | VAG92414B | MERCEDES-BENZ | 456 | 37 | VAG92497 | IVECO | 312 | 24 | | | |
| VAG92397 | HONDA | 273 | 1 | VAG92414B | MERCEDES-BENZ | 456 | 38 | VAG92497 | IVECO | 312 | 25 | | | |
| VAG92397 | HONDA | 273 | 2 | VAG92444 | IVECO | 301 | 2 | VAG92497 | IVECO | 313 | 30 | | | |
| VAG92397 | HONDA | 273 | 3 | VAG92444 | IVECO | 301 | 3 | VAG92497 | IVECO | 314 | 32 | | | |
| VAG92397 | HONDA | 273 | 6 | VAG92444 | IVECO | 301 | 4 | VAG92497 | IVECO | 314 | 33 | | | |
| VAG92397 | HONDA | 274 | 7 | VAG92444 | IVECO | 303 | 6 | VAG92497 | IVECO | 315 | 34 | | | |



NUMERICAL PARTS LIST

Nummerische Teilenummernliste • Elenco riferimenti
Liste des références produits















|  |  |  |  |  |  |  |  |  |  |  |  |  |  |  |
|---|---|---|---|---|---|---|---|--|---|---|---|---|---|---|
| VAG92497 | IVECO | 315 | 36 | VAG96022 | DAEWOO | 164 | 13 | VAG96028 | OPEL | 592 | 28 | | | |
| VAG92497 | IVECO | 315 | 37 | VAG96022 | DAEWOO | 164 | 14 | VAG96028 | OPEL | 597 | 44 | | | |
| VAG92497 | IVECO | 316 | 38 | VAG96022 | OPEL | 584 | 3 | VAG96028 | OPEL | 597 | 45 | | | |
| VAG92497 | IVECO | 316 | 40 | VAG96022 | OPEL | 588 | 16 | VAG96028 | OPEL | 600 | 55 | | | |
| VAG92497 | IVECO | 317 | 41 | VAG96022 | OPEL | 589 | 19 | VAG96028 | OPEL | 600 | 56 | | | |
| VAG92497 | IVECO | 317 | 42 | VAG96022 | OPEL | 589 | 20 | VAG96028 | OPEL | 601 | 57 | | | |
| VAG92497 | IVECO | 318 | 44 | VAG96022 | OPEL | 590 | 24 | VAG96028 | OPEL | 602 | 61 | | | |
| VAG92497 | IVECO | 319 | 45 | VAG96022 | OPEL | 591 | 25 | VAG96028 | OPEL | 604 | 67 | | | |
| VAG92497 | IVECO | 320 | 46 | VAG96022 | OPEL | 592 | 29 | VAG96028 | OPEL | 605 | 69 | | | |
| VAG92497 | IVECO | 320 | 48 | VAG96022 | OPEL | 601 | 58 | VAG96028 | OPEL | 605 | 70 | | | |
| VAG92498 | MAN | 392 | 10 | VAG96022 | OPEL | 601 | 59 | VAG96028 | OPEL | 605 | 71 | | | |
| VAG92498 | MAN | 393 | 11 | VAG96022 | OPEL | 602 | 60 | VAG96028 | OPEL | 606 | 74 | | | |
| VAG92498 | MAN | 393 | 12 | VAG96022 | OPEL | 603 | 63 | VAG96028 | OPEL | 606 | 75 | | | |
| VAG92498 | MAN | 394 | 13 | VAG96022 | OPEL | 603 | 64 | VAG96028 | OPEL | 607 | 77 | | | |
| VAG92498 | MAN | 395 | 14 | VAG96022 | OPEL | 603 | 65 | VAG96028 | SAAB | 726 | 3 | | | |
| VAG92498 | MAN | 395 | 15 | VAG96022 | OPEL | 604 | 66 | VAG96028 | SAAB | 728 | 9 | | | |
| VAG92498 | MAN | 395 | 16 | VAG96022 | SUZUKI | 797 | 16 | VAG96028 | SAAB | 728 | 10 | | | |
| VAG92498 | MAN | 395 | 17 | VAG96022 | VAUXHALL | 820 | 4 | VAG96028 | SAAB | 728 | 12 | | | |
| VAG92498 | MAN | 395 | 18 | VAG96022 | VAUXHALL | 823 | 17 | VAG96028 | SUBARU | 791 | 10 | | | |
| VAG92498 | MAN | 396 | 19 | VAG96022 | VAUXHALL | 824 | 20 | VAG96028 | VAUXHALL | 824 | 22 | | | |
| VAG92498 | MAN | 397 | 21 | VAG96022 | VAUXHALL | 824 | 21 | VAG96028 | VAUXHALL | 825 | 23 | | | |
| VAG92498 | MAN | 398 | 22 | VAG96022 | VAUXHALL | 825 | 25 | VAG96028 | VAUXHALL | 826 | 28 | | | |
| VAG92498 | MAN | 401 | 24 | VAG96022 | VAUXHALL | 826 | 26 | VAG96028 | VAUXHALL | 827 | 29 | | | |
| VAG92498 | MAN | 401 | 25 | VAG96022 | VAUXHALL | 827 | 30 | VAG96028 | VAUXHALL | 832 | 45 | | | |
| VAG92498 | MAN | 402 | 28 | VAG96022 | VAUXHALL | 835 | 58 | VAG96028 | VAUXHALL | 832 | 46 | | | |
| VAG92498 | MAN | 402 | 29 | VAG96022 | VAUXHALL | 836 | 59 | VAG96028 | VAUXHALL | 835 | 56 | | | |
| VAG92498 | MAN | 403 | 30 | VAG96022 | VAUXHALL | 836 | 60 | VAG96028 | VAUXHALL | 835 | 57 | | | |
| VAG92498 | MAN | 404 | 32 | VAG96022 | VAUXHALL | 837 | 63 | VAG96028 | VAUXHALL | 839 | 69 | | | |
| VAG92511 | HONDA | 277 | 20 | VAG96022 | VAUXHALL | 837 | 64 | VAG96028 | VAUXHALL | 839 | 70 | | | |
| VAG92511 | LAND ROVER | 369 | 11 | VAG96022 | VAUXHALL | 838 | 65 | VAG96028 | VAUXHALL | 840 | 74 | | | |
| VAG92511 | MG | 546 | 8 | VAG96022 | VAUXHALL | 838 | 66 | VAG96028 | VAUXHALL | 840 | 75 | | | |
| VAG92511 | ROVER | 723 | 18 | VAG96023 | CHEVROLET | 122 | 27 | VAG96028 | VAUXHALL | 841 | 77 | | | |
| VAG93 | PERKINS | 611 | 3 | VAG96023 | OPEL | 595 | 37 | VAG96029 | OPEL | 605 | 69 | | | |
| VAG93 | PERKINS | 611 | 4 | VAG96023 | VAUXHALL | 830 | 38 | VAG96029 | OPEL | 605 | 70 | | | |
| VAG93 | PERKINS | 611 | 5 | VAG96023 | VAUXHALL | 836 | 61 | VAG96029 | SAAB | 728 | 12 | | | |
| VAG93 | PERKINS | 611 | 6 | VAG96024 | FORD | 255 | 58 | VAG96029 | SUBARU | 791 | 10 | | | |
| VAG93 | PERKINS | 612 | 7 | VAG96024 | FORD | 256 | 59 | VAG96029 | VAUXHALL | 839 | 69 | | | |
| VAG96001 | FORD | 253 | 51 | VAG96024 | FORD | 256 | 60 | VAG96029 | VAUXHALL | 839 | 70 | | | |
| VAG96001 | FORD | 253 | 53 | VAG96024 | FORD | 257 | 61 | VAG96037 | VOLVO | 864 | 51 | | | |
| VAG96001 | FORD | 253 | 54 | VAG96024 | MAZDA | 408 | 13 | VAG96041B | AUDI | 49 | 17 | | | |
| VAG96003 | FORD | 262 | 75 | VAG96025 | FORD | 262 | 74 | VAG96041B | AUDI | 50 | 18 | | | |
| VAG96003 | FORD | 265 | 82 | VAG96026 | BEDFORD | 87 | 2 | VAG96041B | AUDI | 50 | 20 | | | |
| VAG96003 | FORD | 267 | 87 | VAG96026 | OPEL | 588 | 15 | VAG96041B | AUDI | 51 | 22 | | | |
| VAG96003 | FORD | 267 | 88 | VAG96026 | OPEL | 588 | 16 | VAG96041B | AUDI | 51 | 23 | | | |
| VAG96003 | FORD | 267 | 89 | VAG96026 | OPEL | 590 | 24 | VAG96041B | AUDI | 52 | 24 | | | |
| VAG96003 | FORD | 268 | 90 | VAG96026 | VAUXHALL | 823 | 17 | VAG96041B | AUDI | 52 | 25 | | | |
| VAG96004 | FORD | 262 | 75 | VAG96026 | VAUXHALL | 825 | 25 | VAG96041B | AUDI | 52 | 26 | | | |
| VAG96004 | FORD | 265 | 82 | VAG96027 | FORD | 245 | 29 | VAG96041B | AUDI | 54 | 33 | | | |
| VAG96004 | FORD | 267 | 87 | VAG96027 | FORD | 245 | 30 | VAG96041B | AUDI | 59 | 46 | | | |
| VAG96004 | FORD | 267 | 88 | VAG96027 | FORD | 248 | 35 | VAG96041B | AUDI | 59 | 47 | | | |
| VAG96004 | FORD | 267 | 89 | VAG96027 | FORD | 251 | 48 | VAG96041B | AUDI | 67 | 73 | | | |
| VAG96004 | FORD | 268 | 90 | VAG96027 | FORD | 252 | 49 | VAG96041B | AUDI | 68 | 76 | | | |
| VAG96014 | FORD | 240 | 15 | VAG96027 | FORD | 252 | 50 | VAG96041B | AUDI | 72 | 83 | | | |
| VAG96014 | FORD | 240 | 16 | VAG96027 | FORD | 259 | 65 | VAG96041B | FORD | 248 | 37 | | | |
| VAG96014 | FORD | 240 | 18 | VAG96027 | FORD | 259 | 66 | VAG96041B | FORD | 248 | 38 | | | |
| VAG96021 | BEDFORD | 87 | 5 | VAG96027 | FORD | 262 | 73 | VAG96041B | FORD | 253 | 52 | | | |
| VAG96021 | BEDFORD | 88 | 6 | VAG96028 | CHEVROLET | 119 | 12 | VAG96041B | MITSUBISHI | 555 | 15 | | | |
| VAG96021 | OPEL | 595 | 36 | VAG96028 | CHEVROLET | 121 | 20 | VAG96041B | SEAT | 748 | 5 | | | |
| VAG96021 | OPEL | 598 | 48 | VAG96028 | CHEVROLET | 121 | 23 | VAG96041B | SEAT | 749 | 9 | | | |
| VAG96021 | OPEL | 599 | 49 | VAG96028 | CHEVROLET | 123 | 32 | VAG96041B | SEAT | 754 | 25 | | | |
| VAG96021 | VAUXHALL | 830 | 37 | VAG96028 | CHEVROLET | 124 | 34 | VAG96041B | SEAT | 755 | 31 | | | |
| VAG96021 | VAUXHALL | 833 | 49 | VAG96028 | CHEVROLET | 124 | 36 | VAG96041B | SEAT | 755 | 32 | | | |
| VAG96021 | VAUXHALL | 833 | 50 | VAG96028 | CHEVROLET | 125 | 38 | VAG96041B | SEAT | 756 | 34 | | | |
| VAG96022 | BEDFORD | 87 | 2 | VAG96028 | CHEVROLET | 125 | 40 | VAG96041B | SEAT | 756 | 35 | | | |
| VAG96022 | BEDFORD | 87 | 3 | VAG96028 | DAEWOO | 165 | 15 | VAG96041B | SEAT | 757 | 37 | | | |
| VAG96022 | BEDFORD | 87 | 4 | VAG96028 | DAEWOO | 165 | 16 | VAG96041B | SEAT | 757 | 38 | | | |
| VAG96022 | CHEVROLET | 119 | 11 | VAG96028 | DAEWOO | 165 | 17 | VAG96041B | SEAT | 758 | 39 | | | |
| VAG96022 | CHEVROLET | 120 | 18 | VAG96028 | ISUZU | 290 | 5 | VAG96041B | SEAT | 758 | 40 | | | |
| VAG96022 | CHEVROLET | 121 | 22 | VAG96028 | LOTUS | 374 | 4 | VAG96041B | SEAT | 758 | 41 | | | |
| VAG96022 | CHEVROLET | 124 | 35 | VAG96028 | OPEL | 589 | 21 | VAG96041B | SEAT | 759 | 42 | | | |
| VAG96022 | DAEWOO | 163 | 6 | VAG96028 | OPEL | 590 | 22 | VAG96041B | SEAT | 759 | 43 | | | |
| VAG96022 | DAEWOO | 164 | 12 | VAG96028 | OPEL | 592 | 27 | VAG96041B | SEAT | 759 | 44 | | | |













|  |  |  |  |  |  |  |  |  |  |  |  |  |  |  |
|---|---|---|---|---|---|---|---|---|---|---|---|---|---|---|
| VAG96041B | SEAT | 760 | 46 | VAG96043B | BMW | 106 | 38 | VAG96062B | VW | 885 | 5 | | | |
| VAG96041B | SEAT | 761 | 48 | VAG96043B | BMW | 109 | 46 | VAG96062B | VW | 889 | 23 | | | |
| VAG96041B | SEAT | 761 | 51 | VAG96043B | BMW | 109 | 47 | VAG96062B | VW | 889 | 24 | | | |
| VAG96041B | SEAT | 763 | 56 | VAG96043B | BMW | 110 | 48 | VAG96062B | VW | 893 | 33 | | | |
| VAG96041B | SEAT | 765 | 61 | VAG96043B | BMW | 111 | 54 | VAG96062B | VW | 896 | 44 | | | |
| VAG96041B | SEAT | 765 | 62 | VAG96043B | BMW | 113 | 59 | VAG96064 | SUBARU | 791 | 11 | | | |
| VAG96041B | SKODA | 775 | 16 | VAG96043B | BMW | 114 | 63 | VAG96064 | SUBARU | 792 | 12 | | | |
| VAG96041B | SKODA | 775 | 17 | VAG96043B | BMW | 115 | 65 | VAG96064 | SUBARU | 792 | 13 | | | |
| VAG96041B | SKODA | 776 | 19 | VAG96043B | LAND ROVER | 371 | 24 | VAG96065 | SUBARU | 790 | 6 | | | |
| VAG96041B | SKODA | 776 | 20 | VAG96043B | MERCEDES-BENZ | 445 | 14 | VAG96065 | SUBARU | 791 | 7 | | | |
| VAG96041B | SKODA | 776 | 21 | VAG96043B | MERCEDES-BENZ | 446 | 15 | VAG96065 | SUZUKI | 796 | 11 | | | |
| VAG96041B | SKODA | 777 | 22 | VAG96043B | MERCEDES-BENZ | 446 | 16 | VAG96065 | SUZUKI | 796 | 14 | | | |
| VAG96041B | SKODA | 777 | 23 | VAG96043B | MERCEDES-BENZ | 447 | 18 | VAG96067 | CITROËN | 134 | 2 | | | |
| VAG96041B | SKODA | 777 | 24 | VAG96044B | BMW | 93 | 5 | VAG96067 | DAIHATSU | 173 | 1 | | | |
| VAG96041B | SKODA | 777 | 25 | VAG96044B | BMW | 93 | 6 | VAG96067 | DAIHATSU | 173 | 2 | | | |
| VAG96041B | SKODA | 778 | 26 | VAG96044B | BMW | 93 | 7 | VAG96067 | PEUGEOT | 620 | 3 | | | |
| VAG96041B | SKODA | 779 | 31 | VAG96044B | BMW | 97 | 20 | VAG96067 | SUBARU | 790 | 2 | | | |
| VAG96041B | SKODA | 781 | 34 | VAG96044B | BMW | 103 | 31 | VAG96067 | SUBARU | 791 | 8 | | | |
| VAG96041B | SKODA | 781 | 35 | VAG96044B | BMW | 104 | 32 | VAG96067 | TOYOTA | 802 | 1 | | | |
| VAG96041B | VW | 884 | 1 | VAG96044B | BMW | 105 | 35 | VAG96067 | TOYOTA | 802 | 3 | | | |
| VAG96041B | VW | 885 | 5 | VAG96044B | BMW | 106 | 38 | VAG96067 | TOYOTA | 802 | 4 | | | |
| VAG96041B | VW | 893 | 32 | VAG96044B | BMW | 109 | 46 | VAG96067 | TOYOTA | 804 | 10 | | | |
| VAG96041B | VW | 895 | 42 | VAG96044B | BMW | 109 | 47 | VAG96067 | TOYOTA | 805 | 11 | | | |
| VAG96041B | VW | 895 | 43 | VAG96044B | BMW | 110 | 48 | VAG96068 | CHEVROLET | 123 | 31 | | | |
| VAG96041B | VW | 900 | 62 | VAG96044B | BMW | 111 | 54 | VAG96068 | TOYOTA | 806 | 17 | | | |
| VAG96041B | VW | 901 | 63 | VAG96044B | BMW | 113 | 59 | VAG96068 | TOYOTA | 807 | 18 | | | |
| VAG96041B | VW | 902 | 65 | VAG96044B | BMW | 114 | 63 | VAG96068 | TOYOTA | 807 | 19 | | | |
| VAG96041B | VW | 903 | 68 | VAG96044B | BMW | 115 | 65 | VAG96069 | DAIHATSU | 173 | 4 | | | |
| VAG96041B | VW | 904 | 70 | VAG96044B | LAND ROVER | 371 | 24 | VAG96069 | TOYOTA | 810 | 29 | | | |
| VAG96041B | VW | 904 | 72 | VAG96046B | CITROËN | 156 | 70 | VAG96070 | DAIHATSU | 173 | 4 | | | |
| VAG96041B | VW | 905 | 73 | VAG96046B | CITROËN | 156 | 71 | VAG96070 | TOYOTA | 810 | 29 | | | |
| VAG96041B | VW | 905 | 74 | VAG96046B | CITROËN | 156 | 72 | VAG96072 | TOYOTA | 805 | 13 | | | |
| VAG96041B | VW | 906 | 76 | VAG96046B | DAF | 168 | 1 | VAG96073B | AUDI | 46 | 1 | | | |
| VAG96041B | VW | 906 | 77 | VAG96046B | FIAT | 224 | 102 | VAG96073B | AUDI | 47 | 5 | | | |
| VAG96041B | VW | 907 | 78 | VAG96046B | PEUGEOT | 644 | 75 | VAG96073B | AUDI | 48 | 10 | | | |
| VAG96041B | VW | 907 | 79 | VAG96046B | PEUGEOT | 644 | 76 | VAG96073B | AUDI | 48 | 11 | | | |
| VAG96041B | VW | 907 | 80 | VAG96046B | PEUGEOT | 644 | 77 | VAG96073B | AUDI | 56 | 38 | | | |
| VAG96041B | VW | 908 | 81 | VAG96049B | CITROËN | 138 | 16 | VAG96073B | AUDI | 57 | 39 | | | |
| VAG96041B | VW | 909 | 85 | VAG96049B | CITROËN | 141 | 20 | VAG96073B | AUDI | 64 | 62 | | | |
| VAG96041B | VW | 909 | 86 | VAG96049B | NISSAN | 571 | 19 | VAG96073B | AUDI | 64 | 63 | | | |
| VAG96041B | VW | 910 | 88 | VAG96049B | PEUGEOT | 627 | 18 | VAG96073B | AUDI | 65 | 64 | | | |
| VAG96041B | VW | 912 | 92 | VAG96049B | ROVER | 721 | 9 | VAG96073B | AUDI | 65 | 66 | | | |
| VAG96041B | VW | 914 | 96 | VAG96056B | CITROËN | 145 | 34 | VAG96073B | AUDI | 66 | 68 | | | |
| VAG96041B | VW | 917 | 108 | VAG96056B | FIAT | 214 | 64 | VAG96073B | AUDI | 66 | 69 | | | |
| VAG96041B | VW | 921 | 117 | VAG96056B | PEUGEOT | 632 | 34 | VAG96073B | AUDI | 67 | 74 | | | |
| VAG96041B | VW | 921 | 118 | VAG96056B | PEUGEOT | 633 | 36 | VAG96073B | AUDI | 68 | 75 | | | |
| VAG96041B | VW | 922 | 119 | VAG96056B | VOLVO | 862 | 47 | VAG96073B | AUDI | 69 | 77 | | | |
| VAG96041B | VW | 922 | 121 | VAG96057B | RENAULT | 689 | 31 | VAG96073B | AUDI | 70 | 78 | | | |
| VAG96041B | VW | 922 | 122 | VAG96057B | RENAULT | 690 | 34 | VAG96073B | AUDI | 71 | 81 | | | |
| VAG96041B | VW | 924 | 127 | VAG96057B | RENAULT | 690 | 35 | VAG96073B | AUDI | 71 | 82 | | | |
| VAG96041B | VW | 924 | 128 | VAG96057B | RENAULT | 691 | 36 | VAG96073B | AUDI | 73 | 86 | | | |
| VAG96041B | VW | 925 | 130 | VAG96057B | RENAULT | 691 | 37 | VAG96073B | AUDI | 73 | 87 | | | |
| VAG96041B | VW | 933 | 152 | VAG96057B | RENAULT | 692 | 38 | VAG96073B | AUDI | 76 | 95 | | | |
| VAG96042B | BMW | 93 | 5 | VAG96057B | RENAULT | 692 | 39 | VAG96073B | AUDI | 77 | 96 | | | |
| VAG96042B | BMW | 96 | 16 | VAG96057B | VOLVO | 852 | 13 | VAG96073B | AUDI | 77 | 97 | | | |
| VAG96042B | BMW | 96 | 17 | VAG96057B | VOLVO | 855 | 25 | VAG96073B | AUDI | 77 | 98 | | | |
| VAG96042B | BMW | 97 | 19 | VAG96057B | VOLVO | 856 | 26 | VAG96073B | AUDI | 77 | 99 | | | |
| VAG96042B | BMW | 97 | 21 | VAG96057B | VOLVO | 862 | 45 | VAG96073B | AUDI | 78 | 100 | | | |
| VAG96042B | BMW | 103 | 31 | VAG96058 | LAND ROVER | 367 | 3 | VAG96073B | AUDI | 78 | 102 | | | |
| VAG96042B | BMW | 110 | 51 | VAG96058 | LOTUS | 374 | 3 | VAG96073B | AUDI | 78 | 103 | | | |
| VAG96042B | BMW | 111 | 53 | VAG96058 | MG | 546 | 5 | VAG96073B | AUDI | 79 | 106 | | | |
| VAG96042B | BMW | 112 | 56 | VAG96058 | MG | 546 | 6 | VAG96073B | AUDI | 79 | 107 | | | |
| VAG96042B | BMW | 113 | 58 | VAG96058 | ROVER | 722 | 13 | VAG96073B | SEAT | 749 | 6 | | | |
| VAG96043B | BMW | 93 | 5 | VAG96058 | ROVER | 722 | 14 | VAG96073B | SEAT | 749 | 7 | | | |
| VAG96043B | BMW | 93 | 6 | VAG96058 | ROVER | 722 | 16 | VAG96073B | SEAT | 752 | 19 | | | |
| VAG96043B | BMW | 93 | 7 | VAG96062B | SEAT | 748 | 5 | VAG96073B | SEAT | 752 | 20 | | | |
| VAG96043B | BMW | 97 | 20 | VAG96062B | SEAT | 749 | 9 | VAG96073B | SEAT | 752 | 22 | | | |
| VAG96043B | BMW | 101 | 27 | VAG96062B | SEAT | 752 | 21 | VAG96073B | SEAT | 753 | 23 | | | |
| VAG96043B | BMW | 103 | 31 | VAG96062B | SEAT | 754 | 26 | VAG96073B | SEAT | 753 | 24 | | | |
| VAG96043B | BMW | 104 | 32 | VAG96062B | SKODA | 772 | 7 | VAG96073B | SEAT | 754 | 27 | | | |
| VAG96043B | BMW | 105 | 35 | VAG96062B | SKODA | 774 | 11 | VAG96073B | SEAT | 754 | 28 | | | |
| VAG96043B | BMW | 105 | 37 | VAG96062B | VW | 884 | 1 | VAG96073B | SEAT | 762 | 52 | | | |



NUMERICAL PARTS LIST

Nummerische Teilenummernliste • Elenco riferimenti
Liste des références produits













|  |  |  |  |  |  |  |  |  |  |  |  |  |  |  |
|---|---|---|---|---|---|---|---|--|---|---|---|---|---|---|
| VAG96073B | SEAT | | 762 | 53 | VAG96088 | MWM | | 559 | 2 | VAG96111 | HYUNDAI | | 288 | 32 |
| VAG96073B | SEAT | | 765 | 59 | VAG96088 | MWM | | 559 | 3 | VAG96111 | KIA | | 342 | 20 |
| VAG96073B | SEAT | | 766 | 63 | VAG96088 | MWM | | 559 | 4 | VAG96112 | CHEVROLET | | 119 | 14 |
| VAG96073B | SEAT | | 766 | 64 | VAG96088 | MWM | | 559 | 5 | VAG96112 | CHEVROLET | | 119 | 15 |
| VAG96073B | SEAT | | 766 | 65 | VAG96088 | MWM | | 560 | 6 | VAG96112 | CHEVROLET | | 120 | 19 |
| VAG96073B | SKODA | | 771 | 1 | VAG96088 | MWM | | 560 | 7 | VAG96112 | DAEWOO | | 162 | 5 |
| VAG96073B | SKODA | | 772 | 8 | VAG96088 | MWM | | 560 | 8 | VAG96112 | DAEWOO | | 163 | 7 |
| VAG96073B | SKODA | | 773 | 9 | VAG96088 | MWM | | 561 | 13 | VAG96112 | DAEWOO | | 163 | 8 |
| VAG96073B | SKODA | | 773 | 10 | VAG96088 | MWM | | 561 | 14 | VAG96112 | DAEWOO | | 163 | 9 |
| VAG96073B | SKODA | | 774 | 12 | VAG96088 | MWM | | 561 | 15 | VAG96113 | SAAB | | 729 | 13 |
| VAG96073B | SKODA | | 778 | 28 | VAG96088 | MWM | | 561 | 16 | VAG96113 | SAAB | | 729 | 14 |
| VAG96073B | SKODA | | 778 | 29 | VAG96088 | MWM | | 562 | 18 | VAG96114 | CHEVROLET | | 117 | 1 |
| VAG96073B | SKODA | | 780 | 33 | VAG96088 | MWM | | 562 | 20 | VAG96114 | CHEVROLET | | 117 | 2 |
| VAG96073B | SKODA | | 781 | 36 | VAG96088 | MWM | | 563 | 23 | VAG96114 | CHEVROLET | | 117 | 5 |
| VAG96073B | SKODA | | 782 | 37 | VAG96088 | MWM | | 563 | 25 | VAG96114 | DAEWOO | | 162 | 1 |
| VAG96073B | SKODA | | 782 | 38 | VAG96088 | MWM | | 563 | 27 | VAG96114 | DAEWOO | | 162 | 2 |
| VAG96073B | VW | | 884 | 2 | VAG96088 | MWM | | 564 | 29 | VAG96115 | MAN | | 391 | 9 |
| VAG96073B | VW | | 884 | 3 | VAG96089 | IVECO | | 322 | 50 | VAG96115 | MAN | | 396 | 20 |
| VAG96073B | VW | | 889 | 21 | VAG96089 | IVECO | | 322 | 51 | VAG96115 | MAN | | 400 | 23 |
| VAG96073B | VW | | 889 | 22 | VAG96089 | IVECO | | 322 | 53 | VAG96115 | MAN | | 401 | 26 |
| VAG96073B | VW | | 890 | 25 | VAG96089 | IVECO | | 323 | 54 | VAG96115 | MAN | | 402 | 27 |
| VAG96073B | VW | | 891 | 26 | VAG96089 | IVECO | | 323 | 55 | VAG96115 | MAN | | 403 | 31 |
| VAG96073B | VW | | 892 | 27 | VAG96095 | MERCEDES-BENZ | | 443 | 4 | VAG96118 | NISSAN | | 577 | 38 |
| VAG96073B | VW | | 892 | 28 | VAG96095 | MERCEDES-BENZ | | 443 | 5 | VAG96119 | CITROËN | | 149 | 43 |
| VAG96073B | VW | | 892 | 29 | VAG96095 | MERCEDES-BENZ | | 449 | 24 | VAG96119 | CITROËN | | 149 | 44 |
| VAG96073B | VW | | 893 | 31 | VAG96095 | MERCEDES-BENZ | | 449 | 26 | VAG96119 | CITROËN | | 150 | 45 |
| VAG96073B | VW | | 896 | 45 | VAG96095 | MERCEDES-BENZ | | 451 | 30 | VAG96119 | CITROËN | | 150 | 46 |
| VAG96073B | VW | | 896 | 46 | VAG96095 | MERCEDES-BENZ | | 454 | 33 | VAG96119 | CITROËN | | 150 | 47 |
| VAG96073B | VW | | 897 | 47 | VAG96095 | MERCEDES-BENZ | | 455 | 34 | VAG96119 | CITROËN | | 150 | 48 |
| VAG96073B | VW | | 913 | 94 | VAG96095 | MERCEDES-BENZ | | 459 | 45 | VAG96119 | CITROËN | | 152 | 52 |
| VAG96073B | VW | | 913 | 95 | VAG96095 | MERCEDES-BENZ | | 461 | 49 | VAG96119 | CITROËN | | 152 | 53 |
| VAG96073B | VW | | 923 | 124 | VAG96095 | MERCEDES-BENZ | | 462 | 51 | VAG96119 | CITROËN | | 152 | 54 |
| VAG96073B | VW | | 925 | 131 | VAG96095 | MERCEDES-BENZ | | 468 | 65 | VAG96119 | FIAT | | 218 | 76 |
| VAG96073B | VW | | 926 | 132 | VAG96096 | MERCEDES-BENZ | | 443 | 4 | VAG96119 | FIAT | | 218 | 77 |
| VAG96073B | VW | | 926 | 133 | VAG96096 | MERCEDES-BENZ | | 443 | 5 | VAG96119 | FIAT | | 218 | 78 |
| VAG96073B | VW | | 927 | 134 | VAG96096 | MERCEDES-BENZ | | 449 | 24 | VAG96119 | FIAT | | 219 | 80 |
| VAG96073B | VW | | 928 | 137 | VAG96096 | MERCEDES-BENZ | | 449 | 26 | VAG96119 | FIAT | | 219 | 81 |
| VAG96073B | VW | | 928 | 138 | VAG96096 | MERCEDES-BENZ | | 451 | 30 | VAG96119 | FIAT | | 219 | 82 |
| VAG96073B | VW | | 930 | 143 | VAG96096 | MERCEDES-BENZ | | 454 | 33 | VAG96119 | FIAT | | 219 | 84 |
| VAG96073B | VW | | 930 | 144 | VAG96096 | MERCEDES-BENZ | | 455 | 34 | VAG96119 | FIAT | | 220 | 85 |
| VAG96073B | VW | | 931 | 145 | VAG96096 | MERCEDES-BENZ | | 455 | 35 | VAG96119 | FORD | | 260 | 67 |
| VAG96076 | CHEVROLET | | 123 | 29 | VAG96096 | MERCEDES-BENZ | | 471 | 70 | VAG96119 | FORD | | 260 | 68 |
| VAG96076 | SAAB | | 597 | 43 | VAG96096 | MERCEDES-BENZ | | 472 | 71 | VAG96119 | FORD | | 261 | 69 |
| VAG96076 | SAAB | | 726 | 2 | VAG96096 | MERCEDES-BENZ | | 472 | 72 | VAG96119 | FORD | | 261 | 70 |
| VAG96076 | VAUXHALL | | 831 | 44 | VAG96096 | MERCEDES-BENZ | | 473 | 73 | VAG96119 | FORD | | 261 | 71 |
| VAG96077 | CHEVROLET | | 118 | 6 | VAG96096 | MERCEDES-BENZ | | 474 | 75 | VAG96119 | JAGUAR | | 332 | 3 |
| VAG96077 | CHEVROLET | | 118 | 7 | VAG96096 | MERCEDES-BENZ | | 475 | 78 | VAG96119 | LANCIA | | 361 | 44 |
| VAG96077 | CHEVROLET | | 118 | 8 | VAG96096 | MERCEDES-BENZ | | 477 | 81 | VAG96119 | LANCIA | | 362 | 46 |
| VAG96077 | CHEVROLET | | 118 | 9 | VAG96096 | MERCEDES-BENZ | | 480 | 90 | VAG96119 | LANCIA | | 362 | 47 |
| VAG96077 | CHEVROLET | | 123 | 29 | VAG96096 | MERCEDES-BENZ | | 481 | 94 | VAG96119 | LANCIA | | 362 | 48 |
| VAG96077 | OPEL | | 585 | 5 | VAG96096 | MERCEDES-BENZ | | 487 | 107 | VAG96119 | LANCIA | | 363 | 50 |
| VAG96077 | OPEL | | 585 | 6 | VAG96097 | MERCEDES-BENZ | | 473 | 74 | VAG96119 | LANCIA | | 363 | 51 |
| VAG96077 | OPEL | | 586 | 7 | VAG96097 | MERCEDES-BENZ | | 474 | 76 | VAG96119 | LAND ROVER | | 369 | 13 |
| VAG96077 | OPEL | | 586 | 9 | VAG96097 | MERCEDES-BENZ | | 476 | 79 | VAG96119 | PEUGEOT | | 636 | 43 |
| VAG96077 | OPEL | | 586 | 10 | VAG96097 | MERCEDES-BENZ | | 476 | 80 | VAG96119 | PEUGEOT | | 636 | 44 |
| VAG96077 | OPEL | | 587 | 11 | VAG96097 | MERCEDES-BENZ | | 487 | 109 | VAG96119 | PEUGEOT | | 637 | 45 |
| VAG96077 | OPEL | | 587 | 12 | VAG96097 | MERCEDES-BENZ | | 488 | 111 | VAG96119 | PEUGEOT | | 637 | 46 |
| VAG96077 | OPEL | | 587 | 13 | VAG96097 | MERCEDES-BENZ | | 489 | 112 | VAG96119 | PEUGEOT | | 637 | 47 |
| VAG96077 | OPEL | | 597 | 43 | VAG96098 | MERCEDES-BENZ | | 444 | 6 | VAG96119 | PEUGEOT | | 637 | 48 |
| VAG96077 | SAAB | | 726 | 2 | VAG96100 | CITROËN | | 144 | 30 | VAG96119 | PEUGEOT | | 638 | 52 |
| VAG96077 | SUZUKI | | 795 | 7 | VAG96100 | FIAT | | 212 | 60 | VAG96119 | PEUGEOT | | 639 | 53 |
| VAG96077 | SUZUKI | | 795 | 8 | VAG96100 | PEUGEOT | | 630 | 29 | VAG96119 | PEUGEOT | | 639 | 54 |
| VAG96077 | VAUXHALL | | 821 | 7 | VAG96107 | TOYOTA | | 809 | 26 | VAG96119 | SUZUKI | | 799 | 24 |
| VAG96077 | VAUXHALL | | 821 | 8 | VAG96107 | TOYOTA | | 811 | 31 | VAG96119 | SUZUKI | | 800 | 25 |
| VAG96077 | VAUXHALL | | 821 | 9 | VAG96108 | TOYOTA | | 809 | 26 | VAG96119 | SUZUKI | | 860 | 39 |
| VAG96077 | VAUXHALL | | 822 | 11 | VAG96108 | TOYOTA | | 811 | 31 | VAG96120 | NISSAN | | 576 | 33 |
| VAG96077 | VAUXHALL | | 822 | 12 | VAG96110 | CHEVROLET | | 122 | 26 | VAG96120 | NISSAN | | 576 | 34 |
| VAG96077 | VAUXHALL | | 822 | 13 | VAG96110 | LOTUS | | 374 | 1 | VAG96123 | ALFA ROMEO | | 33 | 35 |
| VAG96077 | VAUXHALL | | 822 | 14 | VAG96110 | TOYOTA | | 806 | 14 | VAG96123 | FIAT | | 206 | 46 |
| VAG96077 | VAUXHALL | | 823 | 15 | VAG96110 | TOYOTA | | 806 | 15 | VAG96123 | FIAT | | 207 | 47 |
| VAG96077 | VAUXHALL | | 831 | 44 | VAG96110 | TOYOTA | | 806 | 16 | VAG96123 | FIAT | | 211 | 55 |
| VAG96088 | MWM | | 559 | 1 | VAG96110 | TOYOTA | | 807 | 20 | VAG96123 | FIAT | | 211 | 56 |













|  |  |  |  | 9 |  |  |  |  | 9 |  |  |  |  | 9 |
|---|---|---|---|-----------|---|---|---|---|---------------|---|---|---|---|---|
| VAG96123 | FIAT | 215 | 68 | VAG96134 | MERCEDES-BENZ | 542 | 182 | VAG96149 | MERCEDES-BENZ | 462 | 51 | | | |
| VAG96123 | FIAT | 223 | 97 | VAG96135 | MERCEDES-BENZ | 525 | 158 | VAG96149 | MERCEDES-BENZ | 468 | 65 | | | |
| VAG96123 | LANCIA | 355 | 23 | VAG96135 | MERCEDES-BENZ | 526 | 159 | VAG96149 | MERCEDES-BENZ | 471 | 69 | | | |
| VAG96123 | LANCIA | 356 | 28 | VAG96135 | MERCEDES-BENZ | 528 | 161 | VAG96149 | MERCEDES-BENZ | 472 | 71 | | | |
| VAG96123 | LANCIA | 357 | 29 | VAG96135 | MERCEDES-BENZ | 529 | 163 | VAG96149 | MERCEDES-BENZ | 472 | 72 | | | |
| VAG96123 | LANCIA | 359 | 37 | VAG96135 | MERCEDES-BENZ | 536 | 176 | VAG96149 | MERCEDES-BENZ | 473 | 73 | | | |
| VAG96123 | LANCIA | 364 | 56 | VAG96135 | MERCEDES-BENZ | 537 | 177 | VAG96149 | MERCEDES-BENZ | 474 | 75 | | | |
| VAG96124 | ALFA ROMEO | 28 | 20 | VAG96135 | MERCEDES-BENZ | 538 | 178 | VAG96149 | MERCEDES-BENZ | 475 | 78 | | | |
| VAG96124 | ALFA ROMEO | 29 | 22 | VAG96135 | MERCEDES-BENZ | 541 | 181 | VAG96149 | MERCEDES-BENZ | 477 | 81 | | | |
| VAG96124 | ALFA ROMEO | 29 | 23 | VAG96135 | MERCEDES-BENZ | 542 | 182 | VAG96149 | MERCEDES-BENZ | 480 | 90 | | | |
| VAG96124 | ALFA ROMEO | 30 | 25 | VAG96137 | CHEVROLET | 119 | 13 | VAG96149 | SSANGYONG | 787 | 3 | | | |
| VAG96124 | ALFA ROMEO | 30 | 27 | VAG96137 | OPEL | 590 | 23 | VAG96149 | SSANGYONG | 787 | 4 | | | |
| VAG96124 | ALFA ROMEO | 31 | 28 | VAG96137 | OPEL | 599 | 53 | VAG96149 | SSANGYONG | 788 | 5 | | | |
| VAG96124 | ALFA ROMEO | 31 | 29 | VAG96137 | OPEL | 606 | 72 | VAG96151 | CHEVROLET | 119 | 13 | | | |
| VAG96124 | ALFA ROMEO | 32 | 33 | VAG96137 | VAUXHALL | 825 | 24 | VAG96151 | OPEL | 590 | 23 | | | |
| VAG96124 | FIAT | 207 | 48 | VAG96137 | VAUXHALL | 834 | 54 | VAG96151 | VAUXHALL | 825 | 24 | | | |
| VAG96124 | FIAT | 208 | 49 | VAG96137 | VAUXHALL | 840 | 72 | VAG96152 | MERCEDES-BENZ | 456 | 37 | | | |
| VAG96124 | FIAT | 209 | 50 | VAG96139B | MERCEDES-BENZ | 467 | 62 | VAG96152 | MERCEDES-BENZ | 456 | 38 | | | |
| VAG96124 | FIAT | 209 | 51 | VAG96139B | MERCEDES-BENZ | 481 | 92 | VAG96157B | AUDI | 61 | 51 | | | |
| VAG96124 | FIAT | 211 | 57 | VAG96139B | MERCEDES-BENZ | 481 | 93 | VAG96157B | AUDI | 62 | 55 | | | |
| VAG96124 | FIAT | 212 | 58 | VAG96139B | MERCEDES-BENZ | 486 | 106 | VAG96157B | AUDI | 63 | 57 | | | |
| VAG96124 | LANCIA | 355 | 24 | VAG96139B | MERCEDES-BENZ | 487 | 108 | VAG96157B | AUDI | 64 | 61 | | | |
| VAG96124 | LANCIA | 356 | 26 | VAG96142B | MERCEDES-BENZ | 471 | 70 | VAG96157B | AUDI | 66 | 67 | | | |
| VAG96124 | LANCIA | 357 | 30 | VAG96142B | MERCEDES-BENZ | 474 | 77 | VAG96157B | AUDI | 67 | 72 | | | |
| VAG96124 | LANCIA | 357 | 31 | VAG96142B | MERCEDES-BENZ | 481 | 94 | VAG96157B | AUDI | 70 | 79 | | | |
| VAG96124 | OPEL | 598 | 46 | VAG96142B | MERCEDES-BENZ | 487 | 107 | VAG96157B | AUDI | 79 | 104 | | | |
| VAG96124 | SAAB | 727 | 6 | VAG96143B | BMW | 92 | 4 | VAG96157B | FORD | 253 | 52 | | | |
| VAG96124 | SUZUKI | 798 | 19 | VAG96143B | BMW | 94 | 8 | VAG96157B | MERCEDES-BENZ | 445 | 11 | | | |
| VAG96124 | VAUXHALL | 832 | 47 | VAG96143B | BMW | 102 | 30 | VAG96157B | SEAT | 764 | 58 | | | |
| VAG96126 | RENAULT | 710 | 76 | VAG96143B | BMW | 104 | 34 | VAG96157B | VW | 919 | 113 | | | |
| VAG96126 | RENAULT | 710 | 77 | VAG96144B | MERCEDES-BENZ | 467 | 62 | VAG96157B | VW | 922 | 119 | | | |
| VAG96126 | RENAULT | 712 | 85 | VAG96144B | MERCEDES-BENZ | 480 | 91 | VAG96157B | VW | 922 | 120 | | | |
| VAG96126 | RENAULT | 712 | 86 | VAG96144B | MERCEDES-BENZ | 481 | 92 | VAG96157B | VW | 923 | 123 | | | |
| VAG96127 | RENAULT | 710 | 76 | VAG96144B | MERCEDES-BENZ | 481 | 93 | VAG96157B | VW | 923 | 126 | | | |
| VAG96127 | RENAULT | 710 | 77 | VAG96144B | MERCEDES-BENZ | 482 | 95 | VAG96158 | RENAULT | 694 | 43 | | | |
| VAG96127 | RENAULT | 712 | 85 | VAG96144B | MERCEDES-BENZ | 486 | 106 | VAG96158 | VOLVO | 851 | 12 | | | |
| VAG96127 | RENAULT | 712 | 86 | VAG96144B | MERCEDES-BENZ | 487 | 108 | VAG96158 | VOLVO | 852 | 14 | | | |
| VAG96129 | RENAULT | 717 | 101 | VAG96145 | FIAT | 207 | 47 | VAG96158 | VOLVO | 852 | 15 | | | |
| VAG96129 | RENAULT | 717 | 102 | VAG96145 | FIAT | 211 | 55 | VAG96158 | VOLVO | 853 | 16 | | | |
| VAG96129 | RENAULT | 717 | 103 | VAG96145 | FIAT | 211 | 56 | VAG96158 | VOLVO | 853 | 18 | | | |
| VAG96131 | RENAULT | 715 | 96 | VAG96145 | FIAT | 215 | 68 | VAG96158 | VOLVO | 855 | 23 | | | |
| VAG96132 | CITROËN | 134 | 1 | VAG96145 | LANCIA | 355 | 23 | VAG96158 | VOLVO | 856 | 27 | | | |
| VAG96132 | CITROËN | 134 | 3 | VAG96145 | LANCIA | 356 | 28 | VAG96158 | VOLVO | 856 | 28 | | | |
| VAG96132 | CITROËN | 135 | 4 | VAG96145 | LANCIA | 357 | 29 | VAG96158 | VOLVO | 857 | 29 | | | |
| VAG96132 | CITROËN | 136 | 11 | VAG96145 | LANCIA | 359 | 37 | VAG96158 | VOLVO | 857 | 31 | | | |
| VAG96132 | CITROËN | 137 | 12 | VAG96146 | ALFA ROMEO | 27 | 17 | VAG96158 | VOLVO | 858 | 32 | | | |
| VAG96132 | CITROËN | 137 | 13 | VAG96146 | ALFA ROMEO | 27 | 18 | VAG96158 | VOLVO | 858 | 33 | | | |
| VAG96132 | CITROËN | 138 | 14 | VAG96146 | ALFA ROMEO | 28 | 19 | VAG96158 | VOLVO | 859 | 35 | | | |
| VAG96132 | CITROËN | 138 | 15 | VAG96146 | FIAT | 206 | 46 | VAG96158 | VOLVO | 860 | 38 | | | |
| VAG96132 | CITROËN | 143 | 25 | VAG96146 | FIAT | 207 | 47 | VAG96159 | FORD | 252 | 49 | | | |
| VAG96132 | CITROËN | 143 | 26 | VAG96146 | FIAT | 211 | 55 | VAG96159 | FORD | 259 | 65 | | | |
| VAG96132 | FIAT | 201 | 27 | VAG96146 | FIAT | 211 | 56 | VAG96161B | SEAT | 750 | 12 | | | |
| VAG96132 | PEUGEOT | 620 | 2 | VAG96146 | FIAT | 215 | 68 | VAG96161B | SEAT | 751 | 17 | | | |
| VAG96132 | PEUGEOT | 620 | 4 | VAG96146 | FIAT | 223 | 97 | VAG96161B | SEAT | 754 | 25 | | | |
| VAG96132 | PEUGEOT | 621 | 5 | VAG96146 | LANCIA | 355 | 22 | VAG96161B | VW | 886 | 9 | | | |
| VAG96132 | PEUGEOT | 622 | 10 | VAG96146 | LANCIA | 355 | 23 | VAG96161B | VW | 886 | 10 | | | |
| VAG96132 | PEUGEOT | 623 | 12 | VAG96146 | LANCIA | 356 | 28 | VAG96161B | VW | 888 | 19 | | | |
| VAG96132 | PEUGEOT | 624 | 13 | VAG96146 | LANCIA | 357 | 29 | VAG96161B | VW | 895 | 42 | | | |
| VAG96132 | PEUGEOT | 624 | 14 | VAG96146 | LANCIA | 359 | 37 | VAG96163B | RENAULT | 694 | 42 | | | |
| VAG96132 | PEUGEOT | 628 | 23 | VAG96146 | LANCIA | 364 | 56 | VAG96168B | PORSCHE | 647 | 2 | | | |
| VAG96132 | ZASTAVA | 935 | 2 | VAG96147B | MERCEDES-BENZ | 486 | 106 | VAG96168B | PORSCHE | 647 | 5 | | | |
| VAG96133 | NISSAN | 575 | 31 | VAG96148B | BMW | 92 | 3 | VAG96168B | PORSCHE | 648 | 6 | | | |
| VAG96133 | NISSAN | 576 | 33 | VAG96148B | BMW | 94 | 9 | VAG96168B | PORSCHE | 648 | 7 | | | |
| VAG96133 | NISSAN | 576 | 34 | VAG96148B | BMW | 94 | 10 | VAG96168B | PORSCHE | 648 | 8 | | | |
| VAG96134 | MERCEDES-BENZ | 525 | 158 | VAG96148B | LAND ROVER | 367 | 2 | VAG96168B | PORSCHE | 648 | 9 | | | |
| VAG96134 | MERCEDES-BENZ | 526 | 159 | VAG96148B | ROVER | 722 | 15 | VAG96171 | ALFA ROMEO | 35 | 42 | | | |
| VAG96134 | MERCEDES-BENZ | 528 | 161 | VAG96149 | DAEWOO | 165 | 18 | VAG96171 | FIAT | 215 | 69 | | | |
| VAG96134 | MERCEDES-BENZ | 529 | 163 | VAG96149 | DAEWOO | 166 | 19 | VAG96171 | FIAT | 216 | 71 | | | |
| VAG96134 | MERCEDES-BENZ | 536 | 176 | VAG96149 | DAEWOO | 166 | 20 | VAG96171 | FIAT | 216 | 72 | | | |
| VAG96134 | MERCEDES-BENZ | 537 | 177 | VAG96149 | MERCEDES-BENZ | 455 | 35 | VAG96171 | FIAT | 217 | 73 | | | |
| VAG96134 | MERCEDES-BENZ | 538 | 178 | VAG96149 | MERCEDES-BENZ | 459 | 45 | VAG96171 | LANCIA | 359 | 38 | | | |
| VAG96134 | MERCEDES-BENZ | 541 | 181 | VAG96149 | MERCEDES-BENZ | 461 | 49 | VAG96171 | LANCIA | 360 | 39 | | | |



NUMERICAL PARTS LIST

Numerische Teilenummernliste • Elenco riferimenti
Liste des références produits















|     9 | | | |     9 | | | |     9 | | | |
|---|---------------|-----|-----|---|---------------|-----|----|---|---------------|-----|-----|
| VAG96171 | LANCIA | 360 | 41 | VAG96199 | FIAT | 216 | 70 | VAG96211 | DEUTZ/KHD | 187 | 54 |
| VAG96171 | LANCIA | 361 | 42 | VAG96199 | FIAT | 217 | 74 | VAG96211 | DEUTZ/KHD | 187 | 55 |
| VAG96172B | DACIA | 159 | 5 | VAG96199 | FIAT | 217 | 75 | VAG96211 | DEUTZ/KHD | 187 | 56 |
| VAG96172B | DACIA | 160 | 7 | VAG96199 | LANCIA | 360 | 40 | VAG96211 | DEUTZ/KHD | 188 | 57 |
| VAG96172B | NISSAN | 570 | 15 | VAG96199 | LANCIA | 361 | 43 | VAG96211 | IVECO | 323 | 56 |
| VAG96172B | RENAULT | 674 | 11 | VAG96203 | ALFA ROMEO | 28 | 20 | VAG96211 | IVECO | 324 | 59 |
| VAG96172B | RENAULT | 675 | 12 | VAG96203 | ALFA ROMEO | 29 | 22 | VAG96211 | IVECO | 325 | 61 |
| VAG96172B | RENAULT | 680 | 20 | VAG96203 | ALFA ROMEO | 29 | 23 | VAG96211 | IVECO | 325 | 62 |
| VAG96172B | RENAULT | 683 | 22 | VAG96203 | ALFA ROMEO | 30 | 25 | VAG96211 | IVECO | 325 | 63 |
| VAG96175 | AUTOBIANCHI | 85 | 6 | VAG96203 | ALFA ROMEO | 30 | 27 | VAG96214 | MERCEDES-BENZ | 459 | 44 |
| VAG96175 | AUTOBIANCHI | 85 | 7 | VAG96203 | ALFA ROMEO | 31 | 28 | VAG96214 | MERCEDES-BENZ | 460 | 47 |
| VAG96175 | AUTOBIANCHI | 85 | 8 | VAG96203 | ALFA ROMEO | 31 | 29 | VAG96214 | MERCEDES-BENZ | 461 | 48 |
| VAG96176B | BMW | 96 | 15 | VAG96203 | ALFA ROMEO | 32 | 33 | VAG96214 | MERCEDES-BENZ | 462 | 50 |
| VAG96176B | BMW | 114 | 62 | VAG96203 | FIAT | 207 | 48 | VAG96214 | MERCEDES-BENZ | 469 | 66 |
| VAG96177B | PORSCHE | 648 | 8 | VAG96203 | FIAT | 208 | 49 | VAG96214 | MERCEDES-BENZ | 470 | 67 |
| VAG96177B | PORSCHE | 648 | 9 | VAG96203 | FIAT | 209 | 50 | VAG96214 | MERCEDES-BENZ | 471 | 68 |
| VAG96177B | PORSCHE | 650 | 15 | VAG96203 | FIAT | 209 | 51 | VAG96214 | SSANGYONG | 787 | 1 |
| VAG96177B | PORSCHE | 650 | 16 | VAG96203 | FIAT | 211 | 57 | VAG96214 | SSANGYONG | 787 | 2 |
| VAG96177B | PORSCHE | 650 | 17 | VAG96203 | FIAT | 212 | 58 | VAG96215B | CITROËN | 151 | 51 |
| VAG96178 | DAEWOO | 165 | 18 | VAG96203 | LANCIA | 355 | 24 | VAG96215B | CITROËN | 154 | 61 |
| VAG96178 | DAEWOO | 166 | 19 | VAG96203 | LANCIA | 356 | 26 | VAG96215B | FIAT | 219 | 83 |
| VAG96178 | DAEWOO | 166 | 20 | VAG96203 | LANCIA | 357 | 30 | VAG96215B | LANCIA | 362 | 49 |
| VAG96178 | MERCEDES-BENZ | 449 | 24 | VAG96203 | LANCIA | 357 | 31 | VAG96215B | PEUGEOT | 638 | 51 |
| VAG96178 | MERCEDES-BENZ | 449 | 26 | VAG96203 | OPEL | 598 | 46 | VAG96215B | PEUGEOT | 641 | 61 |
| VAG96178 | MERCEDES-BENZ | 451 | 30 | VAG96203 | SAAB | 727 | 6 | VAG96216B | ALFA ROMEO | 26 | 13 |
| VAG96178 | MERCEDES-BENZ | 455 | 35 | VAG96203 | SUZUKI | 798 | 19 | VAG96216B | ALFA ROMEO | 26 | 14 |
| VAG96178 | MERCEDES-BENZ | 471 | 70 | VAG96203 | VAUXHALL | 832 | 47 | VAG96224B | MERCEDES-BENZ | 486 | 104 |
| VAG96178 | MERCEDES-BENZ | 472 | 71 | VAG96204 | MERCEDES-BENZ | 459 | 44 | VAG96224B | MERCEDES-BENZ | 486 | 105 |
| VAG96178 | MERCEDES-BENZ | 472 | 72 | VAG96204 | MERCEDES-BENZ | 460 | 47 | VAG96226B | DACIA | 160 | 8 |
| VAG96178 | MERCEDES-BENZ | 473 | 73 | VAG96204 | MERCEDES-BENZ | 461 | 48 | VAG96226B | DAEWOO | 554 | 12 |
| VAG96178 | MERCEDES-BENZ | 474 | 75 | VAG96204 | MERCEDES-BENZ | 462 | 50 | VAG96226B | DAEWOO | 595 | 38 |
| VAG96178 | MERCEDES-BENZ | 475 | 78 | VAG96204 | MERCEDES-BENZ | 469 | 66 | VAG96226B | DAEWOO | 679 | 17 |
| VAG96178 | MERCEDES-BENZ | 477 | 81 | VAG96204 | MERCEDES-BENZ | 470 | 67 | VAG96226B | DAEWOO | 684 | 23 |
| VAG96178 | MERCEDES-BENZ | 480 | 90 | VAG96204 | MERCEDES-BENZ | 471 | 68 | VAG96226B | DAEWOO | 685 | 24 |
| VAG96178 | MERCEDES-BENZ | 481 | 94 | VAG96204 | SSANGYONG | 787 | 1 | VAG96226B | DAEWOO | 685 | 25 |
| VAG96178 | MERCEDES-BENZ | 487 | 107 | VAG96204 | SSANGYONG | 787 | 2 | VAG96226B | DAEWOO | 685 | 26 |
| VAG96178 | SSANGYONG | 787 | 3 | VAG96210 | ALFA ROMEO | 28 | 20 | VAG96226B | DAEWOO | 686 | 27 |
| VAG96178 | SSANGYONG | 787 | 4 | VAG96210 | ALFA ROMEO | 29 | 22 | VAG96226B | DAEWOO | 686 | 28 |
| VAG96178 | SSANGYONG | 788 | 5 | VAG96210 | ALFA ROMEO | 29 | 23 | VAG96226B | DAEWOO | 830 | 39 |
| VAG96181B | FIAT | 217 | 74 | VAG96210 | ALFA ROMEO | 30 | 25 | VAG96226B | DAEWOO | 850 | 6 |
| VAG96181B | FIAT | 217 | 75 | VAG96210 | ALFA ROMEO | 30 | 27 | VAG96226B | DAEWOO | 850 | 8 |
| VAG96181B | LANCIA | 360 | 40 | VAG96210 | ALFA ROMEO | 31 | 28 | VAG96226B | DAEWOO | 851 | 9 |
| VAG96181B | LANCIA | 361 | 43 | VAG96210 | ALFA ROMEO | 31 | 29 | VAG96226B | DAEWOO | 851 | 11 |
| VAG96182B | DACIA | 159 | 5 | VAG96210 | ALFA ROMEO | 32 | 33 | VAG96227B | MERCEDES-BENZ | 486 | 104 |
| VAG96182B | DACIA | 160 | 7 | VAG96210 | FIAT | 207 | 48 | VAG96227B | MERCEDES-BENZ | 486 | 105 |
| VAG96182B | NISSAN | 570 | 15 | VAG96210 | FIAT | 208 | 49 | VAG96228B | PORSCHE | 647 | 4 |
| VAG96182B | RENAULT | 674 | 11 | VAG96210 | FIAT | 209 | 50 | VAG96228B | PORSCHE | 767 | 68 |
| VAG96182B | RENAULT | 675 | 12 | VAG96210 | FIAT | 209 | 51 | VAG96228B | VW | 933 | 153 |
| VAG96182B | RENAULT | 680 | 20 | VAG96210 | FIAT | 211 | 57 | VAG96228B | VW | 933 | 154 |
| VAG96182B | RENAULT | 683 | 22 | VAG96210 | FIAT | 212 | 58 | VAG96228B | VW | 933 | 155 |
| VAG96183B | PORSCHE | 649 | 10 | VAG96210 | LANCIA | 355 | 24 | VAG96230 | ALFA ROMEO | 27 | 16 |
| VAG96183B | PORSCHE | 649 | 11 | VAG96210 | LANCIA | 356 | 26 | VAG96230 | ALFA ROMEO | 27 | 17 |
| VAG96183B | PORSCHE | 649 | 12 | VAG96210 | LANCIA | 357 | 30 | VAG96230 | ALFA ROMEO | 27 | 18 |
| VAG96183B | PORSCHE | 649 | 13 | VAG96210 | LANCIA | 357 | 31 | VAG96230 | ALFA ROMEO | 28 | 19 |
| VAG96184 | ALFA ROMEO | 36 | 50 | VAG96210 | OPEL | 598 | 46 | VAG96230 | ALFA ROMEO | 33 | 35 |
| VAG96185 | VOLVO | 864 | 53 | VAG96210 | SAAB | 727 | 6 | VAG96230 | FIAT | 207 | 47 |
| VAG96185 | VOLVO | 865 | 55 | VAG96210 | SUZUKI | 798 | 19 | VAG96230 | FIAT | 211 | 55 |
| VAG96185 | VOLVO | 867 | 60 | VAG96210 | VAUXHALL | 832 | 47 | VAG96230 | FIAT | 211 | 56 |
| VAG96187 | ALFA ROMEO | 36 | 49 | VAG96211 | DEUTZ/KHD | 184 | 40 | VAG96230 | FIAT | 215 | 68 |
| VAG96187 | ALFA ROMEO | 37 | 51 | VAG96211 | DEUTZ/KHD | 184 | 41 | VAG96230 | LANCIA | 355 | 23 |
| VAG96187 | ALFA ROMEO | 37 | 52 | VAG96211 | DEUTZ/KHD | 184 | 42 | VAG96230 | LANCIA | 356 | 28 |
| VAG96187 | ALFA ROMEO | 37 | 53 | VAG96211 | DEUTZ/KHD | 185 | 43 | VAG96230 | LANCIA | 357 | 29 |
| VAG96187 | ALFA ROMEO | 37 | 54 | VAG96211 | DEUTZ/KHD | 185 | 44 | VAG96230 | LANCIA | 359 | 37 |
| VAG96187 | CHRYSLER | 128 | 9 | VAG96211 | DEUTZ/KHD | 185 | 45 | VAG96237B | AUDI | 49 | 15 |
| VAG96187 | CHRYSLER | 129 | 11 | VAG96211 | DEUTZ/KHD | 185 | 46 | VAG96237B | AUDI | 49 | 16 |
| VAG96187 | FORD | 269 | 92 | VAG96211 | DEUTZ/KHD | 185 | 47 | VAG96237B | AUDI | 59 | 44 |
| VAG96187 | JEEP | 336 | 4 | VAG96211 | DEUTZ/KHD | 185 | 48 | VAG96237B | AUDI | 59 | 45 |
| VAG96187 | OPEL | 607 | 80 | VAG96211 | DEUTZ/KHD | 186 | 49 | VAG96237B | AUDI | 60 | 48 |
| VAG96187 | VAUXHALL | 841 | 80 | VAG96211 | DEUTZ/KHD | 186 | 50 | VAG96237B | AUDI | 75 | 90 |
| VAG96190 | OPEL | 608 | 83 | VAG96211 | DEUTZ/KHD | 186 | 51 | VAG96237B | DAEWOO | 555 | 14 |
| VAG96190 | RENAULT | 708 | 71 | VAG96211 | DEUTZ/KHD | 186 | 52 | VAG96237B | DAEWOO | 763 | 55 |
| VAG96190 | VAUXHALL | 842 | 83 | VAG96211 | DEUTZ/KHD | 187 | 53 | VAG96237B | DAEWOO | 764 | 57 |











|  |  |  |  | 9 |  |  |  |  | 9 |  |  |  |  | 9 |
|---|---|---|---|-----------|---|---|---|---|---------------|---|---|---|---|---|
| VAG96237B | SKODA | 774 | 13 | VAG96277 | FORD | 238 | 9 | VAG96314 | SCANIA | 742 | 19 | | | |
| VAG96237B | SKODA | 774 | 14 | VAG96277 | FORD | 239 | 10 | VAG96314 | SCANIA | 742 | 20 | | | |
| VAG96237B | SKODA | 779 | 30 | VAG96277 | FORD | 244 | 25 | VAG96314 | SCANIA | 742 | 21 | | | |
| VAG96237B | SKODA | 780 | 32 | VAG96277 | FORD | 244 | 26 | VAG96314 | SCANIA | 743 | 22 | | | |
| VAG96237B | VW | 900 | 59 | VAG96277 | FORD | 244 | 27 | VAG96320 | MERCEDES-BENZ | 503 | 126 | | | |
| VAG96237B | VW | 900 | 60 | VAG96277 | MAZDA | 406 | 2 | VAG96320 | MERCEDES-BENZ | 505 | 127 | | | |
| VAG96237B | VW | 916 | 107 | VAG96277 | MAZDA | 406 | 3 | VAG96320 | MERCEDES-BENZ | 508 | 128 | | | |
| VAG96237B | VW | 917 | 109 | VAG96279 | HYUNDAI | 287 | 29 | VAG96320 | MERCEDES-BENZ | 509 | 129 | | | |
| VAG96237B | VW | 927 | 135 | VAG96279 | KIA | 342 | 19 | VAG96320 | MERCEDES-BENZ | 509 | 130 | | | |
| VAG96237B | VW | 929 | 140 | VAG96279 | MITSUBISHI | 556 | 20 | VAG96320 | MERCEDES-BENZ | 510 | 131 | | | |
| VAG96238B | NISSAN | 567 | 3 | VAG96280 | HYUNDAI | 287 | 29 | VAG96328 | DEUTZ/KHD | 183 | 35 | | | |
| VAG96238B | RENAULT | 671 | 4 | VAG96280 | KIA | 342 | 19 | VAG96328 | DEUTZ/KHD | 183 | 36 | | | |
| VAG96241 | MERCEDES-BENZ | 457 | 39 | VAG96280 | MITSUBISHI | 556 | 20 | VAG96328 | DEUTZ/KHD | 183 | 37 | | | |
| VAG96241 | MERCEDES-BENZ | 463 | 52 | VAG96286 | MAZDA | 409 | 15 | VAG96328 | DEUTZ/KHD | 184 | 38 | | | |
| VAG96241 | MERCEDES-BENZ | 464 | 53 | VAG96286 | MAZDA | 409 | 17 | VAG96331 | MAN | 386 | 4 | | | |
| VAG96241 | MERCEDES-BENZ | 465 | 55 | VAG96288 | PROTON | 653 | 3 | VAG96331 | MAN | 390 | 8 | | | |
| VAG96241 | MERCEDES-BENZ | 465 | 56 | VAG96288 | PROTON | 653 | 4 | VAG96335 | IVECO | 325 | 60 | | | |
| VAG96241 | MERCEDES-BENZ | 465 | 57 | VAG96291 | CHEVROLET | 122 | 24 | VAG96337 | IVECO | 325 | 60 | | | |
| VAG96241 | MERCEDES-BENZ | 466 | 59 | VAG96291 | CHEVROLET | 122 | 25 | VAG96338 | MERCEDES-BENZ | 446 | 16 | | | |
| VAG96241 | MERCEDES-BENZ | 466 | 60 | VAG96291 | HONDA | 276 | 15 | VAG96338 | MERCEDES-BENZ | 447 | 17 | | | |
| VAG96241 | MERCEDES-BENZ | 467 | 61 | VAG96291 | OPEL | 594 | 34 | VAG96341 | DEUTZ/KHD | 176 | 1 | | | |
| VAG96247 | DAF | 169 | 7 | VAG96291 | OPEL | 594 | 35 | VAG96341 | DEUTZ/KHD | 176 | 2 | | | |
| VAG96247 | DAF | 171 | 10 | VAG96291 | OPEL | 598 | 47 | VAG96341 | DEUTZ/KHD | 176 | 3 | | | |
| VAG96247 | DAF | 171 | 11 | VAG96291 | SAAB | 726 | 4 | VAG96341 | DEUTZ/KHD | 176 | 4 | | | |
| VAG96247 | DAF | 171 | 12 | VAG96291 | SAAB | 727 | 5 | VAG96341 | DEUTZ/KHD | 176 | 5 | | | |
| VAG96247 | DAF | 172 | 13 | VAG96291 | SAAB | 727 | 7 | VAG96341 | DEUTZ/KHD | 176 | 6 | | | |
| VAG96247 | DAF | 172 | 15 | VAG96291 | VAUXHALL | 829 | 35 | VAG96341 | DEUTZ/KHD | 176 | 7 | | | |
| VAG96245B | AUDI | 49 | 15 | VAG96291 | VAUXHALL | 829 | 36 | VAG96342B | CITROËN | 144 | 31 | | | |
| VAG96245B | AUDI | 49 | 16 | VAG96291 | VAUXHALL | 833 | 48 | VAG96342B | CITROËN | 146 | 35 | | | |
| VAG96245B | SKODA | 774 | 13 | VAG96292B | DACIA | 158 | 1 | VAG96342B | CITROËN | 151 | 49 | | | |
| VAG96245B | SKODA | 774 | 14 | VAG96292B | DACIA | 159 | 6 | VAG96342B | CITROËN | 151 | 50 | | | |
| VAG96245B | VW | 900 | 59 | VAG96292B | NISSAN | 567 | 2 | VAG96342B | CITROËN | 153 | 58 | | | |
| VAG96245B | VW | 900 | 60 | VAG96292B | NISSAN | 572 | 22 | VAG96342B | CITROËN | 153 | 59 | | | |
| VAG96246B | BMW | 94 | 11 | VAG96292B | NISSAN | 574 | 27 | VAG96342B | CITROËN | 154 | 63 | | | |
| VAG96246B | BMW | 98 | 23 | VAG96292B | OPEL | 599 | 50 | VAG96342B | FIAT | 218 | 79 | | | |
| VAG96246B | BMW | 100 | 25 | VAG96292B | RENAULT | 669 | 2 | VAG96342B | FIAT | 220 | 88 | | | |
| VAG96246B | BMW | 104 | 33 | VAG96292B | RENAULT | 670 | 3 | VAG96342B | LANCIA | 362 | 45 | | | |
| VAG96246B | BMW | 105 | 36 | VAG96292B | RENAULT | 680 | 18 | VAG96342B | LANCIA | 363 | 52 | | | |
| VAG96246B | BMW | 108 | 42 | VAG96292B | RENAULT | 681 | 21 | VAG96342B | PEUGEOT | 630 | 30 | | | |
| VAG96246B | BMW | 108 | 43 | VAG96292B | RENAULT | 689 | 32 | VAG96342B | PEUGEOT | 632 | 35 | | | |
| VAG96246B | BMW | 109 | 44 | VAG96292B | RENAULT | 689 | 33 | VAG96342B | PEUGEOT | 638 | 49 | | | |
| VAG96246B | BMW | 110 | 50 | VAG96292B | RENAULT | 692 | 40 | VAG96342B | PEUGEOT | 638 | 50 | | | |
| VAG96246B | LAND ROVER | 368 | 6 | VAG96292B | RENAULT | 694 | 41 | VAG96342B | PEUGEOT | 640 | 58 | | | |
| VAG96246B | LAND ROVER | 368 | 7 | VAG96292B | VAUXHALL | 833 | 51 | VAG96342B | PEUGEOT | 640 | 59 | | | |
| VAG96246B | MG | 546 | 7 | VAG96293B | RENAULT | 680 | 19 | VAG96342B | PEUGEOT | 641 | 63 | | | |
| VAG96246B | ROVER | 722 | 17 | VAG96294B | MITSUBISHI | 554 | 13 | VAG96343 | CITROËN | 144 | 31 | | | |
| VAG96271B | CITROËN | 142 | 24 | VAG96294B | NISSAN | 573 | 25 | VAG96343 | CITROËN | 146 | 35 | | | |
| VAG96271B | CITROËN | 155 | 65 | VAG96294B | OPEL | 595 | 39 | VAG96343 | CITROËN | 151 | 49 | | | |
| VAG96271B | CITROËN | 155 | 66 | VAG96294B | RENAULT | 686 | 29 | VAG96343 | CITROËN | 151 | 50 | | | |
| VAG96271B | LANCIA | 365 | 59 | VAG96294B | VAUXHALL | 830 | 40 | VAG96343 | CITROËN | 153 | 58 | | | |
| VAG96271B | PEUGEOT | 629 | 25 | VAG96294B | VOLVO | 851 | 10 | VAG96343 | CITROËN | 153 | 59 | | | |
| VAG96271B | PEUGEOT | 641 | 65 | VAG96295 | RENAULT | 700 | 52 | VAG96343 | CITROËN | 154 | 63 | | | |
| VAG96271B | PEUGEOT | 642 | 66 | VAG96308 | RENAULT | 715 | 94 | VAG96343 | FIAT | 218 | 79 | | | |
| VAG96272 | FIAT | 198 | 19 | VAG96308 | RENAULT | 716 | 99 | VAG96343 | FIAT | 220 | 88 | | | |
| VAG96272 | FIAT | 199 | 21 | VAG96308 | RENAULT | 716 | 100 | VAG96343 | LANCIA | 362 | 45 | | | |
| VAG96272 | FIAT | 200 | 22 | VAG96308 | VOLVO | 867 | 62 | VAG96343 | LANCIA | 363 | 52 | | | |
| VAG96272 | FIAT | 200 | 24 | VAG96308 | VOLVO | 868 | 63 | VAG96343 | PEUGEOT | 630 | 30 | | | |
| VAG96272 | LANCIA | 351 | 9 | VAG96308 | VOLVO | 871 | 67 | VAG96343 | PEUGEOT | 632 | 35 | | | |
| VAG96272 | LANCIA | 352 | 11 | VAG96308 | VOLVO | 872 | 68 | VAG96343 | PEUGEOT | 638 | 49 | | | |
| VAG96272 | LANCIA | 353 | 13 | VAG96308 | VOLVO | 872 | 69 | VAG96343 | PEUGEOT | 638 | 50 | | | |
| VAG96272 | OPEL | 585 | 4 | VAG96309 | MAN | 397 | 21 | VAG96343 | PEUGEOT | 640 | 58 | | | |
| VAG96272 | VAUXHALL | 820 | 5 | VAG96309 | MAN | 398 | 22 | VAG96343 | PEUGEOT | 640 | 59 | | | |
| VAG96272 | VAUXHALL | 820 | 6 | VAG96309 | MAN | 401 | 25 | VAG96343 | PEUGEOT | 641 | 63 | | | |
| VAG96273 | FIAT | 199 | 20 | VAG96309 | MAN | 402 | 28 | VAG96345 | MERCEDES-BENZ | 503 | 126 | | | |
| VAG96273 | LANCIA | 352 | 10 | VAG96309 | MAN | 403 | 30 | VAG96345 | MERCEDES-BENZ | 505 | 127 | | | |
| VAG96273 | ZASTAVA | 935 | 1 | VAG96309 | MAN | 404 | 32 | VAG96345 | MERCEDES-BENZ | 508 | 128 | | | |
| VAG96274 | IVECO | 321 | 49 | VAG96310 | MERCEDES-BENZ | 443 | 1 | VAG96345 | MERCEDES-BENZ | 509 | 129 | | | |
| VAG96276 | IVECO | 322 | 50 | VAG96310 | SMART | 784 | 1 | VAG96345 | MERCEDES-BENZ | 509 | 130 | | | |
| VAG96276 | IVECO | 322 | 51 | VAG96310 | SMART | 784 | 2 | VAG96345 | MERCEDES-BENZ | 510 | 131 | | | |
| VAG96276 | IVECO | 322 | 53 | VAG96314 | SCANIA | 734 | 4 | VAG96346 | ALFA ROMEO | 27 | 15 | | | |
| VAG96276 | IVECO | 323 | 54 | VAG96314 | SCANIA | 737 | 10 | VAG96346 | CHEVROLET | 120 | 16 | | | |
| VAG96276 | IVECO | 323 | 55 | VAG96314 | SCANIA | 738 | 11 | VAG96346 | CHEVROLET | 121 | 21 | | | |



NUMERICAL PARTS LIST

Numerische Teilenummernliste • Elenco riferimenti
Liste des références produits

|  |  |  |  |  |  |  |  |  |  |  |  |  |  |  |
|---|---|---|---|---|---|---|---|--|---|---|---|---|---|---|
| VAG96346 | CHEVROLET | | 123 | 30 | VAG96360 | FIAT | | 210 | 54 | VAG96368 | PEUGEOT | | 641 | 62 |
| VAG96346 | DAEWOO | | 163 | 10 | VAG96360 | FIAT | | 212 | 59 | VAG96369 | MAZDA | | 408 | 10 |
| VAG96346 | FIAT | | 204 | 39 | VAG96360 | FIAT | | 215 | 67 | VAG96369 | NISSAN | | 554 | 11 |
| VAG96346 | FIAT | | 206 | 45 | VAG96360 | LANCIA | | 354 | 19 | VAG96369 | NISSAN | | 572 | 20 |
| VAG96346 | OPEL | | 591 | 26 | VAG96360 | LANCIA | | 355 | 25 | VAG96369 | NISSAN | | 572 | 21 |
| VAG96346 | OPEL | | 593 | 30 | VAG96360 | LANCIA | | 356 | 27 | VAG96370 | MAZDA | | 408 | 10 |
| VAG96346 | OPEL | | 593 | 31 | VAG96360 | LANCIA | | 359 | 36 | VAG96370 | NISSAN | | 554 | 11 |
| VAG96346 | OPEL | | 596 | 41 | VAG96360 | OPEL | | 598 | 47 | VAG96370 | NISSAN | | 572 | 20 |
| VAG96346 | OPEL | | 596 | 42 | VAG96360 | OPEL | | 599 | 51 | VAG96370 | NISSAN | | 572 | 21 |
| VAG96346 | SAAB | | 726 | 1 | VAG96360 | SAAB | | 726 | 4 | VAG96371 | MERCEDES-BENZ | | 448 | 23 |
| VAG96346 | VAUXHALL | | 826 | 27 | VAG96360 | SAAB | | 727 | 7 | VAG96371 | MERCEDES-BENZ | | 451 | 29 |
| VAG96346 | VAUXHALL | | 827 | 31 | VAG96360 | SAAB | | 727 | 8 | VAG96371 | MERCEDES-BENZ | | 453 | 32 |
| VAG96346 | VAUXHALL | | 828 | 32 | VAG96360 | VAUXHALL | | 833 | 48 | VAG96371 | NISSAN | | 555 | 17 |
| VAG96346 | VAUXHALL | | 831 | 42 | VAG96360 | VAUXHALL | | 834 | 52 | VAG96371 | TOYOTA | | 785 | 7 |
| VAG96346 | VAUXHALL | | 831 | 43 | VAG96361B | NISSAN | | 577 | 37 | VAG96372 | VOLVO | | 854 | 20 |
| VAG96347B | CITROËN | | 143 | 25 | VAG96361B | NISSAN | | 578 | 40 | VAG96375 | NISSAN | | 577 | 36 |
| VAG96347B | CITROËN | | 143 | 26 | VAG96361B | OPEL | | 606 | 73 | VAG96375 | NISSAN | | 578 | 41 |
| VAG96347B | NISSAN | | 570 | 15 | VAG96361B | OPEL | | 607 | 78 | VAG96376 | NISSAN | | 577 | 36 |
| VAG96347B | PEUGEOT | | 622 | 10 | VAG96361B | RENAULT | | 700 | 50 | VAG96376 | NISSAN | | 578 | 41 |
| VAG96347B | PEUGEOT | | 624 | 14 | VAG96361B | RENAULT | | 704 | 58 | VAG96381 | DAIHATSU | | 173 | 3 |
| VAG96347B | PEUGEOT | | 628 | 23 | VAG96361B | VAUXHALL | | 840 | 73 | VAG96381 | SUBARU | | 790 | 3 |
| VAG96347B | RENAULT | | 674 | 11 | VAG96361B | VAUXHALL | | 841 | 78 | VAG96381 | TOYOTA | | 803 | 5 |
| VAG96347B | RENAULT | | 675 | 12 | VAG96364 | CITROËN | | 135 | 5 | VAG96382 | DEUTZ/KHD | | 184 | 39 |
| VAG96348 | IVECO | | 322 | 52 | VAG96364 | CITROËN | | 135 | 6 | VAG96382 | RENAULT | | 713 | 87 |
| VAG96349 | IVECO | | 322 | 52 | VAG96364 | CITROËN | | 135 | 7 | VAG96382 | RENAULT | | 713 | 88 |
| VAG96350 | VOLVO | | 873 | 70 | VAG96364 | CITROËN | | 139 | 17 | VAG96382 | VOLVO | | 867 | 61 |
| VAG96353B | AUDI | | 55 | 34 | VAG96364 | CITROËN | | 140 | 18 | VAG96383B | NISSAN | | 574 | 28 |
| VAG96353B | SEAT | | 760 | 47 | VAG96364 | FIAT | | 201 | 28 | VAG96383B | NISSAN | | 574 | 29 |
| VAG96353B | SKODA | | 778 | 27 | VAG96364 | FIAT | | 201 | 29 | VAG96383B | OPEL | | 600 | 54 |
| VAG96353B | VW | | 910 | 87 | VAG96364 | FORD | | 239 | 11 | VAG96383B | OPEL | | 602 | 62 |
| VAG96354B | DACIA | | 159 | 4 | VAG96364 | FORD | | 239 | 13 | VAG96383B | RENAULT | | 695 | 44 |
| VAG96354B | MERCEDES-BENZ | | 443 | 3 | VAG96364 | FORD | | 242 | 22 | VAG96383B | RENAULT | | 696 | 45 |
| VAG96354B | NISSAN | | 570 | 16 | VAG96364 | FORD | | 243 | 23 | VAG96383B | VAUXHALL | | 834 | 55 |
| VAG96354B | RENAULT | | 677 | 16 | VAG96364 | MAZDA | | 406 | 4 | VAG96383B | VAUXHALL | | 837 | 62 |
| VAG96354B | SUZUKI | | 797 | 15 | VAG96364 | MAZDA | | 407 | 6 | VAG96384 | CHRYSLER | | 127 | 2 |
| VAG96357 | LEXUS | | 373 | 1 | VAG96364 | MINI | | 548 | 2 | VAG96384 | FIAT | | 198 | 16 |
| VAG96357 | MINI | | 548 | 1 | VAG96364 | PEUGEOT | | 621 | 6 | VAG96384 | FIAT | | 201 | 25 |
| VAG96357 | SUBARU | | 790 | 4 | VAG96364 | PEUGEOT | | 621 | 7 | VAG96384 | FORD | | 237 | 6 |
| VAG96357 | TOYOTA | | 803 | 7 | VAG96364 | PEUGEOT | | 625 | 15 | VAG96384 | LANCIA | | 351 | 8 |
| VAG96357 | TOYOTA | | 809 | 27 | VAG96364 | PEUGEOT | | 626 | 16 | VAG96384 | LANCIA | | 353 | 15 |
| VAG96357 | TOYOTA | | 811 | 32 | VAG96364 | SUZUKI | | 795 | 9 | VAG96385 | NISSAN | | 569 | 11 |
| VAG96357 | TOYOTA | | 813 | 36 | VAG96364 | SUZUKI | | 796 | 13 | VAG96385 | OPEL | | 586 | 8 |
| VAG96357 | TOYOTA | | 814 | 39 | VAG96364 | TOYOTA | | 804 | 8 | VAG96385 | SUZUKI | | 795 | 6 |
| VAG96359 | ALFA ROMEO | | 24 | 1 | VAG96364 | VOLVO | | 849 | 2 | VAG96385 | VAUXHALL | | 821 | 10 |
| VAG96359 | ALFA ROMEO | | 24 | 2 | VAG96364 | VOLVO | | 849 | 3 | VAG96386B | BMW | | 95 | 12 |
| VAG96359 | CHEVROLET | | 117 | 3 | VAG96365B | CITROËN | | 136 | 10 | VAG96386B | BMW | | 96 | 18 |
| VAG96359 | CHEVROLET | | 117 | 4 | VAG96365B | PEUGEOT | | 622 | 11 | VAG96386B | BMW | | 97 | 22 |
| VAG96359 | CHRYSLER | | 127 | 1 | VAG96366 | FIAT | | 201 | 26 | VAG96386B | BMW | | 100 | 26 |
| VAG96359 | FIAT | | 195 | 9 | VAG96366 | FIAT | | 203 | 35 | VAG96386B | BMW | | 101 | 28 |
| VAG96359 | FIAT | | 196 | 10 | VAG96366 | FIAT | | 204 | 41 | VAG96386B | BMW | | 114 | 61 |
| VAG96359 | FORD | | 236 | 5 | VAG96367 | FORD | | 258 | 62 | VAG96386B | BMW | | 114 | 64 |
| VAG96359 | FORD | | 239 | 12 | VAG96367 | FORD | | 264 | 79 | VAG96386B | BMW | | 115 | 66 |
| VAG96359 | LANCIA | | 350 | 3 | VAG96367 | FORD | | 265 | 80 | VAG96387B | BMW | | 92 | 2 |
| VAG96359 | LANCIA | | 350 | 4 | VAG96367 | FORD | | 265 | 81 | VAG96387B | BMW | | 95 | 14 |
| VAG96359 | OPEL | | 584 | 1 | VAG96367 | MAZDA | | 407 | 5 | VAG96387B | BMW | | 99 | 24 |
| VAG96359 | OPEL | | 584 | 2 | VAG96367 | MAZDA | | 407 | 9 | VAG96387B | BMW | | 107 | 41 |
| VAG96359 | PEUGEOT | | 620 | 1 | VAG96367 | MAZDA | | 409 | 14 | VAG96387B | MINI | | 549 | 8 |
| VAG96359 | SUBARU | | 790 | 1 | VAG96367 | MAZDA | | 410 | 19 | VAG96387B | MINI | | 550 | 9 |
| VAG96359 | SUZUKI | | 794 | 4 | VAG96367 | MAZDA | | 410 | 20 | VAG96387B | MINI | | 550 | 10 |
| VAG96359 | SUZUKI | | 794 | 5 | VAG96367 | VOLVO | | 857 | 30 | VAG96388B | AUDI | | 50 | 19 |
| VAG96359 | VAUXHALL | | 819 | 2 | VAG96367 | VOLVO | | 861 | 40 | VAG96388B | SEAT | | 755 | 30 |
| VAG96359 | VAUXHALL | | 819 | 3 | VAG96368 | CITROËN | | 154 | 62 | VAG96388B | SEAT | | 756 | 33 |
| VAG96360 | ALFA ROMEO | | 25 | 9 | VAG96368 | FIAT | | 221 | 91 | VAG96388B | SKODA | | 774 | 15 |
| VAG96360 | ALFA ROMEO | | 29 | 24 | VAG96368 | FORD | | 261 | 72 | VAG96388B | SKODA | | 775 | 18 |
| VAG96360 | ALFA ROMEO | | 30 | 26 | VAG96368 | FORD | | 262 | 76 | VAG96388B | VW | | 900 | 61 |
| VAG96360 | ALFA ROMEO | | 30 | 27 | VAG96368 | FORD | | 266 | 84 | VAG96388B | VW | | 901 | 64 |
| VAG96360 | ALFA ROMEO | | 32 | 31 | VAG96368 | FORD | | 266 | 85 | VAG96389B | AUDI | | 76 | 93 |
| VAG96360 | ALFA ROMEO | | 33 | 34 | VAG96368 | FORD | | 266 | 86 | VAG96389B | AUDI | | 80 | 108 |
| VAG96360 | CHRYSLER | | 127 | 4 | VAG96368 | JAGUAR | | 332 | 4 | VAG96389B | VW | | 930 | 142 |
| VAG96360 | CHRYSLER | | 127 | 5 | VAG96368 | JAGUAR | | 332 | 5 | VAG96389B | VW | | 931 | 147 |
| VAG96360 | FIAT | | 204 | 40 | VAG96368 | LAND ROVER | | 369 | 14 | VAG96389B | VW | | 932 | 148 |
| VAG96360 | FIAT | | 210 | 52 | VAG96368 | LAND ROVER | | 370 | 17 | VAG96390B | AUDI | | 76 | 93 |

|  |   |  |  |  |   |  |  |
|---|---|---|---|---|---|---|---|
| VAG96390B | AUDI | 80 | 108 | VAG96400 | KIA | 341 | 13 |
| VAG96390B | VW | 930 | 142 | VAG96400 | KIA | 341 | 16 |
| VAG96390B | VW | 931 | 147 | VAG96401 | HYUNDAI | 284 | 19 |
| VAG96390B | VW | 932 | 148 | VAG96401 | HYUNDAI | 285 | 21 |
| VAG96391 | CHEVROLET | 120 | 17 | VAG96401 | HYUNDAI | 286 | 25 |
| VAG96391 | FIAT | 203 | 38 | VAG96401 | KIA | 341 | 14 |
| VAG96391 | SUZUKI | 797 | 17 | VAG96402B | BMW | 95 | 13 |
| VAG96391 | SUZUKI | 798 | 18 | VAG96402B | BMW | 102 | 29 |
| VAG96392B | BMW | 92 | 1 | VAG96402B | BMW | 106 | 39 |
| VAG96392B | CITROËN | 140 | 19 | VAG96402B | BMW | 106 | 40 |
| VAG96392B | CITROËN | 141 | 21 | VAG96402B | BMW | 109 | 45 |
| VAG96392B | CITROËN | 141 | 22 | VAG96402B | BMW | 112 | 55 |
| VAG96392B | CITROËN | 142 | 23 | VAG96403B | BMW | 95 | 13 |
| VAG96392B | MINI | 548 | 3 | VAG96403B | BMW | 102 | 29 |
| VAG96392B | MINI | 548 | 4 | VAG96403B | BMW | 106 | 39 |
| VAG96392B | MINI | 549 | 5 | VAG96403B | BMW | 106 | 40 |
| VAG96392B | MINI | 549 | 6 | VAG96403B | BMW | 109 | 45 |
| VAG96392B | PEUGEOT | 621 | 8 | VAG96403B | BMW | 112 | 55 |
| VAG96392B | PEUGEOT | 622 | 9 | | | | |
| VAG96392B | PEUGEOT | 626 | 17 | | | | |
| VAG96392B | PEUGEOT | 627 | 19 | | | | |
| VAG96392B | PEUGEOT | 627 | 20 | | | | |
| VAG96392B | PEUGEOT | 628 | 21 | | | | |
| VAG96392B | PEUGEOT | 628 | 22 | | | | |
| VAG96393B | BMW | 92 | 1 | | | | |
| VAG96393B | CITROËN | 140 | 19 | | | | |
| VAG96393B | CITROËN | 141 | 21 | | | | |
| VAG96393B | CITROËN | 141 | 22 | | | | |
| VAG96393B | CITROËN | 142 | 23 | | | | |
| VAG96393B | MINI | 548 | 3 | | | | |
| VAG96393B | MINI | 548 | 4 | | | | |
| VAG96393B | MINI | 549 | 5 | | | | |
| VAG96393B | MINI | 549 | 6 | | | | |
| VAG96393B | PEUGEOT | 621 | 8 | | | | |
| VAG96393B | PEUGEOT | 622 | 9 | | | | |
| VAG96393B | PEUGEOT | 626 | 17 | | | | |
| VAG96393B | PEUGEOT | 627 | 19 | | | | |
| VAG96393B | PEUGEOT | 627 | 20 | | | | |
| VAG96393B | PEUGEOT | 628 | 21 | | | | |
| VAG96393B | PEUGEOT | 628 | 22 | | | | |
| VAG96394 | HYUNDAI | 280 | 1 | | | | |
| VAG96394 | HYUNDAI | 280 | 2 | | | | |
| VAG96394 | HYUNDAI | 280 | 3 | | | | |
| VAG96394 | KIA | 338 | 1 | | | | |
| VAG96394 | KIA | 338 | 2 | | | | |
| VAG96394 | KIA | 338 | 3 | | | | |
| VAG96394 | KIA | 339 | 7 | | | | |
| VAG96395 | HYUNDAI | 281 | 6 | | | | |
| VAG96395 | HYUNDAI | 281 | 7 | | | | |
| VAG96395 | HYUNDAI | 281 | 8 | | | | |
| VAG96395 | HYUNDAI | 283 | 14 | | | | |
| VAG96395 | HYUNDAI | 283 | 15 | | | | |
| VAG96395 | KIA | 338 | 4 | | | | |
| VAG96395 | KIA | 338 | 5 | | | | |
| VAG96395 | KIA | 339 | 6 | | | | |
| VAG96395 | KIA | 340 | 11 | | | | |
| VAG96396 | HYUNDAI | 281 | 5 | | | | |
| VAG96396 | HYUNDAI | 282 | 10 | | | | |
| VAG96397 | HYUNDAI | 281 | 5 | | | | |
| VAG96397 | HYUNDAI | 282 | 10 | | | | |
| VAG96398 | HYUNDAI | 282 | 12 | | | | |
| VAG96398 | HYUNDAI | 283 | 13 | | | | |
| VAG96398 | KIA | 339 | 9 | | | | |
| VAG96398 | KIA | 340 | 10 | | | | |
| VAG96399 | HYUNDAI | 283 | 16 | | | | |
| VAG96399 | HYUNDAI | 284 | 17 | | | | |
| VAG96399 | HYUNDAI | 285 | 23 | | | | |
| VAG96399 | KIA | 341 | 13 | | | | |
| VAG96399 | KIA | 341 | 16 | | | | |
| VAG96400 | HYUNDAI | 283 | 16 | | | | |
| VAG96400 | HYUNDAI | 284 | 17 | | | | |
| VAG96400 | HYUNDAI | 285 | 23 | | | | |



NUMERICAL PARTS LIST

Numerische Teilenummernliste • Elenco riferimenti
Liste des références produits

|  | | | |
|---|---------|-----|----|
| VS6049 | VOLVO | 865 | 54 |
| VS6049 | VOLVO | 866 | 56 |
| VS6049 | VOLVO | 866 | 57 |
| VS6049 | VOLVO | 866 | 58 |
| VS6049 | VOLVO | 866 | 59 |
| VS6072 | PERKINS | 612 | 8 |
| VS6072 | PERKINS | 612 | 11 |
| VS6072 | PERKINS | 613 | 12 |
| VS6072 | PERKINS | 613 | 13 |
| VS6103 | SCANIA | 736 | 7 |
| VS6103 | SCANIA | 737 | 9 |
| VS6103 | SCANIA | 738 | 12 |
| VS6103 | SCANIA | 740 | 16 |
| VS6103 | SCANIA | 741 | 18 |
| VS6107 | VOLVO | 868 | 64 |
| VS6337 | VOLVO | 870 | 65 |
| VS6353 | RENAULT | 709 | 73 |

| F(mm) G(mm) E(mm) | F(mm) G(mm) E(mm) | F(mm) G(mm) E(mm) | F(mm) G(mm) E(mm) | | | | | | | | |
|-------------------|---------------------|-------------------|-------------------|---------------------|-----|-----------|---------------------|-----|-----------|---------------------|-----|
| VAG96370 | 4.990 9.240 42.200 | VG5 | VAG96400 | 6.000 11.050 54.500 | VG5 | VAG96368 | 6.970 12.070 51.500 | VG1 | VAG96146 | 7.040 13.050 42.500 | VG3 |
| VAG96346 | 4.990 10.040 37.000 | VG7 | VAG96271B | 6.000 11.060 40.000 | VG3 | VAG96120 | 7.000 11.040 45.300 | VG5 | VAG96331 | 7.040 13.050 60.000 | VG7 |
| VAG96369 | 5.000 9.240 42.200 | VG5 | VAG96383B | 6.000 11.070 42.400 | VG7 | VAG50758 | 7.000 11.150 41.500 | VG1 | VAG96046B | 7.040 13.080 54.000 | VG3 |
| VAG96067 | 5.000 9.700 34.500 | VG5 | VAG96238B | 6.000 11.070 45.000 | VG3 | VAG92321 | 7.000 11.560 43.000 | VG5 | VAG96181B | 7.040 14.050 51.300 | VG3 |
| VAG96360 | 5.000 10.030 46.700 | VG5 | VAG96397 | 6.000 11.100 39.000 | VG5 | VAG96161B | 7.000 11.800 36.500 | VG1 | VAG96199 | 7.040 14.080 51.300 | VG3 |
| VAG96076 | 5.000 10.040 39.000 | VG3 | VAG96396 | 6.000 11.100 42.700 | VG5 | VAG96157B | 7.000 12.000 38.000 | VG5 | VAG96025 | 7.060 13.540 43.000 | VG3 |
| VAG96077 | 5.000 10.040 39.000 | VG3 | VAG96288 | 6.000 11.110 45.500 | VG3 | VAG96039 | 7.000 12.000 45.000 | VG3 | VAG693 | 7.160 11.930 39.000 | VG1 |
| VAG96402B | 5.000 10.040 42.000 | VG1 | VAG92320 | 6.000 11.240 43.000 | VG5 | VAG96111 | 7.000 12.000 52.500 | VG3 | VAG50911 | 7.160 11.960 43.000 | VG1 |
| VAG96384 | 5.000 10.040 44.000 | VG7 | VAG96372 | 6.000 11.520 39.500 | VG7 | VAG96294B | 7.000 12.030 38.300 | VG3 | VAG50969 | 7.160 11.970 42.700 | VG1 |
| VAG96387B | 5.000 10.050 36.000 | VG1 | VAG96266B | 6.000 11.540 39.000 | VG1 | VAG92382B | 7.000 12.050 38.000 | VG3 | VAG92059 | 7.490 12.080 38.900 | VG1 |
| VAG96113 | 5.000 12.000 42.000 | VG3 | VAG96371 | 6.000 11.550 34.500 | VG7 | VAG96041B | 7.000 12.080 36.500 | VG4 | VAG96382 | 7.500 13.030 58.300 | VG7 |
| VAG96392B | 5.010 9.050 41.500 | VG1 | VAG96098 | 6.000 11.550 47.500 | VG3 | VAG92119 | 7.000 12.090 50.000 | VG1 | VAG96014 | 7.910 12.770 54.000 | VG1 |
| VAG96393B | 5.010 9.050 44.500 | VG1 | VAG96354B | 6.000 12.080 40.500 | VG7 | VAG96038 | 7.000 12.100 45.000 | VG3 | VAG92248 | 7.920 12.720 56.380 | VG1 |
| VAG96364 | 5.500 9.530 34.200 | VG1 | VAG96095 | 6.000 12.550 37.600 | VG3 | VAG96037 | 7.000 12.100 55.000 | VG3 | VAG96024 | 7.920 12.770 37.500 | VG3 |
| VAG96394 | 5.500 10.000 48.000 | VG5 | VAG96310 | 6.000 12.560 34.500 | VG7 | VAG96096 | 7.000 12.550 37.600 | VG3 | VAG50912 | 7.920 12.870 46.500 | VG1 |
| VAG96398 | 5.500 10.050 40.500 | VG5 | VAG96148B | 6.000 12.570 39.500 | VG3 | VAG96042B | 7.000 12.550 43.500 | VG3 | VAG50924 | 7.920 12.880 54.000 | VG1 |
| VAG96072 | 5.500 10.300 34.500 | VG5 | VAG96044B | 6.000 12.770 43.500 | VG3 | VAG92364 | 7.000 13.070 42.500 | VG3 | VAG51062 | 7.920 13.510 63.940 | VG4 |
| VAG96381 | 5.500 10.340 43.600 | VG5 | VAG96058 | 6.010 9.880 30.000 | VG3 | VAG96216 | 7.010 13.060 47.500 | VG3 | VAG96001 | 7.930 11.180 60.300 | VG1 |
| VAG96110 | 5.500 10.360 34.500 | VG3 | VAG96376 | 6.010 10.050 44.200 | VG5 | VAG96026 | 7.020 11.040 43.000 | VG1 | VAG50923 | 7.930 12.750 48.500 | VG1 |
| VAG96391 | 5.500 10.570 40.000 | VG7 | VAG92316 | 6.010 10.140 30.000 | VG5 | VAG96022 | 7.020 11.040 45.800 | VG1 | VAG96010 | 7.930 12.750 53.400 | VG1 |
| VAG96365B | 5.500 10.580 38.000 | VG1 | VAG96386B | 6.010 10.150 39.000 | VG1 | VAG92286 | 7.020 11.220 48.010 | VG5 | VAG578 | 7.930 12.750 57.000 | VG1 |
| VAG96114 | 5.500 11.000 43.000 | VG3 | VAG96295 | 6.010 11.040 42.000 | VG5 | VAG92285 | 7.020 11.230 45.050 | VG5 | VAG93 | 7.940 12.740 65.900 | VG4 |
| VAG96395 | 5.500 11.030 31.500 | VG7 | VAG96043B | 6.010 12.560 43.500 | VG3 | VAG96163B | 7.020 12.080 39.000 | VG5 | VAG92199 | 7.950 12.730 49.500 | VG1 |
| VAG96367 | 5.500 11.050 39.000 | VG7 | VAG96272 | 6.020 10.030 39.700 | VG3 | VAG96182B | 7.020 12.080 42.000 | VG3 | VAG50998 | 7.950 12.740 49.400 | VG3 |
| VAG96293B | 5.500 11.060 45.000 | VG1 | VAG96137 | 6.020 10.050 45.000 | VG3 | VAG96158 | 7.020 12.080 45.000 | VG5 | VAG92198 | 7.950 12.750 47.300 | VG1 |
| VAG96292B | 5.500 11.070 40.600 | VG1 | VAG96237B | 6.020 10.070 42.000 | VG3 | VAG96172B | 7.020 12.080 49.000 | VG3 | VAG50913 | 7.950 12.870 49.500 | VG1 |
| VAG96065 | 5.500 11.100 32.000 | VG3 | VAG96151 | 6.020 10.090 45.000 | VG3 | VAG96188B | 7.020 12.090 40.050 | VG3 | VAG50914 | 7.950 12.900 47.300 | VG1 |
| VAG96385 | 5.510 10.590 34.000 | VG7 | VAG92318 | 6.020 10.230 43.300 | VG5 | VAG96338 | 7.020 12.560 40.000 | VG7 | VAG50948 | 7.950 13.550 51.000 | VG4 |
| VAG92360 | 5.520 9.740 40.000 | VG5 | VAG96069 | 6.020 11.040 38.500 | VG5 | VAG96241 | 7.020 12.580 37.500 | VG3 | VAG154 | 7.970 12.750 52.400 | VG1 |
| VAG92397 | 5.530 11.060 47.500 | VG5 | VAG96071 | 6.020 11.040 40.500 | VG5 | VAG96149 | 7.020 12.590 37.500 | VG3 | VAG92293 | 7.980 14.020 37.660 | VG5 |
| VAG96265B | 5.980 10.210 42.000 | VG3 | VAG96073B | 6.020 11.060 36.000 | VG5 | VAG96178 | 7.020 12.760 37.500 | VG1 | VAG92292 | 7.980 14.040 40.570 | VG5 |
| VAG96029 | 5.990 10.050 35.000 | VG3 | VAG96070 | 6.020 11.060 40.500 | VG5 | VAG96145 | 7.020 13.030 46.000 | VG3 | VAG92105B | 7.990 12.080 42.300 | VG4 |
| VAG96028 | 5.990 10.050 45.000 | VG3 | VAG96064 | 6.020 11.070 52.500 | VG1 | VAG96123 | 7.020 13.050 42.250 | VG3 | VAG96276 | 7.990 14.050 62.000 | VG1 |
| VAG92309 | 6.000 9.900 30.000 | VG5 | VAG96343 | 6.020 12.060 40.800 | VG7 | VAG92303B | 7.020 13.050 45.000 | VG5 | VAG96021 | 8.000 12.020 50.000 | VG1 |
| VAG96403B | 6.000 10.040 48.000 | VG1 | VAG96353B | 6.020 12.080 36.500 | VG7 | VAG96224B | 7.020 13.050 45.500 | VG3 | VAG92061B | 8.000 12.080 36.700 | VG4 |
| VAG96375 | 6.000 10.040 60.000 | VG5 | VAG96342B | 6.020 12.110 40.800 | VG3 | VAG96273 | 7.020 13.060 40.000 | VG3 | VAG96107 | 8.000 13.000 46.000 | VG5 |
| VAG96388B | 6.000 10.060 36.000 | VG7 | VAG96119 | 6.030 10.540 41.500 | VG1 | VAG96230 | 7.020 13.060 46.000 | VG3 | VAG96108 | 8.000 13.000 50.000 | VG5 |
| VAG96389B | 6.000 10.060 44.000 | VG7 | VAG96344 | 6.030 10.540 41.500 | VG1 | VAG96347B | 7.020 13.070 48.500 | VG7 | VAG92444 | 8.000 13.040 56.000 | VG3 |
| VAG96390B | 6.000 10.060 65.000 | VG7 | VAG96068 | 6.030 11.060 38.500 | VG5 | VAG96049B | 7.020 13.080 40.200 | VG3 | VAG92445 | 8.000 13.040 60.000 | VG1 |
| VAG96359 | 6.000 10.250 43.280 | VG7 | VAG96286 | 6.050 11.040 45.000 | VG3 | VAG92347B | 7.020 13.140 45.000 | VG3 | VAG92406 | 8.000 13.050 40.000 | VG5 |
| VAG96112 | 6.000 11.000 40.000 | VG1 | VAG96027 | 6.060 12.040 36.000 | VG1 | VAG96143B | 7.020 13.240 45.000 | VG3 | VAG92329B | 8.000 13.070 39.000 | VG3 |
| VAG96101 | 6.000 11.000 48.000 | VG5 | VAG96159 | 6.080 12.040 36.000 | VG1 | VAG96142B | 7.020 13.550 35.500 | VG3 | VAG92369 | 8.000 13.070 60.000 | VG1 |
| VAG92325 | 6.000 11.040 40.500 | VG5 | VAG92294 | 6.500 12.040 32.000 | VG1 | VAG96062B | 7.020 15.000 33.000 | VG4 | VAG96279 | 8.000 13.070 71.000 | VG3 |
| VAG96357 | 6.000 11.040 40.600 | VG5 | VAG92210 | 6.520 12.090 55.000 | VG1 | VAG96097 | 7.030 12.760 50.000 | VG3 | VAG96280 | 8.000 13.070 74.000 | VG3 |
| VAG96401 | 6.000 11.050 36.600 | VG7 | VAG92284 | 6.550 11.240 45.070 | VG5 | VAG96132 | 7.030 13.110 47.600 | VG3 | VAG92322 | 8.000 13.130 71.000 | VG5 |
| VAG96277 | 6.000 11.050 39.000 | VG3 | VAG96133 | 6.600 11.200 45.000 | VG5 | VAG92496 | 7.030 14.040 51.000 | VG1 | VAG92323 | 8.000 13.130 74.000 | VG5 |
| VAG96291 | 6.000 11.050 42.000 | VG3 | VAG92046 | 6.620 12.130 44.000 | VG1 | VAG96002 | 7.040 11.180 60.300 | VG1 | VAG92337 | 8.000 13.300 51.000 | VG3 |
| VAG96399 | 6.000 11.050 46.000 | VG5 | VAG92047 | 6.620 12.130 49.500 | VG1 | VAG96184 | 7.040 12.080 43.000 | VG3 | VAG92158 | 8.000 13.500 46.500 | VG4 |
| VAG96361B | 6.000 11.050 50.000 | VG7 | VAG92511 | 6.960 12.050 28.300 | VG1 | VAG50895 | 7.040 13.030 46.000 | VG1 | VAG92372 | 8.000 14.030 50.000 | VG5 |



VG1



VG2



VG3



VG4

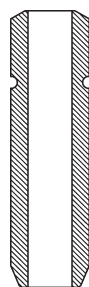

VG5



VG6



VG7



VG8



VALVE GUIDES

Ventil Führung • Guia De Valvulas
Guides De Soupape

| F(mm) | G(mm) | E(mm) | | | F(mm) | G(mm) | E(mm) | | | F(mm) | G(mm) | E(mm) | | | F(mm) | G(mm) | E(mm) | | |
|-----------|-------|--------|--------|-----|------------|-------|--------|--------|-----|-----------|--------|--------|--------|-----|----------|--------|--------|---------|-----|
| VAG92380B | 8.000 | 14.040 | 42.000 | VG3 | VAG96190 | 8.040 | 13.130 | 56.000 | VG3 | VAG96274 | 9.020 | 15.020 | 81.000 | VG3 | VAG50965 | 11.060 | 18.000 | 82.000 | VG1 |
| VAG92297 | 8.000 | 14.050 | 39.500 | VG5 | VAG92497 | 8.040 | 14.030 | 56.000 | VG1 | VAG96139B | 9.020 | 15.050 | 50.500 | VG3 | VAG50964 | 11.060 | 18.040 | 66.000 | VG1 |
| VAG92378B | 8.000 | 14.050 | 46.000 | VG3 | VAG96210 | 8.040 | 14.040 | 43.000 | VG3 | VAG96147B | 9.020 | 15.050 | 54.000 | VG3 | VAG92484 | 11.090 | 17.560 | 75.000 | VG3 |
| VAG51007 | 8.000 | 14.060 | 55.000 | VG3 | VAG92174 | 8.040 | 14.080 | 42.000 | VG4 | VAG92016 | 9.020 | 15.050 | 67.500 | VG1 | VAG92251 | 11.100 | 17.500 | 70.300 | VG1 |
| VAG92366 | 8.000 | 14.100 | 46.500 | VG3 | VAG92175 | 8.040 | 14.080 | 48.000 | VG4 | VAG92017 | 9.020 | 15.050 | 86.500 | VG1 | VAG92089 | 11.990 | 18.030 | 67.050 | VG1 |
| VAG586 | 8.010 | 12.760 | 62.000 | VG1 | VAG96175 | 8.040 | 15.110 | 46.500 | VG3 | VAG92414B | 9.020 | 15.060 | 54.000 | VG5 | VAG92498 | 12.000 | 18.000 | 64.000 | VG3 |
| VAG96089 | 8.010 | 14.080 | 55.000 | VG3 | VAG96329 | 8.050 | 15.040 | 52.800 | VG1 | VAG96134 | 9.020 | 15.070 | 61.000 | VG3 | VAG96309 | 12.020 | 18.050 | 56.000 | VG3 |
| VAG96023 | 8.020 | 12.020 | 43.000 | VG1 | VAG96004 | 8.060 | 12.750 | 60.300 | VG1 | VAG96088 | 9.030 | 15.040 | 58.000 | VG4 | VAG96129 | 12.030 | 20.030 | 105.000 | VG1 |
| VAG92384 | 8.020 | 12.040 | 47.000 | VG3 | VAG96003 | 8.080 | 12.750 | 60.300 | VG1 | VAG96115 | 9.040 | 15.050 | 66.500 | VG7 | VAG92110 | 12.720 | 18.100 | 74.000 | VG1 |
| VAG92301 | 8.020 | 12.050 | 60.000 | VG5 | VAG92044V1 | 8.080 | 13.580 | 65.000 | VG1 | VAG96150 | 9.040 | 16.060 | 67.000 | VG1 | | | | | |
| VAG92096 | 8.020 | 12.080 | 64.500 | VG1 | VAG92073 | 8.100 | 14.050 | 50.500 | VG1 | VAG96202 | 9.040 | 16.070 | 62.000 | VG1 | | | | | |
| VAG96118 | 8.020 | 12.250 | 59.000 | VG1 | VAG96335 | 8.250 | 15.020 | 97.000 | VG7 | VAG96328 | 9.050 | 15.040 | 62.800 | VG1 | | | | | |
| VAG96227B | 8.020 | 13.050 | 43.000 | VG3 | VAG96337 | 8.250 | 15.020 | 97.000 | VG7 | VAG92395 | 9.070 | 17.030 | 78.000 | VG3 | | | | | |
| VAG92332B | 8.020 | 13.070 | 38.700 | VG3 | VAG92282 | 8.500 | 14.000 | 61.000 | VG5 | VAG96131 | 9.070 | 17.520 | 78.000 | VG3 | | | | | |
| VAG92333B | 8.020 | 13.070 | 45.000 | VG3 | VAG92179 | 8.530 | 14.060 | 55.500 | VG1 | VAG92396 | 9.070 | 17.530 | 78.000 | VG3 | | | | | |
| VAG96320 | 8.020 | 13.070 | 60.000 | VG7 | VAG92071 | 8.670 | 13.260 | 64.650 | VG1 | VAG96006 | 9.440 | 12.750 | 76.200 | VG1 | | | | | |
| VAG96215B | 8.020 | 13.090 | 54.500 | VG3 | VAG50828 | 8.720 | 15.920 | 62.500 | VG1 | VAG92051 | 9.510 | 15.890 | 65.900 | VG1 | | | | | |
| VAG96226B | 8.020 | 13.130 | 39.000 | VG5 | VAG92385 | 8.730 | 15.140 | 62.000 | VG3 | VAG50931 | 9.520 | 16.020 | 64.000 | VG1 | | | | | |
| VAG50986 | 8.020 | 13.510 | 59.200 | VG1 | VAG50919 | 8.730 | 15.140 | 65.900 | VG1 | VAG50827 | 9.530 | 15.920 | 63.300 | VG4 | | | | | |
| VAG92234 | 8.020 | 13.520 | 52.000 | VG1 | VAG722 | 8.740 | 14.300 | 76.200 | VG3 | VAG50826 | 9.530 | 15.920 | 63.500 | VG4 | | | | | |
| VAG96345 | 8.020 | 14.050 | 60.000 | VG7 | VAG207 | 8.740 | 14.350 | 71.000 | VG1 | VAG330 | 9.530 | 15.930 | 76.500 | VG1 | | | | | |
| VAG96171 | 8.020 | 14.060 | 42.000 | VG3 | VAG474 | 8.740 | 15.930 | 72.000 | VG1 | VAG381 | 9.550 | 13.560 | 52.600 | VG1 | | | | | |
| VAG96124 | 8.020 | 14.060 | 42.900 | VG3 | VAG92213 | 8.750 | 13.550 | 60.000 | VG1 | VAG92299 | 9.550 | 15.920 | 58.000 | VG3 | | | | | |
| VAG92170B | 8.020 | 14.060 | 50.000 | VG3 | VAG92159 | 8.760 | 14.300 | 57.000 | VG4 | VAG92300 | 9.550 | 15.920 | 61.000 | VG3 | | | | | |
| VAG96187 | 8.020 | 14.060 | 55.000 | VG3 | VAG50963 | 8.760 | 14.350 | 47.800 | VG1 | VAG601 | 9.550 | 15.940 | 58.000 | VG3 | | | | | |
| VAG92324 | 8.020 | 14.080 | 49.000 | VG3 | VAG50949 | 8.760 | 14.360 | 50.000 | VG4 | VAG96180 | 9.550 | 16.020 | 71.000 | VG1 | | | | | |
| VAG96198 | 8.020 | 14.090 | 44.000 | VG3 | VAG50909 | 8.760 | 14.370 | 56.400 | VG1 | VAG96173 | 9.550 | 16.020 | 82.000 | VG3 | | | | | |
| VAG96176B | 8.020 | 14.240 | 50.000 | VG3 | VAG444 | 8.820 | 15.100 | 73.000 | VG4 | VAG92022 | 9.900 | 16.080 | 77.200 | VG3 | | | | | |
| VAG96214 | 8.020 | 14.250 | 39.500 | VG3 | VAG92342B | 9.000 | 14.040 | 48.000 | VG3 | VAG92072 | 9.960 | 17.010 | 81.000 | VG1 | | | | | |
| VAG96100 | 8.020 | 14.370 | 48.000 | VG3 | VAG92298 | 9.000 | 14.050 | 37.500 | VG5 | VAG92109 | 9.980 | 14.010 | 48.510 | VG5 | | | | | |
| VAG96308 | 8.020 | 15.000 | 83.200 | VG3 | VAG92168B | 9.000 | 14.050 | 51.000 | VG1 | VAG92108 | 9.980 | 14.020 | 61.000 | VG5 | | | | | |
| VAG92155 | 8.020 | 15.070 | 57.400 | VG1 | VAG92379B | 9.000 | 14.050 | 51.000 | VG3 | VAG92389 | 10.000 | 16.000 | 67.000 | VG1 | | | | | |
| VAG96185 | 8.020 | 16.020 | 64.500 | VG3 | VAG96267 | 9.000 | 14.060 | 42.500 | VG3 | VAG96314 | 10.000 | 16.000 | 73.000 | VG3 | | | | | |
| VAG96341 | 8.030 | 12.040 | 48.000 | VG4 | VAG92066 | 9.000 | 14.710 | 58.020 | VG5 | VAG92492 | 10.000 | 16.000 | 78.000 | VG4 | | | | | |
| VAG701 | 8.030 | 12.770 | 54.000 | VG1 | VAG92221 | 9.000 | 14.760 | 56.500 | VG1 | VAG92387 | 10.000 | 16.000 | 86.000 | VG1 | | | | | |
| VAG92373 | 8.030 | 13.040 | 56.000 | VG3 | VAG96135 | 9.000 | 15.200 | 61.000 | VG3 | VAG96126 | 10.000 | 16.020 | 78.000 | VG3 | | | | | |
| VAG96056B | 8.030 | 13.070 | 45.000 | VG3 | VAG96216B | 9.010 | 14.050 | 54.000 | VG3 | VAG92344 | 10.000 | 16.040 | 55.000 | VG1 | | | | | |
| VAG96057B | 8.030 | 13.080 | 37.700 | VG5 | VAG92411 | 9.010 | 15.050 | 72.000 | VG5 | VAG92412 | 10.010 | 15.050 | 67.000 | VG5 | | | | | |
| VAG92465B | 8.030 | 14.070 | 52.000 | VG2 | VAG96228B | 9.020 | 13.050 | 66.500 | VG5 | VAG96350 | 10.020 | 16.000 | 83.400 | VG7 | | | | | |
| VAG96203 | 8.030 | 14.080 | 43.000 | VG1 | VAG96177B | 9.020 | 13.060 | 51.000 | VG1 | VAG92345 | 10.020 | 16.050 | 60.000 | VG2 | | | | | |
| VAG92331B | 8.030 | 14.080 | 50.000 | VG1 | VAG96168B | 9.020 | 13.070 | 51.000 | VG1 | VAG96211 | 10.020 | 16.060 | 90.000 | VG4 | | | | | |
| VAG96366 | 8.030 | 14.230 | 59.000 | VG1 | VAG96183B | 9.020 | 13.080 | 40.500 | VG3 | VAG96127 | 10.030 | 16.010 | 67.000 | VG3 | | | | | |
| VAG92288B | 8.030 | 14.280 | 52.000 | VG2 | VAG96144B | 9.020 | 14.050 | 47.500 | VG3 | VAG92485 | 10.030 | 16.040 | 79.000 | VG1 | | | | | |
| VAG96348 | 8.040 | 13.030 | 75.500 | VG7 | VAG96152 | 9.020 | 14.050 | 51.500 | VG3 | VAG92375 | 11.000 | 18.040 | 76.000 | VG1 | | | | | |
| VAG96349 | 8.040 | 13.030 | 75.500 | VG7 | VAG92171B | 9.020 | 14.060 | 51.500 | VG3 | VAG92200B | 11.020 | 15.060 | 45.000 | VG3 | | | | | |
| VAG92193 | 8.040 | 13.050 | 56.000 | VG1 | VAG51028B | 9.020 | 14.060 | 55.000 | VG3 | VAG92172B | 11.020 | 15.060 | 54.300 | VG3 | | | | | |
| VAG92194 | 8.040 | 13.050 | 60.000 | VG1 | VAG92169B | 9.020 | 14.060 | 61.000 | VG3 | VAG92167 | 11.020 | 18.030 | 73.000 | VG1 | | | | | |
| VAG92093 | 8.040 | 13.060 | 50.000 | VG1 | VAG96204 | 9.020 | 14.250 | 37.500 | VG3 | VAG92166 | 11.020 | 18.030 | 80.000 | VG1 | | | | | |
| VAG96056 | 8.040 | 13.080 | 45.000 | VG3 | VAG96247 | 9.020 | 15.000 | 76.500 | VG5 | VAG92080 | 11.060 | 18.000 | 66.000 | VG3 | | | | | |



VG1



VG2



VG3



VG4

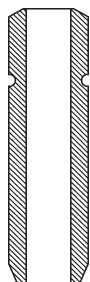

VG5

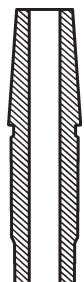

VG6

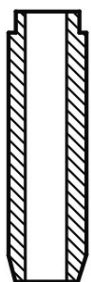

VG7

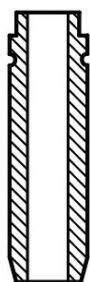

VG8



VALVE SEATS SEMI FINISHED

Ventilsitze - Halbfertig • Sedi Valvola - Semifinite
Sièges De Soupape Semi-Finis • Asientos De Valvulas - Semiterminado
Gniazda Zaworowe - w Pełni Wykończone
Седлаклапанов-Частичнаяобработка • مقاعد صمام - نصف تشطيب

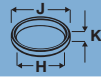

| J(mm) | H(mm) | K(mm) | |
|--------|--------|--------|--------|
| 28.010 | 20.000 | 8.000 | VS6500 |
| 28.640 | 22.290 | 8.000 | VS6566 |
| 28.700 | 22.230 | 4.840 | VS6001 |
| 28.700 | 22.230 | 6.430 | VS6002 |
| 29.010 | 21.000 | 8.500 | VS6501 |
| 30.010 | 22.000 | 8.500 | VS6502 |
| 30.290 | 22.230 | 6.430 | VS6003 |
| 30.290 | 23.810 | 6.430 | VS6004 |
| 31.010 | 23.000 | 8.500 | VS6503 |
| 31.035 | 23.000 | 8.500 | VS6536 |
| 31.810 | 25.460 | 8.000 | VS6568 |
| 31.840 | 25.460 | 8.000 | VS6584 |
| 31.880 | 23.810 | 6.430 | VS6034 |
| 31.880 | 25.400 | 6.430 | VS6005 |
| 32.010 | 24.000 | 8.500 | VS6504 |
| 33.035 | 25.000 | 8.500 | VS6538 |
| 33.400 | 27.050 | 8.000 | VS6569 |
| 33.460 | 25.400 | 6.430 | VS6035 |
| 33.460 | 26.990 | 6.430 | VS6006 |
| 34.010 | 26.000 | 8.500 | VS6506 |
| 34.990 | 28.640 | 8.000 | VS6570 |
| 35.010 | 26.000 | 9.000 | VS6507 |
| 35.050 | 26.990 | 6.430 | VS6007 |
| 35.050 | 28.580 | 6.430 | VS6008 |
| 36.010 | 27.000 | 9.000 | VS6508 |
| 36.035 | 27.000 | 9.000 | VS6541 |
| 36.570 | 30.230 | 8.000 | VS6571 |
| 36.640 | 26.990 | 6.430 | VS6036 |
| 36.640 | 28.580 | 6.430 | VS6009 |
| 37.010 | 28.000 | 9.000 | VS6509 |
| 38.010 | 29.000 | 9.000 | VS6510 |
| 38.035 | 29.000 | 9.000 | VS6543 |
| 38.160 | 31.810 | 8.000 | VS6572 |
| 38.190 | 31.810 | 8.000 | VS6588 |
| 38.230 | 28.580 | 6.430 | VS6011 |
| 38.230 | 30.160 | 4.840 | VS6010 |
| 38.230 | 30.160 | 6.430 | VS6037 |
| 38.230 | 31.750 | 6.430 | VS6038 |
| 39.010 | 30.000 | 9.000 | VS6511 |
| 39.750 | 30.230 | 9.600 | VS6573 |
| 39.780 | 30.230 | 9.600 | VS6589 |
| 39.810 | 30.160 | 6.430 | VS6012 |
| 39.810 | 31.750 | 6.430 | VS6039 |
| 39.810 | 33.340 | 6.430 | VS6041 |
| 40.010 | 30.000 | 9.500 | VS6512 |
| 40.035 | 30.000 | 9.500 | VS6545 |
| 41.010 | 31.000 | 9.500 | VS6513 |
| 41.380 | 33.400 | 9.600 | VS6590 |
| 41.400 | 31.750 | 6.430 | VS6013 |
| 41.400 | 33.340 | 6.430 | VS6042 |
| 42.350 | 32.000 | 9.500 | VS6547 |
| 42.940 | 33.400 | 9.600 | VS6575 |
| 42.990 | 33.340 | 6.430 | VS6014 |
| 42.990 | 34.930 | 6.430 | VS6043 |
| 44.010 | 34.000 | 9.500 | VS6516 |
| 44.580 | 34.930 | 6.430 | VS6015 |
| 45.035 | 34.500 | 10.000 | VS6550 |
| 46.010 | 35.500 | 10.000 | VS6518 |
| 46.035 | 35.500 | 10.000 | VS6551 |
| 46.160 | 38.100 | 6.430 | VS6045 |
| 47.035 | 36.500 | 10.000 | VS6552 |
| 49.010 | 38.500 | 10.000 | VS6521 |
| 49.340 | 39.690 | 8.010 | VS6019 |
| 50.930 | 41.280 | 8.010 | VS6020 |
| 53.010 | 42.000 | 10.500 | VS6525 |
| 56.010 | 45.000 | 11.000 | VS6528 |
| 58.010 | 47.000 | 11.000 | VS6530 |

Ventilsitze - Fertig • Sedi Valvola - Finite
 Sièges De Soupape - Fini • Asientos De Valvulas - Terminado
 Gniazda Zaworowe - Częściowo Wykończone
 Седла Клапанов-Полная Обработка • مقاعد صمام - كاملة التشطيب



VALVE SEATS FULLY FINISHED



| J(mm) | H(mm) | K(mm) | Angle | Part No. |
|--------|--------|-------|-------|----------|
| 40.640 | 34.000 | 8.250 | 45° | VS6064 |
| 42.700 | 31.700 | 9.500 | 45° | VS6072 |
| 46.100 | 37.500 | 6.170 | 30° | VS6049 |
| 51.300 | 40.300 | 7.200 | 45° | VS6353 |
| 54.060 | 44.350 | 6.680 | 30° | VS6107 |
| 56.030 | 47.500 | 7.650 | 30° | VS6103 |
| 56.600 | 44.950 | 9.450 | 45° | VS6337 |

OE INTERCHANGE

OE-Vergleichsliste • Intercambio con OE
Références croisées 1ère Monte

| OE | OE | OE | OE | OE | OE | OE | OE |
|--------------------------|----------------------|------------------------|------------------------|---------------------------|----|----|----|
| ALFA ROMEO | ...ALFA ROMEO | ...AUDI | ...AUDI | ...AUSTIN MORRIS | | | |
| 10110.01503.02 VAG96216B | 7 301 820 V91292 | 030 109 601E V94305 | 051 109 611B V94111 | 12H2520 V34401 | | | |
| 105000150304 VAG92168B | 7 301 821 V91293 | 030 109 601F V91332 | 053 109 611 V91340 | AHU1049 V90194 | | | |
| 10548.03301.01 V90388 | 7 302 157 V91294 | 030 109 601G V94308 | 056 103 419A VAG92061B | CAM1717 V34352 | | | |
| 11608.03301.01 V90388 | 7 547 158 V91291 | 030 109 601N V94715 | 058 103 415 VAG96073B | CAM6669 V90193 | | | |
| 11676.03301.01 V91438 | 7 565 472 VAG96210 | 030 109 611A V91473 | 058 109 601C V94081 | TAM1061 V90357 | | | |
| 140600330000 V3251 | 7 574 742 V91638 | 030 109 611D V94309 | 058 109 611E V94082 | TAM1770 V91142 | | | |
| 19559.03301.00 V91437 | 7 588 577 V91321 | 030 109 611N V94197 | 058 109 611M V94083 | | | | |
| 20380025A VAG96187 | 7 597 080 V91305 | 030 109 611S V94645 | 059 109 601B V94653 | AUTOBIANCHI | | | |
| 332 61 723 VAG586 | 7 609 772 V91300 | 030 109 611T V94405 | 059 109 601F V98008 | 4 265 695 V34457 | | | |
| 332 61 742 VAG701 | 7 616 998 VAG92496 | 032 109 601L V94666 | 059 109 601G V98010 | 4 294 098 V91739 | | | |
| 4 250 803 VAG92366 | 7 617 500 V91306 | 032 109 601M V94666 | 059 109 601J V98010 | 4 340 119 V90399 | | | |
| 4 265 699 VAG92364 | 7 650 916 V91936 | 032 109 611G V94115 | 059 109 611B V94423 | 4 372 331 VAG50895 | | | |
| 4 315 062 V91713 | 7 712 114 V91927 | 035 109 601G V91338 | 059 109 611G V98009 | 4 374 855 V91712 | | | |
| 4 372 331 VAG50895 | 7 722 907 V91935 | 035 109 601H V91338 | 059 109 611H V98011 | 4 377 979 V91282 | | | |
| 4 403 047 V91762 | 7 735 898 V91931 | 035 109 601J V91338 | 059 109 611K V98011 | 4 412 816 V90398 | | | |
| 4 733 258 VAG92369 | 7 735 899 V91932 | 035 109 601K V91338 | 059 109 611M V98011 | 5 942 727 V91288 | | | |
| 4 749 395 VAG92373 | 7 757 052 VAG96123 | 035 109 611F V91030 | 062 109 601 V80022 | 5 942 728 V91289 | | | |
| 4 749 397 VAG92193 | 7 766 564 V91933 | 036 109 601AD V94647 | 062 109 611A V80023 | 7 662 227 V91289 | | | |
| 4 749 398 VAG96190 | 7 766 565 V94582 | 036 109 601P V94247 | 068 109 601C V90179 | 7 666 228 V91288 | | | |
| 4 826 033 V91293 | 7 770 334 V91929 | 036 109 601S V94116 | 068 109 601D V91173 | 7 770 334 V91929 | | | |
| 46 403 681 V94029 | 7 783 225 V91938 | 036 109 611 V90327 | 068 109 601L V91335 | | | | |
| 46 423 334 V91928 | 7 783 841 V91282 | 036 109 611K V94117 | 068 109 601N V91367 | BEDFORD | | | |
| 46 461 209 V94468 | 7 798 620 V91937 | 036 109 611L V94248 | 068 109 611C V90180 | 071 34 379 VAG474 | | | |
| 46 462 159 V91950 | 7 958 073 V91638 | 037 103 419B VAG96041B | 068 109 611D V91174 | 071 66 435 VAG50828 | | | |
| 46 471 639 V94030 | 71 744 388 V98025 | 038 109 601B V94147 | 068 109 611L V91368 | 088 54 549 V33987 | | | |
| 46 517 325 V91949 | 717 41 112 V98001 | 038 109 601E V94649 | 068 109 611L V91409 | 12911-78101 V91253 | | | |
| 46 533 298 V94591 | 717 41 113 V98002 | 038 109 601F V95087 | 069 109 601C V90321 | 12915-84000 V91254 | | | |
| 46 750 859 V94470 | 71739277 V94962 | 038 109 611B V94148 | 069 109 601D V90321 | 5-12552-034-2 V91498 | | | |
| 46 764 378 V94065 | 71739320 V94963 | 038 109 611B V94415 | 069 109 601F V91337 | 90009534 V90230 | | | |
| 46 783 962 V94471 | 7547400 V91290 | 038 109 611E V94650 | 069 109 601H V91336 | 90106086 V90108 | | | |
| 46 787 902 V94589 | A134.958 V91630 | 038 109 611F V94148 | 069 109 611 V91368 | 90106098 V90107 | | | |
| 46 802 049 V94588 | | 038 109 611F V94415 | 06B 109 601D V94424 | 90295011 V91137 | | | |
| 55 185 028 V98026 | AUDI | 038 109 611G V95088 | 06B 109 611C V94425 | 90295015 V91138 | | | |
| 55 185 080 V98027 | 021 109 601H V94145 | 03C 109 601L V80010 | 06D 109 601K V94691 | 90323519 V91211 | | | |
| 55 194 219 V98022 | 021 109 601J V94145 | 03C 109 611Q V80011 | 06D 109 601M V95098 | 90323524 V91212 | | | |
| 55 195 680 V95015 | 021 109 601K V94145 | 03F 109 601A V95149 | 06D 109 611H V80028 | 90499097 V90231 | | | |
| 55 200 422 V98023 | 021 109 611D V94306 | 03F 109 611B V95150 | 06D 109 611H V94692 | 910 07 950 V33981 | | | |
| 55 208 213 V95016 | 021 109 611F V94146 | 03F 109 611C V95150 | 06D 109 611K V94692 | | | | |
| 55202630 V94590 | 022 109 601G V95085 | 03G 109 601A V98007 | 06D 109 611K V95152 | BMW | | | |
| 55204574 V95182 | 022 109 601H V95127 | 03G 109 601B V94697 | 06D 109 611L V94692 | 11 12 2 244 464 VAG96148B | | | |
| 55205125 V95223 | 022 109 611M V95128 | 03G 109 611B V94698 | 06D 109 611L V95152 | 11 12 7 797 711 V95040 | | | |
| 55206233 V95220 | 022 109 611N V95086 | 03G 109 611D V98097 | 06D 109 611T V94692 | 11 34 1 251 879 V34335 | | | |
| 55207517 V98005 | 022 109 611P V95128 | 03H 109 611D V95086 | 06E 109 601E V94691 | 11 34 1 265 453 V91189 | | | |
| 55207955 V98006 | 025 109 601 V94549 | 03H 109 611E V95128 | 06E 109 601H V95097 | 11 34 1 267 721 V91189 | | | |
| 55223836 V95183 | 025 109 601C V94549 | 03L 109 601 V95099 | 06E 109 611D V95152 | 11 34 1 267 722 V91190 | | | |
| 55557741 V98024 | 025 109 612A V94548 | 03L 109 601A V95125 | 074 109 611 V91334 | 11 34 1 280 643 V91190 | | | |
| 60 811 086 VAG96123 | 026 109 601 V94304 | 03L 109 611 V95114 | 078 109 601A V94079 | 11 34 1 309 343 V94275 | | | |
| 605 04 864 V91438 | 026 109 601C V91407 | 03L 109 611A V95126 | 078 109 601B V94079 | 11 34 1 309 487 V94276 | | | |
| 605 07 189 V91437 | 027 109 601C V91416 | 043 109 612 V94411 | 078 109 611C V94303 | 11 34 1 315 508 V94797 | | | |
| 605 07 190 V91438 | 027 109 611B V91372 | 046 109 601G V94547 | 079 109 601B V95098 | 11 34 1 401 104 V94776 | | | |
| 605 21 575 V90388 | 027 109 611C V91372 | 046 109 601J V94547 | 079 109 611D V80024 | 11 34 1 401 105 V94774 | | | |
| 605 40 325 V91630 | 027 109 611D V91372 | 046 109 611F V94011 | 311 109 601 V33815 | 11 34 1 433 480 V94091 | | | |
| 605 64 098 V91308 | 028 109 601B V94108 | 047 109 611D V94419 | | 11 34 1 433 481 V94092 | | | |
| 605 72 412 VAG96184 | 028 109 601B V94414 | 047 198 601D V94418 | AUSTIN | 11 34 1 433 483 V95060 | | | |
| 605 82 739 V94211 | 028 109 601C V94108 | 048 109 601A V91407 | 12A1986 V34858 | 11 34 1 435 461 V94957 | | | |
| 606 74 496 V94591 | 028 109 601C V94414 | 048 109 601E V94450 | 12A1987 V34859 | 11 34 1 435 476 V95059 | | | |
| 608 11 086 VAG96146 | 028 109 601D V94084 | 048 109 611A V91340 | 12G941 V34274 | 11 34 1 438 284 V91925 | | | |
| 608 11 089 VAG96145 | 028 109 601G V94409 | 048 109 611B V94080 | 12H2520 V34401 | 11 34 1 438 284 V94594 | | | |
| 608 11 090 VAG96230 | 028 109 601H V94010 | 049 103 419 VAG92105B | AHU1049 V90194 | 11 34 1 438 381 V94008 | | | |
| 608 11 153 V91933 | 028 109 601J V94112 | 04E 109 601 V95237 | CAM1717 V34352 | 11 34 1 438 385 V91925 | | | |
| 608 11 154 V91934 | 028 109 611E V94109 | 04E 109 601A V80012 | CAM6669 V90193 | 11 34 1 438 449 V94008 | | | |
| 608 12 981 V91932 | 028 109 611G V94085 | 04E 109 601B V95192 | TAM1061 V90357 | 11 34 1 438 451 V91925 | | | |
| 608 12 982 V91931 | 028 109 611J V94410 | 04E 109 611J V95193 | TAM1770 V91142 | 11 34 1 440 304 V94402 | | | |
| 608 13 598 VAG96203 | 028 109 611K V94113 | 04E 109 611K V80013 | | 11 34 1 705 560 V94521 | | | |
| 608 14 604 V94065 | 030 109 601AH V94114 | 04E 109 611L V95238 | AUSTIN MORRIS | 11 34 1 707 519 V94403 | | | |
| 608 14 605 V94064 | 030 109 601AK V94644 | 04L 109 601B V95099 | 12A1986 V34858 | 11 34 1 708 895 V91187 | | | |
| 60813598 VAG96124 | 030 109 601C V94580 | 04L 109 611B V95114 | 12A1987 V34859 | 11 34 1 708 896 V91188 | | | |
| 60814604 V94590 | 030 109 601D V91332 | 051 109 601B V94110 | 12G941 V34274 | 11 34 1 709 941 V91418 | | | |

| OE | OE | OE | OE | OE | OE | OE | OE |
|------------------------|--------------------------|---------------------|----------------------|----------------------|----|----|----|
| ...BMW | ...BMW | ...CHEVROLET | ...CITROËN | ...CITROËN | | | |
| 11 34 1 720 827 V91187 | 11 34 7 805 968 V94960 | 97185860 V94426 | 0948.C0 V94486 | 96 095 457 V94062 | | | |
| 11 34 1 720 828 V91188 | 11 34 7 805 969 V94961 | 97358650 V94427 | 0948.C2 V94601 | 96 096 146 V94063 | | | |
| 11 34 1 722 892 V91410 | 11 34 7 812 615 V95041 | 97385841 V95186 | 0948.C4 V94603 | 96 096 851 V94155 | | | |
| 11 34 1 722 896 V91420 | 11 34 7 812 616 V95154 | 97385842 V95157 | 0948.C7 V94960 | 96 096 852 V94156 | | | |
| 11 34 1 722 908 V91410 | 11 34 7 812 618 V95162 | | 0948.C8 V98081 | 96 101 886 V94155 | | | |
| 11 34 1 722 909 V91411 | 11 34 8 511 622 V95041 | CHRYSLER | 0948.E1 V95135 | 96 101 887 V94156 | | | |
| 11 34 1 722 910 V91420 | 1112 1 263 642 VAG92170B | 04667969AB V95218 | 0948.E2 V94969 | 96 109 183 V94170 | | | |
| 11 34 1 726 903 V91411 | 1112 1 266 761 VAG96176B | 047 777 72AB V94350 | 0948.E5 V95083 | 96 137 360 V91145 | | | |
| 11 34 1 727 352 V91955 | 1112 1 267 676 VAG92347B | 047 777 72AC V94350 | 0948.E8 V95037 | 96 147 032 V91970 | | | |
| 11 34 1 727 358 V91418 | 1112 1 267 677 VAG96143B | 04777770AB V94349 | 0948.F6 V95234 | 96 150 144 V94172 | | | |
| 11 34 1 731 640 V94091 | 1112 1 280 523 VAG92303B | 04777898AA V95219 | 0948.F7 V95137 | 96 150 145 V94171 | | | |
| 11 34 1 731 642 V95059 | 1112 1 715 373 VAG96042B | 04852411AA V95218 | 0948.G4 V95153 | 96 172 597 V94229 | | | |
| 11 34 1 736 549 V94091 | 1112 1 735 534 VAG96043B | 04884690AA V95219 | 0949.21 V34460 | 96 172 795 V94217 | | | |
| 11 34 1 736 558 V94092 | | 04884691AA V95218 | 0949.57 V91275 | 96 180 328 V94567 | | | |
| 11 34 1 736 567 V95059 | CHEVROLET | 05066769AA V98017 | 0949.64 V94024 | 96 183 535 V94155 | | | |
| 11 34 1 736 568 V94092 | 09117912 V94353 | 05066770AA V98016 | 0949.68 V94170 | 96 203 976 V94168 | | | |
| 11 34 1 736 576 V95060 | 12575793 V94962 | 05080044AB VAG96241 | 0949.74 V94017 | 96 219 217 V94173 | | | |
| 11 34 1 738 214 V94008 | 12911-54G00 V95141 | 5175396AA V98071 | 0949.76 V91971 | 96 246 139 V94167 | | | |
| 11 34 1 738 215 V94009 | 12911-69G00 V95007 | 5175397AA V98072 | 0949.79 V94063 | 96 254 645 V94204 | | | |
| 11 34 1 738 218 V91925 | 12911-78B00 V94368 | 55 194 219 V98022 | 0949.80 V94172 | 96 254 648 V94203 | | | |
| 11 34 1 738 220 V94008 | 12915-54G00 V95142 | 55 200 422 V98023 | 0949.87 V94168 | 96 267 448 V94566 | | | |
| 11 34 1 738 221 V94009 | 12915-69G50 V95008 | 55204574 V95182 | 0949.89 V94204 | 96 289 433 V94175 | | | |
| 11 34 1 739 114 V94087 | 13711-0D020 V94142 | 55205125 V95223 | 0949.92 V94176 | 96 298 611 V94176 | | | |
| 11 34 1 739 658 V94087 | 13711-15090 V94144 | 55207517 V98005 | 0949.96 V94179 | 96 450 247 80 V94960 | | | |
| 11 34 1 739 665 V94088 | 13715-16060 V94137 | 55207955 V98006 | 0949.99 V94201 | 96 600 359 80 V98028 | | | |
| 11 34 1 739 820 V91925 | 13715-22040 V94143 | 55223836 V95183 | 0949.A0 V91994 | 96 757 096 80 V98029 | | | |
| 11 34 1 739 821 V91926 | 24405815 V98025 | 605 07 189 V91437 | 0949.A2 V94489 | 96 763 590 80 V95159 | | | |
| 11 34 1 739 822 V91925 | 24454518 V94963 | 605 07 190 V91438 | 0949.A3 V94491 | 96 763 591 80 V95163 | | | |
| 11 34 1 739 823 V91926 | 55 195 680 V95015 | 7701 461 338 V91264 | 0949.A4 V94493 | 97 531 044 V91273 | | | |
| 11 34 1 741 230 V95060 | 55 208 213 V95016 | 7701 461 339 V91265 | 0949.A5 V94199 | 97 531 046 V91272 | | | |
| 11 34 1 741 231 V94092 | 55204574 V95182 | | 0949.A7 V94495 | 97 531 079 V91270 | | | |
| 11 34 2 244 815 V94555 | 55223836 V95183 | CITROËN | 0949.A8 V94204 | 97 531 080 V91271 | | | |
| 11 34 2 246 524 V94089 | 55557741 V98024 | 0220 A0 VAG96100 | 0949.A9 V94487 | 97 533 264 V91273 | | | |
| 11 34 2 246 525 V94090 | 55557862 V98077 | 0220.25 VAG51007 | 0949.B1 V94602 | 97 533 266 V91271 | | | |
| 11 34 2 247 077 V94086 | 55558728 V98078 | 0220.38 VAG92337 | 0949.C1 V94604 | 98 019 609 80 V80020 | | | |
| 11 34 4 457 287 V94403 | 55572520 V80016 | 0220.55 VAG92331B | 0949.C4 V98082 | 98 076 459 80 V80021 | | | |
| 11 34 7 502 173 V94009 | 55572521 V80017 | 0220.60 VAG96132 | 0949.C6 V95136 | 98 418 161 V91940 | | | |
| 11 34 7 502 351 V94009 | 90106792 V90166 | 0220.64 VAG92332B | 0949.C8 V94970 | | | | |
| 11 34 7 503 738 V94403 | 90295011 V91137 | 0220.65 VAG92288B | 0949.E1 V95084 | CUMMINS | | | |
| 11 34 7 503 839 V94403 | 90295015 V91138 | 0220.75 VAG92288B | 0949.E2 V95038 | 3802924 V95067 | | | |
| 11 34 7 505 704 V94595 | 90295019 V91148 | 0220.84 VAG96347B | 0949.F5 V95138 | 3802967 V95068 | | | |
| 11 34 7 533 884 V95035 | 90322694 V91429 | 0220.95 VAG962718 | 4 315 062 V91713 | 3940734 V95068 | | | |
| 11 34 7 533 885 V95036 | 90322697 V91430 | 0220.A2 VAG96119 | 504 072 531 V98042 | 3940735 V95067 | | | |
| 11 34 7 534 508 V95037 | 90323519 V91211 | 0221.17 VAG92333B | 504 081 062 V98043 | | | | |
| 11 34 7 539 915 V95043 | 90323524 V91212 | 0221.17 VAG96056B | 7 617 500 V91306 | DACIA | | | |
| 11 34 7 539 919 V95045 | 90323757 V91149 | 0221.24 VAG96343 | 753 388 480 V95035 | 7701 458 180 V35117 | | | |
| 11 34 7 547 187 V95038 | 90410813 V91998 | 0221.25 VAG96342B | 753 388 580 V95036 | 7701 460 690 V91834 | | | |
| 11 34 7 548 280 V95047 | 90412277 V91997 | 06 005 392 V91145 | 9 640 840 080 V94961 | 7701 461 214 V91261 | | | |
| 11 34 7 548 281 V95048 | 90412912 V91995 | 0948.33 V34459 | 91 512 096 V91280 | 7701 465 088 V91835 | | | |
| 11 34 7 552 053 V80001 | 90412974 V91996 | 0948.56 V91277 | 91 513 446 V91279 | 7701 465 090 V91836 | | | |
| 11 34 7 552 955 V80001 | 90502319 V94097 | 0948.58 V91271 | 91 535 017 V91277 | 7701 468 419 V94442 | | | |
| 11 34 7 553 771 V95043 | 90502326 V94098 | 0948.66 V91972 | 91 535 019 V91275 | 7701 469 373 V94339 | | | |
| 11 34 7 553 772 V95044 | 90529527 V94245 | 0948.68 V94169 | 91 540 748 V91469 | 7701 471 379 V94499 | | | |
| 11 34 7 553 774 V95046 | 90529529 V94246 | 0948.72 V94062 | 91 540 782 V91470 | 7701 471 704 V94338 | | | |
| 11 34 7 553 775 V80025 | 90536095 V94249 | 0948.82 V94167 | 93 501 279 V91143 | 7701 472 124 V94498 | | | |
| 11 34 7 555 760 V80000 | 90536164 V94250 | 0948.85 V94173 | 93 510 415 V91144 | 7701 472 125 V94501 | | | |
| 11 34 7 570 163 V80002 | 93333561 V95189 | 0948.91 V94202 | 93 510 773 V91145 | 7701 476 572 V94609 | | | |
| 11 34 7 570 164 V80003 | 93333562 V95190 | 0948.92 V94175 | 93 510 774 V91145 | 7701 476 573 V94608 | | | |
| 11 34 7 573 840 V95048 | 93743882 V95188 | 0948.93 V94157 | 95 536 523 V91263 | 8200 343 407 V94705 | | | |
| 11 34 7 583 777 V95191 | 96182805 V94367 | 0948.95 V94178 | 95 536 524 V90371 | 8200 343 412 V94706 | | | |
| 11 34 7 583 779 V95191 | 96182806 V94366 | 0948.99 V94200 | 96 003 672 V91144 | | | | |
| 11 34 7 583 780 V95155 | 96182933 V94637 | 0948.A1 V94488 | 96 005 391 V91144 | DAEWOO | | | |
| 11 34 7 585 901 V95153 | 96182934 V94636 | 0948.A2 V91292 | 96 007 817 V94169 | 111 050 05 27 V94377 | | | |
| 11 34 7 587 470 V95037 | 96335948 V98013 | 0948.A3 V94490 | 96 008 334 V94169 | 111 053 02 01 V94480 | | | |
| 11 34 7 791 054 V94670 | 96352793 V94369 | 0948.A4 V94492 | 96 011 363 80 V91144 | 111 053 1101 V94370 | | | |
| 11 34 7 791 055 V94671 | 96376881 V98014 | 0948.A5 V94198 | 96 059 361 V91972 | 11115A70B00 VAG96114 | | | |
| 11 34 7 797 712 V95041 | 96376980 V98015 | 0948.A7 V94494 | 96 059 362 V91970 | 12911-78B00 V94368 | | | |
| 11 34 7 799 612 V95042 | 96440147 V95187 | 0948.A9 V94599 | 96 079 213 V94170 | 55557862 V98077 | | | |



OE INTERCHANGE

OE-Vergleichsliste • Intercambio con OE
Références croisées 1ère Monte

| OE | | OE | | OE | | OE | | OE | |
|------------------|----------|-------------------|----------|----------------------|----------|----------------|----------|----------------|-----------|
| ...DAEWOO | | ...DEUTZ | | ...DEUTZ-FAHR | | ...FIAT | | ...FIAT | |
| 55558728 | V98078 | 0417 0164 | VAG96341 | 1216 4633 | VAG96088 | 46 533 298 | V94591 | 608 11 086 | VAG96146 |
| 611 050 0127 | V94371 | 0417 0898 | V94575 | 129 111 63 | V94723 | 46 750 859 | V94470 | 608 11 089 | VAG96145 |
| 90220112 | V91150 | 0417 0899 | V94529 | 4204015 | V95024 | 46 764 378 | V94065 | 608 11 090 | VAG96230 |
| 90295011 | V91137 | 0417 8158 | V94529 | 4255255 | V95024 | 46 783 962 | V94471 | 608 11 153 | V91933 |
| 90295015 | V91138 | 0420 4014 | V95102 | 4283381 | V95024 | 46 787 902 | V94589 | 608 11 154 | V91934 |
| 90295019 | V91148 | 0420 4015 | V95103 | | | 46 802 049 | V94588 | 608 12 981 | V91932 |
| 90323757 | V91149 | 0420 5254 | V95102 | FIAT | | 46406169 | V91290 | 608 12 982 | V91931 |
| 90410813 | V91998 | 04201238 | VAG96328 | 0948.F6 | V95234 | 46416321 | V94590 | 608 13 598 | VAG96203 |
| 90412277 | V91997 | 0422 0142 | V95227 | 0948.F7 | V95137 | 46518930 | V95015 | 608 14 604 | V94065 |
| 93743882 | V95188 | 0422 5353 | V95226 | 0949.F4 | V94024 | 46518931 | V95016 | 608 14 605 | V94064 |
| 961 829 33 | V94637 | 0422 6412 | V95227 | 0949.F5 | V94017 | 46783962 | V94590 | 7 301 820 | V91292 |
| 96103034 | VAG96112 | 0422 6562 | V95226 | 0949.F5 | V95138 | 46816601 | VAG96359 | 7 301 821 | V91293 |
| 96182805 | V94367 | 0425 0074 | VAG96382 | 12911-69G00 | V95007 | 4757358 | V91292 | 7 302 157 | V91294 |
| 96182806 | V94366 | 0425 5255 | V95103 | 12915-69G50 | V95008 | 4758795 | VAG96089 | 7 547 158 | V91291 |
| 96182934 | V94636 | 0426 7453 | V95226 | 332 61 723 | VAG586 | 4758798 | VAG96276 | 7 565 472 | VAG96210 |
| 96335948 | V98013 | 0426 7455 | V95227 | 332 61 742 | VAG701 | 4846130 | V91947 | 7 574 742 | V91638 |
| 96352793 | V94369 | 0426 8370 | V95226 | 353 722 | V91679 | 5 535 5572 | V98025 | 7 588 577 | V91321 |
| 96376881 | V98014 | 0426 8373 | V95227 | 4 239 918 | V91713 | 5 942 727 | V91288 | 7 597 080 | V91305 |
| 96376980 | V98015 | 0427 1175 | V94575 | 4 250 801 | VAG96171 | 5 942 728 | V91289 | 7 609 772 | V91300 |
| 96440147 | V95187 | 0427 2209 | V94575 | 4 250 803 | VAG92366 | 5 973 128 | V91713 | 7 611 679 | VAG96181B |
| | | 0428 3380 | V95102 | 4 265 695 | V34457 | 5 973 129 | V91762 | 7 616 992 | VAG96199 |
| | | 0428 3381 | V95103 | 4 265 699 | VAG92364 | 5 975 341 | V91636 | 7 616 998 | VAG92496 |
| DAF | | 0490 8629 | VAG96382 | 4 286 929 | V91713 | 5 990 532 | V91767 | 7 617 500 | V91306 |
| 0266 425 | VAG92484 | | | 4 294 098 | V91739 | 5 990 533 | V91392 | 7 650 916 | V91936 |
| 0948.53 | V91151 | | | 4 315 062 | V91713 | 500 362 856 | V98019 | 7 666 227 | V91289 |
| 0948.72 | V94062 | DEUTZ/ KHD | | 4 340 119 | V90399 | 504 069 199 | V94592 | 7 712 114 | V91927 |
| 0948.84 | V94567 | 0210 8183 | V94575 | 4 372 331 | VAG50895 | 504 069 199 | V98018 | 7 722 907 | V91935 |
| 0949.50 | V91152 | 0210 8184 | V94529 | 4 372 331 | VAG92364 | 504 072 531 | V98042 | 7 735 898 | V91931 |
| 0949.79 | V94063 | 0241 2165 | V90418 | 4 374 855 | V91712 | 504 081 062 | V98043 | 7 735 899 | V91932 |
| 0949.90 | V94566 | 0337 1664 | V90312 | 4 403 047 | V90397 | 504 378 070 | V94593 | 7 757 052 | VAG96123 |
| 1254382 | V91756 | 0337 1746 | V94530 | 4 403 047 | V91762 | 504069200 | V91292 | 7 766 564 | V91933 |
| 1259989 | V91755 | 0415 3629 | V90050 | 4 412 816 | V90398 | 55 185 028 | V98026 | 7 766 565 | V91934 |
| 1307654 | V94638 | 0415 3697 | V90051 | 4 621 511 | V91709 | 55 185 080 | V98027 | 7 766 565 | V94582 |
| 1327029 | V94639 | 0415 3773 | V90114 | 4 648 237 | VAG92375 | 55 194 219 | V98022 | 7 770 334 | V91929 |
| 1342220 | V94967 | 0415 9140 | V94757 | 4 658 055 | V91667 | 55 194 993 | V98020 | 7 780 108 | VAG96273 |
| 1345509 | V95211 | 0417 0164 | VAG96341 | 4 659 379 | V91676 | 55 194 994 | V98021 | 7 783 225 | V91938 |
| 1352127 | V95212 | 0417 0898 | V94575 | 4 673 608 | V91667 | 55 195 680 | V95015 | 7 783 841 | V91282 |
| 1362696 | V94968 | 0417 0899 | V94529 | 4 673 608 | V91677 | 55 200 334 | V98022 | 7 798 620 | V91937 |
| 1404918 | V95068 | 0417 8158 | V94529 | 4 673 861 | V91311 | 55 200 335 | V98023 | 7 910 028 074 | V34460 |
| 1404919 | V95067 | 0420 4014 | V95102 | 4 673 862 | V91310 | 55 200 422 | V98023 | 7 910 029 730 | V34459 |
| 1409671 | V95068 | 0420 4015 | V95024 | 4 683 025 | V91688 | 55 208 213 | V95016 | 7 958 073 | V91638 |
| 1603846 | V95213 | 0420 4015 | V95103 | 4 683 026 | V91689 | 55 219 143 | V98022 | 7031135 | V91290 |
| 1628843 | VAG96247 | 0420 5254 | V95102 | 4 704 215 | V91285 | 55 219 144 | V98023 | 71 744 388 | V98025 |
| 1678541 | V95210 | 04201238 | VAG96328 | 4 733 258 | VAG92369 | 55190559 | VAG96384 | 71739277 | V94962 |
| 1684513 | V95209 | 0422 0142 | V95227 | 4 749 395 | VAG92373 | 55202630 | V94590 | 71739320 | V94963 |
| 1684773 | V95213 | 0422 5353 | V95226 | 4 749 397 | VAG92193 | 55204574 | V95182 | 71739771 | VAG96346 |
| 266305 | V91755 | 0422 6412 | V95227 | 4 749 398 | VAG96190 | 55205125 | V95223 | 71742050 | V95141 |
| 266306 | V91756 | 0422 6562 | V95226 | 4 784 890 | V91304 | 55206233 | V95220 | 71747245 | V95142 |
| 286292 | V91385 | 0425 0074 | VAG96382 | 4 802 200 | V91709 | 55207517 | V98005 | 7547400 | V91290 |
| 613965 | V91757 | 0425 5255 | V95103 | 4 802 204 | V91666 | 55207955 | V98006 | 8 823 545 | V91680 |
| 613966 | V91758 | 0426 7453 | V95226 | 4 803 805 | V91301 | 55220016 | V98006 | 8 824 754 | V91693 |
| 674829 | V91758 | 0426 7455 | V95227 | 4 806 718 | V91302 | 55223836 | V95183 | 8 830 045 | V91694 |
| 674830 | V91757 | 0426 8370 | V95226 | 4 813 760 | V91399 | 55225891 | V95223 | 8823544 | V91681 |
| | | 0426 8373 | V95227 | 4 826 033 | V91293 | 55239748 | V95220 | 9 600 781 780 | V94169 |
| | | 0427 1175 | V94575 | 4094941 | V91633 | 55557741 | V98024 | 9 604 295 780 | V94170 |
| DAIHATSU | | 0427 2209 | V94575 | 4146638 | V91633 | 55557862 | V98077 | 9 611 782 880 | V91971 |
| 0948.E2 | V94969 | 0428 3380 | V95102 | 4311899 | VAG96366 | 55558728 | V98078 | 9 623 950 380 | V94200 |
| 0949.C8 | V94970 | 0428 3381 | V95103 | 4374855 | V91633 | 5973129 | V90397 | 9 624 774 280 | V94178 |
| 11126-24020 | VAG92093 | 0490 8629 | VAG96382 | 4424174 | V91653 | 60 811 086 | VAG96123 | 9 624 774 580 | V94179 |
| 13711-23030 | V94132 | 7420 833 932 | V95164 | 4460061 | V91290 | 605 04 864 | V91438 | 9 627 184 380 | V94490 |
| 13711-47010 | V95143 | 7420 833 936 | V95165 | 46 403 681 | V94029 | 605 07 189 | V91437 | 9 628 943 380 | V94175 |
| 13711-74101 | V94138 | | | 46 423 334 | V91928 | 605 07 190 | V91438 | 9 629 861 180 | V94176 |
| 13715-23030 | V94133 | DEUTZ-FAHR | | 46 433 782 | VAG96124 | 605 21 575 | V90388 | 9 634 437 580 | V94491 |
| 13715-47010 | V95144 | 0223 2528 | VAG92155 | 46 441 525 | VAG96272 | 605 40 325 | V91630 | 9 635 317 980 | V94486 |
| 13715-74100 | V94139 | 0337 1664 | V90312 | 46 461 209 | V94468 | 605 64 098 | V91308 | 9 635 318 480 | V94487 |
| | | 0415 9140 | V94757 | 46 462 159 | V91950 | 605 72 412 | VAG96184 | 9 636 001 780 | V94201 |
| DEUTZ | | 0417 0164 | VAG96341 | 46 471 639 | V94030 | 605 82 739 | V94211 | 9 640 840 080 | V94961 |
| 0210 8183 | V94575 | 04201238 | VAG96328 | 46 517 325 | V91949 | 606 74 496 | V94591 | 9 645 024 780 | V94960 |
| 0210 8184 | V94529 | | | | | | | | |
| 0337 1664 | V90312 | 121 657 02 | V94723 | | | | | | |

| OE | OE | OE | OE | OE | OE | OE | OE |
|----------------------|----------------|----------------------|-------------------------|-----------------------|----------------|----------------|----------------|
| ...FIAT | ...FORD | ...FORD | ...FORD | ...FORD | ...FORD | ...FORD | ...FORD |
| 9 676 718 180 V95083 | 1121330 V94379 | 1760579 V95156 | 6172852 V94321 | 928M 6507 C1A V91898 | | | |
| 9 676 718 280 V95084 | 1121331 V94378 | 1760588 V95178 | 6172956 VAG96025 | 928M 6507 C2A V91898 | | | |
| 91 535 017 V91277 | 1121332 V94379 | 1760589 V95179 | 6200033 V91221 | 928M 6507 D1A V91356 | | | |
| 91 535 019 V91275 | 1121333 V94378 | 1871590 V95083 | 6594643 V91161 | 928M 6507E2A V94072 | | | |
| 93 501 279 V91143 | 1122364 V95013 | 1962501 V94352 | 6594643 V91221 | 928M 6507F2A V94074 | | | |
| 96 005 391 V91144 | 1124377 V98033 | 1N2G6505AA V95062 | 6594645 V91160 | 928M6505D2A V94075 | | | |
| 96 059 361 V91972 | 1124378 V98032 | 1N2G6505AB V95062 | 664 0543 V91356 | 93FF 6505 AA V91428 | | | |
| 96 095 457 V94062 | 1124514 V94225 | 1N2G6507A2A V95061 | 6640542 V94075 | 93FF 6507 AA V91821 | | | |
| 96 096 146 V94063 | 1124619 V98033 | 1S4G6507BA V95039 | 6742921 V91898 | 93FF 6507 AA V91993 | | | |
| 96 137 360 V91145 | 1127416 V98034 | 1S4G6507BB V95039 | 6742922 V91898 | 93FF 6507 AF V91993 | | | |
| 96 147 032 V91970 | 1132466 V95140 | 1S4G6507CA V95013 | 6781619 V91821 | 93FF 6507 FA V91821 | | | |
| 96 606 400 80 V98029 | 1132467 V95140 | 1S4G6507CB V95013 | 6781621 V91821 | 9454607 V95049 | | | |
| 96 700 311 V91300 | 1143057 V95064 | 1S6G 6507 AB V98036 | 6G9Q6505AA V95084 | 9454610 V95050 | | | |
| 96 757 088 80 V98028 | 1143059 V95063 | 1S6G6505BA V95014 | 6G9Q6507AB V95083 | 948M 6505 A2A V91991 | | | |
| 96182805 V94367 | 1144339 V95062 | 1S7G 6505 CF V98033 | 7078136 V94007 | 948M 6505C2A V94073 | | | |
| 96182806 V94366 | 1144340 V95061 | 1S7G 6507 C7G V98032 | 7078139 V94006 | 948M 6505D2A V94076 | | | |
| 97 533 264 V91273 | 1145933 V94601 | 1S7G 6507 CE V98032 | 70HM 6505 D3C V34499 | 95VW6505AA V94306 | | | |
| 97 533 266 V91271 | 1151997 V95039 | 1S7G 6507 CF V98032 | 70HM 6505 DE V35122 | 95VW-6505-BA V94011 | | | |
| 98 418 161 V91940 | 1152190 V94602 | 1S7G 6507 CG V98032 | 70HM 6505 EE V34501 | 95VW-6507-AA V94145 | | | |
| 98 468 338 V91939 | 1152191 V94601 | 1S7G6505C7F V98033 | 70HM 6507 AE V90152 | 95VW-6507-BA V94010 | | | |
| 98 474 603 V94222 | 1198044 V94696 | 1S7G6505DF V94694 | 70HM 6507 DD V90178 | 95VW6510AA VAG96024 | | | |
| 98 497 025 V94222 | 1202362 V94602 | 1S7G6507DF V94693 | 70HM6505AF V34509 | 95WM 6505 AA V94007 | | | |
| 98 497 235 V94054 | 1211483 V94693 | 1S7G6507DG V94693 | 711M 6507 DA V34524 | 95WM 6505AA V94007 | | | |
| 99 432 837 V91994 | 1213175 V98032 | 2M5V6505AA V95064 | 7221531 V94386 | 95WM 6507 AA V94006 | | | |
| 99 433 902 V94055 | 1214456 V95140 | 2M5V6507AA V95063 | 7314594 V91991 | 96MM-6505-B1A V94001 | | | |
| 99457452 V91947 | 1216915 V94378 | 2S6Q 6505 AA V94602 | 7402396 VAG96024 | 97358650 V94427 | | | |
| | 1217148 V94378 | 2S6Q 6505 AB V94602 | 77BM 6505 AC V90165 | 977M 6505 AA V91159 | | | |
| FORD | 1229882 V94960 | 2S6Q 6505 AC V94602 | 77BM 6505 DB V90165 | 97MF 6505AA V94061 | | | |
| 021 109 601L V94374 | 1229883 V94961 | 2S6Q 6507 A9B V94601 | 78EM 6505 AA V90351 | 97MM 6507A2B V94056 | | | |
| 021 109 611F V94146 | 1231930 V94491 | 2S6Q 6507 AA V94601 | 78HM 6505 CA V35122 | 97MM 6507B2B V94058 | | | |
| 028 109 601D V94084 | 1231931 V94490 | 2S6Q 6507 AB V94601 | 78HM6505BA V34509 | 97MM-6505-B1A V94003 | | | |
| 028 109 611G V94085 | 1254282 V94381 | 2S7Q 6505 A1A V95140 | 78TM 6505 AA V35264 | 98 MM 6507 C2B V94214 | | | |
| 036 109 611 V90327 | 1254284 V94380 | 2S7Q 6505 A1B V95140 | 791M 6505 DA V34525 | 98MM 6505A2A V94057 | | | |
| 038 109 601B V94147 | 1305906 V94381 | 2S7Q 6505 A2A V95140 | 79HM 6507 EA V90152 | 98MM6505B2B V94059 | | | |
| 038 109 611F V94148 | 1305907 V94380 | 2S7Q 6505 AC V95140 | 81SM 6505 AG V90134V1 | 9M5Q 6507 AA V95234 | | | |
| 038 109 611F V94415 | 1320926 V95039 | 3M5Q 6505 BA V94491 | 81SM 6507 KF V90132 | 9S51-6507-BA V95015 | | | |
| 0949.64 V94024 | 1320927 V95013 | 3M5Q 6505 BB V94491 | 81SM-6510-LC VAG92044V1 | AM5G6505AB V95093 | | | |
| 100 4127 V94306 | 1320928 V98036 | 3M5Q 6507 BA V94490 | 826F 6505 DAA V90233 | AV6Q6505AA V95138 | | | |
| 1004128 V94145 | 1324131 V98033 | 3M5Q-6505-AA V94961 | 826F 6507 DAA V90232 | AV6Q6505AA V95181 | | | |
| 1004444 V94001 | 1324132 V98032 | 55 194 219 V98022 | 83EM 6505 AB V91152 | AV6Q6507AA V95137 | | | |
| 1012747 V94003 | 1324690 V94694 | 55 200 422 V98023 | 83EM 6507 BB V91151 | BK2Q 6505 BA V95140 | | | |
| 1031007 V94061 | 1324691 V94693 | 55 208 213 V95016 | 844F 6510 CA VAG92221 | BK2Q 6505 BB V95140 | | | |
| 1033898 V94073 | 1352129 V94696 | 55204574 V95182 | 849F 6505 AA V91161 | BK2Q 6507 BB V94378 | | | |
| 1033899 V94076 | 1364402 V95062 | 55223836 V95183 | 849F 6507 AA V91160 | CM5G 6505 EA V95178 | | | |
| 1038606 V91159 | 1376413 V95140 | 6018725 V34509 | 84HM6505FA V91810 | CM5G 6507 CB V95156 | | | |
| 1041830 V94072 | 1427813 V95084 | 6041500 V90165 | 85HM6505AA V90933 | CM5G6505FA V95179 | | | |
| 1041838 V94074 | 1451597 V95083 | 6048948 V34509 | 86SM 6505 AD V91147 | DS7Q6507BA V95083 | | | |
| 1050570 V94033 | 1538735 V95015 | 6049412 V35264 | 86SM 6507 AA V91146 | E1ADDN 6510 A VAG330 | | | |
| 1051770 V94057 | 1576381 V90351 | 605 07 189 V91437 | 88WM 6505 DA V94007 | E7EE 6505 B2C V91199 | | | |
| 1051771 V94059 | 1584019 V98033 | 605 07 190 V91438 | 88WM 6505EA V94007 | E7EE 6507 B2A V91198 | | | |
| 1051772 V94056 | 1584022 V98032 | 6086114 V90132 | 88WM 6507 BA V94006 | MD-083 661 V94328 | | | |
| 1051773 V94058 | 1595025 V90152 | 6093969 V90232 | 88WM-6510-CA VAG96025 | MD-083 662 V91239 | | | |
| 1053843 V94225 | 1639605 V94601 | 6103818 V90134V1 | 894F 6505 A1B V91161 | WL51-12-111 V98060 | | | |
| 1053845 V94223 | 1649209 V91199 | 6119437 V91810 | 894F 6507 A1B V91160 | WL51-12-121A V98061 | | | |
| 1066045 V94225 | 1649214 V91198 | 6137194 V91146 | 894F 6507 A1B V94033 | XS4Q 6507 AB V94695 | | | |
| 1072048 V94214 | 1653978 V91159 | 6147911 V90933 | 89BM 6505 CA V91159 | XS6E 6507 A2A V98034 | | | |
| 1078429 V94696 | 1669766 V94010 | 6152128 V91152 | 89BM 6507 AA V91158 | XS6G 6505 B2A V94215 | | | |
| 1089830 V98035 | 1669772 V94011 | 6152129 V91151 | 89BM 6507 BA V91162 | XS7E 6505 D2B V94225 | | | |
| 1096248 V94381 | 1675716 V94491 | 6162460 V91147 | 89FF 6505 AA V91168 | XS7E 6505 D2C V94225 | | | |
| 1096249 V94380 | 1683701 V95234 | 6165227 V91158 | 89FF 6505 BA V94322 | XS7E 6505 D2D V94225 | | | |
| 1096250 V94380 | 1685845 V95138 | 6165228 V91162 | 89FF 6505 FA V91428 | XS7E 6507 D2A V94223 | | | |
| 1101934 V94215 | 1685845 V95181 | 6172656 V91292 | 89FF 6507 BA V94321 | XS7Q 6505 A1B V94379 | | | |
| 1102685 V94381 | 1685847 V95137 | 6172656 V91992 | 89FF 6507 FA V91993 | XS7Q 6505 A2B V94379 | | | |
| 110-G51066 VAG96001 | 1693681 V95093 | 6172845 V91168 | 89SM 6505 AG V90134V1 | XS7Q 6507 A1B V94378 | | | |
| 110-G52021 VAG96014 | 1706989 V95140 | 6172845 V91428 | 89SM 6507 AA V91992 | XS7Q 6507 A1C V94378 | | | |
| 1113187 V98037 | 1706990 V95140 | 6172846 V94322 | 89SM-6507-AA V91292 | XS7Q 6507 A2B V94378 | | | |
| 1113189 V95014 | 1710777 VAG330 | 6172848 V91428 | 914F 6505 A2A V91221 | XS7Q 6507 A2C V94378 | | | |
| 1113197 V94695 | 1738494 V94378 | 6172851 V91993 | 928M 6505 C2A V91991 | YC1Q 6505 A1C V94381 | | | |



OE INTERCHANGE

OE-Vergleichsliste • Intercambio con OE
Références croisées 1ère Monte

| OE | OE | OE | OE | OE | OE | OE | OE |
|------------------------|----------------------------|-----------------------|-----------------------|-----------------------|----|----|----|
| ...FORD | ...HYUNDAI | ...IVECO | ...IVECO | ...KIA | | | |
| YC1Q 6505 A2A V94381 | 22211-02500 V94461 | 0415 3773 V90114 | 98 497 235 V94054 | 22211-37201 V98040 | | | |
| YC1Q 6505 A2B V94381 | 22211-03200 V95203 | 1 908 408 V91301 | 99 432 652 V91301 | 22211-4A061 V98052 | | | |
| YC1Q 6505 A2C V94381 | 22211-03201 V95203 | 1 908 409 V91304 | 99 432 717 V91302 | 22212-02200 V95070 | | | |
| YC1Q 6507 A1B V94380 | 22211-22003 V95017 | 1 908 410 V91302 | 99 432 718 V91304 | 22212-03200 V95204 | | | |
| YC1Q 6507 A1C V94380 | 22211-23000 V98038 | 353 722 V91679 | 99 432 837 V91994 | 22212-23000 V98039 | | | |
| YC1Q 6507 A2B V94380 | 22211-23600 V95201 | 4 648 237 VAG92375 | 99 433 902 V94055 | 22212-23600 V95202 | | | |
| YC1Q 6507 A2C V94380 | 22211-26600 V95021 | 4 658 055 V91667 | 99 456 803 V94218 | 22212-25002 V95236 | | | |
| | 22211-27000 V95133 | 4 659 379 V91676 | 99 457 210 V94219 | 22212-26000 V95022 | | | |
| FORD USA | 22211-27001 V95133 | 4 673 608 V91667 | | 22212-27000 V95134 | | | |
| Y6011-2111 V94960 | 22211-2A100 V95228 | 4 673 608 V91677 | JAGUAR | 22212-2A100 V95229 | | | |
| | 22211-2B000 V95198 | 4 673 861 V91311 | 0948.E1 V95135 | 22212-2B000 V95199 | | | |
| HANOMAG | 22211-2B400 V95198 | 4 673 862 V91310 | 0948.E5 V95083 | 22212-42850 V91239 | | | |
| 352 053 22 29 VAG92411 | 22211-2G000 V95235 | 4 683 025 V91688 | 0949.C6 V95136 | 22212-4A061 V98053 | | | |
| 352 053 37 30 VAG92412 | 22211-33000 V94463 | 4 683 026 V91689 | 0949.E1 V95084 | B6ZA-12-121 V94572 | | | |
| 366 053 07 29 VAG92411 | 22211-37201 V98040 | 4 704 215 V91285 | 1121332 V94379 | MD-083 661 V94328 | | | |
| 403 053 00 20 VAG92089 | 22211-4A061 V98052 | 4 733 258 VAG92369 | 1217148 V94378 | MD198404 V95077 | | | |
| 423 050 00 26 V91020 | 22212-02200 V95070 | 4 749 395 VAG92373 | C26195 +0.13 VAG50913 | MD198406 V95078 | | | |
| 616 053 03 29 VAG92108 | 22212-02500 V94462 | 4 749 397 VAG92193 | C27477 VAG50914 | OK30E-12111 V98048 | | | |
| 616 053 03 30 VAG92109 | 22212-03200 V95204 | 4 749 398 VAG96190 | C29386 VAG50924 | OK30E-12121 V98049 | | | |
| | 22212-03201 V95204 | 4 784 888 V91301 | C29390 VAG50923 | OK551-12111A V94428 | | | |
| HONDA | 22212-22011 V95018 | 4 784 889 V91302 | EAC1395 V90302 | OK551-12121A V94429 | | | |
| 035 109 601K V91338 | 22212-23000 V98039 | 4 784 890 V91304 | EAC1547 V90308 | RF01-12-111 V91171 | | | |
| 035 109 611F V91030 | 22212-23600 V95202 | 4 802 200 V91709 | EAC1548 V90303 | RF01-12-121 V91172 | | | |
| 048 109 611A V91340 | 22212-25002 V95236 | 4 802 204 V91666 | EAC1549 V90304 | | | | |
| 0948.63 V91144 | 22212-26000 V95022 | 4 813 760 V91399 | EAC1550 V90307 | LADA | | | |
| 0949.47 V91145 | 22212-27000 V95134 | 4 826 033 V91293 | EAC2909 V91058 | 0948.49 V91143 | | | |
| 0949.64 V94024 | 22212-27001 V95134 | 4757358 V91292 | | 0948.63 V91144 | | | |
| 12204-PJ7-305 VAG92397 | 22212-2A100 V95229 | 4846130 V91947 | JEEP | 0949.47 V91145 | | | |
| 12205-657-315 VAG92210 | 22212-2B000 V95199 | 4895051 V95068 | 05066769AA V98017 | 0949.64 V94024 | | | |
| 14711-P75-A00 V94093 | 22212-2B010 V95199 | 4895052 V95067 | 05066770AA V98016 | 2101-1007010 V34631 | | | |
| 14711-RBD-E00 V95065 | 22212-33000 V94464 | 500 355 776 V94220 | 605 07 189 V91437 | 2101-1007012 V34632 | | | |
| 14711-RNA-000 V95200 | 22212-42850 V91239 | 500 355 779 V94221 | 605 07 190 V91438 | 2101-1007032 VAG92174 | | | |
| 14711-RNA-A00 V95200 | 22212-4A061 V98053 | 500 362 855 V94592 | 651 050 01 27 V95195 | 2101-1007033 VAG92175 | | | |
| 14721-P08000 V95094 | MD-016441 VAG92046 | 500 362 856 V94593 | 651 053 01 01 V95194 | 2112-1007010 V94950 | | | |
| 14721-P1J-E00 V95094 | MD-016445 VAG92047 | 500 362 856 V98019 | 7701 460 147 V90371 | 2112-1007012 V94951 | | | |
| 14721-P2A-000 V95094 | MD-016460 V90123 | 500354682 V94218 | 7701 460 148 V91263 | 90322694 V91429 | | | |
| 14721-P2A-K00 V95094 | MD-016461 V90124 | 500354685 V94218 | 7701 461 338 V91264 | 90322697 V91430 | | | |
| 14721-P75-A00 V94094 | MD-083 661 V94328 | 500354687 V94219 | 7701 461 339 V91265 | | | | |
| 14721-PE0-000 V90935 | MD-127 840 V94451 | 500355778 V95205 | | LANCIA | | | |
| 14721-PG6-000 V91733 | MD-127 841 V94466 | 500355780 V95206 | KHD | 0948.A5 V94198 | | | |
| 14721-PM3-000 V91731 | MD198404 V95077 | 500391436 VAG96349 | 0213 3731 V90114 | 0949.A5 V94199 | | | |
| 14721-PT6-A00 V94096 | MD198406 V95078 | 500391440 VAG96348 | 0241 2165 V90418 | 332 61 723 VAG586 | | | |
| 14721-RBD-E00 V95066 | OK551-12111A V94428 | 500391476 VAG96335 | 0337 1664 V90312 | 332 61 742 VAG701 | | | |
| 97185860 V94426 | OK551-12121A V94429 | 504 069 199 V94592 | 0337 1746 V94530 | 4 250 801 VAG96171 | | | |
| 97358650 V94427 | | 504 069 199 V98018 | 0414 7322 VAG96211 | 4 250 803 VAG92366 | | | |
| LGH100980 V94019 | INTERNATIONAL HARV. | 504 072 531 V98042 | 0414 7327 VAG92492 | 4 265 695 V34457 | | | |
| LGH100990 V94018 | 795 729 R1 V34789 | 504 081 062 V98043 | 0415 3629 V90050 | 4 265 699 VAG92364 | | | |
| LGH101310 V94099 | 796 122 R1 VAG601 | 504 378 070 V94593 | 0415 3631 V90114 | 4 315 062 V91713 | | | |
| LGH101330 V94100 | | 504042363 V94219 | 0415 3697 V90051 | 4 340 119 V90399 | | | |
| | ISUZU | 504078215 V94219 | 0415 3773 V90114 | 4 372 331 VAG50895 | | | |
| HYUNDAI | 13202-G2403 V94352 | 504080352 V95206 | 0415 9140 V94757 | 4 403 047 V91762 | | | |
| 0948.63 V91144 | 5-11721-016-0 VAG92372 | 504293892 V95206 | 0417 0164 VAG96341 | 4 412 816 V90398 | | | |
| 0949.47 V91145 | 5-12552-034-2 V91498 | 61 315 973 V91942 | 0417 0898 V94575 | 4 733 258 VAG92369 | | | |
| 0949.64 V94024 | 641020 V94662 | 61 321 255 V91942 | 0417 0899 V94529 | 4 749 395 VAG92373 | | | |
| OK55110281 VAG96111 | 641324 V94663 | 7 302 157 V91294 | 04201238 VAG96328 | 4 749 397 VAG92193 | | | |
| 22114-02500 VAG96394 | 8-94110-017-3 V91231 | 7 303 309 V91400 | 223 2528 VAG92155 | 4 749 398 VAG96190 | | | |
| 22114-22905 VAG96396 | 8-94115-059-2 V91232 | 8 823 263 VAG96276 | | 4 826 033 V91293 | | | |
| 22114-23501 VAG96399 | 8-94326-843-0 V91230 | 8 823 545 V91680 | KIA | 46 403 681 V94029 | | | |
| 22114-27000 VAG96401 | 897385841B V95186 | 8 824 754 V91693 | OK55110281 VAG96111 | 46 423 334 V91928 | | | |
| 22114-2A000 VAG96395 | 8973858420 V95157 | 8 830 045 V91694 | 22211-02200 V95069 | 46 433 782 VAG96124 | | | |
| 22114-2B000 VAG96398 | 90410813 V91998 | 8823544 V91681 | 22211-03200 V95203 | 46 441 525 VAG96272 | | | |
| 22114-42000 VAG96279 | 90412277 V91997 | 98 407 026 V91311 | 22211-23000 V98038 | 46 461 209 V94468 | | | |
| 22114-42520 VAG92322 | 97131962 V94344 | 98 418 161 V91940 | 22211-23600 V95201 | 46 462 159 V91950 | | | |
| 22115-22905 VAG96397 | | 98 435 241EZ VAG96274 | 22211-26600 V95021 | 46 471 639 V94030 | | | |
| 22115-23501 VAG96400 | | 98 468 338 V91939 | 22211-27000 V95133 | 46 517 325 V91949 | | | |
| 22115-42000 VAG96280 | IVECO | 98 474 603 V94222 | 22211-2A100 V95228 | 46 533 298 V94591 | | | |
| 22115-42520 VAG92323 | 0241 2165 V90418 | 98 474 604 V91311 | 22211-2B000 V95198 | 46 750 859 V94470 | | | |
| 22211-02200 V95069 | 0415 3697 V90050 | 98 497 025 V94222 | 22211-2G000 V95235 | 46 764 378 V94065 | | | |

| OE | OE | OE | OE | OE | OE | OE |
|---------------------|------------------------|-------------------------|------------------------|-------------------------|----|----|
| ...LANCIA | ...LANCIA | ...LAND ROVER | ...MAN | ...MERCEDES-BENZ | | |
| 46 783 962 V94471 | 7 766 565 V94582 | LGH10064 V94101 | 51.04101.0571 V95034 | 102 050 10 27 V94376 | | |
| 46 787 902 V94589 | 7 770 334 V91929 | LGH10065 V94102 | 51.04101.0574 V95034 | 102 050 11 27 V94376 | | |
| 46 802 049 V94588 | 7 780 108 VAG96273 | LGH100820L V94053 | 5104.101.0537 V95029 | 102 050 17 24 VAG92378B | | |
| 5 942 727 V91288 | 7 783 225 V91938 | LGH100980L V94019 | | 102 050 18 24 VAG92379B | | |
| 5 942 728 V91289 | 7 783 841 V91282 | LGH100990L V94018 | MASSEY FERGUSON | 102 053 13 01 V91441 | | |
| 5 973 129 V90397 | 7 798 620 V91937 | LGH101000 V94026 | 0420002 VAG993 | 102 053 15 01 V91445 | | |
| 5 973 129 V91762 | 7 958 073 V91638 | LGH101060 V91217 | 732 101 M1 V3251 | 102 053 16 01 V91441 | | |
| 5 975 341 V91636 | 9 600 781 780 V94169 | LGH101190L V94053 | 736815 M1 V34025 | 102 053 17 01 V91445 | | |
| 5 990 532 V91767 | 9 604 295 780 V94170 | LGH101360 V94342 | | 102 053 18 01 V91441 | | |
| 5 990 533 V91392 | 9 611 782 880 V91971 | LGJ10033 VAG92316 | MAZDA | 1020503724 VAG96227B | | |
| 55 185 028 V98026 | 9 623 950 380 V94200 | LGJ100900 VAG92385 | 1004444 V94001 | 1020504024 VAG96224B | | |
| 55 185 080 V98027 | 9 624 774 280 V94178 | LR004375 V94378 | 1051770 V94057 | 103 050 03 24 VAG92380B | | |
| 55 194 219 V98022 | 9 624 774 580 V94179 | LR004401 V95140 | 1051772 V94056 | 103 050 07 24 VAG92342B | | |
| 55 194 993 V98020 | 9 627 184 380 V94490 | LR004429 V94378 | 1113187 V98037 | 103 050 13 27 V94285 | | |
| 55 194 994 V98021 | 9 628 943 380 V94175 | LR008130 V95136 | 1113189 V95014 | 103 053 21 01 V94284 | | |
| 55 195 680 V95015 | 9 629 861 180 V94176 | LR029317 V95140 | 13201-1F700 V98073 | 103 053 23 01 V94284 | | |
| 55 200 422 V98023 | 9 634 437 580 V94491 | LR032065 V94378 | 13201-ED000 V95079 | 104 050 10 27 V94289 | | |
| 55 202 630 V94590 | 9 635 317 980 V94486 | WAM1452 VAG92309 | 13202-ED000 V95080 | 104 050 17 27 V94289 | | |
| 55 204 574 V95182 | 9 635 318 480 V94487 | | 13202-F700 V98074 | 104 053 12 01 V94288 | | |
| 55 205 125 V95223 | 9 636 001 780 V94201 | LEXUS | 1320927 V95013 | 104 053 14 01 V94288 | | |
| 55 206 233 V95220 | 9 676 718 180 V95083 | 13711-OR010 V95053 | 6172845 V91168 | 1040505224 VAG96142B | | |
| 55 207 517 V98005 | 9 676 718 280 V95084 | 13715-OR010 V95054 | 6172846 V94322 | 108 050 05 24 VAG92200B | | |
| 55 207 955 V98006 | 96 059 361 V91972 | | 6172848 V91428 | 110 050 00 27 V95072 | | |
| 55 208 213 V95016 | Y4011-2111 V94601 | LEYLAND | 6172851 V91993 | 110 050 07 26 V95071 | | |
| 55 223 836 V95183 | Y4011-2121 V94602 | 12B1339 VAG50909 | 6172852 V94321 | 110 050 41 24 VAG92414B | | |
| 6 265 699 VAG92364 | | 12H2222 VAG50963 | 6781621 V91821 | 110 050 53 24 VAG96152 | | |
| 60 811 086 VAG96123 | LAND ROVER | CAM1717 V34352 | 8-94115-059-2 V91232 | 110 050 54 24 VAG92171B | | |
| 605 04 864 V91438 | 0948.E5 V95083 | | 8-94326-843-0 V91230 | 110 050 65 24 VAG92172B | | |
| 605 07 189 V91437 | 0949.E1 V95084 | LOTUS | B6ZA-12-121 V94572 | 1100505824 VAG96147B | | |
| 605 07 190 V91438 | 11 34 1 736 549 V94091 | 13711-22030 V80018 | C201-12111B V98036 | 111 050 05 27 V94377 | | |
| 605 21 575 V90388 | 11 34 1 741 231 V94092 | 13715-22030 V80019 | C401-12-111A V95039 | 111 050 06 27 V95012 | | |
| 605 40 325 V91630 | 11 34 2 244 815 V94555 | 90410813 V91998 | L801-12-111 V94693 | 111 050 12 27 V94371 | | |
| 605 64 098 V91308 | 11 34 2 247 077 V94086 | 90412277 V91997 | L801-12-121C V94694 | 111 050 14 27 V94371 | | |
| 605 72 412 VAG96184 | 1311281 V95135 | LGH10029 V91209 | LF01-12-111 V98032 | 111 053 01 01 V94480 | | |
| 605 82 739 V94211 | 277593 V3195 | LGH10064 V94101 | LF01-12-121 V98033 | 111 053 02 01 V94480 | | |
| 606 74 496 V94591 | 527240 V3085 | LGH10065 V94102 | LFY1-10-281 VAG96367 | 111 053 03 01 V95011 | | |
| 608 11 086 VAG96146 | 557967 V34365 | LGH100820 V94053 | RF01-10-280 VAG92292 | 111 053 04 01 V95011 | | |
| 608 11 089 VAG96145 | 568686 VAG50948 | LGH101360 V94342 | RF01-10-290 VAG92293 | 111 053 10 29 VAG96096 | | |
| 608 11 090 VAG96230 | 568687 VAG50949 | | RF01-12-111 V91171 | 111 053 11 29 VAG96178 | | |
| 608 11 153 V91933 | 568688 VAG92158 | MAN | RF01-12-121 V91172 | 111 053 1101 V94370 | | |
| 608 11 154 V91934 | 568689 VAG92159 | 51.03201.0087 VAG92498 | RF2A-12-121 V98059 | 113 050 02 27 V94391 | | |
| 608 12 981 V91932 | 603554 VAG50919 | 51.03201.0088 VAG92498 | RF5C-12-111 V98058 | 113 050 03 27 V94393 | | |
| 608 12 982 V91931 | 605759 VAG50948 | 51.03201.01020 VAG96309 | RF5C-12-121 V98059 | 113 053 01 01 V94390 | | |
| 608 13 598 VAG96203 | 605760 VAG50949 | 51.03201.0115 VAG96115 | RFY1-10-291 VAG96286 | 113 053 03 29 VAG96097 | | |
| 608 14 604 V94065 | 614088 V34939 | 51.03201.0122 VAG96331 | WL51-12-111 V98060 | 113 053 05 01 V94390 | | |
| 608 14 605 V94064 | 614089 V34940 | 51.03201.0126 VAG96115 | WL51-12-121A V98061 | 115 050 00 27 V95096 | | |
| 7 301 820 V91292 | ERC7150 V3195 | 51.03201.1034 VAG92498 | Y4011-2111 V94601 | 116 050 01 26 V94257 | | |
| 7 301 821 V91293 | ERC7151 V34365 | 51.03201.1037 VAG92498 | Y4011-2121 V94602 | 116 050 04 26 V94333 | | |
| 7 302 157 V91294 | ERC9738 V91256 | 51.03201.1053 VAG92344 | Y6011-2111 V94960 | 1160504724 VAG96144B | | |
| 7 547 158 V91291 | ERC9739 V91255 | 51.03201.1057 VAG92345 | Y601-12-121 V94961 | 1160505324 VAG96139B | | |
| 7 547 400 V91290 | ERR 6611 V94359 | 51.03201.1079 VAG96115 | Y701-10-280 VAG92321 | 119 053 18 01 V94532 | | |
| 7 565 472 VAG96210 | ERR 6612 V94360 | 51.03201.1090 VAG96115 | ZJ01-12-111A V98062 | 121 053 04 01 V94750 | | |
| 7 574 742 V91638 | ERR1156 V91241 | 51.04101.0348 V94583 | ZJ01-12-121 V98063 | 123 050 18 24 VAG92171B | | |
| 7 588 577 V91321 | ERR1157 V91240 | 51.04101.0375 V94583 | ZJY1-10-281 VAG96367 | 129 053 01 05 V95096 | | |
| 7 597 080 V91305 | ERR1780 V91485 | 51.04101.0410 V91374 | ZY01-12-121 V98065 | 130 050 01 24 VAG51028B | | |
| 7 609 772 V91300 | ERR1781 V91486 | 51.04101.0422 V91771 | ZY01-12-121A V98065 | 135 053 00 01 V98083 | | |
| 7 611 679 VAG96181B | ERR3648 VAG92385 | 51.04101.0425 V91771 | ZY01-12-121B V98065 | 135 053 00 05 V98084 | | |
| 7 616 992 VAG96199 | ERR3777 V91988 | 51.04101.0478 V94583 | | 137 053 02 30 VAG96338 | | |
| 7 616 998 VAG92496 | ERR7027 V91486 | 51.04101.0479 V94564 | MERCEDES-BENZ | 160 050 00 27 VAG96338 | | |
| 7 617 500 V91306 | ERR7338 V91486 | 51.04101.0482 V98055 | 021 109 601K V94145 | 160 050 00 27 V94804 | | |
| 7 650 916 V91936 | ETC4067 V91169 | 51.04101.0483 V98056 | 021 109 611D V94306 | 160 053 00 01 V94803 | | |
| 7 666 227 V91289 | ETC5739 V91255 | 51.04101.0523 V95005 | 102 050 00 27 V91958 | 166 050 03 27 V94395 | | |
| 7 712 114 V91927 | ETC5740 V91256 | 51.04101.0524 V95006 | 102 050 03 27 V91958 | 166 050 04 27 V94397 | | |
| 7 722 907 V91935 | ETC5866 V91170 | 51.04101.0538 V95030 | 102 050 05 27 V94376 | 166 053 0101 V94394 | | |
| 7 735 898 V91931 | ETC8003 VAG92324 | 51.04101.0545 V95034 | 102 050 06 27 V94376 | 166 053 0201 V94396 | | |
| 7 735 899 V91932 | LGH000030 V91485 | 51.04101.0546 V95032 | 102 050 07 27 V94376 | 180 053 11 05 V94536 | | |
| 7 757 052 VAG96123 | LGH000040 V91486 | 51.04101.0547 V94801 | 102 050 08 27 V94376 | 180 053 15 05 V94536 | | |
| 7 766 564 V91933 | LGH10029L V91209 | 51.04101.0548 V94800 | 102 050 09 27 V94376 | 266 050 00 27 V98070 | | |



OE INTERCHANGE

OE-Vergleichsliste • Intercambio con OE
Références croisées 1ère Monte

| OE | OE | OE | OE | OE | OE | OE | OE |
|-------------------------|---------------------------|-------------------------|--------------------------|----------------------|------------------|----|----|
| ...MERCEDES-BENZ | ...MERCEDES-BENZ | ...MERCEDES-BENZ | ...MERCEDES-BENZ | ...MITSUBISHI | ...NISSAN | | |
| 270 050 01 00 V80009 | 601 050 25 27 V91182 | A346 053 00 05 V94577 | MN960089 V98072 | 13202-00QAN V94191 | | | |
| 270 053 00 01 V80008 | 601 053 04 01 V91181 | A355 050 00 27 V90048 | MR984260 V95215 | 13202-00QAP V94609 | | | |
| 271 050 00 27 V98069 | 601 053 12 01 V91181 | A355 050 01 27 V90053 | MR984261 V95216 | 13202-00QOA V95002 | | | |
| 271 050 04 27 V98069 | 601 053 15 01 V91181 | A355 050 01 27 V94577 | MW30620685 V94190 | 13202-01M00 V90363 | | | |
| 271 050 06 27 V95076 | 601 053 17 01 V91181 | | MW30620686 V94191 | 13202-10B00 V91197 | | | |
| 271 050 11 27 V80005 | 6010501024 VAG96204 | MG | | 13202-16A00 V91456 | | | |
| 271 053 00 01 V98068 | 606 050 05 27 V94291 | 11 34 2 247 077 V94086 | MWM | 13202-2F000 V94435 | | | |
| 271 053 05 01 V95177 | 606 050 11 27 V94280 | LGH10029 V91209 | 121 569 04 V94539 | 13202-2F210 V94433 | | | |
| 271 053 06 01 V95075 | 606 050 14 27 V94280 | LGH10064 V94101 | 121 596 05 V94541 | 13202-2J201 V94195 | | | |
| 271 053 10 01 V80004 | 606 053 01 05 V94291 | LGH10065 V94102 | 121 596 06 V94538 | 13202-40L00 V94326 | | | |
| 272 050 02 27 V95074 | 606 053 0230 VAG96149 | LGH100820 V94053 | 121 596 08 V94537 | 13202-40L01 V94326 | | | |
| 272 050 06 27 V95177 | 606 053 03 05 V94291 | LGH100980 V94019 | 129 111 63 V94723 | 13202-4A00A V95225 | | | |
| 272 050 08 27 V95177 | 606 053 05 01 V94290 | LGH100990 V94018 | 6 207 0 460 301 4 V90432 | 13202-4A00D V95225 | | | |
| 272 050 09 27 V95074 | 606 053 06 01 V94290 | LGH101360 V94342 | 6 226 0 460 005 4 V94258 | 13202-4P400 V94431 | | | |
| 272 050 16 27 V95177 | 606 053 06 05 V94279 | | 6 226 0 460 501 4 V94539 | 13202-57J02 V94469 | | | |
| 272 053 02 01 V95073 | 606 053 07 01 V94290 | MINI | 6 226 0 460 503 4 V94541 | 13202-57Y00 V91243 | | | |
| 272 053 05 01 V95176 | 606 053 07 05 V94279 | 11 12 7 797 711 V95040 | 6 226 0 460 701 4 V94538 | 13202-60J02 V94340 | | | |
| 272 053 06 01 V95176 | 606 053 11 01 V94278 | 11 34 7 513 024 V94350 | 6 226 0 460 703 4 V94537 | 13202-99B10 V94016 | | | |
| 272 053 08 01 V95073 | 606 053 12 29 VAG96095 | 11 34 7 533 884 V95035 | 6 228 0 460 301 4 V94260 | 13202-9C601 V94449 | | | |
| 276 050 00 27 V80007 | 607 053 12 00 V94608 | 11 34 7 533 885 V95036 | 6 308 0 460 001 4 V94540 | 13202-9F600 V94434 | | | |
| 278 050 01 26 V80006 | 611 050 01 27 V94399 | 11 34 7 547 187 V95038 | 6 308 0 460 002 4 V94261 | 13202-AD210 V95130 | | | |
| 345 053 71 05 V94577 | 611 050 0127 V94371 | 11 34 7 585 901 V95153 | 630503320034 VAG96088 | 13202-AU300 V95132 | | | |
| 346 053 00 01 V94558 | 611 053 01 01 V94398 | 11 34 7 587 470 V95037 | | 13202-AW300 V94191 | | | |
| 346 053 01 00 V94558 | 611 053 01 05 V94399 | 11 34 7 791 054 V94670 | NISSAN | 13202-BN300 V95130 | | | |
| 346 053 01 05 V90053 | 611 053 0329 VAG96241 | 11 34 7 791 055 V94671 | 035 109 601K V91338 | 13202-BN700 V94609 | | | |
| 346 053 01 05 V94577 | 611 053 04 01 V94398 | 11 34 7 805 968 V94960 | 048 109 611A V91340 | 13202-EB300 V95130 | | | |
| 346 053 02 05 V94577 | 616 050 01 27 V35018 | 11 34 7 805 969 V94961 | 0948.A8 V94171 | 13202-ED000 V95080 | | | |
| 346 053 09 29 VAG92016 | 616 050 05 27 V35018 | 11 34 7 812 616 V95154 | 0949.80 V94172 | 13202-ED00A V95080 | | | |
| 352 053 22 29 VAG92411 | 616 053 03 01 V90225 | 11 34 7 812 618 V95162 | 13201-00QAA V94498 | 13202-ED00C V95080 | | | |
| 352 053 37 30 VAG92412 | 616 053 03 29 VAG92108 | 11 34 8 511 622 V95041 | 13201-00QAC V94190 | 13202-EN200 V95120 | | | |
| 355 050 01 27 V90053 | 616 053 03 30 VAG92109 | 1134 1 485 585 V94349 | 13201-00QAJ V94705 | 13202-EN20B V95120 | | | |
| 355 053 00 05 V90048 | 626 050 09 00 V94609 | 1134 7 513 023 V94349 | 13201-00QAM V94190 | 13202-EN20E V95120 | | | |
| 355 053 03 30 VAG92017 | 628 053 00 01 V98066 | 1134 7 829 943 V94350 | 13201-00QAN V94608 | 13202-F700 V98074 | | | |
| 366 050 00 27 V91131 | 628 053 00 05 V98067 | | 13201-00QOA V95001 | 13202-G2403 V94352 | | | |
| 366 050 01 27 V91131 | 642 050 05 27 V98072 | MITSUBISHI | 13201-0Y000 V94430 | 13202-V7202 V94452 | | | |
| 366 050 01 27 V91361 | 642 050 07 27 V98072 | 038 109 601E V94649 | 13201-10B00 V91195 | 13212-43G01 VAG92384 | | | |
| 366 050 02 27 V91192 | 642 050 08 27 V98072 | 038 109 611E V94650 | 13201-16A00 V91456 | 13212-53J60 VAG92318 | | | |
| 366 050 03 26 V91191 | 642 053 04 01 V98071 | 03G 109 601A V98007 | 13201-1F700 V98073 | 132126F900 VAG96049B | | | |
| 366 050 05 27 V91131 | 651 050 01 27 V95195 | 03G 109 601B V94697 | 13201-22300 V94329 | 13212-9C641 VAG96118 | | | |
| 366 050 06 27 V91131 | 651 053 01 01 V95194 | 03G 109 611B V94698 | 13201-22301 V94329 | 13212-AD260 VAG96375 | | | |
| 366 050 12 26 V91361 | 668 050 02 27 V94401 | 03G 109 611D V98097 | 13201-22J10 V94330 | 13212-D0110 VAG92284 | | | |
| 376 050 00 27 V91131 | 668 053 02 29 VAG96098 | 13201-1F700 V98073 | 13201-22J11 V94330 | 13212-D0111 VAG96120 | | | |
| 376 050 01 27 V91131 | 668 053 03 01 V94400 | 13201-ED000 V95079 | 13201-2F000 V94432 | 13212-ED060 VAG96369 | | | |
| 422 050 00 27 V91133 | 906 050 02 26 V95033 | 13202-ED000 V95080 | 13201-2J201 V94194 | 13213-30002 VAG50909 | | | |
| 422 050 01 27 V91133 | 906 050 03 26 V95003 | 13202-F700 V98074 | 13201-43G01 V91493 | 13213-53J60 VAG92320 | | | |
| 422 050 02 26 V91132 | 906 050 03 27 V95004 | 504 072 531 V98042 | 13201-4A00A V95224 | 13213-53Y60 VAG92360 | | | |
| 422 050 02 27 V91133 | 906 053 01 29 VAG96320 | 504 081 062 V98043 | 13201-4M500 V94437 | 13213-AD260 VAG96376 | | | |
| 422 053 04 30 VAG92089 | 906 053 05 29 VAG96345 | 7701 469 373 V94667 | 13201-57J02 V94476 | 13213-D0110 VAG92285 | | | |
| 423 050 00 26 V91020 | 98 497 235 V94054 | 7701 471 704 V94338 | 13201-57Y00 V94432 | 13213-D0111 VAG96133 | | | |
| 442 050 02 27 V94332 | 99 433 902 V94055 | MD-016441 VAG92046 | 13201-60J02 V94441 | 13213-ED060 VAG96370 | | | |
| 442 050 03 26 V91132 | A 108 050 05 24 VAG92200B | MD-016445 VAG92047 | 13201-60J04 V94441 | 13213-V5514 VAG92285 | | | |
| 442 050 04 27 V91133 | A 270 050 01 00 V80009 | MD-016446 V90123 | 13201-99B10 V94447 | 7701 465 088 V91835 | | | |
| 457 053 00 01 V94316 | A 270 053 00 01 V80008 | MD-016461 V90124 | 13201-9C600 V94448 | 7701 465 090 V91836 | | | |
| 457 053 13 30 VAG96135 | A 271 050 11 27 V80005 | MD050523 VAG92322 | 13201-AD210 V95129 | 7701 468 419 V94442 | | | |
| 541 050 02 26 V94316 | A 271 053 10 01 V80004 | MD050527 VAG92323 | 13201-AU300 V95131 | 7701 469 266 V94180 | | | |
| 541 050 02 27 V94317 | A 276 050 00 27 V80007 | MD-083 659 V91239 | 13201-AW300 V94190 | 7701 469 269 V94181 | | | |
| 541 053 01 01 V95174 | A 278 050 01 26 V80006 | MD-083 661 V94328 | 13201-BN300 V95129 | 7701 472 669 V94513 | | | |
| 541 053 12 30 VAG96134 | A 346 053 00 01 V94558 | MD-083 662 V91239 | 13201-BN700 V94608 | 7701 472 670 V94514 | | | |
| 541 053 13 30 VAG96135 | A 457 050 03 27 V95175 | MD-127 840 V94451 | 13201-EB300 V95129 | 7701 474 286 V94607 | | | |
| 541 053 27 30 VAG96135 | A 457 050 05 27 V95175 | MD-127 841 V94446 | 13201-EB70A V95129 | 7701 474 287 V94606 | | | |
| 541 053 28 30 VAG96135 | A 460 053 00 01 V95174 | MD127841 V94464 | 13201-ED000 V95079 | | | | |
| 601 050 06 24 VAG92297 | A 470 050 04 27 V95122 | MD-139 755 V94570 | 13201-ED00A V95079 | OPEL | | | |
| 601 050 07 24 VAG96214 | A 470 050 06 26 V95121 | MD198404 V95077 | 13201-ED00C V95079 | 0641076 V98024 | | | |
| 601 050 09 24 VAG92298 | A 471 050 04 26 V95123 | MD198406 V95078 | 13201-EN20A V95119 | 0641101 V95183 | | | |
| 601 050 12 27 V91182 | A 471 050 05 27 V95124 | MD-300 702 VAG96288 | 13201-EN20B V95119 | 0641391 V98025 | | | |
| 601 050 19 27 V91182 | A 541 053 01 01 V95174 | MD339752 V95019 | 13201-EN20E V95119 | 0641392 V98025 | | | |
| 601 050 21 27 V91182 | A 601 050 07 24 VAG96214 | MD339754 V95020 | 13202-00QAA V94499 | 0641401 V98078 | | | |
| 601 050 23 27 V91182 | A346 053 00 05 V90053 | MN960088 V98071 | 13202-00QAK V94706 | 0641404 V98005 | | | |

| OE | OE | OE | OE | OE | OE | OE | OE |
|----------------------|----------------------|-------------------|-------------------|--------------------------|----|----|----|
| ...OPEL | ...OPEL | ...PERKINS | ...PEUGEOT | ...PEUGEOT | | | |
| 0641475 V95182 | 641 364 V94246 | 33261752 VAG92300 | 0948.A9 V94599 | 2200.81 VAG96215B | | | |
| 0642 635 V90166 | 641 376 V94963 | 3343F002 VAG92299 | 0948.C0 V94486 | 5 973 129 V91762 | | | |
| 0642008 VAG96021 | 641 379 V98078 | 3343J002 VAG92300 | 0948.C2 V94601 | 504 072 531 V98042 | | | |
| 0642052 V95182 | 641 387 V94427 | 3343J021 VAG92300 | 0948.C4 V94603 | 504 081 062 V98043 | | | |
| 0642890 V90108 | 641 402 V95016 | 3646.01 V94517 | 0948.C7 V94960 | 7 609 772 V91300 | | | |
| 09158569 VAG96346 | 641 403 V98006 | 3647.02 V94518 | 0948.C8 V98081 | 7701 471 170 V95188 | | | |
| 24405805 VAG96346 | 641 464 V98005 | 3650.01 V94519 | 0948.E1 V95135 | 96 254 645 V94204 | | | |
| 44 02 633 V94190 | 641 465 V98006 | 732 101 M1 V3251 | 0948.E2 V94969 | 96 763 590 80 V95159 | | | |
| 44 02 634 V94191 | 641369 V94427 | | 0948.E5 V95083 | 96 763 591 80 V95163 | | | |
| 44 15 921 V94190 | 641463 VAG96360 | PEUGEOT | 0948.E6 V98028 | 98 019 609 80 V80020 | | | |
| 44 15 922 V94191 | 642 011 V98077 | 0220 A0 VAG96100 | 0948.E8 V95037 | 98 076 459 80 V80021 | | | |
| 4411048 V94606 | 642 014 VAG96346 | 0220.16 VAG92179 | 0948.F6 V95234 | 98 418 161 V91940 | | | |
| 4411049 V94607 | 642 027 V95186 | 0220.25 VAG51007 | 0948.F7 V95137 | | | | |
| 4420439 V95001 | 642 030 V80016 | 0220.38 VAG92337 | 0948.G4 V95153 | PORSCHE | | | |
| 4431241 V95002 | 642 078 V98077 | 0220.55 VAG92331B | 0948.H0 V95182 | 021 109 601 V94546 | | | |
| 4431242 V95001 | 642 165 V94355 | 0220.59 VAG92401 | 0949.21 V34460 | 022 109 601G V95085 | | | |
| 46 403 681 V94029 | 642 168 V94097 | 0220.60 VAG96132 | 0949.25 V90351 | 022 109 601H V95127 | | | |
| 46 471 639 V94030 | 642 208 V94356 | 0220.64 VAG92332B | 0949.38 V91263 | 022 109 611M V95128 | | | |
| 46 750 859 V94470 | 642 211 V94098 | 0220.65 VAG92288B | 0949.45 V91152 | 022 109 611N V95086 | | | |
| 46 783 962 V94471 | 642 651 V90230 | 0220.65 VAG92465B | 0949.47 V91145 | 616.105.402.00 V94263 | | | |
| 46 787 902 V94589 | 642 659 V91433 | 0220.72 VAG96056B | 0949.47 V94017 | 616.105.406.01 V94264 | | | |
| 4708925 V95224 | 642 667 V91148 | 0220.75 VAG92288B | 0949.50 V91152 | 911.105.411.00 V94266 | | | |
| 4708933 V95225 | 642 679 V91137 | 0220.84 VAG96347B | 0949.52 V91279 | 911.105.411.20 V94266 | | | |
| 4709231 VAG96385 | 642 683 V91433 | 0220.91 VAG96049B | 0949.57 V91275 | 911.105.415.00 V94267 | | | |
| 4805321 V95187 | 642 758 V91429 | 0220.93 VAG96046B | 0949.58 V91272 | 911.105.415.20 V94267 | | | |
| 4805322 V95188 | 642 763 V90107 | 0220.95 VAG96271B | 0949.59 V91273 | 928 104 328 02 VAG96183B | | | |
| 4817338 V95188 | 642 829 V91150 | 0220.A2 VAG96119 | 0949.60 V94017 | 928.105.409.02 V94335 | | | |
| 4817354 V95187 | 642 854 V91138 | 0220.A6 VAG96364 | 0949.62 V91470 | 928.105.409.03 V94335 | | | |
| 5-12552-034-2 V91498 | 642 858 V91430 | 0221.17 VAG92333B | 0949.64 V94017 | 928.105.410.02 V94544 | | | |
| 55 185 028 V98026 | 642 911 V94353 | 0221.17 VAG96056B | 0949.64 V94024 | 928.105.410.04 V94408 | | | |
| 55 185 080 V98027 | 642063 VAG96028 | 0221.24 VAG96343 | 0949.66 V91970 | 928.105.641.05 V94295 | | | |
| 605 07 189 V91437 | 642067 VAG96359 | 0221.25 VAG96342B | 0949.68 V94170 | 928.105.642.05 V94296 | | | |
| 605 07 190 V91438 | 642699 VAG96360 | 0221.28 VAG96067 | 0949.70 V94156 | 928.105.642.06 V94299 | | | |
| 608 14 604 V94065 | 642700 VAG96360 | 0948.33 V34459 | 0949.73 V94017 | 930 104 321 00 VAG96168B | | | |
| 641 002 V91211 | 642701 VAG96360 | 0948.36 V90371 | 0949.74 V94017 | 930 105 409 13 V94268 | | | |
| 641 006 V91230 | 7701 463 603 V91292 | 0948.47 V91280 | 0949.76 V91971 | 930.105.409.01 V94268 | | | |
| 641 007 V91230 | 7701 467 249 V91940 | 0948.49 V91143 | 0949.79 V94063 | 930.105.409.02 V94270 | | | |
| 641 015 V91959 | 7701 469 373 V94339 | 0948.53 V91151 | 0949.80 V94172 | 930.105.419.03 V94269 | | | |
| 641 020 V94662 | 7701 471 704 V94338 | 0948.56 V91277 | 0949.81 V94217 | 930.105.419.08 V94265 | | | |
| 641 022 V91997 | 7701 472 669 V94513 | 0948.57 V91270 | 0949.87 V94168 | 964 104 321 00 VAG96177B | | | |
| 641 025 V94426 | 7701 472 670 V94514 | 0948.58 V91271 | 0949.89 V94204 | 964.105.409.05 V94545 | | | |
| 641 034 V91995 | 9006074 VAG96346 | 0948.59 V91144 | 0949.90 V94566 | 964.105.419.00 V94300 | | | |
| 641 045 V94245 | 90499097 V90231 | 0948.61 V91469 | 0949.92 V94176 | 964.105.419.03 V94300 | | | |
| 641 048 V94249 | 90531109 VAG96077 | 0948.63 V91144 | 0949.96 V94179 | 964.105.419.04 V94300 | | | |
| 641 051 V94245 | 9158589 VAG96077 | 0948.65 V94155 | 0949.99 V94201 | | | | |
| 641 063 V94962 | 93333561 V95189 | 0948.66 V91972 | 0949.A0 V91994 | PROTON | | | |
| 641 072 V95015 | 93333562 V95190 | 0948.68 V94169 | 0949.A2 V94489 | MD-016460 V90123 | | | |
| 641 073 V94588 | 96103130 V94367 | 0948.72 V94062 | 0949.A3 V94491 | MD-016461 V90124 | | | |
| 641 074 V94588 | 96182805 V94367 | 0948.73 V94155 | 0949.A4 V94493 | | | | |
| 641 075 V94588 | 98 019 609 80 V80020 | 0948.74 V94171 | 0949.A5 V94199 | RENAULT | | | |
| 641 085 V95186 | 98 076 459 80 V80021 | 0948.75 V94229 | 0949.A7 V94495 | 00 20 905 400 VAG96308 | | | |
| 641 086 V95157 | | 0948.82 V94167 | 0949.A8 V94204 | 00 33 123 074 VAG92387 | | | |
| 641 099 V80017 | PERKINS | 0948.83 V94203 | 0949.A9 V94487 | 00 33 123 076 VAG92389 | | | |
| 641 103 V95157 | 0910064 V34025 | 0948.84 V94567 | 0949.B1 V94602 | 0710 941 000 VAG50758 | | | |
| 641 106 V98006 | 3142 A051 V91248 | 0948.85 V94173 | 0949.C1 V94604 | 13201-3562R V95239 | | | |
| 641 300 V91231 | 3142 A052 V91184 | 0948.91 V94202 | 0949.C3 V94961 | 13201-99B10 V94447 | | | |
| 641 302 V91212 | 3142 H002 V91183 | 0948.92 V94175 | 0949.C4 V98082 | 13202-5379R V95240 | | | |
| 641 306 V91149 | 3142 L051 V91247 | 0948.93 V94157 | 0949.C6 V95136 | 13202-99B10 V94016 | | | |
| 641 317 V91960 | 3142 L071 V91249 | 0948.94 V91144 | 0949.C8 V94970 | 1397641-0 V94315 | | | |
| 641 322 V91232 | 3142 L072 V91250 | 0948.95 V94178 | 0949.E1 V95084 | 20441945 V94021 | | | |
| 641 324 V94663 | 3143 1315 V35042 | 0948.99 V94200 | 0949.E2 V95038 | 20459326 V98089 | | | |
| 641 325 V91998 | 3143 1881 V34789 | 0948.A1 V94488 | 0949.E3 V98029 | 20561995 V95160 | | | |
| 641 331 V94542 | 3313E003 VAG701 | 0948.A2 V91292 | 0949.F1 V94491 | 20768506 V95161 | | | |
| 641 340 V91996 | 3314A011 VS6353 | 0948.A3 V94490 | 0949.F5 V95138 | 3142 A051 V91248 | | | |
| 641 346 V94555 | 33152139 VS6072 | 0948.A4 V94492 | 0949.F6 V95036 | 3142 L071 V91249 | | | |
| 641 353 V91987 | 33152153 VS6072 | 0948.A5 V94198 | 0949.F9 V95035 | 3142 L072 V91250 | | | |
| 641 357 V94250 | 33261732 VAG601 | 0948.A7 V94494 | 0949.G2 V95084 | 4 813 760 V91399 | | | |
| 641 360 V94344 | 33261751 VAG601 | 0948.A8 V94171 | 0949.G3 V95183 | 50 00 684 383 VAG96126 | | | |



OE INTERCHANGE

OE-Vergleichsliste • Intercambio con OE
Références croisées 1ère Monte

| OE | OE | OE | OE | OE | OE |
|------------------------|-------------------------|--------------------------|--------------------|-----------------------|----|
| ...RENAULT | ...RENAULT | ...RENAULT TRUCKS | ...ROVER | ...SCANIA | |
| 50 00 684 384 VAG96127 | 7701 467 249 V91940 | 5000 670 121 V91346 | LGH101310 V94099 | 352211 V91200 | |
| 5000 670 730 V91346 | 7701 468 035 V94067 | 5000 670 206 V91346 | LGH101330 V94100 | 352211 V91201 | |
| 5000 676 035 V94474 | 7701 468 169 V94337 | 5000 670 730 V91346 | LGH101360 V94342 | 352212 V91201 | |
| 5000 676 249 V95009 | 7701 468 170 V94319 | 5000 676 035 V91905 | LGJ10034 VAG96058 | 352347 V91202 | |
| 5000 676 254 V95010 | 7701 468 419 V94442 | 5000 676 255 V95009 | LGJ100510 VAG92511 | | |
| 5000 676 255 V95009 | 7701 468 960 V94573 | 5000 676 257 V95010 | TAM1061 V90357 | SEAT | |
| 5000 676 257 V95010 | 7701 468 961 V94574 | 5000 676 258 V91906 | TAM1770 V91142 | 021 109 601L V94374 | |
| 5000 678 287 V91872 | 7701 469 266 V94180 | 5000 678 287 V91872 | WAM1452 VAG92309 | 021 109 611D V94306 | |
| 5000 678 652 V95208 | 7701 469 269 V94181 | 5000 678 652 V95208 | WAM4002 V91175 | 022 109 611M V95128 | |
| 5000 678 873 V95207 | 7701 469 373 V94339 | 5000 678 873 V95207 | WAM4003 V94052 | 022 109 611N V95086 | |
| 5001 001 581 VAG92369 | 7701 469 373 V94667 | 5000 681 141 V91345 | WAM4227 VAG92294 | 025 109 601C V94549 | |
| 5010 284 468 V94627 | 7701 469 684 V94337 | 5010 248 978 V95207 | | 025 109 612A V94548 | |
| 5010 284 847 V94630 | 7701 471 170 V94188 | 5010 248 979 V95208 | SAAB | 026 109 601C V91407 | |
| 5010 284 848 V94631 | 7701 471 354 V94499 | 5010 284 468 V94627 | 12575793 V94962 | 027 103 415 VAG92382B | |
| 5010 295 349 V91345 | 7701 471 378 V94498 | 5010 284 847 V94630 | 24405815 V98025 | 027 103 419 VAG96157B | |
| 5010 359 501 V94620 | 7701 471 379 V94499 | 5010 284 848 V94631 | 24454518 V94963 | 027 109 601C V91416 | |
| 5010 412 164 V94621 | 7701 471 702 V94190 | 5010 295 349 V91345 | 45 00 849 V91997 | 027 109 611D V91372 | |
| 5010 450 309 V94622 | 7701 471 703 V94191 | 5010 359 501 V94620 | 45 00 864 V91998 | 028 109 601C V94108 | |
| 5010 450 590 V94475 | 7701 471 704 V94338 | 5010 412 164 V94621 | 46 750 859 V94470 | 028 109 601C V94414 | |
| 5010 450590 V91906 | 7701 471 705 V94339 | 5010 450 309 V94622 | 46 783 962 V94471 | 028 109 601D V94084 | |
| 5010 553 049 V91905 | 7701 471 711 V94616 | 5010 450 589 V91905 | 46 787 902 V94589 | 028 109 601G V94409 | |
| 5010 553 312 V94475 | 7701 471 712 V94189 | 5010 450590 V91906 | 46 802 049 V94588 | 028 109 601H V94010 | |
| 7 303 309 V91400 | 7701 471 713 V94573 | 5010 553 049 V91905 | 55207517 V98005 | 028 109 601J V94112 | |
| 7420 540 017 V95170 | 7701 471 714 V94574 | 5010 553 312 V94475 | 55207955 V98006 | 028 109 611E V94109 | |
| 7420 564 020 V95171 | 7701 472 124 V94498 | 5010359098 VAG92395 | 55557741 V98024 | 028 109 611G V94085 | |
| 7420 833 932 V95164 | 7701 472 125 V94501 | 7420 540 017 V95170 | 55557862 V98077 | 028 109 611J V94410 | |
| 7420 833 936 V95165 | 7701 472 669 V94513 | 7420 564 020 V95171 | 55558728 V98078 | 028 109 611K V94113 | |
| 7438 610 008 V94044 | 7701 472 670 V94514 | 7420 833 932 V95164 | 608 14 604 V94065 | 030 109 601AG V94149 | |
| 7438 610 034 V94314 | 7701 472 986 V94705 | 7420 833 936 V95165 | 90 502 326 V94098 | 030 109 601AH V94114 | |
| 7438 610 034 V94615 | 7701 473 004 V94706 | ROVER | 90502316 V94355 | 030 109 601AK V94644 | |
| 7438 610 036 V94614 | 7701 473 183 V94609 | 0948.63 V91144 | 90502319 V94097 | 030 109 601AL V94404 | |
| 7700 109 151 VAG96292B | 7701 473 184 V94608 | 0948.A8 V94171 | 90502323 V94356 | 030 109 601C V94580 | |
| 7700 110 386 V94190 | 7701 473 354 V94499 | 0949.47 V91145 | 90536095 V94249 | 030 109 601D V91332 | |
| 7700 110 387 V94190 | 7701 473 355 V94499 | 0949.64 V94024 | 90536164 V94250 | 030 109 601E V94305 | |
| 7700 110 388 V94191 | 7701 474 286 V94607 | 0949.80 V94172 | 91 85 851 V94363 | 030 109 601F V91332 | |
| 7700 110 389 V94191 | 7701 474 287 V94606 | 11 34 2 244 815 V94555 | 93 99 965 V94364 | 030 109 601G V94308 | |
| 7700 114 862 VAG96293B | 7701 474 024 V94190 | 11 34 2 247 077 V94086 | 9399957 VAG96113 | 030 109 601N V94715 | |
| 7700 273 371 V91835 | 7701 476 025 V94191 | 12A1986 V34858 | | 030 109 611A V91473 | |
| 7700 743 529 VAG96163B | 7701 476 572 V94609 | 12A1987 V34859 | SCANIA | 030 109 611D V94309 | |
| 7700 859 086 VAG96294B | 7701 476 573 V94608 | 12G1111 VAG50911 | 1100997 V91202 | 030 109 611N V94197 | |
| 7700 859 517 V94562 | 7701 476 595 V95002 | 12G941 V34274 | 132 85 37 V94445 | 030 109 611S V94645 | |
| 7700 865 550 V94436 | 7701 476 596 V95001 | 12H2520 V34401 | 133 32 30 V94444 | 030 109 611T V94405 | |
| 7700 865 551 V94440 | 7910 245 071 VAG92337 | 14721-PE0-000 V90935 | 136 08 34 V91202 | 032 109 601M V94646 | |
| 7700 865 832 V94442 | 82 00 562 080 VAG96361B | 14721-PG6-000 V91733 | 136 08 36 V91200 | 032 109 611G V94115 | |
| 7701 052 725 VAG96295 | 8200 343 407 V94705 | 14721-PM3-000 V91731 | 1386647 V95168 | 035 109 601J V91338 | |
| 7701 203 675 V91293 | 8200 343 412 V94706 | 14721-PT6-A00 V94096 | 1386648 V95169 | 035 109 601K V91338 | |
| 7701 458 180 V35117 | 96 219 217 V94173 | 605 07 189 V91437 | 139 75 21 V91202 | 035 109 611F V91030 | |
| 7701 460 143 V91263 | 98 468 338 V91939 | 614088 V34939 | 1403823 VAG96314 | 036 109 601AD V94647 | |
| 7701 460 147 V90371 | 99 432 837 V91994 | 614089 V34940 | 1414395 V95169 | 036 109 601P V94247 | |
| 7701 460 148 V91263 | RENAULT TRUCKS | AHU1049 V90194 | 144 58 30 V94445 | 036 109 601S V94116 | |
| 7701 460 690 V91834 | 157983 VAG96131 | CAM1717 V34352 | 1477022 V94444 | 036 109 611K V94117 | |
| 7701 461 214 V91261 | 50 00 153 693 V91346 | CAM6669 V90193 | 1515743 V94444 | 036 109 611L V94248 | |
| 7701 461 214 V91834 | 50 00 663 464 V91346 | ERC6795 V3085 | 1778492 V95113 | 038 109 601B V94147 | |
| 7701 461 338 V91264 | 50 00 663 471 V91346 | LGH000030 V91485 | 1781847 V95113 | 038 109 601E V94649 | |
| 7701 461 339 V91265 | 50 10 248 411 VAG96129 | LGH000040 V91486 | 1785076 V94444 | 038 109 611B V94148 | |
| 7701 462 137 V91317 | 5000 153 692 V91346 | LGH10020 V91217 | 179 11 52 V94445 | 038 109 611E V94650 | |
| 7701 462 385 V94320 | 5000 658 408 V91345 | LGH10029 V91209 | 1854798 V95112 | 038 109 611F V94148 | |
| 7701 462 813 V91269 | 5000 659 741 V91872 | LGH10064 V94101 | 1854799 V95112 | 03C 109 601L V80010 | |
| 7701 462 814 V91267 | 5000 663 469 V91346 | LGH10065 V94102 | 1854801 V95113 | 03C 109 611Q V80011 | |
| 7701 463 081 V91268 | 5000 663 520 V91345 | LGH100820 V94053 | 1886946 V95112 | 03F 109 601A V95149 | |
| 7701 463 082 V91319 | 5000 663 527 V91346 | LGH100980 V94019 | 1887056 V95112 | 03F 109 611C V95150 | |
| 7701 463 603 V91292 | 5000 663 528 V91346 | LGH100990 V94018 | 1903846 V95169 | 03G 109 601A V98007 | |
| 7701 463 603 V91835 | 5000 663 529 V91345 | LGH100990 V94018 | 232018 V34963 | 03G 109 601B V94697 | |
| 7701 465 088 V91835 | 5000 663 530 V91345 | LGH101000 V94026 | 232018 V91202 | 03G 109 611B V94698 | |
| 7701 465 090 V91836 | 5000 663 762 V91905 | LGH101050 V94052 | 247182 VS6103 | 03G 109 611D V98097 | |
| 7701 465 497 V94552 | 5000 667 762 V91905 | LGH101060 V91217 | 294674 V91200 | 03L 109 601 V95099 | |
| 7701 466 606 V94038 | 5000 667 768 V91905 | LGH101180 V94052 | 300957 VAG92166 | 03L 109 601A V95125 | |
| 7701 466 607 V94039 | 5000 667 939 V91906 | LGH101190 V94053 | 300958 VAG92167 | 03L 109 611 V95114 | |
| 7701 467 249 V91294 | | | | | |

| OE | OE | OE | OE | OE | OE |
|------------------------|------------------------|--------------------------|----------------------|----------------------|----|
| ...SEAT | ...SKODA | ...SUBARU | TALBOT | ...TOYOTA | |
| 03L 109 611A V95126 | 03F 109 611C V95150 | 13201AA351 V94118 | 0948.33 V34459 | 13715-37030 V95052 | |
| 046 109 611F V94011 | 03G 109 601A V98007 | 13201AA420 V94120 | 0948.49 V91143 | 13715-40040 V94970 | |
| 047 109 611D V94419 | 03G 109 601B V94697 | 13201AA430 V94122 | 0948.63 V91144 | 13715-47010 V95144 | |
| 047 198 601D V94418 | 03G 109 611B V94698 | 13202AA361 V94119 | 0949.21 V34460 | 13715-54010 V90284 | |
| 048 109 601A V91407 | 03G 109 611D V98097 | 13211AA050 VAG96064 | 0949.47 V91145 | 13715-54020 V90284 | |
| 048 109 601E V94450 | 03L 109 601 V95099 | 13711-21010 V94134 | 0949.64 V94024 | 13715-54040 V94581 | |
| 048 109 611A V91340 | 03L 109 601A V95125 | 13711-33031 V94670 | | 13715-64040 V94460 | |
| 048 109 611B V94080 | 03L 109 611 V95114 | 13711-40040 V94969 | TOYOTA | 13715-67020 V94458 | |
| 049 103 419 VAG92105B | 03L 109 611A V95126 | 13711-47010 V95143 | 0948.63 V91144 | 13715-67040 V95148 | |
| 04E 109 601 V95237 | 047 109 611D V94419 | 13715-21010 V94135 | 0949.47 V91145 | 13715-74100 V94139 | |
| 04E 109 601A V80012 | 047 198 601D V94418 | 13715-33040 V94671 | 11122-10040 VAG92325 | 13715-88361 V95056 | |
| 04E 109 601B V95192 | 048 109 611B V94080 | 13715-40040 V94970 | 11122-15030 VAG96068 | Y4011-2111 V94601 | |
| 04E 109 611J V95193 | 04E 109 601 V95237 | 13715-47010 V95144 | 11122-16010 VAG96070 | Y4011-2121 V94602 | |
| 04E 109 611K V80013 | 04E 109 601A V80012 | 90410813 V91998 | 11122-20020 VAG96110 | | |
| 04E 109 611L V95238 | 04E 109 601B V95192 | 90412277 V91997 | 11122-21010 VAG96067 | VAUXHALL | |
| 051 109 601B V94110 | 04E 109 611J V95193 | | 11122-22030 VAG96072 | 09 158 474 V94246 | |
| 051 109 611B V94111 | 04E 109 611K V80013 | SUZUKI | 11122-30020 VAG96357 | 09117912 V94353 | |
| 053 109 611 V91340 | 04E 109 611L V95238 | 0948.49 V91143 | 11122-31041 VAG96381 | 0948.A2 V91292 | |
| 056 103 419A VAG92061B | 056 103 419A VAG92061B | 0948.63 V91144 | 11122-54010 VAG92406 | 12575793 V94962 | |
| 058 109 601C V94081 | 058 109 601C V94081 | 0948.95 V94178 | 11122-54011 VAG92282 | 12911-78101 V91253 | |
| 058 109 611E V94082 | 058 109 611E V94082 | 0948.C0 V94486 | 11122-64010 VAG96107 | 12915-84000 V91254 | |
| 058 109 611M V94083 | 058 109 611M V94083 | 0948.C4 V94603 | 11122-74030 VAG96069 | 24405815 V98025 | |
| 069 109 601F V91337 | 059 109 601B V94653 | 0948.C7 V94960 | 11126-24020 VAG92093 | 24433078 V98077 | |
| 069 109 601H V91336 | 059 109 601F V98008 | 0949.47 V91145 | 11126-64030 VAG96108 | 24433079 V98078 | |
| 06B 109 601D V94424 | 059 109 611B V94423 | 0949.64 V94024 | 13711-0D020 V94142 | 24454518 V94963 | |
| 06B 109 611C V94425 | 059 109 611G V98009 | 0949.96 V94179 | 13711-0L010 V95145 | 44 15 921 V94190 | |
| 06D 109 601M V95098 | 069 109 601F V91337 | 0949.A9 V94487 | 13711-0R010 V95053 | 44 15 922 V94191 | |
| 06D 109 611H V80028 | 06B 109 601D V94424 | 0949.C1 V94604 | 13711-10020 V91244 | 4411048 V94606 | |
| 06D 109 611L V94692 | 06B 109 611C V94425 | 0949.C3 V94961 | 13711-15090 V94144 | 46 403 681 V90209 | |
| 06D 109 611L V95152 | 06D 109 601M V95098 | 11115-54G00-001 VAG96391 | 13711-21010 V94134 | 46 471 639 V94030 | |
| 06E 109 601E V94691 | 06D 109 611H V80028 | 11115-60B11 VAG96065 | 13711-22020 V80018 | 46 750 859 V94470 | |
| 074 109 611 V91334 | 06D 109 611L V94692 | 11115-77G00-01 VAG96385 | 13711-22030 V80018 | 46 783 962 V94471 | |
| 078 109 601B V94079 | 06D 109 611L V95152 | 1115-60B11-001 VAG96065 | 13711-22040 V94142 | 46 787 902 V94589 | |
| 078 109 611C V94303 | 06E 109 601E V94691 | 12911-51K00 V95224 | 13711-23030 V94132 | 5-12552-034-2 V91498 | |
| 3940 2840 V91391 | 074 109 611 V91334 | 12911-54G00 V95141 | 13711-27010 V94454 | 55 185 028 V98026 | |
| 3940 3030 V91639 | 078 109 601B V94079 | 12911-68L10-000 V95182 | 13711-28010 V94456 | 55 185 080 V98027 | |
| 4 265 695 V34457 | 078 109 611C V94303 | 12911-69G00 V95007 | 13711-30030 V95057 | 55204200 VAG96360 | |
| 4757358 V91292 | | 12911-78101 V91253 | 13711-30040 V95145 | 55204574 V95182 | |
| 7 783 841 V91282 | SMART | 12911-78B00 V94368 | 13711-33030 V94670 | 55205183 V98006 | |
| | 132 053 00 01 V95196 | 12911-78E00 V94510 | 13711-33031 V94670 | 55206431 V98005 | |
| | 132 053 00 05 V95197 | 12911-85E00 V95015 | 13711-37020 V95051 | 55210015 VAG96360 | |
| SKODA | 135 053 00 01 V98083 | 12911-M68K00-000 V95224 | 13711-40040 V94969 | 55210016 VAG96360 | |
| 021 109 611D V94306 | 135 053 00 05 V98084 | 12911-M84400 V98087 | 13711-47010 V95143 | 55210017 VAG96360 | |
| 022 109 601G V95085 | 160 050 00 27 V94804 | 12911-M84420 V98087 | 13711-54010 V90283 | 55223835 V95182 | |
| 022 109 601H V95127 | 160 053 00 01 V94803 | 12915-54G00 V95142 | 13711-54020 V91720 | 55223836 V95183 | |
| 022 109 611M V95128 | 642 050 05 27 V98072 | 12915-54G50 V95142 | 13711-54040 V95147 | 55557741 V98024 | |
| 022 109 611N V95086 | 642 053 04 01 V98071 | 12915-68L10-000 V95183 | 13711-64010 V91466 | 55557862 V98077 | |
| 028 109 601C V94108 | A 132 053 00 01 V95196 | 12915-69G50 V95008 | 13711-64030 V94459 | 55558728 V98078 | |
| 028 109 601C V94414 | A 132 053 00 05 V95197 | 12915-71C50 V94125 | 13711-74101 V94138 | 55565261 V98005 | |
| 028 109 601D V94084 | | 12915-78E00 V94511 | 13711-88362 V95055 | 55565262 V98006 | |
| 028 109 601G V94409 | SSANGYONG | 12915-82000 V91157 | 13712-10010 V91245 | 55572520 V80016 | |
| 028 109 601J V94112 | 0948.53 V91151 | 12915-84000 V91254 | 13715-0R010 V95054 | 55572521 V80017 | |
| 028 109 611E V94109 | 0949.50 V91152 | 12915-85E00 V95016 | 13715-10030 V91246 | 605 07 189 V91437 | |
| 028 109 611G V94085 | 111 053 1101 V94370 | 12915-86F50 V94129 | 13715-11030 V94568 | 605 07 190 V91438 | |
| 028 109 611J V94410 | 601 050 25 27 V91182 | 12915-M68K00-000 V95225 | 13715-15030 V94569 | 608 14 604 V94065 | |
| 028 109 611K V94113 | 601 053 17 01 V91181 | 12991-71C00 V94130 | 13715-16060 V94137 | 7701 467 249 V91940 | |
| 030 109 601AH V94114 | 611 050 0127 V94371 | 13201-BN700 V94608 | 13715-17010 V91721 | 7701 469 373 V94339 | |
| 030 109 611T V94405 | | 13202-BN700 V94609 | 13715-17010 V94581 | 7701 471 704 V94338 | |
| 032 103 419A VAG96062B | SUBARU | 46 750 859 V94470 | 13715-21010 V94135 | 7701 472 669 V94513 | |
| 032 109 601M V94646 | 12911-54G00 V95141 | 46 783 962 V94471 | 13715-22030 V80019 | 7701 472 670 V94514 | |
| 032 109 611G V94115 | 12911-69G00 V95007 | 90409992 V91959 | 13715-22040 V94143 | 90009534 V90230 | |
| 036 109 601AD V94647 | 12911-85E00 V95015 | 90409996 V91960 | 13715-23030 V94133 | 90106086 V90108 | |
| 036 109 601S V94116 | 12915-54G00 V95142 | 90529527 V94245 | 13715-27010 V94455 | 90106098 V90107 | |
| 036 109 611K V94117 | 12915-69G50 V95008 | 90529529 V94246 | 13715-28010 V94457 | 90106325 VAG96021 | |
| 038 109 601B V94147 | 12915-71C50 V94125 | 96352793 V94369 | 13715-30030 V95058 | 90106792 V90166 | |
| 038 109 601E V94649 | 12915-82000 V91157 | | 13715-30040 V95146 | 90169309 V90230 | |
| 038 109 611E V94650 | 12915-85E00 V95016 | | 13715-33040 V94671 | 90215517 V91433 | |
| 038 109 611F V94148 | 12991-71C00 V94130 | | 13715-33041 V94671 | 90220112 V91150 | |
| 03F 109 601A V95149 | | | | | |







OE INTERCHANGE

OE-Vergleichsliste • Intercambio con OE
Références croisées 1ère Monte

| OE | OE | OE | OE | OE | OE | OE | OE |
|----------------------|---------------------|------------------------|------------------------|------------------------|--------------|--------------|--------------|
| ...VAUXHALL | ...VOLVO | ...VOLVO | ...VOLVO | ...VW | ...VW | ...VW | ...VW |
| 90295011 V91137 | 068 109 611D V91174 | 3183283 VAG96308 | 022 109 611M V95128 | 03F 109 611B V95150 | | | |
| 90295015 V91138 | 069 109 601D V90321 | 3342278 V91268 | 022 109 611N V95086 | 03F 109 611C V95150 | | | |
| 90295019 V91148 | 1 378 960 VAG96037 | 3343624 VAG96057B | 022 109 611P V95128 | 03G 109 601A V98007 | | | |
| 90298607 V91433 | 11129092 VAG50964 | 3547603-5 VAG92234 | 025 109 601 V94549 | 03G 109 601B V94697 | | | |
| 90322694 V91429 | 1113189 V95014 | 3978766 V98096 | 025 109 601C V94549 | 03G 109 611B V94698 | | | |
| 90322697 V91430 | 1257613 VAG92061B | 3978768 V98095 | 025 109 612A V94548 | 03G 109 611D V98097 | | | |
| 90323519 V91211 | 1270391 VAG96158 | 419653-1 VAG50986 | 026 109 601 V94304 | 03H 109 611D V95086 | | | |
| 90323524 V91212 | 1317792-8 V94274 | 420553-0 V91204 | 026 109 601C V91407 | 03H 109 611E V95128 | | | |
| 90323757 V91149 | 1320927 V95013 | 421011 VS6049 | 027 103 415 VAG92382B | 03L 109 601 V95099 | | | |
| 90409992 V91959 | 1324131 V98033 | 421297 VAG50964 | 027 103 419 VAG96157B | 03L 109 601A V95125 | | | |
| 90409996 V91960 | 1324132 V98032 | 421680 V91205 | 027 109 601C V91416 | 03L 109 611 V95114 | | | |
| 90410813 V91998 | 1366490 V94314 | 422320 VAG50965 | 027 109 611D V91372 | 03L 109 611A V95126 | | | |
| 90410816 V94542 | 1366882-7 V94044 | 463395-4 V35039 | 028 109 601B V94108 | 043 109 612 V94411 | | | |
| 90412277 V91997 | 1397641-0 V94315 | 463526-4 V35040 | 028 109 601B V94414 | 046 109 601J V94547 | | | |
| 90412712 V91995 | 154 52 90 V91206 | 463771-6 VAG92234 | 028 109 601C V94108 | 046 109 611F V94011 | | | |
| 90412912 V91995 | 1545135 VAG50964 | 465157-6 VAG92096 | 028 109 601C V94414 | 047 109 611D V94419 | | | |
| 90412974 V91996 | 1546437 VAG96308 | 465548-6 V91204 | 028 109 601D V94084 | 047 198 601D V94418 | | | |
| 90499097 V90231 | 15464373 VAG96308 | 465549-4 V90182 | 028 109 601G V94409 | 048 109 601A V91407 | | | |
| 90499097 V91987 | 1547492 V94020 | 466379-5 V90169 | 028 109 601H V94010 | 048 109 601E V94450 | | | |
| 90502316 V94355 | 20405502 V95102 | 466386 VAG92080 | 028 109 601J V94112 | 048 109 611A V91340 | | | |
| 90502319 V94097 | 20405503 V95024 | 467474 VS6107 | 028 109 611E V94109 | 048 109 611B V94080 | | | |
| 90502323 V94356 | 20405503 V95103 | 467502-1 V91206 | 028 109 611G V94085 | 04E 109 601 V95237 | | | |
| 90502326 V94098 | 20405897 VAG96382 | 467503 V91207 | 028 109 611J V94410 | 04E 109 601A V80012 | | | |
| 90511374 V94555 | 20441486 V94021 | 467682 V91207 | 028 109 611K V94113 | 04E 109 601B V95192 | | | |
| 90529527 V94245 | 20441945 V94021 | 467855-3 V91207 | 030 103 419A VAG96161B | 04E 109 611J V95193 | | | |
| 90529529 V94246 | 20450002 V98091 | 468302-5 V34949 | 030 109 601AG V94149 | 04E 109 611K V80013 | | | |
| 90536095 V94249 | 20459326 V98089 | 468303-3 V34950 | 030 109 601AH V94114 | 04E 109 611L V95238 | | | |
| 90536164 V94250 | 20464020 V95171 | 468448 VS6337 | 030 109 601AK V94644 | 04L 109 601B V95099 | | | |
| 9158477 V94245 | 20513284 V95167 | 477877 VAG96185 | 030 109 601AL V94404 | 04L 109 611B V95114 | | | |
| 9158589 VAG96077 | 20513285 V95167 | 479204 V91206 | 030 109 601C V94580 | 051 109 601B V94110 | | | |
| 93160646 V94607 | 20528113 V95089 | 7701 458 180 V35117 | 030 109 601D V91332 | 051 109 611B V94111 | | | |
| 93161681 V95002 | 20540012 V95170 | 7701 460 147 V90371 | 030 109 601E V94305 | 053 109 611 V91340 | | | |
| 93161682 V95001 | 20540013 V95170 | 7701 460 148 V91263 | 030 109 601F V91332 | 056 103 419A VAG92061B | | | |
| 93168105 V95001 | 20540017 V95170 | 7701 460 690 V91834 | 030 109 601G V94308 | 058 103 415 VAG96073B | | | |
| 93177309 VAG96359 | 20551761 V95089 | 7701 461 214 V91261 | 030 109 601N V94715 | 058 109 601C V94081 | | | |
| 93177676 V95015 | 20561995 V95160 | 7701 462 813 V91269 | 030 109 611A V91473 | 058 109 611E V94082 | | | |
| 93178587 V94588 | 20562837 VAG96350 | 7701 462 814 V91267 | 030 109 611D V94309 | 058 109 611M V94083 | | | |
| 93185523 V94588 | 20564019 V95171 | 7701 463 082 V91319 | 030 109 611N V94197 | 059 109 601B V94653 | | | |
| 93190438 V95016 | 20564020 V95171 | 7701 466 606 V94038 | 030 109 611S V94645 | 059 109 601F V98008 | | | |
| 93193754 V95224 | 20564039 V95090 | 7701 466 607 V94039 | 030 109 611T V94405 | 059 109 601G V98010 | | | |
| 93193762 V95225 | 20565912 V95024 | 7701 468 035 V94067 | 032 109 601L V94646 | 059 109 601J V98010 | | | |
| 93194080 VAG96385 | 20565912 V95103 | 7701 469 373 V94339 | 032 109 601M V94646 | 059 109 611B V94423 | | | |
| 93743882 V95188 | 20570965 V95214 | 7701 471 704 V94338 | 032 109 611G V94115 | 059 109 611G V98009 | | | |
| 94110017 V91231 | 20714469 V95102 | 7701 476 024 V94190 | 032103419A VAG96062B | 059 109 611H V98011 | | | |
| 94115059 V91232 | 20739057 V95166 | 7701 476 025 V94191 | 035 109 601G V91338 | 059 109 611K V98011 | | | |
| 94326843 V91230 | 20739058 V95166 | 8148574 V94021 | 035 109 601H V91338 | 059 109 611M V98011 | | | |
| 94363134 V94662 | 20740798 V95160 | 8631650 V98093 | 035 109 601J V91338 | 062 109 601 V80022 | | | |
| 96182805 V94367 | 20768506 V95161 | 8631651 V98094 | 035 109 601K V91338 | 062 109 611A V80023 | | | |
| 96440147 V95187 | 20768519 V95161 | 8653745 V94490 | 035 109 611F V91030 | 068 109 601C V90179 | | | |
| 96440148 V95188 | 20789674 VAG96382 | 8659744 V94491 | 036 109 601AD V94647 | 068 109 601D V91173 | | | |
| 96951454 V95187 | 20833932 V95164 | 8694780 V94694 | 036 109 601P V94247 | 068 109 601L V91335 | | | |
| 97037591 V91232 | 20833936 V95165 | 8694781 V94693 | 036 109 601S V94116 | 068 109 601N V91367 | | | |
| 97043861 V94663 | 20904074 VAG96308 | 918 6565 V94150 | 036 109 611 V90327 | 068 109 611C V90180 | | | |
| 97131962 V94344 | 20916916 VAG96350 | 9454607 V95049 | 036 109 611K V94117 | 068 109 611D V91174 | | | |
| 97185352 V94427 | 20919484 VAG96308 | 9454610 V95050 | 036 109 611L V94248 | 068 109 611L V91368 | | | |
| 97185860 V94426 | 20980413 V95164 | | 037 103 419B VAG96041B | 068 109 611L V91409 | | | |
| 97358650 V94427 | 20997871 V95165 | VW | 038 109 601B V94147 | 069 109 601D V90321 | | | |
| 97385841 V95186 | 21067953 VAG96350 | 020 012 306 A VAG92364 | 038 109 601E V94649 | 069 109 601F V91337 | | | |
| 97385842 V95157 | 21430916 V95090 | 021 101 417A VAG96228B | 038 109 601F V95087 | 069 109 601H V91336 | | | |
| 98 019 609 80 V80020 | 21705499 VAG96382 | 021 109 601 V94546 | 038 109 611B V94148 | 069 109 611 V91368 | | | |
| 98 076 459 80 V80021 | 22494872 VAG96382 | 021 109 601H V94145 | 038 109 611B V94415 | 06B 109 601D V94424 | | | |
| 98113743 V95186 | 24426433 V95166 | 021 109 601J V94145 | 038 109 611E V94650 | 06B 109 611C V94425 | | | |
| 98113744 V95157 | 30711497 V94961 | 021 109 601K V94145 | 038 109 611F V94148 | 06D 109 601K V94691 | | | |
| | 30711498 V94960 | 021 109 601L V94374 | 038 109 611F V94415 | 06D 109 601M V95098 | | | |
| VOLVO | 31330181 V95137 | 021 109 611D V94306 | 038 109 611G V95088 | 06D 109 611H V80028 | | | |
| 028 109 601H V94010 | 31330182 V95138 | 021 109 611F V94146 | 03C 109 601L V80010 | 06D 109 611H V94692 | | | |
| 046 109 611F V94011 | 3165234 V94021 | 022 109 601G V95085 | 03C 109 611Q V80011 | 06D 109 611K V94692 | | | |
| 068 109 611C V90180 | 3169490 V94020 | 022 109 601H V95127 | 03F 109 601A V95149 | 06D 109 611K V95152 | | | |

Intercambio de referencias de equipo original • Odpowiednik OE
 Взаимозаменяемость с оригинальными деталями • تبادل المعدة الأصلية

OE INTERCHANGE

| OE |  OE |  OE |  OE |  OE |  |
|--------------|--|--|---|--|---|
| ...VW | | | | | |
| 06D 109 611L | V94692 | | | | |
| 06D 109 611L | V95152 | | | | |
| 06D 109 611T | V94692 | | | | |
| 06E 109 601E | V94691 | | | | |
| 06E 109 601H | V95097 | | | | |
| 06E 109 611D | V95152 | | | | |
| 074 109 611 | V91334 | | | | |
| 078 109 601A | V94079 | | | | |
| 078 109 601B | V94079 | | | | |
| 078 109 611C | V94303 | | | | |
| 079 109 601B | V95098 | | | | |
| 079 109 611D | V80024 | | | | |
| 13711-54010 | V90283 | | | | |
| 13711-54020 | V91720 | | | | |
| 13715-17010 | V91721 | | | | |
| 13715-54020 | V90284 | | | | |
| 13715-54040 | V94581 | | | | |
| 311 109 601 | V33815 | | | | |



TECHNICAL NOTES

Technische Hinweise • Notes techniques
Note tecniche • Notas técnicas

GB

- 1 Not for engines with increased exhaust brake capacity
- 2 Service valve, for use on re-surfaced cylinder head only
- 3 LPG
- 4 Oversize stem
- 5 Fully finished

DE

- 1 Nicht für Motoren mit erhöhter Abgasbremsleistung
- 2 Reparatur-Ventil, nur bei geplanten Zylinderkopf verwenden
- 3 LPG
- 4 Ventilschaftdichtung mit Übermaß
- 5 Fertiggeschliffene

IT

- 1 Non per motori con potenza motore aumentata
- 2 Ricambio valvola per uso su testate cilindro spianate
- 3 LPG
- 4 Gambo valvola maggiorato
- 5 Finite

FR

- 1 Pas pour moteur avec capacité frein moteur élevée
- 2 Soupape de réparation, pour utilisation uniquement sur une culasse ré-usinée
- 3 LPG
- 4 Tige surdimensionnée
- 5 Entièrement finis

TECHNICAL NOTES

Technische Hinweise • Notes techniques
Note tecniche • Notas técnicas

ES

- 1 No para motores con elevada potencia de frenado del gas de escape
- 2 Válvula de servicio, para uso solamente en culatas rebajadas.
- 3 LPG
- 4 Vástago sobredimensionado
- 5 Totalmente acabada

PL

- 1 Nie do samochodów z powiększoną pojemnością hamulca wydechowego
- 2 Zawór serwisowy, do użycia tylko w przypadku ponownie obrabionej powierzchni głowicy
- 3 LPG
- 4 Trzonek nadwymiarowy
- 5 Całkowicie wykończone

RU

- | | |
|---|--|
| 1 | Неприменимо для двигателей с увеличенной мощностью моторного тормоза |
| 2 | Клапан для ремонта двигателя. Используется только для головок блока, прошедших обработку по плоскости. |
| 3 | Сжиженный газ |
| 4 | Шток ремонтного размера |
| 5 | Полностью обработанный |

AR

- | | |
|---|--|
| 1 | ليس للمحركات ذات العوادم الثقيله |
| 2 | صياغ مخصص لوشوش السيلندر المقشوط سابقا |
| 3 | LPG |
| 4 | جزر صياغ كبير الحجم |
| 5 | منتج كامل التصنيع |



Stem breakage through collet groove



Symptom: Excessive mechanical noise, bent stem and possible head detachment.
Cause: Poor assembly allowing uneven loading. Poor handling, dropping etc. Bouncing the valve after fitting by hitting the tip with a hammer. Valve bounce from excessive seating velocity.
Remedy: May not be possible due to extreme damage this failure can cause, however: Check seats, guides, springs, pistons and bores for damage and repair where necessary. Do not overspeed the engine.

Scuffed/sticking valve stem



Symptom: Poor performance due to low compression. Mechanical breakage due to sticking valves.
Cause: Marginal lubrication from inadequate valve to stem clearance, causing scuffing or metal transfer. This may ream out the valve guide leading to the second cause, excessive oil from too great a clearance carbonising on the stem to cause sticking.
Remedy: Ensure the valve stem to guide clearance is to specification. Ensure the correct valve stem

seals have been used. Replace worn components where necessary.

"Gutter" burnt through valve rim



Symptom: Loss of power. Rough running.
Cause: Valve clearance too small holding the valve off its seat. Sticking stem, poor/uneven seating or misalignment of the valve assembly. Overheating from pre-ignition. Excessive build up of carbon which flakes off the valve face to form a gas leakage path. Hard carbon particlespeen into the seat surface until enough indentations line up to form a gas leakage path.

Remedy: Ensure valve clearance is to specification. Check stem to guide clearance and for any misalignment of the valve assembly. Check engine timing, carburettor settings and injection timing.

Blow hole through valve head, starting from a radial crack

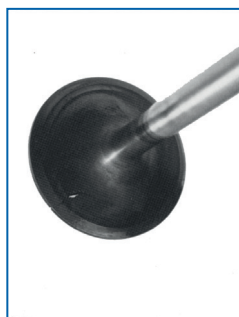

Symptom: Rough running. Loss of compression. Poor starting.
Cause: Similar to a segmental breakage, but gas escapes through the crack and burns a hole. Extreme thermal cycles (continual sudden changing from full power to shut down). Damage marks on the rim producing stress raisers. Mechanical overload from valve bounce.
Remedy: Check remaining valves for signs of cracking, replace where necessary. Ensure the

correct valves have been used. Check engine settings, valve springs, guides and followers. Do not overspeed engine.

Excessive valve stem and guide wear

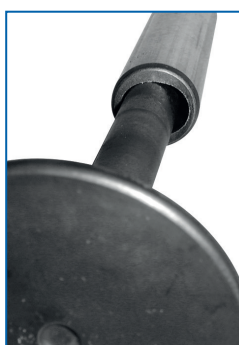

Symptom: Valve gear noise, high oil consumption, exhaust smoke on initial start up.
Cause: Too great or too small valve stem to guide clearance. Poor valve stem lubrication or ingress of dirt through the air intake system. It should be noted that the cause of this problem is not always obvious. Unless the cause is readily apparent, additional advice should be sought.
Remedy: Ensure correct valve and guides are fitted. Check alignment, valve stem to guide clearances, valve stem seals and lubrication system.

Inlet valve underhead carbon build-up



Symptom: Poor starting. Loss of power. Blue smoke from exhaust (when throttle closed).
Cause: Excessive clearance between valve stem and guide. Valve stem seal failure or wear. Excessive oil supply due to blocked drainage paths. Incorrect grade of lubricating oil used.
Remedy: Check valve stems, guides and stem seals for wear and replace where necessary. Ensure there is no blockage in the engine drainage or breathing systems.

TROUBLE TRACER CHART

VALVE TRAIN

Radial cracking of valve head, leading to a triangular segment breaking off



Symptom: Sudden mechanical noise. Rough running. Possible seizure.
Cause: Poor temperature distribution across the valve head resulting in high tensile stresses in the rim, often combined with severe deflection due to abnormal combustion pressures and temperatures. Extreme thermal cycles, (continual sudden changing from full power to shut-down).
 Damage marks on the rim producing stress raisers. Mechanical overload from valve bounce.

Remedy: Check the remaining valves for signs of cracking, replace where necessary. Ensure the correct valves have been used. Check engine settings, valve springs, guides and followers. Do not overspeed the engine.

Valve head breaking off stem



Symptom: Rough engine with sudden mechanical noise.
Cause: Mechanical overload, such as seating velocity too high from excessive valve clearances. Valve bounce, valve to piston contact caused by overspeeding, weak or broken valve springs or sticking valve stem. Uneven seating due to misalignment or distorted valve.
Remedy: May not be possible due to extreme damage this failure can cause, however: Check valve springs, guides and alignment and repair where necessary. Check seat guides, pistons and bores for damage. Reset the valve clearances.

repair where necessary. Check seat guides, pistons and bores for damage. Reset the valve clearances.

Valve breakages -fracture at lower cotter groove



Symptom: Valve breakage shortly after cylinder head rebuild, during initial start-up or during test run.
Cause: Over extension / "pump-up" of hydraulic lifters (photo 1). Incorrect seating of the valve spring

to the head (photo 2). Engine over-speed or weak springs.
Remedy: Where possible fit new hydraulic lifters with new valves. Ensure the engine block is thoroughly cleaned to remove all traces of debris. Take extreme care to seat all valve springs correctly in the recess of the cylinder head. Renew engine oil and replace oil and air filters.

VALVE OPERATING CONDITIONS

- Initial valve opening and final valve closing occurs very gently. Cam lobe profiles include lifting and lowering ramps to achieve this.
- Ensure the valve clearances are not too great to prevent the valve being hammered open or dropped onto its seat.

GRAPH OF CAM LIFT

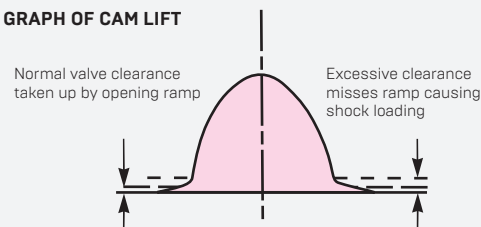

- The valve seat must be concentric with the valve guide. Any eccentricity that exists between the valve seat and guide will force the valve sideways.
- Excessive valve guide wear will occur as a result of this which can lead to a fatigue failure of the valve stem.

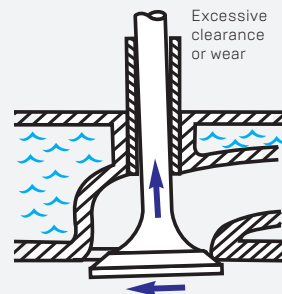

Typical exhaust valve temperature distribution in a spark ignition engine. Figures are degrees in centigrade.

- An exhaust valve may operate at up to 800 °C, and 75% of its cooling is by transferring heat to the valve seat.
- Ensure the valve seat contact is correct and as specified by the engine manufacturer.

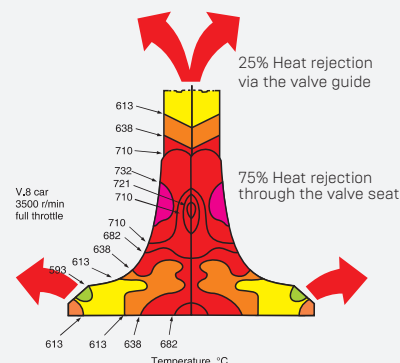



CHECK OUT OUR CATALOGUES



CATAE1501
Camshaft, Kits
and Components



CATAE1901
Valves and
Components



CATGY1601
Engine Bearings



CATGT1901
Piston Rings



CATGT1501
Liners



CATNU1601
Pistons

CATPA1201 - Cylinder Headbolts

CATPA1401 - Gaskets, Oil Seals and Cylinder Headbolts

CATPA1701 - Oil Seals



Combined E&S catalogues per vehicle makes:

CATMX1301 - Audi / Seat / Skoda / Volkswagen

CATMX1402 - PSA Renault

CATMX1403 - BMW / Mini / Mercedes-Benz / Smart / Porsche

CATMX1501 - Alfa / Fiat / Lancia / Iveco

CATMX1601 - Ford - Jaguar - Land Rover - Opel - Saab

Visit www.fmmotorparts.eu
Online catalogue website. Available 24/7

You can obtain these catalogues through your Federal-Mogul Motorparts sales representative or through your local distributor

ENGINE EXPERTISE
BY **FEDERAL-MOGUL**
MOTORPARTS



Federal-Mogul Global Aftermarket EMEA bvba

Prins Boudewijnlaan 5 • 2550 Kontich • Belgium

Central Distribution Centre

Schoondonkweg 17 • 2830 Willebroek • Belgium

Phone +32 (0) 3450 83 10 • Fax +32 (0) 3450 83 38

Federal-Mogul Italy Srl • Aftermarket Division

Via Enrico Fermi 8 • 37135 Verona • Italy

Phone +39 045 828 13 11 • Fax +39 045 828 14 00

Federal-Mogul Aftermarket GmbH

Albert-Ruprecht-Strasse 2 • 71636 Ludwigsburg • Germany

Phone +49 (0) 7141-64865-8230 • Fax +49 (0) 7141-64865-8390

Federal-Mogul Aftermarket UK Limited

Greyhound Drive • Bradford • BD7 1NQ • U.K.

Phone +44 (0) 800 970 0203 • Fax +44 (0) 1274 848282

Federal-Mogul Aftermarket España S.A.

Calle Alcarria, nº 2 • 28823 Coslada • Madrid • Spain

Phone + 34 91 746 1900 • Fax + 34 91 746 18 90

Federal-Mogul Aftermarket France SAS

60-62, rue Danjou • 92517 Boulogne-Billancourt Cedex • France

Phone +33 (0) 1 46 94 27 00 • Fax +33 (0) 1 46 94 27 01

Service Commande de stock :

Phone +33 (0) 810 000 029 • Fax +32 (0) 34 50 80 26

Service Commande express :

Phone +33 (0) 810 000 029 • Fax +32 (0) 34 50 80 26

Federal-Mogul Motorparts Serbia*

Spanskih Boraca 22 • 11070 Novi Beograd • Serbia

Phone +381 11 31 31 918 • Fax +381 11 31 31 848

Federal-Mogul Aftermarket Southern Africa (PTY) Ltd

33 Western Boulevard • 2092 City West Johannesburg • South Africa

Phone +27 (0) 11 630 3000 • Fax +27 (0) 11 630 3106

Federal Mogul Powertrain Otomotiv A.S. (Aftermarket Division)

Meclis-i Mebusan Cad. No: 53 Dereli İş Merkezi 34427 • Fındıklı / İstanbul • Türkiye

Phone +90 212 292 6313 • Fax +90 212 292 6260

Federal-Mogul VCS 000

Smolnaya street 24D, 13th floor • 125445 Moscow • Russia

Phone +7 495 221 50 60 • Fax +7 495 221 50 64

Federal-Mogul Aftermarket Egypt Ltd.

3 El Yemen St., Giza • 12311 Egypt • P.O. Box: 391 Dokki • Egypt

Phone +202 333 85 725 • Fax +202 374 84 147

Federal-Mogul Motorparts Sharjah*

Sharjah Airport International Free Zone (Saif-Zone)

Building X3 • Phone 20, 21, 22 • P.O.Box. 120548 • Sharjah • UAE

Phone +971 6 557 8870 • Fax +971 6 557 8941

* Branch office of Federal-Mogul Global Aftermarket EMEA, bvba



BERU® is a registered trademark of BorgWarner.

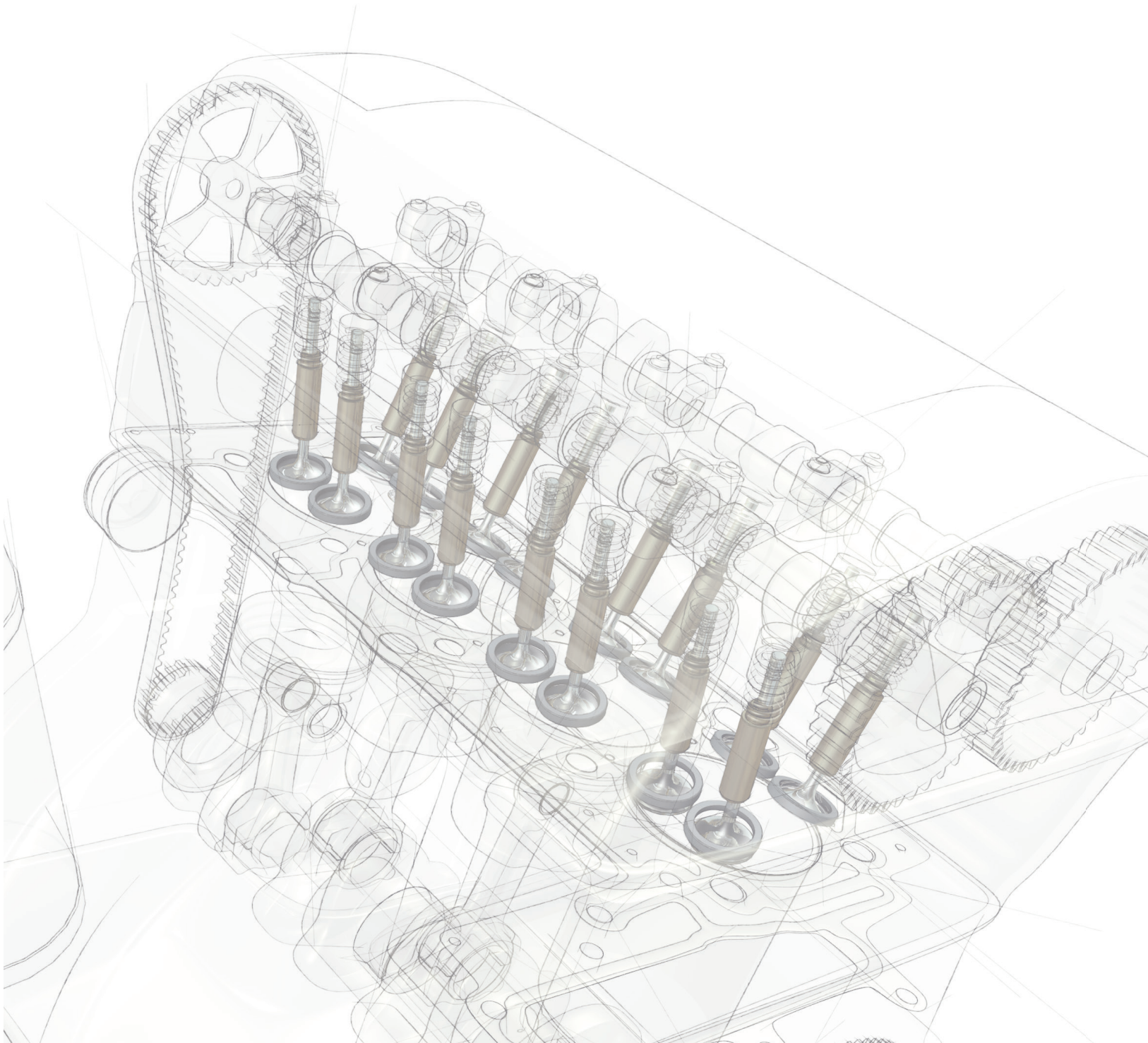

4 060426 174552

