

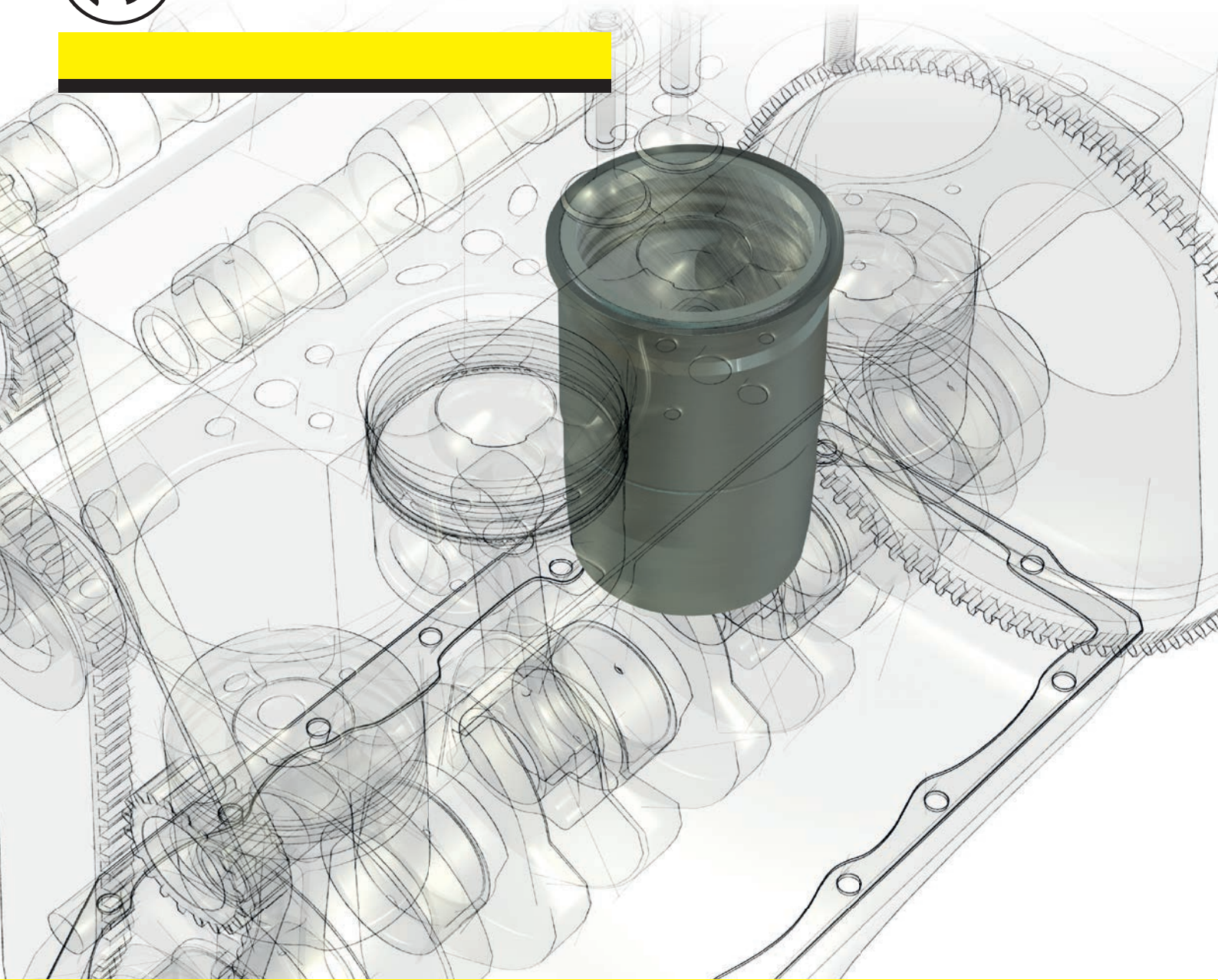

# GOETZE®



Liners  
Laufbuchsen  
Canne  
Chemises  
Camisas  
Tulei  
Цилиндры  
بطانات

CATGT1501



# 2016-2017

ENGINE EXPERTISE BY  **FEDERAL-MOGUL**  
MOTORPARTS



 GLYCO

 GOETZE

*Niral*

 Payen





## Use our know-how to hone your skills

With each diagnosis, each revision, your engine expertise becomes richer. Your skills get broader and deeper. And it's just the same at Federal-Mogul. That's why people rely on you. For example, your eye for detail and your feel for precise cylinder liner honing guarantee optimum engine performance. Your expertise helps us understand which parts you need, and how we can give you even more support to make it easier for you to achieve perfection with each engine job.

**Because our engine expertise... is based on yours.**



**ENGINE EXPERTISE**  
BY  **FEDERAL-MOGUL**  
MOTORPARTS



 **GLYCO**

 **GOETZE**

*Nival*

 **Payen**



# MANUFACTURERS LIST

AGCO SISU	1	LAND ROVER	164 — 166
ALFA ROMEO	2 — 10	LDV	167 — 168
ARO	11 — 13	LEYLAND	169 — 172
AUDI	14 — 16	LOTUS	173
AUSTIN	17 — 18	MAN	174 — 199
AUTOBIANCHI	19 — 20	MAZDA	200 — 201
BEDFORD	21 — 23	MERCEDES-BENZ	202 — 264
BELARUS	24	MG	265 — 266
CHRYSLER	25 — 26	MINI	267 — 268
CITROEN	27 — 40	MITSUBISHI	269 — 270
CLAYTON DEWANDRE	41	NEW HOLLAND	271 — 276
COMPRESSOR	42	NISSAN	277 — 282
CUMMINS	43	OPEL	283 — 288
DACIA	44 — 45	PEGASO	289
DAF	46 — 51	PERKINS	290 — 294
DAIHATSU	52	PEUGEOT	295 — 308
DAVID BROWN	53	RENAULT	309 — 328
DEUTZ / KHD	54 — 61	RENAULT TRUCKS	329 — 337
FIAT	62 — 85	ROVER	338 — 340
FIAT ALLIS-HITACHI	86 — 88	SCANIA	341 — 351
FIAT INDUSTRIAL	89 — 94	SEAT	352 — 356
FORD	95 — 104	SKODA	357 — 359
FORD COMMERCIAL	105 — 107	SSANGYONG	360 — 361
FORD TRACTOR	108 — 110	STEYR	362 — 364
FSO	111 — 112	SUZUKI	365 — 366
HINO	113	TALBOT	367 — 369
HYUNDAI	114 — 115	TOYOTA	370 — 372
IFA	116	UTB	373
IHC	117	VAUXHALL	374 — 378
ISUZU	118 — 120	VM	379
IVECO	121 — 148	VOLKSWAGEN	380 — 389
JAGUAR	149 — 150	VOLVO	390 — 392
JEEP	151 — 152	VOLVO COMMERCIAL	393 — 409
JOHN DEERE	153 — 154	VOLVO PENTA	410 — 411
KAMAZ	155	YUGO	412
KOMATSU	156	ZASTAVA	413 — 414
LANCIA	157 — 163		



# HOW TO USE

Hinweise zur benutzung • Come ci utilizza il catalogo • Instructions pour l'utilisation du catalogue



1 2  
14-636470-00 WH B 79.50 C 122.00 D 89.20 E 85.00

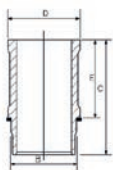

- 1 **Liner Reference**  
B = Outer Diameter  
C = Overall Length  
D = Flange Diameter  
E = Flange Width  
F = Firelip Height
- 2 **Liner Type**  
D = Dry  
WH = Wet Honed  
DH = Dry Honed

## PART NUMBERING STRUCTURE

### CYLINDER LINERS

- 14 - 451160 - 00 Catalogue reference  
14 - 451160 - 00 Cylinder liner  
15 - 451160 - 00 Cylinder liner with seals  
14 - 451160 - 00 Liner type → 01 - 19 = Dry liner  
20 - 99 = Wet liner  
14 - 451160 - 00 Serial number  
14 - 451160 - 00 Size → 0 = STD  
1 = 1st oversize  
2 = 2nd oversize  
14 - 451160 - 00 Version



1 2  
14-636470-00 WH B 79.50 C 122.00 D 89.20 E 85.00

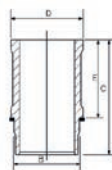

- 1 **Artikelnummer Laufbuchse**  
B = Außendurchmesser  
C = Gesamtlänge  
D = Bunddurchmesser  
E = Bundbreite  
F = Feuersteghöhe
- 2 **Laufbuchsentyp**  
D = trocken  
WH = nass, gehont  
DH = trocken, gehont

## TEILENUMMERIERUNGSSYSTEM

### ZYLINDERLAUFBUCHSEN

- 14 - 451160 - 00 Artikelnummer  
14 - 451160 - 00 Zylinderlaufbuchse  
15 - 451160 - 00 Zylinderlaufbuchse mit  
Abdichtung → 01 - 19 = Trockene  
Zylinderlaufbuchse  
20 - 99 = Nasse  
Zylinderlaufbuchse  
14 - 451160 - 00 Laufbuchsentyp  
14 - 451160 - 00 Seriennummer → 0 = STD  
1 = 1. Übergröße  
2 = 2. Übergröße  
14 - 451160 - 00 Größe  
14 - 451160 - 00 Version



1 2  
14-636470-00 WH B 79.50 C 122.00 D 89.20 E 85.00

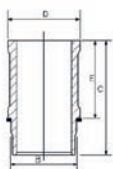

- 1 **Codice Canna Cilindro**  
B = Diametro Esterno  
C = Lunghezza Totale  
D = Diametro Flangia  
E = Larghezza Flangia  
F = Altezza Parafiamma
- 2 **Tipo Canna Cilindro**  
D = A Secco  
WH = Riportata in Umido  
DH = Riportata a Secco

## SISTEMA DI CATALOGAZIONE DEI RICAMBI

### CANNE CILINDRO

- 14 - 451160 - 00 Codice catalogo  
14 - 451160 - 00 Canna cilindro  
15 - 451160 - 00 Canna cilindro con  
guarnizione → 01 - 19 = Canna a secco  
20 - 99 = Canna in umido  
14 - 451160 - 00 Tipo canna cilindro  
14 - 451160 - 00 Numero di seriale → 0 = STD  
1 = 1° maggiorazione  
2 = 2° maggiorazione  
14 - 451160 - 00 Dimensioni  
14 - 451160 - 00 Versione



1 2  
14-636470-00 WH B 79.50 C 122.00 D 89.20 E 85.00

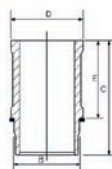

- 1 **Référence de chemise**  
B = Diamètre extérieur  
C = Longueur totale  
D = Diamètre bride  
E = Largeur de collerette  
F = Hauteur du parefeu
- 2 **Type chemise**  
D = Sèche  
WH = Chemise humide  
DH = Chemise sèche

## SYSTÈME DE CODIFICATION

### CHEMISES DE CYLINDRE

- 14 - 451160 - 00 Référence au catalogue  
14 - 451160 - 00 Chemise de cylindre  
15 - 451160 - 00 Chemise de cylindre  
avec joint de chemise → 01 - 19 = Chemise sèche  
20 - 99 = Chemise humide  
14 - 451160 - 00 Type de chemise  
14 - 451160 - 00 Numéro de série → 0 = STD  
1 = 1ère cote réparation  
2 = 2ème cote réparation  
14 - 451160 - 00 Dimension  
14 - 451160 - 00 Version



# HOW TO USE

Cómo usar este catálogo • Jak używać tego katalogu • как пользоваться каталогом • كيفية استخدام هذا الكatalog



1 2

14-636470-00 WH



B 79.50 C 122.00 D 89.20 E 85.00

- 1 Referencia de la camisa  
B = Diámetro exterior  
C = Longitud general  
D = Diámetro de la brida  
E = Anchura de la brida  
F = Altura cortafuego
- 2 Tipo de camisa  
D = Seca  
WH = Alisada húmeda  
DH = Alisada seca



1 2

14-636470-00 WH

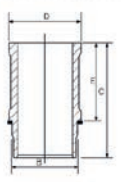

B 79.50 C 122.00 D 89.20 E 85.00

- 1 Numer referencyjny tulei cylindrowej  
C = Średnica zewnętrzna  
C = Długość całkowita  
D = Średnica kotnierza  
E = Szerokość kotnierza  
F = Wysokość odsadzenia
- 2 Typ tulei cylindrowej  
D = Sucha  
WH = Mokra honowana  
DH = Sucha honowana

## SISTEMA DE NUMERACIÓN DE REFERENCIAS

### CAMISAS

- 14 - 451160 - 00 Referencia del catálogo
- 14 - 451160 - 00 Camisa
- 15 - 451160 - 00 Camisa con junta
- 14 - 451160 - 00 Tipo de camisa → 01 - 19 = Camisa seca  
20 - 99 = Camisa húmeda
- 14 - 451160 - 00 Número de serie → 0 = Estándar  
1 = Primera sobredimensión  
2 = Segunda sobredimensión
- 14 - 451160 - 00 Versión

## SYSTEM NUMEROWANIA CZĘŚCI

### TULEJE CYLINDROWE

- 14 - 451160 - 00 Katalogowy numer referencyjny
- 14 - 451160 - 00 Tuleja cylindrowa
- 15 - 451160 - 00 Tuleja cylindrowa z uszczelnieniem → 01 - 19 = Tuleja sucha  
20 - 99 = Tuleja mokra
- 14 - 451160 - 00 Typ tulei
- 14 - 451160 - 00 Numer seryjny → 0 = STD (standard)  
1 = pierwszy nadwymiar  
2 = drugi nadwymiar
- 14 - 451160 - 00 Rozmiar
- 14 - 451160 - 00 Wersja



1 2

14-636470-00 WH



B 79.50 C 122.00 D 89.20 E 85.00

- 1 Информация о гильзе  
B = внешний диаметр  
C = общая длина  
D = диаметр фланца  
E = ширина фланца  
F = высота огнезащитного уплотнения
- 2 Тип гильзы  
D = "сухая"  
WH = "мокрая" с хонинговкой  
DH = "сухая" с хонинговкой



1 2

14-636470-00 WH



B 79.50 C 122.00 D 89.20 E 85.00

- 1 مرجع البطانة  
القطر الخارجي = B  
الطول الكلي = C  
قطر الشفة = D  
عرض الشفة = E  
طول شفة الحماية من النيران = F
- 2 نوع البطانة  
جاف = D  
حجر شحذ رطب = WH  
حجر شحذ جاف = DH

## СИСТЕМА НУМЕРАЦИИ ДЕТАЛЕЙ

### ГИЛЬЗЫ ЦИЛИНДРОВ

- 14 - 451160 - 00 Номер детали в каталоге
- 14 - 451160 - 00 Гильза цилиндра
- 15 - 451160 - 00 Гильза цилиндра с уплотнением → 01 - 19 = "Сухая" гильза  
20 - 99 = "Мокрая" гильза
- 14 - 451160 - 00 Тип гильзы
- 14 - 451160 - 00 Серийный номер → 0 = стандартный  
1 = 1й ремонтный размер  
2 = 2й ремонтный размер
- 14 - 451160 - 00 Размер
- 14 - 451160 - 00 Версия

## نظام ترقيم القطع

### بطانات الأسطوانات

- 14 - 451160 - 00 مرجع الكatalog
- 14 - 451160 - 00 بطانة الاسطوانة → 19 - 01 = بطانة جافة  
99 - 20 = بطانة رطبة
- 15 - 451160 - 00 بطانة الأسطوانة ذات مانع التسريب
- 14 - 451160 - 00 نوع البطانة
- 14 - 451160 - 00 الرقم المسلسل → 0 = قياسي  
1 = الحجم الزائد الأول  
2 = الحجم الزائد الثاني
- 14 - 451160 - 00 الحجم
- 14 - 451160 - 00 الإصدار







**1**

**84 CTA Euro 3**                                  6cyl.     **8420cc**     **187-305kW (254-415PS)**     **Diesel**     **Turbo Intercooled**                                  **TD26025**

**14-476000-00 WH**                                  **111.00**                                  **B 123.00**                                  **C 239.00**                                  **D 0.70**                                  **E 9.04**                                  **F 0.85**

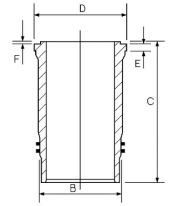



# MODEL INDEX



Modelverzeichnis • Index de modele • Índice de Modelo  
Indeks modelu • Модель автомобиля • دليل الموديل



CCM

x



9

01/86→09/94	<b>33 1.8</b>	VM 82 A, VM 96 A	Diesel	1779	3	<b>11</b>
05/85→02/92	<b>75 1.6</b>	AR 61101	Petrol	1567	4	<b>3</b>
09/85→02/92	<b>75 1.8</b>	AR 06168, AR 06202, AR 61102, AR 61201	Petrol	1779	4	<b>5</b>
05/85→02/92	<b>75 2.0</b>	AR 06166, AR 06212, AR 06224	Petrol	1962	4	<b>10</b>
01/89→02/92	<b>75 2.4</b>	VM 81 A	Diesel	2393	4	<b>11</b>
10/84→07/87	<b>90 1.8</b>	AR 06202	Petrol	1779	4	<b>5</b>
10/84→07/87	<b>90 2.0</b>	AR 01713, AR 06212	Petrol	1962	4	<b>10</b>
10/84→07/87	<b>90 2.4</b>	VM 81 A	Diesel	2393	4	<b>11</b>
07/94→02/99	<b>145 1.9</b>	AR 33601, AR 67501	Diesel	1929	4	<b>7</b>
02/99→01/01	<b>145 1.9</b>	AR 32302	Diesel	1910	4	<b>6</b>
12/94→02/99	<b>146 1.9</b>	AR 33601, AR 67501	Diesel	1929	4	<b>7</b>
02/99→01/01	<b>146 1.9</b>	AR 32302	Diesel	1910	4	<b>6</b>
04/01→03/10	<b>147 1.9</b>	192 A5.000, 192 B1.000, 937 A2.000, 937 A4.000, 937 A5.000	Diesel	1910	4	<b>6</b>
04/93→12/97	<b>155 1.9</b>	AR 67501	Diesel	1929	4	<b>7</b>
01/92→12/97	<b>155 2.0</b>	AR 67203	Petrol	1995	4	<b>9</b>
02/92→04/93	<b>155 2.0</b>	AR 67201	Petrol	1995	4	<b>10</b>
02/92→02/95	<b>155 2.0</b>	AR 67202	Petrol	1970	4	<b>8</b>
04/93→12/97	<b>155 2.5</b>	VM 07 B, VM 31 B	Diesel	2500	4	<b>11</b>
09/97→05/06	<b>156 1.9</b>	192 A5.000, 192 B1.000, 937 A2.000, 937 A4.000, 937 A5.000, AR 32302, AR 37101	Diesel	1910	4	<b>6</b>
09/97→05/06	<b>156 2.4</b>	839 A6.000, 841 C.000, 841 G.000, 841 M.000, 841 N.000, AR 32501	Diesel	2387	5	<b>6</b>
09/05→11/11	<b>159 2.4</b>	939 A3.000	Diesel	2387	5	<b>6</b>
06/87→09/98	<b>164 2.0</b>	AR 06416, AR 06420	Petrol	1962	4	<b>10</b>
10/87→09/98	<b>164 2.0</b>	AR 06476	Petrol	1995	4	<b>9</b>
11/87→09/98	<b>164 2.0</b>	AR 64103	Petrol	1995	4	<b>10</b>
06/87→09/98	<b>164 2.5</b>	VM 08 B, VM 32 B, VM 84 A	Diesel	2500	4	<b>11</b>
06/87→12/93	<b>164 3.0</b>	AR 06410, AR 06412, AR 64301	Petrol	2959	V6	<b>14</b>
09/98→06/07	<b>166 2.4</b>	839 A6.000, 841 C.000, 841 G.000, 841 M.000, 841 N.000, AR 34202	Diesel	2387	5	<b>6</b>
03/68→10/72	<b>1750-2000 1.8</b>	AR 00548	Petrol	1779	4	<b>5</b>
01/73→12/81	<b>2000 GT (USA only)</b>	116 (33)	Petrol	1962	4	<b>10</b>
01/73→12/81	<b>2000 Spider (USA only)</b>	116 (33)	Petrol	1962	4	<b>10</b>
01/73→12/81	<b>2000 Veloce (USA only)</b>	116 (33)	Petrol	1962	4	<b>10</b>
07/74→12/84	<b>Alfetta 1.8</b>	AR 01608, AR 01608 X, AR 01678	Petrol	1779	4	<b>5</b>
09/74→12/84	<b>Alfetta 2.0</b>	AR 01623, AR 01655, AR 01713	Petrol	1962	4	<b>10</b>
04/83→12/84	<b>Alfetta 2.4</b>	VM 4HT 2.4	Diesel	2393	4	<b>11</b>
01/74→12/76	<b>Alfetta GT 1.8</b>	AR 01608, AR 01608 X	Petrol	1779	4	<b>5</b>
06/77→01/86	<b>Alfetta GT 2.0</b>	AR 01623, AR 01655	Petrol	1962	4	<b>10</b>
04/85→12/89	<b>AR 6 1.9</b>	160 D100	Diesel	1929	4	<b>7</b>
04/85→02/86	<b>AR 6 2.4</b>	8144.61.200	Diesel	2445	4	<b>13</b>
09/86→12/89	<b>AR 6 2.4</b>	8144.21.220	Diesel	2445	4	<b>12</b>
03/86→12/89	<b>AR 6 2.5</b>	8144.67.220	Diesel	2500	4	<b>13</b>
	<b>AR 8</b>	8140.27R.2700, 8140.27S.2700	Diesel	2499	4	<b>12</b>
04/78→08/86	<b>AR 8 2.4</b>	8140.61.200	Diesel	2445	4	<b>13</b>
04/85→12/89	<b>AR 8 2.4</b>	8140.21.200 D.I.	Diesel	2445	4	<b>12</b>
09/86→12/89	<b>AR 8 2.5</b>	8144.67.220	Diesel	2500	4	<b>13</b>
01/78→12/79	<b>AR 8 Furgone</b>	8144.61	Diesel	2445	4	<b>13</b>
09/68→12/72	<b>Berlina 1.8</b>	AR 00548, AR 01608	Petrol	1779	4	<b>5</b>
01/06→	<b>Brera 2.4</b>	939 A3.000	Diesel	2387	5	<b>6</b>
01/74→12/78	<b>Giulia 1.3</b>	AR 00530	Petrol	1290	4	<b>2</b>
06/76→12/78	<b>Giulia 1.8</b>	4.108	Diesel	1760	4	<b>4</b>
04/79→07/85	<b>Giulietta 1.8</b>	AR 01678	Petrol	1779	4	<b>5</b>
06/80→04/85	<b>Giulietta 2.0</b>	AR 01655, AR 11671	Petrol	1962	4	<b>10</b>
01/66→12/77	<b>GT 1.3</b>	AR 00530	Petrol	1290	4	<b>2</b>
01/67→12/72	<b>GT 1.8</b>	AR 00548	Petrol	1779	4	<b>5</b>
11/03→09/10	<b>GT 1.9</b>	937 A5.000	Diesel	1910	4	<b>6</b>
07/78→01/86	<b>GTV 2.0</b>	AR 01655, AR 06212	Petrol	1962	4	<b>10</b>
09/08→	<b>Mito 1.3</b>	199 A3.000	Diesel	1248	4	<b>1</b>

Modelverzeichnis • Index de modele • Índice de Modelo  
Indeks modelu • Модель автомобиля • دليل المركبة

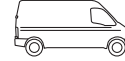

# MODEL INDEX



CCM

x



01/68→12/77	<b>Spider 1.3</b>	AR 00530	Petrol	1290	4	<b>2</b>
01/67→12/71	<b>Spider 1.8</b>	AR 00548	Petrol	1779	4	<b>5</b>
01/71→12/93	<b>Spider 2.0</b>	AR 00512, AR 01544, AR 01588	Petrol	1962	4	<b>10</b>
04/07→	<b>Spider 2.4</b>	939 A3.000	Diesel	2387	5	<b>6</b>
09/77→12/79	<b>Sport 2.0</b>	AR 01623	Petrol	1962	4	<b>10</b>

# ENGINE INDEX

Motorverzeichnis • Index de moteur • Índice de Motor  
Indeks silnika • Модель двигателя • دليل المحرك



CCM



9

116 (33)	Petrol	1962	4	84.00	10
160 D100	Diesel	1929	4	82.60	7
192 A5.000	Diesel	1910	4	82.00	6
192 B1.000	Diesel	1910	4	82.00	6
199 A3.000	Diesel	1248	4	69.60	1
4.108	Diesel	1760	4	79.38	4
8140.21.200 D.I.	Diesel	2445	4	93.00	12
8140.27R.2700	Diesel	2499	4	93.00	12
8140.27S.2700	Diesel	2499	4	93.00	12
8140.61.200	Diesel	2445	4	93.00	14
8144.21.220	Diesel	2445	4	93.00	12
8144.61	Diesel	2445	4	93.00	13
8144.61.200	Diesel	2445	4	93.00	13
8144.67.220	Diesel	2500	4	93.00	14
839 A6.000	Diesel	2387	5	82.00	6
841 C.000	Diesel	2387	5	82.00	6
841 G.000	Diesel	2387	5	82.00	6
841 M.000	Diesel	2387	5	82.00	6
841 N.000	Diesel	2387	5	82.00	6
937 A2.000	Diesel	1910	4	82.00	6
937 A4.000	Diesel	1910	4	82.00	6
937 A5.000	Diesel	1910	4	82.00	6
939 A3.000	Diesel	2387	5	82.00	6
AR 00512	Petrol	1962	4	84.00	10
AR 00530	Petrol	1290	4	74.00	2
AR 00548	Petrol	1779	4	80.00	5
AR 01544	Petrol	1962	4	84.00	10
AR 01588	Petrol	1962	4	84.00	10
AR 01608	Petrol	1779	4	80.00	5
AR 01608 X	Petrol	1779	4	80.00	5
AR 01623	Petrol	1962	4	84.00	10
AR 01655	Petrol	1962	4	84.00	10
AR 01678	Petrol	1779	4	80.00	5
AR 01713	Petrol	1962	4	84.00	10
AR 06166	Petrol	1962	4	84.00	10
AR 06168	Petrol	1779	4	80.00	5
AR 06202	Petrol	1779	4	80.00	5
AR 06212	Petrol	1962	4	84.00	10
AR 06224	Petrol	1962	4	84.00	10
AR 06410	Petrol	2959	V6	93.00	15
AR 06412	Petrol	2959	V6	93.00	15
AR 06416	Petrol	1962	4	84.00	10
AR 06420	Petrol	1962	4	84.00	10
AR 06476	Petrol	1995	4	84.00	9
AR 10512	Petrol	1962	4	84.00	10
AR 11633	Petrol	1962	4	84.00	10
AR 11671	Petrol	1962	4	84.00	10
AR 19510	Petrol	1962	4	84.00	10
AR 32302	Diesel	1910	4	82.00	6
AR 32501	Diesel	2387	5	82.00	6
AR 33601	Diesel	1929	4	82.60	7
AR 34202	Diesel	2387	5	82.00	6
AR 36202	Diesel	2387	5	82.00	6
AR 37101	Diesel	1910	4	82.00	6
AR 61101	Petrol	1567	4	78.00	3
AR 61102	Petrol	1779	4	80.00	5
AR 61201	Petrol	1779	4	80.00	5
AR 64103	Petrol	1995	4	84.00	10
AR 64301	Petrol	2959	V6	93.00	15
AR 67201	Petrol	1995	4	84.00	10



Motorverzeichnis • Index de moteur • Índice de Motor  
Indeks silnika • Модель двигателя • دليل المحرك

## ENGINE INDEX



CCM

x



9

AR 67202	Petrol	1970	4	83.00	<b>8</b>
AR 67203	Petrol	1995	4	84.00	<b>9</b>
AR 67501	Diesel	1929	4	82.60	<b>7</b>
AR 67502	Diesel	1929	4	82.60	<b>7</b>
VM 07 B	Diesel	2500	4	92.00	<b>11</b>
VM 08 B	Diesel	2500	4	92.00	<b>11</b>
VM 31 B	Diesel	2500	4	92.00	<b>11</b>
VM 32 B	Diesel	2500	4	92.00	<b>11</b>
VM 4HT 2.4	Diesel	2393	4	92.00	<b>11</b>
VM 81 A	Diesel	2393	4	92.00	<b>11</b>
VM 82 A	Diesel	1779	3	92.00	<b>11</b>
VM 84 A	Diesel	2500	4	92.00	<b>11</b>
VM 96 A	Diesel	1779	3	92.00	<b>11</b>



1

199 A3.000 4cyl. 1248cc 66kW (89PS) Diesel Turbo Intercooled TD23450

14-022060-00 D 69.60 B 72.50 C 142.00 D 74.00 E 5.00

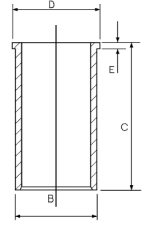

2

AR 00530 4cyl. 1290cc 64-65kW (87-89PS) TD23

15-632500-00 1 74.00 B 80.50 C 139.00 D 90.00 E 89.20

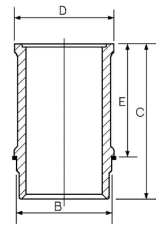

1 Includes seals

1 Schließt Dichtungen ein

1 Inclut des joints

1 Incluye los sellos

3

AR 61101 4cyl. 1567cc 81kW (110PS) TD102

15-632100-00 WH 1 78.00 B 84.00 C 150.00 D 94.00 E 95.50

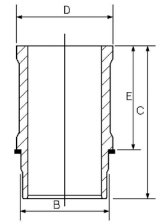

1 Includes seals

1 Schließt Dichtungen ein

1 Inclut des joints

1 Incluye los sellos

4

4.108 4cyl. 1760cc 38kW (52PS) Diesel TD141

14-010900-00 D 79.38 B 82.63 C 165.10

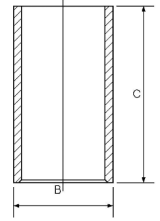



5

AR 00548	4cyl.	1779cc	83-97kW (113-132PS)							TD18
AR 01608	4cyl.	1779cc	89kW (121PS)							TD5340
AR 01608 X	4cyl.	1779cc	85kW (116PS)							TD33
AR 01678	4cyl.	1779cc	90kW (122PS)							TD38
AR 06168	4cyl.	1779cc	88kW (120PS)							TD54
AR 06202	4cyl.	1779cc	85kW (116PS)							TD55
AR 61102	4cyl.	1779cc	88kW (120PS)							TD10149
AR 61201	4cyl.	1779cc	90kW (122PS)							TD103

15-632600-00 *WH* <sup>1</sup> 80.00 B 85.00 C 152.00 D 98.00 E 107.50

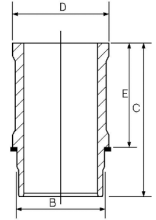

<sup>1</sup> Includes seals

<sup>1</sup> Schließt Dichtungen ein

<sup>1</sup> Inclut des joints

<sup>1</sup> Incluye los sellos

6

192 A5.000 Euro 3	4cyl.	1910cc	103kW (140PS)	Diesel	Turbo Intercooled					TD17981
192 B1.000	4cyl.	1910cc	100kW (136PS)	Diesel	Turbo Intercooled					TD19061
839 A6.000 Euro 3	5cyl.	2387cc	103kW (140PS)	Diesel	Turbo Intercooled					TD18819
841 C.000 Euro 3	5cyl.	2387cc	100-110kW (136-150PS)	Diesel	Turbo Intercooled					TD16383
841 G.000 Euro 3	5cyl.	2387cc	129kW (175PS)	Diesel	Turbo Intercooled					TD18292
841 M.000	5cyl.	2387cc	120-147kW (163-200PS)	Diesel	Turbo Intercooled					TD20934
841 N.000	5cyl.	2387cc	120-147kW (163-200PS)	Diesel	Turbo Intercooled					TD22510
937 A2.000 Euro 3	4cyl.	1910cc	85kW (116PS)	Diesel	Turbo Intercooled					TD16382
937 A4.000 Euro 3	4cyl.	1910cc	103kW (140PS)	Diesel	Turbo Intercooled					TD18844
937 A5.000	4cyl.	1910cc	110kW (150PS)	Diesel	Turbo Intercooled					TD18078
939 A3.000 Euro 4	5cyl.	2387cc	147kW (200PS)	Diesel	Turbo Intercooled					TD18474
AR 32302 Euro 2	4cyl.	1910cc	77kW (105PS)	Diesel	Turbo Intercooled					TD9769
AR 32501 Euro 2	5cyl.	2387cc	100kW (136PS)	Diesel	Turbo Intercooled					TD9770
AR 34202 Euro 2	5cyl.	2387cc	100kW (136PS)	Diesel	Turbo Intercooled					TD11604
AR 36202 Euro 3	5cyl.	2387cc	100-110kW (136-150PS)	Diesel	Turbo Intercooled					TD15636
AR 37101 Euro 3	4cyl.	1910cc	73-103kW (100-140PS)	Diesel	Turbo Intercooled					TD15510

14-021051-00 *D* 82.00 B 85.57 C 155.00 D 88.53 E 4.00  
 14-028960-00 *D* B 85.00 C 155.00 D 88.00 E 4.50

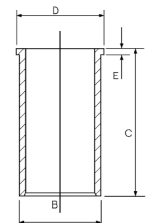





7

160 D100	4cyl.	1929cc	66-68kW (90-92PS)	Diesel	Turbo Intercooled	TD10307
AR 33601	4cyl.	1929cc	66-68kW (90-92PS)	Diesel	Turbo Intercooled	TD5069
AR 67501	4cyl.	1929cc	66-68kW (90-92PS)	Diesel	Turbo Intercooled	TD140
AR 67502	4cyl.	1929cc	66-68kW (90-92PS)	Diesel	Turbo Intercooled	TD21140

14-021311-00 D	82.60	B 86.06	C 154.00	D 89.00	E 4.50
14-023560-00 D		B 86.00	C 154.00	D 89.00	E 4.50
14-023751-00 D		B 87.00	C 154.00	D 89.00	E 4.55

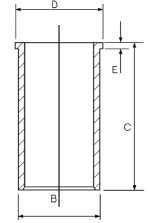

14-014730-00 D	82.60	B 86.09	C 154.00
----------------	-------	---------	----------

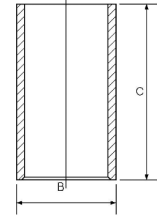

8

AR 67202	4cyl.	1970cc	110kW (150PS)			TD137
----------	-------	--------	---------------	--	--	-------

15-632000-00 WH 1	83.00	B 89.00	C 152.00	D 98.00	E 107.50
-------------------	-------	---------	----------	---------	----------

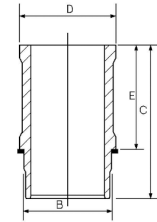

1 Includes seals

1 Schließt Dichtungen ein

1 Inclut des joints

1 Incluye los sellos

9

AR 06476	4cyl.	1995cc	128-129kW (174-175PS)	Turbo Intercooled	TD65
AR 67203	4cyl.	1995cc	137-140kW (186-190PS)	Turbo Intercooled	TD138

14-011041-00 D	84.00	B 88.06	C 152.00
----------------	-------	---------	----------

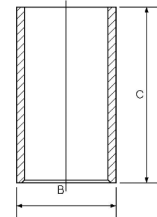



10

116 (33)	4cyl.	1962cc	94kW (128PS)			FM3549
AR 00512	4cyl.	1962cc	96kW (131PS)			TD75
AR 01544	4cyl.	1962cc	94kW (128PS)			TD28
AR 01588	4cyl.	1962cc	88kW (120PS)			TD30
AR 01623	4cyl.	1962cc	94kW (128PS)			TD34
AR 01655	4cyl.	1962cc	94kW (128PS)			TD37
AR 01713	4cyl.	1962cc	94kW (128PS)			TD41
AR 06166	4cyl.	1962cc	107kW (146PS)			TD53
AR 06212	4cyl.	1962cc	94kW (128PS)			TD57
AR 06224	4cyl.	1962cc	107-109kW (146-148PS)			TD58
AR 06416	4cyl.	1962cc	107kW (146PS)			TD62
AR 06420	4cyl.	1962cc	107kW (146PS)			TD63
AR 10512	4cyl.	1962cc	96kW (131PS)			TD5351
AR 11633	4cyl.	1962cc	82-96kW (112-131PS)			TD22398
AR 11671	4cyl.	1962cc	94kW (128PS)			TD70
AR 19510	4cyl.	1962cc	104-109kW (142-148PS)			TD23344
AR 64103	4cyl.	1995cc	107kW (146PS)			TD129
AR 67201	4cyl.	1995cc	107kW (146PS)			TD136

15-632000-00 WH  84.00 B 89.00 C 152.00 D 98.00 E 107.50

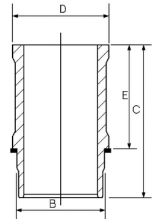

Includes seals

Schließt Dichtungen ein

Inclut des joints

Incluye los sellos

11

VM 4HT 2.4	4cyl.	2393cc	81kW (110PS)	Diesel	Turbo	TD159
VM 07 B	4cyl.	2500cc	92kW (125PS)	Diesel	Turbo	TD149
VM 08 B	4cyl.	2500cc	92kW (125PS)	Diesel	Turbo	TD9771
VM 31 B	4cyl.	2500cc	92kW (125PS)	Diesel	Turbo	TD9768
VM 32 B	4cyl.	2500cc	92kW (125PS)	Diesel	Turbo	TD127
VM 81 A	4cyl.	2393cc	81kW (110PS)	Diesel	Turbo	TD152
VM 82 A	3cyl.	1779cc	53kW (72PS)	Diesel	Turbo	TD153
VM 84 A	4cyl.	2500cc	85kW (116PS)	Diesel	Turbo	TD154
VM 96 A	3cyl.	1779cc	53kW (72PS)	Diesel	Turbo	TD155

14-676420-00 WH 92.00 B 101.50 C 166.80 D 110.00 E 8.90 F 1.20

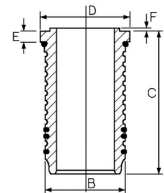



12

8140.27R.2700	4cyl.	2499cc		Diesel	Turbo	FM9102
8140.27S.2700	4cyl.	2499cc		Diesel	Turbo	FM9102
8140.21.200 D.I.	4cyl.	2445cc	68kW (92PS)	Diesel	Turbo	TD143
8144.21.220	4cyl.	2445cc	68kW (92PS)	Diesel	Turbo	TD145

14-021371-00 D	93.00	B 96.01	C 171.00	D 98.92	E 5.00
14-021372-00 D		B 96.05	C 171.00	D 98.92	E 5.00
14-021373-00 D		B 96.17	C 171.00	D 98.92	E 5.00
14-021480-00 DH 1		B 97.035	C 171.00	D 100.00	E 5.00

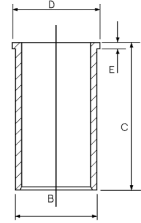

1 Nitrided      1 Nitriert      1 Nitruré      1 Nitrurado

13

8140.61.200	4cyl.	2445cc	53kW (72PS)	Diesel		TD144
8144.61	4cyl.	2445cc	53kW (72PS)	Diesel		FM566
8144.61.200	4cyl.	2445cc	53kW (72PS)	Diesel		TD146
8144.67.220	4cyl.	2500cc	55kW (75PS)	Diesel	Turbo	TD147

14-022560-00 D	93.00	B 96.00	C 167.30	D 98.90	E 5.00
14-028930-00 D		B 97.50	C 167.00	D 100.90	E 5.00
14-028931-00 D		B 97.58	C 167.00	D 100.90	E 5.00
14-028932-00 D		B 97.70	C 167.00	D 100.90	E 5.00

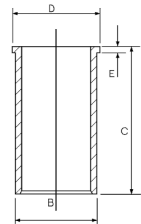

14

AR 06410	V6cyl.	2959cc	147kW (200PS)			TD59
AR 06412	V6cyl.	2959cc	147kW (200PS)			TD61
AR 64301	V6cyl.	2959cc	147kW (200PS)			TD106

15-632400-00 1	93.00	B 99.00	C 119.00	D 109.00	E 78.00
----------------	-------	---------	----------	----------	---------

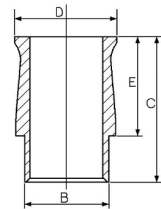

1 Includes seals      1 Schließt Dichtungen ein      1 Inclut des joints      1 Incluye los sellos



Modelverzeichnis • Index de modele • Índice de Modelo  
Indeks modelu • Модель автомобиля • دليل الموديل

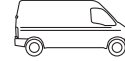

# MODEL INDEX



CCM

x



06/80→11/86	<b>10 1.3</b>	810-02	Petrol	1289	4	<b>1</b>
06/84→10/99	<b>10 1.4</b>	1.4 (C2J)	Petrol	1397	4	<b>3</b>
09/86→10/99	<b>10 1.6</b>	F8M 700	Diesel	1596	4	<b>4</b>
01/83→12/98	<b>240-244 2.5</b>	XD3P	Diesel	2498	4	<b>6</b>
01/99→10/06	<b>Spartana 1.2</b>	C3G 702	Petrol	1239	4	<b>2</b>



1

<b>1.3L</b>	4cyl.	<b>1289cc</b>	<b>40kW (54PS)</b>	<b>FM1486</b>
<b>810/25/26/29/03</b>	4cyl.	<b>1289cc</b>		<b>FM1486</b>
<b>810-02</b>	4cyl.	<b>1289cc</b>	<b>37-40kW (50-54PS)</b>	<b>TD24105</b>

<b>14-630440-00 WH</b>	<b>73.00</b>	<b>B 78.50</b>	<b>C 134.00</b>	<b>D 88.00</b>	<b>E 95.00</b>
<b>15-636590-00 WH</b>		<b>B 78.50</b>	<b>C 134.00</b>	<b>D 87.70</b>	<b>E 95.00</b>

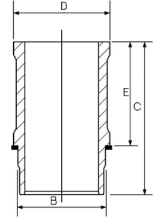

Includes seals      Schließt Dichtungen ein      Inclut des joints      Incluye los sellos

2

<b>C3G 702</b>	4cyl.	<b>1239cc</b>	<b>40kW (54PS)</b>	<b>TD12390</b>
----------------	-------	---------------	--------------------	----------------

<b>14-630120-00 WH</b>	<b>74.00</b>	<b>B 78.60</b>	<b>C 135.00</b>	<b>D 88.20</b>	<b>E 94.90</b>
------------------------	--------------	----------------	-----------------	----------------	----------------

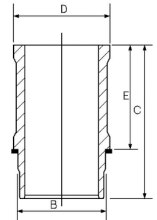

3

<b>1.4 (C2J)</b>	4cyl.	<b>1397cc</b>	<b>46-49kW (62-67PS)</b>	<b>TD201</b>
------------------	-------	---------------	--------------------------	--------------

<b>15-630820-00 WH</b>	<b>76.00</b>	<b>B 80.60</b>	<b>C 134.00</b>	<b>D 90.20</b>	<b>E 95.00</b>
------------------------	--------------	----------------	-----------------	----------------	----------------

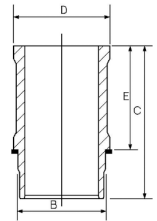

Includes seals      Schließt Dichtungen ein      Inclut des joints      Incluye los sellos

4

<b>F8M 700</b>	4cyl.	<b>1596cc</b>	<b>40kW (55PS)</b>	<b>Diesel</b>	<b>TD21933</b>
----------------	-------	---------------	--------------------	---------------	----------------

<b>14-023730-00 D</b>	<b>78.00</b>	<b>B 149.00</b>	<b>C 83.50</b>	<b>D 4.50</b>
-----------------------	--------------	-----------------	----------------	---------------

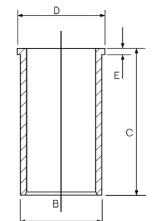



5

<b>XD4.90</b>	4cyl.	<b>2112cc</b>		<b>Diesel</b>	<b>FM1425</b>
<b>XDP4-90</b>	4cyl.	<b>2112cc</b>	<b>42-48kW (57-65PS)</b>	<b>Diesel</b>	<b>FM1425</b>
<b>XDP90</b>	4cyl.	<b>2112cc</b>		<b>Diesel</b>	<b>FM1425</b>

14-604060-00 <i>WH</i>	<b>90.00</b>	<b>B 96.00</b>	<b>C 173.00</b>	<b>D 106.30</b>	<b>E 129.00</b>
------------------------	--------------	----------------	-----------------	-----------------	-----------------

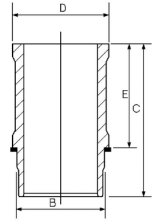

6

<b>XD3P</b>	4cyl.	<b>2498cc</b>	<b>52-55kW (71-75PS)</b>	<b>Diesel</b>	<b>TD202</b>
14-020660-00 <i>D</i>	<b>94.00</b>	<b>B 97.00</b>	<b>C 170.60</b>	<b>D 99.50</b>	<b>E 4.00</b>
14-021520-00 <i>D</i>		<b>B 98.00</b>	<b>C 170.60</b>	<b>D 100.00</b>	<b>E 6.00</b>
14-027270-00 <i>D</i>		<b>B 98.70</b>	<b>C 170.00</b>	<b>D 100.00</b>	<b>E 5.00</b>

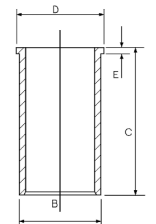

# MODEL INDEX



Modelverzeichnis • Index de modele • Índice de Modelo  
Indeks modelu • Модель автомобиля • دليل الموديل



CCM

x



9

05/72→07/76	<b>80 1.5</b>	YJ, ZB, ZC	Petrol	1471	4	<b>2</b>
08/80→08/91	<b>80 1.6</b>	CR, CY, JK, RA, SB	Diesel	1588	4	<b>1</b>
08/89→01/96	<b>80 1.9</b>	1Y, 1Z, AAZ	Diesel	1896	4	<b>3</b>
10/85→09/91	<b>90 1.6</b>	CY, RA, SB	Diesel	1588	4	<b>1</b>
08/78→11/90	<b>100 2.0</b>	CN, DE, NC	Diesel	1986	5	<b>1</b>
08/89→06/94	<b>100 2.4</b>	3D, AAS	Diesel	2370	5	<b>3</b>
02/00→08/05	<b>A2 1.4</b>	AMF, ATL, BHC	Diesel	1422	3	<b>3</b>
09/96→05/10	<b>A3 1.9</b>	AGR, AHF, ALH, ASV, ASZ, ATD, AXR, BKC, BLS, BXE	Diesel	1896	4	<b>3</b>
01/95→06/08	<b>A4 1.9</b>	1Z, AFF, AFN, AHH, AHU, AJM, ATJ, AVB, AVF, AVG, AWX, BKE	Diesel	1896	4	<b>3</b>
06/94→01/05	<b>A6 1.9</b>	1Z, AFN, AHU, AJM, AVF, AVG, AWX	Diesel	1896	4	<b>3</b>
06/95→08/00	<b>Cabriolet 1.9</b>	1Z, AHU	Diesel	1896	4	<b>3</b>

# ENGINE INDEX

Motorverzeichnis • Index de moteur • Índice de Motor  
Indeks silnika • Модель двигателя • دليل المحرك



CCM

x



9

1Y	Diesel	1896	4	79.50	<b>3</b>
1Z	Diesel	1896	4	79.50	<b>3</b>
3D	Diesel	2370	5	79.50	<b>3</b>
AAS	Diesel	2370	5	79.50	<b>3</b>
AAZ	Diesel	1896	4	79.50	<b>3</b>
ADE	Diesel	1896	4	79.50	<b>3</b>
AFF	Diesel	1896	4	79.50	<b>3</b>
AFN	Diesel	1896	4	79.50	<b>3</b>
AGR	Diesel	1896	4	79.50	<b>3</b>
AHF	Diesel	1896	4	79.50	<b>3</b>
AHH	Diesel	1896	4	79.50	<b>3</b>
AHU	Diesel	1896	4	79.50	<b>3</b>
AJM	Diesel	1896	4	79.50	<b>3</b>
ALH	Diesel	1896	4	79.50	<b>3</b>
AMF	Diesel	1422	3	79.50	<b>3</b>
ANU	Diesel	1896	4	79.50	<b>3</b>
ASV	Diesel	1896	4	79.50	<b>3</b>
ASZ	Diesel	1896	4	79.50	<b>3</b>
ATD	Diesel	1896	4	79.50	<b>3</b>
ATJ	Diesel	1896	4	79.50	<b>3</b>
ATL	Diesel	1422	3	79.50	<b>3</b>
AVB	Diesel	1896	4	79.50	<b>3</b>
AVF	Diesel	1896	4	79.50	<b>3</b>
AVG	Diesel	1896	4	79.50	<b>3</b>
AWX	Diesel	1896	4	79.50	<b>3</b>
AXR	Diesel	1896	4	79.50	<b>3</b>
BHC	Diesel	1422	3	79.50	<b>3</b>
BKC	Diesel	1896	4	79.50	<b>3</b>
BKE	Diesel	1896	4	79.50	<b>3</b>
BLS	Diesel	1896	4	79.50	<b>3</b>
BXE	Diesel	1896	4	79.50	<b>3</b>
CN	Diesel	1986	5	76.50	<b>1</b>
CR	Diesel	1588	4	76.50	<b>1</b>
CY	Diesel	1588	4	76.50	<b>1</b>
DE	Diesel	1986	5	76.50	<b>1</b>
JK	Diesel	1588	4	76.50	<b>1</b>
JKA	Diesel	1588	4	76.50	<b>1</b>
NC	Diesel	1986	5	76.50	<b>1</b>
RA	Diesel	1588	4	76.50	<b>1</b>
SB	Diesel	1588	4	76.50	<b>1</b>
YJ	Petrol	1471	4	76.50	<b>2</b>
ZB	Petrol	1471	4	76.50	<b>2</b>
ZC	Petrol	1471	4	76.50	<b>2</b>



1

CN	5cyl.	1986cc	51kW (69PS)	Diesel	TD247
CR	4cyl.	1588cc	40kW (54PS)	Diesel	TD248
CY	4cyl.	1588cc	51kW (69PS)	Diesel Turbo Intercooled	TD4205
DE	5cyl.	1986cc	64kW (87PS)	Diesel Turbo Intercooled	TD251
JK	4cyl.	1588cc	40kW (54PS)	Diesel	TD269
JKA	4cyl.	1588cc	37-40kW (50-54PS)	Diesel	TD270
NC	5cyl.	1986cc	74kW (100PS)	Diesel Turbo Intercooled	TD299
RA	4cyl.	1588cc	59kW (80PS)	Diesel Turbo Intercooled	TD313
SB	4cyl.	1588cc	59kW (80PS)	Diesel Turbo Intercooled	TD4211

14-021571-00 D  
14-028360-00 D ①

76.50

B 79.56 C 142.00 D 82.50 E 4.50  
B 79.50 C 145.00 D 81.50 E 4.70

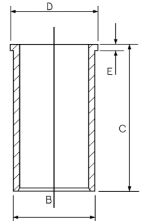

① With recesses on crankshaft side

① Mit kurbelwellenseitigen Aussparungen

① Avec évidements côté vilebrequin

① Con escotaduras en la cara del cigüeñal

2

YJ	4cyl.	1471cc	55kW (75PS)	TD4213
ZB	4cyl.	1471cc	55kW (75PS)	TD366
ZC	4cyl.	1471cc	63kW (86PS)	TD367

14-023470-00 D ②  
14-024670-00 D  
14-028360-00 D ①

76.50

B 79.50 C 142.00 D 82.50 E 4.70  
B 79.50 C 145.00 D 81.50 E 4.70  
B 79.50 C 145.00 D 81.50 E 4.70

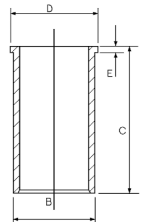

① With recesses on crankshaft side

① Mit kurbelwellenseitigen Aussparungen

① Avec évidements côté vilebrequin

① Con escotaduras en la cara del cigüeñal

② Phosphated

② Phosphatiert

② Phosphatisé

② Fosfatada

3

1Y	4cyl.	1896cc	47kW (64PS)	Diesel	TD213
1Z	4cyl.	1896cc	66kW (89PS)	Diesel Turbo Intercooled	TD214
3D	5cyl.	2370cc	60kW (81PS)	Diesel	TD218
AAS	5cyl.	2370cc	60kW (81PS)	Diesel	TD227
AAZ	4cyl.	1896cc	55kW (75PS)	Diesel Turbo	TD229
ADE	4cyl.	1896cc	55kW (75PS)	Diesel Turbo	TD22656
AFF	4cyl.	1896cc	55kW (75PS)	Diesel Turbo Intercooled	TD11597
AFN	4cyl.	1896cc	81kW (110PS)	Diesel Turbo Intercooled	TD4202
AGR	4cyl.	1896cc	66kW (89PS)	Diesel Turbo Intercooled	TD5076
AHF	4cyl.	1896cc	81kW (110PS)	Diesel Turbo Intercooled	TD9371
AHH	4cyl.	1896cc	66kW (89PS)	Diesel Turbo Intercooled	TD16413
AHU	4cyl.	1896cc	66kW (89PS)	Diesel Turbo Intercooled	TD10814
AJM	4cyl.	1896cc	85kW (116PS)	Diesel Turbo Intercooled	TD11527
ALH	4cyl.	1896cc	66kW (89PS)	Diesel Turbo Intercooled	TD11595
AMF	3cyl.	1422cc	55kW (75PS)	Diesel Turbo Intercooled	TD17156





ANU	4cyl.	1896cc	66kW (89PS)	Diesel	Turbo Intercooled	TD11596
ASV	4cyl.	1896cc	81kW (110PS)	Diesel	Turbo Intercooled	TD15354
ASZ	4cyl.	1896cc	96kW (131PS)	Diesel	Turbo Intercooled	TD15351
ATD	4cyl.	1896cc	74kW (100PS)	Diesel	Turbo Intercooled	TD16028
ATJ	4cyl.	1896cc	85kW (116PS)	Diesel	Turbo Intercooled	TD15989
ATL	3cyl.	1422cc	66kW (89PS)	Diesel	Turbo Intercooled	TD17071
AVB	4cyl.	1896cc	74kW (100PS)	Diesel	Turbo Intercooled	TD16518
AVF	4cyl.	1896cc	96kW (131PS)	Diesel	Turbo Intercooled	TD15348
AVG	4cyl.	1896cc	81kW (110PS)	Diesel	Turbo Intercooled	TD13774
AWX	4cyl.	1896cc	96kW (131PS)	Diesel	Turbo Intercooled	TD16133
AXR	4cyl.	1896cc	74kW (100PS)	Diesel	Turbo Intercooled	TD16416
BHC	3cyl.	1422cc	55kW (75PS)	Diesel	Turbo Intercooled	TD18133
BKC	4cyl.	1896cc	77kW (105PS)	Diesel	Turbo Intercooled	TD17026
BKE	4cyl.	1896cc	85kW (116PS)	Diesel	Turbo Intercooled	TD17596
BLS	4cyl.	1896cc	77kW (105PS)	Diesel	Turbo Intercooled	TD20823
BXE	4cyl.	1896cc	77kW (105PS)	Diesel	Turbo Intercooled	TD22657

14-027950-00 D

79.50

B 82.50

C 152.00

D 85.50

E 4.70

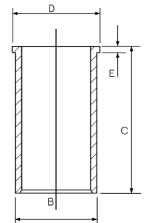

Modelverzeichnis • Index de modele • Índice de Modelo  
Indeks modelu • Модель автомобиля • دليل المركبات

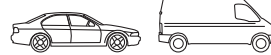

# MODEL INDEX



CCM

x



9

01/67→12/73	<b>1275 GT</b>	A Series	Petrol	1275	4	<b>1</b>
01/67→12/73	<b>1300 GT</b>	A Series	Petrol	1275	4	<b>1</b>
05/73→12/84	<b>Allegro 1.3</b>	A Series (12 H), A Series (12 L)	Petrol	1275	4	<b>1</b>
09/67→12/72	<b>America 1.3</b>	A Series (12 H)	Petrol	1275	4	<b>1</b>
01/60→12/68	<b>Gypsy Series 2 1- ton FG/K 1.5</b>	22 UA	Diesel	2178	4	<b>2</b>
01/60→12/68	<b>Gypsy Series 2 1- ton G4 1.5</b>	22 UA	Diesel	2178	4	<b>2</b>
01/60→12/68	<b>Gypsy Series 2 1- ton LD/M 1.5</b>	22 UA	Diesel	2178	4	<b>2</b>
01/60→12/68	<b>Gypsy Series 2 1- ton WE 1.5</b>	22 UA	Diesel	2178	4	<b>2</b>
01/60→12/68	<b>Gypsy Series 2 1- ton WF/K 1.5</b>	22 UA	Diesel	2178	4	<b>2</b>
03/83→09/92	<b>Maestro 1.3</b>	A+ Series (12 H999), A+ Series (12 HC), A+ Series (12 HE), A Series (12 H)	Petrol	1275	4	<b>1</b>
10/80→04/90	<b>Metro 1.3</b>	12 HA85AA, A+ Series (12 H), A+ Series (12 H996), A+ Series (12 HA), A+ Series (12 HL), A Series (12 H)	Petrol	1275	4	<b>1</b>
01/82→12/88	<b>Metro Vanden Plas 1.3</b>	A+ Series	Petrol	1275	4	<b>1</b>
01/83→	<b>Metropolitan Taxi</b>	19 J	Diesel	2495	4	<b>3</b>
09/69→	<b>Mini 1.3</b>	A+ Series, A Series (12 H)	Petrol	1275	4	<b>1</b>
01/90→	<b>Mini Cooper</b>	A+ Series	Petrol	1275	4	<b>1</b>
01/64→12/71	<b>Mini Cooper S</b>	A Series	Petrol	1275	4	<b>1</b>
04/84→10/88	<b>Montego 1.3</b>	A+ Series (12 HL)	Petrol	1275	4	<b>1</b>
01/55→12/71	<b>Taxicab FX3D</b>	22 UA	Diesel	2178	4	<b>2</b>
01/55→12/71	<b>Taxicab FX4</b>	22 UA	Diesel	2178	4	<b>2</b>





1

12 HA85AA	4cyl.	1275cc	66kW (89PS)	Turbo	TD5469
A+ SERIES	4cyl.	1275cc	46kW (63PS)		FM2934
A+ SERIES (12 H)	4cyl.	1275cc	44kW (60PS)		TD5470
A+ SERIES (12 H996)	4cyl.	1275cc	52kW (71PS)		TD13429
A+ SERIES (12 H999)	4cyl.	1275cc	46kW (63PS)		TD5458
A+ SERIES (12 HA)	4cyl.	1275cc	51kW (69PS)		TD5468
A+ SERIES (12 HC)	4cyl.	1275cc	46kW (63PS)		TD5459
A+ SERIES (12 HE)	4cyl.	1275cc	50kW (68PS)		TD22435
A+ SERIES (12 HL)	4cyl.	1275cc	46kW (63PS)		TD16446
A SERIES	4cyl.	1275cc			FM85
A SERIES (12 H)	4cyl.	1275cc	40-49kW (54-67PS)		TD381
A SERIES (12 H)	4cyl.	1275cc	53kW (72PS)		TD22493
A SERIES (12 L)	4cyl.	1275cc	43kW (58PS)		TD22494

14-010890-00 D 70.62 B 73.09 C 141.28

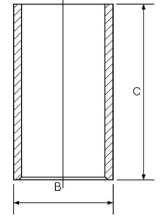

2

22 UA	4cyl.	2178cc	Diesel	FM101
-------	-------	--------	--------	-------

14-021130-00 D 82.55 B 86.59 C 193.68 D 89.61 E 4.70

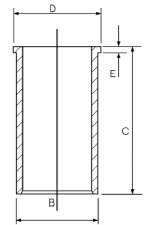

3

19 J	4cyl.	2495cc	Diesel Turbo Indirect Injection	FM3829
------	-------	--------	---------------------------------	--------

14-024710-00 D 90.47 B 94.52 C 191.36 D 99.70 E 4.76

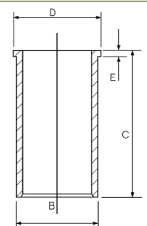

14-010920-00 D 90.47 B 94.50 C 191.36

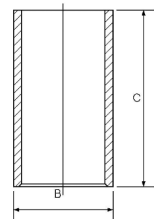

Modelverzeichnis • Index de modele • Índice de Modelo  
 Indeks modelu • Модель автомобиля • دليل المركبات

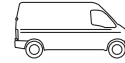

# MODEL INDEX



CCM

x



10/69→12/85	<b>A 112 0.9</b>	A112 A5.000, A112 B2.000	Petrol	903	4	<b>1</b>
03/85→10/95	<b>Y10 1.0</b>	156 A2.000, 156 A2.246, 156 A3.000	Petrol	999	4	<b>2</b>
06/89→10/95	<b>Y10 1.1</b>	156 C.000, 156 C.046	Petrol	1108	4	<b>2</b>



**1**

**A112 A5.000** 4cyl. **903cc** **34kW (46PS)** **TD5111**

**A112 B2.000** 4cyl. **903cc** **31kW (42PS)** **TD13430**

14-011001-00 *D* **65.00** **B 68.04** **C 115.00**

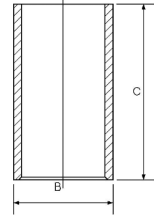

**2**

**156 A2.000** 4cyl. **999cc** **33kW (45PS)** **TD393**

**156 A2.100** 4cyl. **999cc** **31-33kW (42-45PS)** **TD394**

**156 A2.246** 4cyl. **999cc** **33kW (45PS)** **TD16210**

**156 A3.000** 4cyl. **999cc** **33kW (45PS)** **TD397**

**156 C.000** 4cyl. **1108cc** **37-41kW (50-56PS)** **TD398**

**156 C.046** 4cyl. **1108cc** **42kW (57PS)** **TD399**

14-010991-00 *D* **70.00** **B 73.02** **C 116.00**

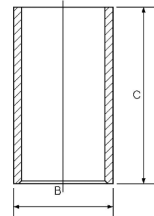

Modelverzeichnis • Index de modele • Índice de Modelo  
 Indeks modelu • Модель автомобиля • دليل المركبة

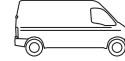

# MODEL INDEX



CCM

x



09/85→08/88	<b>Astramax 1.6</b>	16 D, 16 DA	Diesel	1598	4	<b>2</b>
07/82→08/89	<b>Astra Van 1.6</b>	16 D, 16 DA	Diesel	1598	4	<b>2</b>
09/81→10/87	<b>Blitz 2.1</b>	21D	Diesel	2068	4	<b>5</b>
01/73→10/87	<b>Blitz 2.3</b>	23D	Diesel	2260	4	<b>6</b>

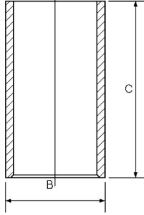

						<b>1</b>
<b>4.108</b>		4cyl.	<b>1760cc</b>		<b>Diesel</b>	<b>FM1346</b>
<b>14-010900-00 D</b>	<b>79.38</b>		<b>B 82.63</b>	<b>C 165.10</b>		

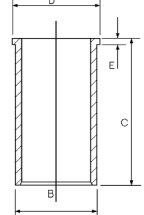
						<b>2</b>
<b>16 D</b>		4cyl.	<b>1598cc</b>	<b>39-40kW (53-54PS)</b>	<b>Diesel</b>	<b>TD412</b>
<b>16 DA</b>		4cyl.	<b>1598cc</b>	<b>40-42kW (54-57PS)</b>	<b>Diesel</b>	<b>TD26851</b>
<b>14-023520-00 D</b>	<b>80.00</b>		<b>B 83.00</b>	<b>C 143.50</b>	<b>D 84.90</b> <b>E 4.50</b>	

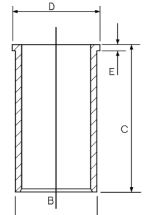
						<b>3</b>
<b>C 190</b>		4cyl.	<b>1952cc</b>	<b>34kW (46PS)</b>	<b>Diesel</b>	<b>FM883</b>
<b>14-021180-00 D</b>	<b>86.00</b>		<b>B 90.13</b>	<b>C 178.50</b>	<b>D 94.00</b> <b>E 4.00</b>	

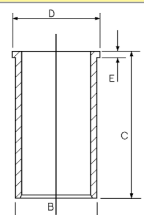
						<b>4</b>
<b>C 223</b>		4cyl.	<b>2238cc</b>	<b>39kW (53PS)</b>	<b>Diesel</b>	<b>TD22879</b>
<b>14-021190-00 D</b>	<b>88.00</b>		<b>B 92.13</b>	<b>C 163.50</b>	<b>D 95.00</b> <b>E 4.00</b>	
<b>14-021440-00 DH 1 2</b>			<b>B 89.97</b>	<b>C 163.32</b>	<b>D 94.89</b> <b>E 0.89</b>	

1 Not suitable for use with pistons having chrome rings

2 Chrome Bore

1 Nicht geeignet zur Verwendung mit Kolben mit Chromringen

2 Bohrung verchromte

1 Ne pas utiliser avec des pistons équipés de segments chromés

2 Alésage chromée

1 No es adecuada para usar con pistones que tengan aros de croma

2 Cromado de cilindro

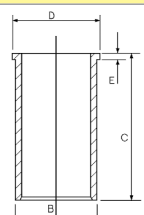
						<b>5</b>
<b>21D</b>		4cyl.	<b>2068cc</b>	<b>44kW (60PS)</b>	<b>Diesel</b>	<b>TD9935</b>
<b>14-024160-00 D</b>	<b>88.00</b>		<b>B 92.00</b>	<b>C 172.00</b>	<b>D 93.90</b> <b>E 4.55</b>	



**6**

**23D** 4cyl. **2260cc** **46-48kW (63-65PS)** **Diesel** **TD418**

**14-024100-00 D** **92.00** **B 95.00** **C 172.00** **D 97.00** **E 4.70**

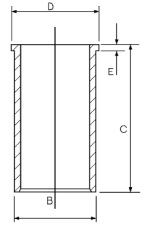

**7**

**220** 4cyl. **3614cc** **48-52kW (65-71PS)** **Diesel** **TD6483**

**330** 6cyl. **5420cc** **72-99kW (98-135PS)** **Diesel Turbo** **TD6485**

**14-021140-00 D** **103.19** **B 108.05** **C 216.15** **D 111.04** **E 4.76**

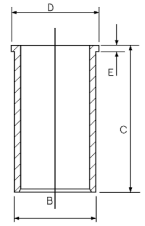

① Push fit cast iron liner to replace original steel liner

① Ausdrückbare Laufbüchse aus Gueisen als Ersatz der original Stahlbüchse

① Chemise fonte à emmencement gras remplaçant la chemise acie d'origine.

① Ajustar a presión la camisa de hierro fundido para reemplaza camisa original de acero



**1**

4.8D 4cyl. 4800cc Diesel FM6376

14-376210-00 WH

110.00

B 125.00

C 246.00

D 132.75

E 9.15

F 1.00

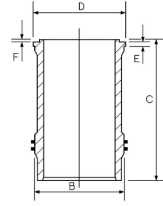



Modelverzeichnis • Index de modele • Índice de Modelo  
 Indeks modelu • Модель автомобиля • دليل الموديل

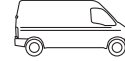

# MODEL INDEX



CCM

x



01/92→09/95	<b>Voyager II 2.5</b>	M00 (HR 425 CL)	Diesel	2499	4	2
-------------	-----------------------	-----------------	--------	------	---	---

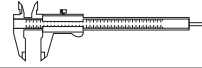

1

**J8S** 4cyl. **2068cc** **59-64kW (80-87PS)** **Diesel** **TD4254**

**14-000320-00 WH** **86.00** **B 93.60** **C 166.00** **D 93.05**

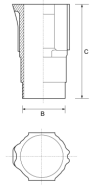

Phosphated

Phosphatiert

Phosphatisé

Fosfatada

2

**M00 (HR 425 CL)** 4cyl. **2499cc** **85-87kW (116-118PS)** **Diesel Turbo** **TD4253**

**VM425HR (M51)** 4cyl. **2500cc** **85kW (116PS)** **Diesel Turbo** **TD4257**

**VM425HS (M52)** 4cyl. **2500cc** **85kW (116PS)** **Diesel Turbo** **TD535**

**14-676420-00 WH** **92.00** **B 101.50** **C 166.80** **D 110.00** **E 8.90** **F 1.20**

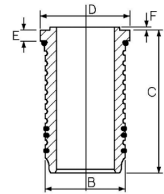

Modelverzeichnis • Index de modele • Índice de Modelo  
 Indeks modelu • Модель автомобиля • دليل المركبة

# MODEL INDEX

**CCM**
**x**

09/86→12/97	<b>AX 1.1</b>	TU1 (H1B), TU1CP (HAZ), TU1 K, TU1M (HDZ)	Petrol	1124	4	<b>1</b>
04/87→12/88	<b>AX 1.3</b>	TU2.4	Petrol	1294	4	<b>5</b>
09/86→04/97	<b>AX 1.4</b>	K1G, TU3CP (KAY), TU3F2 (K1F), TU3F2 (K2B), TU3FJ2 (KFY), TU3FJ2 (KFZ), TU3FM (K2A), TU3FM (KDY), TU3M (KDX), TU3M (KDY), TU3M/Z (KDZ)	Petrol	1360	4	<b>4</b>
07/96→	<b>Berlingo 1.1</b>	TU1M (HDZ)	Petrol	1124	4	<b>1</b>
07/96→	<b>Berlingo 1.4</b>	TU3JP (KFW), TU3JP (KFX)	Petrol	1360	4	<b>4</b>
07/05→	<b>Berlingo 1.6</b>	DV6ATED4 (9HX), DV6BTED4 (9HT), DV6BTED4 (9HW), DV6BUTED4 (9HT), DV6C (9HL), DV6C (9HR), DV6DTED (9HF), DV6DTED (9HP), DV6ETED (9HN), DV6TED4 (9HZ)	Diesel	1560	4	<b>7</b>
07/96→	<b>Berlingo 1.8</b>	XUD7 (A9A/161A)	Diesel	1769	4	<b>8</b>
04/97→	<b>Berlingo 1.8</b>	XU7JB (LFX)	Petrol	1761	4	<b>11</b>
07/96→	<b>Berlingo 1.9</b>	XUD9A (DJY), XUD9A/L (D9B)	Diesel	1905	4	<b>12</b>
07/98→	<b>Berlingo 1.9</b>	DW8 (WJZ) / DW8B (WJY), DW8B (WJY)	Diesel	1868	4	<b>9</b>
10/86→06/92	<b>BX 1.1</b>	TU1 K, TU1M (HDZ)	Petrol	1124	4	<b>1</b>
04/83→02/93	<b>BX 1.4</b>	K1G, TU3A (K1H), TU3M (KDY), TU3M/Z (KDZ)	Petrol	1360	4	<b>4</b>
10/82→12/94	<b>BX 1.6</b>	171C, B6E, XU5 (171A), XU5 (B1AA), XU5CP (BAY/BAZ), XU5J (180Z), XU5J/J2/JA, XU5JA (B6D), XU5M (BDY/B4A), XU5M (BDZ), XU5S (171B), XU5S (171D), XU51C (B1E), XU52C	Petrol	1580	4	<b>11</b>
10/85→12/94	<b>BX 1.8</b>	XUD7 (161), XUD7 (161A), XUD7TE (A8A), XUD7TE (AJZ)	Diesel	1769	4	<b>8</b>
09/83→12/94	<b>BX 1.9</b>	XUD9 (162), XUD9 (D9A), XUD9 (DJZ), XUD9A/U (D9B)	Diesel	1905	4	<b>12</b>
07/86→12/94	<b>BX 1.9</b>	D2E, XU9J1 (DFZ), XU9J2 (D6A), XU9J4 (D6C/DFW), XU9J4 (DFW), XU9JA (DKZ), XU9M (DDZ), XU9S (159A), XU92C (D2A), XU92C (D2C), XU92C (D2F)	Petrol	1905	4	<b>11</b>
06/05→	<b>C1 1.4</b>	DV4TD (8HT)	Diesel	1398	4	<b>2</b>
09/03→	<b>C2 1.4</b>	DV4TD (8HX)	Diesel	1399	4	<b>2</b>
09/03→	<b>C2 1.4</b>	DV4TD (8HZ)	Diesel	1398	4	<b>2</b>
09/03→	<b>C2 1.4</b>	TU3JP-L4 (KFV)	Petrol	1360	4	<b>4</b>
09/05→	<b>C2 1.6</b>	DV6TED4 (9HZ)	Diesel	1560	4	<b>7</b>
04/09→	<b>C2 Enterprise 1.4</b>	DV4TD (8HX)	Diesel	1399	4	<b>2</b>
05/03→	<b>C3 1.4</b>	TU3JP-L4 (KFV)	Petrol	1360	4	<b>4</b>
04/04→	<b>C3 1.4</b>	DV4TD (8HX)	Diesel	1399	4	<b>2</b>
02/02→	<b>C3 I 1.4</b>	DV4TD (8HX)	Diesel	1399	4	<b>2</b>
02/02→	<b>C3 I 1.4</b>	TU3A (KFV), TU3JP-L4 (KFV)	Petrol	1360	4	<b>4</b>
07/03→	<b>C3 I 1.4</b>	DV4TD (8HZ)	Diesel	1398	4	<b>2</b>
09/05→	<b>C3 I 1.6</b>	DV6ATED4 (9HX), DV6TED4 (9HZ)	Diesel	1560	4	<b>7</b>
11/09→	<b>C3 II 1.4</b>	DV4TD (8HZ)	Diesel	1398	4	<b>2</b>
11/09→	<b>C3 II 1.4</b>	TU3A (KFT), TU3A (KFV)	Petrol	1360	4	<b>4</b>
11/09→	<b>C3 II 1.6</b>	DV6ATED4 (9HX), DV6C (9HR), DV6DTED (9HP)	Diesel	1560	4	<b>7</b>
02/09→	<b>C3 Picasso 1.6</b>	DV6ATED4 (9HX), DV6C (9HR), DV6DTED (9HP), DV6TED4 (9HZ)	Diesel	1560	4	<b>7</b>
11/04→	<b>C4 1.6</b>	DV6ATED4 (9HX), DV6TED4 (9HY), DV6TED4 (9HZ)	Diesel	1560	4	<b>7</b>
11/04→07/11	<b>C4 I 1.6</b>	DV6ATED4 (9HX), DV6TED4 (9HY), DV6TED4 (9HZ)	Diesel	1560	4	<b>7</b>
11/09→	<b>C4 II 1.6</b>	DV6C (9HR), DV6DTED (9HP)	Diesel	1560	4	<b>7</b>
04/12→	<b>C4 Aircross 1.6</b>	DV6C (9HL)	Diesel	1560	4	<b>7</b>
09/14→	<b>C4 Cactus 1.6</b>	DV6DTED (9HP)	Diesel	1560	4	<b>7</b>
10/06→	<b>C4 Grand Picasso I 1.6</b>	DV6C (9HL), DV6C (9HR), DV6TED4 (9HY), DV6TED4 (9HZ)	Diesel	1560	4	<b>7</b>
09/13→	<b>C4 Grand Picasso II 1.6</b>	DV6DTED (9HP)	Diesel	1560	4	<b>7</b>

# MODEL INDEX



Modelverzeichnis • Index de modele • Índice de Modelo  
Indeks modelu • Модель автомобиля • دليل الموديل



CCM

x



9

02/07→08/13	<b>C4 Picasso I 1.6</b>	DV6C (9HR), DV6TED4 (9HY), DV6TED4 (9HZ)	Diesel	1560	4	7
02/13→	<b>C4 Picasso II 1.6</b>	DV6DTE (9HP)	Diesel	1560	4	7
09/04→	<b>C5 II 1.6</b>	DV6TED4 (9HY), DV6TED4 (9HZ)	Diesel	1560	4	7
02/08→	<b>C5 III 1.6</b>	DV6C (9HR), DV6TED4 (9HZ)	Diesel	1560	4	7
10/84→12/96	<b>C15 1.1</b>	E1A	Petrol	1118	4	3
10/84→12/96	<b>C15 1.1</b>	TU1 K, TU1M (HDZ), XW7 (109K)	Petrol	1124	4	1
07/87→12/96	<b>C15 1.4</b>	TU3 (K3A), TU3A (K1H), TU3FM (KDY), TU3M (KDY)	Petrol	1360	4	4
07/86→12/00	<b>C15 1.8</b>	XUD7 (161A)	Diesel	1769	4	8
10/00→12/05	<b>C15 1.9</b>	DW8B (WJX), DW8B (WJY)	Diesel	1868	4	9
11/81→02/94	<b>C25 1.8</b>	XM7T (169)	Petrol	1796	4	13
07/87→02/94	<b>C25 1.9</b>	XUD9A (DJY), XUD9A/U (D9B)	Diesel	1905	4	12
04/92→02/94	<b>C25 1.9</b>	M705	Diesel	1929	4	10
09/81→03/94	<b>C25 2.0</b>	XN1T (170A), XN1T (170B), XN1T (170C)	Petrol	1971	4	16
11/81→02/94	<b>C25 2.5</b>	CRD93L (U25/661), CRD93LS (U25/673)	Diesel	2500	4	19
02/80→01/94	<b>C35 2.5</b>	B25/637	Diesel	2500	4	19
01/74→12/92	<b>C35 D</b>	XD3, XD3P	Diesel	2498	4	20
11/12→	<b>C-Elysee 1.6</b>	DV6DTE (9HP), DV6DTE (9HJ)	Diesel	1560	4	7
06/79→08/85	<b>CX I 2.0</b>	829.A5	Petrol	1995	4	17
06/81→08/85	<b>CX I 2.2</b>	J6TA 500 / J6RA 500	Petrol	2165	4	17
02/78→08/85	<b>CX I 2.5</b>	M25/629, M25-648	Diesel	2500	4	19
08/85→12/92	<b>CX II 2.0</b>	829.A5	Petrol	1995	4	17
07/85→12/92	<b>CX II 2.2</b>	J6TA 500 / J6RA 500	Petrol	2165	4	17
08/85→12/92	<b>CX II 2.5</b>	M25/660, M25/669, M25-648	Diesel	2500	4	19
11/09→	<b>DS3 1.6</b>	DV6C (9HL), DV6C (9HR), DV6DTE (9HP)	Diesel	1560	4	7
04/11→	<b>DS4 1.6</b>	DV6C (9HL), DV6C (9HR), DV6DTE (9HP)	Diesel	1560	4	7
11/11→	<b>DS5 1.6</b>	DV6C (9HR)	Diesel	1560	4	7
05/97→07/02	<b>Evasion 1.8</b>	XU7JP (LFW/LFZ/L6A)	Petrol	1761	4	11
11/94→07/02	<b>Evasion 1.9</b>	XUD9BTF (DHX), XUD9TF (D8B), XUD9TF/BTF (DHX)	Diesel	1905	4	12
02/94→04/02	<b>Jumper 1.9</b>	XUD9A (DJY), XUD9A/U (D9B), XUD9BTF (DHX), XUD9TF/BTF (DHX), XUD9UTF (D8C)	Diesel	1905	4	12
04/06→	<b>Jumper 2.2</b>	P22DTE (4HU), P22DTE (4HV)	Diesel	2198	4	14
03/94→04/02	<b>Jumper 2.5</b>	DJ5 (T9A), DJ5TED (THX)	Diesel	2446	4	18
01/99→	<b>Jumper 2.8</b>	8140.43N, 8140.43S, 8140.63 (F28D), F28TDCR	Diesel	2798	4	21
01/07→	<b>Jumpy 1.6</b>	DV6UTED4 (9HU)	Diesel	1560	4	7
10/95→	<b>Jumpy 1.9</b>	XUD9A/U (D9B), XUD9BTF (DHX), XUD9TF (D8B), XUD9TF/BTF (DHX)	Diesel	1905	4	12
04/98→	<b>Jumpy 1.9</b>	DW8 (WJZ) / DW8B (WJY), DW8B (WJY)	Diesel	1868	4	9
07/82→04/85	<b>LNA 1.1</b>	XW7 (109/5E)	Petrol	1124	4	1
02/08→	<b>Nemo 1.4</b>	TU3A (KFT), TU3A (KVF)	Petrol	1360	4	4
05/96→09/03	<b>Saxo 1.1</b>	TU1M (HDZ)	Petrol	1124	4	1
05/96→06/03	<b>Saxo 1.4</b>	TU3JP (KFW), TU3JP (KFX)	Petrol	1360	4	4
09/78→03/91	<b>Visa 1.1</b>	XW7 (109/5), XW7 (109/5F), XW7 (109K)	Petrol	1124	4	1
07/80→06/82	<b>Visa 1.2</b>	129/5	Petrol	1219	4	6
03/82→03/91	<b>Visa 1.4</b>	XY8 (150B)	Petrol	1360	4	4
01/85→03/91	<b>Visa 1.6</b>	XU5J (180A/B6D), XU5JA (B6D)	Petrol	1580	4	11
04/84→03/91	<b>Visa 1.8</b>	XUD7 (161A)	Diesel	1769	4	8
03/93→03/01	<b>Xantia 1.6</b>	XU5JP (BFZ)	Petrol	1580	4	11
03/93→04/03	<b>Xantia 1.8</b>	XU7JB (LFX), XU7JP (LFW/LFZ/L6A), XU7JP4 (LFY)	Petrol	1761	4	11
06/94→04/03	<b>Xantia 1.9</b>	XUD9 (DJZ), XUD9A/L (D9B), XUD9BTF (DHX), XUD9SD (DHW), XUD9TE (DHY), XUD9TF (D8B), XUD9TF/BTF (DHX)	Diesel	1905	4	12
04/97→08/05	<b>Xsara 1.4</b>	TU3JP (KFW), TU3JP (KFX)	Petrol	1360	4	4
01/03→08/05	<b>Xsara 1.4</b>	DV4TD (8HX)	Diesel	1399	4	2

Modelverzeichnis • Index de modele • Índice de Modelo  
Indeks modelu • Модель автомобиля • دليل الموديل



## MODEL INDEX



CCM



04/97→09/00	<b>Xsara 1.8</b>	XU7JB (LFX), XU7JP (LFW/LFZ/L6A), XU7JP4 (LFY)	Petrol	1761	4	11
04/97→09/00	<b>Xsara 1.8</b>	XUD7 (161A), XUD7 (A9A/161A)	Diesel	1769	4	8
04/97→09/00	<b>Xsara 1.9</b>	XUD9A (DJY), XUD9BSD (DHV), XUD9TE (DHY)	Diesel	1905	4	12
07/98→08/05	<b>Xsara 1.9</b>	DW8 (WJZ) / DW8B (WJY), DW8B (WJY)	Diesel	1868	4	9
05/04→	<b>Xsara Picasso 1.6</b>	DV6ATED4 (9HX), DV6TED4 (9HY), DV6TED4 (9HZ)	Diesel	1560	4	7
03/91→06/97	<b>ZX 1.1</b>	TU1 (H1B), TU1 K, TU1M (HDZ)	Petrol	1124	4	1
03/91→10/97	<b>ZX 1.4</b>	TU3JP (KFX), TU3M (KDX), TU3M (KDY), TU3M/Z (KDZ)	Petrol	1360	4	4
03/91→10/97	<b>ZX 1.6</b>	XU5JP (BFZ), XU5M (BDY/B4A)	Petrol	1580	4	11
07/92→02/98	<b>ZX 1.8</b>	XU7JP (LFW/LFZ/L6A), XU7JP4 (LFY)	Petrol	1761	4	11
06/93→10/97	<b>ZX 1.8</b>	XUD7 (161A)	Diesel	1769	4	8
03/91→06/97	<b>ZX 1.9</b>	XU9JA (D6E), XU9JA (DKZ)	Petrol	1905	4	11
03/91→10/97	<b>ZX 1.9</b>	XUD9 (DJZ), XUD9A (DJY), XUD9A/U (D9B), XUD9TE (DHY)	Diesel	1905	4	12

# ENGINE INDEX

Motorverzeichnis • Index de moteur • Índice de Motor  
Indeks silnika • Модель двигателя • دليل المحرك



CCM



9

129/5	Petrol	1219	4	75.00	6
159B	Petrol	1905	4	83.00	11
169B	Petrol	1796	4	84.00	13
171C	Petrol	1580	4	83.00	11
8140.43N	Diesel	2798	4	94.40	21
8140.43S	Diesel	2798	4	94.40	21
8140.63 (F28D)	Diesel	2798	4	94.40	21
829.A5	Petrol	1995	4	88.00	17
B25/637	Diesel	2500	4	93.00	19
B6E	Petrol	1580	4	83.00	11
CRD93B	Diesel	2499	4	93.00	19
CRD93L (U25/661)	Diesel	2500	4	93.00	19
CRD93LS (U25/673)	Diesel	2500	4	93.00	19
D2E	Petrol	1905	4	83.00	11
DJ5 (T9A)	Diesel	2446	4	92.00	18
DJ5TED (THX)	Diesel	2446	4	92.00	18
DV4TD (8HT)	Diesel	1398	4	73.70	2
DV4TD (8HX)	Diesel	1399	4	73.70	2
DV4TD (8HZ)	Diesel	1398	4	73.70	2
DV6ATED4 (9HV)	Diesel	1560	4	75.00	7
DV6ATED4 (9HX)	Diesel	1560	4	75.00	7
DV6BTED4 (9HT)	Diesel	1560	4	75.00	7
DV6BTED4 (9HW)	Diesel	1560	4	75.00	7
DV6BUTED4 (9HT)	Diesel	1560	4	75.00	7
DV6C (9HL)	Diesel	1560	4	75.00	7
DV6C (9HR)	Diesel	1560	4	75.00	7
DV6DBM (9HE)	Diesel	1560	4	75.00	7
DV6DTED (9HF)	Diesel	1560	4	75.00	7
DV6DTED (9HP)	Diesel	1560	4	75.00	7
DV6DTEDM (9HJ)	Diesel	1560	4	75.00	7
DV6ETED (9HN)	Diesel	1560	4	75.00	7
DV6ETED (9HW)	Diesel	1560	4	75.00	7
DV6ETEDM (9HK)	Diesel	1560	4	75.00	7
DV6TED4 (9HY)	Diesel	1560	4	75.00	7
DV6TED4 (9HZ)	Diesel	1560	4	75.00	7
DV6UTED4 (9HU)	Diesel	1560	4	75.00	7
DW8 (WJZ) / DW8B (WJY)	Diesel	1868	4	82.20	9
DW8B (WJX)	Diesel	1868	4	82.20	9
DW8B (WJY)	Diesel	1868	4	82.20	9
E1A	Petrol	1118	4	74.00	3
F28TDCR	Diesel	2798	4	94.40	21
J6TA 500 / J6RA 500	Petrol	2165	4	88.00	17
K1B	Petrol	1360	4	75.00	4
K1G	Petrol	1360	4	75.00	4
KAZ	Petrol	1360	4	75.00	4
M22-629	Diesel	2499	4	93.00	19
M25/629	Diesel	2500	4	93.00	19
M25/660	Diesel	2500	4	93.00	19
M25/669	Diesel	2500	4	93.00	19
M25-637	Diesel	2499	4	93.00	19
M25-648	Diesel	2500	4	93.00	19
M25-661	Diesel	2499	4	93.00	19
M705	Diesel	1929	4	82.60	10
P22DTE (4HU)	Diesel	2198	4	86.00	14
P22DTE (4HV)	Diesel	2198	4	86.00	14
TU1 (H1B)	Petrol	1124	4	72.00	1
TU1 K	Petrol	1124	4	72.00	1
TU1CP (HAZ)	Petrol	1124	4	72.00	1
TU1M (HDZ)	Petrol	1124	4	72.00	1
TU2.4	Petrol	1294	4	75.00	5

Motorverzeichnis • Index de moteur • Índice de Motor  
Indeks silnika • Модель двигателя • دليل المحرك

# ENGINE INDEX



CCM

x



9

TU3 (K3A)	Petrol	1360	4	75.00	4
TU3A (K1H)	Petrol	1360	4	75.00	4
TU3A (K6D)	Petrol	1360	4	75.00	4
TU3A (K6E)	Petrol	1360	4	75.00	4
TU3A (K6F)	Petrol	1360	4	75.00	4
TU3A (KFT)	Petrol	1360	4	75.00	4
TU3A (KfV)	Petrol	1360	4	75.00	4
TU3A (KfW)	Petrol	1360	4	75.00	4
TU3A (KfX)	Petrol	1360	4	75.00	4
TU3CP (KAY)	Petrol	1360	4	75.00	4
TU3F2 (K1F)	Petrol	1360	4	75.00	4
TU3F2 (K2B)	Petrol	1360	4	75.00	4
TU3FJ2 (K2D)	Petrol	1360	4	75.00	4
TU3FJ2 (KfY)	Petrol	1360	4	75.00	4
TU3FJ2 (KfZ)	Petrol	1360	4	75.00	4
TU3FM (K2A)	Petrol	1360	4	75.00	4
TU3FM (KdY)	Petrol	1360	4	75.00	4
TU3JP (KfW)	Petrol	1360	4	75.00	4
TU3JP (KfX)	Petrol	1360	4	75.00	4
TU3JP-L4 (KfV)	Petrol	1360	4	75.00	4
TU3M (KdX)	Petrol	1360	4	75.00	4
TU3M (KdY)	Petrol	1360	4	75.00	4
TU3M/Z (KdZ)	Petrol	1360	4	75.00	4
XD 88	Diesel	1948	4	88.00	15
XD3	Diesel	2498	4	94.00	20
XD3P	Diesel	2498	4	94.00	20
XM7T (169)	Petrol	1796	4	84.00	13
XN1T (170A)	Petrol	1971	4	88.00	16
XN1T (170B)	Petrol	1971	4	88.00	16
XN1T (170C)	Petrol	1971	4	88.00	16
XU5 (171A)	Petrol	1580	4	83.00	11
XU5 (B1AA)	Petrol	1580	4	83.00	11
XU51C (B1E)	Petrol	1580	4	83.00	11
XU52C	Petrol	1580	4	83.00	11
XU5CP (BAY/BAZ)	Petrol	1580	4	83.00	11
XU5J (180A/B6D)	Petrol	1580	4	83.00	11
XU5J (180Z)	Petrol	1580	4	83.00	11
XU5J/J2/JA	Petrol	1580	4	83.00	11
XU5JA (B6D)	Petrol	1580	4	83.00	11
XU5JP (BFZ)	Petrol	1580	4	83.00	11
XU5M (BDY/B4A)	Petrol	1580	4	83.00	11
XU5M (BDZ)	Petrol	1580	4	83.00	11
XU5S (171B)	Petrol	1580	4	83.00	11
XU5S (171D)	Petrol	1580	4	83.00	11
XU7JB (LFX)	Petrol	1761	4	83.00	11
XU7JP (LFW/LFZ/L6A)	Petrol	1761	4	83.00	11
XU7JP4 (LFY)	Petrol	1761	4	83.00	11
XU92C (D2A)	Petrol	1905	4	83.00	11
XU92C (D2C)	Petrol	1905	4	83.00	11
XU92C (D2F)	Petrol	1905	4	83.00	11
XU9J1 (DFZ)	Petrol	1905	4	83.00	11
XU9J2 (D6A)	Petrol	1905	4	83.00	11
XU9J4 (D6C/DFW)	Petrol	1905	4	83.00	11
XU9J4 (DFW)	Petrol	1905	4	83.00	11
XU9JA (D6E)	Petrol	1905	4	83.00	11
XU9JA (DKZ)	Petrol	1905	4	83.00	11
XU9M (DDZ)	Petrol	1905	4	83.00	11
XU9S (159A)	Petrol	1905	4	83.00	11
XUD7 (161)	Diesel	1769	4	80.00	8
XUD7 (161A)	Diesel	1769	4	80.00	8



# ENGINE INDEX

Motorverzeichnis • Index de moteur • Índice de Motor  
Indeks silnika • Модель двигателя • دليل المحرك



CCM

x



9

		CCM	x		
XUD7 (A9A/161A)	Diesel	1769	4	80.00	8
XUD7TE (A8A)	Diesel	1769	4	80.00	8
XUD7TE (AJZ)	Diesel	1769	4	80.00	8
XUD9 (162)	Diesel	1905	4	83.00	12
XUD9 (D9A)	Diesel	1905	4	83.00	12
XUD9 (DJZ)	Diesel	1905	4	83.00	12
XUD9A (DJY)	Diesel	1905	4	83.00	12
XUD9A/L (D9B)	Diesel	1905	4	83.00	12
XUD9A/U (D9B)	Diesel	1905	4	83.00	12
XUD9BSD (DHV)	Diesel	1905	4	83.00	12
XUD9BTF (DHX)	Diesel	1905	4	83.00	12
XUD9SD (DHW)	Diesel	1905	4	83.00	12
XUD9TE (DHY)	Diesel	1905	4	83.00	12
XUD9TF (D8B)	Diesel	1905	4	83.00	12
XUD9UTF (D8C)	Diesel	1905	4	83.00	12
XW7 (109/5)	Petrol	1124	4	72.00	1
XW7 (109/5E)	Petrol	1124	4	72.00	1
XW7 (109/5F)	Petrol	1124	4	72.00	1
XW7 (109K)	Petrol	1124	4	72.00	1
XY8 (150B)	Petrol	1360	4	75.00	4

**1**

<b>TU1 (H1B)</b>	4cyl.	<b>1124cc</b>	<b>40-44kW</b> (55-60PS)				<b>TD658</b>
<b>TU1CP (HAZ)</b>	4cyl.	<b>1124cc</b>	<b>40kW</b> (54PS)				<b>TD5083</b>
<b>TU1 K</b>	4cyl.	<b>1124cc</b>	<b>40-44kW</b> (54-60PS)				<b>TD6562</b>
<b>TU1M (HDZ)</b>	4cyl.	<b>1124cc</b>	<b>40kW</b> (54PS)				<b>TD661</b>
<b>XW7 (109/5)</b>	4cyl.	<b>1124cc</b>	<b>37kW</b> (50PS)				<b>TD564</b>
<b>XW7 (109/5E)</b>	4cyl.	<b>1124cc</b>	<b>33-50kW</b> (45-50PS)				<b>TD565</b>
<b>XW7 (109/5F)</b>	4cyl.	<b>1124cc</b>	<b>33-37kW</b> (45-50PS)				<b>TD566</b>
<b>XW7 (109K)</b>	4cyl.	<b>1124cc</b>	<b>35kW</b> (47PS)				<b>TD563</b>

14-636470-00 *WH*      **72.00**      **B 79.50**      **C 122.00**      **D 89.20**      **E 85.00**

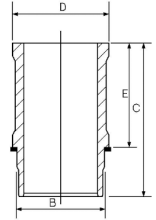
**2**

<b>DV4TD (8HT)</b>	4cyl.	<b>1398cc</b>	<b>40kW</b> (54PS)	<b>Diesel</b>	<b>Turbo</b>		<b>TD25062</b>
<b>DV4TD (8HX) Euro3/Euro4</b>	4cyl.	<b>1399cc</b>	<b>52kW</b> (71PS)	<b>Diesel</b>	<b>Turbo Intercooled</b>		<b>TD16425</b>
<b>DV4TD (8HZ)</b>	4cyl.	<b>1398cc</b>	<b>50kW</b> (68PS)	<b>Diesel</b>	<b>Turbo Intercooled</b>		<b>TD23773</b>

14-020760-00 *D*      **73.70**      **B 76.70**      **C 136.00**      **D 78.20**      **E 5.00**  
 14-020761-00 *D*           **B 76.95**      **C 136.00**      **D 78.45**      **E 5.25**

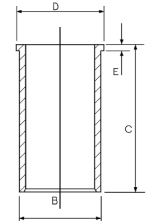
**3**

<b>E1A</b>	4cyl.	<b>1118cc</b>	<b>40kW</b> (54PS)				<b>TD648</b>
------------	-------	---------------	--------------------	--	--	--	--------------

14-636470-00 *WH*      **74.00**      **B 79.50**      **C 122.00**      **D 89.20**      **E 85.00**

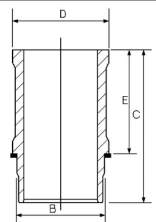
**4**

<b>K1B</b>	4cyl.	<b>1360cc</b>	<b>44kW</b> (60PS)				<b>TD665</b>
<b>K1G</b>	4cyl.	<b>1360cc</b>	<b>51kW</b> (69PS)				<b>TD6567</b>
<b>KAZ</b>	4cyl.	<b>1360cc</b>	<b>44-55kW</b> (54-75PS)				<b>TD6566</b>
<b>TU3 (K3A)</b>	4cyl.	<b>1360cc</b>	<b>40-46kW</b> (54-63PS)				<b>TD6569</b>
<b>TU3A (K1H)</b>	4cyl.	<b>1360cc</b>	<b>47-49kW</b> (64-67PS)				<b>TD4272</b>
<b>TU3A (K6D)</b>	4cyl.	<b>1360cc</b>	<b>53kW</b> (72PS)				<b>TD25067</b>
<b>TU3A (K6E)</b>	4cyl.	<b>1360cc</b>	<b>53kW</b> (72PS)				<b>TD25069</b>
<b>TU3A (K6F)</b>	4cyl.	<b>1360cc</b>	<b>53kW</b> (72PS)				<b>TD25068</b>
<b>TU3A (KFT)</b>	4cyl.	<b>1360cc</b>	<b>54kW</b> (73PS)				<b>TD25070</b>
<b>TU3A (KFV)</b>	4cyl.	<b>1360cc</b>	<b>54kW</b> (73PS)				<b>TD23774</b>





TU3A (KFW)	4cyl.	1360cc	55kW (75PS)	TD25066
TU3A (KFX)	4cyl.	1360cc	55kW (75PS)	TD25074
TU3CP (KAY)	4cyl.	1360cc	44kW (60PS)	TD9546
TU3F2 (K1F)	4cyl.	1360cc	49kW (67PS)	TD666
TU3F2 (K2B)	4cyl.	1360cc	62kW (84PS)	TD669
TU3FJ2 (K2D)	4cyl.	1360cc	55kW (75PS)	TD6568
TU3FJ2 (KFY)	4cyl.	1360cc	66kW (89PS)	TD5078
TU3FJ2 (KFZ)	4cyl.	1360cc	69kW (93PS)	TD5096
TU3FM (K2A)	4cyl.	1360cc	62kW (84PS)	TD668
TU3FM (KDY)	4cyl.	1360cc	55kW (75PS)	TD4277
TU3JP (KFW)	4cyl.	1360cc	55kW (75PS)	TD14731
TU3JP (KFX)	4cyl.	1360cc	55kW (75PS)	TD6554
TU3JP-L4 (KVF)	4cyl.	1360cc	58kW (79PS)	TD16464
TU3M (KDX)	4cyl.	1360cc	55kW (75PS)	TD5080
TU3M (KDY)	4cyl.	1360cc	55kW (75PS)	TD5160
TU3M/Z (KDZ)	4cyl.	1360cc	55kW (75PS)	TD683
XY8 (150B)	4cyl.	1360cc	46kW (63PS)	TD577

14-636600-00 WH 75.00 B 79.50 C 134.50 D 89.20 E 90.00

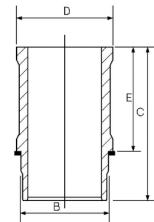

				<b>5</b>
TU2.4	4cyl.	1294cc	70kW (95PS)	TD706

14-638630-00 WH 75.00 B 79.50 C 120.50 D 89.20 E 85.00

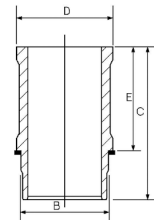

				<b>6</b>
129/5	4cyl.	1219cc	42kW (57PS)	TD574

15-636700-00 WH <sup>†</sup> 75.00 B 79.50 C 122.00 D 89.20 E 82.50

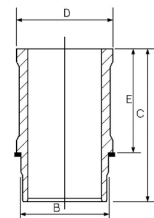

<sup>†</sup> Includes seals

<sup>†</sup> Schließt Dichtungen ein

<sup>†</sup> Inclut des joints

<sup>†</sup> Incluye los sellos



7

DV6ATED4 (9HV)	4cyl.	1560cc	66kW (89PS)	Diesel	Turbo Intercooled	TD24730
DV6ATED4 (9HX) Euro 4	4cyl.	1560cc	66kW (89PS)	Diesel	Turbo Intercooled	TD19913
DV6BTED4 (9HT) Euro 4	4cyl.	1560cc	55kW (75PS)	Diesel	Turbo Intercooled	TD21321
DV6BTED4 (9HW) Euro 4	4cyl.	1560cc	55kW (75PS)	Diesel	Turbo Intercooled	TD27840
DV6BUTED4 (9HT) Euro 4	4cyl.	1560cc	55kW (75PS)	Diesel	Turbo Intercooled	TD21322
DV6C (9HL)	4cyl.	1560cc	82kW (111PS)	Diesel	Turbo	TD26985
DV6C (9HR)	4cyl.	1560cc	82kW (111PS)	Diesel	Turbo Intercooled	TD25690
DV6DBM (9HE) Euro 4	4cyl.	1560cc	66kW (89PS)	Diesel	Turbo Intercooled	TD25095
DV6DTED (9HF) Euro 4	4cyl.	1560cc	66kW (89PS)	Diesel	Turbo Intercooled	TD25094
DV6DTED (9HP) Euro 4	4cyl.	1560cc	68kW (92PS)	Diesel	Turbo Intercooled	TD25092
DV6DTEDM (9HJ) Euro 4	4cyl.	1560cc	68kW (92PS)	Diesel	Turbo Intercooled	TD25093
DV6ETED (9HN) Euro 4	4cyl.	1560cc	55kW (75PS)	Diesel	Turbo Intercooled	TD25096
DV6ETED (9HW) Euro 4	4cyl.	1560cc	55kW (75PS)	Diesel	Turbo Intercooled	TD25632
DV6ETEDM (9HK) Euro 4	4cyl.	1560cc	55kW (75PS)	Diesel	Turbo Intercooled	TD25097
DV6TED4 (9HY)	4cyl.	1560cc	80kW (109PS)	Diesel	Turbo Intercooled	TD19911
DV6TED4 (9HZ) Euro 4	4cyl.	1560cc	80kW (109PS)	Diesel	Turbo Intercooled	TD19824
DV6UTED4 (9HU)	4cyl.	1560cc	66kW (89PS)	Diesel	Turbo Intercooled	TD24692

14-020900-00 *D* 75.00 B 78.00 C 142.00 D 79.50 E 5.00

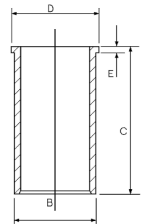

8

XUD7 (161)	4cyl.	1769cc	44kW (60PS)	Diesel		TD586
XUD7 (161A)	4cyl.	1769cc	44kW (60PS)	Diesel		TD4258
XUD7 (A9A/161A)	4cyl.	1769cc	44kW (60PS)	Diesel		TD6555
XUD7TE (A8A)	4cyl.	1769cc	66kW (89PS)	Diesel	Turbo Intercooled	TD602
XUD7TE (AJZ)	4cyl.	1769cc	66kW (89PS)	Diesel	Turbo Intercooled	TD604

14-024740-00 *D* 80.00 B 83.50 C 154.00 D 85.70 E 4.60  
 14-024830-00 *D* B 83.00 C 154.00 D 86.00 E 4.50

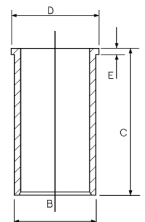



**9**

<b>DW8 (WJZ) / DW8B (WJY)</b>	4cyl.	<b>1868cc</b>	<b>51kW (69PS)</b>	<b>Diesel</b>	<b>TD10708</b>
<b>DW8B (WJX)</b>	4cyl.	<b>1868cc</b>	<b>51kW (69PS)</b>	<b>Diesel</b>	<b>TD26981</b>
<b>DW8B (WJY)</b>	4cyl.	<b>1868cc</b>	<b>51kW (69PS)</b>	<b>Diesel</b>	<b>TD15310</b>

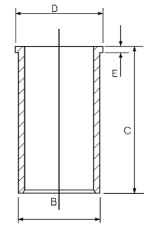
**14-020290-00 D** | **82.20** | **B 85.00** | **C 154.00** | **D 87.00** | **E 5.00**

**10**

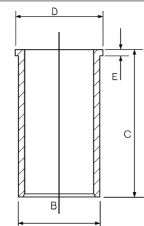
<b>M705</b>	4cyl.	<b>1929cc</b>	<b>60kW (82PS)</b>	<b>Diesel Turbo</b>	<b>TD6574</b>
<b>14-021311-00 D</b>	<b>82.60</b>	<b>B 86.06</b>	<b>C 154.00</b>	<b>D 89.00</b>	<b>E 4.50</b>
<b>14-023560-00 D</b>	<b>B 86.00</b>	<b>C 154.00</b>	<b>D 89.00</b>	<b>E 4.50</b>	
<b>14-023751-00 D</b>	<b>B 87.00</b>	<b>C 154.00</b>	<b>D 89.00</b>	<b>E 4.55</b>	

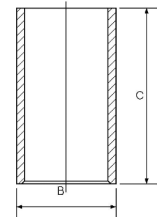

**14-014730-00 D** | **82.60** | **B 86.09** | **C 154.00**

**11**

<b>159B</b>	4cyl.	<b>1905cc</b>	<b>74kW (100PS)</b>	<b>TD21529</b>
<b>171C</b>	4cyl.	<b>1580cc</b>	<b>66kW (89PS)</b>	<b>TD593</b>
<b>B6E</b>	4cyl.	<b>1580cc</b>	<b>85kW (116PS)</b>	<b>TD21866</b>
<b>D2E</b>	4cyl.	<b>1905cc</b>	<b>78-79kW (107-108PS)</b>	<b>TD22449</b>
<b>XU5 (171A)</b>	4cyl.	<b>1580cc</b>	<b>66kW (89PS)</b>	<b>TD591</b>
<b>XU5 (B1AA)</b>	4cyl.	<b>1580cc</b>	<b>58-59kW (79-80PS)</b>	<b>TD12428</b>
<b>XU5CP (BAY/BAZ)</b>	4cyl.	<b>1580cc</b>	<b>55kW (75PS)</b>	<b>TD9550</b>
<b>XU5J (180A/B6D)</b>	4cyl.	<b>1580cc</b>	<b>76kW (103PS)</b>	<b>TD596</b>
<b>XU5J (180Z)</b>	4cyl.	<b>1580cc</b>	<b>76kW (103PS)</b>	<b>TD597</b>
<b>XU5J/J2/JA</b>	4cyl.	<b>1580cc</b>	<b>76kW (103PS)</b>	<b>TD9551</b>
<b>XU5JA (B6D)</b>	4cyl.	<b>1580cc</b>	<b>83kW (113PS)</b>	<b>TD4262</b>
<b>XU5JP (BFZ)</b>	4cyl.	<b>1580cc</b>	<b>65kW (88PS)</b>	<b>TD5101</b>
<b>XU5M (BDY/B4A)</b>	4cyl.	<b>1580cc</b>	<b>65kW (88PS)</b>	<b>TD5097</b>
<b>XU5M (BDZ)</b>	4cyl.	<b>1580cc</b>	<b>65kW (88PS)</b>	<b>TD615</b>
<b>XU5S (171B)</b>	4cyl.	<b>1580cc</b>	<b>66kW (89PS)</b>	<b>TD592</b>
<b>XU5S (171D)</b>	4cyl.	<b>1580cc</b>	<b>64kW (87PS)</b>	<b>TD594</b>
<b>XU7JB (LFX)</b>	4cyl.	<b>1761cc</b>	<b>66kW (89PS)</b>	<b>TD9457</b>
<b>XU7JP (LFW/LFZ/L6A)</b>	4cyl.	<b>1761cc</b>	<b>73kW (99PS)</b>	<b>TD5116</b>
<b>XU7JP4 (LFY)</b>	4cyl.	<b>1761cc</b>	<b>66-85kW (90-116PS)</b>	<b>TD4279</b>





XU9J1 (DFZ)	4cyl.	1905cc	90kW (122PS)			TD9548
XU9J2 (D6A)	4cyl.	1905cc	90kW (122PS)			TD631
XU9J4 (D6C/DFW)	4cyl.	1905cc	116kW (158PS)			TD632
XU9J4 (DFW)	4cyl.	1905cc	116kW (158PS)			TD640
XU9JA (D6E)	4cyl.	1905cc	93kW (126PS)			TD22622
XU9JA (DKZ)	4cyl.	1905cc	90kW (122PS)			TD647
XU9M (DDZ)	4cyl.	1905cc	80kW (109PS)			TD639
XU9S (159A)	4cyl.	1905cc	75kW (102PS)			TD584
XU51C (B1E)	4cyl.	1580cc	53kW (72PS)			TD607
XU52C	4cyl.	1580cc	68kW (92PS)			TD14648
XU92C (D2A)	4cyl.	1905cc	76kW (103PS)			TD628
XU92C (D2C)	4cyl.	1905cc	70kW (95PS)			TD629
XU92C (D2F)	4cyl.	1905cc	80kW (109PS)			TD630

14-634910-00 WH ①

83.00

B 88.60

C 141.00

D 97.00

E 6.50

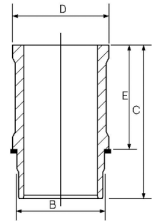

① Use also: 1 NB O-Ring HR566

① Mitverwenden: 1 NB O-Ring HR566

① A utiliser aussi: 1 joint toriques HR566

① Utilizar también: 1 NB junta toricas HR566

12

XUD9 (162)	4cyl.	1905cc	47kW (64PS)	Diesel		TD587
XUD9 (D9A)	4cyl.	1905cc	55kW (72PS)	Diesel		TD4265
XUD9 (DJZ)	4cyl.	1905cc	52kW (71PS)	Diesel		TD646
XUD9A (DJY)	4cyl.	1905cc	51kW (69PS)	Diesel		TD6556
XUD9A/L (D9B)	4cyl.	1905cc	50kW (68PS)	Diesel		TD4267
XUD9A/U (D9B)	4cyl.	1905cc	66kW (89PS)	Diesel		TD4266
XUD9BSD (DHV)	4cyl.	1905cc	55kW (75PS)	Diesel		TD22991
XUD9BTF (DHX)	4cyl.	1905cc	66kW (89PS)	Diesel	Turbo Intercooled	TD4268
XUD9SD (DHW)	4cyl.	1905cc	66kW (89PS)	Diesel	Turbo Intercooled	TD10689
XUD9TE (DHY)	4cyl.	1905cc	44-66kW (60-90PS)	Diesel	Turbo Intercooled	TD4269
XUD9TF (D8B)	4cyl.	1905cc	66kW (89PS)	Diesel	Turbo Intercooled	TD5046
XUD9UTF (D8C)	4cyl.	1905cc	68kW (92PS)	Diesel	Turbo Intercooled	TD4264

14-020530-00 D

83.00

B 85.60

C 153.50

D 88.50

E 3.90

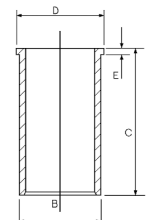



13

169B 4cyl. 1796cc 49-51kW (69-69PS) TD6575

XM7T (169) 4cyl. 1796cc 51kW (69PS) TD588

14-606670-00 WH 1 84.00 B 93.00 C 136.20 D 99.20 E 90.01

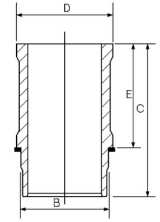

1 Use also: 1 NB O-Ring HR566 1 Mitverwenden: 1 NB O-Ring HR566 1 A utiliser aussi: 1 joint toriques HR566 1 Utilizar también: 1 NB junta toricas HR566

14

P22DTE (4HU) Euro 4 4cyl. 2198cc 88kW (120PS) Diesel Turbo Intercooled TD24538

P22DTE (4HV) Euro 4 4cyl. 2198cc 74kW (100PS) Diesel Turbo Intercooled TD24537

14-021120-00 D 86.00 B 89.00 C 156.00 D 90.90 E 5.00

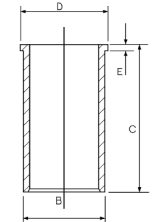

15

XD 88 4cyl. 1948cc 44kW (60PS) Diesel TD23802

14-600420-00 WH 1 88.00 B 96.00 C 173.00 D 106.30 E 129.00

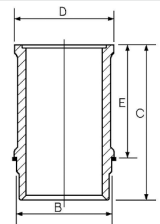

1 Use also: HT022 1 Mitverwenden: HT022 1 A utiliser aussi: HT022 1 Utilizar también: HT022

16

XN1T (170A) 4cyl. 1971cc 57kW (77PS) TD5164

XN1T (170B) 4cyl. 1971cc 57kW (77PS) TD589

XN1T (170C) 4cyl. 1971cc 57kW (77PS) TD590

14-636500-00 WH 88.00 B 93.00 C 135.70 D 101.90 E 89.985

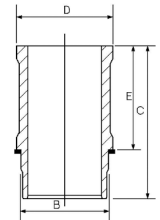





17

829.A5 4cyl. 1995cc 78kW (106PS) TD4259

J6TA 500 / J6RA 500 4cyl. 2165cc 83-85kW (113-116PS) TD663

14-637160-00 WH 88.00 B 93.60 C 140.50 D 104.00 E 93.08

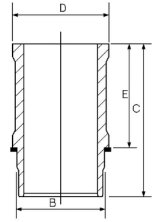

18

DJ5 (T9A) 4cyl. 2446cc 63kW (86PS) Diesel Turbo TD4293

DJ5TED (THX) 4cyl. 2446cc 79kW (107PS) Diesel Turbo Intercooled TD11889

14-020190-00 D 92.00 B 96.00 C 160.00 D 99.00 E 5.00

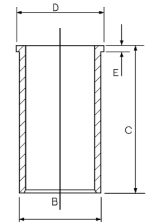

19

B25/637 4cyl. 2500cc 51kW (69PS) Diesel TD6895

CRD93B 4cyl. 2499cc 50kW (68PS) Diesel TD6577

CRD93L (U25/661) 4cyl. 2500cc 54-55kW (73-75PS) Diesel TD625

CRD93LS (U25/673) 4cyl. 2500cc 70kW (95PS) Diesel Turbo TD626

M22-629 4cyl. 2499cc 55kW (75PS) Diesel TD23453

M25/629 4cyl. 2500cc 55kW (75PS) Diesel TD693

M25/660 4cyl. 2500cc 54kW (73PS) Diesel TD696

M25/669 4cyl. 2500cc 88kW (120PS) Diesel Turbo Intercooled TD702

M25-637 4cyl. 2499cc 55kW (75PS) Diesel TD23454

M25-648 4cyl. 2500cc 70kW (95PS) Diesel Turbo TD694

M25-661 4cyl. 2499cc 55kW (75PS) Diesel TD23455

14-013481-00 D 93.00 B 96.10 C 163.00

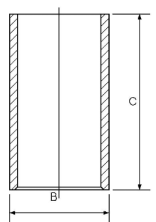

20

XD3 4cyl. 2498cc Diesel FM2303

XD3P 4cyl. 2498cc Diesel FM2303

14-020660-00 D 94.00 B 97.00 C 170.60 D 99.50 E 4.00

14-021520-00 D B 98.00 C 170.60 D 100.00 E 6.00

14-027270-00 D B 98.70 C 170.00 D 100.00 E 5.00

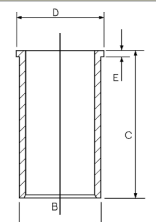



21

8140.43N Euro 3	4cyl.	2798cc	107kW (146PS)	Diesel	Turbo Intercooled	TD18297
8140.43S Euro 3	4cyl.	2798cc	92kW (125PS)	Diesel	Turbo Intercooled	TD17849
8140.63 (F28D)	4cyl.	2798cc	64kW (87PS)	Diesel		TD24977
F28TDCR Euro 3	4cyl.	2798cc	92kW (125PS)	Diesel	Turbo Intercooled	TD16741

14-021321-00 D	94.40	B 97.54	C 167.00	D 100.90	E 5.00
14-021322-00 D		B 97.70	C 167.00	D 100.90	E 5.00
14-028930-00 D		B 97.50	C 167.00	D 100.90	E 5.00
14-028931-00 D		B 97.58	C 167.00	D 100.90	E 5.00
14-028932-00 D		B 97.70	C 167.00	D 100.90	E 5.00

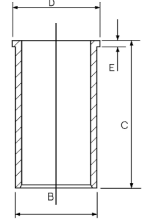

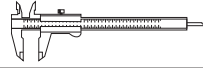

1

13.5 CU.FT

1cyl.

FM353

15 CU.FT.

1cyl.

FM353

14-010960-00 *WH*

66.69

B 72.90

C 88.90

D 79.36

E 77.29

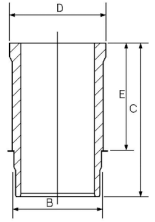



**1**

**MAN** 1cyl. **FM5548**

**MERCEDES-BENZ** 1cyl. **FM5572**

14-000240-00 *WH* ② **90.00** **B 95.00** **C 104.00** **D 140.00** **E 94.00**

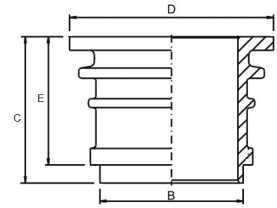

14-000230-00 *DH* ① **90.00** **B 95.00** **C 104.00** **D 127.00** **E 94.00**

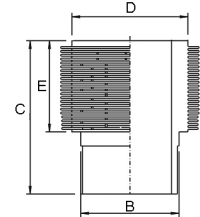

① Air cooled

① Luftgekühlt

① Refroidi par air

① Refrigerado por aire

② Water cooled

② Wassergekühlt

② Refroidi par eau

② Refrigerado por agua

**2**

**MERCEDES-BENZ** 1cyl. **FM15603**

14-000310-00 *DH* **100.00** **B 115.00** **C 102.00** **D 131.00** **E 94.00**  
 14-000350-00 *DH* **B 106.00** **C 101.00** **D 130.00** **E 94.00**

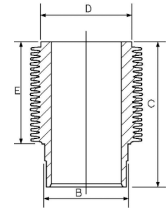



1

6 BT	6cyl.	5880cc	118kW (160PS)	Diesel	Turbo	TD6966
6 BT5.9	6cyl.	5880cc	108kW (147PS)	Diesel	Turbo	TD6613
6 BTA	6cyl.	5880cc	118kW (160PS)	Diesel	Turbo Intercooled	TD7047

14-020610-00 <i>D</i>	102.00	B 106.12	C 204.85	D 108.91	E 4.10	F 0.94	
-----------------------	--------	----------	----------	----------	--------	--------	--

# MODEL INDEX



Modelverzeichnis • Index de modele • Índice de Modelo  
Indeks modelu • Модель автомобиля • دليل الموديل



CCM

x



12/72→05/83	<b>1300 1.3</b>	810-02/-99	Petrol	1289	4	<b>1</b>
06/83→08/90	<b>1304 1.3</b>	810-02/-99	Petrol	1289	4	<b>1</b>
05/83→07/04	<b>1310 1.3</b>	810-02/-99	Petrol	1289	4	<b>1</b>
11/12→	<b>Dokker 1.5</b>	K9K 612	Diesel	1461	4	<b>2</b>
12/12→	<b>Dokker Express 1.5</b>	K9K 612	Diesel	1461	4	<b>2</b>
04/10→	<b>Duster 1.5</b>	K9K 796, K9K 856, K9K 858, K9K 892, K9K 894, K9K 896, K9K 898	Diesel	1461	4	<b>2</b>
03/12→	<b>Lodgy 1.5</b>	K9K 612	Diesel	1461	4	<b>2</b>
09/05→	<b>Logan 1.5</b>	K9K 790, K9K 792, K9K 796, K9K 892	Diesel	1461	4	<b>2</b>
10/12→	<b>Logan II 1.5</b>	K9K 612	Diesel	1461	4	<b>2</b>
02/07→	<b>Logan MCV 1.5</b>	K9K 792, K9K 796, K9K 892	Diesel	1461	4	<b>2</b>
02/13→	<b>Logan MCV II 1.5</b>	K9K 612	Diesel	1461	4	<b>2</b>
11/08→	<b>Sandero 1.5</b>	K9K 792, K9K 796, K9K 892	Diesel	1461	4	<b>2</b>
10/12→	<b>Sandero II 1.5</b>	K9K 612	Diesel	1461	4	<b>2</b>



1

810-02/-99 4cyl. 1289cc 40kW (54PS) TD13436

14-630440-00 WH 73.00 B 78.50 C 134.00 D 88.00 E 95.00  
 15-636590-00 WH 1 B 78.50 C 134.00 D 87.70 E 95.00

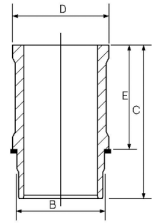

1 Includes seals 1 Schließt Dichtungen ein 1 Inclut des joints 1 Incluye los sellos

2

K9K 612	4cyl.	1461cc	55-66kW (75-90PS)	Diesel	Turbo	TD28005
K9K 790	4cyl.	1461cc	48kW (65PS)	Diesel	Turbo Intercooled	TD18514
K9K 792 Euro 4	4cyl.	1461cc	50kW (68PS)	Diesel	Turbo Intercooled	TD19223
K9K 796	4cyl.	1461cc	63kW (86PS)	Diesel	Turbo Intercooled	TD22403
K9K 856 Euro 5	4cyl.	1461cc	80kW (109PS)	Diesel	Turbo	TD28611
K9K 858 Euro 5	4cyl.	1461cc	80kW (109PS)	Diesel	Turbo	TD28610
K9K 892	4cyl.	1461cc	55-66kW (75-90PS)	Diesel	Turbo Intercooled	TD24780
K9K 894	4cyl.	1461cc	66-67kW (90-91PS)	Diesel	Turbo Intercooled	TD24783
K9K 896	4cyl.	1461cc	79kW (107PS)	Diesel	Turbo Intercooled	TD24784
K9K 898	4cyl.	1461cc	79-80kW (107-109PS)	Diesel	Turbo Intercooled	TD24785

14-020650-00 D 76.00 B 79.10 C 142.00 D 81.00 E 5.00

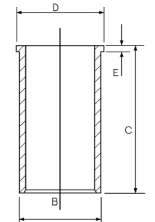

# ENGINE INDEX

Motorverzeichnis • Index de moteur • Índice de Motor  
Indeks silnika • Модель двигателя • دليل المحرك



CCM



9

110E	Petrol	1108	4	70.00	1
110F	Petrol	1108	4	70.00	1
110G	Petrol	1108	4	70.00	1
810/03/25/26/29	Petrol	1289	4	73.00	2
B13,0S	Petrol	1289	4	73.00	2
DF 615	Diesel	6150	6	104.18	4
DH 825	Diesel	8250	6	118.00	5
DHB 825	Diesel	8250	6	118.00	5
DHR 825	Diesel	8250	6	118.00	5
DHS 825	Diesel	8250	6	118.00	5
DHS 825SM	Diesel	8250	6	118.00	5
DHT 825	Diesel	8250	6	118.00	5
DHTD 825	Diesel	8250	6	118.00	5
DHU 825	Diesel	8250	6	118.00	5
DK 1160	Diesel	11630	6	130.00	6
DKA 1160	Diesel	11600	6	130.00	6
DKB 1160	Diesel	11600	6	130.00	6
DKCL 1160	Diesel	11630	6	130.00	6
DKD 1160	Diesel	11630	6	130.00	6
DKDL 1160	Diesel	11630	6	130.00	6
DKFL 1160	Diesel	11630	6	130.00	6
DKL 1160	Diesel	11630	6	130.00	6
DKS 1160	Diesel	11600	6	130.00	6
DKS 1160 E	Diesel	11600	6	130.00	6
DKSB 1160	Diesel	11630	6	130.00	6
DKSE 1160	Diesel	11630	6	130.00	6
DKT 1160	Diesel	11600	6	130.00	6
DKTD 1160	Diesel	11600	6	130.00	6
DKTL 1160	Diesel	11600	6	130.00	6
DKV 1160	Diesel	11600	6	130.00	6
DKVL 1160	Diesel	11600	6	130.00	6
DKX 1160	Diesel	11600	6	130.00	6
DKX 1160 ATi	Diesel	11600	6	130.00	6
DKXE 1160	Diesel	11600	6	130.00	6
DKXE 1160 ATi	Diesel	11630	6	130.00	6
DKZ 1160	Diesel	11630	6	130.00	6
DKZ 1160 ATi	Diesel	11600	6	130.00	6
DNS 620	Diesel	6240	6	104.18	4
DNT 620	Diesel	6240	6	104.18	4
DNTD 620	Diesel	6240	6	104.18	4
DT 615	Diesel	6150	6	104.18	4
DTD 615	Diesel	6150	6	104.18	4
DU 825	Diesel	8250	6	118.00	5
EN 55	Diesel	2498	4	94.00	3
ET 70	Diesel	2498	4	94.00	3
HS 200	Diesel	8250	6	118.00	5
HS 825	Diesel	8250	6	118.00	5
HT 168	Diesel	8250	6	118.00	5
HT 825	Diesel	8250	6	118.00	5
KT 191	Diesel	11627	6	130.00	6
LT 160	Diesel	11630	6	130.00	6
LT 195 1160	Diesel	11627	6	130.00	6
LT 210	Diesel	11630	6	130.00	6
MX 265	Diesel	12900	6	130.00	7
MX 300	Diesel	12900	6	130.00	7
MX 340	Diesel	12900	6	130.00	7
MX 375	Diesel	12900	6	130.00	7
MX-13 303	Diesel	12900	6	130.00	7
MX-13 340	Diesel	12900	6	130.00	7
MX-13 375	Diesel	12900	6	130.00	7



Motorverzeichnis • Index de moteur • Índice de Motor  
Indeks silnika • Модель двигателя • دليل المحرك

# ENGINE INDEX



CCM

x



9

NS 156	Diesel	6240	6	104.18	4
NT 133	Diesel	6240	6	104.18	4
PE 183 C	Diesel	9200	6	118.00	5
PE 212 C	Diesel	9200	6	118.00	5
PE 235 C	Diesel	9200	6	118.00	5
PF 183 M	Diesel	9200	6	118.00	5
PF 212 M	Diesel	9200	6	118.00	5
PF 235 M	Diesel	9200	6	118.00	5
RS 180	Diesel	8661	6	118.00	5
RS 180 L	Diesel	8650	6	118.00	5
RS 180 M	Diesel	8650	6	118.00	5
RS 200	Diesel	8650	6	118.00	5
RS 200 L	Diesel	8650	6	118.00	5
RS 200 M	Diesel	8650	6	118.00	5
RS 222	Diesel	8661	6	118.00	5
RS 222 L	Diesel	8650	6	118.00	5
RS 222 M	Diesel	8650	6	118.00	5
WS 222 G	Diesel	11630	6	130.00	6
WS 222 L	Diesel	11630	6	130.00	6
WS 222 M	Diesel	11630	6	130.00	6
WS 225	Diesel	11600	6	130.00	6
WS 225 ATi	Diesel	11630	6	130.00	6
WS 242	Diesel	11600	6	130.00	6
WS 242 G	Diesel	11630	6	130.00	6
WS 242 L	Diesel	11600	6	130.00	6
WS 242 M	Diesel	11600	6	130.00	6
WS 259	Diesel	11600	6	130.00	6
WS 259 ATi	Diesel	11630	6	130.00	6
WS 268	Diesel	11600	6	130.00	6
WS 268 G	Diesel	11600	6	130.00	6
WS 268 L	Diesel	11600	6	130.00	6
WS 268 M	Diesel	11600	6	130.00	6
WS 282	Diesel	11600	6	130.00	6
WS 282 ATi	Diesel	11630	6	130.00	6
WS 282 L	Diesel	11630	6	130.00	6
WS 295	Diesel	11600	6	130.00	6
WS 295 G	Diesel	11600	6	130.00	6
WS 295 L	Diesel	11600	6	130.00	6
WS 295 M	Diesel	11600	6	130.00	6
WS 295 M Ati	Diesel	11627	6	130.00	6
WS 315	Diesel	11600	6	130.00	6
WS 315 G	Diesel	11627	6	130.00	6
WS 315 L	Diesel	11600	6	130.00	6
WS 315 M	Diesel	11600	6	130.00	6
XD3P	Diesel	2498	4	94.00	3
XD3T	Diesel	2498	4	94.00	3
XE 250 C	Diesel	12580	6	130.00	6
XE 280 C	Diesel	12580	6	130.00	6
XE 280 C1	Diesel	12580	6	130.00	6
XE 315 C	Diesel	12580	6	130.00	6
XE 315 C1	Diesel	12580	6	130.00	6
XE 355 C	Diesel	12580	6	130.00	6
XE 355 C1	Diesel	12580	6	130.00	6
XE 390 C	Diesel	12580	6	130.00	6
XE 390 C1	Diesel	12580	6	130.00	6
XF 250 M	Diesel	12580	6	130.00	6
XF 280 M	Diesel	12580	6	130.00	6
XF 315 M	Diesel	12580	6	130.00	6
XF 355 M	Diesel	12580	6	130.00	6



1

110E	4cyl.	1108cc	35kW (47PS)			TD21909
110F	4cyl.	1108cc	40kW (54PS)			TD21910
110G	4cyl.	1108cc	40kW (54PS)			TD21911

14-636730-00 WH	70.00	B 75.50	C 135.00	D 85.70	E 94.80
-----------------	-------	---------	----------	---------	---------

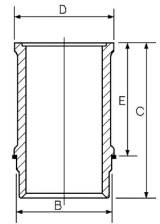

2

810/03/25/26/29	4cyl.	1289cc	40kW (54PS)			FM1486
B13,0S	4cyl.	1289cc	42kW (57PS)			TD5226

14-630440-00 WH	73.00	B 78.50	C 134.00	D 88.00	E 95.00
15-636590-00 WH <sup>1</sup>		B 78.50	C 134.00	D 87.70	E 95.00

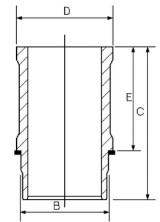

<sup>1</sup> Includes seals

<sup>1</sup> Schließt Dichtungen ein

<sup>1</sup> Inclut des joints

<sup>1</sup> Incluye los sellos

3

EN 55	4cyl.	2498cc	53kW (72PS)	Diesel		TD763
ET 70	4cyl.	2498cc	71kW (96PS)	Diesel	Turbo Intercooled	TD764
XD3P	4cyl.	2498cc	51-58kW (70-79PS)	Diesel		TD22215
XD3T	4cyl.	2498cc	54-70kW (73-95PS)	Diesel	Turbo Intercooled	TD22216

14-020660-00 D	94.00	B 97.00	C 170.60	D 99.50	E 4.00
14-021520-00 D		B 98.00	C 170.60	D 100.00	E 6.00
14-027270-00 D		B 98.70	C 170.00	D 100.00	E 5.00

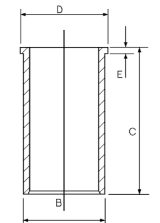

4

DF 615	6cyl.	6150cc	85kW (116PS)	Diesel		TD6601
DNS 620	6cyl.	6240cc	156kW (212PS)	Diesel	Turbo Intercooled	TD6617
DNT 620	6cyl.	6240cc	132kW (180PS)	Diesel	Turbo	TD6615
DNTD 620	6cyl.	6240cc	116kW (158PS)	Diesel	Turbo	TD6614
DT 615	6cyl.	6150cc	111kW (151PS)	Diesel	Turbo	TD6602
DTD 615	6cyl.	6150cc	101-123kW (137-167PS)	Diesel	Turbo	TD6616
NS 156	6cyl.	6240cc	156kW (212PS)	Diesel	Turbo Intercooled	TD12928
NT 133	6cyl.	6240cc	133kW (181PS)	Diesel	Turbo	TD12909

14-025530-00 DH	104.18	B 109.00	C 239.00	D 117.06	E 8.09
-----------------	--------	----------	----------	----------	--------

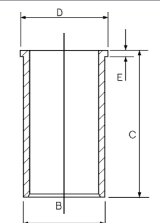



5

DH 825	6cyl.	8250cc	115-121kW (156-165PS)	Diesel		TD6603
DHB 825	6cyl.	8250cc	148kW (201PS)	Diesel	Turbo	TD13229
DHR 825	6cyl.	8250cc	150kW (204PS)	Diesel	Turbo	TD6619
DHS 825	6cyl.	8250cc	184-195kW (250-265PS)	Diesel	Turbo Intercooled	TD6625
DHS 825SM	6cyl.	8250cc	217kW (295PS)	Diesel	Turbo Intercooled	TD6626
DHT 825	6cyl.	8250cc	162-167kW (220-228PS)	Diesel	Turbo	TD6620
DHTD 825	6cyl.	8250cc	151kW (205PS)	Diesel	Turbo	TD6621
DHU 825	6cyl.	8250cc	169kW (230PS)	Diesel	Turbo	TD6623
DU 825	6cyl.	8250cc	159kW (216PS)	Diesel	Turbo	TD6618
HS 200	6cyl.	8250cc	200kW (272PS)	Diesel	Turbo Intercooled	TD6628
HS 825	6cyl.	8250cc	200kW (272PS)	Diesel	Turbo Intercooled	TD12890
HT 168	6cyl.	8250cc	168kW (228PS)	Diesel	Turbo	TD6624
HT 825	6cyl.	8250cc	168kW (228PS)	Diesel	Turbo	TD12891
PE 183 C Euro 3	6cyl.	9200cc	183kW (249PS)	Diesel	Turbo Intercooled	TD13328
PE 212 C Euro 3	6cyl.	9200cc	212kW (288PS)	Diesel	Turbo Intercooled	TD13329
PE 235 C Euro 3	6cyl.	9200cc	235kW (320PS)	Diesel	Turbo Intercooled	TD13330
PF 183 M Euro 2	6cyl.	9200cc	183kW (249PS)	Diesel	Turbo Intercooled	TD11909
PF 212 M Euro 2	6cyl.	9200cc	212kW (288PS)	Diesel	Turbo Intercooled	TD11910
PF 235 M Euro 2	6cyl.	9200cc	235kW (320PS)	Diesel	Turbo Intercooled	TD11911
RS 180	6cyl.	8661cc	180kW (245PS)	Diesel	Turbo Intercooled	TD12553
RS 180 L Euro 1	6cyl.	8650cc	180kW (245PS)	Diesel	Turbo Intercooled	TD6654
RS 180 M Euro 2	6cyl.	8650cc	180kW (245PS)	Diesel	Turbo Intercooled	TD6655
RS 200	6cyl.	8650cc	200kW (272PS)	Diesel	Turbo Intercooled	TD12554
RS 200 L Euro 1	6cyl.	8650cc	200kW (272PS)	Diesel	Turbo Intercooled	TD6656
RS 200 M Euro 2	6cyl.	8650cc	200kW (272PS)	Diesel	Turbo Intercooled	TD6657
RS 222	6cyl.	8661cc	222kW (302PS)	Diesel	Turbo Intercooled	TD12555
RS 222 L Euro 1	6cyl.	8650cc	222kW (302PS)	Diesel	Turbo Intercooled	TD6658
RS 222 M Euro 2	6cyl.	8650cc	222kW (302PS)	Diesel	Turbo Intercooled	TD6659

14-024070-00 *DH*      118.00      B 123.50      C 262.00      D 133.60      E 10.05

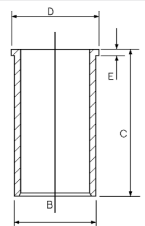

6

DK 1160	6cyl.	11630cc	156kW (212PS)	Diesel	Turbo Intercooled	TD6606
DKA 1160	6cyl.	11600cc	169kW (230PS)	Diesel		TD6608
DKB 1160	6cyl.	11600cc	226kW (307PS)	Diesel	Turbo	TD6627
DKCL 1160	6cyl.	11630cc	156kW (212PS)	Diesel	Turbo Intercooled	TD20105
DKD 1160	6cyl.	11630cc	121kW (165PS)	Diesel	Turbo	TD6605
DKDL 1160	6cyl.	11630cc	121kW (165PS)	Diesel	Turbo Intercooled	TD6640
DKFL 1160	6cyl.	11630cc	191kW (260PS)	Diesel	Turbo Intercooled	TD20107
DKL 1160	6cyl.	11630cc	148-151kW (201-205PS)	Diesel	Turbo Intercooled	TD6641
DKS 1160	6cyl.	11600cc	228kW (310PS)	Diesel	Turbo	TD6629





<b>DKS 1160 E</b>	6cyl.	<b>11600cc</b>	<b>206kW</b> (280PS)	<b>Diesel</b>	<b>Turbo Intercooled</b>	<b>TD6630</b>
<b>DKSB 1160</b>	6cyl.	<b>11630cc</b>	<b>228kW</b> (310PS)	<b>Diesel</b>	<b>Turbo Intercooled</b>	<b>TD20106</b>
<b>DKSE 1160</b>	6cyl.	<b>11630cc</b>	<b>206kW</b> (280PS)	<b>Diesel</b>	<b>Turbo Intercooled</b>	<b>TD22211</b>
<b>DKT 1160</b>	6cyl.	<b>11600cc</b>	<b>213kW</b> (290PS)	<b>Diesel</b>	<b>Turbo</b>	<b>TD6631</b>
<b>DKTD 1160</b>	6cyl.	<b>11600cc</b>	<b>188-191kW</b> (256-260PS)	<b>Diesel</b>	<b>Turbo</b>	<b>TD6632</b>
<b>DKTL 1160</b>	6cyl.	<b>11600cc</b>	<b>185kW</b> (252PS)	<b>Diesel</b>	<b>Turbo</b>	<b>TD6642</b>
<b>DKV 1160</b>	6cyl.	<b>11600cc</b>	<b>212kW</b> (288PS)	<b>Diesel</b>	<b>Turbo</b>	<b>TD6633</b>
<b>DKVL 1160</b>	6cyl.	<b>11600cc</b>	<b>206kW</b> (280PS)	<b>Diesel</b>	<b>Turbo</b>	<b>TD13288</b>
<b>DKX 1160</b>	6cyl.	<b>11600cc</b>	<b>243kW</b> (330PS)	<b>Diesel</b>	<b>Turbo Intercooled</b>	<b>TD6637</b>
<b>DKX 1160 ATI</b>	6cyl.	<b>11600cc</b>	<b>260kW</b> (354PS)	<b>Diesel</b>	<b>Turbo Intercooled</b>	<b>TD6638</b>
<b>DKXE 1160</b>	6cyl.	<b>11600cc</b>	<b>212kW</b> (288PS)	<b>Diesel</b>	<b>Turbo Intercooled</b>	<b>TD6634</b>
<b>DKXE 1160 ATI</b>	6cyl.	<b>11630cc</b>	<b>139-274kW</b> (189-373PS)	<b>Diesel</b>	<b>Turbo Intercooled</b>	<b>TD22212</b>
<b>DKZ 1160</b>	6cyl.	<b>11630cc</b>	<b>139-274kW</b> (189-373PS)	<b>Diesel</b>	<b>Turbo Intercooled</b>	<b>TD22213</b>
<b>DKZ 1160 ATI</b>	6cyl.	<b>11600cc</b>	<b>274kW</b> (373PS)	<b>Diesel</b>	<b>Turbo Intercooled</b>	<b>TD6639</b>
<b>KT 191</b>	6cyl.	<b>11627cc</b>	<b>256kW</b> (348PS)	<b>Diesel</b>	<b>Turbo Intercooled</b>	<b>FM5278</b>
<b>LT 160</b>	6cyl.	<b>11630cc</b>	<b>160-170kW</b> (218-231PS)	<b>Diesel</b>	<b>Turbo Intercooled</b>	<b>TD24104</b>
<b>LT 195 1160</b>	6cyl.	<b>11627cc</b>	<b>195kW</b> (265PS)	<b>Diesel</b>		<b>FM5310</b>
<b>LT 210</b>	6cyl.	<b>11630cc</b>	<b>206-210kW</b> (280-286PS)	<b>Diesel</b>	<b>Turbo Intercooled</b>	<b>TD7173</b>
<b>WS 222 G</b>	6cyl.	<b>11630cc</b>	<b>222kW</b> (302PS)	<b>Diesel</b>	<b>Turbo Intercooled</b>	<b>TD6667</b>
<b>WS 222 L</b>	6cyl.	<b>11630cc</b>	<b>222kW</b> (302PS)	<b>Diesel</b>	<b>Turbo Intercooled</b>	<b>TD6660</b>
<b>WS 222 M</b>	6cyl.	<b>11630cc</b>	<b>222kW</b> (302PS)	<b>Diesel</b>	<b>Turbo Intercooled</b>	<b>TD6661</b>
<b>WS 225</b>	6cyl.	<b>11600cc</b>	<b>225kW</b> (306PS)	<b>Diesel</b>	<b>Turbo Intercooled</b>	<b>TD6668</b>
<b>WS 225 ATI</b>	6cyl.	<b>11630cc</b>	<b>225kW</b> (306PS)	<b>Diesel</b>	<b>Turbo Intercooled</b>	<b>TD7517</b>
<b>WS 242</b>	6cyl.	<b>11600cc</b>	<b>242kW</b> (329PS)	<b>Diesel</b>	<b>Turbo Intercooled</b>	<b>TD6669</b>
<b>WS 242 G</b>	6cyl.	<b>11630cc</b>	<b>242kW</b> (329PS)	<b>Diesel</b>	<b>Turbo Intercooled</b>	<b>TD22214</b>
<b>WS 242 L Euro 1</b>	6cyl.	<b>11600cc</b>	<b>242kW</b> (329PS)	<b>Diesel</b>	<b>Turbo Intercooled</b>	<b>TD6662</b>
<b>WS 242 M Euro 2</b>	6cyl.	<b>11600cc</b>	<b>242kW</b> (329PS)	<b>Diesel</b>	<b>Turbo Intercooled</b>	<b>TD6663</b>
<b>WS 259</b>	6cyl.	<b>11600cc</b>	<b>259kW</b> (352PS)	<b>Diesel</b>	<b>Turbo Intercooled</b>	<b>TD6670</b>
<b>WS 259 ATI</b>	6cyl.	<b>11630cc</b>	<b>259kW</b> (352PS)	<b>Diesel</b>	<b>Turbo Intercooled</b>	<b>TD7518</b>
<b>WS 268</b>	6cyl.	<b>11600cc</b>	<b>268kW</b> (365PS)	<b>Diesel</b>	<b>Turbo Intercooled</b>	<b>TD6671</b>
<b>WS 268 G</b>	6cyl.	<b>11600cc</b>	<b>268kW</b> (365PS)	<b>Diesel</b>	<b>Turbo Intercooled</b>	<b>TD6672</b>
<b>WS 268 L Euro 1</b>	6cyl.	<b>11600cc</b>	<b>268kW</b> (365PS)	<b>Diesel</b>	<b>Turbo Intercooled</b>	<b>TD6664</b>
<b>WS 268 M Euro 2</b>	6cyl.	<b>11600cc</b>	<b>268kW</b> (365PS)	<b>Diesel</b>	<b>Turbo Intercooled</b>	<b>TD6665</b>
<b>WS 282</b>	6cyl.	<b>11600cc</b>	<b>282kW</b> (384PS)	<b>Diesel</b>	<b>Turbo Intercooled</b>	<b>TD11907</b>
<b>WS 282 ATI</b>	6cyl.	<b>11630cc</b>	<b>282kW</b> (384PS)	<b>Diesel</b>	<b>Turbo Intercooled</b>	<b>TD7519</b>
<b>WS 282 L</b>	6cyl.	<b>11630cc</b>	<b>282kW</b> (384PS)	<b>Diesel</b>	<b>Turbo Intercooled</b>	<b>TD6674</b>
<b>WS 295</b>	6cyl.	<b>11600cc</b>	<b>295kW</b> (401PS)	<b>Diesel</b>	<b>Turbo Intercooled</b>	<b>TD6675</b>
<b>WS 295 G</b>	6cyl.	<b>11600cc</b>	<b>295kW</b> (401PS)	<b>Diesel</b>	<b>Turbo Intercooled</b>	<b>TD6676</b>
<b>WS 295 L Euro 1</b>	6cyl.	<b>11600cc</b>	<b>295kW</b> (401PS)	<b>Diesel</b>	<b>Turbo Intercooled</b>	<b>TD6677</b>
<b>WS 295 M Euro 2</b>	6cyl.	<b>11600cc</b>	<b>295kW</b> (401PS)	<b>Diesel</b>	<b>Turbo Intercooled</b>	<b>TD6678</b>
<b>WS 295 M ATI</b>	6cyl.	<b>11627cc</b>	<b>295kW</b> (401PS)	<b>Diesel</b>	<b>Turbo Intercooled</b>	<b>TD6666</b>
<b>WS 315</b>	6cyl.	<b>11600cc</b>	<b>315kW</b> (428PS)	<b>Diesel</b>	<b>Turbo Intercooled</b>	<b>TD11908</b>
<b>WS 315 G</b>	6cyl.	<b>11627cc</b>	<b>315kW</b> (428PS)	<b>Diesel</b>	<b>Turbo</b>	<b>TD6679</b>
<b>WS 315 L Euro 1</b>	6cyl.	<b>11600cc</b>	<b>315kW</b> (428PS)	<b>Diesel</b>	<b>Turbo Intercooled</b>	<b>TD6680</b>
<b>WS 315 M Euro 2</b>	6cyl.	<b>11600cc</b>	<b>315kW</b> (428PS)	<b>Diesel</b>	<b>Turbo Intercooled</b>	<b>TD6681</b>





<b>XE 250 C Euro 3</b>	6cyl.	<b>12580cc</b>	<b>250kW</b> (340PS)	<b>Diesel</b>	<b>Turbo Intercooled</b>	<b>TD13331</b>
<b>XE 280 C Euro 3</b>	6cyl.	<b>12580cc</b>	<b>280kW</b> (381PS)	<b>Diesel</b>	<b>Turbo Intercooled</b>	<b>TD13332</b>
<b>XE 280 C1 Euro 3</b>	6cyl.	<b>12580cc</b>	<b>280kW</b> (381PS)	<b>Diesel</b>	<b>Turbo Intercooled</b>	<b>TD22217</b>
<b>XE 315 C Euro 3</b>	6cyl.	<b>12580cc</b>	<b>315kW</b> (428PS)	<b>Diesel</b>	<b>Turbo Intercooled</b>	<b>TD13333</b>
<b>XE 315 C1 Euro 3</b>	6cyl.	<b>12580cc</b>	<b>315kW</b> (428PS)	<b>Diesel</b>	<b>Turbo Intercooled</b>	<b>TD22218</b>
<b>XE 355 C Euro 3</b>	6cyl.	<b>12580cc</b>	<b>355kW</b> (483PS)	<b>Diesel</b>	<b>Turbo Intercooled</b>	<b>TD13334</b>
<b>XE 355 C1 Euro 3</b>	6cyl.	<b>12580cc</b>	<b>355kW</b> (483PS)	<b>Diesel</b>	<b>Turbo Intercooled</b>	<b>TD22219</b>
<b>XE 390 C Euro 3</b>	6cyl.	<b>12580cc</b>	<b>390kW</b> (530PS)	<b>Diesel</b>	<b>Turbo Intercooled</b>	<b>TD13335</b>
<b>XE 390 C1 Euro 3</b>	6cyl.	<b>12580cc</b>	<b>390kW</b> (530PS)	<b>Diesel</b>	<b>Turbo Intercooled</b>	<b>TD22220</b>
<b>XF 250 M Euro 2</b>	6cyl.	<b>12580cc</b>	<b>250kW</b> (340PS)	<b>Diesel</b>	<b>Turbo Intercooled</b>	<b>TD11912</b>
<b>XF 280 M Euro 2</b>	6cyl.	<b>12580cc</b>	<b>280kW</b> (381PS)	<b>Diesel</b>	<b>Turbo Intercooled</b>	<b>TD11913</b>
<b>XF 315 M Euro 2</b>	6cyl.	<b>12580cc</b>	<b>315kW</b> (428PS)	<b>Diesel</b>	<b>Turbo Intercooled</b>	<b>TD11914</b>
<b>XF 355 M Euro 2</b>	6cyl.	<b>12580cc</b>	<b>355kW</b> (483PS)	<b>Diesel</b>	<b>Turbo Intercooled</b>	<b>TD11915</b>

14-021410-00 *DH*      130.00      B 136.02      C 288.30      D 143.60      E 10.05

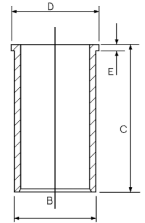

**7**

<b>MX-13 303 Euro 6</b>	6cyl.	<b>12900cc</b>	<b>303kW</b> (412PS)	<b>Diesel</b>	<b>Turbo Intercooled</b>	<b>TD28147</b>
<b>MX-13 340 Euro 6</b>	6cyl.	<b>12900cc</b>	<b>340kW</b> (462PS)	<b>Diesel</b>	<b>Turbo Intercooled</b>	<b>TD28148</b>
<b>MX-13 375 Euro 6</b>	6cyl.	<b>12900cc</b>	<b>375kW</b> (510PS)	<b>Diesel</b>	<b>Turbo Intercooled</b>	<b>TD28149</b>
<b>MX 265 Euro 4/5</b>	6cyl.	<b>12900cc</b>	<b>265kW</b> (360PS)	<b>Diesel</b>	<b>Turbo Intercooled</b>	<b>TD20056</b>
<b>MX 300 Euro 4/5</b>	6cyl.	<b>12900cc</b>	<b>300kW</b> (408PS)	<b>Diesel</b>	<b>Turbo Intercooled</b>	<b>TD18902</b>
<b>MX 340 Euro 4/5</b>	6cyl.	<b>12900cc</b>	<b>340kW</b> (462PS)	<b>Diesel</b>	<b>Turbo Intercooled</b>	<b>TD18903</b>
<b>MX 375 Euro 4/5</b>	6cyl.	<b>12900cc</b>	<b>375kW</b> (510PS)	<b>Diesel</b>	<b>Turbo Intercooled</b>	<b>TD18904</b>

15-451230-00 *WH* ⓘ      130.00      B 146.00      C 268.00      D 157.60      E 12.00      F 0.95

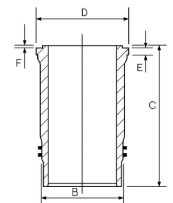

ⓘ Includes Anti-Polish Ring (Fire Ring)

ⓘ Enthält Ölschlitzring

ⓘ Contient le segment raclleur

ⓘ Incluye el segmento rascador



**1**

**11B** 4cyl. **2977cc** **61kW (82PS)** **TD6696**

**B** 4cyl. **2977cc** **57-59kW (78-80PS)** **Diesel** **TD6695**

**14-040150-00 D** **95.00** **B 102.00** **C 190.22** **D 107.75** **E 2.55** **F 1.20**

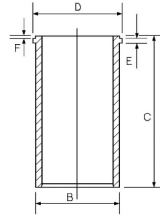



1

AD3/49	3cyl.	2395cc	Diesel	FM428
AD3/55	3cyl.	2695cc	Diesel	FM430
AD4/49	4cyl.	3195cc	Diesel	FM429
AD4/55	4cyl.	3594cc	Diesel	FM431
AD4/55T	4cyl.	3594cc	Diesel Turbo	FM433
AD6/55	6cyl.	5392cc	Diesel	FM3822
AD6/55T	6cyl.	5392cc	Diesel Turbo	FM3823

14-010950-00 *D*      100.04      B 105.08      C 212.22

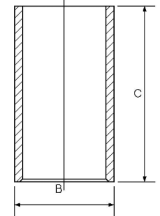

# ENGINE INDEX

Motorverzeichnis • Index de moteur • Índice de Motor  
Indeks silnika • Модель двигателя • دليل المحرك



CCM



9

BF 10L 413 F	Diesel	15953	V10	125.00	13
BF 10L 513	Diesel	15954	V10	125.00	13
BF 10L 513 C	Diesel	15954	V10	125.00	13
BF 10L 513 F	Diesel	15945	V10	125.00	13
BF 12 L 413 F	Diesel	19144	V12	125.00	13
BF 12L 413 F	Diesel	19144	V12	125.00	13
BF 12L 513	Diesel	19144	V12	125.00	13
BF 12L 513 C	Diesel	19144	V12	125.00	13
BF 12L 513 F	Diesel	19144	V12	125.00	13
BF 2L 912	Diesel	1884	2	100.00	3
BF 3L 912	Diesel	2826	3	100.00	3
BF 3L 914	Diesel	3236	3	102.00	9
BF 4L 1011 F	Diesel	2731	4	91.00	1
BF 4L 1011 FT	Diesel	2732	4	91.00	1
BF 4L 912	Diesel	3768	4	100.00	3
BF 4L 913	Diesel	4068	4	102.00	6
BF 4L 913 C	Diesel	4086	4	102.00	5
BF 4L 913 T	Diesel	4086	4	102.00	7
BF 4L 913 T	Diesel	4086	4	102.00	8
BF 4L 914	Diesel	4314	4	102.00	9
BF 4M 1012	Diesel	3192	4	94.00	2
BF 4M 1012 C	Diesel	3192	4	94.00	2
BF 4M 1012 E	Diesel	3192	4	94.00	2
BF 4M 1012 EC	Diesel	3192	4	94.00	2
BF 4M 1013	Diesel	4764	4	108.00	10
BF 4M 1013 C	Diesel	4764	4	108.00	10
BF 4M 1013 E	Diesel	4764	4	108.00	10
BF 4M 1013 EC	Diesel	4764	4	108.00	10
BF 4M 1013 FC	Diesel	4764	4	108.00	10
BF 5L 912	Diesel	4710	5	100.00	3
BF 6L 413 FR	Diesel	9572	V6	125.00	13
BF 6L 513	Diesel	9572	V6	125.00	13
BF 6L 513 C	Diesel	9572	V6	125.00	13
BF 6L 912	Diesel	5655	6	100.00	3
BF 6L 913	Diesel	6128	6	102.00	6
BF 6L 913 C	Diesel	6128	6	102.00	6
BF 6L 913 T	Diesel	6128	6	102.00	7
BF 6L 913 T	Diesel	6128	6	102.00	8
BF 6L 914	Diesel	6472	6	102.00	9
BF 6M 1012	Diesel	4788	6	94.00	2
BF 6M 1012 C	Diesel	4788	6	94.00	2
BF 6M 1012 E	Diesel	4788	6	94.00	2
BF 6M 1012 EC	Diesel	4788	6	94.00	2
BF 6M 1013	Diesel	7145	6	108.00	10
BF 6M 1013 C	Diesel	7145	6	108.00	10
BF 6M 1013 CP	Diesel	7145	6	108.00	10
BF 6M 1013 E	Diesel	7145	6	108.00	10
BF 6M 1013 ECP	Diesel	7145	6	108.00	10
BF 6M 1013 FC	Diesel	7145	6	108.00	10
BF 6M 1015	Diesel	11905	V6	132.00	14
BF 6M 1015 C	Diesel	11905	V6	132.00	14
BF 6M 1015 CP	Diesel	11905	V6	132.00	14
BF 8L 413 F	Diesel	12763	V8	125.00	13
BF 8L 513	Diesel	12763	V8	125.00	13
BF 8L 513 C	Diesel	13738	8	125.00	13
BF 8M 1015	Diesel	15874	V8	132.00	14
BF 8M 1015 C	Diesel	15874	V8	132.00	14
BF 8M 1015 CP	Diesel	15874	V8	132.00	14
F 10L 413	Diesel	14140	V10	120.00	12
F 10L 413 F	Diesel	15953	V10	125.00	13





CCM

x



9

F 10L 413 FW	Diesel	15953	V10	125.00	13
F 10L 413 L	Diesel	14137	V10	120.00	12
F 12L 413	Diesel	16960	V12	120.00	12
F 12L 413 F	Diesel	19144	V12	125.00	13
F 12L 413 FW	Diesel	19144	V12	125.00	13
F 2L 1011 F	Diesel	1366	2	91.00	1
F 2L 912 D	Diesel	1885	2	100.00	4
F 2L 912 W	Diesel	1884	2	100.00	3
F 3L 1011 F	Diesel	2049	3	91.00	1
F 3L 912 D	Diesel	2826	3	100.00	4
F 3L 912 W	Diesel	2826	3	100.00	3
F 3L 913 G	Diesel	3064	3	102.00	5
F 3L 913 G	Diesel	3064	3	102.00	7
F 3L 914	Diesel	3236	3	102.00	9
F 4L 1011 F	Diesel	2732	4	91.00	1
F 4L 413 FR	Diesel	6381	4	125.00	13
F 4L 912 D	Diesel	3770	4	100.00	4
F 4L 912 F	Diesel	4086	4	102.00	7
F 4L 912 W	Diesel	3770	4	100.00	3
F 4L 913	Diesel	4086	4	102.00	5
F 4L 913 D	Diesel	4086	4	102.00	7
F 4L 914	Diesel	4314	4	102.00	9
F 5L 413	Diesel	7070	5	120.00	12
F 5L 413 FR	Diesel	7976	5	125.00	13
F 5L 912 D	Diesel	4712	5	100.00	4
F 5L 912 F	Diesel	5107	5	102.00	7
F 5L 912 W	Diesel	4710	5	100.00	3
F 5L 914	Diesel	5393	5	102.00	9
F 6L 413	Diesel	8478	V6	120.00	12
F 6L 413 F	Diesel	9572	V6	125.00	13
F 6L 413 FR	Diesel	9572	V6	125.00	13
F 6L 413 FW	Diesel	9572	V6	125.00	13
F 6L 413 L	Diesel	8482	V6	120.00	12
F 6L 912 D	Diesel	5655	6	100.00	4
F 6L 912 F	Diesel	6128	6	102.00	7
F 6L 912 W	Diesel	5655	6	100.00	3
F 6L 913	Diesel	6128	6	102.00	5
F 6L 913 D	Diesel	6128	6	102.00	7
F 6L 914	Diesel	6472	6	102.00	9
F 8L 413	Diesel	11310	V8	120.00	12
F 8L 413 F	Diesel	12763	V8	125.00	13
F 8L 413 FW	Diesel	12763	V8	125.00	13
F 8L 413 L	Diesel	11310	V8	120.00	12
TCD 2013 L4 2V	Diesel	4764	4	108.00	10
TCD 2013 L4 4V	Diesel	4764	4	108.00	11
TCD 2013 L6 2V	Diesel	7145	6	108.00	10
TCD 2013 L6 4V	Diesel	7145	6	108.00	11



1

BF 4L 1011 F	4cyl.	2731cc	28-55kW (38-75PS)	Diesel	Turbo	TD17230
BF 4L 1011 FT	4cyl.	2732cc	46kW (63PS)	Diesel	Turbo	TD17228
F 2L 1011 F	2cyl.	1366cc	20-22kW (27-30PS)	Diesel		TD17224
F 3L 1011 F	3cyl.	2049cc	16-33kW (22-45PS)	Diesel		TD17225
F 4L 1011 F	4cyl.	2732cc	24-47kW (33-64PS)	Diesel		TD17227

14-029750-00 *DH*      91.00      B 94.01      C 175.50      D 98.90      E 4.55

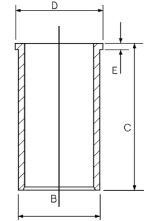

2

BF 4M 1012 Euro 1	4cyl.	3192cc	58-65kW (79-88PS)	Diesel	Turbo Intercooled	TD17235
BF 4M 1012 C Euro 1	4cyl.	3192cc	74-82kW (101-112PS)	Diesel	Turbo Intercooled	TD17236
BF 4M 1012 E Euro 2	4cyl.	3192cc	51-66kW (69-90PS)	Diesel	Turbo	TD17239
BF 4M 1012 EC	4cyl.	3192cc	63-84kW (86-114PS)	Diesel	Turbo Intercooled	TD17233
BF 6M 1012 Euro 1	6cyl.	4788cc	88-98kW (120-133PS)	Diesel	Turbo Intercooled	TD17237
BF 6M 1012 C Euro 1	6cyl.	4788cc	111-123kW (151-167PS)	Diesel	Turbo Intercooled	TD17238
BF 6M 1012 E	6cyl.	4788cc	90-100kW (122-136PS)	Diesel	Turbo	TD17240
BF 6M 1012 EC	6cyl.	4788cc	113-125kW (154-170PS)	Diesel	Turbo Intercooled	TD17234

14-020490-00 *DH*      94.00      B 98.50      C 196.00      D 102.60      E 5.00

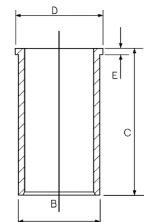

3

BF 2L 912	2cyl.	1884cc		Diesel	Turbo	FM6110
BF 3L 912	3cyl.	2826cc		Diesel	Turbo	FM6111
BF 4L 912	4cyl.	3768cc		Diesel	Turbo	FM6112
BF 5L 912	5cyl.	4710cc		Diesel	Turbo	FM6113
BF 6L 912	6cyl.	5655cc	88-100kW (120-136PS)	Diesel	Turbo	TD18348
F 2L 912 W	2cyl.	1884cc	22kW (30PS)	Diesel		FM6565
F 3L 912 W	3cyl.	2826cc	25kW (34PS)	Diesel		TD19019
F 4L 912 W	4cyl.	3770cc	38kW (52PS)	Diesel		TD19022
F 5L 912 W	5cyl.	4710cc	61kW (82PS)	Diesel		FM6566
F 6L 912 W	6cyl.	5655cc	57kW (77PS)	Diesel		TD19024

14-900080-00 *DH*      100.00      B 110.00      C 222.30      D 120.00      E 137.30

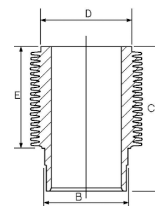



4

<b>F 2L 912 D</b>	2cyl.	<b>1885cc</b>	<b>21-28kW</b> (29-38PS)	<b>Diesel</b>	<b>FM7020</b>
<b>F 3L 912 D</b>	3cyl.	<b>2826cc</b>	<b>26kW</b> (35PS)	<b>Diesel</b>	<b>TD19020</b>
<b>F 4L 912 D</b>	4cyl.	<b>3770cc</b>	<b>38kW</b> (52PS)	<b>Diesel</b>	<b>TD19021</b>
<b>F 5L 912 D</b>	5cyl.	<b>4712cc</b>	<b>58kW</b> (79PS)	<b>Diesel</b>	<b>TD19023</b>
<b>F 6L 912 D</b>	6cyl.	<b>5655cc</b>	<b>42kW</b> (57PS)	<b>Diesel</b>	<b>TD19030</b>

<b>14-900080-00 DH</b> →09/96	<b>100.00</b>	<b>B 110.00</b>	<b>C 222.30</b>	<b>D 120.00</b>	<b>E 137.30</b>
<b>14-900080-10 DH</b> 10/96→		<b>B 110.00</b>	<b>C 222.30</b>	<b>D 120.00</b>	<b>E 136.80</b>

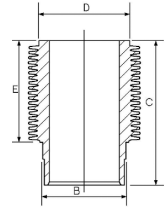

5

<b>F 3L 913 G</b>	3cyl.	<b>3064cc</b>	<b>37kW</b> (50PS)	<b>Diesel</b>	<b>TD17201</b>
<b>F 4L 913</b>	4cyl.	<b>4086cc</b>	<b>50-78kW</b> (68-106PS)	<b>Diesel</b>	<b>TD7277</b>
<b>F 6L 913</b>	6cyl.	<b>6128cc</b>	<b>96kW</b> (131PS)	<b>Diesel</b>	<b>TD7451</b>

<b>14-900060-00 DH</b> <sup>1</sup>	<b>102.00</b>	<b>B 109.50</b>	<b>C 222.30</b>	<b>D 120.00</b>	<b>E 136.80</b>
<b>14-900100-00 DH</b>		<b>B 110.00</b>	<b>C 222.30</b>	<b>D 120.00</b>	<b>E 137.30</b>

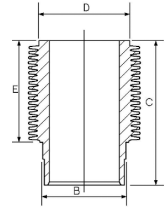

<sup>1</sup> Hone-Lapped

<sup>1</sup> Hongeläppt

<sup>1</sup> Rodée à la pierre

<sup>1</sup> Lapeado buñido

6

<b>BF 4L 913</b>	4cyl.	<b>4068cc</b>	<b>47-78kW</b> (64-106PS)	<b>Diesel Turbo</b>	<b>TD17203</b>
<b>BF 4L 913 C</b>	4cyl.	<b>4086cc</b>	<b>78-92kW</b> (106-125PS)	<b>Diesel Turbo Intercooled</b>	<b>TD21059</b>
<b>BF 6L 913</b>	6cyl.	<b>6128cc</b>	<b>70-118kW</b> (95-160PS)	<b>Diesel Turbo</b>	<b>TD17205</b>
<b>BF 6L 913 C</b>	6cyl.	<b>6128cc</b>	<b>81-142kW</b> (110-193PS)	<b>Diesel Turbo Intercooled</b>	<b>TD17206</b>

<b>14-900060-00 DH</b> <sup>1</sup>	<b>102.00</b>	<b>B 109.50</b>	<b>C 222.30</b>	<b>D 120.00</b>	<b>E 136.80</b>
<b>14-900100-00 DH</b>		<b>B 110.00</b>	<b>C 222.30</b>	<b>D 120.00</b>	<b>E 137.30</b>
<b>14-900110-00 DH</b>		<b>B 109.50</b>	<b>C 220.40</b>	<b>D 124.50</b>	<b>E 134.90</b>
<b>14-900120-00 WH</b>		<b>B 109.80</b>	<b>C 220.40</b>	<b>D 124.50</b>	<b>E 135.40</b>

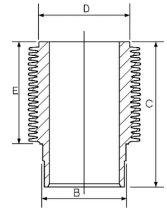

<sup>1</sup> Hone-Lapped

<sup>1</sup> Hongeläppt

<sup>1</sup> Rodée à la pierre

<sup>1</sup> Lapeado buñido



7

F 3L 913 G	3cyl.	3064cc	37kW (50PS)	Diesel	FM6601
F 4L 912 F	4cyl.	4086cc		Diesel	FM5922
F 4L 913 D	4cyl.	4086cc	34-59kW (46-80PS)	Diesel	TD17202
F 5L 912 F	5cyl.	5107cc		Diesel	FM5925
F 6L 912 F	6cyl.	6128cc		Diesel	FM5926
F 6L 913 D	6cyl.	6128cc	51-89kW (69-121PS)	Diesel	TD17204

14-900060-00 DH ①	102.00	B 109.50	C 222.30	D 120.00	E 136.80
14-900100-00 DH	102.00	B 110.00	C 222.30	D 120.00	E 137.30

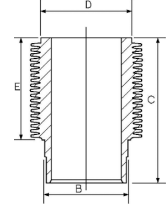

① Hone-Lapped      ① Hongeläppt      ① Rodée à la pierre      ① Lapeado buñido

8

BF 4L 913 T	4cyl.	4086cc	64-78kW (87-106PS)	Diesel Turbo	TD18347
BF 6L 913 T	6cyl.	6128cc	85-112kW (115-152PS)	Diesel Turbo	TD18350

14-900060-00 DH ①	102.00	B 109.50	C 222.30	D 120.00	E 136.80
14-900100-00 DH	102.00	B 110.00	C 222.30	D 120.00	E 137.30
14-900110-00 DH		B 109.50	C 220.40	D 124.50	E 134.90
14-900120-00 WH		B 109.80	C 220.40	D 124.50	E 135.40

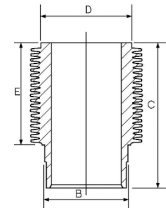

① Hone-Lapped      ① Hongeläppt      ① Rodée à la pierre      ① Lapeado buñido

9

BF 3L 914	3cyl.	3236cc	56kW (76PS)	Diesel Turbo	TD17215
BF 4L 914	4cyl.	4314cc	75kW (102PS)	Diesel Turbo	TD17216
BF 6L 914	6cyl.	6472cc	80-116kW (109-158PS)	Diesel Turbo	TD17217
F 3L 914	3cyl.	3236cc	46kW (63PS)	Diesel	TD17211
F 4L 914	4cyl.	4314cc	61kW (82PS)	Diesel	TD17212
F 5L 914	5cyl.	5393cc	75kW (102PS)	Diesel	TD17213
F 6L 914	6cyl.	6472cc	92kW (125PS)	Diesel	TD17214

14-900120-00 WH	102.00	B 109.80	C 220.40	D 124.50	E 135.40
-----------------	--------	----------	----------	----------	----------

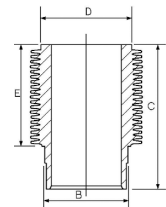



10

BF 4M 1013 Euro 1	4cyl.	4764cc	84-93kW (114-126PS)	Diesel	Turbo	TD17246
BF 4M 1013 C Euro 1	4cyl.	4764cc	104-115kW (141-156PS)	Diesel	Turbo Intercooled	TD17247
BF 4M 1013 E Euro 2	4cyl.	4764cc	77-95kW (105-129PS)	Diesel	Turbo Intercooled	TD17244
BF 4M 1013 EC Euro 2	4cyl.	4764cc	92-125kW (125-170PS)	Diesel	Turbo Intercooled	TD17241
BF 4M 1013 FC Euro 2/3	4cyl.	4764cc	125-140kW (170-190PS)	Diesel	Turbo Intercooled	TD20767
BF 6M 1013 Euro 1	6cyl.	7145cc	126-141kW (171-192PS)	Diesel	Turbo	TD17248
BF 6M 1013 C Euro 1	6cyl.	7145cc	153-170kW (208-231PS)	Diesel	Turbo Intercooled	TD17249
BF 6M 1013 CP Euro 1	6cyl.	7145cc	171-190kW (233-258PS)	Diesel	Turbo Intercooled	TD17250
BF 6M 1013 E Euro 2	6cyl.	7145cc	116-145kW (158-197PS)	Diesel	Turbo Intercooled	TD17245
BF 6M 1013 ECP Euro 2/3	6cyl.	7145cc	176-195kW (239-265PS)	Diesel	Turbo Intercooled	TD17243
BF 6M 1013 FC Euro 2/3	6cyl.	7145cc	200-210kW (272-286PS)	Diesel	Turbo Intercooled	TD20768
TCD 2013 L4 2V Euro 2	4cyl.	4764cc	120kW (163PS)	Diesel	Turbo Intercooled	TD20766
TCD 2013 L6 2V Euro 2	6cyl.	7145cc	200kW (272PS)	Diesel	Turbo Intercooled	TD19988

14-480040-00 WH 108.00 B 120.00 C 229.10 D 128.50 E 9.00 F 1.10

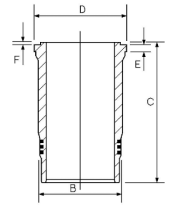

11

TCD 2013 L4 4V Euro 4	4cyl.	4764cc	158kW (215PS)	Diesel	Turbo Intercooled	TD20769
TCD 2013 L6 4V Euro 4	6cyl.	7145cc	243kW (330PS)	Diesel	Turbo Intercooled	TD20765

15-480450-00 WH 108.00 B 120.00 C 228.00 D 131.70 E 8.06

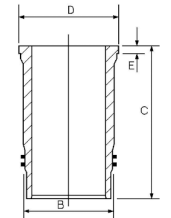

☐ Includes seals

☐ Schließt Dichtungen ein

☐ Inclut des joints

☐ Incluye los sellos

12

F 5L 413	5cyl.	7070cc		Diesel		FM6143
F 6L 413	V6cyl.	8478cc	99-130kW (135-177PS)	Diesel		TD18362
F 6L 413 L	V6cyl.	8482cc	137kW (186PS)	Diesel		FM5381
F 8L 413	V8cyl.	11310cc	169kW (230PS)	Diesel		TD18363
F 8L 413 L	V8cyl.	11310cc	179kW (243PS)	Diesel		FM5382
F 10L 413	V10cyl.	14140cc	167-224kW (227-305PS)	Diesel		TD18352
F 10L 413 L	V10cyl.	14137cc	198-224kW (270-305PS)	Diesel		FM5383
F 12L 413	V12cyl.	16960cc	250kW (340PS)	Diesel		TD18354

14-900070-00 DH 120.00 B 255.40 C 145.00 D 170.20 E 124.80

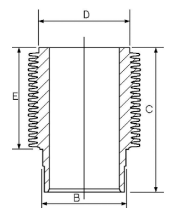



13

BF 6L 413 FR	V6cyl.	9572cc	143kW (195PS)	Diesel	Turbo	TD19028
BF 6L 513	V6cyl.	9572cc	141-210kW (192-286PS)	Diesel	Turbo	TD19240
BF 6L 513 C	V6cyl.	9572cc	112-177kW (152-241PS)	Diesel	Turbo Intercooled	TD21275
BF 8L 413 F	V8cyl.	12763cc	212-235kW (288-320PS)	Diesel	Turbo	TD7329
BF 8L 413 F	V8cyl.	12763cc	212-235kW (288-320PS)	Diesel	Turbo	TD18351
BF 8L 513	V8cyl.	12763cc	235-250kW (320-340PS)	Diesel	Turbo	TD18495
BF 8L 513 C	8cyl.	13738cc	265kW (360PS)	Diesel	Turbo Intercooled	TD26618
BF 10L 413 F	V10cyl.	15953cc	265kW (360PS)	Diesel	Turbo	TD7355
BF 10L 413 F	V10cyl.	15953cc	265-294kW (360-400PS)	Diesel	Turbo	TD18344
BF 10L 513	V10cyl.	15954cc	218-305kW (296-415PS)	Diesel	Turbo	TD18127
BF 10L 513 C	V10cyl.	15954cc	265-294kW (360-400PS)	Diesel	Turbo Intercooled	TD21060
BF 10L 513 F	V10cyl.	15945cc	253-294kW (344-400PS)	Diesel	Turbo	TD19241
BF 12 L 413 F	V12cyl.	19144cc	268-353kW (364-480PS)	Diesel	Turbo	TD6772
BF 12L 413 F	V12cyl.	19144cc	268-353kW (364-480PS)	Diesel	Turbo	TD18346
BF 12L 513	V12cyl.	19144cc	353-367kW (480-499PS)	Diesel	Turbo	TD18496
BF 12L 513 C	V12cyl.	19144cc	386-405kW (525-551PS)	Diesel	Turbo Intercooled	TD18498
BF 12L 513 F	V12cyl.	19144cc	282-353kW (384-480PS)	Diesel	Turbo	TD19029
F 4L 413 FR	4cyl.	6381cc	94kW (128PS)	Diesel		TD18340
F 5L 413 FR	5cyl.	7976cc	94-118kW (128-160PS)	Diesel		TD17882
F 6L 413 F	V6cyl.	9572cc	125-141kW (170-192PS)	Diesel		TD6960
F 6L 413 F	V6cyl.	9572cc	104-188kW (141-256PS)	Diesel		TD18341
F 6L 413 FR	V6cyl.	9572cc	112-141kW (152-192PS)	Diesel		TD21274
F 6L 413 FW	V6cyl.	9572cc	96-121kW (131-165PS)	Diesel		TD17883
F 8L 413 F	V8cyl.	12763cc	147-188kW (200-256PS)	Diesel		TD7256
F 8L 413 F	V8cyl.	12763cc	147-188kW (200-256PS)	Diesel		TD18342
F 8L 413 FW	V8cyl.	12763cc	129-150kW (175-204PS)	Diesel		TD17885
F 10L 413 F	V10cyl.	15953cc	235kW (320PS)	Diesel		TD7331
F 10L 413 F	V10cyl.	15953cc	235kW (320PS)	Diesel		TD18353
F 10L 413 FW	V10cyl.	15953cc	161-202kW (219-275PS)	Diesel		TD17886
F 12L 413 F	V12cyl.	19144cc	224-282kW (305-384PS)	Diesel		TD18355
F 12L 413 FW	V12cyl.	19144cc	193-243kW (262-330PS)	Diesel		TD17888

14-900030-00 DH ①  
14-900050-00 DH ②

125.00

B 139.00 C 250.80 D 154.00 E 169.50  
B 139.00 C 250.76 D 150.00 E 169.50

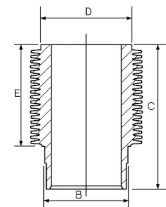

① Hone-Lapped

① Hongeläppt

① Rodée à la pierre

① Lapeado buñido

② Phosphated

② Phosphatiert

② Phosphatisé

② Fosfatada



14

BF 6M 1015	V6cyl.	11905cc	195-250kW (265-340PS)	Diesel	Turbo	TD17254
BF 6M 1015 C	V6cyl.	11905cc	250-345kW (340-469PS)	Diesel	Turbo Intercooled	TD17252
BF 6M 1015 CP	V6cyl.	11905cc	300-384kW (408-522PS)	Diesel	Turbo Intercooled	TD17255
BF 8M 1015	V8cyl.	15874cc	290kW (394PS)	Diesel		TD18499
BF 8M 1015 C	V8cyl.	15874cc	333-459kW (453-624PS)	Diesel	Turbo Intercooled	TD17253
BF 8M 1015 CP	V8cyl.	15874cc	399-517kW (543-703PS)	Diesel	Turbo Intercooled	TD17256

14-450960-00 WH      132.00      B 147.00      C 268.50      D 158.00      E 9.00      F 1.25

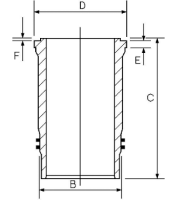

# MODEL INDEX



Modelverzeichnis • Index de modele • Índice de Modelo  
Indeks modelu • Модель автомобиля • دليل الموديل



CCM

x



9

01/66→07/75	<b>124 1.4</b>	124 AC.000, 124 B2.000	Petrol	1438	4	<b>7</b>
09/67→05/71	<b>124 1.4</b>	124 B.0000	Petrol	1438	4	<b>8</b>
01/72→12/77	<b>124 1.8</b>	132 A.C1.000	Petrol	1756	4	<b>16</b>
03/82→11/85	<b>124 2.0</b>	132 C3.031	Petrol	1995	4	<b>16</b>
07/67→03/74	<b>125 1.6</b>	125 A.000, 125 B.000	Petrol	1608	4	<b>8</b>
09/87→06/96	<b>126 0.7</b>	126 A2.000, 126 A2.048	Petrol	704	2	<b>8</b>
06/71→05/83	<b>127 0.9</b>	100 GL.000, 100 GL.048	Petrol	903	4	<b>1</b>
01/77→05/96	<b>127 1.0</b>	127 A.000	Petrol	903	4	<b>1</b>
04/81→12/86	<b>127 1.3</b>	127 A5.000	Diesel	1301	4	<b>6</b>
03/69→12/84	<b>128 1.1</b>	128 A.000, 128 A.048	Petrol	1116	4	<b>7</b>
03/72→02/81	<b>128 1.1</b>	128 AC5.000	Petrol	1116	4	<b>8</b>
06/78→12/84	<b>131 2.5</b>	8144.61	Diesel	2445	4	<b>23</b>
04/72→01/76	<b>132 1.6</b>	132 BB OA O	Petrol	1585	4	<b>8</b>
07/78→07/82	<b>132 2.5</b>	8144.61	Diesel	2445	4	<b>23</b>
04/77→12/81	<b>147 0.9</b>	100 GL.000	Petrol	903	4	<b>1</b>
10/76→12/95	<b>147 1.0</b>	127 A.000	Petrol	903	4	<b>1</b>
07/82→06/84	<b>147 1.3</b>	127 A5.000	Diesel	1301	4	<b>6</b>
08/80→07/82	<b>242-Serie 2.5</b>	B 25.637	Diesel	2498	4	<b>20</b>
07/64→10/72	<b>850 0.8</b>	100 G.000	Petrol	843	4	<b>1</b>
07/64→10/72	<b>850 0.8</b>	100 G.002	Petrol	844	4	<b>1</b>
01/78→01/86	<b>900 T/E Panorama 0.9</b>	100 GF 000	Petrol	903	4	<b>1</b>
01/78→01/86	<b>900 T/E Pulmino 0.9</b>	100 GF 000	Petrol	903	4	<b>1</b>
07/83→08/85	<b>Argenta 2.4</b>	8144.61.500.81	Diesel	2445	4	<b>23</b>
06/81→11/85	<b>Argenta 2.5</b>	8144.61	Diesel	2445	4	<b>23</b>
10/00→10/01	<b>Brava 1.2</b>	188 A5.000	Petrol	1242	4	<b>4</b>
10/95→10/01	<b>Brava 1.9</b>	160 A7.000	Diesel	1929	4	<b>12</b>
03/96→12/02	<b>Brava 1.9</b>	182 A7.000, 182 A8.000, 182 B4.000, 182 B9.000	Diesel	1910	4	<b>10</b>
10/00→10/01	<b>Bravo I 1.2</b>	188 A5.000	Petrol	1242	4	<b>4</b>
10/95→10/01	<b>Bravo I 1.9</b>	160 A7.000	Diesel	1929	4	<b>12</b>
03/96→10/01	<b>Bravo I 1.9</b>	182 A7.000, 182 A8.000, 182 B4.000, 182 B9.000	Diesel	1910	4	<b>10</b>
11/06→	<b>Bravo II 1.9</b>	192 A1.000, 937A5.000	Diesel	1910	4	<b>10</b>
06/74→10/89	<b>Campagnola 2.4</b>	Sofim-8144.61.200	Diesel	2445	4	<b>23</b>
12/91→01/98	<b>Cinquecento 0.7</b>	170 A.000, 170 A.046	Petrol	704	2	<b>8</b>
07/91→12/93	<b>Cinquecento 0.9</b>	170 A1.000, 170 A1.046	Petrol	903	4	<b>1</b>
07/91→07/99	<b>Cinquecento 0.9</b>	1170 A1.046	Petrol	899	4	<b>1</b>
10/94→01/98	<b>Cinquecento 1.1</b>	176 B2.000	Petrol	1108	4	<b>3</b>
11/93→08/96	<b>Coupe 2.0</b>	175 A1.000, 836 A3.000	Petrol	1995	4	<b>16</b>
05/89→12/96	<b>Croma 1.9</b>	154 C6.000, 154 D1.000	Diesel	1929	4	<b>12</b>
06/05→	<b>Croma 1.9</b>	939 A1.000	Diesel	1910	4	<b>10</b>
12/85→08/96	<b>Croma 2.0</b>	154 A1.000, 154 A2.000, 154 C3.046, 154 C4.046, 154 E1.000, 834 B.000, 834 B.048, 834 B.146, 834 C.146	Petrol	1995	4	<b>16</b>
12/85→08/89	<b>Croma 2.4</b>	8144.91	Diesel	2445	4	<b>23</b>
06/05→	<b>Croma 2.4</b>	939A3.000	Diesel	2387	5	<b>10</b>
12/85→12/89	<b>Croma 2.5</b>	8144.67	Diesel	2500	4	<b>23</b>
05/89→08/96	<b>Croma 2.5</b>	8144.97, 8144.97.2400	Diesel	2499	4	<b>22</b>
05/89→08/96	<b>Croma 2.5</b>	8144.97 S, 8144.97 Y	Diesel	2500	4	<b>22</b>
	<b>Daily 2.5d</b>	8140.07	Diesel	2499	4	<b>22</b>
05/04→	<b>Doblo 1.3</b>	188 A9.000, 199 A3.000	Diesel	1248	4	<b>2</b>
03/01→	<b>Doblo 1.9</b>	182 B9.000, 223 A6.000	Diesel	1910	4	<b>10</b>
01/82→10/88	<b>Ducato 1.8</b>	169 B (XM7T)	Petrol	1783	4	<b>17</b>
02/87→04/02	<b>Ducato 1.9</b>	149 B1.000, 230 A2.000, 230 A3.000, 230 A4.000, 280 A1.000	Diesel	1929	4	<b>12</b>
04/98→04/02	<b>Ducato 1.9</b>	D9B (XUD9/A/B/L/Y), D9B (XUD9A), DHX (XUD9TE), DJY	Diesel	1905	4	<b>15</b>
01/82→05/94	<b>Ducato 2.0</b>	170 B, 170 D, XN 1T	Petrol	1971	4	<b>19</b>
07/06→	<b>Ducato 2.2</b>	4HV	Diesel	2198	4	<b>18</b>
01/82→08/90	<b>Ducato 2.4</b>	8144.61	Diesel	2445	4	<b>23</b>
01/82→08/90	<b>Ducato 2.5</b>	CRD93L (U25-661)	Diesel	2500	4	<b>20</b>



Modelverzeichnis • Index de modele • Índice de Modelo  
 Indeks modelu • Модель автомобиля • دليل المركبات

# MODEL INDEX

**CCM**
**x**

**9**

01/82→05/94	<b>Ducato 2.5</b>	8144.67	Diesel	2500	4	<b>23</b>
01/86→08/90	<b>Ducato 2.5</b>	8144.21, 8144.21.220	Diesel	2445	4	<b>22</b>
09/86→05/90	<b>Ducato 2.5</b>	8140.61, 8144.61	Diesel	2445	4	<b>23</b>
09/86→04/02	<b>Ducato 2.5</b>	8140.27, 8140.67	Diesel	2500	4	<b>22</b>
03/94→04/02	<b>Ducato 2.5</b>	8140.47, 8140.47R	Diesel	2499	4	<b>22</b>
10/97→	<b>Ducato 2.8</b>	8140.43, 8140.43S	Diesel	2800	4	<b>24</b>
02/98→	<b>Ducato 2.8</b>	8140.43N, 8140.63	Diesel	2798	4	<b>24</b>
01/89→	<b>Ducato 4x4 Turbo id</b>	8140.27.2700, 8140.27R, 8140.27S	Diesel	2499	4	<b>22</b>
01/89→	<b>Ducato D 2.5</b>	8140.07	Diesel	2499	4	<b>22</b>
02/96→	<b>Ducato Maxi TD 2.8</b>	8140.23.2585, 8140.23.3700, 8140.43.2585, 8140.43.3700, 8140.43.3900	Diesel	2798	4	<b>24</b>
02/96→	<b>Ducato Maxi TD 2.8</b>	8140.23.2585, 8140.23.3700, 8140.43.2585, 8140.43.3700, 8140.43.3900	Diesel	2800	4	<b>24</b>
01/89→	<b>Ducato Maxi Turbo id</b>	8140.27.2700, 8140.27R, 8140.27S	Diesel	2499	4	<b>22</b>
01/89→12/94	<b>Ducato TD 2.5</b>	8140.21.201-203	Diesel	2445	4	<b>22</b>
02/96→	<b>Ducato TD 2.8</b>	8140.23.2585, 8140.23.3700, 8140.43.2585, 8140.43.3700, 8140.43.3900	Diesel	2798	4	<b>24</b>
02/96→	<b>Ducato TD 2.8</b>	8140.23.2585, 8140.23.3700, 8140.43.2585, 8140.43.3700, 8140.43.3900	Diesel	2800	4	<b>24</b>
01/89→12/94	<b>Ducato TD 4x4 2.5</b>	8140.21.201-203	Diesel	2445	4	<b>22</b>
07/91→10/95	<b>Duna 0.9</b>	146 A.048	Petrol	903	4	<b>1</b>
01/87→12/91	<b>Duna 1.7</b>	149 B3.000	Diesel	1697	4	<b>13</b>
04/86→10/92	<b>Elba 1.3</b>	127 A5.000	Diesel	1301	4	<b>6</b>
04/89→10/97	<b>Elba 1.7</b>	146 B2.000	Diesel	1697	4	<b>13</b>
10/77→12/84	<b>Fiorino 0.9</b>	100 GL.000	Petrol	903	4	<b>1</b>
01/80→12/87	<b>Fiorino 1.0</b>	127 A.000	Petrol	903	4	<b>1</b>
11/92→04/96	<b>Fiorino 1.0</b>	156 A2.246	Petrol	999	4	<b>3</b>
03/82→12/87	<b>Fiorino 1.3</b>	127 A5.000	Diesel	1301	4	<b>6</b>
12/87→05/00	<b>Fiorino 1.7</b>	146 B2.000, 149 B3.000	Diesel	1697	4	<b>13</b>
05/84→12/88	<b>Fiorino Pick Up 1.3</b>	127 A5.000	Diesel	1301	4	<b>6</b>
05/88→10/99	<b>Fiorino Pick Up 1.7</b>	146 B2.000, 149 B3.000	Diesel	1697	4	<b>13</b>
10/05→	<b>Grande Punto 1.3</b>	199 A3.000	Diesel	1248	4	<b>2</b>
10/05→	<b>Grande Punto 1.9</b>	939 A1.000	Diesel	1910	4	<b>10</b>
01/04→	<b>Idea 1.2</b>	188 A5.000	Petrol	1242	4	<b>4</b>
01/04→	<b>Idea 1.3</b>	188 A9.000, 199 A3.000	Diesel	1248	4	<b>2</b>
06/07→	<b>Linea 1.3</b>	199 A3.000	Diesel	1248	4	<b>2</b>
09/96→05/02	<b>Marea 1.9</b>	182 A7.000, 182 A8.000, 182 B4.000, 182 B9.000, 186 A6.000	Diesel	1910	4	<b>10</b>
09/96→05/02	<b>Marea 2.4</b>	185 A2.000, 185 A6.000, 839 A5.000	Diesel	2387	5	<b>10</b>
04/99→06/10	<b>Multipla 1.9</b>	182 B4.000, 186 A6.000, 186 A8.000	Diesel	1910	4	<b>10</b>
06/06→	<b>Palio 1.1</b>	187 A1.000	Petrol	1108	4	<b>3</b>
07/97→	<b>Palio 1.2</b>	178 E9.011, 188 A4.000, 188 A5.000	Petrol	1242	4	<b>4</b>
06/03→	<b>Palio 1.3</b>	188 A9.000	Diesel	1248	4	<b>2</b>
09/00→	<b>Palio 1.9</b>	188 A2.000, 223 A6.000	Diesel	1910	4	<b>10</b>
01/86→10/03	<b>Panda 0.8</b>	141 B.000, 156 A4.000, 156 A4.048	Petrol	770	4	<b>1</b>
10/80→06/94	<b>Panda 0.9</b>	100 GL3.000, 146 A.000, 146 A.048	Petrol	903	4	<b>1</b>
04/92→12/96	<b>Panda 0.9</b>	1170 A1.046	Petrol	899	4	<b>1</b>
01/85→02/04	<b>Panda 1.0</b>	156 A2.100, 156 A2.246, 156 A3.000	Petrol	999	4	<b>3</b>
05/91→	<b>Panda 1.1</b>	156 C.046, 176 B2.000, 187 A1.000	Petrol	1108	4	<b>3</b>
09/03→	<b>Panda 1.2</b>	188 A4.000	Petrol	1242	4	<b>4</b>
04/86→12/92	<b>Panda 1.3</b>	156 A5.000	Diesel	1301	4	<b>6</b>
09/03→	<b>Panda 1.3</b>	188 A9.000	Diesel	1248	4	<b>2</b>
01/86→12/90	<b>Penny 1.7</b>	149 B3.000	Diesel	1697	4	<b>13</b>
09/93→02/00	<b>Punto 1.1</b>	176 A6.000, 176 B2.000	Petrol	1108	4	<b>3</b>
09/99→	<b>Punto 1.2</b>	188 A4.000, 188 A5.000	Petrol	1242	4	<b>4</b>
06/03→	<b>Punto 1.3</b>	188 A9.000, 199 A3.000	Diesel	1248	4	<b>2</b>
04/94→02/00	<b>Punto 1.7</b>	176 B3.000	Diesel	1697	4	<b>13</b>
09/99→	<b>Punto 1.9</b>	188 A2.000, 188 A3.000, 188 A7.000	Diesel	1910	4	<b>10</b>
10/09→02/12	<b>Punto Evo 1.3</b>	199 A3.000	Diesel	1248	4	<b>2</b>
01/84→12/89	<b>Regata 1.7</b>	149 B3.000	Diesel	1697	4	<b>13</b>
04/84→07/89	<b>Regata 1.9</b>	149 A1.000, 831 D1.000	Diesel	1929	4	<b>12</b>

# MODEL INDEX



Modelverzeichnis • Index de modele • Índice de Modelo  
Indeks modelu • Модель автомобиля • دليل الموديل



CCM

x



9

10/82→12/87	<b>Ritmo II 1.1</b>	138 B.000	Petrol	1116	4	<b>7</b>
05/85→12/87	<b>Ritmo II 1.7</b>	138 C.000	Diesel	1677	4	<b>13</b>
05/85→12/87	<b>Ritmo II 1.7</b>	149 B3.000	Diesel	1697	4	<b>13</b>
12/85→12/87	<b>Ritmo II 1.9</b>	831 D1.000	Diesel	1929	4	<b>12</b>
01/07→	<b>Scudo 1.6</b>	9HU	Diesel	1560	4	<b>5</b>
02/96→12/06	<b>Scudo 1.9</b>	D8B, D9B (XUD9/A/B/L/Y), DHX (XUD9TE)	Diesel	1905	4	<b>15</b>
04/98→12/06	<b>Scudo 1.9</b>	WJZ (DW8)	Diesel	1868	4	<b>11</b>
01/98→01/10	<b>Seicento 0.9</b>	1170 A1.046	Petrol	899	4	<b>1</b>
01/98→01/10	<b>Seicento 1.1</b>	176 B2.000, 187 A1.000	Petrol	1108	4	<b>3</b>
09/01→	<b>Siena 1.2</b>	178 E8.011, 178 E9.011, 188 A4.000, 188 A5.000	Petrol	1242	4	<b>4</b>
09/03→	<b>Siena 1.3</b>	188 A9.000	Diesel	1248	4	<b>2</b>
11/00→	<b>Siena 1.9</b>	223 A6.000	Diesel	1910	4	<b>10</b>
02/02→11/06	<b>Stilo 1.2</b>	188 A5.000	Petrol	1242	4	<b>4</b>
10/01→08/08	<b>Stilo 1.9</b>	192 A1.000, 192 A3.000, 192 A5.000, 192 B1.000, 937A4.000, 937A5.000	Diesel	1910	4	<b>10</b>
04/03→	<b>Strada 1.2</b>	178 E8.011, 188 A4.000	Petrol	1242	4	<b>4</b>
12/00→	<b>Strada 1.9</b>	188 A2.000, 223 A6.000	Diesel	1910	4	<b>10</b>
03/89→03/94	<b>Talento 1.9</b>	149 B1.000	Diesel	1929	4	<b>12</b>
03/89→03/94	<b>Talento 2.0</b>	170 B	Petrol	1971	4	<b>19</b>
03/90→12/98	<b>Tempra 1.8</b>	159 A4.000, 159 A4.046, 835 C2.000, 835 C4.000, 836 A5.000	Petrol	1756	4	<b>16</b>
05/90→08/96	<b>Tempra 1.9</b>	149 A1.000, 160 A6.000, 160 A7.000, 160 B6.046, 160 D1.000	Diesel	1929	4	<b>12</b>
01/88→10/91	<b>Tipo 1.1</b>	160 A3.000	Petrol	1108	4	<b>3</b>
01/88→10/95	<b>Tipo 1.7</b>	149 B4.000	Diesel	1697	4	<b>13</b>
10/90→10/95	<b>Tipo 1.8</b>	159 A4.000, 159 A4.046, 835 C2.000, 835 C4.000, 836 A5.000	Petrol	1756	4	<b>16</b>
09/90→08/95	<b>Tipo 1.9</b>	149 A1.000, 160 A6.000, 160 A6.046, 160 A7.000, 160 B6.046, 160 D1.000	Diesel	1929	4	<b>12</b>
03/93→04/95	<b>Tipo 2.0</b>	836 A3.000	Petrol	1995	4	<b>16</b>
05/97→08/02	<b>Ulysse 1.8</b>	LFW (XU7 JP)	Petrol	1762	4	<b>14</b>
02/95→08/02	<b>Ulysse 1.9</b>	DHX (XUD9TE)	Diesel	1905	4	<b>15</b>
03/83→07/96	<b>Uno 0.9</b>	100 GL.000, 146 A.000, 146 A.1000	Petrol	903	4	<b>1</b>
04/84→08/00	<b>Uno 1.0</b>	156 A2.000, 156 A2.100, 156 A2.246	Petrol	999	4	<b>3</b>
01/83→08/89	<b>Uno 1.1</b>	138 B.000	Petrol	1116	4	<b>7</b>
04/89→06/06	<b>Uno 1.1</b>	156 C.046, 160 A3.000	Petrol	1108	4	<b>3</b>
08/00→04/10	<b>Uno 1.2</b>	178 E8.011, 178 E9.011, 188 A4.000	Petrol	1242	4	<b>4</b>
06/83→03/92	<b>Uno 1.3</b>	127 A5.000, 146 B1.000	Diesel	1301	4	<b>6</b>
07/86→08/00	<b>Uno 1.7</b>	146 B2.000, 149 B3.000, 149 B4.046	Diesel	1697	4	<b>13</b>
09/89→03/94	<b>Uno 1.9</b>	149 B5.046	Diesel	1929	4	<b>12</b>

Motorverzeichnis • Index de moteur • Índice de Motor  
Indeks silnika • Модель двигателя • دليل المحرك

# ENGINE INDEX



CCM

x



9

100 G.000	Petrol	843	4	65.00	1
100 G.002	Petrol	844	4	65.00	1
100 GC.000	Petrol	844	4	65.00	1
100 GF.000	Petrol	903	4	65.00	1
100 GL.000	Petrol	903	4	65.00	1
100 GL.048	Petrol	903	4	65.00	1
100 GL3.000	Petrol	903	4	65.00	1
100 GS.000	Petrol	844	4	65.00	1
1170 A1.046	Petrol	899	4	65.00	1
124 AC.000	Petrol	1438	4	80.00	7
124 B.0000	Petrol	1438	4	80.00	8
124 B2.000	Petrol	1438	4	80.00	7
125 A.000	Petrol	1608	4	80.00	8
125 B.000	Petrol	1608	4	80.00	8
126 A2.000	Petrol	704	2	80.00	8
126 A2.048	Petrol	704	2	80.00	8
127 A.000	Petrol	903	4	65.00	1
127 A5.000	Diesel	1301	4	76.00	6
128 A.000	Petrol	1116	4	80.00	7
128 A.048	Petrol	1116	4	80.00	7
128 AC5.000	Petrol	1116	4	80.00	8
132 A.C1.000	Petrol	1756	4	84.00	16
132 BB OA O	Petrol	1585	4	80.00	8
132 C3.031	Petrol	1995	4	84.00	16
132 DB.2A-828BC	Petrol	1995	4	84.00	16
138 B.000	Petrol	1116	4	80.00	7
138 C.000	Diesel	1677	4	82.60	13
141 B.000	Petrol	770	4	65.00	1
146 A.000	Petrol	903	4	65.00	1
146 A.048	Petrol	903	4	65.00	1
146 A.1000	Petrol	903	4	65.00	1
146 B1.000	Diesel	1301	4	76.00	6
146 B2.000	Diesel	1697	4	82.60	13
149 A1.000	Diesel	1929	4	82.60	12
149 B1.000	Diesel	1929	4	82.60	12
149 B3.000	Diesel	1697	4	82.60	13
149 B4.000	Diesel	1697	4	82.60	13
149 B4.046	Diesel	1697	4	82.60	13
149 B5.046	Diesel	1929	4	82.60	12
154 A1.000	Petrol	1995	4	84.00	16
154 A2.000	Petrol	1995	4	84.00	16
154 B.000	Diesel	1929	4	82.60	12
154 C3.046	Petrol	1995	4	84.00	16
154 C4.046	Petrol	1995	4	84.00	16
154 C6.000	Diesel	1929	4	82.60	12
154 D1.000	Diesel	1929	4	82.60	12
154 E1.000	Petrol	1995	4	84.00	16
156 A2.000	Petrol	999	4	70.00	3
156 A2.0157	Petrol	999	4	70.00	3
156 A2.050	Petrol	999	4	70.00	3
156 A2.100	Petrol	999	4	70.00	3
156 A2.246	Petrol	999	4	70.00	3
156 A3.000	Petrol	999	4	70.00	3
156 A4.000	Petrol	770	4	65.00	1
156 A4.048	Petrol	770	4	65.00	1
156 A5.000	Diesel	1301	4	76.00	6
156 C.046	Petrol	1108	4	70.00	3
159 A4.000	Petrol	1756	4	84.00	16
159 A4.046	Petrol	1756	4	84.00	16
159 A6.046	Petrol	1995	4	84.00	16

# ENGINE INDEX

Motorverzeichnis • Index de moteur • Índice de Motor  
 Indeks silnika • Модель двигателя • دليل المحرك

**CCM**

**9**

160 A3.000	Petrol	1108	4	70.00	<b>3</b>
160 A6.000	Diesel	1929	4	82.60	<b>12</b>
160 A6.046	Diesel	1929	4	82.60	<b>12</b>
160 A7.000	Diesel	1929	4	82.60	<b>12</b>
160 B6.046	Diesel	1929	4	82.60	<b>12</b>
160 D1.000	Diesel	1929	4	82.60	<b>12</b>
169 B (XM7T)	Petrol	1783	4	84.00	<b>17</b>
170 A.000	Petrol	704	2	80.00	<b>8</b>
170 A.046	Petrol	704	2	80.00	<b>8</b>
170 A1.000	Petrol	903	4	65.00	<b>1</b>
170 A1.046	Petrol	903	4	65.00	<b>1</b>
170 B	Petrol	1971	4	88.00	<b>19</b>
170 D	Petrol	1971	4	88.00	<b>19</b>
175 A1.000	Petrol	1995	4	84.00	<b>16</b>
176 A6.000	Petrol	1108	4	70.00	<b>3</b>
176 B2.000	Petrol	1108	4	70.00	<b>3</b>
176 B3.000	Diesel	1697	4	82.60	<b>13</b>
178 E8.011	Petrol	1242	4	70.80	<b>4</b>
178 E9.011	Petrol	1242	4	70.80	<b>4</b>
182 A7.000	Diesel	1910	4	82.00	<b>10</b>
182 A8.000	Diesel	1910	4	82.00	<b>10</b>
182 B4.000	Diesel	1910	4	82.00	<b>9</b>
182 B4.000	Diesel	1910	4	82.00	<b>10</b>
182 B9.000	Diesel	1910	4	82.00	<b>10</b>
185 A2.000	Diesel	2387	5	82.00	<b>10</b>
185 A6.000	Diesel	2387	5	82.00	<b>10</b>
186 A6.000	Diesel	1910	4	82.00	<b>10</b>
186 A8.000	Diesel	1910	4	82.00	<b>10</b>
187 A1.000	Petrol	1108	4	70.00	<b>3</b>
188 A2.000	Diesel	1910	4	82.00	<b>10</b>
188 A3.000	Diesel	1910	4	82.00	<b>10</b>
188 A4.000	Petrol	1242	4	70.80	<b>4</b>
188 A5.000	Petrol	1242	4	70.80	<b>4</b>
188 A7.000	Diesel	1910	4	82.00	<b>10</b>
188 A9.000	Diesel	1248	4	69.60	<b>2</b>
192 A1.000	Diesel	1910	4	82.00	<b>10</b>
192 A3.000	Diesel	1910	4	82.00	<b>10</b>
192 A5.000	Diesel	1910	4	82.00	<b>10</b>
192 B1.000	Diesel	1910	4	82.00	<b>10</b>
199 A3.000	Diesel	1248	4	69.60	<b>2</b>
200 B	Petrol	903	4	65.00	<b>1</b>
200 BF	Petrol	903	4	65.00	<b>1</b>
200 CF	Petrol	903	4	65.00	<b>1</b>
200 CP1	Petrol	903	4	65.00	<b>1</b>
200 CZ1	Petrol	903	4	65.00	<b>1</b>
223 A6.000	Diesel	1910	4	82.00	<b>10</b>
230 A2.000	Diesel	1929	4	82.60	<b>12</b>
230 A3.000	Diesel	1929	4	82.60	<b>12</b>
230 A4.000	Diesel	1929	4	82.60	<b>12</b>
280 A1.000	Diesel	1929	4	82.60	<b>12</b>
4HU	Diesel	2198	4	86.00	<b>18</b>
4HV	Diesel	2198	4	86.00	<b>18</b>
6132 AZ	Petrol	1995	4	84.00	<b>16</b>
8030.02	Diesel	2592	3	100.00	<b>25</b>
8035.02	Diesel	2592	3	100.00	<b>25</b>
8035.04.265	Diesel	2749	3	103.00	<b>27</b>
8035.04.270	Diesel	2749	3	103.00	<b>27</b>
8035.05.214	Diesel	2931	3	104.00	<b>28</b>
8035.05.215	Diesel	2931	3	104.00	<b>28</b>
8035.06.200	Diesel	2708	3	100.00	<b>26</b>

Motorverzeichnis • Index de moteur • Índice de Motor  
Indeks silnika • Модель двигателя • دليل المحرك

# ENGINE INDEX



CCM

x



9

8035.06.206	Diesel	2708	3	100.00	26
8035.06.208	Diesel	2708	3	100.00	26
8035.06.216	Diesel	2708	3	100.00	26
8035.06.220	Diesel	2708	3	100.00	26
8035.06.222	Diesel	2708	3	100.00	26
8035.06.223	Diesel	2708	3	100.00	26
8035.06.306	Diesel	2708	3	100.00	26
8035.06.307	Diesel	2708	3	100.00	26
8035.06.308	Diesel	2708	3	100.00	26
8035.06.309	Diesel	2708	3	100.00	26
8035.06.317	Diesel	2708	3	100.00	26
8035.06.320	Diesel	2708	3	100.00	26
8035.06.321	Diesel	2708	3	100.00	26
8035.06.322	Diesel	2708	3	100.00	26
8035.06.323	Diesel	2708	3	100.00	26
8040.02	Diesel	3456	4	100.00	25
8040.02.041	Diesel	3456	4	100.00	25
8040.02.267	Diesel	3456	4	100.00	25
8040.02.300	Diesel	3455	4	100.00	25
8040.02.360	Diesel	3456	4	100.00	25
8040.02.367	Diesel	3456	4	100.00	25
8040.04.200	Diesel	3666	4	103.00	27
8040.05.200	Diesel	3908	4	104.00	28
8040.05.230	Diesel	3908	4	104.00	28
8040.05.4990	Diesel	3908	4	104.00	28
8040.25.000	Diesel	3908	4	104.00	28
8040.25.200	Diesel	3908	4	104.00	28
8040.25.220	Diesel	3908	4	104.00	28
8040.25.230	Diesel	3908	4	104.00	28
8040.45.5200	Diesel	3908	4	104.00	28
8040.45.5281	Diesel	3908	4	104.00	28
8040.45D.5100	Diesel	3908	4	104.00	28
8040.45D.5103	Diesel	3908	4	104.00	28
8045.02	Diesel	3455	4	100.00	25
8045.04.270	Diesel	3666	4	103.00	27
8045.05.000	Diesel	3908	4	104.00	28
8045.05.213	Diesel	3908	4	104.00	28
8045.05.215	Diesel	3908	4	104.00	28
8045.06.200	Diesel	3613	4	100.00	26
8045.06.208	Diesel	3613	4	100.00	26
8045.06.213	Diesel	3613	4	100.00	26
8045.06.214	Diesel	3613	4	100.00	26
8045.06.215	Diesel	3613	4	100.00	26
8045.06.225	Diesel	3613	4	100.00	26
8045.06.319	Diesel	3613	4	100.00	26
8045.06.326	Diesel	3613	4	100.00	26
8045.25.310	Diesel	3908	4	104.00	28
8045.25.370	Diesel	3908	4	104.00	28
8045.25.375	Diesel	3908	4	104.00	28
8045.25.376	Diesel	3908	4	104.00	28
8045.25.381	Diesel	3908	4	104.00	28
8055.04.200	Diesel	4583	5	103.00	27
8055.05.000	Diesel	4885	5	104.00	28
8060.02.000	Diesel	5184	6	100.00	25
8060.02.070	Diesel	5184	6	100.00	25
8060.04.000	Diesel	5499	6	103.00	27
8060.04.060	Diesel	5499	6	103.00	27
8060.04.660	Diesel	5499	6	103.00	27
8060.04.669	Diesel	5499	6	103.00	27
8060.04.689	Diesel	5499	6	103.00	27

# ENGINE INDEX

Motorverzeichnis • Index de moteur • Índice de Motor  
Indeks silnika • Модель двигателя • دليل المحرك



CCM



9

8060.05.000	Diesel	5861	6	104.00	28
8060.05.200	Diesel	5861	6	104.00	28
8060.05.246	Diesel	5861	6	104.00	28
8060.05.270	Diesel	5861	6	104.00	28
8060.05.280	Diesel	5861	6	104.00	28
8060.05.285	Diesel	5861	6	104.00	28
8060.05.289	Diesel	5861	6	104.00	28
8060.25.600	Diesel	5861	6	104.00	28
8060.25.621	Diesel	5861	6	104.00	28
8060.25.630	Diesel	5861	6	104.00	28
8060.25.631	Diesel	5861	6	104.00	28
8060.25.641	Diesel	5861	6	104.00	28
8060.25.662	Diesel	5861	6	104.00	28
8060.25.663	Diesel	5861	6	104.00	28
8060.25.669	Diesel	5861	6	104.00	28
8060.25.670	Diesel	5861	6	104.00	28
8060.25.673	Diesel	5861	6	104.00	28
8060.25.678	Diesel	5861	6	104.00	28
8060.25.679	Diesel	5861	6	104.00	28
8060.25R.4200	Diesel	5861	6	104.00	28
8060.25V.4000	Diesel	5861	6	104.00	28
8060.45.600	Diesel	5861	6	104.00	28
8060.45S.6000	Diesel	5861	6	104.00	28
8065.02.007	Diesel	5184	6	100.00	25
8065.02.200	Diesel	5184	6	100.00	25
8065.02.207	Diesel	5184	6	100.00	25
8065.02.217	Diesel	5184	6	100.00	25
8065.04.200	Diesel	5499	6	103.00	27
8065.05.000	Diesel	5863	6	104.00	28
8065.05.330	Diesel	5863	6	104.00	28
8065.24.000	Diesel	5499	6	103.00	27
8065.24.300	Diesel	5499	6	103.00	27
8065.25.080	Diesel	5863	6	104.00	28
8065.25.320	Diesel	5863	6	104.00	28
8140.07	Diesel	2499	4	93.00	22
8140.21.201-203	Diesel	2445	4	93.00	22
8140.212	Diesel	2445	4	93.00	21
8140.214	Diesel	2445	4	93.00	21
8140.23.2585	Diesel	2800	4	94.40	24
8140.23.3700	Diesel	2800	4	94.40	24
8140.27	Diesel	2500	4	93.00	22
8140.27.2100	Diesel	2500	4	93.00	22
8140.27.2700	Diesel	2499	4	93.00	22
8140.27R	Diesel	2499	4	93.00	22
8140.27S	Diesel	2499	4	93.00	22
8140.27S.3700	Diesel	2499	4	93.00	22
8140.29	Diesel	2445	4	93.00	21
8140.43	Diesel	2800	4	94.40	24
8140.43.2585	Diesel	2800	4	94.40	24
8140.43.3700	Diesel	2800	4	94.40	24
8140.43.3900	Diesel	2800	4	94.40	24
8140.43N	Diesel	2798	4	94.40	24
8140.43S	Diesel	2800	4	94.40	24
8140.47	Diesel	2499	4	93.00	22
8140.47.3700	Diesel	2499	4	93.00	22
8140.47R	Diesel	2499	4	93.00	22
8140.47R.2210	Diesel	2499	4	93.00	22
8140.61	Diesel	2445	4	93.00	23
8140.61.204	Diesel	2445	4	93.00	23
8140.63	Diesel	2798	4	94.40	24

Motorverzeichnis • Index de moteur • Índice de Motor  
Indeks silnika • Модель двигателя • دليل المحرك

# ENGINE INDEX



CCM

x



9

8140.63.4000	Diesel	2798	4	94.40	24
8140.67	Diesel	2500	4	93.00	22
8140.67.2700	Diesel	2499	4	93.00	22
8140.67.X230	Diesel	2499	4	93.00	21
8140.97Y	Diesel	2499	4	93.00	21
8142.61	Diesel	2445	4	93.00	23
8144.21	Diesel	2445	4	93.00	22
8144.21.220	Diesel	2445	4	93.00	22
8144.61	Diesel	2445	4	93.00	23
8144.61.500.81	Diesel	2445	4	93.00	23
8144.67	Diesel	2500	4	93.00	23
8144.67.220	Diesel	2499	4	93.00	23
8144.81.2000	Diesel	2445	4	93.00	23
8144.91	Diesel	2445	4	93.00	23
8144.97	Diesel	2499	4	93.00	22
8144.97 S	Diesel	2500	4	93.00	22
8144.97 Y	Diesel	2500	4	93.00	22
8144.97.2200	Diesel	2499	4	93.00	23
8144.97.2400	Diesel	2499	4	93.00	22
8144.97.2500	Diesel	2500	4	93.00	23
8210.22.000	Diesel	13798	6	137.00	32
831 D1.000	Diesel	1929	4	82.60	12
834 B.000	Petrol	1995	4	84.00	16
834 B.048	Petrol	1995	4	84.00	16
834 B.146	Petrol	1995	4	84.00	16
834 C.146	Petrol	1995	4	84.00	16
8340.05	Diesel	5400	4	115.00	30
835 C2.000	Petrol	1756	4	84.00	16
835 C4.000	Petrol	1756	4	84.00	16
836 A3.000	Petrol	1995	4	84.00	16
836 A5.000	Petrol	1756	4	84.00	16
8365.05.500	Diesel	8101	6	115.00	30
8365.05.520	Diesel	8101	6	115.00	30
8365.05.530	Diesel	8101	6	115.00	30
8365.05.531	Diesel	8101	6	115.00	30
8365.05.555	Diesel	8101	6	115.00	30
8365.05.560	Diesel	8101	6	115.00	30
8365.05.570	Diesel	8101	6	115.00	30
8365.05.580	Diesel	8101	6	115.00	30
8365.05.590	Diesel	8101	6	115.00	30
839 A5.000	Diesel	2387	5	82.00	10
8460.21.002	Diesel	9498	6	120.00	31
8460.41S.733	Diesel	9498	6	120.00	31
937A4.000	Diesel	1910	4	82.00	10
937A5.000	Diesel	1910	4	82.00	10
939 A1.000	Diesel	1910	4	82.00	10
939A3.000	Diesel	2387	5	82.00	10
9HU	Diesel	1560	4	75.00	5
A 112 B2	Petrol	903	4	65.00	1
B 25.637	Diesel	2498	4	93.00	20
C 03	Diesel	4940	4	110.00	29
CP 3	Diesel	7412	6	110.00	29
CP 3/32.1.200	Diesel	7412	6	110.00	29
CRD93L (U25-661)	Diesel	2500	4	93.00	20
D8B	Diesel	1905	4	83.00	15
D9B (XUD9/A/B/L/Y)	Diesel	1905	4	83.00	15
D9B (XUD9A)	Diesel	1905	4	83.00	15
DHX (XUD9TE)	Diesel	1905	4	83.00	15
DJY	Diesel	1905	4	83.00	15
DJY (XUD9)	Diesel	1905	4	83.00	15



# ENGINE INDEX

Motorverzeichnis • Index de moteur • Índice de Motor  
Indeks silnika • Модель двигателя • دليل المحرك



CCM

x



9

LFW (XU7 JP)	Petrol	1762	4	83.00	<b>14</b>
M204 A.A.11	Petrol	1108	4	70.00	<b>3</b>
M401 LG.20.0	Petrol	1995	4	84.00	<b>16</b>
M601 HA.20.0	Petrol	1995	4	84.00	<b>16</b>
M619 AA 2.0	Petrol	1995	4	84.00	<b>16</b>
Sofim-8144.61.200	Diesel	2445	4	93.00	<b>23</b>
WJY (DW8)	Diesel	1868	4	82.20	<b>11</b>
WJY (DW8B)	Diesel	1868	4	82.20	<b>11</b>
WJZ (DW8)	Diesel	1868	4	82.20	<b>11</b>
XN 1T	Petrol	1971	4	88.00	<b>19</b>





1

100 G.000	4cyl.	843cc	25kW (34PS)		TD863
100 G.002	4cyl.	844cc	27kW (37PS)		TD864
100 GC.000	4cyl.	844cc	38kW (52PS)		FM513
100 GC.000	4cyl.	844cc	38kW (52PS)		TD868
100 GF 000	4cyl.	903cc	34kW (46PS)		TD6939
100 GL.000	4cyl.	903cc	34kW (46PS)		TD870
100 GL.048	4cyl.	903cc	34kW (46PS)		TD4413
100 GL3.000	4cyl.	903cc	34kW (46PS)		TD869
100 GS.000	4cyl.	844cc			FM513
127 A.000	4cyl.	903cc	34kW (46PS)		TD887
141 B.000	4cyl.	770cc	25kW (34PS)		TD4370
146 A.000	4cyl.	903cc	33kW (45PS)		TD4371
146 A.048	4cyl.	903cc	33kW (45PS)		TD934
146 A.1000	4cyl.	903cc	33kW (45PS)		FM10519
146 A.1000	4cyl.	903cc	33kW (45PS)		TD4372
156 A4.000	4cyl.	770cc	25kW (34PS)		TD11307
156 A4.048	4cyl.	770cc	25kW (34PS)		TD11308
170 A1.000	4cyl.	903cc	30kW (41PS)		TD15810
170 A1.046	4cyl.	903cc	30kW (41PS)		TD15811
200 B	4cyl.	903cc			FM3952
200 BF	4cyl.	903cc			FM3952
200 CF	4cyl.	903cc			FM3952
200 CP1	4cyl.	903cc			FM3952
200 CZ1	4cyl.	903cc			FM3952
1170 A1.046	4cyl.	899cc	30kW (41PS)		FM9123
1170 A1.046	4cyl.	899cc	30kW (41PS)		TD872
A 112 B2	4cyl.	903cc			FM514

14-011001-00 D      65.00      B 68.04      C 115.00

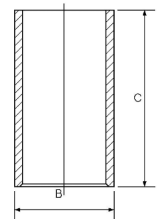

2

188 A9.000	4cyl.	1248cc	51kW (69PS)	Diesel	Turbo Intercooled	TD17456
199 A3.000	4cyl.	1248cc	66kW (89PS)	Diesel	Turbo Intercooled	TD20241

14-022060-00 D      69.60      B 72.50      C 142.00      D 74.00      E 5.00

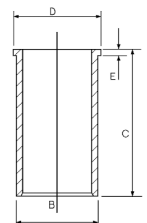



3

156 A2.000	4cyl.	999cc	33-37kW (45-50PS)	TD16230
156 A2.0157	4cyl.	999cc	33kW (45PS)	TD22227
156 A2.050	4cyl.	999cc	33kW (45PS)	TD22228
156 A2.100	4cyl.	999cc	41kW (55PS)	TD4387
156 A2.246	4cyl.	999cc	33kW (45PS)	TD994
156 A3.000	4cyl.	999cc	33kW (45PS)	TD16209
156 C.046	4cyl.	1108cc	37-43kW (50-58PS)	TD4389
160 A3.000	4cyl.	1108cc	41kW (55PS)	TD10189
176 A6.000	4cyl.	1108cc	40kW (54PS)	TD1036
176 B2.000 Euro 2	4cyl.	1108cc	40kW (54PS)	TD4396
187 A1.000 Euro 3	4cyl.	1108cc	40kW (54PS)	FM29209
187 A1.000 Euro 3	4cyl.	1108cc	40kW (54PS)	TD17847
M204 A.A.11	4cyl.	1108cc	40kW (54PS)	FM9125

14-010991-00 D      70.00      B 73.02      C 116.00

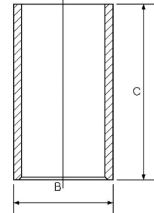

4

178 E8.011	4cyl.	1242cc	48-49kW (65-67PS)	TD25005
178 E9.011	4cyl.	1242cc	51-52kW (69-71PS)	TD24630
188 A4.000 Euro 3	4cyl.	1242cc	44kW (60PS)	TD12790
188 A5.000 Euro 3	4cyl.	1242cc	59kW (80PS)	TD12791

14-021080-00 D      70.80      B 73.80      C 128.00      D 75.00      E 5.00

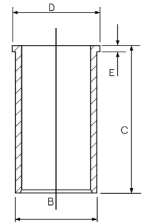

5

9HU	4cyl.	1560cc	66kW (89PS)	Diesel Turbo Intercooled	TD24776
-----	-------	--------	-------------	--------------------------	---------

14-020900-00 D      75.00      B 78.00      C 142.00      D 79.50      E 5.00

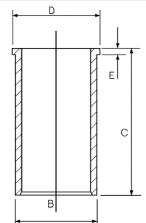



6

127 A5.000	4cyl.	1301cc	33kW (45PS)	Diesel	TD4346
146 B1.000	4cyl.	1301cc	33kW (45PS)	Diesel	TD948
156 A5.000	4cyl.	1301cc	33kW (45PS)	Diesel	TD999

14-021260-00 *D*      76.00      B 80.00      C 133.50      D 81.00      E 5.00

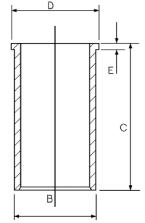

14-012470-00 *D*      76.00      B 79.00      C 139.00

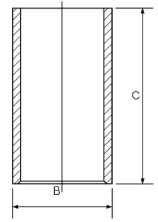

7

124 AC.000	4cyl.	1438cc	66kW (89PS)	TD13413
124 B2.000	4cyl.	1438cc	59kW (80PS)	TD13412
128 A.000	4cyl.	1116cc	33-48kW (45-65PS)	TD888
128 A.048	4cyl.	1116cc	33kW (45PS)	TD5378
138 B.000	4cyl.	1116cc	41kW (55PS)	TD923

14-018920-00 *D*      80.00      B 84.00      C 114.00

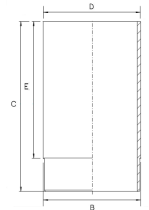

8

124 B.0000	4cyl.	1438cc	51kW (69PS)	TD18853
125 A.000	4cyl.	1608cc	66kW (89PS)	TD878
125 B.000	4cyl.	1608cc	74kW (100PS)	TD879
126 A2.000	2cyl.	704cc	18kW (24PS)	TD4342
126 A2.048	2cyl.	704cc	18kW (24PS)	TD4344
128 AC5.000	4cyl.	1116cc	48kW (65PS)	TD891
132 BB OA O	4cyl.	1585cc	72kW (98PS)	TD6825
170 A.000	2cyl.	704cc	22kW (30PS)	FM9208
170 A.000	2cyl.	704cc	22kW (30PS)	TD1028





170 A.046	2cyl.	704cc	22kW (30PS)				FM9208
-----------	-------	-------	-------------	--	--	--	--------

170 A.046	2cyl.	704cc	22kW (30PS)				TD15809
-----------	-------	-------	-------------	--	--	--	---------

14-028710-00 D	80.00	B 86.53	C 125.10	D 95.00	E 7.80		
----------------	-------	---------	----------	---------	--------	--	--

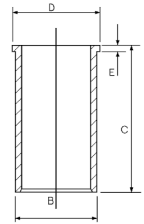

9

182 B4.000 Euro 2	4cyl.	1910cc	77kW (105PS)	Diesel	Turbo Intercooled		FM9266
-------------------	-------	--------	--------------	--------	-------------------	--	--------

14-021051-00 D	82.00	B 85.57	C 155.00	D 88.53	E 4.00		
----------------	-------	---------	----------	---------	--------	--	--

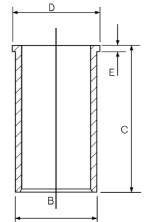

10

182 A7.000	4cyl.	1910cc	55kW (75PS)	Diesel	Turbo Intercooled		TD4403
------------	-------	--------	-------------	--------	-------------------	--	--------

182 A8.000	4cyl.	1910cc	55kW (75PS)	Diesel	Turbo Intercooled		TD4404
------------	-------	--------	-------------	--------	-------------------	--	--------

182 B4.000 Euro 2	4cyl.	1910cc	77kW (105PS)	Diesel	Turbo Intercooled		TD11168
-------------------	-------	--------	--------------	--------	-------------------	--	---------

182 B9.000 Euro 3	4cyl.	1910cc	74-77kW (100-105PS)	Diesel	Turbo Intercooled		TD16399
-------------------	-------	--------	---------------------	--------	-------------------	--	---------

185 A2.000	5cyl.	2387cc	91kW (124PS)	Diesel	Turbo Intercooled		TD4406
------------	-------	--------	--------------	--------	-------------------	--	--------

185 A6.000 Euro 2	5cyl.	2387cc	96kW (131PS)	Diesel	Turbo Intercooled		TD18145
-------------------	-------	--------	--------------	--------	-------------------	--	---------

186 A6.000 Euro 3	4cyl.	1910cc	73kW (99PS)	Diesel	Turbo Intercooled		TD15831
-------------------	-------	--------	-------------	--------	-------------------	--	---------

186 A8.000	4cyl.	1910cc	85kW (116PS)	Diesel	Turbo Intercooled		TD18309
------------	-------	--------	--------------	--------	-------------------	--	---------

188 A2.000 Euro 3	4cyl.	1910cc	73kW (99PS)	Diesel	Turbo Intercooled		TD12788
-------------------	-------	--------	-------------	--------	-------------------	--	---------

188 A3.000	4cyl.	1910cc	44kW (60PS)	Diesel			TD12789
------------	-------	--------	-------------	--------	--	--	---------

188 A7.000 Euro 3	4cyl.	1910cc	73kW (99PS)	Diesel	Turbo Intercooled		TD16409
-------------------	-------	--------	-------------	--------	-------------------	--	---------

192 A1.000	4cyl.	1910cc	85kW (116PS)	Diesel	Turbo Intercooled		TD16398
------------	-------	--------	--------------	--------	-------------------	--	---------

192 A3.000 Euro 3	4cyl.	1910cc	73kW (99PS)	Diesel	Turbo Intercooled		TD16397
-------------------	-------	--------	-------------	--------	-------------------	--	---------

192 A5.000	4cyl.	1910cc	103kW (140PS)	Diesel	Turbo Intercooled		TD17980
------------	-------	--------	---------------	--------	-------------------	--	---------

192 B1.000	4cyl.	1910cc	100kW (136PS)	Diesel	Turbo Intercooled		TD18944
------------	-------	--------	---------------	--------	-------------------	--	---------

223 A6.000 Euro 3	4cyl.	1910cc	44kW (60PS)	Diesel			TD15829
-------------------	-------	--------	-------------	--------	--	--	---------

839 A5.000 Euro 2	5cyl.	2387cc	100kW (136PS)	Diesel	Turbo Intercooled		TD14408
-------------------	-------	--------	---------------	--------	-------------------	--	---------

937A4.000	4cyl.	1910cc	93kW (126PS)	Diesel	Turbo Intercooled		TD18943
-----------	-------	--------	--------------	--------	-------------------	--	---------

937A5.000	4cyl.	1910cc	110kW (150PS)	Diesel	Turbo Intercooled		TD18929
-----------	-------	--------	---------------	--------	-------------------	--	---------

939 A1.000	4cyl.	1910cc	88kW (120PS)	Diesel	Turbo Intercooled		TD18448
------------	-------	--------	--------------	--------	-------------------	--	---------

939A3.000	5cyl.	2387cc	147kW (200PS)	Diesel	Turbo Intercooled		TD18450
-----------	-------	--------	---------------	--------	-------------------	--	---------

14-021051-00 D	82.00	B 85.57	C 155.00	D 88.53	E 4.00		
14-028960-00 D		B 85.00	C 155.00	D 88.00	E 4.50		

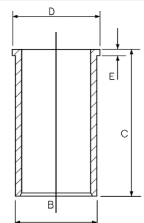



11

WJY (DW8)	4cyl.	1868cc	51kW (69PS)	Diesel	TD21266
WJY (DW8B)	4cyl.	1868cc	51kW (69PS)	Diesel	TD22240
WJZ (DW8)	4cyl.	1868cc	51kW (69PS)	Diesel	TD16300

14-020290-00 *D*      82.20      B 85.00      C 154.00      D 87.00      E 5.00

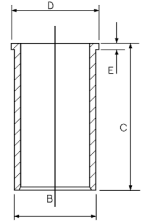

12

149 A1.000	4cyl.	1929cc	48kW (65PS)	Diesel	TD4378
149 B1.000	4cyl.	1929cc	52kW (71PS)	Diesel	TD963
149 B5.046	4cyl.	1929cc	44kW (60PS)	Diesel	TD9602
154 B.000	4cyl.	1929cc	68kW (92PS)	Diesel Turbo Intercooled	TD21460
154 C6.000	4cyl.	1929cc	84kW (114PS)	Diesel Turbo Intercooled	TD9621
154 D1.000	4cyl.	1929cc	84kW (114PS)	Diesel Turbo Intercooled	TD9622
160 A6.000	4cyl.	1929cc	66kW (89PS)	Diesel Turbo Intercooled	TD4394
160 A6.046	4cyl.	1929cc	66kW (89PS)	Diesel Turbo Intercooled	TD1022
160 A7.000	4cyl.	1929cc	48kW (65PS)	Diesel	TD1023
160 B6.046	4cyl.	1929cc	66kW (89PS)	Diesel Turbo Intercooled	TD1025
160 D1.000	4cyl.	1929cc	68kW (92PS)	Diesel Turbo Intercooled	TD1026
230 A2.000	4cyl.	1929cc	60kW (81PS)	Diesel	TD862
230 A3.000	4cyl.	1929cc	60kW (81PS)	Diesel Turbo	TD5481
230 A4.000 Euro 2	4cyl.	1929cc	60kW (81PS)	Diesel Turbo	TD4407
280 A1.000	4cyl.	1929cc	60kW (81PS)	Diesel Turbo	TD1043
831 D1.000	4cyl.	1929cc	62kW (84PS)	Diesel Turbo	TD4410

14-021311-00 *D*      82.60      B 86.06      C 154.00      D 89.00      E 4.50  
 14-023560-00 *D*           B 86.00      C 154.00      D 89.00      E 4.50  
 14-023751-00 *D*           B 87.00      C 154.00      D 89.00      E 4.55

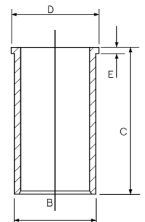

14-014730-00 *D*      82.60      B 86.09      C 154.00

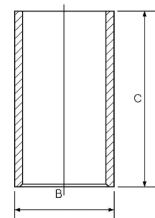



13

138 C.000	4cyl.	1677cc	44kW (60PS)	Diesel	TD925
146 B2.000	4cyl.	1697cc	46kW (63PS)	Diesel	TD949
149 B3.000	4cyl.	1697cc	42kW (57PS)	Diesel	TD967
149 B4.000	4cyl.	1697cc	44kW (60PS)	Diesel	TD968
149 B4.046	4cyl.	1697cc	42-44kW (57-60PS)	Diesel	TD969
176 B3.000	4cyl.	1697cc	42kW (57PS)	Diesel	TD9477

14-023751-00 D	82.60	B 87.00	C 154.00	D 89.00	E 4.55
14-785400-00 D		B 86.00	C 144.00	D 89.00	E 4.50

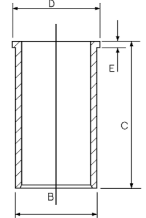

14-014730-00 D	82.60	B 86.09	C 154.00
----------------	-------	---------	----------

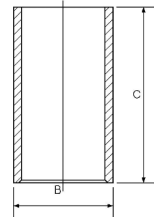

14

LFW (XU7 JP)	4cyl.	1762cc	73kW (99PS)	TD10167
--------------	-------	--------	-------------	---------

14-634910-00 WH 1	83.00	B 88.60	C 141.00	D 97.00	E 6.50
-------------------	-------	---------	----------	---------	--------

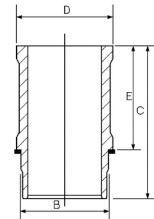

1 Use also: 1 NB O-Ring HR566

1 Mitverwenden: 1 NB O-Ring HR566

1 A utiliser aussi: 1 joint toriques HR566

1 Utilizar también: 1 NB junta toricas HR566

15

D8B	4cyl.	1905cc	66kW (89PS)	Diesel Turbo Intercooled	TD6828
D9B (XUD9/A/B/L/Y)	4cyl.	1905cc	49kW (67PS)	Diesel	TD6827
D9B (XUD9A)	4cyl.	1905cc	47-52kW (64-71PS)	Diesel	TD21265
DHX (XUD9TE)	4cyl.	1905cc	66kW (89PS)	Diesel Turbo Intercooled	TD4352
DJY	4cyl.	1905cc	50kW (68PS)	Diesel	TD12748
DJY (XUD9)	4cyl.	1905cc	50-52kW (68-71PS)	Diesel	TD21267

14-020530-00 D	83.00	B 85.60	C 153.50	D 88.50	E 3.90
----------------	-------	---------	----------	---------	--------

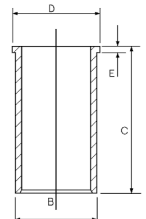



16

132 A.C1.000	4cyl.	1756cc	87kW (118PS)		TD23121
132 C3.031	4cyl.	1995cc	76-77kW (103-105PS)		TD908
132 DB.2A-828BC	4cyl.	1995cc			FM555
154 A1.000	4cyl.	1995cc	66kW (89PS)	Turbo	TD1077
154 A2.000	4cyl.	1995cc	114kW (155PS)	Turbo Intercooled	TD1083
154 C3.046	4cyl.	1995cc	88kW (120PS)		FM9128
154 C3.046	4cyl.	1995cc	88kW (120PS)		TD984
154 C4.046	4cyl.	1995cc	113kW (154PS)	Turbo Intercooled	TD986
154 E1.000	4cyl.	1995cc	109kW (148PS)		TD989
159 A4.000	4cyl.	1756cc	76kW (103PS)		TD1008
159 A4.046	4cyl.	1756cc	76kW (103PS)		TD1009
159 A6.046	4cyl.	1995cc	83-85kW (113-116PS)		FM9130
175 A1.000	4cyl.	1995cc	137kW (186PS)	Turbo Intercooled	TD4395
834 B.000	4cyl.	1995cc	88kW (120PS)		TD1084
834 B.048	4cyl.	1995cc	88kW (120PS)		TD1085
834 B.146	4cyl.	1995cc	88kW (120PS)		TD11707
834 C.146	4cyl.	1995cc	110-112kW (150-152PS)	Turbo Intercooled	TD1064
835 C2.000	4cyl.	1756cc	76kW (103PS)		FM9223
835 C2.000	4cyl.	1756cc	76kW (103PS)		TD1068
835 C4.000	4cyl.	1756cc	66kW (89PS)		TD1069
836 A3.000	4cyl.	1995cc	109kW (148PS)		TD1071
836 A5.000	4cyl.	1756cc	71-74kW (97-101PS)		TD892
6132 AZ	4cyl.	1995cc			FM13978
M401 LG.20.0	4cyl.	1995cc	66kW (89PS)		FM13997
M601 HA.20.0	4cyl.	1995cc	66kW (89PS)		FM13997
M619 AA 2.0	4cyl.	1995cc	100kW (136PS)	Turbo	FM9129

14-011041-00 D 84.00 B 88.06 C 152.00

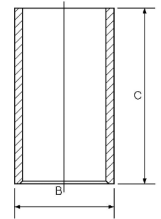

17

169 B (XM7T)	4cyl.	1783cc	49kW (67PS)		TD12750
--------------	-------	--------	-------------	--	---------

14-606670-00 WH 1 84.00 B 93.00 C 136.20 D 99.20 E 90.01

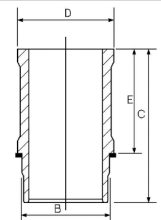

1 Use also: 1 NB O-Ring HR566

1 Mitverwenden: 1 NB O-Ring HR566

1 A utiliser aussi: 1 joint toriques HR566

1 Utilizar también: 1 NB junta toricas HR566



18

4HU Euro 4 4cyl. 2198cc 88kW (120PS) Diesel Turbo Intercooled TD25655

4HV Euro 4 4cyl. 2198cc 74kW (100PS) Diesel Turbo Intercooled TD20266

14-021120-00 D 86.00 B 89.00 C 156.00 D 90.90 E 5.00

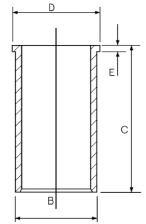

19

170 B 4cyl. 1971cc 55kW (75PS) TD4417

170 D 4cyl. 1971cc 62kW (84PS) TD5102

XN 1T 4cyl. 1971cc 57kW (77PS) TD4418

14-636500-00 WH 88.00 B 93.00 C 135.70 D 101.90 E 89.985

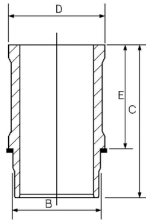

20

B 25.637 4cyl. 2498cc 51kW (69PS) Diesel TD21463

CRD93L (U25-661) 4cyl. 2500cc 54-55kW (73-75PS) Diesel TD22981

14-013481-00 D 93.00 B 96.10 C 163.00

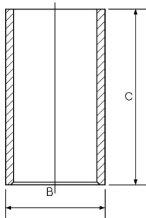

21

8140.212 4cyl. 2445cc 77kW (105PS) Diesel Turbo FM9241

8140.214 4cyl. 2445cc 77kW (105PS) Diesel Turbo FM9241

8140.29 4cyl. 2445cc 77kW (105PS) Diesel Turbo FM9241

8140.97Y 4cyl. 2499cc 85kW (116PS) Diesel Turbo Intercooled FM19100

8140.67.X230 4cyl. 2499cc 63kW (86PS) Diesel FM19237

14-021371-00 D 93.00 B 96.01 C 171.00 D 98.92 E 5.00  
 14-021372-00 D B 96.05 C 171.00 D 98.92 E 5.00  
 14-021373-00 D B 96.17 C 171.00 D 98.92 E 5.00

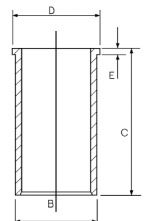





22

8140.07	4cyl.	2499cc	55kW (75PS)	Diesel		FM19101
8140.27	4cyl.	2500cc	70kW (95PS)	Diesel	Turbo	TD1047
8140.27R	4cyl.	2499cc		Diesel	Turbo	FM9102
8140.27S	4cyl.	2499cc		Diesel	Turbo	FM9102
8140.27S.3700 Euro 1	4cyl.	2499cc	77kW (105PS)	Diesel	Turbo Intercooled	TD20152
8140.47	4cyl.	2499cc	85kW (116PS)	Diesel	Turbo Intercooled	TD1048
8140.47R	4cyl.	2499cc	85kW (116PS)	Diesel	Turbo Intercooled	TD1049
8140.47R.2210	4cyl.	2499cc	80kW (109PS)	Diesel	Turbo Intercooled	TD6811
8140.67	4cyl.	2500cc	55kW (75PS)	Diesel	Turbo	TD1052
8144.21	4cyl.	2445cc	68kW (92PS)	Diesel	Turbo	TD4419
8144.97	4cyl.	2499cc	85kW (116PS)	Diesel	Turbo Intercooled	TD1061
8144.97 S	4cyl.	2500cc	85kW (116PS)	Diesel	Turbo Intercooled	TD1059
8144.97 Y	4cyl.	2500cc	85kW (116PS)	Diesel	Turbo Intercooled	TD1060
8140.21.201-203	4cyl.	2445cc	68kW (92PS)	Diesel	Turbo	FM9240
8140.27.2100	4cyl.	2500cc	70kW (95PS)	Diesel	Turbo	TD6800
8140.27.2700	4cyl.	2499cc		Diesel	Turbo	FM9102
8140.47.3700	4cyl.	2499cc	85kW (116PS)	Diesel	Turbo Intercooled	TD6809
8140.67.2700	4cyl.	2499cc	62kW (84PS)	Diesel		TD6810
8144.21.220	4cyl.	2445cc	68kW (92PS)	Diesel	Turbo	TD6803
8144.97.2400	4cyl.	2499cc	83-87kW (113-118PS)	Diesel	Turbo Intercooled	TD22316

- 14-021371-00 D
- 14-021372-00 D
- 14-021373-00 D
- 14-021480-00 DH 1

93.00

B 96.01	C 171.00	D 98.92	E 5.00
B 96.05	C 171.00	D 98.92	E 5.00
B 96.17	C 171.00	D 98.92	E 5.00
B 97.035	C 171.00	D 100.00	E 5.00

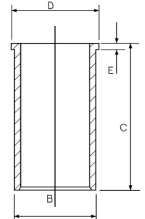

1 Nitrided

1 Nitriert

1 Nitruré

1 Niturado

23

8140.61	4cyl.	2445cc	53kW (72PS)	Diesel		TD1050
8142.61	4cyl.	2445cc	53kW (72PS)	Diesel		TD1053
8144.61	4cyl.	2445cc	53kW (72PS)	Diesel		TD4408
8144.67	4cyl.	2500cc	55kW (75PS)	Diesel		TD1056
8144.91	4cyl.	2445cc	76kW (103PS)	Diesel	Turbo Intercooled	TD1058
8140.61.204	4cyl.	2445cc	53kW (72PS)	Diesel		TD1051
8144.61.500.81	4cyl.	2445cc	66kW (89PS)	Diesel	Turbo	TD1054
8144.67.220	4cyl.	2499cc	55kW (75PS)	Diesel		TD6797
8144.81.2000	4cyl.	2445cc	66-74kW (90-101PS)	Diesel		TD1057
8144.97.2200	4cyl.	2499cc	86-87kW (117-118PS)	Diesel	Turbo Intercooled	TD1062





8144.97.2500	4cyl.	2500cc	85kW (116PS)	Diesel	Turbo Intercooled	TD1063
--------------	-------	--------	--------------	--------	-------------------	--------

SOFIM-8144.61.200	4cyl.	2445cc	53kW (72PS)	Diesel		TD6796
-------------------	-------	--------	-------------	--------	--	--------

14-022560-00 D	93.00	B 96.00	C 167.30	D 98.90	E 5.00
14-028930-00 D		B 97.50	C 167.00	D 100.90	E 5.00
14-028931-00 D		B 97.58	C 167.00	D 100.90	E 5.00
14-028932-00 D		B 97.70	C 167.00	D 100.90	E 5.00

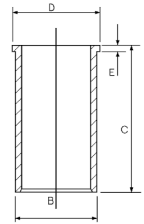

24

8140.63	4cyl.	2798cc	64kW (87PS)	Diesel		TD12749
---------	-------	--------	-------------	--------	--	---------

8140.43N Euro 3	4cyl.	2798cc	107kW (146PS)	Diesel	Turbo Intercooled	TD20450
-----------------	-------	--------	---------------	--------	-------------------	---------

8140.63.4000	4cyl.	2798cc	63kW (86PS)	Diesel		FM15739
--------------	-------	--------	-------------	--------	--	---------

8140.23.2585	4cyl.	2800cc	84kW (114PS)	Diesel	Turbo Intercooled	FM9256
--------------	-------	--------	--------------	--------	-------------------	--------

8140.23.3700	4cyl.	2800cc	84kW (114PS)	Diesel	Turbo Intercooled	FM9256
--------------	-------	--------	--------------	--------	-------------------	--------

8140.43.2585	4cyl.	2800cc	84kW (114PS)	Diesel	Turbo Intercooled	FM9256
--------------	-------	--------	--------------	--------	-------------------	--------

8140.43.3700	4cyl.	2800cc	84kW (114PS)	Diesel	Turbo Intercooled	FM9256
--------------	-------	--------	--------------	--------	-------------------	--------

8140.43.3900	4cyl.	2800cc	84kW (114PS)	Diesel	Turbo Intercooled	FM9256
--------------	-------	--------	--------------	--------	-------------------	--------

8140.43	4cyl.	2800cc	90kW (122PS)	Diesel	Turbo	TD11769
---------	-------	--------	--------------	--------	-------	---------

8140.43S Euro 3	4cyl.	2800cc	94kW (128PS)	Diesel	Turbo Intercooled	TD16196
-----------------	-------	--------	--------------	--------	-------------------	---------

14-021321-00 D	94.40	B 97.54	C 167.00	D 100.90	E 5.00
14-028930-00 D		B 97.50	C 167.00	D 100.90	E 5.00
14-028931-00 D		B 97.58	C 167.00	D 100.90	E 5.00
14-028932-00 D		B 97.70	C 167.00	D 100.90	E 5.00

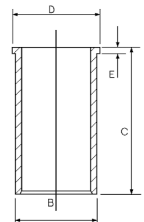

25

8030.02	3cyl.	2592cc	46kW (63PS)	Diesel		TD6922
---------	-------	--------	-------------	--------	--	--------

8035.02	3cyl.	2592cc	33-40kW (45-54PS)	Diesel		TD25194
---------	-------	--------	-------------------	--------	--	---------

8040.02	4cyl.	3456cc	60kW (81PS)	Diesel		TD6840
---------	-------	--------	-------------	--------	--	--------

8045.02	4cyl.	3455cc	44-50kW (60-68PS)	Diesel		TD25195
---------	-------	--------	-------------------	--------	--	---------

8040.02.041	4cyl.	3456cc	56kW (76PS)	Diesel		TD6925
-------------	-------	--------	-------------	--------	--	--------

8040.02.267	4cyl.	3456cc	56kW (76PS)	Diesel		TD5606
-------------	-------	--------	-------------	--------	--	--------

8040.02.300	4cyl.	3455cc	56kW (76PS)	Diesel		TD5605
-------------	-------	--------	-------------	--------	--	--------

8040.02.360	4cyl.	3456cc	56kW (76PS)	Diesel		TD5944
-------------	-------	--------	-------------	--------	--	--------

8040.02.367	4cyl.	3456cc	56kW (76PS)	Diesel		TD5945
-------------	-------	--------	-------------	--------	--	--------

8060.02.000	6cyl.	5184cc	90kW (122PS)	Diesel		TD6852
-------------	-------	--------	--------------	--------	--	--------

8060.02.070	6cyl.	5184cc	90kW (122PS)	Diesel		TD6843
-------------	-------	--------	--------------	--------	--	--------

8065.02.007	6cyl.	5184cc	74kW (100PS)	Diesel		TD25315
-------------	-------	--------	--------------	--------	--	---------

8065.02.200	6cyl.	5184cc	70-74kW (95-101PS)	Diesel		TD25316
-------------	-------	--------	--------------------	--------	--	---------





8065.02.207	6cyl.	5184cc	74kW (100PS)	Diesel	TD25317
8065.02.217	6cyl.	5184cc	74kW (100PS)	Diesel	TD25318

14-021540-00 D	100.00	B 103.00	C 187.00	D 104.00	E 5.00	
----------------	--------	----------	----------	----------	--------	--

14-010170-00 D	100.00	B 103.00	C 187.00			
14-011021-00 D		B 103.06	C 187.00			
14-011022-00 D		B 103.10	C 187.00			
14-013401-00 D		B 103.04	C 187.00			

26

8035.06.200	3cyl.	2708cc	38kW (52PS)	Diesel	TD25535
8035.06.206	3cyl.	2708cc	38kW (52PS)	Diesel	TD25536
8035.06.208	3cyl.	2708cc	38-40kW (52-54PS)	Diesel	TD25537
8035.06.216	3cyl.	2708cc	38kW (52PS)	Diesel	TD25538
8035.06.220	3cyl.	2708cc	33kW (45PS)	Diesel	TD25539
8035.06.222	3cyl.	2708cc	33-38kW (45-52PS)	Diesel	TD25540
8035.06.223	3cyl.	2708cc	38kW (52PS)	Diesel	TD25541
8035.06.306	3cyl.	2708cc	38kW (52PS)	Diesel	TD25542
8035.06.307	3cyl.	2708cc	38kW (52PS)	Diesel	TD25543
8035.06.308	3cyl.	2708cc	38kW (52PS)	Diesel	TD25544
8035.06.309	3cyl.	2708cc	38kW (52PS)	Diesel	TD25545
8035.06.317	3cyl.	2708cc	38kW (52PS)	Diesel	TD25546
8035.06.320	3cyl.	2708cc	34kW (46PS)	Diesel	TD25547
8035.06.321	3cyl.	2708cc	34kW (46PS)	Diesel	TD25548
8035.06.322	3cyl.	2708cc	38kW (52PS)	Diesel	TD25549
8035.06.323	3cyl.	2708cc	33-38kW (45-52PS)	Diesel	TD25550
8045.06.200	4cyl.	3613cc	51kW (69PS)	Diesel	TD25521
8045.06.208	4cyl.	3613cc	51kW (69PS)	Diesel	TD25522
8045.06.213	4cyl.	3613cc	48-51kW (65-69PS)	Diesel	TD25523
8045.06.214	4cyl.	3613cc	73kW (99PS)	Diesel	TD25524
8045.06.215	4cyl.	3613cc	73kW (99PS)	Diesel	TD25525
8045.06.225	4cyl.	3613cc	48kW (65PS)	Diesel	TD25526
8045.06.319	4cyl.	3613cc	48kW (65PS)	Diesel	TD25527
8045.06.326	4cyl.	3613cc	48kW (65PS)	Diesel	TD25528

14-010780-00 D	100.00	B 103.02	C 196.00			
14-010781-00 D		B 103.06	C 196.00			
14-010782-00 D		B 103.10	C 196.00			



27

8035.04.265	3cyl.	2749cc	35kW (47PS)	Diesel		TD25325
8035.04.270	3cyl.	2749cc	43kW (58PS)	Diesel		TD25326
8040.04.200	4cyl.	3666cc	63kW (86PS)	Diesel		TD7263
8045.04.270	4cyl.	3666cc	57kW (77PS)	Diesel		TD25335
8055.04.200	5cyl.	4583cc	63-66kW (86-90PS)	Diesel		TD25345
8060.04.000	6cyl.	5499cc	99kW (135PS)	Diesel		TD6853
8060.04.060	6cyl.	5499cc	96kW (131PS)	Diesel		TD5916
8060.04.660	6cyl.	5499cc	96-102kW (131-139PS)	Diesel		TD6255
8060.04.669	6cyl.	5499cc	99-102kW (135-139PS)	Diesel		TD7292
8060.04.689	6cyl.	5499cc	99-102kW (135-139PS)	Diesel		TD7296
8065.04.200	6cyl.	5499cc	81-85kW (110-116PS)	Diesel		TD25322
8065.24.000	6cyl.	5499cc	99kW (135PS)	Diesel		TD25348
8065.24.300	6cyl.	5499cc	91kW (124PS)	Diesel		TD25352

14-023551-00 D  
14-023552-00 D  
14-023553-00 D

103.00

B 107.06 C 187.00 D 110.00 E 5.00  
B 107.18 C 187.00 D 110.00 E 5.00  
B 107.48 C 187.00 D 110.50 E 5.00

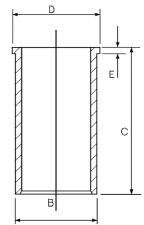

14-010180-00 D  
14-010181-00 D  
14-010182-00 D

103.00

B 107.00 C 187.00  
B 107.06 C 187.00  
B 107.10 C 187.00

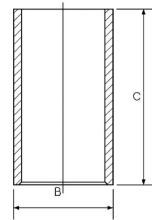

28

8040.45D.5100 Euro 2	4cyl.	3908cc	85kW (116PS)	Diesel	Turbo Intercooled	TD22237
8040.45D.5103 Euro 2	4cyl.	3908cc	85kW (116PS)	Diesel	Turbo Intercooled	TD22238
8060.25V.4000	6cyl.	5861cc	130kW (177PS)	Diesel	Turbo Intercooled	TD7283
8060.25R.4200	6cyl.	5861cc	105kW (143PS)	Diesel	Turbo Intercooled	TD7276
8035.05.214	3cyl.	2931cc	37-44kW (50-60PS)	Diesel		TD22233
8035.05.215	3cyl.	2931cc	37-44kW (50-60PS)	Diesel		TD22234
8040.05.200	4cyl.	3908cc	65kW (88PS)	Diesel		TD7265
8040.05.230	4cyl.	3908cc	65kW (88PS)	Diesel		TD7264
8040.05.4990	4cyl.	3908cc	80kW (109PS)	Diesel	Turbo	TD22235
8040.25.000	4cyl.	3908cc	74-85kW (101-116PS)	Diesel	Turbo	TD21461
8040.25.200	4cyl.	3908cc	85kW (116PS)	Diesel	Turbo	TD7272
8040.25.220	4cyl.	3908cc	85kW (116PS)	Diesel	Turbo	TD7280
8040.25.230	4cyl.	3908cc	74kW (100PS)	Diesel	Turbo	TD7271
8040.45.5200 Euro 2	4cyl.	3908cc	100kW (136PS)	Diesel	Turbo Intercooled	TD21462
8040.45.5281 Euro 2	4cyl.	3908cc	100kW (136PS)	Diesel	Turbo Intercooled	TD22236
8045.05.000	4cyl.	3908cc	59kW (80PS)	Diesel		TD25496
8045.05.213	4cyl.	3908cc	55kW (75PS)	Diesel		TD25500
8045.05.215	4cyl.	3908cc	55kW (75PS)	Diesel		TD25501





8045.25.310	4cyl.	3908cc	63kW (86PS)	Diesel	Turbo	TD25364
8045.25.370	4cyl.	3908cc	75-103kW (102-140PS)	Diesel	Turbo	TD25365
8045.25.375	4cyl.	3908cc	63-103kW (85-140PS)	Diesel	Turbo	TD25366
8045.25.376	4cyl.	3908cc	75-103kW (102-140PS)	Diesel	Turbo	TD25367
8045.25.381	4cyl.	3908cc	80-103kW (109-140PS)	Diesel	Turbo	TD25369
8055.05.000	5cyl.	4885cc	66kW (89PS)	Diesel		TD25384
8060.05.000	6cyl.	5861cc	79-102kW (108-139PS)	Diesel		TD7282
8060.05.200	6cyl.	5861cc	99-102kW (135-139PS)	Diesel		TD7299
8060.05.246	6cyl.	5861cc	101kW (137PS)	Diesel		TD7262
8060.05.270	6cyl.	5861cc	101-102kW (138-139PS)	Diesel		TD7278
8060.05.280	6cyl.	5861cc	102kW (139PS)	Diesel		TD7281
8060.05.285	6cyl.	5861cc	101kW (137PS)	Diesel		TD7274
8060.05.289	6cyl.	5861cc	102kW (139PS)	Diesel		TD7293
8060.25.600	6cyl.	5861cc	130kW (177PS)	Diesel	Turbo	TD7301
8060.25.621	6cyl.	5861cc	110kW (150PS)	Diesel	Turbo	TD7243
8060.25.630	6cyl.	5861cc	100kW (136PS)	Diesel	Turbo	TD5604
8060.25.631	6cyl.	5861cc	100kW (136PS)	Diesel	Turbo	TD5943
8060.25.641	6cyl.	5861cc	103kW (140PS)	Diesel	Turbo	TD7242
8060.25.662	6cyl.	5861cc	96kW (131PS)	Diesel	Turbo	TD5599
8060.25.663	6cyl.	5861cc	88-96kW (118-131PS)	Diesel	Turbo	TD5936
8060.25.669	6cyl.	5861cc	125kW (170PS)	Diesel	Turbo	TD5613
8060.25.670	6cyl.	5861cc	125kW (170PS)	Diesel	Turbo	TD5952
8060.25.673	6cyl.	5861cc	96kW (131PS)	Diesel	Turbo	TD5938
8060.25.678	6cyl.	5861cc	130kW (177PS)	Diesel	Turbo	TD5616
8060.25.679	6cyl.	5861cc	130kW (177PS)	Diesel	Turbo	TD5955
8060.45.600	6cyl.	5861cc	152kW (207PS)	Diesel	Turbo Intercooled	TD7295
8060.45S.6000	6cyl.	5861cc	167kW (227PS)	Diesel	Turbo Intercooled	TD7307
8065.05.000	6cyl.	5863cc	85kW (116PS)	Diesel		TD25488
8065.05.330	6cyl.	5863cc	73kW (99PS)	Diesel		TD25495
8065.25.080	6cyl.	5863cc	105kW (143PS)	Diesel		TD25475
8065.25.320	6cyl.	5863cc	105-110kW (143-150PS)	Diesel		TD25477

14-021361-00 D	104.00	B 107.02	C 198.00	D 110.87	E 5.00
14-021362-00 D		B 107.14	C 198.00	D 110.87	E 5.00
14-021363-00 D		B 107.44	C 198.00	D 110.87	E 5.00
14-021491-00 D		B 107.01	C 198.00	D 109.87	E 5.00
14-021492-00 D		B 107.05	C 198.00	D 109.87	E 5.00
14-021493-00 D		B 107.17	C 198.00	D 109.87	E 5.00
14-021494-00 D		B 107.47	C 198.00	D 109.87	E 5.00
14-024781-00 D		B 107.02	C 198.00	D 109.95	E 5.00

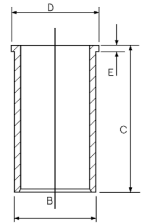

14-010940-00 D	104.00	B 107.00	C 198.00	
14-010941-10 D		B 107.10	C 198.00	
14-010943-10 D		B 107.52	C 198.00	

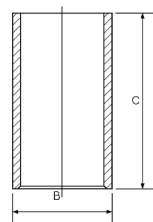



29

C 03	4cyl.	4940cc	67kW (91PS)	Diesel	TD6844
CP 3	6cyl.	7412cc	107kW (146PS)	Diesel	TD6861
CP 3/32.1.200	6cyl.	7412cc	107-110kW (145-150PS)	Diesel	TD6855

14-611250-00 WH	110.00	B 118.00	C 237.00	D 129.50	E 170.00	F 1.00
14-615230-00 WH		B 118.00	C 236.00	D 129.50	E 170.00	F 1.00

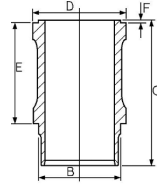

30

8340.05	4cyl.	5400cc	63kW (86PS)	Diesel	TD6849
8365.05.500	6cyl.	8101cc	114kW (155PS)	Diesel	TD25353
8365.05.520	6cyl.	8101cc	104kW (141PS)	Diesel	TD25354
8365.05.530	6cyl.	8101cc	99kW (135PS)	Diesel	TD25355
8365.05.531	6cyl.	8101cc	104kW (141PS)	Diesel	TD25356
8365.05.555	6cyl.	8101cc	96kW (131PS)	Diesel	TD25357
8365.05.560	6cyl.	8101cc	94kW (128PS)	Diesel	TD25358
8365.05.570	6cyl.	8101cc	94kW (128PS)	Diesel	TD25359
8365.05.580	6cyl.	8101cc	94kW (128PS)	Diesel	TD25360
8365.05.590	6cyl.	8101cc	94kW (128PS)	Diesel	TD25361

14-633860-00 WH	115.00	B 122.00	C 235.00	D 129.90	E 167.00
14-684840-00 WH		B 122.00	C 235.00	D 129.70	E 167.00

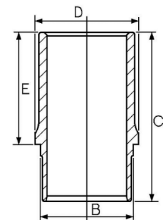

31

8460.41S.733 Euro 1	6cyl.	9498cc	254kW (345PS)	Diesel Turbo Intercooled	TD24865
8460.21.002	6cyl.	9498cc	154-192kW (209-261PS)	Diesel Turbo Intercooled	TD24863

14-450880-00 WH ①	120.00	B 134.00	C 250.00	D 144.80	E 10.02	F 1.00
-------------------	--------	----------	----------	----------	---------	--------

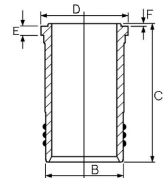

① Nitrided

① Nitriert

① Nitruré

① Nitrurado

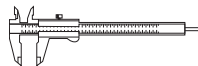

32

8210.22.000

6cyl.

13798cc

224kW (305PS)

Diesel

Turbo

TD22223

		B	C	D	E
14-021230-00 DH	137.00	B 143.02	C 282.00	D 147.00	E 6.00
14-021231-00 DH		B 143.07	C 282.00	D 147.00	E 6.00
14-021232-00 DH		B 143.27	C 282.00	D 147.00	E 6.00
14-021560-10 DH		B 143.00	C 282.00	D 147.00	E 6.06
14-021561-10 DH		B 143.05	C 282.00	D 147.00	E 6.06
14-021562-10 DH		B 143.25	C 282.00	D 147.00	E 6.06
14-021563-10 DH		B 143.50	C 282.00	D 147.00	E 6.06
14-021590-00 DH		B 143.04	C 282.00	D 149.00	E 6.04

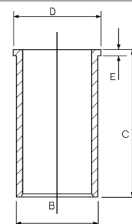

Nitrided

Nitriert

Nitrué

Niturado

# ENGINE INDEX

Motorverzeichnis • Index de moteur • Índice de Motor  
Indeks silnika • Модель двигателя • دليل المحرك



CCM

x



9

615.000	Diesel	2270	4	85.00	1
8035.04	Diesel	2748	3	103.00	2
8065.04-H	Diesel	5499	6	103.00	2
8205.02	Diesel	9820	6	122.00	5
8205.03	Diesel	10308	6	125.00	6
8215.02	Diesel	13798	6	137.00	7
8215.22.520	Diesel	13798	6	137.00	7
8285.02	Diesel	17174	V8	145.00	8
8285.22	Diesel	17174	V8	145.00	8
8361.45.530-836 L	Diesel	8101	6	115.00	4
C 03-13OT	Diesel	5401	4	115.00	4
CN 3	Diesel	3706	3	110.00	3
CP 3/100	Diesel	7412	6	110.00	3





						<b>1</b>
<b>615.000</b>	4cyl.	<b>2270cc</b>	<b>Diesel</b>			<b>FM4127</b>
14-011031-00 <i>D</i>	<b>85.00</b>	<b>B 90.04</b>	<b>C 178.00</b>			

						<b>2</b>
<b>8035.04</b>	3cyl.	<b>2748cc</b>	<b>Diesel</b>			<b>FM4007</b>
<b>8065.04-H</b>	6cyl.	<b>5499cc</b>	<b>Diesel</b>			<b>FM13486</b>
14-010180-00 <i>D</i>	<b>103.00</b>	<b>B 107.00</b>	<b>C 187.00</b>			
14-010181-00 <i>D</i>		<b>B 107.06</b>	<b>C 187.00</b>			
14-010182-00 <i>D</i>		<b>B 107.10</b>	<b>C 187.00</b>			

						<b>3</b>	
<b>CN 3</b>	3cyl.	<b>3706cc</b>	<b>Diesel</b>			<b>FM4028</b>	
<b>CP 3/100</b>	6cyl.	<b>7412cc</b>	<b>Diesel</b>			<b>FM11310</b>	
14-611250-00 <i>WH</i>	<b>110.00</b>	<b>B 118.00</b>	<b>C 237.00</b>	<b>D 129.50</b>	<b>E 170.00</b>	<b>F 1.00</b>	
14-615230-00 <i>WH</i>		<b>B 118.00</b>	<b>C 235.00</b>	<b>D 129.50</b>	<b>E 170.00</b>		

						<b>4</b>
<b>8361.45.530-836 L</b>	6cyl.	<b>8101cc</b>	<b>Diesel Turbo Intercooled</b>		<b>FM9113</b>	
<b>C 03-130T</b>	4cyl.	<b>5401cc</b>	<b>Diesel</b>			<b>FM4030</b>
14-684840-00 <i>WH</i>	<b>115.00</b>	<b>B 122.00</b>	<b>C 235.00</b>	<b>D 129.70</b>	<b>E 167.00</b>	

						<b>5</b>
<b>8205.02</b>	6cyl.	<b>9820cc</b>	<b>Diesel</b>			<b>FM3500</b>
14-020200-00 <i>D</i> <span style="border: 1px solid black; padding: 0 2px;">1</span>	<b>122.00</b>	<b>B 128.00</b>	<b>C 252.00</b>	<b>D 132.00</b>	<b>E 6.00</b>	

1 Nitrided

1 Nitriert

1 Nitrué

1 Niturado



6

8205.03 6cyl. 10308cc Diesel FM595

14-021580-00 DH 1 125.00 B 130.02 C 252.00 D 136.00 E 6.00

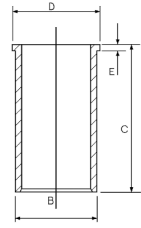

1 Nitrided

1 Nitriert

1 Nitruré

1 Nitrurado

7

8215.02 6cyl. 13798cc Diesel FM3514

8215.22.520 6cyl. 13798cc Diesel Turbo FM9116

14-021230-00 DH 1 137.00 B 143.02 C 282.00 D 147.00 E 6.00  
 14-021231-00 DH 1 B 143.07 C 282.00 D 147.00 E 6.00  
 14-021232-00 DH 1 B 143.27 C 282.00 D 147.00 E 6.00  
 14-021560-10 DH B 143.00 C 282.00 D 147.00 E 6.06  
 14-021561-10 DH B 143.05 C 282.00 D 147.00 E 6.06  
 14-021562-10 DH B 143.25 C 282.00 D 147.00 E 6.06  
 14-021563-10 DH B 143.50 C 282.00 D 147.00 E 6.06  
 14-021590-00 DH 1 B 143.04 C 282.00 D 149.00 E 6.04

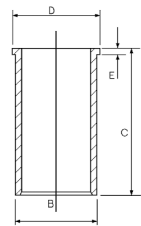

1 Nitrided

1 Nitriert

1 Nitruré

1 Nitrurado

8

8285.02 V8cyl. 17174cc Diesel FM9234

8285.22 V8cyl. 17174cc Diesel Turbo FM14027

14-260080-00 WH 2 145.00 B 158.50 C 262.00 D 174.00 E 10.06 F 0.94  
 15-260080-00 WH 1 2 B 158.50 C 262.00 D 174.00 E 10.06 F 0.94

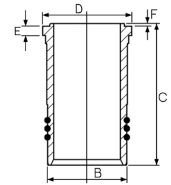

1 Contains 3 seals of 3.00mm

1 Enthält drei 3,00mm Dichtungen

1 Contient 3 joints de 3 mm

1 Contiene 3 retenes de 3.00mm

2 Nitrided

2 Nitriert

2 Nitruré

2 Nitrurado

Motorverzeichnis • Index de moteur • Índice de Motor  
Indeks silnika • Модель двигателя • دليل المحرك

# ENGINE INDEX



CCM

x



9

8140.43C.4000	Diesel	2800	4	94.40	1
8200.02.220	Diesel	9820	6	122.00	6
8200.12.000	Diesel	9820	6	122.00	6
8210.02.000	Diesel	13798	6	137.00	8
8210.02.020	Diesel	13798	6	137.00	8
8210.02.022	Diesel	13798	6	137.00	8
8210.02.032	Diesel	13798	6	137.00	8
8210.02.053	Diesel	13798	6	137.00	8
8210.02.067	Diesel	13798	6	137.00	8
8210.02.069	Diesel	13798	6	137.00	8
8210.02.081	Diesel	13798	6	137.00	8
8210.02.266	Diesel	13798	6	137.00	8
8210.02.267	Diesel	13798	6	137.00	8
8210.02.371	Diesel	13798	6	137.00	8
8210.02.373	Diesel	13798	6	137.00	8
8210.02.377	Diesel	13798	6	137.00	8
8210.02.385	Diesel	13798	6	137.00	8
8210.02.393	Diesel	13798	6	137.00	8
8210.02.405	Diesel	13798	6	137.00	8
8210.02.426	Diesel	13798	6	137.00	8
8210.02.440	Diesel	13798	6	137.00	8
8210.02.441	Diesel	13798	6	137.00	8
8210.02.731	Diesel	13798	6	137.00	8
8210.22	Diesel	13798	6	137.00	9
8210.22.069	Diesel	13798	6	137.00	8
8210.22.101	Diesel	13798	6	137.00	8
8210.22.175	Diesel	13798	6	137.00	8
8210.22.183	Diesel	13798	6	137.00	8
8210.22.235	Diesel	13798	6	137.00	8
8210.22.269	Diesel	13798	6	137.00	8
8210.22.317	Diesel	13798	6	137.00	8
8210.22.373	Diesel	13798	6	137.00	8
8210.22.385	Diesel	13798	6	137.00	8
8210.22.406	Diesel	13798	6	137.00	8
8210.22.569	Diesel	13798	6	137.00	8
8210.22.869	Diesel	13798	6	137.00	8
8210.42 K	Diesel	13798	6	137.00	8
8210.42.009	Diesel	13798	6	137.00	8
8210.42.101	Diesel	13798	6	137.00	8
8210.42.115	Diesel	13798	6	137.00	8
8210.42L.(TCA)	Diesel	13798	6	137.00	8
8210.42L.400	Diesel	13798	6	137.00	8
8211.02.032	Diesel	13798	6	137.00	8
8211.22	Diesel	13798	6	137.00	9
8217.32	Diesel	13798	6	137.00	8
8220.02.701	Diesel	9572	6	125.00	7
8220.02.834	Diesel	9572	6	125.00	7
8220.02.847	Diesel	9572	6	125.00	7
8220.02.856	Diesel	9572	6	125.00	7
8220.02.870	Diesel	9572	6	125.00	7
8220.12.709	Diesel	9572	6	125.00	7
8220.22.002	Diesel	9572	6	125.00	7
8220.22.102	Diesel	9572	6	125.00	7
8220.22.104	Diesel	9572	6	125.00	7
8220.22.106	Diesel	9572	6	125.00	7
8220.22.708	Diesel	9570	6	125.00	7
8220.22.709	Diesel	9570	6	125.00	7
8220.32.701	Diesel	9572	6	125.00	7
8220.32.721	Diesel	9570	6	125.00	7
8220.32.723	Diesel	9570	6	125.00	7

# ENGINE INDEX

Motorverzeichnis • Index de moteur • Índice de Motor  
Indeks silnika • Модель двигателя • دليل المحرك



CCM

x



9

8260.02.405	Diesel	12880	6	145.00	10
8261.1.002	Diesel	12880	6	145.00	10
8280.01.000	Diesel	17174	V8	145.00	10
8280.02.000	Diesel	17174	V8	145.00	10
8280.02.024	Diesel	17174	V8	145.00	10
8280.02.082	Diesel	17174	V8	145.00	10
8280.02.125-135	Diesel	17174	V8	145.00	10
8280.02.274	Diesel	17174	V8	145.00	10
8280.02.275	Diesel	17174	V8	145.00	10
8280.02.289	Diesel	17174	V8	145.00	10
8280.02.405	Diesel	17174	V8	145.00	10
8281.02	Diesel	17174	V8	145.00	10
8281.22.201	Diesel	17174	V8	145.00	10
8360.05	Diesel	8100	6	115.00	4
8360.05.B	Diesel	8100	6	115.00	4
8361.04	Diesel	6850	6	115.00	3
8361.05	Diesel	8102	6	115.00	5
8361.25.510	Diesel	8101	6	115.00	5
8361.45.530	Diesel	8101	6	115.00	5
CN3	Diesel	3706	3	110.00	2



1

8140.43C.4000 4cyl. 2800cc 78kW (106PS) Diesel Turbo Intercooled Direct Injection FM29256

14-021321-00 D	94.40	B 97.54	C 167.00	D 100.90	E 5.00
14-028931-00 D		B 97.58	C 167.00	D 100.90	E 5.00
14-028932-00 D		B 97.70	C 167.00	D 100.90	E 5.00
14-028930-00 D		B 97.50	C 167.00	D 100.90	E 5.00

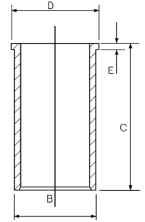

2

CN3 3cyl. 3706cc Diesel FM4028

14-611250-00 WH	110.00	B 118.00	C 237.00	D 129.50	E 170.00	F 1.00
14-615230-00 WH		B 118.00	C 235.00	D 129.50	E 170.00	F 1.00

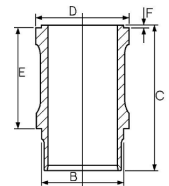

3

8361.04 6cyl. 6850cc 106kW (145PS) Diesel FM4951

14-610020-00 WH ①	115.00	B 122.00	C 215.00	D 129.70	E 147.00
-------------------	--------	----------	----------	----------	----------

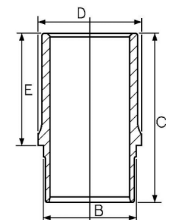

① Liner with "anti-cavitation" galvanized exterior.

① Laufbüchse mit "hohlraumfreiem", verzinktem Äußerem.

① Chemise à extérieur galvanisé "anti-cavitation".

① Camisa con exterior galvanizado "anticavitación".

4

8360.05 6cyl. 8100cc 95-124kW (129-169PS) Diesel TD6854

8360.05.B 6cyl. 8100cc 101-110kW (137-150PS) Diesel TD6856

14-633860-00 WH	115.00	B 122.00	C 235.00	D 129.90	E 167.00
14-684840-00 WH		B 122.00	C 235.00	D 129.70	E 167.00

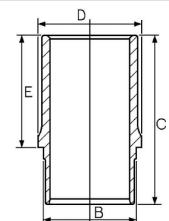



5

8361.05	6cyl.	8102cc	118kW (160PS)	Diesel	FM4952
8361.25.510	6cyl.	8101cc		Diesel	FM19113
8361.45.530	6cyl.	8101cc		Diesel Turbo Intercooled	FM9113
14-684840-00 WH	115.00	B 122.00	C 235.00	D 129.70	E 167.00
14-633860-00 WH	115.00	B 122.00	C 235.00	D 129.90	E 167.00

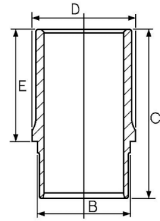

6

8200.02.220	6cyl.	9820cc	147kW (200PS)	Diesel	TD6935
8200.12.000	6cyl.	9820cc	140kW (190PS)	Diesel	TD6906
14-020200-00 D 1	122.00	B 128.00	C 252.00	D 132.00	E 6.00

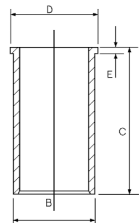

1 Nitrided

1 Nitriert

1 Nitruré

1 Nitrurado

7

8220.02.701	6cyl.	9572cc	148kW (201PS)	Diesel	TD7252
8220.02.834	6cyl.	9572cc	148kW (201PS)	Diesel	TD7361
8220.02.847	6cyl.	9572cc	151kW (205PS)	Diesel	TD6866
8220.02.856	6cyl.	9572cc	151kW (205PS)	Diesel	TD6867
8220.02.870	6cyl.	9572cc	148kW (201PS)	Diesel	TD7327
8220.12.709	6cyl.	9572cc	149kW (203PS)	Diesel	TD7370
8220.22.002	6cyl.	9572cc	177kW (240PS)	Diesel Turbo	TD5618
8220.22.102	6cyl.	9572cc	177kW (240PS)	Diesel Turbo	TD5601
8220.22.104	6cyl.	9572cc	177kW (240PS)	Diesel Turbo	TD5940
8220.22.106	6cyl.	9572cc	177kW (240PS)	Diesel Turbo	TD6258
8220.22.708	6cyl.	9570cc	177kW (240PS)	Diesel Turbo	TD5640
8220.22.709	6cyl.	9570cc	177kW (240PS)	Diesel Turbo	TD5981
8220.32.701	6cyl.	9572cc	177kW (240PS)	Diesel Turbo	TD7379
8220.32.721	6cyl.	9570cc	177kW (240PS)	Diesel Turbo	TD7380
8220.32.723	6cyl.	9570cc	177kW (240PS)	Diesel Turbo	TD7373

14-459010-00 WH 1 2	125.00	B 133.50	C 241.00	D 145.00	E 164.00
14-610010-00 WH 2		B 133.50	C 241.00	D 145.00	E 164.00

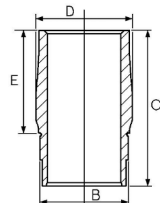

1 "Anti-cavitation" galvanized exterior

1 "Hohlraumfreier" Außenverzinkung

1 Galvanisage extérieur "anti-cavitation"

1 Exterior galvanizado "anticavitación"

2 Nitrided

2 Nitriert

2 Nitruré

2 Nitrurado



8

8210.22	6cyl.	13798cc	221-224kW (300-305PS)	Diesel	Turbo	FM4024
8211.22	6cyl.	13798cc		Diesel	Turbo	FM24024
8210.42 K	6cyl.	13798cc	272kW (370PS)	Diesel		TD7358
8210.42L.(TCA) Euro 1	6cyl.	13798cc	309kW (420PS)	Diesel	Turbo Intercooled	TD7366
8210.42L.400	6cyl.	13798cc	309kW (420PS)	Diesel	Turbo Intercooled	TD7320
8217.32	6cyl.	13798cc		Diesel	Turbo	FM9116
8210.02.000	6cyl.	13798cc	191kW (260PS)	Diesel		TD6868
8210.02.020	6cyl.	13798cc	191kW (260PS)	Diesel		TD6864
8210.02.022	6cyl.	13798cc	191kW (260PS)	Diesel		TD6877
8210.02.032	6cyl.	13798cc	191kW (260PS)	Diesel		TD6923
8210.02.053	6cyl.	13798cc	191kW (260PS)	Diesel		TD6266
8210.02.067	6cyl.	13798cc	191kW (260PS)	Diesel		TD5622
8210.02.069	6cyl.	13798cc	191kW (260PS)	Diesel		TD5959
8210.02.081	6cyl.	13798cc	191kW (260PS)	Diesel		TD6865
8210.02.266	6cyl.	13798cc	191kW (260PS)	Diesel		TD5635
8210.02.267	6cyl.	13798cc	191kW (260PS)	Diesel		TD5976
8210.02.371	6cyl.	13798cc	191kW (260PS)	Diesel		TD5619
8210.02.373	6cyl.	13798cc	191kW (260PS)	Diesel		TD5621
8210.02.377	6cyl.	13798cc	191kW (260PS)	Diesel		TD5958
8210.02.385	6cyl.	13798cc	191kW (260PS)	Diesel		TD6899
8210.02.393	6cyl.	13798cc	191kW (260PS)	Diesel		TD6259
8210.02.405	6cyl.	13798cc	191kW (260PS)	Diesel		TD7254
8210.02.426	6cyl.	13798cc	191kW (260PS)	Diesel		TD7359
8210.02.440	6cyl.	13798cc	191kW (260PS)	Diesel		TD5617
8210.02.441	6cyl.	13798cc	191kW (260PS)	Diesel		TD5956
8210.02.731	6cyl.	13798cc	191kW (260PS)	Diesel		TD5973
8210.22.069	6cyl.	13798cc	221-224kW (300-305PS)	Diesel	Turbo	TD6885
8210.22.101	6cyl.	13798cc	224kW (305PS)	Diesel	Turbo	TD6881
8210.22.175	6cyl.	13798cc	224kW (305PS)	Diesel	Turbo	TD5960
8210.22.183	6cyl.	13798cc	224kW (305PS)	Diesel	Turbo	TD7340
8210.22.235	6cyl.	13798cc	224kW (305PS)	Diesel	Turbo	TD7352
8210.22.269	6cyl.	13798cc	224kW (305PS)	Diesel	Turbo	TD5630
8210.22.317	6cyl.	13798cc	224kW (305PS)	Diesel	Turbo	TD6260
8210.22.373	6cyl.	13798cc	224kW (305PS)	Diesel	Turbo	TD6878
8210.22.385	6cyl.	13798cc	224kW (305PS)	Diesel	Turbo	TD6264
8210.22.406	6cyl.	13798cc	224kW (305PS)	Diesel	Turbo	TD7255
8210.22.569	6cyl.	13798cc	224kW (305PS)	Diesel	Turbo	TD7330
8210.22.869	6cyl.	13798cc	235kW (320PS)	Diesel	Turbo	TD7333
8210.42.009	6cyl.	13798cc	265kW (360PS)	Diesel	Turbo Intercooled	TD7356
8210.42.101	6cyl.	13798cc	265kW (360PS)	Diesel	Turbo Intercooled	TD7336





8210.42.115	6cyl.	13798cc	265kW (360PS)	Diesel	Turbo Intercooled	TD7341
8211.02.032	6cyl.	13798cc	191kW (260PS)	Diesel		TD6376
14-021230-00 DH ①	137.00	B 143.02	C 282.00	D 147.00	E 6.00	
14-021231-00 DH ①		B 143.07	C 282.00	D 147.00	E 6.00	
14-021232-00 DH ①		B 143.27	C 282.00	D 147.00	E 6.00	
14-021560-10 DH		B 143.00	C 282.00	D 147.00	E 6.06	
14-021561-10 DH		B 143.05	C 282.00	D 147.00	E 6.06	
14-021562-10 DH		B 143.25	C 282.00	D 147.00	E 6.06	
14-021563-10 DH		B 143.50	C 282.00	D 147.00	E 6.06	
14-021590-00 DH ①		B 143.04	C 282.00	D 149.00	E 6.04	

① Nitrided

① Nitriert

① Nitruré

① Nitrurado

						<b>9</b>
8281.02	V8cyl.	17174cc		Diesel		FM14026
8260.02.405	6cyl.	12880cc	191kW (260PS)	Diesel		TD7362
8261.1.002	6cyl.	12880cc		Diesel		FM14023
8280.01.000	V8cyl.	17174cc	246kW (335PS)	Diesel		TD6869
8280.02.000	V8cyl.	17174cc	259kW (352PS)	Diesel		TD6879
8280.02.024	V8cyl.	17174cc	259kW (352PS)	Diesel		TD6873
8280.02.082	V8cyl.	17174cc	259kW (352PS)	Diesel		TD6882
8280.02.125-135	V8cyl.	17174cc	259kW (352PS)	Diesel		TD5638
8280.02.274	V8cyl.	17174cc	259kW (352PS)	Diesel		TD5639
8280.02.275	V8cyl.	17174cc	259kW (352PS)	Diesel		TD5980
8280.02.289	V8cyl.	17174cc	259kW (352PS)	Diesel		TD7354
8280.02.405	V8cyl.	17174cc	259kW (352PS)	Diesel		TD7360
8281.22.201	V8cyl.	17174cc	309kW (420PS)	Diesel	Turbo Intercooled	TD6378

14-260080-00 WH ②  
15-260080-00 WH ①②

145.00

B 158.50 C 262.00 D 174.00 E 10.06 F 0.94  
B 158.50 C 262.00 D 174.00 E 10.06 F 0.94

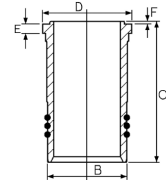

① Contains 3 seals of 3.00mm

① Enthält drei 3,00mm Dichtungen

① Contient 3 joints de 3 mm

① Contiene 3 retenes de 3.00mm

② Nitrided

② Nitriert

② Nitruré

② Nitrurado



Modelverzeichnis • Index de modele • Índice de Modelo  
Indeks modelu • Модель автомобиля • دليل المركبة



# MODEL INDEX



CCM

x



09/73→09/83	<b>A-Series AO409</b>	2402E York	Diesel	3537	6	<b>13</b>
09/73→09/83	<b>A-Series AO509</b>	2402E York	Diesel	3537	6	<b>13</b>
09/73→09/83	<b>A-Series AO609</b>	2402E York	Diesel	3537	6	<b>13</b>
09/73→09/83	<b>A-Series AO709</b>	2402E York	Diesel	3537	6	<b>13</b>
01/68→12/72	<b>Capri 1600</b>	711M, 711M uprated, 2737E	Petrol	1599	4	<b>6</b>
01/67→12/72	<b>Capri 1600 GT</b>	711M uprated, 2737E	Petrol	1599	4	<b>6</b>
01/68→12/70	<b>Capri GT 1716cc (overbored engine)</b>	2737E	Petrol	1599	4	<b>6</b>
02/07→09/10	<b>C-Max 1.6</b>	G8DA, G8DB, HHDA, HHDB	Diesel	1560	4	<b>3</b>
01/71→12/75	<b>Cortina 1600</b>	711M, 711M uprated	Petrol	1599	4	<b>6</b>
01/67→12/70	<b>Cortina 1600 GT</b>	2737E	Petrol	1599	4	<b>6</b>
01/67→12/70	<b>Cortina 1600 MkII</b>	2737E	Petrol	1599	4	<b>6</b>
01/70→12/73	<b>Cortina 1600 MkIII</b>	2737E	Petrol	1599	4	<b>6</b>
01/68→12/70	<b>Cortina GT 1716cc (overbored engine)</b>	2737E	Petrol	1599	4	<b>6</b>
05/86→07/90	<b>Escort '86 1.1</b>	GSG	Petrol	1117	4	<b>2</b>
02/86→07/90	<b>Escort '86 1.3</b>	JLA, JLB	Petrol	1299	4	<b>2</b>
06/70→02/76	<b>Escort I 1.3</b>	J2	Petrol	1298	4	<b>6</b>
12/74→08/80	<b>Escort II 1.3</b>	J2	Petrol	1298	4	<b>6</b>
12/74→08/80	<b>Escort II 1.6</b>	LC	Petrol	1599	4	<b>6</b>
08/83→12/85	<b>Escort III 1.1</b>	GSE	Petrol	1117	4	<b>2</b>
10/85→09/90	<b>Escort IV 1.1</b>	GSG	Petrol	1117	4	<b>2</b>
01/86→07/90	<b>Escort IV 1.3</b>	JLA, JLB	Petrol	1299	4	<b>2</b>
10/77→11/89	<b>Fiesta 1.0</b>	TKA, TKB	Petrol	957	4	<b>2</b>
10/10→	<b>Fiesta 1.6</b>	HHJC	Diesel	1560	4	<b>3</b>
05/76→08/83	<b>Fiesta 1.0.9</b>	TKA, TKW, TLA	Petrol	957	4	<b>2</b>
08/81→08/83	<b>Fiesta 1.6</b>	L3E	Petrol	1599	4	<b>6</b>
09/83→02/89	<b>Fiesta II 1.0</b>	TKB	Petrol	957	4	<b>2</b>
09/83→02/89	<b>Fiesta II 1.1</b>	GSF	Petrol	1117	4	<b>2</b>
11/01→12/10	<b>Fiesta V 1.4</b>	F6JA / DV4TD, F6JB	Diesel	1399	4	<b>1</b>
11/04→09/09	<b>Fiesta V 1.6</b>	HHJA, HHJB	Diesel	1560	4	<b>3</b>
01/09→	<b>Fiesta VI 1.4</b>	F6JB	Diesel	1399	4	<b>1</b>
06/08→	<b>Fiesta VI 1.6</b>	HHJC, HHJD, HHJE, UBJA	Diesel	1560	4	<b>3</b>
11/04→	<b>Focus II 1.6</b>	G8DA, G8DB, HHDA, HHDB	Diesel	1560	4	<b>3</b>
10/03→03/07	<b>Focus C-Max 1.6</b>	G8DA, G8DB, HHDA, HHDB	Diesel	1560	4	<b>3</b>
08/02→07/05	<b>Fusion 1.4</b>	F6JA / DV4TD, F6JB	Diesel	1399	4	<b>1</b>
11/04→12/12	<b>Fusion 1.6</b>	HHJA, HHJB	Diesel	1560	4	<b>3</b>
03/95→05/06	<b>Galaxy 1.9</b>	1Z, AFN, AHU, ANU, AVG	Diesel	1896	4	<b>5</b>
08/82→08/85	<b>Granada 2.5</b>	STP (XD3/XD3P)	Diesel	2498	4	<b>14</b>
01/77→04/82	<b>Granada 2100D</b>	WTA (XD90)	Diesel	2112	4	<b>10</b>
01/77→04/82	<b>Granada 2100D</b>	WTA (XD90)	Diesel	2112	V4	<b>10</b>
01/77→12/82	<b>Granada D 1.9</b>	XD88, XDP88	Diesel	1948	4	<b>8</b>
01/82→	<b>Granada D 2.3</b>	XD2S	Diesel	2304	4	<b>14</b>
01/77→12/82	<b>Granada D GL 1.9</b>	XD88, XDP88	Diesel	1948	4	<b>8</b>
01/77→12/82	<b>Granada D L 1.9</b>	XD88, XDP88	Diesel	1948	4	<b>8</b>
01/77→12/82	<b>Granada D Turnier 1.9</b>	XD88, XDP88	Diesel	1948	4	<b>8</b>
02/93→04/98	<b>Maverick 2.7</b>	TD27, TD27E	Diesel	2664	4	<b>15</b>
09/04→03/07	<b>Mondeo III 2.2</b>	QJBA, QJBB, QJBC, QJBD	Diesel	2198	4	<b>7</b>
12/85→07/90	<b>Orion II 1.3</b>	JLA, JLB	Petrol	1299	4	<b>2</b>
04/11→	<b>Ranger 3.2</b>	SAFA	Diesel	3199	5	<b>16</b>
01/82→	<b>Scorpio D 2.3</b>	XD2S	Diesel	2304	4	<b>14</b>
12/85→12/94	<b>Scorpio I 2.5</b>	SFA (XD3T), SFB (XD3T), STR (XD3/XD3P)	Diesel	2498	4	<b>14</b>
08/93→09/94	<b>Scorpio I 2.5</b>	SCB	Diesel	2500	4	<b>12</b>
10/94→08/98	<b>Scorpio II 2.5</b>	SCC	Diesel	2500	4	<b>12</b>
08/82→02/93	<b>Sierra 2.3</b>	YTR (XD2/XD2P/XD94), YTT (XD2/XD2P/XD94)	Diesel	2304	4	<b>14</b>
01/82→12/85	<b>Sierra 2300 Ghia</b>	XD2S	Diesel	2304	4	<b>14</b>
01/82→12/85	<b>Sierra 2300 GL</b>	XD2S	Diesel	2304	4	<b>14</b>
01/82→	<b>Sierra D 2.3</b>	XD2S	Diesel	2304	4	<b>14</b>
04/06→08/14	<b>Transit 2.2</b>	P8FA, P8FB, PGFA, PGFB, QVFA, QWFA	Diesel	2198	4	<b>7</b>
11/77→10/86	<b>Transit 2.4</b>	4AA	Diesel	2358	4	<b>13</b>
01/00→08/14	<b>Transit 2.4</b>	D2FA, D2FB, D2FE, D4FA, DOFA, F4FA, FXFA, H9FA, H9FB, JXFA, PHFA, PHFC	Diesel	2402	4	<b>9</b>

# MODEL INDEX



Modelverzeichnis • Index de modele • Índice de Modelo  
Indeks modelu • Модель автомобиля • دليل الموديل



CCM

x



9

10/83→07/00	<b>Transit 2.5</b>	4AB, 4BA, 4BC, 4CA, 4CC, 4DA, 4EA, 4EB, 4EC, 4ED, 4FA, 4FB, 4FC, 4FD, 4GA, 4GB, 4GC, 4GD, 4GE, 4GF, 4HA, 4HB, 4HC, 4HD	Diesel	2496	4	<b>13</b>
09/07→08/14	<b>Transit 3.2</b>	SAFA	Diesel	3199	5	<b>16</b>
01/75→12/77	<b>Transit 75</b>	KL16L (751M)	Petrol	1599	4	<b>6</b>
01/70→12/78	<b>Transit 90</b>	4.108	Diesel	1760	4	<b>4</b>
01/75→12/77	<b>Transit 90</b>	KL16L (751M)	Petrol	1599	4	<b>6</b>
01/70→12/78	<b>Transit 115</b>	4.108	Diesel	1760	4	<b>4</b>
01/75→12/77	<b>Transit 115</b>	KL16L (751M)	Petrol	1599	4	<b>6</b>
01/70→12/78	<b>Transit 125</b>	4.108	Diesel	1760	4	<b>4</b>
01/70→12/78	<b>Transit 130</b>	4.108	Diesel	1760	4	<b>4</b>
01/70→12/78	<b>Transit 150</b>	4.108	Diesel	1760	4	<b>4</b>
01/70→12/78	<b>Transit 175</b>	4.108	Diesel	1760	4	<b>4</b>
09/99→	<b>Transit TD</b>	DT24N Duratorq	Diesel	2402	4	<b>9</b>
09/99→	<b>Transit TDi</b>	DT24H Duratorq, DT24P Duratorq	Diesel	2402	4	<b>9</b>
01/65→12/70	<b>Transit V20</b>	4.108	Diesel	1760	4	<b>4</b>
01/65→12/70	<b>Transit V30</b>	4.108	Diesel	1760	4	<b>4</b>
01/65→12/70	<b>Transit V40</b>	4.108	Diesel	1760	4	<b>4</b>
01/65→12/70	<b>Transit V50</b>	4.108	Diesel	1760	4	<b>4</b>
01/65→12/70	<b>Transit V60</b>	4.108	Diesel	1760	4	<b>4</b>
07/06→08/14	<b>Transit Tourneo 2.2</b>	PGFA, PGFB, QVFA, QWFA	Diesel	2198	4	<b>7</b>
08/94→06/00	<b>Transit Tourneo 2.4</b>	4HA	Diesel	2496	4	<b>13</b>
11/94→12/00	<b>Transit Tourneo 2.5</b>	4EB, 4EC, 4FA, 4FB, 4FC, 4FD, 4GA, 4GB, 4GC, 4HA, 4HB, 4HC	Diesel	2496	4	<b>13</b>



CCM

x



9

110/6 AA-Dover	Diesel	5944	6	104.77	17
1Z	Diesel	1896	4	79.50	5
2402E York	Diesel	3537	6	93.67	13
2737E	Petrol	1599	4	80.98	6
4 D 55 T	Diesel	2347	4	91.10	11
4.108	Diesel	1760	4	79.38	4
4AA	Diesel	2358	4	93.67	13
4AB	Diesel	2496	4	93.67	13
4BA	Diesel	2496	4	93.67	13
4BC	Diesel	2496	4	93.67	13
4CA	Diesel	2496	4	93.67	13
4CC	Diesel	2496	4	93.67	13
4DA	Diesel	2496	4	93.67	13
4EA	Diesel	2496	4	93.67	13
4EB	Diesel	2496	4	93.67	13
4EC	Diesel	2496	4	93.67	13
4ED	Diesel	2496	4	93.67	13
4FA	Diesel	2496	4	93.67	13
4FB	Diesel	2496	4	93.67	13
4FC	Diesel	2496	4	93.67	13
4FD	Diesel	2496	4	93.67	13
4GA	Diesel	2496	4	93.67	13
4GB	Diesel	2496	4	93.67	13
4GC	Diesel	2496	4	93.67	13
4GD	Diesel	2496	4	93.67	13
4GE	Diesel	2496	4	93.67	13
4GF	Diesel	2496	4	93.67	13
4HA	Diesel	2496	4	93.67	13
4HB	Diesel	2496	4	93.67	13
4HC	Diesel	2496	4	93.67	13
4HD	Diesel	2496	4	93.67	13
711M	Petrol	1599	4	80.98	6
711M uprated	Petrol	1599	4	80.98	6
AFN	Diesel	1896	4	79.50	5
AHU	Diesel	1896	4	79.50	5
ANU	Diesel	1896	4	79.50	5
AVG	Diesel	1896	4	79.50	5
D2FA	Diesel	2402	4	89.90	9
D2FB	Diesel	2402	4	89.90	9
D2FE	Diesel	2402	4	89.90	9
D4FA	Diesel	2402	4	89.90	9
DOFA	Diesel	2402	4	89.90	9
DT24H Duratorq	Diesel	2402	4	89.90	9
DT24N Duratorq	Diesel	2402	4	89.90	9
DT24P Duratorq	Diesel	2402	4	89.90	9
F4FA	Diesel	2402	4	89.90	9
F6JA / DV4TD	Diesel	1399	4	73.70	1
F6JB	Diesel	1399	4	73.70	1
FXFA	Diesel	2402	4	89.90	9
G8DA	Diesel	1560	4	75.00	3
G8DB	Diesel	1560	4	75.00	3
GSE	Petrol	1117	4	74.00	2
GSF	Petrol	1117	4	74.00	2
GSG	Petrol	1117	4	74.00	2
H9FA	Diesel	2402	4	89.90	9
H9FB	Diesel	2402	4	89.90	9
HHDA	Diesel	1560	4	75.00	3
HHDB	Diesel	1560	4	75.00	3
HHJA	Diesel	1560	4	75.00	3
HHJB	Diesel	1560	4	75.00	3

# ENGINE INDEX

Motorverzeichnis • Index de moteur • Índice de Motor  
Indeks silnika • Модель двигателя • دليل المحرك



CCM



9

HHJC	Diesel	1560	4	75.00	3
HHJD	Diesel	1560	4	75.00	3
HHJE	Diesel	1560	4	75.00	3
J2	Petrol	1298	4	80.98	6
JLA	Petrol	1299	4	74.00	2
JLB	Petrol	1299	4	74.00	2
JXFA	Diesel	2402	4	89.90	9
KL16L (751M)	Petrol	1599	4	80.98	6
L3E	Petrol	1599	4	80.98	6
LC	Petrol	1599	4	80.98	6
P8FA	Diesel	2198	4	86.00	7
P8FB	Diesel	2198	4	86.00	7
PGFA	Diesel	2198	4	86.00	7
PGFB	Diesel	2198	4	86.00	7
PHFA	Diesel	2402	4	89.90	9
PHFC	Diesel	2402	4	89.90	9
QJBA	Diesel	2198	4	86.00	7
QJBB	Diesel	2198	4	86.00	7
QJBC	Diesel	2198	4	86.00	7
QJBD	Diesel	2198	4	86.00	7
QVFA	Diesel	2198	4	86.00	7
QWFA	Diesel	2198	4	86.00	7
SAFA	Diesel	3199	5	96.00	16
SCB	Diesel	2500	4	92.00	12
SCC	Diesel	2500	4	92.00	12
SFA (XD3T)	Diesel	2498	4	94.00	14
SFB (XD3T)	Diesel	2498	4	94.00	14
STP (XD3/XD3P)	Diesel	2498	4	94.00	14
STR (XD3/XD3P)	Diesel	2498	4	94.00	14
TD27	Diesel	2664	4	96.00	15
TD27 T	Diesel	2664	4	96.00	15
TD27E	Diesel	2664	4	96.00	15
TKA	Petrol	957	4	74.00	2
TKB	Petrol	957	4	74.00	2
TKW	Petrol	957	4	74.00	2
TLA	Petrol	957	4	74.00	2
UBJA	Diesel	1560	4	75.00	3
WTA (XD90)	Diesel	2112	V4	90.00	10
XD2S	Diesel	2304	4	94.00	14
XD3P	Diesel	2498	4	94.00	14
XD3T	Diesel	2498	4	94.00	14
XD88	Diesel	1948	4	88.00	8
XDP88	Diesel	1948	4	88.00	8
YTR (XD2/XD2P/XD94)	Diesel	2304	4	94.00	14
YTT (XD2/XD2P/XD94)	Diesel	2304	4	94.00	14



1

<b>F6JA / DV4TD</b>	4cyl.	<b>1399cc</b>	<b>50kW</b> (68PS)	<b>Diesel</b>	<b>Turbo Intercooled</b>	<b>TD17307</b>
<b>F6JB</b>	4cyl.	<b>1399cc</b>	<b>50kW</b> (68PS)	<b>Diesel</b>	<b>Turbo Intercooled</b>	<b>TD17346</b>
14-020760-00 <i>D</i>	<b>73.70</b>	<b>B 76.70</b>	<b>C 136.00</b>	<b>D 78.20</b>	<b>E 5.00</b>	
14-020761-00 <i>D</i>		<b>B 76.95</b>	<b>C 136.00</b>	<b>D 78.45</b>	<b>E 5.25</b>	

2

<b>GSE</b>	4cyl.	<b>1117cc</b>	<b>37kW</b> (50PS)			<b>TD1203</b>
<b>GSF</b>	4cyl.	<b>1117cc</b>	<b>37kW</b> (50PS)			<b>TD1204</b>
<b>GSG</b>	4cyl.	<b>1117cc</b>	<b>37kW</b> (50PS)			<b>TD1205</b>
<b>JLA</b>	4cyl.	<b>1299cc</b>	<b>44kW</b> (60PS)			<b>TD1236</b>
<b>JLB</b>	4cyl.	<b>1299cc</b>	<b>44kW</b> (60PS)			<b>TD1237</b>
<b>TKA</b>	4cyl.	<b>957cc</b>	<b>29kW</b> (39PS)			<b>TD4495</b>
<b>TKB</b>	4cyl.	<b>957cc</b>	<b>33kW</b> (45PS)			<b>TD1452</b>
<b>TKW</b>	4cyl.	<b>957cc</b>	<b>29kW</b> (39PS)			<b>TD4496</b>
<b>TLA</b>	4cyl.	<b>957cc</b>	<b>33kW</b> (45PS)			<b>TD1453</b>
14-010830-00 <i>D</i>	<b>74.00</b>	<b>B 77.16</b>	<b>C 119.61</b>			

3

<b>G8DA</b>	4cyl.	<b>1560cc</b>	<b>80kW</b> (109PS)	<b>Diesel</b>	<b>Turbo Intercooled</b>	<b>TD18508</b>
<b>G8DB</b>	4cyl.	<b>1560cc</b>	<b>80kW</b> (109PS)	<b>Diesel</b>	<b>Turbo Intercooled</b>	<b>TD18509</b>
<b>HHDA Euro 4</b>	4cyl.	<b>1560cc</b>	<b>66kW</b> (89PS)	<b>Diesel</b>	<b>Turbo Intercooled</b>	<b>TD18478</b>
<b>HHDB Euro 4</b>	4cyl.	<b>1560cc</b>	<b>66kW</b> (89PS)	<b>Diesel</b>	<b>Turbo Intercooled</b>	<b>TD18479</b>
<b>HHJA</b>	4cyl.	<b>1560cc</b>	<b>66kW</b> (89PS)	<b>Diesel</b>	<b>Turbo Intercooled</b>	<b>TD17988</b>
<b>HHJB</b>	4cyl.	<b>1560cc</b>	<b>66kW</b> (89PS)	<b>Diesel</b>	<b>Turbo Intercooled</b>	<b>TD17989</b>
<b>HHJC</b>	4cyl.	<b>1560cc</b>	<b>66kW</b> (89PS)	<b>Diesel</b>	<b>Turbo Intercooled</b>	<b>TD24416</b>
<b>HHJD</b>	4cyl.	<b>1560cc</b>	<b>66kW</b> (89PS)	<b>Diesel</b>	<b>Turbo Intercooled</b>	<b>TD23543</b>
<b>HHJE</b>	4cyl.	<b>1560cc</b>	<b>66kW</b> (89PS)	<b>Diesel</b>	<b>Turbo Intercooled</b>	<b>TD24417</b>
<b>UBJA</b>	4cyl.	<b>1560cc</b>	<b>55kW</b> (75PS)	<b>Diesel</b>	<b>Turbo Intercooled</b>	<b>TD24419</b>
14-020900-00 <i>D</i>	<b>75.00</b>	<b>B 78.00</b>	<b>C 142.00</b>	<b>D 79.50</b>	<b>E 5.00</b>	



4

4.108 4cyl. 1760cc Diesel FM1346

14-010900-00 D 79.38 B 82.63 C 165.10

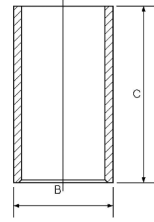

5

1Z 4cyl. 1896cc 66kW (89PS) Diesel Turbo Intercooled TD11370

AFN 4cyl. 1896cc 81kW (110PS) Diesel Turbo Intercooled TD11368

AHU 4cyl. 1896cc 66kW (89PS) Diesel Turbo Intercooled TD11369

ANU 4cyl. 1896cc 66kW (89PS) Diesel Turbo Intercooled TD14917

AVG 4cyl. 1896cc 81kW (110PS) Diesel Turbo Intercooled TD17557

14-027950-00 D 79.50 B 82.50 C 152.00 D 85.50 E 4.70

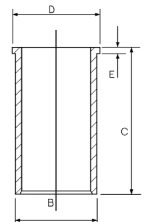

6

711M 4cyl. 1599cc FM2361

711M UPRATED 4cyl. 1599cc FM2350

2737E 4cyl. 1599cc FM2405

J2 4cyl. 1298cc 44kW (60PS) TD1217

KL16L (751M) 4cyl. 1599cc FM2382

L3E 4cyl. 1599cc 62kW (84PS) TD1251

LC 4cyl. 1599cc 62kW (84PS) TD1261

14-010880-00 D 80.98 B 84.21 C 150.37

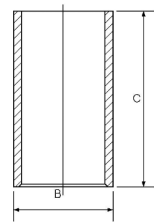

7

P8FA 4cyl. 2198cc 63kW (86PS) Diesel Turbo Intercooled TD20042

P8FB 4cyl. 2198cc 63kW (86PS) Diesel Turbo Intercooled TD21066

PGFA Euro 4 4cyl. 2198cc 103kW (140PS) Diesel Turbo Intercooled TD21067

PGFB 4cyl. 2198cc 103kW (140PS) Diesel Turbo Intercooled TD24463

QJBA 4cyl. 2198cc 114kW (155PS) Diesel Turbo Intercooled TD18756

QJBB 4cyl. 2198cc 114kW (155PS) Diesel Turbo Intercooled TD18757

QJBC 4cyl. 2198cc 110kW (150PS) Diesel Turbo Intercooled TD18782

QJBD 4cyl. 2198cc 110kW (150PS) Diesel Turbo Intercooled TD18783





<b>QVFA Euro 4</b>	4cyl.	<b>2198cc</b>	<b>81kW (110PS)</b>	<b>Diesel</b>	<b>Turbo Intercooled</b>	<b>TD20043</b>
<b>QWFA</b>	4cyl.	<b>2198cc</b>	<b>96kW (131PS)</b>	<b>Diesel</b>	<b>Turbo Intercooled</b>	<b>TD20044</b>

14-021120-00 *D*      86.00      B 89.00      C 156.00      D 90.90      E 5.00

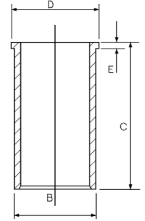

**8**

<b>XD88</b>	4cyl.	<b>1948cc</b>		<b>Diesel</b>		<b>FM1421</b>
<b>XDP88</b>	4cyl.	<b>1948cc</b>		<b>Diesel</b>		<b>FM1421</b>

14-600420-00 *WH* <sup>†</sup>      88.00      B 96.00      C 173.00      D 106.30      E 129.00

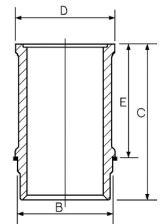

<sup>†</sup> Use also: HT022

<sup>†</sup> Mitverwenden: HT022

<sup>†</sup> A utiliser aussi: HT022

<sup>†</sup> Utilizar también: HT022

**9**

<b>D2FA</b>	4cyl.	<b>2402cc</b>	<b>66kW (89PS)</b>	<b>Diesel</b>	<b>Turbo Intercooled</b>	<b>TD15549</b>
<b>D2FB</b>	4cyl.	<b>2402cc</b>	<b>66kW (89PS)</b>	<b>Diesel</b>	<b>Turbo Intercooled</b>	<b>TD20037</b>
<b>D2FE</b>	4cyl.	<b>2402cc</b>	<b>66kW (89PS)</b>	<b>Diesel</b>	<b>Turbo Intercooled</b>	<b>TD15552</b>
<b>D4FA</b>	4cyl.	<b>2402cc</b>	<b>88kW (120PS)</b>	<b>Diesel</b>	<b>Turbo Intercooled</b>	<b>TD15550</b>
<b>DOFA</b>	4cyl.	<b>2402cc</b>	<b>92kW (125PS)</b>	<b>Diesel</b>	<b>Turbo Intercooled</b>	<b>TD20038</b>
<b>DT24H DURATORQ</b>	4cyl.	<b>2402cc</b>	<b>88kW (120PS)</b>	<b>Diesel</b>	<b>Turbo Intercooled</b>	<b>FM5710</b>
<b>DT24N DURATORQ</b>	4cyl.	<b>2402cc</b>	<b>55kW (75PS)</b>	<b>Diesel</b>	<b>Turbo Intercooled</b>	<b>FM5702</b>
<b>DT24P DURATORQ</b>	4cyl.	<b>2402cc</b>	<b>66kW (89PS)</b>	<b>Diesel</b>	<b>Turbo Intercooled</b>	<b>FM5709</b>
<b>F4FA</b>	4cyl.	<b>2402cc</b>	<b>55kW (75PS)</b>	<b>Diesel</b>	<b>Turbo Intercooled</b>	<b>TD15548</b>
<b>FXFA</b>	4cyl.	<b>2402cc</b>	<b>85kW (116PS)</b>	<b>Diesel</b>	<b>Turbo Intercooled</b>	<b>TD18798</b>
<b>H9FA Euro 4</b>	4cyl.	<b>2402cc</b>	<b>100-103kW (135-140PS)</b>	<b>Diesel</b>	<b>Turbo Intercooled</b>	<b>TD20036</b>
<b>H9FB Euro 4</b>	4cyl.	<b>2402cc</b>	<b>103kW (140PS)</b>	<b>Diesel</b>	<b>Turbo Intercooled</b>	<b>TD20033</b>
<b>JXFA Euro 4</b>	4cyl.	<b>2402cc</b>	<b>85kW (116PS)</b>	<b>Diesel</b>	<b>Turbo Intercooled</b>	<b>TD20034</b>
<b>PHFA</b>	4cyl.	<b>2402cc</b>	<b>74kW (100PS)</b>	<b>Diesel</b>	<b>Turbo Intercooled</b>	<b>TD20035</b>
<b>PHFC Euro 4</b>	4cyl.	<b>2402cc</b>	<b>74kW (100PS)</b>	<b>Diesel</b>	<b>Turbo Intercooled</b>	<b>TD21068</b>

14-020540-00 *DH*      89.90      B 92.50      C 165.00      D 3.00

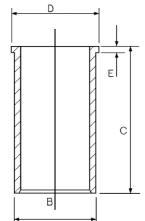



10

WTA (XD90) V4cyl. 2112cc 46kW (63PS) Diesel FM11425

14-604060-00 WH 90.00 B 96.00 C 173.00 D 106.30 E 129.00

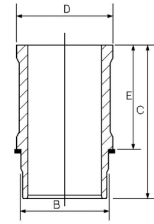

11

4 D 55 T 4cyl. 2347cc 62-70kW (84-95PS) Diesel Turbo TD21262

14-020600-00 DH 91.10 B 94.64 C 165.10 D 96.91 E 5.065

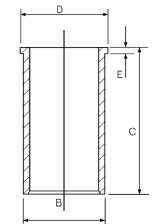

14-015590-00 D 91.10 B 94.13 C 164.50

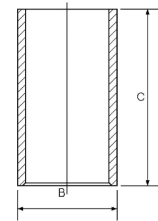

12

SCB 4cyl. 2500cc 85kW (116PS) Diesel Turbo Intercooled TD1443

SCC 4cyl. 2500cc 85kW (116PS) Diesel Turbo Intercooled TD4490

14-676420-00 WH 92.00 B 101.50 C 166.80 D 110.00 E 8.90 F 1.20

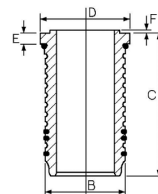

13

4AA 4cyl. 2358cc 46kW (63PS) Diesel TD17094

4AB 4cyl. 2496cc 50kW (68PS) Diesel TD1113

4BA 4cyl. 2496cc 52kW (71PS) Diesel TD1114

4BC 4cyl. 2496cc 52kW (71PS) Diesel TD1115

4CA 4cyl. 2496cc 52kW (71PS) Diesel TD1116

4CC 4cyl. 2496cc 52kW (71PS) Diesel TD1117

4DA 4cyl. 2496cc 59kW (80PS) Diesel TD1118

4EA 4cyl. 2496cc 74kW (100PS) Diesel Turbo TD1119

4EB 4cyl. 2496cc 74kW (100PS) Diesel Turbo TD4424

4EC 4cyl. 2496cc 74kW (100PS) Diesel Turbo TD15214

4ED 4cyl. 2496cc 85kW (116PS) Diesel Turbo TD12093

4FA 4cyl. 2496cc 51kW (69PS) Diesel TD1120







4FB	4cyl.	2496cc	51kW (69PS)	Diesel	TD4426
4FC	4cyl.	2496cc	51kW (69PS)	Diesel	TD4428
4FD	4cyl.	2496cc	51kW (69PS)	Diesel	TD15209
4GA	4cyl.	2496cc	63kW (86PS)	Diesel Turbo	TD4430
4GB	4cyl.	2496cc	63kW (86PS)	Diesel Turbo	TD4432
4GC	4cyl.	2496cc	63kW (86PS)	Diesel Turbo	TD4433
4GD	4cyl.	2496cc	63kW (86PS)	Diesel Turbo	TD15211
4GE	4cyl.	2496cc	63kW (86PS)	Diesel Turbo	TD15212
4GF	4cyl.	2496cc	63kW (86PS)	Diesel Turbo	TD15213
4HA	4cyl.	2496cc	55kW (75PS)	Diesel Turbo	TD4434
4HB	4cyl.	2496cc	56kW (76PS)	Diesel	TD4436
4HC	4cyl.	2496cc	56kW (76PS)	Diesel	TD15210
4HD	4cyl.	2496cc	55kW (75PS)	Diesel Turbo	TD16250
2402E YORK	6cyl.	3537cc		Diesel	FM2463

14-014090-00 *D*      93.67      B 96.94      C 171.45

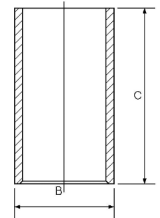

14

SFA (XD3T)	4cyl.	2498cc	68kW (92PS)	Diesel Turbo	TD4492
SFB (XD3T)	4cyl.	2498cc	68kW (92PS)	Diesel Turbo	TD4493
STP (XD3/XD3P)	4cyl.	2498cc	51kW (69PS)	Diesel	TD1448
STR (XD3/XD3P)	4cyl.	2498cc	51kW (69PS)	Diesel	TD1449
XD2S	4cyl.	2304cc	51kW (69PS)	Diesel Turbo	FM1429
XD3P	4cyl.	2498cc	53-58kW (72-79PS)	Diesel	TD22249
XD3T	4cyl.	2498cc	66-70kW (90-95PS)	Diesel Turbo Intercooled	TD22250
YTR (XD2/XD2P/XD94)	4cyl.	2304cc	49kW (67PS)	Diesel	TD1482
YTT (XD2/XD2P/XD94)	4cyl.	2304cc	49kW (67PS)	Diesel	TD1483

14-020660-00 *D*      94.00      B 97.00      C 170.60      D 99.50      E 4.00  
 14-021520-00 *D*           B 98.00      C 170.60      D 100.00      E 6.00  
 14-027270-00 *D*           B 98.70      C 170.00      D 100.00      E 5.00

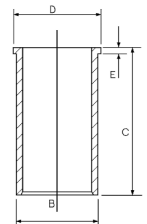



15

<b>TD27</b>	4cyl.	<b>2664cc</b>	<b>92kW</b> (125PS)	<b>Diesel</b>	<b>Turbo</b>	<b>TD4494</b>
<b>TD27E</b>	4cyl.	<b>2664cc</b>	<b>92kW</b> (125PS)	<b>Diesel</b>	<b>Turbo Intercooled</b>	<b>TD9466</b>
<b>TD27 T</b>	4cyl.	<b>2664cc</b>	<b>73-74kW</b> (100-101PS)	<b>Diesel</b>	<b>Turbo</b>	<b>TD1450</b>

<b>14-020110-00 D</b>	<b>96.00</b>	<b>B 99.085</b>	<b>C 160.00</b>	<b>D 105.03</b>	<b>E 5.09</b>	
-----------------------	--------------	-----------------	-----------------	-----------------	---------------	--

16

<b>SAFA</b>	5cyl.	<b>3199cc</b>	<b>147kW</b> (200PS)	<b>Diesel</b>	<b>Bi-Turbo Intercooled</b>	<b>TD21069</b>
-------------	-------	---------------	----------------------	---------------	-----------------------------	----------------

<b>14-020540-00 DH</b>	<b>96.00</b>	<b>B 92.50</b>	<b>C 165.00</b>	<b>D 3.00</b>		
------------------------	--------------	----------------	-----------------	---------------	--	--

17

<b>110/6 AA-DOVER</b>	6cyl.	<b>5944cc</b>	<b>81kW</b> (110PS)	<b>Diesel</b>		<b>TD22248</b>
-----------------------	-------	---------------	---------------------	---------------	--	----------------

<b>14-013700-00 D</b>	<b>104.77</b>	<b>B 108.80</b>	<b>C 219.00</b>			
-----------------------	---------------	-----------------	-----------------	--	--	--

Motorverzeichnis • Index de moteur • Índice de Motor  
Indeks silnika • Модель двигателя • دليل المحرك

# ENGINE INDEX



CCM

x



9

		CCM	x		
<b>110/6 AA-Dover</b>	Diesel	5944	6	104.77	<b>4</b>
<b>2501E, 2502E, 2503E</b>	Diesel	2589	3	106.69	<b>5</b>
<b>2504E, 2508E</b>	Diesel	2867	3	106.69	<b>5</b>
<b>2701E, 2706E</b>	Diesel	3933	4	104.77	<b>3</b>
<b>2704E, 2709E</b>	Diesel	5944	6	104.77	<b>3</b>
<b>2704ET</b>	Diesel	5944	6	104.77	<b>2</b>
<b>2711E</b>	Diesel	4178	4	107.21	<b>6</b>
<b>2712E</b>	Diesel	4162	4	107.21	<b>6</b>
<b>2713E</b>	Diesel	5981	6	104.77	<b>2</b>
<b>2714E</b>	Diesel	6227	6	107.21	<b>6</b>
<b>2715E D-Series parent blk</b>	Diesel	6227	6	107.21	<b>6</b>
<b>590E</b>	Diesel	5416	6	100.00	<b>1</b>
<b>592E</b>	Diesel	3610	4	100.00	<b>1</b>
<b>D233, 2508E</b>	Diesel	3819	4	106.69	<b>5</b>



**1**

590E 6cyl. 5416cc Diesel FM2506

592E 4cyl. 3610cc Diesel FM2503

14-370870-00 WH	100.00	B 111.76	C 223.00	D 120.00	E 11.16	F 0.65	
14-455210-00 WH	100.00	B 109.60	C 223.00	D 117.60	E 11.20	F 0.80	

**2**

2701E, 2706E 4cyl. 3933cc Diesel FM2512

2704E, 2709E 6cyl. 5944cc Diesel FM2514

14-013700-00 D	104.77	B 108.80	C 219.00				
14-045570-00 D	104.77	B 109.372	C 219.55	D 112.85	E 4.76		

**3**

110/6 AA-DOVER 6cyl. 5944cc 110kW (150PS) Diesel Turbo TD6957

2704ET 6cyl. 5944cc Diesel Turbo FM2537

2713E 6cyl. 5981cc Diesel FM2542

14-013700-00 D	104.77	B 108.80	C 219.00				



4

2501E, 2502E, 2503E	3cyl.	2589cc		Diesel	FM6738
2504E, 2508E	3cyl.	2867cc		Diesel	FM6732
D233, 2508E	4cyl.	3819cc		Diesel	FM2974

14-020730-00 <i>D</i>	106.69	B 110.80	C 209.60	D 111.80	E 5.00	
14-010770-00 <i>D</i>	106.69	B 110.78	C 209.55			

5

2711E	4cyl.	4178cc		Diesel	FM2558
2712E	4cyl.	4162cc		Diesel	FM2559
2714E	6cyl.	6227cc		Diesel	FM2560
2715E D-SERIES PARENT BLK	6cyl.	6227cc		Diesel	FM2562

14-014120-00 <i>D</i>	107.21	B 111.40	C 213.00			
14-014640-00 <i>D</i>		B 110.78	C 213.00			

# ENGINE INDEX

Motorverzeichnis • Index de moteur • Índice de Motor  
Indeks silnika • Модель двигателя • دليل المحرك



CCM



9

268 cu.in.	Diesel	4391	4	111.77	4
2715E D-Series parent blk	Diesel	6227	6	107.21	3
3.152	Diesel	2500	3	91.49	1
401 cu.in.	Diesel	6571	6	111.77	4
56G	Diesel	3819	4	106.69	2
6Y series	Diesel	4195	4	106.69	2
6Y series 32D	Diesel	2589	3	106.69	2
6Y series 40D	Diesel	2867	3	106.69	2
6Y, 7A series	Diesel	4195	4	111.77	4
6Y, 7A series	Diesel	4196	4	111.77	4
7A series	Diesel	3294	3	111.77	4
7A series	Diesel	4195	4	106.69	2
7A series 32D	Diesel	2589	3	106.69	2
7A series 32D	Diesel	2950	3	106.69	2
7A series 40D	Diesel	2867	3	106.69	2
BSD 332 (192 cu.in.)	Diesel	3146	3	111.77	4
BSD333	Diesel	3294	3	111.77	4
BSD333 >87	Diesel	3294	3	111.77	4
BSD333H	Diesel	3294	3	111.77	4
BSD442	Diesel	4195	4	111.77	4
BSD444	Diesel	4391	4	111.77	4
BSD444T	Diesel	4391	4	111.77	4



1

3.152	3cyl.	2500cc	22-33kW (30-45PS)	Diesel	Indirect Injection	FM1351
14-021220-00 D ②	91.49	B 93.713	C 216.00	D 96.723	E 3.81	
14-021221-00 D		B 93.967	C 216.00	D 96.723	E 3.81	
14-021222-00 D		B 94.50	C 216.00	D 96.723	E 3.81	
14-021223-00 D		B 96.253	C 216.00	D 97.104	E 3.81	
14-022960-00 D		B 93.66	C 216.00	D 96.72	E 3.76	
14-024680-00 D		B 93.73	C 216.00	D 96.72	E 3.76	
14-025833-00 D		B 95.31	C 216.00	D 98.16	E 5.00	
14-025871-00 D		B 93.76	C 216.14	D 96.85	E 5.00	
14-480320-00 DH ①		B 93.66	C 216.03	D 96.72	E 3.81	

- |   |   |  |  |
|---|---|--|--|
| ① Push fit cast iron liner to replace original steel liner  | ① Ausdrückbare Laufbüchse aus Gueisen als Ersatz der original Stahlbüchse | ① Chemise fonte à emménagement gras remplaçant la chemise acie d'origine.            | ① Ajustar a presión la camisa de hierro fundido para reemplaza camisa original de acero    |
| ② Press fit cast iron liner to replace original steel liner | ② Anpressbare Laufbüchse aus Gueisen als Ersatz der original Stahlbüchse  | ② Chemise fonte à emmancher à la presse pour remplacer la chemise d'origine en acier | ② Ajuste a presión la camisa de hierro fundido para reemplazar la camisa original de acero |

2

6Y SERIES	4cyl.	4195cc		Diesel	FM6757
6Y SERIES 32D	3cyl.	2589cc		Diesel	FM6738
6Y SERIES 40D	3cyl.	2867cc		Diesel	FM6733
7A SERIES	4cyl.	4195cc		Diesel	FM6756
7A SERIES 32D	3cyl.	2950cc		Diesel	FM6735
7A SERIES 32D	3cyl.	2589cc		Diesel	FM6736
7A SERIES 40D	3cyl.	2867cc		Diesel	FM6734
56G	4cyl.	3819cc		Diesel	FM2974

14-020730-00 D	106.69	B 110.80	C 209.60	D 111.80	E 5.00	
14-010770-00 D	106.69	B 110.78	C 209.55			

14-010770-00 D	106.69	B 110.78	C 209.55			
----------------	--------	----------	----------	--	--	--

3

2715E D-SERIES PARENT BLK	6cyl.	6227cc		Diesel	FM2562
---------------------------	-------	--------	--	--------	--------

14-014120-00 D	107.21	B 111.40	C 213.00			
14-014640-00 D		B 110.78	C 213.00			



4

6Y, 7A SERIES	4cyl.	4195cc		Diesel	FM6745
6Y, 7A SERIES	4cyl.	4196cc	55-58kW (75-79PS)	Diesel	FM6752
7A SERIES	3cyl.	3294cc		Diesel	FM6730
268 CU.IN.	4cyl.	4391cc		Diesel	FM6749
268 CU.IN.	4cyl.	4391cc		Diesel	FM6753
401 CU.IN.	6cyl.	6571cc		Diesel Turbo	FM6768
BSD 332 (192 CU.IN.)	3cyl.	3146cc		Diesel	FM3456
BSD333	3cyl.	3294cc		Diesel Direct Injection	FM33519
BSD333 >87	3cyl.	3294cc		Diesel	FM3518
BSD333H	3cyl.	3294cc		Diesel	FM3519
BSD442	4cyl.	4195cc		Diesel	FM6747
BSD444	4cyl.	4391cc		Diesel	FM3521
BSD444T	4cyl.	4391cc		Diesel Turbo	FM3522

14-020740-00 D	111.77	B 114.45	C 208.50	D 120.35	E 2.60
14-020741-00 D		B 116.00	C 208.50	D 120.35	E 2.60
14-020742-00 D		B 116.99	C 208.50	D 120.35	E 2.60
14-021610-00 D		B 114.43	C 208.53	D 120.35	E 2.565
14-021611-00 D		B 116.97	C 208.53	D 120.35	E 2.57

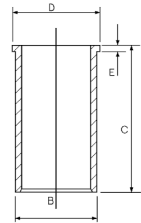



Modelverzeichnis • Index de modele • Índice de Modelo  
Indeks modelu • Модель автомобиля • دليل الموديل

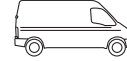

# MODEL INDEX



CCM

x



04/94→09/98	<b>Polonez 1.4</b>	K16 DOHC	Petrol	1396	4	<b>1</b>
04/94→09/98	<b>Polonez 1.9</b>	XUD 9A	Diesel	1905	4	<b>2</b>
08/88→08/92	<b>Polonez II 1.9</b>	XUD 9A	Diesel	1905	4	<b>2</b>
09/92→03/02	<b>Polonez III 1.4</b>	K16 DOHC	Petrol	1396	4	<b>1</b>
09/92→03/02	<b>Polonez III 1.9</b>	XUD 9A	Diesel	1905	4	<b>2</b>



**1**  
**TD1494**

**K16 DOHC** 4cyl. **1396cc** **76kW (103PS)**

**14-710030-00 WH** **75.00** **B 84.10** **C 129.50** **D 87.50** **E 50.05**

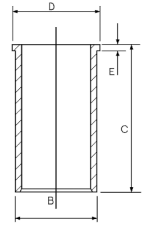

**2**  
**TD1493**

**XUD 9A** 4cyl. **1905cc** **51kW (69PS)** **Diesel**

**14-020530-00 D** **83.00** **B 85.60** **C 153.50** **D 88.50** **E 3.90**

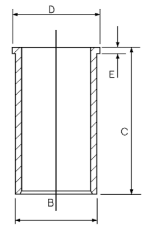



**1**

**B** 4cyl. **2977cc** **59kW (80PS)** **Diesel** **FM1716**

14-040150-00 *D* **95.00** **B 102.00** **C 190.22** **D 107.75** **E 2.55** **F 1.20**

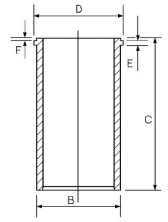

**2**

**3B** 4cyl. **3432cc** **Diesel** **FM3346**

**3BK** 4cyl. **3432cc** **Diesel** **FM3346**

14-040140-00 *D* **102.00** **B 106.00** **C 190.26** **D 111.65** **E 2.51** **F 1.19**

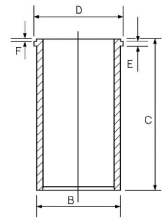

**3**

**EF-750** 8cyl. **16745cc** **Diesel** **FM3371**

**EF750T** 8cyl. **16745cc** **Diesel Turbo** **FM9657**

14-112900-00 *WH* **137.00** **B 151.00** **C 248.00** **D 165.00** **E 12.12** **F 0.80**

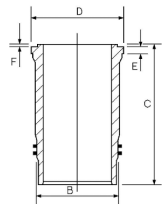

# MODEL INDEX



Modelverzeichnis • Index de modele • Índice de Modelo  
Indeks modelu • Модель автомобиля • دليل الموديل



CCM

x



9

01/87→	<b>Canter 3.3</b>	4D31	Diesel	3298	4	<b>3</b>
	<b>Galopper 2.4</b>	4D55T	Diesel	2346	4	<b>1</b>
08/91→07/98	<b>Galopper I 2.5</b>	4D56T	Diesel	2477	4	<b>2</b>
01/80→12/86	<b>Galopper Jeep 2.4</b>	4D55	Diesel	2346	4	<b>1</b>
01/80→12/86	<b>Galopper Jeep 2.4</b>	4D55	Diesel	2347	4	<b>1</b>
01/80→12/86	<b>Grace Van 1 ton 2.4</b>	4D55	Diesel	2346	4	<b>1</b>
01/80→12/86	<b>Grace Van 1 ton 2.4</b>	4D55	Diesel	2347	4	<b>1</b>
11/06→	<b>H100 2.5</b>	4D56T	Diesel	2477	4	<b>2</b>
01/80→12/86	<b>Porter Truck 2.4</b>	4D55	Diesel	2346	4	<b>1</b>
01/80→12/86	<b>Porter Truck 2.4</b>	4D55	Diesel	2347	4	<b>1</b>
01/85→12/86	<b>Rosa Bus 3.3</b>	4D31	Diesel	3298	4	<b>3</b>
01/82→09/85	<b>Truck ton 3.5</b>	4D31T	Diesel	3298	4	<b>3</b>



**1**

**4D55** 4cyl. **2346cc** Diesel **FM3377**

**4D55T** 4cyl. **2346cc** **49kW (67PS)** Diesel Turbo Intercooled **FM3828**

14-015590-00 *D* 91.10 B 94.13 C 164.50

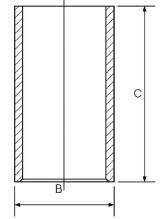

**2**

**4D56T** 4cyl. **2477cc** **62-70kW (84-95PS)** Diesel Turbo Intercooled **TD18860**

14-020600-00 *DH* 91.10 B 94.64 C 165.10 D 96.91 E 5.065

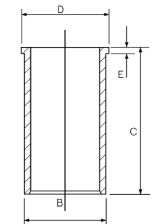

14-015590-00 *D* 91.10 B 94.13 C 164.50

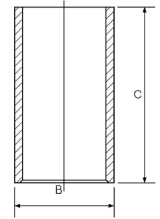

**3**

**4D31** 4cyl. **3298cc** Diesel **FM19502**

**4D31T** 4cyl. **3298cc** Diesel Turbo **FM9515**

14-010970-00 *D* 100.00 B 104.00 C 196.50

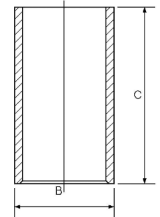



1

4VD14.5 4cyl. 6600cc Diesel FM6397

14-378270-00 WH 1 120.00 B 134.50 C 287.00 D 140.00 E 10.00 F 1.00

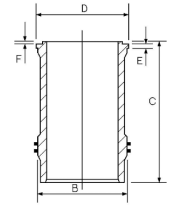

1 Phosphated

1 Phosphatiert

1 Phosphatisé

1 Fosfatada



1

**BD-154** 4cyl. 2720cc Diesel **FM852**

14-440260-00 WH 88.90 B 97.10 C 185.70 D 101.50 E 5.77

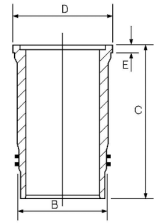

2

**D-155** 3cyl. 2540cc 27-36kW (37-49PS) Diesel **TD18801**

**D-206** 4cyl. 3380cc 40-44kW (54-60PS) Diesel **TD18803**

**D-310** 6cyl. 5070cc 62-68kW (84-92PS) Diesel **TD18806**

14-450270-00 WH 98.42 B 110.75 C 200.00 D 119.00 E 7.70 F 1.10

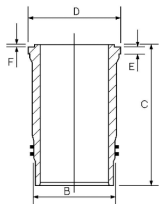

3

**D-179** 3cyl. 2930cc 36-38kW (49-52PS) Diesel **TD18802**

**D-239** 4cyl. 3915cc 45-56kW (61-76PS) Diesel **TD18804**

**D-358** 6cyl. 5863cc 74-101kW (101-137PS) Diesel **TD18807**

**DT-239** 4cyl. 3911cc 59-62kW (80-84PS) Diesel Turbo **TD18810**

**DT-358** 6cyl. 5667cc 88-100kW (120-136PS) Diesel Turbo **TD18808**

14-451170-00 WH 98.42 B 110.75 C 215.00 D 119.00 E 7.70 F 1.10

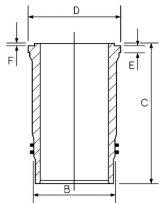

4

**D-246** 4cyl. 4025cc 54-60kW (73-82PS) Diesel **TD18805**

**D-268** 4cyl. 4389cc 57-63kW (78-86PS) Diesel **TD18811**

**DT-402** 6cyl. 6582cc 107-120kW (145-163PS) Diesel Turbo **TD18809**

14-452670-00 WH 100.00 B 111.40 C 216.10 D 119.00 E 7.70 F 1.10

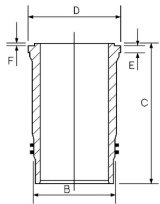

# MODEL INDEX



Modelverzeichnis • Index de modele • Índice de Modelo  
Indeks modelu • Модель автомобиля • دليل الموديل



CCM

x



9

01/83→12/91	<b>Campo 2.2</b>	C 223	Diesel	2238	4	<b>3</b>
01/83→12/90	<b>Campo 2.5</b>	4JA1	Diesel	2499	4	<b>4</b>
10/85→09/92	<b>Elf 2.8</b>	4JB1-T	Diesel	2772	4	<b>5</b>
10/85→09/03	<b>Elf 2.8</b>	4JB1	Diesel	2771	4	<b>5</b>
10/03→	<b>Elf 2.8</b>	4JB-1TC	Diesel	2752	4	<b>5</b>
11/97→08/03	<b>Frontier 2.8</b>	4JB1	Diesel	2771	4	<b>5</b>
09/80→12/90	<b>Gemini 1.5</b>	4EC1, 4EC1T	Diesel	1488	4	<b>1</b>
01/83→07/86	<b>Kb 2.2</b>	C 223	Diesel	2238	4	<b>3</b>
01/83→09/08	<b>Kb 2.5</b>	4JA1	Diesel	2499	4	<b>4</b>
12/90→09/03	<b>Kb 2.8</b>	4JB-1TC	Diesel	2752	4	<b>5</b>
05/90→07/93	<b>Mu 2.8</b>	4JB1-T	Diesel	2772	4	<b>5</b>
07/96→	<b>Pick Up 2.8</b>	4JB1-T	Diesel	2772	4	<b>5</b>
08/06→04/07	<b>Rodeo 2.5</b>	4JA1	Diesel	2499	4	<b>4</b>
05/00→09/03	<b>Tf 2.8</b>	4JB1-T	Diesel	2772	4	<b>5</b>
07/94→08/99	<b>TFR/TFS 2.5</b>	4JA1	Diesel	2499	4	<b>4</b>
09/91→08/99	<b>TFR/TFS 2.8</b>	4JB1	Diesel	2771	4	<b>5</b>
05/84→12/89	<b>Trooper 2.2</b>	C 223	Diesel	2238	4	<b>3</b>
10/87→12/91	<b>Trooper 2.8</b>	4JB1-T	Diesel	2772	4	<b>5</b>
10/88→12/91	<b>Trooper 2.8</b>	4JB-1TC	Diesel	2752	4	<b>5</b>
08/98→12/02	<b>Vega 2.8</b>	4JB1-T	Diesel	2772	4	<b>5</b>





1

**4EC1** 4cyl. **1488cc** **37kW (50PS)** **Diesel** **TD4575**

**4EC1T** 4cyl. **1488cc** **49-54kW (67-73PS)** **Diesel Turbo** **TD4576**

**14-010870-00 D** **76.00** **B 80.00** **C 138.00**

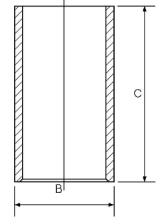

2

**C190** 4cyl. **1951cc** **40kW (54PS)** **Diesel** **TD1685**

**C 240** 4cyl. **2369cc** **44-55kW (60-75PS)** **Diesel** **TD26269**

**14-021180-00 D** **86.00** **B 90.13** **C 178.50** **D 94.00** **E 4.00**

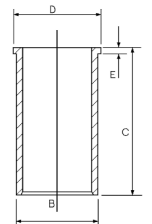

3

**C 223** 4cyl. **2238cc** **39kW (53PS)** **Diesel** **TD1686**

**14-021190-00 D** **88.00** **B 92.13** **C 163.50** **D 95.00** **E 4.00**  
**14-021440-00 DH**   **B 89.97** **C 163.32** **D 94.89** **E 0.89**

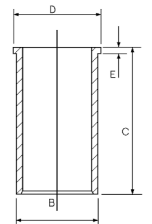

- |  |   |   |   |
|--|---|---|---|
| <input type="checkbox"/> Not suitable for use with pistons having chrome rings | <input type="checkbox"/> Nicht geeignet zur Verwendung mit mit Kolben mit Chromringen | <input type="checkbox"/> Ne pas utiliser avec des pistons équipés de segments chromés | <input type="checkbox"/> No es adecuada para usar con pistones que tengan aros de croma |
| <input type="checkbox"/> Chrome Bore   | <input type="checkbox"/> Bohrung verchromte   | <input type="checkbox"/> Alésage chromée  | <input type="checkbox"/> Cromado de cilindro  |

4

**4JA1** 4cyl. **2499cc** **50-56kW (68-76PS)** **Diesel** **TD1668**

**14-021450-00 DH**   **93.00** **B 95.04** **C 156.31** **D 101.00** **E 0.92**

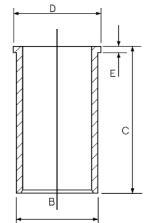

- |  |   |   |   |
|--|---|---|---|
| <input type="checkbox"/> Not suitable for use with pistons having chrome rings | <input type="checkbox"/> Nicht geeignet zur Verwendung mit mit Kolben mit Chromringen | <input type="checkbox"/> Ne pas utiliser avec des pistons équipés de segments chromés | <input type="checkbox"/> No es adecuada para usar con pistones que tengan aros de croma |
| <input type="checkbox"/> Chrome Bore   | <input type="checkbox"/> Bohrung verchromte   | <input type="checkbox"/> Alésage chromée  | <input type="checkbox"/> Cromado de cilindro  |



5

<b>4JB1</b>	4cyl.	<b>2771cc</b>	<b>50-74kW</b> (68-101PS)	<b>Diesel</b>		<b>TD1670</b>
<b>4JB1-T</b>	4cyl.	<b>2772cc</b>	<b>64-74kW</b> (87-101PS)	<b>Diesel Turbo</b>		<b>TD1671</b>
<b>4JB-1TC</b>	4cyl.	<b>2752cc</b>	<b>78kW</b> (106PS)	<b>Diesel Turbo</b>		<b>TD1672</b>

14-021460-00 *DH* ①②

**93.00**

**B 95.04**

**C 181.00**

**D 101.00**

**E 0.92**

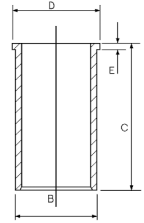

① Not suitable for use with pistons having chrome rings

① Nicht geeignet zur Verwendung mit mit Kolben mit Chromringen

① Ne pas utiliser avec des pistons équipés de segments chromés

① No es adecuada para usar con pistones que tengan aros de croma

② Chrome Bore

② Bohrung verchromte

② Alésage chromée

② Cromado de cilindro



CCM

x



9

203 A/61	Diesel	11548	6	130.00	26
203 H 61	Diesel	11548	6	130.00	26
310 H/61	Diesel	11548	6	130.00	26
8025.01	Diesel	1559	2	95.00	5
8025.02	Diesel	1728	2	100.00	6
803 A.062 (8030.01)	Diesel	2339	3	95.00	5
8030.02	Diesel	2592	3	100.00	6
8035.02	Diesel	2592	3	100.00	6
8035.05	Diesel	2930	3	104.00	13
8035.06	Diesel	2708	3	100.00	7
8035.06.200	Diesel	2708	3	100.00	7
8035.06.206	Diesel	2708	3	100.00	7
8035.06.208	Diesel	2708	3	100.00	7
8035.06.216	Diesel	2708	3	100.00	7
8035.06.220	Diesel	2708	3	100.00	7
8035.06.222	Diesel	2708	3	100.00	7
8035.06.223	Diesel	2708	3	100.00	7
8035.06.306	Diesel	2708	3	100.00	7
8035.06.307	Diesel	2708	3	100.00	7
8035.06.308	Diesel	2708	3	100.00	7
8035.06.309	Diesel	2708	3	100.00	7
8035.06.317	Diesel	2708	3	100.00	7
8035.06.320	Diesel	2708	3	100.00	7
8035.06.321	Diesel	2708	3	100.00	7
8035.06.322	Diesel	2708	3	100.00	7
8035.06.323	Diesel	2708	3	100.00	7
8040.02	Diesel	3455	4	100.00	6
8040.04.200	Diesel	3666	4	103.00	10
8040.05.200	Diesel	3908	4	104.00	12
8040.05.203	Diesel	3908	4	104.00	12
8040.05.230	Diesel	3908	4	104.00	12
8040.05.233	Diesel	3908	4	104.00	12
8040.05.235	Diesel	3908	4	104.00	12
8040.05.4990	Diesel	3908	4	104.00	12
8040.25 B.4200	Diesel	3908	4	104.00	12
8040.25.000	Diesel	3908	4	104.00	12
8040.25.200	Diesel	3908	4	104.00	12
8040.25.220	Diesel	3908	4	104.00	12
8040.25.230	Diesel	3908	4	104.00	12
8040.25.4990	Diesel	3908	4	104.00	13
8040.25X.4000	Diesel	3908	4	104.00	12
8040.45.400	Diesel	3908	4	104.00	12
8040.45.4180	Diesel	3908	4	104.00	12
8040.45.4380	Diesel	3908	4	104.00	12
8040.45.5200	Diesel	3908	4	104.00	12
8040.45.5201	Diesel	3908	4	104.00	12
8040.45.5203	Diesel	3908	4	104.00	12
8040.45.5280	Diesel	3908	4	104.00	12
8040.45.5281	Diesel	3908	4	104.00	12
8040.45D.5100	Diesel	3908	4	104.00	12
8040.45D.5101	Diesel	3908	4	104.00	12
8040.45D.5103	Diesel	3908	4	104.00	12
8040.45D.5105	Diesel	3908	4	104.00	12
8040.45X.4180	Diesel	3908	4	104.00	12
8041 L	Diesel	3666	4	103.00	11
8045.02	Diesel	3455	4	100.00	6
8045.04	Diesel	3666	4	103.00	11
8045.05	Diesel	3908	4	104.00	13
8045.06	Diesel	3613	4	100.00	7
8045.06.200	Diesel	3613	4	100.00	7

# ENGINE INDEX

Motorverzeichnis • Index de moteur • Índice de Motor  
Indeks silnika • Модель двигателя • دليل المحرك



CCM

x



9

8045.06.208	Diesel	3613	4	100.00	7
8045.06.213	Diesel	3613	4	100.00	7
8045.06.214	Diesel	3613	4	100.00	7
8045.06.215	Diesel	3613	4	100.00	7
8045.06.225	Diesel	3613	4	100.00	7
8045.06.319	Diesel	3613	4	100.00	7
8045.06.326	Diesel	3613	4	100.00	7
804A (8040.01)	Diesel	3119	4	95.00	5
8055.04	Diesel	4583	5	103.00	11
806 A (8060.01/.11)	Diesel	4678	6	95.00	5
8060.02.001	Diesel	5184	6	100.00	6
8060.02.003	Diesel	5184	6	100.00	6
8060.04	Diesel	5499	6	103.00	10
8060.04.055	Diesel	5499	6	103.00	10
8060.04.060	Diesel	5499	6	103.00	10
8060.04.070	Diesel	5499	6	103.00	10
8060.04.620	Diesel	5499	6	103.00	10
8060.04.621	Diesel	5499	6	103.00	10
8060.04.630	Diesel	5499	6	103.00	10
8060.04.639	Diesel	5499	6	103.00	10
8060.04.658	Diesel	5499	6	103.00	10
8060.04.660	Diesel	5499	6	103.00	10
8060.04.669	Diesel	5499	6	103.00	10
8060.04.670	Diesel	5499	6	103.00	10
8060.04.672	Diesel	5499	6	103.00	10
8060.04.675	Diesel	5499	6	103.00	10
8060.04.689	Diesel	5499	6	103.00	10
8060.05	Diesel	5861	6	104.00	12
8060.05.200	Diesel	5868	6	104.00	12
8060.05.246	Diesel	5861	6	104.00	12
8060.05.270	Diesel	5861	6	104.00	12
8060.05.280	Diesel	5861	6	104.00	12
8060.05.285	Diesel	5861	6	104.00	12
8060.05.289	Diesel	5861	6	104.00	12
8060.24.601	Diesel	5499	6	103.00	10
8060.24.670	Diesel	5499	6	103.00	10
8060.24.671	Diesel	5499	6	103.00	10
8060.24.678	Diesel	5499	6	103.00	10
8060.25.600	Diesel	5868	6	104.00	12
8060.25.669	Diesel	5861	6	104.00	12
8060.25.670	Diesel	5861	6	104.00	12
8060.25.678	Diesel	5861	6	104.00	12
8060.25.679	Diesel	5861	6	104.00	12
8060.25R 4200	Diesel	5861	6	104.00	12
8060.25R 4300	Diesel	5861	6	104.00	12
8060.25R.4210	Diesel	5861	6	104.00	12
8060.25R.4220	Diesel	5861	6	104.00	12
8060.25R.4225	Diesel	5861	6	104.00	12
8060.25R.4230	Diesel	5861	6	104.00	12
8060.25R.4240	Diesel	5861	6	104.00	12
8060.25R.4250	Diesel	5861	6	104.00	12
8060.25R.4280	Diesel	5861	6	104.00	12
8060.25R.4285	Diesel	5861	6	104.00	12
8060.25R.4290	Diesel	5861	6	104.00	12
8060.25R.4295	Diesel	5861	6	104.00	12
8060.25R.4360	Diesel	5861	6	104.00	12
8060.25R.4362	Diesel	5861	6	104.00	12
8060.25R.4750	Diesel	5861	6	104.00	12
8060.25R.4755	Diesel	5861	6	104.00	12
8060.25R.4760	Diesel	5861	6	104.00	12



CCM

x



9

8060.25R.4764	Diesel	5861	6	104.00	12
8060.25R.4960	Diesel	5861	6	104.00	12
8060.25R.4967	Diesel	5861	6	104.00	12
8060.25R.4968	Diesel	5861	6	104.00	12
8060.25R.4970	Diesel	5861	6	104.00	12
8060.25R.4973	Diesel	5861	6	104.00	12
8060.25R.4980	Diesel	5861	6	104.00	12
8060.25V.4000	Diesel	5868	6	104.00	12
8060.25V.4080	Diesel	5861	6	104.00	12
8060.25V.4800	Diesel	5861	6	104.00	12
8060.45	Diesel	5861	6	104.00	13
8060.45.4100	Diesel	5861	6	104.00	12
8060.45.4100 TCA	Diesel	5861	6	104.00	12
8060.45.4300	Diesel	5861	6	104.00	13
8060.45.4400	Diesel	5861	6	104.00	13
8060.45.4700	Diesel	5861	6	104.00	12
8060.45.4702	Diesel	5861	6	104.00	12
8060.45.4704	Diesel	5861	6	104.00	12
8060.45.4706	Diesel	5861	6	104.00	12
8060.45.4708	Diesel	5861	6	104.00	12
8060.45.5200	Diesel	5861	6	104.00	12
8060.45.5200	Diesel	5861	6	104.00	13
8060.45.5201	Diesel	5861	6	104.00	12
8060.45.5203	Diesel	5861	6	104.00	12
8060.45.5205	Diesel	5861	6	104.00	12
8060.45.5220	Diesel	5861	6	104.00	12
8060.45.5221	Diesel	5861	6	104.00	12
8060.45.5223	Diesel	5861	6	104.00	12
8060.45.5232	Diesel	5861	6	104.00	12
8060.45.5233	Diesel	5861	6	104.00	12
8060.45.5234	Diesel	5861	6	104.00	12
8060.45.5235	Diesel	5861	6	104.00	12
8060.45.5250	Diesel	5861	6	104.00	12
8060.45.5251	Diesel	5861	6	104.00	12
8060.45.5255	Diesel	5861	6	104.00	12
8060.45B	Diesel	5861	6	104.00	13
8060.45B.5100	Diesel	5861	6	104.00	12
8060.45B.5100	Diesel	5861	6	104.00	13
8060.45B.5101	Diesel	5861	6	104.00	12
8060.45B.5103	Diesel	5861	6	104.00	12
8060.45B.5105	Diesel	5861	6	104.00	12
8060.45B.5111	Diesel	5861	6	104.00	12
8060.45B.5112	Diesel	5861	6	104.00	12
8060.45B.5113	Diesel	5861	6	104.00	12
8060.45B.5120	Diesel	5861	6	104.00	12
8060.45B.5121	Diesel	5861	6	104.00	12
8060.45B.5123	Diesel	5861	6	104.00	12
8060.45B.5124	Diesel	5861	6	104.00	12
8060.45B.5145	Diesel	5861	6	104.00	12
8060.45B.5146	Diesel	5861	6	104.00	12
8060.45B.5150	Diesel	5861	6	104.00	12
8060.45B.5151	Diesel	5861	6	104.00	12
8060.45B.5185	Diesel	5861	6	104.00	12
8060.45B.5186	Diesel	5861	6	104.00	12
8060.45K.6090	Diesel	5861	6	104.00	12
8060.45L.4400	Diesel	5861	6	104.00	13
8060.45M.7200	Diesel	5861	6	104.00	13
8060.45R.5000	Diesel	5861	6	104.00	12
8060.45R.5001	Diesel	5861	6	104.00	12
8060.45R.5003	Diesel	5861	6	104.00	12

# ENGINE INDEX

Motorverzeichnis • Index de moteur • Índice de Motor  
Indeks silnika • Модель двигателя • دليل المحرك



CCM



9

8060.45R.5050	Diesel	5861	6	104.00	12
8060.45S TCA	Diesel	5861	6	104.00	12
8060.45S.6000	Diesel	5861	6	104.00	12
8060.45S.6203	Diesel	5861	6	104.00	13
8060.45S.6800	Diesel	5861	6	104.00	12
8060.45S.7200	Diesel	5861	6	104.00	12
8060.45S.7200	Diesel	5861	6	104.00	13
8061 L	Diesel	5499	6	103.00	11
8061.05	Diesel	5861	6	104.00	12
8061.25	Diesel	5868	6	104.00	12
8062.24.070	Diesel	5499	6	103.00	10
8065.04	Diesel	5499	6	103.00	11
8065.25	Diesel	5863	6	104.00	13
8065.E	Diesel	5861	6	104.00	12
8140.07.2585	Diesel	2499	4	93.00	1
8140.07.2700	Diesel	2499	4	93.00	1
8140.07.2701	Diesel	2499	4	93.00	1
8140.07.2710	Diesel	2499	4	93.00	1
8140.07.2711	Diesel	2499	4	93.00	1
8140.07.2712	Diesel	2499	4	93.00	1
8140.07.3700	Diesel	2499	4	93.00	1
8140.07.3710	Diesel	2499	4	93.00	1
8140.07.3711	Diesel	2499	4	93.00	1
8140.07.3712	Diesel	2499	4	93.00	1
8140.07.3713	Diesel	2499	4	93.00	1
8140.21	Diesel	2445	4	93.00	1
8140.21.200	Diesel	2445	4	93.00	1
8140.21.201	Diesel	2445	4	93.00	1
8140.21.202	Diesel	2445	4	93.00	1
8140.21.203	Diesel	2445	4	93.00	1
8140.21.212	Diesel	2445	4	93.00	1
8140.21.214	Diesel	2445	4	93.00	1
8140.21.290	Diesel	2445	4	93.00	1
8140.23.	Diesel	2798	4	94.40	4
8140.23.2585	Diesel	2799	4	94.40	4
8140.23.3700	Diesel	2799	4	94.40	4
8140.23.3701	Diesel	2798	4	94.40	4
8140.23.3710	Diesel	2798	4	94.40	4
8140.23.3711	Diesel	2798	4	94.40	4
8140.23.3713	Diesel	2798	4	94.40	4
8140.23.3720	Diesel	2798	4	94.40	4
8140.23.3721	Diesel	2798	4	94.40	4
8140.23.3730	Diesel	2798	4	94.40	4
8140.23.3731	Diesel	2798	4	94.40	4
8140.23.3750	Diesel	2798	4	94.40	4
8140.23.3751	Diesel	2798	4	94.40	4
8140.23.3760	Diesel	2798	4	94.40	4
8140.27 S	Diesel	2445	4	93.00	1
8140.27.210	Diesel	2445	4	93.00	1
8140.27.213	Diesel	2445	4	93.00	1
8140.27.215	Diesel	2499	4	93.00	1
8140.27.218	Diesel	2499	4	93.00	1
8140.27.2582	Diesel	2499	4	93.00	1
8140.27.2700	Diesel	2499	4	93.00	1
8140.27.2720	Diesel	2499	4	93.00	1
8140.27.2811	Diesel	2499	4	93.00	1
8140.27R.2700	Diesel	2499	4	93.00	1
8140.27R.2780	Diesel	2499	4	93.00	1
8140.27R.2782	Diesel	2499	4	93.00	1
8140.27R.2786	Diesel	2499	4	93.00	1



CCM

x



9

8140.27R.2787	Diesel	2499	4	93.00	1
8140.27S.2700	Diesel	2499	4	93.00	1
8140.27S.2701	Diesel	2499	4	93.00	1
8140.27S.2710	Diesel	2499	4	93.00	1
8140.27S.2711	Diesel	2499	4	93.00	1
8140.27S.2720	Diesel	2499	4	93.00	1
8140.27S.2721	Diesel	2499	4	93.00	1
8140.27S.2730	Diesel	2499	4	93.00	1
8140.27S.2731	Diesel	2499	4	93.00	1
8140.27S.2750	Diesel	2499	4	93.00	1
8140.27S.2751	Diesel	2499	4	93.00	1
8140.27S.2760	Diesel	2499	4	93.00	1
8140.27S.2761	Diesel	2499	4	93.00	1
8140.27S.2770	Diesel	2499	4	93.00	1
8140.27S.2771	Diesel	2499	4	93.00	1
8140.27S.2801	Diesel	2499	4	93.00	1
8140.27S.2811	Diesel	2499	4	93.00	1
8140.27S.2885	Diesel	2499	4	93.00	1
8140.27S.3701	Diesel	2499	4	93.00	1
8140.27S.3711	Diesel	2499	4	93.00	1
8140.27S.3720	Diesel	2499	4	93.00	1
8140.27S.3721	Diesel	2499	4	93.00	1
8140.27S.3750	Diesel	2499	4	93.00	1
8140.27S.3751	Diesel	2499	4	93.00	1
8140.27S.3760	Diesel	2499	4	93.00	1
8140.27S.3761	Diesel	2499	4	93.00	1
8140.27S.3770	Diesel	2499	4	93.00	1
8140.27S.3771	Diesel	2499	4	93.00	1
8140.27S.3780	Diesel	2499	4	93.00	1
8140.27S.3811	Diesel	2499	4	93.00	1
8140.43	Diesel	2798	4	94.40	4
8140.43.2585	Diesel	2798	4	94.40	4
8140.43.3700	Diesel	2799	4	94.40	4
8140.43.3711	Diesel	2798	4	94.40	4
8140.43.3713	Diesel	2798	4	94.40	4
8140.43.3718	Diesel	2798	4	94.40	4
8140.43.3721	Diesel	2798	4	94.40	4
8140.43.3723	Diesel	2798	4	94.40	4
8140.43.3728	Diesel	2798	4	94.40	4
8140.43.3900	Diesel	2798	4	94.40	4
8140.43.3911	Diesel	2798	4	94.40	4
8140.43.3921	Diesel	2798	4	94.40	4
8140.43.3931	Diesel	2798	4	94.40	4
8140.43B	Diesel	2798	4	94.40	4
8140.43B.4300	Diesel	2798	4	94.40	4
8140.43B.4305	Diesel	2798	4	94.40	4
8140.43B.4320	Diesel	2798	4	94.40	4
8140.43B.4325	Diesel	2798	4	94.40	4
8140.43B.4330	Diesel	2798	4	94.40	4
8140.43B.4335	Diesel	2798	4	94.40	4
8140.43C	Diesel	2798	4	94.40	4
8140.43C.4000	Diesel	2798	4	94.40	4
8140.43C.4005	Diesel	2798	4	94.40	4
8140.43C.4020	Diesel	2798	4	94.40	4
8140.43C.4021	Diesel	2798	4	94.40	4
8140.43C.4025	Diesel	2798	4	94.40	4
8140.43C.4026	Diesel	2798	4	94.40	4
8140.43C.4035	Diesel	2798	4	94.40	4
8140.43C.4036	Diesel	2798	4	94.40	4
8140.43N	Diesel	2798	4	94.40	4

# ENGINE INDEX

Motorverzeichnis • Index de moteur • Índice de Motor  
Indeks silnika • Модель двигателя • دليل المحرك



CCM



9

8140.43N.4300	Diesel	2798	4	94.40	4
8140.43N.4320	Diesel	2798	4	94.40	4
8140.43N.4330	Diesel	2798	4	94.40	4
8140.43N.4400	Diesel	2798	4	94.40	4
8140.43N.4430	Diesel	2798	4	94.40	4
8140.43S	Diesel	2798	4	94.40	4
8140.43S.4000	Diesel	2798	4	94.40	4
8140.43S.4020	Diesel	2798	4	94.40	4
8140.43S.4030	Diesel	2798	4	94.40	4
8140.43S.4140	Diesel	2798	4	94.40	4
8140.43S.4300	Diesel	2798	4	94.40	4
8140.43S.4320	Diesel	2798	4	94.40	4
8140.43S.4330	Diesel	2798	4	94.40	4
8140.43S.4400	Diesel	2798	4	94.40	4
8140.43S.4420	Diesel	2798	4	94.40	4
8140.43S.4430	Diesel	2798	4	94.40	4
8140.47 R	Diesel	2499	4	93.00	1
8140.47.2700	Diesel	2499	4	93.00	1
8140.47.2711	Diesel	2499	4	93.00	1
8140.47.2721	Diesel	2499	4	93.00	1
8140.47.2785	Diesel	2499	4	93.00	1
8140.47.3700	Diesel	2499	4	93.00	1
8140.47.3711	Diesel	2499	4	93.00	1
8140.47.3721	Diesel	2499	4	93.00	1
8140.47B.3790	Diesel	2499	4	93.00	1
8140.47B.3795	Diesel	2499	4	93.00	1
8140.47R.2790	Diesel	2499	4	93.00	1
8140.47R.2795	Diesel	2499	4	93.00	1
8140.47S	Diesel	2499	4	93.00	1
8140.61.200	Diesel	2445	4	93.00	2
8140.61.300	Diesel	2445	4	93.00	2
8140.63.	Diesel	2798	4	94.40	4
8140.63.4000	Diesel	2798	4	94.40	4
8140.67 (290B7W)	Diesel	2500	4	93.00	2
8140.67.2585	Diesel	2499	4	93.00	1
8140.67F.	Diesel	2449	4	93.00	1
8140.67F.3700	Diesel	2449	4	93.00	1
8140.67F.3701	Diesel	2499	4	93.00	1
8140.67F.3710	Diesel	2499	4	93.00	1
8140.67F.3711	Diesel	2499	4	93.00	1
8140.67F.3713	Diesel	2499	4	93.00	1
8140.67F.3721	Diesel	2499	4	93.00	1
8140.97.2781	Diesel	2499	4	93.00	3
8140.97.2783	Diesel	2499	4	93.00	3
8144.61.200	Diesel	2445	4	93.00	2
8144.67	Diesel	2500	4	93.00	2
8200.02	Diesel	9820	6	122.00	21
8200.03	Diesel	10308	6	125.00	22
8200.12	Diesel	9820	6	122.00	21
8200.13	Diesel	10308	6	125.00	22
8205.02	Diesel	9820	6	122.00	21
8210.02	Diesel	13798	6	137.00	28
8210.02.067	Diesel	13798	6	137.00	28
8210.02.069	Diesel	13798	6	137.00	28
8210.02.371	Diesel	13798	6	137.00	28
8210.02.373	Diesel	13798	6	137.00	28
8210.02.377	Diesel	13798	6	137.00	28
8210.02.393	Diesel	13798	6	137.00	28
8210.02.440	Diesel	13798	6	137.00	28
8210.02.441	Diesel	13798	6	137.00	28





CCM

x



9

8210.02.731	Diesel	13798	B6	137.00	28
8210.22.105	Diesel	13798	6	137.00	28
8210.22.171	Diesel	13798	6	137.00	28
8210.22.175	Diesel	13798	6	137.00	28
8210.22.183	Diesel	13798	6	137.00	28
8210.22.210	Diesel	13798	6	137.00	28
8210.22.236	Diesel	13798	6	137.00	28
8210.22.269	Diesel	13798	6	137.00	28
8210.22.317	Diesel	13798	6	137.00	28
8210.22.327	Diesel	13798	6	137.00	28
8210.22.385	Diesel	13798	6	137.00	28
8210.22.511	Diesel	13798	6	137.00	28
8210.22.521	Diesel	13798	6	137.00	28
8210.22.523	Diesel	13798	6	137.00	28
8210.22.525	Diesel	13798	6	137.00	28
8210.22.535	Diesel	13798	6	137.00	28
8210.22.537	Diesel	13798	6	137.00	28
8210.22.569	Diesel	13798	6	137.00	28
8210.22.800	Diesel	13798	6	137.00	28
8210.22.869	Diesel	13798	6	137.00	28
8210.22X.069	Diesel	13798	6	137.00	28
8210.22X.235	Diesel	13798	6	137.00	28
8210.22X.523	Diesel	13798	6	137.00	28
8210.22X.575	Diesel	13798	6	137.00	28
8210.42	Diesel	13798	6	137.00	28
8210.42.101	Diesel	13798	6	137.00	28
8210.42.115	Diesel	13798	6	137.00	28
8210.42.151	Diesel	13798	6	137.00	28
8210.42.152	Diesel	13798	6	137.00	28
8210.42.154	Diesel	13798	6	137.00	28
8210.42.155	Diesel	13798	6	137.00	28
8210.42.161	Diesel	13798	6	137.00	28
8210.42.162	Diesel	13798	6	137.00	28
8210.42.165	Diesel	13798	6	137.00	28
8210.42.171	Diesel	13798	6	137.00	28
8210.42.172	Diesel	13798	6	137.00	28
8210.42.175	Diesel	13798	6	137.00	28
8210.42.181	Diesel	13798	6	137.00	28
8210.42.182	Diesel	13798	6	137.00	28
8210.42.185	Diesel	13798	6	137.00	28
8210.42.186	Diesel	13798	6	137.00	28
8210.42.191	Diesel	13798	6	137.00	28
8210.42.195	Diesel	13798	6	137.00	28
8210.42.500	Diesel	13798	6	137.00	28
8210.42K	Diesel	13798	6	137.00	28
8210.42L	Diesel	13790	6	137.00	28
8210.42L	Diesel	13798	6	137.00	28
8210.42L.400	Diesel	13798	6	137.00	28
8210.42M (TCA)	Diesel	13798	6	137.00	28
8211.02	Diesel	13798	6	137.00	28
8212.00	Diesel	13800	6	137.00	28
8215.00	Diesel	13800	6	137.00	28
8217.00	Diesel	13798	6	137.00	28
8220.02.870	Diesel	9572	6	125.00	23
8220.12	Diesel	9572	6	125.00	23
8220.22.002	Diesel	9572	6	125.00	23
8220.22.102	Diesel	9572	6	125.00	23
8220.32	Diesel	9572	6	125.00	23
8260.01	Diesel	12800	6	137.00	28
8260.02	Diesel	12880	6	145.00	29

# ENGINE INDEX

Motorverzeichnis • Index de moteur • Índice de Motor  
Indeks silnika • Модель двигателя • دليل المحرك



CCM



9

8261.02.002	Diesel	12880	6	145.00	29
8280.01	Diesel	17174	V8	145.00	29
8280.02.109	Diesel	17174	V8	145.00	29
8280.02.265	Diesel	17174	V8	145.00	29
8280.02.269	Diesel	17174	V8	145.00	29
8280.02.273	Diesel	17174	V8	145.00	29
8280.02.279	Diesel	17174	V8	145.00	29
8280.02.410	Diesel	17174	V8	145.00	29
8280.02.412	Diesel	17174	V8	145.00	29
8280.22.	Diesel	17174	V8	145.00	29
8280.22.007	Diesel	17174	V8	145.00	29
8280.22.009	Diesel	17200	V8	145.00	29
8280.22.033	Diesel	17174	V8	145.00	29
8280.22.054	Diesel	17174	V8	145.00	29
8280.22.201	Diesel	17174	V8	145.00	29
8280.22.205	Diesel	17174	V8	145.00	29
8280.42.001	Diesel	17174	V8	145.00	29
8280.42.050	Diesel	17174	V8	145.00	30
8280.42S (TCA)	Diesel	17173	V8	145.00	30
8280.42S.342	Diesel	17174	V8	145.00	30
8280.42S.350	Diesel	17174	V8	145.00	30
8280.42S.352	Diesel	17174	V8	145.00	30
8280.42S.362	Diesel	17174	V8	145.00	30
8340.04.040	Diesel	4570	4	115.00	18
8340.04.200	Diesel	4570	4	115.00	18
8340.04.250	Diesel	4570	4	115.00	18
8340.04.300	Diesel	4570	4	115.00	18
8340.04.350	Diesel	4570	4	115.00	18
8340.04.362	Diesel	4570	B4	115.00	18
8340.05.200	Diesel	5401	4	115.00	19
8360.04	Diesel	6855	6	115.00	18
8360.05.200	Diesel	8100	6	115.00	19
8360.05.254	Diesel	8100	6	115.00	19
8360.05.673	Diesel	8100	6	115.00	19
8360.46	Diesel	7685	6	112.00	16
8360.46R.416 (TCA)	Diesel	7685	6	112.00	16
8361.05	Diesel	8102	6	115.00	19
8365.25.500	Diesel	8102	6	115.00	19
8365.25.501	Diesel	8102	6	115.00	19
8365.25.502	Diesel	8102	6	115.00	19
8365.25.503	Diesel	8102	6	115.00	19
8365.25.533	Diesel	8102	6	115.00	19
8460.21.002	Diesel	9500	6	120.00	20
8460.21.010	Diesel	9500	6	120.00	20
8460.21.042	Diesel	9500	6	120.00	20
8460.21.102	Diesel	9500	6	120.00	20
8460.21.106	Diesel	9500	6	120.00	20
8460.21.202	Diesel	9500	6	120.00	20
8460.21.206	Diesel	9500	6	120.00	20
8460.21.601	Diesel	9498	6	120.00	20
8460.21.611	Diesel	9498	6	120.00	20
8460.21.708	Diesel	9500	6	120.00	20
8460.21.710	Diesel	9500	6	120.00	20
8460.21B.613	Diesel	9500	6	120.00	20
8460.21B.615	Diesel	9500	6	120.00	20
8460.41 M	Diesel	9500	6	120.00	20
8460.41 R	Diesel	9500	6	120.00	20
8460.41 S	Diesel	9500	6	120.00	20
8460.41 T	Diesel	9500	6	120.00	20
8460.41.102	Diesel	9500	6	120.00	20



CCM

x



9

8460.41.124	Diesel	9500	6	120.00	20
8460.41.160	Diesel	9500	6	120.00	20
8460.41C	Diesel	9500	6	120.00	20
8460.41C (TCA)	Diesel	9500	6	120.00	20
8460.41C.320	Diesel	9500	6	120.00	20
8460.41K	Diesel	9500	6	120.00	20
8460.41K. TCA	Diesel	9500	6	120.00	20
8460.41K.406	Diesel	9500	6	120.00	20
8460.41K.410	Diesel	9500	6	120.00	20
8460.41L (TCA)	Diesel	9500	6	120.00	20
8460.41L.5020	Diesel	9500	6	120.00	20
BF4L 913 T	Diesel	4086	4	102.00	9
BF6L 913	Diesel	6128	6	102.00	8
BF6L 913 T	Diesel	6128	6	102.00	9
C 21	Diesel	4562	4	110.00	15
C02	Diesel	4397	4	108.00	14
C03	Diesel	4941	4	110.00	15
C03 D	Diesel	4397	4	108.00	14
C055	Diesel	4397	4	108.00	14
C100	Diesel	4941	4	110.00	15
C20	Diesel	4562	4	110.00	15
C41	Diesel	4562	4	110.00	15
C70	Diesel	4941	4	110.00	15
CN3	Diesel	3706	3	110.00	15
CO2 D	Diesel	4397	4	108.00	14
CO3	Diesel	4562	4	110.00	15
CO40	Diesel	4562	4	110.00	15
CP 3	Diesel	7412	6	110.00	15
F10L 413 F	Diesel	15953	V10	125.00	24
F2BE 0681 A	Diesel	7790	6	115.00	17
F2BE 0681 B	Diesel	7790	6	115.00	17
F2BE 0681 C	Diesel	7790	6	115.00	17
F2BE 0681 D	Diesel	7790	6	115.00	17
F2BE 0681 E	Diesel	7790	6	115.00	17
F2BE 0681 F	Diesel	7790	6	115.00	17
F2BE0681DB	Diesel	7790	6	115.00	17
F2BE1682 G	Diesel	7790	6	115.00	17
F3AE 0681 B	Diesel	10300	6	125.00	25
F3AE 0681 D	Diesel	10300	6	125.00	25
F3AE 0681 E	Diesel	10300	6	125.00	25
F3AE0681H	Diesel	10300	6	125.00	25
F3AE3681D	Diesel	10300	6	125.00	25
F3B3681B	Diesel	12880	6	135.00	27
F3BE 0681 A	Diesel	12880	6	135.00	27
F3BE 0681 B	Diesel	12880	6	135.00	27
F3BE 0681 C	Diesel	12880	6	135.00	27
F3BE 0681 D	Diesel	12880	6	135.00	27
F3BE 0681 E	Diesel	12880	6	135.00	27
F3BE 0681 F	Diesel	12880	6	135.00	27
F3BE 0681 G	Diesel	12880	6	135.00	27
F3BE3681A	Diesel	12880	6	135.00	27
F4L 913	Diesel	4086	4	102.00	9
F6L 413 F	Diesel	9570	V6	125.00	24
F8L 413 F	Diesel	12763	V8	125.00	24

**1**

8140.21	4cyl.	2445cc		Diesel	Turbo	FM9103
8140.27R.2700	4cyl.	2499cc	70-67kW (95-92PS)	Diesel	Turbo	TD20420
8140.27R.2780	4cyl.	2499cc	67-70kW (91-95PS)	Diesel	Turbo	TD27393
8140.27R.2782	4cyl.	2499cc	70kW (95PS)	Diesel	Turbo	TD1710
8140.27R.2786	4cyl.	2499cc	67-70kW (91-95PS)	Diesel	Turbo	TD27394
8140.27R.2787	4cyl.	2499cc	67-70kW (91-95PS)	Diesel	Turbo	TD27395
8140.27 S	4cyl.	2445cc	68kW (92PS)	Diesel	Turbo	TD1705
8140.27S.2700	4cyl.	2499cc	76kW (103PS)	Diesel	Turbo	TD20421
8140.27S.2701	4cyl.	2499cc	76kW (103PS)	Diesel	Turbo	TD27396
8140.27S.2710	4cyl.	2499cc	76kW (103PS)	Diesel	Turbo	TD27397
8140.27S.2711	4cyl.	2499cc	76kW (103PS)	Diesel	Turbo	TD27398
8140.27S.2720	4cyl.	2499cc	76kW (103PS)	Diesel	Turbo	TD27399
8140.27S.2721	4cyl.	2499cc	76kW (103PS)	Diesel	Turbo	TD27400
8140.27S.2730	4cyl.	2499cc	76kW (103PS)	Diesel	Turbo	TD27401
8140.27S.2731	4cyl.	2499cc	76kW (103PS)	Diesel	Turbo	TD27402
8140.27S.2750	4cyl.	2499cc	76kW (103PS)	Diesel	Turbo	TD27403
8140.27S.2751	4cyl.	2499cc	76kW (103PS)	Diesel	Turbo	TD27404
8140.27S.2760	4cyl.	2499cc	76kW (103PS)	Diesel	Turbo	TD27405
8140.27S.2761	4cyl.	2499cc	76kW (103PS)	Diesel	Turbo	TD27406
8140.27S.2770	4cyl.	2499cc	76kW (103PS)	Diesel	Turbo	TD27407
8140.27S.2771	4cyl.	2499cc	76kW (103PS)	Diesel	Turbo	TD27408
8140.27S.2801	4cyl.	2499cc	76kW (103PS)	Diesel	Turbo	TD20419
8140.27S.2811	4cyl.	2499cc	76kW (103PS)	Diesel	Turbo	TD27409
8140.27S.2885	4cyl.	2499cc	76kW (103PS)	Diesel	Turbo	TD20422
8140.27S.3701	4cyl.	2499cc	77kW (105PS)	Diesel	Turbo	TD27411
8140.27S.3711	4cyl.	2499cc	77kW (105PS)	Diesel	Turbo	TD27412
8140.27S.3720	4cyl.	2499cc	77kW (105PS)	Diesel	Turbo	TD27413
8140.27S.3721	4cyl.	2499cc	77kW (105PS)	Diesel	Turbo	TD27414
8140.27S.3750	4cyl.	2499cc	77kW (105PS)	Diesel	Turbo	TD27415
8140.27S.3751	4cyl.	2499cc	77kW (105PS)	Diesel	Turbo	TD27416
8140.27S.3760	4cyl.	2499cc	77kW (105PS)	Diesel	Turbo	TD27419
8140.27S.3761	4cyl.	2499cc	77kW (105PS)	Diesel	Turbo	TD27420
8140.27S.3770	4cyl.	2499cc	77kW (105PS)	Diesel	Turbo	TD27422
8140.27S.3771	4cyl.	2499cc	77kW (105PS)	Diesel	Turbo	TD27423
8140.27S.3780	4cyl.	2499cc	77kW (105PS)	Diesel	Turbo	TD27424
8140.27S.3811	4cyl.	2499cc	77kW (105PS)	Diesel	Turbo	TD27426
8140.47B.3790 Euro 1	4cyl.	2499cc	78-83kW (106-113PS)	Diesel	Turbo Intercooled	TD26008
8140.47B.3795 Euro 1	4cyl.	2499cc	78-83kW (106-113PS)	Diesel	Turbo Intercooled	TD26009
8140.47 R	4cyl.	2499cc	80kW (109PS)	Diesel	Turbo Intercooled	TD7234
8140.47R.2790	4cyl.	2499cc	76kW (103PS)	Diesel	Turbo Intercooled	TD1716
8140.47R.2795	4cyl.	2499cc	80kW (109PS)	Diesel	Turbo Intercooled	TD26010
8140.47S Euro 1	4cyl.	2499cc	85kW (116PS)	Diesel	Turbo Intercooled	TD20453
8140.67F. Euro 2	4cyl.	2449cc	60kW (81PS)	Diesel		TD7226
8140.67F.3700 Euro 2	4cyl.	2449cc	60-63kW (82-86PS)	Diesel		TD20428
8140.67F.3701 Euro 2	4cyl.	2499cc	60kW (81PS)	Diesel		TD26292





8140.67F.3710 Euro 2	4cyl.	2499cc	60kW (81PS)	Diesel	TD26293
8140.67F.3711 Euro 2	4cyl.	2499cc	60kW (81PS)	Diesel	TD26294
8140.67F.3713 Euro 2	4cyl.	2499cc	60kW (81PS)	Diesel	TD26295
8140.67F.3721 Euro 2	4cyl.	2499cc	60kW (81PS)	Diesel	TD26296
8140.07.2585 Euro 1	4cyl.	2499cc	55kW (75PS)	Diesel	TD20437
8140.07.2700	4cyl.	2499cc	55kW (75PS)	Diesel	TD1700
8140.07.2701	4cyl.	2499cc	55kW (75PS)	Diesel	TD1701
8140.07.2710	4cyl.	2499cc	55kW (75PS)	Diesel	TD27358
8140.07.2711	4cyl.	2499cc	55kW (75PS)	Diesel	TD27359
8140.07.2712	4cyl.	2499cc	55kW (75PS)	Diesel	TD1702
8140.07.3700 Euro 1	4cyl.	2499cc	53kW (72PS)	Diesel	TD27364
8140.07.3710 Euro 1	4cyl.	2499cc	53kW (72PS)	Diesel	TD20418
8140.07.3711 Euro 1	4cyl.	2499cc	53kW (72PS)	Diesel	TD27365
8140.07.3712 Euro 1	4cyl.	2499cc	53kW (72PS)	Diesel	TD27366
8140.07.3713 Euro 1	4cyl.	2499cc	53kW (72PS)	Diesel	TD27367
8140.21.200	4cyl.	2445cc	68kW (92PS)	Diesel Turbo	TD1703
8140.21.201	4cyl.	2445cc	68kW (92PS)	Diesel Turbo	TD27368
8140.21.202	4cyl.	2445cc	68kW (92PS)	Diesel Turbo	TD27369
8140.21.203	4cyl.	2445cc	68kW (92PS)	Diesel Turbo	TD27370
8140.21.212	4cyl.	2445cc	68kW (92PS)	Diesel Turbo	TD27371
8140.21.214	4cyl.	2445cc	77kW (105PS)	Diesel Turbo	TD1704
8140.21.290	4cyl.	2445cc	68kW (92PS)	Diesel Turbo	TD27372
8140.27.210	4cyl.	2445cc	77kW (105PS)	Diesel Turbo	FM9131
8140.27.213	4cyl.	2445cc	77kW (105PS)	Diesel Turbo	FM9131
8140.27.215	4cyl.	2499cc	76kW (103PS)	Diesel Turbo	TD27387
8140.27.218	4cyl.	2499cc	76kW (103PS)	Diesel Turbo Intercooled	TD26268
8140.27.2582	4cyl.	2499cc	74-79kW (101-107PS)	Diesel Turbo	TD7260
8140.27.2700	4cyl.	2499cc	76kW (103PS)	Diesel Turbo	TD1706
8140.27.2720	4cyl.	2499cc	76kW (103PS)	Diesel Turbo	TD1707
8140.27.2811	4cyl.	2499cc	76kW (103PS)	Diesel Turbo	TD1708
8140.47.2700 Euro 1	4cyl.	2499cc	85kW (116PS)	Diesel Turbo Intercooled	TD1711
8140.47.2711 Euro 1	4cyl.	2499cc	85kW (116PS)	Diesel Turbo Intercooled	TD1712
8140.47.2721 Euro 1	4cyl.	2499cc	85kW (116PS)	Diesel Turbo Intercooled	TD1713
8140.47.2785 Euro 1	4cyl.	2499cc	85kW (116PS)	Diesel Turbo Intercooled	TD1715
8140.47.3700 Euro 1	4cyl.	2499cc	85kW (116PS)	Diesel Turbo Intercooled	TD20477
8140.47.3711 Euro 1	4cyl.	2499cc	85kW (116PS)	Diesel Turbo Intercooled	TD26005
8140.47.3721 Euro 1	4cyl.	2499cc	85kW (116PS)	Diesel Turbo Intercooled	TD26006
8140.67.2585 Euro 2	4cyl.	2499cc	55-63kW (75-86PS)	Diesel Turbo Intercooled	TD20427

14-021371-00 *D*  
14-021372-00 *D*  
14-021373-00 *D*  
14-021480-00 *DH*

93.00

B 96.01	C 171.00	D 98.92	E 5.00
B 96.05	C 171.00	D 98.92	E 5.00
B 96.17	C 171.00	D 98.92	E 5.00
B 97.035	C 171.00	D 100.00	E 5.00

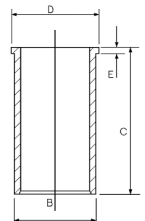

Nitrided

Nitriert

Nitruré

Nitrurado



2

8140.67 (290B7W)	4cyl.	2500cc		Diesel	Indirect Injection	FM9170
8144.67	4cyl.	2500cc		Diesel	Indirect Injection	FM9170
8140.61.200	4cyl.	2445cc	53kW (72PS)	Diesel		TD7225
8140.61.300	4cyl.	2445cc	53kW (72PS)	Diesel		TD20426
8144.61.200	4cyl.	2445cc	53kW (72PS)	Diesel		TD20429

14-022560-00 D	93.00	B 96.00	C 167.30	D 98.90	E 5.00
14-028930-00 D		B 97.50	C 167.00	D 100.90	E 5.00
14-028931-00 D		B 97.58	C 167.00	D 100.90	E 5.00
14-028932-00 D		B 97.70	C 167.00	D 100.90	E 5.00

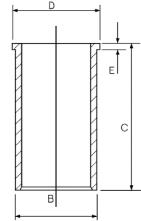

3

8140.97.2781	4cyl.	2499cc	68kW (92PS)	Diesel	Turbo	TD1717
8140.97.2783	4cyl.	2499cc		Diesel	Turbo	FM29100

14-022560-00 D	93.00	B 96.00	C 167.30	D 98.90	E 5.00
14-028930-00 D		B 97.50	C 167.00	D 100.90	E 5.00
14-028931-00 D		B 97.58	C 167.00	D 100.90	E 5.00
14-028932-00 D		B 97.70	C 167.00	D 100.90	E 5.00

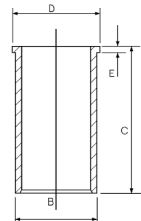

4

8140.43 Euro 2	4cyl.	2798cc	90kW (122PS)	Diesel	Turbo Intercooled	TD7235
8140.43B Euro 3	4cyl.	2798cc	77kW (105PS)	Diesel	Turbo Intercooled	TD16514
8140.43B.4300 Euro 3	4cyl.	2798cc	77kW (105PS)	Diesel	Turbo Intercooled	TD25968
8140.43B.4305 Euro 3	4cyl.	2798cc	77kW (105PS)	Diesel	Turbo Intercooled	TD25966
8140.43B.4320 Euro 3	4cyl.	2798cc	77kW (105PS)	Diesel	Turbo Intercooled	TD25967
8140.43B.4325 Euro 3	4cyl.	2798cc	77kW (105PS)	Diesel	Turbo Intercooled	TD25969
8140.43B.4330 Euro 3	4cyl.	2798cc	77kW (105PS)	Diesel	Turbo Intercooled	TD25970
8140.43B.4335 Euro 3	4cyl.	2798cc	77kW (105PS)	Diesel	Turbo Intercooled	TD25971
8140.43C Euro 2	4cyl.	2798cc	78kW (106PS)	Diesel	Turbo Intercooled	TD14449
8140.43C.4000 Euro 3	4cyl.	2798cc	77kW (105PS)	Diesel	Turbo Intercooled	TD25972
8140.43C.4005 Euro 3	4cyl.	2798cc	77kW (105PS)	Diesel	Turbo Intercooled	TD25973
8140.43C.4020 Euro 3	4cyl.	2798cc	77kW (105PS)	Diesel	Turbo Intercooled	TD25974
8140.43C.4021 Euro 3	4cyl.	2798cc	77kW (105PS)	Diesel	Turbo Intercooled	TD25975
8140.43C.4025 Euro 3	4cyl.	2798cc	77kW (105PS)	Diesel	Turbo Intercooled	TD25976
8140.43C.4026 Euro 3	4cyl.	2798cc	77kW (105PS)	Diesel	Turbo Intercooled	TD25977
8140.43C.4035 Euro 3	4cyl.	2798cc	77kW (105PS)	Diesel	Turbo Intercooled	TD25980
8140.43C.4036 Euro 3	4cyl.	2798cc	77kW (105PS)	Diesel	Turbo Intercooled	TD25981
8140.43N Euro 3	4cyl.	2798cc	107kW (146PS)	Diesel	Turbo Intercooled	TD16873
8140.43N.4300 Euro 3	4cyl.	2798cc	108kW (147PS)	Diesel	Turbo Intercooled	TD25984
8140.43N.4320 Euro 3	4cyl.	2798cc	108kW (147PS)	Diesel	Turbo Intercooled	TD25985
8140.43N.4330 Euro 3	4cyl.	2798cc	108kW (147PS)	Diesel	Turbo Intercooled	TD25986
8140.43N.4400 Euro 3	4cyl.	2798cc	108kW (147PS)	Diesel	Turbo Intercooled	TD25987
8140.43N.4430 Euro 3	4cyl.	2798cc	108kW (147PS)	Diesel	Turbo Intercooled	TD25988







8140.43S Euro 3	4cyl.	2798cc	92kW (125PS)	Diesel	Turbo Intercooled	TD16874
8140.43S.4000 Euro 3	4cyl.	2798cc	92kW (125PS)	Diesel	Turbo Intercooled	TD25995
8140.43S.4020 Euro 3	4cyl.	2798cc	92kW (125PS)	Diesel	Turbo Intercooled	TD25996
8140.43S.4030 Euro 3	4cyl.	2798cc	92kW (125PS)	Diesel	Turbo Intercooled	TD25997
8140.43S.4140 Euro 3	4cyl.	2798cc	92kW (125PS)	Diesel	Turbo Intercooled	TD25998
8140.43S.4300 Euro 3	4cyl.	2798cc	92kW (125PS)	Diesel	Turbo Intercooled	TD25999
8140.43S.4320 Euro 3	4cyl.	2798cc	92kW (125PS)	Diesel	Turbo Intercooled	TD26000
8140.43S.4330 Euro 3	4cyl.	2798cc	92kW (125PS)	Diesel	Turbo Intercooled	TD26001
8140.43S.4400 Euro 3	4cyl.	2798cc	92kW (125PS)	Diesel	Turbo Intercooled	TD26002
8140.43S.4420 Euro 3	4cyl.	2798cc	92kW (125PS)	Diesel	Turbo Intercooled	TD26003
8140.43S.4430 Euro 3	4cyl.	2798cc	92kW (125PS)	Diesel	Turbo Intercooled	TD26004
8140.23.	4cyl.	2798cc	76kW (103PS)	Diesel	Turbo Intercooled	TD7229
8140.23.2585 Euro 2	4cyl.	2799cc	78kW (106PS)	Diesel	Turbo Intercooled	TD16183
8140.23.3700 Euro 2	4cyl.	2799cc	75-76kW (102-105PS)	Diesel	Turbo Intercooled	TD10387
8140.23.3701 Euro 2	4cyl.	2798cc	76kW (103PS)	Diesel	Turbo Intercooled	TD27373
8140.23.3710 Euro 2	4cyl.	2798cc	76kW (103PS)	Diesel	Turbo Intercooled	TD27374
8140.23.3711 Euro 2	4cyl.	2798cc	76kW (103PS)	Diesel	Turbo Intercooled	TD27375
8140.23.3713 Euro 2	4cyl.	2798cc	76kW (103PS)	Diesel	Turbo Intercooled	TD27376
8140.23.3720 Euro 2	4cyl.	2798cc	76kW (103PS)	Diesel	Turbo Intercooled	TD27377
8140.23.3721 Euro 2	4cyl.	2798cc	76kW (103PS)	Diesel	Turbo Intercooled	TD27378
8140.23.3730 Euro 2	4cyl.	2798cc	76kW (103PS)	Diesel	Turbo Intercooled	TD27379
8140.23.3731 Euro 2	4cyl.	2798cc	76kW (103PS)	Diesel	Turbo Intercooled	TD27380
8140.23.3750 Euro 2	4cyl.	2798cc	76kW (103PS)	Diesel	Turbo Intercooled	TD27381
8140.23.3751 Euro 2	4cyl.	2798cc	76kW (103PS)	Diesel	Turbo Intercooled	TD27382
8140.23.3760 Euro 2	4cyl.	2798cc	76kW (103PS)	Diesel	Turbo Intercooled	TD27383
8140.43.2585 Euro 2	4cyl.	2798cc	90-84kW (122-114PS)	Diesel	Turbo Intercooled	TD20423
8140.43.3700 Euro 2	4cyl.	2799cc	84kW (114PS)	Diesel	Turbo Intercooled	TD20424
8140.43.3711 Euro 2	4cyl.	2798cc	90kW (122PS)	Diesel	Turbo Intercooled	TD27427
8140.43.3713 Euro 2	4cyl.	2798cc	90kW (122PS)	Diesel	Turbo Intercooled	TD27428
8140.43.3718 Euro 2	4cyl.	2798cc	90kW (122PS)	Diesel	Turbo Intercooled	TD27429
8140.43.3721 Euro 2	4cyl.	2798cc	90kW (122PS)	Diesel	Turbo Intercooled	TD27430
8140.43.3723 Euro 2	4cyl.	2798cc	90kW (122PS)	Diesel	Turbo Intercooled	TD27431
8140.43.3728 Euro 2	4cyl.	2798cc	77-85kW (105-116PS)	Diesel	Turbo Intercooled	TD27432
8140.43.3900 Euro 2	4cyl.	2798cc	90-84kW (122-114PS)	Diesel	Turbo Intercooled	TD20425
8140.43.3911 Euro 2	4cyl.	2798cc	90kW (122PS)	Diesel	Turbo Intercooled	TD27434
8140.43.3921 Euro 2	4cyl.	2798cc	90kW (122PS)	Diesel	Turbo Intercooled	TD27435
8140.43.3931 Euro 2	4cyl.	2798cc	90kW (122PS)	Diesel	Turbo Intercooled	TD27436
8140.63. Euro 2	4cyl.	2798cc	62kW (84PS)	Diesel	Turbo Intercooled	TD10389
8140.63.4000 Euro 3	4cyl.	2798cc	63kW (86PS)	Diesel	Turbo Intercooled	TD20478

14-021321-00 D  
14-028930-00 D  
14-028931-00 D  
14-028932-00 D

94.40

B 97.54	C 167.00	D 100.90	E 5.00
B 97.50	C 167.00	D 100.90	E 5.00
B 97.58	C 167.00	D 100.90	E 5.00
B 97.70	C 167.00	D 100.90	E 5.00

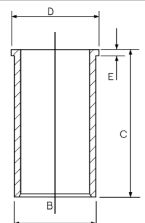



5

803 A.062 (8030.01)	3cyl.	2339cc		Diesel	FM570
804A (8040.01)	4cyl.	3119cc		Diesel	FM4009
806 A (8060.01/.11)	6cyl.	4678cc		Diesel	FM572
8025.01	2cyl.	1559cc		Diesel	FM569

14-010620-00 D	95.00	B 99.00	C 187.00
14-011061-00 D		B 99.10	C 187.00

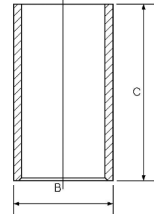

6

8025.02	2cyl.	1728cc		Diesel	FM573
8030.02	3cyl.	2592cc	46kW (63PS)	Diesel	FM574
8030.02	3cyl.	2592cc	46kW (63PS)	Diesel	TD6922
8035.02	3cyl.	2592cc	33-40kW (45-54PS)	Diesel	TD25194
8040.02	4cyl.	3455cc		Diesel	FM575
8045.02	4cyl.	3455cc	44-50kW (60-68PS)	Diesel	TD25195
8060.02.001	6cyl.	5184cc	90kW (122PS)	Diesel	TD10468
8060.02.003	6cyl.	5184cc	90kW (122PS)	Diesel	TD10469

14-021540-00 D	100.00	B 103.00	C 187.00	D 104.00	E 5.00
----------------	--------	----------	----------	----------	--------

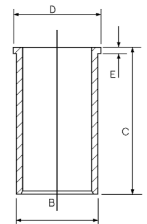

14-010170-00 D	100.00	B 103.00	C 187.00
14-011021-00 D		B 103.06	C 187.00
14-011022-00 D		B 103.10	C 187.00
14-013401-00 D		B 103.04	C 187.00

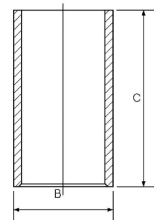

7

8035.06	3cyl.	2708cc	33-40kW (45-54PS)	Diesel	FM4008
8045.06	4cyl.	3613cc	44-73kW (60-99PS)	Diesel	FM8778
8035.06.200	3cyl.	2708cc	38kW (52PS)	Diesel	TD25535
8035.06.206	3cyl.	2708cc	38kW (52PS)	Diesel	TD25536
8035.06.208	3cyl.	2708cc	38-40kW (52-54PS)	Diesel	TD25537
8035.06.216	3cyl.	2708cc	38kW (52PS)	Diesel	TD25538
8035.06.220	3cyl.	2708cc	33kW (45PS)	Diesel	TD25539
8035.06.222	3cyl.	2708cc	33-38kW (45-52PS)	Diesel	TD25540
8035.06.223	3cyl.	2708cc	38kW (52PS)	Diesel	TD25541
8035.06.306	3cyl.	2708cc	38kW (52PS)	Diesel	TD25542
8035.06.307	3cyl.	2708cc	38kW (52PS)	Diesel	TD25543







8035.06.308	3cyl.	2708cc	38kW (52PS)	Diesel	TD25544
8035.06.309	3cyl.	2708cc	38kW (52PS)	Diesel	TD25545
8035.06.317	3cyl.	2708cc	38kW (52PS)	Diesel	TD25546
8035.06.320	3cyl.	2708cc	34kW (46PS)	Diesel	TD25547
8035.06.321	3cyl.	2708cc	34kW (46PS)	Diesel	TD25548
8035.06.322	3cyl.	2708cc	38kW (52PS)	Diesel	TD25549
8035.06.323	3cyl.	2708cc	33-38kW (45-52PS)	Diesel	TD25550
8045.06.200	4cyl.	3613cc	51kW (69PS)	Diesel	TD25521
8045.06.208	4cyl.	3613cc	51kW (69PS)	Diesel	TD25522
8045.06.213	4cyl.	3613cc	48-51kW (65-69PS)	Diesel	TD25523
8045.06.214	4cyl.	3613cc	73kW (99PS)	Diesel	TD25524
8045.06.215	4cyl.	3613cc	73kW (99PS)	Diesel	TD25525
8045.06.225	4cyl.	3613cc	48kW (65PS)	Diesel	TD25526
8045.06.319	4cyl.	3613cc	48kW (65PS)	Diesel	TD25527
8045.06.326	4cyl.	3613cc	48kW (65PS)	Diesel	TD25528

14-010780-00 D	100.00	B 103.02	C 196.00
14-010781-00 D		B 103.06	C 196.00
14-010782-00 D		B 103.10	C 196.00

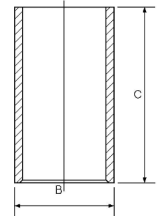

8

BF6L 913	6cyl.	6128cc	118-124kW (160-169PS)	Diesel	Turbo	TD10451
----------	-------	--------	-----------------------	--------	-------	---------

14-900060-00 DH ①	102.00	B 109.50	C 222.30	D 120.00	E 136.80
14-900100-00 DH		B 110.00	C 222.30	D 120.00	E 137.30

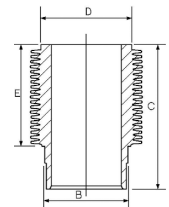

① Hone-Lapped      ① Hongeläppt      ① Rodée à la pierre      ① Lapeado buñido

9

BF4L 913 T	4cyl.	4086cc	64-78kW (87-106PS)	Diesel	Turbo	TD10402
BF6L 913 T	6cyl.	6128cc	96-112kW (131-152PS)	Diesel	Turbo	TD10425
F4L 913	4cyl.	4086cc	64kW (87PS)	Diesel		TD10414

14-900100-00 DH	102.00	B 110.00	C 222.30	D 120.00	E 137.30
-----------------	--------	----------	----------	----------	----------

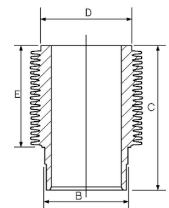



10

8060.04	6cyl.	5499cc	96kW (131PS)	Diesel	TD10457
8040.04.200	4cyl.	3666cc	63kW (86PS)	Diesel	TD10397
8060.04.055	6cyl.	5499cc	96kW (131PS)	Diesel	TD10420
8060.04.060	6cyl.	5499cc	96kW (131PS)	Diesel	TD10417
8060.04.070	6cyl.	5499cc	99kW (135PS)	Diesel	TD10413
8060.04.620	6cyl.	5499cc	99kW (135PS)	Diesel	TD10408
8060.04.621	6cyl.	5499cc	99kW (135PS)	Diesel	TD10409
8060.04.630	6cyl.	5499cc	99kW (135PS)	Diesel	TD10470
8060.04.639	6cyl.	5499cc	99kW (135PS)	Diesel	TD10463
8060.04.658	6cyl.	5499cc	99kW (135PS)	Diesel	TD10390
8060.04.660	6cyl.	5499cc	96-99kW (131-135PS)	Diesel	TD10421
8060.04.669	6cyl.	5499cc	99-102kW (135-139PS)	Diesel	TD10460
8060.04.670	6cyl.	5499cc	99kW (135PS)	Diesel	TD10449
8060.04.672	6cyl.	5499cc	73kW (99PS)	Diesel	TD10450
8060.04.675	6cyl.	5499cc	99kW (135PS)	Diesel	TD10464
8060.04.689	6cyl.	5499cc	99-102kW (135-139PS)	Diesel	TD10462
8060.24.601	6cyl.	5499cc	124kW (168PS)	Diesel Turbo	TD10472
8060.24.670	6cyl.	5499cc	118kW (160PS)	Diesel Turbo	TD10447
8060.24.671	6cyl.	5499cc	118kW (160PS)	Diesel Turbo	TD10448
8060.24.678	6cyl.	5499cc	123kW (167PS)	Diesel Turbo	TD10465
8062.24.070	6cyl.	5499cc	118kW (160PS)	Diesel Turbo	TD10458

- 14-023551-00 D
- 14-023552-00 D
- 14-023553-00 D

103.00

B 107.06	C 187.00	D 110.00	E 5.00
B 107.18	C 187.00	D 110.00	E 5.00
B 107.48	C 187.00	D 110.50	E 5.00

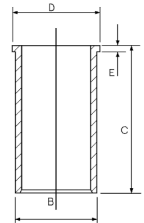

- 14-010180-00 D
- 14-010181-00 D
- 14-010182-00 D

103.00

B 107.00	C 187.00
B 107.06	C 187.00
B 107.10	C 187.00

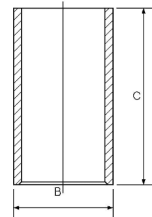

11

8041 L	4cyl.	3666cc	Diesel	FM13483
8045.04	4cyl.	3666cc	Diesel	FM3483
8055.04	5cyl.	4583cc	Diesel	FM3484
8061 L	6cyl.	5499cc	Diesel	FM23487
8065.04	6cyl.	5499cc	Diesel	FM14933

- 14-010180-00 D
- 14-010181-00 D
- 14-010182-00 D

103.00

B 107.00	C 187.00
B 107.06	C 187.00
B 107.10	C 187.00

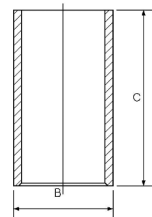

**12**

8040.25 B.4200	4cyl.	3908cc	75kW (102PS)	Diesel	Turbo	TD10403
8040.25X.4000	4cyl.	3908cc	85kW (116PS)	Diesel	Turbo	TD10404
8040.45D.5100 Euro 2	4cyl.	3908cc	100-85kW (136-116PS)	Diesel	Turbo Intercooled	TD20440
8040.45D.5101 Euro 2	4cyl.	3908cc	85kW (116PS)	Diesel	Turbo Intercooled	TD27295
8040.45D.5103 Euro 2	4cyl.	3908cc	85kW (116PS)	Diesel	Turbo Intercooled	TD27296
8040.45D.5105 Euro 2	4cyl.	3908cc	85kW (116PS)	Diesel	Turbo Intercooled	TD27297
8040.45X.4180	4cyl.	3908cc	100kW (136PS)	Diesel	Turbo Intercooled	TD20441
8060.05	6cyl.	5861cc	101kW (137PS)	Diesel		TD10424
8060.25V.4000 Euro 1	6cyl.	5868cc	130kW (177PS)	Diesel	Turbo Intercooled	TD10454
8060.25V.4080	6cyl.	5861cc	130kW (177PS)	Diesel	Turbo Intercooled	TD10476
8060.25V.4800	6cyl.	5861cc	130kW (177PS)	Diesel	Turbo Intercooled	TD10481
8060.25R.4210 Euro 1	6cyl.	5861cc	105kW (143PS)	Diesel	Turbo	TD27309
8060.25R.4220 Euro 1	6cyl.	5861cc	105kW (143PS)	Diesel	Turbo	TD27310
8060.25R.4225 Euro 1	6cyl.	5861cc	105kW (143PS)	Diesel	Turbo	TD27311
8060.25R.4230 Euro 1	6cyl.	5861cc	105kW (143PS)	Diesel	Turbo	TD27312
8060.25R.4240 Euro 1	6cyl.	5861cc	105kW (143PS)	Diesel	Turbo	TD27313
8060.25R.4250 Euro 1	6cyl.	5861cc	105kW (143PS)	Diesel	Turbo	TD27314
8060.25R.4280	6cyl.	5861cc	105kW (143PS)	Diesel	Turbo	TD10475
8060.25R.4285 Euro 1	6cyl.	5861cc	105kW (143PS)	Diesel	Turbo	TD27315
8060.25R.4290 Euro 1	6cyl.	5861cc	105kW (143PS)	Diesel	Turbo	TD27316
8060.25R.4295 Euro 1	6cyl.	5861cc	105kW (143PS)	Diesel	Turbo	TD27317
8060.25R.4360 Euro 1	6cyl.	5861cc	105kW (143PS)	Diesel	Turbo	TD27318
8060.25R.4362 Euro 1	6cyl.	5861cc	105kW (143PS)	Diesel	Turbo	TD27319
8060.25R.4750	6cyl.	5861cc	105kW (143PS)	Diesel	Turbo Intercooled	TD10907
8060.25R.4755	6cyl.	5861cc	105kW (143PS)	Diesel	Turbo	TD10908
8060.25R.4760	6cyl.	5861cc	105kW (143PS)	Diesel	Turbo Intercooled	TD10909
8060.25R.4764	6cyl.	5861cc	105kW (143PS)	Diesel	Turbo Intercooled	TD10910
8060.25R.4960 Euro 1	6cyl.	5861cc	105kW (143PS)	Diesel	Turbo	TD27321
8060.25R.4967 Euro 1	6cyl.	5861cc	105kW (143PS)	Diesel	Turbo	TD27322
8060.25R.4968 Euro 1	6cyl.	5861cc	105kW (143PS)	Diesel	Turbo	TD27323
8060.25R.4970 Euro 1	6cyl.	5861cc	105kW (143PS)	Diesel	Turbo	TD27324
8060.25R.4973 Euro 1	6cyl.	5861cc	105kW (143PS)	Diesel	Turbo	TD27325
8060.25R.4980 Euro 1	6cyl.	5861cc	105kW (143PS)	Diesel	Turbo	TD27326
8060.25R 4200 Euro 1	6cyl.	5861cc	105kW (143PS)	Diesel	Turbo	TD10479
8060.25R 4300	6cyl.	5861cc	105kW (143PS)	Diesel	Turbo Intercooled	TD20414
8060.45B.5101 Euro 2	6cyl.	5861cc	130kW (177PS)	Diesel	Turbo Intercooled	TD27121
8060.45B.5103 Euro 2	6cyl.	5861cc	130kW (177PS)	Diesel	Turbo Intercooled	TD27122
8060.45B.5105 Euro 2	6cyl.	5861cc	130kW (177PS)	Diesel	Turbo Intercooled	TD27123
8060.45B.5111 Euro 2	6cyl.	5861cc	130kW (177PS)	Diesel	Turbo Intercooled	TD27125
8060.45B.5112 Euro 2	6cyl.	5861cc	130kW (177PS)	Diesel	Turbo Intercooled	TD27126
8060.45B.5113 Euro 2	6cyl.	5861cc	130kW (177PS)	Diesel	Turbo Intercooled	TD27127
8060.45B.5120 Euro 2	6cyl.	5861cc	130kW (177PS)	Diesel	Turbo Intercooled	TD27128
8060.45B.5121 Euro 2	6cyl.	5861cc	130kW (177PS)	Diesel	Turbo Intercooled	TD27129
8060.45B.5123 Euro 2	6cyl.	5861cc	130kW (177PS)	Diesel	Turbo Intercooled	TD27130
8060.45B.5124 Euro 2	6cyl.	5861cc	130kW (177PS)	Diesel	Turbo Intercooled	TD27131





8060.45B.5145 Euro 2	6cyl.	5861cc	130kW (177PS)	Diesel	Turbo Intercooled	TD27132
8060.45B.5146 Euro 2	6cyl.	5861cc	130kW (177PS)	Diesel	Turbo Intercooled	TD27133
8060.45B.5150 Euro 2	6cyl.	5861cc	130kW (177PS)	Diesel	Turbo Intercooled	TD27134
8060.45B.5151 Euro 2	6cyl.	5861cc	130kW (177PS)	Diesel	Turbo Intercooled	TD27136
8060.45B.5185 Euro 2	6cyl.	5861cc	130kW (177PS)	Diesel	Turbo Intercooled	TD27139
8060.45B.5186 Euro 2	6cyl.	5861cc	130kW (177PS)	Diesel	Turbo Intercooled	TD27140
8060.45B 5100 Euro 2	6cyl.	5861cc	152-130kW (207-177PS)	Diesel	Turbo Intercooled	TD20415
8060.45K.6090 Euro 1	6cyl.	5861cc	167kW (227PS)	Diesel	Turbo Intercooled	TD20471
8060.45R.5000 Euro 2	6cyl.	5861cc	105kW (143PS)	Diesel	Turbo	TD16717
8060.45R.5001 Euro 2	6cyl.	5861cc	105kW (143PS)	Diesel	Turbo	TD16718
8060.45R.5003 Euro 2	6cyl.	5861cc	105kW (143PS)	Diesel	Turbo	TD16719
8060.45R.5050	6cyl.	5861cc	105kW (143PS)	Diesel	Turbo	TD10911
8060.45S.6000 Euro 1	6cyl.	5861cc	167kW (227PS)	Diesel	Turbo	TD10480
8060.45S.6800 Euro 1	6cyl.	5861cc	167kW (227PS)	Diesel	Turbo	TD10478
8060.45S.7200 Euro 2	6cyl.	5861cc	167kW (227PS)	Diesel	Turbo Intercooled	TD20472
8060.45S TCA	6cyl.	5861cc	167kW (227PS)	Diesel	Turbo Intercooled	TD10482
8061.05	6cyl.	5861cc	82kW (112PS)	Diesel		TD28429
8061.25	6cyl.	5868cc	114kW (155PS)	Diesel	Turbo	FM24133
8065.E	6cyl.	5861cc	82kW (112PS)	Diesel		TD28430
8040.05.200	4cyl.	3908cc	65kW (88PS)	Diesel		TD10399
8040.05.203	4cyl.	3908cc	65kW (88PS)	Diesel		TD16721
8040.05.230	4cyl.	3908cc	65kW (88PS)	Diesel		TD10398
8040.05.233	4cyl.	3908cc	65kW (88PS)	Diesel		TD16723
8040.05.235	4cyl.	3908cc	65kW (88PS)	Diesel		TD16724
8040.05.4990	4cyl.	3908cc	80kW (109PS)	Diesel	Turbo	TD16725
8040.25.000	4cyl.	3908cc	74-85kW (101-116PS)	Diesel	Turbo	TD21461
8040.25.200	4cyl.	3908cc	85kW (116PS)	Diesel	Turbo	TD10407
8040.25.220	4cyl.	3908cc	85kW (116PS)	Diesel	Turbo	TD10416
8040.25.230	4cyl.	3908cc	74kW (100PS)	Diesel	Turbo	TD7271
8040.45.400	4cyl.	3908cc	100kW (136PS)	Diesel	Turbo Intercooled	TD10405
8040.45.4180	4cyl.	3908cc	100kW (136PS)	Diesel	Turbo Intercooled	TD10406
8040.45.4380	4cyl.	3908cc	100kW (136PS)	Diesel	Turbo Intercooled	TD20438
8040.45.5200 Euro 2	4cyl.	3908cc	100kW (136PS)	Diesel	Turbo Intercooled	TD20439
8040.45.5201 Euro 2	4cyl.	3908cc	100kW (136PS)	Diesel	Turbo Intercooled	TD27290
8040.45.5203 Euro 2	4cyl.	3908cc	100kW (136PS)	Diesel	Turbo Intercooled	TD27291
8040.45.5280 Euro 2	4cyl.	3908cc	100kW (136PS)	Diesel	Turbo Intercooled	TD27293
8040.45.5281 Euro 2	4cyl.	3908cc	100kW (136PS)	Diesel	Turbo Intercooled	TD27294
8060.05.200	6cyl.	5868cc	99-102kW (135-139PS)	Diesel		TD10471
8060.05.246	6cyl.	5861cc	101kW (137PS)	Diesel		TD10391
8060.05.270	6cyl.	5861cc	101kW (137PS)	Diesel		TD10412
8060.05.280	6cyl.	5861cc	101kW (137PS)	Diesel		TD10423
8060.05.285	6cyl.	5861cc	101kW (137PS)	Diesel		TD10411
8060.05.289	6cyl.	5861cc	101kW (137PS)	Diesel		TD10461
8060.25.600	6cyl.	5868cc	130kW (177PS)	Diesel	Turbo	TD10473
8060.25.669	6cyl.	5861cc	125kW (170PS)	Diesel	Turbo	TD10459





8060.25.670	6cyl.	5861cc	125kW (170PS)	Diesel	Turbo	TD10453
8060.25.678	6cyl.	5861cc	130kW (177PS)	Diesel	Turbo	TD10466
8060.25.679	6cyl.	5861cc	130kW (177PS)	Diesel	Turbo	TD10467
8060.45.4100 Euro 1	6cyl.	5861cc	152kW (207PS)	Diesel	Turbo	TD10497
8060.45.4100 TCA Euro 1	6cyl.	5861cc	152kW (207PS)	Diesel	Turbo	TD10455
8060.45.4700	6cyl.	5861cc	152kW (207PS)	Diesel	Turbo	TD10913
8060.45.4702 Euro 1	6cyl.	5861cc	152kW (207PS)	Diesel	Turbo	TD10914
8060.45.4704 Euro 1	6cyl.	5861cc	152kW (207PS)	Diesel	Turbo	TD10915
8060.45.4706 Euro 1	6cyl.	5861cc	152kW (207PS)	Diesel	Turbo	TD10916
8060.45.4708	6cyl.	5861cc	152kW (207PS)	Diesel	Turbo	TD10917
8060.45.5200 Euro 2	6cyl.	5861cc	152kW (207PS)	Diesel	Turbo Intercooled	TD27106
8060.45.5201 Euro 2	6cyl.	5861cc	152kW (207PS)	Diesel	Turbo Intercooled	TD27107
8060.45.5203 Euro 2	6cyl.	5861cc	152kW (207PS)	Diesel	Turbo Intercooled	TD27108
8060.45.5205 Euro 2	6cyl.	5861cc	152kW (207PS)	Diesel	Turbo Intercooled	TD27109
8060.45.5220 Euro 2	6cyl.	5861cc	152kW (207PS)	Diesel	Turbo Intercooled	TD27112
8060.45.5221 Euro 2	6cyl.	5861cc	152kW (207PS)	Diesel	Turbo Intercooled	TD27113
8060.45.5223 Euro 2	6cyl.	5861cc	152kW (207PS)	Diesel	Turbo Intercooled	TD27114
8060.45.5232 Euro 2	6cyl.	5861cc	152kW (207PS)	Diesel	Turbo Intercooled	TD27115
8060.45.5233 Euro 2	6cyl.	5861cc	152kW (207PS)	Diesel	Turbo Intercooled	TD27116
8060.45.5234 Euro 2	6cyl.	5861cc	152kW (207PS)	Diesel	Turbo Intercooled	TD27117
8060.45.5235 Euro 2	6cyl.	5861cc	152kW (207PS)	Diesel	Turbo Intercooled	TD27118
8060.45.5250 Euro 2	6cyl.	5861cc	152kW (207PS)	Diesel	Turbo	TD10918
8060.45.5251	6cyl.	5861cc	152kW (207PS)	Diesel	Turbo	TD10919
8060.45.5255	6cyl.	5861cc	152kW (207PS)	Diesel	Turbo	TD10920

14-021361-00 D	104.00	B 107.02	C 198.00	D 110.87	E 5.00
14-021362-00 D		B 107.14	C 198.00	D 110.87	E 5.00
14-021363-00 D		B 107.44	C 198.00	D 110.87	E 5.00
14-021491-00 D		B 107.01	C 198.00	D 109.87	E 5.00
14-021492-00 D		B 107.05	C 198.00	D 109.87	E 5.00
14-021493-00 D		B 107.17	C 198.00	D 109.87	E 5.00
14-021494-00 D		B 107.47	C 198.00	D 109.87	E 5.00
14-024781-00 D		B 107.02	C 198.00	D 109.95	E 5.00

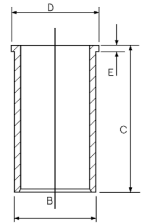

14-010940-00 D	104.00	B 107.00	C 198.00		
14-010941-10 D		B 107.10	C 198.00		
14-010943-10 D		B 107.52	C 198.00		

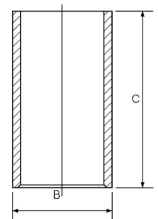



13

8035.05	3cyl.	2930cc		Diesel		FM4032
8045.05	4cyl.	3908cc	54-60kW (73-82PS)	Diesel		FM5567
8060.45 Euro 1	6cyl.	5861cc	152kW (207PS)	Diesel	Turbo Intercooled	TD27439
8060.45B Euro 2	6cyl.	5861cc	130kW (177PS)	Diesel	Turbo Intercooled	TD27442
8060.45B 5100 Euro 2	6cyl.	5861cc	152-130kW (207-177PS)	Diesel	Turbo Intercooled	FM29257
8060.45L.4400	6cyl.	5861cc		Diesel	Turbo	FM19257
8060.45M.7200	6cyl.	5861cc		Diesel	Turbo	FM59257
8060.45S.6203 Euro 1	6cyl.	5861cc	167kW (227PS)	Diesel	Turbo	FM89257
8060.45S.7200 Euro 2	6cyl.	5861cc	167kW (227PS)	Diesel	Turbo Intercooled	FM59257
8065.25	6cyl.	5863cc	94-110kW (128-150PS)	Diesel	Turbo	FM4018
8040.25.4990	4cyl.	3908cc	85kW (116PS)	Diesel	Turbo Intercooled	FM24132
8060.45.4300	6cyl.	5861cc	152kW (207PS)	Diesel	Turbo	FM19257
8060.45.4400	6cyl.	5861cc	152kW (207PS)	Diesel	Turbo	FM19257
8060.45.5200 Euro 2	6cyl.	5861cc	152kW (207PS)	Diesel	Turbo Intercooled	FM29257

14-021361-00 D	104.00	B 107.02	C 198.00	D 110.87	E 5.00
14-021362-00 D		B 107.14	C 198.00	D 110.87	E 5.00
14-021363-00 D		B 107.44	C 198.00	D 110.87	E 5.00
14-021491-00 D		B 107.01	C 198.00	D 109.87	E 5.00
14-021492-00 D		B 107.05	C 198.00	D 109.87	E 5.00
14-021493-00 D		B 107.17	C 198.00	D 109.87	E 5.00
14-021494-00 D		B 107.47	C 198.00	D 109.87	E 5.00
14-024781-00 D		B 107.02	C 198.00	D 109.95	E 5.00

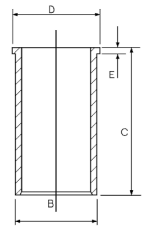

14-010940-00 D	104.00	B 107.00	C 198.00
14-010941-10 D		B 107.10	C 198.00
14-010943-10 D		B 107.52	C 198.00

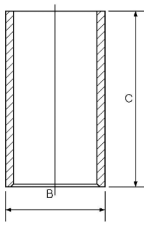

14

CO2	4cyl.	4397cc		Diesel		FM21303
CO3 D	4cyl.	4397cc		Diesel		FM21303
CO55	4cyl.	4397cc		Diesel		FM21303
CO2 D	4cyl.	4397cc		Diesel		FM1303

14-630100-00 WH	108.00	B 116.00	C 243.00	D 128.00	E 150.00	F 1.00
-----------------	--------	----------	----------	----------	----------	--------

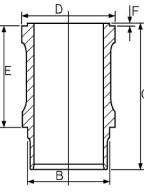



15

CN3	3cyl.	3706cc		Diesel	FM4028
C20	4cyl.	4562cc		Diesel	FM1307
C 21	4cyl.	4562cc		Diesel	FM1307
C41	4cyl.	4562cc		Diesel	FM1307
CO3	4cyl.	4562cc		Diesel	FM1307
CO40	4cyl.	4562cc		Diesel	FM1307
C03	4cyl.	4941cc		Diesel	FM4029
C70	4cyl.	4941cc		Diesel	FM4029
C100	4cyl.	4941cc		Diesel	FM4029
CP 3	6cyl.	7412cc	107kW (146PS)	Diesel	TD6861

14-611250-00 WH  
14-615230-00 WH

110.00

B 118.00 C 237.00 D 129.50 E 170.00 F 1.00  
B 118.00 C 236.00 D 129.50 E 170.00 F 1.00

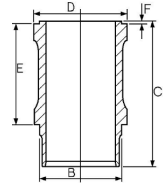

16

8360.46	6cyl.	7685cc	196kW (266PS)	Diesel Turbo	TD27452
8360.46R.416 (TCA)	6cyl.	7685cc	176kW (239PS)	Diesel Turbo Intercooled	TD10511

14-740060-00 WH

112.00

B 120.50 C 232.00 D 128.90 E 87.00

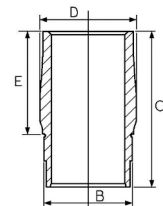

17

F2BE 0681 A Euro 2	6cyl.	7790cc	259kW (352PS)	Diesel Turbo Intercooled	TD10828
F2BE 0681 B Euro 2	6cyl.	7790cc	228kW (310PS)	Diesel Turbo Intercooled	TD10829
F2BE 0681 C Euro 2	6cyl.	7790cc	200kW (272PS)	Diesel Turbo Intercooled	TD10832
F2BE 0681 D Euro 2	6cyl.	7790cc	180kW (245PS)	Diesel Turbo Intercooled	TD10833
F2BE0681DB Euro 2	6cyl.	7790cc	180kW (245PS)	Diesel Turbo Intercooled	TD28229
F2BE 0681 E Euro 2	6cyl.	7790cc	218kW (296PS)	Diesel Turbo Intercooled	TD10830
F2BE 0681 F Euro 2	6cyl.	7790cc	200kW (272PS)	Diesel Turbo Intercooled	TD10831
F2BE1682 G Euro 3	6cyl.	7790cc	259-228kW (352-310PS)	Diesel Turbo Intercooled	TD20019

14-260070-00 WH

115.00

B 128.50 C 211.10 D 136.50 E 8.90 F 1.20

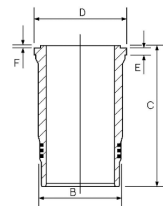





18

8360.04	6cyl.	6855cc	106kW (145PS)	Diesel	FM3523
8340.04.040	4cyl.	4570cc	73kW (99PS)	Diesel	TD10400
8340.04.200	4cyl.	4570cc	74kW (100PS)	Diesel	TD10392
8340.04.250	4cyl.	4570cc	74kW (100PS)	Diesel	TD10393
8340.04.300	4cyl.	4570cc	74kW (100PS)	Diesel	TD10394
8340.04.350	4cyl.	4570cc	74kW (100PS)	Diesel	TD10395
8340.04.362	B4cyl.	4570cc	74kW (100PS)	Diesel	TD10396

14-610020-00 WH <sup>1</sup> 115.00 B 122.00 C 215.00 D 129.70 E 147.00

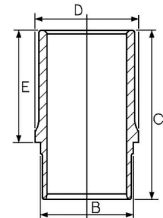

<sup>1</sup> Liner with "anti-cavitation" galvanized exterior.

<sup>1</sup> Laufbüchse mit "hohlraumfreiem", verzinktem Äußerem.

<sup>1</sup> Chemise à extérieur galvanisé "anti-cavitation".

<sup>1</sup> Camisa con exterior galvanizado "anticavitación".

19

8340.05.200	4cyl.	5401cc	84kW (114PS)	Diesel	TD10410
8360.05.200	6cyl.	8100cc	124kW (168PS)	Diesel	TD10484
8360.05.254	6cyl.	8100cc	124kW (168PS)	Diesel	TD10488
8360.05.673	6cyl.	8100cc	118-121kW (160-165PS)	Diesel	TD10494
8361.05	6cyl.	8102cc	118kW (160PS)	Diesel	FM4952
8365.25.500	6cyl.	8102cc	132kW (180PS)	Diesel Turbo	TD18678
8365.25.501	6cyl.	8102cc	118kW (160PS)	Diesel Turbo	TD18679
8365.25.502	6cyl.	8102cc	118-133kW (160-181PS)	Diesel Turbo	TD18680
8365.25.503	6cyl.	8102cc	118kW (160PS)	Diesel Turbo	TD18681
8365.25.533	6cyl.	8102cc	133kW (181PS)	Diesel Turbo	TD18682

14-633860-00 WH 115.00 B 122.00 C 235.00 D 129.90 E 167.00  
14-684840-00 WH B 122.00 C 235.00 D 129.70 E 167.00

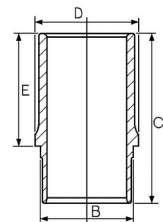

20

8460.21B.613	6cyl.	9500cc	162kW (220PS)	Diesel	FM19114
8460.21B.615	6cyl.	9500cc	162kW (220PS)	Diesel	FM19114
8460.41C	6cyl.	9500cc	221kW (300PS)	Diesel Turbo	TD10807
8460.41C (TCA)	6cyl.	9500cc	221kW (300PS)	Diesel Turbo Intercooled	TD10595
8460.41C.320	6cyl.	9500cc	221kW (300PS)	Diesel Turbo	TD10512
8460.41K Euro 2	6cyl.	9500cc	254kW (345PS)	Diesel Turbo	TD10808
8460.41K. TCA Euro 1	6cyl.	9500cc	254kW (345PS)	Diesel Turbo	TD7342
8460.41K.406	6cyl.	9500cc	254kW (345PS)	Diesel Turbo	TD10513
8460.41K.410	6cyl.	9500cc	254kW (345PS)	Diesel Turbo	TD10709
8460.41L (TCA)	6cyl.	9500cc	276kW (375PS)	Diesel Turbo	TD10573
8460.41L.5020	6cyl.	9500cc	276kW (375PS)	Diesel Turbo	TD10514







8460.41 M	6cyl.	9500cc	278kW (378PS)	Diesel	Turbo Intercooled	TD7250
8460.41 R	6cyl.	9500cc	214-276kW (290-375PS)	Diesel	Turbo Intercooled	TD7248
8460.41 S	6cyl.	9500cc	254kW (345PS)	Diesel		TD7249
8460.41 T	6cyl.	9500cc	185kW (252PS)	Diesel		TD24262
8460.21.002	6cyl.	9500cc	177kW (240PS)	Diesel	Turbo	TD10502
8460.21.010	6cyl.	9500cc	177kW (240PS)	Diesel	Turbo	TD10503
8460.21.042	6cyl.	9500cc	177kW (240PS)	Diesel	Turbo	FM4130
8460.21.102	6cyl.	9500cc	191kW (260PS)	Diesel	Turbo	TD10521
8460.21.106	6cyl.	9500cc	177kW (240PS)	Diesel	Turbo	FM4130
8460.21.202	6cyl.	9500cc	177kW (240PS)	Diesel	Turbo	TD10518
8460.21.206	6cyl.	9500cc	177kW (240PS)	Diesel	Turbo	TD10519
8460.21.601	6cyl.	9498cc	191kW (260PS)	Diesel	Turbo	TD20435
8460.21.611	6cyl.	9498cc	154kW (210PS)	Diesel	Turbo	TD20436
8460.21.708	6cyl.	9500cc	177kW (240PS)	Diesel	Turbo	FM4130
8460.21.710	6cyl.	9500cc	177kW (240PS)	Diesel	Turbo	FM4130
8460.41.102	6cyl.	9500cc	234kW (318PS)	Diesel	Turbo Intercooled	TD10548
8460.41.124	6cyl.	9500cc	234kW (318PS)	Diesel	Turbo Intercooled	TD10599
8460.41.160	6cyl.	9500cc	236kW (321PS)	Diesel	Turbo Intercooled	TD10547

14-450880-00 WH 1      120.00      B 134.00      C 250.00      D 144.80      E 10.02      F 1.00

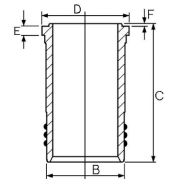

1 Nitrided      1 Nitriert      1 Nitruré      1 Nitrurado

**21**

8200.02	6cyl.	9820cc		Diesel		FM9108
8200.12	6cyl.	9820cc		Diesel		FM9109
8205.02	6cyl.	9820cc		Diesel		FM8845

14-020200-00 D 1      122.00      B 128.00      C 252.00      D 132.00      E 6.00

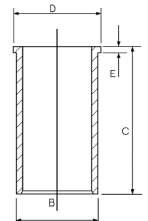

1 Nitrided      1 Nitriert      1 Nitruré      1 Nitrurado

**22**

8200.03	6cyl.	10308cc		Diesel		FM595
8200.13	6cyl.	10308cc		Diesel		FM9110

14-021580-00 DH 1      125.00      B 130.02      C 252.00      D 136.00      E 6.00

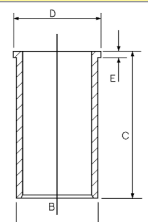

1 Nitrided      1 Nitriert      1 Nitruré      1 Nitrurado



23

8220.12	6cyl.	9572cc	148kW (201PS)	Diesel		FM4020
8220.32	6cyl.	9572cc	177kW (240PS)	Diesel	Turbo	FM9115
8220.02.870	6cyl.	9572cc	148kW (201PS)	Diesel		TD10517
8220.22.002	6cyl.	9572cc	177kW (240PS)	Diesel	Turbo	TD10495
8220.22.102	6cyl.	9572cc	177kW (240PS)	Diesel	Turbo	TD10496

14-459010-00 WH ①②  
14-610010-00 WH ②

125.00

B 133.50 C 241.00 D 145.00 E 164.00  
B 133.50 C 241.00 D 145.00 E 164.00

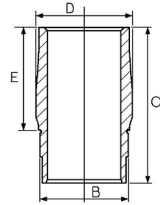

① "Anti-cavitation" galvanized exterior

① "Hohlraumfreier" Außenverzinkung

① Galvanisage extérieur "anti-cavitation"

① Exterior galvanizado "anticavitación"

② Nitrided

② Nitriert

② Nitruré

② Nitrado

24

F6L 413 F	V6cyl.	9570cc	141kW (192PS)	Diesel		TD10483
F8L 413 F	V8cyl.	12763cc	162-212kW (220-288PS)	Diesel		TD10522
F10L 413 F	V10cyl.	15953cc	235kW (320PS)	Diesel	Turbo	TD10527

14-900030-00 DH ①  
14-900050-00 DH ②

125.00

B 139.00 C 250.80 D 154.00 E 169.50  
B 139.00 C 250.76 D 150.00 E 169.50

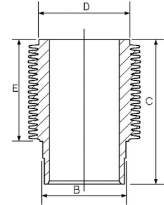

① Hone-Lapped

① Hongeläppt

① Rodée à la pierre

① Lapeado buñido

② Phosphated

② Phosphatiert

② Phosphatisé

② Fosfatada

25

F3AE 0681 B Euro 3	6cyl.	10300cc	294kW (400PS)	Diesel	Turbo Intercooled	TD16551
F3AE 0681 D Euro 2	6cyl.	10300cc	316kW (430PS)	Diesel	Turbo Intercooled	TD14970
F3AE 0681 E Euro 2	6cyl.	10300cc	287kW (390PS)	Diesel	Turbo Intercooled	TD14968
F3AE0681H Euro 3	6cyl.	10300cc	294kW (400PS)	Diesel	Turbo Intercooled	TD24541
F3AE3681D Euro 4/5	6cyl.	10300cc	310kW (422PS)	Diesel	Turbo Intercooled	TD24603

15-260040-00 WH ①

125.00

B 141.00 C 239.00 D 150.60 E 9.96 F 1.20

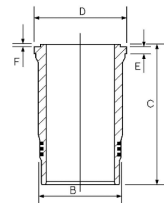

① Includes seals

① Schließt Dichtungen ein

① Inclut des joints

① Incluye los sellos



26

203 A/61	6cyl.	11548cc	130kW (177PS)	Diesel	TD7375
203 H 61	6cyl.	11548cc	132kW (180PS)	Diesel	TD7348
310 H/61	6cyl.	11548cc		Diesel	FM3512

14-018002-00 *D*      130.00      B 136.10      C 282.00

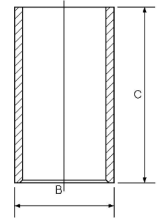

27

F3B3681B Euro 4/5	6cyl.	12880cc	368kW (500PS)	Diesel	Turbo Intercooled	TD20480
F3BE 0681 A Euro 3	6cyl.	12880cc	397kW (540PS)	Diesel	Turbo Intercooled	TD16505
F3BE 0681 B Euro 3	6cyl.	12880cc	368kW (500PS)	Diesel	Turbo Intercooled	TD16550
F3BE 0681 C Euro 3	6cyl.	12880cc	324kW (440PS)	Diesel	Turbo Intercooled	TD16507
F3BE 0681 D Euro 3	6cyl.	12880cc	330kW (449PS)	Diesel	Turbo Intercooled	TD20620
F3BE 0681 E Euro 3	6cyl.	12880cc	353kW (480PS)	Diesel	Turbo Intercooled	TD16506
F3BE 0681 F Euro 3	6cyl.	12880cc	367kW (499PS)	Diesel	Turbo Intercooled	TD20622
F3BE 0681 G Euro 3	6cyl.	12880cc	280kW (381PS)	Diesel	Turbo Intercooled	TD16591
F3BE3681A Euro 4/5	6cyl.	12880cc	412kW (560PS)	Diesel	Turbo Intercooled	TD20645

15-260050-00 *WH*       135.00      B 151.00      C 254.00      D 161.60      E 9.96      F 1.20

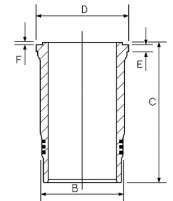

Includes seals

Schließt Dichtungen ein

Inclut des joints

Incluye los sellos

28

8210.02	6cyl.	13798cc	191kW (260PS)	Diesel	TD10598
8210.22X.069	6cyl.	13798cc	224kW (305PS)	Diesel Turbo	TD11329
8210.22X.235	6cyl.	13798cc	224kW (305PS)	Diesel Turbo	TD11407
8210.22X.523	6cyl.	13798cc	224kW (305PS)	Diesel Turbo	TD11408
8210.22X.575	6cyl.	13798cc	224kW (305PS)	Diesel Turbo	TD11330
8210.42	6cyl.	13798cc	346kW (471PS)	Diesel Turbo Intercooled	TD10564
8210.42K Euro 1	6cyl.	13798cc	272kW (370PS)	Diesel Turbo	TD7377
8210.42K Euro 1	6cyl.	13798cc	272kW (370PS)	Diesel Turbo Intercooled	TD10809
8210.42L Euro 2	6cyl.	13790cc	309kW (420PS)	Diesel Turbo	TD7378
8210.42L Euro 2	6cyl.	13798cc	309kW (420PS)	Diesel Turbo	TD10812
8210.42L.400 Euro 1	6cyl.	13798cc	309kW (420PS)	Diesel Turbo	TD10515
8210.42M (TCA) Euro 2	6cyl.	13798cc	345kW (470PS)	Diesel Turbo Intercooled	TD10576
8212.00	6cyl.	13800cc		Diesel	FM8846
8215.00	6cyl.	13800cc		Diesel	FM18846
8217.00	6cyl.	13798cc		Diesel	FM28846
8260.01	6cyl.	12800cc		Diesel	FM8847
8210.02.067	6cyl.	13798cc	191kW (260PS)	Diesel	TD10523





8210.02.069	6cyl.	13798cc	191kW (260PS)	Diesel		TD10525
8210.02.371	6cyl.	13798cc	191kW (260PS)	Diesel		TD10507
8210.02.373	6cyl.	13798cc	191kW (260PS)	Diesel		TD10508
8210.02.377	6cyl.	13798cc	191kW (260PS)	Diesel		TD10509
8210.02.393	6cyl.	13798cc	191kW (260PS)	Diesel		TD10510
8210.02.440	6cyl.	13798cc	191kW (260PS)	Diesel		TD10491
8210.02.441	6cyl.	13798cc	191kW (260PS)	Diesel		TD10492
8210.02.731	B6cyl.	13798cc	191kW (260PS)	Diesel		TD10524
8210.22.105	6cyl.	13798cc	243kW (330PS)	Diesel	Turbo	TD10550
8210.22.171	6cyl.	13798cc	224kW (305PS)	Diesel	Turbo	TD10530
8210.22.175	6cyl.	13798cc	224kW (305PS)	Diesel	Turbo	TD10528
8210.22.183	6cyl.	13798cc	224kW (305PS)	Diesel	Turbo	TD10579
8210.22.210	6cyl.	13798cc	224kW (305PS)	Diesel	Turbo	TD11387
8210.22.236	6cyl.	13798cc	224kW (305PS)	Diesel	Turbo	TD11388
8210.22.269	6cyl.	13798cc	224kW (305PS)	Diesel	Turbo	TD10584
8210.22.317	6cyl.	13798cc	224kW (305PS)	Diesel	Turbo	TD10531
8210.22.327	6cyl.	13798cc	224kW (305PS)	Diesel	Turbo	TD10585
8210.22.385	6cyl.	13798cc	224kW (305PS)	Diesel	Turbo	TD10586
8210.22.511	6cyl.	13798cc	224kW (305PS)	Diesel	Turbo	TD11389
8210.22.521	6cyl.	13798cc	224kW (305PS)	Diesel	Turbo	TD11390
8210.22.523	6cyl.	13798cc	224kW (305PS)	Diesel	Turbo	TD11391
8210.22.525	6cyl.	13798cc	224kW (305PS)	Diesel	Turbo	TD11392
8210.22.535	6cyl.	13798cc	224kW (305PS)	Diesel	Turbo	TD11393
8210.22.537	6cyl.	13798cc	224kW (305PS)	Diesel	Turbo	TD11394
8210.22.569	6cyl.	13798cc	224kW (305PS)	Diesel	Turbo	TD10529
8210.22.800	6cyl.	13798cc		Diesel		FM5053
8210.22.869	6cyl.	13798cc	235kW (320PS)	Diesel	Turbo	TD10549
8210.42.101	6cyl.	13798cc	265kW (360PS)	Diesel	Turbo Intercooled	TD10563
8210.42.115	6cyl.	13798cc	265kW (360PS)	Diesel	Turbo Intercooled	TD10582
8210.42.151	6cyl.	13798cc	277kW (377PS)	Diesel	Turbo Intercooled	TD10552
8210.42.152	6cyl.	13798cc	277kW (377PS)	Diesel	Turbo Intercooled	TD10555
8210.42.154	6cyl.	13798cc	277kW (377PS)	Diesel	Turbo Intercooled	TD10556
8210.42.155	6cyl.	13798cc	277kW (377PS)	Diesel	Turbo Intercooled	TD10580
8210.42.161	6cyl.	13798cc	277kW (377PS)	Diesel	Turbo Intercooled	TD10553
8210.42.162	6cyl.	13798cc	277kW (377PS)	Diesel	Turbo Intercooled	TD10557
8210.42.165	6cyl.	13798cc	277kW (377PS)	Diesel	Turbo Intercooled	TD10588
8210.42.171	6cyl.	13798cc	277kW (377PS)	Diesel	Turbo Intercooled	TD10554
8210.42.172	6cyl.	13798cc	277kW (377PS)	Diesel	Turbo Intercooled	TD10581
8210.42.175	6cyl.	13798cc	277kW (377PS)	Diesel	Turbo Intercooled	TD10590
8210.42.181	6cyl.	13798cc	277kW (377PS)	Diesel	Turbo Intercooled	TD10558
8210.42.182	6cyl.	13798cc	277kW (377PS)	Diesel	Turbo Intercooled	TD10559
8210.42.185	6cyl.	13798cc	277kW (377PS)	Diesel	Turbo Intercooled	TD10591
8210.42.186	6cyl.	13798cc	277kW (377PS)	Diesel	Turbo Intercooled	TD10592
8210.42.191	6cyl.	13798cc	277kW (377PS)	Diesel	Turbo Intercooled	TD10560
8210.42.195	6cyl.	13798cc	277kW (377PS)	Diesel	Turbo Intercooled	TD10593





8210.42.500 Euro 2	6cyl.	13798cc	346kW (471PS)	Diesel	Turbo Intercooled	TD18332
8211.02	6cyl.	13798cc		Diesel		FM10601
14-021230-00 DH ①	137.00	B 143.02	C 282.00	D 147.00	E 6.00	
14-021231-00 DH ①		B 143.07	C 282.00	D 147.00	E 6.00	
14-021232-00 DH ①		B 143.27	C 282.00	D 147.00	E 6.00	
14-021560-10 DH		B 143.00	C 282.00	D 147.00	E 6.06	
14-021561-10 DH		B 143.05	C 282.00	D 147.00	E 6.06	
14-021562-10 DH		B 143.25	C 282.00	D 147.00	E 6.06	
14-021563-10 DH		B 143.50	C 282.00	D 147.00	E 6.06	
14-021590-00 DH ①		B 143.04	C 282.00	D 149.00	E 6.04	

① Nitrided

① Nitriert

① Nitruré

① Nitrurado

29

8260.02	6cyl.	12880cc		Diesel		FM4023
8280.01	V8cyl.	17174cc		Diesel		FM603
8261.02.002	6cyl.	12880cc	165kW (224PS)	Diesel		TD20430
8280.02.109	V8cyl.	17174cc	259kW (352PS)	Diesel		TD10551
8280.02.265	V8cyl.	17174cc		Diesel		FM4026
8280.02.269	V8cyl.	17174cc	259kW (352PS)	Diesel		TD20431
8280.02.273	V8cyl.	17174cc		Diesel		FM4026
8280.02.279	V8cyl.	17174cc		Diesel		FM4026
8280.02.410	V8cyl.	17174cc		Diesel		FM4026
8280.02.412	V8cyl.	17174cc		Diesel		FM4026
8280.22.	V8cyl.	17174cc	280kW (381PS)	Diesel	Turbo	TD10565
8280.22.007	V8cyl.	17174cc	280kW (381PS)	Diesel	Turbo	TD10566
8280.22.009	V8cyl.	17200cc	280kW (381PS)	Diesel	Turbo	TD10583
8280.22.033	V8cyl.	17174cc	280kW (381PS)	Diesel	Turbo	TD10594
8280.22.054	V8cyl.	17174cc	280kW (381PS)	Diesel	Turbo	TD10567
8280.22.201	V8cyl.	17174cc	309kW (420PS)	Diesel	Turbo Intercooled	TD10569
8280.22.205	V8cyl.	17174cc	309kW (420PS)	Diesel	Turbo Intercooled	TD10570
8280.42.001	V8cyl.	17174cc	350kW (476PS)	Diesel	Turbo Intercooled	TD10572

14-260080-00 WH ③  
15-260080-00 WH ①③

145.00

B 158.50 C 262.00 D 174.00 E 10.06 F 0.94  
B 158.50 C 262.00 D 174.00 E 10.06 F 0.94

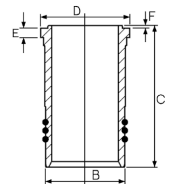

15-680070-00 WH ②③

B 158.50 C 262.00 D 174.00 E 10.06 F 0.94

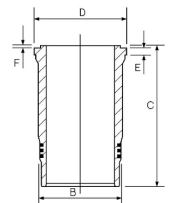

① Contains 3 seals of 3.00mm

① Enthält drei 3,00mm Dichtungen

① Contient 3 joints de 3 mm

① Contiene 3 retenes de 3.00mm

② Contains 1 O-ring 6mm, 2 seals 3mm

② Enthält einen 6,00mm O-Ring, und zwei 3,00 mm Dichtungen

② Contient 1 joint torique de 6mm et 2 joints de 3mm

② Contiene una junta tórica de 6mm, y 2 retenes de 3mm

③ Nitrided

③ Nitriert

③ Nitruré

③ Nitrurado



30

8280.42S (TCA)	V8cyl.	17173cc	378kW (514PS)	Diesel	Turbo Intercooled	TD10577
8280.42S.342 Euro 2	V8cyl.	17174cc	378kW (514PS)	Diesel	Turbo Intercooled	TD20432
8280.42S.350 Euro 2	V8cyl.	17174cc	375kW (510PS)	Diesel	Turbo Intercooled	TD10516
8280.42S.352 Euro 2	V8cyl.	17174cc	378kW (514PS)	Diesel	Turbo Intercooled	TD20433
8280.42S.362 Euro 2	V8cyl.	17174cc	378kW (514PS)	Diesel	Turbo Intercooled	TD20434
8280.42.050	V8cyl.	17174cc	350kW (476PS)	Diesel	Turbo Intercooled	TD10571

15-680070-00 WH ①②

145.00

B 158.50

C 262.00

D 174.00

E 10.06

F 0.94

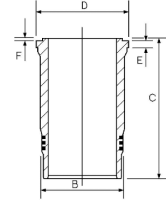

① Contains 1 O-ring 6mm, 2 seals 3mm

① Enthält einen 6,00mm O-Ring, und zwei 3,00 mm Dichtungen

① Contient 1 joint torique de 6mm et 2 joints de 3mm

① Contiene una junta tórica de 6mm, y 2 retenes de 3mm

② Nitrided

② Nitriert

② Nitruré

② Nitrurado

Modelverzeichnis • Index de modele • Índice de Modelo  
Indeks modelu • Модель автомобиля • دليل المركبة

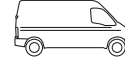

# MODEL INDEX



CCM

x



05/75→12/92	<b>XJ 5.3</b>	V 12 (75-79), V 12 (90-93)	Petrol	5343	V12	<b>2</b>
01/86→05/88	<b>XJSC 5.3</b>	V 12 (90-93)	Petrol	5343	V12	<b>2</b>
10/05→12/09	<b>X-Type 2.2</b>	LJ46G	Diesel	2198	4	<b>1</b>



**1**

**LJ46G** 4cyl. **2198cc** **107-114kW** (146-155PS) **Diesel** **Turbo Intercooled** **TD24454**

**QJBA** 4cyl. **2198cc** **114kW** (155PS) **Diesel** **Turbo Intercooled** **TD24400**

**14-021120-00 D** **86.00** **B 89.00** **C 156.00** **D 90.90** **E 5.00**

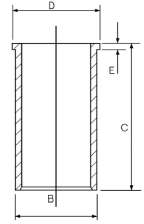

**2**

**V 12 (75-79)** V12cyl. **5343cc** **211kW** (287PS) **TD1731**

**V 12 (90-93)** V12cyl. **5343cc** **197kW** (268PS) **TD4583**

**14-710010-00 WH** **90.00** **B 98.01** **C 144.53** **D 109.22** **E 44.40**

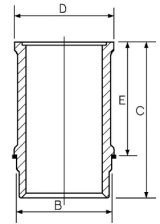



Modelverzeichnis • Index de modele • Índice de Modelo  
Indeks modelu • Модель автомобиля • دليل المركبة



# MODEL INDEX



CCM

x



01/83→12/87	<b>CJ5 - CJ8 2.0</b>	J5R-800	Petrol	1995	4	<b>2</b>
01/83→12/87	<b>CJ5 - CJ8 2.1</b>	J8S-800	Diesel	2068	4	<b>1</b>
01/85→	<b>CJ-7</b>	829, J6R, ZEJ	Petrol	1995	4	<b>2</b>
01/85→	<b>CJ-7 Laredo</b>	829, J6R, ZEJ	Petrol	1995	4	<b>2</b>
01/86→09/90	<b>Comanche 2.1</b>	J8S-814	Diesel	2068	4	<b>1</b>



1

J8S-800	4cyl.	2068cc	44kW (60PS)	Diesel		TD1750
J8S-814	4cyl.	2068cc	63-65kW (86-88PS)	Diesel	Turbo Intercooled	TD1745
J8S-890	4cyl.	2068cc	65kW (88PS)	Diesel	Turbo	TD1749

14-000320-00 WH 1      86.00      B 93.60      C 166.00      D 93.05

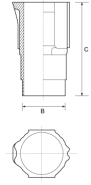

1 Phosphated

1 Phosphatiert

1 Phosphatisé

1 Fosfatada

2

829	4cyl.	1995cc				FM319
J5R-800	4cyl.	1995cc	61-63kW (85-86PS)			TD1747
J6R	4cyl.	1995cc				FM319
ZEJ	4cyl.	1995cc				FM319

14-637160-00 WH      88.00      B 93.60      C 140.50      D 104.00      E 93.08

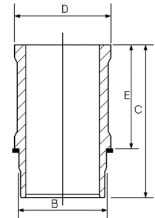



1

3164DL03	3cyl.	2696cc		Diesel	FM5568
4219 DL 01	4cyl.	3588cc	50kW (68PS)	Diesel	TD19035
4219 DL 03	4cyl.	3588cc	50kW (68PS)	Diesel	TD19033
6329 DL 03	6cyl.	5395cc	63kW (86PS)	Diesel	TD19034

14-452740-00 WH	102.00	B 111.00	C 197.00	D 125.00	E 6.045	F 0.815
-----------------	--------	----------	----------	----------	---------	---------

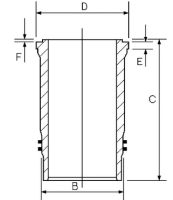

2

6068 D	6cyl.	6788cc	97kW (132PS)	Diesel	FM18849
6068 T	6cyl.	6788cc	130kW (177PS)	Diesel	FM18849

14-450660-00 WH	106.50	B 120.00	C 219.00	D 125.90	E 6.05	F 0.80
-----------------	--------	----------	----------	----------	--------	--------

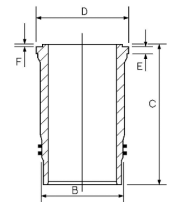

3

4045 D	4cyl.	4525cc	55-63kW (75-85PS)	Diesel Turbo	FM18848
4045 T	4cyl.	4525cc	89kW (121PS)	Diesel Turbo	FM18848

14-450660-00 WH	106.50	B 120.00	C 219.00	D 125.90	E 6.05	F 0.80
-----------------	--------	----------	----------	----------	--------	--------

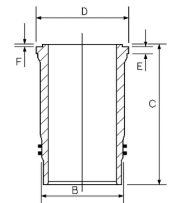

4

300 T	6cyl.	5878cc	130kW (177PS)	Diesel Turbo Intercooled	FM23185
3179 T	3cyl.	2938cc	59kW (80PS)	Diesel Turbo	FM13180
3239DL	3cyl.	2983cc		Diesel	FM6423
4039T	4cyl.	3918cc	82kW (111PS)	Diesel Turbo	FM13182
4239 A	4cyl.	3918cc	87kW (118PS)	Diesel Turbo Intercooled	FM18779
4239 DL	4cyl.	3918cc		Diesel	FM8779
4239 T	4cyl.	3918cc		Diesel Turbo	FM8780
4276	4cyl.	4524cc		Diesel	FM8848
6059.T	6cyl.	5878cc	123kW (167PS)	Diesel Turbo	TD19032
6359A	6cyl.	5876cc	131kW (178PS)	Diesel Turbo Intercooled	FM28781





<b>6359DL</b>	6cyl.	<b>5876cc</b>	<b>Diesel</b>				<b>FM8781</b>
<b>6414</b>	6cyl.	<b>6800cc</b>	<b>Diesel</b>				<b>FM8849</b>

14-450710-00 *WH*      106.50      B 115.697      C 196.00      D 126.00      E 6.86      F 0.815

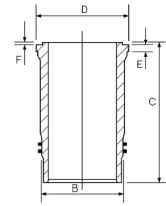



1

53212 V8cyl. 10857cc 155kW (211PS) Diesel FM16424

54112 V8cyl. 10857cc 155kW (211PS) Diesel FM6424

14-458500-00 WH 120.00 B 134.00 C 224.00 D 146.00 E 10.30 F 1.30

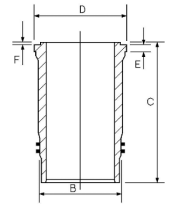

1 Phosphated

1 Phosphatiert

1 Phosphatisé

1 Fosfatada



**1**

4D105-1	4cyl.	3980cc		Diesel					FM9659
4D105-2	4cyl.	3980cc		Diesel					FM9666
6D105-1	6cyl.	6490cc		Diesel					FM3529
6D105-2	6cyl.	6490cc		Diesel					FM9512
S6D105	6cyl.	6490cc		Diesel	Turbo				FM9670
S6D105-3	6cyl.	6490cc		Diesel	Turbo				FM9670

14-693800-00 *WH*      105.00      B 114.90      C 223.00      D 127.10      E 10.10      F 0.90

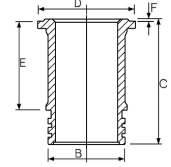

Modelverzeichnis • Index de modele • Índice de Modelo  
Indeks modelu • Модель автомобиля • دليل المركبة



# MODEL INDEX



CCM

x



03/81→06/86	<b>A 112 0.9</b>	A112 A.000, A112 A5.000	Petrol	903	4	<b>1</b>
03/81→06/86	<b>A 112 0.9</b>	A112 B2.000	Petrol	896	4	<b>1</b>
12/39→12/52	<b>Ardea 1.0</b>	A112 A.000	Petrol	903	4	<b>1</b>
12/81→12/84	<b>Beta 2.0</b>	828 B4.000	Petrol	1995	4	<b>7</b>
05/81→09/84	<b>Beta H.P.E. 2.0</b>	828 B4.000	Petrol	1995	4	<b>7</b>
09/89→07/99	<b>Dedra 1.8</b>	835 A2.000, 835 A2.046, 836 A5.000	Petrol	1756	4	<b>7</b>
04/89→07/99	<b>Dedra 1.9</b>	160 D1.000, 835 A4.000, 835 A4.046	Diesel	1929	4	<b>6</b>
09/89→07/99	<b>Dedra 2.0</b>	835 A5.046, 835 A7.000, 835 A7.046, 836 A3.000	Petrol	1995	4	<b>7</b>
08/86→08/92	<b>Delta I 1.6</b>	149 C2.000, 831 B7.000	Petrol	1585	4	<b>7</b>
10/86→12/89	<b>Delta I 1.9</b>	831 D1.000	Diesel	1929	4	<b>6</b>
11/86→01/94	<b>Delta I 2.0</b>	831 B5.000, 831 C5.000, 831 C5.046, 831 D5.000, 831 E5.000, 831 E5.046	Petrol	1995	4	<b>7</b>
06/93→08/99	<b>Delta II 1.8</b>	835 C2.000, 835 C4.000, 836 A6.000, 836 C4.000	Petrol	1756	4	<b>7</b>
10/94→08/99	<b>Delta II 1.9</b>	160 D1.000, 835 A4.000	Diesel	1929	4	<b>6</b>
06/93→08/99	<b>Delta II 2.0</b>	175 A4.000, 836 A2.000, 836 A3.000	Petrol	1995	4	<b>7</b>
02/95→10/01	<b>Kappa 2.0</b>	838 A4.000	Petrol	1995	4	<b>7</b>
08/94→10/01	<b>Kappa 2.4</b>	838 A3.000, 838 A7.000, 838 A8.000	Diesel	2387	5	<b>5</b>
07/99→10/05	<b>Lybra 1.9</b>	937 A2.000, AR 32302, AR 37101	Diesel	1910	4	<b>5</b>
07/99→10/05	<b>Lybra 2.4</b>	839 A5.000, 839 A6.000, 841 C.000, AR 32501	Diesel	2387	5	<b>5</b>
10/04→	<b>Musa 1.3</b>	188 A9.000, 199 A3.000	Diesel	1248	4	<b>2</b>
10/04→	<b>Musa 1.9</b>	188 B2.000	Diesel	1910	4	<b>5</b>
05/86→12/89	<b>Prisma 1.6</b>	149 C2.000, 831 B7.000	Petrol	1585	4	<b>7</b>
01/83→02/92	<b>Prisma 1.9</b>	831 D.000, 831 D1.000	Diesel	1929	4	<b>6</b>
04/86→12/89	<b>Prisma 2.0</b>	831 B4.000	Petrol	1995	4	<b>7</b>
11/84→07/94	<b>Thema 2.0</b>	834 B.000, 834 B.048, 834 B.146, 834 B1.000, 834 B2.246, 834 C.000, 834 C.146, 834 C1.000, 834 F1.000, 834 F2.000	Petrol	1995	4	<b>7</b>
11/84→09/90	<b>Thema 2.4</b>	8144.91	Diesel	2445	4	<b>9</b>
05/88→07/92	<b>Thema 2.5</b>	8144. 97S	Diesel	2500	4	<b>8</b>
06/88→07/94	<b>Thema 2.5</b>	8144.97, 8144.97 Y	Diesel	2499	4	<b>8</b>
07/02→07/09	<b>Thesis 2.4</b>	841 C.000, 841 M.000, 841 N.000	Diesel	2387	5	<b>5</b>
05/03→07/09	<b>Thesis 2.4</b>	841 G.000	Diesel	2387	5	<b>5</b>
05/80→01/87	<b>Trevi 2.0</b>	828 B4.000	Petrol	1995	4	<b>7</b>
11/95→09/03	<b>Y 1.1</b>	176 B2.000	Petrol	1108	4	<b>3</b>
03/96→09/03	<b>Y 1.2</b>	188 A4.000, 188 A5.000	Petrol	1242	4	<b>4</b>
03/85→02/92	<b>Y10 1.0</b>	156 A 2.000, 156 A 2.100, 156 A2.246	Petrol	999	4	<b>3</b>
07/89→12/95	<b>Y10 1.1</b>	156 C.000, 156 C.046, 176 B2.000	Petrol	1108	4	<b>3</b>
10/03→12/11	<b>Ypsilon 1.2</b>	188 A4.000, 188 A5.000	Petrol	1242	4	<b>4</b>
10/03→12/11	<b>Ypsilon 1.3</b>	188 A9.000, 199 A3.000	Diesel	1248	4	<b>2</b>

# ENGINE INDEX

Motorverzeichnis • Index de moteur • Índice de Motor  
Indeks silnika • Модель двигателя • دليل المحرك



CCM



9

Engine Model	Fuel Type	CCM	x	Valve Train	9
149 C2.000	Petrol	1585	4	84.00	7
156 A 2.000	Petrol	999	4	70.00	3
156 A 2.100	Petrol	999	4	70.00	3
156 A2.246	Petrol	999	4	70.00	3
156 C.000	Petrol	1108	4	70.00	3
156 C.046	Petrol	1108	4	70.00	3
160 D1.000	Diesel	1929	4	82.60	6
175 A4.000	Petrol	1995	4	84.00	7
176 B2.000	Petrol	1108	4	70.00	3
188 A4.000	Petrol	1242	4	70.80	4
188 A5.000	Petrol	1242	4	70.80	4
188 A9.000	Diesel	1248	4	69.60	2
188 B2.000	Diesel	1910	4	82.00	5
199 A3.000	Diesel	1248	4	69.60	2
8144. 97S	Diesel	2500	4	93.00	8
8144.91	Diesel	2445	4	93.00	8
8144.97	Diesel	2499	4	93.00	8
8144.97 Y	Diesel	2499	4	93.00	8
8144.97.2200	Diesel	2499	4	93.00	8
8144.97.2400	Diesel	2499	4	93.00	9
828 B4.000	Petrol	1995	4	84.00	7
831 B4.000	Petrol	1995	4	84.00	7
831 B5.000	Petrol	1995	4	84.00	7
831 B7.000	Petrol	1585	4	84.00	7
831 C5.000	Petrol	1995	4	84.00	7
831 C5.046	Petrol	1995	4	84.00	7
831 D.000	Diesel	1929	4	82.60	6
831 D1.000	Diesel	1929	4	82.60	6
831 D5.000	Petrol	1995	4	84.00	7
831 E5.000	Petrol	1995	4	84.00	7
831 E5.046	Petrol	1995	4	84.00	7
834 B.000	Petrol	1995	4	84.00	7
834 B.048	Petrol	1995	4	84.00	7
834 B.146	Petrol	1995	4	84.00	7
834 B1.000	Petrol	1995	4	84.00	7
834 B2.246	Petrol	1995	4	84.00	7
834 C.000	Petrol	1995	4	84.00	7
834 C.146	Petrol	1995	4	84.00	7
834 C1.000	Petrol	1995	4	84.00	7
834 F1.000	Petrol	1995	4	84.00	7
834 F2.000	Petrol	1995	4	84.00	7
835 A2.000	Petrol	1756	4	84.00	7
835 A2.046	Petrol	1756	4	84.00	7
835 A4.000	Diesel	1929	4	82.60	6
835 A4.046	Diesel	1929	4	82.60	6
835 A5.046	Petrol	1995	4	84.00	7
835 A7.000	Petrol	1995	4	84.00	7
835 A7.046	Petrol	1995	4	84.00	7
835 C2.000	Petrol	1756	4	84.00	7
835 C4.000	Petrol	1756	4	84.00	7
836 A2.000	Petrol	1995	4	84.00	7
836 A3.000	Petrol	1995	4	84.00	7
836 A5.000	Petrol	1756	4	84.00	7
836 A6.000	Petrol	1756	4	84.00	7
836 C4.000	Petrol	1756	4	84.00	7
838 A3.000	Diesel	2387	5	82.00	5
838 A4.000	Petrol	1995	4	84.00	7
838 A7.000	Diesel	2387	5	82.00	5
838 A8.000	Diesel	2387	5	82.00	5
839 A5.000	Diesel	2387	5	82.00	5



Motorverzeichnis • Index de moteur • Índice de Motor  
Indeks silnika • Модель двигателя • دليل المحرك

# ENGINE INDEX



CCM

x



9

		CCM	x		
839 A6.000	Diesel	2387	5	82.00	5
841 C.000	Diesel	2387	5	82.00	5
841 G.000	Diesel	2387	5	82.00	5
841 M.000	Diesel	2387	5	82.00	5
841 N.000	Diesel	2387	5	82.00	5
937 A2.000	Diesel	1910	4	82.00	5
937 A5.000	Diesel	1910	4	82.00	5
A112 A.000	Petrol	903	4	65.00	1
A112 A5.000	Petrol	903	4	65.00	1
A112 B2.000	Petrol	896	4	65.00	1
AR 32302	Diesel	1910	4	82.00	5
AR 32501	Diesel	2387	5	82.00	5
AR 37101	Diesel	1910	4	82.00	5



						<b>1</b>
A112 A.000	4cyl.	903cc	29-32kW (40-44PS)			TD1856
A112 A5.000	4cyl.	903cc	29-31kW (40-42PS)			TD1803
A112 B2.000	4cyl.	896cc	29-32kW (40-44PS)			TD4622
14-011001-00 D	65.00	B 68.04	C 115.00			

						<b>2</b>
188 A9.000	4cyl.	1248cc	51kW (69PS)	Diesel	Turbo Intercooled	TD18314
199 A3.000	4cyl.	1248cc	66kW (89PS)	Diesel	Turbo Intercooled	TD20273
14-022060-00 D	69.60	B 72.50	C 142.00	D 74.00	E 5.00	

						<b>3</b>
156 A 2.000	4cyl.	999cc	33kW (45PS)			TD4592
156 A 2.100	4cyl.	999cc	32kW (44PS)			TD4593
156 A2.246	4cyl.	999cc	32kW (44PS)			TD5423
156 C.000	4cyl.	1108cc	42kW (57PS)			TD1854
156 C.046	4cyl.	1108cc	40-37kW (54-50PS)			TD4597
176 B2.000 Euro 2	4cyl.	1108cc	40-55kW (54-75PS)			TD11847
14-010991-00 D	70.00	B 73.02	C 116.00			

						<b>4</b>
188 A4.000 Euro 3	4cyl.	1242cc	44kW (60PS)			TD15501
188 A5.000 Euro 3	4cyl.	1242cc	59kW (80PS)			TD15500
14-021080-00 D	70.80	B 73.80	C 128.00	D 75.00	E 5.00	



5

188 B2.000	4cyl.	1910cc	74kW (100PS)	Diesel	Turbo Intercooled	TD18316
838 A3.000	5cyl.	2387cc	91kW (124PS)	Diesel	Turbo Intercooled	TD4618
838 A7.000	5cyl.	2387cc	91kW (124PS)	Diesel	Turbo Intercooled	TD5437
838 A8.000 Euro 2	5cyl.	2387cc	100kW (136PS)	Diesel	Turbo Intercooled	TD11551
839 A5.000	5cyl.	2387cc	99-96kW (135-131PS)	Diesel	Turbo Intercooled	TD17399
839 A6.000 Euro 3	5cyl.	2387cc	103kW (140PS)	Diesel	Turbo Intercooled	TD15631
841 G.000	5cyl.	2387cc	129kW (175PS)	Diesel	Turbo Intercooled	TD18317
841 C.000 Euro 3	5cyl.	2387cc	110kW (150PS)	Diesel	Turbo Intercooled	TD16472
841 M.000	5cyl.	2387cc	120kW (163PS)	Diesel	Turbo Intercooled	TD19057
841 N.000	5cyl.	2387cc	120kW (163PS)	Diesel	Turbo Intercooled	TD19058
937 A2.000 Euro 3	4cyl.	1910cc	85kW (116PS)	Diesel	Turbo Intercooled	TD18313
937 A5.000	4cyl.	1910cc	110kW (150PS)	Diesel	Turbo Intercooled	TD21086
AR 32302	4cyl.	1910cc	77kW (105PS)	Diesel	Turbo Intercooled	TD17398
AR 32501	5cyl.	2387cc	100-99kW (136-135PS)	Diesel	Turbo Intercooled	TD17400
AR 37101	4cyl.	1910cc	85-80kW (116-109PS)	Diesel	Turbo Intercooled	TD17890

14-021051-00 D  
14-028960-00 D

82.00

B 85.57 C 155.00 D 88.53 E 4.00  
B 85.00 C 155.00 D 88.00 E 4.50

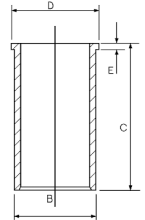

6

160 D1.000	4cyl.	1929cc	66kW (89PS)	Diesel	Turbo Intercooled	TD4610
831 D.000	4cyl.	1929cc	62kW (84PS)	Diesel	Turbo	TD1813
831 D1.000	4cyl.	1929cc	62kW (84PS)	Diesel	Turbo Intercooled	TD4607
835 A4.000	4cyl.	1929cc	68kW (92PS)	Diesel	Turbo	TD1846
835 A4.046	4cyl.	1929cc	68kW (92PS)	Diesel	Turbo	TD5425

14-021311-00 D  
14-023560-00 D  
14-023751-00 D

82.60

B 86.06 C 154.00 D 89.00 E 4.50  
B 86.00 C 154.00 D 89.00 E 4.50  
B 87.00 C 154.00 D 89.00 E 4.55

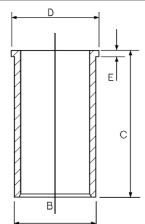

14-014730-00 D

82.60

B 86.09 C 154.00

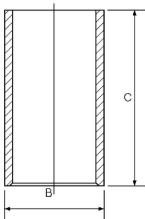



7

149 C2.000	4cyl.	1585cc	66kW (89PS)		TD5432
175 A4.000	4cyl.	1995cc	137kW (186PS)	Turbo Intercooled	TD11827
828 B4.000	4cyl.	1995cc	90kW (122PS)		TD4602
831 B4.000	4cyl.	1995cc	85kW (116PS)		TD1812
831 B5.000	4cyl.	1995cc	121kW (165PS)	Turbo Intercooled	TD1823
831 B7.000	4cyl.	1585cc	80kW (109PS)		TD1817
831 C5.000	4cyl.	1995cc	133kW (181PS)	Turbo Intercooled	TD1821
831 C5.046	4cyl.	1995cc	130kW (177PS)	Turbo Intercooled	TD1822
831 D5.000	4cyl.	1995cc	136kW (185PS)	Turbo	TD1825
831 E5.000	4cyl.	1995cc	137kW (186PS)	Turbo Intercooled	TD1827
831 E5.046	4cyl.	1995cc	137kW (186PS)	Turbo Intercooled	TD1826
834 B.000	4cyl.	1995cc	77kW (105PS)		TD1833
834 B.048	4cyl.	1995cc	88kW (120PS)		TD1829
834 B.146	4cyl.	1995cc	88kW (120PS)		TD1818
834 B1.000	4cyl.	1995cc	88kW (120PS)		TD1830
834 B2.246	4cyl.	1995cc	110kW (150PS)	Turbo	TD1832
834 C.000	4cyl.	1995cc	121kW (165PS)	Turbo Intercooled	TD1834
834 C.146	4cyl.	1995cc	121kW (165PS)	Turbo Intercooled	TD1837
834 C1.000	4cyl.	1995cc	136kW (185PS)	Turbo Intercooled	TD1835
834 F1.000	4cyl.	1995cc	102kW (139PS)		TD1831
834 F2.000	4cyl.	1995cc	136kW (185PS)	Turbo Intercooled	TD1840
835 A2.000	4cyl.	1756cc	79kW (107PS)		TD1845
835 A2.046	4cyl.	1756cc	79kW (107PS)		TD1844
835 A5.046	4cyl.	1995cc	83kW (113PS)		TD1848
835 A7.000	4cyl.	1995cc	130kW (177PS)	Turbo Intercooled	TD1849
835 A7.046	4cyl.	1995cc	130kW (177PS)	Turbo Intercooled	TD1850
835 C2.000	4cyl.	1756cc	76kW (103PS)		TD4612
835 C4.000	4cyl.	1756cc	76kW (103PS)		TD5433
836 A2.000	4cyl.	1995cc	137kW (186PS)	Turbo Intercooled	TD5435
836 A3.000	4cyl.	1995cc	102kW (139PS)		TD4614
836 A5.000	4cyl.	1756cc	76kW (103PS)		TD4615
836 A6.000	4cyl.	1756cc	76kW (103PS)		TD11918
836 C4.000	4cyl.	1756cc	76kW (103PS)		TD5434
838 A4.000	4cyl.	1995cc	150kW (204PS)	Turbo Intercooled	TD4619

14-011041-00 D

84.00

B 88.06

C 152.00

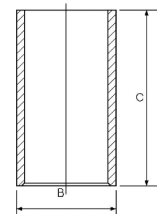



8

8144.97S	4cyl.	2500cc	77kW (105PS)	Diesel	Turbo	TD1785
8144.97	4cyl.	2499cc	85kW (116PS)	Diesel	Turbo Intercooled	TD4601
8144.97 Y	4cyl.	2499cc	85kW (116PS)	Diesel	Turbo Intercooled	TD1786
8144.97.2200	4cyl.	2499cc	87-85kW (118-116PS)	Diesel	Turbo Intercooled	TD19036

14-021371-00 D	93.00	B 96.01	C 171.00	D 98.92	E 5.00
14-021372-00 D		B 96.05	C 171.00	D 98.92	E 5.00
14-021373-00 D		B 96.17	C 171.00	D 98.92	E 5.00
14-021480-00 DH 1		B 97.035	C 171.00	D 100.00	E 5.00

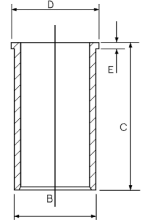

1 Nitrided

1 Nitriert

1 Nitruré

1 Nitrurado

9

8144.91	4cyl.	2445cc	76kW (103PS)	Diesel	Turbo Intercooled	TD4600
8144.97.2400	4cyl.	2499cc	83-87kW (113-118PS)	Diesel	Turbo Intercooled	TD22318

14-022560-00 D	93.00	B 96.00	C 167.30	D 98.90	E 5.00
14-028930-00 D		B 97.50	C 167.00	D 100.90	E 5.00
14-028931-00 D		B 97.58	C 167.00	D 100.90	E 5.00
14-028932-00 D		B 97.70	C 167.00	D 100.90	E 5.00

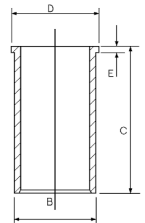

# MODEL INDEX



Modelverzeichnis • Index de modele • Índice de Modelo  
Indeks modelu • Модель автомобиля • دليل الموديل



CCM

x



9

01/57→12/85	<b>88 Series II</b>	2 1/4L	Petrol	2286	4	<b>3</b>
01/58→12/85	<b>88 Series II</b>	2.3L	Diesel	2286	4	<b>3</b>
01/58→12/85	<b>88 Series III</b>	2 1/4L	Petrol	2286	4	<b>3</b>
01/58→12/85	<b>88 Series III</b>	2.3L	Diesel	2286	4	<b>3</b>
01/58→12/85	<b>88 Series IIA</b>	2 1/4L	Petrol	2286	4	<b>3</b>
01/58→12/85	<b>88 Series IIA</b>	2.3L	Diesel	2286	4	<b>3</b>
09/61→12/86	<b>88/109 2.3</b>	10 H, 11H	Petrol	2286	4	<b>3</b>
09/63→12/86	<b>88/109 2.3</b>	10 J	Diesel	2286	4	<b>3</b>
01/84→12/85	<b>90</b>	2 1/4L	Petrol	2286	4	<b>3</b>
01/58→12/85	<b>90 Series II</b>	2.3L	Diesel	2286	4	<b>3</b>
01/58→12/85	<b>90 Series III</b>	2.3L	Diesel	2286	4	<b>3</b>
01/58→12/85	<b>90 Series IIA</b>	2.3L	Diesel	2286	4	<b>3</b>
01/84→08/87	<b>90/110 2.3</b>	10 H	Petrol	2286	4	<b>3</b>
06/84→08/87	<b>90/110 2.3</b>	10 J	Diesel	2286	4	<b>3</b>
09/83→07/90	<b>90/110 2.5</b>	12J, 19J	Diesel	2495	4	<b>3</b>
09/85→07/90	<b>90/110 2.5</b>	17H	Petrol	2495	4	<b>3</b>
01/57→12/85	<b>109 Series II</b>	2 1/4L	Petrol	2286	4	<b>3</b>
01/58→12/85	<b>109 Series III</b>	2 1/4L	Petrol	2286	4	<b>3</b>
01/71→12/84	<b>109 Series III</b>	2.3L	Diesel	2286	4	<b>3</b>
01/58→12/85	<b>109 Series IIA</b>	2 1/4L	Petrol	2286	4	<b>3</b>
09/61→12/71	<b>109 Series IIA</b>	2.3L	Diesel	2286	4	<b>3</b>
01/83→08/86	<b>110</b>	2 1/4L	Petrol	2286	4	<b>3</b>
01/07→	<b>Defender 2.4</b>	244DT	Diesel	2402	4	<b>2</b>
09/90→12/94	<b>Defender 2.5</b>	17H	Petrol	2495	4	<b>3</b>
09/90→	<b>Defender 2.5</b>	11 L (200Tdi), 12J	Diesel	2495	4	<b>3</b>
10/89→10/98	<b>Discovery I 2.5</b>	12 L (200Tdi), 21 L (200Tdi)	Diesel	2495	4	<b>3</b>
09/93→10/98	<b>Discovery I 3.9</b>	35 D, 36 D	Petrol	3950	V8	<b>5</b>
09/99→12/02	<b>Discovery II 4.6</b>	46 D	Petrol	4553	V8	<b>5</b>
02/98→10/06	<b>Freelander 1.8</b>	18 K4F	Petrol	1796	4	<b>1</b>
11/00→10/06	<b>Freelander 2.5</b>	25 K4F	Petrol	2497	V6	<b>1</b>
11/88→07/94	<b>Range Rover I 3.9</b>	35 D, 36 D, 37 D, 38 D	Petrol	3950	V8	<b>5</b>
09/92→07/94	<b>Range Rover I 4.3</b>	40 D	Petrol	4275	V8	<b>5</b>
07/94→03/02	<b>Range Rover II 3.9</b>	42 D	Petrol	3950	V8	<b>5</b>
06/98→03/02	<b>Range Rover II 4.0</b>	42 D	Petrol	3950	V8	<b>5</b>
07/94→03/02	<b>Range Rover II 4.6</b>	46 D	Petrol	4553	V8	<b>5</b>
09/94→	<b>Range Rover V8 4.0</b>	V8	Petrol	3950	V8	<b>5</b>
09/94→	<b>Range Rover V8 HSE 4.6</b>	V8	Petrol	3950	V8	<b>5</b>
09/94→	<b>Range Rover V8 SE 4.0</b>	V8	Petrol	3950	V8	<b>5</b>
01/87→12/89	<b>Range Rover Vogue TD</b>	VM 492 HT	Diesel	2393	4	<b>4</b>



1

18 K4F 4cyl. 1796cc 85-88kW (116-120PS) TD20740

25 K4F V6cyl. 2497cc 130-129kW (177-175PS) TD19716

14-710020-00 WH 80.00 B 84.10 C 129.50 D 87.50 E 50.05

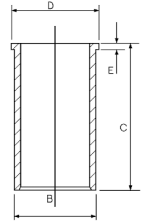

2

244DT 4cyl. 2402cc 90kW (122PS) Diesel Turbo Intercooled TD24907

14-020540-00 DH 89.90 B 92.50 C 165.00 D 95.50 E 3.00

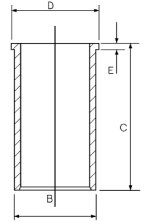

3

2 1/4L 4cyl. 2286cc 51-52kW (69-71PS) FM944

2.3L 4cyl. 2286cc Diesel FM945

10 H 4cyl. 2286cc 52kW (71PS) TD25821

10 J 4cyl. 2286cc 46-51kW (63-69PS) Diesel TD25822

11H 4cyl. 2286cc 51-52kW (69-71PS) TD25824

11 L (200TDI) 4cyl. 2495cc 83-79kW (113-107PS) Diesel Turbo Intercooled TD20407

12J 4cyl. 2495cc 51kW (69PS) Diesel Turbo TD24370

12 L (200TDI) 4cyl. 2495cc 83kW (113PS) Diesel Turbo Intercooled TD20408

17H 4cyl. 2495cc 61kW (82PS) TD19656

19J 4cyl. 2495cc 63kW (86PS) Diesel Turbo TD24369

21 L (200TDI) 4cyl. 2495cc 83kW (113PS) Diesel Turbo Intercooled TD20410

14-024710-00 D 90.47 B 94.52 C 191.36 D 99.70 E 4.76

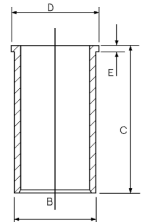

14-010920-00 D 90.47 B 94.50 C 191.36

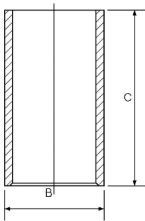



4

VM 492 HT 4cyl. 2393cc Diesel Turbo FM4047

14-676420-00 WH 92.00 B 101.50 C 166.80 D 110.00 E 8.90 F 1.20

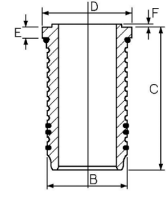

5

35 D	V8cyl.	3950cc	134kW (182PS)	TD22930
36 D	V8cyl.	3950cc	134kW (182PS)	TD22929
37 D	V8cyl.	3950cc	127kW (173PS)	TD22937
38 D	V8cyl.	3950cc	127kW (173PS)	TD22938
40 D	V8cyl.	4275cc	149kW (203PS)	TD22935
42 D	V8cyl.	3950cc	140kW (190PS)	TD22932
46 D	V8cyl.	4553cc	165kW (224PS)	TD22931
V8	V8cyl.	3950cc		FM6884

14-010860-00 D 94.00 B 97.77 C 136.75

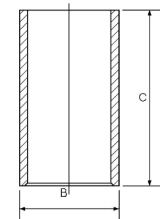



Modelverzeichnis • Index de modele • Índice de Modelo  
Indeks modelu • Модель автомобиля • دليل المركبة

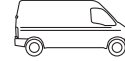

# MODEL INDEX



CCM

x



10/94→03/96	<b>200 1.9</b>	XUD9	Diesel	1905	4	<b>1</b>
04/89→10/96	<b>400 2.5</b>	EN 55	Diesel	2498	4	<b>3</b>
04/89→10/98	<b>400 2.5</b>	ET 70	Diesel	2496	4	<b>3</b>
04/96→04/09	<b>Convoy 2.5</b>	EN 55	Diesel	2498	4	<b>3</b>
04/96→04/09	<b>Convoy 2.5</b>	ET 70	Diesel	2496	4	<b>3</b>
02/05→12/09	<b>Maxus 2.5</b>	VM39C, VM40C	Diesel	2499	4	<b>2</b>
04/96→10/05	<b>Pilot 1.9</b>	XUD9	Diesel	1905	4	<b>1</b>



1

**XUD9** 4cyl. **1905cc** **47-48kW (64-65PS)** **Diesel** **TD26905**

**14-020530-00 D** **83.00** **B 85.60** **C 153.50** **D 88.50** **E 3.90**

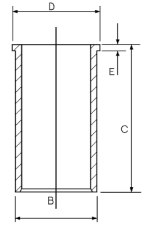

2

**VM39C** 4cyl. **2499cc** **70-88kW (95-120PS)** **Diesel** **TD26107**

**VM40C** 4cyl. **2499cc** **70kW (95PS)** **Diesel** **TD26108**

**14-260090-00 WH** **92.00** **B 101.50** **C 167.80** **D 110.00** **E 6.90** **F 1.00**

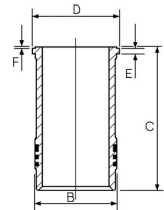

3

**EN 55** 4cyl. **2498cc** **53-56kW (72-76PS)** **Diesel** **TD22927**

**ET 70** 4cyl. **2496cc** **71-74kW (96-101PS)** **Diesel Turbo Intercooled** **TD22928**

**14-020660-00 D** **94.00** **B 97.00** **C 170.60** **D 99.50** **E 4.00**  
**14-021520-00 D** **B 98.00** **C 170.60** **D 100.00** **E 6.00**  
**14-027270-00 D** **B 98.70** **C 170.00** **D 100.00** **E 5.00**

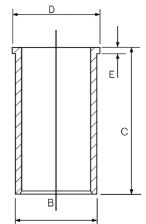

Motorverzeichnis • Index de moteur • Índice de Motor  
Indeks silnika • Модель двигателя • دليل المحرك

# ENGINE INDEX



CCM

x



9

12J	Diesel	2494	4	90.47	3
22 UA	Diesel	2178	4	82.55	1
4.212	Diesel	3470	4	98.48	6
4/98 DT	Diesel	3770	4	98.00	5
4/98 NT	Diesel	3770	4	98.00	5
4/98 NV	Diesel	3771	4	98.00	5
4/98 TT	Diesel	3770	4	98.00	5
4/98 TV	Diesel	3770	4	98.00	5
57J	Diesel	5655	6	100.00	8
57JC	Diesel	5655	6	100.00	8
57VD	Diesel	5655	6	100.00	8
6.354.2	Diesel	5800	6	98.48	7
6.354.4	Diesel	5800	6	98.48	7
6/98 DT	Diesel	5650	6	98.00	5
6/98 DV	Diesel	5655	6	98.00	5
6/98 E	Diesel	5650	6	98.00	5
6/98 NT	Diesel	5650	6	98.00	5
6/98 NV	Diesel	5655	6	98.00	5
6/98 TV	Diesel	5650	6	98.00	5
AD 3.152	Diesel	2500	3	91.49	4
KT 191	Diesel	11627	6	130.00	9
OEJ	Diesel	5655	6	100.00	8
XUD9	Diesel	1905	4	83.00	2
XUD9A	Diesel	1905	4	83.00	2
XUD9B	Diesel	1905	4	83.00	2

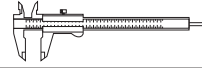

1

22 UA	4cyl.	2178cc	Diesel			FM101
14-021130-00 <i>D</i>	82.55	B 86.59	C 193.68	D 89.61	E 4.70	

2

XUD9	4cyl.	1905cc	Diesel			FM3219
XUD9A	4cyl.	1905cc	Diesel			FM3219
XUD9B	4cyl.	1905cc	Diesel			FM3219
14-020530-00 <i>D</i>	83.00	B 85.60	C 153.50	D 88.50	E 3.90	

3

12J	4cyl.	2494cc	Diesel	Indirect Injection	FM3610	
14-024710-00 <i>D</i>	90.47	B 94.52	C 191.36	D 99.70	E 4.76	
14-010920-00 <i>D</i>	90.47	B 94.50	C 191.36			

4

AD 3.152	3cyl.	2500cc	Diesel	Direct Injection	FM11352	
14-021220-00 <i>D</i> ②	91.49	B 93.713	C 216.00	D 96.723	E 3.81	
14-021221-00 <i>D</i>		B 93.967	C 216.00	D 96.723	E 3.81	
14-021222-00 <i>D</i>		B 94.50	C 216.00	D 96.723	E 3.81	
14-021223-00 <i>D</i>		B 96.253	C 216.00	D 97.104	E 3.81	
14-024680-00 <i>D</i>		B 93.73	C 216.00	D 96.72	E 3.76	
14-025871-00 <i>D</i>		B 93.76	C 216.14	D 96.85	E 5.00	
14-480320-00 <i>DH</i> ①		B 93.66	C 216.03	D 96.72	E 3.81	

① Push fit cast iron liner to replace original steel liner

② Press fit cast iron liner to replace original steel liner

① Ausdrückbare Laufbüchse aus Gueisen als Ersatz der original Stahlbüchse

② Anpressbare Laufbüchse aus Gueisen als Ersatz der original Stahlbüchse

① Chemise fonte à emmenchement gras remplaçant la chemise acie d'origine.

② Chemise fonte à emmancher à la presse pour remplacer la chemise d'origine en acier

① Ajustar a presión la camisa de hierro fundido para reemplaza camisa original de acero

② Ajuste a presión la camisa de hierro fundido para reemplazer la camisa original de acero



5

4/98 DT	4cyl.	3770cc			Diesel	Turbo	FM3751
4/98 NT	4cyl.	3770cc			Diesel	Turbo	FM6803
4/98 NV	4cyl.	3771cc	46-55kW (63-75PS)		Diesel		TD7513
4/98 TT	4cyl.	3770cc			Diesel	Turbo	FM6804
4/98 TV	4cyl.	3770cc			Diesel	Turbo	FM3750
6/98 E	6cyl.	5650cc			Diesel		FM2794
6/98 DT	6cyl.	5650cc			Diesel		FM6806
6/98 DV	6cyl.	5655cc	71-84kW (97-114PS)		Diesel		TD7488
6/98 NT	6cyl.	5650cc			Diesel		FM6806
6/98 NV	6cyl.	5655cc	71-86kW (97-117PS)		Diesel		TD7490
6/98 TV	6cyl.	5650cc			Diesel	Turbo	FM3748

15-450870-00 WH ①  
01/77→12/80  
14-452080-00 WH  
14-452080-10 WH

98.00

B 108.18 C 218.36 D 117.09 E 8.89 F 0.889  
B 109.04 C 220.726 D 117.10 E 8.89 F 0.83  
B 108.18 C 221.54 D 117.09 E 8.89 F 0.889

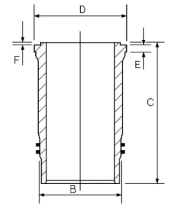

14-470110-00 WH ②

98.00

B 108.18 C 217.55 D 117.10 E 8.89 F 0.83

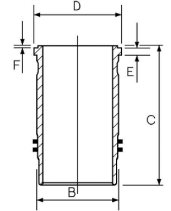

① Includes seals

① Schließt Dichtungen ein

① Inclut des joints

① Incluye los sellos

② Phosphated

② Phosphatiert

② Phosphatisé

② Fosfatada

6

4.212	4cyl.	3470cc			Diesel		FM1359
-------	-------	--------	--	--	--------	--	--------

14-021250-00 DH ①

98.48

B 104.20 C 226.44 D 107.37 E 3.81

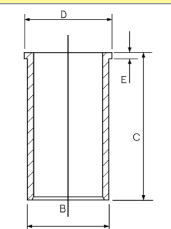

14-040110-00 D ②  
14-040180-00 D ②  
14-040200-00 DH ②  
14-045820-00 D  
14-045821-00 D

98.48

B 103.24 C 227.28 D 106.23 E 3.86 F 0.889  
B 103.24 C 227.28 D 106.43 E 3.71 F 1.041  
B 103.19 C 227.28 D 106.45 E 3.86 F 0.889  
B 103.33 C 227.28 D 106.42 E 3.80 F 0.90  
B 103.83 C 227.28 D 106.42 E 3.80 F 0.90

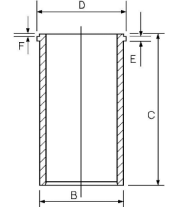

① Push fit, flanged, cast iron liner with 0.040" oversized outside diameter

① Geflanschte Gußeisen-Laufbuchse mit Schiebeseitz und Außendur übermaß

① Chemise en fonte, à collerette ajustage gras, avec diamètre

① Camisa de fundición embridada, ajuste suave, con diámetro ext

② Press fit cast iron liner to replace original steel liner

② Anpressbare Laufbüchse aus Gueisen als Ersatz der original Stahlbüchse

② Chemise fonte à emmancher à la presse pour remplacer la chemise d'origine en acier

② Ajuste a presión la camisa de hierro fundido para reemplazar la camisa original de acero



7

6.354.2 6cyl. 5800cc Diesel FM1364

6.354.4 6cyl. 5800cc Diesel FM1367

14-021250-00 DH ① 98.48 B 104.20 C 226.44 D 107.37 E 3.81

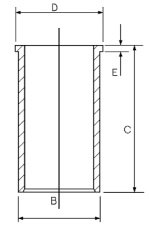

14-040110-00 D ② 98.48 B 103.24 C 227.28 D 106.23 E 3.86 F 0.889  
 14-040180-00 D ② B 103.24 C 227.28 D 106.43 E 3.71 F 1.041  
 14-040200-00 DH ② B 103.19 C 227.28 D 106.45 E 3.86 F 0.889  
 14-045820-00 D B 103.33 C 227.28 D 106.42 E 3.80 F 0.90  
 14-045821-00 D B 103.83 C 227.28 D 106.42 E 3.80 F 0.90

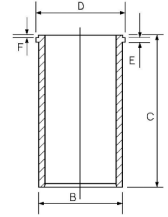

- ① Push fit, flanged, cast iron liner with 0.040" oversized outside diameter
- ② Press fit cast iron liner to replace original steel liner
- ① Geflanschte Gußeisen-Laufbuchse mit Schiebeseitz und Außendur übermaß
- ② Anpressbare Laufbüchse aus Gueisen als Ersatz der original Stahlbüchse
- ① Chemise en fonte, à collerette ajustage gras, avec diamètre
- ② Chemise fonte à emmancher à la presse pour remplacer la chemise d'origine en acier
- ① Camisa de fundición embreadada, ajuste suave, con diámetro ext
- ② Ajuste a presión la camisa de hierro fundido para reemplazar la camisa original de acero

8

57J 6cyl. 5655cc Diesel FM1012

57JC 6cyl. 5655cc Diesel FM1012

57VD 6cyl. 5655cc Diesel FM1012

OEJ 6cyl. 5655cc Diesel FM116

15-450870-00 WH ① 100.00 B 108.18 C 218.36 D 117.09 E 8.89 F 0.889

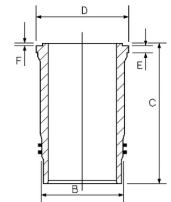

14-470110-00 WH ② 100.00 B 108.18 C 217.55 D 117.10 E 8.89 F 0.83

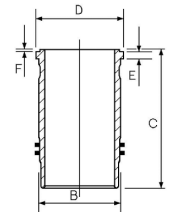

- ① Includes seals
- ② Phosphated
- ① Schließt Dichtungen ein
- ② Phosphatiert
- ① Inclut des joints
- ② Phosphatisé
- ① Incluye los sellos
- ② Fosfatada

9

KT 191 6cyl. 11627cc 256kW (348PS) Diesel Turbo Intercooled FM5278

14-021410-00 DH 130.00 B 136.02 C 288.30 D 143.60 E 10.05

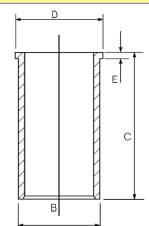



1

18 K4F 4cyl. 1796cc 85-88kW (116-120PS) TD18865

18 K4K (VVC) 4cyl. 1796cc 107-118kW (146-160PS) TD22926

14-710020-00 WH 80.00 B 84.10 C 129.50 D 87.50 E 50.000

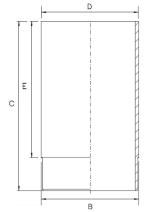

# ENGINE INDEX

Motorverzeichnis • Index de moteur • Índice de Motor  
Indeks silnika • Модель двигателя • دليل المحرك



CCM



9

D 0824	Diesel	4580	4	108.00	1
D 0824 LF	Diesel	4580	4	108.00	1
D 0824 LFL	Diesel	4580	4	108.00	1
D 0824 FL01	Diesel	4580	4	108.00	1
D 0824 GF	Diesel	4580	4	108.00	1
D 0824 GF01	Diesel	4580	4	108.00	1
D 0824 GF02	Diesel	4580	4	108.00	1
D 0824 GF03	Diesel	4580	4	108.00	1
D 0824 LF01	Diesel	4580	4	108.00	1
D 0824 LF02	Diesel	4580	4	108.00	1
D 0824 LF03	Diesel	4580	4	108.00	1
D 0824 LF04	Diesel	4580	4	108.00	1
D 0824 LF05	Diesel	4580	4	108.00	1
D 0824 LF06	Diesel	4580	4	108.00	1
D 0824 LF07	Diesel	4580	4	108.00	1
D 0824 LF08	Diesel	4580	4	108.00	1
D 0824 LF09	Diesel	4580	4	108.00	1
D 0824 LF10	Diesel	4580	4	108.00	1
D 0824 LFL01	Diesel	4580	4	108.00	1
D 0824 LFL02	Diesel	4580	4	108.00	1
D 0824 LFL04	Diesel	4580	4	108.00	1
D 0824 LFL05	Diesel	4580	4	108.00	1
D 0824 LFL06	Diesel	4580	4	108.00	1
D 0824 LFL07	Diesel	4580	4	108.00	1
D 0824 LFL08	Diesel	4580	4	108.00	1
D 0824 LFL09	Diesel	4580	4	108.00	1
D 0824 LFL10	Diesel	4580	4	108.00	1
D 0824 LFO	Diesel	4580	4	108.00	1
D 0824 LFO 01	Diesel	4580	4	108.00	1
D 0824 LOH01	Diesel	4580	4	108.00	1
D 0824 LOH02	Diesel	4580	4	108.00	1
D 0824 LOH03	Diesel	4580	4	108.00	1
D 0824 LOH04	Diesel	4580	4	108.00	1
D 0824 LOH05	Diesel	4580	4	108.00	1
D 0826 LF	Diesel	6870	6	108.00	1
D 0826 LFL	Diesel	6870	6	108.00	1
D 0826 LOH	Diesel	6870	6	108.00	1
D 0826 LUH	Diesel	6870	6	108.00	1
D 0826 F01	Diesel	6871	6	108.00	1
D 0826 F02	Diesel	6871	6	108.00	1
D 0826 FG001	Diesel	6871	6	108.00	1
D 0826 FG002	Diesel	6871	6	108.00	1
D 0826 FO 01	Diesel	6871	6	108.00	1
D 0826 FO 02	Diesel	6871	6	108.00	1
D 0826 GF	Diesel	6871	6	108.00	1
D 0826 GF01	Diesel	6871	6	108.00	1
D 0826 GF02	Diesel	6871	6	108.00	1
D 0826 GF03	Diesel	6871	6	108.00	1
D 0826 GF04	Diesel	6871	6	108.00	1
D 0826 GFA	Diesel	6871	6	108.00	1
D 0826 GFA 03	Diesel	6871	6	108.00	1
D 0826 GFA 04	Diesel	6871	6	108.00	1
D 0826 LE 521	Diesel	6871	6	108.00	1
D 0826 LE 522	Diesel	6871	6	108.00	1
D 0826 LE 523	Diesel	6871	6	108.00	1
D 0826 LE 524	Diesel	6871	6	108.00	1
D 0826 LE 530	Diesel	6871	6	108.00	1
D 0826 LE 531	Diesel	6871	6	108.00	1
D 0826 LE51	Diesel	6871	6	108.00	1
D 0826 LE52	Diesel	6871	6	108.00	1





CCM

x



9

D 0826 LF	Diesel	6590	6	108.00	1
D 0826 LF/217/Silent	Diesel	6870	6	108.00	1
D 0826 LF01	Diesel	6871	6	108.00	1
D 0826 LF02	Diesel	6871	6	108.00	1
D 0826 LF04	Diesel	6871	6	108.00	1
D 0826 LF05	Diesel	6871	6	108.00	1
D 0826 LF06	Diesel	6871	6	108.00	1
D 0826 LF07	Diesel	6871	6	108.00	1
D 0826 LF08	Diesel	6871	6	108.00	1
D 0826 LF09	Diesel	6871	6	108.00	1
D 0826 LF11	Diesel	6871	6	108.00	1
D 0826 LF12	Diesel	6871	6	108.00	1
D 0826 LF13	Diesel	6871	6	108.00	1
D 0826 LF15	Diesel	6871	6	108.00	1
D 0826 LF17	Diesel	6871	6	108.00	1
D 0826 LF18	Diesel	6871	6	108.00	1
D 0826 LFG 15	Diesel	6871	6	108.00	1
D 0826 LFG 16	Diesel	6871	6	108.00	1
D 0826 LFL	Diesel	6871	6	108.00	1
D 0826 LFL02	Diesel	6871	6	108.00	1
D 0826 LFL03	Diesel	6871	6	108.00	1
D 0826 LFL05	Diesel	6871	6	108.00	1
D 0826 LFL06	Diesel	6871	6	108.00	1
D 0826 LFL07	Diesel	6871	6	108.00	1
D 0826 LFL08	Diesel	6871	6	108.00	1
D 0826 LFL09	Diesel	6871	6	108.00	1
D 0826 LFL10	Diesel	6871	6	108.00	1
D 0826 LFOH	Diesel	6871	6	108.00	1
D 0826 LOH	Diesel	6590	6	108.00	1
D 0826 LOH01	Diesel	6871	6	108.00	1
D 0826 LOH02	Diesel	6871	6	108.00	1
D 0826 LOH03	Diesel	6871	6	108.00	1
D 0826 LOH04	Diesel	6871	6	108.00	1
D 0826 LOH05	Diesel	6871	6	108.00	1
D 0826 LOH06	Diesel	6871	6	108.00	1
D 0826 LOH07	Diesel	6871	6	108.00	1
D 0826 LOH10	Diesel	6871	6	108.00	1
D 0826 LOH15	Diesel	6871	6	108.00	1
D 0826 LOH17	Diesel	6871	6	108.00	1
D 0826 LOH18	Diesel	6871	6	108.00	1
D 0826 LOH19	Diesel	6871	6	108.00	1
D 0826 LUE51	Diesel	6870	B6	108.00	1
D 0826 LUH	Diesel	6870	B6	108.00	1
D 0826 LUH	Diesel	6871	6	108.00	1
D 0826 LUH01	Diesel	6871	6	108.00	1
D 0826 LUH02	Diesel	6871	6	108.00	1
D 0826 LUH03	Diesel	6871	6	108.00	1
D 0826 LUH04	Diesel	6871	6	108.00	1
D 0826 LUH05	Diesel	6871	6	108.00	1
D 0826 LUH06	Diesel	6871	6	108.00	1
D 0826 LUH08	Diesel	6871	6	108.00	1
D 0826 LUH09	Diesel	6871	6	108.00	1
D 0826 LUH10	Diesel	6871	6	108.00	1
D 0826 LUH11	Diesel	6871	6	108.00	1
D 0826 LUH12	Diesel	6870	6	108.00	1
D 0826 LUH13	Diesel	6871	6	108.00	1
D 0826 OH	Diesel	6871	6	108.00	1
D 0826 OH01	Diesel	6871	6	108.00	1
D 0826 OH02	Diesel	6871	6	108.00	1
D 0826 OH03	Diesel	6871	6	108.00	1

# ENGINE INDEX

Motorverzeichnis • Index de moteur • Índice de Motor  
Indeks silnika • Модель двигателя • دليل المحرك



CCM

x



9

D 0826 TE 520	Diesel	6596	6	108.00	1
D 0826 TF	Diesel	6596	6	108.00	1
D 0826 TOH	Diesel	6596	6	108.00	1
D 0826 TUE 51	Diesel	6871	6	108.00	1
D 0834 LFL01	Diesel	4580	4	108.00	1
D 0834 LFL02	Diesel	4580	4	108.00	1
D 0834 LFL03	Diesel	4580	4	108.00	1
D 0834 LFL04	Diesel	4580	4	108.00	1
D 0834 LFL20	Diesel	4580	4	108.00	1
D 0834 LFL40	Diesel	4580	4	108.00	1
D 0834 LFL41	Diesel	4580	4	108.00	1
D 0834 LFL42	Diesel	4580	4	108.00	1
D 0834 LFL50	Diesel	4580	4	108.00	1
D 0834 LFL51	Diesel	4580	4	108.00	1
D 0834 LFL52	Diesel	4580	4	108.00	1
D 0834 LFL53	Diesel	4580	4	108.00	1
D 0834 LFL54	Diesel	4580	4	108.00	1
D 0834 LFL55	Diesel	4580	4	108.00	1
D 0834 LOH 40	Diesel	4580	4	108.00	1
D 0834 LOH01	Diesel	4580	4	108.00	1
D 0834 LOH02	Diesel	4580	4	108.00	1
D 0834 LOH03	Diesel	4580	4	108.00	1
D 0834 LOH51	Diesel	4580	4	108.00	1
D 0834 LOH52	Diesel	4580	4	108.00	1
D 0834 LOH53	Diesel	4580	4	108.00	1
D 0836 LF01	Diesel	6871	6	108.00	1
D 0836 LF02	Diesel	6871	6	108.00	1
D 0836 LF03	Diesel	6871	6	108.00	1
D 0836 LF04	Diesel	6871	6	108.00	1
D 0836 LF05	Diesel	6871	6	108.00	1
D 0836 LF41	Diesel	6871	6	108.00	1
D 0836 LF44	Diesel	6871	6	108.00	1
D 0836 LFL01	Diesel	6871	6	108.00	1
D 0836 LFL02	Diesel	6871	6	108.00	1
D 0836 LFL03	Diesel	6871	6	108.00	1
D 0836 LFL04	Diesel	6871	6	108.00	1
D 0836 LFL05	Diesel	6871	6	108.00	1
D 0836 LFL06	Diesel	6871	6	108.00	1
D 0836 LFL07	Diesel	6871	6	108.00	1
D 0836 LFL10	Diesel	6871	6	108.00	1
D 0836 LFL40	Diesel	6871	6	108.00	1
D 0836 LFL41	Diesel	6871	6	108.00	1
D 0836 LFL44	Diesel	6871	6	108.00	1
D 0836 LFL50	Diesel	6871	6	108.00	1
D 0836 LFL51	Diesel	6871	6	108.00	1
D 0836 LFL52	Diesel	6871	6	108.00	1
D 0836 LFL53	Diesel	6871	6	108.00	1
D 0836 LFL54	Diesel	6871	6	108.00	1
D 0836 LFL55	Diesel	6871	6	108.00	1
D 0836 LOH01	Diesel	6871	6	108.00	1
D 0836 LOH02	Diesel	6871	6	108.00	1
D 0836 LOH03	Diesel	6871	6	108.00	1
D 0836 LOH40	Diesel	6871	6	108.00	1
D 0836 LOH41	Diesel	6871	6	108.00	1
D 0836 LOH51	Diesel	6871	6	108.00	1
D 0836 LOH52	Diesel	6871	6	108.00	1
D 0836 LOH55	Diesel	6871	6	108.00	1
D 0836 LOH56	Diesel	6871	6	108.00	1
D 0836 LOH60	Diesel	6871	6	108.00	1
D 0836 LOH61	Diesel	6871	6	108.00	1



CCM

x



9

D 0836 LOH62	Diesel	6871	6	108.00	1
D 0836 LOH63	Diesel	6871	6	108.00	1
D 0836 LOH64	Diesel	6871	6	108.00	1
D 0836 LOH65	Diesel	6871	6	108.00	1
D 0836 M2	Diesel	7030	6	108.00	2
D 0846 HM2	Diesel	7250	6	108.00	2
D 0846 HM42U	Diesel	7252	6	108.00	2
D 0846 HM81H	Diesel	7252	6	108.00	2
D 0846 HM82U	Diesel	7252	6	108.00	2
D 0846 HM91H	Diesel	7252	6	108.00	2
D 0846 HM91U	Diesel	7250	6	108.00	2
D 0846 HM95U	Diesel	7252	6	108.00	2
D 0846 HMN	Diesel	7252	6	108.00	2
D 0846 HMN2	Diesel	7252	6	108.00	2
D 0846 HMN80	Diesel	7252	6	108.00	2
D 0846 HMX-011	Diesel	7250	6	108.00	2
D 0846 HMXU-015	Diesel	7250	6	108.00	2
D 0846 HMY-011	Diesel	7250	6	108.00	2
D 0846 HMYH	Diesel	7252	6	108.00	2
D 0846 HMYN-014	Diesel	7252	6	108.00	2
D 2066 LF	Diesel	10518	6	120.00	3
D 2066 LF01	Diesel	10520	6	120.00	3
D 2066 LF02	Diesel	10520	6	120.00	3
D 2066 LF03	Diesel	10520	6	120.00	3
D 2066 LF04	Diesel	10520	6	120.00	3
D 2066 LF06	Diesel	10520	6	120.00	3
D 2066 LF07	Diesel	10518	6	120.00	3
D 2066 LF11	Diesel	10520	6	120.00	3
D 2066 LF12	Diesel	10520	6	120.00	3
D 2066 LF13	Diesel	10520	6	120.00	3
D 2066 LF14	Diesel	10520	6	120.00	3
D 2066 LF17	Diesel	10518	6	120.00	3
D 2066 LF18	Diesel	10518	6	120.00	3
D 2066 LF19	Diesel	10518	6	120.00	3
D 2066 LF20	Diesel	10518	6	120.00	3
D 2066 LF21	Diesel	10518	6	120.00	3
D 2066 LF22	Diesel	10518	6	120.00	3
D 2066 LF23	Diesel	10518	6	120.00	3
D 2066 LF24	Diesel	10518	6	120.00	3
D 2066 LF25	Diesel	10518	6	120.00	3
D 2066 LF26	Diesel	10518	6	120.00	3
D 2066 LF27	Diesel	10518	6	120.00	3
D 2066 LF28	Diesel	10520	6	120.00	3
D 2066 LF29	Diesel	10520	6	120.00	3
D 2066 LF30	Diesel	10520	6	120.00	3
D 2066 LF31	Diesel	10520	6	120.00	3
D 2066 LF32	Diesel	10520	6	120.00	3
D 2066 LF33	Diesel	10520	6	120.00	3
D 2066 LF35	Diesel	10520	6	120.00	3
D 2066 LF36	Diesel	10520	6	120.00	3
D 2066 LF37	Diesel	10520	6	120.00	3
D 2066 LF38	Diesel	10520	6	120.00	3
D 2066 LF39	Diesel	10520	6	120.00	3
D 2066 LF40	Diesel	10518	6	120.00	3
D 2066 LF41	Diesel	10518	6	120.00	3
D 2066 LF42	Diesel	10518	6	120.00	3
D 2066 LF43	Diesel	10518	6	120.00	3
D 2066 LF44	Diesel	10518	6	120.00	3
D 2066 LF45	Diesel	10518	6	120.00	3
D 2066 LF46	Diesel	10518	6	120.00	3

# ENGINE INDEX

Motorverzeichnis • Index de moteur • Índice de Motor  
Indeks silnika • Модель двигателя • دليل المحرك



CCM



9

D 2066 LF47	Diesel	10518	6	120.00	3
D 2066 LF48	Diesel	10518	6	120.00	3
D 2066 LF49	Diesel	10518	6	120.00	3
D 2066 LF50	Diesel	10518	6	120.00	3
D 2066 LF51	Diesel	10518	6	120.00	3
D 2066 LF52	Diesel	10518	6	120.00	3
D 2066 LF53	Diesel	10518	6	120.00	3
D 2066 LF57	Diesel	10518	6	120.00	3
D 2066 LF58	Diesel	10518	6	120.00	3
D 2066 LF59	Diesel	10518	6	120.00	3
D 2066 LF60	Diesel	10518	6	120.00	3
D 2066 LF62	Diesel	10520	6	120.00	3
D 2066 LF63	Diesel	10520	6	120.00	3
D 2066 LF64	Diesel	10520	6	120.00	3
D 2066 LF65	Diesel	10520	6	120.00	3
D 2066 LF69	Diesel	10520	6	120.00	3
D 2066 LF70	Diesel	10520	6	120.00	3
D 2066 LF71	Diesel	10520	6	120.00	3
D 2066 LF72	Diesel	10520	6	120.00	3
D 2066 LOH 26	Diesel	10518	6	120.00	3
D 2066 LOH 27	Diesel	10518	6	120.00	3
D 2066 LOH01	Diesel	10520	6	120.00	3
D 2066 LOH02	Diesel	10520	6	120.00	3
D 2066 LOH03	Diesel	10520	6	120.00	3
D 2066 LOH04	Diesel	10520	6	120.00	3
D 2066 LOH05	Diesel	10520	6	120.00	3
D 2066 LOH06	Diesel	10520	6	120.00	3
D 2066 LOH07	Diesel	10520	6	120.00	3
D 2066 LOH08	Diesel	10520	6	120.00	3
D 2066 LOH10	Diesel	10518	6	120.00	3
D 2066 LOH11	Diesel	10518	6	120.00	3
D 2066 LOH12	Diesel	10518	6	120.00	3
D 2066 LOH28	Diesel	10518	6	120.00	3
D 2066 LUH 32	Diesel	10518	6	120.00	3
D 2066 LUH 33	Diesel	10518	6	120.00	3
D 2066 LUH 34	Diesel	10518	6	120.00	3
D 2066 LUH 41	Diesel	10518	6	120.00	3
D 2066 LUH 42	Diesel	10518	6	120.00	3
D 2066 LUH 43	Diesel	10518	6	120.00	3
D 2066 LUH 46	Diesel	10518	6	120.00	3
D 2066 LUH 47	Diesel	10518	6	120.00	3
D 2066 LUH 48	Diesel	10518	6	120.00	3
D 2066 LUH07	Diesel	10520	6	120.00	3
D 2066 LUH08	Diesel	10520	6	120.00	3
D 2066 LUH09	Diesel	10520	6	120.00	3
D 2066 LUH11	Diesel	10520	6	120.00	3
D 2066 LUH12	Diesel	10520	6	120.00	3
D 2066 LUH13	Diesel	10520	6	120.00	3
D 2066 LUH14	Diesel	10520	6	120.00	3
D 2066 LUH15	Diesel	10520	6	120.00	3
D 2066 LUH21	Diesel	10520	6	120.00	3
D 2066 LUH22	Diesel	10520	6	120.00	3
D 2066 LUH23	Diesel	10520	6	120.00	3
D 2066 LUH24	Diesel	10520	6	120.00	3
D 2146	Diesel	9660	6	121.00	4
D 2156 HM 2	Diesel	10344	6	121.00	4
D 2156 HM3	Diesel	10344	6	121.00	4
D 2156 HM9	Diesel	10344	6	121.00	4
D 2156 HMN1	Diesel	10344	6	121.00	4
D 2156 HMN6	Diesel	10344	6	121.00	4



CCM

x



9

D 2156 HNY	Diesel	10344	6	121.00	4
D 2156 MGN	Diesel	10344	6	121.00	4
D 2156 MNY	Diesel	10344	6	121.00	4
D 2156 MTN1	Diesel	10344	6	121.00	4
D 2156 MTX	Diesel	10344	6	121.00	4
D 2156 MY	Diesel	10344	6	121.00	4
D 2156 MYN	Diesel	10344	6	121.00	4
D 2530 ME	Diesel	15945	V10	125.00	6
D 2530 MF	Diesel	15945	V10	125.00	6
D 2530 MTE	Diesel	15953	V10	125.00	6
D 2530 MTXF	Diesel	15953	V10	125.00	6
D 2530 MTXF/360	Diesel	15900	V10	125.00	6
D 2530 MXF	Diesel	15945	V10	125.00	6
D 2538 M	Diesel	12763	V8	125.00	6
D 2538 ME	Diesel	12763	V8	125.00	6
D 2538 MF	Diesel	12763	V8	125.00	6
D 2538 MT	Diesel	12763	V8	125.00	6
D 2538 MTE	Diesel	12763	V8	125.00	6
D 2540 MT	Diesel	17426	V10	125.00	6
D 2540 MTF	Diesel	17426	V10	125.00	6
D 2542 MLE	Diesel	20911	V12	125.00	6
D 2542 MTE	Diesel	20911	V12	125.00	6
D 2555 M	Diesel	9200	5	125.00	5
D 2555 MF	Diesel	9200	5	125.00	5
D 2555 MX	Diesel	9200	5	125.00	5
D 2555 MXF	Diesel	9200	5	125.00	5
D 2556 M	Diesel	11045	6	125.00	5
D 2556 MX	Diesel	11045	6	125.00	5
D 2556 MXF	Diesel	11045	6	125.00	5
D 2556 MXUH/175	Diesel	11045	6	125.00	5
D 2556 MXUH/192	Diesel	11045	6	125.00	5
D 2556 MXUH/240	Diesel	11045	6	125.00	5
D 2556 MXUM	Diesel	11045	6	125.00	5
D 2565 HM	Diesel	9510	5	125.00	5
D 2565 M	Diesel	9510	5	125.00	5
D 2565 ME	Diesel	9510	5	125.00	5
D 2565 MF	Diesel	9510	5	125.00	5
D 2565 MFR	Diesel	9510	5	125.00	5
D 2565 MK	Diesel	9510	5	125.00	5
D 2565 MKUL	Diesel	9510	5	125.00	5
D 2565 MR	Diesel	9510	5	125.00	5
D 2565 MT	Diesel	9510	5	125.00	5
D 2565 MUE	Diesel	9510	5	125.00	5
D 2565 MUH	Diesel	9510	5	125.00	5
D 2565 MUL	Diesel	9510	5	125.00	5
D 2566 M	Diesel	11413	6	125.00	5
D 2566 ME	Diesel	11413	6	125.00	5
D 2566 MF	Diesel	11413	6	125.00	5
D 2566 MH	Diesel	11413	6	125.00	5
D 2566 MK	Diesel	11413	6	125.00	5
D 2566 MKF	Diesel	11413	6	125.00	5
D 2566 MKUH/320	Diesel	11413	6	125.00	5
D 2566 MKUL	Diesel	11413	6	125.00	5
D 2566 MLUH	Diesel	11413	6	125.00	5
D 2566 MLUM	Diesel	11413	6	125.00	5
D 2566 MT	Diesel	11413	6	125.00	5
D 2566 MTE	Diesel	11413	6	125.00	5
D 2566 MTF	Diesel	11413	6	125.00	5
D 2566 MTH	Diesel	11413	6	125.00	5
D 2566 MTHO	Diesel	11413	6	125.00	5

# ENGINE INDEX

Motorverzeichnis • Index de moteur • Índice de Motor  
Indeks silnika • Модель двигателя • دليل المحرك



CCM



9

D 2566 MTUH/280	Diesel	11413	6	125.00	5
D 2566 MUE	Diesel	11413	6	125.00	5
D 2566 MUH	Diesel	11413	6	125.00	5
D 2566 MUL	Diesel	11413	6	125.00	5
D 2566 MUM	Diesel	11413	6	125.00	5
D 2566 MXF	Diesel	11413	6	125.00	5
D 2566 UH	Diesel	11413	6	125.00	5
D 2676 LF 08	Diesel	12412	6	126.00	7
D 2676 LF 10	Diesel	12412	6	126.00	7
D 2676 LF 17	Diesel	12412	6	126.00	7
D 2676 LF 18	Diesel	12412	6	126.00	7
D 2676 LF 19	Diesel	12412	6	126.00	7
D 2676 LF 20	Diesel	12412	6	126.00	7
D 2676 LF 21	Diesel	12412	6	126.00	7
D 2676 LF 22	Diesel	12412	6	126.00	7
D 2676 LF 25	Diesel	12412	6	126.00	7
D 2676 LF 26	Diesel	12412	6	126.00	7
D 2676 LF 28	Diesel	12412	6	126.00	7
D 2676 LF 31	Diesel	12412	6	126.00	7
D 2676 LF 32	Diesel	12412	6	126.00	7
D 2676 LF 33	Diesel	12412	6	126.00	7
D 2676 LF01	Diesel	12418	6	126.00	7
D 2676 LF02	Diesel	12412	6	126.00	7
D 2676 LF03	Diesel	12412	6	126.00	7
D 2676 LF04	Diesel	12412	6	126.00	7
D 2676 LF05	Diesel	12412	6	126.00	7
D 2676 LF06	Diesel	12412	6	126.00	7
D 2676 LF07	Diesel	12412	6	126.00	7
D 2676 LF11	Diesel	12418	6	126.00	7
D 2676 LF12	Diesel	12418	6	126.00	7
D 2676 LF13	Diesel	12412	6	126.00	7
D 2676 LF14	Diesel	12412	6	126.00	7
D 2676 LF15	Diesel	12412	6	126.00	7
D 2676 LF16	Diesel	12412	6	126.00	7
D 2676 LOH 28	Diesel	12412	6	126.00	7
D 2676 LOH01	Diesel	12418	6	126.00	7
D 2676 LOH02	Diesel	12418	6	126.00	7
D 2676 LOH03	Diesel	12412	6	126.00	7
D 2676 LOH04	Diesel	12412	6	126.00	7
D 2676 LOH10	Diesel	12412	6	126.00	7
D 2676 LOH26	Diesel	12412	6	126.00	7
D 2676 LOH27	Diesel	12412	6	126.00	7
D 2840 LE	Diesel	18273	V10	128.00	9
D 2840 LE 423	Diesel	18270	V10	128.00	9
D 2840 LF/460	Diesel	18273	V10	128.00	9
D 2840 LF01	Diesel	18273	V10	128.00	9
D 2840 LF04	Diesel	18273	V10	128.00	9
D 2840 LF06	Diesel	18273	V10	128.00	9
D 2840 LF20	Diesel	18273	V10	128.00	9
D 2840 LF21	Diesel	18273	V10	128.00	9
D 2840 LF25	Diesel	18273	V10	128.00	9
D 2840 LXF	Diesel	18273	V10	128.00	9
D 2840 ME	Diesel	18273	V10	128.00	9
D 2840 MF	Diesel	18273	V10	128.00	9
D 2840 MFG	Diesel	18273	V10	128.00	9
D 2840 MFR	Diesel	18273	V10	128.00	9
D 2840 MH	Diesel	18273	V10	128.00	9
D 2840 TL	Diesel	18273	V10	128.00	9
D 2842 LE 202	Diesel	21930	V12	128.00	9
D 2842 LE 211	Diesel	21930	V12	128.00	9



CCM

x



9

D 2842 LE 403	Diesel	21930	V12	128.00	9
D 2842 LE 404	Diesel	21930	V12	128.00	9
D 2842 LE 423	Diesel	21930	V12	128.00	9
D 2842 LE 433	Diesel	21930	V12	128.00	9
D 2842 LE622	Diesel	21927	V12	128.00	9
D 2842 LF	Diesel	21927	V12	128.00	9
D 2842 LF10	Diesel	21927	V12	128.00	9
D 2842 LFX	Diesel	21927	V12	128.00	9
D 2842 LXE	Diesel	21927	V12	128.00	9
D 2842 LYE	Diesel	21927	V12	128.00	9
D 2842 LZE	Diesel	21927	V12	128.00	9
D 2842 ME	Diesel	21927	V12	128.00	9
D 2842 MF	Diesel	21927	V12	128.00	9
D 2848 LE	Diesel	14618	V8	128.00	9
D 2848 LE 423	Diesel	14618	V8	128.00	9
D 2848 LXE	Diesel	14618	V8	128.00	9
D 2848 LYE	Diesel	14618	V8	128.00	9
D 2848 M	Diesel	14618	V8	128.00	9
D 2848 MF	Diesel	14618	V8	128.00	9
D 2848 MH	Diesel	14618	V8	128.00	9
D 2865 LF/260	Diesel	9973	5	128.00	8
D 2865 LF02	Diesel	9973	5	128.00	8
D 2865 LF03	Diesel	9973	5	128.00	8
D 2865 LF05	Diesel	9973	5	128.00	8
D 2865 LF06	Diesel	9973	5	128.00	8
D 2865 LF09	Diesel	9973	5	128.00	8
D 2865 LF21	Diesel	9973	5	128.00	8
D 2865 LF22	Diesel	9973	5	128.00	8
D 2865 LF23	Diesel	9973	5	128.00	8
D 2865 LF24	Diesel	9973	5	128.00	8
D 2865 LFR	Diesel	9973	5	128.00	8
D 2865 LOH 05	Diesel	9973	5	128.00	8
D 2865 LOH 07	Diesel	9973	5	128.00	8
D 2865 LOH 09	Diesel	9973	5	128.00	8
D 2865 LOH01	Diesel	9973	5	128.00	8
D 2865 LOH02	Diesel	9973	5	128.00	8
D 2865 LU01/Silent	Diesel	9973	5	128.00	8
D 2865 LUH02	Diesel	9973	5	128.00	8
D 2865 LUH05	Diesel	9973	5	128.00	8
D 2865 LUH07	Diesel	9973	5	128.00	8
D 2865 LUH08	Diesel	9973	5	128.00	8
D 2865 LUH09	Diesel	9973	5	128.00	8
D 2865 LXF	Diesel	9973	5	128.00	8
D 2865 LXFR	Diesel	9973	5	128.00	8
D 2866 F/240	Diesel	11967	6	128.00	8
D 2866 FR	Diesel	11967	6	128.00	8
D 2866 KF	Diesel	11967	6	128.00	8
D 2866 KFZ	Diesel	11967	6	128.00	8
D 2866 KOH/360	Diesel	11967	6	128.00	8
D 2866 KOH/373	Diesel	11967	6	128.00	8
D 2866 KUH/360	Diesel	11967	6	128.00	8
D 2866 KUL	Diesel	11967	6	128.00	8
D 2866 LF/290	Diesel	11967	6	128.00	8
D 2866 LF03	Diesel	11967	6	128.00	8
D 2866 LF04	Diesel	11967	6	128.00	8
D 2866 LF05	Diesel	11967	6	128.00	8
D 2866 LF06	Diesel	11967	6	128.00	8
D 2866 LF09	Diesel	11967	6	128.00	8
D 2866 LF10	Diesel	11967	6	128.00	8
D 2866 LF14	Diesel	11967	6	128.00	8



# ENGINE INDEX

Motorverzeichnis • Index de moteur • Índice de Motor  
Indeks silnika • Модель двигателя • دليل المحرك



CCM



9

D 2866 LF15	Diesel	11967	6	128.00	8
D 2866 LF16	Diesel	11967	6	128.00	8
D 2866 LF17	Diesel	11967	6	128.00	8
D 2866 LF20	Diesel	11967	6	128.00	8
D 2866 LF21	Diesel	11967	6	128.00	8
D 2866 LF22	Diesel	11967	6	128.00	8
D 2866 LF23	Diesel	11967	6	128.00	8
D 2866 LF24	Diesel	11967	6	128.00	8
D 2866 LF25	Diesel	11967	6	128.00	8
D 2866 LF26	Diesel	11967	6	128.00	8
D 2866 LF27	Diesel	11967	6	128.00	8
D 2866 LF28	Diesel	11967	6	128.00	8
D 2866 LF29	Diesel	11967	6	128.00	8
D 2866 LF30	Diesel	11967	6	128.00	8
D 2866 LF31	Diesel	11967	6	128.00	8
D 2866 LF32	Diesel	11967	6	128.00	8
D 2866 LF32	Diesel	11967	6	128.00	10
D 2866 LF34	Diesel	11967	6	128.00	8
D 2866 LF35	Diesel	11967	6	128.00	8
D 2866 LF36	Diesel	11967	6	128.00	8
D 2866 LF37	Diesel	11967	6	128.00	8
D 2866 LF39	Diesel	11967	6	128.00	10
D 2866 LF40	Diesel	11967	6	128.00	10
D 2866 LF41	Diesel	11967	6	128.00	10
D 2866 LF42	Diesel	11967	6	128.00	10
D 2866 LF43	Diesel	11967	6	128.00	10
D 2866 LFZ/290	Diesel	11967	6	128.00	8
D 2866 LFZ/330	Diesel	11967	6	128.00	8
D 2866 LOH	Diesel	11967	6	128.00	8
D 2866 LOH03	Diesel	11967	6	128.00	8
D 2866 LOH06	Diesel	11967	6	128.00	8
D 2866 LOH07	Diesel	11967	6	128.00	8
D 2866 LOH20	Diesel	11967	6	128.00	8
D 2866 LOH22	Diesel	11967	6	128.00	8
D 2866 LOH23	Diesel	11967	6	128.00	8
D 2866 LOH24	Diesel	11970	6	128.00	8
D 2866 LOH25	Diesel	11967	6	128.00	8
D 2866 LOH26	Diesel	11967	6	128.00	8
D 2866 LOH27	Diesel	11967	6	128.00	8
D 2866 LOH28	Diesel	11967	6	128.00	8
D 2866 LOH29	Diesel	11967	6	128.00	8
D 2866 LOH32	Diesel	11967	6	128.00	8
D 2866 LOH33	Diesel	11967	6	128.00	8
D 2866 LOH34	Diesel	11967	6	128.00	8
D 2866 LU 01	Diesel	11967	6	128.00	8
D 2866 LU 03	Diesel	11967	6	128.00	8
D 2866 LU/330	Diesel	11967	6	128.00	8
D 2866 LUH/330	Diesel	11967	6	128.00	8
D 2866 LUH21	Diesel	11967	6	128.00	8
D 2866 LUH22	Diesel	11967	6	128.00	8
D 2866 LUH23	Diesel	11967	6	128.00	8
D 2866 LUH24	Diesel	11967	6	128.00	8
D 2866 LUH25	Diesel	11967	6	128.00	8
D 2866 LUH26	Diesel	11967	6	128.00	8
D 2866 LUH30	Diesel	11967	6	128.00	8
D 2866 LUL/330	Diesel	11967	6	128.00	8
D 2866 LX	Diesel	11967	6	128.00	8
D 2866 LXF	Diesel	11967	6	128.00	8
D 2866 LXOH	Diesel	11967	6	128.00	8
D 2866 OH	Diesel	11967	6	128.00	8





CCM

x



9

D 2866 T	Diesel	11967	6	128.00	8
D 2866 TOH	Diesel	11967	6	128.00	8
D 2866 TOH/290	Diesel	11967	6	128.00	8
D 2866 TOH/310	Diesel	11967	6	128.00	8
D 2866 TUH	Diesel	11967	6	128.00	8
D 2866 TUH/290	Diesel	11967	6	128.00	8
D 2866 TUH01	Diesel	11967	6	128.00	8
D 2866 UH	Diesel	11967	6	128.00	8
D 2866 UH/240	Diesel	11967	6	128.00	8
D 2866 UM	Diesel	11967	6	128.00	8
D 2876 LF02	Diesel	12816	6	128.00	8
D 2876 LF03	Diesel	12816	6	128.00	8
D 2876 LF04	Diesel	12816	6	128.00	8
D 2876 LF05	Diesel	12816	6	128.00	8
D 2876 LF06	Diesel	12816	6	128.00	8
D 2876 LF07	Diesel	12816	6	128.00	8
D 2876 LF11	Diesel	12816	6	128.00	8
D 2876 LF12	Diesel	12816	6	128.00	11
D 2876 LF13	Diesel	12816	6	128.00	11
D 2876 LF25	Diesel	12816	6	128.00	11
D 2876 LOH / LUH01	Diesel	12816	6	128.00	8
D 2876 LOH02	Diesel	12816	6	128.00	8
D 2876 LOH03	Diesel	12816	6	128.00	8
D 2876 LOH20	Diesel	12816	6	128.00	11
D 2876 LOH21	Diesel	12816	6	128.00	11
D 2876 LUE 604	Diesel	12816	6	128.00	8
D 2876 LUE 605	Diesel	12816	6	128.00	8
D 2876 LUE 606	Diesel	12816	6	128.00	8
E 0834 E 302	Petrol	4580	4	108.00	1
E 0834 E 312	Petrol	4580	4	108.00	1
E 0836 E 302	Petrol	6871	6	108.00	1
E 0836 E 312	Petrol	6871	6	108.00	1
E 2842 E 312	Petrol	21927	V12	128.00	9
E 2842 LE 312	Petrol	21927	V12	128.00	9
E 2842 LE 322	Petrol	21927	V12	128.00	9
E 2848 LE 322	Petrol	14618	V8	128.00	9

**1**

D 0824 Euro 2	4cyl.	4580cc		Diesel		FM4696
D 0824 FL01 Euro 1	4cyl.	4580cc	75kW (102PS)	Diesel	Turbo Intercooled	TD7655
D 0824 GF	4cyl.	4580cc	75kW (102PS)	Diesel		FM7103
D 0824 GF	4cyl.	4580cc	75kW (102PS)	Diesel		TD5648
D 0824 GF01	4cyl.	4580cc	75kW (102PS)	Diesel		FM7103
D 0824 GF01	4cyl.	4580cc	75kW (102PS)	Diesel		TD5988
D 0824 GF02 Euro 1	4cyl.	4580cc	75kW (102PS)	Diesel		TD7639
D 0824 GF03 Euro 1	4cyl.	4580cc	75kW (102PS)	Diesel		TD21287
D 0824 LF Euro 1	4cyl.	4580cc	114kW (155PS)	Diesel		FM5695
D 0824 LF Euro 2	4cyl.	4580cc	83-162kW (113-220PS)	Diesel		FM5696
D 0824 LF01 Euro 1	4cyl.	4580cc	114kW (155PS)	Diesel	Turbo Intercooled	TD7680
D 0824 LF02 Euro 2	4cyl.	4580cc	118kW (160PS)	Diesel	Turbo Intercooled	TD7683
D 0824 LF03 Euro 1	4cyl.	4580cc	118kW (160PS)	Diesel	Turbo Intercooled	TD21278
D 0824 LF04 Euro 1	4cyl.	4580cc	118kW (160PS)	Diesel	Turbo Intercooled	TD21279
D 0824 LF05 Euro 1	4cyl.	4580cc	118kW (160PS)	Diesel	Turbo Intercooled	TD21280
D 0824 LF06 Euro 1	4cyl.	4580cc	118kW (160PS)	Diesel	Turbo Intercooled	TD21281
D 0824 LF07 Euro 1	4cyl.	4580cc	118kW (160PS)	Diesel	Turbo Intercooled	TD21282
D 0824 LF08 Euro 1	4cyl.	4580cc	118kW (160PS)	Diesel	Turbo Intercooled	TD21283
D 0824 LF09 Euro 1	4cyl.	4580cc	118kW (160PS)	Diesel	Turbo Intercooled	TD21284
D 0824 LF10 Euro 1	4cyl.	4580cc	118kW (160PS)	Diesel	Turbo Intercooled	TD21285
D 0824 LFL Euro 1	4cyl.	4580cc	75-118kW (102-160PS)	Diesel		FM5695
D 0824 LFL Euro 2	4cyl.	4580cc	83-162kW (113-220PS)	Diesel		FM5696
D 0824 LFL01 Euro 1	4cyl.	4580cc	114kW (155PS)	Diesel	Turbo Intercooled	TD7658
D 0824 LFL02 Euro 2	4cyl.	4580cc	118kW (160PS)	Diesel	Turbo Intercooled	TD7660
D 0824 LFL04 Euro 2	4cyl.	4580cc	81kW (110PS)	Diesel	Turbo Intercooled	TD7656
D 0824 LFL05 Euro 1	4cyl.	4580cc	114kW (155PS)	Diesel	Turbo Intercooled	TD7659
D 0824 LFL06 Euro 2	4cyl.	4580cc	114kW (155PS)	Diesel	Turbo Intercooled	TD7661
D 0824 LFL07 Euro 2	4cyl.	4580cc	104kW (141PS)	Diesel	Turbo Intercooled	TD7662
D 0824 LFL08 Euro 2	4cyl.	4580cc	83kW (113PS)	Diesel	Turbo Intercooled	TD16523
D 0824 LFL09 Euro 1	4cyl.	4580cc	114kW (155PS)	Diesel	Turbo Intercooled	TD9707
D 0824 LFL10 Euro 2	4cyl.	4580cc	92-162kW (125-220PS)	Diesel	Turbo Intercooled	TD21286
D 0824 LFO Euro 1	4cyl.	4580cc	118kW (160PS)	Diesel	Turbo Intercooled	TD7657
D 0824 LFO 01 Euro 1	4cyl.	4580cc	114kW (155PS)	Diesel	Turbo Intercooled	TD23129
D 0824 LOH01 Euro 1	4cyl.	4580cc	114kW (155PS)	Diesel	Turbo Intercooled	TD7598
D 0824 LOH02 Euro 1	4cyl.	4580cc	114kW (155PS)	Diesel	Turbo Intercooled	TD21288
D 0824 LOH03 Euro 1	4cyl.	4580cc	114kW (155PS)	Diesel	Turbo Intercooled	TD21289
D 0824 LOH04 Euro 1	4cyl.	4580cc	114kW (155PS)	Diesel	Turbo Intercooled	TD21290
D 0824 LOH05 Euro 2	4cyl.	4580cc	114kW (155PS)	Diesel	Turbo Intercooled	TD20537
D 0826 F01	6cyl.	6871cc	110-114kW (150-155PS)	Diesel		TD7681
D 0826 F02	6cyl.	6871cc	110kW (150PS)	Diesel		TD7682
D 0826 FG001	6cyl.	6871cc	169kW (230PS)	Diesel		TD22324
D 0826 FG002	6cyl.	6871cc	169kW (230PS)	Diesel		TD22326
D 0826 FO 01	6cyl.	6871cc	114kW (155PS)	Diesel		TD23134
D 0826 FO 02	6cyl.	6871cc	110kW (150PS)	Diesel		TD23135
D 0826 GF	6cyl.	6871cc	110-114kW (150-155PS)	Diesel	Turbo	TD7647





D 0826 GF01 Euro 1	6cyl.	6871cc	110-114kW (150-155PS)	Diesel		TD7649
D 0826 GF02	6cyl.	6871cc	169kW (230PS)	Diesel		TD22328
D 0826 GF03	6cyl.	6871cc	110kW (150PS)	Diesel		TD7648
D 0826 GF04 Euro 1	6cyl.	6871cc	110-114kW (150-155PS)	Diesel		TD19440
D 0826 GFA	6cyl.	6871cc	114kW (155PS)	Diesel		TD23139
D 0826 GFA 03	6cyl.	6871cc	110kW (150PS)	Diesel		TD23142
D 0826 GFA 04 Euro 1	6cyl.	6871cc	107kW (146PS)	Diesel		TD23143
D 0826 LE51	6cyl.	6871cc	132kW (180PS)	Diesel	Turbo Intercooled	TD19441
D 0826 LE52	6cyl.	6871cc	132kW (180PS)	Diesel	Turbo Intercooled	TD19442
D 0826 LE 521	6cyl.	6871cc	140kW (190PS)	Diesel	Turbo Intercooled	TD22331
D 0826 LE 522 Euro 1	6cyl.	6871cc	154kW (210PS)	Diesel	Turbo Intercooled	TD23144
D 0826 LE 523 Euro 1	6cyl.	6871cc	169kW (230PS)	Diesel	Turbo Intercooled	TD23146
D 0826 LE 524 Euro 1	6cyl.	6871cc	125kW (170PS)	Diesel	Turbo Intercooled	TD23147
D 0826 LE 530 Euro 1	6cyl.	6871cc	147kW (200PS)	Diesel	Turbo Intercooled	TD23149
D 0826 LE 531 Euro 1	6cyl.	6871cc	191kW (260PS)	Diesel	Turbo Intercooled	TD23150
D 0826 LF Euro 1	6cyl.	6870cc	114-198kW (190-270PS)	Diesel	Turbo Intercooled	FM5697
D 0826 LF	6cyl.	6590cc	169kW (230PS)	Diesel	Turbo Intercooled	FM6810
D 0826 LF/217/SILENT	6cyl.	6870cc	160kW (218PS)	Diesel	Turbo Intercooled	TD7723
D 0826 LF01	6cyl.	6871cc	140kW (190PS)	Diesel	Turbo Intercooled	FM7026
D 0826 LF01	6cyl.	6871cc	140kW (190PS)	Diesel	Turbo Intercooled	TD7686
D 0826 LF02 Euro 1	6cyl.	6871cc	169kW (230PS)	Diesel	Turbo Intercooled	FM7026
D 0826 LF02 Euro 1	6cyl.	6871cc	169kW (230PS)	Diesel	Turbo Intercooled	TD7691
D 0826 LF04 Euro 1	6cyl.	6871cc	198kW (270PS)	Diesel	Turbo Intercooled	TD7695
D 0826 LF05	6cyl.	6871cc	140kW (190PS)	Diesel	Turbo Intercooled	TD7687
D 0826 LF06	6cyl.	6871cc	169kW (230PS)	Diesel	Turbo Intercooled	TD7692
D 0826 LF07 Euro 1	6cyl.	6871cc	140kW (190PS)	Diesel	Turbo Intercooled	TD7688
D 0826 LF08 Euro 1	6cyl.	6871cc	169kW (230PS)	Diesel	Turbo Intercooled	TD7693
D 0826 LF09 Euro 1	6cyl.	6871cc	169kW (230PS)	Diesel	Turbo Intercooled	TD22332
D 0826 LF11 Euro 2	6cyl.	6871cc	162kW (220PS)	Diesel	Turbo Intercooled	TD7690
D 0826 LF12 Euro 2	6cyl.	6871cc	140kW (190PS)	Diesel	Turbo Intercooled	TD22337
D 0826 LF13 Euro 2	6cyl.	6871cc	191kW (260PS)	Diesel	Turbo Intercooled	TD7694
D 0826 LF15 Euro 2	6cyl.	6871cc	162kW (220PS)	Diesel	Turbo Intercooled	TD7726
D 0826 LF17 Euro 2	6cyl.	6871cc	191kW (260PS)	Diesel	Turbo Intercooled	TD7727
D 0826 LF18 Euro 2	6cyl.	6871cc	162kW (220PS)	Diesel	Turbo Intercooled	TD10227
D 0826 LFG 15 Euro 2	6cyl.	6871cc	162kW (220PS)	Diesel	Turbo Intercooled	TD23154
D 0826 LFG 16 Euro 2	6cyl.	6871cc	191kW (260PS)	Diesel	Turbo Intercooled	TD23155
D 0826 LFL Euro 1	6cyl.	6870cc	114-198kW (190-270PS)	Diesel		FM5697
D 0826 LFL Euro 1	6cyl.	6871cc	162kW (220PS)	Diesel	Turbo Intercooled	TD19443
D 0826 LFL02 Euro 1	6cyl.	6871cc	169kW (230PS)	Diesel	Turbo Intercooled	TD7664
D 0826 LFL03 Euro 1	6cyl.	6871cc	162kW (220PS)	Diesel	Turbo Intercooled	TD7663
D 0826 LFL05 Euro 1	6cyl.	6871cc	114kW (155PS)	Diesel	Turbo Intercooled	TD21291
D 0826 LFL06 Euro 1	6cyl.	6871cc	162kW (220PS)	Diesel	Turbo Intercooled	TD7665
D 0826 LFL07 Euro 1	6cyl.	6871cc	188kW (256PS)	Diesel	Turbo Intercooled	TD21292
D 0826 LFL08 Euro 1	6cyl.	6871cc	162kW (220PS)	Diesel	Turbo Intercooled	TD21293
D 0826 LFL09 Euro 2	6cyl.	6871cc	191kW (260PS)	Diesel	Turbo Intercooled	TD7725





D 0826 LFL10 Euro 1	6cyl.	6871cc	162kW (220PS)	Diesel	Turbo Intercooled	TD10207
D 0826 LFOH	6cyl.	6871cc	162kW (220PS)	Diesel	Turbo Intercooled	FM7026
D 0826 LOH Euro 2	6cyl.	6870cc	162-191kW (220-260PS)	Diesel		FM5698
D 0826 LOH	6cyl.	6590cc	169kW (230PS)	Diesel	Turbo Intercooled	FM6810
D 0826 LOH01	6cyl.	6871cc	140kW (190PS)	Diesel	Turbo Intercooled	TD7601
D 0826 LOH02	6cyl.	6871cc	140kW (190PS)	Diesel	Turbo Intercooled	TD7679
D 0826 LOH03	6cyl.	6871cc	169kW (230PS)	Diesel	Turbo Intercooled	TD16465
D 0826 LOH04	6cyl.	6871cc	169kW (230PS)	Diesel	Turbo Intercooled	TD16466
D 0826 LOH05	6cyl.	6871cc	169kW (230PS)	Diesel	Turbo Intercooled	TD21295
D 0826 LOH06 Euro 1	6cyl.	6871cc	140kW (190PS)	Diesel	Turbo Intercooled	TD7587
D 0826 LOH07 Euro 1	6cyl.	6871cc	169kW (230PS)	Diesel	Turbo Intercooled	TD16246
D 0826 LOH10 Euro 1	6cyl.	6871cc	184kW (250PS)	Diesel	Turbo Intercooled	TD16247
D 0826 LOH15 Euro 2	6cyl.	6871cc	162kW (220PS)	Diesel	Turbo Intercooled	TD7588
D 0826 LOH17 Euro 2	6cyl.	6871cc	162kW (220PS)	Diesel	Turbo Intercooled	TD17419
D 0826 LOH18 Euro 2	6cyl.	6871cc	191kW (260PS)	Diesel	Turbo Intercooled	TD17420
D 0826 LOH19 Euro 2	6cyl.	6871cc	162kW (220PS)	Diesel	Turbo Intercooled	TD23156
D 0826 LUE51 Euro 1	B6cyl.	6870cc	132kW (180PS)	Diesel	Turbo Intercooled	TD19444
D 0826 LUH Euro 2	6cyl.	6870cc	162-191kW (220-260PS)	Diesel		FM5698
D 0826 LUH	6cyl.	6871cc	157kW (214PS)	Diesel	Turbo Intercooled	TD7597
D 0826 LUH Euro 1	B6cyl.	6870cc	184kW (250PS)	Diesel	Turbo Intercooled	TD7583
D 0826 LUH01 Euro 1	6cyl.	6871cc	198kW (270PS)	Diesel	Turbo Intercooled	TD7596
D 0826 LUH02 Euro 1	6cyl.	6871cc	169-198kW (230-269PS)	Diesel	Turbo Intercooled	TD21301
D 0826 LUH03 Euro 1	6cyl.	6871cc	157kW (214PS)	Diesel	Turbo Intercooled	TD7584
D 0826 LUH04	6cyl.	6871cc	157-169kW (214-230PS)	Diesel	Turbo Intercooled	TD21302
D 0826 LUH05 Euro 1	6cyl.	6871cc	169kW (230PS)	Diesel	Turbo Intercooled	TD7585
D 0826 LUH06 Euro 1	6cyl.	6871cc	169-198kW (230-269PS)	Diesel	Turbo Intercooled	TD21303
D 0826 LUH08 Euro 2	6cyl.	6871cc	162-169kW (220-230PS)	Diesel	Turbo Intercooled	TD21304
D 0826 LUH09 Euro 2	6cyl.	6871cc	169-206kW (230-280PS)	Diesel	Turbo Intercooled	TD21305
D 0826 LUH10 Euro 1	6cyl.	6871cc	169-198kW (230-269PS)	Diesel	Turbo Intercooled	TD21306
D 0826 LUH11 Euro 2	6cyl.	6871cc	162kW (220PS)	Diesel	Turbo Intercooled	TD21307
D 0826 LUH12 Euro 1	6cyl.	6870cc	162kW (220PS)	Diesel	Turbo Intercooled	TD7586
D 0826 LUH13 Euro 2	6cyl.	6871cc	191kW (260PS)	Diesel	Turbo Intercooled	TD16248
D 0826 OH	6cyl.	6871cc	110kW (150PS)	Diesel		FM6810
D 0826 OH	6cyl.	6871cc	110kW (150PS)	Diesel		TD19445
D 0826 OH01	6cyl.	6871cc	114kW (155PS)	Diesel		TD23157
D 0826 OH02	6cyl.	6871cc	110-114kW (150-155PS)	Diesel		TD7599
D 0826 OH03 Euro 1	6cyl.	6871cc	107kW (146PS)	Diesel		TD23158
D 0826 TE 520	6cyl.	6596cc	121-125kW (165-170PS)	Diesel	Turbo	TD23159
D 0826 TF	6cyl.	6596cc	137kW (186PS)	Diesel	Turbo	TD7689
D 0826 TOH	6cyl.	6596cc	132-137kW (180-186PS)	Diesel	Turbo	TD7600
D 0826 TUE 51	6cyl.	6871cc	132kW (180PS)	Diesel	Turbo Intercooled	TD23162
D 0834 LFL01 Euro 3	4cyl.	4580cc	103kW (140PS)	Diesel	Turbo Intercooled	TD17044
D 0834 LFL02 Euro 3	4cyl.	4580cc	103kW (140PS)	Diesel	Turbo Intercooled	TD6591
D 0834 LFL03 Euro 3	4cyl.	4580cc	132kW (180PS)	Diesel	Turbo Intercooled	TD16498
D 0834 LFL04 Euro 3	4cyl.	4580cc	110kW (150PS)	Diesel	Turbo Intercooled	TD18096





D 0834 LFL20 Euro 3	4cyl.	4580cc	125kW (170PS)	Diesel	Turbo Intercooled	TD16829
D 0834 LFL40 Euro 3	4cyl.	4580cc	110kW (150PS)	Diesel	Turbo Intercooled	TD18179
D 0834 LFL41 Euro 3	4cyl.	4580cc	132kW (180PS)	Diesel	Turbo Intercooled	TD18180
D 0834 LFL42 Euro 3	4cyl.	4580cc	151kW (205PS)	Diesel	Turbo Intercooled	TD18181
D 0834 LFL50 Euro 4	4cyl.	4580cc	110kW (150PS)	Diesel	Turbo Intercooled	TD18182
D 0834 LFL51 Euro 4	4cyl.	4580cc	132kW (180PS)	Diesel	Turbo Intercooled	TD18183
D 0834 LFL52 Euro 4	4cyl.	4580cc	151kW (205PS)	Diesel	Turbo Intercooled	TD18184
D 0834 LFL53 Euro 4	4cyl.	4580cc	110kW (150PS)	Diesel	Turbo Intercooled	TD22957
D 0834 LFL54 Euro 4	4cyl.	4580cc	132kW (180PS)	Diesel	Turbo Intercooled	TD22958
D 0834 LFL55 Euro 4	4cyl.	4580cc	151kW (205PS)	Diesel	Turbo Intercooled	TD22969
D 0834 LOH01 Euro 3	4cyl.	4580cc	125kW (170PS)	Diesel	Turbo Intercooled	TD16748
D 0834 LOH02 Euro 3	4cyl.	4580cc	125kW (170PS)	Diesel	Turbo Intercooled	TD16749
D 0834 LOH03 Euro 3	4cyl.	4580cc	125kW (170PS)	Diesel	Turbo Intercooled	TD16750
D 0834 LOH 40 Euro 4	4cyl.	4580cc	132kW (180PS)	Diesel	Turbo Intercooled	TD23680
D 0834 LOH51 Euro 4	4cyl.	4580cc	151kW (205PS)	Diesel	Turbo Intercooled	TD19969
D 0834 LOH52 Euro 4	4cyl.	4580cc	132kW (180PS)	Diesel	Turbo Intercooled	TD23057
D 0834 LOH53 Euro 4	4cyl.	4580cc	151kW (205PS)	Diesel	Turbo Intercooled	TD23058
D 0836 LF01 Euro 2	6cyl.	6871cc	206kW (280PS)	Diesel	Turbo Intercooled	TD14289
D 0836 LF02 Euro 3	6cyl.	6871cc	162kW (220PS)	Diesel	Turbo Intercooled	TD17045
D 0836 LF03 Euro 3	6cyl.	6871cc	206kW (280PS)	Diesel	Turbo Intercooled	TD16503
D 0836 LF04 Euro 3	6cyl.	6871cc	162kW (220PS)	Diesel	Turbo Intercooled	TD16500
D 0836 LF05 Euro 3	6cyl.	6871cc	180kW (245PS)	Diesel	Turbo Intercooled	TD16504
D 0836 LF41 Euro 3	6cyl.	6871cc	206kW (280PS)	Diesel	Turbo Intercooled	TD16827
D 0836 LF44 Euro 3	6cyl.	6871cc	240kW (326PS)	Diesel	Turbo Intercooled	TD16828
D 0836 LFL01 Euro 2/3	6cyl.	6871cc	206kW (280PS)	Diesel	Turbo Intercooled	TD16875
D 0836 LFL02 Euro 2/3	6cyl.	6871cc	162kW (220PS)	Diesel	Turbo Intercooled	TD16499
D 0836 LFL03 Euro 3	6cyl.	6871cc	206kW (280PS)	Diesel	Turbo Intercooled	TD16502
D 0836 LFL04 Euro 3	6cyl.	6871cc	162kW (220PS)	Diesel	Turbo Intercooled	TD17049
D 0836 LFL05 Euro 3	6cyl.	6871cc	180kW (245PS)	Diesel	Turbo Intercooled	TD16501
D 0836 LFL06 Euro 3	6cyl.	6871cc	162kW (220PS)	Diesel	Turbo Intercooled	TD23163
D 0836 LFL07 Euro 3	6cyl.	6871cc	162kW (220PS)	Diesel	Turbo Intercooled	TD16830
D 0836 LFL10 Euro 3	6cyl.	6871cc	162kW (220PS)	Diesel	Turbo Intercooled	TD16831
D 0836 LFL40 Euro 3	6cyl.	6871cc	176kW (239PS)	Diesel	Turbo Intercooled	TD18185
D 0836 LFL41 Euro 3	6cyl.	6871cc	206kW (280PS)	Diesel	Turbo Intercooled	TD18703
D 0836 LFL44 Euro 3	6cyl.	6871cc	240kW (326PS)	Diesel	Turbo Intercooled	TD18704
D 0836 LFL50 Euro 4	6cyl.	6871cc	176kW (239PS)	Diesel	Turbo Intercooled	TD18186
D 0836 LFL51 Euro 4	6cyl.	6871cc	206kW (280PS)	Diesel	Turbo Intercooled	TD19114
D 0836 LFL52 Euro 4	6cyl.	6871cc	177kW (240PS)	Diesel	Turbo Intercooled	TD19113
D 0836 LFL53 Euro 4	6cyl.	6871cc	176kW (239PS)	Diesel	Turbo Intercooled	TD22970
D 0836 LFL54 Euro 4	6cyl.	6871cc	206kW (280PS)	Diesel	Turbo Intercooled	TD22971
D 0836 LFL55 Euro 4	6cyl.	6871cc	240kW (326PS)	Diesel	Turbo Intercooled	TD22972
D 0836 LOH01 Euro 3	6cyl.	6871cc	206kW (280PS)	Diesel	Turbo Intercooled	TD16753
D 0836 LOH02 Euro 3	6cyl.	6871cc	206kW (280PS)	Diesel	Turbo Intercooled	TD16752
D 0836 LOH03 Euro 3	6cyl.	6871cc	162kW (220PS)	Diesel	Turbo Intercooled	TD16751
D 0836 LOH40 Euro 3	6cyl.	6871cc	206kW (280PS)	Diesel	Turbo Intercooled	TD16754





D 0836 LOH41 Euro 3	6cyl.	6871cc	177kW (240PS)	Diesel	Turbo Intercooled	TD16755
D 0836 LOH51 Euro 4	6cyl.	6871cc	206kW (280PS)	Diesel	Turbo Intercooled	TD19971
D 0836 LOH52 Euro 4	6cyl.	6871cc	177kW (240PS)	Diesel	Turbo Intercooled	TD19970
D 0836 LOH55 Euro 4	6cyl.	6871cc	206kW (280PS)	Diesel	Turbo Intercooled	TD23060
D 0836 LOH56 Euro 4	6cyl.	6871cc	177kW (240PS)	Diesel	Turbo Intercooled	TD23059
D 0836 LOH60	6cyl.	6871cc	213kW (290PS)	Diesel	Turbo Intercooled	TD23671
D 0836 LOH61	6cyl.	6871cc	184kW (250PS)	Diesel	Turbo Intercooled	TD23670
D 0836 LOH62 Euro 4	6cyl.	6871cc	191kW (260PS)	Diesel	Turbo Intercooled	TD23164
D 0836 LOH63	6cyl.	6871cc	191kW (260PS)	Diesel	Turbo Intercooled	TD23962
D 0836 LOH64 Euro 5	6cyl.	6871cc	213kW (290PS)	Diesel	Turbo Intercooled	TD23682
D 0836 LOH65 Euro 5	6cyl.	6871cc	184kW (250PS)	Diesel	Turbo Intercooled	TD23681
E 0834 E 302	4cyl.	4580cc	54-62kW (73-84PS)			TD25700
E 0834 E 312	4cyl.	4580cc	37-53kW (50-72PS)			TD25699
E 0836 E 302	6cyl.	6871cc	75kW (102PS)			TD23749
E 0836 E 312	6cyl.	6871cc	56-64kW (76-87PS)			TD23748

14-027680-00 *DH*  
14-027681-00 *DH*

108.00

B 111.50  
B 112.00

C 217.00  
C 217.00

D 115.85  
D 115.85

E 4.00  
E 4.00

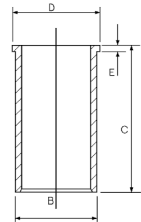

2

D 0836 M2	6cyl.	7030cc	99kW (135PS)	Diesel		TD7644
D 0846 HM2	6cyl.	7250cc	117kW (159PS)	Diesel		TD7654
D 0846 HM42U	6cyl.	7252cc	117kW (159PS)	Diesel		TD8656
D 0846 HM81H	6cyl.	7252cc	117kW (159PS)	Diesel		TD8741
D 0846 HM82U	6cyl.	7252cc	117kW (159PS)	Diesel		TD8745
D 0846 HM91H	6cyl.	7252cc	117kW (159PS)	Diesel		TD7818
D 0846 HM91U	6cyl.	7250cc	117kW (159PS)	Diesel		TD7822
D 0846 HM95U	6cyl.	7252cc	117kW (159PS)	Diesel		TD7827
D 0846 HMN	6cyl.	7252cc	117kW (159PS)	Diesel		TD7651
D 0846 HMN2	6cyl.	7252cc	117kW (159PS)	Diesel		TD19037
D 0846 HMN80	6cyl.	7252cc	132kW (180PS)	Diesel		TD8779
D 0846 HMX-011	6cyl.	7250cc	117kW (159PS)	Diesel		TD8781
D 0846 HMXU-015	6cyl.	7250cc	117kW (159PS)	Diesel		TD7627
D 0846 HMY-011	6cyl.	7250cc	123kW (167PS)	Diesel		TD7707
D 0846 HMYH	6cyl.	7252cc	123kW (167PS)	Diesel		TD7168
D 0846 HMYN-014	6cyl.	7252cc	123kW (167PS)	Diesel		TD7702

14-030350-00 *DH*

108.00

B 112.99

C 254.00

D 118.00

E 5.00

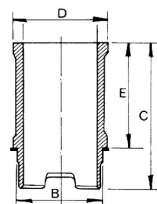



**3**

D 2066 LF Euro 2/3	6cyl.	10518cc	265-307kW (360-430PS)	Diesel	Turbo Intercooled	FM16161
D 2066 LF Euro 3	6cyl.	10518cc		Diesel	Turbo Intercooled	FM46161
D 2066 LF01 Euro 4	6cyl.	10520cc	316kW (430PS)	Diesel	Turbo Intercooled	TD17370
D 2066 LF02 Euro 4	6cyl.	10520cc	287kW (390PS)	Diesel	Turbo Intercooled	TD17371
D 2066 LF03 Euro 4	6cyl.	10520cc	257kW (350PS)	Diesel	Turbo Intercooled	TD17372
D 2066 LF04 Euro 4	6cyl.	10520cc	228kW (310PS)	Diesel	Turbo Intercooled	TD17373
D 2066 LF06 Euro 4	6cyl.	10520cc	294kW (400PS)	Diesel	Turbo Intercooled	FM26161
D 2066 LF06 Euro 4	6cyl.	10520cc	294kW (400PS)	Diesel	Turbo Intercooled	TD19951
D 2066 LF07 Euro 3	6cyl.	10518cc	265kW (360PS)	Diesel	Turbo Intercooled	TD22899
D 2066 LF11 Euro 4	6cyl.	10520cc	316kW (430PS)	Diesel	Turbo Intercooled	TD18098
D 2066 LF12 Euro 4	6cyl.	10520cc	287kW (390PS)	Diesel	Turbo Intercooled	TD18097
D 2066 LF13 Euro 4	6cyl.	10520cc	257kW (350PS)	Diesel	Turbo Intercooled	TD19111
D 2066 LF14 Euro 4	6cyl.	10520cc	228kW (310PS)	Diesel	Turbo Intercooled	TD19109
D 2066 LF17 Euro 5	6cyl.	10518cc	324kW (440PS)	Diesel	Turbo Intercooled	TD23081
D 2066 LF18 Euro 5	6cyl.	10518cc	294kW (400PS)	Diesel	Turbo Intercooled	TD23083
D 2066 LF19 Euro 5	6cyl.	10518cc	265kW (360PS)	Diesel	Turbo Intercooled	TD23084
D 2066 LF20 Euro 5	6cyl.	10518cc	235kW (320PS)	Diesel	Turbo Intercooled	TD23085
D 2066 LF21 Euro 5	6cyl.	10518cc	321kW (437PS)	Diesel	Turbo Intercooled	TD20230
D 2066 LF22 Euro 5	6cyl.	10518cc	294kW (400PS)	Diesel	Turbo Intercooled	TD20229
D 2066 LF23 Euro 5	6cyl.	10518cc	324kW (440PS)	Diesel	Turbo Intercooled	TD19098
D 2066 LF24 Euro 5	6cyl.	10518cc	294kW (400PS)	Diesel	Turbo Intercooled	TD19099
D 2066 LF25 Euro 5	6cyl.	10518cc	324kW (440PS)	Diesel	Turbo Intercooled	TD20363
D 2066 LF26 Euro 5	6cyl.	10518cc	294kW (400PS)	Diesel	Turbo Intercooled	TD20364
D 2066 LF27 Euro 5	6cyl.	10518cc	265kW (360PS)	Diesel	Turbo Intercooled	TD20365
D 2066 LF28 Euro 4	6cyl.	10520cc	235kW (320PS)	Diesel	Turbo Intercooled	TD20366
D 2066 LF29 Euro 4	6cyl.	10520cc	265kW (360PS)	Diesel	Turbo Intercooled	TD25603
D 2066 LF30 Euro 4	6cyl.	10520cc	235kW (320PS)	Diesel	Turbo Intercooled	TD25604
D 2066 LF31 Euro 4	6cyl.	10520cc	324kW (440PS)	Diesel	Turbo Intercooled	TD19094
D 2066 LF32 Euro 4	6cyl.	10520cc	294kW (400PS)	Diesel	Turbo Intercooled	TD19095
D 2066 LF33 Euro 4	6cyl.	10520cc	265kW (360PS)	Diesel	Turbo Intercooled	TD19096
D 2066 LF35 Euro 4	6cyl.	10520cc	235kW (320PS)	Diesel	Turbo Intercooled	TD19097
D 2066 LF36 Euro 4	6cyl.	10520cc	324kW (440PS)	Diesel	Turbo Intercooled	TD20368
D 2066 LF37 Euro 4	6cyl.	10520cc	294kW (400PS)	Diesel	Turbo Intercooled	TD20369
D 2066 LF38 Euro 4	6cyl.	10520cc	265kW (360PS)	Diesel	Turbo Intercooled	TD20370
D 2066 LF39 Euro 4	6cyl.	10520cc	235kW (320PS)	Diesel	Turbo Intercooled	TD20396
D 2066 LF40 Euro 5	6cyl.	10518cc	324kW (440PS)	Diesel	Turbo Intercooled	TD23119
D 2066 LF41 Euro 5	6cyl.	10518cc	294kW (400PS)	Diesel	Turbo Intercooled	TD23104
D 2066 LF42 Euro 5	6cyl.	10518cc	265kW (360PS)	Diesel	Turbo Intercooled	TD23094
D 2066 LF43 Euro 5	6cyl.	10518cc	235kW (320PS)	Diesel	Turbo Intercooled	TD23003
D 2066 LF44 Euro 5	6cyl.	10518cc	324kW (440PS)	Diesel	Turbo Intercooled	TD25456
D 2066 LF45 Euro 5	6cyl.	10518cc	294kW (400PS)	Diesel	Turbo Intercooled	TD25455
D 2066 LF46 Euro 5	6cyl.	10518cc	265kW (360PS)	Diesel	Turbo Intercooled	TD25454
D 2066 LF47 Euro 5	6cyl.	10518cc	235kW (320PS)	Diesel	Turbo Intercooled	TD25453
D 2066 LF48 Euro 3	6cyl.	10518cc	265kW (360PS)	Diesel	Turbo Intercooled	TD25598
D 2066 LF49 Euro 3	6cyl.	10518cc	294kW (400PS)	Diesel	Turbo Intercooled	TD25599





D 2066 LF50 Euro 3	6cyl.	10518cc	324kW (440PS)	Diesel	Turbo Intercooled	TD25600
D 2066 LF51 Euro 5	6cyl.	10518cc	294kW (400PS)	Diesel	Turbo Intercooled	TD23436
D 2066 LF52 Euro 5	6cyl.	10518cc	265kW (360PS)	Diesel	Turbo Intercooled	TD23437
D 2066 LF53 Euro 5	6cyl.	10518cc	235kW (320PS)	Diesel	Turbo Intercooled	TD23438
D 2066 LF57	6cyl.	10518cc	324kW (440PS)	Diesel	Turbo Intercooled	TD25452
D 2066 LF58	6cyl.	10518cc	294kW (400PS)	Diesel	Turbo Intercooled	TD25451
D 2066 LF59	6cyl.	10518cc	265kW (360PS)	Diesel	Turbo Intercooled	TD23688
D 2066 LF60	6cyl.	10518cc	235kW (320PS)	Diesel	Turbo Intercooled	TD23689
D 2066 LF62 Euro 4	6cyl.	10520cc	324kW (440PS)	Diesel	Turbo Intercooled	TD25612
D 2066 LF63 Euro 4	6cyl.	10520cc	294kW (400PS)	Diesel	Turbo Intercooled	TD25613
D 2066 LF64 Euro 4	6cyl.	10520cc	265kW (360PS)	Diesel	Turbo Intercooled	TD25614
D 2066 LF65 Euro 4	6cyl.	10520cc	235kW (320PS)	Diesel	Turbo Intercooled	TD25611
D 2066 LF69 Euro 4	6cyl.	10520cc	324kW (440PS)	Diesel	Turbo Intercooled	TD25620
D 2066 LF70 Euro 4	6cyl.	10520cc	294kW (400PS)	Diesel	Turbo Intercooled	TD25619
D 2066 LF71 Euro 4	6cyl.	10520cc	265kW (360PS)	Diesel	Turbo Intercooled	TD25618
D 2066 LF72 Euro 4	6cyl.	10520cc	235kW (320PS)	Diesel	Turbo Intercooled	TD25617
D 2066 LOH01 Euro 4	6cyl.	10520cc	235kW (320PS)	Diesel	Turbo Intercooled	TD19972
D 2066 LOH02 Euro 4	6cyl.	10520cc	265kW (360PS)	Diesel	Turbo Intercooled	TD19973
D 2066 LOH03 Euro 4	6cyl.	10520cc	294kW (400PS)	Diesel	Turbo Intercooled	TD19974
D 2066 LOH04 Euro 4	6cyl.	10520cc	324kW (440PS)	Diesel	Turbo Intercooled	TD19975
D 2066 LOH05 Euro 4	6cyl.	10520cc	225kW (306PS)	Diesel	Turbo Intercooled	TD23061
D 2066 LOH06 Euro 4	6cyl.	10520cc	265kW (360PS)	Diesel	Turbo Intercooled	TD23062
D 2066 LOH07 Euro 4	6cyl.	10520cc	294kW (400PS)	Diesel	Turbo Intercooled	TD23063
D 2066 LOH08 Euro 4	6cyl.	10520cc	324kW (440PS)	Diesel	Turbo Intercooled	TD23064
D 2066 LOH10 Euro 3	6cyl.	10518cc	316kW (430PS)	Diesel	Turbo Intercooled	TD23073
D 2066 LOH11 Euro 3	6cyl.	10518cc	287kW (390PS)	Diesel	Turbo Intercooled	TD23072
D 2066 LOH12 Euro 3	6cyl.	10518cc	257kW (350PS)	Diesel	Turbo Intercooled	TD23070
D 2066 LOH 26	6cyl.	10518cc	235kW (320PS)	Diesel	Turbo Intercooled	TD23672
D 2066 LOH 27	6cyl.	10518cc	265kW (360PS)	Diesel	Turbo Intercooled	TD23673
D 2066 LOH28 Euro 5	6cyl.	10518cc	294kW (400PS)	Diesel	Turbo Intercooled	TD23396
D 2066 LUH07 Euro 3	6cyl.	10520cc	228kW (310PS)	Diesel	Turbo Intercooled	TD23074
D 2066 LUH08 Euro 3	6cyl.	10520cc	257kW (350PS)	Diesel	Turbo Intercooled	TD23075
D 2066 LUH09 Euro 3	6cyl.	10520cc	287kW (390PS)	Diesel	Turbo Intercooled	TD23076
D 2066 LUH11 Euro 4	6cyl.	10520cc	199kW (271PS)	Diesel	Turbo Intercooled	TD19976
D 2066 LUH12 Euro 4	6cyl.	10520cc	228kW (310PS)	Diesel	Turbo Intercooled	TD19977
D 2066 LUH13 Euro 4	6cyl.	10520cc	257kW (350PS)	Diesel	Turbo Intercooled	TD19978
D 2066 LUH14 Euro 4	6cyl.	10520cc	287kW (390PS)	Diesel	Turbo Intercooled	TD19979
D 2066 LUH15 Euro 4	6cyl.	10520cc	316kW (430PS)	Diesel	Turbo Intercooled	TD19980
D 2066 LUH21 Euro 4	6cyl.	10520cc	199kW (271PS)	Diesel	Turbo Intercooled	TD22860
D 2066 LUH22 Euro 4	6cyl.	10520cc	228kW (310PS)	Diesel	Turbo Intercooled	TD23065
D 2066 LUH23 Euro 4	6cyl.	10520cc	257kW (350PS)	Diesel	Turbo Intercooled	TD23066
D 2066 LUH24 Euro 4	6cyl.	10520cc	287kW (390PS)	Diesel	Turbo Intercooled	TD23067
D 2066 LUH 32 Euro 5	6cyl.	10518cc	235kW (320PS)	Diesel	Turbo Intercooled	TD23683
D 2066 LUH 33 Euro 5	6cyl.	10518cc	265kW (360PS)	Diesel	Turbo Intercooled	TD23684
D 2066 LUH 34 Euro 5	6cyl.	10518cc	294kW (400PS)	Diesel	Turbo Intercooled	TD23685







D 2066 LUH 41	6cyl.	10518cc	206kW (280PS)	Diesel	Turbo Intercooled	TD23963
D 2066 LUH 42	6cyl.	10518cc	235kW (320PS)	Diesel	Turbo Intercooled	TD23964
D 2066 LUH 43	6cyl.	10518cc	257kW (350PS)	Diesel	Turbo Intercooled	TD23965
D 2066 LUH 46	6cyl.	10518cc	206kW (280PS)	Diesel	Turbo Intercooled	TD23674
D 2066 LUH 47	6cyl.	10518cc	235kW (320PS)	Diesel	Turbo Intercooled	TD23675
D 2066 LUH 48	6cyl.	10518cc	265kW (360PS)	Diesel	Turbo Intercooled	TD23676

14-450630-00 WH  
15-450630-00 WH ①

120.00

B 139.50 C 260.00 D 150.00 E 8.07  
B 139.50 C 260.00 D 150.00 E 8.07

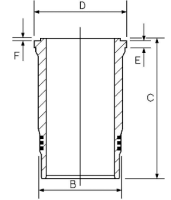

① Includes seals

① Schließt Dichtungen ein

① Inclut des joints

① Incluye los sellos

4

D 2146	6cyl.	9660cc	123kW (167PS)	Diesel		TD7666
D 2156 HM 2	6cyl.	10344cc	141-173kW (192-235PS)	Diesel		TD23165
D 2156 HM3	6cyl.	10344cc	158-169kW (215-230PS)	Diesel		TD7675
D 2156 HM9	6cyl.	10344cc	158-169kW (215-230PS)	Diesel		TD7734
D 2156 HMN1	6cyl.	10344cc	158kW (215PS)	Diesel		TD7700
D 2156 HMN6	6cyl.	10344cc	172kW (234PS)	Diesel		TD8783
D 2156 HNY	6cyl.	10344cc	141-169kW (192-230PS)	Diesel		TD19066
D 2156 MGN	6cyl.	10344cc	141-169kW (192-230PS)	Diesel		TD19067
D 2156 MNY	6cyl.	10344cc	141-169kW (192-230PS)	Diesel		TD19068
D 2156 MTN1	6cyl.	10344cc	188kW (256PS)	Diesel	Turbo Intercooled	TD7715
D 2156 MTX	6cyl.	10344cc	188kW (256PS)	Diesel	Turbo	TD19116
D 2156 MY	6cyl.	10344cc	141-169kW (192-230PS)	Diesel		TD19069
D 2156 MYN	6cyl.	10344cc	141-169kW (192-230PS)	Diesel		TD19070

14-022830-00 DH

121.00

B 125.99 C 287.00 D 132.00 E 8.00

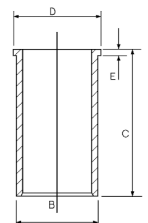

5

D 2555 M	5cyl.	9200cc	123kW (167PS)	Diesel		TD7708
D 2555 MF	5cyl.	9200cc	123kW (167PS)	Diesel		TD7703
D 2555 MX	5cyl.	9200cc	141kW (192PS)	Diesel		TD7710
D 2555 MXF	5cyl.	9200cc	141kW (192PS)	Diesel		TD7705
D 2556 M	6cyl.	11045cc	147kW (200PS)	Diesel		TD7730
D 2556 MX	6cyl.	11045cc	147-194kW (200-264PS)	Diesel		TD7733
D 2556 MXF	6cyl.	11045cc	172-177kW (232-240PS)	Diesel		TD7731
D 2556 MXUH/175	6cyl.	11045cc	129kW (175PS)	Diesel		TD7613
D 2556 MXUH/192	6cyl.	11045cc	141kW (192PS)	Diesel		TD7606
D 2556 MXUH/240	6cyl.	11045cc	177kW (240PS)	Diesel		TD7607





D 2556 MXUM	6cyl.	11045cc	161kW (220PS)	Diesel		TD7439
D 2565 HM	5cyl.	9510cc	92kW (125PS)	Diesel		TD19039
D 2565 M	5cyl.	9510cc	141kW (192PS)	Diesel		TD7711
D 2565 ME	5cyl.	9510cc	84kW (114PS)	Diesel		TD19040
D 2565 MF	5cyl.	9510cc	141kW (192PS)	Diesel		TD7706
D 2565 MFR	5cyl.	9510cc	92kW (125PS)	Diesel		TD19041
D 2565 MK	5cyl.	9510cc	169kW (230PS)	Diesel	Turbo	TD19117
D 2565 MKUL	5cyl.	9510cc	169kW (230PS)	Diesel	Turbo	TD19072
D 2565 MR	5cyl.	9510cc	141kW (192PS)	Diesel		TD23168
D 2565 MT	5cyl.	9510cc	169kW (230PS)	Diesel	Turbo	TD19073
D 2565 MUE	5cyl.	9510cc	141kW (192PS)	Diesel		TD23169
D 2565 MUH	5cyl.	9510cc	92kW (125PS)	Diesel		TD19042
D 2565 MUL	5cyl.	9510cc	141kW (192PS)	Diesel		TD7721
D 2566 M	6cyl.	11413cc	177kW (240PS)	Diesel		TD7735
D 2566 ME	6cyl.	11413cc	125kW (170PS)	Diesel		TD19451
D 2566 MF	6cyl.	11413cc	177kW (240PS)	Diesel		TD7732
D 2566 MH	6cyl.	11413cc	177kW (240PS)	Diesel		TD7414
D 2566 MK	6cyl.	11413cc	235kW (320PS)	Diesel	Turbo	TD7801
D 2566 MKF	6cyl.	11413cc	235kW (320PS)	Diesel	Turbo Intercooled	TD7758
D 2566 MKUH/320	6cyl.	11413cc	235kW (320PS)	Diesel	Turbo Intercooled	TD7633
D 2566 MKUL	6cyl.	11413cc	235kW (320PS)	Diesel	Turbo Intercooled	TD7804
D 2566 MLUH	6cyl.	11413cc	192kW (261PS)	Diesel	Turbo Intercooled	TD7632
D 2566 MLUM	6cyl.	11413cc	227kW (310PS)	Diesel	Turbo Intercooled	TD7625
D 2566 MT	6cyl.	11413cc	206kW (280PS)	Diesel	Turbo	TD7799
D 2566 MTE	6cyl.	11413cc	162kW (220PS)	Diesel	Turbo	TD19074
D 2566 MTF	6cyl.	11413cc	206kW (280PS)	Diesel	Turbo	TD7738
D 2566 MTH	6cyl.	11413cc	213kW (290PS)	Diesel	Turbo	TD7418
D 2566 MTHO	6cyl.	11413cc	206-235kW (280-320PS)	Diesel	Turbo	TD7744
D 2566 MTUH/280	6cyl.	11413cc	206kW (280PS)	Diesel	Turbo	TD7603
D 2566 MUE	6cyl.	11413cc	125kW (170PS)	Diesel		TD19452
D 2566 MUH	6cyl.	11413cc	177kW (240PS)	Diesel	Turbo	TD7407
D 2566 MUL	6cyl.	11413cc	177kW (240PS)	Diesel		TD7803
D 2566 MUM	6cyl.	11413cc	147-177kW (200-241PS)	Diesel		TD7440
D 2566 MXF	6cyl.	11413cc	125kW (170PS)	Diesel		TD19043
D 2566 UH	6cyl.	11413cc	155kW (211PS)	Diesel		TD7616

14-450370-00 WH  
14-454560-00 WH

125.00

B 140.00  
B 140.00

C 270.00  
C 270.00

D 152.00  
D 152.00

E 10.05  
E 10.25

F 1.00  
F 1.00

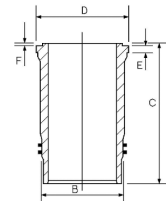



6

D 2530 ME	V10cyl.	15945cc	156kW (212PS)	Diesel		TD19446
D 2530 MF	V10cyl.	15945cc	235kW (320PS)	Diesel		TD5650
D 2530 MTE	V10cyl.	15953cc	223kW (304PS)	Diesel	Turbo	TD19065
D 2530 MTXF	V10cyl.	15953cc	294kW (400PS)	Diesel	Turbo	TD7813
D 2530 MTXF/360	V10cyl.	15900cc	265kW (360PS)	Diesel	Turbo	TD7760
D 2530 MXF	V10cyl.	15945cc	156-235kW (212-320PS)	Diesel		TD19038
D 2538 M	V8cyl.	12763cc	188kW (256PS)	Diesel		TD7743
D 2538 ME	V8cyl.	12763cc	188kW (256PS)	Diesel		TD19447
D 2538 MF	V8cyl.	12763cc	188kW (256PS)	Diesel		TD7737
D 2538 MT	V8cyl.	12763cc	178-235kW (242-320PS)	Diesel	Turbo	TD7748
D 2538 MTE	V8cyl.	12763cc	178kW (242PS)	Diesel	Turbo	TD19064
D 2540 MT	V10cyl.	17426cc	287kW (390PS)	Diesel	Turbo	TD19448
D 2540 MTF	V10cyl.	17426cc	324kW (440PS)	Diesel	Turbo	TD7814
D 2542 MLE	V12cyl.	20911cc	420kW (571PS)	Diesel	Turbo Intercooled	TD19449
D 2542 MTE	V12cyl.	20911cc	283kW (385PS)	Diesel	Turbo	TD19450

14-451090-00 WH

125.00

B 140.00

C 253.00

D 152.00

E 10.05

F 1.00

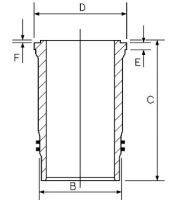

7

D 2676 LF01 Euro 4	6cyl.	12418cc	353kW (480PS)	Diesel	Turbo Intercooled	TD19100
D 2676 LF02 Euro 3	6cyl.	12412cc	353kW (480PS)	Diesel	Turbo Intercooled	TD20542
D 2676 LF03 Euro 2	6cyl.	12412cc	353kW (480PS)	Diesel	Turbo Intercooled	TD20543
D 2676 LF04 Euro 2	6cyl.	12412cc	324kW (440PS)	Diesel	Turbo Intercooled	TD22906
D 2676 LF05 Euro 4	6cyl.	12412cc	353kW (480PS)	Diesel	Turbo Intercooled	TD20371
D 2676 LF06 Euro 5	6cyl.	12412cc	397kW (540PS)	Diesel	Turbo Intercooled	TD23145
D 2676 LF07 Euro 5	6cyl.	12412cc	353kW (480PS)	Diesel	Turbo Intercooled	TD23137
D 2676 LF 08 Euro 5	6cyl.	12412cc	397kW (540PS)	Diesel	Turbo Intercooled	TD25462
D 2676 LF 10 Euro 4	6cyl.	12412cc	324kW (440PS)	Diesel	Turbo Intercooled	TD27718
D 2676 LF11 Euro 4	6cyl.	12418cc	397kW (540PS)	Diesel	Turbo Intercooled	TD19104
D 2676 LF12 Euro 4	6cyl.	12418cc	353kW (480PS)	Diesel	Turbo Intercooled	TD19103
D 2676 LF13 Euro 5	6cyl.	12412cc	397kW (540PS)	Diesel	Turbo Intercooled	TD20372
D 2676 LF14 Euro 5	6cyl.	12412cc	353kW (480PS)	Diesel	Turbo Intercooled	TD20373
D 2676 LF15 Euro 5	6cyl.	12412cc	397kW (540PS)	Diesel	Turbo Intercooled	TD23087
D 2676 LF16 Euro 5	6cyl.	12412cc	353kW (480PS)	Diesel	Turbo Intercooled	TD23088
D 2676 LF 17	6cyl.	12412cc	397kW (540PS)	Diesel	Turbo Intercooled	TD25460
D 2676 LF 18	6cyl.	12412cc	353kW (480PS)	Diesel	Turbo Intercooled	TD25461
D 2676 LF 19 Euro 4	6cyl.	12412cc	397kW (540PS)	Diesel	Turbo Intercooled	TD25615
D 2676 LF 20 Euro 4	6cyl.	12412cc	353kW (480PS)	Diesel	Turbo Intercooled	TD25616
D 2676 LF 21 Euro 5	6cyl.	12412cc	353kW (480PS)	Diesel	Turbo Intercooled	TD23691
D 2676 LF 22 Euro 5	6cyl.	12412cc	324kW (440PS)	Diesel	Turbo Intercooled	TD23692
D 2676 LF 25 Euro 6	6cyl.	12412cc	353kW (480PS)	Diesel	Turbo Intercooled	TD27720





D 2676 LF 26 Euro 6	6cyl.	12412cc	324kW (440PS)	Diesel	Turbo Intercooled	TD27722
D 2676 LF 28 Euro 5	6cyl.	12412cc	324kW (440PS)	Diesel	Turbo Intercooled	TD27723
D 2676 LF 31 Euro 3	6cyl.	12412cc	353kW (480PS)	Diesel	Turbo Intercooled	TD25610
D 2676 LF 32 Euro 4	6cyl.	12412cc	397kW (540PS)	Diesel	Turbo Intercooled	TD25621
D 2676 LF 33 Euro 4	6cyl.	12412cc	353kW (480PS)	Diesel	Turbo Intercooled	TD25623
D 2676 LOH01 Euro 4	6cyl.	12418cc	338kW (460PS)	Diesel	Turbo Intercooled	TD19102
D 2676 LOH02 Euro 4	6cyl.	12418cc	353kW (480PS)	Diesel	Turbo Intercooled	TD19101
D 2676 LOH03 Euro 4	6cyl.	12412cc	338kW (460PS)	Diesel	Turbo Intercooled	TD23068
D 2676 LOH04 Euro 4	6cyl.	12412cc	353kW (480PS)	Diesel	Turbo Intercooled	TD23069
D 2676 LOH10 Euro 3	6cyl.	12412cc	338kW (460PS)	Diesel	Turbo Intercooled	TD23077
D 2676 LOH26 Euro 5	6cyl.	12412cc	324kW (440PS)	Diesel	Turbo Intercooled	TD23400
D 2676 LOH27 Euro 5	6cyl.	12412cc	353kW (480PS)	Diesel	Turbo Intercooled	TD23401
D 2676 LOH 28 Euro 5	6cyl.	12412cc	371kW (505PS)	Diesel	Turbo Intercooled	TD23678

14-451040-00 WH 126.00 B 139.50 C 257.50 D 150.00 E 8.07

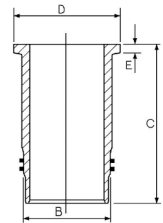

8

D 2865 LF/260	5cyl.	9973cc	191kW (260PS)	Diesel	Turbo Intercooled	TD7776
D 2865 LF02	5cyl.	9973cc	198kW (270PS)	Diesel	Turbo Intercooled	TD7696
D 2865 LF03	5cyl.	9973cc	235kW (320PS)	Diesel	Turbo Intercooled	TD7780
D 2865 LF05 Euro 1	5cyl.	9973cc	198kW (270PS)	Diesel	Turbo Intercooled	TD7777
D 2865 LF06 Euro 1	5cyl.	9973cc	235kW (320PS)	Diesel	Turbo Intercooled	TD7781
D 2865 LF09	5cyl.	9973cc	250kW (340PS)	Diesel	Turbo Intercooled	TD7784
D 2865 LF21 Euro 2	5cyl.	9973cc	250kW (340PS)	Diesel	Turbo Intercooled	TD7769
D 2865 LF22 Euro 1	5cyl.	9973cc	198kW (270PS)	Diesel	Turbo Intercooled	TD7764
D 2865 LF23 Euro 1	5cyl.	9973cc	235kW (320PS)	Diesel	Turbo Intercooled	TD7767
D 2865 LF24 Euro 2	5cyl.	9973cc	213kW (290PS)	Diesel	Turbo Intercooled	TD7766
D 2865 LFR	5cyl.	9973cc	191-235kW (260-320PS)	Diesel	Turbo Intercooled	TD25851
D 2865 LOH01 Euro 1	5cyl.	9973cc	198kW (270PS)	Diesel	Turbo Intercooled	TD9087
D 2865 LOH02 Euro 1	5cyl.	9973cc	235kW (320PS)	Diesel	Turbo Intercooled	TD7754
D 2865 LOH 05 Euro 1	5cyl.	9973cc	191-235kW (260-320PS)	Diesel	Turbo Intercooled	TD25854
D 2865 LOH 07 Euro 2	5cyl.	9973cc	191-250kW (260-340PS)	Diesel	Turbo Intercooled	TD25855
D 2865 LOH 09 Euro 2	5cyl.	9973cc	228kW (310PS)	Diesel	Turbo Intercooled	TD25858
D 2865 LU01/SILENT Euro 1	5cyl.	9973cc	198kW (270PS)	Diesel	Turbo Intercooled	TD7724
D 2865 LUH02 Euro 1	5cyl.	9973cc	198kW (270PS)	Diesel	Turbo Intercooled	TD7578
D 2865 LUH05 Euro 1	5cyl.	9973cc	198kW (270PS)	Diesel	Turbo Intercooled	TD7579
D 2865 LUH07 Euro 2	5cyl.	9973cc	228kW (310PS)	Diesel	Turbo Intercooled	TD7581
D 2865 LUH08 Euro 1	5cyl.	9973cc	235kW (320PS)	Diesel	Turbo Intercooled	TD7612
D 2865 LUH09 Euro 2	5cyl.	9973cc	191kW (260PS)	Diesel	Turbo Intercooled	TD7594
D 2865 LXF	5cyl.	9973cc	191-235kW (260-320PS)	Diesel	Turbo Intercooled	TD25860
D 2865 LXFR	5cyl.	9973cc	191-235kW (260-320PS)	Diesel	Turbo Intercooled	TD25861





D 2866 F/240	6cyl.	11967cc	177kW (240PS)	Diesel		TD7775
D 2866 FR	6cyl.	11967cc	177kW (240PS)	Diesel		TD19127
D 2866 KF	6cyl.	11967cc	265kW (360PS)	Diesel	Turbo Intercooled	TD5651
D 2866 KFZ	6cyl.	11967cc	265kW (360PS)	Diesel	Turbo Intercooled	TD7761
D 2866 KOH/360	6cyl.	11967cc	265kW (360PS)	Diesel	Turbo Intercooled	TD16487
D 2866 KOH/373	6cyl.	11967cc	274kW (373PS)	Diesel	Turbo Intercooled	TD7415
D 2866 KUH/360 Euro 1	6cyl.	11967cc	265kW (360PS)	Diesel	Turbo Intercooled	TD7591
D 2866 KUL	6cyl.	11967cc	265kW (360PS)	Diesel	Turbo Intercooled	TD7786
D 2866 LF/290	6cyl.	11967cc	213kW (290PS)	Diesel	Turbo Intercooled	TD7778
D 2866 LF03	6cyl.	11967cc	272kW (370PS)	Diesel	Turbo Intercooled	TD7787
D 2866 LF04	6cyl.	11967cc	220kW (299PS)	Diesel	Turbo Intercooled	TD7779
D 2866 LF05 Euro 1	6cyl.	11967cc	272kW (370PS)	Diesel	Turbo Intercooled	TD7788
D 2866 LF06	6cyl.	11967cc	309kW (420PS)	Diesel	Turbo Intercooled	TD7792
D 2866 LF09 Euro 1	6cyl.	11967cc	309kW (420PS)	Diesel	Turbo Intercooled	TD7793
D 2866 LF10 Euro 1	6cyl.	11967cc	309kW (420PS)	Diesel	Turbo Intercooled	TD7794
D 2866 LF14 Euro 2	6cyl.	11967cc	294-309kW (400-420PS)	Diesel	Turbo Intercooled	TD21308
D 2866 LF15 Euro 1	6cyl.	11967cc	272kW (370PS)	Diesel	Turbo Intercooled	TD7789
D 2866 LF16 Euro 2	6cyl.	11967cc	294kW (400PS)	Diesel	Turbo Intercooled	TD7791
D 2866 LF17 Euro 2	6cyl.	11967cc	260kW (354PS)	Diesel	Turbo Intercooled	TD21309
D 2866 LF20 Euro 2	6cyl.	11967cc	294kW (400PS)	Diesel	Turbo Intercooled	TD7771
D 2866 LF21 Euro 1	6cyl.	11967cc	272kW (370PS)	Diesel	Turbo Intercooled	TD7770
D 2866 LF22 Euro 1	6cyl.	11967cc	309kW (420PS)	Diesel	Turbo Intercooled	TD7772
D 2866 LF23 Euro 3	6cyl.	11967cc	228kW (310PS)	Diesel	Turbo Intercooled	TD16521
D 2866 LF24 Euro 3	6cyl.	11967cc	265kW (360PS)	Diesel	Turbo Intercooled	TD16522
D 2866 LF25 Euro 3	6cyl.	11967cc	301kW (409PS)	Diesel	Turbo Intercooled	TD16467
D 2866 LF26 Euro 3	6cyl.	11967cc	228kW (310PS)	Diesel	Turbo Intercooled	TD16204
D 2866 LF27 Euro 4	6cyl.	11967cc	265kW (360PS)	Diesel	Turbo Intercooled	TD16205
D 2866 LF28 Euro 3	6cyl.	11967cc	301kW (409PS)	Diesel	Turbo Intercooled	TD15050
D 2866 LF29 Euro 2	6cyl.	11967cc	294kW (400PS)	Diesel	Turbo Intercooled	TD21310
D 2866 LF30 Euro 2	6cyl.	11967cc	301kW (409PS)	Diesel	Turbo Intercooled	TD21311
D 2866 LF31 Euro 2	6cyl.	11967cc	301kW (409PS)	Diesel	Turbo Intercooled	TD14312
D 2866 LF32 Euro 2	6cyl.	11967cc	301kW (409PS)	Diesel	Turbo Intercooled	TD15048
D 2866 LF34 Euro 2	6cyl.	11967cc	228kW (310PS)	Diesel	Turbo Intercooled	TD14308
D 2866 LF35 Euro 2	6cyl.	11967cc	265kW (360PS)	Diesel	Turbo Intercooled	TD14311
D 2866 LF36 Euro 2	6cyl.	11967cc	228kW (310PS)	Diesel	Turbo Intercooled	TD16202
D 2866 LF37 Euro 2	6cyl.	11967cc	265kW (360PS)	Diesel	Turbo Intercooled	TD16203
D 2866 LFZ/290	6cyl.	11967cc	213kW (290PS)	Diesel	Turbo Intercooled	TD7757
D 2866 LFZ/330	6cyl.	11967cc	243kW (330PS)	Diesel	Turbo Intercooled	TD7759
D 2866 LOH	6cyl.	11967cc	243-309kW (330-420PS)	Diesel	Turbo Intercooled	TD7750
D 2866 LOH03	6cyl.	11967cc	309kW (420PS)	Diesel	Turbo Intercooled	TD7808
D 2866 LOH06 Euro 1	6cyl.	11967cc	309kW (420PS)	Diesel	Turbo Intercooled	TD7755
D 2866 LOH07	6cyl.	11967cc	272kW (370PS)	Diesel	Turbo Intercooled	TD7602
D 2866 LOH20 Euro 1	6cyl.	11967cc	309kW (420PS)	Diesel	Turbo Intercooled	TD5647
D 2866 LOH22 Euro 1	6cyl.	11967cc	272kW (370PS)	Diesel	Turbo Intercooled	TD7420
D 2866 LOH23 Euro 2	6cyl.	11967cc	294kW (400PS)	Diesel	Turbo Intercooled	TD7592





D 2866 LOH24 Euro 1	6cyl.	11970cc	230kW (313PS)	Diesel	Turbo Intercooled	TD7752
D 2866 LOH25 Euro 2	6cyl.	11967cc	228kW (310PS)	Diesel	Turbo Intercooled	TD7753
D 2866 LOH26 Euro 2	6cyl.	11967cc	257kW (350PS)	Diesel	Turbo Intercooled	TD7590
D 2866 LOH27 Euro 3	6cyl.	11967cc	228kW (310PS)	Diesel	Turbo Intercooled	TD16760
D 2866 LOH28 Euro 3	6cyl.	11967cc	265kW (360PS)	Diesel	Turbo Intercooled	TD16761
D 2866 LOH29 Euro 3	6cyl.	11967cc	301kW (409PS)	Diesel	Turbo Intercooled	TD16493
D 2866 LOH32 Euro 3	6cyl.	11967cc	228kW (310PS)	Diesel	Turbo Intercooled	TD16746
D 2866 LOH33 Euro 3	6cyl.	11967cc	265kW (360PS)	Diesel	Turbo Intercooled	TD16747
D 2866 LOH34 Euro 3	6cyl.	11967cc	301kW (409PS)	Diesel	Turbo Intercooled	TD16297
D 2866 LU/330	6cyl.	11967cc	243kW (330PS)	Diesel	Turbo Intercooled	TD7809
D 2866 LU 01	6cyl.	11967cc	272kW (370PS)	Diesel	Turbo Intercooled	TD21312
D 2866 LU 03 Euro 1	6cyl.	11967cc	272kW (370PS)	Diesel	Turbo Intercooled	TD21313
D 2866 LUH/330	6cyl.	11967cc	243kW (330PS)	Diesel	Turbo Intercooled	TD7593
D 2866 LUH21 Euro 2	6cyl.	11967cc	257kW (350PS)	Diesel	Turbo Intercooled	TD11167
D 2866 LUH22 Euro 2	6cyl.	11967cc	191kW (260PS)	Diesel	Turbo Intercooled	TD11133
D 2866 LUH23 Euro 3	6cyl.	11967cc	191kW (260PS)	Diesel	Turbo Intercooled	TD16764
D 2866 LUH24 Euro 3	6cyl.	11967cc	228kW (310PS)	Diesel	Turbo Intercooled	TD16765
D 2866 LUH25 Euro 3	6cyl.	11967cc	265kW (360PS)	Diesel	Turbo Intercooled	TD16766
D 2866 LUH26 Euro 2	6cyl.	11967cc	228kW (310PS)	Diesel	Turbo	TD11134
D 2866 LUH30 Euro 3	6cyl.	11967cc	301kW (409PS)	Diesel	Turbo Intercooled	TD16767
D 2866 LUL/330	6cyl.	11967cc	243kW (330PS)	Diesel	Turbo Intercooled	TD7783
D 2866 LX	6cyl.	11967cc	198kW (270PS)	Diesel	Turbo Intercooled	TD19128
D 2866 LXF	6cyl.	11967cc	198-274kW (269-372PS)	Diesel	Turbo Intercooled	TD7785
D 2866 LXOH	6cyl.	11967cc	265-274kW (360-373PS)	Diesel	Turbo Intercooled	TD6728
D 2866 OH	6cyl.	11967cc	177-213kW (241-290PS)	Diesel		TD23745
D 2866 T	6cyl.	11967cc	213kW (290PS)	Diesel	Turbo Intercooled	TD7580
D 2866 TOH	6cyl.	11967cc	229kW (313PS)	Diesel	Turbo Intercooled	TD7745
D 2866 TOH/290	6cyl.	11967cc	213kW (290PS)	Diesel	Turbo Intercooled	TD7746
D 2866 TOH/310	6cyl.	11967cc	229kW (313PS)	Diesel	Turbo Intercooled	TD7747
D 2866 TUH	6cyl.	11967cc	224-229kW (305-311PS)	Diesel	Turbo Intercooled	TD7186
D 2866 TUH/290	6cyl.	11967cc	213-224kW (290-305PS)	Diesel	Turbo Intercooled	TD7589
D 2866 TUH01	6cyl.	11967cc	222kW (302PS)	Diesel	Turbo Intercooled	TD7176
D 2866 UH	6cyl.	11967cc	177-186kW (241-253PS)	Diesel		TD7419
D 2866 UH/240	6cyl.	11967cc	177kW (240PS)	Diesel	Turbo	TD7577
D 2866 UM	6cyl.	11967cc	152-177kW (206-241PS)	Diesel		TD7174
D 2876 LF02 Euro 2	6cyl.	12816cc	338kW (460PS)	Diesel	Turbo Intercooled	TD7773
D 2876 LF03 Euro 3	6cyl.	12816cc	338kW (460PS)	Diesel	Turbo Intercooled	TD17050
D 2876 LF04 Euro 3	6cyl.	12816cc	338kW (460PS)	Diesel	Turbo Intercooled	TD15051
D 2876 LF05 Euro 3	6cyl.	12816cc	375kW (510PS)	Diesel	Turbo Intercooled	TD16206
D 2876 LF06 Euro 2	6cyl.	12816cc	338kW (460PS)	Diesel	Turbo Intercooled	TD14313
D 2876 LF07 Euro 2	6cyl.	12816cc	338kW (460PS)	Diesel	Turbo Intercooled	TD15049
D 2876 LF11 Euro 2	6cyl.	12816cc	338kW (460PS)	Diesel	Turbo Intercooled	TD20603
D 2876 LOH / LUH01 Euro 2	6cyl.	12816cc	338kW (460PS)	Diesel	Turbo Intercooled	TD16249
D 2876 LOH02 Euro 3	6cyl.	12816cc	338kW (460PS)	Diesel	Turbo Intercooled	TD16509
D 2876 LOH03 Euro 3	6cyl.	12816cc	338kW (460PS)	Diesel	Turbo Intercooled	TD16298







D 2876 LUE 604	6cyl.	12816cc	375kW (510PS)	Diesel	Turbo Intercooled	TD27939
D 2876 LUE 605	6cyl.	12816cc	338kW (460PS)	Diesel	Turbo Intercooled	TD27938
D 2876 LUE 606	6cyl.	12816cc	301kW (409PS)	Diesel	Turbo Intercooled	TD27937

- 14-450030-00 WH ①
- 14-452920-00 WH ①
- 14-452921-10 WH ①②
- 14-452930-00 WH ①

128.00

B 144.50	C 270.00	D 153.80	E 10.27	F 1.00
B 144.50	C 270.00	D 153.80	E 10.07	F 1.00
B 145.50	C 270.00	D 154.30	E 10.07	F 1.00
B 144.50	C 270.00	D 153.80	E 10.57	F 1.00

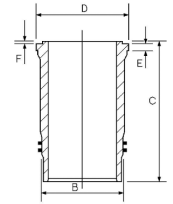

① Use also: 4 O-rings, Set HT019

① Mitverwenden: 4 O-Ringe, Satz: HT019

① A utiliser aussi: 4 joints toriques. Pochette HT019

① Utilizar también: 4 juntas toricas. Juego HT019

② Phosphated

② Phosphatiert

② Phosphatisé

② Fosfatada

9

D 2840 LE	V10cyl.	18273cc	346kW (471PS)	Diesel	Turbo Intercooled	TD19453
D 2840 LE 423	V10cyl.	18270cc	809kW (1100PS)	Diesel	Turbo Intercooled	TD27921
D 2840 LF/460	V10cyl.	18273cc	338kW (460PS)	Diesel	Turbo Intercooled	TD7795
D 2840 LF01	V10cyl.	18273cc	368kW (500PS)	Diesel	Turbo Intercooled	TD7796
D 2840 LF04 Euro 1	V10cyl.	18273cc	368kW (500PS)	Diesel	Turbo Intercooled	TD7797
D 2840 LF06 Euro 1	V10cyl.	18273cc	368kW (500PS)	Diesel	Turbo Intercooled	TD7798
D 2840 LF20 Euro 2	V10cyl.	18273cc	441kW (600PS)	Diesel	Turbo Intercooled	TD7774
D 2840 LF21 Euro 2	V10cyl.	18273cc	441kW (600PS)	Diesel	Turbo Intercooled	TD18099
D 2840 LF25 Euro 3	V10cyl.	18273cc	485-515kW (660-700PS)	Diesel	Turbo Intercooled	TD16824
D 2840 LXF	V10cyl.	18273cc	338kW (460PS)	Diesel	Turbo Intercooled	TD19455
D 2840 ME	V10cyl.	18273cc	244kW (332PS)	Diesel		TD19125
D 2840 MF	V10cyl.	18273cc	268kW (365PS)	Diesel		TD7811
D 2840 MFG	V10cyl.	18273cc	268kW (365PS)	Diesel		TD7812
D 2840 MFR	V10cyl.	18273cc	268-245kW (364-333PS)	Diesel		TD19456
D 2840 MH	V10cyl.	18273cc	244kW (332PS)	Diesel		TD19126
D 2840 TL	V10cyl.	18273cc	603kW (820PS)	Diesel	Turbo Intercooled	FM5425
D 2842 LE 202	V12cyl.	21930cc	446-587kW (607-798PS)	Diesel	Turbo Intercooled	TD25682
D 2842 LE 211	V12cyl.	21930cc	446kW (607PS)	Diesel	Turbo Intercooled	TD27955
D 2842 LE 403	V12cyl.	21930cc	529kW (805PS)	Diesel	Turbo Intercooled	TD27862
D 2842 LE 404	V12cyl.	21930cc	956kW (1300PS)	Diesel	Turbo Intercooled	TD27702
D 2842 LE 423	V12cyl.	21930cc	1000kW (1360PS)	Diesel	Turbo Intercooled	TD27922
D 2842 LE 433	V12cyl.	21930cc	1140kW (1550PS)	Diesel	Turbo Intercooled	TD27923
D 2842 LE622	V12cyl.	21927cc	588kW (800PS)	Diesel	Turbo Intercooled	TD20231
D 2842 LF	V12cyl.	21927cc	735kW (1000PS)	Diesel	Turbo Intercooled	FM5426
D 2842 LF10 Euro 3	V12cyl.	21927cc	735kW (1000PS)	Diesel	Turbo Intercooled	TD20177
D 2842 LFX	V12cyl.	21927cc	735kW (1000PS)	Diesel	Turbo Intercooled	FM5426
D 2842 LXE	V12cyl.	21927cc	662kW (900PS)	Diesel	Turbo Intercooled	FM5426
D 2842 LXE	V12cyl.	21927cc	662kW (900PS)	Diesel	Turbo Intercooled	TD19121
D 2842 LYE	V12cyl.	21927cc	735kW (1000PS)	Diesel	Turbo Intercooled	FM5426
D 2842 LYE	V12cyl.	21927cc	735kW (1000PS)	Diesel	Turbo Intercooled	TD19122
D 2842 LZE	V12cyl.	21927cc	735kW (1000PS)	Diesel	Turbo Intercooled	FM5426
D 2842 LZE	V12cyl.	21927cc	735kW (1000PS)	Diesel	Turbo Intercooled	TD19123
D 2842 ME	V12cyl.	21927cc	275kW (374PS)	Diesel		FM5423





D 2842 ME	V12cyl.	21927cc	275kW (374PS)	Diesel		TD19120
D 2842 MF	V12cyl.	21927cc	338kW (460PS)	Diesel		FM5423
D 2848 LE	V8cyl.	14618cc	206-500kW (280-680PS)	Diesel		FM25422
D 2848 LE 423	V8cyl.	14618cc	662kW (900PS)	Diesel	Turbo Intercooled	TD27920
D 2848 LXE	V8cyl.	14618cc	500kW (680PS)	Diesel	Turbo Intercooled	FM5424
D 2848 LXE	V8cyl.	14618cc	500kW (680PS)	Diesel	Turbo Intercooled	TD19118
D 2848 LYE	V8cyl.	14618cc	500kW (680PS)	Diesel	Turbo Intercooled	FM5424
D 2848 LYE	V8cyl.	14618cc	500kW (680PS)	Diesel	Turbo Intercooled	TD19119
D 2848 M	V8cyl.	14618cc	206kW (280PS)	Diesel		FM5422
D 2848 M	V8cyl.	14618cc	206kW (280PS)	Diesel		TD19075
D 2848 MF	V8cyl.	14618cc	206kW (280PS)	Diesel		FM5422
D 2848 MH	V8cyl.	14618cc	206kW (280PS)	Diesel		FM5422
D 2848 MH	V8cyl.	14618cc	206kW (280PS)	Diesel		TD19076
E 2842 E 312	V12cyl.	21927cc	250-280kW (340-381PS)			TD28171
E 2842 LE 312	V12cyl.	21927cc	360-420kW (490-571PS)		Turbo Intercooled	TD27925
E 2842 LE 322	V12cyl.	21927cc	380-420kW (517-571PS)		Turbo Intercooled	TD27639
E 2848 LE 322	V8cyl.	14618cc	265-295kW (360-401PS)		Turbo Intercooled	TD28166

14-452910-00 WH ①②

128.00

B 144.50

C 253.00

D 153.80

E 10.05

F 1.00

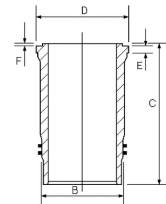

① Use also: 4 O-rings, Set HT019

① Mitverwenden: 4 O-Ringe, Satz: HT019

① A utiliser aussi: 4 joints toriques. Pochette HT019

① Utilizar también: 4 juntas toricas. Juego HT019

② Interference fit = 145.8mm

② Preßsitz = 145.8mm

② Ajustement pressé = 145.8mm

② Encaje a presi<sup>o</sup>n = 145.8mm

10

D 2866 LF32 Euro 2	6cyl.	11967cc	228-301kW (310-410PS)	Diesel	Turbo Intercooled	FM117034
D 2866 LF39 Euro 2	6cyl.	11967cc	228-301kW (310-410PS)	Diesel	Turbo Intercooled	FM127034
D 2866 LF40 Euro 2	6cyl.	11967cc	301kW (409PS)	Diesel	Turbo Intercooled	TD23662
D 2866 LF41 Euro 2	6cyl.	11967cc	301kW (409PS)	Diesel	Turbo Intercooled	TD23005
D 2866 LF42 Euro 2	6cyl.	11967cc	228-301kW (310-410PS)	Diesel	Turbo Intercooled	FM157034
D 2866 LF43 Euro 2	6cyl.	11967cc	265kW (360PS)	Diesel	Turbo Intercooled	TD23004

14-452920-00 WH ①

128.00

B 144.50

C 270.00

D 153.80

E 10.07

F 1.00

14-452921-10 WH ①②

B 145.50

C 270.00

D 154.30

E 10.07

F 1.00

14-452930-00 WH ①

B 144.50

C 270.00

D 153.80

E 10.57

F 1.00

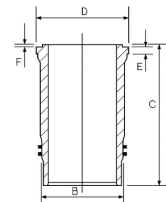

① Use also: 4 O-rings, Set HT019

① Mitverwenden: 4 O-Ringe, Satz: HT019

① A utiliser aussi: 4 joints toriques. Pochette HT019

① Utilizar también: 4 juntas toricas. Juego HT019

② Phosphated

② Phosphatiert

② Phosphatisé

② Fosfatada





11

D 2876 LF12 Euro 3	6cyl.	12816cc	353kW (480PS)	Diesel	Turbo Intercooled	TD16825
D 2876 LF13 Euro 3	6cyl.	12816cc	390kW (530PS)	Diesel	Turbo Intercooled	TD16826
D 2876 LF25 Euro 3	6cyl.	12816cc	353kW (480PS)	Diesel	Turbo Intercooled	TD19115
D 2876 LOH20 Euro 3	6cyl.	12816cc	353kW (480PS)	Diesel	Turbo Intercooled	TD16762
D 2876 LOH21 Euro 3	6cyl.	12816cc	390kW (530PS)	Diesel	Turbo Intercooled	TD18041

14-670050-00 *WH*      128.00      B 144.50      C 268.00      D 153.80      E 8.07

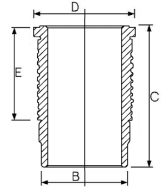

# MODEL INDEX



Modelverzeichnis • Index de modele • Índice de Modelo  
Indeks modelu • Модель автомобиля • دليل الموديل



CCM

x



9

04/03→	<b>2 1.4</b>	F6JA, F6JB	Diesel	1399	4	<b>1</b>
03/85→10/89	<b>B-Serie 2.2</b>	R2	Diesel	2184	4	<b>2</b>
01/84→05/03	<b>E-Serie 2.2</b>	R2	Diesel	2184	4	<b>2</b>
08/86→10/95	<b>Spectron 2.2</b>	R2	Diesel	2184	4	<b>2</b>



**1**

**F6JA** 4cyl. **1399cc** **50kW (68PS)** Diesel Turbo **TD18693**

**F6JB** 4cyl. **1399cc** **50kW (68PS)** Diesel Turbo **TD20951**

14-020760-00 *D* **73.70** **B** 76.70 **C** 136.00 **D** 78.20 **E** 5.00  
 14-020761-00 *D* **B** 76.95 **C** 136.00 **D** 78.45 **E** 5.25

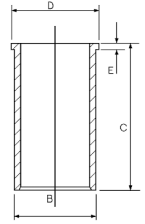

**2**

**R2** 4cyl. **2184cc** **52kW (71PS)** Diesel **TD2030**

14-010840-00 *D* **86.00** **B** 90.00 **C** 179.96

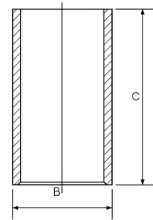

# MODEL INDEX



Modelverzeichnis • Index de modele • Índice de Modelo  
Indeks modelu • Модель автомобиля • دليل الموديل



CCM

x



9

07/76→11/85	2.0	OM 615.940	Diesel	1988	4	1
06/80→05/93	2.0	M 102.920, M 102.922, M 102.939, M 102.963	Petrol	1997	4	4
12/84→06/93	2.0	OM 601.912	Diesel	1978	4	2
01/76→03/79	2.2	OM 615.941	Diesel	2197	4	1
02/76→11/85	2.4	OM 616.912	Diesel	2404	4	8
04/85→06/93	2.5	OM 602.912, OM 602A.962	Diesel	2497	5	2
02/76→11/85	2.9	OM 617.912	Diesel	2998	5	8
08/81→07/85	3.0	OM 617.952	Diesel	2998	5	7
12/84→06/93	3.0	OM 603.912, OM 603.913, OM 603A.960, OM 603A.963	Diesel	2996	6	2
06/91→05/93	3.4	OM 603A.971	Diesel	3449	6	5
01/68→01/77	/8 2.0	OM 615.913	Diesel	1988	4	1
01/68→01/77	/8 2.2	OM 615.912	Diesel	2197	4	1
08/73→01/77	/8 2.4	OM 616.916	Diesel	2404	4	8
08/74→11/76	/8 3.0	OM 617.910	Diesel	2998	5	8
04/88→04/96	100 2.0	OM 615.963, OM 615.970	Diesel	1988	4	1
02/88→02/96	100 2.4	OM 616.963	Diesel	2399	4	7
04/90→08/93	190 1.8	M 102.910	Petrol	1797	4	4
10/82→08/93	190 2.0	M 102.921, M 102.924, M 102.961, M 102.962	Petrol	1997	4	4
08/83→08/93	190 2.0	OM 601.911	Diesel	1978	4	2
04/85→08/93	190 2.5	OM 602.911, OM 602.961	Diesel	2497	5	2
03/93→03/01	C-Class 2.0	OM 601.913, OM 604.915	Diesel	1997	4	2
08/93→03/01	C-Class 2.2	OM 604.910	Diesel	2155	4	6
09/97→03/01	C-Class 2.2	OM 611.960	Diesel	2148	4	3
05/93→03/01	C-Class 2.5	OM 605.910, OM 605.960	Diesel	2497	5	2
09/81→07/85	Coupe 2.9	OM 617.952	Diesel	2998	5	7
06/93→06/95	E-Class 2.0	OM 601.912	Diesel	1978	4	2
01/96→03/02	E-Class 2.0	OM 604.917	Diesel	1997	4	2
06/95→03/02	E-Class 2.2	OM 604.912	Diesel	2155	4	6
06/93→07/99	E-Class 2.5	OM 602A.962, OM 605.911, OM 605.912, OM 605.962	Diesel	2497	5	2
03/96→07/99	E-Class 2.9	OM 602.982	Diesel	2874	5	5
06/93→07/99	E-Class 3.0	OM 603.912, OM 603A.960, OM 603A.963, OM 606.910, OM 606.912, OM 606.962	Diesel	2996	6	2
01/90→07/93	G-Class 2.0	M 102.965	Petrol	1996	4	4
03/79→08/87	G-Class 2.4	OM 616.936	Diesel	2399	4	7
10/87→	G-Class 2.5	OM 602.930, OM 602.931, OM 602.939	Diesel	2497	5	2
04/92→	G-Class 2.9	OM 602.942, OM 602.983	Diesel	2874	5	5
03/79→	G-Class 3.0	OM 603.912, OM 603.931, OM 606.964	Diesel	2996	6	2
12/79→12/91	G-Class 3.0	OM 617.931	Diesel	2998	5	7
09/91→	G-Class 3.4	OM 603A.972	Diesel	3449	6	5
06/61→02/68	Heckflosse 2.0	OM 621.912, OM 621.918	Diesel	1988	4	1
02/73→12/77	Henschel 2-t 2.2	OM 615.917, OM 615.937, OM 615.939	Diesel	2197	4	1
11/80→05/93	Kombi 2.0	M 102.920, M 102.922, M 102.939, M 102.962, M 102.963	Petrol	1997	4	4
09/85→08/91	Kombi 2.0	OM 601.912	Diesel	1978	4	2
09/77→12/85	Kombi 2.4	OM 616.912	Diesel	2404	4	8
09/85→07/93	Kombi 2.5	OM 602.912, OM 602A.962	Diesel	2497	5	2
09/77→11/85	Kombi 2.9	OM 617.912	Diesel	2998	5	8
10/80→11/85	Kombi 2.9	OM 617.952	Diesel	2998	5	7
09/86→06/93	Kombi 3.0	OM 603.912, OM 603A.960, OM 603A.963	Diesel	2996	6	2
11/99→01/03	Mb100 2.3	OM 661.911	Diesel	2299	4	5
10/01→05/05	Mb100 2.9	OM 662.911	Diesel	2874	5	5
09/80→12/85	S-Class 3.0	OM 617.951	Diesel	2998	5	7
09/85→10/98	S-Class 3.0	OM 603.961, OM 606.961	Diesel	2996	6	2
01/93→10/98	S-Class 3.4	OM 603A.971	Diesel	3449	6	5
01/95→04/00	Sprinter 2-t 2.3	OM 601.943	Diesel	2299	4	5
02/95→04/00	Sprinter 2-t 2.9	OM 602.980	Diesel	2874	5	5
02/95→04/00	Sprinter 3-t 2.3	OM 601.943	Diesel	2299	4	5
02/95→08/02	Sprinter 3-t 2.9	OM 602.980	Diesel	2874	5	5

Modelverzeichnis • Index de modele • Índice de Modelo  
Indeks modelu • Модель автомобиля • دليل المركبة



# MODEL INDEX



CCM

x



02/96→05/06	<b>Sprinter 4-t 2.3</b>	OM 601.943	Diesel	2299	4	5
02/96→05/06	<b>Sprinter 4-t 2.9</b>	OM 602.980	Diesel	2874	5	5
10/88→02/96	<b>T1 2.3</b>	OM 601.940	Diesel	2299	4	5
01/77→12/90	<b>T1 2.4</b>	OM 616.917	Diesel	2404	4	8
04/77→01/90	<b>T1 2.4</b>	OM 616.934, OM 616.937, OM 616.939	Diesel	2399	4	7
10/88→02/96	<b>T1 2.8</b>	OM 602.940	Diesel	2874	5	5
12/82→01/90	<b>T1 2.9</b>	OM 617.913	Diesel	2998	5	7
11/88→02/96	<b>T1 2.9</b>	OM 602.940	Diesel	2874	5	5
10/82→01/90	<b>T1 3.0</b>	OM 617.913	Diesel	2998	5	7
11/88→06/95	<b>T1/TN 2.3</b>	OM 601.940	Diesel	2299	4	5
07/81→01/89	<b>T1/TN 2.4</b>	OM 616.913, OM 616.939	Diesel	2399	4	7
11/88→06/95	<b>T1/TN 2.8</b>	OM 602.940	Diesel	2874	5	5
04/82→01/89	<b>T1/TN 2.9</b>	OM 617.913	Diesel	2998	5	7
01/68→12/80	<b>T2/L 2.2</b>	OM 615, OM 615.910	Diesel	2197	4	1
01/75→12/88	<b>T2/L 2.4</b>	OM 616.910	Diesel	2399	4	7
01/75→12/88	<b>T2/L 2.4</b>	OM 616.917	Diesel	2404	4	8
01/70→12/88	<b>T2/L 3.8</b>	OM 314.946, OM 314.948, OM 314.959, OM 314.961, OM 314.962, OM 314.963	Diesel	3782	4	9
01/72→12/88	<b>T2/L 5.7</b>	OM 352.906, OM 352.911, OM 353.963, OM 353.966	Diesel	5673	6	9
03/89→12/94	<b>T2/LN1 2.3</b>	OM 601.941	Diesel	2299	4	5
04/86→04/89	<b>T2/LN1 2.4</b>	OM 616.914	Diesel	2399	4	7
04/86→12/94	<b>T2/LN1 4.0</b>	OM 354.901, OM 354.902, OM 354.903, OM 354.923, OM 354.924, OM 354.925, OM 364.906, OM 364.911, OM 364.912, OM 364.913, OM 364.919, OM 364.920, OM 364.921, OM 364.950, OM 364.952, OM 364.954, OM 364.957, OM 364.958, OM 364.980, OM 364.981, OM 364.984	Diesel	3972	4	10
09/96→	<b>Vario 2.9</b>	OM 602.984, OM 602.985	Diesel	2874	5	5
09/96→	<b>Vario 4.2</b>	OM 900.917, OM 900.919, OM 904.917	Diesel	4249	4	11
09/96→	<b>Vario 4.2</b>	OM 904.908, OM 904.964	Diesel	4250	4	11
09/96→	<b>Vario 4.3</b>	OM 900.918	Diesel	4249	4	11
09/96→	<b>Vario 4.3</b>	OM 904.904, OM 904.923, OM 904.961	Diesel	4250	4	11
03/99→07/03	<b>V-Class 2.2</b>	OM 611.980	Diesel	2148	4	3
09/96→07/03	<b>V-Class 2.3</b>	OM 601A.970	Diesel	2299	4	5
03/99→07/03	<b>Vito 2.2</b>	OM 611.980, OM 611A (60 KW CDI), OM 611LA (75 KW CDI)	Diesel	2148	4	3
02/96→07/03	<b>Vito 2.3</b>	OM 601.942, OM 601A.970	Diesel	2299	4	5

# ENGINE INDEX

Motorverzeichnis • Index de moteur • Índice de Motor  
Indeks silnika • Модель двигателя • دليل المحرك



CCM



9

Engine Code	Fuel Type	CCM	x	Valve Train	9
M 102.910	Petrol	1797	4	89.00	4
M 102.919	Petrol	1797	4	89.00	4
M 102.920	Petrol	1997	4	89.00	4
M 102.921	Petrol	1997	4	89.00	4
M 102.922	Petrol	1997	4	89.00	4
M 102.924	Petrol	1997	4	89.00	4
M 102.938	Petrol	1997	4	89.00	4
M 102.939	Petrol	1997	4	89.00	4
M 102.961	Petrol	1997	4	89.00	4
M 102.962	Petrol	1997	4	89.00	4
M 102.963	Petrol	1997	4	89.00	4
M 102.964	Petrol	1997	4	89.00	4
M 102.965	Petrol	1996	4	89.00	4
M 476.921	Petrol	11967	6	128.00	21
M 476.925	Petrol	11967	6	128.00	21
M 476.926	Petrol	11967	6	128.00	21
M 476.927	Petrol	11967	6	128.00	21
M 476.930	Petrol	11967	6	128.00	21
OM 314.900	Diesel	3782	4	97.00	9
OM 314.910	Diesel	3782	4	97.00	9
OM 314.914	Diesel	3782	4	97.00	9
OM 314.915	Diesel	3782	4	97.00	9
OM 314.916	Diesel	3782	4	97.00	9
OM 314.917	Diesel	3782	4	97.00	9
OM 314.918	Diesel	3782	4	97.00	9
OM 314.919	Diesel	3782	4	97.00	9
OM 314.920	Diesel	3782	4	97.00	9
OM 314.921	Diesel	3782	4	97.00	9
OM 314.922	Diesel	3782	4	97.00	9
OM 314.940	Diesel	3782	4	97.00	9
OM 314.941	Diesel	3782	4	97.00	9
OM 314.942	Diesel	3782	4	97.00	9
OM 314.943	Diesel	3782	4	97.00	9
OM 314.944	Diesel	3782	4	97.00	9
OM 314.945	Diesel	3782	4	97.00	9
OM 314.946	Diesel	3782	4	97.00	9
OM 314.947	Diesel	3782	4	97.00	9
OM 314.948	Diesel	3782	4	97.00	9
OM 314.949	Diesel	3782	4	97.00	9
OM 314.950	Diesel	3782	4	97.00	9
OM 314.951	Diesel	3782	4	97.00	9
OM 314.953	Diesel	3782	4	97.00	9
OM 314.954	Diesel	3782	4	97.00	9
OM 314.956	Diesel	3782	4	97.00	9
OM 314.957	Diesel	3782	4	97.00	9
OM 314.958	Diesel	3782	4	97.00	9
OM 314.959	Diesel	3782	4	97.00	9
OM 314.960	Diesel	3782	4	97.00	9
OM 314.961	Diesel	3782	4	97.00	9
OM 314.962	Diesel	3782	4	97.00	9
OM 314.963	Diesel	3782	4	97.00	9
OM 314.964	Diesel	3782	4	97.00	9
OM 314.970	Diesel	3782	4	97.00	9
OM 352.901	Diesel	5673	6	97.00	9
OM 352.902	Diesel	5673	6	97.00	9
OM 352.903	Diesel	5673	6	97.00	9
OM 352.904	Diesel	5673	6	97.00	9
OM 352.905	Diesel	5673	6	97.00	9
OM 352.906	Diesel	5673	6	97.00	9
OM 352.907	Diesel	5673	6	97.00	9

Motorverzeichnis • Index de moteur • Índice de Motor  
Indeks silnika • Модель двигателя • دليل المحرك

# ENGINE INDEX



CCM

x



9

OM 352.908	Diesel	5673	6	97.00	9
OM 352.909	Diesel	5673	6	97.00	9
OM 352.910	Diesel	5673	6	97.00	9
OM 352.911	Diesel	5673	6	97.00	9
OM 352.912	Diesel	5673	6	97.00	9
OM 352.913	Diesel	5673	6	97.00	9
OM 352.914	Diesel	5673	6	97.00	9
OM 352.915	Diesel	5673	6	97.00	9
OM 352.916	Diesel	5673	6	97.00	9
OM 352.917	Diesel	5673	6	97.00	9
OM 352.918	Diesel	5673	6	97.00	9
OM 352.919	Diesel	5673	6	97.00	9
OM 352.930	Diesel	5673	6	97.00	9
OM 352.931	Diesel	5673	6	97.00	9
OM 352.932	Diesel	5673	6	97.00	9
OM 352.933	Diesel	5673	6	97.00	9
OM 352.934	Diesel	5673	6	97.00	9
OM 352.935	Diesel	5673	6	97.00	9
OM 352.936	Diesel	5673	6	97.00	9
OM 352.937	Diesel	5673	6	97.00	9
OM 352.938	Diesel	5673	6	97.00	9
OM 352.939	Diesel	5673	6	97.00	9
OM 352.942	Diesel	5673	6	97.00	9
OM 352.943	Diesel	5673	6	97.00	9
OM 352.944	Diesel	5673	6	97.00	9
OM 352.945	Diesel	5673	6	97.00	9
OM 352.946	Diesel	5673	6	97.00	9
OM 352.948	Diesel	5673	6	97.00	9
OM 352.949	Diesel	5673	6	97.00	9
OM 352.950	Diesel	5673	6	97.00	9
OM 352.953	Diesel	5673	6	97.00	9
OM 352.954	Diesel	5673	6	97.00	9
OM 352.955	Diesel	5673	6	97.00	9
OM 352.963	Diesel	5673	6	97.00	9
OM 352.964	Diesel	5673	6	97.00	9
OM 352.965	Diesel	5673	6	97.00	9
OM 352.966	Diesel	5673	6	97.00	9
OM 352.967	Diesel	5673	6	97.00	9
OM 352.968	Diesel	5673	6	97.00	9
OM 352.969	Diesel	5673	6	97.00	9
OM 352.970	Diesel	5673	6	97.00	9
OM 352.971	Diesel	5673	6	97.00	9
OM 352.972	Diesel	5673	6	97.00	9
OM 352.973	Diesel	5673	6	97.00	9
OM 352.974	Diesel	5673	6	97.00	9
OM 352.975	Diesel	5673	6	97.00	9
OM 352.976	Diesel	5673	6	97.00	9
OM 352.979	Diesel	5673	6	97.00	9
OM 352.980	Diesel	5673	6	97.00	9
OM 352.981	Diesel	5673	6	97.00	9
OM 352.982	Diesel	5673	6	97.00	9
OM 352.983	Diesel	5673	6	97.00	9
OM 352.984	Diesel	5673	6	97.00	9
OM 352.985	Diesel	5673	6	97.00	9
OM 352.986	Diesel	5673	6	97.00	9
OM 352.987	Diesel	5673	6	97.00	9
OM 352.988	Diesel	5673	6	97.00	9
OM 352.989	Diesel	5673	6	97.00	9
OM 352.990	Diesel	5673	6	97.00	9
OM 352.991	Diesel	5673	6	97.00	9

# ENGINE INDEX

Motorverzeichnis • Index de moteur • Índice de Motor  
Indeks silnika • Модель двигателя • دليل المحرك



CCM



9

Engine Model	Fuel Type	CCM	Piston/Ring	Valve	9
OM 352.994	Diesel	5673	6	97.00	9
OM 352.996	Diesel	5673	6	97.00	9
OM 352.997	Diesel	5673	6	97.00	9
OM 352.998	Diesel	5673	6	97.00	9
OM 352.999	Diesel	5673	6	97.00	9
OM 353.900	Diesel	5673	6	97.00	9
OM 353.902	Diesel	5673	6	97.00	9
OM 353.903	Diesel	5673	6	97.00	9
OM 353.904	Diesel	5673	6	97.00	9
OM 353.905	Diesel	5673	6	97.00	9
OM 353.909	Diesel	5673	6	97.00	9
OM 353.910	Diesel	5673	6	97.00	9
OM 353.911	Diesel	5673	6	97.00	9
OM 353.912	Diesel	5673	6	97.00	9
OM 353.913	Diesel	5673	6	97.00	9
OM 353.914	Diesel	5673	6	97.00	9
OM 353.915	Diesel	5673	6	97.00	9
OM 353.916	Diesel	5673	6	97.00	9
OM 353.917	Diesel	5673	6	97.00	9
OM 353.941	Diesel	5673	6	97.00	9
OM 353.942	Diesel	5673	6	97.00	9
OM 353.943	Diesel	5673	6	97.00	9
OM 353.944	Diesel	5673	6	97.00	9
OM 353.945	Diesel	5673	6	97.00	9
OM 353.946	Diesel	5673	6	97.00	9
OM 353.949	Diesel	5673	6	97.00	9
OM 353.950	Diesel	5673	6	97.00	9
OM 353.951	Diesel	5673	6	97.00	9
OM 353.952	Diesel	5673	6	97.00	9
OM 353.953	Diesel	5673	6	97.00	9
OM 353.954	Diesel	5673	6	97.00	9
OM 353.957	Diesel	5673	6	97.00	9
OM 353.958	Diesel	5673	6	97.00	9
OM 353.959	Diesel	5673	6	97.00	9
OM 353.960	Diesel	5673	6	97.00	9
OM 353.963	Diesel	5673	6	97.00	9
OM 353.964	Diesel	5673	6	97.00	9
OM 353.965	Diesel	5673	6	97.00	9
OM 353.966	Diesel	5673	6	97.00	9
OM 353.967	Diesel	5673	6	97.00	9
OM 353.968	Diesel	5673	6	97.00	9
OM 353.969	Diesel	5673	6	97.00	9
OM 353.970	Diesel	5673	6	97.00	9
OM 353.971	Diesel	5673	6	97.00	9
OM 353.972	Diesel	5673	6	97.00	9
OM 353.973	Diesel	5673	6	97.00	9
OM 353.974	Diesel	5673	6	97.00	9
OM 353.975	Diesel	5673	6	97.00	9
OM 353.976	Diesel	5673	6	97.00	9
OM 353.977	Diesel	5673	6	97.00	9
OM 353.978	Diesel	5673	6	97.00	9
OM 353.981	Diesel	5673	6	97.00	9
OM 353.982	Diesel	5673	6	97.00	9
OM 353.983	Diesel	5673	6	97.00	9
OM 353.984	Diesel	5673	6	97.00	9
OM 353.989	Diesel	5673	6	97.00	9
OM 353.991	Diesel	5673	6	97.00	9
OM 353.995	Diesel	5673	6	97.00	9
OM 353.996	Diesel	5675	6	97.00	9
OM 353.997	Diesel	5673	6	97.00	9



Motorverzeichnis • Index de moteur • Índice de Motor  
Indeks silnika • Модель двигателя • دليل المحرك

# ENGINE INDEX



CCM

x



9

OM 354.900	Diesel	3972	4	97.50	10
OM 354.901	Diesel	3972	4	97.50	10
OM 354.902	Diesel	3972	4	97.50	10
OM 354.903	Diesel	3972	4	97.50	10
OM 354.920	Diesel	3972	4	97.50	10
OM 354.921	Diesel	3972	4	97.50	10
OM 354.922	Diesel	3972	4	97.50	10
OM 354.923	Diesel	3972	4	97.50	10
OM 354.924	Diesel	3972	4	97.50	10
OM 354.925	Diesel	3972	4	97.50	10
OM 354.926	Diesel	3972	4	97.50	10
OM 355.910	Diesel	11581	6	128.00	16
OM 355.911	Diesel	11581	6	128.00	16
OM 355.912	Diesel	11581	6	128.00	16
OM 355.913	Diesel	11581	6	128.00	16
OM 355.914	Diesel	11581	6	128.00	16
OM 355.915	Diesel	11581	6	128.00	16
OM 355.918	Diesel	11581	6	128.00	16
OM 355.960	Diesel	11581	6	128.00	16
OM 355.961	Diesel	11581	6	128.00	16
OM 355.962	Diesel	11581	6	128.00	16
OM 355.963	Diesel	11581	6	128.00	16
OM 355.964	Diesel	11581	6	128.00	16
OM 355.966	Diesel	11581	6	128.00	16
OM 355.967	Diesel	11581	6	128.00	16
OM 355.969	Diesel	11581	6	128.00	16
OM 355.970	Diesel	11581	6	128.00	16
OM 355.974	Diesel	11581	6	128.00	16
OM 355.975	Diesel	11600	6	128.00	16
OM 355.976	Diesel	11581	6	128.00	16
OM 355.977	Diesel	11581	6	128.00	16
OM 355.978	Diesel	11581	6	128.00	16
OM 355.979	Diesel	11581	6	128.00	16
OM 355.980	Diesel	11581	6	128.00	16
OM 355.981	Diesel	11581	6	128.00	16
OM 355.982	Diesel	11581	6	128.00	16
OM 355.983	Diesel	11581	6	128.00	16
OM 355.984	Diesel	11581	6	128.00	16
OM 356.901	Diesel	5958	6	97.50	10
OM 356.902	Diesel	5958	6	97.50	10
OM 356.903	Diesel	5958	6	97.50	10
OM 356.904	Diesel	5958	6	97.50	10
OM 356.905	Diesel	5958	6	97.50	10
OM 356.906	Diesel	5958	6	97.50	10
OM 356.907	Diesel	5958	6	97.50	10
OM 356.908	Diesel	5958	6	97.50	10
OM 356.909	Diesel	5958	6	97.50	10
OM 356.910	Diesel	5958	6	97.50	10
OM 356.911	Diesel	5958	6	97.50	10
OM 356.913	Diesel	5958	6	97.50	10
OM 356.914	Diesel	5958	6	97.50	10
OM 356.915	Diesel	5958	6	97.50	10
OM 356.916	Diesel	5958	6	97.50	10
OM 356.940	Diesel	5958	6	97.50	10
OM 356.941	Diesel	5958	6	97.50	10
OM 356.943	Diesel	5958	6	97.50	10
OM 356.944	Diesel	5958	6	97.50	10
OM 356.945	Diesel	5958	6	97.50	10
OM 356.946	Diesel	5958	6	97.50	10
OM 356.947	Diesel	5958	6	97.50	10

# ENGINE INDEX

Motorverzeichnis • Index de moteur • Índice de Motor  
Indeks silnika • Модель двигателя • دليل المحرك



CCM



9

OM	Motor	CCM	Piston	Valve	Index
OM 356.948	Diesel	5958	6	97.50	10
OM 356.949	Diesel	5958	6	97.50	10
OM 356.951	Diesel	5958	6	97.50	10
OM 356.952	Diesel	5958	6	97.50	10
OM 356.953	Diesel	5958	6	97.50	10
OM 356.956	Diesel	5958	6	97.50	10
OM 356.958	Diesel	5958	6	97.50	10
OM 356.959	Diesel	5958	6	97.50	10
OM 356.977	Diesel	5958	6	97.50	10
OM 356.978	Diesel	5958	6	97.50	10
OM 356.983	Diesel	5958	6	97.50	10
OM 356.984	Diesel	5958	6	97.50	10
OM 356.985	Diesel	5958	6	97.50	10
OM 357.900	Diesel	5958	6	97.50	10
OM 357.901	Diesel	5958	6	97.50	10
OM 357.902	Diesel	5958	6	97.50	10
OM 357.903	Diesel	5958	6	97.50	10
OM 357.904	Diesel	5958	6	97.50	10
OM 357.906	Diesel	5958	6	97.50	10
OM 357.907	Diesel	5958	6	97.50	10
OM 357.908	Diesel	5958	6	97.50	10
OM 357.909	Diesel	5958	6	97.50	10
OM 357.910	Diesel	5958	6	97.50	10
OM 357.915	Diesel	5958	6	97.50	10
OM 357.916	Diesel	5958	6	97.50	10
OM 357.917	Diesel	5958	6	97.50	10
OM 357.918	Diesel	5958	6	97.50	10
OM 357.919	Diesel	5958	6	97.50	10
OM 357.920	Diesel	5958	6	97.50	10
OM 357.921	Diesel	5958	6	97.50	10
OM 357.922	Diesel	5958	6	97.50	10
OM 357.924	Diesel	5958	6	97.50	10
OM 357.925	Diesel	5958	6	97.50	10
OM 357.926	Diesel	5958	6	97.50	10
OM 357.927	Diesel	5958	6	97.50	10
OM 357.929	Diesel	5958	6	97.50	10
OM 357.930	Diesel	5958	6	97.50	10
OM 357.931	Diesel	5958	6	97.50	10
OM 357.932	Diesel	5958	6	97.50	10
OM 357.933	Diesel	5958	6	97.50	10
OM 357.934	Diesel	5958	6	97.50	10
OM 357.935	Diesel	5958	6	97.50	10
OM 357.936	Diesel	5958	6	97.50	10
OM 357.937	Diesel	5958	6	97.50	10
OM 357.938	Diesel	5958	6	97.50	10
OM 357.940	Diesel	5958	6	97.50	10
OM 357.941	Diesel	5958	6	97.50	10
OM 357.942	Diesel	5958	6	97.50	10
OM 357.943	Diesel	5958	6	97.50	10
OM 357.944	Diesel	5958	6	97.50	10
OM 357.945	Diesel	5958	6	97.50	10
OM 357.946	Diesel	5958	6	97.50	10
OM 357.947	Diesel	5958	6	97.50	10
OM 357.948	Diesel	5958	6	97.50	10
OM 357.949	Diesel	5958	6	97.50	10
OM 357.961	Diesel	5958	6	97.50	10
OM 357.962	Diesel	5958	6	97.50	10
OM 357.963	Diesel	5958	6	97.50	10
OM 360.911	Diesel	8720	6	115.00	12
OM 360.914	Diesel	8720	6	115.00	12

Motorverzeichnis • Index de moteur • Índice de Motor  
Indeks silnika • Модель двигателя • دليل المحرك

# ENGINE INDEX



CCM

x



9

OM 360.915	Diesel	8720	6	115.00	12
OM 360.916	Diesel	8720	6	115.00	12
OM 360.917	Diesel	8720	6	115.00	12
OM 360.918	Diesel	8720	6	115.00	12
OM 360.931	Diesel	8720	6	115.00	12
OM 360.933	Diesel	8720	6	115.00	12
OM 360.936	Diesel	8725	6	115.00	12
OM 360.937	Diesel	8725	6	115.00	12
OM 360.939	Diesel	8720	6	115.00	12
OM 360.940	Diesel	8725	6	115.00	12
OM 360.941	Diesel	8725	6	115.00	12
OM 360.942	Diesel	8725	6	115.00	12
OM 360.943	Diesel	8725	6	115.00	12
OM 360.944	Diesel	8725	6	115.00	12
OM 360.946	Diesel	8725	6	115.00	12
OM 360.948	Diesel	8725	6	115.00	12
OM 360.949	Diesel	8725	6	115.00	12
OM 360.980	Diesel	8720	6	115.00	12
OM 360.981	Diesel	8720	6	115.00	12
OM 360.984	Diesel	8720	6	115.00	12
OM 360.985	Diesel	8720	6	115.00	12
OM 360.986	Diesel	8720	6	115.00	12
OM 362.906	Diesel	5700	6	97.00	9
OM 362.909	Diesel	5700	6	97.00	9
OM 362.910	Diesel	5675	6	97.00	9
OM 364.901	Diesel	3972	4	97.50	10
OM 364.906	Diesel	3972	4	97.50	10
OM 364.907	Diesel	3970	4	97.50	10
OM 364.908	Diesel	3972	4	97.50	10
OM 364.911	Diesel	3972	4	97.50	10
OM 364.912	Diesel	3972	4	97.50	10
OM 364.913	Diesel	3972	4	97.50	10
OM 364.918	Diesel	3970	4	97.50	10
OM 364.919	Diesel	3972	4	97.50	10
OM 364.920	Diesel	3972	4	97.50	10
OM 364.921	Diesel	3972	4	97.50	10
OM 364.950	Diesel	3972	4	97.50	10
OM 364.952	Diesel	3972	4	97.50	10
OM 364.954	Diesel	3972	4	97.50	10
OM 364.957	Diesel	3972	4	97.50	10
OM 364.958	Diesel	3972	4	97.50	10
OM 364.980	Diesel	3972	4	97.50	10
OM 364.981	Diesel	3972	4	97.50	10
OM 364.984	Diesel	3972	4	97.50	10
OM 366.905	Diesel	5958	6	97.50	10
OM 366.906	Diesel	5960	6	97.50	10
OM 366.907	Diesel	5958	6	97.50	10
OM 366.908	Diesel	5958	6	97.50	10
OM 366.909	Diesel	5960	6	97.50	10
OM 366.910	Diesel	5958	6	97.50	10
OM 366.912	Diesel	5958	6	97.50	10
OM 366.913	Diesel	5958	6	97.50	10
OM 366.914	Diesel	5958	6	97.50	10
OM 366.917	Diesel	5958	6	97.50	10
OM 366.918	Diesel	5960	6	97.50	10
OM 366.919	Diesel	5958	6	97.50	10
OM 366.930	Diesel	5958	6	97.50	10
OM 366.931	Diesel	5958	6	97.50	10
OM 366.932	Diesel	5958	6	97.50	10
OM 366.933	Diesel	5958	6	97.50	10

# ENGINE INDEX

Motorverzeichnis • Index de moteur • Índice de Motor  
Indeks silnika • Модель двигателя • دليل المحرك



CCM

x



9

OM 366.935	Diesel	5958	6	97.50	10
OM 366.936	Diesel	5960	6	97.50	10
OM 366.937	Diesel	5960	6	97.50	10
OM 366.938	Diesel	5958	6	97.50	10
OM 366.939	Diesel	5958	6	97.50	10
OM 366.940	Diesel	5958	6	97.50	10
OM 366.941	Diesel	5958	6	97.50	10
OM 366.942	Diesel	5958	6	97.50	10
OM 366.943	Diesel	5958	6	97.50	10
OM 366.944	Diesel	5958	6	97.50	10
OM 366.945	Diesel	5958	6	97.50	10
OM 366.946	Diesel	5960	6	97.50	10
OM 366.947	Diesel	5958	6	97.50	10
OM 366.948	Diesel	5958	6	97.50	10
OM 366.951	Diesel	5960	6	97.50	10
OM 366.952	Diesel	5958	6	97.50	10
OM 366.953	Diesel	5958	6	97.50	10
OM 366.954	Diesel	5958	6	97.50	10
OM 366.955	Diesel	5958	6	97.50	10
OM 366.956	Diesel	5958	6	97.50	10
OM 366.957	Diesel	5958	6	97.50	10
OM 366.958	Diesel	5958	6	97.50	10
OM 366.960	Diesel	5960	6	97.50	10
OM 366.962	Diesel	5960	6	97.50	10
OM 366.963	Diesel	5958	6	97.50	10
OM 366.965	Diesel	5958	6	97.50	10
OM 366.966	Diesel	5958	6	97.50	10
OM 366.967	Diesel	5958	6	97.50	10
OM 366.968	Diesel	5958	6	97.50	10
OM 366.969	Diesel	5958	6	97.50	10
OM 366.970	Diesel	5958	6	97.50	10
OM 366.971	Diesel	5958	6	97.50	10
OM 366.972	Diesel	5958	6	97.50	10
OM 366.973	Diesel	5958	6	97.50	10
OM 366.974	Diesel	5958	6	97.50	10
OM 366.975	Diesel	5958	6	97.50	10
OM 366.976	Diesel	5958	6	97.50	10
OM 366.977	Diesel	5958	6	97.50	10
OM 366.978	Diesel	5958	6	97.50	10
OM 366.979	Diesel	5958	6	97.50	10
OM 366.980	Diesel	5960	6	97.50	10
OM 366.981	Diesel	5958	6	97.50	10
OM 366.983	Diesel	5958	6	97.50	10
OM 366.984	Diesel	5958	6	97.50	10
OM 366.988	Diesel	5960	6	97.50	10
OM 366.990	Diesel	5958	6	97.50	10
OM 366.992	Diesel	5958	6	97.50	10
OM 366.993	Diesel	5958	6	97.50	10
OM 366.995	Diesel	5958	6	97.50	10
OM 366.997	Diesel	5960	6	97.50	10
OM 366.999	Diesel	5958	6	97.50	10
OM 401.905	Diesel	9570	V6	125.00	13
OM 401.906	Diesel	9570	V6	125.00	13
OM 401.907	Diesel	9572	V6	125.00	13
OM 401.908	Diesel	9572	V6	125.00	13
OM 401.909	Diesel	9570	V6	125.00	13
OM 401.912	Diesel	9572	V6	125.00	13
OM 401.913	Diesel	9570	V6	125.00	13
OM 401.914	Diesel	9570	V6	125.00	13
OM 401.915	Diesel	9570	V6	125.00	13

Motorverzeichnis • Index de moteur • Índice de Motor  
Indeks silnika • Модель двигателя • دليل المحرك

# ENGINE INDEX



CCM

x



9

OM 401.916	Diesel	9570	V6	125.00	13
OM 401.917	Diesel	9570	V6	125.00	13
OM 401.918	Diesel	9570	V6	125.00	13
OM 401.919	Diesel	9570	V6	125.00	13
OM 401.921	Diesel	9570	V6	125.00	13
OM 401.922	Diesel	9570	V6	125.00	13
OM 401.923	Diesel	9570	V6	125.00	13
OM 401.925	Diesel	9570	V6	125.00	13
OM 401.926	Diesel	9570	V6	125.00	13
OM 401.927	Diesel	9570	V6	125.00	13
OM 401.928	Diesel	9570	V6	125.00	13
OM 401.970	Diesel	9600	V6	125.00	13
OM 401.972	Diesel	9572	V6	125.00	13
OM 401.973	Diesel	9572	V6	125.00	13
OM 401.974	Diesel	9572	V6	125.00	13
OM 401.975	Diesel	9572	V6	125.00	13
OM 401.977	Diesel	9572	V6	125.00	13
OM 401.978	Diesel	9572	V6	125.00	13
OM 401.979	Diesel	9572	V6	125.00	13
OM 401.980	Diesel	9572	V6	125.00	13
OM 401.981	Diesel	9572	V6	125.00	13
OM 401.982	Diesel	9572	V6	125.00	13
OM 401.983	Diesel	9572	V6	125.00	13
OM 401.984	Diesel	9572	V6	125.00	13
OM 401.985	Diesel	9600	V6	125.00	13
OM 401.986	Diesel	9572	V6	125.00	13
OM 401.987	Diesel	9572	V6	125.00	13
OM 401.989	Diesel	9572	V6	125.00	13
OM 401.990	Diesel	9572	V6	125.00	13
OM 401.991	Diesel	9600	V6	125.00	13
OM 401.992	Diesel	9572	V6	125.00	13
OM 401.993	Diesel	9572	V6	125.00	13
OM 401.994	Diesel	9600	V6	125.00	13
OM 402.905	Diesel	12800	V8	125.00	13
OM 402.906	Diesel	12800	V8	125.00	13
OM 402.907	Diesel	12800	V8	125.00	13
OM 402.910	Diesel	12800	V8	125.00	13
OM 402.912	Diesel	12800	V8	125.00	13
OM 402.913	Diesel	12760	V8	125.00	13
OM 402.914	Diesel	12800	V8	125.00	13
OM 402.916	Diesel	12800	V8	125.00	13
OM 402.917	Diesel	12760	V8	125.00	13
OM 402.919	Diesel	12800	V8	125.00	13
OM 402.921	Diesel	12760	V8	125.00	13
OM 402.923	Diesel	12800	V8	125.00	13
OM 402.924	Diesel	12800	V8	125.00	13
OM 402.925	Diesel	12760	V8	125.00	13
OM 402.926	Diesel	12800	V8	125.00	13
OM 402.927	Diesel	12800	V8	125.00	13
OM 402.928	Diesel	12800	V8	125.00	13
OM 402.970	Diesel	12763	V8	125.00	13
OM 402.971	Diesel	12763	V8	125.00	13
OM 402.972	Diesel	12763	V8	125.00	13
OM 402.973	Diesel	12763	V8	125.00	13
OM 402.974	Diesel	12760	V8	125.00	13
OM 402.975	Diesel	12763	V8	125.00	13
OM 402.977	Diesel	12763	V8	125.00	13
OM 402.978	Diesel	12763	V8	125.00	13
OM 402.982	Diesel	12763	V8	125.00	13
OM 402.983	Diesel	12763	V8	125.00	13

# ENGINE INDEX

Motorverzeichnis • Index de moteur • Índice de Motor  
Indeks silnika • Модель двигателя • دليل المحرك



CCM

x



9

OM 402.984	Diesel	12763	V8	125.00	13
OM 402.985	Diesel	12763	V8	125.00	13
OM 402.986	Diesel	12763	V8	125.00	13
OM 402.987	Diesel	12763	V8	125.00	13
OM 402.989	Diesel	12763	V8	125.00	13
OM 402.990	Diesel	12763	V8	125.00	13
OM 402.995	Diesel	12763	V8	125.00	13
OM 402.996	Diesel	12763	V8	125.00	13
OM 403.910	Diesel	15950	V10	125.00	13
OM 403.915	Diesel	15900	V10	125.00	13
OM 403.916	Diesel	15900	V10	125.00	13
OM 403.917	Diesel	15950	V10	125.00	13
OM 403.918	Diesel	15900	V10	125.00	13
OM 403.919	Diesel	15950	V10	125.00	13
OM 403.930	Diesel	15950	V10	125.00	13
OM 403.931	Diesel	15900	V10	125.00	13
OM 403.932	Diesel	15900	V10	125.00	13
OM 403.933	Diesel	15950	V10	125.00	13
OM 403.934	Diesel	15950	V10	125.00	13
OM 403.935	Diesel	15900	V10	125.00	13
OM 404	Diesel	20911	V12	125.00	13
OM 404 A	Diesel	20911	V12	125.00	13
OM 407.905	Diesel	11000	6	125.00	14
OM 407.907	Diesel	11045	6	125.00	14
OM 407.908	Diesel	11000	6	125.00	14
OM 407.909	Diesel	11000	6	125.00	14
OM 407.910	Diesel	11000	6	125.00	14
OM 407.911	Diesel	11000	6	125.00	14
OM 407.913	Diesel	11400	6	125.00	14
OM 407.914	Diesel	11400	6	125.00	14
OM 407.915	Diesel	11400	6	125.00	14
OM 407.916	Diesel	11400	6	125.00	14
OM 407.917	Diesel	11400	6	125.00	14
OM 407.918	Diesel	11400	6	125.00	14
OM 407.919	Diesel	11400	6	125.00	14
OM 407.920	Diesel	11412	6	125.00	14
OM 407.951	Diesel	11413	6	125.00	14
OM 407.955	Diesel	11413	6	125.00	14
OM 409	Diesel	9204	5	125.00	14
OM 409.906	Diesel	9204	5	125.00	14
OM 409.907	Diesel	9204	5	125.00	14
OM 409.908	Diesel	9204	5	125.00	14
OM 421.905	Diesel	10964	V6	128.00	20
OM 421.906	Diesel	10900	V6	128.00	20
OM 421.907	Diesel	10964	V6	128.00	20
OM 421.908	Diesel	10964	V6	128.00	20
OM 421.909	Diesel	10964	V6	128.00	20
OM 421.910	Diesel	10964	V6	128.00	20
OM 421.951	Diesel	10964	V6	128.00	20
OM 422.901	Diesel	14618	V8	128.00	20
OM 422.905	Diesel	14618	V8	128.00	20
OM 422.906	Diesel	14618	V8	128.00	20
OM 422.907	Diesel	14618	V8	128.00	20
OM 422.908	Diesel	14600	V8	128.00	20
OM 422.909	Diesel	14618	V8	128.00	20
OM 422.910	Diesel	14618	V8	128.00	20
OM 422.911	Diesel	14618	V8	128.00	20
OM 422.912	Diesel	14618	V8	128.00	20
OM 422.913	Diesel	14618	V8	128.00	20
OM 422.914	Diesel	14600	V8	128.00	20



Motorverzeichnis • Index de moteur • Índice de Motor  
Indeks silnika • Модель двигателя • دليل المحرك

# ENGINE INDEX



CCM

x



9

OM 422.915	Diesel	14618	V8	128.00	20
OM 422.916	Diesel	14618	V8	128.00	20
OM 422.917	Diesel	14618	V8	128.00	20
OM 422.918	Diesel	14618	V8	128.00	20
OM 422.919	Diesel	14618	V8	128.00	20
OM 422.920	Diesel	14618	V8	128.00	20
OM 422.921	Diesel	14618	V8	128.00	20
OM 422.922	Diesel	14618	V8	128.00	20
OM 422.923	Diesel	14618	V8	128.00	20
OM 422.951	Diesel	14600	V8	128.00	20
OM 422.952	Diesel	14600	V8	128.00	20
OM 422.953	Diesel	14618	V8	128.00	20
OM 422.954	Diesel	14618	V8	128.00	20
OM 422.955	Diesel	14618	V8	128.00	20
OM 422.956	Diesel	14600	V8	128.00	20
OM 422.957	Diesel	14620	V8	128.00	20
OM 422.958	Diesel	14620	V8	128.00	20
OM 422.959	Diesel	14618	V8	128.00	20
OM 422.963	Diesel	14618	V8	128.00	20
OM 423.905	Diesel	18300	V10	128.00	20
OM 423.906	Diesel	18273	V10	128.00	20
OM 423.907	Diesel	18273	V10	128.00	20
OM 423.908	Diesel	18300	V10	128.00	20
OM 423.909	Diesel	18273	V10	128.00	20
OM 423.950	Diesel	18273	V10	128.00	20
OM 424.900	Diesel	21930	V12	128.00	20
OM 424.901	Diesel	21930	V12	128.00	20
OM 424.901-510	Diesel	21930	V12	128.00	20
OM 427 A	Diesel	11967	6	128.00	21
OM 427 LA	Diesel	11967	6	128.00	21
OM 427.905	Diesel	11967	6	128.00	21
OM 427.910	Diesel	11967	6	128.00	21
OM 427.911	Diesel	11967	6	128.00	21
OM 427.950	Diesel	11967	6	128.00	21
OM 427.951	Diesel	11967	6	128.00	21
OM 427.952	Diesel	11967	6	128.00	21
OM 429.951	Diesel	9970	5	128.00	21
OM 429.952	Diesel	9970	5	128.00	21
OM 429.953	Diesel	9970	5	128.00	21
OM 429.955	Diesel	9970	5	128.00	21
OM 440.907	Diesel	15080	V8	130.00	24
OM 440.908	Diesel	15080	V8	130.00	24
OM 440.909	Diesel	15080	V8	130.00	24
OM 440.910	Diesel	15080	V8	130.00	24
OM 440.911	Diesel	15080	V8	130.00	24
OM 440.940	Diesel	14618	V8	128.00	20
OM 440.941	Diesel	14618	V8	128.00	20
OM 440.942	Diesel	14618	V8	128.00	20
OM 440.943	Diesel	14618	V8	128.00	20
OM 440.945	Diesel	14618	V8	128.00	20
OM 440.948	Diesel	14618	V8	128.00	20
OM 440.949	Diesel	14618	V8	128.00	20
OM 440.970	Diesel	14618	V8	128.00	20
OM 440.971	Diesel	14618	V8	128.00	20
OM 440.972	Diesel	14618	V8	128.00	20
OM 440.973	Diesel	14618	V8	128.00	20
OM 440.974	Diesel	14618	V8	128.00	20
OM 440.975	Diesel	14618	V8	128.00	20
OM 440.976	Diesel	14618	V8	128.00	20
OM 440.978	Diesel	14618	V8	128.00	20

# ENGINE INDEX

Motorverzeichnis • Index de moteur • Índice de Motor  
Indeks silnika • Модель двигателя • دليل المحرك



CCM

x



9

OM 440.979	Diesel	14618	V8	128.00	20
OM 440.980	Diesel	14618	V8	128.00	20
OM 440.981	Diesel	14618	V8	128.00	20
OM 440.982	Diesel	14618	V8	128.00	20
OM 440.983	Diesel	14618	V8	128.00	20
OM 440.984	Diesel	14618	V8	128.00	20
OM 440.985	Diesel	14618	V8	128.00	20
OM 440.986	Diesel	14618	V8	128.00	20
OM 440.987	Diesel	14618	V8	128.00	20
OM 440.988	Diesel	14618	V8	128.00	20
OM 440.989	Diesel	14618	V8	128.00	20
OM 440.990	Diesel	14618	V8	128.00	20
OM 440.991	Diesel	14618	V8	128.00	20
OM 441 / Euro 1	Diesel	11309	6	130.00	24
OM 441.905	Diesel	10964	V6	130.00	24
OM 441.906	Diesel	10964	V6	130.00	24
OM 441.907	Diesel	10964	V6	130.00	24
OM 441.908	Diesel	10964	V6	130.00	24
OM 441.909	Diesel	10964	V6	130.00	24
OM 441.911	Diesel	10964	V6	130.00	24
OM 441.912	Diesel	11309	V6	130.00	24
OM 441.913	Diesel	10964	V6	130.00	24
OM 441.914	Diesel	11309	V6	130.00	24
OM 441.915	Diesel	10964	V6	130.00	24
OM 441.916	Diesel	11309	V6	130.00	24
OM 441.917	Diesel	10964	V6	130.00	24
OM 441.918	Diesel	11309	V6	130.00	24
OM 441.919	Diesel	11309	V6	130.00	24
OM 441.920	Diesel	11309	V6	130.00	24
OM 441.923	Diesel	10964	V6	130.00	24
OM 441.924	Diesel	11309	V6	130.00	24
OM 441.925	Diesel	10964	V6	130.00	24
OM 441.926	Diesel	10964	V6	130.00	24
OM 441.927	Diesel	10964	V6	130.00	24
OM 441.932	Diesel	11309	V6	130.00	24
OM 441.951	Diesel	10964	V6	128.00	20
OM 441.952	Diesel	10964	V6	128.00	20
OM 441.953	Diesel	10964	V6	128.00	20
OM 441.960	Diesel	10964	V6	128.00	20
OM 441.961	Diesel	10964	V6	128.00	20
OM 441.962	Diesel	10964	V6	128.00	20
OM 441.980	Diesel	10964	V6	128.00	20
OM 441.981	Diesel	10964	V6	128.00	20
OM 441.982	Diesel	10964	V6	128.00	20
OM 441.983	Diesel	10964	V6	128.00	20
OM 441.985	Diesel	10964	V6	128.00	20
OM 441.986	Diesel	10964	V6	128.00	20
OM 441.987	Diesel	10964	V6	128.00	20
OM 441.988	Diesel	10964	V6	128.00	20
OM 441.989	Diesel	10964	V6	128.00	20
OM 441.990	Diesel	10964	V6	128.00	20
OM 441.991	Diesel	10964	V6	128.00	20
OM 441.992	Diesel	10964	V6	128.00	20
OM 441.993	Diesel	10964	V6	128.00	20
OM 441.994	Diesel	10964	V6	128.00	20
OM 441.995	Diesel	10964	V6	128.00	20
OM 441.996	Diesel	10964	V6	128.00	20
OM 441.997	Diesel	10964	V6	128.00	20
OM 441.998	Diesel	10964	V6	128.00	20
OM 441.999	Diesel	10964	V6	128.00	20



Motorverzeichnis • Index de moteur • Índice de Motor  
Indeks silnika • Модель двигателя • دليل المحرك

# ENGINE INDEX



CCM

x



9

OM 442	Diesel	15080	V8	130.00	24
OM 442 A	Diesel	14618	V8	128.00	20
OM 442.905	Diesel	15080	V8	130.00	24
OM 442.906	Diesel	15080	V8	130.00	24
OM 442.907	Diesel	15080	V8	130.00	24
OM 442.908	Diesel	15080	V8	130.00	24
OM 442.909	Diesel	15080	V8	130.00	24
OM 442.910	Diesel	15080	V8	130.00	24
OM 442.911	Diesel	15080	V8	130.00	24
OM 442.914	Diesel	15080	V8	130.00	24
OM 442.915	Diesel	15078	V8	130.00	24
OM 442.916	Diesel	15078	V8	130.00	24
OM 442.917	Diesel	15080	V8	130.00	24
OM 442.918	Diesel	15080	V8	130.00	24
OM 442.919	Diesel	15080	V8	130.00	24
OM 442.920	Diesel	15080	V8	130.00	24
OM 442.921	Diesel	15080	V8	130.00	24
OM 442.922	Diesel	15080	V8	130.00	24
OM 442.923	Diesel	15080	V8	130.00	24
OM 442.924	Diesel	15080	V8	130.00	24
OM 442.925	Diesel	15080	V8	130.00	24
OM 442.926	Diesel	15080	V8	130.00	24
OM 442.927	Diesel	15078	V8	130.00	24
OM 442.928	Diesel	15078	V8	130.00	24
OM 442.929	Diesel	15080	V8	130.00	24
OM 442.930	Diesel	15100	V8	130.00	24
OM 442.931	Diesel	15100	V8	130.00	24
OM 442.932	Diesel	15080	V8	130.00	24
OM 442.933	Diesel	15080	V8	130.00	24
OM 442.934	Diesel	15080	V8	130.00	24
OM 442.935	Diesel	15080	V8	130.00	24
OM 442.939	Diesel	15080	V8	130.00	24
OM 442.940	Diesel	14618	V8	128.00	20
OM 442.941	Diesel	14618	V8	128.00	20
OM 442.942	Diesel	14618	V8	128.00	20
OM 442.943	Diesel	14620	V8	128.00	20
OM 442.944	Diesel	14618	V8	128.00	20
OM 442.945	Diesel	14618	V8	128.00	20
OM 442.946	Diesel	14618	V8	128.00	20
OM 442.950	Diesel	14618	V8	128.00	20
OM 442.951	Diesel	14618	V8	128.00	20
OM 442.952	Diesel	14618	V8	128.00	20
OM 442.953	Diesel	14618	V8	128.00	20
OM 442.954	Diesel	14618	V8	128.00	20
OM 442.955	Diesel	14618	V8	128.00	20
OM 442.957	Diesel	14618	V8	128.00	20
OM 442.958	Diesel	14618	V8	128.00	20
OM 442.959	Diesel	14618	V8	128.00	20
OM 442.960	Diesel	14618	V8	128.00	20
OM 442.961	Diesel	14618	V8	128.00	20
OM 442.962	Diesel	14618	V8	128.00	20
OM 442.963	Diesel	14618	V8	128.00	20
OM 442.964	Diesel	14618	V8	128.00	20
OM 442.965	Diesel	14618	V8	128.00	20
OM 442.966	Diesel	14618	V8	128.00	20
OM 442.967	Diesel	14618	V8	128.00	20
OM 442.968	Diesel	14618	V8	128.00	20
OM 442.970	Diesel	14618	V8	128.00	20
OM 442.971	Diesel	14620	V8	128.00	20
OM 442.972	Diesel	14620	V8	128.00	20

# ENGINE INDEX

Motorverzeichnis • Index de moteur • Índice de Motor  
Indeks silnika • Модель двигателя • دليل المحرك



CCM



9

OM 442.976	Diesel	14618	V8	128.00	20
OM 442.977	Diesel	14618	V8	128.00	20
OM 442.978	Diesel	14620	V8	128.00	20
OM 442.980	Diesel	14618	V8	128.00	20
OM 442.982	Diesel	14618	V8	128.00	20
OM 442.983	Diesel	14618	V8	128.00	20
OM 442.985	Diesel	14618	V8	128.00	20
OM 442.989	Diesel	14618	V8	128.00	20
OM 442.991	Diesel	14618	V8	128.00	20
OM 442.992	Diesel	14618	V8	128.00	20
OM 442.993	Diesel	14618	V8	128.00	20
OM 442.994	Diesel	14618	V8	128.00	20
OM 442.995	Diesel	14618	V8	128.00	20
OM 442.996	Diesel	14618	V8	128.00	20
OM 442.997	Diesel	14618	V8	128.00	20
OM 442.998	Diesel	14618	V8	128.00	20
OM 442.999	Diesel	14618	V8	128.00	20
OM 443.900	Diesel	18848	V10	130.00	24
OM 443.905	Diesel	18848	V10	130.00	24
OM 443.940	Diesel	18270	V10	128.00	20
OM 443.980	Diesel	18270	V10	128.00	20
OM 444	Diesel	22618	V12	130.00	24
OM 444 LA	Diesel	21927	V12	128.00	19
OM 445.920	Diesel	10964	V6	128.00	20
OM 445.921	Diesel	10964	V6	128.00	20
OM 445.922	Diesel	10964	V6	128.00	20
OM 445.923	Diesel	10964	V6	128.00	20
OM 445.924	Diesel	10960	V6	128.00	20
OM 445.925	Diesel	10964	V6	128.00	20
OM 445.926	Diesel	10964	V6	128.00	20
OM 445.927	Diesel	10964	V6	128.00	20
OM 445.929	Diesel	10964	V6	128.00	20
OM 445.930	Diesel	10964	V6	128.00	20
OM 445.931	Diesel	10964	V6	128.00	20
OM 445.933	Diesel	10964	V6	128.00	20
OM 445.934	Diesel	10964	V6	128.00	20
OM 445.935	Diesel	10964	V6	128.00	20
OM 445.936	Diesel	10964	V6	128.00	20
OM 445.937	Diesel	10964	V6	128.00	20
OM 445.938	Diesel	10960	V6	128.00	20
OM 445.939	Diesel	10964	V6	128.00	20
OM 445.940	Diesel	10964	V6	128.00	20
OM 445.941	Diesel	10960	V6	128.00	20
OM 446.920	Diesel	14618	V8	128.00	20
OM 446.922	Diesel	14618	V8	128.00	20
OM 446.924	Diesel	14618	V8	128.00	20
OM 446.925	Diesel	14618	V8	128.00	20
OM 446.926	Diesel	14618	V8	128.00	20
OM 446.927	Diesel	14618	V8	128.00	20
OM 446.928	Diesel	14618	V8	128.00	20
OM 446.929	Diesel	14618	V8	128.00	20
OM 446.930	Diesel	14618	V8	128.00	20
OM 446.931	Diesel	14618	V8	128.00	20
OM 446.932	Diesel	14618	V8	128.00	20
OM 446.933	Diesel	14618	V8	128.00	20
OM 446.934	Diesel	14618	V8	128.00	20
OM 446.935	Diesel	14618	V8	128.00	20
OM 446.936	Diesel	14618	V8	128.00	20
OM 446.938	Diesel	14618	V8	128.00	20
OM 446.939	Diesel	14618	V8	128.00	20

Motorverzeichnis • Index de moteur • Índice de Motor  
Indeks silnika • Модель двигателя • دليل المحرك

# ENGINE INDEX



CCM

x



9

OM 446.940	Diesel	14618	V8	128.00	20
OM 446.941	Diesel	14618	V8	128.00	20
OM 446.942	Diesel	14618	V8	128.00	20
OM 446.943	Diesel	14618	V8	128.00	20
OM 446.945	Diesel	14618	V8	128.00	20
OM 446.946	Diesel	14618	V8	128.00	20
OM 446.948	Diesel	14618	V8	128.00	20
OM 447	Diesel	11967	6	128.00	21
OM 447 A	Diesel	11967	6	128.00	21
OM 447 LA	Diesel	11967	6	128.00	21
OM 447.902	Diesel	11967	6	128.00	21
OM 447.905	Diesel	11967	6	128.00	21
OM 447.906	Diesel	11967	6	128.00	21
OM 447.907	Diesel	11967	6	128.00	21
OM 447.908	Diesel	11967	6	128.00	21
OM 447.910	Diesel	11967	6	128.00	21
OM 447.911	Diesel	11967	6	128.00	21
OM 447.912	Diesel	11970	6	128.00	21
OM 447.913	Diesel	11967	6	128.00	21
OM 447.914	Diesel	11967	6	128.00	21
OM 447.915	Petrol	11967	6	128.00	21
OM 447.916	Petrol	11967	6	128.00	21
OM 447.947	Diesel	11967	6	128.00	21
OM 447.948	Diesel	11967	6	128.00	21
OM 447.949	Diesel	11967	6	128.00	21
OM 447.950	Diesel	11967	6	128.00	21
OM 447.951	Diesel	11967	6	128.00	21
OM 447.952	Diesel	11967	6	128.00	21
OM 447.953	Diesel	11967	6	128.00	21
OM 447.954	Diesel	11967	6	128.00	21
OM 447.955	Diesel	11967	6	128.00	21
OM 447.956	Diesel	11967	6	128.00	21
OM 447.957	Diesel	11967	6	128.00	21
OM 447.958	Diesel	11970	6	128.00	21
OM 447.959	Diesel	11970	6	128.00	21
OM 447.960	Diesel	11970	6	128.00	21
OM 447.970	Diesel	11967	6	128.00	21
OM 447.971	Diesel	11967	6	128.00	21
OM 447.972	Diesel	11967	6	128.00	21
OM 447.973	Diesel	11967	6	128.00	21
OM 447.974	Diesel	11967	6	128.00	21
OM 447.975	Diesel	11967	6	128.00	21
OM 447.976	Diesel	11967	6	128.00	21
OM 447.977	Diesel	11967	6	128.00	21
OM 447.978	Diesel	11967	6	128.00	21
OM 447.979	Diesel	11967	6	128.00	21
OM 447.980	Diesel	11967	6	128.00	21
OM 447.981	Diesel	11967	6	128.00	21
OM 447.982	Diesel	11967	6	128.00	21
OM 447.983	Diesel	11967	6	128.00	21
OM 447.984	Diesel	11970	6	128.00	21
OM 447.985	Diesel	11967	6	128.00	21
OM 447.986	Diesel	11967	6	128.00	21
OM 447.987	Diesel	11970	6	128.00	21
OM 447.988	Diesel	11970	6	128.00	21
OM 447.990	Diesel	11967	6	128.00	21
OM 447.991	Diesel	11967	6	128.00	21
OM 447.992	Diesel	11967	6	128.00	21
OM 447.993	Diesel	11967	6	128.00	21
OM 447.994	Diesel	11967	6	128.00	21

# ENGINE INDEX

Motorverzeichnis • Index de moteur • Índice de Motor  
Indeks silnika • Модель двигателя • دليل المحرك



CCM

x



9

OM 447.995	Diesel	11967	6	128.00	21
OM 447.996	Diesel	11970	6	128.00	21
OM 447.998	Diesel	11967	6	128.00	21
OM 447.999	Diesel	11967	6	128.00	21
OM 457.910	Diesel	11967	6	128.00	15
OM 457.914	Diesel	11967	6	128.00	17
OM 457.915	Diesel	11967	6	128.00	17
OM 457.916	Diesel	11967	6	128.00	17
OM 457.917	Diesel	11967	6	128.00	17
OM 457.918	Diesel	11967	6	128.00	17
OM 457.919	Diesel	11967	6	128.00	17
OM 457.920	Diesel	11967	6	128.00	17
OM 457.922	Diesel	11967	6	128.00	17
OM 457.923	Diesel	11967	6	128.00	17
OM 457.924	Diesel	11967	6	128.00	17
OM 457.925	Diesel	11967	6	128.00	17
OM 457.926	Diesel	11967	6	128.00	17
OM 457.927	Diesel	11967	6	128.00	17
OM 457.928	Diesel	11967	6	128.00	17
OM 457.929	Diesel	11967	6	128.00	17
OM 457.931	Diesel	11967	6	128.00	17
OM 457.932	Diesel	11967	6	128.00	17
OM 457.933	Diesel	11967	6	128.00	17
OM 457.934	Diesel	11967	6	128.00	17
OM 457.935	Diesel	11967	6	128.00	17
OM 457.936	Diesel	11967	6	128.00	17
OM 457.937	Diesel	11967	6	128.00	17
OM 457.938	Diesel	11967	6	128.00	17
OM 457.939	Diesel	11967	6	128.00	17
OM 457.940	Diesel	11967	6	128.00	17
OM 457.941	Diesel	11967	6	128.00	17
OM 457.942	Diesel	11967	6	128.00	17
OM 457.943	Diesel	11967	6	128.00	17
OM 457.944	Diesel	11967	6	128.00	17
OM 457.945	Diesel	11967	6	128.00	17
OM 457.946	Diesel	11967	6	128.00	17
OM 457.947	Diesel	11967	6	128.00	17
OM 457.948	Diesel	11967	6	128.00	17
OM 457.949	Diesel	11967	6	128.00	17
OM 457.950	Diesel	11967	6	128.00	15
OM 457.951	Diesel	11967	6	128.00	15
OM 457.952	Diesel	11967	6	128.00	15
OM 457.953	Diesel	11967	6	128.00	15
OM 457.954	Diesel	11967	6	128.00	15
OM 457.955	Diesel	11967	6	128.00	17
OM 457.956	Diesel	11967	6	128.00	17
OM 457.957	Diesel	11967	6	128.00	17
OM 457.958	Diesel	11967	6	128.00	17
OM 457.959	Diesel	11967	6	128.00	15
OM 457.960	Diesel	11967	6	128.00	17
OM 457.961	Diesel	11967	6	128.00	17
OM 457.962	Diesel	11967	6	128.00	17
OM 457.964	Diesel	11967	6	128.00	15
OM 457.965	Diesel	11967	6	128.00	15
OM 457.966	Diesel	11967	6	128.00	15
OM 457.967	Diesel	11967	6	128.00	15
OM 457.968	Diesel	11967	6	128.00	15
OM 457.969	Diesel	11967	6	128.00	15
OM 457.973	Diesel	11967	6	128.00	15
OM 457.974	Diesel	11967	6	128.00	15

Motorverzeichnis • Index de moteur • Índice de Motor  
Indeks silnika • Модель двигателя • دليل المحرك

# ENGINE INDEX



CCM

x



9

OM 457.976	Diesel	11967	6	128.00	15
OM 457.977	Diesel	11967	6	128.00	15
OM 457.980	Diesel	11967	6	128.00	15
OM 457.981	Diesel	11967	6	128.00	15
OM 458.960	Diesel	11967	6	128.00	17
OM 458.970	Diesel	11967	6	128.00	17
OM 458.980	Diesel	11967	6	128.00	17
OM 458.990	Diesel	11967	6	128.00	15
OM 458.991	Diesel	11967	6	128.00	15
OM 460.900	Diesel	12816	6	128.00	18
OM 460.901	Diesel	12816	6	128.00	18
OM 460.902	Diesel	12816	6	128.00	18
OM 460.903	Diesel	12816	6	128.00	18
OM 460.904	Diesel	12816	6	128.00	18
OM 460.905	Diesel	12816	6	128.00	18
OM 460.906	Diesel	12816	6	128.00	18
OM 460.907	Diesel	12816	6	128.00	18
OM 460.908	Diesel	12816	6	128.00	18
OM 460.909	Diesel	12816	6	128.00	18
OM 460.910	Diesel	12816	6	128.00	18
OM 460.911	Diesel	12816	6	128.00	18
OM 460.912	Diesel	12816	6	128.00	18
OM 460.913	Diesel	12816	6	128.00	18
OM 460.914	Diesel	12816	6	128.00	18
OM 460.915	Diesel	12816	6	128.00	18
OM 460.916	Diesel	12816	6	128.00	18
OM 460.917	Diesel	12816	6	128.00	18
OM 460.918	Diesel	12816	6	128.00	18
OM 460.919	Diesel	12816	6	128.00	18
OM 460.920	Diesel	12816	6	128.00	18
OM 460.921	Diesel	12816	6	128.00	18
OM 460.922	Diesel	12816	6	128.00	18
OM 460.923	Diesel	12816	6	128.00	18
OM 460.925	Diesel	12816	6	128.00	18
OM 460.929	Diesel	12816	6	128.00	18
OM 460.931	Diesel	12816	6	128.00	18
OM 475.950	Diesel	9973	5	128.00	21
OM 475.951	Diesel	9973	5	128.00	21
OM 475.952	Diesel	9973	5	128.00	21
OM 475.953	Diesel	9973	5	128.00	21
OM 475.954	Diesel	9973	5	128.00	21
OM 475.982	Diesel	9973	5	128.00	21
OM 521.940	Diesel	11946	V6	130.00	23
OM 521.950	Diesel	11946	V6	130.00	23
OM 521.951	Diesel	11946	V6	130.00	23
OM 522 LA	Diesel	15928	V8	130.00	25
OM 522.940	Diesel	15928	V8	130.00	23
OM 522.941	Diesel	15928	V8	130.00	23
OM 522.942	Diesel	15928	V8	130.00	23
OM 522.943	Diesel	15928	V8	130.00	23
OM 522.950	Diesel	15928	V8	130.00	23
OM 541.920	Diesel	11946	V6	130.00	23
OM 541.921	Diesel	11946	V6	130.00	23
OM 541.922	Diesel	11946	V6	130.00	23
OM 541.923	Diesel	11946	V6	130.00	23
OM 541.924	Diesel	11946	V6	130.00	23
OM 541.925	Diesel	11946	V6	130.00	23
OM 541.926	Diesel	11946	V6	130.00	23
OM 541.927	Diesel	11946	V6	130.00	23
OM 541.928	Diesel	11946	V6	130.00	23

# ENGINE INDEX

Motorverzeichnis • Index de moteur • Índice de Motor  
Indeks silnika • Модель двигателя • دليل المحرك



CCM



9

Engine Model	Fuel Type	CCM	Cylinder Configuration	Stroke (mm)	Power (kW)
OM 541.940	Diesel	11946	V6	130.00	23
OM 541.941	Diesel	11946	V6	130.00	23
OM 541.942	Diesel	11946	V6	130.00	23
OM 541.943	Diesel	11946	V6	130.00	23
OM 541.944	Diesel	11946	V6	130.00	23
OM 541.945	Diesel	11946	V6	130.00	23
OM 541.946	Diesel	11946	V6	130.00	23
OM 541.947	Diesel	11946	V6	130.00	23
OM 541.948	Diesel	11946	V6	130.00	23
OM 541.949	Diesel	11946	V6	130.00	23
OM 541.950	Diesel	11946	V6	130.00	23
OM 541.951	Diesel	11946	V6	130.00	23
OM 541.952	Diesel	11946	V6	130.00	23
OM 541.953	Diesel	11946	V6	130.00	22
OM 541.959	Diesel	11946	V6	130.00	22
OM 541.960	Diesel	11946	V6	130.00	23
OM 541.970	Diesel	11946	V6	130.00	22
OM 541.971	Diesel	11946	V6	130.00	22
OM 541.972	Diesel	11946	V6	130.00	22
OM 541.973	Diesel	11946	V6	130.00	22
OM 541.974	Diesel	11946	V6	130.00	22
OM 541.975	Diesel	11946	V6	130.00	22
OM 541.976	Diesel	11946	V6	130.00	22
OM 541.977	Diesel	11946	V6	130.00	22
OM 541.978	Diesel	11946	V6	130.00	23
OM 541.979	Diesel	11946	V6	130.00	22
OM 541.980	Diesel	11946	V6	130.00	23
OM 541.981	Diesel	11946	V6	130.00	23
OM 541.990	Diesel	11946	V6	130.00	22
OM 541.991	Diesel	11946	V6	130.00	22
OM 541.992	Diesel	11946	V6	130.00	22
OM 541.994	Diesel	11946	V6	130.00	23
OM 541.997	Diesel	11946	V6	130.00	22
OM 541.998	Diesel	11946	V6	130.00	22
OM 541.999	Diesel	11946	V6	130.00	22
OM 542.920	Diesel	15928	V8	130.00	23
OM 542.921	Diesel	15928	V8	130.00	23
OM 542.922	Diesel	15928	V8	130.00	23
OM 542.923	Diesel	15928	V8	130.00	23
OM 542.924	Diesel	15928	V8	130.00	23
OM 542.925	Diesel	15928	V8	130.00	23
OM 542.926	Diesel	15928	V8	130.00	23
OM 542.940	Diesel	15928	V8	130.00	23
OM 542.941	Diesel	15928	V8	130.00	23
OM 542.942	Diesel	15928	V8	130.00	23
OM 542.943	Diesel	15928	V8	130.00	23
OM 542.944	Diesel	15928	V8	130.00	23
OM 542.945	Diesel	15928	V8	130.00	23
OM 542.947	Diesel	15928	V8	130.00	23
OM 542.948	Diesel	15928	V8	130.00	23
OM 542.956	Diesel	15928	V8	130.00	23
OM 542.957	Diesel	15928	V8	130.00	23
OM 542.958	Diesel	15928	V8	130.00	23
OM 542.960	Diesel	15928	V8	130.00	22
OM 542.961	Diesel	15928	V8	130.00	22
OM 542.962	Diesel	15928	V8	130.00	22
OM 542.963	Diesel	15928	V8	130.00	22
OM 542.964	Diesel	15928	V8	130.00	22
OM 542.965	Diesel	15928	V8	130.00	22
OM 542.966	Diesel	15928	V8	130.00	22



Motorverzeichnis • Index de moteur • Índice de Motor  
Indeks silnika • Модель двигателя • دليل المحرك

# ENGINE INDEX



CCM

x



9

OM 542.970	Diesel	15928	V8	130.00	22
OM 542.971	Diesel	15928	V8	130.00	22
OM 542.972	Diesel	15928	V8	130.00	23
OM 601.900	Diesel	2299	4	89.00	5
OM 601.911	Diesel	1978	4	87.00	2
OM 601.912	Diesel	1978	4	87.00	2
OM 601.913	Diesel	1997	4	87.00	2
OM 601.915	Diesel	1997	4	87.00	2
OM 601.940	Diesel	2299	4	89.00	5
OM 601.941	Diesel	2299	4	89.00	5
OM 601.942	Diesel	2299	4	89.00	5
OM 601.943	Diesel	2299	4	89.00	5
OM 601A.970	Diesel	2299	4	89.00	5
OM 602.911	Diesel	2497	5	87.00	2
OM 602.912	Diesel	2497	5	87.00	2
OM 602.930	Diesel	2497	5	87.00	2
OM 602.931	Diesel	2497	5	87.00	2
OM 602.938	Diesel	2497	5	87.00	2
OM 602.939	Diesel	2497	5	87.00	2
OM 602.940	Diesel	2874	5	89.00	5
OM 602.941	Diesel	2874	5	89.00	5
OM 602.942	Diesel	2874	5	89.00	5
OM 602.946	Diesel	2874	5	89.00	5
OM 602.947	Diesel	2874	5	89.00	5
OM 602.948	Diesel	2874	5	89.00	5
OM 602.961	Diesel	2497	5	87.00	2
OM 602.980	Diesel	2874	5	89.00	5
OM 602.981	Diesel	2874	5	89.00	6
OM 602.982	Diesel	2874	5	89.00	5
OM 602.983	Diesel	2874	5	89.00	5
OM 602.984	Diesel	2874	5	89.00	5
OM 602.985	Diesel	2874	5	89.00	5
OM 602.986	Diesel	2874	5	89.00	5
OM 602.989	Diesel	2874	5	89.00	6
OM 602.990	Diesel	2497	5	87.00	2
OM 602.991	Diesel	2874	5	89.00	5
OM 602.994	Diesel	2874	5	89.00	5
OM 602.995	Diesel	2874	5	89.00	5
OM 602A.962	Diesel	2497	5	87.00	2
OM 602A.993	Diesel	2497	5	87.00	2
OM 603.912	Diesel	2996	6	87.00	2
OM 603.913	Diesel	2996	6	87.00	2
OM 603.931	Diesel	2996	6	87.00	2
OM 603.950	Diesel	2996	6	87.00	2
OM 603.961	Diesel	2996	6	87.00	2
OM 603.962	Diesel	2996	6	87.00	2
OM 603A.960	Diesel	2996	6	87.00	2
OM 603A.963	Diesel	2996	6	87.00	2
OM 603A.970	Diesel	3449	6	89.00	5
OM 603A.971	Diesel	3449	6	89.00	5
OM 603A.972	Diesel	3449	6	89.00	5
OM 604.910	Diesel	2155	4	89.00	6
OM 604.912	Diesel	2155	4	89.00	6
OM 604.915	Diesel	1997	4	87.00	2
OM 604.917	Diesel	1997	4	87.00	2
OM 605.910	Diesel	2497	5	87.00	2
OM 605.911	Diesel	2497	5	87.00	2
OM 605.912	Diesel	2497	5	87.00	2
OM 605.960	Diesel	2497	5	87.00	2
OM 605.962	Diesel	2497	5	87.00	2

# ENGINE INDEX

Motorverzeichnis • Index de moteur • Índice de Motor  
Indeks silnika • Модель двигателя • دليل المحرك



CCM



9

OM 606.910	Diesel	2996	6	87.00	2
OM 606.912	Diesel	2996	6	87.00	2
OM 606.961	Diesel	2996	6	87.00	2
OM 606.962	Diesel	2996	6	87.00	2
OM 606.964	Diesel	2996	6	87.00	2
OM 611.960	Diesel	2148	4	88.00	3
OM 611.980	Diesel	2148	4	88.00	3
OM 611A (60 KW CDI)	Diesel	2148	4	88.00	3
OM 611LA (75 KW CDI)	Diesel	2148	4	88.00	3
OM 615	Diesel	2197	4	87.00	1
OM 615.910	Diesel	2197	4	87.00	1
OM 615.911	Diesel	2197	4	87.00	1
OM 615.912	Diesel	2197	4	87.00	1
OM 615.913	Diesel	1988	4	87.00	1
OM 615.914	Diesel	2197	4	87.00	1
OM 615.915	Diesel	1988	4	87.00	1
OM 615.916	Diesel	2197	4	87.00	1
OM 615.917	Diesel	2197	4	87.00	1
OM 615.918	Diesel	2197	4	87.00	1
OM 615.919	Diesel	2197	4	87.00	1
OM 615.930	Diesel	2197	4	87.00	1
OM 615.932	Diesel	2197	4	87.00	1
OM 615.936	Diesel	2197	4	87.00	1
OM 615.937	Diesel	2197	4	87.00	1
OM 615.938	Diesel	2197	4	87.00	1
OM 615.939	Diesel	2197	4	87.00	1
OM 615.940	Diesel	1988	4	87.00	1
OM 615.941	Diesel	2197	4	87.00	1
OM 615.942	Diesel	1988	4	87.00	1
OM 615.943	Diesel	1988	4	87.00	1
OM 615.944	Diesel	1988	4	87.00	1
OM 615.961	Diesel	1988	4	87.00	1
OM 615.963	Diesel	1988	4	87.00	1
OM 615.964	Diesel	1988	4	87.00	1
OM 615.965	Diesel	1988	4	87.00	1
OM 615.966	Diesel	1988	4	87.00	1
OM 615.967	Diesel	1988	4	87.00	1
OM 615.968	Diesel	1988	4	87.00	1
OM 615.969	Diesel	1988	4	87.00	1
OM 615.970	Diesel	1988	4	87.00	1
OM 616.910	Diesel	2399	4	90.90	7
OM 616.911	Diesel	2404	4	91.00	8
OM 616.912	Diesel	2404	4	91.00	8
OM 616.913	Diesel	2399	4	90.90	7
OM 616.914	Diesel	2399	4	90.90	7
OM 616.916	Diesel	2404	4	91.00	8
OM 616.917	Diesel	2404	4	91.00	8
OM 616.918	Diesel	2399	4	90.90	7
OM 616.919	Diesel	2399	4	90.90	7
OM 616.930	Diesel	2399	4	90.90	7
OM 616.932	Diesel	2404	4	91.00	8
OM 616.933	Diesel	2404	4	91.00	8
OM 616.934	Diesel	2399	4	90.90	7
OM 616.936	Diesel	2399	4	90.90	7
OM 616.937	Diesel	2399	4	90.90	7
OM 616.938	Diesel	2399	4	90.90	7
OM 616.939	Diesel	2399	4	90.90	7
OM 616.940	Diesel	2399	4	90.90	7
OM 616.942	Diesel	2399	4	90.90	7
OM 616.943	Diesel	2399	4	90.90	7



Motorverzeichnis • Index de moteur • Índice de Motor  
Indeks silnika • Модель двигателя • دليل المحرك

# ENGINE INDEX



CCM

x



9

OM 616.944	Diesel	2399	4	91.00	8
OM 616.960	Diesel	2399	4	91.00	8
OM 616.961	Diesel	2399	4	91.00	8
OM 616.962	Diesel	2399	4	91.00	8
OM 616.963	Diesel	2399	4	90.90	7
OM 617.910	Diesel	2998	5	91.00	8
OM 617.912	Diesel	2998	5	91.00	8
OM 617.913	Diesel	2998	5	90.90	7
OM 617.919	Diesel	2998	5	90.90	7
OM 617.931	Diesel	2998	5	90.90	7
OM 617.932	Diesel	2998	5	90.90	7
OM 617.933	Diesel	2998	5	90.90	7
OM 617.950	Diesel	2998	5	90.90	7
OM 617.951	Diesel	2998	5	90.90	7
OM 617.952	Diesel	2998	5	90.90	7
OM 621.912	Diesel	1988	4	87.00	1
OM 621.913	Diesel	1990	4	87.00	1
OM 621.914	Diesel	1988	4	87.00	1
OM 621.915	Diesel	1988	4	87.00	1
OM 621.916	Diesel	1988	4	87.00	1
OM 621.918	Diesel	1988	4	87.00	1
OM 621.919	Diesel	1988	4	87.00	1
OM 621.930	Diesel	1988	4	87.00	1
OM 621.932	Diesel	1990	4	87.00	1
OM 661.911	Diesel	2299	4	89.00	5
OM 662.911	Diesel	2874	5	89.00	5
OM 900.911	Diesel	4249	4	102.00	11
OM 900.912	Diesel	4249	4	102.00	11
OM 900.913	Diesel	4249	4	102.00	11
OM 900.915	Diesel	4249	4	102.00	11
OM 900.916	Diesel	4249	4	102.00	11
OM 900.917	Diesel	4249	4	102.00	11
OM 900.918	Diesel	4249	4	102.00	11
OM 900.919	Diesel	4249	4	102.00	11
OM 900.920	Diesel	4249	4	102.00	11
OM 900.921	Diesel	4249	4	102.00	11
OM 900.922	Diesel	4249	4	102.00	11
OM 902.910	Diesel	6374	6	102.00	11
OM 902.911	Diesel	6374	6	102.00	11
OM 902.912	Diesel	6374	6	102.00	11
OM 902.913	Diesel	6374	6	102.00	11
OM 902.914	Diesel	6374	6	102.00	11
OM 902.915	Diesel	6374	6	102.00	11
OM 902.916	Diesel	6374	6	102.00	11
OM 902.917	Diesel	6374	6	102.00	11
OM 902.918	Diesel	6374	6	102.00	11
OM 902.919	Diesel	6374	6	102.00	11
OM 902.923	Diesel	6374	6	102.00	11
OM 902.924	Diesel	6374	6	102.00	11
OM 902.925	Diesel	6374	6	102.00	11
OM 902.926	Diesel	6374	6	102.00	11
OM 902.927	Diesel	6374	6	102.00	11
OM 902.930	Diesel	6374	6	102.00	11
OM 902.931	Diesel	6374	6	102.00	11
OM 902.932	Diesel	6374	6	102.00	11
OM 902.933	Diesel	6374	6	102.00	11
OM 902.934	Diesel	6374	6	102.00	11
OM 902.936	Diesel	6374	6	102.00	11
OM 904.903	Diesel	4250	4	102.00	11
OM 904.904	Diesel	4250	4	102.00	11

# ENGINE INDEX

Motorverzeichnis • Index de moteur • Índice de Motor  
Indeks silnika • Модель двигателя • دليل المحرك



CCM

x



9

OM 904.905	Diesel	4249	4	102.00	11
OM 904.906	Diesel	4249	4	102.00	11
OM 904.907	Diesel	4249	4	102.00	11
OM 904.908	Diesel	4250	4	102.00	11
OM 904.909	Diesel	4249	4	102.00	11
OM 904.910	Diesel	4249	4	102.00	11
OM 904.911	Diesel	4249	4	102.00	11
OM 904.912	Diesel	4249	4	102.00	11
OM 904.914	Diesel	4249	4	102.00	11
OM 904.915	Diesel	4249	4	102.00	11
OM 904.916	Diesel	4249	4	102.00	11
OM 904.917	Diesel	4249	4	102.00	11
OM 904.918	Diesel	4249	4	102.00	11
OM 904.919	Diesel	4249	4	102.00	11
OM 904.920	Diesel	4249	4	102.00	11
OM 904.921	Diesel	4249	4	102.00	11
OM 904.922	Diesel	4249	4	102.00	11
OM 904.923	Diesel	4250	4	102.00	11
OM 904.924	Diesel	4249	4	102.00	11
OM 904.925	Diesel	4249	4	102.00	11
OM 904.926	Diesel	4249	4	102.00	11
OM 904.927	Diesel	4249	4	102.00	11
OM 904.928	Diesel	4249	4	102.00	11
OM 904.929	Diesel	4249	4	102.00	11
OM 904.930	Diesel	4249	4	102.00	11
OM 904.931	Diesel	4249	4	102.00	11
OM 904.932	Diesel	4249	4	102.00	11
OM 904.933	Diesel	4249	4	102.00	11
OM 904.934	Diesel	4249	4	102.00	11
OM 904.935	Diesel	4249	4	102.00	11
OM 904.936	Diesel	4250	4	102.00	11
OM 904.937	Diesel	4249	4	102.00	11
OM 904.938	Diesel	4249	4	102.00	11
OM 904.939	Diesel	4249	4	102.00	11
OM 904.940	Diesel	4249	4	102.00	11
OM 904.941	Diesel	4249	4	102.00	11
OM 904.942	Diesel	4249	4	102.00	11
OM 904.943	Diesel	4249	4	102.00	11
OM 904.944	Diesel	4249	4	102.00	11
OM 904.945	Diesel	4249	4	102.00	11
OM 904.946	Diesel	4249	4	102.00	11
OM 904.947	Diesel	4249	4	102.00	11
OM 904.948	Diesel	4249	4	102.00	11
OM 904.949	Diesel	4249	4	102.00	11
OM 904.950	Diesel	4249	4	102.00	11
OM 904.951	Diesel	4249	4	102.00	11
OM 904.952	Diesel	4249	4	102.00	11
OM 904.953	Diesel	4249	4	102.00	11
OM 904.954	Diesel	4249	4	102.00	11
OM 904.955	Diesel	4250	4	102.00	11
OM 904.956	Diesel	4249	4	102.00	11
OM 904.957	Diesel	4249	4	102.00	11
OM 904.959	Diesel	4249	4	102.00	11
OM 904.961	Diesel	4250	4	102.00	11
OM 904.962	Diesel	4249	4	102.00	11
OM 904.964	Diesel	4250	4	102.00	11
OM 904.965	Diesel	4249	4	102.00	11
OM 904.966	Diesel	4249	4	102.00	11
OM 904.967	Diesel	4249	4	102.00	11
OM 904.968	Diesel	4249	4	102.00	11

Motorverzeichnis • Index de moteur • Índice de Motor  
Indeks silnika • Модель двигателя • دليل المحرك

# ENGINE INDEX



CCM

x



9

OM 904.970	Diesel	4249	4	102.00	11
OM 904.972	Diesel	4249	4	102.00	11
OM 904.973	Diesel	4249	4	102.00	11
OM 904.974	Diesel	4249	4	102.00	11
OM 904.975	Diesel	4249	4	102.00	11
OM 904.976	Diesel	4249	4	102.00	11
OM 904.977	Diesel	4249	4	102.00	11
OM 904.978	Diesel	4249	4	102.00	11
OM 904.979	Diesel	4249	4	102.00	11
OM 904.980	Diesel	4249	4	102.00	11
OM 904.981	Diesel	4249	4	102.00	11
OM 906.910	Diesel	6374	6	102.00	11
OM 906.911	Diesel	6374	6	102.00	11
OM 906.912	Diesel	6374	6	102.00	11
OM 906.913	Diesel	6374	6	102.00	11
OM 906.914	Diesel	6374	6	102.00	11
OM 906.915	Diesel	6374	6	102.00	11
OM 906.916	Diesel	6374	6	102.00	11
OM 906.917	Diesel	6374	6	102.00	11
OM 906.918	Diesel	6374	6	102.00	11
OM 906.919	Diesel	6374	6	102.00	11
OM 906.920	Diesel	6374	6	102.00	11
OM 906.921	Diesel	6374	6	102.00	11
OM 906.922	Diesel	6374	6	102.00	11
OM 906.923	Diesel	6374	6	102.00	11
OM 906.924	Diesel	6374	6	102.00	11
OM 906.925	Diesel	6374	6	102.00	11
OM 906.926	Diesel	6374	6	102.00	11
OM 906.927	Diesel	6374	6	102.00	11
OM 906.928	Diesel	6374	6	102.00	11
OM 906.929	Diesel	6374	6	102.00	11
OM 906.930	Diesel	6374	6	102.00	11
OM 906.931	Diesel	6374	6	102.00	11
OM 906.932	Diesel	6374	6	102.00	11
OM 906.933	Diesel	6374	6	102.00	11
OM 906.934	Diesel	6374	6	102.00	11
OM 906.935	Diesel	6374	6	102.00	11
OM 906.936	Diesel	6374	6	102.00	11
OM 906.937	Diesel	6374	6	102.00	11
OM 906.938	Diesel	6374	6	102.00	11
OM 906.939	Diesel	6374	6	102.00	11
OM 906.940	Diesel	6374	6	102.00	11
OM 906.941	Diesel	6374	6	102.00	11
OM 906.944	Diesel	6374	6	102.00	11
OM 906.945	Diesel	6374	6	102.00	11
OM 906.946	Diesel	6374	6	102.00	11
OM 906.947	Diesel	6374	6	102.00	11
OM 906.948	Diesel	6374	6	102.00	11
OM 906.949	Diesel	6374	6	102.00	11
OM 906.950	Diesel	6374	6	102.00	11
OM 906.951	Diesel	6374	6	102.00	11
OM 906.952	Diesel	6374	6	102.00	11
OM 906.953	Diesel	6374	6	102.00	11
OM 906.954	Diesel	6374	6	102.00	11
OM 906.955	Diesel	6374	6	102.00	11
OM 906.956	Diesel	6374	6	102.00	11
OM 906.957	Diesel	6374	6	102.00	11
OM 906.958	Diesel	6374	6	102.00	11
OM 906.959	Diesel	6374	6	102.00	11
OM 906.960	Diesel	6374	6	102.00	11

# ENGINE INDEX

Motorverzeichnis • Index de moteur • Índice de Motor  
Indeks silnika • Модель двигателя • دليل المحرك



CCM

x



9

OM 906.961	Diesel	6374	6	102.00	11
OM 906.962	Diesel	6374	6	102.00	11
OM 906.963	Diesel	6374	6	102.00	11
OM 906.964	Diesel	6374	6	102.00	11
OM 906.965	Diesel	6374	6	102.00	11
OM 906.966	Diesel	6374	6	102.00	11
OM 906.967	Diesel	6374	6	102.00	11
OM 906.968	Diesel	6374	6	102.00	11
OM 906.970	Diesel	6374	6	102.00	11
OM 906.971	Diesel	6374	6	102.00	11
OM 906.973	Diesel	6374	6	102.00	11
OM 906.974	Diesel	6374	6	102.00	11
OM 906.975	Diesel	6374	6	102.00	11
OM 906.976	Diesel	6374	6	102.00	11
OM 906.977	Diesel	6374	6	102.00	11
OM 906.978	Diesel	6374	6	102.00	11
OM 906.979	Diesel	6374	6	102.00	11
OM 906.980	Diesel	6374	6	102.00	11
OM 906.981	Diesel	6374	6	102.00	11
OM 906.982	Diesel	6374	6	102.00	11
OM 906.983	Diesel	6374	6	102.00	11
OM 906.985	Diesel	6374	6	102.00	11
OM 906.986	Diesel	6374	6	102.00	11
OM 906.988	Diesel	6374	6	102.00	11
OM 906.991	Diesel	6374	6	102.00	11
OM 906.992	Diesel	6374	6	102.00	11
OM 906.993	Diesel	6374	6	102.00	11
OM 906.995	Diesel	6374	6	102.00	11
OM 906.998	Diesel	6374	6	102.00	11
OM 907.910	Diesel	4250	4	102.00	11
OM 907.920	Diesel	4250	4	102.00	11
OM 907.930	Diesel	4249	4	102.00	11
OM 907.940	Diesel	4250	4	102.00	11
OM 907.941	Diesel	4249	4	102.00	11
OM 907.960	Diesel	4250	4	102.00	11
OM 907.970	Diesel	4250	4	102.00	11
OM 907.980	Diesel	4249	4	102.00	11
OM 907.990	Diesel	4250	4	102.00	11
OM 909.900	Diesel	6374	6	102.00	11
OM 909.901	Diesel	6374	6	102.00	11
OM 909.910	Diesel	6374	6	102.00	11
OM 909.911	Diesel	6374	6	102.00	11
OM 909.920	Diesel	6374	6	102.00	11
OM 909.921	Diesel	6374	6	102.00	11
OM 909.960	Diesel	6374	6	102.00	11
OM 909.970	Diesel	6374	6	102.00	11
OM 909.971	Diesel	6374	6	102.00	11
OM 941.910	Diesel	11946	V6	130.00	23
OM 941.920	Diesel	11946	V6	130.00	23
OM 941.921	Diesel	11946	V6	130.00	23
OM 941.929	Diesel	11946	V6	130.00	23
OM 941.930	Diesel	11946	V6	130.00	23
OM 941.940	Diesel	11946	V6	130.00	23
OM 941.960	Diesel	11946	V6	130.00	23
OM 941.970	Diesel	11946	V6	130.00	23
OM 941.980	Diesel	11946	V6	130.00	23
OM 941.981	Diesel	11946	V6	130.00	23
OM 941.990	Diesel	11946	V6	130.00	23
OM 942.900	Diesel	15928	V8	130.00	23
OM 942.910	Diesel	15928	V8	130.00	23

Motorverzeichnis • Index de moteur • Índice de Motor  
Indeks silnika • Модель двигателя • دليل المحرك

# ENGINE INDEX



CCM

x



9

OM 942.911	Diesel	15928	V8	130.00	23
OM 942.912	Diesel	15928	V8	130.00	23
OM 942.925	Diesel	15928	V8	130.00	23
OM 942.930	Diesel	15928	V8	130.00	23
OM 942.960	Diesel	15928	V8	130.00	23
OM 942.967	Diesel	15928	V8	130.00	23
OM 942.970	Diesel	15928	V8	130.00	23
OM 942.980	Diesel	15928	V8	130.00	23
OM 942.990	Diesel	15928	V8	130.00	23



1

OM 615	4cyl.	2197cc	40-44kW (55-60PS)	Diesel	TD2231
OM 615.910	4cyl.	2197cc	44kW (60PS)	Diesel	TD2232
OM 615.911	4cyl.	2197cc	33kW (45PS)	Diesel	TD7970
OM 615.912	4cyl.	2197cc	44kW (60PS)	Diesel	TD2233
OM 615.913	4cyl.	1988cc	40kW (54PS)	Diesel	TD2234
OM 615.914	4cyl.	2197cc	40kW (54PS)	Diesel	TD7972
OM 615.915	4cyl.	1988cc	40-44kW (54-60PS)	Diesel	TD17732
OM 615.916	4cyl.	2197cc	40kW (55PS)	Diesel	TD22823
OM 615.917	4cyl.	2197cc	44kW (60PS)	Diesel	TD5683
OM 615.918	4cyl.	2197cc	40kW (55PS)	Diesel	TD22824
OM 615.919	4cyl.	2197cc	38-40kW (52-54PS)	Diesel	TD28785
OM 615.930	4cyl.	2197cc	38kW (52PS)	Diesel	TD22825
OM 615.932	4cyl.	2197cc	44kW (60PS)	Diesel	TD7989
OM 615.936	4cyl.	2197cc	37kW (50PS)	Diesel	TD20151
OM 615.937	4cyl.	2197cc	44kW (60PS)	Diesel	TD2236
OM 615.938	4cyl.	2197cc	44kW (60PS)	Diesel	TD22826
OM 615.939	4cyl.	2197cc	44kW (60PS)	Diesel	TD2237
OM 615.940	4cyl.	1988cc	40-44kW (55-60PS)	Diesel	TD2238
OM 615.941	4cyl.	2197cc	44-49kW (60-67PS)	Diesel	TD2239
OM 615.942	4cyl.	1988cc	40kW (54PS)	Diesel	TD22827
OM 615.943	4cyl.	1988cc	40kW (54PS)	Diesel	TD2240
OM 615.944	4cyl.	1988cc	40kW (54PS)	Diesel	TD2241
OM 615.961	4cyl.	1988cc	44kW (60PS)	Diesel	TD22829
OM 615.963	4cyl.	1988cc	43kW (58PS)	Diesel	TD2242
OM 615.964	4cyl.	1988cc	40kW (54PS)	Diesel	TD22830
OM 615.965	4cyl.	1988cc	40kW (54PS)	Diesel	TD22831
OM 615.966	4cyl.	1988cc	40kW (54PS)	Diesel	TD22832
OM 615.967	4cyl.	1988cc	40kW (54PS)	Diesel	TD22833
OM 615.968	4cyl.	1988cc	40kW (54PS)	Diesel	TD22834
OM 615.969	4cyl.	1988cc	40kW (54PS)	Diesel	TD22835
OM 615.970	4cyl.	1988cc	43-46kW (58-62PS)	Diesel	TD2243
OM 621.912	4cyl.	1988cc	40kW (54PS)	Diesel	TD2268
OM 621.913	4cyl.	1990cc	36-40kW (50-54PS)	Diesel	TD2269
OM 621.914	4cyl.	1988cc	35-40kW (48-54PS)	Diesel	TD2270
OM 621.915	4cyl.	1988cc	40kW (54PS)	Diesel	TD22837
OM 621.916	4cyl.	1988cc	25-29kW (34-39PS)	Diesel	TD7986
OM 621.918	4cyl.	1988cc	40kW (54PS)	Diesel	TD2271
OM 621.919	4cyl.	1988cc	40kW (54PS)	Diesel	TD22838
OM 621.930	4cyl.	1988cc	40kW (54PS)	Diesel	TD22839
OM 621.932	4cyl.	1990cc	40kW (54PS)	Diesel	TD2272

14-022190-00 D

87.00

B 90.00

C 158.40

D 92.00

E 4.70

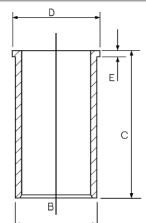



2

OM 601.911	4cyl.	1978cc	53-55kW (72-75PS)	Diesel		TD2206
OM 601.912	4cyl.	1978cc	53-55kW (72-75PS)	Diesel		TD2207
OM 601.913	4cyl.	1997cc	55kW (75PS)	Diesel		TD2208
OM 601.915	4cyl.	1997cc	55kW (75PS)	Diesel		TD5237
OM 602A.962	5cyl.	2497cc	93kW (126PS)	Diesel	Turbo	TD2217
OM 602A.993	5cyl.	2497cc	93kW (126PS)	Diesel	Turbo	TD17821
OM 602.911	5cyl.	2497cc	66-69kW (90-94PS)	Diesel		TD2211
OM 602.912	5cyl.	2497cc	66-69kW (90-94PS)	Diesel		TD2212
OM 602.930	5cyl.	2497cc	62-69kW (84-94PS)	Diesel		TD2213
OM 602.931	5cyl.	2497cc	69kW (93PS)	Diesel		TD2214
OM 602.938	5cyl.	2497cc	68kW (92PS)	Diesel		TD17816
OM 602.939	5cyl.	2497cc	68kW (92PS)	Diesel		TD9422
OM 602.961	5cyl.	2497cc	90-93kW (122-126PS)	Diesel	Turbo	TD2216
OM 602.990	5cyl.	2497cc	63kW (86PS)	Diesel		TD17819
OM 603A.960	6cyl.	2996cc	105-108kW (143-147PS)	Diesel	Turbo	TD2221
OM 603A.963	6cyl.	2996cc	105-108kW (143-147PS)	Diesel	Turbo	TD2223
OM 603.912	6cyl.	2996cc	80-83kW (109-113PS)	Diesel		TD2218
OM 603.913	6cyl.	2996cc	80-83kW (109-113PS)	Diesel		TD2219
OM 603.931	6cyl.	2996cc	80-83kW (109-113PS)	Diesel		TD2220
OM 603.950	6cyl.	2996cc	100-105kW (136-143PS)	Diesel	Turbo	TD21143
OM 603.961	6cyl.	2996cc	107-110kW (143-148PS)	Diesel	Turbo	TD2222
OM 603.962	6cyl.	2996cc	105kW (143PS)	Diesel	Turbo	TD21144
OM 604.915	4cyl.	1997cc	65kW (88PS)	Diesel		TD4677
OM 604.917	4cyl.	1997cc	65kW (88PS)	Diesel		TD9424
OM 605.910	5cyl.	2497cc	83kW (113PS)	Diesel		TD2228
OM 605.911	5cyl.	2497cc	83kW (113PS)	Diesel		TD2229
OM 605.912	5cyl.	2497cc	83kW (113PS)	Diesel		TD4678
OM 605.960	5cyl.	2497cc	110kW (150PS)	Diesel	Turbo Intercooled	TD4679
OM 605.962	5cyl.	2497cc	110kW (150PS)	Diesel	Turbo Intercooled	TD9892
OM 606.910	6cyl.	2996cc	130kW (177PS)	Diesel		TD2230
OM 606.912	6cyl.	2996cc	100kW (136PS)	Diesel		TD4680
OM 606.961	6cyl.	2996cc	130kW (177PS)	Diesel	Turbo Intercooled	TD5238
OM 606.962	6cyl.	2996cc	130kW (177PS)	Diesel	Turbo Intercooled	TD9416
OM 606.964	6cyl.	2996cc	130kW (177PS)	Diesel	Turbo Intercooled	TD9425

14-026240-00 D  
14-026241-00 D

87.00

B 90.105  
B 90.20

C 148.50  
C 148.50

D 92.57  
D 92.75

E 4.70  
E 4.70

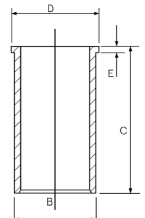





3

OM 611A (60 KW CDI)	4cyl.	2148cc	60kW (81PS)	Diesel		TD14348
OM 611LA (75 KW CDI)	4cyl.	2148cc	75-110kW (102-150PS)	Diesel		TD14349
OM 611.960	4cyl.	2148cc	85-115kW (116-156PS)	Diesel	Turbo Intercooled	TD9529
OM 611.980 Euro 3	4cyl.	2148cc	85-115kW (116-156PS)	Diesel	Turbo Intercooled	TD14350

14-020300-00 D 88.00 B 91.00 C 147.00 D 93.00 E 5.00

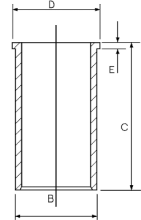

4

M 102.910	4cyl.	1797cc	77-80kW (105-109PS)			TD2061
M 102.919	4cyl.	1797cc	77kW (105PS)			TD2062
M 102.920	4cyl.	1997cc	66-77kW (90-105PS)			TD2063
M 102.921	4cyl.	1997cc	66-77kW (90-105PS)			TD2064
M 102.922	4cyl.	1997cc	62-93kW (84-126PS)			TD2065
M 102.924	4cyl.	1997cc	62-93kW (84-126PS)			TD4653
M 102.938	4cyl.	1997cc	63kW (86PS)			TD22701
M 102.939	4cyl.	1997cc	62-93kW (84-126PS)			TD2069
M 102.961	4cyl.	1997cc	62-93kW (84-126PS)			TD5050
M 102.962	4cyl.	1997cc	62-93kW (84-126PS)			TD4655
M 102.963	4cyl.	1997cc	62-93kW (84-126PS)			TD2078
M 102.964	4cyl.	1997cc	80kW (109PS)			TD17723
M 102.965	4cyl.	1996cc	80kW (109PS)			TD2080

14-025480-00 D 89.00 B 92.02 C 165.00 D 95.05 E 4.10

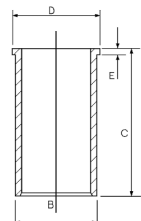

5

OM 601A.970	4cyl.	2299cc	72kW (98PS)	Diesel	Turbo Intercooled	TD4674
OM 601.900 Euro 2	4cyl.	2299cc	62kW (84PS)	Diesel		TD16185
OM 601.940	4cyl.	2299cc	58-60kW (79-82PS)	Diesel		TD2210
OM 601.941	4cyl.	2299cc	58-60kW (79-82PS)	Diesel		TD8041
OM 601.942	4cyl.	2299cc	58kW (79PS)	Diesel		TD5398
OM 601.943	4cyl.	2299cc	58kW (79PS)	Diesel		TD5400
OM 602.940	5cyl.	2874cc	70-72kW (9598PS)	Diesel		TD2215
OM 602.941	5cyl.	2874cc	65-70kW (88-95PS)	Diesel		TD8013
OM 602.942	5cyl.	2874cc	70-72kW (95-98PS)	Diesel		TD2054
OM 602.946	5cyl.	2874cc	70kW (95PS)	Diesel		TD17817
OM 602.947	5cyl.	2874cc	72kW (98PS)	Diesel		TD17818
OM 602.948	5cyl.	2874cc	71kW (96PS)	Diesel		TD8014
OM 602.980	5cyl.	2874cc	75-90kW (102-122PS)	Diesel	Turbo Intercooled	TD8032







OM 602.982	5cyl.	2874cc	95kW (129PS)	Diesel	Turbo Intercooled	TD4675
OM 602.983	5cyl.	2874cc	88kW (120PS)	Diesel	Turbo Intercooled	TD12910
OM 602.984	5cyl.	2874cc	90kW (122PS)	Diesel	Turbo Intercooled	TD5682
OM 602.985	5cyl.	2874cc	90kW (122PS)	Diesel	Turbo Intercooled	TD6020
OM 602.986	5cyl.	2874cc	75-90kW (102-122PS)	Diesel	Turbo	TD9459
OM 602.991	5cyl.	2874cc	70kW (95PS)	Diesel		TD17820
OM 602.994	5cyl.	2874cc	72kW (98PS)	Diesel		TD17822
OM 602.995	5cyl.	2874cc	72kW (98PS)	Diesel		TD28784
OM 603A.970	6cyl.	3449cc	100kW (136PS)	Diesel	Turbo	TD2224
OM 603A.971	6cyl.	3449cc	110kW (150PS)	Diesel	Turbo	TD2225
OM 603A.972	6cyl.	3449cc	100kW (136PS)	Diesel	Turbo	TD2226
OM 661.911	4cyl.	2299cc	57kW (77PS)	Diesel		TD8942
OM 662.911	5cyl.	2874cc	70kW (95PS)	Diesel		TD22700

14-026380-00 D  
14-027210-00 D

89.00

B 91.50 C 156.50 D 96.55 E 4.70  
B 91.50 C 156.50 D 94.05 E 4.70

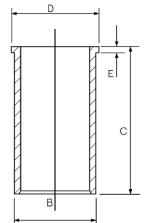

6

OM 602.981 Euro 2	5cyl.	2874cc	85-90kW (116-122PS)	Diesel	Turbo Intercooled	TD14670
OM 602.989 Euro 2	5cyl.	2874cc	85-90kW (116-122PS)	Diesel	Turbo Intercooled	TD14672
OM 604.910	4cyl.	2155cc	55-70kW (75-95PS)	Diesel		TD2227
OM 604.912	4cyl.	2155cc	55-70kW (75-95PS)	Diesel		TD4676

14-027210-00 D

89.00

B 91.50 C 156.50 D 94.05 E 4.70

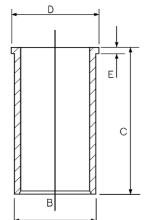

7

OM 616.910	4cyl.	2399cc	48kW (65PS)	Diesel		TD2245
OM 616.913	4cyl.	2399cc	53kW (72PS)	Diesel		TD2247
OM 616.914	4cyl.	2399cc	53kW (72PS)	Diesel		TD8040
OM 616.918	4cyl.	2399cc	35-48kW (48-65PS)	Diesel		TD28786
OM 616.919	4cyl.	2399cc	38-48kW (52-65PS)	Diesel		TD28787
OM 616.930	4cyl.	2399cc	44kW (60PS)	Diesel		TD5677
OM 616.934	4cyl.	2399cc	48kW (65PS)	Diesel		TD2250
OM 616.936	4cyl.	2399cc	53kW (72PS)	Diesel		TD2251
OM 616.937	4cyl.	2399cc	53kW (72PS)	Diesel		TD2252
OM 616.938	4cyl.	2399cc	53kW (72PS)	Diesel		TD17733
OM 616.939	4cyl.	2399cc	53kW (72PS)	Diesel		TD2253
OM 616.940	4cyl.	2399cc	53kW (72PS)	Diesel		TD22836
OM 616.942	4cyl.	2399cc	38kW (52PS)	Diesel		TD7991





OM 616.943	4cyl.	2399cc	44kW (60PS)	Diesel		TD7992
OM 616.963	4cyl.	2399cc	53-56kW (72-76PS)	Diesel		TD2257
OM 617.913	5cyl.	2998cc	65kW (88PS)	Diesel		TD2261
OM 617.919	5cyl.	2998cc	65kW (88PS)	Diesel		TD28789
OM 617.931	5cyl.	2998cc	65kW (88PS)	Diesel		TD2262
OM 617.932	5cyl.	2998cc	65kW (88PS)	Diesel		TD17743
OM 617.933	5cyl.	2998cc	65kW (88PS)	Diesel		TD26550
OM 617.950	5cyl.	2998cc	85-92kW (116-125PS)	Diesel Turbo		TD2263
OM 617.951	5cyl.	2998cc	92kW (125PS)	Diesel Turbo		TD2264
OM 617.952	5cyl.	2998cc	92kW (125PS)	Diesel Turbo		TD2265

14-021350-00 D 90.90 B 94.00 C 158.40 D 96.00 E 4.70

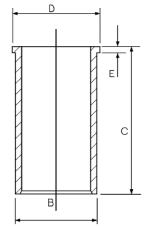

8

OM 616.911	4cyl.	2404cc	38kW (52PS)	Diesel		TD5675
OM 616.912	4cyl.	2404cc	46-53kW (63-72PS)	Diesel		TD9432
OM 616.916	4cyl.	2404cc	48kW (65PS)	Diesel		TD2248
OM 616.917	4cyl.	2404cc	48kW (65PS)	Diesel		TD2249
OM 616.932	4cyl.	2404cc	44kW (60PS)	Diesel		TD6015
OM 616.933	4cyl.	2404cc	44kW (60PS)	Diesel		TD16998
OM 616.944	4cyl.	2399cc	44kW (60PS)	Diesel		TD16937
OM 616.960	4cyl.	2399cc	53kW (72PS)	Diesel		TD2255
OM 616.961	4cyl.	2399cc	53kW (72PS)	Diesel		TD2256
OM 616.962	4cyl.	2399cc	33-53kW (45-72PS)	Diesel		TD28788
OM 617.910	5cyl.	2998cc	59kW (80PS)	Diesel		TD2259
OM 617.912	5cyl.	2998cc	59-65kW (80-88PS)	Diesel		TD2260

14-021350-00 D 91.00 B 94.00 C 158.40 D 96.00 E 4.70

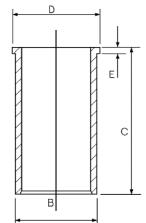

9

OM 314.900	4cyl.	3782cc	46-63kW (63-86PS)	Diesel		TD22733
OM 314.910	4cyl.	3782cc	63kW (86PS)	Diesel		TD5691
OM 314.914	4cyl.	3782cc	35-62kW (48-84PS)	Diesel		TD22546
OM 314.915	4cyl.	3782cc	63kW (86PS)	Diesel		TD16557
OM 314.916	4cyl.	3782cc	40kW (54PS)	Diesel		TD7971
OM 314.917	4cyl.	3782cc	48-55kW (66-75PS)	Diesel		TD7973
OM 314.918	4cyl.	3782cc	53kW (72PS)	Diesel		TD22545
OM 314.919	4cyl.	3782cc	53kW (72PS)	Diesel		TD22547





OM 314.920	4cyl.	3782cc	55kW (75PS)	Diesel		TD28222
OM 314.921	4cyl.	3782cc	48kW (65PS)	Diesel		TD28223
OM 314.922	4cyl.	3782cc	57kW (78PS)	Diesel		TD28585
OM 314.940	4cyl.	3782cc	35-62kW (48-84PS)	Diesel		TD22548
OM 314.941	4cyl.	3782cc	35-62kW (48-84PS)	Diesel		TD22549
OM 314.942	4cyl.	3782cc	35-62kW (48-84PS)	Diesel		TD22550
OM 314.943	4cyl.	3782cc	35-62kW (48-84PS)	Diesel		TD22551
OM 314.944	4cyl.	3782cc	63kW (86PS)	Diesel		TD6028
OM 314.945	4cyl.	3782cc	35-62kW (48-84PS)	Diesel		TD22552
OM 314.946	4cyl.	3782cc	63kW (86PS)	Diesel		TD2202
OM 314.947	4cyl.	3782cc	35-62kW (48-84PS)	Diesel		TD22553
OM 314.948	4cyl.	3782cc	63kW (86PS)	Diesel		TD2203
OM 314.949	4cyl.	3782cc	35-62kW (48-84PS)	Diesel		TD22554
OM 314.950	4cyl.	3782cc	35-62kW (48-84PS)	Diesel		TD22555
OM 314.951	4cyl.	3782cc	35-66kW (48-90PS)	Diesel		TD22556
OM 314.953	4cyl.	3782cc	59kW (80PS)	Diesel		TD7975
OM 314.954	4cyl.	3782cc	35-62kW (48-84PS)	Diesel		TD22557
OM 314.956	4cyl.	3782cc	48kW (65PS)	Diesel		TD16999
OM 314.957	4cyl.	3782cc	53kW (72PS)	Diesel		TD17000
OM 314.958	4cyl.	3782cc	35-62kW (48-84PS)	Diesel		TD22558
OM 314.959	4cyl.	3782cc	63kW (86PS)	Diesel		TD2204
OM 314.960	4cyl.	3782cc	35-62kW (48-84PS)	Diesel		TD22559
OM 314.961	4cyl.	3782cc	63kW (86PS)	Diesel		TD16552
OM 314.962	4cyl.	3782cc	63kW (86PS)	Diesel		TD16553
OM 314.963	4cyl.	3782cc	63kW (86PS)	Diesel		TD16554
OM 314.964	4cyl.	3782cc	63kW (86PS)	Diesel		TD16555
OM 314.970	4cyl.	3782cc	63kW (86PS)	Diesel	Turbo	TD17852
OM 352.901	6cyl.	5673cc	96kW (131PS)	Diesel		TD16626
OM 352.902	6cyl.	5673cc	52kW (71PS)	Diesel		TD7974
OM 352.903	6cyl.	5673cc	66kW (89PS)	Diesel		TD7977
OM 352.904	6cyl.	5673cc	93kW (126PS)	Diesel		TD16627
OM 352.905	6cyl.	5673cc	96kW (131PS)	Diesel		TD7966
OM 352.906	6cyl.	5673cc	81kW (110PS)	Diesel		TD5700
OM 352.907	6cyl.	5673cc	81kW (110PS)	Diesel		TD5702
OM 352.908	6cyl.	5673cc	81-93kW (110-126PS)	Diesel		TD5701
OM 352.909	6cyl.	5673cc	81kW (110PS)	Diesel		TD16606
OM 352.910	6cyl.	5673cc	74kW (100PS)	Diesel		TD16615
OM 352.911	6cyl.	5673cc	81kW (110PS)	Diesel		TD16607
OM 352.912	6cyl.	5673cc	96kW (131PS)	Diesel		TD16628
OM 352.913	6cyl.	5673cc	115kW (156PS)	Diesel	Turbo	TD16643
OM 352.914	6cyl.	5673cc	81kW (110PS)	Diesel		TD7921
OM 352.915	6cyl.	5673cc	93kW (126PS)	Diesel		TD7922
OM 352.916	6cyl.	5673cc	110kW (150PS)	Diesel	Turbo	TD7923
OM 352.917	6cyl.	5673cc	93kW (126PS)	Diesel		TD16629
OM 352.918	6cyl.	5673cc	110kW (150PS)	Diesel	Turbo	TD16641





OM 352.919	6cyl.	5673cc	48kW (65PS)	Diesel		TD7984
OM 352.930	6cyl.	5673cc	96kW (131PS)	Diesel		TD16630
OM 352.931	6cyl.	5673cc	96kW (131PS)	Diesel		TD16631
OM 352.932	6cyl.	5673cc	81kW (110PS)	Diesel		TD16608
OM 352.933	6cyl.	5673cc	81kW (110PS)	Diesel		TD16609
OM 352.934	6cyl.	5673cc	96kW (131PS)	Diesel		TD16632
OM 352.935	6cyl.	5673cc	96kW (131PS)	Diesel		TD16633
OM 352.936	6cyl.	5673cc	96kW (131PS)	Diesel		TD8158
OM 352.937	6cyl.	5673cc	110kW (150PS)	Diesel	Turbo	TD16644
OM 352.938	6cyl.	5673cc	96kW (131PS)	Diesel		TD5738
OM 352.939	6cyl.	5673cc	96kW (131PS)	Diesel		TD16634
OM 352.942	6cyl.	5673cc	74kW (100PS)	Diesel		TD16616
OM 352.943	6cyl.	5673cc	81kW (110PS)	Diesel		TD16610
OM 352.944	6cyl.	5673cc	93kW (126PS)	Diesel		TD16635
OM 352.945	6cyl.	5673cc	96kW (131PS)	Diesel		TD16637
OM 352.946	6cyl.	5673cc	110kW (150PS)	Diesel	Turbo	TD16645
OM 352.948	6cyl.	5673cc	93kW (126PS)	Diesel		TD16638
OM 352.949	6cyl.	5673cc	115kW (156PS)	Diesel	Turbo	TD16646
OM 352.950	6cyl.	5673cc	110kW (150PS)	Diesel	Turbo	TD16647
OM 352.953	6cyl.	5673cc	93kW (126PS)	Diesel		TD16639
OM 352.954	6cyl.	5673cc	93kW (126PS)	Diesel		TD16640
OM 352.955	6cyl.	5673cc	93kW (126PS)	Diesel		TD17012
OM 352.963	6cyl.	5673cc	96kW (131PS)	Diesel		TD6071
OM 352.964	6cyl.	5673cc	96kW (131PS)	Diesel		TD5714
OM 352.965	6cyl.	5673cc	69kW (93PS)	Diesel		TD22738
OM 352.966	6cyl.	5673cc	79kW (107PS)	Diesel		TD22739
OM 352.967	6cyl.	5673cc	74kW (100PS)	Diesel		TD22740
OM 352.968	6cyl.	5673cc	115kW (156PS)	Diesel	Turbo	TD16648
OM 352.969	6cyl.	5673cc	96kW (131PS)	Diesel		TD8089
OM 352.970	6cyl.	5673cc	81kW (110PS)	Diesel		TD16611
OM 352.971	6cyl.	5673cc	74kW (100PS)	Diesel		TD16617
OM 352.972	6cyl.	5673cc	74kW (100PS)	Diesel		TD16618
OM 352.973	6cyl.	5673cc	74kW (100PS)	Diesel		TD16619
OM 352.974	6cyl.	5673cc	74kW (100PS)	Diesel		TD16620
OM 352.975	6cyl.	5673cc	74kW (100PS)	Diesel		TD16621
OM 352.976	6cyl.	5673cc	81kW (110PS)	Diesel		TD16612
OM 352.979	6cyl.	5673cc	81kW (110PS)	Diesel		TD16613
OM 352.980	6cyl.	5673cc	96kW (131PS)	Diesel		TD17015
OM 352.981	6cyl.	5673cc	81kW (110PS)	Diesel		TD16622
OM 352.982	6cyl.	5673cc	81kW (110PS)	Diesel		TD16614
OM 352.983	6cyl.	5673cc	81kW (110PS)	Diesel		TD16623
OM 352.984	6cyl.	5673cc	59kW (80PS)	Diesel		TD7976
OM 352.985	6cyl.	5673cc	81kW (110PS)	Diesel		TD16624
OM 352.986	6cyl.	5673cc	81kW (110PS)	Diesel		TD6037
OM 352.987	6cyl.	5673cc	93kW (126PS)	Diesel		TD17013





OM 352.988	6cyl.	5673cc	96kW (131PS)	Diesel	Turbo	TD16649
OM 352.989	6cyl.	5673cc	81kW (110PS)	Diesel		TD16625
OM 352.990	6cyl.	5673cc	81kW (110PS)	Diesel		TD6036
OM 352.991	6cyl.	5673cc	93kW (126PS)	Diesel		TD17014
OM 352.994	6cyl.	5673cc	110kW (150PS)	Diesel	Turbo	TD16650
OM 352.996	6cyl.	5673cc	96kW (131PS)	Diesel		TD6281
OM 352.997	6cyl.	5673cc	96kW (131PS)	Diesel		TD5713
OM 352.998	6cyl.	5673cc	96kW (131PS)	Diesel		TD6047
OM 352.999	6cyl.	5673cc	79kW (107PS)	Diesel		TD22743
OM 353.900	6cyl.	5673cc	96kW (131PS)	Diesel		TD16651
OM 353.902	6cyl.	5673cc	62kW (84PS)	Diesel		TD5678
OM 353.903	6cyl.	5673cc	81kW (110PS)	Diesel		TD16652
OM 353.904	6cyl.	5673cc	96kW (131PS)	Diesel		TD5697
OM 353.905	6cyl.	5673cc	74kW (100PS)	Diesel		TD7988
OM 353.909	6cyl.	5673cc	124kW (168PS)	Diesel	Turbo	TD8091
OM 353.910	6cyl.	5673cc	124kW (168PS)	Diesel	Turbo	TD8162
OM 353.911	6cyl.	5673cc	124kW (168PS)	Diesel	Turbo	TD8090
OM 353.912	6cyl.	5673cc	124kW (168PS)	Diesel	Turbo	TD8159
OM 353.913	6cyl.	5673cc	124kW (168PS)	Diesel	Turbo	TD8097
OM 353.914	6cyl.	5673cc	124kW (168PS)	Diesel	Turbo	TD16662
OM 353.915	6cyl.	5673cc	81kW (110PS)	Diesel		TD16653
OM 353.916	6cyl.	5673cc	81kW (110PS)	Diesel		TD16654
OM 353.917	6cyl.	5673cc	96kW (131PS)	Diesel		TD16655
OM 353.941	6cyl.	5673cc	96kW (131PS)	Diesel		TD16656
OM 353.942	6cyl.	5673cc	96kW (131PS)	Diesel		TD5709
OM 353.943	6cyl.	5673cc	96kW (131PS)	Diesel		TD5727
OM 353.944	6cyl.	5673cc	96kW (131PS)	Diesel		TD5728
OM 353.945	6cyl.	5673cc	96kW (131PS)	Diesel		TD5710
OM 353.946	6cyl.	5673cc	96kW (131PS)	Diesel		TD6044
OM 353.949	6cyl.	5673cc	81kW (110PS)	Diesel		TD16994
OM 353.950	6cyl.	5673cc	124kW (168PS)	Diesel	Turbo	TD5711
OM 353.951	6cyl.	5673cc	124kW (168PS)	Diesel	Turbo	TD5747
OM 353.952	6cyl.	5673cc	124kW (168PS)	Diesel	Turbo	TD6045
OM 353.953	6cyl.	5673cc	124kW (168PS)	Diesel	Turbo	TD6092
OM 353.954	6cyl.	5673cc	124kW (168PS)	Diesel	Turbo	TD8096
OM 353.957	6cyl.	5673cc	92kW (125PS)	Diesel	Turbo	TD16995
OM 353.958	6cyl.	5673cc	110kW (150PS)	Diesel	Turbo	TD7990
OM 353.959	6cyl.	5673cc	124kW (168PS)	Diesel	Turbo	TD8009
OM 353.960	6cyl.	5673cc	88kW (120PS)	Diesel		TD7980
OM 353.963	6cyl.	5673cc	96kW (131PS)	Diesel		TD5690
OM 353.964	6cyl.	5673cc	96kW (131PS)	Diesel		TD6284
OM 353.965	6cyl.	5673cc	96kW (131PS)	Diesel		TD5715
OM 353.966	6cyl.	5673cc	96kW (131PS)	Diesel		TD6027
OM 353.967	6cyl.	5673cc	74kW (100PS)	Diesel		TD16657
OM 353.968	6cyl.	5673cc	96kW (131PS)	Diesel		TD16658





OM 353.969	6cyl.	5673cc	96kW (131PS)	Diesel		TD16659
OM 353.970	6cyl.	5673cc	124kW (168PS)	Diesel	Turbo	TD5712
OM 353.971	6cyl.	5673cc	124kW (168PS)	Diesel	Turbo	TD6060
OM 353.972	6cyl.	5673cc	124kW (168PS)	Diesel	Turbo	TD16660
OM 353.973	6cyl.	5673cc	92kW (125PS)	Diesel	Turbo	TD7981
OM 353.974	6cyl.	5673cc	127kW (173PS)	Diesel	Turbo	TD16661
OM 353.975	6cyl.	5673cc	124kW (168PS)	Diesel	Turbo	TD6321
OM 353.976	6cyl.	5673cc	110kW (150PS)	Diesel	Turbo	TD17860
OM 353.977	6cyl.	5673cc	124kW (168PS)	Diesel	Turbo	TD22744
OM 353.978	6cyl.	5673cc	127kW (173PS)	Diesel	Turbo	TD16664
OM 353.981	6cyl.	5673cc	96kW (131PS)	Diesel		TD6034
OM 353.982	6cyl.	5673cc	96kW (131PS)	Diesel		TD6048
OM 353.983	6cyl.	5673cc	96kW (131PS)	Diesel		TD17016
OM 353.984	6cyl.	5673cc	96kW (131PS)	Diesel		TD17017
OM 353.989	6cyl.	5673cc	96kW (131PS)	Diesel		TD16663
OM 353.991	6cyl.	5673cc	124kW (168PS)	Diesel	Turbo	TD16665
OM 353.995	6cyl.	5673cc	92kW (125PS)	Diesel	Turbo	TD7999
OM 353.996	6cyl.	5675cc	51-96kW (69-131PS)	Diesel		TD28655
OM 353.997	6cyl.	5673cc	124kW (168PS)	Diesel	Turbo	TD16666
OM 362.906	6cyl.	5700cc	141kW (192PS)	Diesel	Turbo Intercooled	TD5750
OM 362.909	6cyl.	5700cc	141kW (192PS)	Diesel	Turbo Intercooled	TD6080
OM 362.910	6cyl.	5675cc	141kW (192PS)	Diesel	Turbo Intercooled	TD16699

- 14-021850-00 D
- 14-025800-00 D
- 14-025801-00 D
- 14-025802-00 D
- 14-025804-00 D
- 14-025881-00 D
- 14-025883-00 D

97.00

B 101.00	C 222.00	D 103.50	E 5.50
B 100.40	C 222.00	D 103.50	E 5.20
B 101.00	C 222.00	D 104.00	E 5.20
B 102.00	C 222.00	D 105.00	E 5.20
B 103.00	C 222.00	D 106.00	E 5.20
B 101.50	C 222.00	D 104.50	E 4.75
B 103.00	C 222.00	D 106.00	E 4.75

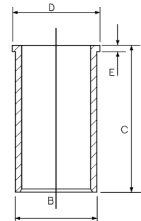

10

OM 354.900 Euro 2	4cyl.	3972cc	77kW (105PS)	Diesel	Turbo Intercooled	TD8054
OM 354.901 Euro 2	4cyl.	3972cc	77kW (105PS)	Diesel	Turbo Intercooled	TD8084
OM 354.902 Euro 2	4cyl.	3972cc	77kW (105PS)	Diesel	Turbo Intercooled	TD5695
OM 354.903 Euro 2	4cyl.	3972cc	77kW (105PS)	Diesel	Turbo Intercooled	TD8083
OM 354.920 Euro 2	4cyl.	3972cc	103kW (140PS)	Diesel	Turbo Intercooled	TD8059
OM 354.921 Euro 2	4cyl.	3972cc	103kW (140PS)	Diesel	Turbo Intercooled	TD8066
OM 354.922 Euro 2	4cyl.	3972cc	103kW (140PS)	Diesel	Turbo Intercooled	TD8061
OM 354.923 Euro 2	4cyl.	3972cc	103kW (140PS)	Diesel	Turbo Intercooled	TD8057
OM 354.924 Euro 2	4cyl.	3972cc	103kW (140PS)	Diesel	Turbo Intercooled	TD8085
OM 354.925 Euro 2	4cyl.	3972cc	103kW (140PS)	Diesel	Turbo Intercooled	TD8087
OM 354.926 Euro 2	4cyl.	3972cc	103kW (140PS)	Diesel	Turbo Intercooled	TD22745
OM 356.901 Euro 1	6cyl.	5958cc	95kW (129PS)	Diesel		TD5704
OM 356.902 Euro 1	6cyl.	5958cc	95kW (129PS)	Diesel		TD8064
OM 356.903 Euro 1	6cyl.	5958cc	95kW (129PS)	Diesel		TD8093
OM 356.904 Euro 1	6cyl.	5958cc	95kW (129PS)	Diesel		TD8098







OM 356.905 Euro 1	6cyl.	5958cc	95kW (129PS)	Diesel		TD8062
OM 356.906 Euro 1	6cyl.	5958cc	95kW (129PS)	Diesel		TD8067
OM 356.907 Euro 1	6cyl.	5958cc	95kW (129PS)	Diesel		TD8099
OM 356.908 Euro 1	6cyl.	5958cc	95kW (129PS)	Diesel		TD8134
OM 356.909 Euro 1	6cyl.	5958cc	95kW (129PS)	Diesel		TD8133
OM 356.910 Euro 1	6cyl.	5958cc	95kW (129PS)	Diesel		TD8132
OM 356.911 Euro 1	6cyl.	5958cc	95kW (129PS)	Diesel		TD6039
OM 356.913 Euro 1	6cyl.	5958cc	100kW (136PS)	Diesel		TD16810
OM 356.914 Euro 1	6cyl.	5958cc	75kW (102PS)	Diesel		TD7994
OM 356.915 Euro 1	6cyl.	5958cc	97kW (132PS)	Diesel		TD16811
OM 356.916 Euro 1	6cyl.	5958cc	97kW (132PS)	Diesel		TD17096
OM 356.940 Euro 1	6cyl.	5958cc	129kW (175PS)	Diesel	Turbo	TD6098
OM 356.941 Euro 1	6cyl.	5958cc	116kW (158PS)	Diesel	Turbo	TD5705
OM 356.943 Euro 1	6cyl.	5958cc	121kW (165PS)	Diesel	Turbo	TD8146
OM 356.944 Euro 1	6cyl.	5958cc	116kW (158PS)	Diesel	Turbo	TD8136
OM 356.945 Euro 1	6cyl.	5958cc	116kW (158PS)	Diesel	Turbo	TD8137
OM 356.946 Euro 1	6cyl.	5958cc	116kW (158PS)	Diesel	Turbo	TD5756
OM 356.947 Euro 1	6cyl.	5958cc	116kW (158PS)	Diesel	Turbo	TD8103
OM 356.948 Euro 1	6cyl.	5958cc	116kW (158PS)	Diesel	Turbo	TD8078
OM 356.949 Euro 1	6cyl.	5958cc	116kW (158PS)	Diesel	Turbo	TD8105
OM 356.951 Euro 1	6cyl.	5958cc	116kW (158PS)	Diesel	Turbo	TD8073
OM 356.952 Euro 1	6cyl.	5958cc	116kW (158PS)	Diesel	Turbo	TD16941
OM 356.953 Euro 1	6cyl.	5958cc	116kW (158PS)	Diesel	Turbo	TD6089
OM 356.956 Euro 1	6cyl.	5958cc	114-115kW (155-156PS)	Diesel	Turbo	TD6018
OM 356.958 Euro 1	6cyl.	5958cc	116kW (158PS)	Diesel	Turbo	TD16812
OM 356.959 Euro 1	6cyl.	5958cc	121kW (165PS)	Diesel	Turbo	TD16813
OM 356.977 Euro 1	6cyl.	5958cc	177kW (240PS)	Diesel	Turbo Intercooled	TD16814
OM 356.978 Euro 1	6cyl.	5958cc	155kW (211PS)	Diesel	Turbo Intercooled	TD16815
OM 356.983 Euro 1	6cyl.	5958cc	177kW (240PS)	Diesel	Turbo Intercooled	TD5724
OM 356.984	6cyl.	5958cc	155kW (211PS)	Diesel	Turbo Intercooled	TD8148
OM 356.985	6cyl.	5958cc	150kW (204PS)	Diesel	Turbo Intercooled	TD8189
OM 357.900	6cyl.	5958cc	125kW (170PS)	Diesel	Turbo Intercooled	TD8069
OM 357.901	6cyl.	5958cc	125kW (170PS)	Diesel	Turbo Intercooled	TD5708
OM 357.902	6cyl.	5958cc	125kW (170PS)	Diesel	Turbo Intercooled	TD5740
OM 357.903	6cyl.	5958cc	125kW (170PS)	Diesel	Turbo Intercooled	TD5742
OM 357.904	6cyl.	5958cc	125kW (170PS)	Diesel	Turbo Intercooled	TD16528
OM 357.906	6cyl.	5958cc	125kW (170PS)	Diesel	Turbo Intercooled	TD8095
OM 357.907	6cyl.	5958cc	125kW (170PS)	Diesel	Turbo Intercooled	TD8138
OM 357.908	6cyl.	5958cc	125kW (170PS)	Diesel	Turbo Intercooled	TD8074
OM 357.909	6cyl.	5958cc	125kW (170PS)	Diesel	Turbo Intercooled	TD5706
OM 357.910	6cyl.	5958cc	125kW (170PS)	Diesel	Turbo Intercooled	TD6041
OM 357.915	6cyl.	5958cc	125kW (170PS)	Diesel	Turbo Intercooled	TD8147
OM 357.916	6cyl.	5958cc	125kW (170PS)	Diesel	Turbo Intercooled	TD8075
OM 357.917	6cyl.	5958cc	125kW (170PS)	Diesel	Turbo Intercooled	TD8079
OM 357.918	6cyl.	5958cc	125kW (170PS)	Diesel	Turbo Intercooled	TD6043





OM 357.919	6cyl.	5958cc	125kW (170PS)	Diesel	Turbo Intercooled	TD8106
OM 357.920	6cyl.	5958cc	155kW (211PS)	Diesel	Turbo Intercooled	TD5720
OM 357.921	6cyl.	5958cc	155kW (211PS)	Diesel	Turbo Intercooled	TD5743
OM 357.922	6cyl.	5958cc	155kW (211PS)	Diesel	Turbo Intercooled	TD8166
OM 357.924 Euro 2	6cyl.	5958cc	155kW (211PS)	Diesel	Turbo Intercooled	TD14688
OM 357.925	6cyl.	5958cc	155kW (211PS)	Diesel	Turbo Intercooled	TD8196
OM 357.926	6cyl.	5958cc	155kW (211PS)	Diesel	Turbo Intercooled	TD16931
OM 357.927	6cyl.	5958cc	155kW (211PS)	Diesel	Turbo Intercooled	TD5723
OM 357.929	6cyl.	5958cc	155kW (211PS)	Diesel	Turbo Intercooled	TD8113
OM 357.930	6cyl.	5958cc	155kW (211PS)	Diesel	Turbo Intercooled	TD8168
OM 357.931 Euro 2	6cyl.	5958cc	155kW (211PS)	Diesel	Turbo Intercooled	TD16820
OM 357.932	6cyl.	5958cc	155kW (211PS)	Diesel	Turbo Intercooled	TD6056
OM 357.933	6cyl.	5958cc	155kW (211PS)	Diesel	Turbo Intercooled	TD8115
OM 357.934	6cyl.	5958cc	155kW (211PS)	Diesel	Turbo Intercooled	TD17097
OM 357.935	6cyl.	5958cc	155kW (211PS)	Diesel	Turbo Intercooled	TD17098
OM 357.936 Euro 2	6cyl.	5958cc	155kW (211PS)	Diesel	Turbo Intercooled	TD16821
OM 357.937 Euro 2	6cyl.	5958cc	155kW (211PS)	Diesel	Turbo Intercooled	TD16822
OM 357.938 Euro 2	6cyl.	5958cc	155kW (211PS)	Diesel	Turbo Intercooled	TD22748
OM 357.940	6cyl.	5958cc	177kW (240PS)	Diesel	Turbo Intercooled	TD5746
OM 357.941	6cyl.	5958cc	177kW (240PS)	Diesel	Turbo Intercooled	TD8169
OM 357.942	6cyl.	5958cc	177kW (240PS)	Diesel	Turbo Intercooled	TD8116
OM 357.943	6cyl.	5958cc	177kW (240PS)	Diesel	Turbo Intercooled	TD5725
OM 357.944	6cyl.	5958cc	177kW (240PS)	Diesel	Turbo Intercooled	TD6058
OM 357.945 Euro 2	6cyl.	5958cc	177kW (240PS)	Diesel	Turbo Intercooled	TD14690
OM 357.946	6cyl.	5958cc	177kW (240PS)	Diesel	Turbo Intercooled	TD8125
OM 357.947	6cyl.	5958cc	177kW (240PS)	Diesel	Turbo Intercooled	TD8170
OM 357.948	6cyl.	5958cc	177kW (240PS)	Diesel	Turbo Intercooled	TD6077
OM 357.949 Euro 2	6cyl.	5958cc	177kW (240PS)	Diesel	Turbo Intercooled	TD16823
OM 357.961	6cyl.	5958cc	125kW (170PS)	Diesel	Turbo Intercooled	TD6073
OM 357.962	6cyl.	5958cc	125kW (170PS)	Diesel	Turbo Intercooled	TD6074
OM 357.963	6cyl.	5958cc	125kW (170PS)	Diesel	Turbo Intercooled	TD6090
OM 364.901	4cyl.	3972cc	83kW (113PS)	Diesel	Turbo	TD21464
OM 364.906	4cyl.	3972cc	66kW (89PS)	Diesel		TD8048
OM 364.907	4cyl.	3970cc	66kW (89PS)	Diesel		TD8052
OM 364.908	4cyl.	3972cc	50kW (68PS)	Diesel		TD17853
OM 364.911	4cyl.	3972cc	66kW (89PS)	Diesel		TD8081
OM 364.912	4cyl.	3972cc	66kW (89PS)	Diesel		TD16804
OM 364.913	4cyl.	3972cc	66kW (89PS)	Diesel		TD8044
OM 364.918	4cyl.	3970cc	63kW (86PS)	Diesel		TD8053
OM 364.919	4cyl.	3972cc	63kW (86PS)	Diesel		TD5692
OM 364.920	4cyl.	3972cc	63kW (86PS)	Diesel		TD8082
OM 364.921 Euro 1	4cyl.	3972cc	63kW (86PS)	Diesel		TD6029
OM 364.950	4cyl.	3972cc	85kW (116PS)	Diesel	Turbo	TD5696
OM 364.952	4cyl.	3972cc	85kW (116PS)	Diesel	Turbo	TD6033
OM 364.954	4cyl.	3972cc	85kW (116PS)	Diesel		TD8045







OM 364.957	4cyl.	3972cc	77kW (105PS)	Diesel	Turbo	TD5693
OM 364.958	4cyl.	3972cc	77kW (105PS)	Diesel	Turbo	TD6030
OM 364.980	4cyl.	3972cc	100kW (136PS)	Diesel	Turbo Intercooled	TD8047
OM 364.981	4cyl.	3972cc	100kW (136PS)	Diesel	Turbo Intercooled	TD8086
OM 364.984	4cyl.	3972cc	100kW (136PS)	Diesel	Turbo Intercooled	TD8088
OM 366.905	6cyl.	5958cc	100kW (136PS)	Diesel	Turbo Intercooled	TD5698
OM 366.906	6cyl.	5960cc	100kW (136PS)	Diesel		TD5748
OM 366.907	6cyl.	5958cc	100kW (136PS)	Diesel		TD5716
OM 366.908	6cyl.	5958cc	81kW (110PS)	Diesel		TD17858
OM 366.909	6cyl.	5960cc	100kW (136PS)	Diesel		TD6078
OM 366.910	6cyl.	5958cc	100kW (136PS)	Diesel		TD8065
OM 366.912	6cyl.	5958cc	74kW (100PS)	Diesel		TD17857
OM 366.913	6cyl.	5958cc	100kW (136PS)	Diesel		TD17100
OM 366.914	6cyl.	5958cc	100kW (136PS)	Diesel		TD6049
OM 366.917	6cyl.	5958cc	100kW (136PS)	Diesel		TD7887
OM 366.918	6cyl.	5960cc	100kW (136PS)	Diesel		TD5739
OM 366.919	6cyl.	5958cc	100kW (136PS)	Diesel		TD16808
OM 366.930	6cyl.	5958cc	100kW (136PS)	Diesel		TD8094
OM 366.931	6cyl.	5958cc	100kW (136PS)	Diesel		TD5717
OM 366.932	6cyl.	5958cc	100kW (136PS)	Diesel		TD8068
OM 366.933	6cyl.	5958cc	100kW (136PS)	Diesel		TD8100
OM 366.935	6cyl.	5958cc	100kW (136PS)	Diesel		TD6050
OM 366.936	6cyl.	5960cc	100kW (136PS)	Diesel		TD8135
OM 366.937	6cyl.	5960cc	100kW (136PS)	Diesel		TD6072
OM 366.938	6cyl.	5958cc	100kW (136PS)	Diesel		TD16809
OM 366.939	6cyl.	5958cc	81kW (110PS)	Diesel		TD7993
OM 366.940	6cyl.	5958cc	100kW (136PS)	Diesel		TD6040
OM 366.941 Euro 1	6cyl.	5958cc	116kW (158PS)	Diesel	Turbo	TD8102
OM 366.942 Euro 1	6cyl.	5958cc	121kW (165PS)	Diesel	Turbo	TD8076
OM 366.943 Euro 1	6cyl.	5958cc	116kW (158PS)	Diesel	Turbo	TD8070
OM 366.944	6cyl.	5958cc	125kW (170PS)	Diesel	Turbo	TD5703
OM 366.945	6cyl.	5958cc	125kW (170PS)	Diesel	Turbo	TD5757
OM 366.946	6cyl.	5960cc	125kW (170PS)	Diesel	Turbo	TD5741
OM 366.947	6cyl.	5958cc	100kW (136PS)	Diesel	Turbo	TD5679
OM 366.948	6cyl.	5958cc	100-115kW (136-156PS)	Diesel	Turbo	TD6017
OM 366.951	6cyl.	5960cc	125kW (170PS)	Diesel	Turbo	TD5749
OM 366.952	6cyl.	5958cc	129kW (175PS)	Diesel	Turbo	TD5766
OM 366.953	6cyl.	5958cc	125kW (170PS)	Diesel	Turbo	TD5718
OM 366.954	6cyl.	5958cc	115-132kW (156-180PS)	Diesel	Turbo	TD17862
OM 366.955	6cyl.	5958cc	100kW (136PS)	Diesel	Turbo	TD6276
OM 366.956	6cyl.	5958cc	100kW (136PS)	Diesel	Turbo	TD6320
OM 366.957	6cyl.	5958cc	125kW (170PS)	Diesel	Turbo	TD16816
OM 366.958	6cyl.	5958cc	100kW (136PS)	Diesel	Turbo	TD17861
OM 366.960	6cyl.	5960cc	125kW (170PS)	Diesel	Turbo	TD17101
OM 366.962	6cyl.	5960cc	125kW (170PS)	Diesel	Turbo	TD5745





OM 366.963	6cyl.	5958cc	125kW (170PS)	Diesel	Turbo	TD8006
OM 366.965	6cyl.	5958cc	125kW (170PS)	Diesel	Turbo	TD7888
OM 366.966	6cyl.	5958cc	125kW (170PS)	Diesel	Turbo	TD5707
OM 366.967	6cyl.	5958cc	125kW (170PS)	Diesel	Turbo	TD5699
OM 366.968	6cyl.	5958cc	125kW (170PS)	Diesel	Turbo	TD8077
OM 366.969	6cyl.	5958cc	125kW (170PS)	Diesel	Turbo	TD8080
OM 366.970	6cyl.	5958cc	125kW (170PS)	Diesel	Turbo	TD8104
OM 366.971	6cyl.	5958cc	125kW (170PS)	Diesel	Turbo	TD8107
OM 366.972	6cyl.	5958cc	125kW (170PS)	Diesel	Turbo	TD17112
OM 366.973	6cyl.	5958cc	125kW (170PS)	Diesel	Turbo	TD6035
OM 366.974	6cyl.	5958cc	125kW (170PS)	Diesel	Turbo	TD6042
OM 366.975	6cyl.	5958cc	125kW (170PS)	Diesel	Turbo	TD5719
OM 366.976	6cyl.	5958cc	125kW (170PS)	Diesel	Turbo	TD6052
OM 366.977	6cyl.	5958cc	92kW (125PS)	Diesel	Turbo	TD17859
OM 366.978	6cyl.	5958cc	125kW (170PS)	Diesel	Turbo	TD6279
OM 366.979	6cyl.	5958cc	125kW (170PS)	Diesel	Turbo	TD6091
OM 366.980	6cyl.	5960cc	148kW (201PS)	Diesel	Turbo Intercooled	TD8141
OM 366.981	6cyl.	5958cc	148kW (201PS)	Diesel	Turbo Intercooled	TD16817
OM 366.983	6cyl.	5958cc	150kW (204PS)	Diesel	Turbo Intercooled	TD8150
OM 366.984	6cyl.	5958cc	150-157kW (204-214PS)	Diesel	Turbo Intercooled	TD8007
OM 366.988	6cyl.	5960cc	148-150kW (201-204PS)	Diesel	Turbo Intercooled	TD5744
OM 366.990	6cyl.	5958cc	150kW (204PS)	Diesel	Turbo Intercooled	TD16818
OM 366.992	6cyl.	5958cc	150kW (204PS)	Diesel	Turbo Intercooled	TD5722
OM 366.993	6cyl.	5958cc	150kW (204PS)	Diesel	Turbo Intercooled	TD8114
OM 366.995	6cyl.	5958cc	150kW (204PS)	Diesel	Turbo Intercooled	TD8167
OM 366.997 Euro 1	6cyl.	5960cc	148-150kW (201-204PS)	Diesel	Turbo Intercooled	TD6075
OM 366.999 Euro 1	6cyl.	5958cc	170kW (231PS)	Diesel	Turbo Intercooled	TD8126

14-025800-00 D	97.50	B 100.40	C 222.00	D 103.50	E 5.20
14-025801-00 D		B 101.00	C 222.00	D 104.00	E 5.20
14-025802-00 D		B 102.00	C 222.00	D 105.00	E 5.20
14-025804-00 D		B 103.00	C 222.00	D 106.00	E 5.20
14-025881-00 D		B 101.50	C 222.00	D 104.50	E 4.75
14-025883-00 D		B 103.00	C 222.00	D 106.00	E 4.75

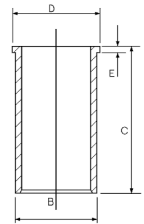

14-012260-00 D	97.50	B 100.40	C 224.00
----------------	-------	----------	----------

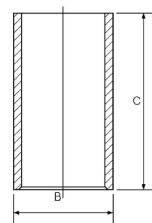

**11**

OM 900.911 Euro 4	4cyl.	4249cc	95kW (129PS)	Diesel	Turbo Intercooled	TD18918
OM 900.912 Euro 4	4cyl.	4249cc	115kW (156PS)	Diesel	Turbo Intercooled	TD18919
OM 900.913 Euro 4	4cyl.	4249cc	130kW (177PS)	Diesel	Turbo Intercooled	TD18920
OM 900.915 Euro 4	4cyl.	4249cc	110-115kW (150-156PS)	Diesel	Turbo Intercooled	TD23299
OM 900.916 Euro 4	4cyl.	4249cc	110-115kW (150-156PS)	Diesel	Turbo Intercooled	TD23300
OM 900.917 Euro 4	4cyl.	4249cc	95kW (129PS)	Diesel	Turbo Intercooled	TD18921
OM 900.918 Euro 4	4cyl.	4249cc	115kW (156PS)	Diesel	Turbo Intercooled	TD18922
OM 900.919 Euro 4	4cyl.	4249cc	130kW (177PS)	Diesel	Turbo Intercooled	TD18923
OM 900.920 Euro 4	4cyl.	4249cc	115kW (156PS)	Diesel	Turbo Intercooled	TD22696
OM 900.921 Euro 4	4cyl.	4249cc	130kW (177PS)	Diesel	Turbo Intercooled	TD22697
OM 900.922 Euro 4	4cyl.	4249cc	95kW (129PS)	Diesel	Turbo Intercooled	TD22698
OM 902.910 Euro 4	6cyl.	6374cc	187kW (254PS)	Diesel	Turbo Intercooled	TD20244
OM 902.911 Euro 4	6cyl.	6374cc	172kW (234PS)	Diesel	Turbo Intercooled	TD20247
OM 902.912 Euro 4	6cyl.	6374cc	194kW (264PS)	Diesel	Turbo Intercooled	TD20249
OM 902.913 Euro 4	6cyl.	6374cc	175kW (238PS)	Diesel	Turbo Intercooled	TD20250
OM 902.914 Euro 4	6cyl.	6374cc	188kW (256PS)	Diesel	Turbo Intercooled	TD20251
OM 902.915 Euro 4	6cyl.	6374cc	210kW (286PS)	Diesel	Turbo Intercooled	TD20252
OM 902.916 Euro 4	6cyl.	6374cc	175kW (238PS)	Diesel	Turbo Intercooled	TD18924
OM 902.917 Euro 4	6cyl.	6374cc	188kW (256PS)	Diesel	Turbo Intercooled	TD18930
OM 902.918 Euro 4	6cyl.	6374cc	210kW (286PS)	Diesel	Turbo Intercooled	TD18931
OM 902.919 Euro 4	6cyl.	6374cc	157kW (214PS)	Diesel	Turbo Intercooled	TD20253
OM 902.923 Euro 4	6cyl.	6374cc	175kW (238PS)	Diesel	Turbo Intercooled	TD23293
OM 902.924 Euro 4	6cyl.	6374cc	210kW (286PS)	Diesel	Turbo Intercooled	TD23294
OM 902.925 Euro 4	6cyl.	6374cc	210kW (286PS)	Diesel	Turbo Intercooled	TD23295
OM 902.926 Euro 4	6cyl.	6374cc	210kW (286PS)	Diesel	Turbo Intercooled	TD23296
OM 902.927 Euro 4	6cyl.	6374cc	210kW (286PS)	Diesel	Turbo Intercooled	TD20257
OM 902.930 Euro 4	6cyl.	6374cc	175kW (238PS)	Diesel	Turbo Intercooled	TD20258
OM 902.931 Euro 4	6cyl.	6374cc	188kW (256PS)	Diesel	Turbo Intercooled	TD20259
OM 902.932 Euro 4	6cyl.	6374cc	210kW (286PS)	Diesel	Turbo Intercooled	TD20260
OM 902.933 Euro 4	6cyl.	6374cc	175kW (238PS)	Diesel	Turbo Intercooled	TD20261
OM 902.934 Euro 4	6cyl.	6374cc	210kW (286PS)	Diesel	Turbo Intercooled	TD23297
OM 902.936 Euro 4	6cyl.	6374cc	210kW (286PS)	Diesel	Turbo Intercooled	TD23298
OM 904.903 Euro 2	4cyl.	4250cc	112kW (152PS)	Diesel	Turbo Intercooled	TD28795
OM 904.904 Euro 2	4cyl.	4250cc	75kW (102PS)	Diesel	Turbo Intercooled	TD16441
OM 904.905 Euro 2	4cyl.	4249cc	90kW (122PS)	Diesel	Turbo Intercooled	TD8055
OM 904.906 Euro 2	4cyl.	4249cc	100kW (136PS)	Diesel	Turbo Intercooled	TD8060
OM 904.907 Euro 2	4cyl.	4249cc	125kW (170PS)	Diesel	Turbo Intercooled	TD8072
OM 904.908 Euro 2	4cyl.	4250cc	100kW (136PS)	Diesel	Turbo Intercooled	TD8024
OM 904.909 Euro 2	4cyl.	4249cc	90kW (122PS)	Diesel	Turbo Intercooled	TD12528
OM 904.910 Euro 2	4cyl.	4249cc	100kW (136PS)	Diesel	Turbo Intercooled	TD12529
OM 904.911 Euro 2	4cyl.	4249cc	125kW (170PS)	Diesel	Turbo Intercooled	TD12530
OM 904.912 Euro 2	4cyl.	4249cc	134kW (182PS)	Diesel	Turbo Intercooled	TD17711
OM 904.914 Euro 2	4cyl.	4249cc	100kW (136PS)	Diesel	Turbo Intercooled	TD16833
OM 904.915 Euro 2	4cyl.	4249cc	90kW (122PS)	Diesel	Turbo Intercooled	TD16834
OM 904.916 Euro 2	4cyl.	4249cc	100kW (136PS)	Diesel	Turbo Intercooled	TD16835





OM 904.917 Euro 2	4cyl.	4249cc	125kW (170PS)	Diesel	Turbo Intercooled	TD16836
OM 904.918 Euro 2	4cyl.	4249cc	90kW (122PS)	Diesel	Turbo Intercooled	TD17752
OM 904.919 Euro 2	4cyl.	4249cc	100kW (136PS)	Diesel	Turbo Intercooled	TD17705
OM 904.920 Euro 2	4cyl.	4249cc	125kW (170PS)	Diesel	Turbo Intercooled	TD17706
OM 904.921 Euro 2	4cyl.	4249cc	112kW (152PS)	Diesel	Turbo Intercooled	TD16837
OM 904.922 Euro 2	4cyl.	4249cc	112kW (152PS)	Diesel	Turbo Intercooled	TD12531
OM 904.923 Euro 2	4cyl.	4250cc	112kW (152PS)	Diesel	Turbo Intercooled	TD16438
OM 904.924 Euro 2	4cyl.	4249cc	100kW (136PS)	Diesel	Turbo Intercooled	TD17707
OM 904.925 Euro 2	4cyl.	4249cc	112kW (152PS)	Diesel	Turbo Intercooled	TD17708
OM 904.926 Euro 2	4cyl.	4249cc	113kW (154PS)	Diesel	Turbo Intercooled	TD17709
OM 904.927 Euro 3	4cyl.	4249cc	110kW (150PS)	Diesel	Turbo Intercooled	TD17324
OM 904.928 Euro 3	4cyl.	4249cc	130kW (177PS)	Diesel	Turbo Intercooled	TD17325
OM 904.929 Euro 2	4cyl.	4249cc	125kW (170PS)	Diesel	Turbo Intercooled	TD17710
OM 904.930 Euro 2	4cyl.	4249cc	100kW (136PS)	Diesel	Turbo Intercooled	TD16838
OM 904.931 Euro 2	4cyl.	4249cc	135kW (184PS)	Diesel	Turbo Intercooled	TD16839
OM 904.932 Euro 2	4cyl.	4249cc	142kW (193PS)	Diesel	Turbo Intercooled	TD17712
OM 904.933 Euro 2	4cyl.	4249cc	128kW (174PS)	Diesel	Turbo Intercooled	TD17713
OM 904.934 Euro 2	4cyl.	4249cc	134kW (182PS)	Diesel	Turbo Intercooled	TD17714
OM 904.935 Euro 2	4cyl.	4249cc	134kW (182PS)	Diesel	Turbo Intercooled	TD17715
OM 904.936 Euro 3	4cyl.	4250cc	110kW (150PS)	Diesel	Turbo Intercooled	TD16916
OM 904.937 Euro 2	4cyl.	4249cc	142kW (193PS)	Diesel	Turbo Intercooled	TD17716
OM 904.938 Euro 2	4cyl.	4249cc	125kW (170PS)	Diesel	Turbo Intercooled	TD17717
OM 904.939 Euro 2	4cyl.	4249cc	128kW (174PS)	Diesel	Turbo Intercooled	TD17718
OM 904.940 Euro 2	4cyl.	4249cc	113kW (154PS)	Diesel	Turbo Intercooled	TD17719
OM 904.941 Euro 2	4cyl.	4249cc	112kW (152PS)	Diesel	Turbo Intercooled	TD17720
OM 904.942 Euro 3	4cyl.	4249cc	130kW (177PS)	Diesel	Turbo Intercooled	TD17721
OM 904.943 Euro 2	4cyl.	4249cc	112kW (152PS)	Diesel	Turbo Intercooled	TD17722
OM 904.944 Euro 2	4cyl.	4249cc	90kW (122PS)	Diesel	Turbo Intercooled	TD17734
OM 904.945 Euro 2	4cyl.	4249cc	125kW (170PS)	Diesel	Turbo Intercooled	TD17735
OM 904.946 Euro 2	4cyl.	4249cc	90-110kW (122-150PS)	Diesel	Turbo Intercooled	TD17736
OM 904.947 Euro 3	4cyl.	4249cc	130kW (177PS)	Diesel	Turbo Intercooled	TD17737
OM 904.948 Euro 2	4cyl.	4249cc	113kW (154PS)	Diesel	Turbo Intercooled	TD17738
OM 904.949 Euro 2	4cyl.	4249cc	128kW (174PS)	Diesel	Turbo Intercooled	TD17739
OM 904.950 Euro 2	4cyl.	4249cc	90-110kW (122-150PS)	Diesel	Turbo Intercooled	TD17740
OM 904.951 Euro 3	4cyl.	4249cc	130kW (177PS)	Diesel	Turbo Intercooled	TD17741
OM 904.952 Euro 3	4cyl.	4249cc	130kW (177PS)	Diesel	Turbo Intercooled	TD17183
OM 904.953 Euro 3	4cyl.	4249cc	110kW (150PS)	Diesel	Turbo Intercooled	TD17184
OM 904.954 Euro 2	4cyl.	4249cc	128kW (174PS)	Diesel	Turbo Intercooled	TD17742
OM 904.955 Euro 3	4cyl.	4250cc	110kW (150PS)	Diesel	Turbo Intercooled	TD16915
OM 904.956 Euro 2	4cyl.	4249cc	142kW (193PS)	Diesel	Turbo Intercooled	TD17744
OM 904.957 Euro 3	4cyl.	4249cc	110kW (150PS)	Diesel	Turbo Intercooled	TD17745
OM 904.959 Euro 2	4cyl.	4249cc	128kW (174PS)	Diesel	Turbo Intercooled	TD17746
OM 904.961 Euro 3	4cyl.	4250cc	90kW (122PS)	Diesel	Turbo Intercooled	TD16918
OM 904.962 Euro 3	4cyl.	4249cc	130kW (177PS)	Diesel	Turbo Intercooled	TD17747
OM 904.964 Euro 3	4cyl.	4250cc	130kW (177PS)	Diesel	Turbo Intercooled	TD16919





OM 904.965 Euro 3	4cyl.	4249cc	110kW (150PS)	Diesel	Turbo Intercooled	TD17748
OM 904.966 Euro 3	4cyl.	4249cc	110kW (150PS)	Diesel	Turbo Intercooled	TD17749
OM 904.967 Euro 3	4cyl.	4249cc	130kW (177PS)	Diesel	Turbo Intercooled	TD17750
OM 904.968 Euro 3	4cyl.	4249cc	130kW (177PS)	Diesel	Turbo Intercooled	TD17751
OM 904.970 Euro 3	4cyl.	4249cc	110kW (150PS)	Diesel	Turbo Intercooled	TD24856
OM 904.972 Euro 3	4cyl.	4249cc	130kW (177PS)	Diesel	Turbo Intercooled	TD24857
OM 904.973 Euro 3	4cyl.	4249cc	130kW (177PS)	Diesel	Turbo Intercooled	TD24858
OM 904.974 Euro 2	4cyl.	4249cc	125kW (170PS)	Diesel	Turbo Intercooled	TD28797
OM 904.975 Euro 3	4cyl.	4249cc	75-110kW (102-150PS)	Diesel	Turbo Intercooled	TD28798
OM 904.976 Euro 3	4cyl.	4249cc	130kW (177PS)	Diesel	Turbo Intercooled	TD24859
OM 904.977	4cyl.	4249cc	110kW (150PS)	Diesel	Turbo Intercooled	TD28799
OM 904.978	4cyl.	4249cc	130kW (177PS)	Diesel	Turbo Intercooled	TD28800
OM 904.979	4cyl.	4249cc	112kW (152PS)	Diesel	Turbo Intercooled	TD28801
OM 904.980	4cyl.	4249cc	130kW (177PS)	Diesel	Turbo Intercooled	TD28802
OM 904.981	4cyl.	4249cc	110kW (150PS)	Diesel	Turbo Intercooled	TD28803
OM 906.910 Euro 2	6cyl.	6374cc	170kW (231PS)	Diesel	Turbo Intercooled	TD11309
OM 906.911 Euro 2	6cyl.	6374cc	205kW (279PS)	Diesel	Turbo Intercooled	TD11310
OM 906.912 Euro 2	6cyl.	6374cc	194kW (264PS)	Diesel	Turbo Intercooled	TD17757
OM 906.913 Euro 2	6cyl.	6374cc	170kW (231PS)	Diesel	Turbo Intercooled	TD17758
OM 906.914 Euro 2	6cyl.	6374cc	157kW (214PS)	Diesel	Turbo Intercooled	TD17759
OM 906.915 Euro 2	6cyl.	6374cc	170kW (231PS)	Diesel	Turbo Intercooled	TD11311
OM 906.916 Euro 2	6cyl.	6374cc	205kW (279PS)	Diesel	Turbo Intercooled	TD11312
OM 906.917 Euro 2	6cyl.	6374cc	170kW (231PS)	Diesel	Turbo Intercooled	TD17760
OM 906.918 Euro 2	6cyl.	6374cc	180kW (245PS)	Diesel	Turbo Intercooled	TD17761
OM 906.919 Euro 2	6cyl.	6374cc	180kW (245PS)	Diesel	Turbo Intercooled	TD11313
OM 906.920 Euro 2	6cyl.	6374cc	170kW (231PS)	Diesel	Turbo Intercooled	TD11314
OM 906.921 Euro 2	6cyl.	6374cc	205kW (279PS)	Diesel	Turbo Intercooled	TD11315
OM 906.922 Euro 2	6cyl.	6374cc	170kW (231PS)	Diesel	Turbo Intercooled	TD11316
OM 906.923 Euro 2	6cyl.	6374cc	205kW (279PS)	Diesel	Turbo Intercooled	TD11317
OM 906.924 Euro 2	6cyl.	6374cc	170kW (231PS)	Diesel	Turbo Intercooled	TD17762
OM 906.925 Euro 3	6cyl.	6374cc	170kW (231PS)	Diesel	Turbo Intercooled	TD16920
OM 906.926 Euro 3	6cyl.	6374cc	205kW (279PS)	Diesel	Turbo Intercooled	TD16923
OM 906.927 Euro 3	6cyl.	6374cc	170kW (231PS)	Diesel	Turbo Intercooled	TD16921
OM 906.928 Euro 3	6cyl.	6374cc	205kW (279PS)	Diesel	Turbo Intercooled	TD16924
OM 906.929 Euro 2	6cyl.	6374cc	172kW (234PS)	Diesel	Turbo Intercooled	TD17763
OM 906.930 Euro 2	6cyl.	6374cc	205kW (279PS)	Diesel	Turbo Intercooled	TD11318
OM 906.931 Euro 2	6cyl.	6374cc	170kW (231PS)	Diesel	Turbo Intercooled	TD11319
OM 906.932 Euro 2	6cyl.	6374cc	172kW (234PS)	Diesel	Turbo Intercooled	TD17764
OM 906.933 Euro 2	6cyl.	6374cc	209kW (284PS)	Diesel	Turbo Intercooled	TD17765
OM 906.934 Euro 2	6cyl.	6374cc	209kW (284PS)	Diesel	Turbo Intercooled	TD17766
OM 906.935 Euro 3	6cyl.	6374cc	170kW (231PS)	Diesel	Turbo Intercooled	TD17326
OM 906.936 Euro 2	6cyl.	6374cc	172kW (234PS)	Diesel	Turbo Intercooled	TD17767
OM 906.937 Euro 2	6cyl.	6374cc	170kW (231PS)	Diesel	Turbo Intercooled	TD17768
OM 906.938 Euro 3	6cyl.	6374cc	205kW (279PS)	Diesel	Turbo Intercooled	TD17769
OM 906.939 Euro 3	6cyl.	6374cc	180kW (245PS)	Diesel	Turbo Intercooled	TD16926







OM 906.940 Euro 2	6cyl.	6374cc	170kW (231PS)	Diesel	Turbo Intercooled	TD11320
OM 906.941 Euro 2	6cyl.	6374cc	205kW (279PS)	Diesel	Turbo Intercooled	TD11321
OM 906.944 Euro 2	6cyl.	6374cc	142kW (193PS)	Diesel	Turbo Intercooled	TD17770
OM 906.945 Euro 2	6cyl.	6374cc	157kW (214PS)	Diesel	Turbo Intercooled	TD17771
OM 906.946 Euro 2	6cyl.	6374cc	187kW (254PS)	Diesel	Turbo Intercooled	TD17772
OM 906.947 Euro 2	6cyl.	6374cc	194kW (264PS)	Diesel	Turbo Intercooled	TD17774
OM 906.948 Euro 2	6cyl.	6374cc	224kW (305PS)	Diesel	Turbo Intercooled	TD17775
OM 906.949 Euro 3	6cyl.	6374cc	180kW (245PS)	Diesel	Turbo Intercooled	TD17776
OM 906.950 Euro 3	6cyl.	6374cc	205kW (279PS)	Diesel	Turbo Intercooled	TD17777
OM 906.951	6cyl.	6374cc	170kW (231PS)	Diesel	Turbo Intercooled	TD17778
OM 906.952 Euro 3	6cyl.	6374cc	205kW (279PS)	Diesel	Turbo Intercooled	TD16925
OM 906.953 Euro 3	6cyl.	6374cc	205kW (279PS)	Diesel	Turbo Intercooled	TD17779
OM 906.954 Euro 2	6cyl.	6374cc	172kW (234PS)	Diesel	Turbo Intercooled	TD17780
OM 906.955 Euro 3	6cyl.	6374cc	205kW (279PS)	Diesel	Turbo Intercooled	TD17327
OM 906.956 Euro 2	6cyl.	6374cc	209kW (284PS)	Diesel	Turbo Intercooled	TD17781
OM 906.957 Euro 2	6cyl.	6374cc	142kW (193PS)	Diesel	Turbo Intercooled	TD17782
OM 906.958 Euro 2	6cyl.	6374cc	157kW (214PS)	Diesel	Turbo Intercooled	TD17783
OM 906.959 Euro 2	6cyl.	6374cc	157kW (214PS)	Diesel	Turbo Intercooled	TD17784
OM 906.960 Euro 3	6cyl.	6374cc	205kW (279PS)	Diesel	Turbo Intercooled	TD17447
OM 906.961 Euro 3	6cyl.	6374cc	205kW (279PS)	Diesel	Turbo Intercooled	TD17459
OM 906.962 Euro 3	6cyl.	6374cc	180kW (245PS)	Diesel	Turbo Intercooled	TD17460
OM 906.963 Euro 3	6cyl.	6374cc	180kW (245PS)	Diesel	Turbo Intercooled	TD17449
OM 906.964	6cyl.	6374cc	170-180kW (231-245PS)	Diesel	Turbo Intercooled	TD17823
OM 906.965	6cyl.	6374cc	205kW (279PS)	Diesel	Turbo Intercooled	TD17824
OM 906.966 Euro 2	6cyl.	6374cc	172kW (234PS)	Diesel	Turbo Intercooled	TD17825
OM 906.967 Euro 2	6cyl.	6374cc	209kW (284PS)	Diesel	Turbo Intercooled	TD17826
OM 906.968 Euro 2	6cyl.	6374cc	172-187kW (230-254PS)	Diesel	Turbo Intercooled	TD17827
OM 906.970 Euro 2	6cyl.	6374cc	194-209kW (194-284PS)	Diesel	Turbo Intercooled	TD17828
OM 906.971	6cyl.	6374cc	170-180kW (231-245PS)	Diesel	Turbo Intercooled	TD17829
OM 906.973 Euro 3	6cyl.	6374cc	170kW (231PS)	Diesel	Turbo Intercooled	TD24855
OM 906.974 Euro 2	6cyl.	6374cc	209kW (284PS)	Diesel	Turbo Intercooled	TD17830
OM 906.975 Euro 2	6cyl.	6374cc	180kW (245PS)	Diesel	Turbo Intercooled	TD17831
OM 906.976 Euro 2	6cyl.	6374cc	209kW (284PS)	Diesel	Turbo Intercooled	TD17773
OM 906.977 Euro 2	6cyl.	6374cc	209kW (284PS)	Diesel	Turbo Intercooled	TD17833
OM 906.978 Euro 2	6cyl.	6374cc	142-157kW (193-214PS)	Diesel	Turbo Intercooled	TD17834
OM 906.979 Euro 2	6cyl.	6374cc	172-187kW (193-254PS)	Diesel	Turbo Intercooled	TD17835
OM 906.980 Euro 2	6cyl.	6374cc	194-209kW (260-280PS)	Diesel	Turbo Intercooled	TD17836
OM 906.981 Euro 2	6cyl.	6374cc	224kW (305PS)	Diesel	Turbo Intercooled	TD17837
OM 906.982	6cyl.	6374cc	170kW (231PS)	Diesel	Turbo Intercooled	TD17838
OM 906.983 Euro 3	6cyl.	6374cc	180kW (245PS)	Diesel	Turbo Intercooled	TD17839
OM 906.985 Euro 2	6cyl.	6374cc	180kW (245PS)	Diesel	Turbo Intercooled	TD17840
OM 906.986 Euro 3	6cyl.	6374cc	205kW (279PS)	Diesel	Turbo Intercooled	TD25471
OM 906.988 Euro 2	6cyl.	6374cc	180kW (245PS)	Diesel	Turbo Intercooled	TD17841
OM 906.991 Euro 3	6cyl.	6374cc	130-205kW (177-279PS)	Diesel	Turbo Intercooled	TD28805
OM 906.992 Euro 3	6cyl.	6374cc	180kW (245PS)	Diesel	Turbo Intercooled	TD28806





OM 906.993 Euro 3	6cyl.	6374cc	205kW (279PS)	Diesel	Turbo Intercooled	TD28807
OM 906.995 Euro 3	6cyl.	6374cc	206kW (280PS)	Diesel	Turbo Intercooled	TD25657
OM 906.998 Euro 3	6cyl.	6374cc	191kW (260PS)	Diesel	Turbo Intercooled	TD28809
OM 907.910 Euro 2	4cyl.	4250cc	75kW (102PS)	Diesel	Turbo Intercooled	TD16840
OM 907.920 Euro 2	4cyl.	4250cc	90kW (122PS)	Diesel	Turbo Intercooled	TD16841
OM 907.930 Euro 2	4cyl.	4249cc	100kW (136PS)	Diesel	Turbo Intercooled	TD17754
OM 907.940 Euro 2	4cyl.	4250cc	125kW (170PS)	Diesel	Turbo Intercooled	TD16842
OM 907.941 Euro 2	4cyl.	4249cc	125kW (170PS)	Diesel	Turbo Intercooled	TD17753
OM 907.960 Euro 2	4cyl.	4250cc	75kW (102PS)	Diesel	Turbo Intercooled	TD16843
OM 907.970 Euro 2	4cyl.	4250cc	90kW (122PS)	Diesel	Turbo Intercooled	TD16844
OM 907.980 Euro 2	4cyl.	4249cc	100kW (136PS)	Diesel	Turbo Intercooled	TD17755
OM 907.990 Euro 2	4cyl.	4250cc	125kW (170PS)	Diesel	Turbo Intercooled	TD16845
OM 909.900	6cyl.	6374cc	170kW (231PS)	Diesel	Turbo Intercooled	TD17443
OM 909.901	6cyl.	6374cc	205kW (279PS)	Diesel	Turbo Intercooled	TD17445
OM 909.910	6cyl.	6374cc	170kW (231PS)	Diesel	Turbo Intercooled	TD16846
OM 909.911	6cyl.	6374cc	170kW (231PS)	Diesel	Turbo Intercooled	TD17444
OM 909.920	6cyl.	6374cc	205kW (279PS)	Diesel	Turbo Intercooled	TD16847
OM 909.921	6cyl.	6374cc	205kW (279PS)	Diesel	Turbo Intercooled	TD17446
OM 909.960	6cyl.	6374cc	170kW (231PS)	Diesel	Turbo Intercooled	TD16848
OM 909.970	6cyl.	6374cc	205kW (279PS)	Diesel	Turbo Intercooled	TD16849
OM 909.971	6cyl.	6374cc	205kW (279PS)	Diesel	Turbo Intercooled	TD16850

14-028610-00 D

102.00

B 106.00

C 220.00

D 109.50

E 6.20

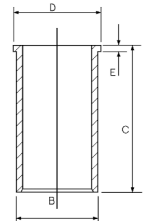

						<b>12</b>
OM 360.911	6cyl.	8720cc	125kW (170PS)	Diesel	Turbo Intercooled	TD7902
OM 360.914	6cyl.	8720cc	141kW (192PS)	Diesel		TD5658
OM 360.915	6cyl.	8720cc	141kW (192PS)	Diesel		TD5996
OM 360.916	6cyl.	8720cc	125kW (170PS)	Diesel		TD5659
OM 360.917	6cyl.	8720cc	125kW (170PS)	Diesel		TD5997
OM 360.918	6cyl.	8720cc	125kW (170PS)	Diesel		TD7894
OM 360.931	6cyl.	8720cc	141kW (192PS)	Diesel		TD6269
OM 360.933	6cyl.	8720cc	125kW (170PS)	Diesel		TD6270
OM 360.936	6cyl.	8725cc	125kW (170PS)	Diesel		TD16688
OM 360.937	6cyl.	8725cc	127kW (173PS)	Diesel		TD16689
OM 360.939	6cyl.	8720cc	125kW (170PS)	Diesel		TD8195
OM 360.940	6cyl.	8725cc	127kW (173PS)	Diesel		TD16691
OM 360.941	6cyl.	8725cc	141kW (192PS)	Diesel		TD16698
OM 360.942	6cyl.	8725cc	127kW (173PS)	Diesel		TD16692
OM 360.943	6cyl.	8725cc	127kW (173PS)	Diesel		TD16693
OM 360.944	6cyl.	8725cc	127kW (173PS)	Diesel		TD16694





OM 360.946	6cyl.	8725cc	127kW (173PS)	Diesel		TD16695
OM 360.948	6cyl.	8725cc	125kW (170PS)	Diesel		TD16696
OM 360.949	6cyl.	8725cc	125kW (170PS)	Diesel		TD16697
OM 360.980	6cyl.	8720cc	141kW (192PS)	Diesel		TD17020
OM 360.981	6cyl.	8720cc	141kW (192PS)	Diesel		TD17021
OM 360.984	6cyl.	8720cc	154kW (210PS)	Diesel	Turbo	TD17022
OM 360.985	6cyl.	8720cc	141kW (192PS)	Diesel	Turbo	TD17024
OM 360.986	6cyl.	8720cc	154kW (210PS)	Diesel	Turbo	TD17023

14-024240-00 D  
14-024241-00 D

115.00

B 120.00  
B 121.00

C 253.50  
C 253.50

D 125.00  
D 126.00

E 5.50  
E 6.00

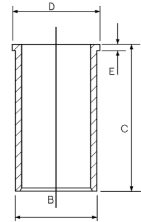

13

OM 401.905	V6cyl.	9570cc	141kW (192PS)	Diesel		TD5730
OM 401.906	V6cyl.	9570cc	141kW (192PS)	Diesel		TD6062
OM 401.907	V6cyl.	9572cc	141kW (192PS)	Diesel		TD16942
OM 401.908	V6cyl.	9572cc	141kW (192PS)	Diesel		TD16943
OM 401.909	V6cyl.	9570cc	141kW (192PS)	Diesel		TD5767
OM 401.912	V6cyl.	9572cc	141kW (192PS)	Diesel		TD7895
OM 401.913	V6cyl.	9570cc	141kW (192PS)	Diesel		TD16944
OM 401.914	V6cyl.	9570cc	141kW (192PS)	Diesel		TD5729
OM 401.915	V6cyl.	9570cc	141kW (192PS)	Diesel		TD6061
OM 401.916	V6cyl.	9570cc	141kW (192PS)	Diesel		TD6099
OM 401.917	V6cyl.	9570cc	188kW (256PS)	Diesel	Turbo	TD16949
OM 401.918	V6cyl.	9570cc	141kW (192PS)	Diesel		TD8118
OM 401.919	V6cyl.	9570cc	141kW (192PS)	Diesel		TD9596
OM 401.921	V6cyl.	9570cc	141kW (192PS)	Diesel		TD16945
OM 401.922	V6cyl.	9570cc	141kW (192PS)	Diesel		TD16946
OM 401.923	V6cyl.	9570cc	141kW (192PS)	Diesel		TD6081
OM 401.925	V6cyl.	9570cc	141kW (192PS)	Diesel		TD8229
OM 401.926	V6cyl.	9570cc	141kW (192PS)	Diesel		TD9597
OM 401.927	V6cyl.	9570cc	141kW (192PS)	Diesel		TD9598
OM 401.928	V6cyl.	9570cc	141kW (192PS)	Diesel		TD16948
OM 401.970	V6cyl.	9600cc	213kW (290PS)	Diesel	Turbo Intercooled	TD7938
OM 401.972	V6cyl.	9572cc	230kW (313PS)	Diesel	Turbo Intercooled	TD5777
OM 401.973	V6cyl.	9572cc	200kW (272PS)	Diesel	Turbo Intercooled	TD5733
OM 401.974 Euro 1	V6cyl.	9572cc	200kW (272PS)	Diesel	Turbo Intercooled	TD7939
OM 401.975 Euro 1	V6cyl.	9572cc	180kW (245PS)	Diesel	Turbo Intercooled	TD5751
OM 401.977 Euro 1	V6cyl.	9572cc	200kW (272PS)	Diesel	Turbo Intercooled	TD5801
OM 401.978 Euro 1	V6cyl.	9572cc	200kW (272PS)	Diesel	Turbo Intercooled	TD6065
OM 401.979 Euro 1	V6cyl.	9572cc	230kW (313PS)	Diesel	Turbo Intercooled	TD5780
OM 401.980 Euro 1	V6cyl.	9572cc	200kW (272PS)	Diesel	Turbo Intercooled	TD6293







OM 401.981 Euro 1	V6cyl.	9572cc	230kW (313PS)	Diesel	Turbo Intercooled	TD6162
OM 401.982 Euro 1	V6cyl.	9572cc	230kW (313PS)	Diesel	Turbo Intercooled	TD17103
OM 401.983	V6cyl.	9572cc	180kW (245PS)	Diesel	Turbo Intercooled	TD17104
OM 401.984	V6cyl.	9572cc	180kW (245PS)	Diesel	Turbo Intercooled	TD8127
OM 401.985	V6cyl.	9600cc	200kW (272PS)	Diesel	Turbo Intercooled	TD5753
OM 401.986	V6cyl.	9572cc	230kW (313PS)	Diesel	Turbo Intercooled	TD8199
OM 401.987	V6cyl.	9572cc	230kW (313PS)	Diesel	Turbo Intercooled	TD6163
OM 401.989	V6cyl.	9572cc	200kW (272PS)	Diesel	Turbo Intercooled	TD6068
OM 401.990	V6cyl.	9572cc	180kW (245PS)	Diesel	Turbo Intercooled	TD16950
OM 401.991	V6cyl.	9600cc	200kW (272PS)	Diesel	Turbo Intercooled	TD6086
OM 401.992	V6cyl.	9572cc	200kW (272PS)	Diesel	Turbo Intercooled	TD17113
OM 401.993	V6cyl.	9572cc	230kW (313PS)	Diesel	Turbo Intercooled	TD6113
OM 401.994	V6cyl.	9600cc	180kW (245PS)	Diesel	Turbo Intercooled	TD6084
OM 402.905	V8cyl.	12800cc	188kW (256PS)	Diesel		TD8179
OM 402.906	V8cyl.	12800cc	188kW (256PS)	Diesel		TD5814
OM 402.907	V8cyl.	12800cc	188kW (256PS)	Diesel		TD7896
OM 402.910	V8cyl.	12800cc	176kW (239PS)	Diesel		TD5752
OM 402.912	V8cyl.	12800cc	188kW (256PS)	Diesel		TD5758
OM 402.913	V8cyl.	12760cc	177kW (240PS)	Diesel		TD17803
OM 402.914	V8cyl.	12800cc	176kW (239PS)	Diesel		TD8230
OM 402.916	V8cyl.	12800cc	188kW (256PS)	Diesel		TD5798
OM 402.917	V8cyl.	12760cc	177kW (240PS)	Diesel		TD17804
OM 402.919	V8cyl.	12800cc	176kW (239PS)	Diesel		TD8154
OM 402.921	V8cyl.	12760cc	177kW (240PS)	Diesel		TD17805
OM 402.923	V8cyl.	12800cc	176kW (239PS)	Diesel		TD8183
OM 402.924	V8cyl.	12800cc	188kW (256PS)	Diesel		TD6291
OM 402.925	V8cyl.	12760cc	188kW (256PS)	Diesel		TD17806
OM 402.926	V8cyl.	12800cc	188kW (256PS)	Diesel		TD6296
OM 402.927	V8cyl.	12800cc	176kW (239PS)	Diesel		TD9606
OM 402.928	V8cyl.	12800cc	176kW (239PS)	Diesel		TD9607
OM 402.970 Euro 1	V8cyl.	12763cc	280kW (381PS)	Diesel	Turbo Intercooled	TD7940
OM 402.971 Euro 1	V8cyl.	12763cc	280kW (381PS)	Diesel	Turbo Intercooled	TD5783
OM 402.972 Euro 1	V8cyl.	12763cc	280kW (381PS)	Diesel	Turbo Intercooled	TD5784
OM 402.973 Euro 1	V8cyl.	12763cc	280kW (381PS)	Diesel	Turbo Intercooled	TD5832
OM 402.974 Euro 1	V8cyl.	12760cc	280-295kW (381-401PS)	Diesel	Turbo Intercooled	TD17807
OM 402.975 Euro 1	V8cyl.	12763cc	280kW (381PS)	Diesel	Turbo Intercooled	TD5818
OM 402.977 Euro 1	V8cyl.	12763cc	280kW (381PS)	Diesel	Turbo Intercooled	TD5826
OM 402.978 Euro 1	V8cyl.	12763cc	280kW (381PS)	Diesel	Turbo Intercooled	TD5786
OM 402.982 Euro 1	V8cyl.	12763cc	280kW (381PS)	Diesel	Turbo Intercooled	TD5830
OM 402.983 Euro 1	V8cyl.	12763cc	280kW (381PS)	Diesel	Turbo Intercooled	TD6182
OM 402.984 Euro 1	V8cyl.	12763cc	280kW (381PS)	Diesel	Turbo Intercooled	TD11268
OM 402.985 Euro 1	V8cyl.	12763cc	280kW (381PS)	Diesel	Turbo Intercooled	TD5806
OM 402.986 Euro 1	V8cyl.	12763cc	280kW (381PS)	Diesel	Turbo Intercooled	TD6151
OM 402.987 Euro 1	V8cyl.	12763cc	280kW (381PS)	Diesel	Turbo Intercooled	TD6178
OM 402.989 Euro 1	V8cyl.	12763cc	280kW (381PS)	Diesel	Turbo Intercooled	TD5807





OM 402.990 Euro 1	V8cyl.	12763cc	280kW (381PS)	Diesel	Turbo Intercooled	TD6153
OM 402.995	V8cyl.	12763cc	280kW (381PS)	Diesel	Turbo Intercooled	TD11267
OM 402.996 Euro 1	V8cyl.	12763cc	280kW (381PS)	Diesel	Turbo Intercooled	TD6121
OM 403.910	V10cyl.	15950cc	184-236kW (250-321PS)	Diesel		TD28696
OM 403.915	V10cyl.	15900cc	236kW (321PS)	Diesel		TD8180
OM 403.916	V10cyl.	15900cc	236kW (321PS)	Diesel		TD5816
OM 403.917	V10cyl.	15950cc	236kW (321PS)	Diesel		TD16953
OM 403.918	V10cyl.	15900cc	235kW (320PS)	Diesel		TD7897
OM 403.919	V10cyl.	15950cc	236kW (321PS)	Diesel		TD16954
OM 403.930	V10cyl.	15950cc	236kW (321PS)	Diesel		TD16955
OM 403.931	V10cyl.	15900cc	235kW (320PS)	Diesel		TD5759
OM 403.932	V10cyl.	15900cc	235kW (320PS)	Diesel		TD6133
OM 403.933	V10cyl.	15950cc	261kW (355PS)	Diesel		TD16956
OM 403.934	V10cyl.	15950cc	236kW (321PS)	Diesel		TD16957
OM 403.935	V10cyl.	15900cc	236kW (321PS)	Diesel		TD6299
OM 404	V12cyl.	20911cc	184-236kW (250-320PS)	Diesel		FM3816
OM 404 A	V12cyl.	20911cc	386kW (525PS)	Diesel	Turbo	FM4262

- 14-451660-00 WH
- 14-452020-00 WH ③
- 14-452310-00 WH ①
- 14-458110-00 WH ②

125.00

B 140.00	C 253.00	D 152.00	E 10.07	F 1.00
B 140.00	C 253.00	D 152.00	E 10.57	F 1.00
B 140.00	C 253.00	D 152.00	E 10.07	F 1.00
B 144.50	C 253.00	D 153.80	E 9.92	F 1.00

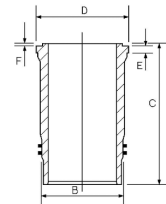

① O ring = HT020

① Ringdichtungen = HT020

① Joints toriques = HT020

① Juntas tóricas para = HT020

② O ring = HL5070

② Ringdichtungen = HL5070

② Joints toriques = HL5070

② Juntas tóricas para = HL5070

③ 4 O-ring version

③ 4 O-Ringe

③ 4 joints toriques

③ 4 juntas toricas

14

OM 407.905	6cyl.	11000cc	132kW (180PS)	Diesel		TD5664
OM 407.907	6cyl.	11045cc	155kW (211PS)	Diesel		TD10767
OM 407.908	6cyl.	11000cc	132kW (180PS)	Diesel	Turbo Intercooled	TD6002
OM 407.909	6cyl.	11000cc	155kW (211PS)	Diesel		TD5665
OM 407.910	6cyl.	11000cc	155kW (211PS)	Diesel		TD6003
OM 407.911	6cyl.	11000cc	155kW (211PS)	Diesel		TD6273
OM 407.913	6cyl.	11400cc	147kW (200PS)	Diesel		TD5666
OM 407.914	6cyl.	11400cc	147kW (200PS)	Diesel		TD6004
OM 407.915	6cyl.	11400cc	147kW (200PS)	Diesel		TD6274
OM 407.916	6cyl.	11400cc	177kW (240PS)	Diesel		TD5667
OM 407.917	6cyl.	11400cc	177kW (240PS)	Diesel		TD6005
OM 407.918	6cyl.	11400cc	177kW (240PS)	Diesel		TD6275
OM 407.919	6cyl.	11400cc	177kW (240PS)	Diesel		TD6006
OM 407.920	6cyl.	11412cc	177kW (240PS)	Diesel		TD17808
OM 407.951	6cyl.	11413cc	206kW (280PS)	Diesel	Turbo	TD5668
OM 407.955	6cyl.	11413cc	206kW (280PS)	Diesel	Turbo	TD6007
OM 409	5cyl.	9204cc	137-141kW (185-192PS)	Diesel		FM6360
OM 409.906	5cyl.	9204cc	135kW (184PS)	Diesel		TD18812





OM 409.907	5cyl.	9204cc	135kW (184PS)	Diesel			TD18813
OM 409.908	5cyl.	9204cc	135kW (184PS)	Diesel			TD18814

14-452370-00 WH ①	125.00	B 140.00	C 265.00	D 152.00	E 10.07	F 1.00
-------------------	--------	----------	----------	----------	---------	--------

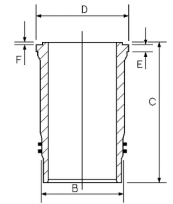

① O ring = HT020

① Ringdichtungen = HT020

① Joints toriques = HT020

① Juntas tóricas para = HT020

15

OM 457.910 Euro 5	6cyl.	11967cc	260-315kW (354-428PS)	Diesel	Turbo Intercooled	TD25467
OM 457.950 Euro 4	6cyl.	11967cc	260-220kW (354-299PS)	Diesel	Turbo Intercooled	TD20337
OM 457.951 Euro 4	6cyl.	11967cc	260kW (354PS)	Diesel	Turbo Intercooled	TD23250
OM 457.952 Euro 4	6cyl.	11967cc	300-220kW (408-299PS)	Diesel	Turbo Intercooled	TD20338
OM 457.953 Euro 4	6cyl.	11967cc	260-315kW (354-428PS)	Diesel	Turbo Intercooled	TD23251
OM 457.954 Euro 4	6cyl.	11967cc	260-220kW (354-299PS)	Diesel	Turbo Intercooled	TD20339
OM 457.959 Euro 4	6cyl.	11967cc	260-220kW (354-299PS)	Diesel	Turbo Intercooled	TD20341
OM 457.964 Euro 4	6cyl.	11967cc	220-260kW (299-408PS)	Diesel	Turbo Intercooled	TD23247
OM 457.965 Euro 4	6cyl.	11967cc	220-300kW (299-408PS)	Diesel	Turbo Intercooled	TD23248
OM 457.966 Euro 4	6cyl.	11967cc	220-260kW (299-354PS)	Diesel	Turbo Intercooled	TD23249
OM 457.967 Euro 4	6cyl.	11967cc	220-260kW (299-354PS)	Diesel	Turbo Intercooled	TD28150
OM 457.968 Euro 4	6cyl.	11967cc	265-315kW (360-428PS)	Diesel	Turbo Intercooled	TD28726
OM 457.969 Euro 4	6cyl.	11967cc	265kW (360PS)	Diesel	Turbo Intercooled	TD28727
OM 457.973 Euro 4	6cyl.	11967cc	220-260kW (299-354PS)	Diesel	Turbo Intercooled	TD27003
OM 457.974 Euro 4	6cyl.	11967cc	220-300kW (299-408PS)	Diesel	Turbo Intercooled	TD28728
OM 457.976 Euro 3	6cyl.	11967cc	260-335kW (354-456PS)	Diesel	Turbo Intercooled	TD28729
OM 457.977 Euro 4	6cyl.	11967cc	220-260kW (299-354PS)	Diesel	Turbo Intercooled	TD28730
OM 457.980 Euro 2	6cyl.	11967cc	260-315kW (354-428PS)	Diesel	Turbo Intercooled	TD25446
OM 457.981 Euro 3	6cyl.	11967cc	260-315kW (354-428PS)	Diesel	Turbo Intercooled	TD25447
OM 458.990	6cyl.	11967cc	220-260kW (299-354PS)	Diesel	Turbo Intercooled	TD28731
OM 458.991	6cyl.	11967cc	295-375kW (401-510PS)	Diesel	Turbo Intercooled	TD28732

13-451070-00 ①	128.00	B 142.50	C 266.30	D 155.60	E 10.12	F 1.10
15-451070-10 WH ②						

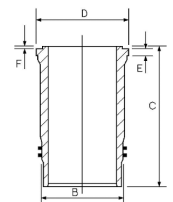

① Anti-polish/Fire ring, also available separately

① Ölschlitzring, auch einzeln erhältlich

① Segment racleur (disponible également séparément)

① Segmento rascador, también disponible por separado

② Includes anti-polish/Fire ring

② Enthält Ölschlitzring

② Contient le segment racleur

② Incluye el segmento rascador



16

OM 355.910	6cyl.	11581cc	169kW (230PS)	Diesel		TD16668
OM 355.911	6cyl.	11581cc	169kW (230PS)	Diesel		TD16669
OM 355.912	6cyl.	11581cc	169kW (230PS)	Diesel		TD16670
OM 355.913	6cyl.	11581cc	169kW (230PS)	Diesel		TD16671
OM 355.914	6cyl.	11581cc	169kW (230PS)	Diesel		TD16672
OM 355.915	6cyl.	11581cc	169kW (230PS)	Diesel		TD7892
OM 355.918	6cyl.	11581cc	169kW (230PS)	Diesel		TD16673
OM 355.960	6cyl.	11581cc	176kW (239PS)	Diesel		TD5813
OM 355.961	6cyl.	11581cc	155kW (211PS)	Diesel		TD16675
OM 355.962	6cyl.	11581cc	177kW (240PS)	Diesel		TD16676
OM 355.963	6cyl.	11581cc	176kW (239PS)	Diesel		TD5812
OM 355.964	6cyl.	11581cc	177kW (240PS)	Diesel		TD16677
OM 355.966	6cyl.	11581cc	155kW (211PS)	Diesel		TD16678
OM 355.967	6cyl.	11581cc	177kW (240PS)	Diesel		TD7893
OM 355.969	6cyl.	11581cc	206kW (280PS)	Diesel	Turbo	TD8212
OM 355.970	6cyl.	11581cc	191kW (260PS)	Diesel		TD16679
OM 355.974	6cyl.	11581cc	177kW (240PS)	Diesel		TD16682
OM 355.975	6cyl.	11600cc	176kW (239PS)	Diesel		TD6160
OM 355.976	6cyl.	11581cc	176kW (239PS)	Diesel		TD6159
OM 355.977	6cyl.	11581cc	205kW (279PS)	Diesel	Turbo	TD16683
OM 355.978	6cyl.	11581cc	177kW (240PS)	Diesel		TD16684
OM 355.979	6cyl.	11581cc	177kW (240PS)	Diesel		TD16685
OM 355.980	6cyl.	11581cc	177kW (240PS)	Diesel		TD16686
OM 355.981	6cyl.	11581cc	184kW (250PS)	Diesel		TD16687
OM 355.982	6cyl.	11581cc	184kW (250PS)	Diesel		TD16674
OM 355.983	6cyl.	11581cc	177kW (240PS)	Diesel		TD5811
OM 355.984	6cyl.	11581cc	177kW (240PS)	Diesel		TD6158

14-025890-00 D  
14-025891-00 D  
14-025892-00 D

128.00

B 133.565 C 287.50 D 137.50 E 5.50  
B 134.065 C 287.50 D 138.00 E 5.50  
B 134.565 C 287.50 D 138.50 E 5.50

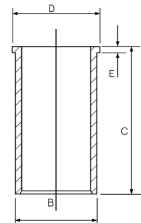

17

OM 457.914 Euro 3	6cyl.	11967cc	250kW (340PS)	Diesel	Turbo Intercooled	TD20335
OM 457.915 Euro 3	6cyl.	11967cc	265kW (360PS)	Diesel	Turbo Intercooled	TD20303
OM 457.916 Euro 3	6cyl.	11967cc	265kW (360PS)	Diesel	Turbo Intercooled	TD20304
OM 457.917 Euro2/Euro3	6cyl.	11967cc	315-260kW (428-354PS)	Diesel	Turbo Intercooled	TD20324
OM 457.918 Euro 3	6cyl.	11967cc	260kW (354PS)	Diesel	Turbo Intercooled	TD20305
OM 457.919 Euro 3	6cyl.	11967cc	315kW (428PS)	Diesel	Turbo Intercooled	TD20306
OM 457.920 Euro 3	6cyl.	11967cc	280kW (381PS)	Diesel	Turbo Intercooled	TD20307
OM 457.922 Euro 3	6cyl.	11967cc	320kW (435PS)	Diesel	Turbo Intercooled	TD20308
OM 457.923 Euro 3	6cyl.	11967cc	280kW (381PS)	Diesel	Turbo Intercooled	TD20309
OM 457.924 Euro 3	6cyl.	11967cc	280kW (381PS)	Diesel	Turbo Intercooled	TD20310





OM 457.925 Euro 3	6cyl.	11967cc	265kW (360PS)	Diesel	Turbo Intercooled	TD20311
OM 457.926 Euro 3	6cyl.	11967cc	265kW (360PS)	Diesel	Turbo Intercooled	TD20312
OM 457.927 Euro 3	6cyl.	11967cc	295kW (401PS)	Diesel	Turbo Intercooled	TD20336
OM 457.928 Euro 3	6cyl.	11967cc	280kW (381PS)	Diesel	Turbo Intercooled	TD20313
OM 457.929 Euro 3	6cyl.	11967cc	265kW (360PS)	Diesel	Turbo Intercooled	TD20314
OM 457.931 Euro 3	6cyl.	11967cc	280kW (381PS)	Diesel	Turbo Intercooled	TD20315
OM 457.932 Euro 3	6cyl.	11967cc	265kW (360PS)	Diesel	Turbo Intercooled	TD20316
OM 457.933 Euro 2	6cyl.	11967cc	260kW (354PS)	Diesel	Turbo Intercooled	TD17662
OM 457.934 Euro 2	6cyl.	11967cc	220kW (299PS)	Diesel	Turbo Intercooled	TD17473
OM 457.935 Euro 2	6cyl.	11967cc	185kW (252PS)	Diesel	Turbo Intercooled	TD17502
OM 457.936 Euro 2	6cyl.	11967cc	300kW (408PS)	Diesel	Turbo Intercooled	TD17653
OM 457.937 Euro 2	6cyl.	11967cc	260-315kW (354-428PS)	Diesel	Turbo Intercooled	TD16489
OM 457.938 Euro 2	6cyl.	11967cc	300kW (408PS)	Diesel	Turbo Intercooled	TD17645
OM 457.939 Euro 2	6cyl.	11967cc	260kW (354PS)	Diesel	Turbo Intercooled	TD20317
OM 457.940 Euro 2	6cyl.	11967cc	260kW (354PS)	Diesel	Turbo Intercooled	TD17654
OM 457.941 Euro 2	6cyl.	11967cc	185-300kW (252-408PS)	Diesel	Turbo Intercooled	TD17641
OM 457.942 Euro 2	6cyl.	11967cc	185-260kW (252-354PS)	Diesel	Turbo Intercooled	TD17448
OM 457.943 Euro 2	6cyl.	11967cc	185kW (252PS)	Diesel	Turbo Intercooled	TD17666
OM 457.944 Euro 2	6cyl.	11967cc	260-310kW (354-422PS)	Diesel	Turbo Intercooled	TD17644
OM 457.945 Euro 2	6cyl.	11967cc	260kW (354PS)	Diesel	Turbo Intercooled	TD20318
OM 457.946 Euro 2	6cyl.	11967cc	220kW (299PS)	Diesel	Turbo Intercooled	TD20319
OM 457.947 Euro 2	6cyl.	11967cc	315-260kW (428-354PS)	Diesel	Turbo Intercooled	TD20320
OM 457.948 Euro 3	6cyl.	11967cc	315-260kW (428-354PS)	Diesel	Turbo Intercooled	TD20227
OM 457.949 Euro 2	6cyl.	11967cc	220kW (299PS)	Diesel	Turbo Intercooled	TD20321
OM 457.955 Euro 3	6cyl.	11967cc	315-260kW (428-354PS)	Diesel	Turbo Intercooled	TD20323
OM 457.956 Euro 3	6cyl.	11967cc	315-260kW (428-354PS)	Diesel	Turbo Intercooled	TD20282
OM 457.957 Euro 3	6cyl.	11967cc	315-260kW (428-354PS)	Diesel	Turbo Intercooled	TD20283
OM 457.958 Euro2/Euro3	6cyl.	11967cc	315-230kW (428-313PS)	Diesel	Turbo Intercooled	TD20340
OM 457.960 Euro 2	6cyl.	11967cc	315-260kW (428-354PS)	Diesel	Turbo Intercooled	TD20322
OM 457.961 Euro 3	6cyl.	11967cc	260-355kW (354-483PS)	Diesel	Turbo Intercooled	TD23252
OM 457.962 Euro 3	6cyl.	11967cc	260-315kW (354-428PS)	Diesel	Turbo Intercooled	TD23253
OM 458.960 Euro 3	6cyl.	11967cc	260kW (354PS)	Diesel	Turbo Intercooled	TD17668
OM 458.970 Euro 3	6cyl.	11967cc	295kW (401PS)	Diesel	Turbo Intercooled	TD17669
OM 458.980 Euro 3	6cyl.	11967cc	335kW (456PS)	Diesel	Turbo Intercooled	TD17670

14-450380-00 WH 1

128.00

B 145.00

C 266.30

D 155.60

E 10.12

F 1.10

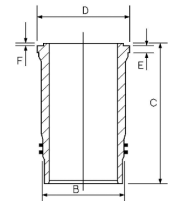



14-450480-00 WH ② | 128.00 | B 144.50 | C 266.30 | D 155.60 | E 10.12 | F 1.10

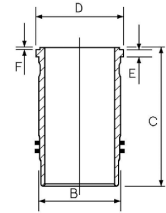

① Use 2 O-rings and 1 Tombak ring, set HL5077

① Mitverwenden: 2 O-rings + 1 Tombak ring, HL5077

① A utiliser aussi: 2 O-Rings + 1 Tombak ring, HL5077

① Utilizar también: 2 O-rings + 1 Tombak ring, HL5077

② Chrome plated outside diameter

② Chrome plated outside diameter

② Diamètre extérieur chromé

② Diámetro exterior cromado

18

OM 460.900 Euro 3	6cyl.	12816cc	324kW (440PS)	Diesel	Turbo Intercooled	TD23255
OM 460.901 Euro 3	6cyl.	12816cc	261kW (355PS)	Diesel	Turbo Intercooled	TD23256
OM 460.902 Euro 3	6cyl.	12816cc	276kW (375PS)	Diesel	Turbo Intercooled	TD23257
OM 460.903 Euro 3	6cyl.	12816cc	276kW (375PS)	Diesel	Turbo Intercooled	TD23258
OM 460.904 Euro 3	6cyl.	12816cc	306kW (416PS)	Diesel	Turbo Intercooled	TD23259
OM 460.905 Euro 3	6cyl.	12816cc	306kW (416PS)	Diesel	Turbo Intercooled	TD23260
OM 460.906 Euro 3	6cyl.	12816cc	261-276kW (355-375PS)	Diesel	Turbo Intercooled	TD23261
OM 460.907 Euro 3	6cyl.	12816cc	336kW (457PS)	Diesel	Turbo Intercooled	TD23262
OM 460.908 Euro 3	6cyl.	12816cc	261-336kW (355-457PS)	Diesel	Turbo Intercooled	TD23263
OM 460.909 Euro 3	6cyl.	12816cc	261-276kW (355-375PS)	Diesel	Turbo Intercooled	TD23264
OM 460.910 Euro 3	6cyl.	12816cc	261-276kW (355-375PS)	Diesel	Turbo Intercooled	TD23265
OM 460.911 Euro 3	6cyl.	12816cc	306-336kW (416-457PS)	Diesel	Turbo Intercooled	TD23266
OM 460.912 Euro 3	6cyl.	12816cc	261-276kW (355-375PS)	Diesel	Turbo Intercooled	TD23267
OM 460.913 Euro 3	6cyl.	12816cc	306-336kW (416-457PS)	Diesel	Turbo Intercooled	TD23268
OM 460.914 Euro 3	6cyl.	12816cc	306-336kW (416-457PS)	Diesel	Turbo Intercooled	TD23269
OM 460.915 Euro 3	6cyl.	12816cc	261-276kW (355-375PS)	Diesel	Turbo Intercooled	TD23270
OM 460.916 Euro 3	6cyl.	12816cc	261-276kW (355-375PS)	Diesel	Turbo Intercooled	TD23271
OM 460.917 Euro 3	6cyl.	12816cc	306-336kW (416-457PS)	Diesel	Turbo Intercooled	TD23272
OM 460.918 Euro 3	6cyl.	12816cc	261-276kW (355-375PS)	Diesel	Turbo Intercooled	TD23273
OM 460.919 Euro 3	6cyl.	12816cc	306-336kW (416-457PS)	Diesel	Turbo Intercooled	TD23274
OM 460.920 Euro 3	6cyl.	12816cc	306-336kW (416-457PS)	Diesel	Turbo Intercooled	TD23275
OM 460.921 Euro 3	6cyl.	12816cc	306-336kW (416-457PS)	Diesel	Turbo Intercooled	TD23276
OM 460.922 Euro 3	6cyl.	12816cc	261-276kW (355-375PS)	Diesel	Turbo Intercooled	TD23277
OM 460.923 Euro 3	6cyl.	12816cc	306-336kW (416-457PS)	Diesel	Turbo Intercooled	TD23278
OM 460.925 Euro 3	6cyl.	12816cc	306-336kW (416-457PS)	Diesel	Turbo Intercooled	TD23279
OM 460.929 Euro 3	6cyl.	12816cc	306-336kW (416-457PS)	Diesel	Turbo Intercooled	TD23280
OM 460.931 Euro 3	6cyl.	12816cc	306-336kW (416-457PS)	Diesel	Turbo Intercooled	TD23281

14-450380-00 WH ①  
14-450480-00 WH ①

128.00 | B 145.00 | C 266.30 | D 155.60 | E 10.12 | F 1.10  
B 144.50 | C 266.30 | D 155.60 | E 10.12 | F 1.10

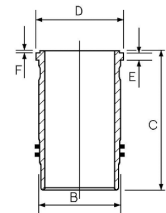

① Chrome plated outside diameter

① Chrome plated outside diameter

① Diamètre extérieur chromé

① Diámetro exterior cromado





19

OM 444 LA V12cyl. 21927cc 478-610kW (530-830PS) Diesel Turbo Intercooled FM6642

14-451160-00 WH ②  
14-452030-00 WH ①  
14-452390-00 WH ②

128.00

B 144.50	C 253.00	D 153.80	E 10.07	F 1.00
B 144.50	C 253.00	D 153.80	E 9.92	F 1.00
B 144.50	C 253.00	D 153.80	E 10.57	F 1.00

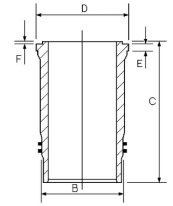

① O ring = HL5070

① Ringdichtungen = HL5070

① Joints toriques = HL5070

① Juntas tóricas para = HL5070

② O ring = HT018

② Ringdichtungen = HT018

② Joints toriques = HT018

② Juntas tóricas para = HT018

20

OM 421.905	V6cyl.	10964cc	159kW (216PS)	Diesel		TD5799
OM 421.906	V6cyl.	10900cc	159kW (216PS)	Diesel		TD8120
OM 421.907	V6cyl.	10964cc	159kW (216PS)	Diesel		TD6139
OM 421.908	V6cyl.	10964cc	159kW (216PS)	Diesel		TD7898
OM 421.909	V6cyl.	10964cc	159kW (216PS)	Diesel		TD17056
OM 421.910	V6cyl.	10964cc	159kW (216PS)	Diesel		TD16958
OM 421.951	V6cyl.	10964cc	184kW (250PS)	Diesel	Turbo	TD7899
OM 422.901	V8cyl.	14618cc	243kW (330PS)	Diesel	Turbo	TD18973
OM 422.905	V8cyl.	14618cc	206kW (280PS)	Diesel		TD5760
OM 422.906	V8cyl.	14618cc	206kW (280PS)	Diesel		TD6093
OM 422.907	V8cyl.	14618cc	206kW (280PS)	Diesel		TD5805
OM 422.908	V8cyl.	14600cc	206kW (280PS)	Diesel		TD7900
OM 422.909	V8cyl.	14618cc	184kW (250PS)	Diesel		TD8157
OM 422.910	V8cyl.	14618cc	206kW (280PS)	Diesel		TD6132
OM 422.911	V8cyl.	14618cc	206kW (280PS)	Diesel		TD6140
OM 422.912	V8cyl.	14618cc	184kW (250PS)	Diesel		TD8231
OM 422.913	V8cyl.	14618cc	206kW (280PS)	Diesel		TD6149
OM 422.914	V8cyl.	14600cc	206kW (280PS)	Diesel		TD5828
OM 422.915	V8cyl.	14618cc	184kW (250PS)	Diesel		TD16959
OM 422.916	V8cyl.	14618cc	206kW (280PS)	Diesel		TD17111
OM 422.917	V8cyl.	14618cc	206kW (280PS)	Diesel		TD11029
OM 422.918	V8cyl.	14618cc	206kW (280PS)	Diesel		TD16960
OM 422.919	V8cyl.	14618cc	206kW (280PS)	Diesel		TD5821
OM 422.920	V8cyl.	14618cc	184kW (250PS)	Diesel		TD8249
OM 422.921	V8cyl.	14618cc	206kW (280PS)	Diesel		TD6173
OM 422.922	V8cyl.	14618cc	206kW (280PS)	Diesel		TD16961
OM 422.923	V8cyl.	14618cc	206kW (280PS)	Diesel		TD16962
OM 422.951	V8cyl.	14600cc	243kW (330PS)	Diesel	Turbo	TD7901
OM 422.952	V8cyl.	14600cc	243kW (330PS)	Diesel	Turbo	TD5761
OM 422.953	V8cyl.	14618cc	276kW (375PS)	Diesel	Turbo Intercooled	TD5763
OM 422.954	V8cyl.	14618cc	243kW (330PS)	Diesel	Turbo	TD6095
OM 422.955	V8cyl.	14618cc	276kW (375PS)	Diesel	Turbo Intercooled	TD5800
OM 422.956	V8cyl.	14600cc	243kW (330PS)	Diesel	Turbo	TD6134
OM 422.957	V8cyl.	14620cc	243kW (330PS)	Diesel	Turbo	TD9613
OM 422.958	V8cyl.	14620cc	243kW (330PS)	Diesel	Turbo	TD9614





OM 422.959	V8cyl.	14618cc	276kW (375PS)	Diesel	Turbo	TD6141
OM 422.963	V8cyl.	14618cc	243kW (330PS)	Diesel	Turbo	TD11028
OM 423.905	V10cyl.	18300cc	261kW (355PS)	Diesel		TD5762
OM 423.906	V10cyl.	18273cc	261kW (355PS)	Diesel		TD6126
OM 423.907	V10cyl.	18273cc	261kW (355PS)	Diesel		TD6289
OM 423.908	V10cyl.	18300cc	261kW (355PS)	Diesel		TD6096
OM 423.909	V10cyl.	18273cc	261kW (355PS)	Diesel		TD16963
OM 423.950	V10cyl.	18273cc	368kW (500PS)	Diesel	Turbo Intercooled	TD5827
OM 424.900	V12cyl.	21930cc	309kW (420PS)	Diesel		TD18815
OM 424.901	V12cyl.	21930cc	441kW (600PS)	Diesel	Turbo Intercooled	TD18816
OM 424.901-510	V12cyl.	21930cc	441kW (600PS)	Diesel	Turbo Intercooled	TD18817
OM 440.940	V8cyl.	14618cc	250kW (340PS)	Diesel	Turbo	TD8194
OM 440.941	V8cyl.	14618cc	250kW (340PS)	Diesel	Turbo	TD5794
OM 440.942	V8cyl.	14618cc	250kW (340PS)	Diesel	Turbo	TD6130
OM 440.943	V8cyl.	14618cc	250kW (340PS)	Diesel	Turbo	TD17122
OM 440.945 Euro 1	V8cyl.	14618cc	250kW (340PS)	Diesel	Turbo	TD16967
OM 440.948	V8cyl.	14618cc	269kW (366PS)	Diesel	Turbo	TD17123
OM 440.949	V8cyl.	14618cc	250kW (340PS)	Diesel	Turbo	TD17124
OM 440.970 Euro 1	V8cyl.	14618cc	320kW (435PS)	Diesel	Turbo Intercooled	TD5797
OM 440.971 Euro 1	V8cyl.	14618cc	370kW (503PS)	Diesel	Turbo Intercooled	TD5788
OM 440.972 Euro 1	V8cyl.	14618cc	320kW (435PS)	Diesel	Turbo Intercooled	TD16968
OM 440.973 Euro 1	V8cyl.	14618cc	370kW (503PS)	Diesel	Turbo Intercooled	TD6124
OM 440.974	V8cyl.	14618cc	320kW (435PS)	Diesel	Turbo Intercooled	TD17125
OM 440.975 Euro 1	V8cyl.	14618cc	370kW (503PS)	Diesel	Turbo Intercooled	TD5833
OM 440.976 Euro 1	V8cyl.	14618cc	370kW (503PS)	Diesel	Turbo Intercooled	TD8227
OM 440.978 Euro 1	V8cyl.	14618cc	320kW (435PS)	Diesel	Turbo Intercooled	TD5787
OM 440.979 Euro 1	V8cyl.	14618cc	320kW (435PS)	Diesel	Turbo Intercooled	TD6138
OM 440.980 Euro 1	V8cyl.	14618cc	320kW (435PS)	Diesel	Turbo Intercooled	TD6179
OM 440.981 Euro 1	V8cyl.	14618cc	370kW (503PS)	Diesel	Turbo Intercooled	TD6152
OM 440.982 Euro 1	V8cyl.	14618cc	370kW (503PS)	Diesel	Turbo Intercooled	TD6185
OM 440.983 Euro 1	V8cyl.	14618cc	370kW (503PS)	Diesel	Turbo Intercooled	TD6306
OM 440.984 Euro 1	V8cyl.	14618cc	320kW (435PS)	Diesel	Turbo Intercooled	TD6305
OM 440.985 Euro 1	V8cyl.	14618cc	320kW (435PS)	Diesel	Turbo Intercooled	TD8256
OM 440.986 Euro 1	V8cyl.	14618cc	320kW (435PS)	Diesel	Turbo Intercooled	TD16969
OM 440.987 Euro 1	V8cyl.	14618cc	280kW (381PS)	Diesel	Turbo Intercooled	TD16970
OM 440.988 Euro 1	V8cyl.	14618cc	280kW (381PS)	Diesel	Turbo Intercooled	TD17126
OM 440.989 Euro 1	V8cyl.	14618cc	280kW (381PS)	Diesel	Turbo Intercooled	TD16971
OM 440.990 Euro 1	V8cyl.	14618cc	280kW (381PS)	Diesel	Turbo Intercooled	TD8225
OM 440.991 Euro 1	V8cyl.	14618cc	320kW (435PS)	Diesel	Turbo Intercooled	TD6122
OM 441.951	V6cyl.	10964cc	243kW (330PS)	Diesel	Turbo Intercooled	TD8187
OM 441.952	V6cyl.	10964cc	191kW (260PS)	Diesel	Turbo	TD17128
OM 441.953	V6cyl.	10964cc	191-200kW (260-272PS)	Diesel	Turbo	TD5999
OM 441.960	V6cyl.	10964cc	243-249kW (330-340PS)	Diesel	Turbo Intercooled	TD5772
OM 441.961	V6cyl.	10964cc	250kW (340PS)	Diesel	Turbo Intercooled	TD16973
OM 441.962	V6cyl.	10964cc	243-249kW (330-340PS)	Diesel	Turbo Intercooled	TD6104







OM 441.980	V6cyl.	10964cc	250kW (340PS)	Diesel	Turbo Intercooled	TD7943
OM 441.981	V6cyl.	10964cc	243-249kW (330-340PS)	Diesel	Turbo Intercooled	TD6103
OM 441.982	V6cyl.	10964cc	250kW (340PS)	Diesel	Turbo Intercooled	TD5824
OM 441.983	V6cyl.	10964cc	243-249kW (330-340PS)	Diesel	Turbo Intercooled	TD6322
OM 441.985	V6cyl.	10964cc	250kW (340PS)	Diesel	Turbo Intercooled	TD6176
OM 441.986 Euro 1	V6cyl.	10964cc	250kW (340PS)	Diesel	Turbo Intercooled	TD5779
OM 441.987 Euro 1	V6cyl.	10964cc	250kW (340PS)	Diesel	Turbo Intercooled	TD5782
OM 441.988 Euro 1	V6cyl.	10964cc	250kW (340PS)	Diesel	Turbo Intercooled	TD5825
OM 441.989 Euro 1	V6cyl.	10964cc	250kW (340PS)	Diesel	Turbo Intercooled	TD5736
OM 441.990 Euro 1	V6cyl.	10964cc	250kW (340PS)	Diesel	Turbo Intercooled	TD6177
OM 441.991 Euro 1	V6cyl.	10964cc	250kW (340PS)	Diesel	Turbo Intercooled	TD6118
OM 441.992 Euro 1	V6cyl.	10964cc	250kW (340PS)	Diesel	Turbo Intercooled	TD6302
OM 441.993 Euro 1	V6cyl.	10964cc	250kW (340PS)	Diesel	Turbo Intercooled	TD6069
OM 441.994 Euro 1	V6cyl.	10964cc	250kW (340PS)	Diesel	Turbo Intercooled	TD16974
OM 441.995 Euro 1	V6cyl.	10964cc	250kW (340PS)	Diesel	Turbo Intercooled	TD16975
OM 441.996 Euro 1	V6cyl.	10964cc	250kW (340PS)	Diesel	Turbo Intercooled	TD6116
OM 441.997 Euro 1	V6cyl.	10964cc	230kW (313PS)	Diesel	Turbo Intercooled	TD16976
OM 441.998 Euro 1	V6cyl.	10964cc	230kW (313PS)	Diesel	Turbo Intercooled	TD8222
OM 441.999 Euro 1	V6cyl.	10964cc	250kW (340PS)	Diesel	Turbo Intercooled	TD16977
OM 442.940	V8cyl.	14618cc	260kW (354PS)	Diesel	Turbo	TD17131
OM 442.941	V8cyl.	14618cc	269kW (366PS)	Diesel	Turbo	TD16978
OM 442.942	V8cyl.	14618cc	260-269kW (354-366PS)	Diesel	Turbo	TD5774
OM 442.943	V8cyl.	14620cc	269kW (366PS)	Diesel	Turbo	TD5793
OM 442.944	V8cyl.	14618cc	260-269kW (354-366PS)	Diesel	Turbo	TD5773
OM 442.945	V8cyl.	14618cc	269kW (366PS)	Diesel	Turbo	TD5829
OM 442.946	V8cyl.	14618cc	266kW (362PS)	Diesel	Turbo	TD5831
OM 442.950	V8cyl.	14618cc	260kW (354PS)	Diesel	Turbo	TD5764
OM 442.951	V8cyl.	14618cc	320kW (435PS)	Diesel	Turbo Intercooled	TD5765
OM 442.952	V8cyl.	14618cc	260kW (354PS)	Diesel	Turbo	TD6135
OM 442.953	V8cyl.	14618cc	320kW (435PS)	Diesel	Turbo Intercooled	TD5819
OM 442.954	V8cyl.	14618cc	269kW (366PS)	Diesel	Turbo	TD10972
OM 442.955	V8cyl.	14618cc	269kW (366PS)	Diesel	Turbo	TD10973
OM 442.957	V8cyl.	14618cc	266kW (362PS)	Diesel	Turbo	TD6183
OM 442.958	V8cyl.	14618cc	260kW (354PS)	Diesel	Turbo	TD6290
OM 442.959	V8cyl.	14618cc	269kW (366PS)	Diesel	Turbo	TD6161
OM 442.960	V8cyl.	14618cc	260-269kW (354-365PS)	Diesel	Turbo	TD5663
OM 442.961	V8cyl.	14618cc	260-269kW (354-365PS)	Diesel	Turbo	TD6001
OM 442.962	V8cyl.	14618cc	260-269kW (354-366PS)	Diesel	Turbo	TD8215
OM 442.963	V8cyl.	14618cc	260-269kW (354-366PS)	Diesel	Turbo	TD5802
OM 442.964	V8cyl.	14618cc	260-269kW (354-366PS)	Diesel	Turbo	TD6146
OM 442.965	V8cyl.	14618cc	260-269kW (354-366PS)	Diesel	Turbo	TD6292
OM 442.966	V8cyl.	14618cc	260-269kW (354-366PS)	Diesel	Turbo	TD6300
OM 442.967	V8cyl.	14618cc	269kW (366PS)	Diesel	Turbo	TD17809
OM 442.968	V8cyl.	14618cc	260-269kW (354-366PS)	Diesel	Turbo	TD6147
OM 442.970	V8cyl.	14618cc	260kW (354PS)	Diesel	Turbo	TD17132





OM 442.971	V8cyl.	14620cc	269kW (366PS)	Diesel	Turbo	TD5795
OM 442.972	V8cyl.	14620cc	269kW (366PS)	Diesel	Turbo	TD6131
OM 442.976	V8cyl.	14618cc	260-269kW (354-366PS)	Diesel	Turbo	TD6323
OM 442.977	V8cyl.	14618cc	250kW (340PS)	Diesel	Turbo	TD8219
OM 442.978	V8cyl.	14620cc	250kW (340PS)	Diesel	Turbo	TD8216
OM 442.980	V8cyl.	14618cc	320kW (435PS)	Diesel	Turbo Intercooled	TD6169
OM 442.982	V8cyl.	14618cc	353-362kW (480-492PS)	Diesel	Turbo Intercooled	TD5796
OM 442.983	V8cyl.	14618cc	329kW (447PS)	Diesel	Turbo Intercooled	TD8248
OM 442.985	V8cyl.	14618cc	353-362kW (480-492PS)	Diesel	Turbo Intercooled	TD5775
OM 442.989	V8cyl.	14618cc	362kW (492PS)	Diesel	Turbo Intercooled	TD5817
OM 442.991	V8cyl.	14618cc	362kW (492PS)	Diesel	Turbo Intercooled	TD17137
OM 442.992	V8cyl.	14618cc	353-362kW (480-492PS)	Diesel	Turbo Intercooled	TD6301
OM 442.993	V8cyl.	14618cc	362kW (492PS)	Diesel	Turbo Intercooled	TD8259
OM 442.994	V8cyl.	14618cc	362kW (492PS)	Diesel	Turbo Intercooled	TD6165
OM 442.995 Euro 1	V8cyl.	14618cc	320kW (435PS)	Diesel	Turbo Intercooled	TD16979
OM 442.996 Euro 1	V8cyl.	14618cc	370kW (503PS)	Diesel	Turbo Intercooled	TD16980
OM 442.997 Euro 1	V8cyl.	14618cc	370kW (503PS)	Diesel	Turbo Intercooled	TD5810
OM 442.998 Euro 1	V8cyl.	14618cc	370kW (503PS)	Diesel	Turbo Intercooled	TD6157
OM 442.999 Euro 1	V8cyl.	14618cc	370kW (503PS)	Diesel	Turbo Intercooled	TD17810
OM 443.940	V10cyl.	18270cc	340kW (462PS)	Diesel	Turbo	TD8214
OM 443.980	V10cyl.	18270cc	412kW (560PS)	Diesel	Turbo Intercooled	TD8254
OM 445.920 Euro 2	V6cyl.	10964cc	250kW (340PS)	Diesel	Turbo Intercooled	TD5781
OM 445.921 Euro 2	V6cyl.	10964cc	250kW (340PS)	Diesel	Turbo Intercooled	TD8200
OM 445.922 Euro 2	V6cyl.	10964cc	250kW (340PS)	Diesel	Turbo Intercooled	TD8252
OM 445.923 Euro 2	V6cyl.	10964cc	250kW (340PS)	Diesel	Turbo Intercooled	TD5737
OM 445.924 Euro 2	V6cyl.	10960cc	180kW (245PS)	Diesel	Turbo Intercooled	TD5754
OM 445.925 Euro 2	V6cyl.	10964cc	180kW (245PS)	Diesel	Turbo Intercooled	TD8197
OM 445.926 Euro 2	V6cyl.	10964cc	200kW (272PS)	Diesel	Turbo Intercooled	TD5776
OM 445.927 Euro 2	V6cyl.	10964cc	200kW (272PS)	Diesel	Turbo Intercooled	TD8235
OM 445.929 Euro 2	V6cyl.	10964cc	230kW (313PS)	Diesel	Turbo Intercooled	TD5778
OM 445.930 Euro 2	V6cyl.	10964cc	230kW (313PS)	Diesel	Turbo Intercooled	TD6164
OM 445.931 Euro 2	V6cyl.	10964cc	230kW (313PS)	Diesel	Turbo Intercooled	TD6298
OM 445.933 Euro 2	V6cyl.	10964cc	200kW (272PS)	Diesel	Turbo Intercooled	TD6070
OM 445.934 Euro 2	V6cyl.	10964cc	250kW (340PS)	Diesel	Turbo Intercooled	TD10969
OM 445.935 Euro 2	V6cyl.	10964cc	213kW (290PS)	Diesel	Turbo Intercooled	TD10970
OM 445.936 Euro 2	V6cyl.	10964cc	200kW (272PS)	Diesel	Turbo Intercooled	TD6109
OM 445.937 Euro 2	V6cyl.	10964cc	230kW (313PS)	Diesel	Turbo Intercooled	TD6112
OM 445.938 Euro 2	V6cyl.	10960cc	180kW (245PS)	Diesel	Turbo Intercooled	TD6087
OM 445.939 Euro 2	V6cyl.	10964cc	250kW (340PS)	Diesel	Turbo Intercooled	TD6117
OM 445.940 Euro 2	V6cyl.	10964cc	200kW (272PS)	Diesel	Turbo Intercooled	TD6148
OM 445.941 Euro 2	V6cyl.	10960cc	180kW (245PS)	Diesel	Turbo Intercooled	TD6288
OM 442 A Euro 1	V8cyl.	14618cc	250kW (340PS)	Diesel	Turbo	FM7008
OM 446.920 Euro 2	V8cyl.	14618cc	390kW (530PS)	Diesel	Turbo Intercooled	TD5789
OM 446.922 Euro 2	V8cyl.	14618cc	320kW (435PS)	Diesel	Turbo Intercooled	TD8207
OM 446.924 Euro 2	V8cyl.	14618cc	280kW (381PS)	Diesel	Turbo Intercooled	TD5785





OM 446.925 Euro 2	V8cyl.	14618cc	280kW (381PS)	Diesel	Turbo Intercooled	TD6120
OM 446.926 Euro 2	V8cyl.	14618cc	280kW (381PS)	Diesel	Turbo Intercooled	TD5834
OM 446.927 Euro 2	V8cyl.	14618cc	280kW (381PS)	Diesel	Turbo Intercooled	TD8203
OM 446.928 Euro 2	V8cyl.	14618cc	280kW (381PS)	Diesel	Turbo Intercooled	TD5808
OM 446.929 Euro 2	V8cyl.	14618cc	280kW (381PS)	Diesel	Turbo Intercooled	TD6155
OM 446.930 Euro 2	V8cyl.	14618cc	280kW (381PS)	Diesel	Turbo Intercooled	TD6186
OM 446.931 Euro 2	V8cyl.	14618cc	280kW (381PS)	Diesel	Turbo Intercooled	TD8257
OM 446.932 Euro 2	V8cyl.	14618cc	390kW (530PS)	Diesel	Turbo Intercooled	TD8260
OM 446.933 Euro 2	V8cyl.	14618cc	390kW (530PS)	Diesel	Turbo Intercooled	TD5820
OM 446.934 Euro 2	V8cyl.	14618cc	280kW (381PS)	Diesel	Turbo Intercooled	TD10974
OM 446.935 Euro 2	V8cyl.	14618cc	320kW (435PS)	Diesel	Turbo Intercooled	TD16982
OM 446.936 Euro 2	V8cyl.	14618cc	320kW (435PS)	Diesel	Turbo Intercooled	TD8247
OM 446.938 Euro 2	V8cyl.	14618cc	280kW (381PS)	Diesel	Turbo Intercooled	TD10975
OM 446.939 Euro 2	V8cyl.	14618cc	320kW (435PS)	Diesel	Turbo Intercooled	TD5835
OM 446.940 Euro 2	V8cyl.	14618cc	320kW (435PS)	Diesel	Turbo Intercooled	TD6187
OM 446.941 Euro 2	V8cyl.	14618cc	320kW (435PS)	Diesel	Turbo Intercooled	TD16983
OM 446.942 Euro 2	V8cyl.	14618cc	320kW (435PS)	Diesel	Turbo Intercooled	TD5809
OM 446.943 Euro 2	V8cyl.	14618cc	320kW (435PS)	Diesel	Turbo Intercooled	TD8204
OM 446.945 Euro 2	V8cyl.	14618cc	390kW (530PS)	Diesel	Turbo Intercooled	TD6171
OM 446.946 Euro 2	V8cyl.	14618cc	390kW (530PS)	Diesel	Turbo Intercooled	TD6125
OM 446.948 Euro 2	V8cyl.	14618cc	320kW (435PS)	Diesel	Turbo Intercooled	TD6156

- 14-451160-00 WH ②
- 14-452030-00 WH ①
- 14-452390-00 WH ②

128.00

B 144.50	C 253.00	D 153.80	E 10.07	F 1.00
B 144.50	C 253.00	D 153.80	E 9.92	F 1.00
B 144.50	C 253.00	D 153.80	E 10.57	F 1.00

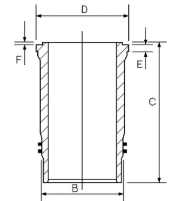

- ① O ring = HL5070
- ② O ring = HT018

- ① Ringdichtungen = HL5070
- ② Ringdichtungen = HT018

- ① Joints toriques = HL5070
- ② Joints toriques = HT018

- ① Juntas tóricas para = HL5070
- ② Juntas tóricas para = HT018

21

M 476.921	6cyl.	11967cc	175kW (238PS)		Turbo Intercooled	TD22729
M 476.925	6cyl.	11967cc	177kW (240PS)		Turbo Intercooled	TD22730
M 476.926	6cyl.	11967cc	177kW (240PS)		Turbo Intercooled	TD22731
M 476.927	6cyl.	11967cc	177kW (240PS)		Turbo Intercooled	TD22732
M 476.930 Euro 2	6cyl.	11967cc	240kW (326PS)		Turbo Intercooled	TD17490
OM 427 A	6cyl.	11967cc	206kW (280PS)	Diesel	Turbo	FM7065
OM 427 LA	6cyl.	11967cc		Diesel	Turbo Intercooled	FM6707
OM 427.905	6cyl.	11967cc	150kW (204PS)	Diesel		TD7951
OM 427.910	6cyl.	11967cc	177kW (240PS)	Diesel		TD5671
OM 427.911	6cyl.	11967cc	177kW (240PS)	Diesel		TD6010
OM 427.950	6cyl.	11967cc	206kW (280PS)	Diesel	Turbo	TD7946
OM 427.951	6cyl.	11967cc	206kW (280PS)	Diesel	Turbo	TD16964
OM 427.952	6cyl.	11967cc	206kW (280PS)	Diesel	Turbo	TD16965
OM 429.951	5cyl.	9970cc	175kW (238PS)	Diesel	Turbo Intercooled	TD8164
OM 429.952	5cyl.	9970cc	175kW (238PS)	Diesel	Turbo Intercooled	TD18818





OM 429.953	5cyl.	9970cc	186kW (253PS)	Diesel	Turbo	TD5755
OM 429.955	5cyl.	9970cc	186kW (253PS)	Diesel	Turbo Intercooled	TD6088
OM 447	6cyl.	11967cc	147kW (200PS)	Diesel		FM7067
OM 447 A	6cyl.	11967cc	206kW (280PS)	Diesel	Turbo	FM7004
OM 447 LA	6cyl.	11967cc		Diesel	Turbo Intercooled	FM6705
OM 447.902	6cyl.	11967cc	184kW (250PS)	Diesel	Turbo	TD28723
OM 447.905	6cyl.	11967cc	150kW (204PS)	Diesel		TD7947
OM 447.906	6cyl.	11967cc	177-184kW (240-250PS)	Diesel		TD5674
OM 447.907	6cyl.	11967cc	177kW (240PS)	Diesel		TD5672
OM 447.908	6cyl.	11967cc	177kW (240PS)	Diesel		TD6011
OM 447.910	6cyl.	11967cc	177kW (240PS)	Diesel		TD7956
OM 447.911	6cyl.	11967cc	150kW (204PS)	Diesel		TD7957
OM 447.912	6cyl.	11970cc	184kW (250PS)	Diesel		TD7961
OM 447.913 Euro 1	6cyl.	11967cc	157kW (214PS)	Diesel		TD7948
OM 447.914 Euro 1	6cyl.	11967cc	157kW (214PS)	Diesel		TD7958
OM 447.915	6cyl.	11967cc	185kW (252PS)			TD16986
OM 447.916	6cyl.	11967cc	185kW (252PS)			TD16987
OM 447.947 Euro 1	6cyl.	11967cc	220kW (299PS)	Diesel	Turbo Intercooled	TD22805
OM 447.948 Euro 2	6cyl.	11967cc	220kW (299PS)	Diesel	Turbo Intercooled	TD22806
OM 447.949 Euro 2	6cyl.	11967cc	157kW (214PS)	Diesel	Turbo Intercooled	TD22807
OM 447.950	6cyl.	11967cc	206kW (280PS)	Diesel	Turbo	TD5673
OM 447.951	6cyl.	11967cc	206kW (280PS)	Diesel	Turbo	TD6012
OM 447.952 Euro 1	6cyl.	11967cc	206kW (280PS)	Diesel	Turbo	TD16988
OM 447.953 Euro 1	6cyl.	11967cc	206kW (280PS)	Diesel	Turbo	TD16989
OM 447.954 Euro 1	6cyl.	11967cc	184kW (250PS)	Diesel	Turbo	TD10976
OM 447.955 Euro 1	6cyl.	11967cc	184kW (250PS)	Diesel	Turbo	TD10977
OM 447.956 Euro 1	6cyl.	11967cc	184kW (250PS)	Diesel	Turbo	TD7949
OM 447.957 Euro 1	6cyl.	11967cc	184kW (250PS)	Diesel	Turbo	TD7959
OM 447.958 Euro 1	6cyl.	11970cc	184kW (250PS)	Diesel	Turbo	TD7962
OM 447.959 Euro 1	6cyl.	11970cc	184kW (250PS)	Diesel	Turbo	TD7954
OM 447.960 Euro 1	6cyl.	11970cc	184kW (250PS)	Diesel	Turbo Intercooled	TD22808
OM 447.970 Euro 2	6cyl.	11967cc	157kW (214PS)	Diesel	Turbo Intercooled	TD10978
OM 447.971 Euro 2	6cyl.	11967cc	184kW (250PS)	Diesel	Turbo Intercooled	TD10979
OM 447.972 Euro 2	6cyl.	11967cc	220kW (299PS)	Diesel	Turbo Intercooled	TD10980
OM 447.973 Euro 2	6cyl.	11967cc	157kW (214PS)	Diesel	Turbo Intercooled	TD10981
OM 447.974 Euro 2	6cyl.	11967cc	184kW (250PS)	Diesel	Turbo Intercooled	TD10982
OM 447.975 Euro 1	6cyl.	11967cc	220kW (299PS)	Diesel	Turbo Intercooled	TD11007
OM 447.976 Euro 2	6cyl.	11967cc	184kW (250PS)	Diesel	Turbo Intercooled	TD10983
OM 447.977 Euro 2	6cyl.	11967cc	220kW (299PS)	Diesel	Turbo Intercooled	TD11009
OM 447.978	6cyl.	11967cc	184kW (250PS)	Diesel	Turbo Intercooled	TD10984
OM 447.979 Euro 2	6cyl.	11967cc	220kW (299PS)	Diesel	Turbo Intercooled	TD10985
OM 447.980 Euro 1	6cyl.	11967cc	220kW (299PS)	Diesel	Turbo Intercooled	TD11008
OM 447.981 Euro 1	6cyl.	11967cc	220kW (299PS)	Diesel	Turbo Intercooled	TD7950
OM 447.982 Euro 1	6cyl.	11967cc	220kW (299PS)	Diesel	Turbo Intercooled	TD17811
OM 447.983 Euro 1	6cyl.	11967cc	220kW (299PS)	Diesel	Turbo Intercooled	TD17812





OM 447.984 Euro 1	6cyl.	11970cc	220kW (299PS)	Diesel	Turbo Intercooled	TD7955
OM 447.985 Euro 1	6cyl.	11967cc	220kW (299PS)	Diesel	Turbo Intercooled	TD10986
OM 447.986 Euro 1	6cyl.	11967cc	220kW (299PS)	Diesel	Turbo Intercooled	TD7960
OM 447.987 Euro 1	6cyl.	11970cc	220kW (299PS)	Diesel	Turbo Intercooled	TD7963
OM 447.988 Euro 2	6cyl.	11970cc	220kW (299PS)	Diesel	Turbo Intercooled	TD16990
OM 447.990 Euro 2	6cyl.	11967cc	184kW (250PS)	Diesel	Turbo Intercooled	TD10987
OM 447.991 Euro 2	6cyl.	11967cc	220kW (299PS)	Diesel	Turbo Intercooled	TD10988
OM 447.992 Euro 2	6cyl.	11967cc	184kW (250PS)	Diesel	Turbo Intercooled	TD10989
OM 447.993 Euro 2	6cyl.	11967cc	220kW (299PS)	Diesel	Turbo Intercooled	TD10990
OM 447.994 Euro 2	6cyl.	11967cc	220kW (299PS)	Diesel	Turbo Intercooled	TD16991
OM 447.995 Euro 1	6cyl.	11967cc	184kW (250PS)	Diesel	Turbo	TD17813
OM 447.996 Euro 2	6cyl.	11970cc	184kW (250PS)	Diesel	Turbo Intercooled	TD22810
OM 447.998 Euro 2	6cyl.	11967cc	220kW (299PS)	Diesel	Turbo Intercooled	TD11010
OM 447.999 Euro 2	6cyl.	11967cc	220kW (299PS)	Diesel	Turbo Intercooled	TD23187
OM 475.950	5cyl.	9973cc	184kW (250PS)	Diesel	Turbo	TD23240
OM 475.951	5cyl.	9973cc	184kW (250PS)	Diesel	Turbo	TD23241
OM 475.952	5cyl.	9973cc	184kW (250PS)	Diesel	Turbo	TD23242
OM 475.953	5cyl.	9973cc	184kW (250PS)	Diesel	Turbo	TD23243
OM 475.954	5cyl.	9973cc	184kW (250PS)	Diesel	Turbo	TD23244
OM 475.982	5cyl.	9973cc	221kW (300PS)	Diesel	Turbo Intercooled	TD23246

14-456980-00 WH <sup>1</sup>

128.00

B 144.50

C 270.00

D 153.80

E 9.92

F 1.00

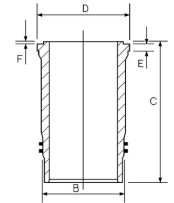

<sup>1</sup> Use also: 3 O-rings and 1 Tombak ring, Set HL5070

<sup>1</sup> Mitverwenden: 3 O-Ringe und 1 Tombakring, Satz: HL5070

<sup>1</sup> A utiliser aussi: 3 joints toriques et 1 joint Tombak. Poche

<sup>1</sup> Utilizar también: 3 juntas toricas y 1 junta Tombak. Juego H L5070

22

OM 541.953 Euro 4/5	V6cyl.	11946cc	320kW (435PS)	Diesel	Turbo Intercooled	TD28777
OM 541.959 Euro 4/5	V6cyl.	11946cc	300kW (408PS)	Diesel	Turbo Intercooled	TD28778
OM 541.970 Euro 4	V6cyl.	11946cc	235kW (320PS)	Diesel	Turbo Intercooled	TD19250
OM 541.971 Euro4/Euro5	V6cyl.	11946cc	235kW (320PS)	Diesel	Turbo Intercooled	TD21001
OM 541.972 Euro 4	V6cyl.	11946cc	265kW (360PS)	Diesel	Turbo Intercooled	TD19251
OM 541.973 Euro 4	V6cyl.	11946cc	265kW (360PS)	Diesel	Turbo Intercooled	TD21022
OM 541.974 Euro 4	V6cyl.	11946cc	300kW (408PS)	Diesel	Turbo Intercooled	TD18997
OM 541.975 Euro 4	V6cyl.	11946cc	300kW (408PS)	Diesel	Turbo Intercooled	TD21023
OM 541.976 Euro 4	V6cyl.	11946cc	320kW (435PS)	Diesel	Turbo Intercooled	TD19000
OM 541.977 Euro 4	V6cyl.	11946cc	320kW (435PS)	Diesel	Turbo Intercooled	TD21024
OM 541.979 Euro 4/5	V6cyl.	11946cc	350kW (476PS)	Diesel	Turbo Intercooled	TD28783
OM 541.990 Euro 5	V6cyl.	11946cc	300kW (408PS)	Diesel	Turbo Intercooled	TD23767
OM 541.991	V6cyl.	11946cc	300kW (408PS)	Diesel	Turbo Intercooled	TD25686
OM 541.992 Euro 5	V6cyl.	11946cc	320kW (435PS)	Diesel	Turbo Intercooled	TD23768
OM 541.997	V6cyl.	11946cc	235kW (320PS)	Diesel	Turbo Intercooled	TD25697
OM 541.998 Euro 5	V6cyl.	11946cc	265kW (360PS)	Diesel	Turbo Intercooled	TD25487







OM 541.999	V6cyl.	11946cc	265kW (360PS)	Diesel	Turbo Intercooled	TD25698
OM 542.960 Euro 5	V8cyl.	15928cc	375kW (510PS)	Diesel	Turbo Intercooled	TD19999
OM 542.961 Euro 5	V8cyl.	15928cc	375kW (510PS)	Diesel	Turbo Intercooled	TD21026
OM 542.962 Euro 5	V8cyl.	15928cc	405kW (551PS)	Diesel	Turbo Intercooled	TD18840
OM 542.963 Euro 5	V8cyl.	15928cc	405kW (551PS)	Diesel	Turbo Intercooled	TD21025
OM 542.964 Euro 5	V8cyl.	15928cc	440kW (598PS)	Diesel	Turbo Intercooled	TD20000
OM 542.965	V8cyl.	15928cc	440kW (598PS)	Diesel	Turbo Intercooled	TD25688
OM 542.966 Euro 5	V8cyl.	15928cc	350-370kW (476-503PS)	Diesel	Turbo Intercooled	TD25103
OM 542.970 Euro 5	V8cyl.	15928cc	448kW (609PS)	Diesel	Turbo Intercooled	TD28779
OM 542.971 Euro 5	V8cyl.	15928cc	448kW (609PS)	Diesel	Turbo Intercooled	TD28780

- 13-451220-00 D ②
- 14-450790-00 WH ①
- 14-451220-00 WH ①
- 15-451220-00 WH ①③

130.00

B 133.85	C 13.43	D 164.10	E 10.12	F 1.10
B 151.20	C 258.00	D 164.20	E 10.12	F 1.10
B 151.20	C 258.00	D 164.20	E 10.12	F 1.10
B 151.20	C 258.00	D 164.10	E 10.12	F 1.10

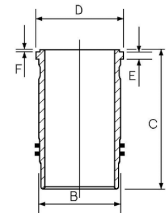

- |  |  |   |  |
|--|--|---|--|
| ① Includes anti-polish/Fire ring                   | ① Enthält Ölschlitzring                  | ① Contient le segment racléur                       | ① Incluye el segmento rascador                       |
| ② Anti-polish/Fire ring, also available separately | ② Ölschlitzring, auch einzeln erhältlich | ② Segment racléur (disponible également) séparément | ② Segmento rascador, también disponible por separado |
| ③ Includes seals                                   | ③ Schließt Dichtungen ein                | ③ Inclut des joints                                 | ③ Incluye los sellos                                 |

23

OM 521.940 Euro 2	V6cyl.	11946cc	315kW (428PS)	Diesel	Turbo Intercooled	TD16791
OM 521.950 Euro 2	V6cyl.	11946cc	260kW (354PS)	Diesel	Turbo Intercooled	TD17671
OM 521.951 Euro 2	V6cyl.	11946cc	335kW (456PS)	Diesel	Turbo Intercooled	TD28776
OM 522.940 Euro 2	V8cyl.	15928cc	420kW (571PS)	Diesel	Turbo Intercooled	TD16800
OM 522.941 Euro 2	V8cyl.	15928cc	413kW (562PS)	Diesel	Turbo Intercooled	TD17672
OM 522.942 Euro 2	V8cyl.	15928cc	362kW (492PS)	Diesel	Turbo Intercooled	TD17673
OM 522.943 Euro 2	V8cyl.	15928cc	362kW (492PS)	Diesel	Turbo Intercooled	TD17674
OM 522.950 Euro 2	V8cyl.	15928cc	530kW (721PS)	Diesel	Turbo Intercooled	TD22822
OM 541.920 Euro 2	V6cyl.	11946cc	230kW (313PS)	Diesel	Turbo Intercooled	TD7872
OM 541.921 Euro 2	V6cyl.	11946cc	315kW (428PS)	Diesel	Turbo Intercooled	TD9673
OM 541.922 Euro 2	V6cyl.	11946cc	260kW (354PS)	Diesel	Turbo Intercooled	TD7873
OM 541.923 Euro 2	V6cyl.	11946cc	290kW (394PS)	Diesel	Turbo Intercooled	TD7874
OM 541.924 Euro 2	V6cyl.	11946cc	290kW (394PS)	Diesel	Turbo Intercooled	TD7880
OM 541.925 Euro 2	V6cyl.	11946cc	315kW (428PS)	Diesel	Turbo Intercooled	TD7875
OM 541.926 Euro 2	V6cyl.	11946cc	230kW (313PS)	Diesel	Turbo Intercooled	TD7879
OM 541.927 Euro 2	V6cyl.	11946cc	260kW (354PS)	Diesel	Turbo Intercooled	TD9679
OM 541.928 Euro 2	V6cyl.	11946cc	315kW (428PS)	Diesel	Turbo Intercooled	TD17679
OM 541.940 Euro2/Euro3	V6cyl.	11946cc	230-235kW (313-320PS)	Diesel	Turbo Intercooled	TD16897
OM 541.941 Euro2/Euro3	V6cyl.	11946cc	230-235kW (313-320PS)	Diesel	Turbo Intercooled	TD16898
OM 541.942 Euro 3	V6cyl.	11946cc	260-265kW (354-360PS)	Diesel	Turbo Intercooled	TD16899
OM 541.943 Euro 3	V6cyl.	11946cc	260-265kW (354-360PS)	Diesel	Turbo Intercooled	TD16900
OM 541.944 Euro 3	V6cyl.	11946cc	290-335kW (394-456PS)	Diesel	Turbo Intercooled	TD16901
OM 541.945 Euro 3	V6cyl.	11946cc	290-300kW (394-408PS)	Diesel	Turbo Intercooled	TD16902





OM 541.946 Euro 3	V6cyl.	11946cc	315-320kW (428-435PS)	Diesel	Turbo Intercooled	TD16903
OM 541.947 Euro 3	V6cyl.	11946cc	315-320kW (428-435PS)	Diesel	Turbo Intercooled	TD16904
OM 541.948 Euro 3	V6cyl.	11946cc	335kW (456PS)	Diesel	Turbo Intercooled	TD16913
OM 541.949 Euro 3	V6cyl.	11946cc	335kW (456PS)	Diesel	Turbo Intercooled	TD16914
OM 541.950 Euro 3	V6cyl.	11946cc	260-300kW (354-408PS)	Diesel	Turbo Intercooled	TD17682
OM 541.951 Euro2/Euro3	V6cyl.	11946cc	230-235kW (313-320PS)	Diesel	Turbo Intercooled	TD17684
OM 541.952 Euro2/Euro3	V6cyl.	11946cc	230-260kW (313-354PS)	Diesel	Turbo Intercooled	TD17685
OM 541.960 Euro 2	V6cyl.	11946cc	240kW (326PS)	Diesel	Turbo Intercooled	TD25520
OM 541.978 Euro 3	V6cyl.	11946cc	350kW (476PS)	Diesel	Turbo Intercooled	TD21007
OM 541.980 Euro 3	V6cyl.	11946cc	335kW (456PS)	Diesel	Turbo Intercooled	TD21000
OM 541.981 Euro 3	V6cyl.	11946cc	335kW (456PS)	Diesel	Turbo Intercooled	TD21003
OM 541.994 Euro 5	V6cyl.	11946cc	335kW (456PS)	Diesel	Turbo Intercooled	TD23769
OM 542.920	V8cyl.	15928cc	390kW (530PS)	Diesel	Turbo Intercooled	TD7877
OM 542.921	V8cyl.	15928cc	350kW (476PS)	Diesel	Turbo Intercooled	TD7876
OM 542.922	V8cyl.	15928cc	420kW (571PS)	Diesel	Turbo Intercooled	TD7878
OM 542.923	V8cyl.	15928cc	420kW (571PS)	Diesel	Turbo Intercooled	TD16905
OM 542.924	V8cyl.	15928cc	420kW (571PS)	Diesel	Turbo Intercooled	TD17686
OM 542.925 Euro 2	V8cyl.	15928cc	350kW (476PS)	Diesel	Turbo Intercooled	TD9683
OM 542.926	V8cyl.	15928cc	390kW (530PS)	Diesel	Turbo Intercooled	TD17687
OM 542.940 Euro 3	V8cyl.	15928cc	370-375kW (503-510PS)	Diesel	Turbo Intercooled	TD16909
OM 542.941 Euro 3	V8cyl.	15928cc	370kW (503PS)	Diesel	Turbo Intercooled	TD16911
OM 542.942 Euro 3	V8cyl.	15928cc	390-395kW (530-537PS)	Diesel	Turbo Intercooled	TD16906
OM 542.943 Euro 3	V8cyl.	15928cc	390-395kW (530-537PS)	Diesel	Turbo Intercooled	TD16907
OM 542.944 Euro 3	V8cyl.	15928cc	420-425kW (571-578PS)	Diesel	Turbo Intercooled	TD16912
OM 542.945 Euro 3	V8cyl.	15928cc	420-425kW (571-578PS)	Diesel	Turbo Intercooled	TD17689
OM 542.947	V8cyl.	15928cc	390-420kW (530-571PS)	Diesel	Turbo Intercooled	TD17690
OM 542.948 Euro 3	V8cyl.	15928cc	320-370kW (435-503PS)	Diesel	Turbo Intercooled	TD17655
OM 542.956 Euro 3	V8cyl.	15928cc	448kW (609PS)	Diesel	Turbo Intercooled	TD17691
OM 542.957 Euro 3	V8cyl.	15928cc	448kW (609PS)	Diesel	Turbo Intercooled	TD17692
OM 542.958 Euro 3	V8cyl.	15928cc	450kW (612PS)	Diesel	Turbo Intercooled	TD24684
OM 542.972 Euro 5	V8cyl.	15928cc	405-480kW (551-653PS)	Diesel	Turbo Intercooled	TD28781
OM 941.910 Euro 2	V6cyl.	11946cc	230kW (313PS)	Diesel	Turbo Intercooled	TD17693
OM 941.920 Euro 2	V6cyl.	11946cc	260kW (354PS)	Diesel	Turbo Intercooled	TD16793
OM 941.921 Euro 2	V6cyl.	11946cc	260kW (354PS)	Diesel	Turbo Intercooled	TD17694
OM 941.929 Euro 2	V6cyl.	11946cc	290kW (394PS)	Diesel	Turbo Intercooled	TD16794
OM 941.930 Euro 2	V6cyl.	11946cc	300kW (408PS)	Diesel	Turbo Intercooled	TD16795
OM 941.940 Euro 2	V6cyl.	11946cc	300kW (428PS)	Diesel	Turbo Intercooled	TD16796
OM 941.960 Euro 2	V6cyl.	11946cc	230kW (313PS)	Diesel	Turbo Intercooled	TD16797
OM 941.970 Euro 2	V6cyl.	11946cc	260kW (354PS)	Diesel	Turbo Intercooled	TD16798
OM 941.980 Euro 2	V6cyl.	11946cc	290kW (394PS)	Diesel	Turbo Intercooled	TD17695
OM 941.981 Euro 2	V6cyl.	11946cc	290-315kW (394-428PS)	Diesel	Turbo Intercooled	TD17696
OM 941.990 Euro 2	V6cyl.	11946cc	315kW (428PS)	Diesel	Turbo Intercooled	TD16799
OM 942.900 Euro 2	V8cyl.	15928cc	350kW (470PS)	Diesel	Turbo Intercooled	TD17697
OM 942.910 Euro 2	V8cyl.	15928cc	350kW (470PS)	Diesel	Turbo Intercooled	TD17698
OM 942.911 Euro 2	V8cyl.	15928cc	350kW (470PS)	Diesel	Turbo Intercooled	TD16801





OM 942.912 Euro 2	V8cyl.	15928cc	350kW (470PS)	Diesel	Turbo Intercooled	TD17699
OM 942.925 Euro 2	V8cyl.	15928cc	400kW (544PS)	Diesel	Turbo Intercooled	TD17700
OM 942.930 Euro 2	V8cyl.	15928cc	420kW (571PS)	Diesel	Turbo Intercooled	TD16802
OM 942.960 Euro 2	V8cyl.	15928cc	350kW (470PS)	Diesel	Turbo Intercooled	TD17701
OM 942.967 Euro 2	V8cyl.	15928cc	370-380kW (503-517PS)	Diesel	Turbo Intercooled	TD17702
OM 942.970 Euro 2	V8cyl.	15928cc	390kW (530PS)	Diesel	Turbo Intercooled	TD17703
OM 942.980 Euro 2	V8cyl.	15928cc	420kW (571PS)	Diesel	Turbo Intercooled	TD16803
OM 942.990 Euro 2	V8cyl.	15928cc	330-448kW (570-609PS)	Diesel	Turbo Intercooled	TD17704

14-458580-00 WH ③

130.00

B 150.00

C 258.00

D 164.10

E 10.12

F 1.10

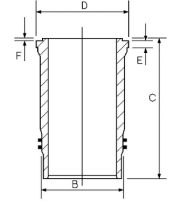

14-450250-00 WH ①②

130.00

B 150.00

C 258.00

D 164.10

E 10.12

F 1.10

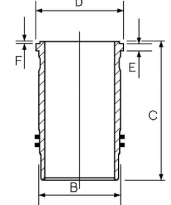

① Has different upper register design compared to 14-458580-00

① Hat unterschiedliche obere Flanschführung im Vergleich zu 14-458580-00

① Profil inférieur de la colerette différent de 14-45880-00

① Tiene un registro superior diferente comparado al 14-458580-00

② Round water channel

② Runder Wasserkanal

② Canal d'eau rond

② Canal de agua redondo

③ Rectangular water channel under flange

③ Rechteckiger Wasserkanal unter dem Buchsenbund

③ Canal d'eau rectangulaire sous la bride

③ Canal de agua rectangular bajo la pestaña

24

OM 440.907 Euro 1	V8cyl.	15080cc	195kW (265PS)	Diesel	TD16966
OM 440.908 Euro 1	V8cyl.	15080cc	206kW (280PS)	Diesel	TD17118
OM 440.909	V8cyl.	15080cc	195kW (265PS)	Diesel	TD8192
OM 440.910 Euro 1	V8cyl.	15080cc	218kW (296PS)	Diesel	TD17119
OM 440.911 Euro 1	V8cyl.	15080cc	218kW (296PS)	Diesel	TD17120
OM 441 / EURO 1	6cyl.	11309cc	151kW (205PS)	Diesel	FM17010
OM 441.905	V6cyl.	10964cc	165kW (224PS)	Diesel	TD5731
OM 441.906	V6cyl.	10964cc	150kW (204PS)	Diesel	TD8184
OM 441.907	V6cyl.	10964cc	150kW (204PS)	Diesel	TD8185
OM 441.908	V6cyl.	10964cc	160-165kW (218-224PS)	Diesel	TD5660
OM 441.909	V6cyl.	10964cc	160-165kW (218-224PS)	Diesel	TD5998
OM 441.911	V6cyl.	10964cc	160-165kW (218-224PS)	Diesel	TD6271
OM 441.912	V6cyl.	11309cc	165kW (224PS)	Diesel	TD6142
OM 441.913	V6cyl.	10964cc	165kW (224PS)	Diesel	Turbo Intercooled TD6063
OM 441.914	V6cyl.	11309cc	165kW (224PS)	Diesel	TD6101
OM 441.915	V6cyl.	10964cc	165kW (224PS)	Diesel	TD8121
OM 441.916	V6cyl.	11309cc	153kW (208PS)	Diesel	TD5768
OM 441.917	V6cyl.	10964cc	160kW (218PS)	Diesel	TD8122
OM 441.918	V6cyl.	11309cc	165kW (224PS)	Diesel	TD10968







OM 441.919	V6cyl.	11309cc	153kW (208PS)	Diesel	TD16972
OM 441.920	V6cyl.	11309cc	153kW (208PS)	Diesel	TD6100
OM 441.923	V6cyl.	10964cc	160kW (218PS)	Diesel	TD5732
OM 441.924	V6cyl.	11309cc	160kW (218PS)	Diesel	TD6143
OM 441.925	V6cyl.	10964cc	160kW (218PS)	Diesel	TD6064
OM 441.926	V6cyl.	10964cc	160kW (218PS)	Diesel	TD8119
OM 441.927	V6cyl.	10964cc	153kW (208PS)	Diesel	TD8123
OM 441.932	V6cyl.	11309cc	151kW (205PS)	Diesel	TD8190
OM 442 Euro 1	V8cyl.	15080cc	195kW (265PS)	Diesel	FM17011
OM 442.905	V8cyl.	15080cc	191kW (260PS)	Diesel	TD8186
OM 442.906	V8cyl.	15080cc	218kW (296PS)	Diesel	TD5769
OM 442.907	V8cyl.	15080cc	213kW (290PS)	Diesel	TD5771
OM 442.908	V8cyl.	15080cc	210kW (286PS)	Diesel	TD5790
OM 442.909	V8cyl.	15080cc	210kW (286PS)	Diesel	TD5791
OM 442.910	V8cyl.	15080cc	213-218kW (290-296PS)	Diesel	TD5662
OM 442.911	V8cyl.	15080cc	218kW (296PS)	Diesel	TD10971
OM 442.914	V8cyl.	15080cc	195kW (265PS)	Diesel	TD5734
OM 442.915	V8cyl.	15078cc	218kW (296PS)	Diesel	TD5822
OM 442.916	V8cyl.	15078cc	218kW (296PS)	Diesel	TD6174
OM 442.917	V8cyl.	15080cc	218kW (296PS)	Diesel	TD6297
OM 442.918	V8cyl.	15080cc	213-218kW (290-296PS)	Diesel	TD6000
OM 442.919	V8cyl.	15080cc	213-218kW (290-296PS)	Diesel	TD6272
OM 442.920	V8cyl.	15080cc	195kW (265PS)	Diesel	TD5735
OM 442.921	V8cyl.	15080cc	195kW (265PS)	Diesel	TD6144
OM 442.922	V8cyl.	15080cc	195kW (265PS)	Diesel	TD5770
OM 442.923	V8cyl.	15080cc	210kW (286PS)	Diesel	TD6127
OM 442.924	V8cyl.	15080cc	210kW (286PS)	Diesel	TD6128
OM 442.925	V8cyl.	15080cc	213kW (290PS)	Diesel	TD5815
OM 442.926	V8cyl.	15080cc	213kW (290PS)	Diesel	TD5792
OM 442.927	V8cyl.	15078cc	213kW (290PS)	Diesel	TD5823
OM 442.928	V8cyl.	15078cc	213kW (290PS)	Diesel	TD6175
OM 442.929	V8cyl.	15080cc	213kW (290PS)	Diesel	TD6129
OM 442.930	V8cyl.	15100cc	213kW (290PS)	Diesel	TD7944
OM 442.931	V8cyl.	15100cc	195kW (265PS)	Diesel	TD7945
OM 442.932	V8cyl.	15080cc	195kW (265PS)	Diesel	TD6066
OM 442.933	V8cyl.	15080cc	195kW (265PS)	Diesel	TD6067
OM 442.934	V8cyl.	15080cc	195kW (265PS)	Diesel	TD6324
OM 442.935	V8cyl.	15080cc	195kW (265PS)	Diesel	TD6102
OM 442.939	V8cyl.	15080cc	213-218kW (290-296PS)	Diesel	TD6319
OM 443.900	V10cyl.	18848cc	331kW (450PS)	Diesel	TD28720





**OM 443.905** V10cyl. **18848cc** **271kW** (369PS) **Diesel** **TD16981**

**OM 444** V12cyl. **22618cc** **Diesel** **FM6641**

**14-456330-00 WH** ① **130.00** **B 144.50** **C 253.00** **D 153.80** **E 9.92** **F 1.00**

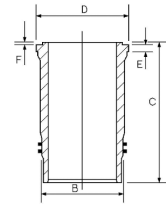

① O ring = HL5070

① Ringdichtungen = HL5070

① Joints toriques = HL5070

① Juntas tóricas para = HL5070

**25**

**OM 522 LA Euro 2** V8cyl. **15928cc** **362-420kW** (496-570PS) **Diesel Turbo Intercooled** **FM15588**

**14-450250-00 WH** ②③ **130.00** **B 150.00** **C 258.00** **D 164.10** **E 10.12** **F 1.10**

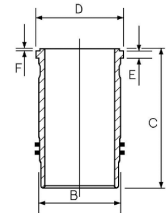

**14-458580-00 WH** ① **130.00** **B 150.00** **C 258.00** **D 164.10** **E 10.12** **F 1.10**

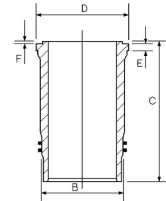

① Rectangular water channel under flange

① Rechteckiger Wasserkanal unter dem

① Canal d'eau rectangulaire sous la bride  
Buchsenbund

① Canal de agua rectangular bajo la pestaña

② Has different upper register design  
compared to 14-458580-00

② Hat unterschiedliche obere Flanschausführung  
im Vergleich zu 14-458580-00

② Profil inferieur de la colerette  
different de 14-45880-00

② Tiene un registro superior diferente  
comparado al 14-458580-00

③ Round water channel

③ Runder Wasserkanal

③ Canal d'eau rond

③ Canal de agua redondo

Modelverzeichnis • Index de modele • Índice de Modelo  
Indeks modelu • Модель автомобиля • دليل الموديل

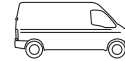

# MODEL INDEX



CCM

x



03/03→05/05	<b>Express 1.4</b>	14 K4F	Petrol	1396	4	<b>2</b>
03/03→05/05	<b>Express 1.8</b>	18 K4F, 18 K4K (VVC)	Petrol	1796	4	<b>3</b>
01/68→12/72	<b>Mk II 1300</b>	A Series	Petrol	1275	4	<b>1</b>
03/95→03/02	<b>MGF 1.8</b>	18 K4F, 18 K4K (VVC)	Petrol	1796	4	<b>3</b>
01/82→12/87	<b>MG Metro 1300</b>	A+ Series	Petrol	1275	4	<b>1</b>
03/02→12/09	<b>MG TF 1.8</b>	18 K4F, 18 K4K (VVC)	Petrol	1796	4	<b>3</b>
06/01→04/05	<b>MG ZR 1.4</b>	14 K4F	Petrol	1396	4	<b>2</b>
06/01→04/05	<b>MG ZR 1.8</b>	18 K4F, 18 K4K (VVC)	Petrol	1796	4	<b>3</b>
07/01→10/05	<b>MG ZS 1.8</b>	18 K4F	Petrol	1796	4	<b>3</b>
07/01→10/05	<b>MG ZS 2.5</b>	25 K4F	Petrol	2497	V6	<b>3</b>
01/03→07/05	<b>MG ZT 1.8</b>	18 K4F	Petrol	1796	4	<b>3</b>
06/01→07/05	<b>MG ZT 2.5</b>	25 K4F	Petrol	2497	V6	<b>3</b>
01/03→07/05	<b>MG ZT- 1.8</b>	18 K4F	Petrol	1796	4	<b>3</b>
10/01→07/05	<b>MG ZT- 2.5</b>	25 K4F	Petrol	2497	V6	<b>3</b>
01/67→12/73	<b>Midget Mk II</b>	A Series	Petrol	1275	4	<b>1</b>



1

**A+ SERIES** 4cyl. **1275cc** **FM2934**

**A SERIES** 4cyl. **1275cc** **FM1176**

14-010890-00 *D* 70.62 B 73.09 C 141.28

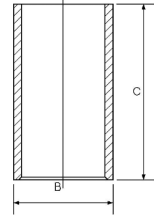

2

**14 K4F** 4cyl. **1396cc** **76kW (103PS)** **TD18866**

14-710030-00 *WH* 75.00 B 84.10 C 129.50 D 87.50 E 50.000

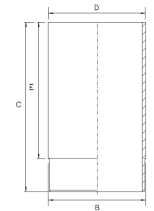

3

**18 K4F** 4cyl. **1796cc** **88kW (120PS)** **TD18234**

**18 K4K (VVC)** 4cyl. **1796cc** **118kW (160PS)** **TD18235**

**25 K4F** V6cyl. **2497cc** **118-140kW (160-190PS)** **TD18236**

14-710020-00 *WH* 80.00 B 84.10 C 129.50 D 87.50 E 50.05

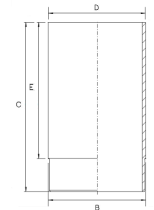

Modelverzeichnis • Index de modele • Índice de Modelo  
Indeks modelu • Модель автомобиля • دليل المركبة

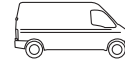

# MODEL INDEX



CCM



11/06→09/10	<b>Mini 1.6</b>	9HZ (DV6TED4)	Diesel	1560	4	1
10/07→02/10	<b>Mini Clubman 1.6</b>	9HZ (DV6TED4)	Diesel	1560	4	1



1

9HZ (DV6TED4) 4cyl. 1560cc 80kW (109PS) Diesel Turbo Intercooled TD20982

14-020900-00 D 75.00 B 78.00 C 142.00 D 79.50 E 5.00

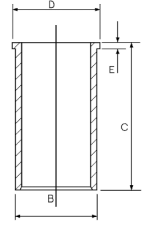

Modelverzeichnis • Index de modele • Índice de Modelo  
Indeks modelu • Модель автомобиля • دليل المركبة



# MODEL INDEX



CCM

x



	<b>Canter</b>	4D34-OA (new type)	Diesel	3907	4	<b>3</b>
09/92→09/96	<b>Canter 2.5</b>	4 D 56 (8V)	Diesel	2477	4	<b>1</b>
09/80→05/84	<b>Galant II 2.3</b>	4 D 55 T	Diesel	2346	4	<b>1</b>
06/98→	<b>Kuda 2.5</b>	4 D 56 (8V)	Diesel	2477	4	<b>1</b>
10/82→10/86	<b>L 200 2.3</b>	4 D 55	Diesel	2347	4	<b>1</b>
10/86→12/07	<b>L 200 2.5</b>	4 D 56 (8V), 4 D 56 TD	Diesel	2477	4	<b>1</b>
09/90→	<b>L 200 2.5</b>	4 D 56 T	Diesel	2476	4	<b>1</b>
04/83→10/86	<b>L 300 2.3</b>	4 D 55	Diesel	2347	4	<b>1</b>
11/86→	<b>L 300 2.5</b>	4 D 56 (8V), 4 D 56 TD	Diesel	2477	4	<b>1</b>
02/87→	<b>L 300 2.5</b>	4 D 56 T	Diesel	2476	4	<b>1</b>
09/96→06/05	<b>L 400 2.5</b>	4 D 56 T	Diesel	2476	4	<b>1</b>
05/95→05/00	<b>L 400 / Space Gear 2.5</b>	4 D 56 TD	Diesel	2477	4	<b>1</b>
05/95→06/05	<b>L 400 / Space Gear 2.5</b>	4 D 56 T	Diesel	2476	4	<b>1</b>
12/82→04/86	<b>Pajero I 2.3</b>	4 D 55 T	Diesel	2346	4	<b>1</b>
10/84→09/86	<b>Pajero I 2.3</b>	4 D 55	Diesel	2347	4	<b>1</b>
05/86→12/91	<b>Pajero I 2.5</b>	4 D 56 T	Diesel	2476	4	<b>1</b>
12/90→04/00	<b>Pajero II 2.5</b>	4 D 56 TD	Diesel	2477	4	<b>1</b>
03/91→08/99	<b>Pajero II 2.5</b>	4 D 56 T	Diesel	2476	4	<b>1</b>
04/00→12/06	<b>Pajero III 2.5</b>	4 D 56 T	Diesel	2476	4	<b>1</b>
07/02→	<b>Pajero Classic 2.5</b>	4 D 56 T	Diesel	2476	4	<b>1</b>
11/97→	<b>Pajero Sport 2.5</b>	4 D 56 T	Diesel	2476	4	<b>1</b>
09/08→	<b>Pajero Sport II 2.5</b>	4 D 56 T	Diesel	2476	4	<b>1</b>
12/99→01/08	<b>Pajero Sport Van 2.5</b>	4 D 56 T	Diesel	2476	4	<b>1</b>



1

4 D 55	4cyl.	2347cc	48-62kW (65-84PS)	Diesel		TD5331
4 D 55 T	4cyl.	2346cc	49kW (67PS)	Diesel	Turbo	TD2292
4 D 56 (8V)	4cyl.	2477cc	51-55kW (69-75PS)	Diesel		TD2293
4 D 56 (12V) Euro 3	4cyl.	2476cc	51-85kW (69-116PS)	Diesel		TD8288
4 D 56 T	4cyl.	2476cc	63kW (86PS)	Diesel	Turbo	TD4682
4 D 56 TD	4cyl.	2477cc	73kW (99PS)	Diesel	Turbo Intercooled	TD2294

14-020600-00 <i>DH</i>	91.10	B 94.64	C 165.10	D 96.91	E 5.065	
14-015590-00 <i>D</i>	91.10	B 94.13	C 164.50			

2

4D30	4cyl.	3297cc	64kW (87PS)	Diesel		TD8268
4D31	4cyl.	3298cc	71kW (96PS)	Diesel		TD8293
4D31T	4cyl.	3298cc	86kW (117PS)	Diesel	Turbo	TD8269

14-010970-00 <i>D</i>	100.00	B 104.00	C 196.50			
-----------------------	--------	----------	----------	--	--	--

3

4D34-OA (NEW TYPE)	4cyl.	3907cc		Diesel		FM26447
4D34-T	4cyl.	3907cc	90kW (122PS)	Diesel	Turbo Intercooled	TD20188

14-015400-00 <i>D</i>	104.00	B 108.01	C 197.40			
-----------------------	--------	----------	----------	--	--	--



Motorverzeichnis • Index de moteur • Índice de Motor  
Indeks silnika • Модель двигателя • دليل المحرك

# ENGINE INDEX



CCM

x



9

614.010	Diesel	1134	2	85.00	1
615.000	Diesel	2270	4	85.00	1
8025.01	Diesel	1559	2	95.00	2
8025.02	Diesel	1728	2	100.00	3
8035.01 / 8035.01.265	Diesel	2338	3	95.00	2
8035.02	Diesel	2592	3	100.00	3
8035.04	Diesel	2748	3	103.00	6
8035.05	Diesel	2930	3	104.00	7
8035.06	Diesel	2708	3	100.00	4
8045.01	Diesel	3119	4	95.00	2
8045.02	Diesel	3455	4	100.00	3
8045.04	Diesel	3666	4	103.00	6
8045.05	Diesel	3908	4	104.00	7
8045.06	Diesel	3613	4	100.00	4
8045.25	Diesel	3908	4	104.00	7
8055.04	Diesel	4583	5	103.00	6
8055.05	Diesel	4882	5	104.00	7
8061 L	Diesel	5499	6	103.00	5
8061.05	Diesel	5419	6	104.00	7
8061L	Diesel	5499	6	103.00	5
8065.02	Diesel	5184	6	100.00	3
8065.04	Diesel	5499	6	103.00	5
8065.05	Diesel	5861	6	104.00	7
8065.06	Diesel	5420	6	100.00	4
8065.24	Diesel	5499	6	103.00	5
8065.25	Diesel	5863	6	104.00	7
8210.02	Diesel	13798	6	137.00	13
8215.22	Diesel	13798	6	137.00	13
8215.22.520	Diesel	13798	6	137.00	13
8365.05.500	Diesel	8102	6	115.00	11
8365.05.590	Diesel	8102	6	115.00	11
8365.25.500/502	Diesel	8102	6	115.00	11
8365.25.501/503/533	Diesel	8102	6	115.00	11
8365.25.503	Diesel	8102	6	115.00	11
8365.25.590	Diesel	8102	6	115.00	11
8460.21	Diesel	9500	6	120.00	12
8460.21.002	Diesel	9500	6	120.00	12
8460.21.042	Diesel	9500	6	120.00	12
8460.21.102	Diesel	9500	6	120.00	12
8460.21.106	Diesel	9500	6	120.00	12
8460.21.708	Diesel	9500	6	120.00	12
8460.21.710	Diesel	9500	6	120.00	12
C03	Diesel	4941	4	110.00	9
C03/20/21/41	Diesel	4562	4	110.00	9
CN3	Diesel	3706	3	110.00	9
CO130	Diesel	4397	4	108.00	8
CO20/60	Diesel	4397	4	108.00	8
CO2D	Diesel	4397	4	108.00	8
CO3-13OT	Diesel	5401	4	115.00	11
CO3D	Diesel	4397	4	108.00	8
CP 3/100	Diesel	7412	6	110.00	9
Genesis 5640	Diesel	4400	4	111.77	10
Genesis 6640, 7740	Diesel	5000	4	111.77	10
Genesis 7840	Diesel	6600	6	111.77	10
Genesis 8240, 8340	Diesel	7500	6	111.77	10



1

614.010 2cyl. 1134cc Diesel FM4129

615.000 4cyl. 2270cc Diesel FM4127

14-011031-00 D 85.00 B 90.04 C 178.00

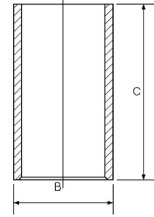

2

8025.01 2cyl. 1559cc Diesel FM569

8035.01 / 8035.01.265 3cyl. 2338cc Diesel FM4006

8045.01 4cyl. 3119cc Diesel FM571

14-010620-00 D 95.00 B 99.00 C 187.00  
14-011061-00 D B 99.10 C 187.00

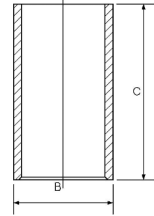

3

8025.02 2cyl. 1728cc Diesel FM573

8035.02 3cyl. 2592cc 33-40kW (45-54PS) Diesel FM3475

8045.02 4cyl. 3455cc 44-50kW (60-68PS) Diesel FM3476

8065.02 6cyl. 5184cc Diesel FM3477

14-021540-00 D 100.00 B 103.00 C 187.00 D 104.00 E 5.00

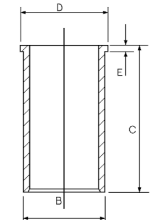

14-010170-00 D 100.00 B 103.00 C 187.00  
14-011021-00 D B 103.06 C 187.00  
14-011022-00 D B 103.10 C 187.00

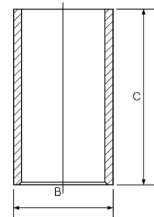



4

8035.06	3cyl.	2708cc	33-40kW (45-54PS)	Diesel	FM4008
8045.06	4cyl.	3613cc		Diesel	FM4013
8065.06	6cyl.	5420cc		Diesel	FM4017

14-010780-00 D	100.00	B 103.02	C 196.00
14-010781-00 D		B 103.06	C 196.00
14-010782-00 D		B 103.10	C 196.00

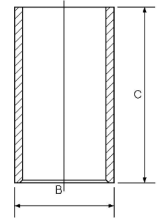

5

8061 L	6cyl.	5499cc		Diesel	FM23487
8061L	6cyl.	5499cc		Diesel	FM23487
8065.04	6cyl.	5499cc		Diesel	FM3486
8065.24	6cyl.	5499cc		Diesel Turbo	FM3487

14-023551-00 D	103.00	B 107.06	C 187.00	D 110.00	E 5.00
14-023552-00 D		B 107.18	C 187.00	D 110.00	E 5.00
14-023553-00 D		B 107.48	C 187.00	D 110.50	E 5.00

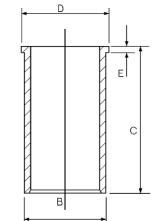

14-010180-00 D	103.00	B 107.00	C 187.00
14-010181-00 D		B 107.06	C 187.00
14-010182-00 D		B 107.10	C 187.00

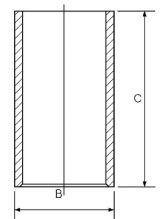

6

8035.04	3cyl.	2748cc		Diesel	FM4007
8045.04	4cyl.	3666cc		Diesel	FM3483
8055.04	5cyl.	4583cc		Diesel	FM3484

14-010180-00 D	103.00	B 107.00	C 187.00
----------------	--------	----------	----------

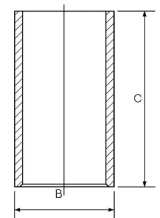



7

8035.05	3cyl.	2930cc		Diesel	FM4032
8045.05	4cyl.	3908cc		Diesel	FM4012
8045.25	4cyl.	3908cc		Diesel Turbo	FM9242
8055.05	5cyl.	4882cc		Diesel	FM4014
8061.05	6cyl.	5419cc		Diesel	FM13485
8065.05	6cyl.	5861cc		Diesel	FM4016
8065.25	6cyl.	5863cc	94-110kW (128-150PS)	Diesel Turbo	FM4018

14-021361-00 D	104.00	B 107.02	C 198.00	D 110.87	E 5.00
14-021362-00 D		B 107.14	C 198.00	D 110.87	E 5.00
14-021363-00 D		B 107.44	C 198.00	D 110.87	E 5.00
14-021491-00 D		B 107.01	C 198.00	D 109.87	E 5.00
14-021492-00 D		B 107.05	C 198.00	D 109.87	E 5.00
14-021493-00 D		B 107.17	C 198.00	D 109.87	E 5.00
14-021494-00 D		B 107.47	C 198.00	D 109.87	E 5.00

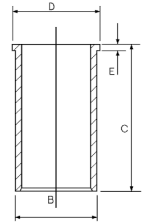

14-010940-00 D	104.00	B 107.00	C 198.00
14-010941-10 D		B 107.10	C 198.00
14-010943-10 D		B 107.52	C 198.00

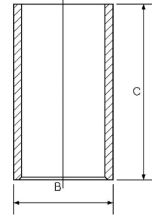

8

CO2D	4cyl.	4397cc		Diesel	FM11303
CO3D	4cyl.	4397cc		Diesel	FM11303
CO20/60	4cyl.	4397cc		Diesel	FM11303
CO130	4cyl.	4397cc		Diesel	FM11303

14-630100-00 WH	108.00	B 116.00	C 243.00	D 128.00	E 150.00	F 1.00
-----------------	--------	----------	----------	----------	----------	--------

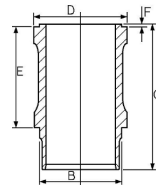

9

C03	4cyl.	4941cc		Diesel	FM14029
C03/20/21/41	4cyl.	4562cc		Diesel	FM11307
CN3	3cyl.	3706cc		Diesel	FM4028
CP 3/100	6cyl.	7412cc		Diesel	FM11310

14-611250-00 WH	110.00	B 118.00	C 237.00	D 129.50	E 170.00	F 1.00
-----------------	--------	----------	----------	----------	----------	--------

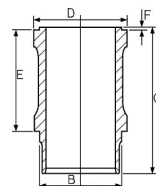



10

GENESIS 5640	4cyl.	4400cc		Diesel	FM6763
GENESIS 6640	4cyl.	5000cc		Diesel	FM6765
GENESIS 7740	4cyl.	5000cc		Diesel Turbo	FM6767
GENESIS 7840	6cyl.	6600cc		Diesel	FM6764
GENESIS 8240, 8340	6cyl.	7500cc		Diesel	FM6766

14-010820-00 *D*      111.77      B 114.40      C 205.60

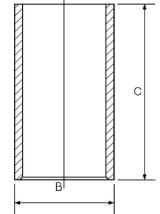

11

8365.05.500	6cyl.	8102cc		Diesel	FM3494
8365.05.590	6cyl.	8102cc		Diesel	FM13494
8365.25.500/502	6cyl.	8102cc		Diesel Turbo	FM9107
8365.25.501/503/533	6cyl.	8102cc		Diesel Turbo	FM29107
8365.25.503	6cyl.	8102cc		Diesel Turbo	FM29107
8365.25.590	6cyl.	8102cc		Diesel Turbo	FM19107
CO3-130T	4cyl.	5401cc		Diesel	FM4030

14-684840-00 *WH*      115.00      B 122.00      C 235.00      D 129.70      E 167.00

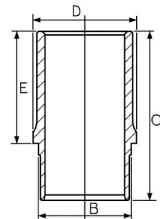

12

8460.21	6cyl.	9500cc	177kW (240PS)	Diesel Turbo	FM4130
8460.21.002	6cyl.	9500cc	177kW (240PS)	Diesel Turbo	FM4130
8460.21.042	6cyl.	9500cc	177kW (240PS)	Diesel Turbo	FM4130
8460.21.102	6cyl.	9500cc	177kW (240PS)	Diesel Turbo	FM4130
8460.21.106	6cyl.	9500cc	177kW (240PS)	Diesel Turbo	FM4130
8460.21.708	6cyl.	9500cc	177kW (240PS)	Diesel Turbo	FM4130
8460.21.710	6cyl.	9500cc	177kW (240PS)	Diesel Turbo	FM4130

14-450880-00 *WH* ①      120.00      B 134.00      C 250.00      D 144.80      E 10.02      F 1.00

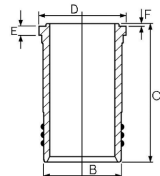

① Nitrided

① Nitriert

① Nitrué

① Niturado



13

8210.02	6cyl.	13798cc	Diesel		FM10601
8215.22	6cyl.	13798cc	Diesel	Turbo	FM9116
8215.22.520	6cyl.	13798cc	Diesel	Turbo	FM9116

14-021231-00 DH <sup>†</sup>	137.00	B 143.07	C 282.00	D 147.00	E 6.00
14-021232-00 DH <sup>†</sup>		B 143.27	C 282.00	D 147.00	E 6.00
14-021560-10 DH		B 143.00	C 282.00	D 147.00	E 6.06
14-021561-10 DH		B 143.05	C 282.00	D 147.00	E 6.06
14-021562-10 DH		B 143.25	C 282.00	D 147.00	E 6.06
14-021563-10 DH		B 143.50	C 282.00	D 147.00	E 6.06

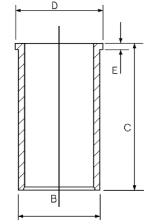

<sup>†</sup> Nitrided

<sup>†</sup> Nitriert

<sup>†</sup> Nituré

<sup>†</sup> Nitrurado

Modelverzeichnis • Index de modele • Índice de Modelo  
Indeks modelu • Модель автомобиля • دليل المركبة



# MODEL INDEX



CCM

x



09/80→12/83	<b>720 2.2</b>	SD22	Diesel	2164	4	<b>3</b>
09/83→12/86	<b>720 2.5</b>	SD25	Diesel	2488	4	<b>5</b>
01/03→	<b>Almera II 1.5</b>	K9K 722	Diesel	1461	4	<b>1</b>
10/93→10/97	<b>Atlas 2.5</b>	TD25	Diesel	2494	4	<b>7</b>
07/96→10/04	<b>Atlas 2.7</b>	TD27TI	Diesel	2664	4	<b>8</b>
01/80→03/97	<b>Bluebird 2.0</b>	LD20	Diesel	1952	4	<b>4</b>
11/87→11/94	<b>Bobby 2.0</b>	LD20	Diesel	1952	4	<b>4</b>
01/89→12/00	<b>Cabstar 2.5</b>	TD25	Diesel	2494	4	<b>7</b>
10/00→04/04	<b>Cabstar 2.7</b>	TD27	Diesel	2663	4	<b>8</b>
01/63→12/77	<b>Cedric</b>	SD20	Diesel	1991	4	<b>3</b>
05/84→08/87	<b>Cedric 2.3</b>	SD23	Diesel	2289	4	<b>5</b>
06/91→10/95	<b>Cedric 2.8</b>	RD28	Diesel	2825	6	<b>4</b>
04/86→08/03	<b>Crew 2.8</b>	RD28	Diesel	2825	6	<b>4</b>
06/91→10/95	<b>Gloria 2.8</b>	RD28	Diesel	2825	6	<b>4</b>
01/63→12/67	<b>Homer</b>	SD20	Diesel	1991	4	<b>3</b>
05/92→10/95	<b>Homy 2.5</b>	TD25	Diesel	2494	4	<b>7</b>
10/93→10/95	<b>Homy 2.7</b>	TD27TI	Diesel	2664	4	<b>8</b>
10/93→10/97	<b>Homy 3.2</b>	SD33	Diesel	3246	6	<b>3</b>
08/03→	<b>Kubistar 1.5</b>	K9K 276, K9K 700, K9K 704, K9K 710, K9K 714, K9K 722	Diesel	1461	4	<b>1</b>
01/79→12/83	<b>Laurel</b>	SD20	Diesel	1991	4	<b>3</b>
04/81→10/84	<b>Laurel 2.0</b>	LD20	Diesel	1952	4	<b>4</b>
01/85→12/89	<b>Laurel 2.8</b>	RD28	Diesel	2825	6	<b>4</b>
01/03→06/10	<b>Micra III 1.5</b>	K9K 276, K9K 704, K9K 708, K9K 722	Diesel	1461	4	<b>1</b>
11/10→	<b>Micra IV 1.5</b>	K9K 700, K9K 704	Diesel	1461	4	<b>1</b>
01/86→03/08	<b>Navara 2.5</b>	TD25	Diesel	2494	4	<b>7</b>
09/87→12/01	<b>Navara 2.7</b>	TD27, TD27T	Diesel	2663	4	<b>8</b>
03/06→	<b>Note 1.5</b>	K9K 276, K9K 292, K9K 700	Diesel	1461	4	<b>1</b>
10/08→	<b>NP200 1.5</b>	K9K 276	Diesel	1461	4	<b>1</b>
09/97→12/04	<b>Pathfinder 2.7</b>	TD27ETi	Diesel	2664	4	<b>8</b>
03/89→03/96	<b>Patrol 2.8</b>	RD28	Diesel	2825	6	<b>4</b>
11/79→06/90	<b>Patrol 3.2</b>	SD33, SD33T	Diesel	3246	6	<b>3</b>
06/80→12/87	<b>Patrol 3.3</b>	SD33, SD33T	Diesel	3246	6	<b>3</b>
01/88→	<b>Patrol 4.2</b>	TD42, TD42T	Diesel	4169	6	<b>8</b>
05/98→09/07	<b>Patrol II 4.2</b>	TD42, TD42T	Diesel	4169	6	<b>8</b>
11/88→06/97	<b>Patrol GR I 4.2</b>	TD42	Diesel	4169	6	<b>8</b>
05/98→06/01	<b>Patrol GR II 2.7</b>	TD27T	Diesel	2663	4	<b>8</b>
05/98→06/01	<b>Patrol GR II 3.2</b>	SD33	Diesel	3246	6	<b>3</b>
06/97→	<b>Patrol GR II 4.2</b>	TD42, TD42T	Diesel	4169	6	<b>8</b>
01/82→09/84	<b>Pick Up 2.2</b>	SD22	Diesel	2164	4	<b>3</b>
04/83→08/88	<b>Pick Up 2.3</b>	SD23	Diesel	2289	4	<b>5</b>
04/83→02/98	<b>Pick Up 2.5</b>	SD25	Diesel	2488	4	<b>5</b>
08/87→	<b>Pick Up 2.5</b>	TD25	Diesel	2494	4	<b>7</b>
08/87→	<b>Pick Up 2.7</b>	TD27, TD27T	Diesel	2663	4	<b>8</b>
03/01→	<b>Primastar 1.9</b>	F9Q 760, F9Q 762	Diesel	1870	4	<b>2</b>
01/96→12/99	<b>Sani 2.7</b>	TD27	Diesel	2663	4	<b>8</b>
11/92→09/01	<b>Serena 2.0</b>	LD20	Diesel	1952	4	<b>4</b>
08/81→07/84	<b>Skyline 2.0</b>	LD20	Diesel	1952	4	<b>4</b>
02/89→02/96	<b>Terrano I 2.7</b>	TD27T	Diesel	2663	4	<b>8</b>
02/93→01/02	<b>Terrano II 2.7</b>	TD27T	Diesel	2663	4	<b>8</b>
05/96→	<b>Terrano II 2.7</b>	TD27TI	Diesel	2664	4	<b>8</b>
06/98→	<b>Terrano Van 2.7</b>	TD27TI	Diesel	2664	4	<b>8</b>
01/07→	<b>Tiida 1.5</b>	K9K 728, K9K 772	Diesel	1461	4	<b>1</b>
11/86→10/98	<b>Trade 2.0</b>	LD20	Diesel	1952	4	<b>4</b>
11/98→09/04	<b>Trade 2.7</b>	TD27T	Diesel	2663	4	<b>8</b>
02/92→09/94	<b>Urvan 2.0</b>	LD20	Diesel	1952	4	<b>4</b>
11/80→07/83	<b>Urvan 2.2</b>	SD22	Diesel	2164	4	<b>3</b>
11/82→11/88	<b>Urvan 2.3</b>	SD23	Diesel	2289	4	<b>5</b>
12/88→05/97	<b>Urvan 2.5</b>	TD25	Diesel	2494	4	<b>7</b>
03/87→04/97	<b>Urvan 2.7</b>	TD27	Diesel	2663	4	<b>8</b>

# MODEL INDEX



Modelverzeichnis • Index de modele • Índice de Modelo  
Indeks modelu • Модель автомобиля • دليل الموديل



CCM

x



9

10/95→08/00	<b>Urvan 2.7</b>	TD27ETi, TD27Ti	Diesel	2664	4	<b>8</b>
02/92→04/97	<b>Urvan 3.2</b>	SD33, SD33T	Diesel	3246	6	<b>3</b>
11/82→12/95	<b>Vanette 2.0</b>	LD20	Diesel	1952	4	<b>4</b>
01/96→	<b>Vanette Cargo 2.0</b>	LD20	Diesel	1952	4	<b>4</b>
01/07→	<b>Versa 1.5</b>	K9K 772	Diesel	1461	4	<b>1</b>



Motorverzeichnis • Index de moteur • Índice de Motor  
Indeks silnika • Модель двигателя • دليل المحرك

# ENGINE INDEX



CCM

x



9

4.165	Diesel	2710	4	92.00	6
F9Q 760	Diesel	1870	4	80.00	2
F9Q 762	Diesel	1870	4	80.00	2
K9K 276	Diesel	1461	4	76.00	1
K9K 292	Diesel	1461	4	76.00	1
K9K 700	Diesel	1461	4	76.00	1
K9K 702	Diesel	1461	4	76.00	1
K9K 704	Diesel	1461	4	76.00	1
K9K 708	Diesel	1461	4	76.00	1
K9K 710	Diesel	1461	4	76.00	1
K9K 714	Diesel	1461	4	76.00	1
K9K 722	Diesel	1461	4	76.00	1
K9K 728	Diesel	1461	4	76.00	1
K9K 772	Diesel	1461	4	76.00	1
LD20	Diesel	1952	4	85.00	4
LD20IIL	Diesel	1952	4	85.00	4
RD28	Diesel	2825	6	85.00	4
SD20	Diesel	1991	4	83.00	3
SD22	Diesel	2164	4	83.00	3
SD23	Diesel	2289	4	89.00	5
SD25	Diesel	2488	4	89.00	5
SD33	Diesel	3246	6	83.00	3
SD33T	Diesel	3246	6	83.00	3
TD25	Diesel	2494	4	92.90	7
TD27	Diesel	2663	4	96.00	8
TD27ETi	Diesel	2664	4	96.00	8
TD27T	Diesel	2663	4	96.00	8
TD27Ti	Diesel	2664	4	96.00	8
TD42	Diesel	4169	6	96.00	8
TD42T	Diesel	4169	6	96.00	8



1

K9K 276	4cyl.	1461cc	62-63kW (84-86PS)	Diesel	Turbo Intercooled	TD23877
K9K 292	4cyl.	1461cc	76kW (103PS)	Diesel	Turbo Intercooled	TD24675
K9K 700	4cyl.	1461cc	48-50kW (65-68PS)	Diesel	Turbo Intercooled	TD21368
K9K 702	4cyl.	1461cc	60kW (81PS)	Diesel	Turbo Intercooled	TD23878
K9K 704 Euro 3	4cyl.	1461cc	48kW (65PS)	Diesel	Turbo	TD17660
K9K 708	4cyl.	1461cc	48-50kW (65-68PS)	Diesel	Turbo Intercooled	TD26291
K9K 710	4cyl.	1461cc	42-45kW (57-61PS)	Diesel	Turbo Intercooled	TD26066
K9K 714	4cyl.	1461cc	42-45kW (57-61PS)	Diesel	Turbo Intercooled	TD26067
K9K 722 Euro 3	4cyl.	1461cc	60kW (81PS)	Diesel	Turbo Intercooled	TD20971
K9K 728	4cyl.	1461cc	74-78kW (101-106PS)	Diesel	Turbo Intercooled	TD24669
K9K 772	4cyl.	1461cc	63-76kW (86-103PS)	Diesel	Turbo	TD28006

14-020650-00 *D*      76.00      B 79.10      C 142.00      D 81.00      E 5.00

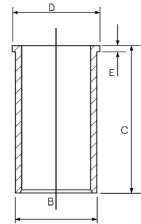

2

F9Q 760	4cyl.	1870cc	74kW (100PS)	Diesel	Turbo	TD20980
F9Q 762	4cyl.	1870cc	60kW (81PS)	Diesel	Turbo	TD20991

14-020280-00 *D*      80.00      B 83.00      C 155.00      D 85.00      E 5.00

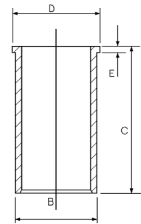

3

SD20	4cyl.	1991cc		Diesel		FM1271
SD22	4cyl.	2164cc	47kW (64PS)	Diesel		TD2512
SD33	6cyl.	3246cc	70kW (85PS)	Diesel		TD2515
SD33T	6cyl.	3246cc	81-88kW (110-120PS)	Diesel	Turbo	TD2516

14-021160-00 *D*      83.00      B 87.00      C 175.50      D 92.96      E 5.00  
 14-021170-00 *DH*      B 87.01      C 175.50      D 93.00      E 5.11

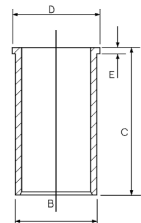



4

<b>LD20</b>	4cyl.	<b>1952cc</b>	<b>43-49kW</b> (58-67PS)	<b>Diesel</b>	<b>TD2482</b>
<b>LD20IIL</b>	4cyl.	<b>1952cc</b>	<b>47-49kW</b> (64-67PS)	<b>Diesel</b>	<b>TD2488</b>
<b>RD28</b>	6cyl.	<b>2825cc</b>	<b>66kW</b> (89PS)	<b>Diesel</b>	<b>TD4711</b>

14-020350-00 <i>D</i>	<b>85.00</b>	<b>B 88.60</b>	<b>C 150.00</b>	<b>D 90.50</b>	<b>E 4.50</b>
14-020351-00 <i>D</i>		<b>B 90.00</b>	<b>C 150.00</b>	<b>D 92.00</b>	<b>E 4.50</b>

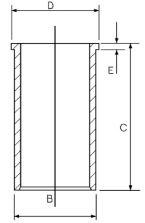

5

<b>SD23</b>	4cyl.	<b>2289cc</b>	<b>50-51kW</b> (68-69PS)	<b>Diesel</b>	<b>TD2513</b>
<b>SD25</b>	4cyl.	<b>2488cc</b>	<b>53-55kW</b> (72-75PS)	<b>Diesel</b>	<b>TD2514</b>

14-021150-00 <i>D</i>	<b>89.00</b>	<b>B 92.08</b>	<b>C 172.00</b>	<b>D 97.99</b>	<b>E 5.12</b>
-----------------------	--------------	----------------	-----------------	----------------	---------------

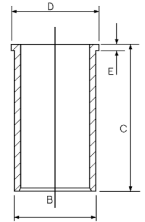

6

<b>4.165</b>	4cyl.	<b>2710cc</b>		<b>Diesel</b>	<b>FM1358</b>
--------------	-------	---------------	--	---------------	---------------

14-043450-00 <i>D</i>	<b>92.00</b>	<b>B 96.914</b>	<b>C 191.19</b>	<b>D 101.00</b>	<b>E 3.91</b>	<b>F 0.70</b>
-----------------------	--------------	-----------------	-----------------	-----------------	---------------	---------------

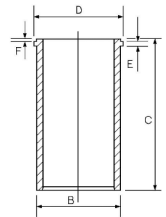

7

<b>TD25</b>	4cyl.	<b>2494cc</b>	<b>55-61kW</b> (75-83PS)	<b>Diesel</b>	<b>TD4714</b>
-------------	-------	---------------	--------------------------	---------------	---------------

14-020120-00 <i>D</i>	<b>92.90</b>	<b>B 96.01</b>	<b>C 159.89</b>	<b>D 101.85</b>	<b>E 5.00</b>
-----------------------	--------------	----------------	-----------------	-----------------	---------------

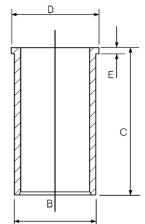



8

<b>TD27</b>	4cyl.	<b>2663cc</b>	<b>58-73kW</b> (79-99PS)	<b>Diesel</b>		<b>TD2532</b>
<b>TD27ETI</b>	4cyl.	<b>2664cc</b>	<b>96kW</b> (131PS)	<b>Diesel</b>	<b>Turbo Intercooled</b>	<b>TD9896</b>
<b>TD27T</b>	4cyl.	<b>2663cc</b>	<b>66-74kW</b> (90-101PS)	<b>Diesel</b>	<b>Turbo</b>	<b>TD2533</b>
<b>TD27TI</b>	4cyl.	<b>2664cc</b>	<b>92kW</b> (125PS)	<b>Diesel</b>	<b>Turbo Intercooled</b>	<b>TD9478</b>
<b>TD42</b>	6cyl.	<b>4169cc</b>	<b>92kW</b> (125PS)	<b>Diesel</b>		<b>TD2535</b>
<b>TD42T</b>	6cyl.	<b>4169cc</b>	<b>107-118kW</b> (146-160PS)	<b>Diesel</b>	<b>Turbo Intercooled</b>	<b>TD10368</b>

14-020110-00 *D*      **96.00**      **B** 99.085      **C** 160.00      **D** 105.03      **E** 5.09

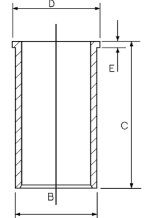

Modelverzeichnis • Index de modele • Índice de Modelo  
Indeks modelu • Модель автомобиля • دليل المركبة



# MODEL INDEX



CCM

x



9

03/98→08/01	<b>Arena 2.5</b>	S8U 758, S8U 780	Diesel	2499	4	<b>13</b>
03/82→08/88	<b>Ascona C 1.6</b>	16 D, 16 DA	Diesel	1598	4	<b>3</b>
12/91→01/99	<b>Astra F 1.7</b>	17 D, 17 DR, X 17 DTL	Diesel	1699	4	<b>5</b>
02/98→04/05	<b>Astra G 1.7</b>	X 17 DTL	Diesel	1699	4	<b>5</b>
02/98→01/05	<b>Astra G 2.0</b>	Y 20 DTL	Diesel	1995	4	<b>6</b>
02/98→04/05	<b>Astra G 2.0</b>	X 20 DTL	Diesel	1896	4	<b>6</b>
06/00→10/05	<b>Astra G 2.2</b>	Z 22 SE	Petrol	2198	4	<b>7</b>
08/87→09/96	<b>Campo 2.2</b>	C 223	Diesel	2238	4	<b>8</b>
06/87→03/93	<b>Corsa A 1.5</b>	15 D (4EC1), 15 DT (T4EC1)	Diesel	1488	4	<b>2</b>
03/93→09/00	<b>Corsa B 1.5</b>	15 D (4EC1), 15 DT (T4EC1), X 15 DT (T4EC1)	Diesel	1488	4	<b>2</b>
03/92→10/98	<b>Frontera A 2.3</b>	23 DTR	Diesel	2260	4	<b>10</b>
09/96→10/98	<b>Frontera A 2.5</b>	25 TDS (VM41B)	Diesel	2500	4	<b>11</b>
03/95→10/98	<b>Frontera A 2.8</b>	28 TDI (4JB1T)	Diesel	2771	4	<b>13</b>
04/95→08/98	<b>Frontera TD 2.8</b>	4 JB1TC	Diesel	2771	4	<b>12</b>
04/95→08/96	<b>Frontera TD Sport 2.8</b>	4 JB1TC	Diesel	2771	4	<b>12</b>
03/82→08/84	<b>Kadett D 1.6</b>	16 D	Diesel	1598	4	<b>3</b>
07/88→08/91	<b>Kadett E 1.5</b>	15 DT (T4EC1)	Diesel	1488	4	<b>2</b>
08/84→12/89	<b>Kadett E 1.6</b>	16 D, 16 DA	Diesel	1598	4	<b>3</b>
08/88→07/94	<b>Kadett E 1.7</b>	17 D, 17 DR	Diesel	1699	4	<b>5</b>
07/98→10/01	<b>Movano 2.8</b>	S9W 700, S9W 702	Diesel	2799	4	<b>15</b>
09/86→03/94	<b>Omega A 2.3</b>	23 DTR, 23 YD, 23 YDT	Diesel	2260	4	<b>10</b>
09/72→08/77	<b>Rekord D 2.1</b>	21 D	Diesel	2068	4	<b>9</b>
09/77→07/78	<b>Rekord E 2.1</b>	21 D	Diesel	2068	4	<b>9</b>
08/78→08/86	<b>Rekord E 2.2</b>	23 D	Diesel	2260	4	<b>10</b>
06/84→08/86	<b>Rekord E 2.2</b>	23 TD	Diesel	2259	4	<b>10</b>
11/82→08/86	<b>Rekord E 2.3</b>	23 D	Diesel	2260	4	<b>10</b>
11/84→08/87	<b>Senator A 2.2</b>	23 TD	Diesel	2259	4	<b>10</b>
09/00→	<b>Speedster 2.2</b>	Z 22 SE	Petrol	2198	4	<b>7</b>
09/88→11/95	<b>Vectra A 1.7</b>	17 D, 17 DR	Diesel	1699	4	<b>5</b>
11/96→04/02	<b>Vectra B 2.0</b>	X 20 DTL	Diesel	1896	4	<b>6</b>
09/00→07/03	<b>Vectra B 2.2</b>	Z 22 SE	Petrol	2198	4	<b>7</b>
04/02→	<b>Vectra C 2.2</b>	Z 22 SE	Petrol	2198	4	<b>7</b>
08/01→	<b>Vivaro 1.9</b>	F9Q 760, F9Q762	Diesel	1870	4	<b>4</b>
07/99→06/05	<b>Zafira A 2.0</b>	X 20 DTL	Diesel	1896	4	<b>6</b>
09/00→06/05	<b>Zafira A 2.2</b>	Z 22 SE	Petrol	2198	4	<b>7</b>

# ENGINE INDEX

Motorverzeichnis • Index de moteur • Índice de Motor  
Indeks silnika • Модель двигателя • دليل المحرك



CCM



9

15 D (4EC1)	Diesel	1488	4	76.00	2
15 DT (T4EC1)	Diesel	1488	4	76.00	2
16 D	Diesel	1598	4	80.00	3
16 DA	Diesel	1598	4	80.00	3
17 D	Diesel	1699	4	82.50	5
17 DR	Diesel	1699	4	82.50	5
21 D	Diesel	2068	4	88.00	9
23 D	Diesel	2260	4	92.00	10
23 DC	Diesel	2260	4	92.00	10
23 DTR	Diesel	2260	4	92.00	10
23 TD	Diesel	2259	4	92.00	10
23 YD	Diesel	2260	4	92.00	10
23 YDT	Diesel	2260	4	92.00	10
25 TDS (VM41B)	Diesel	2500	4	92.00	11
28 TDI (4JB1T)	Diesel	2771	4	93.00	13
4 JB1TC	Diesel	2771	4	93.00	12
688 13	Petrol	1108	4	70.00	1
C 223	Diesel	2238	4	88.00	8
F9Q 760	Diesel	1870	4	80.00	4
F9Q762	Diesel	1870	4	80.00	4
S8U 758	Diesel	2499	4	93.00	14
S8U 780	Diesel	2499	4	93.00	14
S9W 700	Diesel	2799	4	94.40	15
S9W 702	Diesel	2799	4	94.40	15
X 15 DT (T4EC1)	Diesel	1488	4	76.00	2
X 17 DTL	Diesel	1699	4	82.50	5
X 20 DTL	Diesel	1896	4	84.00	6
Y 20 DTL	Diesel	1995	4	84.00	6
Z 22 SE	Petrol	2198	4	86.00	7



**1**

<b>688 13</b>	4cyl.	<b>1108cc</b>	<b>33kW (45PS)</b>				<b>TD23801</b>
<b>14-636730-00 WH</b>	<b>70.00</b>	<b>B 75.50</b>	<b>C 135.00</b>	<b>D 85.70</b>	<b>E 94.80</b>		

**2**

<b>15 D (4EC1)</b>	4cyl.	<b>1488cc</b>	<b>37kW (50PS)</b>	<b>Diesel</b>			<b>TD4732</b>
<b>15 DT (T4EC1)</b>	4cyl.	<b>1488cc</b>	<b>49-53kW (67-72PS)</b>	<b>Diesel</b>	<b>Turbo</b>	<b>TD4733</b>	
<b>X 15 DT (T4EC1)</b>	4cyl.	<b>1488cc</b>	<b>49kW (67PS)</b>	<b>Diesel</b>	<b>Turbo</b>	<b>TD5301</b>	
<b>14-010870-00 D</b>	<b>76.00</b>	<b>B 80.00</b>	<b>C 138.00</b>				

**3**

<b>16 D</b>	4cyl.	<b>1598cc</b>	<b>40kW (54PS)</b>	<b>Diesel</b>			<b>TD4734</b>
<b>16 DA</b>	4cyl.	<b>1598cc</b>	<b>40kW (54PS)</b>	<b>Diesel</b>			<b>TD4735</b>
<b>14-023520-00 D</b>	<b>80.00</b>	<b>B 83.00</b>	<b>C 143.50</b>	<b>D 84.90</b>	<b>E 4.50</b>		

**4**

<b>F9Q 760</b>	4cyl.	<b>1870cc</b>	<b>74kW (100PS)</b>	<b>Diesel</b>	<b>Turbo</b>	<b>TD18872</b>	
<b>F9Q762</b>	4cyl.	<b>1870cc</b>	<b>59-60kW (80-82PS)</b>	<b>Diesel</b>	<b>Turbo</b>	<b>TD18494</b>	
<b>14-020280-00 D</b>	<b>80.00</b>	<b>B 83.00</b>	<b>C 155.00</b>	<b>D 85.00</b>	<b>E 5.00</b>		



5

<b>17 D</b>	4cyl.	<b>1699cc</b>	<b>42kW (57PS)</b>	<b>Diesel</b>	<b>TD4742</b>
<b>17 DR</b>	4cyl.	<b>1699cc</b>	<b>42-44kW (57-60PS)</b>	<b>Diesel</b>	<b>TD4744</b>
<b>X 17 DTL</b>	4cyl.	<b>1699cc</b>	<b>50kW (68PS)</b>	<b>Diesel Turbo Intercooled</b>	<b>TD4821</b>

**14-021200-00 D**      **82.50**      **B 85.58**      **C 143.35**      **D 87.40**      **E 4.55**

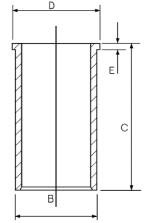

6

<b>X 20 DTL</b>	4cyl.	<b>1896cc</b>	<b>60kW (81PS)</b>	<b>Diesel Turbo</b>	<b>TD4824</b>
<b>Y 20 DTL</b>	4cyl.	<b>1995cc</b>	<b>60kW (81PS)</b>	<b>Diesel Turbo</b>	<b>TD15848</b>

**14-102800-00 D**      **84.00**      **B 87.00**      **C 160.00**      **D 90.00**      **E 4.50**

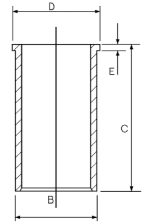

7

<b>Z 22 SE</b>	4cyl.	<b>2198cc</b>	<b>108kW (147PS)</b>		<b>TD14668</b>
----------------	-------	---------------	----------------------	--	----------------

**14-020450-00 D**      **86.00**      **B 89.025**      **C 137.25**      **D 95.45**      **E 4.63**

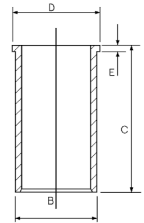

8

<b>C 223</b>	4cyl.	<b>2238cc</b>	<b>39-54kW (53-73PS)</b>	<b>Diesel</b>	<b>TD22878</b>
--------------	-------	---------------	--------------------------	---------------	----------------

**14-021190-00 D**      **88.00**      **B 92.13**      **C 163.50**      **D 95.00**      **E 4.00**  
**14-021440-00 DH 1 2**      **B 89.97**      **C 163.32**      **D 94.89**      **E 0.89**

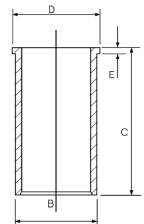

1 Not suitable for use with pistons having chrome rings

1 Nicht geeignet zur Verwendung mit mit Kolben mit Chromringen

1 Ne pas utiliser avec des pistons équipés de segments chromés

1 No es adecuada para usar con pistones que tengan aros de croma

2 Chrome Bore

2 Bohrung verchromte

2 Alésage chromée

2 Cromado de cilindro





9

21 D 4cyl. 2068cc 44kW (60PS) Diesel TD2658

14-024160-00 D 88.00 B 92.00 C 172.00 D 93.90 E 4.55

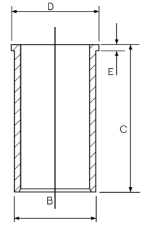

10

23 D 4cyl. 2260cc 48kW (65PS) Diesel TD2663

23 DC 4cyl. 2260cc 70kW (95PS) Diesel TD2662

23 DTR 4cyl. 2260cc 74kW (100PS) Diesel Turbo Intercooled TD4767

23 TD 4cyl. 2259cc 63-74kW (86-101PS) Diesel Turbo TD2665

23 YD 4cyl. 2260cc 54kW (73PS) Diesel TD4768

23 YDT 4cyl. 2260cc 66kW (89PS) Diesel Turbo TD4769

14-024100-00 D 92.00 B 95.00 C 172.00 D 97.00 E 4.70

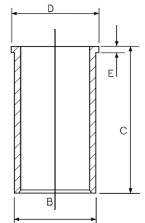

11

25 TDS (VM41B) 4cyl. 2500cc 85kW (116PS) Diesel Turbo Intercooled TD2673

14-676420-00 WH 92.00 B 101.50 C 166.80 D 110.00 E 8.90 F 1.20

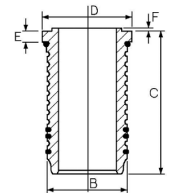

12

4 JB1TC 4cyl. 2771cc 82kW (111PS) Diesel Turbo Intercooled FM19531

14-021450-00 DH 1 2 93.00 B 95.04 C 156.31 D 101.00 E 0.92

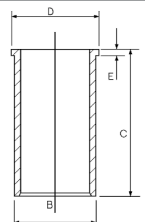

1 Not suitable for use with pistons having chrome rings

1 Nicht geeignet zur Verwendung mit Kolben mit Chromringen

1 Ne pas utiliser avec des pistons équipés de segments chromés

1 No es adecuada para usar con pistones que tengan aros de croma

2 Chrome Bore

2 Bohrung verchromte

2 Alésage chromée

2 Cromado de cilindro



13

28 TDI (4JB1T) 4cyl. 2771cc 85kW (116PS) Diesel Turbo Intercooled TD4774

14-021460-00 DH 1 2 93.00 B 95.04 C 181.00 D 101.00 E 0.92

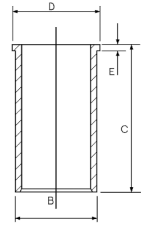

1 Not suitable for use with pistons having chrome rings

1 Nicht geeignet zur Verwendung mit mit Kolben mit Chromringen

1 Ne pas utiliser avec des pistons équipés de segments chromés

1 No es adecuada para usar con pistones que tengan aros de cromado

2 Chrome Bore

2 Bohrung verchromt

2 Alésage chromée

2 Cromado de cilindro

14

S8U 758 4cyl. 2499cc 55-58kW (75-79PS) Diesel TD22880

S8U 780 4cyl. 2499cc 55kW (75PS) Diesel TD22882

14-022560-00 D 93.00 B 96.00 C 167.30 D 98.90 E 5.00  
 14-028930-00 D B 97.50 C 167.00 D 100.90 E 5.00  
 14-028931-00 D B 97.58 C 167.00 D 100.90 E 5.00  
 14-028932-00 D B 97.70 C 167.00 D 100.90 E 5.00

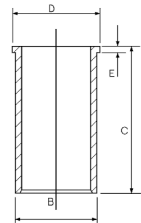

15

S9W 700 4cyl. 2799cc 84kW (114PS) Diesel Turbo Intercooled TD21149

S9W 702 4cyl. 2799cc 84kW (114PS) Diesel Turbo Intercooled TD19360

14-021321-00 D 94.40 B 97.54 C 167.00 D 100.90 E 5.00  
 14-021322-00 D B 97.70 C 167.00 D 100.90 E 5.00  
 14-028930-00 D B 97.50 C 167.00 D 100.90 E 5.00  
 14-028931-00 D B 97.58 C 167.00 D 100.90 E 5.00  
 14-028932-00 D B 97.70 C 167.00 D 100.90 E 5.00

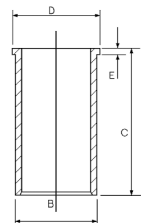



1

CP (D24 ENGINE)

6cyl. 2383cc

Diesel

FM3020

14-021571-00 D	76.50	B 79.56	C 142.00	D 82.50	E 4.50
14-028360-00 D ①		B 79.50	C 145.00	D 81.50	E 4.70

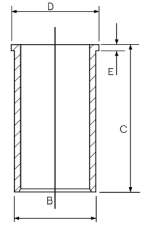

① With recesses on crankshaft side

① Mit kurbelwellenseitigen Aussparungen

① Avec évidements côté vilebrequin

① Con escotaduras en la cara del cigüeñal

# ENGINE INDEX

Motorverzeichnis • Index de moteur • Índice de Motor  
Indeks silnika • Модель двигателя • دليل المحرك



CCM



9

1004.42	Diesel	4230	4	103.00	9
1004-40 / 1004-40T	Diesel	3990	4	100.00	7
1103B-33	Diesel	3300	3	105.00	10
1103C-33	Diesel	3300	3	105.00	10
1104C-44	Diesel	4400	4	105.00	10
3.152	Diesel	2490	3	91.49	4
4.107	Diesel	1760	4	79.38	1
4.108	Diesel	1760	4	79.39	2
4.165	Diesel	2710	4	92.00	5
4.192	Diesel	3140	4	88.90	3
4.203	Diesel	3335	4	91.49	4
4.212	Diesel	3475	4	98.48	6
4.236	Diesel	3864	4	98.48	6
4.248 / A4.248	Diesel	4065	4	101.054	8
6.288	Diesel	4716	6	88.90	3
6.305	Diesel	5000	6	91.49	4
6.354	Diesel	5794	6	98.48	6
6.354 V	Diesel	5794	6	98.48	6
6.354.1	Diesel	5800	6	98.48	6
6.354.2	Diesel	5794	6	98.48	6
6.354.4	Diesel	5794	6	98.48	6
6.372	Diesel	6372	6	101.05	8
AD3.152	Diesel	2499	3	91.49	4
AT4.236	Diesel	3866	4	98.48	6
C4.40	Diesel	3990	4	100.00	7
D235 Phaser 160/180T	Diesel	5985	6	100.00	7
D3.152	Diesel	2500	3	91.49	4
Phaser 90 (1004-4)	Diesel	3990	4	100.00	7
Phaser 110T (1004-4T)	Diesel	3990	4	100.00	7
Phaser 125 (1006-6)	Diesel	5985	6	100.00	7
Phaser 160T (1006-6T) 1989>	Diesel	5985	6	100.00	7
Phaser 180Ti (1006-6TW)	Diesel	5985	6	100.00	7
Phaser 180Ti (CC6.60)	Diesel	5985	6	100.00	7
Phaser 200Ti	Diesel	5985	6	100.00	7
T4.236	Diesel	3866	4	98.48	6
T6.354.1	Diesel	5800	6	98.48	6
T6.354.3	Diesel	5800	6	98.48	6
T6.354.3 CC	Diesel	5800	6	98.48	6
T6.354.4	Diesel	5794	6	98.48	6
T6.60	Diesel	5985	6	100.00	7



1

4.107 4cyl. 1760cc 30kW (41PS) Diesel TD6333

15-370040-00 WH 1 79.38 B 85.67 C 163.53 D 93.70 E 6.40

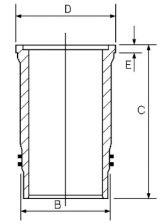

1 Includes seals 1 Schließt Dichtungen ein 1 Inclut des joints 1 Incluye los sellos

2

4.108 4cyl. 1760cc 36kW (49PS) Diesel TD6334

14-010900-00 D 79.39 B 82.63 C 165.10

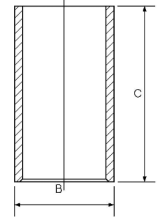

3

4.192 4cyl. 3140cc 29-37kW (39-50PS) Diesel TD6396

6.288 6cyl. 4716cc 45kW (61PS) Diesel TD6498

14-021240-00 D 88.90 B 93.71 C 216.03 D 94.41 E 4.76

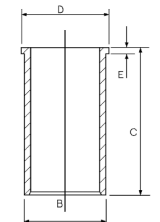

4

3.152 3cyl. 2490cc 22-33kW (30-45PS) Diesel Indirect Injection TD6788

4.203 4cyl. 3335cc 44kW (60PS) Diesel Direct Injection TD7381

6.305 6cyl. 5000cc 73kW (99PS) Diesel TD6399

AD3.152 3cyl. 2499cc Diesel Direct Injection FM11352

D3.152 3cyl. 2500cc Diesel Direct Injection FM1352

14-021220-00 D 2 91.49 B 93.713 C 216.00 D 96.723 E 3.81  
 14-021221-00 D B 93.967 C 216.00 D 96.723 E 3.81  
 14-021222-00 D B 94.50 C 216.00 D 96.723 E 3.81  
 14-021223-00 D B 96.253 C 216.00 D 97.104 E 3.81  
 14-022960-00 D B 93.66 C 216.00 D 96.72 E 3.76  
 14-024680-00 D B 93.73 C 216.00 D 96.72 E 3.76  
 14-025833-00 D B 95.31 C 216.00 D 98.16 E 5.00  
 14-025871-00 D B 93.76 C 216.14 D 96.85 E 5.00  
 14-025873-00 D B 93.88 C 216.14 D 96.97 E 5.00  
 14-480320-00 DH 1 B 93.66 C 216.03 D 96.72 E 3.81

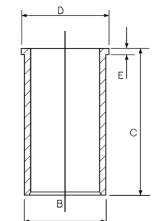

1 Push fit cast iron liner to replace original steel liner 1 Ausdrückbare Laufbüchse aus Gueisen als Ersatz der original Stahlbüchse 1 Chemise fonte à emmencement gras remplaçant la chemise acie d'origine. 1 Ajustar a presión la camisa de hierro fundido para reemplaza camisa original de acero  
 2 Press fit cast iron liner to replace original steel liner 2 Anpressbare Laufbüchse aus Gueisen als Ersatz der original Stahlbüchse 2 Chemise fonte à emmancher à la presse pour remplacer la chemise d'origine en acier 2 Ajuste a presión la camisa de hierro fundido para reemplazar la camisa original de acero



5

4.165 4cyl. 2710cc 47-51kW (65-70PS) Diesel TD6734

14-043450-00 D 92.00 B 96.914 C 191.19 D 101.00 E 3.91 F 0.70

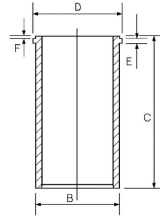

6

4.212 4cyl. 3475cc 44-47kW (60-64PS) Diesel FM1359

4.236 4cyl. 3864cc 65kW (88PS) Diesel TD6398

6.354 6cyl. 5794cc 71-82kW (97-112PS) Diesel Direct Injection TD6713

6.354 V 6cyl. 5794cc 71-87kW (97-118PS) Diesel TD7158

6.354.1 6cyl. 5800cc Diesel FM5218

6.354.2 6cyl. 5794cc 84-87kW (114-118PS) Diesel TD6548

6.354.4 6cyl. 5794cc 94kW (128PS) Diesel TD6546

AT4.236 4cyl. 3866cc Diesel Turbo FM13911

T4.236 4cyl. 3866cc 66-76kW (90-103PS) Diesel Turbo TD6746

T6.354.1 6cyl. 5800cc Diesel Turbo FM1363

T6.354.4 6cyl. 5794cc 110-119kW (150-162PS) Diesel Turbo TD8703

T6.354.3 6cyl. 5800cc Diesel Turbo FM1366

T6.354.3 CC 6cyl. 5800cc 110-111kW (148-151PS) Diesel TD6747

14-021250-00 DH 1 98.48 B 104.20 C 226.44 D 107.37 E 3.81

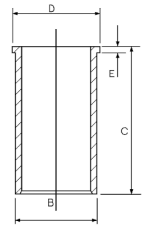

14-040110-00 D 2 98.48 B 103.24 C 227.28 D 106.23 E 3.86 F 0.889

14-040180-00 D 2 B 103.24 C 227.28 D 106.43 E 3.71 F 1.041

14-040200-00 DH 2 B 103.19 C 227.28 D 106.45 E 3.86 F 0.889

14-045820-00 D B 103.33 C 227.28 D 106.42 E 3.80 F 0.90

14-045821-00 D B 103.83 C 227.28 D 106.42 E 3.80 F 0.90

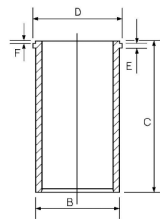

1 Push fit, flanged, cast iron liner with 0.040" oversized outside diameter

1 Geflanschte Gußeisen-Laufbuchse mit Schiebeseit und Außendur übermaß

1 Chemise en fonte, à colerette ajustage gras, avec diamètre

1 Camisa de fundición embreadada, ajuste suave, con diámetro ext

2 Press fit cast iron liner to replace original steel liner

2 Anpressbare Laufbüchse aus Gueisen als Ersatz der original Stahlbüchse

2 Chemise fonte à emmancher à la presse pour remplacer la chemise d'origine en acier

2 Ajuste a presión la camisa de hierro fundido para reemplazar la camisa original de acero



7

1004-40 / 1004-40T	4cyl.	3990cc	48-52kW (65-71PS)	Diesel		TD20891
C4.40	4cyl.	3990cc	88kW (120PS)	Diesel	Turbo Intercooled	FM5069
D235 PHASER 160/180T	6cyl.	5985cc	118-132kW (160-180PS)	Diesel	Turbo	TD6412
PHASER 90 (1004-4)	4cyl.	3990cc		Diesel		FM5072
PHASER 110T (1004-4T)	4cyl.	3990cc	82kW (111PS)	Diesel	Turbo	TD8659
PHASER 125 (1006-6)	6cyl.	5985cc		Diesel		FM5073
PHASER 160T (1006-6T) 1989>	6cyl.	5985cc	119kW (162PS)	Diesel	Turbo	TD6547
PHASER 180TI (1006-6TW)	6cyl.	5985cc	134kW (182PS)	Diesel	Turbo	TD6404
PHASER 180TI (CC6.60) Euro 2	6cyl.	5985cc	131-134kW (177-182PS)	Diesel	Turbo Intercooled	TD8922
PHASER 200TI Euro 1	6cyl.	5985cc	148kW (201PS)	Diesel	Turbo	FM6366
T6.60	6cyl.	5985cc	154kW (210PS)	Diesel	Turbo	FM6365

14-025380-10 <i>DH</i>	100.00	B 104.23	C 226.44	D 107.44	E 3.86
------------------------	--------	----------	----------	----------	--------

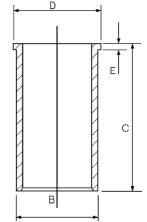

8

4.248 / A4.248	4cyl.	4065cc	53-61kW (72-83PS)	Diesel	Direct Injection	FM26364
6.372	6cyl.	6372cc	87kW (118PS)	Diesel		FM8787

14-040120-00 <i>D</i>	101.05	B 104.25	C 227.28	D 107.44	E 3.86	F 0.762
14-040190-00 <i>DH</i>		B 104.20	C 227.28	D 107.44	E 3.86	F 0.838
14-041140-00 <i>D</i>		B 104.35	C 227.28	D 107.44	E 3.80	F 0.90
14-041610-00 <i>D</i>		B 104.28	C 227.28	D 107.38	E 3.80	F 0.90
14-044690-00 <i>D</i>		B 103.26	C 222.25	D 106.37	E 3.65	F 1.00

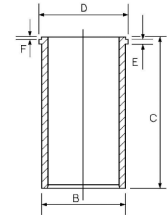

9

1004.42 Euro 1	4cyl.	4230cc	45-51kW (61-69PS)	Diesel		TD23905
----------------	-------	--------	-------------------	--------	--	---------

14-020590-00 <i>D</i>	103.00	B 107.05	C 228.00	D 110.05	E 4.00
-----------------------	--------	----------	----------	----------	--------

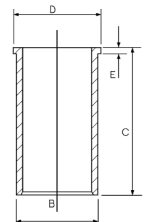



10

1103B-33 Euro 2	3cyl.	3300cc	43kW (58PS)	Diesel		TD23904
1103C-33 Euro 2	3cyl.	3300cc	41kW (55PS)	Diesel	Turbo	TD17273
1104C-44 Euro 2	4cyl.	4400cc	64kW (87PS)	Diesel	Turbo	TD17275

14-020870-00 *D*      105.00      B 108.00      C 227.00      D 109.50      E 5.00

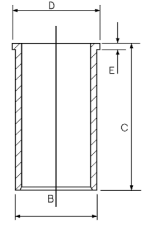



Modelverzeichnis • Index de modele • Índice de Modelo  
Indeks modelu • Модель автомобиля • دليل المركبة



# MODEL INDEX



CCM

x



09/73→06/88	<b>104 1.1</b>	XW3 (109), XW3S, XW3S (121), XW7 (109F)	Petrol	1124	4	<b>1</b>
08/79→06/83	<b>104 1.2</b>	XZ5 (129)	Petrol	1219	4	<b>5</b>
09/91→04/96	<b>106 I 1.1</b>	TU1M (HDZ)	Petrol	1124	4	<b>1</b>
09/91→04/96	<b>106 I 1.4</b>	TU3J2 (KFZ), TU3M (KDY), TU3MC (KDX)	Petrol	1360	4	<b>3</b>
05/96→	<b>106 II 1.1</b>	TU1M (HDY), TU1M (HDZ)	Petrol	1124	4	<b>1</b>
05/96→	<b>106 II 1.4</b>	TU3JP (KFW), TU3JP (KFX)	Petrol	1360	4	<b>3</b>
06/05→	<b>107 1.4</b>	DV4TD (8HT)	Diesel	1398	4	<b>2</b>
08/87→07/90	<b>205 1.1</b>	TU1 (H1A/H1B/H3A)	Petrol	1124	4	<b>1</b>
03/94→	<b>205 1.7</b>	XUD7 (161A)	Diesel	1769	4	<b>8</b>
02/83→07/90	<b>205 1.8</b>	XUD7 (A9A)	Diesel	1769	4	<b>8</b>
02/83→12/94	<b>205 I 1.1</b>	TU1 (H1A/H1B/H3A), TU1M (HDZ), XW7 (109F), XW7 (109N)	Petrol	1124	4	<b>1</b>
02/83→12/94	<b>205 I 1.4</b>	TU3A (K1D), TU3M (KDY), TU3M (KDZ), TU3S (K2B), XY8 (150B)	Petrol	1360	4	<b>3</b>
12/84→12/94	<b>205 I 1.6</b>	XU5 (B1AA), XU5CP (BAZ), XU5J (180), XU5J (180A), XU5M3Z (BDY), XU51C (B1A/B1C/B1E)	Petrol	1580	4	<b>11</b>
08/83→10/87	<b>205 I 1.7</b>	XUD7 (161A)	Diesel	1769	4	<b>8</b>
05/86→12/94	<b>205 I 1.9</b>	XU9J1 (DFZ), XU9JA (D6B)	Petrol	1905	4	<b>11</b>
10/87→09/98	<b>205 II 1.1</b>	TU1 (H1A/H1B/H3A), TU1M (HDZ), XW7 (109N)	Petrol	1124	4	<b>1</b>
10/87→10/90	<b>205 II 1.3</b>	TU2.4	Petrol	1294	4	<b>4</b>
06/87→09/98	<b>205 II 1.4</b>	TU3A (K1D), TU3JP (KFX), TU3M (KDY), TU3M (KDZ), TU3MC (KDX), TU3S (K2B), TU32, XY8 (150B)	Petrol	1360	4	<b>3</b>
10/87→09/98	<b>205 II 1.6</b>	XU5 (B1AA), XU5CP (BAZ), XU5J (180), XU5J (180A), XU5M2Z (BDY), XU5M3Z (BDY), XU5S (171), XU51C (B1A/B1C/B1E)	Petrol	1580	4	<b>11</b>
07/87→09/98	<b>205 II 1.7</b>	XUD7 (161A)	Diesel	1769	4	<b>8</b>
01/90→09/98	<b>205 II 1.8</b>	XUD7T, XUD7TE (A8B)	Diesel	1769	4	<b>8</b>
08/87→09/98	<b>205 II 1.9</b>	XUD9, XUD9 (DJZ)	Diesel	1905	4	<b>12</b>
10/87→09/98	<b>205 II 1.9</b>	XU9J1 (DFZ), XU9JA (D6B), XU9JAZ (DKZ), XU92C (D2A)	Petrol	1905	4	<b>11</b>
09/98→	<b>206 1.4</b>	TU3A (KFV), TU3A (KFW), TU3JP (KFW), TU3JP (KFX), TU3JP-L4	Petrol	1360	4	<b>3</b>
09/01→	<b>206 1.4</b>	DV4TD (8HX)	Diesel	1399	4	<b>2</b>
09/01→	<b>206 1.4</b>	DV4TD (8HZ)	Diesel	1398	4	<b>2</b>
05/04→	<b>206 1.6</b>	DV6TED4 (9HY), DV6TED4 (9HZ)	Diesel	1560	4	<b>6</b>
09/98→11/01	<b>206 1.9</b>	DW8 (WJZ)	Diesel	1868	4	<b>10</b>
01/09→	<b>206+ 1.4</b>	DV4TD (8HX)	Diesel	1399	4	<b>2</b>
01/09→	<b>206+ 1.4</b>	DV4TD (8HZ)	Diesel	1398	4	<b>2</b>
01/09→	<b>206+ 1.4</b>	TU3A (KFT), TU3A (KFV), TU3A (KFW)	Petrol	1360	4	<b>3</b>
09/01→03/09	<b>206 Van 1.4</b>	DV4TD (8HX)	Diesel	1399	4	<b>2</b>
09/01→03/09	<b>206 Van 1.4</b>	DV4TD (8HZ)	Diesel	1398	4	<b>2</b>
04/99→05/07	<b>206 Van 1.9</b>	DW8 (WJZ)	Diesel	1868	4	<b>10</b>
02/06→	<b>207 1.4</b>	DV4TD (8HZ)	Diesel	1398	4	<b>2</b>
02/06→	<b>207 1.4</b>	TU3A (KFV), TU3A (KFW), TU3JP (KFW)	Petrol	1360	4	<b>3</b>
02/06→	<b>207 1.6</b>	DV6ATED4 (9HX), DV6C (9HR), DV6DTED (9HP), DV6TED4 (9HY), DV6TED4 (9HZ)	Diesel	1560	4	<b>6</b>
12/07→	<b>207 1.9</b>	DW8 (WJZ), DW8B (WJY)	Diesel	1868	4	<b>10</b>
02/07→	<b>207 CC 1.6</b>	DV6C (9HR), DV6TED4 (9HZ)	Diesel	1560	4	<b>6</b>
06/07→	<b>207 SW 1.4</b>	TU3A (KFV), TU3JP (KFW)	Petrol	1360	4	<b>3</b>
06/07→	<b>207 SW 1.6</b>	DV6ATED4 (9HX), DV6C (9HR), DV6DTED (9HP), DV6TED4 (9HZ)	Diesel	1560	4	<b>6</b>
03/12→	<b>208 1.6</b>	DV6DTED (9HP), DV6ETEDM (9HK)	Diesel	1560	4	<b>6</b>
11/12→	<b>301 1.6</b>	DV6DTED (9HF)	Diesel	1560	4	<b>6</b>
09/70→10/80	<b>304 1.3</b>	XL5, XL5S	Petrol	1290	4	<b>7</b>
11/77→09/82	<b>305 I 1.3</b>	XL5, XL5 (118)	Petrol	1290	4	<b>7</b>
11/77→09/82	<b>305 I 1.5</b>	XID (149)	Diesel	1548	4	<b>9</b>
11/79→09/82	<b>305 I 1.5</b>	XR5 (142), XR5S (117)	Petrol	1472	4	<b>7</b>
10/82→08/86	<b>305 II 1.3</b>	XL5 (118)	Petrol	1290	4	<b>7</b>
10/82→08/86	<b>305 II 1.5</b>	XR5 (142)	Petrol	1472	4	<b>7</b>
10/82→12/88	<b>305 II 1.6</b>	XU5 (B1AA), XU5CP (BAZ), XU5S (171)	Petrol	1580	4	<b>11</b>
11/82→12/88	<b>305 II 1.8</b>	XUD7 (161A)	Diesel	1769	4	<b>8</b>
10/82→12/88	<b>305 II 1.9</b>	XU9J1 (DFZ), XU92C	Petrol	1905	4	<b>11</b>
10/82→12/88	<b>305 II 1.9</b>	XUD9 (162), XUD9 (D9A)	Diesel	1905	4	<b>12</b>

# MODEL INDEX



Modelverzeichnis • Index de modele • Índice de Modelo  
Indeks modelu • Модель автомобиля • دليل الموديل



CCM

x



9

05/93→05/01	<b>306 1.1</b>	TU1M (HDZ)	Petrol	1124	4	<b>1</b>
05/93→04/02	<b>306 1.4</b>	TU3JP (KFW), TU3JP (KFX), TU3MC (KDX)	Petrol	1360	4	<b>3</b>
04/93→05/01	<b>306 1.8</b>	XUD7 (A9A)	Diesel	1769	4	<b>8</b>
05/93→10/03	<b>306 1.8</b>	XU7JP (LFZ), XU7JP4 (LFY)	Petrol	1761	4	<b>11</b>
04/93→04/02	<b>306 1.9</b>	XUD9, XUD9 (DJZ), XUD9A (DJY), XUD9BSD (DHW), XUD9TE, XUD9TE (DHY)	Diesel	1905	4	<b>12</b>
09/98→04/02	<b>306 1.9</b>	DW8 (WJZ), DW8B (WJY)	Diesel	1868	4	<b>10</b>
03/96→07/01	<b>306 Van 1.4</b>	TU3A (KFW)	Petrol	1360	4	<b>3</b>
05/97→06/00	<b>306 Van 1.8</b>	XUD7 (A9A)	Diesel	1769	4	<b>8</b>
02/94→04/99	<b>306 Van 1.9</b>	XUD9, XUD9TE	Diesel	1905	4	<b>12</b>
02/99→08/02	<b>306 Van 1.9</b>	DW8 (WJZ), DW8B (WJY)	Diesel	1868	4	<b>10</b>
08/00→	<b>307 1.4</b>	TU3JP (KFW)	Petrol	1360	4	<b>3</b>
10/01→	<b>307 1.4</b>	DV4TD (8HX)	Diesel	1399	4	<b>2</b>
10/01→	<b>307 1.4</b>	DV4TD (8HZ)	Diesel	1398	4	<b>2</b>
02/04→	<b>307 1.6</b>	DV6ATED4 (9HV), DV6ATED4 (9HX), DV6TED4 (9HY), DV6TED4 (9HZ)	Diesel	1560	4	<b>6</b>
09/07→	<b>308 1.6</b>	DV6C (9HR), DV6DTE (9HP), DV6TED4 (9HZ)	Diesel	1560	4	<b>6</b>
06/09→	<b>308 CC 1.6</b>	DV6C (9HR)	Diesel	1560	4	<b>6</b>
09/07→	<b>308 SW 1.6</b>	DV6ATED4 (9HV), DV6ATED4 (9HX), DV6C (9HR), DV6DTE (9HP), DV6TED4 (9HZ)	Diesel	1560	4	<b>6</b>
03/89→07/89	<b>309 I 1.4</b>	TU3A (K1D), TU3M (KDY), TU3M (KDZ), TU3S (K2B)	Petrol	1360	4	<b>3</b>
10/85→12/89	<b>309 I 1.6</b>	XU5 (B1AA), XU5CP (BAZ), XU5J (180), XU5J (B6B), XU51C (B1A/B1C/B1E)	Petrol	1580	4	<b>11</b>
10/85→07/89	<b>309 I 1.9</b>	XU9J1 (DFZ), XU9JA (D6B), XU9JAZ (DKZ), XU9M (DDZ), XU9S (D2B)	Petrol	1905	4	<b>11</b>
06/86→07/89	<b>309 I 1.9</b>	XUD9 (162), XUD9 (D9A)	Diesel	1905	4	<b>12</b>
09/89→12/93	<b>309 II 1.1</b>	TU1 (H1A/H1B/H3A), TU1M (HDZ)	Petrol	1124	4	<b>1</b>
07/89→12/93	<b>309 II 1.4</b>	TU3A (K1D), TU3M (KDY), TU3M (KDZ)	Petrol	1360	4	<b>3</b>
07/89→12/93	<b>309 II 1.6</b>	XU5M (BDZ), XU5M2Z (BDY), XU5M3Z (BDY), XU52C (B2A)	Petrol	1580	4	<b>11</b>
07/89→12/93	<b>309 II 1.8</b>	XUD7 (161A), XUD7TE (A8B)	Diesel	1769	4	<b>8</b>
07/89→12/93	<b>309 II 1.9</b>	XU9J1 (DFZ), XU9J4 (D6C/DFW), XU9J4 (DFW), XU9JA (D6B), XU9JAZ (DKZ), XU9M (DDZ)	Petrol	1905	4	<b>11</b>
07/89→12/93	<b>309 II 1.9</b>	XUD9 (162), XUD9 (D9A), XUD9 (DJZ)	Diesel	1905	4	<b>12</b>
04/63→12/71	<b>404 1.6</b>	XC6	Petrol	1618	4	<b>13</b>
01/87→12/92	<b>405 I 1.6</b>	XU5CP (BAZ), XU5M (BDZ), XU5M2Z (BDY), XU5M3Z (BDY), XU51C (B1A/B1C/B1E), XU52C (B2A)	Petrol	1580	4	<b>11</b>
10/87→12/92	<b>405 I 1.8</b>	XUD7TE (A8A), XUD7TE (AJZ)	Diesel	1769	4	<b>8</b>
06/87→12/93	<b>405 I 1.9</b>	XU9J1 (DFZ), XU9J2 (D6A), XU9J4 (D6C/DFW), XU9J4 (DFW), XU9JAZ (DKZ), XU9M (DDZ), XU92C (D2C)	Petrol	1905	4	<b>11</b>
03/88→12/92	<b>405 I 1.9</b>	XUD9 (DJZ), XUD9A (D9B), XUD9A (DJY)	Diesel	1905	4	<b>12</b>
08/92→10/96	<b>405 II 1.4</b>	TU3MC (KDX)	Petrol	1360	4	<b>3</b>
08/92→05/97	<b>405 II 1.6</b>	XU5JP (BFZ), XU5M (BDZ), XU5M2Z (BDY), XU5M3Z (BDY), XU52C (B2A)	Petrol	1580	4	<b>11</b>
08/92→11/99	<b>405 II 1.8</b>	XU7JP (LFZ)	Petrol	1761	4	<b>11</b>
08/92→11/99	<b>405 II 1.9</b>	XUD9, XUD9 (DJZ), XUD9A (D9B), XUD9A (DJY), XUD9TE, XUD9TE (DHY)	Diesel	1905	4	<b>12</b>
11/95→05/04	<b>406 1.6</b>	XU5JP (BFZ)	Petrol	1580	4	<b>11</b>
11/95→10/04	<b>406 1.8</b>	XU7JB (LFX), XU7JP (LFZ), XU7JP4 (LFY)	Petrol	1761	4	<b>11</b>
10/95→10/04	<b>406 1.9</b>	XUD9, XUD9SD (DHW), XUD9TE (D8B), XUD9TE (DHX), XUD9TE (DHY)	Diesel	1905	4	<b>12</b>
05/04→	<b>407 1.6</b>	DV6TED4 (9HZ)	Diesel	1560	4	<b>6</b>
11/10→	<b>408 1.6</b>	DV6C (9HL)	Diesel	1560	4	<b>6</b>
01/80→06/87	<b>504 1.6</b>	XC7P	Petrol	1618	4	<b>13</b>
07/68→10/99	<b>504 1.8</b>	KF6, XM, XM7	Petrol	1796	4	<b>13</b>
03/73→12/89	<b>504 1.9</b>	XD 4.88	Diesel	1948	4	<b>15</b>
01/71→	<b>504 2.0</b>	XN1, XN1 (106), XN2 (107)	Petrol	1971	4	<b>16</b>
02/71→07/86	<b>504 2.1</b>	XD90	Diesel	2112	4	<b>18</b>
07/75→12/89	<b>504 2.3</b>	XD2 (134)	Diesel	2304	4	<b>21</b>
08/90→10/99	<b>504 2.5</b>	XD3P	Diesel	2498	4	<b>21</b>
06/81→09/89	<b>505 1.8</b>	XM7, XM7 (105), XM7A (105C)	Petrol	1796	4	<b>13</b>
08/79→09/89	<b>505 2.0</b>	ZEJ (829)	Petrol	1995	4	<b>17</b>
09/80→09/95	<b>505 2.0</b>	XN1, XN1 (106), XN1A (106E)	Petrol	1971	4	<b>16</b>

Modelverzeichnis • Index de modele • Índice de Modelo  
Indeks modelu • Модель автомобиля • دليل المركبة



# MODEL INDEX



CCM

x



9

05/81→12/93	<b>505 2.2</b>	ZDJ (851), ZDJL (851B), ZDJL (851X)	Petrol	2165	4	<b>17</b>
05/79→06/86	<b>505 2.3</b>	XD2, XD2S (147)	Diesel	2304	4	<b>21</b>
06/81→12/93	<b>505 2.5</b>	XD3 (155), XD3T, XD3T (152A), XD3TE (152B)	Diesel	2498	4	<b>21</b>
11/10→	<b>508 1.6</b>	DV6C (9HR), DV6CTED (9HD)	Diesel	1560	4	<b>6</b>
11/10→	<b>508 SW 1.6</b>	DV6C (9HR), DV6CTED (9HD)	Diesel	1560	4	<b>6</b>
09/79→05/83	<b>604 2.3</b>	XD2S (147)	Diesel	2304	4	<b>21</b>
08/83→12/86	<b>604 2.5</b>	XD3T (152A)	Diesel	2498	4	<b>21</b>
07/95→08/02	<b>806 1.8</b>	XU7JP (LFW)	Petrol	1761	4	<b>11</b>
07/95→08/02	<b>806 1.9</b>	XUD9TE (DHX), XUD9TE (DHY)	Diesel	1905	4	<b>12</b>
04/05→	<b>1007 1.4</b>	DV4TD (8HX)	Diesel	1399	4	<b>2</b>
04/05→	<b>1007 1.4</b>	DV4TD (8HZ)	Diesel	1398	4	<b>2</b>
04/05→	<b>1007 1.4</b>	TU3JP-L4	Petrol	1360	4	<b>3</b>
06/07→	<b>1007 1.6</b>	DV6TED4 (9HZ)	Diesel	1560	4	<b>6</b>
03/13→	<b>2008 1.6</b>	DV6CTED (9HD), DV6DTE (9HP)	Diesel	1560	4	<b>6</b>
06/09→	<b>3008 1.6</b>	DV6C (9HR), DV6CTED (9HD), DV6TED4 (9HZ)	Diesel	1560	4	<b>6</b>
09/09→	<b>5008 1.6</b>	DV6C (9HR), DV6CTED (9HD), DV6TED4 (9HZ)	Diesel	1560	4	<b>6</b>
02/08→	<b>Bipper 1.4</b>	TU3A (KFV)	Petrol	1360	4	<b>3</b>
04/08→	<b>Bipper Tepee 1.4</b>	TU3A (KFV)	Petrol	1360	4	<b>3</b>
03/94→04/02	<b>Boxer 1.9</b>	XUD9A (D9B), XUD9A (DJY), XUD9TE, XUD9TE (DHY), XUD9UTF (D8C)	Diesel	1905	4	<b>12</b>
04/06→	<b>Boxer 2.2</b>	4HU, 4HV	Diesel	2198	4	<b>14</b>
03/94→04/02	<b>Boxer 2.5</b>	DJ5 (T9A), DJ5TED (THX)	Diesel	2446	4	<b>19</b>
01/99→	<b>Boxer 2.8</b>	8140.43N, 8140.43S, 8140.63 (F28D)	Diesel	2798	4	<b>22</b>
01/07→	<b>Expert 1.6</b>	DV6UTED4 (9HU)	Diesel	1560	4	<b>6</b>
10/96→09/00	<b>Expert 1.8</b>	XU7JP (LFZ)	Petrol	1761	4	<b>11</b>
10/95→	<b>Expert 1.9</b>	XUD9A (D9B), XUD9TE, XUD9TE (D8B), XUD9TE (DHX)	Diesel	1905	4	<b>12</b>
06/98→	<b>Expert 1.9</b>	DW8 (WJZ), DW8B (WJY)	Diesel	1868	4	<b>10</b>
01/07→	<b>Expert Tepee 1.6</b>	DV6UTED4 (9HU)	Diesel	1560	4	<b>6</b>
05/10→	<b>Hoggar 1.4</b>	TU3A (KFV)	Petrol	1360	4	<b>3</b>
01/83→01/94	<b>J5 1.8</b>	XM7T (169B)	Petrol	1796	4	<b>13</b>
09/87→03/94	<b>J5 1.9</b>	XUD9, XUD9A (D9B)	Diesel	1905	4	<b>12</b>
09/81→01/94	<b>J5 2.0</b>	XN1P, XN1T, XN1T (170), XN1T (170B), XN1TA	Petrol	1971	4	<b>16</b>
09/81→01/94	<b>J5 2.5</b>	CRD93, CRD93L	Diesel	2498	4	<b>20</b>
09/81→03/94	<b>J5 2.5</b>	CRD93 (U25/651/661), CRD93LS (U25/673)	Diesel	2500	4	<b>20</b>
08/68→03/80	<b>J7 1.6</b>	XC7P	Petrol	1618	4	<b>13</b>
07/70→03/80	<b>J7 1.8</b>	XM7P	Petrol	1796	4	<b>13</b>
08/68→07/78	<b>J7 1.9</b>	XDP 4.88	Diesel	1948	4	<b>15</b>
08/68→07/77	<b>J7 2.1</b>	XDP90	Diesel	2112	4	<b>18</b>
03/80→06/87	<b>J9 1.6</b>	XC7P	Petrol	1618	4	<b>13</b>
03/80→06/87	<b>J9 2.0</b>	XN1P	Petrol	1971	4	<b>16</b>
03/80→07/82	<b>J9 2.3</b>	XD2P / XD94	Diesel	2304	4	<b>21</b>
07/82→06/87	<b>J9 2.5</b>	XD3P	Diesel	2498	4	<b>21</b>
06/96→	<b>Partner 1.1</b>	TU1M (HDZ)	Petrol	1124	4	<b>1</b>
06/96→	<b>Partner 1.4</b>	TU3A (KFV), TU3JP (KFW), TU3JP (KFX), TU3JP-L4, TU32	Petrol	1360	4	<b>3</b>
02/06→	<b>Partner 1.6</b>	DV6ATED4 (9HX), DV6BTED4 (9HT), DV6BTED4 (9HW), DV6C (9HL), DV6DTE (9HF), DV6DTE (9HP), DV6TED4 (9HZ)	Diesel	1560	4	<b>6</b>
06/96→	<b>Partner 1.8</b>	XUD7 (A9A)	Diesel	1769	4	<b>8</b>
03/97→	<b>Partner 1.8</b>	XU7JB (LFX)	Petrol	1761	4	<b>11</b>
05/96→	<b>Partner 1.9</b>	XUD9, XUD9A (DJY)	Diesel	1905	4	<b>12</b>
06/96→	<b>Partner 1.9</b>	DW8 (WJZ), DW8B (WJY)	Diesel	1868	4	<b>10</b>
04/08→	<b>Partner Tepee 1.6</b>	DV6ATED4 (9HX), DV6BTED4 (9HT), DV6BTED4 (9HW), DV6C (9HL), DV6DTE (9HF), DV6DTE (9HP), DV6TED4 (9HZ)	Diesel	1560	4	<b>6</b>

# ENGINE INDEX

Motorverzeichnis • Index de moteur • Índice de Motor  
Indeks silnika • Модель двигателя • دليل المحرك



CCM



9

4HU	Diesel	2198	4	86.00	14
4HV	Diesel	2198	4	86.00	14
8140.43N	Diesel	2798	4	94.40	22
8140.43S	Diesel	2798	4	94.40	22
8140.63 (F28D)	Diesel	2798	4	94.40	22
CRD93	Diesel	2498	4	93.00	20
CRD93 (U25/651/661)	Diesel	2500	4	93.00	20
CRD93L	Diesel	2498	4	93.00	20
CRD93LS (U25/673)	Diesel	2500	4	93.00	20
DJ5 (T9A)	Diesel	2446	4	92.00	19
DJ5TED (THX)	Diesel	2446	4	92.00	19
DV4TD (8HT)	Diesel	1398	4	73.70	2
DV4TD (8HX)	Diesel	1399	4	73.70	2
DV4TD (8HZ)	Diesel	1398	4	73.70	2
DV6ATED4 (9HV)	Diesel	1560	4	75.00	6
DV6ATED4 (9HX)	Diesel	1560	4	75.00	6
DV6BTED4 (9HT)	Diesel	1560	4	75.00	6
DV6BTED4 (9HW)	Diesel	1560	4	75.00	6
DV6C (9HL)	Diesel	1560	4	75.00	6
DV6C (9HR)	Diesel	1560	4	75.00	6
DV6CTED (9HD)	Diesel	1560	4	75.00	6
DV6DTE (9HF)	Diesel	1560	4	75.00	6
DV6DTE (9HP)	Diesel	1560	4	75.00	6
DV6DTE (9HJ)	Diesel	1560	4	75.00	6
DV6ETEDM (9HK)	Diesel	1560	4	75.00	6
DV6TED4 (9HY)	Diesel	1560	4	75.00	6
DV6TED4 (9HZ)	Diesel	1560	4	75.00	6
DV6UTED4 (9HU)	Diesel	1560	4	75.00	6
DW8 (WJZ)	Diesel	1868	4	82.20	10
DW8B (WJY)	Diesel	1868	4	82.20	10
EN 55	Diesel	2498	4	94.00	21
ET 70	Diesel	2496	4	94.00	21
KF6	Petrol	1796	4	84.00	13
TU1 (H1A/H1B/H3A)	Petrol	1124	4	72.00	1
TU1M (HDY)	Petrol	1124	4	72.00	1
TU1M (HDZ)	Petrol	1124	4	72.00	1
TU2.4	Petrol	1294	4	75.00	4
TU32	Petrol	1360	4	75.00	3
TU3A (K1D)	Petrol	1360	4	75.00	3
TU3A (K6D)	Petrol	1360	4	75.00	3
TU3A (K6E)	Petrol	1360	4	75.00	3
TU3A (K6F)	Petrol	1360	4	75.00	3
TU3A (KFT)	Petrol	1360	4	75.00	3
TU3A (KFV)	Petrol	1360	4	75.00	3
TU3A (KFW)	Petrol	1360	4	75.00	3
TU3J2 (KFZ)	Petrol	1360	4	75.00	3
TU3JP (KFW)	Petrol	1360	4	75.00	3
TU3JP (KFX)	Petrol	1360	4	75.00	3
TU3JP-L4	Petrol	1360	4	75.00	3
TU3M (KDY)	Petrol	1360	4	75.00	3
TU3M (KDZ)	Petrol	1360	4	75.00	3
TU3MC (KDX)	Petrol	1360	4	75.00	3
TU3S (K2B)	Petrol	1360	4	75.00	3
XC6	Petrol	1618	4	84.00	13
XC7	Petrol	1618	4	84.00	13
XC7P	Petrol	1618	4	84.00	13
XD 4.88	Diesel	1948	4	88.00	15
XD 88	Diesel	1948	4	88.00	15
XD2	Diesel	2304	4	94.00	21
XD2 (134)	Diesel	2304	4	94.00	21



CCM

x



9

<b>XD2P / XD94</b>	Diesel	2304	4	94.00	<b>21</b>
<b>XD2S</b>	Diesel	2304	4	94.00	<b>21</b>
<b>XD2S (147)</b>	Diesel	2304	4	94.00	<b>21</b>
<b>XD3 (155)</b>	Diesel	2498	4	94.00	<b>21</b>
<b>XD3P</b>	Diesel	2498	4	94.00	<b>21</b>
<b>XD3T</b>	Diesel	2498	4	94.00	<b>21</b>
<b>XD3T (152A)</b>	Diesel	2498	4	94.00	<b>21</b>
<b>XD3TE</b>	Diesel	2498	4	94.00	<b>21</b>
<b>XD3TE (152B)</b>	Diesel	2498	4	94.00	<b>21</b>
<b>XD90</b>	Diesel	2112	4	90.00	<b>18</b>
<b>XDP 4.88</b>	Diesel	1948	4	88.00	<b>15</b>
<b>XDP 4.90</b>	Diesel	2112	4	90.00	<b>18</b>
<b>XDP 6.90</b>	Diesel	3168	6	90.00	<b>18</b>
<b>XDP90</b>	Diesel	2112	4	90.00	<b>18</b>
<b>XID (149)</b>	Diesel	1548	4	80.00	<b>9</b>
<b>XL5</b>	Petrol	1290	4	78.00	<b>7</b>
<b>XL5 (118)</b>	Petrol	1290	4	78.00	<b>7</b>
<b>XL5S</b>	Petrol	1290	4	78.00	<b>7</b>
<b>XM</b>	Petrol	1796	4	84.00	<b>13</b>
<b>XM7</b>	Petrol	1796	4	84.00	<b>13</b>
<b>XM7 (105)</b>	Petrol	1796	4	84.00	<b>13</b>
<b>XM7A (105C)</b>	Petrol	1796	4	84.00	<b>13</b>
<b>XM7P</b>	Petrol	1796	4	84.00	<b>13</b>
<b>XM7T (169B)</b>	Petrol	1796	4	84.00	<b>13</b>
<b>XN1</b>	Petrol	1971	4	88.00	<b>16</b>
<b>XN1 (106)</b>	Petrol	1971	4	88.00	<b>16</b>
<b>XN1A (106E)</b>	Petrol	1971	4	88.00	<b>16</b>
<b>XN1P</b>	Petrol	1971	4	88.00	<b>16</b>
<b>XN1T</b>	Petrol	1971	4	88.00	<b>16</b>
<b>XN1T (170)</b>	Petrol	1971	4	88.00	<b>16</b>
<b>XN1T (170B)</b>	Petrol	1971	4	88.00	<b>16</b>
<b>XN1TA</b>	Petrol	1971	4	88.00	<b>16</b>
<b>XN1TA (170C)</b>	Petrol	1971	4	88.00	<b>16</b>
<b>XN2 (107)</b>	Petrol	1971	4	88.00	<b>16</b>
<b>XR5 (142)</b>	Petrol	1472	4	78.00	<b>7</b>
<b>XR5S (117)</b>	Petrol	1472	4	78.00	<b>7</b>
<b>XU5 (B1AA)</b>	Petrol	1580	4	83.00	<b>11</b>
<b>XU51C (B1A/B1C/B1E)</b>	Petrol	1580	4	83.00	<b>11</b>
<b>XU51C (B1D)</b>	Petrol	1580	4	83.00	<b>11</b>
<b>XU52C (B2A)</b>	Petrol	1580	4	83.00	<b>11</b>
<b>XU5CP (BAZ)</b>	Petrol	1580	4	83.00	<b>11</b>
<b>XU5J (180)</b>	Petrol	1580	4	83.00	<b>11</b>
<b>XU5J (180A)</b>	Petrol	1580	4	83.00	<b>11</b>
<b>XU5J (B6B)</b>	Petrol	1580	4	83.00	<b>11</b>
<b>XU5JP (BFZ)</b>	Petrol	1580	4	83.00	<b>11</b>
<b>XU5M (BDZ)</b>	Petrol	1580	4	83.00	<b>11</b>
<b>XU5M2Z (BDY)</b>	Petrol	1580	4	83.00	<b>11</b>
<b>XU5M3Z (BDY)</b>	Petrol	1580	4	83.00	<b>11</b>
<b>XU5S (171)</b>	Petrol	1580	4	83.00	<b>11</b>
<b>XU7JB (LFX)</b>	Petrol	1761	4	83.00	<b>11</b>
<b>XU7JP (LFW)</b>	Petrol	1761	4	83.00	<b>11</b>
<b>XU7JP (LFZ)</b>	Petrol	1761	4	83.00	<b>11</b>
<b>XU7JP4 (LFY)</b>	Petrol	1761	4	83.00	<b>11</b>
<b>XU92C</b>	Petrol	1905	4	83.00	<b>11</b>
<b>XU92C (D2A)</b>	Petrol	1905	4	83.00	<b>11</b>
<b>XU92C (D2C)</b>	Petrol	1905	4	83.00	<b>11</b>
<b>XU9J1 (DFZ)</b>	Petrol	1905	4	83.00	<b>11</b>
<b>XU9J2 (D6A)</b>	Petrol	1905	4	83.00	<b>11</b>
<b>XU9J4 (D6C/DFW)</b>	Petrol	1905	4	83.00	<b>11</b>
<b>XU9J4 (DFW)</b>	Petrol	1905	4	83.00	<b>11</b>

# ENGINE INDEX

Motorverzeichnis • Index de moteur • Índice de Motor  
Indeks silnika • Модель двигателя • دليل المحرك



CCM



9

Engine Code	Fuel Type	CCM	x	Valve Train	Page
XU9JA (D6B)	Petrol	1905	4	83.00	11
XU9JAZ (DKZ)	Petrol	1905	4	83.00	11
XU9M (DDZ)	Petrol	1905	4	83.00	11
XU9S (D2B)	Petrol	1905	4	83.00	11
XUD7 (161A)	Diesel	1769	4	80.00	8
XUD7 (A9A)	Diesel	1769	4	80.00	8
XUD7T	Diesel	1769	4	80.00	8
XUD7TE (A8A)	Diesel	1769	4	80.00	8
XUD7TE (A8B)	Diesel	1769	4	80.00	8
XUD7TE (AJZ)	Diesel	1769	4	80.00	8
XUD9	Diesel	1905	4	83.00	12
XUD9 (162)	Diesel	1905	4	83.00	12
XUD9 (D9A)	Diesel	1905	4	83.00	12
XUD9 (DJZ)	Diesel	1905	4	83.00	12
XUD9A (D9B)	Diesel	1905	4	83.00	12
XUD9A (D9B/DJY)	Diesel	1905	4	83.00	12
XUD9A (DJY)	Diesel	1905	4	83.00	12
XUD9BSD (DHV)	Diesel	1905	4	83.00	12
XUD9SD (DHW)	Diesel	1905	4	83.00	12
XUD9TE	Diesel	1905	4	83.00	12
XUD9TE (D8B)	Diesel	1905	4	83.00	12
XUD9TE (DHX)	Diesel	1905	4	83.00	12
XUD9TE (DHY)	Diesel	1905	4	83.00	12
XUD9UTF (D8C)	Diesel	1905	4	83.00	12
XW3 (109)	Petrol	1124	4	72.00	1
XW3S	Petrol	1124	4	72.00	1
XW3S (121)	Petrol	1124	4	72.00	1
XW7 (109F)	Petrol	1124	4	72.00	1
XW7 (109N)	Petrol	1124	4	72.00	1
XY8 (150B)	Petrol	1360	4	75.00	3
XZ5 (129)	Petrol	1219	4	75.00	5
ZDJ (851)	Petrol	2165	4	88.00	17
ZDJL (851B)	Petrol	2165	4	88.00	17
ZDJL (851X)	Petrol	2165	4	88.00	17
ZEJ (829)	Petrol	1995	4	88.00	17



**1**

<b>TU1 (H1A/H1B/H3A)</b>	4cyl.	<b>1124cc</b>	<b>40kW</b> (54PS)				<b>TD2758</b>
<b>TU1M (HDY)</b>	4cyl.	<b>1124cc</b>	<b>40kW</b> (54PS)				<b>TD9404</b>
<b>TU1M (HDZ)</b>	4cyl.	<b>1124cc</b>	<b>44kW</b> (60PS)				<b>TD4834</b>
<b>XW3 (109)</b>	4cyl.	<b>1124cc</b>	<b>33kW</b> (45PS)				<b>TD2895</b>
<b>XW3S</b>	4cyl.	<b>1124cc</b>	<b>48kW</b> (65PS)				<b>TD12688</b>
<b>XW3S (121)</b>	4cyl.	<b>1124cc</b>	<b>49kW</b> (67PS)				<b>TD2896</b>
<b>XW7 (109F)</b>	4cyl.	<b>1124cc</b>	<b>37kW</b> (50PS)				<b>TD2899</b>
<b>XW7 (109N)</b>	4cyl.	<b>1124cc</b>	<b>36kW</b> (49PS)				<b>TD2900</b>

14-636470-00 *WH*      72.00      B 79.50      C 122.00      D 89.20      E 85.00

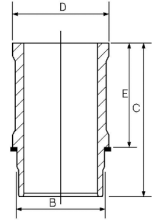
**2**

<b>DV4TD (8HT)</b>	4cyl.	<b>1398cc</b>	<b>40kW</b> (54PS)	<b>Diesel</b>	<b>Turbo Intercooled</b>		<b>TD24924</b>
<b>DV4TD (8HX) Euro3/Euro4</b>	4cyl.	<b>1399cc</b>	<b>52kW</b> (71PS)	<b>Diesel</b>	<b>Turbo Intercooled</b>		<b>TD16368</b>
<b>DV4TD (8HZ)</b>	4cyl.	<b>1398cc</b>	<b>50kW</b> (68PS)	<b>Diesel</b>	<b>Turbo Intercooled</b>		<b>TD17509</b>

14-020760-00 *D*      73.70      B 76.70      C 136.00      D 78.20      E 5.00  
 14-020761-00 *D*      B 76.95      C 136.00      D 78.45      E 5.25

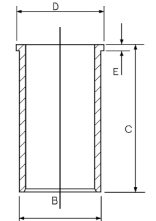
**3**

<b>TU3A (K1D)</b>	4cyl.	<b>1360cc</b>	<b>49kW</b> (67PS)				<b>TD2766</b>
<b>TU3A (K6D)</b>	4cyl.	<b>1360cc</b>	<b>53kW</b> (72PS)				<b>TD24928</b>
<b>TU3A (K6E)</b>	4cyl.	<b>1360cc</b>	<b>53kW</b> (72PS)				<b>TD24930</b>
<b>TU3A (K6F)</b>	4cyl.	<b>1360cc</b>	<b>53kW</b> (72PS)				<b>TD24929</b>
<b>TU3A (KFT)</b>	4cyl.	<b>1360cc</b>	<b>54kW</b> (73PS)				<b>TD24931</b>
<b>TU3A (KFV)</b>	4cyl.	<b>1360cc</b>	<b>54kW</b> (73PS)				<b>TD21111</b>
<b>TU3A (KFW)</b>	4cyl.	<b>1360cc</b>	<b>55kW</b> (75PS)				<b>TD24927</b>
<b>TU3J2 (KFZ)</b>	4cyl.	<b>1360cc</b>	<b>69kW</b> (93PS)				<b>TD2770</b>
<b>TU3JP (KFW)</b>	4cyl.	<b>1360cc</b>	<b>55kW</b> (75PS)				<b>TD14729</b>
<b>TU3JP (KFX)</b>	4cyl.	<b>1360cc</b>	<b>55kW</b> (75PS)				<b>TD5396</b>
<b>TU3JP-L4</b>	4cyl.	<b>1360cc</b>	<b>55kW</b> (75PS)				<b>TD18518</b>
<b>TU3M (KDY)</b>	4cyl.	<b>1360cc</b>	<b>55-58kW</b> (75-79PS)				<b>TD4836</b>
<b>TU3M (KDZ)</b>	4cyl.	<b>1360cc</b>	<b>55kW</b> (75PS)				<b>TD2775</b>
<b>TU3MC (KDX)</b>	4cyl.	<b>1360cc</b>	<b>55-56kW</b> (75-76PS)				<b>TD2777</b>
<b>TU3S (K2B)</b>	4cyl.	<b>1360cc</b>	<b>62kW</b> (84PS)				<b>TD2779</b>





**TU32** 4cyl. **1360cc** **51-52kW (70-71PS)** **TD8507**

**XY8 (150B)** 4cyl. **1360cc** **58-59kW (79-80PS)** **TD2905**

14-636600-00 *WH* 75.00 B 79.50 C 134.50 D 89.20 E 90.00

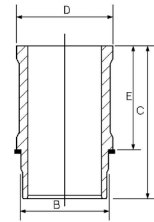

**4**

**TU2.4** 4cyl. **1294cc** **70kW (95PS)** **TD12689**

14-638630-00 *WH* 75.00 B 79.50 C 120.50 D 89.20 E 85.00

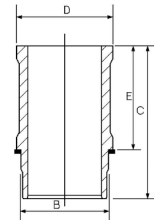

**5**

**XZ5 (129)** 4cyl. **1219cc** **42kW (57PS)** **TD2906**

15-636700-00 *WH* <sup>†</sup> 75.00 B 79.50 C 122.00 D 89.20 E 82.50

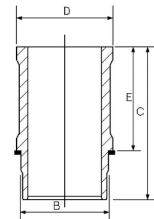

<sup>†</sup> Includes seals

<sup>†</sup> Schließt Dichtungen ein

<sup>†</sup> Inclut des joints

<sup>†</sup> Incluye los sellos

**6**

**DV6ATED4 (9HV)** 4cyl. **1560cc** **66kW (89PS)** Diesel Turbo Intercooled **TD24730**

**DV6ATED4 (9HX) Euro 4** 4cyl. **1560cc** **66kW (89PS)** Diesel Turbo Intercooled **TD20147**

**DV6BTED4 (9HT) Euro 4** 4cyl. **1560cc** **55kW (75PS)** Diesel Turbo Intercooled **TD23537**

**DV6BTED4 (9HW) Euro 4** 4cyl. **1560cc** **55kW (75PS)** Diesel Turbo Intercooled **TD24701**

**DV6C (9HL)** 4cyl. **1560cc** **82-85kW (112-116PS)** Diesel Turbo Intercooled **TD26986**

**DV6C (9HR)** 4cyl. **1560cc** **82kW (111PS)** Diesel Turbo Intercooled **TD26421**

**DV6CTED (9HD)** 4cyl. **1560cc** **84kW (114PS)** Diesel Turbo Intercooled **TD26896**

**DV6DTED (9HF) Euro 4** 4cyl. **1560cc** **66kW (89PS)** Diesel Turbo Intercooled **TD26710**

**DV6DTED (9HP) Euro 4** 4cyl. **1560cc** **68kW (92PS)** Diesel Turbo Intercooled **TD27064**

**DV6DTEDM (9HJ) Euro 4** 4cyl. **1560cc** **68kW (92PS)** Diesel Turbo Intercooled **TD27967**

**DV6ETEDM (9HK) Euro 4** 4cyl. **1560cc** **55kW (75PS)** Diesel Turbo Intercooled **TD27968**

**DV6TED4 (9HY) Euro 4** 4cyl. **1560cc** **80kW (109PS)** Diesel Turbo Intercooled **TD17506**







DV6TED4 (9HZ) Euro 4	4cyl.	1560cc	80kW (109PS)	Diesel	Turbo Intercooled	TD18520
----------------------	-------	--------	--------------	--------	-------------------	---------

DV6UTED4 (9HU)	4cyl.	1560cc	66kW (89PS)	Diesel	Turbo Intercooled	TD24693
----------------	-------	--------	-------------	--------	-------------------	---------

14-020900-00 <i>D</i>	75.00	B 78.00	C 142.00	D 79.50	E 5.00
-----------------------	-------	---------	----------	---------	--------

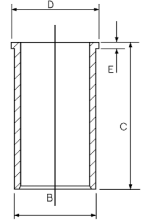

7

XL5	4cyl.	1290cc	44-48kW (60-65PS)			TD4844
-----	-------	--------	-------------------	--	--	--------

XL5 (118)	4cyl.	1290cc	44kW (60PS)			TD2822
-----------	-------	--------	-------------	--	--	--------

XL5S	4cyl.	1290cc	55kW (75PS)			TD2821
------	-------	--------	-------------	--	--	--------

XR5 (142)	4cyl.	1472cc	54kW (73PS)			TD2749
-----------	-------	--------	-------------	--	--	--------

XR5S (117)	4cyl.	1472cc	65kW (88PS)			TD2844
------------	-------	--------	-------------	--	--	--------

15-636490-00 <i>WH</i> ①	78.00	B 82.98	C 133.00	D 89.60	E 97.465
--------------------------	-------	---------	----------	---------	----------

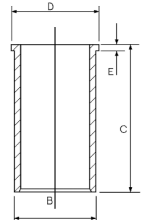

① Includes seals

① Schließt Dichtungen ein

① Inclut des joints

① Incluye los sellos

8

XUD7 (161A)	4cyl.	1769cc	44kW (60PS)	Diesel		TD2882
-------------	-------	--------	-------------	--------	--	--------

XUD7 (A9A)	4cyl.	1769cc	44kW (60PS)	Diesel		TD12351
------------	-------	--------	-------------	--------	--	---------

XUD7T	4cyl.	1769cc	58kW (79PS)	Diesel	Turbo Intercooled	TD18394
-------	-------	--------	-------------	--------	-------------------	---------

XUD7TE (A8A)	4cyl.	1769cc	66kW (89PS)	Diesel	Turbo Intercooled	TD2884
--------------	-------	--------	-------------	--------	-------------------	--------

XUD7TE (A8B)	4cyl.	1769cc	57kW (77PS)	Diesel	Turbo	TD10789
--------------	-------	--------	-------------	--------	-------	---------

XUD7TE (AJZ)	4cyl.	1769cc	66kW (89PS)	Diesel	Turbo Intercooled	TD2885
--------------	-------	--------	-------------	--------	-------------------	--------

14-024740-00 <i>D</i>	80.00	B 83.50	C 154.00	D 85.70	E 4.60
14-024830-00 <i>D</i>		B 83.00	C 154.00	D 86.00	E 4.50

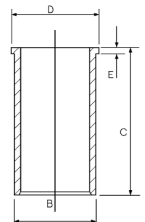

9

XID (149)	4cyl.	1548cc	36kW (49PS)	Diesel		TD2812
-----------	-------	--------	-------------	--------	--	--------

14-634110-00 <i>WH</i> ①②	80.00	B 84.50	C 133.50	D 100.00	E 97.50
---------------------------	-------	---------	----------	----------	---------

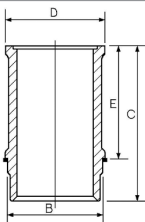

① Use also: 1 x HT006

① Mitverwenden: 1 x HT006

① A utiliser aussi: 1 x HT006

① Utilizar también: 1 x HT006

② Phosphated

② Phosphatiert

② Phosphatisé

② Fosfatada



10

DW8 (WJZ)	4cyl.	1868cc	51kW (69PS)	Diesel	TD9868
DW8B (WJY)	4cyl.	1868cc	51kW (69PS)	Diesel	TD13788

14-020290-00 D	82.20	B 85.00	C 154.00	D 87.00	E 5.00
----------------	-------	---------	----------	---------	--------

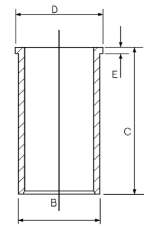

11

XU5 (B1AA)	4cyl.	1580cc	55kW (75PS)	TD2857
XU5CP (BAZ)	4cyl.	1580cc	54-55kW (74-75PS)	TD2859
XU5J (180)	4cyl.	1580cc	76kW (103PS)	TD2862
XU5J (180A)	4cyl.	1580cc	76kW (103PS)	TD2861
XU5J (B6B)	4cyl.	1580cc	76kW (103PS)	TD2858
XU5JP (BFZ)	4cyl.	1580cc	65kW (88PS)	TD2863
XU5M (BDZ)	4cyl.	1580cc	65-66kW (88-90PS)	TD2839
XU5M2Z (BDY)	4cyl.	1580cc	65-71kW (88-97PS)	TD4846
XU5M3Z (BDY)	4cyl.	1580cc	65-66kW (88-90PS)	TD2864
XU5S (171)	4cyl.	1580cc	66-71kW (90-97PS)	TD2865
XU7JB (LFX)	4cyl.	1761cc	66kW (89PS)	TD12708
XU7JP (LFW)	4cyl.	1761cc	73kW (99PS)	TD2867
XU7JP (LFZ)	4cyl.	1761cc	74kW (100PS)	TD2866
XU7JP4 (LFY)	4cyl.	1761cc	81kW (110PS)	TD4849
XU9J1 (DFZ)	4cyl.	1905cc	90kW (122PS)	TD2870
XU9J2 (D6A)	4cyl.	1905cc	90-92kW (122-125PS)	TD22159
XU9J4 (D6C/DFW)	4cyl.	1905cc	116kW (158PS)	TD2873
XU9J4 (DFW)	4cyl.	1905cc	90kW (122PS)	TD2875
XU9JA (D6B)	4cyl.	1905cc	94-96kW (128-131PS)	TD2872
XU9JAZ (DKZ)	4cyl.	1905cc	90kW (122PS)	TD2877
XU9M (DDZ)	4cyl.	1905cc	90kW (122PS)	TD2878
XU9S (D2B)	4cyl.	1905cc	75kW (102PS)	TD2772
XU51C (B1A/B1C/B1E)	4cyl.	1580cc	53-55kW (72-75PS)	TD2856
XU51C (B1D)	4cyl.	1580cc	55kW (75PS)	TD2762
XU52C (B2A)	4cyl.	1580cc	68kW (92PS)	TD12430
XU92C	4cyl.	1905cc	75kW (102PS)	TD2879
XU92C (D2A)	4cyl.	1905cc	75kW (102PS)	TD2869
XU92C (D2C)	4cyl.	1905cc	70kW (95PS)	TD2871

14-634910-00 WH 1	83.00	B 88.60	C 141.00	D 97.00	E 6.50
-------------------	-------	---------	----------	---------	--------

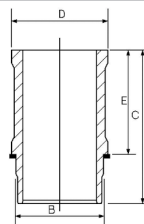

1 Use also: 1 NB O-Ring HR566    1 Mitverwenden: 1 NB O-Ring HR566    1 A utiliser aussi: 1 joint toriques HR566    1 Utilizar también: 1 NB junta toricas HR566



12

XUD9	4cyl.	1905cc	51kW (69PS)	Diesel	TD8478
XUD9 (162)	4cyl.	1905cc	47-48kW (64-65PS)	Diesel	TD2886
XUD9 (D9A)	4cyl.	1905cc	47kW (64PS)	Diesel	TD2754
XUD9 (DJZ)	4cyl.	1905cc	47kW (64PS)	Diesel	TD2891
XUD9A (D9B)	4cyl.	1905cc	51kW (69PS)	Diesel	TD2834
XUD9A (D9B)	4cyl.	1905cc	51kW (69PS)	Diesel	TD2880
XUD9A (D9B/DJY)	4cyl.	1905cc	51kW (69PS)	Diesel	TD10827
XUD9A (DJY)	4cyl.	1905cc	51kW (69PS)	Diesel	TD2887
XUD9BSD (DHV)	4cyl.	1905cc	55kW (75PS)	Diesel	TD9867
XUD9SD (DHW)	4cyl.	1905cc	66kW (89PS)	Diesel Turbo	TD9365
XUD9TE	4cyl.	1905cc	66kW (89PS)	Diesel Turbo Intercooled	TD18953
XUD9TE (D8B)	4cyl.	1905cc	66kW (89PS)	Diesel Turbo Intercooled	TD2751
XUD9TE (DHX)	4cyl.	1905cc	66kW (89PS)	Diesel Turbo Intercooled	TD2889
XUD9TE (DHY)	4cyl.	1905cc	66kW (89PS)	Diesel Turbo Intercooled	TD2888
XUD9UTF (D8C)	4cyl.	1905cc	66kW (89PS)	Diesel Turbo	TD2890

14-020530-00 *D*      83.00      B 85.60      C 153.50      D 88.50      E 3.90

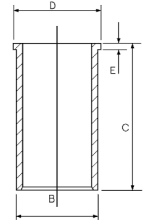

13

KF6	4cyl.	1796cc	71kW (96PS)	TD2755
XC6	4cyl.	1618cc	50-54kW (68-74PS)	TD2793
XC7	4cyl.	1618cc	54kW (73PS)	TD22472
XC7P	4cyl.	1618cc	46kW (63PS)	TD8496
XM	4cyl.	1796cc	60kW (81PS)	TD2824
XM7	4cyl.	1796cc	53-58kW (72-79PS)	TD2825
XM7 (105)	4cyl.	1796cc	55-60kW (75-82PS)	TD2826
XM7A (105C)	4cyl.	1796cc	62-66kW (90-90PS)	TD2827
XM7P	4cyl.	1796cc	48-50kW (65-68PS)	TD8497
XM7T (169B)	4cyl.	1796cc	51kW (69PS)	TD6793

14-606670-00 *WH* <sup>1</sup>      84.00      B 93.00      C 136.20      D 99.20      E 90.01

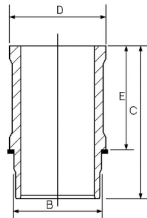

<sup>1</sup> Use also: 1 NB O-Ring HR566

<sup>1</sup> Mitverwenden: 1 NB O-Ring HR566

<sup>1</sup> A utiliser aussi: 1 joint toriques HR566

<sup>1</sup> Utilizar también: 1 NB junta toricas HR566



14

4HU Euro 4	4cyl.	2198cc	88kW (120PS)	Diesel	Turbo Intercooled	TD24470
4HV Euro 4	4cyl.	2198cc	74kW (100PS)	Diesel	Turbo Intercooled	TD24469

14-021120-00 D 86.00 B 89.00 C 156.00 D 90.90 E 5.00

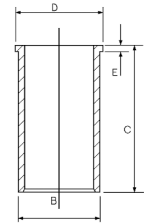

15

XD 4.88	4cyl.	1948cc	40kW (54PS)	Diesel		TD2807
XD 88	4cyl.	1948cc	44kW (60PS)	Diesel		TD23802
XDP 4.88	4cyl.	1948cc	40kW (54PS)	Diesel		TD8499
XDP 4.88	4cyl.	1948cc	36-46kW (49-63PS)	Diesel		TD22477

14-600420-00 WH 88.00 B 96.00 C 173.00 D 106.30 E 129.00

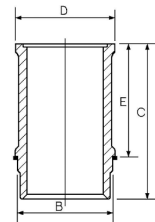

Use also: HT022

Mitverwenden: HT022

A utiliser aussi: HT022

Utilizar también: HT022

16

XN1	4cyl.	1971cc	57kW (77PS)			TD2833
XN1 (106)	4cyl.	1971cc	57kW (77PS)			TD2830
XN1A (106E)	4cyl.	1971cc	57kW (77PS)			TD4845
XN1P	4cyl.	1971cc	57kW (77PS)			TD8502
XN1T	4cyl.	1971cc	55-63kW (75-86PS)			TD22486
XN1T (170)	4cyl.	1971cc	57kW (77PS)			TD2837
XN1T (170B)	4cyl.	1971cc	57kW (77PS)			TD2836
XN1TA	4cyl.	1971cc	62-72kW (84-98PS)			TD8490
XN1TA (170C)	4cyl.	1971cc	62kW (84PS)			TD6804
XN2 (107)	4cyl.	1971cc	78kW (106PS)			TD2831

14-636500-00 WH 88.00 B 93.00 C 135.70 D 101.90 E 89.985

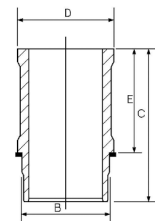



17

ZDJ (851)	4cyl.	2165cc	85kW (116PS)				TD2908
ZDJL (851B)	4cyl.	2165cc	90kW (122PS)				TD2909
ZDJL (851X)	4cyl.	2165cc	84kW (114PS)				TD2910
ZEJ (829)	4cyl.	1995cc	81kW (110PS)				TD2911

14-637160-00 *WH*      88.00      B 93.60      C 140.50      D 104.00      E 93.08

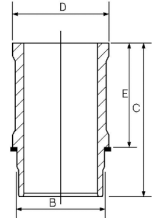

18

XD90	4cyl.	2112cc	48kW (65PS)	Diesel			TD2808
XDP 4.90	4cyl.	2112cc	43-55kW (58-75PS)	Diesel			TD21440
XDP 6.90	6cyl.	3168cc	78kW (106PS)	Diesel			TD22478
XDP90	4cyl.	2112cc	42kW (57PS)	Diesel			TD8500

14-604060-00 *WH*      90.00      B 96.00      C 173.00      D 106.30      E 129.00

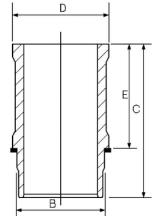

19

DJ5 (T9A)	4cyl.	2446cc	63kW (86PS)	Diesel			TD4830
DJ5TED (THX)	4cyl.	2446cc	79kW (107PS)	Diesel	Turbo Intercooled		TD11067

14-020190-00 *D*      92.00      B 96.00      C 160.00      D 99.00      E 5.00

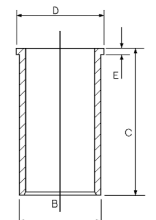

20

CRD93	4cyl.	2498cc	54kW (73PS)	Diesel			TD21168
CRD93 (U25/651/661)	4cyl.	2500cc	54kW (73PS)	Diesel			TD2747
CRD93L	4cyl.	2498cc	70kW (95PS)	Diesel			TD18876
CRD93LS (U25/673)	4cyl.	2500cc	70kW (95PS)	Diesel	Turbo		TD4829

14-013481-00 *D*      93.00      B 96.10      C 163.00

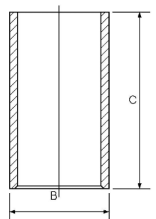



21

EN 55	4cyl.	2498cc	53-56kW (72-76PS)	Diesel		TD6685
ET 70	4cyl.	2496cc	71kW (96PS)	Diesel	Turbo	TD6686
XD2	4cyl.	2304cc	44-53kW (60-72PS)	Diesel		TD22473
XD2 (134)	4cyl.	2304cc	51kW (69PS)	Diesel		TD2800
XD2P / XD94	4cyl.	2304cc	49kW (67PS)	Diesel		TD8504
XD2S	4cyl.	2304cc	54-59kW (73-80PS)	Diesel	Turbo	TD22474
XD2S (147)	4cyl.	2304cc	59kW (80PS)	Diesel	Turbo	TD2802
XD3 (155)	4cyl.	2498cc	51-55kW (70-75PS)	Diesel		TD2803
XD3P	4cyl.	2498cc	53kW (72PS)	Diesel		TD8505
XD3T	4cyl.	2498cc	66-70kW (90-95PS)	Diesel	Turbo Intercooled	TD22475
XD3T (152A)	4cyl.	2498cc	66kW (89PS)	Diesel	Turbo	TD2805
XD3TE	4cyl.	2498cc	54-77kW (73-105PS)	Diesel	Turbo Intercooled	TD22476
XD3TE (152B)	4cyl.	2498cc	77kW (105PS)	Diesel	Turbo	TD2806

14-020660-00 D	94.00	B 97.00	C 170.60	D 99.50	E 4.00
14-021520-00 D		B 98.00	C 170.60	D 100.00	E 6.00
14-027270-00 D		B 98.70	C 170.00	D 100.00	E 5.00

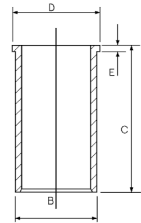

22

8140.43N Euro 3	4cyl.	2798cc	107kW (146PS)	Diesel	Turbo Intercooled	TD24923
8140.43S Euro 3	4cyl.	2798cc	92kW (125PS)	Diesel	Turbo Intercooled	TD17514
8140.63 (F28D)	4cyl.	2798cc	64kW (87PS)	Diesel		TD24917

14-021321-00 D	94.40	B 97.54	C 167.00	D 100.90	E 5.00
14-021322-00 D		B 97.70	C 167.00	D 100.90	E 5.00
14-028930-00 D		B 97.50	C 167.00	D 100.90	E 5.00
14-028931-00 D		B 97.58	C 167.00	D 100.90	E 5.00
14-028932-00 D		B 97.70	C 167.00	D 100.90	E 5.00

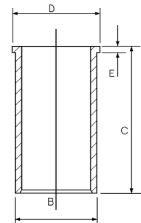

Modelverzeichnis • Index de modele • Índice de Modelo  
Indeks modelu • Модель автомобиля • دليل المركبة



# MODEL INDEX



CCM

x



10/62→09/83	<b>4 0.8</b>	800	Petrol	847	4	<b>1</b>
10/62→07/89	<b>4 0.8</b>	800 01, 800 705, B1B 707	Petrol	845	4	<b>1</b>
10/76→06/90	<b>4 1.1</b>	688 11, 688 12	Petrol	1108	4	<b>2</b>
10/72→12/84	<b>5 0.8</b>	800 710	Petrol	845	4	<b>1</b>
09/80→12/85	<b>5 1.1</b>	688 13, C1E 750, C1E 752, C1E 754	Petrol	1108	4	<b>2</b>
09/75→09/84	<b>5 1.3</b>	810.719, 810.725, 810.726, 810.729	Petrol	1289	4	<b>3</b>
01/82→12/85	<b>5 1.4</b>	C2J 713	Petrol	1397	4	<b>8</b>
10/69→04/80	<b>6 0.8</b>	800.02	Petrol	845	4	<b>1</b>
08/70→04/87	<b>6 1.1</b>	688 10	Petrol	1108	4	<b>2</b>
11/62→10/72	<b>8 1.1</b>	C1E	Petrol	1108	4	<b>2</b>
09/81→05/87	<b>9 1.1</b>	C1E 715, C1E 720	Petrol	1108	4	<b>2</b>
09/81→12/89	<b>9 1.4</b>	C1J 715, C1J 760, C1J 792, C1J 796, C2J 717	Petrol	1397	4	<b>8</b>
10/82→12/88	<b>9 1.6</b>	F8M 700, F8M 720, F8M 730	Diesel	1595	4	<b>10</b>
05/66→10/72	<b>10 1.1</b>	C1E	Petrol	1108	4	<b>2</b>
07/69→10/72	<b>10 1.3</b>	810.03	Petrol	1289	4	<b>3</b>
03/83→06/86	<b>11 1.1</b>	C1E 715, C1E 720	Petrol	1108	4	<b>2</b>
03/83→12/88	<b>11 1.4</b>	C1J 715, C1J 760, C1J 770, C1J 782, C2J 717	Petrol	1397	4	<b>8</b>
08/83→12/88	<b>11 1.6</b>	F8M 700, F8M 720, F8M 730	Diesel	1595	4	<b>10</b>
10/69→08/80	<b>12 1.3</b>	810.02, 810.02/97, 810.05, 810.06	Petrol	1289	4	<b>3</b>
05/76→12/83	<b>14 1.2</b>	129	Petrol	1218	4	<b>6</b>
09/79→06/83	<b>14 1.4</b>	150	Petrol	1360	4	<b>5</b>
03/72→10/80	<b>15 1.3</b>	810.05	Petrol	1289	4	<b>3</b>
04/78→07/86	<b>18 1.4</b>	847 720	Petrol	1397	4	<b>8</b>
10/81→12/86	<b>18 2.0</b>	J6R 716	Petrol	1995	4	<b>14</b>
05/79→07/86	<b>18 2.1</b>	J8S 711, J8S 712	Diesel	2068	4	<b>12</b>
07/88→04/92	<b>19 I 1.1</b>	C1E 700	Petrol	1108	4	<b>2</b>
01/88→12/92	<b>19 I 1.4</b>	E6J 700, E6J 701, E7J 700	Petrol	1390	4	<b>7</b>
07/88→04/92	<b>19 I 1.4</b>	C2J 772, C3J 710	Petrol	1397	4	<b>8</b>
05/92→09/94	<b>19 II 1.2</b>	E7F 730	Petrol	1171	4	<b>7</b>
01/92→06/01	<b>19 II 1.4</b>	E6J 700, E6J 706, E7J 706, E7J 742	Petrol	1390	4	<b>7</b>
04/92→12/95	<b>19 II 1.4</b>	C1J 742, C2J 772, C3J 710	Petrol	1397	4	<b>8</b>
10/77→10/80	<b>20 2.0</b>	829.01	Petrol	1995	4	<b>14</b>
10/80→12/83	<b>20 2.1</b>	852, J8S 702	Diesel	2068	4	<b>12</b>
10/80→12/83	<b>20 2.2</b>	851 700	Petrol	2165	4	<b>14</b>
03/86→08/94	<b>21 2.0</b>	J6R 758, J6R 759, J6R 792, J6R 793, J7R 740, J7R 746, J7R 747, J7R 751, J7R 754	Petrol	1995	4	<b>14</b>
03/86→09/95	<b>21 2.1</b>	J8S 600, J8S 704, J8S 714, J8S 740, J8S 784, J8S 786 (KAT), J8S 788	Diesel	2068	4	<b>12</b>
06/86→06/94	<b>21 2.2</b>	J7T 754	Petrol	2165	4	<b>14</b>
04/84→12/93	<b>25 2.0</b>	J6R 706, J6R 707, J6R 760, J6R 762, J7R 720, J7R 722, J7R 723	Petrol	1995	4	<b>14</b>
04/84→12/92	<b>25 2.1</b>	J8S 706, J8S 708, J8S 736, J8S 738	Diesel	2068	4	<b>12</b>
04/84→12/89	<b>25 2.2</b>	J7T 706, J7T 707, J7T 714, J7T 715, J7T 730	Petrol	2165	4	<b>14</b>
02/82→03/86	<b>30 2.1</b>	J8S 702	Diesel	2068	4	<b>12</b>
01/83→12/90	<b>B 2.4</b>	8140.61.235	Diesel	2445	4	<b>16</b>
04/86→01/92	<b>B 2.4</b>	8140.21.235 IDS	Diesel	2445	4	<b>15</b>
01/91→09/98	<b>Clio I 1.1</b>	C1E 700	Petrol	1108	4	<b>2</b>
05/90→09/98	<b>Clio I 1.2</b>	E5F 710, E7F 700, E7F 706, E7F 708, E7F 750	Petrol	1171	4	<b>7</b>
06/94→02/98	<b>Clio I 1.2</b>	C3G 720	Petrol	1239	4	<b>4</b>
05/90→09/98	<b>Clio I 1.4</b>	E6J 712, E6J 713, E6J 760, E7J 601, E7J 710, E7J 711, E7J 718, E7J 719, E7J 754, E7J 756, E7J 757	Petrol	1390	4	<b>7</b>
09/98→05/05	<b>Clio II 1.4</b>	E7J 634, E7J 780	Petrol	1390	4	<b>7</b>
06/01→	<b>Clio II 1.5</b>	K9K 700, K9K 702, K9K 704, K9K 710, K9K 712, K9K 714, K9K 716, K9K 718, K9K 740	Diesel	1461	4	<b>9</b>
12/99→05/05	<b>Clio II 1.9</b>	F9Q 780	Diesel	1870	4	<b>11</b>
05/05→	<b>Clio III 1.5</b>	K9K 714, K9K 750, K9K 752, K9K 764, K9K 766, K9K 768, K9K 770, K9K 772	Diesel	1461	4	<b>9</b>
11/12→	<b>Clio IV 1.5</b>	K9K 608, K9K 612	Diesel	1461	4	<b>9</b>
02/08→	<b>Clio Grandtour 1.5</b>	K9K 714, K9K 752, K9K 764, K9K 766, K9K 768, K9K 770, K9K 772	Diesel	1461	4	<b>9</b>

# MODEL INDEX



Modelverzeichnis • Index de modele • Índice de Modelo  
Indeks modelu • Модель автомобиля • دليل الموديل



CCM

x



9

01/13→	<b>Clio Grandtour IV 1.5</b>	K9K 608, K9K 612	Diesel	1461	4	<b>9</b>
06/11→	<b>Duster 1.5</b>	K9K 884	Diesel	1461	4	<b>9</b>
07/84→12/92	<b>Espace I 2.0</b>	J6R 234, J6R 236, J7R 760	Petrol	1995	4	<b>14</b>
10/84→12/90	<b>Espace I 2.1</b>	J8S 240, J8S 774	Diesel	2068	4	<b>12</b>
07/86→12/90	<b>Espace I 2.2</b>	J7T 770	Petrol	2165	4	<b>14</b>
01/91→10/96	<b>Espace II 2.0</b>	J7R 768	Petrol	1995	4	<b>14</b>
01/91→10/96	<b>Espace II 2.1</b>	J8S 610, J8S 612, J8S 772, J8S 776, J8S 778	Diesel	2068	4	<b>12</b>
01/91→12/96	<b>Espace II 2.2</b>	J7T 772	Petrol	2165	4	<b>14</b>
02/62→12/81	<b>Estafette 1.1</b>	C1E	Petrol	1108	4	<b>2</b>
08/69→12/81	<b>Estafette 1.3</b>	810.01	Petrol	1289	4	<b>3</b>
07/95→10/99	<b>Express 1.2</b>	C3G 710	Petrol	1239	4	<b>4</b>
02/10→	<b>Fluence 1.5</b>	K9K 830, K9K 832, K9K 834, K9K 836, K9K 837	Diesel	1461	4	<b>9</b>
02/80→10/85	<b>Fuego 1.4</b>	847 720	Petrol	1397	4	<b>8</b>
10/80→10/85	<b>Fuego 2.0</b>	J6R 710, J6R 712, J6R 713, J6R 715	Petrol	1995	4	<b>14</b>
08/82→10/85	<b>Fuego 2.1</b>	J8S 712	Diesel	2068	4	<b>12</b>
04/04→	<b>Grand Scénic II 1.5</b>	K9K 722, K9K 729, K9K 734, K9K P 732	Diesel	1461	4	<b>9</b>
02/09→	<b>Grand Scénic III 1.5</b>	K9K 636, K9K 830, K9K 832, K9K 836, K9K 837, K9K 846	Diesel	1461	4	<b>9</b>
08/97→	<b>Kangoo 1.4</b>	E7J 634, E7J 635, E7J 780	Petrol	1390	4	<b>7</b>
12/01→	<b>Kangoo 1.5</b>	K9K 700, K9K 702, K9K 704, K9K 710, K9K 714, K9K 716, K9K 718, K9K 800, K9K 802, K9K 804, K9K 806, K9K 808	Diesel	1461	4	<b>9</b>
02/00→	<b>Kangoo 1.9</b>	F9Q 780, F9Q 782, F9Q 790	Diesel	1870	4	<b>11</b>
02/08→	<b>Kangoo / Grand Kangoo 1.5</b>	K9K 608, K9K 636, K9K 800, K9K 802, K9K 804, K9K 806, K9K 808	Diesel	1461	4	<b>9</b>
02/09→	<b>Kangoo Be Bop 1.5</b>	K9K 802, K9K 804, K9K 806, K9K 808	Diesel	1461	4	<b>9</b>
03/12→	<b>Laguna 1.5</b>	K9K 846	Diesel	1461	4	<b>9</b>
10/97→03/01	<b>Laguna I 1.9</b>	F9Q 710, F9Q 717, F9Q 718	Diesel	1870	4	<b>11</b>
03/01→	<b>Laguna II 1.9</b>	F9Q 718	Diesel	1870	4	<b>11</b>
10/07→	<b>Laguna III 1.5</b>	K9K 780	Diesel	1461	4	<b>9</b>
07/10→	<b>Latitude 1.5</b>	K9K 782	Diesel	1461	4	<b>9</b>
04/07→	<b>Logan I 1.5</b>	K9K 790, K9K 792, K9K 794, K9K 796	Diesel	1461	4	<b>9</b>
	<b>Master B80</b>	8140.07.2701, 8140.07.2710	Diesel	2499	4	<b>15</b>
07/80→07/98	<b>Master I 2.0</b>	829 730, 829 731, J5R 716, J5R 718, J5R 728	Petrol	1995	4	<b>14</b>
08/80→07/98	<b>Master I 2.0</b>	J8S 330	Diesel	2068	4	<b>12</b>
11/89→04/95	<b>Master I 2.1</b>	J8S 330	Diesel	2068	4	<b>12</b>
08/80→07/98	<b>Master I 2.2</b>	J7T 782, J7T 788	Petrol	2165	4	<b>14</b>
07/80→02/98	<b>Master I 2.4</b>	8140.61.2300, S8U 730, S8U 731	Diesel	2445	4	<b>16</b>
07/80→07/98	<b>Master I 2.5</b>	S8U 742	Diesel	2499	4	<b>16</b>
09/80→07/98	<b>Master I 2.5</b>	8140.61.2300, S8U 731	Diesel	2445	4	<b>16</b>
08/89→07/98	<b>Master I 2.5</b>	S9U 714	Diesel	2499	4	<b>15</b>
07/98→10/01	<b>Master II 2.8</b>	S9W 702	Diesel	2799	4	<b>17</b>
01/97→09/99	<b>Megane 1.4</b>	E7J 764	Petrol	1390	4	<b>7</b>
01/96→08/03	<b>Megane I 1.4</b>	E7J 624, E7J 626, E7J 764	Petrol	1390	4	<b>7</b>
03/97→08/03	<b>Megane I 1.9</b>	F9Q 731, F9Q 732, F9Q 733, F9Q 736, F9Q 738, F9Q 744	Diesel	1870	4	<b>11</b>
11/02→	<b>Megane II 1.5</b>	K9K 722, K9K 724, K9K 728, K9K 729, K9K 732, K9K 734	Diesel	1461	4	<b>9</b>
11/08→	<b>Megane III 1.5</b>	K9K 636, K9K 830, K9K 832, K9K 834, K9K 836, K9K 837, K9K 846, K9K G 832, K9K H 834, K9K J 836	Diesel	1461	4	<b>9</b>
06/10→	<b>Megane CC 1.5</b>	K9K 837	Diesel	1461	4	<b>9</b>
09/90→06/99	<b>Messenger 2.5</b>	8140.07.2530, 8140.07.2585, 8140.47.2530 IDR, 8140.47.2590, 8140.67.2585	Diesel	2499	4	<b>15</b>
09/04→	<b>Modus / Grand Modus 1.5</b>	K9K 750, K9K 752, K9K 760, K9K 762, K9K 764, K9K 766, K9K 768, K9K 770, K9K 772	Diesel	1461	4	<b>9</b>
01/12→	<b>Pulse 1.5</b>	K9K 740	Diesel	1461	4	<b>9</b>
07/85→04/95	<b>Rapid 1.1</b>	C1E 750, C1E 752, C1E 754, C1E 756, C1E 760, C1E 762, C1E 792	Petrol	1108	4	<b>2</b>
09/91→03/98	<b>Rapid 1.2</b>	C3G 710, C3G 712	Petrol	1239	4	<b>4</b>



Modelverzeichnis • Index de modele • Índice de Modelo  
Indeks modelu • Модель автомобиля • دليل الموديل



# MODEL INDEX



CCM

x



05/95→11/98	<b>Rapid 1.2</b>	E7F 708	Petrol	1171	4	7
07/85→03/98	<b>Rapid 1.4</b>	C1J 768, C1J 780, C2J 784, C3J 700, C3J 702, C3J 760, C3J 762	Petrol	1397	4	8
09/91→03/98	<b>Rapid 1.4</b>	E6J 734, E7J 720, E7J 724, E7J 726, E7J 728, E7J 773	Petrol	1390	4	7
03/86→08/98	<b>Rapid 1.6</b>	F8M 720, F8M 730, F8M 736, F8M 760	Diesel	1595	4	10
08/71→11/81	<b>Rodeo 4 0.8</b>	800 01	Petrol	845	4	1
11/81→12/87	<b>Rodeo 5 1.1</b>	688 12	Petrol	1108	4	2
05/70→08/73	<b>Rodeo 6 0.8</b>	800.02	Petrol	845	4	1
08/73→11/81	<b>Rodeo 6 1.1</b>	688 10	Petrol	1108	4	2
11/92→07/96	<b>Safrane I 2.0</b>	J7R 732	Petrol	1995	4	14
11/93→07/96	<b>Safrane I 2.1</b>	J8S 760	Diesel	2068	4	12
04/92→07/96	<b>Safrane I 2.2</b>	J7T 760, J7T 762	Petrol	2165	4	14
02/08→	<b>Sandero/stepway I 1.5</b>	K9K 740	Diesel	1461	4	9
09/99→08/03	<b>Scénic I 1.9</b>	F9Q 731, F9Q 732, F9Q 733, F9Q 736, F9Q 740, F9Q 744, F9Q 748	Diesel	1870	4	11
06/03→	<b>Scénic II 1.5</b>	K9K 722, K9K 724, K9K 728, K9K 729, K9K 732, K9K 734	Diesel	1461	4	9
02/09→	<b>Scénic III 1.5</b>	K9K 636, K9K 830, K9K 832, K9K 836, K9K 837, K9K 846	Diesel	1461	4	9
10/84→12/96	<b>Super 5 1.1</b>	C1E 750, C1E 752, C1E 754, C1E 756, C1E 760	Petrol	1108	4	2
10/84→12/96	<b>Super 5 1.4</b>	C1J 768, C1J 780, C1J 782, C1J 788, C2J 700, C2J 782, C2J 784, C3J 700, C3J 702, C3J 760	Petrol	1397	4	8
10/84→12/96	<b>Super 5 1.6</b>	F8M 720, F8M 730	Diesel	1595	4	10
06/01→	<b>Thalia I 1.5</b>	K9K 700, K9K 702, K9K 706, K9K 714, K9K 740	Diesel	1461	4	9
09/08→	<b>Thalia II 1.5</b>	K9K 612, K9K 700, K9K 718, K9K 740, K9K 834	Diesel	1461	4	9
03/80→06/91	<b>Trafic 1.4</b>	847 700, 847 701, C1J 700	Petrol	1397	4	8
03/80→10/97	<b>Trafic 2.0</b>	J5R 716, J5R 722, J5R 726	Petrol	1995	4	14
03/80→04/98	<b>Trafic 2.1</b>	852 720, 852 750, J8S 620, J8S 758	Diesel	2068	4	12
05/89→06/94	<b>Trafic 2.2</b>	J7T 780	Petrol	2165	4	14
03/80→03/01	<b>Trafic 2.5</b>	8140.61.240, S8U 720, S8U 722	Diesel	2445	4	16
03/89→03/01	<b>Trafic 2.5</b>	8140.67.2500, 8140.67.2550, S8U 750, S8U 752, S8U 758, S8U 780	Diesel	2499	4	16
05/89→03/01	<b>Trafic 2.5</b>	8140.67.2580	Diesel	2499	4	15
03/01→	<b>Trafic li 1.9</b>	F9Q 760, F9Q 762	Diesel	1870	4	11
03/93→10/96	<b>Twingo I 1.2</b>	C3G 700, C3G 702	Petrol	1239	4	4
03/07→	<b>Twingo II 1.5</b>	K9K 718, K9K 740, K9K 820	Diesel	1461	4	9

# ENGINE INDEX

Motorverzeichnis • Index de moteur • Índice de Motor  
Indeks silnika • Модель двигателя • دليل المحرك



CCM



9

129	Petrol	1218	4	75.00	6
150	Petrol	1360	4	75.00	5
670.800	Petrol	845	4	58.00	1
688 02	Petrol	1108	4	70.00	2
688 03	Petrol	1108	4	70.00	2
688 10	Petrol	1108	4	70.00	2
688 11	Petrol	1108	4	70.00	2
688 12	Petrol	1108	4	70.00	2
688 13	Petrol	1108	4	70.00	2
688.11	Petrol	1108	4	70.00	2
800	Petrol	847	4	58.00	1
800 01	Petrol	845	4	58.00	1
800 05	Petrol	845	4	58.00	1
800 705	Petrol	845	4	58.00	1
800 710	Petrol	845	4	58.00	1
800.02	Petrol	845	4	58.00	1
810.01	Petrol	1289	4	73.00	3
810.02	Petrol	1289	4	73.00	3
810.02/97	Petrol	1289	4	73.00	3
810.03	Petrol	1289	4	73.00	3
810.05	Petrol	1289	4	73.00	3
810.06	Petrol	1289	4	73.00	3
810.10	Petrol	1289	4	73.00	3
810.25	Petrol	1289	4	73.00	3
810.26	Petrol	1289	4	73.00	3
810.719	Petrol	1289	4	73.00	3
810.725	Petrol	1289	4	73.00	3
810.726	Petrol	1289	4	73.00	3
810.729	Petrol	1289	4	73.00	3
810.96	Petrol	1289	4	73.00	3
810.97	Petrol	1289	4	73.00	3
8140.07.2530	Diesel	2499	4	93.00	15
8140.07.2585	Diesel	2499	4	93.00	15
8140.07.2700	Diesel	2499	4	93.00	15
8140.07.2701	Diesel	2499	4	93.00	15
8140.07.2710	Diesel	2499	4	93.00	15
8140.07.3700	Diesel	2499	4	93.00	15
8140.21.235 IDS	Diesel	2445	4	93.00	15
8140.27	Diesel	2499	4	93.00	15
8140.27.2560	Diesel	2499	4	93.00	15
8140.27.2565	Diesel	2499	4	93.00	15
8140.27.2582	Diesel	2499	4	93.00	15
8140.27.2585	Diesel	2499	4	93.00	15
8140.27.2700	Diesel	2499	4	93.00	15
8140.47.2530 IDR	Diesel	2499	4	93.00	15
8140.47.2535	Diesel	2499	4	93.00	15
8140.47.2590	Diesel	2499	4	93.00	15
8140.47.2700	Diesel	2499	4	93.00	15
8140.47.2721	Diesel	2499	4	93.00	15
8140.47.2785	Diesel	2499	4	93.00	15
8140.61.2300	Diesel	2445	4	93.00	16
8140.61.235	Diesel	2445	4	93.00	16
8140.61.240	Diesel	2445	4	93.00	16
8140.67.2500	Diesel	2499	4	93.00	16
8140.67.2550	Diesel	2499	4	93.00	16
8140.67.2580	Diesel	2499	4	93.00	15
8140.67.2585	Diesel	2499	4	93.00	15
8140-07	Diesel	2499	4	93.00	15
8140-27 IDS	Diesel	2499	4	93.00	15
8140-47	Diesel	2499	4	93.00	15

Motorverzeichnis • Index de moteur • Índice de Motor  
Indeks silnika • Модель двигателя • دليل المحرك

# ENGINE INDEX



CCM

x



9

829 730	Petrol	1995	4	88.00	14
829 731	Petrol	1995	4	88.00	14
829.01	Petrol	1995	4	88.00	14
847 700	Petrol	1397	4	76.00	8
847 701	Petrol	1397	4	76.00	8
847 720	Petrol	1397	4	76.00	8
851 700	Petrol	2165	4	88.00	14
852	Diesel	2068	4	86.00	12
852 720	Diesel	2068	4	86.00	12
852 750	Diesel	2068	4	86.00	12
B1B 707	Petrol	845	4	58.00	1
C1E	Petrol	1108	4	70.00	2
C1E 700	Petrol	1108	4	70.00	2
C1E 715	Petrol	1108	4	70.00	2
C1E 720	Petrol	1108	4	70.00	2
C1E 750	Petrol	1108	4	70.00	2
C1E 752	Petrol	1108	4	70.00	2
C1E 754	Petrol	1108	4	70.00	2
C1E 756	Petrol	1108	4	70.00	2
C1E 760	Petrol	1108	4	70.00	2
C1E 762	Petrol	1108	4	70.00	2
C1E 764	Petrol	1108	4	70.00	2
C1E 792	Petrol	1108	4	70.00	2
C1J 700	Petrol	1397	4	76.00	8
C1J 715	Petrol	1397	4	76.00	8
C1J 742	Petrol	1397	4	76.00	8
C1J 760	Petrol	1397	4	76.00	8
C1J 768	Petrol	1397	4	76.00	8
C1J 770	Petrol	1397	4	76.00	8
C1J 780	Petrol	1397	4	76.00	8
C1J 782	Petrol	1397	4	76.00	8
C1J 788	Petrol	1397	4	76.00	8
C1J 792	Petrol	1397	4	76.00	8
C1J 796	Petrol	1397	4	76.00	8
C2J 700	Petrol	1397	4	76.00	8
C2J 713	Petrol	1397	4	76.00	8
C2J 717	Petrol	1397	4	76.00	8
C2J 772	Petrol	1397	4	76.00	8
C2J 782	Petrol	1397	4	76.00	8
C2J 784	Petrol	1397	4	76.00	8
C3G 700	Petrol	1239	4	74.00	4
C3G 702	Petrol	1239	4	74.00	4
C3G 710	Petrol	1239	4	74.00	4
C3G 712	Petrol	1239	4	74.00	4
C3G 720	Petrol	1239	4	74.00	4
C3G 750	Petrol	1239	4	74.00	4
C3J 700	Petrol	1397	4	76.00	8
C3J 702	Petrol	1397	4	76.00	8
C3J 710	Petrol	1397	4	76.00	8
C3J 760	Petrol	1397	4	76.00	8
C3J 762	Petrol	1397	4	76.00	8
E5F 710	Petrol	1171	4	75.80	7
E5F 716	Petrol	1171	4	75.80	7
E6J 700	Petrol	1390	4	75.80	7
E6J 701	Petrol	1390	4	75.80	7
E6J 706	Petrol	1390	4	75.80	7
E6J 712	Petrol	1390	4	75.80	7
E6J 713	Petrol	1390	4	75.80	7
E6J 718	Petrol	1390	4	75.80	7
E6J 734	Petrol	1390	4	75.80	7

# ENGINE INDEX

Motorverzeichnis • Index de moteur • Índice de Motor  
Indeks silnika • Модель двигателя • دليل المحرك



CCM



9

E6J 738	Petrol	1390	4	75.80	7
E6J 760	Petrol	1390	4	75.80	7
E7F 700	Petrol	1171	4	75.80	7
E7F 704	Petrol	1171	4	75.80	7
E7F 706	Petrol	1171	4	75.80	7
E7F 708	Petrol	1171	4	75.80	7
E7F 730	Petrol	1171	4	75.80	7
E7F 750	Petrol	1171	4	75.80	7
E7J 601	Petrol	1390	4	75.80	7
E7J 624	Petrol	1390	4	75.80	7
E7J 626	Petrol	1390	4	75.80	7
E7J 634	Petrol	1390	4	75.80	7
E7J 635	Petrol	1390	4	75.80	7
E7J 700	Petrol	1390	4	75.80	7
E7J 706	Petrol	1390	4	75.80	7
E7J 707	Petrol	1390	4	75.80	7
E7J 710	Petrol	1390	4	75.80	7
E7J 711	Petrol	1390	4	75.80	7
E7J 718	Petrol	1390	4	75.80	7
E7J 719	Petrol	1390	4	75.80	7
E7J 720	Petrol	1390	4	75.80	7
E7J 724	Petrol	1390	4	75.80	7
E7J 726	Petrol	1390	4	75.80	7
E7J 728	Petrol	1390	4	75.80	7
E7J 742	Petrol	1390	4	75.80	7
E7J 745	Petrol	1390	4	75.80	7
E7J 754	Petrol	1390	4	75.80	7
E7J 756	Petrol	1390	4	75.80	7
E7J 757	Petrol	1390	4	75.80	7
E7J 764	Petrol	1390	4	75.80	7
E7J 770	Petrol	1390	4	75.80	7
E7J 771	Petrol	1390	4	75.80	7
E7J 773	Petrol	1390	4	75.80	7
E7J 780	Petrol	1390	4	75.80	7
F8M 700	Diesel	1595	4	78.00	10
F8M 720	Diesel	1595	4	78.00	10
F8M 730	Diesel	1595	4	78.00	10
F8M 736	Diesel	1595	4	78.00	10
F8M 760	Diesel	1595	4	78.00	10
F9Q 710	Diesel	1870	4	80.00	11
F9Q 717	Diesel	1870	4	80.00	11
F9Q 718	Diesel	1870	4	80.00	11
F9Q 731	Diesel	1870	4	80.00	11
F9Q 732	Diesel	1870	4	80.00	11
F9Q 733	Diesel	1870	4	80.00	11
F9Q 736	Diesel	1870	4	80.00	11
F9Q 738	Diesel	1870	4	80.00	11
F9Q 740	Diesel	1870	4	80.00	11
F9Q 744	Diesel	1870	4	80.00	11
F9Q 748	Diesel	1870	4	80.00	11
F9Q 760	Diesel	1870	4	80.00	11
F9Q 762	Diesel	1870	4	80.00	11
F9Q 780	Diesel	1870	4	80.00	11
F9Q 782	Diesel	1870	4	80.00	11
F9Q 790	Diesel	1870	4	80.00	11
J5R 716	Petrol	1995	4	88.00	14
J5R 718	Petrol	1995	4	88.00	14
J5R 722	Petrol	1995	4	88.00	14
J5R 726	Petrol	1995	4	88.00	14
J5R 728	Petrol	1995	4	88.00	14

Motorverzeichnis • Index de moteur • Índice de Motor  
Indeks silnika • Модель двигателя • دليل المحرك

# ENGINE INDEX



CCM

x



9

J6R 234	Petrol	1995	4	88.00	14
J6R 236	Petrol	1995	4	88.00	14
J6R 706	Petrol	1995	4	88.00	14
J6R 707	Petrol	1995	4	88.00	14
J6R 710	Petrol	1995	4	88.00	14
J6R 712	Petrol	1995	4	88.00	14
J6R 713	Petrol	1995	4	88.00	14
J6R 715	Petrol	1995	4	88.00	14
J6R 716	Petrol	1995	4	88.00	14
J6R 758	Petrol	1995	4	88.00	14
J6R 759	Petrol	1995	4	88.00	14
J6R 760	Petrol	1995	4	88.00	14
J6R 762	Petrol	1995	4	88.00	14
J6R 792	Petrol	1995	4	88.00	14
J6R 793	Petrol	1995	4	88.00	14
J7R 720	Petrol	1995	4	88.00	14
J7R 722	Petrol	1995	4	88.00	14
J7R 723	Petrol	1995	4	88.00	14
J7R 732	Petrol	1995	4	88.00	14
J7R 740	Petrol	1995	4	88.00	14
J7R 746	Petrol	1995	4	88.00	14
J7R 747	Petrol	1995	4	88.00	14
J7R 751	Petrol	1995	4	88.00	14
J7R 754	Petrol	1995	4	88.00	14
J7R 760	Petrol	1995	4	88.00	14
J7R 768	Petrol	1995	4	88.00	14
J7T 706	Petrol	2165	4	88.00	14
J7T 707	Petrol	2165	4	88.00	14
J7T 714	Petrol	2165	4	88.00	14
J7T 715	Petrol	2165	4	88.00	14
J7T 730	Petrol	2165	4	88.00	14
J7T 754	Petrol	2165	4	88.00	14
J7T 760	Petrol	2165	4	88.00	14
J7T 762	Petrol	2165	4	88.00	14
J7T 770	Petrol	2165	4	88.00	14
J7T 772	Petrol	2165	4	88.00	14
J7T 780	Petrol	2165	4	88.00	14
J7T 782	Petrol	2165	4	88.00	14
J7T 788	Petrol	2165	4	88.00	14
J8S 120	Diesel	2068	4	86.00	12
J8S 232 (852.232)	Diesel	2068	4	86.00	12
J8S 234	Diesel	2068	4	86.00	12
J8S 240	Diesel	2068	4	86.00	12
J8S 330	Diesel	2068	4	86.00	12
J8S 600	Diesel	2068	4	86.00	12
J8S 604	Diesel	2068	4	86.00	12
J8S 610	Diesel	2068	4	86.00	12
J8S 612	Diesel	2068	4	86.00	12
J8S 620	Diesel	2068	4	86.00	12
J8S 702	Diesel	2068	4	86.00	12
J8S 704	Diesel	2068	4	86.00	12
J8S 706	Diesel	2068	4	86.00	12
J8S 708	Diesel	2068	4	86.00	12
J8S 711	Diesel	2068	4	86.00	12
J8S 712	Diesel	2068	4	86.00	12
J8S 714	Diesel	2068	4	86.00	12
J8S 736	Diesel	2068	4	86.00	12
J8S 738	Diesel	2068	4	86.00	12
J8S 740	Diesel	2068	4	86.00	12
J8S 742	Diesel	2068	4	86.00	12

# ENGINE INDEX

Motorverzeichnis • Index de moteur • Índice de Motor  
Indeks silnika • Модель двигателя • دليل المحرك



CCM



9

J8S 746	Diesel	2068	4	86.00	12
J8S 758	Diesel	2068	4	86.00	12
J8S 760	Diesel	2068	4	86.00	12
J8S 772	Diesel	2068	4	86.00	12
J8S 774	Diesel	2068	4	86.00	12
J8S 776	Diesel	2068	4	86.00	12
J8S 778	Diesel	2068	4	86.00	12
J8S 784	Diesel	2068	4	86.00	12
J8S 786 (KAT)	Diesel	2068	4	86.00	12
J8S 788	Diesel	2068	4	86.00	12
J8S 814	Diesel	2068	4	86.00	12
J8S 852	Diesel	2068	4	86.00	12
J8S 890	Diesel	2068	4	86.00	12
K9K 276	Diesel	1461	4	76.00	9
K9K 608	Diesel	1461	4	76.00	9
K9K 612	Diesel	1461	4	76.00	9
K9K 636	Diesel	1461	4	76.00	9
K9K 700	Diesel	1461	4	76.00	9
K9K 702	Diesel	1461	4	76.00	9
K9K 704	Diesel	1461	4	76.00	9
K9K 706	Diesel	1461	4	76.00	9
K9K 708	Diesel	1461	4	76.00	9
K9K 710	Diesel	1461	4	76.00	9
K9K 712	Diesel	1461	4	76.00	9
K9K 714	Diesel	1461	4	76.00	9
K9K 716	Diesel	1461	4	76.00	9
K9K 718	Diesel	1461	4	76.00	9
K9K 722	Diesel	1461	4	76.00	9
K9K 724	Diesel	1461	4	76.00	9
K9K 728	Diesel	1461	4	76.00	9
K9K 729	Diesel	1461	4	76.00	9
K9K 732	Diesel	1461	4	76.00	9
K9K 734	Diesel	1461	4	76.00	9
K9K 740	Diesel	1461	4	76.00	9
K9K 750	Diesel	1461	4	76.00	9
K9K 752	Diesel	1461	4	76.00	9
K9K 760	Diesel	1461	4	76.00	9
K9K 762	Diesel	1461	4	76.00	9
K9K 764	Diesel	1461	4	76.00	9
K9K 766	Diesel	1461	4	76.00	9
K9K 768	Diesel	1461	4	76.00	9
K9K 770	Diesel	1461	4	76.00	9
K9K 772	Diesel	1461	4	76.00	9
K9K 780	Diesel	1461	4	76.00	9
K9K 782	Diesel	1461	4	76.00	9
K9K 790	Diesel	1461	4	76.00	9
K9K 792	Diesel	1461	4	76.00	9
K9K 794	Diesel	1461	4	76.00	9
K9K 796	Diesel	1461	4	76.00	9
K9K 800	Diesel	1461	4	76.00	9
K9K 802	Diesel	1461	4	76.00	9
K9K 804	Diesel	1461	4	76.00	9
K9K 806	Diesel	1461	4	76.00	9
K9K 808	Diesel	1461	4	76.00	9
K9K 812	Diesel	1461	4	76.00	9
K9K 820	Diesel	1461	4	76.00	9
K9K 830	Diesel	1461	4	76.00	9
K9K 832	Diesel	1461	4	76.00	9
K9K 834	Diesel	1461	4	76.00	9
K9K 836	Diesel	1461	4	76.00	9

Motorverzeichnis • Index de moteur • Índice de Motor  
Indeks silnika • Модель двигателя • دليل المحرك

# ENGINE INDEX



CCM

x



9

K9K 837	Diesel	1461	4	76.00	9
K9K 840	Diesel	1461	4	76.00	9
K9K 846	Diesel	1461	4	76.00	9
K9K 884	Diesel	1461	4	76.00	9
K9K F 830	Diesel	1461	4	76.00	9
K9K G 724	Diesel	1461	4	76.00	9
K9K G 832	Diesel	1461	4	76.00	9
K9K H 834	Diesel	1461	4	76.00	9
K9K J 836	Diesel	1461	4	76.00	9
K9K N 837	Diesel	1461	4	76.00	9
K9K P 732	Diesel	1461	4	76.00	9
MIDR 06.24.65	Diesel	12000	6	124.00	18
S8U 720	Diesel	2445	4	93.00	16
S8U 722	Diesel	2445	4	93.00	16
S8U 730	Diesel	2445	4	93.00	16
S8U 731	Diesel	2445	4	93.00	16
S8U 742	Diesel	2499	4	93.00	16
S8U 748	Diesel	2445	4	93.00	16
S8U 750	Diesel	2499	4	93.00	16
S8U 752	Diesel	2499	4	93.00	16
S8U 758	Diesel	2499	4	93.00	16
S8U 780	Diesel	2499	4	93.00	16
S8U 782	Diesel	2499	4	93.00	16
S9U 714	Diesel	2499	4	93.00	15
S9W 700	Diesel	2799	4	94.40	17
S9W 702	Diesel	2799	4	94.40	17
XD88, XDP88	Diesel	1948	4	88.00	13
XDP88	Diesel	1948	4	88.00	13



1

670.800	4cyl.	845cc	19-26kW (26-35PS)	TD22489
800	4cyl.	847cc	27kW (37PS)	TD3023
800 01	4cyl.	845cc	25kW (34PS)	TD3024
800 05	4cyl.	845cc	22-25kW (30-34PS)	TD3025
800 705	4cyl.	845cc	27kW (37PS)	TD4852
800 710	4cyl.	845cc	27kW (37PS)	TD3028
800.02	4cyl.	845cc	21-26kW (29-35PS)	TD21383
B1B 707	4cyl.	845cc	21kW (29PS)	TD4855

15-632200-00 WH

58.00

B 62.50

C 126.00

D 69.80

E 112.80

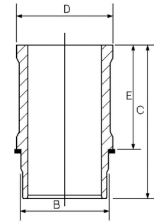

Includes seals

Schließt Dichtungen ein

Inclut des joints

Incluye los sellos

2

688 02	4cyl.	1108cc	41kW (55PS)	TD3012
688 03	4cyl.	1108cc	25-39kW (34-53PS)	TD22492
688 10	4cyl.	1108cc	25-39kW (34-53PS)	TD21382
688 11	4cyl.	1108cc	33kW (45PS)	TD3014
688 12	4cyl.	1108cc	25kW (34PS)	TD3015
688 13	4cyl.	1108cc	33kW (45PS)	TD3013
688.11	4cyl.	1108cc	25-39kW (34-53PS)	TD28180
C1E	4cyl.	1108cc	25-39kW (34-53PS)	TD22490
C1E 700	4cyl.	1108cc	35kW (47PS)	TD3100
C1E 715	4cyl.	1108cc	35kW (47PS)	TD3102
C1E 720	4cyl.	1108cc	35kW (47PS)	TD3105
C1E 750	4cyl.	1108cc	33-34kW (45-46PS)	TD3106
C1E 752	4cyl.	1108cc	33-34kW (45-46PS)	TD3107
C1E 754	4cyl.	1108cc	33-34kW (45-46PS)	TD3108
C1E 756	4cyl.	1108cc	33kW (45PS)	TD3109
C1E 760	4cyl.	1108cc	33kW (45PS)	TD3110
C1E 762	4cyl.	1108cc	33-36kW (45-49PS)	TD3111
C1E 764	4cyl.	1108cc	36kW (49PS)	TD3112
C1E 792	4cyl.	1108cc	33kW (45PS)	TD3113

14-636730-00 WH

70.00

B 75.50

C 135.00

D 85.70

E 94.80

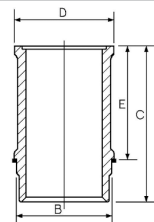





3

810.01	4cyl.	1289cc	26-32kW (37-44PS)	TD8555
810.02	4cyl.	1289cc	37kW (50PS)	TD3033
810.02/97	4cyl.	1289cc	40kW (54PS)	TD3032
810.03	4cyl.	1289cc	35kW (47PS)	TD23613
810.05	4cyl.	1289cc	31-45kW (42-61PS)	TD21386
810.06	4cyl.	1289cc	44kW (60PS)	TD3034
810.10	4cyl.	1289cc	44kW (60PS)	TD21387
810.25	4cyl.	1289cc	31-50kW (42-68PS)	TD22391
810.26	4cyl.	1289cc	31-50kW (42-68PS)	TD22392
810.719	4cyl.	1289cc	33kW (45PS)	TD3035
810.725	4cyl.	1289cc	40kW (54PS)	TD3036
810.726	4cyl.	1289cc	32kW (44PS)	TD3037
810.729	4cyl.	1289cc	40kW (54PS)	TD3038
810.96	4cyl.	1289cc	49kW (67PS)	TD3039
810.97	4cyl.	1289cc	41kW (55PS)	TD3040

14-630440-00 WH  
15-636590-00 WH

73.00

B 78.50 C 134.00 D 88.00 E 95.00  
B 78.50 C 134.00 D 87.70 E 95.00

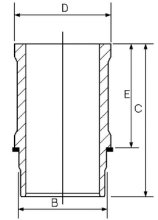

Includes seals

Schließt Dichtungen ein

Inclut des joints

Incluye los sellos

4

C3G 700	4cyl.	1239cc	40kW (54PS)	TD3172
C3G 702	4cyl.	1239cc	40kW (54PS)	TD5515
C3G 710	4cyl.	1239cc	40kW (54PS)	TD3173
C3G 712	4cyl.	1239cc	40kW (54PS)	TD16545
C3G 720	4cyl.	1239cc	40kW (54PS)	TD14314
C3G 750	4cyl.	1239cc	40kW (54PS)	TD22356

14-630120-00 WH

74.00

B 78.60 C 135.00 D 88.20 E 94.90

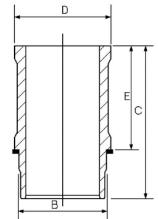

5

150	4cyl.	1360cc	51-52kW (70-71PS)	TD3008
14-636600-00 WH		75.00	B 79.50 C 134.50 D 89.20 E 90.00	

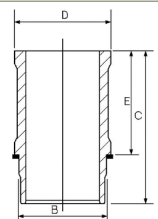



6

129 4cyl. 1218cc 42-43kW (57-58PS) TD3007

15-636700-00 WH <sup>1</sup> 75.00 B 79.50 C 122.00 D 89.20 E 82.50

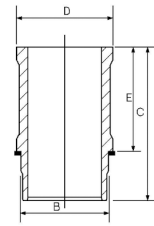

<sup>1</sup> Includes seals

<sup>1</sup> Schließt Dichtungen ein

<sup>1</sup> Inclut des joints

<sup>1</sup> Incluye los sellos

7

E5F 710	4cyl.	1171cc	40-44kW (55-60PS)	TD3181
E5F 716	4cyl.	1171cc	40-44kW (55-60PS)	TD3182
E6J 700	4cyl.	1390cc	58-59kW (79-80PS)	TD3183
E6J 701	4cyl.	1390cc	58-59kW (79-80PS)	TD3184
E6J 706	4cyl.	1390cc	58-59kW (79-80PS)	TD3185
E6J 712	4cyl.	1390cc	55-57kW (75-80PS)	TD3186
E6J 713	4cyl.	1390cc	55-57kW (75-80PS)	TD3187
E6J 718	4cyl.	1390cc	55-57kW (75-78PS)	TD3188
E6J 734	4cyl.	1390cc	43kW (58PS)	TD3189
E6J 738	4cyl.	1390cc	43kW (58PS)	TD3190
E6J 760	4cyl.	1390cc	55-57kW (75-78PS)	TD3191
E7F 700	4cyl.	1171cc	55kW (75PS)	TD3192
E7F 704	4cyl.	1171cc	44kW (60PS)	TD3193
E7F 706	4cyl.	1171cc	55kW (75PS)	TD3194
E7F 708	4cyl.	1171cc	43-44kW (58-60PS)	TD3195
E7F 730	4cyl.	1171cc	46kW (63PS)	TD3196
E7F 750	4cyl.	1171cc	43-44kW (58-60PS)	TD3197
E7J 601	4cyl.	1390cc	58-59kW (80-80PS)	TD3198
E7J 624	4cyl.	1390cc	52kW (71PS)	TD5526
E7J 626	4cyl.	1390cc	55kW (75PS)	TD16362
E7J 634	4cyl.	1390cc	55kW (75PS)	TD17271
E7J 635	4cyl.	1390cc	55kW (75PS)	TD17272
E7J 700	4cyl.	1390cc	55-59kW (75-80PS)	TD3199
E7J 706	4cyl.	1390cc	55-59kW (75-80PS)	TD3200
E7J 707	4cyl.	1390cc	55-59kW (75-80PS)	TD3201
E7J 710	4cyl.	1390cc	58-59kW (80-80PS)	TD3203
E7J 711	4cyl.	1390cc	58-59kW (80-80PS)	TD3204
E7J 718	4cyl.	1390cc	58kW (79PS)	TD3205
E7J 719	4cyl.	1390cc	58kW (79PS)	TD3206
E7J 720	4cyl.	1390cc	55-59kW (75-80PS)	TD3207
E7J 724	4cyl.	1390cc	55-59kW (75-80PS)	TD3208
E7J 726	4cyl.	1390cc	55-59kW (75-80PS)	TD5508
E7J 728	4cyl.	1390cc	58-59kW (79-80PS)	TD3209
E7J 742	4cyl.	1390cc	55kW (75PS)	TD3212
E7J 745	4cyl.	1390cc	55-59kW (75-80PS)	TD3210





E7J 754	4cyl.	1390cc	55-59kW (75-80PS)	TD3211
E7J 756	4cyl.	1390cc	55kW (75PS)	TD17279
E7J 757	4cyl.	1390cc	55kW (75PS)	TD17282
E7J 764	4cyl.	1390cc	55kW (75PS)	TD4858
E7J 770	4cyl.	1390cc	55-59kW (75-80PS)	TD20896
E7J 771	4cyl.	1390cc	55-59kW (75-80PS)	TD20897
E7J 773	4cyl.	1390cc	55-59kW (75-80PS)	TD3213
E7J 780	4cyl.	1390cc	55kW (75PS)	TD9623

15-638390-00 WH <sup>1</sup>

75.80

B 80.60

C 130.00

D 90.20

E 91.50

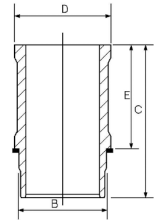

<sup>1</sup> Includes seals

<sup>1</sup> Schließt Dichtungen ein

<sup>1</sup> Inclut des joints

<sup>1</sup> Incluye los sellos

8

847 700	4cyl.	1397cc	47kW (64PS)	TD3067
847 701	4cyl.	1397cc	47kW (64PS)	TD3072
847 720	4cyl.	1397cc	47kW (64PS)	TD5054
C1J 700	4cyl.	1397cc	35-36kW (48-50PS)	TD3122
C1J 715	4cyl.	1397cc	44kW (60PS)	TD3123
C1J 742	4cyl.	1397cc	43-44kW (58-60PS)	TD3125
C1J 760	4cyl.	1397cc	77kW (105PS)	Turbo Intercooled TD3126
C1J 768	4cyl.	1397cc	43-44kW (58-60PS)	TD3128
C1J 770	4cyl.	1397cc	85kW (116PS)	Turbo Intercooled TD3129
C1J 780	4cyl.	1397cc	43kW (58PS)	TD3130
C1J 782	4cyl.	1397cc	85-88kW (115-120PS)	Turbo Intercooled TD3131
C1J 788	4cyl.	1397cc	85-88kW (115-120PS)	Turbo Intercooled TD3134
C1J 792	4cyl.	1397cc	44kW (60PS)	TD3135
C1J 796	4cyl.	1397cc	44kW (60PS)	TD3136
C2J 700	4cyl.	1397cc	52-53kW (71-72PS)	TD3137
C2J 713	4cyl.	1397cc	46kW (63PS)	TD3138
C2J 717	4cyl.	1397cc	53kW (72PS)	TD3141
C2J 772	4cyl.	1397cc	43kW (58PS)	TD3154
C2J 782	4cyl.	1397cc	49kW (67PS)	TD3158
C2J 784	4cyl.	1397cc	44kW (60PS)	TD3161
C3J 700	4cyl.	1397cc	43-44kW (58-60PS)	TD4856
C3J 702	4cyl.	1397cc	43-44kW (58-60PS)	TD3175
C3J 710	4cyl.	1397cc	43-44kW (58-60PS)	TD3176





<b>C3J 760</b>	4cyl.	<b>1397cc</b>	<b>43-44kW</b> (58-60PS)	<b>TD3179</b>
<b>C3J 762</b>	4cyl.	<b>1397cc</b>	<b>43-44kW</b> (58-60PS)	<b>TD3180</b>

15-630820-00 WH ① 76.00 B 80.60 C 134.00 D 90.20 E 95.00

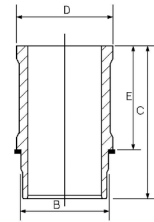

① Includes seals

① Schließt Dichtungen ein

① Inclut des joints

① Incluye los sellos

9

<b>K9K 276</b>	4cyl.	<b>1461cc</b>	<b>62kW</b> (84PS)	<b>Diesel</b>	<b>Turbo Intercooled</b>	<b>TD23876</b>
<b>K9K 608</b>	4cyl.	<b>1461cc</b>	<b>66kW</b> (89PS)	<b>Diesel</b>	<b>Turbo Intercooled</b>	<b>TD27682</b>
<b>K9K 612</b>	4cyl.	<b>1461cc</b>	<b>55kW</b> (75PS)	<b>Diesel</b>	<b>Turbo Intercooled</b>	<b>TD27683</b>
<b>K9K 636 Euro 5</b>	4cyl.	<b>1461cc</b>	<b>81kW</b> (110PS)	<b>Diesel</b>	<b>Turbo Intercooled</b>	<b>TD28220</b>
<b>K9K 700 Euro 3</b>	4cyl.	<b>1461cc</b>	<b>48kW</b> (65PS)	<b>Diesel</b>	<b>Turbo Intercooled</b>	<b>TD16219</b>
<b>K9K 702 Euro 3</b>	4cyl.	<b>1461cc</b>	<b>60kW</b> (81PS)	<b>Diesel</b>	<b>Turbo Intercooled</b>	<b>TD16344</b>
<b>K9K 704 Euro 3</b>	4cyl.	<b>1461cc</b>	<b>48kW</b> (65PS)	<b>Diesel</b>	<b>Turbo Intercooled</b>	<b>TD16343</b>
<b>K9K 706</b>	4cyl.	<b>1461cc</b>	<b>48-50kW</b> (65-68PS)	<b>Diesel</b>	<b>Turbo Intercooled</b>	<b>TD20974</b>
<b>K9K 708</b>	4cyl.	<b>1461cc</b>	<b>48-50kW</b> (65-68PS)	<b>Diesel</b>	<b>Turbo Intercooled</b>	<b>TD26047</b>
<b>K9K 710 Euro 3</b>	4cyl.	<b>1461cc</b>	<b>60kW</b> (81PS)	<b>Diesel</b>	<b>Turbo Intercooled</b>	<b>TD17488</b>
<b>K9K 712 Euro 3</b>	4cyl.	<b>1461cc</b>	<b>74kW</b> (100PS)	<b>Diesel</b>	<b>Turbo Intercooled</b>	<b>TD18419</b>
<b>K9K 714 Euro 4</b>	4cyl.	<b>1461cc</b>	<b>50kW</b> (68PS)	<b>Diesel</b>	<b>Turbo Intercooled</b>	<b>TD21173</b>
<b>K9K 716</b>	4cyl.	<b>1461cc</b>	<b>60kW</b> (81PS)	<b>Diesel</b>	<b>Turbo Intercooled</b>	<b>TD22179</b>
<b>K9K 718 Euro 4</b>	4cyl.	<b>1461cc</b>	<b>62kW</b> (84PS)	<b>Diesel</b>	<b>Turbo Intercooled</b>	<b>TD21171</b>
<b>K9K 722 Euro 3</b>	4cyl.	<b>1461cc</b>	<b>60kW</b> (81PS)	<b>Diesel</b>	<b>Turbo Intercooled</b>	<b>TD16534</b>
<b>K9K 724 Euro 4</b>	4cyl.	<b>1461cc</b>	<b>63kW</b> (86PS)	<b>Diesel</b>	<b>Turbo Intercooled</b>	<b>TD20988</b>
<b>K9K 728 Euro 3</b>	4cyl.	<b>1461cc</b>	<b>74kW</b> (100PS)	<b>Diesel</b>	<b>Turbo Intercooled</b>	<b>TD20707</b>
<b>K9K 729 Euro 3</b>	4cyl.	<b>1461cc</b>	<b>74kW</b> (100PS)	<b>Diesel</b>	<b>Turbo Intercooled</b>	<b>TD20706</b>
<b>K9K 732 Euro 4</b>	4cyl.	<b>1461cc</b>	<b>78kW</b> (106PS)	<b>Diesel</b>	<b>Turbo Intercooled</b>	<b>TD20829</b>
<b>K9K 734</b>	4cyl.	<b>1461cc</b>	<b>78kW</b> (106PS)	<b>Diesel</b>	<b>Turbo Intercooled</b>	<b>TD22192</b>
<b>K9K 740 Euro 4</b>	4cyl.	<b>1461cc</b>	<b>47kW</b> (64PS)	<b>Diesel</b>	<b>Turbo Intercooled</b>	<b>TD20446</b>
<b>K9K 750 Euro 3</b>	4cyl.	<b>1461cc</b>	<b>57-65kW</b> (78-88PS)	<b>Diesel</b>	<b>Turbo Intercooled</b>	<b>TD21133</b>
<b>K9K 752 Euro 3</b>	4cyl.	<b>1461cc</b>	<b>48-50kW</b> (65-68PS)	<b>Diesel</b>	<b>Turbo Intercooled</b>	<b>TD21134</b>
<b>K9K 760 Euro 4</b>	4cyl.	<b>1461cc</b>	<b>50kW</b> (68PS)	<b>Diesel</b>	<b>Turbo Intercooled</b>	<b>TD21135</b>
<b>K9K 762 Euro 4</b>	4cyl.	<b>1461cc</b>	<b>50kW</b> (68PS)	<b>Diesel</b>	<b>Turbo Intercooled</b>	<b>TD20922</b>
<b>K9K 764 Euro 4</b>	4cyl.	<b>1461cc</b>	<b>78kW</b> (106PS)	<b>Diesel</b>	<b>Turbo Intercooled</b>	<b>TD18538</b>
<b>K9K 766 Euro 4</b>	4cyl.	<b>1461cc</b>	<b>63kW</b> (86PS)	<b>Diesel</b>	<b>Turbo Intercooled</b>	<b>TD18537</b>
<b>K9K 768 Euro 4</b>	4cyl.	<b>1461cc</b>	<b>50kW</b> (68PS)	<b>Diesel</b>	<b>Turbo Intercooled</b>	<b>TD18536</b>
<b>K9K 770</b>	4cyl.	<b>1461cc</b>	<b>55-65kW</b> (75-88PS)	<b>Diesel</b>	<b>Turbo Intercooled</b>	<b>TD25691</b>
<b>K9K 772</b>	4cyl.	<b>1461cc</b>	<b>63-76kW</b> (86-103PS)	<b>Diesel</b>	<b>Turbo Intercooled</b>	<b>TD23549</b>
<b>K9K 780 Euro 4</b>	4cyl.	<b>1461cc</b>	<b>76kW</b> (103PS)	<b>Diesel</b>	<b>Turbo Intercooled</b>	<b>TD20817</b>
<b>K9K 782</b>	4cyl.	<b>1461cc</b>	<b>81kW</b> (110PS)	<b>Diesel</b>	<b>Turbo Intercooled</b>	<b>TD27990</b>
<b>K9K 790</b>	4cyl.	<b>1461cc</b>	<b>48kW</b> (65PS)	<b>Diesel</b>	<b>Turbo Intercooled</b>	<b>TD21438</b>
<b>K9K 792</b>	4cyl.	<b>1461cc</b>	<b>50kW</b> (68PS)	<b>Diesel</b>	<b>Turbo Intercooled</b>	<b>TD21439</b>





K9K 794	4cyl.	1461cc	48-50kW (65-68PS)	Diesel	Turbo Intercooled	TD23795
K9K 796	4cyl.	1461cc	63kW (86PS)	Diesel	Turbo Intercooled	TD26080
K9K 800	4cyl.	1461cc	63kW (86PS)	Diesel	Turbo Intercooled	TD22193
K9K 802 Euro 4	4cyl.	1461cc	63kW (86PS)	Diesel	Turbo Intercooled	TD20830
K9K 804 Euro 4	4cyl.	1461cc	78kW (106PS)	Diesel	Turbo Intercooled	TD20831
K9K 806 Euro 4	4cyl.	1461cc	76kW (103PS)	Diesel	Turbo Intercooled	TD20832
K9K 808	4cyl.	1461cc	66kW (89PS)	Diesel	Turbo Intercooled	TD26258
K9K 812	4cyl.	1461cc	60kW (81PS)	Diesel	Turbo Intercooled	TD24967
K9K 820	4cyl.	1461cc	55kW (75PS)	Diesel	Turbo Intercooled	TD25692
K9K 830	4cyl.	1461cc	63kW (86PS)	Diesel	Turbo Intercooled	TD25693
K9K 832 Euro 4	4cyl.	1461cc	78kW (106PS)	Diesel	Turbo Intercooled	TD23521
K9K 834	4cyl.	1461cc	66kW (89PS)	Diesel	Turbo Intercooled	TD23742
K9K 836	4cyl.	1461cc	81kW (110PS)	Diesel	Turbo Intercooled	TD23743
K9K 837 Euro 5	4cyl.	1461cc	81kW (110PS)	Diesel	Turbo Intercooled	TD26246
K9K 840	4cyl.	1461cc	50kW (68PS)	Diesel	Turbo Intercooled	TD22194
K9K 846 Euro 5	4cyl.	1461cc	70kW (95PS)	Diesel	Turbo Intercooled	TD24579
K9K 884 Euro 5	4cyl.	1461cc	66kW (89PS)	Diesel	Turbo Intercooled	TD27697
K9K F 830	4cyl.	1461cc	63kW (86PS)	Diesel	Turbo Intercooled	TD23566
K9K G 724	4cyl.	1461cc	63kW (86PS)	Diesel	Turbo Intercooled	TD19692
K9K G 832	4cyl.	1461cc	78kW (106PS)	Diesel	Turbo Intercooled	TD23522
K9K H 834	4cyl.	1461cc	66kW (89PS)	Diesel	Turbo Intercooled	TD23569
K9K J 836	4cyl.	1461cc	81kW (110PS)	Diesel	Turbo Intercooled	TD23567
K9K N 837	4cyl.	1461cc	81kW (110PS)	Diesel	Turbo Intercooled	TD24968
K9K P 732	4cyl.	1461cc	78kW (106PS)	Diesel	Turbo Intercooled	TD19693

14-020650-00 *D*      76.00      B 79.10      C 142.00      D 81.00      E 5.00

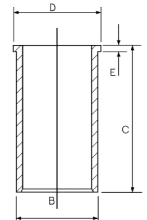

10

F8M 700	4cyl.	1595cc	40kW (54PS)	Diesel	TD3282
F8M 720	4cyl.	1595cc	40kW (54PS)	Diesel	TD3283
F8M 730	4cyl.	1595cc	40kW (54PS)	Diesel	TD3284
F8M 736	4cyl.	1595cc	40kW (54PS)	Diesel	TD3285
F8M 760	4cyl.	1595cc	40kW (54PS)	Diesel	TD3286

14-023730-00 *D*      78.00      B 149.00      C 83.50      D 4.50

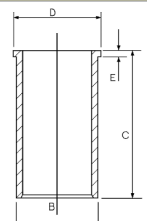



11

F9Q 710	4cyl.	1870cc	74kW (100PS)	Diesel	Turbo Intercooled	TD16190
F9Q 717	4cyl.	1870cc	72-75kW (98-102PS)	Diesel	Turbo Intercooled	TD21136
F9Q 718	4cyl.	1870cc	72kW (98PS)	Diesel	Turbo Intercooled	TD16192
F9Q 731	4cyl.	1870cc	72kW (98PS)	Diesel	Turbo Intercooled	TD16353
F9Q 732	4cyl.	1870cc	72kW (98PS)	Diesel	Turbo Intercooled	TD16347
F9Q 733	4cyl.	1870cc	79-88kW (107-120PS)	Diesel	Turbo Intercooled	TD16363
F9Q 736	4cyl.	1870cc	72kW (98PS)	Diesel	Turbo Intercooled	TD16354
F9Q 738	4cyl.	1870cc	74-79kW (101-107PS)	Diesel	Turbo Intercooled	TD21137
F9Q 740	4cyl.	1870cc	72kW (98PS)	Diesel	Turbo Intercooled	TD16341
F9Q 744	4cyl.	1870cc	59kW (80PS)	Diesel	Turbo Intercooled	TD16361
F9Q 748	4cyl.	1870cc	75-79kW (102-107PS)	Diesel	Turbo Intercooled	TD21138
F9Q 760	4cyl.	1870cc	74kW (100PS)	Diesel	Turbo Intercooled	TD16529
F9Q 762	4cyl.	1870cc	60kW (81PS)	Diesel	Turbo Intercooled	TD18691
F9Q 780	4cyl.	1870cc	72kW (98PS)	Diesel	Turbo Intercooled	TD16339
F9Q 782	4cyl.	1870cc	59kW (80PS)	Diesel	Turbo Intercooled	TD17498
F9Q 790	4cyl.	1870cc	59kW (80PS)	Diesel	Turbo Intercooled	TD16358

14-020280-00 D

80.00

B 83.00

C 155.00

D 85.00

E 5.00

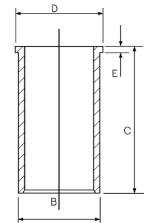

12

852	4cyl.	2068cc	47kW (64PS)	Diesel		TD3077
852 720	4cyl.	2068cc	43-44kW (58-60PS)	Diesel		TD3079
852 750	4cyl.	2068cc	43-44kW (58-60PS)	Diesel		TD3080
J8S 120	4cyl.	2068cc	65-66kW (88-90PS)	Diesel	Turbo	TD3383
J8S 232 (852.232)	4cyl.	2068cc	43kW (58PS)	Diesel		TD3384
J8S 234	4cyl.	2068cc	57kW (77PS)	Diesel		TD3385
J8S 240	4cyl.	2068cc	65kW (88PS)	Diesel	Turbo Intercooled	TD3386
J8S 330	4cyl.	2068cc	44kW (60PS)	Diesel	Turbo	TD3387
J8S 600	4cyl.	2068cc	53kW (72PS)	Diesel	Turbo	TD3388
J8S 604	4cyl.	2068cc	65kW (88PS)	Diesel	Turbo	TD3389
J8S 610	4cyl.	2068cc	65kW (88PS)	Diesel	Turbo Intercooled	TD3390
J8S 612	4cyl.	2068cc	66kW (89PS)	Diesel	Turbo Intercooled	TD5525
J8S 620	4cyl.	2068cc	47kW (64PS)	Diesel		TD5564
J8S 702	4cyl.	2068cc	63kW (86PS)	Diesel	Turbo	TD3382
J8S 704	4cyl.	2068cc	48-49kW (65-67PS)	Diesel	Turbo	TD3391
J8S 706	4cyl.	2068cc	46kW (63PS)	Diesel	Turbo	TD3392
J8S 708	4cyl.	2068cc	63kW (86PS)	Diesel	Turbo Intercooled	TD3393
J8S 711	4cyl.	2068cc	49kW (67PS)	Diesel		TD5431
J8S 712	4cyl.	2068cc	65kW (88PS)	Diesel	Turbo	TD3394
J8S 714	4cyl.	2068cc	65kW (88PS)	Diesel	Turbo	TD3395
J8S 736	4cyl.	2068cc	51kW (69PS)	Diesel	Turbo	TD3396





J8S 738	4cyl.	2068cc	63kW (86PS)	Diesel	Turbo Intercooled	TD3397
J8S 740	4cyl.	2068cc	53kW (72PS)	Diesel	Turbo	TD3398
J8S 742	4cyl.	2068cc	65kW (88PS)	Diesel	Turbo	TD3399
J8S 746	4cyl.	2068cc	65kW (88PS)	Diesel	Turbo	TD3400
J8S 758	4cyl.	2068cc	47kW (64PS)	Diesel	Turbo	TD5565
J8S 760	4cyl.	2068cc	65-66kW (88-90PS)	Diesel	Turbo	TD3401
J8S 772	4cyl.	2068cc	65kW (88PS)	Diesel	Turbo Intercooled	TD3402
J8S 774	4cyl.	2068cc	65kW (88PS)	Diesel	Turbo Intercooled	TD3403
J8S 776	4cyl.	2068cc	65kW (88PS)	Diesel	Turbo Intercooled	TD3404
J8S 778	4cyl.	2068cc	65kW (88PS)	Diesel	Turbo	TD3405
J8S 784	4cyl.	2068cc	51kW (69PS)	Diesel	Turbo	TD3406
J8S 786 (KAT)	4cyl.	2068cc	65kW (88PS)	Diesel	Turbo	TD3407
J8S 788	4cyl.	2068cc	65kW (88PS)	Diesel	Turbo	TD3408
J8S 814	4cyl.	2068cc	65kW (88PS)	Diesel	Turbo Intercooled	TD21257
J8S 852	4cyl.	2068cc	63kW (86PS)	Diesel	Turbo	TD3081
J8S 890	4cyl.	2068cc	65kW (88PS)	Diesel	Turbo Intercooled	TD21258

14-000320-00 WH ①

86.00

B 93.60

C 166.00

D 93.05

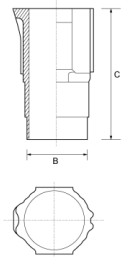

① Phosphated

① Phosphatiert

① Phosphatisé

① Fosfatada

13

XD88, XDP88	4cyl.	1948cc		Diesel		FM1421
XDP88	4cyl.	1948cc		Diesel		FM1421

14-600420-00 WH ①

88.00

B 96.00

C 173.00

D 106.30

E 129.00

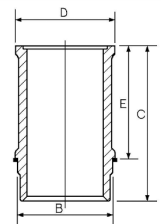

① Use also: HT022

① Mitverwenden: HT022

① A utiliser aussi: HT022

① Utilizar también: HT022

14

829 730	4cyl.	1995cc	81kW (110PS)			TD3045
829 731	4cyl.	1995cc	81kW (110PS)			TD3046
829.01	4cyl.	1995cc	76-80kW (103-109PS)			TD21390
851 700	4cyl.	2165cc	85kW (116PS)			TD3076
J5R 716	4cyl.	1995cc	59-62kW (80-84PS)			TD3302
J5R 718	4cyl.	1995cc	57-60kW (78-82PS)			TD3303
J5R 722	4cyl.	1995cc	59kW (80PS)			TD3304
J5R 726	4cyl.	1995cc	59kW (80PS)			TD3305
J5R 728	4cyl.	1995cc	58kW (79PS)			TD3306
J6R 234	4cyl.	1995cc	79-81kW (107-110PS)			TD3308









15

8140-07	4cyl.	2499cc	55kW (75PS)	Diesel		TD8524
8140-27 IDS	4cyl.	2499cc	78kW (106PS)	Diesel	Turbo	TD8530
8140-47	4cyl.	2499cc	85kW (116PS)	Diesel	Turbo Intercooled	TD8533
8140.27	4cyl.	2499cc	78kW (106PS)	Diesel	Turbo	TD8529
8140.07.2530	4cyl.	2499cc	56kW (76PS)	Diesel		TD3417
8140.07.2585 Euro 1	4cyl.	2499cc	55kW (75PS)	Diesel		TD12192
8140.07.2700	4cyl.	2499cc	55kW (75PS)	Diesel		TD22385
8140.07.2701	4cyl.	2499cc		Diesel	Turbo	FM9101
8140.07.2710	4cyl.	2499cc	55kW (75PS)	Diesel		FM9101
8140.07.3700 Euro 1	4cyl.	2499cc	55kW (75PS)	Diesel	Turbo Intercooled	TD22386
8140.21.235 IDS	4cyl.	2445cc	68-71kW (92-96PS)	Diesel	Turbo	TD3418
8140.27.2560	4cyl.	2499cc	69kW (93PS)	Diesel	Turbo	TD8623
8140.27.2565	4cyl.	2499cc	78kW (106PS)	Diesel	Turbo	TD12197
8140.27.2582	4cyl.	2499cc	92kW (125PS)	Diesel	Turbo	TD3424
8140.27.2585	4cyl.	2499cc	78kW (106PS)	Diesel	Turbo	TD12195
8140.27.2700	4cyl.	2499cc	68-76kW (92-103PS)	Diesel	Turbo	TD21392
8140.47.2530 IDR	4cyl.	2499cc	85kW (116PS)	Diesel	Turbo	TD3425
8140.47.2535	4cyl.	2499cc	85kW (116PS)	Diesel	Turbo Intercooled	TD3426
8140.47.2590 Euro 1	4cyl.	2499cc	85kW (116PS)	Diesel	Turbo Intercooled	TD12199
8140.47.2700 Euro 1	4cyl.	2499cc	85kW (116PS)	Diesel	Turbo Intercooled	TD22395
8140.47.2721 Euro 1	4cyl.	2499cc	85kW (116PS)	Diesel	Turbo Intercooled	TD22396
8140.47.2785 Euro 1	4cyl.	2499cc	85kW (116PS)	Diesel	Turbo Intercooled	TD22397
8140.67.2580 Euro 2	4cyl.	2499cc	55kW (75PS)	Diesel		TD3433
8140.67.2585 Euro 2	4cyl.	2499cc	55-63kW (75-86PS)	Diesel	Turbo Intercooled	TD12193
S9U 714	4cyl.	2499cc	69kW (93PS)	Diesel	Turbo	TD12732

- 14-021371-00 D
- 14-021372-00 D
- 14-021373-00 D
- 14-021480-00 DH 1

93.00

B 96.01	C 171.00	D 98.92	E 5.00
B 96.05	C 171.00	D 98.92	E 5.00
B 96.17	C 171.00	D 98.92	E 5.00
B 97.035	C 171.00	D 100.00	E 5.00

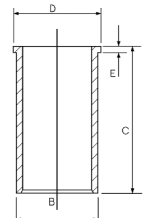

1 Nitrided

1 Nitriert

1 Nitrué

1 Niturado

16

8140.61.2300	4cyl.	2445cc	52kW (71PS)	Diesel		TD3429
8140.61.235	4cyl.	2445cc	53kW (72PS)	Diesel		TD3430
8140.61.240	4cyl.	2445cc	51kW (69PS)	Diesel	Turbo	TD12871
8140.67.2500	4cyl.	2499cc	55kW (75PS)	Diesel		TD3431
8140.67.2550	4cyl.	2499cc	55kW (75PS)	Diesel		TD12872
S8U 720	4cyl.	2445cc	51kW (69PS)	Diesel		TD3413
S8U 722	4cyl.	2445cc	51kW (69PS)	Diesel		TD3414
S8U 730	4cyl.	2445cc	52kW (71PS)	Diesel		TD12873
S8U 731	4cyl.	2445cc	52kW (71PS)	Diesel		TD12730
S8U 742	4cyl.	2499cc	55kW (75PS)	Diesel		TD5442
S8U 748	4cyl.	2445cc	55kW (75PS)	Diesel		TD12735





<b>S8U 750</b>	4cyl.	<b>2499cc</b>	<b>55kW (75PS)</b>	<b>Diesel</b>	<b>TD5566</b>
<b>S8U 752</b>	4cyl.	<b>2499cc</b>	<b>55kW (75PS)</b>	<b>Diesel</b>	<b>TD5567</b>
<b>S8U 758</b>	4cyl.	<b>2499cc</b>	<b>55kW (75PS)</b>	<b>Diesel</b>	<b>TD9689</b>
<b>S8U 780</b>	4cyl.	<b>2499cc</b>	<b>55kW (75PS)</b>	<b>Diesel</b>	<b>TD16328</b>
<b>S8U 782</b>	4cyl.	<b>2499cc</b>	<b>55kW (75PS)</b>	<b>Diesel</b>	<b>TD16329</b>

14-022560-00 <i>D</i>	<b>93.00</b>	<b>B 96.00</b>	<b>C 167.30</b>	<b>D 98.90</b>	<b>E 5.00</b>
14-028930-00 <i>D</i>		<b>B 97.50</b>	<b>C 167.00</b>	<b>D 100.90</b>	<b>E 5.00</b>
14-028931-00 <i>D</i>		<b>B 97.58</b>	<b>C 167.00</b>	<b>D 100.90</b>	<b>E 5.00</b>
14-028932-00 <i>D</i>		<b>B 97.70</b>	<b>C 167.00</b>	<b>D 100.90</b>	<b>E 5.00</b>

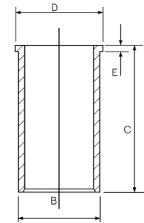

**17**

<b>S9W 700</b>	4cyl.	<b>2799cc</b>	<b>84kW (114PS)</b>	<b>Diesel Turbo Intercooled</b>	<b>TD19362</b>
<b>S9W 702</b>	4cyl.	<b>2799cc</b>	<b>84kW (114PS)</b>	<b>Diesel Turbo</b>	<b>TD13408</b>

14-021321-00 <i>D</i>	<b>94.40</b>	<b>B 97.54</b>	<b>C 167.00</b>	<b>D 100.90</b>	<b>E 5.00</b>
14-028930-00 <i>D</i>		<b>B 97.50</b>	<b>C 167.00</b>	<b>D 100.90</b>	<b>E 5.00</b>
14-028931-00 <i>D</i>		<b>B 97.58</b>	<b>C 167.00</b>	<b>D 100.90</b>	<b>E 5.00</b>
14-028932-00 <i>D</i>		<b>B 97.70</b>	<b>C 167.00</b>	<b>D 100.90</b>	<b>E 5.00</b>

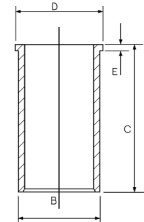

**18**

<b>MIDR 06.24.65</b>	6cyl.	<b>12000cc</b>	<b>287-412kW (390-560PS)</b>	<b>Diesel Turbo Intercooled</b>	<b>TD29100</b>
----------------------	-------	----------------	------------------------------	---------------------------------	----------------

14-740130-00 <i>WH</i>	<b>124.00</b>	<b>B 130.175</b>	<b>C 279.25</b>	<b>D 139.801</b>	<b>E 103.327</b>
------------------------	---------------	------------------	-----------------	------------------	------------------

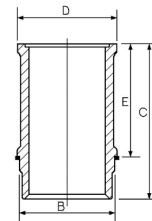

Motorverzeichnis • Index de moteur • Índice de Motor  
Indeks silnika • Модель двигателя • دليل المحرك

# ENGINE INDEX



CCM

x



9

712	Diesel	3320	4	98.00	3
712-01-03	Diesel	3320	4	98.00	3
712-01-04	Diesel	3320	4	98.00	3
714	Diesel	3320	4	98.00	3
720	Diesel	3590	4	102.00	4
720-12	Diesel	3590	4	102.00	4
797	Diesel	5278	6	102.00	5
797-20	Diesel	5490	6	102.00	5
797-21	Diesel	5453	6	102.00	5
797-26	Diesel	5490	6	102.00	5
798	Diesel	5490	6	102.00	5
798-10	Diesel	5490	6	102.00	5
798-20	Diesel	5490	6	102.00	5
8140.23.2585	Diesel	2800	4	94.40	2
8140.43.2585	Diesel	2800	4	94.40	2
8140.43.3700	Diesel	2798	4	94.40	2
8140.43.C.2586	Diesel	2800	4	94.40	2
8140.43.C.3586	Diesel	2800	4	94.40	2
8140.43.C.3588	Diesel	2800	4	94.40	2
8140.43.S.2585	Diesel	2800	4	94.40	2
8140.43.S.3585	Diesel	2800	4	94.40	2
8140.43N.3585	Diesel	2798	4	94.40	2
8140.47.2585	Diesel	2499	4	93.00	1
8140.63.2585	Diesel	2798	4	94.40	2
DCi 11C	Diesel	11100	6	123.00	12
DCi 11E	Diesel	11100	6	123.00	12
DCi 6 W	Diesel	6177	6	102.00	7
DXi 11	Diesel	10800	6	123.00	13
DXi 12	Diesel	12130	6	131.00	15
DXi 13	Diesel	12800	6	131.00	16
DXi 5	Diesel	4800	5	108.00	8
DXi 7	Diesel	7200	5	108.00	8
MACK E.TECH A/46	Diesel	12000	6	124.00	14
MACK E.TECH B/46	Diesel	12000	6	124.00	14
MACK E.TECH C/46	Diesel	12000	6	124.00	14
MDS 06.35.40	Diesel	12024	6	135.00	17
MIDR 04.02.26 A/4	Diesel	4120	4	102.00	6
MIDR 04.02.26 B/4	Diesel	4120	4	102.00	6
MIDR 06.02.12	Diesel	5491	6	102.00	6
MIDR 06.02.12 B	Diesel	5490	6	102.00	6
MIDR 06.02.12 C	Diesel	5490	6	102.00	6
MIDR 06.02.12 D	Diesel	5490	6	102.00	6
MIDR 06.02.26	Diesel	6177	6	102.00	6
MIDR 06.02.26 D	Diesel	6177	6	102.00	6
MIDR 06.02.26 H	Diesel	6177	6	102.00	6
MIDR 06.02.26 Q	Diesel	6177	6	102.00	6
MIDR 06.02.26 U	Diesel	6177	6	102.00	6
MIDR 06.02.26 U/4	Diesel	6177	6	102.00	6
MIDR 06.02.26 V	Diesel	6177	6	102.00	6
MIDR 06.02.26 V/4	Diesel	6177	6	102.00	6
MIDR 06.02.26 V/41	Diesel	6177	6	102.00	6
MIDR 06.02.26 W	Diesel	6177	6	102.00	6
MIDR 06.02.26 W/4	Diesel	6177	6	102.00	6
MIDR 06.02.26 X	Diesel	6177	6	102.00	6
MIDR 06.02.26 Y/41	Diesel	6177	6	102.00	6
MIDR 06.20.45	Diesel	9771	6	120.00	10
MIDR 06.20.45 A	Diesel	9839	6	120.00	10
MIDR 06.20.45 B3	Diesel	9839	6	120.00	9
MIDR 06.20.45 C	Diesel	9840	6	120.00	10
MIDR 06.20.45 C/4	Diesel	9839	6	120.00	9

# ENGINE INDEX

Motorverzeichnis • Index de moteur • Índice de Motor  
Indeks silnika • Модель двигателя • دليل المحرك



CCM



9

Engine Model	Fuel Type	CCM	Cylinders	Power (kW)	Power (HP)
MIDR 06.20.45 D	Diesel	9839	6	120.00	11
MIDR 06.20.45 D/41	Diesel	9839	6	120.00	9
MIDR 06.20.45 D3	Diesel	9839	6	120.00	9
MIDR 06.20.45 E	Diesel	9839	6	120.00	9
MIDR 06.20.45 E/41	Diesel	9839	6	120.00	9
MIDR 06.20.45 E2	Diesel	9839	6	120.00	9
MIDR 06.20.45 E3	Diesel	9839	6	120.00	11
MIDR 06.20.45 H	Diesel	9839	6	120.00	9
MIDR 06.20.45 I41	Diesel	9840	6	120.00	10
MIDR 06.20.45 M41	Diesel	9839	6	120.00	9
MIDR 06.23.56 A/3	Diesel	11100	6	123.00	12
MIDR 06.23.56 A/41	Diesel	11100	6	123.00	12
MIDR 06.23.56 B/41	Diesel	11100	6	123.00	12
MIDR 06.24.65 A/42	Diesel	12000	6	124.00	14
MIDR 06.24.65 B/42	Diesel	12000	6	124.00	14
MIDR 06.24.65 C/42	Diesel	12000	6	124.00	14
MIDR 06.35.40	Diesel	12000	6	135.00	17
MIDR 06.35.40 C	Diesel	11941	6	135.00	17
MIDR 06.35.40 G	Diesel	12024	6	135.00	19
MIDR 06.35.40 H	Diesel	11941	6	135.00	19
MIDR 06.35.40 J/3	Diesel	12024	6	135.00	18
MIDR 06.35.40 J1	Diesel	12024	6	135.00	18
MIDR 06.35.40 L1	Diesel	12024	6	135.00	18
MIDR 06.35.40 M3	Diesel	12024	6	135.00	18
MIDR 06.35.40 N/3	Diesel	12024	6	135.00	18
MIDR 06.35.40 P/41	Diesel	12024	6	135.00	18
MIDS 06.02.12	Diesel	5490	6	102.00	6
MIDS 06.02.12 B	Diesel	5453	6	102.00	5
MIDS 06.02.12 C	Diesel	5490	6	102.00	5
MIDS 06.02.12 D/3	Diesel	5490	6	102.00	6
MIDS 06.20.30	Diesel	8821	6	120.00	10
MIDS 06.20.45 B	Diesel	9839	6	120.00	9
MIDS 06.35.40 D	Diesel	12024	6	135.00	17
MIHR 06.20.45 A41	Diesel	9839	6	120.00	9
MIPR 06.20.45 A3	Diesel	9840	6	120.00	10
MIPR 06.20.45 C3	Diesel	9840	6	120.00	10
MIPS 06.20.30	Diesel	8820	6	120.00	10



1

8140.47.2585 Euro 1 4cyl. 2499cc 85kW (116PS) Diesel Turbo Intercooled TD3428

14-021371-00 D	93.00	B 96.01	C 171.00	D 98.92	E 5.00
14-021372-00 D		B 96.05	C 171.00	D 98.92	E 5.00
14-021373-00 D		B 96.17	C 171.00	D 98.92	E 5.00
14-021480-00 DH ①		B 97.035	C 171.00	D 100.00	E 5.00

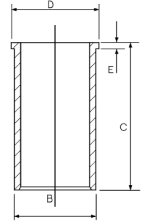

① Nitrided

① Nitriert

① Nitruré

① Nitrurado

2

8140.43N.3585 Euro 3	4cyl.	2798cc	107kW (146PS)	Diesel	Turbo Intercooled	TD17197
8140.23.2585 Euro 2	4cyl.	2800cc	78kW (106PS)	Diesel	Turbo Intercooled	TD12194
8140.43.2585 Euro 2	4cyl.	2800cc	90kW (122PS)	Diesel	Turbo Intercooled	TD12198
8140.43.3700 Euro 2	4cyl.	2798cc	85kW (116PS)	Diesel	Turbo Intercooled	TD22394
8140.43.C.2586	4cyl.	2800cc	78kW (106PS)	Diesel	Turbo Intercooled	TD14090
8140.43.C.3586 Euro 3	4cyl.	2800cc	78kW (106PS)	Diesel	Turbo Intercooled	TD17194
8140.43.C.3588 Euro 3	4cyl.	2800cc	78kW (106PS)	Diesel	Turbo Intercooled	TD17195
8140.43.S.2585 Euro 2	4cyl.	2800cc	92kW (125PS)	Diesel	Turbo Intercooled	TD14091
8140.43.S.3585 Euro 3	4cyl.	2800cc	92kW (125PS)	Diesel	Turbo Intercooled	TD17196
8140.63.2585 Euro 2	4cyl.	2798cc	63kW (86PS)	Diesel	Turbo Intercooled	TD14089

14-021321-00 D	94.40	B 97.54	C 167.00	D 100.90	E 5.00
14-028930-00 D		B 97.50	C 167.00	D 100.90	E 5.00
14-028931-00 D		B 97.58	C 167.00	D 100.90	E 5.00
14-028932-00 D		B 97.70	C 167.00	D 100.90	E 5.00

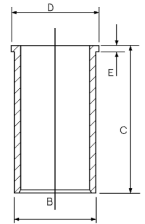

3

712	4cyl.	3320cc	56kW (76PS)	Diesel	TD8669
712-01-03	4cyl.	3320cc	53kW (72PS)	Diesel	TD3019
712-01-04	4cyl.	3320cc	54kW (73PS)	Diesel	TD3020
714	4cyl.	3320cc		Diesel	FM4359

14-261790-00 WH	98.00	B 114.00	C 220.70	D 120.90	E 8.00	F 0.70
14-264190-00 WH		B 111.95	C 220.50	D 118.90	E 8.00	F 0.80

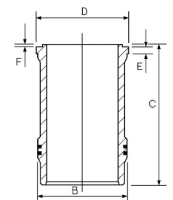



4

720	4cyl.	3590cc	67-72kW (91-98PS)	Diesel		TD3022
720-12	4cyl.	3590cc	67-72kW (90-98PS)	Diesel		TD8609

14-265940-00 WH ① 102.00 B 114.00 C 220.70 D 120.70 E 8.00 F 0.70

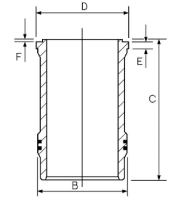

① Phosphated

① Phosphatiert

① Phosphatisé

① Fosfatada

5

797	6cyl.	5278cc	96-97kW (130-132PS)	Diesel		TD8610
797-20	6cyl.	5490cc	96-98kW (130-133PS)	Diesel Turbo		TD8607
797-21	6cyl.	5453cc	76kW (103PS)	Diesel		TD8658
797-26	6cyl.	5490cc	98kW (133PS)	Diesel Turbo		TD8593
798	6cyl.	5490cc	110kW (150PS)	Diesel Turbo		TD8613
798-10	6cyl.	5490cc	113kW (154PS)	Diesel Turbo		TD6210
798-20	6cyl.	5490cc	113kW (154PS)	Diesel Turbo		TD8606
MIDR 06.02.12	6cyl.	5491cc	128-134kW (173-182PS)	Diesel Turbo Intercooled		TD8547
MIDR 06.02.12 B	6cyl.	5490cc	117kW (159PS)	Diesel Turbo Intercooled		TD8644
MIDR 06.02.12 C	6cyl.	5490cc	121-133kW (170-181PS)	Diesel Turbo Intercooled		TD5985
MIDR 06.02.12 D	6cyl.	5490cc	127-134kW (172-182PS)	Diesel Turbo Intercooled		TD8583
MIDR 06.02.26 H	6cyl.	6177cc	133-144kW (181-196PS)	Diesel Turbo Intercooled		TD5645
MIDS 06.02.12 B	6cyl.	5453cc	113-117kW (154-159PS)	Diesel Turbo		TD8608
MIDS 06.02.12 C	6cyl.	5490cc	97-103kW (132-140PS)	Diesel Turbo		TD8615
MIDS 06.02.12 D/3	6cyl.	5490cc	110kW (150PS)	Diesel Turbo		TD14068

14-265950-00 WH ② 102.00 B 114.00 C 235.30 D 121.00 E 8.00 F 0.80

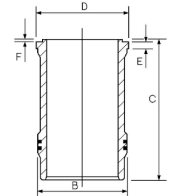

① Includes seals

① Schließt Dichtungen ein

① Inclut des joints

① Incluye los sellos

② Phosphated

② Phosphatiert

② Phosphatisé

② Fosfatada

6

MIDR 04.02.26 A/4 Euro 2	4cyl.	4120cc	100kW (136PS)	Diesel Turbo Intercooled		TD14509
MIDR 04.02.26 B/4 Euro 2	4cyl.	4120cc	110kW (150PS)	Diesel Turbo Intercooled		TD14510
MIDR 06.02.26	6cyl.	6177cc	159kW (216PS)	Diesel Turbo Intercooled		TD14049
MIDR 06.02.26 D	6cyl.	6177cc	166kW (226PS)	Diesel Turbo Intercooled		TD5862
MIDR 06.02.26 V Euro 1	6cyl.	6177cc	129-132kW (175-180PS)	Diesel Turbo Intercooled		TD8618
MIDR 06.02.26 X Euro 1	6cyl.	6177cc	166kW (226PS)	Diesel Turbo Intercooled		TD8536
MIDR 06.02.26 Q	6cyl.	6177cc	137-140kW (186-190PS)	Diesel Turbo		TD8584
MIDR 06.02.26 U Euro 1	6cyl.	6177cc	110kW (150PS)	Diesel Turbo Intercooled		TD8616
MIDR 06.02.26 U/4 Euro 2	6cyl.	6177cc	110kW (150PS)	Diesel Turbo Intercooled		TD12208
MIDR 06.02.26 V/4 Euro 2	6cyl.	6177cc	132kW (180PS)	Diesel Turbo Intercooled		TD14508







9

MIDR 06.20.45 E	6cyl.	9839cc	240-249kW (326-339PS)	Diesel	Turbo Intercooled	TD5860
MIDR 06.20.45 B3 Euro 1	6cyl.	9839cc	195kW (265PS)	Diesel	Turbo Intercooled	TD8592
MIDR 06.20.45 D3 Euro 1	6cyl.	9839cc	222kW (302PS)	Diesel	Turbo Intercooled	TD8539
MIDR 06.20.45 E/41 Euro 2	6cyl.	9839cc	249kW (339PS)	Diesel	Turbo Intercooled	TD8642
MIDR 06.20.45 E2 Euro 1	6cyl.	9839cc	249kW (339PS)	Diesel	Turbo Intercooled	TD8540
MIDR 06.20.45 H	6cyl.	9839cc	227-240kW (310-326PS)	Diesel	Turbo Intercooled	TD6209
MIDR 06.20.45 M41 Euro 2	6cyl.	9839cc	250kW (340PS)	Diesel	Turbo Intercooled	TD21231
MIDS 06.20.45 B	6cyl.	9839cc	192-202kW (260-275PS)	Diesel	Turbo Intercooled	TD8537
MIDR 06.20.45 C/4 Euro 2	6cyl.	9839cc	188kW (256PS)	Diesel	Turbo Intercooled	TD17421
MIDR 06.20.45 D/41 Euro 2	6cyl.	9839cc	219kW (298PS)	Diesel	Turbo Intercooled	TD8641
MIHR 06.20.45 A41 Euro 2	6cyl.	9839cc	185kW (252PS)	Diesel	Turbo Intercooled	TD21269

15-480070-00 WH	120.00	B 135.00	C 261.00	D 147.30	E 9.35	F 0.90
15-480080-00 WH		B 135.00	C 261.00	D 147.30	E 9.38	F 0.30

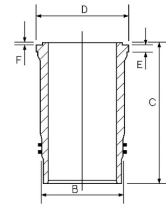

15-450190-00 WH	120.00	B 135.00	C 256.75	D 147.50	E 9.38	F 0.75
-----------------	--------	----------	----------	----------	--------	--------

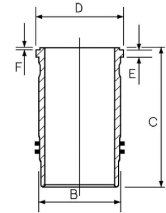

Includes seals      Schließt Dichtungen ein      Includ des joints      Incluye los sellos

10

MIDR 06.20.45 A	6cyl.	9839cc	192kW (261PS)	Diesel	Turbo Intercooled	TD8591
MIDR 06.20.45 C	6cyl.	9840cc	206-210kW (280-285PS)	Diesel	Turbo Intercooled	TD8580
MIPR 06.20.45 C3	6cyl.	9840cc	152kW (207PS)	Diesel	Turbo Intercooled	TD8629
MIDS 06.20.30	6cyl.	8821cc	169kW (230PS)	Diesel	Turbo	TD8595
MIPS 06.20.30	6cyl.	8820cc	166kW (226PS)	Diesel	Turbo	TD8626
MIDR 06.20.45	6cyl.	9771cc	214-222kW (291-302PS)	Diesel	Turbo Intercooled	TD8414
MIDR 06.20.45 I41 Euro 2	6cyl.	9840cc	188kW (256PS)	Diesel	Turbo Intercooled	TD12191
MIPR 06.20.45 A3	6cyl.	9840cc	222kW (302PS)	Diesel	Turbo Intercooled	TD8635

15-480050-00 WH	120.00	B 135.00	C 261.00	D 147.30	E 9.28	F 0.90
→06/88 15-480070-00 WH		B 135.00	C 261.00	D 147.30	E 9.35	F 0.90
06/88→						

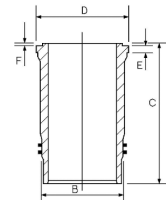

Includes seals      Schließt Dichtungen ein      Includ des joints      Incluye los sellos





11

MIDR 06.20.45 D 6cyl. 9839cc 210-222kW (286-302PS) Diesel Turbo Intercooled TD8538

MIDR 06.20.45 E3 Euro 1 6cyl. 9839cc 249kW (339PS) Diesel Turbo Intercooled TD8541

15-480080-00 WH 120.00 B 135.00 C 261.00 D 147.30 E 9.38 F 0.30

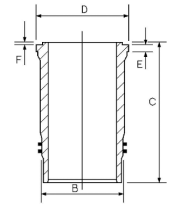

Includes seals Schließt Dichtungen ein Includ des joints Incluye los sellos

12

DCI 11C Euro 3 6cyl. 11100cc 303kW (412PS) Diesel Turbo Intercooled TD16880

DCI 11E Euro 3 6cyl. 11100cc 266kW (362PS) Diesel Turbo Intercooled TD16879

MIDR 06.23.56 A/41 Euro 2 6cyl. 11100cc 280kW (381PS) Diesel Turbo Intercooled TD8643

MIDR 06.23.56 B/41 Euro 2 6cyl. 11100cc 288kW (392PS) Diesel Turbo Intercooled TD12207

MIDR 06.23.56 A/3 Euro 2 6cyl. 11100cc 255kW (347PS) Diesel Turbo Intercooled TD17528

14-450920-00 WH 123.00 B 134.915 C 257.00 D 147.40 E 9.38 F 0.70

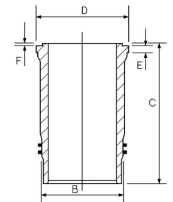

15-450220-00 WH 123.00 B 135.20 C 256.75 D 147.50 E 9.41 F 0.75

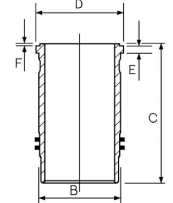

Includes seals Schließt Dichtungen ein Includ des joints Incluye los sellos

13

DXI 11 Euro3/Euro4 6cyl. 10800cc 272kW (370PS) Diesel TD19017

14-480440-00 WH 123.00 B 139.00 C 249.55 D 149.00 E 11.20 F 0.85

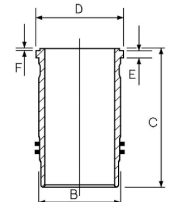



14

MACK E.TECH A/46 Euro 2	6cyl.	12000cc	295kW (401PS)	Diesel	Turbo Intercooled	TD14770
MACK E.TECH B/46 Euro 2	6cyl.	12000cc	324kW (440PS)	Diesel	Turbo Intercooled	TD14771
MACK E.TECH C/46 Euro 2	6cyl.	12000cc	347kW (472PS)	Diesel	Turbo Intercooled	TD14772
MIDR 06.24.65 A/42 Euro 2	6cyl.	12000cc	287kW (390PS)	Diesel	Turbo Intercooled	TD12148
MIDR 06.24.65 B/42 Euro 2	6cyl.	12000cc	316kW (430PS)	Diesel	Turbo Intercooled	TD12188
MIDR 06.24.65 C/42 Euro 2	6cyl.	12000cc	346kW (471PS)	Diesel	Turbo Intercooled	TD12189

14-740130-00 WH 124.00 B 130.175 C 279.25 D 139.801 E 103.327

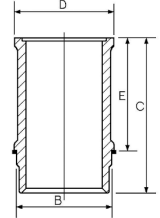

15

DXI 12 Euro 3	6cyl.	12130cc	324kW (440PS)	Diesel	Turbo Intercooled	TD19083
---------------	-------	---------	---------------	--------	-------------------	---------

14-450160-00 WH 131.00 B 150.30 C 276.40 D 159.50 E 11.20 F 3.60  
 15-450160-00 WH <sup>1</sup> B 150.32 C 276.425 D 159.50 E 11.215 F 3.62

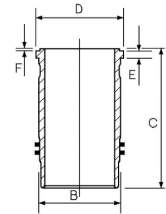

<sup>1</sup> Includes seals

<sup>1</sup> Schließt Dichtungen ein

<sup>1</sup> Inclut des joints

<sup>1</sup> Incluye los sellos

16

DXI 13 Euro 4	6cyl.	12800cc	339kW (461PS)	Diesel	Turbo Intercooled	TD19084
---------------	-------	---------	---------------	--------	-------------------	---------

14-451190-00 W 131.00 B 144.00 C 261.80 D 159.60 E 11.20 F 0.90

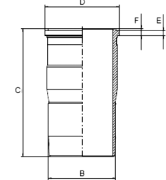

17

MDS 06.35.40	6cyl.	12024cc	177kW (240PS)	Diesel	Turbo Intercooled	TD8668
MIDR 06.35.40	6cyl.	12000cc	235kW (320PS)	Diesel	Turbo Intercooled	TD19965
MIDR 06.35.40 C	6cyl.	11941cc	224-228kW (305-310PS)	Diesel	Turbo Intercooled	TD8645
MIDS 06.35.40 D	6cyl.	12024cc	208kW (283PS)	Diesel	Turbo	TD8542

14-020330-00 DH 135.00 B 143.00 C 286.00 D 149.00 E 7.40  
 14-020510-00 DH B 143.00 C 286.00 D 147.00 E 7.00  
 14-027200-00 DH B 143.25 C 286.00 D 149.00 E 7.40

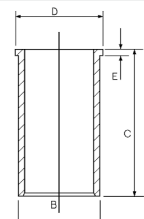



18

MIDR 06.35.40 J/3 Euro 1	6cyl.	12024cc	305kW (415PS)	Diesel	Turbo Intercooled	TD8519
MIDR 06.35.40 J1 Euro 1	6cyl.	12024cc	314kW (427PS)	Diesel	Turbo Intercooled	TD8653
MIDR 06.35.40 L1	6cyl.	12024cc	283kW (385PS)	Diesel	Turbo Intercooled	TD8517
MIDR 06.35.40 M3 Euro 1	6cyl.	12024cc	236kW (321PS)	Diesel	Turbo Intercooled	TD8543
MIDR 06.35.40 N/3 Euro 1	6cyl.	12024cc	283kW (385PS)	Diesel	Turbo Intercooled	TD8518
MIDR 06.35.40 P/41 Euro 2	6cyl.	12024cc	305kW (415PS)	Diesel	Turbo Intercooled	TD12187

14-040040-00 *DH*      135.00      B 143.03      C 288.25      D 149.00      E 7.65      F 1.05

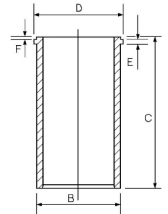

19

MIDR 06.35.40 G	6cyl.	12024cc	243-259kW (330-352PS)	Diesel	Turbo Intercooled	TD12202
MIDR 06.35.40 H	6cyl.	11941cc	264-275kW (359-374PS)	Diesel	Turbo Intercooled	TD8516

14-020330-00 *DH*      135.00      B 143.00      C 286.00      D 149.00      E 7.40

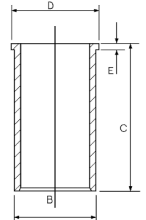

14-040040-00 *DH*      135.00      B 143.03      C 288.25      D 149.00      E 7.65      F 1.05

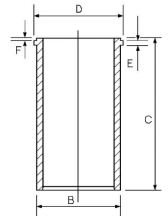

# MODEL INDEX



Modelverzeichnis • Index de modele • Índice de Modelo  
Indeks modelu • Модель автомобиля • دليل الموديل



CCM

x



9

09/99→05/05	<b>25 1.1</b>	11 K4F	Petrol	1120	4	<b>2</b>
10/99→05/05	<b>25 1.4</b>	14 K4F, 14 K4M	Petrol	1396	4	<b>2</b>
10/99→05/05	<b>25 1.6</b>	16 K4F	Petrol	1588	4	<b>4</b>
10/99→05/05	<b>25 1.8</b>	18 K4F, 18 K4K (VVC)	Petrol	1796	4	<b>4</b>
02/00→05/05	<b>45 1.4</b>	14 K4F	Petrol	1396	4	<b>2</b>
02/00→05/05	<b>45 1.6</b>	16 K4F	Petrol	1588	4	<b>4</b>
02/00→05/05	<b>45 1.8</b>	18 K4F	Petrol	1796	4	<b>4</b>
02/99→05/05	<b>75 1.8</b>	18 K4F	Petrol	1796	4	<b>4</b>
02/99→05/05	<b>75 2.5</b>	25 K4F, KV 6	Petrol	2497	V6	<b>4</b>
01/58→12/62	<b>80 Mk II</b>	2286	Petrol	2286	4	<b>6</b>
01/58→12/62	<b>80 P4</b>	2286	Petrol	2286	4	<b>6</b>
04/94→10/97	<b>100 1.1</b>	11 K2D	Petrol	1120	4	<b>2</b>
04/94→10/98	<b>100 1.4</b>	14 K2A, 14 K2D, 14 K4F	Petrol	1396	4	<b>2</b>
03/90→12/98	<b>100 / Metro 1.1</b>	11 K2D	Petrol	1120	4	<b>2</b>
03/90→12/98	<b>100 / Metro 1.4</b>	14 K2A, 14 K2D, 14 K4C, 14 K4D, 14 K4F	Petrol	1396	4	<b>2</b>
01/98→03/00	<b>200 1.1</b>	11 K2D	Petrol	1120	4	<b>2</b>
10/89→03/00	<b>200 1.4</b>	14 K2A, 14 K2D, 14 K2F, 14 K4C, 14 K4D, 14 K4F	Petrol	1396	4	<b>2</b>
11/95→03/00	<b>200 1.6</b>	16 K4F	Petrol	1588	4	<b>4</b>
09/91→10/95	<b>200 1.8</b>	XUD 7TE	Diesel	1769	4	<b>3</b>
11/95→03/00	<b>200 1.8</b>	18 K4F, 18 K4K (VVC)	Petrol	1796	4	<b>4</b>
01/91→12/96	<b>218 D</b>	XUD9/A/B/L/Y	Diesel	1905	4	<b>5</b>
01/91→12/96	<b>218 SD</b>	XUD9/A/B/L/Y	Diesel	1905	4	<b>5</b>
04/90→03/00	<b>400 1.4</b>	14 K2F, 14 K4C, 14 K4D, 14 K4F	Petrol	1396	4	<b>2</b>
05/95→03/00	<b>400 1.6</b>	16 K4F	Petrol	1588	4	<b>4</b>
09/91→11/98	<b>400 1.8</b>	XUD 7TE	Diesel	1769	4	<b>3</b>
06/96→11/98	<b>400 1.8</b>	18 K4K (VVC)	Petrol	1796	4	<b>4</b>
01/92→12/96	<b>418 D</b>	XUD9/A/B/L/Y	Diesel	1905	4	<b>5</b>
01/92→12/96	<b>418 SD</b>	XUD9/A/B/L/Y	Diesel	1905	4	<b>5</b>
01/92→12/96	<b>418 SLD</b>	XUD9/A/B/L/Y	Diesel	1905	4	<b>5</b>
01/90→02/99	<b>800 2.5</b>	492 4 SHIRG	Diesel	2499	4	<b>7</b>
02/96→02/99	<b>800 2.5</b>	25 K4F	Petrol	2497	V6	<b>4</b>
05/82→10/86	<b>2000-3500 2.4</b>	HR 492 HT	Diesel	2393	4	<b>7</b>
04/90→11/99	<b>Cabriolet 1.4</b>	14 K4C, 14 K4D, 14 K4F	Petrol	1396	4	<b>2</b>
01/96→11/99	<b>Cabriolet 1.6</b>	16 K4F	Petrol	1588	4	<b>4</b>
03/96→11/99	<b>Coupe 1.6</b>	16 K4F	Petrol	1588	4	<b>4</b>
03/96→11/99	<b>Coupe 1.8</b>	18 K4K (VVC)	Petrol	1796	4	<b>4</b>
01/91→05/01	<b>Mini 1.3</b>	12 A2B, A+ Series (12 A2D), A+ Series (12 A2E), A Series (12 A2A), A Series (12 A2L)	Petrol	1275	4	<b>1</b>
08/03→05/05	<b>Streetwise 1.4</b>	14 K4F, 14 K4M	Petrol	1396	4	<b>2</b>
01/04→05/05	<b>Streetwise 1.6</b>	16 K4F	Petrol	1588	4	<b>4</b>
08/03→05/05	<b>Streetwise 1.8</b>	18 K4F	Petrol	1796	4	<b>4</b>



1

12 A2B	4cyl.	1275cc	37kW (50PS)	TD4880
A+ SERIES (12 A2D)	4cyl.	1275cc	39kW (53PS)	TD3473
A+ SERIES (12 A2E)	4cyl.	1275cc	46kW (63PS)	TD3487
A+ SERIES (12 H)	4cyl.	1275cc	47kW (64PS)	TD22364
A SERIES (12 A2A)	4cyl.	1275cc	45kW (61PS)	TD9490
A SERIES (12 A2L)	4cyl.	1275cc	45kW (61PS)	TD9489

14-010890-00 *D*      70.62      B 73.09      C 141.28

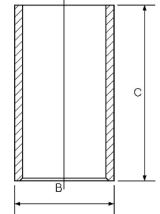

2

11 K2D	4cyl.	1120cc	44kW (60PS)	TD4884
11 K4F	4cyl.	1120cc	55kW (75PS)	TD18365
14 K2A	4cyl.	1396cc	55kW (75PS)	TD3477
14 K2D	4cyl.	1396cc	55kW (75PS)	TD3478
14 K2F	4cyl.	1396cc	55kW (75PS)	TD9499
14 K4C	4cyl.	1396cc	66-70kW (90-95PS)	TD3480
14 K4D	4cyl.	1396cc	75-77kW (102-105PS)	TD3488
14 K4F	4cyl.	1396cc	76kW (103PS)	TD3481
14 K4M	4cyl.	1396cc	62kW (84PS)	TD18231

14-710030-00 *WH*      75.00      B 84.10      C 129.50      D 87.50      E 50.05

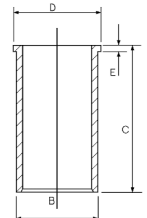

3

XUD 7TE	4cyl.	1769cc	66kW (89PS)	Diesel Turbo	TD3504
14-024740-00 <i>D</i>		80.00	B 83.50      C 154.00	D 85.70      E 4.60	
14-024830-00 <i>D</i>			B 83.00      C 154.00	D 86.00      E 4.50	

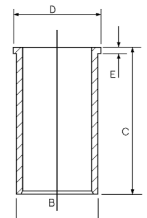



4

16 K4F	4cyl.	1588cc	81kW (110PS)					TD9358
18 K4F	4cyl.	1796cc	87kW (118PS)					TD9483
18 K4F	4cyl.	1796cc	88kW (120PS)					TD11607
18 K4K (VVC)	4cyl.	1796cc	107-110kW (146-150PS)					TD3500
25 K4F	V6cyl.	2497cc	130kW (177PS)					TD9492
KV 6	V6cyl.	2497cc	129kW (175PS)					TD11608

14-710020-00 WH 80.00 B 84.10 C 129.50 D 87.50 E 50.05

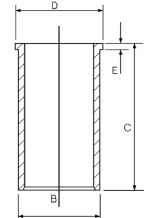

5

XUD9/A/B/L/Y	4cyl.	1905cc		Diesel				FM3219
--------------	-------	--------	--	--------	--	--	--	--------

14-020530-00 D 83.00 B 85.60 C 153.50 D 88.50 E 3.90

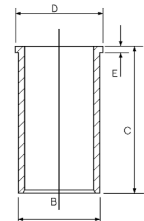

6

2286	4cyl.	2286cc						FM1533
------	-------	--------	--	--	--	--	--	--------

14-010920-00 D 90.47 B 94.50 C 191.36

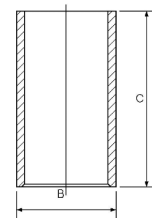

7

492 4 SHIRG	4cyl.	2499cc	87kW (118PS)	Diesel	Turbo Intercooled			TD3502
HR 492 HI	4cyl.	2393cc	81-84kW (110-114PS)	Diesel	Turbo Intercooled			TD22365
HR 492 HT	4cyl.	2393cc	67kW (91PS)	Diesel	Turbo			TD22366
VM-HR 492.4	4cyl.	2393cc	89kW (121PS)	Diesel	Turbo			TD3503

14-676420-00 WH 92.00 B 101.50 C 166.80 D 110.00 E 8.90 F 1.20

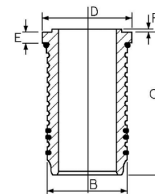

Motorverzeichnis • Index de moteur • Índice de Motor  
Indeks silnika • Модель двигателя • دليل المحرك

# ENGINE INDEX



CCM

x



9

D 11 R 23	Diesel	11022	6	127.00	10
DC 11.01	Diesel	10600	6	127.00	6
DC 11.02	Diesel	10600	6	127.00	6
DC 11.03	Diesel	10600	6	127.00	6
DC 11.04	Diesel	10600	6	127.00	6
DC 11.07	Diesel	10600	6	127.00	6
DC 11.08	Diesel	10600	6	127.00	6
DC 11.09	Diesel	10600	6	127.00	6
DC 12.01	Diesel	11700	6	127.00	5
DC 12.02	Diesel	11700	6	127.00	5
DC 12.03	Diesel	11700	6	127.00	5
DC 12.09	Diesel	11700	6	127.00	5
DC 12.10	Diesel	11700	6	127.00	14
DC 12.13	Diesel	11700	6	127.00	14
DC 12.14	Diesel	11716	6	127.00	14
DC 12.15	Diesel	11716	6	127.00	14
DC 12.17	Diesel	11716	6	127.00	14
DC 12.18	Diesel	11716	6	127.00	14
DC 12.22	Diesel	11716	6	127.00	14
DC 12.23	Diesel	11716	6	127.00	14
DC 12.24	Diesel	11716	6	127.00	14
DC 12.26	Diesel	11716	6	127.00	14
DC 16.01	Diesel	15600	V8	127.00	5
DC 16.02	Diesel	15600	V8	127.00	6
DC 16.03	Diesel	15600	V8	127.00	5
DC 16.04	Diesel	15600	V8	127.00	5
DC 16.05	Diesel	15600	V8	127.00	5
DC 16.06	Diesel	15600	V8	127.00	5
DC 16.08	Diesel	15600	V8	127.00	5
DC 16.09	Diesel	15600	V8	127.00	5
DC 16.17	Diesel	15600	V8	127.00	5
DC 16.18	Diesel	15600	V8	127.00	5
DC 16.19	Diesel	15600	V8	127.00	5
DC 16.22	Diesel	15600	V8	127.00	5
DC 9.01	Diesel	9000	6	115.00	3
DC 9.02	Diesel	9000	6	115.00	3
DC 9.03	Diesel	9000	6	115.00	3
DC 9.04	Diesel	9000	6	115.00	3
DC 9.05	Diesel	9000	6	115.00	3
DC 9.06	Diesel	9000	6	115.00	3
DC 9.16	Diesel	8867	5	127.00	14
DC 9.17	Diesel	8867	5	127.00	14
DN 11.01	Diesel	11020	6	127.00	10
DN 11.01 B10	Diesel	11000	6	127.00	10
DN 11.01 C 09	Diesel	11020	6	127.00	10
DN 11.04 B10	Diesel	11000	6	127.00	10
DN 11.04 C 01	Diesel	11000	6	127.00	10
DN 11.06	Diesel	11020	6	127.00	10
DN 11.07	Diesel	11022	6	127.00	10
DN 11.08	Diesel	11022	6	127.00	10
DN 11.08 B01	Diesel	11020	6	127.00	10
DN 8.01	Diesel	7800	6	115.00	1
DN 8.05 L01 . L04	Diesel	7800	6	115.00	1
DN 9.01	Diesel	8500	6	115.00	2
DS 11	Diesel	11022	6	127.00	8
DS 11 / D11	Diesel	11022	6	127.00	10
DS 11 Agr/Ind 1978>	Diesel	11022	6	127.00	11
DS 11.01	Diesel	11022	6	127.00	10
DS 11.01 B 06	Diesel	11022	6	127.00	10
DS 11.02	Diesel	11022	6	127.00	10

# ENGINE INDEX

Motorverzeichnis • Index de moteur • Índice de Motor  
Indeks silnika • Модель двигателя • دليل المحرك



CCM



9

DS 11.14	Diesel	11022	6	127.00	10
DS 11.15	Diesel	11022	6	127.00	10
DS 11.15 B	Diesel	11022	6	127.00	10
DS 11.18	Diesel	11022	6	127.00	10
DS 11.22	Diesel	11022	6	127.00	7
DS 11.23	Diesel	11022	6	127.00	7
DS 11.34	Diesel	11020	6	127.00	9
DS 11.71	Diesel	11020	6	127.00	9
DS 11.71 C	Diesel	11020	6	127.00	9
DS 11.72	Diesel	11022	6	127.00	9
DS 11.73	Diesel	11020	6	127.00	9
DS 11.74	Diesel	11020	6	127.00	9
DS 11.75	Diesel	11020	6	127.00	7
DS 14	Diesel	14181	V8	127.00	12
DS 14 LB 05	Diesel	14200	V8	127.00	12
DS 14 LB 08	Diesel	14200	V8	127.00	12
DS 14.01	Diesel	14190	V8	127.00	12
DS 14.01 L 01	Diesel	14200	V8	127.00	12
DS 14.02	Diesel	14190	V8	127.00	12
DS 14.06	Diesel	14190	V8	127.00	12
DS 14.06 L01 / L02 / L03	Diesel	14200	V8	127.00	12
DS 14.07	Diesel	14190	V8	127.00	12
DS 14.07 L01	Diesel	14200	V8	127.00	12
DS 14.07 L02	Diesel	14200	V8	127.00	12
DS 14.46	Diesel	14181	V8	127.00	13
DS 8 LB09-LB14	Diesel	7800	6	115.00	1
DS 8.01	Diesel	7800	6	115.00	1
DS 8.05	Diesel	7800	6	115.00	1
DS 8.06	Diesel	7800	6	115.00	1
DS 801 LB14	Diesel	7800	6	115.00	1
DS 801 LB15	Diesel	7800	6	115.00	1
DS 801 LB16	Diesel	7800	6	115.00	1
DS 9.01	Diesel	8475	6	115.00	4
DS 9.02	Diesel	8475	6	115.00	4
DS 9.05	Diesel	8475	6	115.00	2
DS 9.06	Diesel	8475	6	115.00	2
DS 9.08	Diesel	8475	6	115.00	2
DSC 14.63	Diesel	14181	V8	127.00	13
DSC 11	Diesel	11020	6	127.00	8
DSC 11.01	Diesel	11020	6	127.00	9
DSC 11.02	Diesel	11022	6	127.00	9
DSC 11.08	Diesel	11020	6	127.00	11
DSC 11.10	Diesel	11020	6	127.00	11
DSC 11.12	Diesel	11020	6	127.00	9
DSC 11.13	Diesel	11020	6	127.00	9
DSC 11.16	Diesel	11020	6	127.00	9
DSC 11.17	Diesel	11020	6	127.00	9
DSC 11.18	Diesel	11020	6	127.00	9
DSC 11.21	Diesel	11020	6	127.00	7
DSC 11.22	Diesel	11020	6	127.00	7
DSC 11.23	Diesel	11020	6	127.00	7
DSC 11.35	Diesel	11020	6	127.00	7
DSC 11.36	Diesel	11020	6	127.00	7
DSC 11.39	Diesel	11020	6	127.00	7
DSC 11.70	Diesel	11020	6	127.00	7
DSC 11.70 N	Diesel	11020	6	127.00	11
DSC 11.70 S	Diesel	11020	6	127.00	11
DSC 11.71	Diesel	11020	6	127.00	7
DSC 11.74	Diesel	11020	6	127.00	7
DSC 11.75	Diesel	11020	6	127.00	7



Motorverzeichnis • Index de moteur • Índice de Motor  
Indeks silnika • Модель двигателя • دليل المحرك

# ENGINE INDEX



CCM

x



9

DSC 11.79	Diesel	11000	6	127.00	7
DSC 11.81	Diesel	11020	6	127.00	7
DSC 12.01	Diesel	11700	6	127.00	5
DSC 12.02	Diesel	11700	6	127.00	5
DSC 12.03	Diesel	11700	6	127.00	5
DSC 12.05	Diesel	11700	6	127.00	5
DSC 14	Diesel	14181	V8	127.00	12
DSC 14.01	Diesel	14190	V8	127.00	12
DSC 14.02	Diesel	14190	V8	127.00	12
DSC 14.03	Diesel	14190	V8	127.00	15
DSC 14.04	Diesel	14190	V8	127.00	15
DSC 14.05	Diesel	14190	V8	127.00	13
DSC 14.06	Diesel	14190	V8	127.00	13
DSC 14.07 L 01	Diesel	14200	V8	127.00	12
DSC 14.08	Diesel	14190	V8	127.00	15
DSC 14.09	Diesel	14190	V8	127.00	15
DSC 14.10	Diesel	14190	V8	127.00	15
DSC 14.16	Diesel	14190	V8	127.00	15
DSC 9.01	Diesel	8475	6	115.00	4
DSC 9.02	Diesel	8475	6	115.00	4
DSC 9.07	Diesel	8475	6	115.00	2
DSC 9.08	Diesel	8475	6	115.00	2
DSC 9.09	Diesel	8475	6	115.00	2
DSC 9.10	Diesel	8475	6	115.00	2
DSC 9.11	Diesel	9000	6	115.00	3
DSC 9.12	Diesel	9000	6	115.00	3
DSC 9.13	Diesel	9000	6	115.00	3
DSC 9.15	Diesel	9000	6	115.00	3
DSI 11.01	Diesel	11020	6	127.00	10
DSI 14.47	Diesel	14181	V8	127.00	13
DSI 14.50	Diesel	14181	V8	127.00	13
DSI 14.60	Diesel	14181	V8	127.00	13
DSI 14.61	Diesel	14181	V8	127.00	13
DSI 14.63	Diesel	14181	V8	127.00	13
DSI 8.01	Diesel	7800	6	115.00	1
DSI 8.01 L01	Diesel	7800	6	115.00	1
DSI 8.01 L04	Diesel	7800	6	115.00	1
DT 12.02	Diesel	11716	6	127.00	6
DT 12.03	Diesel	11716	6	127.00	14
DT 12.06	Diesel	11716	6	127.00	14
DT 12.08	Diesel	11716	6	127.00	14
DT 12.11	Diesel	11716	6	127.00	14
DT 12.12	Diesel	11716	6	127.00	14
DT 12.14	Diesel	11716	6	127.00	14
DT 12.17	Diesel	11716	6	127.00	14
DT 12.18	Diesel	11716	6	127.00	14
DTC 11.02	Diesel	11020	6	127.00	7



1

DN 8.01	6cyl.	7800cc	123kW (167PS)	Diesel		TD8838
DN 8.05 L01 . L04	6cyl.	7800cc	120kW (163PS)	Diesel		FM5022
DS 8 LB09-LB14	6cyl.	7800cc	140-148kW (190-202PS)	Diesel	Turbo	FM3818
DS 8.01	6cyl.	7800cc	154-170kW (209-231PS)	Diesel	Turbo	TD8842
DS 8.05	6cyl.	7800cc	155kW (211PS)	Diesel	Turbo	TD8839
DS 8.06	6cyl.	7800cc	140kW (190PS)	Diesel	Turbo	TD8840
DS 801 LB14	6cyl.	7800cc	120kW (163PS)	Diesel	Turbo	FM5017
DS 801 LB15	6cyl.	7800cc	120kW (163PS)	Diesel	Turbo	FM5017
DS 801 LB16	6cyl.	7800cc	120kW (163PS)	Diesel	Turbo	FM5017
DSI 8.01	6cyl.	7800cc	178kW (242PS)	Diesel	Turbo Intercooled	TD8841
DSI 8.01 L01	6cyl.	7800cc	170kW (231PS)	Diesel	Turbo Intercooled	FM5023
DSI 8.01 L04	6cyl.	7800cc	170kW (231PS)	Diesel	Turbo Intercooled	FM5023

14-374990-00 WH ①

115.00

B 130.00

C 270.50

D 137.30

E 8.20

F 0.80

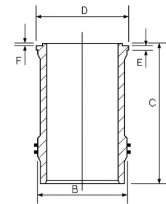

① Use also: HT020

① Mitverwenden: HT020

① A utiliser aussi: HT020

① Utilizar también: HT020

2

DN 9.01	6cyl.	8500cc	150kW (204PS)	Diesel	Turbo	TD8843
DS 9.05 Euro 1	6cyl.	8475cc	167-187kW (220-246PS)	Diesel	Turbo	TD8846
DS 9.06	6cyl.	8475cc	167kW (227PS)	Diesel	Turbo	TD8847
DS 9.08	6cyl.	8475cc	150kW (204PS)	Diesel	Turbo	TD8850
DSC 9.07 Euro 1	6cyl.	8475cc	185kW (252PS)	Diesel	Turbo Intercooled	TD8851
DSC 9.08 Euro 1	6cyl.	8475cc	208kW (283PS)	Diesel	Turbo Intercooled	TD8810
DSC 9.09 Euro 2	6cyl.	8475cc	184kW (250PS)	Diesel	Turbo Intercooled	TD13068
DSC 9.10 Euro 1	6cyl.	8475cc	162kW (220PS)	Diesel	Turbo Intercooled	TD8852

15-608890-00 WH ②

115.00

B 127.90

C 265.60

D 140.82

E 10.26

F 0.83

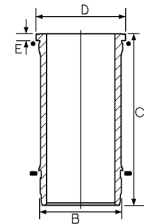

14-374990-00 WH ①

115.00

B 130.00

C 270.50

D 137.30

E 8.20

F 0.80

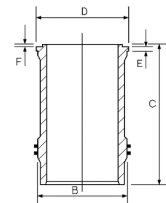

① Use also: HT020

① Mitverwenden: HT020

① A utiliser aussi: HT020

① Utilizar también: HT020

② Includes seals

② Schließt Dichtungen ein

② Inclut des joints

② Incluye los sellos



3

DC 9.01 Euro 3	6cyl.	9000cc	169kW (230PS)	Diesel	Turbo Intercooled	TD15408
DC 9.02 Euro 3	6cyl.	9000cc	191kW (260PS)	Diesel	Turbo Intercooled	TD15411
DC 9.03 Euro 3	6cyl.	9000cc	221kW (300PS)	Diesel	Turbo Intercooled	TD15413
DC 9.04 Euro 3	6cyl.	9000cc	169kW (230PS)	Diesel	Turbo Intercooled	TD15410
DC 9.05 Euro 3	6cyl.	9000cc	191kW (260PS)	Diesel	Turbo Intercooled	TD15412
DC 9.06	6cyl.	9000cc	221kW (300PS)	Diesel	Turbo Intercooled	TD15414
DSC 9.11 Euro 2	6cyl.	9000cc	162kW (220PS)	Diesel	Turbo Intercooled	TD8854
DSC 9.12 Euro 2	6cyl.	9000cc	191kW (260PS)	Diesel	Turbo Intercooled	TD8855
DSC 9.13 Euro 2	6cyl.	9000cc	228kW (310PS)	Diesel	Turbo Intercooled	TD8853
DSC 9.15 Euro 2	6cyl.	9000cc	228kW (310PS)	Diesel	Turbo Intercooled	TD12608

15-600020-00 WH ⓘ 115.00 B 131.00 C 257.50 D 140.74 E 8.07 F 0.18

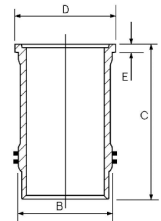

ⓘ Includes seals

ⓘ Schließt Dichtungen ein

ⓘ Includ des joints

ⓘ Incluye los sellos

4

DS 9.01	6cyl.	8475cc	180-185kW (245-252PS)	Diesel	Turbo	TD8844
DS 9.02	6cyl.	8475cc	162-180kW (220-245PS)	Diesel	Turbo	TD8845
DSC 9.01	6cyl.	8475cc	202kW (275PS)	Diesel	Turbo Intercooled	TD8848
DSC 9.02	6cyl.	8475cc	207kW (282PS)	Diesel	Turbo Intercooled	TD8849

15-608890-00 WH ⓘ 115.00 B 127.90 C 265.60 D 140.82 E 10.26 F 0.83

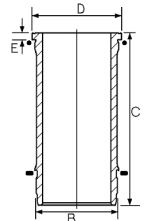

ⓘ Includes seals

ⓘ Schließt Dichtungen ein

ⓘ Includ des joints

ⓘ Incluye los sellos

5

DC 12.01 Euro 3	6cyl.	11700cc	309kW (420PS)	Diesel	Turbo Intercooled	TD15418
DC 12.02 Euro 2	6cyl.	11700cc	265kW (360PS)	Diesel	Turbo Intercooled	TD21080
DC 12.03 Euro 3	6cyl.	11700cc	308kW (420PS)	Diesel	Turbo Intercooled	TD16852
DC 12.09 Euro 3	6cyl.	11700cc	309kW (420PS)	Diesel	Turbo Intercooled	TD22367
DC 16.01 Euro 3	V8cyl.	15600cc	426kW (580PS)	Diesel	Turbo Intercooled	TD15429
DC 16.03 Euro 3	V8cyl.	15600cc	426kW (580PS)	Diesel	Turbo Intercooled	TD17458
DC 16.04 Euro 3	V8cyl.	15600cc	368kW (500PS)	Diesel	Turbo Intercooled	TD17457
DC 16.05 Euro 4	V8cyl.	15600cc	412kW (560PS)	Diesel	Turbo Intercooled	TD18649
DC 16.06 Euro 4	V8cyl.	15600cc	368kW (500PS)	Diesel	Turbo Intercooled	TD18650
DC 16.08 Euro 4	V8cyl.	15600cc	456kW (620PS)	Diesel	Turbo Intercooled	TD18652
DC 16.09 Euro 5	V8cyl.	15600cc	368kW (500PS)	Diesel	Turbo Intercooled	TD18651
DC 16.17 Euro 5	V8cyl.	15600cc	456kW (620PS)	Diesel	Turbo Intercooled	TD20881
DC 16.18 Euro 5	V8cyl.	15600cc	412kW (560PS)	Diesel	Turbo Intercooled	TD20880
DC 16.19 Euro 5	V8cyl.	15600cc	368kW (500PS)	Diesel	Turbo Intercooled	TD20879





DC 16.22	V8cyl.	15600cc	368kW (500PS)	Diesel	Turbo Intercooled	TD28138
DSC 12.01 Euro 2	6cyl.	11700cc	294kW (400PS)	Diesel	Turbo Intercooled	TD8892
DSC 12.02 Euro 2	6cyl.	11700cc	265kW (360PS)	Diesel	Turbo Intercooled	TD8893
DSC 12.03 Euro 2	6cyl.	11700cc	265-325kW (360-442PS)	Diesel	Turbo Intercooled	TD22371
DSC 12.05 Euro 3	6cyl.	11700cc	309kW (420PS)	Diesel	Turbo Intercooled	TD12870

14-112800-00 WH ① 127.00 B 139.00 C 271.12 D 150.00 E 194.27 F 0.65

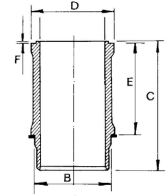

① Relief 8.25mm

① Entlastung 8.25mm

① Le relief 8.25mm

① Relevación 8.25mm

6

DC 11.01 Euro 3	6cyl.	10600cc	250kW (340PS)	Diesel	Turbo Intercooled	TD12769
DC 11.02 Euro 3	6cyl.	10600cc	280kW (381PS)	Diesel	Turbo Intercooled	TD12772
DC 11.03 Euro 3	6cyl.	10600cc	250kW (340PS)	Diesel	Turbo Intercooled	TD15415
DC 11.04 Euro 3	6cyl.	10600cc	280kW (381PS)	Diesel	Turbo Intercooled	TD15416
DC 11.07 Euro 2	6cyl.	10600cc	237kW (322PS)	Diesel	Turbo Intercooled	TD21005
DC 11.08 Euro 3	6cyl.	10600cc	250kW (340PS)	Diesel	Turbo Intercooled	TD17451
DC 11.09 Euro 3	6cyl.	10600cc	279kW (380PS)	Diesel	Turbo Intercooled	TD17452
DC 16.02 Euro 3	V8cyl.	15600cc	353kW (480PS)	Diesel	Turbo Intercooled	TD15428
DT 12.02 Euro 3	6cyl.	11716cc	345kW (470PS)	Diesel	Turbo Intercooled	TD16495

15-570050-00 WH ② 127.00 B 138.50 C 271.12 D 150.00 F 0.80  
 15-570060-00 WH ② B 139.50 C 271.00 D 151.00 F 0.97

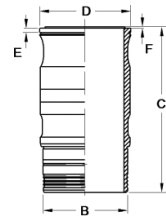

14-112800-00 WH ① 127.00 B 139.00 C 271.12 D 150.00 E 194.27 F 0.65

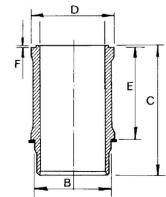

① Relief 8.25mm

① Entlastung 8.25mm

① Le relief 8.25mm

① Relevación 8.25mm

② Includes seals

② Schließt Dichtungen ein

② Inclut des joints

② Incluye los sellos

7

DS 11.22	6cyl.	11022cc	280kW (381PS)	Diesel	Turbo	TD7436
DS 11.23	6cyl.	11022cc	266kW (362PS)	Diesel	Turbo	TD7180
DS 11.75	6cyl.	11020cc	228-230kW (310-313PS)	Diesel	Turbo	TD8821
DSC 11.21 Euro 1	6cyl.	11020cc	235-266kW (320-362PS)	Diesel	Turbo Intercooled	TD8812
DSC 11.22 Euro 1	6cyl.	11020cc	280kW (381PS)	Diesel	Turbo Intercooled	TD8813
DSC 11.23 Euro 1	6cyl.	11020cc	266kW (362PS)	Diesel	Turbo Intercooled	TD8814
DSC 11.35	6cyl.	11020cc	235-266kW (320-362PS)	Diesel	Turbo Intercooled	TD8815





DSC 11.36	6cyl.	11020cc	235-266kW (320-362PS)	Diesel	Turbo Intercooled	TD8816
DSC 11.39 Euro 1	6cyl.	11020cc	258kW (351PS)	Diesel	Turbo Intercooled	TD8882
DSC 11.70 Euro 2	6cyl.	11020cc	280kW (381PS)	Diesel	Turbo Intercooled	TD8884
DSC 11.71	6cyl.	11020cc	235-266kW (320-362PS)	Diesel	Turbo Intercooled	TD8872
DSC 11.74 Euro 1	6cyl.	11020cc	235-266kW (320-362PS)	Diesel	Turbo Intercooled	TD22369
DSC 11.75 Euro 1	6cyl.	11020cc	235-266kW (320-362PS)	Diesel	Turbo Intercooled	TD22370
DSC 11.79 Euro 2	6cyl.	11000cc	250kW (340PS)	Diesel	Turbo Intercooled	TD12768
DSC 11.81	6cyl.	11020cc	305kW (415PS)	Diesel	Turbo Intercooled	TD17286
DTC 11.02 Euro 2	6cyl.	11020cc	295kW (401PS)	Diesel	Turbo Intercooled	TD8885

14-450040-00 WH ③  
14-450110-00 WH ②  
14-450850-00 WH ①

127.00

B 140.00 C 291.00 D 154.00 E 7.94 F 0.90  
B 140.00 C 291.00 D 153.68 E 7.92 F 0.80  
B 140.00 C 291.00 D 153.80 E 8.20 F 0.80

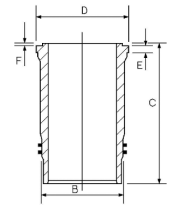

- |                    |                        |                            |                            |
|--------------------|------------------------|----------------------------|----------------------------|
| ① Use also: HL5190 | ① Mitverwenden: HL5190 | ① A utiliser aussi: HL5190 | ① Utilizar también: HL5190 |
| ② Relief 13.00mm   | ② Entlastung 13.00mm   | ② Le relief 13.00mm        | ② Relevación 13.00mm       |
| ③ Relief 12.00mm   | ③ Entlastung 12.00mm   | ③ Le relief 12.00mm        | ③ Relevación 12.00mm       |

8

DS 11	6cyl.	11022cc	184-202kW (250-275PS)	Diesel	Turbo	TD8798
DSC 11	6cyl.	11020cc	220kW (299PS)	Diesel	Turbo Intercooled	FM15084

14-450390-00 WH ②①

127.00

B 140.00 C 291.00 D 153.70 E 7.90 F 0.80

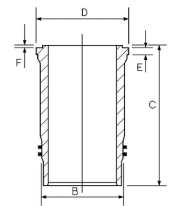

- |                         |                        |                                |                                   |
|-------------------------|------------------------|--------------------------------|-----------------------------------|
| ① Use also: HL5190      | ① Mitverwenden: HL5190 | ① A utiliser aussi: HL5190     | ① Utilizar también: HL5190        |
| ② Bore recess 22mm deep | ② Höhe der Freidrehung | ② Alésage en retrait sur 22 mm | ② Altura del cordón de fuego 22mm |

9

DS 11.34	6cyl.	11020cc	228kW (310PS)	Diesel	Turbo	TD8869
DS 11.71	6cyl.	11020cc	189kW (256PS)	Diesel	Turbo	TD8873
DS 11.71 C	6cyl.	11020cc	189kW (256PS)	Diesel	Turbo	TD5878
DS 11.72	6cyl.	11022cc	230kW (313PS)	Diesel	Turbo	TD8858
DS 11.73	6cyl.	11020cc	228-230kW (310-313PS)	Diesel	Turbo	TD8859
DS 11.74	6cyl.	11020cc	194kW (264PS)	Diesel	Turbo	TD8820
DSC 11.01	6cyl.	11020cc	230kW (313PS)	Diesel	Turbo Intercooled	TD8811
DSC 11.02	6cyl.	11022cc	267kW (363PS)	Diesel	Turbo Intercooled	TD8860
DSC 11.12	6cyl.	11020cc	227-260kW (310-354PS)	Diesel	Turbo Intercooled	TD8861
DSC 11.13	6cyl.	11020cc	267kW (363PS)	Diesel	Turbo Intercooled	TD8878
DSC 11.16	6cyl.	11020cc	239kW (325PS)	Diesel	Turbo Intercooled	TD8879





<b>DSC 11.17</b>	6cyl.	<b>11020cc</b>	<b>237kW</b> (322PS)	<b>Diesel</b>	<b>Turbo Intercooled</b>	<b>TD8880</b>
<b>DSC 11.18</b>	6cyl.	<b>11020cc</b>	<b>267kW</b> (363PS)	<b>Diesel</b>	<b>Turbo Intercooled</b>	<b>TD8826</b>
<b>14-450400-00 WH</b>	<b>127.00</b>	<b>B 140.00</b>	<b>C 291.00</b>	<b>D 153.80</b>	<b>E 7.90</b>	<b>F 0.80</b>
<b>14-450850-00 WH</b>		<b>B 140.00</b>	<b>C 291.00</b>	<b>D 153.80</b>	<b>E 8.20</b>	<b>F 0.80</b>
<b>14-458190-00 WH</b>		<b>B 139.93</b>	<b>C 291.00</b>	<b>D 153.80</b>	<b>E 7.94</b>	<b>F 0.80</b>

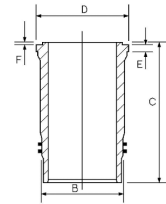

Use also: HL5190

Mitverwenden: HL5190

A utiliser aussi: HL5190

Utilizar también: HL5190

**10**

<b>D 11 R 23</b>	6cyl.	<b>11022cc</b>	<b>143kW</b> (195PS)	<b>Diesel</b>		<b>TD8805</b>
<b>DN 11.01</b>	6cyl.	<b>11020cc</b>	<b>149-153kW</b> (203-208PS)	<b>Diesel</b>		<b>TD8806</b>
<b>DN 11.01 B10</b>	6cyl.	<b>11000cc</b>	<b>155kW</b> (211PS)	<b>Diesel</b>		<b>TD5872</b>
<b>DN 11.01 C 09</b>	6cyl.	<b>11020cc</b>	<b>158kW</b> (215PS)	<b>Diesel</b>		<b>TD8836</b>
<b>DN 11.04 B10</b>	6cyl.	<b>11000cc</b>	<b>155kW</b> (211PS)	<b>Diesel</b>		<b>TD6220</b>
<b>DN 11.04 C 01</b>	6cyl.	<b>11000cc</b>	<b>158kW</b> (215PS)	<b>Diesel</b>	<b>Turbo</b>	<b>TD8837</b>
<b>DN 11.06</b>	6cyl.	<b>11020cc</b>	<b>134kW</b> (182PS)	<b>Diesel</b>		<b>TD8875</b>
<b>DN 11.07</b>	6cyl.	<b>11022cc</b>	<b>139kW</b> (188PS)	<b>Diesel</b>		<b>TD8808</b>
<b>DN 11.08</b>	6cyl.	<b>11022cc</b>	<b>150kW</b> (204PS)	<b>Diesel</b>		<b>TD8886</b>
<b>DN 11.08 B01</b>	6cyl.	<b>11020cc</b>	<b>149kW</b> (203PS)	<b>Diesel</b>		<b>TD8889</b>
<b>DS 11 / D11</b>	6cyl.	<b>11022cc</b>	<b>140-149kW</b> (190-203PS)	<b>Diesel</b>		<b>TD8794</b>
<b>DS 11.01</b>	6cyl.	<b>11022cc</b>	<b>184-202kW</b> (250-275PS)	<b>Diesel</b>	<b>Turbo</b>	<b>TD5874</b>
<b>DS 11.01 B 06</b>	6cyl.	<b>11022cc</b>	<b>184-213kW</b> (250-290PS)	<b>Diesel</b>	<b>Turbo</b>	<b>TD8799</b>
<b>DS 11.02</b>	6cyl.	<b>11022cc</b>	<b>206-245kW</b> (280-333PS)	<b>Diesel</b>	<b>Turbo Intercooled</b>	<b>TD8864</b>
<b>DS 11.14</b>	6cyl.	<b>11022cc</b>	<b>206-245kW</b> (280-333PS)	<b>Diesel</b>	<b>Turbo Intercooled</b>	<b>TD6222</b>
<b>DS 11.15</b>	6cyl.	<b>11022cc</b>	<b>224-245kW</b> (305-333PS)	<b>Diesel</b>	<b>Turbo Intercooled</b>	<b>TD8803</b>
<b>DS 11.15 B</b>	6cyl.	<b>11022cc</b>	<b>224kW</b> (305PS)	<b>Diesel</b>	<b>Turbo Intercooled</b>	<b>TD8801</b>
<b>DS 11.18</b>	6cyl.	<b>11022cc</b>	<b>254kW</b> (345PS)	<b>Diesel</b>	<b>Turbo Intercooled</b>	<b>TD8857</b>
<b>DSI 11.01</b>	6cyl.	<b>11020cc</b>	<b>191kW</b> (260PS)	<b>Diesel</b>	<b>Turbo</b>	<b>TD8874</b>
<b>14-450850-00 WH</b>	<b>127.00</b>	<b>B 140.00</b>	<b>C 291.00</b>	<b>D 153.80</b>	<b>E 8.20</b>	<b>F 0.80</b>
<b>14-453090-00 WH</b>		<b>B 140.00</b>	<b>C 291.00</b>	<b>D 153.80</b>	<b>E 8.00</b>	<b>F 0.80</b>
<b>14-458190-00 WH</b>		<b>B 139.93</b>	<b>C 291.00</b>	<b>D 153.80</b>	<b>E 7.94</b>	<b>F 0.80</b>

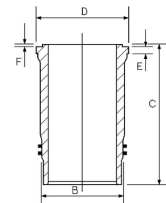

Use also: HL5190

Mitverwenden: HL5190

A utiliser aussi: HL5190

Utilizar también: HL5190



11

DS 11 AGR/IND 1978>	6cyl.	11022cc	184-202kW (250-275PS)	Diesel	Turbo	FM5198
DSC 11.08	6cyl.	11020cc	228kW (310PS)	Diesel	Turbo Intercooled	TD8823
DSC 11.10	6cyl.	11020cc	280kW (381PS)	Diesel	Turbo Intercooled	TD8877
DSC 11.70 N Euro 2	6cyl.	11020cc	280kW (381PS)	Diesel	Turbo Intercooled	FM35084
DSC 11.70 S Euro 2	6cyl.	11020cc	280kW (381PS)	Diesel	Turbo Intercooled	FM35084

14-458190-00 WH ① 127.00 B 139.93 C 291.00 D 153.80 E 7.94 F 0.80

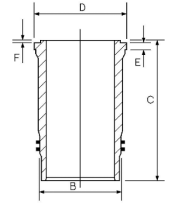

① Use also: HL5190

① Mitverwenden: HL5190

① A utiliser aussi: HL5190

① Utilizar también: HL5190

12

DS 14	V8cyl.	14181cc	257kW (350PS)	Diesel	Turbo	TD8835
DS 14 LB 05	V8cyl.	14200cc	257kW (350PS)	Diesel	Turbo	TD8894
DS 14 LB 08	V8cyl.	14200cc	276kW (375PS)	Diesel	Turbo	TD8895
DS 14.01	V8cyl.	14190cc	283-293kW (385-398PS)	Diesel	Turbo	TD8902
DS 14.01 L 01	V8cyl.	14200cc	276kW (375PS)	Diesel	Turbo	TD8903
DS 14.02	V8cyl.	14190cc	309-320kW (420-435PS)	Diesel	Turbo	TD22368
DS 14.06	V8cyl.	14190cc	285-291kW (388-396PS)	Diesel	Turbo	TD8896
DS 14.06 L01 / L02 / L03	V8cyl.	14200cc	276-291kW (375-396PS)	Diesel	Turbo	TD8904
DS 14.07	V8cyl.	14190cc	293kW (398PS)	Diesel	Turbo	TD8897
DS 14.07 L01	V8cyl.	14200cc	276kW (375PS)	Diesel	Turbo	FM5086
DS 14.07 L02	V8cyl.	14200cc		Diesel	Turbo	FM5086
DSC 14	V8cyl.	14181cc		Diesel	Turbo Intercooled	FM3866
DSC 14.01	V8cyl.	14190cc	309kW (420PS)	Diesel	Turbo Intercooled	TD8898
DSC 14.02	V8cyl.	14190cc	301kW (409PS)	Diesel	Turbo Intercooled	TD8899
DSC 14.07 L 01	V8cyl.	14200cc	298kW (405PS)	Diesel	Turbo Intercooled	TD8905

14-673080-00 WH ①④ 127.00 B 140.00 C 276.00 D 156.00 E 10.05 F 0.40

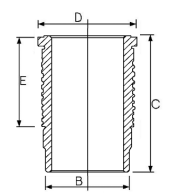

14-670020-00 WH ③ 127.00 B 140.00 C 276.00 D 156.00 E 10.05 F 0.40  
 14-671680-00 WH ①② B 140.00 C 276.00 D 156.00 E 10.10 F 0.40

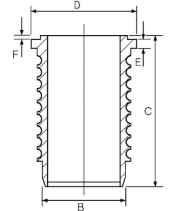

① Use also: HT013

① Mitverwenden: HT013

① A utiliser aussi: HT013

① Utilizar también: HT013

② Relief 22.00mm

② Entlastung 22.00mm

② Le relief 22.00mm

② Relevación 22.00mm

③ Relief 7.00mm

③ Entlastung 7.00mm

③ Le relief 7.00mm

③ Relevación 7.00mm

④ Relief 21.50mm

④ Entlastung 21.50mm

④ Le relief 21.50mm

④ Relevación 21.50mm



13

DS 14.46	V8cyl.	14181cc	300kW (408PS)	Diesel		FM18569
DSC 14.05	V8cyl.	14190cc	290kW (394PS)	Diesel	Turbo Intercooled	TD8900
DSC 14.06	V8cyl.	14190cc	309kW (420PS)	Diesel	Turbo Intercooled	TD8901
DSC 14.63	V8cyl.	14181cc	340kW (462PS)	Diesel	Turbo Intercooled	FM13866
DSI 14.47	V8cyl.	14181cc	341kW (464PS)	Diesel	Turbo Intercooled	TD19149
DSI 14.50	V8cyl.	14181cc	341kW (464PS)	Diesel	Turbo Intercooled	TD19150
DSI 14.60	V8cyl.	14181cc	341kW (464PS)	Diesel	Turbo Intercooled	TD19151
DSI 14.61	V8cyl.	14181cc	341kW (464PS)	Diesel	Turbo Intercooled	TD19152
DSI 14.63	V8cyl.	14181cc	341kW (464PS)	Diesel	Turbo Intercooled	TD19153

14-671680-00 WH 1 2

127.00

B 140.00

C 276.00

D 156.00

E 10.10

F 0.40

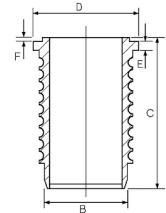

1 Use also: HT013

1 Mitverwenden: HT013

1 A utiliser aussi: HT013

1 Utilizar también: HT013

2 Relief 22.00mm

2 Entlastung 22.00mm

2 Le relief 22.00mm

2 Relevación 22.00mm

14

DC 9.16 Euro 4	5cyl.	8867cc	169kW (230PS)	Diesel	Turbo Intercooled	TD18641
DC 9.17 Euro 4	5cyl.	8867cc	198kW (270PS)	Diesel	Turbo Intercooled	TD18642
DC 12.10 Euro 4	6cyl.	11700cc	250kW (340PS)	Diesel	Turbo Intercooled	TD18644
DC 12.13 Euro 4	6cyl.	11700cc	280kW (381PS)	Diesel	Turbo Intercooled	TD18645
DC 12.14 Euro 3	6cyl.	11716cc	309kW (420PS)	Diesel	Turbo Intercooled	TD17453
DC 12.15	6cyl.	11716cc	309kW (420PS)	Diesel	Turbo Intercooled	TD18647
DC 12.17 Euro 3	6cyl.	11716cc	279kW (380PS)	Diesel	Turbo Intercooled	TD20873
DC 12.18 Euro 5	6cyl.	11716cc	279kW (380PS)	Diesel	Turbo Intercooled	TD20874
DC 12.22 Euro 5	6cyl.	11716cc	309kW (420PS)	Diesel	Turbo Intercooled	TD23694
DC 12.23 Euro 4	6cyl.	11716cc	309kW (420PS)	Diesel	Turbo Intercooled	TD23698
DC 12.24 Euro 4	6cyl.	11716cc	280kW (381PS)	Diesel	Turbo Intercooled	TD23699
DC 12.26 Euro 4	6cyl.	11716cc	250kW (340PS)	Diesel	Turbo Intercooled	TD23700
DT 12.03 Euro 4	6cyl.	11716cc	345kW (470PS)	Diesel	Turbo Intercooled	TD18648
DT 12.06 Euro 4	6cyl.	11716cc	345kW (470PS)	Diesel	Turbo Intercooled	TD17455
DT 12.08	6cyl.	11716cc	324kW (440PS)	Diesel	Turbo Intercooled	TD16716
DT 12.11 Euro 4	6cyl.	11716cc	309kW (420PS)	Diesel	Turbo Intercooled	TD17454
DT 12.12 Euro 4	6cyl.	11716cc	309kW (420PS)	Diesel	Turbo Intercooled	TD18646
DT 12.14	6cyl.	11716cc	309kW (420PS)	Diesel	Turbo Intercooled	TD20876
DT 12.17 Euro 4	6cyl.	11716cc	353kW (480PS)	Diesel	Turbo Intercooled	TD20878
DT 12.18 Euro 3	6cyl.	11716cc	324kW (440PS)	Diesel	Turbo Intercooled	TD20877

15-570050-00 WH 1  
15-570060-00 WH 1

127.00

B 138.50

C 271.12

D 150.00

F 0.80

B 139.50

C 271.00

D 151.00

F 0.97

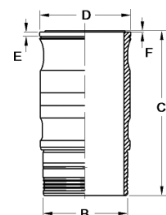

1 Includes seals

1 Schließt Dichtungen ein

1 Inclut des joints

1 Incluye los sellos





15

DSC 14.03	V8cyl.	14190cc	320-346kW (435-470PS)	Diesel	Turbo Intercooled	TD8906
DSC 14.04	V8cyl.	14190cc	346kW (471PS)	Diesel	Turbo Intercooled	TD8907
DSC 14.08 Euro 1	V8cyl.	14190cc	309-331kW (420-450PS)	Diesel	Turbo Intercooled	TD8908
DSC 14.09 Euro 1	V8cyl.	14190cc	368kW (500PS)	Diesel	Turbo Intercooled	TD8909
DSC 14.10 Euro 1	V8cyl.	14190cc	333-346kW (453-471PS)	Diesel	Turbo Intercooled	TD8910
DSC 14.16 Euro 1	V8cyl.	14190cc	368kW (500PS)	Diesel	Turbo Intercooled	TD8912

15-679320-00 WH ②①

127.00

B 139.92

C 275.25

D 155.79

E 10.09

F 0.46

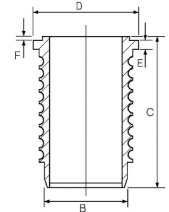

① Includes seals

① Schließt Dichtungen ein

① Inclut des joints

① Incluye los sellos

② Relief 12.00mm

② Entlastung 12.00mm

② Le relief 12.00mm

② Relevación 12.00mm

# MODEL INDEX



Modelverzeichnis • Index de modele • Índice de Modelo  
Indeks modelu • Модель автомобиля • دليل الموديل



CCM

x



9

04/72→12/82	<b>127 0.9</b>	A112 A5.000	Petrol	903	4	<b>1</b>
06/78→12/86	<b>131 2.4</b>	8144.61	Diesel	2445	4	<b>6</b>
05/79→12/82	<b>132 2.2</b>	OM 615.912	Diesel	2197	4	<b>5</b>
04/96→03/10	<b>Alhambra 1.9</b>	1Z, AFN, AHU, ANU, ASZ, AUY, AVG, BTB, BVK	Diesel	1896	4	<b>4</b>
04/04→	<b>Altea 1.9</b>	BJB, BKC, BLS, BXE, BXF	Diesel	1896	4	<b>4</b>
10/06→	<b>Altea XL 1.9</b>	BKC, BLS, BXE, BXF	Diesel	1896	4	<b>4</b>
05/97→06/04	<b>Arosa 1.4</b>	AEX, AKV, APQ	Petrol	1391	4	<b>3</b>
01/00→06/04	<b>Arosa 1.4</b>	AMF	Diesel	1422	3	<b>4</b>
08/97→06/04	<b>Arosa 1.7</b>	AKU	Diesel	1716	4	<b>4</b>
02/93→06/96	<b>Cordoba 1.0</b>	AAU	Petrol	1043	4	<b>2</b>
10/02→06/06	<b>Cordoba 1.2</b>	AZQ	Petrol	1198	3	<b>3</b>
02/93→08/94	<b>Cordoba 1.3</b>	AAV	Petrol	1272	4	<b>2</b>
06/94→06/99	<b>Cordoba 1.4</b>	AEX, AKV, APQ	Petrol	1391	4	<b>3</b>
12/97→04/99	<b>Cordoba 1.4</b>	ANX	Petrol	1390	4	<b>3</b>
10/02→12/05	<b>Cordoba 1.4</b>	AMF	Diesel	1422	3	<b>4</b>
02/93→12/02	<b>Cordoba 1.6</b>	AEE, ALM	Petrol	1598	4	<b>3</b>
02/93→11/09	<b>Cordoba 1.9</b>	1Y, 1Z, AAZ, AEY, AFN, AGP, AGR, AHU, ALH, AQM, ASV, ASY, ASZ, ATD, AXR, BLT, BMT	Diesel	1896	4	<b>4</b>
03/93→09/96	<b>Ibiza II 1.0</b>	AAU	Petrol	1043	4	<b>2</b>
03/93→08/99	<b>Ibiza II 1.3</b>	AAV	Petrol	1272	4	<b>2</b>
09/93→08/99	<b>Ibiza II 1.4</b>	AEX, AKV, APQ	Petrol	1391	4	<b>3</b>
12/97→04/99	<b>Ibiza II 1.4</b>	ANX	Petrol	1390	4	<b>3</b>
03/93→08/99	<b>Ibiza II 1.6</b>	AEE, ALM	Petrol	1598	4	<b>3</b>
03/93→08/99	<b>Ibiza II 1.9</b>	1Y, 1Z, AAZ, AEY, AFN, AHU	Diesel	1896	4	<b>4</b>
08/99→02/02	<b>Ibiza III 1.6</b>	ALM	Petrol	1598	4	<b>3</b>
08/99→02/02	<b>Ibiza III 1.9</b>	AGP, AGR, ALH, AQM, ASV	Diesel	1896	4	<b>4</b>
02/02→06/06	<b>Ibiza IV 1.2</b>	AZQ	Petrol	1198	3	<b>3</b>
05/02→12/05	<b>Ibiza IV 1.4</b>	AMF	Diesel	1422	3	<b>4</b>
02/02→11/09	<b>Ibiza IV 1.9</b>	ASY, ASZ, ATD, AXR, BLT, BMT, BPX, BUK	Diesel	1896	4	<b>4</b>
03/08→06/10	<b>Ibiza V 1.9</b>	BLS, BXJ	Diesel	1896	4	<b>4</b>
11/95→06/03	<b>Inca 1.4</b>	AEX, AKV, APQ	Petrol	1391	4	<b>3</b>
06/97→09/00	<b>Inca 1.6</b>	AEE, ALM	Petrol	1598	4	<b>3</b>
09/96→06/03	<b>Inca 1.7</b>	AHB	Diesel	1716	4	<b>4</b>
11/95→06/03	<b>Inca 1.9</b>	1Y, AEY, ALH, AYQ	Diesel	1896	4	<b>4</b>
11/99→	<b>Leon 1.9</b>	AGR, AHF, ALH, AQM, ARL, ASV, ASZ, AXR, BKC, BLS, BXE, BXF	Diesel	1896	4	<b>4</b>
03/90→12/94	<b>Terra 1.3</b>	MN	Diesel	1272	4	<b>2</b>
10/90→12/95	<b>Terra 1.4</b>	1W	Diesel	1398	4	<b>2</b>
05/91→03/99	<b>Toledo I 1.9</b>	1Y, 1Z, AAZ, AFN, AHU	Diesel	1896	4	<b>4</b>
10/98→05/06	<b>Toledo II 1.9</b>	AGR, AHF, ALH, AQM, ARL, ASV, ASZ, AXR	Diesel	1896	4	<b>4</b>
10/04→05/09	<b>Toledo III 1.9</b>	BJB, BKC, BLS, BXE	Diesel	1896	4	<b>4</b>



CCM

x



9

1W	Diesel	1398	4	75.00	2
1Y	Diesel	1896	4	79.50	4
1Z	Diesel	1896	4	79.50	4
8144.61	Diesel	2445	4	93.00	6
A112 A5.000	Petrol	903	4	65.00	1
AAU	Petrol	1043	4	75.00	2
AAV	Petrol	1272	4	75.00	2
AAZ	Diesel	1896	4	79.50	4
AEE	Petrol	1598	4	76.50	3
AEF	Diesel	1896	4	79.50	4
AEX	Petrol	1391	4	76.50	3
AEY	Diesel	1896	4	79.50	4
AFN	Diesel	1896	4	79.50	4
AGP	Diesel	1896	4	79.50	4
AGR	Diesel	1896	4	79.50	4
AHB	Diesel	1716	4	79.50	4
AHF	Diesel	1896	4	79.50	4
AHU	Diesel	1896	4	79.50	4
AKU	Diesel	1716	4	79.50	4
AKV	Petrol	1391	4	76.50	3
ALH	Diesel	1896	4	79.50	4
ALM	Petrol	1598	4	76.50	3
AMF	Diesel	1422	3	79.50	4
ANU	Diesel	1896	4	79.50	4
ANX	Petrol	1390	4	76.50	3
APQ	Petrol	1391	4	76.50	3
AQM	Diesel	1896	4	79.50	4
ARL	Diesel	1896	4	79.50	4
ASV	Diesel	1896	4	79.50	4
ASY	Diesel	1896	4	79.50	4
ASZ	Diesel	1896	4	79.50	4
ATD	Diesel	1896	4	79.50	4
AUY	Diesel	1896	4	79.50	4
AVG	Diesel	1896	4	79.50	4
AXR	Diesel	1896	4	79.50	4
AYQ	Diesel	1896	4	79.50	4
AZQ	Petrol	1198	3	76.50	3
BJB	Diesel	1896	4	79.50	4
BKC	Diesel	1896	4	79.50	4
BLS	Diesel	1896	4	79.50	4
BLT	Diesel	1896	4	79.50	4
BMT	Diesel	1896	4	79.50	4
BPX	Diesel	1896	4	79.50	4
BTB	Diesel	1896	4	79.50	4
BUK	Diesel	1896	4	79.50	4
BVK	Diesel	1896	4	79.50	4
BXE	Diesel	1896	4	79.50	4
BXF	Diesel	1896	4	79.50	4
BXJ	Diesel	1896	4	79.50	4
MN	Diesel	1272	4	75.00	2
OM 615.912	Diesel	2197	4	87.00	5



1

A112 A5.000 4cyl. 903cc 29-33kW (40-45PS) TD20969

14-011001-00 D 65.00 B 68.04 C 115.00

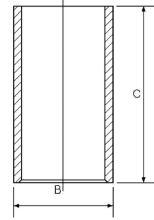

2

1W 4cyl. 1398cc 35kW (47PS) Diesel TD9402

AAU 4cyl. 1043cc 33kW (45PS) TD4892

AAV 4cyl. 1272cc 40kW (54PS) TD4893

MN 4cyl. 1272cc 33kW (45PS) Diesel TD9401

14-025070-00 D 75.00 B 78.00 C 133.00 D 81.00 E 4.50

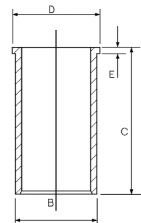

3

AEE 4cyl. 1598cc 55kW (75PS) TD10867

AEX 4cyl. 1391cc 44kW (60PS) TD5532

AKV 4cyl. 1391cc 44kW (60PS) TD12513

ALM 4cyl. 1598cc 55kW (75PS) TD12949

ANX 4cyl. 1390cc 44kW (60PS) TD12514

APQ 4cyl. 1391cc 44kW (60PS) TD12515

AZQ 3cyl. 1198cc 47kW (64PS) TD16459

14-021571-00 D 76.50 B 79.56 C 142.00 D 82.50 E 4.50  
14-028360-00 D 1 B 79.50 C 145.00 D 81.50 E 4.70

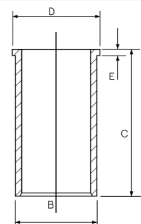

1 With recesses on crankshaft side

1 Mit kurbelwellenseitigen Aussparungen

1 Avec évidements côté vilebrequin

1 Con escotaduras en la cara del cigüeñal

4

1Y 4cyl. 1896cc 47kW (64PS) Diesel TD4891

1Z 4cyl. 1896cc 66kW (89PS) Diesel Turbo Intercooled TD5527

AAZ 4cyl. 1896cc 55kW (75PS) Diesel Turbo TD4894

AEF 4cyl. 1896cc 47kW (64PS) Diesel TD9373

AEY 4cyl. 1896cc 47kW (64PS) Diesel TD5535

AFN 4cyl. 1896cc 81kW (110PS) Diesel Turbo Intercooled TD5531

AGP 4cyl. 1896cc 50kW (68PS) Diesel TD14808

AGR 4cyl. 1896cc 66kW (89PS) Diesel Turbo Intercooled TD13278

AHB 4cyl. 1716cc 42kW (57PS) Diesel TD9403





AHF	4cyl.	1896cc	81kW (110PS)	Diesel	Turbo Intercooled	TD12512
AHU	4cyl.	1896cc	66kW (89PS)	Diesel	Turbo Intercooled	TD5528
AKU	4cyl.	1716cc	44kW (60PS)	Diesel		TD13896
ALH	4cyl.	1896cc	66kW (89PS)	Diesel	Turbo Intercooled	TD13272
AMF	3cyl.	1422cc	55kW (75PS)	Diesel	Turbo Intercooled	TD13895
ANU	4cyl.	1896cc	66kW (89PS)	Diesel	Turbo Intercooled	TD14911
AQM	4cyl.	1896cc	50kW (68PS)	Diesel	Turbo Intercooled	TD13271
ARL	4cyl.	1896cc	110kW (150PS)	Diesel	Turbo Intercooled	TD15768
ASV	4cyl.	1896cc	81kW (110PS)	Diesel	Turbo Intercooled	TD13273
ASY	4cyl.	1896cc	47kW (64PS)	Diesel		TD16461
ASZ	4cyl.	1896cc	96kW (131PS)	Diesel	Turbo Intercooled	TD16463
ATD	4cyl.	1896cc	74kW (100PS)	Diesel	Turbo Intercooled	TD16462
AUY	4cyl.	1896cc	85kW (116PS)	Diesel	Turbo Intercooled	TD14912
AVG	4cyl.	1896cc	81kW (110PS)	Diesel	Turbo Intercooled	TD23884
AXR	4cyl.	1896cc	74kW (100PS)	Diesel	Turbo Intercooled	TD18739
AYQ	4cyl.	1896cc	47kW (64PS)	Diesel		TD16198
BJB	4cyl.	1896cc	77kW (105PS)	Diesel	Turbo Intercooled	TD17356
BKC	4cyl.	1896cc	77kW (105PS)	Diesel	Turbo Intercooled	TD17355
BLS	4cyl.	1896cc	77kW (105PS)	Diesel	Turbo Intercooled	TD18268
BLT	4cyl.	1896cc	96kW (131PS)	Diesel	Turbo Intercooled	TD20516
BMT	4cyl.	1896cc	74kW (100PS)	Diesel	Turbo Intercooled	TD20495
BPX	4cyl.	1896cc	118kW (160PS)	Diesel	Turbo Intercooled	TD17640
BTB	4cyl.	1896cc	110kW (150PS)	Diesel	Turbo Intercooled	TD20625
BUK	4cyl.	1896cc	118kW (160PS)	Diesel	Turbo Intercooled	TD22667
BVK	4cyl.	1896cc	85kW (116PS)	Diesel	Turbo Intercooled	TD20515
BXE	4cyl.	1896cc	77kW (105PS)	Diesel	Turbo Intercooled	TD19819
BXF	4cyl.	1896cc	66kW (89PS)	Diesel	Turbo Intercooled	TD20866
BXJ	4cyl.	1896cc	66kW (89PS)	Diesel	Turbo Intercooled	TD20840

14-027950-00 *D*      79.50      B 82.50      C 152.00      D 85.50      E 4.70

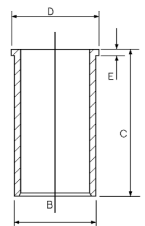

5

OM 615.912	4cyl.	2197cc	44kW (60PS)	Diesel		TD21374
------------	-------	--------	-------------	--------	--	---------

14-022190-00 *D*      87.00      B 90.00      C 158.40      D 92.00      E 4.70

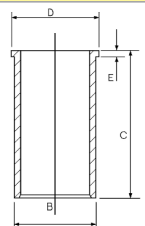



6

8144.61 4cyl. 2445cc 53kW (72PS) Diesel TD3597

14-022560-00 D 93.00 B 96.00 C 167.30 D 98.90 E 5.00

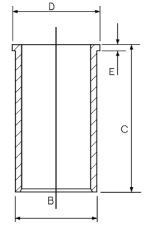

Modelverzeichnis • Index de modele • Índice de Modelo  
Indeks modelu • Модель автомобиля • دليل المركبة



## MODEL INDEX



CCM

x



9

01/03→03/08	<b>Fabia 1.2</b>	AZQ	Petrol	1198	3	2
04/03→03/08	<b>Fabia 1.4</b>	AMF	Diesel	1422	3	3
11/99→03/10	<b>Fabia 1.9</b>	ASY, ASZ, ATD, AXR, BLS, BLT, BSW	Diesel	1896	4	3
08/95→04/02	<b>Felicia 1.6</b>	AEE	Petrol	1598	4	2
10/95→04/02	<b>Felicia I 1.9</b>	AEF	Diesel	1896	4	3
01/98→06/01	<b>Felicia II 1.6</b>	AEE	Petrol	1598	4	2
01/98→06/01	<b>Felicia II 1.9</b>	AEF	Diesel	1896	4	3
09/96→09/04	<b>Octavia 1.6</b>	AEE	Petrol	1598	4	2
09/96→12/10	<b>Octavia 1.9</b>	AGP, AGR, AHF, ALH, AQM, ASV, ASZ, ATD, AXR, BJB, BKC, BLS, BXE	Diesel	1896	4	3
03/06→03/10	<b>Roomster 1.9</b>	AXR, BLS, BSW	Diesel	1896	4	3
12/01→	<b>Superb 1.9</b>	AVB, AVF, AWX, BLS, BXE	Diesel	1896	4	3

Motorverzeichnis • Index de moteur • Índice de Motor  
Indeks silnika • Модель двигателя • دليل المحرك



CCM

x



9

## ENGINE INDEX

781.136	Petrol	1289	4	75.50	1
AEE	Petrol	1598	4	76.50	2
AEF	Diesel	1896	4	79.50	3
AEY	Diesel	1896	4	79.50	3
AGP	Diesel	1896	4	79.50	3
AGR	Diesel	1896	4	79.50	3
AHF	Diesel	1896	4	79.50	3
ALH	Diesel	1896	4	79.50	3
AMF	Diesel	1422	3	79.50	3
AQM	Diesel	1896	4	79.50	3
ASV	Diesel	1896	4	79.50	3
ASY	Diesel	1896	4	79.50	3
ASZ	Diesel	1896	4	79.50	3
ATD	Diesel	1896	4	79.50	3
AVB	Diesel	1896	4	79.50	3
AVF	Diesel	1896	4	79.50	3
AWX	Diesel	1896	4	79.50	3
AXR	Diesel	1896	4	79.50	3
AZQ	Petrol	1198	3	76.50	2
BJB	Diesel	1896	4	79.50	3
BKC	Diesel	1896	4	79.50	3
BLS	Diesel	1896	4	79.50	3
BLT	Diesel	1896	4	79.50	3
BSW	Diesel	1896	4	79.50	3
BXE	Diesel	1896	4	79.50	3



1

781.136 4cyl. 1289cc 46kW (63PS) TD28629

14-634910-00 WH 1 75.50 B 88.60 C 141.00 D 97.00 E 6.50

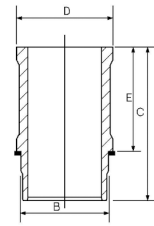

1 Use also: 1 NB O-Ring HR566 1 Mitverwenden: 1 NB O-Ring HR566 1 A utiliser aussi: 1 joint toriques HR566 1 Utilizar también: 1 NB junta toricas HR566

2

AEE 4cyl. 1598cc 55kW (75PS) TD13394

AZQ 3cyl. 1198cc 47kW (64PS) TD17070

14-021571-00 D 76.50 B 79.56 C 142.00 D 82.50 E 4.50  
14-028360-00 D 1 B 79.50 C 145.00 D 81.50 E 4.70

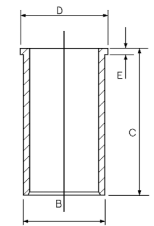

1 With recesses on crankshaft side 1 Mit kurbelwellenseitigen Aussparungen 1 Avec évidements côté vilebrequin 1 Con escotaduras en la cara del cigüeñal

3

AEF	4cyl.	1896cc	47kW (64PS)	Diesel	TD13395
AEY	4cyl.	1896cc	47kW (64PS)	Diesel	TD18729
AGP	4cyl.	1896cc	50kW (68PS)	Diesel	TD16424
AGR	4cyl.	1896cc	66kW (89PS)	Diesel Turbo Intercooled	TD17905
AHF	4cyl.	1896cc	81kW (110PS)	Diesel Turbo Intercooled	TD17910
ALH	4cyl.	1896cc	66kW (89PS)	Diesel Turbo Intercooled	TD16090
AMF	3cyl.	1422cc	55kW (75PS)	Diesel Turbo Intercooled	TD17348
AQM	4cyl.	1896cc	50kW (68PS)	Diesel Turbo Intercooled	TD16089
ASV	4cyl.	1896cc	81kW (110PS)	Diesel Turbo Intercooled	TD16091
ASY	4cyl.	1896cc	47kW (64PS)	Diesel	TD15376
ASZ	4cyl.	1896cc	96kW (131PS)	Diesel Turbo Intercooled	TD17036
ATD	4cyl.	1896cc	74kW (100PS)	Diesel Turbo Intercooled	TD15377
AVB	4cyl.	1896cc	74kW (100PS)	Diesel Turbo Intercooled	TD17037
AVF	4cyl.	1896cc	96kW (131PS)	Diesel Turbo Intercooled	TD18239
AWX	4cyl.	1896cc	96kW (131PS)	Diesel Turbo Intercooled	TD16403
AXR	4cyl.	1896cc	74kW (100PS)	Diesel Turbo Intercooled	TD20195
BJB	4cyl.	1896cc	77kW (105PS)	Diesel Turbo Intercooled	TD17499
BKC	4cyl.	1896cc	77kW (105PS)	Diesel Turbo Intercooled	TD17497
BLS	4cyl.	1896cc	77kW (105PS)	Diesel Turbo Intercooled	TD19091
BLT	4cyl.	1896cc	96kW (131PS)	Diesel Turbo Intercooled	TD20517







<b>BSW</b>	4cyl.	<b>1896cc</b>	<b>77kW (105PS)</b>	<b>Diesel</b>	<b>Turbo Intercooled</b>	<b>TD20004</b>
<b>BXE</b>	4cyl.	<b>1896cc</b>	<b>77kW (105PS)</b>	<b>Diesel</b>	<b>Turbo Intercooled</b>	<b>TD20513</b>

14-027950-00 *D*      79.50      **B** 82.50      **C** 152.00      **D** 85.50      **E** 4.70

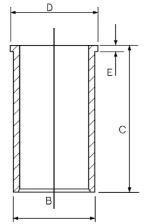

# MODEL INDEX



Modelverzeichnis • Index de modele • Índice de Modelo  
Indeks modelu • Модель автомобиля • دليل الموديل



CCM

x



9

10/92→	<b>Istana 2.9</b>	OM 602.940, OM 602.980	Diesel	2874	5	<b>3</b>
01/97→	<b>Korando</b>	XD3 T, XD3 TE	Diesel	2498	4	<b>4</b>
12/88→12/96	<b>Korando 2.2</b>	DC23	Diesel	2238	4	<b>1</b>
12/96→	<b>Korando 2.3</b>	OM 601.940	Diesel	2299	4	<b>3</b>
06/93→05/97	<b>Korando 2.5</b>	XD3P	Diesel	2498	4	<b>4</b>
12/96→	<b>Korando 2.9</b>	MB-OM 662	Diesel	2874	5	<b>2</b>
03/93→	<b>Musso 2.3</b>	OM 601.940, OM 661.940	Diesel	2299	4	<b>3</b>
03/96→	<b>Musso 2.9</b>	MB-OM 662	Diesel	2874	5	<b>2</b>



1

**DC23** 4cyl. **2238cc** **50kW (68PS)** **Diesel** **TD3611**

14-021190-00 <i>D</i>	88.00	B 92.13	C 163.50	D 95.00	E 4.00
14-021440-00 <i>DH</i> ①②		B 89.97	C 163.32	D 94.89	E 0.89

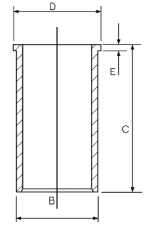

① Not suitable for use with pistons having chrome rings  
 ② Chrome Bore  
 ① Nicht geeignet zur Verwendung mit mit Kolben mit Chromringen  
 ② Bohrung verchromte  
 ① Ne pas utiliser avec des pistons équipés de segments chromés  
 ② Alésage chromée  
 ① No es adecuada para usar con pistones que tengan aros de croma  
 ② Cromado de cilindro

2

**MB-OM 662** 5cyl. **2874cc** **72-73kW (98-99PS)** **Diesel** **TD9355**

**OM 662.983** 5cyl. **2874cc** **88kW (120PS)** **Diesel Turbo Intercooled** **TD21371**

14-026380-00 <i>D</i>	89.00	B 91.50	C 156.50	D 96.55	E 4.70
-----------------------	-------	---------	----------	---------	--------

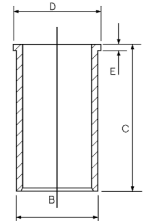

3

**OM 601.940** 4cyl. **2299cc** **57-59kW (77-80PS)** **Diesel** **TD3612**

**OM 602.940** 5cyl. **2874cc** **70kW (95PS)** **Diesel Turbo Intercooled** **TD3613**

**OM 602.980** 5cyl. **2874cc** **90-75kW (122-102PS)** **Diesel Turbo Intercooled** **TD19846**

**OM 661.940** 4cyl. **2299cc** **58kW (79PS)** **Diesel** **TD21373**

**OM 662.940** 5cyl. **2874cc** **70kW (95PS)** **Diesel Turbo Intercooled** **TD21372**

14-026380-00 <i>D</i>	89.00	B 91.50	C 156.50	D 96.55	E 4.70
14-027210-00 <i>D</i>		B 91.50	C 156.50	D 94.05	E 4.70

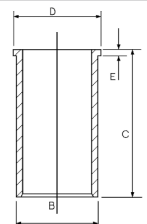

4

**XD3P** 4cyl. **2498cc** **58-53kW (79-72PS)** **Diesel** **TD19458**

**XD3 T** 4cyl. **2498cc** **58kW (79PS)** **Diesel Turbo** **FM4386**

**XD3 TE** 4cyl. **2498cc** **58kW (79PS)** **Diesel Turbo** **FM4386**

14-020660-00 <i>D</i>	94.00	B 97.00	C 170.60	D 99.50	E 4.00
14-021520-00 <i>D</i>		B 98.00	C 170.60	D 100.00	E 6.00
14-027270-00 <i>D</i>		B 98.70	C 170.00	D 100.00	E 5.00

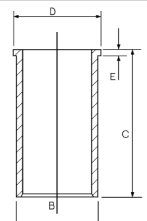

# ENGINE INDEX

Motorverzeichnis • Index de moteur • Índice de Motor  
Indeks silnika • Модель двигателя • دليل المحرك



CCM



9

WD 1015	Diesel	14955	10	126.00	4
WD 208	Diesel	1570	2	100.00	1
WD 210.40	Diesel	1996	2	105.00	3
WD 308	Diesel	2535	3	100.00	1
WD 311	Diesel	2590	3	100.00	2
WD 408	Diesel	3142	4	100.00	1
WD 410.40	Diesel	3983	4	105.00	3
WD 411	Diesel	3465	4	100.00	2
WD 610.18	Diesel	5975	6	105.00	3
WD 610.19	Diesel	5980	6	105.00	3
WD 610.20	Diesel	5975	6	105.00	3
WD 610.40	Diesel	5975	6	105.00	3
WD 610.42	Diesel	5975	6	105.00	3
WD 610.44	Diesel	5975	6	105.00	3
WD 610.50	Diesel	5975	6	105.00	3
WD 611	Diesel	5184	6	100.00	2
WD 615.00	Diesel	9726	6	126.00	5
WD 615.20	Diesel	9726	6	126.00	5
WD 615.60	Diesel	9726	6	126.00	5
WD 615.61	Diesel	9726	6	126.00	5
WD 615.63	Diesel	9726	6	126.00	5
WD 615.64	Diesel	9726	6	126.00	5
WD 615.65	Diesel	9726	6	126.00	5
WD 615.67	Diesel	9726	6	126.00	5
WD 615.68	Diesel	9726	6	126.00	5
WD 615.69	Diesel	9726	6	126.00	5
WD 615.70	Diesel	9726	6	126.00	5
WD 615.71	Diesel	9726	6	126.00	5
WD 615.73	Diesel	9726	6	126.00	5
WD 615.74	Diesel	9726	6	126.00	5
WD 615.75	Diesel	9726	6	126.00	5
WD 615.77	Diesel	9726	6	126.00	5
WD 615.93	Diesel	9726	6	126.00	5
WD 815.00	Diesel	11964	V8	126.00	4
WD1015	Diesel	14955	10	126.00	4
WD311	Diesel	2590	3	100.00	2
WD411	Diesel	3465	4	100.00	2
WD611	Diesel	5184	6	100.00	2



1

WD 208	2cyl.	1570cc		Diesel	FM5578
WD 208	2cyl.	1570cc	22kW (30PS)	Diesel	FM5578
WD 308	3cyl.	2535cc		Diesel	FM5579
WD 308	3cyl.	2535cc	34-37kW (40-45PS)	Diesel	FM5579
WD 408	4cyl.	3142cc		Diesel	FM5580
WD 408	4cyl.	3142cc	52kW (71PS)	Diesel	FM5580

14-450490-00 WH 100.00 B 109.40 C 197.00 D 118.00 E 9.00 F 1.10

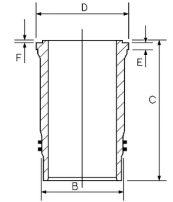

2

WD 311	3cyl.	2590cc		Diesel	FM6191
WD311	3cyl.	2590cc		Diesel	FM6191
WD 411	4cyl.	3465cc		Diesel	FM6192
WD411	4cyl.	3465cc		Diesel	FM6192
WD 611	6cyl.	5184cc		Diesel	FM6193
WD611	6cyl.	5184cc		Diesel	FM6193

14-451080-00 WH 100.00 B 109.40 C 197.00 D 118.00 E 9.00 F 1.10

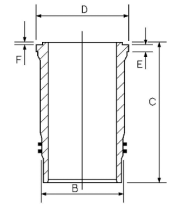

1 Water jacket chromed

1 Am Wassermantel verchromt

1 Chromé sur chambre d'eau

1 Camisa de agua cromada

3

WD 210.40	2cyl.	1996cc	24kW (33PS)	Diesel	FM8854
WD 410.40	4cyl.	3983cc	52kW (71PS)	Diesel	FM8855
WD 610.18	6cyl.	5975cc	81kW (110PS)	Diesel	TD19048
WD 610.19	6cyl.	5980cc	89-97kW (120-132PS)	Diesel	TD8986
WD 610.20	6cyl.	5975cc	97kW (132PS)	Diesel	TD8975
WD 610.40	6cyl.	5975cc	66-84.5kW (90-115PS)	Diesel	TD19049
WD 610.42	6cyl.	5975cc	66-84.5kW (90-115PS)	Diesel	TD19050
WD 610.44	6cyl.	5975cc	66kW (89PS)	Diesel	TD19051
WD 610.50	6cyl.	5975cc	66kW (89PS)	Diesel	TD19052

14-027790-00 D 105.00 B 110.00 C 222.00 D 112.00 E 4.70

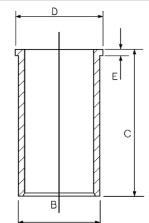



4

WD 815.00	V8cyl.	11964cc	199kW (271PS)	Diesel	Turbo	TD8992
WD 1015	10cyl.	14955cc		Diesel		FM6196
WD1015	10cyl.	14955cc		Diesel		FM6196

14-025420-00 <i>DH</i>	126.00	B 132.00	C 241.00	D 136.00	E 7.00	
------------------------	--------	----------	----------	----------	--------	--

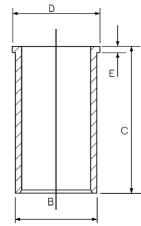

5

WD 615.00	6cyl.	9726cc	148kW (201PS)	Diesel	Turbo	TD8990
WD 615.20	6cyl.	9726cc	148kW (201PS)	Diesel	Turbo	TD8991
WD 615.60	6cyl.	9726cc	191kW (260PS)	Diesel	Turbo	TD8993
WD 615.61	6cyl.	9726cc	191-198kW (260-269PS)	Diesel	Turbo	TD8994
WD 615.63	6cyl.	9726cc	204-206kW (278-280PS)	Diesel	Turbo Intercooled	TD8962
WD 615.64	6cyl.	9726cc	175-177kW (238-241PS)	Diesel	Turbo	TD8960
WD 615.65	6cyl.	9726cc	206kW (280PS)	Diesel	Turbo	TD8997
WD 615.67	6cyl.	9726cc	206kW (280PS)	Diesel	Turbo	TD5895
WD 615.68	6cyl.	9726cc	225-228kW (306-310PS)	Diesel	Turbo Intercooled	TD5883
WD 615.69	6cyl.	9726cc	206kW (280PS)	Diesel	Turbo	TD6242
WD 615.70	6cyl.	9726cc	191kW (260PS)	Diesel	Turbo	TD8995
WD 615.71	6cyl.	9726cc	191kW (260PS)	Diesel	Turbo	TD8996
WD 615.73	6cyl.	9726cc	204kW (277PS)	Diesel	Turbo	TD8963
WD 615.74	6cyl.	9726cc	175kW (238PS)	Diesel	Turbo	TD8961
WD 615.75	6cyl.	9726cc	206kW (280PS)	Diesel	Turbo	TD8998
WD 615.77	6cyl.	9726cc	206kW (280PS)	Diesel	Turbo	TD6311
WD 615.93	6cyl.	9726cc	206kW (280PS)	Diesel	Turbo	TD9005

14-028240-00 <i>DH</i>	126.00	B 130.00	C 241.00	D 134.30	E 4.75	
------------------------	--------	----------	----------	----------	--------	--

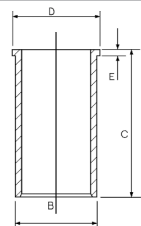

Modelverzeichnis • Index de modele • Índice de Modelo  
 Indeks modelu • Модель автомобиля • دليل الموديل

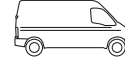

# MODEL INDEX



CCM

x



12/03→	<b>Jimny 1.5</b>	K9K 266, K9K 700	Diesel	1461	4	<b>2</b>
11/98→12/04	<b>Samurai 1.9</b>	XUD9	Diesel	1905	4	<b>3</b>
04/07→	<b>SX4 1.6</b>	9HX	Diesel	1560	4	<b>1</b>
01/95→03/99	<b>Vitara 1.9</b>	XUD9A, XUD9SD	Diesel	1905	4	<b>3</b>



**1**

**9HX Euro 4** 4cyl. **1560cc** **66kW (89PS)** **Diesel** **Turbo Intercooled** **TD21659**

**14-020900-00 D** **75.00** **B 78.00** **C 142.00** **D 79.50** **E 5.00**

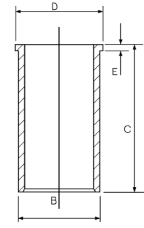

**2**

**K9K 266** 4cyl. **1461cc** **63kW (86PS)** **Diesel** **Turbo Intercooled** **TD24900**

**K9K 700** 4cyl. **1461cc** **48-50kW (65-68PS)** **Diesel** **Turbo Intercooled** **TD21367**

**14-020650-00 D** **76.00** **B 79.10** **C 142.00** **D 81.00** **E 5.00**

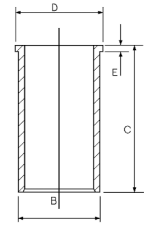

**3**

**XUD9** 4cyl. **1905cc** **46-55kW (63-75PS)** **Diesel** **Turbo Intercooled** **TD16375**

**XUD9A** 4cyl. **1905cc** **50kW (68PS)** **Diesel** **TD5443**

**XUD9SD** 4cyl. **1905cc** **55kW (75PS)** **Diesel** **TD22439**

**XUD9TF/BTF (DHX)** 4cyl. **1905cc** **44-66kW (60-90PS)** **Diesel** **Turbo Intercooled** **TD4268**

**14-020530-00 D** **83.00** **B 85.60** **C 153.50** **D 88.50** **E 3.90**

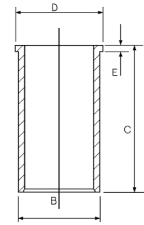



Modelverzeichnis • Index de modele • Índice de Modelo  
Indeks modelu • Модель автомобиля • دليل المركبة



# MODEL INDEX



CCM

x



9

01/82→	<b>Express</b>	U25/651, U25/673	Diesel	2500	4	<b>6</b>
01/90→	<b>Express 290</b>	M25/648, U25/651, U25/673	Diesel	2500	4	<b>6</b>
01/90→	<b>Express 310</b>	M25/648, U25/651, U25/673	Diesel	2500	4	<b>6</b>
01/90→	<b>Express 350</b>	M25/648, U25/651, U25/673	Diesel	2500	4	<b>6</b>
01/89→12/90	<b>Express 1400</b>	M25/648	Diesel	2500	4	<b>6</b>
01/90→	<b>Express Sportsman</b>	M25/648, U25/651, U25/673	Diesel	2500	4	<b>6</b>
07/83→10/90	<b>Express 1000 -1500 1.8</b>	XM7T	Petrol	1796	4	<b>4</b>
07/87→10/90	<b>Express 1000 -1500 1.9</b>	XUD9A	Diesel	1905	4	<b>3</b>
07/82→10/94	<b>Express 1000 -1500 2.0</b>	XN1TA	Petrol	1971	4	<b>5</b>
07/82→10/94	<b>Express 1000 -1500 2.5</b>	CRD93	Diesel	2498	4	<b>6</b>
07/81→10/90	<b>Express 1000 -1800 1.8</b>	XM7T	Petrol	1796	4	<b>4</b>
07/87→10/90	<b>Express 1000 -1800 1.9</b>	XUD9A	Diesel	1905	4	<b>3</b>
07/82→10/90	<b>Express 1000 -1800 2.0</b>	XN1TA	Petrol	1971	4	<b>5</b>
07/82→10/94	<b>Express 1000 -1800 2.5</b>	CRD93	Diesel	2498	4	<b>6</b>
07/82→06/86	<b>Horizon 1.9</b>	XUD9	Diesel	1905	4	<b>3</b>
01/81→06/86	<b>Samba 1.1</b>	XW7	Petrol	1124	4	<b>1</b>
01/81→10/86	<b>Samba 1.4</b>	XY8	Petrol	1360	4	<b>2</b>
01/83→	<b>Tagora</b>	XD2S (U8)	Diesel	2304	4	<b>7</b>
08/81→12/87	<b>Tagora 2.3</b>	XD2S (U8)	Diesel	2304	4	<b>7</b>
01/82→12/83	<b>Tagora TD (U6) 2.3</b>	XD2S (U8)	Diesel	2304	4	<b>7</b>



1

**XW7** 4cyl. **1124cc** **37kW (50PS)** **TD4927**

**14-636470-00 WH** **72.00** **B 79.50** **C 122.00** **D 89.20** **E 85.00**

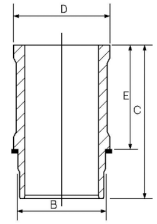

2

**XY8** 4cyl. **1360cc** **59kW (80PS)** **TD4929**

**14-636600-00 WH** **75.00** **B 79.50** **C 134.50** **D 89.20** **E 90.00**

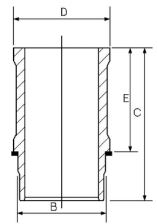

3

**XUD9** 4cyl. **1905cc** **48kW (65PS)** **Diesel** **TD4924**

**XUD9A** 4cyl. **1905cc** **51kW (69PS)** **Diesel** **TD9014**

**14-020530-00 D** **83.00** **B 85.60** **C 153.50** **D 88.50** **E 3.90**

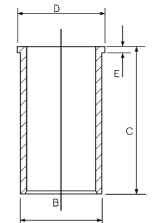

4

**XM7T** 4cyl. **1796cc** **50-51kW (68-69PS)** **TD9013**

**14-606670-00 WH** **84.00** **B 93.00** **C 136.20** **D 99.20** **E 90.01**

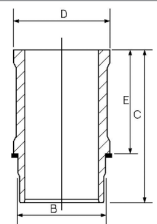

☐ Use also: 1 NB O-Ring HR566

☐ Mitverwenden: 1 NB O-Ring HR566

☐ A utiliser aussi: 1 joint toriques HR566

☐ Utilizar también: 1 NB junta toricas HR566

5

**XN1TA** 4cyl. **1971cc** **57-69kW (78-94PS)** **TD9015**

**14-636500-00 WH** **88.00** **B 93.00** **C 135.70** **D 101.90** **E 89.985**

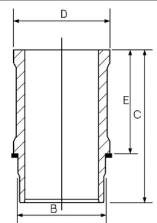



6

CRD93	4cyl.	2498cc	55kW (75PS)	Diesel	TD9017
M25/648	4cyl.	2500cc	70kW (95PS)	Diesel Turbo	FM4338
U25/651	4cyl.	2500cc	52kW (71PS)	Diesel	FM1427
U25/673	4cyl.	2500cc	70kW (95PS)	Diesel Turbo	FM3909

14-013481-00 *D*      93.00      B 96.10      C 163.00

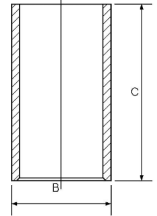

7

XD2	4cyl.	2304cc	44-53kW (60-72PS)	Diesel	TD21365
XD2S (U8)	4cyl.	2304cc	59kW (80PS)	Diesel Turbo	FM1429
XD2S (U8)	4cyl.	2304cc	59kW (80PS)	Diesel Turbo	TD5288

14-020660-00 *D*      94.00      B 97.00      C 170.60      D 99.50      E 4.00  
 14-021520-00 *D*           B 98.00      C 170.60      D 100.00      E 6.00  
 14-027270-00 *D*           B 98.70      C 170.00      D 100.00      E 5.00

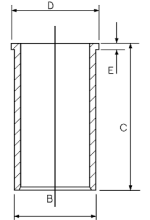

# MODEL INDEX



Modelverzeichnis • Index de modele • Índice de Modelo  
Indeks modelu • Модель автомобиля • دليل الموديل



CCM

x



9

07/84→11/95	<b>4 Runner 2.4</b>	2L, 2L-T	Diesel	2446	4	<b>3</b>
07/05→08/10	<b>Aygo 1.4</b>	2WZ-TV	Diesel	1398	4	<b>1</b>
10/86→10/95	<b>Blizzard 2.5</b>	2L-TII	Diesel	2446	4	<b>3</b>
10/92→08/96	<b>Chaser 2.4</b>	2L, 2L-TII	Diesel	2446	4	<b>3</b>
11/84→01/93	<b>Cressida 2.4</b>	2L-T, 2L-TII	Diesel	2446	4	<b>3</b>
09/88→10/96	<b>Cresta 2.4</b>	2L	Diesel	2446	4	<b>3</b>
08/94→07/02	<b>Crown 2.4</b>	2L-TE	Diesel	2446	4	<b>3</b>
08/77→08/87	<b>Dyna 2.4</b>	2J	Diesel	2449	4	<b>2</b>
08/77→07/01	<b>Dyna 2.4</b>	2L	Diesel	2446	4	<b>3</b>
08/77→08/87	<b>Dyna 3.4</b>	13B	Diesel	3432	4	<b>5</b>
08/85→07/01	<b>Dyna 150 2.4</b>	2L	Diesel	2446	4	<b>3</b>
09/88→06/95	<b>Dyna 150 3.4</b>	3B	Diesel	3432	4	<b>5</b>
08/88→05/95	<b>Dyna 200 3.0</b>	11B	Petrol	2977	4	<b>4</b>
10/92→05/99	<b>Dyna 200 3.4</b>	3B	Diesel	3432	4	<b>5</b>
06/95→05/99	<b>Dyna 300 3.4</b>	3B	Diesel	3432	4	<b>5</b>
04/84→11/89	<b>Hiace II 2.4</b>	2L	Diesel	2446	4	<b>3</b>
08/89→08/95	<b>Hiace III 2.4</b>	2L	Diesel	2446	4	<b>3</b>
08/95→08/06	<b>Hiace IV 2.4</b>	2L, 2L-T	Diesel	2446	4	<b>3</b>
08/88→07/01	<b>Hilux 2.4</b>	2L-T, 2L-TE	Diesel	2446	4	<b>3</b>
01/84→07/05	<b>Hilux II 2.4</b>	2L, 2L-T	Diesel	2446	4	<b>3</b>
08/81→09/96	<b>Mark II 2.4</b>	2L, 2L-TE, 2L-TII	Diesel	2446	4	<b>3</b>
08/89→12/00	<b>Kijang 2.4</b>	2L	Diesel	2446	4	<b>3</b>
08/04→	<b>Kijang Innova 2.4</b>	2L	Diesel	2446	4	<b>3</b>
11/84→05/96	<b>Land Cruiser 2.4</b>	2L, 2L-T	Diesel	2446	4	<b>3</b>
02/74→10/84	<b>Land Cruiser 3.0</b>	B	Diesel	2977	4	<b>4</b>
08/80→12/96	<b>Land Cruiser 3.4</b>	3B	Diesel	3432	4	<b>5</b>
10/85→08/86	<b>Land Cruiser 3.4</b>	13BT	Diesel	3431	4	<b>5</b>
01/75→07/80	<b>Land Cruiser 3.6</b>	H	Diesel	3576	6	<b>2</b>
01/99→10/04	<b>Qualis 2.4</b>	2L	Diesel	2446	4	<b>3</b>
08/99→05/05	<b>Stallion 2.4</b>	2L	Diesel	2446	4	<b>3</b>
01/99→10/04	<b>Tamaraw FX 2.4</b>	2L	Diesel	2446	4	<b>3</b>
04/85→12/91	<b>Town Ace 2.4</b>	2L	Diesel	2446	4	<b>3</b>
12/96→07/07	<b>TUV 2.4</b>	2L	Diesel	2446	4	<b>3</b>

# ENGINE INDEX

Motorverzeichnis • Index de moteur • Índice de Motor  
Indeks silnika • Модель двигателя • دليل المحرك



CCM

x



9

<b>11B</b>	Petrol	2977	4	95.00	<b>4</b>
<b>13B</b>	Diesel	3432	4	102.00	<b>5</b>
<b>13BT</b>	Diesel	3431	4	102.00	<b>5</b>
<b>2J</b>	Diesel	2449	4	88.00	<b>2</b>
<b>2L</b>	Diesel	2446	4	92.00	<b>3</b>
<b>2L-T</b>	Diesel	2446	4	92.00	<b>3</b>
<b>2L-TE</b>	Diesel	2446	4	92.00	<b>3</b>
<b>2L-TII</b>	Diesel	2446	4	92.00	<b>3</b>
<b>2WZ-TV</b>	Diesel	1398	4	73.70	<b>1</b>
<b>3B</b>	Diesel	3432	4	102.00	<b>5</b>
<b>B</b>	Diesel	2977	4	95.00	<b>4</b>
<b>H</b>	Diesel	3576	6	88.00	<b>2</b>



1

**2WZ-TV** 4cyl. **1398cc** **40kW (54PS)** **Diesel** **TD24605**

14-020760-00 <i>D</i>	73.70	B 76.70	C 136.00	D 78.20	E 5.00
14-020761-00 <i>D</i>		B 76.95	C 136.00	D 78.45	E 5.25

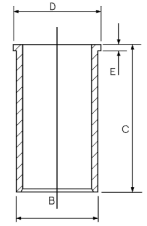

2

**2J** 4cyl. **2449cc** **55kW (75PS)** **Diesel** **TD3759**

**H** 6cyl. **3576cc** **66kW (89PS)** **Diesel** **TD15729**

14-040160-00 <i>D</i>	88.00	B 93.05	C 183.67	D 97.79	E 2.50	F 1.25
-----------------------	-------	---------	----------	---------	--------	--------

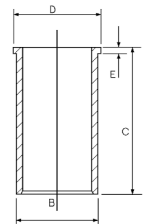

3

**2L** 4cyl. **2446cc** **53-61kW (72-83PS)** **Diesel** **TD4938**

**2L-T** 4cyl. **2446cc** **63-66kW (85-90PS)** **Diesel Turbo** **TD3767**

**2L-TE** 4cyl. **2446cc** **66-71kW (90-97PS)** **Diesel Turbo Intercooled** **TD24627**

**2L-TII** 4cyl. **2446cc** **60-71kW (82-97PS)** **Diesel Turbo** **TD21259**

14-010850-00 <i>D</i>	92.00	B 96.075	C 179.00
-----------------------	-------	----------	----------

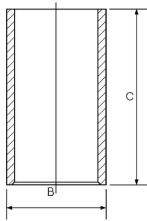

14-040130-00 <i>D</i>	92.00	B 96.00	C 160.00	D 100.80	E 3.50	F 1.00
-----------------------	-------	---------	----------	----------	--------	--------

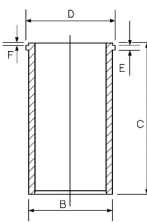

4

**11B** 4cyl. **2977cc** **59kW (80PS)** **TD3703**

**B** 4cyl. **2977cc** **59-63kW (80-86PS)** **Diesel** **TD9039**

14-040150-00 <i>D</i>	95.00	B 102.00	C 190.22	D 107.75	E 2.55	F 1.20
-----------------------	-------	----------	----------	----------	--------	--------

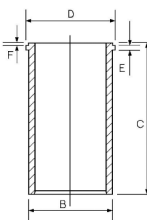



5

<b>3B</b>	4cyl.	<b>3432cc</b>	<b>66-72kW</b> (90-98PS)	<b>Diesel</b>	<b>TD3789</b>
<b>13B</b>	4cyl.	<b>3432cc</b>	<b>66kW</b> (89PS)	<b>Diesel</b>	<b>FM9586</b>
<b>13B</b>	4cyl.	<b>3432cc</b>	<b>66kW</b> (89PS)	<b>Diesel</b>	<b>TD3706</b>
<b>13BT</b>	4cyl.	<b>3431cc</b>	<b>91kW</b> (124PS)	<b>Diesel Turbo</b>	<b>TD3707</b>

<b>14-040140-00 D</b>	<b>102.00</b>	<b>B 106.00</b>	<b>C 190.26</b>	<b>D 111.65</b>	<b>E 2.51</b>	<b>F 1.19</b>
-----------------------	---------------	-----------------	-----------------	-----------------	---------------	---------------

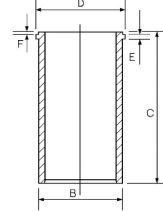

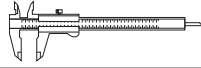

1

D113

4cyl.

Diesel

FM5581

14-260500-00 WH 1

108.00

B 125.00

C 258.00

D 132.00

E 10.10

F 1.30

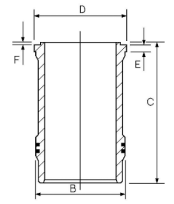

1 Phosphated

1 Phosphatiert

1 Phosphatisé

1 Fosfatada

# MODEL INDEX



Modelverzeichnis • Index de modele • Índice de Modelo  
Indeks modelu • Модель автомобиля • دليل الموديل



CCM

x



9

03/98→08/01	<b>Arena 2.5</b>	S8U 758, S8U 780, S8U 782	Diesel	2499	4	<b>10</b>
02/82→08/86	<b>Astra 1.6</b>	16 D	Diesel	1598	4	<b>2</b>
01/87→08/91	<b>Astra Mk II 1.5</b>	15 DT, 15 DT (T4EC1)	Diesel	1488	4	<b>1</b>
09/84→08/91	<b>Astra Mk II 1.6</b>	16 DA	Diesel	1598	4	<b>2</b>
01/89→12/91	<b>Astra Mk II 1.7</b>	17 D, 17 DR	Diesel	1699	4	<b>4</b>
03/91→09/98	<b>Astra Mk III (F) 1.7</b>	17 D, 17 DR, X 17 DTL	Diesel	1699	4	<b>4</b>
02/98→08/00	<b>Astra Mk IV (G) 1.7</b>	X 17 DTL	Diesel	1699	4	<b>4</b>
02/98→05/05	<b>Astra Mk IV (G) 2.0</b>	X 20 DTL, Y 20 DTL	Diesel	1995	4	<b>5</b>
03/00→10/05	<b>Astra Mk IV (G) 2.2</b>	Z 22 SE	Petrol	2198	4	<b>6</b>
05/86→06/90	<b>Astramax 1.6</b>	16 DA	Diesel	1598	4	<b>2</b>
01/89→07/94	<b>Astramax 1.7</b>	17 D	Diesel	1699	4	<b>4</b>
01/91→08/98	<b>Astravan Mk III (F) 1.7</b>	17 DR, X 17 DTL	Diesel	1699	4	<b>4</b>
08/98→08/06	<b>Astravan Mk IV (G) 1.7</b>	X 17 DTL	Diesel	1699	4	<b>4</b>
08/98→08/06	<b>Astravan Mk IV (G) 2.0</b>	X 20 DTL	Diesel	1995	4	<b>5</b>
12/88→09/96	<b>Brava 2.2</b>	C 223	Diesel	2238	4	<b>7</b>
09/80→	<b>Carlton Mk II 2.3</b>	23 D, 23 TD	Diesel	2260	4	<b>8</b>
09/86→08/88	<b>Carlton Mk III 2.2</b>	23 YDT	Diesel	2260	4	<b>8</b>
09/86→03/94	<b>Carlton Mk III 2.3</b>	23 DTR, 23 YD	Diesel	2260	4	<b>8</b>
03/82→08/88	<b>Cavalier Mk II 1.6</b>	16 D, 16 DA	Diesel	1598	4	<b>2</b>
09/88→11/95	<b>Cavalier Mk III 1.7</b>	17 D, 17 DR	Diesel	1699	4	<b>4</b>
03/93→09/00	<b>Corsa Mk I (B) 1.5</b>	15 D, 15 DT (T4EC1), X 15 DT (T4EC1)	Diesel	1488	4	<b>1</b>
08/94→12/95	<b>Corsavan Mk I (B) 1.5</b>	15 D	Diesel	1488	4	<b>1</b>
09/91→06/98	<b>Frontera Mk I (A) 2.3</b>	23 DTR	Diesel	2260	4	<b>8</b>
11/91→10/98	<b>Frontera Mk I (A) 2.5</b>	25TDS (VM41B)	Diesel	2499	4	<b>9</b>
10/98→10/01	<b>Movano Mk I (A) 2.8</b>	S9W 702	Diesel	2799	4	<b>11</b>
09/87→03/93	<b>Nova 1.5</b>	15 D, 15 DT (T4EC1)	Diesel	1488	4	<b>1</b>
01/91→10/94	<b>Novavan 1.5</b>	15 D	Diesel	1488	4	<b>1</b>
11/84→08/87	<b>Royale 2.2</b>	23 TD	Diesel	2260	4	<b>8</b>
11/84→08/87	<b>Senator 2.2</b>	23 TD	Diesel	2260	4	<b>8</b>
03/01→09/06	<b>Speedster 2.2</b>	Z 22 SE	Petrol	2198	4	<b>6</b>
08/95→10/01	<b>Vectra (B) 2.0</b>	X 20 DTL	Diesel	1995	4	<b>5</b>
08/95→07/03	<b>Vectra (B) 2.2</b>	Z 22 SE	Petrol	2198	4	<b>6</b>
01/02→10/08	<b>Vectra Mk II (C) 2.2</b>	Z 22 SE	Petrol	2198	4	<b>6</b>
08/01→07/14	<b>Vivaro 1.9</b>	F9Q 760, F9Q 762	Diesel	1870	4	<b>3</b>
09/00→07/05	<b>VX220 2.2</b>	Z 22 SE	Petrol	2198	4	<b>6</b>
10/99→08/05	<b>Zafira Mk I (A) 2.0</b>	X 20 DTL	Diesel	1995	4	<b>5</b>
11/98→08/04	<b>Zafira Mk I (A) 2.2</b>	Z 22 SE	Petrol	2198	4	<b>6</b>



Motorverzeichnis • Index de moteur • Índice de Motor  
Indeks silnika • Модель двигателя • دليل المحرك

# ENGINE INDEX



CCM

x



9

15 D	Diesel	1488	4	76.00	1
15 DT	Diesel	1488	4	76.00	1
15 DT (T4EC1)	Diesel	1488	4	76.00	1
16 D	Diesel	1598	4	80.00	2
16 DA	Diesel	1598	4	80.00	2
17 D	Diesel	1699	4	82.50	4
17 DR	Diesel	1699	4	82.50	4
23 D	Diesel	2260	4	92.00	8
23 DTR	Diesel	2260	4	92.00	8
23 TD	Diesel	2260	4	92.00	8
23 YD	Diesel	2260	4	92.00	8
23 YDT	Diesel	2260	4	92.00	8
25 TDS (VM41B)	Diesel	2500	4	92.00	9
25TDS (VM41B)	Diesel	2499	4	92.00	9
C 223	Diesel	2238	4	88.00	7
F9Q 760	Diesel	1870	4	80.00	3
F9Q 762	Diesel	1870	4	80.00	3
S8U 758	Diesel	2499	4	93.00	10
S8U 780	Diesel	2499	4	93.00	10
S8U 782	Diesel	2499	4	93.00	10
S9W 700	Diesel	2799	4	94.40	11
S9W 702	Diesel	2799	4	94.40	11
X 15 DT (T4EC1)	Diesel	1488	4	76.00	1
X 17 DTL	Diesel	1699	4	82.50	4
X 20 DTL	Diesel	1995	4	84.00	5
Y 20 DTL	Diesel	1995	4	84.00	5
Z 22 SE	Petrol	2198	4	86.00	6



1

15 D	4cyl.	1488cc	37kW (50PS)	Diesel		TD21906
15 DT	4cyl.	1488cc	53kW (72PS)	Diesel	Turbo	TD17578
15 DT (T4EC1)	4cyl.	1488cc	49-53kW (67-72PS)	Diesel	Turbo	TD18227
X 15 DT (T4EC1)	4cyl.	1488cc	49kW (67PS)	Diesel	Turbo	TD22871

14-010870-00 D      76.00      B 80.00      C 138.00

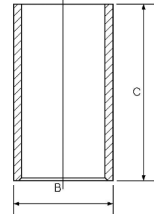

2

16 D	4cyl.	1598cc	40kW (54PS)	Diesel		TD17563
16 DA	4cyl.	1598cc	40kW (54PS)	Diesel		TD17601

14-023520-00 D      80.00      B 83.00      C 143.50      D 84.90      E 4.50

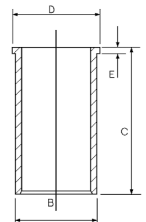

3

F9Q 760	4cyl.	1870cc	74kW (100PS)	Diesel	Turbo Intercooled	TD19375
F9Q 762	4cyl.	1870cc	59-60kW (80-82PS)	Diesel	Turbo	TD21148

14-020280-00 D      80.00      B 83.00      C 155.00      D 85.00      E 5.00

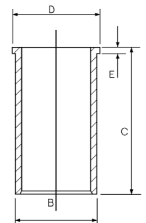

4

17 D	4cyl.	1699cc	42kW (57PS)	Diesel		TD17566
17 DR	4cyl.	1699cc	42-44kW (57-60PS)	Diesel		TD17567
X 17 DTL	4cyl.	1699cc	50kW (68PS)	Diesel	Turbo Intercooled	TD17591

14-021200-00 D      82.50      B 85.58      C 143.35      D 87.40      E 4.55

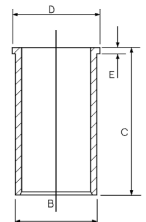



5

**X 20 DTL** 4cyl. **1995cc** **60kW (81PS)** **Diesel Turbo** **TD17627**

**Y 20 DTL** 4cyl. **1995cc** **60kW (81PS)** **Diesel Turbo** **TD17926**

14-102800-00 *D* **84.00** **B 87.00** **C 160.00** **D 90.00** **E 4.50**

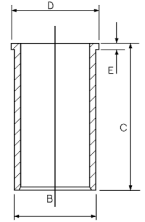

6

**Z 22 SE** 4cyl. **2198cc** **108kW (147PS)** **TD17683**

14-020450-00 *D* **86.00** **B 89.025** **C 137.25** **D 95.45** **E 4.63**

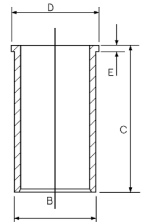

7

**C 223** 4cyl. **2238cc** **39-54kW (53-73PS)** **Diesel** **TD22879**

14-021190-00 *D* **88.00** **B 92.13** **C 163.50** **D 95.00** **E 4.00**

14-021440-00 *DH* <sup>1</sup><sub>2</sub> **B 89.97** **C 163.32** **D 94.89** **E 0.89**

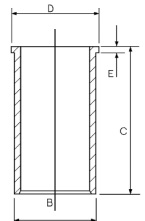

<sup>1</sup> Not suitable for use with pistons having chrome rings

<sup>1</sup> Nicht geeignet zur Verwendung mit mit Kolben mit Chromringen

<sup>1</sup> Ne pas utiliser avec des pistons équipés de segments chromés

<sup>1</sup> No es adecuada para usar con pistones que tengan aros de croma

<sup>2</sup> Chrome Bore

<sup>2</sup> Bohrung verchromte

<sup>2</sup> Alésage chromée

<sup>2</sup> Cromado de cilindro

8

**23 D** 4cyl. **2260cc** **48-52kW (65-71PS)** **Diesel** **TD17575**

**23 DTR** 4cyl. **2260cc** **74kW (100PS)** **Diesel Turbo Intercooled** **TD17576**

**23 TD** 4cyl. **2260cc** **63kW (86PS)** **Diesel Turbo** **TD17577**

**23 YD** 4cyl. **2260cc** **54kW (73PS)** **Diesel** **TD17914**

**23 YDT** 4cyl. **2260cc** **66kW (89PS)** **Diesel Turbo** **TD17579**

14-024100-00 *D* **92.00** **B 95.00** **C 172.00** **D 97.00** **E 4.70**

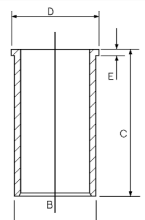



9

25 TDS (VM41B) 4cyl. 2500cc 85kW (116PS) Diesel Turbo Intercooled TD2673

25TDS (VM41B) 4cyl. 2499cc 85kW (116PS) Diesel Turbo Intercooled TD22850

14-676420-00 WH 92.00 B 101.50 C 166.80 D 110.00 E 8.90 F 1.20

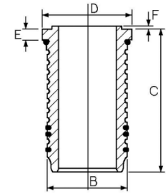

10

S8U 758 4cyl. 2499cc 55-58kW (75-79PS) Diesel TD22883

S8U 780 4cyl. 2499cc 55kW (75PS) Diesel TD22884

S8U 782 4cyl. 2499cc 55kW (75PS) Diesel TD22885

14-022560-00 D 93.00 B 96.00 C 167.30 D 98.90 E 5.00  
 14-028930-00 D B 97.50 C 167.00 D 100.90 E 5.00  
 14-028931-00 D B 97.58 C 167.00 D 100.90 E 5.00  
 14-028932-00 D B 97.70 C 167.00 D 100.90 E 5.00

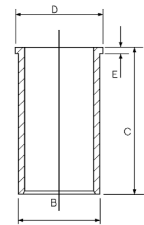

11

S9W 700 4cyl. 2799cc 84kW (114PS) Diesel Turbo TD21150

S9W 702 4cyl. 2799cc 84kW (114PS) Diesel Turbo TD19361

14-021321-00 D 94.40 B 97.54 C 167.00 D 100.90 E 5.00  
 14-021322-00 D B 97.70 C 167.00 D 100.90 E 5.00  
 14-028930-00 D B 97.50 C 167.00 D 100.90 E 5.00  
 14-028931-00 D B 97.58 C 167.00 D 100.90 E 5.00  
 14-028932-00 D B 97.70 C 167.00 D 100.90 E 5.00

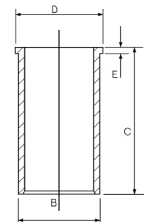



1

R 425 DOHC 4cyl. 2499cc 70-104kW (94-140PS) Diesel Turbo Intercooled TD18633

14-260090-00 WH 92.00 B 101.50 C 167.80 D 110.00 E 6.90 F 1.00

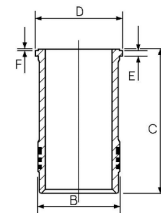

2

HR492HTI 4cyl. 2500cc 85kW (116PS) Diesel Turbo FM4053

VM 392 HT 3cyl. 1779cc Diesel Turbo FM4049

VM 492 HR 4cyl. 2500cc Diesel Turbo FM9171

VM 492 HS 4cyl. 2500cc Diesel Turbo FM9171

VM 492 HT 4cyl. 2393cc Diesel Turbo FM4047

14-676420-00 WH 92.00 B 101.50 C 166.80 D 110.00 E 8.90 F 1.20

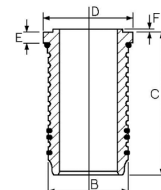

# MODEL INDEX



Modelverzeichnis • Index de modele • Índice de Modelo  
Indeks modelu • Модель автомобиля • دليل الموديل



CCM

x



9

10/98→05/05	<b>Bora 1.9</b>	AGP, AGR, AHF, AJM, ALH, AQM, ARL, ASV, ASZ, ATD, AU, AU, AXR	Diesel	1896	4	4
08/82→07/92	<b>Caddy I 1.6</b>	JK, ME	Diesel	1588	4	2
11/95→01/04	<b>Caddy II 1.4</b>	AEX, AKV, APQ	Petrol	1390	4	2
11/95→12/00	<b>Caddy II 1.6</b>	AEE	Petrol	1598	4	2
07/96→09/00	<b>Caddy II 1.7</b>	AHB	Diesel	1716	4	4
11/95→01/04	<b>Caddy II 1.9</b>	1Y, 1Z, AEF, AEY, AHU, ALE, ALH, AYQ	Diesel	1896	4	4
04/04→08/10	<b>Caddy III 1.9</b>	1Y, BJB, BLS, BSU	Diesel	1896	4	4
04/06→	<b>Crafter 30-35 2.5</b>	CECA, CECB	Diesel	2461	5	6
04/06→	<b>Crafter 30-50 2.5</b>	CECA, CECB	Diesel	2461	5	6
09/82→12/84	<b>Derby 1.3</b>	GK, HK	Petrol	1272	4	1
12/07→	<b>Fox 1.9</b>	ASY	Diesel	1896	4	4
06/02→06/05	<b>Gol III 1.9</b>	1Y, BGG	Diesel	1896	4	4
08/83→07/86	<b>Golf I 1.3</b>	HK	Petrol	1272	4	1
08/76→07/80	<b>Golf I 1.5</b>	CK	Diesel	1471	4	3
08/80→07/83	<b>Golf I 1.6</b>	CR, CY, JK	Diesel	1588	4	2
08/85→10/91	<b>Golf II 1.0</b>	HZ	Petrol	1043	4	1
08/83→12/92	<b>Golf II 1.3</b>	HK, NZ	Petrol	1272	4	1
08/83→10/91	<b>Golf II 1.6</b>	1V, JP, JR, ME, MF, RA, SB	Diesel	1588	4	2
10/91→04/99	<b>Golf III 1.4</b>	AEX, APQ	Petrol	1390	4	2
09/92→08/97	<b>Golf III 1.6</b>	AEA, AEE	Petrol	1598	4	2
11/91→04/99	<b>Golf III 1.9</b>	1Y, 1Z, AAZ, AEY, AFN, AHU, ALE	Diesel	1896	4	4
08/97→06/06	<b>Golf IV 1.9</b>	AAZ, AFN, AGP, AGR, AHF, AHU, AJM, ALE, ALH, AQM, ARL, ASV, ASZ, ATD, AU, AV, AXR	Diesel	1896	4	4
10/03→07/09	<b>Golf V 1.9</b>	BGG, BKC, BLS, BRU, BXE, BXF, BXJ	Diesel	1896	4	4
01/05→12/13	<b>Golf PLUS 1.9</b>	BGG, BKC, BLS, BRU, BXE, BXF, BXJ	Diesel	1896	4	4
08/87→12/88	<b>Iltis 1.6</b>	1C	Diesel	1600	4	2
08/78→07/80	<b>Jetta I 1.5</b>	CK	Diesel	1471	4	3
08/80→12/84	<b>Jetta I 1.6</b>	CR, CY, JK	Diesel	1588	4	2
01/84→12/91	<b>Jetta II 1.3</b>	HK, NZ	Petrol	1272	4	1
01/84→10/91	<b>Jetta II 1.6</b>	1V, JP, JR, ME, MF, RA, SB	Diesel	1588	4	2
08/05→10/10	<b>Jetta III 1.9</b>	BKC, BLS, BXE	Diesel	1896	4	4
12/78→06/96	<b>LT 28-35 I 2.4</b>	1G, 1S, CP, DV, DW	Diesel	2383	6	2
08/89→06/96	<b>LT 28-35 I 2.4</b>	ACL, ACT	Diesel	2384	6	2
11/75→01/80	<b>LT 28-35 I 2.7</b>	CG	Diesel	2710	4	8
05/96→07/06	<b>LT 28-35 II 2.5</b>	AGX, AHD	Diesel	2459	5	6
05/99→07/06	<b>LT 28-35 II 2.5</b>	ANJ, APA, BBE, BBF	Diesel	2461	5	6
05/96→07/06	<b>LT 28-46 II 2.5</b>	AGX, AHD	Diesel	2459	5	6
05/99→07/06	<b>LT 28-46 II 2.5</b>	ANJ, APA, BBE, BBF	Diesel	2461	5	6
08/78→06/96	<b>LT 40-55 I 2.4</b>	1G, 1S, CP, DV, DW	Diesel	2383	6	2
07/90→06/96	<b>LT 40-55 I 2.4</b>	ACL, ACT	Diesel	2384	6	2
01/99→07/05	<b>Lupo 1.4</b>	AMF	Diesel	1422	3	4
09/98→07/05	<b>Lupo 1.7</b>	AKU	Diesel	1716	4	4
04/03→11/09	<b>Multivan V 1.9</b>	AXB, AXC, BRR, BRS	Diesel	1896	4	4
04/03→11/09	<b>Multivan V 2.5</b>	AXD, AXE, BLJ	Diesel	2461	5	6
01/98→09/10	<b>New Beetle 1.9</b>	ALH, ATD, AXR, BEW, BSW	Diesel	1896	4	4
08/02→	<b>Parati III 1.9</b>	1Y, BGG	Diesel	1896	4	4
05/73→12/75	<b>Passat 1.5</b>	YJ, ZB, ZC	Petrol	1471	4	3
02/77→07/80	<b>Passat 1.5</b>	CK	Diesel	1471	4	3
02/79→09/93	<b>Passat 1.6</b>	CR, CY, JK, RA, SB	Diesel	1588	4	2
05/89→11/08	<b>Passat 1.9</b>	1Y, 1Z, AAZ, AFN, AHH, AHU, AJM, ATJ, AVB, AVF, AVG, AWX, BKC, BLS, BXE	Diesel	1896	4	4
12/05→	<b>Pointer 1.9</b>	BGG	Diesel	1896	4	4
01/85→09/94	<b>Polo 1.0</b>	AAU, HZ	Petrol	1043	4	1
10/01→07/07	<b>Polo 1.2</b>	AZQ	Petrol	1198	3	2
09/82→09/94	<b>Polo 1.3</b>	3F, AAV, GK, HK, NZ	Petrol	1272	4	1
08/86→08/90	<b>Polo 1.3</b>	MN	Diesel	1272	4	1
08/90→09/94	<b>Polo 1.4</b>	1W	Diesel	1398	4	1
07/95→09/01	<b>Polo 1.4</b>	AEX, AKV, APQ	Petrol	1390	4	2
01/98→09/01	<b>Polo 1.4</b>	ANX	Petrol	1389	4	2

Modelverzeichnis • Index de modele • Índice de Modelo  
Indeks modelu • Модель автомобиля • دليل الموديل



# MODEL INDEX



CCM

x



10/99→	<b>Polo 1.4</b>	AMF, BAY	Diesel	1422	3	4
09/94→09/01	<b>Polo 1.6</b>	AEA, AEE, ALM	Petrol	1598	4	2
10/94→10/99	<b>Polo 1.6</b>	AHS	Petrol	1588	4	2
04/97→09/01	<b>Polo 1.7</b>	AHG, AKU, AKW	Diesel	1716	4	4
10/94→	<b>Polo 1.9</b>	1Y, AEF, AEY, AFN, AGD, AGP, AGR, AHU, ALE, ALH, AQM, ASV, ASX, ASY, ASZ, ATD, AXR, BLT, BMT	Diesel	1896	4	4
08/81→12/84	<b>Santana 1.6</b>	CR, CY, JK	Diesel	1588	4	2
08/91→07/96	<b>Saveiro I 1.6</b>	SB	Diesel	1588	4	2
09/05→08/09	<b>Saveiro IV 1.9</b>	BGG	Diesel	1896	4	4
08/83→07/84	<b>Scirocco 1.3</b>	HK	Petrol	1272	4	1
02/74→08/75	<b>Scirocco 1.5</b>	YJ, ZB	Petrol	1471	4	3
09/95→03/10	<b>Sharan 1.9</b>	1Z, AFN, AHU, ANU, ASZ, AUY, AVG, BVK	Diesel	1896	4	4
09/07→	<b>Spacefox / Space Cross 1.9</b>	ASY	Diesel	1896	4	4
04/89→03/97	<b>Taro 2.4</b>	2L	Diesel	2446	4	7
01/03→05/10	<b>Touareg 2.5</b>	BAC, BLK, BPD	Diesel	2461	5	6
02/03→05/10	<b>Touran 1.9</b>	AVQ, BKC, BLS, BRU, BXE, BXF, BXJ	Diesel	1896	4	4
01/81→07/92	<b>Transporter III 1.6</b>	CS, JX	Diesel	1588	4	2
07/90→04/03	<b>Transporter IV 1.9</b>	1X, ABL	Diesel	1896	4	4
07/90→04/03	<b>Transporter IV 2.4</b>	AAB, AJA	Diesel	2370	5	4
09/95→04/03	<b>Transporter IV 2.5</b>	ACV, AHY, AJT, AUF, AXG, AXL, AYC, AYY	Diesel	2461	5	6
04/03→11/09	<b>Transporter V 1.9</b>	AXB, AXC, BRR, BRS	Diesel	1896	4	4
04/03→11/09	<b>Transporter V 2.5</b>	AXD, AXE, BLJ	Diesel	2461	5	6
11/91→09/98	<b>Vento 1.4</b>	AEX	Petrol	1390	4	2
09/92→09/98	<b>Vento 1.6</b>	AEA, AEE	Petrol	1598	4	2
11/91→09/98	<b>Vento 1.9</b>	1Y, 1Z, AAZ, AEY, AFN, AHU, ALE	Diesel	1896	4	4
06/96→09/01	<b>Voyage 1.9</b>	1Y, 1Z	Diesel	1896	4	4

# ENGINE INDEX

Motorverzeichnis • Index de moteur • Índice de Motor  
Indeks silnika • Модель двигателя • دليل المحرك



CCM



9

0262	Petrol	1781	4	81.00	5
1C	Diesel	1600	4	76.50	2
1G	Diesel	2383	6	76.50	2
1S	Diesel	2383	6	76.50	2
1V	Diesel	1588	4	76.50	2
1W	Diesel	1398	4	75.00	1
1X	Diesel	1896	4	79.50	4
1Y	Diesel	1896	4	79.50	4
1Z	Diesel	1896	4	79.50	4
28B	Diesel	1896	4	79.50	4
2L	Diesel	2446	4	92.00	7
3F	Petrol	1272	4	75.00	1
686	Diesel	1588	4	76.50	2
68A	Diesel	1588	4	76.50	2
68C	Diesel	1588	4	76.50	2
AAB	Diesel	2370	5	79.50	4
AAU	Petrol	1043	4	75.00	1
AAV	Petrol	1272	4	75.00	1
AAZ	Diesel	1896	4	79.50	4
ABL	Diesel	1896	4	79.50	4
ACL	Diesel	2384	6	76.50	2
ACT	Diesel	2384	6	76.50	2
ACV	Diesel	2461	5	81.00	6
ADE	Diesel	1896	4	79.50	4
ADG	Diesel	1896	4	79.50	4
ADK	Diesel	1588	4	76.50	2
AEA	Petrol	1598	4	76.50	2
AEE	Petrol	1598	4	76.50	2
AEF	Diesel	1896	4	79.50	4
AEX	Petrol	1390	4	76.50	2
AEY	Diesel	1896	4	79.50	4
AFD	Diesel	1896	4	79.50	4
AFN	Diesel	1896	4	79.50	4
AGD	Diesel	1896	4	79.50	4
AGP	Diesel	1896	4	79.50	4
AGR	Diesel	1896	4	79.50	4
AGX	Diesel	2459	5	81.00	6
AHB	Diesel	1716	4	79.50	4
AHD	Diesel	2459	5	81.00	6
AHF	Diesel	1896	4	79.50	4
AHG	Diesel	1716	4	79.50	4
AHH	Diesel	1896	4	79.50	4
AHS	Petrol	1588	4	76.50	2
AHU	Diesel	1896	4	79.50	4
AHY	Diesel	2461	5	81.00	6
AJA	Diesel	2370	5	79.50	4
AJM	Diesel	1896	4	79.50	4
AJT	Diesel	2461	5	81.00	6
AKU	Diesel	1716	4	79.50	4
AKV	Petrol	1390	4	76.50	2
AKW	Diesel	1716	4	79.50	4
ALE	Diesel	1896	4	79.50	4
ALH	Diesel	1896	4	79.50	4
ALM	Petrol	1598	4	76.50	2
AMF	Diesel	1422	3	79.50	4
ANC	Diesel	1896	4	79.50	4
ANF	Diesel	2461	5	81.00	6
ANG	Diesel	2461	5	81.00	6
ANH	Diesel	2461	5	81.00	6
ANJ	Diesel	2461	5	81.00	6



Motorverzeichnis • Index de moteur • Índice de Motor  
Indeks silnika • Модель двигателя • دليل المحرك

# ENGINE INDEX



CCM

x



9

ANU	Diesel	1896	4	79.50	4
ANX	Petrol	1389	4	76.50	2
APA	Diesel	2461	5	81.00	6
APQ	Petrol	1390	4	76.50	2
AQM	Diesel	1896	4	79.50	4
ARD	Diesel	1896	4	79.50	4
ARL	Diesel	1896	4	79.50	4
ASV	Diesel	1896	4	79.50	4
ASX	Diesel	1896	4	79.50	4
ASY	Diesel	1896	4	79.50	4
ASZ	Diesel	1896	4	79.50	4
ATD	Diesel	1896	4	79.50	4
ATJ	Diesel	1896	4	79.50	4
AUF	Diesel	2461	5	81.00	6
AUY	Diesel	1896	4	79.50	4
AVB	Diesel	1896	4	79.50	4
AVF	Diesel	1896	4	79.50	4
AVG	Diesel	1896	4	79.50	4
AVM	Diesel	1896	4	79.50	4
AVQ	Diesel	1896	4	79.50	4
AWX	Diesel	1896	4	79.50	4
AXB	Diesel	1896	4	79.50	4
AXC	Diesel	1896	4	79.50	4
AXD	Diesel	2461	5	81.00	6
AXE	Diesel	2461	5	81.00	6
AXG	Diesel	2461	5	81.00	6
AXL	Diesel	2461	5	81.00	6
AXR	Diesel	1896	4	79.50	4
AYC	Diesel	2461	5	81.00	6
AYQ	Diesel	1896	4	79.50	4
AYY	Diesel	2461	5	81.00	6
AZQ	Petrol	1198	3	76.50	2
BAC	Diesel	2461	5	81.00	6
BAY	Diesel	1422	3	79.50	4
BBE	Diesel	2461	5	81.00	6
BBF	Diesel	2461	5	81.00	6
BCT	Diesel	2461	5	81.00	6
BCU	Diesel	2461	5	81.00	6
BCV	Diesel	2461	5	81.00	6
BEU	Diesel	1896	4	79.50	4
BEW	Diesel	1896	4	79.50	4
BGG	Diesel	1896	4	79.50	4
BGL	Diesel	1896	4	79.50	4
BGM	Diesel	1896	4	79.50	4
BJB	Diesel	1896	4	79.50	4
BJC	Diesel	1896	4	79.50	4
BKC	Diesel	1896	4	79.50	4
BLJ	Diesel	2461	5	81.00	6
BLK	Diesel	2461	5	81.00	6
BLS	Diesel	1896	4	79.50	4
BLT	Diesel	1896	4	79.50	4
BMT	Diesel	1896	4	79.50	4
BPD	Diesel	2461	5	81.00	6
BRR	Diesel	1896	4	79.50	4
BRS	Diesel	1896	4	79.50	4
BRU	Diesel	1896	4	79.50	4
BSU	Diesel	1896	4	79.50	4
BSW	Diesel	1896	4	79.50	4
BTW	Diesel	2460	5	81.00	6
BVK	Diesel	1896	4	79.50	4

# ENGINE INDEX

Motorverzeichnis • Index de moteur • Índice de Motor  
Indeks silnika • Модель двигателя • دليل المحرك



CCM



9

BXE	Diesel	1896	4	79.50	4
BXF	Diesel	1896	4	79.50	4
BXJ	Diesel	1896	4	79.50	4
BXT	Diesel	1896	4	79.50	4
CDXA	Diesel	1896	4	79.50	4
CDXB	Diesel	1896	4	79.50	4
CECA	Diesel	2461	5	81.00	6
CECB	Diesel	2461	5	81.00	6
CG	Diesel	2710	4	92.00	8
CK	Diesel	1471	4	76.50	3
CP	Diesel	2383	6	76.50	2
CR	Diesel	1588	4	76.50	2
CS	Diesel	1588	4	76.50	2
CY	Diesel	1588	4	76.50	2
DV	Diesel	2383	6	76.50	2
DW	Diesel	2383	6	76.50	2
GK	Petrol	1272	4	75.00	1
HK	Petrol	1272	4	75.00	1
HZ	Petrol	1043	4	75.00	1
JK	Diesel	1588	4	76.50	2
JP	Diesel	1588	4	76.50	2
JR	Diesel	1588	4	76.50	2
JX	Diesel	1588	4	76.50	2
ME	Diesel	1588	4	76.50	2
MF	Diesel	1588	4	76.50	2
MN	Diesel	1272	4	75.00	1
NZ	Petrol	1272	4	75.00	1
RA	Diesel	1588	4	76.50	2
SB	Diesel	1588	4	76.50	2
YJ	Petrol	1471	4	76.50	3
ZB	Petrol	1471	4	76.50	3
ZC	Petrol	1471	4	76.50	3



**1**

<b>1W</b>	4cyl.	<b>1398cc</b>	<b>35kW</b> (47PS)	<b>Diesel</b>	<b>TD4959</b>
<b>3F</b>	4cyl.	<b>1272cc</b>	<b>55-57kW</b> (75-78PS)		<b>TD4968</b>
<b>AAU</b>	4cyl.	<b>1043cc</b>	<b>33kW</b> (45PS)		<b>TD4971</b>
<b>AAV</b>	4cyl.	<b>1272cc</b>	<b>40kW</b> (54PS)		<b>TD5159</b>
<b>GK</b>	4cyl.	<b>1272cc</b>	<b>55kW</b> (75PS)		<b>TD4094</b>
<b>HK</b>	4cyl.	<b>1272cc</b>	<b>40kW</b> (54PS)		<b>TD5011</b>
<b>HZ</b>	4cyl.	<b>1043cc</b>	<b>33-37kW</b> (45-50PS)		<b>TD5012</b>
<b>MN</b>	4cyl.	<b>1272cc</b>	<b>33kW</b> (45PS)	<b>Diesel</b>	<b>TD4132</b>
<b>NZ</b>	4cyl.	<b>1272cc</b>	<b>40kW</b> (54PS)		<b>TD4136</b>

14-025070-00 *D*

**75.00**

**B 78.00**

**C 133.00**

**D 81.00**

**E 4.50**

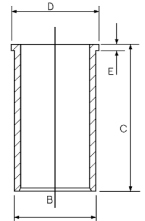

**2**

<b>1C</b>	4cyl.	<b>1600cc</b>	<b>51kW</b> (69PS)	<b>Diesel Turbo</b>	<b>TD13489</b>
<b>1G</b>	6cyl.	<b>2383cc</b>	<b>68kW</b> (92PS)	<b>Diesel Turbo</b>	<b>TD3993</b>
<b>1V</b>	4cyl.	<b>1588cc</b>	<b>44kW</b> (60PS)	<b>Diesel Turbo</b>	<b>TD3996</b>
<b>1S</b>	6cyl.	<b>2383cc</b>	<b>51kW</b> (69PS)	<b>Diesel</b>	<b>TD4958</b>
<b>68A</b>	4cyl.	<b>1588cc</b>	<b>45kW</b> (61PS)	<b>Diesel Turbo</b>	<b>TD22615</b>
<b>68C</b>	4cyl.	<b>1588cc</b>	<b>50kW</b> (68PS)	<b>Diesel Turbo</b>	<b>TD22616</b>
<b>686</b>	4cyl.	<b>1588cc</b>	<b>45kW</b> (61PS)	<b>Diesel Turbo</b>	<b>TD22614</b>
<b>ACL</b>	6cyl.	<b>2384cc</b>	<b>70kW</b> (95PS)	<b>Diesel Turbo</b>	<b>TD4012</b>
<b>ACT</b>	6cyl.	<b>2384cc</b>	<b>51kW</b> (69PS)	<b>Diesel</b>	<b>TD4014</b>
<b>ADK</b>	4cyl.	<b>1588cc</b>	<b>40kW</b> (54PS)	<b>Diesel</b>	<b>TD22619</b>
<b>AEA</b>	4cyl.	<b>1598cc</b>	<b>55kW</b> (75PS)		<b>TD4019</b>
<b>AEE</b>	4cyl.	<b>1598cc</b>	<b>55kW</b> (75PS)		<b>TD4981</b>
<b>AEX</b>	4cyl.	<b>1390cc</b>	<b>40-44kW</b> (54-60PS)		<b>TD4984</b>
<b>AHS</b>	4cyl.	<b>1588cc</b>	<b>55kW</b> (75PS)		<b>TD12948</b>
<b>AKV</b>	4cyl.	<b>1390cc</b>	<b>44kW</b> (60PS)		<b>TD9688</b>
<b>ALM</b>	4cyl.	<b>1598cc</b>	<b>55kW</b> (75PS)		<b>TD15610</b>
<b>ANX</b>	4cyl.	<b>1389cc</b>	<b>44kW</b> (60PS)		<b>TD15613</b>
<b>APQ</b>	4cyl.	<b>1390cc</b>	<b>44kW</b> (60PS)		<b>TD15614</b>
<b>AZQ</b>	3cyl.	<b>1198cc</b>	<b>47kW</b> (64PS)		<b>TD16333</b>
<b>CP</b>	6cyl.	<b>2383cc</b>	<b>55kW</b> (75PS)	<b>Diesel</b>	<b>TD4047</b>
<b>CR</b>	4cyl.	<b>1588cc</b>	<b>40kW</b> (54PS)	<b>Diesel</b>	<b>TD4992</b>
<b>CS</b>	4cyl.	<b>1588cc</b>	<b>37kW</b> (50PS)	<b>Diesel</b>	<b>TD4048</b>
<b>CY</b>	4cyl.	<b>1588cc</b>	<b>51kW</b> (69PS)	<b>Diesel Turbo</b>	<b>TD4052</b>
<b>DV</b>	6cyl.	<b>2383cc</b>	<b>75-80kW</b> (102-109PS)	<b>Diesel Turbo</b>	<b>TD4061</b>
<b>DW</b>	6cyl.	<b>2383cc</b>	<b>55-57kW</b> (75-78PS)	<b>Diesel</b>	<b>TD4062</b>
<b>JK</b>	4cyl.	<b>1588cc</b>	<b>40kW</b> (54PS)	<b>Diesel</b>	<b>TD5013</b>
<b>JP</b>	4cyl.	<b>1588cc</b>	<b>40kW</b> (54PS)	<b>Diesel</b>	<b>TD4120</b>
<b>JR</b>	4cyl.	<b>1588cc</b>	<b>51kW</b> (69PS)	<b>Diesel Turbo</b>	<b>TD4121</b>





<b>JX</b>	4cyl.	<b>1588cc</b>	<b>50kW</b> (68PS)	<b>Diesel Turbo</b>	<b>TD5018</b>
<b>ME</b>	4cyl.	<b>1588cc</b>	<b>40kW</b> (54PS)	<b>Diesel</b>	<b>TD4129</b>
<b>MF</b>	4cyl.	<b>1588cc</b>	<b>51kW</b> (69PS)	<b>Diesel Turbo</b>	<b>TD4130</b>
<b>RA</b>	4cyl.	<b>1588cc</b>	<b>59kW</b> (80PS)	<b>Diesel Turbo Intercooled</b>	<b>TD5024</b>
<b>SB</b>	4cyl.	<b>1588cc</b>	<b>59kW</b> (80PS)	<b>Diesel Turbo Intercooled</b>	<b>TD5028</b>

14-021571-00 D  
14-028360-00 D 1

76.50

B 79.56 C 142.00 D 82.50 E 4.50  
B 79.50 C 145.00 D 81.50 E 4.70

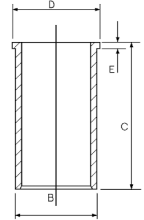

1 With recesses on crankshaft side

1 Mit kurbelwellenseitigen Aussparungen

1 Avec évidements côté vilebrequin

1 Con escotaduras en la cara del cigüeñal

<b>3</b>					
<b>CK</b>	4cyl.	<b>1471cc</b>	<b>37kW</b> (50PS)	<b>Diesel</b>	<b>TD4046</b>
<b>YJ</b>	4cyl.	<b>1471cc</b>	<b>55kW</b> (75PS)		<b>TD5033</b>
<b>ZB</b>	4cyl.	<b>1471cc</b>	<b>55kW</b> (75PS)		<b>TD5037</b>
<b>ZC</b>	4cyl.	<b>1471cc</b>	<b>63kW</b> (86PS)		<b>TD5141</b>

14-023470-00 D 2  
14-024670-00 D  
14-028360-00 D 1

76.50

B 79.50 C 142.00 D 82.50 E 4.70  
B 79.50 C 145.00 D 81.50 E 4.70  
B 79.50 C 145.00 D 81.50 E 4.70

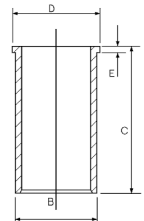

1 With recesses on crankshaft side

1 Mit kurbelwellenseitigen Aussparungen

1 Avec évidements côté vilebrequin

1 Con escotaduras en la cara del cigüeñal

2 Phosphated

2 Phosphatiert

2 Phosphatisé

2 Fosfatada

<b>4</b>					
<b>1X</b>	4cyl.	<b>1896cc</b>	<b>44kW</b> (60PS)	<b>Diesel</b>	<b>TD3997</b>
<b>1Y</b>	4cyl.	<b>1896cc</b>	<b>47-50kW</b> (64-68PS)	<b>Diesel</b>	<b>TD4960</b>
<b>1Z</b>	4cyl.	<b>1896cc</b>	<b>66kW</b> (89PS)	<b>Diesel Turbo Intercooled</b>	<b>TD4961</b>
<b>28B</b>	4cyl.	<b>1896cc</b>	<b>48kW</b> (65PS)	<b>Diesel</b>	<b>TD22609</b>
<b>AAB</b>	5cyl.	<b>2370cc</b>	<b>57kW</b> (77PS)	<b>Diesel</b>	<b>TD4000</b>
<b>AAZ</b>	4cyl.	<b>1896cc</b>	<b>55kW</b> (75PS)	<b>Diesel Turbo</b>	<b>TD4972</b>
<b>ABL</b>	4cyl.	<b>1896cc</b>	<b>50kW</b> (68PS)	<b>Diesel Turbo</b>	<b>TD4009</b>
<b>ADE</b>	4cyl.	<b>1896cc</b>	<b>55kW</b> (75PS)	<b>Diesel Turbo</b>	<b>TD20097</b>
<b>ADG</b>	4cyl.	<b>1896cc</b>	<b>48kW</b> (65PS)	<b>Diesel</b>	<b>TD20098</b>
<b>AEF</b>	4cyl.	<b>1896cc</b>	<b>47kW</b> (64PS)	<b>Diesel</b>	<b>TD4020</b>
<b>AEY</b>	4cyl.	<b>1896cc</b>	<b>47kW</b> (64PS)	<b>Diesel</b>	<b>TD4985</b>
<b>AFD</b>	4cyl.	<b>1896cc</b>	<b>58kW</b> (79PS)	<b>Diesel Turbo</b>	<b>TD16184</b>
<b>AFN</b>	4cyl.	<b>1896cc</b>	<b>81kW</b> (110PS)	<b>Diesel Turbo Intercooled</b>	<b>TD4987</b>
<b>AGD</b>	4cyl.	<b>1896cc</b>	<b>47kW</b> (64PS)	<b>Diesel</b>	<b>TD9372</b>
<b>AGP</b>	4cyl.	<b>1896cc</b>	<b>50kW</b> (68PS)	<b>Diesel</b>	<b>TD9452</b>
<b>AGR</b>	4cyl.	<b>1896cc</b>	<b>66kW</b> (89PS)	<b>Diesel Turbo Intercooled</b>	<b>TD9364</b>
<b>AHB</b>	4cyl.	<b>1716cc</b>	<b>42kW</b> (57PS)	<b>Diesel</b>	<b>TD15028</b>
<b>AHF</b>	4cyl.	<b>1896cc</b>	<b>81kW</b> (110PS)	<b>Diesel Turbo Intercooled</b>	<b>TD9788</b>





AHG	4cyl.	1716cc	42kW (57PS)	Diesel		TD11207
AHH	4cyl.	1896cc	66kW (89PS)	Diesel	Turbo Intercooled	TD10927
AHU	4cyl.	1896cc	66kW (89PS)	Diesel	Turbo Intercooled	TD4990
AJA	5cyl.	2370cc	55kW (75PS)	Diesel		TD11049
AJM	4cyl.	1896cc	85kW (116PS)	Diesel	Turbo Intercooled	TD12588
AKU	4cyl.	1716cc	44kW (60PS)	Diesel		TD9513
AKW	4cyl.	1716cc	42kW (57PS)	Diesel		TD9687
ALE	4cyl.	1896cc	66kW (89PS)	Diesel	Turbo Intercooled	TD9512
ALH	4cyl.	1896cc	66kW (89PS)	Diesel	Turbo Intercooled	TD9455
AMF	3cyl.	1422cc	55kW (75PS)	Diesel	Turbo Intercooled	TD12589
ANC	4cyl.	1896cc	44kW (60PS)	Diesel		TD20491
ANU	4cyl.	1896cc	66kW (89PS)	Diesel	Turbo Intercooled	TD13443
AQM	4cyl.	1896cc	50kW (68PS)	Diesel	Turbo Intercooled	TD11351
ARD	4cyl.	1896cc	44kW (60PS)	Diesel		TD20099
ARL	4cyl.	1896cc	110kW (150PS)	Diesel	Turbo Intercooled	TD15484
ASV	4cyl.	1896cc	81kW (110PS)	Diesel	Turbo Intercooled	TD13773
ASX	4cyl.	1896cc	47kW (64PS)	Diesel		TD15495
ASY	4cyl.	1896cc	47kW (64PS)	Diesel		TD16338
ASZ	4cyl.	1896cc	96kW (131PS)	Diesel	Turbo Intercooled	TD16231
ATD	4cyl.	1896cc	74kW (100PS)	Diesel	Turbo Intercooled	TD15473
ATJ	4cyl.	1896cc	85kW (116PS)	Diesel	Turbo Intercooled	TD16258
AUY	4cyl.	1896cc	85kW (116PS)	Diesel	Turbo Intercooled	TD14915
AVB	4cyl.	1896cc	74kW (100PS)	Diesel	Turbo Intercooled	TD15152
AVF	4cyl.	1896cc	96kW (131PS)	Diesel	Turbo Intercooled	TD15153
AVG	4cyl.	1896cc	81kW (110PS)	Diesel	Turbo Intercooled	TD14988
AVM Euro 3	4cyl.	1896cc	63kW (86PS)	Diesel	Turbo	TD18705
AVQ	4cyl.	1896cc	74kW (100PS)	Diesel	Turbo Intercooled	TD16861
AWX	4cyl.	1896cc	96kW (131PS)	Diesel	Turbo Intercooled	TD15154
AXB	4cyl.	1896cc	77kW (105PS)	Diesel	Turbo Intercooled	TD16867
AXC	4cyl.	1896cc	63kW (86PS)	Diesel	Turbo Intercooled	TD16881
AXR	4cyl.	1896cc	74kW (100PS)	Diesel	Turbo Intercooled	TD16337
AYQ	4cyl.	1896cc	47kW (64PS)	Diesel		TD16863
BAY	3cyl.	1422cc	55kW (75PS)	Diesel	Turbo Intercooled	TD16336
BEU	4cyl.	1896cc	33kW (45PS)	Diesel	Turbo	TD20101
BEW	4cyl.	1896cc	74kW (100PS)	Diesel	Turbo Intercooled	TD19255
BGG	4cyl.	1896cc	47kW (64PS)	Diesel		TD21349
BGL	4cyl.	1896cc	37kW (50PS)	Diesel		TD25870
BGM	4cyl.	1896cc	29kW (39PS)	Diesel		TD25871
BJB	4cyl.	1896cc	77kW (105PS)	Diesel	Turbo Intercooled	TD17078
BJC	4cyl.	1896cc	53kW (72PS)	Diesel	Turbo Intercooled	TD22453
BKC	4cyl.	1896cc	77kW (105PS)	Diesel	Turbo Intercooled	TD17079
BLS	4cyl.	1896cc	77kW (105PS)	Diesel	Turbo Intercooled	TD18224
BLT	4cyl.	1896cc	96kW (131PS)	Diesel	Turbo Intercooled	TD17467
BMT	4cyl.	1896cc	74kW (100PS)	Diesel	Turbo Intercooled	TD20494
BRR	4cyl.	1896cc	62kW (84PS)	Diesel	Turbo Intercooled	TD20159





<b>BRS</b>	4cyl.	<b>1896cc</b>	<b>75kW</b> (102PS)	<b>Diesel</b>	<b>Turbo Intercooled</b>	<b>TD18994</b>
<b>BRU</b>	4cyl.	<b>1896cc</b>	<b>66kW</b> (89PS)	<b>Diesel</b>	<b>Turbo Intercooled</b>	<b>TD17468</b>
<b>BSU</b>	4cyl.	<b>1896cc</b>	<b>55kW</b> (75PS)	<b>Diesel</b>	<b>Turbo Intercooled</b>	<b>TD18755</b>
<b>BSW</b>	4cyl.	<b>1896cc</b>	<b>77kW</b> (105PS)	<b>Diesel</b>	<b>Turbo Intercooled</b>	<b>TD18771</b>
<b>BVK</b>	4cyl.	<b>1896cc</b>	<b>85kW</b> (116PS)	<b>Diesel</b>	<b>Turbo Intercooled</b>	<b>TD20489</b>
<b>BXE</b>	4cyl.	<b>1896cc</b>	<b>77kW</b> (105PS)	<b>Diesel</b>	<b>Turbo Intercooled</b>	<b>TD18908</b>
<b>BXF</b>	4cyl.	<b>1896cc</b>	<b>66kW</b> (89PS)	<b>Diesel</b>	<b>Turbo Intercooled</b>	<b>TD18907</b>
<b>BXJ</b>	4cyl.	<b>1896cc</b>	<b>66kW</b> (89PS)	<b>Diesel</b>	<b>Turbo Intercooled</b>	<b>TD20493</b>
<b>BXT</b>	4cyl.	<b>1896cc</b>	<b>30kW</b> (41PS)	<b>Diesel</b>	<b>Turbo</b>	<b>TD25869</b>
<b>CDXA</b>	4cyl.	<b>1896cc</b>	<b>55kW</b> (75PS)	<b>Diesel</b>		<b>TD23291</b>
<b>CDXB</b>	4cyl.	<b>1896cc</b>	<b>29kW</b> (39PS)	<b>Diesel</b>		<b>TD23292</b>

14-027950-00 *D*      79.50      B 82.50      C 152.00      D 85.50      E 4.70

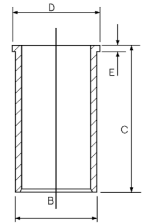

**5**

<b>0262</b>	4cyl.	<b>1781cc</b>	<b>50kW</b> (68PS)			<b>TD27063</b>
-------------	-------	---------------	--------------------	--	--	----------------

14-021571-00 *D*      81.00      B 79.56      C 142.00      D 82.50      E 4.50  
 14-028360-00 *D* ①      B 79.50      C 145.00      D 81.50      E 4.70

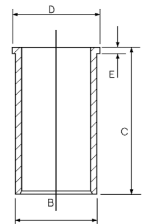

① With recesses on crankshaft side

① Mit kurbelwellenseitigen Aussparungen

① Avec évidements côté vilebrequin

① Con escotaduras en la cara del cigüeñal

**6**

<b>ACV</b>	5cyl.	<b>2461cc</b>	<b>74kW</b> (100PS)	<b>Diesel</b>	<b>Turbo Intercooled</b>	<b>TD4978</b>
<b>AGX</b>	5cyl.	<b>2459cc</b>	<b>55kW</b> (75PS)	<b>Diesel</b>	<b>Turbo Intercooled</b>	<b>TD9295</b>
<b>AHD</b>	5cyl.	<b>2459cc</b>	<b>75kW</b> (102PS)	<b>Diesel</b>	<b>Turbo Intercooled</b>	<b>TD9294</b>
<b>AHY</b>	5cyl.	<b>2461cc</b>	<b>111kW</b> (151PS)	<b>Diesel</b>	<b>Turbo Intercooled</b>	<b>TD10748</b>
<b>AJT</b>	5cyl.	<b>2461cc</b>	<b>65kW</b> (88PS)	<b>Diesel</b>	<b>Turbo Intercooled</b>	<b>TD10747</b>
<b>ANF</b>	5cyl.	<b>2461cc</b>	<b>55kW</b> (75PS)	<b>Diesel</b>		<b>TD20502</b>
<b>ANG</b>	5cyl.	<b>2461cc</b>	<b>88kW</b> (120PS)	<b>Diesel</b>	<b>Turbo</b>	<b>TD20503</b>
<b>ANH</b>	5cyl.	<b>2461cc</b>	<b>111kW</b> (151PS)	<b>Diesel</b>	<b>Turbo</b>	<b>TD20504</b>
<b>ANJ</b>	5cyl.	<b>2461cc</b>	<b>80kW</b> (109PS)	<b>Diesel</b>	<b>Turbo Intercooled</b>	<b>TD13446</b>
<b>APA</b>	5cyl.	<b>2461cc</b>	<b>66kW</b> (89PS)	<b>Diesel</b>	<b>Turbo Intercooled</b>	<b>TD13445</b>
<b>AUF</b>	5cyl.	<b>2461cc</b>	<b>75kW</b> (102PS)	<b>Diesel</b>	<b>Turbo Intercooled</b>	<b>TD16857</b>
<b>AXD</b>	5cyl.	<b>2461cc</b>	<b>96kW</b> (131PS)	<b>Diesel</b>	<b>Turbo Intercooled</b>	<b>TD16868</b>
<b>AXE</b>	5cyl.	<b>2461cc</b>	<b>128kW</b> (174PS)	<b>Diesel</b>	<b>Turbo Intercooled</b>	<b>TD16869</b>
<b>AXG</b>	5cyl.	<b>2461cc</b>	<b>111kW</b> (151PS)	<b>Diesel</b>	<b>Turbo Intercooled</b>	<b>TD17505</b>
<b>AXL</b>	5cyl.	<b>2461cc</b>	<b>75kW</b> (102PS)	<b>Diesel</b>	<b>Turbo Intercooled</b>	<b>TD18687</b>
<b>AYC</b>	5cyl.	<b>2461cc</b>	<b>75kW</b> (102PS)	<b>Diesel</b>	<b>Turbo Intercooled</b>	<b>TD17504</b>
<b>AYY</b>	5cyl.	<b>2461cc</b>	<b>65kW</b> (88PS)	<b>Diesel</b>	<b>Turbo Intercooled</b>	<b>TD17503</b>





<b>BAC</b>	5cyl.	<b>2461cc</b>	<b>128kW</b> (174PS)	<b>Diesel</b>	<b>Turbo Intercooled</b>	<b>TD16855</b>
<b>BBE</b>	5cyl.	<b>2461cc</b>	<b>61kW</b> (82PS)	<b>Diesel</b>	<b>Turbo Intercooled</b>	<b>TD16451</b>
<b>BBF</b>	5cyl.	<b>2461cc</b>	<b>70kW</b> (95PS)	<b>Diesel</b>	<b>Turbo Intercooled</b>	<b>TD16452</b>
<b>BCT</b>	5cyl.	<b>2461cc</b>	<b>40kW</b> (54PS)	<b>Diesel</b>		<b>TD22630</b>
<b>BCU</b>	5cyl.	<b>2461cc</b>	<b>74kW</b> (100PS)	<b>Diesel</b>	<b>Turbo</b>	<b>TD22631</b>
<b>BCV</b>	5cyl.	<b>2461cc</b>	<b>108kW</b> (147PS)	<b>Diesel</b>	<b>Turbo Intercooled</b>	<b>TD22632</b>
<b>BLJ</b>	5cyl.	<b>2461cc</b>	<b>120kW</b> (163PS)	<b>Diesel</b>	<b>Turbo Intercooled</b>	<b>TD20505</b>
<b>BLK</b>	5cyl.	<b>2461cc</b>	<b>120kW</b> (163PS)	<b>Diesel</b>	<b>Turbo Intercooled</b>	<b>TD20506</b>
<b>BPD</b>	5cyl.	<b>2461cc</b>	<b>120kW</b> (163PS)	<b>Diesel</b>	<b>Turbo Intercooled</b>	<b>TD20507</b>
<b>BTW</b>	5cyl.	<b>2460cc</b>	<b>121kW</b> (165PS)	<b>Diesel</b>	<b>Turbo Intercooled</b>	<b>TD20676</b>
<b>CECA</b>	5cyl.	<b>2461cc</b>	<b>100kW</b> (136PS)	<b>Diesel</b>	<b>Turbo Intercooled</b>	<b>TD24721</b>
<b>CECB</b>	5cyl.	<b>2461cc</b>	<b>120kW</b> (163PS)	<b>Diesel</b>	<b>Turbo Intercooled</b>	<b>TD24722</b>

14-020420-00 *D*  
14-020421-00 *D*

**81.00**

**B** 84.00    **C** 158.00    **D** 85.00    **E** 5.00  
**B** 84.50    **C** 158.00    **D** 85.50    **E** 5.50

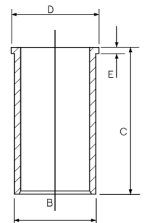

**7**

<b>2L</b>	4cyl.	<b>2446cc</b>	<b>58kW</b> (79PS)	<b>Diesel</b>		<b>TD4966</b>
-----------	-------	---------------	--------------------	---------------	--	---------------

14-010850-00 *D*

**92.00**

**B** 96.075    **C** 179.00

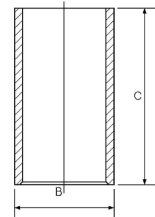

14-040130-00 *D*

**92.00**

**B** 96.00    **C** 160.00    **D** 100.80    **E** 3.50    **F** 1.00

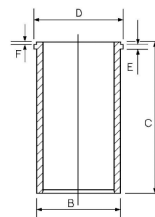

**8**

<b>CG</b>	4cyl.	<b>2710cc</b>	<b>48kW</b> (65PS)	<b>Diesel</b>		<b>TD11148</b>
-----------	-------	---------------	--------------------	---------------	--	----------------

14-043450-00 *D*

**92.00**

**B** 96.914    **C** 191.19    **D** 101.00    **E** 3.91    **F** 0.70

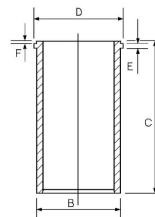

# MODEL INDEX



Modelverzeichnis • Index de modele • Índice de Modelo  
Indeks modelu • Модель автомобиля • دليل الموديل



CCM

x



9

08/75→11/79	<b>66 1.1</b>	B 10	Petrol	1108	4	<b>1</b>
08/75→11/79	<b>66 1.3</b>	B 130	Petrol	1289	4	<b>2</b>
09/78→10/80	<b>240 2.0</b>	D 20	Diesel	1986	5	<b>4</b>
08/78→08/93	<b>240 2.4</b>	D 24	Diesel	2383	6	<b>4</b>
09/79→12/81	<b>260 2.4</b>	D 24	Diesel	2383	6	<b>4</b>
01/89→12/90	<b>340-360 1.3</b>	B 13	Petrol	1289	4	<b>2</b>
08/75→12/88	<b>340-360 1.4</b>	B 14.4 S, B 143 E	Petrol	1397	4	<b>3</b>
08/84→07/91	<b>340-360 1.6</b>	D 16	Diesel	1595	4	<b>5</b>
08/84→07/92	<b>740 2.4</b>	D 24, D 24 T, D 24 TIC	Diesel	2383	6	<b>4</b>
01/82→07/92	<b>760 2.4</b>	D 24, D 24 T, D 24 TIC	Diesel	2383	6	<b>4</b>
04/86→07/90	<b>780 2.4</b>	D 24 TIC	Diesel	2383	6	<b>4</b>
08/90→07/95	<b>940 2.4</b>	D 24, D 24 T, D 24 TIC	Diesel	2383	6	<b>4</b>
08/94→10/98	<b>940 II 2.4</b>	D 24 TIC	Diesel	2383	6	<b>4</b>
09/90→07/94	<b>960 2.4</b>	D 24 TIC	Diesel	2383	6	<b>4</b>

# ENGINE INDEX

Motorverzeichnis • Index de moteur • Índice de Motor  
Indeks silnika • Модель двигателя • دليل المحرك



CCM

x



9

<b>B 10</b>	Petrol	1108	4	70.00	<b>1</b>
<b>B 10 E</b>	Petrol	1108	4	70.00	<b>1</b>
<b>B 13</b>	Petrol	1289	4	73.00	<b>2</b>
<b>B 13 E</b>	Petrol	1289	4	73.00	<b>2</b>
<b>B 130</b>	Petrol	1289	4	73.00	<b>2</b>
<b>B 14 OE</b>	Petrol	1397	4	76.00	<b>3</b>
<b>B 14.4 S</b>	Petrol	1397	4	76.00	<b>3</b>
<b>B 143 E</b>	Petrol	1397	4	76.00	<b>3</b>
<b>D 16</b>	Diesel	1595	4	78.00	<b>5</b>
<b>D 20</b>	Diesel	1986	5	76.50	<b>4</b>
<b>D 24</b>	Diesel	2383	6	76.50	<b>4</b>
<b>D 24 T</b>	Diesel	2383	6	76.50	<b>4</b>
<b>D 24 TIC</b>	Diesel	2383	6	76.50	<b>4</b>





1

**B 10** 4cyl. **1108cc** **33kW** (45PS) **TD3980**

**B 10 E** 4cyl. **1108cc** **33-35kW** (45-48PS) **TD21325**

14-636730-00 *WH* 70.00 B 75.50 C 135.00 D 85.70 E 94.80

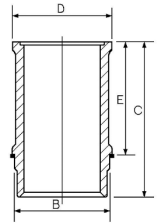

2

**B 13** 4cyl. **1289cc** **49kW** (67PS) **TD3987**

**B 13 E** 4cyl. **1289cc** **42kW** (57PS) **TD21326**

**B 130** 4cyl. **1289cc** **42kW** (57PS) **TD3904**

14-630440-00 *WH* 73.00 B 78.50 C 134.00 D 88.00 E 95.00  
15-636590-00 *WH* B 78.50 C 134.00 D 87.70 E 95.00

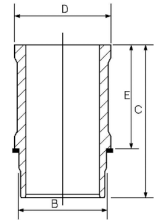

Includes seals Schließt Dichtungen ein Includ des joints Incluye los sellos

3

**B 14 OE** 4cyl. **1397cc** **51kW** (69PS) **TD23445**

**B 14.4 S** 4cyl. **1397cc** **50-53kW** (68-72PS) **TD5142**

**B 143 E** 4cyl. **1397cc** **46-53kW** (63-72PS) **TD3988**

15-630820-00 *WH* 76.00 B 80.60 C 134.00 D 90.20 E 95.00

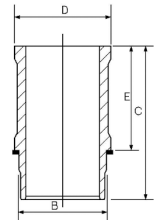

Includes seals Schließt Dichtungen ein Includ des joints Incluye los sellos

4

**D 20** 5cyl. **1986cc** **50kW** (68PS) **Diesel** **TD3983**

**D 24** 6cyl. **2383cc** **58-60kW** (79-82PS) **Diesel** **TD3984**

**D 24 T** 6cyl. **2383cc** **79-82kW** (107-112PS) **Diesel Turbo** **TD3985**

**D 24 TIC** 6cyl. **2383cc** **85-95kW** (115-129PS) **Diesel Turbo Intercooled** **TD3986**

14-021571-00 *D* 76.50 B 79.56 C 142.00 D 82.50 E 4.50  
14-028360-00 *D* B 79.50 C 145.00 D 81.50 E 4.70

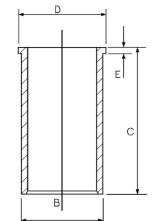

With recesses on crankshaft side Mit kurbelwellenseitigen Aussparungen Avec évidements côté vilebrequin Con escotaduras en la cara del cigüeñal



Motorverzeichnis • Index de moteur • Índice de Motor  
Indeks silnika • Модель двигателя • دليل المحرك

# ENGINE INDEX



CCM

x



9

4.236	Diesel	3866	4	98.48	4
D 100 A	Diesel	9600	6	120.65	13
D 100 B	Diesel	9600	6	120.65	13
D 16A	Diesel	16123	6	144.00	26
D 60	Diesel	5480	6	98.43	1
D 70 B	Diesel	6730	6	104.775	7
D100BHC	Diesel	9600	6	120.65	13
D100BRC	Diesel	9600	6	120.65	13
D10A320	Diesel	9600	6	120.65	17
D10B320	Diesel	9600	6	120.65	17
D11B430	Diesel	10800	6	123.00	18
D11C330	Diesel	10800	6	123.00	19
D11C370	Diesel	10800	6	123.00	19
D11C410	Diesel	10800	6	123.00	19
D12A340	Diesel	12100	6	131.00	24
D12A380	Diesel	12110	6	131.00	24
D12A420	Diesel	12100	6	131.00	24
D12C340	Diesel	12100	6	131.00	24
D12C380	Diesel	12100	6	131.00	24
D12C420	Diesel	12100	6	131.00	24
D12C460	Diesel	12100	6	131.00	24
D12D340	Diesel	12100	6	131.00	24
D12D380	Diesel	12100	6	131.00	24
D12D420	Diesel	12100	6	131.00	24
D12D460	Diesel	12100	6	131.00	24
D12D500	Diesel	12100	6	131.00	24
D13A360	Diesel	12800	6	131.00	25
D13A400	Diesel	12800	6	131.00	25
D13A440	Diesel	12800	6	131.00	25
D13A480	Diesel	12800	6	131.00	25
D13A520	Diesel	12800	6	131.00	25
D13C380	Diesel	12800	6	131.00	25
D13C420	Diesel	12800	6	131.00	25
D13C460	Diesel	12800	6	131.00	25
D13C500	Diesel	12800	6	131.00	25
D13C540	Diesel	12800	6	131.00	25
D16A470	Diesel	16120	6	144.00	26
D16A520	Diesel	16120	6	144.00	26
D16B520	Diesel	16120	6	144.00	26
D6A180	Diesel	5480	6	98.43	2
D6A210	Diesel	5480	6	98.43	2
D6A230	Diesel	5480	6	98.43	2
D6A250	Diesel	5480	6	98.43	2
D6B	Diesel	5480	6	98.43	2
D7A285	Diesel	6730	6	104.775	5
D7B230	Diesel	6730	6	104.775	5
D7B260	Diesel	6730	6	104.775	5
D7C215	Diesel	7300	6	107.00	8
D7C250	Diesel	7300	6	107.00	8
D7C275	Diesel	7300	6	107.00	8
D7C290	Diesel	7300	6	107.00	8
D7C310	Diesel	7300	6	107.00	8
D7E240	Diesel	7100	6	108.00	9
D7E280	Diesel	7100	6	108.00	9
D7E290	Diesel	7100	6	108.00	9
D7E320	Diesel	7100	6	108.00	9
D9A260	Diesel	9364	6	120.00	10
D9A300	Diesel	9364	6	120.00	10
D9A340	Diesel	9364	6	120.00	10
D9A380	Diesel	9364	6	120.00	10

# ENGINE INDEX

Motorverzeichnis • Index de moteur • Índice de Motor  
Indeks silnika • Модель двигателя • دليل المحرك



CCM



9

D9B260	Diesel	9364	6	120.01	11
D9B300	Diesel	9364	6	120.01	11
D9B310	Diesel	9364	6	120.01	11
D9B340	Diesel	9364	6	120.01	11
D9B360	Diesel	9364	6	120.01	11
D9B380	Diesel	9364	6	120.01	11
DH10A	Diesel	9600	6	120.65	17
DH12D340	Diesel	12100	6	131.00	24
DH12D420	Diesel	12100	6	131.00	24
HD 100 A	Diesel	9600	6	120.65	13
HD 100 D	Diesel	9600	6	120.65	13
MD 100A	Diesel	9600	6	120.65	13
MD 100B	Diesel	9600	6	120.65	13
MD 70	Diesel	6730	6	104.775	7
TAMD 120 A	Diesel	11977	6	130.175	21
TAMD 120 B	Diesel	11977	6	130.175	21
TAMD 121	Diesel	11975	6	130.175	21
TAMD 60	Diesel	5480	6	98.43	1
TAMD 70	Diesel	6730	6	104.775	7
TD 100 A	Diesel	9600	6	120.65	12
TD 100 AHC	Diesel	9600	6	120.65	12
TD 100 ARC	Diesel	9600	6	120.65	12
TD 100 B	Diesel	9600	6	120.65	15
TD 100 CHC	Diesel	9600	6	120.65	15
TD 100 F	Diesel	9600	6	120.65	15
TD 100 G	Diesel	9600	6	120.65	15
TD 100 GA	Diesel	9600	6	120.65	15
TD 100 GB	Diesel	9600	6	120.65	16
TD 100 GG	Diesel	9600	6	120.65	16
TD 101	Diesel	9599	6	120.65	16
TD 101 F	Diesel	9600	6	120.65	15
TD 101 FA	Diesel	9600	6	120.65	15
TD 101 FC	Diesel	9600	6	120.65	15
TD 101 FD	Diesel	9600	6	120.65	15
TD 101 G	Diesel	9600	6	120.65	15
TD 101 GA	Diesel	9600	6	120.65	15
TD 102 F	Diesel	9600	6	120.65	17
TD 102 FAQ	Diesel	9600	6	120.65	17
TD 102 FBQ	Diesel	9600	6	120.65	17
TD 102 FCQ	Diesel	9600	6	120.65	17
TD 102 FD	Diesel	9600	6	120.65	17
TD 102 FDQ	Diesel	9600	6	120.65	17
TD 102 FEQ	Diesel	9600	6	120.65	17
TD 102 FF	Diesel	9600	6	120.65	17
TD 102 FGQ	Diesel	9600	6	120.65	17
TD 102 FH	Diesel	9600	6	120.65	17
TD 102 FL	Diesel	9600	6	120.65	17
TD 102 FM	Diesel	9600	6	120.65	17
TD 102 FQ	Diesel	9600	6	120.65	17
TD 102 FS	Diesel	9600	6	120.65	17
TD 102 FT	Diesel	9595	6	120.65	17
TD 103 D10	Diesel	9600	6	120.65	17
TD 103 E	Diesel	9600	6	120.65	17
TD 103 EA	Diesel	9600	6	120.65	17
TD 103 ES	Diesel	9600	6	120.65	17
TD 103 KBE	Diesel	9600	6	120.65	17
TD 103 KF	Diesel	9600	6	120.65	17
TD 120 A	Diesel	12000	6	130.175	21
TD 120 C	Diesel	12000	6	130.175	21
TD 120 D	Diesel	11980	6	130.175	21

Motorverzeichnis • Index de moteur • Índice de Motor  
Indeks silnika • Модель двигателя • دليل المحرك

# ENGINE INDEX



CCM

x



9

TD 120 E	Diesel	11980	6	130.175	21
TD 120 F	Diesel	11980	6	130.175	21
TD 120 FA	Diesel	11980	6	130.175	22
TD 120 FB	Diesel	11980	6	130.175	22
TD 120 FC	Diesel	11980	6	130.175	21
TD 120 FTQ	Diesel	11980	6	130.175	22
TD 120 G	Diesel	11980	6	130.175	21
TD 120 GA	Diesel	11980	6	130.175	21
TD 120 GG	Diesel	11977	6	130.175	21
TD 121 F	Diesel	11980	6	130.175	21
TD 121 FD	Diesel	11980	6	130.175	21
TD 121 FH	Diesel	11980	6	130.175	22
TD 121 FK	Diesel	11980	6	130.175	22
TD 121 G	Diesel	11980	6	130.175	21
TD 121 GD	Diesel	11980	6	130.175	21
TD 122	Diesel	11980	6	130.175	20
TD 122	Diesel	11980	6	130.175	22
TD 122 ED	Diesel	11980	6	130.175	22
TD 122 F	Diesel	11980	6	130.175	20
TD 122 FA	Diesel	11980	6	130.175	20
TD 122 FA	Diesel	11980	6	130.175	22
TD 122 FAQ	Diesel	11980	6	130.175	22
TD 122 FBQ	Diesel	11980	6	130.175	22
TD 122 FCQ	Diesel	11980	6	130.175	22
TD 122 FH	Diesel	11980	6	130.175	22
TD 122 FK	Diesel	11980	6	130.175	20
TD 122 FK	Diesel	11980	6	130.175	22
TD 122 FL	Diesel	11980	6	130.175	22
TD 122 FR	Diesel	11980	6	130.175	20
TD 122 FR	Diesel	11980	6	130.175	22
TD 122 FS	Diesel	11980	6	130.175	20
TD 163 ES	Diesel	16123	6	144.00	26
TD 60 A	Diesel	5480	6	98.43	1
TD 60 B	Diesel	5480	6	98.43	1
TD 60 C	Diesel	5480	6	98.43	1
TD 60 D	Diesel	5480	6	98.43	1
TD 60 DG	Diesel	5480	6	98.43	1
TD 61 B	Diesel	5480	6	98.43	1
TD 61 F	Diesel	5480	6	98.43	1
TD 61 FB	Diesel	5480	6	98.43	1
TD 61 G	Diesel	5480	6	98.43	1
TD 61 GA	Diesel	5480	6	98.43	1
TD 61 GB	Diesel	5480	6	98.43	1
TD 61 GC	Diesel	5480	6	98.43	1
TD 61 GE	Diesel	5480	6	98.43	1
TD 61 GS	Diesel	5480	6	98.43	1
TD 63 E	Diesel	5480	6	98.43	3
TD 63 ES	Diesel	5480	6	98.43	3
TD 70 A	Diesel	6730	6	104.775	7
TD 70 B	Diesel	6730	6	104.775	7
TD 70 C	Diesel	6730	6	104.775	7
TD 70 E	Diesel	6730	6	104.775	7
TD 70 ES	Diesel	6730	6	104.775	7
TD 70 F	Diesel	6730	6	104.775	7
TD 70 FS	Diesel	6730	6	104.775	7
TD 70 G	Diesel	6730	6	104.775	7
TD 70 H	Diesel	6730	6	104.775	7
TD 70 HA	Diesel	6730	6	104.775	7
TD 71 ACE	Diesel	6730	6	104.775	6
TD 71 AG	Diesel	6730	6	104.775	6

# ENGINE INDEX

Motorverzeichnis • Index de moteur • Índice de Motor  
Indeks silnika • Модель двигателя • دليل المحرك



CCM



9

<b>TD 71 AGP</b>	Diesel	6730	6	104.775	<b>6</b>
<b>TD 71 AP</b>	Diesel	6730	6	104.775	<b>6</b>
<b>TD 71 APB</b>	Diesel	6730	6	104.775	<b>6</b>
<b>TD 71 AW</b>	Diesel	6730	6	104.775	<b>6</b>
<b>TD 71 E</b>	Diesel	6730	6	104.775	<b>6</b>
<b>TD 71 F</b>	Diesel	6730	6	104.775	<b>6</b>
<b>TD 71 FA</b>	Diesel	6730	6	104.775	<b>6</b>
<b>TD 71 FC</b>	Diesel	6730	6	104.775	<b>6</b>
<b>TD 71 FD</b>	Diesel	6730	6	104.775	<b>6</b>
<b>TD 71 FQ</b>	Diesel	6730	6	104.775	<b>6</b>
<b>TD 71 FS</b>	Diesel	6730	6	104.775	<b>6</b>
<b>TD 71 FSQ</b>	Diesel	6730	6	104.775	<b>6</b>
<b>TD 71 G</b>	Diesel	6730	6	104.775	<b>6</b>
<b>THD 100 A</b>	Diesel	9600	6	120.65	<b>13</b>
<b>THD 100 D</b>	Diesel	9600	6	120.65	<b>12</b>
<b>THD 100 DB</b>	Diesel	9600	6	120.65	<b>15</b>
<b>THD 100 DC</b>	Diesel	9600	6	120.65	<b>15</b>
<b>THD 100 DD</b>	Diesel	9600	6	120.65	<b>15</b>
<b>THD 100 E</b>	Diesel	9600	6	120.65	<b>15</b>
<b>THD 100 EA</b>	Diesel	9600	6	120.65	<b>15</b>
<b>THD 100 EB</b>	Diesel	9600	6	120.65	<b>15</b>
<b>THD 100 EC</b>	Diesel	9600	6	120.65	<b>15</b>
<b>THD 100 ED</b>	Diesel	9600	6	120.65	<b>15</b>
<b>THD 100 EE</b>	Diesel	9600	6	120.65	<b>15</b>
<b>THD 100 EK</b>	Diesel	9600	6	120.65	<b>15</b>
<b>THD 101</b>	Diesel	9599	6	120.65	<b>16</b>
<b>THD 101 B</b>	Diesel	9600	6	120.65	<b>12</b>
<b>THD 101 G</b>	Diesel	9600	6	120.65	<b>16</b>
<b>THD 101 GB</b>	Diesel	9600	6	120.65	<b>15</b>
<b>THD 101 GC</b>	Diesel	9600	6	120.65	<b>15</b>
<b>THD 101 GD</b>	Diesel	9600	6	120.65	<b>15</b>
<b>THD 101 KB</b>	Diesel	9600	6	120.65	<b>15</b>
<b>THD 101 KC</b>	Diesel	9600	6	120.65	<b>15</b>
<b>THD 101 KE</b>	Diesel	9600	6	120.65	<b>15</b>
<b>THD 101 KF</b>	Diesel	9600	6	120.65	<b>16</b>
<b>THD 102 KA</b>	Diesel	9600	6	120.65	<b>14</b>
<b>THD 102 KB</b>	Diesel	9600	6	120.65	<b>14</b>
<b>THD 102 KD</b>	Diesel	9600	6	120.65	<b>17</b>
<b>THD 102 KF</b>	Diesel	9600	6	120.65	<b>14</b>
<b>THD 102 KJ</b>	Diesel	9600	6	120.65	<b>14</b>
<b>THD 103 KB</b>	Diesel	9600	6	120.65	<b>17</b>
<b>THD 103 KD</b>	Diesel	9600	6	120.65	<b>17</b>
<b>TID 100</b>	Diesel	9600	6	120.65	<b>16</b>
<b>TID 120 F</b>	Diesel	11977	6	130.175	<b>21</b>
<b>TID 121 B</b>	Diesel	11979	6	130.175	<b>23</b>
<b>TID 121 KG</b>	Diesel	11979	6	130.175	<b>23</b>
<b>TID 121 KP</b>	Diesel	11979	6	130.175	<b>23</b>
<b>TID 121 LG</b>	Diesel	11979	6	130.175	<b>23</b>
<b>TID 121 LP</b>	Diesel	11979	6	130.175	<b>23</b>
<b>TID 121 P</b>	Diesel	11979	6	130.175	<b>23</b>
<b>TMD 100 A</b>	Diesel	9600	6	120.65	<b>12</b>
<b>TMD 102</b>	Diesel	9599	6	120.65	<b>13</b>
<b>TMD 102 A</b>	Diesel	9599	6	120.65	<b>14</b>
<b>TMD 102 C</b>	Diesel	9599	6	120.65	<b>14</b>
<b>TMD 120 A</b>	Diesel	11977	6	130.175	<b>21</b>
<b>TMD 70</b>	Diesel	6730	6	104.775	<b>7</b>
<b>TWD 121 G</b>	Diesel	11979	6	130.175	<b>23</b>



**1**

D 60	6cyl.	5480cc	88kW (120PS)	Diesel			TD9146
TAMD 60	6cyl.	5480cc	113kW (154PS)	Diesel	Turbo		FM23661
TD 60 A	6cyl.	5480cc	132kW (180PS)	Diesel	Turbo		TD9095
TD 60 B	6cyl.	5480cc	128-132kW (174-180PS)	Diesel	Turbo		TD9096
TD 60 C	6cyl.	5480cc	108-113kW (147-154PS)	Diesel	Turbo		TD9147
TD 60 D	6cyl.	5480cc	108-113kW (147-154PS)	Diesel	Turbo Intercooled		TD23336
TD 60 DG	6cyl.	5480cc	108-113kW (147-154PS)	Diesel	Turbo Intercooled		TD23337
TD 61 B	6cyl.	5480cc	132kW (180PS)	Diesel	Turbo		FM5040
TD 61 F	6cyl.	5480cc	150-152kW (204-207PS)	Diesel	Turbo Intercooled		TD9225
TD 61 FB	6cyl.	5480cc	153kW (208PS)	Diesel	Turbo Intercooled		TD9211
TD 61 G	6cyl.	5480cc	108-152kW (147-207PS)	Diesel	Turbo Intercooled		TD9221
TD 61 GA	6cyl.	5480cc	112kW (152PS)	Diesel	Turbo		TD9222
TD 61 GB	6cyl.	5480cc	131-132kW (179-180PS)	Diesel	Turbo		TD6249
TD 61 GC	6cyl.	5480cc	132kW (180PS)	Diesel	Turbo		TD9226
TD 61 GE	6cyl.	5480cc	130kW (177PS)	Diesel	Turbo		TD9210
TD 61 GS	6cyl.	5480cc	131-132kW (179-180PS)	Diesel	Turbo		TD5902

15-458900-00 WH ②      98.43      B 110.00      C 237.20      D 119.10      E 9.66      F 3.60

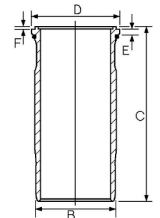

14-400510-00 WH ①      98.43      B 110.00      C 234.50      D 119.10      E 11.61      F 0.74

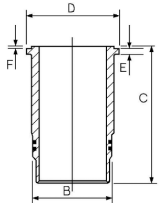

- ① Use also: HT005      ① A utiliser aussi: HT005      ① A utiliser aussi: HT005      ① Utilizar también: HT005
- ② Includes seals      ② Schließt Dichtungen ein      ② Inclut des joints      ② Incluye los sellos

**2**

D6A180 Euro 3	6cyl.	5480cc	132kW (180PS)	Diesel	Turbo Intercooled		TD9219
D6A210 Euro 3	6cyl.	5480cc	154kW (210PS)	Diesel	Turbo Intercooled		TD9220
D6A230 Euro 3	6cyl.	5480cc	169kW (230PS)	Diesel	Turbo Intercooled		TD9227
D6A250 Euro 3	6cyl.	5480cc	184kW (250PS)	Diesel	Turbo Intercooled		TD9228
D6B Euro 3	6cyl.	5480cc	132-184kW (180-250PS)	Diesel	Turbo Intercooled		TD17367

15-450130-00 WH ①      98.43      B 111.30      C 234.75      D 119.088      E 9.415      F 1.05

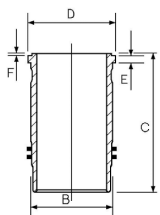

- ① Includes seals      ① Schließt Dichtungen ein      ① Inclut des joints      ① Incluye los sellos



3

**TD 63 E** 6cyl. **5480cc** **132kW** (180PS) **Diesel Turbo Intercooled** **TD9223**

**TD 63 ES** 6cyl. **5480cc** **154kW** (210PS) **Diesel Turbo Intercooled** **TD9224**

**15-459340-00 WH** ① **98.43** **B 111.50** **C 237.41** **D 119.11** **E 9.66** **F 3.60**

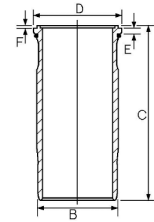

① Includes seals

① Schließt Dichtungen ein

① Inclut des joints

① Incluye los sellos

4

**4.236** 4cyl. **3866cc** **Diesel** **FM1360**

**14-021250-00 DH** ① **98.48** **B 104.20** **C 226.44** **D 107.37** **E 3.81**

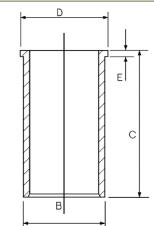

**14-040180-00 D** ② **98.48** **B 103.24** **C 227.28** **D 106.43** **E 3.71** **F 1.041**  
**14-040200-00 DH** ② **B 103.19** **C 227.28** **D 106.45** **E 3.86** **F 0.889**  
**14-045820-00 D** **B 103.33** **C 227.28** **D 106.42** **E 3.80** **F 0.90**  
**14-045821-00 D** **B 103.83** **C 227.28** **D 106.42** **E 3.80** **F 0.90**

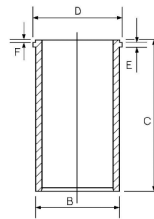

① Push fit, flanged, cast iron liner with 0.040" oversized outside diameter

① Geflanschte Gußeisen-Laufbuchse mit Schiebeseit und Außendur übermaß

① Chemise en fonte, à colerette ajustage gras, avec diamètre

① Camisa de fundición embridada, ajuste suave, con diámetro ext

② Press fit cast iron liner to replace original steel liner

② Anpressbare Laufbüchse aus Gueisen als Ersatz der original Stahlbüchse

② Chemise fonte à emmancher à la presse pour remplacer la chemise d'origine en acier

② Ajuste a presión la camisa de hierro fundido para reemplazar la camisa original de acero

5

**D7A285 Euro 2** 6cyl. **6730cc** **210kW** (286PS) **Diesel Turbo Intercooled** **TD9229**

**D7B230 Euro 2** 6cyl. **6730cc** **169kW** (230PS) **Diesel Turbo Intercooled** **TD9242**

**D7B260 Euro 2** 6cyl. **6730cc** **191kW** (260PS) **Diesel Turbo Intercooled** **TD9243**

**14-450890-00 WH** **104.78** **B 117.00** **C 257.00** **D 129.40** **E 9.40** **F 0.70**

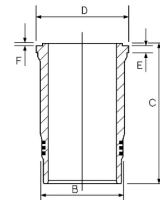

6

**TD 71 ACE** 6cyl. **6730cc** **169kW** (230PS) **Diesel Turbo Intercooled** **TD23334**

**TD 71 AG** 6cyl. **6730cc** **169kW** (230PS) **Diesel Turbo Intercooled** **TD23333**

**TD 71 AGP** 6cyl. **6730cc** **169kW** (230PS) **Diesel Turbo Intercooled** **TD23332**

**TD 71 AP** 6cyl. **6730cc** **169kW** (230PS) **Diesel Turbo Intercooled** **TD23331**

**TD 71 APB** 6cyl. **6730cc** **169kW** (230PS) **Diesel Turbo Intercooled** **TD23330**

**TD 71 AW** 6cyl. **6730cc** **169kW** (230PS) **Diesel Turbo Intercooled** **TD23329**







<b>TD 71 E</b>	6cyl.	<b>6730cc</b>	<b>180kW</b> (245PS)	<b>Diesel</b>	<b>Turbo Intercooled</b>	<b>FM5113</b>
<b>TD 71 F</b>	6cyl.	<b>6730cc</b>	<b>169-180kW</b> (220-245PS)	<b>Diesel</b>	<b>Turbo Intercooled</b>	<b>TD5903</b>
<b>TD 71 FA</b>	6cyl.	<b>6730cc</b>	<b>173kW</b> (235PS)	<b>Diesel</b>	<b>Turbo Intercooled</b>	<b>TD9212</b>
<b>TD 71 FC</b>	6cyl.	<b>6730cc</b>	<b>173kW</b> (235PS)	<b>Diesel</b>	<b>Turbo Intercooled</b>	<b>TD9213</b>
<b>TD 71 FD</b>	6cyl.	<b>6730cc</b>	<b>180kW</b> (245PS)	<b>Diesel</b>	<b>Turbo Intercooled</b>	<b>TD9232</b>
<b>TD 71 FQ</b>	6cyl.	<b>6730cc</b>	<b>169-173kW</b> (220-235PS)	<b>Diesel</b>	<b>Turbo Intercooled</b>	<b>TD6250</b>
<b>TD 71 FS</b>	6cyl.	<b>6730cc</b>	<b>178-184kW</b> (242-250PS)	<b>Diesel</b>	<b>Turbo Intercooled</b>	<b>TD5904</b>
<b>TD 71 FSQ</b>	6cyl.	<b>6730cc</b>	<b>169-184kW</b> (230-250PS)	<b>Diesel</b>	<b>Turbo Intercooled</b>	<b>TD6251</b>
<b>TD 71 G</b>	6cyl.	<b>6730cc</b>	<b>178-184kW</b> (242-250PS)	<b>Diesel</b>	<b>Turbo Intercooled</b>	<b>TD26265</b>

15-458910-00 WH ②① | 104.78 | B 116.94 | C 259.45 | D 127.01 | E 9.66 | F 3.60

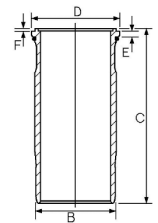

14-459050-00 WH ① | 104.78 | B 116.964 | C 259.45 | D 127.00 | E 9.66 | F 3.59

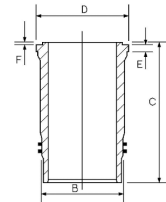

① Relief 18.25mm

① Entlastung 18.25mm

① Le relief 18.25mm

① Relevación 18.25mm

② Includes seals

② Schließt Dichtungen ein

② Inclut des joints

② Incluye los sellos

**7**

<b>D 70 B</b>	6cyl.	<b>6730cc</b>	<b>110kW</b> (150PS)	<b>Diesel</b>		<b>TD9129</b>
<b>MD 70</b>	6cyl.	<b>6730cc</b>	<b>102-106kW</b> (139-145PS)	<b>Diesel</b>		<b>FM6261</b>
<b>TAMD 70</b>	6cyl.	<b>6730cc</b>	<b>206kW</b> (280PS)	<b>Diesel</b>	<b>Turbo</b>	<b>FM6263</b>
<b>TD 70 A</b>	6cyl.	<b>6730cc</b>	<b>136kW</b> (185PS)	<b>Diesel</b>	<b>Turbo</b>	<b>TD9131</b>
<b>TD 70 B</b>	6cyl.	<b>6730cc</b>	<b>152kW</b> (207PS)	<b>Diesel</b>	<b>Turbo</b>	<b>TD9132</b>
<b>TD 70 C</b>	6cyl.	<b>6730cc</b>	<b>149-152kW</b> (202-207PS)	<b>Diesel</b>	<b>Turbo</b>	<b>TD9208</b>
<b>TD 70 E</b>	6cyl.	<b>6730cc</b>	<b>154kW</b> (210PS)	<b>Diesel</b>	<b>Turbo</b>	<b>TD9133</b>
<b>TD 70 ES</b>	6cyl.	<b>6730cc</b>	<b>166kW</b> (226PS)	<b>Diesel</b>	<b>Turbo</b>	<b>TD9250</b>
<b>TD 70 F</b>	6cyl.	<b>6730cc</b>	<b>162-174kW</b> (220-237PS)	<b>Diesel</b>	<b>Turbo</b>	<b>TD9148</b>
<b>TD 70 FS</b>	6cyl.	<b>6730cc</b>	<b>180kW</b> (245PS)	<b>Diesel</b>	<b>Turbo</b>	<b>TD9150</b>
<b>TD 70 G</b>	6cyl.	<b>6730cc</b>	<b>147-156kW</b> (200-212PS)	<b>Diesel</b>	<b>Turbo</b>	<b>TD9151</b>
<b>TD 70 H</b>	6cyl.	<b>6730cc</b>	<b>157kW</b> (214PS)	<b>Diesel</b>	<b>Turbo</b>	<b>TD9097</b>
<b>TD 70 HA</b>	6cyl.	<b>6730cc</b>	<b>143kW</b> (195PS)	<b>Diesel</b>	<b>Turbo</b>	<b>TD9130</b>
<b>TMD 70</b>	6cyl.	<b>6730cc</b>	<b>110-147kW</b> (150-200PS)	<b>Diesel</b>	<b>Turbo</b>	<b>FM6262</b>

15-457590-00 WH ② | 104.78 | B 116.96 | C 256.79 | D 126.98 | E 11.66 | F 0.762

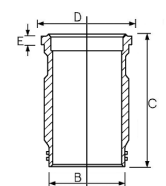



14-573140-00 WH ①      104.78      B 117.00      C 257.00      D 127.00      E 11.66      F 0.74

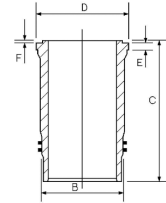

① Use also: HT017

① A utiliser aussi: HT017

① A utiliser aussi: HT017

① Utilizar también: HT017

② Includes seals

② Schließt Dichtungen ein

② Inclut des joints

② Incluye los sellos

**8**

D7C215 Euro 2	6cyl.	7300cc	158kW (215PS)	Diesel	Turbo Intercooled	TD18725
D7C250 Euro 2	6cyl.	7300cc	184kW (250PS)	Diesel	Turbo Intercooled	TD11770
D7C275 Euro 2	6cyl.	7300cc	202kW (275PS)	Diesel	Turbo Intercooled	FM30291
D7C290 Euro 2	6cyl.	7300cc	213kW (290PS)	Diesel	Turbo Intercooled	TD11771
D7C310 Euro 2	6cyl.	7300cc	228kW (310PS)	Diesel	Turbo Intercooled	TD16726

14-450810-00 WH      107.00      B 117.00      C 256.80      D 129.40      E 9.40      F 0.95

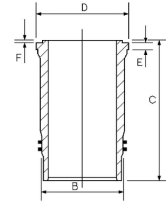

**9**

D7E240 Euro 4	6cyl.	7100cc	177kW (240PS)	Diesel	Turbo Intercooled	TD18965
D7E280 Euro 4	6cyl.	7100cc	206kW (280PS)	Diesel	Turbo Intercooled	TD18964
D7E290 Euro 4	6cyl.	7100cc	213kW (290PS)	Diesel	Turbo Intercooled	TD20460
D7E320 Euro 4	6cyl.	7100cc	235kW (320PS)	Diesel	Turbo Intercooled	TD18963

15-480450-00 WH ①      108.00      B 120.00      C 228.00      D 131.70      E 8.06

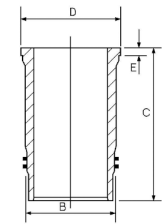

① Includes seals

① Schließt Dichtungen ein

① Inclut des joints

① Incluye los sellos

**10**

D9A260 Euro 3	6cyl.	9364cc	191kW (260PS)	Diesel	Turbo Intercooled	TD16780
D9A300 Euro 3	6cyl.	9364cc	221kW (300PS)	Diesel	Turbo Intercooled	TD16781
D9A340 Euro 3	6cyl.	9364cc	250kW (340PS)	Diesel	Turbo Intercooled	TD16782
D9A380 Euro 3	6cyl.	9364cc	279kW (380PS)	Diesel	Turbo Intercooled	TD16783

14-480230-00 WH      120.00      B 139.00      C 249.55      D 149.00      E 12.05      F 0.85

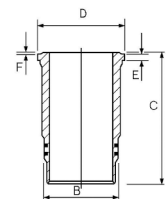



**11**

D9B260 Euro 4/5	6cyl.	9364cc	191kW (260PS)	Diesel	Turbo Intercooled	TD21048
D9B300 Euro 4	6cyl.	9364cc	221kW (300PS)	Diesel	Turbo Intercooled	TD18978
D9B310 Euro 4/5	6cyl.	9364cc	228kW (310PS)	Diesel	Turbo Intercooled	TD21049
D9B340 Euro 4	6cyl.	9364cc	250kW (340PS)	Diesel	Turbo Intercooled	TD18979
D9B360 Euro 4/5	6cyl.	9364cc	265kW (360PS)	Diesel	Turbo Intercooled	TD21050
D9B380 Euro 4	6cyl.	9364cc	280kW (381PS)	Diesel	Turbo Intercooled	TD18980

14-480460-00 WH 120.01 B 139.00 C 250.05 D 149.00 E 0.85 F 11.20

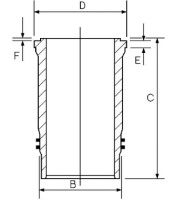

**12**

TD 100 A	6cyl.	9600cc	176-190kW (239-258PS)	Diesel	Turbo	TD9152
TD 100 AHC	6cyl.	9600cc		Diesel	Turbo	FM5118
TD 100 ARC	6cyl.	9600cc		Diesel	Turbo	FM5119
THD 100 D	6cyl.	9600cc	155-177kW (211-241PS)	Diesel	Turbo	TD9119
THD 101 B	6cyl.	9600cc	169-191kW (230-260PS)	Diesel	Turbo	TD23324
TMD 100 A	6cyl.	9600cc		Diesel	Turbo	FM5048

15-457600-00 WH ③ 120.65 B 133.92 C 294.11 D 146.96 E 11.68 F 0.765

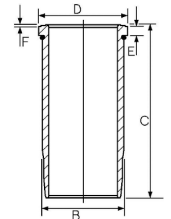

15-677620-00 WH ③ 120.65 B 133.82 C 296.49 D 147.02 E 11.52 F 3.50

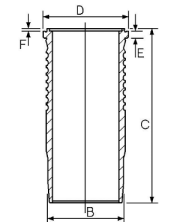

14-673200-00 WH ①② 120.65 B 134.00 C 296.50 D 147.00 E 11.52 F 3.48

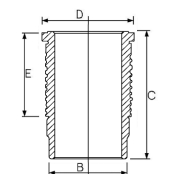

14-450520-00 WH ② 120.65 B 134.00 C 294.00 D 147.00 E 11.77 F 0.78

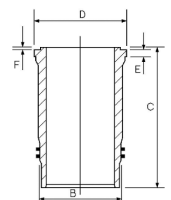

① Water jacket chromed

② Use also: HT008

③ Includes seals

① Am Wassermantel verchromt

② A utiliser aussi: HT008

③ Schließt Dichtungen ein

① Chromé sur chambre d'eau

② A utiliser aussi: HT008

③ Inclut des joints

① Camisa de agua cromada

② Utilizar también: HT008

③ Incluye los sellos



**13**

D 100 A	6cyl.	9600cc	122-147kW (166-200PS)	Diesel			TD9204
D 100 B	6cyl.	9600cc	147kW (200PS)	Diesel			TD9205
D100BHC	6cyl.	9600cc		Diesel			FM5114
D100BRC	6cyl.	9600cc		Diesel			FM5115
HD 100 A	6cyl.	9600cc	129kW (175PS)	Diesel			TD9134
HD 100 D	6cyl.	9600cc	132kW (180PS)	Diesel			TD9135
MD 100A	6cyl.	9600cc		Diesel			FM5116
MD 100B	6cyl.	9600cc		Diesel			FM5117
THD 100 A	6cyl.	9600cc	139-191kW (200-260PS)	Diesel	Turbo		TD9136
TMD 102	6cyl.	9599cc	158-200kW (215-272PS)	Diesel	Turbo Intercooled		FM8860

15-457600-00 WH ②	120.65	B 133.92	C 294.11	D 146.96	E 11.68	F 0.765
-------------------	--------	----------	----------	----------	---------	---------

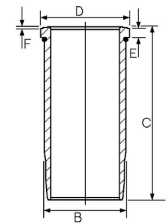

14-450520-00 WH ①	120.65	B 134.00	C 294.00	D 147.00	E 11.77	F 0.78
-------------------	--------	----------	----------	----------	---------	--------

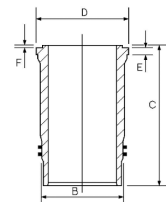

- ① Use also: HT008                      ① A utiliser aussi: HT008                      ① A utiliser aussi: HT008                      ① Utilizar también: HT008
- ② Includes seals                          ② Schließt Dichtungen ein                      ② Inclut des joints                              ② Incluye los sellos

**14**

THD 102 KA	6cyl.	9600cc	210kW (286PS)	Diesel	Turbo Intercooled		TD23325
THD 102 KB Euro 1	6cyl.	9600cc	210kW (286PS)	Diesel	Turbo Intercooled		TD23326
THD 102 KF	6cyl.	9600cc	180-210kW (250-286PS)	Diesel	Turbo Intercooled		TD9121
THD 102 KJ	6cyl.	9600cc	158kW (215PS)	Diesel	Turbo Intercooled		TD9138
TMD 102 A	6cyl.	9599cc	158-200kW (215-272PS)	Diesel	Turbo Intercooled		FM8859
TMD 102 C	6cyl.	9599cc	158-200kW (215-272PS)	Diesel	Turbo Intercooled		FM8859

14-458170-00 WH ①	120.65	B 133.86	C 296.25	D 147.00	E 11.53	F 3.47
-------------------	--------	----------	----------	----------	---------	--------

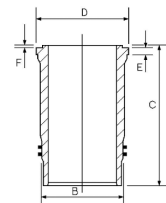

- ① Use also: HT005                      ① A utiliser aussi: HT005                      ① A utiliser aussi: HT005                      ① Utilizar también: HT005

**15**

TD 100 B	6cyl.	9600cc	206-220kW (280-299PS)	Diesel	Turbo		TD9153
TD 100 CHC	6cyl.	9600cc	200kW (272PS)	Diesel	Turbo		TD21338
TD 100 F	6cyl.	9600cc	200kW (272PS)	Diesel	Turbo		TD21339
TD 100 G	6cyl.	9600cc	192-202kW (261-275PS)	Diesel	Turbo		TD9154
TD 100 GA	6cyl.	9600cc	200kW (272PS)	Diesel	Turbo		TD9155





TD 101 F	6cyl.	9600cc	215-220kW (292-299PS)	Diesel	Turbo Intercooled	TD9156
TD 101 FA	6cyl.	9600cc	220kW (299PS)	Diesel	Turbo Intercooled	TD9157
TD 101 FC	6cyl.	9600cc	221kW (300PS)	Diesel	Turbo Intercooled	TD9237
TD 101 FD	6cyl.	9600cc	220-222kW (299-302PS)	Diesel	Turbo Intercooled	TD9238
TD 101 G	6cyl.	9600cc	192-202kW (261-275PS)	Diesel	Turbo	TD9158
TD 101 GA	6cyl.	9600cc	200kW (272PS)	Diesel	Turbo Intercooled	TD9159
THD 100 DB	6cyl.	9600cc	160-203kW (218-276PS)	Diesel	Turbo Intercooled	TD9120
THD 100 DC	6cyl.	9600cc	160-203kW (218-276PS)	Diesel	Turbo Intercooled	TD9104
THD 100 DD	6cyl.	9600cc	203kW (275PS)	Diesel	Turbo	TD9105
THD 100 E	6cyl.	9600cc	160-203kW (218-276PS)	Diesel	Turbo Intercooled	TD9137
THD 100 EA	6cyl.	9600cc	133-180kW (180-245PS)	Diesel	Turbo	TD9106
THD 100 EB	6cyl.	9600cc	160-203kW (218-276PS)	Diesel	Turbo	TD9107
THD 100 EC	6cyl.	9600cc	160-203kW (218-276PS)	Diesel	Turbo	TD9108
THD 100 ED	6cyl.	9600cc	160-203kW (218-276PS)	Diesel	Turbo Intercooled	TD9109
THD 100 EE	6cyl.	9600cc	212kW (288PS)	Diesel	Turbo	TD9110
THD 100 EK	6cyl.	9600cc	179kW (243PS)	Diesel	Turbo	TD9111
THD 101 GB	6cyl.	9600cc	160kW (218PS)	Diesel	Turbo	TD9112
THD 101 GC	6cyl.	9600cc	180kW (245PS)	Diesel	Turbo	TD9113
THD 101 GD	6cyl.	9600cc	160-203kW (218-276PS)	Diesel	Turbo	TD9114
THD 101 KB	6cyl.	9600cc	210kW (286PS)	Diesel	Turbo Intercooled	TD9115
THD 101 KC	6cyl.	9600cc	228kW (310PS)	Diesel	Turbo Intercooled	TD9116
THD 101 KE	6cyl.	9600cc	235kW (320PS)	Diesel	Bi-Turbo Intercooled	TD9117

15-677620-00 WH ④      120.65      B 133.82      C 296.49      D 147.02      E 11.52      F 3.50

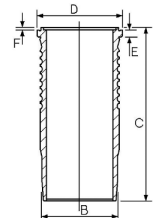

14-673190-00 WH ②      120.65      B 134.00      C 294.00      D 147.00      E 11.74      F 0.81  
 14-673200-00 WH ①②      B 134.00      C 296.50      D 147.00      E 11.52      F 3.48

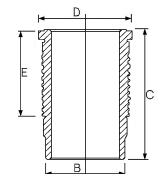

14-458170-00 WH ③      120.65      B 133.86      C 296.25      D 147.00      E 11.53      F 3.47

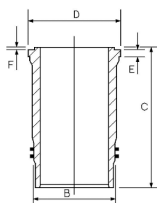

① Water jacket chromed

① Am Wassermantel verchromt

① Chromé sur chambre d'eau

① Camisa de agua cromada

② Use also: HT008

② A utiliser aussi: HT008

② A utiliser aussi: HT008

② Utilizar también: HT008

③ Use also: HT005

③ A utiliser aussi: HT005

③ A utiliser aussi: HT005

③ Utilizar también: HT005

④ Includes seals

④ Schließt Dichtungen ein

④ Inclut des joints

④ Incluye los sellos



**16**

<b>TD 100 GB</b>	6cyl.	<b>9600cc</b>	<b>207-220kW</b> (280-300PS)	<b>Diesel</b>	<b>Turbo</b>	<b>FM3723</b>
<b>TD 100 GG</b>	6cyl.	<b>9600cc</b>		<b>Diesel</b>	<b>Turbo</b>	<b>FM5047</b>
<b>TD 101</b>	6cyl.	<b>9599cc</b>	<b>200kW</b> (272PS)	<b>Diesel</b>	<b>Turbo Intercooled</b>	<b>FM6227</b>
<b>THD 101</b>	6cyl.	<b>9599cc</b>	<b>203-228kW</b> (276-310PS)	<b>Diesel</b>	<b>Turbo Intercooled</b>	<b>FM6228</b>
<b>THD 101 G</b>	6cyl.	<b>9600cc</b>	<b>203kW</b> (275PS)	<b>Diesel</b>	<b>Turbo</b>	<b>FM5168</b>
<b>THD 101 KF</b>	6cyl.	<b>9600cc</b>	<b>228kW</b> (310PS)	<b>Diesel</b>	<b>Turbo Intercooled</b>	<b>FM5161</b>
<b>TID 100</b>	6cyl.	<b>9600cc</b>		<b>Diesel</b>	<b>Turbo Intercooled</b>	<b>FM6265</b>

15-459350-00 WH ④      120.65      B 133.82      C 297.00      D 147.02      E 11.52      F 3.50

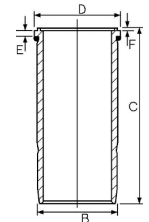

15-677620-00 WH ④      120.65      B 133.82      C 296.49      D 147.02      E 11.52      F 3.50

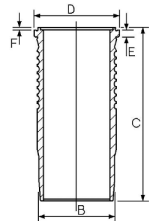

14-673200-00 WH ①②      120.65      B 134.00      C 296.50      D 147.00      E 11.52      F 3.48

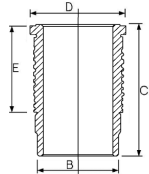

14-458170-00 WH ③      120.65      B 133.86      C 296.25      D 147.00      E 11.53      F 3.47

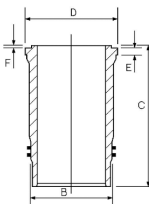

① Water jacket chromed

① Am Wassermantel verchromt

① Chromé sur chambre d'eau

① Camisa de agua cromada

② Use also: HT008

② A utiliser aussi: HT008

② A utilizar aussi: HT008

② Utilizar también: HT008

③ Use also: HT005

③ A utiliser aussi: HT005

③ A utilizar aussi: HT005

③ Utilizar también: HT005

④ Includes seals

④ Schließt Dichtungen ein

④ Inclut des joints

④ Incluye los sellos

**17**

<b>D10A320</b>	6cyl.	<b>9600cc</b>	<b>235kW</b> (320PS)	<b>Diesel</b>		<b>TD9263</b>
<b>D10B320 Euro 2</b>	6cyl.	<b>9600cc</b>	<b>235kW</b> (320PS)	<b>Diesel</b>	<b>Turbo Intercooled</b>	<b>TD16235</b>
<b>DH10A Euro 2</b>	6cyl.	<b>9600cc</b>	<b>180-265kW</b> (245-360PS)	<b>Diesel</b>	<b>Turbo Intercooled</b>	<b>FM45043</b>
<b>TD 102 F</b>	6cyl.	<b>9600cc</b>	<b>230-234kW</b> (313-318PS)	<b>Diesel</b>	<b>Turbo Intercooled</b>	<b>TD9160</b>
<b>TD 102 FAQ</b>	6cyl.	<b>9600cc</b>	<b>221kW</b> (300PS)	<b>Diesel</b>	<b>Turbo Intercooled</b>	<b>TD9161</b>
<b>TD 102 FBQ</b>	6cyl.	<b>9600cc</b>	<b>228kW</b> (310PS)	<b>Diesel</b>	<b>Turbo Intercooled</b>	<b>TD9162</b>
<b>TD 102 FCQ</b>	6cyl.	<b>9600cc</b>	<b>220kW</b> (299PS)	<b>Diesel</b>	<b>Turbo Intercooled</b>	<b>TD9163</b>
<b>TD 102 FD</b>	6cyl.	<b>9600cc</b>	<b>234kW</b> (318PS)	<b>Diesel</b>	<b>Turbo</b>	<b>FM5128</b>





TD 102 FD Euro 1	6cyl.	9600cc	234kW (318PS)	Diesel	Turbo Intercooled	TD21341
TD 102 FDQ	6cyl.	9600cc	232-234kW (316-318PS)	Diesel	Turbo Intercooled	TD9164
TD 102 FEQ	6cyl.	9600cc	191kW (260PS)	Diesel	Turbo Intercooled	TD9165
TD 102 FF	6cyl.	9600cc	230-234kW (313-318PS)	Diesel	Turbo Intercooled	FM5127
TD 102 FF	6cyl.	9600cc	230-234kW (313-318PS)	Diesel	Turbo Intercooled	TD9166
TD 102 FGQ	6cyl.	9600cc	205kW (279PS)	Diesel	Turbo Intercooled	TD9167
TD 102 FH	6cyl.	9600cc	210-234kW (286-318PS)	Diesel	Turbo Intercooled	TD9168
TD 102 FL Euro 1	6cyl.	9600cc	234kW (318PS)	Diesel	Turbo Intercooled	FM5131
TD 102 FL Euro 1	6cyl.	9600cc	234kW (318PS)	Diesel	Turbo Intercooled	TD9169
TD 102 FM	6cyl.	9600cc	230-252kW (313-343PS)	Diesel	Turbo Intercooled	FM5130
TD 102 FM	6cyl.	9600cc	230-252kW (313-343PS)	Diesel	Turbo Intercooled	TD9170
TD 102 FQ	6cyl.	9600cc	234kW (318PS)	Diesel	Turbo	FM5126
TD 102 FS	6cyl.	9600cc	250kW (340PS)	Diesel	Turbo Intercooled	TD9264
TD 102 FT	6cyl.	9595cc	228kW (310PS)	Diesel	Turbo Intercooled	TD9262
TD 103 D10 Euro 2	6cyl.	9600cc	265kW (360PS)	Diesel	Turbo Intercooled	FM35043
TD 103 E Euro 1	6cyl.	9600cc	210-235kW (286-320PS)	Diesel	Turbo Intercooled	TD5900
TD 103 EA Euro 1	6cyl.	9600cc	235kW (320PS)	Diesel	Turbo Intercooled	TD21342
TD 103 ES Euro 1	6cyl.	9600cc	210-235kW (286-320PS)	Diesel	Turbo Intercooled	TD6247
TD 103 KBE Euro 1	6cyl.	9600cc	210kW (286PS)	Diesel	Turbo Intercooled	TD19062
TD 103 KF Euro 1	6cyl.	9600cc	210kW (286PS)	Diesel	Turbo Intercooled	TD19063
THD 102 KD	6cyl.	9600cc	252kW (343PS)	Diesel	Turbo Intercooled	FM5042
THD 102 KD	6cyl.	9600cc	252kW (343PS)	Diesel	Turbo Intercooled	TD9118
THD 103 KB	6cyl.	9600cc	210kW (286PS)	Diesel	Turbo Intercooled	TD9098
THD 103 KD	6cyl.	9600cc	250kW (340PS)	Diesel	Turbo Intercooled	TD9099

14-459040-00 WH  
15-459230-00 WH <sup>1</sup>

120.65

B 134.00  
B 133.82

C 287.25  
C 287.30

D 147.00  
D 147.00

E 11.53  
E 11.50

F 3.47  
F 3.50

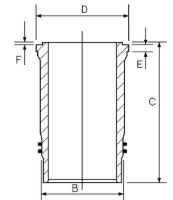

<sup>1</sup> Includes seals

<sup>1</sup> Schließt Dichtungen ein

<sup>1</sup> Inclut des joints

<sup>1</sup> Incluye los sellos

**18**

D11B430 Euro 4/5 6cyl. 10800cc 316kW (430PS) Diesel Turbo Intercooled TD23373

14-480040-00 WH

123.00

B 120.00

C 229.10

D 128.50

E 9.00

F 1.10

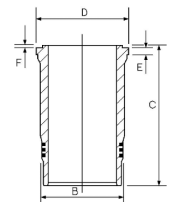



**19**

D11C330 Euro 5	6cyl.	10800cc	243kW (330PS)	Diesel	Turbo Intercooled	TD22373
D11C370 Euro 5	6cyl.	10800cc	272kW (370PS)	Diesel	Turbo Intercooled	TD22374
D11C410 Euro 5	6cyl.	10800cc	302kW (410PS)	Diesel	Turbo Intercooled	TD22376

14-480440-00 WH	123.00	B 139.00	C 249.55	D 149.00	E 11.20	F 0.85
-----------------	--------	----------	----------	----------	---------	--------

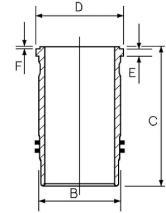

**20**

TD 122	6cyl.	11980cc	309kW (420PS)	Diesel	Turbo Intercooled	TD9184
TD 122 F	6cyl.	11980cc	257-262kW (350-356PS)	Diesel	Turbo	TD9186
TD 122 FA	6cyl.	11980cc	272kW (370PS)	Diesel	Turbo	TD9187
TD 122 FK	6cyl.	11980cc	287-291kW (390-396PS)	Diesel	Turbo Intercooled	TD9191
TD 122 FR	6cyl.	11980cc	262-291kW (356-396PS)	Diesel	Turbo Intercooled	TD9193
TD 122 FS	6cyl.	11980cc	287-291kW (395-396PS)	Diesel	Turbo Intercooled	TD9194

15-458840-00 WH ②	130.18	B 143.85	C 313.25	D 157.62	E 10.52	F 3.25
-------------------	--------	----------	----------	----------	---------	--------

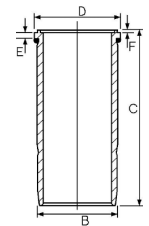

14-450530-00 WH ③	130.18	B 144.00	C 311.00	D 157.60	E 13.52	F 0.76
14-456000-00 WH		B 144.00	C 311.00	D 157.60	E 10.52	F 0.76
14-458180-00 WH		B 143.88	C 313.00	D 157.62	E 10.52	F 3.28
15-457960-00 WH ①②		B 143.89	C 311.00	D 157.62	E 10.55	F 0.864
15-459030-00 WH ②		B 143.91	C 310.52	D 157.58	E 13.55	F 0.686

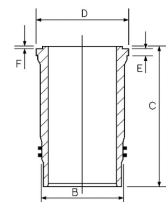

① For cylinder block no.470130 only	① Nur Zylinderblock Nr.470130	① Bloc-cylindres no.470130 seulement	① Bloque de cilindro no.470130 unicamente
② Includes seals	② Schließt Dichtungen ein	② Inclut des joints	② Incluye los sellos
③ Phosphated	③ Phosphatiert	③ Phosphatisé	③ Fosfatada

**21**

TAMD 120 A	6cyl.	11977cc	225-243kW (306-330PS)	Diesel	Turbo	FM5133
TAMD 120 B	6cyl.	11977cc		Diesel	Turbo	FM5134
TAMD 121	6cyl.	11975cc	217-310kW (295-420PS)	Diesel	Turbo	FM6266
TD 120 A	6cyl.	12000cc	243kW (330PS)	Diesel	Turbo	TD9206
TD 120 C	6cyl.	12000cc	260kW (354PS)	Diesel	Turbo	TD9171
TD 120 D	6cyl.	11980cc	273kW (371PS)	Diesel	Turbo	TD9172
TD 120 E	6cyl.	11980cc	225-273kW (306-371PS)	Diesel	Turbo	TD9173
TD 120 F	6cyl.	11980cc	265kW (360PS)	Diesel	Turbo Intercooled	TD9174
TD 120 FC	6cyl.	11980cc	265kW (360PS)	Diesel	Turbo Intercooled	TD9175
TD 120 G	6cyl.	11980cc	226-243kW (307-330PS)	Diesel	Turbo	TD9177
TD 120 GA	6cyl.	11980cc	227kW (310PS)	Diesel	Turbo	TD9178
TD 120 GG	6cyl.	11977cc		Diesel	Turbo	FM5138







<b>TD 121 F</b>	6cyl.	<b>11980cc</b>	<b>272-283kW</b> (370-385PS)	<b>Diesel</b>	<b>Turbo Intercooled</b>	<b>TD9179</b>
<b>TD 121 FD</b>	6cyl.	<b>11980cc</b>	<b>283kW</b> (385PS)	<b>Diesel</b>	<b>Turbo Intercooled</b>	<b>TD9180</b>
<b>TD 121 G</b>	6cyl.	<b>11980cc</b>	<b>235-243kW</b> (320-330PS)	<b>Diesel</b>	<b>Turbo</b>	<b>TD9183</b>
<b>TD 121 GD</b>	6cyl.	<b>11980cc</b>	<b>243kW</b> (330PS)	<b>Diesel</b>	<b>Turbo</b>	<b>TD9143</b>
<b>TID 120 F</b>	6cyl.	<b>11977cc</b>		<b>Diesel</b>	<b>Turbo</b>	<b>FM5045</b>
<b>TMD 120 A</b>	6cyl.	<b>11977cc</b>	<b>225-243kW</b> (306-330PS)	<b>Diesel</b>		<b>FM5132</b>

<b>15-458840-00 WH</b> ②	<b>130.18</b>	<b>B 143.85</b>	<b>C 313.25</b>	<b>D 157.62</b>	<b>E 10.52</b>	<b>F 3.25</b>
--------------------------	---------------	-----------------	-----------------	-----------------	----------------	---------------

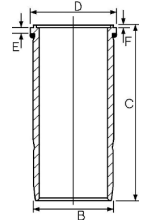

<b>14-450530-00 WH</b> ③	<b>130.18</b>	<b>B 144.00</b>	<b>C 311.00</b>	<b>D 157.60</b>	<b>E 13.52</b>	<b>F 0.76</b>
<b>14-456000-00 WH</b>		<b>B 144.00</b>	<b>C 311.00</b>	<b>D 157.60</b>	<b>E 10.52</b>	<b>F 0.76</b>
<b>15-457960-00 WH</b> ①②		<b>B 143.89</b>	<b>C 311.00</b>	<b>D 157.62</b>	<b>E 10.55</b>	<b>F 0.864</b>
<b>15-459030-00 WH</b> ②		<b>B 143.91</b>	<b>C 310.52</b>	<b>D 157.58</b>	<b>E 13.55</b>	<b>F 0.686</b>

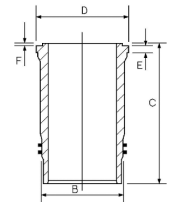

- |                                     |                               |                                      |   |
|-------------------------------------|-------------------------------|--------------------------------------|---|
| ① For cylinder block no.470130 only | ① Nur Zylinderblock Nr.470130 | ① Bloc-cylindres no.470130 seulement | ① Bloque de cilindro no.470130 unicamente |
| ② Includes seals                    | ② Schließt Dichtungen ein     | ② Includ des joints                  | ② Incluye los sellos                      |
| ③ Phosphated                        | ③ Phosphatiert                | ③ Phosphatisé                        | ③ Fosfatada                               |

**22**

<b>TD 120 FA</b>	6cyl.	<b>11980cc</b>	<b>213kW</b> (290PS)	<b>Diesel</b>	<b>Turbo Intercooled</b>	<b>TD9254</b>
<b>TD 120 FB</b>	6cyl.	<b>11980cc</b>	<b>226-265kW</b> (307-360PS)	<b>Diesel</b>	<b>Turbo Intercooled</b>	<b>TD9255</b>
<b>TD 120 FTQ</b>	6cyl.	<b>11980cc</b>	<b>220kW</b> (299PS)	<b>Diesel</b>	<b>Turbo Intercooled</b>	<b>TD9176</b>
<b>TD 121 FH</b>	6cyl.	<b>11980cc</b>	<b>232kW</b> (315PS)	<b>Diesel</b>	<b>Turbo Intercooled</b>	<b>TD9181</b>
<b>TD 121 FK</b>	6cyl.	<b>11980cc</b>	<b>280kW</b> (381PS)	<b>Diesel</b>	<b>Turbo Intercooled</b>	<b>TD9182</b>
<b>TD 122</b>	6cyl.	<b>11980cc</b>	<b>309kW</b> (420PS)	<b>Diesel</b>	<b>Turbo Intercooled</b>	<b>FM3888</b>
<b>TD 122 ED</b>	6cyl.	<b>11980cc</b>	<b>300-310kW</b> (408-422PS)	<b>Diesel</b>	<b>Turbo Intercooled</b>	<b>TD9185</b>
<b>TD 122 FA</b>	6cyl.	<b>11980cc</b>	<b>272kW</b> (370PS)	<b>Diesel</b>	<b>Turbo</b>	<b>FM5142</b>
<b>TD 122 FAQ</b>	6cyl.	<b>11980cc</b>	<b>287kW</b> (390PS)	<b>Diesel</b>	<b>Turbo Intercooled</b>	<b>TD9188</b>
<b>TD 122 FBQ</b>	6cyl.	<b>11980cc</b>	<b>287kW</b> (390PS)	<b>Diesel</b>	<b>Turbo Intercooled</b>	<b>TD9189</b>
<b>TD 122 FCQ</b>	6cyl.	<b>11980cc</b>	<b>287kW</b> (390PS)	<b>Diesel</b>	<b>Turbo Intercooled</b>	<b>TD9190</b>
<b>TD 122 FH Euro 1</b>	6cyl.	<b>11980cc</b>	<b>262kW</b> (356PS)	<b>Diesel</b>	<b>Turbo Intercooled</b>	<b>TD9122</b>
<b>TD 122 FK</b>	6cyl.	<b>11980cc</b>	<b>287-291kW</b> (390-396PS)	<b>Diesel</b>	<b>Turbo Intercooled</b>	<b>FM5147</b>
<b>TD 122 FL</b>	6cyl.	<b>11980cc</b>	<b>291kW</b> (396PS)	<b>Diesel</b>	<b>Turbo Intercooled</b>	<b>TD9123</b>
<b>TD 122 FR</b>	6cyl.	<b>11980cc</b>	<b>262-291kW</b> (356-396PS)	<b>Diesel</b>	<b>Turbo Intercooled</b>	<b>FM5146</b>

<b>15-458840-00 WH</b> ②	<b>130.18</b>	<b>B 143.85</b>	<b>C 313.25</b>	<b>D 157.62</b>	<b>E 10.52</b>	<b>F 3.25</b>
--------------------------	---------------	-----------------	-----------------	-----------------	----------------	---------------

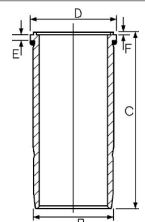



14-456000-00 WH  
14-458180-00 WH  
15-457960-00 WH 1 2

130.18

B 144.00  
B 143.88  
B 143.89

C 311.00  
C 313.00  
C 311.00

D 157.60  
D 157.62  
D 157.62

E 10.52  
E 10.52  
E 10.55

F 0.76  
F 3.28  
F 0.864

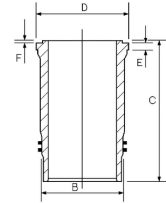

1 For cylinder block no.470130 only

1 Nur Zylinderblock Nr.470130

1 Bloc-cylindres no.470130 seulement

1 Bloque de cilindro no.470130 unicamente

2 Includes seals

2 Schließt Dichtungen ein

2 Inclut des joints

2 Incluye los sellos

**23**

TID 121 B	6cyl.	11979cc	217-305kW (295-415PS)	Diesel	Turbo Intercooled	FM26267
TID 121 KG	6cyl.	11979cc	217-305kW (295-415PS)	Diesel	Turbo Intercooled	FM36267
TID 121 KP	6cyl.	11979cc	217-305kW (295-415PS)	Diesel	Turbo Intercooled	FM46267
TID 121 LG	6cyl.	11979cc	217-305kW (295-415PS)	Diesel	Turbo Intercooled	FM6267
TID 121 LP	6cyl.	11979cc	217-305kW (295-415PS)	Diesel	Turbo Intercooled	FM16267
TID 121 P	6cyl.	11979cc	217-305kW (295-415PS)	Diesel	Turbo Intercooled	FM56267
TWD 121 G	6cyl.	11979cc	217-305kW (295-415PS)	Diesel	Turbo Intercooled	FM66267

15-458840-00 WH 2

130.18

B 143.85

C 313.25

D 157.62

E 10.52

F 3.25

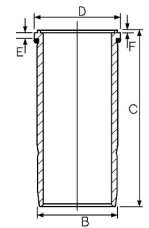

14-456000-00 WH  
15-457960-00 WH 1 2

130.18

B 144.00  
B 143.89

C 311.00  
C 311.00

D 157.60  
D 157.62

E 10.52  
E 10.55

F 0.76  
F 0.864

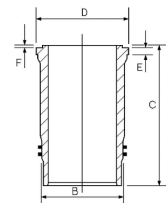

1 For cylinder block no.470130 only

1 Nur Zylinderblock Nr.470130

1 Bloc-cylindres no.470130 seulement

1 Bloque de cilindro no.470130 unicamente

2 Includes seals

2 Schließt Dichtungen ein

2 Inclut des joints

2 Incluye los sellos

**24**

D12A340 Euro 2	6cyl.	12100cc	250kW (340PS)	Diesel	Turbo Intercooled	TD11727
D12A380 Euro 2	6cyl.	12110cc	279kW (380PS)	Diesel	Turbo Intercooled	TD9215
D12A420 Euro 2	6cyl.	12100cc	309kW (420PS)	Diesel	Turbo Intercooled	TD9216
D12C340 Euro 2	6cyl.	12100cc	250kW (340PS)	Diesel	Turbo Intercooled	TD11731
D12C380	6cyl.	12100cc	279kW (380PS)	Diesel	Turbo Intercooled	TD11728
D12C420	6cyl.	12100cc	309kW (420PS)	Diesel	Turbo Intercooled	TD11729
D12C460	6cyl.	12100cc	338kW (460PS)	Diesel	Turbo Intercooled	TD11730
D12D340 Euro 3	6cyl.	12100cc	250kW (340PS)	Diesel	Turbo Intercooled	TD16784
D12D380 Euro 3	6cyl.	12100cc	279kW (380PS)	Diesel	Turbo Intercooled	TD16785
D12D420 Euro 3	6cyl.	12100cc	309kW (420PS)	Diesel	Turbo Intercooled	TD16786
D12D460 Euro 3	6cyl.	12100cc	338kW (460PS)	Diesel	Turbo Intercooled	TD16787
D12D500 Euro 3	6cyl.	12100cc	368kW (500PS)	Diesel	Turbo Intercooled	TD16508





<b>DH12D340 Euro 3</b>	6cyl.	<b>12100cc</b>	<b>250kW</b> (340PS)	<b>Diesel</b>	<b>Turbo Intercooled</b>	<b>TD16511</b>
<b>DH12D420 Euro 3</b>	6cyl.	<b>12100cc</b>	<b>309kW</b> (420PS)	<b>Diesel</b>	<b>Turbo Intercooled</b>	<b>TD16513</b>

14-450160-00 *WH*  
15-450160-00 *WH* 1

**131.00**

**B** 150.30    **C** 276.40    **D** 159.50    **E** 11.20    **F** 3.60  
**B** 150.32    **C** 276.425    **D** 159.50    **E** 11.215    **F** 3.62

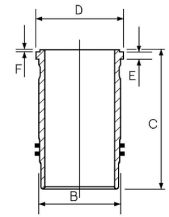

1 Includes seals    1 Schließt Dichtungen ein    1 Inclut des joints    1 Incluye los sellos

**25**

<b>D13A360 Euro 5</b>	6cyl.	<b>12800cc</b>	<b>264kW</b> (359PS)	<b>Diesel</b>	<b>Turbo Intercooled</b>	<b>TD18826</b>
<b>D13A400 Euro 5</b>	6cyl.	<b>12800cc</b>	<b>294kW</b> (400PS)	<b>Diesel</b>	<b>Turbo Intercooled</b>	<b>TD18827</b>
<b>D13A440 Euro 5</b>	6cyl.	<b>12800cc</b>	<b>324kW</b> (440PS)	<b>Diesel</b>	<b>Turbo Intercooled</b>	<b>TD18828</b>
<b>D13A480 Euro 5</b>	6cyl.	<b>12800cc</b>	<b>353kW</b> (480PS)	<b>Diesel</b>	<b>Turbo Intercooled</b>	<b>TD18829</b>
<b>D13A520 Euro 5</b>	6cyl.	<b>12800cc</b>	<b>382kW</b> (520PS)	<b>Diesel</b>	<b>Turbo Intercooled</b>	<b>TD18830</b>
<b>D13C380 Euro 5</b>	6cyl.	<b>12800cc</b>	<b>280kW</b> (381PS)	<b>Diesel</b>	<b>Turbo Intercooled</b>	<b>TD22378</b>
<b>D13C420 Euro 5</b>	6cyl.	<b>12800cc</b>	<b>309kW</b> (420PS)	<b>Diesel</b>	<b>Turbo Intercooled</b>	<b>TD22150</b>
<b>D13C460 Euro 5</b>	6cyl.	<b>12800cc</b>	<b>338kW</b> (460PS)	<b>Diesel</b>	<b>Turbo Intercooled</b>	<b>TD22151</b>
<b>D13C500 Euro 5</b>	6cyl.	<b>12800cc</b>	<b>368kW</b> (500PS)	<b>Diesel</b>	<b>Turbo Intercooled</b>	<b>TD22152</b>
<b>D13C540 Euro 5</b>	6cyl.	<b>12800cc</b>	<b>397kW</b> (540PS)	<b>Diesel</b>	<b>Turbo Intercooled</b>	<b>TD22153</b>

14-451190-00 *W*

**131.00**

**B** 144.00    **C** 261.80    **D** 159.60    **E** 11.20    **F** 0.90

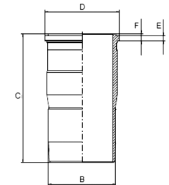

<b>D 16A</b>	6cyl.	<b>16123cc</b>	<b>346-382kW</b> (470-520PS)	<b>Diesel</b>	<b>Turbo Intercooled</b>	<b>TD9217</b>
<b>D16A470 Euro 2</b>	6cyl.	<b>16120cc</b>	<b>346kW</b> (471PS)	<b>Diesel</b>	<b>Turbo Intercooled</b>	<b>TD17534</b>
<b>D16A520</b>	6cyl.	<b>16120cc</b>	<b>382kW</b> (520PS)	<b>Diesel</b>	<b>Turbo Intercooled</b>	<b>TD11767</b>
<b>D16B520</b>	6cyl.	<b>16120cc</b>	<b>382kW</b> (520PS)	<b>Diesel</b>	<b>Turbo Intercooled</b>	<b>TD11768</b>
<b>TD 163 ES</b>	6cyl.	<b>16123cc</b>	<b>368kW</b> (500PS)	<b>Diesel</b>	<b>Turbo Intercooled</b>	<b>TD9200</b>

15-451030-00 *WH* 1

**144.00**

**B** 158.95    **C** 315.00    **D** 171.95    **E** 13.09    **F** 2.00

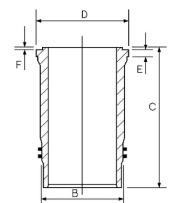

1 Includes seals    1 Schließt Dichtungen ein    1 Inclut des joints    1 Incluye los sellos

# ENGINE INDEX

Motorverzeichnis • Index de moteur • Índice de Motor  
Indeks silnika • Модель двигателя • دليل المحرك



CCM

x



9

MD	Diesel	6730	6	104.775	1
MD	Diesel	9600	6	120.65	2
MD	Diesel	11977	6	130.175	3
TAMD 120	Diesel	11977	6	130.175	3
TMD	Diesel	11977	6	130.175	3
TMD 70	Diesel	6730	6	104.775	1
TMD 100	Diesel	9600	6	120.65	2



**1**

**MD** 6cyl. **6730cc** Diesel Turbo **FM5108**

**TMD 70** 6cyl. **6730cc** Diesel Turbo **FM5108**

15-457590-00 WH ②	104.78	B 116.96	C 256.79	D 126.98	E 11.66	F 0.762	
-------------------	--------	----------	----------	----------	---------	---------	--

14-573140-00 WH ①	104.78	B 117.00	C 257.00	D 127.00	E 11.66	F 0.74	
-------------------	--------	----------	----------	----------	---------	--------	--

① Use also: HT017      ① A utiliser aussi: HT017      ① A utiliser aussi: HT017      ① Utilizar también: HT017  
 ② Includes seals      ② Schließt Dichtungen ein      ② Inclut des joints      ② Incluye los sellos

**2**

**MD** 6cyl. **9600cc** Diesel **FM5116**

**TMD 100** 6cyl. **9600cc** Diesel **FM5116**

15-457600-00 WH ②	120.65	B 133.92	C 294.11	D 146.96	E 11.68	F 0.765	
-------------------	--------	----------	----------	----------	---------	---------	--

14-450520-00 WH ①	120.65	B 134.00	C 294.00	D 147.00	E 11.77	F 0.78	
-------------------	--------	----------	----------	----------	---------	--------	--

① Use also: HT008      ① A utiliser aussi: HT008      ① A utiliser aussi: HT008      ① Utilizar también: HT008  
 ② Includes seals      ② Schließt Dichtungen ein      ② Inclut des joints      ② Incluye los sellos

**3**

**MD** 6cyl. **11977cc** Diesel Turbo **FM3027**

**TAMD 120** 6cyl. **11977cc** Diesel Turbo **FM3027**

**TMD** 6cyl. **11977cc** Diesel Turbo **FM3027**

15-457960-00 WH ①②	130.18	B 143.89	C 311.00	D 157.62	E 10.55	F 0.864	
15-459030-00 WH ②		B 143.91	C 310.52	D 157.58	E 13.55	F 0.686	

① For cylinder block no.470130 only      ① Nur Zylinderblock Nr.470130      ① Bloc-cylindres no.470130 seulement      ① Bloque de cilindro no.470130 unicamente  
 ② Includes seals      ② Schließt Dichtungen ein      ② Inclut des joints      ② Incluye los sellos



1

128 A	4cyl.	1116cc	FM545
128 AC	4cyl.	1116cc	FM545
128 BB.0A	4cyl.	1116cc	FM545

14-018920-00 *D*      80.00      B 84.00      C 114.00

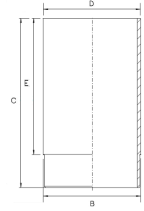

Modelverzeichnis • Index de modele • Índice de Modelo  
Indeks modelu • Модель автомобиля • دليل المركبة

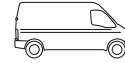

# MODEL INDEX



CCM

x



10/05→	<b>10 1.2</b>	188 A4.000	Petrol	1242	4	<b>1</b>
06/73→12/93	<b>101 1.1</b>	128 A.000, 128 A.064, 128 AC 5000	Petrol	1116	4	<b>2</b>
10/02→11/08	<b>Koral 1.1</b>	128 A.064	Petrol	1116	4	<b>2</b>
04/80→06/95	<b>Yugo 1.1</b>	128 A.000	Petrol	1116	4	<b>2</b>



**1**

**188 A4.000** 4cyl. **1242cc** **44kW (60PS)** **TD24580**

**14-021080-00 D** **70.80** **B 73.80** **C 128.00** **D 75.00** **E 5.00**

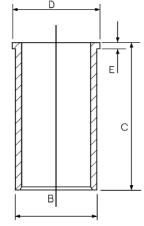

**2**

**128 A.000** 4cyl. **1116cc** **41-44kW (56-60PS)** **TD4183**

**128 A.064** 4cyl. **1116cc** **41kW (55PS)** **TD9409**

**128 AC 5000** 4cyl. **1116cc** **47kW (64PS)** **TD5045**

**14-018920-00 D** **80.00** **B 84.00** **C 114.00**

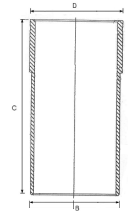





























# NUMERICAL PARTS LIST













Nummerische Teilenummernliste • Liste des références produits  
Liste da referencias













											
13-451070-00	MERCEDES-BENZ	249	15	14-010900-00	ALFA ROMEO	6	4	14-014120-00	FORD COMMERCIAL	107	5
13-451220-00	MERCEDES-BENZ	260	22		BEDFORD	22	1		FORD TRACTOR	109	3
14-000230-00	COMPRESSOR	42	1		FORD	100	4	14-014640-00	FORD COMMERCIAL	107	5
14-000240-00	COMPRESSOR	42	1		PERKINS	291	2		FORD TRACTOR	109	3
14-000310-00	COMPRESSOR	42	2	14-010920-00	AUSTIN	18	3	14-014730-00	ALFA ROMEO	8	7
14-000320-00	CHRYSLER	26	1		LAND ROVER	165	3		CITROEN	36	10
	JEEP	152	1		LEYLAND	170	3		FIAT	75	12
	RENAULT	325	12		ROVER	340	6			76	13
14-000350-00	COMPRESSOR	42	2	14-010940-00	FIAT	83	28		LANCIA	161	6
14-010170-00	FIAT	81	25		IVECO	139	12	14-015400-00	MITSUBISHI	270	3
	IVECO	134	6			140	13	14-015590-00	FORD	102	11
	NEW HOLLAND	272	3		NEW HOLLAND	274	7		HYUNDAI	115	1
14-010180-00	FIAT	82	27	14-010941-10	FIAT	83	28			115	2
	FIAT ALLIS-HITACHI	87	2		IVECO	139	12		MITSUBISHI	270	1
	IVECO	136	10			140	13	14-018002-00	IVECO	145	26
		136	11		NEW HOLLAND	274	7	14-018920-00	FIAT	73	7
	NEW HOLLAND	273	5	14-010943-10	FIAT	83	28		YUGO	412	1
		273	6		IVECO	139	12		ZASTAVA	414	2
14-010181-00	FIAT	82	27			140	13	14-020110-00	FORD	104	15
	FIAT ALLIS-HITACHI	87	2		NEW HOLLAND	274	7		NISSAN	282	8
	IVECO	136	10	14-010950-00	DAVID BROWN	53	1	14-020120-00	NISSAN	281	7
		136	11	14-010960-00	CLAYTON DEWANDRE	41	1	14-020190-00	CITROEN	39	18
	NEW HOLLAND	273	5	14-010970-00	HYUNDAI	115	3		PEUGEOT	307	19
14-010182-00	FIAT	82	27		MITSUBISHI	270	2	14-020200-00	FIAT ALLIS-HITACHI	87	5
	FIAT ALLIS-HITACHI	87	2	14-010991-00	AUTOBIANCHI	20	2		FIAT INDUSTRIAL	92	6
	IVECO	136	10		FIAT	72	3		IVECO	143	21
		136	11		LANCIA	160	3	14-020280-00	NISSAN	280	2
	NEW HOLLAND	273	5	14-011001-00	AUTOBIANCHI	20	1		OPEL	285	4
14-010620-00	IVECO	134	5		FIAT	71	1		RENAULT	324	11
	NEW HOLLAND	272	2		LANCIA	160	1		VAUXHALL	376	3
14-010770-00	FORD COMMERCIAL	107	4		SEAT	354	1	14-020290-00	CITROEN	36	9
	FORD TRACTOR	109	2	14-011021-00	FIAT	81	25		FIAT	75	11
14-010780-00	FIAT	81	26		IVECO	134	6		PEUGEOT	304	10
	IVECO	135	7		NEW HOLLAND	272	3	14-020300-00	MERCEDES-BENZ	230	3
	NEW HOLLAND	273	4	14-011022-00	FIAT	81	25	14-020330-00	RENAULT TRUCKS	336	17
14-010781-00	FIAT	81	26		IVECO	134	6			337	19
	IVECO	135	7		NEW HOLLAND	272	3	14-020350-00	NISSAN	281	4
	NEW HOLLAND	273	4	14-011031-00	FIAT ALLIS-HITACHI	87	1	14-020351-00	NISSAN	281	4
14-010782-00	FIAT	81	26		NEW HOLLAND	272	1	14-020420-00	VOLKSWAGEN	389	6
	IVECO	135	7	14-011041-00	ALFA ROMEO	8	9	14-020421-00	VOLKSWAGEN	389	6
	NEW HOLLAND	273	4		FIAT	77	16	14-020450-00	OPEL	286	7
14-010820-00	NEW HOLLAND	275	10		LANCIA	162	7		VAUXHALL	377	6
14-010830-00	FORD	99	2	14-011061-00	IVECO	134	5	14-020490-00	DEUTZ/KHD	56	2
14-010840-00	MAZDA	201	2		NEW HOLLAND	272	2	14-020510-00	RENAULT TRUCKS	336	17
14-010850-00	TOYOTA	371	3	14-012260-00	MERCEDES-BENZ	240	10	14-020530-00	CITROEN	37	12
	VOLKSWAGEN	389	7	14-012470-00	FIAT	73	6		FIAT	76	15
14-010860-00	LAND ROVER	166	5	14-013401-00	FIAT	81	25		FSO	112	2
14-010870-00	ISUZU	119	1		IVECO	134	6		LDV	168	1
	OPEL	285	2	14-013481-00	CITROEN	39	19		LEYLAND	170	2
	VAUXHALL	376	1		FIAT	78	20		PEUGEOT	305	12
14-010880-00	FORD	100	6		PEUGEOT	307	20		ROVER	340	5
14-010890-00	AUSTIN	18	1		TALBOT	369	6		SUZUKI	366	3
	MG	266	1	14-013700-00	FORD	104	17		TALBOT	368	3
	ROVER	339	1		FORD COMMERCIAL	106	2	14-020540-00	FORD	101	9
						106	3			104	16
				14-014090-00	FORD	103	13		LAND ROVER	165	2

											
14-020590-00	PERKINS	293	9	14-021170-00	NISSAN	280	3	14-021322-00	CITROEN	40	21
14-020600-00	FORD	102	11	14-021180-00	BEDFORD	22	3		OPEL	288	15
	HYUNDAI	115	2		ISUZU	119	2		PEUGEOT	308	22
	MITSUBISHI	270	1	14-021190-00	BEDFORD	22	4		VAUXHALL	378	11
14-020610-00	CUMMINS	43	1		ISUZU	119	3	14-021350-00	MERCEDES-BENZ	232	7
14-020650-00	DACIA	45	2		OPEL	286	8			232	8
	NISSAN	280	1		SSANGYONG	361	1	14-021361-00	FIAT	83	28
	RENAULT	323	9		VAUXHALL	377	7		IVECO	139	12
	SUZUKI	366	2	14-021200-00	OPEL	286	5			140	13
14-020660-00	ARO	13	6		VAUXHALL	376	4		NEW HOLLAND	274	7
	CITROEN	39	20	14-021220-00	FORD TRACTOR	109	1	14-021362-00	FIAT	83	28
	DAF	48	3		LEYLAND	170	4		IVECO	139	12
	FORD	103	14		PERKINS	291	4			140	13
	LDV	168	3	14-021221-00	FORD TRACTOR	109	1		NEW HOLLAND	274	7
	PEUGEOT	308	21		LEYLAND	170	4	14-021363-00	FIAT	83	28
	SSANGYONG	361	4		PERKINS	291	4		IVECO	139	12
	TALBOT	369	7	14-021222-00	FORD TRACTOR	109	1			140	13
14-020730-00	FORD COMMERCIAL	107	4		LEYLAND	170	4		NEW HOLLAND	274	7
	FORD TRACTOR	109	2	14-021223-00	PERKINS	291	4	14-021371-00	ALFA ROMEO	10	12
14-020740-00	FORD TRACTOR	110	4		FORD TRACTOR	109	1		ARO	10	12
14-020741-00	FORD TRACTOR	110	4		LEYLAND	170	4		FIAT	78	21
14-020742-00	FORD TRACTOR	110	4		PERKINS	291	4			79	22
14-020760-00	CITROEN	33	2	14-021230-00	FIAT	85	32		IVECO	131	1
	FORD	99	1		FIAT ALLIS-HITACHI	88	7		LANCIA	163	8
	MAZDA	201	1		FIAT INDUSTRIAL	94	8		RENAULT	327	15
	PEUGEOT	301	2		IVECO	147	28		RENAULT TRUCKS	331	1
	TOYOTA	371	1	14-021231-00	FIAT	85	32	14-021372-00	ALFA ROMEO	10	12
14-020761-00	CITROEN	33	2		FIAT ALLIS-HITACHI	88	7		ARO	10	12
	FORD	99	1		FIAT INDUSTRIAL	94	8		FIAT	78	21
	MAZDA	201	1		IVECO	147	28			79	22
	PEUGEOT	301	2		NEW HOLLAND	276	13		IVECO	131	1
	TOYOTA	371	1	14-021232-00	FIAT	85	32		LANCIA	163	8
14-020870-00	PERKINS	294	10		FIAT ALLIS-HITACHI	88	7		RENAULT	327	15
14-020900-00	CITROEN	35	7		FIAT INDUSTRIAL	94	8		RENAULT TRUCKS	331	1
	FIAT	72	5		IVECO	147	28	14-021373-00	ALFA ROMEO	10	12
	FORD	99	3		NEW HOLLAND	276	13		ARO	10	12
	MINI	268	1	14-021240-00	PERKINS	291	3		FIAT	78	21
	PEUGEOT	303	6	14-021250-00	LEYLAND	171	6			79	22
	SUZUKI	366	1			172	7		IVECO	131	1
14-021051-00	ALFA ROMEO	7	6		PERKINS	292	6		LANCIA	163	8
	FIAT	74	9		VOLVO COMMERCIAL	398	4		RENAULT	327	15
		74	10	14-021260-00	FIAT	73	6		RENAULT TRUCKS	331	1
	LANCIA	161	5	14-021311-00	ALFA ROMEO	8	7	14-021410-00	DAF	51	6
14-021080-00	FIAT	72	4		CITROEN	36	10		LEYLAND	172	9
	LANCIA	160	4		FIAT	75	12	14-021440-00	BEDFORD	22	4
	ZASTAVA	414	1		LANCIA	161	6		ISUZU	119	3
14-021120-00	CITROEN	38	14	14-021321-00	CITROEN	40	21		OPEL	286	8
	FIAT	78	18		FIAT	80	24		SSANGYONG	361	1
	FORD	101	7		FIAT INDUSTRIAL	91	1		VAUXHALL	377	7
	JAGUAR	150	1		IVECO	133	4	14-021450-00	ISUZU	119	4
	PEUGEOT	306	14		OPEL	288	15		OPEL	287	12
14-021130-00	AUSTIN	18	2		PEUGEOT	308	22	14-021460-00	ISUZU	120	5
	LEYLAND	170	1		RENAULT	328	17		OPEL	288	13
14-021140-00	BEDFORD	23	7		RENAULT TRUCKS	331	2				
14-021150-00	NISSAN	281	5		VAUXHALL	378	11				
14-021160-00	NISSAN	280	3								

# NUMERICAL PARTS LIST













Nummerische Teilenummernliste • Liste des références produits  
Liste da referencias













											
14-021480-00	ALFA ROMEO	10	12	14-021571-00	AUDI	15	1	14-023751-00	ALFA ROMEO	8	7
	ARO	10	12		PEGASO	289	1		CITROEN	36	10
	FIAT	79	22		SEAT	354	3		FIAT	75	12
	IVECO	131	1		SKODA	358	2			76	13
	LANCIA	163	8		VOLKSWAGEN	386	2		LANCIA	161	6
	RENAULT	327	15			388	5	14-024070-00	DAF	49	5
	RENAULT TRUCKS	331	1		VOLVO	391	4	14-024100-00	BEDFORD	23	6
14-021491-00	FIAT	83	28	14-021580-00	FIAT ALLIS-HITACHI	88	6		OPEL	287	10
	IVECO	139	12		IVECO	143	22		VAUXHALL	377	8
		140	13	14-021590-00	FIAT	85	32	14-024160-00	BEDFORD	22	5
	NEW HOLLAND	274	7		FIAT ALLIS-HITACHI	88	7		OPEL	287	9
14-021492-00	FIAT	83	28		FIAT INDUSTRIAL	94	8	14-024240-00	MERCEDES-BENZ	246	12
	IVECO	139	12		IVECO	147	28	14-024241-00	MERCEDES-BENZ	246	12
		140	13	14-021610-00	FORD TRACTOR	110	4	14-024670-00	AUDI	15	2
	NEW HOLLAND	274	7	14-021611-00	FORD TRACTOR	110	4		VOLKSWAGEN	386	3
14-021493-00	FIAT	83	28	14-021850-00	MERCEDES-BENZ	236	9	14-024680-00	FORD TRACTOR	109	1
	IVECO	139	12	14-022060-00	ALFA ROMEO	6	1		LEYLAND	170	4
		140	13		FIAT	71	2		PERKINS	291	4
	NEW HOLLAND	274	7		LANCIA	160	2	14-024710-00	AUSTIN	18	3
14-021494-00	FIAT	83	28	14-022190-00	MERCEDES-BENZ	228	1		LAND ROVER	165	3
	IVECO	139	12		SEAT	355	5		LEYLAND	170	3
		140	13	14-022560-00	ALFA ROMEO	10	13	14-024740-00	CITROEN	35	8
	NEW HOLLAND	274	7		ARO	10	13		PEUGEOT	303	8
14-021520-00	ARO	13	6		FIAT	80	23		ROVER	339	3
	CITROEN	39	20		IVECO	132	2	14-024781-00	FIAT	83	28
	DAF	48	3		LANCIA	163	9		IVECO	139	12
	FORD	103	14		OPEL	288	14			140	13
	LDV	168	3		RENAULT	328	16	14-024830-00	CITROEN	35	8
	PEUGEOT	308	21		SEAT	356	6		PEUGEOT	303	8
	SSANGYONG	361	4		VAUXHALL	378	10		ROVER	339	3
	TALBOT	369	7	14-022830-00	MAN	191	4	14-025070-00	SEAT	354	2
14-021540-00	FIAT	81	25	14-022960-00	FORD TRACTOR	109	1		VOLKSWAGEN	385	1
	IVECO	134	6		PERKINS	291	4	14-025380-10	PERKINS	293	7
	NEW HOLLAND	272	3	14-023470-00	AUDI	15	2	14-025420-00	STEYR	364	4
14-021560-10	FIAT	85	32		VOLKSWAGEN	386	3	14-025480-00	MERCEDES-BENZ	230	4
	FIAT ALLIS-HITACHI	88	7	14-023520-00	BEDFORD	22	2	14-025530-00	DAF	48	4
	FIAT INDUSTRIAL	94	8		OPEL	285	3	14-025800-00	MERCEDES-BENZ	236	9
	IVECO	147	28		VAUXHALL	376	2			240	10
	NEW HOLLAND	276	13	14-023551-00	FIAT	82	27	14-025801-00	MERCEDES-BENZ	236	9
14-021561-10	FIAT	85	32		IVECO	136	10			240	10
	FIAT ALLIS-HITACHI	88	7	14-023552-00	NEW HOLLAND	273	5	14-025802-00	MERCEDES-BENZ	236	9
	FIAT INDUSTRIAL	94	8		IVECO	136	10			240	10
	IVECO	147	28	14-023553-00	FIAT	82	27	14-025804-00	MERCEDES-BENZ	236	9
	NEW HOLLAND	276	13		IVECO	136	10			240	10
14-021562-10	FIAT	85	32		NEW HOLLAND	273	5	14-025833-00	FORD TRACTOR	109	1
	FIAT ALLIS-HITACHI	88	7	14-023560-00	ALFA ROMEO	8	7		PERKINS	291	4
	FIAT INDUSTRIAL	94	8		CITROEN	36	10	14-025871-00	FORD TRACTOR	109	1
	IVECO	147	28		LANCIA	161	6		LEYLAND	170	4
	NEW HOLLAND	276	13	14-023730-00	ARO	12	4		PERKINS	291	4
14-021563-10	FIAT	85	32		RENAULT	323	10	14-025873-00	PERKINS	291	4
	FIAT ALLIS-HITACHI	88	7		VOLVO	392	5	14-025881-00	MERCEDES-BENZ	236	9
	FIAT INDUSTRIAL	94	8							240	10
	IVECO	147	28					14-025883-00	MERCEDES-BENZ	236	9
	NEW HOLLAND	276	13							240	10
								14-025890-00	MERCEDES-BENZ	250	16
								14-025891-00	MERCEDES-BENZ	250	16

											
14-025892-00	MERCEDES-BENZ	250	16	14-028931-00	ALFA ROMEO	10	13	14-040180-00	LEYLAND	171	6
14-026240-00	MERCEDES-BENZ	229	2		ARO	10	13			172	7
14-026241-00	MERCEDES-BENZ	229	2		CITROEN	40	21		PERKINS	292	6
14-026380-00	MERCEDES-BENZ	231	5		FIAT	80	23		VOLVO COMMERCIAL	398	4
	SSANGYONG	361	2			80	24	14-040190-00	PERKINS	293	8
		361	3		FIAT INDUSTRIAL	91	1	14-040200-00	LEYLAND	171	6
14-027200-00	RENAULT TRUCKS	336	17		IVECO	132	2			172	7
14-027210-00	MERCEDES-BENZ	231	5			132	3		PERKINS	292	6
		231	6			133	4		VOLVO COMMERCIAL	398	4
	SSANGYONG	361	3		LANCIA	163	9	14-041140-00	PERKINS	293	8
14-027270-00	ARO	13	6		OPEL	288	14	14-041610-00	PERKINS	293	8
	CITROEN	39	20			288	15	14-043450-00	NISSAN	281	6
	DAF	48	3		PEUGEOT	308	22		PERKINS	292	5
	FORD	103	14		RENAULT	328	16		VOLKSWAGEN	389	8
	LDV	168	3			328	17	14-044690-00	PERKINS	293	8
	PEUGEOT	308	21		RENAULT TRUCKS	331	2	14-045570-00	FORD COMMERCIAL	106	2
	SSANGYONG	361	4		VAUXHALL	378	10	14-045820-00	LEYLAND	171	6
	TALBOT	369	7			378	11			172	7
14-027680-00	MAN	188	1	14-028932-00	ALFA ROMEO	10	13		PERKINS	292	6
14-027681-00	MAN	188	1		ARO	10	13		VOLVO COMMERCIAL	398	4
14-027790-00	STEYR	363	3		CITROEN	40	21	14-045821-00	LEYLAND	171	6
14-027950-00	AUDI	16	3		FIAT	80	23			172	7
	FORD	100	5			80	24		PERKINS	292	6
	SEAT	355	4		FIAT INDUSTRIAL	91	1		VOLVO COMMERCIAL	398	4
	SKODA	359	3		IVECO	132	2	14-102800-00	OPEL	286	6
	VOLKSWAGEN	388	4			132	3		VAUXHALL	377	5
14-028240-00	STEYR	364	5			133	4	14-112800-00	SCANIA	346	5
14-028360-00	AUDI	15	1		LANCIA	163	9			346	6
		15	2		OPEL	288	14	14-112900-00	HINO	113	3
	PEGASO	289	1			288	15	14-260070-00	IVECO	141	17
	SEAT	354	3		PEUGEOT	308	22	14-260080-00	FIAT ALLIS-HITACHI	88	8
	SKODA	358	2		RENAULT	328	16		FIAT INDUSTRIAL	94	9
	VOLKSWAGEN	386	2			328	17		IVECO	147	29
		386	3		RENAULT TRUCKS	331	2	14-260090-00	LDV	168	2
		388	5		VAUXHALL	378	10		VM	379	1
	VOLVO	391	4			378	11	14-260500-00	UTB	373	1
14-028610-00	MERCEDES-BENZ	245	11	14-028960-00	ALFA ROMEO	7	6	14-261790-00	RENAULT TRUCKS	331	3
14-028710-00	FIAT	74	8		FIAT	74	10	14-264190-00	RENAULT TRUCKS	331	3
14-028930-00	ALFA ROMEO	10	13		LANCIA	161	5	14-265940-00	RENAULT TRUCKS	332	4
	ARO	10	13	14-029750-00	DEUTZ/KHD	56	1	14-265950-00	RENAULT TRUCKS	332	5
	CITROEN	40	21	14-030350-00	MAN	188	2	14-265960-00	RENAULT TRUCKS	333	6
	FIAT	80	23	14-040040-00	RENAULT TRUCKS	337	18	14-370870-00	FORD COMMERCIAL	106	1
		80	24			337	19	14-374990-00	SCANIA	344	1
	FIAT INDUSTRIAL	91	1	14-040110-00	LEYLAND	171	6			344	2
	IVECO	132	2			172	7	14-376210-00	BELARUS	24	1
		132	3		PERKINS	292	6	14-378270-00	IFA	116	1
		133	4	14-040120-00	PERKINS	293	8	14-400510-00	VOLVO COMMERCIAL	397	1
	LANCIA	163	9	14-040130-00	TOYOTA	371	3	14-440260-00	IHC	117	1
	OPEL	288	14		VOLKSWAGEN	389	7	14-450030-00	MAN	197	8
		288	15	14-040140-00	HINO	113	2	14-450040-00	SCANIA	347	7
	PEUGEOT	308	22		TOYOTA	372	5	14-450110-00	SCANIA	347	7
	RENAULT	328	16	14-040150-00	DAIHATSU	52	1	14-450160-00	RENAULT TRUCKS	336	15
		328	17		HINO	113	1		VOLVO COMMERCIAL	409	24
	RENAULT TRUCKS	331	2		TOYOTA	371	4	14-450250-00	MERCEDES-BENZ	262	23
	VAUXHALL	378	10	14-040160-00	TOYOTA	371	2			264	25
		378	11					14-450270-00	IHC	117	2









# NUMERICAL PARTS LIST

Nummerische Teilenummernliste • Liste des références produits  
Liste da referencias

											
14-450370-00	MAN	192	5	14-453090-00	SCANIA	348	10	14-611250-00	FIAT	84	29
14-450380-00	MERCEDES-BENZ	251	17	14-454560-00	MAN	192	5		FIAT ALLIS-HITACHI	87	3
		252	18	14-455210-00	FORD COMMERCIAL	106	1		FIAT INDUSTRIAL	91	2
14-450390-00	SCANIA	347	8	14-456000-00	VOLVO COMMERCIAL	406	20		IVECO	141	15
14-450400-00	SCANIA	348	9			407	21		NEW HOLLAND	274	9
14-450480-00	MERCEDES-BENZ	252	17			408	22	14-615230-00	FIAT	84	29
		252	18			408	23		FIAT ALLIS-HITACHI	87	3
14-450490-00	STEYR	363	1	14-456330-00	MERCEDES-BENZ	264	24		FIAT INDUSTRIAL	91	2
14-450520-00	VOLVO COMMERCIAL	401	12	14-456980-00	MERCEDES-BENZ	259	21		IVECO	141	15
		402	13	14-458110-00	MERCEDES-BENZ	248	13	14-630100-00	IVECO	140	14
	VOLVO PENTA	411	2	14-458170-00	VOLVO COMMERCIAL	402	14		NEW HOLLAND	274	8
14-450530-00	VOLVO COMMERCIAL	406	20			403	15	14-630120-00	ARO	12	2
		407	21			404	16		RENAULT	319	4
14-450630-00	MAN	191	3	14-458180-00	VOLVO COMMERCIAL	406	20	14-630440-00	ARO	12	1
14-450660-00	JOHN DEERE	153	2			408	22		DACIA	45	1
		153	3	14-458190-00	SCANIA	348	9		DAF	48	2
14-450710-00	JOHN DEERE	154	4			348	10		RENAULT	319	3
14-450790-00	MERCEDES-BENZ	260	22			349	11		VOLVO	391	2
14-450810-00	VOLVO COMMERCIAL	400	8	14-458500-00	KAMAZ	155	1	14-633860-00	FIAT	84	30
14-450850-00	SCANIA	347	7	14-458580-00	MERCEDES-BENZ	262	23		FIAT INDUSTRIAL	91	4
		348	9			264	25			92	5
		348	10	14-459010-00	FIAT INDUSTRIAL	92	7		IVECO	142	19
14-450880-00	FIAT	84	31		IVECO	144	23	14-634110-00	PEUGEOT	303	9
	IVECO	143	20	14-459040-00	VOLVO COMMERCIAL	405	17	14-634910-00	CITROEN	37	11
	NEW HOLLAND	275	12	14-459050-00	VOLVO COMMERCIAL	399	6		FIAT	76	14
14-450890-00	VOLVO COMMERCIAL	398	5	14-470110-00	LEYLAND	171	5		PEUGEOT	304	11
14-450920-00	RENAULT TRUCKS	335	12			172	8		SKODA	358	1
14-450960-00	DEUTZ/KHD	61	14	14-476000-00	AGCO SISU	1	1	14-636470-00	CITROEN	33	1
14-451040-00	MAN	194	7	14-480040-00	DEUTZ/KHD	59	10			33	3
14-451080-00	STEYR	363	2		VOLVO COMMERCIAL	405	18		PEUGEOT	301	1
14-451090-00	MAN	193	6	14-480230-00	VOLVO COMMERCIAL	400	10		TALBOT	368	1
14-451160-00	MERCEDES-BENZ	253	19	14-480320-00	FORD TRACTOR	109	1	14-636500-00	CITROEN	38	16
		257	20		LEYLAND	170	4		FIAT	78	19
14-451170-00	IHC	117	3		PERKINS	291	4		PEUGEOT	306	16
14-451190-00	RENAULT TRUCKS	336	16	14-480440-00	RENAULT TRUCKS	335	13		TALBOT	368	5
	VOLVO COMMERCIAL	409	25		VOLVO COMMERCIAL	406	19	14-636600-00	CITROEN	34	4
14-451220-00	MERCEDES-BENZ	260	22	14-480460-00	VOLVO COMMERCIAL	401	11		PEUGEOT	302	3
14-451660-00	MERCEDES-BENZ	248	13	14-573140-00	VOLVO COMMERCIAL	400	7		RENAULT	319	5
14-452020-00	MERCEDES-BENZ	248	13		VOLVO PENTA	411	1		TALBOT	368	2
14-452030-00	MERCEDES-BENZ	253	19	14-600420-00	CITROEN	38	15	14-636730-00	DAF	48	1
		257	20		FORD	101	8		OPEL	285	1
14-452080-00	LEYLAND	171	5		PEUGEOT	306	15		RENAULT	318	2
14-452080-10	LEYLAND	171	5		RENAULT	325	13		VOLVO	391	1
14-452310-00	MERCEDES-BENZ	248	13	14-604060-00	ARO	13	5	14-637160-00	CITROEN	39	17
14-452370-00	MERCEDES-BENZ	249	14		FORD	102	10		JEEP	152	2
14-452390-00	MERCEDES-BENZ	253	19		PEUGEOT	307	18		PEUGEOT	307	17
		257	20	14-606670-00	CITROEN	38	13		RENAULT	326	14
14-452670-00	IHC	117	4		FIAT	77	17	14-638630-00	CITROEN	34	5
14-452740-00	JOHN DEERE	153	1		PEUGEOT	305	13		PEUGEOT	302	4
14-452910-00	MAN	198	9		TALBOT	368	4	14-670020-00	SCANIA	349	12
14-452920-00	MAN	197	8	14-610010-00	FIAT INDUSTRIAL	92	7	14-670050-00	MAN	199	11
		198	10		IVECO	144	23	14-671680-00	SCANIA	349	12
14-452921-10	MAN	197	8	14-610020-00	FIAT INDUSTRIAL	91	3			350	13
		198	10		IVECO	142	18				
14-452930-00	MAN	197	8								
		198	10								







											
14-673080-00	SCANIA	349	12	15-260040-00	IVECO	144	25	15-608890-00	SCANIA	344	2
14-673190-00	VOLVO COMMERCIAL	403	15	15-260050-00	IVECO	145	27			345	4
14-673200-00	VOLVO COMMERCIAL	401	12	15-260080-00	FIAT ALLIS-HITACHI	88	8	15-630820-00	ARO	12	3
		403	15		FIAT INDUSTRIAL	94	9		RENAULT	322	8
		404	16		IVECO	147	29		VOLVO	391	3
14-676420-00	ALFA ROMEO	9	11	15-265960-00	RENAULT TRUCKS	333	6	15-632000-00	ALFA ROMEO	8	8
	CHRYSLER	26	2	15-370040-00	PERKINS	291	1			9	10
	FORD	102	12	15-450130-00	VOLVO COMMERCIAL	397	2	15-632100-00	ALFA ROMEO	6	3
	LAND ROVER	166	4	15-450160-00	RENAULT TRUCKS	336	15	15-632200-00	RENAULT	318	1
	OPEL	287	11		VOLVO COMMERCIAL	409	24	15-632400-00	ALFA ROMEO	10	14
	ROVER	340	7	15-450190-00	RENAULT TRUCKS	334	9		ARO	10	14
	VAUXHALL	378	9	15-450220-00	RENAULT TRUCKS	335	12	15-632500-00	ALFA ROMEO	6	2
	VM	379	2	15-450630-00	MAN	191	3	15-632600-00	ALFA ROMEO	7	5
14-684840-00	FIAT	84	30	15-450870-00	LEYLAND	171	5	15-636490-00	PEUGEOT	303	7
	FIAT ALLIS-HITACHI	87	4			172	8	15-636590-00	ARO	12	1
	FIAT INDUSTRIAL	91	4	15-451030-00	VOLVO COMMERCIAL	409	26		DACIA	45	1
		92	5	15-451070-10	MERCEDES-BENZ	249	15		DAF	48	2
	IVECO	142	19	15-451220-00	MERCEDES-BENZ	260	22		RENAULT	319	3
	NEW HOLLAND	275	11	15-451230-00	DAF	51	7		VOLVO	391	2
14-693800-00	KOMATSU	156	1	15-457590-00	VOLVO COMMERCIAL	399	7	15-636700-00	CITROEN	34	6
14-710010-00	JAGUAR	150	2		VOLVO PENTA	411	1		PEUGEOT	302	5
14-710020-00	LAND ROVER	165	1	15-457600-00	VOLVO COMMERCIAL	401	12		RENAULT	320	6
	LOTUS	173	1			402	13	15-638390-00	RENAULT	321	7
	MG	266	3		VOLVO PENTA	411	2	15-677620-00	VOLVO COMMERCIAL	401	12
	ROVER	340	4	15-457960-00	VOLVO COMMERCIAL	406	20			403	15
14-710030-00	FSO	112	1			407	21			404	16
	MG	266	2			408	22	15-679320-00	SCANIA	351	15
	ROVER	339	2			408	23	15-680070-00	IVECO	147	29
14-740060-00	IVECO	141	16		VOLVO PENTA	411	3			148	30
14-740130-00	RENAULT	328	18	15-458840-00	VOLVO COMMERCIAL	406	20				
	RENAULT TRUCKS	336	14			407	21				
14-785400-00	FIAT	76	13			407	22				
14-900030-00	DEUTZ/KHD	60	13			408	23				
	IVECO	144	24	15-458900-00	VOLVO COMMERCIAL	397	1				
14-900050-00	DEUTZ/KHD	60	13	15-458910-00	VOLVO COMMERCIAL	399	6				
	IVECO	144	24	15-459030-00	VOLVO COMMERCIAL	406	20				
14-900060-00	DEUTZ/KHD	57	5			407	21				
		57	6		VOLVO PENTA	411	3				
		58	7	15-459230-00	VOLVO COMMERCIAL	405	17				
		58	8	15-459340-00	VOLVO COMMERCIAL	398	3				
	IVECO	135	8	15-459350-00	VOLVO COMMERCIAL	404	16				
14-900070-00	DEUTZ/KHD	59	12	15-480050-00	RENAULT TRUCKS	334	10				
14-900080-00	DEUTZ/KHD	56	3	15-480070-00	RENAULT TRUCKS	334	9				
		57	4			334	10				
14-900080-10	DEUTZ/KHD	57	4	15-480080-00	RENAULT TRUCKS	334	9				
14-900100-00	DEUTZ/KHD	57	5			335	11				
		57	6	15-480090-00	RENAULT TRUCKS	333	6				
		58	7			333	7				
		58	8	15-480450-00	DEUTZ/KHD	59	11				
	IVECO	135	8		RENAULT TRUCKS	333	8				
		135	9		VOLVO COMMERCIAL	400	9				
14-900110-00	DEUTZ/KHD	57	6	15-570050-00	SCANIA	346	6				
		58	8			350	14				
14-900120-00	DEUTZ/KHD	57	6	15-570060-00	SCANIA	346	6				
		58	8			350	14				
		58	9	15-600020-00	SCANIA	345	3				



 <b>GOETZE</b> Liner	 <b>Niiral</b> Kitset	 <b>Niiral</b> Piston	 <b>GOETZE</b> Liner	 <b>Niiral</b> Kitset	 <b>Niiral</b> Piston	 <b>GOETZE</b> Liner	 <b>Niiral</b> Kitset	 <b>Niiral</b> Piston
14-025380-10	88-101700-30	87-101700-00	14-022830-00	88-274800-30	87-274800-30	15-632000-00	89-110200-40	87-110200-40
14-029750-00	88-103200-00	87-103200-00	14-452920-00	88-283100-40	87-283100-40	15-632300-00	89-110500-30	87-110500-30
14-020290-00	88-104000-00	87-104000-00	14-027680-00	88-285900-00	87-285900-00	15-260040-00	89-121900-30	87-121900-00
14-452920-00	88-104300-00	87-104300-00	14-027680-00	88-285900-05	87-285900-05	15-260050-00	89-122000-30	87-122000-00
14-452920-00	88-104300-10	87-104300-10	14-027680-00	88-285900-06	87-285900-06	14-450590-00	89-123200-10	87-123200-10
14-450380-00	88-115800-00	87-115800-00	14-027680-00	88-285900-10	87-285900-10	15-450160-00	89-123200-30	87-123200-00
14-260070-00	88-121800-00	87-121800-00	14-027680-00	88-285900-15	87-285900-15	14-450160-00	89-123200-40	87-123200-40
14-450960-00	88-123900-10	87-123900-10	14-027680-00	88-285900-16	87-285900-16	14-452920-00	89-124500-00	87-124500-00
14-452910-00	88-124500-30	87-124500-30	14-027680-00	88-285900-30	87-285900-30	14-452930-00	89-124500-05	87-124500-00
14-450250-00	88-136000-20	87-136000-20	14-027680-00	88-285900-40	87-285900-40	14-452920-00	89-124500-10	87-124500-10
14-027680-00	88-136500-00	87-136500-00	14-028610-00	88-289300-00	87-289300-00	14-452920-00	89-124500-20	87-124500-20
14-027680-00	88-136500-10	87-136500-10	14-450250-00	88-289600-30	87-289600-30	14-452930-00	89-124500-25	87-124500-20
14-027680-00	88-136500-30	87-136500-30	14-025380-10	88-325600-10	87-325600-10	14-452910-00	89-124500-40	87-124500-40
14-027680-00	88-136500-65	87-136500-65	14-020330-00	88-335300-00	87-335300-00	15-480070-00	89-131400-40	87-131500-00
14-480040-00	88-136900-00	87-136900-00	14-020330-00	88-335900-00	87-335900-00	15-480050-00	89-131500-30	87-131500-00
14-000310-00	88-140500-00	87-140500-00	14-040040-00	88-335900-10	87-335900-10	14-450920-00	89-135500-10	87-135500-10
14-000350-00	88-140500-10	87-140500-10	14-040040-00	88-335900-30	87-335900-30	15-450220-00	89-135500-30	87-135500-00
14-450380-00	88-141800-00	87-141800-00	14-010850-00	88-373800-10	87-373800-10	14-458580-00	89-136000-00	87-136000-00
14-450810-00	88-141900-00	87-141900-00	14-040130-00	88-379800-00	87-379800-00	14-458580-00	89-136000-10	87-136000-10
14-480230-00	88-142000-00	87-142000-00	14-000240-00	88-404500-00	87-404500-00	15-459230-00	89-136800-10	87-136800-10
14-450890-00	88-142800-00	87-142800-00	14-000230-00	88-404500-10	87-404500-10	15-459230-00	89-136800-30	87-136800-30
14-740060-00	88-142900-00	87-142900-00	14-450790-00	88-420900-00	87-420900-00	15-459230-00	89-136800-40	87-136800-40
14-670050-00	88-143800-50	87-143800-50	14-450790-00	88-420900-10	87-420900-10	15-450130-00	89-142500-10	87-142500-10
14-020530-00	88-152000-30	87-152000-10	14-450630-00	88-423000-00	87-423000-00	15-459340-00	89-142500-30	87-142500-00
14-636470-00	88-154300-00	87-154300-00	14-450630-00	88-423000-01	87-423000-01	14-112800-00	89-143600-00	87-143600-00
14-636600-00	88-154400-00	87-154400-00	14-450630-00	88-423000-10	87-423000-10	14-112800-00	89-143600-30	87-143600-30
14-900070-00	88-167600-00	87-167600-00	14-450630-00	88-423000-11	87-423000-11	14-112800-00	89-143600-40	87-143600-40
14-900080-00	88-172500-00	87-172500-00	14-450630-00	88-428600-00	87-428600-00	14-452920-00	89-143800-00	87-143800-00
14-021410-00	88-174100-00	87-174100-00	14-740130-00	88-429600-00	87-429600-00	14-452920-00	89-143800-10	87-143800-10
14-021410-00	88-174100-30	87-174100-30	14-021410-00	88-433300-00	87-433300-00	14-452920-00	89-143800-20	87-143800-20
14-900100-00	88-174600-00	87-174600-00	14-710030-00	88-520500-00	87-520500-00	14-452920-00	89-143800-30	87-143800-30
14-900100-00	88-174600-10	87-174600-10	14-710020-00	88-522700-00	87-522700-00	14-458580-00	89-145900-00	87-145900-00
14-900100-00	88-174600-30	87-174600-30	14-684840-00	88-523000-00	87-523000-00	14-458110-00	89-176000-00	87-176000-00
14-451660-00	88-176800-00	87-176800-00	14-610020-00	88-523000-10	87-523000-10	14-458110-00	89-176000-10	87-176000-10
14-452310-00	88-176800-10	87-176800-10	14-710010-00	88-523600-00	87-523600-00	14-451660-00	89-176800-20	87-176800-00
14-900100-00	88-178400-00	87-178400-00	14-684840-00	88-528000-00	87-528000-00	14-452370-00	89-176800-30	87-176800-30
14-900060-00	88-178400-10	87-178400-10	14-630100-00	88-528100-00	87-528100-00	14-452370-00	89-176800-40	87-176800-40
14-025530-00	88-179000-10	87-179000-10	14-012260-00	88-740000-50	87-740000-50	14-452030-00	89-179300-05	87-179300-05
14-451160-00	88-179300-10	87-179300-10	14-900050-00	88-740300-00	87-740300-00	14-452030-00	89-179300-15	87-179300-15
14-900080-00	88-179400-00	87-179400-00	14-900030-00	88-740300-10	87-740300-10	14-452030-00	89-179300-16	87-179300-16
14-450710-00	88-181100-10	87-181100-10	14-900100-00	88-740900-00	87-740900-00	14-452030-00	89-179300-18	87-179300-10
14-450710-00	88-181100-20	87-181100-20	14-900100-00	88-740900-10	87-740900-10	14-456980-00	89-179300-21	87-179300-20
14-450660-00	88-181100-30	87-181100-30	14-900130-00	88-740900-20	87-740900-20	14-452030-00	89-179300-25	87-179300-25
14-452740-00	88-181800-00	87-181800-00	14-021410-00	88-743400-00	87-743400-00	14-456980-00	89-179300-30	87-179300-30
14-452740-00	88-181800-10	87-181800-10	14-021410-00	88-743400-10	87-743400-10	14-456980-00	89-179300-40	87-179300-40
14-370870-00	88-203500-00	87-203500-00	14-021410-00	88-743400-30	87-743400-30	14-456980-00	89-179300-50	87-179300-50
14-611250-00	88-207500-00	87-207500-00	14-021410-00	88-743400-40	87-743400-40	14-456980-00	89-179300-55	87-179300-55
14-611250-00	88-207500-10	87-207500-10	14-021410-00	88-743400-50	87-743400-50	14-452030-00	89-179300-60	87-179300-60
14-611250-00	88-207500-30	87-207500-30	14-026240-00	88-743600-10	87-743600-10	14-451160-00	89-179300-65	87-179300-65
14-450270-00	88-243300-00	87-243300-00	14-900080-00	88-744600-00	87-744600-00	14-452030-00	89-179300-66	87-179300-65
14-451170-00	88-243600-00	87-243600-00	14-688690-00	88-781800-00	87-781800-00	14-451160-00	89-179300-70	87-179300-70
14-684840-00	88-245500-00	87-245500-00	14-450880-00	88-785300-00	87-785300-00	14-452030-00	89-179300-71	87-179300-70
14-684840-00	88-245500-10	87-245500-10	14-450880-00	88-785300-10	87-785300-10	14-451160-00	89-179300-80	87-179300-80
14-021430-00	88-247200-00	87-247200-00	15-451030-00	89-101100-00	87-101100-00	14-452030-00	89-179300-81	87-179300-80
14-021440-00	88-247600-10	87-247600-10	15-451030-00	89-101100-10	87-101100-10	14-451160-00	89-179300-85	87-179300-85
14-021450-00	88-248000-00	87-248000-00	15-632000-00	89-107100-30	87-107100-30	14-452030-00	89-179300-86	87-179300-85
14-021460-00	88-248000-10	87-248000-10	15-632000-00	89-107100-40	87-107100-40	14-451160-00	89-179300-90	87-179300-90
14-021460-00	88-248000-30	87-248000-30	15-600020-00	89-109200-00	87-109200-00	14-452030-00	89-179300-91	87-179300-90
14-020490-00	88-252800-00	87-252800-00	14-600020-00	89-109200-30	87-109200-00	14-451160-00	89-181700-60	87-181700-00
14-022830-00	88-274800-00	87-274800-00	14-676420-00	89-110100-00	87-110100-00	14-452030-00	89-181700-61	87-181700-00
14-022830-00	88-274800-20	87-274800-20	15-632000-00	89-110200-30	87-110200-30	14-370870-00	89-203500-00	87-203500-00





 <b>GOETZE</b> Liner	 <b>Niiral</b> Kitset	 <b>Niiral</b> Piston	 <b>GOETZE</b> Liner	 <b>Niiral</b> Kitset	 <b>Niiral</b> Piston
14-450270-00	89-243300-10	87-243300-00	15-265960-00	89-522900-40	87-522900-40
14-451170-00	89-243600-10	87-243600-00	15-480090-00	89-522900-50	87-522900-40
14-450370-00	89-280200-10	87-280200-10	15-450870-00	89-525300-00	87-525300-00
14-450370-00	89-280400-00	87-280400-00	14-458190-00	89-526900-00	87-526900-00
14-452920-00	89-283100-00	87-283100-00	15-632100-00	89-527300-00	87-527300-00
14-452920-00	89-283100-30	87-283100-30	15-632600-00	89-528500-00	87-528500-00
14-452930-00	89-283100-40	87-283100-00	15-632500-00	89-530400-00	87-530400-00
14-452930-00	89-283100-41	87-283100-80	14-456330-00	89-743200-00	87-743200-00
14-452930-00	89-283100-42	87-283100-85	14-456330-00	89-743200-10	87-743200-10
14-452930-00	89-283100-43	87-283100-86	14-671680-00	89-960800-10	87-960800-10
14-452920-00	89-283100-60	87-283100-60	15-608890-00	89-960900-00	87-960900-00
14-452920-00	89-283100-80	87-283100-80	15-608890-00	89-960900-10	87-960900-10
14-452920-00	89-283100-85	87-283100-85	14-374990-00	89-961000-00	87-961000-00
14-452920-00	89-283100-86	87-283100-86	14-374990-00	89-961000-10	87-961000-10
14-458580-00	89-289600-00	87-289600-00	15-608890-00	89-961000-20	87-961000-10
14-458580-00	89-289600-20	87-289600-20	14-458190-00	89-962000-00	87-962000-00
15-370040-00	89-313400-00	87-313400-00	15-679320-00	89-962000-10	87-962000-10
15-632200-00	89-333300-00	87-333300-00	14-450040-00	89-962000-30	87-962000-30
15-630820-00	89-333500-00	87-333500-00	14-450110-00	89-962000-35	87-962000-30
14-637160-00	89-334400-00	87-334400-00	14-671680-00	89-962000-40	87-962000-40
14-636730-00	89-334600-00	87-334600-00	15-679320-00	89-962000-50	87-962000-50
14-000320-00	89-337100-00	87-337100-00	14-450390-00	89-962000-65	87-962000-60
14-630120-00	89-337300-00	87-337300-00	14-450390-00	89-962000-70	87-962000-70
15-480080-00	89-337500-00	87-337500-00	14-458190-00	89-962000-80	87-962000-80
15-480080-00	89-337500-10	87-337500-10	14-458190-00	89-990500-00	87-990500-00
15-450190-00	89-337500-30	87-337500-30			
15-450190-00	89-337500-40	87-337500-00			
15-480070-00	89-337500-50	87-337500-50			
15-457600-00	89-396300-00	87-396300-00			
14-400510-00	89-405500-10	87-405500-10			
15-458900-00	89-405500-30	87-405500-10			
15-458840-00	89-405600-60	87-405600-60			
15-459030-00	89-405600-70	87-405600-70			
15-457960-00	89-405600-80	87-405600-70			
15-457590-00	89-407000-00	87-407000-00			
15-459350-00	89-407100-00	87-407100-00			
15-677620-00	89-407100-10	87-407100-00			
15-677620-00	89-407100-20	87-407100-10			
15-459350-00	89-407100-30	87-407100-10			
14-451220-00	89-420900-30	87-420900-00			
14-451220-00	89-420900-40	87-420900-10			
14-451220-00	89-420900-50	87-420900-50			
15-451070-00	89-427000-00	87-427000-00			
15-480450-00	89-430000-00	87-430000-00			
14-451040-00	89-431000-00	87-431000-00			
14-451040-00	89-431000-10	87-431000-10			
14-459040-00	89-431300-00	87-431300-00			
14-451190-00	89-434400-00	87-434400-00			
14-451190-00	89-434400-10	87-434400-10			
15-480090-00	89-435000-00	87-435000-00			
15-480090-00	89-435000-10	87-435000-10			
15-570060-00	89-437600-00	87-437600-00			
15-570060-00	89-437600-10	87-437600-00			
14-480440-00	89-438800-00	87-438800-00			
14-480460-00	89-438900-00	87-438900-00			
15-457960-00	89-501300-00	87-501300-00			
15-458910-00	89-501400-00	87-501400-00			
15-459230-00	89-502600-00	87-502600-00			
15-480090-00	89-522900-00	87-522900-00			
15-480090-00	89-522900-10	87-522900-10			
15-480090-00	89-522900-30	87-522900-30			



**Federal-Mogul Global Aftermarket EMEA bvba**

Prins Boudewijnlaan 5 • B-2550 Kontich • Belgium

**Central Distribution Centre**

Prins Boudewijnlaan 7 • B-2550 Kontich • Belgium

Phone +32 (0) 3450 83 10 • Fax +32 (0) 3450 83 38

**Federal-Mogul Italy Srl****Aftermarket Division**

Via Enrico Fermi 8 • 37135 Verona • Italy

Phone +39 045 828 13 11 • Fax +39 045 828 14 00

**Federal-Mogul Germany GmbH**

Albert-Ruprecht-Strasse 2 • 71636 Ludwigsburg • Germany

Phone +49 (0) 7141-64865-8230 • Fax +49 (0) 7141-64865-8390

**Federal-Mogul Aftermarket UK Limited**

Greyhound Drive • Bradford BD7 1NQ • England

Phone +44 (0) 1274 723481 • Fax: +44 (0) 1274 848282

**Federal-Mogul Ibérica, S.L.****Federal-Mogul Aftermarket España, S.A.**

Calle Alcarria, nº 2 • 28823 Coslada • Madrid • Spain

Phone: + 34 91 746 1900 • Fax: + 34 91 746 18 90

**Federal-Mogul Aftermarket France**

60-62, rue Danjou • 92517 Boulogne-Billancourt Cedex • France

Phone +33 (0) 1 46 94 27 00 • Fax +33 (0) 1 46 94 27 01

**Service Commande de stock :**

Phone +33 (0) 810 000 029 • Fax +32 34 50 80 26

**Service Commande express :**

Phone +33 (0) 810 000 029 • Fax +32 34 50 80 26

**Federal-Mogul Aftermarket****Southern Africa (PTY) Ltd**

33 Western Boulevard • City West • Johannesburg • South Africa

Phone +27 11 630 3000 • Fax +27 11 630 3040

**Federal-Mogul Aftermarket Turkey**

Meclis-i Mebusan Cad. No: 53 Dereli İş Merkezi 34427 • Fındıklı / İstanbul • Türkiye

Phone +90 212 292 6313 • Fax +90 212 292 6260

**Federal-Mogul Aftermarket Russia Ltd**

Smolnaya street 24D, 13th floor • 125445 Moscow • Russia

Phone +7 495 221 50 60 • Fax +7 495 221 50 64





**CATGT1401**  
Piston Rings

