



Gaskets, Oil Seals and Cylinder Headbolts
Dichtungen, Wellendichtringe und Zylinderkopfschrauben
Joints, Bagues d'étanchéité et Vis de culasse
Guarnizioni, Paraoli e Viti Testa Cilindro
Juntas, retenes de aceite y tornillos de culata
Uszczelki, uszczelnienia olejowe i śruby głowicowe
Прокладки, Сальники и Болты ГБЦ
حشيات رؤوس الأسطوانات وسدادات الزيت ومسامير رؤوس الأسطوانات

CATPA1401



2014-2015

ENGINE EXPERTISE BY  **FEDERAL-MOGUL**
MOTORPARTS



 GLYCO

 GOETZE

Niral

 Payen

EN

GASKETS

- Full Set
- Head Set
- Conversion Set
- Without cylinder head gasket
- Without seals
- Without rocker gasket
- Without valve stem seals
- Left
- Right
- Upper
- Lower
- Inlet
- Exhaust
- Set

MISCELLANEOUS

- Front
- Rear
- Inner
- Outer

HEADBOLT

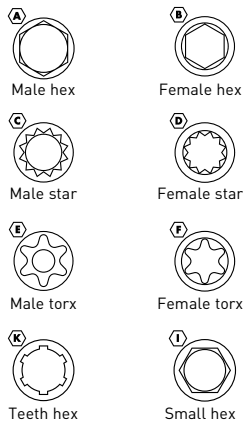

DE

DICHTUNGEN

- Vollsatz
- Kopfsatz
- Kurbelgehäusesatz
- Zylinderkopfdichtung nicht enthalten
- Ohne Öldichtungen
- Ohne Zylinderkopfdeckeldichtungen
- Ohne Ventilschaftdichtringe
- Links
- Rechts
- Oben
- Unten
- Einlaß
- Auslaß
- Satz

VERSCHIEDENES

- Vorne
- Hinten
- Innen
- Außen

ZYLINDERKOPFSCHRAUBEN



FR

JOINTS

- Pochette complète
- Pochette rodage
- Pochette complément
- Joint de culasse non inclus
- Bagues d'étanchéité non inclus
- Joint de couvre culbuteurs non inclus
- Joints de queue de soupape non inclus
- Gauche
- Droite
- Supérieur
- Inférieur
- Admission
- Échappement
- Pochette

ARTICLES DIVERS

- Avant
- Arrière
- Intérieur
- Extérieur

VIS DE CULASSE

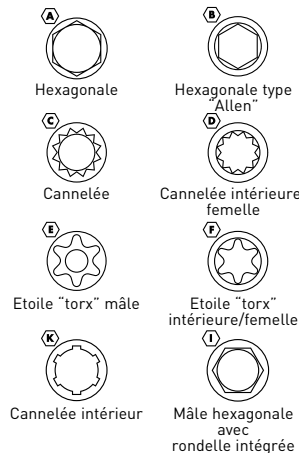

IT

GUARNIZIONI

- Serie motore completa
- Serie smeriglio
- Serie complementare
- Senza guarnizione testa cilindro
- Senza paraoli
- Senza coperchio valvole
- Senza paraoli gambo valvole
- Sinistro
- Destro
- Superiore
- Inferiore
- Aspirazione
- Scarico
- Serie

MINUTERIA

- Anteriore
- Posteriore
- Interna
- Esterna

VITI TESTA CILINDRO



ES

JUNTAS

- Juego completo
- Conjunto de cilindro
- Juego de conversión
- Sin junta de culata
- Sin retenes
- Sin juntas de balancines
- Sin retenes de válvula
- Izquierda
- Derecha
- Superior
- Inferior
- Admisión
- Escape
- Juego

OTRAS PIEZAS

- Delantero
- Trasero
- Interior
- Exterior

TORNILLOS

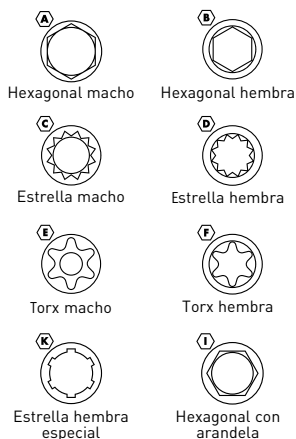

PL

USZCZELKI

- Kompletny zestaw
- Zestaw głowicowy - góra silnika
- Zestaw zamienny - dół silnika
- Bez uszczelki głowicowej
- Bez uszczelnień olejowych
- Bez uszczelki pod dekiel zaworów
- Bez uszczelnień zaworów
- Lewy/Lewa
- Prawy/Prawa
- Górny/Górna
- Dolny/Dolna
- Dolot
- Wydech
- Zestaw

RÓŻNE

- Przedni
- Tylny
- Wewnętrzny
- Zewnętrzny

ŚRUBA GŁOWICOWA

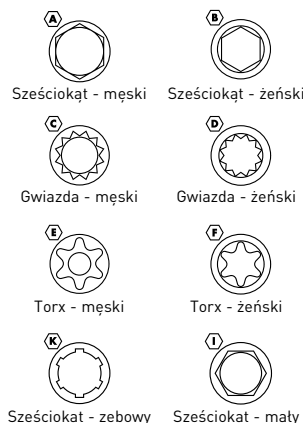

RU

ПРОКЛАДКИ

- Полный комплект
- Комплект прокладок ГБЦ
- Комплект для модернизации
- Без прокладки ГБЦ
- Без уплотнений
- Без прокладок рокеров
- Без маслосъемных колпачков
- Левый/Левая
- Правый/Правая
- Верхний/Верхняя
- Нижний/Нижняя
- Впускного
- Выпускного
- Комплект

РАЗНОЕ

- Передний
- Задний
- Внутренний
- Внешний

БОЛТ ГБЦ



AR

- الحشيات
- المجموعة الكاملة
- مجموعة الرأس
- مجموعة التحويل
- بدون حشية رأس الأسطوانة
- بدون السدادات
- بدون حشية القلب
- بدون سدادات ساق الصمام
- اليسرى اليمنى
- العلوية السفلية
- السحب العادم
- المجموعة

- متنوعة
- الخلفية الأمامية
- الداخلية الخارجية

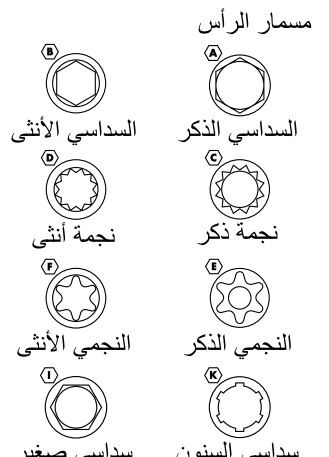

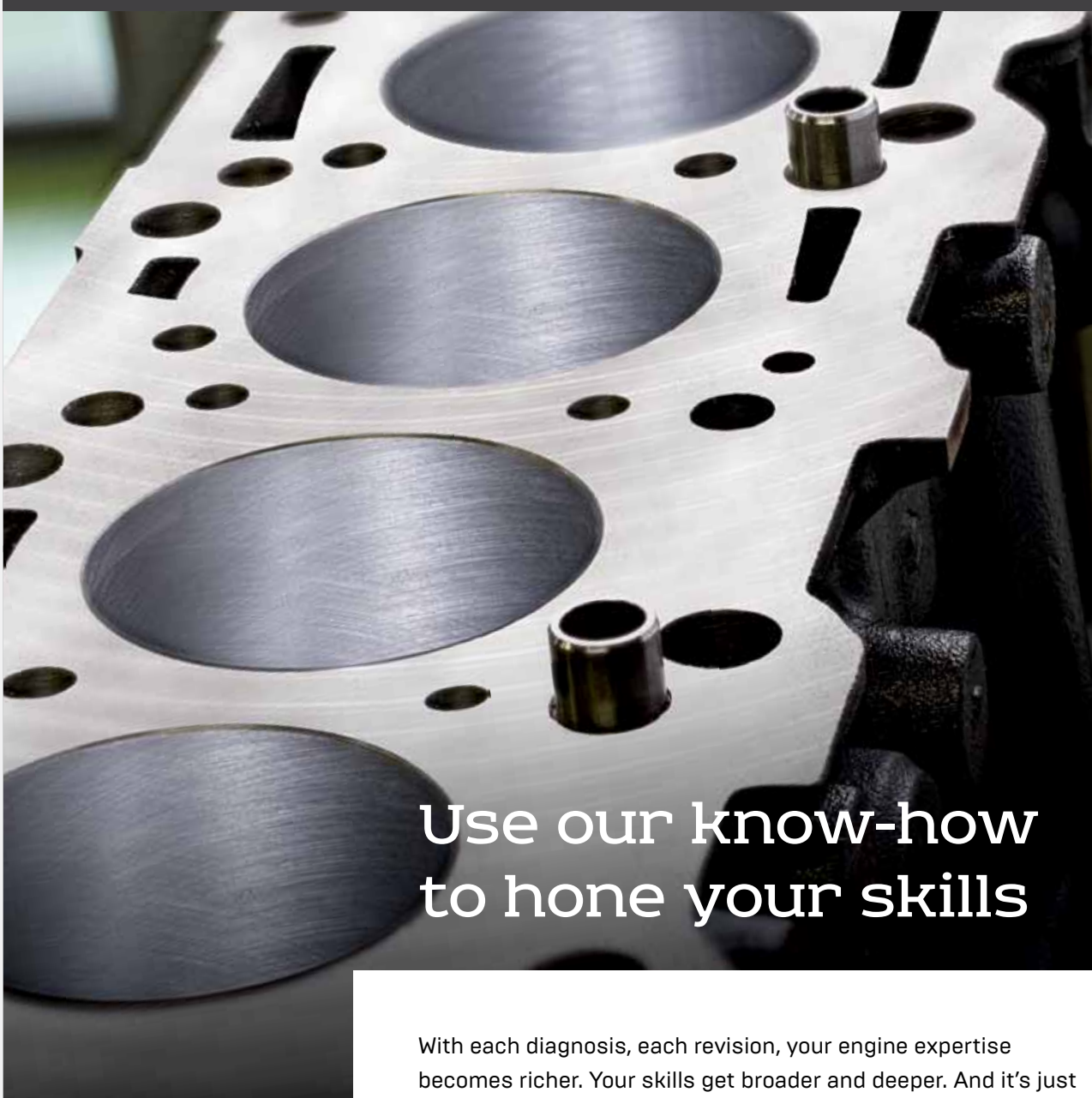

Use our know-how to hone your skills

With each diagnosis, each revision, your engine expertise becomes richer. Your skills get broader and deeper. And it's just the same at Federal-Mogul. That's why people rely on you. For example, your eye for detail and your feel for precise cylinder liner honing guarantee optimum engine performance. Your expertise helps us understand which parts you need, and how we can give you even more support to make it easier for you to achieve perfection with each engine job.

Because our engine expertise... is based on yours.



ENGINE EXPERTISE
BY  **FEDERAL-MOGUL**
MOTORPARTS



ENGINE EXPERTISE

BY  **FEDERAL-MOGUL MOTORPARTS**

DE - Nutzen Sie unser Know-how, um Ihre Kenntnisse weiter zu entwickeln

Mit jeder Diagnose und jeder Instandsetzung wird Ihre Motorenkompetenz umfangreicher. Ihre Kenntnisse werden umfassender und fundierter. Und genauso ist das bei Federal-Mogul. Deshalb verlässt man sich auf Sie. Zum Beispiel gewährleisten Ihr Blick für Details und Ihr Gefühl für Präzision beim Honen von Zylinderlaufbuchsen eine optimale Motorleistung. Ihr Fachwissen verhilft uns zu einem besseren Verständnis, welche Teile Sie benötigen und wie wir Sie noch besser dabei unterstützen können, dass Sie bei allen Motorenarbeiten leichter zur Perfektion gelangen. **Denn unsere Motorenkompetenz... beruht auf der Ihrigen.**

FR - Bénéficiez de notre savoir-faire pour affiner vos compétences

Profitez de chaque diagnostic et de chaque révision pour enrichir votre expertise moteur. C'est l'occasion d'élargir vos compétences. Et c'est exactement ce que fait Federal-Mogul! C'est pourquoi vous bénéficiez de toute la confiance de votre clientèle. Par exemple, votre sens du détail et votre souci de la précision pour la rectification des chemises de cylindre garantissent des performances moteur optimales. Votre expertise nous permet de comprendre vos besoins et d'être à vos côtés pour atteindre la perfection à chaque réparation de moteur. **Car notre expertise moteur... repose sur la vôtre.**

IT - Utilizzare le proprie competenze per perfezionare le abilità

Ad ogni diagnosi, ogni revisione, la vostra competenza sui motori si arricchisce. Le vostre abilità si ampliano ed espandono. Lo stesso succede in Federal-Mogul. Questo è il motivo per cui le persone hanno fiducia in voi. Ad esempio, per il vostro occhio per i dettagli e la ricerca della perfezione nelle canne cilindro che garantiscono performance del motore ottimali. La vostra competenza ci aiuta a capire di quali componenti avete bisogno e come possiamo offrirvi un sostegno maggiore nella ricerca della perfezione in ogni intervento sul motore.

Poiché la nostra competenza sui motori... si basa sulla vostra.

ES - Aproveche nuestros conocimientos para perfeccionar sus habilidades

Cuantos más diagnósticos y revisiones lleva a cabo, más aumenta su experiencia en motores. Se van ampliando y desarrollando sus habilidades. Pues lo mismo sucede en Federal-Mogul. Esa es la razón por la que la gente confía en usted. Por ejemplo, el cuidado que pone en los detalles y la precisión que aporta al alisado de las camisa de cilindro garantizan un rendimiento óptimo del motor. Su experiencia nos ayuda a entender qué piezas necesita y cómo le podemos proporcionar más apoyo todavía para facilitarle que consiga la perfección con cada trabajo del motor.

Porque nuestra experiencia en motores... está basada en la suya.

PL - Skorzystaj z naszej fachowej wiedzy i podnieś swoje umiejętności

Każdy nowo napotkany i rozwiązany problem sprawia, że Twoja fachowa wiedza w zakresie silników staje się bogatsza. Twoje umiejętności stają się szersze i głębsze. Tak samo jak w przypadku Federal-Mogul. Właśnie dlatego wszyscy mogą na Tobie polegać. Na przykład Twoja skrupulatność i dokładność w zakresie honowania tulei cylindrowych gwarantują optymalną pracę silnika. Twoja fachowa wiedza pomaga nam zrozumieć, jakich części potrzebujesz i w jaki sposób możemy zapewnić Ci jeszcze większe wsparcie, byś mógł profesjonalnie rozwiązywać wszystkie problemy związane z naprawami silników.

Ponieważ nasza fachowa wiedza na temat silnika... opiera się na Twoim doświadczeniu.

RU - Совершенствуйте свои навыки с нашими ноу-хау

С каждой диагностикой, с каждым осмотром ваши знания двигателей становятся совершеннее. Навыки углубляются и расширяются. То же происходит и в Federal-Mogul. Поэтому люди доверяют вам. Например, вы умеете видеть детали и чувствовать двигатель, и можете точно назвать размер расточки гильзы цилиндра для оптимальной эффективности двигателя. Ваши знания помогают нам понять, какие детали вам нужны и какую помощь мы можем вам оказать, чтобы вам было проще достичь совершенства в своей работе с двигателем.

Поскольку наше экспертное знание двигателя... основывается на ваших знаниях.

AR - استخدم خبراتك لشحن مهاراتك

ستزداد خبرتك مع كل فحص أو مراجعة تجربتها للمحرك، مع هذه الفحوصات ستصقل مهاراتك وتعمقها، ونفس الشيء بالنسبة لشركة Federal-Mogul، ولهذا يعتمد عليك الناس، فطلي سبيل المثال اهتمامك بالتفاصيل وإحساسك بدواخل المحرك يضمن أفضل أداء للمحرك، ويمكن القول إن خبرتك تساعدنا في التعرف على القطع التي تحتاجها وتعيننا على معرفة الطريقة التي نسهل بها عمك وتحقق بها أكمل صيانة للمهام التي تجربها على المحرك.

لأن خبراتنا في المحركات... مأخوذة منك.



CONTENTS

EN

Contents	II
Terms of business	IV
Numbering structure	VI
Manufacturers list	VII
How to use this catalogue	VIII
New parts list	XVI
Applications by manufacturer	1
Numerical parts list	1742
Interchange OE → Payen	1798
Cylinder headbolts	1838
Oil seals	1844
Materials, washers and seals	1848
Technical notes	1860
Icons and symbols	1880

FR

Contenu	II
Conditions générales de vente	IV
Système de codification	VI
Liste des fabricants	VII
Comment se servir de ce catalogue	X
Liste des nouvelles références	XVI
Applications par constructeur	1
Liste numérique des références	1742
Références croisées 1ère Monte → Payen	1798
Vis de culasse	1838
Bagues d'étanchéité	1844
Joint divers	1848
Notes techniques	1860
Icônes et symboles	1880

DE

Inhaltsverzeichnis	II
Geschäftsbedingungen	IV
Artikelnummer-Struktur	VI
Herstellerliste	VII
So benutzen Sie diesen Katalog	VIII
Neuaufnahmen	XVI
Anwendungen nach Hersteller	1
Numerische Teileliste	1742
Umschlüsselungsliste OE → Payen	1798
Zylinderkopfschrauben	1838
Wellendichtringe	1844
Materialien, Dichtscheiben und Dichtringe	1848
Technische Hinweise	1860
Piktogramme und Symbole	1880

IT

Contenuti	II
Condizioni generali	IV
Struttura catalogazione	VI
Elenco costruttori	VII
Come si utilizza il catalogo	X
Elenco nuovi riferimenti	XVI
Applicazioni per costruttore	1
Elenco riferimenti numerici	1742
Intercambio OE → Payen	1798
Viti testa cilindro	1838
Paraolio	1844
Materiali, rondelle e guarnizioni	1848
Note tecniche	1860
Icone e simboli	1880

ES

Índice	III
Condiciones de venta	V
Estructura de numeración	VI
Lista de fabricantes	VII
Cómo utilizar este catálogo	XII
Lista de referencias nuevas	XVI
Aplicaciones por constructor	1
Lista de referencias	1742
Cruce de referencias entre piezas de equipo original y de Payen	1798
Tornillos de culata	1838
Retenes de aceite	1844
Materiales, arandelas y retenes	1848
Notas técnicas	1860
Iconos y símbolos	1880

RU

Содержание	III
Условия сотрудничества	V
Система нумерации	VI
Список производителей	VII
Как пользоваться каталогом	XIV
Список новой продукции	XVI
Модели автомобилей, сортировка по производителю	1
Список номеров деталей	1742
Взаимозаменяемость OE → Payen	1798
Болты головки блока цилиндров	1838
Сальники	1844
Материалы, шайбы и уплотнения	1848
Технические примечания	1860
Значки и символы	1880

PL

Spis treści	III
Warunki współpracy	V
Struktura numeracji	VI
Lista producentów	VII
Jak używać tego katalogu	XII
Lista nowych części	XVI
Lista zastosowań wg kolejności producentów	1
Lista części	1742
Lista zamienników z numerów OE na Payen	1798
Śruby do głowicy cylindrów	1838
Uszczelnienia olejowe	1844
Śruba głowicowa	1848
Notatki techniczne	1860
Ikony i symbole	1880

AR

III	قائمة الأجزاء الرقمية
V	بنود وشروط المبيعات
VI	نظام ترقيم قطع
VII	التطبيقات حسب جهة التصنيع
XIV	كيفية استخدام هذا الكatalog
XVI	قائمة الأجزاء الجديدة
1	التطبيقات حسب جهة التصنيع
1742	قائمة الأجزاء الرقمية
1798	تبدیل المعدات الأصلية ← Payen
1838	مسمار الرأس
1844	لعمود الكام
1848	مسمار الرأس
1860	المذكرة التقنية
1880	أيقونات ورموز

TERMS OF BUSINESS

EN - IMPORTANT

Reproduction of this catalogue or parts thereof is only allowed with our explicit permission in writing. Pictorial representations and design are copyrighted. Claims for damages, of any form whatsoever, resulting from details made in this catalogue or from incorrect use, application, storage or handling, are explicitly excluded. Contractual rights and any resulting or related claims based thereon, irrespective of form, initially come into being on the basis of a separate written agreement, in particular on the basis of our general terms of sale and delivery.

All former statements lose their validity with the publication of this catalogue.

The catalogue is not an operating manual for the use and installation of cylinder head gaskets, oil seals and cylinder headbolts. It does not contain any advice in a legal sense. The catalogue neither replaces the constantly applicable technical regulations – particularly for tolerances – nor the installation and maintenance stipulations of the individual engine manufacturer.

Also, it is not possible to forego the expertise of those carrying out the installation and application. The individual references made in this catalogue for the installation and the application of cylinder head gaskets, oil seals and cylinder headbolts are instructions solely for the technically qualified specialist and are to be checked and verified by them for their suitability in each case. Federal-Mogul accepts no responsibility for application decisions.

The contents of the catalogue are not intended to create or substitute any contractual agreement which has to be reserved exclusively to a separate agreement between 2 identified parties, whereby seller can be only one of our Federal-Mogul entities as mentioned on the inside back cover.

The right is retained to correct errors and alterations, particularly with regard to amendments in the engine manufacturers' details and stipulations.

DE - ZUR BEACHTUNG

Die Reproduktion dieses Katalogs ist nur mit unserer ausdrücklichen Genehmigung gestattet. Bildliche Darstellungen und der Entwurf sind urheberrechtlich geschützt. Schadenersatzansprüche in jedweder Form unter Berufung auf die Angaben in diesem Katalog oder infolge unsachgemäßen Gebrauchs, unsachgemäßer Anwendung, Lagerung oder Handhabung sind ausdrücklich ausgeschlossen. Vertragliche Rechte und etwaige hieraus folgende oder abgeleitete Ansprüche jedweder Art werden erst durch getrennte schriftliche Vereinbarung, im Besonderen auf der Grundlage unserer allgemeinen Verkaufs- und Lieferbedingungen, begründet. Mit Erscheinen dieses Katalogs verlieren alle früheren Angaben ihre Gültigkeit.

Der Katalog stellt keine Anleitung für den Gebrauch und den Einbau von Zylinderkopfdichtungen, Wellendichtringe und Zylinderkopfschrauben dar. Es werden keine Ratschläge im rechtlichen Sinne abgegeben. Der Katalog ersetzt weder die jeweils geltenden technischen Maßgaben – insbesondere für Toleranzen – noch die Einbau- und Wartungsvorschriften des jeweiligen Motorenherstellers. Auch ist die Sachkenntnis derer, die den Einbau und die Anwendung vornehmen, eine wesentliche Größe. Die Aussagen in diesem Katalog zum Einbau und Einsatz von Zylinderkopfdichtungen, Wellendichtringe und Zylinderkopfschrauben richten sich ausschließlich an den technisch versierten Fachmann und sind von diesem von Fall zu Fall auf Eignung und Gültigkeit zu überprüfen. Federal-Mogul übernimmt keine Verantwortung für Anwendungsentscheidungen.

Der Inhalt des Katalogs begründet oder ersetzt keine vertragliche Vereinbarung, welche ausschließlich einer getrennten Vereinbarung zwischen zwei bestimmten Parteien vorbehalten sein muss, in der die Verkäuferpartei eine unserer innen im Rückdeckel genannten Federal-Mogul Gesellschaften ist. Das Recht auf Berichtigung von Irrtümern und Abänderungen, insbesondere hinsichtlich geänderter Angaben und Bestimmungen der Motorenhersteller, bleibt vorbehalten.

FR - IMPORTANT

La reproduction de ce catalogue, même partielle, n'est autorisée qu'avec notre accord préalable et par écrit. Les illustrations graphiques et la présentation font l'objet d'un copyright. Nous excluons toutes réclamations ayant pour objet ce catalogue ou pouvant résulter de son incompréhension, portant sur de mauvaises utilisations, manipulations, maintenutions ou mauvais stockage. Des droits contractuels et des droits dérivés, de quelque nature qu'ils soient, ne peuvent résulter que d'un accord écrit, sur la base de nos conditions générales de ventes et de livraisons. Ce catalogue annule et remplace toute édition antérieure.

Le catalogue n'est pas une notice d'utilisation et de montage des joints de culasse, bagues d'étanchéité et vis de culasse. Il ne contient pas de directives en tant que telles. Le catalogue ne remplace ni les prescriptions techniques, toujours prioritaires, particulièrement pour les tolérances, ni les prescriptions de montage et d'entretien des fabricants des moteurs figurant dans ce catalogue. Il ne peut en aucun cas remplacer les connaissances professionnelles nécessaires pour le montage et l'utilisation des produits. Les remarques données pour le montage et l'utilisation des joints de culasse, bagues d'étanchéité et vis de culasse sont exclusivement destinées au professionnel averti et de formation technique, à qui il appartiendra de vérifier la conformité des indications pour chaque cas. La responsabilité quant aux décisions d'utilisation ne peut être prise en charge par Federal-Mogul.

Le contenu de ce catalogue ne peut constituer ou remplacer un contrat qui doit faire l'objet d'un document séparé établi entre 2 parties, dont l'une doit être une entité légale de Federal-Mogul (dont la liste figure sur la couverture arrière). Nous nous réservons le droit d'apporter toutes corrections d'erreurs et modifications, suite notamment à de nouvelles données fournies par les constructeurs.

IT - IMPORTANTE

La riproduzione di questo catalogo, anche parziale, è permessa soltanto in seguito ad una autorizzazione scritta. I grafici ed i disegni sono a marchio depositato edepositato coperti da copyright. Reclami per difetti, di qualsiasi natura essi siano, relativi al contenuto di questo catalogo, o all'uso improprio, verranno respinti. Le pretese avanzate od i reclami dovranno essere in conformità con le nostre condizioni generali di vendita.

Il presente catalogo annulla e sostituisce tutte le edizioni precedenti.

Il catalogo non è un manuale per l'utilizzo ed il montaggio di guarnizioni testa cilindro, paraoli e viti testa. Non contiene indicazioni in questo senso. Esso non sostituisce le descrizioni tecniche, sempre prioritarie, in particolare per le tolleranze, ne' le istruzioni relative al montaggio ed alla manutenzione date dai costruttori dei rispettivi motori. Non puo' in nessun caso essere paragonato alla conoscenza professionale necessaria per il montaggio e l'utilizzo. Le considerazioni sul montaggio di guarnizioni testa cilindro, paraoli e viti testa, fatte su questo catalogo, sono destinate esclusivamente a professionisti con formazione tecnica i quali verificheranno l'esattezza delle informazioni, in ogni caso. Le responsabilità derivanti dall'utilizzo improprio dello stesso non potranno essere addebitate alla Federal-Mogul.

I contenuti del catalogo non sostituiscono in alcun modo gli accordi contrattuali che sono riservati esclusivamente a due contraenti definiti; come venditore si intende una delle società Federal-Mogul menzionate sul retro del catalogo.

Ci riserviamo il diritto di apportare correzioni e modifiche al contenuto del catalogo su istruzioni ricevute dal costruttore del motore.

TERMS OF BUSINESS

ES - IMPORTANTE

Queda totalmente prohibida la reproducción, total o parcial, del contenido de este catálogo, salvo previa autorización nuestra, realizada por escrito. Están, asimismo, reservados todos los derechos sobre el diseño y presentación del catálogo. No se aceptará ningún tipo de reclamación que esté basada en la interpretación de los datos contenidos en este catálogo, así como en el incorrecto uso, manipulación o almacenamiento de nuestras piezas. Únicamente se aceptarán reclamaciones que estén basadas en derechos contractuales o en los motivos arriba indicados, siempre que exista un acuerdo especial y por escrito basado en nuestras condiciones generales de venta y suministro.

Con la edición de este catálogo queda anulada toda la información contenida en catálogos anteriores. El catálogo no es un manual para el uso e instalación de las juntas de culata, retenes de aceite y tornillos de culata, y no representa una asesoría técnica en el sentido legal. Los datos del catálogo no sustituyen, en ningún caso, a las especificaciones técnicas, tanto en lo que se refiere a tolerancias como a las instrucciones de instalación y mantenimiento, indicadas por los fabricantes de los motores, especificaciones que serán siempre prioritarias. Se entiende que el uso y montaje de estas piezas está encomendado a personal debidamente cualificado. Las indicaciones sobre uso y montaje de las juntas de culata, retenes de aceite y tornillos de culata, contenidas en este catálogo, están exclusivamente dirigidas a profesionales con la debida capacitación y formación técnica, que deben decidir en cada caso sobre la exactitud de las mismas. La responsabilidad de estas decisiones no puede ser, en ningún caso atribuidas a Federal-Mogul.

La información facilitada en el catálogo no representa o sustituye ningún tipo de acuerdo, quedando a tal efecto, el acuerdo por separado entre dos partes donde sólo entidades de Federal-Mogul, pueden ser identificadas como la parte vendedora como se menciona en la contraportada. Los datos e instrucciones contenidos en este catálogo podrán ser corregidos o modificados sin previo aviso.

PL - WAŻNE

Reprodukcja tego katalogu lub jego części jest możliwa tylko za wyraźną zgodą na piśmie. Ilustracje i grafika są chronione prawem autorskim. Roszczenia dotyczące szkód, niezależnie od formy, wynikających z przedstawionych w tym katalogu treści lub z nieprawidłowego użycia, zastosowania, przechowywania lub obsługi są w sposób wyraźny wyłączone. Prawa umowne i inne wynikające lub związane z roszczeniami na nimi opartymi, niezależnie od formy, są tworzone na podstawie oddzielnej umowy pisemnej, w szczególności na podstawie naszych ogólnych warunków sprzedaży i dostawy. Wszystkie wcześniejsze oświadczenia tracą ważność wraz z opublikowaniem tego katalogu.

Katalog nie jest instrukcją obsługi i instalacji uszczelek głowicowych, uszczelnień olejowych i śrub głowicowych. Nie zawiera porad w sensie prawnym. Katalog nie zastępuje obowiązujących uregulowań technicznych – zwłaszcza w zakresie tolerancji – ani opisów montażu i konserwacji poszczególnych producentów silników.

Nie jest również możliwe pominięcie doświadczenia osób dokonujących doboru i przeprowadzających montaż części. Poszczególne odniesienia zawarte w tym katalogu, a dotyczące doboru, montażu i stosowania uszczelek głowicowych, uszczelnień olejowych i śrub głowicowych, są instrukcjami wyłącznie dla wykwalifikowanego technicznie specjalisty, który w każdym przypadku musi je sprawdzić i zweryfikować ich przydatność. Federal-Mogul nie przyjmuje odpowiedzialności za decyzje dotyczące zastosowania.

Zawartość tego katalogu nie stanowi ani nie zastępuje umowy, która może być zawarta jedynie jako oddzielny dokument podpisany przez dwie strony, przy czym sprzedawcą może być tylko jedna z jednostek koncernu Federal-Mogul, zgodnie z opisem na wewnętrznej stronie tylnej okładki.

Zachowane zostaje prawo korygowania błędów i wprowadzania zmian, zwłaszcza odnośnie zmian dotyczących parametrów i warunków pracy określonych przez producentów silników.

RU - ВАЖНО

Воспроизводство данного каталога или ее частей позволено только с нашим явным разрешением в письменной форме. Иллюстрации и дизайн защищены авторским правом. Требования о возмещении ущерба, любой формы, исходя из содержания каталога или от неправомерного использования, хранения или обращения, явно исключены. Договорные права и любые связанные требования базировались в след за тем, независимо от формы, отдельного первоначально письменного соглашения, в особенности на основе наших общих условий продаж и поставок. Все прежние утверждения теряют свою юридическую силу с публикацией данного каталога.

Каталог не операционное руководство для использования и установки уплотнений, сальников и болтов головки блока цилиндра. Оно не содержит совета в юридическом смысле. Каталог не заменяет постоянно применимые технические инструкции – особенно при допусках – соглашения установки и обслуживания отдельного автопроизводителя. Кроме того, не возможно предсказать профессионализм тех, кто выполняют установку и ремонт.

Отдельные ссылки, сделанные в этом каталоге для установки и замены уплотнений, сальников и болтов головки блока цилиндра являются инструкциями исключительно для технически компетентного специалиста и должны быть проверены ими для их пригодности в каждом случае. Federal-Mogul не несет ответственность за ремонтные работы. Содержание каталога не предназначено, чтобы создавать или заменять любые договорные соглашения, которое должны быть сохранены исключительно к отдельному соглашению между 2мя сторонами, посредством чего продавец может быть только одним из юридических лиц Federal-Mogul как упомянуто на странице обратной стороны. Сохраняется право, исправлять ошибки и изменения, особенно относительно к поправкам по деталям изготовителей двигателя и их условиям.

AR - هام

لا يُسمح بنسخ هذا الدليل أو أي جزء منه إلا بتصريح كتابي صريح. جميع التمثيلات التصويرية والتصميمات محفوظة بموجب حقوق الطبع والنشر ولا تتحمل الشركة صراحة أي مطالبات بخسائر، أيًا كانت صورتها، تنشأ عن التفاصيل الواردة في هذا الدليل أو نتيجة لسوء الاستخدام أو التطبيق أو التخزين أو النقل. أي حقوق تعاقدية أو أي مطالبات لها علاقة بتلك الحقوق أو تنشأ تأسيسًا عليها، بغض النظر عن صورتها، تنشأ تأسيسًا على اتفاق كتابي منفصل، وبخاصة تأسيسًا على شروط البيع والتسليم الخاصة بنا. تفقد كل البيانات السابقة صلاحيتها بمجرد نشر هذا الدليل.

هذا الدليل ليس دليلًا للتشغيل لتوضيح استخدام وتركيب المكابس أو البطانة أو التجميع. كما لا يحتوي على أي نصيحة بالمعنى القانوني، ولا يحل هذا الدليل محل القواعد الفنية المطبقة باستمرار خاصة فيما يتعلق بالتحمل، كما لا يحل محل شروط التركيب والصيانة الخاصة بمصنعي المحركات الفردية.

كذلك لا يمكن الاستعانة عن خبرة الفنيين الذين يقومون بالتركيب أو التطبيق. وجميع الإشارات الواردة في هذا الدليل والتي تتعلق بتركيب وتطبيق المكابس والبطانة وعمليات التجميع هي إرشادات للمتخصصين الفنيين المؤهلين فحسب ويتم مراجعتها والتأكد من ملاءمتها في كل حالة على حدة. ولا تتحمل شركة Federal-Mogul أي مسؤولية تتعلق بقرارات التطبيق.

ليس المقصود بمحتوى هذا الدليل أن يخلق أو يستبدل أي اتفاقات تعاقدية يتم الاحتفاظ بها حصريًا في اتفاقية منفصلة بين طرفين محددتين، والتي يمكن أن يكون بموجبها أحد الكيانات التابعة لشركة Federal-Mogul هو الطرف البائع كما هو موضح في الوجه الداخلي للغلاف الخارجي. وتحتفظ الشركة بحقوقها في تصحيح أي أخطاء وإجراء أي تعديلات وبخاصة فيما يتعلق بتعديل تفاصيل مصنع المحرك والأحكام المنصوص عليها.

PAYEN PART NUMBERING STRUCTURE

2 LETTERS PREFIX for GASKETS and SEALS

3 LETTERS PREFIX for HEADBOLTS

AA – BZ CYLINDER HEAD GASKETS
CA – DZ HEAD SETS
EA – EZ CONVERSION SETS
FA – GZ FULL SETS



JM – JP VALVE COVER GASKETS
HM VALVE COVER SETS
PA – PB SINGLE VALVE STEM SEALS
HR VALVE STEM SEALS SETS



JH – JJ SUMP GASKETS
JA – JD MANIFOLD GASKETS
JE – JF EXHAUST PIPE JOINTS
JR – JS TIMING CASE GASKETS
KA WATER PUMP GASKETS
KK MISCELLANEOUS JOINTS
HA MANIFOLD SETS

HBS HEADBOLT SETS



NA – NZ DYNAMIC OIL SEALS
LK INTEGRATED SEAL and HOUSING
LC – KV MISCELLANEOUS SEALS
HL MISCELLANEOUS SETS

HL5xxx TIMING OIL SEAL SETS



MANUFACTURERS LIST

ACURA	1	MINISUBISHI	810
ALFA ROMEO	6	NISSAN	840
AUDI	38	OPEL	878
AUSTIN	132	PEUGEOT	948
BEDFORD	136	PROTON	1034
BMW	140	RENAULT	1040
CARBODIES	198	ROVER	1276
CHEVROLET	202	SAAB	1294
CHRYSLER	214	SEAT	1310
CITROËN	220	SKODA	1366
DACIA	304	SMART	1402
DAEWOO	312	SSANGYONG	1406
DAIHATSU	322	SUBARU	1412
FIAT	334	SUZUKI	1420
FORD	414	TALBOT	1434
HONDA	544	TOYOTA	1438
HYUNDAI	576	VAUXHALL	1482
INFINITI	594	VOLVO	1544
ISUZU	598	VOLKSWAGEN	1594
IVECO	606		
JAGUAR	620		
JEEP	624		
KIA	628		
LADA	638		
LANCIA	644		
LAND ROVER	668		
LDV	674		
LEXUS	678		
LOTUS	682		
MAZDA	686		
MERCEDES-BENZ	714		
MG	800		
MINI	804		

EN - HOW TO USE

AUDI									
1.9		1Z Diesel		00214		106		3	
80 1.9 TDI	09/91→12/94	1896	4	79.50	SOHC/OHC	66/90	BX800 (MLS), 1.450mm, 1 Hole	DX800▲	EC030 [18]
80 Avant 1.9 TDI	07/92→01/96						BX810 (MLS), 1.530mm, 2 Holes	→Eng.1Z-720 000	
A4 1.9 TDI	01/95→11/00						BX820 (MLS), 1.610mm, 3 Holes	DX801▲	
A4 Avant 1.9 TDI	02/96→09/01							Eng.1Z-720 001→	
A6 1.9 TDI	06/94→10/97								

- 1 Engine information
- 2 Model information
- 3 Payen reference

- 4 **CYLINDER HEAD GASKET**
 - ☐ = Left
 - ☒ = Right
 - ⊖ = Piston protrusion
 - 1.55mm = Thickness
 - 1 hole = Identification mark

- 5 **HEAD SET**
 - ▲ Without cylinder head gasket
 - Without seals
 - ☒ Without valve cover gasket
 - Without valve stem seals
- 6 **FULL SET**
CONVERSION SET
 - ▲ Without cylinder head gasket
 - Without seals
 - ☒ Without valve cover gasket
 - Without valve stem seals

DE - HINWEISE ZUR BENUTZUNG DES KATALOGS

AUDI									
1.9		1Z Diesel		00214		106		3	
80 1.9 TDI	09/91→12/94	1896	4	79.50	SOHC/OHC	66/90	BX800 (MLS), 1.450mm, 1 Hole	DX800▲	EC030 [18]
80 Avant 1.9 TDI	07/92→01/96						BX810 (MLS), 1.530mm, 2 Holes	→Eng.1Z-720 000	
A4 1.9 TDI	01/95→11/00						BX820 (MLS), 1.610mm, 3 Holes	DX801▲	
A4 Avant 1.9 TDI	02/96→09/01							Eng.1Z-720 001→	
A6 1.9 TDI	06/94→10/97								

- 1 Motor-Angaben
- 2 Modell-Angaben
- 3 Payen Best.-Nr.

- 4 **ZYLINDERKOPFDICHTUNG**
 - ☐ = Links
 - ☒ = Rechts
 - ⊖ = Kolbenüberstand
 - 1.55mm = Dicke
 - 1 Loch = Identifizierungs-Hinweis

- 5 **ZYLINDERKOPFDICHTUNGSSATZ**
 - ▲ Ohne Zylinderkopfdichtung
 - Ohne Wellendichtringe
 - ☒ Ohne Ventildeckeldichtung
 - Ohne Ventilschaftdichtungen
- 6 **VOLLSTÄNDIGER SATZ**
KURBELGEHÄUSESATZ
 - ▲ Ohne Zylinderkopfdichtung
 - Ohne Wellendichtringe
 - ☒ Ohne Ventildeckeldichtung
 - Ohne Ventilschaftdichtungen

8	9	10	11	12	13	14	15
HBS018 [Ⓢ] [19] M12x1.75x115.00mm (x10)	JD170 ■ JC152 ■ (x4)	JP003 [4] HM5367 ■ 7	JJ609 (ACM)	HR569 ■ →Eng. IZ-720 000 HR816 ■	■ NA5001 [1][2] 32.00x47.00x10.00mm, FPM ■ NA5001 ■ [1][2] 32.00x47.00x10.00mm, FPM		BV850, BV860, BV870 BX800, BX810, BX820

7 NEW PARTS

8 = HEADBOLT SET
Ⓢ = HEADBOLT SHAPE

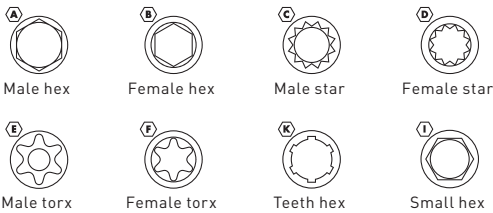

9 MANIFOLD GASKET

Left = **◀**
Right = **▶**
Set = **■**
Inlet = **■**
Exhaust = **■**
Upper = **▲**
Lower = **▼**

= EXHAUST PIPE GASKET

10 VALVE COVER GASKET

Left = **◀**
Right = **▶**
Inlet = **■**
Exhaust = **■**

11 SUMP GASKET

Set = **■**
[57] = Technical note

12 VALVE STEM SEAL

Set = **■**
Inlet = **■**
Exhaust = **■**

13 OIL SEALS

Front = **■**
Rear = **■**
Camshaft seal = **■**
Crankshaft seal = **■**

14 MISCELLANEOUS GASKET/SEALS

Front = **■**
Rear = **■**
Inner = **■**
Outer = **■**
[86] = Technical note

15 SHADOWGRAPH

HINWEISE ZUR BENUTZUNG DES KATALOGS - DE

8	9	10	11	12	13	14	15
HBS018 [Ⓢ] [19] M12x1.75x115.00mm (x10)	JD170 ■ JC152 ■ (x4)	JP003 [4] HM5367 ■ 7	JJ609 (ACM)	HR569 ■ →Eng. IZ-720 000 HR816 ■	■ NA5001 [1][2] 32.00x47.00x10.00mm, FPM ■ NA5001 ■ [1][2] 32.00x47.00x10.00mm, FPM		BV850, BV860, BV870 BX800, BX810, BX820

7 NEUE DICHTUNGEN

8 = ZYLINDERKOPFSCHRAUBE-SATZ
Ⓢ = ZYLINDERKOPF-SCHRAUBEN-FORM



9 ANSAUGKRÜMMER-DICHTUNG

Links = **◀**
Rechts = **▶**
Satz = **■**
Einlass = **■**
Auslass = **■**
Obere = **▲**
Untere = **▼**

= AUSPUFF-KRÜMMERDICHTUNG

10 VENTILDECKELDICHTUNG

Links = **◀**
Rechts = **▶**
Einlass = **■**
Auslass = **■**

11 ÖLWANNENDICHTUNG

Satz = **■**
[57] = Technischer Hinweis

12 VENTILSCHAFTDICHTUNG

Satz = **■**
Einlass = **■**
Auslass = **■**

13 ÖL DICHTUNGEN

Vorn = **■**
Hinten = **■**
Nockenwellendichtring = **■**
Kurbelwellendichtring = **■**

14 VERSCHIEDENE DICHTUNGEN/DICHRINGE

Vorn = **■**
Hinten = **■**
Innen = **■**
Außen = **■**
[86] = Technischer Hinweis

15 SCHATTENBILD

FR - COMMENT UTILISER CE CATALOGUE

AUDI							4		5		6	
1		2		3		4		5		6		
1.9	1Z Diesel 00214	cc	Ø	!	kW/PS	3						
80 1.9 TDI	09/91→12/94	1896	4	79.50	SOHC/OHC	66/90	BX800 (MLS), 1.450mm, 1 Hole		DX800▲ →Eng.1Z-720 000		EC030 [18]	
80 Avant 1.9 TDI	07/92→01/96						BX810 (MLS), 1.530mm, 2 Holes		DX801▲ Eng.1Z-720 001→			
A4 1.9 TDI 2	01/95→11/00						BX820 (MLS), 1.610mm, 3 Holes					
A4 Avant 1.9 TDI	02/96→09/01											
A6 1.9 TDI	06/94→10/97											

- 1 Code moteur
- 2 Identification du modèle
- 3 Référence Payen

- 4 **JOINT DE CULASSE**
 - ☐ = Gauche
 - ☒ = Droit
 - ⊕ = Piston protrusion
 - 1.55mm = Épaisseur
 - 1 trou = marque d'identification

- 5 **POCHETTE RODAGE**
 - ▲ Joint de culasse non inclus
 - Bagues d'étanchéité non incluses
 - ☒ Joint de couvre-culbuteurs non inclus
 - Joints de queue de soupape non inclus
- 6 **POCHETTE COMPLÈTE**
POCHETTE COMPLÈMENT
 - ▲ Joint de culasse non inclus
 - Bagues d'étanchéité non incluses
 - ☒ Joint de couvre-culbuteurs non inclus
 - Joints de queue de soupape non inclus

IT - COME UTILIZZARE IL CATALOGO













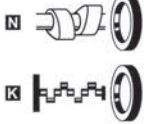

AUDI							4		5		6	
1		2		3		4		5		6		
1.9	1Z Diesel 00214	cc	Ø	!	kW/PS	3						
80 1.9 TDI	09/91→12/94	1896	4	79.50	SOHC/OHC	66/90	BX800 (MLS), 1.450mm, 1 Hole		DX800▲ →Eng.1Z-720 000		EC030 [18]	
80 Avant 1.9 TDI	07/92→01/96						BX810 (MLS), 1.530mm, 2 Holes		DX801▲ Eng.1Z-720 001→			
A4 1.9 TDI 2	01/95→11/00						BX820 (MLS), 1.610mm, 3 Holes					
A4 Avant 1.9 TDI	02/96→09/01											
A6 1.9 TDI	06/94→10/97											

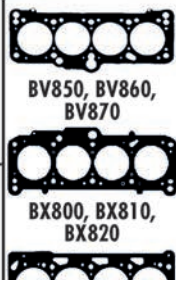
- 1 Codice del motore
- 2 Informazioni sul modello
- 3 Riferimento Payen

- 4 **GUARNIZIONE TESTA CILINDRO**
 - ☐ = Sinistra
 - ☒ = Destra
 - ⊕ = Sporgenza pistone al PMS
 - 1.55mm = Spessore
 - 1 foro = Segno di identificazione

- 5 **SERIE SMERIGLIO**
 - ▲ Senza guarnizione testa cilindro
 - Senza paraoli
 - ☒ Senza guarnizione coperchio valvola
 - Senza paraoli gambo valvola
- 6 **SERIE MOTORE COMPLETA**
SERIE COMPLEMENTARE
 - ▲ Senza guarnizione testa cilindro
 - Senza paraoli
 - ☒ Senza guarnizione coperchio valvola
 - Senza paraoli gambo valvola

COMMENT UTILISER CE CATALOGUE - FR

8	9	10	11	12	13	14	15
							
HBS018 [®] [19] M12x1.75x115.00mm (x10)	JD170  JC152  (x4)	JP003 [4] HM5367  7	JJ609 (ACM)	HR569  → Eng. IZ-720 000 HR816 	 NA5001 [1][2] 32.00x47.00x10.00mm, FPM  NA5001  [1][2] 32.00x47.00x10.00mm, FPM		

7 NOUVEAUX PRODUITS

8  = **POCHETTE DE VIS DE CULASSE**
D = **FORME DE LA VIS DE CULASSE**







9 JOINT DE COLLECTEUR

Gauche = 
Droit = 
Pochette = 
Admission = 
Échappement = 
Supérieur = 
Inférieur = 

 = **BRIDE D'ÉCHAPPEMENT**

10 JOINT DE COUVRE-CULBUTEURS

Gauche = 
Droit = 
Admission = 
Échappement = 





11 JOINT DE CARTER D'HUILE

Pochette = 
[57] = Note technique





12 JOINT DE QUEUE DE SOUPE

Pochette = 
Admission = 
Échappement = 

13 BAGUES D'ÉTANCHÉITÉ













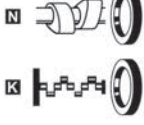

Avant = 
Arrière = 
Bagues d'étanchéité d'arbre à cames = 
Bagues d'étanchéité de vilebrequin = 

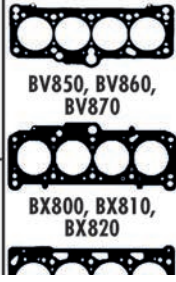
14 JOINTS/ BAGUES DIVERS

Avant = 
Arrière = 
Intérieur = 
Extérieur = 
[86] = Note technique

15 PROJECTION DU PROFIL

COME UTILIZZARE IL CATALOGO - IT

8	9	10	11	12	13	14	15
							
HBS018 [®] [19] M12x1.75x115.00mm (x10)	JD170  JC152  (x4)	JP003 [4] HM5367  7	JJ609 (ACM)	HR569  → Eng. IZ-720 000 HR816 	 NA5001 [1][2] 32.00x47.00x10.00mm, FPM  NA5001  [1][2] 32.00x47.00x10.00mm, FPM		

7 NUOVI ARTICOLI

8  = **SERIE BULLONI TESTA**
D = **FORMA VITI TESTA**







9 GUARNIZIONE COLLETTORE

Sinistro = 
Destro = 
Serie = 
Aspirazione = 
Scarico = 
Superiore = 
Inferiore = 

 = **GUARNIZIONE TUBO DI SCAPPAMENTO**



10 GUARNIZIONE COPERCHIO VALVOLA

Sinistro = 
Destro = 
Aspirazione = 
Scarico = 





11 GUARNIZIONE COPPA

Serie = 
[57] = Nota tecnica





12 PARAOLIO GAMBO VALVOLA

Serie = 
Aspirazione = 
Scarico = 

13 PARAOLI

Anteriore = 
Posteriore = 
Paraolio albero a camme = 
Paraolio albero motore = 

14 TENUTE/GUARNIZIONI VARIE

Anteriore = 
Posteriore = 
Interna = 
Esterna = 
[86] = Nota tecnica

15 IMMAGINI

ES - CÓMO USAR ESTE CATÁLOGO

AUDI							4	5	6
1	2	1Z Diesel 00214	cc	Ø	!	kW/PS	3		
1.9						106	BX800 (MLS), 1.450mm, 1 Hole BX810 (MLS), 1.530mm, 2 Holes BX820 (MLS), 1.610mm, 3 Holes	DX800▲ →Eng.1Z-720 000 DX801▲ Eng.1Z-720 001→	EC030 [18]
80 1.9 TDI	09/91→12/94	1896	4	79.50	SOHC/OHC	66/90			
80 Avant 1.9 TDI	07/92→01/96								
A4 1.9 TDI	01/95→11/00								
A4 Avant 1.9 TDI	02/96→09/01								
A6 1.9 TDI	06/94→10/97								

- 1 Información sobre el motor
2 Información sobre el modelo
3 Referencia de Payen

- 4 JUNTA DE CULATA
 ☐ = Izquierda
 ☒ = Derecha
 ☐ = Resalte del pistón
 1.55mm = Espesor de la junta
 1 hole = N° de muescas

- 5 JUEGO PARTE ALTA
 ▲ Sin junta de culata
 ■ Sin retenes
 ☒ Sin junta de tapa de válvulas
 ○ Sin retenes de válvula
- 6 JUEGO COMPLETO
 JUEGO DE PARTE BAJA
 ▲ Sin junta de culata
 ■ Sin retenes
 ☒ Sin junta de tapa de válvulas
 ○ Sin retenes de válvula

PL - JAK UŻYWAĆ TEGO KATALOGU

AUDI							4	5	6
1	2	1Z Diesel 00214	cc	Ø	!	kW/PS	3		
1.9						106	BX800 (MLS), 1.450mm, 1 Hole BX810 (MLS), 1.530mm, 2 Holes BX820 (MLS), 1.610mm, 3 Holes	DX800▲ →Eng.1Z-720 000 DX801▲ Eng.1Z-720 001→	EC030 [18]
80 1.9 TDI	09/91→12/94	1896	4	79.50	SOHC/OHC	66/90			
80 Avant 1.9 TDI	07/92→01/96								
A4 1.9 TDI	01/95→11/00								
A4 Avant 1.9 TDI	02/96→09/01								
A6 1.9 TDI	06/94→10/97								

- 1 Informacja o silniku
2 Informacja o modelu
3 Numer referencyjny Payen

- 4 USZCZELKA PODGŁOWICOWA
 ☐ = Lewy
 ☒ = Prawy
 ☐ = Wysunięcie tłoka
 1.55 mm = Grubość
 1 otwór = Znak identyfikujący

- 5 ZESTAW GŁOWICOWY - GÓRA SILNIKA
 ▲ Bez uszczelki podgłowicowej
 ■ Bez uszczelnień
 ☒ Bez uszczelki pokrywy zaworów
 ○ Bez uszczelnień trzonka zaworu
- 6 ZESTAW KOMPLETNY
 ZESTAW USZCZELEK - DÓŁ SILNIKA
 ▲ Bez uszczelki podgłowicowej
 ■ Bez uszczelnień
 ☒ Bez uszczelki pokrywy zaworów
 ○ Bez uszczelnień trzonka zaworu

CÓMO USAR ESTE CATÁLOGO - ES

8	9	10	11	12	13	14	15
HBS018 [Ⓞ] [19] M12x1.75x115.00mm (x10)	JD170 ■ JC152 ■ (x4)	JP003 [4] HM5367 ■ 7	JJ609 (ACM)	HR569 ■ →Eng. IZ-720 000 HR816 ■	NA5001 [1][2] 32.00x47.00x10.00mm, FPM NA5001 ■ [1][2] 32.00x47.00x10.00mm, FPM	!	BV850, BV860, BV870 BX800, BX810, BX820

7 NUEVAS REFERENCIAS

8 | = JUEGO DE TORNILLOS
Ⓞ = TIPOS FORMA CABEZA DE TORNILLOS



9 JUNTA DEL COLECTOR DE ESCAPE

Izquierda = **K**
Derecha = **X**
Conjunto = **S**
Admisión = **I**
Escape = **E**
Superior = **▲**
Inferior = **▼**

= JUNTA DEL COLECTOR DE ADMISIÓN

10 JUNTA DE TAPA DE VÁLVULAS

Izquierda = **K**
Derecha = **X**
Admisión = **I**
Escape = **E**

11 JUNTA DEL CÁRTER

Conjunto = **S**
[57] = Nota técnica

12 RETÉN DE VÁLVULA

Conjunto = **S**
Admisión = **I**
Escape = **E**

13 RETENES DE ACEITE

Delantero = **F**
Trasero = **R**
Reten Árbol de Levas = **N**
Reten de Cigüeñal = **K**

14 OTRAS JUNTAS Y RETENES

Delantero = **F**
Trasero = **R**
Interior = **X**
Exterior = **◊**
[86] = Nota técnica

15 GRÁFICO

JAK UŻYWAĆ TEGO KATALOGU - PL

8	9	10	11	12	13	14	15
HBS018 [Ⓞ] [19] M12x1.75x115.00mm (x10)	JD170 ■ JC152 ■ (x4)	JP003 [4] HM5367 ■ 7	JJ609 (ACM)	HR569 ■ →Eng. IZ-720 000 HR816 ■	NA5001 [1][2] 32.00x47.00x10.00mm, FPM NA5001 ■ [1][2] 32.00x47.00x10.00mm, FPM	!	BV850, BV860, BV870 BX800, BX810, BX820

7 NOWE CZĘŚCI

8 | = ZESTAW ŚRUB GŁOWICOWYCH
Ⓞ = KSZTAŁT ŁBÓW ŚRUB GŁOWICOWYCH



9 USZCZELKA KOLEKTORA

Lewy = **K**
Prawy = **X**
Komplet = **S**
Dolotowy = **I**
Wylotowy = **E**
Górny = **▲**
Dolny = **▼**

= USZCZELKA RURY WYDECHOWEJ

10 USZCZELKA POKRYWY ZAWOROWEJ

Lewy = **K**
Prawy = **X**
Dolotowy = **I**
Wylotowy = **E**

11 USZCZELKA MISKI OLEJOWEJ

Komplet = **S**
[57] = Uwaga techniczna

12 USZCZELNIENIE TRZONKA ZAWORU

Komplet = **S**
Dolotowy = **I**
Wylotowy = **E**

13 USZCZELNIENIA OLEJOWE

Przedni = **F**
Tylny = **R**
Uszczelnienie wałka rozrządu = **N**
Uszczelnienie wału korbowego = **K**

14 USZCZELKI/USZCZELNIENIA RÓŻNE

Przedni = **F**
Tylny = **R**
Wewnętrzny = **X**
Zewnętrzny = **◊**
[86] = Uwaga techniczna

15 RYSUNEK PRODUKTU

Payen®

RU - КАК ПОЛЬЗОВАТЬСЯ КАТАЛОГОМ

AUDI														
1.9		1Z Diesel 00214		106		3		4		5		6		
80 1.9 TDI	09/91→12/94	1896	4	79.50	SOHC/OHC	66/90	BX800 (MLS), 1.450mm, 1 Hole	BX810 (MLS), 1.530mm, 2 Holes	BX820 (MLS), 1.610mm, 3 Holes	DX800▲	→Eng.1Z-720 000	DX801▲	Eng.1Z-720 001→	ECO30 [18]
80 Avant 1.9 TDI	07/92→01/96													
A4 1.9 TDI	01/95→11/00													
A4 Avant 1.9 TDI	02/96→09/01													
A6 1.9 TDI	06/94→10/97													

- 1 Тип двигателя
2 Информация о модели
3 Код Payen

- 4 ПРОКЛАДКА ГОЛОВКИ БЛОКА ЦИЛИНДРОВ
 = левая
 = правая
 = выступ поршня
 1.5 мм = Толщина
 1 отверстие = Идентификационный знак

- 5 КОМПЛЕКТЫ ГОЛОВКИ БЛОКА ЦИЛИНДРОВ
 ▲ Без прокладки головки блока цилиндров
 ■ Без сальников
 Без прокладки крышки клапанного механизма
 Без сальников клапанов
- 6 ПОЛНЫЙ КОМПЛЕКТ
 КОМПЛЕКТ БЛОКА ЦИЛИНДРОВ
 ▲ Без прокладки головки блока цилиндров
 ■ Без сальников
 Без прокладки крышки клапанного механизма
 Без сальников клапанов

AR - كيفية استخدام هذا الكاتالوج

AUDI														
1.9		1Z Diesel 00214		106		3		4		5		6		
80 1.9 TDI	09/91→12/94	1896	4	79.50	SOHC/OHC	66/90	BX800 (MLS), 1.450mm, 1 Hole	BX810 (MLS), 1.530mm, 2 Holes	BX820 (MLS), 1.610mm, 3 Holes	DX800▲	→Eng.1Z-720 000	DX801▲	Eng.1Z-720 001→	ECO30 [18]
80 Avant 1.9 TDI	07/92→01/96													
A4 1.9 TDI	01/95→11/00													
A4 Avant 1.9 TDI	02/96→09/01													
A6 1.9 TDI	06/94→10/97													

- 5 مجموعة الرأس
 ▲ بدون حشية رأس الأسطوانة
 ■ بدون السدادات
 بدون حشية غطاء الصمام
 بدون سدادات ساق الصمام
- 6 المجموعة الكاملة
 مجموعة التحويل
 ▲ بدون حشية رأس الأسطوانة
 ■ بدون السدادات
 بدون حشية غطاء الصمام
 بدون سدادات ساق الصمام

- 4 حشية رأس الأسطوانة
 يسرى
 يمنى
 بروز الكباس
 = سماكة 1.55mm
 = تحديد علامة 1 hole

- 1 معلومات المحرك
 2 معلومات الموديل
 3 رقم اللوحة

КАК ПОЛЬЗОВАТЬСЯ КАТАЛОГОМ - RU

8	9	10	11	12	13	14	15
HBS018 [19] M12x1.75x115.00mm (x10)	JD170 [1] JC152 [E] (x4)	JP003 [4] HMS367 [S] 7	JJ609 (ACM)	HR569 [S] →Eng. IZ-720 000 HR816 [S]	NA5001 [1][2] 32.00x47.00x10.00mm, FPM NA5001 [E] [1][2] 32.00x47.00x10.00mm, FPM		BV850, BV860, BV870 BX800, BX810, BX820

7 НОВЫЕ ПОЗИЦИИ В АССОРТИМЕНТЕ

8 = НАБОР БОЛТОВ
 = ФОРМА ГОЛОВКИ БОЛТА



9 ПРОКЛАДКА КОЛЛЕКТОРА

Левая =
 Правая =
 Комплект =
 Впуск =
 Выпуск =
 Верхний =
 Нижний =

= ПРОКЛАДКА ВЫПУСКНОЙ ТРУБЫ

10 ПРОКЛАДКА КРЫШКИ КЛАПАННОГО МЕХАНИЗМА

Левая =
 Правая =
 Впуск =
 Выпуск =

11 ПРОКЛАДКА ПОДДОНА КАРТЕРА

Комплект =
 [57] = Техническое примечание

12 САЛЬНИКИ КЛАПАНОВ

Комплект =
 Впуск =
 Выпуск =

13 САЛЬНИКИ ВАЛОВ

Передние =
 Задние =
 Уплотнения распределительного вала =
 Уплотнения коленчатого вала =

14 ПРОЧИЕ ПРОКЛАДКИ/УПЛОТНЕНИЯ

Передние =
 Задние =
 Внутренние =
 Наружные =

[86] = Техническое примечание

15 СИЛУЭТ

AR - كيفية استخدام هذا الكatalog

8	9	10	11	12	13	14	15
HBS018 [19] M12x1.75x115.00mm (x10)	JD170 [1] JC152 [E] (x4)	JP003 [4] HMS367 [S] 7	JJ609 (ACM)	HR569 [S] →Eng. IZ-720 000 HR816 [S]	NA5001 [1][2] 32.00x47.00x10.00mm, FPM NA5001 [E] [1][2] 32.00x47.00x10.00mm, FPM		BV850, BV860, BV870 BX800, BX810, BX820

13 سدادات الزيت

F = أمامية
 R = خلفية
 N = سداد عمود الكامنة
 K = سداد عمود الكرنك

14 الحشيات / السدادات المتنوعة

F = أمامية
 R = خلفية
 = داخلية
 = خارجية
 [86] = المذكرة التقنية

15 صورة شعاعية

10 حشية غطاء الصمام

K = يسرى
 X = يمنى
 I = السحب
 E = العادم

11 حشية الحوض

S = المجموعة
 [57] = المذكرة التقنية

12 سدادة ساق الصمام

S = المجموعة
 I = السحب
 E = العادم

9 حشية المجمع

K = اليسرى
 X = اليمنى
 S = المجموعة
 I = السحب
 E = العادم
 A = العلوية
 V = السفلية

= حشية أنبوب العادم





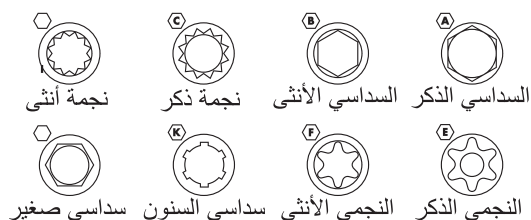



7 القطع الجديدة









= مجموعة مسمار الراس
 = شكل مسمار الراس



NEW PARTS LIST

Liste der Neuaufnahmen • Liste des nouvelles références
Elenco codici nuovi • Lista de nuevas referencias





 	 	 	 
ALFA ROMEO	CHEVROLET	...CITROËN	...FORD
AH6510 12, 14	AH5690 210, 212	NA5324 255	CH5960 442
AH6880 18	AH5700 212	DAEWOO	CH6390 522, 524
AH6890 18	AH5710 212	JD6037 317	CH6430 460, 468
AH6900 18	CH5242 206, 208, 210	DAIHATSU	EH6430 460, 468
CH5240 22	CH5690 210, 212	FG9830 330	EH6520 522
EH5240 22	EH5240 206, 208, 210	HBS508 327	HBS526 539
JD5982 23	JD6037 207	NA5324 327, 331	HM5367 501
JD5993 13	JM7102 213	FIAT	HM5369 523
JM7103 23	JM7115 211, 213	AH6390 406	HR5113 535
JM7117 33	CHRYSLER	AH6400 406	JD5987 461, 469
NA5321 13, 15	AH6510 216	AH6410 406	JD5998 527, 529
AUDI	AH6880 216	AH6510 368, 370	NA5305 539
AH5380 76, 90, 98, 100, 102	AH6890 216	AH6630 404	NA5310 461, 469
AH5960 56	HBS496 217	AH6880 376, 378	NA5323 463, 473, 475, 505, 507, 511, 523
AH6930 94, 96, 98, 102	HBS503 219	AH6890 376, 378	HONDA
BZ530 66, 68, 70	CITROËN	AH6900 376, 378	AH5660 570
CH5960 56	AC5710 256	CG7300 412	AH5661 570
EC5960 116, 118	AH5730 298	CG7381 362	AH5662 570
EH6520 100	AH5731 298	CH5240 382	AH5663 570
HBS510 91	AH5732 298	CH6390 406	AH5664 570
HBS512 117, 127	AH5733 298	EH5240 382	AH5760 560, 568
HBS518 57	AH6390 294	FB5722 408	CH5660 570
HBS536 127, 129	AH6400 294	JD5972 399	CH5760 560, 568
HM5367 81, 83, 85	AH6410 294	JD5981 413	EH5660 570
JD5992 87, 93	AH6440 256, 264	JD5982 383	EH5760 560, 568
JD6005 67, 71, 73, 75	AH6530 272	JD5993 361	HBS520 551
JM7107 87, 93	AH6560 258	JD5997 383, 403	HBS527 561, 569
JR5048 57, 61, 63	AH6570 258	JD6023 399	HBS528 567, 573
NA5305 131	AH6580 258	JM7102 409	HBS532 571
AUSTIN	AH6590 258	JM7103 383	JD5240 555, 559, 561
NA5324 135	AH6600 258	JM7117 409	JD5384 567, 573
BMW	AH6630 284	JM7121 405	JD5984 561, 569
AG5010 162, 164, 166, 168	AH6730 264	NA5202 409	JD5985 561, 569
AG5020 162, 164, 166, 168	CH5730 298	NA5321 371	JD5989 571
AG5030 162, 164, 166, 168	CH6390 294	FORD	JD5990 571
AH5920 178, 180, 190	CH6440 256, 264	AB5133 448, 454	JD6035 555, 557, 561
AH5930 178, 180, 190	CH6530 272	AH5680 460, 468	JD6045 567, 573
AH5940 178, 180, 190	CH6730 264	AH5960 442	JM7083 561, 569
AH5950 178, 180, 190	EH6520 294	AH6390 522, 524	NA5320 561, 567, 571, 573
AH6210 182, 184	HBS508 255	AH6400 522, 524	HYUNDAI
AH6220 152, 160, 162	HBS522 257, 265	AH6410 522, 524	AH6240 580
AH6420 188	HBS535 273, 285	AH6430 460, 468	AH6310 588
CG5011 162, 166	HM5369 295	AH6560 450, 454	AH6320 588
EC5440 152, 154, 160, 162	HM5371 265	AH6570 450, 454	AH6340 582
HBS519 183, 193, 195, 197, 199	HR5111 299, 301	AH6580 450, 454	AH6540 590
HR5107 191	JD5971 285	AH6590 450, 454	CH6240 580
HR5110 163, 165, 167, 169	JD5972 275, 277, 279, 283	AH6600 450, 454	CH6540 590
JD5986 197, 199	JD5998 295	AH7000 442	FH6240 580
JD5991 163, 165, 167, 169	JD5999 299, 301	AH7010 524, 526	HBS525 583
JD6024 153, 155, 161, 163	JD6023 283	AH7120 454	HM5374 581
NA5299 163, 165, 167, 169, 191	JD6034 257, 265	AH7150 456	JD5179 581
	JM7094 299	CA5941 526, 528	JD5983 581
	JM7121 277, 287	CB5132 454	JD6003 581
	NA5318 299, 301	CB5133 448, 454	JD6025 587
	NA5323 299, 301	CH5680 460, 468	JD6032 583

 ...HYUNDAI		 LEXUS		 MITSUBISHI		 ...OPEL	
JD6046	587	AH6700	680	AH6480	834	JD5993	899
ISUZU		AH6710	680	AH6490	834	JM7102	937, 939
NA5322	601	HBS531	681	AH6500	834	JM7103	909, 913, 915, 919, 925
IVECO		JD5988	681	AH7130	818	JM7115	935
CG7300	616, 618	JD6004	681	FF5481	820	NA5327	913, 915, 923
JD5981	617, 619	JM7106	681	HBS537	819, 821	PEUGEOT	
JAGUAR		NA5319	681	JD5372	823, 825, 829	AC5710	990
CH5730	622	PA6055	681	JD6031	819, 821	AH5730	1030
HR5111	623	MAZDA		JD6039	825, 829	AH5731	1030
JD5999	623	AB5133	694	JM7124	819, 821	AH5732	1030
NA5318	623	AH6350	712	NISSAN		AH5733	1030
KIA		AH6560	694	AC5062	860	AH6390	1026
AH6240	632	AH6570	694	AH6280	856	AH6400	1026
AH6310	634	AH6580	694	AH6300	850	AH6410	1026
AH6320	634	AH6590	694	AH6330	858, 862	AH6440	990, 992, 998, 1002
AH6540	636	AH6600	694	AH6620	850	AH6530	1004
CH6240	632	AH6680	704, 706, 708	AH6760	876	AH6560	992
CH6540	636	CB5133	694	AH6770	876	AH6570	992
FH6240	632	CH6350	712	AH7080	868	AH6580	992
HBS525	633	EH6350	712	CH6300	850	AH6590	992
HM5374	633	HBS523	695	EC5063	860	AH6600	992
JD5179	633	JD6026	709	HBS495	855, 859	AH6630	1016
JD5983	633	JD6027	709	HBS504	863, 869	AH6730	998, 1002
JD6003	633	JD6030	699	HBS505	861	CH5730	1030
JD6025	635	JD6036	695, 697, 699	HBS506	851	CH6390	1026
JD6032	633	JD6040	697	HBS516	857	CH6440	990, 992, 998, 1002
JD6046	635	JD6044	697	HR5112	851, 855, 859, 861	CH6530	1004
NA5330	637	MERCEDES-BENZ		JD5977	855, 859, 861	CH6730	998, 1002
LADA		AH6450	742, 744, 746	JD6028	867, 871	EH6520	1026
AH5260	640	AH6460	742, 744, 746	JD6029	867, 871	HBS508	989
AH5270	640	AH6470	742, 744, 746	OPEL		HBS522	991, 993, 999, 1003
DS630	640	HBS511	777, 779, 791, 793, 795, 797	AH5690	934	HBS535	1005, 1017
JD5972	643	HBS534	735, 747	AH5700	934	HM5369	1027
JD5980	643	MG		AH5710	934	HM5371	999, 1003
JH5183	641	KM5021	802	AH6380	930, 932, 934	HR5111	1031, 1033
LANCIA		MINI		AH6510	900	JD5971	1017
AH6510	652	AH6440	806	AH6620	896	JD5972	1005, 1007, 1009, 1013, 1015
AH6880	654	AH6730	806, 808	AH6880	908	JD5998	1027
AH6890	654	CH6440	806	AH6890	908	JD5999	1031, 1033
CG7381	650	CH6730	806	AH6900	908	JD6023	1015
FB5722	664	HBS496	809	AH7170	928, 930	JD6034	991, 993, 999, 1003
JD5997	659, 661	HBS522	807, 809	AH7180	928, 930	JM7094	1031
JM7117	665	JD5959	807	AH7190	928, 930	JM7121	1007, 1019
JM7121	661	JD6034	807	CG9581	934	NA5318	1031, 1033
LAND ROVER		NA5088	807	CH5240	918, 924	NA5323	1031, 1033
CH5730	672			CH5241	908, 912, 914	NA5324	989
HBS530	671			CH5242	908, 914		
HR5111	673			CH5690	934		
JD5999	671, 673			EC5063	924, 926		
NA5318	673			EH5240	908, 912, 914, 918, 924		
NA5323	673			HBS502	945		
				HM5370	935		
				JD5979	897, 899		
				JD5980	929, 933		
				JD5982	919, 925		

NEW PARTS LIST

Liste der Neuaufnahmen • Liste des nouvelles références
Elenco codici nuovi • Lista de nuevas referencias

RENAULT	SKODA	...TOYOTA	VW
AC5062 1198, 1200, 1202, 1204, 1206, 1208, 1210	AH5380 1388, 1400	JD6004 1463, 1469	AH5380 1674, 1710, 1712, 1714
AH6330 1242, 1244	AH5960 1382	JD6023 1463	AH5960 1640, 1642, 1644, 1656
AH6760 1274	AH6930 1400	JM7106 1463, 1469	AH5970 1732, 1734
AH6770 1274	CH5960 1382	NA5088 1455, 1457	AH5980 1732, 1734
AH6780 1106	EC5960 1400	NA5319 1463, 1469	AH5990 1732, 1734
EC5063 1198, 1200, 1202, 1204, 1206, 1208, 1210, 1212, 1216, 1218, 1232	HBS518 1383	NA5324 1453, 1455	AH6930 1700, 1706, 1708, 1714
HBS502 1275	JD5992 1395, 1399	PA6055 1463, 1469	CH5960 1640, 1642, 1644
HBS524 1243	JD6005 1387	VAUXHALL	EC5960 1726, 1730, 1732
JD6033 1107	JH5184 1375, 1377, 1379	AH5690 1532	EG8920 1728, 1730, 1732
JD6038 1107	JM7107 1395, 1399	AH5700 1532	HBS499 1735, 1737
JM7125 1107	JR5048 1383, 1385	AH5710 1532	HBS509 1729, 1731, 1733
NA5322 1107, 1109	NA5305 1375	AH6380 1528	HBS510 1699
NA5328 1137, 1139, 1141, 1143, 1147, 1153, 1155, 1157, 1159, 1161	NA5306 1375, 1377, 1379, 1381	AH6510 1502	HBS513 1721
ROVER	SMART	AH6620 1498	HBS517 1735
KM5021 1280, 1282, 1284, 1286	AH6000 1404	AH6880 1508	HBS518 1641, 1643, 1645
SAAB	AH7130 1404	AH6890 1508	HBS526 1735, 1737
AH6380 1298, 1300, 1304	HBS537 1405	AH6900 1508	HM5367 1661, 1663, 1681, 1683, 1685, 1687, 1689, 1691
CG9581 1304	JD6031 1405	AH7170 1528	JD5992 1693, 1695, 1705, 1707
CH5241 1298	JM7124 1405	AH7180 1528	JD6005 1669, 1671
EH5240 1298	SUBARU	AH7190 1528	JD6047 1733
HBS502 1309	HBS508 1415	CG9581 1534	JM7107 1693, 1695, 1705, 1707
HM5370 1305	JD5959 1415	CH5240 1520, 1524	JM7113 1693, 1695, 1707, 1709
JM7103 1299	NA5226 1415, 1417, 1419	CH5241 1510, 1514	JR5048 1639, 1641, 1643, 1645, 1653, 1655, 1657
NA5327 1299	SUZUKI	CH5242 1510, 1516	NA5305 1627, 1721, 1735, 1737, 1739
SEAT	AC5062 1428	CH5690 1532	NA5306 1625
AH5380 1346, 1362	AH6290 1424	EC5063 1524	
AH5960 1332	AH6560 1426	EH5240 1510, 1514, 1520, 1524	
AH6930 1362	AH6570 1426	HBS502 1543	
CH5960 1332	AH6580 1426	HM5370 1535	
HBS513 1365	AH6590 1426	JD5979 1499, 1501	
HBS518 1333	AH6600 1426	JD5980 1529, 1531	
HBS526 1365	AH6620 1424	JD5982 1521, 1525	
HM5367 1341, 1349, 1351, 1355	HBS497 1429	JD5993 1501	
JD5992 1357, 1359, 1361	JD5972 1431	JM7102 1537	
JD6005 1345, 1347, 1349	JD5994 1427, 1429	JM7103 1511, 1515, 1517, 1521, 1525	
JM7107 1357, 1359, 1361	TALBOT	JM7115 1533	
JM7113 1363	JD5972 1437	NA5327 1515, 1517, 1523	
JR5048 1333, 1339	TOYOTA	VOLVO	
NA5305 1323, 1365	AH6250 1472, 1474	AC5062 1566	
NA5306 1321	AH6260 1472, 1474	AH7150 1554	
	AH6700 1476	CB5452 1578, 1580	
	AH6710 1476	HBS533 1585, 1587, 1589	
	AH6940 1460, 1462, 1468	HR5113 1579, 1589	
	AH7090 1480	JD5372 1563	
	DV371 1458	JD6039 1563	
	FG9830 1454	NA5317 1573, 1585, 1587, 1589	
	GV331 1454		
	HBS500 1481		
	HBS501 1475, 1477		
	HBS508 1453		
	HBS531 1463, 1469		
	JD5959 1455		
	JD5973 1465, 1473		
	JD5978 1459		
	JD5988 1463, 1469		

	Ltr				CC		9
CL Coupe	3.0	10/99 → 09/00	J30A1	Petrol	2997	6	8
INTEGRA Coupe	1.5	01/98 → 12/99	D15A1	Petrol	1488	4	1
INTEGRA Coupe	1.6	01/98 → 12/99	D16A3	Petrol	1590	4	3
INTEGRA Coupe	1.6	01/98 → 12/99	D16A8	Petrol	1590	4	4
INTEGRA Hatchback	1.5	01/98 → 12/99	D15A1	Petrol	1488	4	1
INTEGRA Hatchback	1.6	01/98 → 12/99	D16A1	Petrol	1590	4	2
INTEGRA Hatchback	1.6	01/98 → 12/99	D16A8	Petrol	1590	4	4
INTEGRA Saloon	1.5	01/98 → 12/99	D15A1	Petrol	1488	4	1
INTEGRA Saloon	1.6	01/98 → 12/99	D16A3	Petrol	1590	4	3
INTEGRA Saloon	1.6	01/98 → 12/99	D16A8	Petrol	1590	4	4
LEGEND Coupe	2.7	01/98 → 08/99	C27A1	Petrol	2675	6	5
LEGEND II	3.2	08/99 → 08/99	C32A	Petrol	3206	6	10
LEGEND III	3.5	08/99 →	C35A2	Petrol	3474	6	12
LEGEND	2.7	01/98 → 08/99	C27A1	Petrol	2675	6	5
NSX Targa (NA1)	3.0	01/99 → 12/99	C30A3	Petrol	2977	6	6
NSX Targa (NA1)	3.0	01/99 → 12/99	C30A4	Petrol	2977	6	7
NSX	3.0	01/99 → 08/99	C30A3	Petrol	2977	6	6
NSX	3.0	01/99 → 08/99	C30A4	Petrol	2977	6	7
NSX	3.2	08/99 →	C32B2	Petrol	3179	6	11
RL	3.5	10/99 → 09/00	C35A2	Petrol	3474	6	12
RL	3.5	10/00 → 09/00	C35A5	Petrol	3474	6	13
SLX	3.2	11/99 → 09/99	6VD1	Petrol	3165	6	9
SLX	3.5	11/99 → 09/99	C35A5	Petrol	3474	6	13

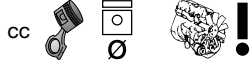

kW/PS

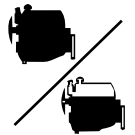

Model	Year Range	cc	Cyls	Power (kW/PS)	Engine Type	Code	Material	Code	Notes
1.5 Integra 1.5	D15A1 01/85→12/90	1488	4	74.00	SOHC/OHC	1 63/86	BM990 (Graphite)	DM995	
1.6 Integra 1.6	D16A1 01/85→12/90	1590	4	75.00	DOHC	2 74/101	BV350 (Graphite)	DV351 [3]	
1.6 Integra 1.6	D16A3 01/85→12/90	1590	4	75.00	DOHC	3 74/101	BV350 (Graphite)	DV351 [3]	
1.6 Integra 1.6 i	D16A8 01/85→12/90	1590	4	75.00	DOHC	4 88/120	BV350 (Graphite)	DV351 [3]	
2.7 Legend 2.7	C27A1 01/87→08/91	2675	6	87.00	SOHC/OHC, V	5 123-130/ 167-177	BR650 (Graphite) (x2)	DR650 [3]	
3 NSX 3.0	C30A3 01/90→08/97	2977	6	90.00	DOHC, V	6 201/274	AG7860 (SMG) (x2)		
3 NSX R 3.0 NSX T 3.0	C30A4 01/92→08/97 01/95→12/97	2977	6	90.00	DOHC	7 188/256	AG7860 (SMG) (x2)		
3 CL Coupe 3.0 VT	J30A1 10/96→09/00	2997	6	86.00	SOHC/OHC, V	8 149/203	AG9170 (MLS) (x2)	CG9170	EG5770
3.2 SLX 3.2 AWD	6VD1 11/95→09/99	3165	6	93.40	DOHC, V	9 140/190			
3.2 Legend II 3.2	C32A 08/91→08/96	3206	6	90.00	DOHC, V	10 151/205	BV090 (Graphite) BV100 (Graphite)	DV090 [3]	
3.2 NSX 3.2	C32B2 08/97→	3179	6	93.00	V	11 206/280	AG7870 (MLS) (x2)		
3.5 Legend III 3.5 RL 3.5	C35A2 08/96→ 10/95→09/00	3474	6	90.00	DOHC, V	12 151/205	BV090 (Graphite) BV100 (Graphite)	DV090 [3]	

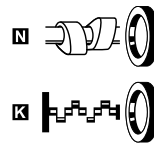
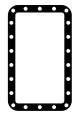
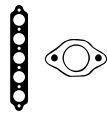

BM990

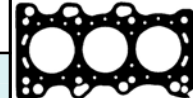

BR650



BV090

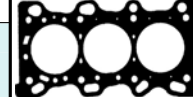

BV100



BV350



JC687



JC791



JD052



JD075

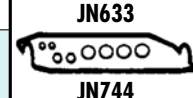

JN633



JN744



JJ364

						<p>N NJ313 [1] 29.00x45.00x8.00mm, ACM</p> <p>K NJ312 [2] 80.00x100.00x10.00mm, MVQ</p>	
	<p>JD075 [1] JD052 [2] ⊙ JE625 ⊙ JF024 (x2)</p>	JN744 [4]				<p>N NJ254 [1] 27.00x43.00x9.00mm, NBR</p>	
	<p>JD075 [1] JD052 [2] ⊙ JE625 ⊙ JF024 (x2)</p>	JN744 [4]				<p>N NJ254 [1] 27.00x43.00x9.00mm, NBR</p>	
	<p>JD075 [1] JD052 [2] ⊙ JE625 ⊙ JF024 (x2)</p>	JN744 [4]				<p>N NJ254 [1] 27.00x43.00x9.00mm, NBR</p>	
	<p>JC791 [1] (x2) JC687 [2] (x2) ⊙ JE625</p>	JN633 [4]	JJ364	PA305		<p>N NJ242 [2] 35.00x50.00x8.00mm, NBR</p> <p>N NJ933 [2] 35.00x50.00x8.00mm, FPM</p> <p>K NF678 [2] 35.00x50.00x8.00mm, ACM</p> <p>K NB698 [1] 80.00x98.00x10.00mm, FPM</p>	
		HM5248 [2] (x2)				<p>N NJ933 (x2) [2] 35.00x50.00x8.00mm, FPM</p> <p>K NK023 [2] 41.00x56.00x8.00mm, ACM</p> <p>K NB698 [1] 80.00x98.00x10.00mm, FPM</p>	
		HM5248 [2] (x2)				<p>N NJ933 (x2) [2] 35.00x50.00x8.00mm, FPM</p> <p>K NK023 [2] 41.00x56.00x8.00mm, ACM</p> <p>K NB698 [1] 80.00x98.00x10.00mm, FPM</p>	
						<p>K NB698 [1] 80.00x98.00x10.00mm, FPM</p>	
						<p>K NA5108 [2] 42.00x55.00x7.00mm, FPM/ACM</p>	
		HM5248 [2] (x2)		<p>PB355 [1] PB356 [2]</p>		<p>N NJ933 (x2) [2] 35.00x50.00x8.00mm, FPM</p> <p>K NF678 [2] 35.00x50.00x8.00mm, ACM</p> <p>K NK023 [2] 41.00x56.00x8.00mm, ACM</p> <p>K NB698 [1] 80.00x98.00x10.00mm, FPM</p>	
		HM5247 [2]				<p>N NJ933 (x2) [2] 35.00x50.00x8.00mm, FPM</p> <p>K NK023 [2] 41.00x56.00x8.00mm, ACM</p> <p>K NB698 [1] 80.00x98.00x10.00mm, FPM</p>	
		HM5248 [2] (x2)		<p>PB355 [1] PB356 [2]</p>		<p>N NJ933 (x2) [2] 35.00x50.00x8.00mm, FPM</p> <p>K NB698 [1] 80.00x98.00x10.00mm, FPM</p>	

ACURA









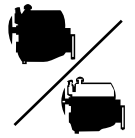



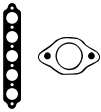

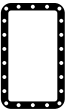
cc

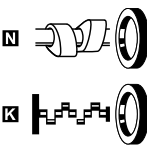

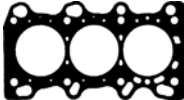
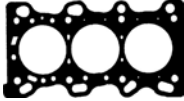
kW/PS



3.5		C35A5				13	BV090 (Graphite)	DV090 [3]
RL 3.5	10/00→09/04	3474	6	90.00	DOHC, V	151-153/ 205-208	BV100 (Graphite)	
SLX 3.5 AWD	11/97→09/99							

							 <p>BV090</p>  <p>BV100</p>
		<p>HM5248  (x2)</p>		<p>PB355  PB356 </p>	<p> NJ933 (x2) [2] 35.00x50.00x8.00mm, FPM  NB698  [1] 80.00x98.00x10.00mm, FPM</p>		



Ltr







CC



9

Model	Ltr	Year Range	Model Code	Fuel	CC	Gears	9
33 (905)	1.2	06/98→12/98	AR 30585	Petrol	1186	4	4
33 (905)	1.3	05/98→12/98	AR 30168	Petrol	1351	4	18
33 (905)	1.3	05/98→12/98	AR 30502	Petrol	1351	4	19
33 (905)	1.3	06/98→12/98	AR 30586	Petrol	1351	4	20
33 (905)	1.3	10/98→12/98	AR 30587	Petrol	1351	4	21
33 (905)	1.5	06/98→12/98	AR 30146	Petrol	1490	4	26
33 (905)	1.5	05/98→12/99	AR 30182	Petrol	1490	4	27
33 (905)	1.5	06/98→12/98	AR 30508	Petrol	1490	4	28
33 (905)	1.5	06/98→12/98	AR 30588	Petrol	1490	4	29
33 (905)	1.7	09/98→12/98	AR 30558	Petrol	1712	4	43
33 (905)	1.8	01/98→06/99	VM 82 A	Diesel	1779	3	66
33 (907A)	1.4	07/99→09/99	AR 30755	Petrol	1351	4	22
33 (907A)	1.5	07/99→08/99	AR 30750	Petrol	1490	4	30
33 (907A)	1.5	01/99→09/99	AR 30751	Petrol	1490	4	31
33 (907A)	1.7	01/99→09/99	AR 30736	Petrol	1712	4	44
33 (907A)	1.7	01/99→09/99	AR 30737	Petrol	1712	4	45
33 (907A)	1.7	01/99→09/99	AR 30746	Petrol	1712	4	46
33 (907A)	1.7	01/99→09/99	AR 30747	Petrol	1712	4	47
33 (907A)	1.8	07/99→09/99	VM 96 A	Diesel	1779	3	67
33 Sportwagon (905A)	1.4	01/98→12/98	AR 30587	Petrol	1351	4	21
33 Sportwagon (905A)	1.5	12/98→12/98	AR 30146	Petrol	1490	4	26
33 Sportwagon (905A)	1.5	12/98→12/98	AR 30508	Petrol	1490	4	28
33 Sportwagon (905A)	1.5	12/98→12/98	AR 30588	Petrol	1490	4	29
33 Sportwagon (905A)	1.7	09/98→12/98	AR 30558	Petrol	1712	4	43
33 Sportwagon (905A)	1.7	09/98→12/98	AR 30737	Petrol	1712	4	45
33 Sportwagon (905A)	1.8	01/98→12/98	VM 96 A	Diesel	1779	3	67
33 Sportwagon (907B)	1.4	06/99→09/99	AR 30587	Petrol	1351	4	21
33 Sportwagon (907B)	1.4	06/99→09/99	AR 30755	Petrol	1351	4	22
33 Sportwagon (907B)	1.5	01/99→09/99	AR 30751	Petrol	1490	4	31
33 Sportwagon (907B)	1.7	01/99→03/99	AR 30736	Petrol	1712	4	44
33 Sportwagon (907B)	1.7	01/99→09/99	AR 30737	Petrol	1712	4	45
33 Sportwagon (907B)	1.7	01/99→03/99	AR 30746	Petrol	1712	4	46
33 Sportwagon (907B)	1.7	01/99→09/99	AR 30747	Petrol	1712	4	47
75 (162B)	1.8	09/98→02/99	AR 06134	Petrol	1779	4	56
75 (162B)	1.8	02/98→01/99	AR 06158	Petrol	1779	4	57
75 (162B)	1.8	09/98→02/99	AR 06168	Petrol	1779	4	58
75 (162B)	1.8	09/98→06/98	AR 06202	Petrol	1779	4	59
75 (162B)	1.8	09/98→02/99	AR 61102	Petrol	1779	4	60
75 (162B)	1.8	08/98→02/99	AR 61201	Petrol	1779	4	61
75 (162B)	1.8	05/98→12/99	AR 61202	Petrol	1779	4	62
75 (162B)	1.8	08/98→02/99	AR 67101	Petrol	1773	4	63
75 (162B)	2.0	01/98→02/99	AR 06166	Petrol	1962	4	91
75 (162B)	2.0	05/98→02/99	AR 06224	Petrol	1962	4	92
75 (162B)	2.0	05/98→09/99	VM 80 A	Diesel	1995	4	108
75 (162B)	2.4	01/98→02/99	VM 81 A	Diesel	2393	4	122
145 (930)	1.4	07/99→12/99	AR 33501	Petrol	1351	4	23
145 (930)	1.4	12/99→01/00	AR 33503	Petrol	1370	4	24
145 (930)	1.4	12/99→01/00	AR 38501	Petrol	1370	4	25
145 (930)	1.6	10/99→12/99	AR 33201	Petrol	1596	4	39
145 (930)	1.6	12/99→01/00	AR 38201	Petrol	1598	4	41
145 (930)	1.6	12/99→01/00	AR 67601	Petrol	1598	4	42
145 (930)	1.7	10/99→12/99	AR 33401	Petrol	1712	4	50
145 (930)	1.8	03/99→01/00	AR 32201	Petrol	1747	4	48
145 (930)	1.8	12/99→12/99	AR 38401	Petrol	1747	4	51
145 (930)	1.8	12/99→12/99	AR 67106	Petrol	1747	4	54
145 (930)	1.9	02/99→01/00	AR 32302	Diesel	1910	4	82
145 (930)	1.9	10/99→02/99	AR 33601	Diesel	1929	4	83
145 (930)	1.9	10/99→02/99	AR 67501	Diesel	1929	4	85
145 (930)	2.0	03/99→01/00	AR 32301	Petrol	1970	4	97
146 (930)	1.4	12/99→12/99	AR 33501	Petrol	1351	4	23
146 (930)	1.4	11/99→01/00	AR 33503	Petrol	1370	4	24
146 (930)	1.4	11/99→01/00	AR 38501	Petrol	1370	4	25
146 (930)	1.6	12/99→12/99	AR 33201	Petrol	1596	4	39
146 (930)	1.6	11/99→01/00	AR 38201	Petrol	1598	4	41
146 (930)	1.6	11/99→01/00	AR 67601	Petrol	1598	4	42
146 (930)	1.7	12/99→12/99	AR 33401	Petrol	1712	4	50
146 (930)	1.8	03/99→01/00	AR 32201	Petrol	1747	4	48
146 (930)	1.8	11/99→01/00	AR 38401	Petrol	1747	4	51
146 (930)	1.8	11/99→01/00	AR 67106	Petrol	1747	4	54
146 (930)	1.9	02/99→01/00	AR 32302	Diesel	1910	4	82

	Ltr				CC		9
146 (930)	1.9	12/99→02/99	AR 33601	Diesel	1929	4	83
146 (930)	1.9	12/99→02/99	AR 67501	Diesel	1929	4	85
146 (930)	2.0	03/99→01/00	AR 32301	Petrol	1970	4	97
147 (937)	1.6	01/00→03/01	AR 32104	Petrol	1598	4	38
147 (937)	1.6	01/00→03/01	AR 37203	Petrol	1598	4	40
147 (937)	1.9	06/00→03/01	182 B9.000	Diesel	1910	4	69
147 (937)	1.9	11/00→03/01	192 A5.000	Diesel	1910	4	70
147 (937)	1.9	10/00→03/01	192 B1.000	Diesel	1910	4	71
147 (937)	1.9	04/00→03/01	937 A2.000	Diesel	1910	4	72
147 (937)	1.9	09/00→09/00	937 A4.000	Diesel	1910	4	73
147 (937)	1.9	07/00→03/01	937 A5.000	Diesel	1910	4	74
147 (937)	1.9	06/00→03/01	937 A6.000	Diesel	1910	4	75
147 (937)	1.9	10/00→03/01	939 A7.000	Diesel	1910	4	80
147 (937)	1.9	11/00→09/00	AR 37101	Diesel	1910	4	84
147 (937)	2.0	07/00→05/00	937 A1.000	Petrol	1970	4	88
147 (937)	2.0	01/00→03/01	AR 32310	Petrol	1970	4	98
147 (937)	3.2	02/00→03/01	932 A.000	Petrol	3179	6	138
155 (167)	1.6	05/99→12/99	AR 67601	Petrol	1598	4	42
155 (167)	1.7	04/99→04/99	AR 67103	Petrol	1748	4	52
155 (167)	1.7	04/99→04/99	AR 67105	Petrol	1748	4	53
155 (167)	1.7	05/99→12/99	AR 67106	Petrol	1747	4	54
155 (167)	1.8	01/99→12/99	AR 67101	Petrol	1773	4	63
155 (167)	1.8	01/99→12/99	AR 67102	Petrol	1773	4	64
155 (167)	1.8	02/99→12/99	AR 67402	Petrol	1756	4	65
155 (167)	1.9	04/99→12/99	AR 67501	Diesel	1929	4	85
155 (167)	2.0	02/99→04/99	AR 67201	Petrol	1995	4	105
155 (167)	2.0	02/99→02/99	AR 67202	Petrol	1995	4	106
155 (167)	2.0	01/99→12/99	AR 67203	Petrol	1995	4	107
155 (167)	2.5	04/99→12/99	VM 07 B	Diesel	2499	4	128
155 (167)	2.5	04/99→12/99	VM 31 B	Diesel	2499	4	130
156 (932)	1.6	09/99→09/00	AR 32102	Petrol	1598	4	36
156 (932)	1.6	09/99→09/00	AR 32103	Petrol	1598	4	37
156 (932)	1.6	09/99→09/00	AR 32104	Petrol	1598	4	38
156 (932)	1.6	09/99→09/00	AR 67601	Petrol	1598	4	42
156 (932)	1.8	09/99→10/00	AR 32201	Petrol	1747	4	48
156 (932)	1.8	10/00→09/00	AR 32205	Petrol	1747	4	49
156 (932)	1.9	11/00→09/00	192 A5.000	Diesel	1910	4	70
156 (932)	1.9	11/00→11/00	192 B1.000	Diesel	1910	4	71
156 (932)	1.9	05/00→09/00	937 A2.000	Diesel	1910	4	72
156 (932)	1.9	11/00→09/00	937 A4.000	Diesel	1910	4	73
156 (932)	1.9	07/00→09/00	937 A5.000	Diesel	1910	4	74
156 (932)	1.9	09/99→10/00	AR 32302	Diesel	1910	4	82
156 (932)	1.9	10/00→05/00	AR 37101	Diesel	1910	4	84
156 (932)	2.0	03/00→09/00	937 A1.000	Petrol	1970	4	88
156 (932)	2.0	09/99→10/00	AR 32301	Petrol	1970	4	97
156 (932)	2.0	10/00→03/00	AR 32310	Petrol	1970	4	98
156 (932)	2.4	10/00→09/00	839 A6.000	Diesel	2387	5	110
156 (932)	2.4	03/00→09/00	841 C000	Diesel	2387	5	111
156 (932)	2.4	10/00→09/00	841 G.000	Diesel	2387	5	112
156 (932)	2.4	06/00→09/00	841 M.000	Diesel	2387	5	114
156 (932)	2.4	09/99→09/00	AR 32501	Diesel	2387	5	120
156 (932)	2.5	09/99→12/00	AR 32401	Petrol	2492	6	124
156 (932)	2.5	10/00→09/00	AR 32405	Petrol	2492	6	125
156 (932)	3.2	03/00→09/00	932 A.000	Petrol	3179	6	138
156 Sportwagon (932)	1.6	05/00→05/00	AR 32102	Petrol	1598	4	36
156 Sportwagon (932)	1.6	05/00→05/00	AR 32103	Petrol	1598	4	37
156 Sportwagon (932)	1.6	05/00→05/00	AR 32104	Petrol	1598	4	38
156 Sportwagon (932)	1.6	05/00→05/00	AR 67601	Petrol	1598	4	42
156 Sportwagon (932)	1.8	05/00→10/00	AR 32201	Petrol	1747	4	48
156 Sportwagon (932)	1.8	10/00→05/00	AR 32205	Petrol	1747	4	49
156 Sportwagon (932)	1.9	11/00→05/00	192 A5.000	Diesel	1910	4	70
156 Sportwagon (932)	1.9	11/00→11/00	192 B1.000	Diesel	1910	4	71
156 Sportwagon (932)	1.9	05/00→05/00	937 A2.000	Diesel	1910	4	72
156 Sportwagon (932)	1.9	11/00→05/00	937 A4.000	Diesel	1910	4	73
156 Sportwagon (932)	1.9	07/00→05/00	937 A5.000	Diesel	1910	4	74
156 Sportwagon (932)	1.9	05/00→10/00	AR 32302	Diesel	1910	4	82
156 Sportwagon (932)	1.9	10/00→05/00	AR 37101	Diesel	1910	4	84
156 Sportwagon (932)	2.0	03/00→05/00	932 A2.000	Petrol	1970	4	87
156 Sportwagon (932)	2.0	03/00→05/00	937 A1.000	Petrol	1970	4	88
156 Sportwagon (932)	2.0	05/00→10/00	AR 32301	Petrol	1970	4	97



Ltr















CC











9

156 Sportwagon (932)	2.0	10/00→03/00	AR 32310	Petrol	1970	4	98
156 Sportwagon (932)	2.4	10/00→05/00	839 A6.000	Diesel	2387	5	110
156 Sportwagon (932)	2.4	03/00→05/00	841 C000	Diesel	2387	5	111
156 Sportwagon (932)	2.4	10/00→05/00	841 G.000	Diesel	2387	5	112
156 Sportwagon (932)	2.4	06/00→05/00	841 M.000	Diesel	2387	5	114
156 Sportwagon (932)	2.4	05/00→09/00	AR 32501	Diesel	2387	5	120
156 Sportwagon (932)	2.5	05/00→10/00	AR 32401	Petrol	2492	6	124
156 Sportwagon (932)	2.5	10/00→05/00	AR 32405	Petrol	2492	6	125
156 Sportwagon (932)	3.2	03/00→05/00	932 A.000	Petrol	3179	6	138
159 (939)	1.8	03/00→11/01	939 A4.000	Petrol	1796	4	55
159 (939)	1.9	09/00→11/01	937 A7.000	Diesel	1910	4	76
159 (939)	1.9	09/00→11/01	937 A8.000	Diesel	1910	4	77
159 (939)	1.9	09/00→11/01	939 A1.000	Diesel	1910	4	78
159 (939)	1.9	09/00→11/01	939 A2.000	Diesel	1910	4	79
159 (939)	1.9	09/00→11/01	939 A7.000	Diesel	1910	4	80
159 (939)	1.9	09/00→11/01	939 A8.000	Diesel	1910	4	81
159 (939)	2.0	05/00→11/01	844 A2.000	Diesel	1956	4	86
159 (939)	2.2	09/00→11/01	939 A5.000	Petrol	2198	4	109
159 (939)	2.4	09/00→11/01	939 A3.000	Diesel	2387	5	116
159 (939)	2.4	05/00→11/01	939 A9.000	Diesel	2387	5	117
159 Sportwagon (939)	1.8	03/00→11/01	939 A4.000	Petrol	1796	4	55
159 Sportwagon (939)	1.9	03/00→11/01	937 A7.000	Diesel	1910	4	76
159 Sportwagon (939)	1.9	03/00→11/01	937 A8.000	Diesel	1910	4	77
159 Sportwagon (939)	1.9	03/00→11/01	939 A1.000	Diesel	1910	4	78
159 Sportwagon (939)	1.9	03/00→11/01	939 A2.000	Diesel	1910	4	79
159 Sportwagon (939)	2.0	05/00→11/01	844 A2.000	Diesel	1956	4	86
159 Sportwagon (939)	2.2	03/00→11/01	939 A5.000	Petrol	2198	4	109
159 Sportwagon (939)	2.4	03/00→11/01	939 A3.000	Diesel	2387	5	116
159 Sportwagon (939)	2.4	05/00→11/01	939 A9.000	Diesel	2387	5	117
164 (164)	2.0	06/98→09/99	AR 06416	Petrol	1995	4	93
164 (164)	2.0	06/98→12/99	AR 06420	Petrol	1995	4	94
164 (164)	2.0	10/98→09/99	AR 06476	Petrol	1995	4	95
164 (164)	2.0	03/99→09/99	AR 64101	Petrol	1997	6	102
164 (164)	2.0	09/99→09/99	AR 64102	Petrol	1996	6	103
164 (164)	2.0	09/99→09/99	AR 64103	Petrol	1995	4	104
164 (164)	2.5	09/99→09/99	VM 08 B	Diesel	2499	4	129
164 (164)	2.5	09/99→09/99	VM 32 B	Diesel	2499	4	131
164 (164)	2.5	06/98→09/99	VM 84 A	Diesel	2499	4	132
164 (164)	3.0	09/99→09/99	AR 64304	Petrol	2959	6	137
166 (936)	2.0	09/99→10/00	AR 34102	Petrol	1996	6	99
166 (936)	2.0	09/99→10/00	AR 34103	Petrol	1970	4	100
166 (936)	2.0	10/00→06/00	AR 36301	Petrol	1970	4	101
166 (936)	2.4	10/00→06/00	839 A6.000	Diesel	2387	5	110
166 (936)	2.4	04/00→06/00	841 C000	Diesel	2387	5	111
166 (936)	2.4	10/00→06/00	841 G.000	Diesel	2387	5	112
166 (936)	2.4	10/00→06/00	841 H.000	Diesel	2387	5	113
166 (936)	2.4	10/00→06/00	841 M.000	Diesel	2387	5	114
166 (936)	2.4	07/00→06/00	936 B.000	Diesel	2387	5	115
166 (936)	2.4	09/99→10/00	AR 34202	Diesel	2387	5	121
166 (936)	2.5	09/99→10/00	AR 34201	Petrol	2492	6	126
166 (936)	2.5	10/00→06/00	AR 36201	Petrol	2492	6	127
166 (936)	3.0	09/99→10/00	AR 34301	Petrol	2959	6	135
166 (936)	3.0	10/00→06/00	AR 36101	Petrol	2959	6	136
166 (936)	3.2	10/00→06/00	936 A.000	Petrol	3179	6	139
ALFASUD Sprint (902.A)	1.4	07/97→12/98	AR 30168	Petrol	1351	4	18
ALFASUD Sprint (902.A)	1.7	10/98→12/98	AR 30558	Petrol	1712	4	43
AR 6 Box (280)	1.9	04/98→12/98	160 D100	Diesel	1929	4	68
AR 6 Box (280)	2.4	09/98→12/98	8144.21.220	Diesel	2445	4	119
AR 6 Box (280)	2.5	03/98→12/98	8144.67.220	Diesel	2499	4	123
AR 6 Bus (280)	1.9	04/98→12/98	160 D100	Diesel	1929	4	68
AR 8 Box (280)	2.4	04/98→12/98	8140.21.200 D.I.	Diesel	2445	4	118
AR 8 Box (280)	2.5	09/98→12/98	8144.67.220	Diesel	2499	4	123
AR 8 Platform/Chassis (280)	2.4	04/98→12/98	8140.21.200 D.I.	Diesel	2445	4	118
AR 8 Platform/Chassis (280)	2.5	09/98→12/98	8144.67.220	Diesel	2499	4	123
BRERA	2.0	03/00→	844 A2.000	Diesel	1956	4	86
BRERA	2.2	01/00→	939 A5.000	Petrol	2198	4	109
BRERA	2.4	01/00→	939 A3.000	Diesel	2387	5	116
BRERA	2.4	05/00→	939 A9.000	Diesel	2387	5	117
GIULIETTA (940)	1.4	04/01→	198 A4.000	Petrol	1368	4	6
GIULIETTA (940)	1.4	04/01→	198 A4.000	LPG	1368	4	6

	Ltr				CC		9
GIULIETTA (940)	1.4	04/01→	198 A4.000	Bi-Fuel	1368	4	6
GIULIETTA (940)	1.4	04/01→	940 A2.000	Petrol	1368	4	10
GIULIETTA (940)	1.4	04/01→	940 A6.000	Petrol	1368	4	11
GIULIETTA (940)	1.4	04/01→	955 A8.000	Petrol	1368	4	16
GIULIETTA (940)	1.6	04/01→	940 A3.000	Diesel	1598	4	33
GT (937)	1.8	11/00→09/01	AR 32205	Petrol	1747	4	49
GT (937)	1.9	11/00→09/01	937 A5.000	Diesel	1910	4	74
GT (937)	1.9	05/00→09/01	937 A6.000	Diesel	1910	4	75
GT (937)	2.0	11/00→09/01	932 A2.000	Petrol	1970	4	87
GT (937)	2.0	11/00→09/01	937 A1.000	Petrol	1970	4	88
GT (937)	3.2	11/00→09/01	936 A.000	Petrol	3179	6	139
GTV (916C_)	1.8	05/99→10/00	AR 32201	Petrol	1747	4	48
GTV (916C_)	2.0	04/00→10/00	937 A1.000	Petrol	1970	4	88
GTV (916C_)	2.0	06/99→09/99	AR 16202	Petrol	1996	6	96
GTV (916C_)	2.0	05/99→08/00	AR 32301	Petrol	1970	4	97
GTV (916C_)	2.0	06/99→10/00	AR 32310	Petrol	1970	4	98
GTV (916C_)	3.0	10/99→10/00	AR 16102	Petrol	2959	6	133
GTV (916C_)	3.0	10/00→10/00	AR 16105	Petrol	2959	6	134
GTV (916C_)	3.2	04/00→10/00	936 A6.000	Petrol	3179	6	140
MITO (955)	1.3	09/00→	199 A3.000	Diesel	1248	4	1
MITO (955)	1.3	10/00→	199 B1.000	Diesel	1248	4	2
MITO (955)	1.3	01/01→	199 B4.000	Diesel	1248	4	3
MITO (955)	1.4	09/00→	198 A1.000	Petrol	1368	4	5
MITO (955)	1.4	09/00→	198 A4.000	Petrol	1368	4	6
MITO (955)	1.4	09/00→	198 A4.000	LPG	1368	4	6
MITO (955)	1.4	09/00→	198 A4.000	Bi-Fuel	1368	4	6
MITO (955)	1.4	09/00→	199 A6.000	Petrol	1368	4	7
MITO (955)	1.4	09/00→	199 A8.000	Petrol	1368	4	8
MITO (955)	1.4	03/01→	350 A1.000	Petrol	1368	4	9
MITO (955)	1.4	10/00→	940 A2.000	Petrol	1368	4	10
MITO (955)	1.4	09/00→	955 A1.000	Petrol	1368	4	12
MITO (955)	1.4	10/00→	955 A2.000	Petrol	1368	4	13
MITO (955)	1.4	08/01→	955 A6.000	Petrol	1368	4	14
MITO (955)	1.4	10/00→	955 A7.000	Petrol	1368	4	15
MITO (955)	1.4	10/00→	955 A8.000	Petrol	1368	4	16
MITO (955)	1.4	05/01→	955 A9.000	Petrol	1368	4	17
MITO (955)	1.6	09/00→	198 A2.000	Diesel	1598	4	32
MITO (955)	1.6	09/00→	955 A3.000	Diesel	1598	4	34
MITO (955)	1.6	09/00→	955 A4.000	Diesel	1598	4	35
SPIDER (115)	2.0	08/98→12/99	AR 01544	Petrol	1962	4	89
SPIDER (115)	2.0	01/99→12/99	AR 01588	Petrol	1962	4	90
SPIDER (916S_)	1.8	05/99→04/00	AR 32201	Petrol	1747	4	48
SPIDER (916S_)	2.0	04/00→04/00	937 A1.000	Petrol	1970	4	88
SPIDER (916S_)	2.0	05/99→04/00	AR 16202	Petrol	1996	6	96
SPIDER (916S_)	2.0	05/99→08/00	AR 32301	Petrol	1970	4	97
SPIDER (916S_)	2.0	06/99→04/00	AR 32310	Petrol	1970	4	98
SPIDER (916S_)	3.0	01/99→10/00	AR 16102	Petrol	2959	6	133
SPIDER (916S_)	3.0	09/99→08/00	AR 16105	Petrol	2959	6	134
SPIDER (916S_)	3.2	04/00→04/00	936 A6.000	Petrol	3179	6	140
SPIDER (939)	2.0	04/00→	844 A2.000	Diesel	1956	4	86
SPIDER (939)	2.2	09/00→	939 A5.000	Petrol	2198	4	109
SPIDER (939)	2.4	04/00→	939 A3.000	Diesel	2387	5	116

		CC			9			CC			9
160 D100	Diesel	1929	4	82.60	68	AR 30168	Petrol	1351	4	80.00	18
182 B9.000	Diesel	1910	4	82.00	69	AR 30182	Petrol	1490	4	84.00	27
192 A5.000	Diesel	1910	4	82.00	70	AR 30502	Petrol	1351	4	80.00	19
192 B1.000	Diesel	1910	4	82.00	71	AR 30508	Petrol	1490	4	84.00	28
198 A1.000	Petrol	1368	4	72.00	5	AR 30558	Petrol	1712	4	87.00	43
198 A2.000	Diesel	1598	4	79.50	32	AR 30585	Petrol	1186	4	80.00	4
198 A4.000	Petrol	1368	4	72.00	6	AR 30586	Petrol	1351	4	80.00	20
198 A4.000	LPG	1368	4	72.00	6	AR 30587	Petrol	1351	4	80.00	21
198 A4.000	Bi-Fuel	1368	4	72.00	6	AR 30588	Petrol	1490	4	84.00	29
199 A3.000	Diesel	1248	4	69.60	1	AR 30736	Petrol	1712	4	87.00	44
199 A6.000	Petrol	1368	4	72.00	7	AR 30737	Petrol	1712	4	87.00	45
199 A8.000	Petrol	1368	4	72.00	8	AR 30746	Petrol	1712	4	87.00	46
199 B1.000	Diesel	1248	4	69.60	2	AR 30747	Petrol	1712	4	87.00	47
199 B4.000	Diesel	1248	4	69.60	3	AR 30750	Petrol	1490	4	84.00	30
350 A1.000	Petrol	1368	4	72.00	9	AR 30751	Petrol	1490	4	84.00	31
8140.21.200 D.I.	Diesel	2445	4	93.00	118	AR 30755	Petrol	1351	4	80.00	22
8144.21.220	Diesel	2445	4	93.00	119	AR 32102	Petrol	1598	4	82.00	36
8144.67.220	Diesel	2499	4	93.00	123	AR 32103	Petrol	1598	4	82.00	37
839 A6.000	Diesel	2387	5	82.00	110	AR 32104	Petrol	1598	4	82.00	38
841 C000	Diesel	2387	5	82.00	111	AR 32201	Petrol	1747	4	82.00	48
841 G.000	Diesel	2387	5	82.00	112	AR 32205	Petrol	1747	4	82.00	49
841 H.000	Diesel	2387	5	82.00	113	AR 32301	Petrol	1970	4	83.00	97
841 M.000	Diesel	2387	5	82.00	114	AR 32302	Diesel	1910	4	82.00	82
844 A2.000	Diesel	1956	4	83.00	86	AR 32310	Petrol	1970	4	83.00	98
932 A.000	Petrol	3179	6	93.00	138	AR 32401	Petrol	2492	6	88.00	124
932 A2.000	Petrol	1970	4	83.00	87	AR 32405	Petrol	2492	6	88.00	125
936 A.000	Petrol	3179	6	93.00	139	AR 32501	Diesel	2387	5	82.00	120
936 A6.000	Petrol	3179	6	93.00	140	AR 33201	Petrol	1596	4	84.00	39
936 B.000	Diesel	2387	5	82.00	115	AR 33401	Petrol	1712	4	87.00	50
937 A1.000	Petrol	1970	4	83.00	88	AR 33501	Petrol	1351	4	80.00	23
937 A2.000	Diesel	1910	4	82.00	72	AR 33503	Petrol	1370	4	82.00	24
937 A4.000	Diesel	1910	4	82.00	73	AR 33601	Diesel	1929	4	82.60	83
937 A5.000	Diesel	1910	4	82.00	74	AR 34102	Petrol	1996	6	80.00	99
937 A6.000	Diesel	1910	4	82.00	75	AR 34103	Petrol	1970	4	83.00	100
937 A7.000	Diesel	1910	4	82.00	76	AR 34201	Petrol	2492	6	88.00	126
937 A8.000	Diesel	1910	4	82.00	77	AR 34202	Diesel	2387	5	82.00	121
939 A1.000	Diesel	1910	4	82.00	78	AR 34301	Petrol	2959	6	93.00	135
939 A2.000	Diesel	1910	4	82.00	79	AR 36101	Petrol	2959	6	93.00	136
939 A3.000	Diesel	2387	5	82.00	116	AR 36201	Petrol	2492	6	88.00	127
939 A4.000	Petrol	1796	4	80.50	55	AR 36301	Petrol	1970	4	83.00	101
939 A5.000	Petrol	2198	4	86.00	109	AR 37101	Diesel	1910	4	82.00	84
939 A7.000	Diesel	1910	4	82.00	80	AR 37203	Petrol	1598	4	82.00	40
939 A8.000	Diesel	1910	4	82.00	81	AR 38201	Petrol	1598	4	82.00	41
939 A9.000	Diesel	2387	5	82.00	117	AR 38401	Petrol	1747	4	82.00	51
940 A2.000	Petrol	1368	4	72.00	10	AR 38501	Petrol	1370	4		25
940 A3.000	Diesel	1598	4	79.50	33	AR 61102	Petrol	1779	4	80.00	60
940 A6.000	Petrol	1368	4	72.00	11	AR 61201	Petrol	1779	4	80.00	61
955 A1.000	Petrol	1368	4	72.00	12	AR 61202	Petrol	1779	4	80.00	62
955 A2.000	Petrol	1368	4	72.00	13	AR 64101	Petrol	1997	6	80.00	102
955 A3.000	Diesel	1598	4	79.50	34	AR 64102	Petrol	1996	6	80.00	103
955 A4.000	Diesel	1598	4	79.50	35	AR 64103	Petrol	1995	4	84.00	104
955 A6.000	Petrol	1368	4	72.00	14	AR 64304	Petrol	2959	6	93.00	137
955 A7.000	Petrol	1368	4	72.00	15	AR 67101	Petrol	1773	4	84.00	63
955 A8.000	Petrol	1368	4	72.00	16	AR 67102	Petrol	1773	4	84.00	64
955 A9.000	Petrol	1368	4	72.00	17	AR 67103	Petrol	1748	4	83.40	52
AR 01544	Petrol	1962	4	84.00	89	AR 67105	Petrol	1748	4	83.50	53
AR 01588	Petrol	1962	4	84.00	90	AR 67106	Petrol	1747	4	82.00	54
AR 06134	Petrol	1779	4	80.00	56	AR 67201	Petrol	1995	4	84.00	105
AR 06158	Petrol	1779	4	80.00	57	AR 67202	Petrol	1995	4	84.00	106
AR 06166	Petrol	1962	4	84.00	91	AR 67203	Petrol	1995	4	84.00	107
AR 06168	Petrol	1779	4	80.00	58	AR 67402	Petrol	1756	4	84.00	65
AR 06202	Petrol	1779	4	80.00	59	AR 67501	Diesel	1929	4	82.60	85
AR 06224	Petrol	1962	4	84.00	92	AR 67601	Petrol	1598	4	82.00	42
AR 06416	Petrol	1995	4	84.00	93	VM 07 B	Diesel	2499	4	92.00	128
AR 06420	Petrol	1995	4	84.00	94	VM 08 B	Diesel	2499	4	92.00	129
AR 06476	Petrol	1995	4	84.00	95	VM 31 B	Diesel	2499	4	92.00	130
AR 16102	Petrol	2959	6	93.00	133	VM 32 B	Diesel	2499	4	92.00	131
AR 16105	Petrol	2959	6	93.00	134	VM 80 A	Diesel	1995	4	88.00	108
AR 16202	Petrol	1996	6	80.00	96	VM 81 A	Diesel	2393	4	92.00	122
AR 30146	Petrol	1490	4	84.00	26	VM 82 A	Diesel	1779	3	92.00	66

		CC			9			CC			9
VM 84 A	Diesel	2499	4	92.00	132						
VM 96 A	Diesel	1779	3	92.00	67						



cc



kW/PS

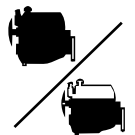

1.2	199 A3.000	Diesel					1			
Mito 1.3 JTDM	09/08→	1248	4	69.60	DOHC	66/90	AD5800 (MLS), 0.720mm AD5810 (MLS), 0.820mm, 1 Hole AD5820 (MLS), 0.920mm, 2 Holes	CD5820 ▲	ED5820 FD5820 ▲	
1.2	199 B1.000	Diesel					2			
Mito 1.3 JTDM	10/09→	1248	4	69.60	DOHC	70/95	AD5800 (MLS), 0.720mm AD5810 (MLS), 0.820mm, 1 Hole AD5820 (MLS), 0.920mm, 2 Holes	CD5810 ▲	ED5810	
1.2	199 B4.000	Diesel					3			
Mito 1.3 JTDM	01/11→	1248	4	69.60	DOHC	62/84	AD5800 (MLS), 0.720mm AD5810 (MLS), 0.820mm, 1 Hole AD5820 (MLS), 0.920mm, 2 Holes	CD5810 ▲	ED5820 FD5820 ▲	
1.2	AR 30585						4			
33 1.2 (905.A)	06/83→12/89	1186	4	80.00	SOHC/OHC, BOXER	50/68	AN350 (Fibre) (x2)	CN353 [3]		
1.4	198 A1.000						5			
Mito 1.4 Turbo	09/08→	1368	4	72.00	DOHC	110/150	AH6510 (MLS)		EE5180 [3]	
1.4	198 A4.000						6			
Giulietta 1.4 Giulietta 1.4 TB Mito 1.4 Mito 1.4 Bifuel	12/11→ 04/10→ 09/08→ 07/11→	1368	4	72.00	DOHC	88/120	AH6510 (MLS)		EE5180 [3]	
1.4	199 A6.000						7			
Mito 1.4	09/08→	1368	4	72.00	DOHC	70/95	AG7310 (MLS)		EE5180 [3]	
1.4	199 A8.000						8			
Mito 1.4 TB	09/08→	1368	4	72.00	DOHC	114/155	AH6510 (MLS)		EE5180 [3]	
1.4	350 A1.000						9			
Mito 1.4	03/11→	1368	4	72.00	SOHC/OHC	57/78	AG7380 (MLS)	CG7380	EE5242	
1.4	940 A2.000						10			
Giulietta 1.4 TB Mito 1.4 TB	04/10→ 10/09→	1368	4	72.00	SOHC/OHC	125/170	AH6510 (MLS)			
1.4	940 A6.000						11			
Giulietta 1.4 TB	04/10→	1368	4	72.00		85/116	AH6510 (MLS)			

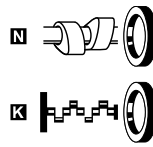
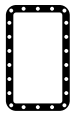
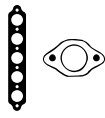

AD5800



AD5810



AD5820



AN350



JA899



JD5375



JE696



JM5176

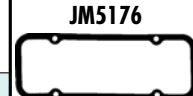

JN588



JH565

HBS353 [5] M10x1.25x119.00mm (x10)	JD5993 [1] JD5413 [3] (MLS)	JM5259 (SE)		HR791 [3]	NA5223 [2] 40.00x52.00x7.00mm, FPM NA5230 [2] 78.00x100.00x9.00mm, PTFE	
HBS353 [5] M10x1.25x119.00mm (x10)		JM5259 (SE)			NA5223 [2] 40.00x52.00x7.00mm, FPM NA5230 [2] 78.00x100.00x9.00mm, PTFE	
HBS353 [5] M10x1.25x119.00mm (x10)		JM5259 (SE)			NA5223 [2] 40.00x52.00x7.00mm, FPM NA5230 [2] 78.00x100.00x9.00mm, PTFE	
	JA899 [x4] JE696	JN588 [4]	JH565		NA5064 [2] 35.00x58.00x10.00mm, ACM NA5063 [2] 40.00x56.00x10.00mm, ACM NA5065 [1] 62.00x80.00x12.00mm, ACM	JR349 [6] KV124 [6]
HBS247 [5] M9x1.25x87.00mm (x10)		JM5176	HR397	HR814 [3]	NA5058 [2] 40.00x55.00x7.00mm, FPM NA5057 [2] 27.00x37.00x7.00mm, FPM LK5001 [1][2][7] 74.00x187.50x17.000mm, FPM	
HBS247 [5] M9x1.25x87.00mm (x10)		JM5176	HR397	HR814 [3]	NA5058 [2] 40.00x55.00x7.00mm, FPM NA5057 [2] 27.00x37.00x7.00mm, FPM LK5001 [1][2][7] 74.00x187.50x17.000mm, FPM	
HBS247 [5] M9x1.25x87.00mm (x10)		JM5176	HR397	HR814 [3]	NA5058 [2] 40.00x55.00x7.00mm, FPM NA5321 [2] 31.00x55.00x7.00mm, FPM NA5057 [2] 27.00x37.00x7.00mm, FPM LK5001 [1][2][7] 74.00x187.50x17.000mm, FPM	
HBS247 [5] M9x1.25x87.00mm (x10)		JM5176	HR397	HR814 [3]	NA5058 [2] 40.00x55.00x7.00mm, FPM NA5057 [2] 27.00x37.00x7.00mm, FPM LK5001 [1][2][7] 74.00x187.50x17.000mm, FPM	
HBS052 [5] M9x1.25x95.00mm (x10)	HA5053 [1][3] JD5375 [3]	JM7099 [4] (SMG)	HR397	PA5025 (x8)	NA5058 [2] 40.00x55.00x7.00mm, FPM NA5057 [2] 27.00x37.00x7.00mm, FPM NA5061 [1] 74.00x88.00x8.00mm, FPM	
HBS247 [5] M9x1.25x87.00mm (x10)				HR814 [3]	NA5321 [2] 31.00x55.00x7.00mm, FPM NA5057 [2] 27.00x37.00x7.00mm, FPM LK5001 [1][2][7] 74.00x187.50x17.000mm, FPM	
HBS247 [5] M9x1.25x87.00mm (x10)					NA5057 [2] 27.00x37.00x7.00mm, FPM LK5001 [1][2][7] 74.00x187.50x17.000mm, FPM	

ALFA ROMEO



cc



kW/PS

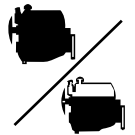

1.4	955 A1.000	12	AH6510 (MLS)		EE5242				
Mito 1.4	09/08→	1368	4	72.00	DOHC	57-58/ 78-79			
1.4	955 A2.000	13	AH6510 (MLS)						
Mito 1.4 TB	10/09→	1368	4	72.00	SOHC/OHC	99/135			
1.4	955 A6.000	14	AG7310 (MLS)						
Mito 1.4	08/10→	1368	4	72.00	SOHC/OHC	77/105			
1.4	955 A7.000	15	AH6510 (MLS)						
Mito 1.4 TB	10/09→	1368	4	72.00	DOHC	99/135			
1.4	955 A8.000	16	AH6510 (MLS)						
Giulietta 1.4 TB	04/10→	1368	4	72.00	SOHC/OHC	120/163			
Mito 1.4 TB	10/09→								
1.4	955 A9.000	17	AG7310 (MLS)						
Mito 1.4	05/11→	1368	4	72.00	DOHC	51/69			
1.4	AR 30168	18	AN350 (Fibre)					CN353 [3]	
33 1.3	10/84→12/89	1351	4	80.00	SOHC/OHC, BOXER	63-66/ 85-90			
33 1.3 i.e.	05/83→12/89								
Alfasud Sprint	07/79→12/89								
1.4	AR 30502	19	AN350 (Fibre)					CN353 [3]	
33 1.3	05/83→12/89	1351	4	80.00	SOHC/OHC, BOXER	55-58/ 75-79			
1.4	AR 30586	20	AN350 (Fibre)					CN353 [3]	
33 1.3	06/83→12/89	1351	4	80.00	SOHC/OHC, BOXER	55/75			
1.4	AR 30587	21	AN350 (Fibre)					CN353 [3]	
33 1.3	10/84→12/89	1351	4	80.00	SOHC/OHC, BOXER	63-66/ 86-90			
33 1.4	01/84→12/88								
33 1.4 i.e.	06/91→09/94								

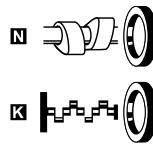
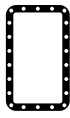
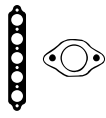

AN350



JA899



JE744



JN588



JH565

HBS247 [5]
M9x1.25x87.00mm (x10)

HBS247 [5]
M9x1.25x87.00mm (x10)

HBS247 [5]
M9x1.25x87.00mm (x10)

HBS247 [5]
M9x1.25x87.00mm (x10)

HBS247 [5]
M9x1.25x87.00mm (x10)

HBS247 [5]
M9x1.25x87.00mm (x10)

JA899 [4]
JE744

JN588 (x2)[4]

JH565

HR602

NA5057 [2]
27.00x37.00x7.00mm, FPM
LK5001 [1][2][7]
74.00x187.50x17.000mm, FPM

NA5321 [2]
31.00x55.00x7.00mm, FPM
NA5057 [2]
27.00x37.00x7.00mm, FPM
LK5001 [1][2][7]
74.00x187.50x17.000mm, FPM

NA5321 [2]
31.00x55.00x7.00mm, FPM
NA5057 [2]
27.00x37.00x7.00mm, FPM
LK5001 [1][2][7]
74.00x187.50x17.000mm, FPM

NA5321 [2]
31.00x55.00x7.00mm, FPM
NA5057 [2]
27.00x37.00x7.00mm, FPM
LK5001 [1][2][7]
74.00x187.50x17.000mm, FPM

NA5321 [2]
31.00x55.00x7.00mm, FPM
NA5057 [2]
27.00x37.00x7.00mm, FPM
LK5001 [1][2][7]
74.00x187.50x17.000mm, FPM

NA5057 [2]
27.00x37.00x7.00mm, FPM
LK5001 [1][2][7]
74.00x187.50x17.000mm, FPM

NA5064 [2]
35.00x58.00x10.00mm, ACM
NA5063 [2]
40.00x56.00x10.00mm, ACM
NA5065 [1]
62.00x80.00x12.00mm, ACM

NA5064 [2]
35.00x58.00x10.00mm, ACM
NA5063 [2]
40.00x56.00x10.00mm, ACM
NA5065 [1]
62.00x80.00x12.00mm, ACM

NA5064 [2]
35.00x58.00x10.00mm, ACM
NA5063 [2]
40.00x56.00x10.00mm, ACM
NA5065 [1]
62.00x80.00x12.00mm, ACM

NA5064 [2]
35.00x58.00x10.00mm, ACM
NA5063 [2]
40.00x56.00x10.00mm, ACM
NA5065 [1]
62.00x80.00x12.00mm, ACM



cc



kW/PS

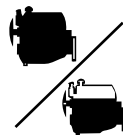

1.4	AR 30755	22					AN350 (Fibre)	CN353 [3]	
33 1.4 4x4 33 1.4 i.e.	07/90→12/92 06/91→09/94	1351	4	80.00	SOHC/OHC, BOXER	65-66/ 88-90			
1.4	AR 33501	23					AN350 (Fibre)	CN353 [3]	
145 1.4 i.e. 146 1.4 i.e.	07/94→12/96 12/94→12/96	1351	4	80.00	SOHC/OHC, BOXER	66/90			
1.4	AR 33503	24					BY390 (Fibre), 1.200mm AY510 (Fibre), 1.400mm	DY390 [3] →05/98 DY391 [3] 06/98→	GY390 →05/98 GY391 06/98→
145 1.4 16V 146 1.4 16V	12/96→01/01 11/96→01/01	1370	4	82.00	DOHC	76/103			
1.4	AR 38501	25					BY390 (Fibre), 1.200mm 12/96→ AY510 (Fibre), 1.400mm 12/96→	DY390 [3] 12/96→05/98 DY391 [3] 06/98→	GY390 12/96→05/98 GY391 06/98→
145 1.4 16V 146 1.4 16V	12/96→01/01 11/96→01/01	1370	4		DOHC	76/103			
1.5	AR 30146	26					BE620 (Fibre) (x2)	DE622 [3]	
33 1.5 33 1.5 4x4 33 1.5 QV	12/86→12/89 09/86→12/89 06/84→12/89	1490	4	84.00	SOHC/OHC, BOXER	75-77/ 102-105			
1.5	AR 30182	27					BE620 (Fibre) (x2)	DE622 [3]	
33 1.5	05/83→12/93	1490	4	84.00	SOHC/OHC, BOXER	70/95			
1.5	AR 30508	28					BE620 (Fibre)	DE622 [3]	
33 1.5 33 1.5 4x4 33 1.5 QV	12/86→12/89 12/86→03/89 06/84→12/89	1490	4	84.00	SOHC/OHC, BOXER	77/105			
1.5	AR 30588	29					BE620 (Fibre) (x2)	DE622 [3]	
33 1.5 33 1.5 4x4 33 1.5 QV	07/86→12/89 07/86→12/89 06/84→12/89	1490	4	84.00	SOHC/OHC, BOXER	75-77/ 102-105			
1.5	AR 30750	30					BE620 (Fibre) (x2)	DE623 [3]	
33 1.5 i.e.	07/90→08/91	1490	4	84.00	SOHC/OHC	74/101			

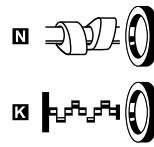
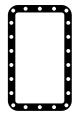
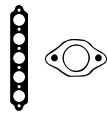

AN350, BE620



AY510



BY390



JA899



JD221



JD273



JD466



JE744



HL700



JR349



KV124

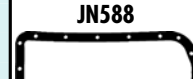

JN588



JH565



JJ450

	JA899 [x4] JE744	JN588 (x2)[4]	JH565	HR363 [x] HR602 [x]	NA5064 [2] 35.00x58.00x10.00mm, ACM NA5063 [2] 40.00x56.00x10.00mm, ACM NA5065 [1] 62.00x80.00x12.00mm, ACM	KV124 [6]		
	JA899 [x4] JE744	JN588 (x2)[4]	JH565	HR363 [x] HR602 [x]	NA5064 [2] 35.00x58.00x10.00mm, ACM NA5063 [2] 40.00x56.00x10.00mm, ACM NA5065 [1] 62.00x80.00x12.00mm, ACM	HJ287 [8] JR349 [6] KV124 [6]		
HBS262 [5] M10x1.25x220.00mm (x10)	JD466 [x] JD273 [x] (MLS)	HL700 [x]	HR354	HR599 [x]	NA5053 [2] 30.00x42.00x7.00mm, FPM NA5070 [2] 31.00x41.00x7.00mm, FPM NF888 [1] 93.00x172.00x12.00mm, FPM			
HBS262 [5] M10x1.25x220.00mm (x10) 12/96→	JD466 [x] 12/96→ JD273 [x] (MLS) 12/96→	HL700 [x] 12/96→	HR354 12/96→	HR599 [x] 12/96→	NA5053 [2] 30.00x42.00x7.00mm, FPM 12/96→ NA5070 [2] 31.00x41.00x7.00mm, FPM 12/96→ NF888 [1] 93.00x172.00x12.00mm, FPM 12/96→			
	JA899 [x4]	JN588 (x2)[4]	JH565		NA5064 [2] 35.00x58.00x10.00mm, ACM NA5063 [2] 40.00x56.00x10.00mm, ACM NA5065 [1] 62.00x80.00x12.00mm, ACM			
	JA899 [x4]	JN588 (x2)[4]	JH565		NA5064 [2] 35.00x58.00x10.00mm, ACM NA5063 [2] 40.00x56.00x10.00mm, ACM NA5065 [1] 62.00x80.00x12.00mm, ACM	JR349 [6] KV124 [6]		
	JA899 [x]	JN588 [4]	JH565		NA5064 [2] 35.00x58.00x10.00mm, ACM NA5063 [2] 40.00x56.00x10.00mm, ACM NA5065 [1] 62.00x80.00x12.00mm, ACM			
	JA899 [x4]	JN588 (x2)[4]	JH565		NA5064 [2] 35.00x58.00x10.00mm, ACM NA5063 [2] 40.00x56.00x10.00mm, ACM NA5065 [1] 62.00x80.00x12.00mm, ACM	JR349 [6] KV124 [6]		
	JD221 (x2) JA899 [x4]	JN588 (x2)[4]	JJ450	HR363 [x]	NA5064 [2] 35.00x58.00x10.00mm, ACM NA5063 [2] 40.00x56.00x10.00mm, ACM NA5065 [1] 62.00x80.00x12.00mm, ACM	JR349 [6] KV124 [6]		

ALFA ROMEO



cc



kW/PS

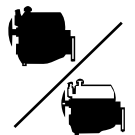

1.5	AR 30751					31	BE620 (Fibre) (x2)	DE623 [3]	
33 1.5 i.e	01/90→09/94	1490	4	84.00	SOHC/OHC, BOXER	71-72/ 97-98			
1.6	198 A2.000 Diesel					32	AH6880 (MLS), 0.82mm AH6890 (MLS), 0.92mm, 1 Hole AH6900 (MLS), 1.02mm, 2 Holes		
Mito 1.6 JTDM	09/08→	1598	4	79.50	DOHC	88/120			
1.6	940 A3.000 Diesel					33	AH6880 (MLS), 0.82mm AH6890 (MLS), 0.92mm, 1 Hole AH6900 (MLS), 1.02mm, 2 Holes		
Giulietta 1.6	04/10→	1598	4	79.50	DOHC	77/105			
1.6	955 A3.000 Diesel					34	AH6880 (MLS), 0.82mm AH6890 (MLS), 0.92mm, 1 Hole AH6900 (MLS), 1.02mm, 2 Holes		
Mito 1.6 JTDM	09/08→	1598	4	79.50	DOHC	88/120			
1.6	955 A4.000 Diesel					35	AH6880 (MLS), 0.82mm AH6890 (MLS), 0.92mm, 1 Hole AH6900 (MLS), 1.02mm, 2 Holes		
Mito 1.6 JTDM	09/08→	1598	4	79.50	DOHC	85/115			
1.6	AR 32102					36	BW720 (Fibre), 1.650mm AY500 (Fibre), 1.85mm	DW721 [3] →05/98 DW722 [3] 06/98→	GW722
156 1.6 16V	09/97→05/06	1598	4	82.00	DOHC	88/120			
1.6	AR 32103					37	AA5420 (MLS), 0.380mm BW720 (Fibre), 1.650mm	CA5420 [3]	EA5420 [3]
156 1.6 16V	09/97→05/06	1598	4	82.00	DOHC	88/120			
1.6	AR 32104					38	AA5420 (MLS), 0.380mm BW720 (Fibre), 1.650mm	CA5420 [3]	EA5420 [3]
147 1.6 16V	01/01→03/10	1598	4	82.00	DOHC	88/120			
156 1.6 16V	09/97→05/06								
1.6	AR 33201					39	BE620 (Fibre) (x2)	DE623 [3]	
145 1.6 i.e.	10/94→12/96	1596	4	84.00	SOHC/OHC, BOXER	76/103			
146 1.6 i.e.	12/94→12/96								
1.6	AR 37203					40	AA5420 (MLS), 0.380mm	CA5420 [3]	EA5420 [3]
147 1.6 16V ECO	01/01→03/10	1598	4	82.00		76/103			

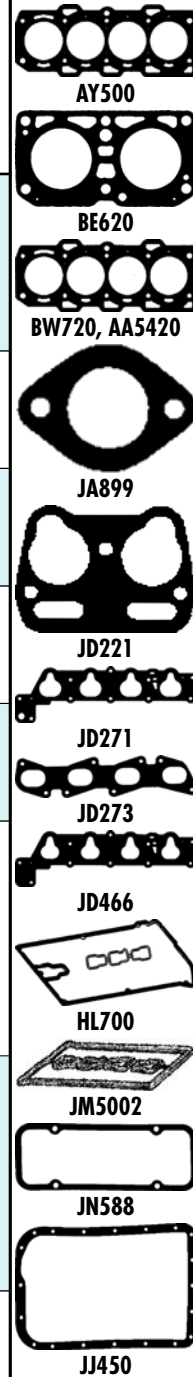
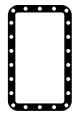

	JD221 (x2) JA899 (x4)	JN588 (x2)[4]	JJ450	HR363	NA5064 [2] 35.00x58.00x10.00mm, ACM NA5063 [2] 40.00x56.00x10.00mm, ACM NA5065 [1] 62.00x80.00x12.00mm, ACM	JR349 [6] KV124 [6]
					NA5070 [2] 31.00x41.00x7.00mm, FPM NF888 [1] 93.00x172.00x12.00mm, FPM	
					NA5070 [2] 31.00x41.00x7.00mm, FPM NF888 [1] 93.00x172.00x12.00mm, FPM	
					NA5070 [2] 31.00x41.00x7.00mm, FPM NF888 [1] 93.00x172.00x12.00mm, FPM	
					NA5070 [2] 31.00x41.00x7.00mm, FPM NF888 [1] 93.00x172.00x12.00mm, FPM	
HBS132 [5] M10x1.25x254.00mm (x10)	JD271 (Metal) JD273 (MLS)	JM5002 (Elastomer)	HR354	HR599	NA5053 [2] 30.00x42.00x7.00mm, FPM NA5069 [2] 55.00x68.00x8.00mm, FPM NA5070 [2] 31.00x41.00x7.00mm, FPM NF888 [1] 93.00x172.00x12.00mm, FPM	
HBS262 [5] M10x1.25x220.00mm (x10)	JD271 (Metal) JD273 (MLS)	JM5002 (Elastomer) HL700	HR354	HR599	NA5053 [2] 30.00x42.00x7.00mm, FPM NA5069 [2] 55.00x68.00x8.00mm, FPM NA5070 [2] 31.00x41.00x7.00mm, FPM NF888 [1] 93.00x172.00x12.00mm, FPM	
HBS262 [5] M10x1.25x220.00mm (x10)	JD271 (Metal) JD273 (MLS)	JM5002 (Elastomer) HL700	HR354	HR599	NA5053 [2] 30.00x42.00x7.00mm, FPM NA5069 [2] 55.00x68.00x8.00mm, FPM NA5070 [2] 31.00x41.00x7.00mm, FPM NF888 [1] 93.00x172.00x12.00mm, FPM	
	JD221 (x2) JA899 (x4)	JN588 (x2)[4]	JJ450	HR363	NA5064 [2] 35.00x58.00x10.00mm, ACM	JR349 [6] KV124 [6]
HBS262 [5] M10x1.25x220.00mm (x10)	JD271 (Metal) JD466 (Steel) JD273 (MLS)	JM5002 (Elastomer)	HR354	HR599	NA5053 [2] 30.00x42.00x7.00mm, FPM NA5069 [2] 55.00x68.00x8.00mm, FPM NA5070 [2] 31.00x41.00x7.00mm, FPM NF888 [1] 93.00x172.00x12.00mm, FPM	



kW/PS

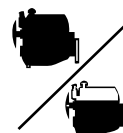

1.6 AR 38201		41		BW720 (Fibre), 1.650mm AY500 (Fibre), 1.85mm		DW721 [3] →05/98 DW722 [3] 06/98→06/00	GW721 [3] →05/98 GW722 06/98→06/00
145 1.6 16V	12/96→01/01	1598	4	82.00	DOHC	88/120	
146 1.6 16V	11/96→01/01						
1.6 AR 67601		42		BW720 (Fibre), 1.650mm AY500 (Fibre), 1.85mm		DW721 [3] →05/98 DW722 [3] 06/98→06/00	GW721 [3] →05/98 GW722 06/98→06/00
145 1.6 16V	12/96→01/01	1598	4	82.00	DOHC	88/120	
146 1.6 16V	11/96→01/01						
155 1.6V T.S.	05/96→12/97						
156 1.6 16V	09/97→05/06						
1.7 AR 30558		43		BP990 (Fibre) (x2)			
33 1.7 i.e.	09/88→12/89	1712	4	87.00	BOXER	77/105	
33 1.7 i.e. 4x4	09/88→12/89						
Alfasud Sprint	10/87→12/89						
1.7 AR 30736		44		BP990 (Fibre) (x2)			
33 1.7 i.e.	01/90→09/94	1712	4	87.00	BOXER	79/107	
33 1.7 i.e. 4x4	01/90→03/92						
1.7 AR 30737		45		BP990 (Fibre) (x2)			
33 1.7 i.e.	01/90→09/94	1712	4	87.00	SOHC/OHC, BOXER	77-79/ 105-107	
33 1.7 i.e. 4x4	09/88→03/92						
1.7 AR 30746		46		AA5550 (Fibre) (x2) BT340 (Graphite) (x2)		DT340 [3]	GT340 [3]
33 1.7 16V	01/90→03/92	1712	4	87.00	BOXER	101/137	
33 1.7 16V 4x4	01/90→09/94						
1.7 AR 30747		47		AA5550 (Fibre) (x2) BT340 (Graphite) (x2)		DT340 [3]	GT340 [3]
33 1.7 16V	01/90→09/94	1712	4	87.00	BOXER	95-97/ 129-132	
33 1.7 16V 4x4	01/90→09/94						
1.7 AR 32201		48		BW720 (Fibre), 1.650mm AY500 (Fibre), 1.85mm		DW722 [3]	GW721 [3] GW722
145 1.8 i.e. 16V	03/98→01/01	1747	4	82.00	DOHC	106/144	
146 1.8 16V	03/98→01/01						
156 1.8 16V	09/97→10/00						
GTV 1.8 16V	05/98→10/05						
Spider 1.8	05/98→04/05						
1.7 AR 32205		49		AA5420 (MLS), 0.380mm		CA5420 [3]	EA5420 [3]
156 1.8 16V	10/00→05/06	1747	4	82.00	DOHC	103/140	
GT Coupe 1.8 TS	11/03→09/10						



HBS132 [5] M10x1.25x254.00mm (x10)	JD271 [1] (Metal) JD273 [2] (MLS)	HL700 [2]	HR354	HR599 [2]	NA5053 [2] 30.00x42.00x7.00mm, FPM NA5069 [2] 55.00x68.00x8.00mm, FPM NA5070 [2] 31.00x41.00x7.00mm, FPM NF888 [1] 93.00x172.00x12.00mm, FPM	
HBS132 [5] M10x1.25x254.00mm (x10)	JD271 [1] (Metal) JD273 [2] (MLS)	HL700 [2]	HR354	HR599 [2]	NA5053 [2] 30.00x42.00x7.00mm, FPM NA5069 [2] 55.00x68.00x8.00mm, FPM NA5070 [2] 31.00x41.00x7.00mm, FPM NF888 [1] 93.00x172.00x12.00mm, FPM	
	JD221 (x2) JA899 [2] (x4) JE744		JH565	HR363 [2]	NA5064 [2] 35.00x58.00x10.00mm, ACM NA5063 [2] 40.00x56.00x10.00mm, ACM NA5065 [1] 62.00x80.00x12.00mm, ACM	KV124 [6]
	JD221 (x2) JA899 [2] (x4) JE744		JH565	HR363 [2]	NA5064 [2] 35.00x58.00x10.00mm, ACM NA5063 [2] 40.00x56.00x10.00mm, ACM NA5065 [1] 62.00x80.00x12.00mm, ACM	KV124 [6]
	JD221 (x2) JA899 [2] (x4) JE744		JH565	HR363 [2]	NA5064 [2] 35.00x58.00x10.00mm, ACM NA5063 [2] 40.00x56.00x10.00mm, ACM NA5065 [1] 62.00x80.00x12.00mm, ACM	KV124 [6]
	JD014 [1] (x4) JD565 [2] (x4)	JN811 [1] (x5) [4] JN810 [2] (x5) [4]		HR800 [2]	NA5063 [2] 40.00x56.00x10.00mm, ACM NA5065 [1] 62.00x80.00x12.00mm, ACM	
	JD014 [1] (x4) JD565 [2] (x4)	JN811 [1] (x5) [4] JN810 [2] (x5) [4]		HR800 [2]	NA5063 [2] 40.00x56.00x10.00mm, ACM NA5065 [1] 62.00x80.00x12.00mm, ACM	
HBS132 [5] M10x1.25x254.00mm (x10)	JD271 [1] (Metal) JD273 [2] (MLS)	JM5002 (Elastomer) HL700 [2]	HR354	HR599 [2]	NA5053 [2] 30.00x42.00x7.00mm, FPM NA5069 [2] 55.00x68.00x8.00mm, FPM NA5070 [2] 31.00x41.00x7.00mm, FPM NF888 [1] 93.00x172.00x12.00mm, FPM	
HBS262 [5] M10x1.25x220.00mm (x10)	JD271 [1] (Metal) JD273 [2] (MLS)	JM5002 (Elastomer)	HR354	HR599 [2]	NA5053 [2] 30.00x42.00x7.00mm, FPM NA5069 [2] 55.00x68.00x8.00mm, FPM NA5070 [2] 31.00x41.00x7.00mm, FPM NF888 [1] 93.00x172.00x12.00mm, FPM	

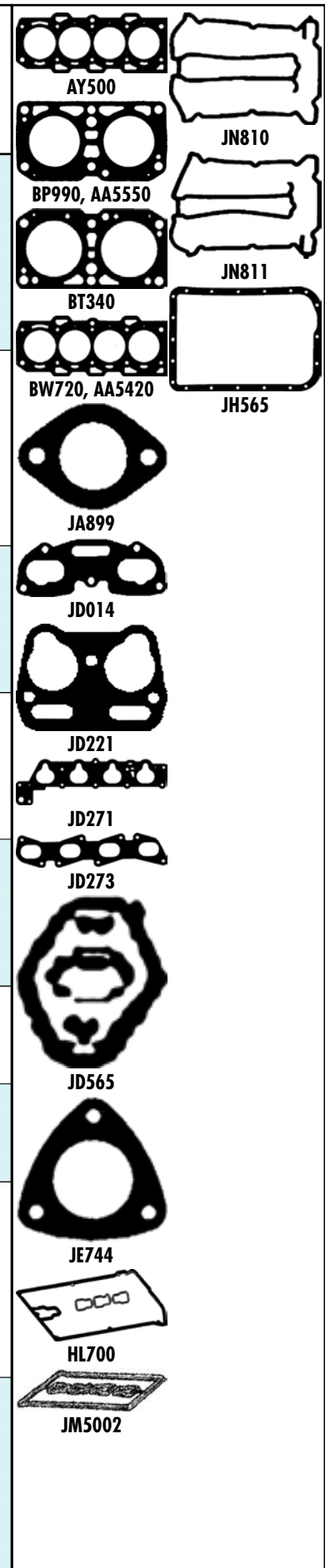

ALFA ROMEO



kW/PS

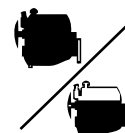

1.7	AR 33401	50	AA5550 (Fibre) (x2) BT340 (Graphite) (x2)	DT340 [3]	GT340 [3]	
145 1.7 i.e. 16V	10/94→12/96	1712	4	87.00	DOHC, BOXER	95/129
146 1.7 i.e. 16V	12/94→12/96					
1.7	AR 38401	51	BW720 (Fibre), 1.650mm AY500 (Fibre), 1.85mm	DW722 [3]	GW721 [3] GW722	
145 1.8 16V	12/96→12/98	1747	4	82.00	DOHC	103/140
146 1.8 16V	11/96→01/01					
1.7	AR 67103	52	BW410 (Fibre)	DW410 [3]	GW410 [3]	
155 1.7 T.S.	04/93→04/96	1748	4	83.40	DOHC	83/113
1.7	AR 67105	53	BW410 (Fibre)	DW410 [3]	GW410 [3]	
155 1.7 T.S.	04/93→04/96	1748	4	83.50	DOHC	83-85/ 113-115
1.7	AR 67106	54	BW720 (Fibre), 1.650mm AY500 (Fibre), 1.85mm	DW722 [3]	GW721 [3] GW722	
145 1.8 16V	12/96→12/98	1747	4	82.00	DOHC	103/140
146 1.8 16V	11/96→01/01					
155 1.7 T.S. 16V	05/96→12/97					
1.8	939 A4.000	55	AH5240 (MLS)	CH5240	EH5240	
159 1.8 MPI	03/07→11/11	1796	4	80.50	DOHC	96-103/ 131-140
1.8	AR 06134	56	BT360 (Fibre)			
75 1.8 T	09/86→02/92	1779	4	80.00		110/150
1.8	AR 06158	57	BT360 (Fibre)			
75 1.8	02/86→01/90	1779	4	80.00		114/155
1.8	AR 06168	58	BH850 (Fibre)	DH854		
75 1.8	09/88→02/92	1779	4	80.00		88/120
1.8	AR 06202	59	BH850 (Fibre)	DH854		
75 1.8	09/85→06/89	1779	4	80.00		85-89/ 116-121
1.8	AR 61102	60	BH850 (Fibre)			
75 1.8	09/88→02/92	1779	4	80.00		88/120
1.8	AR 61201	61	BH850 (Fibre)	DH854	GH858	
75 1.8	08/89→02/92	1779	4	80.00	DOHC	90/122
1.8	AR 61202	62	BH850 (Fibre)	DH854		
75 1.8	05/89→12/92	1779	4	80.00		87-95/ 118-129
1.8	AR 67101	63	BW410 (Fibre)	DW410 [3]	GW410 [3]	
75 1.8	08/89→02/92	1773	4	84.00	DOHC	93-95/ 126-129
155 1.8 T.S.	01/92→12/96					
155 1.8 T.S.	02/92→06/93					
1.8	AR 67102	64	BW410 (Fibre)	DW410 [3]	GW410 [3]	
155 1.8 T.S.	01/92→12/96	1773	4	84.00	DOHC	93/127
1.8	AR 67402	65	BW410 (Fibre)	DW410 [3]	GW410 [3]	
155 1.8 T.S.	02/92→12/97	1756	4	84.00	DOHC	77/105
1.8	VM 82 A Diesel	66	BK570 (Fibre), 1.420mm, 0 Notches (x3) BP260 (Fibre), 1.520mm, 2 Notches BK580 (Fibre), 1.620mm, 1 Notch (x3)	DR040 ▲○		
33 1.8 TD	01/86→06/90	1779	3	92.00	OHV	54/73



		JD014 ■ (x4) JD565 ■ (x4)	JN811 ■ [4] JN810 ■ [4]	JH565	HR800 ■	NA5063 ■ [2] 40.00x56.00x10.00mm, ACM NA5065 ■ [1] 62.00x80.00x12.00mm, ACM NA5053 [2] 30.00x42.00x7.00mm, FPM NA5069 [2] 55.00x68.00x8.00mm, FPM NA5070 ■ [2] 31.00x41.00x7.00mm, FPM NF888 ■ [1] 93.00x172.00x12.00mm, FPM	
HBS132 ⊗ [5] M10x1.25x254.00mm (x10)	JD271 ■ (Metal) JD273 ■ (MLS)	HL700 ■	HR354	HR599 ■			
	JD235 ■ JD015 ■ (x4)	JN940 [4]		HR363 ■		NF722 ■ [2] 35.00x50.00x10.00mm, MVQ	
	JD235 ■ JD015 ■ (x4)	JN940 [4]		HR363 ■		NF722 ■ [2] 35.00x50.00x10.00mm, MVQ	
HBS132 ⊗ [5] M10x1.25x254.00mm (x10)	JD271 ■ (Metal) JD273 ■ (MLS)	HL700 ■	HR354	HR599 ■		NA5053 [2] 30.00x42.00x7.00mm, FPM NA5069 [2] 55.00x68.00x8.00mm, FPM NA5070 ■ [2] 31.00x41.00x7.00mm, FPM NF888 ■ [1] 93.00x172.00x12.00mm, FPM	
HBS055 ⊗ [5] M10x1.25x153.00mm (x10)	JD5982 ■	JM7103 (Elastomer)	HR397			NC006 [2] 35.00x48.00x7.00mm, MVQ NA5174 ■ [2] 31.50x42.00x7.00mm, FPM	NA5174 [2] [10]
		JN806 (MVQ)	JJ452 (MVQ)			NA5066 ■ [2] 35.00x50.00x10.00mm, ACM	
		JN806 (MVQ)	JJ452 (MVQ)			NA5066 ■ [2] 35.00x50.00x10.00mm, ACM	
	JA829 ■					NA5066 ■ [2] 35.00x50.00x10.00mm, ACM	
	JA829 ■					NA5066 ■ [2] 35.00x50.00x10.00mm, ACM	
	JA829 ■					NA5066 ■ [2] 35.00x50.00x10.00mm, ACM	
	JD018 ■ JA829 ■ (x4) JE696 (x2)	JN806 (MVQ)	JJ452 (MVQ)			NA5066 ■ [2] 35.00x50.00x10.00mm, ACM	KD383 [11]
	JD018 ■ JA829 ■ JE696 (x2)	JN806 (MVQ)	JJ452 (MVQ)			NA5066 ■ [2] 35.00x50.00x10.00mm, ACM	
	JD235 ■ JD015 ■ (x4)	JN940 [4]		HR363 ■		NF722 ■ [2] 35.00x50.00x10.00mm, MVQ	
	JD235 ■ JD015 ■ (x4)	JN940 [4]		HR363 ■		NF722 ■ [2] 35.00x50.00x10.00mm, MVQ	
	JD235 ■ JD015 ■ (x4)	JN940 [4]		HR363 ■		NF722 ■ [2] 35.00x50.00x10.00mm, MVQ	
HBS107 ⊗ [12] M14x1.75x137.00mm (x8)	JC928 ■ (x3) JD5144 (x3) JD025 ■ (x3) JF123						

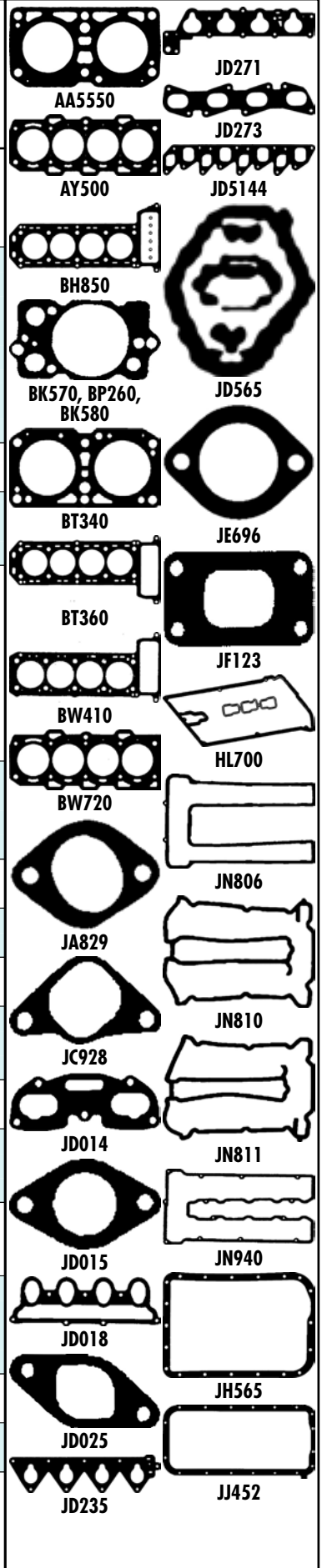



cc



kW/PS

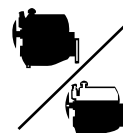

1.8	VM 96 A Diesel	67							
33 1.8 TD	01/86→09/94	1779	3	92.00	OHV	62/84	BK570 (Fibre), 1.420mm, 0 Notches (x3) BP260 (Fibre), 1.520mm, 2 Notches BK580 (Fibre), 1.620mm, 1 Notch (x3)	DR040 ▲○	
1.9	160 D100 Diesel	68							
AR 6 1.9 D	04/85→12/89	1929	4	82.60	SOHC/OHC	51/69	BV680 (Fibre), 1.670mm, 0 Notches BV690 (Fibre), 1.750mm, 1 Notch BV700 (Fibre), 1.850mm, 2 Notches	DV680 ▲[3]	
1.9	182 B9.000 Diesel	69							
147 1.9 JTD	06/03→03/10	1910	4	82.00	SOHC/OHC	74-77/ 101-105	AA5560 (MLS), 0.820mm, 0 Holes AA5570 (MLS), 0.920mm, 1 Hole AA5580 (MLS), 1.020mm, 2 Holes	CA5560 ▲[3] →Eng.4081110 CA5561 ▲ Eng.4081111→	EE5181 [3] FA5560 ▲[3]
1.9	192 A5.000 Diesel	70							
147 1.9 JTD 16V 156 1.9 JTD 16V	11/02→03/10 11/02→05/06	1910	4	82.00	DOHC	103/140	AD5840 (MLS), 0.820mm, 0 Holes AD5850 (MLS), 0.920mm, 1 Hole AD5860 (MLS), 1.020mm, 2 Holes	CD5840 ▲	EE5181 [3]
1.9	192 B1.000 Diesel	71							
147 1.9 JTD 16V 156 1.9 JTD	10/04→03/10 11/02→11/04	1910	4	82.00	DOHC	100/136	AD5840 (MLS), 0.820mm, 0 Holes AD5850 (MLS), 0.920mm, 1 Hole AD5860 (MLS), 1.020mm, 2 Holes	CD5840 ▲	EE5181 [3]
1.9	937 A2.000 Diesel	72							
147 1.9 JTD 156 1.9 JTD	04/01→03/10 05/01→05/06	1910	4	82.00	SOHC/OHC	85/115	AA5560 (MLS), 0.820mm, 0 Holes AA5570 (MLS), 0.920mm, 1 Hole AA5580 (MLS), 1.020mm, 2 Holes	CA5560 ▲[3] →Eng.4081110 CA5561 ▲ Eng.4081111→	FA5560 ▲[3]
1.9	937 A4.000 Diesel	73							
147 1.9 JTD 16V 156 1.9 JTD	09/03→09/04 11/03→05/06	1910	4	82.00	DOHC	93-103/ 126-140	AD5840 (MLS), 0.820mm, 0 Holes AD5850 (MLS), 0.920mm, 1 Hole AD5860 (MLS), 1.020mm, 2 Holes	CD5840 ▲	EE5181 [3]
1.9	937 A5.000 Diesel	74							
147 1.9 JTDM 16V 156 1.9 JTD GT Coupe 1.9 JTD	07/05→03/10 07/04→05/06 11/03→09/10	1910	4	82.00	DOHC	110/150	AD5840 (MLS), 0.820mm, 0 Holes AD5850 (MLS), 0.920mm, 1 Hole AD5860 (MLS), 1.020mm, 2 Holes	CD5840 ▲	EE5181 [3]
1.9	937 A6.000 Diesel	75							
147 1.9 JTDM 16V GT 1.9 JTD	06/08→03/10 05/08→09/10	1910	4	82.00	DOHC	125/170	AD5840 (MLS), 0.820mm, 0 Holes AD5850 (MLS), 0.920mm, 1 Hole AD5860 (MLS), 1.020mm, 2 Holes	CD5840 ▲	EE5181 [3]
1.9	937 A7.000 Diesel	76							
159 1.9 JTDM 159 1.9 JTDM 8V	03/06→11/11 09/05→11/11	1910	4	82.00	SOHC/OHC	85/115	AG7440 (MLS) AG7390 (MLS), 0.820mm AG7400 (MLS), 0.920mm, 1 Hole	CG7390 ▲	EG7390 FA5560 ▲[3]
1.9	937 A8.000 Diesel	77							
159 1.9 JTDM 159 1.9 JTDM 16V	03/06→11/11 09/05→11/11	1910	4	82.00	DOHC	100-100/ 136-136	AD5840 (MLS), 0.820mm, 0 Holes AD5850 (MLS), 0.920mm, 1 Hole AD5860 (MLS), 1.020mm, 2 Holes	CD5840 ▲	EG7450

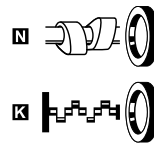
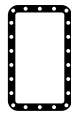
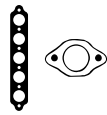

HBS107 [12] M14x1.75x137.00mm (x8)	JC928 [x3] JD5144 (x3) JD025 [x3] ◀- JF123					
HBS095 [5] M12x1.25x133.00mm (x10)						
HBS227 [5] M12x1.25x218.00mm (x10)	JA5035 [] JD468 [] (MLS)	JM5028 (Elastomer) →Eng.4081110 JM5204 (Elastomer) Eng.4081111→		HR363 []	NA5053 [2] 30.00x42.00x7.00mm, FPM NA5070 [2] 31.00x41.00x7.00mm, FPM NF888 [1] 93.00x172.00x12.00mm, FPM	
HBS370 [5] M12x1.25x225.00mm (x10)	JD5376 []	JM7055 (SE)		HR5095 []	NA5070 [2] 31.00x41.00x7.00mm, FPM NF888 [1] 93.00x172.00x12.00mm, FPM	
HBS370 [5] M12x1.25x225.00mm (x10)	JD5376 []	JM7055 (SE)	HR397	HR5095 []	NA5053 [2] 30.00x42.00x7.00mm, FPM NA5070 [2] 31.00x41.00x7.00mm, FPM NF888 [1] 93.00x172.00x12.00mm, FPM	
HBS227 [5] M12x1.25x218.00mm (x10)	JA5035 [] (Metal) JD580 [] (Felt) JD468 [] (MLS)	JM5028 (Elastomer) →Eng.4081110 JM5204 (Elastomer) Eng.4081111→		HR363 []	NA5053 [2] 30.00x42.00x7.00mm, FPM NA5070 [2] 31.00x41.00x7.00mm, FPM NF888 [1] 93.00x172.00x12.00mm, FPM	
HBS370 [5] M12x1.25x225.00mm (x10)	JD5376 []	JM7055 (SE)	HR397	HR5095 []	NA5053 [2] 30.00x42.00x7.00mm, FPM NA5070 [2] 31.00x41.00x7.00mm, FPM NF888 [1] 93.00x172.00x12.00mm, FPM	
HBS370 [5] M12x1.25x225.00mm (x10)	JD5376 []	JM7055 (SE)		HR5095 []	NA5053 [2] 30.00x42.00x7.00mm, FPM NA5070 [2] 31.00x41.00x7.00mm, FPM NF888 [1] 93.00x172.00x12.00mm, FPM	
HBS227 [5] M12x1.25x218.00mm (x10)	JA5035 [] JD580 [] (Felt) JD468 [] (MLS)	JM5204 (Elastomer) Eng.4081111→	HR397	HR363 []	NA5053 [2] 30.00x42.00x7.00mm, FPM NA5070 [2] 31.00x41.00x7.00mm, FPM NF888 [1] 93.00x172.00x12.00mm, FPM	
HBS370 [5] M12x1.25x225.00mm (x10)		JM7055 (SE)		HR5095 []	NA5053 [2] 30.00x42.00x7.00mm, FPM NA5070 [2] 31.00x41.00x7.00mm, FPM NF888 [1] 93.00x172.00x12.00mm, FPM	

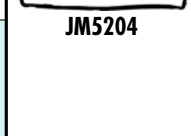
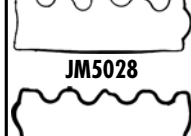
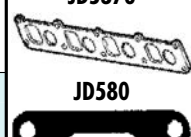
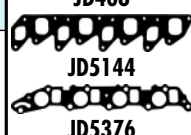
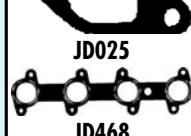
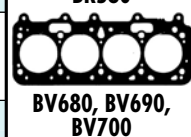

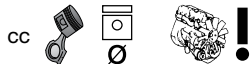

kW/PS

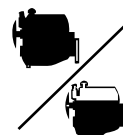

1.9	939 A1.000	Diesel				78	AG7440 (MLS) AG7390 (MLS), 0.820mm AG7400 (MLS), 0.920mm, 1 Hole	CG7390 ▲	EG7390
159 1.9 JTDM 159 1.9 JTDM 8V	03/06→11/11 09/05→11/11	1910	4	82.00	SOHC/OHC	88/120			
1.9	939 A2.000	Diesel				79	AD5840 (MLS), 0.820mm, 0 Holes AD5850 (MLS), 0.920mm, 1 Hole AD5860 (MLS), 1.020mm, 2 Holes		EG7450
159 1.9 JTDM 159 1.9 JTDM 16V	03/06→11/11 09/05→11/11	1910	4	82.00	DOHC	110/150			
1.9	939 A7.000	Diesel				80	AG7440 (MLS) AG7390 (MLS), 0.820mm AG7400 (MLS), 0.920mm, 1 Hole	CG7390 ▲	EG7390
147 1.9 JTDM 159 1.9 JTDM 8V	10/04→03/10 09/05→11/11	1910	4	82.00	SOHC/OHC	85/115			
1.9	939 A8.000	Diesel				81	AD5840 (MLS), 0.820mm, 0 Holes AD5850 (MLS), 0.920mm, 1 Hole AD5860 (MLS), 1.020mm, 2 Holes	CG7410	EG7450
159 1.9 JTDM 16V	09/05→11/11	1910	4	82.00	DOHC	100/136			
1.9	AR 32302	Diesel				82	AY520 (MLS), 1.600mm, 0 Holes AY530 (MLS), 1.700mm, 1 Hole AY540 (MLS), 1.800mm, 2 Holes		
145 1.9 JTD 146 1.9 JTD 156 1.9 JTD	02/99→01/01 02/99→01/01 09/97→10/00	1910	4	82.00	SOHC/OHC	77/105			
1.9	AR 33601	Diesel				83	BR680 (Graphite), 1.650mm AC5140 (MLS), 1.660mm BV680 (Fibre), 1.670mm, 0 Notches BV690 (Fibre), 1.750mm, 1 Notch AC5150 (MLS), 1.760mm BV700 (Fibre), 1.850mm, 2 Notches AC5180 (MLS), 1.860mm BW980 (Fibre), 1.930mm, 3 Notches AC5160 (MLS), 1.960mm	DV680 ▲ ^[3]	EV684 ^[3] GV680 ▲
145 1.9 TD 146 1.9 TD	10/94→02/99 12/94→02/99	1929	4	82.60	SOHC/OHC	66-68/ 90-92			
1.9	AR 37101	Diesel				84	AA5560 (MLS), 0.820mm, 0 Holes 01/01→09/03 AA5570 (MLS), 0.920mm, 1 Hole 01/01→09/03 AA5580 (MLS), 1.020mm, 2 Holes 01/01→09/03	CA5560 ▲ ^[3]	EE5181 ^[3] FA5560 ▲ ^[3]
147 1.9 JTD 156 1.9 JTD	11/00→09/04 10/00→05/01	1910	4	82.00	SOHC/OHC	81/110		01/01→ →Eng.4081110 CA5561 ▲ 01/01→ Eng.4081111→	01/01→ 01/01→
1.9	AR 67501	Diesel				85	AC5140 (MLS), 1.660mm BV680 (Fibre), 1.670mm, 0 Notches BV690 (Fibre), 1.750mm, 1 Notch AC5150 (MLS), 1.760mm BV700 (Fibre), 1.850mm, 2 Notches AC5180 (MLS), 1.860mm BW980 (Fibre), 1.930mm, 3 Notches AC5160 (MLS), 1.960mm	DV680 ▲ ^[3]	EV684 ^[3] GV680 ▲
145 1.9 TD 146 1.9 TD 155 1.9 TD	10/94→02/99 12/94→02/99 04/93→12/97	1929	4	82.60	SOHC/OHC	66-68/ 90-92			

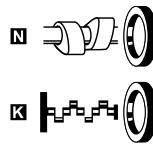
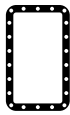
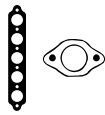

HBS227 [5] M12x1.25x218.00mm (x10)	JD580 [1] (Felt) JD468 [1] (MLS)	JM5204 (Elastomer)	HR397	HR363 [1]	NA5053 [2] 30.00x42.00x7.00mm, FPM NA5070 [2] 31.00x41.00x7.00mm, FPM NF888 [1] 93.00x172.00x12.00mm, FPM	
HBS370 [5] M12x1.25x225.00mm (x10) →07/07 HBS465 [5] M12x1.25x220.00mm (x10) 07/07→	JD5376 [1] JD273 [1] (MLS)	JM7055 (SE)		HR5095 [1]	NA5053 [2] 30.00x42.00x7.00mm, FPM NA5070 [2] 31.00x41.00x7.00mm, FPM NF888 [1] 93.00x172.00x12.00mm, FPM	
HBS227 [5] M12x1.25x218.00mm (x10)	JD580 [1] (Felt) JD468 [1] (MLS)	JM5204 (Elastomer) Eng.4081111→	HR397	HR363 [1]	NA5053 [2] 30.00x42.00x7.00mm, FPM NA5070 [2] 31.00x41.00x7.00mm, FPM NF888 [1] 93.00x172.00x12.00mm, FPM	
HBS370 [5] M12x1.25x225.00mm (x10) HBS465 [5] M12x1.25x220.00mm (x10)	JD5376 [1] JD273 [1] (MLS)	JM7055 (SE)		HR5095 [1]	NA5053 [2] 30.00x42.00x7.00mm, FPM NA5070 [2] 31.00x41.00x7.00mm, FPM NF888 [1] 93.00x172.00x12.00mm, FPM	
HBS227 [5] M12x1.25x218.00mm (x10)	JA5035 [1] JD580 [1] (Felt)				NA5053 [2] 30.00x42.00x7.00mm, FPM NA5070 [2] 31.00x41.00x7.00mm, FPM NF888 [1] 93.00x172.00x12.00mm, FPM	
HBS095 [5] M12x1.25x133.00mm (x10)	JC738	JN459 [4]	JJ298	HR596 [1]	NA5187 [2] 30.00x52.00x7.00mm, ACM NB742 [2] 30.00x43.00x8.00mm, ACM NB732 [1] 74.00x90.00x10.00mm, FPM	
HBS227 [5] M12x1.25x218.00mm (x10) 01/01→	JA5035 [1] 01/01→ JD580 [1] (Felt) 01/01→ JD468 [1] (MLS) 01/01→	JM5028 (Elastomer) 01/01→ →Eng.4081110 JM5204 (Elastomer) 01/01→ Eng.4081111→			NA5053 [2] 30.00x42.00x7.00mm, FPM 01/01→ NA5070 [2] 31.00x41.00x7.00mm, FPM 01/01→ NF888 [1] 93.00x172.00x12.00mm, FPM 01/01→	
HBS095 [5] M12x1.25x133.00mm (x10)	JC738	JN459 [4]	JJ298	HR363 [1]	NA5187 [2] 30.00x52.00x7.00mm, ACM NB742 [2] 30.00x43.00x8.00mm, ACM NB732 [1] 74.00x90.00x10.00mm, FPM	

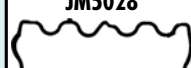
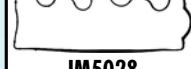
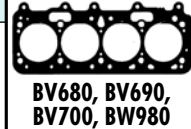
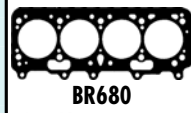
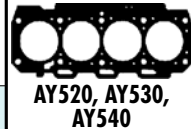
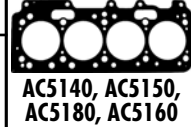
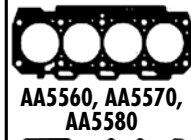

ALFA ROMEO









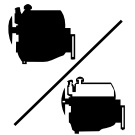



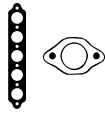

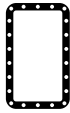

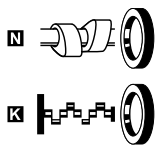











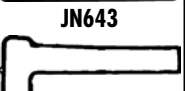

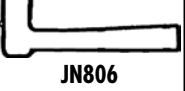





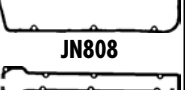

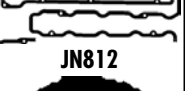
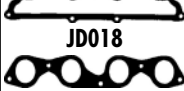















cc



kW/PS



2.0	844 A2.000	Diesel					86			
159 2.0 JTDM	05/09→11/11	1956	4	83.00	DOHC	120/163				
Axor 2 2633 K	05/09→11/11									
Brera 2.0 JTDM	03/08→									
Spider 2.0 JTDM	04/09→									
2.0	932 A2.000						87			
156 2.0	03/02→05/06	1970	4	83.00	DOHC	119-121/ 162-165				
GT 2.0 JTS	12/06→09/10									
GT Coupe 2.0 JTS	11/03→09/10									
2.0	937 A1.000						88	AD5870 (MLS)		
147 2.0	07/02→05/05	1970	4	83.00	DOHC	119-122/ 162-166				
156 2.0 JTS	03/02→05/06									
GT Coupe 2.0 JTS	11/03→09/10									
GTV 2.0 JTS	04/03→10/05									
Spider 2.0	04/03→04/05									
2.0	AR 01544						89	AN300 (Fibre)		
Spider 2000	08/86→12/90	1962	4	84.00		85/116				
2.0	AR 01588						90	BT350 (Fibre) AA5520 1.850mm [4]	CN306 DT350 [13]	
Spider 2000	01/90→12/93	1962	4	84.00		88/120				
2.0	AR 06166						91	BT350 (Fibre) AA5520 1.850mm [4]	DT350 [13]	GT350 [3]
75 2.0 T.S.	01/87→02/92	1962	4	84.00	SOHC/OHC	107/146				
2.0	AR 06224						92	BT350 (Fibre) AA5520 1.850mm [4]	DT350 [13]	GT350 [3]
75 2.0 T.S.	01/87→02/92	1962	4	84.00	DOHC	107-109/ 146-148				
75 1114,1114 L	05/85→02/92									
2.0	AR 06416						93	BT350 (Fibre) AA5520 1.850mm [4]	DT350 [13]	GT350 [3]
164 2.0 T.S.	06/87→09/92	1995	4	84.00	DOHC	105/143				
2.0	AR 06420						94	BT350 (Fibre) AA5520 1.850mm [4]	DT350 [13]	GT350 [3]
164 2.0 T.S.	06/87→12/90	1995	4	84.00	DOHC	109/148				
2.0	AR 06476						95	BT420 (Fibre) →Eng.1033624 BT440 (Fibre) Eng.1033625→	DT420 01/88→12/89 →Eng.1033624	
164 2.0 Turbo	10/87→09/98	1995	4	84.00	DOHC	128-129/ 174-175				
2.0	AR 16202						96	BW280 (Fibre) BW290 (Fibre)	DW282 →Eng.7485 DW281 Eng.7486→	GW281 →Eng.7485 GW282 Eng.7486→
GTV 2.0 V6 T	06/95→09/98	1996	6	80.00	SOHC/OHC, V	148/202				
Spider 2.0	05/98→04/05									
2.0	AR 32301						97	BW710 (Fibre), 1.650mm	DW711 [3] →05/98 DW712 [3] 05/98→	GW711 →05/98 GW712 [3] 05/98→
145 2.0 16V	03/98→01/01	1970	4	83.00	DOHC	114/155				
146 2.0 16V	03/98→01/01									
156 2.0 16V	09/97→10/00									
GTV 2.0 T.SPARE	05/98→08/00									
Spider 2.0	05/98→08/00									

      								
						 NA5070 [2] 31.00x41.00x7.00mm, FPM		 AN300  HL700  JM5002  BT350, AA5520  JM5023  BT420, BT440  JM5024  BW280  JM5024  BW290  JN643  BW710  JN806  JA829  JN807  JC662  JN808  JD015  JN812  JD018  KV102  JD019  JD222  JJ413  JD224  JJ451  JD271  JJ452  JD273  JE696
						 NA5053 [2] 30.00x42.00x7.00mm, FPM  NA5070 [2] 31.00x41.00x7.00mm, FPM		
HBS132 [5] M10x1.25x254.00mm (x10)						 NA5053 [2] 30.00x42.00x7.00mm, FPM  NA5070 [2] 31.00x41.00x7.00mm, FPM  NF888 [1] 93.00x172.00x12.00mm, FPM		
	JD018 [1] JA829 [x4]	JN806 (MVQ) KV102	JJ452 (MVQ) KV086			 NA5066 [2] 35.00x50.00x10.00mm, ACM	KD383 [11]	
	JE696	JN812 [4]	JJ452 (MVQ) KV086	HR363 [5]		 NA5066 [2] 35.00x50.00x10.00mm, ACM		
	JD015 [5] JE696	JN812 [4]	JJ452 (MVQ)	HR363 [5]		 NA5066 [2] 35.00x50.00x10.00mm, ACM		
	JD015 [x4] JE696	JN812 [4]	JJ452 (MVQ)	HR363 [5]		 NA5066 [2] 35.00x50.00x10.00mm, ACM		
	JD015 [x4] JE696	JN812 [4]	JJ451	HR363 [5]		 NA5066 [2] 35.00x50.00x10.00mm, ACM		
	JD015 [x4] JE696	JN812 [4]	JJ451	HR363 [5]		 NA5066 [2] 35.00x50.00x10.00mm, ACM		
HBS092 [5] M10x1.25x115.00mm (x10)	JC662 [1] JD019 [5]	JN643 (x2) [4]	JJ413	HR363 [5]		 NA5187 [2] 30.00x52.00x7.00mm, ACM  NB742 [2] 30.00x43.00x8.00mm, ACM  NA5062 [1] 74.00x90.00x10.00mm, ACM  NB732 [1] 74.00x90.00x10.00mm, FPM		
	JD222 [1] JD224 [x6]	JM5023 [3] (SE) JN808 [4] → Eng.7485 JM5024 [3] (SE) JN807 [4] → Eng.7485		HR815 [5]				
HBS132 [5] M10x1.25x254.00mm (x10)	JD271 [1] (Metal) JD273 [5] (MLS)	JM5002 (Elastomer) 05/98 → HL700 [5] → 05/98	HR354	HR599 [5]		 NA5053 [2] 30.00x42.00x7.00mm, FPM  NA5070 [2] 31.00x41.00x7.00mm, FPM  NF888 [1] 93.00x172.00x12.00mm, FPM		

ALFA ROMEO



kW/PS

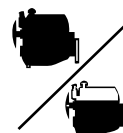

2.0	AR 32310	98			AD5950 (MLS), 0.450mm →05/00 AA5420 (MLS), 0.380mm 06/00→	CA5420 [3]	EA5420 [3]
147 2.0 16V 156 2.0 16V GTV 2.0 T.SPARK Spider 2.0	01/01→03/10 10/00→03/02 06/95→10/05 06/95→04/05	1970	4	83.00	DOHC	110/150	
2.0	AR 34102	99			BW280 (Fibre) [3] AY610 (Fibre) [3]	CY610 →Eng.004108 CY611 Eng.004109→	FY610 [3] →Eng.004108 FY611 [3] Eng.004109→
166 2.0 V6	09/98→10/00	1996	6	80.00	SOHC/OHC, V	151/205	
2.0	AR 34103	100			BW710 (Fibre), 1.650mm	DW712 [3]	GW712 [3]
166 2.0 T.Spark	09/98→10/00	1970	4	83.00	DOHC	114/155	
2.0	AR 36301	101			AA5420 (MLS), 0.380mm	CA5420 [3]	EA5420 [3]
166 2.0 T.Spark	10/00→06/07	1970	4	83.00	DOHC	110/150	
2.0	AR 64101	102			BW280 (Fibre) [3] BW290 (Fibre) [3]	DW280	GW280
164 2.0 V6 Turbo	03/91→09/92	1997	6	80.00	DOHC, V	150/204	
2.0	AR 64102	103			BW280 (Fibre) [3] BW290 (Fibre) [3]	DW280	GW280
164 2.0 V6 Turbo	09/92→09/98	1996	6	80.00	SOHC/OHC, V	148-150/ 201-204	
2.0	AR 64103	104			BW410 (Fibre)	DW410 [3]	GW410 [3]
164 2.0 T.S.	09/92→09/98	1995	4	84.00	DOHC	106/144	
2.0	AR 67201	105			BW410 (Fibre)	DW410 [3]	GW410 [3]
155 2.0 T.S.	02/92→04/93	1995	4	84.00	DOHC	106/144	
2.0	AR 67202	106			BW410 (Fibre)	DW410 [3]	GW410 [3]
155 2.0 T.S.	02/92→02/95	1995	4	84.00	DOHC	104/141	
2.0	AR 67203	107			BT440 (Fibre)	DT447	GT447 [3]
155 2.0T	01/92→12/97	1995	4	84.00	DOHC	137-140/ 186-190	
2.0	VM 80 A Diesel	108			AY400 (MLS), 1.420mm, 0 Notches BK570 (Fibre), 1.420mm, 0 Notches (x4) AY410 (MLS), 1.520mm, 2 Notches BP260 (Fibre), 1.520mm, 2 Notches AY420 (MLS), 1.620mm, 1 Notch BK580 (Fibre), 1.620mm, 1 Notch (x4)	DK570 ▲	GK570 ▲ [14]
75 2.0 TD	05/85→09/92	1995	4	88.00	SOHC/OHC	70/95	

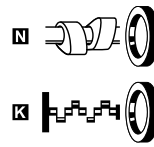
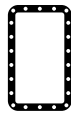
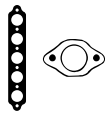

HBS132 [5]
M10x1.25x254.00mm (x10)

JD271 [1]
(Metal)
JD273 [1]
(MLS)

JM5002
(Elastomer)

HR599 [1]

NA5053 [2]
30.00x42.00x7.00mm, FPM
NA5070 [2]
31.00x41.00x7.00mm, FPM
NF888 [1]
93.00x172.00x12.00mm, FPM

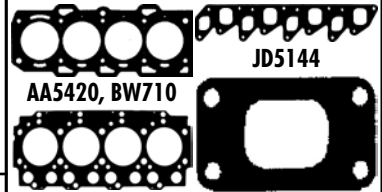

JD222 [x2]
JD224 [x6]

JM5023 [1]
(SE)
JN808 [4]
→Eng.004108
JM5024 [1]
(SE)
JN807 [4]
→Eng.004108

HR815 [1]

HR599 [1]

NJ951 [2]
32.00x50.00x8.00mm, FPM
NJ951 [2]
32.00x50.00x8.00mm, FPM

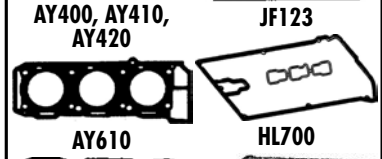

HBS132 [5]
M10x1.25x254.00mm (x10)

JD271 [1]
(Metal)
JD273 [1]
(MLS)

JM5002
(Elastomer)
HL700 [1]

HR354

HR599 [1]

NA5053 [2]
30.00x42.00x7.00mm, FPM
NA5070 [2]
31.00x41.00x7.00mm, FPM
NF888 [1]
93.00x172.00x12.00mm, FPM

KL476 [10]

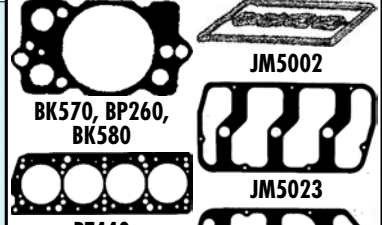

HBS132 [5]
M10x1.25x254.00mm (x10)

JD222 [1]
JD224 [x6]

JM5002
(Elastomer)

HR599 [1]

NA5053 [2]
30.00x42.00x7.00mm, FPM
NA5070 [2]
31.00x41.00x7.00mm, FPM
NF888 [1]
93.00x172.00x12.00mm, FPM
NA5104 [1]
90.00x110.00x12.00mm, PTFE

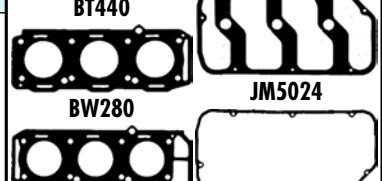

JD222 [1]
JD224 [x6]

JP068 [4]
JN808 [4]
JN807 [4]

JN940 [4]

HR363 [1]

NA5066 [2]
35.00x50.00x10.00mm, ACM
NA5065 [1]
62.00x80.00x12.00mm, ACM

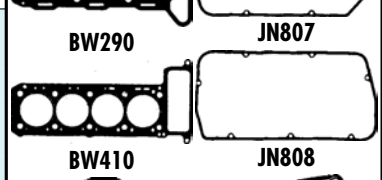

JD222 [1]
JD224 [x6]

JN808 [4]
JN807 [4]

JN940 [4]

HR363 [1]

NA5066 [2]
35.00x50.00x10.00mm, ACM
NA5065 [1]
62.00x80.00x12.00mm, ACM

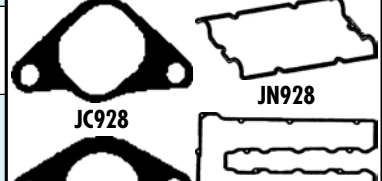

JD235 [1]
JD015 [x4]

JN940 [4]

JN940 [4]

HR363 [1]

NA5066 [2]
35.00x50.00x10.00mm, ACM
NA5065 [1]
62.00x80.00x12.00mm, ACM

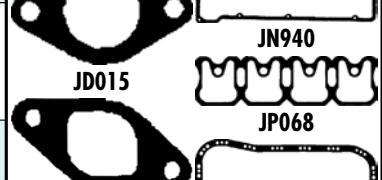

HBS093 [5]
M10x1.25x172.00mm (x10)

JD151

JN928 [4]

JJ413

HR599 [1]

NA5053 [2]
30.00x42.00x7.00mm, FPM
NB825 [2]
30.00x43.00x8.00mm, FPM
NA5062 [1]
74.00x90.00x10.00mm, ACM
NB732 [1]
74.00x90.00x10.00mm, FPM

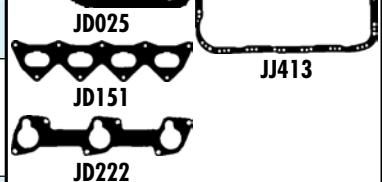

HBS105 [12]
M14x1.75x137.00mm (x10)

JC928 [1]
JD5144
JD025 [x4]
JF123

JN928 [4]

HR599 [1]

NA5053 [2]
30.00x42.00x7.00mm, FPM
NB825 [2]
30.00x43.00x8.00mm, FPM
NA5062 [1]
74.00x90.00x10.00mm, ACM
NB732 [1]
74.00x90.00x10.00mm, FPM



ALFA ROMEO



cc



kW/PS

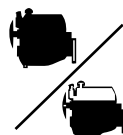

2.2	939 A5.000					109	AG9580 (MLS)		
159 2.2 JTS	09/05→11/11	2198	4	86.00	DOHC	136/185			
Brera 2.2 JTS	01/06→								
Spider 2.2 JTS	09/06→								
2.4	839 A6.000	Diesel					110	AA5780 (MLS), 0.820mm AA5790 (MLS), 0.920mm AA5800 (MLS), 1.020mm	CA5780 ▲ [3] EA5780
156 2.4 JTD	10/00→05/06	2387	5	82.00	SOHC/OHC	103/140			
166 2.4 JTD	10/00→06/07								
2.4	841 C000	Diesel					111	AA5780 (MLS), 0.820mm AA5790 (MLS), 0.920mm AA5800 (MLS), 1.020mm	CA5780 ▲ [3] EA5780
156 2.4 JTD	03/02→05/06	2387	5	82.00	SOHC/OHC	110/150			
166 2.4 JTD	04/02→06/07								
2.4	841 G.000	Diesel					112	AD5910 (MLS), 0.820mm AD5920 (MLS), 0.920mm AD5930 (MLS), 1.020mm	CD5910 ED5910 [3]
156 2.4 JTD	10/03→05/06	2387	5	82.00	DOHC	129/175			
166 2.4 JTD	10/03→06/07								
2.4	841 H.000	Diesel					113	AD5910 (MLS), 0.820mm AD5920 (MLS), 0.920mm AD5930 (MLS), 1.020mm	CD5910 ED5910 [3]
166 2.4 JTD	10/03→06/07	2387	5	82.00	DOHC	129/175			
2.4	841 M.000	Diesel					114	AD5910 (MLS), 0.820mm AD5920 (MLS), 0.920mm AD5930 (MLS), 1.020mm	CD5910 ED5910 [3]
156 2.4 JTD	06/03→05/06	2387	5	82.00	DOHC	120-147/ 163-200			
166 2.4 JTD	10/03→06/07								
2.4	936 B.000	Diesel					115	AG7410 (MLS), 0.820mm, 0 Holes AG7420 (MLS), 0.920mm, 1 Hole AG7430 (MLS), 1.020mm, 2 Holes	CG7410 EG7410
166 2.4 JTD	07/05→06/07	2387	5	82.00	DOHC	136/185			
2.4	939 A3.000	Diesel					116	AG7410 (MLS), 0.820mm, 0 Holes AG7420 (MLS), 0.920mm, 1 Hole AG7430 (MLS), 1.020mm, 2 Holes	CG7410 EG7410
159 2.4 JTDM	09/05→11/11	2387	5	82.00	DOHC	147-154/ 200-209			
Brera 2.4 JTDM	01/06→								
Spider 2.4 JTDM	04/07→								
2.4	939 A9.000	Diesel					117	AG7410 (MLS), 0.820mm, 0 Holes AG7420 (MLS), 0.920mm, 1 Hole AG7430 (MLS), 1.020mm, 2 Holes	CG7410 EG7410
159 2.4 JTDM	05/07→11/11	2387	5	82.00	DOHC	154/210			
159 2.4 JTDM Q4	05/07→11/11								
Brera 2.4 JTDM	05/07→								
2.4	8140.21.200 D.I.	Diesel					118	BR070 (Fibre), 1.200mm AB5110 (Fibre), 1.500mm	DS381 ▲ [3] FB5100 ▲ [16]
AR 8 2.4 TD	04/85→12/88	2445	4	93.00	SOHC/OHC	68/92			
AR 8 Van 2.4 TD	04/85→12/89								
2.4	8144.21.220	Diesel					119	BR070 (Fibre), 1.200mm	DS381 ▲ [3] FB5100 ▲ [16]
AR 6 Van 2.4 TD	09/86→12/89	2445	4	93.00	SOHC/OHC	68/92			
2.4	AR 32501	Diesel					120	AY550 (MLS), 1.600mm AY560 (MLS), 1.700mm, 1 Hole	CY520 ▲ [3] FY520 ▲ [3]
156 2.4 JTD	09/97→10/00	2387	5	82.00	SOHC/OHC	99-100/ 135-136			
2.4	AR 34202	Diesel					121	AY550 (MLS), 1.600mm AY560 (MLS), 1.700mm, 1 Hole AY570 (MLS), 1.800mm, 2 Holes	CY520 ▲ [3] FY520 ▲ [3]
166 2.4 JTD	09/98→10/00	2387	5	82.00	SOHC/OHC	100/136			

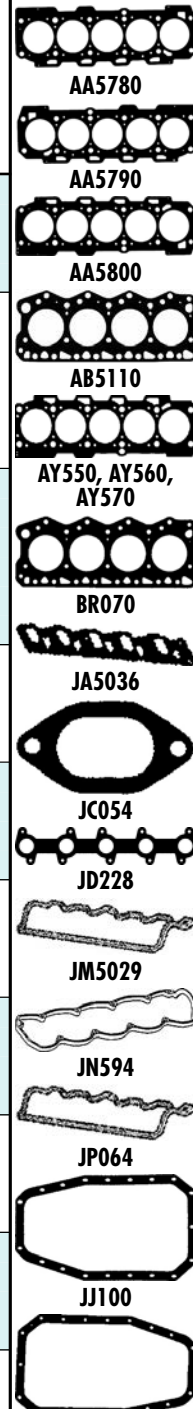
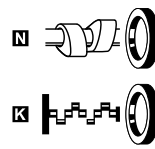
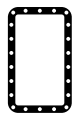
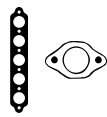



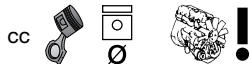



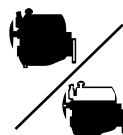



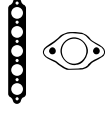

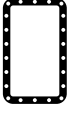

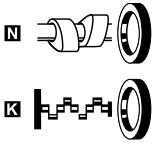







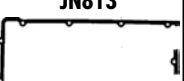

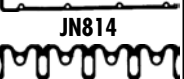







	KG5337 ■ (MVQ) JD5868 ■				NA5108 ■ [2] 42.00x55.00x7.00mm, FPM/ACM NB806 ■ [1] 90.00x104.00x11.00mm, FPM	
HBS257 ⊗ [5] M12x1.25x218.00mm (x12)	JA5036 ■ (Metal) JD228 ■	JM5029 (Elastomer)		HR363 ■	NA5053 [2] 30.00x42.00x7.00mm, FPM NA5070 ■ [2] 31.00x41.00x7.00mm, FPM NF888 ■ [1] 93.00x172.00x12.00mm, FPM	KL477 [10] KA845 [15]
HBS257 ⊗ [5] M12x1.25x218.00mm (x12)	JA5036 ■ JD228 ■	JM5029 (Elastomer)		HR363 ■	NA5053 [2] 30.00x42.00x7.00mm, FPM NA5070 ■ [2] 31.00x41.00x7.00mm, FPM NF888 ■ [1] 93.00x172.00x12.00mm, FPM	KL477 [10] KA845 [15]
HBS371 ⊗ [5] M12x1.25x225.00mm (x12)		JM7117 (Steel)			NA5070 ■ [2] 31.00x41.00x7.00mm, FPM NF888 ■ [1] 93.00x172.00x12.00mm, FPM	
HBS371 ⊗ [5] M12x1.25x225.00mm (x12)		JM7117 (Steel)			NA5070 ■ [2] 31.00x41.00x7.00mm, FPM NF888 ■ [1] 93.00x172.00x12.00mm, FPM	
HBS371 ⊗ [5] M12x1.25x225.00mm (x12)		JM7117 (Steel)			NA5070 ■ [2] 31.00x41.00x7.00mm, FPM NF888 ■ [1] 93.00x172.00x12.00mm, FPM	
HBS371 ⊗ [5] M12x1.25x225.00mm (x12)		JM7117 (Steel)			NA5070 ■ [2] 31.00x41.00x7.00mm, FPM NF888 ■ [1] 93.00x172.00x12.00mm, FPM	
HBS371 ⊗ [5] M12x1.25x225.00mm (x12)		JM7117 (Steel)			NA5070 ■ [2] 31.00x41.00x7.00mm, FPM NF888 ■ [1] 93.00x172.00x12.00mm, FPM	
HBS371 ⊗ [5] M12x1.25x225.00mm (x12)		JM7117 (Steel)			NA5070 ■ [2] 31.00x41.00x7.00mm, FPM NF888 ■ [1] 93.00x172.00x12.00mm, FPM	
HBS011 [5] M12x1.25x119.00mm (x12)	JC054 ■ (x4)	JN594 [4]	JJ100 (Cork) JJ519	HR602 ■	NP068 [2] 55.00x70.00x8.00mm, FPM	KK5599 [17] Eng.2921820→
HBS011 [5] M12x1.25x119.00mm (x12)	JC054 ■	JN594 [4]	JJ100 (Cork) JJ519	HR602 ■	NP068 [2] 55.00x70.00x8.00mm, FPM	
HBS257 ⊗ [5] M12x1.25x218.00mm (x12)	JA5036 ■ JD228 ■				NA5053 [2] 30.00x42.00x7.00mm, FPM NA5070 ■ [2] 31.00x41.00x7.00mm, FPM	
HBS257 ⊗ [5] M12x1.25x218.00mm (x12)	JA5036 ■ (Metal) →01/00 JD5810 ■ 02/00→ JD228 ■	JP064 [4]		HR363 ■	NA5053 [2] 30.00x42.00x7.00mm, FPM NA5070 ■ [2] 31.00x41.00x7.00mm, FPM NF888 ■ [1] 93.00x172.00x12.00mm, FPM	KA845 [15]



kW/PS



2.4	VM 81 A Diesel	122					AY400 (MLS), 1.420mm, 0 Notches	DK570 ▲	GK570 ▲ [14]
75 2.4 TD	01/89→02/92	2393	4	92.00		81/110	BK570 (Fibre), 1.420mm, 0 Notches (x4) AY410 (MLS), 1.520mm, 2 Notches BP260 (Fibre), 1.520mm, 2 Notches AY420 (MLS), 1.620mm, 1 Notch BK580 (Fibre), 1.620mm, 1 Notch (x4)		
2.5	8144.67.220 Diesel	123					AY290 (Fibre), 1.600mm	DE588 ▲ [3]	FY291 ▲ [16]
AR 6 Van 2.5 D	03/86→12/89	2499	4	93.00	SOHC/OHC	55/75	AY300 (Fibre), 1.700mm AY310 (Fibre), 1.800mm		
AR 8 2.5 D	09/86→12/89								
AR 8 Van 2.5 D	09/86→12/89								
2.5	AR 32401	124					AY630 (Fibre) ☒	CY620 [3]	FY620
156 2.5 V6 24V	09/97→12/01	2492	6	88.00	DOHC, V	140/190	AY620 (Fibre) ☒		
2.5	AR 32405	125					BT380 (Fibre), 1.650mm ☒	CY620 [3]	FY620
156 2.5 V6 24V	10/00→05/06	2492	6	88.00	DOHC, V	141/192	AY640 (Fibre), 1.650mm ☒		
2.5	AR 34201	126					AY630 (Fibre) ☒	CY620 [3]	FY620
166 2.5 V6 24V	09/98→10/00	2492	6	88.00	DOHC, V	140/190	AY620 (Fibre) ☒		
2.5	AR 36201	127					BT380 (Fibre), 1.650mm ☒	CY620 [3]	FY620
166 2.5 V6 24V	10/00→06/07	2492	6	88.00	DOHC, V	138/188	AY640 (Fibre), 1.650mm ☒		
2.5	VM 07 B Diesel	128					AY400 (MLS), 1.420mm, 0 Notches	DK570 ▲	GK573 ▲ [3] [18]
155 2.5 TD	04/93→12/97	2499	4	92.00	SOHC/OHC	92/125	AY410 (MLS), 1.520mm, 2 Notches BP260 (Fibre), 1.520mm, 2 Notches AY420 (MLS), 1.620mm, 1 Notch		
2.5	VM 08 B Diesel	129					AY400 (MLS), 1.420mm, 0 Notches	DK570 ▲	GK573 ▲ [3] [18]
164 2.5 TD	09/92→09/98	2499	4	92.00	OHV	92/125	AY410 (MLS), 1.520mm, 2 Notches AY420 (MLS), 1.620mm, 1 Notch		
2.5	VM 31 B Diesel	130					AY400 (MLS), 1.420mm, 0 Notches	DK570 ▲	GK573 ▲ [3] [18]
155 2.5 TD	04/93→12/97	2499	4	92.00	DOHC	92-125/ 125-170	04/95→ AY410 (MLS), 1.520mm, 2 Notches 04/95→ AY420 (MLS), 1.620mm, 1 Notch 04/95→	04/95→	04/95→
2.5	VM 32 B Diesel	131					BP260 (Fibre), 1.520mm, 2 Notches	DK570 ▲	GK573 ▲ [3] [18]
164 2.5 TD	09/92→09/98	2499	4	92.00	OHV	92/125	AY420 (MLS), 1.620mm, 1 Notch		
2.5	VM 84 A Diesel	132					AY400 (MLS), 1.420mm, 0 Notches	DK570 ▲	GK572 ▲ [18] GK573 ▲ [3] [18]
164 2.5 TD	06/87→09/92	2499	4	92.00	OHV	84/114	BK570 (Fibre), 1.420mm, 0 Notches (x4) AY410 (MLS), 1.520mm, 2 Notches BP260 (Fibre), 1.520mm, 2 Notches AY420 (MLS), 1.620mm, 1 Notch BK580 (Fibre), 1.620mm, 1 Notch (x4)		
3.0	AR 16102	133					BT380 (Fibre), 1.650mm ☒	CY640 [3]	FY640
GTV 3.0 V6 24V	10/96→10/00	2959	6	93.00	DOHC, V	162/220	AY640 (Fibre), 1.650mm ☒		
Spider 3.0	01/99→10/03								
3.0	AR 16105	134					BT380 (Fibre), 1.650mm ☒	CY640 [3]	FY640
GTV 3.0 V6 24V	10/00→10/05	2959	6	93.00	DOHC, V	160/218	AY640 (Fibre), 1.650mm ☒		
Spider 3.0 V6	09/94→08/00								
3.0	AR 34301	135					BT380 (Fibre), 1.650mm ☒	CY640 [3]	FY640
166 3.0 V6 24V	09/98→10/00	2959	6	93.00	DOHC, V	166/226	AY640 (Fibre), 1.650mm ☒		
3.0	AR 36101	136					BT380 (Fibre), 1.650mm ☒	CY640 [3]	FY640
166 3.0 V6 24V	10/00→06/07	2959	6	93.00	DOHC, V	162/220	AY640 (Fibre), 1.650mm ☒		
3.0	AR 64304	137					BT380 (Fibre), 1.650mm ☒		GK573 ▲ [3] [18]
164 3.0	04/93→08/97	2959	6	93.00	DOHC, V	168-171/ 228-233	BT390 (Fibre) ☒		
164 3.0 24V QV	09/92→09/98								
3.2	932 A.000	138					BT380 (Fibre), 1.650mm ☒	CY640 [3]	FY640
147 3.2 GTA	02/03→03/10	3179	6	93.00	DOHC, V	184/250	AY640 (Fibre), 1.650mm ☒		
156 3.2 GTA	03/02→05/06								
3.2	936 A.000	139					BT380 (Fibre), 1.650mm ☒	CY640 [3]	FY640
166 3.2 V6 24V	10/03→06/07	3179	6	93.00	DOHC, V	176/240	AY640 (Fibre), 1.650mm ☒		
GT 3.2 GTA	11/03→09/10								

									
HBS105 [12] M14x1.75x137.00mm (x10)	JC928 [1] JD5144 JD025 [x4] JF123								 AY290, AY300, AY310  JN462  JN594  AY400, AY410, AY420  JN813  AY620, AY640  JN814  AY630  JP068  BK570, BP260, BK580  JP070  BT380  JP071  BT390  JJ100  JC054  JJ519  JC055  JC928  JD025  JD5144  JD586  JD587  JD586  JD587  JD587  JF123
HBS011 [5] M12x1.25x119.00mm (x12)	JC054 [x4] JC055 [x4] JD586 [x2] JD587 [x6] JD586 [x2] JD587 [x6] JD586 [x2] JD587 [x6] JD586 [x2] JD587 [x6]	JN462 [4] JN594 [4] Eng.574799→ JP071 [x4] JP070 [x4] JP071 [x4] JP070 [x4] JP071 [x4] JP070 [x4] JP071 [x4] JP070 [x4]	JJ100 (Cork) JJ519	HR602 [x]	NPO68 [2] 55.00x70.00x8.00mm, FPM NF833 [1] 90.00x115.00x13.00mm, FPM				
HBS108 [12] M14x1.75x137.00mm (x10)	JD5144	JP068 [4]							
HBS105 [12] M14x1.75x137.00mm (x10)	JD5144	JP068 [4]							
HBS105 [12] M14x1.75x137.00mm (x10) 04/95→	JD5144 04/95→	JP068 [4] 04/95→							
HBS105 [12] M14x1.75x137.00mm (x10)	JD5144	JP068 [4]							
HBS105 [12] M14x1.75x137.00mm (x10)	JC928 [x4] JD5144 JD586 [x2] JD587 [x6] JD586 [x2] JD587 [x6] JD586 [x2] JD587 [x6] JD586 [x2] JD587 [x6]	JP071 [x4] JP070 [x4] JP071 [x4] JP070 [x4] JP071 [x4] JP070 [x4] JP071 [x4] JP070 [x4]							
		JP068 [4] JN813 [x4] JN814 [x4]	KV086	HR800 [x]					
	JD586 [x] JD587 [x]	JP071 [x4] JP070 [x4]		HR662 [x]	NA5001 [1][2] 32.00x47.00x10.00mm, FPM				
	JD586 [x] JD587 [x]	JP071 [x4] JP070 [x4]		HR662 [x]	NA5001 [1][2] 32.00x47.00x10.00mm, FPM				

ALFA ROMEO









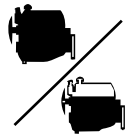



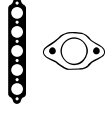

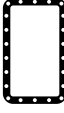

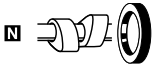



cc



kW/PS



3.2		936 A6.000		140		BT380 (Fibre), 1.650mm		CY640 [3]	FY640
GTV 3.2 V6 24V	04/03→10/05	3179	6	93.00	DOHC, V	176/240	AY640 (Fibre), 1.650mm		
Spider 3.2	04/03→04/05								

					 		 AY640  BT380  JD586  JD587  JP070  JP071
	JD586  JD587 	JP071  [4] JP070  [4]		HR662 	NA5001  [1] [2] 32.00x47.00x10.00mm, FPM		



Ltr







CC



9

Model	Ltr	Year Range	Code	Fuel	CC	Gear	Index
80 (89, 89Q, 8A, B3)	1.6	08/99→10/99	ABB	Petrol	1595	4	13
80 (89, 89Q, 8A, B3)	1.6	08/98→09/99	PP	Petrol	1595	4	37
80 (89, 89Q, 8A, B3)	1.6	09/98→08/99	RA	Diesel	1588	4	38
80 (89, 89Q, 8A, B3)	1.6	09/98→08/99	RN	Petrol	1595	4	39
80 (89, 89Q, 8A, B3)	1.6	09/98→08/99	SB	Diesel	1588	4	40
80 (89, 89Q, 8A, B3)	1.8	06/98→08/99	DZ	Petrol	1781	4	93
80 (89, 89Q, 8A, B3)	1.8	09/98→10/99	JN	Petrol	1781	4	94
80 (89, 89Q, 8A, B3)	1.8	09/98→10/99	NE	Petrol	1781	4	97
80 (89, 89Q, 8A, B3)	1.8	09/98→10/99	PM	Petrol	1781	4	100
80 (89, 89Q, 8A, B3)	1.8	10/98→01/99	RU	Petrol	1781	4	101
80 (89, 89Q, 8A, B3)	1.8	09/98→08/99	SD	Petrol	1847	4	102
80 (89, 89Q, 8A, B3)	1.8	09/98→12/99	SF	Petrol	1781	4	103
80 (89, 89Q, 8A, B3)	1.9	08/98→08/99	1Y	Diesel	1896	4	105
80 (89, 89Q, 8A, B3)	2.0	08/98→10/99	3A	Petrol	1984	4	130
80 (89, 89Q, 8A, B3)	2.0	03/99→09/99	6A	Petrol	1984	4	131
80 (89, 89Q, 8A, B3)	2.0	10/99→08/99	AAD	Petrol	1984	4	132
80 (89, 89Q, 8A, B3)	2.3	10/98→07/98	NG	Petrol	2309	5	235
80 (8C, B4)	1.6	09/99→12/99	ABM	Petrol	1595	4	14
80 (8C, B4)	1.6	06/99→12/99	ADA	Petrol	1595	4	15
80 (8C, B4)	1.9	09/99→12/99	1Z	Diesel	1896	4	106
80 (8C, B4)	1.9	09/99→12/99	AAZ	Diesel	1896	4	107
80 (8C, B4)	2.0	09/99→12/99	ABK	Petrol	1984	4	134
80 (8C, B4)	2.0	09/99→12/99	ABT	Petrol	1984	4	135
80 (8C, B4)	2.0	04/99→12/99	ACE	Petrol	1984	4	136
80 (8C, B4)	2.2	02/99→12/99	ABY	Petrol	2226	5	222
80 (8C, B4)	2.3	09/99→12/99	NG	Petrol	2309	5	235
80 (8C, B4)	2.6	06/99→12/99	ABC	Petrol	2598	6	267
80 (8C, B4)	2.8	09/99→12/99	AAH	Petrol	2771	6	289
80 Avant (8C, B4)	1.6	06/99→01/99	ADA	Petrol	1595	4	15
80 Avant (8C, B4)	1.9	07/99→01/99	1Z	Diesel	1896	4	106
80 Avant (8C, B4)	1.9	09/99→12/99	AAZ	Diesel	1896	4	107
80 Avant (8C, B4)	2.0	07/99→01/99	ABK	Petrol	1984	4	134
80 Avant (8C, B4)	2.0	07/99→01/99	ABT	Petrol	1984	4	135
80 Avant (8C, B4)	2.0	12/99→01/99	ACE	Petrol	1984	4	136
80 Avant (8C, B4)	2.0	11/99→01/99	ADW	Petrol	1984	4	137
80 Avant (8C, B4)	2.2	02/99→07/99	ABY	Petrol	2226	5	222
80 Avant (8C, B4)	2.2	03/99→05/99	ADU	Petrol	2226	5	223
80 Avant (8C, B4)	2.3	09/99→11/99	NG	Petrol	2309	5	235
80 Avant (8C, B4)	2.6	07/99→01/99	ABC	Petrol	2598	6	267
80 Avant (8C, B4)	2.8	09/99→01/99	AAH	Petrol	2771	6	289
90 (89, 89Q, 8A, B3)	1.6	04/98→09/99	RA	Diesel	1588	4	38
90 (89, 89Q, 8A, B3)	1.6	04/98→09/99	SB	Diesel	1588	4	40
90 (89, 89Q, 8A, B3)	2.0	08/98→07/99	6A	Petrol	1984	4	131
90 (89, 89Q, 8A, B3)	2.0	08/98→09/99	NM	Petrol	1994	5	213
90 (89, 89Q, 8A, B3)	2.0	07/98→09/99	PS	Petrol	1994	5	214
90 (89, 89Q, 8A, B3)	2.2	04/98→09/99	KV	Petrol	2226	5	228
90 (89, 89Q, 8A, B3)	2.3	06/98→09/99	7A	Petrol	2309	5	232
90 (89, 89Q, 8A, B3)	2.3	04/98→09/99	NG	Petrol	2309	5	235
100 (44, 44Q, C3)	1.8	03/98→11/99	4B	Petrol	1781	4	41
100 (44, 44Q, C3)	1.8	08/98→07/98	DS	Petrol	1781	4	92
100 (44, 44Q, C3)	1.8	08/98→07/98	JW	Petrol	1781	4	96
100 (44, 44Q, C3)	1.8	08/98→07/98	NP	Petrol	1781	4	98
100 (44, 44Q, C3)	1.8	03/98→11/99	PH	Petrol	1781	4	99
100 (44, 44Q, C3)	1.8	02/98→07/99	SH	Petrol	1781	4	104
100 (44, 44Q, C3)	2.0	03/98→11/99	NC	Diesel	1986	5	212
100 (44, 44Q, C3)	2.0	01/98→11/99	RT	Petrol	1994	5	215
100 (44, 44Q, C3)	2.2	06/98→11/99	HX	Petrol	2226	5	224
100 (44, 44Q, C3)	2.2	08/98→11/99	KU	Petrol	2226	5	227
100 (44, 44Q, C3)	2.2	08/98→11/99	MC	Petrol	2226	5	230
100 (44, 44Q, C3)	2.3	01/99→11/99	AAR	Petrol	2309	5	233
100 (44, 44Q, C3)	2.3	08/98→11/99	NF	Petrol	2309	5	234
100 (44, 44Q, C3)	2.4	08/98→07/99	3D	Diesel	2370	5	236
100 (44, 44Q, C3)	2.5	01/99→11/99	1T	Diesel	2461	5	253
100 (4A, C4)	2.0	12/99→06/99	AAD	Petrol	1984	4	132
100 (4A, C4)	2.0	12/99→06/99	AAE	Petrol	1984	4	133
100 (4A, C4)	2.0	12/99→06/99	ABK	Petrol	1984	4	134
100 (4A, C4)	2.0	01/99→06/99	ACE	Petrol	1984	4	136
100 (4A, C4)	2.2	08/99→06/99	AAN	Petrol	2226	5	221
100 (4A, C4)	2.3	12/99→06/99	AAR	Petrol	2309	5	233
100 (4A, C4)	2.4	12/99→06/99	AAS	Diesel	2370	5	237

	Ltr				CC		9
100 (4A, C4)	2.5	12/99 → 06/99	AAT	Diesel	2461	5	254
100 (4A, C4)	2.5	12/99 → 06/99	ABP	Diesel	2461	5	255
100 (4A, C4)	2.6	03/99 → 06/99	ABC	Petrol	2598	6	267
100 (4A, C4)	2.6	07/99 → 06/99	ACZ	Petrol	2598	6	268
100 (4A, C4)	2.8	12/99 → 06/99	AAH	Petrol	2771	6	289
100 Avant (44, 44Q, C3)	1.8	03/98 → 11/99	4B	Petrol	1781	4	41
100 Avant (44, 44Q, C3)	1.8	08/98 → 07/98	DS	Petrol	1781	4	92
100 Avant (44, 44Q, C3)	1.8	08/98 → 07/98	JW	Petrol	1781	4	96
100 Avant (44, 44Q, C3)	1.8	08/98 → 07/98	NP	Petrol	1781	4	98
100 Avant (44, 44Q, C3)	1.8	03/98 → 11/99	PH	Petrol	1781	4	99
100 Avant (44, 44Q, C3)	1.8	02/98 → 07/99	SH	Petrol	1781	4	104
100 Avant (44, 44Q, C3)	2.0	03/98 → 11/99	NC	Diesel	1986	5	212
100 Avant (44, 44Q, C3)	2.0	01/98 → 11/99	RT	Petrol	1994	5	215
100 Avant (44, 44Q, C3)	2.2	06/98 → 11/99	HX	Petrol	2226	5	224
100 Avant (44, 44Q, C3)	2.2	08/98 → 11/99	KU	Petrol	2226	5	227
100 Avant (44, 44Q, C3)	2.2	08/98 → 11/99	MC	Petrol	2226	5	230
100 Avant (44, 44Q, C3)	2.3	01/99 → 11/99	AAR	Petrol	2309	5	233
100 Avant (44, 44Q, C3)	2.3	08/98 → 11/99	NF	Petrol	2309	5	234
100 Avant (44, 44Q, C3)	2.4	08/98 → 11/99	3D	Diesel	2370	5	236
100 Avant (44, 44Q, C3)	2.5	01/99 → 11/99	IT	Diesel	2461	5	253
100 Avant (4A, C4)	2.0	12/99 → 06/99	AAD	Petrol	1984	4	132
100 Avant (4A, C4)	2.0	09/99 → 06/99	AAE	Petrol	1984	4	133
100 Avant (4A, C4)	2.0	09/99 → 06/99	ABK	Petrol	1984	4	134
100 Avant (4A, C4)	2.0	07/99 → 06/99	ACE	Petrol	1984	4	136
100 Avant (4A, C4)	2.2	09/99 → 06/99	AAN	Petrol	2226	5	221
100 Avant (4A, C4)	2.3	09/99 → 06/99	AAR	Petrol	2309	5	233
100 Avant (4A, C4)	2.4	12/99 → 06/99	AAS	Diesel	2370	5	237
100 Avant (4A, C4)	2.5	12/99 → 06/99	AAT	Diesel	2461	5	254
100 Avant (4A, C4)	2.5	12/99 → 06/99	ABP	Diesel	2461	5	255
100 Avant (4A, C4)	2.6	03/99 → 06/99	ABC	Petrol	2598	6	267
100 Avant (4A, C4)	2.6	07/99 → 07/99	ACZ	Petrol	2598	6	268
100 Avant (4A, C4)	2.8	09/99 → 06/99	AAH	Petrol	2771	6	289
200 (44, 44Q)	2.2	02/98 → 12/99	1B	Petrol	2226	5	218
200 (44, 44Q)	2.2	02/98 → 12/99	2B	Petrol	2226	5	219
200 (44, 44Q)	2.2	03/98 → 12/99	3B	Petrol	2226	5	220
200 (44, 44Q)	2.2	01/98 → 12/99	MC	Petrol	2226	5	230
200 (44, 44Q)	2.3	11/98 → 09/99	NF	Petrol	2309	5	234
200 Avant (44, 44Q)	2.2	02/98 → 12/99	1B	Petrol	2226	5	218
200 Avant (44, 44Q)	2.2	07/98 → 12/99	3B	Petrol	2226	5	220
200 Avant (44, 44Q)	2.2	09/98 → 09/99	MC	Petrol	2226	5	230
200 Avant (44, 44Q)	2.3	11/98 → 09/99	NF	Petrol	2309	5	234
A1 (8X1)	1.2	05/01 →	CBZA	Petrol	1197	4	2
A1 (8X1)	1.4	05/01 →	CAXA	Petrol	1390	4	9
A1 (8X1)	1.4	05/01 →	CNVA	Petrol	1390	4	12
A1 (8X1)	1.6	03/01 →	CAYB	Diesel	1598	4	33
A1 (8X1)	1.6	05/01 →	CAYC	Diesel	1598	4	34
A1 (8X1)	2.0	05/01 →	CFHB	Diesel	1968	4	198
A1 (8X1)	2.0	09/01 →	CFHD	Diesel	1968	4	199
A1 Sportback (8XA)	1.2	01/01 →	CBZA	Petrol	1197	4	2
A1 Sportback (8XA)	1.4	11/01 →	CAXA	Petrol	1390	4	9
A1 Sportback (8XA)	1.4	11/01 →	CNVA	Petrol	1390	4	12
A1 Sportback (8XA)	1.6	11/01 →	CAYB	Diesel	1598	4	33
A1 Sportback (8XA)	1.6	11/01 →	CAYC	Diesel	1598	4	34
A1 Sportback (8XA)	2.0	05/01 →	CFHB	Diesel	1968	4	198
A1 Sportback (8XA)	2.0	09/01 →	CFHD	Diesel	1968	4	199
A2 (8Z0)	1.2	03/00 → 08/00	ANY	Diesel	1191	3	1
A2 (8Z0)	1.4	02/00 → 08/00	AMF	Diesel	1422	3	4
A2 (8Z0)	1.4	11/00 → 08/00	ATL	Diesel	1422	3	5
A2 (8Z0)	1.4	02/00 → 08/00	AUA	Petrol	1390	4	6
A2 (8Z0)	1.4	02/00 → 08/00	BBY	Petrol	1390	4	7
A2 (8Z0)	1.4	02/00 → 08/00	BHC	Diesel	1422	3	8
A2 (8Z0)	1.6	05/00 → 08/00	BAD	Petrol	1598	4	25
A3 (8L1)	1.6	09/99 → 05/00	AEH	Petrol	1595	4	17
A3 (8L1)	1.6	09/99 → 05/00	AKL	Petrol	1595	4	19
A3 (8L1)	1.6	09/99 → 05/00	APF	Petrol	1595	4	22
A3 (8L1)	1.6	08/00 → 05/00	AVU	Petrol	1595	4	24
A3 (8L1)	1.6	08/00 → 05/00	BFQ	Petrol	1595	4	27
A3 (8L1)	1.8	09/99 → 05/00	AGN	Petrol	1781	4	45
A3 (8L1)	1.8	12/99 → 05/00	AGU	Petrol	1781	4	46
A3 (8L1)	1.8	10/99 → 05/00	AJQ	Petrol	1781	4	49



Ltr







CC



9

	Ltr				CC		
A3 (8L1)	1.8	03/99→04/00	AMK	Petrol	1781	4	51
A3 (8L1)	1.8	09/99→05/00	APG	Petrol	1781	4	55
A3 (8L1)	1.8	12/99→05/00	APP	Petrol	1781	4	56
A3 (8L1)	1.8	03/99→04/00	APY	Petrol	1781	4	60
A3 (8L1)	1.8	12/99→05/00	AQA	Petrol	1781	4	61
A3 (8L1)	1.8	12/99→05/00	ARX	Petrol	1781	4	66
A3 (8L1)	1.8	10/99→05/00	ARY	Petrol	1781	4	67
A3 (8L1)	1.8	12/99→05/00	ARZ	Petrol	1781	4	68
A3 (8L1)	1.8	03/99→04/00	AUL	Petrol	1781	4	70
A3 (8L1)	1.8	12/99→05/00	AUM	Petrol	1781	4	71
A3 (8L1)	1.8	12/99→05/00	AUQ	Petrol	1781	4	72
A3 (8L1)	1.8	10/00→05/00	BAM	Petrol	1781	4	78
A3 (8L1)	1.9	09/99→07/00	AGR	Diesel	1896	4	110
A3 (8L1)	1.9	08/99→07/00	AHF	Diesel	1896	4	111
A3 (8L1)	1.9	09/99→07/00	ALH	Diesel	1896	4	115
A3 (8L1)	1.9	08/99→07/00	ASV	Diesel	1896	4	116
A3 (8L1)	1.9	08/00→05/00	ASZ	Diesel	1896	4	117
A3 (8L1)	1.9	10/00→05/00	ATD	Diesel	1896	4	118
A3 (8L1)	1.9	10/00→05/00	AXR	Diesel	1896	4	124
A3 (8P1)	1.2	04/01→08/01	CBZB	Petrol	1197	4	3
A3 (8P1)	1.4	09/00→08/01	CAXC	Petrol	1390	4	10
A3 (8P1)	1.4	09/00→08/01	CMSA	Petrol	1390	4	11
A3 (8P1)	1.6	08/00→09/00	BAG	Petrol	1598	4	26
A3 (8P1)	1.6	05/00→08/01	BGU	Petrol	1595	4	28
A3 (8P1)	1.6	08/00→09/00	BLF	Petrol	1598	4	29
A3 (8P1)	1.6	08/00→09/00	BLP	Petrol	1598	4	30
A3 (8P1)	1.6	05/00→08/01	BSE	Petrol	1595	4	31
A3 (8P1)	1.6	05/00→08/01	BSF	Petrol	1595	4	32
A3 (8P1)	1.6	05/00→08/01	CAYB	Diesel	1598	4	33
A3 (8P1)	1.6	05/00→08/01	CAYC	Diesel	1598	4	34
A3 (8P1)	1.6	05/00→08/01	CCSA	Petrol	1595	4	35
A3 (8P1)	1.6	05/00→08/01	CMXA	Petrol	1595	4	36
A3 (8P1)	1.6	05/00→08/01	CMXA	Flexfuel	1595	4	36
A3 (8P1)	1.8	11/00→08/01	BYT	Petrol	1798	4	84
A3 (8P1)	1.8	11/00→08/01	BZB	Petrol	1798	4	85
A3 (8P1)	1.8	11/00→08/01	CDAA	Petrol	1798	4	89
A3 (8P1)	1.9	05/00→05/01	BKC	Diesel	1896	4	125
A3 (8P1)	1.9	05/00→05/01	BLS	Diesel	1896	4	127
A3 (8P1)	1.9	05/00→05/01	BXE	Diesel	1896	4	129
A3 (8P1)	2.0	05/00→06/00	AXW	Petrol	1984	4	140
A3 (8P1)	2.0	09/00→08/01	AXX	Petrol	1984	4	141
A3 (8P1)	2.0	05/00→08/01	AZV	Diesel	1968	4	142
A3 (8P1)	2.0	11/00→08/01	BHZ	Petrol	1984	4	144
A3 (8P1)	2.0	05/00→08/01	BKD	Diesel	1968	4	145
A3 (8P1)	2.0	05/00→06/00	BLR	Petrol	1984	4	147
A3 (8P1)	2.0	05/00→06/00	BLX	Petrol	1984	4	148
A3 (8P1)	2.0	05/00→06/00	BLY	Petrol	1984	4	149
A3 (8P1)	2.0	05/00→06/00	BMB	Petrol	1984	4	150
A3 (8P1)	2.0	06/00→06/00	BMM	Diesel	1968	4	151
A3 (8P1)	2.0	03/00→08/01	BMN	Diesel	1968	4	152
A3 (8P1)	2.0	06/00→06/00	BUY	Diesel	1968	4	163
A3 (8P1)	2.0	05/00→06/00	BVY	Petrol	1984	4	166
A3 (8P1)	2.0	05/00→06/00	BVZ	Petrol	1984	4	167
A3 (8P1)	2.0	09/00→08/01	BWA	Petrol	1984	4	168
A3 (8P1)	2.0	02/00→08/01	BZC	Petrol	1984	4	172
A3 (8P1)	2.0	09/00→08/01	CAWB	Petrol	1984	4	181
A3 (8P1)	2.0	05/00→08/01	CBAA	Diesel	1968	4	182
A3 (8P1)	2.0	05/00→08/01	CBAB	Diesel	1968	4	183
A3 (8P1)	2.0	03/00→08/01	CBBB	Diesel	1968	4	184
A3 (8P1)	2.0	09/00→08/01	CCZA	Petrol	1984	4	187
A3 (8P1)	2.0	11/00→08/01	CDLA	Petrol	1984	4	189
A3 (8P1)	2.0	02/00→08/01	CDLC	Petrol	1984	4	191
A3 (8P1)	2.0	05/00→08/01	CFFA	Diesel	1968	4	195
A3 (8P1)	2.0	05/00→08/01	CFFB	Diesel	1968	4	196
A3 (8P1)	2.0	03/00→08/01	CFGB	Diesel	1968	4	197
A3 (8P1)	2.0	05/00→08/01	CLJA	Diesel	1968	4	208
A3 (8P1)	3.2	07/00→05/00	BDB	Petrol	3189	6	324
A3 (8P1)	3.2	07/00→05/00	BMJ	Petrol	3189	6	326
A3 (8P1)	3.2	07/00→05/00	BUB	Petrol	3189	6	328
A3 Convertible (8P7)	1.2	03/01→	CBZB	Petrol	1197	4	3

	Ltr				CC		9
A3 Convertible (8P7)	1.4	02/01→	CAXC	Petrol	1390	4	10
A3 Convertible (8P7)	1.6	09/00→	BSE	Petrol	1595	4	31
A3 Convertible (8P7)	1.6	05/00→	CAYC	Diesel	1598	4	34
A3 Convertible (8P7)	1.8	04/00→	BZB	Petrol	1798	4	85
A3 Convertible (8P7)	1.8	04/00→	CDAA	Petrol	1798	4	89
A3 Convertible (8P7)	1.9	04/00→	BLS	Diesel	1896	4	127
A3 Convertible (8P7)	2.0	04/00→	CAWB	Petrol	1984	4	181
A3 Convertible (8P7)	2.0	04/00→	CBAA	Diesel	1968	4	182
A3 Convertible (8P7)	2.0	04/00→	CBAB	Diesel	1968	4	183
A3 Convertible (8P7)	2.0	04/00→	CCZA	Petrol	1984	4	187
A3 Convertible (8P7)	2.0	04/00→	CFFA	Diesel	1968	4	195
A3 Convertible (8P7)	2.0	04/00→	CFFB	Diesel	1968	4	196
A3 Sportback (8PA)	1.2	04/01→	CBZB	Petrol	1197	4	3
A3 Sportback (8PA)	1.4	09/00→	CAXC	Petrol	1390	4	10
A3 Sportback (8PA)	1.4	09/00→	CMSA	Petrol	1390	4	11
A3 Sportback (8PA)	1.6	09/00→	BGU	Petrol	1595	4	28
A3 Sportback (8PA)	1.6	09/00→	BLF	Petrol	1598	4	29
A3 Sportback (8PA)	1.6	09/00→	BLP	Petrol	1598	4	30
A3 Sportback (8PA)	1.6	09/00→	BSE	Petrol	1595	4	31
A3 Sportback (8PA)	1.6	09/00→	BSF	Petrol	1595	4	32
A3 Sportback (8PA)	1.6	05/00→	CAYB	Diesel	1598	4	33
A3 Sportback (8PA)	1.6	05/00→	CAYC	Diesel	1598	4	34
A3 Sportback (8PA)	1.6	09/00→	CCSA	Petrol	1595	4	35
A3 Sportback (8PA)	1.6	09/00→	CMXA	Petrol	1595	4	36
A3 Sportback (8PA)	1.6	09/00→	CMXA	Flexfuel	1595	4	36
A3 Sportback (8PA)	1.8	11/00→	BYT	Petrol	1798	4	84
A3 Sportback (8PA)	1.8	11/00→	BZB	Petrol	1798	4	85
A3 Sportback (8PA)	1.8	11/00→	CDAA	Petrol	1798	4	89
A3 Sportback (8PA)	1.9	09/00→05/01	BKC	Diesel	1896	4	125
A3 Sportback (8PA)	1.9	09/00→05/01	BLS	Diesel	1896	4	127
A3 Sportback (8PA)	1.9	09/00→05/01	BXE	Diesel	1896	4	129
A3 Sportback (8PA)	2.0	09/00→	AXX	Petrol	1984	4	141
A3 Sportback (8PA)	2.0	09/00→	AZV	Diesel	1968	4	142
A3 Sportback (8PA)	2.0	06/00→	BHZ	Petrol	1984	4	144
A3 Sportback (8PA)	2.0	09/00→	BKD	Diesel	1968	4	145
A3 Sportback (8PA)	2.0	09/00→	BLR	Petrol	1984	4	147
A3 Sportback (8PA)	2.0	09/00→	BLX	Petrol	1984	4	148
A3 Sportback (8PA)	2.0	09/00→	BLY	Petrol	1984	4	149
A3 Sportback (8PA)	2.0	09/00→	BMB	Petrol	1984	4	150
A3 Sportback (8PA)	2.0	06/00→06/00	BMM	Diesel	1968	4	151
A3 Sportback (8PA)	2.0	03/00→	BMN	Diesel	1968	4	152
A3 Sportback (8PA)	2.0	09/00→	BPY	Petrol	1984	4	157
A3 Sportback (8PA)	2.0	06/00→06/00	BUY	Diesel	1968	4	163
A3 Sportback (8PA)	2.0	09/00→	BVY	Petrol	1984	4	166
A3 Sportback (8PA)	2.0	09/00→	BVZ	Petrol	1984	4	167
A3 Sportback (8PA)	2.0	09/00→	BWA	Petrol	1984	4	168
A3 Sportback (8PA)	2.0	09/00→	CAWB	Petrol	1984	4	181
A3 Sportback (8PA)	2.0	09/00→	CBAA	Diesel	1968	4	182
A3 Sportback (8PA)	2.0	09/00→	CBAB	Diesel	1968	4	183
A3 Sportback (8PA)	2.0	03/00→	CBBB	Diesel	1968	4	184
A3 Sportback (8PA)	2.0	09/00→	CBFA	Petrol	1984	4	185
A3 Sportback (8PA)	2.0	09/00→	CCZA	Petrol	1984	4	187
A3 Sportback (8PA)	2.0	06/00→	CDLA	Petrol	1984	4	189
A3 Sportback (8PA)	2.0	07/00→	CDLC	Petrol	1984	4	191
A3 Sportback (8PA)	2.0	09/00→	CFFA	Diesel	1968	4	195
A3 Sportback (8PA)	2.0	09/00→	CFFB	Diesel	1968	4	196
A3 Sportback (8PA)	2.0	03/00→	CFGB	Diesel	1968	4	197
A3 Sportback (8PA)	2.0	09/00→	CLJA	Diesel	1968	4	208
A3 Sportback (8PA)	3.2	09/00→05/00	BMJ	Petrol	3189	6	326
A3 Sportback (8PA)	3.2	09/00→05/00	BUB	Petrol	3189	6	328
A4 (8D2, B5)	1.6	11/99→10/00	ADP	Petrol	1595	4	16
A4 (8D2, B5)	1.6	11/99→10/00	AHL	Petrol	1595	4	18
A4 (8D2, B5)	1.6	07/00→11/00	ALZ	Petrol	1595	4	20
A4 (8D2, B5)	1.6	11/99→10/00	ANA	Petrol	1595	4	21
A4 (8D2, B5)	1.6	11/99→10/00	ARM	Petrol	1595	4	23
A4 (8D2, B5)	1.8	01/99→11/00	ADR	Petrol	1781	4	42
A4 (8D2, B5)	1.8	01/99→11/00	AEB	Petrol	1781	4	43
A4 (8D2, B5)	1.8	04/99→11/00	AFY	Petrol	1781	4	44
A4 (8D2, B5)	1.8	12/99→11/00	AJL	Petrol	1781	4	47
A4 (8D2, B5)	1.8	05/00→09/00	AMB	Petrol	1781	4	50



Ltr







CC



9

Model	Ltr	Year	Code	Fuel	CC	Gears	Power (kW)
A4 (8D2, B5)	1.8	01/99→11/00	ANB	Petrol	1781	4	53
A4 (8D2, B5)	1.8	01/99→11/00	APT	Petrol	1781	4	57
A4 (8D2, B5)	1.8	01/99→11/00	APU	Petrol	1781	4	58
A4 (8D2, B5)	1.8	01/99→11/00	ARG	Petrol	1781	4	63
A4 (8D2, B5)	1.8	01/99→11/00	ARK	Petrol	1781	4	65
A4 (8D2, B5)	1.8	01/99→11/00	AVV	Petrol	1781	4	74
A4 (8D2, B5)	1.8	01/99→11/00	AWT	Petrol	1781	4	77
A4 (8D2, B5)	1.9	01/99→11/00	IZ	Diesel	1896	4	106
A4 (8D2, B5)	1.9	12/99→11/00	AFF	Diesel	1896	4	108
A4 (8D2, B5)	1.9	10/99→11/00	AFN	Diesel	1896	4	109
A4 (8D2, B5)	1.9	01/99→11/00	AHH	Diesel	1896	4	112
A4 (8D2, B5)	1.9	01/99→11/00	AHU	Diesel	1896	4	113
A4 (8D2, B5)	1.9	03/00→11/00	AJM	Diesel	1896	4	114
A4 (8D2, B5)	1.9	03/00→11/00	ATJ	Diesel	1896	4	119
A4 (8D2, B5)	1.9	10/99→11/00	AVG	Diesel	1896	4	122
A4 (8D2, B5)	2.4	07/99→07/99	AFM	Petrol	2393	6	238
A4 (8D2, B5)	2.4	03/99→11/00	AGA	Petrol	2393	6	239
A4 (8D2, B5)	2.4	08/99→11/00	AJG	Petrol	2393	6	240
A4 (8D2, B5)	2.4	03/99→11/00	ALF	Petrol	2393	6	241
A4 (8D2, B5)	2.4	03/99→11/00	AML	Petrol	2393	6	243
A4 (8D2, B5)	2.4	08/99→11/00	AMM	Petrol	2393	6	244
A4 (8D2, B5)	2.4	03/99→11/00	APS	Petrol	2393	6	246
A4 (8D2, B5)	2.4	08/99→11/00	APZ	Petrol	2393	6	247
A4 (8D2, B5)	2.4	03/99→11/00	ARJ	Petrol	2393	6	248
A4 (8D2, B5)	2.5	09/99→11/00	AFB	Diesel	2496	6	257
A4 (8D2, B5)	2.5	09/99→11/00	AKN	Diesel	2496	6	259
A4 (8D2, B5)	2.6	01/99→11/00	ABC	Petrol	2598	6	267
A4 (8D2, B5)	2.6	01/99→07/99	ACZ	Petrol	2598	6	268
A4 (8D2, B5)	2.7	09/99→09/00	AGB	Petrol	2671	6	269
A4 (8D2, B5)	2.7	02/99→09/00	AJK	Petrol	2671	6	270
A4 (8D2, B5)	2.7	08/99→12/99	APB	Petrol	2671	6	271
A4 (8D2, B5)	2.7	09/99→09/00	AZB	Petrol	2671	6	275
A4 (8D2, B5)	2.8	01/99→07/99	AAH	Petrol	2771	6	289
A4 (8D2, B5)	2.8	10/99→08/00	ACK	Petrol	2771	6	290
A4 (8D2, B5)	2.8	10/99→08/00	ALG	Petrol	2771	6	294
A4 (8D2, B5)	2.8	10/99→08/00	AMX	Petrol	2771	6	295
A4 (8D2, B5)	2.8	10/99→08/00	APR	Petrol	2771	6	296
A4 (8D2, B5)	2.8	10/99→08/00	AQD	Petrol	2771	6	297
A4 (8E2, B6)	1.6	11/00→12/00	ALZ	Petrol	1595	4	20
A4 (8E2, B6)	1.8	07/00→12/00	AMB	Petrol	1781	4	50
A4 (8E2, B6)	1.8	11/00→07/00	AVJ	Petrol	1781	4	73
A4 (8E2, B6)	1.8	11/00→12/00	BEX	Petrol	1781	4	79
A4 (8E2, B6)	1.8	07/00→12/00	BFB	Petrol	1781	4	80
A4 (8E2, B6)	1.9	05/00→12/00	AVB	Diesel	1896	4	120
A4 (8E2, B6)	1.9	11/00→12/00	AVF	Diesel	1896	4	121
A4 (8E2, B6)	1.9	11/00→12/00	AWX	Diesel	1896	4	123
A4 (8E2, B6)	1.9	06/00→12/00	BKE	Diesel	1896	4	126
A4 (8E2, B6)	2.0	11/00→12/00	ALT	Petrol	1984	4	138
A4 (8E2, B6)	2.0	07/00→12/00	AWA	Petrol	1984	4	139
A4 (8E2, B6)	2.4	09/00→12/00	AMM	Petrol	2393	6	244
A4 (8E2, B6)	2.4	09/00→12/00	BDV	Petrol	2393	6	251
A4 (8E2, B6)	2.5	11/00→12/00	AKE	Diesel	2496	6	258
A4 (8E2, B6)	2.5	08/00→07/00	AYM	Diesel	2496	6	260
A4 (8E2, B6)	2.5	11/00→12/00	BAU	Diesel	2496	6	261
A4 (8E2, B6)	2.5	07/00→12/00	BCZ	Diesel	2496	6	262
A4 (8E2, B6)	2.5	07/00→12/00	BDG	Diesel	2496	6	263
A4 (8E2, B6)	2.5	11/00→12/00	BDH	Diesel	2496	6	264
A4 (8E2, B6)	2.5	07/00→12/00	BFC	Diesel	2496	6	265
A4 (8E2, B6)	3.0	11/00→12/00	ASN	Petrol	2976	6	304
A4 (8E2, B6)	3.0	11/00→12/00	AVK	Petrol	2976	6	305
A4 (8E2, B6)	3.0	04/00→12/00	BBJ	Petrol	2976	6	306
A4 (8EC, B7)	1.6	11/00→06/00	ALZ	Petrol	1595	4	20
A4 (8EC, B7)	1.8	11/00→06/00	BFB	Petrol	1781	4	80
A4 (8EC, B7)	1.9	11/00→06/00	BKE	Diesel	1896	4	126
A4 (8EC, B7)	1.9	11/00→06/00	BRB	Diesel	1896	4	128
A4 (8EC, B7)	2.0	11/00→06/00	ALT	Petrol	1984	4	138
A4 (8EC, B7)	2.0	11/00→06/00	BGB	Petrol	1984	4	143
A4 (8EC, B7)	2.0	11/00→06/00	BLB	Diesel	1968	4	146
A4 (8EC, B7)	2.0	11/00→06/00	BNA	Diesel	1968	4	153
A4 (8EC, B7)	2.0	11/00→06/00	BPG	Petrol	1984	4	154

	Ltr				CC		9
A4 (8EC, B7)	2.0	10/00 → 06/00	BPJ	Petrol	1984	4	155
A4 (8EC, B7)	2.0	11/00 → 06/00	BPW	Diesel	1968	4	156
A4 (8EC, B7)	2.0	06/00 → 06/00	BRD	Diesel	1968	4	159
A4 (8EC, B7)	2.0	11/00 → 06/00	BRE	Diesel	1968	4	160
A4 (8EC, B7)	2.0	11/00 → 06/00	BRF	Diesel	1968	4	161
A4 (8EC, B7)	2.0	06/00 → 06/00	BUL	Petrol	1984	4	162
A4 (8EC, B7)	2.0	06/00 → 06/00	BVA	Diesel	1968	4	164
A4 (8EC, B7)	2.0	09/00 → 09/00	BVG	Diesel	1968	4	165
A4 (8EC, B7)	2.0	11/00 → 06/00	BWE	Petrol	1984	4	169
A4 (8EC, B7)	2.0	11/00 → 06/00	BWT	Petrol	1984	4	170
A4 (8EC, B7)	2.0	10/00 → 06/00	BYK	Petrol	1984	4	171
A4 (8EC, B7)	2.5	11/00 → 05/00	BDG	Diesel	2496	6	263
A4 (8EC, B7)	2.7	01/00 → 06/00	BPP	Diesel	2698	6	279
A4 (8EC, B7)	2.7	11/00 → 06/00	BSG	Diesel	2698	6	280
A4 (8EC, B7)	3.0	01/00 → 06/00	ASB	Diesel	2967	6	303
A4 (8EC, B7)	3.0	11/00 → 07/00	BBJ	Petrol	2976	6	306
A4 (8EC, B7)	3.0	11/00 → 06/00	BKN	Diesel	2967	6	307
A4 (8K2, B8)	1.8	01/00 →	CABA	Petrol	1798	4	86
A4 (8K2, B8)	1.8	11/00 →	CABB	Petrol	1798	4	87
A4 (8K2, B8)	1.8	01/00 →	CDHA	Petrol	1798	4	90
A4 (8K2, B8)	1.8	11/00 →	CDHB	Petrol	1798	4	91
A4 (8K2, B8)	2.0	06/00 →	CADA	Petrol	1984	4	173
A4 (8K2, B8)	2.0	06/00 →	CAEA	Petrol	1984	4	174
A4 (8K2, B8)	2.0	06/00 →	CAEB	Petrol	1984	4	175
A4 (8K2, B8)	2.0	11/00 →	CAGA	Diesel	1968	4	176
A4 (8K2, B8)	2.0	11/00 →	CAGB	Diesel	1968	4	177
A4 (8K2, B8)	2.0	06/00 →	CAGC	Diesel	1968	4	178
A4 (8K2, B8)	2.0	01/00 →	CAHA	Diesel	1968	4	179
A4 (8K2, B8)	2.0	08/00 →	CAHB	Diesel	1968	4	180
A4 (8K2, B8)	2.0	06/00 →	CDNB	Petrol	1984	4	193
A4 (8K2, B8)	2.0	06/00 →	CDNC	Petrol	1984	4	194
A4 (8K2, B8)	2.0	11/00 →	CFKA	Petrol/Ethanol	1984	4	200
A4 (8K2, B8)	2.0	11/01 →	CGLC	Diesel	1968	4	203
A4 (8K2, B8)	2.0	08/00 →	CGLD	Diesel	1968	4	204
A4 (8K2, B8)	2.0	11/00 →	CJCA	Diesel	1968	4	205
A4 (8K2, B8)	2.0	11/00 →	CJCB	Diesel	1968	4	206
A4 (8K2, B8)	2.0	06/00 →	CJCC	Diesel	1968	4	207
A4 (8K2, B8)	2.0	11/00 →	CMEA	Diesel	1968	4	209
A4 (8K2, B8)	2.0	11/01 →	CMGB	Diesel	1968	4	211
A4 (8K2, B8)	2.7	11/00 →	CAMA	Diesel	2698	6	281
A4 (8K2, B8)	2.7	11/00 →	CAMB	Diesel	2698	6	282
A4 (8K2, B8)	2.7	11/00 →	CGKA	Diesel	2698	6	287
A4 (8K2, B8)	2.7	11/00 →	CGKB	Diesel	2698	6	288
A4 (8K2, B8)	3.0	11/00 →	CAKA	Petrol	2995	6	313
A4 (8K2, B8)	3.0	11/00 →	CAPA	Diesel	2967	6	314
A4 (8K2, B8)	3.0	11/00 →	CCWA	Diesel	2967	6	319
A4 (8K2, B8)	3.0	06/00 →	CCWB	Diesel	2967	6	320
A4 Allroad (8KH, B8)	2.0	09/00 →	CAGA	Diesel	1968	4	176
A4 Allroad (8KH, B8)	2.0	09/00 →	CAGB	Diesel	1968	4	177
A4 Allroad (8KH, B8)	2.0	04/00 →	CAHA	Diesel	1968	4	179
A4 Allroad (8KH, B8)	2.0	04/00 →	CAHB	Diesel	1968	4	180
A4 Allroad (8KH, B8)	2.0	04/00 →	CDNC	Petrol	1984	4	194
A4 Allroad (8KH, B8)	2.0	11/01 →	CGLC	Diesel	1968	4	203
A4 Allroad (8KH, B8)	2.0	04/00 →	CGLD	Diesel	1968	4	204
A4 Allroad (8KH, B8)	2.0	09/00 →	CJCA	Diesel	1968	4	205
A4 Allroad (8KH, B8)	2.0	09/00 →	CJCB	Diesel	1968	4	206
A4 Allroad (8KH, B8)	3.0	04/00 →	CCWA	Diesel	2967	6	319
A4 Avant (8D5, B5)	1.6	11/99 → 09/00	ADP	Petrol	1595	4	16
A4 Avant (8D5, B5)	1.6	11/99 → 09/00	AHL	Petrol	1595	4	18
A4 Avant (8D5, B5)	1.6	07/00 → 09/00	ALZ	Petrol	1595	4	20
A4 Avant (8D5, B5)	1.6	11/99 → 09/00	ANA	Petrol	1595	4	21
A4 Avant (8D5, B5)	1.6	11/99 → 09/00	ARM	Petrol	1595	4	23
A4 Avant (8D5, B5)	1.8	01/99 → 09/00	ADR	Petrol	1781	4	42
A4 Avant (8D5, B5)	1.8	01/99 → 09/00	AEB	Petrol	1781	4	43
A4 Avant (8D5, B5)	1.8	07/99 → 09/00	AFY	Petrol	1781	4	44
A4 Avant (8D5, B5)	1.8	12/99 → 09/00	AJL	Petrol	1781	4	47
A4 Avant (8D5, B5)	1.8	01/99 → 09/00	ANB	Petrol	1781	4	53
A4 Avant (8D5, B5)	1.8	01/99 → 09/00	APT	Petrol	1781	4	57
A4 Avant (8D5, B5)	1.8	01/99 → 09/00	APU	Petrol	1781	4	58
A4 Avant (8D5, B5)	1.8	01/99 → 09/00	ARG	Petrol	1781	4	63



Ltr







CC



9

Model	Ltr	Year	Code	Fuel	CC	Gear	Power (kW)
A4 Avant (8D5, B5)	1.8	01/99→09/00	ARK	Petrol	1781	4	65
A4 Avant (8D5, B5)	1.8	02/99→09/00	AVV	Petrol	1781	4	74
A4 Avant (8D5, B5)	1.8	01/99→09/00	AWT	Petrol	1781	4	77
A4 Avant (8D5, B5)	1.9	02/99→09/00	1Z	Diesel	1896	4	106
A4 Avant (8D5, B5)	1.9	03/99→09/00	AFB	Diesel	1896	4	108
A4 Avant (8D5, B5)	1.9	02/99→09/00	AFN	Diesel	1896	4	109
A4 Avant (8D5, B5)	1.9	02/99→09/00	AHH	Diesel	1896	4	112
A4 Avant (8D5, B5)	1.9	02/99→09/00	AHU	Diesel	1896	4	113
A4 Avant (8D5, B5)	1.9	03/00→09/00	AJM	Diesel	1896	4	114
A4 Avant (8D5, B5)	1.9	03/00→09/00	ATJ	Diesel	1896	4	119
A4 Avant (8D5, B5)	1.9	02/99→09/00	AVG	Diesel	1896	4	122
A4 Avant (8D5, B5)	2.4	07/99→07/99	AFM	Petrol	2393	6	238
A4 Avant (8D5, B5)	2.4	03/99→09/00	AGA	Petrol	2393	6	239
A4 Avant (8D5, B5)	2.4	08/99→09/00	AJG	Petrol	2393	6	240
A4 Avant (8D5, B5)	2.4	03/99→09/00	ALF	Petrol	2393	6	241
A4 Avant (8D5, B5)	2.4	03/99→09/00	AML	Petrol	2393	6	243
A4 Avant (8D5, B5)	2.4	08/99→09/00	AMM	Petrol	2393	6	244
A4 Avant (8D5, B5)	2.4	03/99→09/00	APS	Petrol	2393	6	246
A4 Avant (8D5, B5)	2.4	08/99→09/00	APZ	Petrol	2393	6	247
A4 Avant (8D5, B5)	2.4	03/99→09/00	ARJ	Petrol	2393	6	248
A4 Avant (8D5, B5)	2.5	09/99→09/00	AFB	Diesel	2496	6	257
A4 Avant (8D5, B5)	2.5	09/99→09/00	AKN	Diesel	2496	6	259
A4 Avant (8D5, B5)	2.6	01/99→09/00	ABC	Petrol	2598	6	267
A4 Avant (8D5, B5)	2.7	09/99→09/00	AGB	Petrol	2671	6	269
A4 Avant (8D5, B5)	2.7	05/00→09/00	ASJ	Petrol	2671	6	273
A4 Avant (8D5, B5)	2.7	09/99→09/00	AZB	Petrol	2671	6	275
A4 Avant (8D5, B5)	2.7	05/00→09/00	AZR	Petrol	2671	6	276
A4 Avant (8D5, B5)	2.8	01/99→09/99	AAH	Petrol	2771	6	289
A4 Avant (8D5, B5)	2.8	10/99→09/00	ACK	Petrol	2771	6	290
A4 Avant (8D5, B5)	2.8	10/99→09/00	ALG	Petrol	2771	6	294
A4 Avant (8D5, B5)	2.8	10/99→09/00	AMX	Petrol	2771	6	295
A4 Avant (8D5, B5)	2.8	10/99→09/00	APR	Petrol	2771	6	296
A4 Avant (8D5, B5)	2.8	10/99→09/00	AQD	Petrol	2771	6	297
A4 Avant (8D5, B5)	2.8	03/99→09/00	ATX	Petrol	2771	6	298
A4 Avant (8E5, B6)	1.6	09/00→12/00	ALZ	Petrol	1595	4	20
A4 Avant (8E5, B6)	1.8	09/00→12/00	AAMB	Petrol	1781	4	50
A4 Avant (8E5, B6)	1.8	09/00→07/00	AVJ	Petrol	1781	4	73
A4 Avant (8E5, B6)	1.8	11/00→12/00	BEX	Petrol	1781	4	79
A4 Avant (8E5, B6)	1.8	07/00→12/00	BFB	Petrol	1781	4	80
A4 Avant (8E5, B6)	1.9	11/00→12/00	AVB	Diesel	1896	4	120
A4 Avant (8E5, B6)	1.9	09/00→12/00	AVF	Diesel	1896	4	121
A4 Avant (8E5, B6)	1.9	09/00→12/00	AWX	Diesel	1896	4	123
A4 Avant (8E5, B6)	1.9	06/00→12/00	BKE	Diesel	1896	4	126
A4 Avant (8E5, B6)	2.0	09/00→12/00	ALT	Petrol	1984	4	138
A4 Avant (8E5, B6)	2.0	07/00→12/00	AWA	Petrol	1984	4	139
A4 Avant (8E5, B6)	2.4	09/00→12/00	AMM	Petrol	2393	6	244
A4 Avant (8E5, B6)	2.4	09/00→12/00	BDV	Petrol	2393	6	251
A4 Avant (8E5, B6)	2.5	10/00→12/00	AKE	Diesel	2496	6	258
A4 Avant (8E5, B6)	2.5	09/00→07/00	AYM	Diesel	2496	6	260
A4 Avant (8E5, B6)	2.5	09/00→12/00	BAU	Diesel	2496	6	261
A4 Avant (8E5, B6)	2.5	07/00→12/00	BCZ	Diesel	2496	6	262
A4 Avant (8E5, B6)	2.5	07/00→12/00	BDG	Diesel	2496	6	263
A4 Avant (8E5, B6)	2.5	09/00→12/00	BDH	Diesel	2496	6	264
A4 Avant (8E5, B6)	2.5	07/00→12/00	BFC	Diesel	2496	6	265
A4 Avant (8E5, B6)	3.0	09/00→12/00	ASN	Petrol	2976	6	304
A4 Avant (8E5, B6)	3.0	09/00→12/00	AVK	Petrol	2976	6	305
A4 Avant (8E5, B6)	3.0	04/00→12/00	BBJ	Petrol	2976	6	306
A4 Avant (8ED, B7)	1.6	11/00→06/00	ALZ	Petrol	1595	4	20
A4 Avant (8ED, B7)	1.8	11/00→06/00	BFB	Petrol	1781	4	80
A4 Avant (8ED, B7)	1.9	11/00→06/00	BKE	Diesel	1896	4	126
A4 Avant (8ED, B7)	1.9	11/00→06/00	BRB	Diesel	1896	4	128
A4 Avant (8ED, B7)	2.0	11/00→06/00	ALT	Petrol	1984	4	138
A4 Avant (8ED, B7)	2.0	11/00→06/00	BGB	Petrol	1984	4	143
A4 Avant (8ED, B7)	2.0	11/00→06/00	BLB	Diesel	1968	4	146
A4 Avant (8ED, B7)	2.0	11/00→06/00	BNA	Diesel	1968	4	153
A4 Avant (8ED, B7)	2.0	10/00→06/00	BPJ	Petrol	1984	4	155
A4 Avant (8ED, B7)	2.0	11/00→06/00	BPW	Diesel	1968	4	156
A4 Avant (8ED, B7)	2.0	06/00→06/00	BRD	Diesel	1968	4	159
A4 Avant (8ED, B7)	2.0	11/00→06/00	BRE	Diesel	1968	4	160
A4 Avant (8ED, B7)	2.0	11/00→06/00	BRF	Diesel	1968	4	161

	Ltr				CC		9
A4 Avant (8ED, B7)	2.0	06/00→06/00	BUL	Petrol	1984	4	162
A4 Avant (8ED, B7)	2.0	06/00→06/00	BVA	Diesel	1968	4	164
A4 Avant (8ED, B7)	2.0	09/00→09/00	BVG	Diesel	1968	4	165
A4 Avant (8ED, B7)	2.0	11/00→06/00	BWE	Petrol	1984	4	169
A4 Avant (8ED, B7)	2.0	11/00→06/00	BWT	Petrol	1984	4	170
A4 Avant (8ED, B7)	2.0	10/00→06/00	BYK	Petrol	1984	4	171
A4 Avant (8ED, B7)	2.5	11/00→05/00	BDG	Diesel	2496	6	263
A4 Avant (8ED, B7)	2.7	01/00→06/00	BPP	Diesel	2698	6	279
A4 Avant (8ED, B7)	2.7	11/00→03/00	BSG	Diesel	2698	6	280
A4 Avant (8ED, B7)	3.0	01/00→06/00	ASB	Diesel	2967	6	303
A4 Avant (8ED, B7)	3.0	11/00→07/00	BBJ	Petrol	2976	6	306
A4 Avant (8ED, B7)	3.0	11/00→06/00	BKN	Diesel	2967	6	307
A4 Avant (8K5, B8)	1.8	11/00→	CABB	Petrol	1798	4	87
A4 Avant (8K5, B8)	1.8	04/00→	CDHA	Petrol	1798	4	90
A4 Avant (8K5, B8)	1.8	11/00→	CDHB	Petrol	1798	4	91
A4 Avant (8K5, B8)	2.0	06/00→	CADA	Petrol	1984	4	173
A4 Avant (8K5, B8)	2.0	06/00→	CAEA	Petrol	1984	4	174
A4 Avant (8K5, B8)	2.0	04/00→	CAGA	Diesel	1968	4	176
A4 Avant (8K5, B8)	2.0	04/00→	CAGB	Diesel	1968	4	177
A4 Avant (8K5, B8)	2.0	06/00→	CAGC	Diesel	1968	4	178
A4 Avant (8K5, B8)	2.0	04/00→	CAHA	Diesel	1968	4	179
A4 Avant (8K5, B8)	2.0	08/00→	CAHB	Diesel	1968	4	180
A4 Avant (8K5, B8)	2.0	06/00→	CDNB	Petrol	1984	4	193
A4 Avant (8K5, B8)	2.0	06/00→	CDNC	Petrol	1984	4	194
A4 Avant (8K5, B8)	2.0	11/00→	CFKA	Petrol/Ethanol	1984	4	200
A4 Avant (8K5, B8)	2.0	11/01→	CGLC	Diesel	1968	4	203
A4 Avant (8K5, B8)	2.0	08/00→	CGLD	Diesel	1968	4	204
A4 Avant (8K5, B8)	2.0	04/00→	CJCA	Diesel	1968	4	205
A4 Avant (8K5, B8)	2.0	04/00→	CJCB	Diesel	1968	4	206
A4 Avant (8K5, B8)	2.0	06/00→	CJCC	Diesel	1968	4	207
A4 Avant (8K5, B8)	2.0	04/00→	CMEA	Diesel	1968	4	209
A4 Avant (8K5, B8)	2.7	04/00→	CAMA	Diesel	2698	6	281
A4 Avant (8K5, B8)	2.7	06/00→	CAMB	Diesel	2698	6	282
A4 Avant (8K5, B8)	2.7	04/00→	CGKA	Diesel	2698	6	287
A4 Avant (8K5, B8)	2.7	06/00→	CGKB	Diesel	2698	6	288
A4 Avant (8K5, B8)	3.0	11/00→	CAKA	Petrol	2995	6	313
A4 Avant (8K5, B8)	3.0	04/00→	CAPA	Diesel	2967	6	314
A4 Avant (8K5, B8)	3.0	04/00→	CCWA	Diesel	2967	6	319
A4 Avant (8K5, B8)	3.0	06/00→	CCWB	Diesel	2967	6	320
A4 Convertible (8H7, B6, 8HE, B7)	1.8	10/00→10/00	AMB	Petrol	1781	4	50
A4 Convertible (8H7, B6, 8HE, B7)	1.8	07/00→03/00	BFB	Petrol	1781	4	80
A4 Convertible (8H7, B6, 8HE, B7)	2.0	09/00→12/00	ALT	Petrol	1984	4	138
A4 Convertible (8H7, B6, 8HE, B7)	2.0	01/00→03/00	BPW	Diesel	1968	4	156
A4 Convertible (8H7, B6, 8HE, B7)	2.0	01/00→03/00	BRC	Diesel	1968	4	158
A4 Convertible (8H7, B6, 8HE, B7)	2.0	11/00→03/00	BWE	Petrol	1984	4	169
A4 Convertible (8H7, B6, 8HE, B7)	2.0	01/00→03/00	BWT	Petrol	1984	4	170
A4 Convertible (8H7, B6, 8HE, B7)	2.4	04/00→12/00	AMM	Petrol	2393	6	244
A4 Convertible (8H7, B6, 8HE, B7)	2.4	04/00→12/00	BDV	Petrol	2393	6	251
A4 Convertible (8H7, B6, 8HE, B7)	2.5	08/00→12/00	BCZ	Diesel	2496	6	262
A4 Convertible (8H7, B6, 8HE, B7)	2.5	08/00→12/00	BDG	Diesel	2496	6	263
A4 Convertible (8H7, B6, 8HE, B7)	2.5	08/00→12/00	BFC	Diesel	2496	6	265
A4 Convertible (8H7, B6, 8HE, B7)	2.7	06/00→03/00	BPP	Diesel	2698	6	279
A4 Convertible (8H7, B6, 8HE, B7)	3.0	01/00→03/00	ASB	Diesel	2967	6	303
A4 Convertible (8H7, B6, 8HE, B7)	3.0	04/00→12/00	ASN	Petrol	2976	6	304
A4 Convertible (8H7, B6, 8HE, B7)	3.0	01/00→03/00	BKN	Diesel	2967	6	307
A5 (8T3)	1.8	10/00→	CABD	Petrol	1798	4	88
A5 (8T3)	1.8	05/00→	CDHB	Petrol	1798	4	91
A5 (8T3)	2.0	06/00→	CAEB	Petrol	1984	4	175
A5 (8T3)	2.0	08/00→	CAHA	Diesel	1968	4	179
A5 (8T3)	2.0	08/00→	CAHB	Diesel	1968	4	180
A5 (8T3)	2.0	11/00→	CDNB	Petrol	1984	4	193
A5 (8T3)	2.0	06/00→	CDNC	Petrol	1984	4	194
A5 (8T3)	2.0	10/01→	CGLC	Diesel	1968	4	203
A5 (8T3)	2.0	08/00→	CGLD	Diesel	1968	4	204
A5 (8T3)	2.7	06/00→	CAMA	Diesel	2698	6	281
A5 (8T3)	2.7	09/00→	CAMB	Diesel	2698	6	282
A5 (8T3)	2.7	06/00→	CGKA	Diesel	2698	6	287
A5 (8T3)	2.7	09/00→	CGKB	Diesel	2698	6	288
A5 (8T3)	3.0	10/01→	CAKA	Petrol	2995	6	313
A5 (8T3)	3.0	06/00→	CAPA	Diesel	2967	6	314



Ltr







CC



9

Model	Ltr	Year	Code	Fuel	CC	Power	Price
A5 (8T3)	3.0	06/00→	CCWA	Diesel	2967	6	319
A5 (8T3)	3.0	03/00→	CCWB	Diesel	2967	6	320
A5 Convertible (8F7)	1.8	10/01→	CABD	Petrol	1798	4	88
A5 Convertible (8F7)	1.8	09/00→	CDHB	Petrol	1798	4	91
A5 Convertible (8F7)	2.0	03/00→	CAEA	Petrol	1984	4	174
A5 Convertible (8F7)	2.0	03/00→	CAEB	Petrol	1984	4	175
A5 Convertible (8F7)	2.0	05/00→	CAHA	Diesel	1968	4	179
A5 Convertible (8F7)	2.0	05/00→	CAHB	Diesel	1968	4	180
A5 Convertible (8F7)	2.0	03/00→	CDNB	Petrol	1984	4	193
A5 Convertible (8F7)	2.0	03/00→	CDNC	Petrol	1984	4	194
A5 Convertible (8F7)	2.0	10/01→	CGLC	Diesel	1968	4	203
A5 Convertible (8F7)	2.0	05/00→	CGLD	Diesel	1968	4	204
A5 Convertible (8F7)	2.0	10/01→	CJCA	Diesel	1968	4	205
A5 Convertible (8F7)	2.7	03/00→	CGKA	Diesel	2698	6	287
A5 Convertible (8F7)	2.7	05/00→	CGKB	Diesel	2698	6	288
A5 Convertible (8F7)	3.0	06/00→	CAKA	Petrol	2995	6	313
A5 Convertible (8F7)	3.0	03/00→	CCWA	Diesel	2967	6	319
A5 Sportback (8TA)	1.8	11/00→	CDHB	Petrol	1798	4	91
A5 Sportback (8TA)	2.0	09/00→	CAGA	Diesel	1968	4	176
A5 Sportback (8TA)	2.0	09/00→	CAGB	Diesel	1968	4	177
A5 Sportback (8TA)	2.0	09/00→	CAHA	Diesel	1968	4	179
A5 Sportback (8TA)	2.0	09/00→	CAHB	Diesel	1968	4	180
A5 Sportback (8TA)	2.0	09/00→	CDNB	Petrol	1984	4	193
A5 Sportback (8TA)	2.0	09/00→	CDNC	Petrol	1984	4	194
A5 Sportback (8TA)	2.0	10/01→	CGLC	Diesel	1968	4	203
A5 Sportback (8TA)	2.0	09/00→	CGLD	Diesel	1968	4	204
A5 Sportback (8TA)	2.0	09/00→	CJCA	Diesel	1968	4	205
A5 Sportback (8TA)	2.0	09/00→	CJCB	Diesel	1968	4	206
A5 Sportback (8TA)	2.0	09/00→	CMEA	Diesel	1968	4	209
A5 Sportback (8TA)	2.7	09/00→	CGKA	Diesel	2698	6	287
A5 Sportback (8TA)	2.7	09/00→	CGKB	Diesel	2698	6	288
A5 Sportback (8TA)	3.0	01/01→	CAKA	Petrol	2995	6	313
A5 Sportback (8TA)	3.0	09/00→	CCWA	Diesel	2967	6	319
A6 (4A, C4)	1.8	12/99→10/99	ADR	Petrol	1781	4	42
A6 (4A, C4)	1.9	06/99→10/99	IZ	Diesel	1896	4	106
A6 (4A, C4)	1.9	06/99→10/99	AHU	Diesel	1896	4	113
A6 (4A, C4)	2.0	06/99→10/99	AAE	Petrol	1984	4	133
A6 (4A, C4)	2.0	06/99→10/99	ABK	Petrol	1984	4	134
A6 (4A, C4)	2.0	06/99→10/99	ACE	Petrol	1984	4	136
A6 (4A, C4)	2.0	08/99→07/99	ADW	Petrol	1984	4	137
A6 (4A, C4)	2.2	06/99→10/99	AAN	Petrol	2226	5	221
A6 (4A, C4)	2.3	06/99→12/99	AAR	Petrol	2309	5	233
A6 (4A, C4)	2.4	07/99→06/99	AFM	Petrol	2393	6	238
A6 (4A, C4)	2.5	06/99→10/99	AAT	Diesel	2461	5	254
A6 (4A, C4)	2.5	08/99→10/99	AEL	Diesel	2461	5	256
A6 (4A, C4)	2.6	06/99→10/99	ABC	Petrol	2598	6	267
A6 (4A, C4)	2.6	06/99→10/99	ACZ	Petrol	2598	6	268
A6 (4A, C4)	2.8	06/99→10/99	AAH	Petrol	2771	6	289
A6 (4A, C4)	2.8	12/99→10/99	ACK	Petrol	2771	6	290
A6 (4A, C4)	2.8	06/99→10/99	AEJ	Petrol	2771	6	291
A6 (4A, C4)	2.8	06/99→10/99	AFC	Petrol	2771	6	292
A6 (4B, C5)	1.8	01/99→01/00	AEB	Petrol	1781	4	43
A6 (4B, C5)	1.8	05/99→01/00	AFY	Petrol	1781	4	44
A6 (4B, C5)	1.8	12/99→01/00	AJL	Petrol	1781	4	47
A6 (4B, C5)	1.8	07/99→01/00	AJP	Petrol	1781	4	48
A6 (4B, C5)	1.8	01/99→01/00	ANB	Petrol	1781	4	53
A6 (4B, C5)	1.8	07/99→01/00	ANQ	Petrol	1781	4	54
A6 (4B, C5)	1.8	01/99→01/00	APU	Petrol	1781	4	58
A6 (4B, C5)	1.8	07/99→01/00	AQE	Petrol	1781	4	62
A6 (4B, C5)	1.8	07/99→01/00	ARH	Petrol	1781	4	64
A6 (4B, C5)	1.8	01/99→01/00	ARK	Petrol	1781	4	65
A6 (4B, C5)	1.8	01/99→01/00	AWL	Petrol	1781	4	75
A6 (4B, C5)	1.8	01/99→01/00	AWT	Petrol	1781	4	77
A6 (4B, C5)	1.9	04/99→10/00	AFN	Diesel	1896	4	109
A6 (4B, C5)	1.9	07/00→01/00	AJM	Diesel	1896	4	114
A6 (4B, C5)	1.9	08/00→01/00	AVF	Diesel	1896	4	121
A6 (4B, C5)	1.9	04/99→10/00	AVG	Diesel	1896	4	122
A6 (4B, C5)	1.9	08/00→01/00	AWX	Diesel	1896	4	123
A6 (4B, C5)	2.0	08/00→01/00	ALT	Petrol	1984	4	138
A6 (4B, C5)	2.4	02/99→01/00	AGA	Petrol	2393	6	239

	Ltr				CC		9
A6 (4B, C5)	2.4	02/99→01/00	AJG	Petrol	2393	6	240
A6 (4B, C5)	2.4	02/99→01/00	ALF	Petrol	2393	6	241
A6 (4B, C5)	2.4	07/99→01/00	ALW	Petrol	2393	6	242
A6 (4B, C5)	2.4	02/99→01/00	AML	Petrol	2393	6	243
A6 (4B, C5)	2.4	02/99→01/00	AMM	Petrol	2393	6	244
A6 (4B, C5)	2.4	02/99→01/00	APC	Petrol	2393	6	245
A6 (4B, C5)	2.4	02/99→01/00	APS	Petrol	2393	6	246
A6 (4B, C5)	2.4	02/99→01/00	APZ	Petrol	2393	6	247
A6 (4B, C5)	2.4	02/99→01/00	ARJ	Petrol	2393	6	248
A6 (4B, C5)	2.4	07/99→01/00	ARN	Petrol	2393	6	249
A6 (4B, C5)	2.4	07/99→01/00	ASM	Petrol	2393	6	250
A6 (4B, C5)	2.4	08/00→01/00	BDV	Petrol	2393	6	251
A6 (4B, C5)	2.5	07/99→01/00	AFB	Diesel	2496	6	257
A6 (4B, C5)	2.5	02/00→01/00	AKE	Diesel	2496	6	258
A6 (4B, C5)	2.5	07/99→01/00	AKN	Diesel	2496	6	259
A6 (4B, C5)	2.5	08/00→01/00	AYM	Diesel	2496	6	260
A6 (4B, C5)	2.5	02/00→01/00	BAU	Diesel	2496	6	261
A6 (4B, C5)	2.5	07/00→01/00	BCZ	Diesel	2496	6	262
A6 (4B, C5)	2.5	07/00→01/00	BDG	Diesel	2496	6	263
A6 (4B, C5)	2.5	02/00→01/00	BDH	Diesel	2496	6	264
A6 (4B, C5)	2.5	07/00→01/00	BFC	Diesel	2496	6	265
A6 (4B, C5)	2.5	02/00→01/00	BND	Diesel	2496	6	266
A6 (4B, C5)	2.7	12/99→01/00	AJK	Petrol	2671	6	270
A6 (4B, C5)	2.7	05/00→07/00	APB	Petrol	2671	6	271
A6 (4B, C5)	2.7	08/00→01/00	ARE	Petrol	2671	6	272
A6 (4B, C5)	2.7	05/00→07/00	BEL	Petrol	2671	6	277
A6 (4B, C5)	2.7	08/00→01/00	BES	Petrol	2671	6	278
A6 (4B, C5)	2.8	02/99→01/00	ACK	Petrol	2771	6	290
A6 (4B, C5)	2.8	10/99→05/00	AGE	Petrol	2771	6	293
A6 (4B, C5)	2.8	02/99→01/00	ALG	Petrol	2771	6	294
A6 (4B, C5)	2.8	02/99→01/00	AMX	Petrol	2771	6	295
A6 (4B, C5)	2.8	02/99→01/00	APR	Petrol	2771	6	296
A6 (4B, C5)	2.8	02/99→01/00	AQD	Petrol	2771	6	297
A6 (4B, C5)	2.8	07/99→01/00	ATX	Petrol	2771	6	298
A6 (4B, C5)	2.8	07/99→01/00	BBG	Petrol	2771	6	299
A6 (4B, C5)	3.0	08/00→01/00	ASN	Petrol	2976	6	304
A6 (4B, C5)	3.0	06/00→07/00	BBJ	Petrol	2976	6	306
A6 (4F2, C6)	2.0	07/00→10/00	BLB	Diesel	1968	4	146
A6 (4F2, C6)	2.0	07/00→03/01	BNA	Diesel	1968	4	153
A6 (4F2, C6)	2.0	06/00→03/01	BPJ	Petrol	1984	4	155
A6 (4F2, C6)	2.0	07/00→10/00	BRE	Diesel	1968	4	160
A6 (4F2, C6)	2.0	07/00→03/01	BRF	Diesel	1968	4	161
A6 (4F2, C6)	2.0	09/00→06/00	BVG	Diesel	1968	4	165
A6 (4F2, C6)	2.0	06/00→03/01	BYK	Petrol	1984	4	171
A6 (4F2, C6)	2.0	07/00→03/01	CAGB	Diesel	1968	4	177
A6 (4F2, C6)	2.0	11/00→03/01	CAHA	Diesel	1968	4	179
A6 (4F2, C6)	2.0	04/00→03/01	CAHB	Diesel	1968	4	180
A6 (4F2, C6)	2.4	05/00→10/00	BDW	Petrol	2393	6	252
A6 (4F2, C6)	2.7	11/00→10/00	BPP	Diesel	2698	6	279
A6 (4F2, C6)	2.7	11/00→03/01	BSG	Diesel	2698	6	280
A6 (4F2, C6)	2.7	10/00→03/01	CANA	Diesel	2698	6	283
A6 (4F2, C6)	2.7	11/00→03/01	CANB	Diesel	2698	6	284
A6 (4F2, C6)	2.7	10/00→03/01	CANC	Diesel	2698	6	285
A6 (4F2, C6)	2.7	06/00→03/01	CAND	Diesel	2698	6	286
A6 (4F2, C6)	2.8	11/00→10/00	BDX	Petrol	2773	6	300
A6 (4F2, C6)	2.8	10/00→03/01	CCDA	Petrol	2773	6	301
A6 (4F2, C6)	2.8	10/00→03/01	CCEA	Petrol	2773	6	302
A6 (4F2, C6)	3.0	06/00→03/01	ASB	Diesel	2967	6	303
A6 (4F2, C6)	3.0	05/00→05/00	BBJ	Petrol	2976	6	306
A6 (4F2, C6)	3.0	05/00→05/00	BMK	Diesel	2967	6	308
A6 (4F2, C6)	3.0	05/00→03/01	BNG	Diesel	2967	6	309
A6 (4F2, C6)	3.0	10/00→03/01	CAJA	Petrol	2995	6	312
A6 (4F2, C6)	3.0	10/00→03/01	CDYA	Diesel	2967	6	321
A6 (4F2, C6)	3.0	05/00→03/01	CDYB	Diesel	2967	6	322
A6 (4F2, C6)	3.0	10/00→03/01	CDYC	Diesel	2967	6	323
A6 (4G2, C7)	2.0	03/01→05/01	CAEB	Petrol	1984	4	175
A6 (4G2, C7)	2.0	05/01→	CDNB	Petrol	1984	4	193
A6 (4G2, C7)	2.0	03/01→	CGLC	Diesel	1968	4	203
A6 (4G2, C7)	2.0	03/01→	CGLD	Diesel	1968	4	204
A6 (4G2, C7)	2.0	03/01→	CMGB	Diesel	1968	4	211



Ltr







CC



9

Model	Ltr	Period	Code	Fuel	CC	Power	Price
A6 Allroad (4FH, C6)	2.7	05/00→10/00	BPP	Diesel	2698	6	279
A6 Allroad (4FH, C6)	2.7	05/00→08/01	BSG	Diesel	2698	6	280
A6 Allroad (4FH, C6)	2.7	10/00→08/01	CANC	Diesel	2698	6	285
A6 Allroad (4FH, C6)	2.7	05/00→08/01	CAND	Diesel	2698	6	286
A6 Allroad (4FH, C6)	3.0	05/00→10/00	ASB	Diesel	2967	6	303
A6 Allroad (4FH, C6)	3.0	05/00→08/01	BNG	Diesel	2967	6	309
A6 Allroad (4FH, C6)	3.0	10/00→08/01	CAJA	Petrol	2995	6	312
A6 Allroad (4FH, C6)	3.0	10/00→08/01	COYA	Diesel	2967	6	321
A6 Allroad (4FH, C6)	3.0	05/00→08/01	CDYB	Diesel	2967	6	322
A6 Allroad (4FH, C6)	3.0	10/00→08/01	CDYC	Diesel	2967	6	323
A6 Avant (4A, C4)	1.8	12/99→12/99	ADR	Petrol	1781	4	42
A6 Avant (4A, C4)	1.9	06/99→12/99	1Z	Diesel	1896	4	106
A6 Avant (4A, C4)	1.9	06/99→12/99	AHU	Diesel	1896	4	113
A6 Avant (4A, C4)	2.0	06/99→12/99	AAE	Petrol	1984	4	133
A6 Avant (4A, C4)	2.0	06/99→12/99	ABK	Petrol	1984	4	134
A6 Avant (4A, C4)	2.0	06/99→12/99	ACE	Petrol	1984	4	136
A6 Avant (4A, C4)	2.2	06/99→12/99	AAN	Petrol	2226	5	221
A6 Avant (4A, C4)	2.3	06/99→12/99	AAR	Petrol	2309	5	233
A6 Avant (4A, C4)	2.4	07/99→12/99	AFM	Petrol	2393	6	238
A6 Avant (4A, C4)	2.5	06/99→12/99	AAT	Diesel	2461	5	254
A6 Avant (4A, C4)	2.5	08/99→12/99	AEL	Diesel	2461	5	256
A6 Avant (4A, C4)	2.6	06/99→12/99	ABC	Petrol	2598	6	267
A6 Avant (4A, C4)	2.6	06/99→02/99	ACZ	Petrol	2598	6	268
A6 Avant (4A, C4)	2.8	06/99→12/99	AAH	Petrol	2771	6	289
A6 Avant (4A, C4)	2.8	12/99→12/99	ACK	Petrol	2771	6	290
A6 Avant (4A, C4)	2.8	06/99→12/99	AEJ	Petrol	2771	6	291
A6 Avant (4B, C5)	1.8	12/99→01/00	AEB	Petrol	1781	4	43
A6 Avant (4B, C5)	1.8	02/99→01/00	AFY	Petrol	1781	4	44
A6 Avant (4B, C5)	1.8	12/99→01/00	AJL	Petrol	1781	4	47
A6 Avant (4B, C5)	1.8	12/99→01/00	AJP	Petrol	1781	4	48
A6 Avant (4B, C5)	1.8	12/99→01/00	ANB	Petrol	1781	4	53
A6 Avant (4B, C5)	1.8	12/99→01/00	APU	Petrol	1781	4	58
A6 Avant (4B, C5)	1.8	12/99→01/00	AQE	Petrol	1781	4	62
A6 Avant (4B, C5)	1.8	12/99→01/00	ARH	Petrol	1781	4	64
A6 Avant (4B, C5)	1.8	12/99→01/00	ARK	Petrol	1781	4	65
A6 Avant (4B, C5)	1.8	12/99→01/00	AWT	Petrol	1781	4	77
A6 Avant (4B, C5)	1.9	02/99→04/00	AFN	Diesel	1896	4	109
A6 Avant (4B, C5)	1.9	07/00→01/00	AJM	Diesel	1896	4	114
A6 Avant (4B, C5)	1.9	08/00→01/00	AVF	Diesel	1896	4	121
A6 Avant (4B, C5)	1.9	08/00→01/00	AWX	Diesel	1896	4	123
A6 Avant (4B, C5)	2.0	08/00→01/00	ALT	Petrol	1984	4	138
A6 Avant (4B, C5)	2.4	12/99→01/00	AGA	Petrol	2393	6	239
A6 Avant (4B, C5)	2.4	12/99→01/00	AJG	Petrol	2393	6	240
A6 Avant (4B, C5)	2.4	12/99→01/00	ALF	Petrol	2393	6	241
A6 Avant (4B, C5)	2.4	07/99→01/00	ALW	Petrol	2393	6	242
A6 Avant (4B, C5)	2.4	12/99→01/00	AML	Petrol	2393	6	243
A6 Avant (4B, C5)	2.4	12/99→01/00	AMM	Petrol	2393	6	244
A6 Avant (4B, C5)	2.4	12/99→01/00	APC	Petrol	2393	6	245
A6 Avant (4B, C5)	2.4	12/99→01/00	APS	Petrol	2393	6	246
A6 Avant (4B, C5)	2.4	12/99→01/00	APZ	Petrol	2393	6	247
A6 Avant (4B, C5)	2.4	12/99→01/00	ARJ	Petrol	2393	6	248
A6 Avant (4B, C5)	2.4	07/99→01/00	ARN	Petrol	2393	6	249
A6 Avant (4B, C5)	2.4	07/99→01/00	ASM	Petrol	2393	6	250
A6 Avant (4B, C5)	2.4	08/00→01/00	BDV	Petrol	2393	6	251
A6 Avant (4B, C5)	2.5	12/99→01/00	AFB	Diesel	2496	6	257
A6 Avant (4B, C5)	2.5	02/00→01/00	AKE	Diesel	2496	6	258
A6 Avant (4B, C5)	2.5	12/99→01/00	AKN	Diesel	2496	6	259
A6 Avant (4B, C5)	2.5	08/00→01/00	AYM	Diesel	2496	6	260
A6 Avant (4B, C5)	2.5	02/00→01/00	BAU	Diesel	2496	6	261
A6 Avant (4B, C5)	2.5	07/00→01/00	BCZ	Diesel	2496	6	262
A6 Avant (4B, C5)	2.5	07/00→01/00	BDG	Diesel	2496	6	263
A6 Avant (4B, C5)	2.5	02/00→01/00	BDH	Diesel	2496	6	264
A6 Avant (4B, C5)	2.5	07/00→01/00	BFC	Diesel	2496	6	265
A6 Avant (4B, C5)	2.7	12/99→01/00	AJK	Petrol	2671	6	270
A6 Avant (4B, C5)	2.7	08/00→01/00	ARE	Petrol	2671	6	272
A6 Avant (4B, C5)	2.7	12/99→01/00	AZA	Petrol	2671	6	274
A6 Avant (4B, C5)	2.7	08/00→01/00	BES	Petrol	2671	6	278
A6 Avant (4B, C5)	2.8	12/99→01/00	ACK	Petrol	2771	6	290
A6 Avant (4B, C5)	2.8	12/99→05/00	AGE	Petrol	2771	6	293
A6 Avant (4B, C5)	2.8	12/99→01/00	ALG	Petrol	2771	6	294

	Ltr				CC		9
A6 Avant (4B, C5)	2.8	12/99→01/00	AMX	Petrol	2771	6	295
A6 Avant (4B, C5)	2.8	12/99→01/00	APR	Petrol	2771	6	296
A6 Avant (4B, C5)	2.8	12/99→01/00	AQD	Petrol	2771	6	297
A6 Avant (4B, C5)	2.8	07/99→01/00	ATX	Petrol	2771	6	298
A6 Avant (4B, C5)	3.0	08/00→01/00	ASN	Petrol	2976	6	304
A6 Avant (4F5, C6)	2.0	06/00→10/00	BLB	Diesel	1968	4	146
A6 Avant (4F5, C6)	2.0	06/00→08/01	BNA	Diesel	1968	4	153
A6 Avant (4F5, C6)	2.0	06/00→08/01	BPJ	Petrol	1984	4	155
A6 Avant (4F5, C6)	2.0	06/00→10/00	BRE	Diesel	1968	4	160
A6 Avant (4F5, C6)	2.0	06/00→08/01	BRF	Diesel	1968	4	161
A6 Avant (4F5, C6)	2.0	09/00→06/00	BVG	Diesel	1968	4	165
A6 Avant (4F5, C6)	2.0	06/00→08/01	CAGB	Diesel	1968	4	177
A6 Avant (4F5, C6)	2.0	10/00→08/01	CAHA	Diesel	1968	4	179
A6 Avant (4F5, C6)	2.0	04/00→08/01	CAHB	Diesel	1968	4	180
A6 Avant (4F5, C6)	2.4	03/00→10/00	BDW	Petrol	2393	6	252
A6 Avant (4F5, C6)	2.7	03/00→10/00	BPP	Diesel	2698	6	279
A6 Avant (4F5, C6)	2.7	03/00→08/01	BSG	Diesel	2698	6	280
A6 Avant (4F5, C6)	2.7	10/00→08/01	CANA	Diesel	2698	6	283
A6 Avant (4F5, C6)	2.7	03/00→08/01	CANB	Diesel	2698	6	284
A6 Avant (4F5, C6)	2.7	10/00→08/01	CANC	Diesel	2698	6	285
A6 Avant (4F5, C6)	2.7	06/00→08/01	CAND	Diesel	2698	6	286
A6 Avant (4F5, C6)	2.8	11/00→10/00	BDX	Petrol	2773	6	300
A6 Avant (4F5, C6)	2.8	10/00→08/01	CCDA	Petrol	2773	6	301
A6 Avant (4F5, C6)	2.8	10/00→08/01	CCEA	Petrol	2773	6	302
A6 Avant (4F5, C6)	3.0	06/00→08/01	ASB	Diesel	2967	6	303
A6 Avant (4F5, C6)	3.0	03/00→05/00	BBJ	Petrol	2976	6	306
A6 Avant (4F5, C6)	3.0	03/00→05/00	BMK	Diesel	2967	6	308
A6 Avant (4F5, C6)	3.0	03/00→08/01	BNG	Diesel	2967	6	309
A6 Avant (4F5, C6)	3.0	10/00→08/01	CAJA	Petrol	2995	6	312
A6 Avant (4F5, C6)	3.0	10/00→08/01	CDYA	Diesel	2967	6	321
A6 Avant (4F5, C6)	3.0	03/00→08/01	CDYB	Diesel	2967	6	322
A6 Avant (4F5, C6)	3.0	10/00→08/01	CDYC	Diesel	2967	6	323
A6 Avant (4G5, C7)	2.0	06/01→	CDNB	Petrol	1984	4	193
A6 Avant (4G5, C7)	2.0	05/01→	CGLC	Diesel	1968	4	203
A6 Avant (4G5, C7)	2.0	05/01→	CGLD	Diesel	1968	4	204
A6 Avant (4G5, C7)	2.0	05/01→	CMGB	Diesel	1968	4	211
A8 (4D2, 4D8)	2.5	01/99→04/00	AFB	Diesel	2496	6	257
A8 (4D2, 4D8)	2.5	09/00→09/00	AKE	Diesel	2496	6	258
A8 (4D2, 4D8)	2.5	01/99→04/00	AKN	Diesel	2496	6	259
A8 (4D2, 4D8)	2.8	03/99→03/99	AAH	Petrol	2771	6	289
A8 (4D2, 4D8)	2.8	04/99→09/00	ACK	Petrol	2771	6	290
A8 (4D2, 4D8)	2.8	07/99→03/99	AEJ	Petrol	2771	6	291
A8 (4D2, 4D8)	2.8	04/99→09/00	ALG	Petrol	2771	6	294
A8 (4D2, 4D8)	2.8	04/99→09/00	AMX	Petrol	2771	6	295
A8 (4D2, 4D8)	2.8	04/99→09/00	APR	Petrol	2771	6	296
A8 (4D2, 4D8)	2.8	04/99→09/00	AQD	Petrol	2771	6	297
A8 (4D2, 4D8)	3.3	06/00→09/00	AKF	Diesel	3328	8	329
A8 (4E_)	2.8	08/00→07/01	BDX	Petrol	2773	6	300
A8 (4E_)	3.0	08/00→07/01	ASB	Diesel	2967	6	303
A8 (4E_)	3.0	07/00→05/00	ASN	Petrol	2976	6	304
A8 (4E_)	3.0	07/00→05/00	BBJ	Petrol	2976	6	306
A8 (4E_)	3.0	11/00→07/01	BNG	Diesel	2967	6	309
ALLROAD (4BH, C5)	2.5	05/00→08/00	AKE	Diesel	2496	6	258
ALLROAD (4BH, C5)	2.5	05/00→08/00	BAU	Diesel	2496	6	261
ALLROAD (4BH, C5)	2.5	05/00→08/00	BCZ	Diesel	2496	6	262
ALLROAD (4BH, C5)	2.7	09/00→08/00	APB	Petrol	2671	6	271
ALLROAD (4BH, C5)	2.7	05/00→08/00	ARE	Petrol	2671	6	272
ALLROAD (4BH, C5)	2.7	09/00→08/00	BEL	Petrol	2671	6	277
ALLROAD (4BH, C5)	2.7	05/00→08/00	BES	Petrol	2671	6	278
CABRIOLET (8G7, B4)	1.8	01/99→08/00	ADR	Petrol	1781	4	42
CABRIOLET (8G7, B4)	1.9	06/99→08/00	1Z	Diesel	1896	4	106
CABRIOLET (8G7, B4)	1.9	06/99→08/00	AHU	Diesel	1896	4	113
CABRIOLET (8G7, B4)	2.0	01/99→07/99	ABK	Petrol	1984	4	134
CABRIOLET (8G7, B4)	2.0	06/99→07/99	ACE	Petrol	1984	4	136
CABRIOLET (8G7, B4)	2.3	05/99→07/99	NG	Petrol	2309	5	235
CABRIOLET (8G7, B4)	2.6	06/99→08/00	ABC	Petrol	2598	6	267
CABRIOLET (8G7, B4)	2.6	05/99→08/00	ACZ	Petrol	2598	6	268
CABRIOLET (8G7, B4)	2.8	11/99→08/00	AAH	Petrol	2771	6	289
COUPE (81, 85)	1.8	09/98→10/98	DS	Petrol	1781	4	92
COUPE (81, 85)	1.8	12/98→10/98	DZ	Petrol	1781	4	93



Ltr















CC









9

	Ltr				CC		
COUPE (81, 85)	1.8	01/98→10/98	JN	Petrol	1781	4	94
COUPE (81, 85)	1.8	09/98→10/98	JV	Petrol	1781	4	95
COUPE (81, 85)	1.8	09/98→10/98	NE	Petrol	1781	4	97
COUPE (81, 85)	1.8	04/98→10/98	SF	Petrol	1781	4	103
COUPE (81, 85)	2.0	03/98→04/98	SK	Petrol	1994	5	216
COUPE (81, 85)	2.2	09/98→10/98	HY	Petrol	2226	5	225
COUPE (81, 85)	2.2	08/98→10/98	JT	Petrol	2226	5	226
COUPE (81, 85)	2.2	09/98→10/98	KV	Petrol	2226	5	228
COUPE (81, 85)	2.3	01/98→10/98	NG	Petrol	2309	5	235
COUPE (89, 88)	1.8	08/98→07/99	DZ	Petrol	1781	4	93
COUPE (89, 88)	2.0	05/98→07/99	3A	Petrol	1984	4	130
COUPE (89, 88)	2.0	05/98→12/99	AAD	Petrol	1984	4	132
COUPE (89, 88)	2.0	05/98→12/99	ABK	Petrol	1984	4	134
COUPE (89, 88)	2.0	08/99→12/99	ACE	Petrol	1984	4	136
COUPE (89, 88)	2.0	08/98→07/99	NM	Petrol	1994	5	213
COUPE (89, 88)	2.2	09/99→09/99	3B	Petrol	2226	5	220
COUPE (89, 88)	2.2	10/99→12/99	ABY	Petrol	2226	5	222
COUPE (89, 88)	2.2	11/98→07/99	KV	Petrol	2226	5	228
COUPE (89, 88)	2.3	11/98→12/99	7A	Petrol	2309	5	232
COUPE (89, 88)	2.3	10/98→12/99	NG	Petrol	2309	5	235
COUPE (89, 88)	2.6	08/99→12/99	ABC	Petrol	2598	6	267
COUPE (89, 88)	2.8	08/99→12/99	AAH	Petrol	2771	6	289
Q3 (8U)	2.0	06/01→	CCZC	Petrol	1984	4	188
Q3 (8U)	2.0	09/01→	CFFA	Diesel	1968	4	195
Q3 (8U)	2.0	09/01→	CFFB	Diesel	1968	4	196
Q5 (8R)	2.0	11/00→	CAEB	Petrol	1984	4	175
Q5 (8R)	2.0	08/00→	CAGA	Diesel	1968	4	176
Q5 (8R)	2.0	08/00→	CAGB	Diesel	1968	4	177
Q5 (8R)	2.0	11/00→	CAHA	Diesel	1968	4	179
Q5 (8R)	2.0	11/00→	CAHB	Diesel	1968	4	180
Q5 (8R)	2.0	08/00→	CDNB	Petrol	1984	4	193
Q5 (8R)	2.0	11/00→	CDNC	Petrol	1984	4	194
Q5 (8R)	2.0	11/00→	CGLA	Diesel	1968	4	201
Q5 (8R)	2.0	11/00→	CGLB	Diesel	1968	4	202
Q5 (8R)	2.0	06/01→	CGLC	Diesel	1968	4	203
Q5 (8R)	2.0	11/00→	CGLD	Diesel	1968	4	204
Q5 (8R)	2.0	08/00→	CJCA	Diesel	1968	4	205
Q5 (8R)	2.0	08/00→	CJCB	Diesel	1968	4	206
Q5 (8R)	2.0	11/00→	CMGA	Diesel	1968	4	210
Q5 (8R)	2.0	06/01→	CMGB	Diesel	1968	4	211
Q5 (8R)	3.0	11/00→	CCWA	Diesel	2967	6	319
Q5 (8R)	3.0	11/00→	CCWB	Diesel	2967	6	320
Q7 (4L)	3.0	03/00→05/00	BUG	Diesel	2967	6	310
Q7 (4L)	3.0	03/00→05/01	BUN	Diesel	2967	6	311
Q7 (4L)	3.0	11/00→	CASA	Diesel	2967	6	315
Q7 (4L)	3.0	03/00→05/01	CASB	Diesel	2967	6	316
Q7 (4L)	3.0	06/00→05/01	CATA	Diesel	2967	6	317
Q7 (4L)	3.0	11/00→	CCMA	Diesel	2967	6	318
QUATTRO (85)	2.1	02/98→07/98	WX	Petrol	2144	5	217
QUATTRO (85)	2.2	08/98→07/98	1B	Petrol	2226	5	218
QUATTRO (85)	2.2	08/98→07/98	MB	Petrol	2226	5	229
QUATTRO (85)	2.2	08/98→07/99	RR	Petrol	2226	5	231
TT (8J3)	1.8	06/00→	CDAA	Petrol	1798	4	89
TT (8J3)	2.0	08/00→06/01	BPY	Petrol	1984	4	157
TT (8J3)	2.0	08/00→06/01	BWA	Petrol	1984	4	168
TT (8J3)	2.0	06/00→	CBBB	Diesel	1968	4	184
TT (8J3)	2.0	08/00→06/01	CCTA	Petrol	1984	4	186
TT (8J3)	2.0	06/00→06/01	CCZA	Petrol	1984	4	187
TT (8J3)	2.0	05/00→	CDLA	Petrol	1984	4	189
TT (8J3)	2.0	05/00→	CDLB	Petrol	1984	4	190
TT (8J3)	2.0	05/00→	CDMA	Petrol	1984	4	192
TT (8J3)	2.0	06/00→	CFGB	Diesel	1968	4	197
TT (8J3)	3.2	08/00→06/01	BUB	Petrol	3189	6	328
TT (8N3)	1.8	10/99→06/00	AJQ	Petrol	1781	4	49
TT (8N3)	1.8	10/99→06/00	AMU	Petrol	1781	4	52
TT (8N3)	1.8	10/99→06/00	APP	Petrol	1781	4	56
TT (8N3)	1.8	10/99→06/00	APX	Petrol	1781	4	59
TT (8N3)	1.8	10/99→06/00	ARY	Petrol	1781	4	67
TT (8N3)	1.8	10/99→06/00	ATC	Petrol	1781	4	69
TT (8N3)	1.8	09/00→06/00	AUM	Petrol	1781	4	71

	Ltr				CC		9
TT (8N3)	1.8	10/99→06/00	AUQ	Petrol	1781	4	72
TT (8N3)	1.8	10/99→06/00	AWP	Petrol	1781	4	76
TT (8N3)	1.8	10/99→06/00	BAM	Petrol	1781	4	78
TT (8N3)	1.8	03/00→06/00	BFV	Petrol	1781	4	81
TT (8N3)	1.8	09/00→06/00	BVP	Petrol	1781	4	82
TT (8N3)	1.8	09/00→06/00	BVR	Petrol	1781	4	83
TT (8N3)	3.2	07/00→06/00	BHE	Petrol	3189	6	325
TT (8N3)	3.2	07/00→06/00	BPF	Petrol	3189	6	327
TT Roadster (8J9)	1.8	06/00→	CDAA	Petrol	1798	4	89
TT Roadster (8J9)	2.0	03/00→06/01	BPY	Petrol	1984	4	157
TT Roadster (8J9)	2.0	03/00→06/01	BWA	Petrol	1984	4	168
TT Roadster (8J9)	2.0	06/00→	CBBB	Diesel	1968	4	184
TT Roadster (8J9)	2.0	03/00→06/01	CCTA	Petrol	1984	4	186
TT Roadster (8J9)	2.0	06/00→06/01	CCZA	Petrol	1984	4	187
TT Roadster (8J9)	2.0	05/00→	CDLA	Petrol	1984	4	189
TT Roadster (8J9)	2.0	05/00→	CDLB	Petrol	1984	4	190
TT Roadster (8J9)	2.0	05/00→	CDMA	Petrol	1984	4	192
TT Roadster (8J9)	2.0	06/00→	CFGB	Diesel	1968	4	197
TT Roadster (8J9)	3.2	03/00→06/01	BUB	Petrol	3189	6	328
TT Roadster (8N9)	1.8	10/99→06/00	AJQ	Petrol	1781	4	49
TT Roadster (8N9)	1.8	10/99→06/00	AMU	Petrol	1781	4	52
TT Roadster (8N9)	1.8	10/99→06/00	APP	Petrol	1781	4	56
TT Roadster (8N9)	1.8	10/99→06/00	APX	Petrol	1781	4	59
TT Roadster (8N9)	1.8	02/00→06/00	ARY	Petrol	1781	4	67
TT Roadster (8N9)	1.8	10/99→06/00	ATC	Petrol	1781	4	69
TT Roadster (8N9)	1.8	01/00→06/00	AUM	Petrol	1781	4	71
TT Roadster (8N9)	1.8	10/99→06/00	AUQ	Petrol	1781	4	72
TT Roadster (8N9)	1.8	10/99→06/00	AWP	Petrol	1781	4	76
TT Roadster (8N9)	1.8	10/99→06/00	BAM	Petrol	1781	4	78
TT Roadster (8N9)	1.8	09/00→06/00	BVP	Petrol	1781	4	82
TT Roadster (8N9)	1.8	09/00→06/00	BVR	Petrol	1781	4	83
TT Roadster (8N9)	3.2	07/00→06/00	BHE	Petrol	3189	6	325
TT Roadster (8N9)	3.2	07/00→06/00	BPF	Petrol	3189	6	327

		CC			9			CC			9
1B	Petrol	2226	5	81.00	218	AMB	Petrol	1781	4	81.00	50
1T	Diesel	2461	5	81.00	253	AMF	Diesel	1422	3	79.50	4
1Y	Diesel	1896	4	79.50	105	AMK	Petrol	1781	4	81.00	51
1Z	Diesel	1896	4	79.50	106	AML	Petrol	2393	6	81.00	243
2B	Petrol	2226	5	81.00	219	AMM	Petrol	2393	6	81.00	244
3A	Petrol	1984	4	82.50	130	AMU	Petrol	1781	4	81.00	52
3B	Petrol	2226	5	81.00	220	AMX	Petrol	2771	6	82.50	295
3D	Diesel	2370	5	79.50	236	ANA	Petrol	1595	4	81.00	21
4B	Petrol	1781	4	81.00	41	ANB	Petrol	1781	4	81.40	53
6A	Petrol	1984	4	82.50	131	ANQ	Petrol	1781	4	81.00	54
7A	Petrol	2309	5	82.50	232	ANY	Diesel	1191	3	76.50	1
AAD	Petrol	1984	4	82.50	132	APB	Petrol	2671	6	81.00	271
AAE	Petrol	1984	4	82.50	133	APC	Petrol	2393	6	81.00	245
AAH	Petrol	2771	6	82.50	289	APF	Petrol	1595	4	81.00	22
AAN	Petrol	2226	5	81.00	221	APG	Petrol	1781	4	81.00	55
AAR	Petrol	2309	5	82.50	233	APP	Petrol	1781	4	81.00	56
AAS	Diesel	2370	5	79.50	237	APR	Petrol	2771	6	82.50	296
AAT	Diesel	2461	5	81.00	254	APS	Petrol	2393	6	81.00	246
AAZ	Diesel	1896	4	79.50	107	APT	Petrol	1781	4	81.00	57
ABB	Petrol	1595	4	81.00	13	APU	Petrol	1781	4	81.00	58
ABC	Petrol	2598	6	82.50	267	APX	Petrol	1781	4	81.00	59
ABK	Petrol	1984	4	82.50	134	APY	Petrol	1781	4	81.00	60
ABM	Petrol	1595	4	81.00	14	APZ	Petrol	2393	6	81.00	247
ABP	Diesel	2461	5	81.00	255	AQA	Petrol	1781	4	81.00	61
ABT	Petrol	1984	4	82.50	135	AQD	Petrol	2771	6	82.50	297
ABY	Petrol	2226	5	81.00	222	AQE	Petrol	1781	4	81.00	62
ACE	Petrol	1984	4	82.50	136	ARE	Petrol	2671	6	81.00	272
ACK	Petrol	2771	6	82.50	290	ARG	Petrol	1781	4	81.00	63
ACZ	Petrol	2598	6	82.50	268	ARH	Petrol	1781	4	81.00	64
ADA	Petrol	1595	4	81.00	15	ARJ	Petrol	2393	6	81.00	248
ADP	Petrol	1595	4	81.00	16	ARK	Petrol	1781	4	81.00	65
ADR	Petrol	1781	4	81.00	42	ARM	Petrol	1595	4	81.00	23
ADU	Petrol	2226	5	81.00	223	ARN	Petrol	2393	6	81.00	249
ADW	Petrol	1984	4	82.50	137	ARX	Petrol	1781	4	81.00	66
AEB	Petrol	1781	4	81.00	43	ARY	Petrol	1781	4	81.00	67
AEH	Petrol	1595	4	81.00	17	ARZ	Petrol	1781	4	81.00	68
AEJ	Petrol	2771	6	82.50	291	ASB	Diesel	2967	6	83.00	303
AEL	Diesel	2461	5	81.00	256	ASJ	Petrol	2671	6	81.00	273
AFB	Diesel	2496	6	78.30	257	ASM	Petrol	2393	6	81.00	250
AFC	Petrol	2771	6	82.50	292	ASN	Petrol	2976	6	82.50	304
AFF	Diesel	1896	4	79.50	108	ASV	Diesel	1896	4	79.50	116
AFM	Petrol	2393	6	81.00	238	ASZ	Diesel	1896	4	79.50	117
AFN	Diesel	1896	4	79.50	109	ATC	Petrol	1781	4	81.00	69
AFY	Petrol	1781	4	81.00	44	ATD	Diesel	1896	4	79.50	118
AGA	Petrol	2393	6	81.00	239	ATJ	Diesel	1896	4	79.50	119
AGB	Petrol	2671	6	81.00	269	ATL	Diesel	1422	3	79.50	5
AGE	Petrol	2771	6	82.50	293	ATX	Petrol	2771	6	82.50	298
AGN	Petrol	1781	4	81.00	45	AUA	Petrol	1390	4	76.50	6
AGR	Diesel	1896	4	79.50	110	AUL	Petrol	1781	4	81.00	70
AGU	Petrol	1781	4	81.00	46	AUM	Petrol	1781	4	81.00	71
AHF	Diesel	1896	4	79.50	111	AUQ	Petrol	1781	4	81.00	72
AHH	Diesel	1896	4	79.50	112	AVB	Diesel	1896	4	79.50	120
AHL	Petrol	1595	4	81.00	18	AVF	Diesel	1896	4	79.50	121
AHU	Diesel	1896	4	79.50	113	AVG	Diesel	1896	4	79.50	122
AJG	Petrol	2393	6	81.00	240	AVJ	Petrol	1781	4	81.00	73
AJK	Petrol	2671	6	81.00	270	AVK	Petrol	2976	6	82.50	305
AJL	Petrol	1781	4	81.00	47	AVU	Petrol	1595	4	81.00	24
AJM	Diesel	1896	4	79.50	114	AVV	Petrol	1781	4	81.00	74
AJP	Petrol	1781	4	81.00	48	AWA	Petrol	1984	4	82.50	139
AJQ	Petrol	1781	4	81.00	49	AWL	Petrol	1781	4	81.00	75
AKE	Diesel	2496	6	78.30	258	AWP	Petrol	1781	4	81.00	76
AKF	Diesel	3328	8	78.30	329	AWT	Petrol	1781	4	81.00	77
AKL	Petrol	1595	4	81.00	19	AWX	Diesel	1896	4	79.50	123
AKN	Diesel	2496	6	78.30	259	AXR	Diesel	1896	4	79.50	124
ALF	Petrol	2393	6	81.00	241	AXW	Petrol	1984	4	82.50	140
ALG	Petrol	2771	6	82.50	294	AXX	Petrol	1984	4	82.50	141
ALH	Diesel	1896	4	79.50	115	AYM	Diesel	2496	6	78.30	260
ALT	Petrol	1984	4	82.50	138	AZA	Petrol	2671	6	81.00	274
ALW	Petrol	2393	6	81.00	242	AZB	Petrol	2671	6	81.00	275
ALZ	Petrol	1595	4	81.00	20	AZR	Petrol	2671	6	81.00	276

		CC			9			CC			9
AZV	Diesel	1968	4	81.00	142	BVZ	Petrol	1984	4	82.50	167
BAD	Petrol	1598	4	76.50	25	BWA	Petrol	1984	4	82.50	168
BAG	Petrol	1598	4	76.50	26	BWE	Petrol	1984	4	82.50	169
BAM	Petrol	1781	4	81.00	78	BWT	Petrol	1984	4	82.50	170
BAU	Diesel	2496	6	78.30	261	BXE	Diesel	1896	4	79.50	129
BBG	Petrol	2771	6	82.50	299	BYK	Petrol	1984	4	82.50	171
BBJ	Petrol	2976	6	82.50	306	BYT	Petrol	1798	4	82.50	84
BBY	Petrol	1390	4	76.50	7	BZB	Petrol	1798	4	81.00	85
BCZ	Diesel	2496	6	78.30	262	BZC	Petrol	1984	4	82.50	172
BDB	Petrol	3189	6	84.00	324	CABA	Petrol	1798	4	82.50	86
BDG	Diesel	2496	6	78.30	263	CABB	Petrol	1798	4	82.50	87
BDH	Diesel	2496	6	78.30	264	CABD	Petrol	1798	4	82.50	88
BDV	Petrol	2393	6	81.00	251	CADA	Petrol	1984	4	82.50	173
BDW	Petrol	2393	6	81.00	252	CAEA	Petrol	1984	4	82.50	174
BDX	Petrol	2773	6	84.50	300	CAEB	Petrol	1984	4	82.50	175
BEL	Petrol	2671	6	81.00	277	CAGA	Diesel	1968	4	81.00	176
BES	Petrol	2671	6	81.00	278	CAGB	Diesel	1968	4	81.00	177
BEX	Petrol	1781	4	81.00	79	CAGC	Diesel	1968	4	81.00	178
BFB	Petrol	1781	4	81.00	80	CAHA	Diesel	1968	4	81.00	179
BFC	Diesel	2496	6	78.30	265	CAHB	Diesel	1968	4	81.00	180
BFQ	Petrol	1595	4	81.00	27	CAJA	Petrol	2995	6	84.50	312
BFV	Petrol	1781	4	81.00	81	CAKA	Petrol	2995	6		313
BGB	Petrol	1984	4	82.50	143	CAMA	Diesel	2698	6	83.00	281
BGU	Petrol	1595	4	81.00	28	CAMB	Diesel	2698	6	83.00	282
BHC	Diesel	1422	3	79.50	8	CANA	Diesel	2698	6	83.00	283
BHE	Petrol	3189	6	84.00	325	CANB	Diesel	2698	6	83.00	284
BHZ	Petrol	1984	4	82.50	144	CANC	Diesel	2698	6	83.00	285
BKC	Diesel	1896	4	79.50	125	CAND	Diesel	2698	6	83.00	286
BKD	Diesel	1968	4	81.00	145	CAPA	Diesel	2967	6	83.00	314
BKE	Diesel	1896	4	79.50	126	CASA	Diesel	2967	6	83.00	315
BKN	Diesel	2967	6	83.00	307	CASB	Diesel	2967	6	83.00	316
BLB	Diesel	1968	4	81.00	146	CATA	Diesel	2967	6	83.00	317
BLF	Petrol	1598	4	76.50	29	CAWB	Petrol	1984	4	82.50	181
BLP	Petrol	1598	4	76.50	30	CAXA	Petrol	1390	4	76.50	9
BLR	Petrol	1984	4	82.50	147	CAXC	Petrol	1390	4	76.50	10
BLS	Diesel	1896	4	79.50	127	CAYB	Diesel	1598	4	79.50	33
BLX	Petrol	1984	4	82.50	148	CAYC	Diesel	1598	4	79.50	34
BLY	Petrol	1984	4	82.50	149	CBAA	Diesel	1968	4	81.00	182
BMB	Petrol	1984	4	82.50	150	CBAB	Diesel	1968	4	81.00	183
BMJ	Petrol	3189	6	84.00	326	CBBB	Diesel	1968	4	81.00	184
BMK	Diesel	2967	6	83.00	308	CBFA	Petrol	1984	4	82.50	185
BMM	Diesel	1968	4	81.00	151	CBZA	Petrol	1197	4	71.00	2
BMN	Diesel	1968	4	81.00	152	CBZB	Petrol	1197	4	71.00	3
BNA	Diesel	1968	4	81.00	153	CCDA	Petrol	2773	6	84.50	301
BND	Diesel	2496	6	78.30	266	CCFA	Petrol	2773	6	84.50	302
BNG	Diesel	2967	6	83.00	309	CCMA	Diesel	2967	6	83.00	318
BPF	Petrol	3189	6	84.00	327	CCSA	Petrol	1595	4	81.00	35
BPG	Petrol	1984	4	82.50	154	CCTA	Petrol	1984	4	82.50	186
BPJ	Petrol	1984	4	82.50	155	CCWA	Diesel	2967	6	83.00	319
BPP	Diesel	2698	6	81.40	279	CCWB	Diesel	2967	6	83.00	320
BPW	Diesel	1968	4	81.00	156	CCZA	Petrol	1984	4	82.50	187
BPY	Petrol	1984	4	82.50	157	CCZC	Petrol	1984	4	82.50	188
BRB	Diesel	1896	4	79.50	128	CDAA	Petrol	1798	4	82.50	89
BRC	Diesel	1968	4	81.00	158	CDHA	Petrol	1798	4	82.50	90
BRD	Diesel	1968	4	81.00	159	CDHB	Petrol	1798	4	82.50	91
BRE	Diesel	1968	4	81.00	160	CDLA	Petrol	1984	4	82.50	189
BRF	Diesel	1968	4	81.00	161	CDLB	Petrol	1984	4	82.50	190
BSE	Petrol	1595	4	81.00	31	CDLC	Petrol	1984	4	82.50	191
BSF	Petrol	1595	4	81.00	32	CDMA	Petrol	1984	4	82.50	192
BSG	Diesel	2698	6	81.40	280	CDNB	Petrol	1984	4	82.50	193
BUB	Petrol	3189	6	84.00	328	CDNC	Petrol	1984	4	82.50	194
BUG	Diesel	2967	6	83.00	310	CDYA	Diesel	2967	6	83.00	321
BUL	Petrol	1984	4	82.50	162	CDYB	Diesel	2967	6	83.00	322
BUN	Diesel	2967	6	83.00	311	CDYC	Diesel	2967	6	83.00	323
BUY	Diesel	1968	4	81.00	163	CFFA	Diesel	1968	4	81.00	195
BVA	Diesel	1968	4	81.00	164	CFFB	Diesel	1968	4	81.00	196
BVG	Diesel	1968	4	81.00	165	CFGB	Diesel	1968	4	81.00	197
BVP	Petrol	1781	4	81.00	82	CFHB	Diesel	1968	4	81.00	198
BVR	Petrol	1781	4	81.00	83	CFHD	Diesel	1968	4	81.00	199
BVY	Petrol	1984	4	82.50	166	CFKA	Petrol/Ethanol	1984	4	82.50	200



CC



9



CC



9

CGKA	Diesel	2698	6	83.00	287
CGKB	Diesel	2698	6	83.00	288
CGLA	Diesel	1968	4	81.00	201
CGLB	Diesel	1968	4	81.00	202
CGLC	Diesel	1968	4	81.00	203
CGLD	Diesel	1968	4	81.00	204
CJCA	Diesel	1968	4	81.00	205
CJCB	Diesel	1968	4	81.00	206
CJCC	Diesel	1968	4	81.00	207
CLJA	Diesel	1968	4	81.00	208
CMEA	Diesel	1968	4	81.00	209
CMGA	Diesel	1968	4	81.00	210
CMGB	Diesel	1968	4	81.00	211
CMSA	Petrol	1390	4	76.50	11
CMXA	Petrol	1595	4	81.00	36
CMXA	Flexfuel	1595	4	81.00	36
CNVA	Petrol	1390	4	76.50	12
DS	Petrol	1781	4	81.00	92
DZ	Petrol	1781	4	81.00	93
HX	Petrol	2226	5	81.00	224
HY	Petrol	2226	5	81.00	225
JN	Petrol	1781	4	81.00	94
JT	Petrol	2226	5	81.00	226
JV	Petrol	1781	4	81.00	95
JW	Petrol	1781	4	81.00	96
KU	Petrol	2226	5	81.00	227
KV	Petrol	2226	5	81.00	228
MB	Petrol	2226	5	81.00	229
MC	Petrol	2226	5	81.00	230
NC	Diesel	1986	5	76.50	212
NE	Petrol	1781	4	81.00	97
NF	Petrol	2309	5	82.50	234
NG	Petrol	2309	5	82.50	235
NM	Petrol	1994	5	81.00	213
NP	Petrol	1781	4	81.00	98
PH	Petrol	1781	4	81.00	99
PM	Petrol	1781	4	81.00	100
PP	Petrol	1595	4	81.00	37
PS	Petrol	1994	5	81.00	214
RA	Diesel	1588	4	76.50	38
RN	Petrol	1595	4	81.00	39
RR	Petrol	2226	5	81.00	231
RT	Petrol	1994	5	81.00	215
RU	Petrol	1781	4	81.00	101
SB	Diesel	1588	4	76.50	40
SD	Petrol	1847	4	82.50	102
SF	Petrol	1781	4	81.00	103
SH	Petrol	1781	4	81.00	104
SK	Petrol	1994	5	81.00	216
WX	Petrol	2144	5	79.50	217



cc



kW/PS

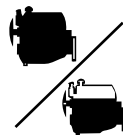

1.2 ANY Diesel							1	AC5190 (MLS), 1.450mm, 1 Hole AC5200 (MLS), 1.530mm, 2 Holes AC5210 (MLS), 1.610mm, 3 Holes	CC5190 ▲ ☒ [3]	ED5650 [18]
A2 1.2 TDI	03/01→08/05	1191	3	76.50	SOHC/OHC	45/61				
1.2 CBZA							2			
A1 1.2 TFSI	05/10→	1197	4	71.00	SOHC/OHC	63/86				
1.2 CBZB							3			
A3 1.2 TSI	04/10→08/12	1197	4	71.00	SOHC/OHC	77/105				
A3 Cabrio TFSI	03/10→									
A3 Sportback	04/10→									
1.4 AMF Diesel							4	AD5650 (MLS), 1.450mm, 1 Hole AD5660 (MLS), 1.530mm, 2 Holes AD5670 (MLS), 1.610mm, 3 Holes	CD5650 ▲	ED5650 [18]
A2 1.4 TDI	02/00→08/05	1422	3	79.50	SOHC/OHC	55/75				
1.4 ATL Diesel							5	AD5650 (MLS), 1.450mm, 1 Hole AD5660 (MLS), 1.530mm, 2 Holes AD5670 (MLS), 1.610mm, 3 Holes	CD5650 ▲	ED5650 [18]
A2 1.4 TDI	11/03→08/05	1422	3	79.50	SOHC/OHC	66/90				
1.4 AUA							6	AB5701 (MLS)	CB5700 ☒	EB5700 [3][18]
A2 1.4	02/00→08/05	1390	4	76.50	DOHC	55/75				
1.4 BBY							7	AB5701 (MLS)	CB5700 ☒	EB5700 [3][18]
A2 1.4	02/00→08/05	1390	4	76.50	DOHC	55/75				
1.4 BHC Diesel							8	AD5650 (MLS), 1.450mm, 1 Hole AD5660 (MLS), 1.530mm, 2 Holes AD5670 (MLS), 1.610mm, 3 Holes	CD5650 ▲	ED5650 [18]
A2 1.4 TDI	02/00→08/05	1422	3	79.50	SOHC/OHC	55/75				
1.4 CAXA							9	AH5960 (MLS), 0.800mm	CH5960	
A1 1.4 TFSI	05/10→	1390	4	76.50	DOHC	90/122				
1.4 CAXC							10	AH5960 (MLS), 0.800mm	CH5960	
A3 1.4 TFSI	09/07→08/12	1390	4	76.50	DOHC	92/125				
A3 Cabrio TFSI	02/11→									
A3 Sportback	09/07→									
1.4 CMSA							11	AH5960 (MLS), 0.800mm	CH5960	
A3 1.4 TFSI	09/07→08/12	1390	4	76.50	DOHC	92/125				
A3 Sportback	09/07→									
1.4 CNVA							12			
A1 1.4 TFSI	05/10→	1390	4	76.50	DOHC	90/122				

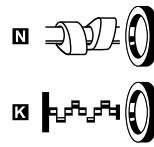
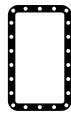
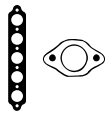

AC5190, AC5200,
AC5210



AD5650, AD5660,
AD5670



JD5228



JD5278



JD5279



JD5298



JE5036

HBS311 [19] M12x1.75x115.00mm (x8)	JD5278 JD5279 JE5036 (MLS)	JM7032 (NBR)	HR397	HR5068	NA5124 [2] 32.00x47.00x10.00mm, PTFE/ACM NA5106 [2] 35.00x48.00x10.00mm, PTFE LK5003 [1][7] 85.00x131.00x15.700mm, PTFE	
		HR397	HR397	PA5041 6.00/12.20x10.00 (FPM)	NA5124 [2] 32.00x47.00x10.00mm, PTFE/ACM NA5124 [2] 32.00x47.00x10.00mm, PTFE/ACM	
		HR397	HR397	PA5041 6.00/12.20x10.00 (FPM)	NA5124 [2] 32.00x47.00x10.00mm, PTFE/ACM NA5124 [2] 32.00x47.00x10.00mm, PTFE/ACM	
HBS264 [19] M12x1.75x172.00mm (x8)	JD5278 JD5279	JM7032 (NBR)	HR397	HR5068	NA5124 [2] 32.00x47.00x10.00mm, PTFE/ACM NA5106 [2] 35.00x48.00x10.00mm, PTFE LK5003 [1][7] 85.00x131.00x15.700mm, PTFE	
HBS264 [19] M12x1.75x172.00mm (x8)	JD5278 JD5279	JM7032 (NBR)		HR5068	NA5124 [2] 32.00x47.00x10.00mm, PTFE/ACM NA5106 [2] 35.00x48.00x10.00mm, PTFE LK5003 [1][7] 85.00x131.00x15.700mm, PTFE	
HBS249 [5] M9x1.25x138.00mm (x10)	JD5228 (x4) JD5298	HR397	HR397	PA5041 (x16) 6.00/12.20x10.00 (FPM) HR791	NA5180 [2] 27.00x42.00x8.00mm, FPM NA5185 [2] 32.00x42.00x6.00mm, FPM	KA5025 [15] KK5551 [20]
HBS249 [5] M9x1.25x138.00mm (x10)	JD5228 (x4) JD5298	HR397	HR397	PA5041 (x16) 6.00/12.20x10.00 (FPM) HR791	NA5180 [2] 27.00x42.00x8.00mm, FPM NA5185 [2] 32.00x42.00x6.00mm, FPM	KA5025 [15] KK5551 [20]
HBS264 [19] M12x1.75x172.00mm (x8)	JD5278 JD5279	JM7032 (NBR)		HR5068	NA5106 [2] 35.00x48.00x10.00mm, PTFE/ACM NA5124 [2] 32.00x47.00x10.00mm, PTFE/ACM NA5106 [2] 35.00x48.00x10.00mm, PTFE LK5003 [1][7] 85.00x131.00x15.700mm, PTFE	
HBS518 [5][21]	JD5809 JD5814			PA5041 6.00/12.20x10.00 (FPM) HR791	NA5106 [2] 35.00x48.00x10.00mm, PTFE	
HBS518 [5][21]	JD5809 JD5814	HR397	HR397	PA5041 6.00/12.20x10.00 (FPM) HR791	NA5106 [2] 35.00x48.00x10.00mm, PTFE/ACM NA5106 [2] 35.00x48.00x10.00mm, PTFE	JR5048 [6]
HBS518 [5][21]	JD5809 JD5814	HR397		PA5041 6.00/12.20x10.00 (FPM) HR791	NA5106 [2] 35.00x48.00x10.00mm, PTFE/ACM NA5106 [2] 35.00x48.00x10.00mm, PTFE	JR5048 [6]
					NA5106 [2] 35.00x48.00x10.00mm, PTFE/ACM NA5106 [2] 35.00x48.00x10.00mm, PTFE	JR5048 [6]







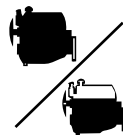

cc

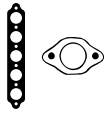

kW/PS

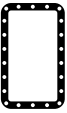

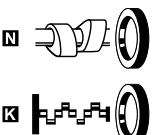
1.6	ABB	13	BM360 (Fibre)	DM361	EG873				
80 1.6	08/90→10/91	1595	4	81.00	SOHC/OHC	73-75/ 99-102			
1.6	ABM	14	BM360 (Fibre)	DM361 →Ch.8C-P-185 000 DM367 Ch.8C-P-185 001→	EB970 Ch.8C-P-220 001→				
80 1.6	09/91→12/94	1595	4	81.00	SOHC/OHC	52/71			
1.6	ADA	15	BM360 (Fibre)	DM361 →Ch.8C-P-185 000 DM367 Ch.8C-P-185 001→	EG872 →Ch.8C-P-220 000				
80 1.6 E 80 Avant 1.6 E	06/93→12/94 06/93→01/96	1595	4	81.00	SOHC/OHC	74/101			
1.6	ADP	16	AY940 (MLS)	CY942	EC5220 [3][18] EY940				
A4 1.6 A4 Avant 1.6	11/94→10/00 11/94→09/01	1595	4	81.00	SOHC/OHC	74/101			
1.6	AEH	17	AC5220 (MLS)	CY980	EC080 [18] EC5220 [3][18]				
A3 1.6	09/96→05/03	1595	4	81.00	SOHC/OHC	74/101			
1.6	AHL	18	AC5220 (MLS)	CC5220 [3]	EC080 [18] EC5220 [3][18] EY940				
A4 1.6 A4 Avant 1.6	11/94→10/00 11/94→09/01	1595	4	81.00	SOHC/OHC	74/100			
1.6	AKL	19	AC5220 (MLS)	CY980	EC080 [18] EC5220 [3][18]				
A3 1.6	09/96→05/03	1595	4	81.00	SOHC/OHC	74/101			

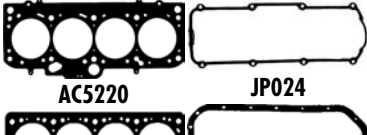
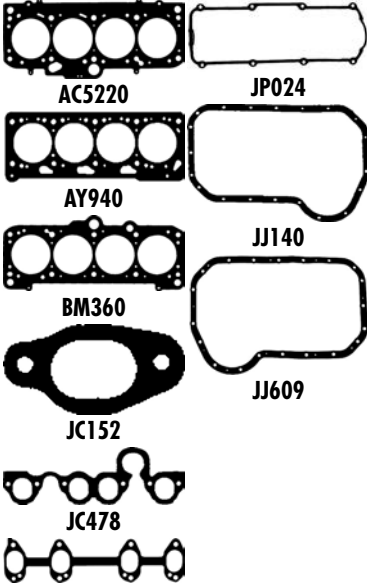
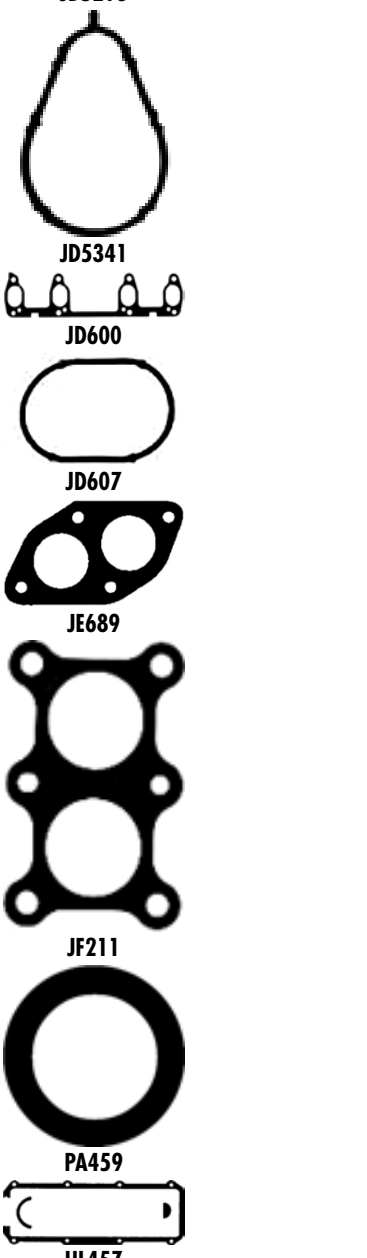
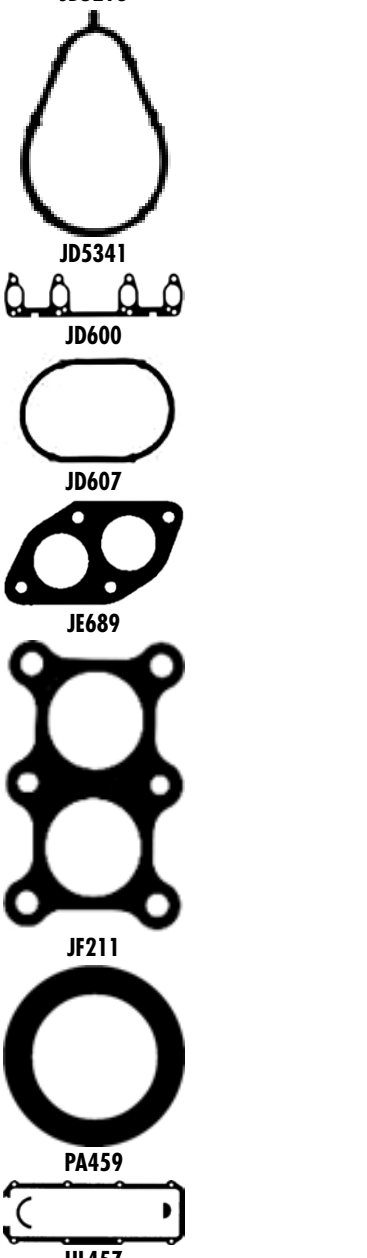
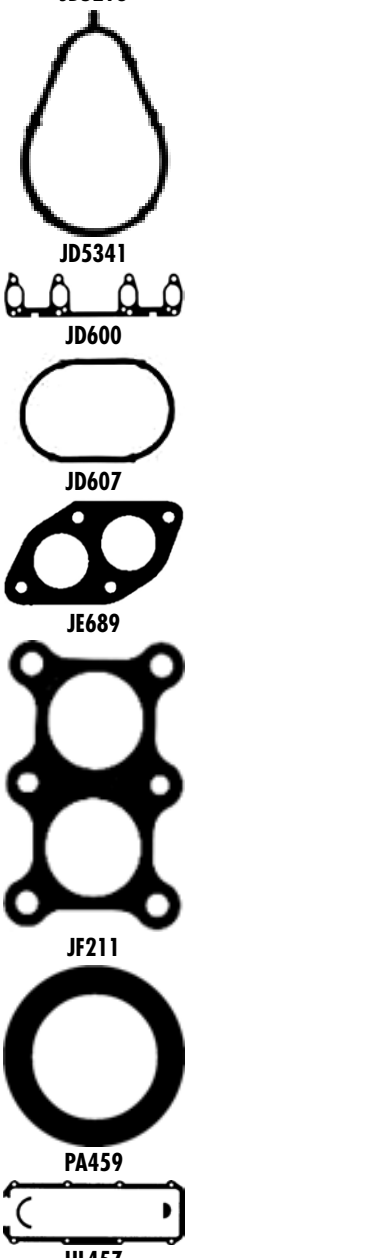
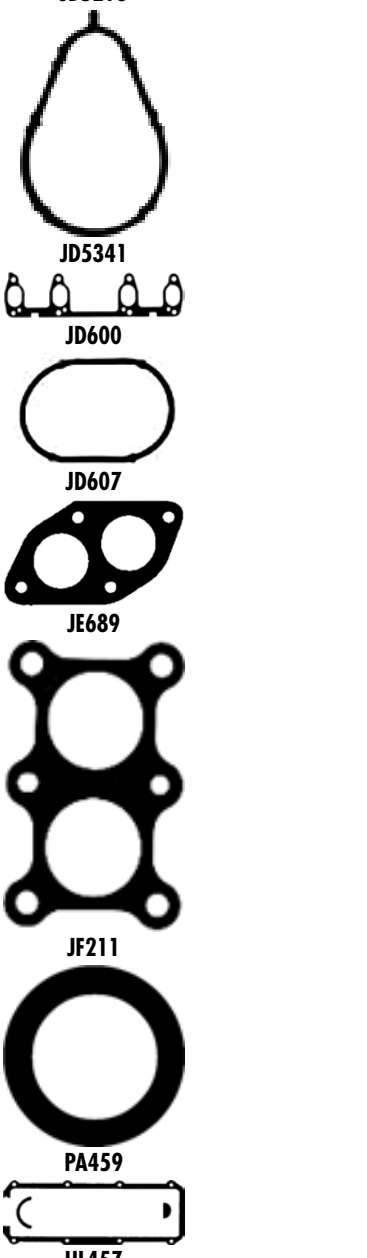
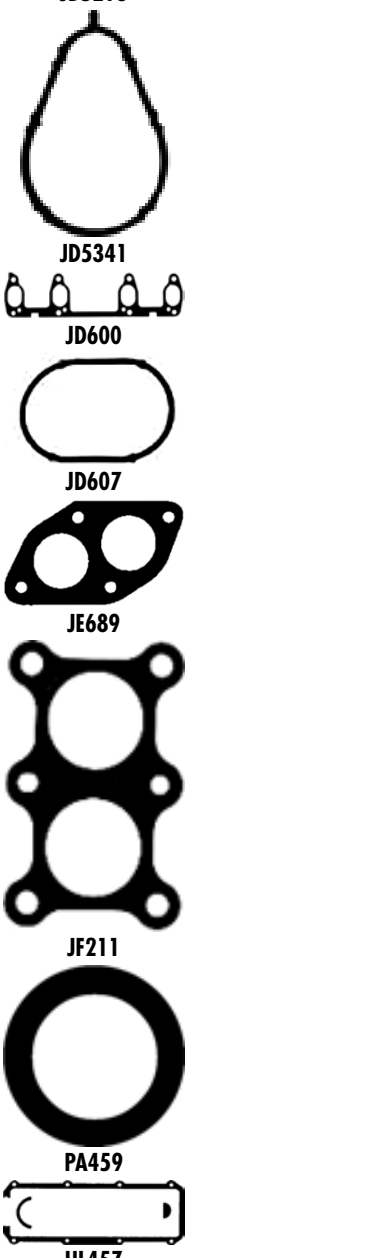
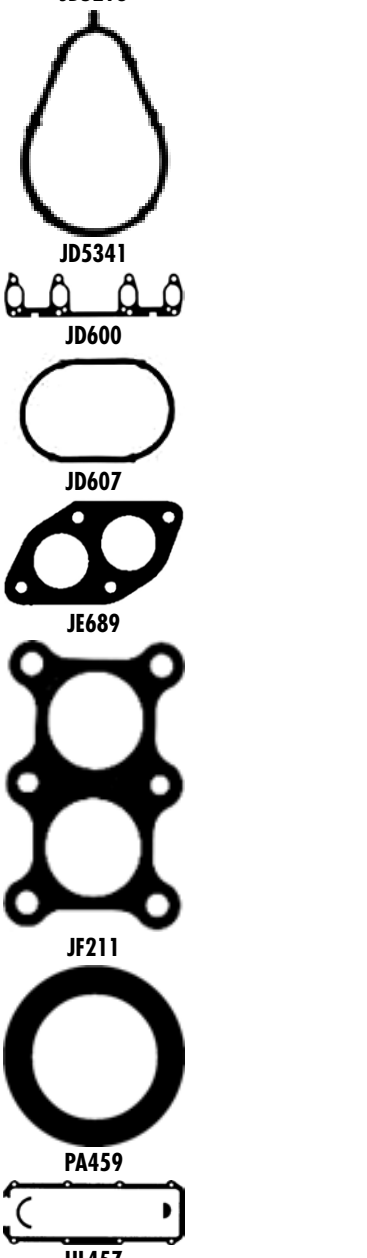
							
HBS043 [22] M11x1.50x95.00mm (x10)	JC478 [1] JC152 [x4] ☉ JE689	JPO24 [4] Ch.8C-P-185 001→ HL457 [23] (Cork) →Ch.8C-P-185 000 HM5053 [24] (ACM) →Ch.8C-P-185 000	JJ140 (SMG) →Ch.8C-P-220 000	HR569 [5]	NA5001 [1][2] 32.00x47.00x10.00mm, FPM NA5001 [1][2] 32.00x47.00x10.00mm, FPM NA5133 [1] 85.00x105.00x11.00mm, FPM	KA5020 [15]	
HBS043 [22] M11x1.50x95.00mm (x10)	JC478 [1] PA459 [1] (NBR) JC152 [x4] ☉ JE689	JPO24 [4] Ch.8C-P-185 001→ HL457 [23] (Cork) →Ch.8C-P-185 000	JJ140 (SMG) →Ch.8C-P-220 000 JJ609 (ACM)	HR569 [5] HR816 [5] Eng.034 670→	NA5001 [1][2] 32.00x47.00x10.00mm, FPM NA5001 [1][2] 32.00x47.00x10.00mm, FPM NA5133 [1] 85.00x105.00x11.00mm, FPM		
HBS043 [22] M11x1.50x95.00mm (x10)	JC478 [1] PA459 [1] (NBR) JC152 [x4] ☉ JE689	JPO24 [4] Ch.8C-P-185 001→ HL457 [23] (Cork) →Ch.8C-P-185 000	JJ140 (SMG) →Ch.8C-P-220 000	HR569 [5] →Eng.034 669 HR816 [5] Eng.034 670→	NA5001 [1][2] 32.00x47.00x10.00mm, FPM NA5001 [1][2] 32.00x47.00x10.00mm, FPM NA5133 [1] 85.00x105.00x11.00mm, FPM		
HBS043 [22] M11x1.50x95.00mm (x10)	JD5341 [1]	JPO24 [4]	JH5117 JJ609 (ACM)	HR816 [5]	NA5001 [1][2] 32.00x47.00x10.00mm, FPM NA5001 [1][2] 32.00x47.00x10.00mm, FPM NA5133 [1] 85.00x105.00x11.00mm, FPM LK5008 [1][7] 85.00x131.00x15.700mm, PTFE LK5006 [7] 85.00x131.00x16.000mm, PTFE		
HBS246 [22] M10x1.50x120.00mm (x10)	JD607 [x4] JD5293 [1] JD600 [1] ☉ JF211	JPO24 [4]	HR397 JH5117	HR816 [5]	NA5124 [2] 32.00x47.00x10.00mm, PTFE/ACM NA5001 [1][2] 32.00x47.00x10.00mm, FPM NA5106 [2] 35.00x48.00x10.00mm, PTFE NA5124 [2] 32.00x47.00x10.00mm, PTFE/ACM NB716 [2] 35.00x48.00x10.00mm, FPM LK5008 [1][7] 85.00x131.00x15.700mm, PTFE		
HBS246 [22] M10x1.50x120.00mm (x10)	JD5341 [1] JC152 [x4] ☉ JE689	JPO24 [4]	HR397	HR816 [5]	NA5124 [2] 32.00x47.00x10.00mm, PTFE/ACM NA5106 [2] 35.00x48.00x10.00mm, PTFE LK5008 [1][7] 85.00x131.00x15.700mm, PTFE LK5006 [7] 85.00x131.00x16.000mm, PTFE		
HBS246 [22] M10x1.50x120.00mm (x10)	JD607 [x4] JD600 [1] ☉ JF211	JPO24 [4]	HR397 JH5117	HR816 [5]	NA5124 [2] 32.00x47.00x10.00mm, PTFE/ACM NA5106 [2] 35.00x48.00x10.00mm, PTFE NA5124 [2] 32.00x47.00x10.00mm, PTFE/ACM NB716 [2] 35.00x48.00x10.00mm, FPM LK5008 [1][7] 85.00x131.00x15.700mm, PTFE		



cc



kW/PS



1.6										
ALZ							20	AC5220 (MLS)	CC5223	EC5220 [3][18]
A4 1.6	07/00→06/08	1595	4	81.00	SOHC/OHC	75/102				
A4 Avant 1.6	07/00→09/01									
ANA							21	AC5220 (MLS)	CC5220 [3]	EC5220 [3][18] EY940
A4 1.6	11/94→10/00	1595	4	81.00	SOHC/OHC	74/100				
A4 Avant 1.6	11/94→09/01									
APF							22	AC5220 (MLS)	CC5221 [3]	EC5220 [3][18]
A3 1.6	09/96→05/03	1595	4	81.00	SOHC/OHC	74/101				
ARM							23	AC5220 (MLS)	CC5220 [3]	EC5220 [3][18] EY940
A4 1.6	11/94→10/00	1595	4	81.00	SOHC/OHC	74/100				
A4 Avant 1.6	11/94→09/01									
AVU							24	AC5220 (MLS)	CC5222 [3]	EC5220 [3][18]
A3 1.6	08/00→05/03	1595	4	81.00	SOHC/OHC	75/102				
BAD							25	AC5280 (MLS)	CC5282	
A2 1.6 FSI	05/02→08/05	1598	4	76.50	DOHC	81/110				
BAG							26	AG8850 (MLS)	CG8850	
A3 1.6 FSI	08/03→09/07	1598	4	76.50	DOHC	85/115				
BFQ							27	AC5220 (MLS)	CC5222 [3]	EC5220 [3][18]
A3 1.6	08/00→05/03	1595	4	81.00	SOHC/OHC	75/102				
BGU							28	AC5220 (MLS)	CC5222 [3]	EC5220 [3][18]
A3 1.6	05/03→08/12	1595	4	81.00	SOHC/OHC	75/102				
A3 Sportback 1.6	09/04→									



AC5220



AC5280



JC152



JD5293



JD5298

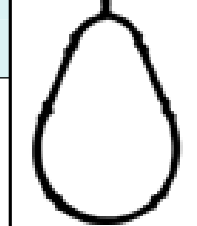

JD5341



JE689

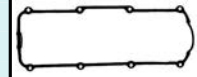

JP024

HBS246 [22] M10x1.50x120.00mm (x10)	JD5341 [x4] JC152 [x4]	JM5205 (Elastomer)	HR397	PA5041 (x8) 6.00/12.20x10.00 (FPM) HR817	NA5124 [2] 32.00x47.00x10.00mm, PTFE/ACM NA5106 [2] 35.00x48.00x10.00mm, PTFE LK5008 [1][7] 85.00x131.00x15.700mm, PTFE	
HBS246 [22] M10x1.50x120.00mm (x10)	JD5341 [x4] JC152 [x4] JE689	JPO24 [4]	JH5117	HR816	NA5124 [2] 32.00x47.00x10.00mm, PTFE/ACM NA5106 [2] 35.00x48.00x10.00mm, PTFE LK5008 [1][7] 85.00x131.00x15.700mm, PTFE LK5006 [7] 85.00x131.00x16.000mm, PTFE	
HBS246 [22] M10x1.50x120.00mm (x10)	JD5340 [x4] JD5293	JPO24 [4]	HR397	HR816	NA5124 [2] 32.00x47.00x10.00mm, PTFE/ACM NA5106 [2] 35.00x48.00x10.00mm, PTFE LK5008 [1][7] 85.00x131.00x15.700mm, PTFE	
HBS246 [22] M10x1.50x120.00mm (x10)	JD5341 [x4] JC152 [x4] JE689	JPO24 [4]	JH5117	HR816	NA5124 [2] 32.00x47.00x10.00mm, PTFE/ACM NA5106 [2] 35.00x48.00x10.00mm, PTFE LK5008 [1][7] 85.00x131.00x15.700mm, PTFE LK5006 [7] 85.00x131.00x16.000mm, PTFE	
HBS246 [22] M10x1.50x120.00mm (x10)	JD5340 [x4] JD5293	JM5205 (Elastomer)	HR397	PA5041 (x8) 6.00/12.20x10.00 (FPM) HR817	NA5124 [2] 32.00x47.00x10.00mm, PTFE/ACM NA5106 [2] 35.00x48.00x10.00mm, PTFE LK5008 [1][7] 85.00x131.00x15.700mm, PTFE	
HBS316 [5] M9x1.25x97.00mm (x10)	JD5809 JD5298	HR397		PA5041 (x16) 6.00/12.20x10.00 (FPM) HR791	NA5180 [2] 27.00x42.00x8.00mm, FPM NA5185 [2] 32.00x42.00x6.00mm, FPM	
HBS249 [5] M9x1.25x138.00mm (x10)	JD5809 JD5814	HR397		PA5041 (x16) 6.00/12.20x10.00 (FPM) HR791	NA5106 [2] 35.00x48.00x10.00mm, PTFE LK5013 [1][7][25] 85.00x111.00x15.50mm, PTFE LK5011 [7][26] 85.00x131.00x15.94mm, PTFE	JR5048 [6]
HBS246 [22] M10x1.50x120.00mm (x10)	JD5340 [x4] JD5293	JM5205 (Elastomer)	HR397	PA5041 (x8) 6.00/12.20x10.00 (FPM) HR817	NA5124 [2] 32.00x47.00x10.00mm, PTFE/ACM NA5106 [2] 35.00x48.00x10.00mm, PTFE LK5008 [1][7] 85.00x131.00x15.700mm, PTFE	
HBS246 [22] M10x1.50x120.00mm (x10)	JD5340 [x4] JD5293	JM5205 (Elastomer)	HR397	PA5041 (x8) 6.00/12.20x10.00 (FPM) HR817	NA5124 [2] 32.00x47.00x10.00mm, PTFE/ACM NA5106 [2] 35.00x48.00x10.00mm, PTFE NA5124 [2] 32.00x47.00x10.00mm, PTFE/ACM LK5008 [1][7] 85.00x131.00x15.700mm, PTFE	



cc



kW/PS



1.6		BLF					29	AG8850 (MLS)	CG8850	
A3 1.6 FSI	08/03→09/07	1598	4	76.50	DOHC	85/115				
A3 Sportback	09/04→									
1.6		BLP					30	AG8850 (MLS)	CG8850	
A3 1.6 FSI	08/03→09/07	1598	4	76.50	DOHC	85/115				
A3 Sportback	09/04→									
1.6		BSE					31	AC5220 (MLS)	CC5222 [3]	
A3 1.6	05/03→08/12	1595	4	81.00	SOHC/OHC	75/102				
A3 Cabrio 1.6	09/08→									
A3 Sportback 1.6	09/04→									
1.6		BSF					32	AC5220 (MLS)	CC5222 [3]	
A3 1.6	05/03→08/12	1595	4	81.00	SOHC/OHC	75/102				
A3 Sportback 1.6	09/04→									
1.6		CAYB Diesel					33			
A1 1.6 TDI	03/11→	1598	4	79.50	DOHC	66/90				
A3 1.6 TDI	05/09→08/12									
A3 Sportback	05/09→									
1.6		CAYC Diesel					34			
A1 1.6 TDI	05/10→	1598	4	79.50	DOHC	77/105				
A3 1.6 TDI	05/09→08/12									
A3 Cabrio TDI	05/09→									
A3 Sportback	05/09→									
1.6		CCSA					35	AC5220 (MLS)	CC5222 [3]	
A3 1.6	05/03→08/12	1595	4	81.00	SOHC/OHC	75/102				
A3 Sportback 1.6	09/04→									
1.6		CMXA					36	AC5220 (MLS)	CC5222 [3]	
A3 1.6	05/03→08/12	1595	4	81.00	SOHC/OHC	75/102				
A3 Sportback	01/11→									
A3 Sportback 1.6	09/04→									
Manager G 300.18	01/11→08/12									
1.6		PP					37	BM360 (Fibre)	DM360	EG873
80 1.6	08/87→09/91	1595	4	81.00	SOHC/OHC	51/70				

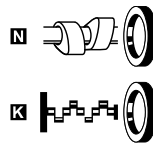
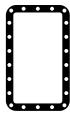
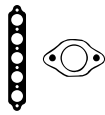

AC5220



BM360



JC152



JC478

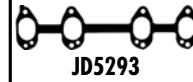

JD5293



JE138

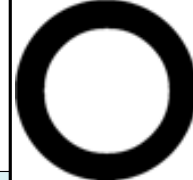

PA459



HL457



JJ140

HBS249 [5] M9x1.25x138.00mm (x10)	JD5809 [1] JD5814 [2]	HR397 [3]		PA5041 6.00/12.20x10.00 (FPM) HR791 [4]	NA5106 [2] 35.00x48.00x10.00mm, PTFE LK5013 [1][7][25] 85.00x111.00x15.50mm, PTFE LK5011 [7][26] 85.00x131.00x15.94mm, PTFE	JR5048 [6]
HBS249 [5] M9x1.25x138.00mm (x10)	JD5809 [1] JD5814 [2]	HR397 [3]		PA5041 6.00/12.20x10.00 (FPM) HR791 [4]	NA5106 [2] 35.00x48.00x10.00mm, PTFE LK5013 [1][7][25] 85.00x111.00x15.50mm, PTFE LK5011 [7][26] 85.00x131.00x15.94mm, PTFE	JR5048 [6]
HBS246 [22] M10x1.50x120.00mm (x10)	JD5340 [1] (x4) JD5293 [2]	JM5205 (Elastomer)	HR397	PA5041 6.00/12.20x10.00 (FPM) HR817 [4]	NA5124 [2] 32.00x47.00x10.00mm, PTFE/ACM NA5106 [2] 35.00x48.00x10.00mm, PTFE LK5008 [1][7] 85.00x131.00x15.700mm, PTFE	
HBS246 [22] M10x1.50x120.00mm (x10)	JD5340 [1] (x4) JD5293 [2]	JM5205 (Elastomer)	HR397	PA5041 6.00/12.20x10.00 (FPM) HR817 [4]	NA5124 [2] 32.00x47.00x10.00mm, PTFE/ACM NA5106 [2] 35.00x48.00x10.00mm, PTFE LK5008 [1][7] 85.00x131.00x15.700mm, PTFE	
		HR397 [3]	HR397	PA5041 6.00/12.20x10.00 (FPM)	NA5106 [2] 35.00x48.00x10.00mm, PTFE	
HBS364 [19] M12x1.75x149.00mm (x10)		HR397 [3]	HR397	PA5041 6.00/12.20x10.00 (FPM)	NA5106 [2] 35.00x48.00x10.00mm, PTFE	
HBS246 [22] M10x1.50x120.00mm (x10)	JD5340 [1] (x4) JD5293 [2]	JM5205 (Elastomer)	HR397	PA5041 (x8) 6.00/12.20x10.00 (FPM) HR817 [4]	NA5124 [2] 32.00x47.00x10.00mm, PTFE/ACM NA5106 [2] 35.00x48.00x10.00mm, PTFE LK5008 [1][7] 85.00x131.00x15.700mm, PTFE	
HBS246 [22] M10x1.50x120.00mm (x10)	JD5340 [1] (x4) JD5293 [2]	JM5205 (Elastomer)	HR397	PA5041 (x8) 6.00/12.20x10.00 (FPM) HR817 [4]	NA5106 [2] 35.00x48.00x10.00mm, PTFE/ACM NA5124 [2] 32.00x47.00x10.00mm, PTFE/ACM NA5106 [2] 35.00x48.00x10.00mm, PTFE LK5008 [1][7] 85.00x131.00x15.700mm, PTFE	
HBS043 [22] M11x1.50x95.00mm (x10)	JC478 [1] PA459 [1] (NBR) JC152 [1] (x4) JE138 [27]	HL457 [23] (Cork) HM5053 [24] (ACM)	JJ140 (SMG)	HR569 [4]	NA5001 [1][2] 32.00x47.00x10.00mm, FPM NA5001 [1][2] 32.00x47.00x10.00mm, FPM NA5133 [1] 85.00x105.00x11.00mm, FPM	KA5020 [15]









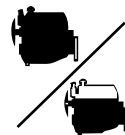



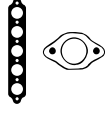

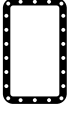

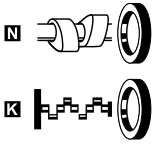







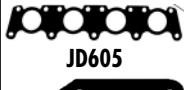



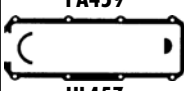





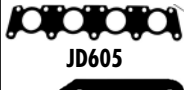



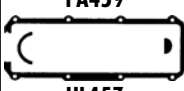





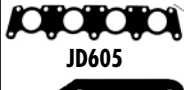



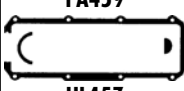





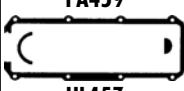



cc

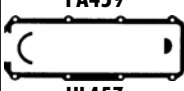

kW/PS

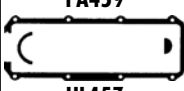

1.6 RA Diesel							38	BN940 (Fibre), 1.530mm, 1 Hole BN950 (Fibre), 1.570mm, 2 Holes BN960 (Fibre), 1.610mm, 3 Holes	DD502 ▲	EG873
80 1.6 TD	09/86→08/91	1588	4	76.50	SOHC/OHC	59/80				
90 1.6 TD	04/87→09/91									
1.6 RN							39	BM360 (Fibre)	DM363	EG873
80 1.6	09/86→08/91	1595	4	81.00	SOHC/OHC	55/75				
1.6 SB Diesel							40	BN940 (Fibre), 1.530mm, 1 Hole BN950 (Fibre), 1.570mm, 2 Holes BN960 (Fibre), 1.610mm, 3 Holes	DD502 ▲	EG873
80 1.6 TD	09/86→08/91	1588	4	76.50	SOHC/OHC	59/80				
90 1.6 TD	04/87→09/91									
1.8 4B							41	BM360 (Fibre)	DM360	EG873
100 1.8 CAT	03/85→11/90	1781	4	81.00	SOHC/OHC	66/90				
100 1.8 quattro	08/85→11/90									
100 Avant 1.8	03/85→11/90									
1.8 ADR							42	AY970 (MLS)	CY970	EY840
A4 1.8	01/95→11/00	1781	4	81.00	DOHC	92-95/ 125-129				
A4 1.8 quattro	01/95→11/00									
A4 Avant 1.8	01/96→09/01									
A6 1.8	12/95→10/97									
A6 1.8 quattro	12/95→10/97									
A6 Avant 1.8	12/95→12/97									
Cabriolet	01/97→08/00									
1.8 AEB							43	AY970 (MLS)	CY970	EY840
A4 1.8 T	01/95→11/00	1781	4	81.00	DOHC	110/150				
A4 1.8 T quattro	01/95→11/00									
A4 Avant 1.8 T	01/96→09/01									
A6 1.8 T	01/97→01/05									
A6 1.8 T quattro	02/97→01/05									
A6 Avant 1.8 T	12/97→01/05									
1.8 AFY							44	AY970 (MLS)	CY970	EY840
A4 1.8	04/95→11/00	1781	4	81.00	DOHC	85/115				
A4 1.8 quattro	07/95→11/00									
A4 Avant 1.8	07/95→09/01									
A6 1.8	05/97→01/05									
A6 Avant 1.8	02/98→01/05									

      							
HBS018 [19] M12x1.75x115.00mm (x10)	JC243 [1] JC152 [x4]	HL457 [23] (Cork) HM5053 [24] (ACM)	JJ140 (SMG)	HR569 [5]	NA5001 [1][2] 32.00x47.00x10.00mm, FPM NA5001 [1][2] 32.00x47.00x10.00mm, FPM NA5133 [1] 85.00x105.00x11.00mm, FPM	KA5020 [15]	 AY970  BM360  BN940, BN950, BN960  JC152  JC243  JC478  JD604  JD605  JE689  JE904  PA459  HL457  JJ140  JJ610
HBS043 [22] M11x1.50x95.00mm (x10)	JC478 [1] PA459 [1] (NBR) JC152 [x4]  JE689	HL457 [23] (Cork) HM5053 [24] (ACM)	JJ140 (SMG)	HR569 [5]	NA5001 [1][2] 32.00x47.00x10.00mm, FPM NA5001 [1][2] 32.00x47.00x10.00mm, FPM NA5133 [1] 85.00x105.00x11.00mm, FPM	KA5020 [15]	 JC152  JC243  JC478  JD604  JD605  JE689  JE904  PA459  HL457  JJ140  JJ610
HBS018 [19] M12x1.75x115.00mm (x10)	JC243 [1] JC152 [x4]	HL457 [23] (Cork) HM5053 [24] (ACM)	JJ140 (SMG)	HR569 [5]	NA5001 [1][2] 32.00x47.00x10.00mm, FPM NA5001 [1][2] 32.00x47.00x10.00mm, FPM NA5133 [1] 85.00x105.00x11.00mm, FPM	KA5020 [15]	 JC152  JC243  JC478  JD604  JD605  JE689  JE904  PA459  HL457  JJ140  JJ610
HBS043 [22] M11x1.50x95.00mm (x10)	JC478 [1] PA459 [1] (NBR) JC152 [x4]  JE904	HL457 [23] (Cork) HM5053 [24] (ACM)	JJ140 (SMG)	HR569 [5]	NA5001 [1][2] 32.00x47.00x10.00mm, FPM NA5001 [1][2] 32.00x47.00x10.00mm, FPM NA5133 [1] 85.00x105.00x11.00mm, FPM	KA5020 [15]	 JE689  JE904  PA459  HL457  JJ140  JJ610
HBS171 [22] M11x1.50x101.00mm (x10) HBS268 [22] M10x1.50x120.00mm (x10)	JD604 [1] JD605 [1]  JE689	HL732 [5]	JJ610	PA5041 (x20) 6.00/12.20x10.00 (FPM) HR822 [5]	NA5001 (x2)[1][2] 32.00x47.00x10.00mm, FPM NA5124 (x2)[2] 32.00x47.00x10.00mm, PTFE/ACM NA5001 [1][2] 32.00x47.00x10.00mm, FPM NA5133 [1] 85.00x105.00x11.00mm, FPM LK5006 [7] 85.00x131.00x16.000mm, PTFE		 JE689  JE904  PA459  HL457  JJ140  JJ610
HBS171 [22] M11x1.50x101.00mm (x10) HBS268 [22] M10x1.50x120.00mm (x10)	JD604 [1] JD605 [1]  JE689	HL732 [5]	JJ610	PA5041 (x20) 6.00/12.20x10.00 (FPM) HR822 [5]	NA5001 (x2)[1][2] 32.00x47.00x10.00mm, FPM NA5124 (x2)[2] 32.00x47.00x10.00mm, PTFE/ACM NA5001 [1][2] 32.00x47.00x10.00mm, FPM NA5133 [1] 85.00x105.00x11.00mm, FPM LK5006 [7] 85.00x131.00x16.000mm, PTFE		 JE689  JE904  PA459  HL457  JJ140  JJ610



cc



kW/PS

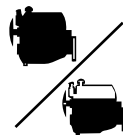

1.8		AGN					45	AY970 (MLS)	CY971	EY841 [3]
A3 1.8	09/96→05/03	1781	4	81.00	DOHC	92/125				
1.8		AGU					46	AY970 (MLS)	CY971	EY841 [3]
A3 1.8 T	12/96→05/03	1781	4	81.00	DOHC	110/150				
A3 1.8 T quattro	12/96→05/03									
1.8		AJL					47	AY970 (MLS)	CY970	EY840
A4 1.8 T	12/97→11/00	1781	4	81.00	DOHC	132/180				
A4 1.8 T quattro	12/97→11/00									
A4 Avant 1.8 T	12/97→09/01									
A6 1.8 T	12/97→01/05									
A6 1.8 T quattro	12/97→01/05									
A6 Avant 1.8 T	12/97→01/05									
1.8		AJP					48	BZ530 (MLS), 1.6mm	CY970	EC5220 [3][18]
A6 1.8	07/97→01/05	1781	4	81.00	DOHC	92/125				
A6 Avant 1.8	12/97→01/05									
1.8		AJQ					49	AY970 (MLS)	CY971	
A3 1.8 T	12/98→05/03	1781	4	81.00	DOHC	132/180				
A3 1.8 T quattro	10/98→05/03									
TT Coupe 1.8 T	10/98→06/06									
TT Roadster	10/99→06/06									
1.8		AMB					50	AY970 (MLS)	CY971	EY841 [3]
A4 1.8	05/00→10/05	1781	4	81.00	DOHC	125/170				
A4 1.8 T	07/01→12/04									
A4 1.8 T quattro	07/01→12/04									
1.8		AMK					51	AY970 (MLS)	CY971	EY841 [3]
A3 1.8 S3	03/99→04/02	1781	4	81.00	DOHC	154/209				

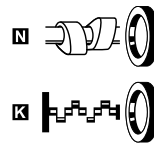
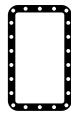
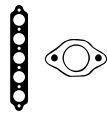

AY970



JD604



JD605



JD607



JE689



JJ610

HBS268 [22]
M10x1.50x120.00mm (x10)

JD607 [1]
JD605 [3]
☉JF205

HL732 [3]

HR397

PA5041 (x20)
6.00/12.20x10.00
(FPM)
HR822 [3]

☒ NA5124 (x2)[2]
32.00x47.00x10.00mm, PTFE/ACM
☒ NA5106 [2]
35.00x48.00x10.00mm, PTFE
☒ NB716 [2]
35.00x48.00x10.00mm, FPM
☒ LK5003 [1][7]
85.00x131.00x15.700mm, PTFE

HBS171 [22]
M11x1.50x101.00mm (x10)
HBS268 [22]
M10x1.50x120.00mm (x10)

JD604 [1]
JD605 [3]
☉JF205

HL732 [3]

PA5041 (x20)
6.00/12.20x10.00
(FPM)
HR822 [3]

☒ NA5001 [1][2]
32.00x47.00x10.00mm, FPM
☒ NA5124 (x2)[2]
32.00x47.00x10.00mm, PTFE/ACM
☒ NA5106 [2]
35.00x48.00x10.00mm, PTFE
☒ NB716 [2]
35.00x48.00x10.00mm, FPM
☒ LK5003 [1][7]
85.00x131.00x15.700mm, PTFE

HBS171 [22]
M11x1.50x101.00mm (x10)
HBS268 [22]
M10x1.50x120.00mm (x10)

JD604 [1]
JD605 [3]
☉JE689

HL732 [3]

JJ610

PA5041 (x20)
6.00/12.20x10.00
(FPM)
HR822 [3]

☒ NA5001 [1][2]
32.00x47.00x10.00mm, FPM
☒ NA5133 [1]
85.00x105.00x11.00mm, FPM
☒ LK5006 [7]
85.00x131.00x16.000mm, PTFE

HBS268 [22]
M10x1.50x120.00mm (x10)

JD604 [1]
JD605 [3]
(Steel)
1.00mm
JD605 [3]
☉JE689

HL732 [3]

JH5117

PA5041 (x20)
6.00/12.20x10.00
(FPM)
HR822 [3]

☒ NA5124 [2]
32.00x47.00x10.00mm, PTFE/ACM
☒ LK5008 [1][7]
85.00x131.00x15.700mm, PTFE

HBS268 [22]
M10x1.50x120.00mm (x10)

JD604 [1]
JD605 [3]
☉JF205

HL732 [3]

HR397
JH5117

PA5041 (x20)
6.00/12.20x10.00
(FPM)
HR822 [3]

☒ NA5001 [1][2]
32.00x47.00x10.00mm, FPM
☒ NA5124 (x2)[2]
32.00x47.00x10.00mm, PTFE/ACM
☒ NA5001 [1][2]
32.00x47.00x10.00mm, FPM
☒ NB716 [2]
35.00x48.00x10.00mm, FPM
☒ LK5003 [1][7]
85.00x131.00x15.700mm, PTFE

HBS268 [22]
M10x1.50x120.00mm (x10)

JD604 [1]
→Eng.8E-3-500 000
JD605 [3]
JD5813 [3]
Eng.8E-4-000 001→

HL732 [3]

PA5041 (x20)
6.00/12.20x10.00
(FPM)
HR822 [3]

☒ NA5106 [2]
35.00x48.00x10.00mm, PTFE/ACM
☒ NA5124 (x2)[2]
32.00x47.00x10.00mm, PTFE/ACM
☒ NA5106 [2]
35.00x48.00x10.00mm, PTFE
☒ LK5003 [1][7]
85.00x131.00x15.700mm, PTFE

HBS268 [22]
M10x1.50x120.00mm (x10)

JD604 [1]
JD605 [3]
(Steel)
1.00mm
JD605 [3]
☉JF205

HL732 [3]

HR397

PA5041 (x20)
6.00/12.20x10.00
(FPM)
HR822 [3]

☒ NA5001 [1][2]
32.00x47.00x10.00mm, FPM
☒ NA5124 (x2)[2]
32.00x47.00x10.00mm, PTFE/ACM
☒ LK5003 [1][7]
85.00x131.00x15.700mm, PTFE



cc



kW/PS

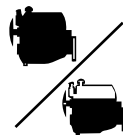

1.8		AMU					52	AY970 (MLS)	CY971	EY841 [3]
TT Coupe 1.8 T	10/98→06/06	1781	4	81.00	DOHC	165/224				
TT Roadster	10/99→06/06									
1.8		ANB					53	AY970 (MLS)	CY970	EY841 [3]
A4 1.8 T	01/95→11/00	1781	4	81.40	DOHC	110/150				
A4 1.8 T quattro	01/95→11/00									
A4 Avant 1.8 T	01/96→09/01									
A6 1.8 T	01/97→01/05									
A6 1.8 T quattro	02/97→01/05									
A6 Avant 1.8 T	12/97→01/05									
1.8		ANQ					54	BZ530 (MLS), 1.6mm	CY971	EC5220 [3][18]
A6 1.8	07/97→01/05	1781	4	81.00	DOHC	92/125				
1.8		APG					55	AY970 (MLS)		EY841 [3]
A3 1.8	09/96→05/03	1781	4	81.00	DOHC	92/125				
1.8		APP					56	AY970 (MLS)	CY971	EY841 [3]
A3 1.8 T	12/98→05/03	1781	4	81.00	DOHC	132/180				
TT Coupe 1.8 T	10/98→06/06									
TT Roadster	10/99→06/06									
1.8		APT					57	AY970 (MLS)	CY970	EY841 [3]
A4 1.8	01/95→11/00	1781	4	81.00	DOHC	92/125				
A4 1.8 quattro	01/95→11/00									
A4 Avant 1.8	01/96→09/01									
1.8		APU					58	AY970 (MLS)	CY970	
A4 1.8 T	01/95→11/00	1781	4	81.00		110/150				
A4 1.8 T quattro	01/95→11/00									
A4 Avant 1.8 T	01/96→09/01									
A6 1.8 T	01/97→01/05									
A6 1.8 T quattro	02/97→01/05									
A6 Avant 1.8 T	12/97→01/05									
1.8		APX					59	AY970 (MLS)	CY971	EY841 [3]
TT Coupe 1.8 T	10/98→06/06	1781	4	81.00	DOHC	165/224				
TT Roadster	10/99→06/06									

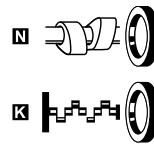
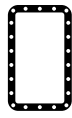
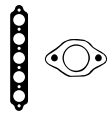

AY970



JD604



JD605



JD607



JE689



JJ610

HBS268 [22] M10x1.50x120.00mm (x10)	JD604 JD605 JE205	HL732	JH5117	PA5041 (x20) 6.00/12.20x10.00 (FPM) HR822	NA5001 [1][2] 32.00x47.00x10.00mm, FPM NA5124 (x2)[2] 32.00x47.00x10.00mm, PTFE/ACM	
HBS171 [22] M11x1.50x101.00mm (x10) HBS268 [22] M10x1.50x120.00mm (x10)	JD604 JD605 JE689	HL732	JJ610	PA5041 (x20) 6.00/12.20x10.00 (FPM) HR822	NA5124 (x2)[2] 32.00x47.00x10.00mm, PTFE/ACM NA5124 [2] 32.00x47.00x10.00mm, PTFE/ACM LK5006 [7] 85.00x131.00x16.00mm, PTFE	
HBS268 [22] M10x1.50x120.00mm (x10)	JD604 JD605 JE689	HL732	JH5117	PA5041 (x20) 6.00/12.20x10.00 (FPM) HR822	NA5001 (x2)[1][2] 32.00x47.00x10.00mm, FPM NA5124 (x2)[2] 32.00x47.00x10.00mm, PTFE/ACM LK5008 [1][7] 85.00x131.00x15.700mm, PTFE	
HBS268 [22] M10x1.50x120.00mm (x10)	JD607 JD605 JE205	HL732	HR397 JH5117	PA5041 (x20) 6.00/12.20x10.00 (FPM) HR822	NA5124 (x2)[2] 32.00x47.00x10.00mm, PTFE/ACM LK5003 [1][7] 85.00x131.00x15.700mm, PTFE	
HBS268 [22] M10x1.50x120.00mm (x10)	JD604 JD605 JE205	HL732	HR397 JH5117	PA5041 (x20) 6.00/12.20x10.00 (FPM) HR822	NA5001 [1][2] 32.00x47.00x10.00mm, FPM NA5124 (x2)[2] 32.00x47.00x10.00mm, PTFE/ACM NB716 [2] 35.00x48.00x10.00mm, FPM LK5003 [1][7] 85.00x131.00x15.700mm, PTFE	
HBS171 [22] M11x1.50x101.00mm (x10) HBS268 [22] M10x1.50x120.00mm (x10)	JD604 JD605 JE689	HL732	JJ610	PA5041 (x20) 6.00/12.20x10.00 (FPM) HR822	NA5124 (x2)[2] 32.00x47.00x10.00mm, PTFE/ACM NA5124 [2] 32.00x47.00x10.00mm, PTFE/ACM LK5006 [7] 85.00x131.00x16.00mm, PTFE	
HBS171 [22] M11x1.50x101.00mm (x10) HBS268 [22] M10x1.50x120.00mm (x10)	JD604 JD605 JE689	HL732	JJ610	PA5041 (x20) 6.00/12.20x10.00 (FPM) HR822	NA5124 (x2)[2] 32.00x47.00x10.00mm, PTFE/ACM NA5124 [2] 32.00x47.00x10.00mm, PTFE/ACM LK5006 [7] 85.00x131.00x16.00mm, PTFE	
HBS268 [22] M10x1.50x120.00mm (x10)	JD604 JD605	HL732		PA5041 (x20) 6.00/12.20x10.00 (FPM) HR822	NA5001 [1][2] 32.00x47.00x10.00mm, FPM NA5124 (x2)[2] 32.00x47.00x10.00mm, PTFE/ACM NB716 [2] 35.00x48.00x10.00mm, FPM LK5003 [1][7] 85.00x131.00x15.700mm, PTFE	



cc



kW/PS

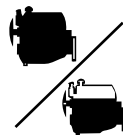

1.8		APY					60	AY970 (MLS)	CY971	EY841 [3]
A3 1.8 S3	03/99→04/02	1781	4	81.00	DOHC	154/209				
1.8		AQA					61	AY970 (MLS)	CY971	EY841 [3]
A3 1.8 T	12/96→05/03	1781	4	81.00	DOHC	110/150				
A3 1.8 T quattro	12/96→05/03									
1.8		AQE					62	BZ530 (MLS), 1.6mm	CY970	EC5220 [3][18]
A6 1.8	07/97→01/05	1781	4	81.00	DOHC	92/125				
A6 Avant 1.8	12/97→01/05									
1.8		ARG					63	AY970 (MLS)	CY970	
A4 1.8	01/95→11/00	1781	4	81.00	DOHC	92/125				
A4 1.8 quattro	01/95→11/00									
A4 Avant 1.8	01/96→09/01									
1.8		ARH					64	BZ530 (MLS), 1.6mm	CY970	EC5220 [3][18]
A6 1.8	07/97→01/05	1781	4	81.00	DOHC	92/125				
A6 Avant 1.8	12/97→01/05									
1.8		ARK					65	AY970 (MLS)	CY970	EC5220 [3][18]
A4 1.8 T	01/95→11/00	1781	4	81.00	DOHC	110/150				
A4 1.8 T quattro	01/95→11/00									
A4 Avant 1.8 T	01/96→09/01									
A6 1.8 T	01/97→01/05									
A6 1.8 T quattro	02/97→01/05									
A6 Avant 1.8 T	12/97→01/05									
1.8		ARX					66	AY970 (MLS)	CY971	
A3 1.8 T quattro	12/96→05/03	1781	4	81.00	DOHC	110/150				

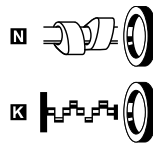
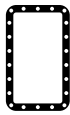
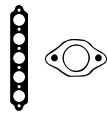

AY970



JD604



JD605



JE689

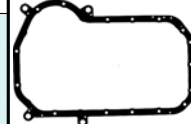

JJ610

HBS268 [22]
M10x1.50x120.00mm (x10)

JD604 [1]
JD6005 [1]
(Steel)
1.00mm
JD605 [3]

HL732 [3]

HR397

PA5041 (x20)
6.00/12.20x10.00
(FPM)
HR822 [3]

NA5001 [1][2]
32.00x47.00x10.00mm, FPM
NA5124 (x2)[2]
32.00x47.00x10.00mm, PTFE/ACM
NB716 [2]
35.00x48.00x10.00mm, FPM
LK5003 [1][7]
85.00x131.00x15.700mm, PTFE

HBS268 [22]
M10x1.50x120.00mm (x10)

JD604 [1]
JD6005 [1]
(Steel)
1.00mm
JD605 [3]
JF205

HL732 [3]

JH5117

PA5041 (x20)
6.00/12.20x10.00
(FPM)
HR822 [3]

NA5001 [1][2]
32.00x47.00x10.00mm, FPM
NA5124 (x2)[2]
32.00x47.00x10.00mm, PTFE/ACM
NA5106 [2]
35.00x48.00x10.00mm, PTFE
NB716 [2]
35.00x48.00x10.00mm, FPM
LK5003 [1][7]
85.00x131.00x15.700mm, PTFE

JD604 [1]
JD6005 [1]
(Steel)
1.00mm
JD605 [3]
JE689

HL732 [3]

JH5117

PA5041 (x20)
6.00/12.20x10.00
(FPM)
HR822 [3]

NA5124 [2]
32.00x47.00x10.00mm, PTFE/ACM
LK5008 [1][7]
85.00x131.00x15.700mm, PTFE

HBS171 [22]
M11x1.50x101.00mm (x10)
HBS268 [22]
M10x1.50x120.00mm (x10)

JD604 [1]
JD605 [3]
JE689

HL732 [3]

JJ610

PA5041 (x20)
6.00/12.20x10.00
(FPM)
HR822 [3]

NA5124 (x2)[2]
32.00x47.00x10.00mm, PTFE/ACM
NA5124 [2]
32.00x47.00x10.00mm, PTFE/ACM
LK5006 [7]
85.00x131.00x16.000mm, PTFE

HBS268 [22]
M10x1.50x120.00mm (x10)

JD604 [1]
JD6005 [1]
(Steel)
1.00mm
JD605 [3]
JE689

HL732 [3]

JH5117

PA5041 (x20)
6.00/12.20x10.00
(FPM)
HR822 [3]

NA5124 [2]
32.00x47.00x10.00mm, PTFE/ACM
LK5008 [1][7]
85.00x131.00x15.700mm, PTFE

HBS268 [22]
M10x1.50x120.00mm (x10)

JD604 [1]
JD605 [3]
JE5075

HL732 [3]

PA5041 (x20)
6.00/12.20x10.00
(FPM)
HR822 [3]

NA5001 [1][2]
32.00x47.00x10.00mm, FPM
NA5001 [1][2]
32.00x47.00x10.00mm, FPM
LK5006 [7]
85.00x131.00x16.000mm, PTFE

HBS268 [22]
M10x1.50x120.00mm (x10)

JD604 [1]
JD605 [3]
JF205

HL732 [3]

JH5117

PA5041 (x20)
6.00/12.20x10.00
(FPM)
HR822 [3]

NA5001 [1][2]
32.00x47.00x10.00mm, FPM
NA5124 (x2)[2]
32.00x47.00x10.00mm, PTFE/ACM
NA5106 [2]
35.00x48.00x10.00mm, PTFE
NB716 [2]
35.00x48.00x10.00mm, FPM
LK5003 [1][7]
85.00x131.00x15.700mm, PTFE



kW/PS

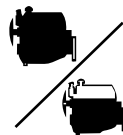

1.8		ARY					67	AY970 (MLS)	CY971	
A3 1.8 T	12/98→05/03	1781	4	81.00	DOHC	132/180				
A3 1.8 T quattro	10/98→05/03									
TT Coupe 1.8 T	10/98→06/06									
TT Roadster	02/00→06/06									
1.8		ARZ					68	AY970 (MLS)	CY971	
A3 1.8 T	12/96→05/03	1781	4	81.00	DOHC	110/150				
1.8		ATC					69	AY970 (MLS)	CY971	EY841 [3]
TT Coupe 1.8 T	10/98→06/06	1781	4	81.00	DOHC	132/180				
TT Roadster	10/99→06/06									
1.8		AUL					70	AY970 (MLS)	CY971	EY841 [3]
A3 1.8 S3	03/99→04/02	1781	4	81.00	DOHC	154/209				
1.8		AUM					71	AY970 (MLS)	CY971	EY841 [3]
A3 1.8 T	12/96→05/03	1781	4	81.00	DOHC	110/150				
TT Coupe 1.8 T	09/02→06/06									
TT Roadster	01/01→06/06									
1.8		AUQ					72	AY970 (MLS)	CY971	EY841 [3]
A3 1.8 T	12/98→05/03	1781	4	81.00	DOHC	132/180				
TT Coupe 1.8 T	10/98→06/06									
TT Roadster	10/99→06/06									
1.8		AVJ					73	AY970 (MLS)	CY971	EY841 [3]
A4 1.8 T	11/00→07/02	1781	4	81.00	DOHC	110/150				
A4 1.8 T quattro	11/00→07/02									

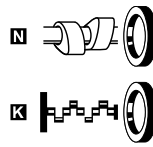
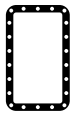
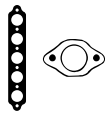

AY970



JD604



JD605



JE689

HBS268 [22]
M10x1.50x120.00mm (x10)

JD604
JD605
JF205

HL732

HR397
JH5117

PA5041 (x20)
6.00/12.20x10.00
(FPM)
HR822

NA5001 [1][2]
32.00x47.00x10.00mm, FPM
NA5124 (x2)[2]
32.00x47.00x10.00mm, PTFE/ACM
NA5001 [1][2]
32.00x47.00x10.00mm, FPM
NB716 [2]
35.00x48.00x10.00mm, FPM
LK5003 [1][7]
85.00x131.00x15.700mm, PTFE

HBS268 [22]
M10x1.50x120.00mm (x10)

JD604
JD605
(Steel)
1.00mm
JD605
JF205

HL732

JH5117

PA5041 (x20)
6.00/12.20x10.00
(FPM)
HR822

NA5001 [1][2]
32.00x47.00x10.00mm, FPM
NA5124 (x2)[2]
32.00x47.00x10.00mm, PTFE/ACM
NA5106 [2]
35.00x48.00x10.00mm, PTFE
NB716 [2]
35.00x48.00x10.00mm, FPM
LK5003 [1][7]
85.00x131.00x15.700mm, PTFE

HBS268 [22]
M10x1.50x120.00mm (x10)

JD604
JD605
JF205

HL732

JH5117

PA5041 (x20)
6.00/12.20x10.00
(FPM)
HR822

NA5001 [1][2]
32.00x47.00x10.00mm, FPM
NA5124 (x2)[2]
32.00x47.00x10.00mm, PTFE/ACM

HBS268 [22]
M10x1.50x120.00mm (x10)

JD604
JD605

HL732

JH5117

PA5041 (x20)
6.00/12.20x10.00
(FPM)
HR822

NA5124 (x2)[2]
32.00x47.00x10.00mm, PTFE/ACM

HBS268 [22]
M10x1.50x120.00mm (x10)

JD604
JD605
JF205

HL732

JH5117

PA5041 (x20)
6.00/12.20x10.00
(FPM)
HR822

NA5001 [1][2]
32.00x47.00x10.00mm, FPM
NA5124 [2]
32.00x47.00x10.00mm, PTFE/ACM
NA5106 [2]
35.00x48.00x10.00mm, PTFE
NB716 [2]
35.00x48.00x10.00mm, FPM
LK5003 [1][7]
85.00x131.00x15.700mm, PTFE

HBS268 [22]
M10x1.50x120.00mm (x10)

JD604
JD605

HL732

HR397
JH5117

PA5041 (x20)
6.00/12.20x10.00
(FPM)
HR822

NA5001 [1][2]
32.00x47.00x10.00mm, FPM
NA5124 (x2)[2]
32.00x47.00x10.00mm, PTFE/ACM
NA5001 [1][2]
32.00x47.00x10.00mm, FPM
NA5106 [2]
35.00x48.00x10.00mm, PTFE
NB716 [2]
35.00x48.00x10.00mm, FPM
LK5003 [1][7]
85.00x131.00x15.700mm, PTFE

HBS268 [22]
M10x1.50x120.00mm (x10)

JD604
JD605
JE689

HL732

HR397

PA5041 (x20)
6.00/12.20x10.00
(FPM)
HR822

NA5001 [1][2]
32.00x47.00x10.00mm, FPM
NA5124 (x2)[2]
32.00x47.00x10.00mm, PTFE/ACM
NB716 [2]
35.00x48.00x10.00mm, FPM
LK5003 [1][7]
85.00x131.00x15.700mm, PTFE



cc



kW/PS

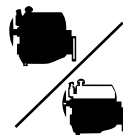

1.8		AVV					74	AY970 (MLS)	CY970	
A4 1.8	01/95→11/00	1781	4	81.00	DOHC	92/125				
A4 Avant 1.8	02/96→09/01									
1.8		AWL					75	AY970 (MLS)	CY971	EY841 [3]
A6 1.8 T	01/97→01/05	1781	4	81.00		110/150				
1.8		AWP					76	AY970 (MLS)	CY971	EY841 [3]
TT Coupe 1.8 T	10/98→06/06	1781	4	81.00	DOHC	132/180				
TT Roadster	10/99→06/06									
1.8		AWT					77	AY970 (MLS)	CY971	EY841 [3]
A4 1.8 T	01/95→11/00	1781	4	81.00	DOHC	110/150				
A4 1.8 T quattro	01/95→11/00									
A4 Avant 1.8 T	01/96→09/01									
A6 1.8 T	01/97→01/05									
A6 1.8 T quattro	02/97→01/05									
A6 Avant 1.8 T	12/97→01/05									
1.8		BAM					78	AY970 (MLS)	CY971	EY841 [3]
A3 1.8 S3	10/01→05/03	1781	4	81.00	DOHC	165/224				
TT Coupe 1.8 T	10/98→06/06									
TT Roadster	10/99→06/06									
1.8		BEX					79	AY970 (MLS)	CY971	EY841 [3]
A4 1.8 T	11/02→12/04	1781	4	81.00	DOHC	140/190				
A4 1.8 T quattro	11/02→12/04							→Ch.8E-3-500 000		
1.8		BFB					80	AY970 (MLS)	CY971	EY841 [3]
A4 1.8 T	07/02→03/09	1781	4	81.00	DOHC	120/163				
A4 1.8 T quattro	07/02→06/08							→Ch.8E-3-500 000		

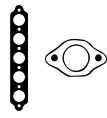

AY970



JD604



JD605



JE689

HBS268 [22]
M10x1.50x120.00mm (x10)

JD605 [E]
JE689

HL732 [E]

PA5041 (x20)
6.00/12.20x10.00
(FPM)

NA5124 (x2)[2]
32.00x47.00x10.00mm, PTFE/ACM
NA5124 [E] [2]
32.00x47.00x10.00mm, PTFE/ACM
LK5006 [E] [7]
85.00x131.00x16.000mm, PTFE

HBS268 [22]
M10x1.50x120.00mm (x10)

JD604 [I]
JD605 [E]
JF205

HL732 [E]

JH5117

PA5041 (x20)
6.00/12.20x10.00
(FPM)
HR822 [E]

NA5001 [1][2]
32.00x47.00x10.00mm, FPM
NA5106 [2]
35.00x48.00x10.00mm, PTFE/ACM
NA5124 (x2)[2]
32.00x47.00x10.00mm, PTFE/ACM
NA5106 [E] [2]
35.00x48.00x10.00mm, PTFE

HBS268 [22]
M10x1.50x120.00mm (x10)

JD604 [I]
JD605 [E]

HL732 [E]

JH5117

PA5041 (x20)
6.00/12.20x10.00
(FPM)
HR822 [E]

NA5001 [1][2]
32.00x47.00x10.00mm, FPM
NA5124 (x2)[2]
32.00x47.00x10.00mm, PTFE/ACM
NA5106 [E] [2]
35.00x48.00x10.00mm, PTFE
LK5003 [E] [1][7]
85.00x131.00x15.700mm, PTFE

HBS268 [22]
M10x1.50x120.00mm (x10)

JD604 [I]
JD605 [E]
JE5075

HL732 [E]

HR397
JH5117

PA5041 (x20)
6.00/12.20x10.00
(FPM)
HR822 [E]

NA5001 [1][2]
32.00x47.00x10.00mm, FPM
NA5124 (x2)[2]
32.00x47.00x10.00mm, PTFE/ACM
NA5106 [E] [2]
35.00x48.00x10.00mm, PTFE
NB716 [E] [2]
35.00x48.00x10.00mm, FPM
LK5003 [E] [1][7]
85.00x131.00x15.700mm, PTFE
LK5006 [E] [7]
85.00x131.00x16.000mm, PTFE

HBS268 [22]
M10x1.50x120.00mm (x10)

JD604 [I]
JD605 [E]

HL732 [E]

HR397

PA5041 (x20)
6.00/12.20x10.00
(FPM)
HR822 [E]

NA5001 (x2)[1][2]
32.00x47.00x10.00mm, FPM
NB716 [E] [2]
35.00x48.00x10.00mm, FPM
LK5003 [E] [1][7]
85.00x131.00x15.700mm, PTFE

HBS268 [22]
M10x1.50x120.00mm (x10)

JD604 [I]
→Ch.8E-3-500 000
JD6005 [I]
(Steel)
1.00mm
→Ch.8E-3-500 000
JD605 [E]
→Ch.8E-3-500 000

HL732 [E]

PA5041 (x20)
6.00/12.20x10.00
(FPM)
HR822 [E]

NA5106 [2]
35.00x48.00x10.00mm, PTFE/ACM
NA5124 (x2)[2]
32.00x47.00x10.00mm, PTFE/ACM
NA5106 [E] [2]
35.00x48.00x10.00mm, PTFE
LK5003 [E] [1][7]
85.00x131.00x15.700mm, PTFE

HBS268 [22]
M10x1.50x120.00mm (x10)

JD604 [I]
→Ch.8E-3-500 000
JD6005 [I]
(Steel)
1.00mm
→Ch.8E-3-500 000
JD605 [E]
→Ch.8E-3-500 000

HL732 [E]

PA5041 (x20)
6.00/12.20x10.00
(FPM)
HR822 [E]

NA5106 [2]
35.00x48.00x10.00mm, PTFE/ACM
NA5124 (x2)[2]
32.00x47.00x10.00mm, PTFE/ACM
NA5106 [E] [2]
35.00x48.00x10.00mm, PTFE
LK5003 [E] [1][7]
85.00x131.00x15.700mm, PTFE



cc



kW/PS

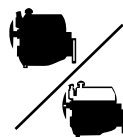

1.8							81	AY970 (MLS)	CY971	EY841 [3]
TT 1.8 T quattro	03/05→06/06	1781	4	81.00	DOHC	176/239				
1.8							82	AY970 (MLS)	CY971	EY841 [3]
TT 1.8 T	09/05→06/06	1781	4	81.00	DOHC	120/163				
TT Roadster	09/05→06/06									
1.8							83	AY970 (MLS)	CY971	EY841 [3]
TT 1.8 T	09/05→06/06	1781	4	81.00	DOHC	140/190				
TT 1.8 T quattro	09/05→06/06									
TT Roadster	09/05→06/06									
1.8							84	AH5380 (MLS)		
A3 1.8 TFSI	11/06→08/12	1798	4	82.50	DOHC	118/160				
A3 Sportback	11/06→									
1.8							85	AH5380 (MLS)		
A3 1.8 TFSI	11/06→08/12	1798	4	81.00	DOHC	118/160				
A3 Cabrio TFSI	04/08→									
A3 Sportback	11/06→									
1.8							86	AH5380 (MLS)		
A4 1.8 TFSI	01/08→	1798	4	82.50	DOHC	88/120				
1.8							87	AH5380 (MLS)		
A4 1.8 TFSI	11/07→	1798	4	82.50	DOHC	118/160				
1.8							88	AH5380 (MLS)		
A5 1.8 TFSI	10/07→	1798	4	82.50	DOHC	125/170				
1.8							89	AH5380 (MLS)		
A3 1.8 quattro	07/08→08/12	1798	4	82.50	DOHC	118/160				
A3 1.8 TFSI	11/06→08/12									
A3 Cabrio TFSI	04/08→									
A3 Sportback	11/06→									
TT 1.8 TFSI	06/08→									
TT Roadster	06/08→									
1.8							90	AH5380 (MLS)		
A4 1.8 TFSI	01/08→	1798	4	82.50	DOHC	88/120				
A4 Avant TFSI	04/08→									
1.8							91	AH5380 (MLS)		
A4 1.8 TFSI	11/07→	1798	4	82.50	DOHC	118/160				
A5 1.8 TFSI	05/09→									

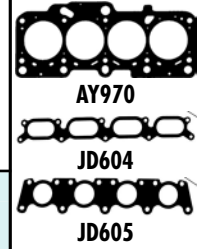

HBS268 [22] M10x1.50x120.00mm (x10)	JD604 [1] JD605 [1]	HL732 [1]		PA5041 (x20) 6.00/12.20x10.00 (FPM) HR822 [1]	NA5001 [1][2] 32.00x47.00x10.00mm, FPM NA5124 (x2)[2] 32.00x47.00x10.00mm, PTFE/ACM LK5003 [1][7] 85.00x131.00x15.700mm, PTFE	
HBS268 [22] M10x1.50x120.00mm (x10)	JD604 [1] JD605 [1]	HL732 [1]		PA5041 (x20) 6.00/12.20x10.00 (FPM) HR822 [1]	NA5001 [1][2] 32.00x47.00x10.00mm, FPM NA5124 (x2)[2] 32.00x47.00x10.00mm, PTFE/ACM LK5003 [1][7] 85.00x131.00x15.700mm, PTFE	
HBS268 [22] M10x1.50x120.00mm (x10)	JD604 [1] JD605 [1]	HL732 [1]		PA5041 (x20) 6.00/12.20x10.00 (FPM) HR822 [1]	NA5001 [1][2] 32.00x47.00x10.00mm, FPM NA5124 (x2)[2] 32.00x47.00x10.00mm, PTFE/ACM LK5003 [1][7] 85.00x131.00x15.700mm, PTFE	
HBS476 [22] M10x1.50x117.00mm (x10)			HR397	PA5041 (x16) 6.00/12.20x10.00 (FPM) HR791 [1]		
HBS476 [22] M10x1.50x117.00mm (x10)		HR397 [1]	HR397	PA5041 (x16) 6.00/12.20x10.00 (FPM) HR791 [1]		
HBS476 [22] M10x1.50x117.00mm (x10)				PA5041 (x16) 6.00/12.20x10.00 (FPM) HR791 [1]		
HBS476 [22] M10x1.50x117.00mm (x10)				PA5041 (x16) 6.00/12.20x10.00 (FPM) HR791 [1]		
HBS476 [22] M10x1.50x117.00mm (x10)		HR397 [1]	HR397	PA5041 (x16) 6.00/12.20x10.00 (FPM) HR791 [1]	NA5124 [2] 32.00x47.00x10.00mm, PTFE/ACM	
HBS476 [22] M10x1.50x117.00mm (x10)		HR397 [1]	HR397	PA5041 (x16) 6.00/12.20x10.00 (FPM) HR791 [1]	NA5124 [2] 32.00x47.00x10.00mm, PTFE/ACM	
HBS476 [22] M10x1.50x117.00mm (x10)		HR397 [1]	HR397	PA5041 (x16) 6.00/12.20x10.00 (FPM) HR791 [1]	NA5124 [2] 32.00x47.00x10.00mm, PTFE/ACM	



cc



kW/PS

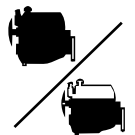

1.8		DS				92		BM360 (Fibre)	DM360	EG873
100 1.8	08/83→07/89	1781	4	81.00	SOHC/OHC	66/90				
100 Avant 1.8	08/83→07/89									
Coupe 1.8 GT	09/82→10/88									
1.8		DZ				93		BM360 (Fibre)	DM360	EG873
80 1.8 E	06/86→08/91	1781	4	81.00	SOHC/OHC	82/112				
80 1.8 E quattro	09/86→08/91									
Coupe 1.8	08/89→07/91									
Coupe 1.8 GT	12/84→10/88									
1.8		JN				94		BM360 (Fibre)	DM361	EG873
80 1.8 S	09/86→10/91	1781	4	81.00	SOHC/OHC	66-68/ 90-93				
80 1.8 S quattro	09/86→09/91									
Coupe 1.8 GT	01/85→10/88									
1.8		JV				95		BM360 (Fibre)	DM360	EG873
Coupe 1.8 GT	09/82→10/88	1781	4	81.00	SOHC/OHC	66/90				
1.8		JW				96		BM360 (Fibre)	DM360	EG873
100 1.8	08/83→07/89	1781	4	81.00	SOHC/OHC	66/90				
100 1.8 quattro	10/84→07/88									
100 Avant 1.8	08/83→07/89									
1.8		NE				97		BM360 (Fibre)	DM360	EG873
80 1.8 S	09/86→10/91	1781	4	81.00	SOHC/OHC	66/90				
80 1.8 S quattro	09/86→09/91									
Coupe 1.8 GT	09/85→10/88									
1.8		NP				98		BM360 (Fibre)	DM360	EG873
100 1.8	08/83→07/89	1781	4	81.00	SOHC/OHC	66/90				
100 1.8 quattro	10/84→07/88									
100 Avant 1.8	08/83→07/89									
1.8		PH				99		BM360 (Fibre)	DM361	EG873
100 1.8 CAT	03/85→11/90	1781	4	81.00	SOHC/OHC	66/90				
100 1.8 quattro	08/85→11/90									
100 Avant 1.8	03/85→11/90									
1.8		PM				100		BM360 (Fibre)	DM361	EG873
80 1.8 S	09/86→10/91	1781	4	81.00		66/90				
80 1.8 S quattro	09/86→09/91									

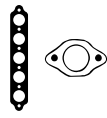

BM360



JC152



JC478



JE138



JE689



JE904

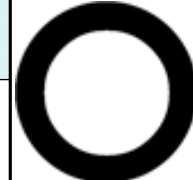

PA459

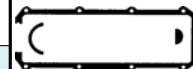

HL457



JJ140



cc



kW/PS

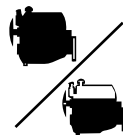

1.8	RU						101	BM360 (Fibre)	DM360	EG873
80 1.8	10/86→01/90	1781	4	81.00	SOHC/OHC	55/75				
1.8	SD						102	BT810 (Fibre)	DT813	EG873
80 1.8	09/86→07/88	1847	4	82.50	SOHC/OHC	83/113				
80 1.8 quattro	09/86→08/90									
1.8	SF						103	BM360 (Fibre)	DM360	EG873
80 1.8 S	09/86→12/90	1781	4	81.00	SOHC/OHC	65/88				
80 1.8 S quattro	09/86→07/90									
Coupe 1.8 GT	04/86→10/88									
1.8	SH						104	BM360 (Fibre)	DM360	EG873
100 1.8	02/86→07/88	1781	4	81.00	SOHC/OHC	65-66/ 88-90				
100 1.8 quattro	08/86→07/90									
100 Avant 1.8	02/86→07/90									
1.9	1Y Diesel						105	BV850 (MLS), 1.530mm, 1 Hole BV860 (MLS), 1.570mm, 2 Holes BV870 (MLS), 1.610mm, 3 Holes	DV850 ▲ →Eng.580 000 DV851 ▲ Eng.580 001→	EC030 [18] →Eng.800000
80 1.9 D	08/89→08/91	1896	4	79.50	SOHC/OHC	50/68				
1.9	1Z Diesel						106	BX800 (MLS), 1.450mm, 1 Hole BX810 (MLS), 1.530mm, 2 Holes BX820 (MLS), 1.610mm, 3 Holes	DX800 ▲ →Eng.1Z-720 000 DX801 ▲ Eng.1Z-720 001→	EC030 [18]
80 1.9 TDI	09/91→12/94	1896	4	79.50	SOHC/OHC	66/90				
80 Avant 1.9 TDI	07/92→01/96									
A4 1.9 TDI	01/95→11/00									
A4 Avant 1.9 TDI	02/96→09/01									
A6 1.9 TDI	06/94→10/97									
A6 Avant 1.9 TDI	06/94→12/97									
Cabriolet	06/95→08/00									
1.9	AAZ Diesel						107	BV850 (MLS), 1.530mm, 1 Hole BV860 (MLS), 1.570mm, 2 Holes BV870 (MLS), 1.610mm, 3 Holes	DV850 ▲	EC030 [18]
80 1.9 TD	09/91→12/94	1896	4	79.50	SOHC/OHC	55/75				
80 Avant 1.9 TD	09/91→12/94									
1.9	AFF Diesel						108	BX800 (MLS), 1.450mm, 1 Hole BX810 (MLS), 1.530mm, 2 Holes BX820 (MLS), 1.610mm, 3 Holes	DX800 ▲ →Eng.002 000 DX801 ▲ Eng.002 001→	EC030 [18]
A4 1.9 TDI	12/95→11/00	1896	4	79.50	SOHC/OHC	55/75				
A4 Avant 1.9 TDI	03/96→09/01									

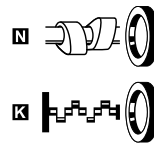
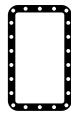
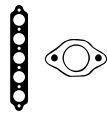

HBS043 [22] M11x1.50x95.00mm (x10)	JC478 [1] PA459 [1] (NBR) JC152 [x4] ☉JE689	HL457 [23] (Cork) HM5053 [24] (ACM)	JJ140 (SMG)	HR569 [5]	NA5001 [1][2] 32.00x47.00x10.00mm, FPM ☒ NA5001 [1][2] 32.00x47.00x10.00mm, FPM ☒ NA5133 [1] 85.00x105.00x11.00mm, FPM	
HBS043 [22] M11x1.50x95.00mm (x10)	JC152 [x4] ☉JE689	HL457 [23] (Cork) HM5053 [24] (ACM)	JJ140 (SMG)	HR363 [5] HR569 [5]	NA5001 [1][2] 32.00x47.00x10.00mm, FPM ☒ NA5001 [1][2] 32.00x47.00x10.00mm, FPM ☒ NA5133 [1] 85.00x105.00x11.00mm, FPM	KA5020 [15]
HBS043 [22] M11x1.50x95.00mm (x10)	JC478 [1] PA459 [1] (NBR) JC152 [x4] ☉JE689	HL457 [23] (Cork) HM5053 [24] (ACM)	JJ140 (SMG)	HR569 [5]	NA5001 [1][2] 32.00x47.00x10.00mm, FPM ☒ NA5001 [1][2] 32.00x47.00x10.00mm, FPM ☒ NA5133 [1] 85.00x105.00x11.00mm, FPM	
HBS043 [22] M11x1.50x95.00mm (x10)	JC478 [1] PA459 [1] (NBR) JC152 [x4] ☉JE904	HL457 [23] (Cork) HM5053 [24] (ACM)	JJ140 (SMG)	HR569 [5]	NA5001 [1][2] 32.00x47.00x10.00mm, FPM ☒ NA5001 [1][2] 32.00x47.00x10.00mm, FPM ☒ NA5133 [1] 85.00x105.00x11.00mm, FPM	KA5020 [15]
HBS018 [19] M12x1.75x115.00mm (x10)	JD170 [1] JC152 [x4] ☉JE138 [27] ☉JE5076	JN914 [4] HM5058 [5]	JH5023	HR569 [5] →Eng.580 000 HR816 [5] Eng.580 001 →	NA5001 [1][2] 32.00x47.00x10.00mm, FPM ☒ NA5001 [1][2] 32.00x47.00x10.00mm, FPM ☒ NA5133 [1] 85.00x105.00x11.00mm, FPM ☒ LK5006 [7] 85.00x131.00x16.00mm, PTFE	
HBS018 [19] M12x1.75x115.00mm (x10)	JD170 [1] JC152 [x4]	JP003 [4] HM5367 [5]	JJ609 (ACM)	HR569 [5] →Eng.1Z-720 000 HR816 [5] Eng.1Z-720 001 →	NA5001 [1][2] 32.00x47.00x10.00mm, FPM ☒ NA5001 [1][2] 32.00x47.00x10.00mm, FPM ☒ NA5133 [1] 85.00x105.00x11.00mm, FPM	
HBS018 [19] M12x1.75x115.00mm (x10)	JD170 [1] JC152 [x4] ☉JE5076	JN914 [4] HM5058 [5]	JH5023	HR569 [5]	NA5001 [1][2] 32.00x47.00x10.00mm, FPM ☒ NA5001 [1][2] 32.00x47.00x10.00mm, FPM ☒ NA5133 [1] 85.00x105.00x11.00mm, FPM	
HBS018 [19] M12x1.75x115.00mm (x10)	JD170 [1] JC152 [x4]	JP003 [4] HM5367 [5]	JJ609 (ACM)	HR569 [5] →Eng.002 000 HR816 [5] Eng.002 001 →	NA5001 [1][2] 32.00x47.00x10.00mm, FPM ☒ NA5001 [1][2] 32.00x47.00x10.00mm, FPM ☒ NA5133 [1] 85.00x105.00x11.00mm, FPM ☒ LK5006 [7] 85.00x131.00x16.00mm, PTFE	

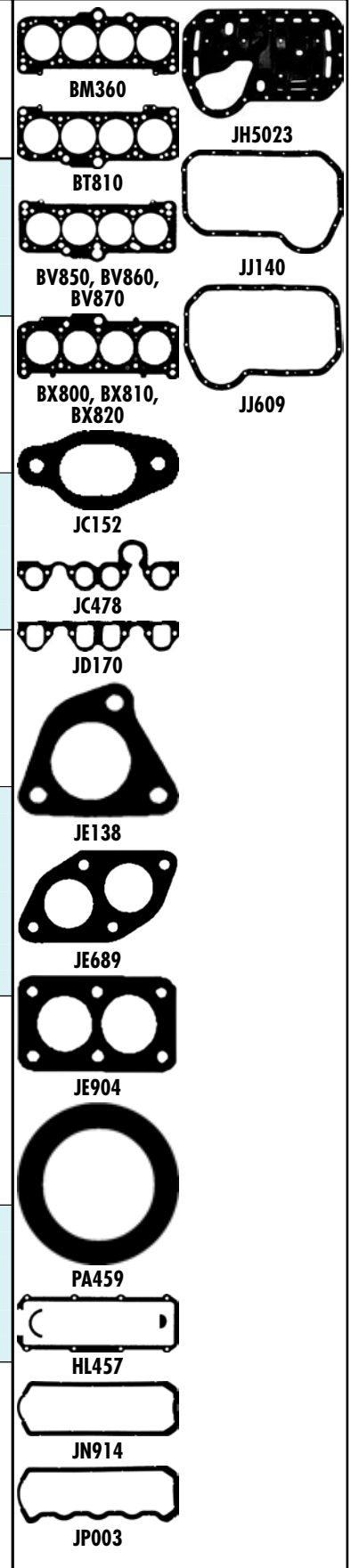



cc



kW/PS

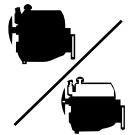

1.9	AFN Diesel					109			
A4 1.9 TDI	10/95→11/00	1896	4	79.50	SOHC/OHC	81/110	BX800 (MLS), 1.450mm, 1 Hole BX810 (MLS), 1.530mm, 2 Holes BX820 (MLS), 1.610mm, 3 Holes	DX800 ▲ →Eng.002 000 DX801 ▲ Eng.002 001→	ECO30 [18] →Eng.576000
A4 Avant 1.9 TDI	02/96→09/01								
A4 Avant TDI	09/96→09/01								
A6 1.9 TDI	04/97→10/00								
A6 Avant 1.9 TDI	02/98→04/01								
1.9	AGR Diesel					110			
A3 1.9 TDI	09/96→07/01	1896	4	79.50	SOHC/OHC	66/90	BZ010 (MLS), 1.450mm, 1 Hole →Eng.151 000 BZ020 (MLS), 1.530mm, 2 Holes →Eng.151 000 BZ030 (MLS), 1.610mm, 3 Holes →Eng.151 000 BZ040 (MLS), 1.470mm, 1 Hole Eng.151 001→ BZ050 (MLS), 1.570mm, 2 Holes Eng.151 001→ BZ060 (MLS), 1.670mm, 3 Holes Eng.151 001→	DZ010 ▲☒	ECO60 [18]
1.9	AHF Diesel					111			
A3 1.9 TDI	08/97→07/01	1896	4	79.50	SOHC/OHC	81/110	BZ010 (MLS), 1.450mm, 1 Hole →Eng.140 000 BZ020 (MLS), 1.530mm, 2 Holes →Eng.140 000 BZ030 (MLS), 1.610mm, 3 Holes →Eng.140 000 BZ040 (MLS), 1.470mm, 1 Hole Eng.140 001→ BZ050 (MLS), 1.570mm, 2 Holes Eng.140 001→ BZ060 (MLS), 1.670mm, 3 Holes Eng.140 001→	DZ010 ▲☒	ECO60 [18]
1.9	AHH Diesel					112			
A4 1.9 TDI	01/95→11/00	1896	4	79.50	SOHC/OHC	66/90	BX800 (MLS), 1.450mm, 1 Hole BX810 (MLS), 1.530mm, 2 Holes BX820 (MLS), 1.610mm, 3 Holes	DX801 ▲	ECO30 [18]
A4 Avant 1.9 TDI	02/96→09/01								
1.9	AHU Diesel					113			
A4 1.9 DUO	03/98→09/01	1896	4	79.50	SOHC/OHC	66/90	BX800 (MLS), 1.450mm, 1 Hole BX810 (MLS), 1.530mm, 2 Holes BX820 (MLS), 1.610mm, 3 Holes	DX800 ▲ →Eng.720 000 DX801 ▲ Eng.720 001→	ECO30 [18] →Eng.390000
A4 1.9 TDI	01/95→11/00								
A4 Avant 1.9 TDI	02/96→09/01								
A6 1.9 TDI	06/94→10/97								
A6 Avant 1.9 TDI	06/94→12/97								
Cabriolet	06/95→08/00								
1.9	AJM Diesel					114			
A4 1.9 TDI	03/00→11/00	1896	4	79.50	SOHC/OHC	85/115	AF5381 (MLS), 1.490mm, 1 Hole AF5391 (MLS), 1.530mm, 2 Holes AF5401 (MLS), 1.650mm, 3 Holes	CC5231 ▲	ECO60 [18]
A4 Avant 1.9 TDI	03/00→09/01								
A4 Avant TDI	03/00→09/01								
A6 1.9 TDI	07/00→01/05								
A6 Avant 1.9 TDI	07/00→01/05								

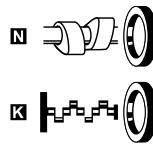
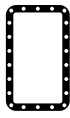
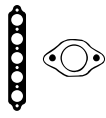

BX800, BX810,
BX820



BZ010, BZ020,
BZ030



BZ040, BZ050,
BZ060



JC152



JD170



JP003



JJ609



cc



kW/PS

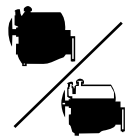

1.9		ALH Diesel				115			
A3 1.9 TDI	09/96→07/01	1896	4	79.50	SOHC/OHC	66/90	BZ010 (MLS), 1.450mm, 1 Hole →Eng.085 000 BZ020 (MLS), 1.530mm, 2 Holes →Eng.085 000 BZ030 (MLS), 1.610mm, 3 Holes →Eng.085 000 BZ040 (MLS), 1.470mm, 1 Hole Eng.085 001→ BZ050 (MLS), 1.570mm, 2 Holes Eng.085 001→ BZ060 (MLS), 1.670mm, 3 Holes Eng.085 001→	DZ010 ▲☒	EC060 [18]
1.9		ASV Diesel				116			
A3 1.9 TDI	08/97→07/01	1896	4	79.50	SOHC/OHC	81/110	BZ040 (MLS), 1.470mm, 1 Hole BZ050 (MLS), 1.570mm, 2 Holes BZ060 (MLS), 1.670mm, 3 Holes	DZ010 ▲☒	EC060 [18]
1.9		ASZ Diesel				117			
A3 1.9 TDI	08/00→05/03	1896	4	79.50	SOHC/OHC	96/130	AF5381 (MLS), 1.490mm, 1 Hole AF5391 (MLS), 1.530mm, 2 Holes AF5401 (MLS), 1.650mm, 3 Holes	CC5230 ▲	EC060 [18]
1.9		ATD Diesel				118			
A3 1.9 TDI	10/00→05/03	1896	4	79.50	SOHC/OHC	74/101	AF5381 (MLS), 1.490mm, 1 Hole AF5391 (MLS), 1.530mm, 2 Holes AF5401 (MLS), 1.650mm, 3 Holes	CC5230 ▲	EC060 [18]
1.9		ATJ Diesel				119			
A4 1.9 TDI	03/00→11/00	1896	4	79.50	SOHC/OHC	85/115	AF5381 (MLS), 1.490mm, 1 Hole AF5391 (MLS), 1.530mm, 2 Holes AF5401 (MLS), 1.650mm, 3 Holes	CC5231 ▲	EC060 [18]
A4 Avant TDI	03/00→09/01								
1.9		AVB Diesel				120			
A4 1.9 TDI	05/01→12/04	1896	4	79.50	SOHC/OHC	74/101	AF5381 (MLS), 1.490mm, 1 Hole AF5391 (MLS), 1.530mm, 2 Holes AF5401 (MLS), 1.650mm, 3 Holes	CC5230 ▲	EB5370 [3][18] EC060 [18]
1.9		AVF Diesel				121			
A4 1.9 TDI	11/00→12/04	1896	4	79.50	SOHC/OHC	96/130	AF5381 (MLS), 1.490mm, 1 Hole AF5391 (MLS), 1.530mm, 2 Holes AF5401 (MLS), 1.650mm, 3 Holes	CC5230 ▲	EC060 [18]
A6 1.9 TDI	08/01→01/05								
A6 Avant 1.9 TDI	08/01→01/05								
1.9		AVG Diesel				122			
A4 1.9 TDI	10/95→11/00	1896	4	79.50	SOHC/OHC	81/110	BX800 (MLS), 1.450mm, 1 Hole BX810 (MLS), 1.530mm, 2 Holes BX820 (MLS), 1.610mm, 3 Holes	DX801 ▲	EC030 [18]
A4 Avant 1.9 TDI	02/96→09/01								
A4 Avant TDI	09/96→09/01								
A6 1.9 TDI	04/97→10/00								

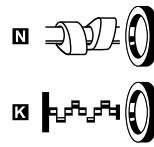
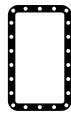
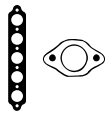

BX800, BX810,
BX820



BZ010, BZ020,
BZ030



BZ040, BZ050,
BZ060



JC152



JD170



JD600



JD606



JP003



JJ609

HBS018 [19]
M12x1.75x115.00mm (x10)

JD170 [1]
JC152 [x4]
JD606 [1]

HR397

HR816 [1]

NA5001 [1][2]
32.00x47.00x10.00mm, FPM
NA5001 [1][2]
32.00x47.00x10.00mm, FPM
NB716 [2]
35.00x48.00x10.00mm, FPM
LK5003 [1][7]
85.00x131.00x15.700mm, PTFE
LK5006 [7]
85.00x131.00x16.000mm, PTFE

HBS018 [19]
M12x1.75x115.00mm (x10)

JD170 [1]
JC152 [x4]

HR397

HR816 [1]

NA5001 [1][2]
32.00x47.00x10.00mm, FPM
NA5106 [2]
35.00x48.00x10.00mm, PTFE
NB716 [2]
35.00x48.00x10.00mm, FPM
LK5003 [1][7]
85.00x131.00x15.700mm, PTFE

HBS300 [19]
M12x1.75x166.00mm (x10)

JD170 [1]
JC152 [x4]

JM5203
(Elastomer)

HR397

HR816 [1]

NA5124 [2]
32.00x47.00x10.00mm, PTFE/ACM
NA5106 [2]
35.00x48.00x10.00mm, PTFE
LK5003 [1][7]
85.00x131.00x15.700mm, PTFE

HBS300 [19]
M12x1.75x166.00mm (x10)

JD170 [1]
JD600 [1]

JM5203
(Elastomer)

HR397

HR816 [1]

NA5124 [2]
32.00x47.00x10.00mm, PTFE/ACM
NA5106 [2]
35.00x48.00x10.00mm, PTFE
LK5003 [1][7]
85.00x131.00x15.700mm, PTFE

HBS300 [19]
M12x1.75x166.00mm (x10)

JD170 [1]
JC152 [x4]

JM5120
(Elastomer)

HR397

HR816 [1]

NA5124 [2]
32.00x47.00x10.00mm, PTFE/ACM
NA5106 [2]
35.00x48.00x10.00mm, PTFE
NA5124 [2]
32.00x47.00x10.00mm, PTFE/ACM
LK5003 [1][7]
85.00x131.00x15.700mm, PTFE

HBS300 [19]
M12x1.75x166.00mm (x10)

JD170 [1]
JD600 [1]

JM5203
(Elastomer)

HR397

HR816 [1]

NA5124 [2]
32.00x47.00x10.00mm, PTFE/ACM
NA5106 [2]
35.00x48.00x10.00mm, PTFE
NA5124 [2]
32.00x47.00x10.00mm, PTFE/ACM
LK5003 [1][7]
85.00x131.00x15.700mm, PTFE

HBS300 [19]
M12x1.75x166.00mm (x10)

JD170 [1]
JD600 [1]

JM5203
(Elastomer)

HR397

HR816 [1]

NA5124 [2]
32.00x47.00x10.00mm, PTFE/ACM
NA5106 [2]
35.00x48.00x10.00mm, PTFE
LK5003 [1][7]
85.00x131.00x15.700mm, PTFE

HBS018 [19]
M12x1.75x115.00mm (x10)

JD170 [1]
JC152 [x4]
JE5075

JP003 [4]
HM5367 [1]

HR397

HR816 [1]

NA5001 [1][2]
32.00x47.00x10.00mm, FPM
NA5001 [1][2]
32.00x47.00x10.00mm, FPM
LK5006 [7]
85.00x131.00x16.000mm, PTFE



cc



kW/PS

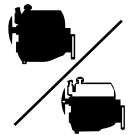

1.9		AWX Diesel				123			
A4 1.9 TDI	11/00→12/04	1896	4	79.50	SOHC/OHC	96/130	AF5381 (MLS), 1.490mm, 1 Hole	CC5230 ▲	ECO60 [18]
A6 1.9 TDI	08/01→01/05						AF5391 (MLS), 1.530mm, 2 Holes		
A6 Avant 1.9 TDI	08/01→01/05						AF5401 (MLS), 1.650mm, 3 Holes		
1.9		AXR Diesel				124			
A3 1.9 TDI	10/00→05/03	1896	4	79.50	SOHC/OHC	74/100	AF5381 (MLS), 1.490mm, 1 Hole	CC5230 ▲	ECO60 [18]
							AF5391 (MLS), 1.530mm, 2 Holes		
							AF5401 (MLS), 1.650mm, 3 Holes		
1.9		BKC Diesel				125			
A3 1.9 TDI	05/03→05/10	1896	4	79.50	SOHC/OHC	77/105	AF5381 (MLS), 1.490mm, 1 Hole	CC5230 ▲	EF5380
A3 Sportback	09/04→05/10						AF5391 (MLS), 1.530mm, 2 Holes		
							AF5401 (MLS), 1.650mm, 3 Holes		
1.9		BKE Diesel				126			
A4 1.9 TDI	06/04→06/08	1896	4	79.50	SOHC/OHC	85/116	AF5381 (MLS), 1.490mm, 1 Hole	CC5230 ▲	
							AF5391 (MLS), 1.530mm, 2 Holes		
							AF5401 (MLS), 1.650mm, 3 Holes		
1.9		BLS Diesel				127			
A3 1.9 TDI	05/03→05/10	1896	4	79.50	SOHC/OHC	77/105	AF5381 (MLS), 1.490mm, 1 Hole	CC5230 ▲	EF5380
A3 Cabrio TDI	04/08→						AF5391 (MLS), 1.530mm, 2 Holes		
A3 Sportback	09/04→05/10						AF5401 (MLS), 1.650mm, 3 Holes		
1.9		BRB Diesel				128			
A4 1.9 TDI	11/04→06/08	1896	4	79.50	SOHC/OHC	85/116	AF5381 (MLS), 1.490mm, 1 Hole	CC5230 ▲	
							AF5391 (MLS), 1.530mm, 2 Holes		
							AF5401 (MLS), 1.650mm, 3 Holes		
1.9		BXE Diesel				129			
A3 1.9 TDI	05/03→05/10	1896	4	79.50	SOHC/OHC	77/105	AF5381 (MLS), 1.490mm, 1 Hole	CC5230 ▲	EF5380
A3 Sportback	09/04→05/10						AF5391 (MLS), 1.530mm, 2 Holes		
							AF5401 (MLS), 1.650mm, 3 Holes		

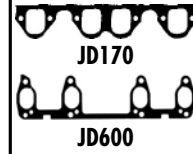
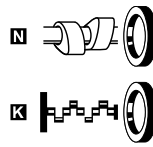
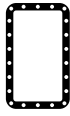
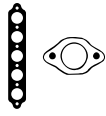

HBS300 [19] M12x1.75x166.00mm (x10)	JD170 [1] JD600 [1]	JM5203 (Elastomer)	HR397	HR816 [1]	NA5124 [2] 32.00x47.00x10.00mm, PTFE/ACM NA5106 [2] 35.00x48.00x10.00mm, PTFE NA5124 [2] 32.00x47.00x10.00mm, PTFE/ACM LK5003 [1][7] 85.00x131.00x15.700mm, PTFE
HBS300 [19] M12x1.75x166.00mm (x10)	JD170 [1] JD600 [1]	JM5203 (Elastomer)	HR397	HR816 [1]	NA5124 [2] 32.00x47.00x10.00mm, PTFE/ACM NA5106 [2] 35.00x48.00x10.00mm, PTFE NA5124 [2] 32.00x47.00x10.00mm, PTFE/ACM LK5003 [1][7] 85.00x131.00x15.700mm, PTFE
HBS300 [19] M12x1.75x166.00mm (x10)	JD170 [1] JD600 [1]	JM5203 (Elastomer)	HR397	HR816 [1]	NA5124 [2] 32.00x47.00x10.00mm, PTFE/ACM NA5106 [2] 35.00x48.00x10.00mm, PTFE NA5124 [2] 32.00x47.00x10.00mm, PTFE/ACM LK5012 [1][7][28] 85.00x132.00x15.70mm, ACM
HBS300 [19] M12x1.75x166.00mm (x10)	JD170 [1] JD600 [1]	JM5203 (Elastomer)		HR816 [1]	NA5106 [2] 35.00x48.00x10.00mm, PTFE/ACM NA5124 [2] 32.00x47.00x10.00mm, PTFE/ACM NA5106 [2] 35.00x48.00x10.00mm, PTFE LK5003 [1][7] 85.00x131.00x15.700mm, PTFE
HBS300 [19] M12x1.75x166.00mm (x10)	JD170 [1] JD5992 [29] (Steel)	JM7107 (ACM)	HR397	HR816 [1]	NA5124 [2] 32.00x47.00x10.00mm, PTFE/ACM NA5106 [2] 35.00x48.00x10.00mm, PTFE NA5124 [2] 32.00x47.00x10.00mm, PTFE/ACM LK5012 [1][7][28] 85.00x132.00x15.70mm, ACM
HBS300 [19] M12x1.75x166.00mm (x10)	JD170 [1] JD600 [1]	JM5203 (Elastomer)		HR816 [1]	NA5106 [2] 35.00x48.00x10.00mm, PTFE/ACM NA5124 [2] 32.00x47.00x10.00mm, PTFE/ACM NA5106 [2] 35.00x48.00x10.00mm, PTFE LK5003 [1][7] 85.00x131.00x15.700mm, PTFE
HBS300 [19] M12x1.75x166.00mm (x10)	JD170 [1] JD600 [1]	JM5203 (Elastomer)	HR397	HR816 [1]	NA5124 [2] 32.00x47.00x10.00mm, PTFE/ACM NA5106 [2] 35.00x48.00x10.00mm, PTFE NA5124 [2] 32.00x47.00x10.00mm, PTFE/ACM LK5012 [1][7][28] 85.00x132.00x15.70mm, ACM



cc



kW/PS

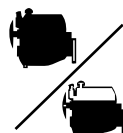

2.0	3A						130	BT810 (Fibre)	DT813	ET811
80 2.0 E	08/88→10/90	1984	4	82.50	SOHC/OHC	82-83/ 112-113				
80 2.0 E quattro	08/88→09/90									
80 2.0 quattro	08/88→07/90									
Coupe 2.0	05/89→07/90									
2.0	6A						131	BT810 (Fibre)	DT813	ES471 →Ch.1H-PB-130 001 EB970 Ch.1H-PB-130 001→
80 2.0 E 16V	03/90→09/91	1984	4	82.50	DOHC	101/137				
90 2.0 quattro	08/89→07/90									
2.0	AAD						132	BT810 (Fibre) 12/90→12/92	DT814 12/90→12/92	ES471 12/90→12/92 →Ch.1H-PB-130 001 EB970 12/90→12/92 Ch.1H-PB-130 001→
80 2.0	10/90→08/91	1984	4	82.50	SOHC/OHC	82-85/ 112-115				
80 2.0 quattro	10/90→08/91									
100 2.0 E	12/90→06/94									
100 Avant 2.0 E	09/91→06/94									
100 Avant 2.0E	12/90→07/92									
Coupe 2.0	05/89→12/96									
2.0	AAE						133	BT810 (Fibre) BY750 (MLS)	DT814 →Ch.4A-P-160 000 DY750 DT815 Ch.4A-P-160 001→	EG872 →07/92
100 2.0	12/90→06/94	1984	4	82.50	SOHC/OHC	74/100				
100 Avant 2.0 E	09/91→06/94									
A6 2.0	06/94→10/97									
A6 Avant 2.0	06/94→12/97									
2.0	ABK						134	BT810 (Fibre) 10/90→	DT814 10/90→	EB970 10/90→
Cabrio 2.0 E	01/93→07/98	1984	4	82.50	SOHC/OHC	85/115				
80 2.0 E	09/91→12/94									
80 2.0 E quattro	09/91→12/94									
80 Avant 2.0 E	07/92→01/96									
100 2.0 E	12/90→06/94									
100 Avant 2.0 E	09/91→06/94									
A6 2.0	06/94→10/97									
A6 Avant 2.0	06/94→12/97									
Coupe 2.0	05/89→12/96									
2.0	ABT						135	BT810 (Fibre)	DT815 →Ch.8C-P-185 164 DT81C	EB970
80 2.0	09/91→12/94	1984	4	82.50	SOHC/OHC	66/90				
80 Avant 2.0	07/92→01/96									
2.0	ACE						136	BY750 (MLS)	DY751 →Eng.017 542 DY752 Eng.017 543→	EG872 [30] →07/92 →Ch.4A-P-055 000
80 2.0 E 16V	04/92→01/96	1984	4	82.50	DOHC	101-103/ 137-140				
80 2.0E 16V	12/92→07/95									
100 2.0 E 16V	01/92→06/94									
A6 2.0 16V	06/94→12/97									
A6 Avant 2.0 16V	06/94→12/97									
Cabriolet	06/95→07/96									
Coupe 2.0 16 V	08/92→12/96									

HBS043 [22] M11x1.50x95.00mm (x10)	JC152 [x4] JE689	HL457 [23] (Cork) HM5053 [24] (ACM)	JJ140 (SMG)	HR569	NA5001 [1][2] 32.00x47.00x10.00mm, FPM NA5001 [1][2] 32.00x47.00x10.00mm, FPM NA5133 [1] 85.00x105.00x11.00mm, FPM		BT810 BY750 JC152 JD281 JD282 JD482 JD483 JE689 JF206 PA459 HL457 HL731 JP024 JJ140 	JJ609 	
HBS028 [22] M11x1.50x147.00mm (x10)	JD281 [1] JD282 [x4] JF206	HL606	JJ140 (SMG)	HR599 HR816 [x2]	NA5001 [1][2] 32.00x47.00x10.00mm, FPM NA5001 [1][2] 32.00x47.00x10.00mm, FPM NA5133 [1] 85.00x105.00x11.00mm, FPM		JD281 JD282 JD482 JD483 JE689 JF206 PA459 HL457 HL731 JP024 JJ140 	JJ609 	
HBS043 [22] M11x1.50x95.00mm (x10) 12/90→12/92	JD483 [1] 12/90→12/92 JC152 [x4] 12/90→12/92 JE689 12/90→12/92	HL457 [23] (Cork) 12/90→12/92 HM5053 [24] (ACM) 12/90→12/92	JJ140 (SMG) 12/90→12/92	HR569 12/90→12/92	NA5001 [1][2] 32.00x47.00x10.00mm, FPM 12/90→12/92 NA5001 [1][2] 32.00x47.00x10.00mm, FPM 12/90→12/92 NA5133 [1] 85.00x105.00x11.00mm, FPM 12/90→12/92		JD281 JD282 JD482 JD483 JE689 JF206 PA459 HL457 HL731 JP024 JJ140 	JJ609 	
HBS043 [22] M11x1.50x95.00mm (x10)	PA459 [1] (NBR) JC152 [x4]	JP024 [4] HL457 [23] (Cork) →Ch.4A-P-160 000 HM5053 [24] (ACM)	JJ140 (SMG) →07/92	HR569 →Eng.032 209 HR816 Eng.032 210→	NA5001 [1][2] 32.00x47.00x10.00mm, FPM NA5001 [1][2] 32.00x47.00x10.00mm, FPM NA5133 [1] 85.00x105.00x11.00mm, FPM		JD281 JD282 JD482 JD483 JE689 JF206 PA459 HL457 HL731 JP024 JJ140 	JJ609 	
HBS043 [22] M11x1.50x95.00mm (x10) 10/90→	JD483 [1] 10/90→ JC152 [x4] 10/90→ JE689 10/90→	JP024 [4] 10/90→ HL457 [23] (Cork) 10/90→ HM5053 [24] (ACM) 10/90→	JJ140 (SMG) 10/90→ JJ609 (ACM) 10/90→	HR569 10/90→	NA5001 [1][2] 32.00x47.00x10.00mm, FPM 10/90→ NA5001 [1][2] 32.00x47.00x10.00mm, FPM 10/90→ NA5133 [1] 85.00x105.00x11.00mm, FPM 10/90→		JD281 JD282 JD482 JD483 JE689 JF206 PA459 HL457 HL731 JP024 JJ140 	JJ609 	
HBS043 [22] M11x1.50x95.00mm (x10)	JD482 [1] JC152 [x4]	JP024 [4] HM5053 [24] (ACM) →Ch.8C-P-185 164	JJ140 (SMG)	HR569 →Eng.246 861 HR816 Eng.246 862→	NA5001 [1][2] 32.00x47.00x10.00mm, FPM NA5001 [1][2] 32.00x47.00x10.00mm, FPM NA5133 [1] 85.00x105.00x11.00mm, FPM		JD281 JD282 JD482 JD483 JE689 JF206 PA459 HL457 HL731 JP024 JJ140 	JJ609 	
HBS028 [22] M11x1.50x147.00mm (x10) →Eng.017 543	JD282 [x4] JE689	HL606 →Eng.017 542 HL731 Eng.017 543→	JJ140 [30] (SMG) →07/92 →Ch.4A-P-055 000	HR599 HR816 [x2]	NA5001 [1][2] 32.00x47.00x10.00mm, FPM NA5001 [1][2] 32.00x47.00x10.00mm, FPM NA5133 [1] 85.00x105.00x11.00mm, FPM		JD281 JD282 JD482 JD483 JE689 JF206 PA459 HL457 HL731 JP024 JJ140 	JJ609 	



cc



kW/PS

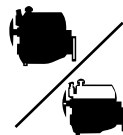

2.0										
ADW							137	AF5360 (MLS), 1.610mm, 3 Holes	DY750	EB970
80 Avant 2.0	11/93→01/96	1984	4	82.50	SOHC/OHC	79/107				
A6 2.0	08/95→07/96									
ALT							138	AG8810 (MLS)	CG8420	EG9600
A4 2.0	11/00→06/08	1984	4	82.50	DOHC	96/130				
A4 Avant 2.0	09/01→06/08									
A6 2.0	08/01→01/05									
A6 Avant 2.0	08/01→01/05									
AWA							139	AG9600 (MLS)	CG9600	EG9600
A4 2.0 FSI	07/02→12/04	1984	4	82.50	DOHC	110/150				
A4 Avant 2.0 FSI	07/02→12/04									
AXW							140	AG9600 (MLS)	CG9600	EG9600
A3 2.0 FSI	05/03→06/08	1984	4	82.50	DOHC	110/150				
AXX							141	AH5380 (MLS)		
A3 2.0 quattro	09/04→08/12	1984	4	82.50	DOHC	147/200				
A3 2.0 TFSI	09/04→08/12									
A3 Sportback	09/04→									
AZV Diesel							142	AG8970 (MLS), 1.550mm, 1 Hole AG8800 (MLS), 1.630mm, 2 Holes AG8960 (MLS), 1.710mm, 3 Holes	CG8410 ▲	EF5380
A3 2.0 TDI	05/03→08/12	1968	4	81.00	DOHC	100/136				
A3 Sportback	09/04→									
BGB							143			
A4 2.0 TFSI	11/04→06/08	1984	4	82.50	DOHC	147/200				
A4 Avant TFSI	11/04→06/08									
BHZ							144			
A3 S3 quattro	11/06→08/12	1984	4	82.50	DOHC	195/265				
A3 Sportback	06/08→									

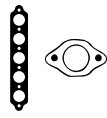

AF5360



JC152



JE689

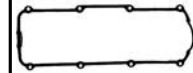

JP024

HBS043 [22] M11x1.50x95.00mm (x10)	JC152 [x4] JE689	JPO24 [4]		HR363 [5]	NA5001 [1][2] 32.00x47.00x10.00mm, FPM NA5001 [1][2] 32.00x47.00x10.00mm, FPM NA5133 [1] 85.00x105.00x11.00mm, FPM	
HBS510 [22]	JD5820 [1] JD5813 [5]	JM7030 (SE)		PA5041 (x8) 6.00/12.20x10.00 (FPM) HR817 [5]	NA5124 [2] 32.00x47.00x10.00mm, PTFE/ACM NA5106 [2] 35.00x48.00x10.00mm, PTFE LK5008 [1][7] 85.00x131.00x15.700mm, PTFE	
HBS363 [22] M10x1.50x122.00mm (x10)	JD5873 [1] (FPM) JD5813 [5]	JM7048 (SE)		PA5041 (x16) 6.00/12.20x10.00 (FPM) HR791 [5]	NA5106 [2] 35.00x48.00x10.00mm, PTFE/ACM NA5124 [2] 32.00x47.00x10.00mm, PTFE/ACM NA5106 [2] 35.00x48.00x10.00mm, PTFE LK5008 [1][7] 85.00x131.00x15.700mm, PTFE	
HBS363 [22] M10x1.50x122.00mm (x10)	JD5873 [1] (FPM) JD5813 [5]	JM7048 (SE)		PA5041 (x16) 6.00/12.20x10.00 (FPM) HR791 [5]	NA5124 [2] 32.00x47.00x10.00mm, PTFE/ACM NA5106 [2] 35.00x48.00x10.00mm, PTFE NA5124 [2] 32.00x47.00x10.00mm, PTFE/ACM LK5008 [1][7] 85.00x131.00x15.700mm, PTFE	
HBS363 [22] M10x1.50x122.00mm (x10) HBS476 [22] M10x1.50x117.00mm (x10)				PA5041 (x16) 6.00/12.20x10.00 (FPM) HR791 [5]	NA5124 [2] 32.00x47.00x10.00mm, PTFE/ACM NA5106 [2] 35.00x48.00x10.00mm, PTFE LK5003 [1][7] 85.00x131.00x15.700mm, PTFE	
HBS364 [19] M12x1.75x149.00mm (x10)	JD5805 [1] JD5806 [1] JD5815 [5]	JM7031 (Elastomer)	HR397	PA5041 (x16) 6.00/12.20x10.00 (FPM) HR791 [5]	NA5124 (x2)[2] 32.00x47.00x10.00mm, PTFE/ACM NA5106 [2] 35.00x48.00x10.00mm, PTFE LK5012 [1][7][28] 85.00x132.00x15.70mm, ACM	KK5522 [31]
HBS476 [22] M10x1.50x117.00mm (x10)				PA5041 (x16) 6.00/12.20x10.00 (FPM) HR791 [5]	NA5106 [2] 35.00x48.00x10.00mm, PTFE/ACM NA5106 [2] 35.00x48.00x10.00mm, PTFE LK5003 [1][7] 85.00x131.00x15.700mm, PTFE	
HBS476 [22] M10x1.50x117.00mm (x10)				PA5041 (x16) 6.00/12.20x10.00 (FPM) HR791 [5]	NA5106 [2] 35.00x48.00x10.00mm, PTFE/ACM NA5124 [2] 32.00x47.00x10.00mm, PTFE/ACM NA5106 [2] 35.00x48.00x10.00mm, PTFE LK5003 [1][7] 85.00x131.00x15.700mm, PTFE	



cc



kW/PS



2.0	BKD Diesel					145			
A3 2.0 TDI 16V A3 Sportback	05/03→08/12 09/04→	1968	4	81.00	DOHC	103/140	AG8970 (MLS), 1.550mm, 1 Hole AG8800 (MLS), 1.630mm, 2 Holes AG8960 (MLS), 1.710mm, 3 Holes	CG8410 ▲	EF5380
2.0	BLB Diesel					146			
A4 2.0 TDI 16V A4 Avant TDI A6 2.0 TDI A6 Avant 2.0 TDI	11/04→06/08 11/04→06/08 07/04→10/08 06/05→10/08	1968	4	81.00	DOHC	103/140	AG8970 (MLS), 1.550mm, 1 Hole AG8800 (MLS), 1.630mm, 2 Holes AG8960 (MLS), 1.710mm, 3 Holes	CG8410 ▲	EF5380
2.0	BLR					147			
A3 2.0 FSI A3 Sportback	05/03→06/08 09/04→	1984	4	82.50	DOHC	110/150	AG9600 (MLS)	CG9600	EG9600
2.0	BLX					148			
A3 2.0 FSI A3 Sportback	05/03→06/08 09/04→	1984	4	82.50	DOHC	110/150	AG9600 (MLS)	CG9600	EG9600
2.0	BLY					149			
A3 2.0 FSI A3 Sportback	05/03→06/08 09/04→	1984	4	82.50	DOHC	110/150	AG9600 (MLS)	CG9600	EG9600
2.0	BMB					150			
A3 2.0 FSI A3 Sportback	05/03→06/08 09/04→	1984	4	82.50	DOHC	110/150	AG9600 (MLS)	CG9600	EG9600
2.0	BMM Diesel					151			
A3 2.0 TDI A3 Sportback	06/05→06/08 06/05→06/08	1968	4	81.00	SOHC/OHC	103/140	AG9630 (MLS), 1.450mm, 1 Hole AG9640 (MLS), 1.530mm, 2 Holes AG9650 (MLS), 1.610mm, 3 Holes	CG8410 ▲	EF5380
2.0	BMN Diesel					152			
A3 2.0 TDI A3 Sportback	03/06→08/12 03/06→	1968	4	81.00	DOHC	125/170	AG8970 (MLS), 1.550mm, 1 Hole AG8800 (MLS), 1.630mm, 2 Holes AG8960 (MLS), 1.710mm, 3 Holes	CG8410 ▲	EF5380

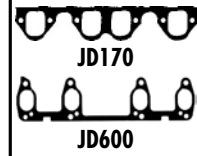

HBS364 [19] M12x1.75x149.00mm (x10)	JD5806 [1] →11/06 JD5805 [1] 12/06→ JD5815 [3] JD600 [3]	JM7031 (Elastomer)	HR397	PA5041 (x16) 6.00/12.20x10.00 (FPM) HR791 [3]	NA5124 (x2) [2] 32.00x47.00x10.00mm, PTFE/ACM NA5106 [2] 35.00x48.00x10.00mm, PTFE NA5124 [2] 32.00x47.00x10.00mm, PTFE/ACM LK5012 [1] [7] [28] 85.00x132.00x15.70mm, ACM	KK5522 [31]
HBS364 [19] M12x1.75x149.00mm (x10)	JD5806 [1] JD5815 [3]	JM7029 (Elastomer)		PA5041 (x16) 6.00/12.20x10.00 (FPM) HR791 [3]	NA5106 [2] 35.00x48.00x10.00mm, PTFE/ACM NA5106 [2] 35.00x48.00x10.00mm, PTFE LK5012 [1] [7] [28] 85.00x132.00x15.70mm, ACM	KK5522 [31]
HBS363 [22] M10x1.50x122.00mm (x10)	JD5873 [1] (FPM) JD5813 [3]	JM7078 (Elastomer)	HR397	PA5041 (x16) 6.00/12.20x10.00 (FPM) HR791 [3]	NA5124 [2] 32.00x47.00x10.00mm, PTFE/ACM NA5106 [2] 35.00x48.00x10.00mm, PTFE LK5008 [1] [7] 85.00x131.00x15.70mm, PTFE	
HBS363 [22] M10x1.50x122.00mm (x10)	JD5873 [1] (FPM) JD5813 [3]	JM7078 (Elastomer)	HR397	PA5041 (x16) 6.00/12.20x10.00 (FPM) HR791 [3]	NA5124 [2] 32.00x47.00x10.00mm, PTFE/ACM NA5106 [2] 35.00x48.00x10.00mm, PTFE LK5008 [1] [7] 85.00x131.00x15.70mm, PTFE	
HBS363 [22] M10x1.50x122.00mm (x10)	JD5873 [1] (FPM) JD5813 [3]	JM7078 (Elastomer)	HR397	PA5041 (x16) 6.00/12.20x10.00 (FPM) HR791 [3]	NA5124 [2] 32.00x47.00x10.00mm, PTFE/ACM NA5106 [2] 35.00x48.00x10.00mm, PTFE LK5008 [1] [7] 85.00x131.00x15.70mm, PTFE	
HBS363 [22] M10x1.50x122.00mm (x10)	JD5873 [1] (FPM) JD5813 [3]	JM7048 (SE)	HR397	PA5041 (x16) 6.00/12.20x10.00 (FPM) HR791 [3]	NA5106 [2] 35.00x48.00x10.00mm, PTFE/ACM NA5124 [2] 32.00x47.00x10.00mm, PTFE/ACM NA5106 [2] 35.00x48.00x10.00mm, PTFE LK5008 [1] [7] 85.00x131.00x15.70mm, PTFE	
HBS300 [19] M12x1.75x166.00mm (x10)	JD170 [1] JD5992 [3] [29] (Steel)	JM7031 (Elastomer) JM7107 (ACM)	HR397	HR599 [3] HR816 [3]	NA5124 [2] 32.00x47.00x10.00mm, PTFE/ACM NA5106 [2] 35.00x48.00x10.00mm, PTFE LK5012 [1] [7] [28] 85.00x132.00x15.70mm, ACM	
HBS364 [19] M12x1.75x149.00mm (x10)	JD5806 [1] (Metal) →11/06 JD5805 [1] (Elastomer) 12/06→ JD5815 [3]	JM7031 (Elastomer)	HR397	PA5041 (x16) 6.00/12.20x10.00 (FPM) HR791 [3]	NA5124 (x2) [2] 32.00x47.00x10.00mm, PTFE/ACM NA5106 [2] 35.00x48.00x10.00mm, PTFE LK5012 [1] [7] [28] 85.00x132.00x15.70mm, ACM	KK5522 [31]



cc



kW/PS

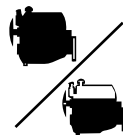

2.0 BNA Diesel 153							AG8970 (MLS), 1.550mm, 1 Hole AG8800 (MLS), 1.630mm, 2 Holes AG8960 (MLS), 1.710mm, 3 Holes	CG8410 ▲	EF5380
A4 2.0 TDI	11/04→06/08	1968	4	81.00	DOHC	100/136			
A4 Avant 2.0 TDI	11/04→06/08								
A6 2.0 TDI	07/04→03/11								
A6 Avant 2.0 TDI	06/05→08/11								
2.0 BPG 154									
A4 2.0 TFSI	11/04→06/08	1984	4	82.50	DOHC	147/200			
2.0 BPJ 155							AH6930 (MLS)		
A4 2.0 TFSI	10/06→06/08	1984	4	82.50	DOHC	125/170			
A4 Avant TFSI	10/06→06/08								
A6 2.0 TFSI	06/05→03/11								
A6 Avant	06/05→08/11								
2.0 BPW Diesel 156							AG9630 (MLS), 1.450mm, 1 Hole AG9640 (MLS), 1.530mm, 2 Holes AG9650 (MLS), 1.610mm, 3 Holes	CC5231 ▲	EB5370 [3][18]
A4 2.0 TDI	11/04→03/09	1968	4	81.00	SOHC/OHC	103/140			
2.0 BPY 157							AH6930 (MLS)		
A3 Sportback	09/04→	1984	4	82.50	DOHC	147/200			
TT 2.0 TFSI	08/06→06/10								
TT Roadster	03/07→06/10								
2.0 BRC Diesel 158							AG9630 (MLS), 1.450mm, 1 Hole AG9640 (MLS), 1.530mm, 2 Holes AG9650 (MLS), 1.610mm, 3 Holes	CC5231 ▲	EB5370 [3][18]
A4 2.0 TDI	01/06→03/09	1968	4	81.00	SOHC/OHC	100/136			
2.0 BRD Diesel 159							AG8970 (MLS), 1.550mm, 1 Hole AG8800 (MLS), 1.630mm, 2 Holes AG8960 (MLS), 1.710mm, 3 Holes	CG8410 ▲	EF5380
A4 2.0 TDI	06/06→06/08	1968	4	81.00	DOHC	125/170			
A4 Avant 2.0 TDi	06/06→06/08								
A4 Avant TDI	06/06→06/08								

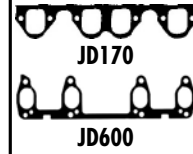
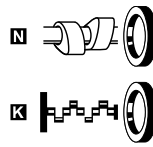
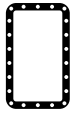
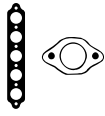

HBS364 [19] M12x1.75x149.00mm (x10)	JD5805 [1] (Elastomer) JD5806 [1] (Metal) JD5815 [3]	JM7029 (Elastomer)		PA5041 (x16) 6.00/12.20x10.00 (FPM) HR791 [3]	NA5106 [2] 35.00x48.00x10.00mm, PTFE/ACM NA5124 (x2) [2] 32.00x47.00x10.00mm, PTFE/ACM NA5106 [2] 35.00x48.00x10.00mm, PTFE LK5012 [1] [7] [28] 85.00x132.00x15.70mm, ACM	KK5522 [31]
HBS476 [22] M10x1.50x117.00mm (x10)	JD5872 [1] (ACM)	JM7046 [32] (ACM) JM7047 [27] (ACM)		PA5041 (x16) 6.00/12.20x10.00 (FPM) HR791 [3]		
HBS476 [22] M10x1.50x117.00mm (x10)				PA5041 (x16) 6.00/12.20x10.00 (FPM) HR791 [3]	NA5106 [2] 35.00x48.00x10.00mm, PTFE/ACM NA5124 [2] 32.00x47.00x10.00mm, PTFE/ACM NA5106 [2] 35.00x48.00x10.00mm, PTFE LK5003 [1] [7] 85.00x131.00x15.700mm, PTFE	
HBS300 [19] M12x1.75x166.00mm (x10)	JD170 [1] JD600 [3]	JM5203 (Elastomer)		HR599 [3] HR646 [3] HR816 [3]	NA5106 [2] 35.00x48.00x10.00mm, PTFE/ACM NA5124 [2] 32.00x47.00x10.00mm, PTFE/ACM NA5106 [2] 35.00x48.00x10.00mm, PTFE LK5003 [1] [7] 85.00x131.00x15.700mm, PTFE	
HBS476 [22] M10x1.50x117.00mm (x10)				PA5041 (x16) 6.00/12.20x10.00 (FPM) HR791 [3]	NA5124 [2] 32.00x47.00x10.00mm, PTFE/ACM NA5106 [2] 35.00x48.00x10.00mm, PTFE LK5003 [1] [7] 85.00x131.00x15.700mm, PTFE	
HBS300 [19] M12x1.75x166.00mm (x10)	JD170 [1] JD600 [3] JE5075	JM5203 (Elastomer)		HR599 [3] HR646 [3] HR816 [3]	NA5106 [2] 35.00x48.00x10.00mm, PTFE/ACM NA5124 [2] 32.00x47.00x10.00mm, PTFE/ACM NA5106 [2] 35.00x48.00x10.00mm, PTFE LK5003 [1] [7] 85.00x131.00x15.700mm, PTFE	
HBS364 [19] M12x1.75x149.00mm (x10)	JD5806 [1] JD5815 [3]	JM7029 (Elastomer)		PA5041 (x16) 6.00/12.20x10.00 (FPM) HR791 [3]	NA5106 [2] 35.00x48.00x10.00mm, PTFE/ACM NA5124 [2] 32.00x47.00x10.00mm, PTFE/ACM NA5106 [2] 35.00x48.00x10.00mm, PTFE LK5012 [1] [7] [28] 85.00x132.00x15.70mm, ACM	KK5522 [31]



cc



kW/PS

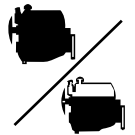

2.0		BRE Diesel				160			CG8410 ▲	EF5380
A4 2.0 TDI 16V	11/04→06/08	1968	4	81.00	DOHC	103/140	AG8970 (MLS), 1.550mm, 1 Hole AG8800 (MLS), 1.630mm, 2 Holes AG8960 (MLS), 1.710mm, 3 Holes			
A4 Avant TDI	11/04→06/08									
A6 2.0 TDI	07/04→10/08									
A6 Avant 2.0 TDI	06/05→10/08									
2.0		BRF Diesel				161			CG8410 ▲	EF5380
A4 2.0 TDI	11/04→06/08	1968	4	81.00	DOHC	100/136	AG8970 (MLS), 1.550mm, 1 Hole AG8800 (MLS), 1.630mm, 2 Holes AG8960 (MLS), 1.710mm, 3 Holes			
A4 Avant 2.0 TDI	11/04→06/08									
A6 2.0 TDI	07/04→03/11									
A6 Avant 2.0 TDI	06/05→08/11									
2.0		BUL				162	AH6930 (MLS)			
A4 2.0 TFSI	06/05→06/08	1984	4	82.50	DOHC	162/220				
A4 Avant TFSI	06/05→06/08									
2.0		BUY Diesel				163			CG8410 ▲	EF5380
A3 2.0 TDI	06/06→06/08	1968	4	81.00	DOHC	120/163	AG8970 (MLS), 1.550mm, 1 Hole AG8800 (MLS), 1.630mm, 2 Holes AG8960 (MLS), 1.710mm, 3 Holes			
A3 Sportback	06/06→06/08									
2.0		BVA Diesel				164			CG8410 ▲	EF5380
A4 2.0 TDI	06/06→06/08	1968	4	81.00	DOHC	120/163	AG8970 (MLS), 1.550mm, 1 Hole AG8800 (MLS), 1.630mm, 2 Holes AG8960 (MLS), 1.710mm, 3 Holes			
2.0		BVG Diesel				165			CG8410 ▲	EF5380
A4 2.0 TDI	09/05→09/06	1968	4	81.00	DOHC	89/121	AG8970 (MLS), 1.550mm, 1 Hole AG8800 (MLS), 1.630mm, 2 Holes AG8960 (MLS), 1.710mm, 3 Holes			
A6 2.0 TDI	09/05→06/06									
2.0		BVY				166	AG9600 (MLS)		CG9600	EG9600
A3 2.0 FSI	05/03→06/08	1984	4	82.50	DOHC	110/150				
A3 Sportback	09/04→									
2.0		BVZ				167	AG9600 (MLS)		CG9600	EG9600
A3 2.0 FSI	05/03→06/08	1984	4	82.50	DOHC	110/150				
A3 Sportback	09/04→									

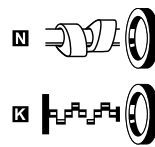
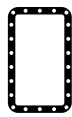
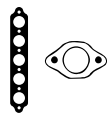

HBS364 [19] M12x1.75x149.00mm (x10)	JD5806 [1] JD5815 [2]	JM7029 (Elastomer)		PA5041 (x16) 6.00/12.20x10.00 (FPM) HR791 [3]	NA5106 [2] 35.00x48.00x10.00mm, PTFE/ACM NA5124 [2] 32.00x47.00x10.00mm, PTFE/ACM NA5106 [2] 35.00x48.00x10.00mm, PTFE LK5012 [1][7][28] 85.00x132.00x15.70mm, ACM	KK5522 [31]
HBS364 [19] M12x1.75x149.00mm (x10)	JD5805 [1] (Elastomer) JD5806 [1] (Metal) JD5815 [2]	JM7029 (Elastomer)		PA5041 (x16) 6.00/12.20x10.00 (FPM) HR791 [3]	NA5106 [2] 35.00x48.00x10.00mm, PTFE/ACM NA5124 (x2)[2] 32.00x47.00x10.00mm, PTFE/ACM NA5106 [2] 35.00x48.00x10.00mm, PTFE LK5012 [1][7][28] 85.00x132.00x15.70mm, ACM	KK5522 [31]
HBS476 [22] M10x1.50x117.00mm (x10)				PA5041 6.00/12.20x10.00 (FPM)	NA5106 [2] 35.00x48.00x10.00mm, PTFE/ACM NA5106 [2] 35.00x48.00x10.00mm, PTFE LK5003 [1][7] 85.00x131.00x15.700mm, PTFE	
	JD5806 [1] →11/06 Ch.8P.7.120 000→ JD5805 [1] 12/06→ →Ch.8P.7.120 001	JM7031 (Elastomer)		PA5041 6.00/12.20x10.00 (FPM) HR791 [3]	NA5106 [2] 35.00x48.00x10.00mm, PTFE/ACM NA5124 (x2)[2] 32.00x47.00x10.00mm, PTFE/ACM NA5106 [2] 35.00x48.00x10.00mm, PTFE LK5012 [1][7][28] 85.00x132.00x15.70mm, ACM	
	JD5806 [1] JD5815 [2] JE5075	JM7029 (Elastomer)		PA5041 (x16) 6.00/12.20x10.00 (FPM) HR791 [3]	NA5106 [2] 35.00x48.00x10.00mm, PTFE/ACM NA5124 (x2)[2] 32.00x47.00x10.00mm, PTFE/ACM NA5106 [2] 35.00x48.00x10.00mm, PTFE LK5012 [1][7][28] 85.00x132.00x15.70mm, ACM	
	JD5806 [1] JD5815 [2] JE5075	JM7029 (Elastomer)		PA5041 (x16) 6.00/12.20x10.00 (FPM) HR791 [3]	NA5106 [2] 35.00x48.00x10.00mm, PTFE/ACM NA5124 [2] 32.00x47.00x10.00mm, PTFE/ACM NA5106 [2] 35.00x48.00x10.00mm, PTFE LK5012 [1][7][28] 85.00x132.00x15.70mm, ACM	
HBS363 [22] M10x1.50x122.00mm (x10)	JD5873 [1] (FPM) JD5813 [2]	JM7078 (Elastomer)	HR397	PA5041 (x16) 6.00/12.20x10.00 (FPM) HR791 [3]	NA5124 [2] 32.00x47.00x10.00mm, PTFE/ACM NA5106 [2] 35.00x48.00x10.00mm, PTFE LK5008 [1][7] 85.00x131.00x15.700mm, PTFE	
HBS363 [22] M10x1.50x122.00mm (x10)	JD5873 [1] (FPM) JD5813 [2]	JM7078 (Elastomer)	HR397	PA5041 (x16) 6.00/12.20x10.00 (FPM) HR791 [3]	NA5124 [2] 32.00x47.00x10.00mm, PTFE/ACM NA5106 [2] 35.00x48.00x10.00mm, PTFE LK5008 [1][7] 85.00x131.00x15.700mm, PTFE	



cc



kW/PS

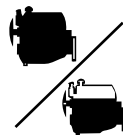

2.0		BWA				168	AH6930 (MLS)		
A3 2.0 quattro	09/04→08/12	1984	4	82.50	DOHC	147/200			
A3 2.0 TFSI	09/04→08/12								
A3 Sportback	09/04→								
TT 2.0 TFSI	08/06→06/10								
TT Roadster	03/07→06/10								
2.0		BWE				169	AH6930 (MLS)		
A4 2.0	11/05→03/09	1984	4	82.50	DOHC	147/200			
A4 2.0 TFSI	11/04→06/08								
A4 2.0 TFSI 16V	01/06→03/09								
A4 Avant TFSI	11/04→06/08								
2.0		BWT				170	AH6930 (MLS)		
A4 2.0 TFSI	11/04→06/08	1984	4	82.50	DOHC	147/200			
A4 2.0 TFSI 16V	01/06→03/09								
A4 Avant TFSI	11/04→06/08								
2.0		BYK				171	AH6930 (MLS)		
A4 2.0 TFSI	10/06→06/08	1984	4	82.50	DOHC	125/170			
A4 Avant TFSI	10/06→06/08								
A6 2.0 TFSI	06/05→03/11								
2.0		BZC				172	AH6930 (MLS)		
A3 S3 quattro	02/07→08/12	1984	4	82.50	DOHC	188/256			
2.0		CADA				173	AH5380 (MLS)		
A4 2.0 TFSI	06/08→	1984	4	82.50	DOHC	155/211			
A4 Avant TFSI	06/08→								
2.0		CAEA				174	AH5380 (MLS)		
A4 2.0 TFSI	06/08→	1984	4	82.50	DOHC	132/180			
A4 Avant TFSI	06/08→								
A5 2.0 TFSI	03/09→								
2.0		CAEB				175	AH5380 (MLS)		
A4 2.0 TFSI	06/08→	1984	4	82.50	DOHC	155/211			
A5 2.0 TFSI	06/08→								
A6 2.0 TFSI	03/11→05/13								
Q5 2.0 TFSI	11/08→								
2.0		CAGA Diesel				176			
A4 2.0 TDI	11/07→	1968	4	81.00	DOHC	105/143			
A4 Avant 2.0 TDi	04/08→								
A4 Avant TDI	04/08→								
A4 Allroad	09/09→								
A5 Sportback	09/09→								
Q5 2.0 TDI	08/09→								

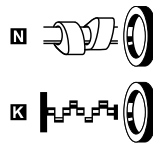
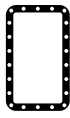
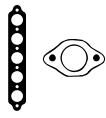

HBS476 [22] M10x1.50x117.00mm (x10)			HR397	PA5041 (x16) 6.00/12.20x10.00 (FPM) HR791 [5]	NA5106 [2] 35.00x48.00x10.00mm, PTFE LK5003 [1][7] 85.00x131.00x15.700mm, PTFE	
HBS476 [22] M10x1.50x117.00mm (x10)			HR397	PA5041 (x16) 6.00/12.20x10.00 (FPM) HR791 [5]	NA5106 [2] 35.00x48.00x10.00mm, PTFE/ACM NA5106 [2] 35.00x48.00x10.00mm, PTFE LK5003 [1][7] 85.00x131.00x15.700mm, PTFE	
HBS476 [22] M10x1.50x117.00mm (x10)			HR397	PA5041 (x16) 6.00/12.20x10.00 (FPM) HR791 [5]		
HBS476 [22] M10x1.50x117.00mm (x10)				PA5041 6.00/12.20x10.00 (FPM)	NA5106 [2] 35.00x48.00x10.00mm, PTFE/ACM NA5124 [2] 32.00x47.00x10.00mm, PTFE/ACM NA5106 [2] 35.00x48.00x10.00mm, PTFE LK5003 [1][7] 85.00x131.00x15.700mm, PTFE	
HBS476 [22] M10x1.50x117.00mm (x10)				PA5041 (x16) 6.00/12.20x10.00 (FPM) HR791 [5]	NA5106 [2] 35.00x48.00x10.00mm, PTFE/ACM NA5124 [2] 32.00x47.00x10.00mm, PTFE/ACM NA5106 [2] 35.00x48.00x10.00mm, PTFE LK5003 [1][7] 85.00x131.00x15.700mm, PTFE	
HBS476 [22] M10x1.50x117.00mm (x10)				PA5041 (x16) 6.00/12.20x10.00 (FPM) HR791 [5]		
HBS476 [22] M10x1.50x117.00mm (x10)				PA5041 (x16) 6.00/12.20x10.00 (FPM) HR791 [5]		
		HR397 [5]	HR397	PA5041 6.00/12.20x10.00 (FPM)	NA5106 [2] 35.00x48.00x10.00mm, PTFE/ACM NA5106 [2] 35.00x48.00x10.00mm, PTFE	



cc



kW/PS

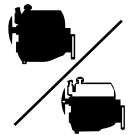

2.0 CAGB Diesel 177									EF5380
A4 2.0 TDI	11/07→	1968	4	81.00	DOHC	100/136			
A4 Allroad	09/09→								
A5 Sportback	09/09→								
A6 2.0 TDI	07/04→03/11								
A6 Avant 2.0 TDI	06/05→08/11								
Q5 2.0 TDI	08/09→								
2.0 CAGC Diesel 178									
A4 2.0 TDi	06/08→	1968	4	81.00	DOHC	88/120			
A4 Avant 2.0 TDI	06/08→								
2.0 CAHA Diesel 179									
A4 2.0 TDI	01/08→	1968	4	81.00	DOHC	125/170			
A4 Avant 2.0 TDI	04/08→								
A4 Avant TDI	08/08→								
A4 Allroad	04/09→								
A5 2.0 TDI	08/08→								
A5 Sportback	09/09→								
A6 2.0 TDI	11/08→03/11								
A6 Avant 2.0 TDI	10/08→08/11								
Q5 2.0 TDI	11/08→								
2.0 CAHB Diesel 180									
A4 2.0 TDI	08/08→	1968	4	81.00	DOHC	120/163			
A4 Avant 2.0 TDI	08/08→								
A4 Allroad	04/09→								
A5 2.0 TDI	08/08→								
A5 Sportback	09/09→								
A6 2.0 TDI	04/09→03/11								
A6 Avant 2.0 TDI	04/09→08/11								
Q5 2.0 TDI	11/08→								
2.0 CAWB 181							AH5380 (MLS)		
A3 2.0 TFSI	09/04→08/12	1984	4	82.50	DOHC	147/200			
A3 Cabrio TFSI	04/08→								
A3 Sportback	09/04→								
2.0 CBAA Diesel 182							AG8970 (MLS), 1.550mm, 1 Hole AG8800 (MLS), 1.630mm, 2 Holes AG8960 (MLS), 1.710mm, 3 Holes	CG8410 ▲	EF5380
A3 2.0 TDI	05/03→08/12	1968	4	81.00	DOHC	100/136			
A3 Cabrio TDI	04/08→								
A3 Sportback	09/04→								
2.0 CBAB Diesel 183									EF5380 EH6520
A3 2.0 TDI 16V	05/03→08/12	1968	4	81.00	DOHC	103/140			
A3 Cabrio TDI	04/08→								
A3 Sportback	09/04→								
2.0 CBBB Diesel 184									
A3 2.0 TDI	03/06→08/12	1968	4	81.00	DOHC	125/170			
A3 Sportback	03/06→								
TT 2.0 TDI	06/08→								
TT Roadster	06/08→								
2.0 CBFA 185							AH5380 (MLS)		
A3 Sportback	09/04→	1984	4	82.50	DOHC	147/200			

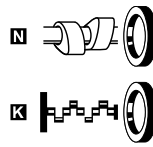
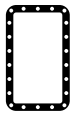
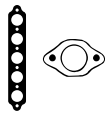

	JD5815			PA5041 (x16) 6.00/12.20x10.00 (FPM) HR791	NAS106 [2] 35.00x48.00x10.00mm, PTFE/ACM NAS124 [2] 32.00x47.00x10.00mm, PTFE/ACM NAS106 [2] 35.00x48.00x10.00mm, PTFE	
		HR397	HR397	PA5041 6.00/12.20x10.00 (FPM)	NAS106 [2] 35.00x48.00x10.00mm, PTFE	
		HR397	HR397	PA5041 6.00/12.20x10.00 (FPM)	NAS106 [2] 35.00x48.00x10.00mm, PTFE/ACM NAS106 [2] 35.00x48.00x10.00mm, PTFE	
				PA5041 6.00/12.20x10.00 (FPM) HR791	NAS106 [2] 35.00x48.00x10.00mm, PTFE/ACM NAS124 [2] 32.00x47.00x10.00mm, PTFE/ACM NAS106 [2] 35.00x48.00x10.00mm, PTFE	
HBS476 [22] M10x1.50x117.00mm (x10)				PA5041 (x16) 6.00/12.20x10.00 (FPM) HR791		
HBS364 [19] M12x1.75x149.00mm (x10)	JD5805 (Elastomer) JD5806 (Metal) JD5815	JM7031 (Elastomer)		PA5041 (x16) 6.00/12.20x10.00 (FPM) HR791	NAS106 [2] 35.00x48.00x10.00mm, PTFE NAS124 [2] 32.00x47.00x10.00mm, PTFE/ACM	KK5522 [31]
	JD5805 JD5815			PA5041 6.00/12.20x10.00 (FPM) HR791	NAS124 [2] 32.00x47.00x10.00mm, PTFE/ACM NAS106 [2] 35.00x48.00x10.00mm, PTFE	KK5522 [31]
	JD5815			PA5041 6.00/12.20x10.00 (FPM) HR791	NAS124 [2] 32.00x47.00x10.00mm, PTFE/ACM NAS106 [2] 35.00x48.00x10.00mm, PTFE	
HBS476 [22] M10x1.50x117.00mm (x10)				PA5041 (x16) 6.00/12.20x10.00 (FPM) HR791		



cc



kW/PS

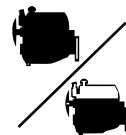

2.0		CCTA					186	AH5380 (MLS)		
TT 2.0 TFSI	08/06→06/10	1984	4	82.50	DOHC	147/200				
TT Roadster	03/07→06/10									
2.0		CCZA					187	AH5380 (MLS)		
A3 2.0 quattro	09/04→08/12	1984	4	82.50	DOHC	147/200				
A3 2.0 TFSI	09/04→08/12									
A3 Cabrio TFSI	04/08→									
A3 Sportback	09/04→									
TT 2.0 TFSI	06/08→06/10									
TT Roadster	06/08→06/10									
2.0		CCZC					188			
Q3 2.0 TFSI	06/11→	1984	4	82.50	DOHC	125/170				
2.0		CDLA					189	AH6930 (MLS)		
A3 S3 quattro	11/06→08/12	1984	4	82.50	DOHC	195/265				
A3 Sportback	06/08→									
TT 2.0 quattro	05/08→									
TT Roadster	05/08→									
2.0		CDLB					190	AH6930 (MLS)		
TT 2.0 TFSI	05/08→	1984	4	82.50	DOHC	200/272				
TT Roadster	05/08→									
2.0		CDLC					191	AH6930 (MLS)		
A3 S3 quattro	02/07→08/12	1984	4	82.50	DOHC	188/256				
A3 Sportback	07/08→									
2.0		CDMA					192	AH6930 (MLS)		
TT 2.0 quattro	05/08→	1984	4	82.50	DOHC	195/265				
TT Roadster	05/08→									
2.0		CDNB					193	AH5380 (MLS)		
A4 2.0 TFSI	06/08→	1984	4	82.50	DOHC	132/180				
A4 Avant TFSI	06/08→									
A5 2.0 TFSI	11/08→									
A6 2.0 TFSI	05/11→									
A6 3.3.360 DFLK	06/11→									
Q5 2.0 TFSI	08/09→									
2.0		CDNC					194	AH5380 (MLS)		
A4 2.0 TFSI	06/08→	1984	4	82.50	DOHC	155/211				
A4 Avant TFSI	06/08→									
A4 Allroad	04/09→									
A5 2.0 TFSI	06/08→									
Q5 2.0 TFSI	11/08→									
2.0		CFFA Diesel					195		EF5380	
A3 2.0 TDI	05/03→08/12	1968	4	81.00	DOHC	100/136				
A3 Cabrio TDI	04/08→									
A3 Sportback	09/04→									
Q3 2.0 TDI	09/11→									

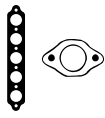

HBS476 [22] M10x1.50x117.00mm (x10)				PA5041 (x16) 6.00/12.20x10.00 (FPM) HR791		
HBS476 [22] M10x1.50x117.00mm (x10)		HR397		PA5041 (x16) 6.00/12.20x10.00 (FPM) HR791	NA5124 [2] 32.00x47.00x10.00mm, PTFE/ACM	
				PA5041 6.00/12.20x10.00 (FPM)		
HBS476 [22] M10x1.50x117.00mm (x10)			HR397	PA5041 (x16) 6.00/12.20x10.00 (FPM) HR791	NA5124 [2] 32.00x47.00x10.00mm, PTFE/ACM NA5106 [2] 35.00x48.00x10.00mm, PTFE LK5003 [1][7] 85.00x131.00x15.700mm, PTFE	
HBS476 [22] M10x1.50x117.00mm (x10)			HR397	PA5041 (x16) 6.00/12.20x10.00 (FPM) HR791	NA5106 [2] 35.00x48.00x10.00mm, PTFE/ACM NA5106 [2] 35.00x48.00x10.00mm, PTFE LK5003 [1][7] 85.00x131.00x15.700mm, PTFE	
HBS476 [22] M10x1.50x117.00mm (x10)			HR397	PA5041 (x16) 6.00/12.20x10.00 (FPM) HR791	NA5124 [2] 32.00x47.00x10.00mm, PTFE/ACM NA5106 [2] 35.00x48.00x10.00mm, PTFE LK5003 [1][7] 85.00x131.00x15.700mm, PTFE	
HBS476 [22] M10x1.50x117.00mm (x10)				PA5041 (x16) 6.00/12.20x10.00 (FPM) HR791	NA5106 [2] 35.00x48.00x10.00mm, PTFE/ACM NA5106 [2] 35.00x48.00x10.00mm, PTFE LK5003 [1][7] 85.00x131.00x15.700mm, PTFE	
HBS476 [22] M10x1.50x117.00mm (x10)				PA5041 (x16) 6.00/12.20x10.00 (FPM) HR791		
HBS476 [22] M10x1.50x117.00mm (x10)				PA5041 (x16) 6.00/12.20x10.00 (FPM) HR791		
HBS476 [22] M10x1.50x117.00mm (x10)				PA5041 (x16) 6.00/12.20x10.00 (FPM) HR791		
HBS364 [19] M12x1.75x149.00mm (x10)		HR397	HR397	PA5041 6.00/12.20x10.00 (FPM)	NA5106 [2] 35.00x48.00x10.00mm, PTFE	KK5522 [31]



cc



kW/PS

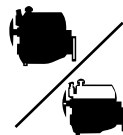

2.0	CFFB Diesel					196
A3 2.0 TDI 16V	05/03→08/12	1968	4	81.00	DOHC	103/140
A3 Cabrio TDI	04/08→					
A3 Sportback	09/04→					
Q3 2.0 TDI	09/11→					
2.0	CFGB Diesel					197
A3 2.0 TDI	03/06→08/12	1968	4	81.00	DOHC	125/170
A3 Sportback	03/06→					
TT 2.0 TDI	06/08→					
TT Roadster	06/08→					
2.0	CFHB Diesel					198
A1 2.0 TDI	05/12→	1968	4	81.00	DOHC	100/136
2.0	CFHD Diesel					199
A1 2.0 TDI	09/11→	1968	4	81.00	DOHC	105/143
2.0	CFKA					200
A4 2.0 TFSI	11/09→	1984	4	82.50	DOHC	132/180
A4 Avant TFSI	11/09→					
2.0	CGLA Diesel					201
Q5 2.0 TDI	11/08→	1968	4	81.00	DOHC	120/163
2.0	CGLB Diesel					202
Q5 2.0 TDI	11/08→	1968	4	81.00	DOHC	125/170
2.0	CGLC Diesel					203
A4 2.0 TDI	11/11→	1968	4	81.00	DOHC	130/177
A4 Allroad	11/11→					
A5 2.0 TDI	10/11→					
A6 2.0 TDI	03/11→					
Q5 Q5	06/12→					
2.0	CGLD Diesel					204
A4 2.0 TDI	08/08→	1968	4	81.00	DOHC	120/163
A4 Avant 2.0 TDI	08/08→					
A4 Allroad	04/09→					
A5 2.0 TDI	08/08→					
A5 Sportback	09/09→					
A6 2.0 TDI	03/11→					
Q5 2.0 TDI	11/08→					
2.0	CJCA Diesel					205
A4 2.0 TDI	11/07→	1968	4	81.00	DOHC	105/143
A4 Avant 2.0 TDi	04/08→					
A4 Avant TDI	04/08→					
A4 Allroad	09/09→					
A5 2.0 TDi	10/11→					
A5 Sportback	09/09→					
Q5 2.0 TDI	08/09→					
2.0	CJCB Diesel					206
A4 2.0 TDI	11/07→	1968	4	81.00	DOHC	100/136
A4 Allroad	09/09→					
A5 Sportback	09/09→					
Q5 2.0 TDI	08/09→					
Q5 Q5	11/10→					

EF5380

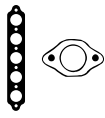

			HR397	HR397	PA5041 6.00/12.20x10.00 (FPM)	NAS106 [2] 35.00x48.00x10.00mm, PTFE	
			HR397	HR397	PA5041 6.00/12.20x10.00 (FPM)	NAS106 [2] 35.00x48.00x10.00mm, PTFE	
HBS364 [19] M12x1.75x149.00mm (x10)					PA5041 6.00/12.20x10.00 (FPM)	NAS106 [2] 35.00x48.00x10.00mm, PTFE	KK5522 [31]
			HR397	HR397	PA5041 6.00/12.20x10.00 (FPM)	NAS106 [2] 35.00x48.00x10.00mm, PTFE/ACM NAS106 [2] 35.00x48.00x10.00mm, PTFE	
HBS476 [22] M10x1.50x117.00mm (x10)					PA5041 6.00/12.20x10.00 (FPM)		
					PA5041 6.00/12.20x10.00 (FPM)	NAS106 [2] 35.00x48.00x10.00mm, PTFE/ACM NAS106 [2] 35.00x48.00x10.00mm, PTFE	
					PA5041 6.00/12.20x10.00 (FPM)	NAS106 [2] 35.00x48.00x10.00mm, PTFE/ACM NAS106 [2] 35.00x48.00x10.00mm, PTFE	
						NAS106 [2] 35.00x48.00x10.00mm, PTFE/ACM NAS106 [2] 35.00x48.00x10.00mm, PTFE	
						NAS106 [2] 35.00x48.00x10.00mm, PTFE/ACM NAS106 [2] 35.00x48.00x10.00mm, PTFE	
					PA5041 6.00/12.20x10.00 (FPM)	NAS106 [2] 35.00x48.00x10.00mm, PTFE/ACM NAS106 [2] 35.00x48.00x10.00mm, PTFE	
					PA5041 6.00/12.20x10.00 (FPM)	NAS106 [2] 35.00x48.00x10.00mm, PTFE/ACM NAS106 [2] 35.00x48.00x10.00mm, PTFE	



cc



kW/PS

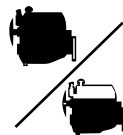

2.0	CJCC Diesel						207			
A4 2.0 TDi	06/08→	1968	4	81.00	DOHC		88/120			
A4 Avant 2.0 TDi	06/08→									
2.0	CLJA Diesel						208			
A3 2.0 TDi 16V	05/03→08/12	1968	4	81.00	DOHC		103/140			
A3 Sportback	09/04→									
2.0	CMEA Diesel						209			
A4 2.0 TDi	11/07→	1968	4	81.00	DOHC		105/143			
A4 Avant 2.0 TDi	04/08→									
A5 Sportback	09/09→									
2.0	CMGA Diesel						210			
Q5 2.0 TDi	11/08→	1968	4	81.00	DOHC		125/170			
2.0	CMGB Diesel						211			
A4 2.0 TDi	11/11→	1968	4	81.00	DOHC		130/177			
A6 2.0 TDi	03/11→									
Q5 Q5	06/12→									
2.0	NC Diesel						212	BT470 (Fibre), 1.610mm, 3 Holes	DL491 ▲	EW860
100 2.0 D Turbo	03/88→11/90	1986	5	76.50			74/100			
100 Avant 2.0 TD	03/88→11/90									
2.0	NM						213	AY960 (MLS)	CY960	EC010
90 2.0 20 V	08/89→07/91	1994	5	81.00	SOHC/OHC		118/160			
90 2.0 20V qua	08/88→09/91									
Coupe 2.0 20 V	08/89→07/91									
2.0	PS						214	BM840 (Fibre)		EX995
90 2.0	07/88→09/91	1994	5	81.00	SOHC/OHC		85/115			
2.0	RT						215	BM840 (Fibre)	DM840	EX995
100 2.0 CAT	01/88→11/90	1994	5	81.00	SOHC/OHC		85/115			
100 Avant E CAT	01/88→11/90									
2.0	SK						216	BM840 (Fibre)	DM840	EX995
Coupe 2.0	03/86→04/88	1994	5	81.00	SOHC/OHC		83/113			

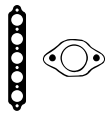

AY960



BM840



BT470



JC152

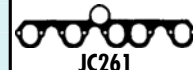

JC261



JD171



JD282



JD327



JD602



JE689



JF206



HL460

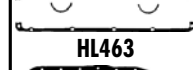

HL463

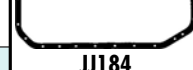

JJ184



JJ501

					NA5106 [2] 35.00x48.00x10.00mm, PTFE	
				PA5041 6.00/12.20x10.00 (FPM) HR791	NA5124 [2] 32.00x47.00x10.00mm, PTFE/ACM NA5106 [2] 35.00x48.00x10.00mm, PTFE	
				PA5041 6.00/12.20x10.00 (FPM) HR791	NA5106 [2] 35.00x48.00x10.00mm, PTFE/ACM NA5124 [2] 32.00x47.00x10.00mm, PTFE/ACM NA5106 [2] 35.00x48.00x10.00mm, PTFE	
				PA5041 6.00/12.20x10.00 (FPM)	NA5106 [2] 35.00x48.00x10.00mm, PTFE/ACM NA5106 [2] 35.00x48.00x10.00mm, PTFE	
					NA5106 [2] 35.00x48.00x10.00mm, PTFE/ACM NA5106 [2] 35.00x48.00x10.00mm, PTFE	
HBS021 [19] M12x1.75x115.00mm (x12)	JC261 JC152 (x5) JF206	HL463	JJ184	HR615	NA5001 [1][2] 32.00x47.00x10.00mm, FPM NB716 [2] 35.00x48.00x10.00mm, FPM NA5133 [1] 85.00x105.00x11.00mm, FPM	KK5470 [20]
HBS269 [22] M11x1.50x141.50mm (x12)	JD602 JD282 (x5)	HL730	JJ501	HR5085 (x5)	NA5001 [1][2] 32.00x47.00x10.00mm, FPM NB716 [2] 35.00x48.00x10.00mm, FPM NA5133 [1] 85.00x105.00x11.00mm, FPM	
HBS021 [19] M12x1.75x115.00mm (x12) HBS024 [22] M11x1.50x95.00mm (x12)	JD327 JD171 JC152 (x5) JE689	JN438 (Elastomer) HL460 (Cork) → Ch.8A-L-200 000 HM5277 (Elastomer) → Ch.8A-L-200 000	JJ184	HR615	NA5001 [1][2] 32.00x47.00x10.00mm, FPM NB716 [2] 35.00x48.00x10.00mm, FPM NA5133 [1] 85.00x105.00x11.00mm, FPM	
HBS024 [22] M11x1.50x95.00mm (x12)	JC261 JD327 JD171 JC152 (x5) JE689	JN438 (Elastomer) HL460 (Cork) → Ch.44-L-072 000 HM5277 (Elastomer) → Ch.44-L-072 000	JJ184	HR615	NA5001 [1][2] 32.00x47.00x10.00mm, FPM NB716 [2] 35.00x48.00x10.00mm, FPM NA5133 [1] 85.00x105.00x11.00mm, FPM	
HBS024 [22] M11x1.50x95.00mm (x12)	JC261 JC152 (x5) JE689	HL460 (Cork) HM5227 (NBR)	JJ184	HR615	NA5001 [1][2] 32.00x47.00x10.00mm, FPM NB716 [2] 35.00x48.00x10.00mm, FPM NA5133 [1] 85.00x105.00x11.00mm, FPM LK5006 [7] 85.00x131.00x16.00mm, PTFE	



cc



kW/PS

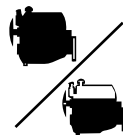

2.1	WX						217	BD620 (Fibre)	DD622	EX995
Quattro 2.1	02/82→07/89	2144	5	79.50	SOHC/OHC	120/163				
2.2	1B						218	BM840 (Fibre)	DM840	EX995
200 2.2 Turbo	02/88→12/90	2226	5	81.00	SOHC/OHC	147/200				
200 2.2T	02/88→11/90									
200 Avant 2.2T	02/88→12/91									
Quattro 2.2T	08/87→07/89									
2.2	2B						219	BM840 (Fibre)	DM840	EX995
200 2.2 Turbo	02/88→12/90	2226	5	81.00	SOHC/OHC	140/190				
2.2	3B						220	AY960 (MLS)	CY960	EC010
200 2.2 20V T	03/89→12/90	2226	5	81.00	DOHC	162/220				
Coupe 2.2 S2	09/90→09/92									
2.2	AAN						221	AY960 (MLS)	CY960	EC010
100 2.2 S4 T	08/91→06/94	2226	5	81.00	DOHC	169/230				
A6 2.2 S6 T	06/94→12/97									
2.2	ABY						222	AY960 (MLS)	CY960	EC010
80 2.2 S2	02/93→07/95	2226	5	81.00	DOHC	169/230				
Coupe 2.2 S2	10/92→12/96									
2.2	ADU						223	AY960 (MLS)	CY960	EC010
80 2.2 RS2	03/94→05/95	2226	5	81.00	DOHC	232/315				
2.2	HX						224	BM840 (Fibre)	DM840	EX995
100 2.2	06/89→11/90	2226	5	81.00	SOHC/OHC	101/138				
100 2.2 quattro	06/89→11/90									
100 Avant 2.2	06/89→11/90									
2.2	HY						225	BM840 (Fibre)	DM840	EX995
Coupe 2.2 GT	09/84→10/88	2226	5	81.00	SOHC/OHC	100/136		→Ch.8A-L-200 000		

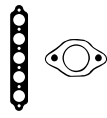

AY960



BD620



BM840



JC152



JC261



JD282

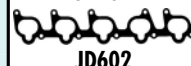

JD602



JD603



JE689

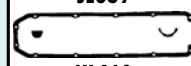

HL460



JJ184

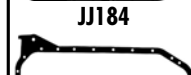

JJ501



cc



kW/PS

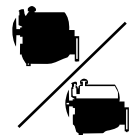

2.2	JT	226	5	81.00	SOHC/OHC	88/120	226	BM840 (Fibre)	DM840 →Ch.8A-L-200 000	EX995
Coupe 2.2	08/85→10/88									
2.2	KU	226	5	81.00	SOHC/OHC	101-103/ 137-140	227	BM840 (Fibre)	DM840	EX995
100 2.2	08/84→11/90									
100 2.2 quattro	08/84→11/90									
100 Avant 2.2	08/84→11/90									
2.2	KV	226	5	81.00	SOHC/OHC	100/136	228	BM840 (Fibre)	DM840 →Ch.8A-L-200 000	EX995
90 2.2 E	04/87→07/91									
90 2.2 E quattro	04/87→09/91									
Coupe 2.2	10/84→07/91									
Coupe 2.2 GT	09/84→10/88									
2.2	MB	226	5	81.00	SOHC/OHC	147/200	229	BM840 (Fibre)	DM840	EX995
Quattro 2.2T	08/87→07/89									
2.2	MC	226	5	81.00	SOHC/OHC	121/165	230	BM840 (Fibre)	DM840	EX995
100 2.2 E T	08/86→11/90									
100 2.2 T	08/86→11/90									
100 2.2 Turbo	08/86→11/90									
100 Avant T	08/86→11/90									
200 2.2 T	09/83→12/91									
200 2.2 Turbo	08/85→09/91									
2.2	RR	226	5	81.00	DOHC	162/220	231	AY960 (MLS)	CY960	EC010
Quattro 2.2 20V	08/89→07/91									
2.3	7A	2309	5	82.50	DOHC	123-125/ 167-170	232			EC010
90 2.3 E 20V	06/88→09/91									
Coupe 2.3 20V	11/88→12/96									
2.3	AAR	2309	5	82.50	SOHC/OHC	98/133	233	BT820 (Fibre)	DT820 [3]	EX995
100 2.3	01/90→11/90									
100 2.3 E	01/90→06/94									
100 2.3 quattro	01/90→11/90									
100 Avant 2.3	03/90→11/90									
100 Avant 2.3 E	09/91→06/94									
A6 2.3	06/94→12/95									
A6 2.3 quattro	06/94→12/95									
A6 Avant 2.3	06/94→12/95									

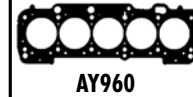
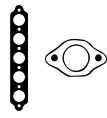

AY960



BM840



BT820



JC152



JC261



JD171



JD282



JD327

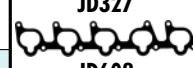

JD602

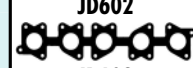

JD603

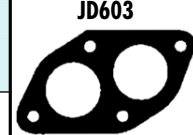

JE689

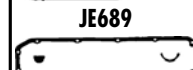

HL460



JJ184



JJ501

HBS024 [22]
M11x1.50x95.00mm (x12)

JC261 [1]
JC152 [5] (x5)
JE689

JN438
(Elastomer)
HL460 [5]
(Cork)
→Ch.8A-L-200 000
HM5277 [5]
(Elastomer)
→Ch.8A-L-200 000

JJ184

HR615 [5]

NA5001 [1][2]
32.00x47.00x10.00mm, FPM
NB716 [2]
35.00x48.00x10.00mm, FPM
NA5133 [1]
85.00x105.00x11.00mm, FPM

HBS024 [22]
M11x1.50x95.00mm (x12)

JC261 [1]
JC152 [5] (x5)
JE689

JN438
(Elastomer)
HL460 [5]
(Cork)
HM5277 [5]
(Elastomer)

JJ184

HR615 [5]

NA5001 [1][2]
32.00x47.00x10.00mm, FPM
NB716 [2]
35.00x48.00x10.00mm, FPM
NA5133 [1]
85.00x105.00x11.00mm, FPM

HBS024 [22]
M11x1.50x95.00mm (x12)

JC261 [1]
JC152 [5] (x5)
JE689

JN438
(Elastomer)
HL460 [5]
(Cork)
→Ch.8A-L-200 000
HM5277 [5]
(Elastomer)
→Ch.8A-L-200 000

JJ184

HR615 [5]

NA5001 [1][2]
32.00x47.00x10.00mm, FPM
NA5001 [1][2]
32.00x47.00x10.00mm, FPM
NB716 [2]
35.00x48.00x10.00mm, FPM
NA5133 [1]
85.00x105.00x11.00mm, FPM

HBS024 [22]
M11x1.50x95.00mm (x12)

JC261 [1]
JC152 [5] (x5)

JN438
(Elastomer)
HL460 [5]
(Cork)
HM5277 [5]
(Elastomer)

JJ184

HR615 [5]

NA5001 [1][2]
32.00x47.00x10.00mm, FPM
NB716 [2]
35.00x48.00x10.00mm, FPM
NA5133 [1]
85.00x105.00x11.00mm, FPM

HBS024 [22]
M11x1.50x95.00mm (x12)

JC261 [1]
JC152 [5] (x5)

JN438
(Elastomer)
HL460 [5]
(Cork)
HM5277 [5]
(Elastomer)

JJ184

HR615 [5]

NA5001 [1][2]
32.00x47.00x10.00mm, FPM
NB716 [2]
35.00x48.00x10.00mm, FPM
NA5133 [1]
85.00x105.00x11.00mm, FPM

HBS269 [22]
M11x1.50x141.50mm (x12)

JD602 [1]
JD282 [5] (x5)
JD603 [5]

HL730 [5]

JJ501

NA5001 [1][2]
32.00x47.00x10.00mm, FPM
NB716 [2]
35.00x48.00x10.00mm, FPM
NA5133 [1]
85.00x105.00x11.00mm, FPM

HBS269 [22]
M11x1.50x141.50mm (x12)

JD602 [1]
JD282 [5] (x5)

HL730 [5]

JJ501

NA5001 [1][2]
32.00x47.00x10.00mm, FPM
NB716 [2]
35.00x48.00x10.00mm, FPM
NA5133 [1]
85.00x105.00x11.00mm, FPM

HBS024 [22]
M11x1.50x95.00mm (x12)

JD327 [1] [2]
JD171 [1] [2]
JC152 [5] (x5)

JJ184

HR615 [5]

NA5001 [1][2]
32.00x47.00x10.00mm, FPM
NA5001 [1][2]
32.00x47.00x10.00mm, FPM
NA5133 [1]
85.00x105.00x11.00mm, FPM



cc



kW/PS

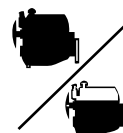

2.3	NF						234	BT820 (Fibre)	DT820 [3]	EX995
100 2.3 E	08/86→11/90	2309	5	82.50	SOHC/OHC	100/136				
100 Avant 2.3	08/86→11/90									
200 2.3	11/86→09/91									
200 Avant 2.3	11/86→09/91									
2.3	NG						235	BT820 (Fibre)	DT820 [3]	EX995
Cabrio 2.3 E	05/91→07/94	2309	5	82.50	SOHC/OHC	98-100/ 133-136				
80 2.3 E	09/91→12/94									
80 2.3 E quattro	09/91→12/94									
80 2.3 quattro	10/87→07/89									
90 2.3 E	04/87→09/91									
90 2.3 E quattro	04/87→09/91									
Coupe 2.3	01/87→12/96									
2.4	3D Diesel						236	AF5340 (MLS), 1.530mm, 1 Hole AF5350 (MLS), 1.570mm, 2 Holes AF5360 (MLS), 1.610mm, 3 Holes	DW830 ▲	
100 2.4 D	08/89→07/91	2370	5	79.50	SOHC/OHC	60/82				
100 Avant 2.4 D	08/89→11/90									
2.4	AAS Diesel						237	AF5340 (MLS), 1.530mm, 1 Hole AF5350 (MLS), 1.570mm, 2 Holes AF5360 (MLS), 1.610mm, 3 Holes	DW830 ▲	
100 2.4 D	12/90→06/94	2370	5	79.50	SOHC/OHC	60/82				
100 Avant 2.4 D	12/90→06/94									
2.4	AFM						238	AY061 (Fibre), 2.000mm (x2)	DT660	
A4 2.4	07/95→07/97	2393	6	81.00	V	110/150				
A6 2.4	07/95→12/97									
2.4	AGA						239	BZ960 (MLS) (x2)	DZ960 ○ (x2)	
A4 2.4	03/97→09/01	2393	6	81.00	V	121/165				
A4 2.4 quattro	03/97→09/01									
A6 2.4	02/97→01/05									
A6 2.4 quattro	02/97→01/05									
A6 Avant 2.4	12/97→01/05									
2.4	AJG						240	BZ960 (MLS) (x2)	DZ960 ○ (x2)	
A4 2.4	08/97→11/00	2393	6	81.00	DOHC, V	120/163				
A4 Avant 2.4	08/97→09/01									
A6 2.4	02/97→01/05									
A6 2.4 quattro	02/97→01/05									
A6 Avant 2.4	12/97→01/05									
2.4	ALF						241	BZ960 (MLS) (x2)	DZ960 ○ (x2)	
A4 2.4	03/97→09/01	2393	6	81.00	DOHC, V	121/165				
A4 2.4 quattro	03/97→09/01									
A6 2.4	02/97→01/05									
A6 2.4 quattro	02/97→01/05									
A6 Avant 2.4	12/97→01/05									
2.4	ALW						242	BZ960 (MLS) (x2)	DZ960 ○ (x2)	
A6 2.4	07/98→01/05	2393	6	81.00	DOHC, V	100/136				
A6 Avant 2.4	07/98→01/05									

HBS024 [22] M11x1.50x95.00mm (x12)	JC261 [1] JD327 [1] [2] JD171 [1] [2] JC152 [1] (x5)	JN438 (Elastomer) HL460 [1] (Cork) HM5277 [1] (Elastomer)	JJ184	HR615 [1]	NA5001 [1] [2] 32.00x47.00x10.00mm, FPM NB716 [2] 35.00x48.00x10.00mm, FPM NA5133 [1] 85.00x105.00x11.00mm, FPM		AF5340 AF5350 AF5360	
HBS024 [22] M11x1.50x95.00mm (x12)	JD327 [1] [2] JD171 [1] [2] JC152 [1] (x5)	JN438 (Elastomer) HL460 [1] (Cork) HM5277 [1] (Elastomer)	JJ184	HR615 [1]	NA5001 [1] [2] 32.00x47.00x10.00mm, FPM NB716 [2] 35.00x48.00x10.00mm, FPM NA5133 [1] 85.00x105.00x11.00mm, FPM		BT820 BZ960	
HBS021 [19] M12x1.75x115.00mm (x12)	JD312 [1] JC152 [1] (x5) JE138 [27]	JN915 [4]		HR615 [1]	NA5001 [1] [2] 32.00x47.00x10.00mm, FPM NB716 [2] 35.00x48.00x10.00mm, FPM NA5133 [1] 85.00x105.00x11.00mm, FPM		JC152 JC261	
HBS021 [19] M12x1.75x115.00mm (x12)	JD312 [1] JC152 [1] (x5) JE138 [27]	JN915 [4]		HR615 [1]	NA5001 [1] [2] 32.00x47.00x10.00mm, FPM NB716 [2] 35.00x48.00x10.00mm, FPM NA5133 [1] 85.00x105.00x11.00mm, FPM		JD171 JD312	
HBS064 [22] M11x1.50x137.00mm (x16)		JM5166 (ACM)		HR662 [1]	NA5133 [1] 85.00x105.00x11.00mm, FPM		JD327	
HBS270 [22] M11x1.50x133.00mm (x16)		HM5224 [1]		PA5041 (x30) 6.00/12.20x10.00 (FPM)	NA5001 [1] [2] 32.00x47.00x10.00mm, FPM NA5106 [2] 35.00x48.00x10.00mm, PTFE NB716 [2] 35.00x48.00x10.00mm, FPM		JE138	
HBS270 [22] M11x1.50x133.00mm (x16)		HM5224 [1]		PA5041 (x30) 6.00/12.20x10.00 (FPM)	NA5001 [1] [2] 32.00x47.00x10.00mm, FPM NB716 [2] 35.00x48.00x10.00mm, FPM NB619 [1] 130.00x160.00x15.00mm, FPM		HL460 JN915	
HBS270 [22] M11x1.50x133.00mm (x16)		HM5224 [1]		PA5041 (x30) 6.00/12.20x10.00 (FPM)	NA5001 [1] [2] 32.00x47.00x10.00mm, FPM NB716 [2] 35.00x48.00x10.00mm, FPM NB619 [1] 130.00x160.00x15.00mm, FPM		JJ184	
HBS270 [22] M11x1.50x133.00mm (x16)		HM5224 [1]		PA5041 (x30) 6.00/12.20x10.00 (FPM)	NA5001 [1] [2] 32.00x47.00x10.00mm, FPM NB716 [2] 35.00x48.00x10.00mm, FPM NB619 [1] 130.00x160.00x15.00mm, FPM			



cc



kW/PS

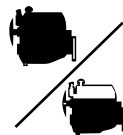

2.4		AML					243	BZ960 (MLS) (x2)	DZ960 ○ (x2)
A4 2.4	03/97→09/01	2393	6	81.00	V	121/165			
A4 2.4 quattro	03/97→09/01								
A6 2.4	02/97→01/05								
A6 2.4 quattro	02/97→01/05								
A6 Avant 2.4	12/97→01/05								
2.4		AMM					244	BZ960 (MLS) (x2)	DZ960 ○ (x2)
A4 2.4	08/97→12/05	2393	6	81.00	DOHC, V	120/163			
A4 Avant 2.4	08/97→12/04								
A6 2.4	02/97→01/05								
A6 Avant 2.4	12/97→01/05								
2.4		APC					245	BZ960 (MLS) (x2)	DZ960 ○ (x2)
A6 2.4	02/97→01/05	2393	6	81.00	DOHC, V	115/156			
A6 2.4 quattro	08/98→07/99								
A6 Avant 2.4	12/97→01/05								
2.4		APS					246	BZ960 (MLS) (x2)	DZ960 ○ (x2)
A4 2.4	03/97→09/01	2393	6	81.00	DOHC, V	121/165			
A4 2.4 quattro	03/97→09/01								
A6 2.4	02/97→01/05								
A6 2.4 quattro	02/97→01/05								
A6 Avant 2.4	12/97→01/05								
2.4		APZ					247	BZ960 (MLS) (x2)	DZ960 ○ (x2)
A4 2.4	08/97→11/00	2393	6	81.00	DOHC, V	120/163			
A4 2.4 quattro	08/97→11/00								
A4 Avant 2.4	08/97→09/01								
A6 2.4	02/97→01/05								
A6 2.4 quattro	02/97→01/05								
A6 Avant 2.4	12/97→01/05								
2.4		ARJ					248	BZ960 (MLS) (x2)	DZ960 ○ (x2)
A4 2.4	03/97→09/01	2393	6	81.00	DOHC, V	121/165			
A4 2.4 quattro	03/97→09/01								
A6 2.4	02/97→01/05								
A6 2.4 quattro	02/97→01/05								
A6 Avant 2.4	12/97→01/05								
2.4		ARN					249	BZ960 (MLS) (x2)	DZ960 ○ (x2)
A6 2.4	07/98→01/05	2393	6	81.00	DOHC, V	100/136			
A6 Avant 2.4	07/98→01/05								
2.4		ASM					250	BZ960 (MLS) (x2)	DZ960 ○ (x2)
A6 2.4	07/98→01/05	2393	6	81.00	DOHC, V	100/136			
A6 Avant 2.4	07/98→01/05								
2.4		BDV					251	BZ960 (MLS) (x2)	DZ960 ○ (x2)
A4 2.4	09/01→12/05	2393	6	81.00	DOHC, V	125/170			
A4 Avant 2.4	09/01→12/04								
A6 2.4	08/01→01/05								
A6 2.4 quattro	08/01→01/05								
A6 Avant 2.4	08/01→01/05								

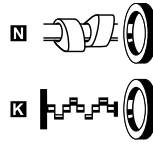
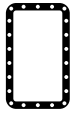
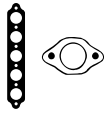

BZ960

HBS270 [22] M11x1.50x133.00mm (x16)		HM5224		PA5041 (x30) 6.00/12.20x10.00 (FPM)	NA5001 [1][2] 32.00x47.00x10.00mm, FPM NB716 [2] 35.00x48.00x10.00mm, FPM NB619 [1] 130.00x160.00x15.00mm, FPM	
HBS270 [22] M11x1.50x133.00mm (x16)		HM5224		PA5041 (x30) 6.00/12.20x10.00 (FPM)	NA5001 [1][2] 32.00x47.00x10.00mm, FPM NB716 [2] 35.00x48.00x10.00mm, FPM NB619 [1] 130.00x160.00x15.00mm, FPM	
HBS270 [22] M11x1.50x133.00mm (x16)		HM5224		PA5041 (x30) 6.00/12.20x10.00 (FPM)	NA5001 [1][2] 32.00x47.00x10.00mm, FPM NB716 [2] 35.00x48.00x10.00mm, FPM NB619 [1] 130.00x160.00x15.00mm, FPM	
HBS270 [22] M11x1.50x133.00mm (x16)		HM5224		PA5041 (x30) 6.00/12.20x10.00 (FPM)	NA5001 [1][2] 32.00x47.00x10.00mm, FPM NB716 [2] 35.00x48.00x10.00mm, FPM NB619 [1] 130.00x160.00x15.00mm, FPM	
HBS270 [22] M11x1.50x133.00mm (x16)		HM5224		PA5041 (x30) 6.00/12.20x10.00 (FPM)	NA5001 [1][2] 32.00x47.00x10.00mm, FPM NB716 [2] 35.00x48.00x10.00mm, FPM NB619 [1] 130.00x160.00x15.00mm, FPM	
HBS270 [22] M11x1.50x133.00mm (x16)		HM5224		PA5041 (x30) 6.00/12.20x10.00 (FPM)	NA5001 [1][2] 32.00x47.00x10.00mm, FPM NB716 [2] 35.00x48.00x10.00mm, FPM NB619 [1] 130.00x160.00x15.00mm, FPM	
HBS270 [22] M11x1.50x133.00mm (x16)		HM5224		PA5041 (x30) 6.00/12.20x10.00 (FPM)	NA5001 [1][2] 32.00x47.00x10.00mm, FPM NB716 [2] 35.00x48.00x10.00mm, FPM NB619 [1] 130.00x160.00x15.00mm, FPM	
HBS270 [22] M11x1.50x133.00mm (x16)		HM5224		PA5041 (x30) 6.00/12.20x10.00 (FPM)	NA5001 [1][2] 32.00x47.00x10.00mm, FPM NB716 [2] 35.00x48.00x10.00mm, FPM NB619 [1] 130.00x160.00x15.00mm, FPM	
HBS270 [22] M11x1.50x133.00mm (x16)		HM5224		PA5041 6.00/12.20x10.00 (FPM)	NA5001 [1][2] 32.00x47.00x10.00mm, FPM NB716 [2] 35.00x48.00x10.00mm, FPM NB619 [1] 130.00x160.00x15.00mm, FPM	



cc



kW/PS



2.4		BDW					252			
A6 2.4	05/04→10/08	2393	6	81.00	DOHC, V	130/177				
A6 2.4 quattro	01/05→10/08									
A6 Avant 2.4	03/05→10/08									
2.5		1T Diesel					253	AF5310 (MLS), 1.510mm, 1 Hole	DW860 ▲	EW860
100 2.5 TDI	01/90→11/90	2461	5	81.00	SOHC/OHC	88/120	AF5320 (MLS), 1.570mm, 2 Holes	DW861 ▲		
							AF5330 (MLS), 1.610mm, 3 Holes			
2.5		AAT Diesel					254	AF5310 (MLS), 1.510mm, 1 Hole	DW860 ▲	EW860
100 2.5 TDI	12/90→06/94	2461	5	81.00	SOHC/OHC	84-85/ 114-116	AF5320 (MLS), 1.570mm, 2 Holes	DW861 ▲		
A6 2.5 TDI	06/94→10/97						AF5330 (MLS), 1.610mm, 3 Holes			
A6 Avant 2.5 TDI	06/94→12/97									
2.5		ABP Diesel					255	AF5310 (MLS), 1.510mm, 1 Hole	DW860 ▲	EW860
100 2.5 TDI	12/90→06/94	2461	5	81.00	SOHC/OHC	85/115	AF5320 (MLS), 1.570mm, 2 Holes	DW861 ▲		
							AF5330 (MLS), 1.610mm, 3 Holes			
2.5		AEL Diesel					256	AF5310 (MLS), 1.510mm, 1 Hole	DW860 ▲	EW860
A6 2.5 TDI	08/94→10/97	2461	5	81.00	SOHC/OHC	103/140	AF5320 (MLS), 1.570mm, 2 Holes			
A6 Avant	07/95→12/97						AF5330 (MLS), 1.610mm, 3 Holes			
A6 Avant 2.5 TDI	08/94→12/97									
2.5		AFB Diesel					257	AC5960 (MLS), 1.100mm, 1 Hole (x2)	CC5960 ▲ [33]	EC5960
A4 2.5 TDI	09/97→11/00	2496	6	78.30	DOHC, V	110/150	AC5970 (MLS), 1.150mm, 2 Holes (x2)			
A4 Avant 2.5 TDI	09/97→09/01						AC5980 (MLS), 1.200mm, 3 Holes (x2)			
A4 Avant TDI	09/97→09/01									
A6 2.5 TDI	07/97→01/05									
A6 Avant	12/97→01/05									
A6 Avant 2.5 TDI	12/97→01/05									
A8 2.5 TDI	01/97→04/00									
2.5		AKE Diesel					258	AC5960 (MLS), 1.100mm, 1 Hole (x2)	CC5960 ▲ [33]	EC5960
A4 2.5 TDI	10/00→12/04	2496	6	78.30	DOHC, V	132/180	AC5970 (MLS), 1.150mm, 2 Holes (x2)			
A6 2.5 TDI	02/00→01/05						AC5980 (MLS), 1.200mm, 3 Holes (x2)			
A6 Avant	02/00→01/05									
A6 Avant 2.5 TDI	02/00→01/05									
A8 2.5 TDI	09/00→09/02									
Allroad TDI	05/00→08/05									
2.5		AKN Diesel					259	AC5960 (MLS), 1.100mm, 1 Hole (x2)	CC5960 ▲ [33]	EC5960
A4 2.5 TDI	09/97→11/00	2496	6	78.30	DOHC, V	110/150	AC5970 (MLS), 1.150mm, 2 Holes (x2)			
A4 Avant 2.5 TDI	09/97→09/01						AC5980 (MLS), 1.200mm, 3 Holes (x2)			
A4 Avant TDI	09/97→09/01									
A6 2.5 TDI	07/97→01/05									
A6 Avant	12/97→01/05									
A6 Avant 2.5 TDI	12/97→01/05									
A8 2.5 TDI	01/97→04/00									
2.5		AYM Diesel					260	AC5960 (MLS), 1.100mm, 1 Hole (x2)	CC5960 ▲ [33]	EC5960
A4 2.5 TDI	08/01→07/02	2496	6	78.30	DOHC, V	114/155	AC5970 (MLS), 1.150mm, 2 Holes (x2)			
A6 2.5 TDI	08/01→01/05						AC5980 (MLS), 1.200mm, 3 Holes (x2)			
A6 Avant 2.5 TDI	08/01→01/05									

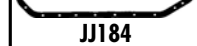
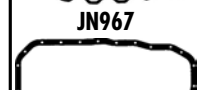
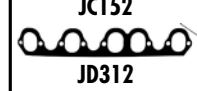
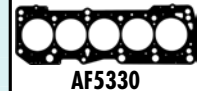
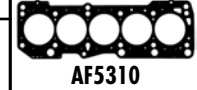
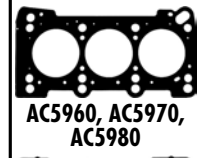



cc



kW/PS

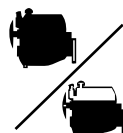

2.5		BAU Diesel				261	AC5960 (MLS), 1.100mm, 1 Hole (x2)		CC5960 ▲ [33]	EC5960
A4 2.5 TDI	11/00→12/04	2496	6	78.30	DOHC, V	132/180	AC5970 (MLS), 1.150mm, 2 Holes (x2)			
A6 2.5 TDI	02/00→01/05						AC5980 (MLS), 1.200mm, 3 Holes (x2)			
A6 Avant	02/00→01/05									
A6 Avant 2.5 TDI	02/00→01/05									
Allroad TDI	05/00→08/05									
2.5		BCZ Diesel				262	AC5960 (MLS), 1.100mm, 1 Hole (x2)		CC5960 ▲ [33]	EC5960
A4 2.5 TDI	07/02→12/05	2496	6	78.30	DOHC, V	120/163	AC5970 (MLS), 1.150mm, 2 Holes (x2)			
A6 2.5 TDI	07/02→01/05						AC5980 (MLS), 1.200mm, 3 Holes (x2)			
A6 Avant 2.5 TDI	07/02→01/05									
Allroad TDI	05/03→08/05									
2.5		BDG Diesel				263	AC5960 (MLS), 1.100mm, 1 Hole (x2)		CC5960 ▲ [33]	EC5960
A4 2.5 TDI	07/02→05/06	2496	6	78.30	DOHC, V	120/163	AC5970 (MLS), 1.150mm, 2 Holes (x2)			
A4 Avant 2.5 TDI	11/04→05/06						AC5980 (MLS), 1.200mm, 3 Holes (x2)			
A6 2.5 TDI	07/02→01/05									
A6 Avant 2.5 TDI	07/02→01/05									
2.5		BDH Diesel				264	AC5960 (MLS), 1.100mm, 1 Hole (x2)		CC5960 ▲ [33]	EC5960
A4 2.5 TDI	11/00→12/04	2496	6	78.30	DOHC, V	132/180	AC5970 (MLS), 1.150mm, 2 Holes (x2)			
A6 2.5 TDI	02/00→01/05						AC5980 (MLS), 1.200mm, 3 Holes (x2)			
A6 Avant	02/00→01/05									
A6 Avant 2.5 TDI	02/00→01/05									
2.5		BFC Diesel				265	AC5960 (MLS), 1.100mm, 1 Hole (x2)		CC5960 ▲ [33]	EC5960
A4 2.5 TDI	07/02→12/05	2496	6	78.30	DOHC, V	120/163	AC5970 (MLS), 1.150mm, 2 Holes (x2)			
A6 2.5 TDI	07/02→01/05						AC5980 (MLS), 1.200mm, 3 Holes (x2)			
A6 Avant 2.5 TDI	07/02→01/05									
2.5		BND Diesel				266	AC5960 (MLS), 1.100mm, 1 Hole (x2)		CC5960 ▲ [33]	EC5960
A6 2.5 TDI	02/00→01/05	2496	6	78.30	DOHC, V	132/180	AC5970 (MLS), 1.150mm, 2 Holes (x2)			
							AC5980 (MLS), 1.200mm, 3 Holes (x2)			
2.6		ABC				267	AY061 (Fibre), 2.000mm (x2)			EY850
Cabrio 2.6	06/93→08/00	2598	6	82.50	SOHC/OHC, V	110/150				
80 2.6	07/92→07/95									
80 2.6 quattro	06/92→12/94									
80 Avant 2.6	07/92→01/96									
100 2.6	03/92→06/94									
100 2.6 quattro	04/92→06/94									
100 Avant 2.6	03/92→06/94									
A4 2.6	01/95→11/00									
A4 2.6 quattro	01/95→11/00									
A4 Avant 2.6	01/96→09/01									
A6 2.6	06/94→10/97									
A6 2.6 quattro	06/94→10/97									
A6 Avant 2.6	06/94→12/97									
Coupe 2.6	08/92→12/96									

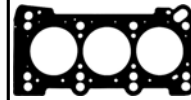
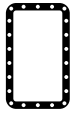
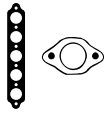

AC5960, AC5970,
AC5980

<p>HBS265 [22] M12x1.50x155.00mm (x16)</p>	<p>JD5810 (x2) JD5851 (x6) (Fibre)</p>	<p>HM5223 (x2) (ACM)</p>		<p>PA5041 (x24) 6.00/12.20x10.00 (FPM) HR5062</p>	<p>NA5001 [1][2] 32.00x47.00x10.00mm, FPM NB716 [2] 35.00x48.00x10.00mm, FPM</p>	
<p>HBS361 [22] M12x1.50x159.00mm (x16)</p>	<p>JD5810 (x2) JD5851 (x6) (Fibre)</p>	<p>HM5223 (x2) (ACM)</p>		<p>PA5041 (x24) 6.00/12.20x10.00 (FPM) HR5062</p>	<p>NA5001 [1][2] 32.00x47.00x10.00mm, FPM</p>	
<p>HBS361 [22] M12x1.50x159.00mm (x16)</p>	<p>JD5810 (x2) JD5851 (x6) (Fibre)</p>	<p>HM5223 (x2) (ACM)</p>		<p>PA5041 (x24) 6.00/12.20x10.00 (FPM) HR5062</p>	<p>NA5001 [1][2] 32.00x47.00x10.00mm, FPM NA5001 [1][2] 32.00x47.00x10.00mm, FPM NB716 [2] 35.00x48.00x10.00mm, FPM NB928 [2] 105.00x130.00x12.00mm, FPM</p>	
<p>HBS361 [22] M12x1.50x159.00mm (x16)</p>	<p>JD5810 (x2) JD5851 (x6) (Fibre)</p>	<p>HM5223 (x2) (ACM)</p>		<p>PA5041 (x24) 6.00/12.20x10.00 (FPM) HR5062</p>	<p>NA5001 [1][2] 32.00x47.00x10.00mm, FPM NB716 [2] 35.00x48.00x10.00mm, FPM</p>	
<p>HBS265 [22] M12x1.50x155.00mm (x16)</p>	<p>JD5810 (x2) JD5851 (x6) (Fibre)</p>	<p>HM5223 (x2) (ACM)</p>		<p>PA5041 (x24) 6.00/12.20x10.00 (FPM) HR5062</p>	<p>NA5001 [1][2] 32.00x47.00x10.00mm, FPM</p>	
<p>HBS265 [22] M12x1.50x155.00mm (x16)</p>	<p>JD5810 (x2) JD5851 (x6) (Fibre)</p>	<p>HM5223 (x2) (ACM)</p>		<p>PA5041 (x24) 6.00/12.20x10.00 (FPM) HR5062</p>	<p>NA5001 [1][2] 32.00x47.00x10.00mm, FPM</p>	
<p>HBS064 [22] M11x1.50x137.00mm (x16)</p>		<p>JM5166 (ACM)</p>	<p>JH5118</p>	<p>HR5068 (x2) HR662</p>	<p>NA5001 (x3)[1][2] 32.00x47.00x10.00mm, FPM NB716 [2] 35.00x48.00x10.00mm, FPM NA5133 [1] 85.00x105.00x11.00mm, FPM</p>	



cc



kW/PS



Model	Year Range	CC	Cylinders	Power (kW/PS)	Engine Type	Part No.	Material	Part No.	Part No.
2.6 ACZ 268									
T00 2.6	07/93→06/94	2598	6	82.50	SOHC/OHC, V	102/139	AY061 (Fibre), 2.000mm (x2)	DT660	EY850
100 Avant 2.6	07/93→06/94								
100 Avant 2.6E	08/93→07/94								
A4 2.6	01/96→07/97								
A6 2.6	06/94→10/97								
A6 Avant 2.6	06/94→02/97								
Cabriolet	05/95→08/00								
2.7 AGB 269									
A4 Avant S4	09/97→09/01	2671	6	81.00	DOHC, V	195/265	BZ960 (MLS) (x2)		
A4 S4 quattro	09/97→09/01								
2.7 AJK 270									
A4 2.7 Turbo	02/99→09/00	2671	6	81.00	DOHC, V	169/230	BZ960 (MLS) (x2)		
A6 2.7 T	02/99→01/05								
A6 2.7 T quattro	12/97→01/05								
A6 Avant 2.7 T	12/97→01/05								
2.7 APB 271									
A4 2.7 Bi T	08/98→12/98	2671	6	81.00	DOHC, V	187/254			
A6 2.7	05/01→07/04								
A6 2.7 quattro	05/01→07/04								
Allroad 2.7	09/00→08/05								
2.7 ARE 272									
A6 2.7 T quattro	08/01→01/05	2671	6	81.00	DOHC, V	184/250	BZ960 (MLS) (x2)		
A6 Avant 2.7 T	08/01→01/05								
Allroad 2.7 T	05/00→08/05								
2.7 ASJ 273									
A4 RS4 quattro	05/00→09/01	2671	6	81.00	DOHC, V	280/380			
2.7 AZA 274									
A6 Avant 2.7 T	12/97→01/05	2671	6	81.00	DOHC, V	169/230	BZ960 (MLS) (x2)		
2.7 AZB 275									
A4 Avant S4	09/97→09/01	2671	6	81.00	DOHC, V	195/265	BZ960 (MLS) (x2)		
A4 S4 quattro	09/97→09/01								
2.7 AZR 276									
A4 RS4 quattro	05/00→09/01	2671	6	81.00	DOHC, V	280/380			
2.7 BEL 277									
A6 2.7	05/01→07/04	2671	6	81.00	DOHC, V	187-195/ 254-265			
A6 2.7 quattro	05/01→07/04								
Allroad 2.7	09/00→08/05								
2.7 BES 278									
A6 2.7 T quattro	08/01→01/05	2671	6	81.00	DOHC, V	184/250	BZ960 (MLS) (x2)		
A6 Avant 2.7 T	08/01→01/05								
Allroad 2.7 T	05/00→08/05								
2.7 BPP Diesel 279									
A4 2.7 TDI	01/06→03/09	2698	6	81.40	DOHC, V	132/180	AG8880 (MLS), 1.100mm, 1 Hole [32] AG8900 (MLS), 1.100mm, 1 Hole [27] AG8860 (MLS), 1.150mm, 2 Holes [32] AG8870 (MLS), 1.150mm, 2 Holes [27] AG8890 (MLS), 1.200mm, 3 Holes [32] AG8910 (MLS), 1.200mm, 3 Holes [27]	CG8880 ▲ [34][35]	
A4 Avant 2.7 TDi	01/06→06/08								
A6 2.7 TDI	11/04→10/08								
A6 Avant	03/05→10/08								
A6 Avant 2.7 TDi	03/05→10/08								

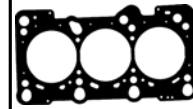

BZ960

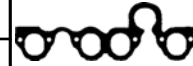

JC478

HBS064 [22] M11x1.50x137.00mm (x16)		JM5166 (ACM)	JH5118	HR569 [3]	NA5001 (x3) [1][2] 32.00x47.00x10.00mm, FPM NB716 [2] 35.00x48.00x10.00mm, FPM NA5133 [1] 85.00x105.00x11.00mm, FPM	
HBS270 [22] M11x1.50x133.00mm (x16)	JC478 [1]	HM5224 [3]		PA5041 (x30) 6.00/12.20x10.00 (FPM)	NA5001 [1][2] 32.00x47.00x10.00mm, FPM	
HBS270 [22] M11x1.50x133.00mm (x16)	JC478 [1]	HM5224 [3]		PA5041 (x30) 6.00/12.20x10.00 (FPM)	NA5001 [1][2] 32.00x47.00x10.00mm, FPM	
HBS270 [22] M11x1.50x133.00mm (x16)		HM5224 [3]		PA5041 6.00/12.20x10.00 (FPM)	NA5001 [1][2] 32.00x47.00x10.00mm, FPM	
HBS270 [22] M11x1.50x133.00mm (x16)		HM5224 [3]		PA5041 (x30) 6.00/12.20x10.00 (FPM)	NA5001 [1][2] 32.00x47.00x10.00mm, FPM	
HBS270 [22] M11x1.50x133.00mm (x16)		HM5224 [3]		PA5041 (x30) 6.00/12.20x10.00 (FPM)	NA5001 [1][2] 32.00x47.00x10.00mm, FPM	
HBS270 [22] M11x1.50x133.00mm (x16)		HM5224 [3]		PA5041 (x30) 6.00/12.20x10.00 (FPM)	NA5001 [1][2] 32.00x47.00x10.00mm, FPM	
HBS270 [22] M11x1.50x133.00mm (x16)	JC478 [1]	HM5224 [3]		PA5041 6.00/12.20x10.00 (FPM)	NA5001 [1][2] 32.00x47.00x10.00mm, FPM	
HBS270 [22] M11x1.50x133.00mm (x16)		HM5224 [3]		PA5041 6.00/12.20x10.00 (FPM)	NA5001 [1][2] 32.00x47.00x10.00mm, FPM	
HBS270 [22] M11x1.50x133.00mm (x16)		HM5224 [3]		PA5041 6.00/12.20x10.00 (FPM)	NA5001 [1][2] 32.00x47.00x10.00mm, FPM	
HBS270 [22] M11x1.50x133.00mm (x16)		HM5224 [3]		PA5041 6.00/12.20x10.00 (FPM)	NA5001 [1][2] 32.00x47.00x10.00mm, FPM	
HBS270 [22] M11x1.50x133.00mm (x16)		HM5224 [3]		PA5041 6.00/12.20x10.00 (FPM)	NA5001 [1][2] 32.00x47.00x10.00mm, FPM	
HBS361 [22] M12x1.50x159.00mm (x16)	JD5872 [1] (ACM)	JM7046 [32] (ACM) JM7047 [27] (ACM)		PA5041 (x24) 6.00/12.20x10.00 (FPM) HR5062 [3]	NA5001 [1][2] 32.00x47.00x10.00mm, FPM	



cc



kW/PS



2.7		BSG Diesel				280		AG8880 (MLS), 1.100mm, 1 Hole [32]		CG8880 ▲ [34][35]	
A4 2.7 TDI	11/05→06/08	2698	6	81.40	DOHC, V	120/163	AG8900 (MLS), 1.100mm, 1 Hole [27]				
A6 2.7 TDI	11/04→08/11						AG8860 (MLS), 1.150mm, 2 Holes [32]				
A6 Avant	06/05→08/11						AG8870 (MLS), 1.150mm, 2 Holes [27]				
A6 Avant 2.7 TDI	03/05→08/11						AG8890 (MLS), 1.200mm, 3 Holes [32]				
							AG8910 (MLS), 1.200mm, 3 Holes [27]				
2.7		CAMA Diesel				281					
A4 2.7 TDI	11/07→	2698	6	83.00	DOHC, V	140/190					
A5 2.7 TDI	06/07→										
2.7		CAMB Diesel				282					
A4 2.7 TDI	11/07→	2698	6	83.00	DOHC, V	120/163					
A5 2.7 TDI	09/07→										
2.7		CANA Diesel				283					
A6 2.7 TDI	10/08→08/11	2698	6	83.00	DOHC, V	140/190					
2.7		CANB Diesel				284					
A6 2.7 TDI	11/04→03/11	2698	6	83.00	DOHC, V	120/163					
A6 Avant 2.7 TDI	03/05→08/11										
2.7		CANC Diesel				285					
A6 2.7 TDI	10/08→08/11	2698	6	83.00	DOHC, V	140/190					
2.7		CAND Diesel				286					
A6 2.7 TDI	06/05→08/11	2698	6	83.00	DOHC, V	120/163					
A6 Avant	06/05→08/11										
2.7		CGKA Diesel				287					
A4 2.7 TDI	11/07→	2698	6	83.00	DOHC, V	140/190					
A5 2.7 TDI	06/07→										
2.7		CGKB Diesel				288					
A4 2.7 TDI	11/07→	2698	6	83.00	DOHC, V	120/163					
A5 2.7 TDI	09/07→										
2.8		AAH				289		AY061 (Fibre), 2.000mm (x2)		EY850	
Cabrio 2.8	11/92→08/00	2771	6	82.50	SOHC/OHC, V	128/174					
80 2.8	09/91→07/95										
80 2.8 quattro	09/91→12/94										
80 Avant 2.8	09/91→01/96										
100 2.8 E	12/90→06/94										
100 Avant 2.8 E	09/91→06/94										
A4 2.8	09/95→07/97										
A4 2.8 quattro	01/95→07/97										
A4 Avant 2.8	01/96→09/96										
A6 2.8	06/94→12/97										
A6 2.8 quattro	06/94→10/97										
A6 Avant 2.8	06/94→12/97										
A8 2.8	03/94→03/96										
A8 2.8 quattro	03/94→03/96										
Coupe 2.8	08/91→12/96										

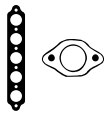

HBS361 [22]
M12x1.50x159.00mm (x16)

JD5872 [1]
(ACM)

JM7046 [32]
(ACM)
JM7047 [27]
(ACM)

PA5041
6.00/12.20x10.00
(FPM)
HR5062 [5]

NA5001 [1][2]
32.00x47.00x10.00mm, FPM

JD5872 [1]
(ACM)

JM7046 [32]
(ACM)
JM7047 [27]
(ACM)

PA5041
6.00/12.20x10.00
(FPM)

NA5001 [1][2]
32.00x47.00x10.00mm, FPM

JD5872 [1]
(ACM)

JM7046 [32]
(ACM)
JM7047 [27]
(ACM)

PA5041
6.00/12.20x10.00
(FPM)

NA5001 [1][2]
32.00x47.00x10.00mm, FPM

JD5872 [1]
(ACM)

JM7046 [32]
(ACM)
JM7047 [27]
(ACM)

PA5041
6.00/12.20x10.00
(FPM)

NA5001 [1][2]
32.00x47.00x10.00mm, FPM

JD5872 [1]
(ACM)

JM7046 [32]
(ACM)
JM7047 [27]
(ACM)

PA5041
6.00/12.20x10.00
(FPM)

NA5001 [1][2]
32.00x47.00x10.00mm, FPM

JD5872 [1]
(ACM)

JM7046 [32]
(ACM)
JM7047 [27]
(ACM)

PA5041
6.00/12.20x10.00
(FPM)

NA5001 [1][2]
32.00x47.00x10.00mm, FPM

JD5872 [1]
(ACM)

JM7046 [32]
(ACM)
JM7047 [27]
(ACM)

PA5041
6.00/12.20x10.00
(FPM)

NA5001 [1][2]
32.00x47.00x10.00mm, FPM

JD5872 [1]
(ACM)

JM7046 [32]
(ACM)
JM7047 [27]
(ACM)

PA5041
6.00/12.20x10.00
(FPM)

NA5001 [1][2]
32.00x47.00x10.00mm, FPM

JD5872 [1]
(ACM)

JM7046 [32]
(ACM)
JM7047 [27]
(ACM)

PA5041
6.00/12.20x10.00
(FPM)

NA5001 [1][2]
32.00x47.00x10.00mm, FPM

HBS064 [22]
M11x1.50x137.00mm (x16)

JM5166
(ACM)

JH5118

HR5068 [5] (x2)

NA5001 (x3) [1][2]
32.00x47.00x10.00mm, FPM
NB716 [2]
35.00x48.00x10.00mm, FPM
NA5133 [1]
85.00x105.00x11.00mm, FPM



cc



kW/PS

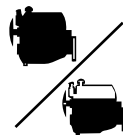

2.8							290			EY850
A4 2.8	10/96→11/00	2771	6	82.50	DOHC, V	142/193				
A4 2.8 quattro	10/96→08/01									
A4 Avant 2.8	10/96→09/01									
A6 2.8	12/95→01/05									
A6 2.8 quattro	12/95→01/05									
A6 Avant 2.8	12/95→01/05									
A8 2.8	04/96→09/02									
A8 2.8 quattro	04/96→09/02									
2.8							291	AY061 (Fibre), 2.000mm (x2)	DY850 →Ch.4A-T029513	EY850
A6 2.8	06/94→12/97	2771	6	82.50	SOHC/OHC, V	120-128/ 163-174				
A6 2.8 quattro	06/94→10/97									
A6 Avant 2.8	06/94→12/97									
A8 2.8	07/95→03/96									
A8 2.8 quattro	07/95→03/96									
2.8							292	AY061 (Fibre), 2.000mm (x2)		
A6 2.8	06/94→10/97	2771	6	82.50	V6	120-128/ 163-174				
2.8							293			
A6 2.8	10/97→05/00	2771	6	82.50	DOHC, V	132/180				
A6 2.8 quattro	01/98→04/00									
A6 Avant 2.8	12/97→05/00									
2.8							294			
A4 2.8	10/96→11/00	2771	6	82.50	DOHC, V	142/193				
A4 2.8 quattro	10/96→08/01									
A4 Avant 2.8	10/96→09/01									
A6 2.8	02/97→01/05									
A6 2.8 quattro	02/97→01/05									
A6 Avant 2.8	12/97→01/05									
A8 2.8	04/96→09/02									
2.8							295			
A4 2.8	10/96→11/00	2771	6	82.50	DOHC, V	142/193				
A4 2.8 quattro	10/96→08/01									
A4 Avant 2.8	10/96→09/01									
A6 2.8	02/97→01/05									
A6 2.8 quattro	02/97→01/05									
A6 Avant 2.8	12/97→01/05									
A8 2.8	04/96→09/02									
A8 2.8 quattro	04/96→09/02									
2.8							296			
A4 2.8	10/96→11/00	2771	6	82.50	DOHC, V	142/193				
A4 2.8 quattro	10/96→08/01									
A4 Avant 2.8	10/96→09/01									
A6 2.8	02/97→01/05									
A6 2.8 quattro	02/97→01/05									
A6 Avant 2.8	12/97→01/05									
A8 2.8	04/96→09/02									
A8 2.8 quattro	04/96→09/02									

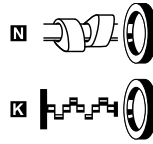
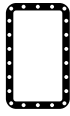
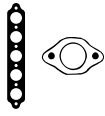

HBS270 [22] M11x1.50x133.00mm (x16)		HM5224	JH5118	PA5041 (x30) 6.00/12.20x10.00 (FPM)	NA5001 (x4)[1][2] 32.00x47.00x10.00mm, FPM NB716 [2] 35.00x48.00x10.00mm, FPM NA5133 [1] 85.00x105.00x11.00mm, FPM	
HBS064 [22] M11x1.50x137.00mm (x16)		JM5166 (x2) (ACM)	JH5118	HR602	NA5001 (x3)[1][2] 32.00x47.00x10.00mm, FPM NB716 [2] 35.00x48.00x10.00mm, FPM NA5133 [1] 85.00x105.00x11.00mm, FPM	
HBS064 [22] M11x1.50x137.00mm (x16)		JM5166 (ACM)		HR662	NA5001 [1][2] 32.00x47.00x10.00mm, FPM NA5133 [1] 85.00x105.00x11.00mm, FPM	
HBS270 [22] M11x1.50x133.00mm (x16)		HM5224		PA5041 (x30) 6.00/12.20x10.00 (FPM)	NA5001 [1][2] 32.00x47.00x10.00mm, FPM NA5106 [2] 35.00x48.00x10.00mm, PTFE NB716 [2] 35.00x48.00x10.00mm, FPM	
HBS270 [22] M11x1.50x133.00mm (x16)		HM5224		PA5041 (x30) 6.00/12.20x10.00 (FPM)	NA5001 (x4)[1][2] 32.00x47.00x10.00mm, FPM NA5106 [2] 35.00x48.00x10.00mm, PTFE	
HBS270 [22] M11x1.50x133.00mm (x16)		HM5224		PA5041 (x30) 6.00/12.20x10.00 (FPM)	NA5001 [1][2] 32.00x47.00x10.00mm, FPM NA5106 [2] 35.00x48.00x10.00mm, PTFE	
HBS270 [22] M11x1.50x133.00mm (x16)		HM5224		PA5041 (x30) 6.00/12.20x10.00 (FPM)	NA5001 (x4)[1][2] 32.00x47.00x10.00mm, FPM NA5106 [2] 35.00x48.00x10.00mm, PTFE	



cc



kW/PS



2.8 AQA 297									
A4 2.8	10/96→11/00	2771	6	82.50	DOHC, V	142/193			
A4 2.8 quattro	10/96→08/01								
A4 Avant 2.8	10/96→09/01								
A6 2.8	02/97→01/05								
A6 2.8 quattro	02/97→01/05								
A6 Avant 2.8	12/97→01/05								
A8 2.8	04/96→09/02								
A8 2.8 quattro	04/96→09/02								
2.8 ATX 298									
A4 2.8	03/99→09/00	2771	6	82.50	DOHC, V	140/190			
A4 2.8 quattro	03/99→09/00								
A6 2.8	07/99→01/05								
A6 2.8 quattro	07/99→05/01								
A6 Avant 2.8	07/99→01/05								
2.8 BBG 299									
A6 2.8	07/99→01/05	2771	6	82.50	DOHC, V	140/190			
2.8 BDX 300									
A6 2.8 FSI	11/06→10/08	2773	6	84.50	DOHC, V	154/210			
A8 2.8 FSI	08/07→07/10								
2.8 CCDA 301									
A6 2.8 FSI	10/08→03/11	2773	6	84.50	DOHC, V	140/190			
A6 Avant	10/08→08/11								
A6 Avant 2.8 FSI	10/08→08/11								
2.8 CCEA 302									
A6 2.8 FSI	10/08→03/11	2773	6	84.50	DOHC, V	162/220			
A6 Avant	10/08→08/11								
A6 Avant 2.8 FSI	10/08→08/11								
3.0 ASB Diesel 303							AG8880 (MLS), 1.100mm, 1 Hole [32]	CG8880 ▲ [34][35]	
A4 3.0 TDI	01/06→03/09	2967	6	83.00	DOHC, V	171/233	AG8900 (MLS), 1.100mm, 1 Hole [27]		
A4 Avant TDI	01/06→06/08						AG8860 (MLS), 1.150mm, 2 Holes [32]		
A6 3.0 TDI	05/06→08/11						AG8870 (MLS), 1.150mm, 2 Holes [27]		
A6 Avant	06/06→10/08						AG8890 (MLS), 1.200mm, 3 Holes [32]		
A8 3.0 TDI	08/03→07/10						AG8910 (MLS), 1.200mm, 3 Holes [27]		
3.0 ASN 304									
A4 3.0	11/00→12/05	2976	6	82.50	DOHC, V	162/220			
A4 3.0 quattro	11/00→12/05								
A4 Avant 3.0	09/01→12/04								
A6 3.0	08/01→01/05								
A6 3.0 quattro	08/01→01/05								
A6 Avant 3.0	08/01→01/05								
A8 3.0	07/03→05/05								
3.0 AVK 305									
A4 3.0	11/00→12/04	2976	6	82.50	DOHC, V	162/220			
A4 3.0 quattro	11/00→12/04								
A4 Avant 3.0	09/01→12/04								

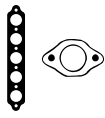

HBS270 [22] M11x1.50x133.00mm (x16)		HM5224		PA5041 (x30) 6.00/12.20x10.00 (FPM)	NA5001 (x4) [1] [2] 32.00x47.00x10.00mm, FPM NA5106 [2] 35.00x48.00x10.00mm, PTFE	
HBS270 [22] M11x1.50x133.00mm (x16)		HM5224		PA5041 (x30) 6.00/12.20x10.00 (FPM)	NA5001 [1] [2] 32.00x47.00x10.00mm, FPM NA5106 [2] 35.00x48.00x10.00mm, PTFE	
HBS270 [22] M11x1.50x133.00mm (x16)		HM5224		PA5041 (x30) 6.00/12.20x10.00 (FPM)	NA5001 [1] [2] 32.00x47.00x10.00mm, FPM NA5106 [2] 35.00x48.00x10.00mm, PTFE	
HBS512 [22]				PA5041 6.00/12.20x10.00 (FPM)		
				PA5041 6.00/12.20x10.00 (FPM)		
				PA5041 6.00/12.20x10.00 (FPM)		
HBS361 [22] M12x1.50x159.00mm (x16)	JD5872 (ACM)	JM7046 [32] (ACM) JM7047 [27] (ACM)		PA5041 (x24) 6.00/12.20x10.00 (FPM)	NA5001 [1] [2] 32.00x47.00x10.00mm, FPM	
HBS536 (x2) [22]				PA5041 6.00/12.20x10.00 (FPM)	NA5106 [2] 35.00x48.00x10.00mm, PTFE/ACM NA5106 [2] 35.00x48.00x10.00mm, PTFE	
HBS536 (x2) [22]				PA5041 6.00/12.20x10.00 (FPM)		



cc



kW/PS

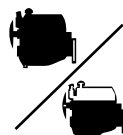

3.0		BBJ				306				
A4 3.0	04/01→05/06	2976	6	82.50	DOHC, V	160/218				
A4 3.0 quattro	04/01→07/06									
A4 Avant 3.0	04/01→07/06									
A6 3.0	08/04→05/06									
A6 3.0 quattro	05/04→05/06									
A6 3.0 quattro	06/01→07/04									
A6 Avant 3.0	03/05→05/06									
A8 3.0	07/03→05/06									
3.0		BKN Diesel				307		AG8880 (MLS), 1.100mm, 1 Hole [32]	CG8880 ▲ [34][35]	
A4 3.0 TDI	11/04→03/09	2967	6	83.00	SOHC/OHC, V	150/204	AG8900 (MLS), 1.100mm, 1 Hole [27]			
A4 Avant TDI	11/04→06/08						AG8860 (MLS), 1.150mm, 2 Holes [32]			
							AG8870 (MLS), 1.150mm, 2 Holes [27]			
							AG8890 (MLS), 1.200mm, 3 Holes [32]			
							AG8910 (MLS), 1.200mm, 3 Holes [27]			
3.0		BMK Diesel				308		AG8880 (MLS), 1.100mm, 1 Hole [32]	CG8880 ▲ [34][35]	
A6 3.0 TDI	05/04→05/06	2967	6	83.00	DOHC, V	165/225	AG8900 (MLS), 1.100mm, 1 Hole [27]			
A6 Avant	03/05→05/06						AG8860 (MLS), 1.150mm, 2 Holes [32]			
							AG8870 (MLS), 1.150mm, 2 Holes [27]			
							AG8890 (MLS), 1.200mm, 3 Holes [32]			
							AG8910 (MLS), 1.200mm, 3 Holes [27]			
3.0		BNG Diesel				309		AG8880 (MLS), 1.100mm, 1 Hole [32]	CG8880 ▲ [34][35]	
A6 3.0 TDI	05/04→08/11	2967	6	83.00	DOHC, V	155/211	AG8900 (MLS), 1.100mm, 1 Hole [27]			
A6 Avant	03/05→08/11						AG8860 (MLS), 1.150mm, 2 Holes [32]			
A8 3.0 TDI	11/03→07/10						AG8870 (MLS), 1.150mm, 2 Holes [27]			
							AG8890 (MLS), 1.200mm, 3 Holes [32]			
							AG8910 (MLS), 1.200mm, 3 Holes [27]			
3.0		BUG Diesel				310		AG8880 (MLS), 1.100mm, 1 Hole [32]	CG8880 ▲ [34][35]	
Q7 3.0 TDI	03/06→05/08	2967	6	83.00	DOHC, V	171/233	AG8900 (MLS), 1.100mm, 1 Hole [27]			
							AG8860 (MLS), 1.150mm, 2 Holes [32]			
							AG8870 (MLS), 1.150mm, 2 Holes [27]			
							AG8890 (MLS), 1.200mm, 3 Holes [32]			
							AG8910 (MLS), 1.200mm, 3 Holes [27]			
3.0		BUN Diesel				311		AG8880 (MLS), 1.100mm, 1 Hole [32]	CG8880 ▲ [34][35]	
Q7 3.0 TDI	03/06→05/10	2967	6	83.00	DOHC, V	155/211	AG8900 (MLS), 1.100mm, 1 Hole [27]			
							AG8860 (MLS), 1.150mm, 2 Holes [32]			
							AG8870 (MLS), 1.150mm, 2 Holes [27]			
							AG8890 (MLS), 1.200mm, 3 Holes [32]			
							AG8910 (MLS), 1.200mm, 3 Holes [27]			
3.0		CAJA				312				
A6 3.0 TFSI	10/08→08/11	2995	6	84.50	DOHC, V	213/290				
A6 Avant	10/08→08/11									
3.0		CAKA				313				
A4 Avant S4	11/08→	2995	6		DOHC, V	245/333				
A4 S4 quattro	11/08→									
A5 S5 quattro	06/09→									
3.0		CAPA Diesel				314				
A4 3.0 TDI	11/07→	2967	6	83.00	DOHC, V	176/240				
A5 3.0 TDI	06/07→									
3.0		CASA Diesel				315				
Q7 3.0 TDI	11/07→	2967	6	83.00	DOHC, V	176/240				



HBS536 (x2) [22]				PA5041 6.00/12.20x10.00 (FPM)	NA5106 [2] 35.00x48.00x10.00mm, PTFE/ACM NA5106 [2] 35.00x48.00x10.00mm, PTFE	
HBS361 [22] M12x1.50x159.00mm (x16)	JD5872 (ACM)	JM7046 [32] (ACM) JM7047 [27] (ACM)		PA5041 (x24) 6.00/12.20x10.00 (FPM)	NA5001 [1] [2] 32.00x47.00x10.00mm, FPM	
HBS361 [22] M12x1.50x159.00mm (x16)	JD5872 (ACM)	JM7046 [32] (ACM) JM7047 [27] (ACM)		PA5041 (x24) 6.00/12.20x10.00 (FPM)	NA5001 [1] [2] 32.00x47.00x10.00mm, FPM	
HBS361 [22] M12x1.50x159.00mm (x16)	JD5872 (ACM)	JM7046 [32] (ACM) JM7047 [27] (ACM)		PA5041 (x24) 6.00/12.20x10.00 (FPM)	NA5001 [1] [2] 32.00x47.00x10.00mm, FPM	
HBS361 [22] M12x1.50x159.00mm (x16)	JD5872 (ACM)	JM7046 [32] (ACM) JM7047 [27] (ACM)		PA5041 (x24) 6.00/12.20x10.00 (FPM)	NA5001 [1] [2] 32.00x47.00x10.00mm, FPM	
HBS361 [22] M12x1.50x159.00mm (x16)	JD5872 (ACM)	JM7046 [32] (ACM) JM7047 [27] (ACM)		PA5041 (x24) 6.00/12.20x10.00 (FPM)	NA5001 [1] [2] 32.00x47.00x10.00mm, FPM	
				PA5041 6.00/12.20x10.00 (FPM)		
				PA5041 6.00/12.20x10.00 (FPM)		
	JD5872 (ACM)	JM7046 [32] (ACM) JM7047 [27] (ACM)		PA5041 6.00/12.20x10.00 (FPM)	NA5001 [1] [2] 32.00x47.00x10.00mm, FPM	
	JD5872 (ACM)	JM7046 [32] (ACM) JM7047 [27] (ACM)		PA5041 6.00/12.20x10.00 (FPM)	NA5001 [1] [2] 32.00x47.00x10.00mm, FPM	



cc



kW/PS

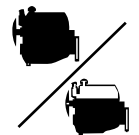

3.0	CASB Diesel						316			
Q7 3.0 TDI	03/06→05/10	2967	6	83.00	DOHC, V	155/211				
3.0	CATA Diesel						317			
Q7 3.0 TDI	06/09→05/12	2967	6	83.00	DOHC, V	165/224				
3.0	CCMA Diesel						318			
Q7 3.0 TDI	11/07→	2967	6	83.00	DOHC, V	176/240				
3.0	CCWA Diesel						319			
A4 3.0 TDI	11/07→	2967	6	83.00	DOHC, V	176/240				
A4 Allroad	04/09→									
A5 3.0 TDI	06/07→									
Q5 Q5	11/08→									
3.0	CCWB Diesel						320			
A4 3.0 TDI	06/08→	2967	6	83.00	DOHC, V	155/211				
A5 3.0 TDI	03/08→									
Q5 Q5	11/08→									
3.0	CDYA Diesel						321			
A6 3.0 TDI	10/08→08/11	2967	6	83.00	DOHC, V	176/240				
3.0	CDYB Diesel						322			
A6 3.0 TDI	05/04→08/11	2967	6	83.00	DOHC, V	155/211				
A6 Avant	03/05→08/11									
3.0	CDYC Diesel						323			
A6 3.0 TDI	10/08→08/11	2967	6	83.00	DOHC, V	176/240				
3.2	BDB						324	AG9610 (MLS)	CG9610	
A3 3.2 V6	07/03→05/09	3189	6	84.00	DOHC, VR	184/250				
3.2	BHE						325	AG9610 (MLS)	CG9610	
TT 3.2 VR6	07/03→06/06	3189	6	84.00	DOHC, V	184/250				
TT Roadster	07/03→06/06									
3.2	BMJ						326	AG9610 (MLS)	CG9610	
A3 3.2 V6	07/03→05/09	3189	6	84.00	DOHC, VR	184/250				
A3 Sportback	09/04→05/09									
3.2	BPF						327	AG9610 (MLS)	CG9610	
TT 3.2 VR6	07/03→06/06	3189	6	84.00	DOHC, VR	184/250				
TT Roadster	07/03→06/06									
3.2	BUB						328	AG9610 (MLS)	CG9610	
A3 3.2 V6	07/03→05/09	3189	6	84.00	DOHC, V	184/250				
A3 Sportback	09/04→05/09									
TT 3.2 V6	08/06→06/10									
TT Roadster	03/07→06/10									
3.3	AKF Diesel						329			
A8 3.3 TDI	06/00→09/02	3328	8	78.30	DOHC, V	165/224				

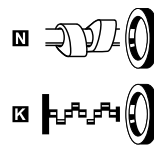
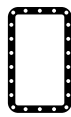
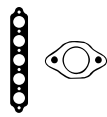

	JD5872 ■ (ACM)	JM7046 [32] (ACM) JM7047 [27] (ACM)		PA5041 6.00/12.20x10.00 (FPM)	NA5001 [1][2] 32.00x47.00x10.00mm, FPM	
	JD5872 ■ (ACM)	JM7046 [32] (ACM) JM7047 [27] (ACM)		PA5041 6.00/12.20x10.00 (FPM)	NA5001 [1][2] 32.00x47.00x10.00mm, FPM	
	JD5872 ■ (ACM)	JM7046 [32] (ACM) JM7047 [27] (ACM)		PA5041 6.00/12.20x10.00 (FPM)	NA5001 [1][2] 32.00x47.00x10.00mm, FPM	
	JD5872 ■ (ACM)	JM7046 [32] (ACM) JM7047 [27] (ACM)		PA5041 6.00/12.20x10.00 (FPM)	NA5001 [1][2] 32.00x47.00x10.00mm, FPM	
	JD5872 ■ (ACM)	JM7046 [32] (ACM) JM7047 [27] (ACM)		PA5041 6.00/12.20x10.00 (FPM)	NA5001 [1][2] 32.00x47.00x10.00mm, FPM	
	JD5872 ■ (ACM)	JM7046 [32] (ACM) JM7047 [27] (ACM)		PA5041 6.00/12.20x10.00 (FPM)	NA5001 [1][2] 32.00x47.00x10.00mm, FPM	
	JD5872 ■ (ACM)	JM7046 [32] (ACM) JM7047 [27] (ACM)		PA5041 6.00/12.20x10.00 (FPM)	NA5001 [1][2] 32.00x47.00x10.00mm, FPM	
	JD5872 ■ (ACM)	JM7046 [32] (ACM) JM7047 [27] (ACM)		PA5041 6.00/12.20x10.00 (FPM)	NA5001 [1][2] 32.00x47.00x10.00mm, FPM	
	JD5874 ■ (FPM)	JM7045 (Elastomer)		PA5041 (x24) 6.00/12.20x10.00 (FPM)	NA5106 [2] 35.00x48.00x10.00mm, PTFE/ACM NA5106 ■ [2] 35.00x48.00x10.00mm, PTFE NA5305 ■ [1][36]	
	JD5874 ■ (FPM)	JM7045 (Elastomer)		PA5041 (x24) 6.00/12.20x10.00 (FPM)	NA5106 [2] 35.00x48.00x10.00mm, PTFE/ACM NA5106 ■ [2] 35.00x48.00x10.00mm, PTFE	
	JD5874 ■ (FPM)	JM7045 (Elastomer)		PA5041 (x24) 6.00/12.20x10.00 (FPM)	NA5106 [2] 35.00x48.00x10.00mm, PTFE/ACM NA5106 ■ [2] 35.00x48.00x10.00mm, PTFE	
	JD5874 ■ (FPM)	JM7045 (Elastomer)		PA5041 (x24) 6.00/12.20x10.00 (FPM)		
	JD5874 ■ (FPM)	JM7045 (Elastomer)		PA5041 (x24) 6.00/12.20x10.00 (FPM)	NA5106 [2] 35.00x48.00x10.00mm, PTFE/ACM NA5106 ■ [2] 35.00x48.00x10.00mm, PTFE	
HBS470 © [22] M12x1.50x159.00mm (x20)	JD5851 ■ (Fibre)			PA5041 6.00/12.20x10.00 (FPM) HR791 ■ (x2)	NA5001 (x2)[1][2] 32.00x47.00x10.00mm, FPM	



Ltr



CC



9

Model	Ltr	Year Range	Engine	Fuel	CC	Spec	Index
MAESTRO (XC)	1.3	03/98→09/99	12 H	Petrol	1275	4	4
MAESTRO (XC)	1.6	03/98→08/99	16 HC37	Petrol	1598	4	9
MAESTRO (XC)	2.0	10/98→08/99	20 HA50AA	Petrol	1994	4	11
MAESTRO (XC)	2.0	10/98→08/99	20 HC51AA	Petrol	1994	4	12
MAESTRO (XC)	2.0	10/98→08/99	20 HC81	Petrol	1994	4	13
METRO	1.0	10/98→04/99	99 H	Petrol	999	4	1
METRO	1.0	10/98→04/99	99 HA65P	Petrol	999	4	2
METRO	1.3	10/98→04/99	12 H	Petrol	1275	4	4
METRO	1.3	10/98→04/99	12 HA83AA	Petrol	1275	4	5
METRO	1.3	10/98→04/99	12 HA85AA	Petrol	1275	4	6
METRO	1.3	11/98→04/99	12 HC21AA	Petrol	1273	4	7
MINI	1.0	09/98→06/99	99 HD81	Petrol	999	4	3
MONTEGO (XE)	1.3	10/98→08/98	12 HL	Petrol	1275	4	8
MONTEGO (XE)	1.6	04/98→08/98	16 HC37	Petrol	1598	4	9
MONTEGO (XE)	2.0	04/98→08/98	20 H	Petrol	1994	4	10
MONTEGO (XE)	2.0	04/98→08/98	20 HSC	Petrol	1994	4	14
MONTEGO Estate (XE)	1.3	10/98→10/98	12 HL	Petrol	1275	4	8
MONTEGO Estate (XE)	1.6	10/98→08/98	16 HC37	Petrol	1598	4	9
MONTEGO Estate (XE)	2.0	10/98→08/99	20 H	Petrol	1994	4	10
MONTEGO Estate (XE)	2.0	10/98→08/99	20 HSC	Petrol	1994	4	14

AUSTIN



kW/PS

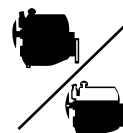

1	99 H	1	AF070 (Fibre)		EF07C [3]
Metro 1.0	10/80→04/90	999 4 64.60 OHV 29-33/39-45			
1	99 HA65P	2	AF070 (Fibre)	CF073 [13]	
Metro 1.0 Surf	10/80→04/90	999 4 64.60 OHV 35/48			
1	99 HD81	3	AF070 (Fibre)	CF073 [13]	EF07C [3]
Mini Sport	09/88→06/93	999 4 30/41			
1.3	12 H	4	BK450 (Fibre)	DK450 [13]	
Maestro 1.3	03/83→09/92	1275 4 70.60 OHV 40-49/54-67			
Metro 1.3	10/80→04/90				
1.3	12 HA83AA	5	BK450 (Fibre)		EK451 [3]
Metro 1.3	10/80→04/90	1275 4 70.60 OHV 51/69			
1.3	12 HA85AA	6	BK450 (Fibre)	DK451	EF464 [3]
Metro 1.3 Turbo	10/83→04/90	1275 4 70.60 OHV 66/90			
1.3	12 HC21AA	7	BK450 (Fibre)		EF464 [3]
Metro 1.3 Surf	11/85→04/90	1273 4 70.60 OHV 44/60			
1.3	12 HL	8	BK450 (Fibre)		EF464 [3]
Montego 1.3	10/84→10/88	1275 4 70.60 OHV 46-51/63-69			
1.6	16 HC37	9	BL380 (Fibre)	DL381	
Maestro Mayfair	03/83→08/90	1598 4 76.20 SOHC/OHC 61/83			
Montego 1.6 LS	10/84→08/88				
Montego LS,HL	04/84→08/88				
2.0	20 H	10	BN670 (Fibre)	DN671 [3]	
Montego 2.0	04/84→08/91	1994 4 84.50 SOHC/OHC 69-83/94-113			
Montego 2.0 HLI	10/84→08/88				
2.0	20 HA50AA	11	BN670 (Fibre)	DN671 [3]	
Maestro 2.0 EFi	10/84→08/90	1994 4 84.50 OHV 83/113			
2.0	20 HC51AA	12	BN670 (Fibre)	DN671 [3]	
Maestro 2.0 EFi	10/84→08/90	1994 4 84.50 SOHC/OHC 83/113			
2.0	20 HC81	13	BN670 (Fibre)	DN671 [3]	
Maestro 2.0 EFi	10/84→08/90	1994 4 84.50 SOHC/OHC 83/113			
2.0	20 HSC	14	BN670 (Fibre)	DN671 [3]	
Montego 2.0	04/84→08/91	1994 4 84.50 SOHC/OHC 74/101			

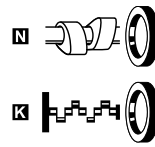
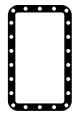

AF070



BK450



BL380



BN670



JA439

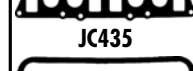

JC435



JM302

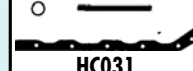

HC031



JJ315

		JA439	JM302 [4]	HC031 [S]	HR339 [S] (x2)	<input checked="" type="checkbox"/> NA473 [F] [2] 39.70x59.00x9.50mm, NBR <input checked="" type="checkbox"/> NA584 [R] [1] 55.00x70.00x10.00mm, MVQ <input checked="" type="checkbox"/> NA5324 [R] [1] 74.00x89.00x8.50mm, FPM	HJ013 [8] [S] JR264 [6]
		JA439	JM302 [4]	HC031 [S]	HR339 [S] (x2)	<input checked="" type="checkbox"/> NA473 [F] [2] 39.70x59.00x9.50mm, NBR <input checked="" type="checkbox"/> NA584 [R] [1] 55.00x70.00x10.00mm, MVQ	HJ013 [8] [S] JR264 [6]
		JA439	JM302 [4]	HC063 [S]	HR339 [S] (x2)	<input checked="" type="checkbox"/> NA473 [F] [2] 39.70x59.00x9.50mm, NBR <input checked="" type="checkbox"/> NA584 [R] [1] 55.00x70.00x10.00mm, MVQ <input checked="" type="checkbox"/> NB291 [R] [1] 82.60x98.70x12.70mm, MVQ	HJ013 [8] [S] JR264 [6]
		JA439	JM302 [4]		HR339 [S] (x2)	<input checked="" type="checkbox"/> NA473 [F] [2] 39.70x59.00x9.50mm, NBR <input checked="" type="checkbox"/> NB291 [R] [1] 82.60x98.70x12.70mm, MVQ	JR264 [6]
			JM302 [4]	HC031 [S]	HR339 [S] (x2)	<input checked="" type="checkbox"/> NA473 [F] [2] 39.70x59.00x9.50mm, NBR <input checked="" type="checkbox"/> NA584 [R] [1] 55.00x70.00x10.00mm, MVQ	HJ013 [8] [S] JR264 [6]
		JA439	JM302 [4]		HR339 [S] (x2)	<input checked="" type="checkbox"/> NA473 [F] [2] 39.70x59.00x9.50mm, NBR <input checked="" type="checkbox"/> NA584 [R] [1] 55.00x70.00x10.00mm, MVQ	HJ013 [8] [S] JR264 [6]
		JA439	JM302 [4]		HR339 [S] (x2)	<input checked="" type="checkbox"/> NA473 [F] [2] 39.70x59.00x9.50mm, NBR <input checked="" type="checkbox"/> NA584 [R] [1] 55.00x70.00x10.00mm, MVQ <input checked="" type="checkbox"/> NB772 [R] [1] 88.90x104.80x9.52mm, MVQ	HJ013 [8] [S] JR264 [6]
		JC435		JJ315			
		JC435		JJ315			
		JC435		JJ315			
		JC435		JJ315			
		JC435		JJ315			



Ltr



CC



9

	Ltr				CC		
ASTRA VAN Estate	1.3	09/98→09/98	13 NB	Petrol	1297	4	2
ASTRA VAN Estate	1.3	09/98→09/98	13 S	Petrol	1297	4	3
ASTRA VAN Estate	1.4	09/98→08/99	14 NV	Petrol	1389	4	4
ASTRA VAN Estate	1.6	09/98→08/98	16 D	Diesel	1598	4	5
ASTRA VAN Estate	1.6	09/98→08/98	16 DA	Diesel	1598	4	6
ASTRA VAN Estate	1.6	09/98→08/99	16 SV	Petrol	1598	4	7
ASTRA VAN Estate	1.7	09/98→08/99	17 D	Diesel	1699	4	8
ASTRAMAX Estate	1.3	09/98→06/99	13 NB	Petrol	1297	4	2
ASTRAMAX Estate	1.4	09/98→06/99	14 NV	Petrol	1389	4	4
ASTRAMAX Estate	1.6	09/98→08/98	16 D	Diesel	1598	4	5
ASTRAMAX Estate	1.6	09/98→08/98	16 DA	Diesel	1598	4	6
ASTRAMAX Estate	1.7	09/98→06/99	17 D	Diesel	1699	4	8
MIDI Box	1.8	09/98→05/98	4ZB1	Petrol	1817	4	9
MIDI Bus	1.8	09/98→05/98	4ZB1	Petrol	1817	4	9
RASCAL Box	1.0	07/98→06/99	FA10A	Petrol	970	4	1
RASCAL Bus	1.0	07/98→06/99	FA10A	Petrol	970	4	1
RASCAL Pickup	1.0	06/98→06/99	FA10A	Petrol	970	4	1
RASCAL Platform/Chassis	1.0	06/98→06/99	FA10A	Petrol	970	4	1

BEDFORD



cc



kW/PS



1.0		FA10A					1				
Rascal 1.0	06/86→06/90	970	4	65.50	SOHC/OHC	34/46	BL390 (Graphite)	DL391	GL391 [3]		
1.3		13 NB					2				
Astra Van 1.3	09/84→09/89	1297	4	75.00	SOHC/OHC	44/60	BK470 (Fibre)	DK470 DK471	EK470 [3]		
Astramax 1.3	09/85→06/90										
1.3		13 S					3				
Astra Van 1.3	09/84→09/89	1297	4	75.00	SOHC/OHC	42-55/ 57-75	BK470 (Fibre)	DK470 DK471	EK470 [3]		
1.4		14 NV					4				
Astra Van 1.4	09/89→08/91	1389	4	77.60	SOHC/OHC	44-55/ 60-75	BS260 (Fibre)	DS260	ES260		
Astramax 1.4	09/89→06/90										
1.6		16 D Diesel					5				
Astra Van 1.6 D	09/85→08/88	1598	4	80.00	SOHC/OHC	39-40/ 53-54	BL010 (Fibre), 1.400mm →0.750mm BL020 (Fibre), 1.500mm, 1 Notch →0.750→0.850mm BL030 (Fibre), 1.600mm, 2 Notches →0.850mm→	DL010 ▲ DL011 ▲	EK481 [3] EK485		
Astramax 1.6 D	09/85→08/88										
1.6		16 DA Diesel					6				
Astra Van 1.6 D	09/87→08/89	1598	4	80.00	SOHC/OHC	40-42/ 54-57	BL010 (Fibre), 1.400mm →0.750mm BL020 (Fibre), 1.500mm, 1 Notch →0.750→0.850mm BL030 (Fibre), 1.600mm, 2 Notches →0.850mm→	DL010 ▲ DL011 ▲	EK481 [3] EK485		
Astramax 1.6 D	09/85→08/88										
1.6		16 SV					7				
Astra Van 1.6	09/84→08/91	1598	4	79.00	SOHC/OHC	60-66/ 82-90	BP800 (Fibre)	DP800	EK484		
1.7		17 D Diesel					8				
Astra Van 1.7 D	09/88→08/91	1699	4	82.50	SOHC/OHC	42/57	BY340 (Fibre), 1.400mm, 1 Notch BY350 (Fibre), 1.500mm, 2 Notches	DL011 ▲	EK485		
Astramax 1.7 D	09/88→06/90										
1.8		4ZB1					9				
Midi 1.8	09/84→05/88	1817	4	84.00	SOHC/OHC	63/86	BM330 (Graphite)	DM330 [13]			

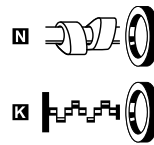
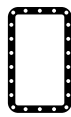
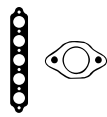

	JC420 ■ (x2) JD097 ■ ⊕JE735	JN414 (Elastomer)	JJ273	PA305 (x8)	NJ336 ■ [2] 32.00x47.00x8.00mm, NBR NJ336 ■ [2] 32.00x47.00x8.00mm, NBR NJ337 ■ [1] 60.00x80.00x8.00mm, NBR	
HBS002 ⊕ [5] M10x1.25x140.00mm (x10)	JC280 ■ JC281 ■ JC282 ■	JN344 [4] JN626 [4]	JH5005 (Cork) JJ120 (Cork)	HR342 ■	NC006 [2] 35.00x48.00x7.00mm, MVQ	
HBS002 ⊕ [5] M10x1.25x140.00mm (x10)	JC280 ■ JC281 ■ JC282 ■ ⊕JE119	JN626 [4]	JH5005 (Cork) JJ120 (Cork)	HR342 ■	NC006 [2] 35.00x48.00x7.00mm, MVQ NB698 ■ [1] 80.00x98.00x10.00mm, FPM	
HBS002 ⊕ [5] M10x1.25x140.00mm (x10)	JC824 ■ JC281 ■ JC282 ■	JN626 [4]	JH5005 (Cork) JJ120 (Cork)	HR342 ■	NC006 [2] 35.00x48.00x7.00mm, MVQ NB698 ■ [1] 80.00x98.00x10.00mm, FPM	
HBS074 ⊕ [5] M11x1.25x154.00mm (x10)	JC436 ■ JC437 ■ ⊕JE119	JN453 [4] JN693 [4]	JJ200	HR343 ■	NC006 [2] 35.00x48.00x7.00mm, MVQ NB806 ■ [1] 90.00x104.00x11.00mm, FPM	
HBS074 ⊕ [5] M11x1.25x154.00mm (x10)	JC436 ■ JC437 ■ ⊕JE119	JN453 [4] JN693 [4]	JJ200	HR343 ■	NC006 [2] 35.00x48.00x7.00mm, MVQ	
HBS002 ⊕ [5] M10x1.25x140.00mm (x10)	JC824 ■ JC281 ■ JC282 ■	JN626 [4]	JH5005 (Cork) JJ120 (Cork)	HR342 ■	NC006 [2] 35.00x48.00x7.00mm, MVQ NB698 ■ [1] 80.00x98.00x10.00mm, FPM	
HBS074 ⊕ [5] M11x1.25x154.00mm (x10)	JC436 ■ JC437 ■ ⊕JE119	JN693 [4]	JJ200	HR343 ■	NC006 [2] 35.00x48.00x7.00mm, MVQ	
	JC670 ■ JC683 ■	JN634 [4] HL532 ■	JJ358	PA933 ■ (x8)	NJ454 ■ [1][2] 30.00x45.00x8.00mm, NBR NJ323 ■ [2] 40.00x56.00x7.00mm, NBR NJ322 ■ [1] 95.00x118.00x10.00mm, NBR	

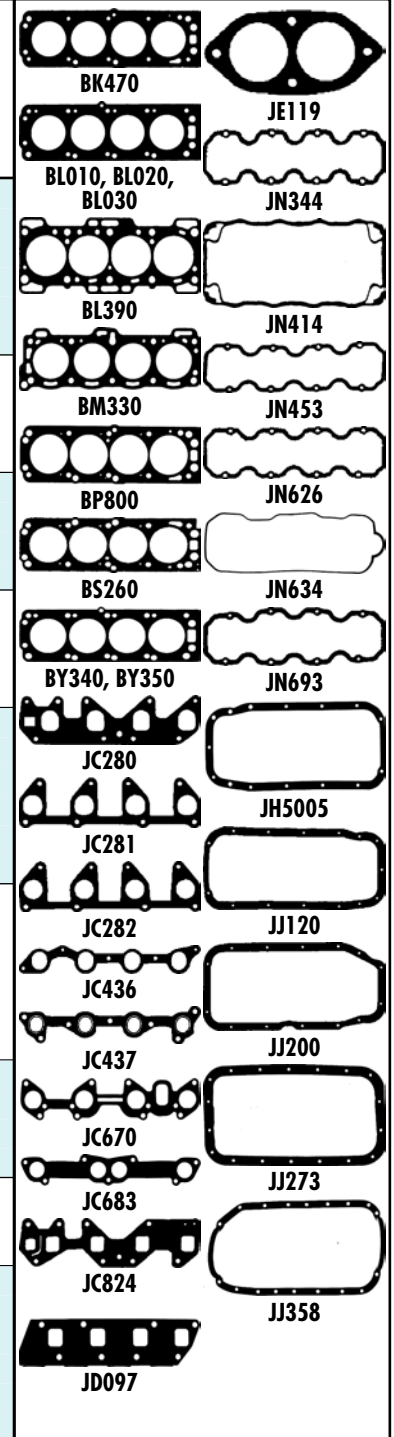



Ltr







CC



9

Model	Ltr	Year Range	Engine	Fuel	CC	Gear	9
1 (E81)	1.6	03/00→09/01	N43 B16 A	Petrol	1597	4	6
1 (E81)	1.6	03/00→09/01	N45 B16 A	Petrol	1596	4	8
1 (E81)	2.0	09/00→09/01	N43 B20 A	Petrol	1995	4	38
1 (E81)	2.0	09/00→09/01	N46 B20 B	Petrol	1995	4	41
1 (E81)	2.0	09/00→09/01	N46 B20 C	Petrol	1995	4	42
1 (E81)	2.0	09/00→09/01	N47 D20 A	Diesel	1995	4	44
1 (E81)	2.0	03/00→09/01	N47 D20 B	Diesel	1995	4	45
1 (E81)	2.0	09/00→09/01	N47 D20 C	Diesel	1995	4	46
1 (E81)	2.0	03/00→09/01	N47 D20 D	Diesel	1995	4	47
1 (E81)	3.0	09/00→09/01	N52 B30 A	Petrol	2996	6	94
1 (E81)	3.0	09/00→09/01	N52 B30 B	Petrol	2996	6	95
1 (E81)	3.0	09/00→09/01	N52 B30 BF	Petrol	2996	6	96
1 (E87)	1.6	11/00→09/01	N43 B16 A	Petrol	1597	4	6
1 (E87)	1.6	11/00→09/01	N45 B16 A	Petrol	1596	4	8
1 (E87)	2.0	11/00→09/01	M47 D20 (204D4)	Diesel	1995	4	26
1 (E87)	2.0	11/00→09/01	N43 B20 A	Petrol	1995	4	38
1 (E87)	2.0	11/00→09/01	N46 B20 A	Petrol	1995	4	40
1 (E87)	2.0	11/00→09/01	N46 B20 B	Petrol	1995	4	41
1 (E87)	2.0	11/00→09/01	N46 B20 C	Petrol	1995	4	42
1 (E87)	2.0	11/00→09/01	N47 D20 A	Diesel	1995	4	44
1 (E87)	2.0	03/00→09/01	N47 D20 B	Diesel	1995	4	45
1 (E87)	2.0	11/00→09/01	N47 D20 C	Diesel	1995	4	46
1 (E87)	2.0	03/00→09/01	N47 D20 D	Diesel	1995	4	47
1 (E87)	3.0	03/00→09/01	N52 B30 A	Petrol	2996	6	94
1 (E87)	3.0	03/00→09/01	N52 B30 B	Petrol	2996	6	95
1 (E87)	3.0	03/00→09/01	N52 B30 BF	Petrol	2996	6	96
1 (F20)	2.0	12/01→	N47 D20 C	Diesel	1995	4	46
1 (F20)	2.0	08/01→	N47 D20 D	Diesel	1995	4	47
1 (F20)	3.0	11/01→	N55 B30 A	Petrol/Electro	2979	6	103
1 (F20)	3.0	11/01→	N55 B30 A	Petrol	2979	6	103
1 (F21)	2.0	12/01→	N47 D20 C	Diesel	1995	4	46
1 (F21)	2.0	12/01→	N47 D20 D	Diesel	1995	4	47
1 (F21)	3.0	12/01→	N55 B30 A	Petrol/Electro	2979	6	103
1 (F21)	3.0	12/01→	N55 B30 A	Petrol	2979	6	103
1 Convertible (E88)	2.0	03/00→	N43 B20 A	Petrol	1995	4	38
1 Convertible (E88)	2.0	03/00→	N46 B20 B	Petrol	1995	4	41
1 Convertible (E88)	2.0	03/00→	N46 B20 C	Petrol	1995	4	42
1 Convertible (E88)	2.0	03/00→	N47 D20 A	Diesel	1995	4	44
1 Convertible (E88)	2.0	09/00→	N47 D20 B	Diesel	1995	4	45
1 Convertible (E88)	2.0	03/00→	N47 D20 C	Diesel	1995	4	46
1 Convertible (E88)	3.0	03/00→	N52 B30 A	Petrol	2996	6	94
1 Convertible (E88)	3.0	03/00→	N54 B30 A	Petrol	2979	6	101
1 Convertible (E88)	3.0	03/00→	N55 B30 A	Petrol/Electro	2979	6	103
1 Convertible (E88)	3.0	03/00→	N55 B30 A	Petrol	2979	6	103
1 Coupe (E82)	2.0	09/00→	N43 B20 A	Petrol	1995	4	38
1 Coupe (E82)	2.0	09/00→	N46 B20 B	Petrol	1995	4	41
1 Coupe (E82)	2.0	10/00→	N47 D20 A	Diesel	1995	4	44
1 Coupe (E82)	2.0	10/00→	N47 D20 B	Diesel	1995	4	45
1 Coupe (E82)	2.0	10/00→	N47 D20 C	Diesel	1995	4	46
1 Coupe (E82)	3.0	10/00→	N53 B30 A	Petrol	2996	6	100
1 Coupe (E82)	3.0	10/00→	N54 B30 A	Petrol	2979	6	101
1 Coupe (E82)	3.0	10/00→	N55 B30 A	Petrol/Electro	2979	6	103
1 Coupe (E82)	3.0	10/00→	N55 B30 A	Petrol	2979	6	103
3 (E30)	1.6	09/98→12/99	M10 B16	Petrol	1573	4	1
3 (E30)	1.6	09/98→06/99	M40 B16	Petrol	1596	4	2
3 (E30)	1.8	09/98→06/99	M40 B18	Petrol	1796	4	11
3 (E30)	1.8	09/98→08/99	M42 B18	Petrol	1796	4	13
3 (E30)	2.0	12/98→06/99	M20 B20	Petrol	1990	6	23
3 (E30)	2.0	05/98→12/99	S14 204 EA	Petrol	1990	4	49
3 (E30)	2.3	02/98→05/98	S14 B23	Petrol	2303	4	52
3 (E30)	2.3	07/98→06/99	S14 B23	Petrol	2303	4	53
3 (E30)	2.3	10/98→10/99	S14 B23 (EVO I)	Petrol	2302	4	54
3 (E30)	2.4	09/98→08/99	M21 D24	Diesel	2443	6	55
3 (E30)	2.4	09/98→08/99	M21 D24 W	Diesel	2443	6	56
3 (E30)	2.4	09/98→08/99	M21 D24 WA	Diesel	2443	6	57
3 (E30)	2.5	09/98→08/99	M20 B25	Petrol	2494	6	58
3 (E30)	2.7	10/98→12/98	M20 B27	Petrol	2693	6	75
3 (E36)	1.6	09/99→09/99	M40 B16	Petrol	1596	4	2
3 (E36)	1.6	09/99→02/99	M43 B16	Petrol	1596	4	3
3 (E36)	1.6	09/99→02/99	M43 B16	Bi-Fuel	1596	4	3

	Ltr				CC		9
3 (E36)	1.7	01/99→02/99	M41 D18 (Inter.)	Diesel	1665	4	10
3 (E36)	1.8	12/99→10/99	M40 B18	Petrol	1796	4	11
3 (E36)	1.8	03/99→02/99	M42 B18	Petrol	1796	4	13
3 (E36)	1.8	10/99→02/99	M43 B18	Petrol	1796	4	14
3 (E36)	1.8	10/99→02/99	M43 B18	Bi-Fuel	1796	4	14
3 (E36)	1.9	09/99→02/99	M44 B19	Petrol	1895	4	22
3 (E36)	2.0	09/99→02/99	M50 B(20 6 S1)	Petrol	1991	6	30
3 (E36)	2.0	09/99→02/99	M50 B(20 6 S2) Vanos	Petrol	1991	6	31
3 (E36)	2.0	09/99→02/99	M50 B20	Petrol	1991	6	32
3 (E36)	2.0	09/99→02/99	M50 B20 TU	Petrol	1991	6	33
3 (E36)	2.0	09/99→02/99	M52 B(20 6 S3) Vanos	Petrol	1991	6	34
3 (E36)	2.0	09/99→02/99	M52 B20	Petrol	1991	6	36
3 (E36)	2.5	09/99→09/99	M50 B25	Petrol	2494	6	59
3 (E36)	2.5	09/99→09/99	M50 B25 (Vanos)	Petrol	2494	6	60
3 (E36)	2.5	09/99→09/99	M50 B25 TU	Petrol	2494	6	61
3 (E36)	2.5	09/99→02/99	M51 D25	Diesel	2497	6	62
3 (E36)	2.5	05/99→02/99	M51 D25 (Inter.)	Diesel	2503	6	63
3 (E36)	2.5	03/99→02/99	M52 B25 (Vanos)	Petrol	2494	6	64
3 (E36)	2.8	01/99→02/99	M52 B28	Petrol	2793	6	76
3 (E36)	2.8	01/99→02/99	M52 B28 TU	Petrol	2793	6	77
3 (E46)	1.6	04/00→02/00	M43 B16	Petrol	1596	4	3
3 (E46)	1.6	04/00→02/00	M43 B16	Bi-Fuel	1596	4	3
3 (E46)	1.6	04/00→02/00	M43 B16 (164E3)	Petrol	1596	4	4
3 (E46)	1.6	06/00→02/00	N45 B16	Petrol	1596	4	7
3 (E46)	1.6	06/00→02/00	N45 B16 A	Petrol	1596	4	8
3 (E46)	1.8	02/00→02/00	N42 B18	Petrol	1796	4	15
3 (E46)	1.8	02/00→02/00	N46 B18	Petrol	1796	4	16
3 (E46)	1.8	02/00→02/00	N46 B18 A	Petrol	1796	4	17
3 (E46)	1.9	02/99→09/00	M43 B19	Petrol	1895	4	19
3 (E46)	1.9	09/99→02/00	M43 B19 (194E1)	Petrol	1895	4	20
3 (E46)	1.9	02/99→09/00	M43 B19 TU	Petrol	1895	4	21
3 (E46)	2.0	02/99→04/00	M47 204 D1	Diesel	1951	4	24
3 (E46)	2.0	04/99→03/00	M47 D20	Diesel	1951	4	25
3 (E46)	2.0	09/00→02/00	M47N 204 D4	Diesel	1995	4	28
3 (E46)	2.0	03/99→09/00	M52 B(20 6 S3) Vanos	Petrol	1991	6	34
3 (E46)	2.0	03/99→09/00	M52 B20	Petrol	1991	6	36
3 (E46)	2.0	09/00→02/00	N42 B20	Petrol	1995	4	37
3 (E46)	2.0	09/00→02/00	N46 B20	Petrol	1995	4	39
3 (E46)	2.0	09/00→02/00	N46 B20 A	Petrol	1995	4	40
3 (E46)	2.2	09/00→02/00	M54 226 S1	Petrol	2171	6	50
3 (E46)	2.2	09/00→02/00	M54 B22	Petrol	2171	6	51
3 (E46)	2.5	03/99→09/00	M52 B25 (Vanos)	Petrol	2494	6	64
3 (E46)	2.5	03/99→09/00	M52 B25 TU	Petrol	2494	6	65
3 (E46)	2.5	09/00→02/00	M54 256 S5	Petrol	2494	6	66
3 (E46)	2.5	09/00→02/00	M54 B25	Petrol	2494	6	67
3 (E46)	2.8	02/99→06/00	M52 B28	Petrol	2793	6	76
3 (E46)	3.0	06/00→02/00	M54 306 S3	Petrol	2979	6	80
3 (E46)	3.0	06/00→02/00	M54 B30	Petrol	2979	6	81
3 (E46)	3.0	10/99→02/00	M57 D30	Diesel	2926	6	78
3 (E46)	3.0	03/00→02/00	M57N 306 D2	Diesel	2993	6	87
3 (E90)	1.6	09/00→12/01	N43 B16 A	Petrol	1597	4	6
3 (E90)	1.6	02/00→12/01	N45 B16	Petrol	1596	4	7
3 (E90)	1.6	02/00→12/01	N45 B16 A	Petrol	1596	4	8
3 (E90)	1.6	02/00→12/01	N45 B16 TU2	Petrol	1596	4	9
3 (E90)	2.0	09/00→12/01	M47N 204 D4	Diesel	1995	4	28
3 (E90)	2.0	03/00→12/01	N43 B20 A	Petrol	1995	4	38
3 (E90)	2.0	01/00→03/00	N46 B20	Petrol	1995	4	39
3 (E90)	2.0	01/00→03/00	N46 B20 A	Petrol	1995	4	40
3 (E90)	2.0	09/00→03/00	N46 B20 B	Petrol	1995	4	41
3 (E90)	2.0	01/00→03/00	N46 B20 C	Petrol	1995	4	42
3 (E90)	2.0	09/00→12/01	N47 D20 A	Diesel	1995	4	44
3 (E90)	2.0	01/00→12/01	N47 D20 C	Diesel	1995	4	46
3 (E90)	2.5	01/00→12/01	N52 B25	Petrol	2497	6	71
3 (E90)	2.5	01/00→12/01	N52 B25 A	Petrol	2497	6	72
3 (E90)	2.5	04/00→12/01	N52N B25 A	Petrol	2497	6	74
3 (E90)	3.0	09/00→12/01	M57 306 D3	Diesel	2993	6	82
3 (E90)	3.0	09/00→12/01	M57 D30 TU2	Diesel	2993	6	86
3 (E90)	3.0	09/00→12/01	M57N 306 D5	Diesel	2993	6	89
3 (E90)	3.0	01/00→12/01	M57N2 306 D3	Diesel	2993	6	91
3 (E90)	3.0	01/00→12/01	N52 B30	Petrol	2996	6	93



Ltr







CC



9

	Ltr				CC		9
3 (E90)	3.0	01/00→12/01	N52 B30 A	Petrol	2996	6	94
3 (E90)	3.0	09/00→12/01	N53 B30	Petrol	2996	6	99
3 (E90)	3.0	09/00→12/01	N53 B30 A	Petrol	2996	6	100
3 (E90)	3.0	09/00→12/01	N54 B30 A	Petrol	2979	6	101
3 (E90)	3.0	09/00→12/01	N55 B30 A	Petrol/Electro	2979	6	103
3 (E90)	3.0	09/00→12/01	N55 B30 A	Petrol	2979	6	103
3 (E90)	3.0	01/00→12/01	N57 D30 A	Diesel	2993	6	105
3 (F30, F35)	2.0	10/01→	N47 D20 C	Diesel	1995	4	46
3 (F30, F35)	2.0	10/01→	N47 D20 D	Diesel	1995	4	47
3 (F30, F35)	3.0	10/01→	N55 B30 A	Petrol/Electro	2979	6	103
3 (F30, F35)	3.0	10/01→	N55 B30 A	Petrol	2979	6	103
3 (F30, F35)	3.0	01/01→	N57 D30 A	Diesel	2993	6	105
3 Compact (E36)	1.6	03/99→08/00	M43 B16	Petrol	1596	4	3
3 Compact (E36)	1.6	03/99→08/00	M43 B16	Bi-Fuel	1596	4	3
3 Compact (E36)	1.7	01/99→08/00	M41 D18 (Inter.)	Diesel	1665	4	10
3 Compact (E36)	1.8	11/99→08/99	M42 B18	Petrol	1796	4	13
3 Compact (E36)	1.9	12/99→08/00	M43 B19 (194E1)	Petrol	1895	4	20
3 Compact (E36)	1.9	07/99→08/00	M44 B19	Petrol	1895	4	22
3 Compact (E36)	2.5	08/99→08/00	M52 B25 (Vanos)	Petrol	2494	6	64
3 Compact (E46)	1.6	06/00→02/00	N40 B16 A	Petrol	1596	4	5
3 Compact (E46)	1.6	06/00→02/00	N45 B16 A	Petrol	1596	4	8
3 Compact (E46)	1.8	06/00→02/00	N42 B18	Petrol	1796	4	15
3 Compact (E46)	1.8	06/00→02/00	N46 B18 A	Petrol	1796	4	17
3 Compact (E46)	2.0	10/00→12/00	M47 204 D1	Diesel	1951	4	24
3 Compact (E46)	2.0	09/00→02/00	M47N 204 D4	Diesel	1995	4	28
3 Compact (E46)	2.0	09/00→02/00	N42 B20	Petrol	1995	4	37
3 Compact (E46)	2.0	09/00→02/00	N46 B20 A	Petrol	1995	4	40
3 Compact (E46)	2.5	06/00→02/00	M54 256 S5	Petrol	2494	6	66
3 Compact (E46)	2.5	06/00→02/00	M54 B25	Petrol	2494	6	67
3 Convertible (E30)	1.8	09/99→10/99	M40 B18	Petrol	1796	4	11
3 Convertible (E30)	1.8	06/98→02/99	M40 B18 C	Petrol	1796	4	12
3 Convertible (E30)	2.0	04/98→10/99	M20 B20	Petrol	1990	6	23
3 Convertible (E30)	2.3	06/98→06/99	S14 B23	Petrol	2303	4	53
3 Convertible (E30)	2.5	09/98→10/99	M20 B25	Petrol	2494	6	58
3 Convertible (E36)	1.8	01/99→04/99	M43 B18	Petrol	1796	4	14
3 Convertible (E36)	1.8	01/99→04/99	M43 B18	Bi-Fuel	1796	4	14
3 Convertible (E36)	2.0	12/99→04/99	M50 B(20 6 S2) Vanos	Petrol	1991	6	31
3 Convertible (E36)	2.0	12/99→04/99	M50 B20	Petrol	1991	6	32
3 Convertible (E36)	2.0	12/99→04/99	M50 B20 TU	Petrol	1991	6	33
3 Convertible (E36)	2.0	12/99→04/99	M52 B(20 6 S3) Vanos	Petrol	1991	6	34
3 Convertible (E36)	2.0	12/99→04/99	M52 B20	Petrol	1991	6	36
3 Convertible (E36)	2.5	03/99→03/99	M50 B25	Petrol	2494	6	59
3 Convertible (E36)	2.5	03/99→03/99	M50 B25 TU	Petrol	2494	6	61
3 Convertible (E36)	2.5	06/99→04/99	M52 B25 (Vanos)	Petrol	2494	6	64
3 Convertible (E36)	2.8	03/99→04/99	M52 B28	Petrol	2793	6	76
3 Convertible (E36)	2.8	03/99→04/99	M52 B28 TU	Petrol	2793	6	77
3 Convertible (E46)	2.0	02/00→	M47N 204 D4	Diesel	1995	4	28
3 Convertible (E46)	2.0	09/00→	N42 B20	Petrol	1995	4	37
3 Convertible (E46)	2.0	09/00→	N46 B20	Petrol	1995	4	39
3 Convertible (E46)	2.0	02/00→	N46 B20 B	Petrol	1995	4	41
3 Convertible (E46)	2.2	09/00→	M54 226 S1	Petrol	2171	6	50
3 Convertible (E46)	2.2	09/00→	M54 B22	Petrol	2171	6	51
3 Convertible (E46)	2.5	04/00→09/00	M52 B25 (Vanos)	Petrol	2494	6	64
3 Convertible (E46)	2.5	09/00→	M54 256 S5	Petrol	2494	6	66
3 Convertible (E46)	3.0	06/00→	M54 306 S3	Petrol	2979	6	80
3 Convertible (E46)	3.0	08/00→	M57N 306 D2	Diesel	2993	6	87
3 Convertible (E93)	2.0	01/00→	N43 B20 A	Petrol	1995	4	38
3 Convertible (E93)	2.0	03/00→08/00	N46 B20	Petrol	1995	4	39
3 Convertible (E93)	2.0	03/00→08/00	N46N B20 B	Petrol	1995	4	43
3 Convertible (E93)	2.0	03/00→	N47 D20 A	Diesel	1995	4	44
3 Convertible (E93)	2.0	01/00→	N47 D20 C	Diesel	1995	4	46
3 Convertible (E93)	2.5	03/00→	N52 B25	Petrol	2497	6	71
3 Convertible (E93)	2.5	03/00→	N52 B25 A	Petrol	2497	6	72
3 Convertible (E93)	2.5	03/00→	N52N B25 A	Petrol	2497	6	74
3 Convertible (E93)	3.0	03/00→	M57 D30 (306D3)	Diesel	2993	6	85
3 Convertible (E93)	3.0	01/00→	M57N2 306 D3	Diesel	2993	6	91
3 Convertible (E93)	3.0	03/00→	N52N B30 B	Petrol	2996	6	98
3 Convertible (E93)	3.0	03/00→	N53 B30	Petrol	2996	6	99
3 Convertible (E93)	3.0	03/00→	N53 B30 A	Petrol	2996	6	100
3 Convertible (E93)	3.0	03/00→	N54 B30 A	Petrol	2979	6	101

	Ltr				CC		9
3 Convertible (E93)	3.0	03/00 →	N54 B30 B	Petrol	2979	6	102
3 Convertible (E93)	3.0	03/00 →	N55 B30 A	Petrol/Electro	2979	6	103
3 Convertible (E93)	3.0	03/00 →	N55 B30 A	Petrol	2979	6	103
3 Convertible (E93)	3.0	01/00 →	N57 D30 A	Diesel	2993	6	105
3 Coupe (E36)	1.6	09/99 → 04/99	M43 B16	Petrol	1596	4	3
3 Coupe (E36)	1.6	09/99 → 04/99	M43 B16	Bi-Fuel	1596	4	3
3 Coupe (E36)	1.8	03/99 → 10/99	M42 B18	Petrol	1796	4	13
3 Coupe (E36)	1.9	09/99 → 04/99	M44 B19	Petrol	1895	4	22
3 Coupe (E36)	2.0	03/99 → 04/99	M50 B(20 6 S1)	Petrol	1991	6	30
3 Coupe (E36)	2.0	03/99 → 04/99	M50 B(20 6 S2) Vanos	Petrol	1991	6	31
3 Coupe (E36)	2.0	03/99 → 04/99	M50 B20	Petrol	1991	6	32
3 Coupe (E36)	2.0	03/99 → 04/99	M50 B20 TU	Petrol	1991	6	33
3 Coupe (E36)	2.0	03/99 → 04/99	M52 B(20 6 S3) Vanos	Petrol	1991	6	34
3 Coupe (E36)	2.0	03/99 → 04/99	M52 B20	Petrol	1991	6	36
3 Coupe (E36)	2.5	03/99 → 04/99	M50 B25	Petrol	2494	6	59
3 Coupe (E36)	2.5	03/99 → 04/99	M50 B25 (Vanos)	Petrol	2494	6	60
3 Coupe (E36)	2.5	03/99 → 04/99	M50 B25 TU	Petrol	2494	6	61
3 Coupe (E36)	2.5	03/99 → 04/99	M52 B25 (Vanos)	Petrol	2494	6	64
3 Coupe (E36)	2.8	01/99 → 04/99	M52 B28	Petrol	2793	6	76
3 Coupe (E36)	2.8	01/99 → 04/99	M52 B28 TU	Petrol	2793	6	77
3 Coupe (E46)	1.6	04/00 →	M43 B16 (164E3)	Petrol	1596	4	4
3 Coupe (E46)	1.6	06/00 →	N45 B16 A	Petrol	1596	4	8
3 Coupe (E46)	1.9	11/99 → 09/00	M43 B19	Petrol	1895	4	19
3 Coupe (E46)	2.0	11/00 →	M47N 204 D4	Diesel	1995	4	28
3 Coupe (E46)	2.0	08/99 → 09/00	M52 B(20 6 S4)	Petrol	1991	6	35
3 Coupe (E46)	2.0	08/99 → 09/00	M52 B20	Petrol	1991	6	36
3 Coupe (E46)	2.0	09/00 →	N42 B20	Petrol	1995	4	37
3 Coupe (E46)	2.0	09/00 →	N46 B20	Petrol	1995	4	39
3 Coupe (E46)	2.0	03/00 →	N46 B20 A	Petrol	1995	4	40
3 Coupe (E46)	2.2	09/00 →	M54 226 S1	Petrol	2171	6	50
3 Coupe (E46)	2.2	09/00 →	M54 B22	Petrol	2171	6	51
3 Coupe (E46)	2.5	04/99 → 09/00	M52 B25 (Vanos)	Petrol	2494	6	64
3 Coupe (E46)	2.5	09/00 →	M54 256 S5	Petrol	2494	6	66
3 Coupe (E46)	2.8	04/99 → 06/00	M52 B28	Petrol	2793	6	76
3 Coupe (E46)	3.0	06/00 →	M54 306 S3	Petrol	2979	6	80
3 Coupe (E46)	3.0	03/00 →	M57N 306 D2	Diesel	2993	6	87
3 Coupe (E92)	1.6	09/00 →	N43 B16 A	Petrol	1597	4	6
3 Coupe (E92)	2.0	03/00 →	N43 B20 A	Petrol	1995	4	38
3 Coupe (E92)	2.0	11/00 → 06/00	N46 B20 A	Petrol	1995	4	40
3 Coupe (E92)	2.0	11/00 → 06/00	N46N B20 B	Petrol	1995	4	43
3 Coupe (E92)	2.0	03/00 →	N47 D20 A	Diesel	1995	4	44
3 Coupe (E92)	2.0	09/00 →	N47 D20 C	Diesel	1995	4	46
3 Coupe (E92)	2.5	09/00 →	N52 B25	Petrol	2497	6	71
3 Coupe (E92)	2.5	09/00 →	N52 B25 A	Petrol	2497	6	72
3 Coupe (E92)	2.5	09/00 →	N52 B25 C	Petrol	2497	6	73
3 Coupe (E92)	2.5	06/00 →	N52N B25 A	Petrol	2497	6	74
3 Coupe (E92)	3.0	09/00 →	M57 306 D3	Diesel	2993	6	82
3 Coupe (E92)	3.0	09/00 →	M57 D30 TU2	Diesel	2993	6	86
3 Coupe (E92)	3.0	09/00 →	M57N 306 D5	Diesel	2993	6	89
3 Coupe (E92)	3.0	01/00 →	M57N2 306 D3	Diesel	2993	6	91
3 Coupe (E92)	3.0	09/00 →	N52 B30 A	Petrol	2996	6	94
3 Coupe (E92)	3.0	08/00 → 11/00	N52N B30 A	Petrol	2996	6	97
3 Coupe (E92)	3.0	09/00 →	N53 B30	Petrol	2996	6	99
3 Coupe (E92)	3.0	09/00 →	N53 B30 A	Petrol	2996	6	100
3 Coupe (E92)	3.0	09/00 →	N54 B30 A	Petrol	2979	6	101
3 Coupe (E92)	3.0	09/00 →	N55 B30 A	Petrol/Electro	2979	6	103
3 Coupe (E92)	3.0	09/00 →	N55 B30 A	Petrol	2979	6	103
3 Coupe (E92)	3.0	01/00 →	N57 D30 A	Diesel	2993	6	105
3 Coupe (E92)	3.0	03/00 →	N57N 306 D3	Diesel	2993	6	107
3 GRAN TURISMO (F34)	2.0	03/01 →	N47 D20 C	Diesel	1995	4	46
3 GRAN TURISMO (F34)	2.0	03/01 →	N47 D20 D	Diesel	1995	4	47
3 GRAN TURISMO (F34)	3.0	03/01 →	N55 B30 A	Petrol/Electro	2979	6	103
3 GRAN TURISMO (F34)	3.0	03/01 →	N55 B30 A	Petrol	2979	6	103
3 Touring (E30)	1.6	09/99 → 06/99	M40 B16	Petrol	1596	4	2
3 Touring (E30)	1.8	09/98 → 06/99	M40 B18	Petrol	1796	4	11
3 Touring (E30)	2.0	01/98 → 12/99	M20 B20	Petrol	1990	6	23
3 Touring (E30)	2.4	01/98 → 06/99	M21 D24	Diesel	2443	6	55
3 Touring (E30)	2.4	01/98 → 06/99	M21 D24 WA	Diesel	2443	6	57
3 Touring (E30)	2.5	07/98 → 10/99	M20 B25	Petrol	2494	6	58
3 Touring (E36)	1.6	01/99 → 10/99	M43 B16	Petrol	1596	4	3



Ltr







CC



9

Model	Ltr	Year Range	Engine	Fuel	CC	Gear	9
3 Touring (E36)	1.6	01/99→10/99	M43 B16	Bi-Fuel	1596	4	3
3 Touring (E36)	1.7	01/99→10/99	M41 D18 (Inter.)	Diesel	1665	4	10
3 Touring (E36)	1.8	07/99→10/99	M43 B18	Petrol	1796	4	14
3 Touring (E36)	1.8	07/99→10/99	M43 B18	Bi-Fuel	1796	4	14
3 Touring (E36)	2.0	01/99→10/99	M50 B20	Petrol	1991	6	32
3 Touring (E36)	2.0	01/99→10/99	M50 B20 TU	Petrol	1991	6	33
3 Touring (E36)	2.0	01/99→10/99	M52 B(20 6 S3) Vanos	Petrol	1991	6	34
3 Touring (E36)	2.0	01/99→10/99	M52 B20	Petrol	1991	6	36
3 Touring (E36)	2.5	01/99→10/99	M51 D25 (Inter.)	Diesel	2503	6	63
3 Touring (E36)	2.5	09/99→10/99	M52 B25 (Vanos)	Petrol	2494	6	64
3 Touring (E36)	2.8	01/99→10/99	M52 B28	Petrol	2793	6	76
3 Touring (E36)	2.8	01/99→10/99	M52 B28 TU	Petrol	2793	6	77
3 Touring (E46)	1.6	06/00→02/00	N45 B16	Petrol	1596	4	7
3 Touring (E46)	1.6	06/00→02/00	N45 B16 A	Petrol	1596	4	8
3 Touring (E46)	1.8	03/00→02/00	N42 B18	Petrol	1796	4	15
3 Touring (E46)	1.8	03/00→02/00	N46 B18	Petrol	1796	4	16
3 Touring (E46)	1.8	03/00→02/00	N46 B18 A	Petrol	1796	4	17
3 Touring (E46)	1.9	10/99→09/00	M43 B19	Petrol	1895	4	19
3 Touring (E46)	1.9	10/99→09/00	M43 B19 TU	Petrol	1895	4	21
3 Touring (E46)	2.0	03/00→02/00	M47 204 D1	Diesel	1951	4	24
3 Touring (E46)	2.0	03/00→02/00	M47 D20	Diesel	1951	4	25
3 Touring (E46)	2.0	09/00→02/00	M47N 204 D4	Diesel	1995	4	28
3 Touring (E46)	2.0	10/99→09/00	M52 B(20 6 S3) Vanos	Petrol	1991	6	34
3 Touring (E46)	2.0	10/99→09/00	M52 B20	Petrol	1991	6	36
3 Touring (E46)	2.0	09/00→02/00	N42 B20	Petrol	1995	4	37
3 Touring (E46)	2.0	09/00→02/00	N46 B20	Petrol	1995	4	39
3 Touring (E46)	2.0	09/00→02/00	N46 B20 A	Petrol	1995	4	40
3 Touring (E46)	2.2	09/00→02/00	M54 226 S1	Petrol	2171	6	50
3 Touring (E46)	2.2	09/00→02/00	M54 B22	Petrol	2171	6	51
3 Touring (E46)	2.5	09/00→02/00	M54 256 S5	Petrol	2494	6	66
3 Touring (E46)	2.5	09/00→02/00	M54 B25	Petrol	2494	6	67
3 Touring (E46)	2.8	10/99→06/00	M52 B28	Petrol	2793	6	76
3 Touring (E46)	3.0	06/00→02/00	M54 306 S3	Petrol	2979	6	80
3 Touring (E46)	3.0	06/00→02/00	M54 B30	Petrol	2979	6	81
3 Touring (E46)	3.0	10/99→02/00	M57 D30	Diesel	2926	6	78
3 Touring (E46)	3.0	03/00→02/00	M57N 306 D2	Diesel	2993	6	87
3 Touring (E91)	1.6	05/00→05/01	N43 B16 A	Petrol	1597	4	6
3 Touring (E91)	2.0	09/00→	M47 D20 TU	Diesel	1951	4	27
3 Touring (E91)	2.0	09/00→	M47N 204 D4	Diesel	1995	4	28
3 Touring (E91)	2.0	09/00→	M47N 204 D5	Diesel	1995	4	29
3 Touring (E91)	2.0	09/00→	N43 B20 A	Petrol	1995	4	38
3 Touring (E91)	2.0	09/00→	N46 B20	Petrol	1995	4	39
3 Touring (E91)	2.0	09/00→	N46 B20 A	Petrol	1995	4	40
3 Touring (E91)	2.0	01/00→	N46 B20 B	Petrol	1995	4	41
3 Touring (E91)	2.0	09/00→	N46 B20 C	Petrol	1995	4	42
3 Touring (E91)	2.0	09/00→	N47 D20 A	Diesel	1995	4	44
3 Touring (E91)	2.0	09/00→	N47 D20 C	Diesel	1995	4	46
3 Touring (E91)	2.5	09/00→	N52 B25	Petrol	2497	6	71
3 Touring (E91)	2.5	09/00→	N52 B25 A	Petrol	2497	6	72
3 Touring (E91)	2.5	09/00→	N52 B25 C	Petrol	2497	6	73
3 Touring (E91)	2.5	04/00→06/00	N52N B25 A	Petrol	2497	6	74
3 Touring (E91)	3.0	09/00→	M57 306 D3	Diesel	2993	6	82
3 Touring (E91)	3.0	09/00→	M57 D30 TU2	Diesel	2993	6	86
3 Touring (E91)	3.0	09/00→	M57N 306 D5	Diesel	2993	6	89
3 Touring (E91)	3.0	01/00→	M57N2 306 D3	Diesel	2993	6	91
3 Touring (E91)	3.0	09/00→	N52 B30	Petrol	2996	6	93
3 Touring (E91)	3.0	09/00→	N52 B30 A	Petrol	2996	6	94
3 Touring (E91)	3.0	09/00→	N53 B30	Petrol	2996	6	99
3 Touring (E91)	3.0	09/00→	N53 B30 A	Petrol	2996	6	100
3 Touring (E91)	3.0	09/00→	N54 B30 A	Petrol	2979	6	101
3 Touring (E91)	3.0	09/00→	N55 B30 A	Petrol/Electro	2979	6	103
3 Touring (E91)	3.0	09/00→	N55 B30 A	Petrol	2979	6	103
3 Touring (E91)	3.0	01/00→	N57 D30 A	Diesel	2993	6	105
3 Touring (F31)	2.0	06/01→	N47 D20 C	Diesel	1995	4	46
3 Touring (F31)	2.0	03/01→	N47 D20 D	Diesel	1995	4	47
3 Touring (F31)	3.0	03/01→	N55 B30 A	Petrol/Electro	2979	6	103
3 Touring (F31)	3.0	03/01→	N55 B30 A	Petrol	2979	6	103
3 Touring (F31)	3.0	06/01→	N57 D30 A	Diesel	2993	6	105
4 Coupe (F32)	2.0	07/01→	N47 D20 C	Diesel	1995	4	46
4 Coupe (F32)	3.0	07/01→	N55 B30 A	Petrol/Electro	2979	6	103

	Ltr				CC		9
4 Coupe (F32)	3.0	07/01 →	N55 B30 A	Petrol	2979	6	103
5 (E34)	1.8	08/98 → 09/99	M40 B18	Petrol	1796	4	11
5 (E34)	1.8	08/98 → 09/99	M43 B18	Petrol	1796	4	14
5 (E34)	1.8	08/98 → 09/99	M43 B18	Bi-Fuel	1796	4	14
5 (E34)	2.0	01/98 → 08/99	M20 B20	Petrol	1990	6	23
5 (E34)	2.0	09/98 → 09/99	M50 B(20 6 S1)	Petrol	1991	6	30
5 (E34)	2.0	09/98 → 09/99	M50 B(20 6 S2) Vanos	Petrol	1991	6	31
5 (E34)	2.0	09/98 → 09/99	M50 B20	Petrol	1991	6	32
5 (E34)	2.0	09/98 → 09/99	M50 B20 TU	Petrol	1991	6	33
5 (E34)	2.4	03/98 → 09/99	M21 D24	Diesel	2443	6	55
5 (E34)	2.4	03/98 → 09/99	M21 D24 WA	Diesel	2443	6	57
5 (E34)	2.5	01/98 → 08/99	M20 B25	Petrol	2494	6	58
5 (E34)	2.5	09/98 → 09/99	M50 B25	Petrol	2494	6	59
5 (E34)	2.5	09/98 → 09/99	M50 B25 TU	Petrol	2494	6	61
5 (E34)	2.5	04/99 → 09/99	M51 D25	Diesel	2497	6	62
5 (E34)	2.5	09/99 → 09/99	M51 D25 (Inter.)	Diesel	2503	6	63
5 (E34)	2.5	09/98 → 09/99	M52 B25 (Vanos)	Petrol	2494	6	64
5 (E34)	3.0	01/98 → 08/99	M30 B30	Petrol	2986	6	79
5 (E34)	3.0	09/99 → 09/99	M60 B30	Petrol	2997	8	92
5 (E34)	4.0	09/99 → 09/99	M60 B40	Petrol	3982	8	121
5 (E39)	2.0	02/00 → 06/00	M47 204 D1	Diesel	1951	4	24
5 (E39)	2.0	02/00 → 06/00	M47 D20	Diesel	1951	4	25
5 (E39)	2.0	01/99 → 06/00	M52 B(20 6 S3) Vanos	Petrol	1991	6	34
5 (E39)	2.0	01/99 → 09/00	M52 B(20 6 S4)	Petrol	1991	6	35
5 (E39)	2.0	01/99 → 09/00	M52 B20	Petrol	1991	6	36
5 (E39)	2.2	09/00 → 06/00	M54 B22	Petrol	2171	6	51
5 (E39)	2.5	01/99 → 06/00	M51 D25	Diesel	2497	6	62
5 (E39)	2.5	01/99 → 06/00	M51 D25 (Inter.)	Diesel	2503	6	63
5 (E39)	2.5	11/99 → 09/00	M52 B25 (Vanos)	Petrol	2494	6	64
5 (E39)	2.5	11/99 → 09/00	M52 B25 TU	Petrol	2494	6	65
5 (E39)	2.5	09/00 → 06/00	M54 256 S5	Petrol	2494	6	66
5 (E39)	2.5	09/00 → 06/00	M54 B25	Petrol	2494	6	67
5 (E39)	2.5	02/00 → 06/00	M57 D25	Diesel	2497	6	68
5 (E39)	2.8	11/99 → 09/00	M52 B28	Petrol	2793	6	76
5 (E39)	2.8	11/99 → 09/00	M52 B28 TU	Petrol	2793	6	77
5 (E39)	3.0	09/00 → 06/00	M54 306 S3	Petrol	2979	6	80
5 (E39)	3.0	09/00 → 06/00	M54 B30	Petrol	2979	6	81
5 (E39)	3.0	08/99 → 06/00	M57 D30	Diesel	2926	6	78
5 (E39)	3.5	04/99 → 03/99	M62 B(35 8 S1)	Petrol	3498	8	115
5 (E39)	3.5	04/99 → 06/00	M62 B(35 8 S2)	Petrol	3498	8	116
5 (E39)	3.5	04/99 → 03/99	M62 B35	Petrol	3498	8	117
5 (E39)	3.5	04/99 → 06/00	M62 B35 TU	Petrol	3498	8	118
5 (E39)	4.4	04/99 → 06/00	M62 448 S2	Petrol	4398	8	122
5 (E39)	4.4	04/99 → 06/00	M62 B44	Petrol	4398	8	123
5 (E39)	4.4	04/99 → 06/00	M62 B44 TU	Petrol	4398	8	124
5 (E60)	2.0	07/00 → 03/01	M47 D20 (204D4)	Diesel	1995	4	26
5 (E60)	2.0	09/00 → 03/01	N43 B20 A	Petrol	1995	4	38
5 (E60)	2.0	04/00 → 12/00	N46 B20 B	Petrol	1995	4	41
5 (E60)	2.0	07/00 → 03/01	N47 D20 A	Diesel	1995	4	44
5 (E60)	2.0	07/00 → 03/01	N47 D20 C	Diesel	1995	4	46
5 (E60)	2.2	07/00 → 03/01	M54 226 S1	Petrol	2171	6	50
5 (E60)	2.2	07/00 → 03/01	M54 B22	Petrol	2171	6	51
5 (E60)	2.5	09/00 → 03/01	M54 256 S5	Petrol	2494	6	66
5 (E60)	2.5	09/00 → 03/01	M54 B25	Petrol	2494	6	67
5 (E60)	2.5	06/00 → 03/01	M57 D25 TU	Diesel	2497	6	69
5 (E60)	2.5	06/00 → 03/01	M57N 256 D4	Diesel	2497	6	70
5 (E60)	2.5	07/00 → 03/01	N52 B25	Petrol	2497	6	71
5 (E60)	2.5	07/00 → 03/01	N52 B25 A	Petrol	2497	6	72
5 (E60)	3.0	07/00 → 03/01	M54 306 S3	Petrol	2979	6	80
5 (E60)	3.0	07/00 → 03/01	M54 B30	Petrol	2979	6	81
5 (E60)	3.0	07/00 → 03/01	M57 306 D3	Diesel	2993	6	82
5 (E60)	3.0	09/00 → 03/01	M57 306 D4	Diesel	2993	6	83
5 (E60)	3.0	07/00 → 03/01	M57 D30 (306D3)	Diesel	2993	6	85
5 (E60)	3.0	01/00 → 03/01	M57N 306 D5	Diesel	2993	6	89
5 (E60)	3.0	09/00 → 03/01	M57N2 306 D3	Diesel	2993	6	91
5 (E60)	3.0	07/00 → 03/01	N52 B30	Petrol	2996	6	93
5 (E60)	3.0	07/00 → 03/01	N52 B30 A	Petrol	2996	6	94
5 (E60)	3.0	01/00 → 03/01	N53 B30	Petrol	2996	6	99
5 (E60)	3.0	01/00 → 03/01	N53 B30 A	Petrol	2996	6	100
5 (E60)	3.0	07/00 → 03/01	N57 306 D2	Diesel	2993	6	104



Ltr







CC



9

Model	Ltr	Year Range	Engine	Fuel	CC	Gear	Price
5 (E60)	4.4	09/00→03/01	N62 B44	Petrol	4398	8	125
5 (E60)	4.8	07/00→03/01	N62 B48 B	Petrol	4799	8	130
5 (F10, F18)	2.0	03/01→	N47 D20 C	Diesel	1995	4	46
5 (F10, F18)	2.0	09/01→	N47 D20 D	Diesel	1995	4	47
5 (F10, F18)	3.0	03/01→	N53 B30 A	Petrol	2996	6	100
5 (F10, F18)	3.0	03/01→	N55 B30 A	Petrol/Electro	2979	6	103
5 (F10, F18)	3.0	03/01→	N55 B30 A	Petrol	2979	6	103
5 (F10, F18)	3.0	03/01→	N57 D30 A	Diesel	2993	6	105
5 (F10, F18)	3.0	09/01→	N57S D30 B	Diesel	2993	6	109
5 GRAN TURISMO (F07)	2.0	10/01→	N47 D20 C	Diesel	1995	4	46
5 GRAN TURISMO (F07)	3.0	10/00→	N55 B30 A	Petrol/Electro	2979	6	103
5 GRAN TURISMO (F07)	3.0	10/00→	N55 B30 A	Petrol	2979	6	103
5 GRAN TURISMO (F07)	3.0	10/00→	N57 D30 A	Diesel	2993	6	105
5 GRAN TURISMO (F07)	3.0	09/01→	N57S D30 B	Diesel	2993	6	109
5 Touring (E34)	1.8	03/99→09/99	M40 B18	Petrol	1796	4	11
5 Touring (E34)	1.8	09/99→01/99	M43 B18	Petrol	1796	4	14
5 Touring (E34)	1.8	09/99→01/99	M43 B18	Bi-Fuel	1796	4	14
5 Touring (E34)	2.0	11/99→01/99	M50 B(20 6 S1)	Petrol	1991	6	30
5 Touring (E34)	2.0	11/99→01/99	M50 B(20 6 S2) Vanos	Petrol	1991	6	31
5 Touring (E34)	2.0	11/99→01/99	M50 B20	Petrol	1991	6	32
5 Touring (E34)	2.0	11/99→01/99	M50 B20 TU	Petrol	1991	6	33
5 Touring (E34)	2.5	11/99→01/99	M50 B25	Petrol	2494	6	59
5 Touring (E34)	2.5	11/99→01/99	M50 B25 TU	Petrol	2494	6	61
5 Touring (E34)	2.5	03/99→01/99	M51 D25	Diesel	2497	6	62
5 Touring (E34)	2.5	12/99→01/99	M51 D25 (Inter.)	Diesel	2503	6	63
5 Touring (E34)	2.5	02/99→01/99	M52 B25 (Vanos)	Petrol	2494	6	64
5 Touring (E34)	3.0	09/99→01/99	M60 B30	Petrol	2997	8	92
5 Touring (E34)	4.0	09/99→01/99	M60 B40	Petrol	3982	8	121
5 Touring (E39)	2.0	02/00→09/00	M47 204 D1	Diesel	1951	4	24
5 Touring (E39)	2.0	02/00→09/00	M47 D20	Diesel	1951	4	25
5 Touring (E39)	2.0	01/99→05/00	M52 B(20 6 S3) Vanos	Petrol	1991	6	34
5 Touring (E39)	2.0	01/99→09/00	M52 B(20 6 S4)	Petrol	1991	6	35
5 Touring (E39)	2.0	01/99→09/00	M52 B20	Petrol	1991	6	36
5 Touring (E39)	2.2	09/00→05/00	M54 B22	Petrol	2171	6	51
5 Touring (E39)	2.5	03/99→05/00	M51 D25 (Inter.)	Diesel	2503	6	63
5 Touring (E39)	2.5	01/99→09/00	M52 B25 (Vanos)	Petrol	2494	6	64
5 Touring (E39)	2.5	01/99→09/00	M52 B25 TU	Petrol	2494	6	65
5 Touring (E39)	2.5	09/00→05/00	M54 256 S5	Petrol	2494	6	66
5 Touring (E39)	2.5	09/00→05/00	M54 B25	Petrol	2494	6	67
5 Touring (E39)	2.5	02/00→05/00	M57 D25	Diesel	2497	6	68
5 Touring (E39)	2.8	01/99→09/00	M52 B28	Petrol	2793	6	76
5 Touring (E39)	2.8	01/99→09/00	M52 B28 TU	Petrol	2793	6	77
5 Touring (E39)	3.0	09/00→05/00	M54 306 S3	Petrol	2979	6	80
5 Touring (E39)	3.0	08/99→05/00	M57 D30	Diesel	2926	6	78
5 Touring (E39)	4.4	01/99→05/00	M62 448 S2	Petrol	4398	8	122
5 Touring (E39)	4.4	01/99→05/00	M62 B44	Petrol	4398	8	123
5 Touring (E39)	4.4	01/99→05/00	M62 B44 TU	Petrol	4398	8	124
5 Touring (E61)	2.0	07/00→	M47 D20 (204D4)	Diesel	1995	4	26
5 Touring (E61)	2.0	07/00→	N43 B20 A	Petrol	1995	4	38
5 Touring (E61)	2.0	07/00→	N47 D20 A	Diesel	1995	4	44
5 Touring (E61)	2.0	07/00→	N47 D20 C	Diesel	1995	4	46
5 Touring (E61)	2.5	06/00→	M54 256 S5	Petrol	2494	6	66
5 Touring (E61)	2.5	06/00→	M54 B25	Petrol	2494	6	67
5 Touring (E61)	2.5	06/00→	M57 D25 TU	Diesel	2497	6	69
5 Touring (E61)	2.5	06/00→	M57N 256 D4	Diesel	2497	6	70
5 Touring (E61)	2.5	07/00→	N52 B25	Petrol	2497	6	71
5 Touring (E61)	2.5	07/00→	N52 B25 A	Petrol	2497	6	72
5 Touring (E61)	3.0	06/00→	M54 306 S3	Petrol	2979	6	80
5 Touring (E61)	3.0	07/00→	M57 306 D3	Diesel	2993	6	82
5 Touring (E61)	3.0	09/00→	M57 306 D4	Diesel	2993	6	83
5 Touring (E61)	3.0	09/00→	M57 D30 (306D3)	Diesel	2993	6	85
5 Touring (E61)	3.0	01/00→	M57N 306 D5	Diesel	2993	6	89
5 Touring (E61)	3.0	07/00→	N52 B30	Petrol	2996	6	93
5 Touring (E61)	3.0	07/00→	N52 B30 A	Petrol	2996	6	94
5 Touring (E61)	3.0	01/00→	N53 B30	Petrol	2996	6	99
5 Touring (E61)	3.0	01/00→	N53 B30 A	Petrol	2996	6	100
5 Touring (E61)	3.0	06/00→	N57 306 D2	Diesel	2993	6	104
5 Touring (E61)	4.4	06/00→	N62 B44	Petrol	4398	8	125
5 Touring (E61)	4.8	07/00→	N62 B48 A	Petrol	4799	8	129
5 Touring (E61)	4.8	07/00→	N62 B48 B	Petrol	4799	8	130

	Ltr				CC		9
5 Touring (F11)	2.0	09/01 →	N47 D20 C	Diesel	1995	4	46
5 Touring (F11)	2.0	09/01 →	N47 D20 D	Diesel	1995	4	47
5 Touring (F11)	3.0	09/01 →	N53 B30 A	Petrol	2996	6	100
5 Touring (F11)	3.0	09/01 →	N55 B30 A	Petrol/Electro	2979	6	103
5 Touring (F11)	3.0	09/01 →	N55 B30 A	Petrol	2979	6	103
5 Touring (F11)	3.0	09/01 →	N57 D30 A	Diesel	2993	6	105
5 Touring (F11)	3.0	09/01 →	N57S D30 B	Diesel	2993	6	109
6 (E24)	3.4	04/98 → 09/99	M30 B35	Petrol	3430	6	110
6 (E24)	3.4	06/97 → 08/98	M30 B35 (LJetronic,10:1)	Petrol	3453	6	113
6 (E24)	3.4	06/97 → 10/98	M30 B35 (Motronic,10:1)	Petrol	3430	6	111
6 (E24)	3.4	01/98 → 05/98	M30 B35 (Motronic,8:1,Kat.)	Petrol	3430	6	112
6 (E24)	3.4	06/97 → 08/98	M30 B35 (Motronic,9.3:1)	Petrol	3453	6	114
6 (E63)	3.0	09/00 →	N52 B30	Petrol	2996	6	93
6 (E63)	3.0	09/00 →	N52 B30 A	Petrol	2996	6	94
6 (E63)	3.0	07/00 →	N53 B30	Petrol	2996	6	99
6 (E63)	3.0	07/00 →	N57N 306 D5	Diesel	2993	6	108
6 (E63)	4.4	01/00 →	N62 B44	Petrol	4398	8	125
6 (E63)	4.4	01/00 →	N62 B44 A	Petrol	4398	8	126
6 (E63)	4.8	07/00 →	N62 B48 B	Petrol	4799	8	130
6 Convertible (E64)	3.0	07/00 →	M57N 306 D5	Diesel	2993	6	89
6 Convertible (E64)	3.0	09/00 →	N52 B30	Petrol	2996	6	93
6 Convertible (E64)	3.0	09/00 →	N52 B30 A	Petrol	2996	6	94
6 Convertible (E64)	3.0	07/00 →	N53 B30	Petrol	2996	6	99
6 Convertible (E64)	4.4	04/00 →	N62 B44	Petrol	4398	8	125
6 Convertible (E64)	4.4	04/00 →	N62 B44 A	Petrol	4398	8	126
6 Convertible (E64)	4.8	07/00 →	N62 B48 B	Petrol	4799	8	130
6 Convertible (F12)	3.0	03/01 →	N55 B30 A	Petrol/Electro	2979	6	103
6 Convertible (F12)	3.0	03/01 →	N55 B30 A	Petrol	2979	6	103
6 Coupe (F13)	3.0	11/01 →	N55 B30 A	Petrol/Electro	2979	6	103
6 Coupe (F13)	3.0	11/01 →	N55 B30 A	Petrol	2979	6	103
6 Gran Coupe (F06)	3.0	11/01 →	N55 B30 A	Petrol/Electro	2979	6	103
6 Gran Coupe (F06)	3.0	11/01 →	N55 B30 A	Petrol	2979	6	103
7 (E32)	3.0	12/98 → 09/99	M30 B30	Petrol	2986	6	79
7 (E32)	3.0	04/99 → 09/99	M60 B30	Petrol	2997	8	92
7 (E32)	4.0	04/99 → 09/99	M60 B40	Petrol	3982	8	121
7 (E32)	5.0	09/98 → 09/99	M70 B50	Petrol	4988	12	131
7 (E38)	2.5	04/99 → 11/00	M51 D25 (Inter.)	Diesel	2503	6	63
7 (E38)	2.8	08/99 → 11/00	M52 B28	Petrol	2793	6	76
7 (E38)	2.8	08/99 → 11/00	M52 B28 TU	Petrol	2793	6	77
7 (E38)	3.0	08/99 → 04/00	M57 D30	Diesel	2926	6	78
7 (E38)	3.0	10/99 → 11/00	M60 B30	Petrol	2997	8	92
7 (E38)	3.5	01/99 → 11/00	M62 B(35 8 S1)	Petrol	3498	8	115
7 (E38)	3.5	01/99 → 11/00	M62 B35	Petrol	3498	8	117
7 (E38)	3.9	05/99 → 11/00	M67 D39	Diesel	3901	8	119
7 (E38)	4.0	10/99 → 11/00	M60 B40	Petrol	3982	8	121
7 (E38)	4.4	01/99 → 11/00	M62 448 S2	Petrol	4398	8	122
7 (E38)	4.4	01/99 → 11/00	M62 B44	Petrol	4398	8	123
7 (E38)	4.4	01/99 → 11/00	M62 B44 TU	Petrol	4398	8	124
7 (E38)	5.4	12/99 → 11/00	M73 B54	Petrol	5379	12	132
7 (E65, E66, E67)	3.0	03/00 →	M54 306 S3	Petrol	2979	6	80
7 (E65, E66, E67)	3.0	03/00 →	M54 B30	Petrol	2979	6	81
7 (E65, E66, E67)	3.0	07/00 →	M57 306 D3	Diesel	2993	6	82
7 (E65, E66, E67)	3.0	10/00 →	M57N 306 D2	Diesel	2993	6	87
7 (E65, E66, E67)	3.0	10/00 →	M57N2 306 D2	Diesel	2993	6	90
7 (E65, E66, E67)	3.0	03/00 →	N52 B30	Petrol	2996	6	93
7 (E65, E66, E67)	3.0	03/00 →	N52 B30 A	Petrol	2996	6	94
7 (E65, E66, E67)	3.0	07/00 →	N57N 306 D2	Diesel	2993	6	106
7 (E65, E66, E67)	3.9	10/00 →	N67 398 D1	Diesel	3901	8	120
7 (E65, E66, E67)	4.4	11/00 →	N62 B44	Petrol	4398	8	125
7 (E65, E66, E67)	4.4	11/00 →	N62 B44 A	Petrol	4398	8	126
7 (E65, E66, E67)	4.8	07/00 →	N62 B48 B	Petrol	4799	8	130
7 (E65, E66)	3.0	03/00 →	N52 B30 A	Petrol	2996	6	94
7 (F01, F02, F03, F04)	3.0	06/00 →	N52 B30 A	Petrol	2996	6	94
7 (F01, F02, F03, F04)	3.0	06/00 →	N52 B30 BF	Petrol	2996	6	96
7 (F01, F02, F03, F04)	3.0	10/00 →	N54 B30 A	Petrol	2979	6	101
7 (F01, F02, F03, F04)	3.0	07/01 →	N55 B30 A	Petrol/Electro	2979	6	103
7 (F01, F02, F03, F04)	3.0	07/01 →	N55 B30 A	Petrol	2979	6	103
7 (F01, F02, F03, F04)	3.0	10/00 →	N57 D30 A	Diesel	2993	6	105
7 (F01, F02, F03, F04)	3.0	09/00 →	N57S D30 B	Diesel	2993	6	109
8 (E31)	4.0	02/99 → 02/99	M60 B40	Petrol	3982	8	121



Ltr















CC



9

Model	Ltr	Year Range	Engine	Fuel	CC	Gear	9
8 (E31)	4.4	01/99→12/99	M62 B44	Petrol	4398	8	123
8 (E31)	4.4	01/99→12/99	M62 B44 TU	Petrol	4398	8	124
8 (E31)	5.0	04/99→10/99	M70 B50	Petrol	4988	12	131
8 (E31)	5.4	09/99→12/99	M73 B54	Petrol	5379	12	132
X1 (E84)	2.0	01/01→	N46 B20 B	Petrol	1995	4	41
X1 (E84)	2.0	03/00→	N47 D20 C	Diesel	1995	4	46
X1 (E84)	2.0	10/00→	N47 D20 D	Diesel	1995	4	47
X1 (E84)	2.0	10/00→	N47S D20 D	Diesel	1995	4	48
X1 (E84)	3.0	10/00→	N52 B30 A	Petrol	2996	6	94
X3 (E83)	2.0	10/00→	M47N 204 D4	Diesel	1995	4	28
X3 (E83)	2.0	07/00→	N46 B20	Petrol	1995	4	39
X3 (E83)	2.0	07/00→	N46 B20 A	Petrol	1995	4	40
X3 (E83)	2.0	09/00→	N46 B20 B	Petrol	1995	4	41
X3 (E83)	2.0	09/00→	N47 D20 A	Diesel	1995	4	44
X3 (E83)	2.0	09/00→	N47 D20 C	Diesel	1995	4	46
X3 (E83)	2.5	01/00→	M54 256 S5	Petrol	2494	6	66
X3 (E83)	2.5	01/00→	M54 B25	Petrol	2494	6	67
X3 (E83)	2.5	09/00→	N52 B25 A	Petrol	2497	6	72
X3 (E83)	3.0	01/00→	M54 306 S3	Petrol	2979	6	80
X3 (E83)	3.0	01/00→	M54 B30	Petrol	2979	6	81
X3 (E83)	3.0	09/00→	M57 306 D5	Diesel	2993	6	84
X3 (E83)	3.0	01/00→	M57N2 306 D2	Diesel	2993	6	90
X3 (E83)	3.0	09/00→	M57N2 306 D3	Diesel	2993	6	91
X3 (E83)	3.0	09/00→	N52 B30 A	Petrol	2996	6	94
X3 (E83)	3.0	09/00→	N57N 306 D5	Diesel	2993	6	108
X3 (F25)	2.0	09/01→	N47 D20 C	Diesel	1995	4	46
X3 (F25)	3.0	04/01→	N52 B30 A	Petrol	2996	6	94
X3 (F25)	3.0	09/01→	N55 B30 A	Petrol/Electro	2979	6	103
X3 (F25)	3.0	09/01→	N55 B30 A	Petrol	2979	6	103
X3 (F25)	3.0	05/01→	N57 D30 A	Diesel	2993	6	105
X5 (E53)	3.0	05/00→	M54 306 S3	Petrol	2979	6	80
X5 (E53)	3.0	05/00→	M54 B30	Petrol	2979	6	81
X5 (E53)	3.0	08/00→	M57N 306 D2	Diesel	2993	6	87
X5 (E53)	3.0	12/00→	M57N 306 D4	Diesel	2993	6	88
X5 (E53)	4.4	05/00→	M62 B44	Petrol	4398	8	123
X5 (E53)	4.4	05/00→	M62 B44 TU	Petrol	4398	8	124
X5 (E53)	4.4	12/00→	N62 B44	Petrol	4398	8	125
X5 (E53)	4.4	12/00→	N62 B44 A	Petrol	4398	8	126
X5 (E53)	4.6	02/00→	M62 B46	Petrol	4619	8	127
X5 (E53)	4.6	02/00→	M67 468 S1	Petrol	4619	8	128
X5 (E53)	4.8	04/00→	N62 B48 A	Petrol	4799	8	129
X5 (E70)	3.0	02/00→09/00	M57 306 D3	Diesel	2993	6	82
X5 (E70)	3.0	02/00→09/00	M57 D30 (306D3)	Diesel	2993	6	85
X5 (E70)	3.0	09/00→	M57N 306 D5	Diesel	2993	6	89
X5 (E70)	3.0	02/00→09/00	N52 B30	Petrol	2996	6	93
X5 (E70)	3.0	02/00→03/01	N52 B30 A	Petrol	2996	6	94
X5 (E70)	3.0	09/01→	N55 B30 A	Petrol/Electro	2979	6	103
X5 (E70)	3.0	09/01→	N55 B30 A	Petrol	2979	6	103
X5 (E70)	3.0	09/00→	N57 D30 A	Diesel	2993	6	105
X5 (E70)	3.0	09/01→	N57S D30 B	Diesel	2993	6	109
X5 (E70)	4.8	02/00→	N62 B48 B	Petrol	4799	8	130
X6 (E71, E72)	3.0	05/00→	M57N2 306 D3	Diesel	2993	6	91
X6 (E71, E72)	3.0	05/00→	N54 B30 A	Petrol	2979	6	101
X6 (E71, E72)	3.0	09/00→	N55 B30 A	Petrol/Electro	2979	6	103
X6 (E71, E72)	3.0	09/00→	N55 B30 A	Petrol	2979	6	103
X6 (E71, E72)	3.0	09/00→	N57 D30 A	Diesel	2993	6	105
X6 (E71, E72)	3.0	05/00→	N57N 306 D5	Diesel	2993	6	108
X6 (E71, E72)	3.0	10/01→	N57S D30 B	Diesel	2993	6	109
Z1	2.5	06/98→06/99	M20 B25	Petrol	2494	6	58
Z3 (E36)	1.8	10/99→10/99	M43 B18	Petrol	1796	4	14
Z3 (E36)	1.8	10/99→10/99	M43 B18	Bi-Fuel	1796	4	14
Z3 (E36)	1.9	07/99→01/00	M43 194 E1	Petrol	1895	4	18
Z3 (E36)	1.9	07/99→01/00	M43 B19	Petrol	1895	4	19
Z3 (E36)	1.9	07/99→01/00	M43 B19 TU	Petrol	1895	4	21
Z3 (E36)	1.9	10/99→03/99	M44 B19	Petrol	1895	4	22
Z3 (E36)	2.0	04/99→01/00	M52 B(20 6 S4)	Petrol	1991	6	35
Z3 (E36)	2.0	04/99→01/00	M52 B20	Petrol	1991	6	36
Z3 (E36)	2.2	08/00→01/00	M54 226 S1	Petrol	2171	6	50
Z3 (E36)	2.2	08/00→01/00	M54 B22	Petrol	2171	6	51
Z3 (E36)	2.8	04/99→06/00	M52 B28	Petrol	2793	6	76

	Ltr				CC		9
Z3 (E36)	2.8	04/99 → 06/00	M52 B28 TU	Petrol	2793	6	77
Z3 (E36)	3.0	06/00 → 01/00	M54 306 S3	Petrol	2979	6	80
Z3 (E36)	3.0	06/00 → 01/00	M54 B30	Petrol	2979	6	81
Z3 Coupe (E36)	2.8	07/99 → 06/00	M52 B28	Petrol	2793	6	76
Z3 Coupe (E36)	3.0	06/00 → 06/00	M54 306 S3	Petrol	2979	6	80
Z4 (E85)	2.0	04/00 →	N46 B20	Petrol	1995	4	39
Z4 (E85)	2.0	04/00 →	N46 B20 A	Petrol	1995	4	40
Z4 (E85)	2.2	10/00 →	M54 226 S1	Petrol	2171	6	50
Z4 (E85)	2.2	10/00 →	M54 B22	Petrol	2171	6	51
Z4 (E85)	2.5	02/00 →	M54 256 S5	Petrol	2494	6	66
Z4 (E85)	2.5	02/00 →	M54 B25	Petrol	2494	6	67
Z4 (E85)	2.5	01/00 →	N52 B25 A	Petrol	2497	6	72
Z4 (E85)	3.0	02/00 →	M54 306 S3	Petrol	2979	6	80
Z4 (E85)	3.0	02/00 →	M54 B30	Petrol	2979	6	81
Z4 (E85)	3.0	01/00 →	N52 B30	Petrol	2996	6	93
Z4 (E85)	3.0	01/00 →	N52 B30 A	Petrol	2996	6	94
Z4 (E89)	2.5	05/00 →	N52 B25 A	Petrol	2497	6	72
Z4 (E89)	3.0	05/00 →	N52 B30 A	Petrol	2996	6	94
Z4 (E89)	3.0	05/00 →	N54 B30 A	Petrol	2979	6	101
Z4 Coupe (E86)	3.0	03/00 →	N52 B30	Petrol	2996	6	93
Z4 Coupe (E86)	3.0	03/00 →	N52 B30 A	Petrol	2996	6	94

		CC			9			CC			9
M10 B16	Petrol	1573	4	84.00	1	M60 B30	Petrol	2997	8	84.00	92
M20 B20	Petrol	1990	6	80.00	23	M60 B40	Petrol	3982	8	89.00	121
M20 B25	Petrol	2494	6	84.00	58	M62 448 S2	Petrol	4398	8	92.00	122
M20 B27	Petrol	2693	6	84.00	75	M62 B(35 8 S1)	Petrol	3498	8	84.00	115
M21 D24	Diesel	2443	6	80.00	55	M62 B(35 8 S2)	Petrol	3498	8	84.00	116
M21 D24 W	Diesel	2443	6	80.00	56	M62 B35	Petrol	3498	8	84.00	117
M21 D24 WA	Diesel	2443	6	80.00	57	M62 B35 TU	Petrol	3498	8	84.00	118
M30 B30	Petrol	2986	6	89.00	79	M62 B44	Petrol	4398	8	92.00	123
M30 B35	Petrol	3430	6	92.00	110	M62 B44 TU	Petrol	4398	8	92.00	124
M30 B35 (LJetronic,10:1)	Petrol	3453	6	93.40	113	M62 B46	Petrol	4619	8	93.00	127
M30 B35 (Motronic,10:1)	Petrol	3430	6	92.00	111	M67 468 SI	Petrol	4619	8	94.30	128
M30 B35 (Motronic,8:1,Kat.)	Petrol	3430	6	92.00	112	M67 D39	Diesel	3901	8	84.00	119
M30 B35 (Motronic,9.3:1)	Petrol	3453	6	93.40	114	M70 B50	Petrol	4988	12	84.00	131
M40 B16	Petrol	1596	4	84.00	2	M73 B54	Petrol	5379	12	85.00	132
M40 B18	Petrol	1796	4	84.00	11	N40 B16 A	Petrol	1596	4	84.00	5
M40 B18 C	Petrol	1796	4	84.00	12	N42 B18	Petrol	1796	4	84.00	15
M41 D18 (Inter.)	Diesel	1665	4	80.00	10	N42 B20	Petrol	1995	4	84.00	37
M42 B18	Petrol	1796	4	84.00	13	N43 B16 A	Petrol	1597	4	82.00	6
M43 194 E1	Petrol	1895	4	85.00	18	N43 B20 A	Petrol	1995	4	84.00	38
M43 B16	Petrol	1596	4	84.00	3	N45 B16	Petrol	1596	4	84.00	7
M43 B16	Bi-Fuel	1596	4	84.00	3	N45 B16 A	Petrol	1596	4	84.00	8
M43 B16 (164E3)	Petrol	1596	4	84.00	4	N45 B16 TU2	Petrol	1596	4	84.00	9
M43 B18	Petrol	1796	4	84.00	14	N46 B18	Petrol	1796	4	84.00	16
M43 B18	Bi-Fuel	1796	4	84.00	14	N46 B18 A	Petrol	1796	4	84.00	17
M43 B19	Petrol	1895	4	85.00	19	N46 B20	Petrol	1995	4	84.00	39
M43 B19 (194E1)	Petrol	1895	4	85.00	20	N46 B20 A	Petrol	1995	4	84.00	40
M43 B19 TU	Petrol	1895	4	85.00	21	N46 B20 B	Petrol	1995	4	84.00	41
M44 B19	Petrol	1895	4	85.00	22	N46 B20 C	Petrol	1995	4	84.00	42
M47 204 D1	Diesel	1951	4	84.00	24	N46N B20 B	Petrol	1995	4	84.00	43
M47 D20	Diesel	1951	4	84.00	25	N47 D20 A	Diesel	1995	4	84.00	44
M47 D20 (204D4)	Diesel	1995	4	84.00	26	N47 D20 B	Diesel	1995	4	84.00	45
M47 D20 TU	Diesel	1951	4	84.00	27	N47 D20 C	Diesel	1995	4	84.00	46
M47N 204 D4	Diesel	1995	4	84.00	28	N47 D20 D	Diesel	1995	4	84.00	47
M47N 204 D5	Diesel	1995	4	84.00	29	N47S D20 D	Diesel	1995	4	84.00	48
M50 B(20 6 S1)	Petrol	1991	6	80.00	30	N52 B25	Petrol	2497	6	82.00	71
M50 B(20 6 S2) Vanos	Petrol	1991	6	80.00	31	N52 B25 A	Petrol	2497	6	82.00	72
M50 B20	Petrol	1991	6	80.00	32	N52 B25 C	Petrol	2497	6	82.00	73
M50 B20 TU	Petrol	1991	6	80.00	33	N52 B30	Petrol	2996	6	85.00	93
M50 B25	Petrol	2494	6	84.00	59	N52 B30 A	Petrol	2996	6	85.00	94
M50 B25 (Vanos)	Petrol	2494	6	84.00	60	N52 B30 B	Petrol	2996	6	85.00	95
M50 B25 TU	Petrol	2494	6	84.00	61	N52 B30 BF	Petrol	2996	6	85.00	96
M51 D25	Diesel	2497	6	80.00	62	N52N B25 A	Petrol	2497	6	85.00	74
M51 D25 (Inter.)	Diesel	2503	6	80.00	63	N52N B30 A	Petrol	2996	6	85.00	97
M52 B(20 6 S3) Vanos	Petrol	1991	6	80.00	34	N52N B30 B	Petrol	2996	6	85.00	98
M52 B(20 6 S4)	Petrol	1991	6	80.00	35	N53 B30	Petrol	2996	6	85.00	99
M52 B20	Petrol	1991	6	80.00	36	N53 B30 A	Petrol	2996	6	85.00	100
M52 B25 (Vanos)	Petrol	2494	6	84.00	64	N54 B30 A	Petrol	2979	6	84.00	101
M52 B25 TU	Petrol	2494	6	84.00	65	N54 B30 B	Petrol	2979	6	84.00	102
M52 B28	Petrol	2793	6	84.00	76	N55 B30 A	Petrol/Electro	2979	6	84.00	103
M52 B28 TU	Petrol	2793	6	84.00	77	N55 B30 A	Petrol	2979	6	84.00	103
M54 226 S1	Petrol	2171	6	80.00	50	N57 306 D2	Diesel	2993	6	84.00	104
M54 256 S5	Petrol	2494	6	84.00	66	N57 D30 A	Diesel	2993	6	84.00	105
M54 306 S3	Petrol	2979	6	84.00	80	N57N 306 D2	Diesel	2993	6	84.00	106
M54 B22	Petrol	2171	6	80.00	51	N57N 306 D3	Diesel	2993	6	84.00	107
M54 B25	Petrol	2494	6	84.00	67	N57N 306 D5	Diesel	2993	6	84.00	108
M54 B30	Petrol	2979	6	84.00	81	N57S D30 B	Diesel	2993	6	84.00	109
M57 306 D3	Diesel	2993	6	84.00	82	N62 B44	Petrol	4398	8	92.00	125
M57 306 D4	Diesel	2993	6	84.00	83	N62 B44 A	Petrol	4398	8	92.00	126
M57 306 D5	Diesel	2993	6	84.00	84	N62 B48 A	Petrol	4799	8	93.00	129
M57 D25	Diesel	2497	6	80.00	68	N62 B48 B	Petrol	4799	8	93.00	130
M57 D25 TU	Diesel	2497	6	84.00	69	N67 398 D1	Diesel	3901	8	84.00	120
M57 D30	Diesel	2926	6	84.00	78	S14 204 EA	Petrol	1990	4	89.00	49
M57 D30 (306D3)	Diesel	2993	6	84.00	85	S14 B23	Petrol	2303	4	93.40	52
M57 D30 TU2	Diesel	2993	6	84.00	86	S14 B23	Petrol	2303	4	93.40	53
M57N 256 D4	Diesel	2497	6	84.00	70	S14 B23 (EVO I)	Petrol	2302	4	93.40	54
M57N 306 D2	Diesel	2993	6	84.00	87						
M57N 306 D4	Diesel	2993	6	84.00	88						
M57N 306 D5	Diesel	2993	6	84.00	89						
M57N2 306 D2	Diesel	2993	6	84.00	90						
M57N2 306 D3	Diesel	2993	6	84.00	91						



cc



kW/PS



1.6							1			
M10 B16							BC910 (Fibre)			
3 315 (E30)	09/82→12/91	1573	4	84.00	CIH	55-77/ 75-105				
M40 B16							BR830 (Fibre)	DR830 [3]	ER830	
3 (E30)	09/91→06/94	1596	4	84.00	SOHC/OHC	73-75/ 99-102				
3 316 i (E30)	09/87→06/94									
3 316 i (E36)	09/90→09/93									
M43 B16							BR830 (Fibre)	DR831 [13]	EB5660 [3]	
3 (E36)	01/96→10/99									
3 316 i (E36)	09/90→02/98									
3 316 i (E46)	04/00→02/05									
3 C 316 i (E36)	09/93→04/99									
3 Compact (E36)	03/94→08/00									
M43 B16 (164E3)							BR830 (Fibre)		EB5660 [3]	
3 316 i (E46)	04/00→02/05									
3 Coupe (E46)	04/00→									
N40 B16 A							AC5440 (MLS), 0.400mm AC5470 (MLS), 0.700mm	CC5441	EC5440	
3 Compact (E46)	06/02→02/05	1596	4	84.00		85/115				
N43 B16 A									EC5440	
1 1 (E87)	11/03→09/12	1597	4	82.00	DOHC	85-90/ 115-122				
1 116 i (E81)	03/07→09/12									
3 316 i (E90)	09/07→12/11									
3 C 316 i (E92)	09/07→									
3 Touring (E91)	09/07→									
N45 B16							AC5440 (MLS), 0.400mm →12/06 AC5470 (MLS), 0.700mm →12/06 AH6220 (MLS), 0.800mm 01/07→	CC5441	EC5440	
3 316 i (E46)	06/02→02/05									
3 316 i (E90)	02/06→12/11									
3 Touring (E46)	06/02→02/05									
N45 B16 A							AC5440 (MLS), 0.400mm →12/06 AC5470 (MLS), 0.700mm →12/06 AH6220 (MLS), 0.800mm 01/07→	CC5441	EC5440	
1 1 (E87)	11/03→09/12									
1 116 i (E81)	03/07→09/12									
3 316 i (E46)	06/02→02/05									
3 316 i (E90)	02/06→12/11									
3 Compact (E46)	06/02→02/05									
3 Coupe (E46)	06/02→									
3 Touring (E46)	06/02→02/05									
N45 B16 TU2							AH6220 (MLS), 0.800mm 01/07→		EC5440	
3 316 i (E90)	02/06→12/11	1596	4	84.00	DOHC	85-90/ 115-122				

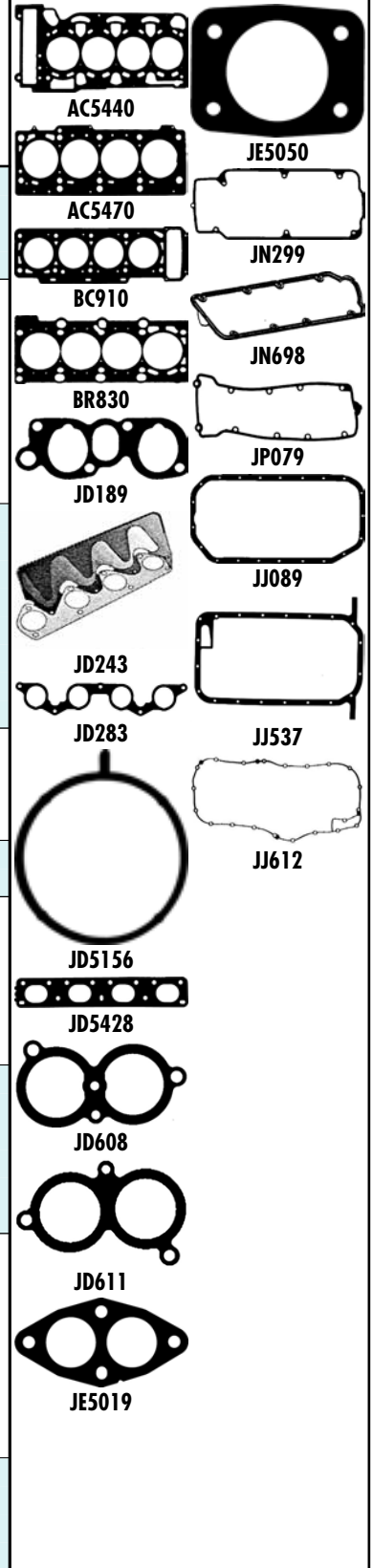
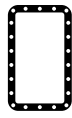



kW/PS

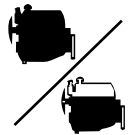

1.7		M41 D18 (Inter.) Diesel			10		AY270 (Fibre), 1.680mm, 2 Holes AY280 (Fibre), 1.870mm, 3 Holes		CY270 ▲ [13]	EY270 [3]
3 318 tds (E36)	01/95→10/99	1665	4	80.00	SOHC/OHC	66/90				
3 Compact (E36)	01/95→08/00									
1.8		M40 B18			11		BR830 (Fibre)		DR830 [3]	ER830 →06/94
3 (E30)	09/87→06/91	1796	4	84.00	SOHC/OHC	83-85/ 113-116				
3 318 i (E30)	09/87→06/94									
3 318 i (E36)	12/90→10/93									
3 Cabrio (E30)	09/90→10/93									
5 518 i (E34)	08/89→09/95									
1.8		M40 B18 C			12		BR830 (Fibre)		DR830 [3]	ER830
3 Cabrio (E30)	06/88→02/92	1796	4	84.00	SOHC/OHC	103/140				
1.8		M42 B18			13		BY560 (Fibre)		DY542 [13] →09/92 DY541 09/92→09/93 DY520 [3] 09/93→	
3 318 is (E30)	09/89→08/91	1796	4	84.00	DOHC	100-103/ 136-140				
3 318 is (E36)	03/93→02/98									
3 Compact (E36)	11/94→08/95									
3 Coupe (E36)	03/92→10/95									
1.8		M43 B18			14		BR830 (Fibre)		DR831 [13]	
3 (E36)	07/95→10/99	1796	4	84.00	SOHC/OHC	85/115				
3 318 i (E36)	10/93→02/98									
3 Cabrio (E36)	01/94→04/99									
5 (E34)	09/94→01/97									
5 518 g (E34)	11/95→06/96									
5 518 i (E34)	08/89→09/95									
Z3 1.8 (E36)	10/95→10/98									
1.8		N42 B18			15		AC5440 (MLS), 0.400mm AC5470 (MLS), 0.700mm		CC5440	EC5440
3 316 i (E46)	02/02→02/05	1796	4	84.00	DOHC	85/115				
3 Compact (E46)	06/01→02/05									
3 Touring (E46)	03/02→02/05									
1.8		N46 B18			16		AC5440 (MLS), 0.400mm AC5470 (MLS), 0.700mm		CC5440	EC5440
3 316 i (E46)	02/02→02/05	1796	4	84.00	DOHC	85/115				
3 Touring (E46)	03/02→02/05									
1.8		N46 B18 A			17		AC5440 (MLS), 0.400mm AC5470 (MLS), 0.700mm		CC5440	EC5440
3 316 i (E46)	02/02→02/05	1796	4	84.00	DOHC	85/115				
3 Compact (E46)	06/01→02/05									
3 Touring (E46)	03/02→02/05									

HBS121 [22] M12x1.50x146.50mm (x10)	JD612 [x4] [37] [38] [39] JD275 [x2]	JP078 [4]	JJ614	PA5041 (x8) 6.00/12.20x10.00 (FPM) HR817	<input checked="" type="checkbox"/> NA5105 [2] 48.00x65.00x10.00mm, PTFE <input checked="" type="checkbox"/> NF637 [2] 48.00x65.00x10.00mm, FPM <input checked="" type="checkbox"/> NA5104 [1] 90.00x110.00x12.00mm, PTFE <input checked="" type="checkbox"/> NB431 [1] 90.00x110.00x12.00mm, FPM	 AC5440	 JE5019
HBS069 [22] M10x1.50x95.00mm (x10)	JD189 [x2] JD283 [x1] JD243 	JN698 [4]	JJ537	HR646	<input checked="" type="checkbox"/> NB799 [1] [2] 38.00x50.00x7.00mm, FPM →06/94 <input checked="" type="checkbox"/> NB980 [2] 42.00x52.00x7.50mm, FPM →06/94 <input checked="" type="checkbox"/> NA5104 [1] 90.00x110.00x12.00mm, PTFE →06/94 <input checked="" type="checkbox"/> NB431 [1] 90.00x110.00x12.00mm, FPM →06/94	 AC5470	 JN698
HBS069 [22] M10x1.50x95.00mm (x10)	JD243	JN698 [4]	JJ537	HR646	<input checked="" type="checkbox"/> NB799 [1] [2] 38.00x50.00x7.00mm, FPM <input checked="" type="checkbox"/> NB980 [2] 42.00x52.00x7.50mm, FPM <input checked="" type="checkbox"/> NA5104 [1] 90.00x110.00x12.00mm, PTFE <input checked="" type="checkbox"/> NB431 [1] 90.00x110.00x12.00mm, FPM	 AY270, AY280	 JP027
HBS069 [22] M10x1.50x95.00mm (x10)	JD490 [x2] JD561 [x2]	JP027 [4] JP032 [4] JP077 (x3) [4] [40] <input checked="" type="checkbox"/> HL733	JJ537	HR646 →09/93 HR817 (x2) 09/93→	<input checked="" type="checkbox"/> NA5099 [2] 44.00x60.00x10.00mm, PTFE <input checked="" type="checkbox"/> NC015 [2] 44.00x60.00x10.00mm, FPM <input checked="" type="checkbox"/> NA5104 [1] 90.00x110.00x12.00mm, PTFE <input checked="" type="checkbox"/> NB431 [1] 90.00x110.00x12.00mm, FPM	 BR830	 JP032
HBS069 [22] M10x1.50x95.00mm (x10)	JD283 [x1] JD608 [x2] →09/95 JD611 [x2] 09/95→ JD243 	JP079 (Elastomer)	JH5050 JJ537 →09/95 JJ612 08/95→	HR646	<input checked="" type="checkbox"/> NA5099 [2] 44.00x60.00x10.00mm, PTFE <input checked="" type="checkbox"/> NC015 [2] 44.00x60.00x10.00mm, FPM <input checked="" type="checkbox"/> NA5104 [1] 90.00x110.00x12.00mm, PTFE <input checked="" type="checkbox"/> NB431 [1] 90.00x110.00x12.00mm, FPM	 BY560	 JP077
HBS467 [22]	JD6024 [x4] HA5024 [x4]	HM5160			KK5684 [41]	 JD243	 JP078
HBS467 [22]	JD6024 [x4] HA5024 [x4]	HM5160				 JD275	 JP079
HBS467 [22]	JD6024 [x4] HA5024 [x4]	HM5160				 JD283	 JJ537
HBS467 [22]	JD6024 [x4] HA5024 [x4]	HM5160				 JD490	 JD561
HBS467 [22]	JD6024 [x4] HA5024 [x4]	HM5160				 JD561	 JD608
						 JD611	 JJ612
						 JD612	 JJ614



cc



kW/PS



1.9	M43 194 E1	18			AB5660 (Fibre)	CB5660 [13]	EB5660 [3]
Z3 1.9 (E36)	07/98→01/03	1895	4	85.00	SOHC/OHC	85-87/ 116-118	
1.9	M43 B19	19			AB5660 (Fibre)	CB5660 [13]	EB5660 [3]
3 318 i (E46)	02/98→09/01	1895	4	85.00	SOHC/OHC	87/118	
3 Coupe (E46)	11/99→09/01						
3 Touring(E46)	10/99→09/01						
Z3 1.9 (E36)	07/98→01/03						
1.9	M43 B19 (194E1)	20			AB5660 (Fibre)	CB5660 [13]	EB5660 [3]
3 316 i (E46)	09/98→02/05	1895	4	85.00	SOHC/OHC	77/105	
3 Compact (E36)	12/98→08/00						
1.9	M43 B19 TU	21			AB5660 (Fibre)	CB5660 [13]	EB5660 [3]
3 318 i (E46)	02/98→09/01	1895	4	85.00	SOHC/OHC	77-87/ 105-118	
3 Touring(E46)	10/99→09/01						
Z3 1.9 (E36)	07/98→01/03						
1.9	M44 B19	22			BZ130 (Fibre)	DZ130 [13]	
3 318 is (E36)	09/95→02/98	1895	4	85.00	DOHC	103/140	
3 Compact (E36)	07/95→08/00						
3 Coupe (E36)	09/95→04/99						
Z3 1.9 (E36)	10/95→03/99						
2.0	M20 B20	23			BD630 (Fibre) BR841 (Fibre), 2.08mm	DD631	EX932
3 320 i (E30)	12/85→12/91	1990	6	80.00	CIH	90-110/ 122-150	
3 Cabrio (E30)	04/86→10/93						
5 520 i (E34)	01/88→08/91						
2.0	M47 204 D1 Diesel	24			BZ500 (MLS), 1.450mm, 1 Hole BZ510 (MLS), 1.550mm, 2 Holes BZ520 (MLS), 1.650mm, 3 Holes AC5300 (MLS), 1.800mm	DZ661 ▲ [13]	EZ800 [3]
3 318 d (E46)	09/01→03/03	1951	4	84.00		85-100/ 116-136	
3 320 d (E46)	02/98→04/05						
3 Compact (E46)	10/01→12/02						
3 Touring(E46)	03/00→02/05						
5 (E39)	02/00→09/03						
5 520 d (E39)	02/00→06/03						
2.0	M47 D20 Diesel	25			BZ500 (MLS), 1.450mm, 1 Hole BZ510 (MLS), 1.550mm, 2 Holes BZ520 (MLS), 1.650mm, 3 Holes AC5300 (MLS), 1.800mm	DZ661 ▲ [13]	EZ800 [3]
3 318 d (E46)	09/01→03/03	1951	4	84.00	DOHC	85-100/ 116-136	
3 320 d (E46)	04/98→09/01						
3 Touring(E46)	03/00→02/05						
5 (E39)	02/00→09/03						
5 520 d (E39)	02/00→06/03						
2.0	M47 D20 (204D4) Diesel	26			AC5410 (MLS), 1.450mm, 1 Hole AC5420 (MLS), 1.550mm, 2 Holes AC5430 (MLS), 1.650mm, 3 Holes	CC5410 ■▲	EC5410
1 1 (E87)	11/03→09/12	1995	4	84.00	DOHC	85-130/ 116-177	
5 520 d (E60)	07/05→03/10						
5 520 d (E61)	07/05→						
2.0	M47 D20 TU Diesel	27			AC5410 (MLS), 1.450mm, 1 Hole AC5420 (MLS), 1.550mm, 2 Holes AC5430 (MLS), 1.650mm, 3 Holes	CC5410 ■▲	EC5410
3 Touring(E91)	09/05→	1951	4	84.00	DOHC	85-110/ 116-150	

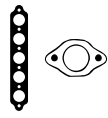

HBS069 [22] M10x1.50x95.00mm (x10)	JD5858 [1] JD243 [1] ☉JE5019	JP079 (Elastomer)	JH5050	HR646 [1]	NA5099 [2] 44.00x60.00x10.00mm, PTFE NA5104 [1] 90.00x110.00x12.00mm, PTFE	JR5031 [6] JR5046 [6]
HBS069 [22] M10x1.50x95.00mm (x10)	JD5858 [1] JD243 [1] ☉JE5019	JP079 (Elastomer)	JH5050	HR646 [1] (x8)	NA5099 [2] 44.00x60.00x10.00mm, PTFE NA5104 [1] 90.00x110.00x12.00mm, PTFE	JR5031 [6] JR5046 [6]
HBS069 [22] M10x1.50x95.00mm (x10)	JD5858 [1] JD243 [1] ☉JE5019	JP079 (Elastomer)	JH5050	HR646 [1]	NA5099 [2] 44.00x60.00x10.00mm, PTFE NA5104 [1] 90.00x110.00x12.00mm, PTFE	JR5031 [6] JR5046 [6]
HBS069 [22] M10x1.50x95.00mm (x10)	JD5858 [1] JD243 [1] ☉JE5019	JP079 (Elastomer)	JH5050	HR646 [1]	NA5099 [2] 44.00x60.00x10.00mm, PTFE NA5104 [1] 90.00x110.00x12.00mm, PTFE	JR5031 [6] JR5046 [6]
HBS069 [22] M10x1.50x95.00mm (x10)	JD611 [1] (x2)	JP027 [4] JPO32 [4] JPO77 (x3) [4] [40] HL733 [1]		PA5041 (x16) 6.00/12.20x10.00 (FPM) HR817 (x2)	NC015 [2] 44.00x60.00x10.00mm, FPM NA5104 [1] 90.00x110.00x12.00mm, PTFE NB431 [1] 90.00x110.00x12.00mm, FPM	
HBS041 [22] M10x1.50x150.00mm (x14)	JD239 [1] ☉JE5074 ☉JE555 (x2) [42]	JN297 [4]	JJ104	HR662 [1]	NB799 [1] [2] 38.00x50.00x7.00mm, FPM NF637 [2] 48.00x65.00x10.00mm, FPM NA5104 [1] 90.00x110.00x12.00mm, PTFE NB431 [1] 90.00x110.00x12.00mm, FPM	
HBS121 [22] M12x1.50x146.50mm (x10)	JD5108 [1] JD5107 [1] [1] JD5183 [1] (x1)	JM5118	HR397	PA5016 HR5045 [1]	NA5105 [2] 48.00x65.00x10.00mm, PTFE NA5104 [1] 90.00x110.00x12.00mm, PTFE	JR5022 [17]
HBS121 [22] M12x1.50x146.50mm (x10)	JD5108 [1] (x4) JD5107 [1] [1] (x4) JD5183 [1]	JM5118	HR397	PA5016 HR5045 [1]	NA5105 [2] 48.00x65.00x10.00mm, PTFE NA5104 [1] 90.00x110.00x12.00mm, PTFE	JR5022 [17]
HBS121 [22] M12x1.50x146.50mm (x10)	JD5108 [1] JD5183 [1]	JM5167 (Elastomer)	JH5070	HR5045 [1]	NA5103 [2] 55.00x68.00x8.00mm, PTFE LK5007 [1] [7] 90.00x173.00x24.00mm, PTFE	
HBS121 [22] M12x1.50x146.50mm (x10)	JD5108 [1] JD5183 [1]	JM5167 (Elastomer)	JH5070	HR5045 [1]	LK5007 [1] [7] 90.00x173.00x24.00mm, PTFE	

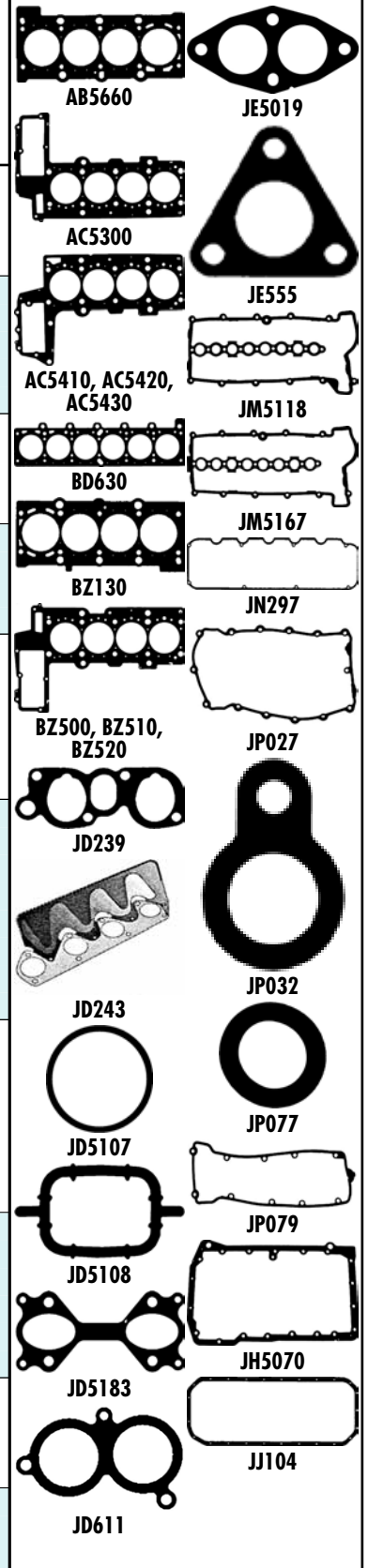













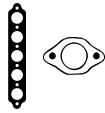

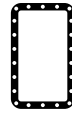

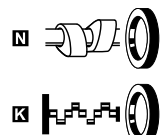

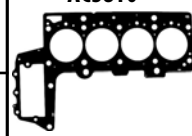
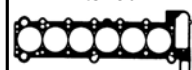

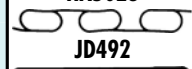

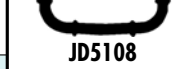
cc

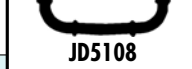

kW/PS

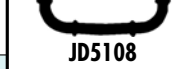

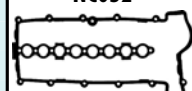
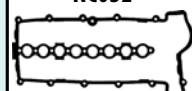
2.0		M47N 204 D4 Diesel				28			CC5410 ■▲	EC5410
3 318 d (E46)	03/03→02/05	1995	4	84.00	DOHC	85-130/ 116-177	AC5410 (MLS), 1.450mm, 1 Hole AC5420 (MLS), 1.550mm, 2 Holes AC5430 (MLS), 1.650mm, 3 Holes			
3 320 d (E46)	09/01→02/05									
3 320 d (E90)	09/05→12/11									
3 Cabrio (E46)	02/05→									
3 Compact (E46)	09/01→02/05									
3 Coupe (E46)	11/03→									
3 Touring (E46)	09/01→02/05									
3 Touring (E91)	09/05→									
X3 2.0 d (E83)	10/04→									
2.0		M47N 204 D5 Diesel				29			CC5410 ■▲	EC5410
3 Touring (E91)	09/05→	1995	4	84.00		120/163	AC5410 (MLS), 1.450mm, 1 Hole AC5420 (MLS), 1.550mm, 2 Holes AC5430 (MLS), 1.650mm, 3 Holes			
2.0		M50 B(20 6 S1)				30			DT680 [13]	ET681
3 320 i (E36)	09/90→02/98	1991	6	80.00	DOHC	110/150	BT680 (Fibre)		→09/92	
3 C 320 i (E36)	03/92→04/99								DT681 [13]	
5 (E34)	09/89→09/95								09/92→	
5 520 i (E34)	11/91→01/97									
2.0		M50 B(20 6 S2) Vanos				31			DT680 [13]	ET681
3 320 i (E36)	09/90→02/98	1991	6	80.00	DOHC	110/150	BT680 (Fibre)		→09/92	
3 C 320 i (E36)	03/92→04/99								DT681 [13]	
3 Cabrio (E36)	12/93→04/99								09/92→	
5 (E34)	09/89→09/95									
5 520 i (E34)	11/91→01/97									
2.0		M50 B20				32			DT680 [13]	ET681
3 320 i (E36)	09/90→10/99	1991	6	80.00	DOHC	110/150	BT680 (Fibre)		→09/92	
3 C 320 i (E36)	03/92→04/99								DT681 [13]	
3 Cabrio (E36)	12/93→04/99								09/92→	
5 (E34)	09/89→09/95									
5 520 i (E34)	11/91→01/97									
2.0		M50 B20 TU				33			DT680 [13]	ET681
3 320 i (E36)	09/90→10/99	1991	6	80.00	DOHC	110/150	BT680 (Fibre)		→09/92	
3 C 320 i (E36)	03/92→04/99								DT681 [13]	
3 Cabrio (E36)	12/93→04/99								09/92→	
5 (E34)	09/89→09/95									
5 520 i (E34)	11/91→01/97									
2.0		M52 B(20 6 S3) Vanos				34			DY570 [13]	EW802
3 320 i (E36)	09/90→10/99	1991	6	80.00	DOHC	100-110/ 136-150	BT680 (Fibre) →09/98 AC5310 (MLS) 09/98→		→09/95	09/98→
3 320 i (E46)	03/98→09/00								DY571 ■	
3 C 320 i (E36)	03/92→04/99								09/95→	
3 Cabrio (E36)	12/93→04/99									
3 Touring (E46)	10/99→09/00									
5 (E39)	01/97→05/04									
5 520 i (E39)	01/96→06/03									

								
HBS121 [22] M12x1.50x146.50mm (x10)	JD5108 [1] JD5183 [3]	JM5167 (Elastomer)	JH5070	HR5045 [5]	NA5103 [2] 55.00x68.00x8.00mm, PTFE LK5007 [1][7] 90.00x173.00x24.00mm, PTFE	JR5022 [17]		 AC5310  AC5410, AC5420, AC5430  BT680  HA5023  JD492
HBS121 [22] M12x1.50x146.50mm (x10)	JD5108 [1] JD5183 [3]	JM5167 (Elastomer)	JH5070	HR5045 [5]	NA5103 [2] 55.00x68.00x8.00mm, PTFE LK5007 [1][7] 90.00x173.00x24.00mm, PTFE	JR5022 [17]		 JD497  JD5108  JD5183  JD561
HBS068 [22][43] M10x1.50x95.00mm (x14)	NC052 [1] (x6) HA5023 [1] [5] JD561 [3] (x3)	HL734 [5]		HR662 [5] (x2) →09/92 HR280 [5] (x2) 09/92→	NF637 [2] 48.00x65.00x10.00mm, FPM NA5104 [1] 90.00x110.00x12.00mm, PTFE NB431 [1] 90.00x110.00x12.00mm, FPM	KK5682 [41] JR5044 [6]		 JD497  JD5108  JD5183  JD561
HBS068 [22][43] M10x1.50x95.00mm (x14)	NC052 [1] (x6) HA5023 [1] [5] JD561 [3] (x3)	HL735 [5]	JJ611	HR662 [5] (x2) →09/92 HR280 [5] (x2) 09/92→	NF637 [2] 48.00x65.00x10.00mm, FPM NA5104 [1] 90.00x110.00x12.00mm, PTFE NB431 [1] 90.00x110.00x12.00mm, FPM	KK5484 JR5044 [6]		 JD5108  JD5183  JD561
HBS068 [22][43] M10x1.50x95.00mm (x14)	NC052 [1] (x6) HA5023 [1] [5] JD561 [3]	HL734 [5] →09/92 HL735 [5] 09/92→		HR662 [5] (x2) →09/92 HR280 [5] (x2) 09/92→	NF637 [2] 48.00x65.00x10.00mm, FPM NA5104 [1] 90.00x110.00x12.00mm, PTFE NB431 [1] 90.00x110.00x12.00mm, FPM	KK5484 JR5044 [6]		 NC052  JM5167
HBS068 [22][43] M10x1.50x95.00mm (x14)	NC052 [1] (x6) HA5023 [1] [5] JD561 [3]	HL734 [5] →09/92 HL735 [5] 09/92→		HR662 [5] (x2) →09/92 HR280 [5] (x2) 09/92→	NF637 [2] 48.00x65.00x10.00mm, FPM NA5104 [1] 90.00x110.00x12.00mm, PTFE NB431 [1] 90.00x110.00x12.00mm, FPM	KK5484 JR5044 [6]		 JM5167  JH5070
HBS067 [22][44] M10x1.50x110.00mm (x14) HBS413 [22][44] M10x1.50x110.00mm (x14)	JD492 [1] (x2) NC052 [1] (x6) HA5023 [1] [5] JD497 [3] (x2) JD5916 [3]	HL735 [5] →08/95 HL736 [5] 09/95→	JJ611	PA5041 (x24) 6.00/12.20x10.00 (FPM) HR280 [5] (x2)	NA5105 [2] 48.00x65.00x10.00mm, PTFE NF637 [2] 48.00x65.00x10.00mm, FPM NA5104 [1] 90.00x110.00x12.00mm, PTFE NB431 [1] 90.00x110.00x12.00mm, FPM	KK5520 [41] KK5484 [45] JR5044 [6]		 JJ611













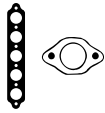

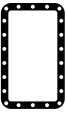

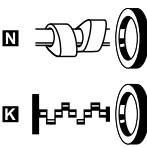
cc

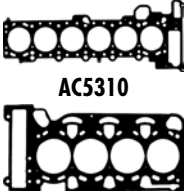

kW/PS

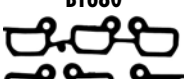
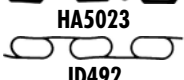

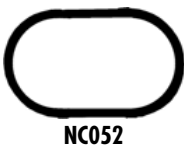
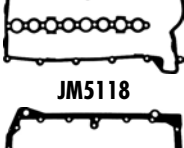
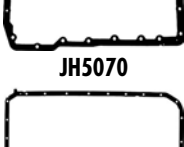
2.0		M52 B(20 6 S4)				35		BT680 (Fibre)		DY571 ■	EW802
3 Coupe (E46)	08/99→09/00	1991	6	80.00	DOHC	110/150	→09/98				09/98→
5 (E39)	01/97→09/00							AC5310 (MLS)			
5 520 i (E39)	01/96→09/00							09/98→			
Z3 2.0 (E36)	04/99→01/03										
2.0		M52 B20				36		BT680 (Fibre)		DY570 [13]	EW802
3 320 i (E36)	09/90→10/99	1991	6	80.00	DOHC	110/150	→09/98			→09/95	09/98→
3 320 i (E46)	03/98→09/00							AC5310 (MLS)		DY571 ■	
3 C 320 i (E36)	03/92→04/99							09/98→		09/95→	
3 Cabrio (E36)	12/93→04/99										
3 Coupe (E46)	08/99→09/00										
3 Touring(E46)	10/99→09/00										
5 (E39)	01/97→09/00										
5 520 i (E39)	01/96→09/00										
Z3 2.0 (E36)	04/99→01/03										
2.0		N42 B20				37		AC5440 (MLS), 0.400mm		CC5440	
3 318 i (E46)	09/01→02/05	1995	4	84.00	DOHC	105/143	→12/06			→12/06	
3 Cabrio (E46)	09/01→							AC5470 (MLS), 0.700mm			
3 Compact (E46)	09/01→02/05							→12/06			
3 Coupe (E46)	09/01→							AH6220 (MLS), 0.800mm			
3 Touring(E46)	09/01→02/05							01/07→			
2.0		N43 B20 A				38		AC5440 (MLS), 0.400mm		CC5440	
1 1 (E87)	11/03→09/12	1995	4	84.00	DOHC	90-125/ 122-170	→12/06			→12/06	
1 116 i (E81)	11/08→09/12							AC5470 (MLS), 0.700mm			
1 118 i (E81)	09/06→09/12							→12/06			
1 118i (E81)	09/06→09/12							AH6220 (MLS), 0.800mm			
1 120i (E81)	09/06→09/12							01/07→			
1 C 120 i (E82)	09/09→										
1 Cabrio (E88)	03/08→										
3 318 i (E90)	09/07→12/11										
3 320 i (E90)	03/07→12/11										
3 C 318 i (E92)	03/10→										
3 C 320 i (E92)	03/07→										
3 Cabrio (E93)	01/07→										
3 Touring(E91)	09/07→										
5 520 i (E60)	09/07→03/10										
5 520 i (E61)	07/07→08/10										
2.0		N46 B20				39		AC5440 (MLS), 0.400mm		CC5440	
3 318 i (E46)	09/01→02/05	1995	4	84.00	DOHC	95-125/ 129-170	→12/06			→12/06	EC5440
3 318 i (E90)	09/05→03/07							AC5470 (MLS), 0.700mm			
3 320 i (E90)	01/05→03/07							→12/06			
3 Cabrio (E46)	09/01→							AH6220 (MLS), 0.800mm			
3 Cabrio (E93)	03/07→08/07							01/07→			
3 Coupe (E46)	09/01→										
3 Touring(E46)	09/01→02/05										
3 Touring(E91)	09/05→										
X3 2.0 i (E83)	07/05→										
Z4 2.0 i (E85)	04/05→										

							
HBS068 ☉ [22][43] M10x1.50x95.00mm (x14) HBS413 ☉ [22][44] M10x1.50x110.00mm (x14)	JD492 ■ (x2) HA5023 ■ ■ ■ JD497 ■ (x2) JD5916 ■ ☉-JF191 (x2)	HL736 ■ →09/98	JJ611	PA5041 (x24) 6.00/12.20x10.00 (FPM) HR280 ■ (x2)	NA5105 ■ [2] 48.00x65.00x10.00mm, PTFE NF637 ■ [2] 48.00x65.00x10.00mm, FPM NA5104 ■ [1] 90.00x110.00x12.00mm, PTFE NB431 ■ [1] 90.00x110.00x12.00mm, FPM	KK5520 [41] KK5484 [45] JR5044 [6]	 AC5310  AC5440  AC5470  BT680
HBS413 ☉ [22][44] M10x1.50x110.00mm (x14)	JD492 ■ (x2) NC052 ■ (x6) HA5023 ■ ■ ■ JD497 ■ (x2) →09/98 JD5916 ■ (x2) 09/98→ ☉-JF191 (x2)	HL735 ■ →08/95 HL736 ■ 10/95→09/98	JJ611	PA5041 (x24) 6.00/12.20x10.00 (FPM) HR280 ■ (x2)	NA5103 ■ [2] 55.00x68.00x8.00mm, PTFE NF637 ■ [2] 48.00x65.00x10.00mm, FPM NA5104 ■ [1] 90.00x110.00x12.00mm, PTFE NB431 ■ [1] 90.00x110.00x12.00mm, FPM	KK5520 KK5484	 HA5023  JD492  JD497
HBS467 ☉ [22]	JD6024 ■ (x4) HA5024 ■ ■ ■	JM5118 HM5160 ■	JH5070				 JF191
HBS467 ☉ [22]	JD5864 ■ (x4) JD5909 ■ (x4)						 NC052  JM5118  JH5070
HBS467 ☉ [22]	JD6024 ■ (x4) HA5024 ■ ■ ■	HM5160 ■					 JJ611



cc



kW/PS



2.0	N46 B20 A					40			
11 (E87)	11/03→09/12	1995	4	84.00	DOHC	95-125/ 129-170	AC5440 (MLS), 0.400mm →12/06	CC5440 →12/06	EC5440
3 318 i (E46)	09/01→02/05						AC5470 (MLS), 0.700mm →12/06		
3 320 i (E90)	01/05→03/07						AH6220 (MLS), 0.800mm 01/07→		
3 C 320 i (E92)	11/06→06/07								
3 Compact (E46)	09/01→02/05								
3 Coupe (E46)	03/05→								
3 Touring(E46)	09/01→02/05								
3 Touring(E91)	09/05→								
X3 2.0 i (E83)	07/05→								
Z4 2.0 i (E85)	04/05→								
2.0	N46 B20 B					41			
11 (E87)	11/03→09/12	1995	4	84.00	DOHC	95-125/ 129-170	AC5440 (MLS), 0.400mm →12/06	CC5440 →12/06	EC5440
1 118 i (E81)	09/06→09/12						AC5470 (MLS), 0.700mm →12/06		
1 118i (E81)	09/06→09/12						AH6220 (MLS), 0.800mm 01/07→		
1 120i (E81)	09/06→09/12								
1 C 120 i (E82)	09/09→								
1 Cabrio (E88)	03/08→								
3 318 i (E90)	09/05→03/07								
3 Cabrio (E46)	02/05→								
3 Touring(E91)	01/06→								
5 520 i (E60)	04/06→12/09								
X1 sD18 i (E84)	01/10→								
X3 xD20 i (E83)	09/08→								
2.0	N46 B20 C					42			
11 (E87)	11/03→09/12	1995	4	84.00	DOHC	95-125/ 129-170	AC5440 (MLS), 0.400mm →12/06	CC5440 →12/06	EC5440
1 120i (E81)	09/06→09/12						AC5470 (MLS), 0.700mm →12/06		
1 Cabrio (E88)	03/08→						AH6220 (MLS), 0.800mm 01/07→		
3 320 i (E90)	01/05→03/07								
3 Touring(E91)	09/05→								
2.0	N46N B20 B					43			
3 C 320 i (E92)	11/06→06/07	1995	4			110/150	AH6220 (MLS), 0.800mm 01/07→		
3 Cabrio (E93)	03/07→08/07								
2.0	N47 D20 A Diesel					44			
11 (E87)	11/03→09/12	1995	4	84.00	DOHC	85-130/ 116-177	AG5010 (MLS), 1.460mm, 1 Notch AG5020 (MLS), 1.560mm, 2 Notches AG5030 (MLS), 1.660mm, 3 Notches	CG5011	
1 116d (E81)	11/08→09/12								
1 118d (E81)	09/06→09/12								
1 120d (E81)	09/06→09/12								
1 C 120 d (E82)	10/07→								
1 Cabrio (E88)	03/08→								
3 318 d (E90)	09/05→12/11								
3 320 d (E90)	09/07→12/11								
3 C 320 d (E92)	03/07→								
3 Cabrio (E93)	03/07→								
3 Coupe (E92)	03/07→								
3 Touring(E91)	09/05→								
5 520 d (E60)	07/05→03/10								
5 520 d (E61)	07/05→								
X3 2.0 d (E83)	09/07→								



AC5440



AC5470



JD5428



JE5050

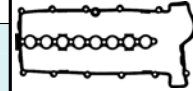

JM5167

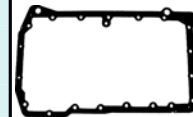

JH5070

HBS467 [22]

JD6024 [x4]
HA5024 [S]
JD5428 [E]

HM5160 [E]

HBS467 [22]

JD6024 [x4]
HA5024 [S]
JD5428 [E]
JE5050
1.300mm

HM5160 [E]

HBS467 [22]

JD6024 [x4]
HA5024 [S]
JD5428 [E]

HM5160 [E]

JD6024 [x4]
HA5024 [S]
JD5428 [E]
JE5050
1.300mm

HM5368 [E]

JD5991 [x4]
(FPM)

JM5167
(Elastomer)

JH5070

HR5110 [E]

NA5299 [2]
55.0x68.0x8.0mm, FPM

JR5022 [17]



cc



kW/PS



2.0		N47 D20 B		Diesel		45		AG5010 (MLS), 1.460mm, 1 Notch			
1 1 (E87)	03/07→09/12	1995	4	84.00	DOHC	150/204		AG5020 (MLS), 1.560mm, 2 Notches			
1 123d (E81)	03/07→09/12							AG5030 (MLS), 1.660mm, 3 Notches			
1 C 123 d (E82)	10/07→										
1 Cabrio (E88)	09/08→										
2.0		N47 D20 C		Diesel		46		AG5010 (MLS), 1.460mm, 1 Notch		CG5011	
1 (F20)	02/12→	1995	4	84.00	DOHC	66-145/ 90-197		05/07→			
1 (F21)	02/12→							AG5020 (MLS), 1.560mm, 2 Notches			
1 1 (E87)	11/03→09/12							05/07→			
1 116 d (F20)	12/10→							AG5030 (MLS), 1.660mm, 3 Notches			
1 116 d (F21)	01/12→							05/07→			
1 116d (E81)	11/08→09/12										
1 118 d (F20)	12/10→										
1 118 d (F21)	12/11→										
1 118d (E81)	09/06→09/12										
1 120 d (F20)	12/10→										
1 120 d (F21)	07/12→										
1 120d (E81)	09/06→09/12										
1 C 118 d (E82)	09/09→										
1 C 120 d (E82)	10/07→										
1 Cabrio (E88)	03/08→										
3 (E90)	07/08→12/11										
3 (F30)	10/11→										
3 316 d (E90)	07/09→12/11										
3 316 d (F30)	02/12→										
3 318 d (E90)	09/05→12/11										
3 318 d (E91)	07/07→										
3 318 d (F30)	02/12→										
3 320 d (E90)	01/05→12/11										
3 320 d (F30)	10/11→										
3 320 xd (E90)	09/07→12/11										
3 C 320 d (E92)	01/10→										
3 Cabrio (E93)	01/08→										
3 Coupe (E92)	09/08→										
3 GT (F34)	03/13→										
3 GT 318 d (F34)	03/13→										
3 GT 320 d (F34)	03/13→										
3 Touring (E91)	09/05→										
3 Touring (F31)	06/12→										
4 C 420 d (F32)	07/13→										
5 (F10)	02/13→										
5 518 d (F10)	01/13→										
5 518 d (F11)	01/13→										
5 520 d (E60)	07/05→03/10										
5 520 d (E61)	07/05→										
5 520 d (F10)	03/10→										
5 520 d (F11)	09/10→										
5 520 dxD (F11)	02/13→										
5 GT 520 d (F07)	10/11→										
X1 sD16 d (E84)	04/12→										
X1 sD18 d (E84)	03/09→										
X1 sD20 d (E84)	10/09→										
X1 xD18 d (E84)	03/09→										
X1 xD20 d (E84)	10/09→										
X3 Sdrive (F25)	08/11→										
X3 sDrive (F25)	08/11→										
X3 xD18 d (E83)	09/08→										
X3 xD20 d (E83)	09/08→										
X3 xD20 d (F25)	09/10→										

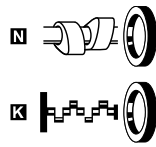
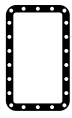
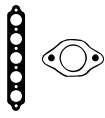

JD5991 **I**
(FPM)

JD5991 **I** (x4)
(FPM)

HR5110 **S**

HR5110 **S**

K NA5299 **F** [2]
55.0x68.0x8.0mm, FPM

K NA5299 **F** [2]
55.0x68.0x8.0mm, FPM



cc



kW/PS



2.0		N47 D20 D		Diesel		47		AG5010 (MLS), 1.460mm, 1 Notch	
1 1 (E87)	03/07→09/12	1995	4	84.00	DOHC	150-160/	204-218	AG5020 (MLS), 1.560mm, 2 Notches	AG5030 (MLS), 1.660mm, 3 Notches
1 123d (E81)	03/07→09/12								
1 125 d (F20)	08/11→								
1 125 d (F21)	12/11→								
3 325 d (F30)	10/11→								
3 GT 325 d (F34)	03/13→								
3 Touring(F31)	03/13→								
5 (F10)	09/11→								
5 525 d (F10)	09/11→								
5 525 d (F11)	09/11→								
5 525 dxD (F11)	09/11→								
X1 xD25 d (E84)	10/09→								
2.0		N47S D20 D		Diesel		48		AG5010 (MLS), 1.460mm, 1 Notch	
X1 xD23 d (E84)	10/09→	1995	4	84.00		150/204		AG5020 (MLS), 1.560mm, 2 Notches	AG5030 (MLS), 1.660mm, 3 Notches
2.0		S14 204 EA				49			
3 320 is (E30)	05/88→12/90	1990	4	89.00	DOHC	141/192			
2.2		M54 226 S1				50		AC5310 (MLS)	
3 320 i (E46)	09/00→02/05	2171	6	80.00	DOHC	125/170		CC5310 ▲ →09/02	EW802
3 Cabrio (E46)	09/00→							CC5901	
3 Coupe (E46)	09/00→							10/02→	
3 Touring(E46)	09/00→02/05								
5 520 i (E60)	07/03→03/10								
Z3 2.2 (E36)	08/00→01/03								
Z4 2.2 i (E85)	10/03→								
2.2		M54 B22				51		AC5310 (MLS)	
3 320 i (E46)	09/00→02/05	2171	6	80.00	DOHC	125/170		CC5310 ▲ →09/02	EW802
3 Cabrio (E46)	09/00→							CC5901	
3 Coupe (E46)	09/00→							10/02→	
3 Touring(E46)	09/00→02/05								
5 (E39)	09/00→05/04								
5 520 i (E39)	09/00→06/03								
5 520 i (E60)	07/03→03/10								
Z3 2.2 (E36)	08/00→01/03								
Z4 2.2 i (E85)	10/03→								
2.3		S14 B23				52			
3 M3 2.3 (E30)	02/87→05/89	2303	4	93.40	DOHC	147/200			
2.3		S14 B23				53			
3 M3 2.3 (E30)	07/86→06/91	2303	4	93.40	DOHC	143-162/	195-220		
3 Cabrio (E30)	06/88→06/91								
2.3		S14 B23 (EVO I)				54			
3 M3 EVO I 2.3	10/88→10/90	2302	4	93.40	CIH	162/220			

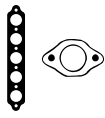

AC5310

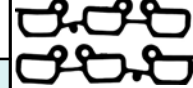

HA5023



JJ089



JJ611

	JD5991 (x4) (FPM)			HR5110	NA5299 [2] 55.0x68.0x8.0mm, FPM	
	JD5991 (FPM)			HR5110	NA5299 [2] 55.0x68.0x8.0mm, FPM	
				HR599	NC015 [2] 44.00x60.00x10.00mm, FPM NA5104 [1] 90.00x110.00x12.00mm, PTFE NB431 [1] 90.00x110.00x12.00mm, FPM	
HBS068 [22][43] M10x1.50x95.00mm (x14) HBS413 [22][44] M10x1.50x110.00mm (x14)	HA5023 JD5916 JE5012	HM5069	JJ611	PA5041 (x24) 6.00/12.20x10.00 (FPM) HR280 (x2) HR5062	NA5105 [2] 48.00x65.00x10.00mm, PTFE NA5104 [1] 90.00x110.00x12.00mm, PTFE	
HBS068 [22][43] M10x1.50x95.00mm (x14) HBS413 [22][44] M10x1.50x110.00mm (x14)	HA5023 JD5916 JE5012	HM5069	JJ611	PA5041 (x24) 6.00/12.20x10.00 (FPM) HR280 (x2)	NA5105 [2] 48.00x65.00x10.00mm, PTFE NA5104 [1] 90.00x110.00x12.00mm, PTFE	
			JJ089	HR599	NC015 [2] 44.00x60.00x10.00mm, FPM NA5104 [1] 90.00x110.00x12.00mm, PTFE	
			JJ089	HR599	NC015 [2] 44.00x60.00x10.00mm, FPM NA5104 [1] 90.00x110.00x12.00mm, PTFE	
			JJ089	HR599	NC015 [2] 44.00x60.00x10.00mm, FPM NA5104 [1] 90.00x110.00x12.00mm, PTFE	



cc



kW/PS



2.4	M21 D24 Diesel	55	BR420 (Fibre), 1.550mm, 1 Hole	EX934
3 324 td (E30) 5 524 td (E34)	09/87→06/93 03/88→09/95	2443 6 80.00 SOHC/OHC	85/115 BR430 (Fibre), 1.680mm, 2 Holes BR440 (Fibre), 1.870mm, 3 Holes	
2.4	M21 D24 W Diesel	56	BR420 (Fibre), 1.550mm, 1 Hole	EX934
3 324 d (E30)	09/85→08/91	2443 6 80.00 SOHC/OHC	63/86 BR430 (Fibre), 1.680mm, 2 Holes BR440 (Fibre), 1.870mm, 3 Holes	
2.4	M21 D24 WA Diesel	57	BR420 (Fibre), 1.550mm, 1 Hole	EX934
3 324 td (E30) 5 524 td (E34)	09/87→06/93 03/88→09/95	2443 6 80.00 SOHC/OHC	85/115 BR430 (Fibre), 1.680mm, 2 Holes BR440 (Fibre), 1.870mm, 3 Holes	
2.5	M20 B25	58	BL680 (Fibre)	DL681
3 325 i (E30) 3 Cabrio (E30) 5 525 i (E34) Z1 Cabrio 2.5	09/83→10/93 09/87→10/93 01/88→08/91 06/88→06/91	2494 6 84.00 CIH	125-126/ 170-171	EX932
2.5	M50 B25	59	BT691 [4]	DT691 [13]
3 325 i (E36) 3 C 325 i (E36) 3 Cabrio (E36) 5 (E34) 5 525 i (E34) 5 525 ix (E34)	09/90→09/95 03/92→04/99 03/93→03/95 09/89→09/95 11/91→01/97 02/92→01/97	2494 6 84.00 DOHC	141/192	10/92→ ET681
2.5	M50 B25 (Vanos)	60	BT691 [4]	DT691 [13]
3 325 i (E36) 3 C 325 i (E36)	09/90→09/95 03/92→04/99	2494 6 84.00 DOHC	141/192	09/92→ ET681
2.5	M50 B25 TU	61	BT691 [4]	DT691 [13]
3 325 i (E36) 3 C 325 i (E36) 3 Cabrio (E36) 5 (E34) 5 525 i (E34)	09/90→09/95 03/92→04/99 03/93→03/95 09/89→09/95 11/91→01/97	2494 6 84.00 DOHC	141/192	09/92→ ET681
2.5	M51 D25 Diesel	62	BW730 (Fibre), 1.680mm, 2 Holes	DW730 ▲
3 325 td (E36) 5 525 td (E34) 5 525 td (E39)	09/91→02/98 03/93→01/97 01/97→06/03	2497 6 80.00 SOHC/OHC	85/115 →01/94 BW740 (Fibre), 1.870mm, 3 Holes →01/94 BZ120 (Fibre), 1.870mm, 3 Holes 01/94→ BZ111 (Fibre), 1.680mm, 2 Holes 02/94→	→08/92 DW731 ▲ [13] 09/92→ DZ121 ▲ [13] 09/95→ EW730 [3] →01/94 EY280 02/94→

HBS065 [22] M11x1.50x140.00mm (x14)	JD275 [1] JE5074	JN578 [4]	JJ104	HR662 [1]	NB799 [1][2] 38.00x50.00x7.00mm, FPM NA5104 [1] 90.00x110.00x12.00mm, PTFE NB431 [1] 90.00x110.00x12.00mm, FPM	BL680 BR420, BR430, BR440 BW730, BW740	JN578 JN955 JJ104 JJ536
HBS065 [22] M11x1.50x140.00mm (x14)	JD275 [x6] JE5074	JN578 [4]	JJ104	HR662 [x2]	NB799 [1][2] 38.00x50.00x7.00mm, FPM NF637 [2] 48.00x65.00x10.00mm, FPM NA5104 [1] 90.00x110.00x12.00mm, PTFE NB431 [1] 90.00x110.00x12.00mm, FPM	BZ120 JD239 JD274 JD275 JD276 JD493 JD5134 JD561	
HBS065 [22] M11x1.50x140.00mm (x14)	JD275 [x6] JE5074	JN578 [4]	JJ104	HR662 [x2]	NB799 [1][2] 38.00x50.00x7.00mm, FPM NF637 [2] 48.00x65.00x10.00mm, FPM NA5104 [1] 90.00x110.00x12.00mm, PTFE NB431 [1] 90.00x110.00x12.00mm, FPM	JD274 JD275 JD276 JD493 JD5134 JD561	
HBS041 [22] M10x1.50x150.00mm (x14)	JD239 [1] JE5074	JN297 [4]	JJ104	HR662 [x2]	NB799 [1][2] 38.00x50.00x7.00mm, FPM NF637 [2] 48.00x65.00x10.00mm, FPM NA5104 [1] 90.00x110.00x12.00mm, PTFE NB431 [1] 90.00x110.00x12.00mm, FPM	JD276 JD493 JD5134 JD561	
HBS068 [22][43] M10x1.50x95.00mm (x14)	JD493 [x6] JD561 [x3] JF191	HL734 [1] →09/92 HL735 [1] 10/92→	JJ611	PA5041 (x24) 6.00/12.20x10.00 (FPM) 10/92→ HR280 [x2]	NF637 [2] 48.00x65.00x10.00mm, FPM NA5104 [1] 90.00x110.00x12.00mm, PTFE NB431 [1] 90.00x110.00x12.00mm, FPM	JR5044 [6]	JD5134 JD561
HBS068 [22][43] M10x1.50x95.00mm (x14)	JD493 [x6] JD561 [x3] JF191	HL734 [1] →09/92 HL735 [1] 10/92→	JJ611	PA5041 (x24) 6.00/12.20x10.00 (FPM) 10/92→ HR280 [x2]	NF637 [2] 48.00x65.00x10.00mm, FPM NA5104 [1] 90.00x110.00x12.00mm, PTFE NB431 [1] 90.00x110.00x12.00mm, FPM	JR5044 [6]	JD561 JD612
HBS068 [22][43] M10x1.50x95.00mm (x14)	JD493 [x6] JD561 [x3] JF191	HL734 [1] →09/92 HL735 [1] 10/92→	JJ611	PA5041 (x24) 6.00/12.20x10.00 (FPM) 10/92→ HR280 [x2]	NF637 [2] 48.00x65.00x10.00mm, FPM NA5104 [1] 90.00x110.00x12.00mm, PTFE NB431 [1] 90.00x110.00x12.00mm, FPM	JR5044 [6]	JD612 JF191
HBS066 [22] M12x1.50x146.50mm (x14)	JD274 [x6] →08/95 JD612 [37][38] [39] 09/95→ JD275 [x4] →08/92 JD276 [x1] JD5134 [1] 09/92→	JN955 [4] →01/96 JM5063 (Elastomer) 01/96→	JJ536	PA5041 (x12) 6.00/12.20x10.00 (FPM) 09/92→ HR280 [x2]	NA5105 [2] 48.00x65.00x10.00mm, PTFE NF637 [2] 48.00x65.00x10.00mm, FPM NA5104 [1] 90.00x110.00x12.00mm, PTFE NB431 [1] 90.00x110.00x12.00mm, FPM	JM5063 JN297	



cc



kW/PS



2.5	M51 D25 (Inter.) Diesel	2503	6	80.00	SOHC/OHC	105/143	63	BW730 (Fibre), 1.680mm, 2 Holes →01/94 BW740 (Fibre), 1.870mm, 3 Holes →01/94 BZ111 (Fibre), 1.680mm, 2 Holes 02/94→ BZ120 (Fibre), 1.870mm, 3 Holes 02/94→	DW730 ▲ →09/92 DW731 ▲ [13] 09/92→ DZ121 ▲ [13] 09/95→	EW730 [3] →01/94 EY280 02/94→
3 325 tds (E36) 5 (E39) 5 525 tds (E34) 5 525 tds (E39) 7 725 tds (E38)	05/93→10/99 03/97→05/04 09/91→01/97 01/96→06/03 04/96→11/01									
2.5	M52 B25 (Vanos)	2494	6	84.00	DOHC	125-141/ 170-192	64	BT691 [4] →08/98 AC5900 (MLS), 0.700mm 09/98→ AF5190 (MLS), 1.000mm 09/98→	DT693 ■○ →09/95 DT692 ■ 09/95→08/98	EW802 09/98→
3 (E36) 3 323 i (E36) 3 323 i (E46) 3 C 323 i (E36) 3 Cabrio (E36) 3 Cabrio (E46) 3 Compact (E36) 3 Coupe (E46) 5 (E34) 5 (E39) 5 523 i (E39) 5 525 i X(E34) 5 525 ix (E34)	09/95→10/99 03/95→02/98 03/98→09/00 03/95→04/99 06/95→04/99 04/00→09/00 08/97→08/00 04/99→09/00 09/89→09/95 01/97→09/00 11/95→09/00 10/91→09/95 02/92→01/97									
2.5	M52 B25 TU	2494	6	84.00	DOHC	125/170	65	AC5900 (MLS), 0.700mm AF5190 (MLS), 1.000mm	CC5900 [13]	EW802 09/98→
3 323 i (E46) 5 (E39) 5 523 i (E39)	03/98→09/00 01/97→09/00 11/95→09/00									
2.5	M54 256 S5	2494	6	84.00	DOHC	141/192	66	AC5900 (MLS), 0.700mm AF5190 (MLS), 1.000mm	CC5310 ▲ →09/02 CC5901 10/02→	EW802
3 325 i (E46) 3 325 xi (E46) 3 Cabrio (E46) 3 Compact (E46) 3 Coupe (E46) 3 Touring (E46) 5 (E39) 5 525 i (E39) 5 525 i (E60) 5 525 i (E61) X3 2.5 i (E83) Z4 2.5 i (E85)	09/00→02/05 09/00→02/05 09/00→ 06/01→02/05 09/00→ 09/00→02/05 09/00→05/04 09/00→06/03 09/03→03/10 06/04→ 01/04→ 02/03→									
2.5	M54 B25	2494	6	84.00	DOHC	141/192	67	AC5900 (MLS), 0.700mm AF5190 (MLS), 1.000mm	CC5310 ▲ →09/02 CC5901 10/02→	EW802
3 325 i (E46) 3 Compact (E46) 3 Touring (E46) 5 (E39) 5 525 i (E39) 5 525 i (E60) 5 525 i (E61) X3 2.5 i (E83) Z4 2.5 i (E85)	09/00→02/05 06/01→02/05 09/00→02/05 09/00→05/04 09/00→06/03 09/03→03/10 06/04→ 01/04→ 02/03→									

HBS066 [22] M12x1.50x146.50mm (x14)	JD274 [x6] →08/95 JD612 [x6] [37] [38][39] 09/95→ JD275 [x4] →08/92 JD276 [x1] JD5134 09/92→	JN955 [4] →01/96 JM5063 (Elastomer) 01/96→	JJ536	PA5041 (x12) 6.00/12.20x10.00 (FPM) 09/92→ HR280 [x2]	NA5105 [2] 48.00x65.00x10.00mm, PTFE NF637 [2] 48.00x65.00x10.00mm, FPM NA5104 [1] 90.00x110.00x12.00mm, PTFE NB431 [1] 90.00x110.00x12.00mm, FPM	AC5900 JM5063 JN955 AF5190 JJ536 BW730, BW740 JJ611 BZ120 HA5023 JD274 JD275 JD276 JD492 JD497 JD5134 JD612 JF191
HBS067 [22][44] M10x1.50x110.00mm (x14) HBS068 [22][43] M10x1.50x95.00mm (x14)	JD492 [x2] HA5023 [x2] JD497 [x2] JD5916 JF191	HL735 →09/95 HL736 10/95→	JJ611	PA5041 (x24) 6.00/12.20x10.00 (FPM) HR280 [x2]	NA5105 [2] 48.00x65.00x10.00mm, PTFE NF637 [2] 48.00x65.00x10.00mm, FPM NA5104 [1] 90.00x110.00x12.00mm, PTFE NB431 [1] 90.00x110.00x12.00mm, FPM	KK5520 [41] KK5484 [45] JR5044 [6] HA5023 JD274 JD275 JD276 JD492 JD497 JD5134 JD612 JF191
HBS067 [22][44] M10x1.50x110.00mm (x14) HBS068 [22][43] M10x1.50x95.00mm (x14)	JD492 [x2] HA5023 [x2] JD497 JD5916 JF191	HL736	JJ611	PA5041 (x24) 6.00/12.20x10.00 (FPM) HR280 [x2]	NA5103 [2] 55.00x68.00x8.00mm, PTFE NA5104 [1] 90.00x110.00x12.00mm, PTFE	JD276 JD492 JD497 JD5134 JD612 JF191
HBS413 [22][44] M10x1.50x110.00mm (x14)	HA5023 [x2] JD5916 JE5012	HM5069	JJ611	PA5041 (x24) 6.00/12.20x10.00 (FPM) HR280 [x2] HR5062	NA5105 [2] 48.00x65.00x10.00mm, PTFE NA5104 [1] 90.00x110.00x12.00mm, PTFE	JD5134 JD612 JF191
HBS413 [22][44] M10x1.50x110.00mm (x14)	HA5023 [x2] JD5916 JE5012	HM5069	JJ611	PA5041 (x24) 6.00/12.20x10.00 (FPM) HR280 [x2] HR5062	NA5105 [2] 48.00x65.00x10.00mm, PTFE NA5104 [1] 90.00x110.00x12.00mm, PTFE	JD5134 JD612 JF191



cc



kW/PS



2.5	M57 D25 Diesel	68						
5 (E39) 5 525 d (E39)	02/00→05/04 02/00→06/03	2497	6	80.00	DOHC	120/163	AC5320 (MLS), 1.450mm, 1 Hole AC5330 (MLS), 1.550mm, 2 Holes AC5340 (MLS), 1.650mm, 3 Holes AB5990 (MLS), 1.800mm	DZ660 ▲ [13] EZ660 [3]
2.5	M57 D25 TU Diesel	69						
5 525 d (E60) 5 525 d (E61)	06/04→03/10 06/04→	2497	6	84.00	DOHC	130/177	AG9000 (MLS), 1.450mm, 1 Hole AG9010 (MLS), 1.550mm, 2 Holes AG9020 (MLS), 1.650mm, 3 Holes	CG9000 ▲
2.5	M57N 256 D4 Diesel	70						
5 525 d (E60) 5 525 d (E61)	06/04→03/10 06/04→	2497	6	84.00	DOHC	120-130/ 163-177	AG9000 (MLS), 1.450mm, 1 Hole AG9010 (MLS), 1.550mm, 2 Holes AG9020 (MLS), 1.650mm, 3 Holes	CG9000 ▲
2.5	N52 B25	71						
3 325 i (E90) 3 C 325 i (E92) 3 Cabrio (E93) 3 Touring (E91) 5 523 i (E60) 5 523 i (E61) 5 525 i (E60) 5 525 i (E61)	01/05→12/11 09/06→ 03/07→ 09/05→ 07/05→03/10 07/05→ 07/05→03/10 07/05→	2497	6	82.00	DOHC	130-160/ 177-218	AG9540 (MLS), 1.200mm AG9550 (MLS), 1.500mm	CG9540 EG9540
2.5	N52 B25 A	72						
3 323 i (E90) 3 325 i (E90) 3 325 xi (E90) 3 C 325 i (E92) 3 Cabrio (E93) 3 Coupe (E92) 3 Touring (E91) 5 523 i (E60) 5 523 i (E61) 5 525 i (E60) 5 525 i (E61) 5 525 xi (E60) 5 525 xi (E61) X3 2.5 si (E83) X3 xD25 i (E83) Z4 sD 23 (E89) Z4 2.5 i (E85) Z4 2.5 si (E85)	04/06→12/11 01/05→12/11 01/05→12/11 09/06→ 03/07→ 09/06→ 09/05→ 07/05→03/10 07/05→ 07/05→03/10 07/05→ 07/05→03/10 07/05→ 09/06→ 09/08→ 05/09→ 01/06→ 01/06→	2497	6	82.00		130-160/ 177-218	AG9540 (MLS), 1.200mm AG9550 (MLS), 1.500mm	CG9540 EG9540
2.5	N52 B25 C	73						
3 C 325 i (E92) 3 Coupe (E92) 3 Touring (E91)	09/06→ 09/06→ 09/05→	2497	6	82.00	DOHC	160/218	AG9540 (MLS), 1.200mm AG9550 (MLS), 1.500mm	CG9540 EG9540
2.5	N52N B25 A	74						
3 323 i (E90) 3 C 323 i (E92) 3 Cabrio (E93) 3 Touring (E91)	04/06→12/11 06/06→ 03/07→ 04/06→06/07	2497	6			130/177	AG9540 (MLS), 1.200mm AG9550 (MLS), 1.500mm	CG9540 EG9540

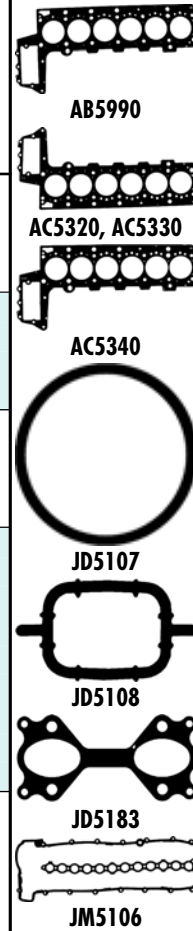
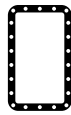
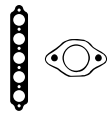

HBS066 [22] M12x1.50x146.50mm (x14)	JD5108 [1] JD5107 [1] [2] JD5183 [1]	JM5106 (Elastomer)	JH5110 (SE)	PA5041 (x24) 6.00/12.20x10.00 (FPM)	NA5103 [2] 55.00x68.00x8.00mm, PTFE NA5104 [1] 90.00x110.00x12.00mm, PTFE	
HBS066 [22] M12x1.50x146.50mm (x14)	JD5108 [1] JD5107 [1] [2]	JM5106 (Elastomer)	JH5110 (SE)	PA5016 (x24)	NA5103 [2] 55.00x68.00x8.00mm, PTFE LK5007 [1] [7] 90.00x173.00x24.00mm, PTFE	
HBS066 [22] M12x1.50x146.50mm (x14)	JD5108 [1] JD5107 [1] [2]	JM5106 (Elastomer)	JH5110 (SE)	PA5016 (x24)	NA5103 [2] 55.00x68.00x8.00mm, PTFE LK5007 [1] [7] 90.00x173.00x24.00mm, PTFE	
HBS468 [22]	JD5864 [1] (x6) JD5909 [1] JE5058 [1] (Fibre)	HM5288 [1]	JH5103			
HBS468 [22]	JD5864 [1] (x6) JD5909 [1] JE5058 [1] (Fibre)	HM5288 [1]	JH5103			
HBS468 [22]	JD5864 [1] (x6) JD5909 [1] JE5058 [1] (Fibre)	HM5278 [1]	JH5103			
HBS468 [22]	JD5864 [1] (x6) JD5909 [1] JE5058 [1] (Fibre)	HM5278 [1]	JH5103			



cc



kW/PS



2.7		M20 B27				75		BL680 (Fibra)	DL681	EX932
3 325 e (E30)	10/83→12/88	2693	6	84.00	CIH	90-95/ 122-129				
2.8		M52 B28				76		BT691 [4] →08/98 AC5900 (MLS), 0.700mm 09/98→ AF5190 (MLS), 1.000mm 09/98→	DT693 ■○ →09/95 DT692 ■ 09/95→08/98 CC5900 [13] 09/98→	EW802 09/98→
3 328 i (E36)	01/95→10/99	2793	6	84.00	DOHC	141-142/ 192-193				
3 328 i (E46)	02/98→06/00									
3 C 328 i (E36)	01/95→04/99									
3 Cabrio (E36)	03/95→04/99									
3 Coupe (E46)	04/99→06/00									
3 Touring(E46)	10/99→06/00									
5 (E39)	01/97→09/00									
5 528 i (E39)	11/95→09/00									
7 728 i,iL (E38)	08/95→11/01									
Z3 2.8 (E36)	04/97→06/00									
Z3 Coupe (E36)	07/97→06/00									
2.8		M52 B28 TU				77		BT691 [4] →08/98 AC5900 (MLS), 0.700mm 09/98→ AF5190 (MLS), 1.000mm 09/98→	DT693 ■○ →09/95 DT692 ■ 09/95→09/98 CC5900 [13] 09/98→	EW802 09/98→
3 328 i (E36)	01/95→10/99	2793	6	84.00	DOHC	142/193				
3 C 328 i (E36)	01/95→04/99									
3 Cabrio (E36)	03/95→04/99									
5 (E39)	01/97→09/00									
5 528 i (E39)	11/95→09/00									
7 728 i,iL (E38)	08/95→11/01									
7 728i X (E38)	11/95→09/01									
Z3 2.8 (E36)	04/97→06/00									
2.9		M57 D30 Diesel				78		BZ660 (MLS), 1.450mm, 1 Hole BZ670 (MLS), 1.550mm, 2 Holes BZ680 (MLS), 1.650mm, 3 Holes AB5980 (MLS), 1.800mm	DZ660 ▲[13]	EZ660 [3]
3 330 d (E46)	10/99→02/05	2926	6	84.00	SOHC/OHC	135-142/ 184-193				
3 330 xd (E46)	06/00→02/05									
3 Touring(E46)	10/99→02/05									
5 (E39)	08/98→05/04									
5 530 d (E39)	08/98→06/03									
7 730 d (E38)	08/98→04/00									
3.0		M30 B30				79		BS320 (Fibra), 1.250mm		
5 530 i (E34)	01/88→08/91	2986	6	89.00	CIH	131-147/ 178-200				
7 730 i,iL (E32)	12/86→09/94									

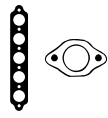

HBS041 [22] M10x1.50x150.00mm (x14)	JE5074	JN297 [4]	JJ104	HR662	NB799 [1][2] 38.00x50.00x7.00mm, FPM NF637 [2] 48.00x65.00x10.00mm, FPM NA5104 [1] 90.00x110.00x12.00mm, PTFE NB431 [1] 90.00x110.00x12.00mm, FPM	
HBS068 [22][43] M10x1.50x95.00mm (x14) HBS413 [22][44] M10x1.50x110.00mm (x14) 09/98→	JD492 (x2) →08/98 HA5023 [1][5] 08/98→ JD497 (x2) →09/98 JD5916 JF191 (x2)	HL735 →09/95 HL736 09/95→	JJ611	PA5041 (x24) 6.00/12.20x10.00 (FPM) HR280 (x2)	NA5105 [2] 48.00x65.00x10.00mm, PTFE NA5104 [1] 90.00x110.00x12.00mm, PTFE	KK5520 [41] KK5484 [45] JR5044 [6]
HBS068 [22][43] M10x1.50x95.00mm (x14) HBS413 [22][44] M10x1.50x110.00mm (x14) 09/98→	JD492 (x2) →08/98 HA5023 [1][5] 08/98→ JD497 (x2) →09/98 JD5916 JF191 (x2)	HL735 →09/95 HL736 09/95→	JJ611	PA5041 (x24) 6.00/12.20x10.00 (FPM) HR280 (x2)	NA5105 [2] 48.00x65.00x10.00mm, PTFE NA5104 [1] 90.00x110.00x12.00mm, PTFE	KK5520 KK5484 JR5044 [6]
HBS066 [22] M12x1.50x146.50mm (x14)	JD5108 (x6) JD5107 [1][2] JD5183	JM5106 (Elastomer)	JH5110 (SE)	PA5016	NA5103 [2] 55.00x68.00x8.00mm, PTFE NA5104 [1] 90.00x110.00x12.00mm, PTFE	
HBS071 [19] M12x1.75x157.00mm (x14)	JC929 (x6)	JN542 [4]	JJ538	HR569	NA5104 [1] 90.00x110.00x12.00mm, PTFE NB431 [1] 90.00x110.00x12.00mm, FPM NB792 [2] 42.00x62.00x12.00mm, FPM	

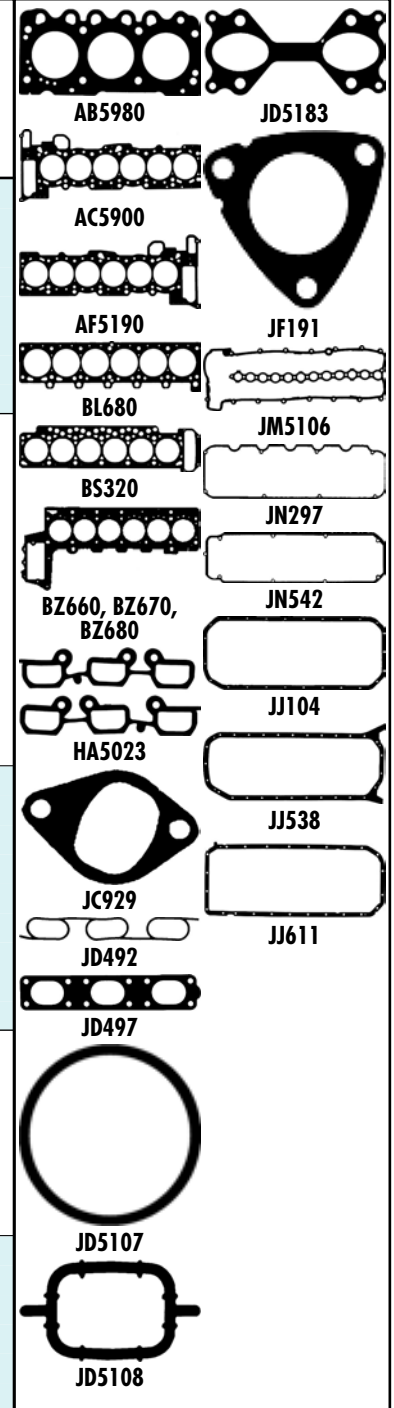













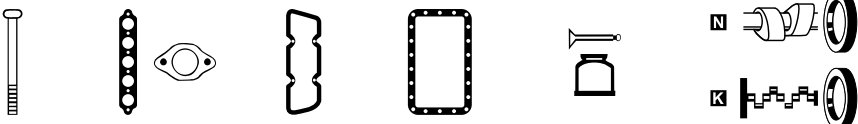

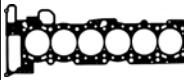













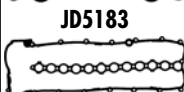











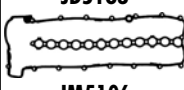







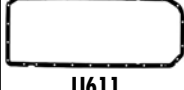

cc



kW/PS



3.0		M54 306 S3				80		AC5900 (MLS), 0.700mm AF5190 (MLS), 1.000mm		CC5310 ▲ →09/02 CC5901 10/02→		EW802	
3 330 i (E46)	06/00→02/05	2979	6	84.00	DOHC	163-170/ 222-231							
3 330 xi (E46)	06/00→02/05												
3 Cabrio (E46)	06/00→												
3 Coupe (E46)	06/00→												
3 Touring(E46)	06/00→02/05												
5 (E39)	09/00→05/04												
5 530 i (E39)	09/00→06/03												
5 530 i (E60)	07/03→03/10												
5 530 i (E61)	06/04→												
7 (E65, E66)	03/03→												
X3 3.0i xD(E83)	01/04→												
X5 3.0 i (E53)	05/00→												
Z3 3.0 (E36)	06/00→01/03												
Z3 Coupe (E36)	06/00→06/03												
Z4 3.0 i (E85)	02/03→												
3.0		M54 B30				81		AC5900 (MLS), 0.700mm AF5190 (MLS), 1.000mm		CC5310 ▲ →09/02 CC5901 10/02→		EW802	
3 330 i (E46)	06/00→02/05	2979	6	84.00	DOHC	170/231							
3 Touring(E46)	06/00→02/05												
5 530 i (E39)	09/00→06/03												
5 530 i (E60)	07/03→03/10												
7 (E65, E66)	03/03→												
X3 3.0i xD(E83)	01/04→												
X5 3.0 i (E53)	05/00→												
Z3 3.0 (E36)	06/00→01/03												
Z4 3.0 i (E85)	02/03→												
3.0		M57 306 D3 Diesel				82		AH5920 (MLS), 1.470mm, 1 Hole AH5930 (MLS), 1.570mm, 2 Holes AH5940 (MLS), 1.670mm, 3 Holes AH5950 (MLS), 1.770mm		CG9000 ▲			
3 325 d (E90)	09/06→12/11	2993	6	84.00		145-173/ 197-235							
3 330 d (E90)	09/05→12/11												
3 330 xd (E90)	09/05→12/11												
3 C 330 d (E92)	09/06→												
3 Coupe (E92)	09/06→												
3 Touring(E91)	09/05→												
5 525 d (E60)	01/07→03/10												
5 525 d (E61)	01/07→												
5 525 xd (E60)	01/07→03/10												
5 525 xd (E61)	01/07→												
5 530 d (E60)	07/03→03/10												
5 530 d (E61)	07/05→												
5 530 xd (E60)	07/05→03/10												
5 530 xd (E61)	07/05→												
7 730(E65, E66)	07/05→												
X5 3.0 d (E70)	02/07→09/08												
3.0		M57 306 D4 Diesel				83		AG9000 (MLS), 1.450mm, 1 Hole AG9010 (MLS), 1.550mm, 2 Holes AG9020 (MLS), 1.650mm, 3 Holes		CG9000 ▲			
5 535 d (E60)	09/04→03/10	2993	6	84.00	DOHC	200/272							
5 535 d (E61)	09/04→												
3.0		M57 306 D5 Diesel				84		AH5920 (MLS), 1.470mm, 1 Hole AH5930 (MLS), 1.570mm, 2 Holes AH5940 (MLS), 1.670mm, 3 Holes AH5950 (MLS), 1.770mm					
X3 3.0 sd (E83)	09/06→	2993	6	84.00	DOHC	210/286							

							 AC5900
HBS413  [22][44] M10x1.50x110.00mm (x14)	HA5023   JD5916   JE5012	HM5069 	JJ611	PA5041 (x24) 6.00/12.20x10.00 (FFM) HR5062 	<input checked="" type="checkbox"/> NA5105  [2] 48.00x65.00x10.00mm, PTFE <input checked="" type="checkbox"/> NA5104  [1] 90.00x110.00x12.00mm, PTFE	 AF5190  HA5023  JD5107  JD5108  JD5183  JM5106  JJ611	
HBS413  [22][44] M10x1.50x110.00mm (x14)	HA5023   JD5916   JE5012	HM5069 	JJ611	PA5041 (x24) 6.00/12.20x10.00 (FFM) HR5062 	<input checked="" type="checkbox"/> NA5105  [2] 48.00x65.00x10.00mm, PTFE <input checked="" type="checkbox"/> NA5104  [1] 90.00x110.00x12.00mm, PTFE	 JD5183  JM5106  JJ611	
HBS066  [22] M12x1.50x146.50mm (x14)	JD5108  JD5107   JD5183 	JM5106 (Elastomer)	JH5110 (SE)	PA5016	<input checked="" type="checkbox"/> NA5103  [2] 55.00x68.00x8.00mm, PTFE <input checked="" type="checkbox"/> NA5104  [1] 90.00x110.00x12.00mm, PTFE <input checked="" type="checkbox"/> LK5007  [1][7] 90.00x173.00x24.00mm, PTFE	 JJ611	
HBS066  [22] M12x1.50x146.50mm (x14)	JD5108  JD5107  	JM5106 (Elastomer)	JH5110 (SE)	PA5016	<input checked="" type="checkbox"/> NA5103  [2] 55.00x68.00x8.00mm, PTFE <input checked="" type="checkbox"/> LK5007  [1][7] 90.00x173.00x24.00mm, PTFE		
	JD5108  JD5107  	JM5106 (Elastomer)	JH5110 (SE)				



cc



kW/PS



3.0	M57 D30 (306D3)	Diesel	85	AH5920 (MLS), 1.470mm, 1 Hole AH5930 (MLS), 1.570mm, 2 Holes AH5940 (MLS), 1.670mm, 3 Holes AH5950 (MLS), 1.770mm	CG9000 ▲		
3 Cabrio (E93)	03/07→	2993	6	84.00	145-173/ 197-235		
5 (E60)	09/08→03/10						
5 525 dxD (E61)	09/08→						
5 530 d (E60)	07/03→03/10						
5 530 dxD (E61)	09/08→						
X5 3.0 d (E70)	02/07→09/08						
3.0	M57 D30 TU2	Diesel	86	AH5920 (MLS), 1.470mm, 1 Hole 03/06→ AH5930 (MLS), 1.570mm, 2 Holes 03/06→ AH5940 (MLS), 1.670mm, 3 Holes 03/06→ AH5950 (MLS), 1.770mm 03/06→	CG9000 ▲		
3 330 d (E90)	09/05→12/11	2993	6	84.00	DOHC	145-173/ 197-235	
3 330 xd (E90)	09/05→12/11						
3 C 325 d (E92)	03/07→						
3 C 330 d (E92)	09/06→						
3 Coupe (E92)	09/06→						
3 Touring (E91)	09/05→						
3.0	M57N 306 D2	Diesel	87	AG9000 (MLS), 1.450mm, 1 Hole AG9010 (MLS), 1.550mm, 2 Holes AG9020 (MLS), 1.650mm, 3 Holes	CG9000 ▲		
3 330 d (E46)	03/03→02/05	2993	6	84.00	DOHC	150-155/ 204-211	
3 330 xd (E46)	03/03→02/05						
3 Cabrio (E46)	08/05→						
3 Coupe (E46)	03/03→						
3 Touring (E46)	03/03→02/05						
7 (E65, E66)	10/02→						
X5 3.0 d (E53)	08/04→						
3.0	M57N 306 D4	Diesel	88	AG9000 (MLS), 1.450mm, 1 Hole AG9010 (MLS), 1.550mm, 2 Holes AG9020 (MLS), 1.650mm, 3 Holes	CG9000 ▲		
X5 3.0 d (E53)	12/03→	2993	6	84.00	DOHC	160/218	
3.0	M57N 306 D5	Diesel	89	AH5920 (MLS), 1.470mm, 1 Hole AH5930 (MLS), 1.570mm, 2 Holes AH5940 (MLS), 1.670mm, 3 Holes AH5950 (MLS), 1.770mm			
3 335 d (E90)	09/06→12/11	2993	6	84.00	DOHC	210/286	
3 C 335 d (E92)	09/06→						
3 Touring (E91)	09/06→						
5 535 d (E60)	01/07→03/10						
5 535 d (E61)	01/07→						
6 Cabrio (E64)	07/07→						
X5 3.0 sd (E70)	09/07→09/08						
X5 xD35 d (E70)	09/08→						
3.0	M57N2 306 D2	Diesel	90	AH5920 (MLS), 1.470mm, 1 Hole 02/06→ AH5930 (MLS), 1.570mm, 2 Holes 02/06→ AH5940 (MLS), 1.670mm, 3 Holes 02/06→ AH5950 (MLS), 1.770mm 02/06→	CG9000 ▲		
7 (E65, E66)	10/02→	2993	6	84.00	DOHC	160/218	
X3 3.0 d (E83)	01/04→						
3.0	M57N2 306 D3	Diesel	91	AH5920 (MLS), 1.470mm, 1 Hole AH5930 (MLS), 1.570mm, 2 Holes AH5940 (MLS), 1.670mm, 3 Holes AH5950 (MLS), 1.770mm			
3 330 d (E90)	01/09→12/11	2993	6	84.00	DOHC	150-180/ 204-245	
3 C 325 d (E92)	04/10→						
3 C 330 d (E92)	01/09→						
3 Cabrio (E93)	01/09→						
3 Coupe (E92)	01/09→						
3 Touring (E91)	01/09→						
5 (E60)	09/08→03/10						
X3 xD30 d (E83)	09/08→						
X6 30 d	05/08→						
X6 xD30 d	09/10→						

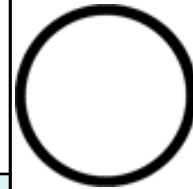
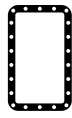
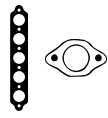

JD5107



JD5108



JD5183

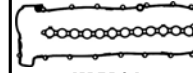

JM5106



cc



kW/PS

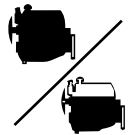

3.0		M60 B30					92				
5 (E34)	09/92→01/97	2997	8	84.00	DOHC, V	155-160/ 211-218					
5 1419 C, 1419 CL	09/92→09/95										
7 730 (E32)	04/92→09/94										
7 730 i, iL (E38)	10/94→11/01										
3.0		N52 B30					93		AH6210 (MLS), 1.160mm AG9290 (MLS), 1.200mm	CG9540	EG9540
3 330 i (E90)	01/05→12/11	2996	6	85.00	DOHC	190-200/ 258-272					
3 Touring (E91)	09/05→										
5 530 i (E60)	07/05→03/10										
5 530 i (E61)	07/05→										
6 630 i (E63)	09/04→										
6 Cabrio (E64)	09/04→										
7 (E65, E66)	03/05→										
X5 3.0 si (E70)	02/07→09/08										
Z4 3.0 si (E85)	01/06→										
Z4 Coupe (E86)	03/06→										
3.0		N52 B30 A					94		AH6210 (MLS), 1.160mm AG9290 (MLS), 1.200mm	CG9540	EG9540
1 1 (E87)	03/05→09/12	2996	6	85.00	DOHC	160-200/ 218-272					
1 130i (E81)	09/06→09/12										
1 Cabrio (E88)	03/08→										
3 330 i (E90)	01/05→12/11										
3 330 xi (E90)	01/05→12/11										
3 C 330 i (E92)	09/06→										
3 Coupe (E92)	09/06→										
3 Touring (E91)	09/05→										
5 530 i (E60)	07/05→03/10										
5 530 i (E61)	07/05→										
5 530 xi (E60)	07/05→03/10										
5 530 xi (E61)	07/05→										
6 630 i (E63)	09/04→										
6 Cabrio (E64)	09/04→										
7 (E65, E66)	03/05→										
7 730 i	06/08→										
X1 xD25 i (E84)	01/10→										
X1 xD28 i (E84)	10/09→										
X3 3.0 si (E83)	09/06→										
X3 xD28 i (F25)	04/11→										
X3 xD30 i (E83)	09/08→										
X5 3.0 si (E70)	02/07→09/08										
X5 xD30 i (E70)	09/08→03/10										
Z4 sD 30 (E89)	05/09→										
Z4 3.0 si (E85)	01/06→										
Z4 Coupe (E86)	03/06→										
3.0		N52 B30 B					95		AH6210 (MLS), 1.160mm AG9290 (MLS), 1.200mm	CG9540	EG9540
1 1 (E87)	03/05→09/12	2996	6	85.00	DOHC	190-195/ 258-265					
1 130i (E81)	09/06→09/12										
3.0		N52 B30 BF					96		AH6210 (MLS), 1.160mm AG9290 (MLS), 1.200mm	CG9540	EG9540
1 1 (E87)	03/05→09/12	2996	6	85.00	DOHC	190-195/ 258-265					
1 130i (E81)	09/06→09/12										
7 730 i	06/08→										

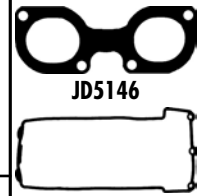
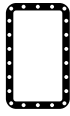
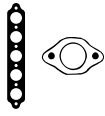

HBS519 ☉ (x2)[21][22]	JD5146 ☒ [46]	JM5109 ☒ (SE) JM5107 ☒ (SE) JM5108 ☒ (SE)	JH5115 JH5116	PA5041 (x32) 6.00/12.20x10.00 (FPM) HR791 ☒	☒ NA5105 ☒ [2] 48.00x65.00x10.00mm, PTFE ☒ NF637 ☒ [2] 48.00x65.00x10.00mm, FPM ☒ NA5132 ☒ [1] 100.00x125.00x13.00mm, FPM	
HBS468 ☉ [22]	JD5864 ☒ (x6) JD5909 ☒	HM5288 ☒	JH5103			
HBS468 ☉ [22]	JD5864 ☒ (x6) JD5909 ☒	HM5288 ☒	JH5103			
HBS468 ☉ [22]	JD5864 ☒ (x6) JD5909 ☒	HM5288 ☒	JH5103			
HBS468 ☉ [22]	JD5864 ☒ (x6) JD5909 ☒	HM5288 ☒	JH5103			



cc



kW/PS



3.0		N52N B30 A				97		AG9290 (MLS), 1.200mm	CG9540	
3 C 328 i (E92)	08/06→11/07	2996	6	85.00		187/254	→01/11			
3.0		N52N B30 B				98		AG9290 (MLS), 1.200mm	CG9540	
3 Cabrio (E93)	03/07→	2996	6			190/258	→01/11			
3.0		N53 B30				99		AH6210 (MLS), 1.160mm	CG9540	EG9540
3 325 i (E90)	09/07→12/11	2996	6	85.00	DOHC	160-200/ 218-272				
3 330 i (E90)	09/07→12/11									
3 C 325 i (E92)	09/07→									
3 C 330 i (E92)	09/06→									
3 Cabrio (E93)	03/07→									
3 Touring (E91)	09/07→									
5 525 i (E60)	01/07→03/10									
5 525 i (E61)	01/07→									
5 530 i (E60)	01/07→03/10									
5 530 i (E61)	01/07→									
6 630 i (E63)	07/07→									
6 Cabrio (E64)	07/07→									
3.0										
1 C 125 i (E82)	10/07→	2996	6	85.00	DOHC	150-200/ 204-272				
3 (E90)	09/08→12/11									
3 325 i (E90)	09/07→12/11									
3 325 i (E91)	01/12→									
3 325 xi (E90)	09/07→12/11									
3 330 i (E90)	09/07→12/11									
3 330 xi (E90)	09/07→12/11									
3 C 325 i (E92)	09/07→									
3 C 330 i (E92)	09/06→									
3 Cabrio (E93)	03/07→									
3 Coupe (E92)	09/07→									
3 Touring (E91)	09/07→									
5 (E60)	09/08→03/10									
5 523 i (F10)	03/10→									
5 523 i (F11)	09/10→									
5 525 i (E60)	01/07→03/10									
5 525 i (E61)	01/07→									
5 525 ixD (E61)	09/08→									
5 525 xi (E60)	01/07→03/10									
5 525 xi (E61)	01/07→									
5 528 i (F10)	03/10→									
5 528 i (F11)	09/10→									
5 530 i (E60)	01/07→03/10									
5 530 i (E61)	01/07→									
5 530 i (F10)	09/11→									
5 530 i (F11)	09/11→									
5 530 ixD (E61)	09/08→									
5 530 xi (E60)	01/07→03/10									
5 530 xi (E61)	01/07→									

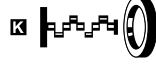
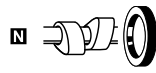
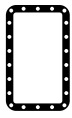
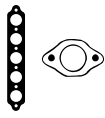

HBS468 ☉ [22]	JD5864 ■ (x6) JD5909 ■	HM5278 ■	JH5103			
HBS468 ☉ [22]	JD5864 ■ (x6) JD5909 ■	HM5278 ■	JH5103			
HBS468 ☉ [22]	JD5864 ■ (x6) JD5909 ■		JH5103			
HBS468 ☉ [22]	JD5864 ■ (x6) JD5909 ■		JH5103			



cc



kW/PS

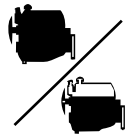

3.0		N54 B30 A				101		AH5120 (MLS)	
1 C 135 i (E82)	10/07→	2979	6	84.00	DOHC	200-250/ 272-340			
1 Cabrio (E88)	03/08→								
1 Coupe M (E82)	04/11→06/12								
3 (E90)	09/08→12/11								
3 335 i (E90)	09/06→12/11								
3 335 xi (E90)	09/07→12/11								
3 C 335 i (E92)	09/06→								
3 Cabrio (E93)	03/07→								
3 Coupe (E92)	09/06→								
3 Touring (E91)	09/06→								
7 740 i	10/08→								
X6 35 i	05/08→								
X6 xD35 i	09/08→								
Z4 sD 35 (E89)	05/09→								
Z4 sD 35s (E89)	09/10→								
3.0		N54 B30 B				102		AH5120 (MLS)	
3 Cabrio (E93)	03/07→	2979	6	84.00	DOHC	225/306			

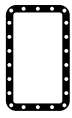
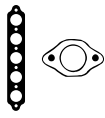

JD5864 ■ (x6)

JM7098
(ACM)

JH5103

JD5864 ■ (x6)

JM7098
(ACM)

JH5103



cc



kW/PS

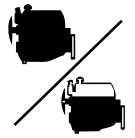

3.0		N55 B30 A			103		AH6420 (MLS), 1.195mm	
1 (F21)	02/12→	2979	6	84.00	DOHC, V	200-235/ 272-320		
1 M 135 (F20)	02/12→							
1 M 135 i (F20)	11/11→							
1 M 135 i (F21)	12/11→							
1 C 135 i (E82)	10/07→							
1 Cabrio (E88)	03/08→							
3 (E90)	09/08→12/11							
3 (F30)	10/11→							
3 335 i (E90)	09/06→12/11							
3 335 i (F30)	10/11→							
3 335 xi (E90)	09/07→12/11							
3 C 335 i (E92)	09/06→							
3 Cabrio (E93)	03/07→							
3 Coupe (E92)	09/06→							
3 GT (F34)	03/13→							
3 GT 335 i (F34)	03/13→							
3 Touring (E91)	09/06→							
3 Touring (F31)	03/13→							
4 C 435 i (F32)	07/13→							
4 Coupe (F32)	07/13→							
5 (F10)	03/10→							
5 535 i (F10)	03/10→							
5 535 i (F11)	09/10→							
5 535 ixD (F11)	09/11→							
5 GT (F07)	09/10→							
5 GT 535 i (F07)	10/09→							
6 C 640 i (F13)	11/10→							
6 Cabrio (F12)	03/11→							
6 Coupe (F13)	01/13→							
6 Gran Coupe	11/10→							
7 740 i	07/12→							
7 ActiveHybrid	07/12→							
X3 xD35 i (F25)	09/10→							
X5 xD35 i (E70)	09/10→							
X6 xD35 i	09/08→							
3.0		N57 306 D2 Diesel			104		AG9000 (MLS), 1.450mm, 1 Hole	
5 530 d (E60)	07/03→03/10	2993	6	84.00		160/218	AG9010 (MLS), 1.550mm, 2 Holes	CG9000 ▲
5 530 d (E61)	06/04→							

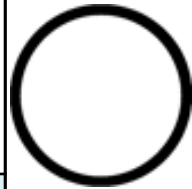
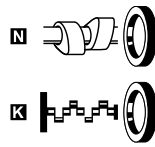
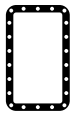

JD5107



JD5108



JD5183

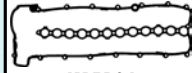

JM5106

JD5864 ■ (x6)

JH5103

HBS066 © [22]
M12x1.50x146.50mm (x14)

JD5108 ■
JD5107 ■ ■
JD5183 ■

JM5106
(Elastomer)

JH5110
(SE)

PA5016 (x24)

■ NAS103 ■ [2]
55.00x68.00x8.00mm, PTFE
■ LK5007 ■ [1][7]
90.00x173.00x24.00mm, PTFE



cc



kW/PS

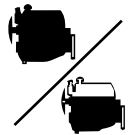

3.0		N57 D30 A		Diesel		105																			
3 (E90)	01/09→12/11	2993	6	84.00	DOHC	150-190/ 204-258																			
3 (F30)	03/13→																								
3 325 d (E90)	01/10→12/11																								
3 330 d (E90)	01/09→12/11																								
3 330 d (F30)	01/12→																								
3 C 325 d (E92)	04/10→																								
3 C 330 d (E92)	01/09→																								
3 Cabrio (E93)	01/09→																								
3 Coupe (E92)	01/09→																								
3 Touring (E91)	01/09→																								
3 Touring (F31)	06/12→																								
5 (F10)	09/11→																								
5 525 d (F10)	03/10→																								
5 525 d (F11)	09/10→																								
5 530 d (F10)	03/10→																								
5 530 d (F11)	09/10→																								
5 530 dxD (F11)	09/11→																								
5 GT (F07)	10/09→																								
5 GT 530 d (F07)	10/09→																								
7 730 d	10/08→																								
X3 xD30 d (F25)	05/11→																								
X5 xD30 d (E70)	09/08→																								
X6 xD30 d	09/08→																								
3.0		N57N 306 D2		Diesel		106		AG9000 (MLS), 1.450mm, 1 Hole	CG9000 ▲																
7 730 (E65, E66)	07/05→	2993	6	84.00	DOHC	170/231	AG9010 (MLS), 1.550mm, 2 Holes																		
							AG9020 (MLS), 1.650mm, 3 Holes																		
3.0							N57N 306 D3		Diesel		107		AH5920 (MLS), 1.470mm, 1 Hole	CG9000 ▲											
3 C 325 d (E92)	03/07→						2993	6	84.00		145-170/ 197-231	AH5930 (MLS), 1.570mm, 2 Holes													
												AH5940 (MLS), 1.670mm, 3 Holes													
												AH5950 (MLS), 1.770mm													
3.0												N57N 306 D5		Diesel		108		AH5920 (MLS), 1.470mm, 1 Hole							
6 635 d (E63)	07/07→											2993	6	84.00	DOHC	210/286	AH5930 (MLS), 1.570mm, 2 Holes								
X3 xD35 d (E83)	09/08→																AH5940 (MLS), 1.670mm, 3 Holes								
X6 35 d	05/08→																AH5950 (MLS), 1.770mm								
X6 xD35 d	09/08→																								
3.0																	N57S D30 B		Diesel		109				
5 535 d (F10)	09/10→																2993	6	84.00		220-225/ 299-306				
5 535 d (F11)	09/10→																								
5 GT (F07)	09/10→																								
5 GT 535 d (F07)	09/10→																								
7 740 d	09/09→																								
7 740 d xDrive	09/09→																								
X5 xD40 d (E70)	09/10→																								
X6 xD40 d	10/10→																								

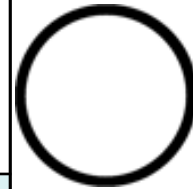
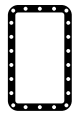

JD5107



JD5108



JD5183

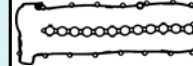

JM5106

HR5107 S

K NA5299 F [2]
55.0x68.0x8.0mm, FPM

JD5108 I
JD5107 I K
JD5183 E

JM5106
(Elastomer)

PA5016 (x24)

K NA5103 E [2]
55.00x68.00x8.00mm, PTFE
K LK5007 R [1][7]
90.00x173.00x24.00mm, PTFE

JD5108 I
JD5107 I K
JD5183 E

JM5106
(Elastomer)

PA5016 (x24)

K NA5103 E [2]
55.00x68.00x8.00mm, PTFE
K LK5007 R [1][7]
90.00x173.00x24.00mm, PTFE

JD5108 I
JD5107 I K
JD5183 E

JM5106
(Elastomer)

PA5016 (x24)

K NA5103 E [2]
55.00x68.00x8.00mm, PTFE

HR5107 S

K NA5299 F [2]
55.0x68.0x8.0mm, FPM



cc



kW/PS

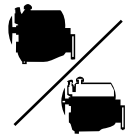

3.4	M30 B35	110	BL690 (Fibre)	DL690
6 635 CSi (E24)	04/85→09/90	3430 6 92.00 CIH	136-185/ 185-252 →08/86	→06/86 DL691 06/86→08/86
3.4	M30 B35 (Motronic, 10:1)	111	BL690 (Fibre)	DL690
6 635 CSi (E24)	06/78→10/89	3430 6 92.00 CIH	160/218	→06/87 DL691 06/87→
3.4	M30 B35 (Motronic, 8:1, Kat.)	112	BL690 (Fibre)	DL690
6 635 CSi (E24)	01/85→05/89	3430 6 92.00 CIH	136/185	→06/87 DL691 06/87→
3.5	M30 B35 (L-Jetronic, 10:1)	113	BL690 (Fibre)	DL690
6 635 CSi (E24)	06/78→08/88	3453 6 93.40 CIH	160/218	→06/87 DL691 06/87→
3.5	M30 B35 (Motronic, 9.3:1)	114	BL690 (Fibre)	DL690
6 635 CSi (E24)	06/78→08/88	3453 6 93.40 CIH	160/218	→06/87 DL691 06/87→
3.5	M62 B(35 8 S1)	115	AC5640 (MLS), 1.740mm	CC5350
5 535 i (E39)	04/96→03/99	3498 8 84.00 DOHC, V	→09/97	
7 735 i,jL (E38)	01/96→11/01		AC5650 (MLS), 1.740mm	
			→09/97	
3.5	M62 B(35 8 S2)	116	AC5640 (MLS), 1.740mm	CC5350
5 535 i (E39)	04/99→06/03	3498 8 84.00 DOHC, V	180/245	
			AC5650 (MLS), 1.740mm	

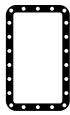
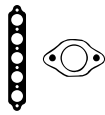

AC5640



AC5650



BL690



JC929



JD315



JD5146



JM5097

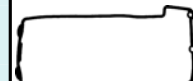

JM5108



JN300

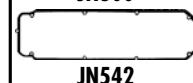

JN542

HBS071 [19] M12x1.75x157.00mm (x14) →08/86	JC929 [x6] →08/86 JD315 [x6] →08/86 JE5074 →08/86	JN542 [4] →08/86			NA5104 [1] 90.00x110.00x12.00mm, PTFE →08/86 NB431 [1] 90.00x110.00x12.00mm, FPM →08/86 NB792 [2] 42.00x62.00x12.00mm, FPM →08/86	
HBS071 [19] M12x1.75x157.00mm (x14)	JC929 [x6] →06/87 JD315 [x6] 08/87→ JE5074	JN300 [4] →09/80 JN542 [4]	HR397		NA5104 [1] 90.00x110.00x12.00mm, PTFE NB431 [1] 90.00x110.00x12.00mm, FPM NB792 [2] 42.00x62.00x12.00mm, FPM	
HBS071 [19] M12x1.75x157.00mm (x14)	JC929 [x6] →06/87 JD315 [x6] 08/87→ JE5074	JN542 [4]			NA5104 [1] 90.00x110.00x12.00mm, PTFE NB431 [1] 90.00x110.00x12.00mm, FPM NB792 [2] 42.00x62.00x12.00mm, FPM	
HBS071 [19] M12x1.75x157.00mm (x14)	JC929 [x6] →06/87 JD315 [x6] 08/87→ JE5074	JN300 [4] →09/80 JN542 [4]	HR397		NA5104 [1] 90.00x110.00x12.00mm, PTFE NB431 [1] 90.00x110.00x12.00mm, FPM NB792 [2] 42.00x62.00x12.00mm, FPM	
HBS071 [19] M12x1.75x157.00mm (x14)	JC929 [x6] →06/87 JD315 [x6] 08/87→ JE5074	JN300 [4] →09/80 JN542 [4]	HR397		NA5104 [1] 90.00x110.00x12.00mm, PTFE NB431 [1] 90.00x110.00x12.00mm, FPM NB792 [2] 42.00x62.00x12.00mm, FPM	
HBS519 [x2][21][22]	JD5146 [46]	JM5097 [47] (Elastomer) JM5109 [SE] →09/98 JM5098 (Elastomer) JM5107 [x2] (SE) JM5096 [48] (Elastomer) JM5108 [SE] →09/98 HM5067 [49] 09/98→ HM5066 [50] 09/98→	JH5115 JH5116	PA5041 (x32) 6.00/12.20x10.00 (FPM) HR791	NA5105 [2] 48.00x65.00x10.00mm, PTFE NF637 [2] 48.00x65.00x10.00mm, FPM NA5132 [1] 100.00x125.00x13.00mm, FPM	
HBS519 [x2][21][22]	JD5146 [46]	HM5067 [49] HM5066 [50]	JH5115 JH5116	PA5041 (x16) 6.00/12.20x10.00 (FPM) HR791 (x2)	NA5105 [2] 48.00x65.00x10.00mm, PTFE NF637 [2] 48.00x65.00x10.00mm, FPM NA5132 [1] 100.00x125.00x13.00mm, FPM	













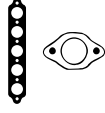

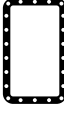

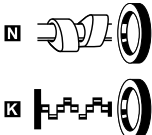

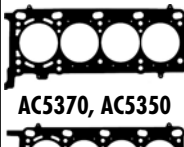



cc



kW/PS

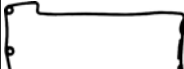

3.5	M62 B35					117			
5 535 i (E39) 7 735 i,iL (E38)	04/96→03/99 01/96→11/01	3498	8	84.00	DOHC, V	173/235	AC5640 (MLS), 1.740mm ☒ →09/97 AC5650 (MLS), 1.740mm ☒ →09/97	CC5350 ■▲	
3.5	M62 B35 TU					118	AC5640 (MLS), 1.740mm ☒ AC5650 (MLS), 1.740mm ☒	CC5350 ■▲	
5 535 i (E39)	04/99→06/03	3498	8	84.00	DOHC, V	175-180/ 238-245			
3.9	M67 D39 Diesel					119	AE5360 (MLS), 1.520mm, 2 Holes ☒ AE5370 (MLS), 1.620mm, 3 Holes ☒ AE5340 (MLS), 1.520mm, 2 Holes ☒ AE5350 (MLS), 1.620mm, 3 Holes ☒		
7 740 d (E38)	05/99→11/01	3901	8	84.00	DOHC, V	180/245			
3.9	N67 398 D1 Diesel					120	AE5360 (MLS), 1.520mm, 2 Holes ☒ AE5370 (MLS), 1.620mm, 3 Holes ☒ AE5340 (MLS), 1.520mm, 2 Holes ☒ AE5350 (MLS), 1.620mm, 3 Holes ☒		
7 (E65, E66)	10/02→	3901	8	84.00	DOHC, V	190/258			
4.0	M60 B40					121	BX281 (Fibre) ☒ [49] BX300 (Fibre) ☒ BX270 (Fibre) ☒ [50] BX290 (Fibre) ☒		
5 540 i (E34) 5 540 i V8 (E34) 7 740 (E32) 7 740 i,iL (E38) 8 840 i (E31)	09/93→01/97 09/92→09/95 04/92→09/94 10/94→11/01 02/93→02/96	3982	8	89.00	DOHC	210/286			
4.4	M62 448 S2					122	AC5380 (Fibre) ☒ →09/97 AC5370 (Fibre) ☒ →09/97 AC5360 (MLS) ☒ 09/97→ AC5350 (MLS) ☒ 09/97→	CC5350 ■▲ 09/98→	
5 (E39) 5 540 i (E39) 7 740 i,iL (E38)	01/97→05/04 04/96→06/03 01/96→11/01	4398	8	92.00	DOHC, V	210/286			

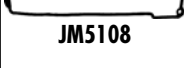
							
HBS519 ☉ (x2)[21][22]	JD5146 ☒ [46]	JM5109 ☒ (SE) →09/98 JM5107 (SE) →09/98 JM5108 ☒ (SE) →09/98 HM5067 ☒☒ [49] HM5066 ☒☒ [50]	JH5115 JH5116	PA5041 (x16) 6.00/12.20x10.00 (FPM) HR791 ☒	☒ N A5103 ☒ [2] 55.00x68.00x8.00mm, PTFE ☒ N F637 ☒ [2] 48.00x65.00x10.00mm, FPM ☒ N A5132 ☒ [1] 100.00x125.00x13.00mm, FPM		ACS370, ACS350  ACS380, ACS360  AC5640  AC5650 
HBS519 ☉ (x2)[21][22]	JD5146 ☒ [46]	JM5109 ☒ (SE) JM5107 (SE) JM5108 ☒ (SE) HM5067 ☒☒ [49] HM5066 ☒☒ [50]	JH5115 JH5116	PA5041 (x16) 6.00/12.20x10.00 (FPM) HR791 ☒	☒ N A5103 ☒ [2] 55.00x68.00x8.00mm, PTFE ☒ N F637 ☒ [2] 48.00x65.00x10.00mm, FPM ☒ N A5132 ☒ [1] 100.00x125.00x13.00mm, FPM		 AE5340  AE5350 
			JH5116	PA5016 (x32) HR5045 ☒ (x2)	☒ N F637 ☒ [2] 48.00x65.00x10.00mm, FPM ☒ N A5132 ☒ [1] 100.00x125.00x13.00mm, FPM		AE5360, AE5370 
				HR5045 ☒ (x2)	☒ N F637 ☒ [2] 48.00x65.00x10.00mm, FPM ☒ N A5132 ☒ [1] 100.00x125.00x13.00mm, FPM		BX270  BX300 
HBS519 ☉ (x2)[21][22]	JD5146 ☒ [46]	JM5109 ☒ (SE) JM5107 ☒ (x2) (SE) JM5108 ☒ (SE)	JH5115 JH5116	PA5041 (x32) 6.00/12.20x10.00 (FPM) HR791 ☒	☒ N A5105 ☒ [2] 48.00x65.00x10.00mm, PTFE ☒ N F637 ☒ [2] 48.00x65.00x10.00mm, FPM ☒ N A5132 ☒ [1] 100.00x125.00x13.00mm, FPM		 JD5146 
HBS519 ☉ (x2)[21][22]	JD5146 ☒ (x3)[46]	JM5097 ☒ [47] (Elastomer) JM5109 ☒ (SE) →09/98 JM5098 (Elastomer) JM5107 (x2) (SE) →09/98 JM5096 ☒ [48] (Elastomer) JM5108 ☒ (SE) →09/98 HM5067 ☒☒ [49] 09/98 → HM5066 ☒☒ [50] 09/98 →	JH5115 JH5116	PA5041 (x32) 6.00/12.20x10.00 (FPM) HR791 ☒	☒ N A5103 ☒ [2] 55.00x68.00x8.00mm, PTFE ☒ N F637 ☒ [2] 48.00x65.00x10.00mm, FPM ☒ N A5132 ☒ [1] 100.00x125.00x13.00mm, FPM		 JM5097  JM5108



cc



kW/PS

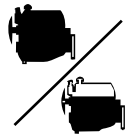

4.4		M62 B44				123			
5 (E39)	01/97→05/04	4398	8	92.00	DOHC, V	210/286	→09/97	AC5380 (Fibre)	CC5350
5 540 i (E39)	04/96→06/03							AC5370 (Fibre)	09/98→
7 740 i,iL (E38)	01/96→11/01							→09/97	
8 840 Ci (E31)	01/96→12/99							AC5360 (MLS)	
X5 4.4 i (E53)	05/00→							09/97→	
								AC5350 (MLS)	
								09/97→	
4.4		M62 B44 TU				124			
5 (E39)	01/97→05/04	4398	8	92.00	DOHC, V	210/286	→09/97	AC5380 (Fibre)	CC5350
5 540 i (E39)	04/96→06/03							→09/97	09/98→
7 740 i,iL (E38)	01/96→11/01							AC5370 (Fibre)	
8 840 Ci (E31)	01/96→12/99							→09/97	
X5 4.4 i (E53)	05/00→							AC5360 (MLS)	
								09/97→	
								AC5350 (MLS)	
								09/97→	
4.4		N62 B44				125			
5 545 i (E60)	09/03→03/10	4398	8	92.00	DOHC, V	235-245/ 320-333			CC5350
5 545 i (E61)	06/04→								
6 645 Ci (E63)	01/04→								
6 Cabrio (E64)	04/04→								
7 (E65, E66)	11/01→								
X5 4.4 i (E53)	12/03→								
4.4		N62 B44 A				126			
6 645 Ci (E63)	01/04→	4398	8	92.00	DOHC, V	235-245/ 320-333			CC5350
6 Cabrio (E64)	04/04→								
7 (E65, E66)	11/01→								
X5 4.4 i (E53)	12/03→								
4.6		M62 B46				127			
X5 4.6 is (E53)	02/02→	4619	8	93.00	DOHC, V	255/347			CC5350

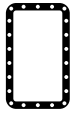
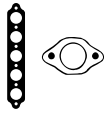

ACS370, ACS350



ACS380, ACS360



JD5146

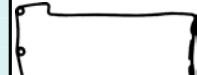

JM5097



JM5108

HBS519 (x2)[21][22]

JD5146 (x3)[46]

JM5097 [47]
(Elastomer)
JM5109 [47]
(SE)
→09/98
JM5098
(Elastomer)
JM5107 (x2)
(SE)
→09/98
JM5096 [48]
(Elastomer)
JM5108 [48]
(SE)
→09/98
HM5067 [49]
09/98 →
HM5066 [50]
09/98 →

JH5115
JH5116

PA5041 (x32)
6.00/12.20x10.00
(FPM)
HR791 [49]

NA5105 [2]
48.00x65.00x10.00mm, PTFE
NF637 [2]
48.00x65.00x10.00mm, FPM
NA5132 [1]
100.00x125.00x13.00mm, FPM

HBS519 (x2)[21][22]

JD5146 (x3)[46]

JM5097 [47]
(Elastomer)
JM5109 [47]
(SE)
→09/98
JM5098
(Elastomer)
JM5107 (x2)
(SE)
→09/98
JM5096 [48]
(Elastomer)
JM5108 [48]
(SE)
→09/98
HM5067 [49]
09/98 →
HM5066 [50]
09/98 →

JH5115
JH5116

PA5041 (x32)
6.00/12.20x10.00
(FPM)
HR791 [49]

NA5103 [2]
55.00x68.00x8.00mm, PTFE
NF637 [2]
48.00x65.00x10.00mm, FPM
NA5132 [1]
100.00x125.00x13.00mm, FPM

JD5986 [47]
(SE)
JD5146 (x3)[46]

JM5097 [47]
(Elastomer)
JM5096 [48]
(Elastomer)
HM5296 [50]
HM5297 [49]

HR791 [49]

NF637 [2]
48.00x65.00x10.00mm, FPM
NA5132 [1]
100.00x125.00x13.00mm, FPM

JD5986 [47]
(SE)
JD5146 (x3)[46]

JM5096 [48]
(Elastomer)
HM5296 [50]
HM5297 [49]

HR791 [49]

NF637 [2]
48.00x65.00x10.00mm, FPM
NA5132 [1]
100.00x125.00x13.00mm, FPM

HBS519 (x2)[21][22]

JD5146 (x3)[46]

HM5067 [49]
HM5066 [50]

NA5103 [2]
55.00x68.00x8.00mm, PTFE
NA5132 [1]
100.00x125.00x13.00mm, FPM



cc



kW/PS



4.6		M67 468 S1					128		CC5350 ■▲	
X5 4.6 is (E53)	02/02→	4619	8	94.30	DOHC, V	255/347				
4.8		N62 B48 A					129			
5 550 i (E61)	07/05→	4799	8	93.00	DOHC, V	261-270/				
X5 4.8 is (E53)	04/04→					355-367				
4.8		N62 B48 B					130			
5 550 i (E60)	07/05→03/10	4799	8	93.00	DOHC, V	261-270/				
5 550 i (E61)	07/05→					355-367				
6 650 i (E63)	07/05→									
6 Cabrio (E64)	07/05→									
7 (E65, E66)	07/05→									
X5 4.8 i (E70)	02/07→09/08									
X5 xD48 i (E70)	09/08→									
5.4		M70 B50					131			
7 (E32)	09/87→09/94	4988	12	84.00	SOHC/OHC, V	220-230/				
8 850 i, Ci (E31)	04/90→10/94					300-313				
5.4		M73 B54					132			
7 750 i, iL (E38)	12/94→11/01	5379	12	85.00	DOHC, V	240/326				
8 850 Ci (E31)	09/94→12/99									

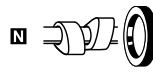
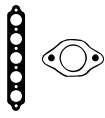

JD5146



JH5056

HBS519 (x2)[21][22]	JD5146 (x3)[46]	JM5096 (48) (Elastomer) HM5067 (49) HM5066 (50)		HR791 (x2)	NA5132 (1) 100.00x125.00x13.00mm, FPM	
	JD5986 (x2) (SE) JD5146 (x3)[46]	HM5296 (50) HM5297 (49)				
	JD5986 (x2) (SE) JD5146 (x3)[46]	HM5296 (50) HM5297 (49)				
			JH5056 JH5111	HR662	NA5267 (2) 55.00x72.00x10.00mm, FPM NA5132 (1) 100.00x125.00x13.00mm, FPM	
			JH5111	HR662	NA5267 (2) 55.00x72.00x10.00mm, FPM NA5132 (1) 100.00x125.00x13.00mm, FPM	

CARBODIES

Model Index • Modelverzeichnis • Index de modele • Indice motore • Índice de modelo • Indeks modelu • Модель автомобиля • دليل الموديل



Ltr



CC



9

	Ltr	01/98→12/98	25V	Diesel	2494	4	1
FL2	2.5	01/98→12/98	25V	Diesel	2494	4	1
FX4	2.5	09/98→12/98	25V	Diesel	2494	4	1
FX4S	2.5	01/98→12/98	25V	Diesel	2494	4	1

CARBODIES







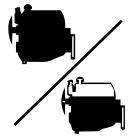

cc

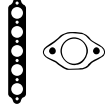

kW/PS

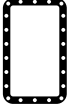

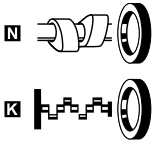
2.5		25V Diesel			1		BM850 (Fibre)	DM850 [13]	EM850 [3]
FL2 2.5 D	01/85→12/89	2494	4	90.47		49-50/			
FX4 2.5 D	09/85→12/89					67-68			
FX4S 2.5 D	01/86→12/89								

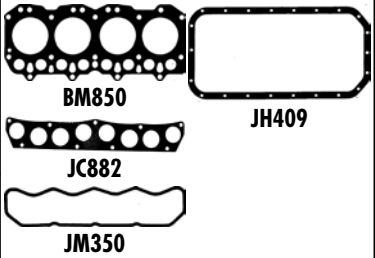
							
	JC882	JM350 [4]	JH409	HR635 [x2]	<input checked="" type="checkbox"/> NB849 [2] 48.70x63.50x8.00mm, FPM <input checked="" type="checkbox"/> NB848 [1] 100.00x120.00x11.00mm, PTFE		



Ltr











CC



9

Model	Ltr	Year	Model Name	Fuel	CC	Seats	Price
ASTRA Hatchback	2.0	08/00→	C 20 SEL	Petrol	1998	4	27
ASTRA Hatchback	2.0	03/99→07/00	X 20 XEV	Petrol	1998	4	31
ASTRA Hatchback	2.0	08/00→	Y 20 DTH	Diesel	1995	4	32
ASTRA Saloon	2.0	08/00→12/01	C 20 SEL	Petrol	1998	4	27
ASTRA Saloon	2.0	03/99→07/00	X 20 XEV	Petrol	1998	4	31
ASTRA Saloon	2.0	08/00→12/01	Y 20 DTH	Diesel	1995	4	32
AVEO Hatchback (T250, T255)	1.2	10/00→	F12S3	Petrol	1150	4	5
AVEO Hatchback (T250, T255)	1.4	04/00→	F14D4	Petrol	1399	4	10
AVEO Hatchback (T300)	1.3	07/01→	LDV	Diesel	1248	4	6
AVEO Hatchback (T300)	1.3	07/01→	LSF	Diesel	1248	4	7
AVEO Hatchback (T300)	1.6	03/01→	F16D4	Petrol	1598	4	16
AVEO Saloon (T250, T255)	1.2	03/00→12/00	F12S3	Petrol	1150	4	5
AVEO Saloon (T250, T255)	1.4	03/00→12/00	F14D3	Petrol	1399	4	9
AVEO Saloon (T250, T255)	1.4	09/00→	F14D4	Petrol	1399	4	10
AVEO Saloon (T250, T255)	1.5	05/00→	F15S3	Petrol	1498	4	13
AVEO Saloon (T250, T255)	1.6	01/00→	A16DMS	Petrol	1598	4	14
AVEO Saloon (T250, T255)	1.6	05/00→	F16D3	Petrol	1598	4	15
AVEO Saloon (T250, T255)	1.6	05/00→	LXV	Petrol	1598	4	18
AVEO Saloon (T300)	1.3	07/01→	LDV	Diesel	1248	4	6
AVEO Saloon (T300)	1.3	07/01→	LSF	Diesel	1248	4	7
AVEO Saloon (T300)	1.6	03/01→	F16D4	Petrol	1598	4	16
CAPTIVA (C100, C140)	2.0	10/00→	Z 20 S	Diesel	1991	4	34
CORSA Pickup	1.4	08/99→07/99	C 14 NZ	Petrol	1389	4	8
CORSA Pickup	1.6	08/00→	Z 16 SE	Petrol	1598	4	20
CORSA Pickup	1.7	08/00→	Y 17 DT	Diesel	1686	4	21
CORSA Saloon	1.4	08/99→07/99	C 14 NZ	Petrol	1389	4	8
CORSA Saloon	1.6	08/99→07/00	X 16 XE	Petrol	1598	4	19
CRUZE (J300)	1.6	05/00→	F16D3	Petrol	1598	4	15
CRUZE (J300)	1.6	05/00→	F16D4	Petrol	1598	4	16
CRUZE (J300)	1.6	05/00→	LDE	Petrol	1598	4	17
CRUZE (J300)	1.6	05/00→	LXV	Petrol	1598	4	18
CRUZE (J300)	1.8	05/00→	2H0	Petrol/Petroleum Gas (LPG)	1796	4	22
CRUZE (J300)	1.8	05/00→	2H0	Petrol	1796	4	22
CRUZE (J300)	2.0	05/00→	Z 20 S1	Diesel	1991	4	35
CRUZE Hatchback (J305)	1.6	06/01→	F16D4	Petrol	1598	4	16
CRUZE Hatchback (J305)	2.0	01/01→	LLW	Diesel	1991	4	28
CRUZE Station Wagon (J308)	1.6	08/01→	LDE	Petrol	1598	4	17
CRUZE Station Wagon (J308)	1.8	08/01→	2H0	Petrol/Petroleum Gas (LPG)	1796	4	22
CRUZE Station Wagon (J308)	1.8	08/01→	2H0	Petrol	1796	4	22
EPICA (KL1_)	2.0	01/00→12/00	T20SED	Petrol	1998	4	29
EPICA (KL1_)	2.0	01/00→12/00	X 20 XEV	Petrol	1998	4	31
EPICA (KL1_)	2.0	01/00→	Z 20 S	Diesel	1991	4	34
EVANDA	2.0	03/00→	X 20 SED	Petrol	1998	4	30
KALOS Saloon	1.2	03/00→	F12S3	Petrol	1150	4	5
KALOS Saloon	1.4	03/00→	F14D3	Petrol	1399	4	9
KALOS Saloon	1.4	03/00→	F14S3	Petrol	1399	4	11
KALOS	1.2	03/00→	B12S1	Petrol	1150	4	4
KALOS	1.4	03/00→	F14D3	Petrol	1399	4	9
KALOS	1.4	03/00→	F14S3	Petrol	1399	4	11
LACETTI (J200)	1.4	03/00→	F14D3	Petrol	1399	4	9
LACETTI (J200)	1.6	03/00→	F16D3	Petrol	1598	4	15
LACETTI (J200)	1.8	08/00→	F18D3	Petrol	1796	4	23
LACETTI (J200)	1.8	03/00→	T18SED	Petrol	1799	4	24
LACETTI (J200)	2.0	01/00→	Z 20 DM	Diesel	1991	4	33
LANOS Hatchback	1.5	11/00→	A15SMS	Petrol	1498	4	12
LANOS Hatchback	1.6	11/00→	A16DMS	Petrol	1598	4	14
LANOS Saloon	1.5	11/00→	A15SMS	Petrol	1498	4	12
LANOS Saloon	1.6	11/00→	A16DMS	Petrol	1598	4	14
MATIZ (M200, M250)	0.8	03/00→	F8CV	Petrol/Petroleum Gas (LPG)	796	3	1
MATIZ (M200, M250)	0.8	03/00→	F8CV	Petrol	796	3	1
MATIZ (M200, M250)	1.0	03/00→	B10S	Petrol	995	4	2
MATIZ (M200, M250)	1.0	03/00→	B10S1	Petrol/Petroleum Gas (LPG)	995	4	3
MATIZ (M200, M250)	1.0	03/00→	B10S1	Petrol	995	4	3
NIVA	1.8	01/00→12/00	Z 18 XE	Petrol	1796	4	25
NUBIRA Estate	1.6	03/00→	F16D3	Petrol	1598	4	15
NUBIRA Estate	1.8	08/00→	F18D3	Petrol	1796	4	23
NUBIRA Estate	1.8	03/00→	T18SED	Petrol	1799	4	24
NUBIRA Estate	2.0	01/00→	Z 20 DM	Diesel	1991	4	33
NUBIRA Estate	2.0	01/00→	Z 20 S	Diesel	1991	4	34
NUBIRA Saloon	1.4	01/00→	F14D3	Petrol	1399	4	9

	Ltr				CC		9
NUBIRA Saloon	1.6	03/00 →	F16D3	Petrol	1598	4	15
NUBIRA Saloon	1.8	01/00 →	F18D3	Petrol	1796	4	23
NUBIRA Saloon	1.8	03/00 →	T18SED	Petrol	1799	4	24
NUBIRA Saloon	2.0	01/00 →	Z 20 S	Diesel	1991	4	34
OPTRA (1J_)	1.6	08/00 → 12/00	F16D3	Petrol	1598	4	15
OPTRA (1J_)	1.8	08/00 → 12/00	T18SED	Petrol	1799	4	24
OPTRA Estate	1.6	06/00 →	F16D3	Petrol	1598	4	15
OPTRA Hatchback	1.8	06/00 →	T18SED	Petrol	1799	4	24
OPTRA	2.0	06/99 → 07/00	X 20 SED	Petrol	1998	4	30
ORLANDO (J309)	1.8	02/01 →	2H0	Petrol/Petroleum Gas (LPG)	1796	4	22
ORLANDO (J309)	1.8	02/01 →	2H0	Petrol	1796	4	22
REZZO	1.6	03/00 →	A16DMS	Petrol	1598	4	14
REZZO	2.0	03/00 →	T20SED	Petrol	1998	4	29
SPARK	0.8	09/00 →	F8CV	Petrol/Petroleum Gas (LPG)	796	3	1
SPARK	0.8	09/00 →	F8CV	Petrol	796	3	1
SPARK	1.0	05/00 →	B10S	Petrol	995	4	2
SPARK	1.0	05/00 →	B10S1	Petrol/Petroleum Gas (LPG)	995	4	3
SPARK	1.0	05/00 →	B10S1	Petrol	995	4	3
TRAX	1.6	12/01 →	F16D4	Petrol	1598	4	16
TRAX	1.6	12/01 →	LDE	Petrol	1598	4	17
VECTRA	2.0	03/99 → 12/00	20 NEJ	Petrol	1998	4	26
VECTRA	2.0	03/99 → 04/99	C 20 SEL	Petrol	1998	4	27
VECTRA	2.2	04/00 → 04/00	Z 22 SE	Petrol	2198	4	36
VECTRA	2.2	01/00 → 07/00	Z 22 YH	Petrol	2198	4	37
VIVA	1.8	09/00 → 03/00	Z 18 XE	Petrol	1796	4	25
VIVANT	1.6	08/00 →	A16DMS	Petrol	1598	4	14
VIVANT	2.0	01/00 →	T20SED	Petrol	1998	4	29
VIVANT	2.0	08/00 →	X 20 SED	Petrol	1998	4	30
ZAFIRA (F75)	1.8	07/00 → 06/00	Z 18 XE	Petrol	1796	4	25
ZAFIRA (F75)	2.0	04/00 →	C 20 SEL	Petrol	1998	4	27
ZAFIRA	2.2	07/00 →	Z 22 YH	Petrol	2198	4	37

		CC			9
20 NEJ	Petrol	1998	4	86.00	26
2HO	Petrol/ Petroleum Gas (LPG)	1796	4	80.50	22
2HO	Petrol	1796	4	80.50	22
A15SMS	Petrol	1498	4	76.50	12
A16DMS	Petrol	1598	4	79.00	14
B10S	Petrol	995	4	68.50	2
B10S1	Petrol/ Petroleum Gas (LPG)	995	4	68.50	3
B10S1	Petrol	995	4	68.50	3
B12S1	Petrol	1150	4	68.50	4
C 14 NZ	Petrol	1389	4	77.60	8
C 20 SEL	Petrol	1998	4	86.00	27
F12S3	Petrol	1150	4	68.50	5
F14D3	Petrol	1399	4	77.90	9
F14D4	Petrol	1399	4	77.90	10
F14S3	Petrol	1399	4	77.90	11
F15S3	Petrol	1498	4	76.50	13
F16D3	Petrol	1598	4	79.00	15
F16D4	Petrol	1598	4	79.00	16
F18D3	Petrol	1796	4	81.60	23
F8CV	Petrol/ Petroleum Gas (LPG)	796	3	68.50	1
F8CV	Petrol	796	3	68.50	1
LDE	Petrol	1598	4	79.00	17
LDV	Diesel	1248	4	69.60	6
LLW	Diesel	1991	4	83.00	28
LSF	Diesel	1248	4	69.60	7
LXV	Petrol	1598	4	79.00	18
T18SED	Petrol	1799	4	81.60	24
T20SED	Petrol	1998	4	86.00	29
X 16 XE	Petrol	1598	4	79.00	19
X 20 SED	Petrol	1998	4	86.00	30
X 20 XEV	Petrol	1998	4	86.00	31
Y 17 DT	Diesel	1686	4	79.00	21
Y 20 DTH	Diesel	1995	4	84.00	32
Z 16 SE	Petrol	1598	4	79.00	20
Z 18 XE	Petrol	1796	4	80.50	25
Z 20 DM	Diesel	1991	4	83.00	33
Z 20 S	Diesel	1991	4	83.00	34
Z 20 S1	Diesel	1991	4	83.00	35
Z 22 SE	Petrol	2198	4	86.00	36
Z 22 YH	Petrol	2198	4	86.00	37



CHEVROLET



cc



kW/PS



0.8	F8CV						1	AD5690 (Fibre)	CD5691	ED5690 FD5690
Matiz 0.8	03/05→	796	3	68.50	SOHC/OHC	38/52				
Matiz 0.8 LPG	03/05→									
Spark 0.8	09/00→12/04									
1.0	B10S						2	AG7990 (Graphite)	CG7990	ED5690 FG7990
Matiz 1.0	03/05→	995	4	68.50	SOHC/OHC	46-47/ 63-64				
Spark 1.0 SX	05/05→									
1.0	B10S1						3	AG7990 (Graphite)	CG7990	ED5690 FG7990
Matiz 1.0	03/05→	995	4	68.50	SOHC/OHC	49/67				
Matiz 1.0 LPG	03/05→									
Spark 1.0 SX	05/05→									
1.2	B12S1						4	AG7990 (Graphite)	CG7990	ED5690 FG7990
Kalos 1.2	03/05→	1150	4	68.50	SOHC/OHC	53-56/ 72-76				
1.2	F12S3						5	AG7990 (Graphite)	CG7990	ED5690 FG7990
Aveo 1.2	03/06→12/07	1150	4	68.50	SOHC/OHC	53/72				
Kalos 1.2	03/05→									
1.2	LDV Diesel						6	AD5800 (MLS), 0.720mm AD5810 (MLS), 0.820mm, 1 Hole AD5820 (MLS), 0.920mm, 2 Holes	CD5810 ▲	ED5810
Aveo 1.3 D	07/11→	1248	4	69.60	DOHC	55/75				
1.2	LSF Diesel						7	AD5800 (MLS), 0.720mm AD5810 (MLS), 0.820mm, 1 Hole AD5820 (MLS), 0.920mm, 2 Holes	CD5810 ▲	ED5810
Aveo 1.3 D	07/11→	1248	4	69.60	DOHC	70/95				
1.4	C 14 NZ						8	BS260 (Fibre)	DS260	EK470 [3]
Corso 1.4 GLS	08/94→07/97	1389	4	77.60	SOHC/OHC	44/60				
Corso Pick Up	08/94→07/97									
1.4	F14D3						9	AG8000 (MLS)	CG8000	FG8000
Aveo 1.4	03/06→12/07	1399	4	77.90	DOHC	69-70/ 94-95				
Kalos 1.4 16V	03/05→									
Lacetti 1.4 16V	03/05→									
Nubira 1.4	01/05→									
1.4	F14D4						10	AH5240 (MLS)	CH5242 (MLS)	EH5240
Aveo 1.4	04/08→	1399	4	77.90	DOHC	74/101				

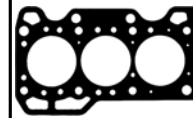
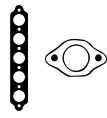

AD5690



AD5800



AD5810



AD5820



BS260



JC281



JC824



JD5794



JE120



JN626

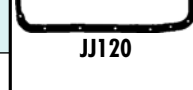

JH5005



JJ120

CHEVROLET



cc



kW/PS



Engine Code	Model	Year	CC	Cyl	Power (kW/PS)	Configuration	Code	Material	Accessories
1.4	F14S3						11	BP800 (Fibre)	
Kalos 1.4	03/05→	1399	4	77.90	DOHC	61/83			
1.5	A15SMS						12	BS260 (Fibre)	DS261 [3] ES260
Lanos 1.5	11/05→	1498	4	76.50	SOHC/OHC	63/86			
1.5	F15S3						13	BZ300 (Fibre)	
Aveo 1.5	05/05→	1498	4	76.50	SOHC/OHC	62/84			
1.6	A16DMS						14	AB5230 (Fibre)	CB5230 [3] HC5006 [3][18]
Aveo 1.6	01/06→	1598	4	79.00	DOHC	74-79/ 101-107			
Lanos 1.6 16V	11/05→								
Rezzo 1.6	03/05→								
Vivant 1.6	08/01→								
1.6	F16D3						15	AG8000 (MLS)	
Aveo 1.6	05/05→	1598	4	79.00	DOHC	74-80/ 101-109			
Cruze 1.6	05/09→								
Lacetti 1.6	03/05→								
Nubira 1.6	03/05→								
Optra 1.6	08/03→12/08								
1.6	F16D4						16	AH5240 (MLS)	CH5242 (MLS) EH5240
Aveo 1.6	03/11→	1598	4	79.00	DOHC	83-91/ 113-124			
Cruze 1.6	05/09→								
Trax 1.6	12/12→								
Trax 1.6 AWD	12/12→								
1.6	LDE						17	AH5240 (MLS)	CH5242 (MLS) EH5240
Cruze 1.6	05/09→	1598	4	79.00	DOHC	83-91/ 113-124			
Trax 1.6	12/12→								
Trax 1.6 AWD	12/12→								
1.6	LXV						18	AH5240 (MLS)	CH5242 (MLS) EH5240
Aveo 1.6	05/05→	1598	4	79.00	DOHC	76-81/ 103-110			
Cruze 1.6	05/09→								
1.6	X 16 XE						19	AY220 (Fibre)	CY220 [3] EY230
Corsa 1.6 GS	08/97→07/02	1598	4	79.00	DOHC	75-80/ 102-108			
1.6	Z 16 SE						20	AE5920 (Steel)	CE5920 [3] EB5541 [18]
Corsa Pick Up	08/01→	1598	4	79.00	SOHC/OHC	62-64/ 84-87			
1.7	Y 17 DT Diesel						21	AE5520 (MLS), 1.450mm, 1 Hole AE5530 (MLS), 1.500mm, 2 Holes AE5540 (MLS), 1.550mm, 3 Notches	CE5521 ▲ [3] EE5520 [3]
Corsa Pick Up	08/01→	1686	4	79.00	DOHC	55/75			

HBS002 [5] M10x1.25x140.00mm (x10)			HR397		NC006 [2] 35.00x48.00x7.00mm, MVQ NF812 [1] 30.00x42.00x8.00mm, ACM NB698 [1] 80.00x98.00x10.00mm, FPM		 AB5230 AE5520, AE5530, AE5540 AE5920 AY220 BP800 BS260 BZ300 JC281 JC823 JD444 JD448 JD5329 JD5332 JD5336 JD5398 JD5399 JD5794 JN929 JH5005 JJ575
HBS002 [5] M10x1.25x140.00mm (x10)	JC823 [1] JC281 [1]	JN929 [4]	JH5005 (Cork)	PA565 (x8) HR342 [1]	NC006 [2] 35.00x48.00x7.00mm, MVQ NB698 [1] 80.00x98.00x10.00mm, FPM		
HBS002 [5] M10x1.25x140.00mm (x10)					NC006 [2] 35.00x48.00x7.00mm, MVQ NB698 [1] 80.00x98.00x10.00mm, FPM		
HBS285 [5] M10x1.25x166.00mm (x10)	JD5774 [1] (Graphite) JD5739 [1] (Fibre) JD5794 [1] (MLS)	JM5303	HR397	HR5092 [1]	NA5177 [2] 42.00x56.00x7.00mm, FPM NF812 [1] 30.00x42.00x8.00mm, ACM NB698 [1] 80.00x98.00x10.00mm, FPM		
HBS285 [5] M10x1.25x166.00mm (x10)	JD5774 [1] (Graphite) JD5739 [1] (Fibre) JD5794 [1] (MLS)	JM5303	HR397	NA5164 (x16) [51] 26.5 (FPM) 16.00mm	NA5177 [2] 42.00x56.00x7.00mm, FPM NA5177 [2] 42.00x56.00x7.00mm, FPM NB698 [1] 80.00x98.00x10.00mm, FPM		
HBS055 [5] M10x1.25x153.00mm (x10)					NC006 [2] 35.00x48.00x7.00mm, MVQ NA5174 [2] 31.50x42.00x7.00mm, FPM	NA5174 [2] [10]	
HBS055 [5] M10x1.25x153.00mm (x10)					NC006 [2] 35.00x48.00x7.00mm, MVQ NA5174 [2] 31.50x42.00x7.00mm, FPM		
HBS055 [5] M10x1.25x153.00mm (x10)					NC006 [2] 35.00x48.00x7.00mm, MVQ NA5174 [2] 31.50x42.00x7.00mm, FPM		
HBS055 [5] M10x1.25x153.00mm (x10)	JD448 [1] JD444 [1]		JJ575	PA5041 (x16) 6.00/12.20x10.00 (FPM) HR791 [1] (x1)	NC006 (x2) [2] 35.00x48.00x7.00mm, MVQ NB697 [2] 26.00x42.00x8.00mm, FPM NB698 [1] 80.00x98.00x10.00mm, FPM		
HBS002 [5] M10x1.25x140.00mm (x10)	JD5398 [1] JD5399 [1]	JN929 [4]		HR342 [1]	NC006 [2] 35.00x48.00x7.00mm, MVQ NB697 [2] 26.00x42.00x8.00mm, FPM NB698 [1] 80.00x98.00x10.00mm, FPM		
HBS036 [22] M12x1.50x102.00mm (x10)	JD5332 [1] →Eng.721438 JD5336 [1] [2] JD5333 [1] Eng.721439→ JD5329 [1]	JM5197 (Elastomer)		HR791 [1]	NB884 [2] 38.00x50.00x5.50mm, FPM NJ449 [2] 40.00x52.00x6.00mm, NBR NK103 [1] 87.00x100.00x8.50mm, FPM		

CHEVROLET



cc



kW/PS



1.8	2HO					22	AH5240 (MLS)	CH5242 (MLS)	EH5240
Cruze 1.8	05/09→	1796	4	80.50	DOHC	102-104/ 139-141			
Cruze 1.8 LPG	06/11→								
Orlanda 1.8	02/11→								
Orlanda 1.8 LPG	06/11→								
1.8	F18D3					23	BY240 (Fibre)		EC102
Lacetti 1.8	08/05→	1796	4	81.60	DOHC	89/121			
Nubira 1.8	08/05→								
1.8	T18SED					24	AH5240 (MLS)	CH5242 (MLS)	EH5240
Lacetti 1.8	03/05→	1799	4	81.60	DOHC	90/122			
Nubira 1.8	03/05→								
Optra 1.8	08/03→12/08								
Optra 1.8 SRV	06/06→								
1.8	Z 18 XE					25	AC5460 (MLS)	CC5460 [3]	
Niva 1.8 4x4	01/07→12/09	1796	4	80.50	DOHC	90-92/ 122-125			
Viva 1.8	09/03→03/08								
Zafira 1.8	07/00→06/05								
2.0	20 NEJ					26	BP820 (Fibre)	DP820 [3]	HC5007
Vectra 2.0	03/96→12/05	1998	4	86.00	SOHC/OHC	81/110			
2.0	C 20 SEL					27	BY250 (Fibre)	DY250 [3]	HC5007
Astra 2.0	08/02→	1998	4	86.00	DOHC	100/136			
Astra 2.0 GLS	08/02→12/11								
Vectra 2.0	03/96→04/98								
Zafira 2.0	04/01→								
2.0	LLW Diesel					28	AH5690 (MLS)	CH5690	
Cruze 2.0 CDI	01/12→	1991	4	83.00	DOHC	92-110/ 125-150			
2.0	T20SED					29	BY250 (Fibre)	DY250 [3]	EC100 [3]
Epica 2.0	01/05→12/06	1998	4	86.00	DOHC	89-98/ 121-133			
Rezzo 2.0	03/05→								
Vivant 2.0 CX	01/05→								
2.0	X 20 SED					30	BY250 (Fibre)	DY250 [3]	EC100 [3]
Evanda 2.0	03/05→	1998	4	86.00	DOHC	89-98/ 121-133			
Optra 2.0	06/99→07/03								
Vivant 2.0	08/00→								
2.0	X 20 XEV					31	BY250 (Fibre)	DY250 [3]	EC130 HC5007
Astra 2.0	03/99→07/02	1998	4	86.00	DOHC	94/128			
Astra 2.0 GLS	03/99→07/02								
Epica 2.0	01/05→12/06								

HBS055 [5] M10x1.25x153.00mm (x10)					<input checked="" type="checkbox"/> NC006 [2] 35.00x48.00x7.00mm, MVQ <input checked="" type="checkbox"/> NA5174 [2] 31.50x42.00x7.00mm, FPM	NA5174 [2][10]	AC5460 BP820 BY240 BY250 JC282 JC756 JD451 JD5196 JD5197 JE120 JM5092 JN693 JP016 JJ459 JJ615 JJ616 JJ617	JJ617	
	JD451 [1]	JP016 [4]	HR397	HR791 [3] (x1)	<input checked="" type="checkbox"/> NC006 [2] 35.00x48.00x7.00mm, MVQ <input checked="" type="checkbox"/> NB700 [2] 31.00x50.00x8.00mm, MVQ <input checked="" type="checkbox"/> NB806 [1] 90.00x104.00x11.00mm, FPM				
HBS055 [5] M10x1.25x153.00mm (x10)					<input checked="" type="checkbox"/> NC006 [2] 35.00x48.00x7.00mm, MVQ <input checked="" type="checkbox"/> NA5174 [2] 31.50x42.00x7.00mm, FPM				
HBS055 [5] M10x1.25x153.00mm (x10)	JD5196 [1] JD5197 [1] JE120	JM5092 (Elastomer)		PA5025 (x16) HR5048 [3] (x1)	<input checked="" type="checkbox"/> NC006 (x2) [2] 35.00x48.00x7.00mm, MVQ <input checked="" type="checkbox"/> NA5174 [2] 31.50x42.00x7.00mm, FPM <input checked="" type="checkbox"/> NB698 [1] 80.00x98.00x10.00mm, FPM	NA5174 [2][10]			
HBS053 [5] M11x1.25x140.00mm (x10)	JC756 [1] JC282 [1] JE120	JN693 [4]	JJ616 [2] JJ617 [2]	HR342 [3]	<input checked="" type="checkbox"/> NC006 [2] 35.00x48.00x7.00mm, MVQ <input checked="" type="checkbox"/> NB700 [2] 31.00x50.00x8.00mm, MVQ <input checked="" type="checkbox"/> NB806 [1] 90.00x104.00x11.00mm, FPM				
HBS054 [5] M11x1.25x105.00mm (x10)	JD451 [1] JD5300 [1] (MLS) JE120	JP016 [4]	JJ616 [2] JJ617 [2]	PA5041 (x16) 6.00/12.20x10.00 (FPM) HR791 [3]	<input checked="" type="checkbox"/> NC006 [2] 35.00x48.00x7.00mm, MVQ <input checked="" type="checkbox"/> NB700 [2] 31.00x50.00x8.00mm, MVQ <input checked="" type="checkbox"/> NB806 [1] 90.00x104.00x11.00mm, FPM				
		JM7115 (NBR)							
HBS054 [5] M11x1.25x105.00mm (x10)	JD451 [1] JD5300 [1] (MLS)	JP016 [4]	JJ459 JJ616 [2] JJ617 [2]	HR791 [3]	<input checked="" type="checkbox"/> NC006 [2] 35.00x48.00x7.00mm, MVQ <input checked="" type="checkbox"/> NB700 [2] 31.00x50.00x8.00mm, MVQ <input checked="" type="checkbox"/> NB806 [1] 90.00x104.00x11.00mm, FPM				
HBS054 [5] M11x1.25x105.00mm (x10)	JD451 [1] JD5300 [1] (MLS)	JP016 [4]	JJ459 JJ616 [2] JJ617 [2]	HR791 [3]	<input checked="" type="checkbox"/> NC006 [2] 35.00x48.00x7.00mm, MVQ <input checked="" type="checkbox"/> NB700 [2] 31.00x50.00x8.00mm, MVQ <input checked="" type="checkbox"/> NB806 [1] 90.00x104.00x11.00mm, FPM				
HBS054 [5] M11x1.25x105.00mm (x10)	JD451 [1] JD5300 [1] (MLS) JE120	JP016 [4]	JJ615 JJ616 [2] JJ617 [2]	PA5041 (x16) 6.00/12.20x10.00 (FPM) HR791 [3] (x1)	<input checked="" type="checkbox"/> NC006 (x2) [2] 35.00x48.00x7.00mm, MVQ <input checked="" type="checkbox"/> NB700 [2] 31.00x50.00x8.00mm, MVQ <input checked="" type="checkbox"/> NB806 [1] 90.00x104.00x11.00mm, FPM				

CHEVROLET



cc



kW/PS



2.0		Y 20 DTH Diesel			32		AB5670 (MLS), 1.300mm, 1 Notch AB5680 (MLS), 1.400mm, 2 Notches		CB5670 ▲ [13]	EB5670 [3]
Astra 2.0 DTi	08/02→12/11	1995	4	84.00	SOHC/OHC	74/101				
2.0		Z 20 DM Diesel			33		AH5690 (MLS) AH5700 (MLS), 1.200mm, 2 Holes AH5710 (MLS), 1.300mm, 3 Holes		CH5690	
Lacetti 2.0 D	01/07→	1991	4	83.00	DOHC	89/121				
Nubira 2.0 D	01/07→									
2.0		Z 20 S Diesel			34		AH5690 (MLS) AH5700 (MLS), 1.200mm, 2 Holes AH5710 (MLS), 1.300mm, 3 Holes		CH5690	
Captiva	10/06→	1991	4	83.00	DOHC	89-110/ 121-150				
Epica 2.0 D	01/07→									
Nubira 2.0 D	01/05→									
2.0		Z 20 S1 Diesel			35		AH5690 (MLS) AH5700 (MLS), 1.200mm, 2 Holes AH5710 (MLS), 1.300mm, 3 Holes		CH5690	
Cruze 2.0 CDI	05/09→	1991	4	83.00	DOHC	92-110/ 125-150				
2.2		Z 22 SE			36		AG9580 (MLS)		CG9580	
Vectra 2.2	04/02→04/04	2198	4	86.00	DOHC	108/147				
2.2		Z 22 YH			37		AG9590 (MLS)		CG9590	
Vectra 2.2	01/05→07/06	2198	4	86.00	DOHC	110-114/ 150-155				
Zafira 2.2	07/05→									

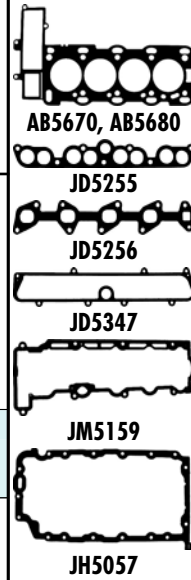

HBS036 [22] M12x1.50x102.00mm (x10)	JD5347 [1] [2] JD5255 [1] [2] JD5256 [2]	JM5159 (SE)	JH5057	PA5041 (x16) 6.00/12.20x10.00 (FPM) HR791 [2]	<input checked="" type="checkbox"/> NA5069 [2] 55.00x68.00x8.00mm, FPM <input checked="" type="checkbox"/> NA5069 [2] 55.00x68.00x8.00mm, FPM <input checked="" type="checkbox"/> NA5209 [1] 99.00x114.00x11.00mm, FPM <input checked="" type="checkbox"/> NB469 [1] 77.00x100.00x11.50mm, FPM	
		JM7115 (NBR)				
		JM7115 (NBR)				
		JM7115 (NBR)				
HBS416 [22] M11x1.50x163.00mm (x10)	KG5337 [1] (MVQ) JD5868 [2]	JM7102 (Elastomer) HM5300 [2] (NBR)			<input checked="" type="checkbox"/> NC006 [2] 35.00x48.00x7.00mm, MVQ <input checked="" type="checkbox"/> NA5108 [2] 42.00x55.00x7.00mm, FPM/ACM <input checked="" type="checkbox"/> NB806 [1] 90.00x104.00x11.00mm, FPM	
HBS416 [22] M11x1.50x163.00mm (x10)	JD5869 [1] [2] (x3) JD5870 [1] [2] (x1) JD5868 [2]	JM7102 (Elastomer)	HR397		<input checked="" type="checkbox"/> NA5108 [2] 42.00x55.00x7.00mm, FPM/ACM <input checked="" type="checkbox"/> NB806 [1] 90.00x104.00x11.00mm, FPM	



Ltr



CC



9

	Ltr				CC		
CIRRUS	2.0	09/00→04/00	ECC	Petrol	1996	4	10
CIRRUS	2.4	05/99→09/00	EDZ	Petrol	2429	4	12
CROSSFIRE Roadster	3.2	05/00→12/00	EGX	Petrol	3199	6	19
CROSSFIRE Roadster	3.2	09/00→12/00	EGZ	Petrol	3199	6	20
CROSSFIRE	3.2	07/00→12/00	EGX	Petrol	3199	6	19
CROSSFIRE	3.2	09/00→12/00	EGZ	Petrol	3199	6	20
DELTA	1.4	08/01→	198 A4.000	Petrol	1368	4	2
DELTA	1.4	08/01→	198 A7.000	Petrol	1368	4	3
DELTA	1.6	08/01→	198 A2.000	Diesel	1598	4	4
LE BARON Convertible	3.0	01/99→12/99	6G72	Petrol	2972	6	17
NEON (PL)	1.8	09/99→08/99	EBD	Petrol	1796	4	6
NEON (PL)	2.0	05/99→08/99	420H	Petrol	1996	4	7
NEON (PL)	2.0	06/99→08/99	ECC	Petrol	1996	4	10
NEON II	1.6	11/00→12/00	EJD	Petrol	1598	4	5
NEON II	1.8	01/00→	EBD	Petrol	1796	4	6
NEON II	2.0	08/99→12/00	420H	Petrol	1996	4	7
PT CRUISER (PT_)	1.6	11/00→12/01	EJD	Petrol	1598	4	5
PT CRUISER (PT_)	2.0	06/00→12/01	ECC	Petrol	1996	4	10
PT CRUISER (PT_)	2.2	03/00→12/01	EDJ	Diesel	2148	4	11
PT CRUISER (PT_)	2.4	06/00→12/01	EDZ	Petrol	2429	4	12
PT CRUISER Convertible	2.4	03/00→03/00	EDZ	Petrol	2429	4	12
SARATOGA	3.0	09/98→12/99	6G72	Petrol	2972	6	17
SEBRING (JR)	2.0	04/00→06/00	ECC	Petrol	1996	4	10
SEBRING (JR)	2.4	04/00→06/00	EDZ	Petrol	2429	4	12
SEBRING Convertible (JR)	2.0	04/00→06/00	ECC	Petrol	1996	4	10
SEBRING Convertible (JR)	2.4	04/00→06/00	EDZ	Petrol	2429	4	12
STRATUS (JA)	2.0	12/99→04/00	COO	Petrol	1995	4	9
STRATUS (JA)	2.4	12/99→	EDZ	Petrol	2429	4	12
STRATUS Convertible (JX)	2.0	06/99→04/00	420X	Petrol	1996	4	8
VOYAGER I (AS)	3.3	10/98→09/99	EGA	Petrol	3301	6	21
VOYAGER II (ES)	2.5	01/99→09/99	09B	Diesel	2500	4	13
VOYAGER II (ES)	2.5	01/99→09/99	M00	Diesel	2500	4	16
VOYAGER II (ES)	3.0	01/99→09/99	300	Petrol	2972	6	18
VOYAGER II (ES)	3.0	01/99→09/99	6G72	Petrol	2972	6	17
VOYAGER II (ES)	3.3	08/99→09/99	EGA	Petrol	3301	6	21
VOYAGER II (ES)	3.3	08/99→09/99	ROO	Petrol	3301	6	22
VOYAGER III (GS)	2.0	01/99→03/00	COO	Petrol	1995	4	9
VOYAGER III (GS)	2.4	02/99→03/00	EDZ	Petrol	2429	4	12
VOYAGER III (GS)	2.5	01/99→03/00	425 CLIRS/X	Diesel	2499	4	14
VOYAGER III (GS)	2.5	01/99→03/00	ENC	Diesel	2499	4	15
VOYAGER III (GS)	3.3	01/99→03/00	ROO	Petrol	3301	6	22
VOYAGER IV (RG, RS)	2.4	02/00→12/00	EDZ	Petrol	2429	4	12
VOYAGER IV (RG, RS)	2.5	02/00→12/00	ENC	Diesel	2499	4	15
VOYAGER IV (RG, RS)	3.3	02/00→12/00	EGA	Petrol	3301	6	21
YPSILON	1.2	05/01→	169 A4.000	Petrol	1242	4	1



cc



kW/PS



Model	Year	CC	Cyls	Power (kW/PS)	Configuration	Code	Part No.	Accessories
1.2 Ypsilon 1.2	05/11→	1242	4	70.80	SOHC/OHC	1	AG7380 (MLS)	CG7380
1.4 Delta 1.4	08/11→	1368	4	72.00	DOHC	2	AH6510 (MLS)	
1.4 Delta 1.4 16V	08/11→	1368	4	72.00	DOHC	3	AH6510 (MLS)	
1.6 Delta 1.6 DMtj	08/11→	1598	4	79.50	DOHC	4	AH6880 (MLS), 0.82mm AH6890 (MLS), 0.92mm, 1 Hole	
1.6 Neon II 1.6 PT cruiser 1.6	11/01→12/06 11/01→12/10	1598	4	77.00	SOHC/OHC	5	AC5920 (MLS), 0.650mm	CC5920 [3] EC5921
1.8 Neon 1.8 16V Neon II 1.8	09/97→08/99 01/00→	1796	4	83.00	SOHC/OHC	6	AC5550 (MLS)	CC5550 [3]
2.0 Neon T 114 G/340 Neon II 2.0 16V	05/94→08/99 08/99→12/06	1996	4	87.50	SOHC/OHC	7	AC5550 (MLS)	CC5550 [3]
2.0 Stratus 2.0 LE	06/96→04/01	1996	4	87.50	SOHC/OHC	8	AC5550 (MLS)	CC5550 [3]
2.0 Stratus 2.0 LE Voyager III	12/95→04/01 01/95→03/01	1995	4		SOHC/OHC	9	AC5550 (MLS)	CC5550 [3]
2.0 Cirrus 2.0 Neon T 114 G/340 PT cruiser 2.0 Sebring 2.0	09/00→04/07 06/94→08/99 06/00→12/10 04/01→06/07	1996	4	87.50	DOHC	10	AC5560 (MLS) →12/01 AC5720 (MLS) 01/02→	CC5562 [3] →12/01 CC5720 ○ [3] 01/02→
2.1 PT cruiser CRD	03/02→12/10	2148	4	88.00	DOHC	11	AC5620 (MLS), 1.200mm	EC5620 [3]
2.4 Cirrus 2.4 LX PT cruiser 2.4 Sebring 2.4 Stratus 2.4 16 V Stratus 2.4 16V Voyager III 2.4 Voyager IV 2.4	05/94→09/00 06/00→12/10 04/01→06/07 12/95→04/01 12/95→ 02/97→03/01 02/00→12/08	2429	4	87.50	DOHC	12	AC5570 (MLS)	
2.5 Voyager II	01/92→09/95	2500	4			13	BK570 (Fibre), 1.420mm, 0 Notches BP260 (Fibre), 1.520mm, 2 Notches BK580 (Fibre), 1.620mm, 1 Notch	DK570 ▲ GK572 ▲ [18]

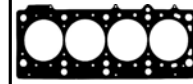
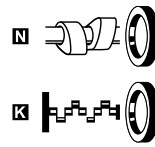
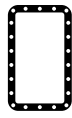

AC5550

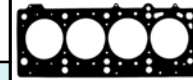

AC5560



AC5570



AC5620



AC5720



AC5920



BK570, BP260,
BK580



JD5144



JD5375



JD5380

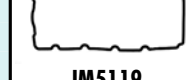

JM5119



JP068

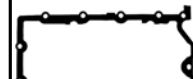

JH5051

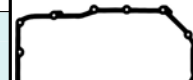

JH5060

HBS052 [5] M9x1.25x95.00mm (x10)	HA5053 [1] [3] JD5375 [3]	JM7099 [4] (SMG)			NA5057 [2] 27.00x37.00x7.00mm, FPM	
					NA5057 [2] 27.00x37.00x7.00mm, FPM	
					NA5057 [2] 27.00x37.00x7.00mm, FPM	
HBS496 [22] [22]	JD5826 [1] (Elastomer) JD5827 [3] (SE)	JM5119 (Elastomer)	JH5051		NA5139 [2] 32.00x45.00x6.00mm, FPM NA5140 [1] 91.00x111.00x10.00mm, FPM	
HBS391 [22] [22]		HM5225 [3]	JH5060	HR5061 [3]	NC006 [2] 35.00x48.00x7.00mm, MVQ NA5139 [2] 32.00x45.00x6.00mm, FPM NA5140 [1] 91.00x111.00x10.00mm, FPM	
HBS391 [22] [22]		HM5225 [3]	JH5060	HR5061 [3]	NC006 [2] 35.00x48.00x7.00mm, MVQ NA5139 [2] 32.00x45.00x6.00mm, FPM NA5140 [1] 91.00x111.00x10.00mm, FPM	
HBS391 [22] [22]		HM5225 [3]	JH5060	HR5061 [3]	NC006 [2] 35.00x48.00x7.00mm, MVQ NA5139 [2] 32.00x45.00x6.00mm, FPM NA5140 [1] 91.00x111.00x10.00mm, FPM	
HBS391 [22] [22]		HM5225 [3]	JH5060	HR5061 [3]	NC006 [2] 35.00x48.00x7.00mm, MVQ NA5139 [2] 32.00x45.00x6.00mm, FPM NA5140 [1] 91.00x111.00x10.00mm, FPM	
			JH5060	HR5061 [3]	NC006 [2] 35.00x48.00x7.00mm, MVQ NA5139 [2] 32.00x45.00x6.00mm, FPM NA5140 [1] 91.00x111.00x10.00mm, FPM	
HBS292 [19] M12x1.75x102.00mm (x10)	JD5380 [3] (MLS)				NA5131 [2] 45.00x67.00x8.00mm, PTFE NA5074 [1] 93.00x133.50x15.50mm, PTFE	KA5036 [15]
HBS279 [22] M11x1.50x109.00mm (x4)		JM5119 (Elastomer)	JH5060	HR5061 [3]	NC006 (x2) [2] 35.00x48.00x7.00mm, MVQ NA5139 [2] 32.00x45.00x6.00mm, FPM NA5140 [1] 91.00x111.00x10.00mm, FPM	
HBS108 [12] M14x1.75x137.00mm (x10)	JD5144	JP068 [4]				



cc



kW/PS



2.5	425 CLIRS/X Diesel	14										
Voyager III	01/95→03/01	2499	4	92.00	OHV	85/116	AY400 (MLS), 1.420mm, 0 Notches	DK573 ▲	GK573 ▲ [3] [18]			
							AY410 (MLS), 1.520mm, 2 Notches					
							AY420 (MLS), 1.620mm, 1 Notch					
2.5	ENC Diesel	15										
Voyager III	01/95→03/01	2499	4	92.00	OHV	85-105/	AG9660 (MLS), 1.320mm	CG9660 ▲	EG9660			
Voyager IV	02/00→12/08					116-141	AG9670 (MLS), 1.420mm		FG9660 ▲			
							AG9680 (MLS), 1.520mm					
2.5	M00 Diesel	16										
Voyager II	01/92→09/95	2500	4			85-87/	BK570 (Fibre), 1.420mm, 0 Notches	DK570 ▲	GK572 ▲ [18]			
						116-118	BP260 (Fibre), 1.520mm, 2 Notches					
							BK580 (Fibre), 1.620mm, 1 Notch					
3.0	6G72	17										
Le Baron 3.0 i	01/90→12/96	2972	6	91.10	SOHC/OHC, V	105-108/	BR600 (Graphite)	DR600 [3]	GR600 [3]			
Saratoga 3.0	09/89→12/95					143-147						
Voyager II 3.0 i	01/91→09/95											
3.0	300	18										
Voyager II 3.0 i	01/91→09/95	2972	6			108/147	BR600 (Graphite)	DR600 [3]	GR600 [3]			
3.2	EGX	19										
Crossfire 3.2	07/03→12/07	3199	6	89.90	V	160/218	AE5750 (MLS) ☒	CE5760 ☒☒				
Crossfire R	05/04→12/07						AE5760 (MLS) ☒					
3.2	EGZ	20										
Crossfire SRT-6	09/04→12/07	3199	6	89.90	DOHC, V	243-246/	AE5750 (MLS) ☒	CE5760 ☒☒				
Crossfire R	09/04→12/07					330-335	AE5760 (MLS) ☒					
3.3	EGA	21										
Voyager I 3.3	10/89→09/90	3301	6	93.00	OHV, V	110-128/	AC5590 (Fibre) ☒	CC5580				
Voyager II	08/90→09/95					150-174	AC5580 (Fibre) ☒					
Voyager II 3.3 i	08/90→09/95											
Voyager IV	02/00→12/08											
Voyager IV 3.3	02/00→12/08											
3.3	R00	22										
Voyager II	08/90→09/95	3301	6			116-120/	AC5590 (Fibre) ☒	CC5580				
Voyager III	01/95→03/01					156-163	AC5580 (Fibre) ☒					

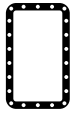
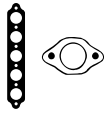

AC5580



AE5750



AY400, AY410,
AY420



BK570, BP260,
BK580



BR600



JD5144

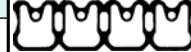

JP068

HBS108 [12]
M14x1.75x137.00mm (x10)

JD5144

JP068 [4]

HBS108 [12]
M14x1.75x137.00mm (x10)

JD5875
(MLS)

JM7049
(SE)

HBS108 [12]
M14x1.75x137.00mm (x10)

JD5144

JP068 [4]

HBS402 [5]
M12x1.25x102.00mm (x16)
01/90→

NJ933 [2]
35.00x50.00x8.00mm, FPM
 NJ874 [2]
37.00x50.00x6.00mm, ACM

HBS402 [5]
M12x1.25x102.00mm (x16)

NJ874 [2]
37.00x50.00x6.00mm, ACM

NA5131 [2]
45.00x67.00x8.00mm, PTFE
 NA5168 [1]
93.00x114.00x11.50mm, PTFE

NA5131 [2]
45.00x67.00x8.00mm, PTFE
 NA5168 [1]
93.00x114.00x11.50mm, PTFE

HBS503 [22]

HBS503 [22]



Ltr







CC



9

Model	Ltr	Year	Engine	Fuel	CC	Seats	Index
2 CV	0.6	08/97→07/99	A06/664	Petrol	602	2	1
AX (ZA-)	1.0	09/98→06/99	C1A	Petrol	954	4	4
AX (ZA-)	1.0	12/98→12/98	C3A	Petrol	954	4	5
AX (ZA-)	1.0	07/98→12/99	CDY (TU9M)	Petrol	954	4	6
AX (ZA-)	1.0	02/98→12/99	CDZ (TU9M)	Petrol	954	4	7
AX (ZA-)	1.1	12/98→04/99	H1A	Petrol	1124	4	12
AX (ZA-)	1.1	09/98→12/99	H1B	Petrol	1124	4	13
AX (ZA-)	1.1	09/98→12/98	HAZ (TU1CP)	Petrol	1124	4	14
AX (ZA-)	1.1	09/98→12/99	HDZ (TU1M)	Petrol	1124	4	15
AX (ZA-)	1.3	04/98→12/98	M4A	Petrol	1294	4	19
AX (ZA-)	1.4	06/98→12/98	K1F	Petrol	1360	4	30
AX (ZA-)	1.4	09/98→12/99	K2A	Petrol	1360	4	32
AX (ZA-)	1.4	01/98→12/99	K2B	Petrol	1360	4	33
AX (ZA-)	1.4	09/98→07/99	K9A (TUD3)	Diesel	1360	4	35
AX (ZA-)	1.4	08/99→12/99	K9Y (TUD3Y)	Diesel	1360	4	36
AX (ZA-)	1.4	12/98→12/98	KAY (TU3CP)	Petrol	1360	4	37
AX (ZA-)	1.4	04/98→04/99	KDX (TU3M/Z)	Petrol	1360	4	38
AX (ZA-)	1.4	04/98→04/99	KDY (TU3FM)	Petrol	1360	4	39
AX (ZA-)	1.4	04/98→04/99	KDY (TU3M)	Petrol	1360	4	40
AX (ZA-)	1.4	04/98→04/99	KDZ (TU3M/Z)	Petrol	1360	4	41
AX (ZA-)	1.4	08/99→12/99	KFY (TU3FJ2)	Petrol	1360	4	48
AX (ZA-)	1.4	06/99→12/99	KFZ (TU3FJ2)	Petrol	1360	4	49
AX (ZA-)	1.5	08/99→12/99	VJY (TUD5)	Diesel	1527	4	50
AX (ZA-)	1.5	08/99→12/99	VJZ (TUD5)	Diesel	1527	4	51
AXEL	1.1	01/98→03/99	G11/631	Petrol	1129	4	11
BERLINGO (MF)	1.1	07/99→	HDZ (TU1M)	Petrol	1124	4	15
BERLINGO (MF)	1.1	07/99→	HFX (TU1JP)	Petrol	1124	4	16
BERLINGO (MF)	1.4	07/99→	KFW (TU3JP)	Petrol/Electro	1360	4	46
BERLINGO (MF)	1.4	07/99→	KFW (TU3JP)	Petrol	1360	4	46
BERLINGO (MF)	1.4	07/99→	KFW (TU3JP)	Gas	1360	4	46
BERLINGO (MF)	1.4	07/99→	KFW (TU3JP)	Bi-Fuel	1360	4	46
BERLINGO (MF)	1.4	07/99→	KFX (TU3JP)	Petrol	1360	4	47
BERLINGO (MF)	1.6	07/00→	9HW (DV6ATED)	Diesel	1560	4	64
BERLINGO (MF)	1.6	07/00→	9HX (DV6ATED4)	Diesel	1560	4	65
BERLINGO (MF)	1.6	08/00→	9HZ (DV6ATED4)	Diesel	1560	4	67
BERLINGO (MF)	1.6	07/00→	DV6B	Diesel	1560	4	84
BERLINGO (MF)	1.6	10/00→	NFU (TU5JP4)	Petrol	1587	4	88
BERLINGO (MF)	1.6	10/00→	NFU (TU5JP4)	Flexfuel	1587	4	88
BERLINGO (MF)	1.8	07/99→	A9A (XUD7)	Diesel	1769	4	99
BERLINGO (MF)	1.8	04/99→	LFX (XU7JB)	Petrol	1761	4	101
BERLINGO (MF)	1.9	07/99→	D9B (XUD9A/L)	Diesel	1905	4	114
BERLINGO (MF)	1.9	07/99→	DJY (XUD9A)	Diesel	1905	4	123
BERLINGO (MF)	1.9	07/99→	WJY (DW8B)	Diesel	1868	4	126
BERLINGO (MF)	1.9	07/99→	WJZ (DW8)	Diesel	1868	4	127
BERLINGO (MF)	2.0	12/99→	RHY (DW10TD)	Diesel	1997	4	162
BERLINGO Box (M_)	1.1	07/99→	HDZ (TU1M)	Petrol	1124	4	15
BERLINGO Box (M_)	1.1	07/99→	HFX (TU1JP)	Petrol	1124	4	16
BERLINGO Box (M_)	1.4	07/99→	KFW (TU3JP)	Petrol/Electro	1360	4	46
BERLINGO Box (M_)	1.4	07/99→	KFW (TU3JP)	Petrol	1360	4	46
BERLINGO Box (M_)	1.4	07/99→	KFW (TU3JP)	Gas	1360	4	46
BERLINGO Box (M_)	1.4	07/99→	KFW (TU3JP)	Bi-Fuel	1360	4	46
BERLINGO Box (M_)	1.4	07/99→	KFX (TU3JP)	Petrol	1360	4	47
BERLINGO Box (M_)	1.6	07/00→	9HW (DV6ATED)	Diesel	1560	4	64
BERLINGO Box (M_)	1.6	07/00→	9HX (DV6ATED4)	Diesel	1560	4	65
BERLINGO Box (M_)	1.6	07/00→	DV6B	Diesel	1560	4	84
BERLINGO Box (M_)	1.6	10/00→	NFU (TU5JP4)	Petrol	1587	4	88
BERLINGO Box (M_)	1.6	10/00→	NFU (TU5JP4)	Flexfuel	1587	4	88
BERLINGO Box (M_)	1.8	07/99→	A9A (XUD7)	Diesel	1769	4	99
BERLINGO Box (M_)	1.8	08/99→10/00	LFX (XU7JB)	Petrol	1761	4	101
BERLINGO Box (M_)	1.9	07/99→	DJY (XUD9A)	Diesel	1905	4	123
BERLINGO Box (M_)	1.9	07/99→	WJY (DW8B)	Diesel	1868	4	126
BERLINGO Box (M_)	1.9	07/99→	WJZ (DW8)	Diesel	1868	4	127
BERLINGO Box (M_)	2.0	12/99→	RHY (DW10TD)	Diesel	1997	4	162
BERLINGO Box	1.6	07/01→	5FK (EP6CB)	Petrol	1598	4	52
BERLINGO Box	1.6	11/00→	5FS (EP6C)	Petrol/Petroleum Gas (LPG)	1598	4	54
BERLINGO Box	1.6	11/00→	5FS (EP6C)	Petrol	1598	4	54
BERLINGO Box	1.6	07/01→	9HR (DV6C)	Diesel	1560	4	60
BERLINGO Box	1.6	04/00→	9HT (DV6BUTED4)	Diesel	1560	4	62
BERLINGO Box	1.6	04/00→	9HX (DV6ATED4)	Diesel	1560	4	65
BERLINGO Box	1.6	04/00→	9HZ (DV6ATED4)	Diesel	1560	4	67

	Ltr				CC		9
BERLINGO Box	1.6	04/00 →	NFR (TU5JP4B)	Petrol	1587	4	85
BERLINGO Box	1.6	04/00 →	NFU (TU5JP4)	Petrol	1587	4	88
BERLINGO Box	1.6	04/00 →	NFU (TU5JP4)	Flexfuel	1587	4	88
BERLINGO	1.4	03/00 →	KFW (TU3JP)	Petrol/Electro	1360	4	46
BERLINGO	1.4	03/00 →	KFW (TU3JP)	Petrol	1360	4	46
BERLINGO	1.4	03/00 →	KFW (TU3JP)	Gas	1360	4	46
BERLINGO	1.4	03/00 →	KFW (TU3JP)	Bi-Fuel	1360	4	46
BERLINGO	1.6	07/01 →	5FK (EP6CB)	Petrol	1598	4	52
BERLINGO	1.6	11/00 →	5FS (EP6C)	Petrol/Petroleum Gas (LPG)	1598	4	54
BERLINGO	1.6	11/00 →	5FS (EP6C)	Petrol	1598	4	54
BERLINGO	1.6	07/01 →	9HR (DV6C)	Diesel	1560	4	60
BERLINGO	1.6	04/00 →	9HT (DV6BTED4)	Diesel	1560	4	61
BERLINGO	1.6	04/00 →	9HX (DV6ATED4)	Diesel	1560	4	65
BERLINGO	1.6	04/00 →	9HZ (DV6TED4)	Diesel	1560	4	67
BERLINGO	1.6	04/00 →	NFR (TU5JP4B)	Petrol	1587	4	85
BERLINGO	1.6	04/00 →	NFU (TU5JP4)	Petrol	1587	4	88
BERLINGO	1.6	04/00 →	NFU (TU5JP4)	Flexfuel	1587	4	88
BX (XB-)	1.1	10/98 → 06/99	H1A	Petrol	1124	4	12
BX (XB-)	1.1	10/98 → 06/99	HDZ (TU1M)	Petrol	1124	4	15
BX (XB-)	1.4	01/98 → 12/98	K1H (TU3A)	Petrol	1360	4	31
BX (XB-)	1.4	01/98 → 02/99	KDY (TU3M)	Petrol	1360	4	40
BX (XB-)	1.4	01/98 → 02/99	KDZ (TU3M/Z)	Petrol	1360	4	41
BX (XB-)	1.6	10/98 → 06/98	171A	Petrol	1580	4	68
BX (XB-)	1.6	10/98 → 06/98	171B	Petrol	1580	4	69
BX (XB-)	1.6	10/98 → 06/98	171C	Petrol	1580	4	70
BX (XB-)	1.6	07/98 → 02/99	171D	Petrol	1580	4	71
BX (XB-)	1.6	03/98 → 02/99	180Z	Petrol	1580	4	72
BX (XB-)	1.6	09/98 → 02/99	B1A (XU51C/K)	Petrol	1580	4	75
BX (XB-)	1.6	01/98 → 02/99	B1E (XU51C)	Petrol	1580	4	76
BX (XB-)	1.6	01/98 → 01/99	B6D	Petrol	1580	4	77
BX (XB-)	1.6	01/98 → 01/99	B6E	Petrol	1580	4	78
BX (XB-)	1.6	09/98 → 02/99	BAY (XU5CP)	Petrol	1580	4	79
BX (XB-)	1.6	09/98 → 02/99	BAZ (XU5CP)	Petrol	1580	4	80
BX (XB-)	1.6	05/98 → 02/99	BDY (XU5M)	Petrol	1580	4	81
BX (XB-)	1.6	05/98 → 02/99	BDZ (XU5M)	Petrol	1580	4	82
BX (XB-)	1.6	10/98 → 12/99	XU52C	Petrol	1580	4	92
BX (XB-)	1.8	10/98 → 09/99	161 (XUD7)	Diesel	1769	4	95
BX (XB-)	1.8	03/98 → 02/99	A8A (XUD7TE)	Diesel	1769	4	98
BX (XB-)	1.8	03/98 → 02/99	AJZ (XUD7TE)	Diesel	1769	4	100
BX (XB-)	1.9	07/98 → 05/98	159A	Petrol	1905	4	104
BX (XB-)	1.9	09/98 → 09/99	162 (XUD9)	Diesel	1905	4	105
BX (XB-)	1.9	07/98 → 05/98	D2A (XU92C)	Petrol	1905	4	106
BX (XB-)	1.9	09/98 → 11/98	D2C (XU92C)	Petrol	1905	4	107
BX (XB-)	1.9	04/98 → 02/99	D2F	Petrol	1905	4	108
BX (XB-)	1.9	07/98 → 02/99	D6A (XU9J2)	Petrol	1905	4	109
BX (XB-)	1.9	09/98 → 12/98	D6C (XU9J4)	Petrol	1905	4	110
BX (XB-)	1.9	09/98 → 09/99	D9A (XUD9)	Diesel	1905	4	113
BX (XB-)	1.9	03/98 → 02/99	D9B (XUD9A/U)	Diesel	1905	4	115
BX (XB-)	1.9	06/98 → 02/99	DDZ (XU9M)	Petrol	1905	4	116
BX (XB-)	1.9	03/98 → 02/99	DFW (XU9J4)	Petrol	1905	4	117
BX (XB-)	1.9	09/98 → 09/99	DJZ (XUD9Y)	Diesel	1905	4	124
BX (XB-)	1.9	06/98 → 02/99	DKZ (XU9JA)	Petrol	1905	4	125
BX Break (XB-)	1.4	01/98 → 12/98	K1H (TU3A)	Petrol	1360	4	31
BX Break (XB-)	1.4	01/98 → 02/99	KDY (TU3M)	Petrol	1360	4	40
BX Break (XB-)	1.6	06/98 → 06/98	171A	Petrol	1580	4	68
BX Break (XB-)	1.6	06/98 → 06/98	171B	Petrol	1580	4	69
BX Break (XB-)	1.6	04/98 → 01/99	171C	Petrol	1580	4	70
BX Break (XB-)	1.6	07/98 → 12/99	171D	Petrol	1580	4	71
BX Break (XB-)	1.6	03/98 → 12/99	180Z	Petrol	1580	4	72
BX Break (XB-)	1.6	10/98 → 12/99	B1E (XU51C)	Petrol	1580	4	76
BX Break (XB-)	1.6	01/98 → 01/99	B6D	Petrol	1580	4	77
BX Break (XB-)	1.6	01/98 → 01/99	B6E	Petrol	1580	4	78
BX Break (XB-)	1.6	09/98 → 12/99	BAY (XU5CP)	Petrol	1580	4	79
BX Break (XB-)	1.6	09/98 → 12/99	BAZ (XU5CP)	Petrol	1580	4	80
BX Break (XB-)	1.6	05/98 → 12/99	BDY (XU5M)	Petrol	1580	4	81
BX Break (XB-)	1.6	05/98 → 12/99	BDZ (XU5M)	Petrol	1580	4	82
BX Break (XB-)	1.8	10/98 → 09/99	161A (XUD7)	Diesel	1769	4	96
BX Break (XB-)	1.8	03/98 → 12/99	A8A (XUD7TE)	Diesel	1769	4	98
BX Break (XB-)	1.8	03/98 → 12/99	AJZ (XUD7TE)	Diesel	1769	4	100
BX Break (XB-)	1.9	09/98 → 11/99	162 (XUD9)	Diesel	1905	4	105



Ltr







CC



9

Model	Ltr	Year Range	Engine	Fuel	CC	Seats	Price
BX Break (XB-)	1.9	07/98→12/99	D2A (XU92C)	Petrol	1905	4	106
BX Break (XB-)	1.9	12/98→12/98	D2C (XU92C)	Petrol	1905	4	107
BX Break (XB-)	1.9	02/99→12/99	D6A (XU9J2)	Petrol	1905	4	109
BX Break (XB-)	1.9	09/98→11/99	D9A (XUD9)	Diesel	1905	4	113
BX Break (XB-)	1.9	03/98→12/99	D9B (XUD9A/U)	Diesel	1905	4	115
BX Break (XB-)	1.9	06/98→12/99	DDZ (XU9M)	Petrol	1905	4	116
BX Break (XB-)	1.9	07/98→12/99	DFZ (XU9J1)	Petrol	1905	4	118
BX Break (XB-)	1.9	09/98→11/99	DJZ (XUD9Y)	Diesel	1905	4	124
BX Break (XB-)	1.9	06/98→12/99	DKZ (XU9JA)	Petrol	1905	4	125
C1 (PM_, PN_)	1.0	06/00→	1KR-FE	Petrol	998	3	3
C1 (PM_, PN_)	1.4	06/00→	DV4D	Diesel	1398	4	29
C2 (JM_)	1.1	09/00→	HFX (TU1JP)	Petrol	1124	4	16
C2 (JM_)	1.4	09/00→	8HX (DV4TD)	Diesel	1398	4	24
C2 (JM_)	1.4	06/00→	KFU (ET3J4)	Petrol	1360	4	43
C2 (JM_)	1.4	09/00→	KFV (TU3JP)	Petrol	1360	4	45
C2 (JM_)	1.4	09/00→	KFV (TU3JP)	Bi-Fuel	1360	4	45
C2 (JM_)	1.6	09/00→	9HZ (DV6TED4)	Diesel	1560	4	67
C2 (JM_)	1.6	01/00→	NFS (TU5JP4S)	Petrol	1587	4	86
C2 (JM_)	1.6	09/00→	NFU (TU5JP4)	Petrol	1587	4	88
C2 (JM_)	1.6	09/00→	NFU (TU5JP4)	Flexfuel	1587	4	88
C2 ENTERPRISE	1.4	04/00→	8HX (DV4TD)	Diesel	1398	4	24
C3 I (FC_)	1.1	02/00→	HFX (TU1JP)	Petrol	1124	4	16
C3 I (FC_)	1.4	02/00→	8HX (DV4TD)	Diesel	1398	4	24
C3 I (FC_)	1.4	02/00→	8HY (DV4TED4)	Diesel	1398	4	25
C3 I (FC_)	1.4	12/00→	KFU (ET3J4)	Petrol	1360	4	43
C3 I (FC_)	1.4	02/00→	KFV (TU3JP)	Petrol	1360	4	45
C3 I (FC_)	1.4	02/00→	KFV (TU3JP)	Bi-Fuel	1360	4	45
C3 I (FC_)	1.6	10/00→	9HX (DV6ATED4)	Diesel	1560	4	65
C3 I (FC_)	1.6	09/00→	9HZ (DV6TED4)	Diesel	1560	4	67
C3 I (FC_)	1.6	02/00→	NFU (TU5JP4)	Petrol	1587	4	88
C3 I (FC_)	1.6	02/00→	NFU (TU5JP4)	Flexfuel	1587	4	88
C3 II	1.1	11/00→	HFX (TU1JP)	Petrol	1124	4	16
C3 II	1.4	11/00→	8FP (EP3)	Petrol/Petroleum Gas (LPG)	1397	4	20
C3 II	1.4	11/00→	8FP (EP3)	Petrol	1397	4	20
C3 II	1.4	11/00→	8HR (DV4C)	Diesel	1398	4	22
C3 II	1.4	11/00→	8HZ (DV4TD)	Diesel	1398	4	26
C3 II	1.4	11/00→	KFT (TU3A)	Petrol	1360	4	42
C3 II	1.4	11/00→	KFV (TU3A)	Petrol	1360	4	44
C3 II	1.6	11/00→	5FS (EP6C)	Petrol/Petroleum Gas (LPG)	1598	4	54
C3 II	1.6	11/00→	5FS (EP6C)	Petrol	1598	4	54
C3 II	1.6	11/00→	9HR (DV6C)	Diesel	1560	4	60
C3 II	1.6	11/00→	9HX (DV6ATED4)	Diesel	1560	4	65
C3 Picasso	1.4	02/00→	8FP (EP3)	Petrol/Petroleum Gas (LPG)	1397	4	20
C3 Picasso	1.4	02/00→	8FP (EP3)	Petrol	1397	4	20
C3 Picasso	1.4	02/00→	8FS (EP3)	Petrol	1397	4	21
C3 Picasso	1.6	02/00→	5FS (EP6C)	Petrol/Petroleum Gas (LPG)	1598	4	54
C3 Picasso	1.6	02/00→	5FS (EP6C)	Petrol	1598	4	54
C3 Picasso	1.6	02/00→	5FW (EP6)	Petrol	1598	4	58
C3 Picasso	1.6	05/01→	9HR (DV6C)	Diesel	1560	4	60
C3 Picasso	1.6	02/00→	9HX (DV6ATED4)	Diesel	1560	4	65
C3 Picasso	1.6	02/00→	9HZ (DV6TED4)	Diesel	1560	4	67
C3 Pluriel (HB_)	1.4	04/00→	8HX (DV4TD)	Diesel	1398	4	24
C3 Pluriel (HB_)	1.4	05/00→	KFV (TU3JP)	Petrol	1360	4	45
C3 Pluriel (HB_)	1.4	05/00→	KFV (TU3JP)	Bi-Fuel	1360	4	45
C3 Pluriel (HB_)	1.6	05/00→	NFU (TU5JP4)	Petrol	1587	4	88
C3 Pluriel (HB_)	1.6	05/00→	NFU (TU5JP4)	Flexfuel	1587	4	88
C4 Coupe (LA_)	1.4	11/00→	KFU (ET3J4)	Petrol	1360	4	43
C4 Coupe (LA_)	1.6	07/00→	5FW (EP6)	Petrol	1598	4	58
C4 Coupe (LA_)	1.6	07/00→	5FX (EP6DT)	Petrol	1598	4	59
C4 Coupe (LA_)	1.6	11/00→	9HX (DV6ATED4)	Diesel	1560	4	65
C4 Coupe (LA_)	1.6	11/00→	9HY (DV6TED4)	Diesel	1560	4	66
C4 Coupe (LA_)	1.6	11/00→	9HZ (DV6TED4)	Diesel	1560	4	67
C4 Coupe (LA_)	1.6	11/00→	NFU (TU5JP4)	Petrol	1587	4	88
C4 Coupe (LA_)	1.6	11/00→	NFU (TU5JP4)	Flexfuel	1587	4	88
C4 Coupe (LA_)	2.0	11/00→	RFK (EW10J4S)	Petrol	1997	4	138
C4 Coupe (LA_)	2.0	11/00→	RFN (EW10J4)	Petrol	1997	4	139
C4 Coupe (LA_)	2.0	11/00→	RHR (DW10BTED4)	Diesel	1997	4	155
C4 Grand Picasso I (UA_)	1.6	07/00→	5FT (EP6DT)	Petrol	1598	4	55
C4 Grand Picasso I (UA_)	1.6	09/01→	5FV (EP6CDT)	Petrol	1598	4	56
C4 Grand Picasso I (UA_)	1.6	07/00→	5FW (EP6)	Petrol	1598	4	58

	Ltr				CC		9
C4 Grand Picasso I (UA_)	1.6	10/00 →	5FX (EP6DT)	Petrol	1598	4	59
C4 Grand Picasso I (UA_)	1.6	09/01 →	9HR (DV6C)	Diesel	1560	4	60
C4 Grand Picasso I (UA_)	1.6	10/00 →	9HY (DV6TED4)	Diesel	1560	4	66
C4 Grand Picasso I (UA_)	1.6	10/00 →	9HZ (DV6TED4)	Diesel	1560	4	67
C4 Grand Picasso I (UA_)	1.8	10/00 →	6FY (EW7A)	Petrol	1749	4	93
C4 Grand Picasso I (UA_)	1.8	10/00 →	6FY (EW7A)	Bi-Fuel	1749	4	93
C4 Grand Picasso I (UA_)	2.0	10/00 →	RFJ (EW10A)	Petrol	1997	4	137
C4 Grand Picasso I (UA_)	2.0	10/00 →	RFJ (EW10A)	Flexfuel	1997	4	137
C4 Grand Picasso I (UA_)	2.0	09/01 →	RHH (DW10CTED4)	Diesel	1997	4	151
C4 Grand Picasso I (UA_)	2.0	10/00 →	RHJ (DW10BTED4)	Diesel	1997	4	152
C4 Grand Picasso I (UA_)	2.0	10/00 →	RHR (DW10BTED4)	Diesel	1997	4	155
C4 I (LC_)	1.4	11/00 →	KFU (ET3J4)	Petrol	1360	4	43
C4 I (LC_)	1.6	07/00 →	5FT (EP6DT)	Petrol	1598	4	55
C4 I (LC_)	1.6	07/00 →	5FW (EP6)	Petrol	1598	4	58
C4 I (LC_)	1.6	07/00 →	5FX (EP6DT)	Petrol	1598	4	59
C4 I (LC_)	1.6	11/00 →	9HX (DV6ATED4)	Diesel	1560	4	65
C4 I (LC_)	1.6	11/00 →	9HY (DV6TED4)	Diesel	1560	4	66
C4 I (LC_)	1.6	11/00 →	9HZ (DV6TED4)	Diesel	1560	4	67
C4 I (LC_)	1.6	11/00 →	NFU (TU5JP4)	Petrol	1587	4	88
C4 I (LC_)	1.6	11/00 →	NFU (TU5JP4)	Flexfuel	1587	4	88
C4 I (LC_)	2.0	11/00 →	RFJ (EW10A)	Petrol	1997	4	137
C4 I (LC_)	2.0	11/00 →	RFJ (EW10A)	Flexfuel	1997	4	137
C4 I (LC_)	2.0	11/00 →	RFK (EW10J4S)	Petrol	1997	4	138
C4 I (LC_)	2.0	11/00 →	RFN (EW10J4)	Petrol	1997	4	139
C4 I (LC_)	2.0	11/00 →	RHR (DW10BTED4)	Diesel	1997	4	155
C4 II (B7)	1.4	11/00 →	8FP (EP3)	Petrol/Petroleum Gas (LPG)	1397	4	20
C4 II (B7)	1.4	11/00 →	8FP (EP3)	Petrol	1397	4	20
C4 II (B7)	1.6	11/00 →	5FS (EP6C)	Petrol/Petroleum Gas (LPG)	1598	4	54
C4 II (B7)	1.6	11/00 →	5FS (EP6C)	Petrol	1598	4	54
C4 II (B7)	1.6	11/00 →	5FV (EP6CDT)	Petrol	1598	4	56
C4 II (B7)	1.6	11/00 →	9HR (DV6C)	Diesel	1560	4	60
C4 Picasso I (UD_)	1.6	07/00 →	5FT (EP6DT)	Petrol	1598	4	55
C4 Picasso I (UD_)	1.6	09/01 →	5FV (EP6CDT)	Petrol	1598	4	56
C4 Picasso I (UD_)	1.6	07/00 →	5FW (EP6)	Petrol	1598	4	58
C4 Picasso I (UD_)	1.6	07/00 →	5FX (EP6DT)	Petrol	1598	4	59
C4 Picasso I (UD_)	1.6	09/01 →	9HR (DV6C)	Diesel	1560	4	60
C4 Picasso I (UD_)	1.6	02/00 →	9HY (DV6TED4)	Diesel	1560	4	66
C4 Picasso I (UD_)	1.6	02/00 →	9HZ (DV6TED4)	Diesel	1560	4	67
C4 Picasso I (UD_)	1.8	02/00 →	6FY (EW7A)	Petrol	1749	4	93
C4 Picasso I (UD_)	1.8	02/00 →	6FY (EW7A)	Bi-Fuel	1749	4	93
C4 Picasso I (UD_)	2.0	02/00 →	RFJ (EW10A)	Petrol	1997	4	137
C4 Picasso I (UD_)	2.0	02/00 →	RFJ (EW10A)	Flexfuel	1997	4	137
C4 Picasso I (UD_)	2.0	09/01 →	RHH (DW10CTED4)	Diesel	1997	4	151
C4 Picasso I (UD_)	2.0	02/00 →	RHJ (DW10BTED4)	Diesel	1997	4	152
C4 Picasso I (UD_)	2.0	02/00 →	RHR (DW10BTED4)	Diesel	1997	4	155
C4 Picasso II	1.6	02/01 →	5FS (EP6C)	Petrol/Petroleum Gas (LPG)	1598	4	54
C4 Picasso II	1.6	02/01 →	5FS (EP6C)	Petrol	1598	4	54
C4 Picasso II	1.6	02/01 →	5FV (EP6CDT)	Petrol	1598	4	56
C4 Saloon	1.6	07/00 →	9HY (DV6TED4)	Diesel	1560	4	66
C4 Saloon	1.6	07/00 →	9HZ (DV6TED4)	Diesel	1560	4	67
C4 Saloon	1.6	07/00 →	NFU (TU5JP4)	Petrol	1587	4	88
C4 Saloon	1.6	07/00 →	NFU (TU5JP4)	Flexfuel	1587	4	88
C4 Saloon	2.0	07/00 →	RFJ (EW10A)	Petrol	1997	4	137
C4 Saloon	2.0	07/00 →	RFJ (EW10A)	Flexfuel	1997	4	137
C5 I (DC_)	1.8	03/00 → 08/00	6FZ (EW7J4)	Petrol	1749	4	94
C5 I (DC_)	2.0	03/00 → 08/00	RFN (EW10J4)	Petrol	1997	4	139
C5 I (DC_)	2.0	03/00 → 08/00	RHS (DW10ATED)	Diesel	1997	4	156
C5 I (DC_)	2.0	03/00 → 08/00	RHY (DW10TD)	Diesel	1997	4	162
C5 I (DC_)	2.0	03/00 → 08/00	RHZ (DW10ATED)	Diesel	1997	4	163
C5 I (DC_)	2.0	03/00 → 08/00	RLZ (EW10D)	Petrol	1997	4	164
C5 I (DC_)	2.2	03/00 → 08/00	4HX (DW12TED4/FAP)	Diesel	2179	4	178
C5 I (DC_)	3.0	03/00 → 08/00	XFX (ES9J4S)	Petrol	2946	6	202
C5 I Break (DE_)	1.8	06/00 → 08/00	6FZ (EW7J4)	Petrol	1749	4	94
C5 I Break (DE_)	2.0	06/00 → 08/00	RFN (EW10J4)	Petrol	1997	4	139
C5 I Break (DE_)	2.0	06/00 → 08/00	RHS (DW10ATED)	Diesel	1997	4	156
C5 I Break (DE_)	2.0	06/00 → 08/00	RHY (DW10TD)	Diesel	1997	4	162
C5 I Break (DE_)	2.0	06/00 → 08/00	RHZ (DW10ATED)	Diesel	1997	4	163
C5 I Break (DE_)	2.0	06/00 → 08/00	RLZ (EW10D)	Petrol	1997	4	164
C5 I Break (DE_)	2.2	06/00 → 08/00	4HX (DW12TED4/FAP)	Diesel	2179	4	178
C5 I Break (DE_)	3.0	06/00 → 08/00	XFX (ES9J4S)	Petrol	2946	6	202



Ltr







CC



9

C5 II (RC_)	1.6	09/00→	9HY (DV6TED4)	Diesel	1560	4	66
C5 II (RC_)	1.6	09/00→	9HZ (DV6TED4)	Diesel	1560	4	67
C5 II (RC_)	1.8	09/00→	6FY (EW7A)	Petrol	1749	4	93
C5 II (RC_)	1.8	09/00→	6FY (EW7A)	Bi-Fuel	1749	4	93
C5 II (RC_)	1.8	09/00→	6FZ (EW7J4)	Petrol	1749	4	94
C5 II (RC_)	2.0	09/00→	RFJ (EW10A)	Petrol	1997	4	137
C5 II (RC_)	2.0	09/00→	RFJ (EW10A)	Flexfuel	1997	4	137
C5 II (RC_)	2.0	09/00→	RHR (DW10BTED4)	Diesel	1997	4	155
C5 II (RC_)	2.2	04/00→	4HT (DW12BTED4)	Diesel	2179	4	174
C5 II (RC_)	2.2	09/00→	4HX (DW12TED4/FAP)	Diesel	2179	4	178
C5 II (RC_)	3.0	09/00→	XFV (ES9A)	Petrol	2946	6	201
C5 II (RC_)	3.0	09/00→	XFX (ES9J4S)	Petrol	2946	6	202
C5 II Break (RE_)	1.6	09/00→	9HY (DV6TED4)	Diesel	1560	4	66
C5 II Break (RE_)	1.6	09/00→	9HZ (DV6TED4)	Diesel	1560	4	67
C5 II Break (RE_)	1.8	09/00→	6FY (EW7A)	Petrol	1749	4	93
C5 II Break (RE_)	1.8	09/00→	6FY (EW7A)	Bi-Fuel	1749	4	93
C5 II Break (RE_)	1.8	09/00→	6FZ (EW7J4)	Petrol	1749	4	94
C5 II Break (RE_)	2.0	09/00→	RFJ (EW10A)	Petrol	1997	4	137
C5 II Break (RE_)	2.0	09/00→	RFJ (EW10A)	Flexfuel	1997	4	137
C5 II Break (RE_)	2.0	09/00→	RHR (DW10BTED4)	Diesel	1997	4	155
C5 II Break (RE_)	2.2	04/00→	4HT (DW12BTED4)	Diesel	2179	4	174
C5 II Break (RE_)	2.2	09/00→	4HX (DW12TED4/FAP)	Diesel	2179	4	178
C5 II Break (RE_)	3.0	09/00→	XFV (ES9A)	Petrol	2946	6	201
C5 III (RD_)	1.6	07/01→	5FS (EP6C)	Petrol/Petroleum Gas (LPG)	1598	4	54
C5 III (RD_)	1.6	07/01→	5FS (EP6C)	Petrol	1598	4	54
C5 III (RD_)	1.6	07/01→	9HR (DV6C)	Diesel	1560	4	60
C5 III (RD_)	1.6	02/00→	9HZ (DV6TED4)	Diesel	1560	4	67
C5 III (RD_)	1.8	02/00→	6FY (EW7A)	Petrol	1749	4	93
C5 III (RD_)	1.8	02/00→	6FY (EW7A)	Bi-Fuel	1749	4	93
C5 III (RD_)	2.0	02/00→	RFJ (EW10A)	Petrol	1997	4	137
C5 III (RD_)	2.0	02/00→	RFJ (EW10A)	Flexfuel	1997	4	137
C5 III (RD_)	2.0	04/00→	RHH (DW10CTED4)	Diesel	1997	4	151
C5 III (RD_)	2.0	02/00→	RHR (DW10BTED4)	Diesel	1997	4	155
C5 III (RD_)	2.2	02/00→	4HT (DW12BTED4)	Diesel	2179	4	174
C5 III (RD_)	2.7	02/00→	DT17ED4	Diesel	2720	6	194
C5 III (RD_)	3.0	04/00→	DT20C	Diesel	2993	6	204
C5 III (RD_)	3.0	02/00→	XFU (ES9A)	Petrol	2946	6	200
C5 III Break (TD_)	1.6	07/01→	5FS (EP6C)	Petrol/Petroleum Gas (LPG)	1598	4	54
C5 III Break (TD_)	1.6	07/01→	5FS (EP6C)	Petrol	1598	4	54
C5 III Break (TD_)	1.6	04/00→	5FV (EP6DT)	Petrol	1598	4	57
C5 III Break (TD_)	1.6	07/01→	9HR (DV6C)	Diesel	1560	4	60
C5 III Break (TD_)	1.6	02/00→	9HZ (DV6TED4)	Diesel	1560	4	67
C5 III Break (TD_)	1.8	02/00→	6FY (EW7A)	Petrol	1749	4	93
C5 III Break (TD_)	1.8	02/00→	6FY (EW7A)	Bi-Fuel	1749	4	93
C5 III Break (TD_)	2.0	02/00→	RFJ (EW10A)	Petrol	1997	4	137
C5 III Break (TD_)	2.0	02/00→	RFJ (EW10A)	Flexfuel	1997	4	137
C5 III Break (TD_)	2.0	04/00→	RHH (DW10CTED4)	Diesel	1997	4	151
C5 III Break (TD_)	2.0	02/00→	RHR (DW10BTED4)	Diesel	1997	4	155
C5 III Break (TD_)	2.2	02/00→	4HT (DW12BTED4)	Diesel	2179	4	174
C5 III Break (TD_)	2.7	02/00→	DT17ED4	Diesel	2720	6	194
C5 III Break (TD_)	2.7	02/00→	UHZ (DT17BTED4)	Diesel	2720	6	195
C5 III Break (TD_)	3.0	04/00→	DT20C	Diesel	2993	6	204
C5 III Break (TD_)	3.0	02/00→	XFU (ES9A)	Petrol	2946	6	200
C6 (TD_)	2.2	06/00→	4HT (DW12BTED4)	Diesel	2179	4	174
C6 (TD_)	2.7	09/00→	DT17ED4	Diesel	2720	6	194
C6 (TD_)	2.7	09/00→	UHZ (DT17BTED4)	Diesel	2720	6	195
C6 (TD_)	3.0	04/00→	DT20C	Diesel	2993	6	204
C6 (TD_)	3.0	09/00→	XFV (ES9A)	Petrol	2946	6	201
C6 (TD_)	3.0	09/00→	XFX (ES9J4S)	Petrol	2946	6	202
C8 (EA_, EB_)	2.0	09/00→	RFJ (EW10A)	Petrol	1997	4	137
C8 (EA_, EB_)	2.0	09/00→	RFJ (EW10A)	Flexfuel	1997	4	137
C8 (EA_, EB_)	2.0	07/00→	RFN (EW10J4)	Petrol	1997	4	139
C8 (EA_, EB_)	2.0	03/00→	RHE (DW10CTED4)	Diesel	1997	4	150
C8 (EA_, EB_)	2.0	03/00→	RHH (DW10CTED4)	Diesel	1997	4	151
C8 (EA_, EB_)	2.0	02/00→	RHK (DW10UTED4)	Diesel	1997	4	153
C8 (EA_, EB_)	2.0	07/00→	RHM (DW10ATED4)	Diesel	1997	4	154
C8 (EA_, EB_)	2.0	03/00→	RHR (DW10BTED4)	Diesel	1997	4	155
C8 (EA_, EB_)	2.0	07/00→	RHT (DW10ATED4)	Diesel	1997	4	157
C8 (EA_, EB_)	2.0	07/00→	RHW (DW10ATED4)	Diesel	1997	4	160
C8 (EA_, EB_)	2.2	07/00→	3FZ (EW12J4)	Petrol	2230	4	172

	Ltr				CC		9
C8 (EA_, EB_)	2.2	06/00 →	4HT (DW12BTED4)	Diesel	2179	4	174
C8 (EA_, EB_)	2.2	07/00 →	4HW (DW12TED4)	Diesel	2179	4	177
C8 (EA_, EB_)	3.0	07/00 →	XFX (ES914S)	Petrol	2946	6	202
C15 (VD_)	1.0	10/98 →12/99	TU9	Petrol	954	4	8
C15 (VD_)	1.0	10/98 →12/99	XV8	Petrol	954	4	9
C15 (VD_)	1.1	10/98 →12/99	E1A	Petrol	1124	4	10
C15 (VD_)	1.1	11/98 →07/99	H1A	Petrol	1124	4	12
C15 (VD_)	1.1	07/98 →12/99	HDZ (TU1M)	Petrol	1124	4	15
C15 (VD_)	1.3	07/98 →05/98	G1A	Petrol	1294	4	18
C15 (VD_)	1.4	05/98 →12/99	150D (XY7)	Petrol	1360	4	28
C15 (VD_)	1.4	07/98 →12/99	K1H (TU3A)	Petrol	1360	4	31
C15 (VD_)	1.4	07/98 →12/99	K3A	Petrol	1360	4	34
C15 (VD_)	1.4	05/99 →12/99	KDY (TU3FM)	Petrol	1360	4	39
C15 (VD_)	1.4	05/99 →12/99	KDY (TU3M)	Petrol	1360	4	40
C15 (VD_)	1.8	07/98 →12/00	161A (XUD7)	Diesel	1769	4	96
C15 Estate	1.1	08/98 →07/99	HDZ (TU1M)	Petrol	1124	4	15
C15 Estate	1.4	05/98 →10/99	150D (XY7)	Petrol	1360	4	28
C15 Estate	1.4	05/99 →07/99	KDY (TU3M)	Petrol	1360	4	40
C15 Estate	1.8	04/98 →08/00	161A (XUD7)	Diesel	1769	4	96
C25 Box (280_, 290_)	1.8	11/98 →01/99	169 (XM7T)	Petrol	1796	4	97
C25 Box (280_, 290_)	1.9	01/98 →01/99	DJY (XUD9A)	Diesel	1905	4	123
C25 Box (280_, 290_)	2.0	09/98 →03/99	170A (XN1T)	Petrol	1971	4	129
C25 Box (280_, 290_)	2.0	09/98 →03/99	170B (XN1T)	Petrol	1971	4	130
C25 Box (280_, 290_)	2.0	02/99 →03/99	170C (XN1T)	Petrol	1971	4	131
C25 Box (280_, 290_)	2.5	11/98 →01/99	CRD93L (U25-661)	Diesel	2500	4	186
C25 Box (280_, 290_)	2.5	08/99 →01/99	CRD93LS (U25-673)	Diesel	2500	4	187
C25 Bus (280_, 290_)	1.8	11/98 →02/99	169 (XM7T)	Petrol	1796	4	97
C25 Bus (280_, 290_)	1.9	07/98 →02/99	D9B (XUD9A/U)	Diesel	1905	4	115
C25 Bus (280_, 290_)	2.0	09/98 →02/99	170A (XN1T)	Petrol	1971	4	129
C25 Bus (280_, 290_)	2.0	09/98 →02/99	170B (XN1T)	Petrol	1971	4	130
C25 Bus (280_, 290_)	2.0	02/99 →02/99	170C (XN1T)	Petrol	1971	4	131
C25 Bus (280_, 290_)	2.5	10/98 →02/99	CRD93L (U25-661)	Diesel	2500	4	186
C25 Bus (280_, 290_)	2.5	08/98 →02/99	CRD93LS (U25-673)	Diesel	2500	4	187
C25 Platform/Chassis (280_, 290_)	2.0	01/98 →03/99	170C (XN1T)	Petrol	1971	4	131
C25 Platform/Chassis (280_, 290_)	2.5	11/98 →01/99	CRD93L (U25-661)	Diesel	2500	4	186
C25 Platform/Chassis (280_, 290_)	2.5	01/98 →01/99	CRD93LS (U25-673)	Diesel	2500	4	187
C35 Box	2.0	11/97 →01/99	B20614	Petrol	1985	4	133
C35 Box	2.5	02/98 →01/99	B25637	Diesel	2498	4	185
C35 Bus	2.0	11/97 →01/99	B20614	Petrol	1985	4	133
C35 Bus	2.5	02/98 →01/99	B25637	Diesel	2498	4	185
C35 Pickup	2.0	11/97 →01/99	B20614	Petrol	1985	4	133
C35 Pickup	2.5	02/98 →01/99	B25637	Diesel	2498	4	185
CCROSSER (EP_)	2.0	11/01 →	4B11	Petrol	1998	4	128
CCROSSER (EP_)	2.2	02/00 →	4HN (DW12MTED4)	Diesel	2179	4	173
CCROSSER ENTERPRISE	2.2	01/00 →	4HN (DW12MTED4)	Diesel	2179	4	173
CX II Break	2.2	07/98 →12/99	J6T A500	Petrol	2165	4	180
CX II Break	2.5	08/98 →12/99	M25-659	Petrol	2500	4	188
CX II Break	2.5	05/98 →12/99	M25-660	Diesel	2500	4	189
CX II Break	2.5	05/98 →12/99	M25-668	Petrol	2498	4	192
CX II Break	2.5	01/98 →12/99	M25-669	Diesel	2500	4	193
CX II	2.0	08/98 →12/99	829 A5	Petrol	1995	4	132
CX II	2.2	07/98 →12/99	J6T A500	Petrol	2165	4	180
CX II	2.5	08/98 →12/99	M25-659	Petrol	2500	4	188
CX II	2.5	08/98 →12/99	M25-660	Diesel	2500	4	189
CX II	2.5	08/98 →12/99	M25-662	Petrol	2500	4	190
CX II	2.5	09/98 →12/99	M25-667	Petrol	2498	4	191
CX II	2.5	05/98 →12/99	M25-668	Petrol	2498	4	192
CX II	2.5	01/98 →12/99	M25-669	Diesel	2500	4	193
DS3	1.4	04/01 →	8FP (EP3)	Petrol/Petroleum Gas (LPG)	1397	4	20
DS3	1.4	04/01 →	8FP (EP3)	Petrol	1397	4	20
DS3	1.4	04/01 →	8HR (DV4C)	Diesel	1398	4	22
DS3	1.6	04/01 →	5FR (EP6DT)	Petrol	1598	4	53
DS3	1.6	04/01 →	5FS (EP6C)	Petrol/Petroleum Gas (LPG)	1598	4	54
DS3	1.6	04/01 →	5FS (EP6C)	Petrol	1598	4	54
DS3	1.6	01/01 →	5FX (EP6DT)	Petrol	1598	4	59
DS3	1.6	11/00 →	9HR (DV6C)	Diesel	1560	4	60
DS3 Convertible	1.6	01/01 →	5FR (EP6DT)	Petrol	1598	4	53
DS3 Convertible	1.6	01/01 →	5FS (EP6C)	Petrol/Petroleum Gas (LPG)	1598	4	54
DS3 Convertible	1.6	01/01 →	5FS (EP6C)	Petrol	1598	4	54
DS4	1.6	04/01 →	5FS (EP6C)	Petrol/Petroleum Gas (LPG)	1598	4	54



Ltr







CC



9

Model	Ltr	Year Range	Engine	Fuel	CC	Gear	Power (kW)
DS4	1.6	04/01→	5FS (EP6C)	Petrol	1598	4	54
DS4	1.6	04/01→	5FV (EP6CDT)	Petrol	1598	4	56
DS4	1.6	04/01→	9HR (DV6C)	Diesel	1560	4	60
DS4	2.0	04/01→	RHH (DW10CTED4)	Diesel	1997	4	151
DSS	1.6	11/01→	5FV (EP6CDT)	Petrol	1598	4	56
DS5	1.6	11/01→	9HR (DV6C)	Diesel	1560	4	60
DSS	2.0	11/01→	RHH (DW10CTED4)	Diesel	1997	4	151
EVASION (22, U6)	1.8	05/99→07/00	LFZ (XU7JP)	Petrol	1761	4	103
EVASION (22, U6)	1.9	11/99→07/00	D8B (XUD9TF)	Diesel	1905	4	111
EVASION (22, U6)	1.9	11/99→07/00	DHX (XUD9TF/BTF)	Diesel	1905	4	121
EVASION (22, U6)	2.0	05/00→07/00	RFN (EW10J4)	Petrol	1997	4	139
EVASION (22, U6)	2.0	06/99→07/00	RFU (XU10J2/C)	Petrol	1998	4	142
EVASION (22, U6)	2.0	05/99→04/00	RFV (XU10J4R)	Petrol	1998	4	143
EVASION (22, U6)	2.0	06/99→07/00	RGX (XU10J2TE)	Petrol	1998	4	148
EVASION (22, U6)	2.0	09/99→07/00	RHW (DW10ATED4)	Diesel	1997	4	160
EVASION (22, U6)	2.0	08/99→07/00	RHZ (DW10ATED)	Diesel	1997	4	163
EVASION (22, U6)	2.1	05/99→07/00	P8C (XUD11BTE)	Diesel	2088	4	168
JUMPER Box (230L)	1.9	03/99→04/00	D8C (XUD9UTF)	Diesel	1905	4	112
JUMPER Box (230L)	1.9	02/99→04/00	D9B (XUD9A/U)	Diesel	1905	4	115
JUMPER Box (230L)	1.9	03/99→04/00	DHX (XUD9TF/BTF)	Diesel	1905	4	121
JUMPER Box (230L)	1.9	07/99→04/00	DJY (XUD9A)	Diesel	1905	4	123
JUMPER Box (230L)	2.0	03/99→04/00	RFW (XU10J2U)	Petrol	1998	4	144
JUMPER Box (230L)	2.0	11/00→04/00	RHV (DW10UTD)	Diesel	1997	4	159
JUMPER Box (230L)	2.5	03/99→04/00	T8A (DJ5T)	Diesel	2446	4	181
JUMPER Box (230L)	2.5	03/99→04/00	T9A (DJ5)	Diesel	2446	4	182
JUMPER Box (230L)	2.5	12/99→11/00	THX (DJ5TED)	Diesel	2446	4	183
JUMPER Box (230L)	2.8	09/00→04/00	8140.43S	Diesel	2798	4	197
JUMPER Box (230L)	2.8	01/99→02/00	8140.63 (F28D)	Diesel	2798	4	198
JUMPER Box (244)	2.0	04/00→	RHV (DW10TD)	Diesel	1997	4	158
JUMPER Box (244)	2.0	04/00→	RHV (DW10UTD)	Diesel	1997	4	159
JUMPER Box (244)	2.0	04/00→	XU10J2	Petrol	1998	4	166
JUMPER Box (244)	2.0	04/00→	XU10J2	Bi-Fuel	1998	4	166
JUMPER Box (244)	2.2	04/00→	4HY (DW12UTED4)	Diesel	2179	4	179
JUMPER Box (244)	2.8	05/00→	8140.43N	Diesel	2798	4	196
JUMPER Box (244)	2.8	04/00→	8140.43S	Diesel	2798	4	197
JUMPER Box	2.2	04/00→	4HU (P22DTE)	Diesel	2198	4	175
JUMPER Box	2.2	04/00→	4HV (P22DTE)	Diesel	2198	4	176
JUMPER Bus (230P)	1.9	02/99→04/00	D8C (XUD9UTF)	Diesel	1905	4	112
JUMPER Bus (230P)	1.9	01/99→04/00	D9B (XUD9A/U)	Diesel	1905	4	115
JUMPER Bus (230P)	2.0	02/99→04/00	RFW (XU10J2U)	Petrol	1998	4	144
JUMPER Bus (230P)	2.5	08/99→04/00	T8A (DJ5T)	Diesel	2446	4	181
JUMPER Bus (230P)	2.5	08/99→04/00	T9A (DJ5)	Diesel	2446	4	182
JUMPER Bus (230P)	2.5	12/99→11/00	THX (DJ5TED)	Diesel	2446	4	183
JUMPER Bus (230P)	2.8	09/00→04/00	8140.43S	Diesel	2798	4	197
JUMPER Bus (230P)	2.8	01/99→02/00	8140.63 (F28D)	Diesel	2798	4	198
JUMPER Bus (244, Z_)	2.0	04/00→	RHV (DW10UTD)	Diesel	1997	4	159
JUMPER Bus (244, Z_)	2.0	04/00→	XU10J2	Petrol	1998	4	166
JUMPER Bus (244, Z_)	2.0	04/00→	XU10J2	Bi-Fuel	1998	4	166
JUMPER Bus (244, Z_)	2.2	04/00→	4HY (DW12UTED4)	Diesel	2179	4	179
JUMPER Bus (244, Z_)	2.8	04/00→	8140.43S	Diesel	2798	4	197
JUMPER Bus	2.2	04/00→	4HU (P22DTE)	Diesel	2198	4	175
JUMPER Bus	2.2	04/00→	4HV (P22DTE)	Diesel	2198	4	176
JUMPER Platform/Chassis (230)	1.9	03/99→04/00	D8C (XUD9UTF)	Diesel	1905	4	112
JUMPER Platform/Chassis (230)	1.9	03/99→04/00	DHX (XUD9TF/BTF)	Diesel	1905	4	121
JUMPER Platform/Chassis (230)	2.0	03/99→04/00	RFW (XU10J2U)	Petrol	1998	4	144
JUMPER Platform/Chassis (230)	2.5	03/99→04/00	T8A (DJ5T)	Diesel	2446	4	181
JUMPER Platform/Chassis (230)	2.5	03/99→04/00	T9A (DJ5)	Diesel	2446	4	182
JUMPER Platform/Chassis (230)	2.5	12/99→04/00	THX (DJ5TED)	Diesel	2446	4	183
JUMPER Platform/Chassis (230)	2.8	09/00→04/00	8140.43S	Diesel	2798	4	197
JUMPER Platform/Chassis (230)	2.8	01/99→02/00	8140.63 (F28D)	Diesel	2798	4	198
JUMPER Platform/Chassis (244)	2.0	04/00→	RHV (DW10UTD)	Diesel	1997	4	159
JUMPER Platform/Chassis (244)	2.2	02/00→	4HY (DW12UTED4)	Diesel	2179	4	179
JUMPER Platform/Chassis (244)	2.8	05/00→	8140.43N	Diesel	2798	4	196
JUMPER Platform/Chassis (244)	2.8	04/00→	8140.43S	Diesel	2798	4	197
JUMPER Platform/Chassis (244)	2.8	02/00→06/00	F28TDCR	Diesel	2798	4	199
JUMPER Platform/Chassis	2.2	04/00→	4HU (P22DTE)	Diesel	2198	4	175
JUMPER Platform/Chassis	2.2	04/00→	4HV (P22DTE)	Diesel	2198	4	176
JUMPY (U6U)	1.6	10/99→	1580 SPI	Petrol	1581	4	74
JUMPY (U6U)	1.6	10/99→	220 A2.000	Petrol	1581	4	73
JUMPY (U6U)	1.9	04/99→	D8B (XUD9TF)	Diesel	1905	4	111

	Ltr				CC		9
JUMPY (U6U)	1.9	10/99→04/99	D9B (XUD9A/U)	Diesel	1905	4	115
JUMPY (U6U)	1.9	10/99→	DHX (XUD9TF/BTF)	Diesel	1905	4	121
JUMPY (U6U)	1.9	04/99→	WJZ (DW8)	Diesel	1868	4	127
JUMPY (U6U)	2.0	04/00→12/00	RFN (EW10J4)	Petrol	1997	4	139
JUMPY (U6U)	2.0	03/00→	RHW (DW10ATED4)	Diesel	1997	4	160
JUMPY (U6U)	2.0	10/99→	RHX (DW10BTED)	Diesel	1997	4	161
JUMPY (U6U)	2.0	03/00→	RHZ (DW10ATED)	Diesel	1997	4	163
JUMPY Box (BS_, BT_, BY_, BZ_)	1.6	10/99→	1580 SPI	Petrol	1581	4	74
JUMPY Box (BS_, BT_, BY_, BZ_)	1.6	10/99→	220 A2.000	Petrol	1581	4	73
JUMPY Box (BS_, BT_, BY_, BZ_)	1.9	10/99→08/99	D9B (XUD9A/U)	Diesel	1905	4	115
JUMPY Box (BS_, BT_, BY_, BZ_)	1.9	10/99→	DHX (XUD9TF/BTF)	Diesel	1905	4	121
JUMPY Box (BS_, BT_, BY_, BZ_)	1.9	04/99→	WJY (DW8B)	Diesel	1868	4	126
JUMPY Box (BS_, BT_, BY_, BZ_)	1.9	04/99→	WJZ (DW8)	Diesel	1868	4	127
JUMPY Box (BS_, BT_, BY_, BZ_)	2.0	01/00→	RHW (DW10ATED4)	Diesel	1997	4	160
JUMPY Box (BS_, BT_, BY_, BZ_)	2.0	10/99→	RHX (DW10BTED)	Diesel	1997	4	161
JUMPY Box (BS_, BT_, BY_, BZ_)	2.0	01/00→	RHZ (DW10ATED)	Diesel	1997	4	163
JUMPY Box	1.6	01/00→	9HU (DV6UTED4)	Diesel	1560	4	63
JUMPY Box	2.0	01/00→	RFH (EW10A)	Petrol	1997	4	136
JUMPY Box	2.0	07/01→	RHH (DW10CTED4)	Diesel	1997	4	151
JUMPY Box	2.0	01/00→	RHK (DW10UTED4)	Diesel	1997	4	153
JUMPY Box	2.0	01/00→	RHR (DW10BTED4)	Diesel	1997	4	155
JUMPY Platform/Chassis (BU_, BV_, BW_, BX_)	1.9	10/99→	D8B (XUD9TF)	Diesel	1905	4	111
JUMPY Platform/Chassis (BU_, BV_, BW_, BX_)	2.0	12/00→10/00	RFN (EW10J4)	Petrol	1997	4	139
JUMPY Platform/Chassis (BU_, BV_, BW_, BX_)	2.0	12/00→10/00	RHW (DW10ATED4)	Diesel	1997	4	160
JUMPY Platform/Chassis (BU_, BV_, BW_, BX_)	2.0	10/99→	RHX (DW10BTED)	Diesel	1997	4	161
JUMPY Platform/Chassis (BU_, BV_, BW_, BX_)	2.0	12/00→10/00	RHZ (DW10ATED)	Diesel	1997	4	163
JUMPY	1.6	01/00→	9HU (DV6UTED4)	Diesel	1560	4	63
JUMPY	2.0	01/00→	RFH (EW10A)	Petrol	1997	4	136
JUMPY	2.0	07/01→	RHH (DW10CTED4)	Diesel	1997	4	151
JUMPY	2.0	01/00→	RHK (DW10UTED4)	Diesel	1997	4	153
JUMPY	2.0	01/00→	RHR (DW10BTED4)	Diesel	1997	4	155
NEMO Box (AA_)	1.3	10/01→	FHZ (F13DTE5)	Diesel	1248	4	17
NEMO Box (AA_)	1.4	02/00→	8HS (DV4TD)	Diesel	1398	4	23
NEMO Box (AA_)	1.4	02/00→	KFV (TU3A)	Petrol	1360	4	44
NEMO Estate	1.3	10/01→	FHZ (F13DTE5)	Diesel	1248	4	17
NEMO Estate	1.4	04/00→	8HS (DV4TD)	Diesel	1398	4	23
NEMO Estate	1.4	04/00→	KFT (TU3A)	Petrol	1360	4	42
NEMO Estate	1.4	04/00→	KFV (TU3A)	Petrol	1360	4	44
SAXO (SQ, S1)	1.0	05/99→06/00	CDZ (TU9M)	Petrol	954	4	7
SAXO (SQ, S1)	1.1	05/99→09/00	HDZ (TU1M)	Petrol	1124	4	15
SAXO (SQ, S1)	1.1	05/99→09/00	HFX (TU1JP)	Petrol	1124	4	16
SAXO (SQ, S1)	1.4	05/99→06/00	KFW (TU3JP)	Petrol/Electro	1360	4	46
SAXO (SQ, S1)	1.4	05/99→06/00	KFW (TU3JP)	Petrol	1360	4	46
SAXO (SQ, S1)	1.4	05/99→06/00	KFW (TU3JP)	Gas	1360	4	46
SAXO (SQ, S1)	1.4	05/99→06/00	KFW (TU3JP)	Bi-Fuel	1360	4	46
SAXO (SQ, S1)	1.4	05/99→06/00	KFX (TU3JP)	Petrol	1360	4	47
SAXO (SQ, S1)	1.5	09/99→09/00	VJY (TUD5)	Diesel	1527	4	50
SAXO (SQ, S1)	1.5	09/99→06/00	VJZ (TUD5)	Diesel	1527	4	51
SAXO (SQ, S1)	1.6	09/00→04/00	NFT	Petrol	1587	4	87
SAXO (SQ, S1)	1.6	02/99→04/00	NFX (TU5JP4)	Petrol	1587	4	90
SAXO (SQ, S1)	1.6	02/99→06/00	NFZ (TU5JP)	Petrol	1587	4	91
VISA	0.6	07/98→03/99	V06/665	Petrol	652	2	2
VISA	1.0	09/98→06/98	XV8	Petrol	954	4	9
VISA	1.4	03/98→03/99	150B (XY8)	Petrol	1360	4	27
VISA	1.4	07/98→03/99	150D (XY7)	Petrol	1360	4	28
VISA	1.6	06/98→03/99	B6D	Petrol	1580	4	77
VISA	1.8	04/98→03/99	161A (XUD7)	Diesel	1769	4	96
XANTIA (X1)	1.6	03/99→01/99	BFZ (XU5JP)	Petrol	1580	4	83
XANTIA (X1)	1.8	04/99→01/99	LFX (XU7JB)	Petrol	1761	4	101
XANTIA (X1)	1.8	06/99→01/99	LFY (XU7JP4)	Petrol	1762	4	102
XANTIA (X1)	1.8	03/99→01/99	LFZ (XU7JP)	Petrol	1761	4	103
XANTIA (X1)	1.9	06/99→01/99	D9B (XUD9A/L)	Diesel	1905	4	114
XANTIA (X1)	1.9	02/99→01/99	DHW (XUD9SD)	Diesel	1905	4	120
XANTIA (X1)	1.9	10/99→01/99	DHX (XUD9TF/BTF)	Diesel	1905	4	121
XANTIA (X1)	1.9	10/99→01/99	DHY (XUD9TE/Y)	Diesel	1905	4	122
XANTIA (X1)	1.9	06/99→01/99	DJZ (XUD9Y)	Diesel	1905	4	124
XANTIA (X1)	2.0	06/99→01/99	RFT (XU10J4/Z)	Petrol	1998	4	141
XANTIA (X1)	2.0	06/99→01/99	RFV (XU10J4R)	Petrol	1998	4	143
XANTIA (X1)	2.0	03/99→01/99	RFX (XU10J2C)	Petrol	1998	4	145
XANTIA (X1)	2.0	03/99→01/99	RFY (XU10J4/Z)	Petrol	1998	4	146



Ltr







CC



9

Model	Ltr	Year Range	Engine Code	Fuel Type	CC	Seats	Price
XANTIA (X1)	2.0	06/99→01/99	RGX (XU10J2TE)	Petrol	1998	4	148
XANTIA (X1)	2.1	06/99→01/99	P8C (XUD11BTE)	Diesel	2088	4	168
XANTIA (X1)	3.0	01/99→01/99	XFZ (ES9J4)	Petrol	2946	6	203
XANTIA (X2)	1.6	01/99→03/00	BFZ (XU5JP)	Petrol	1580	4	83
XANTIA (X2)	1.8	01/99→04/00	LFX (XU7JB)	Petrol	1761	4	101
XANTIA (X2)	1.8	01/99→04/00	LFY (XU7JP4)	Petrol	1762	4	102
XANTIA (X2)	1.9	01/99→04/00	DHW (XUD9SD)	Diesel	1905	4	120
XANTIA (X2)	1.9	01/99→04/00	DHX (XUD9TF/BTF)	Diesel	1905	4	121
XANTIA (X2)	1.9	01/99→04/00	DHY (XUD9TE/Y)	Diesel	1905	4	122
XANTIA (X2)	2.0	01/99→04/00	RFV (XU10J4R)	Petrol	1998	4	143
XANTIA (X2)	2.0	01/99→04/00	RFX (XU10J2C)	Petrol	1998	4	145
XANTIA (X2)	2.0	01/99→04/00	RGX (XU10J2TE)	Petrol	1998	4	148
XANTIA (X2)	2.0	03/99→04/00	RHY (DW10TD)	Diesel	1997	4	162
XANTIA (X2)	2.0	02/99→04/00	RHZ (DW10ATED)	Diesel	1997	4	163
XANTIA (X2)	2.1	01/99→02/99	P8C (XUD11BTE)	Diesel	2088	4	168
XANTIA (X2)	3.0	01/99→04/00	XFZ (ES9J4)	Petrol	2946	6	203
XANTIA Break (X1)	1.8	04/99→01/99	LFX (XU7JB)	Petrol	1761	4	101
XANTIA Break (X1)	1.8	06/99→01/99	LFY (XU7JP4)	Petrol	1762	4	102
XANTIA Break (X1)	1.8	06/99→01/99	LFZ (XU7JP)	Petrol	1761	4	103
XANTIA Break (X1)	1.9	06/99→01/99	DBB (XUD9TF)	Diesel	1905	4	111
XANTIA Break (X1)	1.9	04/99→01/99	DHW (XUD9SD)	Diesel	1905	4	120
XANTIA Break (X1)	1.9	06/99→01/99	DHX (XUD9TF/BTF)	Diesel	1905	4	121
XANTIA Break (X1)	1.9	06/99→01/99	DHY (XUD9TE/Y)	Diesel	1905	4	122
XANTIA Break (X1)	2.0	06/99→01/99	RFV (XU10J4R)	Petrol	1998	4	143
XANTIA Break (X1)	2.0	06/99→01/99	RFX (XU10J2C)	Petrol	1998	4	145
XANTIA Break (X1)	2.0	06/99→01/99	RGX (XU10J2TE)	Petrol	1998	4	148
XANTIA Break (X1)	2.1	06/99→01/99	P8C (XUD11BTE)	Diesel	2088	4	168
XANTIA Break (X2)	1.8	01/99→04/00	LFX (XU7JB)	Petrol	1761	4	101
XANTIA Break (X2)	1.8	01/99→04/00	LFY (XU7JP4)	Petrol	1762	4	102
XANTIA Break (X2)	1.9	01/99→04/00	DBB (XUD9TF)	Diesel	1905	4	111
XANTIA Break (X2)	1.9	01/99→04/00	DHW (XUD9SD)	Diesel	1905	4	120
XANTIA Break (X2)	1.9	01/99→04/00	DHX (XUD9TF/BTF)	Diesel	1905	4	121
XANTIA Break (X2)	2.0	01/99→04/00	RFV (XU10J4R)	Petrol	1998	4	143
XANTIA Break (X2)	2.0	01/99→04/00	RFX (XU10J2C)	Petrol	1998	4	145
XANTIA Break (X2)	2.0	01/99→04/00	RGX (XU10J2TE)	Petrol	1998	4	148
XANTIA Break (X2)	2.0	03/99→04/00	RHY (DW10TD)	Diesel	1997	4	162
XANTIA Break (X2)	2.0	02/99→04/00	RHZ (DW10ATED)	Diesel	1997	4	163
XANTIA Break (X2)	2.1	01/99→02/99	P8C (XUD11BTE)	Diesel	2088	4	168
XANTIA Break (X2)	3.0	01/99→04/00	XFZ (ES9J4)	Petrol	2946	6	203
XM (Y3)	2.0	05/98→06/99	R6A	Petrol	1998	4	134
XM (Y3)	2.0	05/98→04/99	RDZ (XU10MZ)	Petrol	1998	4	135
XM (Y3)	2.0	05/98→06/99	RFZ (XU10J2)	Petrol	1998	4	147
XM (Y3)	2.0	09/99→06/99	RGY (XU10J2E/Z)	Petrol	1998	4	149
XM (Y3)	2.1	05/98→06/99	P8A (XUD11ATE)	Diesel	2088	4	167
XM (Y3)	2.1	05/98→06/99	P9A (XUD11A)	Diesel	2138	4	169
XM (Y3)	2.1	05/98→06/99	PHZ (XUD11ATE)	Diesel	2088	4	170
XM (Y3)	2.1	05/98→06/99	PJZ (XUD11ATE)	Diesel	2088	4	171
XM (Y3)	3.0	05/98→06/99	SFZ (ZPJ/Z)	Petrol	2963	6	205
XM (Y3)	3.0	07/99→06/99	SKZ (ZPJ4/Z)	Petrol	2963	6	206
XM (Y3)	3.0	05/98→06/99	UFZ (ZPJ/Z)	Petrol	2963	6	207
XM (Y3)	3.0	07/99→06/99	UKZ (ZPJ4/Z)	Petrol	2963	6	208
XM (Y4)	2.0	05/99→10/00	RFV (XU10J4R)	Petrol	1998	4	143
XM (Y4)	2.0	05/99→10/00	RGX (XU10J2TE)	Petrol	1998	4	148
XM (Y4)	2.1	05/99→10/00	P8A (XUD11ATE)	Diesel	2088	4	167
XM (Y4)	2.1	05/99→10/00	P8C (XUD11BTE)	Diesel	2088	4	168
XM (Y4)	2.1	03/99→08/99	P9A (XUD11A)	Diesel	2138	4	169
XM (Y4)	2.1	05/99→10/00	PHZ (XUD11ATE)	Diesel	2088	4	170
XM (Y4)	2.1	05/99→10/00	PJZ (XUD11ATE)	Diesel	2088	4	171
XM (Y4)	2.5	05/99→10/00	THY (DK5ATE)	Diesel	2446	4	184
XM (Y4)	3.0	05/99→10/00	SFZ (ZPJ/Z)	Petrol	2963	6	205
XM (Y4)	3.0	05/99→10/00	SKZ (ZPJ4/Z)	Petrol	2963	6	206
XM (Y4)	3.0	05/99→10/00	UFZ (ZPJ/Z)	Petrol	2963	6	207
XM (Y4)	3.0	05/99→10/00	UKZ (ZPJ4/Z)	Petrol	2963	6	208
XM (Y4)	3.0	04/99→10/00	XFZ (ES9J4)	Petrol	2946	6	203
XM Break (Y3)	2.0	05/98→06/99	R6A	Petrol	1998	4	134
XM Break (Y3)	2.0	11/99→04/99	RDZ (XU10MZ)	Petrol	1998	4	135
XM Break (Y3)	2.0	11/99→04/99	RFZ (XU10J2)	Petrol	1998	4	147
XM Break (Y3)	2.0	09/99→04/99	RGY (XU10J2E/Z)	Petrol	1998	4	149
XM Break (Y3)	2.0	11/99→04/99	XU10ZC	Petrol	1998	4	165
XM Break (Y3)	2.1	11/99→04/99	P8A (XUD11ATE)	Diesel	2088	4	167

	Ltr				CC		9
XM Break (Y3)	2.1	11/99 → 04/99	P8C (XUD11BTE)	Diesel	2088	4	168
XM Break (Y3)	2.1	11/99 → 04/99	P9A (XUD11A)	Diesel	2138	4	169
XM Break (Y3)	2.1	11/99 → 04/99	PHZ (XUD11ATE)	Diesel	2088	4	170
XM Break (Y3)	2.1	11/99 → 04/99	PJZ (XUD11ATE)	Diesel	2088	4	171
XM Break (Y3)	3.0	11/99 → 04/99	SFZ (ZPJ/Z)	Petrol	2963	6	205
XM Break (Y3)	3.0	11/99 → 04/99	UFZ (ZPJ/Z)	Petrol	2963	6	207
XM Break (Y4)	2.0	05/99 → 10/00	RFV (XU10J4R)	Petrol	1998	4	143
XM Break (Y4)	2.0	05/99 → 10/00	RGX (XU10J2TE)	Petrol	1998	4	148
XM Break (Y4)	2.0	05/99 → 10/00	RGY (XU10J2TE/Z)	Petrol	1998	4	149
XM Break (Y4)	2.1	05/99 → 10/00	P8C (XUD11BTE)	Diesel	2088	4	168
XM Break (Y4)	2.1	07/99 → 06/99	P9A (XUD11A)	Diesel	2138	4	169
XM Break (Y4)	2.1	05/99 → 10/00	PHZ (XUD11ATE)	Diesel	2088	4	170
XM Break (Y4)	2.1	05/99 → 10/00	PJZ (XUD11ATE)	Diesel	2088	4	171
XM Break (Y4)	2.5	05/99 → 10/00	THY (DK5ATE)	Diesel	2446	4	184
XM Break (Y4)	3.0	05/99 → 10/00	SFZ (ZPJ/Z)	Petrol	2963	6	205
XM Break (Y4)	3.0	05/99 → 10/00	UFZ (ZPJ/Z)	Petrol	2963	6	207
XM Break (Y4)	3.0	04/99 → 10/00	XFZ (ES9J4)	Petrol	2946	6	203
XSARA (N1)	1.4	01/00 → 03/00	8HX (DV4TD)	Diesel	1398	4	24
XSARA (N1)	1.4	04/99 → 03/00	KFW (TU3JP)	Petrol/Electro	1360	4	46
XSARA (N1)	1.4	04/99 → 03/00	KFW (TU3JP)	Petrol	1360	4	46
XSARA (N1)	1.4	04/99 → 03/00	KFW (TU3JP)	Gas	1360	4	46
XSARA (N1)	1.4	04/99 → 03/00	KFW (TU3JP)	Bi-Fuel	1360	4	46
XSARA (N1)	1.4	04/99 → 03/00	KFX (TU3JP)	Petrol	1360	4	47
XSARA (N1)	1.5	04/99 → 09/00	VJZ (TUD5)	Diesel	1527	4	51
XSARA (N1)	1.6	09/00 → 03/00	NFU (TU5JP4)	Petrol	1587	4	88
XSARA (N1)	1.6	09/00 → 03/00	NFU (TU5JP4)	Flexfuel	1587	4	88
XSARA (N1)	1.6	04/99 → 09/00	NFZ (TU5JP)	Petrol	1587	4	91
XSARA (N1)	1.8	04/99 → 09/00	161A (XUD7)	Diesel	1769	4	96
XSARA (N1)	1.8	09/00 → 10/00	6FZ (EW7J4)	Petrol	1749	4	94
XSARA (N1)	1.8	04/99 → 09/00	A9A (XUD7)	Diesel	1769	4	99
XSARA (N1)	1.8	04/99 → 09/00	LFX (XU7JB)	Petrol	1761	4	101
XSARA (N1)	1.8	04/99 → 09/00	LFY (XU7JP4)	Petrol	1762	4	102
XSARA (N1)	1.8	04/99 → 09/00	LFZ (XU7JP)	Petrol	1761	4	103
XSARA (N1)	1.9	01/99 → 09/00	DHV (XUD9BSD)	Diesel	1905	4	119
XSARA (N1)	1.9	04/99 → 09/00	DHY (XUD9TE/Y)	Diesel	1905	4	122
XSARA (N1)	1.9	04/99 → 09/00	DJY (XUD9A)	Diesel	1905	4	123
XSARA (N1)	1.9	07/99 → 03/00	WJY (DW8B)	Diesel	1868	4	126
XSARA (N1)	1.9	07/99 → 03/00	WJZ (DW8)	Diesel	1868	4	127
XSARA (N1)	2.0	09/00 → 03/00	RFN (EW10J4)	Petrol	1997	4	139
XSARA (N1)	2.0	04/99 → 09/00	RFS (XU10J4RS)	Petrol	1998	4	140
XSARA (N1)	2.0	07/99 → 09/00	RFV (XU10J4R)	Petrol	1998	4	143
XSARA (N1)	2.0	02/99 → 03/00	RHY (DW10TD)	Diesel	1997	4	162
XSARA (N1)	2.0	05/00 → 03/00	RHZ (DW10ATED)	Diesel	1997	4	163
XSARA Box	2.0	09/00 → 03/00	RHY (DW10TD)	Diesel	1997	4	162
XSARA Break (N2)	1.4	01/00 → 08/00	8HX (DV4TD)	Diesel	1398	4	24
XSARA Break (N2)	1.4	10/99 → 08/00	KFW (TU3JP)	Petrol/Electro	1360	4	46
XSARA Break (N2)	1.4	10/99 → 08/00	KFW (TU3JP)	Petrol	1360	4	46
XSARA Break (N2)	1.4	10/99 → 08/00	KFW (TU3JP)	Gas	1360	4	46
XSARA Break (N2)	1.4	10/99 → 08/00	KFW (TU3JP)	Bi-Fuel	1360	4	46
XSARA Break (N2)	1.4	10/99 → 08/00	KFX (TU3JP)	Petrol	1360	4	47
XSARA Break (N2)	1.5	10/99 → 09/00	VJZ (TUD5)	Diesel	1527	4	51
XSARA Break (N2)	1.6	09/00 → 08/00	NFU (TU5JP4)	Petrol	1587	4	88
XSARA Break (N2)	1.6	09/00 → 08/00	NFU (TU5JP4)	Flexfuel	1587	4	88
XSARA Break (N2)	1.6	10/99 → 09/00	NFZ (TU5JP)	Petrol	1587	4	91
XSARA Break (N2)	1.8	10/99 → 09/00	A9A (XUD7)	Diesel	1769	4	99
XSARA Break (N2)	1.8	10/99 → 09/00	LFX (XU7JB)	Petrol	1761	4	101
XSARA Break (N2)	1.8	10/99 → 09/00	LFY (XU7JP4)	Petrol	1762	4	102
XSARA Break (N2)	1.8	10/99 → 09/00	LFZ (XU7JP)	Petrol	1761	4	103
XSARA Break (N2)	1.9	01/99 → 09/00	DHV (XUD9BSD)	Diesel	1905	4	119
XSARA Break (N2)	1.9	10/99 → 09/00	DHY (XUD9TE/Y)	Diesel	1905	4	122
XSARA Break (N2)	1.9	10/99 → 09/00	DJY (XUD9A)	Diesel	1905	4	123
XSARA Break (N2)	1.9	07/99 → 08/00	WJY (DW8B)	Diesel	1868	4	126
XSARA Break (N2)	1.9	07/99 → 08/00	WJZ (DW8)	Diesel	1868	4	127
XSARA Break (N2)	2.0	09/00 → 08/00	RFN (EW10J4)	Petrol	1997	4	139
XSARA Break (N2)	2.0	07/99 → 09/00	RFV (XU10J4R)	Petrol	1998	4	143
XSARA Break (N2)	2.0	02/99 → 08/00	RHY (DW10TD)	Diesel	1997	4	162
XSARA Break (N2)	2.0	05/00 → 08/00	RHZ (DW10ATED)	Diesel	1997	4	163
XSARA Coupe (NO)	1.4	01/00 → 03/00	8HX (DV4TD)	Diesel	1398	4	24
XSARA Coupe (NO)	1.4	03/99 → 03/00	KFW (TU3JP)	Petrol/Electro	1360	4	46
XSARA Coupe (NO)	1.4	03/99 → 03/00	KFW (TU3JP)	Petrol	1360	4	46



Ltr



















CC



9

	Ltr				CC		
XSARA Coupe (NO)	1.4	03/99→03/00	KFW (TU3JP)	Gas	1360	4	46
XSARA Coupe (NO)	1.4	03/99→03/00	KFW (TU3JP)	Bi-Fuel	1360	4	46
XSARA Coupe (NO)	1.4	03/99→03/00	KFX (TU3JP)	Petrol	1360	4	47
XSARA Coupe (NO)	1.6	09/00→03/00	NFU (TU5JP4)	Petrol	1587	4	88
XSARA Coupe (NO)	1.6	09/00→03/00	NFU (TU5JP4)	Flexfuel	1587	4	88
XSARA Coupe (NO)	1.6	02/99→09/00	NFZ (TU5JP)	Petrol	1587	4	91
XSARA Coupe (NO)	1.8	02/99→09/00	LFX (XU7JB)	Petrol	1761	4	101
XSARA Coupe (NO)	1.8	02/99→09/00	LFY (XU7JP4)	Petrol	1762	4	102
XSARA Coupe (NO)	1.8	02/99→09/00	LFZ (XU7JP)	Petrol	1761	4	103
XSARA Coupe (NO)	1.9	02/99→09/00	DHY (XUD9TE/Y)	Diesel	1905	4	122
XSARA Coupe (NO)	1.9	02/99→09/00	DJY (XUD9A)	Diesel	1905	4	123
XSARA Coupe (NO)	1.9	02/99→03/00	WJY (DW8B)	Diesel	1868	4	126
XSARA Coupe (NO)	1.9	02/99→03/00	WJZ (DW8)	Diesel	1868	4	127
XSARA Coupe (NO)	2.0	09/00→03/00	RFN (EW10J4)	Petrol	1997	4	139
XSARA Coupe (NO)	2.0	02/99→03/00	RFS (XU10J4RS)	Petrol	1998	4	140
XSARA Coupe (NO)	2.0	08/99→08/00	RFV (XU10J4R)	Petrol	1998	4	143
XSARA Coupe (NO)	2.0	02/99→03/00	RHY (DW10TD)	Diesel	1997	4	162
XSARA Coupe (NO)	2.0	05/00→03/00	RHZ (DW10ATED)	Diesel	1997	4	163
XSARA PICASSO (N68)	1.6	09/00→	9HX (DV6ATED4)	Diesel	1560	4	65
XSARA PICASSO (N68)	1.6	05/00→	9HY (DV6TED4)	Diesel	1560	4	66
XSARA PICASSO (N68)	1.6	09/00→	NFU (TU5JP4)	Petrol	1587	4	88
XSARA PICASSO (N68)	1.6	09/00→	NFU (TU5JP4)	Flexfuel	1587	4	88
XSARA PICASSO (N68)	1.6	12/99→	NFV (TU5JP)	Petrol	1587	4	89
XSARA PICASSO (N68)	1.6	12/99→	NFZ (TU5JP)	Petrol	1587	4	91
XSARA PICASSO (N68)	1.8	02/00→	6FZ (EW7J4)	Petrol	1749	4	94
XSARA PICASSO (N68)	2.0	01/00→	RFN (EW10J4)	Petrol	1997	4	139
XSARA PICASSO (N68)	2.0	12/99→	RHY (DW10TD)	Diesel	1997	4	162
XSARA PICASSO (N68)	2.0	12/99→	RHZ (DW10ATED)	Diesel	1997	4	163
ZX (N2)	1.1	03/99→08/99	H1A	Petrol	1124	4	12
ZX (N2)	1.1	03/99→08/99	HTB	Petrol	1124	4	13
ZX (N2)	1.1	03/99→06/99	HDZ (TU1M)	Petrol	1124	4	15
ZX (N2)	1.4	07/99→10/99	K9Y (TUD3Y)	Diesel	1360	4	36
ZX (N2)	1.4	03/99→06/99	KDX (TU3M/Z)	Petrol	1360	4	38
ZX (N2)	1.4	03/99→06/99	KDZ (TU3M/Z)	Petrol	1360	4	41
ZX (N2)	1.4	03/99→06/99	KFX (TU3JP)	Petrol	1360	4	47
ZX (N2)	1.6	03/99→06/99	BDY (XU5M)	Petrol	1580	4	81
ZX (N2)	1.6	03/99→06/99	BFZ (XU5JP)	Petrol	1580	4	83
ZX (N2)	1.8	06/99→06/99	161A (XUD7)	Diesel	1769	4	96
ZX (N2)	1.8	01/99→10/99	LFY (XU7JP4)	Petrol	1762	4	102
ZX (N2)	1.8	07/99→10/99	LFZ (XU7JP)	Petrol	1761	4	103
ZX (N2)	1.9	07/99→06/99	D9B (XUD9A/U)	Diesel	1905	4	115
ZX (N2)	1.9	07/99→06/99	DHY (XUD9TE/Y)	Diesel	1905	4	122
ZX (N2)	1.9	07/99→06/99	DJY (XUD9A)	Diesel	1905	4	123
ZX (N2)	1.9	03/99→06/99	DJZ (XUD9Y)	Diesel	1905	4	124
ZX (N2)	1.9	03/99→06/99	DKZ (XU9JA)	Petrol	1905	4	125
ZX (N2)	2.0	05/99→10/99	RFS (XU10J4RS)	Petrol	1998	4	140
ZX (N2)	2.0	07/99→06/99	RFT (XU10J4/Z)	Petrol	1998	4	141
ZX (N2)	2.0	07/99→10/99	RFX (XU10J2C)	Petrol	1998	4	145
ZX (N2)	2.0	07/99→10/99	RFY (XU10J4/Z)	Petrol	1998	4	146
ZX Break (N2)	1.4	10/99→10/99	KDX (TU3M/Z)	Petrol	1360	4	38
ZX Break (N2)	1.4	10/99→10/99	KDY (TU3M)	Petrol	1360	4	40
ZX Break (N2)	1.4	10/99→10/99	KFX (TU3JP)	Petrol	1360	4	47
ZX Break (N2)	1.6	10/99→10/99	BDY (XU5M)	Petrol	1580	4	81
ZX Break (N2)	1.6	10/99→10/99	BFZ (XU5JP)	Petrol	1580	4	83
ZX Break (N2)	1.8	10/99→10/99	161A (XUD7)	Diesel	1769	4	96
ZX Break (N2)	1.8	01/99→02/99	LFY (XU7JP4)	Petrol	1762	4	102
ZX Break (N2)	1.8	10/99→10/99	LFZ (XU7JP)	Petrol	1761	4	103
ZX Break (N2)	1.9	06/99→10/99	D9B (XUD9A/U)	Diesel	1905	4	115
ZX Break (N2)	1.9	10/99→10/99	DHY (XUD9TE/Y)	Diesel	1905	4	122
ZX Break (N2)	1.9	10/99→10/99	DJZ (XUD9Y)	Diesel	1905	4	124

		CC			9			CC			9
150B (XY8)	Petrol	1360	4	75.00	27	B25637	Diesel	2498	4	93.00	185
150D (XY7)	Petrol	1360	4	75.00	28	B6D	Petrol	1580	4	83.00	77
1580 SPI	Petrol	1581	4	86.40	74	B6E	Petrol	1580	4	83.00	78
159A	Petrol	1905	4	83.00	104	BAY (XU5CP)	Petrol	1580	4	83.00	79
161 (XUD7)	Diesel	1769	4	80.00	95	BAZ (XU5CP)	Petrol	1580	4	83.00	80
161A (XUD7)	Diesel	1769	4	80.00	96	BDY (XU5M)	Petrol	1580	4	83.00	81
162 (XUD9)	Diesel	1905	4	83.00	105	BDZ (XU5M)	Petrol	1580	4	83.00	82
169 (XM7T)	Petrol	1796	4	84.00	97	BFZ (XU5JP)	Petrol	1580	4	83.00	83
170A (XN1T)	Petrol	1971	4	88.00	129	C1A	Petrol	954	4	70.00	4
170B (XN1T)	Petrol	1971	4	88.00	130	C3A	Petrol	954	4	70.00	5
170C (XN1T)	Petrol	1971	4	88.00	131	CDY (TU9M)	Petrol	954	4	70.00	6
171A	Petrol	1580	4	83.00	68	CDZ (TU9M)	Petrol	954	4	70.00	7
171B	Petrol	1580	4	83.00	69	CRD93L (U25-661)	Diesel	2500	4	93.00	186
171C	Petrol	1580	4	83.00	70	CRD93LS (U25-673)	Diesel	2500	4	93.00	187
171D	Petrol	1580	4	83.00	71	D2A (XU92C)	Petrol	1905	4	83.00	106
180Z	Petrol	1580	4	83.00	72	D2C (XU92C)	Petrol	1905	4	83.00	107
1KR-FE	Petrol	998	3	71.00	3	D2F	Petrol	1905	4	83.00	108
220 A2.000	Petrol	1581	4	86.40	73	D6A (XU9J2)	Petrol	1905	4	83.00	109
3FZ (EW12J4)	Petrol	2230	4	86.00	172	D6C (XU9J4)	Petrol	1905	4	83.00	110
4B11	Petrol	1998	4	86.00	128	D8B (XUD9TF)	Diesel	1905	4	83.00	111
4HN (DW12MTED4)	Diesel	2179	4	85.00	173	D8C (XUD9UTF)	Diesel	1905	4	83.00	112
4HT (DW12BTED4)	Diesel	2179	4	85.00	174	D9A (XUD9)	Diesel	1905	4	83.00	113
4HU (P22DTE)	Diesel	2198	4	86.00	175	D9B (XUD9A/L)	Diesel	1905	4	83.00	114
4HV (P22DTE)	Diesel	2198	4	86.00	176	D9B (XUD9A/U)	Diesel	1905	4	83.00	115
4HW (DW12TED4)	Diesel	2179	4	85.00	177	DDZ (XU9M)	Petrol	1905	4	83.00	116
4HX (DW12TED4/FAP)	Diesel	2179	4	85.00	178	DFW (XU9J4)	Petrol	1905	4	83.00	117
4HY (DW12UTED4)	Diesel	2179	4	85.00	179	DFZ (XU9J1)	Petrol	1905	4	83.00	118
5FK (EP6CB)	Petrol	1598	4	77.00	52	DHV (XUD9BSD)	Diesel	1905	4	83.00	119
5FR (EP6DT)	Petrol	1598	4	77.00	53	DHW (XUD9SD)	Diesel	1905	4	83.00	120
5FS (EP6C)	Petrol/ Petroleum Gas (LPG)	1598	4	77.00	54	DHX (XUD9TF/BTF)	Diesel	1905	4	83.00	121
5FS (EP6C)	Petrol	1598	4	77.00	54	DHY (XUD9TE/Y)	Diesel	1905	4	83.00	122
5FT (EP6DT)	Petrol	1598	4	77.00	55	DJY (XUD9A)	Diesel	1905	4	83.00	123
5FV (EP6CDT)	Petrol	1598	4	77.00	56	DJZ (XUD9Y)	Diesel	1905	4	83.00	124
5FV (EP6DT)	Petrol	1598	4	77.00	57	DKZ (XU9JA)	Petrol	1905	4	83.00	125
5FW (EP6)	Petrol	1598	4	77.00	58	DT17ED4	Diesel	2720	6	81.00	194
5FX (EP6DT)	Petrol	1598	4	77.00	59	DT20C	Diesel	2993	6	84.00	204
6FY (EW7A)	Petrol	1749	4	82.70	93	DV4D	Diesel	1398	4	73.50	29
6FY (EW7A)	Bi-Fuel	1749	4	82.70	93	DV6B	Diesel	1560	4	75.00	84
6FZ (EW7J4)	Petrol	1749	4	82.70	94	E1A	Petrol	1124	4	72.00	10
8140.43N	Diesel	2798	4	94.40	196	F28TDCR	Diesel	2798	4	94.40	199
8140.43S	Diesel	2798	4	94.40	197	FHZ (F13DTE5)	Diesel	1248	4	69.60	17
8140.63 (F28D)	Diesel	2798	4	94.40	198	G11/631	Petrol	1129	4	74.00	11
829 A5	Petrol	1995	4	88.00	132	G1A	Petrol	1294	4	76.70	18
8FP (EP3)	Petrol/ Petroleum Gas (LPG)	1397	4	77.00	20	H1A	Petrol	1124	4	72.00	12
8FP (EP3)	Petrol	1397	4	77.00	20	H1B	Petrol	1124	4	72.00	13
8FS (EP3)	Petrol	1397	4	77.00	21	HAZ (TU1CP)	Petrol	1124	4	72.00	14
8HR (DV4C)	Diesel	1398	4	73.70	22	HDZ (TU1M)	Petrol	1124	4	72.00	15
8HS (DV4TD)	Diesel	1398	4	73.70	23	HFX (TU1JP)	Petrol	1124	4	72.00	16
8HX (DV4TD)	Diesel	1398	4	73.70	24	J6TA500	Petrol	2165	4	88.00	180
8HY (DV4TED4)	Diesel	1398	4	73.70	25	K1F	Petrol	1360	4	75.00	30
8HZ (DV4TD)	Diesel	1398	4	73.70	26	K1H (TU3A)	Petrol	1360	4	75.00	31
9HR (DV6C)	Diesel	1560	4	75.00	60	K2A	Petrol	1360	4	75.00	32
9HT (DV6BTED4)	Diesel	1560	4	75.00	61	K2B	Petrol	1360	4	75.00	33
9HT (DV6BUTED4)	Diesel	1560	4	75.00	62	K3A	Petrol	1360	4	75.00	34
9HU (DV6UTED4)	Diesel	1560	4	75.00	63	K9A (TUD3)	Diesel	1360	4	75.00	35
9HW (DV6TED4)	Diesel	1560	4	75.00	64	K9Y (TUD3Y)	Diesel	1360	4	75.00	36
9HX (DV6ATED4)	Diesel	1560	4	75.00	65	KAY (TU3CP)	Petrol	1360	4	75.00	37
9HY (DV6TED4)	Diesel	1560	4	75.00	66	KDX (TU3M/Z)	Petrol	1360	4	75.00	38
9HZ (DV6TED4)	Diesel	1560	4	75.00	67	KDY (TU3FM)	Petrol	1360	4	75.00	39
A06/664	Petrol	602	2	74.00	1	KDY (TU3M)	Petrol	1360	4	75.00	40
A8A (XUD7TE)	Diesel	1769	4	80.00	98	KDZ (TU3M/Z)	Petrol	1360	4	75.00	41
A9A (XUD7)	Diesel	1769	4	80.00	99	KFT (TU3A)	Petrol	1360	4	75.00	42
AJZ (XUD7TE)	Diesel	1769	4	80.00	100	KFU (ET3J4)	Petrol	1360	4	75.00	43
B1A (XU51C/K)	Petrol	1580	4	83.00	75	KFV (TU3A)	Petrol	1360	4	75.00	44
B1E (XU51C)	Petrol	1580	4	83.00	76	KFV (TU3JP)	Petrol	1360	4	75.00	45
B20614	Petrol	1985	4	86.00	133	KFV (TU3JP)	Bi-Fuel	1360	4	75.00	45
						KFW (TU3JP)	Petrol/Electro	1360	4	75.00	46
						KFW (TU3JP)	Petrol	1360	4	75.00	46
						KFW (TU3JP)	Gas	1360	4	75.00	46
						KFW (TU3JP)	Bi-Fuel	1360	4	75.00	46

		CC			9			CC			9
KFX (TU3JP)	Petrol	1360	4	75.00	47	VJZ (TUD5)	Diesel	1527	4	77.00	51
KFY (TU3FJ2)	Petrol	1360	4	75.00	48	WJY (DW8B)	Diesel	1868	4	82.20	126
KFZ (TU3FJ2)	Petrol	1360	4	75.00	49	WJZ (DW8)	Diesel	1868	4	82.20	127
LFX (XU7JB)	Petrol	1761	4	83.00	101	XFU (ES9A)	Petrol	2946	6	87.00	200
LFY (XU7JP4)	Petrol	1762	4	83.00	102	XFY (ES9A)	Petrol	2946	6	87.00	201
LFZ (XU7JP)	Petrol	1761	4	83.00	103	XFX (ES9J4S)	Petrol	2946	6	87.00	202
M25-659	Petrol	2500	4	93.00	188	XFZ (ES9J4)	Petrol	2946	6	87.00	203
M25-660	Diesel	2500	4	93.00	189	XU102C	Petrol	1998	4	86.00	165
M25-662	Petrol	2500	4	93.00	190	XU10J2	Petrol	1998	4	86.00	166
M25-667	Petrol	2498	4	93.00	191	XU10J2	Bi-Fuel	1998	4	86.00	166
M25-668	Petrol	2498	4	93.00	192	XU52C	Petrol	1580	4	83.00	92
M25-669	Diesel	2500	4	93.00	193	XV8	Petrol	954	4	70.00	9
M4A	Petrol	1294	4	75.00	19						
NFR (TU5JP4B)	Petrol	1587	4	78.50	85						
NFS (TU5JP4S)	Petrol	1587	4	78.50	86						
NFT	Petrol	1587	4	78.50	87						
NFU (TU5JP4)	Petrol	1587	4	78.50	88						
NFU (TU5JP4)	Flexfuel	1587	4	78.50	88						
NFV (TU5JP)	Petrol	1587	4	78.50	89						
NFX (TU5JP4)	Petrol	1587	4	78.50	90						
NFZ (TU5JP)	Petrol	1587	4	78.50	91						
P8A (XUD11ATE)	Diesel	2088	4	85.00	167						
P8C (XUD11BTE)	Diesel	2088	4	85.00	168						
P9A (XUD11A)	Diesel	2138	4	86.00	169						
PHZ (XUD11ATE)	Diesel	2088	4	85.00	170						
PJZ (XUD11ATE)	Diesel	2088	4	85.00	171						
R6A	Petrol	1998	4		134						
RDZ (XU10M2)	Petrol	1998	4	86.00	135						
RFH (EW10A)	Petrol	1997	4	85.00	136						
RFJ (EW10A)	Petrol	1997	4	85.00	137						
RFJ (EW10A)	Flexfuel	1997	4	85.00	137						
RFK (EW10J4S)	Petrol	1997	4	85.00	138						
RFN (EW10J4)	Petrol	1997	4	85.00	139						
RFS (XU10J4RS)	Petrol	1998	4	86.00	140						
RFT (XU10J4/Z)	Petrol	1998	4	86.00	141						
RFU (XU10J2/C)	Petrol	1998	4	86.00	142						
RFV (XU10J4R)	Petrol	1998	4	86.00	143						
RFW (XU10J2U)	Petrol	1998	4	86.00	144						
RFX (XU10J2C)	Petrol	1998	4	86.00	145						
RFY (XU10J4/Z)	Petrol	1998	4	86.00	146						
RFZ (XU10J2)	Petrol	1998	4	86.00	147						
RGX (XU10J2TE)	Petrol	1998	4	86.00	148						
RGY (XU10J2TE/Z)	Petrol	1998	4	86.00	149						
RHE (DW10CTED4)	Diesel	1997	4	85.00	150						
RHH (DW10CTED4)	Diesel	1997	4	85.00	151						
RHJ (DW10BTED4)	Diesel	1997	4	85.00	152						
RHK (DW10UTED4)	Diesel	1997	4	85.00	153						
RHM (DW10ATED4)	Diesel	1997	4	85.00	154						
RHR (DW10BTED4)	Diesel	1997	4	85.00	155						
RHS (DW10ATED)	Diesel	1997	4	85.00	156						
RHT (DW10ATED4)	Diesel	1997	4	85.00	157						
RHV (DW10TD)	Diesel	1997	4	85.00	158						
RHV (DW10UTD)	Diesel	1997	4	85.00	159						
RHW (DW10ATED4)	Diesel	1997	4	85.00	160						
RHX (DW10BTED)	Diesel	1997	4	85.00	161						
RHY (DW10TD)	Diesel	1997	4	85.00	162						
RHZ (DW10ATED)	Diesel	1997	4	85.00	163						
RLZ (EW10D)	Petrol	1997	4	85.00	164						
SFZ (ZPJ/Z)	Petrol	2963	6	93.00	205						
SKZ (ZPJ4/Z)	Petrol	2963	6	93.00	206						
T8A (DJ5T)	Diesel	2446	4	92.00	181						
T9A (DJ5)	Diesel	2446	4	92.00	182						
THX (DJ5TED)	Diesel	2446	4	92.00	183						
THY (DK5ATE)	Diesel	2446	4	92.00	184						
TU9	Petrol	954	4	70.00	8						
UFZ (ZPJ/Z)	Petrol	2963	6	93.00	207						
UHZ (DT17BTED4)	Diesel	2720	6	81.00	195						
UKZ (ZPJ4/Z)	Petrol	2963	6	93.00	208						
VO6/665	Petrol	652	2	77.00	2						
VJY (TUD5)	Diesel	1527	4	77.00	50						

Sommaire

Type Mines OU C.N.I.T.*	9	Type Mines OU C.N.I.T.*	9	Type Mines OU C.N.I.T.*	9	Type Mines OU C.N.I.T.*	9
2 CV		ZAZW	41	GJRHYB	162	MCT1204CN424	101
AK-AK	1	ZAZX	41	GJWJYB	126	MCT1204CP195	101
AZ-KA	1	ZAZY	32	M10CTRVP0000180	88	MCT1204CP196	101
AZ-KA4X4	1			M10CTRVP000J163	65	MCT1204CQ524	101
AZ-KAA	1			M10CTRVP000L165	67	MCT1204CR525	101
		Axel		M10CTRVP000M166	67	MCT1214CC290	85
		TATB	11	M10CTRVP000N167	85	MCT1303CX753	88
		TATH	11	M10CTRVP000N652	61	MCT1303CY754	88
				M10CTRVP000P168	88	MCT1304C5590	88
AX		Berlingo		M10CTRVP000X177	65	MCT1304C6591	88
MCT000AKV302	7	7A5F	52	M10CTRVP000Y178	65	MCT1304CS613	88
MCT000AKW303	6	7A9HTC	62	M10CTRVP000Z179	67	MCT1313CF019	88
MCT1001KH242	7	7A9HVC	65	M10CTRVP001W042	65	MCT1314CY291	88
VCT000AK4302	6	7A9HXC	65	M10CTRVP004T036	60	MCT5004CE071	114
ZADA	13	7ANFRC	85	M10CTRVP005W620	60	MCT5004CF072	114
ZADAB	13	7B9HLD	60	MAHDA	15	MCT5004CG073	114
ZADAC	13	7B9HNO	62	MAHDZD	15	MCT5103CV759	126
ZADB	13	7B9HTC	62	MAHDZF	15	MCT5103CW760	126
ZADBB	13	7B9HXC	65	MAHDZF/GPL	15	MCT5104C8346	126
ZADBC	13	7BNFRC	85	MAHKB	15	MCT5104C9347	126
ZADC	13	7C9HTC	62	MBA9AE	99	MCT5104CW431	126
ZADD	38	7CNFRC	85	MBAPAG	99	MCT5104CW528	126
ZADDB	38	7D9HNO	62	MBD9BE	123	MCT5104CX432	126
ZADE	38	7D9HTC	62	MBHDZE	15	MCT5104CX529	126
ZADEB	38	7D9HXC	65	MBHDZF	15	MCT5113CA155	64
ZADF	36	7E9HXC	65	MBHFXXB	15	MCT5113CU369	61
ZADG	36	7F9HXC	65	MBK5AG	46	MCT5204C7565	162
ZADH	38	7J5F5K0	52	MBK6CG	46	MCT5204CG502	162
ZADJ	38	7J5F50	54	MBKFWB	46	MCT5204CL604	162
ZADM	49	7J9HLD	60	MBKFXE	46	MCT5204CM605	162
ZADN	49	7J9HNO	61	MBKFXF	46	MCT5204CU649	162
ZAKE	50	7J9HPO	65	MBRHYB	162	MCT5212CJ446	65
ZAKET	51	7J9HP8/1PS	65	MBRHYF	162	MCT5213CW167	65
ZAKF	51	7J9HTC	61	MBWJYB	126	MCT5312CT447	67
ZAKH	50	7J9HVC	65	MBWJYP	126	MCT5314CS284	67
ZAKHT	51	7J9HXC	65	MBWJZC	126	MCT6204BA009	162
ZAKJ	50	7J9HZC	67	MBWJZF	126	MCT9003CE837	46
ZALAT	12	7JNFRC	85	MCA9AE	99	MCT9103CL773	46
ZALB	38	7JNFUC	88	MCA9AG	99	MCT9103CN836	46
ZALC	38	7S9HLD	60	MCD9BE	123	MCT9113C2365	46
ZALF	38	7S9HPO	65	MCKFWB	46	MCWJYB	126
ZALG	38	7S9HZC	67	MCKFXF	46	MCWJZF	126
ZALH	7	GB9HWC	64	MCRHYB	162	MEA9AE	99
ZALJ	7	GB9HXC	65	MCRHYF	162	MED9BE	123
ZAZA	4	GBHFXB	15	MCT000AC0193	101	MEWJYB	126
ZAZAB	4	GBKFWB	46	MCT000AC1449	46	MEWJZF	126
ZAZAE	4	GBKFWBGNV	46	MCT000AC2062	15	MFA9AE	99
ZAZAR	4	GBKFWBGPL	46	MCT000AC2450	46	MFD9BE	114
ZAZART	5	GBKFWC	46	MCT000AC3063	46	MFDJYF	114
ZAZAT	4	GBKFWCGN	46	MCT000AC4064	114	MFDJYF/A	114
ZAZB	12	GBNFUB	88	MCT000ACW092	46	MFHDZE	15
ZAZBD	12	GBRHYB	162	MCT000ACX093	46	MFHDZF	15
ZAZBT	12	GBWJYB	126	MCT000ACY094	114	MFHFXB	15
ZAZC	37	GBWJYBDG	126	MCT000ACZ095	114	MFK5AG	46
ZAZCD	30	GC9HW	64	MCT000ACZ192	101	MFK6CG	46
ZAZD	32	GC9HXC	65	MCT1103CF755	46	MFKFWB	46
ZAZDD	32	GCKFWB	46	MCT1103CG756	46	MFKFWB/A	46
ZAZE	4	GCKFWBGNV	46	MCT1104C5064	46	MFKFXB/IF	46
ZAZF	12	GCKFWBGPL	46	MCT1104C6065	46	MFKFXF	46
ZAZH	4	GCNFUB	88	MCT1104C7066	46	MFKFXF/A	46
ZAZHB	4	GCRHYB	162	MCT1104CA069	46	MFKFXF/AIF	46
ZAZJ	12	GCRHYBDG	162	MCT1104CB070	46	MFKFXF/GPL	46
ZAZJD	12	GCWJYB	126	MCT1104CE425	46	MFLFXF	101
ZAZK	37	GEWJYB	126	MCT1104CE522	46	MFLFXF/A	101
ZAZKD	30	GJ9HW	64	MCT1104CF426	46	MNFUB	88
ZAZL	19	GJ9HXC	65	MCT1104CF523	46	MNFUB/A	88
ZAZM	14	GJKFWB	46	MCT1104CG427	46	MNFUF/A	88
ZAZN	37	GJKFWBGNV	46	MCT1104CH428	46	MFRHYB/A	162
ZAZP	14	GJKFWBGPL	46	MCT1104CP568	46	MFRHYF	162
ZAZR	37	GJKFWC	46	MCT1104CP569	46	MFRHYF/A	162
ZAZS	14	GJNFUB	88	MCT1113C2023	46	MFWJYB	126
ZAZT	35	GJNFUC	88	MCT1204CM423	101	MFWJYB/A	126
ZAZTT	35						
ZAZU	35						
ZAZV	35						

* C.N.I.T. = Code National d'Identification du Type (code D2.1 sur nouvelles cartes grises)

Sommaire

Type Mines OU C.N.I.T.*	9	Type Mines OU C.N.I.T.*	9	Type Mines OU C.N.I.T.*	9	Type Mines OU C.N.I.T.*	9
MFWJZF	126	XBFP	116	JMHFXB	16	FCKFVC	45
MFWJZF/A	126	XBFT	106	JMHFXC	16	FCKFVC/IF	45
N10CTRCT0016207	62	XBFTA	109	JMKFUC/P	43	FCKFVCGN	45
N10CTRCT001S168	62	XBFW	81	JMKFUC/PS	43	FCKFVE	45
UCT5213CW167	65	XBFZ	109	JMKFVB	45	FCKFVF/IF	45
VCT000AC8095	123	XBHD	40	JMKFVB/P	45	FCNFU/B	88
VCT5104C6432	126	XBHKA	118	JMKFVC	45	FCNFUB	88
BX		XBHL	118	JMKFVC/P	45	FCNFUC	88
HBHYA	81	XBHLA	118	JMNFSC	86	FCNFUC/IF	88
XBEA	72	XBHLB	118	JMNFUB/P	88	FCNFUC/P	88
XBEE	75	XBHS	96	JMNFUC	88	FCNFUF	88
XBEEBC	76	XBXCE	105	JMNFUC/P	88	FL8HYB	25
XBEG	109	XBXE	70	MCT1001R0775	16	FL9HXC	65
XBEGA	109	XBXEBC	68	MCT1001RF973	16	FLKFUC	43
XBEJ	110	XBXEE	70	MCT1001RG974	16	FLKFVC	45
XBEK	100	XBXF	105	MCT1001RH975	16	FLNFUC	88
XBEP	15	XBXFE	115	MCT1001RP860	16	FN8HYB	25
XBEW	116	XBXFT	115	MCT1101R3793	45	FN8HZB	24
XBEX	100	XBXH	106	MCT1101R4794	45	FNHFVB	16
XBey	104	XBXHA	106	MCT1101R4988	45	FNHFVC/IF	16
XBEYA	125	XBXN	106	MCT1101R6990	45	FNKFUB	43
XBFA	76	XBXS	71	MCT1101R7991	45	FNKFVB	45
XBFC	117	XBXTC	118	MCT1101RU856	45	FNKFVC/IF	45
XBFE	108	XBXV	105	MCT1301RM828	88	FNKFVE	45
XBFG	40	XBXX	76	MCT1401RU862	86	FNKFVF/IF	45
XBFN	108	C1		MCT1411RH000	86	FNNFUB	88
XBFR	125	MCT1001T6937	3	MCT3111R6013	45	FR8HYB	25
XBFS	116	MCT1002TA939	3	MCT3211RA298	43	FR8XZB	24
XBFSA	116	MCT1011TN299	3	MCT3311RJ006	88	FRHFXT	16
XBFSC	116	MCT1012TW087	3	MCT5001R3985	24	FRKFWB/GNV	45
XBfv	81	MCT3001TD938	3	MCT5001R4986	24	HB8HXB	24
XBFX	125	MCT3012T3088	3	MCT5001R8929	24	HB8HZB	24
XBfy	109	MCT5001TF995	29	MCT5001R9797	24	HB8HZC	24
XBfYA	109	MCT5002TJ996	29	MCT5001R9930	24	HBKFVB	45
XBHA	125	MCT5011T3084	29	MCT5001RN847	24	HBKFVC	45
XBHC	40	PM8HTC	29	MCT5001RS780	24	HBNFUB	88
XBHK	116	PMCFAC	3	MCT5001RT781	24	HBNFUB/P	88
XBHKB	116	PMCFB0/P	3	MCT5001RU976	24	HBNFUC	88
XBHM	108	PMCFB4	3	MCT5001RV977	24	HBNFUC/P	88
XBHP	75	PMCFB0/P	3	MCT5311RC162	67	M10CTRVP0000241	88
XBHR	100	PN8HTC	29	UCT1001RG974	16	M10CTRVP0001242	88
XBHY	40	PNCFAC	3	UCT1101R6990	45	M10CTRVP0002243	43
XBXB	68	PNCFB0/P	3	UCT1411RH000	86	M10CTRVP0004245	43
XBxBAA	68	PNCFB4	3	UCT3111R6013	45	M10CTRVP0005246	43
XBxBE	68	PNCFB0/P	3	UCT3211RA298	43	M10CTRVP0006247	43
XBXC	105	UCT1001T6937	3	UCT3311RJ006	88	M10CTRVP0008249	24
XBxCA	105	UCT1002TA939	3	UCT5001R3985	24	M10CTRVP0009250	24
XBxCAA	115	UCT1011TN299	3	UCT5001RN847	24	M10CTRVP000A251	24
XBxCE	115	UCT1012TW087	3	UCT5001RV977	24	M10CTRVP000B252	24
XBxCT	115	UCT3001TD938	3	UCT5311RC162	67	M10CTRVP000F256	67
XBXE	92	UCT3012T3088	3	UCT7001R2978	24	M10CTRVP000G257	67
XBXFE	105	UCT5001TF995	29	C3		M10CTRVP000T234	16
XBxG	104	UCT5002TJ996	29	FC8HXB	24	M10CTRVP000U235	45
XBxGA	106	UCT5011T3084	29	FC8HXB/P	24	M10CTRVP000W237	45
XBxK	68	C2		FC8HXB/P	24	M10CTRVP000X238	88
XBxM	104	JG8HXB	24	FC8HXB	24	M10CTRVP000Y239	88
XBxMA	104	JG8HXB/P	24	FC8HXC	24	M10CTRVP000Z240	88
XBxP	95	JG8HZCT	24	FC8HYB	25	MCT1002P9845	16
XBxR	12	JGHFXBT	16	FC8HZ	24	MCT1002PB944	16
XBxU	115	JGHFXCT	16	FC8HZB	24	MCT1002PC945	16
XBxW	79	JGKFVBT	45	FC8HZBT	24	MCT1002PD946	16
XBxX	79	JGNFUC/P	88	FC8HZC	24	MCT1002PE681	16
BX Break		JM8HXB	24	FC8HZC/P	24	MCT1002PJ686	16
HBHZ	81	JM8HXB/P	24	FC9HXC	65	MCT1012PP145	16
XBEB	72	JM8HXC	24	FC9HXC	67	MCT1101QH747	45
XBED	96	JM8HXC/P	24	FCHFXB	16	MCT1101QJ748	45
XBEB	109	JM8HZB	24	FCHFXC	16	MCT1102P2961	45
XBEBHA	109	JM8HZC	24	FCHFXC/IF	16	MCT1102P3962	45
XBEL	100	JM8HZC/P	24	FCKFU	43	MCT1102P4963	45
XBEBZ	125	JM9HZC	67	FCKFUC	43	MCT1102P6965	45
				FCKFUC/P	43	MCT1102PH843	45
				FCKFVB	45	MCT1102PJ844	45

* C.N.I.T. = Code National d'Identification du Type (code D2.1 sur nouvelles cartes grises)

Sommaire

Type Mines OU C.N.I.T.*	9	Type Mines OU C.N.I.T.*	9	Type Mines OU C.N.I.T.*	9	Type Mines OU C.N.I.T.*	9
MCT1102PN680	45	UCT5202PE951	65	SH9HZC	67	M10CTRV005X948	60
MCT1102PS685	45	UCT5202PF952	65	C4		M10CTRV005Y949	60
MCT1105Q5957	45	UCT5202PQ830	25	LA5FWC	58	MCT1201SE890	43
MCT1105Q6958	45	UCT5212PD295	65	LA5FWF	58	MCT1202SP899	43
MCT1105QP747	45	UCT5312PL002	67	LA5FXE	59	MCT1301SP891	88
MCT1115QX294	45	UCT5312PM003	67	LA5FXH	59	MCT1301S0892	88
MCT1212P9048	43	UCT7002P5981	24	LA9HVC	65	MCT1302S0900	88
MCT1212PA049	43	VCT1002PN681	16	LA9HXC	65	MCT1302S1901	88
MCT1302P2905	88	VCT5002PL678	24	LA9HYC	66	MCT1411SN332	58
MCT1302P6679	88	VCT5002PQ841	24	LA9HYB	66	MCT1412SW339	58
MCT1302P6715	88	VCT5202P4677	25	LA9HYC	66	MCT1501SC894	139
MCT1302P6970	88	C3 II		LA9HZC	66	MCT1502SM902	139
MCT1302P7971	88	FC8HZC	22	LA9HZH	66	MCT1611S9334	59
MCT1302PH920	88	FCHFXC	16	LAKFUC	43	MCT1611SR025	139
MCT1302PQ735	88	M10CTRV0049464	22	LAN6AC	88	MCT1612S3341	59
MCT1302PS967	88	M10CTRV0005961	20	LANFUC	88	MCT1612SV027	137
MCT1302PT968	88	M10CTRV0049961	54	LANFUF	88	MCT1701SV893	138
MCT3102PB964	45	M10CTRV004A962	54	LANFUL	88	MCT1711S2026	138
MCT3102PR750	45	M10CTRV004H606	54	LARFJC	139	MCT3301S1933	88
MCT3102PX684	45	M10CTRV004J607	54	LARFKC	138	MCT3301S2934	88
MCT3212P3169	43	M10CTRV004S071	22	LARFNC	139	MCT3302S5935	88
MCT3212P4170	43	SC5FS0	54	LARHR	155	MCT3302S6936	88
MCT3302P0969	88	SC5FS0/1	54	LARHRH	155	MCT3412S3340	58
MCT3302P9906	88	SC5FS9	54	LC5FTF	55	MCT3602SP924	137
MCT3302PX736	88	SC8FP0	20	LC5FWC	58	MCT3612SL338	55
MCT3305QX959	88	SC8FP0/P	20	LC5FWF	58	MCT5201SN887	65
MCT3312P5028	88	SC8FR0	20	LC5FXE	59	MCT5202SY896	65
MCT3312PH004	88	SC8FR0/1	20	LC9HVC	65	MCT5211SG236	65
MCT3312PJ005	88	SC8HP4	22	LC9HXC	65	MCT5211S3355	65
MCT3312PR050	88	SC8HP4/TPS	22	LC9HYB	66	MCT5212S7164	65
MCT5002P0788	24	SC8HR0	22	LC9HYC	66	MCT5212S9360	65
MCT5002P0982	24	SC8HR4	22	LC9HZ	66	MCT5212S3342	65
MCT5002P1983	24	SC8HZC	22	LC9HZC	66	MCT5212SY191	65
MCT5002P4925	24	SC8HZC/1	22	LC9HZH	66	MCT5212S7164	65
MCT5002P5926	24	SC9HR8	60	LCKFUC	43	MCT5301SY888	66
MCT5002P7928	24	SC9HXC	65	LCNFUC	88	MCT5301S2889	66
MCT5002P8796	24	SC9HXC/1	65	LCNFUF	88	MCT5302S9897	66
MCT5002PC678	24	SCHFV0	16	LCNFUL	88	MCT5302SA898	66
MCT5002PH841	24	SCHFV0/1	16	LCRFJC	137	MCT5311SF358	66
MCT5002PX979	24	SCK5FS0/1	54	LCRFJF	137	MCT5311SG032	66
MCT5002PY980	24	SCKFT0	42	LCRFNC	139	MCT5312SE222	66
MCT5005Q2855	24	SCKFT0/1	42	LCRHR	155	MCT5312SK034	66
MCT5005Q9923	24	SCKT0/GPL	42	LCRHR8	155	MCT5312SK361	66
MCT5015QE018	24	C3 Picasso		LCRHRH	155	MCT5501SP895	155
MCT5202PE951	65	M10CTRV004E700	54	LCRHRJ	155	MCT5501SU997	155
MCT5202PF952	65	M10CTRV004J704	60	LD9HZC	66	MCT5502S2903	155
MCT5202PG917	25	M10CTRV004J705	60	LDNFUC	88	MCT5511S1033	155
MCT5202PH918	25	M10CTRV005G579	54	LDREJ	137	MCT5511SV160	155
MCT5202PQ830	25	M10CTRV007M935	54	LG9HXC	65	MCT5512S5035	155
MCT5202PV677	25	M10CTRV007N936	54	LG9HZC	66	MCT5611SA359	155
MCT5212PD295	65	MCT1212YF372	20	M10CTRV0000205	55	MCT5612SW379	155
MCT5312PL002	67	MCT1412YF449	54	M10CTRV0001181	58	MCT7311S0046	66
MCT5312PM003	67	MCT5212YS373	65	M10CTRV0001206	58	MCT7311S2336	66
MCT7002P5981	24	MCT5212YT374	65	M10CTRV0004184	59	MCT7312S3047	66
MCT9012P9008	45	MCT5312Y4375	67	M10CTRV0004209	59	MCT7312S8343	66
UCT1002PC945	16	MCT5312Y5376	67	M10CTRV0008188	65	MCT7511S0052	155
UCT1012PP145	16	SH5FS0	54	M10CTRV0008213	65	MCT7512ST053	155
UCT1102P3962	45	SH5FS0/P	54	M10CTRV0008191	66	MCT9311SG214	88
UCT1302P6970	88	SH5FS8	54	M10CTRV0008216	66	MCT9312SJ215	88
UCT1302PS967	88	SH5FS8/OP	54	M10CTRV000E219	66	NC5FLO	54
UCT3312PH004	88	SH5FS8/P	54	M10CTRV000F220	43	NC5FS0	54
UCT3312PJ005	88	SH5FWC	54	M10CTRV000P194	66	NC5FS0/1	54
UCT3312PR050	88	SH8FP0	20	M10CTRV000P229	155	NC5FS9	54
UCT5002P1983	24	SH8FR	20	M10CTRV000R195	43	NC5FS9/1	54
UCT5002P4925	24	SH8FSC	20	M10CTRV000Z204	155	NC5FV8	56
UCT5002P5926	24	SH9HD8	60	M10CTRV0040952	60	NC5FV8/P	56
UCT5002PC678	24	SH9HD8/1	60	M10CTRV0041953	60	NC8FP0	20
UCT5002PH841	24	SH9HR8	60	M10CTRV004W948	60	NC8FR0	20
UCT5002PX979	24	SH9HR8/1	60	M10CTRV004X949	60	NC9HD7	60
UCT5002PY980	24	SH9HXC	65	M10CTRV005T944	60	NC9HD8	60
				M10CTRV005U945	60	NC9HD8/1PS	60
						NC9HD8/1S	60

* C.N.I.T. = Code National d'Identification du Type (code D2.1 sur nouvelles cartes grises)

Sommaire

Type Mines OU C.N.I.T.*	9	Type Mines OU C.N.I.T.*	9	Type Mines OU C.N.I.T.*	9	Type Mines OU C.N.I.T.*	9
NC9HD8/PS	60	UAREFH	137	UD9HYC	66	MCT3902MK533	202
NC9HD8/S	60	UARHH	151	UD9HZC	66	MCT3912ME235	200
NC9HR8	60	UARHJH	152	UD9HZH	66	MCT5202M4617	162
NC9HR8/1	60	UARHRF	152	UDRFJF	137	MCT5302M6645	163
NC9HR8/1PS	60	UARHRJ	152	UDRFJH	137	MCT5302MC942	66
NC9HR8/1S	60	UCT1516VD105	93	UDRHH	151	MCT5302MJ913	66
NC9HR8/2PS	60	UCT3616VH068	137	UDRHJH	152	MCT5302MP531	163
NC9HR8/2S	60	UCT5316V6106	66	UDRHRF	152	MCT5302MY867	66
NC9HR8/PS	60	UCT5316VP063	66	UDRHRJ	152	MCT5312MF229	67
NC9HR8/S	60	UCT7316VW065	66	UE9HZC	66	MCT5312MV051	66
NX9HD8	60	UE9HR8	60	UE9HZH	66	MCT5312MX380	67
UCT1201SE890	43					MCT5502M5879	155
UCT1202SP899	43					MCT5502M6880	155
UCT1301SP891	88					MCT5502M8530	178
UCT1301SQ892	88					MCT5502ME791	178
UCT1302S0900	88					MCT5502M6865	155
UCT3302S5935	88					MCT5512M2232	155
UCT3602SP924	137					MCT5512MY458	155
UCT5201SN887	65					MCT5712M4056	174
UCT5202SY896	65					MCT5712MG226	174
UCT5211SG236	65					MCT5712MH227	174
UCT5211SJ335	65					MCT5712MM038	174
UCT5212SJ237	65					MCT7302M7737	156
UCT5212SR342	65					MCT7302MP622	163
UCT5301SY888	66					MCT7502MH885	178
UCT5301SZ889	66					MCT7502ML598	178
UCT5302S9897	66					MCT7512M9233	155
UCT5302SA898	66					MCT7512M2029	155
UCT5311SF358	66					MCT7712M0082	174
UCT5311SG032	66					MCT7712MY080	174
UCT5312SK034	66					MCT7812MF234	194
UCT5312SK361	66					MCT9612M8313	137
UCT5501SP895	155					RC4HPH	174
UCT5502SZ903	155					RC4HRJ	174
UCT5511SV160	155					RC4HSJ	174
UCT7311S0046	66					RC4HTH	174
UCT7311SZ336	66					RC4HXE	178
UCT7312S3047	66					RC6FYC	93
UCT7312S8343	66					RC6FZB	94
UCT7511S0052	155					RC6FZC/IF	94
UCT7512ST053	155					RC9HYB	66
UCT9312SJ215	88					RC9HZC	66
						RCRFJC	137
						RCRFJF	137
						RCRRHG	155
						RCRRRH	155
						RCRRRJ	155
						RCXFUJ	201
						RCXFVJ	201
						RD4HTH	174
						RD5FS8	54
						RD5FS8/P	54
						RD5FV8	56
						RD5FVA	56
						RD6FYC	93
						RD9HR8	60
						RD9HR8/PS	60
						RD9HZC	67
						RD9HZC/1	67
						RDRFJC	137
						RDRFJCCF	137
						RDRFJF	137
						RDRHH4	151
						RDRHH8	151
						RDRHHA	151
						RDRHR8	155
						RDRHRH	155
						RDRHRJ	155
						RDUHJZ	194
						RDX8ZA	204
						RDXFVJ	200
						UCT5302MJ913	66

C4 Picasso

C5

C4 Grand Pic

* C.N.I.T. = Code National d'Identification du Type (code D2.1 sur nouvelles cartes grises)

Sommaire

Type Mines OU C.N.I.T.*	9	Type Mines OU C.N.I.T.*	9	Type Mines OU C.N.I.T.*	9	Type Mines OU C.N.I.T.*	9
UCT5312MV051	66	MCT5314M3249	66	MCT7712UY363	174	C15	
UCT5502M5879	155	MCT5504MB881	155	MCT7802U5993	194	VOPA	10
UCT5502M6880	155	MCT5504MC882	155	TD4HSJ	174	VDPB	96
UCT5502MG865	155	MCT5504MF630	178	TD4HTH	174	VDPBF	96
UCT5712MM038	174	MCT5504MJ792	178	TD4HTJ	174	VDPF	10
UCT7512MZ029	155	MCT5514M3459	155	TDUHZJ	194	VDPL	8
UCT7712MY080	174	MCT5514MQ252	155	TDX8ZA	204	VDPV	96
C5 Break		MCT5614MY383	155	TDXFVJ	201	VDPVF	96
DE4HXB	178	MCT5714M5247	174	TDXFVU	201	VDPV	10
DE4HXE	178	MCT5714MR039	174	C8			
DE4HXF	178	MCT7304MV624	156	EA3FZC	172	VDPV	18
DE4HXG	178	MCT7504MM631	178	EA4HWB	177	VDPW	18
DE6FZB	94	MCT7504MM886	178	EA4HWG	177	VDPX	12
DE6FZC	94	MCT7514M4030	155	EARFNC	139	VDPY	12
DERFNB	139	MCT7514MX253	155	EARHME	154	VDPYF	12
DERFNC	139	MCT7714M3081	174	EARHTB	154	VDPZ	12
DERFNE	139	MCT7814M3254	194	EAXFWF	202	VDSA	31
DERFNF	139	MCT9614MD314	137	EB3FZC	172	VDSB	31
DERHYB	162	RE4HSJ	174	EB4HTH	174	VDESC	15
DERHZB	156	RE4HTH	174	EB4HTB	177	VDSO	8
DERHZE	156	RE4HXE	178	EB4HWB	177	VDOE	15
DERHZF	163	RE6FYC	93	EBRFJC	137	VDSG	34
DERLZB	164	RE6FZB	94	EBRFJF	137	VDSJ	34
DERLZC	164	RE6FZC/IF	94	EBRFNC	139	VDSV	12
DEXFXB	202	RE9HYB	66	EBRFNF	139	VDSX	96
DEXFXC	202	RE9HZC	66	EBRHH8	150	VDSZ	15
DEXFXE	202	RERFJC	137	EBRHHA	150	VDVN	15
DEXFXF	202	RERFJF	137	EBRHHK	153	C15 (VD-)	
M10CTRVP000C059	174	RERHRG	155	EBRHME	154	VDPM	28
M10CTRVP000F062	93	RERHRH	155	EBRHHH	155	VDSA	28
M10CTRVP000G063	67	RERHRJ	155	EBRHTB	154	C15 Estate	
M10CTRVP000J065	137	REXFUJ	201	EBRHWB	154	VDPG	96
M10CTRVP000K067	137	REXFVJ	201	EBXFWF	202	VDPJ	28
M10CTRVP000L905	155	RW4HTH	174	M10CTRVP000D024	174	VDPK	28
M10CTRVP000S075	155	RW5FS8	54	M10CTRVP000G027	153	VDPZ	15
M10CTRVP000S973	151	RW5FS8/P	54	M10CTRVP000H028	155	VDSF	15
M10CTRVP000T076	155	RW5FV8	57	M10CTRVP000L032	174	C25	
M10CTRVP000U077	194	RW5FVA	57	MCT1506N4662	139	280A10	97
M10CTRVP000V078	204	RW6FYC	93	MCT1616NJ011	137	280A50	186
M10CTRVP000W079	200	RW9HR8	60	MCT1706NP663	172	280B20	129
M10CTRVP0014341	155	RW9HR8/PS	60	MCT1706NQ664	172	280B20A	129
M10CTRVP0027925	60	RW9HZC	67	MCT3506NF764	139	280B50	186
M10CTRVP004K354	54	RW9HZC/1	67	MCT3616NH173	137	280B50A	186
M10CTRVP0051916	54	RWRFJC	137	MCT3616NN010	137	280B50B	186
M10CTRVP007C961	60	RWRFJCF	137	MCT3616NP012	137	280B90	187
MCT1404MK876	94	RWRFJF	137	MCT3806NB730	202	280B90A	187
MCT1404MX634	94	RWRHDA	155	MCT5306N0666	154	280B90B	187
MCT1404MY635	94	RWRHH4	151	MCT5306N2668	154	280B94	187
MCT1504M5632	139	RWRHH8	151	MCT5416N4041	153	280C10	97
MCT1504MC772	139	RWRHHA	151	MCT5506NN669	177	280C10A	97
MCT1514M7015	93	RWRHR8	155	MCT5506NP670	177	280C20B	129
MCT1514MA248	93	RWRHRH	155	MCT5506NY838	177	280C20C	129
MCT1514MG096	93	RWRHRJ	155	MCT5506N2839	177	280C50	186
MCT1604MP871	137	RWUHZJ	194	MCT5516NR054	155	280C50A	186
MCT1604MZ616	139	RWX8ZA	204	MCT5516NS055	155	280C50B	186
MCT1614MM250	137	RWXFVJ	200	MCT5716NG217	174	280C50C	186
MCT1904MP647	202	UCT5304MP914	66	MCT5716NJ219	174	280C54B	186
MCT3504MC633	139	UCT5314M3249	66	MCT5716NJ220	174	280C90B	187
MCT3504MY752	139	UCT5504MC882	155	MCT5716NK221	174	280C94B	187
MCT3604MA912	137	UCT5514MQ252	155	MCT7306N8790	154	280G	123
MCT3604MV872	137	UCT5714M5247	174	UCT5306N2668	154	280G50	186
MCT3614MT251	137	UCT5714MR039	174	UCT5416N4041	153	280G501	186
MCT3904M6648	202	UCT7514M4030	155	UCT5506NY838	177	280G502	186
MCT3904MJ916	201	UCT7514MX253	155	UCT5506NZ839	177	280G503	186
MCT3904MN884	202	UCT7714M3081	174	UCT5516NR054	155	280G504	186
MCT3914M2255	200	C6		UCT5516NS055	155	280G505	186
MCT5204M9618	162	M10CTRVP000J259	174	UCT5716NK221	174	280G506	186
MCT5304M3868	66	MCT3902U4994	201	UCT7306N8790	154	280G50M	186
MCT5304MH943	66	MCT3912U6061	201				
MCT5304MP623	156	MCT5712UE058	174				
MCT5304MP914	66	MCT5712UF059	174				

* C.N.I.T. = Code National d'Identification du Type (code D2.1 sur nouvelles cartes grises)

Type Mines OU C.N.I.T.*	9	Type Mines OU C.N.I.T.*	9	Type Mines OU C.N.I.T.*	9	Type Mines OU C.N.I.T.*	9
280G52A	186	M10CTRVP000R099	173	DS4		231C24/E	144
280G52B	186	MCT6714WC180	173	M10CTRVP002N747	56	231C32/D	115
280G90	187	MCT6714WD181	173	M10CTRVP004R943	56	231C42	183
280G901	187	UCT6714WC180	173	NX5FS0	54	231C42/9	183
280G902	187	UCT6714WD181	173	NX5FV8	56	231C44	183
280G903	187	VU4HK8	173	NX5FV8/P	56	231C44/9	183
280G904	187	VU4HK8/P	173	NX9HR8	60	231C44/E	183
280G905	187	VU4HNNH	173	NXRHH8	151	231C62	115
280G906	187	VU4HNNH/1	173	NXRHHA	151	231C62/9	115
280G907	187	VV4HNNH	173			231C72	112
280G945	187	VV4HNNH/1	173	DS5		231C72/9	112
290A11	97			KF9HR8/PS	60	231C82	112
290A22	129	CX II		KFRHH8	151	231C82/9	112
290A42	131	MAMM	189	KFRHH8/1	151	231C82/D	112
290A62	186	MAMP	132	KN9HR8/PS	60	231C82/E	112
290B22	129	MAMS	189	M10CTRVP002M940	151	231C92	181
290B222	129	MAN	188	M10CTRVP004V523	60	231C92/9	181
290B223	129	MANG	188	M10CTRVP004X525	151	231G22	144
290B42	131	MANGA	188	N10CTRCT004U713	60	231G22/2	144
290B52	186	MANHH	188			231G32	144
290B54	186	MANK	190	Evasion		231G42	183
290B62	123	MANKC	191	AFRHWB	160	231G42/2	183
290B90	187	MANP	190	MCT5306HL657	160	231G52	182
290B92	187	MANR	180	MCT5306HN562	160	231G52/2	182
290B94	187	MANRBC	180	MCT5306HP563	160	231G72	112
290C11	97	MANT	193	MCT5306HP625	160	231G82	112
290C22	129	MANU	193	MCT5306HP660	160	231G92	181
290C42	131			MCT5306HP660	160	231GL2	197
290C44	131	CX II Break		MCT5306HQ626	160	231H22	144
290C52	186	MAMN	189			231H32	144
290C54	186	MAMNE	189	Jumper		231H42	183
290C62	115	MANJ	188	231A22	144	231H52	182
290C92	187	MANS	180	231A22/B	144	231H72	112
290C94	187	MANV	193	231A24	144	231H82	112
290G42	131			231A32	123	231H92	181
290G52	186	DS3		231A32/B	144	231J42	183
290G54	186	M10CTRVP000R389	60	231A34	144	231J52	182
290G92	187	M10CTRVP001B093	22	231A42	183	231J92	181
290G921	187	M10CTRVP001D095	60	231A52	182	231JL2	197
290G922	187	M10CTRVP001P071	60	231A62	115	231V22	144
290G924	187	M10CTRVP004B963	54	231A62/B	115	231V22/9	144
290G926	187	M10CTRVP004C963	54	231A72	112	231V22/D	144
290G94	187	M10CTRVP004C964	54	231A72/B	112	231V24	144
290GJ2	187	M10CTRVP004N612	54	231A74	121	231V24/9	144
290H42	131	M10CTRVP004P613	54	231A82	112	231V24/D	144
290H52	186	M10CTRVP0056630	54	231A84	121	231V42	183
290H92	187	M10CTRVP007Z391	54	231AJ2	159	231V42/9	183
290J32	131	SA5FN8	59	231AL2	197	231V42/D	183
290J42	131	SA5FR8	53	231B12	144	231V44	183
290J52	186	SA5FS0	54	231B22	144	231V44/9	183
290J92	187	SA5FS0/1	54	231B22/B	144	231V44/D	183
290K32	131	SA5FS9	54	231B24	144	231V52	182
290K42	131	SA5FS9/1	54	231B42	183	231V52/9	182
290K52	186	SA5FV8	53	231B42/B	183	231V52/D	182
290L32	131	SA5FX8	59	231B44	183	231V54	182
290L42	131	SA8FP0/P	20	231B52	182	231V54/9	182
290L52	186	SA8FR0	20	231B52/B	182	231V54/D	182
290L92	187	SA8HP4/PS	22	231B54	182	231V62	115
290M62	123	SA8HR0	22	231B72	112	231V62/9	115
290S62	115	SA8HR4	22	231B72/B	112	231V72	112
2C50BDG	186	SA9HR8	60	231B74	121	231V72/9	112
2C90BDG	187	SA9HR8/S	60	231B82	112	231V82	112
				231B82/B	121	231V82/9	112
				231B84	121	231V82/D	112
C35		DS3 Cabrio		231B92	181	231V92	181
BFBC	133	M10CTRVP0041626	54	231BJ2	159	231V94	181
BFBG	185	M10CTRVP004T970	54	231BL2	197	231V94/9	181
		M10CTRVP0054470	54	231C22	144	231VH2/D	197
C-Crosser		M10CTRVP0055690	54	231C22/9	144	231VJ2/D	159
M10CTRVP0006089	173	M10CTRVP005N708	54	231C22/E	144	232	197
M10CTRVP0008091	173	M10CTRVP0072394	54	231C24	144	232A22	144
M10CTRVP000B737	173	SB5FS0	54	231C24/9	144	232A62	115
M10CTRVP000P097	173	SB5FS9	54	231C24/D	144		

* C.N.I.T. = Code National d'Identification du Type (code D2.1 sur nouvelles cartes grises)

Sommaire

Type Mines OU C.N.I.T.*	9	Type Mines OU C.N.I.T.*	9	Type Mines OU C.N.I.T.*	9	Type Mines OU C.N.I.T.*	9
232A72	112	232J54/1	182	233G22	144	MCT000AEB227	182
232B22	144	232J92	181	233G22/1	144	MCT000AEG232	182
232B22/1	144	232JB2	198	233G42	183	MCT000AEH233	182
232B22/1/B	144	232K22	144	233G42/1	183	MCT000AEJ137	182
232B22/B	144	232K42	183	233G42/2	183	MCT000AEJ235	182
232B42	183	232K42/2	183	233G52	182	MCT000AEL237	144
232B42/1	183	232K44	183	233G52/1	182	MCT000AEM202	182
232B42/1B	183	232K44/2	183	233G52/2	182	MCT000AEN239	144
232B42/B	183	232K52	182	233G92	181	MCT000AEP204	112
232B44	183	232K52/2	182	233G92/1	181	MCT000AHL173	103
232B44/1	183	232K54	182	233H22	144	MCT000AHM174	103
232B52	182	232K54/2	182	233H22/1	144	MCT000AHN175	142
232B52/1	182	232K92	181	233H42	183	MCT000AHP176	148
232B52/1/B	182	232K94	183	233H42/1	183	MCT000AHO178	111
232B52/B	182	232K94/2	183	233H52	182	MCT000AHR179	168
232B54	182	232L22	144	233H52/1	182	MCT1303E2465	144
232B54/1	182	232L22/1	144	233H92	181	MCT1303EJ481	144
232B72	112	232L42	183	233H92/1	181	MCT1303EJ482	144
232B72/1	112	232L52	182	233J22	144	MCT1303EM352	144
232B72/B	112	232L52/1	182	233J22/B	144	MCT1303EN353	144
232B82	112	232L54	182	233J42	183	MCT1306E9272	144
232B82/1	121	232L92	181	233J42/B	183	MCT1306EA298	144
232B82/B	121	232N22	144	233J44	183	MCT1306H2226	103
232B92	181	232N42	183	233J52	182	MCT1306H3227	103
232B92/1	181	232N44	183	233J52/B	182	MCT1403EG688	166
232BJ2	159	232N52	182	233J54	182	MCT1403EJ691	166
232BL2	197	232N54	182	233J92	181	MCT1406HA224	142
232BL21	197	232N92	181	233J94	181	MCT1506HJ514	139
232C32/D	115	232N94	183	233JL2	197	MCT1506HU658	139
232C62	115	232V22	144	233K22	144	MCT1506HZ627	139
232C62/9	115	232V22/9	144	233K22/1	144	MCT1606HT223	148
232C72	112	232V22/D	144	233K42	183	MCT3506H1659	139
232C72/9	112	232V22/G	144	233K42/1	183	MCT3506H6628	139
232C82/D	112	232V22/H	144	233K42/2	183	MCT3506HQ515	139
232F22	144	232V24	144	233K44	183	MCT5203E0655	159
232F42	183	232V24/9	144	233K44/2	183	MCT5203E1656	159
232F52	182	232V24/D	144	233K52	182	MCT5203E3489	182
232F92	181	232V42	183	233K52/1	182	MCT5203E5782	159
232G22	144	232V42/9	183	233K52/2	182	MCT5203E7784	159
232G22/2	144	232V42/D	183	233K54	182	MCT5203EA471	182
232G42	183	232V42/G	183	233K54/1	182	MCT5203ED341	112
232G42/2	183	232V42/H	183	233K54/2	182	MCT5203EF476	182
232G52	182	232V44	183	233K92	181	MCT5203EF695	159
232G52/1	182	232V44/9	183	233K92/1	181	MCT5203EG696	159
232G52/2	182	232V44/D	183	233K92/2	181	MCT5203EH697	159
232G54	182	232V52	182	233K94	183	MCT5203EV359	182
232G72	112	232V52/9	182	233L22	144	MCT5203EW360	182
232G82	121	232V52/D	182	233L22/1	144	MCT5203EX361	182
232G92	181	232V52/G	182	233L42	183	MCT5203EY653	159
232H22	144	232V52/H	182	233L42/1	183	MCT5206EJ280	182
232H22/1	144	232V52G	182	233L52	182	MCT5206EK306	182
232H42	183	232V54	182	233L52/1	182	MCT5206H3225	111
232H44	183	232V54/9	182	233L54/1	182	MCT5303E0742	179
232H52	182	232V54/D	182	233L92	181	MCT5303E1743	179
232H52/1	182	232V82	112	233L92/1	181	MCT5303EA486	183
232H54	182	232V82/9	112	233N22	144	MCT5303EB487	183
232H72	112	232V82/D	112	233N42	183	MCT5303ES698	179
232H82	121	232V92	181	233N44	183	MCT5303ET699	179
232H92	181	232V94	181	233N52	182	MCT5303EV701	179
232J12	144	232V94/9	181	233N54	182	MCT5303EW702	179
232J22	144	233B22	144	233N92	181	MCT5303EX739	179
232J22/1	144	233B42	183	233N94	183	MCT5303EY740	179
232J22/B	144	233B42/B	183	321A34	144	MCT5306HF457	163
232J42	183	233B44	183	AFRFNC	139	MCT5306HH229	168
232J42/1	183	233B52	182	AFRFNF	139	MCT5306HN562	163
232J42/B	183	233B92	181	AFRFVB	143	MCT5306HP563	163
232J44	183	233D22	144	AFRHZA	163	MCT5413E3152	175
232J44/1	183	233D42	183	AFRHZA/T	163	MCT5413EY147	175
232J52	182	233D52	182	MCT000AE8127	144	MCT5503E6570	197
232J52/1	182	233D92	181	MCT000AE9225	182	MCT5503E9573	197
232J52/B	182	233F22	144	MCT000AEA129	112	MCT5503EA574	197
232J54	182	233F42	183	MCT000AEA226	182	MCT5503EB575	197

* C.N.I.T. = Code National d'Identification du Type (code D2.1 sur nouvelles cartes grises)

Type Mines OU C.N.I.T.*	9	Type Mines OU C.N.I.T.*	9	Type Mines OU C.N.I.T.*	9	Type Mines OU C.N.I.T.*	9
MCT5503EC576	197	ZARMP	179	Jumpy		M10CTRVP000Z107	153
MCT5503EH703	197	ZARMRA	179	BADHXA	121	MCT000AJ0186	111
MCT5503EJ704	197	ZATMF	166	BARFNC	139	MCT000AJ1187	111
MCT5503EK706	197	ZBAMD	159	BARFNF	139	MCT000AJ2188	111
MCT5503EL707	197	ZBAMF	158	BARHWP	160	MCT000AJ3189	111
MCT5503EM708	197	ZBAMFA	158	BARHXA	161	MCT000AJJ459	111
MCT7503EY714	197	ZBAMFAAX	158	BARHZA	163	MCT000AJJ460	115
U6UA	148	ZBAMFABX	158	BARHZB	163	MCT000AJU180	73
U6UB	142	ZBAMNB	158	BAWJZA	127	MCT000AJV181	73
U6UB/T	143	ZBAMNBAX	158	BBDHXA	121	MCT000AJW182	73
U6UC	111	ZBAMNC	158	BDRFNC	139	MCT000AJX183	73
U6UC/T	111	ZBAMNCAX	158	BDRHXB	161	MCT000AJY184	115
U6UE	103	ZBAMP	159	BDRHZA	163	MCT000AJZ185	115
U6UE/1	103	ZBAMRB	159	BDRHZB	163	MCT1103JP236	73
U6UE/1/T	103	ZBPAB	197	BWJZA	127	MCT1103JP237	73
U6UJ	111	ZBPMAA	197	BCRHZA	163	MCT1103JQ238	73
U6UJ/8	111	ZBPMAAY	197	BDDHXA	121	MCT1103JR239	73
U6UJ/T	111	ZBPMCC	197	BDRFNC	139	MCT1103JS398	73
U6UW	168	ZBPMCCAY	197	BDRFNF	139	MCT1103JT399	73
U6UW/T	168	ZBPMD	197	BDRHWP	160	MCT1103JU400	73
VCT000AH0179	168	ZBPMF	197	BDRHXB	161	MCT1103JV401	73
VCT000AHZ178	111	ZBPMH	197	BDRHZA	163	MCT1613JB183	136
VCT1506HS514	143	ZBPMP	197	BDRHZB	163	MCT1613JF187	136
VCT5203E6361	182	ZBPMRB	197	BWJYB	127	MCT1614J5139	136
VCT5206HC225	111	ZBRMD	179	BWJZA	127	MCT1614J8142	136
VCT5303EW474	181	ZBRMF	179	BEDHXA	121	MCT5103J5241	115
VCT5306HP457	168	ZBRMH	179	BERFNC	139	MCT5103JA246	127
VCT5306HQ229	168	ZBRMP	179	BERHWP	160	MCT5103JC248	115
YAAMF	176	ZBRMRB	179	BERHXA	161	MCT5103JC672	127
YAAMFA	176	ZBTMF	166	BERHXB	161	MCT5203J4230	111
YAAMFAAX	176	ZBTMP	166	BERHZA	163	MCT5203J5231	111
YAAMFABX	176	ZCMNCA	196	BERHZA	163	MCT5203J6232	111
YAAMFB	176	ZCMNCAY	196	BERHXB	161	MCT5203J7233	111
YAAMFBBX	176	ZCPMAB	197	BERHZA	163	MCT5203J8234	111
YAAMM	176	ZCPMABAY	197	BERHXB	161	MCT5203J9235	111
YAAMP	176	ZCPMD	197	BHRHZA	163	MCT5203JA818	161
YABMF	175	ZCPMH	197	BSDHXA	121	MCT5203JB819	161
YABMFA	175	ZCPMM	197	BSRHXA	161	MCT5203JD821	161
YABMFAAX	175	ZCPMNC	197	BSRHXB	161	MCT5203JE822	161
YABMPA	175	ZCPMNCAY	197	BSRHZA	163	MCT5203JJ245	111
YBAMD	176	ZCPMNCBY	197	BTRHWP	160	MCT5203JJ247	111
YBAMF	176	ZCPWNB	197	BTWJYB	126	MCT5214JY124	63
YBAMFB	176	ZCPWNBAY	197	BTWJZA	126	MCT5303J0543	163
YBAMFBBX	176	ZCRMCB	179	BUDHXA	111	MCT5303J1544	160
YBAMFCBX	176	ZCRMCBAX	179	BURHZA	163	MCT5303JH815	163
YBAMG	176	ZCRMCC	179	BVWJZA	126	MCT5303JJ816	163
YBBMD	175	ZCRMCCAX	179	BWDHXA	111	MCT5303JJ817	163
YBBMF	175	ZCRMD	179	BWRHXB	161	MCT5303JP823	163
YBBMFCBX	175	ZCRMDC	179	BWRHZA	163	MCT5303JQ824	163
YBBMG	175	ZCRMDCAX	179	BXRFC	139	MCT5303JS826	163
YBBMP	175	ZCRMH	179	BXWJZA	126	MCT5303JT827	163
YCAMD	176	ZCRMM	179	BYDHXA	121	MCT5413J4184	153
YCAMF	176	ZCRMNB	179	BYRHWP	160	MCT5413J8188	153
YCAMFB	176	ZCRMNBAX	179	BYRHXA	161	MCT5413JW079	153
YCAMFBAX	176	ZCRMNBX	179	BYRHXB	161	MCT5414JM128	153
YCAMFBBX	176	ZCRMNC	179	BYRHZA	163	MCT5513JF185	155
YCAMG	176	ZCRMNCAX	179	BZDHXA	121	MCT5513JJ189	155
YCBMAC	175	ZCRMNCBX	179	BZRHWP	160	U6KS	121
YCBMACAX	175	ZCTMF	166	BZRHXB	161	U6KU	111
YCBMD	175	ZCTMM	166	BZWJYB	126	U6KU/R	111
YCBMF	175	ZCTMNB	166	BZWJZA	126	U6UF	115
YCBMG	175	ZCTMNBAM	166	M10CTRVP0000108	155	U6UG	73
YCBMHC	175	ZCTMNC	166	M10CTRVP0006114	63	U6UH	121
YCBMHX	175	ZCTMNCAG	166	M10CTRVP0009117	153	U6UK	111
ZAAMF	158	ZCMNC	196	M10CTRVP000A118	155	U6UL	111
ZAAMFA	158	ZCMNCAY	196	M10CTRVP000E122	153	U6UN	73
ZAAMFABX	158	ZDAMFA	158	M10CTRVP000F123	155	U6UN/R	73
ZAAMP	159	ZDAMFAAX	158	M10CTRVP000J127	153	U6UP	115
ZAAMR	159			M10CTRVP000K128	155	U6UR	111
ZAPMF	197			M10CTRVP000P133	153	U6UR/8	111
ZAPMP	197			M10CTRVP000R134	155	U6UR/9	111
ZARMF	179			M10CTRVP000W104	63	U6US/5	121

* C.N.I.T. = Code National d'Identification du Type (code D2.1 sur nouvelles cartes grises)

Sommaire

Type Mines OU C.N.I.T.*	9	Type Mines OU C.N.I.T.*	9	Type Mines OU C.N.I.T.*	9	Type Mines OU C.N.I.T.*	9
MCT000AAT091	203	X14G	168	MCT000AAT443	143	X2DHXF	111
MCT000AAT116	121	X15A	143	MCT000AAU020	143	X2DHXF/T	111
MCT000AAU311	145	X15C	102	MCT000AAU056	143	X2DHXM	111
MCT000AAV021	141	X15C/GPL	102	MCT000AAU444	143	X2LFXF	101
MCT000AAV118	102	X15D	203	MCT000AAV021	148	X2LFYB/IF	102
MCT000AAV445	121	X15F	141	MCT000AAV057	143	X2LFYC	102
MCT000AAW119	143	X16A	114	MCT000AAV312	143	X2LFYC/GPL	102
MCT000AAW313	143	X16C	102	MCT000AAW022	103	X2LFYF	102
MCT000AAW446	121	X16D	148	MCT000AAW058	148	X2P8CF	168
MCT000AAAY412	121	X16G	168	MCT000AAX023	103	X2RFVF	143
MCT000AAZ122	141	X17A	103	MCT000AAX059	148	X2RFVM	143
MCT000AAZ316	141	X17B	145	MCT000AAX447	111	X2RFXM	145
MCT000AAZ413	121	X18A	121	MCT000AAAY024	103	X2RGXF	148
MCT1202AN078	101	X18AAPPA	121	MCT000AAAY060	168	X2RHYE	162
MCT1202AU376	83	X18D	168	MCT000AAAY157	120	X2RHYE/T	162
MCT1202AV377	101	X18E	121	MCT000AAAY315	143	X2RHZF	163
MCT1202AZ151	101	X19B	103	MCT000AAAY448	111	X2XFZF	203
MCT1402A2389	102	X19C	143	MCT000AAZ025	103	X2XFZM	203
MCT1402A3390	102	X19E	143	MCT000AAZ061	168		
MCT1402A5004	102	X1BFZF	83	MCT1204A4152	101		
MCT1402A7394	102	X1DHWF	120	MCT1404A0164	102	XM	
MCT1402AL153	102	X1DHXF	121	MCT1404A5194	102	MCT000AF0154	203
MCT1402AM154	102	X1DHXM	121	MCT1404A9392	102	MCT000AFB262	167
MCT1402AQ158	102	X1L6AG	103	MCT1404AA393	102	MCT000AFC263	167
MCT1402AR159	102	X1LFXF	101	MCT1404AS156	102	MCT000AFD264	167
MCT1402AS160	102	X1LFYB/IF	102	MCT1404AT157	102	MCT000AFK138	143
MCT1402AU417	102	X1LFYC	102	MCT1404AT581	102	MCT000AFL139	143
MCT1502AA168	143	X1LFYC/GPL	102	MCT1504AF169	143	MCT000AFM140	143
MCT1502AD171	143	X1LFYF	102	MCT1604AV175	148	MCT000AFR145	148
MCT1602AS176	141	X1LFYM	102	MCT1804AJ178	203	MCT000AFS146	148
MCT1802A9076	203	X1P8CF	168	MCT3504AP173	143	MCT000AFT147	184
MCT1802AG180	203	X1RFVF	143	MCT3804AP179	203	MCT000AFW150	167
MCT1802AM380	203	X1RFVF/D3	143	MCT5104A0182	120	MCT000AFX151	167
MCT3402AA391	102	X1RFVG	143	MCT5104AF222	120	MCT000AFZ153	203
MCT3402AT155	102	X1RFVU	143	MCT5204A1586	162	MCT1502FJ197	143
MCT3402AZ161	102	X1RFXM	145	MCT5204AC184	111	MCT1502FL199	143
MCT3502AK172	145	X1RGXF	148	MCT5204AJ445	162	MCT1602FW200	148
MCT3802AJ177	203	X1RHYF	162	MCT5204AZ002	111	MCT1802FJ202	203
MCT3802AT381	203	X1RHZB	163	MCT5304A3456	163	MCT3502FQ198	143
MCT5102A2382	120	X1RHZF	163	MCT5304AK340	168	MCT3602F3201	148
MCT5102AV181	120	X1XFZM	203	MCT5304AN404	163	MCT3802FP203	203
MCT5202A7183	121	X7P8CF	168	MCT5304AT191	168	MCT5302FJ204	167
MCT5202A9185	121	X7RFVF	143	MCT7204AL187	111	MCT5302FK206	167
MCT5202AD444	162	X7RGXF	148	MCT7204AM443	111	MCT5502F7209	184
MCT5202AW585	162	X7RHZF	163	MCT7204AN189	111	MCT7302FP205	167
MCT5302AH402	163	X7XFZF	203	VCT000AA6447	111	MCT7302FR207	167
MCT5302AJ403	163			VCT000AAH325	111	Y3AC	134
MCT5302AN383	168	Xantia Break		VCT000AAL002	111	Y3ACA	134
MCT5302AP190	168	MCT000AA0317	148	VCT5204AL184	111	Y3AD	205
MCT5302AP384	168	MCT000AA0414	111	VCT5204AR445	111	Y3AE	169
MCT5302AQ192	168	MCT000AA1415	111	X11E	103	Y3AF	167
MCT5302AX454	163	MCT000AA4321	203	X11EA	103	Y3AG	207
MCT5302AY455	163	MCT000AA5419	102	X12A	103	Y3AGA	207
MCT7202AG186	121	MCT000AA6323	120	X12E	103	Y3AH	147
MCT7202AH442	121	MCT000AA6420	102	X12EA	103	Y3AHA	147
MCT7202AJ188	121	MCT000AA8325	111	X12G	168	Y3AJ	135
X11A	103	MCT000AA9423	102	X12H	102	Y3AK	167
X11D	148	MCT000AAA036	168	X13E	143	Y3AL	206
X11F	148	MCT000AAA169	102	X13EA	143	Y3AX	149
X11G	168	MCT000AAB037	168	X13H	102	Y3AXA	149
X12B	83	MCT000AAB328	168	X14H	120	Y3AZ	147
X12D	120	MCT000AAC002	111	X15E	145	Y3CM	205
X12F	101	MCT000AAC171	102	X15EA	145	Y3CU	206
X13A	124	MCT000AAD003	111	X15G	168	Y4CZ	143
X13C	114	MCT000AAD172	103	X16E	148	Y4GG	148
X13G	168	MCT000AAE004	148	X16EA	148	Y4GN	205
X13L	114	MCT000AAE331	102	X16G	101	Y4GU	206
X14A	141	MCT000AAF005	148	X17E	111	Y4GV	169
X14B	121	MCT000AAG006	145	X17E/T	111	Y4GX	167
X14C	102	MCT000AAH007	145	X17F	111	Y4GZ	167
X14D	203	MCT000AAS309	102	X17T/F	111	Y4NX	184
X14F	141	MCT000AAT310	102	X2DHWF	120	Y4RN	167
						Y4TD	167

* C.N.I.T. = Code National d'Identification du Type (code D2.1 sur nouvelles cartes grises)

Type Mines OU C.N.I.T.*	9	Type Mines OU C.N.I.T.*	9	Type Mines OU C.N.I.T.*	9	Type Mines OU C.N.I.T.*	9
Y4TR	205	MCT1102GJ102	46	N1RHVB	162	N2NFUB	88
Y4TT	148	MCT1102GJ103	46	N1RHYB/T	162	N2NFUN	88
Y4TV	143	MCT1102GV600	46	N1RHYF	162	N2NFZF	91
Y4TX	143	MCT1202G0110	101	N1RHZN	163	N2RFN1	139
Y4WG	203	MCT1202G2112	101	N1RHZN	163	N2RFN1/IF	139
Y4WH	203	MCT1202GW106	91	N1VJZF	51	N2RFNB	139
XM Break		MCT1202GY108	91	N1WJYB	126	N2RFNN	139
MCT000AF2156	203	MCT1302GX557	88	N1WJYB/T	126	N2RFVF	143
MCT000AFE265	168	MCT1302GZ620	88	N1WJZF	126	N2RFVM	143
MCT000AFG267	168	MCT1402G4130	102	N1WJZF/T	126	N2RHYB	162
MCT000AFN141	143	MCT1402GT119	102	N2RHYB/T	162	N2RHYF	162
MCT000AFP143	148	MCT1402GZ125	102	N6DHYF	122	N2RHZB	163
MCT000AFQ144	143	MCT1502G3385	143	VCT000AG2279	123	N2RHZN	163
MCT000AFU148	168	MCT1502GK560	139	VCT000AGJ162	123	N2VJZF	51
MCT000AFV149	168	MCT3202GG447	91	VCT000AGY275	123	N2WJYB	126
MCT000AFY152	184	MCT3302G9588	88	VCT5002GR136	123	N2WJYB/T	126
MCT1504F0210	143	MCT3302GK114	103	VCT5002GT138	123	N2WJZF	126
MCT1604FC212	148	MCT3302GM116	103	Xsara Break			
MCT3804F5215	203	MCT3302GS643	88	MCT000AG4290	102	N2WJZF/T	126
MCT5304F1219	168	MCT3502GA386	143	MCT000AGL296	101	UCT5204GS801	162
MCT5304FZ217	168	MCT3502GF610	139	MCT000AGN273	103	Xsara Coupe	
MCT5504FN221	184	MCT3502GP717	139	MCT000AGP433	46	MCT000AGJ268	140
MCT7304F4216	168	MCT5002GE132	123	MCT000AGQ276	119	MCT000AGJ294	101
MCT7304F6218	168	MCT5002GJ136	123	MCT000AGQ301	46	MCT000AGL271	103
Y3AP	134	MCT5002GK138	123	MCT000AGV281	122	MCT000AGN431	46
Y3AR	147	MCT5002GU766	24	MCT1104GF555	46	MCT000AGP274	123
Y3ARA	147	MCT5102G0374	123	MCT1104GJ099	46	MCT000AGP299	46
Y3AS	169	MCT5102GG548	123	MCT1104GP104	46	MCT000AGW282	102
Y3AT	167	MCT5201G9145	122	MCT1104GP105	46	MCT000AGY284	102
Y3ATA	167	MCT5201GC148	122	MCT1204G3109	91	MCT1101G7553	46
Y3AW	205	MCT5201GK799	122	MCT1204G7113	101	MCT1101GC098	46
Y3AWA	205	MCT5202G9143	122	MCT1304G2558	88	MCT1101GF101	46
Y3AY	149	MCT5202GC146	122	MCT1304G4621	88	MCT1101GS599	46
Y3AYA	149	MCT5202GE439	162	MCT1404G4216	102	MCT1201GV107	91
Y3CN	205	MCT5202GF149	122	MCT1504G9387	143	MCT1201GZ111	101
Y3CNA	205	MCT5202GN800	162	MCT1504GP561	139	MCT1301GU556	88
Y4CW	168	MCT5202GQ451	122	MCT3304GE589	88	MCT1301GW619	88
Y4GB	143	MCT5202GT551	122	MCT3304GR117	103	MCT1401G0128	102
Y4GM	148	MCT5302GT638	163	MCT3504GR117	103	MCT1401GU122	102
Y4GR	205	MCT7302G0639	163	MCT3504GK611	139	MCT1401GV123	102
Y4GW	169	N0A9AF/T	96	MCT3504GR388	143	MCT1401GZ127	102
Y4GY	168	N0DHYF	122	MCT3504GU718	139	MCT1501GH559	139
Y4MZ	168	N0KFXF/T	46	MCT5004GP139	123	MCT1701GP546	140
Y4NW	168	N18HZB	24	MCT5004GZ767	24	MCT1701GX131	140
Y4NY	184	N18HZB/T	24	MCT5104G5375	119	MCT3201GD446	91
Y4RM	184	N1DHYB	119	MCT5104GL549	123	MCT3301G6587	88
Y4TN	205	N1DHYF	122	MCT5204GH147	122	MCT3301GJ115	103
Y4TS	148	N1DHYF/T	122	MCT5204GK441	122	MCT3501GC609	139
Y4TU	143	N1DJYF	123	MCT5204GS801	162	MCT3501GM716	139
Y4WK	203	N1DJYF/T	123	MCT5204GW453	162	MCT5001GH137	123
Xsara		N1KFWB	46	MCT5204GY552	162	MCT5001GR765	24
MCT000AG0286	102	N1KFWB/IF	46	MCT5304GZ640	163	MCT5101GD547	126
MCT000AG5158	91	N1KFXB/IF	46	MCT7304G6641	163	MCT5101GX373	123
MCT000AG6159	101	N1KXF	46	N28HZB	24	MCT5201GA437	162
MCT000AG7160	46	N1KXF/GPL	46	N28HZB/T	24	MCT5201GB438	162
MCT000AG8161	123	N1KFXG	46	N2A9AF	99	MCT5201GK799	162
MCT000AG9162	122	N1LXF	101	N2A9AF/T	99	MCT5201GM449	162
MCT000AGB164	103	N1LFYF	102	N2DHVB	119	MCT5201GN450	162
MCT000AGC165	102	N1LFYF/GPL	102	N2DHWF	119	MCT5201GQ550	162
MCT000AGH292	91	N1LFZM	103	N2DHYF	122	MCT5301GP636	163
MCT000AGK295	101	N1LFZU	103	N2DJYF	123	MCT7301GW637	163
MCT000AGM272	103	N1NFUB	88	N2KFWB	46	N08HZB	24
MCT000AGP275	123	N1NFUN	88	N2KFWB/IF	46	N08HZB/T	24
MCT000AGP300	46	N1NFZ	91	N2KFWB/T	46	N0DJYF	123
MCT000AGP432	46	N1NFZF	91	N2KFXB	46	N0KFWB	46
MCT000AGR277	122	N1NFZG	91	N2KFXF	46	N0KFWB/IF	46
MCT000AGS278	122	N1RFN1	139	N2KFXF/GPL	46	N0KFWB/T	46
MCT000AGT279	122	N1RFN1/IF	139	N2KXF/T	46	N0KFXB	46
MCT1102GA554	46	N1RFNB	139	N2KXF/T/GPL	46	N0KXF	46
MCT1102GD097	46	N1RFNN	139	N2LXF	101	N0KXF/GPL	46
		N1RFVF	143	N2LYF	102	N0KXF/T	46
		N1RFVM	143	N2LFZM	103	N0KXF/T/GPL	46

* C.N.I.T. = Code National d'Identification du Type (code D2.1 sur nouvelles cartes grises)

Type Mines OU C.N.I.T.*	9	Type Mines OU C.N.I.T.*	9	Type Mines OU C.N.I.T.*	9	Type Mines OU C.N.I.T.*	9
NOKFXG	46	ZX		N2F5	122		
NOLFXF	101	MCT000ADJ103	115	N2G2	81		
NOLFYF	102	MCT1101DH081	38	N2H4	103		
NOLFYF/GPL	102	MCT1401DE084	102	N2H5	115		
NOLFZM	103	N2A1	12	N2J1	115		
NONFUB	88	N2A3	15	N2J1/T	115		
NONFUN	88	N2A4	15	N2K9	102		
NONFZF	91	N2A4/T	15	N2L6	115		
NONFZM	91	N2A7	41	N2M1	38		
NORFN1	139	N2A9	38				
NORFN1/IF	139	N2B1	38				
NORFNB	139	N2B2	81				
NORFNN	139	N2B2A	81				
NORFSB	140	N2B4	81				
NORHYB	162	N2B4A	81				
NORHYB/T	162	N2B5	81				
NORHYF	162	N2B8	125				
NORHZB	163	N2B8A	125				
NORHZN	163	N2C2/T	96				
NOWJYB	126	N2C3	115				
NOWJYB/T	126	N2C3A	115				
NOWJZF	126	N2C4	115				
NOWJZF/T	126	N2C4/T	115				
N3WJZF	126	N2C4T	115				
N6LFYF	102	N2C6	124				
N6RFSF	140	N2C7	122				
N6RHYB	162	N2C8	122				
N6RHYF	162	N2C9	12				
VCT000AG0277	126	N2D8	124				
VCT000AGX274	126	N2E1	38				
VCT000AGX299	46	N2E1/T	38				
VCT5101G6373	126	N2E3	103				
		N2E3A	103				
Xsara Picasso		N2E4	103				
CH6FZB	94	N2E4A	103				
CH6FZC/IF	94	N2E6	145				
CH9HXC	65	N2E7	145				
CH9HYB	66	N2E8	145				
CH9HZC	66	N2E9	115				
CHNFU	88	N2F1	141				
CHNFVB	89	N2G1	81				
CHNFVK	89	N2G1A	81				
CHNFZA	91	N2H6	36				
CHRFNE	139	N2H8	115				
CHRFNF	139	N2H8/T	115				
CHRHYA	162	N2H9	115				
CHRHVB	162	N2J3	145				
MCT1206LD498	91	N2J9	141				
MCT1206LN508	89	N2K5	102				
MCT1206LT744	91	N2K7	102				
MCT1316L6031	88	N2L1	140				
MCT1316LW021	88	N2L2	15				
MCT1406L0537	94	N2L2/T	15				
MCT1406L6676	94	N2L3	15				
MCT1406LY499	94	N2L5	115				
MCT3506LJ770	139	N2L7	38				
MCT3516LN022	139	N2L9	38				
MCT5206LR500	162	YBBMFB	12				
MCT5206LS501	162	YBBMFBAX	12				
MCT5216LR377	65						
MCT5216LX020	65	ZX Break					
MCT5306L1863	66	MCT000ADL105	38				
MCT5306LE840	66	MCT000ADM106	81				
MCT5306LN849	66	MCT000ADQ110	115				
UCT1316L6031	88	MCT000ADS112	122				
UCT1316LW021	88	MCT5004D2094	115				
UCT5206LS501	162	N2C5	124				
UCT5216LR377	65	N2D5	115				
UCT5216LX020	65	N2D5/T	115				
UCT5306L1863	66	N2D7	38				
UCT5306LN849	66	N2D9	122				
		N2F2	102				

* C.N.I.T. = Code National d'Identification du Type (code D2.1 sur nouvelles cartes grises)

IDENTIFICATION JOINTS DE CULASSE - Moteur Diesel CYLINDER HEAD GASKET IDENTIFICATION - Diesel Engine PEUGEOT - CITROËN - Moteur XUD7 Atmo / XUD7 N.A. Engine

Moteurs / Engines XUD7 Atmo / N.A. → Alésage / Bore = 80 mm - 1769 cm³

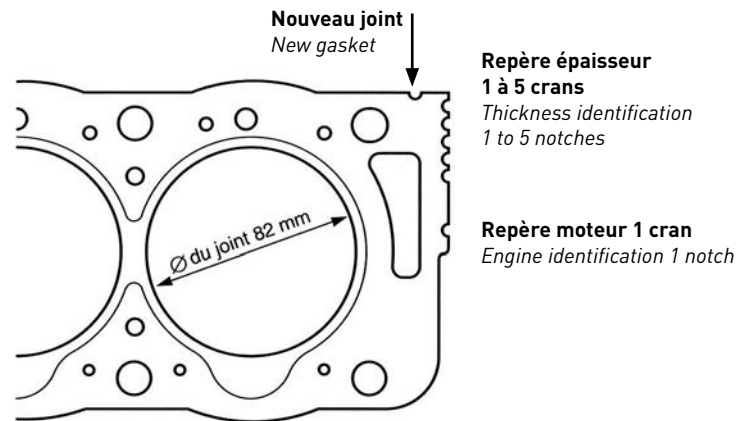
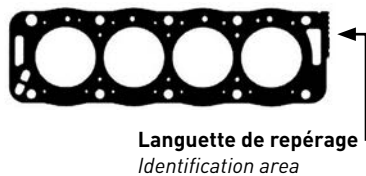

ANCIENS JOINTS FIBREUX (3 épaisseurs différentes) <i>OLD FIBER GASKETS</i> <i>(3 different thicknesses)</i>	
	1 Cran / Notch
	2 Crans / Notches
	3 Crans / Notches

NOUVEAUX JOINTS FIBREUX (5 épaisseurs différentes) <i>NEW FIBER GASKETS (5 different thicknesses)</i>		
	1 Cran / Notch	BX 830 Ép. / Thick. = 1,36 mm*
	2 Crans / Notches	BX 840 Ép. / Thick. = 1,40 mm*
	3 Crans / Notches	BX 850 Ép. / Thick. = 1,44 mm*
	4 Crans / Notches	BX 860 Ép. / Thick. = 1,48 mm*
	5 Crans / Notches	BX 870 Ép. / Thick. = 1,52 mm*

* L'épaisseur correspond à l'épaisseur serrée sur moteur.
* The above thickness refers to the assembled thickness.



Attention: mesurer systématiquement les dépassements de pistons au PMH pour déterminer le joint de culasse d'épaisseur optimale (voir les notes techniques en fin de catalogue pour identifier la correspondance entre le dépassement du piston et la réf. de joint).

Warning: it is strongly recommended that the gasket selection be made after measuring the UDC piston protrusion; see the technical notes at the end of the catalogue to have the link between the piston protrusion and the gasket part number.

IDENTIFICATION JOINTS DE CULASSE - Moteur Diesel CYLINDER HEAD GASKET IDENTIFICATION - Diesel Engine PEUGEOT - CITROËN - Moteur XUD7 Turbo / XUD7 T.C. Engine

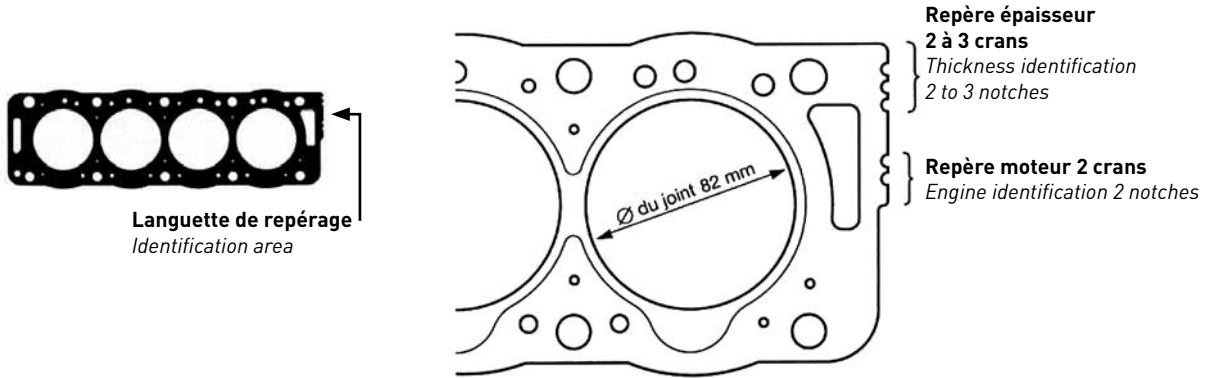
Moteurs / Engines XUD7 Turbo / T.C. → Alésage / Bore = 80 mm - 1769 cm³



	
2 Crans / Notches	3 Crans / Notches
BX 780 Ép. / Thick. = 1,65 mm*	BX 790 Ép. / Thick. = 1,80 mm*
<p>* L'épaisseur indiquée correspond à l'épaisseur libre (avant montage). * The above thickness refers to the thickness before the assembly of the engine.</p>	

Attention: mesurer systématiquement les dépassements de pistons au PMH pour déterminer le joint de culasse d'épaisseur optimale (voir les notes techniques en fin de catalogue pour identifier la correspondance entre le dépassement du piston et la réf. de joint).

Warning: it is strongly recommended that the gasket selection be made after measuring the UDC piston protrusion; see the technical notes at the end of the catalogue to have the link between the piston protrusion and the gasket part number.

IDENTIFICATION JOINTS DE CULASSE - Moteur Diesel CYLINDER HEAD GASKET IDENTIFICATION - Diesel Engine PEUGEOT - CITROËN - Moteur XUD9 Atmo / XUD9 N.A. Engine

Moteurs / Engines XUD9 Atmo / N.A. → Alésage / Bore = 83 mm - 1905 cm³

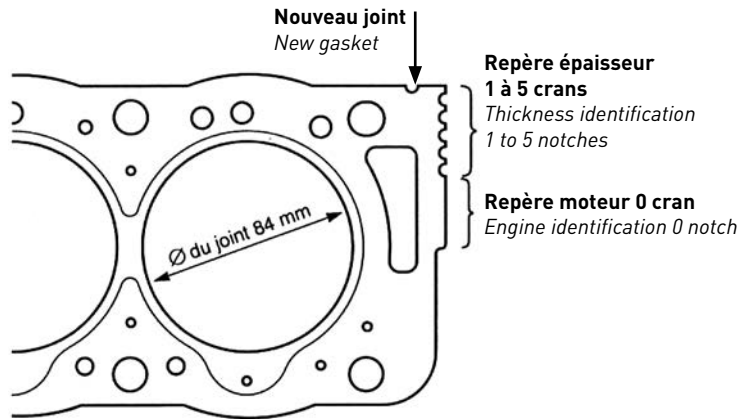
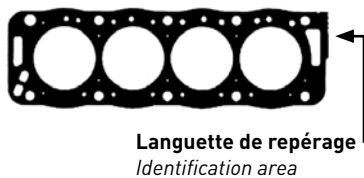



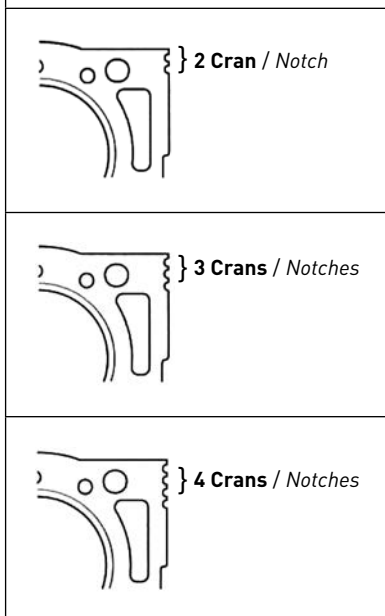

ANCIENS JOINTS FIBREUX (3 épaisseurs différentes) OLD FIBER GASKETS (3 different thicknesses)



Ces joints ne sont plus disponibles.
The gaskets are deleted.

NOUVEAUX JOINTS FIBREUX (5 épaisseurs différentes) NEW FIBER GASKETS (5 different thicknesses)

 } 1 Cran / Notch	BX 880 Ép. / Thick. = 1,36 mm*
 } 2 Crans / Notches	BX 890 Ép. / Thick. = 1,40 mm*
 } 3 Crans / Notches	BX 900 Ép. / Thick. = 1,44 mm*
 } 4 Crans / Notches	BX 910 Ép. / Thick. = 1,48 mm*
 } 5 Crans / Notches	BX 920 Ép. / Thick. = 1,52 mm*

* L'épaisseur correspond à l'épaisseur serrée sur moteur.
* The above thickness refers to the assembled thickness.

Attention: mesurer systématiquement les dépassements de pistons au PMH pour déterminer le joint de culasse d'épaisseur optimale (voir les notes techniques en fin de catalogue pour identifier la correspondance entre le dépassement du piston et la réf. de joint).

Warning: it is strongly recommended that the gasket selection be made after measuring the UDC piston protrusion; see the technical notes at the end of the catalogue to have the link between the piston protrusion and the gasket part number.

IDENTIFICATION JOINTS DE CULASSE - Moteur Diesel CYLINDER HEAD GASKET IDENTIFICATION - Diesel Engine PEUGEOT - CITROËN - Moteur XUD9 Turbo / XUD9 T.C. Engine

Moteurs / Engines XUD9 Turbo / T.C. → Alésage / Bore = 83 mm - 1905 cm³

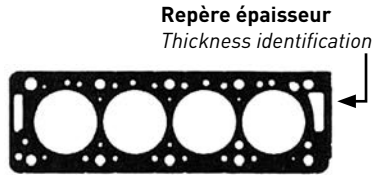



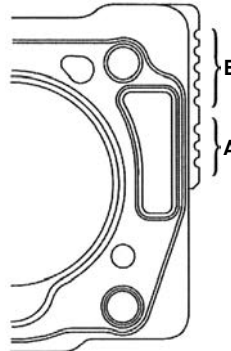

Joint métal-élastomère PAYEN
Steel elastomer gasket PAYEN
A = Repère moteur = 3 crans
A = Engine identification = 3 notches
B = Repère épaisseur = 1 à 5 crans
B = Thickness identification = 1 to 5 notches

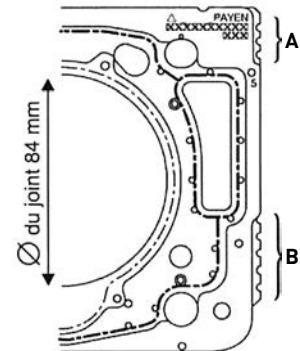



Joint métallique multifeuille
Multi-layer steel gasket
(ELRING)

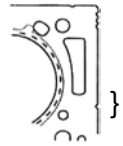
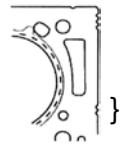
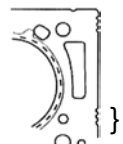

Joint métal-élastomère
Steel elastomer gasket
PAYEN

ANCIENS JOINTS FIBREUX OLD FIBER GASKETS	
 } 1 Cran / Notch	
 } 2 Crans / Notches	BV 920
 } 3 Crans / Notches	BV 930
 } 4 Crans / Notches	

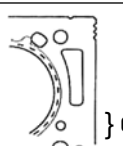
NOUVEAUX JOINTS METAL-ELASTOMERE (5 + 1 épaisseurs différentes) STEEL ELASTOMER GASKETS (5 + 1 different thicknesses)	
 } 1 Cran / Notch	BX 930 Ép. / Thick. = 1,36 mm*
 } 2 Crans / Notches	BX 940 Ép. / Thick. = 1,40 mm*
 } 3 Crans / Notches	BX 950 Ép. / Thick. = 1,44 mm*
 } 4 Crans / Notches	BX 960 Ép. / Thick. = 1,48 mm*
 } 5 Crans / Notches	BX 970 Ép. / Thick. = 1,52 mm*
 } 0 Cran / Notch	BX 980 Ép. / Thick. = 1,59 mm* Pour bloc rectifié For resurfaced block
* L'épaisseur indiquée correspond à l'épaisseur serrée sur moteur. * The above thickness refers to the assembled thickness.	

IDENTIFICATION JOINTS DE CULASSE - Moteur Diesel CYLINDER HEAD GASKET IDENTIFICATION - Diesel Engine PEUGEOT - CITROËN - Moteur / Engine XUD11 ATA et / and BTE

Moteurs / Engines XUD11 ATE et / and BTE → Alésage / Bore = 85 mm - 2088 cm³

Anciens joints de culasse fibreux 4 épaisseurs
Old fiber gaskets (4 different thicknesses)

Nouveaux joints métalliques multifeuilles (5+2 classes)
New multi-layer steel gaskets



Languette de repérage
Identification area



Languette de repérage
Identification area

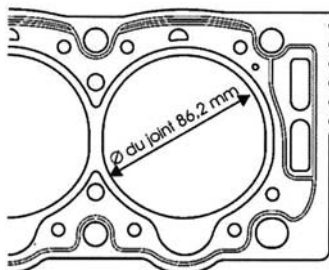

2 à 5 trous
2 to 5 holes

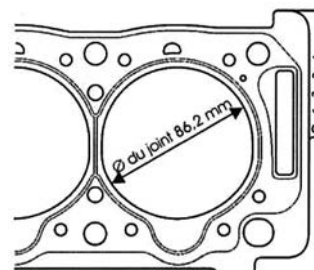

Repère classe d'épaisseur réalisé par un rond blanc sur le chiffre correspondant.
Thickness class identification with white spot on the class identification number.

ANCIENS JOINTS FIBREUX (4 épaisseurs différentes) <i>OLD FIBER GASKETS (4 different thicknesses)</i>
2 Trous / Holes
3 Trous / Holes
4 Trous / Holes
5 Trous / Holes

ANCIENS JOINTS FIBREUX (5 classes) <i>OLD FIBER GASKETS (3 classes)</i>	NOUVEAUX JOINTS MÉTALLIQUES MULTIFEUILLES (3 + 2 classes) <i>NEW MULTI-LAYER STEEL GASKETS (3 + 2 classes)</i>
	 BY 930 Classe / Class 0 (1 + 2 trous / holes) Ép. / Thick. = 1,35 mm*
	 BY 941 Classe / Class 1 Ép. / Thick. = 1,52 mm*
	 BY 961 Classe / Class 2 Ép. / Thick. = 1,62 mm*
	 BY 981 Classe / Class 3 Ép. / Thick. = 1,72 mm*
	 BY 990 Classe / Class 6 (1 + 4 trous / holes) Ép. / Thick. = 1,77 mm*

Attention: mesurer systématiquement les dépassements de pistons au PMH pour déterminer le joint de culasse d'épaisseur optimale (voir les notes techniques en fin de catalogue pour identifier la correspondance entre le dépassement du piston et la réf. de joint).

Warning: it is strongly recommended that the gasket selection be made after measuring the UDC piston protrusion; see the technical notes at the end of the catalogue to have the link between the piston protrusion and the gasket part number.

* L'épaisseur correspond à l'épaisseur serrée sur moteur.
* The above thickness refers to the assembled thickness.

IDENTIFICATION JOINTS DE CULASSE - Moteur Diesel CYLINDER HEAD GASKET IDENTIFICATION - Diesel Engine PEUGEOT - CITROËN - Moteur DW8 Atmo / DW8 N.A. Engine

Moteurs / Engines DW8 Atmo / DW8 N.A.

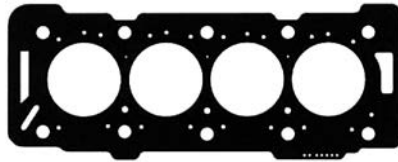

Languette de repérage
Identification area

	1 Trou /Hole	AA5830 Ép. / Thick. = 1,26 mm*
	2 Trous /Holes	AA5840 Ép. / Thick. = 1,30 mm*
	3 Trous /Holes	AA5850 Ép. / Thick. = 1,34 mm*
	4 Trous /Holes	AA5860 Ép. / Thick. = 1,38 mm*
	5 Trous /Holes	AA5870 Ép. / Thick. = 1,42 mm*
	2 Trous /Holes	AA5880 Ép. / Thick. = 1,46 mm*
* L'épaisseur correspond à l'épaisseur serrée sur moteur. * The above thickness refers to the assembled thickness.		

Attention: mesurer systématiquement les dépassements de pistons au PMH pour déterminer le joint de culasse d'épaisseur optimale (voir les notes techniques en fin de catalogue pour identifier la correspondance entre le dépassement du piston et la réf. de joint).



Warning: it is strongly recommended that the gasket selection be made after measuring the UDC piston protrusion; see the technical notes at the end of the catalogue to have the link between the piston protrusion and the gasket part number.

IDENTIFICATION JOINTS DE CULASSE - Moteur Diesel CYLINDER HEAD GASKET IDENTIFICATION - Diesel Engine PEUGEOT - CITROËN - Moteur DW10 Turbo / DW10 T.C. Engine

Moteurs / Engines DW10 Turbo / DW10 T.C.

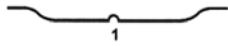
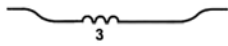

Languette de repérage
Identification area

	1 Cran /Noth	AC5011 Ép. / Thick. = 1,30 mm*
	3 Crans /Nothes	AC5031 Ép. / Thick. = 1,40 mm*
	5 Crans /Nothes	AC5051 Ép. / Thick. = 1,50 mm*
<p>* L'épaisseur correspond à l'épaisseur serrée sur moteur. * The above thickness refers to the assembled thickness.</p>		

Attention: mesurer systématiquement les dépassements de pistons au PMH pour déterminer le joint de culasse d'épaisseur optimale (voir les notes techniques en fin de catalogue pour identifier la correspondance entre le dépassement du piston et la réf. de joint).

Warning: it is strongly recommended that the gasket selection be made after measuring the UDC piston protrusion; see the technical notes at the end of the catalogue to have the link between the piston protrusion and the gasket part number.









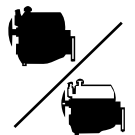



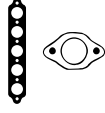

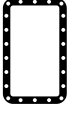

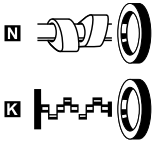



cc



kW/PS

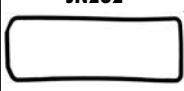

0.6	A06/664						1		DF050 ▲○ [13]	GF051 ▲○ [16]
2 CV 6	08/79→07/90	602	2	74.00	OHV	20-21/ 27-29				
0.6	V06/665						2			GF054 ▲ [3]
Visa 0.6	07/82→03/91	652	2	77.00	OHV, BOXER	24/33				
1.0	1KR-FE						3	AG9310 (MLS)	CG9310	EG9310
C1 1.0	06/05→	998	3	71.00	DOHC	50-51/ 68-69				
1.0	C1A						4	BS810 (Fibre), 1.300mm BR490 (Fibre), 1.500mm	DS810 DT012 ▲	EH951 [14][18] EH952 [3]
AX 10	09/86→06/92	954	4	70.00	SOHC/OHC	32-34/ 44-46				
1.0	C3A						5	BS810 (Fibre), 1.300mm BR490 (Fibre), 1.500mm	DS810 DT012 ▲	EH951 [14][18] EH952 [3]
AX 10 E	12/86→12/88	954	4	70.00	SOHC/OHC	30-33/ 42-45				
1.0	CDY (TU9M)						6	BS810 (Fibre), 1.300mm 07/92→ BR490 (Fibre), 1.500mm 07/92→	DS810 07/92→ DT012 ▲ 07/92→	EH951 [14][18] 07/92→ EH952 [3] 07/92→
AX 10	07/86→12/98	954	4	70.00	SOHC/OHC	33-37/ 45-50				
1.0	CDZ (TU9M)						7	BS810 (Fibre), 1.300mm BR490 (Fibre), 1.500mm	DS810 DT012 ▲	EH951 [14][18] EH952 [3]
AX 10 Saxo 1.0 X	02/87→12/98 05/96→06/03	954	4	70.00	SOHC/OHC	33-37/ 45-50				
1.0	TU9						8	BS810 (Fibre), 1.300mm BR490 (Fibre), 1.500mm	DS810 DT012 ▲	EH951 [14][18] EH952 [3]
C15 Van 1.0	10/84→12/97	954	4	70.00	SOHC/OHC	33/45				
1.0	XV8						9	BN580 (Fibre), 1.200mm BH950 (Fibre), 1.200mm, 1 Notch	DN582 ▲	EH950 [3][14]
C15 Van 1.0 Visa 1.0	10/84→12/97 09/84→06/88	954	4	70.00	SOHC/OHC	33/45				
1.1	E1A						10		DF107 ▲ [13]	
C15 Van 1.1	10/84→12/96	1124	4	72.00	OHV	35/48				
1.1	G11/631						11		DF490 ▲○ [3]	GF492 ▲○ [3]
Axel 11	01/84→03/91	1129	4	74.00	SOHC/OHC, BOXER	40-42/ 55-57				

								
		JB864 ■ (x2) JB830 ■ (x2)	JN232 (x2)[4]			☒ NF812 ■ [1] 30.00x42.00x8.00mm, ACM ☒ NF809 ■ [1] 56.00x69.00x10.00mm, FPM	NF036 (x6)[1][52] [2] ■ NF505 (x2)[1][53] [2] NF577 (x8)[1][54] [2]	 BH950  BN580  BS810, BR490
		JB864 ■ (x2) JB830 ■ (x2)	JN232 (x2)[4]	⇒PA217 16.30x22.00x2.000mm		☒ NF812 ■ [1] 30.00x42.00x8.00mm, ACM ☒ NF810 ■ [1] 57.50x70.00x10.00mm, MVQ		 JB830
HBS508 ⊕ [22]	JD5845 ■ (NBR) JD5846 ■ (MLS) JD5863 ■ ☒ (SE)	JM7042 (ACM)				☒ NAs260 [2] 38.00x50.00x6.00mm, FPM ☒ NAs260 ■ [2] 38.00x50.00x6.00mm, FPM ☒ NAs324 ■ [1] 74.00x89.00x8.50mm, FPM		 JB833
HBS039 ⊕ [22] M10x1.50x175.00mm (x10)	JD551 ■ (x2) JC702 ■ (x2) ☉JE189	JN658 [4]	JJ586 ⇒PB852 16.00x24.00x1.500mm ⇒PA349 22.00x16.00x2.000mm	PA858 HR599 ■ HR642 ■		☒ NF870 ■ [2] 42.00x66.00x6.00mm, FPM/ACM ☒ NF850 ■ [1] 85.00x105.00x8.00mm, FPM ☒ NF857 ■ [1] 85.00x105.00x9.00mm, FPM/ACM	HR564 [55] ■ NF836 [1][2][53] ☒ NF826 [2][53] ■	 JB864
HBS039 ⊕ [22] M10x1.50x175.00mm (x10)	JD551 ■ (x2) JC702 ■ (x2) ☉JE189	JN658 [4]	JJ586 ⇒PB852 16.00x24.00x1.500mm ⇒PA349 22.00x16.00x2.000mm	HR599 ■		☒ NF870 ■ [2] 42.00x66.00x6.00mm, FPM/ACM ☒ NF850 ■ [1] 85.00x105.00x8.00mm, FPM ☒ NF857 ■ [1] 85.00x105.00x9.00mm, FPM/ACM	HR564 [55] ■ NF836 [1][2][53] ☒ NF826 [2][53] ■	 JC702
HBS039 ⊕ [22] M10x1.50x175.00mm (x10) 07/92→	JD551 ■ (x2) 07/92→ JC702 ■ (x2) 07/92→ ☉JE189 07/92→	JN658 [4] 07/92→	⇒PB852 16.00x24.00x1.500mm ⇒PA349 22.00x16.00x2.000mm JJ586 07/92→	HR599 ■ 07/92→		☒ NF870 ■ [2] 42.00x66.00x6.00mm, FPM/ACM 07/92→ ☒ NF850 ■ [1] 85.00x105.00x8.00mm, FPM 07/92→ ☒ NF857 ■ [1] 85.00x105.00x9.00mm, FPM/ACM 07/92→	HR564 [55] ■ NF836 [1][2][53] ☒ NF826 [2][53] ■	 JD551
HBS039 ⊕ [22] M10x1.50x175.00mm (x10)	JD551 ■ (x2) JC702 ■ (x2) ☉JE189	JN658 [4]	JJ586	PA858 HR599 ■ HR642 ■		☒ NF870 ■ [2] 42.00x66.00x6.00mm, FPM/ACM ☒ NF850 ■ [1] 85.00x105.00x8.00mm, FPM ☒ NF857 ■ [1] 85.00x105.00x9.00mm, FPM/ACM	NF836 [1][2][53] ☒ NF826 [2][53] ■	 JE189
HBS039 ⊕ [22] M10x1.50x175.00mm (x10)	JD551 ■ (x2) JC702 ■ (x2) ☉JE189	JN658 [4]	JJ586	PA858 HR599 ■ HR642 ■		☒ NF870 ■ [2] 42.00x66.00x6.00mm, FPM/ACM ☒ NF850 ■ [1] 85.00x105.00x8.00mm, FPM ☒ NF857 ■ [1] 85.00x105.00x9.00mm, FPM/ACM	NF836 [1][2][53] ☒ NF826 [2][53] ■	 JN232
HBS039 ⊕ [22] M10x1.50x175.00mm (x10)	JD551 ■ (x2) JC702 ■ (x2) ☉JE189	JN658 [4]	JJ586	PA858 HR599 ■ HR642 ■		☒ NF870 ■ [2] 42.00x66.00x6.00mm, FPM/ACM ☒ NF850 ■ [1] 85.00x105.00x8.00mm, FPM ☒ NF857 ■ [1] 85.00x105.00x9.00mm, FPM/ACM	NF836 [1][2][53] ☒ NF826 [2][53] ■	 JN596
HBS039 ⊕ [22] M10x1.50x175.00mm (x10)		JN596 [4]		HR569 ■		☒ NF678 ■ [2] 35.00x50.00x8.00mm, ACM ☒ NF641 ■ [1] 78.00x100.00x10.00mm, MVQ		 JN658
								 JJ586
		JB833 ■ (x4)		⇒PA217 16.30x22.00x2.000mm		☒ NF677 (x2)[2] 28.00x52.00x10.00mm, ACM ☒ NF763 ■ [1] 57.50x120.00x10.00mm, FPM/ACM	NF812 [1][56]	









cc

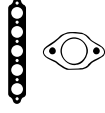

kW/PS

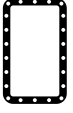

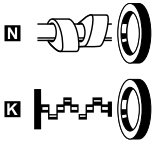
1.1	H1A					12	AD5700 (Fibre), 1.250mm AD5710 (Fibre), 1.500mm	DT010 DT012 ▲	EH951 [14][18] EH952 [3]
AX 11	12/86→04/94	1124	4	72.00	SOHC/OHC	40-44/ 54-60			
AX 11 4x4	06/91→07/92								
BX 11	10/86→06/92								
C15 1.1	11/88→07/96								
ZX 1.1	03/91→08/93								
1.1	H1B					13	AD5700 (Fibre), 1.250mm AD5710 (Fibre), 1.500mm	DT010 DT012 ▲	EH951 [14][18] EH952 [3]
AX 11	09/86→12/97	1124	4	72.00	SOHC/OHC	40-44/ 55-60			
ZX 1.1	03/91→08/93								
1.1	HAZ (TU1CP)					14	AD5700 (Fibre), 1.250mm AD5710 (Fibre), 1.500mm	DT010 DT012 ▲	EH951 [14][18] EH952 [3]
AX 11	09/88→12/89	1124	4	72.00	SOHC/OHC	40/54			
1.1	HDZ (TU1M)					15	AD5700 (Fibre), 1.250mm BS810 (Fibre), 1.300mm AD5710 (Fibre), 1.500mm BR490 (Fibre), 1.500mm	DT010 DT012 ▲	EH951 [14][18] EH952 [3]
AX 11	09/86→12/97	1124	4	72.00	SOHC/OHC	40-44/ 55-60			
Berlingo 1.1 i	07/96→								
BX 11	10/88→06/92								
C15 Van 1.1 i	07/88→12/96								
C15 Estate 1.1	08/88→07/96								
Saxo 1.1 X,SX	05/96→09/03								
ZX 1.1	03/91→06/97								
1.1	HFX (TU1JP)					16	AC5700 (Fibre), 1.260mm AC5710 (Fibre), 1.46mm	CC5700	EC5700
Berlingo 1.1 i	07/96→	1124	4	72.00		44/60			
C2 1.1	09/03→								
C3 1.1 i	02/02→								
C3 II 1.1	11/09→								
Saxo 1.1 X,SX	05/96→09/03								
1.2	FHZ (F13DTE5) Diesel					17			
Nemo 1.3 HDi 75	10/10→	1248	4	69.60	DOHC	55/75			
1.3	G1A					18	BF170 (Fibre), 1.300mm BG490 (Fibre), 1.800mm	DF106 ▲○ [13] DF107 ▲ [13]	EF102
C15 Van 1.3	07/87→05/88	1294	4	76.70		47/64			
1.3	M4A					19	AD5700 (Fibre), 1.250mm AD5710 (Fibre), 1.500mm	DT013 ▲ [3]	EH951 [14][18] EH952 [3]
AX 1.3 Sport	04/87→12/88	1294	4	75.00	SOHC/OHC	69-70/ 94-95			
1.4	8FP (EP3)					20	AH6440 (MLS), 0.900mm		
C3 II 1.4 VTi 95	11/09→	1397	4	77.00	DOHC	70/95			
C3 Picasso	02/09→								
C4 1.4 VTi 95	11/09→								
DS3 1.4 VTi 95	04/10→								
1.4	8FS (EP3)					21	AH6440 (MLS), 0.900mm	CH6440 (MLS)	
C3 Picasso	02/09→	1397	4	77.00	DOHC	70/95			
1.4	8HR (DV4C) Diesel					22			
C3 II 1.4 HDi 70	11/09→	1398	4	73.70	SOHC/OHC	50/68			
DS3 1.4 HDi 70	04/10→								

      							
HBS039 [22] M10x1.50x175.00mm (x10)	JD551 [x2] JC702 [x2] JE189	JN658 [4]	JJ586 PB852 16.00x24.00x1.500mm PA349 22.00x16.00x2.000mm	HR642 [5]	NF870 [2] 42.00x66.00x6.00mm, FPM/ACM NF850 [1] 85.00x105.00x8.00mm, FPM NF857 [1] 85.00x105.00x9.00mm, FPM/ACM	HR564 [55]	AC5700 AD5710 BF170, BG490 BS810, BR490 JB836 JB837 JC702 JD551 JE189 JN238 JN658 HC341 JJ586
HBS039 [22] M10x1.50x175.00mm (x10)	JD551 [x2] JC702 [x2] JE189	JN658 [4]	JJ586 PB852 16.00x24.00x1.500mm PA349 22.00x16.00x2.000mm	PA858 HR642 [5]	NF870 [2] 42.00x66.00x6.00mm, FPM/ACM NF850 [1] 85.00x105.00x8.00mm, FPM NF857 [1] 85.00x105.00x9.00mm, FPM/ACM	HR564 [55]	
HBS039 [22] M10x1.50x175.00mm (x10)	JD551 [x2] JC702 [x2] JE189	JN658 [4]	JJ586 PB852 16.00x24.00x1.500mm PA349 22.00x16.00x2.000mm	HR642 [5]	NF870 [2] 42.00x66.00x6.00mm, FPM/ACM NF850 [1] 85.00x105.00x8.00mm, FPM NF857 [1] 85.00x105.00x9.00mm, FPM/ACM	HR564 [55]	
HBS039 [22] M10x1.50x175.00mm (x10)	JD551 [x2] HA5028 [x2] JC702 [x2] JE189	JN658 [4]	JJ586 PB852 16.00x24.00x1.500mm PA349 22.00x16.00x2.000mm	HR599 [5] HR642 [5]	NF870 [2] 42.00x66.00x6.00mm, FPM/ACM NF850 [1] 85.00x105.00x8.00mm, FPM NF857 [1] 85.00x105.00x9.00mm, FPM/ACM	HR564 [55]	
HBS039 [22] M10x1.50x175.00mm (x10)	HA5028 [x2]	JN658 [4]	JJ586 PB852 16.00x24.00x1.500mm PA349 22.00x16.00x2.000mm	HR599 [5]	NF870 [2] 42.00x66.00x6.00mm, FPM/ACM NF850 [1] 85.00x105.00x8.00mm, FPM NF857 [1] 85.00x105.00x9.00mm, FPM/ACM	HR564 [55]	
					NA5223 [2] 40.00x52.00x7.00mm, FPM NA5230 [2] 78.00x100.00x9.00mm, PTFE		
	JB836 [x2] JB837 [x2]	JN238 [4]	HC341 [x2] PA349 22.00x16.00x2.000mm	HR569 [5]	NF692 [1] 71.00x88.00x8.00mm, MVQ NF694 [2] 40.00x58.00x8.00mm, ACM		
HBS039 [22] M10x1.50x175.00mm (x10)	JD551 [x2] JC702 [x2] JE189	JN658 [4]	JJ586 PB852 16.00x24.00x1.500mm PA349 22.00x16.00x2.000mm	HR569 [5]	NF870 [2] 42.00x66.00x6.00mm, FPM/ACM NF850 [1] 85.00x105.00x8.00mm, FPM NF857 [1] 85.00x105.00x9.00mm, FPM/ACM	HR564 [55]	
	JD6034 [x4] (Elastomer)						
HBS522 [21][57]	JD6034 [x4] (Elastomer)						
					NA5258 [2] 27.00x47.00x7.00mm, PTFE		













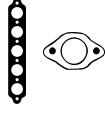

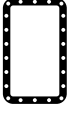

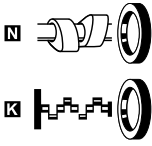

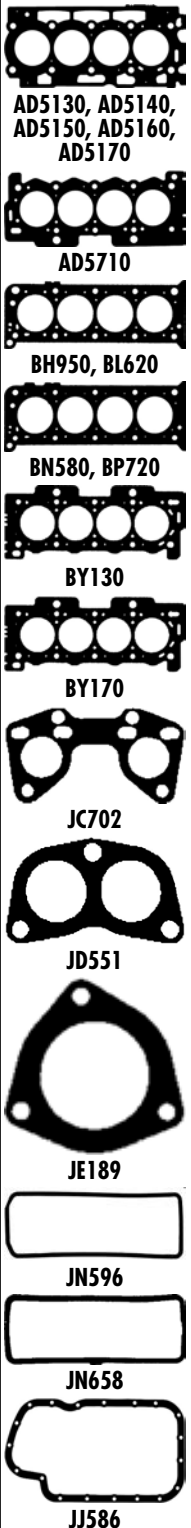
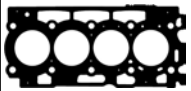

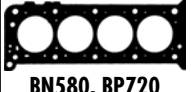
cc



kW/PS

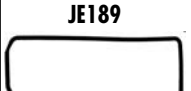
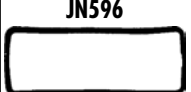

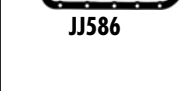
1.4	8HS (DV4TD) Diesel	23							
Nemo 1.4 HDi	02/08→	1398	4	73.70	SOHC/OHC	50/68	AH6560 (MLS), 1.25mm, 2 Notches AH6570 (MLS), 1.3mm, 3 Notches AH6580 (MLS), 1.35mm, 1 Notch AH6590 (MLS), 1.4mm, 4 Notches AH6600 (MLS), 1.45mm, 5 Notches	CD5130 ▲	
1.4	8HX (DV4TD) Diesel	24							
C2 1.4 HDi	09/03→	1398	4	73.70	SOHC/OHC	50/68	AH6560 (MLS), 1.25mm, 2 Notches AH6570 (MLS), 1.3mm, 3 Notches AH6580 (MLS), 1.35mm, 1 Notch AH6590 (MLS), 1.4mm, 4 Notches AH6600 (MLS), 1.45mm, 5 Notches	CD5130 ▲	ED5130
C3 1.4 HDi	02/02→								
Xsara 1.4 HDi	01/03→03/05								
Xsara Break	01/03→08/05								
Xsara Coupe	01/03→03/05								
1.4	8HY (DV4TED4) Diesel	25							
C3 1.4 16V HDi	02/02→	1398	4	73.70	DOHC	66/90	AD5130 (MLS), 1.250mm, 2 Notches AD5140 (MLS), 1.300mm, 3 Notches AD5150 (MLS), 1.350mm, 1 Notch AD5160 (MLS), 1.400mm, 4 Notches AD5170 (MLS), 1.450mm, 5 Notches	CD5140 ▲	ED5130
1.4	8HZ (DV4TD) Diesel	26							
C3 II 1.4 HDi 70	11/09→	1398	4	73.70	SOHC/OHC	50/68	AH6560 (MLS), 1.25mm, 2 Notches AH6570 (MLS), 1.3mm, 3 Notches AH6580 (MLS), 1.35mm, 1 Notch AH6590 (MLS), 1.4mm, 4 Notches AH6600 (MLS), 1.45mm, 5 Notches	CD5130 ▲	ED5130
1.4	150B (XY8)	27							
Visa 14 GT	03/82→03/91	1360	4	75.00	SOHC/OHC	55-58/ 75-79	BH950 (Fibre), 1.200mm, 1 Notch →11/85 BL620 (Fibre), 1.400mm →11/85 BN580 (Fibre), 1.200mm 11/85→ BP720 (Fibre), 1.400mm 11/85→	DN582 ▲	EH950 [3][14]
1.4	150D (XY7)	28							
C15 (VD-_) 1.4 E	05/87→12/96	1360	4	75.00	SOHC/OHC	44/60	BP720 (Fibre), 1.400mm →03/91 →Eng.3281 BN580 (Fibre), 1.200mm →03/91 Eng.3280→		EH950 [3][14] →03/91
C15 Estate 1.4	05/87→10/92								
Visa 14	07/84→03/91								
1.4	DV4D Diesel	29							
C1 1.4 HDi	06/05→	1398	4	73.50	SOHC/OHC	40/54	AH6560 (MLS), 1.25mm, 2 Notches AH6570 (MLS), 1.3mm, 3 Notches AH6580 (MLS), 1.35mm, 1 Notch AH6590 (MLS), 1.4mm, 4 Notches AH6600 (MLS), 1.45mm, 5 Notches	CD5130 ▲	ED5130
1.4	K1F	30							
AX 14	06/88→12/89	1360	4	75.00	SOHC/OHC	49/67	AD5700 (Fibre), 1.250mm AD5710 (Fibre), 1.500mm	DT010 DT012 ▲	EH951 [14][18] EH952 [3]
1.4	K1H (TU3A)	31							
BX 14	01/89→12/89	1360	4	75.00	SOHC/OHC	47-49/ 64-67		DT010	
BX Break 14	01/89→12/89								
C15 Van 1.4	07/87→12/96								
1.4	K2A	32							
AX 1.4 4x4	09/86→07/92	1360	4	75.00	SOHC/OHC	61-65/ 84-88	BY130 (Fibre), 1.280mm BY170 (Fibre), 1.500mm	DY130 ▲[3]	EY130 [3]
AX 14	01/88→12/92								

									
HBS359 [22] M11x1.50x147.00mm (x10)	HA5029 [1] [5] JD5829 [5]	JM5299				NA5258 [2] 27.00x47.00x7.00mm, PTFE			 AD5130, AD5140, AD5150, AD5160, AD5170  AD5710  BH950, BL620  BN580, BP720
HBS359 [22] M11x1.50x147.00mm (x10)	HA5029 [1] [5] JD5829 [5]	JM5299	KG5157 10.00x20.00x2.000mm			NA5258 [2] 27.00x47.00x7.00mm, PTFE NA5259 [2] 40.00x55.00x6.40mm, PTFE			 BY130  BY170
HBS359 [22] M11x1.50x147.00mm (x10)	JD5830 [1] [5] HA5031 [1] [5] [5] HA5030 [1] [5] [5] JD5829 [5]	JM7034 (Elastomer)	KG5157 10.00x20.00x2.000mm			NA5258 [2] 27.00x47.00x7.00mm, PTFE NA5259 [2] 40.00x55.00x6.40mm, PTFE			 JC702  JE189
HBS359 [22] M11x1.50x147.00mm (x10)	HA5029 [1] [5] JD5829 [5]	JM5299				NA5258 [2] 27.00x47.00x7.00mm, PTFE NA5259 [2] 40.00x55.00x6.40mm, PTFE			 JN596  JN658
HBS011 [5] M12x1.25x119.00mm (x12)		JN596 [4]	PA349 22.00x16.00x2.000mm		HR300 [5]	NF678 [2] 35.00x50.00x8.00mm, ACM NF641 [1] 78.00x100.00x10.00mm, MVQ		HR564 [5] [5] HG108 [8] [5] [8] HL442 [8] [5] [9] HG093 [6] [6] [1] LV847 [17]	 JJ586
HBS011 [5] M12x1.25x119.00mm (x12) →03/91						NF678 [2] 35.00x50.00x8.00mm, ACM →03/91 NF641 [1] 78.00x100.00x10.00mm, MVQ →03/91			 JE189
HBS359 [22] M11x1.50x147.00mm (x10)	HA5029 [1] [5] JD5829 [5]	JM5299	KG5157 10.00x20.00x2.000mm			NA5258 [2] 27.00x47.00x7.00mm, PTFE NA5259 [2] 40.00x55.00x6.40mm, PTFE			 JN596  JN658
HBS039 [22] M10x1.50x175.00mm (x10)	JD551 [1] (x2) JC702 [1] (x2)  JE189	JN658 [4]	JJ586 PB852 16.00x24.00x1.500mm PA349 22.00x16.00x2.000mm		HR642 [5]	NF870 [2] 42.00x66.00x6.00mm, FPM/ACM NF850 [1] 85.00x105.00x8.00mm, FPM NF857 [1] 85.00x105.00x9.00mm, FPM/ACM		HR564 [5] [5]	 JJ586
	JD551 [1] (x2) JC702 [1] (x2)	JN658 [4]			HR599 [5]	NF870 [2] 42.00x66.00x6.00mm, FPM/ACM NF850 [1] 85.00x105.00x8.00mm, FPM			
HBS039 [22] M10x1.50x175.00mm (x10)	JD551 [1] (x2) JC702 [1] (x2)	JN658 [4]			HR599 [5]	NF870 [2] 42.00x66.00x6.00mm, FPM/ACM NF850 [1] 85.00x105.00x8.00mm, FPM			









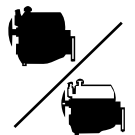



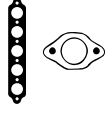

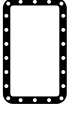

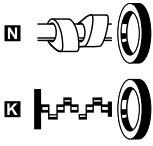











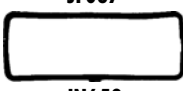

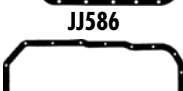
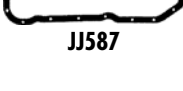

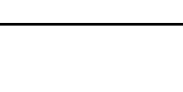







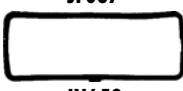

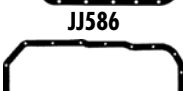
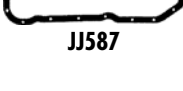

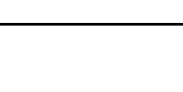









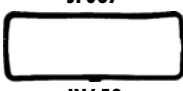

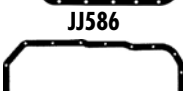
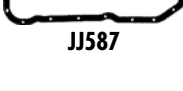

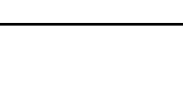





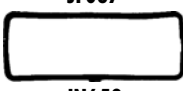

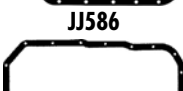
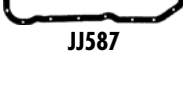

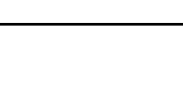



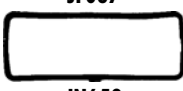

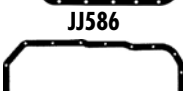
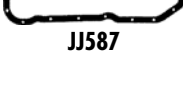

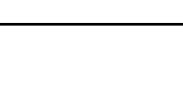



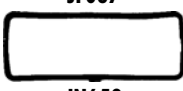

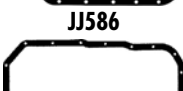
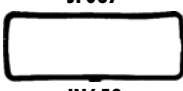

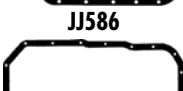
cc

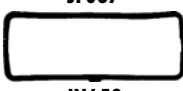

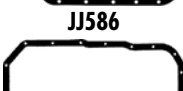
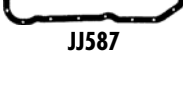
kW/PS

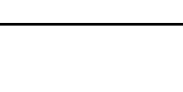

1.4							33			DT010	
AX 14	K2B	01/88→12/92	1360	4	75.00	SOHC/OHC	62-65/ 85-89				
1.4							34	AD5710 (Fibre), 1.500mm		DT010 DT012 ▲	EH951 [14][18]
C15 1.4 E	K3A	07/87→12/96	1360	4	75.00	SOHC/OHC	40-46/ 54-63				
1.4		Diesel					35	BS730 (SE), 1.800mm BY120 (Fibre), 1.800mm		DS731 ▲	EH951 [14][18] EH952 [3]
AX 1.4 D 4x4	K9A (TUD3)	06/91→07/92	1360	4	75.00	SOHC/OHC	38-39/ 52-53				
AX 14 D		09/88→06/92									
1.4		Diesel					36	BS730 (SE), 1.800mm BY120 (Fibre), 1.800mm		DS731 ▲	EH951 [14][18] EH952 [3]
AX 14 D	K9Y (TUD3Y)	08/91→12/97	1360	4	75.00	SOHC/OHC	37-39/ 50-53				
ZX 1.4 D		07/94→10/97									
1.4							37	AD5700 (Fibre), 1.250mm 03/87→ AD5710 (Fibre), 1.500mm 03/87→		DT010 03/87→ DT012 ▲ 03/87→	EH951 [14][18] EH952 [3] 03/87→
AX 14	KAY (TU3CP)	12/86→12/88	1360	4	75.00	SOHC/OHC	44/60				
1.4		KDX (TU3M/Z)					38	BY130 (Fibre), 1.280mm 03/89→		DT010 03/89→	EH951 [14][18] 03/89→ EH952 [3] 03/89→
AX 14		04/87→04/97	1360	4	75.00	SOHC/OHC	55/75				
AX 14 4x4		08/91→12/96									
ZX 1.4 i		03/91→06/97									
ZX Break 1.4 i		10/93→10/97									
1.4		KDY (TU3FM)					39	BY130 (Fibre), 1.280mm BY170 (Fibre), 1.500mm		DY130 ▲[3]	EY130 [3]
AX 14		04/87→04/97	1360	4	75.00	SOHC/OHC	55-58/ 75-79				
AX 14 4x4		08/91→12/96									
C15 Van 1.4 i		05/91→12/96									
1.4		KDY (TU3M)					40	AY110 (Fibre) AD5700 (Fibre), 1.250mm AD5710 (Fibre), 1.500mm		DT010 DT012 ▲	EH951 [14][18] EH952 [3]
AX 14		04/87→04/97	1360	4	75.00	SOHC/OHC	55-58/ 75-79				
AX 14 4x4		08/91→12/96									
BX 14		01/89→02/93									
BX Break 14		01/89→02/93									
C15 Van 1.4 i		05/91→12/96									
C15 Estate 1.4		05/91→07/96									
ZX Break 1.4 i		10/93→10/97									

      							
HBS011 [5] M12x1.25x119.00mm (x12)	JD551 [1] (x2) HA5028 [1] [5] JC702 [1] (x2)	JN658 [4]		HR599 [5]	NF870 [1] [2] 42.00x66.00x6.00mm, FPM/ACM NF850 [1] [1] 85.00x105.00x8.00mm, FPM NF857 [1] [1] 85.00x105.00x9.00mm, FPM/ACM		 AD5710  BS730, BY120  BY130  BY170  JC702  JD551  JE189  JF067  JN658  JN758  JJ586  JJ587  HR564  HR836  NF826  NF857  PA858  PB259
HBS039 [22] M10x1.50x175.00mm (x10)	JD551 [1] (x2) JC702 [1] (x2) JE189	JN658 [4]	JJ586 = PB852 16.00x24.00x1.500mm	HR642 [5]	NF870 [1] [2] 42.00x66.00x6.00mm, FPM/ACM NF850 [1] [1] 85.00x105.00x8.00mm, FPM NF857 [1] [1] 85.00x105.00x9.00mm, FPM/ACM	HR564 [5] [5]	 BS730, BY120  BY130  BY170  JC702  JD551  JE189  JF067  JN658  JN758  JJ586  JJ587  HR564  HR836  NF826  NF857  PA858  PB259
HBS082 [22] M10x1.50x185.00mm (x10)	JF067	JN758 [4]	JJ586 = PA349 22.00x16.00x2.000mm	PA858 HR642 [5]	NF870 [1] [2] 42.00x66.00x6.00mm, FPM/ACM NF850 [1] [1] 85.00x105.00x8.00mm, FPM NF857 [1] [1] 85.00x105.00x9.00mm, FPM/ACM	HR564 [5] [5] NF836 [1] [2] [5] [3] NF826 [2] [5] [3] [2] PB259 [4] [5]	 JC702  JD551  JE189  JF067  JN658  JN758  JJ586  JJ587  HR564  HR836  NF826  NF857  PA858  PB259
HBS082 [22] M10x1.50x185.00mm (x10)	JF067	JN758 [4]	JJ586 = PA349 22.00x16.00x2.000mm	PA858 HR642 [5]	NF870 [1] [2] 42.00x66.00x6.00mm, FPM/ACM NF850 [1] [1] 85.00x105.00x8.00mm, FPM NF857 [1] [1] 85.00x105.00x9.00mm, FPM/ACM	HR564 [5] [5] NF836 [1] [2] [5] [3] NF826 [2] [5] [3] [2] PB259 [4] [5]	 JD551  JE189  JF067  JN658  JN758  JJ586  JJ587  HR564  HR836  NF826  NF857  PA858  PB259
HBS039 [22] M10x1.50x175.00mm (x10) 03/87→	JD551 [1] (x2) 03/87→ HA5028 [1] [5] 03/87→ JC702 [1] (x2) 03/87→ JE189 03/87→	JN658 [4] 03/87→	= PB852 16.00x24.00x1.500mm = PA349 22.00x16.00x2.000mm JJ586 03/87→	HR642 [5] 03/87→	NF870 [1] [2] 42.00x66.00x6.00mm, FPM/ACM 03/87→ NF850 [1] [1] 85.00x105.00x8.00mm, FPM 03/87→ NF857 [1] [1] 85.00x105.00x9.00mm, FPM/ACM 03/87→	HR564 [5] [5]	 JE189  JF067  JN658  JN758  JJ586  JJ587  HR564  HR836  NF826  NF857  PA858  PB259
HBS039 [22] M10x1.50x175.00mm (x10) 03/89→	JD551 [1] (x2) 03/89→ HA5028 [1] [5] 03/89→ JC702 [1] (x2) 03/89→	JN658 [4] 03/89→	JJ586 03/89→	HR599 [5] 03/89→	NF870 [1] [2] 42.00x66.00x6.00mm, FPM/ACM 03/89→ NF850 [1] [1] 85.00x105.00x8.00mm, FPM 03/89→ NF857 [1] [1] 85.00x105.00x9.00mm, FPM/ACM 03/89→		 JN658  JN758  JJ586  JJ587
HBS039 [22] M10x1.50x175.00mm (x10)	JD551 [1] JC702 [1] (x2)	JN658 [4]	JJ587	HR599 [5] HR642 [5]	NF870 [1] [2] 42.00x66.00x6.00mm, FPM/ACM NF850 [1] [1] 85.00x105.00x8.00mm, FPM NF857 [1] [1] 85.00x105.00x9.00mm, FPM/ACM		 JN658  JN758  JJ586  JJ587
HBS039 [22] M10x1.50x175.00mm (x10)	JD551 [1] (x2) HA5028 [1] [5] JC702 [1] (x2) JE189	JN658 [4]	JJ586 = PB852 16.00x24.00x1.500mm = PA349 22.00x16.00x2.000mm	HR599 [5] HR642 [5]	NF870 [1] [2] 42.00x66.00x6.00mm, FPM/ACM NF850 [1] [1] 85.00x105.00x8.00mm, FPM NF857 [1] [1] 85.00x105.00x9.00mm, FPM/ACM	HR564 [5] [5]	 JE189  JF067  JN658  JN758  JJ586  JJ587  HR564  HR836  NF826  NF857  PA858  PB259













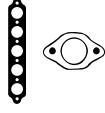

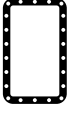

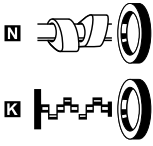









cc

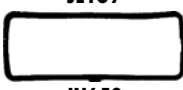

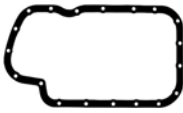
kW/PS



1.4		KDZ (TU3M/Z)					41	AD5700 (Fibre), 1.250mm BY130 (Fibre), 1.280mm AD5710 (Fibre), 1.500mm		DT010 DT012 ▲	EH951 [14][18] EH952 [3]
AX 14	04/87→04/97	1360	4	75.00	SOHC/OHC	55-59/ 75-80					
AX 14 4x4	08/91→12/96										
AX 14 GT	01/89→12/91										
BX 14	01/89→02/93										
ZX 1.4	03/91→06/97										
ZX 1.4 i	03/91→06/97										
1.4		KFT (TU3A)					42	AD5700 (Fibre), 1.250mm AD5710 (Fibre), 1.500mm			
C3 II 1.4	11/09→	1360	4	75.00	SOHC/OHC	54/73					
Nemo 1.4	04/09→										
1.4		KFU (ET3J4)					43	AG9030 (Fibre), 1.400mm		CG9030	EG9030
C2 1.4 16V	06/06→	1360	4	75.00	DOHC	65/88					
C3 1.4 16V	12/03→										
C4 1.4 16V	11/04→										
C4 Coupe 1.4 16V	11/04→										
1.4		KFV (TU3A)					44	AD5700 (Fibre), 1.250mm AD5710 (Fibre), 1.500mm			
C3 II 1.4	11/09→	1360	4	75.00	SOHC/OHC	49-59/ 67-80					
Nemo 1.4	02/08→										
1.4		KFV (TU3JP)					45	AD5700 (Fibre), 1.250mm AD5710 (Fibre), 1.500mm		DT012 ▲	EH951 [14][18]
C2 1.4	09/03→	1360	4	75.00	SOHC/OHC	54-58/ 73-79					
C3 1.4	05/03→										
C3 1.4 Hybrid	05/05→										
C3 1.4 i	02/02→										
C3 1.4 i Bi	02/02→										
1.4		KFW (TU3JP)					46	AD5700 (Fibre), 1.250mm AD5710 (Fibre), 1.500mm		DT012 ▲	EH951 [14][18]
Berlingo	11/02→	1360	4	75.00	SOHC/OHC	47-55/ 64-75					
Berlingo 1.4	11/02→10/05										
Berlingo 1.4 GNC	11/02→										
Berlingo 1.4 i	07/96→										
Saxo 1.4 VTS	05/96→06/03										
Xsara 1.4 i	04/97→03/05										
Xsara Break	10/97→08/05										
Xsara Coupe	03/98→03/05										
1.4		KFX (TU3JP)					47	AY110 (Fibre) AD5700 (Fibre), 1.250mm BY130 (Fibre), 1.280mm AD5710 (Fibre), 1.500mm		DT010 DT012 ▲	EH951 [14][18] EH952 [3]
Berlingo 1.4 i	07/96→	1360	4	75.00	SOHC/OHC	53-55/ 72-75					
Saxo 1.4 VTS	05/96→06/03										
Xsara 1.4 i	04/97→03/05										
Xsara Break	10/97→08/05										
Xsara Coupe	03/98→03/05										
ZX 1.4 i	03/91→06/97										
ZX Break 1.4 i	10/93→10/97										
1.4		KFY (TU3FJ2)					48	AY110 (Fibre) BY170 (Fibre), 1.500mm		DY130 ▲ [3]	EY130 [3]
AX 1.4 GTi	08/91→12/96	1360	4	75.00	SOHC/OHC	66/90					
1.4		KFZ (TU3FJ2)					49	AY110 (Fibre) BY170 (Fibre), 1.500mm		DY130 ▲ [3]	EY130 [3]
AX 1.4 GTi	06/91→12/96	1360	4	75.00	SOHC/OHC	69-74/ 94-100					

								
HBS039 [22] M10x1.50x175.00mm (x10)	JD551 [x2] HA5028 [S] JC702 [x2] 	JN658 [4]	JJ586 =PB852 16.00x24.00x1.500mm =PA349 22.00x16.00x2.000mm	HR642 [S]	NF870 [2] 42.00x66.00x6.00mm, FPM/ACM NF850 [1] 85.00x105.00x8.00mm, FPM NF857 [1] 85.00x105.00x9.00mm, FPM/ACM	HR564 [55][S]	 AD5710  BY130  BY170  JC702	
	 JE5072 (MLS)			HR599 [S]	NF870 [2] 42.00x66.00x6.00mm, FPM/ACM		 JD538	
HBS489 [22] M10x1.50x117.00mm (x10)	JD5882 [FPM]  JE5072 (MLS)	JM7051 (SE) JM7052 (SE)			NF870 [2] 42.00x66.00x6.00mm, FPM/ACM NF850 [1] 85.00x105.00x8.00mm, FPM		 JE189	
HBS039 [22] M10x1.50x175.00mm (x10)	HA5028 [S] JC702 [x2]  JE5072 (MLS)	JN658 [4]		HR599 [S]	NF870 [2] 42.00x66.00x6.00mm, FPM/ACM		 JD551	
HBS039 [22] M10x1.50x175.00mm (x10)	JD538 [x4] HA5028 [S] JC702 [x2]	JN658 [4]		PA850 HR599 [S] HR642 [S]	NF870 [2] 42.00x66.00x6.00mm, FPM/ACM NF850 [1] 85.00x105.00x8.00mm, FPM NF857 [1] 85.00x105.00x9.00mm, FPM/ACM		 JE189	
HBS039 [22] M10x1.50x175.00mm (x10)	HA5028 [S] JC702 [x2]  JE5072 (MLS)	JN658 [4]		HR599 [S]	NF870 [2] 42.00x66.00x6.00mm, FPM/ACM NF850 [1] 85.00x105.00x8.00mm, FPM NF857 [1] 85.00x105.00x9.00mm, FPM/ACM		 JN658	
HBS039 [22] M10x1.50x175.00mm (x10)	JD538 [x4] JD551 [x2] HA5028 [S] JC702 [x2]  JE189  JE5072 (MLS)	JN658 [4]	JJ586	HR599 [S] HR642 [S]	NF870 [2] 42.00x66.00x6.00mm, FPM/ACM NF850 [1] 85.00x105.00x8.00mm, FPM NF857 [1] 85.00x105.00x9.00mm, FPM/ACM		 JJ586	
HBS039 [22] M10x1.50x175.00mm (x10)	HA5028 [S] JC702 [x2] 	JN658 [4]	JJ587 =PB852 16.00x24.00x1.500mm	HR599 [S] HR642 [S]	NF870 [2] 42.00x66.00x6.00mm, FPM/ACM NF850 [1] 85.00x105.00x8.00mm, FPM NF857 [1] 85.00x105.00x9.00mm, FPM/ACM	HR564 [55][S] NF836 [1][2][53] NF826 [2][53][S]	 JJ587	
HBS039 [22] M10x1.50x175.00mm (x10)	HA5028 [S] JC702 [x2] 	JN658 [4]	JJ587 =PB852 16.00x24.00x1.500mm	HR599 [S] HR642 [S]	NF870 [2] 42.00x66.00x6.00mm, FPM/ACM NF850 [1] 85.00x105.00x8.00mm, FPM NF857 [1] 85.00x105.00x9.00mm, FPM/ACM	HR564 [55][S] NF836 [1][2][53] NF826 [2][53][S]		



cc



kW/PS

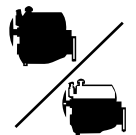

1.5		VJY (TUD5)		Diesel		50		BY150 (Fibre), 1.750mm	DY150 ▲ ^[3]
AX 15 D	08/94→12/97	1527	4	77.00	SOHC/OHC	40-42/			
Saxo 1.5 D	09/96→09/03					54-57			
1.5		VJZ (TUD5)		Diesel		51		BY150 (Fibre), 1.750mm	CY140 ▲ ^[3] DY150 ▲ ^[3]
AX 15 D	08/94→12/97	1527	4	77.00	SOHC/OHC	42-43/			
Saxo 1.5 D	09/96→06/01					57-58			
Xsara 1.5 D	04/97→09/00								
Xsara Break	10/97→09/00								
1.6		5FK (EP6CB)				52		AH6440 (MLS), 0.900mm	
Berlingo 1.6 95	07/10→	1598	4	77.00	DOHC	72/98			
1.6		5FR (EP6DT)				53		AH6730 (MLS), 0.9mm	CH6730 (MLS)
DS3 1.6 THP 155	04/10→	1598	4	77.00	DOHC	115/156			
DS3 Cabrio	01/13→								
1.6		5FS (EP6C)				54		AH6440 (MLS), 0.900mm	CH6440 (MLS)
Berlingo	11/09→	1598	4	77.00	DOHC	88/120			
C3 II VTi 120	11/09→								
C3 Picasso	02/09→								
C4 1.6 VTi 120	11/09→								
C4 LPG	09/11→								
C4 Picasso	02/13→								
C5 1.6 VTi 120	07/10→								
C5 Break	07/10→								
DS3 1.6 VTi 120	04/10→								
DS3 Cabrio	01/13→								
DS4 1.6 VTi 120	04/11→								
1.6		5FT (EP6DT)				55		AH6730 (MLS), 0.9mm	CH6730 (MLS)
C4 1.6 THP 140	07/08→	1598	4	77.00	DOHC	103/140			
C4 Grand Pic	07/08→								
C4 Picasso	07/08→								
1.6		5FV (EP6CDT)				56		AH6730 (MLS), 0.9mm	CH6730 (MLS)
C4 1.6 THP 155	11/09→	1598	4	77.00	DOHC	115/156			
C4 Grand Pic	09/10→								
C4 Picasso	09/10→								
DS4 1.6 THP 155	04/11→								
DS5 1.6 THP 155	11/11→								
1.6		5FV (EP6DT)				57		AH6730 (MLS), 0.9mm	CH6730 (MLS)
C5 Break	04/09→	1598	4	77.00	DOHC	115/156			
1.6		5FW (EP6)				58		AH6440 (MLS), 0.900mm	CH6440 (MLS)
C3 Picasso	02/09→	1598	4	77.00	DOHC	88/120			
C4 1.6 VTi 120	07/08→								
C4 Grand Pic	07/08→								
C4 Picasso	07/08→								
1.6		5FX (EP6DT)				59		AH6730 (MLS), 0.9mm	CH6730 (MLS)
C4 1.6 THP 150	07/08→	1598	4	77.00	DOHC	110/150			
C4 Grand Pic	10/08→								
C4 Picasso	07/08→								
DS3 1.6 THP 150	01/10→								

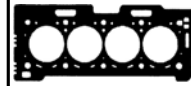
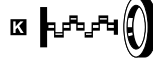
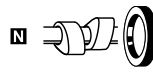
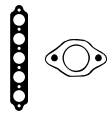

BY150



JD498

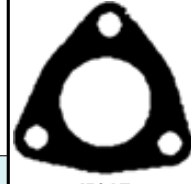

JF067

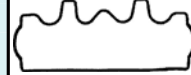

JP041



JJ587

HBS113 ⑤ [22] M11x1.50x185.00mm (x10)	JD498 ■ JF067	JP041 [4]	JJ587	HR599 ⑤ HR642 ⑤	☒ NF870 ⑤ [2] 42.00x66.00x6.00mm, FPM/ACM ☒ NF850 ⑤ [1] 85.00x105.00x8.00mm, FPM ☒ NF857 ⑤ [1] 85.00x105.00x9.00mm, FPM/ACM	NF836 [1][2][53] ☒ NF826 [2][53]☒ PB259 [45]
HBS113 ⑤ [22] M11x1.50x185.00mm (x10)	JF067	JP041 [4]	JJ587	HR599 ⑤ HR642 ⑤	☒ NF870 ⑤ [2] 42.00x66.00x6.00mm, FPM/ACM ☒ NF850 ⑤ [1] 85.00x105.00x8.00mm, FPM ☒ NF857 ⑤ [1] 85.00x105.00x9.00mm, FPM/ACM	NF836 [1][2][53] ☒ NF826 [2][53]☒ PB259 [45]
	JD6034 ■ (x4) (Elastomer)					
HBS522 ⑤ [21][57]		HM5371 ⑤				
HBS522 ⑤ [21][57]	JD6034 ■ (x4) (Elastomer)					
HBS522 ⑤ [21][57]		HM5371 ⑤				
HBS522 ⑤ [21][57]		HM5371 ⑤				
HBS522 ⑤ [21][57]		HM5371 ⑤				
HBS522 ⑤ [21][57]	JD6034 ■ (x4) (Elastomer)					
HBS522 ⑤ [21][57]		HM5371 ⑤				



cc



kW/PS



1.6		9HR (DV6C)		Diesel		60				
Berlingo	07/10→	1560	4	75.00	SOHC/OHC	82-84/	112-114			
C3 II HDi 110	11/09→									
C3 Picasso	05/10→									
C4 1.6 HDi 110	11/09→									
C4 1.6 HDi 115	07/12→									
C4 Grand Pic	09/10→									
C4 Picasso	09/10→									
C5 1.6 HDi 110	07/10→									
C5 1.6 HDi 115	01/12→									
C5 Break	07/10→									
DS3 1.6 HDi 110	11/09→									
DS4 1.6 HDi 110	04/11→									
DS5 1.6 HDi 110	11/11→									
1.6		9HT (DV6BTED4)		Diesel		61		AD5130 (MLS), 1.250mm, 2 Notches	CD5140 ▲	
Berlingo 1.6 75	04/08→	1560	4	75.00	DOHC	55/75		AD5140 (MLS), 1.300mm, 3 Notches		
								AD5150 (MLS), 1.350mm, 1 Notch		
								AD5160 (MLS), 1.400mm, 4 Notches		
								AD5170 (MLS), 1.450mm, 5 Notches		
1.6		9HT (DV6BUTED4)		Diesel		62		AD5130 (MLS), 1.250mm, 2 Notches	CD5140 ▲	
Berlingo 1.6 75	04/08→	1560	4	75.00	DOHC	55/75		AD5140 (MLS), 1.300mm, 3 Notches		
								AD5150 (MLS), 1.350mm, 1 Notch		
								AD5160 (MLS), 1.400mm, 4 Notches		
								AD5170 (MLS), 1.450mm, 5 Notches		
1.6		9HU (DV6UTED4)		Diesel		63				
Jumpy 1.6 HDi 90	01/07→	1560	4	75.00	DOHC	66/90				
1.6		9HW (DV6ETED)		Diesel		64		AD5130 (MLS), 1.250mm, 2 Notches	CD5140 ▲	
Berlingo 1.6 75	07/05→	1560	4	75.00	DOHC	55/75		AD5140 (MLS), 1.300mm, 3 Notches		
								AD5150 (MLS), 1.350mm, 1 Notch		
								AD5160 (MLS), 1.400mm, 4 Notches		
								AD5170 (MLS), 1.450mm, 5 Notches		
1.6		9HX (DV6ATED4)		Diesel		65		AD5130 (MLS), 1.250mm, 2 Notches	CD5140 ▲	
Berlingo 1.6 90	07/05→	1560	4	75.00	DOHC	66-68/	90-92	AD5140 (MLS), 1.300mm, 3 Notches		
C3 1.6V HDi	10/05→							AD5150 (MLS), 1.350mm, 1 Notch		
C3 II 1.6 HDi 90	11/09→							AD5160 (MLS), 1.400mm, 4 Notches		
C3 Picasso	02/09→							AD5170 (MLS), 1.450mm, 5 Notches		
C4 1.6 HDi	11/04→									
C4 Coupe 1.6 HDi	11/04→									
Xsara Picasso	09/05→									
1.6		9HY (DV6TED4)		Diesel		66		AD5130 (MLS), 1.250mm, 2 Notches	CD5140 ▲	
C4 1.6 HDi	11/04→	1560	4	75.00	DOHC	80-85/	109-116	AD5140 (MLS), 1.300mm, 3 Notches		
C4 Coupe 1.6 HDi	11/04→							AD5150 (MLS), 1.350mm, 1 Notch		
C4 Grand Pic	10/06→							AD5160 (MLS), 1.400mm, 4 Notches		
C4 Picasso	02/07→							AD5170 (MLS), 1.450mm, 5 Notches		
C5 1.6 HDi	09/04→									
C5 Break 1.6 HDi	09/04→									
Xsara Picasso	05/04→									

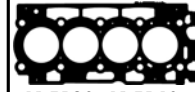
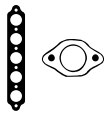

AD5130, AD5140,
AD5150, AD5160,
AD5170

						<p>NA5258 [2] 27.00x47.00x7.00mm, PTFE</p>	
<p>HBS359 [22] M11x1.50x147.00mm (x10)</p>	<p>JD5830 [1] [2] HA5031 [1] [2] [3] HA5030 [1] [2] [3] JD5829 [3]</p>					<p>NA5258 [2] 27.00x47.00x7.00mm, PTFE NA5259 [2] 40.00x55.00x6.40mm, PTFE</p>	
<p>HBS359 [22] M11x1.50x147.00mm (x10)</p>	<p>JD5830 [1] [2] HA5031 [1] [2] [3] HA5030 [1] [2] [3] JD5829 [3]</p>					<p>NA5258 [2] 27.00x47.00x7.00mm, PTFE NA5259 [2] 40.00x55.00x6.40mm, PTFE</p>	
						<p>NA5258 [2] 27.00x47.00x7.00mm, PTFE</p>	
<p>HBS359 [22] M11x1.50x147.00mm (x10)</p>	<p>JD5830 [1] [2] HA5031 [1] [2] [3] HA5030 [1] [2] [3] JD5829 [3]</p>					<p>NA5258 [2] 27.00x47.00x7.00mm, PTFE NA5259 [2] 40.00x55.00x6.40mm, PTFE</p>	
<p>HBS359 [22] M11x1.50x147.00mm (x10)</p>	<p>JD5830 [1] [2] HA5031 [1] [2] [3] HA5030 [1] [2] [3] JD5829 [3]</p>	<p>JM7034 (Elastomer)</p>	<p>KG5157 10.00x20.00x2.000mm</p>			<p>NA5258 [2] 27.00x47.00x7.00mm, PTFE NA5259 [2] 40.00x55.00x6.40mm, PTFE</p>	
<p>HBS359 [22] M11x1.50x147.00mm (x10)</p>	<p>JD5830 [1] [2] HA5031 [1] [2] [3] HA5030 [1] [2] [3] JD5829 [3]</p>	<p>JM7034 (Elastomer)</p>				<p>NA5258 [2] 27.00x47.00x7.00mm, PTFE NA5259 [2] 40.00x55.00x6.40mm, PTFE</p>	



cc



kW/PS

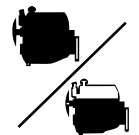

1.6		9HZ (DV6TED4) Diesel		67		AD5130 (MLS), 1.250mm, 2 Notches AD5140 (MLS), 1.300mm, 3 Notches AD5150 (MLS), 1.350mm, 1 Notch AD5160 (MLS), 1.400mm, 4 Notches AD5170 (MLS), 1.450mm, 5 Notches		CD5140 ▲	
Berlingo	08/05→	1560	4	75.00	DOHC	80/109			
C2 1.6 HDi	09/05→								
C3 1.6 16V HDi	09/05→								
C3 Picasso	02/09→								
C4 1.6 HDi	11/04→								
C4 Coupe 1.6 HDi	11/04→								
C4 Grand Pic	10/06→								
C4 Picasso	02/07→								
C5 1.6 HDi	09/04→								
C5 Break 1.6 HDi	09/04→								
1.6		171A		68		BL650 (Fibre), 1.200mm		DL650	
BX 16	10/82→06/88	1580	4	83.00	SOHC/OHC	66-67/ 90-92			
BX Break 16	06/85→06/88								
1.6		171B		69		BL650 (Fibre), 1.200mm		DL650	
BX 16	10/82→06/88	1580	4	83.00	SOHC/OHC	66-67/ 90-92			
BX Break 16	06/85→06/88								
1.6		171C		70		BL650 (Fibre), 1.200mm BR510 (Fibre), 1.440mm		DN590 ▲ [3] EL650 [3] GL650 [3]	
BX 16	10/82→06/88	1580	4	83.00	SOHC/OHC	66-68/ 90-92			
BX Break 16	04/83→01/92								
1.6		171D		71		BL650 (Fibre), 1.200mm BR510 (Fibre), 1.440mm		DN590 ▲ [3] EL650 [3] GL650 [3]	
BX 16	07/85→02/93	1580	4	83.00	SOHC/OHC	64/87			
BX Break 16	07/85→12/94								
1.6		180Z		72		BL650 (Fibre), 1.200mm BR510 (Fibre), 1.440mm		DL650 DN590 ▲ [3] EL650 [3] GL650 [3]	
BX 16	03/86→02/93	1580	4	83.00	SOHC/OHC	76/103			
BX Break 16	03/86→12/94								
1.6		220 A2.000		73		AY460 (Fibre) BR630 (Fibre)		DR630 [3] ET400 GR630 [3]	
Jumpy 1.6	10/95→08/00	1581	4	86.40	SOHC/OHC	59-60/ 80-81			
Jumpy Box 1.6 i	10/95→								
1.6		1580 SPI		74		AY460 (Fibre) BR630 (Fibre)		DR630 [3] ET400 GR630 [3]	
Jumpy 1.6	10/95→	1581	4	86.40	SOHC/OHC	58/79			
Jumpy Box 1.6 i	10/95→								
1.6		B1A (XU51C/K)		75		BL650 (Fibre), 1.200mm BR510 (Fibre), 1.440mm		DL650 DN590 ▲ [3] EL650 [3] GL650 [3]	
BX 16	09/87→02/93	1580	4	83.00	SOHC/OHC	58-59/ 79-80			
1.6		B1E (XU51C)		76		BL650 (Fibre), 1.200mm BR510 (Fibre), 1.440mm		DL650 DN590 ▲ [3] EL650 [3] GL650 [3]	
BX 16	01/87→02/93	1580	4	83.00	SOHC/OHC	53-59/ 72-80			
BX Break 16	10/87→12/94								
1.6		B6D		77		BL650 (Fibre), 1.200mm BR510 (Fibre), 1.440mm		DL650 DN590 ▲ [3] EL650 [3] GL650 [3]	
BX 1.6	01/87→01/92	1580	4	83.00	SOHC/OHC	83-85/ 113-116			
BX Break 1.6	01/87→01/92								
Visa 16 GTI	06/86→03/91								
1.6		B6E		78		BL650 (Fibre), 1.200mm BR510 (Fibre), 1.440mm		DL650 DN590 ▲ [3] EL650 [3] GL650 [3]	
BX 1.6	01/87→01/92	1580	4	83.00	SOHC/OHC	85/116			
BX Break 1.6	01/87→01/92								

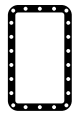
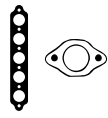

AD5130, AD5140,
AD5150, AD5160,
AD5170



AY460, BR630



BL650, BR510



JC415



JC750



JD146



LT634



JN547



JN805

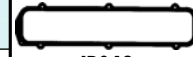

JP049

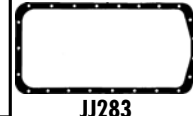

JJ283



JJ453













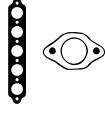

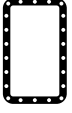

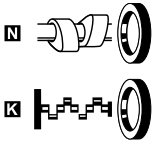

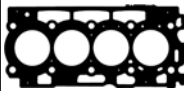
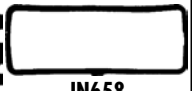

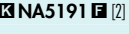
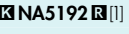

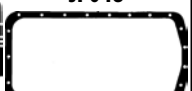

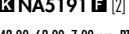
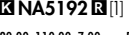

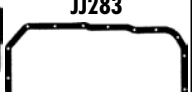
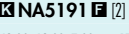
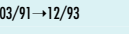

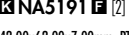
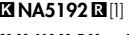



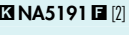
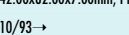

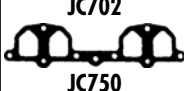
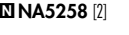
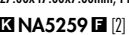



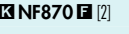
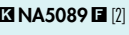

cc

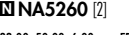
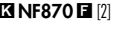
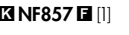

kW/PS

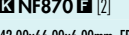
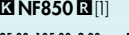
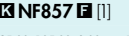

1.6 BAY (XU5CP)						79	BL650 (Fibre), 1.200mm BR510 (Fibre), 1.440mm	DL650 DN590 ▲ [3]	EL650 [3] GL650 [3]
BX 16	09/88→02/93	1580	4	83.00	SOHC/OHC	55/75			
BX Break 16	09/88→12/94								
1.6 BAZ (XU5CP)						80	BL650 (Fibre), 1.200mm BR510 (Fibre), 1.440mm	DL650 DN590 ▲ [3]	EL650 [3] GL650 [3]
BX 16	09/88→02/93	1580	4	83.00	SOHC/OHC	55/75			
BX Break 16	09/88→12/94								
1.6 BDY (XU5M)						81	BL650 (Fibre), 1.200mm 03/91→12/93	DL650 03/91→12/93	EL650 [3] 03/91→12/93
BX 16 E	05/89→02/93	1580	4	83.00	SOHC/OHC	65/88			
BX Break 16	05/89→12/94								
ZX 1.6 i	03/91→06/97								
ZX Break 1.6 i	10/93→10/97								
1.6 BDZ (XU5M)						82	BL650 (Fibre), 1.200mm BR510 (Fibre), 1.440mm	DL650 DN590 ▲ [3]	EL650 [3] GL650 [3]
BX 16 E	05/89→02/93	1580	4	83.00	SOHC/OHC	65/89			
BX Break 16	05/89→12/94								
1.6 BFZ (XU5JP)						83	BL650 (Fibre), 1.200mm 10/93→ BR510 (Fibre), 1.440mm 10/93→	CY130 ▲ [3] 10/93→	EL650 [3] 10/93→
Xantia 1.6 i	03/93→01/98	1580	4	83.00	SOHC/OHC	65/88			
Xantia 1.6 i SX	01/98→03/01								
ZX 1.6 i	03/91→06/97								
ZX Break 1.6 i	10/93→10/97								
1.6 DV6B Diesel						84	AD5130 (MLS), 1.250mm, 2 Notches AD5140 (MLS), 1.300mm, 3 Notches AD5150 (MLS), 1.350mm, 1 Notch AD5160 (MLS), 1.400mm, 4 Notches AD5170 (MLS), 1.450mm, 5 Notches		
Berlingo 1.6 75	07/05→	1560	4	75.00	DOHC	55/75			
1.6 NFR (TU5JP4B)						85	AD5180 (MLS), 0.620mm		
Berlingo 1.6	04/08→	1587	4	78.50	DOHC	66/90			
1.6 NFS (TU5JP4S)						86	AD5180 (MLS), 0.620mm	CD5180	ED5180
C2 1.6 VTS	01/05→	1587	4	78.50		90/122			
1.6 NFT						87	BY180 (Fibre), 1.50mm AY120 (Fibre), 1.70mm	DY130 ▲ [3]	EY130 [3]
Saxo 1.6	02/01→04/04	1587	4	78.50	SOHC/OHC	72-74/ 98-101			
Saxo 1.6 VTS	09/00→09/03								

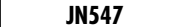
      		 					
HBS038 [22] M11x1.50x175.00mm (x10) HBS083 [22] M11x1.50x168.00mm (x10)	JC750 [1] JC415 [x4] 	JN547 [4]	JJ283 [62]	HR569 [5]	 [2] 42.00x62.00x7.00mm, PTFE  [1] 90.00x110.00x7.00mm, PTFE	KA611 [15]	 AD5180  JJ283
HBS038 [22] M11x1.50x175.00mm (x10) HBS083 [22] M11x1.50x168.00mm (x10)	JC750 [1] JC415 [x4] 	JN547 [4]	JJ283 [62]	HR569 [5]	 [2] 42.00x62.00x7.00mm, PTFE  [1] 90.00x110.00x7.00mm, PTFE	KA611 [15]	 AY120  JJ587
			JJ283 [62] 03/91→12/93		 [2] 42.00x62.00x7.00mm, PTFE 03/91→12/93  [1] 90.00x110.00x7.00mm, PTFE 03/91→12/93	KA611 [15]	 BL650, BR510  BY180
	JC750 [1] JC415 [x4]	JN547 [4]	JJ283 [62]	HR569 [5]	 [2] 42.00x62.00x7.00mm, PTFE  [1] 90.00x110.00x7.00mm, PTFE	KA611 [15]	 JC415
HBS038 [22] M11x1.50x175.00mm (x10) 10/93→ →Eng.07448 HBS260 [22] M11x1.50x168.00mm (x10) 10/93→ Eng.07448→	JD519 [x2] 10/93→ JD520 [x4] 10/93→	JPO43 [4] 10/93→	 PA349 22.00x16.00x2.000mm  PB907 14.00x21.00x2.000mm JJ283 [62] 10/93→	HR569 [5] 10/93→	 [2] 42.00x62.00x7.00mm, PTFE 10/93→  [1] 90.00x110.00x7.00mm, PTFE 10/93→	HR566 [55] KA611 [15]	 JC702  JC750
HBS359 [22] M11x1.50x147.00mm (x10)					 [2] 27.00x47.00x7.00mm, PTFE  [2] 40.00x55.00x6.40mm, PTFE		 JD519  JD520
HBS254 [22] M10x1.50x122.00mm (x10)	 JE5072 (MLS)				 [2] 42.00x66.00x6.00mm, FPM/ACM  [2] 38.00x50.00x8.00mm, NBR  [1] 85.00x105.00x8.00mm, FPM		 JE189
HBS254 [22] M10x1.50x122.00mm (x10)	HA5032 [1]  JE5072 (MLS)	JM7035 (Elastomer)	JH5107 (ACM)  PB852 16.00x24.00x1.500mm  PA349 22.00x16.00x2.000mm		 [2] 38.00x50.00x6.00mm, FPM  [2] 42.00x66.00x6.00mm, FPM/ACM  [1] 85.00x105.00x9.00mm, FPM/ACM		 JE189
HBS039 [22] M10x1.50x175.00mm (x10)	JD530 [x4] JC702 [x2]  JE189	JN658 [4]	JJ587  PB852 16.00x24.00x1.500mm  PA349 22.00x16.00x2.000mm	HR642 [5]	 [2] 42.00x66.00x6.00mm, FPM/ACM  [1] 85.00x105.00x8.00mm, FPM  [1] 85.00x105.00x9.00mm, FPM/ACM		 LT634  JN547



cc



kW/PS



1.6		NFU (TU5JP4)				88	AD5180 (MLS), 0.620mm	CD5180	ED5180
Berlingo	10/00→	1587	4	78.50	DOHC	80-81/ 109-110			
Berlingo 1.6	04/08→								
Berlingo 1.6 16V	10/00→								
C2 1.6	09/03→								
C3 1.6	05/03→								
C3 1.6 16V	02/02→								
C4 1.6 16V	11/04→								
C4 Coupe 1.6 16V	11/04→								
Xsara 1.6 16V	09/00→03/05								
Xsara Break	09/00→08/05								
Xsara Coupe	09/00→03/05								
Xsara Picasso	09/05→								
1.6		NFV (TU5JP)				89	BY180 (Fibre), 1.50mm AY120 (Fibre), 1.70mm	DY130 ▲ [3]	EY130 [3]
Xsara Picasso	12/99→	1587	4	78.50	SOHC/OHC	70/95			
1.6		NFX (TU5JP4)				90	AE5010 (MLS), 1.370mm AE5020 (MLS), 1.570mm AE5030 (MLS), 1.770mm	CE5010	
Saxo 1.6	02/96→04/04	1587	4	78.50	DOHC	82-88/ 112-120			
Saxo 1.6 VTS	06/96→09/03								
1.6		NFZ (TU5JP)				91	BY180 (Fibre), 1.50mm 08/97→ AY120 (Fibre), 1.70mm 08/97→	DY130 ▲ [3] 08/97→	EY130 [3] 08/97→
Saxo 1.6	02/96→06/03	1587	4	78.50	SOHC/OHC	65-66/ 88-90			
Saxo 1.6 VTL, VTR	05/96→06/03								
Xsara 1.6 i	04/97→09/00								
Xsara Break	10/97→09/00								
Xsara Coupe	02/98→09/00								
Xsara Picasso	12/99→								
1.6		XU52C				92	BL650 (Fibre), 1.200mm BR510 (Fibre), 1.440mm	DN590 ▲ [3]	EL650 [3] GL650 [3]
BX 16	10/82→12/92	1580	4	83.00	SOHC/OHC	65-85/ 88-116			
1.7		6FY (EW7A)				93	AH6530 (MLS)	CH6530	
C4 Grand Pic	10/06→	1749	4	82.70	DOHC	92/125			
C4 Picasso	02/07→								
C5 1.8 16V	09/05→								
C5 Break 1.8 16V	09/05→								
1.7		6FZ (EW7J4)				94	AD5310 (MLS), 0.750mm	CD5310	ED5300
C5 1.8 16V	03/01→08/04	1749	4	82.70	DOHC	85/115			
C5 Break 1.8 16V	06/01→08/04								
Xsara 1.8 VTS	09/00→10/04								
Xsara Picasso	02/00→								

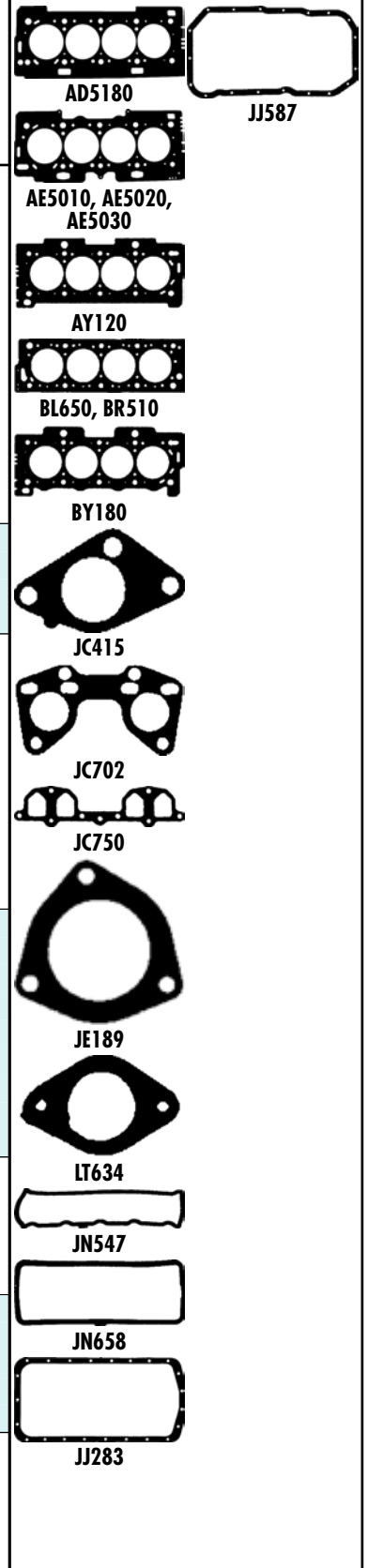
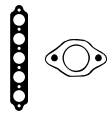

HBS254 [22]
M10x1.50x122.00mm (x10)

HA5032 [1]
JE5072
(MLS)

JM7035
(Elastomer)

JH5107
(ACM)
=PB852
16.00x24.00x1.500mm
=PA349
22.00x16.00x2.000mm

NA5260 [2]
38.00x50.00x6.00mm, FPM
NA5260 [2]
38.00x50.00x6.00mm, FPM
NF870 [2]
42.00x66.00x6.00mm, FPM/ACM
NF850 [1]
85.00x105.00x8.00mm, FPM
NF857 [1]
85.00x105.00x9.00mm, FPM/ACM

AD5180
AE5010, AE5020, AE5030
AY120
BL650, BR510



JJ587

HBS039 [22]
M10x1.50x175.00mm (x10)

JD530 [x4]
JC702 [x2]

JN658 [4]

JJ587

HR599
HR642

NF870 [2]
42.00x66.00x6.00mm, FPM/ACM
NF850 [1]
85.00x105.00x8.00mm, FPM



BY180

HBS254 [22]
M10x1.50x122.00mm (x10)

JE5044
(MLS)

NA5260 [2]
38.00x50.00x6.00mm, FPM
NF870 [2]
42.00x66.00x6.00mm, FPM/ACM
NA5089 [2]
38.00x50.00x8.00mm, NBR
NF850 [1]
85.00x105.00x8.00mm, FPM
NF857 [1]
85.00x105.00x9.00mm, FPM/ACM

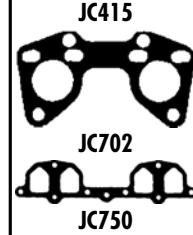

JC415

JC702

JC750

HBS039 [22]
M10x1.50x175.00mm (x10)
08/97→

JD530 [x4]
08/97→
JC702 [x2]
08/97→
JE189
08/97→

JN658 [4]
08/97→

=PB852
16.00x24.00x1.500mm
=PA349
22.00x16.00x2.000mm
JJ587
08/97→

HR642
08/97→

NF870 [2]
42.00x66.00x6.00mm, FPM/ACM
08/97→
NF850 [1]
85.00x105.00x8.00mm, FPM
08/97→
NF857 [1]
85.00x105.00x9.00mm, FPM/ACM
08/97→

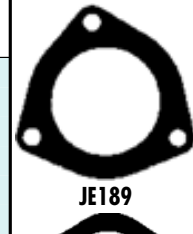

JE189

HBS083 [22]
M11x1.50x168.00mm (x10)

JC750 [1]
JC415 [x4]
LT634

JN547 [4]

JJ283 [62]
=PA349
22.00x16.00x2.000mm
=PB907
14.00x21.00x2.000mm

HR569

NA5191 [2]
42.00x62.00x7.00mm, PTFE
NA5192 [1]
90.00x110.00x7.00mm, PTFE

HR566 [55]
KA611 [15]
LC292 [x2][45]

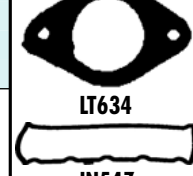

LT634

JN547

HBS535 [22]

JM5139
JM5283

NA5256 [2]
40.00x55.00x6.50mm, FPM

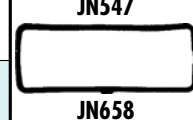

JN658

HBS259 [22]
M11x1.50x144.50mm (x10)

JM5139
JM5283

=PB907
14.00x21.00x2.000mm

HR5080

NA5256 [2]
40.00x55.00x6.50mm, FPM



JJ283



cc



kW/PS



1.8	161 (XUD7)	Diesel				95			
BX 1.8 D	10/85→09/93	1769	4	80.00	SOHC/OHC	44/60	BX830 (Fibre), 1.360mm, 1 Notch ☞0.560→0.670mm BX840 (Fibre), 1.400mm, 2 Notches ☞0.680→0.710mm BX850 (Fibre), 1.440mm, 3 Notches ☞0.720→0.750mm BX860 (Fibre), 1.480mm, 4 Notches ☞0.760→0.790mm BX870 (Fibre), 1.520mm, 5 Notches ☞0.800→0.830mm	DJ720 ▲	EL890 [3] GJ720 ▲
1.8	161A (XUD7)	Diesel				96			
BX Break 1.8 D	10/85→09/93	1769	4	80.00	SOHC/OHC	43-44/ 58-60	BX830 (Fibre), 1.360mm, 1 Notch ☞0.560→0.670mm BX840 (Fibre), 1.400mm, 2 Notches ☞0.680→0.710mm BX850 (Fibre), 1.440mm, 3 Notches ☞0.720→0.750mm BX860 (Fibre), 1.480mm, 4 Notches ☞0.760→0.790mm BX870 (Fibre), 1.520mm, 5 Notches ☞0.800→0.830mm	DJ720 ▲	EL890 [3] GJ720 ▲
C15 Van 1.8 D	07/86→12/00								
C15 Estate 1.8 D	04/87→08/00								
Visa 17 D	04/84→03/91								
Xsara 1.8 D	04/97→09/00								
ZX 1.8 D	06/93→06/97								
ZX Break 1.8 D	10/93→10/97								
1.8	169 (XM7T)					97			
C25 1.8	11/81→01/94	1796	4	84.00	OHV	49-51/ 69-69		DM533 ▲ [3]	EM531 [3]
C25 1.8 E	07/87→02/94								
1.8	A8A (XUD7TE)	Diesel				98			
BX 1.8 TRD Turbo	03/88→02/93	1769	4	80.00	SOHC/OHC	66/90	BR780 (Fibre), 1.650mm, 2 Notches ☞0.650→0.770mm BR790 (Fibre), 1.800mm, 3 Notches ☞0.770→0.820mm		
BX Break 1.8TRD	03/88→12/94								
1.8	A9A (XUD7)	Diesel				99			
Berlingo 1.8 D	07/98→	1769	4	80.00	SOHC/OHC	43-44/ 58-60	BX830 (Fibre), 1.360mm, 1 Notch ☞0.560→0.670mm BX840 (Fibre), 1.400mm, 2 Notches ☞0.680→0.710mm BX850 (Fibre), 1.440mm, 3 Notches ☞0.720→0.750mm BX860 (Fibre), 1.480mm, 4 Notches ☞0.760→0.790mm BX870 (Fibre), 1.520mm, 5 Notches ☞0.800→0.830mm	DJ720 ▲	EL890 [3] GJ720 ▲
Berlingo 1.8D	07/96→								
Xsara 1.8 D	04/97→09/00								
Xsara Break	10/97→09/00								
1.8	AJZ (XUD7TE)	Diesel				100			
BX 1.8 TRD Turbo	03/88→02/93	1769	4	80.00	SOHC/OHC	66/90	BR780 (Fibre), 1.650mm, 2 Notches ☞0.650→0.770mm BR790 (Fibre), 1.800mm, 3 Notches ☞0.770→0.820mm		
BX Break 1.8TRD	03/88→12/94								
1.8	LFX (XU7JB)					101			
Berlingo	08/99→10/02	1761	4	83.00	SOHC/OHC	66/90	BL650 (Fibre), 1.200mm 05/97→ BR510 (Fibre), 1.440mm 05/97→	DL651 ▲ 05/97→	EL650 [3] 05/97→
Berlingo 1.8 i	04/97→								
Xantia 1.8 i	04/97→04/03								
Xantia Break	04/97→04/03								
Xsara 1.8 i	04/97→09/00								
Xsara Break	10/97→09/00								
Xsara Coupe	02/98→09/00								

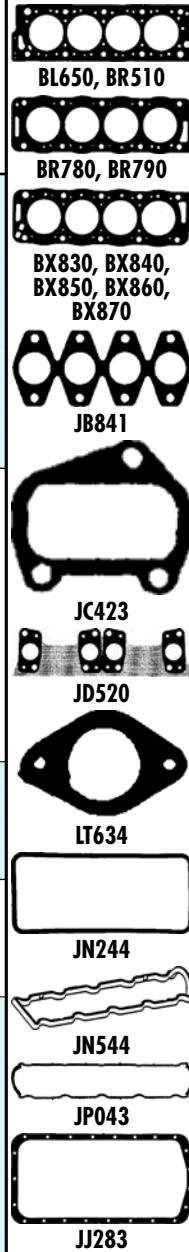

HBS084 [22]
M12x1.50x120.00mm (x10)
→Eng.08469
HBS245 [22]
M12x1.50x125.00mm (x10)
Eng.08470→

JD5972 [1]
JC423 [2]
LT634

JN544 [4]

JJ283 [62]
PA349
22.00x16.00x2.000mm

HR569 [5]

NF841 (x2)[1][2]
35.00x50.00x8.00mm, FPM
NA5191 [2]
42.00x62.00x7.00mm, PTFE
NA5192 [1]
90.00x110.00x7.00mm, PTFE

KA611 [15]

HBS084 [22]
M12x1.50x120.00mm (x10)
→Eng.08469
HBS245 [22]
M12x1.50x125.00mm (x10)
Eng.08470→

JD5972 [1]
JC423 [2]
LT634

JN544 [4]

JJ283 [62]

HR569 [5]

NF841 (x2)[1][2]
35.00x50.00x8.00mm, FPM
NA5191 [2]
42.00x62.00x7.00mm, PTFE
NA5192 [1]
90.00x110.00x7.00mm, PTFE

KA611 [15]

HBS038 [22]
M11x1.50x175.00mm (x10)
04/89→

JB841 [5]

JN244 [4]

PA349
22.00x16.00x2.000mm

HR569 [5]

NA5191 [2]
42.00x62.00x7.00mm, PTFE
NA5192 [1]
90.00x110.00x7.00mm, PTFE

HL472 [55][5]

HBS084 [22]
M12x1.50x120.00mm (x10)
→Eng.08469
HBS245 [22]
M12x1.50x125.00mm (x10)
Eng.08470→

JD5972 [1]
JC423 [2]
LT634

JN544 [4]

JJ283 [62]

HR569 [5]

NF841 [1][2]
35.00x50.00x8.00mm, FPM
NA5191 [2]
42.00x62.00x7.00mm, PTFE

KA611 [15]

NF841 (x2)[1][2]
35.00x50.00x8.00mm, FPM
NA5191 [2]
42.00x62.00x7.00mm, PTFE
NA5192 [1]
90.00x110.00x7.00mm, PTFE

KA611 [15]

HBS260 [22]
M11x1.50x168.00mm (x10)
05/97→

JD5254 [1] (x4)
05/97→
JD520 [5]
05/97→

JP043 [4]
05/97→

JJ283 [62]
05/97→

HR569 [5]
05/97→

NF841 [1][2]
35.00x50.00x8.00mm, FPM
NA5191 [2]
42.00x62.00x7.00mm, PTFE
NA5191 [2]
42.00x62.00x7.00mm, PTFE
05/97→

KA611 [15]

KA611 [15]



cc



kW/PS



1.8		LFY (XU7JP4)				102	AD5100 (Fibre)	CD5100 →Eng.7965	
Xantia 1.8 i 16V	06/95→04/03	1762	4	83.00	DOHC	81-85/ 110-116			
Xantia Break	06/95→04/03								
Xsara 1.8 i 16V	04/97→09/00								
Xsara Break	10/97→09/00								
Xsara Coupe	02/98→09/00								
ZX 1.8	04/96→10/97								
ZX 1.8 i 16V	01/96→06/97								
ZX Break 1.8i	01/96→02/98								
1.8		LFZ (XU7JP)				103	BL650 (Fibre), 1.200mm BR510 (Fibre), 1.440mm	CY130 ▲ [3] CY131 ▲ [3] [63]	EL650 [3]
Jumper 1.8	05/97→07/02	1761	4	83.00	SOHC/OHC	73-76/ 99-103			
Xantia 1.8 i	03/93→01/98								
Xantia Break	06/95→01/98								
Xsara 1.8 i Aut.	04/97→09/00								
Xsara Break	10/97→09/00								
Xsara Coupe	02/98→09/00								
ZX 1.8	07/94→10/97								
ZX 1.8 i	07/92→06/97								
ZX Break 1.8 i	10/93→10/97								
1.9		159A				104	BL650 (Fibre), 1.200mm BR510 (Fibre), 1.440mm	DL650 DN590 ▲ [3]	EL650 [3] GL650 [3]
BX 19	07/86→05/89	1905	4	83.00	SOHC/OHC	75-77/ 102-105			
1.9		162 (XUD9) Diesel				105	BX880 (Fibre), 1.360mm, 1 Notch ☞0.560→0.670mm BX890 (Fibre), 1.400mm, 2 Notches ☞0.680→0.710mm BX900 (Fibre), 1.440mm, 3 Notches ☞0.720→0.750mm BX910 (Fibre), 1.480mm, 4 Notches ☞0.760→0.790mm BX920 (Fibre), 1.520mm, 5 Notches ☞0.800→0.830mm	DJ720 ▲	EL890 [3] GJ720 ▲
BX 19 D	09/83→09/93	1905	4	83.00	SOHC/OHC	47/65			
BX Break 19 D	09/83→11/94								
1.9		D2A (XU92C)				106	BL650 (Fibre), 1.200mm BR510 (Fibre), 1.440mm	DL650 DN590 ▲ [3]	EL650 [3] GL650 [3]
BX 19	07/86→05/89	1905	4	83.00		75-77/ 102-105			
BX Break 19	07/86→12/94								
1.9		D2C (XU92C)				107	BL650 (Fibre), 1.200mm BR510 (Fibre), 1.440mm	DN590 ▲ [3]	EL650 [3] GL650 [3]
BX 19	09/86→11/89	1905	4	83.00	SOHC/OHC	70/95			
BX Break 19	12/87→12/89								
1.9		D2F				108	BL650 (Fibre), 1.200mm BR510 (Fibre), 1.440mm	DL650 DN590 ▲ [3]	EL650 [3] GL650 [3]
BX 19 E 4x4	04/89→02/93	1905	4	83.00	SOHC/OHC	80/109			
1.9		D6A (XU9J2)				109	BL650 (Fibre), 1.200mm BR510 (Fibre), 1.440mm	DL650 DN590 ▲ [3]	EL650 [3] GL650 [3]
BX 19 GTi	07/86→02/93	1905	4	83.00	SOHC/OHC	90-92/ 122-125			
BX Break 1.9 Tzi	02/92→12/94								

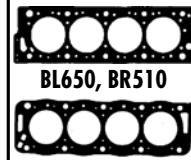
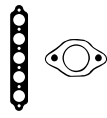

BL650, BR510



BX880, BX890,
BX900, BX910,
BX920

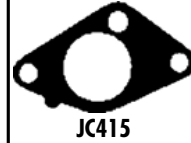

JC415



JC423



JC750



JC759



JD519



JD520



LT634



JN544

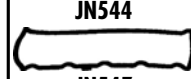

JN547

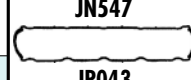

JP043

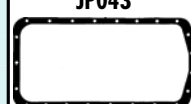

JJ283













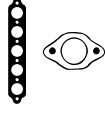

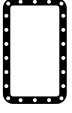

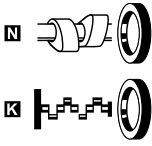









cc



kW/PS

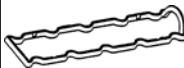
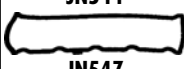
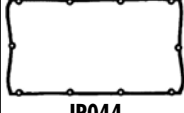
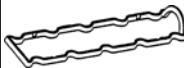
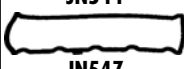
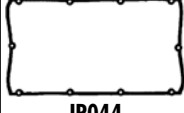

1.9	D6C (XU9J4)					110	BR510 (Fibre), 1.440mm	DF180 ○ [13] DR510 [3]	EL650 [3]
BX 19 GTi 16V	09/87→12/88	1905	4	83.00	DOHC	116/158			
1.9	D8B (XUD9TF)	Diesel				111	BX930 (SE), 1.360mm, 1 Notch BX940 (SE), 1.400mm, 2 Notches BX950 (SE), 1.440mm, 3 Notches BX960 (SE), 1.480mm, 4 Notches BX970 (SE), 1.520mm, 5 Notches BX980 (SE), 1.590mm ☞0.830mm→	DJ720 ▲	EL890 [3] GJ720 ▲
Jumper 1.9 TD	11/94→07/02	1905	4	83.00	SOHC/OHC	66-68/ 90-92			
Jumpy 1.9 TD	04/96→								
Xantia Break	06/95→04/03								
1.9	D8C (XUD9UTF)	Diesel				112	BX930 (SE), 1.360mm, 1 Notch BX940 (SE), 1.400mm, 2 Notches BX950 (SE), 1.440mm, 3 Notches BX960 (SE), 1.480mm, 4 Notches BX970 (SE), 1.520mm, 5 Notches BX980 (SE), 1.590mm ☞0.830mm→	DJ720 ▲	EL890 [3] GJ720 ▲
Jumper 1.9 TD	02/94→04/02	1905	4	83.00	SOHC/OHC	66-68/ 90-92			
1.9	D9A (XUD9)	Diesel				113	BX880 (Fibre), 1.360mm, 1 Notch ☞0.560→0.670mm BX890 (Fibre), 1.400mm, 2 Notches ☞0.680→0.710mm BX900 (Fibre), 1.440mm, 3 Notches ☞0.720→0.750mm BX910 (Fibre), 1.480mm, 4 Notches ☞0.760→0.790mm BX920 (Fibre), 1.520mm, 5 Notches ☞0.800→0.830mm	DJ720 ▲	EL890 [3] GJ720 ▲
BX 19 D	09/83→09/93	1905	4	83.00	SOHC/OHC	47/64			
BX Break 19 D	09/83→11/94								
1.9	D9B (XUD9A/L)	Diesel				114	BX880 (Fibre), 1.360mm, 1 Notch ☞0.560→0.670mm BX890 (Fibre), 1.400mm, 2 Notches ☞0.680→0.710mm BX900 (Fibre), 1.440mm, 3 Notches ☞0.720→0.750mm BX910 (Fibre), 1.480mm, 4 Notches ☞0.760→0.790mm BX920 (Fibre), 1.520mm, 5 Notches ☞0.800→0.830mm	DJ720 ▲	EL890 [3] GJ720 ▲
Berlingo 1.9 D	07/96→	1905	4	83.00	SOHC/OHC	50-51/ 68-69			
Xantia 1.9 D	06/94→01/98								
1.9	D9B (XUD9A/U)	Diesel				115	BX880 (Fibre), 1.360mm, 1 Notch ☞0.560→0.670mm BX890 (Fibre), 1.400mm, 2 Notches ☞0.680→0.710mm BX900 (Fibre), 1.440mm, 3 Notches ☞0.720→0.750mm BX910 (Fibre), 1.480mm, 4 Notches ☞0.760→0.790mm BX920 (Fibre), 1.520mm, 5 Notches ☞0.800→0.830mm	DJ720 ▲	EL890 [3] GJ720 ▲
BX 19 D	03/87→02/93	1905	4	83.00	SOHC/OHC	50-51/ 68-69			
BX Break 19 D	03/87→12/94								
C25 1.9 D	07/87→02/94								
Jumper 1.9 D	02/94→04/02								
Jumpy 1.9 D	10/95→08/98								
ZX 1.9 D	07/93→06/97								
ZX Break 1.9 D	06/94→10/97								
1.9	DDZ (XU9M)					116	BL650 (Fibre), 1.200mm BR510 (Fibre), 1.440mm	DL650 DN590 ▲ [3]	EL650 [3] GL650 [3]
BX 19 E	06/88→02/93	1905	4	83.00	SOHC/OHC	80/109			
BX Break 19	06/88→12/94								

								
HBS038 [22] M11x1.50x175.00mm (x10)	JD5763 [x2] JD5764	JPO44 [4]	JJ283 [62] =PA349 22.00x16.00x2.000mm	HR599	NF869 (x2)[1] 32.00x45.00x8.00mm, FPM NA5191 [2] 42.00x62.00x7.00mm, PTFE NA5192 [1] 90.00x110.00x7.00mm, PTFE	HR566 [55] KA611 [15] LC292 (x2)[45]	 BR510, BL650  BX880, BX890, BX900, BX910, BX920  BX930, BX940, BX950, BX960, BX970, BX980	
HBS277 [22] M12x1.50x148.00mm (x10)	JC759 (Steel)	JN544 [4]	JJ283 [62] =PA349 22.00x16.00x2.000mm =PB907 14.00x21.00x2.000mm	HR569	NF841 [1][2] 35.00x50.00x8.00mm, FPM NB959 [2] 35.00x50.00x7.00mm, FPM NA5191 [2] 42.00x62.00x7.00mm, PTFE NA5192 [1] 90.00x110.00x7.00mm, PTFE	KA611 [15]	 JC415  JC423  JC750  JC759  JC991  LT634	
HBS277 [22] M12x1.50x148.00mm (x10)	JC991 [64][65][66]	JN544 [4]	JJ283 [62] =PA349 22.00x16.00x2.000mm =PB907 14.00x21.00x2.000mm	HR569	NF841 [1][2] 35.00x50.00x8.00mm, FPM NB959 [2] 35.00x50.00x7.00mm, FPM NA5191 [2] 42.00x62.00x7.00mm, PTFE NA5192 [1] 90.00x110.00x7.00mm, PTFE	KA611 [15]	 JC423  JC750  JC759  JC991  LT634	
HBS084 [22] M12x1.50x120.00mm (x10)	JD5972 JC759 (Steel) JC423	JN544 [4]	JJ283 [62] =PA349 22.00x16.00x2.000mm =PB907 14.00x21.00x2.000mm	HR569	NF841 [1][2] 35.00x50.00x8.00mm, FPM NA5191 [2] 42.00x62.00x7.00mm, PTFE NA5192 [1] 90.00x110.00x7.00mm, PTFE	KA611 [15]	 LT634  JN544  JN547  JP044	
HBS084 [22] M12x1.50x120.00mm (x10)	JC759 (Steel) JC423	JN544 [4]	JJ283 [62] =PA349 22.00x16.00x2.000mm =PB907 14.00x21.00x2.000mm	HR569	NB959 [2] 35.00x50.00x7.00mm, FPM NF841 [1][2] 35.00x50.00x8.00mm, FPM NA5191 [2] 42.00x62.00x7.00mm, PTFE NA5192 [1] 90.00x110.00x7.00mm, PTFE	KA611 [15]	 JN544  JN547  JP044  JJ283	
HBS084 [22] M12x1.50x120.00mm (x10)	JC759 (Steel) JC423	JN544 [4]	JJ283 [62] =PA349 22.00x16.00x2.000mm =PB907 14.00x21.00x2.000mm	HR569	NB959 [2] 35.00x50.00x7.00mm, FPM NF841 [1][2] 35.00x50.00x8.00mm, FPM NA5191 [2] 42.00x62.00x7.00mm, PTFE NA5192 [1] 90.00x110.00x7.00mm, PTFE NB959 [2] 35.00x50.00x7.00mm, FPM	KA611 [15]	 JJ283	
HBS083 [22] M11x1.50x168.00mm (x10)	JC750 JC415 [x4] 	JN547 [4]	JJ283 [62] =PA349 22.00x16.00x2.000mm =PB907 14.00x21.00x2.000mm	HR569	NA5191 [2] 42.00x62.00x7.00mm, PTFE NA5192 [1] 90.00x110.00x7.00mm, PTFE	HR566 [55] KA611 [15] LC292 (x2)[45]		



cc



kW/PS



1.9	DFW (XU9J4)					117	BR510 (Fibre), 1.440mm	DF180 ○ [3] DR510 [3]	EL650 [3]
BX 19 GTi 16V	03/88→02/93	1905	4	83.00	DOHC	108-110/ 147-150			
1.9	DFZ (XU9J1)					118	BL650 (Fibre), 1.200mm BR510 (Fibre), 1.440mm	DL650 DN590 ▲ [3]	EL650 [3] GL650 [3]
BX Break 19	07/86→12/94	1905	4	83.00	SOHC/OHC	75/102			
1.9	DHV (XUD9BSD)	Diesel				119	BX930 (SE), 1.360mm, 1 Notch BX940 (SE), 1.400mm, 2 Notches BX950 (SE), 1.440mm, 3 Notches BX960 (SE), 1.480mm, 4 Notches BX970 (SE), 1.520mm, 5 Notches BX980 (SE), 1.590mm ☞0.830mm→	DJ720 ▲	EL890 [3] GJ720 ▲
Xsara 1.9 SD Xsara Break	01/98→09/00 01/98→09/00	1905	4	83.00	SOHC/OHC	55/75			
1.9	DHW (XUD9SD)	Diesel				120	BX930 (SE), 1.360mm, 1 Notch BX940 (SE), 1.400mm, 2 Notches BX950 (SE), 1.440mm, 3 Notches BX960 (SE), 1.480mm, 4 Notches BX970 (SE), 1.520mm, 5 Notches BX980 (SE), 1.590mm ☞0.830mm→	DJ720 ▲	EL890 [3] GJ720 ▲
Xantia 1.9 SD Xantia Break SD	02/96→04/03 04/97→04/03	1905	4	83.00	SOHC/OHC	50-55/ 68-75			
1.9	DHX (XUD9TF/BTF)	Diesel				121	BX930 (SE), 1.360mm, 1 Notch BX940 (SE), 1.400mm, 2 Notches BX950 (SE), 1.440mm, 3 Notches BX960 (SE), 1.480mm, 4 Notches BX970 (SE), 1.520mm, 5 Notches BX980 (SE), 1.590mm ☞0.830mm→	DJ720 ▲	EL890 [3] GJ720 ▲
Jumper 1.9 TD Jumpy 1.9 TD Xantia 1.9 T D Xantia 1.9T D Xantia Break	03/94→07/02 10/95→ 10/94→01/98 01/98→04/03 06/95→04/03	1905	4	83.00	SOHC/OHC	66-68/ 90-92			
1.9	DHY (XUD9TE/Y)	Diesel				122	BX930 (SE), 1.360mm, 1 Notch BX940 (SE), 1.400mm, 2 Notches BX950 (SE), 1.440mm, 3 Notches BX960 (SE), 1.480mm, 4 Notches BX970 (SE), 1.520mm, 5 Notches BX980 (SE), 1.590mm ☞0.830mm→	DJ720 ▲	EL890 [3] GJ720 ▲
Xantia 1.9 T D Xantia 1.9T D Xantia Break Xsara 1.9 TD Xsara Coupe Xsara Break ZX 1.9 TD ZX Break 1.9 TD	10/94→01/98 01/98→04/03 06/95→01/98 04/97→09/00 02/98→09/00 10/97→09/00 07/92→06/97 10/93→10/97	1905	4	83.00	SOHC/OHC	66/90			
1.9	DJY (XUD9A)	Diesel				123	BX880 (Fibre), 1.360mm, 1 Notch ☞0.560→0.670mm BX890 (Fibre), 1.400mm, 2 Notches ☞0.680→0.710mm BX900 (Fibre), 1.440mm, 3 Notches ☞0.720→0.750mm BX910 (Fibre), 1.480mm, 4 Notches ☞0.760→0.790mm BX920 (Fibre), 1.520mm, 5 Notches ☞0.800→0.830mm	DJ720 ▲	EL890 [3] GJ720 ▲
Berlingo 1.9 D Berlingo 1.9D C25 1.9 D 1400 Jumper 1.9 D Xsara 1.9 D Xsara Break Xsara Coupe ZX 1.9 D	07/96→10/99 07/96→ 01/88→01/94 07/99→04/02 04/97→09/00 10/97→09/00 02/98→09/00 07/93→06/97	1905	4	83.00	SOHC/OHC	50-52/ 68-71			

HBS038 [22] M11x1.50x175.00mm (x10)	JD5763 [x2] JD5764	JP044 [4]	JJ283 [62] =PA349 22.00x16.00x2.000mm	HR599	NF869 (x2)[1] 32.00x45.00x8.00mm, FPM NA5191 [2] 42.00x62.00x7.00mm, PTFE NA5192 [1] 90.00x110.00x7.00mm, PTFE	HR566 [55] KA611 [15] LC292 (x2)[45]
HBS083 [22] M11x1.50x168.00mm (x10)	JC750 JC415 [x4] LT634	JN547 [4]	JJ283 [62] =PA349 22.00x16.00x2.000mm =PB907 14.00x21.00x2.000mm	HR569	NA5191 [2] 42.00x62.00x7.00mm, PTFE NA5192 [1] 90.00x110.00x7.00mm, PTFE	HR566 [55] KA611 [15] LC292 (x2)[45]
HBS084 [22] M12x1.50x120.00mm (x10)	JC759 (Steel) JC991	JN544 [4]	JJ283 [62] =PA349 22.00x16.00x2.000mm =PB907 14.00x21.00x2.000mm	HR569	NB959 [2] 35.00x50.00x7.00mm, FPM NF841 [1][2] 35.00x50.00x8.00mm, FPM NA5191 [2] 42.00x62.00x7.00mm, PTFE NA5192 [1] 90.00x110.00x7.00mm, PTFE	KA611 [15]
HBS084 [22] M12x1.50x120.00mm (x10)	JC759 (Steel) JC991	JN544 [4]	JJ283 [62] =PA349 22.00x16.00x2.000mm =PB907 14.00x21.00x2.000mm	HR569	NF841 [1][2] 35.00x50.00x8.00mm, FPM NB959 [2] 35.00x50.00x7.00mm, FPM NA5191 [2] 42.00x62.00x7.00mm, PTFE NA5192 [1] 90.00x110.00x7.00mm, PTFE	KA611 [15]
HBS277 [22] M12x1.50x148.00mm (x10)	JC759 (Steel)	JN544 [4]	JJ283 [62] =PA349 22.00x16.00x2.000mm =PB907 14.00x21.00x2.000mm	HR569	NF841 [1][2] 35.00x50.00x8.00mm, FPM NB959 [2] 35.00x50.00x7.00mm, FPM Eng.06265→ NA5191 [2] 42.00x62.00x7.00mm, PTFE NA5192 [1] 90.00x110.00x7.00mm, PTFE	KA611 [15]
HBS277 [22] M12x1.50x148.00mm (x10)	JC759 (Steel) JC991 JC423 [x2]	JN544 [4]	JJ283 [62] =PA349 22.00x16.00x2.000mm =PB907 14.00x21.00x2.000mm	HR569	NF841 [1][2] 35.00x50.00x8.00mm, FPM NB959 [2] 35.00x50.00x7.00mm, FPM NA5191 [2] 42.00x62.00x7.00mm, PTFE NA5192 [1] 90.00x110.00x7.00mm, PTFE	KA611 [15]
HBS084 [22] M12x1.50x120.00mm (x10)	JC759 (Steel) JC991 JC423	JN544 [4]	JJ283 [62]	HR569	NF841 [1][2] 35.00x50.00x8.00mm, FPM NA5191 [2] 42.00x62.00x7.00mm, PTFE NA5192 [1] 90.00x110.00x7.00mm, PTFE	KA611 [15]

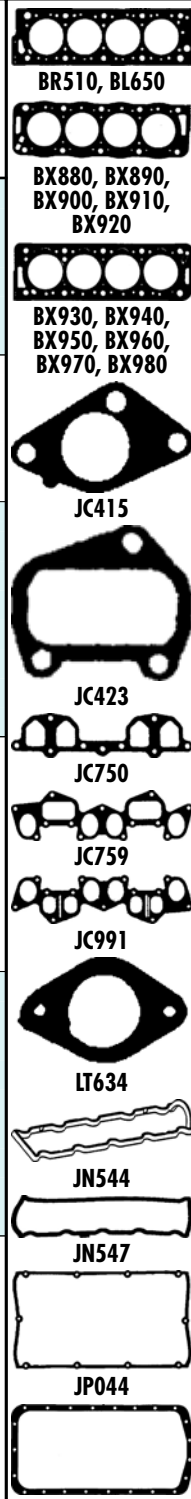









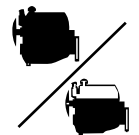





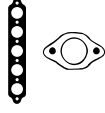

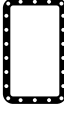

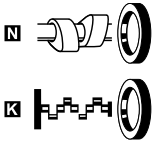

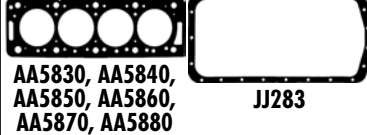
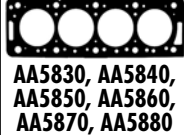

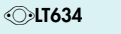
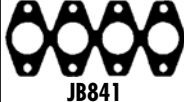

cc



kW/PS

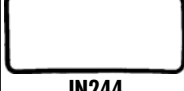

1.9	DJZ (XUD9Y)	Diesel			124	BX880 (Fibre), 1.360mm, 1 Notch -0.560→-0.670mm BX890 (Fibre), 1.400mm, 2 Notches -0.680→-0.710mm BX900 (Fibre), 1.440mm, 3 Notches -0.720→-0.750mm BX910 (Fibre), 1.480mm, 4 Notches -0.760→-0.790mm BX920 (Fibre), 1.520mm, 5 Notches -0.800→-0.830mm	DJ720 ▲	EL890 [3] GJ720 ▲
BX 19 D	09/83→09/93	1905	4	83.00	SOHC/OHC	47-50/ 65-68		
BX Break 19 D	09/83→11/94							
Xantia 1.9 D	06/94→01/98							
ZX 1.9 D	03/91→06/97							
ZX Break 1.9 D	10/93→10/97							
1.9	DKZ (XU9JA)	Diesel			125	BL650 (Fibre), 1.200mm BR510 (Fibre), 1.440mm	DN590 ▲ [3]	EL650 [3] GL650 [3]
BX 19 GTi	06/88→02/93	1905	4	83.00	SOHC/OHC	88/120		
BX Break 19	06/88→12/94							
ZX 1.9 i	03/91→06/97							
1.9	WJY (DW8B)	Diesel			126	AA5830 (SE), 1.260mm, 1 Hole -0.510→-0.540mm AA5840 (SE), 1.300mm, 2 Holes -0.550→-0.580mm AA5850 (SE), 1.340mm, 3 Holes -0.590→-0.620mm AA5860 (SE), 1.380mm, 4 Holes -0.630→-0.660mm AA5870 (SE), 1.420mm, 5 Holes -0.670→-0.700mm AA5880 (SE), 1.460mm, 6 Holes -0.710→-0.750mm	CA5830 ▲ [3]	EA5830
Berlingo	07/98→	1868	4	82.20	SOHC/OHC	51-52/ 69-70		
Berlingo 1.9 D	07/98→							
Jumpy 1.9 D 70	04/98→							
Xsara 1.9 D	07/98→03/05							
Xsara Break	07/98→08/05							
Xsara Coupe	02/99→03/05							
1.9	WJZ (DW8)	Diesel			127	AA5830 (SE), 1.260mm, 1 Hole -0.510→-0.540mm AA5840 (SE), 1.300mm, 2 Holes -0.550→-0.580mm AA5850 (SE), 1.340mm, 3 Holes -0.590→-0.620mm AA5860 (SE), 1.380mm, 4 Holes -0.630→-0.660mm AA5870 (SE), 1.420mm, 5 Holes -0.670→-0.700mm AA5880 (SE), 1.460mm, 6 Holes -0.710→-0.750mm	CA5830 ▲ [3]	EA5830
Berlingo	07/98→	1868	4	82.20	SOHC/OHC	51-52/ 69-70		
Berlingo 1.9 D	07/98→							
Jumpy 1.9 D 70	04/98→							
Xsara 1.9 D	07/98→03/05							
Xsara Break	07/98→08/05							
Xsara Coupe	02/99→03/05							
2.0	4B11	Diesel			128			
C-Crosser	11/10→	1998	4	86.00	DOHC	108-118/ 147-160		
C-Crosser 2.0	11/10→							
2.0	170A (XN1T)	Diesel			129	BM530 (Fibre), 1.400mm BN780 (Fibre), 1.600mm	DM530 [13] DM533 ▲ [3]	EM531 [3]
C25 2.0 E	09/81→02/94	1971	4	88.00				
C25 Van 2.0 E	09/81→03/94							
2.0	170B (XN1T)	Diesel			130	BM530 (Fibre), 1.400mm BN780 (Fibre), 1.600mm	DM530 [13] DM533 ▲ [3]	EM531 [3]
C25 2.0 E	09/81→02/94	1971	4	88.00	OHV	58-62/ 79-84		
C25 Van 2.0 E	09/81→03/94							
2.0	170C (XN1T)	Diesel			131	BM530 (Fibre), 1.400mm BN780 (Fibre), 1.600mm	DM530 [13] DM533 ▲ [3]	EM531 [3]
C25 2.0	01/87→03/94	1971	4	88.00	OHV	62/84		
C25 Van 2.0	02/91→03/94							

							
HBS084 [22] M12x1.50x120.00mm (x10)	JD5972 [1] JC759 (Steel) JC991 JC423 [3]	JN544 [4]	JJ283 [62]	HR569 [3]	NF841 [1][2] 35.00x50.00x8.00mm, FPM NA5191 [2] 42.00x62.00x7.00mm, PTFE NA5192 [1] 90.00x110.00x7.00mm, PTFE NB959 [2] 35.00x50.00x7.00mm, FPM	KA611 [15]	 AA5830, AA5840, AA5850, AA5860, AA5870, AA5880  JJ283  BL650, BR510  BM530, BN780  BX880, BX890, BX900, BX910, BX920
HBS038 [22] M11x1.50x175.00mm (x10) HBS083 [22] M11x1.50x168.00mm (x10)	JC750 [1] JC415 [3] (x4)  LT634	JN547 [4]	JJ283 [62] ⇒PA349 22.00x16.00x2.000mm ⇒PB907 14.00x21.00x2.000mm	HR569 [3]	NA5191 [2] 42.00x62.00x7.00mm, PTFE NA5192 [1] 90.00x110.00x7.00mm, PTFE	HR566 [55][3] KA611 [15] LC292 (x2)[45]	 JB841
HBS084 [22] M12x1.50x120.00mm (x10) →Eng.08469 HBS245 [22] M12x1.50x125.00mm (x10) Eng.08470→	JD6023 [1] (x2) 0.8mm HA5008 [1][3] JD5192 [3]	JM5088 [3] (Elastomer) JM5089 [3] (Elastomer)	HR569 [3]	HR569 [3]	NB959 [2] 35.00x50.00x7.00mm, FPM NF841 [1][2] 35.00x50.00x8.00mm, FPM NA5191 [2] 42.00x62.00x7.00mm, PTFE NA5192 [1] 90.00x110.00x7.00mm, PTFE		 JC415  JC423
HBS084 [22] M12x1.50x120.00mm (x10) →Eng.08469 HBS245 [22] M12x1.50x125.00mm (x10) Eng.08470→	JD6023 [1] (x2) 0.8mm HA5008 [1][3] JD5192 [3] (x2) JD5280 [3]	JM5088 [3] (Elastomer) JM5089 [3] (Elastomer)	⇒KG5157 10.00x20.00x2.000mm ⇒PB907 14.00x21.00x2.000mm	HR569 [3]	NB959 [2] 35.00x50.00x7.00mm, FPM NF841 [1][2] 35.00x50.00x8.00mm, FPM NA5191 [2] 42.00x62.00x7.00mm, PTFE NA5192 [1] 90.00x110.00x7.00mm, PTFE		 JC750  JC759  JC991  JD5280
					NA5108 [2] 42.00x55.00x7.00mm, FPM/ACM		 LT634
HBS038 [22] M11x1.50x175.00mm (x10)	JB841 [3]	JN244 [4]		HR569 [3]	NA5191 [2] 42.00x62.00x7.00mm, PTFE NA5192 [1] 90.00x110.00x7.00mm, PTFE		 JN244
HBS038 [22] M11x1.50x175.00mm (x10)	JB841 [3]	JN244 [4]		HR569 [3]	NA5191 [2] 42.00x62.00x7.00mm, PTFE NA5192 [1] 90.00x110.00x7.00mm, PTFE		 JN544
HBS038 [22] M11x1.50x175.00mm (x10)	JB841 [3]	JN244 [4]		HR569 [3]	NA5191 [2] 42.00x62.00x7.00mm, PTFE NA5192 [1] 90.00x110.00x7.00mm, PTFE		 JN547













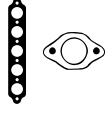

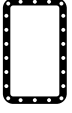

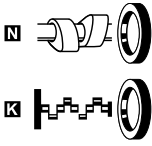























































cc

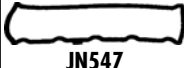

kW/PS

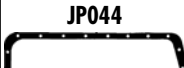
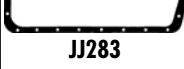

2.0	829 A5					132			
CX II 20 RE	08/85→12/92	1995	4	88.00	SOHC/OHC	75-78/ 102-106	BH930 (Fibre), 1.200mm		GH930 [3]
2.0	B20614					133	BF040 (Fibre), 1.200mm	DF044 [13]	GF044 [3]
C35 2.0	11/73→01/94	1985	4	86.00		65/88			
2.0	R6A					134	BV140 (Fibre), 1.250mm		
XM 2.0	05/89→06/94	1998	4			90-96/ 122-130			
XM Break 2.0	05/89→06/94								
2.0	RDZ (XU10MZ)					135	BS820 (Fibre), 1.250mm	DS820 ▲ [3]	ES820 [3]
XM 2.0 i	05/89→04/94	1998	4	86.00	SOHC/OHC	79/107			
XM Break 2.0 i	11/91→04/94								
2.0	RFH (EW10A)					136	AH6630 (MLS)		
Jumpy 2.0 i	01/07→	1997	4	85.00	DOHC	103/140			
2.0	RFJ (EW10A)					137	AD5300 (MLS) AH6630 (MLS)		
C4 2.0 16V	11/04→	1997	4	85.00	DOHC	103-104/ 140-141			
C4 Grand Pic	10/06→								
C4 Picasso	02/07→								
C5 2.0 16V	09/04→								
C5 Break	02/08→								
C5 Break 2.0 16V	09/04→								
C8 2.0 16V	09/05→								
2.0	RFK (EW10J4S)					138	AD5300 (MLS)	CD5300	ED5300
C4 2.0 16V	11/04→	1997	4	85.00	DOHC	130/177			
C4 Coupe 2.0 16V	11/04→								
2.0	RFN (EW10J4)					139	AD5300 (MLS)	CD5300	ED5300
C4 2.0 16V	11/04→	1997	4	85.00	DOHC	100-105/ 136-143			
C4 Coupe 2.0 16V	11/04→								
C5 2.0 16V	03/01→08/04								
C5 Break 2.0 16V	06/01→08/04								
C8 2.0 16V	07/02→								
Jumper 2.0 16V	05/00→07/02								
Jumpy 2.0	04/00→12/06								
Xsara 2.0 16V	09/00→03/05								
Xsara Break	09/00→08/05								
Xsara Coupe	09/00→03/05								
Xsara Picasso	01/03→								
2.0	RFS (XU10J4RS)					140	AY070 (Fibre)	CY070	
Xsara 2.0 16V	04/97→09/00	1998	4	86.00	DOHC	120-122/ 163-166			
Xsara Coupe	02/98→03/05								
ZX 2.0	09/96→10/97								
ZX 2.0 i 16V	05/96→06/97								
2.0	RFT (XU10J4/Z)					141	AY090 (Fibre), 1.250mm AY100 (Fibre), 1.450mm	CY090 ▲ [3]	ES820 [3]
Xantia 2.0 i 16V	06/94→01/98	1998	4	86.00	DOHC	110-114/ 150-155			
ZX 2.0 i 16V	07/92→06/97								

								
		JB954 	JN292 [4]	PA349 22.00x16.00x2.000mm	HR569 	NF687 [2] 35.00x47.00x7.00mm, FPM NF648  [2] 50.00x68.00x10.00mm, MVQ NF843  [2] 50.00x68.00x10.00mm, FPM/ACM NF844  [1] 90.00x110.00x11.00mm, FPM/ACM	NF849 [2] [56]	 AY070  AY090, AY100  BF040  BH930
		JB869 	JN234 [4]	PA217 16.30x22.00x2.000mm				 BS820  BV140
						NA5191  [2] 42.00x62.00x7.00mm, PTFE	KA611 [15]	 JB869  JB954
HBS084  [22] M12x1.50x120.00mm (x10)	JC415  (x4)	JN547 [4]	JJ283 [62] PA349 22.00x16.00x2.000mm PB907 14.00x21.00x2.000mm	HR569 		NA5191  [2] 42.00x62.00x7.00mm, PTFE NA5192  [1] 90.00x110.00x7.00mm, PTFE	KA611 [15]	 JB869  JB954  JC415
HBS535  [22]								 JB869  JB954  JC415
HBS259  [22] M11x1.50x144.50mm (x10) HBS535  [22]	JD5971 	JM5139  JM5283 				NA5256  [2] 40.00x55.00x6.50mm, FPM		 JD536  JD539
HBS259  [22] M11x1.50x144.50mm (x10) HBS535  [22]	JD5971 	JM5139  JM5283 				NA5256  [2] 40.00x55.00x6.50mm, FPM NF844  [1] 90.00x110.00x11.00mm, FPM/ACM		 JD539  JN234
HBS259  [22] M11x1.50x144.50mm (x10)		JM5139  JM5283 	PB907 14.00x21.00x2.000mm					 JN234  JN292
HBS087  [22] M12x1.50x110.00mm (x10) →Eng.08581	JD536  JD539 		PB907 14.00x21.00x2.000mm	HR5080  →Eng.07359 HR5081  Eng.07360 → →Eng.07965		NA5191  [2] 42.00x62.00x7.00mm, PTFE NA5192  [1] 90.00x110.00x7.00mm, PTFE	KA611 [15]	 JN292  JN547
HBS087  [22] M12x1.50x110.00mm (x10) →Eng.08581	JD536  JD535 	JPO44 [4]	JJ283 [62] PA349 22.00x16.00x2.000mm PB907 14.00x21.00x2.000mm	HR642 		NA5191  [2] 42.00x62.00x7.00mm, PTFE NA5192  [1] 90.00x110.00x7.00mm, PTFE	KA611 [15]	 JP044  JJ283



cc



kW/PS



2.0		RFU (XU10J2/C)					142	BV140 (Fibre), 1.250mm BY320 (Fibre), 1.450mm		CY082 ▲ [3]	ES820 [3]
Jumper 2.0	06/94→07/02	1998	4	86.00	SOHC/OHC	89/121					
2.0		RFV (XU10J4R)					143	AY070 (Fibre) BV140 (Fibre), 1.250mm		CY070	
Jumper 2.0 16V	05/98→04/00	1998	4	86.00	DOHC	97-99/ 132-135					
Xantia 2.0 i 16V	06/95→04/03										
Xantia Break	06/95→04/03										
XM 2.0 i 16V	05/94→10/00										
XM Break	05/94→10/00										
Xsara 2.0 16V	07/98→09/00										
Xsara Coupe 2.0	08/98→08/00										
Xsara Break	07/98→09/00										
2.0		RFW (XU10J2U)					144	BV140 (Fibre), 1.250mm BY320 (Fibre), 1.450mm		CY081 ▲ [3]	ES820 [3]
Jumper 2.0	02/94→04/02	1998	4	86.00	SOHC/OHC	80/109					
Jumper 2.0 4x4	08/96→04/02										
Jumper Box 2.0	03/94→04/02										
2.0		RFX (XU10J2C)					145	BV140 (Fibre), 1.250mm BY320 (Fibre), 1.450mm		CY080 ▲ [3]	ES820 [3]
Xantia 2.0 i	03/93→04/03	1998	4	86.00	SOHC/OHC	89-90/ 120-122					
Xantia Break	06/95→04/03										
ZX 2.0	07/94→10/97										
ZX 2.0 i	07/92→06/97										
2.0		RFY (XU10J4/Z)					146	AY090 (Fibre), 1.250mm AY100 (Fibre), 1.450mm		CY090 ▲ [3]	ES820 [3]
Xantia 2.0 i 16V	03/93→01/98	1998	4	86.00	DOHC	110-114/ 150-155					
ZX 2.0 i 16V	07/92→10/94										
2.0		RFZ (XU10J2)					147	BV140 (Fibre), 1.250mm BY320 (Fibre), 1.450mm		CY080 ▲ [3]	ES820 [3]
XM 2.0 i	05/89→06/94	1998	4	86.00	SOHC/OHC	89-90/ 121-122					
XM Break 2.0 i	11/91→04/94										
2.0		RGX (XU10J2TE)					148	BY310 (Fibre), 1.250mm BY320 (Fibre), 1.450mm		DY310 ▲ [3]	ES820 [3]
Jumper 2.0 C.T.	06/94→07/02	1998	4	86.00	SOHC/OHC	108/147					
Xantia 2.0 Turbo	06/95→04/03										
Xantia Break	06/95→04/03										
XM 2.0 Turbo	05/94→10/00										
XM Break	05/94→10/00										
2.0		RGY (XU10J2TE/Z)					149	BV140 (Fibre), 1.250mm BY320 (Fibre), 1.450mm		DY310 ▲ [3]	ES820 [3]
XM 2.0 i Turbo	09/92→06/94	1998	4	86.00		104-108/ 141-147					
XM Break	05/94→10/00										
XM Break 2.0 T	09/92→04/94										
2.0		RHE (DW10CTED4) Diesel					150				EA5830
C8 2.0 HDi 165	03/06→	1997	4	85.00	DOHC	120/163					

							 AY070 AY090, AY100 BV140, BY320, BY310
HBS084 [22] M12x1.50x120.00mm (x10)	HA510 [1] [5] JC415 [5] (x4)	JN547 [4]	JJ283 [62] =PA349 22.00x16.00x2.000mm =PB907 14.00x21.00x2.000mm	HR569 [5]	NA5191 [2] [2] 42.00x62.00x7.00mm, PTFE NA5192 [1] [1] 90.00x110.00x7.00mm, PTFE	KA611 [15]	 HA510 HA512 JC415 JD519 JD520 JD536 JD539 JN547 JP043 JP044 JJ283
HBS087 [22] M12x1.50x110.00mm (x10) →Eng.08581	JD536 [1] [5] JD539 [5]	JM7121 [5] (Elastomer)	HR5080 [5] →Eng.07359 HR5081 [5] Eng.07360→ →Eng.07965	NA5191 [2] [2] 42.00x62.00x7.00mm, PTFE NA5192 [1] [1] 90.00x110.00x7.00mm, PTFE	KA611 [15]	 HA510 HA512 JC415 JD519 JD520 JD536 JD539 JN547 JP043 JP044 JJ283	
HBS245 [22] M12x1.50x125.00mm (x10)	JD519 [1] [5] (x2) JC415 [5] (x4)	JN547 [4]	JJ283 [62] =PA349 22.00x16.00x2.000mm =PB907 14.00x21.00x2.000mm	HR569 [5]	NA5191 [2] [2] 42.00x62.00x7.00mm, PTFE NA5192 [1] [1] 90.00x110.00x7.00mm, PTFE	KA611 [15]	 HA510 HA512 JC415 JD519 JD520 JD536 JD539 JN547 JP043 JP044 JJ283
HBS084 [22] M12x1.50x120.00mm (x10)	HA510 [1] [5] JD520 [5] (x4)	JP043 [4]	JJ283 [62] =PA349 22.00x16.00x2.000mm =PB907 14.00x21.00x2.000mm	HR569 [5]	NA5191 [2] [2] 42.00x62.00x7.00mm, PTFE NA5192 [1] [1] 90.00x110.00x7.00mm, PTFE	KA611 [15]	 HA510 HA512 JC415 JD519 JD520 JD536 JD539 JN547 JP043 JP044 JJ283
HBS087 [22] M12x1.50x110.00mm (x10) →Eng.08581	JD536 [1] [5] JD535 [5]	JP044 [4]	JJ283 [62] =PA349 22.00x16.00x2.000mm =PB907 14.00x21.00x2.000mm	HR642 [5]	NA5191 [2] [2] 42.00x62.00x7.00mm, PTFE NA5192 [1] [1] 90.00x110.00x7.00mm, PTFE	KA611 [15]	 HA510 HA512 JC415 JD519 JD520 JD536 JD539 JN547 JP043 JP044 JJ283
HBS084 [22] M12x1.50x120.00mm (x10)	HA510 [1] [5] JD520 [5] (x4)	JP043 [4]	JJ283 [62] =PA349 22.00x16.00x2.000mm =PB907 14.00x21.00x2.000mm	HR569 [5]	NA5191 [2] [2] 42.00x62.00x7.00mm, PTFE NA5192 [1] [1] 90.00x110.00x7.00mm, PTFE	KA611 [15]	 HA510 HA512 JC415 JD519 JD520 JD536 JD539 JN547 JP043 JP044 JJ283
HBS084 [22] M12x1.50x120.00mm (x10)	HA512 [5] [5]	JN547 [4]	JJ283 [62] =PB907 14.00x21.00x2.000mm	HR569 [5]	NA5191 [2] [2] 42.00x62.00x7.00mm, PTFE NA5192 [1] [1] 90.00x110.00x7.00mm, PTFE	KA611 [15]	 HA510 HA512 JC415 JD519 JD520 JD536 JD539 JN547 JP043 JP044 JJ283
HBS084 [22] M12x1.50x120.00mm (x10)	HA512 [5] [5]	JN547 [4]	JJ283 [62] =PB907 14.00x21.00x2.000mm	HR569 [5]	NA5035 [2] 27.00x47.00x7.00mm, FPM NA5191 [2] [2] 42.00x62.00x7.00mm, PTFE NA5192 [1] [1] 90.00x110.00x7.00mm, PTFE	KA611 [15]	 HA510 HA512 JC415 JD519 JD520 JD536 JD539 JN547 JP043 JP044 JJ283



cc



kW/PS

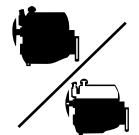

2.0	RHH (DW10CTED4)	Diesel	151				
C4 Grand Pic	09/10→	1997	4	85.00	DOHC	120/163	EA5830
C4 Picasso	09/10→						
C5 2.0 HDi 165	04/09→						
C5 Break	04/09→						
C8 2.0 HDi 165	03/06→						
DS4 2.0 HDi 165	04/11→						
DS5 2.0 HDi 165	11/11→						
Jumpy HDi 165	07/10→						
2.0	RHJ (DW10BTED4)	Diesel	152				EA5830
C4 Grand Pic	10/06→	1997	4	85.00	DOHC	100/136	AD5490 (MLS), 1.250mm, 2 Notches AD5500 (MLS), 1.300mm, 3 Holes AD5510 (MLS), 1.350mm, 4 Holes AD5520 (MLS), 1.400mm, 5 Holes
C4 Picasso	02/07→						
2.0	RHK (DW10UTED4)	Diesel	153				CD5500 ▲ EA5830
C8 2.0 HDi	02/07→	1997	4	85.00	DOHC	79-88/ 107-120	AD5490 (MLS), 1.250mm, 2 Notches AD5500 (MLS), 1.300mm, 3 Holes AD5510 (MLS), 1.350mm, 4 Holes AD5520 (MLS), 1.400mm, 5 Holes
Jumpy HDi 120	01/07→						
2.0	RHM (DW10ATED4)	Diesel	154				CC5010 ▲ [3] CC5011 ▲ EA5830
C8 2.0 HDi	07/02→	1997	4	85.00	DOHC	79/107	AC5011 (MLS), 1.300mm, 1 Hole →0.470→0.605mm AC5020 (MLS), 1.350mm, 2 Holes →0.605→0.655mm AC5031 (MLS), 1.400mm, 3 Holes →0.655→0.705mm AC5040 (MLS), 1.450mm, 4 Holes →0.705→0.755mm AC5051 (MLS), 1.500mm, 5 Holes →0.755→0.830mm
2.0	RHR (DW10BTED4)	Diesel	155				CD5500 ▲ EA5830 ED5500
C4 2.0 HDi	11/04→	1997	4	85.00	DOHC	100/136	AD5490 (MLS), 1.250mm, 2 Notches AD5500 (MLS), 1.300mm, 3 Holes AD5510 (MLS), 1.350mm, 4 Holes AD5520 (MLS), 1.400mm, 5 Holes
C4 Coupe 2.0 HDi	11/04→						
C4 Grand Pic	10/06→						
C4 Picasso	02/07→						
C5 2.0 HDi	09/04→						
C5 Break 2.0 HDi	09/04→						
C8 2.0 HDi	03/06→						
Jumpy HDi 140	01/07→						
2.0	RHS (DW10ATED)	Diesel	156				CC5010 ▲ [3] →Eng.8331 CC5011 ▲ Eng.8332 → EA5830
C5 2.0 HDi	03/01→08/04	1997	4	85.00	SOHC/OHC	79/107	AC5011 (MLS), 1.300mm, 1 Hole →0.470→0.605mm AC5020 (MLS), 1.350mm, 2 Holes →0.605→0.655mm AC5031 (MLS), 1.400mm, 3 Holes →0.655→0.705mm AC5040 (MLS), 1.450mm, 4 Holes →0.705→0.755mm AC5051 (MLS), 1.500mm, 5 Holes →0.755→0.830mm
C5 Break 2.0 HDi	06/01→08/04						

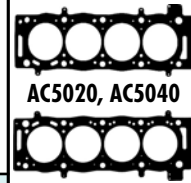
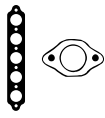

					<p>NA5035 [2] 27.00x47.00x7.00mm, FPM</p> <p>NA5191 [2] 42.00x62.00x7.00mm, PTFE</p> <p>NA5192 [1] 90.00x110.00x7.00mm, PTFE</p>	
<p>HBS261 [22] M12x1.50x126.00mm (x10)</p>					<p>NA5035 [2] 27.00x47.00x7.00mm, FPM</p>	
<p>HBS261 [22] M12x1.50x126.00mm (x10)</p>	<p>JD5881 [3]</p>	<p>HM5289 [3]</p>		<p>HR5046 [3] (x2)</p>	<p>NA5035 [2] 27.00x47.00x7.00mm, FPM</p> <p>NA5191 [2] 42.00x62.00x7.00mm, PTFE</p> <p>NA5192 [1] 90.00x110.00x7.00mm, PTFE</p>	
<p>HBS261 [22] M12x1.50x126.00mm (x10)</p>	<p>JD5191 [1] JD5190 [3]</p>	<p>JM5087 (Elastomer) JM5141 (Elastomer)</p>		<p>HR5046 [3]</p>	<p>NA5035 [2] 27.00x47.00x7.00mm, FPM</p> <p>NA5191 [2] 42.00x62.00x7.00mm, PTFE</p> <p>NA5192 [1] 90.00x110.00x7.00mm, PTFE</p>	
<p>HBS261 [22] M12x1.50x126.00mm (x10)</p>	<p>JD5881 [3]</p>	<p>JM5141 (Elastomer) HM5289 [3]</p>		<p>HR5046 [3] (x2)</p>	<p>NA5035 [2] 27.00x47.00x7.00mm, FPM</p> <p>NA5191 [2] 42.00x62.00x7.00mm, PTFE</p> <p>NA5192 [1] 90.00x110.00x7.00mm, PTFE</p>	
<p>HBS261 [22] M12x1.50x126.00mm (x10)</p>	<p>JD5191 [1] JD5190 [3]</p>	<p>JM5141 (Elastomer)</p>		<p>HR5046 [3]</p>	<p>NA5035 [2] 27.00x47.00x7.00mm, FPM</p> <p>NA5191 [2] 42.00x62.00x7.00mm, PTFE</p> <p>NA5192 [1] 90.00x110.00x7.00mm, PTFE</p>	

AD5490, AD5500,
AD5510, AD5520



cc





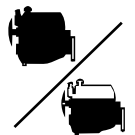



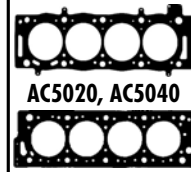
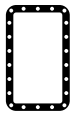
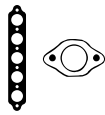















































kW/PS



2.0	RHT (DW10ATED4)	Diesel	157	AC5011 (MLS), 1.300mm, 1 Hole ☞0.470→0.605mm AC5020 (MLS), 1.350mm, 2 Holes ☞0.605→0.655mm AC5031 (MLS), 1.400mm, 3 Holes ☞0.655→0.705mm AC5040 (MLS), 1.450mm, 4 Holes ☞0.705→0.755mm AC5051 (MLS), 1.500mm, 5 Holes ☞0.755→0.830mm	CC5010 ▲ [3] CC5011 ▲	EA5830
C8 2.0 HDI	07/02→	1997	4 85.00 DOHC	79/107		
2.0	RHV (DW10TD)	Diesel	158			EA5830
Jumper 2.0 HDi	04/02→	1997	4 85.00 SOHC/OHC	62/84		
2.0	RHV (DW10UTD)	Diesel	159	AC5011 (MLS), 1.300mm, 1 Hole ☞0.470→0.605mm AC5020 (MLS), 1.350mm, 2 Holes ☞0.605→0.655mm AC5031 (MLS), 1.400mm, 3 Holes ☞0.655→0.705mm AC5040 (MLS), 1.450mm, 4 Holes ☞0.705→0.755mm AC5051 (MLS), 1.500mm, 5 Holes ☞0.755→0.830mm	CC5010 ▲ [3]	EA5830
Jumper 2.0 HDi	11/01→04/02	1997	4 85.00 SOHC/OHC	62/84		
2.0	RHW (DW10ATED4)	Diesel	160	AC5011 (MLS), 1.300mm, 1 Hole ☞0.470→0.605mm AC5020 (MLS), 1.350mm, 2 Holes ☞0.605→0.655mm AC5031 (MLS), 1.400mm, 3 Holes ☞0.655→0.705mm AC5040 (MLS), 1.450mm, 4 Holes ☞0.705→0.755mm AC5051 (MLS), 1.500mm, 5 Holes ☞0.755→0.830mm	CC5010 ▲ [3] CC5011 ▲	EA5830
C8 2.0 HDI	07/02→	1997	4 85.00 DOHC	79-80/		
Evasion 2.0 HDI	09/99→07/02			107-109		
Jumpy HDi 110	03/00→10/06					
2.0	RHX (DW10BTED)	Diesel	161	AC5011 (MLS), 1.300mm, 1 Hole ☞0.470→0.605mm AC5020 (MLS), 1.350mm, 2 Holes ☞0.605→0.655mm AC5031 (MLS), 1.400mm, 3 Holes ☞0.655→0.705mm AC5040 (MLS), 1.450mm, 4 Holes ☞0.705→0.755mm AC5051 (MLS), 1.500mm, 5 Holes ☞0.755→0.830mm	CC5010 ▲ [3]	EA5830
Jumpy 2.0 HDI 95	10/99→	1997	4 85.00 SOHC/OHC	69/94		
2.0	RHY (DW10TD)	Diesel	162	BL650 (Fibre), 1.200mm AC5011 (MLS), 1.300mm, 1 Hole ☞0.470→0.605mm AC5020 (MLS), 1.350mm, 2 Holes ☞0.605→0.655mm AC5031 (MLS), 1.400mm, 3 Holes ☞0.655→0.705mm AC5040 (MLS), 1.450mm, 4 Holes ☞0.705→0.755mm AC5051 (MLS), 1.500mm, 5 Holes ☞0.755→0.830mm	CC5010 ▲ [3]	EA5830
Berlingo	12/99→10/05	1997	4 85.00 SOHC/OHC	66/90		
Berlingo 2.0 90	12/99→					
C5 2.0 HDI	03/01→08/04					
C5 Break 2.0 HDI	06/01→08/04					
Xantia HDi 90	03/99→04/03					
Xantia Break	03/99→04/03					
Xsara 2.0 HDi	09/00→03/05					
Xsara 2.0 HDi 90	02/99→03/05					
Xsara Break	02/99→08/05					
Xsara Coupe	02/99→03/05					
Xsara Picasso	12/99→					



HBS261  [22] M12x1.50x126.00mm (x10)	JD5191  JD5190 	JM5087 (Elastomer) JM5141 (Elastomer)		HR5046 	 NA5035 [2] 27.00x47.00x7.00mm, FPM  NA5191  [2] 42.00x62.00x7.00mm, PTFE  NA5192  [1] 90.00x110.00x7.00mm, PTFE	
					 NA5035 [2] 27.00x47.00x7.00mm, FPM  NA5191  [2] 42.00x62.00x7.00mm, PTFE  NA5192  [1] 90.00x110.00x7.00mm, PTFE	
HBS261  [22] M12x1.50x126.00mm (x10)	JD5191  JD5190 	JM5087 (Elastomer)	 KG5157 10.00x20.00x2.000mm  PB907 14.00x21.00x2.000mm	HR5046 	 NA5035 [2] 27.00x47.00x7.00mm, FPM  NA5191  [2] 42.00x62.00x7.00mm, PTFE  NA5192  [1] 90.00x110.00x7.00mm, PTFE	
HBS261  [22] M12x1.50x126.00mm (x10)	JD5191  JD5190 	JM5087 (Elastomer) JM5141 (Elastomer)		HR5046 	 NA5035 [2] 27.00x47.00x7.00mm, FPM  NA5191  [2] 42.00x62.00x7.00mm, PTFE  NA5192  [1] 90.00x110.00x7.00mm, PTFE	
HBS261  [22] M12x1.50x126.00mm (x10)	JD5191  JD5190 	JM5087 (Elastomer)		HR5046 	 NA5035 [2] 27.00x47.00x7.00mm, FPM  NA5191  [2] 42.00x62.00x7.00mm, PTFE  NA5192  [1] 90.00x110.00x7.00mm, PTFE	
HBS261  [22] M12x1.50x126.00mm (x10)	JD5191  JD5190 	JM5087 (Elastomer)	 KG5157 10.00x20.00x2.000mm  PB907 14.00x21.00x2.000mm	HR5046 	 NA5035 [2] 27.00x47.00x7.00mm, FPM  NA5191  [2] 42.00x62.00x7.00mm, PTFE  NA5192  [1] 90.00x110.00x7.00mm, PTFE	

BL650



cc



kW/PS



2.0	RHZ (DW10ATED)	Diesel	163	AC5011 (MLS), 1.300mm, 1 Hole →0.470→0.605mm AC5020 (MLS), 1.350mm, 2 Holes →0.605→0.655mm AC5031 (MLS), 1.400mm, 3 Holes →0.655→0.705mm AC5040 (MLS), 1.450mm, 4 Holes →0.705→0.755mm AC5051 (MLS), 1.500mm, 5 Holes →0.755→0.830mm	CC5010 ▲ [3] →Eng.8331 CC5011 ▲ Eng.8332→	EA5830
C5 2.0 HDI	03/01→08/04	1997	4	85.00	SOHC/OHC	79-81/ 107-110
C5 Break 2.0 HDI	06/01→08/04					
Jumper 2.0 HDI	08/99→07/02					
Jumpy HDI 110	03/00→10/06					
Xantia HDI 109	02/99→04/03					
Xantia Break	02/99→04/03					
Xsara HDI 109	05/01→03/05					
Xsara Break	05/01→08/05					
Xsara Coupe	05/01→03/05					
Xsara Picasso	12/99→					
2.0	RLZ (EW10D)		164	AD5300 (MLS)	CD5300	ED5300
C5 2.0 16V HPi	03/01→08/04	1997	4	85.00	DOHC	103/140
C5 Break	06/01→08/04					
2.0	XU102C		165	BS820 (Fibre), 1.250mm	DS820 ▲ [3]	ES820 [3]
XM Break 2.0 i	11/91→04/94	1998	4	86.00	SOHC/OHC	79/107
2.0	XU10J2		166	BV140 (Fibre), 1.250mm BY320 (Fibre), 1.450mm	CY081 ▲ [3]	ES820 [3]
Jumper 2.0	04/02→	1998	4	86.00	SOHC/OHC	81/110
Jumper 2.0 bi	02/03→					
Jumper Box 2.0	04/02→					
2.1	P8A (XUD11ATE)	Diesel	167	BY930 (MLS), 1.350mm →10/94 →0.540→0.640mm BY941 (MLS), 1.520mm →0.650→0.760mm BY950 (MLS), 1.570mm →0.770→0.810mm BY961 (MLS), 1.620mm →0.820→0.860mm BY970 (MLS), 1.670mm 10/94→ BY981 (MLS), 1.720mm 10/94→ →0.920→0.960mm	DV150 ▲ [3]	EV150 [3]
XM 2.1 TD 12V	05/89→10/00	2088	4	85.00	SOHC/OHC	80-81/ 109-110
XM Break 12V	11/91→04/94					
2.1	P8C (XUD11BTE)	Diesel	168	BY930 (MLS), 1.350mm →0.540→0.640mm BY941 (MLS), 1.520mm →0.650→0.760mm BY950 (MLS), 1.570mm →0.770→0.810mm BY961 (MLS), 1.620mm →0.820→0.860mm BY970 (MLS), 1.670mm BY981 (MLS), 1.720mm →0.920→0.960mm	DV150 ▲ [3]	EV150 [3]
Jumper 2.1 TD	05/96→07/02	2088	4	85.00	SOHC/OHC	80/109
Xantia 2.1T D	06/95→02/99					
Xantia Break	06/96→02/99					
XM 2.1 TD 12V	05/94→10/00					
XM Break 12V	11/91→10/00					
2.1	P9A (XUD11A)	Diesel	169	BV150 (Fibre), 1.580mm, 2 Notches →0.650→0.770mm BV160 (Fibre), 1.700mm, 3 Notches →0.770→0.820mm	DV150 ▲ [3]	EV150 [3]
XM 2.1 D 12V	05/89→06/94	2138	4	86.00	SOHC/OHC	60-61/ 82-83
XM 2.1 D12 VSX	03/96→08/96					
XM Break	11/91→04/94					
XM Break 2.1 D12	07/94→06/96					



AC5020, AC5040



BS820



BV140, BY320



BV150



BV160



BY930, BY950,
BY970



JC415



JD230



JD519



JD529

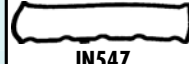

JN547



JP045



JJ283



cc



kW/PS



2.1	PHZ (XUD11ATE)	Diesel					170		DV150 ▲[3]	EV150 [3]
XM 2.1 TD 12V	05/89→10/00	2088	4	85.00	SOHC/OHC	80-81/109-110	BY930 (MLS), 1.350mm →10/94 ☞0.540→0.640mm BY941 (MLS), 1.520mm ☞0.650→0.760mm BY950 (MLS), 1.570mm ☞0.770→0.810mm BY961 (MLS), 1.620mm ☞0.820→0.860mm BY970 (MLS), 1.670mm 10/94→ BY981 (MLS), 1.720mm 10/94→ ☞0.920→0.960mm			
XM Break 12V	11/91→10/00									
2.1	PJZ (XUD11ATE)	Diesel					171		DV150 ▲[3]	EV150 [3]
XM 2.1 TD 12V	05/89→10/00	2088	4	85.00	SOHC/OHC	80/109	BY930 (MLS), 1.350mm →10/94 ☞0.540→0.640mm BY941 (MLS), 1.520mm ☞0.650→0.760mm BY950 (MLS), 1.570mm ☞0.770→0.810mm BY961 (MLS), 1.620mm ☞0.820→0.860mm BY970 (MLS), 1.670mm 10/94→ BY981 (MLS), 1.720mm 10/94→ ☞0.920→0.960mm			
XM Break 12V	11/91→10/00									
2.2	3FZ (EW12J4)					172	AG9750 (MLS)	CG9750	EG9750	
C8 2.2	07/02→	2230	4	86.00	DOHC	116/158				
2.2	4HN (DW12MTED4)	Diesel					173		EH6520	
C-Crosser	02/07→	2179	4	85.00	DOHC	115/156				
2.2	4HT (DW12BTED4)	Diesel					174		CD5490 ▲	ED5490 EH6520
C5 2.2 HDi	04/06→	2179	4	85.00	DOHC	125/170				
C5 Break 2.2 HDi	04/06→									
C6 2.2 HDi	06/06→									
C8 2.2 HDi	06/06→									
2.2	4HU (P22DTE)	Diesel					175	AH6390 (MLS), 1.100mm, 1 Notch AH6400 (MLS), 1.150mm, 2 Notches AH6410 (MLS), 1.200mm, 3 Notches	CH6390 ▲	EA5970 [3]
Jumper HDi 120	04/06→	2198	4	86.00	DOHC	88/120				
2.2	4HV (P22DTE)	Diesel					176	AH6390 (MLS), 1.100mm, 1 Notch AH6400 (MLS), 1.150mm, 2 Notches AH6410 (MLS), 1.200mm, 3 Notches	CH6390 ▲	EA5970 [3]
Jumper HDi 100	04/06→	2198	4	86.00	DOHC	74/101				
2.2	4HW (DW12TED4)	Diesel					177	AD5490 (MLS), 1.250mm, 2 Notches AD5500 (MLS), 1.300mm, 3 Holes AD5510 (MLS), 1.350mm, 4 Holes AD5520 (MLS), 1.400mm, 5 Holes	CD5490 ▲	ED5490
C8 2.2 HDi	07/02→	2179	4	85.00	DOHC	94/128				
2.2	4HX (DW12TED4/FAP)	Diesel					178	AD5490 (MLS), 1.250mm, 2 Notches AD5500 (MLS), 1.300mm, 3 Holes AD5510 (MLS), 1.350mm, 4 Holes AD5520 (MLS), 1.400mm, 5 Holes	CD5490 ▲	ED5490
C5 2.2 HDi	03/01→08/04	2179	4	85.00	DOHC	94-98/128-133				
C5 Break 2.2 HDi	06/01→08/04									

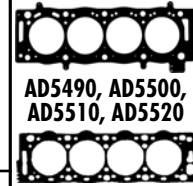
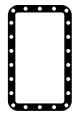

AD5490, AD5500,
AD5510, AD5520

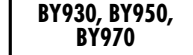

BY930, BY950,
BY970



JD230

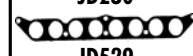

JD529



JM5037



JP045

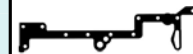

HC5004



JJ283



cc



kW/PS

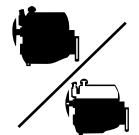

2.2	4HY (DW12UTED4)	Diesel	179	AH5080 (MLS), 1.250mm, 1 Hole AH5090 (MLS), 1.300mm, 2 Holes AH5100 (MLS), 1.350mm, 3 Holes AH5110 (MLS), 1.400mm, 4 Holes			
Jumper 2.2 HDi	02/02→06/06	2179	4	85.00	SOHC/OHC	74/101	
2.2	J6T A500		180	BH930 (Fibre), 1.200mm			GH930 ○ [3]
CX II 22 TRS	07/85→12/92	2165	4	88.00	SOHC/OHC	83-85/ 113-115	
CX II Break	07/85→12/92						
2.4	T8A (DJ5T)	Diesel	181	BY140 (Fibre)		DY140 ▲ [3]	EY140
Jumper 2.5 TD	03/94→04/02	2446	4	92.00		76/103	
2.4	T9A (DJ5)	Diesel	182	BY140 (Fibre)		DY140 ▲ [3]	EY140
Jumper 2.5 D	03/94→04/02	2446	4	92.00		63/86	
Jumper 2.5 D 4x4	08/96→04/02						
Jumper 2.5 TDi	03/00→04/02						
2.4	THX (DJ5TED)	Diesel	183	AE5050 (MLS)		CE5050 ▲ [3]	EY140
Jumper 2.5 TDi	12/96→04/02	2446	4	92.00		79/107	
2.4	THY (DK5ATE)	Diesel	184	BY140 (Fibre)		DY140 ▲ [3]	EY140
XM 2.5 TD	05/94→10/00	2446	4	92.00	SOHC/OHC	95/129	
XM Break 2.5 TD	05/94→10/00						
2.5	B25637	Diesel	185	BG540 (Fibre), 1.350mm		DG542 ▲ ○ [13]	GG541 ○ [3]
C35 2.5 D	02/80→01/94	2498	4	93.00		51/69	
2.5	CRD93L (U25-661)	Diesel	186	BG450 (Fibre), 1.350mm			FY291 ▲ [16]
C25 2.5 D	11/81→02/94	2500	4	93.00	SOHC/OHC	54-55/ 73-75	
C25 2.5 D 4x4	01/87→02/94						
2.5	CRD93LS (U25-673)	Diesel	187	BL830 (Fibre), 1.800mm		DL831 ▲ [13]	GL830 [3]
C25 2.5 D †	08/87→02/94	2500	4	93.00	SOHC/OHC	70/95	
C25 2.5 D Turbo	08/87→02/94						
C25 2.5 DT	01/87→01/94						
C25 2.5 DT 4x4	08/91→01/94						
2.5	M25-659		188	BR280 (Fibre), 1.400mm			
CX II 25 TRi	08/85→12/92	2500	4	93.00		96-100/ 131-138	
CX II Break	08/85→12/92						

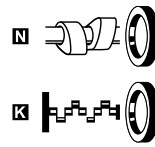

AE5050



BG450



BG540



BH930



BL830



BR280



BY140



JB868



JB869



JB954



JD532



JE651

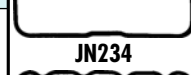

JN234



JN253



JN292

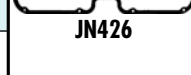

JN426







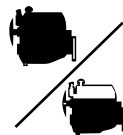

cc

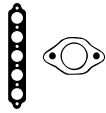

kW/PS

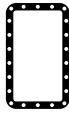

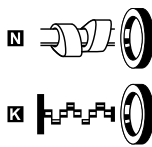
2.5	M25-660 Diesel	189	BG450 (Fibre), 1.350mm	DG452 ▲ [13]	GG452 ○ [3]
CX II 25 D CX II Break 25 D	08/85→12/92 05/86→12/92	2500 4 93.00	54/75		
2.5	M25-662	190	BR280 (Fibre), 1.400mm		
CX II 25 GTi T2	08/85→12/92	2500 4 93.00	122/166		
2.5	M25-667	191	BR280 (Fibre), 1.400mm		
CX II 25 GTi T2	09/86→12/92	2498 4 93.00 OHV	115/156		
2.5	M25-668	192	BR280 (Fibre), 1.400mm		
CX II 25 GTi CX II Break 25 i	05/86→12/92 05/86→12/92	2498 4 93.00 OHV	89-98/ 121-133		
2.5	M25-669 Diesel	193	BL830 (Fibre), 1.800mm	DL831 ▲ [13]	GL830 [3]
CX II 25 D Turbo CX II Break	01/87→12/92 01/87→12/92	2500 4 93.00	88/120		
2.7	DT17ED4 Diesel	194	AH5730 (MLS), 1.17mm, 2 Notches (x2) AH5731 (MLS), 1.22mm, 3 Notches (x2) [67] AH5732 (MLS), 1.27mm, 4 Notches (x2) [67] AH5733 (MLS), 1.32mm, 5 Notches (x2) [67]	CH5730	
C5 2.7 HDi C5 Break 2.7 HDi C6 2.7 HDi	02/08→ 02/08→ 09/05→	2720 6 81.00 DOHC, V	150/204		
2.7	UHZ (DT17BTED4) Diesel	195		CH5730	
C5 Break 2.7 HDi C6 2.7 HDi	02/08→ 09/05→	2720 6 81.00 DOHC, V	150/204		
2.8	8140.43N Diesel	196	BX390 (Fibre), 1.200mm BX400 (Fibre), 1.300mm BX410 (Fibre), 1.400mm BX420 (Fibre), 1.500mm		GX392 ▲ [3]
Jumper 2.8 HDi	05/04→	2798 4 94.40 SOHC/OHC	107/146		
2.8	8140.43S Diesel	197	BX390 (Fibre), 1.200mm BX400 (Fibre), 1.300mm BX410 (Fibre), 1.400mm BX420 (Fibre), 1.500mm	DX392 ▲	GX392 ▲ [3]
Jumper 2.8 Hdi	09/00→04/02	2798 4 94.40 SOHC/OHC	92-94/ 125-128		
2.8	8140.63 (F28D) Diesel	198	BX390 (Fibre), 1.200mm BX400 (Fibre), 1.300mm BX410 (Fibre), 1.400mm BX420 (Fibre), 1.500mm	DX392 ▲	GX392 ▲ [3]
Jumper 2.8 D	01/99→02/02	2798 4 94.40	64/87		

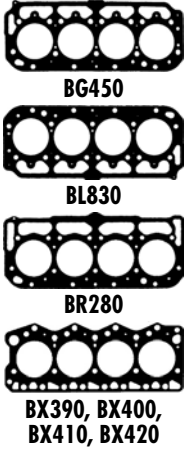
							
HBS017 [22] M12x1.50x145.00mm (x8)	JB868 [x4] JB869 [x4] ⊙JE651	JN426 [4]	PA217 16.30x22.00x2.000mm	HR340 [5]	NF741 [1] 29.00x46.00x10.00mm, ACM NF776 [2] 75.00x90.00x11.50mm, FPM/ACM NF752 [1] 95.00x112.00x12.50mm, FPM		BG450 BL830 BR280 BR280 BX390, BX400, BX410, BX420
	JB868 [x4] JB869 [x4] ⊙JE651	JN234 [4]	PA217 16.30x22.00x2.000mm	HR340 [5]	NF741 [1] 29.00x46.00x10.00mm, ACM NF752 [1] 95.00x112.00x12.50mm, FPM		JB868 JB869
	JB868 [x4] JB869 [x4] ⊙JE651	JN234 [4]	PA217 16.30x22.00x2.000mm	HR340 [5]	NF741 [1] 29.00x46.00x10.00mm, ACM NF752 [1] 95.00x112.00x12.50mm, FPM		JB868 JB869
HBS017 [22] M12x1.50x145.00mm (x8)	JB868 [x4] JB869 [x4] ⊙JE651	JN234 [4]	PA217 16.30x22.00x2.000mm	HR340 [5]	NF741 [1] 29.00x46.00x10.00mm, ACM NF752 [1] 95.00x112.00x12.50mm, FPM		JB868 JB869
HBS017 [22] M12x1.50x145.00mm (x8)	JB868 [x4] JB869 [x4] ⊙JE651	JN426 [4]	PA217 16.30x22.00x2.000mm	HR340 [5]	NF741 [1] 29.00x46.00x10.00mm, ACM NF776 [2] 75.00x90.00x11.50mm, FPM/ACM NF752 [1] 95.00x112.00x12.50mm, FPM		JC054 JC055
	JD5999 [5]	JM7094 (ACM)		HR5111 [5]	NA5318 [1][2] 26.0x45.0x8.0mm, FPM NA5323 [2] 35.00x50.00x7.00mm, PTFE		JC054 JC055
HBS255 [5] M12x1.25x90.00mm (x8)	JC054 [x4] JC055 [x4] ⊙JF123	JPO69 [4]	JH5178 (SMG) JJ613	HR602 [5]	NP068 [2] 55.00x70.00x8.00mm, FPM NP067 [2] 50.00x70.00x10.00mm, FPM NF883 [1] 114.00x177.00x13.00mm, FPM NF885 [2] 70.00x179.00x16.00mm, FPM	KD929 [68][69] KD931 [68][69] LC281 [6] Elastomer	JF123
HBS255 [5] M12x1.25x90.00mm (x8)	JC054 [x4] JC055 [x4] ⊙JF123	JPO69 [4]	JH5178 (SMG) JJ613	HR602 [5]	NP068 [2] 55.00x70.00x8.00mm, FPM NP067 [2] 50.00x70.00x10.00mm, FPM NF883 [1] 114.00x177.00x13.00mm, FPM NF885 [2] 70.00x179.00x16.00mm, FPM	KD929 [68][69] KD931 [68][69] LC281 [6] Elastomer	JN234 JN426
HBS255 [5] M12x1.25x90.00mm (x8)	JC054 [x4] JC055 [x4] ⊙JF123	JPO69 [4]	JH5178 (SMG) JJ613	HR602 [5]	NP068 [2] 55.00x70.00x8.00mm, FPM NP067 [2] 50.00x70.00x10.00mm, FPM NF883 [1] 114.00x177.00x13.00mm, FPM NF885 [2] 70.00x179.00x16.00mm, FPM	KD929 [68][69] KD931 [68][69] LC281 [6] Elastomer	JN426 JP069
HBS255 [5] M12x1.25x90.00mm (x8)	JC054 [x4] JC055 [x4]	JPO69 [4]	JH5178 (SMG) JJ613	HR602 [5]	NP068 [2] 55.00x70.00x8.00mm, FPM NP067 [2] 50.00x70.00x10.00mm, FPM NP067 [2] 50.00x70.00x10.00mm, FPM NF883 [1] 114.00x177.00x13.00mm, FPM NF885 [2] 70.00x179.00x16.00mm, FPM		JP069 JJ613



cc



kW/PS

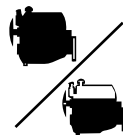

2.8		F28TDCR Diesel			199			
Jumper 2.8 HDi	02/02→06/06	2798	4	94.40	SOHC/OHC	94/128	BX400 (Fibre), 1.300mm BX410 (Fibre), 1.400mm BX420 (Fibre), 1.500mm	
2.9		XFU (ES9A)			200			
C5 3.0 V6	02/08→	2946	6	87.00	DOHC, V	155/211		
C5 Break 3.0 V6	02/08→							
2.9		XFV (ES9A)			201		AH5060 (MLS), 0.740mm ☒ AH5050 (MLS), 0.950mm ☒ AH5040 (MLS), 0.740mm ☒ AH5070 (MLS), 0.950mm ☒	
C5 3.0 V6	09/04→	2946	6	87.00	DOHC, V	152-155/ 207-211	CH5040 ☒ CH5060 ☒	
C5 Break 3.0 V6	09/04→							
C6 3.0 V6	09/05→							
2.9		XFX (ES9J4S)			202		AH5060 (MLS), 0.740mm ☒ AH5050 (MLS), 0.950mm ☒ AH5040 (MLS), 0.740mm ☒ AH5070 (MLS), 0.950mm ☒	
C5 3.0 V6	03/01→08/04	2946	6	87.00	DOHC, V	150-155/ 204-211	CH5040 ☒ CH5060 ☒	
C5 Break 3.0 V6	06/01→08/04							
C6 3.0 V6	09/05→							
C8 3.0 V6	07/02→							
2.9		XFZ (ES9J4)			203		AG9710 (MLS), 1.400mm ☒ AG9720 (MLS), 1.650mm ☒ AG9730 (MLS), 1.400mm ☒ AG9740 (MLS), 1.650mm ☒	
Xantia 3.0 i 24V	01/97→01/98	2946	6	87.00	DOHC, V	140/190	CG9710 CG9720 ☒ CG9740 ☒	EG9710
Xantia 3.0 V6	01/98→04/03							
Xantia Break V6	01/98→04/03							
XM 3.0 V6	04/97→10/00							
XM Break 3.0 V6	04/97→10/00							
3.0		DT20C Diesel			204			
C5 3.0 HDi 240	04/09→	2993	6	84.00	DOHC, V	155-177/ 211-241		
C5 Break	04/09→							
C6 3.0 HDi	04/09→							
3.0		SFZ (ZPJ/Z)			205			
XM 3.0 V6	05/89→10/00	2963	6	93.00	SOHC/OHC, V	123-125/ 167-170		
XM Break 3.0 V6	11/91→10/00							
3.0		SKZ (ZPJ4/Z)			206			
XM 3.0 V6 24V	07/90→10/00	2963	6	93.00	DOHC, V	147/200		
3.0		UFZ (ZPJ/Z)			207			
XM 3.0	05/89→05/94	2963	6	93.00	SOHC/OHC	123-125/ 167-170		
XM 3.0 V6	05/89→10/00							
XM Break 3.0 V6	11/91→10/00							

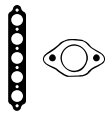

BX400, BX410,
BX420



JC054



JC055



JP069

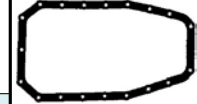

JJ613

CITROËN



cc





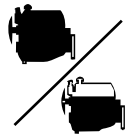





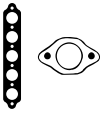

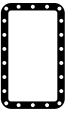
kW/PS

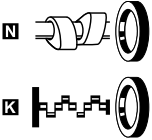

3.0 **UKZ (ZPJ4/Z)** **208**

XM 3.0 V6 24V	07/90→10/00	2963	6	93.00	DOHC, V	147/200
---------------	-------------	------	---	-------	---------	---------

						
<p>HBS127  [22] M12x1.50x178.00mm (x16)</p>					<p><input checked="" type="checkbox"/> NF869 [1] 32.00x45.00x8.00mm, FPM</p> <p><input checked="" type="checkbox"/> NAS191  [2] 42.00x62.00x7.00mm, PTFE</p> <p><input checked="" type="checkbox"/> NF835  [1] 80.00x100.00x8.00mm, FPM/ACM</p> <p><input checked="" type="checkbox"/> NF634  [1] 80.00x100.00x13.00mm, MVQ</p>	



Ltr







CC



9

Model	Ltr	Year Range	Engine Code	Fuel Type	CC	Seats	Category
1304 Pickup	1.3	06/98→08/99	810-02-/99	Petrol	1289	4	1
1310 Estate	1.3	05/98→07/00	810-02-/99	Petrol	1289	4	1
1310 Saloon (U, X)	1.3	05/98→07/00	810-02-/99	Petrol	1289	4	1
DUSTER	1.5	04/01→	K9K 796	Diesel	1461	4	7
DUSTER	1.5	10/01→	K9K 892	Diesel	1461	4	8
DUSTER	1.5	10/01→	K9K 894	Diesel	1461	4	9
DUSTER	1.5	06/01→	K9K 896	Diesel	1461	4	10
DUSTER	1.5	06/01→	K9K 898	Diesel	1461	4	11
DUSTER	1.6	06/01→	K4M 606	Petrol	1598	4	12
DUSTER	1.6	04/01→	K4M 690	Petrol	1598	4	13
DUSTER	1.6	04/01→	K4M 690	Flexfuel	1598	4	13
DUSTER	1.6	04/01→	K4M 690	Bi-Fuel	1598	4	13
DUSTER	1.6	04/01→	K4M 696	Petrol/Petroleum Gas (LPG)	1598	4	15
DUSTER	1.6	04/01→	K4M 696	Petrol/Ethanol	1598	4	15
DUSTER	1.6	04/01→	K4M 696	Petrol	1598	4	15
DUSTER	1.6	04/01→	K4M 696	Bi-Fuel	1598	4	15
LOGAN (LS_)	1.4	09/00→	K7J 710	Petrol/Petroleum Gas (LPG)	1390	4	3
LOGAN (LS_)	1.4	09/00→	K7J 710	Petrol	1390	4	3
LOGAN (LS_)	1.4	02/00→	K7J 714	Petrol/Petroleum Gas (LPG)	1390	4	4
LOGAN (LS_)	1.5	09/00→	K9K 790	Diesel	1461	4	5
LOGAN (LS_)	1.5	01/00→	K9K 792	Diesel	1461	4	6
LOGAN (LS_)	1.5	09/00→	K9K 796	Diesel	1461	4	7
LOGAN (LS_)	1.5	05/01→	K9K 892	Diesel	1461	4	8
LOGAN (LS_)	1.6	02/00→	K4M 690	Petrol	1598	4	13
LOGAN (LS_)	1.6	02/00→	K4M 690	Flexfuel	1598	4	13
LOGAN (LS_)	1.6	02/00→	K4M 690	Bi-Fuel	1598	4	13
LOGAN (LS_)	1.6	02/00→	K4M 696	Petrol/Petroleum Gas (LPG)	1598	4	15
LOGAN (LS_)	1.6	02/00→	K4M 696	Petrol/Ethanol	1598	4	15
LOGAN (LS_)	1.6	02/00→	K4M 696	Petrol	1598	4	15
LOGAN (LS_)	1.6	02/00→	K4M 696	Bi-Fuel	1598	4	15
LOGAN (LS_)	1.6	09/00→	K7M 710	Petrol	1598	4	16
LOGAN (LS_)	1.6	09/00→	K7M 710	Bi-Fuel	1598	4	16
LOGAN (LS_)	1.6	05/01→	K7M 718	Bi-Fuel	1598	4	17
LOGAN (LS_)	1.6	05/01→	K7M 800	Petrol	1598	4	18
LOGAN (LS_)	1.6	05/01→	K7M 800	Bi-Fuel	1598	4	18
LOGAN EXPRESS (FS_)	1.4	03/00→	K7J 710	Petrol/Petroleum Gas (LPG)	1390	4	3
LOGAN EXPRESS (FS_)	1.4	03/00→	K7J 710	Petrol	1390	4	3
LOGAN EXPRESS (FS_)	1.5	03/00→	K9K 792	Diesel	1461	4	6
LOGAN EXPRESS (FS_)	1.5	03/00→	K9K 796	Diesel	1461	4	7
LOGAN EXPRESS (FS_)	1.5	05/01→	K9K 892	Diesel	1461	4	8
LOGAN EXPRESS (FS_)	1.6	03/00→	K7M 710	Petrol	1598	4	16
LOGAN EXPRESS (FS_)	1.6	03/00→	K7M 710	Bi-Fuel	1598	4	16
LOGAN EXPRESS (FS_)	1.6	05/01→	K7M 800	Petrol	1598	4	18
LOGAN EXPRESS (FS_)	1.6	05/01→	K7M 800	Bi-Fuel	1598	4	18
LOGAN MCV (KS_)	1.4	02/00→	K7J 710	Petrol/Petroleum Gas (LPG)	1390	4	3
LOGAN MCV (KS_)	1.4	02/00→	K7J 710	Petrol	1390	4	3
LOGAN MCV (KS_)	1.5	02/00→	K9K 792	Diesel	1461	4	6
LOGAN MCV (KS_)	1.5	09/00→	K9K 796	Diesel	1461	4	7
LOGAN MCV (KS_)	1.5	05/01→	K9K 892	Diesel	1461	4	8
LOGAN MCV (KS_)	1.6	02/00→	K4M 690	Petrol	1598	4	13
LOGAN MCV (KS_)	1.6	02/00→	K4M 690	Flexfuel	1598	4	13
LOGAN MCV (KS_)	1.6	02/00→	K4M 690	Bi-Fuel	1598	4	13
LOGAN MCV (KS_)	1.6	11/00→	K4M 694	Flexfuel	1598	4	14
LOGAN MCV (KS_)	1.6	11/00→	K4M 694	Bi-Fuel	1598	4	14
LOGAN MCV (KS_)	1.6	02/00→	K4M 696	Petrol/Petroleum Gas (LPG)	1598	4	15
LOGAN MCV (KS_)	1.6	02/00→	K4M 696	Petrol/Ethanol	1598	4	15
LOGAN MCV (KS_)	1.6	02/00→	K4M 696	Petrol	1598	4	15
LOGAN MCV (KS_)	1.6	02/00→	K4M 696	Bi-Fuel	1598	4	15
LOGAN MCV (KS_)	1.6	02/00→	K7M 710	Petrol	1598	4	16
LOGAN MCV (KS_)	1.6	02/00→	K7M 710	Bi-Fuel	1598	4	16
LOGAN MCV (KS_)	1.6	05/01→	K7M 800	Petrol	1598	4	18
LOGAN MCV (KS_)	1.6	05/01→	K7M 800	Bi-Fuel	1598	4	18
LOGAN Pickup (US_)	1.4	01/00→	K7J 710	Petrol/Petroleum Gas (LPG)	1390	4	3
LOGAN Pickup (US_)	1.4	01/00→	K7J 710	Petrol	1390	4	3
LOGAN Pickup (US_)	1.5	03/00→	K9K 792	Diesel	1461	4	6
LOGAN Pickup (US_)	1.5	03/00→	K9K 796	Diesel	1461	4	7
LOGAN Pickup (US_)	1.5	05/01→	K9K 892	Diesel	1461	4	8
LOGAN Pickup (US_)	1.6	03/00→	K7M 710	Petrol	1598	4	16
LOGAN Pickup (US_)	1.6	03/00→	K7M 710	Bi-Fuel	1598	4	16
LOGAN Pickup (US_)	1.6	05/01→	K7M 800	Petrol	1598	4	18

	Ltr				CC		9
LOGAN Pickup (US_)	1.6	05/01→	K7M 800	Bi-Fuel	1598	4	18
NOVA	1.4	04/99→03/00	C2J	Petrol	1397	4	2
SANDERO	1.4	06/00→	K7J 710	Petrol/Petroleum Gas (LPG)	1390	4	3
SANDERO	1.4	06/00→	K7J 710	Petrol	1390	4	3
SANDERO	1.4	01/00→	K7J 714	Petrol/Petroleum Gas (LPG)	1390	4	4
SANDERO	1.5	11/00→	K9K 792	Diesel	1461	4	6
SANDERO	1.5	11/00→	K9K 796	Diesel	1461	4	7
SANDERO	1.5	05/01→	K9K 892	Diesel	1461	4	8
SANDERO	1.6	01/01→	K4M 690	Petrol	1598	4	13
SANDERO	1.6	01/01→	K4M 690	Flexfuel	1598	4	13
SANDERO	1.6	01/01→	K4M 690	Bi-Fuel	1598	4	13
SANDERO	1.6	01/01→	K4M 694	Flexfuel	1598	4	14
SANDERO	1.6	01/01→	K4M 694	Bi-Fuel	1598	4	14
SANDERO	1.6	01/01→	K4M 696	Petrol/Petroleum Gas (LPG)	1598	4	15
SANDERO	1.6	01/01→	K4M 696	Petrol/Ethanol	1598	4	15
SANDERO	1.6	01/01→	K4M 696	Petrol	1598	4	15
SANDERO	1.6	01/01→	K4M 696	Bi-Fuel	1598	4	15
SANDERO	1.6	06/00→	K7M 710	Petrol	1598	4	16
SANDERO	1.6	06/00→	K7M 710	Bi-Fuel	1598	4	16
SANDERO	1.6	05/01→	K7M 800	Petrol	1598	4	18
SANDERO	1.6	05/01→	K7M 800	Bi-Fuel	1598	4	18
SOLENZA	1.4	02/00→	K7J 710	Petrol/Petroleum Gas (LPG)	1390	4	3
SOLENZA	1.4	02/00→	K7J 710	Petrol	1390	4	3
SOLENZA	1.9	02/00→	F8Q 630	Diesel	1870	4	19

DACIA



cc



kW/PS



1.3		810-02/-99					1	BT080 (Fibre), 1.500mm		EF380 [3][14]
1304 1.3	06/83→08/90	1289	4	73.00	SOHC/OHC	40/54				
1310 1.3	05/83→07/04									
1.4		C2J					2			
Nova 1.4	04/96→03/01	1397	4	76.00	SOHC/OHC	48/65				
1.4		K7J 710					3	AH5170 (MLS)		
Logan 1.4	09/04→	1390	4	79.50	SOHC/OHC	55/75				
Logan MPI LPG	02/06→									
Logan Express	03/09→									
Sandero 1.4	06/08→									
Solenza 1.4	02/03→									
1.4		K7J 714					4	AH5170 (MLS)		
Logan MPI LPG	02/06→	1390	4	79.50	SOHC/OHC	53-55/ 72-75				
Sandero 1.4 LPG	01/09→									
1.5		K9K 790 Diesel					5	AG9490 (MLS), 0.75mm [70][71]		CE5200 ▲
Logan 1.5 dCi	09/05→	1461	4	76.00	SOHC/OHC	48/65				EE5200
1.5		K9K 792 Diesel					6	AG9490 (MLS), 0.75mm [70][71]		CE5200 ▲
Logan 1.5 dCi	01/06→	1461	4	76.00	SOHC/OHC	50/68				EE5200
Logan Express	03/09→									
Sandero 1.5 dCi	11/08→									
1.5		K9K 796 Diesel					7	AG9490 (MLS), 0.75mm [70][71]		CE5200 ▲
Duster 1.5 dCi	04/10→	1461	4	76.00	SOHC/OHC	63/86				
Logan 1.5 dCi	09/07→									
Logan Express	03/09→									
Sandero 1.5 dCi	11/08→									
1.5		K9K 892 Diesel					8			
Duster 1.5 dCi	10/10→	1461	4	76.00	SOHC/OHC	55-66/ 75-90				
Logan 1.5 dCi	05/10→									
Logan dCi	05/10→									
Logan Express	05/10→									
Sandero 1.5 dCi	05/10→									
1.5		K9K 894 Diesel					9			
Duster dCi 4x4	10/10→	1461	4	76.00	SOHC/OHC	66-67/ 90-91				

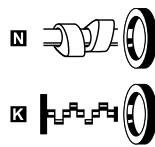
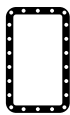
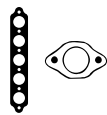

BT080

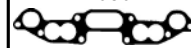

JB851



JN600



JN789

	JB851	JN600 [4]			<p>☒ NF722 ☒ [2] 35.00x50.00x10.00mm, MVQ</p> <p>☒ NF634 ☒ [1] 80.00x100.00x13.00mm, MVQ</p>	
					<p>☒ NF835 ☒ [1] 80.00x100.00x8.00mm, FPM/ACM</p> <p>☒ NF722 ☒ [2] 35.00x50.00x10.00mm, MVQ</p> <p>☒ NF634 ☒ [1] 80.00x100.00x13.00mm, MVQ</p>	
HBS102 ☉ [22] M10x1.50x113.00mm (x5)	JD5315 ☐ (x4) JD418 ☒	JN789 [4]		HR646 ☒	<p>☒ NAs016 35.00x47.00x7.00mm, FPM/ACM</p> <p>☒ NAs053 [2] 30.00x42.00x7.00mm, FPM</p> <p>☒ NAs016 ☒ [2] 35.00x47.00x7.00mm, FPM/ACM</p> <p>☒ NF835 ☒ [1] 80.00x100.00x8.00mm, FPM/ACM</p>	
HBS102 ☉ [22] M10x1.50x113.00mm (x5)	JD5315 ☐ (x4) JD418 ☒	JN789 [4]		HR646 ☒	<p>☒ NAs016 35.00x47.00x7.00mm, FPM/ACM</p> <p>☒ NAs053 [2] 30.00x42.00x7.00mm, FPM</p> <p>☒ NAs016 ☒ [2] 35.00x47.00x7.00mm, FPM/ACM</p> <p>☒ NF835 ☒ [1] 80.00x100.00x8.00mm, FPM/ACM</p>	
HBS299 ☉ [22] M11x1.50x125.00mm (x10)	JD5402 ☒ ☉-KK5643	JM7054 (NBR)		HR817 ☒	<p>☒ NAs215 [2] 28.00x42.00x5.00mm, FPM</p> <p>☒ NAs255 ☒ [2] 35.00x47.00x7.00mm, PTFE/ACM</p> <p>☒ NAs118 ☒ [1][2] 80.00x100.00x9.00mm, PTFE</p>	
HBS299 ☉ [22] M11x1.50x125.00mm (x10)	JD5402 ☒ ☉-KK5643	JM7054 (NBR)	JH5109 (NBR)	HR817 ☒	<p>☒ NAs215 [2] 28.00x42.00x5.00mm, FPM</p> <p>☒ NAs255 ☒ [2] 35.00x47.00x7.00mm, PTFE/ACM</p> <p>☒ NAs118 ☒ [1][2] 80.00x100.00x9.00mm, PTFE</p>	
HBS299 ☉ [22] M11x1.50x125.00mm (x10)	JD5402 ☒ ☉-KK5643	JM7054 (NBR)	JH5109 (NBR)	HR817 ☒	<p>☒ NAs215 [2] 28.00x42.00x5.00mm, FPM</p> <p>☒ NAs255 ☒ [2] 35.00x47.00x7.00mm, PTFE/ACM</p> <p>☒ NAs118 ☒ [1][2] 80.00x100.00x9.00mm, PTFE</p>	
	JD5402 ☒		JH5109 (NBR)	HR817 ☒	<p>☒ NAs215 [2] 28.00x42.00x5.00mm, FPM</p> <p>☒ NAs255 ☒ [2] 35.00x47.00x7.00mm, PTFE/ACM</p> <p>☒ NAs118 ☒ [1][2] 80.00x100.00x9.00mm, PTFE</p>	
	JD5402 ☒		JH5109 (NBR)	HR817 ☒	<p>☒ NAs215 [2] 28.00x42.00x5.00mm, FPM</p> <p>☒ NAs255 ☒ [2] 35.00x47.00x7.00mm, PTFE/ACM</p> <p>☒ NAs118 ☒ [1][2] 80.00x100.00x9.00mm, PTFE</p>	

DACIA



cc



kW/PS

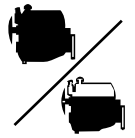

1.5 K9K 896 Diesel 10									
Duster 1.5 dCi	06/10→	1461	4	76.00	SOHC/OHC	79/107			
1.5 K9K 898 Diesel 11									
Duster dCi 4x4	06/10→	1461	4	76.00	SOHC/OHC	79-81/ 107-110			
1.6 K4M 606 12							AC5100 (MLS), 1.200mm	CC5110	
Duster 16V 4x4	06/10→	1598	4	79.50	DOHC	77/105			
1.6 K4M 690 13							AC5100 (MLS), 1.200mm	CC5100 [3]	
Duster 1.6 16V	04/10→	1598	4	79.50	DOHC	77/105			
Logan 1.6 16V	02/06→								
Logan 16V HiFl	11/09→								
Sandero 1.6 16V	07/11→								
Sandero 16V Bi	01/11→								
1.6 K4M 694 14							AC5100 (MLS), 1.200mm	CC5100 [3]	
Logan 16V HiFl	11/09→	1598	4	79.50	DOHC	77/105			
Sandero 16V Bi	01/11→								
1.6 K4M 696 15							AC5100 (MLS), 1.200mm		
Duster 1.6 16V	04/10→	1598	4	79.50	DOHC	77/105			
Duster 16V HiFl	08/10→								
Duster 16V LPG	04/11→								
Logan 1.6 16V	02/06→								
Logan 16V Flexi	07/10→								
Sandero 16V Bi	01/11→								
1.6 K7M 710 16							BY030 (Fibre)	DY030 [3]	EA220 [3]
Logan 1.6	09/04→	1598	4	79.50	SOHC/OHC	64/87			
Logan 1.6 Bifuel	11/08→								
Logan Express	03/09→								
Sandero 1.6	06/08→								
1.6 K7M 718 17							AH5170 (MLS)		
Logan 1.6 Bifuel	05/10→	1598	4	79.50	SOHC/OHC	62/84			

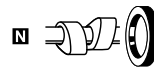
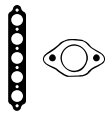

AC5100



BY030



JN789

		JD5402		JH5109 (NBR)	HR817	NA5215 [2] 28.00x42.00x5.00mm, FPM NA5255 [2] 35.00x47.00x7.00mm, PTFE/ACM NA5118 [1][2] 80.00x100.00x9.00mm, PTFE	
		JD5402		JH5109 (NBR)	HR817	NA5215 [2] 28.00x42.00x5.00mm, FPM NA5255 [2] 35.00x47.00x7.00mm, PTFE/ACM NA5118 [1][2] 80.00x100.00x9.00mm, PTFE	
HBS301 [22] M10x1.50x117.00mm (x10)	JD5393 JD5394	HR397		PA5013 (x16)	NA5016 35.00x47.00x7.00mm, FPM/ACM NA5016 [2] 35.00x47.00x7.00mm, FPM/ACM NF835 [1] 80.00x100.00x8.00mm, FPM/ACM		
HBS301 [22] M10x1.50x117.00mm (x10)	JD5393 JD5394	HR397		PA5013 (x16)	NA5215 [2] 28.00x42.00x5.00mm, FPM NA5016 35.00x47.00x7.00mm, FPM/ACM NA5016 [2] 35.00x47.00x7.00mm, FPM/ACM NF835 [1] 80.00x100.00x8.00mm, FPM/ACM		
HBS301 [22] M10x1.50x117.00mm (x10)	JD5393 JD5394	HR397		PA5013 (x16)	NA5215 [2] 28.00x42.00x5.00mm, FPM NA5016 35.00x47.00x7.00mm, FPM/ACM NA5016 [2] 35.00x47.00x7.00mm, FPM/ACM NF835 [1] 80.00x100.00x8.00mm, FPM/ACM		
HBS301 [22] M10x1.50x117.00mm (x10)	JD5393 JD5394	HR397		PA5013 (x16)	NA5215 [2] 28.00x42.00x5.00mm, FPM NA5016 35.00x47.00x7.00mm, FPM/ACM NA5016 [2] 35.00x47.00x7.00mm, FPM/ACM NF835 [1] 80.00x100.00x8.00mm, FPM/ACM		
HBS102 [22] M10x1.50x113.00mm (x5)	JD434 JD418	JN789 [4]	PA349 22.00x16.00x2.00mm	HR646	NA5016 35.00x47.00x7.00mm, FPM/ACM NA5053 [2] 30.00x42.00x7.00mm, FPM NA5016 [2] 35.00x47.00x7.00mm, FPM/ACM NF835 [1] 80.00x100.00x8.00mm, FPM/ACM		
HBS102 [22] M10x1.50x113.00mm (x5)	JD5315 (x4) JD418	JN789 [4]		HR646	NA5016 35.00x47.00x7.00mm, FPM/ACM NA5053 [2] 30.00x42.00x7.00mm, FPM NA5016 [2] 35.00x47.00x7.00mm, FPM/ACM NF835 [1] 80.00x100.00x8.00mm, FPM/ACM		

DACIA



cc



kW/PS

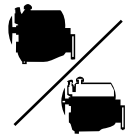

1.6		K7M 800					18		
Logan 1.6 Bifuel	05/10→	1598	4	79.50	SOHC/OHC	62/84			
Logan 1.6 MPI 85	05/10→								
Logan Express	05/10→								
Sandero MPI 85	05/10→								
1.9		F8Q 630	Diesel				19		
Solenza 1.9 D	02/03→	1870	4	80.00	SOHC/OHC	46-48/ 63-65	AD5030 (Fibre), 1.400mm, 2 Holes AD5040 (Fibre), 1.500mm, 1 Hole AD5050 (Fibre), 1.600mm, 3 Holes	DL961 ▲ [3]	EC5060

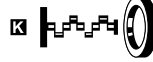
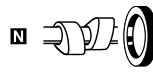
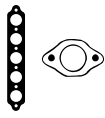

AD5030, AD5040,
AD5050



JD409

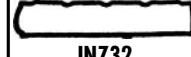

JN732

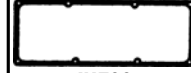

JN789

JN789 [4]

HR646 [2]

NA5016
35.00x47.00x7.00mm, FPM/ACM
 NA5053 [2]
30.00x42.00x7.00mm, FPM
 NA5016 [2]
35.00x47.00x7.00mm, FPM/ACM
 NF835 [1]
80.00x100.00x8.00mm, FPM/ACM

HBS120 [22]
M12x1.50x118.00mm (x10)

JD409

JN732 [4]

JH5041

HR569 [2]

NF846 [2]
25.00x42.00x7.00mm, FPM/ACM
 NA5036 [2]
42.00x54.00x6.00mm, FPM
 NF850 [1]
85.00x105.00x8.00mm, FPM
 NA5037 [1]
85.00x105.00x11.00mm, ACM



Ltr







CC



9

Model	Ltr	Year Range	Engine	Fuel	CC	Seats	Price
ARANOS	1.8	01/99→11/99	Y18L	Petrol	1796	4	16
ARANOS	2.0	01/99→11/99	C20LE	Petrol	1998	4	17
BROUGHAM	2.0	08/99→12/99	X 20 XEV	Petrol	1998	4	20
ESPERO (KLEJ)	1.5	10/99→06/99	A15MF	Petrol	1498	4	9
ESPERO (KLEJ)	1.5	10/99→09/99	G15MF	Petrol	1498	4	11
ESPERO (KLEJ)	1.8	02/99→09/99	C18LE	Petrol	1796	4	14
ESPERO (KLEJ)	2.0	10/99→06/99	C20LE	Petrol	1998	4	17
EVANDA (KLAL)	2.0	08/00→	X 20 SED	Petrol	1998	4	19
GENTRA Hatchback	1.4	05/00→	F14D3	Petrol	1399	4	6
GENTRA Hatchback	1.6	05/00→	F16D3	Petrol	1598	4	13
GENTRA Saloon	1.2	11/00→04/00	B12S1	Petrol	1150	4	4
GENTRA Saloon	1.4	05/00→	F14D3	Petrol	1399	4	6
GENTRA Saloon	1.5	11/00→04/00	A15SMS	Petrol	1498	4	10
GENTRA Saloon	1.6	05/00→	F16D3	Petrol	1598	4	13
KALOS (KLAS)	1.2	04/00→	B12S1	Petrol	1150	4	4
KALOS (KLAS)	1.4	04/00→	F14D3	Petrol	1399	4	6
KALOS (KLAS)	1.4	09/00→	F14S3	Petrol	1399	4	7
KALOS Saloon (KLAS)	1.4	05/00→12/00	F14D3	Petrol	1399	4	6
KALOS Saloon (KLAS)	1.4	11/00→12/00	F14S3	Petrol	1399	4	7
KORANDO (KJ)	2.9	01/99→	MB-OM 601 29TD	Diesel	2874	5	25
KORANDO (KJ)	2.9	01/99→	MB-OM 662	Diesel	2874	5	26
KORANDO (KJ)	3.2	01/99→	M 104.995	Petrol	3199	6	28
KORANDO Cabrio (KJ)	2.9	02/99→	MB-OM 601 29TD	Diesel	2874	5	25
KORANDO Cabrio (KJ)	2.9	02/99→	MB-OM 662	Diesel	2874	5	26
LACETTI Estate	1.5	04/99→05/99	A15DMS	Petrol	1498	4	8
LACETTI Estate	1.5	04/99→05/99	A15SMS	Petrol	1498	4	10
LACETTI Estate	1.8	04/99→05/99	C18LE	Petrol	1796	4	14
LACETTI Hatchback (KLAN)	1.4	02/00→	F14D3	Petrol	1399	4	6
LACETTI Hatchback (KLAN)	1.6	02/00→	F16D3	Petrol	1598	4	13
LACETTI Hatchback (KLAN)	1.8	02/00→	T18SED	Petrol	1799	4	15
LACETTI Saloon (J200)	1.8	08/00→12/00	T18SED	Petrol	1799	4	15
LACETTI Saloon	1.5	04/99→05/99	A15DMS	Petrol	1498	4	8
LACETTI Saloon	1.5	04/99→05/99	A15SMS	Petrol	1498	4	10
LACETTI Saloon	1.6	06/99→07/00	A16DMS	Petrol	1598	4	12
LACETTI Saloon	1.8	04/99→05/99	C18LE	Petrol	1796	4	14
LACETTI Saloon	2.0	04/99→07/00	X 20 SED	Petrol	1998	4	19
LANOS (KLAT)	1.4	05/99→	A14SMS	Petrol	1349	4	5
LANOS (KLAT)	1.5	05/99→	A15SMS	Petrol	1498	4	10
LANOS (KLAT)	1.6	05/99→	A16DMS	Petrol	1598	4	12
LANOS Saloon (KLAT)	1.4	05/99→	A14SMS	Petrol	1349	4	5
LANOS Saloon (KLAT)	1.5	05/99→	A15SMS	Petrol	1498	4	10
LANOS Saloon (KLAT)	1.6	05/99→	A16DMS	Petrol	1598	4	12
LEGANZA (KLAV)	1.8	06/99→07/00	C18LE	Petrol	1796	4	14
LEGANZA (KLAV)	2.0	07/00→04/00	T20SED	Petrol	1998	4	18
LEGANZA (KLAV)	2.0	06/99→12/00	X 20 SED	Petrol	1998	4	19
LEGANZA (KLAV)	2.2	04/99→12/00	T22SED	Petrol	2198	4	22
LEMANS	2.0	09/99→07/99	C20LE	Petrol	1998	4	17
MAGNUS	2.0	07/99→	X 20 SED	Petrol	1998	4	19
MATIZ (KLYA)	0.8	09/99→	F8CV	Petrol	796	3	2
MATIZ (KLYA)	1.0	01/00→	B10S	Petrol	995	4	3
MUSSO (FJ)	2.3	01/99→	M 111.970	Petrol	2295	4	24
MUSSO (FJ)	2.9	01/99→	MB-OM 601 29TD	Diesel	2874	5	25
MUSSO (FJ)	2.9	01/99→09/99	MB-OM 662	Diesel	2874	5	26
MUSSO (FJ)	3.2	01/99→	M 104.992	Petrol	3199	6	27
NEXIA (KLETN)	1.5	02/99→08/99	A15MF	Petrol	1498	4	9
NEXIA (KLETN)	1.5	02/99→08/99	G15MF	Petrol	1498	4	11
NEXIA Saloon (KLETN)	1.5	02/99→08/99	A15MF	Petrol	1498	4	9
NEXIA Saloon (KLETN)	1.5	02/99→08/99	G15MF	Petrol	1498	4	11
NEXIA Saloon	1.6	07/00→	F16D3	Petrol	1598	4	13
NUBIRA (KLAJ)	1.6	05/99→	A16DMS	Petrol	1598	4	12
NUBIRA (KLAJ)	1.8	04/99→05/99	C18LE	Petrol	1796	4	14
NUBIRA (KLAJ)	2.0	05/99→	X 20 SED	Petrol	1998	4	19
NUBIRA (KLAJ)	2.0	05/99→	Z20L	Petrol	1998	4	21
NUBIRA Saloon (KLAJ)	1.5	06/99→07/00	A15DMS	Petrol	1498	4	8
NUBIRA Saloon (KLAJ)	1.6	05/99→	A16DMS	Petrol	1598	4	12
NUBIRA Saloon (KLAJ)	1.8	04/99→05/99	C18LE	Petrol	1796	4	14
NUBIRA Saloon (KLAJ)	2.0	12/00→	T20SED	Petrol	1998	4	18
NUBIRA Saloon (KLAJ)	2.0	05/99→	X 20 SED	Petrol	1998	4	19
NUBIRA Saloon (KLAN)	1.4	10/00→12/00	F14D3	Petrol	1399	4	6
NUBIRA Saloon (KLAN)	1.6	07/00→	F16D3	Petrol	1598	4	13

	Ltr				CC		9
NUBIRA Saloon (KLAN)	1.8	07/00 →	T18SED	Petrol	1799	4	15
NUBIRA Wagon (KLAJ)	1.6	05/99 →	A16DMS	Petrol	1598	4	12
NUBIRA Wagon (KLAJ)	1.8	04/99 → 05/99	C18LE	Petrol	1796	4	14
NUBIRA Wagon (KLAJ)	2.0	12/00 →	T20SED	Petrol	1998	4	18
NUBIRA Wagon (KLAJ)	2.0	05/99 →	X 20 SED	Petrol	1998	4	19
NUBIRA Wagon (KLAN)	1.6	07/00 →	F16D3	Petrol	1598	4	13
NUBIRA Wagon (KLAN)	1.8	06/00 →	C18LE	Petrol	1796	4	14
NUBIRA Wagon (KLAN)	1.8	07/00 →	T18SED	Petrol	1799	4	15
PRINCE (J19)	2.0	08/99 → 08/99	X 20 XEV	Petrol	1998	4	20
PRINCE (J19)	2.2	08/99 → 08/99	X 22 XE	Petrol	2198	4	23
REZZO (KLAU)	1.6	09/00 →	A16DMS	Petrol	1598	4	12
REZZO (KLAU)	2.0	09/00 →	T20SED	Petrol	1998	4	18
REZZO (KLAU)	2.0	09/00 →	X 20 SED	Petrol	1998	4	19
TICO (KLY3)	0.8	02/99 → 12/00	F8C	Petrol	796	3	1
TICO (KLY3)	0.8	01/99 → 12/00	F8CV	Petrol	796	3	2
TOSCA	1.8	02/00 →	T18SED	Petrol	1799	4	15



CC



9



CC



9

A14SMS	Petrol	1349	4	76.50	5
A15DMS	Petrol	1498	4	76.50	8
A15MF	Petrol	1498	4	76.50	9
A15SMS	Petrol	1498	4	76.50	10
A16DMS	Petrol	1598	4	79.00	12
B10S	Petrol	995	4	68.50	3
B12S1	Petrol	1150	4	68.50	4
C18LE	Petrol	1796	4	84.80	14
C20LE	Petrol	1998	4	86.00	17
F14D3	Petrol	1399	4	77.90	6
F14S3	Petrol	1399	4	77.90	7
F16D3	Petrol	1598	4	79.00	13
F8C	Petrol	796	3	68.50	1
F8CV	Petrol	796	3	68.50	2
G15MF	Petrol	1498	4	76.50	11
M 104.992	Petrol	3199	6	89.90	27
M 104.995	Petrol	3199	6	89.90	28
M 111.970	Petrol	2295	4	90.90	24
MB-OM 601 29TD	Diesel	2874	5		25
MB-OM 662	Diesel	2874	5		26
T18SED	Petrol	1799	4	81.60	15
T20SED	Petrol	1998	4	86.00	18
T22SED	Petrol	2198	4	86.00	22
X 20 SED	Petrol	1998	4	86.00	19
X 20 XEV	Petrol	1998	4	86.00	20
X 22 XE	Petrol	2198	4	86.00	23
Y18L	Petrol	1796	4	84.80	16
Z20L	Petrol	1998	4	86.00	21



cc



kW/PS



0.8	F8C						1	AD5690 (Fibre)	CD5690 [3]	ED5690 FD5690
Tico 0.8	02/95→12/00	796	3	68.50	SOHC/OHC	35/48				
0.8	F8CV						2	AD5690 (Fibre)	CD5690 [3]	ED5690 FD5690
Matiz 0.8	09/98→	796	3	68.50	SOHC/OHC	38/52				
Tico 0.8	01/96→12/00									
1.0	B10S						3	AG7990 (Graphite)	CG7990	ED5690 FG7990
Matiz 1.0	01/03→	995	4	68.50	SOHC/OHC	47/64				
1.2	B12S1						4	AG7990 (Graphite)	CG7990	ED5690 FG7990
Gentra 1.2 SE	11/02→04/05	1150	4	68.50	SOHC/OHC	53-56/ 72-76				
Kalos 1.2	04/03→									
1.3	A14SMS						5	BS260 (Fibre)	DS261 [3]	ES260
Lanos 1.4	05/97→	1349	4	76.50	SOHC/OHC	55/75				
1.4	F14D3						6	AG8000 (MIS)	CG8000	FG8000
Gentra 1.4	05/05→	1399	4	77.90	DOHC	69-70/ 94-95				
Gentra 1.4 SR	05/03→04/05									
Kalos 1.4	05/03→12/04									
Kalos 1.4 16V	04/03→									
Lacetti 1.4	02/04→									
Nubira 1.4	10/03→12/04									
1.4	F14S3						7	BP800 (Fibre)		
Kalos 1.4	09/02→12/04	1399	4	77.90	DOHC	61/83				
1.5	A15DMS						8	BS260 (Fibre)	DS261 [3]	ES260
Lacetti 1.5 SE	04/98→05/99	1498	4	76.50	DOHC	81/110				
Nubira 1.5 SE	06/99→07/03									
1.5	A15MF						9	BZ300 (Fibre)		EK484
Espero 1.5 16V	10/93→06/99	1498	4	76.50	DOHC	65-66/ 88-90				
Nexia 1.5 16V	02/95→08/97									
Nexia 16V	02/95→08/97									
1.5	A15SMS						10	BS260 (Fibre)	DS261 [3]	ES260
Gentra 1.5 SE	11/02→04/05	1498	4	76.50	SOHC/OHC	62-73/ 84-99				
Lacetti 1.5 SX	04/97→05/99									
Lanos 1.5	05/97→06/99									

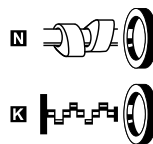
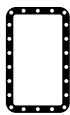
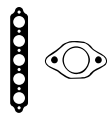

AD5690



BP800



BS260



BZ300



JC281



JC823



JD5794

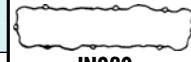

JN929



JH5005



cc



kW/PS



1.5		G15MF					11	BP800 (Fibre)	DP800	EK484
Espero 1.5	10/97→09/99	1498	4	76.50	SOHC/OHC	44-59/				
Nexia 1.5	02/95→08/97					55-80				
1.6		A16DMS					12	AB5230 (Fibre)	CB5230 [3]	HC5006 [3][18]
Lacetti 1.6	06/99→07/03	1598	4	79.00	DOHC	76-78/				
Lanos 1.6 16V	05/97→					103-106				
Nubira 1.6	08/02→07/03									
Nubira 1.6 16V	05/97→									
Rezzo 1.6	09/00→									
1.6		F16D3					13	AG8000 (MLS)		
Gentra 1.6 LS	05/05→	1598	4	79.00	DOHC	77-80/				
Lacetti 1.6	02/04→					105-109				
Nexia 1.6	07/08→									
Nubira 1.6	07/03→									
1.8		C18LE					14	BP810 (Fibre)	DP810	EK482
Espero 1.8	02/95→09/99	1796	4	84.80	SOHC/OHC	66-74/				
Lacetti 1.8 SX	04/97→05/99					90-100				
Leganza 1.8 CD	06/97→07/03									
Nubira 1.8	04/97→05/99									
1.8		T18SED					15	BY240 (Fibre)	DY240 [3]	HC5007
Lacetti 1.8	02/04→	1799	4	81.60	DOHC	90/122				
Lacetti 1.8 CDX	08/03→12/04									
Nubira 1.8	07/03→									
Tosca 1.8	02/06→									
1.8		Y18L					16	BP810 (Fibre)	DP810	EK482
Aranos 1.8	01/95→11/97	1796	4	84.80	SOHC/OHC	70/95				
2.0		C20LE					17	BP820 (Fibre)	DP820 [3]	EK482
Aranos 2.0	01/95→11/97	1998	4	86.00	SOHC/OHC	72-85/				
Espero 2.0	10/93→06/99					98-116				
Lemans 2.0 GSE	09/90→07/93									
2.0		T20SED					18	BY250 (Fibre)	DY250 [3]	EC100 [3]
Leganza 2.0 16V	07/00→04/04	1998	4	86.00	DOHC	93-94/				
Nubira 2.0 16V	12/00→					126-128				
Rezzo 2.0	09/00→									

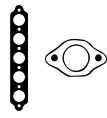

AB5230	JJ385
BP800	JJ459
BP810	JJ616
BP820	JJ617
BY240	
BY250	
JC281	
JC282	
JC756	
JC757	
JC823	
JD451	
JD5794	
JE120	
JN626	
JN693	
JP016	
JH5005	

HBS002 [5] M10x1.25x140.00mm (x10)	JC823 [1] JC281 [1] ☉JE120	JN626 [4]	JH5005 (Cork)	PA565 (x8) HR342 [1]	NC006 [2] 35.00x48.00x7.00mm, MVQ ☒ NB697 [2] 26.00x42.00x8.00mm, FPM ☒ NB698 [1] 80.00x98.00x10.00mm, FPM	
HBS285 [5] M10x1.25x166.00mm (x10)	JD5774 [1] (Graphite) JD5739 [1] (Fibre) JD5794 [1] (MLS)	JM5303	HR397	HR5092 [1]	NA5177 [2] 42.00x56.00x7.00mm, FPM ☒ NF812 [1] 30.00x42.00x8.00mm, ACM ☒ NB698 [1] 80.00x98.00x10.00mm, FPM	
HBS285 [5] M10x1.25x166.00mm (x10)	JD5774 [1] (Graphite) JD5739 [1] (Fibre) JD5794 [1] (MLS)	JM5303	HR397	NA5164 (x16) [51] 26.5 (FPM) 16.00mm	NA5177 [2] 42.00x56.00x7.00mm, FPM ☒ NF812 [1] 30.00x42.00x8.00mm, ACM ☒ NB698 [1] 80.00x98.00x10.00mm, FPM	
HBS053 [5] M11x1.25x140.00mm (x10)	JC757 [1] JC282 [1] ☉JE120	JN693 [4]	JJ385	PA565 (x8) HR342 [1]	NC006 [2] 35.00x48.00x7.00mm, MVQ ☒ NB700 [2] 31.00x50.00x8.00mm, MVQ ☒ NB806 [1] 90.00x104.00x11.00mm, FPM	
HBS377 [5] M10x1.25x97.00mm (x8)			HR397		NC006 [2] 35.00x48.00x7.00mm, MVQ ☒ NJ377 [2] 32.00x47.00x6.00mm, ACM ☒ NB700 [2] 31.00x50.00x8.00mm, MVQ ☒ NJ337 [1] 60.00x80.00x8.00mm, NBR ☒ NB806 [1] 90.00x104.00x11.00mm, FPM	
HBS053 [5] M11x1.25x140.00mm (x10)	JC757 [1] JC282 [1] ☉JE120	JN693 [4]	JJ385	PA565 (x8) HR342 [1]	NC006 [2] 35.00x48.00x7.00mm, MVQ ☒ NB700 [2] 31.00x50.00x8.00mm, MVQ ☒ NB806 [1] 90.00x104.00x11.00mm, FPM	
HBS053 [5] M11x1.25x140.00mm (x10)	JC756 [1] JC282 [1] ☉JE120	JN693 [4]	JJ385	PA565 (x8) HR342 [1]	NC006 [2] 35.00x48.00x7.00mm, MVQ ☒ NB807 [1] 55.00x70.10x8.00mm, FPM ☒ NB700 [2] 31.00x50.00x8.00mm, MVQ ☒ NB806 [1] 90.00x104.00x11.00mm, FPM	
HBS054 [5] M11x1.25x105.00mm (x10)	JD451 [1] JD5300 [1] (MLS)	JP016 [4]	JJ459 JJ616 [1] JJ617 [1]	HR791 [1]	NC006 [2] 35.00x48.00x7.00mm, MVQ ☒ NB700 [2] 31.00x50.00x8.00mm, MVQ ☒ NB806 [1] 90.00x104.00x11.00mm, FPM	



cc



kW/PS

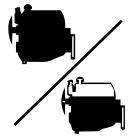

2.0		X 20 SED					19	BY250 (Fibre)	DY250 [3]	EC100 [3]
Evanda 2.0	08/02→	1998	4	86.00	DOHC	89-98/ 121-133				
Lacetti 2.0	04/97→07/03									
Leganza 2.0 16V	06/97→12/02									
Magnus 2.0	07/99→									
Nubira 2.0 16V	05/97→									
Rezzo 2.0	09/01→									
2.0		X 20 XEV					20	BY250 (Fibre)	DY250 [3]	HC5007
Brougham 2.0	08/94→12/97	1998	4	86.00	DOHC	100/136				
Prince 2.0	08/93→08/98									
2.0		Z20L					21	BY250 (Fibre)	DY250 [3]	EC100 [3]
Nubira 2.0 16V	05/97→	1998	4	86.00	DOHC	98/133				
2.2		T22SED					22	BY250 (Fibre)		EC100 [3]
Leganza 2.2 16V	04/99→12/02	2198	4	86.00	DOHC	100/136				
2.2		X 22 XE					23	BY250 (Fibre)	DY254 DY255	EC102
Prince 2.2	08/97→08/99	2198	4	86.00	DOHC	100/136				
2.3		M 111.970					24	BZ900 (Fibre)	DZ900 ○ [13]	EV810
Musso 2.3	01/99→	2295	4	90.90	DOHC	103-110/ 140-150				
2.9		MB-OM 601 29TD Diesel					25	BW380 (Fibre), 1.800mm	DW381 ☒ ○ [13]	
Korando 2.9 TD	01/99→	2874	5		SOHC/OHC	88-95/ 120-129				
Musso 2.9 TD 4x4	01/99→									
2.9		MB-OM 662 Diesel					26	BW380 (Fibre), 1.800mm	DW380 ☒ ○ DW381 ☒ ○ [13]	EN720 [3]
Korando 2.9 D	01/99→	2874	5			72-73/ 98-99				
Musso 2.9 D 4x4	01/99→09/99									
3.2		M 104.992					27	AE5330 (Fibre), 1.240mm	CE5330 ○ [3]	
Musso 3.2	01/99→	3199	6	89.90	DOHC	162/220				
3.2		M 104.995					28	AE5330 (Fibre), 1.240mm	CE5330 ○ [3]	
Korando 3.2	01/99→	3199	6	89.90	DOHC	154-156/ 209-212				

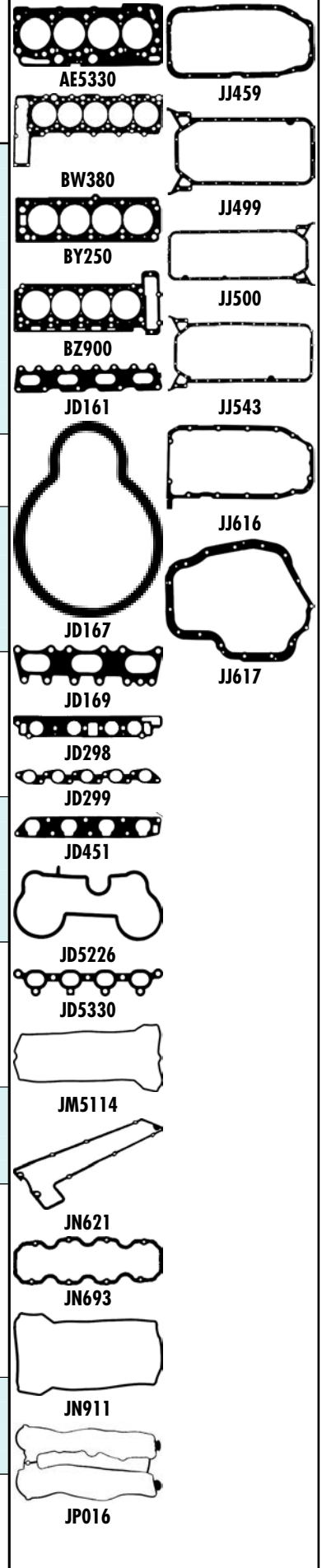

HBS054 [5] M11x1.25x105.00mm (x10)	JD451 [1] JD5300 [3] (MLS)	JN693 [4] JP016 [4]	JJ459 JJ616 [2] JJ617 [2]	PA5041 (x16) 6.00/12.20x10.00 (FPM) PA565 (x8) HR342 [3] HR5092 [3] HR791 [3]	NA5177 [2] 42.00x56.00x7.00mm, FPM NC006 [2] [2] 35.00x48.00x7.00mm, MVQ NB700 [2] [2] 31.00x50.00x8.00mm, MVQ NF812 [1] [1] 30.00x42.00x8.00mm, ACM NB698 [1] [1] 80.00x98.00x10.00mm, FPM NB806 [1] [1] 90.00x104.00x11.00mm, FPM	
HBS054 [5] M11x1.25x105.00mm (x10)					NC006 [2] 35.00x48.00x7.00mm, MVQ	
HBS054 [5] M11x1.25x105.00mm (x10)	JD451 [1] JD5330 [3]	JP016 [4]	JJ616 [2] JJ617 [2]	PA5041 (x16) 6.00/12.20x10.00 (FPM) HR791 [3]	NC006 [2] 35.00x48.00x7.00mm, MVQ NB700 [2] [2] 31.00x50.00x8.00mm, MVQ NB806 [1] [1] 90.00x104.00x11.00mm, FPM	
HBS054 [5] M11x1.25x105.00mm (x10)	JD451 [1]	JP016 [4]	JJ616 [2] JJ617 [2]	PA5041 6.00/12.20x10.00 (FPM) HR791 [3]	NC006 [2] 35.00x48.00x7.00mm, MVQ NB700 [2] [2] 31.00x50.00x8.00mm, MVQ NB806 [1] [1] 90.00x104.00x11.00mm, FPM	
HBS054 [5] M11x1.25x105.00mm (x10)	JD451 [1]	JP016 [4]	JJ459	PA5041 6.00/12.20x10.00 (FPM) HR791 [3]	NC006 [2] 35.00x48.00x7.00mm, MVQ NB700 [2] [2] 31.00x50.00x8.00mm, MVQ NB806 [1] [1] 90.00x104.00x11.00mm, FPM	
HBS150 [19] M12x1.75x102.00mm (x10)	JD5226 [1] (x2) JD161 [3]	JN911 [4]	JJ499	HR5055 [3]	NB973 [2] [2] 45.00x67.00x8.00mm, FPM NB974 [1] [1] 93.00x114.00x13.00mm, FPM NA5074 [1] [1] 93.00x133.50x15.50mm, PTFE	
HBS059 [22] M10x1.50x115.00mm (x6)	JD298 [1] JD299 [3]	JN621 [4]	JJ543		NA5131 [2] [2] 45.00x67.00x8.00mm, PTFE NA5074 [1] [1] 93.00x133.50x15.50mm, PTFE	
HBS059 [22] M10x1.50x115.00mm (x6)	JD298 [1] JD299 [3]	JN621 [4]	JJ543 =KJ779		NA5131 [2] [2] 45.00x67.00x8.00mm, PTFE NB973 [2] [2] 45.00x67.00x8.00mm, FPM NB974 [1] [1] 93.00x114.00x13.00mm, FPM NA5074 [1] [1] 93.00x133.50x15.50mm, PTFE	
HBS152 [19] M12x1.75x160.00mm (x14)	JD167 [1] (x6) JD169 [3] (x2)	JM5114 (Elastomer)	JJ500	HR5055 [3]	NB973 [2] [2] 45.00x67.00x8.00mm, FPM NB974 [1] [1] 93.00x114.00x13.00mm, FPM	
HBS152 [19] M12x1.75x160.00mm (x14)	JD167 [1] JD169 [3]	JM5114 (Elastomer)	JJ500	HR5055 [3]	NB973 [2] [2] 45.00x67.00x8.00mm, FPM NB974 [1] [1] 93.00x114.00x13.00mm, FPM	



Ltr







CC



9

Model	Ltr	Year Range	Engine	Fuel	CC	Seats	Category
1000 Box	1.0	07/98→10/99	CB 10	Petrol	993	3	10
1000 Bus	1.0	06/99→10/99	CB 10	Petrol	993	3	10
1000 Pickup	1.0	06/99→10/99	CB 10	Petrol	993	3	10
1300 Box	1.3	06/99→	HCE	Petrol	1296	4	20
1300 Bus	1.3	06/99→	HCE	Petrol	1296	4	20
1300 Pickup	1.3	06/99→	HCE	Petrol	1296	4	20
ALTIS Hatchback	2.2	10/99→07/00	5S-FE	Petrol	2164	4	31
ALTIS	2.2	10/99→07/00	5S-FE	Petrol	2164	4	31
ALTIS	2.4	08/00→	2AZ-FE	Petrol	2362	4	32
APPLAUSE I (A101, A111)	1.6	06/98→07/99	HD	Petrol	1590	4	27
APPLAUSE I (A101, A111)	1.6	06/98→07/99	HD-E	Petrol	1590	4	29
APPLAUSE II (A101)	1.6	07/99→05/00	HD-E	Petrol	1590	4	29
ASCEND	1.6	06/99→03/99	HD-E	Petrol	1590	4	29
BEGO	1.3	11/00→	K3-VE	Petrol	1298	4	22
BOON	1.0	01/01→	1KR-FE	Petrol	998	3	8
CERIA	0.8	08/99→09/99	ED 10	Petrol	847	3	5
CERIA	0.8	10/99→02/00	ED 20	Petrol	847	3	7
CERIA	1.0	06/00→	EJ-VE	Petrol	989	3	18
CHARADE (L2_)	1.0	03/00→	EJ-VE	Petrol	989	3	18
CHARADE III (G100, G101, G102)	1.0	03/98→12/99	CB 23	Petrol	993	3	12
CHARADE III (G100, G101, G102)	1.0	03/98→10/99	CB 61	Petrol	993	3	13
CHARADE III (G100, G101, G102)	1.0	04/98→12/99	CB 90	Petrol	993	3	14
CHARADE III (G100, G101, G102)	1.0	03/98→12/99	CL	Diesel	993	3	15
CHARADE III (G100, G101, G102)	1.0	03/98→12/99	CL 61	Diesel	993	3	16
CHARADE III (G100, G101, G102)	1.3	06/98→01/99	HCE	Petrol	1296	4	20
CHARADE III Saloon (G102)	1.3	11/99→02/99	HCE	Petrol	1296	4	20
CHARADE IV (G200, G202)	1.0	09/99→03/99	CB 22	Petrol	993	3	11
CHARADE IV (G200, G202)	1.3	01/99→11/99	HC	Petrol	1296	4	19
CHARADE IV (G200, G202)	1.3	05/99→11/99	HCE	Petrol	1296	4	20
CHARADE IV (G200, G202)	1.5	06/99→11/99	HEE	Petrol	1499	4	25
CHARADE IV (G200, G202)	1.5	06/99→11/99	HEEG	Petrol	1499	4	26
CHARADE IV (G200, G202)	1.6	03/99→11/99	HD-E	Petrol	1590	4	29
CHARADE IV Saloon (G203)	1.5	08/99→	HEE	Petrol	1499	4	25
CHARADE IV Saloon (G203)	1.6	03/99→03/99	HD-E	Petrol	1590	4	29
CITIVAN Bus	1.3	06/99→10/99	HCE	Petrol	1296	4	20
CITY BREEZE Bus	1.3	09/99→	HCE	Petrol	1296	4	20
COO	1.0	10/00→	EJ-DE	Petrol	989	3	17
COO	1.0	10/00→	EJ-VE	Petrol	989	3	18
COO	1.3	10/00→	K3-VE	Petrol	1298	4	22
COO	1.3	10/00→	K3-VET	Petrol	1298	4	24
COPEN	1.3	03/00→	K3-VE	Petrol	1298	4	22
CUORE II (L80, L81)	0.8	09/98→12/99	ED 10	Petrol	847	3	5
CUORE III (L201)	0.7	08/99→11/99	EF-EL	Petrol	659	3	2
CUORE III (L201)	0.7	08/99→09/99	EF-JL	Petrol	659	3	3
CUORE III (L201)	0.8	10/99→12/99	ED 10 K	Petrol	847	3	6
CUORE IV (L501)	0.8	01/99→11/99	ED 20	Petrol	847	3	7
CUORE V (L5)	0.8	11/99→10/99	ED 20	Petrol	847	3	7
CUORE VI (L7_)	1.0	10/99→05/00	EJ-DE	Petrol	989	3	17
CUORE VI (L7_)	1.0	10/00→02/00	EJ-VE	Petrol	989	3	18
CUORE VII (L251)	0.7	03/00→	EF-JL	Petrol	659	3	3
CUORE VII (L251)	1.0	05/00→	EJ-VE	Petrol	989	3	18
CUORE VIII	1.0	04/00→	1KR-FE	Petrol	998	3	8
DEVAN Box	1.3	06/99→10/99	HCE	Petrol	1296	4	20
DEVAN Bus	1.3	06/99→10/99	HCE	Petrol	1296	4	20
DEVAN Bus	1.6	11/99→10/00	HDC	Petrol	1590	4	28
EXTOL Box	1.3	07/00→	K3-VE	Petrol	1298	4	22
EXTOL Bus (S22_, S23_)	1.3	07/00→	K3-VE	Petrol	1298	4	22
FEROZA Hard Top (F300)	1.6	10/98→	HDC	Petrol	1590	4	28
FEROZA Hard Top (F300)	1.6	10/98→	HD-E	Petrol	1590	4	29
FEROZA Soft Top (F300)	1.6	10/98→	HDC	Petrol	1590	4	28
FEROZA Soft Top (F300)	1.6	10/98→	HD-E	Petrol	1590	4	29
GRAN MOVE (G3)	1.5	10/99→08/99	HEE	Petrol	1499	4	25
GRAN MOVE (G3)	1.5	10/99→08/99	HEEG	Petrol	1499	4	26
GRAN MOVE (G3)	1.6	05/99→	HDEP	Petrol	1590	4	30
HIJET Box (S85)	0.5	10/99→12/99	AB 30	Petrol	547	2	1
HIJET Box (S85)	1.3	05/99→	HCE	Petrol	1296	4	20
HIJET Box (S85)	1.6	10/99→12/99	HDC	Petrol	1590	4	28
HIJET Box	0.8	06/98→12/98	CD	Petrol	843	3	4
HIJET Box	1.0	06/98→12/98	CB	Petrol	993	3	9
HIJET Box	1.0	07/98→10/99	CB 10	Petrol	993	3	10

	Ltr				CC		9
HIJET Bus	0.8	06/98→12/98	CD	Petrol	843	3	4
HIJET Bus	1.0	06/98→12/98	CB	Petrol	993	3	9
HIJET Pickup (_U20)	0.8	07/98→10/99	CD	Petrol	843	3	4
HIJET Pickup (_U20)	1.0	07/98→10/99	CB 10	Petrol	993	3	10
HIJET Pickup	1.3	06/99→	HCE	Petrol	1296	4	20
HIJET Pickup	1.6	11/99→	HDC	Petrol	1590	4	28
LEEZA Coupe	0.7	08/99→08/99	EF-JL	Petrol	659	3	3
MATERIA (M4 _)	1.0	10/00→	EJ-DE	Petrol	989	3	17
MATERIA (M4 _)	1.0	10/00→	EJ-VE	Petrol	989	3	18
MATERIA (M4 _)	1.3	10/00→	K3-VE	Petrol	1298	4	22
MATERIA (M4 _)	1.3	10/00→	K3-VET	Petrol	1298	4	24
MOVE (L6, L9)	0.8	10/99→	ED 20	Petrol	847	3	7
MOVE (L6, L9)	1.0	10/99→	EJ-DE	Petrol	989	3	17
ROCKY Hard Top (F7, F8)	2.8	12/98→04/99	DL 51	Diesel	2765	4	33
ROCKY Hard Top (F7, F8)	2.8	09/99→12/99	DL 52	Diesel	2765	4	34
ROCKY Soft Top (F7, F8)	2.8	12/98→04/99	DL 51	Diesel	2765	4	33
ROCKY Soft Top (F7, F8)	2.8	09/99→12/99	DL 52	Diesel	2765	4	34
RUSH	1.3	11/00→	K3-VE	Petrol	1298	4	22
SIRION (M1)	1.0	04/99→10/00	EJ-DE	Petrol	989	3	17
SIRION (M1)	1.0	09/00→01/00	EJ-VE	Petrol	989	3	18
SIRION (M1)	1.3	08/00→03/00	K3-VE2	Petrol	1298	4	23
SIRION (M3 _)	1.0	01/00→	1KR-FE	Petrol	998	3	8
SIRION (M3 _)	1.3	01/00→	K3-VE	Petrol	1298	4	22
SKYWING	1.0	02/98→02/99	CB 22	Petrol	993	3	11
SKYWING	1.0	02/98→02/99	CB 23	Petrol	993	3	12
SKYWING	1.0	11/99→02/99	CB 90	Petrol	993	3	14
SOCIAL	1.6	05/98→06/99	HDC	Petrol	1590	4	28
SOCIAL	1.6	05/98→08/99	HD-E	Petrol	1590	4	29
STORIA	1.0	04/00→	1KR-FE	Petrol	998	3	8
STORIA	1.3	04/00→	K3-VE	Petrol	1298	4	22
TERIOS (J1)	1.3	10/99→10/00	HE-EJ	Petrol	1296	4	21
TERIOS (J1)	1.3	10/00→10/00	K3-VE	Petrol	1298	4	22
TERIOS (J1)	1.5	05/99→10/00	HEE	Petrol	1499	4	25
TERIOS (J1)	1.6	05/99→10/00	HDC	Petrol	1590	4	28
TERIOS (J2 _)	1.3	11/00→	K3-VE	Petrol	1298	4	22
TREVIS	1.0	06/00→	EJ-VE	Petrol	989	3	18
XENIA	1.0	01/00→	EJ-DE	Petrol	989	3	17
XENIA	1.3	01/00→	K3-VE	Petrol	1298	4	22
YRV (M2)	1.0	02/00→	EJ-VE	Petrol	989	3	18
YRV (M2)	1.3	02/00→	K3-VE	Petrol	1298	4	22
YRV (M2)	1.3	07/00→	K3-VET	Petrol	1298	4	24
ZEBRA Box	0.8	04/98→05/99	CD	Petrol	843	3	4
ZEBRA Box	1.0	07/98→05/99	CB 10	Petrol	993	3	10
ZEBRA Box	1.3	06/99→10/00	HCE	Petrol	1296	4	20
ZEBRA Bus	0.8	04/98→09/99	CD	Petrol	843	3	4
ZEBRA Bus	1.0	07/98→05/99	CB 10	Petrol	993	3	10
ZEBRA Bus	1.3	06/99→	HCE	Petrol	1296	4	20
ZEBRA Pickup	0.8	04/98→05/99	CD	Petrol	843	3	4
ZEBRA Pickup	1.0	07/98→05/99	CB 10	Petrol	993	3	10
ZEBRA Pickup	1.3	06/99→10/00	HCE	Petrol	1296	4	20



CC



9



CC



9

1KR-FE	Petrol	998	3	71.00	8
2AZ-FE	Petrol	2362	4	88.50	32
5S-FE	Petrol	2164	4	87.00	31
AB 30	Petrol	547	2	71.60	1
CB	Petrol	993	3	76.00	9
CB 10	Petrol	993	3	76.00	10
CB 22	Petrol	993	3	76.00	11
CB 23	Petrol	993	3	76.00	12
CB 61	Petrol	993	3	76.00	13
CB 90	Petrol	993	3	76.00	14
CD	Petrol	843	3	70.00	4
CL	Diesel	993	3	76.00	15
CL 61	Diesel	993	3	76.00	16
DL 51	Diesel	2765	4	92.00	33
DL 52	Diesel	2765	4	92.00	34
ED 10	Petrol	847	3	66.60	5
ED 10 K	Petrol	847	3	66.60	6
ED 20	Petrol	847	3	66.60	7
EF-EL	Petrol	659	3	68.00	2
EF-JL	Petrol	659	3	68.00	3
EJ-DE	Petrol	989	3	72.00	17
EJ-VE	Petrol	989	3	72.00	18
HC	Petrol	1296	4	76.00	19
HCE	Petrol	1296	4	76.00	20
HD	Petrol	1590	4	76.00	27
HDC	Petrol	1590	4	76.00	28
HD-E	Petrol	1590	4	76.00	29
HDEP	Petrol	1590	4	76.00	30
HEE	Petrol	1499	4	76.00	25
HEEG	Petrol	1499	4	76.00	26
HE-EJ	Petrol	1296	4	76.00	21
K3-VE	Petrol	1298	4	72.00	22
K3-VE2	Petrol	1298	4	72.00	23
K3-VET	Petrol	1298	4	72.00	24



cc



kW/PS



Model	Year Range	CC	Cyls	Power (kW/PS)	Configuration	Code	Material	Accessories
0.5 AB 30						1	BJ630 (Graphite)	DN250 [3]
Hijet Van 0.5	10/94→12/95	547	2	71.60	SOHC/OHC	20/27		
0.7 EF-EL						2	BR140 (Graphite)	DR140 [3]
Cuore III 0.7	08/90→11/94	659	3	68.00	SOHC/OHC	30-40/ 41-54		
0.7 EF-JL						3	AG7970 (MLS)	CG7970
Cuore III 0.7	08/90→09/94	659	3	68.00	SOHC/OHC	47/64		
Cuore VII 0.7	03/03→							
Leeza 0.7 Turbo	08/90→08/94							
0.8 CD						4	BS090 (Graphite)	
Hijet 0.8	06/86→10/90	843	3	70.00	SOHC/OHC	29/39		
Zebra 0.8	04/86→05/98							
0.8 ED 10						5	BR140 (Graphite)	DR140 [3] GR140 [3]
Ceria 0.8	08/90→09/98	847	3	66.60	SOHC/OHC	29-32/ 39-44		
Cuore II 0.8	09/85→12/90							
0.8 ED 10 K						6	BR140 (Graphite)	DR140 [3] GR140 [3]
Cuore III 0.8	10/90→12/94	847	3	66.60	SOHC/OHC	26-30/ 35-41		
0.8 ED 20						7	BR140 (Graphite)	DR140 [3] GR140 [3]
Ceria 0.8	10/98→02/03	847	3	66.60	SOHC/OHC	31-32/ 42-44		
Cuore IV 0.8	01/95→11/96							
Cuore V 0.8	11/96→10/98							
Move 0.8	10/96→							
1.0 1KR-FE						8	AG9310 (MLS)	CG9310 EG9310
Boon 1.0	01/10→	998	3	71.00	DOHC	50-51/ 68-70		
Cuore VIII 1.0	04/07→							
Sirion 1.0	01/05→							
Sirion 1.0 DVVT	04/05→							
Storia 1.0	04/05→							
1.0 CB						9	BS430 (Graphite)	DS431 [3]
Hijet 1.0	06/86→12/89	993	3	76.00	SOHC/OHC	33/45		
Hijet Van 1.0	06/86→12/89							
1.0 CB 10						10	BS430 (Graphite)	DS431 [3]
1000 1.0	07/86→10/97	993	3	76.00	SOHC/OHC	33/45		
1000 1.0 4x4	07/86→12/89							
Hijet 1.0 4x4	07/86→10/90							
Hijet Touring	07/86→10/90							
Zebra 1.0	07/87→05/98							
1.0 CB 22						11	BS430 (Graphite)	DS435 [3] GS435 [3]
Charade IV 1.0	09/94→03/96	993	3	76.00	SOHC/OHC	38/52		
Skywing 1.0	02/87→02/93							
1.0 CB 23						12	BS430 (Graphite)	DS435 [3] GS435 [3]
Charade III 1.0	03/87→12/92	993	3	76.00	SOHC/OHC	38/52		
Skywing 1.0	02/87→02/93							
1.0 CB 61						13	BS430 (Graphite)	DS432 [3] GS435 [3] GS438 [3]
Charade III	03/87→10/90	993	3	76.00	SOHC/OHC	50/68		

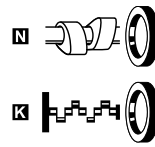

BJ630



BR140



BS090



BS430

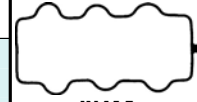

JN415



JN663



JJ126

JN663 [4]

JN415 [4]

JJ126

PA387 (x6)

NJ268 [2]
32.00x48.00x7.00mm, NBR
 NJ324 F [2]
34.00x48.00x7.00mm, ACM
 NJ269 B [1]
58.00x74.00x10.00mm, ACM

JN663 [4]

HR397

PA889 (x6)

NC048 [2]
38.00x52.00x6.00mm, FPM
 NJ269 B [1]
58.00x74.00x10.00mm, ACM

JN663 [4]

HR397

PA889 (x6)

NC048 [2]
38.00x52.00x6.00mm, FPM
 NJ269 B [1]
58.00x74.00x10.00mm, ACM

JN663 [4]

HR397

PA889 (x6)

NC048 [2]
38.00x52.00x6.00mm, FPM
 NJ269 B [1]
58.00x74.00x10.00mm, ACM

HBS508 [22]

JD5845
(NBR)
JD5846
(MLS)
JD5863
(SE)

JM7042
(ACM)

HR397

NA5260 [2]
38.00x50.00x6.00mm, FPM
 NA5260 F [2]
38.00x50.00x6.00mm, FPM
 NA5324 B [1]
74.00x89.00x8.50mm, FPM

NC048 [2]
38.00x52.00x6.00mm, FPM
 NJ269 B [1]
58.00x74.00x10.00mm, ACM

NJ324 F [2]
34.00x48.00x7.00mm, ACM
 NJ269 B [1]
58.00x74.00x10.00mm, ACM

JE146

JN415 [4]

JJ126

PA387 (x6)

NJ268 [2]
32.00x48.00x7.00mm, NBR
 NJ324 F [2]
34.00x48.00x7.00mm, ACM
 NJ269 B [1]
58.00x74.00x10.00mm, ACM



cc



kW/PS



1.0		CB 90				14		BS430 (Graphite)	DS435 [3]	GS435 [3]
Charade III 1.0	04/89→12/92	993	3	76.00	SOHC/OHC	40-41/				
Skywing 1.0	11/90→02/93					54-56				
1.0		CL Diesel				15		BR670 (Graphite)	DR670	GR670
Charade III	03/87→12/92	993	3	76.00	SOHC/OHC	27-35/				
						37-48				
1.0		CL 61 Diesel				16		BR670 (Graphite)	DR670	GR670
Charade III	03/87→12/92	993	3	76.00	SOHC/OHC	35/48				
1.0		EJ-DE				17		AG5920 (MLS)	CG5920	FG5920 [150]
Coo 1.0	10/06→	989	3	72.00	DOHC	40-46/		→08/98	→08/98	
Cuore VI 1.0	11/98→09/00					54-63		MOVE/CUORE	MOVE/CUORE	
Cuore VI 1.0i	10/98→05/03							CG5290	FG5290 [73]	
Materia 1.0	10/06→							09/98→	09/98→	
Move 1.0 i	10/98→							SIRION	SIRION	
Sirion 1.0	04/98→10/00									
Sirion 1.0 i	04/98→09/00									
Sirion 1.0 i 4WD	04/99→09/00									
Xenia 1.0	01/02→									
1.0		EJ-VE				18		AG5920 (MLS)	CG5290	FG5290 [73]
Ceria 1.0 DVVT	06/05→	989	3	72.00	SOHC/OHC	43/58		SIRION		
Charade 1.0	03/03→									
Coo 1.0	10/06→									
Cuore VI DVVT	10/00→02/03									
Cuore VII 1.0	05/03→									
Materia 1.0 DVVT	10/06→									
Sirion 1.0 i	09/00→01/05									
Sirion 1.0 i 4WD	09/00→01/05									
Trevis 1.0	06/06→									
YRV 1.0	02/01→									
1.3		HC				19		BR880 (Graphite)	DR882 [3]	GR882
Charade IV 1.3	09/96→11/99	1296	4	76.00	SOHC/OHC	44-62/				
Charade IV 1.3i	01/93→11/99					60-84				
1.3		HCE				20		BR880 (Graphite)	DR880 [3]	GR880 [3]
1300 1.3	06/98→	1296	4	76.00	SOHC/OHC	48-66/				
Charade III	06/88→01/93					65-90				
Charade III 1.3	11/90→02/93									
Charade IV 1.3	05/96→11/99									
Citivan 1.3	06/98→10/99									
City Breeze 1.3	09/99→									
Devan 1.3	06/98→10/99									
Hijet 1.3	06/98→10/99									
Hijet 1.3 i 16V	05/98→									
Zebra 1.3	06/98→10/05									



BR670



BR880



BS430



JN415



JN700



JJ126



cc



kW/PS



1.3 HE-EJ							21	BR880 (Graphite)		
Terios 1.3 4WD	10/97→10/00	1296	4	76.00	SOHC/OHC	61/83				
1.3 K3-VE							22	AG9830 (MLS)	CG9830	FG9830 (MLS)
Bego 1.3 DVVT	11/05→	1298	4	72.00	DOHC	63-75/ 86-102				
Bego DVVT	11/05→									
Coo 1.3	10/06→									
Copen 1.3	03/06→									
Extol 1.3	07/00→									
Extol 1.3 4x4	07/00→09/03									
Extol 1.3 L	10/03→									
Materia 1.3	10/06→									
Rush 1.3	11/05→									
Sirion 1.3	01/05→									
Sirion 1.3 4WD	04/05→									
Storia 1.3 4x4	04/05→									
Terios 1.3	09/01→10/05									
Terios 1.3 4WD	10/00→10/05									
Terios 1.3 DVVT	11/05→									
Xenia 1.3	01/02→									
YRV 1.3	02/01→									
YRV 1.3 4WD	02/01→									
1.3 K3-VE2							23	AG9830 (MLS)	CG9830	FG9830 (MLS)
Sirion 1.3 Sport	08/00→01/05	1298	4	72.00	DOHC	75/102				
Sirion 1.3Sp	08/00→03/05									
1.3 K3-VET							24	AG9830 (MLS)	CG9830	FG9830 (MLS)
Coo 1.3 Turbo	10/06→	1298	4	72.00	DOHC	95/129				
Materia DVVT	10/06→									
YRV 1.3 GTri	07/02→									
1.5 HEE							25	BR880 (Graphite)	DR880 [3]	GR880 [3]
Charade IV	06/94→03/96	1499	4	76.00	SOHC/OHC	55-66/ 75-90				
Charade IV 1.5	10/94→									
Charade IV 1.5i	08/94→11/99									
Gran Move 1.5 GX	10/96→08/98									
Terios 1.5	05/99→10/05									
1.5 HEEG							26	BR880 (Graphite)	DR880 [3]	GR880 [3]
Charade IV	06/94→03/96	1499	4	76.00	SOHC/OHC	55-71/ 75-97				
Charade IV 1.5i	01/97→11/99									
Gran Move	10/96→08/98									
Gran Move 1.5	10/96→07/98									
Gran Move 1.5 GX	10/96→08/98									
1.6 HD							27	BR880 (Graphite)	DR880 [3]	GR881 [3]
Applause I 1.6	06/89→07/97	1590	4	76.00	SOHC/OHC	66-67/ 90-91	12/91→	→12/89 DR881 [3] 01/90→12/90 DR883 [3] 01/91→	01/90→12/90 GR883 [3] 01/91→	

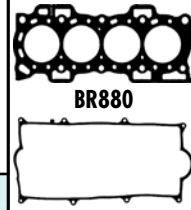

		JN700 [4]			NB884 [2] 38.00x50.00x5.50mm, FPM NJ324 [2] 34.00x48.00x7.00mm, ACM	
HBS312 [5] M9x1.25x84.00mm (x10)	JD5836 [1] JD5837 [2] (MLS) 0.500mm	JM5149 (Elastomer)	HR397		NJ353 [2] 35.00x49.00x6.00mm, NBR NJ286 [2] 36.00x49.00x7.00mm, NBR NA5324 [1] 74.00x89.00x8.50mm, FPM	
HBS312 [5] M9x1.25x84.00mm (x10)	JD5836 [1] JD5837 [2] (MLS) 0.500mm	JM5149 (Elastomer)			NJ353 [2] 35.00x49.00x6.00mm, NBR	
HBS312 [5] M9x1.25x84.00mm (x10)	JD5836 [1] JD5837 [2] (MLS) 0.500mm	JM5149 (Elastomer)			NJ353 [2] 35.00x49.00x6.00mm, NBR NA5324 [1] 74.00x89.00x8.50mm, FPM	
		JN700 [4]		PA305	NJ347 [2] 38.00x50.00x8.00mm, NBR NK209 [2] 33.80x48.00x6.00mm, MVQ NJ360 [1] 80.00x100.00x8.50mm, MVQ	
		JN700 [4]		PA305	NJ347 [2] 38.00x50.00x8.00mm, NBR NK209 [2] 33.80x48.00x6.00mm, MVQ NJ360 [1] 80.00x100.00x8.50mm, MVQ	
	JE146 →12/89	JN700 [4]	JJ435 01/90→	PA952 (x16)	NJ347 [2] 38.00x50.00x8.00mm, NBR NK209 [2] 33.80x48.00x6.00mm, MVQ NJ360 [1] 80.00x100.00x8.50mm, MVQ	



cc



kW/PS



1.6		HDC					28	BR880 (Graphite)	DR880 [3]	GR880 [3]
Devan 1.6	11/99→10/05	1590	4	76.00	SOHC/OHC	52-66/ 71-90				
Feroza 1.6 16V	10/88→									
Hijet 1.6	10/94→12/95									
Social 1.6	05/89→06/92									
Terios 1.6	05/99→10/05									
1.6		HD-E					29	BR880 (Graphite)	DR880 [3]	GR880 [3]
Applause I 1.6	06/89→07/97	1590	4	76.00	SOHC/OHC	70-77/ 95-105				
Applause II 1.6	07/97→05/00									
Ascend 1.6	06/94→03/96									
Charade IV	03/93→11/99									
Feroza 1.6 i 16V	10/88→									
Social 1.6	05/89→08/97									
1.6		HDEP					30	BR880 (Graphite)	DR880 [3]	
Gran Move	06/98→07/02	1590	4	76.00	SOHC/OHC	67-77/ 91-105				
Gran Move 1.6	05/98→									
Gran Move 1.6 GX	06/98→07/02									
2.2		5S-FE					31	AG9140 (MLS)	CG9140	EG6250
Altis 2.2 4x4	10/96→07/01	2164	4	87.00	DOHC	93-103/ 126-140				
Altis 2.2 SL	10/96→07/01									
Altis 2.2 SL 4x4	10/96→07/01									
2.4		2AZ-FE					32	AF5840 (MLS), 0.400mm		
Altis 2.4	08/01→12/05	2362	4	88.50	DOHC	112-116/ 152-158				
Altis 2.4 4x4	08/01→12/05									
Altis DVVT	01/06→									
2.8		DL 51 Diesel					33	BM900 (Graphite)	DP564 [3]	
Rocky 2.8 TD	12/87→04/93	2765	4	92.00	OHV	67/91				
2.8		DL 52 Diesel					34	BM900 (Graphite)	DP564 [3]	
Rocky 2.8 TD	09/91→12/98	2765	4	92.00	OHV	72-75/ 98-102				

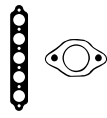

BM900

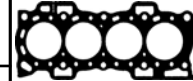

BR880



JN655



JN700

	JE146	JN700 [4]		PA305	NB884 [2] 38.00x50.00x5.50mm, FPM NJ347 [2] 38.00x50.00x8.00mm, NBR NK209 [2] 33.80x48.00x6.00mm, MVQ	
		JN700 [4]		PA952	NJ347 [2] 38.00x50.00x8.00mm, NBR NK209 [2] 33.80x48.00x6.00mm, MVQ NJ360 [1] 80.00x100.00x8.50mm, MVQ	
					NJ347 [2] 38.00x50.00x8.00mm, NBR NK209 [2] 33.80x48.00x6.00mm, MVQ	
HBS200 © [5] M10x1.25x94.50mm (x10)		JN655 (Elastomer) HM5276 [3] (Elastomer)			NJ347 [2] 38.00x50.00x8.00mm, NBR NJ215 [1] 85.00x105.00x10.00mm, FPM	
HBS441 © [22] M11x1.50x162.00mm (x10)	JD5170 [1] JD5171 [3] (MLS) 0.400mm	JM7036 (Elastomer)	HR397	PA5020	NJ347 [2] 38.00x50.00x8.00mm, NBR	
		JN636 [4]				
		JN636 [4]				



Ltr







CC



9

	Ltr				CC		
126	0.7	07/98→09/00	126 A1.048	Petrol	652	2	1
126	0.7	09/98→06/99	126 A2.000	Petrol	704	2	2
126	0.7	09/98→06/99	126 A2.048	Petrol	704	2	3
126	0.7	01/98→06/99	141 A.000	Petrol	652	2	4
147	1.0	10/97→12/99	127 A.000	Petrol	1049	4	16
500	1.2	10/00→	169 A4.000	Petrol/Petroleum Gas (LPG)	1242	4	35
500	1.2	10/00→	169 A4.000	Petrol	1242	4	35
500	1.3	10/00→	169 A1.000	Diesel	1248	4	34
500	1.3	12/00→	199 B1.000	Diesel	1248	4	53
500	1.4	10/00→	169 A3.000	Petrol	1368	4	76
500	1.4	08/00→	312 A1.000	Petrol	1368	4	90
500	1.4	08/00→	312 A3.000	Petrol	1368	4	91
500 C	1.2	09/00→	169 A4.000	Petrol/Petroleum Gas (LPG)	1242	4	35
500 C	1.2	09/00→	169 A4.000	Petrol	1242	4	35
500 C	1.3	09/00→	169 A1.000	Diesel	1248	4	34
500 C	1.3	09/00→	199 B1.000	Diesel	1248	4	53
500 C	1.4	09/00→	169 A3.000	Petrol	1368	4	76
500 C	1.4	05/01→	312 A1.000	Petrol	1368	4	90
500 C	1.4	09/00→	312 A3.000	Petrol	1368	4	91
500L	1.3	09/01→	199 B4.000	Diesel	1248	4	55
500L	1.4	09/01→	843 A1.000	Petrol	1368	4	94
500L	1.6	09/01→	199 B5.000	Diesel	1598	4	127
BARCETTA (183)	1.8	04/99→05/00	183 A1.000	Petrol	1747	4	144
BARCETTA (183)	1.8	04/99→05/00	188 A6.000	Petrol	1747	4	145
BRAVA (182)	1.2	12/99→12/00	182 B2.000	Petrol	1242	4	45
BRAVA (182)	1.2	10/00→10/00	188 A5.000	Petrol	1242	4	47
BRAVA (182)	1.4	10/99→08/99	182 A3.000	Petrol	1370	4	81
BRAVA (182)	1.4	10/99→10/00	182 A5.000	Petrol	1370	4	82
BRAVA (182)	1.6	02/99→10/00	182 A4.000	Petrol	1581	4	117
BRAVA (182)	1.6	10/99→10/00	182 A6.000	Petrol	1581	4	118
BRAVA (182)	1.6	01/99→12/00	182 B6.000	Petrol	1596	4	120
BRAVA (182)	1.6	01/99→12/00	182 B6.000	Gas	1596	4	120
BRAVA (182)	1.6	01/99→12/00	182 B6.000	Bi-Fuel	1596	4	120
BRAVA (182)	1.8	10/99→10/00	182 A2.000	Petrol	1747	4	143
BRAVA (182)	1.9	10/99→10/00	160 A7.000	Diesel	1929	4	158
BRAVA (182)	1.9	03/99→10/00	182 A7.000	Diesel	1910	4	161
BRAVA (182)	1.9	03/99→10/00	182 A8.000	Diesel	1910	4	162
BRAVA (182)	1.9	12/99→10/00	182 B4.000	Diesel	1910	4	163
BRAVA (182)	1.9	09/00→10/00	182 B9.000	Diesel	1910	4	164
BRAVA (182)	2.0	09/99→08/00	182 B7.000	Petrol	1998	5	216
BRAVO I (182)	1.2	12/99→10/00	182 B2.000	Petrol	1242	4	45
BRAVO I (182)	1.2	10/00→10/00	188 A5.000	Petrol	1242	4	47
BRAVO I (182)	1.4	10/99→10/00	182 A3.000	Petrol	1370	4	81
BRAVO I (182)	1.4	10/99→10/00	182 A5.000	Petrol	1370	4	82
BRAVO I (182)	1.6	03/99→10/00	182 A4.000	Petrol	1581	4	117
BRAVO I (182)	1.6	10/99→10/00	182 A6.000	Petrol	1581	4	118
BRAVO I (182)	1.6	09/00→02/00	182 B6.000	Petrol	1596	4	120
BRAVO I (182)	1.6	09/00→02/00	182 B6.000	Gas	1596	4	120
BRAVO I (182)	1.6	09/00→02/00	182 B6.000	Bi-Fuel	1596	4	120
BRAVO I (182)	1.8	10/99→10/00	182 A2.000	Petrol	1747	4	143
BRAVO I (182)	1.9	10/99→10/00	160 A7.000	Diesel	1929	4	158
BRAVO I (182)	1.9	03/99→10/00	182 A7.000	Diesel	1910	4	161
BRAVO I (182)	1.9	03/99→10/00	182 A8.000	Diesel	1910	4	162
BRAVO I (182)	1.9	12/99→10/00	182 B4.000	Diesel	1910	4	163
BRAVO I (182)	1.9	09/00→10/00	182 B9.000	Diesel	1910	4	164
BRAVO I (182)	2.0	10/99→07/99	182 A1.000	Petrol	1998	5	214
BRAVO I (182)	2.0	07/99→10/00	182 B7.000	Petrol	1998	5	216
BRAVO II (198)	1.4	04/00→	192 B2.000	Petrol/Petroleum Gas (LPG)	1368	4	83
BRAVO II (198)	1.4	04/00→	192 B2.000	Petrol	1368	4	83
BRAVO II (198)	1.4	09/00→	198 A1.000	Petrol	1368	4	84
BRAVO II (198)	1.4	09/00→	198 A4.000	Petrol	1368	4	85
BRAVO II (198)	1.4	09/00→	198 A4.000	Bi-Fuel	1368	4	85
BRAVO II (198)	1.4	03/00→	198 A7.000	Petrol	1368	4	86
BRAVO II (198)	1.6	03/00→	198 A2.000	Diesel	1598	4	124
BRAVO II (198)	1.6	03/00→	198 A3.000	Diesel	1598	4	125
BRAVO II (198)	1.6	03/00→	198 A6.000	Diesel	1598	4	126
BRAVO II (198)	1.6	11/00→	955 A4.000	Diesel	1598	4	134
BRAVO II (198)	1.9	04/00→	192 A8.000	Diesel	1910	4	174
BRAVO II (198)	1.9	11/00→	192 B4.000	Diesel	1910	4	177
BRAVO II (198)	1.9	04/00→12/00	192 B5.000	Diesel	1910	4	178

	Ltr				CC		9
BRAVO II (198)	1.9	04/00 →	937 A5.000	Diesel	1910	4	190
BRAVO Van (198)	1.6	03/00 →	198 A3.000	Diesel	1598	4	125
CAMPAGNOLA	2.0	06/97 → 10/98	6132 AZ 2.000	Petrol	1995	4	223
CINQUECENTO (170)	0.7	12/99 → 01/99	170 A.000	Petrol	704	2	5
CINQUECENTO (170)	0.9	07/99 → 07/99	1170 A1.000	Petrol	899	4	14
CINQUECENTO (170)	0.9	07/99 → 07/99	1170 A1.046	Petrol	899	4	15
CINQUECENTO (170)	0.9	07/99 → 12/99	170 A1.000	Petrol	903	4	12
CINQUECENTO (170)	0.9	07/99 → 12/99	170 A1.046	Petrol	903	4	13
CINQUECENTO (170)	1.1	10/99 → 01/99	176 B2.000	Petrol	1108	4	32
COUPE (FA/175)	1.8	03/99 → 08/00	183 A1.000	Petrol	1747	4	144
COUPE (FA/175)	2.0	11/99 → 08/99	175 A1.000	Petrol	1995	4	212
COUPE (FA/175)	2.0	08/99 → 08/00	175 A3.000	Petrol	1998	5	213
COUPE (FA/175)	2.0	08/99 → 04/99	182 A1.000	Petrol	1998	5	214
COUPE (FA/175)	2.0	04/99 → 08/00	182 B3.000	Petrol	1998	5	215
COUPE (FA/175)	2.0	11/99 → 08/99	836 A3.000	Petrol	1995	4	222
CROMA (154)	1.9	05/98 → 10/99	154 C6.000	Diesel	1929	4	154
CROMA (154)	1.9	11/99 → 12/99	154 D1.000	Diesel	1929	4	155
CROMA (154)	2.0	12/98 → 02/98	154 A1.000	Petrol	1995	4	202
CROMA (154)	2.0	12/98 → 06/99	154 A2.000	Petrol	1995	4	203
CROMA (154)	2.0	10/98 → 08/99	154 C3.046	Petrol	1995	4	204
CROMA (154)	2.0	06/98 → 08/99	154 C4.046	Petrol	1995	4	205
CROMA (154)	2.0	08/99 → 08/99	154 E1.000	Petrol	1995	4	206
CROMA (154)	2.0	03/98 → 09/99	834 B.000	Petrol	1995	4	218
CROMA (154)	2.0	03/98 → 09/99	834 B.048	Petrol	1995	4	219
CROMA (154)	2.0	10/98 → 08/99	834 B.146	Petrol	1995	4	220
CROMA (154)	2.0	11/98 → 08/99	834 C.146	Petrol	1995	4	221
CROMA (154)	2.4	12/98 → 08/98	8144.91.2000	Diesel	2445	4	257
CROMA (154)	2.5	12/98 → 12/98	8144.67	Diesel	2500	4	262
CROMA (154)	2.5	05/98 → 08/99	8144.97	Diesel	2499	4	263
CROMA (154)	2.5	12/99 → 08/99	8144.97 S	Diesel	2500	4	264
CROMA (154)	2.5	05/98 → 08/99	8144.97.2400	Diesel	2499	4	265
CROMA (194)	1.8	12/00 →	939 A4.000	Petrol	1796	4	150
CROMA (194)	1.9	06/00 →	939 A1.000	Diesel	1910	4	192
CROMA (194)	1.9	06/00 →	939 A2.000	Diesel	1910	4	193
CROMA (194)	1.9	06/00 →	939 A7.000	Diesel	1910	4	194
CROMA (194)	1.9	12/00 →	939 A8.000	Diesel	1910	4	195
CROMA (194)	2.2	06/00 →	194 A1.000	Petrol	2198	4	242
CROMA (194)	2.4	06/00 →	939 A3.000	Diesel	2387	5	253
DOBLO (119)	1.2	03/00 →	223 A5.000	Petrol	1242	4	56
DOBLO (119)	1.3	12/00 → 05/00	188 A9.000	Diesel	1248	4	48
DOBLO (119)	1.3	05/00 →	199 A2.000	Diesel	1248	4	49
DOBLO (119)	1.3	10/00 →	223 A9.000	Diesel	1248	4	57
DOBLO (119)	1.4	10/00 →	350 A1.000	Petrol/Petroleum Gas (LPG)	1368	4	92
DOBLO (119)	1.4	10/00 →	350 A1.000	Petrol/Natural Gas (CNG)	1368	4	92
DOBLO (119)	1.4	10/00 →	350 A1.000	Petrol	1368	4	92
DOBLO (119)	1.4	10/00 →	350 A1.000	Natural Gas	1368	4	92
DOBLO (119)	1.4	10/00 →	350 A1.000	Bi-Fuel	1368	4	92
DOBLO (119)	1.6	10/00 →	182 B6.000	Petrol	1596	4	120
DOBLO (119)	1.6	10/00 →	182 B6.000	Gas	1596	4	120
DOBLO (119)	1.6	10/00 →	182 B6.000	Bi-Fuel	1596	4	120
DOBLO (119)	1.9	10/00 →	182 B9.000	Diesel	1910	4	164
DOBLO (119)	1.9	03/00 →	223 A6.000	Diesel	1910	4	180
DOBLO (119)	1.9	07/00 →	223 A7.000	Diesel	1910	4	181
DOBLO (119)	1.9	07/00 →	223 B1.000	Diesel	1910	4	182
DOBLO (119)	1.9	10/00 →	223 B2.000	Diesel	1910	4	183
DOBLO Box Body / Estate (263)	1.3	02/01 →	199 A3.000	Diesel	1248	4	50
DOBLO Box Body / Estate (263)	1.3	02/01 →	263 A2.000	Diesel	1248	4	58
DOBLO Box Body / Estate (263)	1.4	06/01 →	198 A4.000	Petrol	1368	4	85
DOBLO Box Body / Estate (263)	1.4	06/01 →	198 A4.000	Bi-Fuel	1368	4	85
DOBLO Box Body / Estate (263)	1.4	02/01 →	843 A1.000	Petrol	1368	4	94
DOBLO Box Body / Estate (263)	1.6	02/01 →	198 A3.000	Diesel	1598	4	125
DOBLO Box Body / Estate (263)	1.6	02/01 →	263 A3.000	Diesel	1598	4	129
DOBLO Box Body / Estate (263)	1.6	02/01 →	263 A4.000	Diesel	1598	4	130
DOBLO Cargo (223)	1.2	03/00 →	223 A5.000	Petrol	1242	4	56
DOBLO Cargo (223)	1.3	05/00 → 12/00	188 A9.000	Diesel	1248	4	48
DOBLO Cargo (223)	1.3	10/00 → 01/01	199 A2.000	Diesel	1248	4	49
DOBLO Cargo (223)	1.3	08/00 →	223 A9.000	Diesel	1248	4	57
DOBLO Cargo (223)	1.4	10/00 →	350 A1.000	Petrol/Petroleum Gas (LPG)	1368	4	92
DOBLO Cargo (223)	1.4	10/00 →	350 A1.000	Petrol/Natural Gas (CNG)	1368	4	92
DOBLO Cargo (223)	1.4	10/00 →	350 A1.000	Petrol	1368	4	92



Ltr







CC



9

Model	Ltr	Year	Engine	Fuel	CC	Gear	Power
DOBLO Cargo (223)	1.4	10/00→	350 A1.000	Natural Gas	1368	4	92
DOBLO Cargo (223)	1.4	10/00→	350 A1.000	Bi-Fuel	1368	4	92
DOBLO Cargo (223)	1.6	10/00→	182 B6.000	Petrol	1596	4	120
DOBLO Cargo (223)	1.6	10/00→	182 B6.000	Gas	1596	4	120
DOBLO Cargo (223)	1.6	10/00→	182 B6.000	Bi-Fuel	1596	4	120
DOBLO Cargo (223)	1.9	10/00→	182 B9.000	Diesel	1910	4	164
DOBLO Cargo (223)	1.9	03/00→	223 A6.000	Diesel	1910	4	180
DOBLO Cargo (223)	1.9	07/00→	223 A7.000	Diesel	1910	4	181
DOBLO Cargo (223)	1.9	07/00→	223 B1.000	Diesel	1910	4	182
DOBLO MPV (152, 263)	1.3	02/01→	199 A3.000	Diesel	1248	4	50
DOBLO MPV (152, 263)	1.3	02/01→	263 A2.000	Diesel	1248	4	58
DOBLO MPV (152, 263)	1.4	02/01→	198 A4.000	Petrol	1368	4	85
DOBLO MPV (152, 263)	1.4	02/01→	198 A4.000	Bi-Fuel	1368	4	85
DOBLO MPV (152, 263)	1.4	02/01→	843 A1.000	Petrol	1368	4	94
DOBLO MPV (152, 263)	1.6	02/01→	198 A3.000	Diesel	1598	4	125
DOBLO MPV (152, 263)	1.6	02/01→	263 A4.000	Diesel	1598	4	130
DOBLO Platform/Chassis (263)	1.3	02/01→	199 A3.000	Diesel	1248	4	50
DOBLO Platform/Chassis (263)	1.3	02/01→	263 A2.000	Diesel	1248	4	58
DOBLO Platform/Chassis (263)	1.4	04/01→	843 A1.000	Petrol	1368	4	94
DOBLO Platform/Chassis (263)	1.6	02/01→	198 A3.000	Diesel	1598	4	125
DOBLO Platform/Chassis (263)	1.6	02/01→	263 A3.000	Diesel	1598	4	129
DOBLO Platform/Chassis (263)	1.6	02/01→	263 A4.000	Diesel	1598	4	130
DUCATO Box (230L)	1.9	03/99→04/00	230 A2.000	Diesel	1929	4	184
DUCATO Box (230L)	1.9	03/99→04/00	230 A3.000	Diesel	1929	4	185
DUCATO Box (230L)	1.9	08/99→04/00	230 A4.000	Diesel	1929	4	186
DUCATO Box (230L)	1.9	04/99→04/00	DJY	Diesel	1905	4	200
DUCATO Box (230L)	2.0	03/99→04/00	RFW	Petrol	1998	4	229
DUCATO Box (230L)	2.0	10/00→04/00	RHV (DW10)	Diesel	1997	4	234
DUCATO Box (230L)	2.5	03/99→04/00	8140.47	Diesel	2500	4	259
DUCATO Box (230L)	2.5	03/99→04/00	8140.47R	Diesel	2500	4	260
DUCATO Box (230L)	2.5	03/99→04/00	8140.67	Diesel	2500	4	261
DUCATO Box (230L)	2.8	10/99→04/00	8140.43	Diesel	2800	4	267
DUCATO Box (230L)	2.8	11/00→04/00	8140.43S	Diesel	2798	4	269
DUCATO Box (230L)	2.8	05/99→04/00	8140.63	Diesel	2800	4	270
DUCATO Box (244)	2.0	04/00→	RFL	Petrol	1998	4	225
DUCATO Box (244)	2.0	04/00→	RFL	Bi-Fuel	1998	4	225
DUCATO Box (244)	2.0	04/00→	RHV (DW10)	Diesel	1997	4	234
DUCATO Box (244)	2.3	04/00→	F1AE0481C	Diesel	2286	4	243
DUCATO Box (244)	2.8	05/00→	8140.43N	Diesel	2798	4	268
DUCATO Box (244)	2.8	04/00→	8140.43S	Diesel	2798	4	269
DUCATO Box (250)	2.2	07/00→	4HV	Diesel	2198	4	240
DUCATO Box (250)	2.3	07/00→	F1AE0481D	Diesel	2287	4	244
DUCATO Box (250)	2.3	01/00→	F1AE0481N	Diesel	2287	4	245
DUCATO Box (250)	2.3	01/00→	F1AE3481D	Diesel	2287	4	246
DUCATO Box (250)	2.3	06/01→	F1AE3481E	Diesel	2287	4	247
DUCATO Box (250)	2.3	10/01→	F1AE3481G	Diesel	2287	4	248
DUCATO Box (250)	3.0	07/00→	F1CE0481D	Diesel	2999	4	272
DUCATO Box (250)	3.0	06/01→	F1CE3481E	Diesel	2999	4	273
DUCATO Box (250)	3.0	07/00→	F1CE3481M	Diesel	2999	4	274
DUCATO Box (250)	3.0	04/01→	F1CE3481N	Diesel	2999	4	275
DUCATO Box (280)	1.9	01/98→08/99	149 B1.000	Diesel	1929	4	152
DUCATO Box (280)	1.9	03/98→08/99	280 A1.000	Diesel	1929	4	187
DUCATO Box (280)	2.0	07/98→08/99	170 B	Petrol	1971	4	210
DUCATO Box (280)	2.0	03/98→08/99	170 D	Petrol	1971	4	211
DUCATO Box (280)	2.0	01/98→08/99	XN 1T	Petrol	1971	4	238
DUCATO Box (280)	2.4	01/98→08/99	8144.61	Diesel	2428	4	256
DUCATO Box (280)	2.5	09/98→05/99	8140.27	Diesel	2500	4	258
DUCATO Box (280)	2.5	09/98→05/99	8140.61	Diesel	2445	4	254
DUCATO Box (280)	2.5	09/98→05/99	8144.61	Diesel	2428	4	256
DUCATO Box (280)	2.5	01/98→08/99	8144.67	Diesel	2500	4	262
DUCATO Box (280)	2.5	01/98→08/99	CRD93L (U25-661)	Diesel	2500	4	266
DUCATO Box (290)	1.9	07/99→03/99	149 B1.000	Diesel	1929	4	152
DUCATO Box (290)	1.9	03/98→03/99	280 A1.000	Diesel	1929	4	187
DUCATO Box (290)	2.0	06/99→05/99	170 D	Petrol	1971	4	211
DUCATO Box (290)	2.5	07/99→03/99	8140.27	Diesel	2500	4	258
DUCATO Box (290)	2.5	06/99→05/99	8144.67	Diesel	2500	4	262
DUCATO Bus (230)	1.9	06/99→04/00	230 A2.000	Diesel	1929	4	184
DUCATO Bus (230)	1.9	03/99→04/00	230 A3.000	Diesel	1929	4	185
DUCATO Bus (230)	1.9	08/99→04/00	230 A4.000	Diesel	1929	4	186
DUCATO Bus (230)	1.9	04/99→04/00	D9B	Diesel	1905	4	198

	Ltr				CC		9
DUCATO Bus (230)	1.9	04/99→04/00	D9B (XUD9A)	Diesel	1905	4	199
DUCATO Bus (230)	1.9	04/99→04/00	DJY	Diesel	1905	4	200
DUCATO Bus (230)	2.0	03/99→04/00	RFW	Petrol	1998	4	229
DUCATO Bus (230)	2.0	10/00→04/00	RHV (DW10)	Diesel	1997	4	234
DUCATO Bus (230)	2.5	03/99→04/00	8140.47	Diesel	2500	4	259
DUCATO Bus (230)	2.5	07/99→04/00	8140.47R	Diesel	2500	4	260
DUCATO Bus (230)	2.5	08/99→04/00	8140.67	Diesel	2500	4	261
DUCATO Bus (230)	2.8	10/99→04/00	8140.43	Diesel	2800	4	267
DUCATO Bus (230)	2.8	11/00→04/00	8140.43S	Diesel	2798	4	269
DUCATO Bus (230)	2.8	02/99→04/00	8140.63	Diesel	2800	4	270
DUCATO Bus (244, Z_)	2.0	04/00→	RFL	Petrol	1998	4	225
DUCATO Bus (244, Z_)	2.0	04/00→	RFL	Bi-Fuel	1998	4	225
DUCATO Bus (244, Z_)	2.0	04/00→	RHV (DW10)	Diesel	1997	4	234
DUCATO Bus (244, Z_)	2.3	04/00→	F1AE0481C	Diesel	2286	4	243
DUCATO Bus (244, Z_)	2.8	04/00→07/00	8140.43N	Diesel	2798	4	268
DUCATO Bus (244, Z_)	2.8	04/00→	8140.43S	Diesel	2798	4	269
DUCATO Bus (250)	2.2	07/00→	4HV	Diesel	2198	4	240
DUCATO Bus (250)	2.3	07/00→	F1AE0481D	Diesel	2287	4	244
DUCATO Bus (250)	2.3	01/00→	F1AE3481D	Diesel	2287	4	246
DUCATO Bus (250)	2.3	06/01→	F1AE3481E	Diesel	2287	4	247
DUCATO Bus (250)	2.3	10/01→	F1AE3481G	Diesel	2287	4	248
DUCATO Bus (250)	3.0	07/00→	F1CE0481D	Diesel	2999	4	272
DUCATO Bus (250)	3.0	06/01→	F1CE3481E	Diesel	2999	4	273
DUCATO Bus (250)	3.0	07/00→	F1CE3481M	Diesel	2999	4	274
DUCATO Bus (250)	3.0	04/01→	F1CE3481N	Diesel	2999	4	275
DUCATO Panorama (280)	1.9	02/98→08/99	149 B1.000	Diesel	1929	4	152
DUCATO Panorama (280)	1.9	03/98→08/99	280 A1.000	Diesel	1929	4	187
DUCATO Panorama (280)	2.0	01/98→08/99	170 B	Petrol	1971	4	210
DUCATO Panorama (280)	2.0	09/98→08/99	170 D	Petrol	1971	4	211
DUCATO Panorama (280)	2.5	01/98→08/99	8144.21	Diesel	2445	4	255
DUCATO Panorama (280)	2.5	01/98→08/99	8144.67	Diesel	2500	4	262
DUCATO Panorama (280)	2.5	01/98→08/99	CRD93L (U25-661)	Diesel	2500	4	266
DUCATO Panorama (290)	1.9	07/99→03/99	149 B1.000	Diesel	1929	4	152
DUCATO Panorama (290)	1.9	07/99→03/99	280 A1.000	Diesel	1929	4	187
DUCATO Panorama (290)	2.0	06/99→05/99	170 D	Petrol	1971	4	211
DUCATO Panorama (290)	2.5	08/99→03/99	8140.27	Diesel	2500	4	258
DUCATO Panorama (290)	2.5	07/99→03/99	8144.67	Diesel	2500	4	262
DUCATO Platform/Chassis (230)	1.9	03/99→04/00	230 A2.000	Diesel	1929	4	184
DUCATO Platform/Chassis (230)	1.9	03/99→04/00	230 A3.000	Diesel	1929	4	185
DUCATO Platform/Chassis (230)	1.9	08/99→04/00	230 A4.000	Diesel	1929	4	186
DUCATO Platform/Chassis (230)	1.9	04/99→04/00	DJY	Diesel	1905	4	200
DUCATO Platform/Chassis (230)	2.0	06/99→04/00	RFW	Petrol	1998	4	229
DUCATO Platform/Chassis (230)	2.0	07/00→04/00	RHV (DW10)	Diesel	1997	4	234
DUCATO Platform/Chassis (230)	2.5	03/99→04/00	8140.47	Diesel	2500	4	259
DUCATO Platform/Chassis (230)	2.5	03/99→04/00	8140.47R	Diesel	2500	4	260
DUCATO Platform/Chassis (230)	2.5	03/99→04/00	8140.67	Diesel	2500	4	261
DUCATO Platform/Chassis (230)	2.8	05/99→04/00	8140.43	Diesel	2800	4	267
DUCATO Platform/Chassis (230)	2.8	11/00→04/00	8140.43S	Diesel	2798	4	269
DUCATO Platform/Chassis (230)	2.8	02/99→04/00	8140.63	Diesel	2800	4	270
DUCATO Platform/Chassis (244)	2.0	04/00→07/00	RFL	Petrol	1998	4	225
DUCATO Platform/Chassis (244)	2.0	04/00→07/00	RFL	Bi-Fuel	1998	4	225
DUCATO Platform/Chassis (244)	2.0	04/00→07/00	RHV (DW10)	Diesel	1997	4	234
DUCATO Platform/Chassis (244)	2.3	04/00→07/00	F1AE0481C	Diesel	2286	4	243
DUCATO Platform/Chassis (244)	2.8	05/00→07/00	8140.43N	Diesel	2798	4	268
DUCATO Platform/Chassis (244)	2.8	04/00→07/00	8140.43S	Diesel	2798	4	269
DUCATO Platform/Chassis (250)	2.2	07/00→	4HV	Diesel	2198	4	240
DUCATO Platform/Chassis (250)	2.3	07/00→	F1AE0481D	Diesel	2287	4	244
DUCATO Platform/Chassis (250)	2.3	01/00→	F1AE0481N	Diesel	2287	4	245
DUCATO Platform/Chassis (250)	2.3	01/00→	F1AE3481D	Diesel	2287	4	246
DUCATO Platform/Chassis (250)	2.3	06/01→	F1AE3481E	Diesel	2287	4	247
DUCATO Platform/Chassis (250)	2.3	10/01→	F1AE3481G	Diesel	2287	4	248
DUCATO Platform/Chassis (250)	3.0	07/00→	F1CE0481D	Diesel	2999	4	272
DUCATO Platform/Chassis (250)	3.0	06/01→	F1CE3481E	Diesel	2999	4	273
DUCATO Platform/Chassis (250)	3.0	07/00→	F1CE3481M	Diesel	2999	4	274
DUCATO Platform/Chassis (250)	3.0	04/01→	F1CE3481N	Diesel	2999	4	275
DUCATO Platform/Chassis (280)	1.9	01/98→08/99	149 B1.000	Diesel	1929	4	152
DUCATO Platform/Chassis (280)	1.9	03/98→08/99	280 A1.000	Diesel	1929	4	187
DUCATO Platform/Chassis (280)	2.0	07/98→08/99	170 B	Petrol	1971	4	210
DUCATO Platform/Chassis (280)	2.0	08/98→08/99	170 D	Petrol	1971	4	211
DUCATO Platform/Chassis (280)	2.5	01/98→08/99	8144.21	Diesel	2445	4	255



Ltr







CC



9

Model	Ltr	Year Range	Price	Fuel Type	CC	Seats	Price
DUCATO Platform/Chassis (280)	2.5	07/98→08/99	8144.67	Diesel	2500	4	262
DUCATO Platform/Chassis (280)	2.5	07/98→08/99	CRD93L (U25-661)	Diesel	2500	4	266
DUCATO Platform/Chassis (290)	1.9	03/98→03/99	280 A1.000	Diesel	1929	4	187
DUCATO Platform/Chassis (290)	2.0	06/99→05/99	170 D	Petrol	1971	4	211
DUCATO Platform/Chassis (290)	2.5	07/99→03/99	8140.27	Diesel	2500	4	258
DUCATO Platform/Chassis (290)	2.5	07/99→03/99	8144.67	Diesel	2500	4	262
DUNA (146 B)	1.1	01/98→12/99	146 A6.000	Petrol	1116	4	26
DUNA (146 B)	1.3	01/98→12/99	146 A5.000	Petrol	1301	4	63
DUNA (146 B)	1.7	01/98→12/99	149 B3.000	Diesel	1698	4	137
DUNA Saloon	1.1	07/99→07/99	146 A4.048	Petrol	1116	4	25
DUNA Weekend (146 B)	1.1	01/98→12/99	146 A6.000	Petrol	1116	4	26
DUNA Weekend (146 B)	1.3	01/98→12/99	146 A5.000	Petrol	1301	4	63
DUNA Weekend (146 B)	1.7	01/98→12/99	149 B3.000	Diesel	1698	4	137
ELBA (146)	1.3	04/98→10/99	127 A5.000	Diesel	1302	4	59
ELBA (146)	1.7	04/98→12/99	146 B2.000	Diesel	1698	4	135
FIORINO (147)	1.1	11/98→04/98	146 A9.000	Petrol	1116	4	27
FIORINO (147)	1.3	12/98→08/99	146 A5.000	Petrol	1301	4	63
FIORINO (147)	1.5	01/98→08/99	149 C1.000	Petrol	1499	4	103
FIORINO (147)	1.7	12/98→12/99	149 B3.000	Diesel	1698	4	137
FIORINO Box (146)	1.1	05/98→12/99	146 A9.000	Petrol	1116	4	27
FIORINO Box (146)	1.3	01/98→12/99	146 A5.000	Petrol	1301	4	63
FIORINO Box (146)	1.4	11/99→05/00	146 C5.000	Petrol	1372	4	71
FIORINO Box (146)	1.4	05/99→05/00	146 D5.000	Petrol	1372	4	72
FIORINO Box (146)	1.5	05/98→12/99	149 C1.000	Petrol	1499	4	103
FIORINO Box (146)	1.6	10/99→05/00	146 C6.000	Petrol	1581	4	105
FIORINO Box (146)	1.6	10/99→05/00	146 D6.000	Petrol	1581	4	106
FIORINO Box (146)	1.7	01/98→10/99	146 B2.000	Diesel	1698	4	135
FIORINO Box (146)	1.7	01/99→05/00	146 D7.000	Diesel	1698	4	136
FIORINO Box (146)	1.7	05/98→05/00	149 B3.000	Diesel	1698	4	137
FIORINO Box Body / Estate (225)	1.3	11/00→	199 A2.000	Diesel	1248	4	49
FIORINO Box Body / Estate (225)	1.3	11/00→	199 A9.000	Diesel	1248	4	52
FIORINO Box Body / Estate (225)	1.3	07/00→	199 B1.000	Diesel	1248	4	53
FIORINO Box Body / Estate (225)	1.4	10/00→	350 A1.000	Petrol/Petroleum Gas (LPG)	1368	4	92
FIORINO Box Body / Estate (225)	1.4	10/00→	350 A1.000	Petrol/Natural Gas (CNG)	1368	4	92
FIORINO Box Body / Estate (225)	1.4	10/00→	350 A1.000	Petrol	1368	4	92
FIORINO Box Body / Estate (225)	1.4	10/00→	350 A1.000	Natural Gas	1368	4	92
FIORINO Box Body / Estate (225)	1.4	10/00→	350 A1.000	Bi-Fuel	1368	4	92
FIORINO Pick up (146)	1.3	01/98→12/99	146 A5.000	Petrol	1301	4	63
FIORINO Pick up (146)	1.4	05/99→05/00	146 D5.000	Petrol	1372	4	72
FIORINO Pick up (146)	1.5	01/98→10/99	149 C1.000	Petrol	1499	4	103
FIORINO Pick up (146)	1.6	01/99→05/00	146 C6.000	Petrol	1581	4	105
FIORINO Pick up (146)	1.6	01/99→05/00	146 D6.000	Petrol	1581	4	106
FIORINO Pick up (146)	1.7	10/99→10/99	146 B2.000	Diesel	1698	4	135
FIORINO Pick up (146)	1.7	01/99→05/00	146 D7.000	Diesel	1698	4	136
FIORINO Pick up (146)	1.7	05/98→10/99	149 B3.000	Diesel	1698	4	137
FIORINO Pick up (147)	1.3	05/98→12/98	127 A5.000	Diesel	1302	4	59
IDEA	1.2	01/00→	188 A5.000	Petrol	1242	4	47
IDEA	1.3	01/00→	188 A9.000	Diesel	1248	4	48
IDEA	1.3	10/00→	199 A3.000	Diesel	1248	4	50
IDEA	1.3	05/00→	199 B1.000	Diesel	1248	4	53
IDEA	1.4	12/00→	192 B2.000	Petrol/Petroleum Gas (LPG)	1368	4	83
IDEA	1.4	12/00→	192 B2.000	Petrol	1368	4	83
IDEA	1.4	10/00→	350 A1.000	Petrol/Petroleum Gas (LPG)	1368	4	92
IDEA	1.4	10/00→	350 A1.000	Petrol/Natural Gas (CNG)	1368	4	92
IDEA	1.4	10/00→	350 A1.000	Petrol	1368	4	92
IDEA	1.4	10/00→	350 A1.000	Natural Gas	1368	4	92
IDEA	1.4	10/00→	350 A1.000	Bi-Fuel	1368	4	92
IDEA	1.4	01/00→	843 A1.000	Petrol	1368	4	94
IDEA	1.6	05/00→	350 A2.000	Diesel	1598	4	131
IDEA	1.9	01/00→	188 B2.000	Diesel	1910	4	170
LINEA (323)	1.3	06/00→	199 A3.000	Diesel	1248	4	50
LINEA (323)	1.4	09/00→	198 A4.000	Petrol	1368	4	85
LINEA (323)	1.4	09/00→	198 A4.000	Bi-Fuel	1368	4	85
LINEA (323)	1.4	06/00→	350 A1.000	Petrol/Petroleum Gas (LPG)	1368	4	92
LINEA (323)	1.4	06/00→	350 A1.000	Petrol/Natural Gas (CNG)	1368	4	92
LINEA (323)	1.4	06/00→	350 A1.000	Petrol	1368	4	92
LINEA (323)	1.4	06/00→	350 A1.000	Natural Gas	1368	4	92
LINEA (323)	1.4	06/00→	350 A1.000	Bi-Fuel	1368	4	92
LINEA (323)	1.6	06/00→	198 A3.000	Diesel	1598	4	125
MAREA (185)	1.2	10/99→05/00	182 B2.000	Petrol	1242	4	45

	Ltr				CC		9
MAREA (185)	1.4	09/99 → 05/00	182 A3.000	Petrol	1370	4	81
MAREA (185)	1.6	09/99 → 05/00	182 A4.000	Petrol	1581	4	117
MAREA (185)	1.6	09/00 → 08/00	182 B5.098	Petrol	1581	4	119
MAREA (185)	1.6	09/00 → 08/00	182 B6.000	Petrol	1596	4	120
MAREA (185)	1.6	09/00 → 08/00	182 B6.000	Gas	1596	4	120
MAREA (185)	1.6	09/00 → 08/00	182 B6.000	Bi-Fuel	1596	4	120
MAREA (185)	1.6	03/99 → 05/00	185 A3.000	Petrol	1581	4	121
MAREA (185)	1.6	03/99 → 05/00	185 A3.000	Bi-Fuel	1581	4	121
MAREA (185)	1.6	04/99 → 05/00	186 A4.000	Bi-Fuel	1581	4	123
MAREA (185)	1.8	09/99 → 05/00	182 A2.000	Petrol	1747	4	143
MAREA (185)	1.9	09/99 → 05/00	182 A7.000	Diesel	1910	4	161
MAREA (185)	1.9	09/99 → 05/00	182 A8.000	Diesel	1910	4	162
MAREA (185)	1.9	04/99 → 01/00	182 B4.000	Diesel	1910	4	163
MAREA (185)	1.9	01/00 → 05/00	186 A6.000	Diesel	1910	4	165
MAREA (185)	2.0	09/99 → 04/99	182 A1.000	Petrol	1998	5	214
MAREA (185)	2.0	04/99 → 01/00	182 B7.000	Petrol	1998	5	216
MAREA (185)	2.0	01/00 → 05/00	185 A8.000	Petrol	1998	5	217
MAREA (185)	2.4	09/99 → 04/99	185 A2.000	Diesel	2387	5	249
MAREA (185)	2.4	04/99 → 05/00	185 A6.000	Diesel	2387	5	250
MAREA (185)	2.4	04/99 → 05/00	839 A5.000	Diesel	2387	5	252
MAREA Weekend (185)	1.2	10/99 → 05/00	182 B2.000	Petrol	1242	4	45
MAREA Weekend (185)	1.4	09/99 → 05/00	182 A3.000	Petrol	1370	4	81
MAREA Weekend (185)	1.6	09/99 → 05/00	182 A4.000	Petrol	1581	4	117
MAREA Weekend (185)	1.6	09/00 → 08/00	182 B6.000	Petrol	1596	4	120
MAREA Weekend (185)	1.6	09/00 → 08/00	182 B6.000	Gas	1596	4	120
MAREA Weekend (185)	1.6	09/00 → 08/00	182 B6.000	Bi-Fuel	1596	4	120
MAREA Weekend (185)	1.8	09/99 → 05/00	182 A2.000	Petrol	1747	4	143
MAREA Weekend (185)	1.9	09/99 → 05/00	182 A7.000	Diesel	1910	4	161
MAREA Weekend (185)	1.9	09/99 → 05/00	182 A8.000	Diesel	1910	4	162
MAREA Weekend (185)	1.9	04/99 → 05/00	182 B4.000	Diesel	1910	4	163
MAREA Weekend (185)	1.9	09/99 → 05/00	182 B9.000	Diesel	1910	4	164
MAREA Weekend (185)	1.9	01/00 → 05/00	186 A6.000	Diesel	1910	4	165
MAREA Weekend (185)	2.0	09/99 → 04/99	182 A1.000	Petrol	1998	5	214
MAREA Weekend (185)	2.0	04/99 → 02/00	182 B7.000	Petrol	1998	5	216
MAREA Weekend (185)	2.0	01/00 → 05/00	185 A8.000	Petrol	1998	5	217
MAREA Weekend (185)	2.4	09/99 → 04/99	185 A2.000	Diesel	2387	5	249
MAREA Weekend (185)	2.4	04/99 → 05/00	185 A6.000	Diesel	2387	5	250
MAREA Weekend (185)	2.4	04/99 → 05/00	839 A5.000	Diesel	2387	5	252
MULTIPLA (186)	1.6	04/99 → 06/01	182 A4.000	Petrol	1581	4	117
MULTIPLA (186)	1.6	09/00 → 06/01	182 B6.000	Petrol	1596	4	120
MULTIPLA (186)	1.6	09/00 → 06/01	182 B6.000	Gas	1596	4	120
MULTIPLA (186)	1.6	09/00 → 06/01	182 B6.000	Bi-Fuel	1596	4	120
MULTIPLA (186)	1.6	04/99 → 06/01	186 A3.000	Gas	1581	4	122
MULTIPLA (186)	1.6	04/99 → 06/01	186 A4.000	Bi-Fuel	1581	4	123
MULTIPLA (186)	1.9	04/99 → 06/01	182 B4.000	Diesel	1910	4	163
MULTIPLA (186)	1.9	03/00 → 07/00	186 A6.000	Diesel	1910	4	165
MULTIPLA (186)	1.9	07/00 → 06/01	186 A8.000	Diesel	1910	4	166
PALIO (178BX)	1.2	06/99 →	176 A8.000	Petrol	1242	4	37
PALIO (178BX)	1.2	06/99 →	178 B5.000	Petrol	1242	4	41
PALIO (178BX)	1.2	07/99 → 08/00	178 B7.045	Petrol	1242	4	42
PALIO (178BX)	1.2	07/99 → 08/00	178 C4.066	Petrol	1242	4	43
PALIO (178BX)	1.2	06/99 →	178 E2.000	Petrol	1242	4	44
PALIO (178BX)	1.2	07/99 → 08/00	188 A4.000	Petrol/Petroleum Gas (LPG)	1242	4	46
PALIO (178BX)	1.2	07/99 → 08/00	188 A4.000	Petrol	1242	4	46
PALIO (178BX)	1.2	07/99 → 08/00	188 A4.000	Flexfuel	1242	4	46
PALIO (178BX)	1.2	07/99 → 08/00	188 A4.000	Bi-Fuel	1242	4	46
PALIO (178BX)	1.4	04/99 →	178 B2.000	Petrol	1372	4	79
PALIO (178BX)	1.4	04/99 →	178 B2.016	Petrol	1372	4	80
PALIO (178BX)	1.6	04/99 →	178 B3.000	Petrol	1581	4	114
PALIO Weekend (178DX)	1.2	04/99 → 02/00	178 B5.000	Petrol	1242	4	41
PALIO Weekend (178DX)	1.2	02/00 →	178 C4.066	Petrol	1242	4	43
PALIO Weekend (178DX)	1.2	06/99 → 10/00	178 E2.000	Petrol	1242	4	44
PALIO Weekend (178DX)	1.2	07/99 →	188 A4.000	Petrol/Petroleum Gas (LPG)	1242	4	46
PALIO Weekend (178DX)	1.2	07/99 →	188 A4.000	Petrol	1242	4	46
PALIO Weekend (178DX)	1.2	07/99 →	188 A4.000	Flexfuel	1242	4	46
PALIO Weekend (178DX)	1.2	07/99 →	188 A4.000	Bi-Fuel	1242	4	46
PALIO Weekend (178DX)	1.2	09/00 →	188 A5.000	Petrol	1242	4	47
PALIO Weekend (178DX)	1.4	07/99 → 08/00	178 B2.000	Petrol	1372	4	79
PALIO Weekend (178DX)	1.6	04/99 → 02/00	178 B3.000	Petrol	1581	4	114
PALIO Weekend (178DX)	1.6	07/99 → 10/00	178 C7.098	Petrol	1581	4	115



Ltr







CC



9

Model	Ltr	Period	Code	Fuel	CC	Seats	Power
PALIO Weekend (178DX)	1.6	07/99→10/00	178 D2.011	Petrol	1581	4	116
PALIO Weekend (178DX)	1.6	02/00→	182 B6.000	Petrol	1596	4	120
PALIO Weekend (178DX)	1.6	02/00→	182 B6.000	Gas	1596	4	120
PALIO Weekend (178DX)	1.6	02/00→	182 B6.000	Bi-Fuel	1596	4	120
PALIO Weekend (178DX)	1.7	04/99→03/00	176 A3.000	Diesel	1698	4	139
PALIO Weekend (178DX)	1.9	09/00→	188 A2.000	Diesel	1910	4	167
PALIO Weekend (178DX)	1.9	03/00→	223 A6.000	Diesel	1910	4	180
PANDA (141A_)	0.7	01/98→07/00	141 A.000	Petrol	652	2	4
PANDA (141A_)	0.8	01/98→01/99	141 B.000	Petrol	769	4	6
PANDA (141A_)	0.8	01/98→01/99	156 A4.000	Petrol	770	4	7
PANDA (141A_)	0.8	01/99→10/00	156 A4.048	Petrol	770	4	8
PANDA (141A_)	0.9	10/98→06/99	100 GL3.000	Petrol	903	4	9
PANDA (141A_)	0.9	04/99→12/99	1170 A1.046	Petrol	899	4	15
PANDA (141A_)	0.9	10/98→06/99	146 A.000	Petrol	903	4	10
PANDA (141A_)	1.0	05/98→08/99	141 C2.000	Petrol	999	4	17
PANDA (141A_)	1.0	01/98→04/99	156 A2.100	Petrol	999	4	19
PANDA (141A_)	1.0	05/98→08/99	156 A2.246	Petrol	999	4	20
PANDA (141A_)	1.0	01/98→12/99	156 A3.000	Petrol	999	4	21
PANDA (141A_)	1.0	01/98→07/98	156 A3.100	Petrol	999	4	22
PANDA (141A_)	1.1	05/99→07/00	156 C.046	Petrol	1108	4	29
PANDA (141A_)	1.1	02/99→07/00	176 B2.000	Petrol	1108	4	32
PANDA (141A_)	1.1	02/99→09/00	187 A1.000	Petrol	1108	4	33
PANDA (141A_)	1.3	04/98→12/99	156 A5.000	Diesel	1302	4	67
PANDA (169)	1.1	09/00→	187 A1.000	Petrol	1108	4	33
PANDA (169)	1.2	11/00→	169 A4.000	Petrol/Petroleum Gas (LPG)	1242	4	35
PANDA (169)	1.2	11/00→	169 A4.000	Petrol	1242	4	35
PANDA (169)	1.2	09/00→	188 A4.000	Petrol/Petroleum Gas (LPG)	1242	4	46
PANDA (169)	1.2	09/00→	188 A4.000	Petrol	1242	4	46
PANDA (169)	1.2	09/00→	188 A4.000	Flexfuel	1242	4	46
PANDA (169)	1.2	09/00→	188 A4.000	Bi-Fuel	1242	4	46
PANDA (169)	1.3	06/00→	169 A1.000	Diesel	1248	4	34
PANDA (169)	1.3	09/00→	188 A9.000	Diesel	1248	4	48
PANDA (169)	1.4	10/00→	169 A3.000	Petrol	1368	4	76
PANDA (169)	1.4	01/01→	350 A1.000	Petrol/Petroleum Gas (LPG)	1368	4	92
PANDA (169)	1.4	01/01→	350 A1.000	Petrol/Natural Gas (CNG)	1368	4	92
PANDA (169)	1.4	01/01→	350 A1.000	Petrol	1368	4	92
PANDA (169)	1.4	01/01→	350 A1.000	Natural Gas	1368	4	92
PANDA (169)	1.4	01/01→	350 A1.000	Bi-Fuel	1368	4	92
PANDA (312)	1.2	02/01→	169 A4.000	Petrol/Petroleum Gas (LPG)	1242	4	35
PANDA (312)	1.2	02/01→	169 A4.000	Petrol	1242	4	35
PANDA (312)	1.3	02/01→	199 A9.000	Diesel	1248	4	52
PANDA Van (141_)	0.8	01/98→07/99	141 B.000	Petrol	769	4	6
PANDA Van (141_)	1.0	01/98→02/99	156 A2.100	Petrol	999	4	19
PANDA Van (141_)	1.0	08/99→02/00	156 A2.246	Petrol	999	4	20
PANDA Van (141_)	1.0	01/98→02/99	156 A3.100	Petrol	999	4	22
PANDA Van (141_)	1.1	05/99→03/99	156 C.046	Petrol	1108	4	29
PANDA Van (141_)	1.1	09/00→02/00	187 A1.000	Petrol	1108	4	33
PANDA Van (169)	1.1	09/00→	187 A1.000	Petrol	1108	4	33
PANDA Van (169)	1.2	09/01→	169 A4.000	Petrol/Petroleum Gas (LPG)	1242	4	35
PANDA Van (169)	1.2	09/01→	169 A4.000	Petrol	1242	4	35
PANDA Van (169)	1.2	09/00→	188 A4.000	Petrol/Petroleum Gas (LPG)	1242	4	46
PANDA Van (169)	1.2	09/00→	188 A4.000	Petrol	1242	4	46
PANDA Van (169)	1.2	09/00→	188 A4.000	Flexfuel	1242	4	46
PANDA Van (169)	1.2	09/00→	188 A4.000	Bi-Fuel	1242	4	46
PANDA Van (169)	1.3	01/00→	169 A1.000	Diesel	1248	4	34
PANDA Van (169)	1.3	03/00→	188 A9.000	Diesel	1248	4	48
PANDA Van (169)	1.4	10/00→	350 A1.000	Petrol/Petroleum Gas (LPG)	1368	4	92
PANDA Van (169)	1.4	10/00→	350 A1.000	Petrol/Natural Gas (CNG)	1368	4	92
PANDA Van (169)	1.4	10/00→	350 A1.000	Petrol	1368	4	92
PANDA Van (169)	1.4	10/00→	350 A1.000	Natural Gas	1368	4	92
PANDA Van (169)	1.4	10/00→	350 A1.000	Bi-Fuel	1368	4	92
PENNY VAN (257)	1.1	01/98→12/99	146 A6.000	Petrol	1116	4	26
PENNY VAN (257)	1.3	01/98→12/99	146 A5.000	Petrol	1301	4	63
PENNY VAN (257)	1.7	01/98→12/99	149 B3.000	Diesel	1698	4	137
PREMIO	1.6	03/98→12/99	159 A3.000	Petrol	1581	4	108
PUNTO (176)	1.1	09/99→09/99	176 A6.000	Petrol	1108	4	31
PUNTO (176)	1.1	09/99→09/99	176 B2.000	Petrol	1108	4	32
PUNTO (176)	1.2	01/99→09/99	176 A7.000	Petrol	1242	4	36
PUNTO (176)	1.2	10/99→09/99	176 A8.000	Petrol	1242	4	37
PUNTO (176)	1.2	03/99→09/99	176 B1.000	Petrol	1242	4	38

	Ltr				CC		9
PUNTO (176)	1.2	03/99→09/99	176 B4.000	Petrol	1242	4	39
PUNTO (176)	1.2	04/99→09/99	176 B9.000	Petrol	1242	4	40
PUNTO (176)	1.4	01/99→09/99	176 A4.000	Petrol	1372	4	77
PUNTO (176)	1.4	09/99→09/99	176 B6.000	Petrol	1372	4	78
PUNTO (176)	1.6	01/99→04/99	176 A9.000	Petrol	1581	4	113
PUNTO (176)	1.7	01/99→09/99	176 A3.000	Diesel	1698	4	139
PUNTO (176)	1.7	01/99→09/99	176 A5.000	Diesel	1698	4	140
PUNTO (176)	1.7	04/99→09/99	176 B3.000	Diesel	1698	4	141
PUNTO (176)	1.7	09/99→09/99	176 B7.000	Diesel	1698	4	142
PUNTO (188)	1.2	09/99→	188 A4.000	Petrol/Petroleum Gas (LPG)	1242	4	46
PUNTO (188)	1.2	09/99→	188 A4.000	Petrol	1242	4	46
PUNTO (188)	1.2	09/99→	188 A4.000	Flexfuel	1242	4	46
PUNTO (188)	1.2	09/99→	188 A4.000	Bi-Fuel	1242	4	46
PUNTO (188)	1.2	09/99→	188 A5.000	Petrol	1242	4	47
PUNTO (188)	1.3	06/00→	188 A9.000	Diesel	1248	4	48
PUNTO (188)	1.4	09/00→	843 A1.000	Petrol	1368	4	94
PUNTO (188)	1.8	09/99→	183 A1.000	Petrol	1747	4	144
PUNTO (188)	1.8	09/99→	188 A6.000	Petrol	1747	4	145
PUNTO (188)	1.9	09/99→	188 A2.000	Diesel	1910	4	167
PUNTO (188)	1.9	09/99→	188 A3.000	Diesel	1910	4	168
PUNTO (188)	1.9	10/00→	188 A7.000	Diesel	1910	4	169
PUNTO (188)	1.9	06/00→	188 B2.000	Diesel	1910	4	170
PUNTO (199)	1.2	03/01→	169 A4.000	Petrol/Petroleum Gas (LPG)	1242	4	35
PUNTO (199)	1.2	03/01→	169 A4.000	Petrol	1242	4	35
PUNTO (199)	1.3	03/01→	199 A2.000	Diesel	1248	4	49
PUNTO (199)	1.3	03/01→	199 A9.000	Diesel	1248	4	52
PUNTO (199)	1.3	03/01→	199 B1.000	Diesel	1248	4	53
PUNTO (199)	1.3	03/01→	199 B4.000	Diesel	1248	4	55
PUNTO (199)	1.4	03/01→	199 A7.000	Petrol	1368	4	88
PUNTO (199)	1.4	03/01→	350 A1.000	Petrol/Petroleum Gas (LPG)	1368	4	92
PUNTO (199)	1.4	03/01→	350 A1.000	Petrol/Natural Gas (CNG)	1368	4	92
PUNTO (199)	1.4	03/01→	350 A1.000	Petrol	1368	4	92
PUNTO (199)	1.4	03/01→	350 A1.000	Natural Gas	1368	4	92
PUNTO (199)	1.4	03/01→	350 A1.000	Bi-Fuel	1368	4	92
PUNTO (199)	1.4	03/01→	955 A2.000	Petrol	1368	4	95
PUNTO (199)	1.4	03/01→	955 A6.000	Petrol	1368	4	96
PUNTO / GRANDE PUNTO (199)	1.2	09/01→	169 A4.000	Petrol/Petroleum Gas (LPG)	1242	4	35
PUNTO / GRANDE PUNTO (199)	1.2	09/01→	169 A4.000	Petrol	1242	4	35
PUNTO / GRANDE PUNTO (199)	1.2	10/00→12/01	188 A4.000	Petrol/Petroleum Gas (LPG)	1242	4	46
PUNTO / GRANDE PUNTO (199)	1.2	10/00→12/01	188 A4.000	Petrol	1242	4	46
PUNTO / GRANDE PUNTO (199)	1.2	10/00→12/01	188 A4.000	Flexfuel	1242	4	46
PUNTO / GRANDE PUNTO (199)	1.2	10/00→12/01	188 A4.000	Bi-Fuel	1242	4	46
PUNTO / GRANDE PUNTO (199)	1.2	10/00→	199 A4.000	Petrol/Petroleum Gas (LPG)	1242	4	51
PUNTO / GRANDE PUNTO (199)	1.2	10/00→	199 A4.000	Petrol	1242	4	51
PUNTO / GRANDE PUNTO (199)	1.3	10/00→	199 A2.000	Diesel	1248	4	49
PUNTO / GRANDE PUNTO (199)	1.3	10/00→	199 A3.000	Diesel	1248	4	50
PUNTO / GRANDE PUNTO (199)	1.3	07/00→	199 B2.000	Diesel	1248	4	54
PUNTO / GRANDE PUNTO (199)	1.3	04/01→	199 B4.000	Diesel	1248	4	55
PUNTO / GRANDE PUNTO (199)	1.3	04/01→	223 A9.000	Diesel	1248	4	57
PUNTO / GRANDE PUNTO (199)	1.4	09/00→	198 A4.000	Petrol	1368	4	85
PUNTO / GRANDE PUNTO (199)	1.4	09/00→	198 A4.000	Bi-Fuel	1368	4	85
PUNTO / GRANDE PUNTO (199)	1.4	10/00→	199 A6.000	Petrol	1368	4	87
PUNTO / GRANDE PUNTO (199)	1.4	06/00→	199 A7.000	Petrol	1368	4	88
PUNTO / GRANDE PUNTO (199)	1.4	12/00→	199 A8.000	Petrol	1368	4	89
PUNTO / GRANDE PUNTO (199)	1.4	10/00→	350 A1.000	Petrol/Petroleum Gas (LPG)	1368	4	92
PUNTO / GRANDE PUNTO (199)	1.4	10/00→	350 A1.000	Petrol/Natural Gas (CNG)	1368	4	92
PUNTO / GRANDE PUNTO (199)	1.4	10/00→	350 A1.000	Petrol	1368	4	92
PUNTO / GRANDE PUNTO (199)	1.4	10/00→	350 A1.000	Natural Gas	1368	4	92
PUNTO / GRANDE PUNTO (199)	1.4	10/00→	350 A1.000	Bi-Fuel	1368	4	92
PUNTO / GRANDE PUNTO (199)	1.4	10/00→	955 A6.000	Petrol	1368	4	96
PUNTO / GRANDE PUNTO (199)	1.4	12/00→	955 A8.000	Petrol	1368	4	97
PUNTO / GRANDE PUNTO (199)	1.6	07/00→	955 A3.000	Diesel	1598	4	133
PUNTO / GRANDE PUNTO (199)	1.9	10/00→	199 A5.000	Diesel	1910	4	179
PUNTO / GRANDE PUNTO (199)	1.9	10/00→	939 A1.000	Diesel	1910	4	192
PUNTO / GRANDE PUNTO (199)	1.9	06/00→	939 A7.000	Diesel	1910	4	194
PUNTO Convertible (176C)	1.2	04/99→06/00	176 A7.000	Petrol	1242	4	36
PUNTO Convertible (176C)	1.2	05/99→06/00	176 B1.000	Petrol	1242	4	38
PUNTO Convertible (176C)	1.2	05/99→06/00	176 B4.000	Petrol	1242	4	39
PUNTO Convertible (176C)	1.2	04/99→06/00	176 B9.000	Petrol	1242	4	40
PUNTO Convertible (176C)	1.6	04/99→04/99	176 A9.000	Petrol	1581	4	113



Ltr







CC



9

Model	Ltr	Year Range	Price	Fuel Type	CC	Seats	Category
PUNTO EVO (199)	1.2	10/00 → 02/01	169 A4.000	Petrol/Petroleum Gas (LPG)	1242	4	35
PUNTO EVO (199)	1.2	10/00 → 02/01	169 A4.000	Petrol	1242	4	35
PUNTO EVO (199)	1.2	10/00 → 02/01	199 A4.000	Petrol/Petroleum Gas (LPG)	1242	4	51
PUNTO EVO (199)	1.2	10/00 → 02/01	199 A4.000	Petrol	1242	4	51
PUNTO EVO (199)	1.3	10/00 → 02/01	199 A2.000	Diesel	1248	4	49
PUNTO EVO (199)	1.3	10/00 → 02/01	199 A3.000	Diesel	1248	4	50
PUNTO EVO (199)	1.3	10/00 → 02/01	199 A9.000	Diesel	1248	4	52
PUNTO EVO (199)	1.3	10/00 → 02/01	199 B1.000	Diesel	1248	4	53
PUNTO EVO (199)	1.3	07/00 → 02/01	199 B2.000	Diesel	1248	4	54
PUNTO EVO (199)	1.3	10/00 → 02/01	199 B4.000	Diesel	1248	4	55
PUNTO EVO (199)	1.3	10/00 → 02/01	223 A9.000	Diesel	1248	4	57
PUNTO EVO (199)	1.4	07/00 → 02/01	199 A7.000	Petrol	1368	4	88
PUNTO EVO (199)	1.4	07/00 → 02/01	199 A8.000	Petrol	1368	4	89
PUNTO EVO (199)	1.4	06/00 → 02/01	350 A1.000	Petrol/Petroleum Gas (LPG)	1368	4	92
PUNTO EVO (199)	1.4	06/00 → 02/01	350 A1.000	Petrol/Natural Gas (CNG)	1368	4	92
PUNTO EVO (199)	1.4	06/00 → 02/01	350 A1.000	Petrol	1368	4	92
PUNTO EVO (199)	1.4	06/00 → 02/01	350 A1.000	Natural Gas	1368	4	92
PUNTO EVO (199)	1.4	06/00 → 02/01	350 A1.000	Bi-Fuel	1368	4	92
PUNTO EVO (199)	1.4	10/00 → 02/01	955 A2.000	Petrol	1368	4	95
PUNTO EVO (199)	1.4	10/00 → 02/01	955 A6.000	Petrol	1368	4	96
PUNTO EVO (199)	1.4	07/00 → 02/01	955 A8.000	Petrol	1368	4	97
PUNTO EVO (199)	1.6	10/00 → 02/01	955 A3.000	Diesel	1598	4	133
PUNTO EVO Box (199)	1.3	03/00 →	199 A2.000	Diesel	1248	4	49
PUNTO EVO Box (199)	1.3	03/00 →	199 A9.000	Diesel	1248	4	52
PUNTO EVO Box (199)	1.4	03/00 →	350 A1.000	Petrol/Petroleum Gas (LPG)	1368	4	92
PUNTO EVO Box (199)	1.4	03/00 →	350 A1.000	Petrol/Natural Gas (CNG)	1368	4	92
PUNTO EVO Box (199)	1.4	03/00 →	350 A1.000	Petrol	1368	4	92
PUNTO EVO Box (199)	1.4	03/00 →	350 A1.000	Natural Gas	1368	4	92
PUNTO EVO Box (199)	1.4	03/00 →	350 A1.000	Bi-Fuel	1368	4	92
PUNTO Van (176L)	1.1	04/99 → 02/00	176 B2.000	Petrol	1108	4	32
PUNTO Van (176L)	1.7	04/99 → 02/00	176 A5.000	Diesel	1698	4	140
PUNTO Van (176L)	1.7	04/99 → 02/00	176 B3.000	Diesel	1698	4	141
PUNTO Van (176L)	1.7	09/99 → 09/99	176 B7.000	Diesel	1698	4	142
PUNTO Van (188AX)	1.2	02/00 → 10/00	188 A4.000	Petrol/Petroleum Gas (LPG)	1242	4	46
PUNTO Van (188AX)	1.2	02/00 → 10/00	188 A4.000	Petrol	1242	4	46
PUNTO Van (188AX)	1.2	02/00 → 10/00	188 A4.000	Flexfuel	1242	4	46
PUNTO Van (188AX)	1.2	02/00 → 10/00	188 A4.000	Bi-Fuel	1242	4	46
PUNTO Van (188AX)	1.3	06/00 → 10/00	188 A9.000	Diesel	1248	4	48
PUNTO Van (188AX)	1.9	02/00 → 10/00	188 A3.000	Diesel	1910	4	168
PUNTO Van (188AX)	1.9	02/00 → 10/00	188 A7.000	Diesel	1910	4	169
PUNTO Van (199)	1.3	04/00 →	199 A2.000	Diesel	1248	4	49
PUNTO Van (199)	1.3	01/01 → 02/01	199 A3.000	Diesel	1248	4	50
PUNTO Van (199)	1.3	04/00 →	199 A9.000	Diesel	1248	4	52
PUNTO Van (199)	1.3	03/00 →	199 B1.000	Diesel	1248	4	53
PUNTO Van (199)	1.3	03/01 →	199 B4.000	Diesel	1248	4	55
PUNTO Van (199)	1.4	04/00 →	350 A1.000	Petrol/Petroleum Gas (LPG)	1368	4	92
PUNTO Van (199)	1.4	04/00 →	350 A1.000	Petrol/Natural Gas (CNG)	1368	4	92
PUNTO Van (199)	1.4	04/00 →	350 A1.000	Petrol	1368	4	92
PUNTO Van (199)	1.4	04/00 →	350 A1.000	Natural Gas	1368	4	92
PUNTO Van (199)	1.4	04/00 →	350 A1.000	Bi-Fuel	1368	4	92
QUBO (225)	1.3	02/00 →	199 A2.000	Diesel	1248	4	49
QUBO (225)	1.3	07/01 →	199 B1.000	Diesel	1248	4	53
QUBO (225)	1.4	10/00 →	350 A1.000	Petrol/Petroleum Gas (LPG)	1368	4	92
QUBO (225)	1.4	10/00 →	350 A1.000	Petrol/Natural Gas (CNG)	1368	4	92
QUBO (225)	1.4	10/00 →	350 A1.000	Petrol	1368	4	92
QUBO (225)	1.4	10/00 →	350 A1.000	Natural Gas	1368	4	92
QUBO (225)	1.4	10/00 →	350 A1.000	Bi-Fuel	1368	4	92
REGATA (138)	1.3	09/98 → 07/98	149 A3.000	Petrol	1301	4	65
REGATA (138)	1.3	09/98 → 07/98	149 A7.000	Petrol	1302	4	66
REGATA (138)	1.5	07/98 → 07/98	138 C2.048	Petrol	1499	4	102
REGATA (138)	1.5	07/98 → 07/98	149 C1.000	Petrol	1499	4	103
REGATA (138)	1.7	05/98 → 03/98	149 B3.000	Diesel	1698	4	137
REGATA (138)	1.9	04/98 → 07/98	149 A1.000	Diesel	1929	4	151
REGATA (138)	1.9	05/98 → 07/98	831 D1.000	Diesel	1929	4	188
REGATA Weekend	1.3	01/98 → 07/98	138 B2.000	Petrol	1302	4	60
REGATA Weekend	1.5	01/98 → 04/98	138 B3.000	Petrol	1498	4	100
REGATA Weekend	1.5	09/98 → 07/98	138 B3.048	Petrol	1498	4	101
REGATA Weekend	1.5	12/98 → 07/98	138 C2.048	Petrol	1499	4	102
REGATA Weekend	1.7	01/98 → 12/98	149 B3.000	Diesel	1698	4	137
REGATA Weekend	1.9	04/98 → 07/98	149 A1.000	Diesel	1929	4	151

	Ltr				CC		9
REGATA Weekend	1.9	05/98→07/98	831 D1.000	Diesel	1929	4	188
RITMO Convertible	1.5	01/98→07/98	138 A4.000	Petrol	1498	4	99
RITMO II (138A)	1.5	09/98→12/98	138 A2.000	Petrol	1498	4	98
RITMO II (138A)	1.5	09/98→12/98	138 C2.048	Petrol	1499	4	102
RITMO II (138A)	1.5	09/98→12/98	149 C1.000	Petrol	1499	4	103
SCUDO (270_)	1.6	01/00→	9HU	Diesel	1560	4	104
SCUDO (270_)	2.0	03/00→	RFH (EW10A)	Petrol	1997	4	224
SCUDO (270_)	2.0	01/00→	RHK	Diesel	1997	4	231
SCUDO (270_)	2.0	01/00→	RHR	Diesel	1997	4	233
SCUDO Box (220L)	1.6	02/99→12/00	220 A 2.000	Petrol	1581	4	128
SCUDO Box (220L)	1.9	02/99→12/00	D8B	Diesel	1905	4	197
SCUDO Box (220L)	1.9	02/99→12/00	D9B	Diesel	1905	4	198
SCUDO Box (220L)	1.9	04/99→12/00	WJZ (DW8)	Diesel	1868	4	201
SCUDO Box (220L)	2.0	05/00→12/00	RFN (EW10J4)	Petrol	1997	4	226
SCUDO Box (220L)	2.0	05/99→12/00	RHW (DW10ATED4)	Diesel	1997	4	235
SCUDO Box (220L)	2.0	12/99→12/00	RHX	Diesel	1997	4	236
SCUDO Box (220L)	2.0	12/00→12/00	RHZ	Diesel	1997	4	237
SCUDO Box (270_)	1.6	01/00→	9HU	Diesel	1560	4	104
SCUDO Box (270_)	2.0	03/00→	RFH (EW10A)	Petrol	1997	4	224
SCUDO Box (270_)	2.0	01/00→	RHK	Diesel	1997	4	231
SCUDO Box (270_)	2.0	01/00→	RHR	Diesel	1997	4	233
SCUDO Combinato (220P)	1.6	02/99→12/00	220 A 2.000	Petrol	1581	4	128
SCUDO Combinato (220P)	1.9	02/99→12/00	D8B	Diesel	1905	4	197
SCUDO Combinato (220P)	1.9	02/99→04/99	D9B	Diesel	1905	4	198
SCUDO Combinato (220P)	1.9	04/99→12/00	WJZ (DW8)	Diesel	1868	4	201
SCUDO Combinato (220P)	2.0	06/00→12/00	RFN (EW10J4)	Petrol	1997	4	226
SCUDO Combinato (220P)	2.0	05/99→12/00	RHW (DW10ATED4)	Diesel	1997	4	235
SCUDO Combinato (220P)	2.0	01/00→12/00	RHX	Diesel	1997	4	236
SCUDO Combinato (220P)	2.0	12/99→12/00	RHZ	Diesel	1997	4	237
SCUDO Platform/Chassis (270_)	1.6	01/00→	9HU	Diesel	1560	4	104
SCUDO Platform/Chassis (270_)	2.0	01/00→	RHK	Diesel	1997	4	231
SCUDO Platform/Chassis (270_)	2.0	01/00→	RHR	Diesel	1997	4	233
SEICI	1.9	06/00→	D19AA	Diesel	1910	4	196
SEICENTO (187)	0.9	01/99→01/01	1170 A1.046	Petrol	899	4	15
SEICENTO (187)	1.1	01/99→01/01	176 B2.000	Petrol	1108	4	32
SEICENTO (187)	1.1	01/99→01/01	187 A1.000	Petrol	1108	4	33
SEICENTO Van (187)	0.9	01/99→01/01	1170 A1.046	Petrol	899	4	15
SEICENTO Van (187)	1.1	01/99→01/01	176 B2.000	Petrol	1108	4	32
SIENA (178_)	1.2	09/99→	178 B5.000	Petrol	1242	4	41
SIENA (178_)	1.2	09/00→	178 C4.066	Petrol	1242	4	43
SIENA (178_)	1.2	09/00→	188 A4.000	Petrol/Petroleum Gas (LPG)	1242	4	46
SIENA (178_)	1.2	09/00→	188 A4.000	Petrol	1242	4	46
SIENA (178_)	1.2	09/00→	188 A4.000	Flexfuel	1242	4	46
SIENA (178_)	1.2	09/00→	188 A4.000	Bi-Fuel	1242	4	46
SIENA (178_)	1.2	09/00→	188 A5.000	Petrol	1242	4	47
SIENA (178_)	1.3	09/00→	188 A9.000	Diesel	1248	4	48
SIENA (178_)	1.4	04/99→	178 B2.000	Petrol	1372	4	79
SIENA (178_)	1.4	04/99→	178 B2.016	Petrol	1372	4	80
SIENA (178_)	1.6	09/99→	178 B3.000	Petrol	1581	4	114
SIENA (178_)	1.6	11/00→	182 B6.000	Petrol	1596	4	120
SIENA (178_)	1.6	11/00→	182 B6.000	Gas	1596	4	120
SIENA (178_)	1.6	11/00→	182 B6.000	Bi-Fuel	1596	4	120
SIENA (178_)	1.7	02/00→	176 A3.000	Diesel	1698	4	139
SIENA (178_)	1.9	11/00→	223 A6.000	Diesel	1910	4	180
SIENA	1.3	11/00→	188 A9.000	Diesel	1248	4	48
STILO (192)	1.2	02/00→11/00	188 A5.000	Petrol	1242	4	47
STILO (192)	1.4	03/00→11/00	192 B2.000	Petrol/Petroleum Gas (LPG)	1368	4	83
STILO (192)	1.4	03/00→11/00	192 B2.000	Petrol	1368	4	83
STILO (192)	1.4	01/00→11/00	843 A1.000	Petrol	1368	4	94
STILO (192)	1.6	10/00→11/00	182 B6.000	Petrol	1596	4	120
STILO (192)	1.6	10/00→11/00	182 B6.000	Gas	1596	4	120
STILO (192)	1.6	10/00→11/00	182 B6.000	Bi-Fuel	1596	4	120
STILO (192)	1.8	10/00→11/00	192 A4.000	Petrol	1747	4	146
STILO (192)	1.9	10/00→11/00	192 A1.000	Diesel	1910	4	171
STILO (192)	1.9	02/00→11/00	192 A3.000	Diesel	1910	4	172
STILO (192)	1.9	01/00→11/00	192 A5.000	Diesel	1910	4	173
STILO (192)	1.9	09/00→11/00	192 A8.000	Diesel	1910	4	174
STILO (192)	1.9	09/00→11/00	192 A9.000	Diesel	1910	4	175
STILO (192)	1.9	04/00→11/00	192 B1.000	Diesel	1910	4	176
STILO (192)	1.9	09/00→11/00	192 B5.000	Diesel	1910	4	178



Ltr















CC











9

Model	Ltr	Year	Price	Fuel	CC	Seats	Index
STILO (192)	1.9	09/00→11/00	937 A4.000	Diesel	1910	4	189
STILO (192)	1.9	09/00→11/00	937 A5.000	Diesel	1910	4	190
STILO (192)	1.9	10/00→11/00	937 A7.000	Diesel	1910	4	191
STILO (192)	2.4	10/00→11/00	192 A2.000	Petrol	2446	5	251
STILO Multi Wagon (192)	1.4	03/00→08/00	192 B2.000	Petrol/Petroleum Gas (LPG)	1368	4	83
STILO Multi Wagon (192)	1.4	03/00→08/00	192 B2.000	Petrol	1368	4	83
STILO Multi Wagon (192)	1.4	01/00→08/00	843 A1.000	Petrol	1368	4	94
STILO Multi Wagon (192)	1.6	01/00→08/00	182 B6.000	Petrol	1596	4	120
STILO Multi Wagon (192)	1.6	01/00→08/00	182 B6.000	Gas	1596	4	120
STILO Multi Wagon (192)	1.6	01/00→08/00	182 B6.000	Bi-Fuel	1596	4	120
STILO Multi Wagon (192)	1.8	01/00→08/00	192 A4.000	Petrol	1747	4	146
STILO Multi Wagon (192)	1.9	01/00→08/00	192 A1.000	Diesel	1910	4	171
STILO Multi Wagon (192)	1.9	01/00→08/00	192 A3.000	Diesel	1910	4	172
STILO Multi Wagon (192)	1.9	01/00→08/00	192 A5.000	Diesel	1910	4	173
STILO Multi Wagon (192)	1.9	09/00→08/00	192 A8.000	Diesel	1910	4	174
STILO Multi Wagon (192)	1.9	09/00→08/00	192 A9.000	Diesel	1910	4	175
STILO Multi Wagon (192)	1.9	04/00→08/00	192 B1.000	Diesel	1910	4	176
STILO Multi Wagon (192)	1.9	09/00→08/00	192 B5.000	Diesel	1910	4	178
STILO Multi Wagon (192)	1.9	09/00→08/00	937 A4.000	Diesel	1910	4	189
STILO Multi Wagon (192)	1.9	09/00→08/00	937 A5.000	Diesel	1910	4	190
STILO Multi Wagon (192)	1.9	01/00→08/00	937 A7.000	Diesel	1910	4	191
STRADA (178E)	1.2	06/99→	178 B5.000	Petrol	1242	4	41
STRADA (178E)	1.2	04/00→	188 A4.000	Petrol/Petroleum Gas (LPG)	1242	4	46
STRADA (178E)	1.2	04/00→	188 A4.000	Petrol	1242	4	46
STRADA (178E)	1.2	04/00→	188 A4.000	Flexfuel	1242	4	46
STRADA (178E)	1.2	04/00→	188 A4.000	Bi-Fuel	1242	4	46
STRADA (178E)	1.3	10/01→	199 B1.000	Diesel	1248	4	53
STRADA (178E)	1.3	05/00→	223 A9.000	Diesel	1248	4	57
STRADA (178E)	1.7	06/99→	176 A3.000	Diesel	1698	4	139
STRADA (178E)	1.9	04/00→	188 A2.000	Diesel	1910	4	167
STRADA (178E)	1.9	12/00→	223 A6.000	Diesel	1910	4	180
TALENTO Box (290)	1.9	03/98→03/99	149 B1.000	Diesel	1929	4	152
TALENTO Box (290)	2.0	03/98→03/99	170 B	Petrol	1971	4	210
TALENTO Bus (290)	1.9	03/98→03/99	149 B1.000	Diesel	1929	4	152
TALENTO Bus (290)	2.0	03/98→03/99	170 B	Petrol	1971	4	210
TALENTO Platform/Chassis (290)	1.9	03/98→03/99	149 B1.000	Diesel	1929	4	152
TALENTO Platform/Chassis (290)	2.0	03/98→03/99	170 B	Petrol	1971	4	210
TEMPRA (159)	1.4	03/99→08/99	159 A2.000	Petrol	1372	4	73
TEMPRA (159)	1.4	03/99→08/99	160 A1.046	Petrol	1372	4	74
TEMPRA (159)	1.4	03/99→08/99	836 A4.000	Petrol	1372	4	93
TEMPRA (159)	1.6	03/99→04/99	159 A3.000	Petrol	1581	4	108
TEMPRA (159)	1.6	06/99→07/99	159 A3.046	Petrol	1581	4	109
TEMPRA (159)	1.6	04/99→08/99	159 A3.048	Petrol	1581	4	110
TEMPRA (159)	1.6	06/99→08/99	159 B9.000	Petrol	1581	4	111
TEMPRA (159)	1.6	06/99→08/99	835 C1.000	Petrol	1581	4	132
TEMPRA (159)	1.8	03/99→08/99	159 A4.000	Petrol	1756	4	147
TEMPRA (159)	1.8	03/99→08/99	159 A4.046	Petrol	1756	4	148
TEMPRA (159)	1.9	07/99→08/99	149 A1.000	Diesel	1929	4	151
TEMPRA (159)	1.9	05/99→08/99	160 A6.000	Diesel	1929	4	156
TEMPRA (159)	1.9	07/99→08/99	160 A7.000	Diesel	1929	4	158
TEMPRA (159)	1.9	07/99→08/99	160 B6.046	Diesel	1929	4	159
TEMPRA (159)	1.9	05/99→08/99	160 D1.000	Diesel	1929	4	160
TEMPRA (159)	2.0	10/99→08/99	159 A6.046	Petrol	1995	4	208
TEMPRA S.W. (159)	1.4	03/99→08/99	159 A2.000	Petrol	1372	4	73
TEMPRA S.W. (159)	1.4	10/99→08/99	160 A1.046	Petrol	1372	4	74
TEMPRA S.W. (159)	1.4	10/99→08/99	836 A4.000	Petrol	1372	4	93
TEMPRA S.W. (159)	1.6	12/99→04/99	159 A3.000	Petrol	1581	4	108
TEMPRA S.W. (159)	1.6	10/99→08/99	159 A3.046	Petrol	1581	4	109
TEMPRA S.W. (159)	1.6	10/99→08/99	159 A3.048	Petrol	1581	4	110
TEMPRA S.W. (159)	1.6	06/99→08/99	159 B9.000	Petrol	1581	4	111
TEMPRA S.W. (159)	1.6	10/99→08/99	835 C1.000	Petrol	1581	4	132
TEMPRA S.W. (159)	1.8	03/99→08/99	159 A4.000	Petrol	1756	4	147
TEMPRA S.W. (159)	1.8	03/99→12/99	159 A4.046	Petrol	1756	4	148
TEMPRA S.W. (159)	1.9	07/99→08/99	149 A1.000	Diesel	1929	4	151
TEMPRA S.W. (159)	1.9	07/99→02/99	160 A6.000	Diesel	1929	4	156
TEMPRA S.W. (159)	1.9	07/99→08/99	160 A7.000	Diesel	1929	4	158
TEMPRA S.W. (159)	1.9	03/99→06/99	160 B6.046	Diesel	1929	4	159
TEMPRA S.W. (159)	1.9	07/99→02/99	160 D1.000	Diesel	1929	4	160
TEMPRA S.W. (159)	2.0	01/99→03/99	159 A6.046	Petrol	1995	4	208
TIPO (160)	1.1	01/98→10/99	160 A3.000	Petrol	1108	4	30

	Ltr				CC		9
TIPO (160)	1.4	05/98→04/99	159 A2.000	Petrol	1372	4	73
TIPO (160)	1.4	05/98→04/99	160 A1.046	Petrol	1372	4	74
TIPO (160)	1.4	07/98→12/98	160 A1.048	Petrol	1372	4	75
TIPO (160)	1.4	05/98→04/99	836 A4.000	Petrol	1372	4	93
TIPO (160)	1.6	02/98→05/99	149 C2.046	Petrol	1595	4	107
TIPO (160)	1.6	05/98→10/99	159 A3.000	Petrol	1581	4	108
TIPO (160)	1.6	07/99→01/99	159 A3.046	Petrol	1581	4	109
TIPO (160)	1.6	10/99→04/99	159 A3.048	Petrol	1581	4	110
TIPO (160)	1.6	01/98→10/99	160 A2.000	Petrol	1581	4	112
TIPO (160)	1.6	10/99→04/99	835 C1.000	Petrol	1581	4	132
TIPO (160)	1.7	01/98→10/99	149 B4.000	Diesel	1697	4	138
TIPO (160)	1.8	10/99→04/99	159 A4.000	Petrol	1756	4	147
TIPO (160)	1.8	10/99→06/99	159 A4.046	Petrol	1756	4	148
TIPO (160)	1.8	11/98→06/99	160 A5.000	Petrol	1756	4	149
TIPO (160)	1.9	07/99→08/99	149 A1.000	Diesel	1929	4	151
TIPO (160)	1.9	09/99→04/99	160 A6.000	Diesel	1929	4	156
TIPO (160)	1.9	09/99→04/99	160 A6.046	Diesel	1929	4	157
TIPO (160)	1.9	07/99→08/99	160 A7.000	Diesel	1929	4	158
TIPO (160)	1.9	03/99→06/99	160 B6.046	Diesel	1929	4	159
TIPO (160)	1.9	09/99→04/99	160 D1.000	Diesel	1929	4	160
TIPO (160)	2.0	06/99→03/99	159 A5.046	Petrol	1995	4	207
TIPO (160)	2.0	03/99→04/99	159 A6.046	Petrol	1995	4	208
TIPO (160)	2.0	07/99→04/99	160 A8.046	Petrol	1995	4	209
TIPO (160)	2.0	03/99→04/99	836 A3.000	Petrol	1995	4	222
ULYSSE (179AX)	2.0	08/00→06/01	RFN (EW10J4)	Petrol	1997	4	226
ULYSSE (179AX)	2.0	05/00→06/01	RHK	Diesel	1997	4	231
ULYSSE (179AX)	2.0	05/00→08/00	RHM (DW10ATED4)	Diesel	1997	4	232
ULYSSE (179AX)	2.0	05/00→06/01	RHR	Diesel	1997	4	233
ULYSSE (179AX)	2.0	08/00→08/00	RHW (DW10ATED4)	Diesel	1997	4	235
ULYSSE (179AX)	2.2	08/00→08/00	4HW (DW12ATED4)	Diesel	2179	4	241
ULYSSE (179AX)	3.0	08/00→06/01	XFW	Petrol	2946	6	271
ULYSSE (220)	2.0	09/00→08/00	RFN (EW10J4)	Petrol	1997	4	226
ULYSSE (220)	2.0	06/99→08/00	RFU (XU10J2C)	Petrol	1998	4	227
ULYSSE (220)	2.0	05/99→09/00	RFV	Petrol	1998	4	228
ULYSSE (220)	2.0	06/99→08/00	RGX (XU10J2CTE)	Petrol	1998	4	230
ULYSSE (220)	2.0	05/99→08/00	RHW (DW10ATED4)	Diesel	1997	4	235
ULYSSE (220)	2.0	10/99→08/00	RHZ	Diesel	1997	4	237
ULYSSE (220)	2.1	03/99→10/99	P8C	Diesel	2088	4	239
UNO (146A/E)	0.9	03/98→09/99	146 A.000	Petrol	903	4	10
UNO (146A/E)	0.9	03/98→09/99	146 A1.000	Petrol	903	4	11
UNO (146A/E)	1.0	06/98→12/99	156 A2.048	Petrol	999	4	18
UNO (146A/E)	1.0	06/98→12/99	156 A2.100	Petrol	999	4	19
UNO (146A/E)	1.0	04/98→10/99	156 A2.246	Petrol	999	4	20
UNO (146A/E)	1.1	01/98→08/98	138 B.000	Petrol	1116	4	23
UNO (146A/E)	1.1	01/98→12/98	146 A4.044	Petrol	1116	4	24
UNO (146A/E)	1.1	05/98→08/98	146 A4.048	Petrol	1116	4	25
UNO (146A/E)	1.1	06/99→12/99	146 C3.000	Petrol	1116	4	28
UNO (146A/E)	1.1	01/99→12/99	156 C.046	Petrol	1108	4	29
UNO (146A/E)	1.1	04/98→12/99	160 A3.000	Petrol	1108	4	30
UNO (146A/E)	1.3	06/98→03/99	127 A5.000	Diesel	1302	4	59
UNO (146A/E)	1.3	04/98→08/98	146 A2.000	Petrol	1301	4	61
UNO (146A/E)	1.3	09/98→03/99	146 A2.246	Petrol	1301	4	62
UNO (146A/E)	1.3	06/98→03/99	146 B1.000	Diesel	1301	4	64
UNO (146A/E)	1.3	05/98→08/98	149 A7.000	Petrol	1302	4	66
UNO (146A/E)	1.4	09/98→09/99	146 A8.046	Petrol	1372	4	68
UNO (146A/E)	1.4	10/98→10/99	146 B.000	Diesel	1367	4	69
UNO (146A/E)	1.4	10/98→10/99	146 B3.000	Diesel	1367	4	70
UNO (146A/E)	1.4	09/98→07/99	160 A1.046	Petrol	1372	4	74
UNO (146A/E)	1.4	09/98→10/99	160 A1.048	Petrol	1372	4	75
UNO (146A/E)	1.5	10/98→12/99	138 C2.048	Petrol	1499	4	102
UNO (146A/E)	1.5	10/98→12/99	149 C1.000	Petrol	1499	4	103
UNO (146A/E)	1.6	12/98→12/99	159 A3.046	Petrol	1581	4	109
UNO (146A/E)	1.7	09/98→12/99	146 B2.000	Diesel	1698	4	135
UNO (146A/E)	1.7	07/98→08/98	149 B3.000	Diesel	1698	4	137
UNO (146A/E)	1.9	09/98→03/99	149 B5.046	Diesel	1929	4	153
UNO Box (146)	0.9	02/98→07/99	146 A.000	Petrol	903	4	10
UNO Box (146)	0.9	02/98→07/99	146 A1.000	Petrol	903	4	11
UNO Box (146)	1.1	02/98→02/99	146 A4.048	Petrol	1116	4	25
UNO Box (146)	1.1	02/98→02/99	146 A6.000	Petrol	1116	4	26
UNO Box (146)	1.7	02/98→02/99	146 B2.000	Diesel	1698	4	135

		CC			9			CC			9
100 GL3.000	Petrol	903	4	65.00	9	159 A6.046	Petrol	1995	4	84.00	208
1170 A1.000	Petrol	899	4	65.00	14	159 B9.000	Petrol	1581	4	86.40	111
1170 A1.046	Petrol	899	4	65.00	15	160 A1.046	Petrol	1372	4	80.50	74
126 A1.048	Petrol	652	2	77.00	1	160 A1.048	Petrol	1372	4	80.50	75
126 A2.000	Petrol	704	2	80.00	2	160 A2.000	Petrol	1581	4	86.40	112
126 A2.048	Petrol	704	2	80.00	3	160 A3.000	Petrol	1108	4	70.00	30
127 A.000	Petrol	1049	4	76.00	16	160 A5.000	Petrol	1756	4	84.00	149
127 A5.000	Diesel	1302	4	76.10	59	160 A6.000	Diesel	1929	4	82.60	156
138 A2.000	Petrol	1498	4	86.40	98	160 A6.046	Diesel	1929	4	82.60	157
138 A4.000	Petrol	1498	4	86.40	99	160 A7.000	Diesel	1929	4	82.60	158
138 B.000	Petrol	1116	4	80.00	23	160 A8.046	Petrol	1995	4	84.00	209
138 B2.000	Petrol	1302	4	86.40	60	160 B6.046	Diesel	1929	4	82.60	159
138 B3.000	Petrol	1498	4	86.40	100	160 D1.000	Diesel	1929	4	82.60	160
138 B3.048	Petrol	1498	4	86.40	101	169 A1.000	Diesel	1248	4	69.60	34
138 C2.048	Petrol	1499	4	86.40	102	169 A3.000	Petrol	1368	4	72.00	76
141 A.000	Petrol	652	2	77.00	4	169 A4.000	Petrol/ Petroleum Gas (LPG)	1242	4	70.80	35
141 B.000	Petrol	769	4	65.00	6	169 A4.000	Petrol	1242	4	70.80	35
141 C2.000	Petrol	999	4	70.00	17	170 A.000	Petrol	704	2	80.00	5
146 A.000	Petrol	903	4	65.00	10	170 A1.000	Petrol	903	4	65.00	12
146 A1.000	Petrol	903	4	65.00	11	170 A1.046	Petrol	903	4	65.00	13
146 A2.000	Petrol	1301	4	80.50	61	170 B	Petrol	1971	4	88.00	210
146 A2.246	Petrol	1301	4	80.50	62	170 D	Petrol	1971	4	88.00	211
146 A4.044	Petrol	1116	4	80.00	24	175 A1.000	Petrol	1995	4	84.00	212
146 A4.048	Petrol	1116	4	80.00	25	175 A3.000	Petrol	1998	5	82.00	213
146 A5.000	Petrol	1301	4	86.40	63	176 A3.000	Diesel	1698	4	82.60	139
146 A6.000	Petrol	1116	4	80.00	26	176 A4.000	Petrol	1372	4	80.50	77
146 A8.046	Petrol	1372	4	80.50	68	176 A5.000	Diesel	1698	4	82.60	140
146 A9.000	Petrol	1116	4	80.00	27	176 A6.000	Petrol	1108	4	70.00	31
146 B.000	Diesel	1367	4	78.00	69	176 A7.000	Petrol	1242	4	70.80	36
146 B1.000	Diesel	1301	4	76.10	64	176 A8.000	Petrol	1242	4	70.80	37
146 B2.000	Diesel	1698	4	82.60	135	176 A9.000	Petrol	1581	4	86.40	113
146 B3.000	Diesel	1367	4	78.00	70	176 B1.000	Petrol	1242	4	70.80	38
146 C3.000	Petrol	1116	4	80.00	28	176 B2.000	Petrol	1108	4	70.00	32
146 C5.000	Petrol	1372	4	80.50	71	176 B3.000	Diesel	1698	4	82.60	141
146 C6.000	Petrol	1581	4	86.40	105	176 B4.000	Petrol	1242	4	70.80	39
146 D5.000	Petrol	1372	4	80.50	72	176 B6.000	Petrol	1372	4	80.50	78
146 D6.000	Petrol	1581	4	86.40	106	176 B7.000	Diesel	1698	4	82.60	142
146 D7.000	Diesel	1698	4	82.60	136	176 B9.000	Petrol	1242	4	70.80	40
149 A1.000	Diesel	1929	4	82.60	151	178 B2.000	Petrol	1372	4	80.50	79
149 A3.000	Petrol	1301	4	86.40	65	178 B2.016	Petrol	1372	4	80.50	80
149 A7.000	Petrol	1302	4	86.40	66	178 B3.000	Petrol	1581	4	86.40	114
149 B1.000	Diesel	1929	4	82.60	152	178 B5.000	Petrol	1242	4	70.80	41
149 B3.000	Diesel	1698	4	82.60	137	178 B7.045	Petrol	1242	4	70.80	42
149 B4.000	Diesel	1697	4	82.60	138	178 C4.066	Petrol	1242	4	70.80	43
149 B5.046	Diesel	1929	4	82.60	153	178 C7.098	Petrol	1581	4	86.40	115
149 C1.000	Petrol	1499	4	86.40	103	178 D2.011	Petrol	1581	4	86.40	116
149 C2.046	Petrol	1595	4	84.00	107	178 E2.000	Petrol	1242	4	70.80	44
154 A1.000	Petrol	1995	4	84.00	202	182 A1.000	Petrol	1998	5	82.00	214
154 A2.000	Petrol	1995	4	84.00	203	182 A2.000	Petrol	1747	4	82.00	143
154 C3.046	Petrol	1995	4	84.00	204	182 A3.000	Petrol	1370	4	82.00	81
154 C4.046	Petrol	1995	4	84.00	205	182 A4.000	Petrol	1581	4	86.40	117
154 C6.000	Diesel	1929	4	82.60	154	182 A5.000	Petrol	1370	4	82.00	82
154 D1.000	Diesel	1929	4	82.60	155	182 A6.000	Petrol	1581	4	86.40	118
154 E1.000	Petrol	1995	4	84.00	206	182 A7.000	Diesel	1910	4	82.00	161
156 A2.048	Petrol	999	4	70.00	18	182 A8.000	Diesel	1910	4	82.00	162
156 A2.100	Petrol	999	4	70.00	19	182 B2.000	Petrol	1242	4	70.80	45
156 A2.246	Petrol	999	4	70.00	20	182 B3.000	Petrol	1998	5	82.00	215
156 A3.000	Petrol	999	4	70.00	21	182 B4.000	Diesel	1910	4	82.00	163
156 A3.100	Petrol	999	4	70.00	22	182 B5.098	Petrol	1581	4	86.40	119
156 A4.000	Petrol	770	4	65.00	7	182 B6.000	Petrol	1596	4	80.50	120
156 A4.048	Petrol	770	4	65.00	8	182 B6.000	Gas	1596	4	80.50	120
156 A5.000	Diesel	1302	4	76.10	67	182 B6.000	Bi-Fuel	1596	4	80.50	120
156 C.046	Petrol	1108	4	70.00	29	182 B7.000	Petrol	1998	5	82.00	216
159 A2.000	Petrol	1372	4	80.50	73	182 B9.000	Diesel	1910	4	82.00	164
159 A3.000	Petrol	1581	4	86.40	108	183 A1.000	Petrol	1747	4	82.00	144
159 A3.046	Petrol	1581	4	86.40	109	185 A2.000	Diesel	2387	5	82.00	249
159 A3.048	Petrol	1581	4	86.40	110	185 A3.000	Petrol	1581	4	86.40	121
159 A4.000	Petrol	1756	4	84.00	147	185 A3.000	Bi-Fuel	1581	4	86.40	121
159 A4.046	Petrol	1756	4	84.00	148						
159 A5.046	Petrol	1995	4	84.00	207						

		CC			9			CC			9
185 A6.000	Diesel	2387	5	82.00	250	280 A1.000	Diesel	1929	4	82.60	187
185 A8.000	Petrol	1998	5	82.00	217	312 A1.000	Petrol	1368	4	72.00	90
186 A3.000	Gas	1581	4	86.40	122	312 A3.000	Petrol	1368	4	72.00	91
186 A4.000	Bi-Fuel	1581	4	86.40	123	350 A1.000	Petrol/ Petroleum Gas (LPG)	1368	4	72.00	92
186 A6.000	Diesel	1910	4	82.00	165						
186 A8.000	Diesel	1910	4	82.00	166	350 A1.000	Petrol/ Natural Gas (CNG)	1368	4	72.00	92
187 A1.000	Petrol	1108	4	70.00	33						
188 A2.000	Diesel	1910	4	82.00	167	350 A1.000	Petrol	1368	4	72.00	92
188 A3.000	Diesel	1910	4	82.00	168						
188 A4.000	Petrol/ Petroleum Gas (LPG)	1242	4	70.80	46	350 A1.000	Natural Gas	1368	4	72.00	92
						350 A1.000	Bi-Fuel	1368	4	72.00	92
188 A4.000	Petrol	1242	4	70.80	46	350 A2.000	Diesel	1598	4	79.50	131
188 A4.000	Flexfuel	1242	4	70.80	46	4HV	Diesel	2198	4	86.00	240
188 A4.000	Bi-Fuel	1242	4	70.80	46	4HW (DW12ATED4)	Diesel	2179	4	85.00	241
188 A5.000	Petrol	1242	4	70.80	47	6132 AZ 2.000	Petrol	1995	4		223
188 A6.000	Petrol	1747	4	82.00	145	8140.27	Diesel	2500	4	93.00	258
188 A7.000	Diesel	1910	4	82.00	169	8140.43	Diesel	2800	4	94.40	267
188 A9.000	Diesel	1248	4	69.60	48	8140.43N	Diesel	2798	4	94.40	268
188 B2.000	Diesel	1910	4	82.00	170	8140.43S	Diesel	2798	4	94.40	269
192 A1.000	Diesel	1910	4	82.00	171	8140.47	Diesel	2500	4	93.00	259
192 A2.000	Petrol	2446	5	83.00	251	8140.47R	Diesel	2500	4	93.00	260
192 A3.000	Diesel	1910	4	82.00	172	8140.61	Diesel	2445	4	93.00	254
192 A4.000	Petrol	1747	4	82.00	146	8140.63	Diesel	2800	4	94.40	270
192 A5.000	Diesel	1910	4	82.00	173	8140.67	Diesel	2500	4	93.00	261
192 A8.000	Diesel	1910	4	82.00	174	8144.21	Diesel	2445	4	93.00	255
192 A9.000	Diesel	1910	4	82.00	175	8144.61	Diesel	2428	4	93.00	256
192 B1.000	Diesel	1910	4	82.00	176	8144.67	Diesel	2500	4	93.00	262
192 B2.000	Petrol/ Petroleum Gas (LPG)	1368	4	72.00	83	8144.91.2000	Diesel	2445	4	93.00	257
						8144.97	Diesel	2499	4	93.00	263
192 B2.000	Petrol	1368	4	72.00	83	8144.97 S	Diesel	2500	4	93.00	264
192 B4.000	Diesel	1910	4	82.00	177	8144.97.2400	Diesel	2499	4	93.00	265
192 B5.000	Diesel	1910	4	82.00	178	831 D1.000	Diesel	1929	4	82.60	188
194 A1.000	Petrol	2198	4	86.00	242	834 B.000	Petrol	1995	4	84.00	218
198 A1.000	Petrol	1368	4	72.00	84	834 B.048	Petrol	1995	4	84.00	219
198 A2.000	Diesel	1598	4	79.50	124	834 B.146	Petrol	1995	4	84.00	220
198 A3.000	Diesel	1598	4	79.50	125	834 C.146	Petrol	1995	4	84.00	221
198 A4.000	Petrol	1368	4	72.00	85	835 C1.000	Petrol	1581	4	86.40	132
198 A4.000	Bi-Fuel	1368	4	72.00	85	836 A3.000	Petrol	1995	4	84.00	222
198 A6.000	Diesel	1598	4	79.50	126	836 A4.000	Petrol	1372	4	80.50	93
198 A7.000	Petrol	1368	4	72.00	86	839 A5.000	Diesel	2387	5	82.00	252
199 A2.000	Diesel	1248	4	69.60	49	843 A1.000	Petrol	1368	4	72.00	94
199 A3.000	Diesel	1248	4	69.60	50	937 A4.000	Diesel	1910	4	82.00	189
199 A4.000	Petrol/ Petroleum Gas (LPG)	1242	4	70.80	51	937 A5.000	Diesel	1910	4	82.00	190
						937 A7.000	Diesel	1910	4	82.00	191
199 A4.000	Petrol	1242	4	70.80	51	939 A1.000	Diesel	1910	4	82.00	192
199 A5.000	Diesel	1910	4	82.00	179	939 A2.000	Diesel	1910	4	82.00	193
199 A6.000	Petrol	1368	4	72.00	87	939 A3.000	Diesel	2387	5	82.00	253
199 A7.000	Petrol	1368	4	72.00	88	939 A4.000	Petrol	1796	4	80.50	150
199 A8.000	Petrol	1368	4	72.00	89	939 A7.000	Diesel	1910	4	82.00	194
199 A9.000	Diesel	1248	4	69.60	52	939 A8.000	Diesel	1910	4	82.00	195
199 B1.000	Diesel	1248	4	69.60	53	955 A2.000	Petrol	1368	4	72.00	95
199 B2.000	Diesel	1248	4	69.60	54	955 A3.000	Diesel	1598	4	79.50	133
199 B4.000	Diesel	1248	4	69.60	55	955 A4.000	Diesel	1598	4	79.50	134
199 B5.000	Diesel	1598	4	79.50	127	955 A6.000	Petrol	1368	4	72.00	96
220 A 2.000	Petrol	1581	4	86.40	128	955 A8.000	Petrol	1368	4	72.00	97
223 A5.000	Petrol	1242	4	70.80	56	9HU	Diesel	1560	4	75.00	104
223 A6.000	Diesel	1910	4	82.00	180	CRD93L (U25-661)	Diesel	2500	4	93.00	266
223 A7.000	Diesel	1910	4	82.00	181	D19AA	Diesel	1910	4	82.00	196
223 A9.000	Diesel	1248	4	69.60	57	D8B	Diesel	1905	4	83.00	197
223 B1.000	Diesel	1910	4	82.00	182	D9B	Diesel	1905	4	83.00	198
223 B2.000	Diesel	1910	4	82.00	183	D9B (XUD9A)	Diesel	1905	4	83.00	199
230 A2.000	Diesel	1929	4	82.60	184	D1Y	Diesel	1905	4	83.00	200
230 A3.000	Diesel	1929	4	82.60	185	F1AE0481C	Diesel	2286	4	88.00	243
230 A4.000	Diesel	1929	4	82.60	186	F1AE0481D	Diesel	2287	4	88.00	244
263 A2.000	Diesel	1248	4	69.60	58	F1AE0481N	Diesel	2287	4	88.00	245
263 A3.000	Diesel	1598	4	79.50	129	F1AE3481D	Diesel	2287	4	88.00	246
263 A4.000	Diesel	1598	4	79.50	130	F1AE3481E	Diesel	2287	4	88.00	247
						F1AE3481G	Diesel	2287	4	88.00	248
						F1CE0481D	Diesel	2999	4	95.80	272



CC



9



CC



9

F1CE3481E	Diesel	2999	4	95.80	273
F1CE3481M	Diesel	2999	4	95.80	274
F1CE3481N	Diesel	2999	4	95.80	275
P8C	Diesel	2088	4	85.00	239
RFH (EW10A)	Petrol	1997	4	85.00	224
RFL	Petrol	1998	4	86.00	225
RFL	Bi-Fuel	1998	4	86.00	225
RFN (EW10J4)	Petrol	1997	4	85.00	226
RFU (XU10J2C)	Petrol	1998	4	86.00	227
RFV	Petrol	1998	4	86.00	228
RFW	Petrol	1998	4	86.00	229
RGX (XU10J2CTE)	Petrol	1998	4	86.00	230
RHK	Diesel	1997	4	85.00	231
RHM (DW10ATED4)	Diesel	1997	4	85.00	232
RHR	Diesel	1997	4	85.00	233
RHV (DW10)	Diesel	1997	4	85.00	234
RHW (DW10ATED4)	Diesel	1997	4	85.00	235
RHX	Diesel	1997	4	85.00	236
RHZ	Diesel	1997	4	85.00	237
WJZ (DW8)	Diesel	1868	4	82.20	201
XFW	Petrol	2946	6	87.00	271
XN 1T	Petrol	1971	4	88.00	238

FIAT



cc



kW/PS

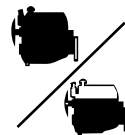

0.7	126 A1.048	1	BD790 (Fibre), 1.200mm	DD790	GD671 GD790 [16]	
126 650	07/81→09/00	652	2	77.00	OHV	17-20/ 23-27
0.7	126 A2.000	2	BT860 (Fibre)		GR480	
126 700	09/87→06/96	704	2	80.00	OHV	19/26
0.7	126 A2.048	3	BT860 (Fibre)	DR480	GR480	
126 700	09/87→06/96	704	2	80.00	OHV	19/26
0.7	141 A.000	4	BP050 (Fibre) BP030 (Fibre), 1.800mm	DP051 DR611 [13] Eng.8061128→ DS570 Eng.8061128→	GP051 GR611 [3]	
126 650	01/83→06/96	652	2	77.00	OHV	22/30
Panda 650	01/82→07/04					
0.7	170 A.000	5	BT860 (Fibre)	DT270 [13]	GT270 [3]	
Cinquecento 0.7	12/91→01/96	704	2	80.00	OHV	23/31
0.8	141 B.000	6	BP520 (Fibre), 1.200mm BP030 (Fibre), 1.800mm	DR611 [13] Eng.8061128→ DS570 Eng.8061128→	GR611 [3]	
Panda 750	01/86→01/95	769	4	65.00	SOHC/OHC	25/34
0.8	156 A4.000	7	BP660 (Fibre)	DP660 [13]	EP280 GP660	
Panda 750	01/86→01/95	770	4	65.00	SOHC/OHC	25/34
0.8	156 A4.048	8	BP660 (Fibre)	DP660 [13]	GP660	
Panda 750	01/95→10/03	770	4	65.00	SOHC/OHC	25/34
0.9	100 GL3.000	9	BP520 (Fibre), 1.200mm BP030 (Fibre), 1.800mm	CG01A ▲ →Eng.8064870 DP011 [13] →Eng.8064870 DR610	GP011 →Eng.8064870	
Panda 900	10/80→06/94	903	4	65.00	OHV	33/45
0.9	146 A.000	10	BP520 (Fibre), 1.200mm BP030 (Fibre), 1.800mm	CG01A ▲ →Eng.8064870 DP011 [13] →Eng.8064870 DR610	GP011 →Eng.8064870	
Panda 900	10/80→06/94	903	4	65.00	OHV	33/45
Uno 0.9 45	03/83→09/92					
Uno 45 0.9	02/88→07/96					
0.9	146 A1.000	11	BP520 (Fibre), 1.200mm BP030 (Fibre), 1.800mm	CG01A ▲ →Eng.8064870 DP011 [13] →Eng.8064870 DR610	GP011 →Eng.8064870	
Uno 0.9 45	03/83→09/92	903	4	65.00	OHV	33/45
Uno 45 0.9	02/88→07/96					
0.9	170 A1.000	12	AY430 (Fibre) BT260 (Fibre)	DT260 [3]	GT260 [75]	
Cinquecento 0.9	07/91→12/93	903	4	65.00		30/41
0.9	170 A1.046	13	AY430 (Fibre) BT260 (Fibre)	DT260 [3]	GT260 [75]	
Cinquecento	07/91→12/93	903	4	65.00	OHV	30/41
0.9	1170 A1.000	14	AY430 (Fibre) BT260 (Fibre)	DT260 [3]	GP011 GT260 [75]	
Cinquecento	07/91→07/99	899	4	65.00	SOHC/OHC	29-30/ 40-41
0.9	1170 A1.046	15	BT260 (Fibre)	DT260 [3]	GT260 [75]	
Cinquecento	07/91→07/99	899	4	65.00	SOHC/OHC	29/39
Panda 900	04/92→12/96					
Seicento 0.9	01/98→01/10					

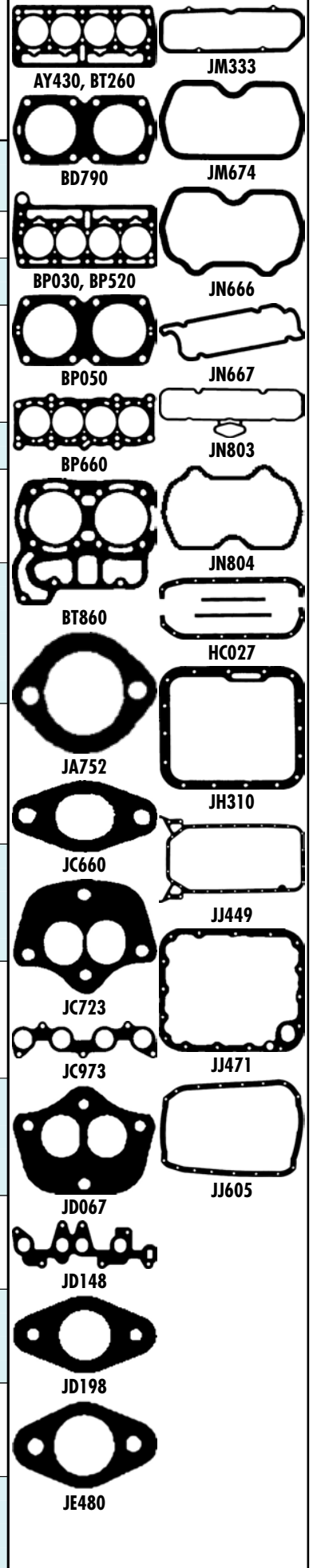

	JC723 [1] JA752 [2] JE480	JM674 [4] JN666 [4]	JH310	KG393	NA5045 [1] 53.00x68.00x10.00mm, ACM	
	JC723 [1] JD198 [x2]	JN666 [4]	JJ471		NA5045 [1] 53.00x68.00x10.00mm, ACM	
	JC723 [1] JD198 [x2]	JN666 [4]	JJ471		NA5045 [1] 53.00x68.00x10.00mm, ACM	
	JA752 [x2] JC973 [2]	JM333 [4] JM674 [4]	JH310 JJ449	KG393 HR596 [2]	NA5049 [1] 64.00x80.00x8.00mm, ACM NB728 [2] 53.00x68.00x10.00mm, ACM	KD726 [11] JR087 [6]
	JD067 [1] JD198 [x2]	JN804 [4]	JJ471			KH007 [10]
HBS297 [5] M9x1.25x91.00mm (x9)	JC973 [2]	JM333 [4]	JJ449	HR599 [2]	NA5049 [1] 64.00x80.00x8.00mm, ACM	
HBS052 [5] M9x1.25x95.00mm (x10)	JD148 [1] JC660 [2]	JN667 [4]		HR599 [2]	NA5053 [2] 30.00x42.00x7.00mm, FPM NB815 [2] 23.00x35.00x7.00mm, FPM NB814 [1] 70.00x88.00x8.00mm, FPM	KA5032 [41] JR673 [6]
HBS052 [5] M9x1.25x95.00mm (x10)				HR599 [2]	NA5053 [2] 30.00x42.00x7.00mm, FPM NB815 [2] 23.00x35.00x7.00mm, FPM NB814 [1] 70.00x88.00x8.00mm, FPM	
HBS297 [5] M9x1.25x91.00mm (x9)	JC973 [2]	JM333 [4]	HC027 [2]	HR599 [2]	NA5049 [1] 64.00x80.00x8.00mm, ACM NB808 [1] 64.00x80.00x8.00mm, FPM	
HBS297 [5] M9x1.25x91.00mm (x9)	JC973 [2]	JM333 [4]	HC027 [2] →Eng.8064870	HR599 [2]	NA5049 [1] 64.00x80.00x8.00mm, ACM NB808 [1] 64.00x80.00x8.00mm, FPM	JR556 [6]
HBS297 [5] M9x1.25x91.00mm (x9)	JC973 [2]	JM333 [4]	HC027 [2] →Eng.8064870	HR599 [2]	NA5049 [1] 64.00x80.00x8.00mm, ACM NB808 [1] 64.00x80.00x8.00mm, FPM	JR556 [6]
HBS297 [5] M9x1.25x91.00mm (x9)	JC973 [2]	JN803 [4]	JJ449	HR599 [2]	NA5177 [2] 42.00x56.00x7.00mm, FPM NB808 [1] 64.00x80.00x8.00mm, FPM	KA295 [15]
HBS297 [5] M9x1.25x91.00mm (x9)	JC973 [2]	JN803 [4]	JJ449	HR599 [2]	NA5177 [2] 42.00x56.00x7.00mm, FPM NB808 [1] 64.00x80.00x8.00mm, FPM	KA295 [15]
HBS297 [5] M9x1.25x91.00mm (x9)	JC973 [2]	JN803 [4]	JJ605	HR599 [2]	NA5177 [2] 42.00x56.00x7.00mm, FPM NB808 [1] 64.00x80.00x8.00mm, FPM	
HBS297 [5] M9x1.25x91.00mm (x9)	JC973 [2]	JN803 [4]	JJ605	HR599 [2]	NA5177 [2] 42.00x56.00x7.00mm, FPM NB808 [1] 64.00x80.00x8.00mm, FPM	LR922 [10] KA295 [15] HJ291 [8] [2]

FIAT



cc



kW/PS



1.0		127 A.000				16		BP060 (Fibre), 1.200mm			
147 1.0	10/76→12/95	1049	4	76.00	SOHC/OHC	37-41/ 50-56					
1.0		141 C2.000				17		BP280 (Fibre), 1.650mm BV940 (Fibre), 2.000mm		DV675	EP280 GP282 [3]
Panda 1000 4x4	05/86→12/94	999	4	70.00	SOHC/OHC	31-33/ 42-45					
Panda 1000 i.e.	10/87→08/98										
1.0		156 A2.048				18		BP280 (Fibre), 1.650mm BV940 (Fibre), 2.000mm		DV675	GP282 [3]
Uno 1.0 45	06/86→12/93	999	4	70.00		32/44					
1.0		156 A2.100				19		BP280 (Fibre), 1.650mm BV940 (Fibre), 2.000mm		DV675	GP282 [3]
Panda 1000	01/86→04/92	999	4	70.00	SOHC/OHC	32-33/ 44-45					
Panda 1000 4x4	01/86→07/89										
Uno 1.0 45	06/86→12/93										
1.0		156 A2.246				20		BP280 (Fibre), 1.650mm BV940 (Fibre), 2.000mm		DV675	EP280 GP282 [3]
Panda 1000 4x4	05/86→12/94	999	4	70.00	SOHC/OHC	33/45					
Panda 1000 i.e.	08/92→02/04										
Panda 1000 i.e.	10/87→08/98										
Uno 1.0 i.e. 45	04/84→10/95										
1.0		156 A3.000				21		BP280 (Fibre), 1.650mm BV940 (Fibre), 2.000mm		DV675	EP280
Panda 26.292 DFK	01/86→12/92	999	4	70.00	SOHC/OHC	37/50					
Panda 1000	01/85→12/92										
1.0		156 A3.100				22		BP280 (Fibre), 1.650mm BV940 (Fibre), 2.000mm		DV675	GP282 [3]
Panda 1000	01/86→02/92	999	4	70.00	SOHC/OHC	32-33/ 44-45					
Panda 1000 4x4	01/86→07/89										
1.1		138 B.000				23		BJ850 (Fibre)		DJ851 ▲ DJ852	GJ852
Uno 1.1 55	01/83→08/89	1116	4	80.00	SOHC/OHC	40-44/ 55-60					
1.1		146 A4.044				24		BJ850 (Fibre)		DJ851 ▲ DJ852	GJ852
Uno 1.1 50	01/86→12/89	1116	4	80.00	SOHC/OHC	37/50					
1.1		146 A4.048				25		BJ850 (Fibre) BP290 (Fibre)		DJ851 ▲ DJ852	GJ852 GK590
Duna 1.1	07/91→07/96	1116	4	80.00	SOHC/OHC	43/58					
Uno 1.1 60	05/85→08/89										
Uno 60 1.1	02/88→02/92										



BJ850



BP060



BP280, BV940



BP290



JC973



JD146



JD148

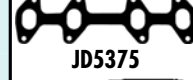

JD5375



JF145

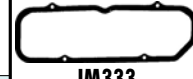

JM333



JN283



JN667



JN805



JP049

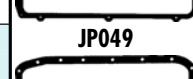

KD717



HC027



JH494



JJ453

HBS279 [22]
M11x1.50x109.00mm (x4)

JC973 [E]

JM333 [4]
JN283 [4]

HC027 [E]

HR599 [E]

NA808 [1]
64.00x80.00x8.00mm, FPM

KD226 [11]
JR556 [6]
KT446 [76]

HBS052 [5]
M9x1.25x95.00mm (x10)

JD148 [I]
JD5375 [E]
JF145 (MLS)

JN667 [4]

HR354

HR599 [E]

NA5053 [2]
30.00x42.00x7.00mm, FPM
NB815 [2]
23.00x35.00x7.00mm, FPM
NB814 [1]
70.00x88.00x8.00mm, FPM

KA5032 [41]
JR673 [6]

HBS052 [5]
M9x1.25x95.00mm (x10)

JD148 [I]
JD5375 [E]
JF145 (MLS)

JN667 [4]

HR354

HR599 [E]

NA5053 [2]
30.00x42.00x7.00mm, FPM
NB815 [2]
23.00x35.00x7.00mm, FPM
NB814 [1]
70.00x88.00x8.00mm, FPM

JR673 [6]

HBS052 [5]
M9x1.25x95.00mm (x10)

JD148 [I]
JD5375 [E]
JF145 (MLS)

JN667 [4]

HR354

HR599 [E]

NA5053 [2]
30.00x42.00x7.00mm, FPM
NB815 [2]
23.00x35.00x7.00mm, FPM
NB814 [1]
70.00x88.00x8.00mm, FPM

KA5032 [41]
JR673 [6]

HBS052 [5]
M9x1.25x95.00mm (x10)

JD148 [I]
JD5375 [E]
JF145 (MLS)

JN667 [4]

HR354

HR599 [E]

NA5053 [2]
30.00x42.00x7.00mm, FPM
NB815 [2]
23.00x35.00x7.00mm, FPM
NB814 [1]
70.00x88.00x8.00mm, FPM

KA5032 [41]
JR673 [6]
→02/02
KK5001 [17]
03/02→

HBS052 [5]
M9x1.25x95.00mm (x10)

JD148 [I]
JD5375 [E]
JF145 (MLS)

JN667 [4]

HR354

HR599 [E]

NA5053 [2]
30.00x42.00x7.00mm, FPM
NB815 [2]
23.00x35.00x7.00mm, FPM
NB814 [1]
70.00x88.00x8.00mm, FPM

JR673 [6]

HBS052 [5]
M9x1.25x95.00mm (x10)

JD148 [I]
JD5375 [E]
JF145 (MLS)

JN667 [4]

HR354

HR599 [E]

NA5053 [2]
30.00x42.00x7.00mm, FPM
NB815 [2]
23.00x35.00x7.00mm, FPM
NB814 [1]
70.00x88.00x8.00mm, FPM

JR673 [6]

HBS051 [5]
M10x1.25x98.00mm (x5)

JD146

JP049 [E]
(Cork)
JN805 [4]

JJ453

HR596 [E]

NA5187 [2]
30.00x52.00x7.00mm, ACM
NB818 [2]
40.00x56.00x7.00mm, ACM
NA5049 [1]
64.00x80.00x8.00mm, ACM

KA293 [15]
KD717 [11]

HBS051 [5]
M10x1.25x98.00mm (x5)

JD146

JP049 [E]
(Cork)
JN805 [4]

JJ453

HR596 [E]

NA5187 [2]
30.00x52.00x7.00mm, ACM
NB818 [2]
40.00x56.00x7.00mm, ACM
NA5049 [1]
64.00x80.00x8.00mm, ACM

HBS098 [5]
M10x1.25x116.00mm (x5)

JD146

JN283 [4]
JP049 [E]
(Cork)
JN805 [4]

JH494

HR596 [E]

NA5187 [2]
30.00x52.00x7.00mm, ACM
NB818 [2]
40.00x56.00x7.00mm, ACM
NA5049 [1]
64.00x80.00x8.00mm, ACM

KD717 [11]



cc



kW/PS



1.1		146 A6.000				26		BP290 (Fibre)		DP293 [3]	GK590
Duna 1.1 60	01/87→12/91	1116	4	80.00	SOHC/OHC	43/58	01/87→12/91		01/87→12/91		01/87→12/91
Penny 1.1	01/86→12/90										
Uno 60 1.1	02/88→02/92										
1.1		146 A9.000				27		BP290 (Fibre)		DP293 [3]	GK590
Fiorino 1.1 60	11/86→12/93	1116	4	80.00	SOHC/OHC	40/55					
1.1		146 C3.000				28		BP280 (Fibre), 1.650mm BV940 (Fibre), 2.000mm		DV675	GP282 [3]
Uno 50 i.e. 1.1	06/92→12/93	1116	4	80.00	SOHC/OHC	36/49					
1.1		156 C.046				29		BP280 (Fibre), 1.650mm BV940 (Fibre), 2.000mm		DV675	EP280 GP282 [3]
Panda 1.1	05/91→03/95	1108	4	70.00	SOHC/OHC	37-43/ 50-58					
Panda 1100	05/91→07/04										
Uno 1.1 50	01/90→12/93										
1.1		160 A3.000				30		BP280 (Fibre), 1.650mm BV940 (Fibre), 2.000mm		DV675	GP282 [3]
Tipo 1.1	01/88→10/91	1108	4	70.00	SOHC/OHC	41-42/ 56-57					
Uno 1.1 60	04/89→12/92										
1.1		176 A6.000				31		BP280 (Fibre), 1.650mm BV940 (Fibre), 2.000mm		DP289 ☒ DV675	GP282 [3]
Punto 1.1 55	09/93→09/99	1108	4	70.00	SOHC/OHC	40/54					
1.1		176 B2.000				32		BP280 (Fibre), 1.650mm BV940 (Fibre), 2.000mm		DV675	EP280 GP282 [3]
Cinquecento	10/94→01/98	1108	4	70.00	SOHC/OHC	40/54					
Panda 1100	02/95→09/03										
Panda 1100 4x4	02/95→07/04										
Punto 1.1	04/96→02/00										
Punto 1.1 55	09/93→09/99										
Seicento 1.1	01/98→01/10										
1.1		187 A1.000				33		BP280 (Fibre), 1.650mm BV940 (Fibre), 2.000mm		DP286 →Eng.2543171	EE5242 GP282 [3] GP286
Panda 1.1	09/00→02/04	1108	4	70.00	SOHC/OHC	40-42/ 54-57					
Panda 1100	02/95→09/03										
Seicento 1.1	01/98→01/10										

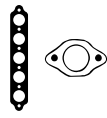

BP280, BV940



BP290



JA5010



JD146



JD148



JD5155



JD5375



JF145



JM5019



JN283



JN667



JN805

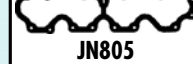

JP049

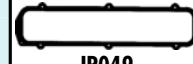

JH494

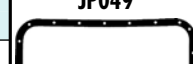

JJ078

HBS098 [5]
M10x1.25x116.00mm (x5)
01/87→12/91

JD146
01/87→12/91
JD5155
01/87→12/91

JN283 [4]
01/87→12/91
JP049 [2]
(Cork)
01/87→12/91
JN805 [4]
01/87→12/91

JH494
01/87→12/91

HR596 [5]
01/87→12/91

NA5187 [2]
30.00x52.00x7.00mm, ACM
01/87→12/91
NB818 [2]
40.00x56.00x7.00mm, ACM
01/87→12/91
NA5049 [1]
64.00x80.00x8.00mm, ACM
01/87→12/91

KA294 [15]
HJ279 [8][61]
KT446 [76]

HBS098 [5]
M10x1.25x116.00mm (x5)

JD5155

JN283 [4]

JJ078

HR596 [5]

NA5187 [2]
30.00x52.00x7.00mm, ACM
NB818 [2]
40.00x56.00x7.00mm, ACM
NB730 [1]
70.00x85.00x8.00mm, ACM

KA294 [15]
HJ279 [8][61]
JR556 [6]
KT446 [76]

HBS052 [5]
M9x1.25x95.00mm (x10)

JD148 [1]
JD5375 [5]
JF145
(MLS)

JN667 [4]

HR354

HR599 [5]

NA5053 [2]
30.00x42.00x7.00mm, FPM
NB815 [2]
23.00x35.00x7.00mm, FPM
NA5061 [1]
74.00x88.00x8.00mm, FPM

KA294 [15]
HJ279 [8][61]
JR556 [6]
KT446 [76]

HBS052 [5]
M9x1.25x95.00mm (x10)

JD148 [1]
JD5375 [5] (x2)
JF145
(MLS)

JN667 [4]

HR354

HR599 [5]

NA5053 [2]
30.00x42.00x7.00mm, FPM
NB815 [2]
23.00x35.00x7.00mm, FPM
NB814 [1]
70.00x88.00x8.00mm, FPM

KA5032 [41]
JR673 [6]
→02/02
KK5001 [17]
03/02→

HBS052 [5]
M9x1.25x95.00mm (x10)

JD148 [1]
JD5375 [5]
JF145
(MLS)

JN667 [4]

HR354

HR599 [5]

NA5053 [2]
30.00x42.00x7.00mm, FPM
NB815 [2]
23.00x35.00x7.00mm, FPM
NB814 [1]
70.00x88.00x8.00mm, FPM

KA5032 [41]
HJ280 [8]
JR673 [6]

HBS052 [5]
M9x1.25x95.00mm (x10)

JD148 [1]
JD5375 [5]
JF145
(MLS)

JN667 [4]

HR354

HR599 [5]

NA5053 [2]
30.00x42.00x7.00mm, FPM
NB815 [2]
23.00x35.00x7.00mm, FPM
NA5061 [1]
74.00x88.00x8.00mm, FPM

KA5032 [41]
JR673 [6]

HBS052 [5]
M9x1.25x95.00mm (x10)

JD148 [1]
JD5375 [5]
JF145
(MLS)

JN667 [4]

HR354

HR599 [5]

NA5053 [2]
30.00x42.00x7.00mm, FPM
NB815 [2]
23.00x35.00x7.00mm, FPM
NA5061 [1]
74.00x88.00x8.00mm, FPM
Eng.6315750→

KA5032 [41]
HJ280 [8]
JR673 [6]
KK5001 [17]
03/02→

HBS052 [5]
M9x1.25x95.00mm (x10)

JA5010 [1]
JD5375 [5]
JF145
(MLS)

JM5019
(Elastomer)

HR354

HR599 [5]

NA5053 [2]
30.00x42.00x7.00mm, FPM
NA5061 [1]
74.00x88.00x8.00mm, FPM
NA5057 [2]
27.00x37.00x7.00mm, FPM
Eng.2888158→

KA5032 [41]
JR673 [6]
KK5001 [17]
03/02→



cc



kW/PS



1.2	169 A1.000	Diesel				34	AD5800 (MLS), 0.720mm AD5810 (MLS), 0.820mm, 1 Hole AD5820 (MLS), 0.920mm, 2 Holes	CD5810 ▲	ED5810 FD5810
500 1.3 D Mij	10/07→	1248	4	69.60	DOHC	55/75			
500 C 1.3 D Mij	09/09→								
Panda 1.3 D 4X4	09/10→								
Panda 1.3 D Mij	01/06→								
Panda 1.3 JTD	01/06→								
1.2	169 A4.000					35	AG7380 (MLS)	CG7380	EE5242
500 1.2	10/07→	1242	4	70.80	SOHC/OHC	51/69			
500 1.2 LPG	12/10→								
500 C 1.2	09/09→								
Panda 1.2	03/10→								
Panda 1.2 4x4	11/09→								
Panda 1.2 LPG	09/10→								
Punto 1.2	09/10→								
Punto Evo 1.2	10/09→02/12								
1.2	176 A7.000					36	AE5240 (MLS) BV670 (Fibre), 1.650mm AE5550 (Fibre), 1.850mm	DV675	EE5242 GV670 [3]
Punto 1.2 60	01/94→09/99	1242	4	70.80	SOHC/OHC	43-44/ 58-60			
Punto Cabrio	04/94→06/00								
1.2	176 A8.000					37	AE5240 (MLS) BV670 (Fibre), 1.650mm AE5550 (Fibre), 1.850mm	DV675	EV670 [3] GV671 [3]
Palio 1.2	06/98→	1242	4	70.80	SOHC/OHC	54/73			
Punto 1.2 75	10/93→09/99								
1.2	176 B1.000					38	AE5240 (MLS) BV670 (Fibre), 1.650mm AE5550 (Fibre), 1.850mm	DV675	EV670 [3] GV671 [3]
Punto 1.2 60	03/94→09/99	1242	4	70.80	SOHC/OHC	44/60			
Punto Cabrio	05/95→06/00								
1.2	176 B4.000					39	AE5240 (MLS) BV670 (Fibre), 1.650mm AE5550 (Fibre), 1.850mm	DV675	EV670 [3] GV671 [3]
Punto 1.2 60	03/94→09/99	1242	4	70.80	SOHC/OHC	44/60			
Punto Cabrio	05/95→06/00								
1.2	176 B9.000					40	AD5830 (MLS) BY380 (Fibre), 1.650mm	DY382 →Eng.0616936 CE5180 Eng.0616937 →	EE5180 [3] →06/99 GY383 →Eng.0616937
Punto 1.2 16V 85	04/97→09/99	1242	4	70.80	DOHC	63/86			
Punto Cabrio	04/97→06/00								
1.2	178 B5.000					41	AE5240 (MLS) BV670 (Fibre), 1.650mm AE5550 (Fibre), 1.850mm	DV675	EE5242 →Eng.2935743 EE5180 [3] Eng.2935743 → FE5240 GV671 [3]
Palio 1.2	04/96→02/01	1242	4	70.80	SOHC/OHC	50-55/ 68-75			
Siena 1.2	09/98→								
Strada 1.2	06/99→								

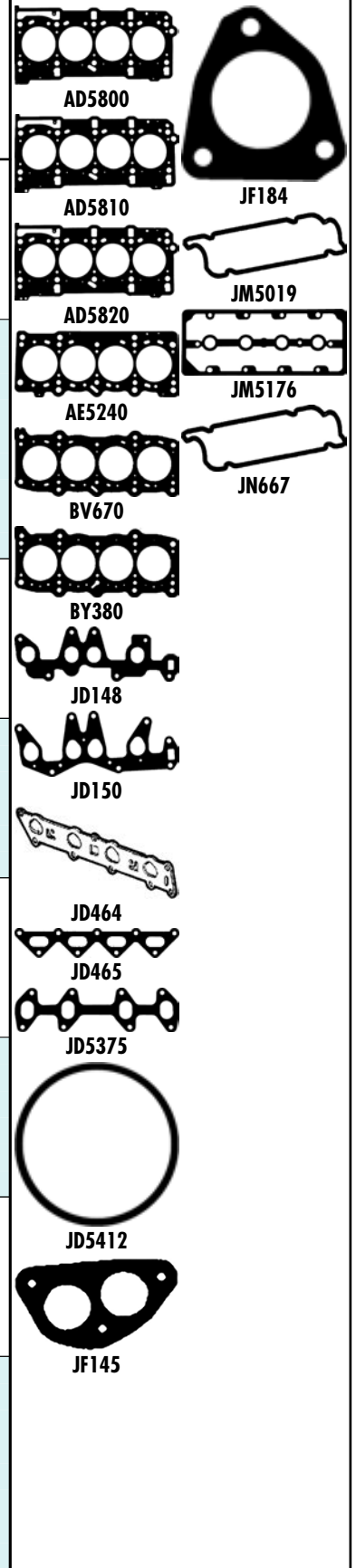
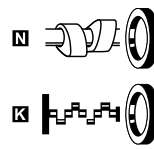
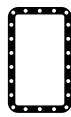
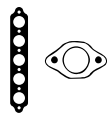

HBS353 [5] M10x1.25x119.00mm (x10)	JD5411 [1] JD5412 [1] [2] JD5413 [1] (MLS)	JM5259 [4] (SE)		HR5088 [1]	NA5223 [2] [2] 40.00x52.00x7.00mm, FPM NA5230 [2] [2] 78.00x100.00x9.00mm, PTFE	
HBS052 [5] M9x1.25x95.00mm (x10)	HA5053 [1] [1] JD5375 [1]	JM7099 [4] (SMG)			NA5058 [2] 40.00x55.00x7.00mm, FPM NA5057 [2] [2] 27.00x37.00x7.00mm, FPM NA5061 [1] [1] 74.00x88.00x8.00mm, FPM	
HBS052 [5] M9x1.25x95.00mm (x10)	JD148 [1] JD5375 [1] (x2) JF145 [1] (MLS)	JN667 [4]	HR354	HR599 [1]	NA5053 [2] 30.00x42.00x7.00mm, FPM NB815 [2] [2] 23.00x35.00x7.00mm, FPM NA5061 [1] [1] 74.00x88.00x8.00mm, FPM	KA5032 [41] JR673 [6]
HBS052 [5] M9x1.25x95.00mm (x10)	JD150 [1] JD5375 [1] JF145 [1] (MLS)	JN667 [4]	HR354	HR599 [1]	NA5053 [2] 30.00x42.00x7.00mm, FPM NB815 [2] [2] 23.00x35.00x7.00mm, FPM NA5061 [1] [1] 74.00x88.00x8.00mm, FPM	KA5032 [41] JR673 [6] 03/02→02/02 KK5001 [17] 03/02→
HBS052 [5] M9x1.25x95.00mm (x10)	JD5375 [1] JF145 [1] (MLS)	JN667 [4]	HR354	HR599 [1]	NA5053 [2] 30.00x42.00x7.00mm, FPM NB815 [2] [2] 23.00x35.00x7.00mm, FPM NA5061 [1] [1] 74.00x88.00x8.00mm, FPM	JR673 [6]
HBS052 [5] M9x1.25x95.00mm (x10)	JD150 [1] JD5375 [1] JF145 [1] (MLS)	JN667 [4]	HR354	HR599 [1]	NA5053 [2] 30.00x42.00x7.00mm, FPM NB815 [2] [2] 23.00x35.00x7.00mm, FPM NA5061 [1] [1] 74.00x88.00x8.00mm, FPM	KA5032 [41] JR673 [6]
HBS247 [5] M9x1.25x87.00mm (x10)	JD464 [1] JD465 [1] JF184 [1]	JM5176	HR354	HR814 [1]	NA5058 [2] 40.00x55.00x7.00mm, FPM NA5057 [2] [2] 27.00x37.00x7.00mm, FPM NA5061 [1] [1] 74.00x88.00x8.00mm, FPM	KA5032 [41] JR673 [6] →06/99
HBS052 [5] M9x1.25x95.00mm (x10)	JD150 [1] JD5375 [1] (x2) JF145 [1] (MLS)	JN667 [4] →11/99 JM5019 [4] (Elastomer) 12/99→	HR354	HR599 [1]	NA5053 [2] 30.00x42.00x7.00mm, FPM NA5057 [2] [2] 27.00x37.00x7.00mm, FPM NB815 [2] [2] 23.00x35.00x7.00mm, FPM NA5061 [1] [1] 74.00x88.00x8.00mm, FPM	KA5032 [41] JR673 [6] 03/02→02/02 KK5001 [17] 03/02→













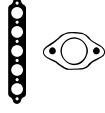

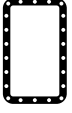

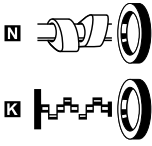





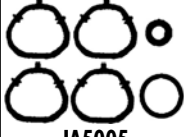





cc



kW/PS

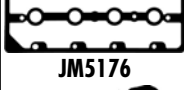

1.2		178 B7.045				42			DV675	EE5242 EV670 [3] FE5240
Palio 1.2	07/97→08/02	1242	4	70.80	SOHC/OHC	44/60	AE5240 (MLS) BV670 (Fibre), 1.650mm AE5550 (Fibre), 1.850mm			
1.2		178 C4.066				43			DV672 [3] DV675 CE5242 Eng.2939661→	EE5242 EV670 [3] FE5240 GV671 [3]
Palio 1.2	07/97→08/02	1242	4	70.80	SOHC/OHC	44-64/ 60-63	BV670 (Fibre), 1.650mm AE5550 (Fibre), 1.850mm →08/03 AE5240 (MLS) 10/03→			
Siena 1.2	09/01→									
1.2		178 E2.000				44			DV675	EE5242 FE5240 GV671 [3]
Palio 1.2	06/98→10/02	1242	4	70.80	SOHC/OHC	50-54/ 68-73	BV670 (Fibre), 1.650mm AE5550 (Fibre), 1.850mm			
1.2		182 B2.000				45			DY382 →Eng.0616937 CE5180 Eng.0616938→	EE5180 [3] GY383
Brava 1.2 16V	12/98→12/02	1242	4	70.80	DOHC	60-64/ 82-87	BY380 (Fibre), 1.650mm →Eng.0616937 AD5830 (MLS) Eng.0616938→			
Brava 1.2 16V 80	12/98→12/02									
Bravo l 80	12/98→10/01									
Marea 1.2 16V	10/98→05/02									
1.2		188 A4.000				46			DV672 [3] →Eng.1890665 CE5241 Eng.2533528→ →Eng.2935742, 2939660 CE5242 Eng.2939662→	EE5242 →Eng.2939661 EV670 [3] Eng.2939662→ FE5240
Palio 1.2	07/97→08/02	1242	4	70.80	SOHC/OHC	44/60	BV670 (Fibre), 1.650mm →08/03 AE5550 (Fibre), 1.850mm →08/03 AE5240 (MLS) 09/03→			
Palio 1.2 Flex	07/97→08/02									
Palio 1.2 LPG	07/97→08/02									
Panda 1.2	09/03→									
Panda 1.2 4x4	09/04→									
Panda 1.2 Bi	01/07→									
Panda 1.2 LPG	04/09→									
Punto 1.2	09/03→12/11									
Punto 1.2 60	09/99→10/09									
Punto 1.2 Bifuel	08/07→									
Siena 1.2	09/01→									
Strada 1.2	04/03→									
1.2		188 A5.000				47			DY383 →Eng.0616937 CE5181 Eng.0616937→ CG7310 05/06→	EE5180 [3] GY383 →Eng.0616937
Brava 1.2 16V 80	10/00→10/01	1242	4	70.80	DOHC	57-59/ 78-80	AD5830 (MLS) →07/04 BY380 (Fibre), 1.650mm →Eng.0616937 AG7310 (MLS) 05/06→			
Bravo l 80	10/00→10/01									
Idea 1.2 16V	01/04→									
Palio 1.2	09/01→									
Punto 1.2 16V 80	09/99→									
Siena 1.2	09/01→									
Stilo 1.2 16V	02/02→11/06									

								
HBS052 [5] M9x1.25x95.00mm (x10)	JD150 ■ JD5375 ■ (x2)  JF145 (MLS)	JN667 [4] →11/99 JM5019 (Elastomer) 12/99 →06/02	HR354	HR599 ■	NA5053 [2] 30.00x42.00x7.00mm, FPM →Eng.2935743 NB815 ■ [2] 23.00x35.00x7.00mm, FPM →Eng.2935743 NA5061 ■ [1] 74.00x88.00x8.00mm, FPM NA5057 ■ [2] 27.00x37.00x7.00mm, FPM Eng.2935744→			 AE5240  BV670  BY380  JA5005  JA5006  JA5010  JD150
HBS052 [5] M9x1.25x95.00mm (x10)	JD150 ■ JD5375 ■ (x2)  JF145 (MLS)	JM5019 (Elastomer)	HR354	HR599 ■	NA5053 [2] 30.00x42.00x7.00mm, FPM →Eng.2935743 NB815 ■ [2] 23.00x35.00x7.00mm, FPM →Eng.2935743 NA5061 ■ [1] 74.00x88.00x8.00mm, FPM NA5057 ■ [2] 27.00x37.00x7.00mm, FPM Eng.2935744→			 KA5032 [41] JR673 [6] →02/02 KK5001 [17] 03/02→
HBS052 [5] M9x1.25x95.00mm (x10)	JD150 ■ JD5375 ■  JF145 (MLS)	JN667 [4]	HR354	HR599 ■	NA5053 [2] 30.00x42.00x7.00mm, FPM NB815 ■ [2] 23.00x35.00x7.00mm, FPM NA5061 ■ [1] 74.00x88.00x8.00mm, FPM	KA5032 [41] JR673 [6] →02/02 KK5001 [17] 03/02→		 JD464  JD465  JD5375
HBS247 ⊗ [5] M9x1.25x87.00mm (x10)	JD464 ■ JD465 ■  JF184	JM5176	HR354	HR814 ■	NA5058 [2] 40.00x55.00x7.00mm, FPM NA5057 ■ [2] 27.00x37.00x7.00mm, FPM NA5061 ■ [1] 74.00x88.00x8.00mm, FPM	KA5032 [41] JR673 [6] →06/99		 JF145  JF184
HBS052 [5] M9x1.25x95.00mm (x10)	JA5010 ■ JD5375 ■  JF145 (MLS)	JM5019 (Elastomer) →Eng.2939661 JM7099 [4] (SMG) Eng.2939662→	HR354	HR800 ■	NA5053 [2] 30.00x42.00x7.00mm, FPM →Eng.2939600 NA5057 ■ [2] 27.00x37.00x7.00mm, FPM →Eng.2939661 NB815 ■ [2] 23.00x35.00x7.00mm, FPM →Eng.2939600 NA5061 ■ [1] 74.00x88.00x8.00mm, FPM	KA5032 [41] JR673 [6] →02/02 KK5001 [17] 03/02→		 JM5019  JM5176
HBS247 ⊗ [5] M9x1.25x87.00mm (x10)	JA5005 ■ (Elastomer) JA5006 ■	JM5176		HR814 ■	NA5058 [2] 40.00x55.00x7.00mm, FPM NA5057 ■ [2] 27.00x37.00x7.00mm, FPM LK5001 ■ [1] [2] [7] 74.00x187.50x17.000mm, FPM	KA5032 [41]		 JN667

FIAT



cc



kW/PS



1.2	188 A9.000	Diesel		48	AD5800 (MLS), 0.720mm AD5810 (MLS), 0.820mm, 1 Hole AD5820 (MLS), 0.920mm, 2 Holes	CD5810 ▲	ED5800 FD5810
Doblo 1.3 16V	05/04→12/06	1248	4	69.60	DOHC	51-55/ 70-75	
Idea 1.3 JTD	01/04→						
Panda 1.3 JTD	09/03→						
Punto 1.3	06/03→						
Punto 1.3 D Mtj	02/05→10/09						
Punto Mtj	06/03→10/05						
Sienna 1.3 JTD	09/03→						
1.2	199 A2.000	Diesel		49	AD5800 (MLS), 0.720mm AD5810 (MLS), 0.820mm, 1 Hole AD5820 (MLS), 0.920mm, 2 Holes	CD5810 ▲	ED5810 FD5810
Doblo 1.3 D Mtj	10/05→01/10	1248	4	69.60	DOHC	55-56/ 75-76	
Doblo 1.3 JTD	05/05→						
Fiorino 1.3 Mtj	02/08→						
Punto 1.3 D Mtj	10/05→						
Punto Evo Mtj	03/09→02/12						
Qubo 1.3 D Mtj	09/08→						
1.2	199 A3.000	Diesel		50	AD5800 (MLS), 0.720mm AD5810 (MLS), 0.820mm, 1 Hole AD5820 (MLS), 0.920mm, 2 Holes	CD5820 ▲	ED5820 FD5820 ▲
Doblo 1.3 D Mtj	02/10→	1248	4	69.60	DOHC	66-68/ 90-93	
Idea 1.3 D Mtj	10/05→						
Linea 1.3 D Mtj	06/07→						
Punto 1.3 D Mtj	10/05→02/12						
Punto Evo Mtj	10/09→02/12						
1.2	199 A4.000			51	AE5240 (MLS) AG7380 (MLS)	CE5242	EE5242
Punto 1.2	10/05→	1242	4	70.80	SOHC/OHC	48-51/ 65-69	
Punto 1.2 LPG	07/08→						
Punto Evo 1.2	10/09→02/12						
1.2	199 A9.000	Diesel		52	AD5800 (MLS), 0.720mm AD5810 (MLS), 0.820mm, 1 Hole AD5820 (MLS), 0.920mm, 2 Holes	CD5810 ▲	ED5810 FD5810
Fiorino 1.3 Mtj	02/08→	1248	4	69.60	DOHC	55/75	
Panda 1.3 D Mtj	02/12→						
Punto 1.3 D Mtj	04/08→						
Punto Evo Mtj	03/09→02/12						
1.2	199 B1.000	Diesel		53	AD5800 (MLS), 0.720mm AD5810 (MLS), 0.820mm, 1 Hole AD5820 (MLS), 0.920mm, 2 Holes	CD5810 ▲	ED5810
500 1.3 D Mtj	12/09→	1248	4	69.60	DOHC	70/95	
500 C 1.3 D Mtj	09/09→						
Fiorino 1.3D	07/09→						
Idea 1.3 D Mtj	05/08→						
Punto 1.3 D Mtj	03/09→						
Punto Evo Mtj	10/09→02/12						
Qubo 1.3 D Mtj	07/10→						
Strada 1.3D Mtj	10/10→						
1.2	199 B2.000	Diesel		54	AD5800 (MLS), 0.720mm AD5810 (MLS), 0.820mm, 1 Hole AD5820 (MLS), 0.920mm, 2 Holes	CD5810 ▲	ED5810
Punto 1.3 D Mtj	07/08→	1248	4	69.60	SOHC/OHC	51/69	
Punto Evo Mtj	07/08→02/12						
1.2	199 B4.000	Diesel		55	AD5800 (MLS), 0.720mm AD5810 (MLS), 0.820mm, 1 Hole AD5820 (MLS), 0.920mm, 2 Holes	CD5810 ▲	ED5820 FD5820 ▲
500L 1.3 D Mtj	09/12→	1248	4	69.60	DOHC	62/84	
Punto 1.3 D Mtj	04/10→						
Punto Evo Mtj	10/09→02/12						

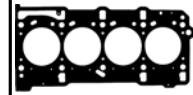

AD5800



AD5810



AD5820



AE5240



JD5375

HBS353 [5] M10x1.25x119.00mm (x10)	JD5411 [1] JD5413 [1] (MLS)	JM5259 (SE)		HR5088 [1]	NA5223 [2] 40.00x52.00x7.00mm, FPM NA5230 [2] 78.00x100.00x9.00mm, PTFE	KK5646 [17]
HBS353 [5] M10x1.25x119.00mm (x10)	JD5411 [1] JD5413 [1] (MLS)	JM5259 (SE)		HR5088 [1]	NA5223 [2] 40.00x52.00x7.00mm, FPM NA5230 [2] 78.00x100.00x9.00mm, PTFE	
HBS353 [5] M10x1.25x119.00mm (x10)	JD5993 [1] JD5413 [1] (MLS)	JM5259 (SE)		HR791 [1]	NA5223 [2] 40.00x52.00x7.00mm, FPM NA5230 [2] 78.00x100.00x9.00mm, PTFE	
HBS052 [5] M9x1.25x95.00mm (x10)	HA5053 [1] [1] JD5375 [1]	JM7099 [4] (SMG)			NA5053 [2] 30.00x42.00x7.00mm, FPM NA5057 [2] 27.00x37.00x7.00mm, FPM NA5061 [1] 74.00x88.00x8.00mm, FPM	
HBS353 [5] M10x1.25x119.00mm (x10)	JD5411 [1] JD5413 [1] (MLS)	JM5259 (SE)		HR791 [1]	NA5223 [2] 40.00x52.00x7.00mm, FPM NA5230 [2] 78.00x100.00x9.00mm, PTFE	
HBS353 [5] M10x1.25x119.00mm (x10)		JM5259 (SE)			NA5223 [2] 40.00x52.00x7.00mm, FPM NA5230 [2] 78.00x100.00x9.00mm, PTFE	
HBS353 [5] M10x1.25x119.00mm (x10)		JM5259 (SE)			NA5223 [2] 40.00x52.00x7.00mm, FPM NA5230 [2] 78.00x100.00x9.00mm, PTFE	
HBS353 [5] M10x1.25x119.00mm (x10)		JM5259 (SE)			NA5223 [2] 40.00x52.00x7.00mm, FPM NA5230 [2] 78.00x100.00x9.00mm, PTFE	



cc



kW/PS



1.2	223 A5.000					56			
Doblo 1.2	03/01→	1242	4	70.80	SOHC/OHC	48/65	BV670 (Fibre), 1.650mm →08/03 AE5550 (Fibre), 1.850mm →08/03 AE5240 (MLS) 09/03→	DV672 [3] →08/03 CE5241 Eng.2533528→ CG7381 09/03→ →Eng.2533527	EE5242 FE5240 09/03→
1.2	223 A9.000 Diesel					57			
Doblo 1.3 D Mtj	10/05→	1248	4	69.60	DOHC	62/84	AD5800 (MLS), 0.720mm AD5810 (MLS), 0.820mm, 1 Hole AD5820 (MLS), 0.920mm, 2 Holes	CD5820 ▲	ED5820 FD5820 ▲
Doblo 1.3 Mtj	08/06→								
Punto 1.3 D Mtj	04/10→								
Punto Evo Mtj	10/09→02/12								
Strada 1.3D Mtj	05/06→								
1.2	263 A2.000 Diesel					58			
Doblo 1.3 D Mtj	02/10→	1248	4	69.60	DOHC	66/90	AD5800 (MLS), 0.720mm AD5810 (MLS), 0.820mm, 1 Hole AD5820 (MLS), 0.920mm, 2 Holes	CD5820 ▲	ED5820 FD5820 ▲
1.3	127 A5.000 Diesel					59			
Elba 1.3 D	04/86→10/92	1302	4	76.10	SOHC/OHC	33/45	BP290 (Fibre) BJ860 (Fibre), 1.650mm BJ870 (Fibre), 1.800mm, 1 Notch BJ880 (Fibre), 1.950mm, 2 Notches	DJ872 ▲	GJ872 ▲ [3]
Fiorino 1.3 D	05/84→12/88								
Uno 1.3 Super D	06/83→03/92								
1.3	138 B2.000					60			
Regata Weekend	01/84→07/89	1302	4	86.40	SOHC/OHC	50-51/ 68-69	BP860 (Fibre)	DJ851 ▲ →Eng.5750056 DP871 →Eng.5750056	GP871 →Eng.5750056
1.3	146 A2.000					61			
Uno 1.3 i.e. T	04/85→08/89	1301	4	80.50		77/105	BP300 (Fibre)		
1.3	146 A2.246					62			
Uno 1.3 i.e. T	09/89→03/91	1301	4	80.50		74/100	BP300 (Fibre)		
1.3	146 A5.000					63			
Duna 1.3 70	01/87→12/91	1301	4	86.40	SOHC/OHC	49/67	BP290 (Fibre) 01/87→12/91	DP293 [3] 01/87→12/91	GK590 01/87→12/91
Fiorino 1.3	12/87→12/94								
Fiorino 1.3 70	01/88→12/94								
Penny 1.3	01/86→12/90								
1.3	146 B1.000 Diesel					64			
Uno 1.3 Super D	06/83→03/92	1301	4	76.10	SOHC/OHC	33/45	BJ860 (Fibre), 1.650mm BJ870 (Fibre), 1.800mm, 1 Notch BJ880 (Fibre), 1.950mm, 2 Notches	DJ872 ▲	GJ872 ▲ [3]
1.3	149 A3.000					65			
Regata 1.3 70	09/83→07/89	1301	4	86.40	SOHC/OHC	48/65	BP860 (Fibre)	DJ851 ▲ DP871 →Eng.5750056	GP871 →Eng.5750056



HBS052 [5] M9x1.25x95.00mm (x10)	JA5010 [1] JD5375 [1] (x2)	JM5019 (Elastomer)	HR354	HR599 [5] →08/03	NA5053 [2] 30.00x42.00x7.00mm, FPM NB815 [2] [2] 23.00x35.00x7.00mm, FPM NA5061 [1] [1] 74.00x88.00x8.00mm, FPM	KA5032 [41] JR673 [6] KK5001 [17] 03/02→
HBS353 [5] M10x1.25x119.00mm (x10)		JM5259 (SE)			NA5223 [2] [2] 40.00x52.00x7.00mm, FPM NA5230 [2] [2] 78.00x100.00x9.00mm, PTFE	
HBS353 [5] M10x1.25x119.00mm (x10)		JM5259 (SE)			NA5223 [2] [2] 40.00x52.00x7.00mm, FPM NA5230 [2] [2] 78.00x100.00x9.00mm, PTFE	
	JD5155	JN669 (Cork) (Elastomer)	JJ440	HR596 [5]	NA5187 [2] [2] 30.00x52.00x7.00mm, ACM NA5051 [2] [2] 40.00x56.00x7.00mm, FPM NA5052 [1] [1] 70.00x85.00x8.00mm, FPM	KA294 [15] HJ274 [8] [5] KD717 [11] JR556 [6]
HBS051 [5] M10x1.25x98.00mm (x5)	JD146 JE390 [1]	JPO49 [2] (Cork) JN805 [4] [4]	JJ453	HR596 [5]	NA5187 [2] [2] 30.00x52.00x7.00mm, ACM NB818 [2] [2] 40.00x56.00x7.00mm, ACM NA5049 [1] [1] 64.00x80.00x8.00mm, ACM	HJ279 [8] [6] [1] KD717 [11]
HBS051 [5] M10x1.25x98.00mm (x5)	LT439 [1] [1] [1] JD021 (x2)	JM663 [4] [4] JN805 [4] [4]		HR363 [5]	NA5187 [2] [2] 30.00x52.00x7.00mm, ACM NB818 [2] [2] 40.00x56.00x7.00mm, ACM	
HBS051 [5] M10x1.25x98.00mm (x5)	LT439 [1] [1] [1] JD021	JM663 [4] [4] JN805 [4] [4]		HR363 [5]	NA5187 [2] [2] 30.00x52.00x7.00mm, ACM NB818 [2] [2] 40.00x56.00x7.00mm, ACM	
	JD5155 01/87→12/91	JN283 [4] 01/87→12/91	JJ078 01/87→12/91	HR596 [5] 01/87→12/91	NA5187 [2] [2] 30.00x52.00x7.00mm, ACM 01/87→12/91 NB818 [2] [2] 40.00x56.00x7.00mm, ACM 01/87→12/91 NB730 [1] [1] 70.00x85.00x8.00mm, ACM 01/87→12/91	KA294 [15] JR556 [6] 01/87→12/91 KT446 [76]
	JD5155	JN669 (Cork)	JJ078	HR596 [5]	NA5051 [2] [2] 40.00x56.00x7.00mm, FPM NA5052 [1] [1] 70.00x85.00x8.00mm, FPM	JR556 [6]
HBS051 [5] M10x1.25x98.00mm (x5)	JD146 JE390 [1]	JPO49 [2] (Cork) JN805 [4] [4]	JJ453 →Eng.9508753	HR596 [5]	NA5187 [2] [2] 30.00x52.00x7.00mm, ACM NB818 [2] [2] 40.00x56.00x7.00mm, ACM NA5049 [1] [1] 64.00x80.00x8.00mm, ACM	

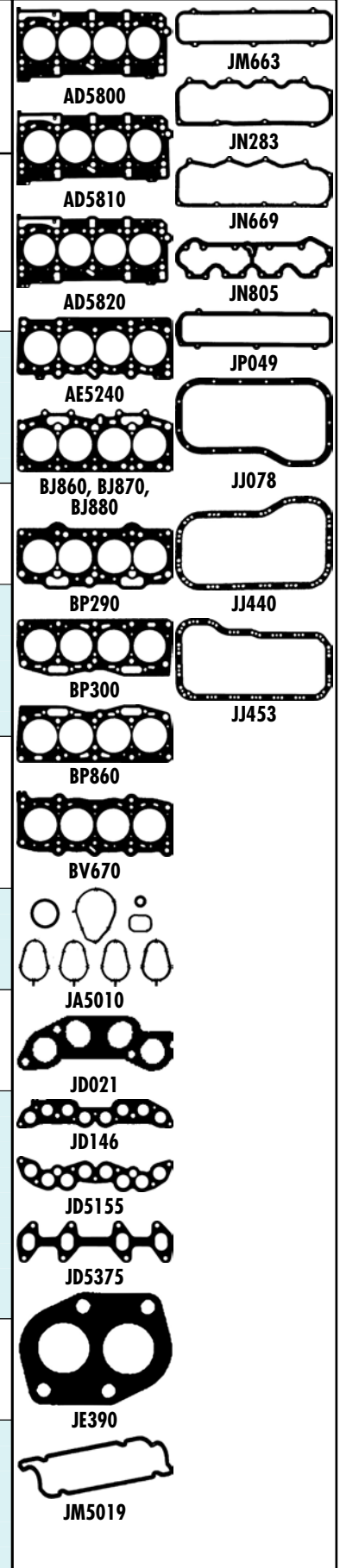

FIAT



cc



kW/PS



1.3	149 A7.000					66	BP860 (Fibre)	DJ851 ▲ →Eng.5750056 DP871 →Eng.5750056	GP871 →Eng.5750056
Regata 1.3 70 Uno 1.3 70	09/83→07/89 05/85→08/89	1302	4	86.40	SOHC/OHC	48/65			
1.3	156 A5.000	Diesel				67	BJ860 (Fibre), 1.650mm BJ870 (Fibre), 1.800mm, 1 Notch BJ880 (Fibre), 1.950mm, 2 Notches	DJ872 ▲	GJ872 ▲ [3]
Panda 1300 D	04/86→12/92	1302	4	76.10	SOHC/OHC	27/37			
1.4	146 A8.046					68	BT400 (Fibre)	DT400 [13]	GT400 [13]
Uno 1.4 i.e. T	09/89→09/93	1372	4	80.50	SOHC/OHC	82/112			
1.4	146 B.000	Diesel				69	BR120 (Fibre), 2.090mm, 2 Notches	DR100 ▲	GR100 ▲ [3]
Uno 1.4 TD 70	10/86→10/90	1367	4	78.00		52/71			
1.4	146 B3.000	Diesel				70	BR120 (Fibre), 2.090mm, 2 Notches	DR100 ▲	GR100 ▲ [3]
Uno 1.4 TD 70	10/86→10/90	1367	4	78.00		52/70			
1.4	146 C5.000					71	BT400 (Fibre)	DR620	GR620 [3]
Fiorino 1.4 Fiorino 1.4 70	11/92→10/96 05/94→05/01	1372	4	80.50	SOHC/OHC	49-52/ 67-71			
1.4	146 D5.000					72	BT400 (Fibre)	DR620	GR620 [3]
Fiorino 1.4 Fiorino 1.4 70	05/94→05/01 05/94→05/01	1372	4	80.50	SOHC/OHC	49/67			
1.4	159 A2.000					73	BR620 (Fibre) 02/90→04/93	DR620 02/90→04/93	GR620 [3] 02/90→04/93
Tempra 1.4 i.e. Tipo 1.4 i.e.	03/91→08/96 05/89→04/95	1372	4	80.50	SOHC/OHC	57/78			
1.4	160 A1.046					74	BR620 (Fibre)	DR620	GR620 [3]
Tempra 1.4 i.e. Tipo 1.4 i.e. Uno 1.4 Uno 1.4 i.e. 70	03/92→08/96 05/89→04/95 07/91→07/96 09/89→12/93	1372	4	80.50	SOHC/OHC	49-51/ 67-69			

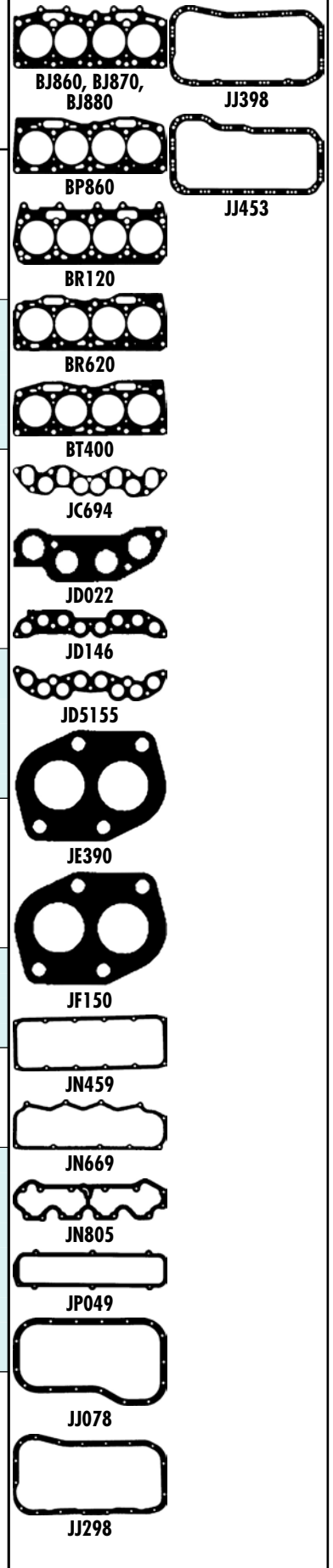
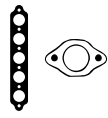



cc



kW/PS

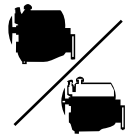

1.4		160 A1.048					75	BR620 (Fibre)	DR620	GR620 [3]
Tipo 1.4	07/87→12/89	1372	4	80.50	SOHC/OHC	50-52/69-71				
Uno 1.4 S 70	09/89→10/92									
1.4		169 A3.000					76	AG6220 (MLS)	CG6220	EE5242
500 1.4	10/07→	1368	4	72.00	DOHC	74/100				
500 C 1.4	09/09→									
Panda 1.4	10/06→									
1.4		176 A4.000					77	BT400 (Fibre)	DT401 [3]	ET400 GT401
Punto GT	01/94→09/96	1372	4	80.50	SOHC/OHC	96-98/131-136				
1.4		176 B6.000					78	BT400 (Fibre)	DT401 [3]	ET400 GT401
Punto GT	09/96→09/99	1372	4	80.50	SOHC/OHC	96/131				
1.4		178 B2.000					79	BR620 (Fibre)	DR620	ET400 GR620 [3]
Palio 1.4	04/96→08/01	1372	4	80.50	SOHC/OHC	51/69				
Siena 1.4	04/96→									
1.4		178 B2.016					80	BR620 (Fibre)	DR620	ET400 GR620 [3]
Palio 1.4 CAT	04/96→	1372	4	80.50	SOHC/OHC	51/69				
Siena 1.4 CAT	04/96→									
1.4		182 A3.000					81	AY480 (Fibre) BX040 (Fibre), 1.200mm	DX040 [3]	GX041
Brava 1.4 12V	10/95→08/98	1370	4	82.00	SOHC/OHC	59/80				
Bravo I 1.4	10/95→10/01									
Marea 1.4 12V 80	09/96→05/02									
1.4		182 A5.000					82	AY480 (Fibre) BX040 (Fibre), 1.200mm	DX040 [3]	GX041
Brava 1.4	10/95→10/01	1370	4	82.00	SOHC/OHC	55/75				
Bravo I 1.4	10/95→10/01									
1.4		192 B2.000					83	AG6220 (MLS) →04/06 AG7310 (MLS) 04/06→	CG6220 →04/06 CG7310 04/06→	EE5242
Bravo II 1.4	04/07→	1368	4	72.00	DOHC	66/90				
Bravo II 1.4 LPG	11/09→									
Idea 1.4	12/03→									
Stilo 1.4 16V	03/05→11/06									
Stilo Multi W	03/05→08/08									

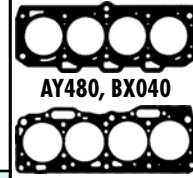
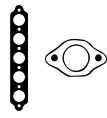

AY480, BX040

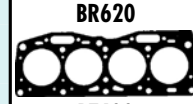

BR620



BT400



JA5006



JD022



JD146



JD342



JD343



JF150



JM5176



JN805

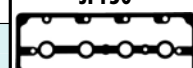

JN972



JP049



JJ453

HBS051 [5] M10x1.25x98.00mm (x5)	JD146 JF150	JPO49 [2] (Cork) JN805 [4]	JJ453	HR363 [2] HR569 [2]	NA5187 [2] 30.00x52.00x7.00mm, ACM NA5051 [2] 40.00x56.00x7.00mm, FPM NB808 [1] 64.00x80.00x8.00mm, FPM	
HBS247 [5] M9x1.25x87.00mm (x10)	JA5006 [2]	JM5176	HR397		NA5058 [2] 40.00x55.00x7.00mm, FPM NA5057 [2] 27.00x37.00x7.00mm, FPM LK5001 [1][2][7] 74.00x187.50x17.00mm, FPM	
HBS051 [5] M10x1.25x98.00mm (x5)	JD022	JPO49 [2] (Cork) JN805 [4]	JJ453	HR363 [2]	NA5187 [2] 30.00x52.00x7.00mm, ACM NB818 [2] 40.00x56.00x7.00mm, ACM NF887 [1][7] 64.00x112.50x20.00mm, FPM	KV122 [77]
HBS051 [5] M10x1.25x98.00mm (x5)	JD022	JPO49 [2] (Cork) JN805 [4]	JJ453	HR363 [2]	NA5187 [2] 30.00x52.00x7.00mm, ACM NB818 [2] 40.00x56.00x7.00mm, ACM NF887 [1][7] 64.00x112.50x20.00mm, FPM	KV122 [77]
HBS051 [5] M10x1.25x98.00mm (x5)	JD146	JPO49 [2] (Cork) JN805 [4]	JJ453	HR363 [2]	NA5187 [2] 30.00x52.00x7.00mm, ACM NA5051 [2] 40.00x56.00x7.00mm, FPM NB818 [2] 40.00x56.00x7.00mm, ACM NB808 [1] 64.00x80.00x8.00mm, FPM	
HBS051 [5] M10x1.25x98.00mm (x5)	JD146	JPO49 [2] (Cork) JN805 [4]	JJ453	HR363 [2]	NA5187 [2] 30.00x52.00x7.00mm, ACM NA5051 [2] 40.00x56.00x7.00mm, FPM NB818 [2] 40.00x56.00x7.00mm, ACM NB808 [1] 64.00x80.00x8.00mm, FPM	
HBS130 [5] M10x1.25x163.00mm (x10)	JD342 [1] JD343 [2]	JN972 [4]	HR354	HR800 [2]	NA5053 [2] 30.00x42.00x7.00mm, FPM NA5070 [2] 31.00x41.00x7.00mm, FPM NF888 [1] 93.00x172.00x12.00mm, FPM	KA845 [15] HJ282 [8][2]
HBS130 [5] M10x1.25x163.00mm (x10)	JD342 [1] JD343 [2]	JN972 [4]	HR354	HR599 [2]	NA5053 [2] 30.00x42.00x7.00mm, FPM NA5070 [2] 31.00x41.00x7.00mm, FPM NF888 [1] 93.00x172.00x12.00mm, FPM	KA845 [15] HJ282 [8][2]
HBS247 [5] M9x1.25x87.00mm (x10)	JA5006 [2]	JM5176	HR397		NA5058 [2] 40.00x55.00x7.00mm, FPM NA5057 [2] 27.00x37.00x7.00mm, FPM LK5001 [1][2][7] 74.00x187.50x17.00mm, FPM	

FIAT



cc



kW/PS



1.4	198 A1.000	84	AH6510 (MLS)		EE5180 [3]				
Bravo II 1.4 T	09/07→	1368	4	72.00	DOHC	110-112/ 150-152			
1.4	198 A4.000	85	AH6510 (MLS)		EE5180 [3]				
Bravo II 1.4 T	09/07→	1368	4	72.00	DOHC	88/120			
Doblo 1.4	02/10→								
Linea 1.4 T-Jet	09/07→								
Punto 1.4 T-Jet	09/07→								
1.4	198 A7.000	86	AH6510 (MLS)		EE5180 [3]				
Bravo II 1.4 16V	03/08→	1368	4	72.00	DOHC	103/140			
1.4	199 A6.000	87	AG7310 (MLS)		EE5180 [3]				
Punto 1.4 16V	10/05→	1368	4	72.00	DOHC	70-71/ 95-97			
1.4	199 A7.000	88	AG7380 (MLS)	CG7380	EE5180 [3]				
Punto 1.4	06/06→	1368	4	72.00	SOHC/OHC	55/75			
Punto Evo 1.4	07/09→02/12								
1.4	199 A8.000	89	AH6510 (MLS)		EE5180 [3]				
Punto 1.4 Abarth	12/07→	1368	4	72.00	DOHC	114-132/ 155-180			
Punto Evo 1.4	07/08→02/12								
1.4	312 A1.000	90	AH6510 (MLS)						
500 1.4 Abarth	08/08→	1368	4	72.00	DOHC	99-140/ 135-190			
500 C 1.4 Abarth	05/11→								
1.4	312 A3.000	91	AH6510 (MLS)						
500 1.4 Abarth	08/08→	1368	4	72.00	DOHC	103-132/ 140-180			
500 C 1.4 Abarth	09/09→								

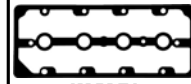
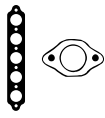

JM5176

HBS247 [5] M9x1.25x87.00mm (x10)		JM5176	HR397	HR814 [5]	NA5058 [2] 40.00x55.00x7.00mm, FPM NA5057 [2] 27.00x37.00x7.00mm, FPM LK5001 [1][2][7] 74.00x187.50x17.000mm, FPM	
HBS247 [5] M9x1.25x87.00mm (x10)		JM5176	HR397	HR814 [5]	NA5058 [2] 40.00x55.00x7.00mm, FPM NA5057 [2] 27.00x37.00x7.00mm, FPM LK5001 [1][2][7] 74.00x187.50x17.000mm, FPM	
HBS247 [5] M9x1.25x87.00mm (x10)		JM5176	HR397	HR814 [5]	NA5058 [2] 40.00x55.00x7.00mm, FPM NA5057 [2] 27.00x37.00x7.00mm, FPM LK5001 [1][2][7] 74.00x187.50x17.000mm, FPM	
HBS247 [5] M9x1.25x87.00mm (x10)		JM5176	HR397	HR814 [5]	NA5058 [2] 40.00x55.00x7.00mm, FPM NA5057 [2] 27.00x37.00x7.00mm, FPM LK5001 [1][2][7] 74.00x187.50x17.000mm, FPM	
HBS052 [5] M9x1.25x95.00mm (x10)	HA5053 [5]	JM7099 [4] (SMG)	HR397	PA5025 (x8)	NA5058 [2] 40.00x55.00x7.00mm, FPM NA5057 [2] 27.00x37.00x7.00mm, FPM NA5061 [1] 74.00x88.00x8.00mm, FPM	
HBS247 [5] M9x1.25x87.00mm (x10)		JM5176	HR397	HR814 [5]	NA5058 [2] 40.00x55.00x7.00mm, FPM NA5057 [2] 27.00x37.00x7.00mm, FPM LK5001 [1][2][7] 74.00x187.50x17.000mm, FPM	
HBS247 [5] M9x1.25x87.00mm (x10)				HR814 [5]	NA5058 [2] 40.00x55.00x7.00mm, FPM NA5057 [2] 27.00x37.00x7.00mm, FPM LK5001 [1][2][7] 74.00x187.50x17.000mm, FPM	
HBS247 [5] M9x1.25x87.00mm (x10)		JM5176	HR397	HR814 [5]	NA5058 [2] 40.00x55.00x7.00mm, FPM NA5057 [2] 27.00x37.00x7.00mm, FPM LK5001 [1][2][7] 74.00x187.50x17.000mm, FPM	

FIAT







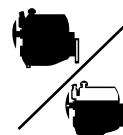

cc

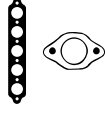

kW/PS

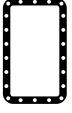

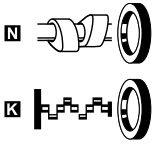
1.4		350 A1.000				92	AG7380 (MLS)	CG7380	EE5242
Doblo 1.4	10/05→	1368	4	72.00	SOHC/OHC	51-57/ 69-78			
Fiorino 1.4	10/09→								
Idea 1.4	10/05→								
Idea 1.4 LPG	03/09→								
Linea 1.4	06/07→								
Panda 1.4	10/09→								
Punto 1.4	10/05→								
Punto 1.4 Bifuel	03/12→								
Punto 1.4 LPG	12/08→								
Punto Evo 1.4	03/09→02/12								
Qubo 1.4	10/09→								
1.4		836 A4.000				93	BR620 (Fibre)	DR620	GR620 [3]
Tempra 1.4 i.e.	03/92→08/96	1372	4	80.50	SOHC/OHC	51/69			
Tipo 1.4 i.e.	05/89→04/95								
1.4		843 A1.000				94	AG6220 (MLS) →04/06 AG7310 (MLS) 04/06→	CG6220 →04/06 CG7310 04/06→	EE5180 [3]
500L 1.4	09/12→	1368	4	72.00	DOHC	66-70/ 90-95			
Doblo 1.4	02/10→								
Idea 1.4 16V	01/04→								
Punto 1.4	09/03→								
Stilo 1.4 16V	01/04→11/06								
Stilo Multi W	01/04→08/08								
1.4		955 A2.000				95	AH6510 (MLS)		
Punto 1.4	03/12→	1368	4	72.00	SOHC/OHC	99/135			
Punto Evo 1.4	10/09→02/12								
1.4		955 A6.000				96	AH6510 (MLS)		
Punto 1.4	03/12→	1368	4	72.00	SOHC/OHC	77/105			
Punto 1.4 16V	10/09→								
Punto Evo 1.4	10/09→02/12								
1.4		955 A8.000				97	AH6510 (MLS)		
Punto 1.4 Abarth	12/07→	1368	4	72.00	SOHC/OHC	120-132/ 163-180			
Punto Evo 1.4	07/08→02/12								
1.5		138 A2.000				98	BP110 (Fibre)		GP861
Ritmo Il 75 1.5	09/85→12/88	1498	4	86.40	SOHC/OHC	55-57/ 75-78			
1.5		138 A4.000				99	BP110 (Fibre)	DP110 →Eng.4525272	
Ritmo 1.5 85	01/80→07/89	1498	4	86.40	SOHC/OHC	63/86			

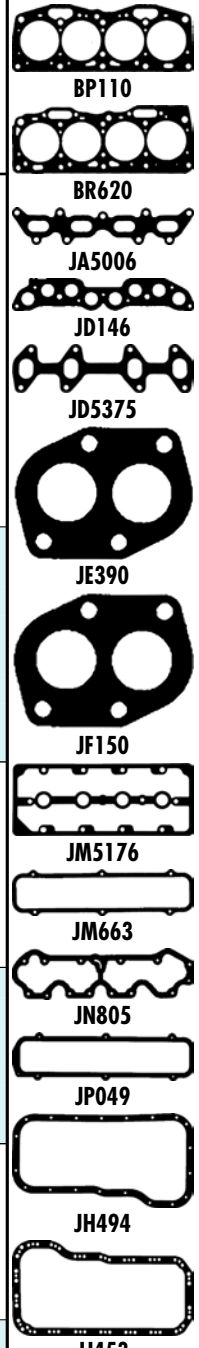
									
HBS052 [5] M9x1.25x95.00mm (x10)	HA5053 [1] [3] JD5375 [3]	JM7099 [4] (SMG)	HR397	PA5025 (x8)	<input checked="" type="checkbox"/> NA5058 [2] 40.00x55.00x7.00mm, FPM <input checked="" type="checkbox"/> NA5057 [2] 27.00x37.00x7.00mm, FPM <input checked="" type="checkbox"/> NA5061 [1] 74.00x88.00x8.00mm, FPM				BP110 BR620 JA5006 JD146 JD5375 JE390 JF150
HBS051 [5] M10x1.25x98.00mm (x5)	JD146 JF150	JPO49 [2] (Cork) JN805 [4]	JJ453	HR363 [3]	<input checked="" type="checkbox"/> NA5187 [2] 30.00x52.00x7.00mm, ACM <input checked="" type="checkbox"/> NA5051 [2] 40.00x56.00x7.00mm, FPM <input checked="" type="checkbox"/> NB818 [2] 40.00x56.00x7.00mm, ACM <input checked="" type="checkbox"/> NB808 [1] 64.00x80.00x8.00mm, FPM				JE390 JF150
HBS247 [5] M9x1.25x87.00mm (x10)	JA5006 [3]	JM5176	HR397	HR814 [3]	<input checked="" type="checkbox"/> NA5058 [2] 40.00x55.00x7.00mm, FPM <input checked="" type="checkbox"/> NA5057 [2] 27.00x37.00x7.00mm, FPM <input checked="" type="checkbox"/> LK5001 [1] [2] [7] 74.00x187.50x17.000mm, FPM				JM5176 JM663
HBS247 [5] M9x1.25x87.00mm (x10)				HR814 [3]	<input checked="" type="checkbox"/> NA5321 [2] 31.00x55.00x7.00mm, FPM <input checked="" type="checkbox"/> NA5057 [2] 27.00x37.00x7.00mm, FPM <input checked="" type="checkbox"/> LK5001 [1] [2] [7] 74.00x187.50x17.000mm, FPM				JN805 JP049
HBS247 [5] M9x1.25x87.00mm (x10)				HR814 [3]	<input checked="" type="checkbox"/> NA5321 [2] 31.00x55.00x7.00mm, FPM <input checked="" type="checkbox"/> NA5057 [2] 27.00x37.00x7.00mm, FPM <input checked="" type="checkbox"/> LK5001 [1] [2] [7] 74.00x187.50x17.000mm, FPM				JH494
HBS247 [5] M9x1.25x87.00mm (x10)				HR814 [3]	<input checked="" type="checkbox"/> NA5057 [2] 27.00x37.00x7.00mm, FPM <input checked="" type="checkbox"/> LK5001 [1] [2] [7] 74.00x187.50x17.000mm, FPM				JJ453
HBS051 [5] M10x1.25x98.00mm (x5)	JD146 JE390 [3]	JM663 [4] JN805 [4]	JH494	HR596 [3]	<input checked="" type="checkbox"/> NA5187 [2] 30.00x52.00x7.00mm, ACM <input checked="" type="checkbox"/> NB818 [2] 40.00x56.00x7.00mm, ACM <input checked="" type="checkbox"/> NA5049 [1] 64.00x80.00x8.00mm, ACM				
HBS051 [5] M10x1.25x98.00mm (x5)	JD146 JE390 [3]	JM663 [4] JN805 [4]	JH494	HR596 [3]	<input checked="" type="checkbox"/> NA5187 [2] 30.00x52.00x7.00mm, ACM <input checked="" type="checkbox"/> NB818 [2] 40.00x56.00x7.00mm, ACM <input checked="" type="checkbox"/> NA5049 [1] 64.00x80.00x8.00mm, ACM	KA294 [15]			

FIAT



cc



kW/PS



1.5	138 B3.000					100	BP860 (Fibre)	DP860	GP861
Regata Weekend	01/84→04/89	1498	4	86.40	SOHC/OHC	55-61/ 75-83			
1.5	138 B3.048					101	BP860 (Fibre)	DP861	GP861
Regata Weekend	09/84→07/89	1498	4	86.40	SOHC/OHC	55-57/ 75-78			
1.5	138 C2.048					102	BP860 (Fibre)	DJ851 ▲ DP860	GP861
Regata	07/85→07/89	1499	4	86.40	SOHC/OHC	55/75			
Regata Weekend	12/86→07/89								
Ritmo II 1.5 '75	09/85→12/88								
Uno 1.5 i.e. '75	10/85→12/93								
1.5	149 C1.000					103	BP860 (Fibre)	DP861 Eng.5750056→	GP861
Fiorino 1.5 '75	05/88→12/93	1499	4	86.40	SOHC/OHC	55/75			
Fiorino 1.5 iE	01/88→10/92								
Fiorino Van 1.5	01/88→08/93								
Regata	07/85→07/89								
Ritmo II 1.5 '75	09/85→12/88								
Uno 1.5 i.e. '75	10/85→12/93								
1.6	9HU Diesel					104	AD5130 (MLS), 1.250mm, 2 Notches AD5140 (MLS), 1.300mm, 3 Notches AD5150 (MLS), 1.350mm, 1 Notch AD5160 (MLS), 1.400mm, 4 Notches AD5170 (MLS), 1.450mm, 5 Notches	CD5140 ▲	ED5130
Scudo 1.6 D Mtj	01/07→	1560	4	75.00	DOHC	66/90			
1.6	146 C6.000					105	AY460 (Fibre)	DR630 [3]	
Fiorino 1.6	01/94→05/01	1581	4	86.40	SOHC/OHC	55/75			
Fiorino 75 1.6	10/93→05/01								
1.6	146 D6.000					106	AY460 (Fibre)	DR630 [3]	
Fiorino 1.6	01/94→05/01	1581	4	86.40	SOHC/OHC	55/75			
Fiorino 75 1.6	10/93→05/01								
1.6	149 C2.046					107	BT420 (Fibre)	DT423 [13]	
Tipo 1.6 i.e.	02/88→05/91	1595	4	84.00	SOHC/OHC	66/90			
1.6	159 A3.000					108	AY460 (Fibre) 02/90→04/93	DR630 [3] 02/90→04/93	GT446 [16] 01/91→04/93
Premio 1.6	03/85→12/96	1581	4	86.40	SOHC/OHC	62-66/ 84-90			
Tempra 1.6	03/90→04/93								
Tipo 1.6 SX DGT	05/89→10/95								
1.6	159 A3.046					109	AY460 (Fibre) BR630 (Fibre)	DR630 [3]	ET400 GR630 [3]
Tempra 1.6 i.e.	06/90→08/96	1581	4	86.40	SOHC/OHC	57-65/ 78-88			
Tipo 1.6 i.e.	07/90→01/93								
Uno 1.6	12/89→12/93								

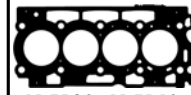
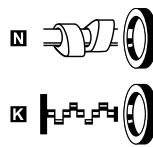
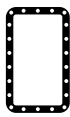
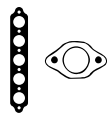

AD5130, AD5140,
AD5150, AD5160,
AD5170



AY460, BR630



BP860



BT420



JA757



JD146



JE390



JN805

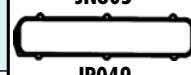

JP049



JH494



JJ453



cc



kw/PS

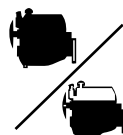

1.6		159 A3.048				110		AY460 (Fibre) BR630 (Fibre)		DR630 [3]	ET400 GR630 [3]
Tempra 1.6	04/90→06/93	1581	4	86.40	SOHC/OHC	51-55/ 69-75					
Tempra 1.6 i.e.	06/92→08/96										
Tipo 1.6 i.e.	10/92→04/95										
1.6		159 B9.000				111		AY460 (Fibre) BR630 (Fibre)		DR631	ET400
Tempra 1.6 i.e.	06/94→08/96	1581	4	86.40	SOHC/OHC	63-66/ 86-90					
1.6		160 A2.000				112		AY460 (Fibre) BR630 (Fibre)		DP689 →12/90 DT446 01/91→	ET400 GT446 [16] 01/91→
Tipo 1.6	01/88→10/91	1581	4	86.40	SOHC/OHC	58-62/ 79-84					
1.6		176 A9.000				113		AY460 (Fibre) BR630 (Fibre)		DR631	ET400
Punto 1.6 90	01/94→04/97	1581	4	86.40	SOHC/OHC	65/88					
Punto Cabrio	04/94→04/97										
1.6		178 B3.000				114		BX030 (Fibre), 1.650mm AY470 (Fibre), 1.850mm		CY470 [3] →09/99 DX030 [3] →09/99	ET400 GX030 [3] →Eng.9508753
Palio 1.6 16V	04/96→02/01	1581	4	86.40	DOHC	74-78/ 100-106					
Siena 1.6 16V	09/98→										
1.6		178 C7.098				115		BX030 (Fibre), 1.650mm AY470 (Fibre), 1.850mm		CY470 [3] DX030 [3]	EB5150 GX030 [3]
Palio 1.6	07/97→10/03	1581	4	86.40	DOHC	68-76/ 92-103					
1.6		178 D2.011				116		BX030 (Fibre), 1.650mm AY470 (Fibre), 1.850mm		CY470 [3] DX030 [3]	EB5150 GX030 [3]
Palio 1.6	07/97→10/03	1581	4	86.40	DOHC	68-73/ 92-99					
1.6		182 A4.000				117		BX030 (Fibre), 1.650mm AY470 (Fibre), 1.850mm		CY470 [3] DX030 [3]	EB5150 GX030 [3]
Brava 1.6 16V	02/96→10/01	1581	4	86.40	DOHC	76/103					
Bravo I 1.6 16V	03/96→10/01										
Marea 1.6 100	09/96→05/02										
Multipla 100	04/99→06/10										
1.6		182 A6.000				118		BX030 (Fibre), 1.650mm AY470 (Fibre), 1.850mm		CY470 [3] DX030 [3]	EB5150 GX030 [3] →Eng.9508753
Brava 1.6 16V	10/95→10/01	1581	4	86.40	DOHC	66/90					
Bravo I 1.6 16V	10/95→10/01										

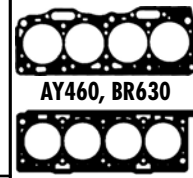
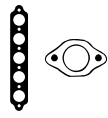

AY460, BR630

BX030, AY470

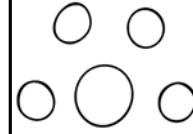

HA5005



JA757



JD146



JD5143



JF150



JN643

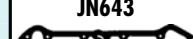

JN805

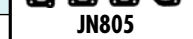

JN973

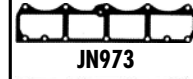

JP024

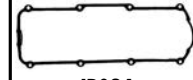

JP049

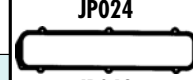

JJ298



JJ413

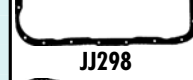

JJ453

HBS051 [5]
M10x1.25x98.00mm (x5)
01/93→

JD146
JF150

JPO49 [4]
(Cork)
JN805 [4]

JJ453

HR363 [5]

NA5187 [2]
30.00x52.00x7.00mm, ACM
NA5051 [2]
40.00x56.00x7.00mm, FPM
NB818 [2]
40.00x56.00x7.00mm, ACM

KA294 [15]

HBS051 [5]
M10x1.25x98.00mm (x5)

JD146

JPO24 [4]

JJ453

HR363 [5]

NA5187 [2]
30.00x52.00x7.00mm, ACM
NA5051 [2]
40.00x56.00x7.00mm, FPM
NA5049 [1]
64.00x80.00x8.00mm, ACM

KA294 [15]

HBS051 [5]
M10x1.25x98.00mm (x5)

JA757 [5]

JN643 [4]
JPO49 [4]
(Cork)
JN805 [4]

JJ298
(Cork)
JJ413

HR569 [5]

NA5187 [2]
30.00x52.00x7.00mm, ACM
NA5051 [2]
40.00x56.00x7.00mm, FPM
NA5049 [1]
64.00x80.00x8.00mm, ACM

KA294 [15]

HBS051 [5]
M10x1.25x98.00mm (x5)

JD146

JPO49 [4]
(Cork)
JN805 [4]

JJ453

HR363 [5]

NA5187 [2]
30.00x52.00x7.00mm, ACM
NB818 [2]
40.00x56.00x7.00mm, ACM
NF887 [1][7]
64.00x112.50x20.00mm, FPM

KA294 [15]

HBS131 [5]
M10x1.25x100.00mm (x10)

JD5143 [5]

JN973 [4]

JJ453

HR800 [5]

NA5187 [2]
30.00x52.00x7.00mm, ACM
NA5051 [2]
40.00x56.00x7.00mm, FPM
NB818 [2]
40.00x56.00x7.00mm, ACM
NF887 [1][7]
64.00x112.50x20.00mm, FPM

HJ282 [8][5]

HBS131 [5]
M10x1.25x100.00mm (x10)

HA5005 [5]
JD5143 [5]

JN973 [4]

JJ453

HR800 [5]

NA5187 [2]
30.00x52.00x7.00mm, ACM
NA5051 [2]
40.00x56.00x7.00mm, FPM
NB818 [2]
40.00x56.00x7.00mm, ACM
NF887 [1][7]
64.00x112.50x20.00mm, FPM

HJ282 [8][5]

HBS131 [5]
M10x1.25x100.00mm (x10)

HA5005 [5]
JD5143 [5]

JN973 [4]

JJ453

HR599 [5]

NA5051 [2]
40.00x56.00x7.00mm, FPM
NB818 [2]
40.00x56.00x7.00mm, ACM

HJ282 [8][5]

HBS131 [5]
M10x1.25x100.00mm (x10)

HA5005 [5]
JD5143 [5]

JN973 [4]

JJ453

HR800 [5]

NA5187 [2]
30.00x52.00x7.00mm, ACM
NA5051 [2]
40.00x56.00x7.00mm, FPM
NB818 [2]
40.00x56.00x7.00mm, ACM
NF887 [1][7]
64.00x112.50x20.00mm, FPM

HJ282 [8][5]

HBS131 [5]
M10x1.25x100.00mm (x10)

HA5005 [5]
JD5143 [5]

JN973 [4]

JJ453

HR800 [5]

NA5187 [2]
30.00x52.00x7.00mm, ACM
NB818 [2]
40.00x56.00x7.00mm, ACM
NF887 [1][7]
64.00x112.50x20.00mm, FPM

HJ282 [8][5]



cc



kW/PS



1.6	182 B5.098					119				
Marea 1.6 SX	09/00→08/02	1581	4	86.40	DOHC	72/98	BX030 (Fibre), 1.650mm AY470 (Fibre), 1.850mm	CY470 [3] DX030 [3]	EB5150 GX030 [3]	
1.6	182 B6.000					120				
Brava 1.6 16V	01/99→12/02	1596	4	80.50	DOHC	68-78/ 92-106	AB5150 (Fibre) →Eng.505170 AD5970 (MLS) Eng.505169→	CB5150 [3] →Eng.505169 CD5970 [3] (MLS) Eng.505169→	EB5150 FD5970	
Doblo 1.6	09/02→									
Doblo 1.6 16V	10/01→									
Marea 1.6	09/00→08/02									
Multipia 1.6	09/00→06/10									
Multipia 16V	10/01→06/10									
Palio 1.6 16V	02/01→									
Siena 1.6	11/00→									
Stilo 1.6 16V	10/01→11/06									
Stilo Multi W	01/03→08/08									
1.6	185 A3.000					121				
Marea 1.6	03/99→08/00	1581	4	86.40	DOHC	68-76/ 92-103	BX030 (Fibre), 1.650mm 01/00→ AY470 (Fibre), 1.850mm 01/00→	CY470 [3] 01/00→ DX030 [3] 01/00→	EB5150 01/00→ GX030 [3] 01/00→	
Marea 1.6 100	04/99→05/02									
1.6	186 A3.000					122				
Multipia 16V	04/99→06/10	1581	4	86.40	DOHC	70/95	BX030 (Fibre), 1.650mm AY470 (Fibre), 1.850mm	CY470 [3] DX030 [3]	GX030 [3] →Eng.9508753	
1.6	186 A4.000					123				
Marea 1.6 100	04/99→05/02	1581	4	86.40	DOHC	68-76/ 92-103	BX030 (Fibre), 1.650mm AY470 (Fibre), 1.850mm	CY470 [3] DX030 [3]	EB5150 GX030 [3]	
Multipia 16V	04/99→06/10									
1.6	198 A2.000	Diesel				124				
Bravo II 1.6 D	03/08→	1598	4	79.50	DOHC	88/120	AH6880 (MLS), 0.82mm AH6890 (MLS), 0.92mm, 1 Hole AH6900 (MLS), 1.02mm, 2 Holes			
1.6	198 A3.000	Diesel				125				
Bravo 1.6 D Mtj	03/08→	1598	4	79.50	DOHC	77/105	AH6880 (MLS), 0.82mm AH6890 (MLS), 0.92mm, 1 Hole AH6900 (MLS), 1.02mm, 2 Holes			
Bravo II 1.6 D	03/08→									
Doblo 1.6 D Mtj	02/10→									
Doblo 1.6D	02/10→									
Linea 1.6 D Mtj	06/09→									

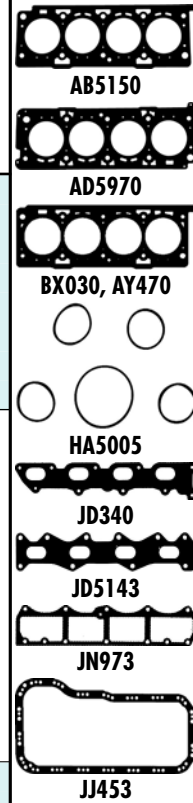
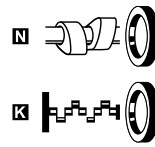
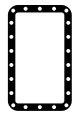
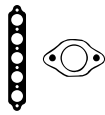

HBS131 [5] M10x1.25x100.00mm (x10)	HA5005 [5] JD5143 [5]	JN973 [4]		HR599 [5]	NA5187 [2] 30.00x52.00x7.00mm, ACM NA5051 [2] 40.00x56.00x7.00mm, FPM NB818 [2] 40.00x56.00x7.00mm, ACM NF887 [1][7] 64.00x112.50x20.00mm, FPM	
HBS131 [5] M10x1.25x100.00mm (x10)	HA5005 [5] JD5143 [5]	JN973 [4]	HR397	HR800 [5]	NA5187 [2] 30.00x52.00x7.00mm, ACM NA5051 [2] 40.00x56.00x7.00mm, FPM NB818 [2] 40.00x56.00x7.00mm, ACM NF887 [1][7] 64.00x112.50x20.00mm, FPM	
HBS131 [5] M10x1.25x100.00mm (x10) 01/00→	JD340 [1] 01/00→ JD5143 [5] 01/00→	JN973 [4] 01/00→	JJ453 01/00→	HR599 [5] 01/00→	NA5187 (x2) [2] 30.00x52.00x7.00mm, ACM 01/00→ NA5051 [2] 40.00x56.00x7.00mm, FPM 01/00→ NB818 [2] 40.00x56.00x7.00mm, ACM 01/00→ NF887 [1][7] 64.00x112.50x20.00mm, FPM 01/00→	
HBS131 [5] M10x1.25x100.00mm (x10)	JD340 [1] JD5143 [5]	JN973 [4]	JJ453	HR599 [5]	NA5187 [2] 30.00x52.00x7.00mm, ACM NA5051 [2] 40.00x56.00x7.00mm, FPM NB818 [2] 40.00x56.00x7.00mm, ACM NF887 [1][7] 64.00x112.50x20.00mm, FPM	HJ282 [8][5]
HBS131 [5] M10x1.25x100.00mm (x10)	JD340 [1] JD5143 [5]	JN973 [4]	JJ453	HR599 [5]	NA5187 (x2) [2] 30.00x52.00x7.00mm, ACM NA5051 [2] 40.00x56.00x7.00mm, FPM NB818 [2] 40.00x56.00x7.00mm, ACM NF887 [1][7] 64.00x112.50x20.00mm, FPM	
					NA5070 [2] 31.00x41.00x7.00mm, FPM NF888 [1] 93.00x172.00x12.00mm, FPM	
					NA5070 [2] 31.00x41.00x7.00mm, FPM NF888 [1] 93.00x172.00x12.00mm, FPM	

FIAT



cc



kW/PS



Model	Year Range	Engine Type	Cylinders	Power (kW/PS)	Configuration	Accessories	Notes	Other	
1.6 Bravo II 1.6 D	198 A6.000 03/08→	Diesel	1598	4	79.50	DOHC	126 66/90	AH6880 (MLS), 0.82mm AH6890 (MLS), 0.92mm, 1 Hole AH6900 (MLS), 1.02mm, 2 Holes	
1.6 500L 1.6 D Mtj	199 B5.000 09/12→	Diesel	1598	4	79.50	DOHC	127 77/105	AH6880 (MLS), 0.82mm AH6890 (MLS), 0.92mm, 1 Hole AH6900 (MLS), 1.02mm, 2 Holes	
1.6 Scudo 1.6	220 A 2.000 02/96→12/06		1581	4	86.40		128 58/79	AY460 (Fibre) BR630 (Fibre)	DR630 [3] DR632 [3]
1.6 Doblo 1.6 D Mtj	263 A3.000 02/10→	Diesel	1598	4	79.50		129 74/101	AH6880 (MLS), 0.82mm AH6890 (MLS), 0.92mm, 1 Hole AH6900 (MLS), 1.02mm, 2 Holes	
1.6 Doblo 1.6 D Mtj Doblo 1.6D	263 A4.000 02/10→ 02/10→	Diesel	1598	4	79.50	DOHC	130 66/90	AH6880 (MLS), 0.82mm AH6890 (MLS), 0.92mm, 1 Hole AH6900 (MLS), 1.02mm, 2 Holes	
1.6 Idea 1.6 D Mtj	350 A2.000 05/08→	Diesel	1598	4	79.50	DOHC	131 85-88/ 116-120	AH6880 (MLS), 0.82mm AH6890 (MLS), 0.92mm, 1 Hole AH6900 (MLS), 1.02mm, 2 Holes	
1.6 Tempra 1.6 i.e. Tipo 1.6 i.e.	835 C1.000 10/90→08/96 10/92→04/95		1581	4	86.40	SOHC/OHC	132 55-57/ 75-78	AY460 (Fibre) BR630 (Fibre)	DR630 [3] →12/93 ET400 GR630 [3]
1.6 Punto 1.6 D Mtj Punto Evo Mtj	955 A3.000 07/08→ 10/09→02/12	Diesel	1598	4	79.50	DOHC	133 88/120	AH6880 (MLS), 0.82mm AH6890 (MLS), 0.92mm, 1 Hole AH6900 (MLS), 1.02mm, 2 Holes	
1.6 Bravo II 1.6 D	955 A4.000 11/08→	Diesel	1598	4	79.50	DOHC	134 85/115	AH6880 (MLS), 0.82mm AH6890 (MLS), 0.92mm, 1 Hole AH6900 (MLS), 1.02mm, 2 Holes	
1.7 Elba 1.7 D Fiorino 1.7 D Fiorino 1.7D 60 Uno 1.7 D Uno 1.7D 60	146 B2.000 04/89→12/96 01/88→10/99 05/88→10/96 02/88→02/92 09/89→12/93	Diesel	1698	4	82.60	SOHC/OHC	135 42-44/ 57-60	AG6060 (MLS), 1.200mm AG7300 (MLS), 1.300mm BT220 (Fibre), 1.650mm BT230 (Fibre), 1.800mm, 1 Notch BT240 (Fibre), 1.950mm, 2 Notches	DV680 ▲ [3] EV684 [3] GV680 ▲
1.7 Fiorino 1.7 TD Fiorino 65 TD	146 D7.000 01/97→05/01 01/97→05/01	Diesel	1698	4	82.60	SOHC/OHC	136 46/63	BR680 (Graphite), 1.650mm BV680 (Fibre), 1.670mm, 0 Notches BV690 (Fibre), 1.750mm, 1 Notch BV700 (Fibre), 1.850mm, 2 Notches BW980 (Fibre), 1.930mm, 3 Notches	DV680 ▲ [3] EV684 [3] GV680 ▲



AY460, BR630



BR680



BT220, BT230,
BT240



BV680, BV690,
BV700, BW980



JC738



JD146



JF150



JN459

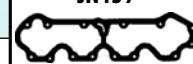

JN805

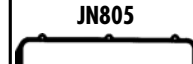

JP049

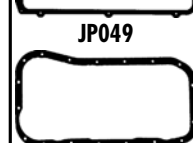

JJ298



JJ398

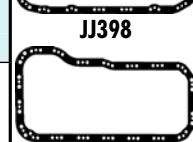

JJ453

					<input checked="" type="checkbox"/> NA5070 [2] 31.00x41.00x7.00mm, FPM <input checked="" type="checkbox"/> NF888 [1] 93.00x172.00x12.00mm, FPM	
HBS051 [5] M10x1.25x98.00mm (x5)	JD146 JF150	JPO49 [4] (Cork) JN805 [4]	JJ453	HR363 [5]	<input checked="" type="checkbox"/> NA5187 [2] 30.00x52.00x7.00mm, ACM <input checked="" type="checkbox"/> NB818 [2] 40.00x56.00x7.00mm, ACM <input checked="" type="checkbox"/> NF887 [1][7] 64.00x112.50x20.00mm, FPM	KA294 [15]
					<input checked="" type="checkbox"/> NA5070 [2] 31.00x41.00x7.00mm, FPM <input checked="" type="checkbox"/> NF888 [1] 93.00x172.00x12.00mm, FPM	
					<input checked="" type="checkbox"/> NA5070 [2] 31.00x41.00x7.00mm, FPM <input checked="" type="checkbox"/> NF888 [1] 93.00x172.00x12.00mm, FPM	
HBS051 [5] M10x1.25x98.00mm (x5)	JD146 JF150	JPO49 [4] (Cork) JN805 [4]	JJ453	HR363 [5] HR569 [5]	<input checked="" type="checkbox"/> NA5187 [2] 30.00x52.00x7.00mm, ACM <input checked="" type="checkbox"/> NA5051 [2] 40.00x56.00x7.00mm, FPM <input checked="" type="checkbox"/> NB818 [2] 40.00x56.00x7.00mm, ACM <input checked="" type="checkbox"/> NA5049 [1] 64.00x80.00x8.00mm, ACM <input checked="" type="checkbox"/> NB808 [1] 64.00x80.00x8.00mm, FPM	KA294 [15]
					<input checked="" type="checkbox"/> NA5070 [2] 31.00x41.00x7.00mm, FPM <input checked="" type="checkbox"/> NF888 [1] 93.00x172.00x12.00mm, FPM	
					<input checked="" type="checkbox"/> NA5070 [2] 31.00x41.00x7.00mm, FPM <input checked="" type="checkbox"/> NF888 [1] 93.00x172.00x12.00mm, FPM	
HBS095 [5] M12x1.25x133.00mm (x10)	JC738	JN459 [4]	JJ298 (Cork) (Elastomer) JJ398	HR596 [5]	<input checked="" type="checkbox"/> NA5187 [2] 30.00x52.00x7.00mm, ACM <input checked="" type="checkbox"/> NB742 [2] 30.00x43.00x8.00mm, ACM <input checked="" type="checkbox"/> NA5062 [1] 74.00x90.00x10.00mm, ACM	LV583 [41] LT498 [17]
HBS095 [5] M12x1.25x133.00mm (x10)	JC738	JN459 [4]	JJ298 (Cork) (Elastomer) → Eng.9185 JJ398 Eng.9186 →	HR596 [5]	<input checked="" type="checkbox"/> NA5187 [2] 30.00x52.00x7.00mm, ACM <input checked="" type="checkbox"/> NB742 [2] 30.00x43.00x8.00mm, ACM <input checked="" type="checkbox"/> NA5062 [1] 74.00x90.00x10.00mm, ACM <input checked="" type="checkbox"/> NB732 [1] 74.00x90.00x10.00mm, FPM	LT498 [17]



cc



kW/PS



1.7	149 B3.000	Diesel				137		DV680 ▲[3]	EV684 [3] GV680 ▲
Duna 1.7 DS	01/87→12/91	1698	4	82.60	SOHC/OHC	44/60	BT220 (Fibre), 1.650mm ACS140 (MLS), 1.660mm ACS150 (MLS), 1.760mm BT230 (Fibre), 1.800mm, 1 Notch ACS180 (MLS), 1.860mm BT240 (Fibre), 1.950mm, 2 Notches ACS160 (MLS), 1.960mm		
Fiorino 1.7 D	12/87→10/99								
Fiorino 1.7D 60	05/88→05/00								
Penny 1.7 D	01/86→12/90								
Regata 1.7 D 60	05/85→03/89								
Regata Weekend	01/84→12/89								
Uno 1.7D 60	07/86→08/89								
1.7	149 B4.000	Diesel				138		DV680 ▲[3]	EV684 [3] GV680 ▲
Tipo 1.7 D	01/88→10/95	1697	4	82.60		42-45/ 57-61	BT220 (Fibre), 1.650mm ACS140 (MLS), 1.660mm ACS150 (MLS), 1.760mm BT230 (Fibre), 1.800mm, 1 Notch ACS180 (MLS), 1.860mm BT240 (Fibre), 1.950mm, 2 Notches ACS160 (MLS), 1.960mm		
1.7	176 A3.000	Diesel				139		DV680 ▲[3]	EV684 [3] GV680 ▲
Palio 1.7 TD	04/96→03/01	1698	4	82.60	SOHC/OHC	51-53/ 69-72	BR680 (Graphite), 1.650mm BT220 (Fibre), 1.650mm ACS140 (MLS), 1.660mm BV680 (Fibre), 1.670mm, 0 Notches BV690 (Fibre), 1.750mm, 1 Notch ACS150 (MLS), 1.760mm BV700 (Fibre), 1.850mm, 2 Notches ACS180 (MLS), 1.860mm BW980 (Fibre), 1.930mm, 3 Notches ACS160 (MLS), 1.960mm		
Punto 1.7 TD	01/94→09/99								
Siena 1.7 TD	02/06→								
Strada 1.7 TD	06/99→								
1.7	176 A5.000	Diesel				140		DV680 ▲[3]	EV684 [3] GV680 ▲
Punto 1.7 TD	01/94→02/00	1698	4	82.60	SOHC/OHC	52-59/ 71-80	BR680 (Graphite), 1.650mm ACS140 (MLS), 1.660mm BV680 (Fibre), 1.670mm, 0 Notches BV690 (Fibre), 1.750mm, 1 Notch ACS150 (MLS), 1.760mm BV700 (Fibre), 1.850mm, 2 Notches ACS180 (MLS), 1.860mm BW980 (Fibre), 1.930mm, 3 Notches ACS160 (MLS), 1.960mm		
1.7	176 B3.000	Diesel				141		DV680 ▲[3]	EV684 [3] GV680 ▲
Punto 1.7 D	04/94→02/00	1698	4	82.60	SOHC/OHC	42/57	BT220 (Fibre), 1.650mm 04/96→ BT230 (Fibre), 1.800mm, 1 Notch 04/96→ BT240 (Fibre), 1.950mm, 2 Notches 04/96→	04/96→	04/96→ GV680 ▲ 04/96→
1.7	176 B7.000	Diesel				142		DV680 ▲[3]	EV684 [3] GV680 ▲
Punto 1.7 TD	09/96→09/99	1698	4	82.60	SOHC/OHC	46-47/ 63-64	BR680 (Graphite), 1.650mm ACS140 (MLS), 1.660mm BV680 (Fibre), 1.670mm, 0 Notches BV690 (Fibre), 1.750mm, 1 Notch ACS150 (MLS), 1.760mm BV700 (Fibre), 1.850mm, 2 Notches ACS180 (MLS), 1.860mm BW980 (Fibre), 1.930mm, 3 Notches ACS160 (MLS), 1.960mm		
Punto 1.7 TD 60	09/96→09/99								

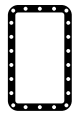

AC5140, AC5150,
AC5180, AC5160



BR680



BT220, BT230,
BT240



BV680, BV690,
BV700, BW980



JC738



JN459



JJ298



JJ398

FIAT

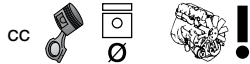

kW/PS

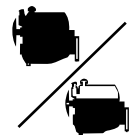

1.7	182 A2.000						143	BW720 (Fibre), 1.650mm AY500 (Fibre), 1.85mm	DW720 →06/99 DW723 [13] 07/99→	GW724 [3] →06/99
Brava 1.8 GT 16V Bravo I 1.8 GT Marea 1.8 115	10/95→10/01 10/95→10/01 09/96→05/02	1747	4	82.00	DOHC	83/113				
1.7	183 A1.000						144	BW720 (Fibre), 1.650mm AY500 (Fibre), 1.85mm	DW723 [13]	GW723 [3]
Barchetta 16V Coupe 1.8 16V Punto HGT	04/95→05/05 03/96→08/00 09/99→	1747	4	82.00	DOHC	92-97/ 125-132				
1.7	188 A6.000						145	AA5420 (MLS), 0.380mm	CA5421 [3]	EA5420 [3]
Barchetta 16V Punto HGT	04/95→05/05 09/99→	1747	4	82.00	DOHC	96/130				
1.7	192 A4.000						146	AA5420 (MLS), 0.380mm	CA5421 [3]	EA5420 [3]
Stilo 1.8 16V Stilo Multi W	10/01→11/06 01/03→08/08	1747	4	82.00	DOHC	96-98/ 130-133				
1.8	159 A4.000						147	BT440 (Fibre)	DT446	GT446 [16]
Tempra 1.8 4x4 Tempra 1.8 i.e. Tipo 1.8 i.e.	07/92→06/93 03/90→08/96 10/90→04/95	1756	4	84.00	DOHC	74-81/ 101-110				
1.8	159 A4.046						148	BT440 (Fibre)	DT440 [3] DT446	GT440 [3]
Tempra 1.8 i.e. Tipo 1.8 i.e.	03/92→08/96 10/90→06/93	1756	4	84.00	SOHC/OHC	77/105				
1.8	160 A5.000						149	BT440 (Fibre)	DT441	
Tipo 1.8 Sport	11/89→06/92	1756	4	84.00	DOHC	100/136				
1.8	939 A4.000						150	AH5240 (MLS)	CH5240	EH5240
Croma 1.8 16V	12/05→	1796	4	80.50	DOHC	96-103/ 131-140				

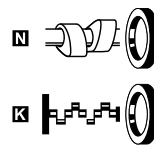
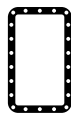
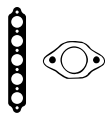

AY500



BT440

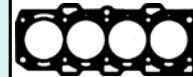

BW720, AA5420



JA5007



JA757



JC662



JD019

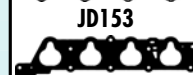

JD151



JD153



JD271



JD273



HL701



JN643, JN819



JN928



JN948



JJ298



JJ413



cc



kW/PS



1.9	149 A1.000	Diesel		151				DV680 ▲ ^[3]	EV684 ^[3] GV680 ▲
Regata 1.9 D 65	04/84→07/89	1929	4	82.60	SOHC/OHC	48/65	AC5140 (MLS), 1.660mm BV680 (Fibre), 1.670mm, 0 Notches BV690 (Fibre), 1.750mm, 1 Notch AC5150 (MLS), 1.760mm BV700 (Fibre), 1.850mm, 2 Notches AC5180 (MLS), 1.860mm BW980 (Fibre), 1.930mm, 3 Notches AC5160 (MLS), 1.960mm		
Regata Weekend	04/84→07/89								
Tempra 1.9 D	07/91→08/96								
Tipo 1.9 D	07/91→08/96								
1.9	149 B1.000	Diesel		152				DV680 ▲ ^[3]	EV684 ^[3] GV680 ▲
Ducato 1.9 D	02/87→03/94	1929	4	82.60		51-52/ 70-71	BR680 (Graphite), 1.650mm BV680 (Fibre), 1.670mm, 0 Notches BV690 (Fibre), 1.750mm, 1 Notch BV700 (Fibre), 1.850mm, 2 Notches BW980 (Fibre), 1.930mm, 3 Notches		
Talento 1.9 D	03/89→03/94								
1.9	149 B5.046	Diesel		153				DT290 ▲ ^[3]	
Uno 1.9 D	09/89→03/94	1929	4	82.60	SOHC/OHC	44/60	BT220 (Fibre), 1.650mm BT230 (Fibre), 1.800mm, 1 Notch BT240 (Fibre), 1.950mm, 2 Notches		
1.9	154 C6.000	Diesel		154				DT300 ▲	GT300 ▲
Croma 1900 T	05/89→10/92	1929	4	82.60	SOHC/OHC	66-68/ 90-92	BT320 (Fibre), 1.950mm, 2 Notches		
1.9	154 D1.000	Diesel		155				DT300 ▲	GT300 ▲
Croma 1900 T	11/92→12/96	1929	4	82.60	SOHC/OHC	69/94	BT320 (Fibre), 1.950mm, 2 Notches		
1.9	160 A6.000	Diesel		156				DV680 ▲ ^[3]	EV684 ^[3] GV680 ▲
Tempra 1.9 TD	05/90→08/96	1929	4	82.60	SOHC/OHC	66-68/ 90-92	BR680 (Graphite), 1.650mm AC5140 (MLS), 1.660mm BV680 (Fibre), 1.670mm, 0 Notches BV690 (Fibre), 1.750mm, 1 Notch AC5150 (MLS), 1.760mm BV700 (Fibre), 1.850mm, 2 Notches AC5180 (MLS), 1.860mm BW980 (Fibre), 1.930mm, 3 Notches AC5160 (MLS), 1.960mm		
Tipo 1.9 TD	09/90→04/95								
1.9	160 A6.046	Diesel		157				DV680 ▲ ^[3]	EV684 ^[3] GV680 ▲
Tipo 1.9 TD	09/90→04/95	1929	4	82.60	SOHC/OHC	66/90	BR680 (Graphite), 1.650mm BV680 (Fibre), 1.670mm, 0 Notches BV690 (Fibre), 1.750mm, 1 Notch AC5150 (MLS), 1.760mm BV700 (Fibre), 1.850mm, 2 Notches AC5180 (MLS), 1.860mm BW980 (Fibre), 1.930mm, 3 Notches AC5160 (MLS), 1.960mm		



AC5140, AC5150,
AC5180, AC5160



BR680



BT220, BT230,
BT240



BT320



BV680, BV690,
BV700, BW980



JC738



JD013



JN459

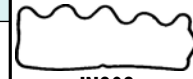

JN809



JJ298

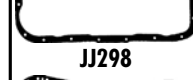

JJ398



cc



kW/PS

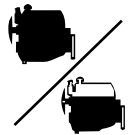

1.9	160 A7.000	Diesel			158				
Brava 1.9 D Bravo I 1.9 D Tempra 1.9 D Tipo 1.9 D	10/95→10/01 10/95→10/01 07/91→08/96 07/91→08/96	1929	4	82.60	SOHC/OHC	48/65	BT220 (Fibre), 1.650mm ACS140 (MLS), 1.660mm ACS150 (MLS), 1.760mm BT230 (Fibre), 1.800mm, 1 Notch ACS180 (MLS), 1.860mm BT240 (Fibre), 1.950mm, 2 Notches ACS160 (MLS), 1.960mm	DV680 ▲[3]	EV684 [3] GV680 ▲
1.9	160 B6.046	Diesel			159				
Tempra 1.9 TD Tipo 1.9 TD	03/92→08/96 03/92→06/93	1929	4	82.60		59/82	BV680 (Fibre), 1.670mm, 0 Notches BV690 (Fibre), 1.750mm, 1 Notch BV700 (Fibre), 1.850mm, 2 Notches BW980 (Fibre), 1.930mm, 3 Notches	DS435 [3] DV680 ▲[3]	EV684 [3] GV680 ▲
1.9	160 D1.000	Diesel			160				
Tempra 1.9 TD Tipo 1.9 TD	05/90→08/96 09/90→04/95	1929	4	82.60	SOHC/OHC	65-66/ 88-90	ACS140 (MLS), 1.660mm BV680 (Fibre), 1.670mm, 0 Notches BV690 (Fibre), 1.750mm, 1 Notch ACS150 (MLS), 1.760mm BV700 (Fibre), 1.850mm, 2 Notches ACS180 (MLS), 1.860mm BW980 (Fibre), 1.930mm, 3 Notches ACS160 (MLS), 1.960mm	DV680 ▲[3]	EV684 [3] GV680 ▲
1.9	182 A7.000	Diesel			161				
Brava 100 S Bravo I 100 S Marea 1.9 TD 100	03/96→10/01 03/96→10/01 09/96→05/02	1910	4	82.00	SOHC/OHC	74/100	BY410 (Fibre), 1.600mm →12/98 BY420 (Fibre), 1.700mm, 1 Notch →12/98 BY430 (Fibre), 1.800mm, 2 Notches →12/98 BE440 (MLS), 1.600mm 01/99→ BE450 (MLS), 1.700mm 01/99→ BE460 (MLS), 1.800mm 01/99→	DY410 ▲[3]	GY411 ▲[3]
1.9	182 A8.000	Diesel			162				
Brava 75 S Bravo I 75 S Marea 1.9 TD 75	03/96→10/01 03/96→10/01 09/96→05/02	1910	4	82.00	SOHC/OHC	55/75	BY410 (Fibre), 1.600mm →12/98 BY420 (Fibre), 1.700mm, 1 Notch →12/98 BY430 (Fibre), 1.800mm, 2 Notches →12/98 BE440 (MLS), 1.600mm 01/99→ BE450 (MLS), 1.700mm 01/99→ BE460 (MLS), 1.800mm 01/99→	DY410 ▲[3]	GY411 ▲[3]
1.9	182 B4.000	Diesel			163				
Brava 105 Bravo I 105 Marea 1.9 105 Multipla 105	12/98→10/01 12/98→10/01 04/99→05/02 04/99→06/10	1910	4	82.00	SOHC/OHC	77-79/ 105-107	AY520 (MLS), 1.600mm, 0 Holes AY530 (MLS), 1.700mm, 1 Hole AY540 (MLS), 1.800mm, 2 Holes	CY550 ▲[3]	FY550 ▲[3]

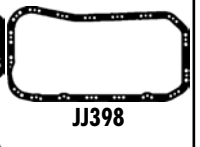
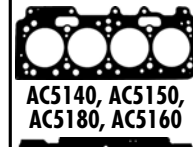

HBS095 [5]
M12x1.25x133.00mm (x10)

JC738

JN459 [4]

JJ298
(Cork)
(Elastomer)
JJ398

HR596 [5]

NA5187 [2]
30.00x52.00x7.00mm, ACM
NB742 [2]
30.00x43.00x8.00mm, ACM
NA5062 [1]
74.00x90.00x10.00mm, ACM

LV583 [41]
KT639 [6]
LT498 [17]

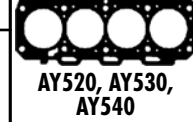

HBS095 [5]
M12x1.25x133.00mm (x10)

JC738

JN459 [4]

JJ298
(Cork)
JJ398

HR596 [5]

NA5187 [2]
30.00x52.00x7.00mm, ACM
NB742 [2]
30.00x43.00x8.00mm, ACM
NA5062 [1]
74.00x90.00x10.00mm, ACM

LV583 [41]
HJ283 [8]
LT498 [17]

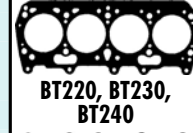

HBS095 [5]
M12x1.25x133.00mm (x10)

JC738

JN459 [4]

JJ298
JJ398

HR596 [5]

NA5187 [2]
30.00x52.00x7.00mm, ACM
NB742 [2]
30.00x43.00x8.00mm, ACM
NA5062 [1]
74.00x90.00x10.00mm, ACM
NB732 [1]
74.00x90.00x10.00mm, FPM

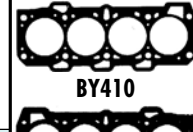
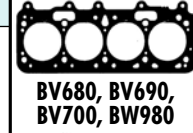

HBS227 [5]
M12x1.25x218.00mm (x10)

JD467 [1]
JD468 [1]
(MLS)

JP019 [4]

HR354

HR363 [5]

NA5053 [2]
30.00x42.00x7.00mm, FPM
NA5070 [2]
31.00x41.00x7.00mm, FPM
NF888 [1]
93.00x172.00x12.00mm, FPM

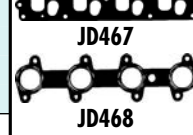
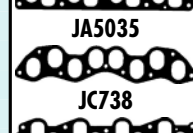
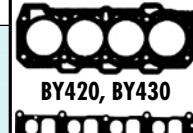

HBS227 [5]
M12x1.25x218.00mm (x10)

JD467 [1]
JD468 [1]
(MLS)

JP019 [4]

HR354

HR363 [5]

NA5053 [2]
30.00x42.00x7.00mm, FPM
NA5070 [2]
31.00x41.00x7.00mm, FPM
NF888 [1]
93.00x172.00x12.00mm, FPM

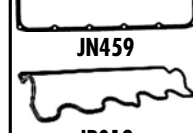
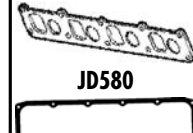

HBS227 [5]
M12x1.25x218.00mm (x10)

JD580 [1]
(Felt)
→12/99
JA5035 [1]
01/00→
JD468 [1]
(MLS)

JP063 [4]

HR363 [5]

NA5053 [2]
30.00x42.00x7.00mm, FPM
NA5070 [2]
31.00x41.00x7.00mm, FPM
NF888 [1]
93.00x172.00x12.00mm, FPM

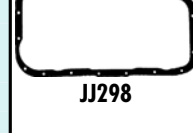
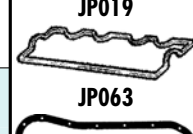



cc



kW/PS



1.9	182 B9.000	Diesel				164	AA5560 (MLS), 0.820mm, 0 Holes AA5570 (MLS), 0.920mm, 1 Hole AA5580 (MLS), 1.020mm, 2 Holes	CA5560 ▲ [3] →Eng.4081110 CA5561 ▲ Eng.4081111→	EE5181 [3] FA5560 ▲ [3]
Brava 1.9 JTD Bravo I 1.9 JTD Doblo 1.9 JTD Marea 1.9 TD 100	09/00→10/01 09/00→10/01 10/01→ 09/96→05/02	1910	4	82.00	SOHC/OHC	74-77/ 100-105			
1.9	186 A6.000	Diesel				165	AA5560 (MLS), 0.820mm, 0 Holes AA5570 (MLS), 0.920mm, 1 Hole AA5580 (MLS), 1.020mm, 2 Holes	CA5560 ▲ [3] →Eng.4081110 CA5561 ▲ Eng.4081111→	EE5181 [3] FA5560 ▲ [3]
Marea 1.9 110 Multipla JTD	01/01→05/02 03/01→07/02	1910	4	82.00	SOHC/OHC	81/110			
1.9	186 A8.000	Diesel				166	AA5560 (MLS), 0.820mm, 0 Holes AA5570 (MLS), 0.920mm, 1 Hole AA5580 (MLS), 1.020mm, 2 Holes	CA5560 ▲ [3] →Eng.4081110 CA5561 ▲ Eng.4081111→	
Multipla JTD	07/02→06/10	1910	4	82.00	SOHC/OHC	85/115			
1.9	188 A2.000	Diesel				167	AA5560 (MLS), 0.820mm, 0 Holes →09/03 AA5570 (MLS), 0.920mm, 1 Hole →09/03 AA5580 (MLS), 1.020mm, 2 Holes →09/03 AG7440 (MLS) 10/03→ AG7390 (MLS), 0.820mm 10/03→ AG7400 (MLS), 0.920mm, 1 Hole 10/03→	CA5560 ▲ [3] →Eng.4081110 CA5561 ▲ Eng.4081111→	FA5560 ▲ [3]
Palio 1.9 JTD Punto 1.9 JTD 80 Strada 1.9 JTD	09/01→ 09/99→ 04/03→	1910	4	82.00	SOHC/OHC	59/80			
1.9	188 A3.000	Diesel				168	BZ790 (MLS), 0.800mm BZ800 (MLS), 0.900mm, 1 Notch BZ810 (MLS), 1.000mm, 2 Notches	DZ790 ▲ [3]	GZ790 ▲
Punto 1.9 D 60 Punto 1.9 DS 60	02/00→10/09 09/99→	1910	4	82.00	SOHC/OHC	44/60			
1.9	188 A7.000	Diesel				169	AA5560 (MLS), 0.820mm, 0 Holes →09/03 AA5570 (MLS), 0.920mm, 1 Hole →09/03 AA5580 (MLS), 1.020mm, 2 Holes →09/03 AG7440 (MLS) 10/03→ AG7390 (MLS), 0.820mm 10/03→ AG7400 (MLS), 0.920mm, 1 Hole 10/03→	CA5560 ▲ [3] →Eng.4081110 CA5561 ▲ Eng.4081111→	FA5560 ▲ [3]
Punto 1.9 JTD	02/00→10/09	1910	4	82.00	SOHC/OHC	63/86			

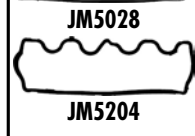
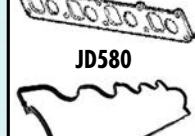
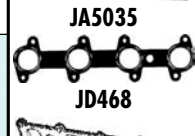
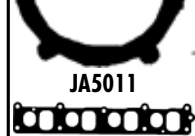
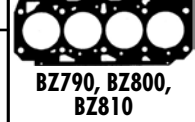



cc



kW/PS



1.9	188 B2.000	Diesel				170			
Idea 1.9 JTD Punto 1.9 JTD	01/04→ 06/03→	1910	4	82.00	SOHC/OHC	74/101	AA5560 (MLS), 0.820mm, 0 Holes →09/03 AA5570 (MLS), 0.920mm, 1 Hole →09/03 AA5580 (MLS), 1.020mm, 2 Holes →09/03 AG7440 (MLS) 10/03→ AG7390 (MLS), 0.820mm 10/03→ AG7400 (MLS), 0.920mm, 1 Hole 10/03→	CA5560 ▲ [3] →Eng.4081110 CA5561 ▲ Eng.4081111→	EE5181 [3]
1.9	192 A1.000	Diesel				171			
Stilo 1.9 JTD Stilo Multi W	10/01→11/06 01/03→08/08	1910	4	82.00	SOHC/OHC	85/115	AA5560 (MLS), 0.820mm, 0 Holes →09/03 AA5570 (MLS), 0.920mm, 1 Hole →09/03 AA5580 (MLS), 1.020mm, 2 Holes →09/03 AG7440 (MLS) 09/03→ AG7390 (MLS), 0.820mm 09/03→ AG7400 (MLS), 0.920mm, 1 Hole 09/03→	CA5560 ▲ [3] →Eng.4081110 CA5561 ▲ Eng.4081111→ CG7390 ▲ 09/03→	EG7390 FA5560 ▲ [3]
1.9	192 A3.000	Diesel				172			
Stilo 1.9 JTD Stilo Multi W	02/02→11/06 01/03→08/08	1910	4	82.00	SOHC/OHC	59/80	AA5560 (MLS), 0.820mm, 0 Holes AG7390 (MLS), 0.820mm AA5570 (MLS), 0.920mm, 1 Hole AA5580 (MLS), 1.020mm, 2 Holes AG7440 (MLS) 10/03→ AG7400 (MLS), 0.920mm, 1 Hole 10/03→	CA5560 ▲ [3] →Eng.4081110 CA5561 ▲ Eng.4081111→	FA5560 ▲ [3]
1.9	192 A5.000	Diesel				173			
Stilo 1.9 JTD Stilo Multi W	01/04→11/06 01/04→08/08	1910	4	82.00	DOHC	103/140	AD5840 (MLS), 0.820mm, 0 Holes AD5850 (MLS), 0.920mm, 1 Hole AD5860 (MLS), 1.020mm, 2 Holes	CD5840 ▲	EE5181 [3]
1.9	192 A8.000	Diesel				174			
Bravo II 1.9 D Stilo 1.9 D Mtj Stilo Multi W	04/07→ 09/05→11/06 09/05→08/08	1910	4	82.00	SOHC/OHC	88/120	AG7440 (MLS) AG7390 (MLS), 0.820mm AG7400 (MLS), 0.920mm, 1 Hole	CA5561 ▲ CG7390 ▲	
1.9	192 A9.000	Diesel				175			
Stilo 1.9 D Mtj Stilo Multi W	09/05→11/06 09/05→08/08	1910	4	82.00	SOHC/OHC	74/100	AG7440 (MLS) AG7390 (MLS), 0.820mm AG7400 (MLS), 0.920mm, 1 Hole	CA5560 ▲ [3] →Eng.4081110 CA5561 ▲ Eng.4081111→	EE5181 [3]
1.9	192 B1.000	Diesel				176			
Stilo 1.9 JTD Stilo Multi W	04/04→11/06 04/04→08/08	1910	4	82.00	DOHC	100/136	AD5840 (MLS), 0.820mm, 0 Holes AD5850 (MLS), 0.920mm, 1 Hole AD5860 (MLS), 1.020mm, 2 Holes	CD5840 ▲	EE5181 [3]

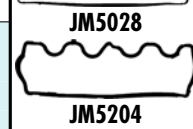
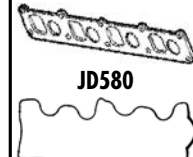
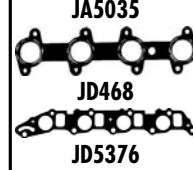
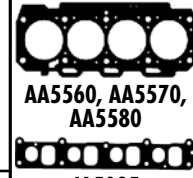
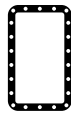
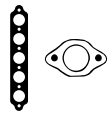

FIAT



cc



kW/PS



1.9	192 B4.000	Diesel				177	AG7440 (MLS) AG7390 (MLS), 0.820mm AG7400 (MLS), 0.920mm, 1 Hole	CA5560 ▲ [3] →Eng.4081110 CG7390 ▲ CA5561 ▲ Eng.4081111→	EE5181 [3]
Bravo II 1.9 D	11/06→	1910	4	82.00	SOHC/OHC	85/116			
1.9	192 B5.000	Diesel				178	AG7440 (MLS) AG7390 (MLS), 0.820mm AG7400 (MLS), 0.920mm, 1 Hole	CA5560 ▲ [3] →Eng.4081110 CG7390 ▲ CA5561 ▲ Eng.4081111→	EE5181 [3]
Bravo II 1.9 D	04/07→12/08	1910	4	82.00	SOHC/OHC	66/90			
Stilo 1.9 JTD	09/04→11/06								
Stilo Multi W	09/04→08/08								
1.9	199 A5.000	Diesel				179	AG7440 (MLS) AG7390 (MLS), 0.820mm AG7400 (MLS), 0.920mm, 1 Hole	CG7390 ▲	EG7390
Punto 1.9 D Mfj	10/05→	1910	4	82.00	SOHC/OHC	96/131			
1.9	223 A6.000	Diesel				180	BZ790 (MLS), 0.800mm BZ800 (MLS), 0.900mm, 1 Notch BZ810 (MLS), 1.000mm, 2 Notches	DZ790 ▲ [3]	EE5181 [3] GZ790 ▲
Doblo 1.9 D	03/01→	1910	4	82.00	SOHC/OHC	46-48/ 63-65			
Palio 1.9 D	03/01→								
Siena 1.9 D	11/00→								
Strada 1.9 D	12/00→								
1.9	223 A7.000	Diesel				181	AA5560 (MLS), 0.820mm, 0 Holes →09/03 AA5570 (MLS), 0.920mm, 1 Hole →09/03 AA5580 (MLS), 1.020mm, 2 Holes →09/03 AG7440 (MLS) 10/03→ AG7390 (MLS), 0.820mm 10/03→ AG7400 (MLS), 0.920mm, 1 Hole 10/03→	CA5560 ▲ [3] →Eng.4081110 CA5561 ▲ Eng.4081111→	EE5181 [3]
Doblo 1.9 JTD	07/03→	1910	4	82.00	SOHC/OHC	77/105			
1.9	223 B1.000	Diesel				182	AA5560 (MLS), 0.820mm, 0 Holes →09/03 AA5570 (MLS), 0.920mm, 1 Hole →09/03 AA5580 (MLS), 1.020mm, 2 Holes →09/03 AG7440 (MLS) 10/03→ AG7390 (MLS), 0.820mm 10/03→ AG7400 (MLS), 0.920mm, 1 Hole 10/03→	CA5560 ▲ [3] →Eng.4081110 CA5561 ▲ Eng.4081111→	EE5181 [3]
Doblo 1.9 JTD	07/03→	1910	4	82.00	SOHC/OHC	77/105			

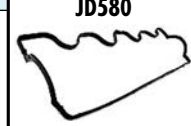
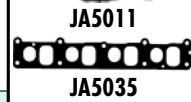
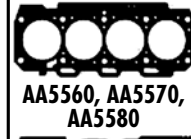
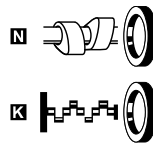
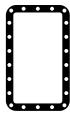
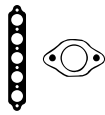



cc



kW/PS



1.9	223 B2.000	Diesel				183			
Doblo 1.9 JTD	10/01→	1910	4	82.00	SOHC/OHC	74/100	AA5560 (MLS), 0.820mm, 0 Holes →09/03 AA5570 (MLS), 0.920mm, 1 Hole →09/03 AA5580 (MLS), 1.020mm, 2 Holes →09/03 AG7440 (MLS) 10/03→ AG7390 (MLS), 0.820mm 10/03→ AG7400 (MLS), 0.920mm, 1 Hole 10/03→	CA5560 ▲ [3] →Eng.4081110 CA5561 ▲ Eng.4081111→	EE5181 [3] FA5560 ▲ [3]
1.9	230 A2.000	Diesel				184			
Ducato Ducato 1.9 D	06/95→04/02 03/94→04/02	1929	4	82.60	SOHC/OHC	51/70	BR680 (Graphite), 1.650mm AC5140 (MLS), 1.660mm BV680 (Fibre), 1.670mm, 0 Notches BV690 (Fibre), 1.750mm, 1 Notch AC5150 (MLS), 1.760mm BR690 (Graphite), 1.800mm, 1 Notch BV700 (Fibre), 1.850mm, 2 Notches AC5180 (MLS), 1.860mm BR700 (Graphite), 1.950mm, 2 Notches AC5160 (MLS), 1.960mm	DV680 ▲ [3]	EV684 [3] GV680 ▲
1.9	230 A3.000	Diesel				185			
Ducato Ducato 1.9 TD	03/94→04/02 03/94→04/02	1929	4	82.60	SOHC/OHC	60/82	BR680 (Graphite), 1.650mm AC5140 (MLS), 1.660mm BV680 (Fibre), 1.670mm, 0 Notches BV690 (Fibre), 1.750mm, 1 Notch AC5150 (MLS), 1.760mm BV700 (Fibre), 1.850mm, 2 Notches AC5180 (MLS), 1.860mm BW980 (Fibre), 1.930mm, 3 Notches AC5160 (MLS), 1.960mm	DV680 ▲ [3]	EV684 [3] GV680 ▲
1.9	230 A4.000	Diesel				186			
Ducato Ducato 1.9 TD	08/94→04/02 08/94→04/02	1929	4	82.60	SOHC/OHC	59/80	BR680 (Graphite), 1.650mm AC5140 (MLS), 1.660mm BV680 (Fibre), 1.670mm, 0 Notches BV690 (Fibre), 1.750mm, 1 Notch AC5150 (MLS), 1.760mm BV700 (Fibre), 1.850mm, 2 Notches AC5180 (MLS), 1.860mm BW980 (Fibre), 1.930mm, 3 Notches AC5160 (MLS), 1.960mm	DV680 ▲ [3]	EV684 [3] GV680 ▲
1.9	280 A1.000	Diesel				187			
Ducato 1.9 TD	03/89→03/94	1929	4	82.60	SOHC/OHC	60/82	BR680 (Graphite), 1.650mm BV680 (Fibre), 1.670mm, 0 Notches BV690 (Fibre), 1.750mm, 1 Notch BR690 (Graphite), 1.800mm, 1 Notch BV700 (Fibre), 1.850mm, 2 Notches BW980 (Fibre), 1.930mm, 3 Notches BR700 (Graphite), 1.950mm, 2 Notches	DV680 ▲ [3]	EV684 [3] GV680 ▲
1.9	831 D1.000	Diesel				188			
Regata 1.9 TD 80 Regata Weekend	05/86→07/89 05/86→07/89	1929	4	82.60	SOHC/OHC	59/80	BR680 (Graphite), 1.650mm BV680 (Fibre), 1.670mm, 0 Notches BR690 (Graphite), 1.800mm, 1 Notch BR700 (Graphite), 1.950mm, 2 Notches	DT290 ▲ [3]	GV680 ▲
1.9	937 A4.000	Diesel				189			
Stilo 1.9 JTD Stilo Multi W	09/03→11/06 09/03→08/08	1910	4	82.00	DOHC	93/126	AD5840 (MLS), 0.820mm, 0 Holes AD5850 (MLS), 0.920mm, 1 Hole AD5860 (MLS), 1.020mm, 2 Holes	CD5840 ▲	EE5181 [3]



HBS227 [5] M12x1.25x218.00mm (x10)	JA5035 [1] JD580 [1] (Felt) JD468 [1] (MLS)	JM5028 (Elastomer) →Eng.4081110 JM5204 (Elastomer) Eng.4081111 →	HR397	HR363 [1]	NA5053 [2] 30.00x42.00x7.00mm, FPM NA5070 [2] 31.00x41.00x7.00mm, FPM NF888 [1] 93.00x172.00x12.00mm, FPM	
HBS095 [5] M12x1.25x133.00mm (x10)	JC738	JN459 [4]	JJ298 (Cork) (Elastomer) JJ398	HR363 [1]	NA5187 [2] 30.00x52.00x7.00mm, ACM NB742 [2] 30.00x43.00x8.00mm, ACM NA5062 [1] 74.00x90.00x10.00mm, ACM	LV583 [41] LV589 [6] LT498 [17]
HBS095 [5] M12x1.25x133.00mm (x10)	JC738	JN459 [4]	JJ298 (Cork) (Elastomer) JJ398	HR363 [1]	NA5187 [2] 30.00x52.00x7.00mm, ACM NB742 [2] 30.00x43.00x8.00mm, ACM NA5062 [1] 74.00x90.00x10.00mm, ACM NB644 [1] 74.00x90.00x10.00mm, NBR	LV583 [41] LV589 [6] LT498 [17]
HBS095 [5] M12x1.25x133.00mm (x10)	JC738	JN459 [4]	JJ298 (Cork) (Elastomer) JJ398	HR363 [1]	NA5187 [2] 30.00x52.00x7.00mm, ACM NB742 [2] 30.00x43.00x8.00mm, ACM NA5062 [1] 74.00x90.00x10.00mm, ACM NB644 [1] 74.00x90.00x10.00mm, NBR	LV583 [41] LV589 [6] LT498 [17]
HBS095 [5] M12x1.25x133.00mm (x10)	JC738	JN459 [4]	JJ298 (Cork) (Elastomer) JJ398	HR596 [1]	NA5187 [2] 30.00x52.00x7.00mm, ACM NB742 [2] 30.00x43.00x8.00mm, ACM NA5062 [1] 74.00x90.00x10.00mm, ACM NB644 [1] 74.00x90.00x10.00mm, NBR	LV583 [41] LT498 [17]
HBS095 [5] M12x1.25x133.00mm (x10)	JC738	JN568 [4]	JJ298 (Cork) (Elastomer) JJ398	HR596 [1]	NA5187 [2] 30.00x52.00x7.00mm, ACM NB742 [2] 30.00x43.00x8.00mm, ACM NA5062 [1] 74.00x90.00x10.00mm, ACM	LT023 [15] LV583 [41] KT639 [6] LT498 [17]
HBS370 [5] M12x1.25x225.00mm (x10)	JD5376 [1]	JM7055 (SE)	HR397	HR5095 [1]	NA5053 [2] 30.00x42.00x7.00mm, FPM NA5070 [2] 31.00x41.00x7.00mm, FPM NF888 [1] 93.00x172.00x12.00mm, FPM	

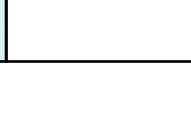
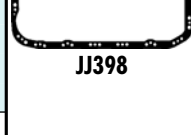
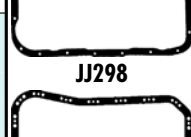
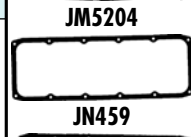
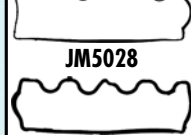
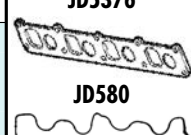
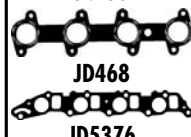
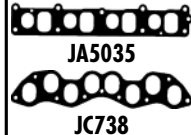
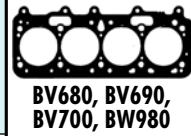
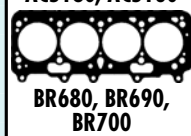
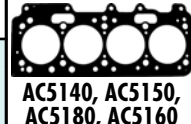
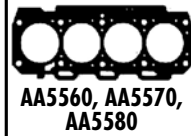



cc



kW/PS



1.9	937 A5.000	Diesel	190					AD5840 (MLS), 0.820mm, 0 Holes	CD5840 ▲	EE5181 [3]
Bravo II 1.9 D	04/07→	1910	4	82.00	DOHC	110/150	AD5850 (MLS), 0.920mm, 1 Hole			
Stilo 1.9 D Mtj	09/05→11/06						AD5860 (MLS), 1.020mm, 2 Holes			
Stilo Multi W	09/05→08/08									
1.9	937 A7.000	Diesel	191					AA5560 (MLS), 0.820mm, 0 Holes	CA5560 ▲ [3]	EG7390
Stilo 1.9 JTD	10/01→11/06	1910	4	82.00	SOHC/OHC	85/115	→09/03	→Eng.4081110	FA5560 ▲ [3]	
Stilo Multi W	01/03→08/08						AA5570 (MLS), 0.920mm, 1 Hole	CG7390 ▲		
							→09/03	CA5561 ▲		
							AA5580 (MLS), 1.020mm, 2 Holes	Eng.4081111→		
							→09/03			
							AG7440 (MLS)			
							10/03→			
							AG7390 (MLS), 0.820mm			
							10/03→			
							AG7400 (MLS), 0.920mm, 1 Hole			
							10/03→			
1.9	939 A1.000	Diesel	192					AG7440 (MLS)	CG7390 ▲	EG7390
Croma 1.9 D Mtj	06/05→	1910	4	82.00	SOHC/OHC	88/120	AG7390 (MLS), 0.820mm			
Punto 1.9 D Mtj	10/05→						AG7400 (MLS), 0.920mm, 1 Hole			
1.9	939 A2.000	Diesel	193					AD5840 (MLS), 0.820mm, 0 Holes		EG7450
Croma 1.9 D Mtj	06/05→	1910	4	82.00	DOHC	110/150	AD5850 (MLS), 0.920mm, 1 Hole			
							AD5860 (MLS), 1.020mm, 2 Holes			
1.9	939 A7.000	Diesel	194					AG7440 (MLS)	CG7390 ▲	EG7390
Croma 1.9 D Mtj	06/05→	1910	4	82.00	SOHC/OHC	85/115	AG7390 (MLS), 0.820mm			
Punto 1.9 D Mtj	06/06→						AG7400 (MLS), 0.920mm, 1 Hole			
1.9	939 A8.000	Diesel	195					AD5840 (MLS), 0.820mm, 0 Holes		EG7450
Croma 1.9 D Mtj	12/05→	1910	4	82.00	DOHC	100/136	AD5850 (MLS), 0.920mm, 1 Hole			
							AD5860 (MLS), 1.020mm, 2 Holes			
1.9	D19AA	Diesel	196					AG7440 (MLS)	CG7390 ▲	EG7390
Sedici 1.9D Mtj	06/06→	1910	4	82.00	SOHC/OHC	88/120	AG7390 (MLS), 0.820mm			
							AG7400 (MLS), 0.920mm, 1 Hole			
1.9	D8B	Diesel	197					BX930 (SE), 1.360mm, 1 Notch	DJ720 ▲	EL890 [3]
Scudo 1.9 TD	02/96→12/06	1905	4	83.00	SOHC/OHC	68/92	BX940 (SE), 1.400mm, 2 Notches		GJ720 ▲	
							BX950 (SE), 1.440mm, 3 Notches			
							BX960 (SE), 1.480mm, 4 Notches			
							BX970 (SE), 1.520mm, 5 Notches			
							BX980 (SE), 1.590mm			
							☞0.830mm→			

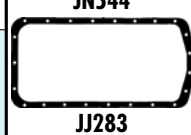
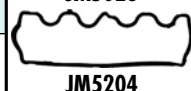
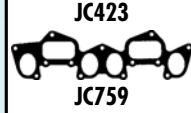
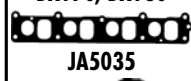
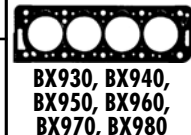
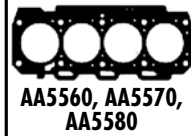
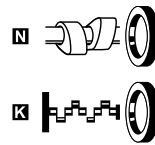
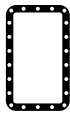
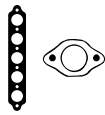

FIAT



cc



kW/PS



1.9 D9B Diesel						198	BX880 (Fibre), 1.360mm, 1 Notch ☞0.560→0.670mm BX890 (Fibre), 1.400mm, 2 Notches ☞0.680→0.710mm BX900 (Fibre), 1.440mm, 3 Notches ☞0.720→0.750mm BX910 (Fibre), 1.480mm, 4 Notches ☞0.760→0.790mm BX920 (Fibre), 1.520mm, 5 Notches ☞0.800→0.830mm	DJ720 ▲	EL890 [3] GJ720 ▲
Ducato 1.9 D	04/98→04/02	1905	4	83.00	SOHC/OHC	50-51/ 68-69			
Scudo 1.9 D	02/96→12/06								
1.9 D9B (XUD9A) Diesel						199	BX880 (Fibre), 1.360mm, 1 Notch ☞0.560→0.670mm BX890 (Fibre), 1.400mm, 2 Notches ☞0.680→0.710mm BX900 (Fibre), 1.440mm, 3 Notches ☞0.720→0.750mm BX910 (Fibre), 1.480mm, 4 Notches ☞0.760→0.790mm BX920 (Fibre), 1.520mm, 5 Notches ☞0.800→0.830mm	DJ720 ▲	EL890 [3] GJ720 ▲
Ducato 1.9 D	04/98→04/02	1905	4	83.00	SOHC/OHC	47-52/ 64-71			
1.9 DJY Diesel						200	BX880 (Fibre), 1.360mm, 1 Notch ☞0.560→0.670mm BX890 (Fibre), 1.400mm, 2 Notches ☞0.680→0.710mm BX900 (Fibre), 1.440mm, 3 Notches ☞0.720→0.750mm BX910 (Fibre), 1.480mm, 4 Notches ☞0.760→0.790mm BX920 (Fibre), 1.520mm, 5 Notches ☞0.800→0.830mm	DJ720 ▲	EL890 [3] GJ720 ▲
Ducato 1.9 D	04/98→04/02	1905	4	83.00	SOHC/OHC	50/68			
1.9 WJZ (DW8) Diesel						201	AA5830 (SE), 1.260mm, 1 Hole ☞0.510→0.540mm AA5840 (SE), 1.300mm, 2 Holes ☞0.550→0.580mm AA5850 (SE), 1.340mm, 3 Holes ☞0.590→0.620mm AA5860 (SE), 1.380mm, 4 Holes ☞0.630→0.660mm AA5870 (SE), 1.420mm, 5 Holes ☞0.670→0.700mm AA5880 (SE), 1.460mm, 6 Holes ☞0.710→0.750mm	CA5830 ▲ [3]	EA5830
Scudo 1.9 D	04/98→12/06	1868	4	82.20	SOHC/OHC	51-52/ 69-71			
2.0 154 A1.000						202	BT510 (Fibre) BT520 (Fibre)	DP688 [3]	
Croma 2000 CHT	12/85→02/89	1995	4	84.00	DOHC	66/90			
2.0 154 A2.000						203	BT420 (Fibre)	DT420	
Croma 2000 †	12/85→06/90	1995	4	84.00	DOHC	114/155		→Eng.1239615	
2.0 154 C3.046						204	BT420 (Fibre)	DT420	GT440 [3]
Croma 2000 i.e.	10/87→08/96	1995	4	84.00	DOHC	85/116		→Eng.1033481	



AA5830, AA5840,
AA5850, AA5860,
AA5870, AA5880



BT420



BT510



BT520



BX880, BX890,
BX900, BX910,
BX920



JA757



JC423



JC662



JN544



JN643

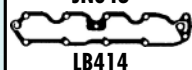

LB414



JJ283



JJ298



JJ413

HBS084 [22]
M12x1.50x120.00mm (x10)

JD5972 [1]
JC423 [2]

JN544 [4]

JJ283 [62]

HR569 [2]

☒ NF841 [1][2]
35.00x50.00x8.00mm, FPM
☒ NA5191 [2]
42.00x62.00x7.00mm, PTFE
☒ NA5192 [1]
90.00x110.00x7.00mm, PTFE

KA611 [15]

HBS084 [22]
M12x1.50x120.00mm (x10)

JD5972 [1]
JC423 [2]

JN544 [4]

JJ283 [62]

HR569 [2]

☒ NF841 [1][2]
35.00x50.00x8.00mm, FPM
☒ NA5191 [2]
42.00x62.00x7.00mm, PTFE
☒ NA5192 [1]
90.00x110.00x7.00mm, PTFE

KA611 [15]

HBS084 [22]
M12x1.50x120.00mm (x10)

JD5972 [1]
JC423 [2]

JN544 [4]

JJ283 [62]

HR569 [2]

☒ NF841 [1][2]
35.00x50.00x8.00mm, FPM
☒ NA5191 [2]
42.00x62.00x7.00mm, PTFE
☒ NA5192 [1]
90.00x110.00x7.00mm, PTFE

KA611 [15]

HBS084 [22]
M12x1.50x120.00mm (x10)
→Eng.08469
HBS245 [22]
M12x1.50x125.00mm (x10)
Eng.08470→

JD6023 [1] (x2)
0.8mm
HA5008 [1] [2]
JD5192 [2] (x2)

JM5088 [2]
(Elastomer)
JM5089 [2]
(Elastomer)

⇒KG5157
10.00x20.00x2.000mm
⇒PB907
14.00x21.00x2.000mm

HR569 [2]

☒ NF841 [1][2]
35.00x50.00x8.00mm, FPM
☒ NA5191 [2]
42.00x62.00x7.00mm, PTFE
☒ NA5192 [1]
90.00x110.00x7.00mm, PTFE

KA611 [15]

HBS092 [5]
M10x1.25x115.00mm (x10)

JA757 [2]

JN643 [4]
LB414 [2]

JJ298
JJ413

HR596 [2]

☒ NA5187 (x2)[2]
30.00x52.00x7.00mm, ACM
☒ NB742 [2]
30.00x43.00x8.00mm, ACM
☒ NB732 [1]
74.00x90.00x10.00mm, FPM

KA611 [15]

HBS092 [5]
M10x1.25x115.00mm (x10)

JC662 [1]
JA757 [2]

JN643 (x2)[4]

JJ298
→Eng.1239615
JJ413

HR569 [2]

KT639 [6]

HBS092 [5]
M10x1.25x115.00mm (x10)

JC662 [1]
JA757 [2]

JN643 (x2)[4]

JJ413

HR569 [2]

☒ NA5187 (x2)[2]
30.00x52.00x7.00mm, ACM
☒ NB742 [2]
30.00x43.00x8.00mm, ACM
☒ NA5062 [1]
74.00x90.00x10.00mm, ACM

KA611 [15]

FIAT



cc



kW/PS



2.0	154 C4.046	205					BT420 (Fibre)	DT420	
Croma 2000 †	06/87→08/96	1995	4	84.00	DOHC	110/150	BT510 (Fibre)	→Eng.1033481 DT413 [3] Eng.1033482→	
2.0	154 E1.000	206					BT440 (Fibre)	DT441	
Croma 2000 16V	08/92→08/96	1995	4	84.00	DOHC	101/137			
2.0	159 A5.046	207					BT440 (Fibre)	DT440 [3] DT446	
Tipo 2.0 i.e.	06/90→03/92	1995	4	84.00		80-85/ 109-116			
2.0	159 A6.046	208					BT440 (Fibre)	DT446 DT449 [3]	
Tempra 2.0 i.e.	10/90→08/96	1995	4	84.00		83-85/ 113-116			
Tipo 2.0 i.e.	03/90→04/95								
2.0	160 A8.046	209					BT410 (Fibre)	DT411 [16]	
Tipo 2.0 16V	07/91→04/95	1995	4	84.00	DOHC	107/146			
2.0	170 B	210					BM530 (Fibre), 1.400mm	DM533 ▲ [3]	
Ducato 2.0	07/85→08/90	1971	4	88.00	OHV	55/75			
Talento 2.0	03/89→03/94								
2.0	170 D	211					BM530 (Fibre), 1.400mm	DM533 ▲ [3]	
Ducato 2.0	08/88→03/94	1971	4	88.00		62/84			
Ducato 2.0 4x4	06/90→05/94								
2.0	175 A1.000	212					BT440 (Fibre)	DT447	GT447 [3]
Coupe 2.0 16VT	11/93→08/96	1995	4	84.00	DOHC	140/190			
2.0	175 A3.000	213					AY320 (MLS), 1.800mm	CY320	FY320
Coupe 2.0 20VT	08/96→08/00	1998	5	82.00	DOHC	162/220			
2.0	182 A1.000	214					BW321 (Fibre)	DW320	GW321 [3]
Bravo I 20V	10/95→07/98	1998	5	82.00	DOHC	108/147			
Coupe 2.0 20V	08/96→04/98								
Marea 2.0 150	09/96→04/99								



HBS092 [5] M10x1.25x115.00mm (x10)	JC662 [1] JA757 [1]	JN643 (x2)[4] LB414 [1]	JJ413	HR569 [1]	NA5187 (x2)[2] 30.00x52.00x7.00mm, ACM NB742 [2] 30.00x43.00x8.00mm, ACM NA5062 [1] 74.00x90.00x10.00mm, ACM	
HBS093 [5] M10x1.25x172.00mm (x10)	JD153 [1] JD151	JN928 [4]	JJ413	HR599 [1]	NA5053 [2] 30.00x42.00x7.00mm, FPM NB742 [2] 30.00x43.00x8.00mm, ACM NA5187 (x2)[2] 30.00x52.00x7.00mm, ACM	
HBS093 [5] M10x1.25x172.00mm (x10)				HR569 [1]	NA5187 (x2)[2] 30.00x52.00x7.00mm, ACM	
HBS093 [5] M10x1.25x172.00mm (x10)	JC662 [1] JD019 [1]		JJ298 (Cork)	HR363 [1]	NA5187 [2] 30.00x52.00x7.00mm, ACM NB742 [2] 30.00x43.00x8.00mm, ACM NB825 [2] 30.00x43.00x8.00mm, FPM	OK627 [45] HJ283 [8][1]
HBS093 [5] M10x1.25x172.00mm (x10)	JD153 [1] JD151	JN928 [4]	JJ413	HR599 [1]	NA5053 [2] 30.00x42.00x7.00mm, FPM	
HBS038 [22] M11x1.50x175.00mm (x10)	JB851	JN244 [4]			NA5191 [2] 42.00x62.00x7.00mm, PTFE	
HBS038 [22] M11x1.50x175.00mm (x10)	JB841 [1]	JN244 [4]			NA5191 [2] 42.00x62.00x7.00mm, PTFE	
HBS093 [5] M10x1.25x172.00mm (x10)	JD151 JD152 [1]	JN928 [4]	JJ413	HR599 [1]	NA5053 [2] 30.00x42.00x7.00mm, FPM NB825 [2] 30.00x43.00x8.00mm, FPM NB732 [1] 74.00x90.00x10.00mm, FPM	
HBS133 [5] M10x1.25x254.00mm (x12)	JD225 [1] JD226 [1]	JN933 [4]	HR354	HR800 [1]	NA5053 [2] 30.00x42.00x7.00mm, FPM NA5069 [2] 55.00x68.00x8.00mm, FPM NA5070 [2] 31.00x41.00x7.00mm, FPM NF888 [1] 93.00x172.00x12.00mm, FPM	KA845 [15]
HBS133 [5] M10x1.25x254.00mm (x12)	JD225 [1] JD226 [1]	JN933 [4]	HR354	HR800 [1]	NA5053 [2] 30.00x42.00x7.00mm, FPM NA5069 [2] 55.00x68.00x8.00mm, FPM NA5070 [2] 31.00x41.00x7.00mm, FPM NF888 [1] 93.00x172.00x12.00mm, FPM	KA845 [15]

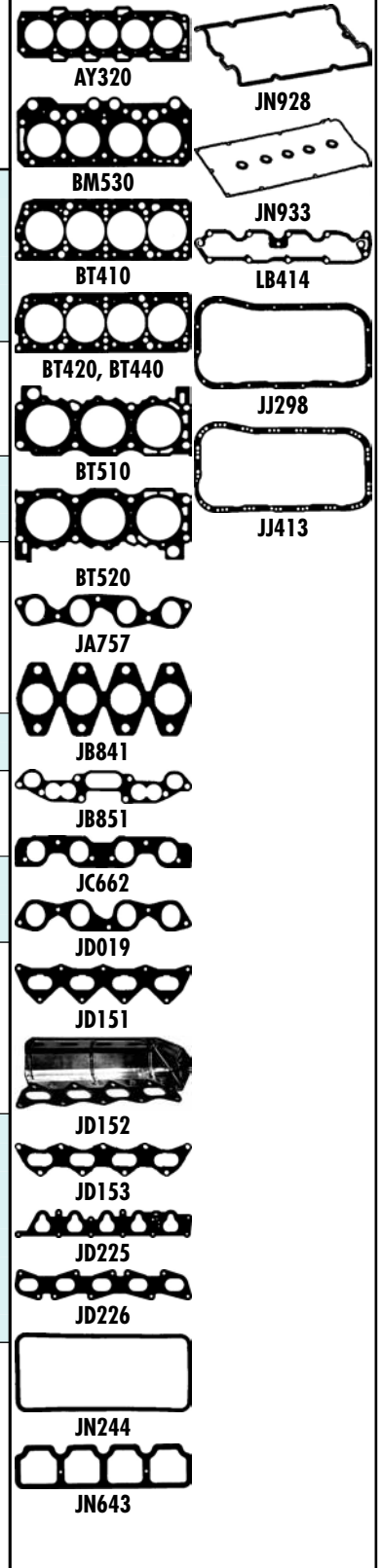

FIAT



cc



kW/PS

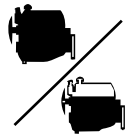

2.0	182 B3.000						215	BW321 (Fibre)	DW322 [3]	ED5960
Coupe 2.0 20V	04/98→08/00	1998	5	82.00	DOHC	113/154	05/98→	05/98→	05/98→	
2.0	182 B7.000						216	BW321 (Fibre)	DW322 [3]	EW320 [3]
Brava 2.0	09/98→08/00	1998	5	82.00		113/154				
Bravo I 20V	07/98→10/01									
Marea 2.0 155	04/99→02/03									
2.0	185 A8.000						217	AA5590 (MLS), 0.490mm	CA5590 [3]	ED5960
Marea 2.0 150	01/01→05/02	1998	5	82.00	DOHC	110/150				
2.0	834 B.000						218	BT410 (Fibre) BT420 (Fibre)	DT410 DT413 [3]	GT410
Croma 2000 i.e.	03/87→09/92	1995	4	84.00		88/120				
2.0	834 B.048						219	BT420 (Fibre) BT410 (Fibre) Eng.1033482→	DT420 →Eng.1033481 DT413 [3] Eng.1033492→	
Croma 2000 i.e.	03/86→09/90	1995	4	84.00		83/113				
2.0	834 B.146						220	BT420 (Fibre)	DT420 →Eng.1033481	GT440 [3]
Croma 2000 i.e.	10/87→08/96	1995	4	84.00		85/116				
2.0	834 C.146						221	BT420 (Fibre)	DT420 →Eng.1033481 DT413 [3] Eng.1033482→	
Croma 2000 t	11/86→08/96	1995	4	84.00	DOHC	110-112/ 150-152				
2.0	836 A3.000						222	BT440 (Fibre)	DT443 DT448	
Coupe 2.0i 16V	11/93→08/96	1995	4	84.00	DOHC	102/139				
Tipo 2.0 Sport	03/93→04/95									
2.0	6132 AZ 2.000						223	BP190 (Fibre)	DP190	
Campagnola 2.0	06/74→10/89	1995	4		OHV	59/80				

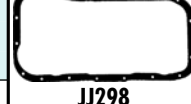
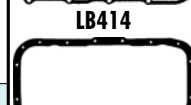
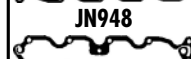
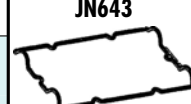
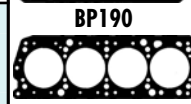
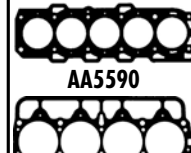

HBS133 [5]
M10x1.25x254.00mm (x12)
05/98→

JD225 [1]
05/98→
JD226 [1]
05/98→

JM5018
(Elastomer)
05/98→

HR354
05/98→

HR800 [1]
05/98→

NA5053 [2]
30.00x42.00x7.00mm, FPM
05/98→
NA5069 [2]
55.00x68.00x8.00mm, FPM
05/98→
NA5070 [2]
31.00x41.00x7.00mm, FPM
05/98→
NF888 [1]
93.00x172.00x12.00mm, FPM
05/98→

HBS133 [5]
M10x1.25x254.00mm (x12)

JD225 [1]
JD226 [1]

JM5018
(Elastomer)

HR354

HR800 [1]

NA5053 [2]
30.00x42.00x7.00mm, FPM
NA5069 [2]
55.00x68.00x8.00mm, FPM
NA5070 [2]
31.00x41.00x7.00mm, FPM
NF888 [1]
93.00x172.00x12.00mm, FPM

HBS133 [5]
M10x1.25x254.00mm (x12)

JD225 [1]
JD226 [1]

JM5018
(Elastomer)

HR354

HR800 [1]

NA5053 [2]
30.00x42.00x7.00mm, FPM
NA5069 [2]
55.00x68.00x8.00mm, FPM
NA5070 [2]
31.00x41.00x7.00mm, FPM
NF888 [1]
93.00x172.00x12.00mm, FPM

HBS092 [5]
M10x1.25x115.00mm (x10)

JC662 [1]
JA757 [1]

JN643 (x2)[4]
LB414 [1]

JJ298
JJ413

HR363 [1]

NB742 [2]
30.00x43.00x8.00mm, ACM
NA5062 [1]
74.00x90.00x10.00mm, ACM
NB732 [1]
74.00x90.00x10.00mm, FPM

HBS092 [5]
M10x1.25x115.00mm (x10)

JC662 [1]
JA757 [1]

JN643 (x2)[4]
JN948 [4]
LB414 [1]

JJ413

HR363 [1]

NA5187 (x2)[2]
30.00x52.00x7.00mm, ACM
NA5062 [1]
74.00x90.00x10.00mm, ACM
NB732 [1]
74.00x90.00x10.00mm, FPM

HBS092 [5]
M10x1.25x115.00mm (x10)

JC662 [1]
JA757 [1]

JN643 (x2)[4]
JN948 [4]
LB414 [1]

JJ413

HR363 [1]

NA5187 (x2)[2]
30.00x52.00x7.00mm, ACM
NA5062 [1]
74.00x90.00x10.00mm, ACM
NB732 [1]
74.00x90.00x10.00mm, FPM

HBS093 [5]
M10x1.25x172.00mm (x10)

JD153 [1]
JD5997 [1]

JN928 [4]

JJ413

HR800 [1]

NA5053 [2]
30.00x42.00x7.00mm, FPM
NB742 [2]
30.00x43.00x8.00mm, ACM
NB732 [1]
74.00x90.00x10.00mm, FPM

KT639 [6]

KT639 [6]

KT639 [6]

KT639 [6]

KT639 [6]

KT639 [6]



cc



kW/PS



2.0		RFH (EW10A)				224	AH6630 (MLS)			
Scudo 2.0	03/07→	1997	4	85.00	DOHC	103/140				
Scudo 2.0 4x4	03/07→									
2.0		RFL				225	BY320 (Fibre), 1.450mm		CY081 ▲ [3] DS820 ▲ [3]	ES820 [3]
Ducato	11/02→	1998	4	86.00	SOHC/OHC	81/110				
Ducato 2.0	04/02→07/06									
Ducato 2.0 4x4	05/02→07/06									
2.0		RFN (EW10J4)				226	AD5300 (MLS)		CD5300	EG9750
Scudo 2.0	05/00→12/06	1997	4	85.00	DOHC	100/136				
Scudo 2.0 16V	06/00→12/06									
Ulysse 2.0	08/02→06/11									
Ulysse 2.0 16V	09/00→08/02									
2.0		RFU (XU10J2C)				227	BV140 (Fibre), 1.250mm BY320 (Fibre), 1.450mm		CY082 ▲ [3]	ES820 [3]
Ulysse 2.0	06/94→08/02	1998	4	86.00	SOHC/OHC	89/121				
2.0		RFV				228	AY070 (Fibre) 07/98→ BV140 (Fibre), 1.250mm 07/98→			
Ulysse 2.0 16V	05/98→09/00	1998	4	86.00	DOHC	97-100/ 132-136				
2.0		RFW				229	BV140 (Fibre), 1.250mm BY320 (Fibre), 1.450mm		CY081 ▲ [3]	ES820 [3]
Ducato	03/94→04/02	1998	4	86.00	SOHC/OHC	80/109				
Ducato 2.0	03/94→04/02									
Ducato 2.0 4x4	11/94→11/01									
Ducato 2.0 4x4	11/94→04/02									
2.0		RGX (XU10J2CTE)				230	BT440 (Fibre) BY310 (Fibre), 1.250mm BY320 (Fibre), 1.450mm		DY310 ▲ [3]	ES820 [3]
Ulysse 2.0 Turbo	06/94→08/02	1998	4	86.00	SOHC/OHC	108/147				
2.0		RHK Diesel				231	AD5490 (MLS), 1.250mm, 2 Notches AD5500 (MLS), 1.300mm, 3 Holes AD5510 (MLS), 1.350mm, 4 Holes AD5520 (MLS), 1.400mm, 5 Holes		CD5500 ▲	ED5500
Scudo 2.0 D Mtj	01/07→	1997	4	85.00	DOHC	88/120				
Ulysse 2.0D Mtj	05/06→06/11									
2.0		RHM (DW10ATED4) Diesel				232	AD5490 (MLS), 1.250mm, 2 Notches AD5520 (MLS), 1.400mm, 5 Holes		CC5010 ▲ [3] CD5490 ▲	ED5500
Ulysse 2.0 JTD	05/03→08/06	1997	4	85.00	DOHC	79/107				
2.0		RHR Diesel				233	AD5490 (MLS), 1.250mm, 2 Notches AD5500 (MLS), 1.300mm, 3 Holes AD5510 (MLS), 1.350mm, 4 Holes AD5520 (MLS), 1.400mm, 5 Holes		CD5500 ▲	ED5500
Scudo 2.0 D Mtj	01/07→	1997	4	85.00	DOHC	100/136				
Ulysse 2.0D Mtj	05/06→06/11									



AD5490, AD5500,
AD5510, AD5520



AY070



BT440



BY320, BV140,
BY310



JD151



JD153



JD536

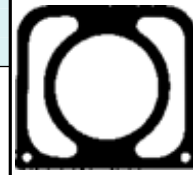

JD539



JN547



JJ283



cc



kW/PS



2.0	RHV (DW10)	Diesel				234			
Ducato 2.0 JTD	07/01→07/06	1997	4	85.00	DOHC	62/84	AC5011 (MLS), 1.300mm, 1 Hole ☞0.470→0.605mm AC5020 (MLS), 1.350mm, 2 Holes ☞0.605→0.655mm AC5031 (MLS), 1.400mm, 3 Holes ☞0.655→0.705mm AC5040 (MLS), 1.450mm, 4 Holes ☞0.705→0.755mm AC5051 (MLS), 1.500mm, 5 Holes ☞0.755→0.830mm	CC5010 ▲ [3]	EA5830
2.0	RHW (DW10ATED4)	Diesel				235			
Scudo 2.0 JTD	05/99→12/06	1997	4	85.00	DOHC	80/109	AD5490 (MLS), 1.250mm, 2 Notches AD5500 (MLS), 1.300mm, 3 Holes AD5510 (MLS), 1.350mm, 4 Holes AD5520 (MLS), 1.400mm, 5 Holes	CD5490 ▲	ED5500
Ulysse 2.0 16V	05/99→08/02								
Ulysse 2.0 JTD	08/02→08/06								
2.0	RHX Diesel					236			
Scudo 2.0 JTD	12/99→12/06	1997	4	85.00	SOHC/OHC	69/94	AC5011 (MLS), 1.300mm, 1 Hole ☞0.470→0.605mm AC5020 (MLS), 1.350mm, 2 Holes ☞0.605→0.655mm AC5031 (MLS), 1.400mm, 3 Holes ☞0.655→0.705mm AC5040 (MLS), 1.450mm, 4 Holes ☞0.705→0.755mm AC5051 (MLS), 1.500mm, 5 Holes ☞0.755→0.830mm	CC5010 ▲ [3]	EA5830
2.0	RHZ Diesel					237			
Scudo 2.0 JTD	12/99→12/06	1997	4	85.00	SOHC/OHC	80/109	AC5011 (MLS), 1.300mm, 1 Hole ☞0.470→0.605mm AC5020 (MLS), 1.350mm, 2 Holes ☞0.605→0.655mm AC5031 (MLS), 1.400mm, 3 Holes ☞0.655→0.705mm AC5040 (MLS), 1.450mm, 4 Holes ☞0.705→0.755mm AC5051 (MLS), 1.500mm, 5 Holes ☞0.755→0.830mm	CC5010 ▲ [3]	EA5830
Ulysse 2.0 JTD	10/99→08/02								
2.0	XN 1T					238			
Ducato 2.0	01/82→08/90	1971	4	88.00	OHV	58-60/ 79-82	BM530 (Fibre), 1.400mm	DM533 ▲ [3] DM530 [13] 01/84→	EM531 [3] GM533 ○ [13]
2.1	P8C Diesel					239			
Ulysse 2.1 TD	03/96→10/99	2088	4	85.00	SOHC/OHC	80/109	BY941 (MLS), 1.520mm ☞0.650→0.760mm BY950 (MLS), 1.570mm ☞0.770→0.810mm BY961 (MLS), 1.620mm ☞0.820→0.860mm BY970 (MLS), 1.670mm BY981 (MLS), 1.720mm ☞0.920→0.960mm	DV150 ▲ [3]	EV150 [3]
2.2	4HV Diesel					240			
Ducato	07/06→	2198	4	86.00	DOHC	74/101	AH6390 (MLS), 1.100mm, 1 Notch AH6400 (MLS), 1.150mm, 2 Notches AH6410 (MLS), 1.200mm, 3 Notches	CH6390 ▲	
2.2	4HW (DW12ATED4) Diesel					241			
Ulysse 2.2 JTD	08/02→08/06	2179	4	85.00	DOHC	94/128	AD5490 (MLS), 1.250mm, 2 Notches AD5500 (MLS), 1.300mm, 3 Holes AD5510 (MLS), 1.350mm, 4 Holes AD5520 (MLS), 1.400mm, 5 Holes	CD5490 ▲	ED5490

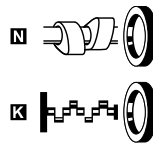
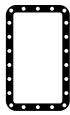
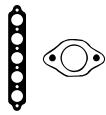

AC5020, AC5040



AD5490, AD5500,
AD5510, AD5520



BM530



BY950, BY970



JB841



JD230



JD5291



JE647

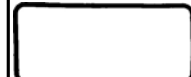

JN244



JP045



JJ283

FIAT



cc



kW/PS



2.2	194 A1.000					242	AG9580 (MLS)		
Croma 2.2 16V	06/05→	2198	4	86.00	DOHC	108/147			
2.3	F1AE0481C	Diesel				243	AB5720 (MLS), 1.100mm AB5730 (MLS), 1.200mm AB5740 (MLS), 1.300mm	CB5720 ▲ [13] 08/04→	FB5721 ▲ [13] →08/04 FB5722 ▲ 08/04→
Ducato 2.3 JTD	04/02→07/06	2286	4	88.00	DOHC	81/110			
2.3	F1AE0481D	Diesel				244	AB5720 (MLS), 1.100mm AB5730 (MLS), 1.200mm AB5740 (MLS), 1.300mm	CB5720 ▲ [13]	FB5722 ▲
Ducato	07/06→	2287	4	88.00	DOHC	88/120			
2.3	F1AE0481N	Diesel				245	AB5720 (MLS), 1.100mm AB5730 (MLS), 1.200mm AB5740 (MLS), 1.300mm	CB5720 ▲ [13]	FB5722 ▲
Ducato	01/07→	2287	4	88.00	DOHC	96/131			
2.3	F1AE3481D	Diesel				246	AB5720 (MLS), 1.100mm AB5730 (MLS), 1.200mm AB5740 (MLS), 1.300mm	CB5720 ▲ [13]	FB5722 ▲
Ducato	01/07→	2287	4	88.00	DOHC	96/131			
2.3	F1AE3481E	Diesel				247	AB5720 (MLS), 1.100mm AB5730 (MLS), 1.200mm AB5740 (MLS), 1.300mm	CB5720 ▲ [13]	FB5722 ▲
Ducato	06/11→	2287	4	88.00	DOHC	109/148			
2.3	F1AE3481G	Diesel				248	AB5720 (MLS), 1.100mm AB5730 (MLS), 1.200mm AB5740 (MLS), 1.300mm	CB5720 ▲ [13]	FB5722 ▲
Ducato	10/11→	2287	4	88.00	DOHC	83/113			
2.4	185 A2.000	Diesel				249	AA5720 (MLS), 1.600mm BW340 (Fibre), 1.600mm AA5730 (MLS), 1.700mm, 1 Notch BW350 (Fibre), 1.700mm, 1 Notch AA5740 (MLS), 1.800mm, 2 Notches BW360 (Fibre), 1.800mm, 2 Notches	DW340 ▲ [3]	GW341 ▲ [3]
Marea 2.4 TD 125	09/96→04/99	2387	5	82.00	SOHC/OHC	91/125			
2.4	185 A6.000	Diesel				250	AY550 (MLS), 1.600mm AY560 (MLS), 1.700mm, 1 Hole AY570 (MLS), 1.800mm, 2 Holes	CY520 ▲ [3]	FY520 ▲ [3]
Marea 2.4 130	04/99→05/02	2387	5	82.00	SOHC/OHC	96/130			
2.4	192 A2.000					251	AA5590 (MLS), 0.490mm	CA5590 [3]	ED5960
Stilo 2.4 20V	10/01→11/06	2446	5	83.00	DOHC	117-125/ 159-170			
2.4	839 A5.000	Diesel				252	AY550 (MLS), 1.600mm AY560 (MLS), 1.700mm, 1 Hole AY570 (MLS), 1.800mm, 2 Holes	CY520 ▲ [3]	FY520 ▲ [3]
Marea 2.4 130	04/99→05/02	2387	5	82.00		96-99/ 131-135			
2.4	939 A3.000	Diesel				253	AG7410 (MLS), 0.820mm, 0 Holes AG7420 (MLS), 0.920mm, 1 Hole AG7430 (MLS), 1.020mm, 2 Holes	CG7410	EG7410
Croma 2.4 D Mtj	06/05→	2387	5	82.00	DOHC	147/200			



AA5590



AA5720, AA5730,
AA5740



AB5720, AB5730,
AB5740



AY550, AY560,
AY570



BW340, BW350,
BW360

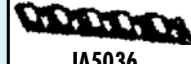

JA5036



JD225



JD226



JD228

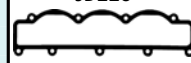

JD5338

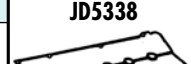

JM5018

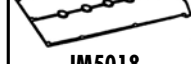

JM5201

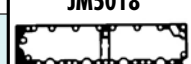

JM5202



JN934

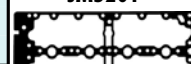

JP064

HBS416 [22]
M11x1.50x163.00mm (x10)
KG5337 [1]
(MVQ)
JD5868 [3]

JM7102
(Elastomer)

NA5108 [2]
42.00x55.00x7.00mm, FPM/ACM
NB806 [1]
90.00x104.00x11.00mm, FPM

HBS251 [22]
M11x1.50x133.00mm (x4)

JD5338 [1]
JD5337 [3]
JM5201
(SE)
→08/04
JM5202
(Elastomer)
08/04→

JH5077

NA5201 [2]
34.00x60.00x10.00mm, FPM
NA5202 [2]
50.0x80.0x14.0mm, FPM

KD931 [68][69]
KK5598 [68][69]

HBS251 [22]
M11x1.50x133.00mm (x4)

JD5338 [1]
JD5337 [3]
JM5202
(Elastomer)

JH5077

NA5201 [2]
34.00x60.00x10.00mm, FPM
NA5202 [2]
50.0x80.0x14.0mm, FPM

HBS251 [22]
M11x1.50x133.00mm (x4)

JD5338 [1]
JD5337 [3]
JM5202
(Elastomer)

JH5077

NA5201 [2]
34.00x60.00x10.00mm, FPM
NA5202 [2]
50.0x80.0x14.0mm, FPM

HBS251 [22]
M11x1.50x133.00mm (x4)

JD5338 [1]
JD5337 [3]
JM5202
(Elastomer)

JH5077

NA5201 [2]
34.00x60.00x10.00mm, FPM
NA5202 [2]
50.0x80.0x14.0mm, FPM

HBS251 [22]
M11x1.50x133.00mm (x4)

JD5338 [1]
JD5337 [3]
JM5202
(Elastomer)

JH5077

NA5201 [2]
34.00x60.00x10.00mm, FPM
NA5202 [2]
50.0x80.0x14.0mm, FPM

HBS251 [22]
M11x1.50x133.00mm (x4)

JD5338 [1]
JD5337 [3]
JM5202
(Elastomer)

JH5077

NA5201 [2]
34.00x60.00x10.00mm, FPM
NA5202 [2]
50.0x80.0x14.0mm, FPM

HBS257 [5]
M12x1.25x218.00mm (x12)

JD228 [3]
JN934 [4]

HR363 [3]

NA5053 [2]
30.00x42.00x7.00mm, FPM
NA5070 [2]
31.00x41.00x7.00mm, FPM
NF888 [1]
93.00x172.00x12.00mm, FPM

KA845 [15]

HBS257 [5]
M12x1.25x218.00mm (x12)

JA5036 [1]
JD228 [3]
JP064 [4]

HR363 [3]

NA5053 [2]
30.00x42.00x7.00mm, FPM
NA5070 [2]
31.00x41.00x7.00mm, FPM
NF888 [1]
93.00x172.00x12.00mm, FPM

HBS133 [5]
M10x1.25x254.00mm (x12)

JD225 [1]
JD226 [3]
JM5018
(Elastomer)

HR354

HR800 [3]

NA5053 [2]
30.00x42.00x7.00mm, FPM
NA5069 [2]
55.00x68.00x8.00mm, FPM
NA5070 [2]
31.00x41.00x7.00mm, FPM
NF888 [1]
93.00x172.00x12.00mm, FPM

KL477 [10]
KA845 [15]
HJ283 [8][3]

HBS257 [5]
M12x1.25x218.00mm (x12)

JA5036 [1]
JD228 [3]
JP064 [4]

HR363 [3]

NA5053 [2]
30.00x42.00x7.00mm, FPM
NA5070 [2]
31.00x41.00x7.00mm, FPM
NF888 [1]
93.00x172.00x12.00mm, FPM

HBS371 [5]
M12x1.25x225.00mm (x12)

JM7117
(Steel)

NA5070 [2]
31.00x41.00x7.00mm, FPM
NF888 [1]
93.00x172.00x12.00mm, FPM

FIAT













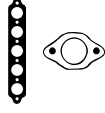

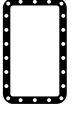

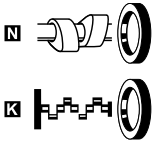







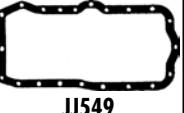

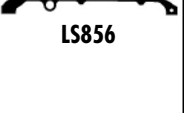













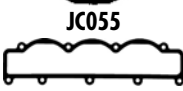









cc



kw/PS



2.4	8140.61 Diesel	254	AB5720 (MLS), 1.100mm AB5730 (MLS), 1.200mm AB5740 (MLS), 1.300mm	CB5720 ▲ [13]	FB5721 ▲ [13]
Ducato 2.5 D	09/86→05/90	2445	4	93.00	53-55/ 72-75
Ducato 2.5 D 4x4	09/86→05/90				
2.4	8144.21 Diesel	255	BR070 (Fibre), 1.200mm	DS381 ▲ [3]	FB5100 ▲ [16]
Ducato	01/86→08/90	2445	4	93.00	SOHC/OHC 68/92
Ducato 2.5 TD	01/86→08/90				
2.4	8144.61 Diesel	256	BE580 (Fibre), 1.350mm	DE588 ▲ [3]	FY291 ▲ [16]
Ducato 2.4 D	01/82→08/90	2428	4	93.00	SOHC/OHC 53-55/ 72-75
Ducato 2.5 D 4x4	09/86→05/90				
2.4	8144.91.2000 Diesel	257	BR090 (Fibre), 1.800mm	DP273 ▲	
Croma 2500 TD	12/85→08/89	2445	4	93.00	74/101
2.5	8140.27 Diesel	258	AB5100 (Fibre), 1.200mm AY580 (Fibre), 1.300mm AY590 (Fibre), 1.400mm AB5110 (Fibre), 1.500mm	DR073 ▲ DS381 ▲ [3] Eng.1050634→	FB5102 ▲ [16]
Ducato	09/86→03/94	2500	4	93.00	SOHC/OHC 70/95
Ducato 2.5 TD	07/90→03/94				
2.5	8140.47 Diesel	259	AB5100 (Fibre), 1.200mm AY580 (Fibre), 1.300mm AY590 (Fibre), 1.400mm AB5110 (Fibre), 1.500mm	DS381 ▲ [3]	FB5101 ▲ [16]
Ducato	03/94→04/02	2500	4	93.00	SOHC/OHC 80-85/ 109-116
Ducato 2.5 TD	06/94→08/98				
Ducato 2.5 TDI	03/94→04/02				
2.5	8140.47R Diesel	260	AB5100 (Fibre), 1.200mm AY580 (Fibre), 1.300mm AY590 (Fibre), 1.400mm AB5110 (Fibre), 1.500mm	DS381 ▲ [3]	FB5100 ▲ [16]
Ducato	07/94→04/02	2500	4	93.00	80/110
Ducato 2.5 TDI	03/94→04/02				
2.5	8140.67 Diesel	261	AY290 (Fibre), 1.600mm AY300 (Fibre), 1.700mm AY310 (Fibre), 1.800mm	DE588 ▲ [3]	
Ducato	08/94→04/02	2500	4	93.00	55-62/ 75-84
Ducato 2.5 D	03/94→04/02				
Ducato 2.5 D 4x4	03/94→04/02				
2.5	8144.67 Diesel	262	AY290 (Fibre), 1.600mm AY300 (Fibre), 1.700mm AY310 (Fibre), 1.800mm	DE588 ▲ [3]	FY291 ▲ [16]
Croma 2500 D	12/85→12/89	2500	4	93.00	SOHC/OHC 55/75
Ducato 2.5 D	01/82→05/94				
Ducato 2.5 D 4x4	01/87→03/94				
2.5	8144.97 Diesel	263	AY290 (Fibre), 1.600mm AY300 (Fibre), 1.700mm AY310 (Fibre), 1.800mm	DP273 ▲	
Croma 2500 TD	05/89→08/96	2499	4	93.00	85/115
2.5	8144.97 S Diesel	264	AY290 (Fibre), 1.600mm AY300 (Fibre), 1.700mm AY310 (Fibre), 1.800mm	DP273 ▲	
Croma 2500 TDE	12/91→08/96	2500	4	93.00	SOHC/OHC 77/105
2.5	8144.97.2400 Diesel	265	AY290 (Fibre), 1.600mm AY300 (Fibre), 1.700mm AY310 (Fibre), 1.800mm	DP273 ▲	
Croma 2500 TD	05/89→08/96	2499	4	93.00	SOHC/OHC 83-87/ 113-118
2.5	CRD93L (U25-661) Diesel	266	AY290 (Fibre), 1.600mm AY300 (Fibre), 1.700mm AY310 (Fibre), 1.800mm		FY291 ▲ [16]
Ducato 2.5 D	01/82→08/90	2500	4	93.00	SOHC/OHC 54-55/ 73-75

      							
HBS251 [22] M11x1.50x133.00mm (x4)	JD5338 [1] JD5337 [2]	JM5201 (SE)	JH5077 LS856 [1]	HR602 [2]	 NPO68 [2] 55.00x70.00x8.00mm, FPM  NF833 [1] 90.00x115.00x13.00mm, FPM		 AB5100, AB5110  JJ100  AB5720, AB5730, AB5740  JJ519  AY290, AY300, AY310  JJ549  BE580  LS856
HBS011 [5] M12x1.25x119.00mm (x12)	JC054 [1] JC055 [2]	JN594 [4]	JJ100 (Cork)	HR602 [2]	 NPO68 [2] 55.00x70.00x8.00mm, FPM  NF833 [1] 90.00x115.00x13.00mm, FPM	LS859 [6]	
HBS011 [5] M12x1.25x119.00mm (x12)	JC054 [1] (x4) JC055 [2] (x4)	JN462 [4] →Eng.574798 JN594 [4] Eng.544799→	JJ100 (Cork) JJ519	HR602 [2]	 NPO68 [2] 55.00x70.00x8.00mm, FPM  NF833 [1] 90.00x115.00x13.00mm, FPM	HJ271 [8] KL221 [6] LS859 [6]	
HBS011 [5] M12x1.25x119.00mm (x12)	JC054 [1] JC055 [2]	JN585 [4]		HR602 [2]	 NPO68 [2] 55.00x70.00x8.00mm, FPM  NF853 [1] 100.00x118.00x10.00mm, FPM	KA546 [15]	 BR070, AY580, AY590  BR090  JC054  JC055
HBS011 [5] M12x1.25x119.00mm (x12)	JC054 [1] JC055 [2] JF123	JN956 [4] JN594 [4] Eng.574799→	JJ519	HR602 [2]	 NPO68 [2] 55.00x70.00x8.00mm, FPM  NF853 [1] 100.00x118.00x10.00mm, FPM	HJ271 [8] KD929 [68] JR580 [6] →Eng.2921820 KK5599 [17] KV927 [76]	
HBS011 [5] M12x1.25x119.00mm (x12)	JC054 [1] JC055 [2]	JN594 [4] JN956 [4]		HR602 [2]	 NPO68 [2] 55.00x70.00x8.00mm, FPM  NF853 [1] 100.00x118.00x10.00mm, FPM	JR580 [6] →09/99 →Eng.2921820 KK5599 [17] Eng.2921820→	 JC055  JD5338
HBS011 [5] M12x1.25x119.00mm (x12)	JC054 [1] JC055 [2]	JN956 [4]	JH5178 (SMG)	HR602 [2]	 NPO68 [2] 55.00x70.00x8.00mm, FPM  NF853 [1] 100.00x118.00x10.00mm, FPM	JR580 [6] →09/99 →Eng.2921820 KK5599 [17] Eng.2921820→	 JF123  JM5201
HBS011 [5] M12x1.25x119.00mm (x12)	JC054 [1] JC055 [2]	JN596 [4] JN956 [4]	JH5178 (SMG)	HR602 [2] HR801 [2]	 NPO68 [2] 55.00x70.00x8.00mm, FPM  NF853 [1] 100.00x118.00x10.00mm, FPM	KA546 [15] LS859 [6]	 JN462  JN585
HBS011 [5] M12x1.25x119.00mm (x12)	JC054 [1] (x4) JC055 [2] (x4)	JN462 [4]	JJ100 (Cork) JJ519	HR602 [2]	 NPO68 [2] 55.00x70.00x8.00mm, FPM  NF853 [1] 100.00x118.00x10.00mm, FPM		 JN594  JN596
HBS011 [5] M12x1.25x119.00mm (x12)	JC054 [1] JC055 [2]	JN585 [4]	JJ549		 NPO68 [2] 55.00x70.00x8.00mm, FPM  NF853 [1] 100.00x118.00x10.00mm, FPM	KA546 [15]	 JN956
HBS011 [5] M12x1.25x119.00mm (x12)	JC054 [1] JC055 [2]	JN585 [4]	JJ549		 NPO68 [2] 55.00x70.00x8.00mm, FPM  NF853 [1] 100.00x118.00x10.00mm, FPM		
HBS011 [5] M12x1.25x119.00mm (x12)	JC054 [1] (x4) JC055 [2] (x4)	JN462 [4]	JJ100 (Cork) JJ519	HR602 [2]	 NPO68 [2] 55.00x70.00x8.00mm, FPM  NF853 [1] 100.00x118.00x10.00mm, FPM	LS859 [6]	



cc



kW/PS

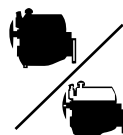

2.8	8140.43 Diesel					267	BX390 (Fibre), 1.200mm BX400 (Fibre), 1.300mm BX410 (Fibre), 1.400mm BX420 (Fibre), 1.500mm	DX391 ▲ [3]	GX410 ▲ [3]
Ducato	06/99→04/02	2800	4	94.40	SOHC/OHC	90/122			
Ducato 2.8 iTD	05/98→09/01								
Ducato 2.8 TDI	10/97→04/02								
2.8	8140.43N Diesel					268	BX390 (Fibre), 1.200mm BX400 (Fibre), 1.300mm BX410 (Fibre), 1.400mm BX420 (Fibre), 1.500mm	DX392 ▲	GX392 ▲ [3]
Ducato	05/04→07/06	2798	4	94.40	SOHC/OHC	107/146			
Ducato 2.8 JTD	04/04→07/06								
2.8	8140.43S Diesel					269	BX390 (Fibre), 1.200mm BX400 (Fibre), 1.300mm BX410 (Fibre), 1.400mm BX420 (Fibre), 1.500mm	DX391 ▲ [3] DX392 ▲	GX392 ▲ [3]
Ducato	11/00→07/06	2798	4	94.40	SOHC/OHC	94/128			
Ducato 2.8 JTD	11/00→07/06								
2.8	8140.63 Diesel					270	AY680 (Fibre), 1.600mm AY690 (Fibre), 1.700mm AY700 (Fibre), 1.800mm	CY680 ▲ [3]	FY691 ▲ [3]
Ducato	05/98→11/01	2800	4	94.40		64/87			
Ducato 2.8 D	02/98→04/02								
Ducato 2.8 D 4x4	08/98→04/02								
2.9	XFW					271	AH5060 (MLS), 0.740mm AH5050 (MLS), 0.950mm AH5040 (MLS), 0.740mm AH5070 (MLS), 0.950mm	CH5040 CH5060	
Ulysse 3.0	08/02→06/11	2946	6	87.00	DOHC, V	150-152/ 204-207			
3.0	F1CE0481D Diesel					272	AG6050 (MLS), 1.100mm AG6060 (MLS), 1.200mm AG7300 (MLS), 1.300mm	CG7300 ▲	
Ducato	07/06→	2999	4	95.80	DOHC	115-116/ 156-158			
3.0	F1CE3481E Diesel					273	AG6050 (MLS), 1.100mm AG6060 (MLS), 1.200mm AG7300 (MLS), 1.300mm	CG7300 ▲	
Ducato	06/11→	2999	4	95.80	DOHC	130/177			
3.0	F1CE3481M Diesel					274	AG6050 (MLS), 1.100mm AG6060 (MLS), 1.200mm AG7300 (MLS), 1.300mm	CG7300 ▲	
Ducato	07/06→	2999	4	95.80	DOHC	115/156			
3.0	F1CE3481N Diesel					275	AG6050 (MLS), 1.100mm AG6060 (MLS), 1.200mm AG7300 (MLS), 1.300mm	CG7300 ▲	
Ducato	04/10→	2999	4	95.80	DOHC	107/146			

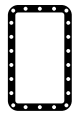
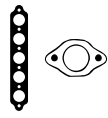

AY680, AY690,
AY700

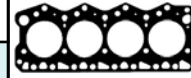

BX390, BX400,
BX410, BX420



JC054



JC055



JF123



JN956



JP069



JJ613

HBS255 [5]
M12x1.25x90.00mm (x8)

JC054 [1]
JC055 [1]
☉ JF123

JN956 [4]

JH5178
(SMG)

HR602 [1]

☒ NP068 [2]
55.00x70.00x8.00mm, FPM
☒ NF883 [1]
114.00x177.00x13.00mm, FPM
☒ NF885 [2]
70.00x179.00x16.00mm, FPM

JR580 [6]
→09/99
→Eng.2921820
LC281 [6]
Elastomer
KK5599 [17]
Eng.2921820→

HBS255 [5]
M12x1.25x90.00mm (x8)

JC055 [1]

JN956 [4]

HR602 [1]

☒ NP068 [2]
55.00x70.00x8.00mm, FPM
☒ NF883 [1]
114.00x177.00x13.00mm, FPM
☒ NF885 [2]
70.00x179.00x16.00mm, FPM

JR580 [6]

HBS255 [5]
M12x1.25x90.00mm (x8)

JC054 [1] (x4)
JC055 [1] (x4)
☉ JF123

JP069 [4]

JH5178
(SMG)
JJ613

HR602 [1]

☒ NP068 [2]
55.00x70.00x8.00mm, FPM
☒ NF883 [1]
114.00x177.00x13.00mm, FPM
☒ NF885 [2]
70.00x179.00x16.00mm, FPM

KD929 [68][69]
KD931 [68][69]
LC281 [6]
Elastomer

HBS255 [5]
M12x1.25x90.00mm (x8)

JC054 [1]
JC055 [1] (x4)
☉ JF123

JP069 [4]

JH5178
(SMG)
JJ613

HR602 [1]

☒ NP068 [2]
55.00x70.00x8.00mm, FPM
☒ NF883 [1]
114.00x177.00x13.00mm, FPM
☒ NF885 [2]
70.00x179.00x16.00mm, FPM

JR580 [6]
→09/99
→Eng.2921820
LC281 [6]
Elastomer
LC282 [6]
LS859 [6][1]
KK5599 [17]
Eng.2921820→

HBS272 [22]
M10x1.50x147.00mm (x16)

JD5906 [1]
JD5907 [1] (x2)

HR397

HR5062 [1]

☒ NA5260 [2]
38.00x50.00x6.00mm, FPM
☒ NA5177 [2]
42.00x56.00x7.00mm, FPM
☒ NF867 [1]
98.00x120.00x7.00mm, FPM/ACM

JD5981 [1]
(SMG)

JD5981 [1]
(SMG)

JD5981 [1]
(SMG)

JD5981 [1]
(SMG)



Ltr







CC



9

	Ltr				CC		
G-MAX	1.6	02/00→	G8DA	Diesel	1560	4	118
G-MAX	1.6	02/00→	G8DB	Diesel	1560	4	119
G-MAX	1.6	02/00→	G8DC	Diesel	1560	4	120
G-MAX	1.6	02/00→	G8DD	Diesel	1560	4	121
G-MAX	1.6	02/00→	GPDA	Diesel	1560	4	124
G-MAX	1.6	02/00→	HHDA	Diesel	1560	4	126
G-MAX	1.6	02/00→	HHDB	Diesel	1560	4	127
G-MAX	1.6	02/00→	HWDA	Petrol	1596	4	134
G-MAX	1.6	02/00→	HWDB	Petrol	1596	4	135
G-MAX	1.6	02/00→	MTDA	Diesel	1560	4	170
G-MAX	1.6	02/00→	SHDA	Petrol	1596	4	173
G-MAX	1.6	02/00→	SHDB	Petrol	1596	4	174
G-MAX	1.6	02/00→	SHDC	Petrol	1596	4	175
G-MAX	1.8	02/00→	KKDA	Diesel	1753	4	213
G-MAX	1.8	02/00→	Q7DA	Petrol/Ethanol	1798	4	221
G-MAX	1.8	02/00→	Q7DA	Petrol	1798	4	221
G-MAX	1.8	02/00→	QQDA	Petrol	1798	4	222
G-MAX	1.8	02/00→	QQDB	Petrol	1798	4	223
G-MAX	1.8	02/00→	QQDC	Petrol	1798	4	224
G-MAX	2.0	02/00→	AODA	Petrol	1999	4	286
G-MAX	2.0	02/00→	AODB	Petrol	1999	4	287
G-MAX	2.0	02/00→	AODE	Petrol	1999	4	288
G-MAX	2.0	02/00→	G6DA	Diesel	1997	4	311
G-MAX	2.0	02/00→	G6DB	Diesel	1997	4	312
G-MAX	2.0	02/00→	G6DC	Diesel	1997	4	313
G-MAX	2.0	02/00→	G6DD	Diesel	1997	4	314
G-MAX	2.0	02/00→	G6DE	Diesel	1997	4	315
G-MAX	2.0	02/00→	G6DF	Diesel	1997	4	316
G-MAX	2.0	02/00→	G6DG	Diesel	1997	4	317
G-MAX	2.0	02/00→	IXDA	Diesel	1997	4	322
G-MAX	2.0	02/00→	SYDA	Petrol/Petroleum Gas (LPG)	1999	4	368
G-MAX	2.0	02/00→	SYDA	Petrol/Natural Gas (CNG)	1999	4	368
G-MAX	2.0	02/00→	SYDA	Petrol	1999	4	368
COUGAR (EC_)	2.0	08/99→12/00	EDBA	Petrol	1988	4	300
COUGAR (EC_)	2.0	08/99→12/00	EDBB	Petrol	1988	4	301
COUGAR (EC_)	2.0	08/99→12/00	EDBC	Petrol	1988	4	302
COUGAR (EC_)	2.0	08/99→12/00	EDBD	Petrol	1988	4	303
COUGAR (EC_)	2.5	08/99→12/00	LCBA	Petrol	2544	6	446
COUGAR (EC_)	2.5	06/00→12/00	LCBB	Petrol	2495	6	447
COUGAR (EC_)	2.5	06/00→12/00	LCBC	Petrol	2495	6	448
COUGAR (EC_)	2.5	06/00→12/00	LCBE	Petrol	2495	6	450
COUGAR (EC_)	2.5	01/00→12/00	SGA	Petrol	2495	6	456
COURIER Pickup	1.8	06/99→02/00	RTK	Diesel	1753	4	264
ECONOVAN (KBA, KCA)	1.4	03/98→03/99	UC	Petrol	1416	4	105
ECONOVAN Box (KAA)	1.4	03/98→03/99	UC	Petrol	1416	4	105
ESCORT '86 Express (AVF)	1.1	05/98→07/99	GSG	Petrol	1117	4	6
ESCORT '86 Express (AVF)	1.3	07/98→07/99	JBA	Petrol	1297	4	48
ESCORT '86 Express (AVF)	1.3	02/98→07/99	JBB	Petrol	1297	4	49
ESCORT '86 Express (AVF)	1.3	02/98→07/99	JLA	Petrol	1297	4	64
ESCORT '86 Express (AVF)	1.3	02/98→07/99	JLB	Petrol	1297	4	65
ESCORT '86 Express (AVF)	1.4	02/98→07/99	F6B	Petrol	1392	4	71
ESCORT '86 Express (AVF)	1.4	02/98→07/99	F6D	Petrol	1392	4	73
ESCORT '86 Express (AVF)	1.4	02/98→07/99	FUC	Petrol	1392	4	87
ESCORT '86 Express (AVF)	1.6	02/98→07/99	LTA	Diesel	1608	4	162
ESCORT '86 Express (AVF)	1.6	02/98→07/99	LUC	Petrol	1597	4	165
ESCORT '86 Express (AVF)	1.8	07/98→07/99	RTA	Diesel	1753	4	255
ESCORT '86 Express (AVF)	1.8	07/98→07/99	RTB	Diesel	1753	4	256
ESCORT '91 Express (AVL)	1.3	07/99→12/99	JBD	Petrol	1297	4	51
ESCORT '91 Express (AVL)	1.4	07/99→12/99	F6F	Petrol	1392	4	75
ESCORT '91 Express (AVL)	1.4	07/99→12/99	F6G	Petrol	1392	4	76
ESCORT '91 Express (AVL)	1.8	07/99→12/99	RTH	Diesel	1753	4	262
ESCORT '95 Box (AVL)	1.4	01/99→	F4B	Petrol	1391	4	69
ESCORT '95 Box (AVL)	1.8	01/99→	RFD	Diesel	1753	4	240
ESCORT '95 Box (AVL)	1.8	01/99→	RFK	Diesel	1753	4	241
ESCORT '95 Box (AVL)	1.8	01/99→	RFS	Diesel	1753	4	245
ESCORT '95 Box (AVL)	1.8	01/99→	RTF	Diesel	1753	4	260
ESCORT '95 Box (AVL)	1.8	01/99→	RTH	Diesel	1753	4	262
ESCORT '95 Box (AVL)	1.8	12/99→06/00	RVA	Diesel	1753	4	268
ESCORT CLASSIC (AAL, ABL)	1.6	10/99→07/00	LIE	Petrol	1597	4	140
ESCORT CLASSIC (AAL, ABL)	1.8	10/99→07/00	RFD	Diesel	1753	4	240

	Ltr				CC		9
ESCORT CLASSIC (AAL, ABL)	1.8	10/99 → 07/00	RFK	Diesel	1753	4	241
ESCORT CLASSIC Turnier (ANL)	1.6	02/99 → 07/00	L1E	Petrol	1597	4	140
ESCORT CLASSIC Turnier (ANL)	1.8	02/99 → 07/00	RFD	Diesel	1753	4	240
ESCORT CLASSIC Turnier (ANL)	1.8	02/99 → 07/00	RFK	Diesel	1753	4	241
ESCORT IV (GAF, AWF, ABFT)	1.1	12/98 → 07/99	GSG	Petrol	1117	4	6
ESCORT IV (GAF, AWF, ABFT)	1.3	07/98 → 10/99	JBA	Petrol	1297	4	48
ESCORT IV (GAF, AWF, ABFT)	1.3	01/98 → 07/99	JBB	Petrol	1297	4	49
ESCORT IV (GAF, AWF, ABFT)	1.3	01/98 → 07/99	JLA	Petrol	1297	4	64
ESCORT IV (GAF, AWF, ABFT)	1.3	01/98 → 07/99	JLB	Petrol	1297	4	65
ESCORT IV (GAF, AWF, ABFT)	1.4	01/98 → 07/99	F6B	Petrol	1392	4	71
ESCORT IV (GAF, AWF, ABFT)	1.4	01/98 → 07/99	F6D	Petrol	1392	4	73
ESCORT IV (GAF, AWF, ABFT)	1.4	01/98 → 07/99	FUA	Petrol	1392	4	84
ESCORT IV (GAF, AWF, ABFT)	1.4	10/98 → 10/99	FUAA	Petrol	1392	4	85
ESCORT IV (GAF, AWF, ABFT)	1.4	01/98 → 07/99	FUC	Petrol	1392	4	87
ESCORT IV (GAF, AWF, ABFT)	1.6	01/98 → 07/99	LNB	Petrol	1597	4	158
ESCORT IV (GAF, AWF, ABFT)	1.6	01/98 → 12/98	LP2	Petrol	1597	4	159
ESCORT IV (GAF, AWF, ABFT)	1.6	01/98 → 01/98	LTC	Diesel	1608	4	164
ESCORT IV (GAF, AWF, ABFT)	1.6	04/98 → 07/99	LUG	Petrol	1597	4	166
ESCORT IV (GAF, AWF, ABFT)	1.8	01/98 → 07/99	RTA	Diesel	1753	4	255
ESCORT IV (GAF, AWF, ABFT)	1.8	01/98 → 07/99	RTB	Diesel	1753	4	256
ESCORT IV Convertible (ALF)	1.4	02/98 → 07/99	F6B	Petrol	1392	4	71
ESCORT IV Convertible (ALF)	1.4	02/98 → 07/99	F6D	Petrol	1392	4	73
ESCORT IV Convertible (ALF)	1.4	01/98 → 07/99	FUA	Petrol	1392	4	84
ESCORT IV Convertible (ALF)	1.4	02/98 → 07/99	FUC	Petrol	1392	4	87
ESCORT IV Estate (AWF, AVF)	1.1	10/98 → 09/99	GSG	Petrol	1117	4	6
ESCORT IV Estate (AWF, AVF)	1.3	01/98 → 07/99	JBB	Petrol	1297	4	49
ESCORT IV Estate (AWF, AVF)	1.3	01/98 → 07/99	JLA	Petrol	1297	4	64
ESCORT IV Estate (AWF, AVF)	1.3	01/98 → 07/99	JLB	Petrol	1297	4	65
ESCORT IV Estate (AWF, AVF)	1.4	01/98 → 07/99	F6B	Petrol	1392	4	71
ESCORT IV Estate (AWF, AVF)	1.4	01/98 → 07/99	F6D	Petrol	1392	4	73
ESCORT IV Estate (AWF, AVF)	1.4	01/98 → 07/99	FUA	Petrol	1392	4	84
ESCORT IV Estate (AWF, AVF)	1.4	10/98 → 10/99	FUAA	Petrol	1392	4	85
ESCORT IV Estate (AWF, AVF)	1.4	01/98 → 07/99	FUC	Petrol	1392	4	87
ESCORT IV Estate (AWF, AVF)	1.6	01/98 → 07/99	LP2	Petrol	1597	4	159
ESCORT IV Estate (AWF, AVF)	1.6	01/98 → 01/98	LTC	Diesel	1608	4	164
ESCORT IV Estate (AWF, AVF)	1.8	01/98 → 07/99	RTA	Diesel	1753	4	255
ESCORT IV Estate (AWF, AVF)	1.8	01/98 → 07/99	RTB	Diesel	1753	4	256
ESCORT V (GAL)	1.3	07/99 → 09/99	J4B	Petrol	1299	4	33
ESCORT V (GAL)	1.3	07/99 → 09/99	J6A	Petrol	1299	4	46
ESCORT V (GAL)	1.4	07/99 → 09/99	F6F	Petrol	1392	4	75
ESCORT V (GAL)	1.4	07/99 → 09/99	F6G	Petrol	1392	4	76
ESCORT V (GAL)	1.6	07/99 → 12/99	LJF	Petrol	1598	4	157
ESCORT V (GAL)	1.6	07/99 → 08/99	LUJ	Petrol	1598	4	168
ESCORT V (GAL)	1.6	07/99 → 08/99	LUK	Petrol	1598	4	169
ESCORT V (GAL)	1.8	02/99 → 12/99	RDA	Petrol	1796	4	233
ESCORT V (GAL)	1.8	02/99 → 12/99	RQB	Petrol	1796	4	253
ESCORT V (GAL)	1.8	07/99 → 12/99	RTE	Diesel	1753	4	259
ESCORT V (GAL)	1.8	07/99 → 12/99	RTF	Diesel	1753	4	260
ESCORT V (GAL)	1.8	07/99 → 12/99	RTH	Diesel	1753	4	262
ESCORT V (GAL)	2.0	05/99 → 12/99	N7A	Petrol	1998	4	333
ESCORT V Convertible (ALL)	1.4	07/99 → 12/99	F6F	Petrol	1392	4	75
ESCORT V Convertible (ALL)	1.4	07/99 → 12/99	F6G	Petrol	1392	4	76
ESCORT V Convertible (ALL)	1.6	07/99 → 12/99	LJF	Petrol	1598	4	157
ESCORT V Convertible (ALL)	1.8	02/99 → 12/99	RDA	Petrol	1796	4	233
ESCORT V Convertible (ALL)	1.8	02/99 → 12/99	RQB	Petrol	1796	4	253
ESCORT V Estate (GAL, AVL)	1.3	09/99 → 09/99	J4B	Petrol	1299	4	33
ESCORT V Estate (GAL, AVL)	1.3	09/99 → 09/99	J6A	Petrol	1299	4	46
ESCORT V Estate (GAL, AVL)	1.4	07/99 → 09/99	F6F	Petrol	1392	4	75
ESCORT V Estate (GAL, AVL)	1.4	07/99 → 09/99	F6G	Petrol	1392	4	76
ESCORT V Estate (GAL, AVL)	1.6	07/99 → 09/99	LJF	Petrol	1598	4	157
ESCORT V Estate (GAL, AVL)	1.6	07/99 → 08/99	LUJ	Petrol	1598	4	168
ESCORT V Estate (GAL, AVL)	1.6	07/99 → 08/99	LUK	Petrol	1598	4	169
ESCORT V Estate (GAL, AVL)	1.8	02/99 → 12/99	RDA	Petrol	1796	4	233
ESCORT V Estate (GAL, AVL)	1.8	07/99 → 12/99	RTE	Diesel	1753	4	259
ESCORT V Estate (GAL, AVL)	1.8	07/99 → 12/99	RTF	Diesel	1753	4	260
ESCORT V Estate (GAL, AVL)	1.8	07/99 → 12/99	RTH	Diesel	1753	4	262
ESCORT VI (GAL)	1.3	09/99 → 01/99	J4B	Petrol	1299	4	33
ESCORT VI (GAL)	1.3	09/99 → 01/99	J6A	Petrol	1299	4	46
ESCORT VI (GAL)	1.4	01/99 → 01/99	F4B	Petrol	1391	4	69
ESCORT VI (GAL)	1.4	09/99 → 01/99	F6F	Petrol	1392	4	75



Ltr







CC



9

Model	Ltr	Year	Code	Fuel	CC	Seats	Price
ESCORT VI (GAL)	1.4	09/99→01/99	F6G	Petrol	1392	4	76
ESCORT VI (GAL)	1.4	01/99→01/99	FUH	Petrol	1392	4	91
ESCORT VI (GAL)	1.6	09/99→01/99	LIE	Petrol	1597	4	140
ESCORT VI (GAL)	1.6	01/99→01/99	LIH	Petrol	1597	4	143
ESCORT VI (GAL)	1.8	09/99→01/99	RDA	Petrol	1796	4	233
ESCORT VI (GAL)	1.8	02/99→01/99	RFD	Diesel	1753	4	240
ESCORT VI (GAL)	1.8	02/99→01/99	RFK	Diesel	1753	4	241
ESCORT VI (GAL)	1.8	02/99→01/99	RFS	Diesel	1753	4	245
ESCORT VI (GAL)	1.8	09/99→01/99	RQB	Petrol	1796	4	253
ESCORT VI (GAL)	1.8	09/99→01/99	RTE	Diesel	1753	4	259
ESCORT VI (GAL)	1.8	09/99→01/99	RTF	Diesel	1753	4	260
ESCORT VI (GAL)	1.8	09/99→01/99	RTH	Diesel	1753	4	262
ESCORT VI (GAL)	2.0	09/99→01/99	NSF	Petrol	1994	4	331
ESCORT VI (GAL)	2.0	09/99→01/99	N7A	Petrol	1998	4	333
ESCORT VI Convertible (ALL)	1.4	07/99→01/99	F4B	Petrol	1391	4	69
ESCORT VI Convertible (ALL)	1.4	12/99→04/99	F6F	Petrol	1392	4	75
ESCORT VI Convertible (ALL)	1.4	12/99→04/99	F6G	Petrol	1392	4	76
ESCORT VI Convertible (ALL)	1.6	12/99→01/99	LIE	Petrol	1597	4	140
ESCORT VI Convertible (ALL)	1.6	02/99→01/99	LIH	Petrol	1597	4	143
ESCORT VI Convertible (ALL)	1.8	12/99→01/99	RDA	Petrol	1796	4	233
ESCORT VI Convertible (ALL)	1.8	12/99→01/99	RQB	Petrol	1796	4	253
ESCORT VI Estate (GAL)	1.3	09/99→01/99	J4B	Petrol	1299	4	33
ESCORT VI Estate (GAL)	1.3	09/99→01/99	J6A	Petrol	1299	4	46
ESCORT VI Estate (GAL)	1.4	01/99→01/99	F4B	Petrol	1391	4	69
ESCORT VI Estate (GAL)	1.4	09/99→01/99	F6F	Petrol	1392	4	75
ESCORT VI Estate (GAL)	1.4	09/99→01/99	F6G	Petrol	1392	4	76
ESCORT VI Estate (GAL)	1.4	01/99→01/99	FUH	Petrol	1392	4	91
ESCORT VI Estate (GAL)	1.6	09/99→01/99	LIE	Petrol	1597	4	140
ESCORT VI Estate (GAL)	1.6	01/99→01/99	LIH	Petrol	1597	4	143
ESCORT VI Estate (GAL)	1.8	01/99→01/99	RDA	Petrol	1796	4	233
ESCORT VI Estate (GAL)	1.8	02/99→01/99	RFD	Diesel	1753	4	240
ESCORT VI Estate (GAL)	1.8	02/99→01/99	RFK	Diesel	1753	4	241
ESCORT VI Estate (GAL)	1.8	02/99→01/99	RQB	Petrol	1796	4	253
ESCORT VI Estate (GAL)	1.8	09/99→01/99	RTH	Diesel	1753	4	262
ESCORT VI Saloon (GAL)	1.3	08/99→01/99	J4B	Petrol	1299	4	33
ESCORT VI Saloon (GAL)	1.3	08/99→01/99	J6A	Petrol	1299	4	46
ESCORT VI Saloon (GAL)	1.4	08/99→01/99	F4B	Petrol	1391	4	69
ESCORT VI Saloon (GAL)	1.4	08/99→04/99	F6F	Petrol	1392	4	75
ESCORT VI Saloon (GAL)	1.4	08/99→04/99	F6G	Petrol	1392	4	76
ESCORT VI Saloon (GAL)	1.4	08/99→01/99	FUH	Petrol	1392	4	91
ESCORT VI Saloon (GAL)	1.6	08/99→01/99	LIE	Petrol	1597	4	140
ESCORT VI Saloon (GAL)	1.6	01/99→01/99	LIH	Petrol	1597	4	143
ESCORT VI Saloon (GAL)	1.6	08/99→01/99	LIK	Petrol	1597	4	145
ESCORT VI Saloon (GAL)	1.8	08/99→01/99	RDA	Petrol	1796	4	233
ESCORT VI Saloon (GAL)	1.8	08/99→01/99	RFD	Diesel	1753	4	240
ESCORT VI Saloon (GAL)	1.8	08/99→01/99	RFK	Diesel	1753	4	241
ESCORT VI Saloon (GAL)	1.8	08/99→01/99	RTE	Diesel	1753	4	259
ESCORT VI Saloon (GAL)	1.8	08/99→01/99	RTF	Diesel	1753	4	260
ESCORT VI Saloon (GAL)	1.8	08/99→01/99	RTH	Diesel	1753	4	262
ESCORT VII (GAL, AAL, ABL)	1.3	01/99→10/99	J4B	Petrol	1299	4	33
ESCORT VII (GAL, AAL, ABL)	1.3	01/99→10/99	J6A	Petrol	1299	4	46
ESCORT VII (GAL, AAL, ABL)	1.4	01/99→10/99	F4B	Petrol	1391	4	69
ESCORT VII (GAL, AAL, ABL)	1.6	01/99→10/99	LIE	Petrol	1597	4	140
ESCORT VII (GAL, AAL, ABL)	1.6	01/99→08/99	LIH	Petrol	1597	4	143
ESCORT VII (GAL, AAL, ABL)	1.8	01/99→08/99	RDA	Petrol	1796	4	233
ESCORT VII (GAL, AAL, ABL)	1.8	01/99→10/99	RFD	Diesel	1753	4	240
ESCORT VII (GAL, AAL, ABL)	1.8	01/99→10/99	RFK	Diesel	1753	4	241
ESCORT VII (GAL, AAL, ABL)	1.8	01/99→10/99	RKC	Petrol	1796	4	248
ESCORT VII (GAL, AAL, ABL)	1.8	01/99→12/99	RTE	Diesel	1753	4	259
ESCORT VII (GAL, AAL, ABL)	1.8	01/99→12/99	RTF	Diesel	1753	4	260
ESCORT VII (GAL, AAL, ABL)	1.8	01/99→12/99	RTH	Diesel	1753	4	262
ESCORT VII (GAL, AAL, ABL)	1.8	12/99→10/99	RVA	Diesel	1753	4	268
ESCORT VII (GAL, AAL, ABL)	2.0	02/99→10/99	NSF	Petrol	1994	4	331
ESCORT VII (GAL, AAL, ABL)	2.0	02/99→10/99	N7A	Petrol	1998	4	333
ESCORT VII Convertible (ALL)	1.4	02/99→08/99	F4B	Petrol	1391	4	69
ESCORT VII Convertible (ALL)	1.6	02/99→09/99	LIE	Petrol	1597	4	140
ESCORT VII Convertible (ALL)	1.6	02/99→12/99	LIH	Petrol	1597	4	143
ESCORT VII Convertible (ALL)	1.8	02/99→08/99	RDA	Petrol	1796	4	233
ESCORT VII Convertible (ALL)	1.8	09/99→08/99	RFD	Diesel	1753	4	240
ESCORT VII Convertible (ALL)	1.8	09/99→08/99	RFK	Diesel	1753	4	241

	Ltr				CC		9
ESCORT VII Convertible (ALL)	1.8	10/99→08/99	RKC	Petrol	1796	4	248
ESCORT VII Convertible (ALL)	1.8	02/99→08/00	ROB	Petrol	1796	4	253
ESCORT VII Convertible (ALL)	1.8	10/99→08/99	RVA	Diesel	1753	4	268
ESCORT VII Estate (GAL, ANL)	1.3	01/99→01/99	J4B	Petrol	1299	4	33
ESCORT VII Estate (GAL, ANL)	1.3	01/99→01/99	J6A	Petrol	1299	4	46
ESCORT VII Estate (GAL, ANL)	1.4	01/99→02/99	F4B	Petrol	1391	4	69
ESCORT VII Estate (GAL, ANL)	1.4	01/99→02/99	FUH	Petrol	1392	4	91
ESCORT VII Estate (GAL, ANL)	1.6	01/99→02/99	L1E	Petrol	1597	4	140
ESCORT VII Estate (GAL, ANL)	1.6	01/99→08/99	L1H	Petrol	1597	4	143
ESCORT VII Estate (GAL, ANL)	1.8	01/99→08/99	RDA	Petrol	1796	4	233
ESCORT VII Estate (GAL, ANL)	1.8	01/99→02/99	RFD	Diesel	1753	4	240
ESCORT VII Estate (GAL, ANL)	1.8	01/99→02/99	RFK	Diesel	1753	4	241
ESCORT VII Estate (GAL, ANL)	1.8	01/99→02/99	RKC	Petrol	1796	4	248
ESCORT VII Estate (GAL, ANL)	1.8	01/99→02/99	RTE	Diesel	1753	4	259
ESCORT VII Estate (GAL, ANL)	1.8	01/99→02/99	RTF	Diesel	1753	4	260
ESCORT VII Estate (GAL, ANL)	1.8	01/99→02/99	RTH	Diesel	1753	4	262
ESCORT VII Estate (GAL, ANL)	1.8	12/99→02/99	RVA	Diesel	1753	4	268
ESCORT VII Saloon (GAL, AFL)	1.3	01/99→02/99	J4B	Petrol	1299	4	33
ESCORT VII Saloon (GAL, AFL)	1.3	01/99→02/99	J6A	Petrol	1299	4	46
ESCORT VII Saloon (GAL, AFL)	1.4	01/99→02/99	F4B	Petrol	1391	4	69
ESCORT VII Saloon (GAL, AFL)	1.4	01/99→02/99	FUH	Petrol	1392	4	91
ESCORT VII Saloon (GAL, AFL)	1.6	01/99→02/99	L1E	Petrol	1597	4	140
ESCORT VII Saloon (GAL, AFL)	1.6	01/99→08/99	L1H	Petrol	1597	4	143
ESCORT VII Saloon (GAL, AFL)	1.6	01/99→02/99	L1K	Petrol	1597	4	145
ESCORT VII Saloon (GAL, AFL)	1.8	01/99→08/99	RDA	Petrol	1796	4	233
ESCORT VII Saloon (GAL, AFL)	1.8	01/99→02/99	RFD	Diesel	1753	4	240
ESCORT VII Saloon (GAL, AFL)	1.8	01/99→02/99	RFK	Diesel	1753	4	241
ESCORT VII Saloon (GAL, AFL)	1.8	01/99→02/99	RKC	Petrol	1796	4	248
ESCORT VII Saloon (GAL, AFL)	1.8	01/99→12/99	RTE	Diesel	1753	4	259
ESCORT VII Saloon (GAL, AFL)	1.8	01/99→12/99	RTF	Diesel	1753	4	260
ESCORT VII Saloon (GAL, AFL)	1.8	01/99→12/99	RTH	Diesel	1753	4	262
ESCORT VII Saloon (GAL, AFL)	1.8	12/99→02/99	RVA	Diesel	1753	4	268
FIESTA Box (F3L, F5L)	1.3	09/99→02/99	J6B	Petrol	1299	4	47
FIESTA Box (F3L, F5L)	1.8	09/99→02/99	RTC	Diesel	1753	4	257
FIESTA Box (F3L, F5L)	1.8	09/99→02/99	RTD	Diesel	1753	4	258
FIESTA Box (F3L, F5L)	1.8	09/99→02/99	RTG	Diesel	1753	4	261
FIESTA Box (FVD)	1.0	08/98→11/98	TKB	Petrol	957	4	1
FIESTA Box (FVD)	1.4	09/98→09/98	F6A	Petrol	1393	4	70
FIESTA Box (FVD)	1.6	09/98→09/98	LTB	Diesel	1608	4	163
FIESTA Box (FVD)	1.8	03/98→12/99	RTC	Diesel	1753	4	257
FIESTA Box (FVD)	1.8	03/98→12/99	RTD	Diesel	1753	4	258
FIESTA Box (FVD)	1.8	03/98→12/99	RTG	Diesel	1753	4	261
FIESTA Box (J5_, J3_)	1.3	02/99→	J4C	Petrol	1299	4	34
FIESTA Box (J5_, J3_)	1.4	04/99→10/99	FHA	Petrol	1388	4	80
FIESTA Box (J5_, J3_)	1.8	02/99→	RTK	Diesel	1753	4	264
FIESTA Box (J5_, J3_)	1.8	09/00→	RTN	Diesel	1753	4	265
FIESTA Box (J5_, J3_)	1.8	09/00→	RTP	Diesel	1753	4	266
FIESTA Box (JV_)	1.8	05/99→	RTJ	Diesel	1753	4	263
FIESTA Box (JV_)	1.8	05/99→	RTK	Diesel	1753	4	264
FIESTA Box (JV_)	1.8	03/00→	RTN	Diesel	1753	4	265
FIESTA Box (JV_)	1.8	03/00→	RTP	Diesel	1753	4	266
FIESTA Box (JV_)	1.8	03/00→	RTQ	Diesel	1753	4	267
FIESTA II (FBD)	1.0	09/98→02/98	TKB	Petrol	957	4	1
FIESTA II (FBD)	1.0	09/98→11/98	TLB	Petrol	999	4	2
FIESTA II (FBD)	1.1	09/98→02/98	GLC	Petrol	1117	4	4
FIESTA II (FBD)	1.1	09/98→02/98	GSF	Petrol	1117	4	5
FIESTA II (FBD)	1.1	05/98→02/98	GSH	Petrol	1117	4	7
FIESTA II (FBD)	1.4	10/98→02/98	F6A	Petrol	1393	4	70
FIESTA II (FBD)	1.4	10/98→02/98	F6C	Petrol	1392	4	72
FIESTA II (FBD)	1.4	10/98→11/98	FUB	Petrol	1392	4	86
FIESTA II (FBD)	1.4	02/98→02/98	FUD	Petrol	1392	4	88
FIESTA II (FBD)	1.6	04/98→02/98	LTB	Diesel	1608	4	163
FIESTA III (GFJ)	1.0	03/98→12/99	TLB	Petrol	999	4	2
FIESTA III (GFJ)	1.1	03/98→12/99	G6A	Petrol	1119	4	3
FIESTA III (GFJ)	1.1	03/98→12/99	GUD	Petrol	1119	4	8
FIESTA III (GFJ)	1.1	03/98→12/99	GUE	Petrol	1119	4	9
FIESTA III (GFJ)	1.3	05/99→01/99	J6B	Petrol	1299	4	47
FIESTA III (GFJ)	1.3	03/98→12/99	JBC	Petrol	1299	4	50
FIESTA III (GFJ)	1.4	03/98→12/99	F4A	Petrol	1391	4	68
FIESTA III (GFJ)	1.4	03/98→12/99	F6E	Petrol	1392	4	74



Ltr







CC



9

	Ltr				CC		
FIESTA III (GFJ)	1.4	11/99→12/99	FUF	Petrol	1392	4	89
FIESTA III (GFJ)	1.4	03/98→12/99	FUG	Petrol	1392	4	90
FIESTA III (GFJ)	1.4	03/98→12/99	FUJ	Petrol	1392	4	92
FIESTA III (GFJ)	1.6	01/99→12/99	LIG	Petrol	1597	4	142
FIESTA III (GFJ)	1.6	03/99→10/99	LHA	Petrol	1598	4	154
FIESTA III (GFJ)	1.6	03/98→01/99	LJC	Petrol	1597	4	155
FIESTA III (GFJ)	1.6	03/98→03/99	LJD	Petrol	1598	4	156
FIESTA III (GFJ)	1.6	01/98→01/99	LUH	Petrol	1597	4	167
FIESTA III (GFJ)	1.8	02/99→12/99	RDB	Petrol	1796	4	234
FIESTA III (GFJ)	1.8	03/99→12/99	RFL	Diesel	1753	4	242
FIESTA III (GFJ)	1.8	02/99→12/99	RQC	Petrol	1796	4	254
FIESTA III (GFJ)	1.8	03/98→12/99	RTC	Diesel	1753	4	257
FIESTA III (GFJ)	1.8	03/98→12/99	RTD	Diesel	1753	4	258
FIESTA III (GFJ)	1.8	03/98→12/99	RTG	Diesel	1753	4	261
FIESTA IV (JA_, JB_)	1.3	08/99→01/00	DHA	Petrol	1242	4	10
FIESTA IV (JA_, JB_)	1.3	08/99→01/00	DHB	Petrol	1242	4	11
FIESTA IV (JA_, JB_)	1.3	08/99→01/00	DHC	Petrol	1242	4	12
FIESTA IV (JA_, JB_)	1.3	08/99→01/00	DHD	Petrol	1242	4	13
FIESTA IV (JA_, JB_)	1.3	08/99→01/00	DHE	Petrol	1242	4	14
FIESTA IV (JA_, JB_)	1.3	08/99→01/00	DHF	Petrol	1242	4	15
FIESTA IV (JA_, JB_)	1.3	08/99→01/00	DHG	Petrol	1242	4	16
FIESTA IV (JA_, JB_)	1.3	08/99→01/00	J4C	Petrol	1299	4	34
FIESTA IV (JA_, JB_)	1.3	08/99→01/00	J4J	Petrol	1299	4	36
FIESTA IV (JA_, JB_)	1.3	08/99→01/00	J4L	Petrol	1299	4	38
FIESTA IV (JA_, JB_)	1.3	08/99→01/00	J4Q	Petrol	1299	4	42
FIESTA IV (JA_, JB_)	1.3	08/99→01/00	J4R	Petrol	1299	4	43
FIESTA IV (JA_, JB_)	1.3	08/99→01/00	J4T	Petrol	1299	4	45
FIESTA IV (JA_, JB_)	1.3	08/99→01/00	JJA	Petrol	1299	4	52
FIESTA IV (JA_, JB_)	1.3	08/99→01/00	JJC	Petrol	1299	4	54
FIESTA IV (JA_, JB_)	1.3	08/99→01/00	JJE	Petrol	1299	4	56
FIESTA IV (JA_, JB_)	1.3	08/99→01/00	JJJ	Petrol	1299	4	60
FIESTA IV (JA_, JB_)	1.3	08/99→01/00	JJK	Petrol	1299	4	61
FIESTA IV (JA_, JB_)	1.3	08/99→01/00	JJM	Petrol	1299	4	63
FIESTA IV (JA_, JB_)	1.4	04/99→01/00	FHA	Petrol	1388	4	80
FIESTA IV (JA_, JB_)	1.4	04/99→01/00	FHE	Petrol	1388	4	82
FIESTA IV (JA_, JB_)	1.6	02/00→01/00	LIT	Petrol	1596	4	149
FIESTA IV (JA_, JB_)	1.6	02/00→01/00	LIV	Petrol	1596	4	150
FIESTA IV (JA_, JB_)	1.8	08/99→04/00	RTJ	Diesel	1753	4	263
FIESTA IV (JA_, JB_)	1.8	08/99→04/00	RTK	Diesel	1753	4	264
FIESTA IV (JA_, JB_)	1.8	04/00→01/00	RTN	Diesel	1753	4	265
FIESTA IV (JA_, JB_)	1.8	04/00→01/00	RTP	Diesel	1753	4	266
FIESTA IV (JA_, JB_)	1.8	04/00→01/00	RTQ	Diesel	1753	4	267
FIESTA Saloon	1.3	10/01→	STJB	Petrol	1242	4	26
FIESTA V (JH_, JD_)	1.3	11/00→	A9JA	Petrol	1299	4	29
FIESTA V (JH_, JD_)	1.3	11/00→	A9JB	Petrol	1299	4	30
FIESTA V (JH_, JD_)	1.3	11/00→	BAJA	Petrol	1299	4	32
FIESTA V (JH_, JD_)	1.3	05/00→	FUJA	Petrol	1242	4	19
FIESTA V (JH_, JD_)	1.3	05/00→	FUJB	Petrol	1242	4	20
FIESTA V (JH_, JD_)	1.3	03/00→	M7JA	Petrol	1242	4	21
FIESTA V (JH_, JD_)	1.3	03/00→	M7JB	Petrol	1242	4	22
FIESTA V (JH_, JD_)	1.4	11/00→	F6JA	Diesel	1399	4	77
FIESTA V (JH_, JD_)	1.4	11/00→	F6JB	Diesel	1399	4	78
FIESTA V (JH_, JD_)	1.4	11/00→	FXJA	Petrol	1388	4	97
FIESTA V (JH_, JD_)	1.4	11/00→	FXJB	Petrol	1388	4	98
FIESTA V (JH_, JD_)	1.6	11/00→	FYJA	Petrol	1596	4	116
FIESTA V (JH_, JD_)	1.6	11/00→	FYJB	Petrol	1596	4	117
FIESTA V (JH_, JD_)	1.6	11/00→	HHJA	Diesel	1560	4	128
FIESTA V (JH_, JD_)	1.6	11/00→	HHJB	Diesel	1560	4	129
FIESTA V (JH_, JD_)	2.0	03/00→	N4JB	Petrol	1999	4	330
FIESTA Van	1.3	10/00→	A9JA	Petrol	1299	4	29
FIESTA Van	1.3	10/00→	A9JB	Petrol	1299	4	30
FIESTA Van	1.3	01/00→	SNJA	Petrol	1242	4	23
FIESTA Van	1.3	01/00→	SNJB	Petrol	1242	4	24
FIESTA Van	1.4	10/00→	F6JA	Diesel	1399	4	77
FIESTA Van	1.4	10/00→	F6JB	Diesel	1399	4	78
FIESTA Van	1.4	07/01→	F6JD	Diesel	1399	4	79
FIESTA Van	1.4	07/01→	KVJA	Diesel	1399	4	100
FIESTA Van	1.6	01/00→	HHJC	Diesel	1560	4	130
FIESTA Van	1.6	01/00→	HHJD	Diesel	1560	4	131
FIESTA Van	1.6	01/00→	HHJE	Diesel	1560	4	132

	Ltr				CC		9
FIESTA VI	1.3	10/00 →	SNJA	Petrol	1242	4	23
FIESTA VI	1.3	10/00 →	SNJB	Petrol	1242	4	24
FIESTA VI	1.3	10/00 →	STJA	Petrol	1242	4	25
FIESTA VI	1.3	10/00 →	STJB	Petrol	1242	4	26
FIESTA VI	1.4	01/00 →	F6JB	Diesel	1399	4	78
FIESTA VI	1.4	07/01 →	F6JD	Diesel	1399	4	79
FIESTA VI	1.4	07/01 →	KVJA	Diesel	1399	4	100
FIESTA VI	1.4	01/00 →	RTJA	Petrol/Petroleum Gas (LPG)	1388	4	101
FIESTA VI	1.4	01/00 →	RTJB	Petrol/Petroleum Gas (LPG)	1388	4	102
FIESTA VI	1.4	10/00 →	SPJA	Petrol	1388	4	103
FIESTA VI	1.4	10/00 →	SPJC	Petrol	1388	4	104
FIESTA VI	1.6	10/00 →	HHJC	Diesel	1560	4	130
FIESTA VI	1.6	10/00 →	HHJD	Diesel	1560	4	131
FIESTA VI	1.6	10/00 →	HHJE	Diesel	1560	4	132
FIESTA VI	1.6	10/00 →	HHJF	Diesel	1560	4	133
FIESTA VI	1.6	10/00 →	HXJA	Petrol	1596	4	138
FIESTA VI	1.6	10/00 →	HXJB	Petrol	1596	4	139
FIESTA VI	1.6	10/00 →	UBJA	Diesel	1560	4	177
FOCUS (DAW, DBW)	1.4	10/99 →11/00	FXDA	Petrol	1388	4	93
FOCUS (DAW, DBW)	1.4	10/99 →11/00	FXDB	Petrol	1388	4	94
FOCUS (DAW, DBW)	1.4	10/99 →11/00	FXDC	Petrol	1388	4	95
FOCUS (DAW, DBW)	1.4	10/99 →11/00	FXDD	Petrol	1388	4	96
FOCUS (DAW, DBW)	1.6	10/99 →11/00	FYDA	Petrol	1596	4	111
FOCUS (DAW, DBW)	1.6	10/99 →11/00	FYDB	Petrol	1596	4	112
FOCUS (DAW, DBW)	1.6	10/99 →11/00	FYDC	Petrol	1596	4	113
FOCUS (DAW, DBW)	1.6	10/99 →11/00	FYDD	Petrol	1596	4	114
FOCUS (DAW, DBW)	1.6	10/99 →11/00	FYDH	Petrol/Ethanol	1596	4	115
FOCUS (DAW, DBW)	1.6	10/99 →11/00	FYDH	Petrol	1596	4	115
FOCUS (DAW, DBW)	1.8	08/99 →11/00	BHDA	Diesel	1753	4	180
FOCUS (DAW, DBW)	1.8	08/99 →11/00	BHDB	Diesel	1753	4	181
FOCUS (DAW, DBW)	1.8	10/99 →11/00	C9DA	Diesel	1753	4	183
FOCUS (DAW, DBW)	1.8	10/99 →11/00	C9DB	Diesel	1753	4	184
FOCUS (DAW, DBW)	1.8	10/99 →11/00	C9DC	Diesel	1753	4	185
FOCUS (DAW, DBW)	1.8	10/99 →11/00	EYDB	Petrol	1796	4	193
FOCUS (DAW, DBW)	1.8	10/99 →11/00	EYDC	Petrol	1796	4	194
FOCUS (DAW, DBW)	1.8	10/99 →11/00	EYDD	Petrol	1796	4	195
FOCUS (DAW, DBW)	1.8	10/99 →11/00	EYDE	Petrol	1796	4	196
FOCUS (DAW, DBW)	1.8	10/99 →11/00	EYDF	Petrol	1796	4	197
FOCUS (DAW, DBW)	1.8	10/99 →11/00	EYDG	Petrol	1796	4	198
FOCUS (DAW, DBW)	1.8	10/99 →11/00	EYDI	Petrol	1796	4	199
FOCUS (DAW, DBW)	1.8	10/99 →11/00	EYDJ	Petrol	1796	4	200
FOCUS (DAW, DBW)	1.8	10/99 →11/00	EYDL	Petrol	1796	4	201
FOCUS (DAW, DBW)	1.8	03/00 →11/00	F9DA	Diesel	1753	4	205
FOCUS (DAW, DBW)	1.8	03/00 →11/00	F9DB	Diesel	1753	4	206
FOCUS (DAW, DBW)	1.8	08/00 →11/00	FFDA	Diesel	1753	4	208
FOCUS (DAW, DBW)	2.0	03/00 →11/00	ALDA	Petrol	1988	4	283
FOCUS (DAW, DBW)	2.0	10/99 →11/00	EDDB	Petrol	1988	4	304
FOCUS (DAW, DBW)	2.0	10/99 →11/00	EDDC	Petrol	1988	4	305
FOCUS (DAW, DBW)	2.0	10/99 →11/00	EDDD	Petrol	1988	4	306
FOCUS (DAW, DBW)	2.0	10/99 →11/00	EDDF	Petrol	1988	4	307
FOCUS (DAW, DBW)	2.0	10/00 →11/00	HMDA	Petrol	1988	4	321
FOCUS C-MAX	1.6	10/00 →03/00	G8DA	Diesel	1560	4	118
FOCUS C-MAX	1.6	10/00 →03/00	G8DB	Diesel	1560	4	119
FOCUS C-MAX	1.6	02/00 →03/00	HHDA	Diesel	1560	4	126
FOCUS C-MAX	1.6	02/00 →03/00	HHDB	Diesel	1560	4	127
FOCUS C-MAX	1.6	10/00 →03/00	HWDA	Petrol	1596	4	134
FOCUS C-MAX	1.6	10/00 →03/00	HWDB	Petrol	1596	4	135
FOCUS C-MAX	1.6	08/00 →03/00	HXDA	Petrol	1596	4	136
FOCUS C-MAX	1.6	08/00 →03/00	SIDA	Petrol/Petroleum Gas (LPG)	1596	4	176
FOCUS C-MAX	1.6	08/00 →03/00	SIDA	Petrol	1596	4	176
FOCUS C-MAX	1.8	10/00 →03/00	CSDA	Petrol	1798	4	191
FOCUS C-MAX	1.8	10/00 →03/00	CSDB	Petrol	1798	4	192
FOCUS C-MAX	1.8	01/00 →03/00	KKDA	Diesel	1753	4	213
FOCUS C-MAX	1.8	04/00 →03/00	Q7DA	Petrol/Ethanol	1798	4	221
FOCUS C-MAX	1.8	04/00 →03/00	Q7DA	Petrol	1798	4	221
FOCUS C-MAX	1.8	04/00 →03/00	QQDA	Petrol	1798	4	222
FOCUS C-MAX	1.8	04/00 →03/00	QQDB	Petrol	1798	4	223
FOCUS C-MAX	1.8	09/00 →03/00	QQDC	Petrol	1798	4	224
FOCUS C-MAX	2.0	03/00 →03/00	AODA	Petrol	1999	4	286
FOCUS C-MAX	2.0	03/00 →03/00	AODB	Petrol	1999	4	287



Ltr







CC



9

Model	Ltr	Year Range	Code	Fuel Type	CC	Seats	Price
FOCUS G-MAX	2.0	10/00→03/00	G6DA	Diesel	1997	4	311
FOCUS G-MAX	2.0	10/00→03/00	G6DB	Diesel	1997	4	312
FOCUS G-MAX	2.0	10/00→03/00	G6DC	Diesel	1997	4	313
FOCUS G-MAX	2.0	10/00→03/00	G6DD	Diesel	1997	4	314
FOCUS G-MAX	2.0	10/00→03/00	G6DE	Diesel	1997	4	315
FOCUS G-MAX	2.0	10/00→03/00	G6DF	Diesel	1997	4	316
FOCUS G-MAX	2.0	10/00→03/00	G6DG	Diesel	1997	4	317
FOCUS G-MAX	2.0	03/00→03/00	SYDA	Petrol/Petroleum Gas (LPG)	1999	4	368
FOCUS G-MAX	2.0	03/00→03/00	SYDA	Petrol/Natural Gas (CNG)	1999	4	368
FOCUS G-MAX	2.0	03/00→03/00	SYDA	Petrol	1999	4	368
FOCUS Estate (DNW)	1.4	02/99→11/00	FXDA	Petrol	1388	4	93
FOCUS Estate (DNW)	1.4	02/99→11/00	FXDB	Petrol	1388	4	94
FOCUS Estate (DNW)	1.4	02/99→11/00	FXDC	Petrol	1388	4	95
FOCUS Estate (DNW)	1.4	02/99→11/00	FXDD	Petrol	1388	4	96
FOCUS Estate (DNW)	1.6	02/99→11/00	FYDA	Petrol	1596	4	111
FOCUS Estate (DNW)	1.6	02/99→11/00	FYDB	Petrol	1596	4	112
FOCUS Estate (DNW)	1.6	02/99→11/00	FYDC	Petrol	1596	4	113
FOCUS Estate (DNW)	1.6	02/99→11/00	FYDD	Petrol	1596	4	114
FOCUS Estate (DNW)	1.6	02/99→11/00	FYDH	Petrol/Ethanol	1596	4	115
FOCUS Estate (DNW)	1.6	02/99→11/00	FYDH	Petrol	1596	4	115
FOCUS Estate (DNW)	1.8	08/99→11/00	BHDA	Diesel	1753	4	180
FOCUS Estate (DNW)	1.8	08/99→11/00	BHDB	Diesel	1753	4	181
FOCUS Estate (DNW)	1.8	02/99→11/00	C9DA	Diesel	1753	4	183
FOCUS Estate (DNW)	1.8	02/99→11/00	C9DB	Diesel	1753	4	184
FOCUS Estate (DNW)	1.8	02/99→11/00	C9DC	Diesel	1753	4	185
FOCUS Estate (DNW)	1.8	02/99→11/00	EYDB	Petrol	1796	4	193
FOCUS Estate (DNW)	1.8	02/99→11/00	EYDC	Petrol	1796	4	194
FOCUS Estate (DNW)	1.8	02/99→11/00	EYDD	Petrol	1796	4	195
FOCUS Estate (DNW)	1.8	02/99→11/00	EYDE	Petrol	1796	4	196
FOCUS Estate (DNW)	1.8	02/99→11/00	EYDF	Petrol	1796	4	197
FOCUS Estate (DNW)	1.8	02/99→11/00	EYDG	Petrol	1796	4	198
FOCUS Estate (DNW)	1.8	02/99→11/00	EYDI	Petrol	1796	4	199
FOCUS Estate (DNW)	1.8	02/99→11/00	EYDJ	Petrol	1796	4	200
FOCUS Estate (DNW)	1.8	02/99→11/00	EYDL	Petrol	1796	4	201
FOCUS Estate (DNW)	1.8	03/00→11/00	F9DA	Diesel	1753	4	205
FOCUS Estate (DNW)	1.8	03/00→11/00	F9DB	Diesel	1753	4	206
FOCUS Estate (DNW)	1.8	08/00→11/00	FFDA	Diesel	1753	4	208
FOCUS Estate (DNW)	2.0	08/00→11/00	ALDA	Petrol	1988	4	283
FOCUS Estate (DNW)	2.0	02/99→11/00	EDDB	Petrol	1988	4	304
FOCUS Estate (DNW)	2.0	02/99→11/00	EDDC	Petrol	1988	4	305
FOCUS Estate (DNW)	2.0	02/99→11/00	EDDD	Petrol	1988	4	306
FOCUS Estate (DNW)	2.0	02/99→11/00	EDDF	Petrol	1988	4	307
FOCUS II (DA_)	1.4	11/00→	ASDA	Petrol	1388	4	66
FOCUS II (DA_)	1.4	11/00→	ASDB	Petrol	1388	4	67
FOCUS II (DA_)	1.6	11/00→	G8DA	Diesel	1560	4	118
FOCUS II (DA_)	1.6	11/00→	G8DB	Diesel	1560	4	119
FOCUS II (DA_)	1.6	11/00→	G8DC	Diesel	1560	4	120
FOCUS II (DA_)	1.6	11/00→	G8DD	Diesel	1560	4	121
FOCUS II (DA_)	1.6	11/00→	G8DE	Diesel	1560	4	122
FOCUS II (DA_)	1.6	11/00→	G8DF	Diesel	1560	4	123
FOCUS II (DA_)	1.6	01/00→	GPDA	Diesel	1560	4	124
FOCUS II (DA_)	1.6	01/00→	GPDC	Diesel	1560	4	125
FOCUS II (DA_)	1.6	01/00→	HHDA	Diesel	1560	4	126
FOCUS II (DA_)	1.6	01/00→	HHDB	Diesel	1560	4	127
FOCUS II (DA_)	1.6	11/00→	HWDA	Petrol	1596	4	134
FOCUS II (DA_)	1.6	11/00→	HWDB	Petrol	1596	4	135
FOCUS II (DA_)	1.6	11/00→	HXDA	Petrol	1596	4	136
FOCUS II (DA_)	1.6	11/00→	HXDB	Petrol	1596	4	137
FOCUS II (DA_)	1.6	11/00→	MTDA	Diesel	1560	4	170
FOCUS II (DA_)	1.6	11/00→	SHDA	Petrol	1596	4	173
FOCUS II (DA_)	1.6	10/00→	SIDA	Petrol/Petroleum Gas (LPG)	1596	4	176
FOCUS II (DA_)	1.6	10/00→	SIDA	Petrol	1596	4	176
FOCUS II (DA_)	1.8	01/00→	KKDA	Diesel	1753	4	213
FOCUS II (DA_)	1.8	01/00→	KKDB	Diesel	1753	4	214
FOCUS II (DA_)	1.8	01/00→	Q7DA	Petrol/Ethanol	1798	4	221
FOCUS II (DA_)	1.8	01/00→	Q7DA	Petrol	1798	4	221
FOCUS II (DA_)	1.8	03/00→	QQDB	Petrol	1798	4	223
FOCUS II (DA_)	1.8	12/00→	QQDD	Petrol/Ethanol	1798	4	225
FOCUS II (DA_)	2.0	11/00→	AODA	Petrol	1999	4	286
FOCUS II (DA_)	2.0	11/00→	AODB	Petrol	1999	4	287

	Ltr				CC		9
FOCUS II (DA_)	2.0	11/00 →	G6DA	Diesel	1997	4	311
FOCUS II (DA_)	2.0	11/00 →	G6DB	Diesel	1997	4	312
FOCUS II (DA_)	2.0	11/00 →	G6DD	Diesel	1997	4	314
FOCUS II (DA_)	2.0	11/00 →	G6DE	Diesel	1997	4	315
FOCUS II (DA_)	2.0	11/00 →	G6DF	Diesel	1997	4	316
FOCUS II (DA_)	2.0	02/00 →	IXDA	Diesel	1997	4	322
FOCUS II (DA_)	2.0	06/00 →	SYDA	Petrol/Petroleum Gas (LPG)	1999	4	368
FOCUS II (DA_)	2.0	06/00 →	SYDA	Petrol/Natural Gas (CNG)	1999	4	368
FOCUS II (DA_)	2.0	06/00 →	SYDA	Petrol	1999	4	368
FOCUS II (DA_)	2.5	10/00 →	HYDA	Petrol	2522	5	443
FOCUS II (DA_)	2.5	01/00 →	JZDA	Petrol	2521	5	445
FOCUS II Convertible	1.6	10/00 →	HWDA	Petrol	1596	4	134
FOCUS II Convertible	1.6	10/00 →	HWDB	Petrol	1596	4	135
FOCUS II Convertible	2.0	10/00 →	AODA	Petrol	1999	4	286
FOCUS II Convertible	2.0	10/00 →	AODB	Petrol	1999	4	287
FOCUS II Convertible	2.0	10/00 →	G6DA	Diesel	1997	4	311
FOCUS II Convertible	2.0	10/00 →	G6DB	Diesel	1997	4	312
FOCUS II Convertible	2.0	10/00 →	G6DD	Diesel	1997	4	314
FOCUS II Estate (DA_)	1.4	11/00 →	ASDA	Petrol	1388	4	66
FOCUS II Estate (DA_)	1.4	11/00 →	ASDB	Petrol	1388	4	67
FOCUS II Estate (DA_)	1.6	11/00 →	G8DA	Diesel	1560	4	118
FOCUS II Estate (DA_)	1.6	11/00 →	G8DB	Diesel	1560	4	119
FOCUS II Estate (DA_)	1.6	11/00 →	G8DC	Diesel	1560	4	120
FOCUS II Estate (DA_)	1.6	11/00 →	G8DD	Diesel	1560	4	121
FOCUS II Estate (DA_)	1.6	11/00 →	G8DE	Diesel	1560	4	122
FOCUS II Estate (DA_)	1.6	11/00 →	G8DF	Diesel	1560	4	123
FOCUS II Estate (DA_)	1.6	11/00 →	GPDA	Diesel	1560	4	124
FOCUS II Estate (DA_)	1.6	11/00 →	GPDC	Diesel	1560	4	125
FOCUS II Estate (DA_)	1.6	11/00 →	HHDA	Diesel	1560	4	126
FOCUS II Estate (DA_)	1.6	11/00 →	HHDB	Diesel	1560	4	127
FOCUS II Estate (DA_)	1.6	11/00 →	HWDA	Petrol	1596	4	134
FOCUS II Estate (DA_)	1.6	11/00 →	HWDB	Petrol	1596	4	135
FOCUS II Estate (DA_)	1.6	11/00 →	HXDA	Petrol	1596	4	136
FOCUS II Estate (DA_)	1.6	11/00 →	HXDB	Petrol	1596	4	137
FOCUS II Estate (DA_)	1.6	11/00 →	MTDA	Diesel	1560	4	170
FOCUS II Estate (DA_)	1.6	11/00 →	SHDA	Petrol	1596	4	173
FOCUS II Estate (DA_)	1.6	10/00 →	SIDA	Petrol/Petroleum Gas (LPG)	1596	4	176
FOCUS II Estate (DA_)	1.6	10/00 →	SIDA	Petrol	1596	4	176
FOCUS II Estate (DA_)	1.8	11/00 →	KKDA	Diesel	1753	4	213
FOCUS II Estate (DA_)	1.8	11/00 →	KKDB	Diesel	1753	4	214
FOCUS II Estate (DA_)	1.8	01/00 →	Q7DA	Petrol/Ethanol	1798	4	221
FOCUS II Estate (DA_)	1.8	01/00 →	Q7DA	Petrol	1798	4	221
FOCUS II Estate (DA_)	1.8	03/00 →	QQDB	Petrol	1798	4	223
FOCUS II Estate (DA_)	2.0	11/00 →	AODA	Petrol	1999	4	286
FOCUS II Estate (DA_)	2.0	11/00 →	AODB	Petrol	1999	4	287
FOCUS II Estate (DA_)	2.0	11/00 →	G6DA	Diesel	1997	4	311
FOCUS II Estate (DA_)	2.0	11/00 →	G6DB	Diesel	1997	4	312
FOCUS II Estate (DA_)	2.0	11/00 →	G6DD	Diesel	1997	4	314
FOCUS II Estate (DA_)	2.0	11/00 →	G6DE	Diesel	1997	4	315
FOCUS II Estate (DA_)	2.0	11/00 →	G6DF	Diesel	1997	4	316
FOCUS II Estate (DA_)	2.0	02/00 →	IXDA	Diesel	1997	4	322
FOCUS II Estate (DA_)	2.0	06/00 →	SYDA	Petrol/Petroleum Gas (LPG)	1999	4	368
FOCUS II Estate (DA_)	2.0	06/00 →	SYDA	Petrol/Natural Gas (CNG)	1999	4	368
FOCUS II Estate (DA_)	2.0	06/00 →	SYDA	Petrol	1999	4	368
FOCUS II Saloon (DA_)	1.4	04/00 →	ASDA	Petrol	1388	4	66
FOCUS II Saloon (DA_)	1.4	04/00 →	ASDB	Petrol	1388	4	67
FOCUS II Saloon (DA_)	1.6	04/00 →	G8DA	Diesel	1560	4	118
FOCUS II Saloon (DA_)	1.6	04/00 →	G8DB	Diesel	1560	4	119
FOCUS II Saloon (DA_)	1.6	04/00 →	G8DC	Diesel	1560	4	120
FOCUS II Saloon (DA_)	1.6	04/00 →	G8DD	Diesel	1560	4	121
FOCUS II Saloon (DA_)	1.6	04/00 →	G8DE	Diesel	1560	4	122
FOCUS II Saloon (DA_)	1.6	04/00 →	G8DF	Diesel	1560	4	123
FOCUS II Saloon (DA_)	1.6	04/00 →	HHDA	Diesel	1560	4	126
FOCUS II Saloon (DA_)	1.6	04/00 →	HHDB	Diesel	1560	4	127
FOCUS II Saloon (DA_)	1.6	04/00 →	HWDA	Petrol	1596	4	134
FOCUS II Saloon (DA_)	1.6	04/00 →	HWDB	Petrol	1596	4	135
FOCUS II Saloon (DA_)	1.6	04/00 →	HXDA	Petrol	1596	4	136
FOCUS II Saloon (DA_)	1.6	04/00 →	HXDB	Petrol	1596	4	137
FOCUS II Saloon (DA_)	1.6	04/00 →	MTDA	Diesel	1560	4	170
FOCUS II Saloon (DA_)	1.6	04/00 →	SHDA	Petrol	1596	4	173



Ltr







CC



9

Model	Ltr	Year Range	Code	Fuel Type	CC	Seats	Price
FOCUS II Saloon (DA_)	1.8	04/00→	KKDA	Diesel	1753	4	213
FOCUS II Saloon (DA_)	1.8	04/00→	KKDB	Diesel	1753	4	214
FOCUS II Saloon (DA_)	1.8	06/00→	Q7DA	Petrol/Ethanol	1798	4	221
FOCUS II Saloon (DA_)	1.8	06/00→	Q7DA	Petrol	1798	4	221
FOCUS II Saloon (DA_)	1.8	03/00→	QQDB	Petrol	1798	4	223
FOCUS II Saloon (DA_)	2.0	04/00→	AODA	Petrol	1999	4	286
FOCUS II Saloon (DA_)	2.0	04/00→	AODB	Petrol	1999	4	287
FOCUS II Saloon (DA_)	2.0	04/00→	G6DA	Diesel	1997	4	311
FOCUS II Saloon (DA_)	2.0	04/00→	G6DB	Diesel	1997	4	312
FOCUS II Saloon (DA_)	2.0	04/00→	G6DD	Diesel	1997	4	314
FOCUS II Saloon (DA_)	2.0	02/00→	IXDA	Diesel	1997	4	322
FOCUS Saloon (DFW)	1.4	02/99→11/00	FXDA	Petrol	1388	4	93
FOCUS Saloon (DFW)	1.4	02/99→11/00	FXDB	Petrol	1388	4	94
FOCUS Saloon (DFW)	1.4	02/99→11/00	FXDC	Petrol	1388	4	95
FOCUS Saloon (DFW)	1.4	02/99→11/00	FXDD	Petrol	1388	4	96
FOCUS Saloon (DFW)	1.6	02/99→11/00	FYDA	Petrol	1596	4	111
FOCUS Saloon (DFW)	1.6	02/99→11/00	FYDB	Petrol	1596	4	112
FOCUS Saloon (DFW)	1.6	02/99→11/00	FYDC	Petrol	1596	4	113
FOCUS Saloon (DFW)	1.6	02/99→11/00	FYDD	Petrol	1596	4	114
FOCUS Saloon (DFW)	1.6	02/99→11/00	FYDH	Petrol/Ethanol	1596	4	115
FOCUS Saloon (DFW)	1.6	02/99→11/00	FYDH	Petrol	1596	4	115
FOCUS Saloon (DFW)	1.8	08/00→03/00	BHDA	Diesel	1753	4	180
FOCUS Saloon (DFW)	1.8	08/00→03/00	BHDB	Diesel	1753	4	181
FOCUS Saloon (DFW)	1.8	02/99→11/00	C9DA	Diesel	1753	4	183
FOCUS Saloon (DFW)	1.8	02/99→11/00	C9DB	Diesel	1753	4	184
FOCUS Saloon (DFW)	1.8	02/99→11/00	C9DC	Diesel	1753	4	185
FOCUS Saloon (DFW)	1.8	02/99→11/00	EYDB	Petrol	1796	4	193
FOCUS Saloon (DFW)	1.8	02/99→11/00	EYDC	Petrol	1796	4	194
FOCUS Saloon (DFW)	1.8	02/99→11/00	EYDD	Petrol	1796	4	195
FOCUS Saloon (DFW)	1.8	02/99→11/00	EYDE	Petrol	1796	4	196
FOCUS Saloon (DFW)	1.8	02/99→11/00	EYDF	Petrol	1796	4	197
FOCUS Saloon (DFW)	1.8	02/99→11/00	EYDG	Petrol	1796	4	198
FOCUS Saloon (DFW)	1.8	02/99→11/00	EYDI	Petrol	1796	4	199
FOCUS Saloon (DFW)	1.8	02/99→11/00	EYDJ	Petrol	1796	4	200
FOCUS Saloon (DFW)	1.8	02/99→11/00	EYDL	Petrol	1796	4	201
FOCUS Saloon (DFW)	1.8	03/00→11/00	F9DA	Diesel	1753	4	205
FOCUS Saloon (DFW)	1.8	03/00→11/00	F9DB	Diesel	1753	4	206
FOCUS Saloon (DFW)	1.8	08/00→11/00	FFDA	Diesel	1753	4	208
FOCUS Saloon (DFW)	2.0	02/99→11/00	EDDB	Petrol	1988	4	304
FOCUS Saloon (DFW)	2.0	02/99→11/00	EDDC	Petrol	1988	4	305
FOCUS Saloon (DFW)	2.0	02/99→11/00	EDDD	Petrol	1988	4	306
FOCUS Saloon (DFW)	2.0	02/99→11/00	EDDF	Petrol	1988	4	307
FUSION (JU_)	1.3	08/00→	FUJA	Petrol	1242	4	19
FUSION (JU_)	1.3	08/00→	FUJB	Petrol	1242	4	20
FUSION (JU_)	1.4	08/00→	F6JA	Diesel	1399	4	77
FUSION (JU_)	1.4	08/00→	F6JB	Diesel	1399	4	78
FUSION (JU_)	1.4	08/00→	FXJA	Petrol	1388	4	97
FUSION (JU_)	1.4	08/00→	FXJB	Petrol	1388	4	98
FUSION (JU_)	1.4	08/00→	FXJC	Petrol	1388	4	99
FUSION (JU_)	1.4	01/01→	UTJA	Petrol/Petroleum Gas (LPG)	1388	4	106
FUSION (JU_)	1.6	08/00→	FYJA	Petrol	1596	4	116
FUSION (JU_)	1.6	08/00→	FYJB	Petrol	1596	4	117
FUSION (JU_)	1.6	11/00→	HHJA	Diesel	1560	4	128
FUSION (JU_)	1.6	11/00→	HHJB	Diesel	1560	4	129
GALAXY (WGR)	1.9	03/99→05/00	IZ	Diesel	1896	4	274
GALAXY (WGR)	1.9	08/99→04/00	AFN	Diesel	1896	4	275
GALAXY (WGR)	1.9	03/99→05/00	AHU	Diesel	1896	4	276
GALAXY (WGR)	1.9	03/99→05/00	ANU	Diesel	1896	4	277
GALAXY (WGR)	1.9	02/00→05/00	ASZ	Diesel	1896	4	278
GALAXY (WGR)	1.9	04/00→05/00	AUY	Diesel	1896	4	279
GALAXY (WGR)	1.9	08/99→04/00	AVG	Diesel	1896	4	280
GALAXY (WGR)	1.9	05/00→05/00	BTB	Diesel	1896	4	281
GALAXY (WGR)	2.0	11/99→05/00	NSE	Petrol	1998	4	358
GALAXY (WGR)	2.3	01/99→05/00	ESSA	Petrol	2295	4	394
GALAXY (WGR)	2.3	09/00→05/00	ESSB	Petrol	2295	4	395
GALAXY (WGR)	2.3	01/99→05/00	YSB	Petrol	2295	4	400
GALAXY (WGR)	2.8	11/99→04/00	AAA	Petrol	2792	6	462
GALAXY (WGR)	2.8	11/99→04/00	AMY	Petrol	2792	6	463
GALAXY (WGR)	2.8	04/00→05/00	AYL	Petrol	2792	6	464
GALAXY	1.8	05/00→	FFWA	Diesel	1753	4	209

	Ltr				CC		9
GALAXY	1.8	05/00 →	QYWA	Diesel	1753	4	227
GALAXY	2.0	05/00 →	AOWA	Petrol	1999	4	289
GALAXY	2.0	05/00 →	AOWB	Petrol	1999	4	290
GALAXY	2.0	05/00 →	AZWA	Diesel	1997	4	293
GALAXY	2.0	05/00 →	AZWC	Diesel	1997	4	294
GALAXY	2.0	11/00 →	KLWA	Diesel	1997	4	324
GALAXY	2.0	05/00 →	QXWA	Diesel	1997	4	364
GALAXY	2.0	05/00 →	QXWB	Diesel	1997	4	365
GALAXY	2.0	05/00 →	QXWC	Diesel	1997	4	366
GALAXY	2.0	05/00 →	TBWA	Petrol/Ethanol	1999	4	371
GALAXY	2.0	05/00 →	TBWB	Petrol/Ethanol	1999	4	372
GALAXY	2.2	03/00 →	Q4BA	Diesel	2179	4	379
GALAXY	2.2	03/00 →	Q4WA	Diesel	2179	4	380
KA (RB_)	1.3	08/00 →11/00	A9A	Petrol	1299	4	27
KA (RB_)	1.3	08/00 →11/00	A9B	Petrol	1299	4	28
KA (RB_)	1.3	09/99 →11/00	BAA	Petrol	1299	4	31
KA (RB_)	1.3	09/99 →11/00	J4D	Petrol	1299	4	35
KA (RB_)	1.3	09/99 →11/00	J4K	Petrol	1299	4	37
KA (RB_)	1.3	09/99 →11/00	J4M	Petrol	1299	4	39
KA (RB_)	1.3	09/99 →11/00	J4N	Petrol	1299	4	40
KA (RB_)	1.3	09/99 →11/00	J4P	Petrol	1299	4	41
KA (RB_)	1.3	09/99 →11/00	J4S	Petrol	1299	4	44
KA (RB_)	1.3	09/99 →10/00	JJB	Petrol	1299	4	53
KA (RB_)	1.3	06/99 →11/00	JJD	Petrol	1299	4	55
KA (RB_)	1.3	06/99 →11/00	JJF	Petrol	1299	4	57
KA (RB_)	1.3	06/99 →11/00	JJG	Petrol	1299	4	58
KA (RB_)	1.3	06/99 →11/00	JJH	Petrol	1299	4	59
KA (RB_)	1.3	06/99 →11/00	JJL	Petrol	1299	4	62
KA (RB_)	1.6	07/00 →11/00	CDB	Petrol	1599	4	107
KA (RB_)	1.6	07/00 →11/00	CDC	Petrol	1599	4	108
KA Van (RB)	1.3	05/00 →05/00	BAA	Petrol	1299	4	31
KA Van (RB)	1.3	05/00 →05/00	J4D	Petrol	1299	4	35
KA Van (RB)	1.3	05/00 →05/00	J4K	Petrol	1299	4	37
KA Van (RB)	1.3	05/00 →05/00	J4M	Petrol	1299	4	39
KA Van (RB)	1.3	05/00 →05/00	J4N	Petrol	1299	4	40
KA Van (RB)	1.3	05/00 →05/00	J4P	Petrol	1299	4	41
KA Van (RB)	1.3	05/00 →05/00	J4S	Petrol	1299	4	44
KA	1.2	10/00 →	FP4	Petrol	1242	4	18
KA	1.3	10/00 →	FD4	Diesel	1248	4	17
KUGA I	2.0	03/00 →	G6DG	Diesel	1997	4	317
KUGA I	2.5	03/00 →	HYDB	Petrol	2522	5	444
MAVERICK (UDS, UNS)	2.4	09/99 →04/99	KA-24	Petrol	2389	4	413
MAVERICK (UDS, UNS)	2.4	02/99 →08/99	KA24-E	Petrol	2389	4	414
MAVERICK (UDS, UNS)	2.7	02/99 →08/99	TD27	Diesel	2663	4	460
MAVERICK (UDS, UNS)	2.7	09/99 →04/99	TD27E	Diesel	2664	4	461
MAVERICK VAN	2.7	06/99 →04/99	TD27	Diesel	2663	4	460
MAVERICK VAN	2.7	06/99 →04/99	TD27E	Diesel	2664	4	461
MAVERICK	2.0	02/00 →	YF	Petrol	1989	4	374
MAVERICK	2.3	03/00 →	GZ	Petrol	2261	4	396
MAVERICK	3.0	02/00 →	AJ	Petrol	2967	6	479
METROSTAR	2.5	10/00 →02/00	LCBD	Petrol	2495	6	449
MONDEO I (GBP)	1.6	02/99 →08/99	L1F	Petrol	1597	4	141
MONDEO I (GBP)	1.6	07/99 →08/99	L1J	Petrol	1597	4	144
MONDEO I (GBP)	1.8	06/99 →08/99	RFM	Diesel	1753	4	243
MONDEO I (GBP)	1.8	06/99 →08/99	RFN	Diesel	1753	4	244
MONDEO I (GBP)	1.8	02/99 →08/99	RKA	Petrol	1796	4	246
MONDEO I (GBP)	1.8	07/99 →08/99	RKB	Petrol	1796	4	247
MONDEO I (GBP)	2.0	02/99 →08/99	NGA	Petrol	1988	4	350
MONDEO I (GBP)	2.5	07/99 →08/99	SEA	Petrol	2544	6	453
MONDEO I Estate (BNP)	1.6	04/99 →08/99	L1F	Petrol	1597	4	141
MONDEO I Estate (BNP)	1.6	07/99 →08/99	L1J	Petrol	1597	4	144
MONDEO I Estate (BNP)	1.8	06/99 →08/99	RFM	Diesel	1753	4	243
MONDEO I Estate (BNP)	1.8	06/99 →08/99	RFN	Diesel	1753	4	244
MONDEO I Estate (BNP)	1.8	04/99 →08/99	RKA	Petrol	1796	4	246
MONDEO I Estate (BNP)	1.8	07/99 →08/99	RKB	Petrol	1796	4	247
MONDEO I Estate (BNP)	2.0	01/99 →08/99	NGA	Petrol	1988	4	350
MONDEO I Estate (BNP)	2.5	07/99 →08/99	SEA	Petrol	2544	6	453
MONDEO I Saloon (GBP)	1.6	02/99 →08/99	L1F	Petrol	1597	4	141
MONDEO I Saloon (GBP)	1.6	07/99 →08/99	L1J	Petrol	1597	4	144
MONDEO I Saloon (GBP)	1.8	06/99 →08/99	RFM	Diesel	1753	4	243



Ltr







CC



9

Model	Ltr	Year	Code	Fuel	CC	Gear	Price
MONDEO I Saloon (GBP)	1.8	06/99→08/99	RFN	Diesel	1753	4	244
MONDEO I Saloon (GBP)	1.8	02/99→08/99	RKA	Petrol	1796	4	246
MONDEO I Saloon (GBP)	1.8	01/99→08/99	RKB	Petrol	1796	4	247
MONDEO I Saloon (GBP)	2.0	02/99→08/99	NGA	Petrol	1988	4	350
MONDEO I Saloon (GBP)	2.5	07/99→08/99	SEA	Petrol	2544	6	453
MONDEO II (BAP)	1.6	09/99→11/00	L1J	Petrol	1597	4	144
MONDEO II (BAP)	1.6	05/99→11/00	L1L	Petrol	1597	4	146
MONDEO II (BAP)	1.6	05/99→11/00	L1N	Petrol	1597	4	147
MONDEO II (BAP)	1.6	05/99→11/00	L1Q	Petrol	1597	4	148
MONDEO II (BAP)	1.8	09/99→11/00	RFN	Diesel	1753	4	244
MONDEO II (BAP)	1.8	09/99→11/00	RKB	Petrol	1796	4	247
MONDEO II (BAP)	1.8	09/99→11/00	RKF	Petrol	1796	4	249
MONDEO II (BAP)	1.8	09/99→11/00	RKH	Petrol	1796	4	250
MONDEO II (BAP)	1.8	09/99→11/00	RKJ	Petrol	1796	4	251
MONDEO II (BAP)	1.8	09/99→11/00	RKK	Petrol	1796	4	252
MONDEO II (BAP)	2.0	09/99→11/00	NGA	Petrol	1988	4	350
MONDEO II (BAP)	2.0	09/99→11/00	NGB	Petrol	1988	4	351
MONDEO II (BAP)	2.0	09/99→11/00	NGC	Petrol	1988	4	352
MONDEO II (BAP)	2.0	09/99→11/00	NGD	Petrol	1988	4	353
MONDEO II (BAP)	2.5	09/99→11/00	SEA	Petrol	2544	6	453
MONDEO II (BAP)	2.5	06/00→11/00	SEB	Petrol	2495	6	454
MONDEO II (BAP)	2.5	06/00→11/00	SEC	Petrol	2495	6	455
MONDEO II (BAP)	2.5	05/99→11/00	SGA	Petrol	2495	6	456
MONDEO II Estate (BNP)	1.6	09/99→11/00	L1J	Petrol	1597	4	144
MONDEO II Estate (BNP)	1.6	05/99→11/00	L1L	Petrol	1597	4	146
MONDEO II Estate (BNP)	1.6	05/99→11/00	L1N	Petrol	1597	4	147
MONDEO II Estate (BNP)	1.6	05/99→11/00	L1Q	Petrol	1597	4	148
MONDEO II Estate (BNP)	1.8	09/99→11/00	RFN	Diesel	1753	4	244
MONDEO II Estate (BNP)	1.8	09/99→11/00	RKB	Petrol	1796	4	247
MONDEO II Estate (BNP)	1.8	09/99→11/00	RKF	Petrol	1796	4	249
MONDEO II Estate (BNP)	1.8	09/99→11/00	RKH	Petrol	1796	4	250
MONDEO II Estate (BNP)	1.8	09/99→11/00	RKJ	Petrol	1796	4	251
MONDEO II Estate (BNP)	1.8	09/99→11/00	RKK	Petrol	1796	4	252
MONDEO II Estate (BNP)	2.0	09/99→11/00	NGA	Petrol	1988	4	350
MONDEO II Estate (BNP)	2.0	09/99→11/00	NGB	Petrol	1988	4	351
MONDEO II Estate (BNP)	2.0	09/99→11/00	NGC	Petrol	1988	4	352
MONDEO II Estate (BNP)	2.0	09/99→11/00	NGD	Petrol	1988	4	353
MONDEO II Estate (BNP)	2.5	09/99→11/00	SEA	Petrol	2544	6	453
MONDEO II Estate (BNP)	2.5	10/99→11/00	SEB	Petrol	2495	6	454
MONDEO II Estate (BNP)	2.5	10/99→11/00	SEC	Petrol	2495	6	455
MONDEO II Estate (BNP)	2.5	05/99→11/00	SGA	Petrol	2495	6	456
MONDEO II Saloon (BFP)	1.6	09/99→11/00	L1J	Petrol	1597	4	144
MONDEO II Saloon (BFP)	1.6	05/99→11/00	L1L	Petrol	1597	4	146
MONDEO II Saloon (BFP)	1.6	05/99→11/00	L1N	Petrol	1597	4	147
MONDEO II Saloon (BFP)	1.6	05/99→11/00	L1Q	Petrol	1597	4	148
MONDEO II Saloon (BFP)	1.8	09/99→11/00	RFN	Diesel	1753	4	244
MONDEO II Saloon (BFP)	1.8	09/99→11/00	RKB	Petrol	1796	4	247
MONDEO II Saloon (BFP)	1.8	09/99→11/00	RKF	Petrol	1796	4	249
MONDEO II Saloon (BFP)	1.8	09/99→11/00	RKH	Petrol	1796	4	250
MONDEO II Saloon (BFP)	1.8	09/99→11/00	RKJ	Petrol	1796	4	251
MONDEO II Saloon (BFP)	1.8	09/99→11/00	RKK	Petrol	1796	4	252
MONDEO II Saloon (BFP)	2.0	09/99→11/00	NGA	Petrol	1988	4	350
MONDEO II Saloon (BFP)	2.0	09/99→11/00	NGB	Petrol	1988	4	351
MONDEO II Saloon (BFP)	2.0	09/99→11/00	NGC	Petrol	1988	4	352
MONDEO II Saloon (BFP)	2.0	09/99→11/00	NGD	Petrol	1988	4	353
MONDEO II Saloon (BFP)	2.5	06/00→11/00	LCBD	Petrol	2495	6	449
MONDEO II Saloon (BFP)	2.5	09/99→11/00	SEA	Petrol	2544	6	453
MONDEO II Saloon (BFP)	2.5	06/00→11/00	SEB	Petrol	2495	6	454
MONDEO II Saloon (BFP)	2.5	06/00→11/00	SEC	Petrol	2495	6	455
MONDEO II Saloon (BFP)	2.5	05/99→11/00	SGA	Petrol	2495	6	456
MONDEO III (B5Y)	1.8	06/00→08/00	CFBA	Petrol	1798	4	186
MONDEO III (B5Y)	1.8	11/00→08/00	CGBA	Petrol	1798	4	187
MONDEO III (B5Y)	1.8	11/00→08/00	CGBB	Petrol	1798	4	188
MONDEO III (B5Y)	1.8	11/00→08/00	CHBA	Petrol	1798	4	189
MONDEO III (B5Y)	1.8	11/00→08/00	CHBB	Petrol	1798	4	190
MONDEO III (B5Y)	2.0	11/00→08/00	C1BA	Petrol	1999	4	295
MONDEO III (B5Y)	2.0	11/00→08/00	C1BB	Petrol	1999	4	296
MONDEO III (B5Y)	2.0	11/00→08/00	DSBA	Diesel	1998	4	298
MONDEO III (B5Y)	2.0	11/00→08/00	D6BA	Diesel	1998	4	299
MONDEO III (B5Y)	2.0	10/00→08/00	FMBA	Diesel	1998	4	310

	Ltr				CC		9
MONDEO III (B5Y)	2.0	11/00 → 08/00	HJBA	Diesel	1998	4	318
MONDEO III (B5Y)	2.0	11/00 → 08/00	HJBB	Diesel	1998	4	319
MONDEO III (B5Y)	2.0	11/00 → 08/00	HJBC	Diesel	1998	4	320
MONDEO III (B5Y)	2.0	10/00 → 08/00	N7BA	Diesel	1998	4	334
MONDEO III (B5Y)	2.0	11/00 → 08/00	SDBA	Diesel	1998	4	367
MONDEO III (B5Y)	2.2	09/00 → 08/00	QJBA	Diesel	2198	4	381
MONDEO III (B5Y)	2.2	09/00 → 08/00	QJBB	Diesel	2198	4	382
MONDEO III (B5Y)	2.2	09/00 → 08/00	QJBC	Diesel	2198	4	383
MONDEO III (B5Y)	2.2	09/00 → 08/00	QJBD	Diesel	2198	4	384
MONDEO III (B5Y)	2.5	11/00 → 08/00	LCBD	Petrol	2495	6	449
MONDEO III (B5Y)	3.0	04/00 → 08/00	MEBA	Petrol	2967	6	480
MONDEO III (B5Y)	3.0	09/00 → 08/00	REBA	Petrol	2967	6	481
MONDEO III Estate (BWY)	1.8	06/00 → 08/00	CFBA	Petrol	1798	4	186
MONDEO III Estate (BWY)	1.8	11/00 → 08/00	CGBA	Petrol	1798	4	187
MONDEO III Estate (BWY)	1.8	11/00 → 08/00	CGBB	Petrol	1798	4	188
MONDEO III Estate (BWY)	1.8	11/00 → 08/00	CHBA	Petrol	1798	4	189
MONDEO III Estate (BWY)	1.8	11/00 → 08/00	CHBB	Petrol	1798	4	190
MONDEO III Estate (BWY)	2.0	11/00 → 08/00	CJBA	Petrol	1999	4	295
MONDEO III Estate (BWY)	2.0	11/00 → 08/00	CJBB	Petrol	1999	4	296
MONDEO III Estate (BWY)	2.0	11/00 → 08/00	D5BA	Diesel	1998	4	298
MONDEO III Estate (BWY)	2.0	11/00 → 08/00	D6BA	Diesel	1998	4	299
MONDEO III Estate (BWY)	2.0	10/00 → 08/00	FMBA	Diesel	1998	4	310
MONDEO III Estate (BWY)	2.0	11/00 → 08/00	HJBA	Diesel	1998	4	318
MONDEO III Estate (BWY)	2.0	11/00 → 08/00	HJBB	Diesel	1998	4	319
MONDEO III Estate (BWY)	2.0	11/00 → 08/00	HJBC	Diesel	1998	4	320
MONDEO III Estate (BWY)	2.0	10/00 → 08/00	N7BA	Diesel	1998	4	334
MONDEO III Estate (BWY)	2.0	11/00 → 08/00	SDBA	Diesel	1998	4	367
MONDEO III Estate (BWY)	2.2	09/00 → 08/00	QJBA	Diesel	2198	4	381
MONDEO III Estate (BWY)	2.2	09/00 → 08/00	QJBB	Diesel	2198	4	382
MONDEO III Estate (BWY)	2.2	09/00 → 08/00	QJBC	Diesel	2198	4	383
MONDEO III Estate (BWY)	2.2	09/00 → 08/00	QJBD	Diesel	2198	4	384
MONDEO III Estate (BWY)	2.5	11/00 → 08/00	LCBD	Petrol	2495	6	449
MONDEO III Estate (BWY)	3.0	04/00 → 08/00	MEBA	Petrol	2967	6	480
MONDEO III Estate (BWY)	3.0	09/00 → 08/00	REBA	Petrol	2967	6	481
MONDEO III Saloon (B4Y)	1.8	06/00 → 08/00	CFBA	Petrol	1798	4	186
MONDEO III Saloon (B4Y)	1.8	11/00 → 08/00	CGBA	Petrol	1798	4	187
MONDEO III Saloon (B4Y)	1.8	11/00 → 08/00	CGBB	Petrol	1798	4	188
MONDEO III Saloon (B4Y)	1.8	11/00 → 08/00	CHBA	Petrol	1798	4	189
MONDEO III Saloon (B4Y)	1.8	11/00 → 08/00	CHBB	Petrol	1798	4	190
MONDEO III Saloon (B4Y)	2.0	11/00 → 08/00	CJBA	Petrol	1999	4	295
MONDEO III Saloon (B4Y)	2.0	11/00 → 08/00	CJBB	Petrol	1999	4	296
MONDEO III Saloon (B4Y)	2.0	11/00 → 08/00	D5BA	Diesel	1998	4	298
MONDEO III Saloon (B4Y)	2.0	11/00 → 08/00	D6BA	Diesel	1998	4	299
MONDEO III Saloon (B4Y)	2.0	10/00 → 08/00	FMBA	Diesel	1998	4	310
MONDEO III Saloon (B4Y)	2.0	11/00 → 08/00	HJBA	Diesel	1998	4	318
MONDEO III Saloon (B4Y)	2.0	11/00 → 08/00	HJBB	Diesel	1998	4	319
MONDEO III Saloon (B4Y)	2.0	11/00 → 08/00	HJBC	Diesel	1998	4	320
MONDEO III Saloon (B4Y)	2.0	10/00 → 08/00	N7BA	Diesel	1998	4	334
MONDEO III Saloon (B4Y)	2.0	11/00 → 08/00	SDBA	Diesel	1998	4	367
MONDEO III Saloon (B4Y)	2.2	09/00 → 08/00	QJBA	Diesel	2198	4	381
MONDEO III Saloon (B4Y)	2.2	09/00 → 08/00	QJBB	Diesel	2198	4	382
MONDEO III Saloon (B4Y)	2.2	09/00 → 08/00	QJBC	Diesel	2198	4	383
MONDEO III Saloon (B4Y)	2.2	09/00 → 08/00	QJBD	Diesel	2198	4	384
MONDEO III Saloon (B4Y)	2.5	11/00 → 08/00	LCBD	Petrol	2495	6	449
MONDEO III Saloon (B4Y)	3.0	04/00 → 08/00	MEBA	Petrol	2967	6	480
MONDEO III Saloon (B4Y)	3.0	09/00 → 08/00	REBA	Petrol	2967	6	481
MONDEO IV Saloon	1.6	03/00 →	PNBA	Petrol	1596	4	171
MONDEO IV Saloon	1.6	03/00 →	RHBA	Petrol	1596	4	172
MONDEO IV Saloon	1.8	03/00 →	FFBA	Diesel	1753	4	207
MONDEO IV Saloon	1.8	06/00 →	KHBA	Diesel	1753	4	212
MONDEO IV Saloon	1.8	06/00 →	QYBA	Diesel	1753	4	226
MONDEO IV Saloon	2.0	03/00 →	AOBA	Petrol	1999	4	284
MONDEO IV Saloon	2.0	03/00 →	AOBC	Petrol	1999	4	285
MONDEO IV Saloon	2.0	03/00 →	AZBA	Diesel	1997	4	291
MONDEO IV Saloon	2.0	11/00 →	KLBA	Diesel	1997	4	323
MONDEO IV Saloon	2.0	11/00 →	LPBA	Diesel	1997	4	325
MONDEO IV Saloon	2.0	03/00 →	QXBA	Diesel	1997	4	362
MONDEO IV Saloon	2.0	03/00 →	QXBB	Diesel	1997	4	363
MONDEO IV Saloon	2.0	03/00 →	TBBA	Petrol/Petroleum Gas (LPG)	1999	4	369
MONDEO IV Saloon	2.0	03/00 →	TBBA	Petrol/Ethanol	1999	4	369



Ltr







CC



9

Model	Ltr	Year Range	Code	Fuel	CC	Power (kW)	Power (HP)
MONDEO IV Saloon	2.0	03/00→	TBBA	Petrol	1999	4	369
MONDEO IV Saloon	2.0	03/00→	TBBB	Petrol/Ethanol	1999	4	370
MONDEO IV Saloon	2.0	03/00→	UFBA	Diesel	1997	4	373
MONDEO IV Saloon	2.2	03/00→	Q4BA	Diesel	2179	4	379
MONDEO IV Saloon	2.5	03/00→	HUBA	Petrol	2521	5	441
MONDEO IV Turnier	1.6	03/00→	PNBA	Petrol	1596	4	171
MONDEO IV Turnier	1.6	03/00→	RHBA	Petrol	1596	4	172
MONDEO IV Turnier	1.8	03/00→	FFBA	Diesel	1753	4	207
MONDEO IV Turnier	1.8	06/00→	KHBA	Diesel	1753	4	212
MONDEO IV Turnier	1.8	06/00→	QYBA	Diesel	1753	4	226
MONDEO IV Turnier	2.0	03/00→	AOBA	Petrol	1999	4	284
MONDEO IV Turnier	2.0	03/00→	AOBC	Petrol	1999	4	285
MONDEO IV Turnier	2.0	03/00→	AZBA	Diesel	1997	4	291
MONDEO IV Turnier	2.0	03/00→	AZBC	Diesel	1997	4	292
MONDEO IV Turnier	2.0	11/00→	KLBA	Diesel	1997	4	323
MONDEO IV Turnier	2.0	11/00→	LPBA	Diesel	1997	4	325
MONDEO IV Turnier	2.0	03/00→	QXBA	Diesel	1997	4	362
MONDEO IV Turnier	2.0	03/00→	QXBB	Diesel	1997	4	363
MONDEO IV Turnier	2.0	03/00→	TBBA	Petrol/Petroleum Gas (LPG)	1999	4	369
MONDEO IV Turnier	2.0	03/00→	TBBA	Petrol/Ethanol	1999	4	369
MONDEO IV Turnier	2.0	03/00→	TBBA	Petrol	1999	4	369
MONDEO IV Turnier	2.0	03/00→	TBBB	Petrol/Ethanol	1999	4	370
MONDEO IV Turnier	2.0	03/00→	UFBA	Diesel	1997	4	373
MONDEO IV Turnier	2.2	03/00→	Q4BA	Diesel	2179	4	379
MONDEO IV Turnier	2.5	03/00→	HUBA	Petrol	2521	5	441
MONDEO IV	1.6	03/00→	PNBA	Petrol	1596	4	171
MONDEO IV	1.6	03/00→	RHBA	Petrol	1596	4	172
MONDEO IV	1.8	03/00→	FFBA	Diesel	1753	4	207
MONDEO IV	1.8	06/00→	KHBA	Diesel	1753	4	212
MONDEO IV	1.8	06/00→	QYBA	Diesel	1753	4	226
MONDEO IV	2.0	03/00→	AOBA	Petrol	1999	4	284
MONDEO IV	2.0	03/00→	AOBC	Petrol	1999	4	285
MONDEO IV	2.0	03/00→	AZBA	Diesel	1997	4	291
MONDEO IV	2.0	03/00→	AZBC	Diesel	1997	4	292
MONDEO IV	2.0	11/00→	KLBA	Diesel	1997	4	323
MONDEO IV	2.0	11/00→	LPBA	Diesel	1997	4	325
MONDEO IV	2.0	03/00→	QXBA	Diesel	1997	4	362
MONDEO IV	2.0	03/00→	QXBB	Diesel	1997	4	363
MONDEO IV	2.0	03/00→	TBBA	Petrol/Petroleum Gas (LPG)	1999	4	369
MONDEO IV	2.0	03/00→	TBBA	Petrol/Ethanol	1999	4	369
MONDEO IV	2.0	03/00→	TBBA	Petrol	1999	4	369
MONDEO IV	2.0	03/00→	TBBB	Petrol/Ethanol	1999	4	370
MONDEO IV	2.0	03/00→	UFBA	Diesel	1997	4	373
MONDEO IV	2.2	03/00→	Q4BA	Diesel	2179	4	379
MONDEO IV	2.5	03/00→	HUBA	Petrol	2521	5	441
ORION II (AFF)	1.3	12/98→07/99	JBB	Petrol	1297	4	49
ORION II (AFF)	1.3	12/98→07/99	JLA	Petrol	1297	4	64
ORION II (AFF)	1.3	12/98→07/99	JLB	Petrol	1297	4	65
ORION II (AFF)	1.4	02/98→07/99	F6B	Petrol	1392	4	71
ORION II (AFF)	1.4	02/98→07/99	F6D	Petrol	1392	4	73
ORION II (AFF)	1.4	12/98→07/99	FUA	Petrol	1392	4	84
ORION II (AFF)	1.4	03/98→07/99	FUAA	Petrol	1392	4	85
ORION II (AFF)	1.4	01/98→07/99	FUC	Petrol	1392	4	87
ORION II (AFF)	1.6	04/98→12/98	LP2	Petrol	1597	4	159
ORION II (AFF)	1.6	12/98→01/98	LTC	Diesel	1608	4	164
ORION II (AFF)	1.6	12/98→07/99	LUC	Petrol	1597	4	165
ORION II (AFF)	1.8	01/98→07/99	RTA	Diesel	1753	4	255
ORION II (AFF)	1.8	01/98→07/99	RTB	Diesel	1753	4	256
ORION III (GAL)	1.3	07/99→12/99	J4B	Petrol	1299	4	33
ORION III (GAL)	1.3	07/99→12/99	J6A	Petrol	1299	4	46
ORION III (GAL)	1.4	07/99→12/99	F6F	Petrol	1392	4	75
ORION III (GAL)	1.4	07/99→12/99	F6G	Petrol	1392	4	76
ORION III (GAL)	1.4	07/99→12/99	FUH	Petrol	1392	4	91
ORION III (GAL)	1.6	07/99→12/99	LIE	Petrol	1597	4	140
ORION III (GAL)	1.6	07/99→12/99	LIK	Petrol	1597	4	145
ORION III (GAL)	1.6	07/99→09/99	LJF	Petrol	1598	4	157
ORION III (GAL)	1.6	07/99→12/99	LUJ	Petrol	1598	4	168
ORION III (GAL)	1.6	07/99→12/99	LUK	Petrol	1598	4	169
ORION III (GAL)	1.8	02/99→12/99	RDA	Petrol	1796	4	233
ORION III (GAL)	1.8	03/99→12/99	RFD	Diesel	1753	4	240

	Ltr				CC		9
ORION III (GAL)	1.8	03/99→12/99	RFK	Diesel	1753	4	241
ORION III (GAL)	1.8	01/99→12/99	ROB	Petrol	1796	4	253
ORION III (GAL)	1.8	11/99→12/99	RTE	Diesel	1753	4	259
ORION III (GAL)	1.8	11/99→12/99	RTF	Diesel	1753	4	260
ORION III (GAL)	1.8	11/99→12/99	RTH	Diesel	1753	4	262
P 100 II	1.8	10/98→12/99	RFA	Diesel	1753	4	238
P 100 II	2.0	10/98→12/99	NAE	Petrol	1993	4	342
PUMA (EC_)	1.4	11/99→10/00	FHD	Petrol	1388	4	81
PUMA (EC_)	1.4	11/99→10/00	FHF	Petrol	1388	4	83
PUMA (EC_)	1.6	08/00→06/00	LIW	Petrol	1596	4	151
PUMA (EC_)	1.7	03/99→06/00	MHA	Petrol	1679	4	178
PUMA (EC_)	1.7	03/99→06/00	MHB	Petrol	1679	4	179
RANGER (TU_)	1.8	06/99→02/00	RKA	Petrol	1796	4	246
RANGER (TU_)	2.5	10/99→04/00	WL	Diesel	2500	4	458
RANGER (TU_)	2.5	10/99→06/00	WLT	Diesel	2500	4	459
SCORPIO I (GAE, GGE)	1.8	04/98→02/99	REC	Petrol	1796	4	235
SCORPIO I (GAE, GGE)	2.0	11/98→10/99	N8A	Petrol	1998	4	335
SCORPIO I (GAE, GGE)	2.0	05/98→09/99	N9D	Petrol	1998	4	339
SCORPIO I (GAE, GGE)	2.0	04/98→08/98	NEL	Petrol	1993	4	349
SCORPIO I (GAE, GGE)	2.0	04/98→09/99	NRA	Petrol	1993	4	354
SCORPIO I (GAE, GGE)	2.0	10/98→12/99	NRC	Petrol	1993	4	355
SCORPIO I (GAE, GGE)	2.0	04/98→09/99	NRI	Petrol	1993	4	356
SCORPIO I (GAE, GGE)	2.5	08/99→09/99	SCB	Diesel	2500	4	451
SCORPIO I (GAE, GGE)	2.9	04/99→09/99	BOA	Petrol	2933	6	471
SCORPIO I (GAE, GGE)	2.9	09/98→09/99	BRC	Petrol	2933	6	473
SCORPIO I (GAE, GGE)	2.9	09/98→09/99	BRD	Petrol	2933	6	474
SCORPIO I (GAE, GGE)	2.9	09/98→09/99	BRE	Petrol	2933	6	475
SCORPIO I (GAE, GGE)	2.9	09/98→09/99	BRF	Petrol	2933	6	476
SCORPIO I Estate (GGE)	2.0	09/99→09/99	N9D	Petrol	1998	4	339
SCORPIO I Estate (GGE)	2.0	09/99→09/99	N9F	Petrol	1998	4	341
SCORPIO I Estate (GGE)	2.5	08/99→09/99	SCB	Diesel	2500	4	451
SCORPIO I Estate (GGE)	2.9	08/99→09/99	BOA	Petrol	2933	6	471
SCORPIO I Estate (GGE)	2.9	05/98→09/99	BRD	Petrol	2933	6	474
SCORPIO I Estate (GGE)	2.9	05/98→09/99	BRE	Petrol	2933	6	475
SCORPIO I Estate (GGE)	2.9	05/98→09/99	BRF	Petrol	2933	6	476
SCORPIO I Saloon (GGE)	1.8	01/98→10/98	REC	Petrol	1796	4	235
SCORPIO I Saloon (GGE)	1.9	11/99→09/99	NRA	Petrol	1993	4	354
SCORPIO I Saloon (GGE)	2.0	05/98→02/99	N9B	Petrol	1998	4	337
SCORPIO I Saloon (GGE)	2.0	05/98→09/99	N9D	Petrol	1998	4	339
SCORPIO I Saloon (GGE)	2.0	02/99→09/99	N9F	Petrol	1998	4	341
SCORPIO I Saloon (GGE)	2.5	08/99→09/99	SCB	Diesel	2500	4	451
SCORPIO I Saloon (GGE)	2.9	04/99→09/99	BOA	Petrol	2933	6	471
SCORPIO I Saloon (GGE)	2.9	09/98→12/99	BRD	Petrol	2933	6	474
SCORPIO I Saloon (GGE)	2.9	09/98→12/99	BRE	Petrol	2933	6	475
SCORPIO I Saloon (GGE)	2.9	09/98→12/99	BRF	Petrol	2933	6	476
SCORPIO II (GFR, GGR)	2.0	10/99→08/99	N3A	Petrol	1998	4	326
SCORPIO II (GFR, GGR)	2.0	10/99→08/99	NSD	Petrol	1998	4	357
SCORPIO II (GFR, GGR)	2.3	06/99→08/99	Y5A	Petrol	2295	4	399
SCORPIO II (GFR, GGR)	2.5	10/99→08/99	SCC	Diesel	2500	4	452
SCORPIO II (GFR, GGR)	2.5	09/99→08/99	VM	Diesel	2500	4	457
SCORPIO II (GFR, GGR)	2.9	10/99→08/99	BOB	Petrol	2933	6	472
SCORPIO II (GFR, GGR)	2.9	02/99→08/99	BRG	Petrol	2933	6	477
SCORPIO II Estate (GNR, GGR)	2.0	10/99→08/99	N3A	Petrol	1998	4	326
SCORPIO II Estate (GNR, GGR)	2.0	10/99→08/99	NSD	Petrol	1998	4	357
SCORPIO II Estate (GNR, GGR)	2.3	06/99→08/99	Y5A	Petrol	2295	4	399
SCORPIO II Estate (GNR, GGR)	2.5	10/99→08/99	SCC	Diesel	2500	4	452
SCORPIO II Estate (GNR, GGR)	2.5	09/99→08/99	VM	Diesel	2500	4	457
SCORPIO II Estate (GNR, GGR)	2.9	10/99→08/99	BOB	Petrol	2933	6	472
SCORPIO II Estate (GNR, GGR)	2.9	02/99→08/99	BRG	Petrol	2933	6	477
SIERRA (GBG, GB4)	1.6	10/98→02/99	L6B	Petrol	1598	4	152
SIERRA (GBG, GB4)	1.6	01/98→02/99	LSE	Petrol	1597	4	160
SIERRA (GBG, GB4)	1.6	01/98→02/99	LSF	Petrol	1597	4	161
SIERRA (GBG, GB4)	1.8	01/98→05/98	R2A	Petrol	1796	4	228
SIERRA (GBG, GB4)	1.8	05/98→02/99	R2C	Petrol	1769	4	229
SIERRA (GBG, GB4)	1.8	05/98→02/99	R6A	Petrol	1769	4	232
SIERRA (GBG, GB4)	1.8	01/98→09/98	RED	Petrol	1796	4	236
SIERRA (GBG, GB4)	1.8	10/98→09/98	REF	Petrol	1796	4	237
SIERRA (GBG, GB4)	1.8	08/98→02/99	RFA	Diesel	1753	4	238
SIERRA (GBG, GB4)	1.8	08/98→02/99	RFB	Diesel	1753	4	239
SIERRA (GBG, GB4)	1.8	08/98→02/99	RFL	Diesel	1753	4	242



Ltr







CC



9

	Ltr				CC		
SIERRA (GBG, GB4)	2.0	01/98→02/99	N4A	Petrol	1993	4	327
SIERRA (GBG, GB4)	2.0	01/98→02/99	N4B	Petrol	1993	4	328
SIERRA (GBG, GB4)	2.0	01/98→02/99	N4I	Petrol	1993	4	329
SIERRA (GBG, GB4)	2.0	07/98→12/99	N8A	Petrol	1998	4	335
SIERRA (GBG, GB4)	2.0	01/98→02/99	N8C	Petrol	1993	4	336
SIERRA (GBG, GB4)	2.0	01/99→02/99	N9C	Petrol	1998	4	338
SIERRA (GBG, GB4)	2.0	12/99→02/99	N9E	Petrol	1998	4	340
SIERRA (GBG, GB4)	2.0	01/98→12/98	NE5	Petrol	1993	4	347
SIERRA (GBG, GB4)	2.0	01/98→12/98	NEJ	Petrol	1993	4	348
SIERRA (GBG, GB4)	2.8	08/98→02/99	PR8	Petrol	2792	6	466
SIERRA (GBG, GB4)	2.9	08/98→02/99	B4B	Petrol	2936	6	469
SIERRA (GBG, GB4)	2.9	08/98→02/99	B4C	Petrol	2936	6	470
SIERRA Estate (BNG)	1.6	10/98→02/99	L6B	Petrol	1598	4	152
SIERRA Estate (BNG)	1.6	01/98→02/99	LSE	Petrol	1597	4	160
SIERRA Estate (BNG)	1.6	01/98→02/99	LSF	Petrol	1597	4	161
SIERRA Estate (BNG)	1.8	01/98→05/98	R2A	Petrol	1796	4	228
SIERRA Estate (BNG)	1.8	05/98→02/99	R2C	Petrol	1769	4	229
SIERRA Estate (BNG)	1.8	05/98→02/99	R6A	Petrol	1769	4	232
SIERRA Estate (BNG)	1.8	01/98→05/98	RED	Petrol	1796	4	236
SIERRA Estate (BNG)	1.8	10/98→05/98	REF	Petrol	1796	4	237
SIERRA Estate (BNG)	1.8	08/98→02/99	RFA	Diesel	1753	4	238
SIERRA Estate (BNG)	1.8	08/98→02/99	RFB	Diesel	1753	4	239
SIERRA Estate (BNG)	1.8	08/98→02/99	RFL	Diesel	1753	4	242
SIERRA Estate (BNG)	1.9	10/98→09/99	N8A	Petrol	1998	4	335
SIERRA Estate (BNG)	2.0	01/98→02/99	N4A	Petrol	1993	4	327
SIERRA Estate (BNG)	2.0	01/98→02/99	N4B	Petrol	1993	4	328
SIERRA Estate (BNG)	2.0	01/98→02/99	N4I	Petrol	1993	4	329
SIERRA Estate (BNG)	2.0	01/98→02/99	N8C	Petrol	1993	4	336
SIERRA Estate (BNG)	2.0	05/98→02/99	N9C	Petrol	1998	4	338
SIERRA Estate (BNG)	2.0	12/99→02/99	N9E	Petrol	1998	4	340
SIERRA Estate (BNG)	2.0	01/98→02/99	NE5	Petrol	1993	4	347
SIERRA Estate (BNG)	2.0	01/98→02/99	NEJ	Petrol	1993	4	348
SIERRA Estate (BNG)	2.8	01/98→02/99	PR7	Petrol	2792	6	465
SIERRA Estate (BNG)	2.8	01/98→02/99	PR8	Petrol	2792	6	466
SIERRA Estate (BNG)	2.8	01/98→08/98	PRG	Petrol	2792	6	467
SIERRA Estate (BNG)	2.9	08/98→02/99	B4B	Petrol	2936	6	469
SIERRA Estate (BNG)	2.9	08/98→02/99	B4C	Petrol	2936	6	470
SIERRA Hatchback (GBC, GBG)	1.6	10/98→02/99	L6B	Petrol	1598	4	152
SIERRA Hatchback (GBC, GBG)	1.6	01/98→02/99	LSE	Petrol	1597	4	160
SIERRA Hatchback (GBC, GBG)	1.6	01/98→02/99	LSF	Petrol	1597	4	161
SIERRA Hatchback (GBC, GBG)	1.8	01/98→05/98	R2A	Petrol	1796	4	228
SIERRA Hatchback (GBC, GBG)	1.8	05/98→02/99	R2C	Petrol	1769	4	229
SIERRA Hatchback (GBC, GBG)	1.8	05/98→02/99	R6A	Petrol	1769	4	232
SIERRA Hatchback (GBC, GBG)	1.8	01/98→05/98	RED	Petrol	1796	4	236
SIERRA Hatchback (GBC, GBG)	1.8	10/98→05/98	REF	Petrol	1796	4	237
SIERRA Hatchback (GBC, GBG)	1.8	08/98→02/99	RFA	Diesel	1753	4	238
SIERRA Hatchback (GBC, GBG)	1.8	08/98→02/99	RFB	Diesel	1753	4	239
SIERRA Hatchback (GBC, GBG)	1.8	08/98→02/99	RFL	Diesel	1753	4	242
SIERRA Hatchback (GBC, GBG)	2.0	01/98→02/99	N4A	Petrol	1993	4	327
SIERRA Hatchback (GBC, GBG)	2.0	01/98→02/99	N4B	Petrol	1993	4	328
SIERRA Hatchback (GBC, GBG)	2.0	01/98→02/99	N4I	Petrol	1993	4	329
SIERRA Hatchback (GBC, GBG)	2.0	06/98→02/99	N8A	Petrol	1998	4	335
SIERRA Hatchback (GBC, GBG)	2.0	01/98→02/99	N8C	Petrol	1993	4	336
SIERRA Hatchback (GBC, GBG)	2.0	06/98→02/99	N9B	Petrol	1998	4	337
SIERRA Hatchback (GBC, GBG)	2.0	06/98→03/99	N9C	Petrol	1998	4	338
SIERRA Hatchback (GBC, GBG)	2.0	12/99→02/99	N9E	Petrol	1998	4	340
SIERRA Hatchback (GBC, GBG)	2.0	01/98→02/99	NE5	Petrol	1993	4	347
SIERRA Hatchback (GBC, GBG)	2.0	01/98→02/99	NEJ	Petrol	1993	4	348
SIERRA Hatchback (GBC, GBG)	2.8	01/98→02/99	PR7	Petrol	2792	6	465
SIERRA Hatchback (GBC, GBG)	2.8	01/98→02/99	PR8	Petrol	2792	6	466
SIERRA Hatchback (GBC, GBG)	2.8	01/98→08/98	PRG	Petrol	2792	6	467
SIERRA Hatchback (GBC, GBG)	2.9	08/98→02/99	B4A	Petrol	2936	6	468
SIERRA Hatchback (GBC, GBG)	2.9	08/98→02/99	B4B	Petrol	2936	6	469
SIERRA Hatchback (GBC, GBG)	2.9	08/98→02/99	B4C	Petrol	2936	6	470
S-MAX	1.8	01/00→	FFWA	Diesel	1753	4	209
S-MAX	1.8	05/00→	QYWA	Diesel	1753	4	227
S-MAX	2.0	05/00→	AOWA	Petrol	1999	4	289
S-MAX	2.0	05/00→	AOWB	Petrol	1999	4	290
S-MAX	2.0	05/00→	AZWA	Diesel	1997	4	293
S-MAX	2.0	05/00→	AZWC	Diesel	1997	4	294

	Ltr				CC		9
S-MAX	2.0	11/00 →	KLWA	Diesel	1997	4	324
S-MAX	2.0	05/00 →	QXWA	Diesel	1997	4	364
S-MAX	2.0	05/00 →	QXWB	Diesel	1997	4	365
S-MAX	2.0	05/00 →	QXWC	Diesel	1997	4	366
S-MAX	2.0	05/00 →	TBWA	Petrol/Ethanol	1999	4	371
S-MAX	2.0	05/00 →	TBWB	Petrol/Ethanol	1999	4	372
S-MAX	2.2	03/00 →	Q4WA	Diesel	2179	4	380
S-MAX	2.5	05/00 →	HUWA	Petrol	2521	5	442
STREET KA	1.6	05/00 → 07/00	CDRA	Petrol	1599	4	109
STREET KA	1.6	05/00 → 07/00	CDRB	Petrol	1599	4	110
TOURNEO CONNECT	1.8	06/00 →	BHPA	Diesel	1753	4	182
TOURNEO CONNECT	1.8	06/00 →	EYPA	Petrol	1796	4	202
TOURNEO CONNECT	1.8	06/00 →	EYPC	Petrol/Petroleum Gas (LPG)	1796	4	203
TOURNEO CONNECT	1.8	06/00 →	EYPC	Petrol	1796	4	203
TOURNEO CONNECT	1.8	06/00 →	EYPD	Petrol	1796	4	204
TOURNEO CONNECT	1.8	06/00 →	HCPA	Diesel	1753	4	210
TOURNEO CONNECT	1.8	06/00 →	HCPB	Diesel	1753	4	211
TOURNEO CONNECT	1.8	06/00 →	P7PA	Diesel	1753	4	215
TOURNEO CONNECT	1.8	06/00 →	P7PB	Diesel	1753	4	216
TOURNEO CONNECT	1.8	06/00 →	P9PA	Diesel	1753	4	217
TOURNEO CONNECT	1.8	06/00 →	P9PB	Diesel	1753	4	218
TOURNEO CONNECT	1.8	06/00 →	P9PC	Diesel	1753	4	219
TOURNEO CONNECT	1.8	06/00 →	P9PD	Diesel	1753	4	220
TOURNEO CONNECT	1.8	06/00 →	R2PA	Diesel	1753	4	230
TOURNEO CONNECT	1.8	06/00 →	R3PA	Diesel	1753	4	231
TOURNEO CONNECT	1.8	08/00 →	RWPA	Diesel	1753	4	269
TOURNEO CONNECT	1.8	08/00 →	RWPC	Diesel	1753	4	270
TOURNEO CONNECT	1.8	08/00 →	RWPD	Diesel	1753	4	271
TOURNEO CONNECT	1.8	06/00 →	RWPE	Diesel	1753	4	272
TOURNEO CONNECT	1.8	06/00 →	RWPF	Diesel	1753	4	273
TRANSIT Box (E_)	2.0	09/99 → 06/99	NBA	Petrol	1993	4	345
TRANSIT Box (E_)	2.0	09/99 → 06/99	NCA	Petrol	1994	4	346
TRANSIT Box (E_)	2.0	06/99 → 03/00	NSF	Petrol	1998	4	359
TRANSIT Box (E_)	2.0	06/99 → 03/00	NSG	Petrol	1998	4	360
TRANSIT Box (E_)	2.5	05/99 → 06/99	4BC	Diesel	2496	4	419
TRANSIT Box (E_)	2.5	05/99 → 06/99	4CC	Diesel	2496	4	421
TRANSIT Box (E_)	2.5	05/99 → 06/99	4DA	Diesel	2496	4	422
TRANSIT Box (E_)	2.5	05/99 → 06/99	4EA	Diesel	2496	4	423
TRANSIT Box (E_)	2.5	06/99 → 03/00	4EB	Diesel	2496	4	424
TRANSIT Box (E_)	2.5	06/99 → 03/00	4EC	Diesel	2496	4	425
TRANSIT Box (E_)	2.5	05/99 → 03/00	4ED	Diesel	2496	4	426
TRANSIT Box (E_)	2.5	05/99 → 03/00	4FA	Diesel	2496	4	427
TRANSIT Box (E_)	2.5	06/99 → 03/00	4FB	Diesel	2496	4	428
TRANSIT Box (E_)	2.5	06/99 → 03/00	4FC	Diesel	2496	4	429
TRANSIT Box (E_)	2.5	06/99 → 03/00	4FD	Diesel	2496	4	430
TRANSIT Box (E_)	2.5	10/99 → 03/00	4GA	Diesel	2496	4	431
TRANSIT Box (E_)	2.5	06/99 → 03/00	4GB	Diesel	2496	4	432
TRANSIT Box (E_)	2.5	06/99 → 03/00	4GC	Diesel	2496	4	433
TRANSIT Box (E_)	2.5	06/99 → 03/00	4GD	Diesel	2496	4	434
TRANSIT Box (E_)	2.5	06/99 → 03/00	4GE	Diesel	2496	4	435
TRANSIT Box (E_)	2.5	06/99 → 03/00	4GF	Diesel	2496	4	436
TRANSIT Box (E_)	2.5	10/99 → 03/00	4HA	Diesel	2496	4	437
TRANSIT Box (E_)	2.5	06/99 → 03/00	4HB	Diesel	2496	4	438
TRANSIT Box (E_)	2.5	06/99 → 03/00	4HC	Diesel	2496	4	439
TRANSIT Box (E_)	2.5	10/99 → 03/00	4HD	Diesel	2496	4	440
TRANSIT Box (FA_)	2.0	08/00 → 05/00	ABFA	Diesel	1998	4	282
TRANSIT Box (FA_)	2.0	08/00 → 05/00	D3FA	Diesel	1998	4	297
TRANSIT Box (FA_)	2.0	08/00 → 05/00	F3FA	Diesel	1998	4	308
TRANSIT Box (FA_)	2.0	08/00 → 05/00	FIFA	Diesel	1998	4	309
TRANSIT Box (FA_)	2.3	03/00 → 05/00	E5FA	Petrol	2295	4	392
TRANSIT Box (FA_)	2.3	03/00 → 05/00	E5FC	Petrol	2295	4	393
TRANSIT Box (FA_)	2.4	01/00 → 05/00	D2FA	Diesel	2402	4	401
TRANSIT Box (FA_)	2.4	01/00 → 05/00	D2FB	Diesel	2402	4	402
TRANSIT Box (FA_)	2.4	01/00 → 05/00	D2FE	Diesel	2402	4	403
TRANSIT Box (FA_)	2.4	01/00 → 05/00	D4FA	Diesel	2402	4	404
TRANSIT Box (FA_)	2.4	07/00 → 05/00	DOFA	Diesel	2402	4	405
TRANSIT Box (FA_)	2.4	01/00 → 05/00	F4FA	Diesel	2402	4	406
TRANSIT Box (FA_)	2.4	03/00 → 05/00	FXFA	Diesel	2402	4	407
TRANSIT Box (FA_)	2.4	03/00 → 05/00	H9FA	Diesel	2402	4	408
TRANSIT Box (T_)	1.6	09/98 → 09/99	LAT	Petrol	1593	4	153



Ltr







CC



9

Model	Ltr	Year Range	Engine Code	Fuel Type	CC	Seats	Price
TRANSIT Box (T__)	2.0	09/98→09/99	NAT	Petrol	1994	4	343
TRANSIT Box (T__)	2.0	09/98→09/99	NAV	Petrol	1994	4	344
TRANSIT Box (T__)	2.5	01/98→09/99	4AB	Diesel	2496	4	417
TRANSIT Box (T__)	2.5	10/98→09/99	4BA	Diesel	2496	4	418
TRANSIT Box (T__)	2.5	10/98→09/99	4CA	Diesel	2496	4	420
TRANSIT Box	2.2	04/00→	P8FA	Diesel	2198	4	375
TRANSIT Box	2.2	04/00→	P8FB	Diesel	2198	4	376
TRANSIT Box	2.2	10/00→	PGFA	Diesel	2198	4	377
TRANSIT Box	2.2	10/00→	PGFB	Diesel	2198	4	378
TRANSIT Box	2.2	04/00→	QVFA	Diesel	2198	4	385
TRANSIT Box	2.2	04/00→	QWFA	Diesel	2198	4	386
TRANSIT Box	2.2	10/00→	SRFA	Diesel	2198	4	387
TRANSIT Box	2.2	10/00→	SRFB	Diesel	2198	4	388
TRANSIT Box	2.2	10/00→	SRFC	Diesel	2198	4	389
TRANSIT Box	2.2	10/00→	SRFD	Diesel	2198	4	390
TRANSIT Box	2.2	10/00→	SRFE	Diesel	2198	4	391
TRANSIT Box	2.3	04/00→	GZFA	Petrol	2295	4	397
TRANSIT Box	2.3	04/00→	GZFC	Petrol	2295	4	398
TRANSIT Box	2.4	11/00→	H9FB	Diesel	2402	4	409
TRANSIT Box	2.4	04/00→	H9FD	Diesel	2402	4	410
TRANSIT Box	2.4	04/00→	JXFA	Diesel	2402	4	411
TRANSIT Box	2.4	04/00→	JXFC	Diesel	2402	4	412
TRANSIT Box	2.4	04/00→	PHFA	Diesel	2402	4	415
TRANSIT Box	2.4	04/00→	PHFC	Diesel	2402	4	416
TRANSIT Bus (E__)	2.0	09/99→09/99	NBA	Petrol	1993	4	345
TRANSIT Bus (E__)	2.0	09/99→07/99	NCA	Petrol	1994	4	346
TRANSIT Bus (E__)	2.0	09/99→03/00	NSF	Petrol	1998	4	359
TRANSIT Bus (E__)	2.0	09/99→03/00	NSG	Petrol	1998	4	360
TRANSIT Bus (E__)	2.0	06/99→03/00	NSH	Petrol/Natural Gas (CNG)	1998	4	361
TRANSIT Bus (E__)	2.0	06/99→03/00	NSH	Petrol	1998	4	361
TRANSIT Bus (E__)	2.5	08/99→07/99	4BC	Diesel	2496	4	419
TRANSIT Bus (E__)	2.5	08/99→07/99	4CC	Diesel	2496	4	421
TRANSIT Bus (E__)	2.5	09/99→07/99	4DA	Diesel	2496	4	422
TRANSIT Bus (E__)	2.5	09/99→07/99	4EA	Diesel	2496	4	423
TRANSIT Bus (E__)	2.5	07/99→03/00	4EB	Diesel	2496	4	424
TRANSIT Bus (E__)	2.5	07/99→03/00	4EC	Diesel	2496	4	425
TRANSIT Bus (E__)	2.5	08/99→03/00	4ED	Diesel	2496	4	426
TRANSIT Bus (E__)	2.5	08/99→03/00	4FA	Diesel	2496	4	427
TRANSIT Bus (E__)	2.5	08/99→03/00	4FB	Diesel	2496	4	428
TRANSIT Bus (E__)	2.5	08/99→03/00	4FC	Diesel	2496	4	429
TRANSIT Bus (E__)	2.5	08/99→03/00	4FD	Diesel	2496	4	430
TRANSIT Bus (E__)	2.5	10/99→03/00	4GA	Diesel	2496	4	431
TRANSIT Bus (E__)	2.5	10/99→03/00	4GB	Diesel	2496	4	432
TRANSIT Bus (E__)	2.5	10/99→03/00	4GC	Diesel	2496	4	433
TRANSIT Bus (E__)	2.5	01/99→03/00	4GD	Diesel	2496	4	434
TRANSIT Bus (E__)	2.5	01/99→03/00	4GE	Diesel	2496	4	435
TRANSIT Bus (E__)	2.5	01/99→03/00	4GF	Diesel	2496	4	436
TRANSIT Bus (E__)	2.5	08/99→06/00	4HA	Diesel	2496	4	437
TRANSIT Bus (E__)	2.5	07/99→03/00	4HB	Diesel	2496	4	438
TRANSIT Bus (E__)	2.5	07/99→03/00	4HC	Diesel	2496	4	439
TRANSIT Bus (E__)	2.5	08/99→06/00	4HD	Diesel	2496	4	440
TRANSIT Bus (E__)	2.9	01/99→09/99	BRT	Petrol	2935	6	478
TRANSIT Bus (FD__, FB__, FS__, FZ__, FC__)	2.0	08/00→05/00	ABFA	Diesel	1998	4	282
TRANSIT Bus (FD__, FB__, FS__, FZ__, FC__)	2.0	08/00→05/00	D3FA	Diesel	1998	4	297
TRANSIT Bus (FD__, FB__, FS__, FZ__, FC__)	2.0	08/00→05/00	F3FA	Diesel	1998	4	308
TRANSIT Bus (FD__, FB__, FS__, FZ__, FC__)	2.0	08/00→05/00	FIFA	Diesel	1998	4	309
TRANSIT Bus (FD__, FB__, FS__, FZ__, FC__)	2.3	08/00→05/00	E5FA	Petrol	2295	4	392
TRANSIT Bus (FD__, FB__, FS__, FZ__, FC__)	2.3	08/00→05/00	E5FC	Petrol	2295	4	393
TRANSIT Bus (FD__, FB__, FS__, FZ__, FC__)	2.4	01/00→05/00	D2FA	Diesel	2402	4	401
TRANSIT Bus (FD__, FB__, FS__, FZ__, FC__)	2.4	01/00→05/00	D2FB	Diesel	2402	4	402
TRANSIT Bus (FD__, FB__, FS__, FZ__, FC__)	2.4	01/00→05/00	D2FE	Diesel	2402	4	403
TRANSIT Bus (FD__, FB__, FS__, FZ__, FC__)	2.4	01/00→05/00	D4FA	Diesel	2402	4	404
TRANSIT Bus (FD__, FB__, FS__, FZ__, FC__)	2.4	07/00→05/00	DOFA	Diesel	2402	4	405
TRANSIT Bus (FD__, FB__, FS__, FZ__, FC__)	2.4	01/00→05/00	F4FA	Diesel	2402	4	406
TRANSIT Bus (FD__, FB__, FS__, FZ__, FC__)	2.4	03/00→05/00	FXFA	Diesel	2402	4	407
TRANSIT Bus (FD__, FB__, FS__, FZ__, FC__)	2.4	03/00→05/00	H9FA	Diesel	2402	4	408
TRANSIT Bus (T__)	1.6	12/98→01/98	LAT	Petrol	1593	4	153
TRANSIT Bus (T__)	2.0	12/98→09/99	N6T	Petrol	1993	4	332
TRANSIT Bus (T__)	2.0	11/98→09/99	NAT	Petrol	1994	4	343
TRANSIT Bus (T__)	2.0	11/98→09/99	NAV	Petrol	1994	4	344

	Ltr				CC		9
TRANSIT Bus (T_)	2.5	12/98 → 09/99	4AB	Diesel	2496	4	417
TRANSIT Bus (T_)	2.5	09/98 → 09/99	4BA	Diesel	2496	4	418
TRANSIT Bus (T_)	2.5	09/98 → 09/99	4CA	Diesel	2496	4	420
TRANSIT Bus	2.2	04/00 →	P8FA	Diesel	2198	4	375
TRANSIT Bus	2.2	04/00 →	P8FB	Diesel	2198	4	376
TRANSIT Bus	2.2	10/00 →	PGFA	Diesel	2198	4	377
TRANSIT Bus	2.2	10/00 →	PGFB	Diesel	2198	4	378
TRANSIT Bus	2.2	04/00 →	QVFA	Diesel	2198	4	385
TRANSIT Bus	2.2	04/00 →	QWFA	Diesel	2198	4	386
TRANSIT Bus	2.2	10/00 →	SRFA	Diesel	2198	4	387
TRANSIT Bus	2.2	10/00 →	SRFB	Diesel	2198	4	388
TRANSIT Bus	2.2	10/00 →	SRFC	Diesel	2198	4	389
TRANSIT Bus	2.2	10/00 →	SRFD	Diesel	2198	4	390
TRANSIT Bus	2.2	10/00 →	SRFE	Diesel	2198	4	391
TRANSIT Bus	2.4	11/00 →	H9FB	Diesel	2402	4	409
TRANSIT Bus	2.4	04/00 →	H9FD	Diesel	2402	4	410
TRANSIT Bus	2.4	04/00 →	JXFA	Diesel	2402	4	411
TRANSIT Bus	2.4	04/00 →	JXFC	Diesel	2402	4	412
TRANSIT Bus	2.4	04/00 →	PHFA	Diesel	2402	4	415
TRANSIT Bus	2.4	04/00 →	PHFC	Diesel	2402	4	416
TRANSIT CONNECT (P65_, P70_, P80_)	1.8	06/00 →	BHPA	Diesel	1753	4	182
TRANSIT CONNECT (P65_, P70_, P80_)	1.8	06/00 →	EYPA	Petrol	1796	4	202
TRANSIT CONNECT (P65_, P70_, P80_)	1.8	06/00 →	EYPC	Petrol/Petroleum Gas (LPG)	1796	4	203
TRANSIT CONNECT (P65_, P70_, P80_)	1.8	06/00 →	EYPC	Petrol	1796	4	203
TRANSIT CONNECT (P65_, P70_, P80_)	1.8	06/00 →	EYPD	Petrol	1796	4	204
TRANSIT CONNECT (P65_, P70_, P80_)	1.8	06/00 →	HCPA	Diesel	1753	4	210
TRANSIT CONNECT (P65_, P70_, P80_)	1.8	06/00 →	HCPB	Diesel	1753	4	211
TRANSIT CONNECT (P65_, P70_, P80_)	1.8	06/00 →	P7PA	Diesel	1753	4	215
TRANSIT CONNECT (P65_, P70_, P80_)	1.8	06/00 →	P7PB	Diesel	1753	4	216
TRANSIT CONNECT (P65_, P70_, P80_)	1.8	06/00 →	P9PA	Diesel	1753	4	217
TRANSIT CONNECT (P65_, P70_, P80_)	1.8	06/00 →	P9PB	Diesel	1753	4	218
TRANSIT CONNECT (P65_, P70_, P80_)	1.8	06/00 →	P9PC	Diesel	1753	4	219
TRANSIT CONNECT (P65_, P70_, P80_)	1.8	06/00 →	P9PD	Diesel	1753	4	220
TRANSIT CONNECT (P65_, P70_, P80_)	1.8	06/00 →	R2PA	Diesel	1753	4	230
TRANSIT CONNECT (P65_, P70_, P80_)	1.8	06/00 →	R3PA	Diesel	1753	4	231
TRANSIT CONNECT (P65_, P70_, P80_)	1.8	08/00 →	RWPA	Diesel	1753	4	269
TRANSIT CONNECT (P65_, P70_, P80_)	1.8	08/00 →	RWPC	Diesel	1753	4	270
TRANSIT CONNECT (P65_, P70_, P80_)	1.8	08/00 →	RWPD	Diesel	1753	4	271
TRANSIT CONNECT (P65_, P70_, P80_)	1.8	06/00 →	RWPE	Diesel	1753	4	272
TRANSIT CONNECT (P65_, P70_, P80_)	1.8	06/00 →	RWPF	Diesel	1753	4	273
TRANSIT Platform/Chassis (E_)	2.0	09/99 → 08/99	NCA	Petrol	1998	4	346
TRANSIT Platform/Chassis (E_)	2.0	08/99 → 03/00	NSF	Petrol	1998	4	359
TRANSIT Platform/Chassis (E_)	2.0	08/99 → 03/00	NSG	Petrol	1998	4	360
TRANSIT Platform/Chassis (E_)	2.5	09/99 → 08/99	4BC	Diesel	2496	4	419
TRANSIT Platform/Chassis (E_)	2.5	09/99 → 08/99	4CC	Diesel	2496	4	421
TRANSIT Platform/Chassis (E_)	2.5	09/99 → 08/99	4DA	Diesel	2496	4	422
TRANSIT Platform/Chassis (E_)	2.5	09/99 → 08/99	4EA	Diesel	2496	4	423
TRANSIT Platform/Chassis (E_)	2.5	08/99 → 03/00	4EB	Diesel	2496	4	424
TRANSIT Platform/Chassis (E_)	2.5	08/99 → 03/00	4EC	Diesel	2496	4	425
TRANSIT Platform/Chassis (E_)	2.5	05/99 → 03/00	4ED	Diesel	2496	4	426
TRANSIT Platform/Chassis (E_)	2.5	09/99 → 03/00	4FA	Diesel	2496	4	427
TRANSIT Platform/Chassis (E_)	2.5	08/99 → 03/00	4FB	Diesel	2496	4	428
TRANSIT Platform/Chassis (E_)	2.5	08/99 → 03/00	4FC	Diesel	2496	4	429
TRANSIT Platform/Chassis (E_)	2.5	08/99 → 03/00	4FD	Diesel	2496	4	430
TRANSIT Platform/Chassis (E_)	2.5	11/99 → 03/00	4GA	Diesel	2496	4	431
TRANSIT Platform/Chassis (E_)	2.5	08/99 → 03/00	4GB	Diesel	2496	4	432
TRANSIT Platform/Chassis (E_)	2.5	08/99 → 03/00	4GC	Diesel	2496	4	433
TRANSIT Platform/Chassis (E_)	2.5	08/99 → 03/00	4GD	Diesel	2496	4	434
TRANSIT Platform/Chassis (E_)	2.5	08/99 → 03/00	4GE	Diesel	2496	4	435
TRANSIT Platform/Chassis (E_)	2.5	08/99 → 03/00	4GF	Diesel	2496	4	436
TRANSIT Platform/Chassis (E_)	2.5	10/99 → 07/00	4HA	Diesel	2496	4	437
TRANSIT Platform/Chassis (E_)	2.5	08/99 → 03/00	4HB	Diesel	2496	4	438
TRANSIT Platform/Chassis (E_)	2.5	08/99 → 03/00	4HC	Diesel	2496	4	439
TRANSIT Platform/Chassis (E_)	2.5	10/99 → 07/00	4HD	Diesel	2496	4	440
TRANSIT Platform/Chassis (FM_, FN_)	2.0	08/00 → 05/00	ABFA	Diesel	1998	4	282
TRANSIT Platform/Chassis (FM_, FN_)	2.0	08/00 → 05/00	D3FA	Diesel	1998	4	297
TRANSIT Platform/Chassis (FM_, FN_)	2.0	08/00 → 05/00	F3FA	Diesel	1998	4	308
TRANSIT Platform/Chassis (FM_, FN_)	2.0	08/00 → 05/00	FIFA	Diesel	1998	4	309
TRANSIT Platform/Chassis (FM_, FN_)	2.3	04/00 → 05/00	E5FA	Petrol	2295	4	392
TRANSIT Platform/Chassis (FM_, FN_)	2.3	04/00 → 05/00	E5FC	Petrol	2295	4	393



Ltr















CC















9





Model	Ltr	Year Range	Code	Fuel Type	CC	Cylinders	Price
TRANSIT Platform/Chassis (FM __, FN __)	2.4	01/00→05/00	D2FA	Diesel	2402	4	401
TRANSIT Platform/Chassis (FM __, FN __)	2.4	01/00→05/00	D2FB	Diesel	2402	4	402
TRANSIT Platform/Chassis (FM __, FN __)	2.4	01/00→05/00	D2FE	Diesel	2402	4	403
TRANSIT Platform/Chassis (FM __, FN __)	2.4	01/00→05/00	D4FA	Diesel	2402	4	404
TRANSIT Platform/Chassis (FM __, FN __)	2.4	07/00→05/00	DOFA	Diesel	2402	4	405
TRANSIT Platform/Chassis (FM __, FN __)	2.4	01/00→05/00	F4FA	Diesel	2402	4	406
TRANSIT Platform/Chassis (FM __, FN __)	2.4	03/00→05/00	FXFA	Diesel	2402	4	407
TRANSIT Platform/Chassis (FM __, FN __)	2.4	03/00→05/00	H9FA	Diesel	2402	4	408
TRANSIT Platform/Chassis (T __)	2.0	11/98→09/99	N6T	Petrol	1993	4	332
TRANSIT Platform/Chassis (T __)	2.0	01/98→09/99	NAT	Petrol	1994	4	343
TRANSIT Platform/Chassis (T __)	2.0	01/98→09/99	NAV	Petrol	1994	4	344
TRANSIT Platform/Chassis (T __)	2.5	01/98→01/98	4AB	Diesel	2496	4	417
TRANSIT Platform/Chassis (T __)	2.5	09/98→09/99	4BA	Diesel	2496	4	418
TRANSIT Platform/Chassis (T __)	2.5	09/98→09/99	4CA	Diesel	2496	4	420
TRANSIT Platform/Chassis	2.2	04/00→	P8FA	Diesel	2198	4	375
TRANSIT Platform/Chassis	2.2	04/00→	P8FB	Diesel	2198	4	376
TRANSIT Platform/Chassis	2.2	10/00→	PGFA	Diesel	2198	4	377
TRANSIT Platform/Chassis	2.2	10/00→	PGFB	Diesel	2198	4	378
TRANSIT Platform/Chassis	2.2	04/00→	QVFA	Diesel	2198	4	385
TRANSIT Platform/Chassis	2.2	04/00→	QWFA	Diesel	2198	4	386
TRANSIT Platform/Chassis	2.2	10/00→	SRFA	Diesel	2198	4	387
TRANSIT Platform/Chassis	2.2	10/00→	SRFB	Diesel	2198	4	388
TRANSIT Platform/Chassis	2.2	10/00→	SRFC	Diesel	2198	4	389
TRANSIT Platform/Chassis	2.2	10/00→	SRFD	Diesel	2198	4	390
TRANSIT Platform/Chassis	2.2	10/00→	SRFE	Diesel	2198	4	391
TRANSIT Platform/Chassis	2.3	04/00→	GZFA	Petrol	2295	4	397
TRANSIT Platform/Chassis	2.3	04/00→	GZFC	Petrol	2295	4	398
TRANSIT Platform/Chassis	2.4	11/00→	H9FB	Diesel	2402	4	409
TRANSIT Platform/Chassis	2.4	04/00→	H9FD	Diesel	2402	4	410
TRANSIT Platform/Chassis	2.4	04/00→	JXFA	Diesel	2402	4	411
TRANSIT Platform/Chassis	2.4	04/00→	JXFC	Diesel	2402	4	412
TRANSIT Platform/Chassis	2.4	04/00→	PHFA	Diesel	2402	4	415
TRANSIT Platform/Chassis	2.4	04/00→	PHFC	Diesel	2402	4	416
TRANSIT TOURNEO	2.0	11/99→12/00	NSH	Petrol/Natural Gas (CNG)	1998	4	361
TRANSIT TOURNEO	2.0	11/99→12/00	NSH	Petrol	1998	4	361
TRANSIT TOURNEO	2.2	10/00→	PGFA	Diesel	2198	4	377
TRANSIT TOURNEO	2.2	10/00→	PGFB	Diesel	2198	4	378
TRANSIT TOURNEO	2.2	07/00→	QVFA	Diesel	2198	4	385
TRANSIT TOURNEO	2.2	07/00→	QWFA	Diesel	2198	4	386
TRANSIT TOURNEO	2.2	10/00→	SRFA	Diesel	2198	4	387
TRANSIT TOURNEO	2.2	10/00→	SRFB	Diesel	2198	4	388
TRANSIT TOURNEO	2.2	10/00→	SRFC	Diesel	2198	4	389
TRANSIT TOURNEO	2.2	10/00→	SRFD	Diesel	2198	4	390
TRANSIT TOURNEO	2.2	10/00→	SRFE	Diesel	2198	4	391
TRANSIT TOURNEO	2.4	08/99→06/00	4HA	Diesel	2496	4	437
TRANSIT TOURNEO	2.5	04/99→12/00	4EB	Diesel	2496	4	424
TRANSIT TOURNEO	2.5	04/99→12/00	4EC	Diesel	2496	4	425
TRANSIT TOURNEO	2.5	11/99→12/00	4FA	Diesel	2496	4	427
TRANSIT TOURNEO	2.5	11/99→12/00	4FB	Diesel	2496	4	428
TRANSIT TOURNEO	2.5	11/99→12/00	4FC	Diesel	2496	4	429
TRANSIT TOURNEO	2.5	11/99→12/00	4FD	Diesel	2496	4	430
TRANSIT TOURNEO	2.5	11/99→12/00	4GA	Diesel	2496	4	431
TRANSIT TOURNEO	2.5	11/99→12/00	4GB	Diesel	2496	4	432
TRANSIT TOURNEO	2.5	11/99→12/00	4GC	Diesel	2496	4	433
TRANSIT TOURNEO	2.5	11/99→12/00	4HA	Diesel	2496	4	437
TRANSIT TOURNEO	2.5	11/99→12/00	4HB	Diesel	2496	4	438
TRANSIT TOURNEO	2.5	11/99→12/00	4HC	Diesel	2496	4	439

		CC			9			CC			9
1Z	Diesel	1896	4	79.50	274	BTB	Diesel	1896	4	79.50	281
4AB	Diesel	2496	4	93.67	417	C9DA	Diesel	1753	4	82.50	183
4BA	Diesel	2496	4	93.67	418	C9DB	Diesel	1753	4	82.50	184
4BC	Diesel	2496	4	93.70	419	C9DC	Diesel	1753	4	82.50	185
4CA	Diesel	2496	4	93.67	420	CDB	Petrol	1599	4	82.00	107
4CC	Diesel	2496	4	94.00	421	CDC	Petrol	1599	4	82.00	108
4DA	Diesel	2496	4	93.67	422	CDRA	Petrol	1599	4	82.00	109
4EA	Diesel	2496	4	93.67	423	CDRB	Petrol	1599	4	82.00	110
4EB	Diesel	2496	4	93.70	424	CFBA	Petrol	1798	4	83.00	186
4EC	Diesel	2496	4	93.70	425	CGBA	Petrol	1798	4	83.00	187
4ED	Diesel	2496	4	93.67	426	CGBB	Petrol	1798	4	83.00	188
4FA	Diesel	2496	4	94.00	427	CHBA	Petrol	1798	4	83.00	189
4FB	Diesel	2496	4	93.70	428	CHBB	Petrol	1798	4	83.00	190
4FC	Diesel	2496	4	93.70	429	CJBA	Petrol	1999	4	87.50	295
4FD	Diesel	2496	4	93.70	430	CJBB	Petrol	1999	4	87.50	296
4GA	Diesel	2496	4	93.67	431	CSDA	Petrol	1798	4	83.00	191
4GB	Diesel	2496	4	93.67	432	CSDB	Petrol	1798	4	83.00	192
4GC	Diesel	2496	4	93.67	433	D2FA	Diesel	2402	4	89.90	401
4GD	Diesel	2496	4	93.67	434	D2FB	Diesel	2402	4	89.90	402
4GE	Diesel	2496	4	93.70	435	D2FE	Diesel	2402	4	89.90	403
4GF	Diesel	2496	4	93.70	436	D3FA	Diesel	1998	4	86.00	297
4HA	Diesel	2496	4	93.67	437	D4FA	Diesel	2402	4	89.90	404
4HB	Diesel	2496	4	93.67	438	D5BA	Diesel	1998	4	86.00	298
4HC	Diesel	2496	4	93.70	439	D6BA	Diesel	1998	4	86.00	299
4HD	Diesel	2496	4	93.70	440	DHA	Petrol	1242	4	71.90	10
A9A	Petrol	1299	4	74.00	27	DHB	Petrol	1242	4	71.90	11
A9B	Petrol	1299	4	74.00	28	DHC	Petrol	1242	4	71.90	12
A9JA	Petrol	1299	4	74.00	29	DHD	Petrol	1242	4	71.90	13
A9JB	Petrol	1299	4	74.00	30	DHE	Petrol	1242	4	71.90	14
AAA	Petrol	2792	6	81.00	462	DHF	Petrol	1242	4	71.90	15
ABFA	Diesel	1998	4	86.00	282	DHG	Petrol	1242	4	71.90	16
AFN	Diesel	1896	4	79.50	275	DOFA	Diesel	2402	4	89.90	405
AHU	Diesel	1896	4	79.50	276	E5FA	Petrol	2295	4	89.60	392
AJ	Petrol	2967	6	89.00	479	E5FC	Petrol	2295	4	89.60	393
ALDA	Petrol	1988	4	84.80	283	E5SA	Petrol	2295	4	89.60	394
AMY	Petrol	2792	6	81.00	463	E5SB	Petrol	2295	4	89.60	395
ANU	Diesel	1896	4	79.50	277	EDBA	Petrol	1988	4	84.80	300
AOBA	Petrol	1999	4	87.50	284	EDBB	Petrol	1988	4	84.80	301
AOBC	Petrol	1999	4	87.50	285	EDBC	Petrol	1988	4	84.80	302
AODA	Petrol	1999	4	87.50	286	EDBD	Petrol	1988	4	84.80	303
AODB	Petrol	1999	4	87.50	287	EDDB	Petrol	1988	4	84.80	304
AODE	Petrol	1999	4	87.50	288	EDDC	Petrol	1988	4	84.80	305
AOWA	Petrol	1999	4	87.50	289	EDDD	Petrol	1988	4	84.80	306
AOWB	Petrol	1999	4	87.50	290	EDDF	Petrol	1988	4	84.80	307
ASDA	Petrol	1388	4	76.00	66	EYDB	Petrol	1796	4	80.60	193
ASDB	Petrol	1388	4	76.00	67	EYDC	Petrol	1796	4	80.60	194
ASZ	Diesel	1896	4	79.50	278	EYDD	Petrol	1796	4	80.60	195
AUY	Diesel	1896	4	79.50	279	EYDE	Petrol	1796	4	80.60	196
AVG	Diesel	1896	4	79.50	280	EYDF	Petrol	1796	4	80.60	197
AYL	Petrol	2792	6	81.00	464	EYDG	Petrol	1796	4	80.60	198
AZBA	Diesel	1997	4	86.00	291	EYDI	Petrol	1796	4	80.60	199
AZBC	Diesel	1997	4	85.00	292	EYDJ	Petrol	1796	4	80.60	200
AZWA	Diesel	1997	4	85.00	293	EYDL	Petrol	1796	4	80.60	201
AZWC	Diesel	1997	4	85.00	294	EYPA	Petrol	1796	4	80.60	202
B4A	Petrol	2936	6	93.00	468	EYPC	Petrol/ Petroleum Gas (LPG)	1796	4	80.60	203
B4B	Petrol	2936	6	93.00	469	EYPD	Petrol	1796	4	80.60	204
B4C	Petrol	2936	6	93.00	470	F3FA	Diesel	1998	4	86.00	308
BAA	Petrol	1299	4	74.00	31	F4A	Petrol	1391	4	77.25	68
BAJA	Petrol	1299	4	74.00	32	F4B	Petrol	1391	4	77.25	69
BHDA	Diesel	1753	4	82.50	180	F4FA	Diesel	2402	4	89.90	406
BHDB	Diesel	1753	4	82.50	181	F6A	Petrol	1393	4	77.25	70
BHPA	Diesel	1753	4	82.50	182	F6B	Petrol	1392	4	77.25	71
BOA	Petrol	2933	6	93.00	471	F6C	Petrol	1392	4	77.25	72
BOB	Petrol	2933	6	93.00	472	F6D	Petrol	1392	4	77.25	73
BRC	Petrol	2933	6	93.00	473	F6E	Petrol	1392	4	77.25	74
BRD	Petrol	2933	6	93.00	474	F6F	Petrol	1392	4	77.25	75
BRE	Petrol	2933	6	93.00	475	F6G	Petrol	1392	4	77.24	76
BRF	Petrol	2933	6	93.00	476						
BRG	Petrol	2933	6	93.00	477						
BRT	Petrol	2935	6	93.00	478						

		CC			9			CC			9
F6JA	Diesel	1399	4	73.70	77	H9FD	Diesel	2402	4	89.90	410
F6JB	Diesel	1399	4	73.70	78	HCPA	Diesel	1753	4	82.50	210
F6JD	Diesel	1399	4	73.70	79	HCPB	Diesel	1753	4	82.50	211
F9DA	Diesel	1753	4	82.50	205	HHDA	Diesel	1560	4	75.00	126
F9DB	Diesel	1753	4	82.50	206	HHDB	Diesel	1560	4	75.00	127
FD4	Diesel	1248	4		17	HHJA	Diesel	1560	4	75.00	128
FFBA	Diesel	1753	4	82.50	207	HHJB	Diesel	1560	4	75.00	129
FFDA	Diesel	1753	4	82.50	208	HHJC	Diesel	1560	4	75.00	130
FFWA	Diesel	1753	4	82.50	209	HHJD	Diesel	1560	4	75.00	131
FHA	Petrol	1388	4	76.00	80	HHJE	Diesel	1560	4	75.00	132
FHD	Petrol	1388	4	76.00	81	HHJF	Diesel	1560	4	75.00	133
FHE	Petrol	1388	4	76.00	82	HJBA	Diesel	1998	4	86.00	318
FHF	Petrol	1388	4	76.00	83	HJBB	Diesel	1998	4	86.00	319
FIFA	Diesel	1998	4	86.00	309	HJBC	Diesel	1998	4	86.00	320
FMBA	Diesel	1998	4	86.00	310	HMDA	Petrol	1988	4	84.80	321
FP4	Petrol	1242	4		18	HUBA	Petrol	2521	5	83.00	441
FUA	Petrol	1392	4	77.25	84	HUWA	Petrol	2521	5	83.00	442
FUAA	Petrol	1392	4	77.25	85	HWDA	Petrol	1596	4	79.00	134
FUB	Petrol	1392	4	77.25	86	HWDB	Petrol	1596	4	79.00	135
FUC	Petrol	1392	4	77.25	87	HXDA	Petrol	1596	4	79.00	136
FUD	Petrol	1392	4	77.25	88	HXDB	Petrol	1596	4	79.00	137
FUF	Petrol	1392	4	77.25	89	HXJA	Petrol	1596	4	79.00	138
FUG	Petrol	1392	4	77.25	90	HXJB	Petrol	1596	4	79.00	139
FUH	Petrol	1392	4	77.25	91	HYDA	Petrol	2522	5	83.00	443
FUJ	Petrol	1392	4	77.25	92	HYDB	Petrol	2522	5	83.00	444
FUJA	Petrol	1242	4	71.90	19	IXDA	Diesel	1997	4		322
FUJB	Petrol	1242	4	71.90	20	J4B	Petrol	1299	4	74.00	33
FXDA	Petrol	1388	4	76.00	93	J4C	Petrol	1299	4	74.00	34
FXDB	Petrol	1388	4	76.00	94	J4D	Petrol	1299	4	74.00	35
FXDC	Petrol	1388	4	76.00	95	J4J	Petrol	1299	4	74.00	36
FXDD	Petrol	1388	4	76.00	96	J4K	Petrol	1299	4	74.00	37
FXFA	Diesel	2402	4	89.90	407	J4L	Petrol	1299	4	74.00	38
FXJA	Petrol	1388	4	76.00	97	J4M	Petrol	1299	4	74.00	39
FXJB	Petrol	1388	4	76.00	98	J4N	Petrol	1299	4	74.00	40
FXJC	Petrol	1388	4	76.00	99	J4P	Petrol	1299	4	74.00	41
FYDA	Petrol	1596	4	79.00	111	J4Q	Petrol	1299	4	74.00	42
FYDB	Petrol	1596	4	79.00	112	J4R	Petrol	1299	4	74.00	43
FYDC	Petrol	1596	4	79.00	113	J4S	Petrol	1299	4	74.00	44
FYDD	Petrol	1596	4	79.00	114	J4T	Petrol	1299	4	74.00	45
FYDH	Petrol/Ethanol	1596	4	79.00	115	J6A	Petrol	1299	4	74.00	46
FYDH	Petrol	1596	4	79.00	115	J6B	Petrol	1299	4	74.00	47
FYJA	Petrol	1596	4	79.00	116	JBA	Petrol	1297	4	73.96	48
FYJB	Petrol	1596	4	79.00	117	JBB	Petrol	1297	4	73.96	49
G6A	Petrol	1119	4	68.70	3	JBC	Petrol	1299	4	74.00	50
G6DA	Diesel	1997	4	85.00	311	JBD	Petrol	1297	4	74.00	51
G6DB	Diesel	1997	4	85.00	312	JJA	Petrol	1299	4	74.00	52
G6DC	Diesel	1997	4	85.00	313	JJB	Petrol	1299	4	74.00	53
G6DD	Diesel	1997	4	85.00	314	JJC	Petrol	1299	4	74.00	54
G6DE	Diesel	1997	4	85.00	315	JJD	Petrol	1299	4	74.00	55
G6DF	Diesel	1997	4	85.00	316	JJE	Petrol	1299	4	74.00	56
G6DG	Diesel	1997	4	85.00	317	JJF	Petrol	1299	4	74.00	57
G8DA	Diesel	1560	4	75.00	118	JJG	Petrol	1299	4	74.00	58
G8DB	Diesel	1560	4	75.00	119	JJH	Petrol	1299	4	74.00	59
G8DC	Diesel	1560	4	75.00	120	JJJ	Petrol	1299	4	74.00	60
G8DD	Diesel	1560	4	75.00	121	JJK	Petrol	1299	4	74.00	61
G8DE	Diesel	1560	4	75.00	122	JJL	Petrol	1299	4	74.00	62
G8DF	Diesel	1560	4	75.00	123	JJM	Petrol	1299	4	74.00	63
GLC	Petrol	1117	4	74.00	4	JLA	Petrol	1297	4	73.96	64
GPDA	Diesel	1560	4	75.00	124	JLB	Petrol	1297	4	73.96	65
GPDC	Diesel	1560	4	75.00	125	JXFA	Diesel	2402	4	89.90	411
GSF	Petrol	1117	4	74.00	5	JXFC	Diesel	2402	4	89.90	412
GSG	Petrol	1117	4	74.00	6	JZDA	Petrol	2521	5		445
GSH	Petrol	1117	4	74.00	7	KA-24	Petrol	2389	4	89.00	413
GUD	Petrol	1119	4	68.70	8	KA24-E	Petrol	2389	4	89.00	414
GUE	Petrol	1119	4	68.70	9	KHBA	Diesel	1753	4	82.50	212
GZ	Petrol	2261	4	87.50	396	KKDA	Diesel	1753	4	82.50	213
GZFA	Petrol	2295	4		397	KKDB	Diesel	1753	4	82.50	214
GZFC	Petrol	2295	4		398	KLBA	Diesel	1997	4	85.00	323
H9FA	Diesel	2402	4	89.90	408	KLVA	Diesel	1997	4		324
H9FB	Diesel	2402	4	89.90	409	KVJA	Diesel	1399	4	73.70	100

		CC			9			CC			9
LIE	Petrol	1597	4	76.00	140	NRA	Petrol	1993	4	90.83	354
LIF	Petrol	1597	4	76.00	141	NRC	Petrol	1993	4	90.83	355
LIG	Petrol	1597	4	76.00	142	NRI	Petrol	1993	4	90.83	356
LIH	Petrol	1597	4	76.00	143	NSD	Petrol	1998	4	86.00	357
LIJ	Petrol	1597	4	76.00	144	NSE	Petrol	1998	4	86.00	358
LIK	Petrol	1597	4	76.00	145	NSF	Petrol	1998	4	86.00	359
LIL	Petrol	1597	4	76.00	146	NSG	Petrol	1998	4	86.00	360
LIN	Petrol	1597	4	76.00	147	NSH	Petrol/	1998	4	86.00	361
LIQ	Petrol	1597	4	76.00	148		Natural				
LIT	Petrol	1596	4	76.00	149		Gas (CNG)				
LIV	Petrol	1596	4	76.00	150	NSH	Petrol	1998	4	86.00	361
LIW	Petrol	1596	4	79.00	151	P7PA	Diesel	1753	4		215
L6B	Petrol	1598	4	80.00	152	P7PB	Diesel	1753	4		216
LAT	Petrol	1593	4	87.65	153	P8FA	Diesel	2198	4	86.00	375
LCBA	Petrol	2544	6	82.40	446	P8FB	Diesel	2198	4	86.00	376
LCBB	Petrol	2495	6	81.60	447	P9PA	Diesel	1753	4	82.50	217
LCBC	Petrol	2495	6	81.60	448	P9PB	Diesel	1753	4	82.50	218
LCBD	Petrol	2495	6	81.60	449	P9PC	Diesel	1753	4	82.50	219
LCBE	Petrol	2495	6	81.60	450	P9PD	Diesel	1753	4	82.50	220
LHA	Petrol	1598	4	80.00	154	PGFA	Diesel	2198	4	86.00	377
LJC	Petrol	1597	4	80.00	155	PGFB	Diesel	2198	4		378
LJD	Petrol	1598	4	80.00	156	PHFA	Diesel	2402	4	89.90	415
LJF	Petrol	1598	4	79.96	157	PHFC	Diesel	2402	4	89.90	416
LNB	Petrol	1597	4	79.96	158	PNBA	Petrol	1596	4	79.00	171
LP2	Petrol	1597	4	80.00	159	PR7	Petrol	2792	6	93.00	465
LPBA	Diesel	1997	4	86.00	325	PR8	Petrol	2792	6	93.00	466
LSE	Petrol	1597	4	81.30	160	PRG	Petrol	2792	6	93.00	467
LSF	Petrol	1597	4	81.30	161	Q4BA	Diesel	2179	4	85.00	379
LTA	Diesel	1608	4	80.00	162	Q4WA	Diesel	2179	4	85.00	380
LTB	Diesel	1608	4	80.00	163	Q7DA	Petrol/Ethanol	1798	4	83.00	221
LTC	Diesel	1608	4	80.00	164	Q7DA	Petrol	1798	4	83.00	221
LUC	Petrol	1597	4	80.00	165	QJBA	Diesel	2198	4	86.00	381
LUG	Petrol	1597	4	80.00	166	QJBB	Diesel	2198	4	86.00	382
LUH	Petrol	1597	4	76.00	167	QJBC	Diesel	2198	4	86.00	383
LUJ	Petrol	1598	4	80.00	168	QJBD	Diesel	2198	4	86.00	384
LUK	Petrol	1598	4	80.00	169	QQDA	Petrol	1798	4	83.00	222
M7JA	Petrol	1242	4	71.90	21	QQDB	Petrol	1798	4	83.00	223
M7JB	Petrol	1242	4	71.90	22	QQDC	Petrol	1798	4	83.00	224
MEBA	Petrol	2967	6	89.00	480	QQDD	Petrol/Ethanol	1798	4	83.00	225
MHA	Petrol	1679	4	80.00	178	QVFA	Diesel	2198	4	86.00	385
MHB	Petrol	1679	4	80.00	179	QWFA	Diesel	2198	4	86.00	386
MTDA	Diesel	1560	4	75.00	170	QXBA	Diesel	1997	4	85.00	362
N3A	Petrol	1998	4	86.00	326	QXBB	Diesel	1997	4	85.00	363
N4A	Petrol	1993	4	90.83	327	QXWA	Diesel	1997	4	85.00	364
N4B	Petrol	1993	4	90.80	328	QXWB	Diesel	1997	4	85.00	365
N4I	Petrol	1993	4	90.83	329	QXWC	Diesel	1997	4	85.00	366
N4JB	Petrol	1999	4	87.50	330	QYBA	Diesel	1753	4	82.50	226
NSF	Petrol	1994	4	90.83	331	QYWA	Diesel	1753	4	82.50	227
N6T	Petrol	1993	4	90.80	332	R2A	Petrol	1796	4	86.20	228
N7A	Petrol	1998	4	86.00	333	R2C	Petrol	1769	4	80.00	229
N7BA	Diesel	1998	4	86.00	334	R2PA	Diesel	1753	4		230
N8A	Petrol	1998	4	86.00	335	R3PA	Diesel	1753	4	82.50	231
N8C	Petrol	1993	4	86.00	336	R6A	Petrol	1769	4	80.00	232
N9B	Petrol	1998	4	86.00	337	RDA	Petrol	1796	4	80.60	233
N9C	Petrol	1998	4	86.00	338	RDB	Petrol	1796	4	80.60	234
N9D	Petrol	1998	4	86.00	339	REBA	Petrol	2967	6	89.00	481
N9E	Petrol	1998	4	86.00	340	REC	Petrol	1796	4	86.20	235
N9F	Petrol	1998	4	86.00	341	RED	Petrol	1796	4	86.20	236
NAE	Petrol	1993	4	90.83	342	REF	Petrol	1796	4	86.20	237
NAT	Petrol	1994	4	90.80	343	RFA	Diesel	1753	4	82.50	238
NAV	Petrol	1994	4	90.83	344	RFB	Diesel	1753	4	82.50	239
NBA	Petrol	1993	4	90.80	345	RFD	Diesel	1753	4	82.50	240
NCA	Petrol	1994	4	90.80	346	RFK	Diesel	1753	4	82.50	241
NE5	Petrol	1993	4	90.80	347	RFL	Diesel	1753	4	82.50	242
NEJ	Petrol	1993	4	90.80	348	RFM	Diesel	1753	4	82.50	243
NEL	Petrol	1993	4	90.83	349	RFN	Diesel	1753	4	82.50	244
NGA	Petrol	1988	4	84.80	350	RFS	Diesel	1753	4	82.50	245
NGB	Petrol	1988	4	84.80	351	RHBA	Petrol	1596	4	79.00	172
NGC	Petrol	1988	4	84.80	352	RKA	Petrol	1796	4	80.60	246
NGD	Petrol	1988	4	84.80	353	RKB	Petrol	1796	4	80.60	247

		CC			9
RKC	Petrol	1796	4	80.60	248
RKF	Petrol	1796	4	80.60	249
RKH	Petrol	1796	4	80.60	250
RKJ	Petrol	1796	4	80.60	251
RKK	Petrol	1796	4	80.60	252
RQB	Petrol	1796	4	80.60	253
RQC	Petrol	1796	4	80.60	254
RTA	Diesel	1753	4	82.50	255
RTB	Diesel	1753	4	82.50	256
RTC	Diesel	1753	4	82.50	257
RTD	Diesel	1753	4	82.50	258
RTE	Diesel	1753	4	82.50	259
RTF	Diesel	1753	4	82.50	260
RTG	Diesel	1753	4	82.50	261
RTH	Diesel	1753	4	82.50	262
RTJ	Diesel	1753	4	82.50	263
RTJA	Petrol/ Petroleum Gas (LPG)	1388	4	76.00	101
RTJB	Petrol/ Petroleum Gas (LPG)	1388	4	76.00	102
RTK	Diesel	1753	4	82.50	264
RTN	Diesel	1753	4	82.50	265
RTP	Diesel	1753	4	82.50	266
RTQ	Diesel	1753	4	82.50	267
RVA	Diesel	1753	4	82.50	268
RWPA	Diesel	1753	4	82.50	269
RWPC	Diesel	1753	4	82.50	270
RWPD	Diesel	1753	4	82.50	271
RWPE	Diesel	1753	4	82.50	272
RWPF	Diesel	1753	4	82.50	273
SCB	Diesel	2500	4	92.00	451
SCC	Diesel	2500	4	92.00	452
SDBA	Diesel	1998	4	86.00	367
SEA	Petrol	2544	6	82.40	453
SEB	Petrol	2495	6	81.60	454
SEC	Petrol	2495	6	81.60	455
SGA	Petrol	2495	6	81.60	456
SHDA	Petrol	1596	4	79.00	173
SHDB	Petrol	1596	4	79.00	174
SHDC	Petrol	1596	4	79.00	175
SIDA	Petrol/ Petroleum Gas (LPG)	1596	4	79.00	176
SIDA	Petrol	1596	4	79.00	176
SNJA	Petrol	1242	4		23
SNJB	Petrol	1242	4		24
SPJA	Petrol	1388	4	76.00	103
SPJC	Petrol	1388	4	76.00	104
SRFA	Diesel	2198	4		387
SRFB	Diesel	2198	4		388
SRFC	Diesel	2198	4		389
SRFD	Diesel	2198	4		390
SRFE	Diesel	2198	4		391
STJA	Petrol	1242	4		25
STJB	Petrol	1242	4		26
SYDA	Petrol/ Petroleum Gas (LPG)	1999	4	87.50	368
SYDA	Petrol/ Natural Gas (CNG)	1999	4	87.50	368
SYDA	Petrol	1999	4	87.50	368
TBBA	Petrol/ Petroleum Gas (LPG)	1999	4	87.50	369
TBBA	Petrol/Ethanol	1999	4	87.50	369
TBBA	Petrol	1999	4	87.50	369
TBBB	Petrol/Ethanol	1999	4	87.50	370

		CC			9
TBWA	Petrol/Ethanol	1999	4		371
TBWB	Petrol/Ethanol	1999	4		372
TD27	Diesel	2663	4	96.00	460
TD27E	Diesel	2664	4	96.00	461
TKB	Petrol	957	4	74.00	1
TLB	Petrol	999	4	68.70	2
UBJA	Diesel	1560	4	75.00	177
UC	Petrol	1416	4	77.00	105
UFBA	Diesel	1997	4	85.00	373
UTJA	Petrol/ Petroleum Gas (LPG)	1388	4	76.00	106
VM	Diesel	2500	4	92.00	457
WL	Diesel	2500	4	93.00	458
WLT	Diesel	2500	4	93.00	459
Y5A	Petrol	2295	4	89.60	399
Y5B	Petrol	2295	4	89.60	400
YF	Petrol	1989	4	84.80	374



cc



kW/PS



Model	Year Range	CC	Cylinders	Power (kW/PS)	Configuration	Code	Engine	Transmission	Accessories
1.0 TKB 1									
Fiesta 1.0	08/83→11/89	957	4	74.00	OHV	33/45	BC240 (Fibre)	DC240 [13]	EG340
Fiesta II 1.0	09/83→02/89								
1.0 TLB 2									
Fiesta II 2422 L	09/83→11/89	999	4	68.70	OHV	33/45	BT110 (Fibre)	DT110	EG340
Fiesta III 1.0	03/89→12/95								
1.1 G6A 3									
Fiesta III 1.1	03/89→12/95	1119	4	68.70		37/50	BT110 (Fibre)	DT110	EG340 →03/92 EH752 [3] 04/92→
1.1 GLC 4									
Fiesta II 1.1	09/83→02/89	1117	4	74.00	OHV	37/50	BC240 (Fibre)	DC240 [13]	EG340
1.1 GSF 5									
Fiesta II 1.1	09/83→02/89	1117	4	74.00	OHV	37/50	BC240 (Fibre)	DC240 [13]	EG340
1.1 GSG 6									
Escort '86 Exp	05/86→07/90	1117	4	74.00	OHV	37/50	BC240 (Fibre)	DC240 [13]	EG340
Escort IV 1.1	10/85→09/90								
1.1 GSH 7									
Fiesta II 1.1	05/86→02/89	1117	4	74.00	OHV	36/49	BC240 (Fibre)	DC240 [13]	EG340
1.1 GUD 8									
Fiesta III 1.1	03/89→12/95	1119	4	68.70	OHV	40/55	BT110 (Fibre)	DT110	EG340 →03/92 EH752 [3] 04/92→
1.1 GUE 9									
Fiesta III 1.1	03/89→12/95	1119	4	68.70	OHV	40/55	BT110 (Fibre)	DT110	EG340 →03/92 EH752 [3] 04/92→
1.2 DHA 10									
Fiesta IV 16V	08/95→01/02	1242	4	71.90	DOHC	55/75	BY650 (MLS) →04/98 AB5120 (MLS) 05/98→	DY650 ☒ [3] →04/98 DY651 05/98→	EY650 [3]
1.2 DHB 11									
Fiesta IV 16V	08/95→01/02	1242	4	71.90	DOHC	55/75	BY650 (MLS) →04/98 AB5120 (MLS) 05/98→	DY650 ☒ [3] →04/98 DY651 05/98→	EY650 [3]

HBS050 [22] M11x1.50x120.00mm (x10)	JB862 [1] JB799 [x4]	JN105 [4]	HC355 [1] =KG664	PB180 (x8) 8.00x12.0/15.40x9.50 866N W (FPM)	NA576 [2] 36.50x52.30x8.00mm, MVQ NB564 [1] 60.45x76.18x10.00mm, FPM		AB5120		BC240
HBS050 [22] M11x1.50x120.00mm (x10)	JD009 [1] JD545 [x4] HA497 [1] [1]	JN105 [4]	HC355 [1] =KG664	HR655 [1]	NA576 [2] 36.50x52.30x8.00mm, MVQ NB564 [1] 60.45x76.18x10.00mm, FPM		BT110		BY650
HBS050 [22] M11x1.50x120.00mm (x10)	JD009 [1] JD545 [x4] HA497 [1] [1]	JN105 [4]	HC355 [1] →03/92 =KG664 HC452 [1] 04/92→	HR655 [1]	NA576 [2] 36.50x52.30x8.00mm, MVQ NB564 [1] 60.45x76.18x10.00mm, FPM →03/92 NB788 [1] 79.40x95.30x11.10mm, PTFE 04/92→		HA497		JB799
HBS050 [22] M11x1.50x120.00mm (x10)	JB862 [1] JB799 [x4]	JN105 [4]	HC355 [1] =KG664	PB180 (x8) 8.00x12.0/15.40x9.50 866N W (FPM)	NA576 [2] 36.50x52.30x8.00mm, MVQ NB564 [1] 60.45x76.18x10.00mm, FPM		JB862		JD009
HBS050 [22] M11x1.50x120.00mm (x10)	JB862 [1] JB799 [x4]	JN105 [4]	HC355 [1] =KG664	PB180 (x8) 8.00x12.0/15.40x9.50 866N W (FPM)	NA576 [2] 36.50x52.30x8.00mm, MVQ NB564 [1] 60.45x76.18x10.00mm, FPM		JD5164		JD5230
HBS050 [22] M11x1.50x120.00mm (x10)	JB862 [1] JB799 [x4]	JN105 [4]	HC355 [1] =KG664	PB180 (x8) 8.00x12.0/15.40x9.50 866N W (FPM)	NA576 [2] 36.50x52.30x8.00mm, MVQ NB564 [1] 60.45x76.18x10.00mm, FPM		JD545		JM5155
HBS050 [22] M11x1.50x120.00mm (x10)	JD009 [1] JD545 [x4] HA497 [1] [1]	JN105 [4]	HC355 [1] →03/92 =KG664 HC452 [1] 04/92→	HR655 [1]	NA576 [2] 36.50x52.30x8.00mm, MVQ NB564 [1] 60.45x76.18x10.00mm, FPM →03/92 NB788 [1] 79.40x95.30x11.10mm, PTFE		JN105		HC355
HBS050 [22] M11x1.50x120.00mm (x10)	JD009 [1] JD545 [x4] HA497 [1] [1]	JN105 [4]	HC355 [1] →03/92 =KG664 HC452 [1] 04/92→	HR655 [1]	NA576 [2] 36.50x52.30x8.00mm, MVQ NB564 [1] 60.45x76.18x10.00mm, FPM →03/92 NB788 [1] 79.40x95.30x11.10mm, PTFE		HC452		JE5025
HBS078 [22] M10x1.50x143.00mm (x10)	JD5230 [1] JD5164 [1]	JM5155 [78] (Elastomer) JM7060 [79] (Elastomer)	JE5025	HR809 [1] [1] HR808 [1] [1]	NC048 [2] 38.00x52.00x6.00mm, FPM NA5137 [2] 32.90x47.40x5.00mm, FPM LK5004 [1] [7] 80.00x182.00x19.400mm, PTFE		JE5025		
HBS078 [22] M10x1.50x143.00mm (x10)	JD5230 [1] JD5164 [1]	JM5155 [78] (Elastomer) JM7060 [79] (Elastomer)	JE5025	HR809 [1] [1] HR808 [1] [1]	NC048 [2] 38.00x52.00x6.00mm, FPM NA5137 [2] 32.90x47.40x5.00mm, FPM LK5004 [1] [7] 80.00x182.00x19.400mm, PTFE				



cc



kW/PS



1.2	DHC	12	BY650 (MLS)	DY650	EY650				
Fiesta IV 16V	08/95→01/02	1242	4	71.90	DOHC	55/75	→04/98 AB5120 (MLS) 05/98→	→04/98 DY651 05/98→	EY650 [3]
Fiesta IV 16V	08/95→01/02	1242	4	71.90	DOHC	55/75	→04/98 AB5120 (MLS) 05/98→	→04/98 DY651 05/98→	EY650 [3]
Fiesta IV 16V	08/95→01/02	1242	4	71.90	DOHC	55/75	→04/98 AB5120 (MLS) 05/98→	→04/98 DY651 05/98→	EY650 [3]
Fiesta IV 16V	08/95→01/02	1242	4	71.90	DOHC	55/75	→04/98 AB5120 (MLS) 05/98→	→04/98 DY651 05/98→	EY650 [3]
Fiesta IV 16V	08/95→01/02	1242	4	71.90	DOHC	55/75	→04/98 AB5120 (MLS) 05/98→	→04/98 DY651 05/98→	EY650 [3]
Ka 1.3 TDCi	10/08→	1248	4		DOHC	55/75	AD5800 (MLS), 0.720mm AD5810 (MLS), 0.820mm, 1 Hole AD5820 (MLS), 0.920mm, 2 Holes	CD5810 ▲	ED5800
Ka 1.2	10/08→	1242	4		SOHC/OHC	51/69	AG7380 (MLS)	CG7380	EE5180 [3]
Fiesta V 16V Fusion 1.25	05/02→ 08/04→	1242	4	71.90	DOHC	55/75	AB5120 (MLS) →12/02 AG8310 (Steel) 12/02→	CB5120	EB5120
Fiesta V 16V Fusion 1.25	05/02→ 08/04→	1242	4	71.90	DOHC	55/75	AB5120 (MLS) →12/02 AG8310 (Steel) 12/02→	CB5120	EB5120
Fiesta V 16V	03/03→	1242	4	71.90	DOHC	51/70	AG8310 (Steel)	CB5120	EB5120



AB5120

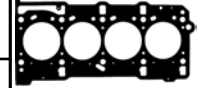

AD5800



AD5810



AD5820



BY650



JD5164



JD5230

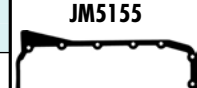

JM5155



JE5025



cc



kW/PS



1.2	M7JB	22	AG8310 (Steel)	CB5120	EB5120
Fiesta V 1.6V	03/03→	1242 4 71.90 DOHC 51/70			
1.2	SNJA	23	AH7000 (MLS), 0.3mm AH5960 (MLS), 0.800mm	CH5960	
Fiesta Van 1.25	01/09→	1242 4 DOHC 60/82			
Fiesta VI 1.25	10/08→				
1.2	SNJB	24	AH7000 (MLS), 0.3mm AH5960 (MLS), 0.800mm	CH5960	
Fiesta Van 1.25	01/09→	1242 4 DOHC 60/82			
Fiesta VI 1.25	10/08→				
1.2	STJA	25	AH7000 (MLS), 0.3mm		
Fiesta VI 1.25	10/08→	1242 4 DOHC 44/60			
1.2	STJB	26	AH7000 (MLS), 0.3mm		
Fiesta 1.25	10/12→	1242 4 DOHC 44/60			
Fiesta VI 1.25	10/08→				
1.3	A9A	27	AD5020 (MLS)	CD5020 [13]	EC5890
Ka 1.3 i	08/02→11/08	1299 4 74.00 SOHC/OHC 51/70			
1.3	A9B	28	AD5020 (MLS)	CD5020 [13]	EC5890
Ka 1.3 i	08/02→11/08	1299 4 74.00 SOHC/OHC 51/70			
1.3	A9JA	29	AD5020 (MLS)	CD5020 [13]	EC5890
Fiesta V 1.3	11/01→	1299 4 74.00 SOHC/OHC 51/69			
Fiesta Van 1.3	10/03→				
1.3	A9JB	30	AD5020 (MLS)	CD5020 [13]	EC5890
Fiesta V 1.3	11/01→	1299 4 74.00 SOHC/OHC 51/69			
Fiesta Van 1.3	10/03→				
1.3	BAA	31	AD5020 (MLS)	CD5020 [13]	EY671
Ka 1.3 i	05/02→05/05	1299 4 74.00 SOHC/OHC 44/60			
Ka S 150.09/B	09/96→11/08				
1.3	BAJA	32	AD5020 (MLS)	CD5020 [13]	EC5890
Fiesta V 1.3	11/01→	1299 4 74.00 SOHC/OHC 44/60			
1.3	J4B	33	BT140 (Fibre)	DT140	EH752 [3]
Escort V 1.3	07/90→09/92	1299 4 74.00 SOHC/OHC 44/60			
Escort VI 1.3	09/92→01/95				
Escort VII 1.3	01/95→02/99				
Orion III 1.3	07/90→12/93				
1.3	J4C	34	BT140 (Fibre)	DY671 [13]	EY671
Fiesta Van 1.3	02/96→	1299 4 74.00 44/60			
Fiesta IV 1.3 i	08/95→01/02				

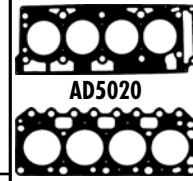

AD5020

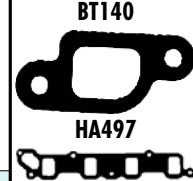

BT140

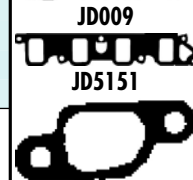

HA497

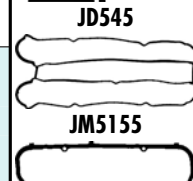

JD009

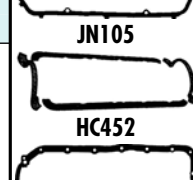

JD5151

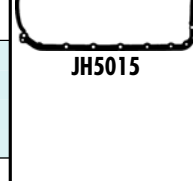

JM5155



JN105



HC452



JH5015



cc



kW/PS



1.3	J4D	35	BT140 (Fibre)	DY671 [13]	EY671
Ka 1.3 i	05/02→05/05	1299	4	74.00	44/60
Ka S 150.09/B	09/96→11/08				
1.3	J4J	36	BT140 (Fibre)	DY671 [13]	EY671
Fiesta IV 1.3 i	08/95→01/02	1299	4	74.00	44/60
1.3	J4K	37	BT140 (Fibre)	DY671 [13]	EY671
Ka 1.3 i	05/02→05/05	1299	4	74.00	44/60
Ka S 150.09/B	09/96→11/08				
1.3	J4L	38	BT140 (Fibre)	DY671 [13]	EY671
Fiesta IV 1.3 i	08/95→01/02	1299	4	74.00	44/60
1.3	J4M	39	BT140 (Fibre)	DY671 [13]	EY671
Ka 1.3 i	05/02→05/05	1299	4	74.00	44/60
Ka S 150.09/B	09/96→11/08				
1.3	J4N	40	BT140 (Fibre)	DY671 [13]	EY671
Ka 1.3 i	05/02→05/05	1299	4	74.00	44/60
Ka S 150.09/B	09/96→11/08				
1.3	J4P	41	BT140 (Fibre)	DY671 [13]	EY671
Ka 1.3 i	05/02→05/05	1299	4	74.00	44/60
Ka S 150.09/B	09/96→11/08				
1.3	J4Q	42	BT140 (Fibre)	DY671 [13]	EY671
Fiesta IV 1.3 i	08/95→01/02	1299	4	74.00	44/60
1.3	J4R	43	BT140 (Fibre)	DY671 [13]	EY671
Fiesta IV 1.3 i	08/95→01/02	1299	4	74.00	44/60
1.3	J4S	44	BT140 (Fibre)	DY671 [13]	EY671
Ka 1.3 i	05/02→05/05	1299	4	74.00	44/60
Ka S 150.09/B	09/96→11/08				
1.3	J4T	45	BT140 (Fibre)	DY671 [13]	EY671
Fiesta IV 1.3 i	08/95→01/02	1299	4	74.00	44/60
1.3	J6A	46	BT140 (Fibre)	DY671 [13]	EY671
Escort V 1.3	07/90→09/92	1299	4	74.00	SOHC/OHC 44/60
Escort VI 1.3	09/92→01/95				
Escort VII 1.3	01/95→02/99				
Orion III 1.3	07/90→12/93				
1.3	J6B	47	BT140 (Fibre)	DT110 DT140	EG340 EH752 [3]
Fiesta Van 1.3	09/91→02/96	1299	4	74.00	44/60
Fiesta III 1.3	05/91→01/97				
1.3	JBA	48	BT140 (Fibre)	DT140	EH752 [3]
Escort '86 Exp	07/88→07/90	1297	4	73.96	SOHC/OHC 44-46/ 60-63
Escort IV 1.3	07/88→10/90				

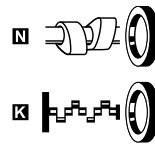
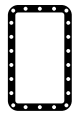

BT140



HA497



JB799



JD009



JD515



JD545

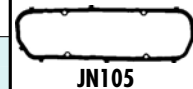

JN105

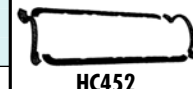

HC452



JH5015



cc



kW/PS



Model	Year Range	CC	Cyls	Power (kW/PS)	Configuration	Code	Code	Code	
1.3 JBB						49	BC240 (Fibre)	DC240 [13]	EG340 [80] →08/88
Escort '86 Exp	02/86→07/90	1297	4	73.96	OHV	44/60			
Escort IV 1.3	01/86→07/90								
Orion II 1.3	12/85→07/90								
1.3 JBC						50	BT140 (Fibre)	DT140	EG340
Fiesta III 1.3	03/89→12/92	1299	4	74.00	SOHC/OHC	44/60			
1.3 JBD						51	BT140 (Fibre)	DT140	EG340
Escort '91 Exp	07/90→12/94	1297	4	74.00		46/63			
1.3 JJA						52	BT140 (Fibre)	DY671 [13]	EY671
Fiesta IV 1.3 i	08/95→01/02	1299	4	74.00	OHV	37/50			
1.3 JJB						53	BT140 (Fibre)	DY671 [13]	EY671
Ka 33.332 DFS	09/96→10/02	1299	4	74.00		37/50			
1.3 JJC						54	BT140 (Fibre)	DY671 [13]	EY671
Fiesta IV 1.3 i	08/95→01/02	1299	4	74.00	SOHC/OHC	37/50			
1.3 JJD						55	BT140 (Fibre)	DY671 [13]	EY671
Ka 1.3 i	06/98→11/08	1299	4	74.00	SOHC/OHC	36/49			
1.3 JJE						56	BT140 (Fibre)	DY671 [13]	EY671
Fiesta IV 1.3 i	08/95→01/02	1299	4	74.00		37/50			
1.3 JJF						57	BT140 (Fibre)	DY671 [13]	EY671
Ka 1.3 i	06/98→11/08	1299	4	74.00		36/49			
1.3 JJG						58	BT140 (Fibre)	DY671 [13]	EY671
Ka 1.3 i	06/98→11/08	1299	4	74.00		36/49			
1.3 JJH						59	BT140 (Fibre)	DY671 [13]	EY671
Ka 1.3 i	06/98→11/08	1299	4	74.00		36/49			
1.3 JJJ						60	BT140 (Fibre)	DY671 [13]	EY671
Fiesta IV 1.3 i	08/95→01/02	1299	4	74.00		37/50			
1.3 JJK						61	BT140 (Fibre)	DY671 [13]	EY671
Fiesta IV 1.3 i	08/95→01/02	1299	4	74.00		37/50			
1.3 JJL						62	BT140 (Fibre)	DY671 [13]	EY671
Ka 1.3 i	06/98→11/08	1299	4	74.00		36/49			
1.3 JJM						63	BT140 (Fibre)	DY671 [13]	EY671
Fiesta IV 1.3 i	08/95→01/02	1299	4	74.00	SOHC/OHC	37/50			







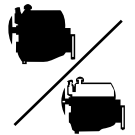



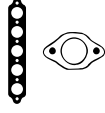

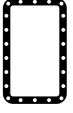

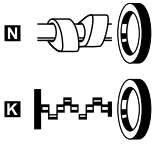

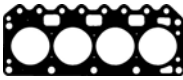



HBS050 [22] M11x1.50x120.00mm (x10)	JB862 [1] JB799 [x4] JE719	JN105 [4]	HC452 [1] =KG664	PB180 (x8) 8.00x12.0/15.40x9.50 866N W (FPM)	NA576 [2] 36.50x52.30x8.00mm, MVQ NB788 [1] 79.40x95.30x11.10mm, PTFE			BC240	
HBS050 [22] M11x1.50x120.00mm (x10)	JD009 [1] JD545 [x4] HA497 [x4]	JN105 [4]	HC452 [1] =KG664	HR655 [1]	NA576 [2] 36.50x52.30x8.00mm, MVQ NB788 [1] 79.40x95.30x11.10mm, PTFE			BT140	
HBS050 [22] M11x1.50x120.00mm (x10)	JD009 [1] JD545 [x4] HA497 [x4]	JN105 [4]	HC452 [1] =KG664	HR655 [1]	NA576 [2] 36.50x52.30x8.00mm, MVQ NB788 [1] 79.40x95.30x11.10mm, PTFE			HA497	
HBS050 [22] M11x1.50x120.00mm (x10)	JD5151 [1] JD545 [x4] HA497 [x4]	JN105 [4]	JH5015 [1] =KG664	HR655 [1]	NA576 [2] 36.50x52.30x8.00mm, MVQ NB788 [1] 79.40x95.30x11.10mm, PTFE			JB799	
HBS050 [22] M11x1.50x120.00mm (x10)	JD5151 [1] JD545 [x4] HA497 [x4]	JN105 [4]	JH5015 [1] =KG664	HR655 [1]	NA576 [2] 36.50x52.30x8.00mm, MVQ NB788 [1] 79.40x95.30x11.10mm, PTFE			JB862	
HBS050 [22] M11x1.50x120.00mm (x10)	JD5151 [1] JD545 [x4] HA497 [x4]	JN105 [4]	JH5015 [1] =KG664	HR655 [1]	NA576 [2] 36.50x52.30x8.00mm, MVQ NB788 [1] 79.40x95.30x11.10mm, PTFE			JD009	
HBS050 [22] M11x1.50x120.00mm (x10)	JD5151 [1] JD545 [x4] HA497 [x4]	JN105 [4]	JH5015 [1] =KG664	HR655 [1]	NA576 [2] 36.50x52.30x8.00mm, MVQ NB788 [1] 79.40x95.30x11.10mm, PTFE			JD5151	
HBS050 [22] M11x1.50x120.00mm (x10)	JD5151 [1] JD545 [x4] HA497 [x4]	JN105 [4]	JH5015 [1] =KG664	HR655 [1]	NA576 [2] 36.50x52.30x8.00mm, MVQ NB788 [1] 79.40x95.30x11.10mm, PTFE			JE719	
HBS050 [22] M11x1.50x120.00mm (x10)	JD5151 [1] JD545 [x4] HA497 [x4]	JN105 [4]	JH5015 [1] =KG664	HR655 [1]	NA576 [2] 36.50x52.30x8.00mm, MVQ NB788 [1] 79.40x95.30x11.10mm, PTFE			JN105	
HBS050 [22] M11x1.50x120.00mm (x10)	JD5151 [1] JD545 [x4] HA497 [x4]	JN105 [4]	JH5015 [1] =KG664	HR655 [1]	NA576 [2] 36.50x52.30x8.00mm, MVQ NB788 [1] 79.40x95.30x11.10mm, PTFE			HC452	
HBS050 [22] M11x1.50x120.00mm (x10)	JD5151 [1] JD545 [x4] HA497 [x4]	JN105 [4]	JH5015 [1] =KG664	HR655 [1]	NA576 [2] 36.50x52.30x8.00mm, MVQ NB788 [1] 79.40x95.30x11.10mm, PTFE			JH5015	
HBS050 [22] M11x1.50x120.00mm (x10)	JD5151 [1] JD545 [x4] HA497 [x4]	JN105 [4]	JH5015 [1] =KG664	HR655 [1]	NA576 [2] 36.50x52.30x8.00mm, MVQ NB788 [1] 79.40x95.30x11.10mm, PTFE				
HBS050 [22] M11x1.50x120.00mm (x10)	JD5151 [1] JD545 [x4] HA497 [x4]	JN105 [4]	JH5015 [1] =KG664	HR655 [1]	NA576 [2] 36.50x52.30x8.00mm, MVQ NB788 [1] 79.40x95.30x11.10mm, PTFE				
HBS050 [22] M11x1.50x120.00mm (x10)	JD5151 [1] JD545 [x4] HA497 [x4]	JN105 [4]	JH5015 [1] =KG664	HR655 [1]	NA576 [2] 36.50x52.30x8.00mm, MVQ NB788 [1] 79.40x95.30x11.10mm, PTFE				
HBS050 [22] M11x1.50x120.00mm (x10)	JD5151 [1] JD545 [x4] HA497 [x4]	JN105 [4]	JH5015 [1] =KG664	HR655 [1]	NA576 [2] 36.50x52.30x8.00mm, MVQ NB788 [1] 79.40x95.30x11.10mm, PTFE				
HBS050 [22] M11x1.50x120.00mm (x10)	JD5151 [1] JD545 [x4] HA497 [x4]	JN105 [4]	JH5015 [1] =KG664	HR655 [1]	NA576 [2] 36.50x52.30x8.00mm, MVQ NB788 [1] 79.40x95.30x11.10mm, PTFE				



kW/PS

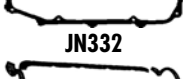
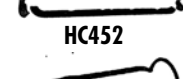

1.3	JLA	64	BC240 (Fibre)	DC240 [13]	EG340 [80]				
Escort '86 Exp	02/86→07/90	1297	4	73.96	OHV	44/60			
Escort IV 1.3	01/86→07/90								
Orion II 1.3	12/85→07/90								
1.3	JLB	65	BC240 (Fibre)	DC240 [13]	EG340 [80]				
Escort '86 Exp	02/86→07/90	1297	4	73.96	OHV	44/60			
Escort IV 1.3	01/86→07/90								
Orion II 1.3	12/85→07/90								
1.4	ASDA	66	AB5133 (MLS)	CB5133 ☒					
Focus II 1.4	11/04→	1388	4	76.00	DOHC	59/80			
1.4	ASDB	67	AB5133 (MLS)	CB5133 ☒					
Focus II 1.4	11/04→	1388	4	76.00	DOHC	59/80			
1.4	F4A	68	BY740 (Fibre)	DY741 [3]	EA441				
Fiesta III 1.4	03/89→12/95	1391	4	77.25		54/73			
1.4	F4B	69	BY740 (Fibre)	DY741 [3]	EA441				
Escort '95 Exp	01/95→	1391	4	77.25		54-55/ 73-75			
Escort VI	07/93→01/95								
Escort VI 1.4	01/94→01/95								
Escort VI 1.4 i	08/93→01/95								
Escort VII 1.4	01/95→02/99								
1.4	F6A	70	BY740 (Fibre)	DY740 [3]	EA441				
Fiesta 1.4	09/86→09/89	1393	4	77.25	SOHC/OHC	52-54/ 71-73			
Fiesta II 1.4	10/86→02/89								
1.4	F6B	71	BY740 (Fibre)	DY740 [3]					
Escort '86 Exp	02/86→07/90	1392	4	77.25	SOHC/OHC	52-54/ 71-73			
Escort IV	02/87→07/90								
Escort IV 1.4	01/86→07/90								
Orion II 1.4	02/87→07/90								
1.4	F6C	72	BY740 (Fibre)	DY740 [3]	EA441				
Fiesta II 1.4	10/86→02/89	1392	4	77.25	SOHC/OHC	52/71			
1.4	F6D	73	BY740 (Fibre)	DY740 [3]	EA441				
Escort '86 Exp	02/86→07/90	1392	4	77.25	SOHC/OHC	54/73			
Escort IV	02/87→07/90								
Escort IV 1.4	01/86→07/90								
Orion II 1.4	02/87→07/90								

								
HBS050 [22] M11x1.50x120.00mm (x10) →08/88	JB862 [1] JB799 [x4] ☉JE719	JN105 [4]	HC452 [80] =KG664	PB180 (x8) 8.00x12.0/15.40x9.50 866N W (FPM)	NA576 [2] 36.50x52.30x8.00mm, MVQ NB788 [1] 79.40x95.30x11.10mm, PTFE			 BC240  BY740  JB799  JB862  JC790  JC829  JD188  JD498  JD554  JE719  JM5155  JN105  JN332  HC452  JJ348
HBS001 [22] M10x1.50x135.00mm (x10) →08/88 HBS050 [22] M11x1.50x120.00mm (x10)	JB862 [1] JB799 [x4] ☉JE719	JN105 [4]	HC452 [80] =KG664	PB180 (x8) 8.00x12.0/15.40x9.50 866N W (FPM)	NA576 [2] 36.50x52.30x8.00mm, MVQ NB788 [1] 79.40x95.30x11.10mm, PTFE			
HBS078 [22] M10x1.50x143.00mm (x10)	JD5866 [1] JD5865 [1]	JM5155 [78] (Elastomer) JM7060 [79] (Elastomer)			NC048 [2] 38.00x52.00x6.00mm, FPM NA5137 [2] 32.90x47.40x5.00mm, FPM LK5004 [1] [7] 80.00x182.00x19.400mm, PTFE			
HBS078 [22] M10x1.50x143.00mm (x10)	JD5866 [1] JD5865 [1]	JM5155 [78] (Elastomer) JM7060 [79] (Elastomer)			NC048 [2] 38.00x52.00x6.00mm, FPM NA5137 [2] 32.90x47.40x5.00mm, FPM LK5004 [1] [7] 80.00x182.00x19.400mm, PTFE			
HBS001 [22] M10x1.50x135.00mm (x10)	JD188 [1] [2] JD554 [1] [2] JC829 [1]	JN332 [4]	JJ348 =KG664	HR661 [1]	NA5190 [2] 42.00x56.00x7.00mm, FPM NB645 [2] 35.00x50.00x7.00mm, MVQ NB847 [1] 88.00x108.00x11.00mm, FPM			
HBS001 [22] M10x1.50x135.00mm (x10)	JD188 [1] [2] JD554 [1] [2] JC829 [1]	JN332 [4]	JJ348 =KG664	HR661 [1]	NA5190 [2] 42.00x56.00x7.00mm, FPM NB645 [2] 35.00x50.00x7.00mm, MVQ NB847 [1] 88.00x108.00x11.00mm, FPM			
HBS001 [22] M10x1.50x135.00mm (x10)	JD498 [1] JD188 [1] [2] JC790 [1]	JN332 [4]	JJ348 =KG664		NA5190 [2] 42.00x56.00x7.00mm, FPM NB645 [2] 35.00x50.00x7.00mm, MVQ NB847 [1] 88.00x108.00x11.00mm, FPM			
HBS001 [22] M10x1.50x135.00mm (x10)	JD498 [1] JC790 [1] ☉JE719	JN332 [4]	JJ348 =KG664	HR661 [1]	NA5190 [2] 42.00x56.00x7.00mm, FPM NB645 [2] 35.00x50.00x7.00mm, MVQ NB847 [1] 88.00x108.00x11.00mm, FPM			
HBS001 [22] M10x1.50x135.00mm (x10)	JD498 [1] JC790 [1]	JN332 [4]	JJ348 =KG664	HR661 [1]	NA5190 [2] 42.00x56.00x7.00mm, FPM NB645 [2] 35.00x50.00x7.00mm, MVQ NB847 [1] 88.00x108.00x11.00mm, FPM			
HBS001 [22] M10x1.50x135.00mm (x10)	JD498 [1] JC790 [1] ☉JE719	JN332 [4]	JJ348 =KG664	HR661 [1]	NA5190 [2] 42.00x56.00x7.00mm, FPM NB645 [2] 35.00x50.00x7.00mm, MVQ NB847 [1] 88.00x108.00x11.00mm, FPM			



cc



kW/PS



1.4	F6E	74	BY740 (Fibre)	DY740 [3]	EA441				
Fiesta III 1.4	03/89→12/95	1392	4	77.25	SOHC/OHC	52/71			
1.4	F6F	75	BY740 (Fibre)	DY740 [3]	EA441				
Escort '91 Exp	07/90→12/94	1392	4	77.25	SOHC/OHC	52/71			
Escort V 1.4	07/90→09/92								
Escort V Cabrio	07/90→12/92								
Escort VI	12/92→04/94								
Escort VI 1.4	09/92→01/95								
Orion III 1.4	07/90→12/93								
1.4	F6G	76	BY740 (Fibre)	DY740 [3]	EA441				
Escort '91 Exp	07/90→12/94	1392	4	77.24	SOHC/OHC	52/71			
Escort V 1.4	07/90→09/92								
Escort V Cabrio	07/90→12/92								
Escort VI	12/92→04/94								
Escort VI 1.4	09/92→01/95								
Orion III 1.4	07/90→12/93								
1.4	F6JA Diesel	77	AH6560 (MLS), 1.25mm, 2 Notches AH6570 (MLS), 1.3mm, 3 Notches AH6580 (MLS), 1.35mm, 1 Notch AH6590 (MLS), 1.4mm, 4 Notches AH6600 (MLS), 1.45mm, 5 Notches	CD5130 ▲	ED5130				
Fiesta V TDCi	11/01→	1399	4	73.70	SOHC/OHC	50-51/ 68-69			
Fiesta Van TDCi	10/03→								
Fusion 1.4 TDCi	08/02→								
1.4	F6JB Diesel	78	AH6560 (MLS), 1.25mm, 2 Notches AH6570 (MLS), 1.3mm, 3 Notches AH6580 (MLS), 1.35mm, 1 Notch AH6590 (MLS), 1.4mm, 4 Notches AH6600 (MLS), 1.45mm, 5 Notches	CD5130 ▲	ED5130				
Fiesta V TDCi	11/01→	1399	4	73.70	SOHC/OHC	50/68			
Fiesta Van TDCi	10/03→								
Fiesta VI TDCi	01/09→								
Fusion 1.4 TDCi	08/02→								
1.4	F6JD Diesel	79	AH6560 (MLS), 1.25mm, 2 Notches AH6570 (MLS), 1.3mm, 3 Notches AH6580 (MLS), 1.35mm, 1 Notch AH6590 (MLS), 1.4mm, 4 Notches AH6600 (MLS), 1.45mm, 5 Notches	CD5130 ▲	ED5130				
Fiesta Van TDCi	07/10→	1399	4	73.70	SOHC/OHC	51/70			
Fiesta VI TDCi	07/10→								
1.4	FHA	80	BY660 (MLS) →05/98 AB5130 (MLS) 06/98→	DY660 [3] →05/98 CB5130 [3][78] 06/98→	EY650 [3]				
Fiesta 1.4 i	04/96→10/99	1388	4	76.00	DOHC	66/90			
Fiesta IV i 16V	04/96→01/02								
1.4	FHD	81	BY660 (MLS) →05/98 AB5130 (MLS) 06/98→	DY660 [3] →05/98 CB5130 [3][78] 06/98→	EY650 [3]				
Puma Coupe 16V	11/97→10/00	1388	4	76.00	DOHC	66/90			
1.4	FHE	82	BY660 (MLS) →05/98 AB5130 (MLS) 06/98→	DY660 [3] →05/98 CB5130 [3][78] 06/98→	EY650 [3]				
Fiesta IV i 16V	04/96→01/02	1388	4	76.00	DOHC	66/90			

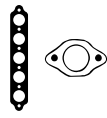

AB5130



BY660



BY740



JC790



JD498



JD5164

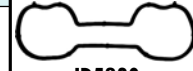

JD5230

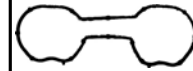

JD5290



JE719



JM5155

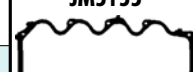

JN332

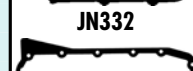

JE5025

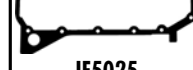

JJ348



NCO48

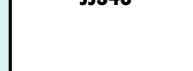

NAS137

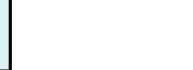

LK5004



NA5190



NB645

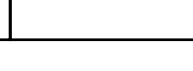

NB847



cc



kW/PS



1.4	FHF						83	BY660 (MLS) →05/98 AB5130 (MLS) 06/98→	DY660 [3] →05/98 CB5130 [3][78] 06/98→	EY650 [3]
Puma Coupe 1.6V	11/97→10/00	1388	4	76.00	DOHC		66/90			
1.4	FUA						84	BY740 (Fibre)	DY740 [3]	EA441
Escort IV	01/86→07/90	1392	4	77.25	SOHC/OHC		55/75			
Escort IV 1.4	01/86→07/90									
Orion II 1.4	12/85→07/90									
1.4	FUAA						85	BY740 (Fibre)	DY740 [3]	EA441
Escort IV 1.4	10/85→10/90	1392	4	77.25	SOHC/OHC		51-55/ 69-75			
Orion II 1.4	03/86→07/90									
1.4	FUB						86	BY740 (Fibre)	DP790 [3]	EA441
Fiesta II 1.4	10/85→11/89	1392	4	77.25	SOHC/OHC		55/75			
1.4	FUC						87	BY740 (Fibre)	DP790 [3]	EA441
Escort '86 Exp	02/86→07/90	1392	4	77.25	SOHC/OHC		54/73			
Escort IV	02/87→07/90									
Escort IV 1.4	01/86→07/90									
Orion II 1.4	01/86→07/90									
1.4	FUD						88	BY740 (Fibre)	DP790 [3]	EA441
Fiesta II 1.4	02/87→02/89	1392	4	77.25	SOHC/OHC		54/73			
1.4	FUF						89	BY740 (Fibre)		
Fiesta III 1.4	11/92→12/96	1392	4	77.25	SOHC/OHC		55/75			
1.4	FUG						90	BY740 (Fibre)	DP790 [3]	EA441
Fiesta III 1.4	03/89→12/95	1392	4	77.25	SOHC/OHC		54/73			
1.4	FUH						91	BY740 (Fibre)	DY741 [3]	EA441
Escort VI 1.4	01/94→01/95	1392	4	77.25	SOHC/OHC		54-55/ 71-75			
Escort VI 1.4 i	08/93→01/95									
Escort VII 1.4	01/95→02/99									
Orion III 1.4	07/90→12/93									
1.4	FUJ						92	BY740 (Fibre)	DP790 [3]	EA441
Fiesta III 1.4	03/89→12/95	1392	4	77.25	SOHC/OHC		54/73			

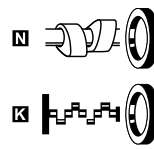
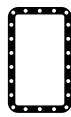
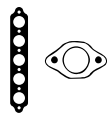

HBS078 [22] M10x1.50x143.00mm (x10)	JD5230 ■ →05/98 JD5290 ■ (x2) 06/98→ JD5164 ■	JM5155 [78] (Elastomer) JM7060 [79] (Elastomer)	JE5025	HR809 ■■ HR808 ■■	NA5190 [2] 38.00x52.00x6.00mm, FPM ■ NA5137 ■ [2] 32.90x47.40x5.00mm, FPM ■ LK5004 ■ [1][7] 80.00x182.00x19.400mm, PTFE	
HBS001 [22] M10x1.50x135.00mm (x10)	JD498 ■ JC790 ■ ⊙JE719	JN332 [4]	JJ348 =KG664	HR661 ■	NA5190 [2] 42.00x56.00x7.00mm, FPM ■ NB645 ■ [2] 35.00x50.00x7.00mm, MVQ ■ NB847 ■ [1] 88.00x108.00x11.00mm, FPM	
HBS001 [22] M10x1.50x135.00mm (x10)	JD498 ■ JC790 ■ ⊙JE719	JN332 [4]	JJ348 =KG664	HR661 ■	NA5190 [2] 42.00x56.00x7.00mm, FPM ■ NB645 ■ [2] 35.00x50.00x7.00mm, MVQ ■ NB847 ■ [1] 88.00x108.00x11.00mm, FPM	
HBS001 [22] M10x1.50x135.00mm (x10)	JD498 ■ JC790 ■ ⊙JE719	JN332 [4]	JJ348 =KG664		NA5190 [2] 42.00x56.00x7.00mm, FPM ■ NB645 ■ [2] 35.00x50.00x7.00mm, MVQ ■ NB847 ■ [1] 88.00x108.00x11.00mm, FPM	
HBS001 [22] M10x1.50x135.00mm (x10)	JD498 ■ JC790 ■ ⊙JE719	JN332 [4]	JJ348 =KG664		NA5190 [2] 42.00x56.00x7.00mm, FPM ■ NB645 ■ [2] 35.00x50.00x7.00mm, MVQ ■ NB847 ■ [1] 88.00x108.00x11.00mm, FPM	
			JJ348 =KG664		NA5177 [2] 42.00x56.00x7.00mm, FPM ■ NB848 ■ [1] 100.00x120.00x11.00mm, PTFE	
HBS001 [22] M10x1.50x135.00mm (x10)	JD498 ■ JC790 ■	JN332 [4]	JJ348 =KG664		NA5190 [2] 42.00x56.00x7.00mm, FPM ■ NB645 ■ [2] 35.00x50.00x7.00mm, MVQ ■ NB847 ■ [1] 88.00x108.00x11.00mm, FPM	
HBS001 [22] M10x1.50x135.00mm (x10)	JD188 ■■ JD554 ■■ JC829 ■	JN332 [4]	JJ348 =KG664	HR661 ■	NA5190 [2] 42.00x56.00x7.00mm, FPM ■ NB645 ■ [2] 35.00x50.00x7.00mm, MVQ ■ NB847 ■ [1] 88.00x108.00x11.00mm, FPM	
HBS001 [22] M10x1.50x135.00mm (x10)	JD498 ■ JC790 ■	JN332 [4]	JJ348 =KG664		NA5190 [2] 42.00x56.00x7.00mm, FPM ■ NB645 [2] 35.00x50.00x7.00mm, MVQ ■ NB847 ■ [1] 88.00x108.00x11.00mm, FPM	

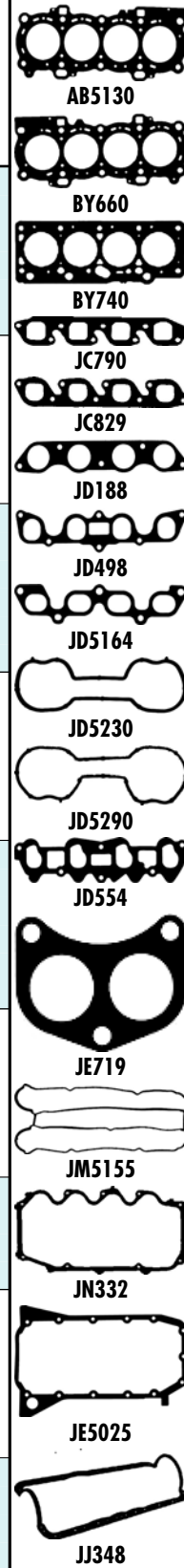



cc



kW/PS



1.4	FXDA	93	AB5130 (MLS)	CB5130 [3][78]	EY650 [3]				
Focus 1.4 16V	10/98→11/04	1388	4	76.00	DOHC	55/75	→11/02 AB5133 (MLS) 12/02→		
1.4	FXDB	94	AB5130 (MLS)	CB5130 [3][78]	EY650 [3]				
Focus 1.4 16V	10/98→11/04	1388	4	76.00	DOHC	55/75	→11/02 AB5133 (MLS) 12/02→		
1.4	FXDC	95	AB5130 (MLS)	CB5130 [3][78]	EY650 [3]				
Focus 1.4 16V	10/98→11/04	1388	4	76.00	DOHC	55/75	→11/02 AB5133 (MLS) 12/02→		
1.4	FXDD	96	AB5130 (MLS)	CB5130 [3][78]	EY650 [3]				
Focus 1.4 16V	10/98→11/04	1388	4	76.00	DOHC	55/75	→11/02 AB5133 (MLS) 12/02→		
1.4	FXJA	97	AB5130 (MLS)	CB5132 ☒ →11/02 CB5133 ☒ 12/02→	EB5120				
Fiesta V 1.4 16V Fusion 1.4	11/01→ 08/02→	1388	4	76.00	DOHC	59/80	→11/02 AB5133 (MLS) 12/02→		
1.4	FXJB	98	AB5130 (MLS)	CB5133 ☒ 12/02→	EB5120				
Fiesta V 1.4 16V Fusion 1.4	11/01→ 08/02→	1388	4	76.00	DOHC	59/80	→11/02 AB5133 (MLS) 12/02→		
1.4	FXJC	99	AB5130 (MLS)						
Fusion 1.4	08/02→	1388	4	76.00	DOHC	59/80	→08/03 AB5133 (MLS) 09/03→10/08 AH7120 (MLS), 0.3mm 11/08→		
1.4	KVJA Diesel	100	AH6560 (MLS), 1.25mm, 2 Notches AH6570 (MLS), 1.3mm, 3 Notches AH6580 (MLS), 1.35mm, 1 Notch AH6590 (MLS), 1.4mm, 4 Notches AH6600 (MLS), 1.45mm, 5 Notches	CD5130 ▲	ED5130				
Fiesta Van TDCi Fiesta VI TDCi	07/10→ 07/10→	1399	4	73.70	SOHC/OHC	51/70			
1.4	RTJA	101	AH7120 (MLS), 0.3mm						
Fiesta VI LPG	01/09→	1388	4	76.00	DOHC	68-71/ 92-97			
1.4	RTJB	102	AH7120 (MLS), 0.3mm						
Fiesta VI LPG	01/09→	1388	4	76.00	DOHC	68-71/ 92-97			
1.4	SPJA	103	AH7120 (MLS), 0.3mm						
Fiesta VI 1.4	10/08→	1388	4	76.00	DOHC	71/97			
1.4	SPJC	104	AH7120 (MLS), 0.3mm						
Fiesta VI 1.4	10/08→	1388	4	76.00	DOHC	71/97			
1.4	UC	105	BE540 (Graphite)	DE545					
Econovan 1.4	03/86→03/92	1416	4	77.00	SOHC/OHC	48/65			
1.4	UTJA	106	AH7120 (MLS), 0.3mm						
Fusion 1.4 LPG	01/10→	1388	4	76.00	DOHC	59/80			



AB5130



BE540



JA086



JD5164

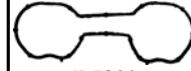

JD5290



JM5155



JE5025

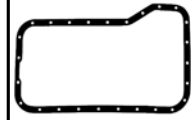

JH040

HBS078 [22] M10x1.50x143.00mm (x10)	JD5290 [x2] JD5164 [E] →11/03 JD5865 [E] 11/03→	JM5155 [78] (Elastomer) JM7060 [79] (Elastomer)	JE5025	HR809 [S][E] HR808 [S][E]	NC048 [2] 38.00x52.00x6.00mm, FPM NA5137 [E] [2] 32.90x47.40x5.00mm, FPM LK5004 [E] [1][7] 80.00x182.00x19.400mm, PTFE	
HBS078 [22] M10x1.50x143.00mm (x10)	JD5290 [x2] JD5164 [E] →11/03 JD5865 [E] 11/03→	JM5155 [78] (Elastomer) JM7060 [79] (Elastomer)	JE5025	HR809 [S][E] HR808 [S][E]	NC048 [2] 38.00x52.00x6.00mm, FPM NA5137 [E] [2] 32.90x47.40x5.00mm, FPM LK5004 [E] [1][7] 80.00x182.00x19.400mm, PTFE	
HBS078 [22] M10x1.50x143.00mm (x10)	JD5290 [x2] JD5164 [E] →11/03 JD5865 [E] 11/03→	JM5155 [78] (Elastomer) JM7060 [79] (Elastomer)	JE5025	HR809 [S][E] HR808 [S][E]	NC048 [2] 38.00x52.00x6.00mm, FPM NA5137 [E] [2] 32.90x47.40x5.00mm, FPM LK5004 [E] [1][7] 80.00x182.00x19.400mm, PTFE	
HBS078 [22] M10x1.50x143.00mm (x10)	JD5290 [x2] JD5164 [E] →11/03 JD5865 [E] 11/03→	JM5155 [78] (Elastomer) JM7060 [79] (Elastomer)	JE5025	HR809 [S][E] HR808 [S][E]	NC048 [2] 38.00x52.00x6.00mm, FPM NA5137 [E] [2] 32.90x47.40x5.00mm, FPM LK5004 [E] [1][7] 80.00x182.00x19.400mm, PTFE	
HBS078 [22] M10x1.50x143.00mm (x10)	JD5866 [E] JD5164 [E] →10/03 JD5865 [E] 11/03→	JM5155 [78] (Elastomer) JM7060 [79] (Elastomer)		HR809 [S][E] HR808 [S][E]	NC048 [2] 38.00x52.00x6.00mm, FPM NA5137 [E] [2] 32.90x47.40x5.00mm, FPM LK5004 [E] [1][7] 80.00x182.00x19.400mm, PTFE	
HBS078 [22] M10x1.50x143.00mm (x10)	JD5866 [E] JD5164 [E] →10/03 JD5865 [E] 11/03→	JM5155 [78] (Elastomer) JM7060 [79] (Elastomer)		HR809 [S][E] HR808 [S][E]	NC048 [2] 38.00x52.00x6.00mm, FPM NA5137 [E] [2] 32.90x47.40x5.00mm, FPM LK5004 [E] [1][7] 80.00x182.00x19.400mm, PTFE	
HBS078 [22] M10x1.50x143.00mm (x10)	JD5164 [E] →10/03 JD5865 [E] 11/03→	JM5155 [78] (Elastomer)		HR809 [S][E] HR808 [S][E]	NC048 [2] 38.00x52.00x6.00mm, FPM NA5137 [E] [2] 32.90x47.40x5.00mm, FPM LK5004 [E] [1][7] 80.00x182.00x19.400mm, PTFE	
HBS359 [22] M11x1.50x147.00mm (x10)	HA5029 [E] JD5829 [E]	JM5299			NA5258 [2] 27.00x47.00x7.00mm, PTFE NA5259 [E] [2] 40.00x55.00x6.40mm, PTFE	
HBS078 [22] M10x1.50x143.00mm (x10)					NC048 [2] 38.00x52.00x6.00mm, FPM	
HBS078 [22] M10x1.50x143.00mm (x10)					NC048 [2] 38.00x52.00x6.00mm, FPM	
HBS078 [22] M10x1.50x143.00mm (x10)		JM5155 [78] (Elastomer)			NC048 [2] 38.00x52.00x6.00mm, FPM	
HBS078 [22] M10x1.50x143.00mm (x10)		JM5155 [78] (Elastomer)			NC048 [2] 38.00x52.00x6.00mm, FPM	
HBS056 [19] M12x1.75x92.50mm (x10)	JA086 [E]	JM053 [4]	JH040	KJ710 (x8)	NB384 [E] [2] 40.00x55.00x8.00mm, NBR	
HBS078 [22] M10x1.50x143.00mm (x10)		JM5155 [78] (Elastomer)			NC048 [2] 38.00x52.00x6.00mm, FPM	



cc



kw/PS



Model	Code	Start	End	CC	Cyls	Power (kW/PS)	Configuration	Engine Code	Accessories	
1.6 CDB 107								AC5890 (MLS)	CC5890 [3]	EC5890
Ka 1.6 i	07/03→11/08	1599	4	82.00	SOHC/OHC	70/95				
1.6 CDC 108								AC5890 (MLS)	CC5890 [3]	EC5890
Ka 1.6 i	07/03→11/08	1599	4	82.00	SOHC/OHC	70/95				
1.6 CDRA 109								AC5890 (MLS)	CC5890 [3]	EC5890
Street Ka 1.6	05/03→07/05	1599	4	82.00	SOHC/OHC	70/95				
1.6 CDRB 110								AC5890 (MLS)	CC5890 [3]	EC5890
Street Ka 1.6	05/03→07/05	1599	4	82.00	SOHC/OHC	70/95				
1.6 FYDA 111								AG9560 (MLS), 0.320mm →12/02 AC5860 (MLS), 0.500mm 10/03→	CG9560 →12/02 CC5860 [3] 10/03→	EY650 [3]
Focus 1.6 16V	10/98→11/04	1596	4	79.00	DOHC	74/100				
1.6 FYDB 112								AG9560 (MLS), 0.320mm →12/02 AC5860 (MLS), 0.500mm 10/03→	CG9560 →12/02 CC5860 [3] 10/03→	EY650 [3]
Focus 1.6 16V	10/98→11/04	1596	4	79.00	DOHC	74/100				
1.6 FYDC 113								AG9560 (MLS), 0.320mm →12/02 AC5860 (MLS), 0.500mm 10/03→	CG9560 →12/02 CC5860 [3] 10/03→	EY650 [3]
Focus 1.6 16V	10/98→11/04	1596	4	79.00	DOHC	74/100				
1.6 FYDD 114								AG9560 (MLS), 0.320mm →12/02 AC5860 (MLS), 0.500mm 10/03→	CG9560 →12/02 CC5860 [3] 10/03→	EY650 [3]
Focus 1.6 16V	10/98→11/04	1596	4	79.00	DOHC	74/100				
1.6 FYDH 115								AG9560 (MLS), 0.320mm →12/02 AC5860 (MLS), 0.500mm 10/03→	CG9560 →12/02 CC5860 [3] 10/03→	EY650 [3]
Focus 1.6 16V Focus 16V	10/98→11/04 01/02→11/04	1596	4	79.00	DOHC	74-75/ 100-102				
1.6 FYJA 116								AG9560 (MLS), 0.320mm →12/02 AC5860 (MLS), 0.500mm 10/03→09/08 AH7150 (MLS) 10/08→	CG9560 →12/02 CC5860 [3] 10/03→09/08	EB5120
Fiesta V 1.6 16V Fusion 1.6	11/01→ 08/02→	1596	4	79.00	DOHC	74/100				
1.6 FYJB 117								AG9560 (MLS), 0.320mm →12/02 AC5860 (MLS), 0.500mm 10/03→09/08 AH7150 (MLS) 10/08→	CG9560 →12/02 CC5860 [3] 10/03→09/08	EB5120
Fiesta V 1.6 16V Fusion 1.6	11/01→ 08/02→	1596	4	79.00	DOHC	74/100				

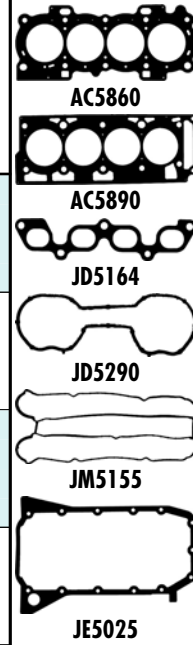

HBS358 [22] M11x1.50x158.00mm (x10)	JD5227 [1] JD5219 [5]	JM5104 (Elastomer)	JH5046	PA5033 (x8)	NA5147 [2] 40.00x62.00x7.40mm, PTFE NA5130 [1][7] 79.00x196.00x21.50mm, PTFE	
HBS358 [22] M11x1.50x158.00mm (x10)	JD5227 [1] JD5219 [5]	JM5104 (Elastomer)	JH5046	PA5033 (x8)	NA5147 [2] 40.00x62.00x7.40mm, PTFE NA5130 [1][7] 79.00x196.00x21.50mm, PTFE	
HBS358 [22] M11x1.50x158.00mm (x10)	JD5227 [1] JD5219 [5]	JM5104 (Elastomer)	JH5046	PA5033 (x8)	NA5147 [2] 40.00x62.00x7.40mm, PTFE NA5130 [1][7] 79.00x196.00x21.50mm, PTFE	
HBS358 [22] M11x1.50x158.00mm (x10)	JD5227 [1] JD5219 [5]	JM5104 (Elastomer)	JH5046	PA5033 (x8)	NA5147 [2] 40.00x62.00x7.40mm, PTFE NA5130 [1][7] 79.00x196.00x21.50mm, PTFE	
HBS078 [22] M10x1.50x143.00mm (x10)	JD5290 [1] JD5164 [5] →11/03 JD5865 [5] 11/03→	JM5155 [78] (Elastomer) JM7060 [79] (Elastomer)	JE5025	HR809 [5][E] HR808 [5][I]	NC048 [2] 38.00x52.00x6.00mm, FPM NA5137 [2] 32.90x47.40x5.00mm, FPM LK5004 [1][7] 80.00x182.00x19.400mm, PTFE	
HBS078 [22] M10x1.50x143.00mm (x10)	JD5290 [1] JD5164 [5] →11/03 JD5865 [5] 11/03→	JM5155 [78] (Elastomer) JM7060 [79] (Elastomer)	JE5025	HR809 [5][E] HR808 [5][I]	NC048 [2] 38.00x52.00x6.00mm, FPM NA5137 [2] 32.90x47.40x5.00mm, FPM LK5004 [1][7] 80.00x182.00x19.400mm, PTFE	
HBS078 [22] M10x1.50x143.00mm (x10)	JD5290 [1] JD5164 [5] →11/03 JD5865 [5] 11/03→	JM5155 [78] (Elastomer) JM7060 [79] (Elastomer)	JE5025	HR809 [5][E] HR808 [5][I]	NC048 [2] 38.00x52.00x6.00mm, FPM NA5137 [2] 32.90x47.40x5.00mm, FPM LK5004 [1][7] 80.00x182.00x19.400mm, PTFE	
HBS078 [22] M10x1.50x143.00mm (x10)	JD5290 [1] JD5164 [5] →11/03 JD5865 [5] 11/03→	JM5155 [78] (Elastomer) JM7060 [79] (Elastomer)	JE5025	HR809 [5][E] HR808 [5][I]	NC048 [2] 38.00x52.00x6.00mm, FPM NA5137 [2] 32.90x47.40x5.00mm, FPM LK5004 [1][7] 80.00x182.00x19.400mm, PTFE	
HBS078 [22] M10x1.50x143.00mm (x10)	JD5290 [1] (x2) JD5164 [5] →11/03 JD5865 [5] 11/03→	JM5155 [78] (Elastomer) JM7060 [79] (Elastomer)	JE5025	HR809 [5][E] HR808 [5][I]	NC048 [2] 38.00x52.00x6.00mm, FPM NA5137 [2] 32.90x47.40x5.00mm, FPM LK5004 [1][7] 80.00x182.00x19.400mm, PTFE	
HBS078 [22] M10x1.50x143.00mm (x10)	JD5866 [1] JD5865 [5]	JM5155 [78] (Elastomer) JM7060 [79] (Elastomer)		HR809 [5][E] HR808 [5][I]	NC048 [2] 38.00x52.00x6.00mm, FPM NA5137 [2] 32.90x47.40x5.00mm, FPM LK5004 [1][7] 80.00x182.00x19.400mm, PTFE	
HBS078 [22] M10x1.50x143.00mm (x10)	JD5866 [1] JD5865 [5]	JM5155 [78] (Elastomer) JM7060 [79] (Elastomer)		HR809 [5][E] HR808 [5][I]	NC048 [2] 38.00x52.00x6.00mm, FPM NA5137 [2] 32.90x47.40x5.00mm, FPM LK5004 [1][7] 80.00x182.00x19.400mm, PTFE	



cc





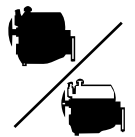



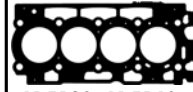
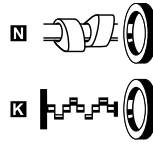
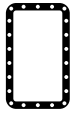
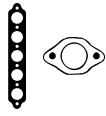



















































































































































kW/PS



1.6 G8DA Diesel 118							AD5130 (MLS), 1.250mm, 2 Notches AD5140 (MLS), 1.300mm, 3 Notches AD5150 (MLS), 1.350mm, 1 Notch AD5160 (MLS), 1.400mm, 4 Notches AD5170 (MLS), 1.450mm, 5 Notches	CD5140 ▲	ED5130
C-MAX 1.6 TDCi	02/07→	1560	4	75.00	DOHC	80/109			
Focus C-MAX	10/03→03/07								
Focus II TDCi	11/04→								
1.6 G8DB Diesel 119							AD5130 (MLS), 1.250mm, 2 Notches AD5140 (MLS), 1.300mm, 3 Notches AD5150 (MLS), 1.350mm, 1 Notch AD5160 (MLS), 1.400mm, 4 Notches AD5170 (MLS), 1.450mm, 5 Notches	CD5140 ▲	ED5130
C-MAX 1.6 TDCi	02/07→	1560	4	75.00	DOHC	80/109			
Focus C-MAX	10/03→03/07								
Focus II TDCi	11/04→								
1.6 G8DC Diesel 120							AD5130 (MLS), 1.250mm, 2 Notches AD5140 (MLS), 1.300mm, 3 Notches AD5150 (MLS), 1.350mm, 1 Notch AD5160 (MLS), 1.400mm, 4 Notches AD5170 (MLS), 1.450mm, 5 Notches	CD5140 ▲	ED5130
C-MAX 1.6 TDCi	02/07→	1560	4	75.00	DOHC	74/100			
Focus II TDCi	11/04→								
1.6 G8DD Diesel 121							AD5130 (MLS), 1.250mm, 2 Notches AD5140 (MLS), 1.300mm, 3 Notches AD5150 (MLS), 1.350mm, 1 Notch AD5160 (MLS), 1.400mm, 4 Notches AD5170 (MLS), 1.450mm, 5 Notches	CD5140 ▲	ED5130
C-MAX 1.6 TDCi	02/07→	1560	4	75.00	DOHC	80/109			
Focus II TDCi	11/04→								
1.6 G8DE Diesel 122							AD5130 (MLS), 1.250mm, 2 Notches AD5140 (MLS), 1.300mm, 3 Notches AD5150 (MLS), 1.350mm, 1 Notch AD5160 (MLS), 1.400mm, 4 Notches AD5170 (MLS), 1.450mm, 5 Notches	CD5140 ▲	ED5130
Focus II TDCi	11/04→	1560	4	75.00	DOHC	80/109			
1.6 G8DF Diesel 123							AD5130 (MLS), 1.250mm, 2 Notches AD5140 (MLS), 1.300mm, 3 Notches AD5150 (MLS), 1.350mm, 1 Notch AD5160 (MLS), 1.400mm, 4 Notches AD5170 (MLS), 1.450mm, 5 Notches	CD5140 ▲	ED5130
Focus II TDCi	11/04→	1560	4	75.00	DOHC	80/109			
1.6 GPDA Diesel 124							AD5130 (MLS), 1.250mm, 2 Notches AD5140 (MLS), 1.300mm, 3 Notches AD5150 (MLS), 1.350mm, 1 Notch AD5160 (MLS), 1.400mm, 4 Notches AD5170 (MLS), 1.450mm, 5 Notches	CD5140 ▲	ED5130
C-MAX 1.6 TDCi	02/07→	1560	4	75.00	DOHC	66/90			
Focus II TDCi	11/04→								
1.6 GPDC Diesel 125							AD5130 (MLS), 1.250mm, 2 Notches AD5140 (MLS), 1.300mm, 3 Notches AD5150 (MLS), 1.350mm, 1 Notch AD5160 (MLS), 1.400mm, 4 Notches AD5170 (MLS), 1.450mm, 5 Notches	CD5140 ▲	ED5130
Focus II TDCi	11/04→	1560	4	75.00	DOHC	66/90			
1.6 HHDA Diesel 126							AD5130 (MLS), 1.250mm, 2 Notches AD5140 (MLS), 1.300mm, 3 Notches AD5150 (MLS), 1.350mm, 1 Notch AD5160 (MLS), 1.400mm, 4 Notches AD5170 (MLS), 1.450mm, 5 Notches	CD5140 ▲	ED5130
C-MAX 1.6 TDCi	02/07→	1560	4	75.00	DOHC	66/90			
Focus C-MAX	02/05→03/07								
Focus II TDCi	11/04→								
1.6 HHDB Diesel 127							AD5130 (MLS), 1.250mm, 2 Notches AD5140 (MLS), 1.300mm, 3 Notches AD5150 (MLS), 1.350mm, 1 Notch AD5160 (MLS), 1.400mm, 4 Notches AD5170 (MLS), 1.450mm, 5 Notches	CD5140 ▲	ED5130
C-MAX 1.6 TDCi	02/07→	1560	4	75.00	DOHC	66/90			
Focus C-MAX	02/05→03/07								
Focus II TDCi	11/04→								
1.6 HHJA Diesel 128							AD5130 (MLS), 1.250mm, 2 Notches AD5140 (MLS), 1.300mm, 3 Notches AD5150 (MLS), 1.350mm, 1 Notch AD5160 (MLS), 1.400mm, 4 Notches AD5170 (MLS), 1.450mm, 5 Notches	CD5140 ▲	ED5130
Fiesta V TDCi	11/04→	1560	4	75.00	DOHC	66/90			
Fusion 1.6 TDCi	11/04→								



AD5130, AD5140,
AD5150, AD5160,
AD5170

HBS359  [22] M11x1.50x147.00mm (x10)	JD5830    HA5031    HA5030    JD5829 	JM7034 (Elastomer)			 NA5258 [2] 27.00x47.00x7.00mm, PTFE  NA5259  [2] 40.00x55.00x6.40mm, PTFE	
HBS359  [22] M11x1.50x147.00mm (x10)	JD5830    HA5031    HA5030    JD5829 	JM7034 (Elastomer)			 NA5258 [2] 27.00x47.00x7.00mm, PTFE  NA5259  [2] 40.00x55.00x6.40mm, PTFE	
HBS359  [22] M11x1.50x147.00mm (x10)	JD5830    HA5031    HA5030    JD5829 	JM7034 (Elastomer)			 NA5258 [2] 27.00x47.00x7.00mm, PTFE  NA5259  [2] 40.00x55.00x6.40mm, PTFE	
HBS359  [22] M11x1.50x147.00mm (x10)	JD5830    HA5031    HA5030    JD5829 	JM7034 (Elastomer)			 NA5258 [2] 27.00x47.00x7.00mm, PTFE  NA5259  [2] 40.00x55.00x6.40mm, PTFE	
HBS359  [22] M11x1.50x147.00mm (x10)	JD5830    HA5031    HA5030    JD5829 	JM7034 (Elastomer)			 NA5258 [2] 27.00x47.00x7.00mm, PTFE  NA5259  [2] 40.00x55.00x6.40mm, PTFE	
HBS359  [22] M11x1.50x147.00mm (x10)	JD5830    HA5031    HA5030    JD5829 	JM7034 (Elastomer)			 NA5258 [2] 27.00x47.00x7.00mm, PTFE  NA5259  [2] 40.00x55.00x6.40mm, PTFE	
HBS359  [22] M11x1.50x147.00mm (x10)	JD5830    HA5031    HA5030    JD5829 	JM7034 (Elastomer)			 NA5258 [2] 27.00x47.00x7.00mm, PTFE  NA5259  [2] 40.00x55.00x6.40mm, PTFE	
HBS359  [22] M11x1.50x147.00mm (x10)	JD5830    HA5031    HA5030    JD5829 	JM7034 (Elastomer)			 NA5258 [2] 27.00x47.00x7.00mm, PTFE  NA5259  [2] 40.00x55.00x6.40mm, PTFE	
HBS359  [22] M11x1.50x147.00mm (x10)	JD5830    HA5031    HA5030    JD5829 	JM7034 (Elastomer)			 NA5258 [2] 27.00x47.00x7.00mm, PTFE  NA5259  [2] 40.00x55.00x6.40mm, PTFE	
HBS359  [22] M11x1.50x147.00mm (x10)	JD5830    HA5031    HA5030    JD5829 	JM7034 (Elastomer)			 NA5258 [2] 27.00x47.00x7.00mm, PTFE  NA5259  [2] 40.00x55.00x6.40mm, PTFE	
HBS359  [22] M11x1.50x147.00mm (x10)	JD5830    HA5031    HA5030    JD5829 	JM7034 (Elastomer)			 NA5258 [2] 27.00x47.00x7.00mm, PTFE  NA5259  [2] 40.00x55.00x6.40mm, PTFE	



cc



kW/PS



1.6	HHJB Diesel	129	AD5130 (MLS), 1.250mm, 2 Notches AD5140 (MLS), 1.300mm, 3 Notches AD5150 (MLS), 1.350mm, 1 Notch AD5160 (MLS), 1.400mm, 4 Notches AD5170 (MLS), 1.450mm, 5 Notches	CD5140 ▲	ED5130	
Fiesta V TDCi	11/04→	1560	4	75.00	DOHC	66/90
Fusion 1.6 TDCi	11/04→					
1.6	HHJC Diesel	130	AD5130 (MLS), 1.250mm, 2 Notches AD5140 (MLS), 1.300mm, 3 Notches AD5150 (MLS), 1.350mm, 1 Notch AD5160 (MLS), 1.400mm, 4 Notches AD5170 (MLS), 1.450mm, 5 Notches	CD5140 ▲	ED5130	
Fiesta Van TDCi	01/09→	1560	4	75.00	DOHC	66/90
Fiesta VI TDCi	10/08→					
1.6	HHJD Diesel	131	AD5130 (MLS), 1.250mm, 2 Notches AD5140 (MLS), 1.300mm, 3 Notches AD5150 (MLS), 1.350mm, 1 Notch AD5160 (MLS), 1.400mm, 4 Notches AD5170 (MLS), 1.450mm, 5 Notches	CD5140 ▲	ED5130	
Fiesta Van TDCi	01/09→	1560	4	75.00	DOHC	66/90
Fiesta VII TDCi	10/08→					
1.6	HHJE Diesel	132	AD5130 (MLS), 1.250mm, 2 Notches AD5140 (MLS), 1.300mm, 3 Notches AD5150 (MLS), 1.350mm, 1 Notch AD5160 (MLS), 1.400mm, 4 Notches AD5170 (MLS), 1.450mm, 5 Notches	CD5140 ▲	ED5130	
Fiesta Van TDCi	01/09→	1560	4	75.00	DOHC	66/90
Fiesta VI TDCi	10/08→					
1.6	HHJF Diesel	133	AD5130 (MLS), 1.250mm, 2 Notches AD5140 (MLS), 1.300mm, 3 Notches AD5150 (MLS), 1.350mm, 1 Notch AD5160 (MLS), 1.400mm, 4 Notches AD5170 (MLS), 1.450mm, 5 Notches	CD5140 ▲	ED5130	
Fiesta VI TDCi	10/08→	1560	4	75.00	DOHC	55/75
1.6	HWDA	134	AG9560 (MLS), 0.320mm →02/07 AC5860 (MLS), 0.500mm 03/07→	CC5860 [3] →03/07 CG9560 →02/07	EB5120	
C-MAX 1.6	02/07→	1596	4	79.00	DOHC	74/100
Focus C-MAX	10/03→03/07					
Focus II 1.6	11/04→					
Focus II Cabrio	10/06→					
1.6	HWDB	135	AG9560 (MLS), 0.320mm →02/07 AC5860 (MLS), 0.500mm 03/07→	CG9560 →02/07 CC5860 [3] 03/07→	EB5120	
C-MAX 1.6	02/07→	1596	4	79.00	DOHC	74/100
Focus C-MAX	10/03→03/07					
Focus II 1.6	11/04→					
Focus II Cabrio	10/06→					
1.6	HXDA	136	AH5680 (MLS)	CH5680		
Focus C-MAX	08/04→03/07	1596	4	79.00	DOHC	85/115
Focus II 1.6 Ti	11/04→					
1.6	HXDB	137	AH5680 (MLS)	CH5680		
Focus II 1.6 Ti	11/04→	1596	4	79.00	DOHC	85/115
1.6	HXJA	138	AH6430 (MLS)	CH6430 (MLS)	EH6430	
Fiesta VI 1.6 Ti	10/08→	1596	4	79.00	DOHC	88-89/ 120-121
1.6	HXJB	139	AH6430 (MLS)	CH6430 (MLS)	EH6430	
Fiesta VI 1.6 Ti	10/08→	1596	4	79.00	DOHC	88/120
1.6	L1E	140	BW630 (Fibre)	DW630 DW635 ▲	EW630 [3]	
Escort 1.6 16V	10/98→07/00	1597	4	76.00	DOHC	66/90
Escort VI	12/92→01/95					
Escort VI i 16V	09/92→01/95					
Escort VII	02/95→09/99					
Escort VII 16V	01/95→02/99					
Orion III i 16V	07/92→12/93					

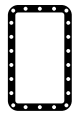

AC5860



AD5130, AD5140,
AD5150, AD5160,
AD5170



BW630



JD264



JD265



JE5021

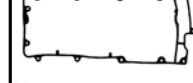

JM5034



JM5155



JN950



JJ531



cc



kW/PS



1.6	L1F	141						BW630 (Fibre)	DW631 DW655 ▲	EW630 [3]
Mondeo I i 16V	02/93→08/96	1597	4	76.00	DOHC	66/90				
1.6	L1G	142						BW630 (Fibre)	DW630 DW635 ▲	EW630 [3]
Fiesta III 16V	01/94→12/95	1597	4	76.00	DOHC	65-66/ 88-90				
1.6	L1H	143						BW630 (Fibre)	DW630 DW635 ▲	EW630 [3]
Escort VI	02/94→01/95	1597	4	76.00	DOHC	65/88				
Escort VI i 16V	01/94→01/95									
Escort VII	02/95→12/96									
Escort VII 16V	01/95→08/95									
1.6	L1J	144						BW630 (Fibre)	DW631 →08/98 DW655 ▲	EW630 [3]
Mondeo I i 16V	07/94→08/96	1597	4	76.00	DOHC	65-66/ 88-90				
Mondeo II 1.6 i	09/96→11/00									
1.6	L1K	145						BW630 (Fibre)	DW630 DW635 ▲	EW630 [3]
Escort VI i 16V	08/93→01/95	1597	4	76.00	DOHC	66-70/ 90-95				
Escort VII 16v	01/95→02/99									
Orion III i 16V	07/92→12/93									
1.6	L1L	146						BW630 (Fibre)	DW631 →08/98 DW655 ▲	EW630 [3]
Mondeo II i 16V	05/98→11/00	1597	4	76.00	DOHC	70/95				
1.6	L1N	147						BW630 (Fibre)	DW631 →08/98	EW630 [3]
Mondeo II i 16V	05/98→11/00	1597	4	76.00	DOHC	70/95				
1.6	L1Q	148						BW630 (Fibre)	DW631 →08/98	EW630 [3]
Mondeo II i 16V	05/98→11/00	1597	4	76.00	DOHC	70/95				



BW630



JD264



JD265



JD266

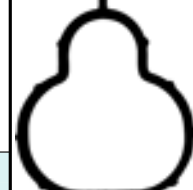

JD5311



JD5312



JE5021



JM5154

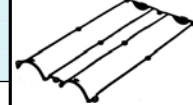

JN950

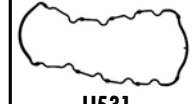







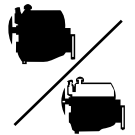



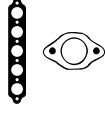

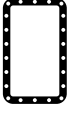

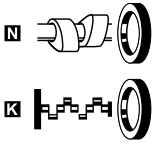











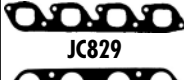







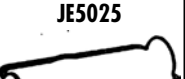

JJ531

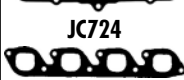

kW/PS

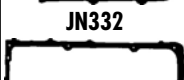

1.6	L1T						149	AC5860 (MLS), 0.500mm	CC5860 [3]	EY650 [3]
Fiesta IV 1.6V	02/00→01/02	1596	4	76.00	DOHC		76/103			
1.6	L1V						150	AC5860 (MLS), 0.500mm	CC5860 [3]	EY650 [3]
Fiesta IV 1.6V	02/00→01/02	1596	4	76.00	DOHC		76/103			
1.6	L1W						151	AC5860 (MLS), 0.500mm		
Puma 1.6 1.6V	08/00→06/02	1596	4	79.00	DOHC		76/103			
1.6	L6B						152	BJ440 (Fibre)	DJ445 [3]	EA441
Sierra 1.6 i	10/89→02/93	1598	4	80.00	SOHC/OHC		59/80			
1.6	LAT						153	AH850 (Fibre)	CH854 [3]	EH850 [3]
Transit 1.6	09/85→09/92	1593	4	87.65	SOHC/OHC		46-48/ 63-65			
1.6	LHA						154	BN470 (Fibre)	DN472	EA441
Fiesta III T	03/90→10/92	1598	4	80.00	SOHC/OHC		96-98/ 131-133			
1.6	LJC						155	BJ440 (Fibre)	DJ444	EA441
Fiesta III XR2i	03/89→01/94	1597	4	80.00	SOHC/OHC		81/110			
1.6	LJD						156	BJ440 (Fibre)	DJ444	EA441
Fiesta III XR2i	03/89→03/93	1598	4	80.00	SOHC/OHC		76/103			
1.6	LJF						157	BJ440 (Fibre)	DJ444	EA441
Escort V 1.6	07/90→12/92	1598	4	79.96	SOHC/OHC		77/105			
Escort V Cabrio	07/90→12/92									
Orion III 1.6 i	07/90→09/92									
1.6	LNB						158	BN470 (Fibre)	DN471 [3]	EA441
Escort IV T RS	01/86→07/90	1597	4	79.96	SOHC/OHC		97/132			

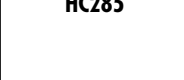
      						 	
HBS078 [22] M10x1.50x143.00mm (x10)	JD5290 [1] JD5164 [3]	JM5155 [78] (Elastomer) JM7060 [79] (Elastomer)	JE5025	HR809 [3] HR808 [3]	NC048 [2] 38.00x52.00x6.00mm, FPM NA5137 [2] 32.90x47.40x5.00mm, FPM LK5004 [1] [7] 80.00x182.00x19.400mm, PTFE		               
HBS078 [22] M10x1.50x143.00mm (x10)	JD5290 [1] JD5164 [3]	JM5155 [78] (Elastomer) JM7060 [79] (Elastomer)	JE5025	HR809 [3] HR808 [3]	NC048 [2] 38.00x52.00x6.00mm, FPM NA5137 [2] 32.90x47.40x5.00mm, FPM LK5004 [1] [7] 80.00x182.00x19.400mm, PTFE		 
HBS078 [22] M10x1.50x143.00mm (x10)		JM7060 [79] (Elastomer)			NC048 [2] 38.00x52.00x6.00mm, FPM		
HBS001 [22] M10x1.50x135.00mm (x10)		JN332 [4]	JJ348 =KG664	HR661 [3]	NA5190 [2] 42.00x56.00x7.00mm, FPM NB645 [2] 35.00x50.00x7.00mm, MVQ NB847 [1] 88.00x108.00x11.00mm, FPM	KT738 [45]	
HBS056 [19] M12x1.75x92.50mm (x10)	JA769 [1] JA768 [3] JA770 (x3)	JN620 [4]	HC285 [3]	PB180 (x8) 8.00x12.0/15.40x9.50 866N W (FPM)	NA5190 (x2) [2] 42.00x56.00x7.00mm, FPM NA5190 [2] 42.00x56.00x7.00mm, FPM NB788 [1] 79.40x95.30x11.10mm, PTFE	KA289 [15] KT738 [45]	
HBS001 [22] M10x1.50x135.00mm (x10)	JD188 [1] JC724 [1] JC829 [3]	JN332 [4]	JJ348 =KG664	HR661 [3]	NA5190 [2] 42.00x56.00x7.00mm, FPM NB645 [2] 35.00x50.00x7.00mm, MVQ NB847 [1] 88.00x108.00x11.00mm, FPM		      
HBS001 [22] M10x1.50x135.00mm (x10)	JD188 [1] JC724 [1] JC829 [3]	JN332 [4]	JJ348 =KG664	HR661 [3]	NA5190 [2] 42.00x56.00x7.00mm, FPM NB645 [2] 35.00x50.00x7.00mm, MVQ NB847 [1] 88.00x108.00x11.00mm, FPM		 
HBS001 [22] M10x1.50x135.00mm (x10)	JD188 [1] JC724 [1] JC829 [3]	JN332 [4]	JJ348 =KG664	HR661 [3]	NA5190 [2] 42.00x56.00x7.00mm, FPM NB645 [2] 35.00x50.00x7.00mm, MVQ NB847 [1] 88.00x108.00x11.00mm, FPM		 
HBS001 [22] M10x1.50x135.00mm (x10)	JD188 [1] JC724 [1] JC829 [3]	JN332 [4]	JJ348 =KG664	HR661 [3]	NA5190 [2] 42.00x56.00x7.00mm, FPM NB645 [2] 35.00x50.00x7.00mm, MVQ NB847 [1] 88.00x108.00x11.00mm, FPM		 
HBS001 [22] M10x1.50x135.00mm (x10)	JD498 [1]	JN332 [4]	JJ348 =KG664		NA5190 [2] 42.00x56.00x7.00mm, FPM NB645 [2] 35.00x50.00x7.00mm, MVQ NB847 [1] 88.00x108.00x11.00mm, FPM		

FORD













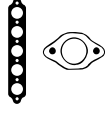

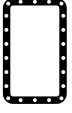

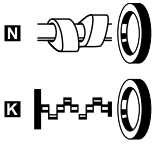















































































































cc



kW/PS



1.6		LP2					159	BJ440 (Fibre)	DJ442	EA441 EM940
Escort IV 1.6	01/86→07/90	1597	4	80.00	SOHC/OHC	58/79				
Orion II 1.6	04/86→12/88									
1.6		LSE					160	BN140 (Fibre)	DN140 [3]	EH850 [3]
Sierra 1.6	01/87→02/93	1597	4	81.30	SOHC/OHC	55/75				
1.6		LSF					161	BN140 (Fibre)	DN140 [3]	EH850 [3]
Sierra 1.6	01/88→02/93	1597	4	81.30	SOHC/OHC	53/72				
1.6		LTA Diesel					162	BM950 (Fibre), 1.360mm, 2 Holes BM960 (Fibre), 1.420mm, 3 Holes BM980 (Fibre), 1.520mm, 4 Holes	DM940 ▲	EM940
Escort '86 Exp	02/86→07/90	1608	4	80.00	SOHC/OHC	40/54				
1.6		LTB Diesel					163	BM950 (Fibre), 1.360mm, 2 Holes BM960 (Fibre), 1.420mm, 3 Holes BM980 (Fibre), 1.520mm, 4 Holes	DM940 ▲	EM940
Fiesta 1.6 D	09/83→09/89	1608	4	80.00	SOHC/OHC	40/54				
Fiesta II 1.6 D	04/84→02/89									
1.6		LTC Diesel					164	BM950 (Fibre), 1.360mm, 2 Holes BM960 (Fibre), 1.420mm, 3 Holes BM980 (Fibre), 1.520mm, 4 Holes	DM940 ▲	EM940
Escort IV 1.6 D	01/86→01/89	1608	4	80.00	SOHC/OHC	40/54				
Orion II 1.6 D	12/85→01/89									
1.6		LUC					165	BJ440 (Fibre)	DJ442	EA441
Escort '86 Exp	02/86→07/90	1597	4	80.00	SOHC/OHC	60-66/ 81-90				
Orion II 1.6	12/85→07/90									
1.6		LUG					166	BJ440 (Fibre)	DJ442	EA441
Escort IV 1.6	04/89→07/90	1597	4	80.00	SOHC/OHC	65-66/ 88-90				
1.6		LUH					167	BJ440 (Fibre)	DJ442	EA441
Fiesta III 1.6	01/89→01/94	1597	4	76.00	SOHC/OHC	65-66/ 88-90				
1.6		LUJ					168	BJ440 (Fibre)	DJ442	EA441
Escort V 1.6	07/90→08/92	1598	4	80.00	SOHC/OHC	65-66/ 88-90				
Orion III 1.6	07/90→12/92									

								
HBS001  [22] M10x1.50x135.00mm (x10)	JD498  JC790   JE719	JN332 [4]	JJ348 =KG664			 NA5190 [2] 42.00x56.00x7.00mm, FPM  NB645  [2] 35.00x50.00x7.00mm, MVQ  NB847  [1] 88.00x108.00x11.00mm, FPM		
HBS056  [19] M12x1.75x92.50mm (x10)	JA769  JA768  JA770  (x3)  JE719	JN620 [4]	HC285  =KG664	PB180 (x8) 8.00x12.0/15.40x9.50 866N W (FPM)		 NA5190  (x2) [2] 42.00x56.00x7.00mm, FPM  NA5190  [2] 42.00x56.00x7.00mm, FPM  NB788  [1] 79.40x95.30x11.10mm, PTFE	KA289 [15] KT738 [45]	
HBS056  [19] M12x1.75x92.50mm (x10)	JA769  JA768  JA770  (x3)  JE719	JN620 [4]	HC285  =KG664	PB180 (x8) 8.00x12.0/15.40x9.50 866N W (FPM)		 NA5190  (x2) [2] 42.00x56.00x7.00mm, FPM  NA5190  [2] 42.00x56.00x7.00mm, FPM  NB788  [1] 79.40x95.30x11.10mm, PTFE	KA289 [15] KT738 [45]	
HBS007 	JC565  JE5022 	HL474 	JJ334 =KG664	HR659 		 NB785 [2] 28.00x38.00x7.00mm, FPM  NB786  [2] 42.00x58.00x11.00mm, FPM  NB788  [1] 79.40x95.30x11.10mm, PTFE		
HBS007 	JC565  JE5022 	HL474 	JJ334 =KG664	HR659 		 NB785 [2] 28.00x38.00x7.00mm, FPM  NB786  [2] 42.00x58.00x11.00mm, FPM  NB788  [1] 79.40x95.30x11.10mm, PTFE		
HBS007 	JC565  JE5022 	HL474 	JJ334 =KG664	HR659 		 NB785 [2] 28.00x38.00x7.00mm, FPM  NB786  [2] 42.00x58.00x11.00mm, FPM  NB788  [1] 79.40x95.30x11.10mm, PTFE		
HBS001  [22] M10x1.50x135.00mm (x10)	JD498  JC790   JE719	JN332 [4]	JJ348 =KG664			 NA5190 [2] 42.00x56.00x7.00mm, FPM  NB645  [2] 35.00x50.00x7.00mm, MVQ  NB847  [1] 88.00x108.00x11.00mm, FPM		
HBS001  [22] M10x1.50x135.00mm (x10)	JD498  JC790   JE719	JN332 [4]	JJ348 =KG664			 NA5190 [2] 42.00x56.00x7.00mm, FPM  NB645  [2] 35.00x50.00x7.00mm, MVQ  NB847  [1] 88.00x108.00x11.00mm, FPM		
HBS001  [22] M10x1.50x135.00mm (x10)	JD498  JC790   JE719	JN332 [4]	JJ348 =KG664			 NA5190 [2] 42.00x56.00x7.00mm, FPM  NB645  [2] 35.00x50.00x7.00mm, MVQ  NB847  [1] 88.00x108.00x11.00mm, FPM		
HBS001  [22] M10x1.50x135.00mm (x10)	JD498  JC790   JE719	JN332 [4]	JJ348 =KG664			 NA5190 [2] 42.00x56.00x7.00mm, FPM  NB645  [2] 35.00x50.00x7.00mm, MVQ  NB847  [1] 88.00x108.00x11.00mm, FPM		
HBS001  [22] M10x1.50x135.00mm (x10)	JD498  JC790   JE719	JN332 [4]	JJ348 =KG664			 NA5190 [2] 42.00x56.00x7.00mm, FPM  NB645  [2] 35.00x50.00x7.00mm, MVQ  NB847  [1] 88.00x108.00x11.00mm, FPM		







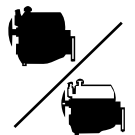

cc

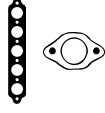

kW/PS

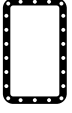

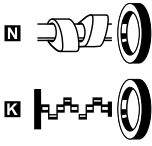
1.6		LUK				169	BJ440 (Fibre)		DJ442	EA441
Escort V 1.6	07/90→08/92	1598	4	80.00	SOHC/OHC	65-66/ 88-90				
Orion III 1.6	07/90→12/92									
1.6		MTDA Diesel				170	AD5130 (MLS), 1.250mm, 2 Notches AD5140 (MLS), 1.300mm, 3 Notches AD5150 (MLS), 1.350mm, 1 Notch AD5160 (MLS), 1.400mm, 4 Notches AD5170 (MLS), 1.450mm, 5 Notches		CD5140 ▲	ED5130
C-MAX 1.6 TDCi	02/07→	1560	4	75.00	DOHC	74/100				
Focus II TDCi	11/04→									
1.6		PNBA				171	AH6430 (MLS)		CH6430 (MLS)	EH6430
Mondeo IV 1.6 Ti	03/07→	1596	4	79.00	DOHC	92/125				
1.6		RHBA				172	AH6430 (MLS)		CH6430 (MLS)	EH6430
Mondeo IV 1.6 Ti	03/07→	1596	4	79.00	DOHC	81/110				
1.6		SHDA				173	AG9560 (MLS), 0.320mm →02/07 AC5860 (MLS), 0.500mm 03/07→		CG9560 →02/07 CC5860 [3] 03/07→	EB5120
C-MAX 1.6	02/07→	1596	4	79.00	DOHC	74/101				
Focus II 1.6	11/04→									
1.6		SHDB				174	AG9560 (MLS), 0.320mm →02/07 AC5860 (MLS), 0.500mm 03/07→			EB5120
C-MAX 1.6	02/07→	1596	4	79.00	DOHC	74/101				
1.6		SHDC				175	AG9560 (MLS), 0.320mm →02/07 AC5860 (MLS), 0.500mm 03/07→		CG9560 →02/07 CC5860 [3] 03/07→	EB5120
C-MAX 1.6	02/07→	1596	4	79.00	DOHC	74/101				
1.6		SIDA				176	AH5680 (MLS)		CH5680	
Focus C-MAX	08/04→03/07	1596	4	79.00	DOHC	85/115				
Focus II 1.6 LPG	10/09→									
1.6		UBJA Diesel				177	AD5130 (MLS), 1.250mm, 2 Notches AD5140 (MLS), 1.300mm, 3 Notches AD5150 (MLS), 1.350mm, 1 Notch AD5160 (MLS), 1.400mm, 4 Notches AD5170 (MLS), 1.450mm, 5 Notches		CD5140 ▲	ED5130
Fiesta VI TDCi	10/08→	1560	4	75.00	DOHC	55/75				
1.7		MHA				178	AC5290 (MLS)		CC5290	
Puma Coupe 1.6V	03/97→06/02	1679	4	80.00	DOHC	92/125				
1.7		MHB				179	AC5290 (MLS)		CC5290	
Puma Coupe 1.6V	03/97→06/02	1679	4	80.00	DOHC	92/125				
1.8		BHDA Diesel				180	AB5300 (MLS), 1.270mm, 2 Teeth AB5310 (MLS), 1.320mm, 3 Teeth AB5320 (MLS), 1.370mm, 4 Teeth AB5330 (MLS), 1.420mm, 5 Teeth AB5340 (MLS), 1.470mm, 6 Teeth AB5350 (MLS), 1.520mm, 7 Teeth		DZ720 ▲ [3]	EZ720 [3]
Focus DI / TDDi	08/99→03/05	1753	4	82.50	SOHC/OHC	55-57/ 75-78				
1.8		BHDB Diesel				181	AB5300 (MLS), 1.270mm, 2 Teeth AB5310 (MLS), 1.320mm, 3 Teeth AB5320 (MLS), 1.370mm, 4 Teeth AB5330 (MLS), 1.420mm, 5 Teeth AB5340 (MLS), 1.470mm, 6 Teeth AB5350 (MLS), 1.520mm, 7 Teeth		DZ720 ▲ [3]	EZ720 [3]
Focus DI / TDDi	08/99→03/05	1753	4	82.50	SOHC/OHC	55-57/ 75-78				
1.8		BHPA Diesel				182	AB5300 (MLS), 1.270mm, 2 Teeth AB5310 (MLS), 1.320mm, 3 Teeth AB5320 (MLS), 1.370mm, 4 Teeth AB5330 (MLS), 1.420mm, 5 Teeth AB5340 (MLS), 1.470mm, 6 Teeth AB5350 (MLS), 1.520mm, 7 Teeth		DZ720 ▲ [3]	EZ720 [3]
Tourneo Con.	06/02→	1753	4	82.50	SOHC/OHC	55-57/ 75-78				
Transit 1.8 Di	06/02→									

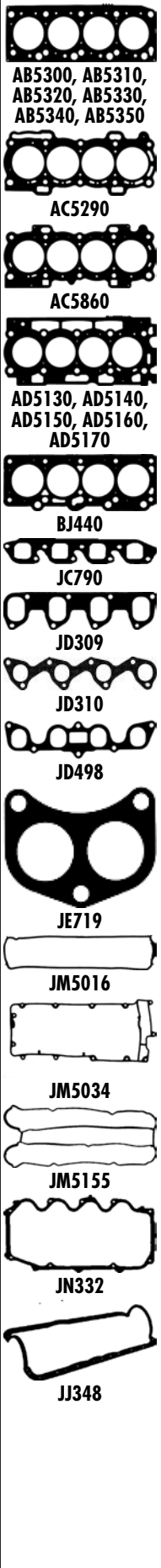
								
HBS001 [22] M10x1.50x135.00mm (x10)	JD498 [1] JC790 [1] JE719	JN332 [4]	JJ348 =KG664		NA5190 [2] 42.00x56.00x7.00mm, FPM NB645 [2] 35.00x50.00x7.00mm, MVQ NB847 [1] 88.00x108.00x11.00mm, FPM			AB5300, AB5310, AB5320, AB5330, AB5340, AB5350 AC5290 AC5860 AD5130, AD5140, AD5150, AD5160, AD5170
HBS359 [22] M11x1.50x147.00mm (x10)	HA5031 [1] [2] [3] HA5030 [1] [2] [3] JD5829 [1]	JM7034 (Elastomer)			NA5258 [2] 27.00x47.00x7.00mm, PTFE NA5259 [2] 40.00x55.00x6.40mm, PTFE			AD5130, AD5140, AD5150, AD5160, AD5170
HBS078 [22] M10x1.50x143.00mm (x10)	JD5987 [1] (x4) JD5865 [1]	JM7092 (Elastomer) HR397 [1]			NA5310 (x2) [2] 46.00x56.40x7.00mm, FPM			AD5130, AD5140, AD5150, AD5160, AD5170
HBS078 [22] M10x1.50x143.00mm (x10)	JD5987 [1] (x4) JD5865 [1]	JM7092 (Elastomer) HR397 [1]			NA5310 (x2) [2] 46.00x56.40x7.00mm, FPM			AD5130, AD5140, AD5150, AD5160, AD5170
HBS078 [22] M10x1.50x143.00mm (x10)	JD5866 [1] JD5865 [1]	JM5155 [78] (Elastomer) JM7060 [79] (Elastomer)			NC048 [2] 38.00x52.00x6.00mm, FPM			AD5130, AD5140, AD5150, AD5160, AD5170
HBS078 [22] M10x1.50x143.00mm (x10)	JD5866 [1] JD5865 [1]	JM5155 [78] (Elastomer) JM7060 [79] (Elastomer)			NC048 [2] 38.00x52.00x6.00mm, FPM			AD5130, AD5140, AD5150, AD5160, AD5170
HBS078 [22] M10x1.50x143.00mm (x10)	JD5866 [1] JD5865 [1]	JM5155 [78] (Elastomer) JM7060 [79] (Elastomer)			NC048 [2] 38.00x52.00x6.00mm, FPM			AD5130, AD5140, AD5150, AD5160, AD5170
HBS078 [22] M10x1.50x143.00mm (x10)		JM5155 [78] (Elastomer)			NA5310 (x2) [2] 46.00x56.40x7.00mm, FPM			AD5130, AD5140, AD5150, AD5160, AD5170
HBS359 [22] M11x1.50x147.00mm (x10)	HA5031 [1] [2] [3] HA5030 [1] [2] [3] JD5829 [1]	JM5034 (Elastomer)			NA5258 [2] 27.00x47.00x7.00mm, PTFE NA5259 [2] 40.00x55.00x6.40mm, PTFE			AD5130, AD5140, AD5150, AD5160, AD5170
HBS415 [22] M10x1.50x140.00mm (x10)			=KG664		NC048 [2] 38.00x52.00x6.00mm, FPM			AD5130, AD5140, AD5150, AD5160, AD5170
HBS415 [22] M10x1.50x140.00mm (x10)			=KG664		NC048 [2] 38.00x52.00x6.00mm, FPM			AD5130, AD5140, AD5150, AD5160, AD5170
HBS243 [19] M12x1.75x177.00mm (x8)	JD309 [1] JD310 [1]	JM5016	JH5008	PB180 8.00x12.0/15.40x9.50 866N W (FPM) HR801 [1]	NB785 [2] 28.00x38.00x7.00mm, FPM NA5013 [1] 30.00x50.00x7.50mm, PTFE NC086 [1] 79.80x184.00x18.80mm, PTFE			AD5130, AD5140, AD5150, AD5160, AD5170
HBS243 [19] M12x1.75x177.00mm (x8)	JD309 [1] JD310 [1]	JM5016	JH5008	PB180 8.00x12.0/15.40x9.50 866N W (FPM) HR801 [1]	NB785 [2] 28.00x38.00x7.00mm, FPM NA5013 [1] 30.00x50.00x7.50mm, PTFE NC086 [1] 79.80x184.00x18.80mm, PTFE			AD5130, AD5140, AD5150, AD5160, AD5170
HBS243 [19] M12x1.75x177.00mm (x8)	JD309 [1] JD310 [1]	JM5016	JH5008	PB180 (x8) 8.00x12.0/15.40x9.50 866N W (FPM) HR801 [1]	NB785 [2] 28.00x38.00x7.00mm, FPM NA5013 [1] 30.00x50.00x7.50mm, PTFE NC086 [1] 79.80x184.00x18.80mm, PTFE			AD5130, AD5140, AD5150, AD5160, AD5170



cc



kW/PS

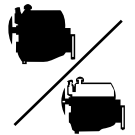

1.8	C9DA Diesel	183	Focus TD / TDDi	10/98→11/04	1753	4	82.50	SOHC/OHC	66/90	AB5300 (MLS), 1.270mm, 2 Teeth AB5310 (MLS), 1.320mm, 3 Teeth AB5320 (MLS), 1.370mm, 4 Teeth AB5330 (MLS), 1.420mm, 5 Teeth AB5340 (MLS), 1.470mm, 6 Teeth AB5350 (MLS), 1.520mm, 7 Teeth	DZ720 ▲[3]	EZ720 [3]
1.8	C9DB Diesel	184	Focus TD / TDDi	10/98→11/04	1753	4	82.50	SOHC/OHC	66/90	AB5300 (MLS), 1.270mm, 2 Teeth AB5310 (MLS), 1.320mm, 3 Teeth AB5320 (MLS), 1.370mm, 4 Teeth AB5330 (MLS), 1.420mm, 5 Teeth AB5340 (MLS), 1.470mm, 6 Teeth AB5350 (MLS), 1.520mm, 7 Teeth	DZ720 ▲[3]	EZ720 [3]
1.8	C9DC Diesel	185	Focus TD / TDDi	10/98→11/04	1753	4	82.50	SOHC/OHC	66/90	AB5300 (MLS), 1.270mm, 2 Teeth AB5310 (MLS), 1.320mm, 3 Teeth AB5320 (MLS), 1.370mm, 4 Teeth AB5330 (MLS), 1.420mm, 5 Teeth AB5340 (MLS), 1.470mm, 6 Teeth AB5350 (MLS), 1.520mm, 7 Teeth	DZ720 ▲[3]	EZ720 [3]
1.8	CFBA	186	Mondeo III SCi	06/03→08/07	1798	4	83.00	DOHC	96/130	AC5940 (MLS)	DW643 [3]	ED5220 [3]
1.8	CGBA	187	Mondeo III 16V	11/00→08/07	1798	4	83.00	DOHC	81/110	AC5940 (MLS)	DW642 [3][79] DW643 [3][78]	ED5220 [3]
1.8	CGBB	188	Mondeo III 16V	11/00→08/07	1798	4	83.00	DOHC	81/110	AC5940 (MLS)	DW642 [3][79] DW643 [3][78]	ED5220 [3]
1.8	CHBA	189	Mondeo III 16V	11/00→08/07	1798	4	83.00	DOHC	92/125	AC5940 (MLS)	DW642 [3][79] DW643 [3][78]	ED5220 [3]
1.8	CHBB	190	Mondeo III 16V	11/00→08/07	1798	4	83.00	DOHC	92/125	AC5940 (MLS)	DW642 [3][79] DW643 [3][78]	ED5220 [3]
1.8	CSDA	191	Focus C-MAX 1.8	10/03→03/07	1798	4	83.00	DOHC	88/120	AC5940 (MLS)	DW642 [3][79] DW643 [3][78]	ED5220 [3]
1.8	CSDB	192	Focus C-MAX 1.8	10/03→03/07	1798	4	83.00	DOHC	88/120	AC5940 (MLS)	DW642 [3][79] DW643 [3][78]	ED5220 [3]
1.8	EYDB	193	Focus 1.8 16V	10/98→11/04	1796	4	80.60	DOHC	85/115	AC5800 (MLS)	CC5800 [3] →04/99 CC5801 [3] 09/99→	EC5800 [3]
1.8	EYDC	194	Focus 1.8 16V	10/98→11/04	1796	4	80.60	DOHC	85/115	AC5800 (MLS)	CC5800 [3] →04/99 CC5801 [3] 09/99→	EC5800 [3]



AB5300, AB5310,
AB5320, AB5330,
AB5340, AB5350



AC5800



AC5940



JD309



JD310



JD5299



JD5311



JD5312

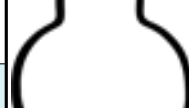

JD5313



JE5037



JM5016



JM5154



JH5061



kW/PS

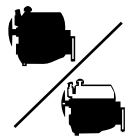

1.8	EYDD	1796	4	80.60	DOHC	195	AC5800 (MLS)	CC5800 [3] →04/99 CC5801 [3] 09/99→	EC5800 [3]
Focus 1.8 16V	10/98→11/04					85/115			
1.8	EYDE	1796	4	80.60	DOHC	196	AC5800 (MLS)	CC5800 [3] →04/99 CC5801 [3] 09/99→	EC5800 [3]
Focus 1.8 16V	10/98→11/04					85/115			
1.8	EYDF	1796	4	80.60	DOHC	197	AC5800 (MLS)	CC5800 [3] →04/99 CC5801 [3] 09/99→	EC5800 [3]
Focus 1.8 16V	10/98→11/04					85/115			
1.8	EYDG	1796	4	80.60	DOHC	198	AC5800 (MLS)	CC5800 [3] →04/99 CC5801 [3] 09/99→	EC5800 [3]
Focus 1.8 16V	10/98→11/04					85/115			
1.8	EYDI	1796	4	80.60	DOHC	199	AC5800 (MLS)	CC5800 [3] →04/99 CC5801 [3] 09/99→	EC5800 [3]
Focus 1.8 16V	10/98→11/04					85/115			
1.8	EYDJ	1796	4	80.60	DOHC	200	AC5800 (MLS)	CC5800 [3] →04/99 CC5801 [3] 09/99→	EC5800 [3]
Focus 1.8 16V	10/98→11/04					85/115			
1.8	EYDL	1796	4	80.60	DOHC	201	AC5800 (MLS)	CC5800 [3] →04/99 CC5801 [3] 09/99→	EC5800 [3]
Focus 1.8 16V	10/98→11/04					85/115			
1.8	EYPA	1796	4	80.60	DOHC	202	AC5800 (MLS)	CC5801 [3]	EC5800 [3]
Tourneo Con. Transit 1.8 16V	06/02→ 06/02→					85/116			

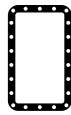
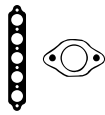

AC5800



JD5311

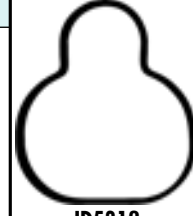

JD5312



JD5313



JM5154



JH5061



cc



kW/PS



1.8		EYPC				203	AC5800 (MLS)	CC5801 [3]	EC5800 [3]
Tourneo Con.	06/02→	1796	4	80.60	DOHC	85/116			
Transit 1.8 16V	06/02→								
Transit 1.8 LPG	06/02→								
1.8		EYPD				204	AC5800 (MLS)	CC5801 [3] 09/02→	EC5800 [3]
Tourneo Con.	06/02→	1796	4	80.60	DOHC	85/115			
Transit 1.8 16V	06/02→								
1.8		F9DA Diesel				205	AB5300 (MLS), 1.270mm, 2 Teeth AB5310 (MLS), 1.320mm, 3 Teeth AB5320 (MLS), 1.370mm, 4 Teeth AB5330 (MLS), 1.420mm, 5 Teeth AB5340 (MLS), 1.470mm, 6 Teeth AB5350 (MLS), 1.520mm, 7 Teeth	DZ720 ▲[3]	EZ720 [3]
Focus 1.8 TDCi	03/01→11/04	1753	4	82.50	SOHC/OHC	85/115			
1.8		F9DB Diesel				206	AB5300 (MLS), 1.270mm, 2 Teeth AB5310 (MLS), 1.320mm, 3 Teeth AB5320 (MLS), 1.370mm, 4 Teeth AB5330 (MLS), 1.420mm, 5 Teeth AB5340 (MLS), 1.470mm, 6 Teeth AB5350 (MLS), 1.520mm, 7 Teeth	DZ720 ▲[3]	EZ720 [3]
Focus 1.8 TDCi	03/01→11/04	1753	4	82.50	SOHC/OHC	85/115			
1.8		FFBA Diesel				207	AB5300 (MLS), 1.270mm, 2 Teeth AB5310 (MLS), 1.320mm, 3 Teeth AB5320 (MLS), 1.370mm, 4 Teeth AB5330 (MLS), 1.420mm, 5 Teeth AB5340 (MLS), 1.470mm, 6 Teeth AB5350 (MLS), 1.520mm, 7 Teeth	DZ720 ▲[3]	EZ720 [3]
Mondeo IV TDCi	03/07→	1753	4	82.50	DOHC	74/100			
1.8		FFDA Diesel				208	AB5300 (MLS), 1.270mm, 2 Teeth AB5310 (MLS), 1.320mm, 3 Teeth AB5320 (MLS), 1.370mm, 4 Teeth AB5330 (MLS), 1.420mm, 5 Teeth AB5340 (MLS), 1.470mm, 6 Teeth AB5350 (MLS), 1.520mm, 7 Teeth	DZ720 ▲[3]	EZ720 [3]
Focus 1.8 TDCi	08/02→11/04	1753	4	82.50	SOHC/OHC	74/100			
1.8		FFWA Diesel				209	AB5300 (MLS), 1.270mm, 2 Teeth AB5310 (MLS), 1.320mm, 3 Teeth AB5320 (MLS), 1.370mm, 4 Teeth AB5330 (MLS), 1.420mm, 5 Teeth AB5340 (MLS), 1.470mm, 6 Teeth AB5350 (MLS), 1.520mm, 7 Teeth	DZ720 ▲[3]	EZ720 [3]
Galaxy 1.8 TDCi	05/06→	1753	4	82.50	SOHC/OHC	74/100			
S-Max 1.8 TDCi	01/07→								
1.8		HCPA Diesel				210	AB5300 (MLS), 1.270mm, 2 Teeth AB5310 (MLS), 1.320mm, 3 Teeth AB5320 (MLS), 1.370mm, 4 Teeth AB5330 (MLS), 1.420mm, 5 Teeth AB5340 (MLS), 1.470mm, 6 Teeth AB5350 (MLS), 1.520mm, 7 Teeth	DZ720 ▲[3]	EZ720 [3]
Tourneo Con.	06/02→	1753	4	82.50	SOHC/OHC	66/90			
Transit 1.8 TDCi	06/02→								
1.8		HCPB Diesel				211	AB5300 (MLS), 1.270mm, 2 Teeth AB5310 (MLS), 1.320mm, 3 Teeth AB5320 (MLS), 1.370mm, 4 Teeth AB5330 (MLS), 1.420mm, 5 Teeth AB5340 (MLS), 1.470mm, 6 Teeth AB5350 (MLS), 1.520mm, 7 Teeth	DZ720 ▲[3]	EZ720 [3]
Tourneo Con.	06/02→	1753	4	82.50	SOHC/OHC	66/90			
Transit 1.8 TDCi	06/02→								

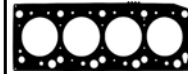
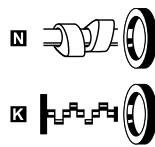
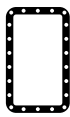
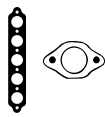

AB5300, AB5310,
AB5320, AB5330,
AB5340, AB5350



AC5800



JD309



JD310

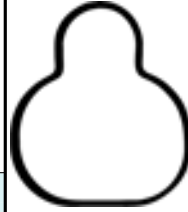

JD5312



JD5313



JM5016



JH5061

HBS031 [22] M10x1.50x102.00mm (x10)	JD5312 [x4] JD5313 [x4]	JM5184 (Elastomer) Pale blue	JH5061	HR5033 [x]	NB958 [2] 42.00x53.00x7.00mm, FPM NA5323 [2] 35.00x50.00x7.00mm, PTFE NB959 [2] 35.00x50.00x7.00mm, FPM NB847 [1] 88.00x108.00x11.00mm, FPM	
HBS031 [22] M10x1.50x102.00mm (x10)	JD5312 [x4] JD5313 [x4]	JM5184 (Elastomer) Pale blue	JH5061	HR5033 [x]	NB958 [2] 42.00x53.00x7.00mm, FPM NB959 [2] 35.00x50.00x7.00mm, FPM NB847 [1] 88.00x108.00x11.00mm, FPM	
HBS243 [19] M12x1.75x177.00mm (x8)	JD309 [x] JD310 [x]	JM5016	JH5008	PB180 8.00x12.0/15.40x9.50 866N W (FPM) HR801 [x]	NB785 [2] 28.00x38.00x7.00mm, FPM NA5013 [1] 30.00x50.00x7.50mm, PTFE NC086 [1] 79.80x184.00x18.80mm, PTFE	
HBS243 [19] M12x1.75x177.00mm (x8)	JD309 [x] JD310 [x]	JM5016	JH5008	PB180 8.00x12.0/15.40x9.50 866N W (FPM) HR801 [x]	NB785 [2] 28.00x38.00x7.00mm, FPM NA5013 [1] 30.00x50.00x7.50mm, PTFE NC086 [1] 79.80x184.00x18.80mm, PTFE	
HBS243 [19] M12x1.75x177.00mm (x8)	JD309 [x] JD310 [x]	JM5016	JH5008	PB180 8.00x12.0/15.40x9.50 866N W (FPM) HR801 [x]	NB785 [2] 28.00x38.00x7.00mm, FPM NA5013 [1] 30.00x50.00x7.50mm, PTFE NC086 [1] 79.80x184.00x18.80mm, PTFE	
HBS243 [19] M12x1.75x177.00mm (x8)	JD309 [x] JD310 [x]	JM5016	JH5008	PB180 8.00x12.0/15.40x9.50 866N W (FPM) HR801 [x]	NB785 [2] 28.00x38.00x7.00mm, FPM NA5013 [1] 30.00x50.00x7.50mm, PTFE NC086 [1] 79.80x184.00x18.80mm, PTFE	
HBS243 [19] M12x1.75x177.00mm (x8)	JD309 [x] JD310 [x]	JM5016	JH5008	PB180 8.00x12.0/15.40x9.50 866N W (FPM) HR801 [x]	NB785 [2] 28.00x38.00x7.00mm, FPM NA5013 [1] 30.00x50.00x7.50mm, PTFE NC086 [1] 79.80x184.00x18.80mm, PTFE	
HBS243 [19] M12x1.75x177.00mm (x8)	JD309 [x] JD310 [x]	JM5016	JH5008	PB180 (x8) 8.00x12.0/15.40x9.50 866N W (FPM) HR801 [x]	NB785 [2] 28.00x38.00x7.00mm, FPM NA5013 [1] 30.00x50.00x7.50mm, PTFE NC086 [1] 79.80x184.00x18.80mm, PTFE	
HBS243 [19] M12x1.75x177.00mm (x8)	JD309 [x] JD310 [x]	JM5016	JH5008	PB180 (x8) 8.00x12.0/15.40x9.50 866N W (FPM) HR801 [x]	NB785 [2] 28.00x38.00x7.00mm, FPM NA5013 [1] 30.00x50.00x7.50mm, PTFE NC086 [1] 79.80x184.00x18.80mm, PTFE	



cc



kW/PS



1.8		KHBA Diesel				212		AB5300 (MLS), 1.270mm, 2 Teeth AB5310 (MLS), 1.320mm, 3 Teeth AB5320 (MLS), 1.370mm, 4 Teeth AB5330 (MLS), 1.420mm, 5 Teeth AB5340 (MLS), 1.470mm, 6 Teeth AB5350 (MLS), 1.520mm, 7 Teeth	DZ720 ▲ [3]	EZ720 [3]
Mondeo IV TDCi	06/07→	1753	4	82.50	DOHC	92/125				
1.8		KKDA Diesel				213		AB5300 (MLS), 1.270mm, 2 Teeth AB5310 (MLS), 1.320mm, 3 Teeth AB5320 (MLS), 1.370mm, 4 Teeth AB5330 (MLS), 1.420mm, 5 Teeth AB5340 (MLS), 1.470mm, 6 Teeth AB5350 (MLS), 1.520mm, 7 Teeth	DZ720 ▲ [3]	EZ720 [3]
C-MAX 1.8 TDCi	02/07→	1753	4	82.50	DOHC	85/115				
Focus C-MAX	01/05→03/07									
Focus II TDCi	11/04→									
1.8		KKDB Diesel				214		AB5300 (MLS), 1.270mm, 2 Teeth AB5310 (MLS), 1.320mm, 3 Teeth AB5320 (MLS), 1.370mm, 4 Teeth AB5330 (MLS), 1.420mm, 5 Teeth AB5340 (MLS), 1.470mm, 6 Teeth AB5350 (MLS), 1.520mm, 7 Teeth	DZ720 ▲ [3]	EZ720 [3]
Focus II TDCi	11/04→	1753	4	82.50	DOHC	85/115				
1.8		P7PA Diesel				215		AB5300 (MLS), 1.270mm, 2 Teeth AB5310 (MLS), 1.320mm, 3 Teeth AB5320 (MLS), 1.370mm, 4 Teeth AB5330 (MLS), 1.420mm, 5 Teeth AB5340 (MLS), 1.470mm, 6 Teeth AB5350 (MLS), 1.520mm, 7 Teeth	DZ720 ▲ [3]	EZ720 [3]
Tourneo Con.	06/02→	1753	4		SOHC/OHC	55/75				
Transit 1.8 Di	06/02→									
1.8		P7PB Diesel				216		AB5300 (MLS), 1.270mm, 2 Teeth AB5310 (MLS), 1.320mm, 3 Teeth AB5320 (MLS), 1.370mm, 4 Teeth AB5330 (MLS), 1.420mm, 5 Teeth AB5340 (MLS), 1.470mm, 6 Teeth AB5350 (MLS), 1.520mm, 7 Teeth	DZ720 ▲ [3]	EZ720 [3]
Tourneo Con.	06/02→	1753	4		SOHC/OHC	55/75				
Transit 1.8 Di	06/02→									
1.8		P9PA Diesel				217		AB5300 (MLS), 1.270mm, 2 Teeth AB5310 (MLS), 1.320mm, 3 Teeth AB5320 (MLS), 1.370mm, 4 Teeth AB5330 (MLS), 1.420mm, 5 Teeth AB5340 (MLS), 1.470mm, 6 Teeth AB5350 (MLS), 1.520mm, 7 Teeth	DZ720 ▲ [3]	EZ720 [3]
Tourneo Con.	06/02→	1753	4	82.50	SOHC/OHC	66/90				
Transit 1.8 TDCi	06/02→									
1.8		P9PB Diesel				218		AB5300 (MLS), 1.270mm, 2 Teeth AB5310 (MLS), 1.320mm, 3 Teeth AB5320 (MLS), 1.370mm, 4 Teeth AB5330 (MLS), 1.420mm, 5 Teeth AB5340 (MLS), 1.470mm, 6 Teeth AB5350 (MLS), 1.520mm, 7 Teeth	DZ720 ▲ [3]	EZ720 [3]
Tourneo Con.	06/02→	1753	4	82.50	SOHC/OHC	66/90				
Transit 1.8 TDCi	06/02→									
1.8		P9PC Diesel				219		AB5300 (MLS), 1.270mm, 2 Teeth AB5310 (MLS), 1.320mm, 3 Teeth AB5320 (MLS), 1.370mm, 4 Teeth AB5330 (MLS), 1.420mm, 5 Teeth AB5340 (MLS), 1.470mm, 6 Teeth AB5350 (MLS), 1.520mm, 7 Teeth	DZ720 ▲ [3]	EZ720 [3]
Tourneo Con.	06/02→	1753	4	82.50	SOHC/OHC	66/90				
Transit 1.8 TDCi	06/02→									
1.8		P9PD Diesel				220		AB5300 (MLS), 1.270mm, 2 Teeth AB5310 (MLS), 1.320mm, 3 Teeth AB5320 (MLS), 1.370mm, 4 Teeth AB5330 (MLS), 1.420mm, 5 Teeth AB5340 (MLS), 1.470mm, 6 Teeth AB5350 (MLS), 1.520mm, 7 Teeth	DZ720 ▲ [3]	EZ720 [3]
Tourneo Con.	06/02→	1753	4	82.50	SOHC/OHC	66/90				
Transit 1.8 TDCi	06/02→									
1.8		Q7DA				221		AC5940 (MLS)	DW643 [3]	ED5220 [3]
C-MAX FIFuel	02/07→	1798	4	83.00	DOHC	92/125				
Focus C-MAX	04/04→03/07									
Focus II 1.8	03/06→									
Focus II FIFuel	01/06→									

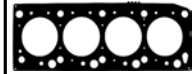
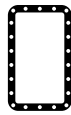
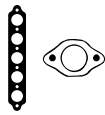

AB5300, AB5310,
AB5320, AB5330,
AB5340, AB5350

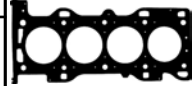

AC5940



JD309



JD310



JD5299



JE5037

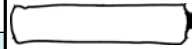

JM5016













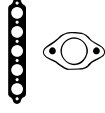

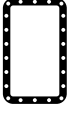
cc

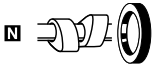

kW/PS



1.8	QQDA	222	AC5940 (MLS)	DW643 [3]	ED5220 [3]				
C-MAX 1.8	02/07→	1798	4	83.00	DOHC	92/125			
Focus C-MAX	04/04→03/07								
1.8	QQDB	223	AC5940 (MLS)	DW643 [3]	ED5220 [3]				
C-MAX 1.8	02/07→	1798	4	83.00	DOHC	92/125			
Focus C-MAX	04/04→03/07								
Focus II 1.8	03/06→								
1.8	QQDC	224	AC5940 (MLS)	DW643 [3]	ED5220 [3]				
C-MAX 1.8	02/07→	1798	4	83.00	DOHC	90/122			
Focus C-MAX 1.8	09/05→03/07								
1.8	QQDD	225	AC5940 (MLS)	DW643 [3]	ED5220 [3]				
Focus II FLFuel	12/05→	1798	4	83.00	DOHC	96/131			
1.8	QYBA Diesel	226	AB5300 (MLS), 1.270mm, 2 Teeth AB5310 (MLS), 1.320mm, 3 Teeth AB5320 (MLS), 1.370mm, 4 Teeth AB5330 (MLS), 1.420mm, 5 Teeth AB5340 (MLS), 1.470mm, 6 Teeth AB5350 (MLS), 1.520mm, 7 Teeth	DZ720 ▲ [3]	EZ720 [3]				
Mondeo IV TDCi	06/07→	1753	4	82.50	SOHC/OHC	92/125			
1.8	QYWA Diesel	227	AB5300 (MLS), 1.270mm, 2 Teeth AB5310 (MLS), 1.320mm, 3 Teeth AB5320 (MLS), 1.370mm, 4 Teeth AB5330 (MLS), 1.420mm, 5 Teeth AB5340 (MLS), 1.470mm, 6 Teeth AB5350 (MLS), 1.520mm, 7 Teeth	DZ720 ▲ [3]	EZ720 [3]				
Galaxy 1.8 TDCi	05/06→	1753	4	82.50	SOHC/OHC	92/125			
S-Max 1.8 TDCi	05/06→								
1.8	R2A	228	BN150 (Fibre)	DN150	EH850 [3]				
Sierra 1.8	01/87→05/88	1796	4	86.20	SOHC/OHC	66/90			
1.8	R2C	229	BX480 (Fibre)	DX480					
Sierra 1.8	05/88→02/93	1769	4	80.00	SOHC/OHC	64/87			
1.8	R2PA Diesel	230	AB5300 (MLS), 1.270mm, 2 Teeth AB5310 (MLS), 1.320mm, 3 Teeth AB5320 (MLS), 1.370mm, 4 Teeth AB5330 (MLS), 1.420mm, 5 Teeth AB5340 (MLS), 1.470mm, 6 Teeth AB5350 (MLS), 1.520mm, 7 Teeth	DZ720 ▲ [3]	EZ720 [3]				
Tourneo Con.	06/02→	1753	4		SOHC/OHC	55/75			
Transit 1.8 Di	06/02→								
1.8	R3PA Diesel	231	AB5300 (MLS), 1.270mm, 2 Teeth AB5310 (MLS), 1.320mm, 3 Teeth AB5320 (MLS), 1.370mm, 4 Teeth AB5330 (MLS), 1.420mm, 5 Teeth AB5340 (MLS), 1.470mm, 6 Teeth AB5350 (MLS), 1.520mm, 7 Teeth	DZ720 ▲ [3]	EZ720 [3]				
Tourneo Con.	06/02→	1753	4	82.50	SOHC/OHC	66/90			
Transit 1.8 TDCi	06/02→								
1.8	R6A	232	BX480 (Fibre)	DX480					
Sierra 1.8	05/88→02/93	1769	4	80.00	SOHC/OHC	64-66/ 87-90			

													
HBS369 [5] M10x1.50x145.50mm (x10)	JD5299 [x4] JE5037	JM5153 [78] (Elastomer)		HR5063		NA5157 [2] 37.00x50.00x8.00mm, PTFE LK5005 [1][7] 88.00x188.00x15.000mm, PTFE			AB5300, AB5310, AB5320, AB5330, AB5340, AB5350	JN815	AC5940	HC285	JJ455
HBS369 [5] M10x1.50x145.50mm (x10)	JD5299 [x4] JE5037	JM5153 [78] (Elastomer)		HR5063		NA5157 [2] 37.00x50.00x8.00mm, PTFE LK5005 [1][7] 88.00x188.00x15.000mm, PTFE			BN150		BX480		
HBS369 [5] M10x1.50x145.50mm (x10)	JD5299 [x4] JE5037	JM5153 (Elastomer)		HR5063		NA5157 [2] 37.00x50.00x8.00mm, PTFE LK5005 [1][7] 88.00x188.00x15.000mm, PTFE			JA768		JA769		
HBS369 [5] M10x1.50x145.50mm (x10)	JD5299 [x4] JE5037	JM5153 (Elastomer)		HR5063		NA5157 [2] 37.00x50.00x8.00mm, PTFE LK5005 [1][7] 88.00x188.00x15.000mm, PTFE			JA770		JC790		
HBS243 [19] M12x1.75x177.00mm (x8)	JD309 JD310	JM5016	JH5008	PB180 8.00x12.0/15.40x9.50 866N W (FPM) HR801		NB785 [2] 28.00x38.00x7.00mm, FPM NA5013 [1] 30.00x50.00x7.50mm, PTFE NC086 [1] 79.80x184.00x18.80mm, PTFE			JD028		JD309		
HBS243 [19] M12x1.75x177.00mm (x8)	JD309 JD310	JM5016	JH5008	HR801		NB785 [2] 28.00x38.00x7.00mm, FPM NA5013 [1] 30.00x50.00x7.50mm, PTFE NC086 [1] 79.80x184.00x18.80mm, PTFE			JD310		JD5299		
HBS056 [19] M12x1.75x92.50mm (x10)	JA769 JA768 JA770 (x3) JE719	JN620 [4]	HC285 =KG664	PB180 (x8) 8.00x12.0/15.40x9.50 866N W (FPM) HR631		NA5190 [2] 42.00x56.00x7.00mm, FPM NB645 [2] 35.00x50.00x7.00mm, MVQ NB847 [1] 88.00x108.00x11.00mm, FPM			JE5037		JE719		
HBS006 [22] M10x1.50x133.00mm (x10)	JD028 JC790	JN815 [4]	JJ455 =KG664	HR661		NA5190 [2] 42.00x56.00x7.00mm, FPM NB645 [2] 35.00x50.00x7.00mm, MVQ NB847 [1] 88.00x108.00x11.00mm, FPM			JM5016		JN620		
HBS243 [19] M12x1.75x177.00mm (x8)	JD309 JD310	JM5016	JH5008	PB180 (x8) 8.00x12.0/15.40x9.50 866N W (FPM) HR801		NB785 [2] 28.00x38.00x7.00mm, FPM NA5013 [1] 30.00x50.00x7.50mm, PTFE NC086 [1] 79.80x184.00x18.80mm, PTFE							
HBS243 [19] M12x1.75x177.00mm (x8)	JD310	JM5016	JH5008	PB180 (x8) 8.00x12.0/15.40x9.50 866N W (FPM) HR801		NB785 [2] 28.00x38.00x7.00mm, FPM NA5013 [1] 30.00x50.00x7.50mm, PTFE NC086 [1] 79.80x184.00x18.80mm, PTFE							
HBS006 [22] M10x1.50x133.00mm (x10)	JD028 JC790	JN815 [4]	JJ455	HR661		NA5190 [2] 42.00x56.00x7.00mm, FPM NB645 [2] 35.00x50.00x7.00mm, MVQ NB847 [1] 88.00x108.00x11.00mm, FPM							









cc

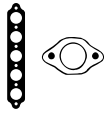

kW/PS

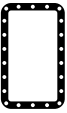

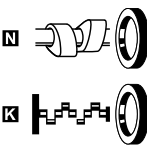
1.8		RDA					233	BW640 (Fibre)	DW640	EW630 [3]
Escort V 1.8 16V	02/92→12/92	1796	4	80.60	DOHC	77/105				
Escort V XR3i	02/92→12/92									
Escort VI	12/92→01/95									
Escort VI i 16V	09/92→01/95									
Escort VI XR3i	08/93→01/95									
Escort VII	02/95→08/98									
Escort VII 16V	01/95→08/95									
Orion III i 16V	02/92→12/93									
1.8		RDB					234	BW640 (Fibre)	DW640	EW630 [3]
Fiesta III 16V	02/92→12/95	1796	4	80.60	DOHC	77/105				
1.8		REC					235	BN150 (Fibre)	DN150	EH850 [3]
Scorpio I 1.8	04/85→02/92	1796	4	86.20	SOHC/OHC	66/90				
1.8		RED					236	BN150 (Fibre)	DN150	EH850 [3]
Sierra 1.8	01/87→09/89	1796	4	86.20	SOHC/OHC	59-66/ 80-90				
1.8		REF					237	BN150 (Fibre)	DN150	EH850 [3]
Sierra 1.8	10/87→09/89	1796	4	86.20	SOHC/OHC	59/80				
1.8		RFA Diesel					238	BT190 (Fibre), 1.360mm, 2 Teeth →08/92 ☞0.430→0.680mm BT200 (Fibre), 1.420mm, 3 Teeth →08/92 ☞0.681→0.740mm BT210 (Fibre), 1.520mm, 4 Teeth →08/92 ☞0.741→0.860mm BW010 (Fibre), 1.360mm, 2 Notches 09/92→ ☞0.430→0.680mm AB5800 (Fibre), 1.360mm, 2 Teeth 09/92→ ☞0.430→0.680mm BW020 (Fibre), 1.420mm, 3 Notches 09/92→ ☞0.681→0.740mm AB5810 (Fibre), 1.420mm, 3 Teeth 09/92→ ☞0.681→0.740mm BW030 (Fibre), 1.520mm, 4 Notches 09/92→ ☞0.741→0.860mm AB5820 (Fibre), 1.520mm, 4 Teeth 09/92→ ☞0.741→0.860mm	DT193 ▲ [3]	ET190 [80] ET191 [82] GT190 ▲ [82]
P 100 II 1.8 TD	10/87→12/92	1753	4	82.50	SOHC/OHC	55-57/ 75-78				
Sierra 1.8 TD	08/88→02/93									

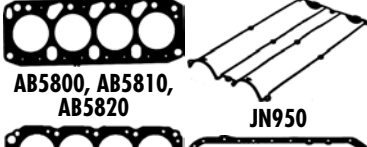
							
HBS031 [22] M10x1.50x102.00mm (x10)	JD265 [81] JD264 [81] JE5021	JN950 [4]	JJ531 =KG664	HR5033	NB958 [2] 42.00x53.00x7.00mm, FPM NB959 [2] 35.00x50.00x7.00mm, FPM NB847 [1] 88.00x108.00x11.00mm, FPM		AB5800, AB5810, AB5820 JN950 BN150 HC285 BT190, BT200, BT210 JJ456 BW010, BW020, BW030 JJ463 BW640 JJ531
HBS031 [22] M10x1.50x102.00mm (x10)	JD265 [81] JD264 [81] JE5021	JN950 [4]	JJ531 =KG664	HR5033	NB958 [2] 42.00x53.00x7.00mm, FPM NB959 [2] 35.00x50.00x7.00mm, FPM NB847 [1] 88.00x108.00x11.00mm, FPM		JA768 JA769 JA770 JA779
HBS056 [19] M12x1.75x92.50mm (x10)	JA769 JA768 JA770 (x3) JE719	JN620 [4]	HC285 =KG664	PB180 (x8) 8.00x12.0/15.40x9.50 866N W (FPM) HR631	NA5190 [2] 42.00x56.00x7.00mm, FPM	KA289 [15] KT738 [45]	JA768 JA769 JA770 JA779
HBS056 [19] M12x1.75x92.50mm (x10)	JA769 JA768 JA770 (x3) JE719	JN620 [4]	HC285 =KG664	PB180 (x8) 8.00x12.0/15.40x9.50 866N W (FPM) HR631	NA5190 [2] 42.00x56.00x7.00mm, FPM		JA768 JA769 JA770 JA779
HBS056 [19] M12x1.75x92.50mm (x10)	JA769 JA768 JA770 (x3) JE719	JN620 [4]	HC285 =KG664	PB180 (x8) 8.00x12.0/15.40x9.50 866N W (FPM) HR631	NA5190 [2] 42.00x56.00x7.00mm, FPM		JD240 JD264 JD265 JD310 JE5021
HBS007 [19] →07/92 HBS033 [19] M12x1.75x136.00mm (x10) 08/92→	JD240 JD310	JN816 [4]	JJ456 [80] JJ463 [82]	PB180 (x8) 8.00x12.0/15.40x9.50 866N W (FPM) HR659 →08/92 HR801 09/92→	NB785 [2] 28.00x38.00x7.00mm, FPM NB984 [2] 66.67x89.30x10.00mm, FPM NB788 [1] 79.40x95.30x11.10mm, PTFE NC086 [1] 79.80x184.00x18.80mm, PTFE	NC044 [2][56]	JE719 JN620 JN816



cc



kW/PS



1.8		RFB Diesel				239			
Sierra 1.8 TD	08/88→02/93	1753	4	82.50	SOHC/OHC	55-57/ 75-78	BT190 (Fibre), 1.360mm, 2 Teeth →08/92 ☞0.430→0.680mm BT200 (Fibre), 1.420mm, 3 Teeth →08/92 ☞0.681→0.740mm BT210 (Fibre), 1.520mm, 4 Teeth →08/92 ☞0.741→0.860mm BW010 (Fibre), 1.360mm, 2 Notches 09/92→ ☞0.430→0.680mm AB5800 (Fibre), 1.360mm, 2 Teeth 09/92→ ☞0.430→0.680mm BW020 (Fibre), 1.420mm, 3 Notches 09/92→ ☞0.681→0.740mm AB5810 (Fibre), 1.420mm, 3 Teeth 09/92→ ☞0.681→0.740mm BW030 (Fibre), 1.520mm, 4 Notches 09/92→ ☞0.741→0.860mm AB5820 (Fibre), 1.520mm, 4 Teeth 09/92→ ☞0.741→0.860mm	DT193 ▲[3]	ET190 [80] ET191 [82] GT190 ▲ [82]
1.8		RFD Diesel				240			
Escort 1.8 TD	10/98→07/00	1753	4	82.50	SOHC/OHC	66/90	BW010 (Fibre), 1.360mm, 2 Notches →06/92 ☞0.430→0.680mm BW020 (Fibre), 1.420mm, 3 Notches →06/92 ☞0.681→0.740mm BW030 (Fibre), 1.520mm, 4 Notches →06/92 ☞0.741→0.860mm AB5800 (Fibre), 1.360mm, 2 Teeth 07/92→ ☞0.430→0.680mm AB5810 (Fibre), 1.420mm, 3 Teeth 07/92→ ☞0.681→0.740mm AB5820 (Fibre), 1.520mm, 4 Teeth 07/92→ ☞0.741→0.860mm	DT193 ▲[3]	ET190 [80] →11/93 ET191 [82] GT190 ▲ [82] →11/93

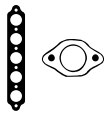

AB5800, AB5810,
AB5820



BT190, BT200,
BT210



BW010, BW020,
BW030

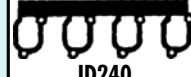

JD240



JD309



JD310



JN816



JJ456



JJ463

HBS007 [19]
→07/92
HBS033 [19]
M12x1.75x136.00mm (x10)
08/92→

JD240
JD310

JN816 [4]

JJ456 [80]
JJ463 [82]

PB180 (x8)
8.00x12.0/15.40x9.50
866N W (FPM)
HR659
→08/92
HR801
09/92→

NB785 [2]
28.00x38.00x7.00mm, FPM
 NB984 [2]
66.67x89.30x10.00mm, FPM
 NB788 [1]
79.40x95.30x11.10mm, PTFE
 NC086 [1]
79.80x184.00x18.80mm, PTFE

NC044 [2][56]

HBS033 [19]
M12x1.75x136.00mm (x10)

JD309
JD310

JN816 [4]

JJ456
JJ463 [82]

PB180 (x8)
8.00x12.0/15.40x9.50
866N W (FPM)
HR801

NB785 [2]
28.00x38.00x7.00mm, FPM
 NB984 [2]
66.67x89.30x10.00mm, FPM
 NB788 [1]
79.40x95.30x11.10mm, PTFE
 NC086 [1]
79.80x184.00x18.80mm, PTFE

NC044 [2][56]



cc



kW/PS

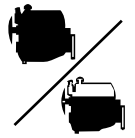

1.8	RFK Diesel					241		DT193 ▲ [3]	ET190 [80] ET191 [82] GT190 ▲ [82]
Escort 1.8 TD Escort '95 Exp Escort VI 1.8 TD Escort VII Escort VII TD Orion III 1.8 TD	10/98→07/00 01/95→ 02/93→01/95 09/95→08/98 01/95→02/99 03/92→12/93	1753	4	82.50	SOHC/OHC	66/90	BW010 (Fibre), 1.360mm, 2 Notches →06/92 -0.430→0.680mm BW020 (Fibre), 1.420mm, 3 Notches →06/92 -0.681→0.740mm BW030 (Fibre), 1.520mm, 4 Notches →06/92 -0.741→0.860mm AB5800 (Fibre), 1.360mm, 2 Teeth 07/92→ -0.430→0.680mm AB5810 (Fibre), 1.420mm, 3 Teeth 07/92→ -0.681→0.740mm AB5820 (Fibre), 1.520mm, 4 Teeth 07/92→ -0.741→0.860mm		
1.8	RFL Diesel					242		DT193 ▲ [3]	ET190 [80] ET191 [82] GT190 ▲ [82]
Fiesta III TD Sierra 1.8 TD	03/93→12/95 08/88→02/93	1753	4	82.50	SOHC/OHC	55-57/ 75-78	BT190 (Fibre), 1.360mm, 2 Teeth →08/92 -0.430→0.680mm BT200 (Fibre), 1.420mm, 3 Teeth →08/92 -0.681→0.740mm BT210 (Fibre), 1.520mm, 4 Teeth →08/92 -0.741→0.860mm BW010 (Fibre), 1.360mm, 2 Notches 09/92→ -0.430→0.680mm AB5800 (Fibre), 1.360mm, 2 Teeth 09/92→ -0.430→0.680mm BW020 (Fibre), 1.420mm, 3 Notches 09/92→ -0.681→0.740mm AB5810 (Fibre), 1.420mm, 3 Teeth 09/92→ -0.681→0.740mm BW030 (Fibre), 1.520mm, 4 Notches 09/92→ -0.741→0.860mm AB5820 (Fibre), 1.520mm, 4 Teeth 09/92→ -0.741→0.860mm		
1.8	RFM Diesel					243		DT193 ▲ [3]	ET191 [82] ET192 [3]
Mondeo I 1.8 TD	06/93→08/96	1753	4	82.50	SOHC/OHC	65-66/ 88-90	BM360 (Fibre) BW010 (Fibre), 1.360mm, 2 Notches -0.430→0.680mm AB5800 (Fibre), 1.360mm, 2 Teeth -0.430→0.680mm BW020 (Fibre), 1.420mm, 3 Notches -0.681→0.740mm AB5810 (Fibre), 1.420mm, 3 Teeth -0.681→0.740mm BW030 (Fibre), 1.520mm, 4 Notches -0.741→0.860mm AB5820 (Fibre), 1.520mm, 4 Teeth -0.741→0.860mm		

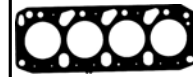
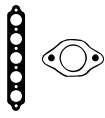

AB5800, AB5810,
AB5820



BM360



BT190, BT200,
BT210



BW010, BW020,
BW030



JD240



JD309



JD310



JN816



JJ456



JJ463



cc



kW/PS



1.8	RFN Diesel					244		DT193 ▲ [3]	ET191 [82] ET192 [3]
Mondeo I 1.8 TD	06/93→08/96	1753	4	82.50	SOHC/OHC	65-66/ 88-90	BM360 (Fibre) BW010 (Fibre), 1.360mm, 2 Notches ☞0.430→0.680mm AB5800 (Fibre), 1.360mm, 2 Teeth ☞0.430→0.680mm BW020 (Fibre), 1.420mm, 3 Notches ☞0.681→0.740mm AB5810 (Fibre), 1.420mm, 3 Teeth ☞0.681→0.740mm BW030 (Fibre), 1.520mm, 4 Notches ☞0.741→0.860mm AB5820 (Fibre), 1.520mm, 4 Teeth ☞0.741→0.860mm		
Mondeo II 1.8 TD	09/96→11/00								
1.8	RFS Diesel					245		DT193 ▲ [3]	ET190 [80] →11/93 ET191 [82] →11/93 ET192 [3] 12/93→ GT190 ▲ [82] →11/93
Escort '95 Exp	01/95→	1753	4	82.50	SOHC/OHC	66/90	BW010 (Fibre), 1.360mm, 2 Notches ☞0.430→0.680mm AB5800 (Fibre), 1.360mm, 2 Teeth ☞0.430→0.680mm BW020 (Fibre), 1.420mm, 3 Notches ☞0.681→0.740mm AB5810 (Fibre), 1.420mm, 3 Teeth ☞0.681→0.740mm BW030 (Fibre), 1.520mm, 4 Notches ☞0.741→0.860mm AB5820 (Fibre), 1.520mm, 4 Teeth ☞0.741→0.860mm		
Escort VI 1.8 TD	02/93→01/95								
1.8	RKA					246		DW641	EW630 [3]
Mondeo I	02/93→08/96	1796	4	80.60	DOHC	85/115	BW640 (Fibre)		
Mondeo I i 16V	02/93→08/96								
Ranger 1.8	06/99→02/02								
1.8	RKB					247		DW641 →08/98	EW630 [3] →12/98 EC5800 [3] 01/99→
Mondeo I i 16V	01/94→08/96	1796	4	80.60	DOHC	82-85/ 111-116	BW640 (Fibre) →12/98 AC5800 (MLS) [83] 01/99→		
Mondeo II 1.8 i	09/96→11/00								
1.8	RKC					248		DW641 →08/98	EW630 [3] →12/98 EC5800 [3] 01/99→
Escort VII	10/95→08/98	1796	4	80.60	DOHC	85/115	BW640 (Fibre) →12/98 AC5800 (MLS) [83] 01/99→		
Escort VII 16V	01/95→02/99								
1.8	RKF					249		DW641 →08/98	EW630 [3] →12/98 EC5800 [3] 01/99→
Mondeo II 1.8 i	09/96→11/00	1796	4	80.60	DOHC	85/115	BW640 (Fibre) →12/98 AC5800 (MLS) 01/99→		

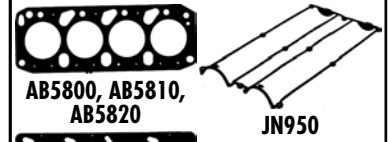
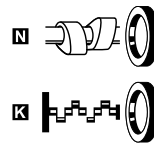
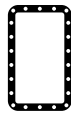
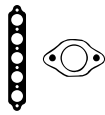

AB5800, AB5810, AB5820

JN950



AC5800

JH5061



BM360

JJ456



BW010, BW020, BW030

JJ463



BW640

JJ531

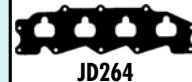

JD264



JD265



JD266



JD309



JD310



JD5311



JD5312



JE5021



JM5154





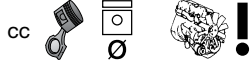

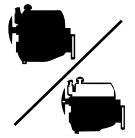

JN816

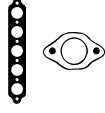

kW/PS

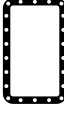

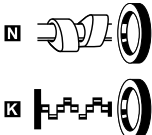
1.8	RKH					250			
Mondeo II 1.8 i	09/96→11/00	1796	4	80.60	DOHC	85/115	BW640 (Fibre) →12/98 AC5800 (MLS) 01/99→	DW641 →08/98	EW630 [3] →12/98 EC5800 [3] 01/99→
1.8	RKJ					251			
Mondeo II 1.8 i	09/96→11/00	1796	4	80.60	DOHC	85/115	BW640 (Fibre) →12/98 AC5800 (MLS) 01/99→	DW641 →08/98	EW630 [3] →12/98 EC5800 [3] 01/99→
1.8	RKK					252			
Mondeo II 1.8 i	09/96→11/00	1796	4	80.60	DOHC	85/115	BW640 (Fibre) →12/98 AC5800 (MLS) 01/99→	DW641 →08/98	EW630 [3] →12/98 EC5800 [3] 01/99→
1.8	RQB					253			
Escort V XR3i	02/92→12/92	1796	4	80.60	DOHC	96/130	BW640 (Fibre) →12/98 AC5800 (MLS) [83] 01/99→	DW641 →08/98	EW630 [3] →12/98 EC5800 [3] 01/99→
Escort VI	12/92→01/95								
Escort VI i 1.6V	02/93→01/95								
Escort VI XR3i	09/92→01/95								
Escort VII	02/95→08/00								
Orion III i 1.6V	01/92→12/93								
1.8	RQC					254			
Fiesta III XR2i	02/92→12/95	1796	4	80.60	DOHC	96/130	BW640 (Fibre)	DW641	EW630 [3]
1.8	RTA Diesel					255			
Escort '86 Exp	07/88→07/90	1753	4	82.50	SOHC/OHC	44/60	BT190 (Fibre), 1.360mm, 2 Teeth 08/88→ ☞0.430→0.680mm BT200 (Fibre), 1.420mm, 3 Teeth 08/88→ ☞0.681→0.740mm BT210 (Fibre), 1.520mm, 4 Teeth 08/88→ ☞0.741→0.860mm	DT193 ▲ [3]	ET190 [80] ET191 [82] GT190 ▲ [82]
Escort IV 1.8 D	01/89→07/90								
Orion II 1.8 D	01/89→07/90								

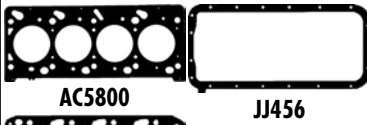
							
HBS031 [22] M10x1.50x102.00mm (x10)	JD5311 [x4] →09/99 JD5312 [x4] 09/99→ JE5021 []	JN950 [4] →07/98 JM5154 (SE) 08/98→04/99 JM5184 (Elastomer) Pale blue 04/99→	JJ531 →12/98 =KG664 JH5061 12/98→	HR5033 []	NB958 [2] 42.00x53.00x7.00mm, FPM NB959 [2] 35.00x50.00x7.00mm, FPM NB847 [1] 88.00x108.00x11.00mm, FPM		AC5800 JJ456 BT190, BT200, BT210 JJ463 BW640 JJ531 JD240
HBS031 [22] M10x1.50x102.00mm (x10)	JD5311 [x4] →09/99 JD5312 [x4] 09/99→ JE5021 []	JN950 [4] →07/98 JM5154 (SE) 08/98→04/99 JM5184 (Elastomer) Pale blue 04/99→	JJ531 →12/98 =KG664 JH5061 12/98→	HR5033 []	NB958 [2] 42.00x53.00x7.00mm, FPM NB959 [2] 35.00x50.00x7.00mm, FPM NB847 [1] 88.00x108.00x11.00mm, FPM		JD266 JD310
HBS031 [22] M10x1.50x102.00mm (x10)	JD5311 [x4] →09/99 JD5312 [x4] 09/99→ JE5021 []	JN950 [4] →07/98 JM5154 (SE) 08/98→04/99 JM5184 (Elastomer) Pale blue 04/99→	JJ531 →12/98 =KG664 JH5061 12/98→	HR5033 []	NB958 [2] 42.00x53.00x7.00mm, FPM NB959 [2] 35.00x50.00x7.00mm, FPM NB847 [1] 88.00x108.00x11.00mm, FPM		JD5311
HBS031 [22] M10x1.50x102.00mm (x10)	JD266 [84] →08/95 JD5311 [x4] 08/95→09/99 JD5312 [x4] 09/99→ JE5021 []	JN950 [4] →07/98 JM5154 (SE) 08/98→04/99 JM5184 (Elastomer) Pale blue 04/99→	JJ531 →08/98 =KG664 JH5061 12/98→	HR5033 []	NB958 [2] 42.00x53.00x7.00mm, FPM NB959 [2] 35.00x50.00x7.00mm, FPM NB847 [1] 88.00x108.00x11.00mm, FPM		JD5312 JE5021
HBS031 [22] M10x1.50x102.00mm (x10)	JD266 [84] →08/95 JD5311 [x4] 08/95→ JE5021 []	JN950 [4]	JJ531 =KG664	HR5033 []	NB958 [2] 42.00x53.00x7.00mm, FPM NB959 [2] 35.00x50.00x7.00mm, FPM NB847 [1] 88.00x108.00x11.00mm, FPM		JM5154 JN816
HBS007 []	JD240 [] JD310 []	JN816 [4]	JJ456 [80] JJ463 [82]	HR801 [] HR659 [] 08/88→	NB785 [2] 28.00x38.00x7.00mm, FPM NB984 [2] 66.67x89.30x10.00mm, FPM NB788 [1] 79.40x95.30x11.10mm, PTFE	NC044 [2][56]	JN950 JH5061



cc



kW/PS



1.8		RTB Diesel				256			
Escort '86 Exp	07/88→07/90	1753	4	82.50	SOHC/OHC	44/60	BT190 (Fibre), 1.360mm, 2 Teeth 08/88→ ☒0.430→0.680mm	DT193 ▲ [3]	ET190 [80] ET191 [82] GT190 ▲ [82]
Escort IV 1.8 D	01/89→07/90						BT200 (Fibre), 1.420mm, 3 Teeth 08/88→ ☒0.681→0.740mm		
Orion II 1.8 D	01/89→07/90						BT210 (Fibre), 1.520mm, 4 Teeth 08/88→ ☒0.741→0.860mm		
1.8		RTC Diesel				257			
Fiesta Van 1.8 D	03/89→02/96	1753	4	82.50	SOHC/OHC	43-44/ 58-60	BT190 (Fibre), 1.360mm, 2 Teeth →08/92 ☒0.430→0.680mm	DT193 ▲ [3]	ET190 [80] ET191 [82] GT190 ▲ [82]
Fiesta III 1.8 D	03/89→12/95						BT200 (Fibre), 1.420mm, 3 Teeth →08/92 ☒0.681→0.740mm		
							BT210 (Fibre), 1.520mm, 4 Teeth →08/92 ☒0.741→0.860mm		
							BW010 (Fibre), 1.360mm, 2 Notches 09/92→ ☒0.430→0.680mm		
							AB5800 (Fibre), 1.360mm, 2 Teeth 09/92→ ☒0.430→0.680mm		
							BW020 (Fibre), 1.420mm, 3 Notches 09/92→ ☒0.681→0.740mm		
							AB5810 (Fibre), 1.420mm, 3 Teeth 09/92→ ☒0.681→0.740mm		
							BW030 (Fibre), 1.520mm, 4 Notches 09/92→ ☒0.741→0.860mm		
							AB5820 (Fibre), 1.520mm, 4 Teeth 09/92→ ☒0.741→0.860mm		

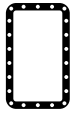
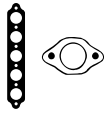

AB5800, AB5810,
AB5820



BT190, BT200,
BT210



BW010, BW020,
BW030

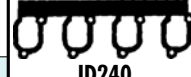

JD240



JD310



JN816



JJ456



JJ463

HBS007

JD240
JD310

JN816 [4]

JJ456 [80]
JJ463 [82]

HR801
HR659
08/88→

NB785 [2]
28.00x38.00x7.00mm, FPM
 NB984 [2]
66.67x89.30x10.00mm, FPM
 NB788 [1]
79.40x95.30x11.10mm, PTFE

NC044 [2][56]

HBS007

→07/92

HBS033 [19]

M12x1.75x136.00mm (x10)

08/92→

JD240
JD310

JN816 [4]

JJ456 [80]
JJ463 [82]

PB180 (x8)
8.00x12.0/15.40x9.50
866N W (FPM)
09/92→
HR659
→08/92
HR801
09/92→

NB785 [2]
28.00x38.00x7.00mm, FPM
 NB984 [2]
66.67x89.30x10.00mm, FPM
 NB788 [1]
79.40x95.30x11.10mm, PTFE

NC044 [2][56]



cc



kW/PS

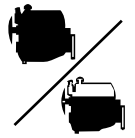

1.8	RTD Diesel					258		DT193 ▲ [3]	ET190 [80] ET191 [82] GT190 ▲ [82]
Fiesta Van 1.8 D Fiesta III 1.8 D	03/89→02/96 03/89→12/95	1753	4	82.50	SOHC/OHC	43-44/ 58-60	BT190 (Fibre), 1.360mm, 2 Teeth →08/92 ☞0.430→0.680mm BT200 (Fibre), 1.420mm, 3 Teeth →08/92 ☞0.681→0.740mm BT210 (Fibre), 1.520mm, 4 Teeth →08/92 ☞0.741→0.860mm BW010 (Fibre), 1.360mm, 2 Notches 09/92→ ☞0.430→0.680mm AB5800 (Fibre), 1.360mm, 2 Teeth 09/92→ ☞0.430→0.680mm BW020 (Fibre), 1.420mm, 3 Notches 09/92→ ☞0.681→0.740mm AB5810 (Fibre), 1.420mm, 3 Teeth 09/92→ ☞0.681→0.740mm BW030 (Fibre), 1.520mm, 4 Notches 09/92→ ☞0.741→0.860mm AB5820 (Fibre), 1.520mm, 4 Teeth 09/92→ ☞0.741→0.860mm		
1.8	RTE Diesel					259		DT193 ▲ [3]	ET190 [80] ET191 [82] GT190 ▲ [82]
Escort V 1.8 D Escort VI 1.8 D Escort VII 1.8 D Orion III 1.8 D	07/90→12/92 09/92→01/95 01/95→02/99 11/90→12/93	1753	4	82.50	SOHC/OHC	44/60	BT190 (Fibre), 1.360mm, 2 Teeth →08/92 ☞0.430→0.680mm BT200 (Fibre), 1.420mm, 3 Teeth →08/92 ☞0.681→0.740mm BT210 (Fibre), 1.520mm, 4 Teeth →08/92 ☞0.741→0.860mm BW010 (Fibre), 1.360mm, 2 Notches 08/92→ ☞0.430→0.680mm AB5800 (Fibre), 1.360mm, 2 Teeth 08/92→ ☞0.430→0.680mm BW020 (Fibre), 1.420mm, 3 Notches 08/92→ ☞0.681→0.740mm AB5810 (Fibre), 1.420mm, 3 Teeth 08/92→ ☞0.681→0.740mm AB5820 (Fibre), 1.520mm, 4 Teeth 08/92→ ☞0.741→0.860mm BW030 (Fibre), 1.520mm, 4 Notches 09/92→ ☞0.741→0.860mm		

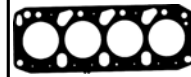
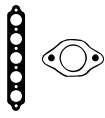

AB5800, AB5810,
AB5820



BT190, BT200,
BT210



BW010, BW020,
BW030



JD240



JD310



JN816



JJ456



JJ463

HBS007
→07/92
HBS033 [19]
M12x1.75x136.00mm (x10)
08/92→

JD240
JD310

JN816 [4]

JJ456 [80]
JJ463 [82]

PB180 (x8)
8.00x12.0/15.40x9.50
866N W (FPM)
09/92→
HR659
→08/92
HR801
09/92→

NB785 [2]
28.00x38.00x7.00mm, FPM
 NB984 [2]
66.67x89.30x10.00mm, FPM
 NB788 [1]
79.40x95.30x11.10mm, PTFE

NC044 [2][56]

HBS007
→07/92
HBS033 [19]
M12x1.75x136.00mm (x10)
08/92→

JD240
JD310

JN816 [4]

JJ456 [80]
JJ463 [82]

PB180 (x8)
8.00x12.0/15.40x9.50
866N W (FPM)
08/92→
HR659
→08/92
HR801
09/92→

NB785 [2]
28.00x38.00x7.00mm, FPM
 NB984 [2]
66.67x89.30x10.00mm, FPM
 NB788 [1]
79.40x95.30x11.10mm, PTFE

NC044 [2][56]



cc



kW/PS

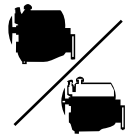

1.8		RTF	Diesel				260			
Escort '95 Exp	01/95→	1753	4	82.50	SOHC/OHC	44/60	BT190 (Fibre), 1.360mm, 2 Teeth →08/92 ☒0.430→0.680mm BT200 (Fibre), 1.420mm, 3 Teeth →08/92 ☒0.681→0.740mm BT210 (Fibre), 1.520mm, 4 Teeth →08/92 ☒0.741→0.860mm BW010 (Fibre), 1.360mm, 2 Notches 08/92→ ☒0.430→0.680mm AB5800 (Fibre), 1.360mm, 2 Teeth 08/92→ ☒0.430→0.680mm BW020 (Fibre), 1.420mm, 3 Notches 08/92→ ☒0.681→0.740mm AB5810 (Fibre), 1.420mm, 3 Teeth 08/92→ ☒0.681→0.740mm AB5820 (Fibre), 1.520mm, 4 Teeth 08/92→ ☒0.741→0.860mm BW030 (Fibre), 1.520mm, 4 Notches 09/92→ ☒0.741→0.860mm	DT193 ▲ [3]	ET190 [80] ET191 [82] GT190 ▲ [82]	
1.8		RTG	Diesel				261			
Fiesta Van 1.8 D	03/89→02/96	1753	4	82.50	SOHC/OHC	43-44/ 58-60	BT190 (Fibre), 1.360mm, 2 Teeth →08/92 ☒0.430→0.680mm BT200 (Fibre), 1.420mm, 3 Teeth →08/92 ☒0.681→0.740mm BT210 (Fibre), 1.520mm, 4 Teeth →08/92 ☒0.741→0.860mm BW010 (Fibre), 1.360mm, 2 Notches 09/92→ ☒0.430→0.680mm AB5800 (Fibre), 1.360mm, 2 Teeth 09/92→ ☒0.430→0.680mm BW020 (Fibre), 1.420mm, 3 Notches 09/92→ ☒0.681→0.740mm AB5810 (Fibre), 1.420mm, 3 Teeth 09/92→ ☒0.681→0.740mm BW030 (Fibre), 1.520mm, 4 Notches 09/92→ ☒0.741→0.860mm AB5820 (Fibre), 1.520mm, 4 Teeth 09/92→ ☒0.741→0.860mm	DT193 ▲ [3]	ET190 [80] →11/93 ET191 [82] →11/93 ET192 [3] 12/93→ GT190 ▲ [82] →11/93	

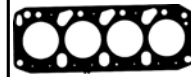
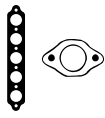

AB5800, AB5810,
AB5820



BT190, BT200,
BT210



BW010, BW020,
BW030



JD240



JD310



JN816



JJ456



JJ463

HBS007
→07/92
HBS033 [19]
M12x1.75x136.00mm (x10)
08/92→

JD240
JD310

JN816 [4]

JJ456 [80]
JJ463 [82]

PB180 (x8)
8.00x12.0/15.40x9.50
866N W (FPM)
08/92→
HR659
→08/92
HR801
09/92→

NB785 [2]
28.00x38.00x7.00mm, FPM
 NB984 [2]
66.67x89.30x10.00mm, FPM
 NB788 [1]
79.40x95.30x11.10mm, PTFE

NC044 [2][56]

HBS007
→07/92
HBS033 [19]
M12x1.75x136.00mm (x10)
08/92→

JD240
JD310

JN816 [4]

JJ456 [80]
JJ463 [82]

PB180 (x8)
8.00x12.0/15.40x9.50
866N W (FPM)
09/92→
HR659
→08/92
HR801
09/92→

NB785 [2]
28.00x38.00x7.00mm, FPM
 NB984 [2]
66.67x89.30x10.00mm, FPM
 NB788 [1]
79.40x95.30x11.10mm, PTFE

NC044 [2][56]



cc



kW/PS



1.8	RTH Diesel					262			
Escort '91 Exp Escort '95 Exp Escort V 1.8 D Escort VI 1.8 D Escort VII 1.8 D Orion III 1.8 D	07/90→12/94 01/95→ 07/90→12/92 09/92→01/95 01/95→02/99 11/90→12/93	1753	4	82.50	SOHC/OHC	44/60	BT190 (Fibre), 1.360mm, 2 Teeth →09/92 ☞0.430→0.680mm BT200 (Fibre), 1.420mm, 3 Teeth →08/92 ☞0.681→0.740mm BW030 (Fibre), 1.520mm, 4 Notches ☞0.741→0.860mm BT210 (Fibre), 1.520mm, 4 Teeth →08/92 ☞0.741→0.860mm BW010 (Fibre), 1.360mm, 2 Notches 08/92→ ☞0.430→0.680mm AB5800 (Fibre), 1.360mm, 2 Teeth 08/92→ ☞0.430→0.680mm BW020 (Fibre), 1.420mm, 3 Notches 08/92→ ☞0.681→0.740mm AB5810 (Fibre), 1.420mm, 3 Teeth 08/92→ ☞0.681→0.740mm AB5820 (Fibre), 1.520mm, 4 Teeth 08/92→ ☞0.741→0.860mm	DT193 ▲ [3] →03/94	ET190 [80] →11/93 ET191 [82] →11/93 ET192 [3] 12/93→ GT190 ▲ [82] →11/93
1.8	RTJ Diesel					263			
Fiesta Van 1.8 D Fiesta IV 1.8 D	05/98→ 08/95→04/00	1753	4	82.50	SOHC/OHC	44/60	BW010 (Fibre), 1.360mm, 2 Notches ☞0.430→0.680mm AB5800 (Fibre), 1.360mm, 2 Teeth ☞0.430→0.680mm BW020 (Fibre), 1.420mm, 3 Notches ☞0.681→0.740mm AB5810 (Fibre), 1.420mm, 3 Teeth ☞0.681→0.740mm BW030 (Fibre), 1.520mm, 4 Notches ☞0.741→0.860mm AB5820 (Fibre), 1.520mm, 4 Teeth ☞0.741→0.860mm	DT193 ▲ [3]	ET192 [3]
1.8	RTK Diesel					264			
Courier 1.8 D Fiesta Van 1.8 D Fiesta IV 1.8 D	06/99→02/02 02/96→ 08/95→04/00	1753	4	82.50	SOHC/OHC	44/60	BW010 (Fibre), 1.360mm, 2 Notches ☞0.430→0.680mm AB5800 (Fibre), 1.360mm, 2 Teeth ☞0.430→0.680mm BW020 (Fibre), 1.420mm, 3 Notches ☞0.681→0.740mm AB5810 (Fibre), 1.420mm, 3 Teeth ☞0.681→0.740mm BW030 (Fibre), 1.520mm, 4 Notches ☞0.741→0.860mm AB5820 (Fibre), 1.520mm, 4 Teeth ☞0.741→0.860mm	DT193 ▲ [3]	ET192 [3]
1.8	RTN Diesel					265			
Fiesta 1.8 DI Fiesta Van TD Fiesta IV 1.8 DI	09/00→ 03/00→ 04/00→01/02	1753	4	82.50	SOHC/OHC	55-57/ 75-78	AB5300 (MLS), 1.270mm, 2 Teeth AB5310 (MLS), 1.320mm, 3 Teeth AB5320 (MLS), 1.370mm, 4 Teeth AB5330 (MLS), 1.420mm, 5 Teeth AB5340 (MLS), 1.470mm, 6 Teeth AB5350 (MLS), 1.520mm, 7 Teeth	DZ720 ▲ [3]	EZ720 [3]

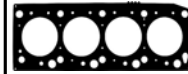
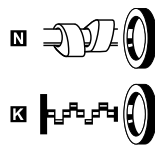
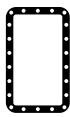
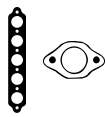

AB5300, AB5310,
AB5320, AB5330,
AB5340, AB5350



AB5800, AB5810,
AB5820



BT190, BT200,
BT210



BW030, BW010,
BW020



JA5085



JD240



JD309



JD310

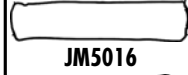

JM5016

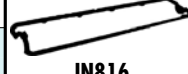

JN816



JJ456

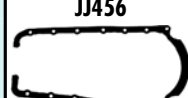

JJ463



cc



kW/PS

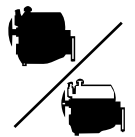

1.8		RTP Diesel					266			DZ720 ▲ [3]	EZ720 [3]	
Fiesta 1.8 DI	09/00→	1753	4	82.50	SOHC/OHC	55-57/75-78	AB5300 (MLS), 1.270mm, 2 Teeth	AB5310 (MLS), 1.320mm, 3 Teeth	AB5320 (MLS), 1.370mm, 4 Teeth	AB5330 (MLS), 1.420mm, 5 Teeth	AB5340 (MLS), 1.470mm, 6 Teeth	AB5350 (MLS), 1.520mm, 7 Teeth
Fiesta Van TD	03/00→											
Fiesta IV 1.8 DI	04/00→01/02											
1.8		RTQ Diesel					267			DZ720 ▲ [3]	EZ720 [3]	
Fiesta Van TD	03/00→	1753	4	82.50	SOHC/OHC	55-57/75-78	AB5300 (MLS), 1.270mm, 2 Teeth	AB5310 (MLS), 1.320mm, 3 Teeth	AB5320 (MLS), 1.370mm, 4 Teeth	AB5330 (MLS), 1.420mm, 5 Teeth	AB5340 (MLS), 1.470mm, 6 Teeth	AB5350 (MLS), 1.520mm, 7 Teeth
Fiesta IV 1.8 DI	04/00→01/02											
1.8		RVA Diesel					268			DT193 ▲ [3]	ET192 [3]	
Escort '95 Exp	12/95→06/01	1753	4	82.50	SOHC/OHC	51/70	BW010 (Fibre), 1.360mm, 2 Notches ☞0.430→0.680mm	AB5800 (Fibre), 1.360mm, 2 Teeth ☞0.430→0.680mm	BW020 (Fibre), 1.420mm, 3 Notches ☞0.681→0.740mm	AB5810 (Fibre), 1.420mm, 3 Teeth ☞0.681→0.740mm	BW030 (Fibre), 1.520mm, 4 Notches ☞0.741→0.860mm	AB5820 (Fibre), 1.520mm, 4 Teeth ☞0.741→0.860mm
Escort VII	10/96→08/99											
Escort VII TD	12/95→02/99											
1.8		RWPA Diesel					269			DZ720 ▲ [3]	EZ720 [3]	
Tourneo Con.	08/06→	1753	4	82.50	SOHC/OHC	81/110	AB5300 (MLS), 1.270mm, 2 Teeth	AB5310 (MLS), 1.320mm, 3 Teeth	AB5320 (MLS), 1.370mm, 4 Teeth	AB5330 (MLS), 1.420mm, 5 Teeth	AB5340 (MLS), 1.470mm, 6 Teeth	AB5350 (MLS), 1.520mm, 7 Teeth
Transit 1.8 TDCi	08/06→											
1.8		RWPC Diesel					270			DZ720 ▲ [3]	EZ720 [3]	
Tourneo Con.	08/06→	1753	4	82.50	SOHC/OHC	81/110	AB5300 (MLS), 1.270mm, 2 Teeth	AB5310 (MLS), 1.320mm, 3 Teeth	AB5320 (MLS), 1.370mm, 4 Teeth	AB5330 (MLS), 1.420mm, 5 Teeth	AB5340 (MLS), 1.470mm, 6 Teeth	AB5350 (MLS), 1.520mm, 7 Teeth
Transit 1.8 TDCi	08/06→											
1.8		RWPD Diesel					271			DZ720 ▲ [3]	EZ720 [3]	
Tourneo Con.	08/06→	1753	4	82.50	SOHC/OHC	81/110	AB5300 (MLS), 1.270mm, 2 Teeth	AB5310 (MLS), 1.320mm, 3 Teeth	AB5320 (MLS), 1.370mm, 4 Teeth	AB5330 (MLS), 1.420mm, 5 Teeth	AB5340 (MLS), 1.470mm, 6 Teeth	AB5350 (MLS), 1.520mm, 7 Teeth
Transit 1.8 TDCi	08/06→											
1.8		RWPE Diesel					272			DZ720 ▲ [3]	EZ720 [3]	
Tourneo Con.	06/02→	1753	4	82.50	SOHC/OHC	66/90	AB5300 (MLS), 1.270mm, 2 Teeth	AB5310 (MLS), 1.320mm, 3 Teeth	AB5320 (MLS), 1.370mm, 4 Teeth	AB5330 (MLS), 1.420mm, 5 Teeth	AB5340 (MLS), 1.470mm, 6 Teeth	AB5350 (MLS), 1.520mm, 7 Teeth
Transit 1.8 TDCi	06/02→											
1.8		RWPF Diesel					273			DZ720 ▲ [3]	EZ720 [3]	
Tourneo Con.	06/02→	1753	4	82.50	SOHC/OHC	66/90	AB5300 (MLS), 1.270mm, 2 Teeth	AB5310 (MLS), 1.320mm, 3 Teeth	AB5320 (MLS), 1.370mm, 4 Teeth	AB5330 (MLS), 1.420mm, 5 Teeth	AB5340 (MLS), 1.470mm, 6 Teeth	AB5350 (MLS), 1.520mm, 7 Teeth
Transit 1.8 TDCi	06/02→											

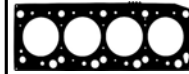
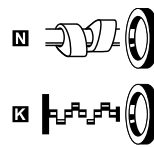
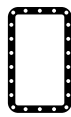
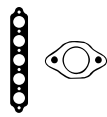

AB5300, AB5310,
AB5320, AB5330,
AB5340, AB5350



AB5800, AB5810,
AB5820



BW010, BW020,
BW030



JD309



JD310



JM5016



JN816



JJ463

FORD



cc



kW/PS



1.9	1Z Diesel					274	BX800 (MLS), 1.450mm, 1 Hole BX810 (MLS), 1.530mm, 2 Holes BX820 (MLS), 1.610mm, 3 Holes	DX800 ▲	ECO30 [18]
Galaxy 1.9 TDI	03/95→05/06	1896	4	79.50	SOHC/OHC	66/90			
1.9	AFN Diesel					275	BX800 (MLS), 1.450mm, 1 Hole BX810 (MLS), 1.530mm, 2 Holes BX820 (MLS), 1.610mm, 3 Holes	DX800 ▲	ECO30 [18]
Galaxy 1.9 TDI	08/97→04/00	1896	4	79.50	SOHC/OHC	81/110			
1.9	AHU Diesel					276	BX800 (MLS), 1.450mm, 1 Hole BX810 (MLS), 1.530mm, 2 Holes BX820 (MLS), 1.610mm, 3 Holes	DX800 ▲	ECO30 [18]
Galaxy 1.9 TDI	03/95→05/06	1896	4	79.50	SOHC/OHC	66/90			
1.9	ANU Diesel					277	BX800 (MLS), 1.450mm, 1 Hole BX810 (MLS), 1.530mm, 2 Holes BX820 (MLS), 1.610mm, 3 Holes	DX800 ▲	ECO30 [18]
Galaxy 1.9 TDI	03/95→05/06	1896	4	79.50	SOHC/OHC	66/90			
1.9	ASZ Diesel					278	AF5381 (MLS), 1.490mm, 1 Hole AF5391 (MLS), 1.530mm, 2 Holes AF5401 (MLS), 1.650mm, 3 Holes	CC5230 ▲	ECO60 [18]
Galaxy 1.9 TDI	02/03→05/06	1896	4	79.50	SOHC/OHC	96/130			
1.9	AUY Diesel					279	AF5381 (MLS), 1.490mm, 1 Hole AF5391 (MLS), 1.530mm, 2 Holes AF5401 (MLS), 1.650mm, 3 Holes	CC5231 ▲	ECO60 [18]
Galaxy 1.9 TDI	04/00→05/06	1896	4	79.50	SOHC/OHC	85/115			
1.9	AVG Diesel					280	BX800 (MLS), 1.450mm, 1 Hole BX810 (MLS), 1.530mm, 2 Holes BX820 (MLS), 1.610mm, 3 Holes	DX800 ▲	ECO30 [18]
Galaxy 1.9 TDI	08/97→04/00	1896	4	79.50	SOHC/OHC	81/110			
1.9	BTB Diesel					281	AF5381 (MLS), 1.490mm, 1 Hole AF5391 (MLS), 1.530mm, 2 Holes AF5401 (MLS), 1.650mm, 3 Holes	CC5230 ▲	ECO60 [18]
Galaxy 1.9 TDI	05/05→05/06	1896	4	79.50	SOHC/OHC	110/150			
2.0	ABFA Diesel					282	AA5970 (MLS), 1.100mm, 1 Hole AA5980 (MLS), 1.150mm, 2 Holes AA5990 (MLS), 1.200mm, 3 Holes	CA5970 ▲ [3]	EA5970 [3]
Transit 2.0 DI	08/00→05/06	1998	4	86.00	DOHC	74/100			
2.0	ALDA					283	AE5320 (MLS)		
Focus ST170	03/02→11/04	1988	4	84.80	DOHC	127/173			

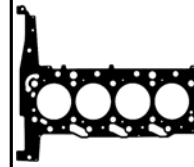
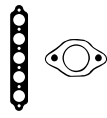

HBS018 [19]
M12x1.75x115.00mm (x10)

JD170 [1]
JC152 [2]

JP003 [4]
HM5367 [3]

JJ609
(ACM)

HR363 [3]
→04/96
HR646 [3]
05/96→

NA5001 [1][2]
32.00x47.00x10.00mm, FPM
NA5001 [1][2]
32.00x47.00x10.00mm, FPM
NA5133 [1]
85.00x105.00x11.00mm, FPM

**AA5970, AA5980,
AA5990**



AE5320



**BX800, BX810,
BX820**



JA5085

HBS018 [19]
M12x1.75x115.00mm (x10)

JD170 [1]
JC152 [2]

JP003 [4]
HM5367 [3]

JJ609
(ACM)

HR816 [3]

NA5001 [1][2]
32.00x47.00x10.00mm, FPM
NA5001 [1][2]
32.00x47.00x10.00mm, FPM
NA5133 [1]
85.00x105.00x11.00mm, FPM



JC152



JD170

HBS018 [19]
M12x1.75x115.00mm (x10)

JD170 [1]
JC152 [2]

JP003 [4]
HM5367 [3]

JJ609
(ACM)

HR363 [3]
→04/96
HR646 [3]
05/96→

NA5001 [1][2]
32.00x47.00x10.00mm, FPM
NA5001 [1][2]
32.00x47.00x10.00mm, FPM
NA5133 [1]
85.00x105.00x11.00mm, FPM

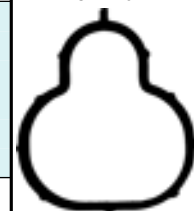

JD5311



JD5313



JD600

HBS018 [19]
M12x1.75x115.00mm (x10)

JD170 [1]
JC152 [2]

JP003 [4]
HM5367 [3]

JJ609
(ACM)

HR363 [3]
→04/96
HR646 [3]
05/96→

NA5001 [1][2]
32.00x47.00x10.00mm, FPM
NA5001 [1][2]
32.00x47.00x10.00mm, FPM
NA5133 [1]
85.00x105.00x11.00mm, FPM



JD600



JM5037

HBS300 [19]
M12x1.75x166.00mm (x10)

JD170 [1]
JD600 [2]

JM5203
(Elastomer)

HR816 [3]

NA5124 [2]
32.00x47.00x10.00mm, PTFE/ACM
NA5106 [2]
35.00x48.00x10.00mm, PTFE
LK5003 [1][7]
85.00x131.00x15.700mm, PTFE

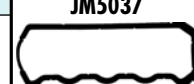

JP003



HC5004

HBS300 [19]
M12x1.75x166.00mm (x10)

JD170 [1]
JD600 [2]

JM5203
(Elastomer)

HR816 [3]

NA5124 [2]
32.00x47.00x10.00mm, PTFE/ACM
NA5106 [2]
35.00x48.00x10.00mm, PTFE
LK5003 [1][7]
85.00x131.00x15.700mm, PTFE

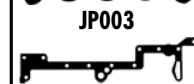

JH5061



JH5061

HBS018 [19]
M12x1.75x115.00mm (x10)

JD170 [1]
JC152 [2]

JP003 [4]
HM5367 [3]

JJ609
(ACM)

HR816 [3]

NA5001 [1][2]
32.00x47.00x10.00mm, FPM
NA5001 [1][2]
32.00x47.00x10.00mm, FPM
NA5133 [1]
85.00x105.00x11.00mm, FPM

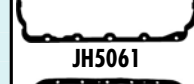

JH5061



JJ609

HBS300 [19]
M12x1.75x166.00mm (x10)

JD170 [1]
JD600 [2]

JM5203
(Elastomer)

HR816 [3]

NA5124 [2]
32.00x47.00x10.00mm, PTFE/ACM
NA5106 [2]
35.00x48.00x10.00mm, PTFE
LK5003 [1][7]
85.00x131.00x15.700mm, PTFE



JH5061

HBS296 [22]
M10x1.50x159.00mm (x10)

HA5020 [1][3]
JA5085 [2]

JM5037
(Elastomer)

HC5004 [3]

HR5082 [3]

NA5028 [1]
36.00x50.00x7.00mm, PTFE
NA5031 [2]
50.00x86.50x13.70mm, PTFE
NA5030 [1]
106.00x196.00x15.20mm, FPM



JH5061

HBS031 [22]
M10x1.50x102.00mm (x10)

JD5311 [1] (x4)
JD5313 [2]

JH5061

JH5061

HR5063 [3]

NB958 [1] (x2) [2]
42.00x53.00x7.00mm, FPM
NB959 [2]
35.00x50.00x7.00mm, FPM
NB847 [1]
88.00x108.00x11.00mm, FPM

FORD



cc



kW/PS



2.0	AOBA	284	AD5220 (MLS)	CD5221 [3]	
Mondeo IV 2.0	03/07→	1999 4 87.50 DOHC 107/145			
2.0	AOBC	285	AD5220 (MLS)	CD5221 [3]	
Mondeo IV 2.0	03/07→	1999 4 87.50 DOHC 107/145			
2.0	AODA	286	AD5220 (MLS)	CD5221 [3]	ED5220 [3]
C-MAX 2.0 Focus C-MAX Focus II 2.0	02/07→ 03/04→03/07 11/04→	1999 4 87.50 DOHC 107/145			
2.0	AODB	287	AD5220 (MLS) AY061 (Fibre), 2.000mm (x2)	CD5221 [3]	ED5220 [3]
C-MAX 2.0 Focus C-MAX Focus II 2.0	02/07→ 03/04→03/07 11/04→	1999 4 87.50 DOHC 107/145			
2.0	AODE	288	AD5220 (MLS)	CD5221 [3]	ED5220 [3]
C-MAX 2.0	02/07→	1999 4 87.50 DOHC 107/145			
2.0	AOWA	289	AD5220 (MLS)	CD5221 [3]	ED5220 [3]
Galaxy 2.0 S-Max 2.0	05/06→ 05/06→	1999 4 87.50 DOHC 107/145			
2.0	AOWB	290	AD5220 (MLS)	CD5221 [3]	ED5220 [3]
Galaxy 2.0 S-Max 2.0	05/06→ 05/06→	1999 4 87.50 DOHC 107/145			
2.0	AZBA Diesel	291	AD5490 (MLS), 1.250mm, 2 Notches AD5500 (MLS), 1.300mm, 3 Holes AD5510 (MLS), 1.350mm, 4 Holes AD5520 (MLS), 1.400mm, 5 Holes	CD5500 ▲	ED5500
Mondeo IV TDCi	03/07→	1997 4 86.00 DOHC 96/131			
2.0	AZBC Diesel	292	AD5490 (MLS), 1.250mm, 2 Notches AD5500 (MLS), 1.300mm, 3 Holes AD5510 (MLS), 1.350mm, 4 Holes AD5520 (MLS), 1.400mm, 5 Holes	CD5500 ▲	ED5500
Mondeo IV TDCi	03/07→	1997 4 85.00 DOHC 100-103/ 136-140			

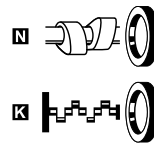
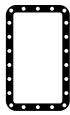
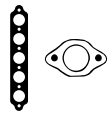

AD5220













AD5490, AD5500,
AD5510, AD5520



JD5299



JE5037

HBS369  [5] M10x1.50x145.50mm (x10)	JD5299  (x4) JE5037 	JM5153 [78] (Elastomer)	HR397	HR5063 	NA5157 [2] 37.00x50.00x8.00mm, PTFE NA5157  [2] 37.00x50.00x8.00mm, PTFE LK5005  [1] [7] 88.00x188.00x15.000mm, PTFE	
HBS369  [5] M10x1.50x145.50mm (x10)	JD5299  (x4) JE5037 	JM5153 [78] (Elastomer)	HR397	HR5063 	NA5157 [2] 37.00x50.00x8.00mm, PTFE NA5157  [2] 37.00x50.00x8.00mm, PTFE LK5005  [1] [7] 88.00x188.00x15.000mm, PTFE	
HBS369  [5] M10x1.50x145.50mm (x10)	JD5299  (x4) JE5037 	JM5153 [78] (Elastomer)	HR397	HR5063 	NA5157 [2] 37.00x50.00x8.00mm, PTFE NA5157  [2] 37.00x50.00x8.00mm, PTFE LK5005  [1] [7] 88.00x188.00x15.000mm, PTFE	
HBS369  [5] M10x1.50x145.50mm (x10)	JD5299  (x4) JE5037 	JM5153 [78] (Elastomer)	HR397	HR5063 	NA5157 [2] 37.00x50.00x8.00mm, PTFE NA5157  [2] 37.00x50.00x8.00mm, PTFE LK5005  [1] [7] 88.00x188.00x15.000mm, PTFE	
HBS369  [5] M10x1.50x145.50mm (x10)	JD5299  (x4) JE5037 	JM5153 [78] (Elastomer)	HR397	HR5063 	NA5157 [2] 37.00x50.00x8.00mm, PTFE NA5157  [2] 37.00x50.00x8.00mm, PTFE LK5005  [1] [7] 88.00x188.00x15.000mm, PTFE	
HBS369  [5] M10x1.50x145.50mm (x10)	JD5299  (x4) JE5037 	JM5153 [78] (Elastomer)	HR397	HR5063 	NA5157 [2] 37.00x50.00x8.00mm, PTFE NA5157  [2] 37.00x50.00x8.00mm, PTFE LK5005  [1] [7] 88.00x188.00x15.000mm, PTFE	
HBS369  [5] M10x1.50x145.50mm (x10)	JD5299  (x4) JE5037 	JM5153 [78] (Elastomer)	HR397	HR5063 	NA5157 [2] 37.00x50.00x8.00mm, PTFE NA5157  [2] 37.00x50.00x8.00mm, PTFE LK5005  [1] [7] 88.00x188.00x15.000mm, PTFE	
HBS368  [22]	JD5881 	HM5289 			NA5035 [2] 27.00x47.00x7.00mm, FPM NA5191  [2] 42.00x62.00x7.00mm, PTFE NA5192  [1] 90.00x110.00x7.00mm, PTFE	
HBS368  [22]	JD5881 	HM5289 			NA5035 [2] 27.00x47.00x7.00mm, FPM NA5191  [2] 42.00x62.00x7.00mm, PTFE NA5192  [1] 90.00x110.00x7.00mm, PTFE	













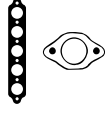

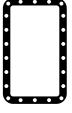

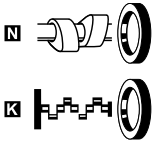

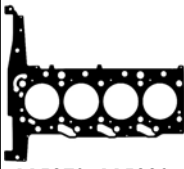
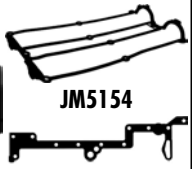
cc

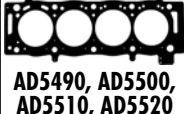

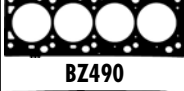
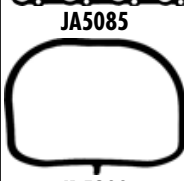
kW/PS

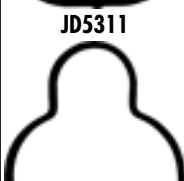
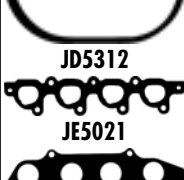

2.0	AZWA Diesel					293	AD5490 (MLS), 1.250mm, 2 Notches AD5500 (MLS), 1.300mm, 3 Holes AD5510 (MLS), 1.350mm, 4 Holes AD5520 (MLS), 1.400mm, 5 Holes	CD5500 ▲	ED5500
Galaxy 2.0 TDCi S-Max 2.0 TDCi	05/06→ 05/06→	1997	4	85.00	DOHC	96/130			
2.0	AZWC Diesel					294	AD5490 (MLS), 1.250mm, 2 Notches AD5500 (MLS), 1.300mm, 3 Holes AD5510 (MLS), 1.350mm, 4 Holes AD5520 (MLS), 1.400mm, 5 Holes	CD5500 ▲	ED5500
Galaxy 2.0 TDCi S-Max 2.0 TDCi	05/06→ 05/06→	1997	4	85.00	DOHC	100/136			
2.0	CJBA					295	AD5220 (MLS)	CD5220 [3][79] CD5221 [3][78]	ED5220 [3]
Mondeo III 16V	11/00→08/07	1999	4	87.50	DOHC	107/146			
2.0	CJBB					296	AD5220 (MLS)	CD5220 [3][79] CD5221 [3][78]	ED5220 [3]
Mondeo III 16V	11/00→08/07	1999	4	87.50	DOHC	107/146			
2.0	D3FA Diesel					297	AA5970 (MLS), 1.100mm, 1 Hole AA5980 (MLS), 1.150mm, 2 Holes AA5990 (MLS), 1.200mm, 3 Holes	CA5970 ▲ [3]	EA5970 [3]
Transit 2.0 DI	08/00→05/06	1998	4	86.00	DOHC	55/75			
2.0	D5BA Diesel					298	AA5970 (MLS), 1.100mm, 1 Hole AA5980 (MLS), 1.150mm, 2 Holes AA5990 (MLS), 1.200mm, 3 Holes	CA5970 ▲ [3]	EA5970 [3]
Mondeo III 16V	11/00→08/07	1998	4	86.00	DOHC	66/90			
2.0	D6BA Diesel					299	AA5970 (MLS), 1.100mm, 1 Hole AA5980 (MLS), 1.150mm, 2 Holes AA5990 (MLS), 1.200mm, 3 Holes	CA5970 ▲ [3]	EA5970 [3]
Mondeo III 16V	11/00→08/07	1998	4	86.00	DOHC	85/115			
2.0	EDBA					300	BZ490 (MLS) →04/99 AE5320 (MLS) 02/99→	CE5320 [3] →04/99 DZ490 [3]	EC5800 [3] 05/99→
Cougar 2.0 16V	08/98→12/01	1988	4	84.80	DOHC	96/131			

									 AA5970, AA5980, AA5990	 JM5154
HBS368 [22]	JD5881 [E]	HM5289 [E]					NA5035 [2] 27.00x47.00x7.00mm, FPM NA5191 [2] 42.00x62.00x7.00mm, PTFE NA5192 [1] 90.00x110.00x7.00mm, PTFE		 AD5220	 HC5004
HBS368 [22]	JD5881 [E]	HM5289 [E]					NA5035 [2] 27.00x47.00x7.00mm, FPM NA5191 [2] 42.00x62.00x7.00mm, PTFE NA5192 [1] 90.00x110.00x7.00mm, PTFE		 AD5490, AD5500, AD5510, AD5520	 JH5061
HBS369 [5] M10x1.50x145.50mm (x10)	JD5299 [x4] JE5037 [E]	JM5153 [78] (Elastomer) JM5158 [79] (Elastomer)			HR5063 [E]		NA5157 [2] 37.00x50.00x8.00mm, PTFE NA5157 [2] 37.00x50.00x8.00mm, PTFE LK5005 [1][7] 88.00x188.00x15.000mm, PTFE		 AE5320	
HBS369 [5] M10x1.50x145.50mm (x10)	JD5299 [x4] JE5037 [E]	JM5153 [78] (Elastomer) JM5158 [79] (Elastomer)			HR5063 [E]		NA5157 [2] 37.00x50.00x8.00mm, PTFE NA5157 [2] 37.00x50.00x8.00mm, PTFE LK5005 [1][7] 88.00x188.00x15.000mm, PTFE		 BZ490	
HBS296 [22] M10x1.50x159.00mm (x10)	HA5020 [E] JA5085 [E]	JM5037 (Elastomer)	HC5004 [E]		HR5082 [E]		NA5028 [1] 36.00x50.00x7.00mm, PTFE NA5031 [2] 50.00x86.50x13.70mm, PTFE NA5030 [1] 106.00x196.00x15.20mm, FPM		 JA5085	
HBS296 [22] M10x1.50x159.00mm (x10)	HA5020 [E] JA5085 [E]	JM5037 (Elastomer)	HC5004 [E]		HR5082 [E]		NA5028 [1] 36.00x50.00x7.00mm, PTFE NA5031 [2] 50.00x86.50x13.70mm, PTFE NA5030 [1] 106.00x196.00x15.20mm, FPM		 JD5299	
HBS296 [22] M10x1.50x159.00mm (x10)	HA5020 [E] JA5085 [E]	JM5037 (Elastomer)	HC5004 [E]		HR5082 [E]		NA5028 [1] 36.00x50.00x7.00mm, PTFE NA5031 [2] 50.00x86.50x13.70mm, PTFE NA5030 [1] 106.00x196.00x15.20mm, FPM		 JD5311	
HBS296 [22] M10x1.50x159.00mm (x10)	HA5020 [E] JA5085 [E]	JM5037 (Elastomer)	HC5004 [E]		HR5082 [E]		NA5028 [1] 36.00x50.00x7.00mm, PTFE NA5031 [2] 50.00x86.50x13.70mm, PTFE NA5030 [1] 106.00x196.00x15.20mm, FPM		 JD5312	
HBS031 [22] M10x1.50x102.00mm (x10)	JD5311 [x4] →09/99 JD5312 [x4] 10/99→ JE5021 [E]	JM5154 (SE) →09/99 JM5184 (Elastomer) Pale blue 10/99→	JH5061		HR5033 [E]		NB958 [2] 42.00x53.00x7.00mm, FPM NB959 [2] 35.00x50.00x7.00mm, FPM NA5066 [2] 35.00x50.00x10.00mm, ACM NB847 [1] 88.00x108.00x11.00mm, FPM NA5323 [2] 35.00x50.00x7.00mm, PTFE 01/99→		 JE5021	 JE5037
									 JM5037	



cc



kW/PS



2.0	EDBB						301	BZ490 (MLS) →01/99 AE5320 (MLS) 02/99→	DZ490 [3] →04/99 CE5320 [3] 05/99→	EC5800 [3]
Cougar 2.0 16V	08/98→12/01	1988	4	84.80	DOHC	96/131				
2.0	EDBC <th colspan="5"></th> <th>302</th> <th>BZ490 (MLS) →01/99 AE5320 (MLS) 02/99→</th> <th>DZ490 [3] →04/99 CE5320 [3] 05/99→</th> <th> EC5800 [3]</th>						302	BZ490 (MLS) →01/99 AE5320 (MLS) 02/99→	DZ490 [3] →04/99 CE5320 [3] 05/99→	EC5800 [3]
Cougar 2.0 16V	08/98→12/01	1988	4	84.80	DOHC	96/131				
2.0	EDBD <th colspan="5"></th> <th>303</th> <th>BZ490 (MLS) →01/99 AE5320 (MLS) 02/99→</th> <th>DZ490 [3] →04/99 CE5320 [3] 05/99→</th> <th> EC5800 [3]</th>						303	BZ490 (MLS) →01/99 AE5320 (MLS) 02/99→	DZ490 [3] →04/99 CE5320 [3] 05/99→	EC5800 [3]
Cougar 2.0 16V	08/98→12/01	1988	4	84.80	DOHC	96/131				
2.0	EDDB <th colspan="5"></th> <th>304</th> <th>BZ490 (MLS) →01/99 AE5320 (MLS) 02/99→</th> <th>DZ490 [3] →04/99 CE5320 [3] 05/99→</th> <th> EC5800 [3]</th>						304	BZ490 (MLS) →01/99 AE5320 (MLS) 02/99→	DZ490 [3] →04/99 CE5320 [3] 05/99→	EC5800 [3]
Focus 2.0 16V	10/98→11/04	1988	4	84.80	DOHC	96/131				
2.0	EDDC <th colspan="5"></th> <th>305</th> <th>BZ490 (MLS) →01/99 AE5320 (MLS) 02/99→</th> <th>DZ490 [3] →04/99 CE5320 [3] 05/99→</th> <th> EC5800 [3]</th>						305	BZ490 (MLS) →01/99 AE5320 (MLS) 02/99→	DZ490 [3] →04/99 CE5320 [3] 05/99→	EC5800 [3]
Focus 2.0 16V	10/98→11/04	1988	4	84.80	DOHC	96/131				
2.0	EDDD <th colspan="5"></th> <th>306</th> <th>BZ490 (MLS) →01/99 AE5320 (MLS) 02/99→</th> <th>DZ490 [3] →04/99 CE5320 [3] 05/99→</th> <th> EC5800 [3]</th>						306	BZ490 (MLS) →01/99 AE5320 (MLS) 02/99→	DZ490 [3] →04/99 CE5320 [3] 05/99→	EC5800 [3]
Focus 2.0 16V	10/98→11/04	1988	4	84.80	DOHC	96/131				

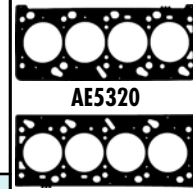

AE5320

BZ490



JD5311

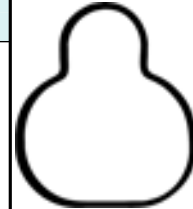

JD5312



JD5313



JE5021



JM5154



JH5061



cc



kW/PS



2.0	EDDF						307	BZ490 (MLS) AE5320 (MLS) 02/99→	DZ490 [3] →04/99 CE5320 [3] 05/99→	EC5800 [3]
Focus 2.0 16V	10/98→11/04	1988	4	84.80	DOHC		96/131			
2.0	F3FA Diesel						308	AA5970 (MLS), 1.100mm, 1 Hole AA5980 (MLS), 1.150mm, 2 Holes AA5990 (MLS), 1.200mm, 3 Holes	CA5970 ▲ [3]	EA5970 [3]
Transit 2.0 DI	08/00→05/06	1998	4	86.00	DOHC		63/86			
2.0	FIFA Diesel						309	AA5970 (MLS), 1.100mm, 1 Hole AA5980 (MLS), 1.150mm, 2 Holes AA5990 (MLS), 1.200mm, 3 Holes	CA5970 ▲ [3]	EA5970 [3]
Transit 2.0 TDCi	08/02→05/06	1998	4	86.00	DOHC		92/125			
2.0	FMBA Diesel						310	AA5970 (MLS), 1.100mm, 1 Hole AA5980 (MLS), 1.150mm, 2 Holes AA5990 (MLS), 1.200mm, 3 Holes	CA5970 ▲ [3] →05/02	EA5970 [3]
Mondeo III TDCi	10/01→08/07	1998	4	86.00	DOHC		96/130			
2.0	G6DA Diesel						311	AD5490 (MLS), 1.250mm, 2 Notches AD5500 (MLS), 1.300mm, 3 Holes AD5510 (MLS), 1.350mm, 4 Holes AD5520 (MLS), 1.400mm, 5 Holes	CD5500 ▲	ED5500
C-MAX 2.0 TDCi	02/07→	1997	4	85.00	DOHC		100/136			
Focus C-MAX	10/03→03/07									
Focus II TDCi	11/04→									
2.0	G6DB Diesel						312	AD5490 (MLS), 1.250mm, 2 Notches AD5500 (MLS), 1.300mm, 3 Holes AD5510 (MLS), 1.350mm, 4 Holes AD5520 (MLS), 1.400mm, 5 Holes	CD5500 ▲	ED5500
C-MAX 2.0 TDCi	02/07→	1997	4	85.00	DOHC		100/136			
Focus C-MAX	10/03→03/07									
Focus II TDCi	11/04→									
2.0	G6DC Diesel						313	AD5490 (MLS), 1.250mm, 2 Notches AD5500 (MLS), 1.300mm, 3 Holes AD5510 (MLS), 1.350mm, 4 Holes AD5520 (MLS), 1.400mm, 5 Holes	CD5500 ▲	ED5500
C-MAX 2.0 TDCi	02/07→	1997	4	85.00	DOHC		98/133			
Focus C-MAX	10/03→03/07									
2.0	G6DD Diesel						314	AD5490 (MLS), 1.250mm, 2 Notches AD5500 (MLS), 1.300mm, 3 Holes AD5510 (MLS), 1.350mm, 4 Holes AD5520 (MLS), 1.400mm, 5 Holes	CD5500 ▲	ED5500
C-MAX 2.0 TDCi	02/07→	1997	4	85.00	DOHC		100/136			
Focus C-MAX	10/03→03/07									
Focus II TDCi	11/04→									
2.0	G6DE Diesel						315	AD5490 (MLS), 1.250mm, 2 Notches AD5500 (MLS), 1.300mm, 3 Holes AD5510 (MLS), 1.350mm, 4 Holes AD5520 (MLS), 1.400mm, 5 Holes	CD5500 ▲	ED5500
C-MAX 2.0 TDCi	02/07→	1997	4	85.00	DOHC		98/133			
Focus C-MAX	10/03→03/07									
Focus II TDCi	11/04→									

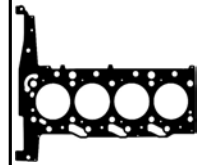
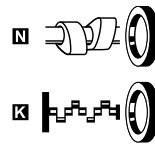
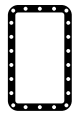
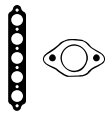

HBS031 [22]
M10x1.50x102.00mm (x10)

JD5311 [1] (x4)
→09/99
JD5312 [1] (x4)
10/99→
JD5313 [3]

JM5154
(SE)
→09/99
JM5184
(Elastomer)
Pale blue
10/99→

JH5061

HR5033 [3]

NA958 [2]
42.00x53.00x7.00mm, FPM
NA5066 [2]
35.00x50.00x10.00mm, ACM
NB959 [2]
35.00x50.00x7.00mm, FPM
NA5066 [2]
35.00x50.00x10.00mm, ACM
NB847 [1]
88.00x108.00x11.00mm, FPM

AA5970, AA5980, AA5990



AD5490, AD5500, AD5510, AD5520



AE5320



BZ490



JA5085

HBS296 [22]
M10x1.50x159.00mm (x10)

HA5020 [1] [3]
JA5085 [3]

JM5037
(Elastomer)

HC5004 [3]

HR5082 [3]

NA5028 [1]
36.00x50.00x7.00mm, PTFE
NA5031 [2]
50.00x86.50x13.70mm, PTFE
NA5030 [1]
106.00x196.00x15.20mm, FPM

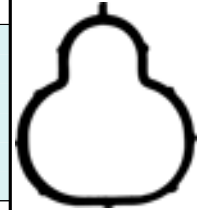

JD5311

HBS296 [22]
M10x1.50x159.00mm (x10)

HA5020 [1] [3]
JA5085 [3]

JM5037
(Elastomer)

HC5004 [3]

HR5082 [3]

NA5028 [1]
36.00x50.00x7.00mm, PTFE
NA5031 [2]
50.00x86.50x13.70mm, PTFE
NA5030 [1]
106.00x196.00x15.20mm, FPM

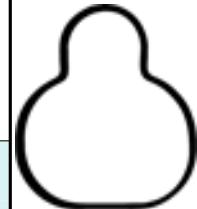

JD5312

HBS296 [22]
M10x1.50x159.00mm (x10)

HA5020 [1] [3]
JA5085 [3]
→05/02
JE5059 [85]
0.600mm
06/02→

JM5037
(Elastomer)

HC5004 [3]

HR5082 [3]

NA5028 [1]
36.00x50.00x7.00mm, PTFE
NA5031 [2]
50.00x86.50x13.70mm, PTFE
NA5030 [1]
106.00x196.00x15.20mm, FPM



JD5313

HBS368 [22]

JD5881 [3]

HM5289 [3]

JH5118

HR5046 [3]

NA5035 [2]
27.00x47.00x7.00mm, FPM
NA5191 [2]
42.00x62.00x7.00mm, PTFE
NA5192 [1]
90.00x110.00x7.00mm, PTFE



JM5037

HBS368 [22]

JD5881 [3]

HM5289 [3]

JH5118

HR5046 [3]

NA5035 [2]
27.00x47.00x7.00mm, FPM
NA5191 [2]
42.00x62.00x7.00mm, PTFE
NA5192 [1]
90.00x110.00x7.00mm, PTFE



JM5154

HBS368 [22]

JD5881 [3]

HM5289 [3]

JH5118

HR5046 [3]

NA5035 [2]
27.00x47.00x7.00mm, FPM
NA5191 [2]
42.00x62.00x7.00mm, PTFE
NA5192 [1]
90.00x110.00x7.00mm, PTFE

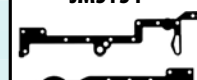

HC5004

HBS368 [22]

JD5881 [3]

HM5289 [3]

JH5118

HR5046 [3] (x2)

NA5035 [2]
27.00x47.00x7.00mm, FPM
NA5191 [2]
42.00x62.00x7.00mm, PTFE
NA5192 [1]
90.00x110.00x7.00mm, PTFE



JH5061

HBS368 [22]

JD5881 [3]

HM5289 [3]

JH5118

HR5046 [3] (x2)

NA5035 [2]
27.00x47.00x7.00mm, FPM
NA5191 [2]
42.00x62.00x7.00mm, PTFE
NA5192 [1]
90.00x110.00x7.00mm, PTFE



cc



kW/PS



2.0	G6DF Diesel					316	AD5490 (MLS), 1.250mm, 2 Notches AD5500 (MLS), 1.300mm, 3 Holes AD5510 (MLS), 1.350mm, 4 Holes AD5520 (MLS), 1.400mm, 5 Holes	CD5500 ▲	ED5500
C-MAX 2.0 TDCi	02/07→	1997	4	85.00	DOHC	98/133			
Focus C-MAX	10/03→03/07								
Focus II TDCi	11/04→								
2.0	G6DG Diesel					317	AD5490 (MLS), 1.250mm, 2 Notches AD5500 (MLS), 1.300mm, 3 Holes AD5510 (MLS), 1.350mm, 4 Holes AD5520 (MLS), 1.400mm, 5 Holes	CD5500 ▲	ED5500
C-MAX 2.0 TDCi	02/07→	1997	4	85.00	DOHC	100/136			
Focus C-MAX	10/03→03/07								
Kuga 2.0 TDCi	03/08→								
Kuga TDCi 4x4	03/08→								
2.0	HJBA Diesel					318	AA5970 (MLS), 1.100mm, 1 Hole AA5980 (MLS), 1.150mm, 2 Holes AA5990 (MLS), 1.200mm, 3 Holes	CA5970 ▲ [3] →05/02	EA5970 [3]
Mondeo III 16V	11/00→08/07	1998	4	86.00	DOHC	85/115			
2.0	HJBB Diesel					319	AA5970 (MLS), 1.100mm, 1 Hole AA5980 (MLS), 1.150mm, 2 Holes AA5990 (MLS), 1.200mm, 3 Holes	CA5970 ▲ [3] →05/02	EA5970 [3]
Mondeo III 16V	11/00→08/07	1998	4	86.00	DOHC	85/115			
2.0	HJBC Diesel					320	AA5970 (MLS), 1.100mm, 1 Hole AA5980 (MLS), 1.150mm, 2 Holes AA5990 (MLS), 1.200mm, 3 Holes	CA5970 ▲ [3] →05/02	EA5970 [3]
Mondeo III 16V	11/00→08/07	1998	4	86.00	DOHC	85/115			
2.0	HMDA					321	AE5320 (MLS)		
Focus RS	10/02→11/04	1988	4	84.80	DOHC	158/215			
2.0	IXDA Diesel					322	AD5490 (MLS), 1.250mm, 2 Notches AD5500 (MLS), 1.300mm, 3 Holes AD5510 (MLS), 1.350mm, 4 Holes AD5520 (MLS), 1.400mm, 5 Holes	CD5500 ▲	ED5500
C-MAX 2.0 TDCi	02/08→	1997	4		DOHC	81/110			
Focus II TDCi	02/08→								
2.0	KLBA Diesel					323	AD5490 (MLS), 1.250mm, 2 Notches AD5500 (MLS), 1.300mm, 3 Holes AD5510 (MLS), 1.350mm, 4 Holes AD5520 (MLS), 1.400mm, 5 Holes	CD5500 ▲	ED5500
Mondeo IV TDCi	11/07→	1997	4	85.00	DOHC	85/116			
2.0	KLWA Diesel					324	AD5490 (MLS), 1.250mm, 2 Notches AD5500 (MLS), 1.300mm, 3 Holes AD5510 (MLS), 1.350mm, 4 Holes AD5520 (MLS), 1.400mm, 5 Holes	CD5500 ▲	ED5500
Galaxy 2.0 TDCi	11/07→	1997	4		DOHC	85/115			
S-Max 2.0 TDCi	11/07→								
2.0	LPBA Diesel					325	AD5490 (MLS), 1.250mm, 2 Notches AD5500 (MLS), 1.300mm, 3 Holes AD5510 (MLS), 1.350mm, 4 Holes AD5520 (MLS), 1.400mm, 5 Holes	CD5500 ▲	ED5500
Mondeo IV TDCi	11/07→	1997	4	86.00	DOHC	85/115			

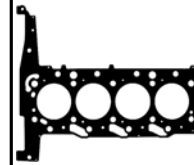
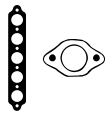

AA5970, AA5980, AA5990



AD5490, AD5500, AD5510, AD5520



AE5320



JA5085



JM5037



JD5312



JD5313

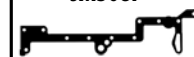

JM5037



HC5004



JH5061

HBS368 [22]

JD5881 [2]

HM5289 [2]

JH5118

HR5046 [x2]

NA5035 [2]
27.00x47.00x7.00mm, FPM
NA5191 [2]
42.00x62.00x7.00mm, PTFE
NA5192 [1]
90.00x110.00x7.00mm, PTFE

!

HBS368 [22]

JD5881 [2]

HM5289 [2]

JH5118

HR5046 [2]

NA5035 [2]
27.00x47.00x7.00mm, FPM
NA5191 [2]
42.00x62.00x7.00mm, PTFE
NA5192 [1]
90.00x110.00x7.00mm, PTFE

!

HBS296 [22]
M10x1.50x159.00mm (x10)

HA5020 [2]
JA5085 [2]

JM5037
(Elastomer)

HC5004 [2]

HR5082 [2]

NA5028 [1]
36.00x50.00x7.00mm, PTFE
NA5031 [2]
50.00x86.50x13.70mm, PTFE
NA5030 [1]
106.00x196.00x15.20mm, FPM

!

HBS296 [22]
M10x1.50x159.00mm (x10)

HA5020 [2]
JA5085 [2]

JM5037
(Elastomer)

HC5004 [2]

HR5082 [2]

NA5028 [1]
36.00x50.00x7.00mm, PTFE
NA5031 [2]
50.00x86.50x13.70mm, PTFE
NA5030 [1]
106.00x196.00x15.20mm, FPM

!

HBS296 [22]
M10x1.50x159.00mm (x10)

HA5020 [2]
JA5085 [2]

JM5037
(Elastomer)

HC5004 [2]

HR5082 [2]

NA5028 [1]
36.00x50.00x7.00mm, PTFE
NA5031 [2]
50.00x86.50x13.70mm, PTFE
NA5030 [1]
106.00x196.00x15.20mm, FPM

!

HBS031 [22]
M10x1.50x102.00mm (x10)

JD5312 [4]
JD5313 [2]

JM5184
(Elastomer)
Pale blue

JH5061

HR5033 [2]

NB958 [2]
42.00x53.00x7.00mm, FPM
NA5323 [2]
35.00x50.00x7.00mm, PTFE

!

HBS368 [22]

JD5881 [2]

HM5289 [2]

JH5118

HR5046 [2]

NA5035 [2]
27.00x47.00x7.00mm, FPM
NA5191 [2]
42.00x62.00x7.00mm, PTFE
NA5192 [1]
90.00x110.00x7.00mm, PTFE

!

HBS368 [22]

JD5881 [2]

HM5289 [2]

JH5118

HR5046 [2]

NA5035 [2]
27.00x47.00x7.00mm, FPM
NA5191 [2]
42.00x62.00x7.00mm, PTFE
NA5192 [1]
90.00x110.00x7.00mm, PTFE

!

HBS368 [22]

JD5881 [2]

HM5289 [2]

JH5118

HR5046 [2]

NA5035 [2]
27.00x47.00x7.00mm, FPM
NA5191 [2]
42.00x62.00x7.00mm, PTFE
NA5192 [1]
90.00x110.00x7.00mm, PTFE

!

HBS368 [22]

JD5881 [2]

HM5289 [2]

JH5118

HR5046 [2]

NA5035 [2]
27.00x47.00x7.00mm, FPM
NA5191 [2]
42.00x62.00x7.00mm, PTFE
NA5192 [1]
90.00x110.00x7.00mm, PTFE

!



cc



kW/PS



2.0	N3A	326	BY640 (MLS)	DY641					
Scorpio II 16V	10/94→08/98	1998	4	86.00	DOHC	100/136			
2.0	N4A <td>327 <td>AH860 (Fibre)</td> <td>CH865 [3]</td> <td> EH850 [3]</td> </td>	327 <td>AH860 (Fibre)</td> <td>CH865 [3]</td> <td> EH850 [3]</td>	AH860 (Fibre)	CH865 [3]	EH850 [3]				
Sierra 2.0 i	01/87→02/93	1993	4	90.83	SOHC/OHC	85/115			
2.0	N4B <td>328 <td>AH860 (Fibre)</td> <td>CH865 [3]</td> <td> EH850 [3]</td> </td>	328 <td>AH860 (Fibre)</td> <td>CH865 [3]</td> <td> EH850 [3]</td>	AH860 (Fibre)	CH865 [3]	EH850 [3]				
Sierra 2.0 i	01/87→02/93	1993	4	90.80	SOHC/OHC	74/100			
2.0	N4I <td>329 <td>AH860 (Fibre)</td> <td>CH865 [3]</td> <td> EH850 [3]</td> </td>	329 <td>AH860 (Fibre)</td> <td>CH865 [3]</td> <td> EH850 [3]</td>	AH860 (Fibre)	CH865 [3]	EH850 [3]				
Sierra 2.0 i	01/87→02/93	1993	4	90.83	SOHC/OHC	85/115			
2.0	N4JB <td>330 <td>AD5220 (MLS)</td> <td>CD5220 [3][79] CD5221 [3][78]</td> <td></td> </td>	330 <td>AD5220 (MLS)</td> <td>CD5220 [3][79] CD5221 [3][78]</td> <td></td>	AD5220 (MLS)	CD5220 [3][79] CD5221 [3][78]					
Fiesta V ST150	03/05→	1999	4	87.50	DOHC	110/150			
2.0	N5F <td>331</td> <td></td> <td></td> <td></td> <td></td> <td></td> <td></td> <td></td>	331							
Escort VI RS	09/92→01/95	1994	4	90.83	DOHC	162-167/ 220-227			
Escort VII RS	02/95→10/98								
2.0	N6T <td>332 <td>AH860 (Fibre)</td> <td>CH864 [3]</td> <td> EH850 [3]</td> </td>	332 <td>AH860 (Fibre)</td> <td>CH864 [3]</td> <td> EH850 [3]</td>	AH860 (Fibre)	CH864 [3]	EH850 [3]				
Transit 2.0	11/85→09/92	1993	4	90.80	SOHC/OHC	57/78			
2.0	N7A <td>333 <td>BY640 (MLS)</td> <td>DY640</td> <td></td> </td>	333 <td>BY640 (MLS)</td> <td>DY640</td> <td></td>	BY640 (MLS)	DY640					
Escort V RS 2000	05/91→12/92	1998	4	86.00	DOHC	110/150			
Escort VI RS	09/92→01/95								
Escort VII RS	02/95→10/98								
2.0	N7BA Diesel <td>334 <td>AA5970 (MLS), 1.100mm, 1 Hole AA5980 (MLS), 1.150mm, 2 Holes AA5990 (MLS), 1.200mm, 3 Holes</td> <td>CA5970 ▲ [3] →05/02</td> <td> EA5970 [3]</td> </td>	334 <td>AA5970 (MLS), 1.100mm, 1 Hole AA5980 (MLS), 1.150mm, 2 Holes AA5990 (MLS), 1.200mm, 3 Holes</td> <td>CA5970 ▲ [3] →05/02</td> <td> EA5970 [3]</td>	AA5970 (MLS), 1.100mm, 1 Hole AA5980 (MLS), 1.150mm, 2 Holes AA5990 (MLS), 1.200mm, 3 Holes	CA5970 ▲ [3] →05/02	EA5970 [3]				
Mondeo III TDCi	10/01→08/07	1998	4	86.00	DOHC	96/130			
2.0	N8A <td>335 <td>BT481 (Fibre)</td> <td>DT482</td> <td> EX550 [3]</td> </td>	335 <td>BT481 (Fibre)</td> <td>DT482</td> <td> EX550 [3]</td>	BT481 (Fibre)	DT482	EX550 [3]				
Scorpio I 2.0	11/88→10/92	1998	4	86.00	DOHC	80/109			
Sierra 1.9	10/88→09/91								
Sierra 2.0	07/89→12/92								
Sierra 2.0 i	06/89→02/93								

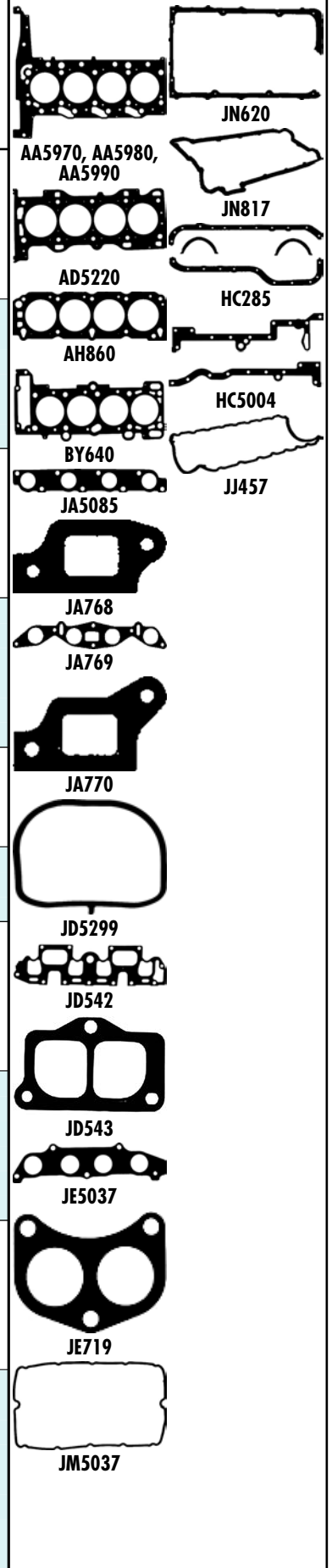

HBS032 [22] M11x1.50x178.00mm (x10)			≡ KG664	HR655 (x2)	NA5190 [2] 42.00x56.00x7.00mm, FPM NA5190 [2] 42.00x56.00x7.00mm, FPM NB847 [1] 88.00x108.00x11.00mm, FPM	
HBS056 [19] M12x1.75x92.50mm (x10)	JA769 [1] JA768 [1] JA770 (x3) ⊕ JE719	JN620 [4]	HC285 [1] ≡ KG664	PB180 (x8) 8.00x12.0/15.40x9.50 866N W (FPM)	NA5190 [2] 42.00x56.00x7.00mm, FPM NA5190 [2] 42.00x56.00x7.00mm, FPM NB788 [1] 79.40x95.30x11.10mm, PTFE	
HBS056 [19] M12x1.75x92.50mm (x10)	JA769 [1] JA768 [1] JA770 (x3) ⊕ JE719	JN620 [4]	HC285 [1] ≡ KG664	PB180 (x8) 8.00x12.0/15.40x9.50 866N W (FPM)	NA5190 [2] 42.00x56.00x7.00mm, FPM NA5190 [2] 42.00x56.00x7.00mm, FPM NB788 [1] 79.40x95.30x11.10mm, PTFE	
HBS056 [19] M12x1.75x92.50mm (x10)	JA769 [1] JA768 [1] JA770 (x3) ⊕ JE719	JN620 [4]	HC285 [1] ≡ KG664	PB180 (x8) 8.00x12.0/15.40x9.50 866N W (FPM)	NA5190 [2] 42.00x56.00x7.00mm, FPM NA5190 [2] 42.00x56.00x7.00mm, FPM NB788 [1] 79.40x95.30x11.10mm, PTFE	
HBS369 [5] M10x1.50x145.50mm (x10)	JD5299 [1] (x4) JE5037 [1]	JM5153 [78] (Elastomer) JM5158 [79] (Elastomer)		HR5063 [1]	NA5157 [2] 37.00x50.00x8.00mm, PTFE LK5005 [1] [7] 88.00x188.00x15.00mm, PTFE	
HBS032 [22] M11x1.50x178.00mm (x10)						
HBS056 [19] M12x1.75x92.50mm (x10)	JA769 [1] JA768 [1] JA770 (x3)	JN620 [4]	HC285 [1] ≡ KG664		NA5190 (x2) [2] 42.00x56.00x7.00mm, FPM NA5190 [2] 42.00x56.00x7.00mm, FPM NB788 [1] 79.40x95.30x11.10mm, PTFE	
HBS032 [22] M11x1.50x178.00mm (x10)			≡ KG664	HR655 [1]	NA5190 [2] 42.00x56.00x7.00mm, FPM NA5190 [2] 42.00x56.00x7.00mm, FPM NB847 [1] 88.00x108.00x11.00mm, FPM	
HBS296 [22] M10x1.50x159.00mm (x10)	HA5020 [1] [1] JA5085 [1] →05/02 JE5059 [85] 0.600mm 06/02→	JM5037 (Elastomer)	HC5004 [1]	HR5082 [1]	NA5028 [1] 36.00x50.00x7.00mm, PTFE NA5031 [2] 50.00x86.50x13.70mm, PTFE NA5030 [1] 106.00x196.00x15.20mm, FPM	
HBS032 [22] M11x1.50x178.00mm (x10)	JD542 [1] (x2) JD543 [1] (x2)	JN817 [4]	JJ457 →10/90 ≡ KG664	HR655 [1]	NB645 [2] 35.00x50.00x7.00mm, MVQ NA5190 [2] 42.00x56.00x7.00mm, FPM NB847 [1] 88.00x108.00x11.00mm, FPM NB848 [1] 100.00x120.00x11.00mm, PTFE	



cc



kW/PS



2.0	N8C	336	AH860 (Fibre)	CH864 [3]	EH850 [3]				
Sierra 2.0	01/87→02/93	1993	4	86.00	DOHC	77/105			
2.0	N9B <td>337</td> <td>BT481 (Fibre)</td> <td>DT482</td> <td> EX550 [3]</td>	337	BT481 (Fibre)	DT482	EX550 [3]				
Scorpio I 2.0 i	05/89→02/92	1998	4	86.00	DOHC	92/125			
Sierra 2.0 i	06/89→02/93								
2.0	N9C <td>338</td> <td>BT481 (Fibre)</td> <td>DT482 [86]</td> <td> EX550 [3]</td>	338	BT481 (Fibre)	DT482 [86]	EX550 [3]				
Sierra 2.0 4x4	10/91→03/93	1998	4	86.00	DOHC	88-92/ 120-125			
Sierra 2.0 4x4	05/89→02/93								
Sierra 2.0 i	05/89→02/93								
2.0	N9D <td>339</td> <td>BT481 (Fibre)</td> <td>DT482 [86]</td> <td> EX550 [3]</td>	339	BT481 (Fibre)	DT482 [86]	EX550 [3]				
Scorpio I 2.0 i	05/89→09/94	1998	4	86.00	DOHC	88/120	→08/94	→08/94	
							BX550 (MLS)	DX550 [3]	
							08/94→	08/94→	
2.0	N9E <td>340</td> <td>BT481 (Fibre)</td> <td>DT482</td> <td> EX550 [3]</td>	340	BT481 (Fibre)	DT482	EX550 [3]				
Sierra i DOHC	12/91→02/93	1998	4	86.00	DOHC	85/115			
2.0	N9F <td>341</td> <td>BT481 (Fibre)</td> <td>DT482</td> <td> EX550 [3]</td>	341	BT481 (Fibre)	DT482	EX550 [3]				
Scorpio I 2.0 i	09/91→09/94	1998	4	86.00	DOHC	85/115	→08/94	→05/94	
							BX550 (MLS)	DX550 [3]	
							08/94→	05/94→	
2.0	NAE <td>342</td> <td>AH860 (Fibre)</td> <td>CH864 [3]</td> <td> EH850 [3]</td>	342	AH860 (Fibre)	CH864 [3]	EH850 [3]				
P 100 II 2.0	10/87→12/92	1993	4	90.83	SOHC/OHC	57/78			
2.0	NAT <td>343</td> <td>AH860 (Fibre)</td> <td>CH864 [3]</td> <td> EH850 [3]</td>	343	AH860 (Fibre)	CH864 [3]	EH850 [3]				
Transit 2.0	09/85→09/92	1994	4	90.80	SOHC/OHC	57/78			
2.0	NAV <td>344</td> <td>AH860 (Fibre)</td> <td>CH864 [3]</td> <td> EH850 [3]</td>	344	AH860 (Fibre)	CH864 [3]	EH850 [3]				
Transit 2.0	09/85→09/92	1994	4	90.83	SOHC/OHC	55-57/ 75-78			
2.0	NBA <td>345</td> <td>AH860 (Fibre)</td> <td>CH865 [3]</td> <td> EH850 [3]</td>	345	AH860 (Fibre)	CH865 [3]	EH850 [3]				
Transit 2.0	09/91→09/94	1993	4	90.80	SOHC/OHC	66/90			

HBS056 [19] M12x1.75x92.50mm (x10)	JA769 JA768 JA770 (x3) JE719	JN620 [4]	HC285 =KG664	PB180 (x8) 8.00x12.0/15.40x9.50 866N W (FPM) HR631 HR661	NB645 [2] 35.00x50.00x7.00mm, MVQ NAS190 [2] 42.00x56.00x7.00mm, FPM NB847 [1] 88.00x108.00x11.00mm, FPM	AH860 BX550 JA768 JA769 JA770 JD542 JD543 JE719 JN620 JN817 HC285 JJ457	
HBS032 [22] M11x1.50x178.00mm (x10)	JD542 JD543 (x2)	JN817 [4]	JJ457 =KG664	HR655	NB645 [2] 35.00x50.00x7.00mm, MVQ NAS190 [2] 42.00x56.00x7.00mm, FPM NB847 [1] 88.00x108.00x11.00mm, FPM	JA768 JA769 JA770 JD542 JD543 JE719 JN620 JN817 HC285 JJ457	
HBS032 [22] M11x1.50x178.00mm (x10)	JD542 JD543 (x2)	JN817 [4]	JJ457 =KG664	HR655	NB645 [2] 35.00x50.00x7.00mm, MVQ NAS190 [2] 42.00x56.00x7.00mm, FPM NB847 [1] 88.00x108.00x11.00mm, FPM	JA768 JA769 JA770 JD542 JD543 JE719 JN620 JN817 HC285 JJ457	
HBS032 [22] M11x1.50x178.00mm (x10)	JD542 JD543 (x2)	JN817 [4]	JJ457 =KG664	HR655	NB645 [2] 35.00x50.00x7.00mm, MVQ NAS190 [2] 42.00x56.00x7.00mm, FPM NB847 [1] 88.00x108.00x11.00mm, FPM	JA768 JA769 JA770 JD542 JD543 JE719 JN620 JN817 HC285 JJ457	
HBS032 [22] M11x1.50x178.00mm (x10)	JD542 JD543 (x2)	JN817 [4]	=KG664	HR655	NB645 [2] 35.00x50.00x7.00mm, MVQ NAS190 [2] 42.00x56.00x7.00mm, FPM NB847 [1] 88.00x108.00x11.00mm, FPM	JA768 JA769 JA770 JD542 JD543 JE719 JN620 JN817 HC285 JJ457	
HBS056 [19] M12x1.75x92.50mm (x10)	JA769 JA768 JA770 (x3) JE719	JN620 [4]	HC285 =KG664	PB180 (x8) 8.00x12.0/15.40x9.50 866N W (FPM) HR631	NAS190 (x2) [2] 42.00x56.00x7.00mm, FPM NAS190 [2] 42.00x56.00x7.00mm, FPM NB788 [1] 79.40x95.30x11.10mm, PTFE	AH860 BX550 JA768 JA769 JA770 JD542 JD543 JE719 JN620 JN817 HC285 JJ457	
HBS056 [19] M12x1.75x92.50mm (x10)	JA769 JA768 JA770 (x3) JE719	JN620 [4]	HC285 =KG664	PB180 (x8) 8.00x12.0/15.40x9.50 866N W (FPM) HR631	NAS190 [2] 42.00x56.00x7.00mm, FPM NAS190 [2] 42.00x56.00x7.00mm, FPM NB788 [1] 79.40x95.30x11.10mm, PTFE	AH860 BX550 JA768 JA769 JA770 JD542 JD543 JE719 JN620 JN817 HC285 JJ457	
HBS056 [19] M12x1.75x92.50mm (x10)	JA769 JA768 JA770 (x3) JE719	JN620 [4]	HC285 =KG664	PB180 (x8) 8.00x12.0/15.40x9.50 866N W (FPM) HR631	NAS190 [2] 42.00x56.00x7.00mm, FPM NAS190 [2] 42.00x56.00x7.00mm, FPM NB788 [1] 79.40x95.30x11.10mm, PTFE	AH860 BX550 JA768 JA769 JA770 JD542 JD543 JE719 JN620 JN817 HC285 JJ457	
HBS056 [19] M12x1.75x92.50mm (x10)	JA769 JA768 JA770 (x3) JE719	JN620 [4]	HC285 =KG664	PB180 (x8) 8.00x12.0/15.40x9.50 866N W (FPM) HR631	NAS190 [2] 42.00x56.00x7.00mm, FPM NAS190 [2] 42.00x56.00x7.00mm, FPM NB788 [1] 79.40x95.30x11.10mm, PTFE	AH860 BX550 JA768 JA769 JA770 JD542 JD543 JE719 JN620 JN817 HC285 JJ457	

FORD



cc



kW/PS



2.0	NCA						346	AH860 (Fibre)	CH865 [3]	EH850 [3]
Transit 2.0	09/91→08/94	1994	4	90.80	SOHC/OHC		72/98			
Transit 2.0 i	09/91→07/94									
2.0	NE5						347	AH860 (Fibre)	CH865 [3]	EH850 [3]
Sierra 2.0 i	01/87→02/93	1993	4	90.80	SOHC/OHC		74/100			
2.0	NEJ						348	AH860 (Fibre)	CH865 [3]	EH850 [3]
Sierra 2.0 i	01/87→02/93	1993	4	90.80	SOHC/OHC		74/100			
2.0	NEL						349	AH860 (Fibre)	CH864 [3]	EH850 [3]
Scorpio I 2.0	04/85→08/89	1993	4	90.83	SOHC/OHC		77/105			
2.0	NGA						350	BW650 (Fibre)	DW650	EW630 [3]
Mondeo I i 16V	01/93→08/96	1988	4	84.80	DOHC		96-100/	→05/98	→05/98	→12/98
Mondeo II 2.0 i	09/96→11/00						131-136	BZ490 (MLS)	DZ491	EC5800 [3]
								05/98→01/99	05/98→01/99	12/98→
								AE5320 (MLS)	DW655 ▲	
								01/99→	01/99→	
2.0	NGB						351	BW650 (Fibre)	DW650	EW630 [3]
Mondeo II 2.0 i	09/96→11/00	1988	4	84.80	DOHC		96/131	→05/98	→05/98	→12/98
								BZ490 (MLS)	DZ491	EC5800 [3]
								05/98→01/99	05/98→01/99	12/98→
								AE5320 (MLS)	DW655 ▲	
								01/99→	01/99→	
2.0	NGC						352	BW650 (Fibre)	DW650	EW630 [3]
Mondeo II 2.0 i	09/96→11/00	1988	4	84.80	DOHC		96/131	→05/98	→05/98	→12/98
								BZ490 (MLS)	DZ491	EC5800 [3]
								05/98→01/99	05/98→01/99	12/98→
								AE5320 (MLS)	DW655 ▲	
								01/99→	01/99→	

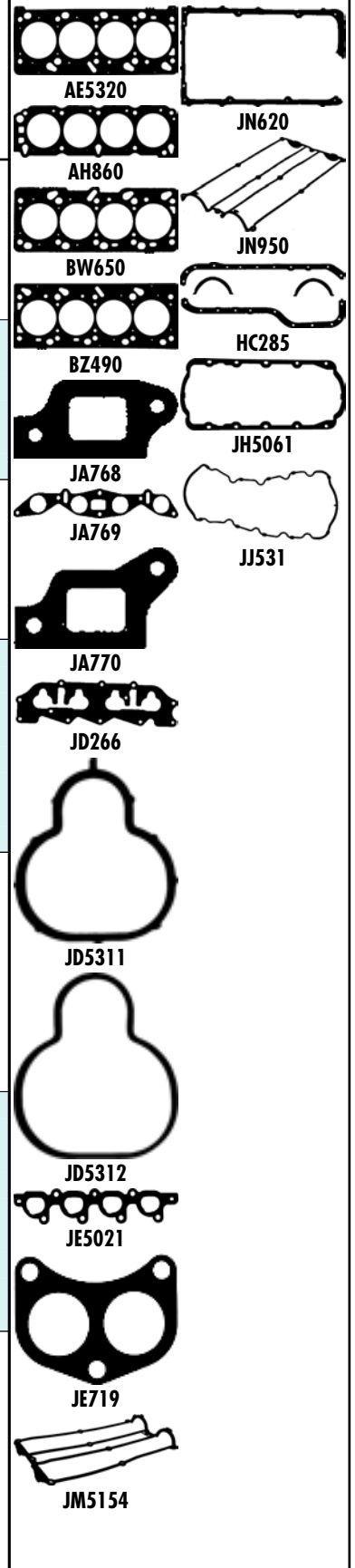
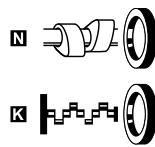
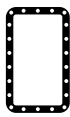
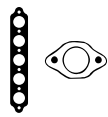

HBS056 [19] M12x1.75x92.50mm (x10)	JA769 ■ JA768 ■ JA770 ■ (x3) ☉JE719	JN620 [4]	HC285 ■ ≡KG664	PB180 (x8) 8.00x12.0/15.40x9.50 866N W (FPM) HR631 ■	NA5190 [2] 42.00x56.00x7.00mm, FPM ☒ NA5190 ■ [2] 42.00x56.00x7.00mm, FPM ☒ NB788 ■ [1] 79.40x95.30x11.10mm, PTFE	
HBS056 [19] M12x1.75x92.50mm (x10)	JA769 ■ JA768 ■ JA770 ■ (x3) ☉JE719	JN620 [4]	HC285 ■ ≡KG664	PB180 (x8) 8.00x12.0/15.40x9.50 866N W (FPM) HR631 ■	NA5190 [2] 42.00x56.00x7.00mm, FPM ☒ NA5190 ■ [2] 42.00x56.00x7.00mm, FPM ☒ NB788 ■ [1] 79.40x95.30x11.10mm, PTFE	
HBS056 [19] M12x1.75x92.50mm (x10)	JA769 ■ JA768 ■ JA770 ■ (x3) ☉JE719	JN620 [4]	HC285 ■ ≡KG664	PB180 (x8) 8.00x12.0/15.40x9.50 866N W (FPM) HR631 ■	NA5190 [2] 42.00x56.00x7.00mm, FPM ☒ NA5190 ■ [2] 42.00x56.00x7.00mm, FPM ☒ NB788 ■ [1] 79.40x95.30x11.10mm, PTFE	
HBS056 [19] M12x1.75x92.50mm (x10)	JA769 ■ JA768 ■ JA770 ■ (x3) ☉JE719	JN620 [4]	HC285 ■ ≡KG664	PB180 (x8) 8.00x12.0/15.40x9.50 866N W (FPM) HR631 ■	NB645 [2] 35.00x50.00x7.00mm, MVQ ☒ NA5190 ■ (x2) [2] 42.00x56.00x7.00mm, FPM ☒ NA5190 ■ [2] 42.00x56.00x7.00mm, FPM ☒ NB788 ■ [1] 79.40x95.30x11.10mm, PTFE	
HBS031 [22] M10x1.50x102.00mm (x10)	JD266 ■ →05/98 JD5311 ■ (x4) 05/98→08/99 JD5312 ■ (x4) 08/98→04/99 09/99→ JE5021 ■	JN950 [4] →05/98 JM5154 (SE) 08/98→04/99 JM5184 (Elastomer) Pale blue 05/99→	JJ531 →05/98 ≡KG664 JH5061 05/98→	HR5033 ■	NB958 [2] 42.00x53.00x7.00mm, FPM ☒ NB959 ■ [2] 35.00x50.00x7.00mm, FPM ☒ NB847 ■ [1] 88.00x108.00x11.00mm, FPM	
HBS031 [22] M10x1.50x102.00mm (x10)	JD266 ■ →05/98 JD5311 ■ (x4) 05/98→08/99 JD5312 ■ (x4) 09/99→ JE5021 ■	JN950 [4] →05/98 JM5154 (SE) 08/98→04/99 JM5184 (Elastomer) Pale blue 05/99→	JJ531 →05/98 ≡KG664 JH5061 05/98→	HR5033 ■	NB958 [2] 42.00x53.00x7.00mm, FPM ☒ NB959 ■ [2] 35.00x50.00x7.00mm, FPM ☒ NB847 ■ [1] 88.00x108.00x11.00mm, FPM	
HBS031 [22] M10x1.50x102.00mm (x10)	JD266 ■ →05/98 JD5311 ■ (x4) 05/98→08/99 JD5312 ■ (x4) 09/99→ JE5021 ■	JN950 [4] →05/98 JM5154 (SE) 08/98→04/99 JM5184 (Elastomer) Pale blue 05/99→	JJ531 →05/98 ≡KG664 JH5061 05/98→	HR5033 ■	NB958 [2] 42.00x53.00x7.00mm, FPM ☒ NB959 ■ [2] 35.00x50.00x7.00mm, FPM ☒ NB847 ■ [1] 88.00x108.00x11.00mm, FPM	



cc



kW/PS



2.0	NGD						353	BW650 (Fibre) →05/98 BZ490 (MLS) 05/98→01/99 AE5320 (MLS) 01/99→	DW650 →05/98 DZ491 05/98→01/99 DW655 ▲ 01/99→	EW630 [3] →12/98 EC5800 [3] 12/98→
Mondeo II 2.0 i	09/96→11/00	1988	4	84.80	DOHC	96/131				
2.0	NRA						354	AH860 (Fibre)	CH865 [3]	EH850 [3]
Scorpio I 1.9 Scorpio I 2.0 i	11/92→09/93 04/85→09/94	1993	4	90.83	SOHC/OHC	85/115				
2.0	NRC						355	AH860 (Fibre)	CH865 [3]	EH850 [3]
Scorpio I 2.0 i	10/85→12/90	1993	4	90.83	SOHC/OHC	74/100				
2.0	NRI						356	AH860 (Fibre)	CH865 [3]	EH850 [3]
Scorpio I 2.0 i	04/85→09/94	1993	4	90.83	SOHC/OHC	85/115				
2.0	NSD						357	AC5910 (MLS), 1.600mm		
Scorpio II 2.0 i	10/94→08/98	1998	4	86.00	DOHC	85/115				
2.0	NSE						358	AC5910 (MLS), 1.600mm		
Galaxy 2.0 i	11/95→05/06	1998	4	86.00	DOHC	85/116				
2.0	NSF						359	AC5910 (MLS), 1.600mm		
Transit 2.0	06/94→03/00	1998	4	86.00	DOHC	84/114				
2.0	NSG						360	AC5910 (MLS), 1.600mm		
Transit 2.0	06/94→03/00	1998	4	86.00	DOHC	84/114				
2.0	NSH						361	BX550 (MLS)		
Transit 2.0 Transit 2.0 CNG	11/94→12/00 06/94→03/00	1998	4	86.00	DOHC	74-84/ 101-114				

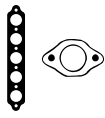

HBS031 [22] M10x1.50x102.00mm (x10)	JD266 [1] →05/98 JD5311 [1] (x4) 05/98→08/99 JD5312 [1] (x4) 09/99→ JE5021 [1]	JN950 [4] →05/98 JM5154 (SE) JH5061 05/98→ JM5184 (Elastomer) Pale blue 05/99→	JJ531 →05/98 =KG664 JH5061 05/98→	HR5033 [1]	NB958 [2] 42.00x53.00x7.00mm, FPM NB959 [2] 35.00x50.00x7.00mm, FPM NB847 [1] 88.00x108.00x11.00mm, FPM	
HBS056 [19] M12x1.75x92.50mm (x10)	JA769 [1] JA768 [1] JA770 [1] (x3) JE719	JN620 [4]	HC285 [1] =KG664	PB180 (x8) 8.00x12.0/15.40x9.50 866N W (FPM) HR631 [1]	NA5190 [2] 42.00x56.00x7.00mm, FPM NA5190 [2] 42.00x56.00x7.00mm, FPM NB788 [1] 79.40x95.30x11.10mm, PTFE	
HBS056 [19] M12x1.75x92.50mm (x10)	JA769 [1] JA768 [1] JA770 [1] (x3) JE719	JN620 [4]	HC285 [1] =KG664	PB180 (x8) 8.00x12.0/15.40x9.50 866N W (FPM) HR631 [1]	NA5190 [2] 42.00x56.00x7.00mm, FPM NA5190 [2] 42.00x56.00x7.00mm, FPM NB788 [1] 79.40x95.30x11.10mm, PTFE	KA289 [15] KT738 [45]
HBS056 [19] M12x1.75x92.50mm (x10)	JA769 [1] JA768 [1] JA770 [1] (x3) JE719	JN620 [4]	HC285 [1] =KG664	PB180 (x8) 8.00x12.0/15.40x9.50 866N W (FPM) HR631 [1]	NA5190 [2] (x2) 42.00x56.00x7.00mm, FPM NA5190 [2] 42.00x56.00x7.00mm, FPM NB788 [1] 79.40x95.30x11.10mm, PTFE	
HBS032 [22] M11x1.50x178.00mm (x10)	JD542 [1] (x2) JD543 [1] (x2)	JN817 [4]	JJ457 =KG664	HR655 [1]	NA5190 [2] 42.00x56.00x7.00mm, FPM NA5190 [2] 42.00x56.00x7.00mm, FPM NB847 [1] 88.00x108.00x11.00mm, FPM	
HBS032 [22] M11x1.50x178.00mm (x10)	JD542 [1] (x2) JD543 [1] (x2)	JN817 [4]	JJ457 =KG664	HR655 [1]	NA5190 [2] 42.00x56.00x7.00mm, FPM NA5190 [2] 42.00x56.00x7.00mm, FPM NB847 [1] 88.00x108.00x11.00mm, FPM	
HBS032 [22] M11x1.50x178.00mm (x10)	JD542 [1] (x2) JD543 [1] (x2)	JN817 [4]	JJ457 =KG664	HR655 [1]	NA5190 [2] 42.00x56.00x7.00mm, FPM NA5190 [2] 42.00x56.00x7.00mm, FPM NB847 [1] 88.00x108.00x11.00mm, FPM	
HBS032 [22] M11x1.50x178.00mm (x10)	JD542 [1] (x2) JD543 [1] (x2)	JN817 [4]	JJ457 =KG664	HR655 [1]	NA5190 [2] 42.00x56.00x7.00mm, FPM NA5190 [2] 42.00x56.00x7.00mm, FPM NB847 [1] 88.00x108.00x11.00mm, FPM	
HBS032 [22] M11x1.50x178.00mm (x10)			=KG664	HR655 [1]	NA5190 [2] 42.00x56.00x7.00mm, FPM NA5190 [2] 42.00x56.00x7.00mm, FPM NB847 [1] 88.00x108.00x11.00mm, FPM	

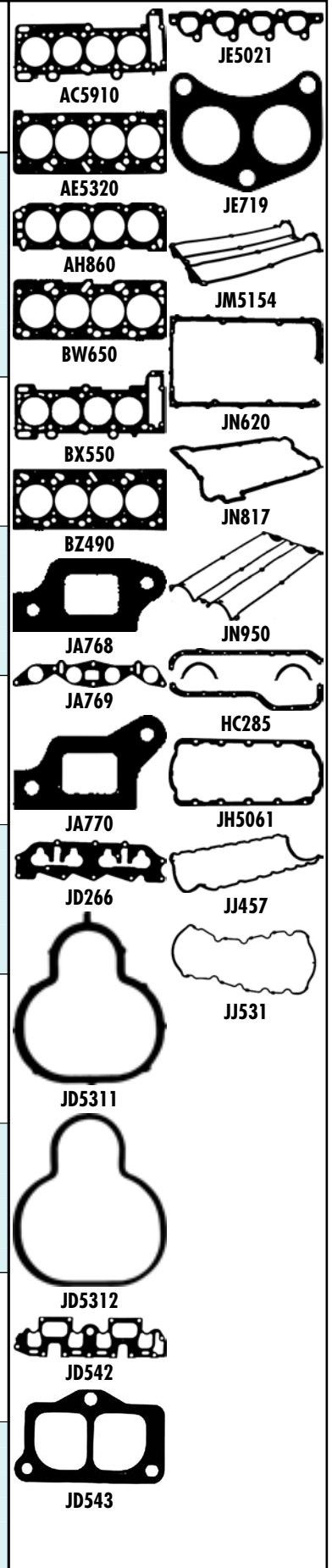



cc



kW/PS



2.0	QXBA Diesel	362	AD5490 (MLS), 1.250mm, 2 Notches AD5500 (MLS), 1.300mm, 3 Holes AD5510 (MLS), 1.350mm, 4 Holes AD5520 (MLS), 1.400mm, 5 Holes	CD5500 ▲	ED5500
Mondeo IV TDCi	03/07→	1997 4 85.00 DOHC 103/140			
2.0	QXBB Diesel	363	AD5490 (MLS), 1.250mm, 2 Notches AD5500 (MLS), 1.300mm, 3 Holes AD5510 (MLS), 1.350mm, 4 Holes AD5520 (MLS), 1.400mm, 5 Holes	CD5500 ▲	ED5500
Mondeo IV TDCi	03/07→	1997 4 85.00 DOHC 103/140			
2.0	QXWA Diesel	364	AD5490 (MLS), 1.250mm, 2 Notches AD5500 (MLS), 1.300mm, 3 Holes AD5510 (MLS), 1.350mm, 4 Holes AD5520 (MLS), 1.400mm, 5 Holes	CD5500 ▲	ED5500
Galaxy 2.0 TDCi S-Max 2.0 TDCi	05/06→ 05/06→	1997 4 85.00 DOHC 103/140			
2.0	QXWB Diesel	365	AD5490 (MLS), 1.250mm, 2 Notches AD5500 (MLS), 1.300mm, 3 Holes AD5510 (MLS), 1.350mm, 4 Holes AD5520 (MLS), 1.400mm, 5 Holes	CD5500 ▲	ED5500
Galaxy 2.0 TDCi S-Max 2.0 TDCi	05/06→ 05/06→	1997 4 85.00 DOHC 103/140			
2.0	QXWC Diesel	366	AD5490 (MLS), 1.250mm, 2 Notches AD5500 (MLS), 1.300mm, 3 Holes AD5510 (MLS), 1.350mm, 4 Holes AD5520 (MLS), 1.400mm, 5 Holes	CD5500 ▲	ED5500
Galaxy 2.0 TDCi S-Max 2.0 TDCi	05/06→ 05/06→	1997 4 85.00 DOHC 103/140			
2.0	SDBA Diesel	367	AA5970 (MLS), 1.100mm, 1 Hole AA5980 (MLS), 1.150mm, 2 Holes AA5990 (MLS), 1.200mm, 3 Holes	CA5970 ▲ [3] →05/02	EA5970 [3]
Mondeo III 16V	11/00→08/07	1998 4 86.00 DOHC 66/90			
2.0	SYDA	368	AD5220 (MLS)	CD5221 [3]	ED5220 [3]
C-MAX 2.0 C-MAX 2.0 CNG C-MAX 2.0 LPG Focus C-MAX Focus II 2.0 CNG Focus II 2.0 LPG	02/07→ 04/09→ 06/08→ 03/04→03/07 04/09→ 06/08→	1999 4 87.50 DOHC 107/145			
2.0	TBBA	369	AD5220 (MLS)	CD5221 [3]	ED5220 [3]
Mondeo IV Mondeo IV 2.0 Mondeo IV LPG	03/09→ 03/07→ 07/09→	1999 4 87.50 DOHC 107/145			
2.0	TBBB	370	AD5220 (MLS)	CD5221 [3]	ED5220 [3]
Mondeo IV	03/09→	1999 4 87.50 DOHC 107/145			

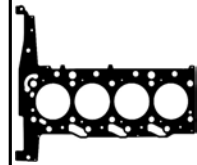
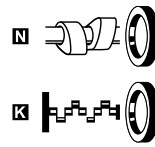
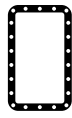

HBS368 [22]	JD5881 [3]	HM5289 [3]	JH5118	HR5046 [3] (x2)	<p>NA5035 [2] 27.00x47.00x7.00mm, FPM</p> <p>NA5191 [2] 42.00x62.00x7.00mm, PTFE</p> <p>NA5192 [1] 90.00x110.00x7.00mm, PTFE</p>	
HBS368 [22]	JD5881 [3]	HM5289 [3]	JH5118	HR5046 [3] (x2)	<p>NA5035 [2] 27.00x47.00x7.00mm, FPM</p> <p>NA5191 [2] 42.00x62.00x7.00mm, PTFE</p> <p>NA5192 [1] 90.00x110.00x7.00mm, PTFE</p>	
HBS368 [22]	JD5881 [3]	HM5289 [3]	JH5118	HR5046 [3] (x2)	<p>NA5035 [2] 27.00x47.00x7.00mm, FPM</p> <p>NA5191 [2] 42.00x62.00x7.00mm, PTFE</p> <p>NA5192 [1] 90.00x110.00x7.00mm, PTFE</p>	
HBS368 [22]	JD5881 [3]	HM5289 [3]	JH5118	HR5046 [3] (x2)	<p>NA5035 [2] 27.00x47.00x7.00mm, FPM</p> <p>NA5191 [2] 42.00x62.00x7.00mm, PTFE</p> <p>NA5192 [1] 90.00x110.00x7.00mm, PTFE</p>	
HBS368 [22]	JD5881 [3]	HM5289 [3] (x2)	JH5118	HR5046 [3] (x2)	<p>NA5035 [2] 27.00x47.00x7.00mm, FPM</p> <p>NA5191 [2] 42.00x62.00x7.00mm, PTFE</p> <p>NA5192 [1] 90.00x110.00x7.00mm, PTFE</p>	
HBS296 [22] M10x1.50x159.00mm (x10)	HA5020 [3] JA5085 [3]	JM5037 (Elastomer)	HC5004 [3]	HR5082 [3]	<p>NA5028 [1] 36.00x50.00x7.00mm, PTFE</p> <p>NA5031 [2] 50.00x86.50x13.70mm, PTFE</p> <p>NA5030 [1] 106.00x196.00x15.20mm, FPM</p>	
HBS369 [5] M10x1.50x145.50mm (x10)	JD5299 [3] (x4) JE5037 [3]	JM5153 [78] (Elastomer)		HR5063 [3]	<p>NA5157 [2] 37.00x50.00x8.00mm, PTFE</p> <p>NA5157 [2] 37.00x50.00x8.00mm, PTFE</p> <p>LK5005 [1] [7] 88.00x188.00x15.000mm, PTFE</p>	
HBS369 [5] M10x1.50x145.50mm (x10)	JD5299 [3] (x4) JE5037 [3]	JM5153 [78] (Elastomer)		HR5063 [3]	<p>NA5157 [2] 37.00x50.00x8.00mm, PTFE</p> <p>NA5157 [2] 37.00x50.00x8.00mm, PTFE</p> <p>LK5005 [1] [7] 88.00x188.00x15.000mm, PTFE</p>	
HBS369 [5] M10x1.50x145.50mm (x10)	JD5299 [3] JE5037 [3]	JM5153 [78] (Elastomer)		HR5063 [3]	<p>NA5157 [2] 37.00x50.00x8.00mm, PTFE</p> <p>NA5157 [2] 37.00x50.00x8.00mm, PTFE</p> <p>LK5005 [1] [7] 88.00x188.00x15.000mm, PTFE</p>	

AA5970, AA5980,
AA5990



AD5220



AD5490, AD5500,
AD5510, AD5520



JA5085



JD5299



JE5037



JM5037

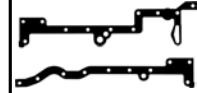

HC5004



cc



kW/PS



2.0	TBWA					371	AD5220 (MLS)	CD5221 [3]	ED5220 [3]
Galaxy FI-Fuel	05/06→	1999	4		DOHC	107/145			
S-Max FI-Fuel	05/06→								
2.0	TBWB					372	AD5220 (MLS)	CD5221 [3]	ED5220 [3]
Galaxy FI-Fuel	05/06→	1999	4		DOHC	107/145			
S-Max FI-Fuel	05/06→								
2.0	UFBA Diesel					373	AD5490 (MLS), 1.250mm, 2 Notches AD5500 (MLS), 1.300mm, 3 Holes AD5510 (MLS), 1.350mm, 4 Holes AD5520 (MLS), 1.400mm, 5 Holes	CD5500 ▲	ED5500
Mondeo IV TDCi	03/07→	1997	4	85.00	DOHC	103/140			
2.0	YF					374	AE5320 (MLS)	CE5320 [3]	
Maverick 2.0 16V	02/01→	1989	4	84.80	DOHC	91/124			
2.2	P8FA Diesel					375	AH6390 (MLS), 1.100mm, 1 Notch AH6400 (MLS), 1.150mm, 2 Notches AH6410 (MLS), 1.200mm, 3 Notches	CH6390 ▲	EA5970 [3]
Transit 2.2 TDCi	04/06→	2198	4	86.00	DOHC	63/85			
2.2	P8FB Diesel					376	AH6390 (MLS), 1.100mm, 1 Notch AH6400 (MLS), 1.150mm, 2 Notches AH6410 (MLS), 1.200mm, 3 Notches	CH6390 ▲	EA5970 [3]
Transit 2.2 TDCi	04/06→	2198	4	86.00	DOHC	63/85			
2.2	PGFA Diesel					377	AH6390 (MLS), 1.100mm, 1 Notch AH6400 (MLS), 1.150mm, 2 Notches AH6410 (MLS), 1.200mm, 3 Notches	CH6390 ▲	EA5970 [3]
Transit 2.2 TDCi	10/07→	2198	4	86.00	DOHC	103/140			
2.2	PGFB Diesel					378	AH6390 (MLS), 1.100mm, 1 Notch AH6400 (MLS), 1.150mm, 2 Notches AH6410 (MLS), 1.200mm, 3 Notches	CH6390 ▲	EA5970 [3]
Transit 2.2 TDCi	10/07→	2198	4		DOHC	103/140			
2.2	Q4BA Diesel					379			EH6520
Galaxy 2.2 TDCi	03/08→	2179	4	85.00	DOHC	129/175			
Mondeo IV TDCi	03/08→								
2.2	Q4WA Diesel					380			EH6520
Galaxy 2.2 TDCi	03/08→	2179	4	85.00	DOHC	129/175			
S-Max 2.2 TDCi	03/08→								
2.2	QJBA Diesel					381	AA5970 (MLS), 1.100mm, 1 Hole AA5980 (MLS), 1.150mm, 2 Holes AA5990 (MLS), 1.200mm, 3 Holes		EA5970 [3]
Mondeo III TDCi	09/04→08/07	2198	4	86.00	DOHC	114/155			

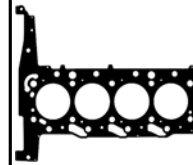
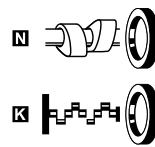
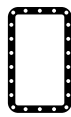
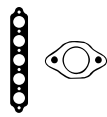

HBS369 [5] M10x1.50x145.50mm (x10)	JD5299 [1] JE5037 [1]	JM5153 [78] (Elastomer)		HR5063 [1]	NA5157 [2] 37.00x50.00x8.00mm, PTFE NA5157 [2] 37.00x50.00x8.00mm, PTFE LK5005 [1][7] 88.00x188.00x15.00mm, PTFE	
HBS369 [5] M10x1.50x145.50mm (x10)	JD5299 [1] JE5037 [1]	JM5153 [78] (Elastomer)		HR5063 [1]	NA5157 [2] 37.00x50.00x8.00mm, PTFE NA5157 [2] 37.00x50.00x8.00mm, PTFE LK5005 [1][7] 88.00x188.00x15.00mm, PTFE	
HBS368 [22]	JD5881 [1]	HM5289 [1]	JH5118	HR5046 [1]	NA5035 [2] 27.00x47.00x7.00mm, FPM NA5191 [2] 42.00x62.00x7.00mm, PTFE NA5192 [1] 90.00x110.00x7.00mm, PTFE	
HBS031 [22] M10x1.50x102.00mm (x10)	JD5312 [1] (x4) JD5313 [1]	JM5184 (Elastomer) Pale blue	JH5061	HR5033 [1]	NB958 (x2)[2] 42.00x53.00x7.00mm, FPM NA5323 [2] 35.00x50.00x7.00mm, PTFE NB959 [2] 35.00x50.00x7.00mm, FPM	
	HA5020 [1] [1]	JM5037 (Elastomer)	HC5004 [1]	HR5082 [1]	NA5031 [2] 50.00x86.50x13.70mm, PTFE NA5030 [1] 106.00x196.00x15.20mm, FPM	
	HA5020 [1] [1]	JM5037 (Elastomer)	HC5004 [1]	HR5082 [1]	NA5031 [2] 50.00x86.50x13.70mm, PTFE NA5030 [1] 106.00x196.00x15.20mm, FPM	
	HA5020 [1] [1]	JM5037 (Elastomer)	HC5004 [1]	HR5082 [1]	NA5031 [2] 50.00x86.50x13.70mm, PTFE NA5030 [1] 106.00x196.00x15.20mm, FPM	
	HA5020 [1] [1]	JM5037 (Elastomer)	HC5004 [1]	HR5082 [1]	NA5031 [2] 50.00x86.50x13.70mm, PTFE NA5030 [1] 106.00x196.00x15.20mm, FPM	
HBS261 [22] M12x1.50x126.00mm (x10)		HM5369 [1]			NA5035 [2] 27.00x47.00x7.00mm, FPM NA5191 [2] 42.00x62.00x7.00mm, PTFE NA5192 [1] 90.00x110.00x7.00mm, PTFE	
HBS261 [22] M12x1.50x126.00mm (x10)		HM5369 [1]			NA5035 [2] 27.00x47.00x7.00mm, FPM NA5191 [2] 42.00x62.00x7.00mm, PTFE NA5192 [1] 90.00x110.00x7.00mm, PTFE	
HBS296 [22] M10x1.50x159.00mm (x10)		JM5037 (Elastomer)	HC5004 [1]	HR5082 [1]	NA5028 [1] 36.00x50.00x7.00mm, PTFE NA5031 [2] 50.00x86.50x13.70mm, PTFE NA5030 [1] 106.00x196.00x15.20mm, FPM	

AA5970, AA5980, AA5990

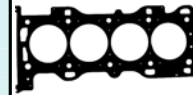

AD5220



AD5490, AD5500, AD5510, AD5520



AE5320



JD5299

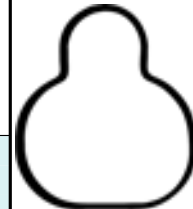

JD5312



JD5313



JE5037



JM5037



HC5004

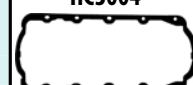

JH5061



cc



kW/PS



2.2	QJBB Diesel	382	AA5970 (MLS), 1.100mm, 1 Hole AA5980 (MLS), 1.150mm, 2 Holes AA5990 (MLS), 1.200mm, 3 Holes	EA5970 [3]
Mondeo III TDCi	09/04→08/07	2198 4 86.00 DOHC	114/155	
2.2	QJBC Diesel	383	AA5970 (MLS), 1.100mm, 1 Hole AA5980 (MLS), 1.150mm, 2 Holes AA5990 (MLS), 1.200mm, 3 Holes	EA5970 [3]
Mondeo III TDCi	09/04→08/07	2198 4 86.00 DOHC	110/150	
2.2	QJBD Diesel	384	AA5970 (MLS), 1.100mm, 1 Hole AA5980 (MLS), 1.150mm, 2 Holes AA5990 (MLS), 1.200mm, 3 Holes	EA5970 [3]
Mondeo III TDCi	09/04→08/07	2198 4 86.00 DOHC	110/150	
2.2	QVFA Diesel	385	AH6390 (MLS), 1.100mm, 1 Notch AH6400 (MLS), 1.150mm, 2 Notches AH6410 (MLS), 1.200mm, 3 Notches	CH6390 ▲ EA5970 [3]
Transit 2.2 TDCi	04/06→	2198 4 86.00 DOHC	81/110	
2.2	QWFA Diesel	386	AH6390 (MLS), 1.100mm, 1 Notch AH6400 (MLS), 1.150mm, 2 Notches AH6410 (MLS), 1.200mm, 3 Notches	CH6390 ▲ EA5970 [3]
Transit 2.2 TDCi	04/06→	2198 4 86.00 DOHC	96/130	
2.2	SRFA Diesel	387	AH6390 (MLS), 1.100mm, 1 Notch AH6400 (MLS), 1.150mm, 2 Notches AH6410 (MLS), 1.200mm, 3 Notches	CH6390 ▲ EA5970 [3]
Transit 2.2 TDCi	10/08→	2198 4 DOHC	85/115	
2.2	SRFB Diesel	388	AH6390 (MLS), 1.100mm, 1 Notch AH6400 (MLS), 1.150mm, 2 Notches AH6410 (MLS), 1.200mm, 3 Notches	CH6390 ▲ EA5970 [3]
Transit 2.2 TDCi	10/08→	2198 4 DOHC	85/115	
2.2	SRFC Diesel	389	AH6390 (MLS), 1.100mm, 1 Notch AH6400 (MLS), 1.150mm, 2 Notches AH6410 (MLS), 1.200mm, 3 Notches	CH6390 ▲ EA5970 [3]
Transit 2.2 TDCi	10/08→	2198 4 DOHC	85/115	
2.2	SRFD Diesel	390	AH6390 (MLS), 1.100mm, 1 Notch AH6400 (MLS), 1.150mm, 2 Notches AH6410 (MLS), 1.200mm, 3 Notches	CH6390 ▲ EA5970 [3]
Transit 2.2 TDCi	10/08→	2198 4 DOHC	85/115	
2.2	SRFE Diesel	391	AH6390 (MLS), 1.100mm, 1 Notch AH6400 (MLS), 1.150mm, 2 Notches AH6410 (MLS), 1.200mm, 3 Notches	CH6390 ▲ EA5970 [3]
Transit 2.2 TDCi	10/08→	2198 4 DOHC	85/115	
2.3	E5FA	392	AH7010 (MLS)	
Transit 2.3	08/00→03/06	2295 4 89.60 DOHC	107/146	
Transit 2.3 16V	08/00→05/06			
2.3	E5FC	393	AH7010 (MLS)	
Transit 2.3	03/01→03/06	2295 4 89.60 DOHC	103-107/ 140-146	
Transit 2.3 16V	08/00→05/06			
2.3	E5SA	394	AC5680 (MLS)	CC5680
Galaxy 2.3 16V	01/97→05/06	2295 4 89.60 DOHC	107/146	

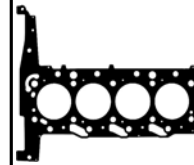
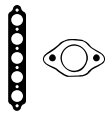

AA5970, AA5980, AA5990



AC5680



JM5037

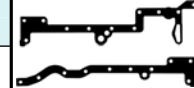

HC5004

HBS296 [22] M10x1.50x159.00mm (x10)		JM5037 (Elastomer)	HC5004 [S]	HR5082 [S]	NA5028 [1] 36.00x50.00x7.00mm, PTFE NA5031 [2] 50.00x86.50x13.70mm, PTFE NA5030 [1] 106.00x196.00x15.20mm, FPM	
HBS296 [22] M10x1.50x159.00mm (x10)		JM5037 (Elastomer)	HC5004 [S]	HR5082 [S]	NA5028 [1] 36.00x50.00x7.00mm, PTFE NA5031 [2] 50.00x86.50x13.70mm, PTFE NA5030 [1] 106.00x196.00x15.20mm, FPM	
HBS296 [22] M10x1.50x159.00mm (x10)		JM5037 (Elastomer)	HC5004 [S]	HR5082 [S]	NA5028 [1] 36.00x50.00x7.00mm, PTFE NA5031 [2] 50.00x86.50x13.70mm, PTFE NA5030 [1] 106.00x196.00x15.20mm, FPM	
	HA5020 [1] [S]	JM5037 (Elastomer)	HC5004 [S]	HR5082 [S]	NA5031 [2] 50.00x86.50x13.70mm, PTFE NA5030 [1] 106.00x196.00x15.20mm, FPM	
	HA5020 [1] [S]	JM5037 (Elastomer)	HC5004 [S]	HR5082 [S]	NA5031 [2] 50.00x86.50x13.70mm, PTFE NA5030 [1] 106.00x196.00x15.20mm, FPM	
	HA5020 [1] [S]	JM5037 (Elastomer)	HC5004 [S]	HR5082 [S]	NA5031 [2] 50.00x86.50x13.70mm, PTFE NA5030 [1] 106.00x196.00x15.20mm, FPM	
	HA5020 [1] [S]	JM5037 (Elastomer)	HC5004 [S]	HR5082 [S]	NA5031 [2] 50.00x86.50x13.70mm, PTFE NA5030 [1] 106.00x196.00x15.20mm, FPM	
	HA5020 [1] [S]	JM5037 (Elastomer)	HC5004 [S]	HR5082 [S]	NA5031 [2] 50.00x86.50x13.70mm, PTFE NA5030 [1] 106.00x196.00x15.20mm, FPM	
	HA5020 [1] [S]	JM5037 (Elastomer)	HC5004 [S]	HR5082 [S]	NA5031 [2] 50.00x86.50x13.70mm, PTFE NA5030 [1] 106.00x196.00x15.20mm, FPM	
	HA5020 [1] [S]	JM5037 (Elastomer)	HC5004 [S]	HR5082 [S]	NA5031 [2] 50.00x86.50x13.70mm, PTFE NA5030 [1] 106.00x196.00x15.20mm, FPM	
HBS032 [22] M11x1.50x178.00mm (x10)		HM5238 [S]	KG664	HR655 (x2)	NA5177 [2] 42.00x56.00x7.00mm, FPM NB848 [1] 100.00x120.00x11.00mm, PTFE	
HBS032 [22] M11x1.50x178.00mm (x10)		HM5238 [S]	KG664	HR655 (x2)	NA5177 [2] 42.00x56.00x7.00mm, FPM NB848 [1] 100.00x120.00x11.00mm, PTFE	
HBS032 [22] M11x1.50x178.00mm (x10)		HM5238 [S]	KG664	HR655 (x2)	NA5177 [2] 42.00x56.00x7.00mm, FPM NB848 [1] 100.00x120.00x11.00mm, PTFE	



cc



kW/PS



2.3	E5SB	395	AC5680 (MLS)	CC5680		
Galaxy 2.3 16V	09/01→05/06	2295	4	89.60	DOHC	103/140
2.3	GZ	396	AD5220 (MLS)	CD5220 [3][79] CD5221 [3][78]	ED5220 [3]	
Maverick 2.3 16V	03/04→	2261	4	87.50	DOHC	108-114/ 147-155
2.3	GZFA	397	AD5220 (MLS)	CD5221 [3]	ED5220 [3]	
Transit 2.3 16V	04/06→	2295	4		DOHC	100-107/ 136-145
2.3	GZFC	398	AD5220 (MLS)	CD5221 [3]	ED5220 [3]	
Transit 2.3 16V	04/06→	2295	4		DOHC	107/145
2.3	Y5A	399	AC5680 (MLS) AH7010 (MLS)	CC5680		
Scorpio II 16V	06/96→08/98	2295	4	89.60	DOHC	108/147
2.3	Y5B	400	AC5680 (MLS)	CC5680		
Galaxy 2.3 16V	01/97→05/06	2295	4	89.60	DOHC	107/146
2.4	D2FA Diesel	401	AA5940 (MLS), 1.100mm, 1 Hole AA5950 (MLS), 1.150mm, 2 Holes AA5960 (MLS), 1.200mm, 3 Holes	CA5941 ▲	EA5940 [3]	
Transit 2.4 DI	01/00→05/06	2402	4	89.90	DOHC	66/90
2.4	D2FB Diesel	402	AA5940 (MLS), 1.100mm, 1 Hole AA5950 (MLS), 1.150mm, 2 Holes AA5960 (MLS), 1.200mm, 3 Holes	CA5941 ▲	EA5940 [3]	
Transit 2.4 DI	01/00→05/06	2402	4	89.90	DOHC	66/90
2.4	D2FE Diesel	403	AA5940 (MLS), 1.100mm, 1 Hole AA5950 (MLS), 1.150mm, 2 Holes AA5960 (MLS), 1.200mm, 3 Holes	CA5941 ▲	EA5940 [3]	
Transit 2.4 DI	01/00→05/06	2402	4	89.90	DOHC	66/90
Transit 2.4 TDdi	10/01→03/06					
2.4	D4FA Diesel	404	AA5940 (MLS), 1.100mm, 1 Hole AA5950 (MLS), 1.150mm, 2 Holes AA5960 (MLS), 1.200mm, 3 Holes	CA5941 ▲	EA5940 [3]	
Transit 2.4 DI	01/00→05/06	2402	4	89.90	DOHC	88/120
Transit 2.4 TDdi	08/00→08/03					
2.4	DOFA Diesel	405	AA5940 (MLS), 1.100mm, 1 Hole AA5950 (MLS), 1.150mm, 2 Holes AA5960 (MLS), 1.200mm, 3 Holes	CA5941 ▲	EA5940 [3]	
Transit 2.4 TDE	07/01→05/06	2402	4	89.90	DOHC	92/125
2.4	F4FA Diesel	406	AA5940 (MLS), 1.100mm, 1 Hole AA5950 (MLS), 1.150mm, 2 Holes AA5960 (MLS), 1.200mm, 3 Holes	CA5941 ▲	EA5940 [3]	
Transit 2.4 DI	01/00→05/06	2402	4	89.90	DOHC	55/75
Transit 2.4 TD	08/00→08/03					
2.4	FXFA Diesel	407	AA5940 (MLS), 1.100mm, 1 Hole AA5950 (MLS), 1.150mm, 2 Holes AA5960 (MLS), 1.200mm, 3 Holes	CA5941 ▲	EA5940 [3]	
Transit 2.4 TDE	03/04→05/06	2402	4	89.90	DOHC	85/115
2.4	H9FA Diesel	408	AA5940 (MLS), 1.100mm, 1 Hole AA5950 (MLS), 1.150mm, 2 Holes AA5960 (MLS), 1.200mm, 3 Holes	CA5941 ▲	EA5940 [3]	
Transit 2.4 TDCi	03/04→05/06	2402	4	89.90	DOHC	101/137
2.4	H9FB Diesel	409	AA5940 (MLS), 1.100mm, 1 Hole AA5950 (MLS), 1.150mm, 2 Holes AA5960 (MLS), 1.200mm, 3 Holes	CA5941 ▲	EA5940 [3]	
Transit TDCi	11/06→	2402	4	89.90	DOHC	103/140

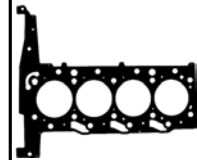
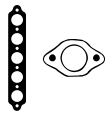

AA5940, AA5950, AA5960



AC5680



AD5220



JD5299



JE5037



JM5037



HC5004

HBS032 [22] M11x1.50x178.00mm (x10)		HM5238 [5] ⇒KG664	HR655 [5] (x2)	NA5177 [2] 42.00x56.00x7.00mm, FPM NB848 [1] 100.00x120.00x11.00mm, PTFE	
HBS369 [5] M10x1.50x145.50mm (x10)	JD5299 [4] JE5037 [5]	JM5153 [78] (Elastomer)	HR5063 [5]	NA5157 [2] 37.00x50.00x8.00mm, PTFE LK5005 [1] [7] 88.00x188.00x15.000mm, PTFE	
HBS369 [5] M10x1.50x145.50mm (x10)	JD5299 [4] JE5037 [5]	JM5153 [78] (Elastomer)	HR5063 [5]	NA5157 [2] 37.00x50.00x8.00mm, PTFE LK5005 [1] [7] 88.00x188.00x15.000mm, PTFE	
HBS369 [5] M10x1.50x145.50mm (x10)	JD5299 [4] JE5037 [5]	JM5153 [78] (Elastomer)	HR5063 [5]	NA5157 [2] 37.00x50.00x8.00mm, PTFE LK5005 [1] [7] 88.00x188.00x15.000mm, PTFE	
HBS032 [22] M11x1.50x178.00mm (x10)		HM5238 [5] ⇒KG664	HR655 [5]	NA5177 [2] 42.00x56.00x7.00mm, FPM NB848 [1] 100.00x120.00x11.00mm, PTFE	
HBS032 [22] M11x1.50x178.00mm (x10)		HM5238 [5] ⇒KG664	HR655 [5]	NA5177 [2] 42.00x56.00x7.00mm, FPM NB848 [1] 100.00x120.00x11.00mm, PTFE	
HBS296 [22] M10x1.50x159.00mm (x10)	HA5020 [5] JD5998 [5] (MLS)	JM5037 [78] (Elastomer)	HC5004 [5]	HR5082 [5] NA5031 [2] 50.00x86.50x13.70mm, PTFE NA5030 [1] 106.00x196.00x15.20mm, FPM	
HBS296 [22] M10x1.50x159.00mm (x10)	HA5020 [5] JD5998 [5] (MLS)	JM5037 [78] (Elastomer)	HC5004 [5]	HR5082 [5] NA5031 [2] 50.00x86.50x13.70mm, PTFE NA5030 [1] 106.00x196.00x15.20mm, FPM	
HBS296 [22] M10x1.50x159.00mm (x10)	HA5020 [5] JD5998 [5] (MLS)	JM5037 [78] (Elastomer)	HC5004 [5]	HR5082 [5] NA5031 [2] 50.00x86.50x13.70mm, PTFE NA5030 [1] 106.00x196.00x15.20mm, FPM	
HBS296 [22] M10x1.50x159.00mm (x10)	HA5020 [5] JD5998 [5] (MLS)	JM5037 [78] (Elastomer)	HC5004 [5]	HR5082 [5] NA5031 [2] 50.00x86.50x13.70mm, PTFE NA5030 [1] 106.00x196.00x15.20mm, FPM	
HBS296 [22] M10x1.50x159.00mm (x10)	HA5020 [5] JD5998 [5] (MLS)	JM5037 [78] (Elastomer)	HC5004 [5]	HR5082 [5] NA5031 [2] 50.00x86.50x13.70mm, PTFE NA5030 [1] 106.00x196.00x15.20mm, FPM	
HBS296 [22] M10x1.50x159.00mm (x10)	HA5020 [5] JD5998 [5] (MLS)	JM5037 [78] (Elastomer)	HC5004 [5]	HR5082 [5] NA5031 [2] 50.00x86.50x13.70mm, PTFE NA5030 [1] 106.00x196.00x15.20mm, FPM	
HBS296 [22] M10x1.50x159.00mm (x10)	HA5020 [5] JD5998 [5] (MLS)	JM5037 [78] (Elastomer)	HC5004 [5]	HR5082 [5] NA5031 [2] 50.00x86.50x13.70mm, PTFE NA5030 [1] 106.00x196.00x15.20mm, FPM	
HBS296 [22] M10x1.50x159.00mm (x10)	HA5020 [5] JD5998 [5] (MLS)	JM5037 [78] (Elastomer)	HC5004 [5]	HR5082 [5] NA5031 [2] 50.00x86.50x13.70mm, PTFE NA5030 [1] 106.00x196.00x15.20mm, FPM	
HBS296 [22] M10x1.50x159.00mm (x10)	HA5020 [5] JD5998 [5] (MLS)	JM5037 [78] (Elastomer)	HC5004 [5]	HR5082 [5] NA5031 [2] 50.00x86.50x13.70mm, PTFE NA5030 [1] 106.00x196.00x15.20mm, FPM	



cc



kW/PS



2.4	H9FD Diesel	410	AA5940 (MLS), 1.100mm, 1 Hole AA5950 (MLS), 1.150mm, 2 Holes AA5960 (MLS), 1.200mm, 3 Holes	CA5941 ▲	EA5940 [3]	
Transit 2.4 TDCi	04/06→	2402	4	89.90	DOHC	103/140
2.4	JXFA Diesel	411	AA5940 (MLS), 1.100mm, 1 Hole AA5950 (MLS), 1.150mm, 2 Holes AA5960 (MLS), 1.200mm, 3 Holes	CA5941 ▲	EA5940 [3]	
Transit 2.4 TDCi	04/06→	2402	4	89.90	DOHC	85/115
2.4	JXFC Diesel	412	AA5940 (MLS), 1.100mm, 1 Hole AA5950 (MLS), 1.150mm, 2 Holes AA5960 (MLS), 1.200mm, 3 Holes	CA5941 ▲	EA5940 [3]	
Transit 2.4 TDCi	04/06→	2402	4	89.90	DOHC	85/115
2.4	KA-24	413	BS770 (Graphite)	DS771 [13]	GS770 [3]	
Maverick	09/96→04/98	2389	4	89.00	SOHC/OHC	85-87/ 116-118
Maverick 2.4 i	09/96→04/98					
2.4	KA24-E	414	BS770 (Graphite)	DS771 [13]	GS770 [3]	
Maverick 2.4 i	02/93→08/96	2389	4	89.00	SOHC/OHC	91/124
2.4	PHFA Diesel	415	AA5940 (MLS), 1.100mm, 1 Hole AA5950 (MLS), 1.150mm, 2 Holes AA5960 (MLS), 1.200mm, 3 Holes	CA5941 ▲	EA5940 [3]	
Transit 2.4 TDCi	04/06→	2402	4	89.90	DOHC	74/100
2.4	PHFC Diesel	416	AA5940 (MLS), 1.100mm, 1 Hole AA5950 (MLS), 1.150mm, 2 Holes AA5960 (MLS), 1.200mm, 3 Holes	CA5941 ▲	EA5940 [3]	
Transit 2.4 TDCi	04/06→	2402	4	89.90	DOHC	74/100
2.5	4AB Diesel	417	BT800 (Fibre)	DT800 ▲ →08/89 DT803 [13] →08/89 DT802 08/89→08/91 DT806 08/89→	EN260 [3] →09/88 ET800 [80] 10/88→	
Transit 2.5 D	12/85→09/92	2496	4	93.67	OHV	50-52/ 68-71
2.5	4BA Diesel	418	BT800 (Fibre)	DT800 ▲ →08/89 DT802 08/89→08/91 DT806 08/89→	ET800 [80] 10/88→	
Transit 2.5 D	09/88→09/92	2496	4	93.67		52/71
Transit 2.5 DI	09/88→09/92					
2.5	4BC Diesel	419	BT800 (Fibre)	DT802 DT806 [88]	ET800	
Transit 2.5 DI	05/91→08/94	2496	4	93.70	SOHC/OHC	52/70
2.5	4CA Diesel	420	BT800 (Fibre)	DT800 ▲ →08/89 DT802 08/89→08/91 DT806 08/89→	ET800 [80] 10/88→	
Transit 2.5 D	09/88→09/92	2496	4	93.67	OHV	52/71
Transit 2.5 DI	09/88→09/92					

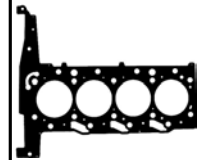

HBS296 [22] M10x1.50x159.00mm (x10)	HA5020 [1] [5] JD5998 [E] (MLS)	JM5037 (Elastomer)	HC5004 [S]	HR5082 [S]	NA5031 [E] [2] 50.00x86.50x13.70mm, PTFE NA5030 [E] [1] 106.00x196.00x15.20mm, FPM	
HBS296 [22] M10x1.50x159.00mm (x10)	HA5020 [1] [5] JD5998 [E] (MLS)	JM5037 (Elastomer)	HC5004 [S]	HR5082 [S]	NA5031 [E] [2] 50.00x86.50x13.70mm, PTFE NA5030 [E] [1] 106.00x196.00x15.20mm, FPM	
HBS296 [22] M10x1.50x159.00mm (x10)	HA5020 [1] [5] JD5998 [E] (MLS)	JM5037 (Elastomer)	HC5004 [S]	HR5082 [S]	NA5031 [E] [2] 50.00x86.50x13.70mm, PTFE NA5030 [E] [1] 106.00x196.00x15.20mm, FPM	
HBS432 [22] M10x1.50x110.00mm (x10)	JC901 [1] JC900 [E] (x2)	JN743 [4]		PA933 [E] (x4) PA079 [1] (x8)	NJ287 [E] [1] 80.00x100.00x10.00mm, MVQ	
HBS432 [22] M10x1.50x110.00mm (x10)	JC901 [1] JC900 [E] (x2)	JN743 [4]		PA933 [E] (x4) PA079 [1] (x8)	NJ287 [E] [1] 80.00x100.00x10.00mm, MVQ	
HBS296 [22] M10x1.50x159.00mm (x10)	HA5020 [1] [5] JD5998 [E] (MLS)	JM5037 (Elastomer)	HC5004 [S]	HR5082 [S]	NA5031 [E] [2] 50.00x86.50x13.70mm, PTFE NA5030 [E] [1] 106.00x196.00x15.20mm, FPM	
HBS296 [22] M10x1.50x159.00mm (x10)	HA5020 [1] [5] JD5998 [E] (MLS)	JM5037 (Elastomer)	HC5004 [S]	HR5082 [S]	NA5031 [E] [2] 50.00x86.50x13.70mm, PTFE NA5030 [E] [1] 106.00x196.00x15.20mm, FPM	
HBS008 [19] M12x1.75x92.00mm (x18)	JD064 [1] JD066 [E]	JN460 [4] →08/89 JM5027 (SE) 08/89→ JN821 [87] (Cork) 08/89→	HC451 [S] →09/88 JJ484 10/88→	HR5064 [S]	NB856 [2] 47.62x66.50x11.00mm, PTFE NB788 [E] [1] 79.40x95.30x11.10mm, PTFE →09/88 NB854 [E] [1] 79.00x99.00x9.50mm, PTFE 10/88→ NB855 [E] [2] 67.00x86.00x9.50mm, PTFE 10/88→	
HBS008 [19] M12x1.75x92.00mm (x18)	JD064 [1] JD066 [E]	JN460 [4] →08/89 JM5027 (SE) 08/89→ JN821 [87] (Cork) 08/89→	JJ484 10/88→	HR5064 [S]	NB856 [2] 47.62x66.50x11.00mm, PTFE NB854 [E] [1] 79.00x99.00x9.50mm, PTFE 10/88→ NB855 [E] [2] 67.00x86.00x9.50mm, PTFE 10/88→	
HBS008 [19] M12x1.75x92.00mm (x18)	JD064 [1] JD066 [E]	JM5027 (SE) JN821 [87] (Cork)	JJ484	HR5064 [S]	NB856 [2] 47.62x66.50x11.00mm, PTFE NB854 [E] [1] 79.00x99.00x9.50mm, PTFE 10/88→ NB855 [E] [2] 67.00x86.00x9.50mm, PTFE	
HBS008 [19] M12x1.75x92.00mm (x18)	JD064 [1] JD066 [E]	JN460 [4] →08/89 JM5027 (SE) 08/89→ JN821 [87] (Cork) 08/89→	JJ484 10/88→	HR5064 [S]	NB856 [2] 47.62x66.50x11.00mm, PTFE NB854 [E] [1] 79.00x99.00x9.50mm, PTFE 10/88→ NB855 [E] [2] 67.00x86.00x9.50mm, PTFE	

AA5940, AA5950, AA5960



BS770

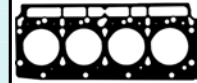

BT800



JC900

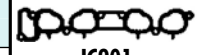

JC901



JD064



JD066

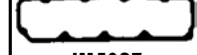

JM5027



JM5037

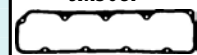

JN460



JN743

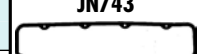

JN821

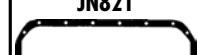

HC451



HC5004



JJ484



cc



kW/PS

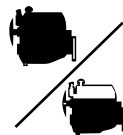

2.5	4CC Diesel	421	BT800 (Fibre)	DT802 DT806 [88]	ET800
Transit 2.5 DI	05/91→08/94	2496 4 94.00 OHV	52/70		
2.5	4DA Diesel	422	BT800 (Fibre)	DT802 DT806	ET800
Transit 2.5 DI	05/91→08/94	2496 4 93.67 OHV	59/80		
2.5	4EA Diesel	423	BT800 (Fibre)	DT801 [89] DT805 [88]	ET800
Transit 2.5 TD	05/91→08/94	2496 4 93.67 OHV	74/100		
2.5	4EB Diesel	424	BT800 (Fibre)	DT801 [89] DT805	ET800 [62]
Transit 2.5 TD	07/94→12/00	2496 4 93.70 SOHC/OHC	74/101		
Transit 2.5 TDI	06/94→03/00				
2.5	4EC Diesel	425	BT800 (Fibre)	DT801 [89] DT805	ET800 [62]
Transit 2.5 TD	07/94→12/00	2496 4 93.70 OHV	74/101		
Transit 2.5 TDI	06/94→03/00				
2.5	4ED Diesel	426	BT800 (Fibre)	DT801 [89] DT805 [88]	ET800
Transit 2.5 DI	08/97→03/00	2496 4 93.67 OHV	85/116		
2.5	4FA Diesel	427	BT800 (Fibre)	DT802 DT806 [88]	ET800
Transit 2.5 DI	05/91→12/00	2496 4 94.00 OHV	51-52/ 69-70		
2.5	4FB Diesel	428	BT800 (Fibre)	DT802 DT806 [88]	ET800
Transit 2.5 DI	06/94→12/00	2496 4 93.70 SOHC/OHC	51/70		
2.5	4FC Diesel	429	BT800 (Fibre)	DT802 DT806 [88]	ET800
Transit 2.5 DI	06/94→12/00	2496 4 93.70	51/70		
2.5	4FD Diesel	430	BT800 (Fibre)	DT802 DT806 [88]	ET800
Transit 2.5 DI	06/94→12/00	2496 4 93.70 OHV	51/69		

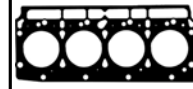
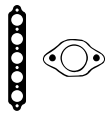

BT800

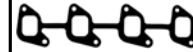

JD064

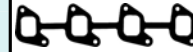

JD065



JD066



JM5027



JN821



JJ484

HBS008 [19] M12x1.75x92.00mm (x18)	JD064 JD066	JM5027 (SE) JN821 [87] (Cork)	JJ484	HR5064	NB856 [2] 47.62x66.50x11.00mm, PTFE NB854 [1] 79.00x99.00x9.50mm, PTFE NB855 [2] 67.00x86.00x9.50mm, PTFE	
HBS008 [19] M12x1.75x92.00mm (x18)	JD064 JD066	JM5027 (SE) JN821 [87] (Cork)	JJ484	HR5064	NB856 [2] 47.62x66.50x11.00mm, PTFE NB854 [1] 79.00x99.00x9.50mm, PTFE NB855 [2] 67.00x86.00x9.50mm, PTFE	
HBS008 [19] M12x1.75x92.00mm (x18)	JD065 JD066	JM5027 (SE) JN821 [87] (Cork)	JJ484	HR5064	NB856 [2] 47.62x66.50x11.00mm, PTFE NB854 [1] 79.00x99.00x9.50mm, PTFE NB855 [2] 67.00x86.00x9.50mm, PTFE	
HBS008 [19] M12x1.75x92.00mm (x18)	JD065 JD066	JM5027 (SE) JN821 [87] (Cork)	JJ484	HR5064	NB856 [2] 47.62x66.50x11.00mm, PTFE NB854 [1] 79.00x99.00x9.50mm, PTFE NB855 [2] 67.00x86.00x9.50mm, PTFE	
HBS008 [19] M12x1.75x92.00mm (x18)	JD065 JD066	JM5027 (SE) JN821 [87] (Cork)	JJ484	HR5064	NB856 [2] 47.62x66.50x11.00mm, PTFE NB854 [1] 79.00x99.00x9.50mm, PTFE NB855 [2] 67.00x86.00x9.50mm, PTFE	
HBS008 [19] M12x1.75x92.00mm (x18)	JD065 JD066	JM5027 (SE) JN821 [87] (Cork)	JJ484	HR5064	NB856 [2] 47.62x66.50x11.00mm, PTFE NB854 [1] 79.00x99.00x9.50mm, PTFE NB855 [2] 67.00x86.00x9.50mm, PTFE	
HBS008 [19] M12x1.75x92.00mm (x18)	JD064 JD066	JM5027 (SE) JN821 [87] (Cork)	JJ484	HR5064	NB856 [2] 47.62x66.50x11.00mm, PTFE NB854 [1] 79.00x99.00x9.50mm, PTFE NB855 [2] 67.00x86.00x9.50mm, PTFE	
HBS008 [19] M12x1.75x92.00mm (x18)	JD064 JD066	JM5027 (SE) JN821 [87] (Cork)	JJ484	HR5064	NB856 [2] 47.62x66.50x11.00mm, PTFE NB854 [1] 79.00x99.00x9.50mm, PTFE NB855 [2] 67.00x86.00x9.50mm, PTFE	
HBS008 [19] M12x1.75x92.00mm (x18)	JD064 JD066	JM5027 (SE) JN821 [87] (Cork)	JJ484	HR5064	NB856 [2] 47.62x66.50x11.00mm, PTFE NB854 [1] 79.00x99.00x9.50mm, PTFE NB855 [2] 67.00x86.00x9.50mm, PTFE	

FORD



cc



kW/PS



2.5	4GA Diesel	431	BT800 (Fibre)	DT801 [89] DT805 [88]	ET800
Transit 2.5 DI Transit 2.5 TD	10/92→06/94 10/92→12/00	2496 4 93.67 OHV 63/85			
2.5	4GB Diesel	432	BT800 (Fibre)	DT801 [89] DT805 [88]	ET800
Transit 2.5 TD	10/92→12/00	2496 4 93.67 OHV 63/85			
2.5	4GC Diesel	433	BT800 (Fibre)	DT801 [89] DT805 [88]	ET800
Transit 2.5 TD	10/92→12/00	2496 4 93.67 OHV 63/85			
2.5	4GD Diesel	434	BT800 (Fibre)	DT801 [89] DT805	ET800 [62]
Transit 2.5 TD	06/94→03/00	2496 4 93.67 OHV 63/86			
2.5	4GE Diesel	435	BT800 (Fibre)	DT801 [89] DT805	ET800 [62]
Transit 2.5 TD	06/94→03/00	2496 4 93.70 SOHC/OHC 63/86			
2.5	4GF Diesel	436	BT800 (Fibre)	DT801 [89] DT805	ET800 [62]
Transit 2.5 TD	06/94→03/00	2496 4 93.70 SOHC/OHC 63/85			
2.5	4HA Diesel	437	BT800 (Fibre)	DT801 [89] DT805 [88]	ET800 [62]
Transit 2.4 D Transit 2.5 DI Transit 2.5 TD	08/94→06/00 11/94→12/00 08/94→07/00	2496 4 93.67 OHV 55-56/75			
2.5	4HB Diesel	438	BT800 (Fibre)	DT802 DT806	ET800
Transit 2.5 DI	06/94→12/00	2496 4 93.67 OHV 56/76			
2.5	4HC Diesel	439	BT800 (Fibre)	DT802 DT806	ET800
Transit 2.5 DI	06/94→12/00	2496 4 93.70 SOHC/OHC 56/76			
2.5	4HD Diesel	440	BT800 (Fibre)	DT801 [89] DT805 [88]	ET800 [62]
Transit 2.5 TD	08/94→07/00	2496 4 93.70 SOHC/OHC 55/75			

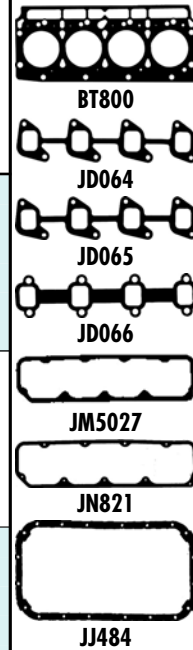
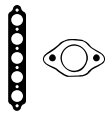

HBS008 [19] M12x1.75x92.00mm (x18)	JD065 JD066	JM5027 (SE) JN821 [87] (Cork)	JJ484	HR5064	NB856 [2] 47.62x66.50x11.00mm, PTFE NB854 [1] 79.00x99.00x9.50mm, PTFE NB855 [2] 67.00x86.00x9.50mm, PTFE	
HBS008 [19] M12x1.75x92.00mm (x18)	JD065 JD066	JM5027 (SE) JN821 [87] (Cork)	JJ484	HR5064	NB856 [2] 47.62x66.50x11.00mm, PTFE NB854 [1] 79.00x99.00x9.50mm, PTFE NB855 [2] 67.00x86.00x9.50mm, PTFE	
HBS008 [19] M12x1.75x92.00mm (x18)	JD065 JD066	JM5027 (SE) JN821 [87] (Cork)	JJ484	HR5064	NB856 [2] 47.62x66.50x11.00mm, PTFE NB854 [1] 79.00x99.00x9.50mm, PTFE NB855 [2] 67.00x86.00x9.50mm, PTFE	
HBS008 [19] M12x1.75x92.00mm (x18)	JD065 JD066	JM5027 (SE) JN821 [87] (Cork)	JJ484	HR5064	NB856 [2] 47.62x66.50x11.00mm, PTFE NB854 [1] 79.00x99.00x9.50mm, PTFE NB855 [2] 67.00x86.00x9.50mm, PTFE	
HBS008 [19] M12x1.75x92.00mm (x18)	JD065 JD066	JM5027 (SE) JN821 [87] (Cork)	JJ484	HR5064	NB856 [2] 47.62x66.50x11.00mm, PTFE NB854 [1] 79.00x99.00x9.50mm, PTFE NB855 [2] 67.00x86.00x9.50mm, PTFE	
HBS008 [19] M12x1.75x92.00mm (x18)	JD065 JD066	JM5027 (SE) JN821 [87] (Cork)	JJ484	HR5064	NB856 [2] 47.62x66.50x11.00mm, PTFE NB854 [1] 79.00x99.00x9.50mm, PTFE NB855 [2] 67.00x86.00x9.50mm, PTFE	
HBS008 [19] M12x1.75x92.00mm (x18)	JD065 JD066	JM5027 (SE) JN821 [87] (Cork)	JJ484	HR5064	NB856 [2] 47.62x66.50x11.00mm, PTFE NB854 [1] 79.00x99.00x9.50mm, PTFE NB855 [2] 67.00x86.00x9.50mm, PTFE	
HBS008 [19] M12x1.75x92.00mm (x18)	JD064 JD066	JM5027 (SE) JN821 [87] (Cork)	JJ484	HR5064	NB856 [2] 47.62x66.50x11.00mm, PTFE NB854 [1] 79.00x99.00x9.50mm, PTFE NB855 [2] 67.00x86.00x9.50mm, PTFE	
HBS008 [19] M12x1.75x92.00mm (x18)	JD064 JD066	JM5027 (SE) JN821 [87] (Cork)	JJ484	HR5064	NB856 [2] 47.62x66.50x11.00mm, PTFE NB854 [1] 79.00x99.00x9.50mm, PTFE NB855 [2] 67.00x86.00x9.50mm, PTFE	
HBS008 [19] M12x1.75x92.00mm (x18)	JD065 JD066	JM5027 (SE) JN821 [87] (Cork)	JJ484	HR5064	NB856 [2] 47.62x66.50x11.00mm, PTFE NB854 [1] 79.00x99.00x9.50mm, PTFE NB855 [2] 67.00x86.00x9.50mm, PTFE	



cc



kW/PS



2.5	HUBA						441	AG8320 (MLS)		
Mondeo IV 2.5	03/07→	2521	5	83.00	DOHC	162/220				
2.5	HUWA						442	AG8320 (MLS)		
S-Max 2.5 ST	05/06→	2521	5	83.00	DOHC	162/220				
2.5	HYDA						443	AG8320 (MLS)		
Focus II 2.5 ST	10/05→	2522	5	83.00	DOHC	166/225				
2.5	HYDB						444	AG8320 (MLS)		
Kuga 2.5	03/09→	2522	5	83.00	DOHC	147/200				
Kuga 2.5 4x4	03/09→									
2.5	JZDA						445	AG8320 (MLS)		
Focus II 2.5 RS	01/09→	2521	5			224-257/ 305-350				
Focus II RS 500	05/10→									
2.5	LCBA						446	AC5880 (MLS) <input checked="" type="checkbox"/>		
Cougar 2.5 V6	08/98→12/01	2544	6	82.40	DOHC, V	125/170	→09/00	AC5870 (MLS) <input checked="" type="checkbox"/>		
							→09/00	AC5790 (MLS) <input checked="" type="checkbox"/>		
							10/00→	AC5780 (MLS) <input checked="" type="checkbox"/>		
							10/00→			
2.5	LCBB						447	AC5880 (MLS) <input checked="" type="checkbox"/>		
Cougar 2.5 V6	06/00→12/01	2495	6	81.60	DOHC, V	125/170	→09/00	AC5870 (MLS) <input checked="" type="checkbox"/>		
							→09/00	AC5790 (MLS) <input checked="" type="checkbox"/>		
							10/00→	AC5780 (MLS) <input checked="" type="checkbox"/>		
							10/00→			
2.5	LCBC						448	AC5880 (MLS) <input checked="" type="checkbox"/>		
Cougar 2.5 V6	06/00→12/01	2495	6	81.60	DOHC, V	125/170	→09/00	AC5870 (MLS) <input checked="" type="checkbox"/>		
							→09/00	AC5790 (MLS) <input checked="" type="checkbox"/>		
							10/00→	AC5780 (MLS) <input checked="" type="checkbox"/>		
							10/00→			



AC5780



AC5790



AC5870



AC5880



JH5065













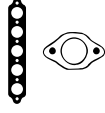

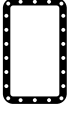
cc

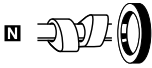

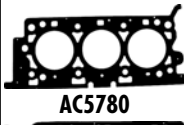
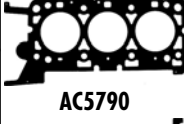
kW/PS

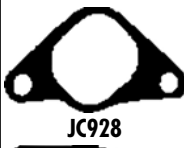

2.5	LCBD						449	AC5880 (MLS)	CC5870	
Metrostart 2.5	10/00→02/07	2495	6	81.60	DOHC, V	125/170	→09/00			
Mondeo II 24V	06/00→11/00						AC5870 (MLS)			
Mondeo III 24V	11/00→08/07						→09/00			
							AC5790 (MLS)			
							10/00→			
							AC5780 (MLS)			
							10/00→			
2.5	LCBE						450	AC5880 (MLS)		
Cougar 2.5 V6	06/00→12/01	2495	6	81.60	DOHC, V	125/170	→09/00			
							AC5870 (MLS)			
							→09/00			
							AC5790 (MLS)			
							10/00→			
							AC5780 (MLS)			
							10/00→			
2.5	SCB Diesel						451	AY400 (MLS), 1.420mm, 0 Notches	DK570 ▲	GK572 ▲ [18]
Scorpio I 2.5 TD	08/93→09/94	2500	4	92.00		85/115	BK570 (Fibre), 1.420mm, 0 Notches (x4)			
							AY410 (MLS), 1.520mm, 2 Notches			
							BP260 (Fibre), 1.520mm, 2 Notches			
							AY420 (MLS), 1.620mm, 1 Notch			
							BK580 (Fibre), 1.620mm, 1 Notch (x4)			
2.5	SCC Diesel						452	AY400 (MLS), 1.420mm, 0 Notches	DK570 ▲	GK572 ▲ [18]
Scorpio II TD	10/94→08/98	2500	4	92.00		85/115	BK570 (Fibre), 1.420mm, 0 Notches (x4)			
							AY410 (MLS), 1.520mm, 2 Notches			
							BP260 (Fibre), 1.520mm, 2 Notches			
							AY420 (MLS), 1.620mm, 1 Notch			
							BK580 (Fibre), 1.620mm, 1 Notch (x4)			
2.5	SEA						453	AC5880 (MLS)	CC5870	
Mondeo I 24V	07/94→08/96	2544	6	82.40	DOHC, V	125/170	AC5870 (MLS)			
Mondeo II 24V	09/96→11/00									
2.5	SEB						454	AC5880 (MLS)	CC5870	
Mondeo II 24V	10/99→11/00	2495	6	81.60	DOHC, V	125/170	→09/00			
							AC5870 (MLS)			
							→09/00			
							AC5790 (MLS)			
							10/00→			
							AC5780 (MLS)			
							10/00→			
2.5	SEC						455	AC5880 (MLS)	CC5870	
Mondeo II 24V	10/99→11/00	2495	6	81.60	DOHC, V	125/170	→09/00			
							AC5870 (MLS)			
							→09/00			
							AC5790 (MLS)			
							10/00→			
							AC5780 (MLS)			
							10/00→			
2.5	SGA						456	AC5880 (MLS)	CC5870	
Cougar ST 200	01/00→12/01	2495	6	81.60	DOHC, V	151/205	→09/00			
Mondeo II ST200	05/99→11/00						AC5870 (MLS)			
							→09/00			
							AC5790 (MLS)			
							10/00→			
							AC5780 (MLS)			
							10/00→			

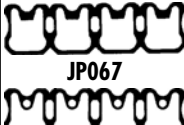
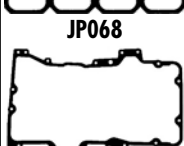
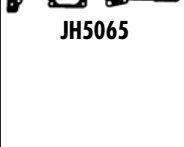
       						
HBS392 [22] M10x1.50x150.00mm (x16)	JD5926 [x2] (MLS)		JH5065 →10/03		NA5175 [1] 91.00x108.00x9.50mm, NBR	 AC5780  AC5790  AC5870  AC5880  AY400, AY410, AY420  BK570, BP260, BK580  JC928  JD025  JF123  JP067  JP068  JH5065
HBS392 [22] M10x1.50x150.00mm (x16)	JD5926 [x2] (MLS)		JH5065		NA5175 [1] 91.00x108.00x9.50mm, NBR	
HBS108 [12] M14x1.75x137.00mm (x10)	JC928 [1] JD025 [1] JF123	JP067 [4] JP068 [4] [93]				
HBS108 [12] M14x1.75x137.00mm (x10)	JC928 [1] JD025 [1] JF123	JP067 [4] JP068 [4] [93]				
HBS392 [22] M10x1.50x150.00mm (x16)	JD5926 [x2] (MLS)		JH5065		NA5175 [1] 91.00x108.00x9.50mm, NBR	
HBS392 [22] M10x1.50x150.00mm (x16)	JD5926 [x2] (MLS)		JH5065		NA5175 [1] 91.00x108.00x9.50mm, NBR	
HBS392 [22] M10x1.50x150.00mm (x16)	JD5926 [x2] (MLS)		JH5065		NA5175 [1] 91.00x108.00x9.50mm, NBR	
HBS392 [22] M10x1.50x150.00mm (x16)	JD5926 [x2] (MLS)		JH5065		NA5175 [1] 91.00x108.00x9.50mm, NBR	













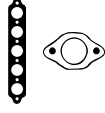

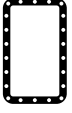

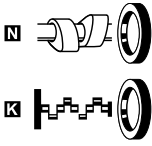















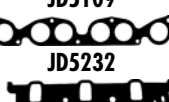



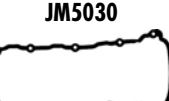

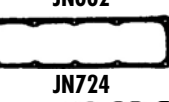















cc

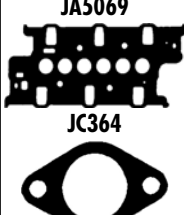

kw/PS

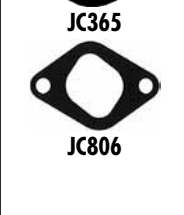

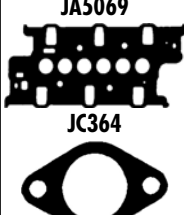
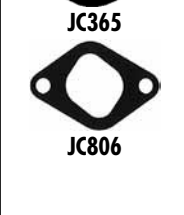
2.5	VM Diesel	457					AY400 (MLS), 1.420mm, 0 Notches	DK570 ▲	GK572 ▲ [18]
Scorpio II TD	09/96→08/98	2500	4	92.00	SOHC/OHC	92/125	BK570 (Fibre), 1.420mm, 0 Notches (x4) AY410 (MLS), 1.520mm, 2 Notches BP260 (Fibre), 1.520mm, 2 Notches AY420 (MLS), 1.620mm, 1 Notch BK580 (Fibre), 1.620mm, 1 Notch (x4)		
2.5	WL Diesel	458					AA5130 (MLS)	CA5130 [3]	
Ranger 2.5 D	10/99→04/02	2500	4	93.00	SOHC/OHC	57/78			
Ranger 2.5 D 4x4	10/99→04/02								
2.5	WL-T Diesel	459					AA5130 (MLS)	CA5130 [3]	
Ranger 2.5 TD	10/99→06/06	2500	4	93.00	SOHC/OHC	62-80/ 84-109			
2.7	TD27 Diesel	460					AC5750 (MLS), 1.200mm, 1 Notch	CC5750 ▲	GS200
Maverick 2.7 TD	02/93→04/98	2663	4	96.00	OHV	74/100	AC5760 (MLS), 1.250mm, 2 Notches AC5770 (MLS), 1.300mm, 3 Notches		
2.7	TD27E Diesel	461					AC5750 (MLS), 1.200mm, 1 Notch	CC5750 ▲	GS200
Maverick 2.7 TD	06/96→04/98	2664	4	96.00	OHV	92/125	AC5760 (MLS), 1.250mm, 2 Notches AC5770 (MLS), 1.300mm, 3 Notches		
2.8	AAA	462					AA5430 (Fibre)	CA5431 [13]	
Galaxy 2.8 i V6	11/95→04/00	2792	6	81.00	DOHC, VR	128/174			
2.8	AMY	463					AA5430 (Fibre)	CA5431 [13]	
Galaxy 2.8 i V6	11/95→04/00	2792	6	81.00	DOHC, VR	128/174			
2.8	AYL	464					AG5000 (MLS)	CG5030	EG7800
Galaxy 2.8 V6	04/00→05/06	2792	6	81.00	DOHC, V	150/204			
2.8	PR7	465					BL400 (Fibre) ☒	DL401 [95]	
Sierra 2.8 i	01/87→02/93	2792	6	93.00	OHV, V	107/146	BL410 (Fibre) ☒	DL402	
Sierra 2.8 i 4x4	01/87→02/93								
Sierra 2.8 i XR	01/87→02/93								
2.8	PR8	466					BL400 (Fibre) ☒	DL401 [95]	
Sierra 2.8 i	01/87→02/93	2792	6	93.00	OHV, V	105-107/ 143-145	BL410 (Fibre) ☒	DL402	
2.8	PRG	467					BL400 (Fibre) ☒	DL401 [95]	
Sierra 2.8 i 4x4	01/87→08/88	2792	6	93.00	OHV, V	110/150	BL410 (Fibre) ☒	DL402	
Sierra 2.8 i XR	01/87→08/88								
2.9	B4A	468					BT510 (Fibre) ☒	DT510 [3]	ET490 [3]
Sierra 2.9 i XR	08/88→02/93	2936	6	93.00	V	110/150	BT520 (Fibre) ☒		

										
HBS108 [12] M14x1.75x137.00mm (x10)	JC928 [1] JD025 [1]  JF123	JPO67 [4] JPO68 [4] [93]							 AA5430  AC5750, AC5760, AC5770  AG5000  AY400, AY410, AY420  BK570, BP260, BK580  BL400  BL410  BT510  BT520  JA5068	 JC928  JD025  JD5109  JD5232  JM5030  JM5099  JM875  JN616  JN662  JN724  JP067  JP068  JH5013  JJ458
HBS288 [22] M12x1.25x113.00mm (x10)							NA5196 [1] [2] 90.00x110.00x9.00mm, ACM NA5197 [2] 53.00x69.85x11.00mm, MVQ		 NA5196  NA5197	
HBS288 [22] M12x1.25x113.00mm (x10)							NA5196 [1] [2] 90.00x110.00x9.00mm, ACM NA5197 [2] 53.00x69.85x11.00mm, MVQ		 NA5196  NA5197	
HBS194 [22] M12x1.50x113.00mm (x18)	JC805 [1] JC806 [1] (x4)	JN724 [4]					NJ829 [1] [2] 86.00x100.00x10.00mm, MVQ NJ831 [2] 58.00x80.00x10.00mm, NBR		 NJ829  NJ831	
HBS194 [22] M12x1.50x113.00mm (x18)	JC805 [1] JC806 [1] (x4)	JN724 [4]					NJ829 [1] [2] 86.00x100.00x10.00mm, MVQ NJ831 [2] 58.00x80.00x10.00mm, NBR		 NJ829  NJ831	
HBS077 [22] M11x1.50x144.00mm (x3)	JA5068 [1] JD5232 [1] JA5069 [1] [32] JD5109 [1] [27]	JM5030 (Elastomer) JM5099 (Elastomer)	JH5013			HR662 [1]	NB716 [2] 35.00x48.00x10.00mm, FPM NA5133 [1] 85.00x105.00x11.00mm, FPM		 NB716  NA5133	
HBS077 [22] M11x1.50x144.00mm (x3)	JA5068 [1] JD5232 [1] JA5069 [1] [32] JD5109 [1] [27]	JM5030 (Elastomer) →Eng.146.000 JM5099 (Elastomer) Eng.146.001 →	JH5013			HR662 [1]	NB716 [2] 35.00x48.00x10.00mm, FPM NA5133 [1] 85.00x105.00x11.00mm, FPM		 NB716  NA5133	
HBS077 [22] M11x1.50x144.00mm (x3) HBS526 [21] [94]		JM7045 (Elastomer)				PA5041 (x24) 6.00/12.20x10.00 (FPM) HR5062 [1]	NA5106 [2] 35.00x48.00x10.00mm, PTFE NA5305 [1] [36]		 NA5106  NA5305	
	JC364 [1] JC365 [1] (x4)	JM875 (x2) [4] [95] JN616 (x2) [4]	JJ458 = KG664			PB180 (x12) 8.00x12.0/15.40x9.50 866N W (FPM) HR633 [1] [1] HR630 [1] [1]	NA5190 [2] 42.00x56.00x7.00mm, FPM NB564 [1] 60.45x76.18x10.00mm, FPM		 PB180  NA5190  NB564	
	JC364 [1] JC365 [1] (x4)	JM875 (x2) [4] [95] JN616 (x2) [4]	JJ458 = KG664			PB180 (x12) 8.00x12.0/15.40x9.50 866N W (FPM) HR633 [1] [1] HR630 [1] [1]	NA5190 [2] 42.00x56.00x7.00mm, FPM NB564 [1] 60.45x76.18x10.00mm, FPM		 PB180  NA5190  NB564	
	JC364 [1] JC365 [1] (x4)	JM875 (x2) [4] [95] JN616 (x2) [4]	JJ458 = KG664			PB180 (x12) 8.00x12.0/15.40x9.50 866N W (FPM) HR633 [1] [1] HR630 [1] [1]	NA5190 [2] 42.00x56.00x7.00mm, FPM NB564 [1] 60.45x76.18x10.00mm, FPM		 PB180  NA5190  NB564	
HBS057 [19] M12x1.75x87.00mm (x16)	JD5268 [1] JE5020 [1] (x6)	JN662 (x2) [4]	JJ458 = KG664			PB180 (x12) 8.00x12.0/15.40x9.50 866N W (FPM) HR660 [1]	NA5190 [2] 42.00x56.00x7.00mm, FPM NA5190 [2] 42.00x56.00x7.00mm, FPM NB564 [1] 60.45x76.18x10.00mm, FPM		 JD5268  JE5020  JN662  PB180 NA5190 NB564	



cc



kW/PS



2.9	B4B					469	BT510 (Fibre) ❏ BT520 (Fibre) ❏	DT510 [3]	ET490 [3]
Sierra 2.9	08/88→02/93	2936	6	93.00	V	107-110/ 145-150			
Sierra 2.9 4x4	08/88→02/93								
Sierra 2.9 i	08/88→02/93								
Sierra 2.9 i XR	08/88→02/93								
2.9	B4C					470	BT510 (Fibre) ❏ BT520 (Fibre) ❏	DT510 [3]	ET490 [3]
Sierra 2.9	08/88→02/93	2936	6	93.00	V	107-110/ 145-150			
Sierra 2.9 4x4	08/88→02/93								
Sierra 2.9 i	08/88→02/93								
Sierra 2.9 i XR	08/88→02/93								
2.9	BOA					471	BT510 (Fibre) ❏ BT520 (Fibre) ❏	DT510 [3]	ET490 [3]
Scorpio I 24V	04/91→09/94	2933	6	93.00	DOHC, V	143/195			
2.9	BOB					472	BT510 (Fibre) ❏ BT520 (Fibre) ❏	DT510 [3]	ET490 [3]
Scorpio II 24V	10/94→08/98	2933	6	93.00	DOHC, V	152/207			
2.9	BRC					473	BT510 (Fibre) ❏ BT520 (Fibre) ❏	DT510 [3]	ET490 [3]
Scorpio I 2.9 i	09/86→09/94	2933	6	93.00	OHV, V	110/150			
2.9	BRD					474	BT510 (Fibre) ❏ BT520 (Fibre) ❏	DT510 [3]	ET490 [3]
Scorpio I 2.9 i	09/86→12/94	2933	6	93.00	OHV, V	107/145			
2.9	BRE					475	BT510 (Fibre) ❏ BT520 (Fibre) ❏	DT510 [3]	ET490 [3]
Scorpio I 2.9 i	09/86→12/94	2933	6	93.00	V	107/145			
Scorpio I CAT	10/87→09/94								
2.9	BRF					476	BT510 (Fibre) ❏ BT520 (Fibre) ❏	DT510 [3]	ET490 [3]
Scorpio I 2.9 i	09/86→12/94	2933	6	93.00	V	107/145			
2.9	BRG					477	BT510 (Fibre) ❏ BT520 (Fibre) ❏	DT510 [3]	ET490 [3]
Scorpio II 2.9 i	02/95→08/98	2933	6	93.00	V	110/150			

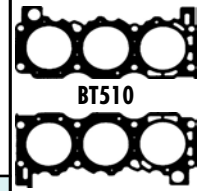

BT510

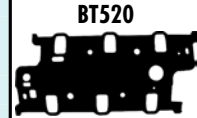

BT520

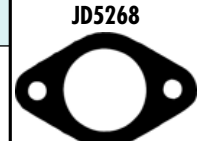

JD5268

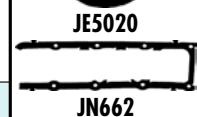

JE5020



JN662



JJ458

HBS057 [19] M12x1.75x87.00mm (x16)	JD5268 [1] JE5020 [6] (x6)	JN662 (x2)[4]	JJ458 =KG664	PB180 (x12) 8.00x12.0/15.40x9.50 866N W (FPM) HR660 [6]	NA5190 [2] 42.00x56.00x7.00mm, FPM NA5190 [2] 42.00x56.00x7.00mm, FPM NB564 [1] 60.45x76.18x10.00mm, FPM
HBS057 [19] M12x1.75x87.00mm (x16)	JD5268 [1] JE5020 [6] (x6)	JN662 (x2)[4]	JJ458 =KG664	PB180 (x12) 8.00x12.0/15.40x9.50 866N W (FPM) HR660 [6]	NA5190 [2] 42.00x56.00x7.00mm, FPM NA5190 [2] 42.00x56.00x7.00mm, FPM NB564 [1] 60.45x76.18x10.00mm, FPM
HBS057 [19] M12x1.75x87.00mm (x16)	JD5268 [1] JE5020 [6] (x6)	JN662 (x2)[4] HM5236 [6]	JJ458	PB180 (x12) 8.00x12.0/15.40x9.50 866N W (FPM) HR660 [6] (x2)	NA5190 [2] 42.00x56.00x7.00mm, FPM NA5190 [2] 42.00x56.00x7.00mm, FPM NB564 [1] 60.45x76.18x10.00mm, FPM
HBS140 [19] M12x1.75x115.00mm (x16)	JD5268 [1] JE5020 [6] (x6)	JN662 (x2)[4] HM5236 [6]	JJ458	PB180 (x12) 8.00x12.0/15.40x9.50 866N W (FPM) HR660 [6] (x2)	NA5190 [2] 42.00x56.00x7.00mm, FPM NA5190 [2] 42.00x56.00x7.00mm, FPM NB564 [1] 60.45x76.18x10.00mm, FPM
HBS057 [19] M12x1.75x87.00mm (x16)	JD5268 [1] JE5020 [6] (x6)	JN662 (x2)[4]	JJ458 =KG664	PB180 (x12) 8.00x12.0/15.40x9.50 866N W (FPM) HR660 [6]	NA5190 [2] 42.00x56.00x7.00mm, FPM NA5190 [2] 42.00x56.00x7.00mm, FPM NB564 [1] 60.45x76.18x10.00mm, FPM
HBS057 [19] M12x1.75x87.00mm (x16)	JD5268 [1] JE5020 [6] (x6)	JN662 (x2)[4] HM5236 [6]	JJ458 =KG664	PB180 (x12) 8.00x12.0/15.40x9.50 866N W (FPM) HR660 [6]	NA5190 [2] 42.00x56.00x7.00mm, FPM NA5190 [2] 42.00x56.00x7.00mm, FPM NB564 [1] 60.45x76.18x10.00mm, FPM
HBS057 [19] M12x1.75x87.00mm (x16)	JD5268 [1] JE5020 [6] (x6)	JN662 (x2)[4] HM5236 [6]	JJ458 =KG664	PB180 (x12) 8.00x12.0/15.40x9.50 866N W (FPM) HR660 [6]	NA5190 [2] 42.00x56.00x7.00mm, FPM NA5190 [2] 42.00x56.00x7.00mm, FPM NB564 [1] 60.45x76.18x10.00mm, FPM
HBS057 [19] M12x1.75x87.00mm (x16)	JD5268 [1] JE5020 [6] (x6)	JN662 (x2)[4] HM5236 [6]	JJ458 =KG664	PB180 (x12) 8.00x12.0/15.40x9.50 866N W (FPM) HR660 [6]	NA5190 [2] 42.00x56.00x7.00mm, FPM NA5190 [2] 42.00x56.00x7.00mm, FPM NB564 [1] 60.45x76.18x10.00mm, FPM
HBS057 [19] M12x1.75x87.00mm (x16)	JD5268 [1] JE5020 [6] (x6)	JN662 (x2)[4] HM5236 [6]	JJ458 =KG664	PB180 (x12) 8.00x12.0/15.40x9.50 866N W (FPM) HR660 [6]	NA5190 [2] 42.00x56.00x7.00mm, FPM NA5190 [2] 42.00x56.00x7.00mm, FPM NB564 [1] 60.45x76.18x10.00mm, FPM

FORD









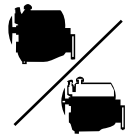



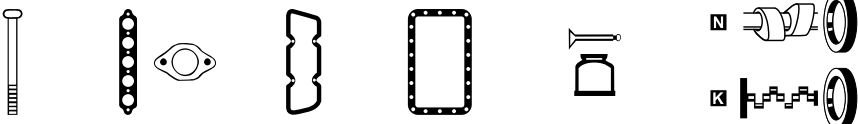

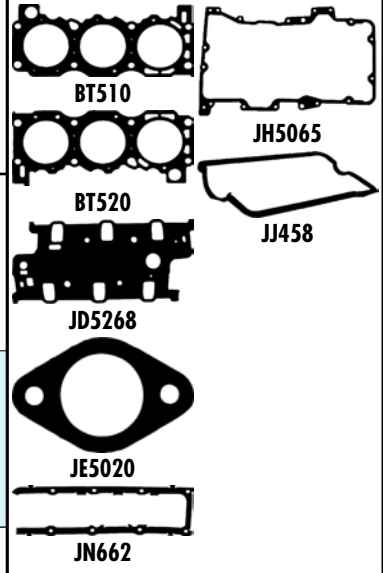

















cc



kW/PS



2.9	BRT						478	BT510 (Fibre)	DT510 [3]	ET490 [3]
Transit 2.9 i	01/91→09/94	2935	6	93.00	OHV, V	104-107/ 141-145	BT520 (Fibre)			
3.0	AJ						479	AG7820 (MLS)	CG7810	
Maverick V6 24V	02/01→	2967	6	89.00	DOHC, V	145-149/ 197-203	AG7810 (MLS)			
3.0	MEBA						480			
Mondeo III ST220	04/02→08/07	2967	6	89.00	DOHC, V	166/226				
3.0	REBA						481			
Mondeo III 24V	09/04→08/07	2967	6	89.00	DOHC, V	150/204				

									
HBS057  [19] M12x1.75x87.00mm (x16)	JD5268  JE5020  (x6)	JN662 (x2)[4] HM5236 	JJ458 KG664 	PB180 8.00x12.0/15.40x9.50 866N W (FPM) HR660 	NA5190 [2] 42.00x56.00x7.00mm, FPM NA5190  [2] 42.00x56.00x7.00mm, FPM NB564  [1] 60.45x76.18x10.00mm, FPM				
HBS392  [22] M10x1.50x150.00mm (x16)	JD5930   (x6) (FPM) JD5931   (x6) (MVQ) JD5926  (x2) (MLS)	JM5294  JM5293 	JH5065 →10/03		NA5175  [1] 91.00x108.00x9.50mm, NBR				
HBS392  [22] M10x1.50x150.00mm (x16)	JD5926  (x2) (MLS)	JM5294  JM5293 	JH5065 →10/03		NA5175  [1] 91.00x108.00x9.50mm, NBR				
HBS392  [22] M10x1.50x150.00mm (x16)	JD5926  (x2) (MLS)	JM5294  JM5293 	JH5065		NA5175  [1] 91.00x108.00x9.50mm, NBR				



Ltr







CC



9

Model	Ltr	Year Range	Code	Fuel	CC	Gears	Price
ACCORD III (CA4, CA5)	2.0	11/98→12/98	A20A1	Petrol	1955	4	68
ACCORD III (CA4, CA5)	2.0	11/98→05/98	A20A2	Petrol	1955	4	69
ACCORD III (CA4, CA5)	2.0	01/98→12/98	A20A3	Petrol	1955	4	70
ACCORD III (CA4, CA5)	2.0	10/98→12/98	B20A8	Petrol	1958	4	74
ACCORD III Aerodeck (CA5)	2.0	10/98→12/98	A20A1	Petrol	1955	4	68
ACCORD III Aerodeck (CA5)	2.0	11/98→05/98	A20A2	Petrol	1955	4	69
ACCORD III Aerodeck (CA5)	2.0	10/98→12/98	A20A3	Petrol	1955	4	70
ACCORD IV (CB)	2.0	01/99→03/99	F20A2	Petrol	1997	4	78
ACCORD IV (CB)	2.0	01/99→03/99	F20A3	Petrol	1997	4	79
ACCORD IV (CB)	2.0	01/99→03/99	F20A4	Petrol	1997	4	80
ACCORD IV (CB)	2.0	01/99→03/99	F20A6	Petrol	1997	4	81
ACCORD IV (CB)	2.0	01/99→03/99	F20A8	Petrol	1997	4	83
ACCORD IV (CB)	2.2	01/99→03/99	F22A3	Petrol	2156	4	100
ACCORD IV Aerodeck (CB)	2.0	03/99→12/99	F20Z3	Petrol	1997	4	91
ACCORD IV Aerodeck (CB)	2.2	01/99→12/99	F22A7	Petrol	2156	4	101
ACCORD IV Aerodeck (CB)	2.2	01/99→12/99	F22A8	Petrol	2156	4	102
ACCORD IV Coupe (CC1)	2.0	01/99→09/99	F20A7	Petrol	1997	4	82
ACCORD V (CC7, CD)	2.0	03/99→01/99	F20Z1	Petrol	1997	4	89
ACCORD V (CC7, CD)	2.0	03/99→01/99	F20Z2	Petrol	1997	4	90
ACCORD V (CC7, CD)	2.3	03/99→01/99	H23A3	Petrol	2259	4	116
ACCORD V (CE, CF)	1.9	02/99→10/99	F18A3	Petrol	1850	4	65
ACCORD V (CE, CF)	2.0	04/99→10/99	20T2N	Diesel	1994	4	67
ACCORD V (CE, CF)	2.0	02/99→10/99	F20Z1	Petrol	1997	4	89
ACCORD V (CE, CF)	2.2	02/99→10/99	F22Z2	Petrol	2156	4	105
ACCORD V Aerodeck (CE)	2.0	09/99→02/99	F20B3	Petrol	1997	4	84
ACCORD V Aerodeck (CE)	2.2	09/99→02/99	F22B5	Petrol	2156	4	103
ACCORD V Coupe (CD7, CD9)	2.0	09/99→12/99	F20B3	Petrol	1997	4	84
ACCORD V Coupe (CD7, CD9)	2.2	09/99→02/99	F22B5	Petrol	2156	4	103
ACCORD VI (CG, CK)	1.8	10/99→12/00	F18B2	Petrol	1850	4	66
ACCORD VI (CG, CK)	2.0	02/99→12/00	20T2N	Diesel	1994	4	67
ACCORD VI (CG, CK)	2.0	10/99→01/00	F20B6	Petrol	1997	4	86
ACCORD VI (CG, CK)	2.2	02/99→12/00	H22A7	Petrol	2157	4	108
ACCORD VI (CG, CK)	2.3	01/00→06/00	F23A1	Petrol	2254	4	111
ACCORD VI (CG, CK)	2.3	01/00→06/00	F23Z5	Petrol	2254	4	114
ACCORD VI (CG, CK)	3.0	10/99→12/00	J30A1	Petrol	2997	6	129
ACCORD VI Aerodeck (CM)	2.3	02/99→	F23A7	Petrol	2254	4	113
ACCORD VI Aerodeck (CM)	2.4	09/00→09/00	K24A2	Petrol	2354	4	119
ACCORD VI Coupe (CG)	2.0	02/99→06/00	F20B5	Petrol	1997	4	85
ACCORD VI Coupe (CG)	2.0	02/99→06/00	F20B7	Petrol	1997	4	87
ACCORD VI Coupe (CG)	2.3	02/99→10/00	F23A3	Petrol	2254	4	112
ACCORD VI Coupe (CG)	3.0	02/99→06/00	J30A1	Petrol	2997	6	129
ACCORD VI Hatchback (CH)	1.8	12/99→12/00	F18B2	Petrol	1850	4	66
ACCORD VI Hatchback (CH)	2.0	12/99→10/00	20T2N	Diesel	1994	4	67
ACCORD VI Hatchback (CH)	2.0	12/99→12/00	F20B6	Petrol	1997	4	86
ACCORD VI Hatchback (CH)	2.3	11/00→12/00	F23Z5	Petrol	2254	4	114
ACCORD VII (CL)	2.0	02/00→	K20A6	Petrol	1998	4	96
ACCORD VII (CL)	2.2	01/00→	N22A1	Diesel	2204	4	109
ACCORD VII (CL)	2.4	02/00→	K24A	Petrol	2354	4	117
ACCORD VII (CL)	2.4	02/00→	K24A3	Petrol	2354	4	120
ACCORD VII (CL)	2.4	09/00→	K24A8	Petrol	2354	4	123
ACCORD VII (CM)	2.4	02/00→09/00	K24A2	Petrol	2354	4	119
ACCORD VII (CM)	2.4	02/00→09/00	K24A4	Petrol	2354	4	121
ACCORD VII Tourer (CM)	2.0	04/00→	K20A6	Petrol	1998	4	96
ACCORD VII Tourer (CM)	2.2	01/00→	N22A1	Diesel	2204	4	109
ACCORD VII Tourer (CM)	2.4	04/00→	K24A	Petrol	2354	4	117
ACCORD VII Tourer (CM)	2.4	09/00→	K24A1	Petrol	2354	4	118
ACCORD VII Tourer (CM)	2.4	09/00→09/00	K24A2	Petrol	2354	4	119
ACCORD VIII (CU)	2.0	07/00→	R20A3	Petrol	1997	4	99
ACCORD VIII Estate	2.0	07/00→	R20A3	Petrol	1997	4	99
ASCOT	2.2	11/99→10/99	F22A7	Petrol	2156	4	101
ASCOT	2.2	11/99→10/99	F22A8	Petrol	2156	4	102
CITY Saloon (CG_)	1.5	02/99→11/99	D15B7	Petrol	1493	4	27
CITY Saloon (CG_)	1.8	02/99→11/99	XUD7T	Diesel	1769	4	64
CITY Saloon (GM)	1.4	09/00→	L13Z1	Petrol	1339	4	12
CITY Saloon	1.2	05/00→09/00	L12A2	Petrol	1243	4	5
CITY Saloon	1.2	10/00→	L12A3	Petrol	1243	4	6
CITY Saloon	1.3	09/00→09/00	L13A1	Petrol	1339	4	10
CITY Saloon	1.5	12/99→09/00	D15B7	Petrol	1493	4	27
CIVIC II Shuttle (EE)	1.4	01/98→12/99	D14A1	Petrol	1396	4	14
CIVIC II Shuttle (EE)	1.5	01/98→11/99	D15B2	Petrol	1493	4	26

	Ltr				CC		9
CIVIC II Shuttle (EE)	1.6	01/98→12/99	D16A	Petrol	1590	4	35
CIVIC II Shuttle (EE)	1.6	01/98→02/99	D16A6	Petrol	1590	4	36
CIVIC II Shuttle (EE)	1.6	01/98→12/99	D16A7	Petrol	1590	4	37
CIVIC IV Hatchback (EC, ED, EE)	1.3	10/98→12/98	D13B1	Petrol	1343	4	7
CIVIC IV Hatchback (EC, ED, EE)	1.3	09/98→09/99	D13B2	Petrol	1343	4	8
CIVIC IV Hatchback (EC, ED, EE)	1.4	10/98→12/98	D14A1	Petrol	1396	4	14
CIVIC IV Hatchback (EC, ED, EE)	1.5	10/98→09/99	D15B2	Petrol	1493	4	26
CIVIC IV Hatchback (EC, ED, EE)	1.6	10/98→09/99	B16A1	Petrol	1595	4	33
CIVIC IV Hatchback (EC, ED, EE)	1.6	10/98→09/99	D16A6	Petrol	1590	4	36
CIVIC IV Hatchback (EC, ED, EE)	1.6	09/98→09/99	D16A7	Petrol	1590	4	37
CIVIC IV Hatchback (EC, ED, EE)	1.6	09/98→09/99	D16A9	Petrol	1590	4	39
CIVIC IV Hatchback (EC, ED, EE)	1.6	10/98→09/99	D16Z2	Petrol	1590	4	49
CIVIC IV Saloon (ED)	1.3	10/98→12/98	D13B1	Petrol	1343	4	7
CIVIC IV Saloon (ED)	1.4	10/98→12/98	D14A1	Petrol	1396	4	14
CIVIC IV Saloon (ED)	1.5	10/98→09/99	D15B2	Petrol	1493	4	26
CIVIC IV Saloon (ED)	1.6	11/98→09/99	D16A6	Petrol	1590	4	36
CIVIC IV Saloon (ED)	1.6	09/98→09/99	D16A7	Petrol	1590	4	37
CIVIC IV Saloon (ED)	1.6	10/98→09/99	D16Z2	Petrol	1590	4	49
CIVIC IV Saloon (ED)	1.6	01/98→12/98	D16Z5	Petrol	1590	4	50
CIVIC V Coupe (EJ)	1.5	08/99→11/99	D15B7	Petrol	1493	4	27
CIVIC V Coupe (EJ)	1.6	01/99→11/99	B16A2	Petrol	1595	4	34
CIVIC V Coupe (EJ)	1.6	01/99→03/99	D16Y6	Petrol	1590	4	46
CIVIC V Coupe (EJ)	1.6	01/99→11/99	D16Y7	Petrol	1590	4	47
CIVIC V Coupe (EJ)	1.6	01/99→03/99	D16Z9	Petrol	1590	4	53
CIVIC V Hatchback (EG)	1.3	10/99→11/99	D13B2	Petrol	1343	4	8
CIVIC V Hatchback (EG)	1.4	01/99→04/99	D14A2	Petrol	1396	4	15
CIVIC V Hatchback (EG)	1.5	10/99→11/99	D15B2	Petrol	1493	4	26
CIVIC V Hatchback (EG)	1.5	10/99→11/99	D15Z1	Petrol	1493	4	28
CIVIC V Hatchback (EG)	1.5	10/99→11/99	D15Z2	Petrol	1493	4	29
CIVIC V Hatchback (EG)	1.6	10/99→11/99	B16A2	Petrol	1595	4	34
CIVIC V Hatchback (EG)	1.6	10/99→09/99	D16A9	Petrol	1590	4	39
CIVIC V Hatchback (EG)	1.6	10/99→09/99	D16Y1	Petrol	1590	4	43
CIVIC V Hatchback (EG)	1.6	10/99→11/99	D16Z6	Petrol	1590	4	51
CIVIC V Saloon (EG, EH)	1.3	01/99→12/99	D13B2	Petrol	1343	4	8
CIVIC V Saloon (EG, EH)	1.5	10/99→12/99	D15B2	Petrol	1493	4	26
CIVIC V Saloon (EG, EH)	1.5	10/99→12/99	D15B7	Petrol	1493	4	27
CIVIC V Saloon (EG, EH)	1.5	10/99→12/99	D15Z1	Petrol	1493	4	28
CIVIC V Saloon (EG, EH)	1.6	10/99→11/99	B16A2	Petrol	1595	4	34
CIVIC V Saloon (EG, EH)	1.6	08/99→10/99	D16A7	Petrol	1590	4	37
CIVIC V Saloon (EG, EH)	1.6	10/99→10/99	D16Y1	Petrol	1590	4	43
CIVIC V Saloon (EG, EH)	1.6	10/99→11/99	D16Z6	Petrol	1590	4	51
CIVIC V Saloon (EG, EH)	1.6	10/99→11/99	D16Z7	Petrol	1590	4	52
CIVIC VI Aerodeck (MB, MC)	1.4	04/99→02/00	D14A7	Petrol	1396	4	19
CIVIC VI Aerodeck (MB, MC)	1.4	04/99→02/00	D14A8	Petrol	1396	4	20
CIVIC VI Aerodeck (MB, MC)	1.5	04/99→02/00	D15Z8	Petrol	1493	4	32
CIVIC VI Aerodeck (MB, MC)	1.8	04/99→02/00	B18C4	Petrol	1797	4	60
CIVIC VI Aerodeck (MB, MC)	2.0	04/99→02/00	20T2N	Diesel	1994	4	67
CIVIC VI Coupe (EJ, EM1)	1.6	04/99→12/00	B16A2	Petrol	1595	4	34
CIVIC VI Coupe (EJ, EM1)	1.6	03/99→03/00	D16Y7	Petrol	1590	4	47
CIVIC VI Coupe (EJ, EM1)	1.6	03/99→03/00	D16Y8	Petrol	1590	4	48
CIVIC VI Fastback (MA, MB)	1.4	09/99→02/00	D14A2	Petrol	1396	4	15
CIVIC VI Fastback (MA, MB)	1.4	09/99→02/00	D14A5	Petrol	1396	4	18
CIVIC VI Fastback (MA, MB)	1.4	09/99→02/00	D14A7	Petrol	1396	4	19
CIVIC VI Fastback (MA, MB)	1.4	09/99→02/00	D14A8	Petrol	1396	4	20
CIVIC VI Fastback (MA, MB)	1.5	09/99→01/99	D15Z3	Petrol	1493	4	30
CIVIC VI Fastback (MA, MB)	1.5	01/99→02/00	D15Z8	Petrol	1493	4	32
CIVIC VI Fastback (MA, MB)	1.6	01/99→02/00	B16A2	Petrol	1595	4	34
CIVIC VI Fastback (MA, MB)	1.6	09/99→01/99	D16Y2	Petrol	1590	4	44
CIVIC VI Fastback (MA, MB)	1.6	09/99→01/99	D16Y3	Petrol	1590	4	45
CIVIC VI Fastback (MA, MB)	1.8	01/99→02/00	B18C4	Petrol	1797	4	60
CIVIC VI Fastback (MA, MB)	2.0	11/99→10/00	20T2N	Diesel	1994	4	67
CIVIC VI Hatchback (EJ, EK)	1.4	11/99→02/00	D14A3	Petrol	1396	4	16
CIVIC VI Hatchback (EJ, EK)	1.4	11/99→02/00	D14A4	Petrol	1396	4	17
CIVIC VI Hatchback (EJ, EK)	1.4	11/99→02/00	D14Z1	Petrol	1396	4	21
CIVIC VI Hatchback (EJ, EK)	1.4	11/99→02/00	D14Z2	Petrol	1396	4	22
CIVIC VI Hatchback (EJ, EK)	1.5	11/99→02/00	D15Z6	Petrol	1493	4	31
CIVIC VI Hatchback (EJ, EK)	1.6	11/99→02/00	B16A2	Petrol	1595	4	34
CIVIC VI Hatchback (EJ, EK)	1.6	10/99→09/00	D16A7	Petrol	1590	4	37
CIVIC VI Hatchback (EJ, EK)	1.6	10/99→09/00	D16Y2	Petrol	1590	4	44
CIVIC VI Hatchback (EJ, EK)	2.0	11/99→10/00	20T2N	Diesel	1994	4	67



Ltr















CC



9

Model	Ltr	Year Range	Engine Code	Fuel	CC	Gears	Index
CIVIC VI Saloon (EJ, EK)	1.2	11/99→03/00	L12A	Petrol	1243	4	3
CIVIC VI Saloon (EJ, EK)	1.4	11/99→02/00	D14A4	Petrol	1396	4	17
CIVIC VI Saloon (EJ, EK)	1.4	11/99→02/00	D14Z2	Petrol	1396	4	22
CIVIC VI Saloon (EJ, EK)	1.5	11/99→02/00	D15Z6	Petrol	1493	4	31
CIVIC VI Saloon (EJ, EK)	1.6	11/99→02/00	B16A2	Petrol	1595	4	34
CIVIC VI Saloon (EJ, EK)	1.6	10/99→12/00	D16Y2	Petrol	1590	4	44
CIVIC VI Saloon (EJ, EK)	1.6	11/99→02/00	D16Y6	Petrol	1590	4	46
CIVIC VI Saloon (EJ, EK)	1.6	11/99→02/00	D16Y8	Petrol	1590	4	48
CIVIC VI Saloon (EJ, EK)	1.7	11/99→03/00	D17A6	Petrol	1668	4	57
CIVIC VII Coupe (EM2)	1.6	02/00→12/00	D16V1	Petrol	1590	4	40
CIVIC VII Coupe (EM2)	1.7	05/00→12/00	D17A5	Petrol	1668	4	56
CIVIC VII Coupe (EM2)	1.7	05/00→12/00	D17A8	Petrol	1668	4	58
CIVIC VII Coupe (EM2)	1.7	05/00→12/00	D17A9	Petrol	1668	4	59
CIVIC VII Hatchback (EU, EP, EV)	1.4	02/00→09/00	D14Z5	Petrol	1396	4	23
CIVIC VII Hatchback (EU, EP, EV)	1.4	02/00→09/00	D14Z6	Petrol	1396	4	24
CIVIC VII Hatchback (EU, EP, EV)	1.6	02/00→09/00	D16V1	Petrol	1590	4	40
CIVIC VII Hatchback (EU, EP, EV)	1.7	01/00→09/00	4EE-2	Diesel	1686	4	54
CIVIC VII Hatchback (EU, EP, EV)	1.7	01/00→08/00	D17A6	Petrol	1668	4	57
CIVIC VII Hatchback (EU, EP, EV)	2.0	09/00→09/00	K20A2	Petrol	1998	4	93
CIVIC VII Hatchback (EU, EP, EV)	2.0	09/00→09/00	K20A3	Petrol	1998	4	94
CIVIC VII Saloon (ES)	1.2	04/00→10/00	L12A1	Petrol	1243	4	4
CIVIC VII Saloon (ES)	1.4	12/00→09/00	D14Z5	Petrol	1396	4	23
CIVIC VII Saloon (ES)	1.6	02/00→09/00	D16V1	Petrol	1590	4	40
CIVIC VII Saloon (ES)	1.7	02/00→09/00	D17A6	Petrol	1668	4	57
CIVIC VII Saloon (ES)	2.0	10/00→09/00	K20A3	Petrol	1998	4	94
CIVIC VIII Hatchback (FN, FK)	1.4	01/00→	L13A7	Petrol	1339	4	11
CIVIC VIII Hatchback (FN, FK)	1.4	10/00→	L13Z1	Petrol	1339	4	12
CIVIC VIII Hatchback (FN, FK)	1.8	01/00→	R18A2	Petrol	1799	4	63
CIVIC VIII Hatchback (FN, FK)	2.2	01/00→	N22A2	Diesel	2204	4	110
CIVIC VIII Saloon (FD, FA)	1.3	01/00→	LDA2	Petrol/Electro	1339	4	13
CIVIC VIII Saloon (FD, FA)	1.8	09/00→02/01	R18A1	Petrol	1798	4	62
CIVIC VIII Saloon (FD, FA)	1.8	02/00→	R18A2	Petrol	1799	4	63
CIVIC VIII Saloon (FD, FA)	2.0	02/00→02/01	K20A3	Petrol	1998	4	94
CONCERTO (HW)	1.4	08/98→10/99	D14A1	Petrol	1396	4	14
CONCERTO (HW)	1.4	08/98→10/99	D14A8	Petrol	1396	4	20
CONCERTO (HW)	1.5	08/98→03/99	D15B2	Petrol	1493	4	26
CONCERTO (HW)	1.6	08/98→03/99	D16A8	Petrol	1590	4	38
CONCERTO (HW)	1.6	10/98→10/99	D16A9	Petrol	1590	4	39
CONCERTO (HW)	1.6	08/98→03/99	D16Z2	Petrol	1590	4	49
CONCERTO (HW)	1.8	08/99→10/99	XUD7T	Diesel	1769	4	64
CONCERTO Saloon (HWW)	1.4	08/98→10/99	D14A1	Petrol	1396	4	14
CONCERTO Saloon (HWW)	1.4	08/98→10/99	D14A8	Petrol	1396	4	20
CONCERTO Saloon (HWW)	1.5	08/98→05/99	D15B2	Petrol	1493	4	26
CONCERTO Saloon (HWW)	1.6	08/98→03/99	D16A8	Petrol	1590	4	38
CONCERTO Saloon (HWW)	1.6	10/98→10/99	D16A9	Petrol	1590	4	39
CONCERTO Saloon (HWW)	1.6	08/98→03/99	D16Z2	Petrol	1590	4	49
CROSSROAD	1.8	02/00→08/01	R18A2	Petrol	1799	4	63
CR-V (RD)	2.0	10/99→01/99	B20B	Petrol	1973	4	76
CR-V (RD)	2.0	01/99→02/00	B20Z1	Petrol	1973	4	77
CR-V II (RD_)	2.0	07/00→09/00	K20A4	Petrol	1998	4	95
CR-V II (RD_)	2.2	02/00→09/00	N22A2	Diesel	2204	4	110
CR-V II (RD_)	2.4	09/00→09/00	K24A1	Petrol	2354	4	118
CR-V III (RE)	2.2	01/00→	N22A2	Diesel	2204	4	110
CR-V III (RE)	2.4	09/00→	K24A	Petrol	2354	4	117
CR-V III (RE)	2.4	04/00→	K24A1	Petrol	2354	4	118
CR-V III (RE)	2.4	09/00→	K24Z1	Petrol	2354	4	124
CRX II (ED, EE)	1.6	10/98→02/99	B16A1	Petrol	1595	4	33
CRX II (ED, EE)	1.6	10/98→05/98	D16A	Petrol	1590	4	35
CRX II (ED, EE)	1.6	10/98→05/98	D16A6	Petrol	1590	4	36
CRX II (ED, EE)	1.6	10/98→12/98	D16A8	Petrol	1590	4	38
CRX II (ED, EE)	1.6	10/98→12/98	D16A9	Petrol	1590	4	39
CRX II (ED, EE)	1.6	10/98→02/99	D16Z5	Petrol	1590	4	50
CRX III (EH, EG)	1.5	01/99→04/99	D15B7	Petrol	1493	4	27
CRX III (EH, EG)	1.6	03/99→12/99	B16A2	Petrol	1595	4	34
CRX III (EH, EG)	1.6	03/99→12/99	D16Y8	Petrol	1590	4	48
CRX III (EH, EG)	1.6	03/99→12/99	D16Z6	Petrol	1590	4	51
DOMANI	1.6	10/99→09/99	D16A	Petrol	1590	4	35
DOMANI	1.6	11/98→12/99	D16Z2	Petrol	1590	4	49
ELEMENT	2.4	07/00→12/01	K24A6	Petrol	2354	4	122
ELYSION	2.4	05/00→	K24A1	Petrol	2354	4	118

	Ltr				CC		9
FR-V (BE)	1.7	08/00 →	D17A2	Petrol	1668	4	55
FR-V (BE)	1.8	01/00 →	R18A1	Petrol	1798	4	62
FR-V (BE)	2.0	08/00 →	K20A9	Petrol	1998	4	97
FR-V (BE)	2.2	07/00 →	N22A1	Diesel	2204	4	109
HR-V (GH)	1.6	03/99 →	D16W1	Petrol	1590	4	41
HR-V (GH)	1.6	10/99 →	D16W5	Petrol	1590	4	42
INSIGHT (ZE)	1.0	04/00 →12/00	ECA1	Petrol	995	3	2
INTEGRA (DA)	1.5	10/98 →08/98	D15A1	Petrol	1488	4	25
INTEGRA (DC5)	2.0	10/00 →	K20A2	Petrol	1998	4	93
INTEGRA (DC5)	2.0	02/00 →	K20A3	Petrol	1998	4	94
INTEGRA (DC5)	2.0	02/00 →	K20Z1	Petrol	1998	4	98
INTEGRA Coupe (DC2, DC4)	1.8	11/99 →10/00	B18C6	Petrol	1797	4	61
JAZZ II (GD)	1.2	03/00 →07/00	L12A1	Petrol	1243	4	4
JAZZ II (GD)	1.3	03/00 →09/00	L13A1	Petrol	1339	4	10
JAZZ II (GD)	1.4	03/00 →07/00	L13A1	Petrol	1339	4	10
JAZZ III (GE)	1.4	07/00 →	L13Z1	Petrol	1339	4	12
JAZZ Saloon	1.3	05/00 →	L13A1	Petrol	1339	4	10
LEGEND I (HS, KA)	2.5	02/98 →06/98	C25A2	Petrol	2494	6	125
LEGEND I (HS, KA)	2.7	01/98 →12/99	C27A1	Petrol	2675	6	126
LEGEND I Coupe (KA3)	2.7	10/98 →12/99	C27A1	Petrol	2675	6	126
LEGEND II (KA7)	3.2	01/99 →02/99	C32A2	Petrol	3206	6	130
LEGEND II Coupe (KA8)	3.2	01/99 →02/99	C32A2	Petrol	3206	6	130
LOGO (GA3)	1.3	03/99 →03/00	D13B7	Petrol	1343	4	9
NSX Convertible (NA)	3.0	03/99 →09/00	C30A3	Petrol	2977	6	127
NSX Convertible (NA)	3.0	03/99 →09/00	C30A4	Petrol	2977	6	128
NSX Convertible (NA)	3.2	01/99 →09/00	C32B2	Petrol	3179	6	131
NSX Coupe (NA)	3.0	06/99 →09/00	C30A3	Petrol	2977	6	127
NSX Coupe (NA)	3.0	06/99 →09/00	C30A4	Petrol	2977	6	128
NSX Coupe (NA)	3.2	01/99 →09/00	C32B2	Petrol	3179	6	131
ODYSSEY (RB_)	2.4	11/00 →	K24A	Petrol	2354	4	117
ODYSSEY (RB_)	2.4	10/00 →	K24A4	Petrol	2354	4	121
PRELUDE III (BA)	2.0	04/98 →01/99	B20A3	Petrol	1958	4	71
PRELUDE III (BA)	2.0	08/98 →01/99	B20A4	Petrol	1958	4	72
PRELUDE III (BA)	2.0	10/98 →12/99	B20A7	Petrol	1958	4	73
PRELUDE III (BA)	2.0	04/99 →01/99	B20A9	Petrol	1958	4	75
PRELUDE IV (BB)	2.0	02/99 →09/99	F20A4	Petrol	1997	4	80
PRELUDE IV (BB)	2.2	02/99 →09/99	H22A2	Petrol	2157	4	106
PRELUDE IV (BB)	2.3	02/99 →09/99	H23A2	Petrol	2259	4	115
PRELUDE V (BB)	2.0	10/99 →10/00	F20A4	Petrol	1997	4	80
PRELUDE V (BB)	2.2	10/99 →10/00	H22A5	Petrol	2157	4	107
S2000 (AP)	2.0	06/99 →	F20C VTEC	Petrol	1997	4	88
SHUTTLE (RA)	2.2	10/99 →02/99	F22B8	Petrol	2156	4	104
SHUTTLE (RA)	2.3	10/99 →06/00	F23A7	Petrol	2254	4	113
STEPWAGON	2.0	10/00 →	K20A6	Petrol	1998	4	96
STEPWAGON	2.0	10/00 →09/00	K20A9	Petrol	1998	4	97
STEPWAGON	2.4	10/00 →	K24A3	Petrol	2354	4	120
STREAM (RN)	1.7	05/00 →	D17A2	Petrol	1668	4	55
STREAM (RN)	2.0	05/00 →	K20A1	Petrol	1998	4	92
STREAM	1.8	10/00 →	R18A2	Petrol	1799	4	63
TODAY	0.5	09/98 →09/98	EH	Petrol	545	2	1
TORNEO Saloon	2.0	04/99 →12/99	F20Z2	Petrol	1997	4	90

		CC			9			CC			9
20T2N	Diesel	1994	4	84.50	67	F18A3	Petrol	1850	4	85.00	65
4EE-2	Diesel	1686	4	79.00	54	F18B2	Petrol	1850	4	85.00	66
A20A1	Petrol	1955	4	82.70	68	F20A2	Petrol	1997	4	85.00	78
A20A2	Petrol	1955	4	82.70	69	F20A3	Petrol	1997	4	85.00	79
A20A3	Petrol	1955	4	82.70	70	F20A4	Petrol	1997	4	85.00	80
B16A1	Petrol	1595	4	81.00	33	F20A6	Petrol	1997	4	85.00	81
B16A2	Petrol	1595	4	81.00	34	F20A7	Petrol	1997	4	85.00	82
B18C4	Petrol	1797	4	81.00	60	F20A8	Petrol	1997	4	85.00	83
B18C6	Petrol	1797	4	81.00	61	F20B3	Petrol	1997	4	85.00	84
B20A3	Petrol	1958	4	81.00	71	F20B5	Petrol	1997	4	85.00	85
B20A4	Petrol	1958	4	81.00	72	F20B6	Petrol	1997	4	85.00	86
B20A7	Petrol	1958	4	81.00	73	F20B7	Petrol	1997	4	85.00	87
B20A8	Petrol	1958	4	81.00	74	F20C VTEC	Petrol	1997	4	87.00	88
B20A9	Petrol	1958	4	81.00	75	F20Z1	Petrol	1997	4	85.00	89
B20B	Petrol	1973	4	84.00	76	F20Z2	Petrol	1997	4	85.00	90
B20Z1	Petrol	1973	4	84.00	77	F20Z3	Petrol	1997	4	85.00	91
C25A2	Petrol	2494	6	84.00	125	F22A3	Petrol	2156	4	85.00	100
C27A1	Petrol	2675	6	87.00	126	F22A7	Petrol	2156	4	85.00	101
C30A3	Petrol	2977	6	90.00	127	F22A8	Petrol	2156	4	85.00	102
C30A4	Petrol	2977	6	90.00	128	F22B5	Petrol	2156	4	85.00	103
C32A2	Petrol	3206	6	90.00	130	F22B8	Petrol	2156	4	85.00	104
C32B2	Petrol	3179	6	93.00	131	F22Z2	Petrol	2156	4	85.00	105
D13B1	Petrol	1343	4	75.00	7	F23A1	Petrol	2254	4	86.00	111
D13B2	Petrol	1343	4	75.00	8	F23A3	Petrol	2254	4	86.00	112
D13B7	Petrol	1343	4	75.00	9	F23A7	Petrol	2254	4	86.00	113
D14A1	Petrol	1396	4	75.00	14	F23Z5	Petrol	2254	4	86.00	114
D14A2	Petrol	1396	4	75.00	15	H22A2	Petrol	2157	4	87.00	106
D14A3	Petrol	1396	4	75.00	16	H22A5	Petrol	2157	4	87.00	107
D14A4	Petrol	1396	4	75.00	17	H22A7	Petrol	2157	4	87.00	108
D14A5	Petrol	1396	4	75.00	18	H23A2	Petrol	2259	4	87.00	115
D14A7	Petrol	1396	4	75.00	19	H23A3	Petrol	2259	4	87.00	116
D14A8	Petrol	1396	4	75.00	20	J30A1	Petrol	2997	6	86.00	129
D14Z1	Petrol	1396	4	75.00	21	K20A1	Petrol	1998	4	86.00	92
D14Z2	Petrol	1396	4	75.00	22	K20A2	Petrol	1998	4	86.00	93
D14Z5	Petrol	1396	4	75.00	23	K20A3	Petrol	1998	4	86.00	94
D14Z6	Petrol	1396	4	75.00	24	K20A4	Petrol	1998	4	86.00	95
D15A1	Petrol	1488	4	74.00	25	K20A6	Petrol	1998	4	86.00	96
D15B2	Petrol	1493	4	75.00	26	K20A9	Petrol	1998	4	86.00	97
D15B7	Petrol	1493	4	75.00	27	K20Z1	Petrol	1998	4	86.00	98
D15Z1	Petrol	1493	4	75.00	28	K24A	Petrol	2354	4	87.00	117
D15Z2	Petrol	1493	4	75.00	29	K24A1	Petrol	2354	4	87.00	118
D15Z3	Petrol	1493	4	75.00	30	K24A2	Petrol	2354	4	87.00	119
D15Z6	Petrol	1493	4	75.00	31	K24A3	Petrol	2354	4	87.00	120
D15Z8	Petrol	1493	4	75.00	32	K24A4	Petrol	2354	4	87.00	121
D16A	Petrol	1590	4	75.00	35	K24A6	Petrol	2354	4	87.00	122
D16A6	Petrol	1590	4	75.00	36	K24A8	Petrol	2354	4	87.00	123
D16A7	Petrol	1590	4	75.00	37	K24Z1	Petrol	2354	4	87.00	124
D16A8	Petrol	1590	4	75.00	38	L12A	Petrol	1243	4	73.00	3
D16A9	Petrol	1590	4	75.00	39	L12A1	Petrol	1243	4	73.00	4
D16V1	Petrol	1590	4	75.00	40	L12A2	Petrol	1243	4	73.00	5
D16W1	Petrol	1590	4	75.00	41	L12A3	Petrol	1243	4	73.00	6
D16W5	Petrol	1590	4	75.00	42	L13A1	Petrol	1339	4	73.00	10
D16Y1	Petrol	1590	4	75.00	43	L13A7	Petrol	1339	4	73.00	11
D16Y2	Petrol	1590	4	75.00	44	L13Z1	Petrol	1339	4	73.00	12
D16Y3	Petrol	1590	4	75.00	45	LDA2	Petrol/Electro	1339	4	73.00	13
D16Y6	Petrol	1590	4	75.00	46	N22A1	Diesel	2204	4	85.00	109
D16Y7	Petrol	1590	4	75.00	47	N22A2	Diesel	2204	4	85.00	110
D16Y8	Petrol	1590	4	75.00	48	R18A1	Petrol	1798	4	81.00	62
D16Z2	Petrol	1590	4	75.00	49	R18A2	Petrol	1799	4	81.00	63
D16Z5	Petrol	1590	4	75.00	50	R20A3	Petrol	1997	4	81.00	99
D16Z6	Petrol	1590	4	75.00	51	XUD7T	Diesel	1769	4	80.00	64
D16Z7	Petrol	1590	4	75.00	52						
D16Z9	Petrol	1590	4	75.00	53						
D17A2	Petrol	1668	4	75.00	55						
D17A5	Petrol	1668	4	75.00	56						
D17A6	Petrol	1668	4	75.00	57						
D17A8	Petrol	1668	4	75.00	58						
D17A9	Petrol	1668	4	75.00	59						
ECA1	Petrol	995	3	72.00	2						
EH	Petrol	545	2	72.00	1						



cc



kW/PS

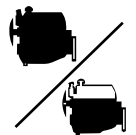

Model	Year Range	CC	Cyls	Power (kW/PS)	Configuration	Code	Material	Code	Notes
0.5 Today 0.5	EH 09/85→09/88	545	2	72.00	SOHC/OHC	23/31	1 BJ610 (Graphite)	DJ610 →Eng.2000000	GJ610 [16] →Eng.2000000 GJ611 [3]
1.0 Insight 1.0 Vtec Insight Hybrid	ECA1 04/00→10/04 04/00→12/06	995	3	72.00		50-56/ 68-76	2 AG7960 (MLS)		FG7960
1.2 Civic IV 1.2	L12A 11/97→03/01	1243	4	73.00		55/75	3 AG9180 (MLS)	CG9180	
1.2 Civic VII Jazz II 1.2	L12A1 04/01→10/04 03/02→07/08	1243	4	73.00		57/78	4 AG9180 (MLS)	CG9180	
1.2 City Saloon 1.2	L12A2 05/03→09/05	1243	4	73.00	SOHC/OHC	58/79	5		
1.2 City Saloon 1.2	L12A3 10/05→	1243	4	73.00	SOHC/OHC	61/83	6		
1.3 Civic IV 1.3	D13B1 10/87→12/89	1343	4	75.00	SOHC/OHC	55/75	7 BR540 (Graphite)	DR540 [3]	GR540 [3]
1.3 Civic IV 1.3 Civic IV 1.3 16V Civic IV 16V	D13B2 01/92→12/92 10/91→11/95 09/89→09/91	1343	4	75.00	SOHC/OHC	55-63/ 75-86	8 BV350 (Graphite) →01/92 AG7890 (MLS) 01/92→	DV351 [3] →01/92 CG7890 01/92→	EV020
1.3 Logo 1.3	D13B7 03/99→03/02	1343	4	75.00	SOHC/OHC	48/65	9 BV020 (MLS)	DV021	GV021
1.3 City Saloon 4WD City Saloon SES Jazz II 1.3 iDSi Jazz II 1.4 Jazz saloon 1.3	L13A1 09/01→10/04 05/03→09/05 03/02→09/07 03/02→07/08 05/03→	1339	4	73.00	SOHC/OHC	59-63/ 80-86	10 AG9180 (MLS)	CG9180	
1.3 Civic VIII 1.4	L13A7 01/06→	1339	4	73.00	SOHC/OHC	61/83	11 AG9180 (MLS)	CG9180	
1.3 City Saloon Vtc Civic VIII 1.4 Jazz III 1.4 Jazz III 1.4 i	L13Z1 09/08→ 10/08→ 11/08→ 07/08→	1339	4	73.00	SOHC/OHC	73-74/ 99-101	12 AG9180 (MLS)	CG9180	
1.3 Civic VIII	LDA2 01/06→	1339	4	73.00	SOHC/OHC	70-85/ 95-116	13		

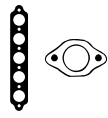

BJ610



BR540



BV020



BV350

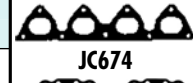

JC674



JC863



JN404

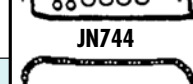

JN744



JJ309





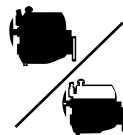



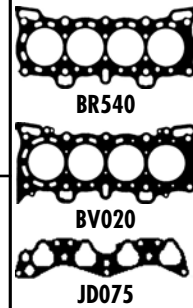
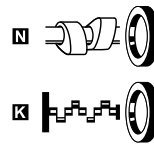
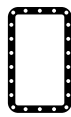
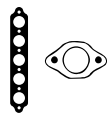







































































kW/PS



1.4	D14A1	14	BR540 (Graphite)	DR540 [3]	EV020
Civic 2 1.6V Civic IV 1.4 L Concerto 1.4	01/88→12/92 10/87→12/89 08/89→10/92	1396 4 75.00	SOHC/OHC 61-66/ 83-90	→12/89	→12/89
1.4	D14A2	15	BV020 (MLS)		EV020
Civic IV 1.4 1.6V Civic IV 1.4 i	01/95→04/97 09/94→02/01	1396 4 75.00	SOHC/OHC 66/90		
1.4	D14A3	16	BV020 (MLS)		EV020
Civic IV 1.4 i	11/95→02/01	1396 4 75.00	SOHC/OHC 55/75		
1.4	D14A4	17	BV020 (MLS)		EV020
Civic IV 1.4 Civic IV 1.4 i Civic IV 1.4 i S	11/95→10/98 11/95→02/01 11/95→02/01	1396 4 75.00	SOHC/OHC 55-66/ 75-90		
1.4	D14A5	18	BV020 (MLS)		EV020
Civic IV 1.4 i	09/95→02/01	1396 4 75.00	DOHC 55/75		
1.4	D14A7	19	BV020 (MLS)		EV020
Civic IV Civic IV 1.4 i	04/98→02/01 09/95→02/01	1396 4 75.00	SOHC/OHC 55/75		
1.4	D14A8	20	BR540 (Graphite) BV020 (MLS)		EV020
Civic IV Civic IV 1.4 i Concerto 1.4	04/98→02/01 09/94→02/01 08/89→10/91	1396 4 75.00	SOHC/OHC 66/90		
1.4	D14Z1	21	BV020 (MLS)		EV020
Civic IV 1.4 i	11/95→02/01	1396 4 75.00	SOHC/OHC 55/75		
1.4	D14Z2	22	BV020 (MLS)		EV020
Civic IV 1.4 i Civic IV 1.4 i S	11/95→02/01 11/95→02/01	1396 4 75.00	SOHC/OHC 66/90		



	JD5748  →12/89	JM5135 →12/89	JH5173 →12/89	PA969  (x8) →12/89 PB356  (x8) →12/89	 NJ313 [1] 29.00x45.00x8.00mm, ACM →12/89  NJ381  [1] 31.00x46.00x8.00mm, NBR →12/89  NJ312  [2] 80.00x100.00x10.00mm, MVQ →12/89	
	JD5748 	JM5135	JH5173	PA969  (x8) PB356  (x8)	 NJ313 [1] 29.00x45.00x8.00mm, ACM  NJ381  [1] 31.00x46.00x8.00mm, NBR  NJ312  [2] 80.00x100.00x10.00mm, MVQ	
	JD075  JD5748 	JM5135	JH5173	PA969  (x8) PB356  (x8)	 NJ313 [1] 29.00x45.00x8.00mm, ACM  NJ381  [1] 31.00x46.00x8.00mm, NBR  NJ312  [2] 80.00x100.00x10.00mm, MVQ	
	JD075  JD5748 	JM5135	JH5173	PA969  (x8) PB356  (x8)	 NJ313 [1] 29.00x45.00x8.00mm, ACM  NJ381  [1] 31.00x46.00x8.00mm, NBR  NJ312  [2] 80.00x100.00x10.00mm, MVQ	
	JD075  JD5748 	JM5135	JH5173	PA969  (x8) PB356  (x8)	 NJ313 [1] 29.00x45.00x8.00mm, ACM  NJ381  [1] 31.00x46.00x8.00mm, NBR  NJ312  [2] 80.00x100.00x10.00mm, MVQ	
	JD075  JD5748 	JM5135	JH5173	PA969  (x8) PB356  (x8)	 NJ313 [1] 29.00x45.00x8.00mm, ACM  NJ381  [1] 31.00x46.00x8.00mm, NBR  NJ312  [2] 80.00x100.00x10.00mm, MVQ	
	JD075  JD5748 	JM5135	JH5173	PA969  (x8) PB356  (x8)	 NJ313 [1] 29.00x45.00x8.00mm, ACM  NJ381  [1] 31.00x46.00x8.00mm, NBR  NJ312  [2] 80.00x100.00x10.00mm, MVQ	
	JD075  JD5748 	JM5135	JH5173	PA969  (x8) PB356  (x8)	 NJ313 [1] 29.00x45.00x8.00mm, ACM  NJ381  [1] 31.00x46.00x8.00mm, NBR  NJ312  [2] 80.00x100.00x10.00mm, MVQ	
	JD075  JD5748 	JM5135	JH5173	PA969  (x8) PB356  (x8)	 NJ313 [1] 29.00x45.00x8.00mm, ACM  NJ381  [1] 31.00x46.00x8.00mm, NBR  NJ312  [2] 80.00x100.00x10.00mm, MVQ	



cc



kW/PS



Model	Year Range	CC	Cyls	Power (kW/PS)	Configuration	Stroke (mm)	Part No.	Accessories
1.4 D14Z5							23	
Civic VII	02/01→09/05	1396	4	75.00	SOHC/OHC	66/90	AD5230 (MLS), 0.700mm	CD5230
Civic VII 1.4	12/00→09/05							
1.4 D14Z6							24	
Civic VII	02/01→09/05	1396	4	75.00	SOHC/OHC	55-66/ 75-90	AD5230 (MLS), 0.700mm	CD5230
Civic VII 1.4 i	02/01→09/05							
1.5 D15A1							25	
Integra 1.5	10/85→08/89	1488	4	74.00	SOHC/OHC	63/86	BM990 (Graphite)	DM995
1.5 D15B2							26	
Civic 2 16V	01/88→11/91	1493	4	75.00	SOHC/OHC	61-74/ 83-101	BV020 (MLS)	DV020 EV020 GV020 [3]
Civic IV 1.5	10/93→12/95							
Civic IV 16V	10/87→11/95							
Civic IV Mk	01/92→12/92							
Concerto 16V	08/89→05/95							
1.5 D15B7							27	
City Saloon 1.5	02/97→09/03	1493	4	75.00	SOHC/OHC	67-77/ 91-105	BV020 (MLS)	EV020
Civic IV 1.5	10/93→12/95							
Civic IV Lsi	01/94→11/95							
CRX III 1.5	01/94→04/98							
1.5 D15Z1							28	
Civic IV 1.5	06/93→12/95	1493	4	75.00	SOHC/OHC	66-88/ 90-120	BV020 (MLS)	DV020 EV020 GV020 [3]
Civic IV 16V	10/91→11/95							
1.5 D15Z2							29	
Civic IV 16V	10/91→11/95	1493	4	75.00	DOHC	66/90	BV020 (MLS)	DR541 EV020
1.5 D15Z3							30	
Civic IV	09/94→01/97	1493	4	75.00	DOHC	66/90	BV020 (MLS)	DY863 01/95→12/96 EV020
1.5 D15Z6							31	
Civic IV	11/95→02/01	1493	4	75.00	SOHC/OHC	84/114	BV020 (MLS)	DY863 EV020
1.5 D15Z8							32	
Civic IV	01/97→02/01	1493	4	75.00	SOHC/OHC	84/114	BV020 (MLS)	DY863 EV020
1.6 B16A1							33	
Civic IV 16V	10/89→09/91	1595	4	81.00	DOHC	110/150	BV040 (MLS) 01/91→	DV041 01/91→ EV050
CRX II Vtec	10/89→02/92							
1.6 B16A2							34	
Civic IV	11/95→02/01	1595	4	81.00	SOHC/OHC	118/160	BV040 (MLS) →12/00	DV041 →12/00 EV050
Civic IV 1.6 VTi	10/91→02/01							
Civic IV 16V	10/91→11/95							
Civic IV Vtec	01/94→11/95							
CRX III Vti	03/92→12/98							

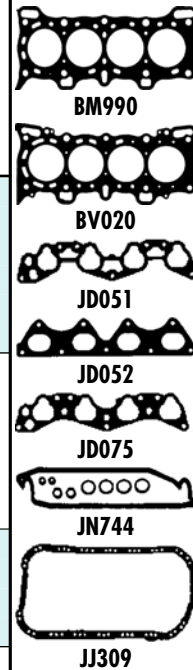
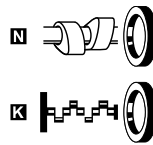
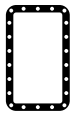
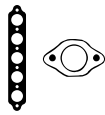

HBS300 [19] M12x1.75x166.00mm (x10)	JD6035 0.25mm JD5748	JM5134	JH5173	PB355 (x8) PB356 (x8)	NJ313 [1] 29.00x45.00x8.00mm, ACM NB884 [2] 38.00x50.00x5.50mm, FPM NJ312 [2] 80.00x100.00x10.00mm, MVQ	
HBS300 [19] M12x1.75x166.00mm (x10)	JD6035 0.25mm JD5748	JM5134	JH5173	PB355 (x8) PB356 (x8)	NJ313 [1] 29.00x45.00x8.00mm, ACM NB884 [2] 38.00x50.00x5.50mm, FPM NJ312 [2] 80.00x100.00x10.00mm, MVQ	
					NJ313 [1] 29.00x45.00x8.00mm, ACM NJ312 [2] 80.00x100.00x10.00mm, MVQ	
	JF024 (x2)	JN679 [4]	JJ309	PA969 (x8)	NJ381 [1] 31.00x46.00x8.00mm, NBR NJ312 [2] 80.00x100.00x10.00mm, MVQ	
	JD051 JD052 JE625	JN744 [4]		PB355 (x8) PB356 (x8)	NJ313 [1] 29.00x45.00x8.00mm, ACM NJ313 [1] 29.00x45.00x8.00mm, ACM NJ312 [2] 80.00x100.00x10.00mm, MVQ	
	JF024 (x2)	JN679 [4]	JJ309	PA969 (x8) PB356 (x8)	NJ381 [1] 31.00x46.00x8.00mm, NBR NJ312 [2] 80.00x100.00x10.00mm, MVQ	
	JF119	JN679 [4]	JJ309	PA969 (x8) PB356	NJ381 [1] 31.00x46.00x8.00mm, NBR NJ312 [2] 80.00x100.00x10.00mm, MVQ	
	JD075 JD5240 (MLS) JD5748			PB355 PB356	NJ313 [1] 29.00x45.00x8.00mm, ACM NJ312 [2] 80.00x100.00x10.00mm, MVQ	
	JD075 JD5748			PB355 PB356	NJ313 [1] 29.00x45.00x8.00mm, ACM NJ312 [2] 80.00x100.00x10.00mm, MVQ	
	JD075 JD5748			PB355 PB356	NJ313 [1] 29.00x45.00x8.00mm, ACM NJ312 [2] 80.00x100.00x10.00mm, MVQ	
		HM5228			NJ254 [1] 27.00x43.00x9.00mm, NBR	
		HM5228			NJ254 [1] 27.00x43.00x9.00mm, NBR	

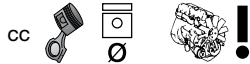

kW/PS

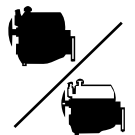

1.6		D16A					35	BV350 (Graphite)	DV351 [3]	
Civic 2 4x4	01/88→12/92	1590	4	75.00	SOHC/OHC	79-91/ 107-124				
CRX II 1.6 i 16V	10/87→05/88									
Domani 1.6	10/95→09/99									
Domani AWD	10/95→09/99									
1.6		D16A6					36	BV350 (Graphite)	DV351 [3]	
Civic 2 16V	01/88→02/95	1590	4	75.00	SOHC/OHC	79-81/ 107-110				
Civic IV 16V	10/87→09/91									
CRX II 1.6 i 16V	10/87→05/88									
1.6		D16A7					37	BV350 (Graphite)	DV351 [3]	
Civic 2 4x4	01/88→12/92	1590	4	75.00	SOHC/OHC	85-96/ 115-131				
Civic IV 1.6	10/95→09/00									
Civic IV 1.6 EX	08/93→10/95									
Civic IV 16V	09/87→09/91									
1.6		D16A8					38	BS880 (Graphite)	DS881 [3]	GS881 [3]
Concerto 16V	08/89→03/95	1590	4	75.00	DOHC	90-96/ 122-131				
CRX II 1.6 i 16V	10/87→12/89									
1.6		D16A9					39	BS880 (Graphite)	DS881 [3]	GS881 [3]
Civic IV 1.6	10/91→09/95	1590	4	75.00	DOHC	96/131				
Civic IV 16V	09/87→09/91									
Concerto 1.6	10/89→10/92									
CRX II 1.6 i 16V	10/87→12/89									
1.6		D16V1					40	AD5230 (MLS), 0.700mm	CD5230	FD5230
Civic VII 1.6	02/01→09/05	1590	4	75.00		78-81/ 106-110				
Civic VII 1.6 i	02/01→12/05									
1.6		D16W1					41	BV020 (MLS)	DV020	GY861
HR-V 1.6 16V	03/99→	1590	4	75.00	SOHC/OHC	77/105				
HR-V 1.6 16V 4WD	03/99→									
1.6		D16W5					42	BV020 (MLS)	DV020	
HR-V 1.6 16V 4WD	10/99→	1590	4	75.00	SOHC/OHC	91/124				
1.6		D16Y1					43	BV020 (MLS)	DV351 [3]	EV020
Civic IV 1.6	10/91→09/95	1590	4	75.00	SOHC/OHC	96/131				

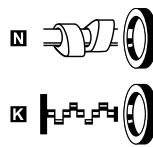
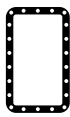
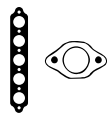

BS880



BV020



BV350



JC674



JD052



JD075

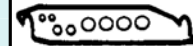

JN744

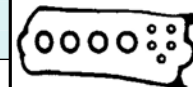

JN857



JN925



JJ309

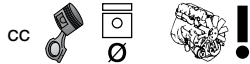

kW/PS

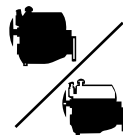

Engine Code	Model	Year Range	CC	Cylinders	Power (kW/PS)	Configuration	Accessories
1.6 D16Y2	44						
Civic IV		09/94→01/97	1590	4	75.00	DOHC	BV020 (MLS) 93/126
Civic IV 1.6		10/95→12/00					DV020 EV020
1.6 D16Y3	45						
Civic IV		09/94→01/97	1590	4	75.00	DOHC	AG7900 (MLS) 83/113
							CG7900 01/95→
1.6 D16Y6	46						
Civic IV		11/95→02/01	1590	4	75.00	SOHC/OHC	BV020 (MLS) 92/125
Civic IV Vtec		01/94→03/96					DV022
1.6 D16Y7	47						
Civic IV 1.6		05/96→04/99	1590	4	75.00	SOHC/OHC	BV020 (MLS) 77/105
Civic IV 1.6 i		01/94→03/00					DV022 08/95→
1.6 D16Y8	48						
Civic IV		11/95→02/01	1590	4	75.00	SOHC/OHC	BV020 (MLS) 84-92/114-125
CRX III 1.6 Esi		03/92→12/98					DV022 11/95→
							EV020 11/95→
							GV020 [3] 11/95→
1.6 D16Z2	49						
Civic IV 1.6V		10/87→09/91	1590	4	75.00	SOHC/OHC	BV350 (Graphite) 78-82/106-112
Concerto 1.6 16V		08/89→03/95					DV351 [3]
Concerto 1.6V		08/89→03/95					
Domani 1.6		11/88→12/97					
1.6 D16Z5	50						
Civic IV 1.6		01/88→12/89	1590	4	75.00	DOHC	BS880 (Graphite) 91/124
Civic IV 1.6 4x4		01/89→12/89					DS881 [3]
CRX II 1.6 i 16V		10/87→02/92					
1.6 D16Z6	51						
Civic IV 1.6		10/91→10/93	1590	4	75.00	SOHC/OHC	BV020 (MLS) 91-96/124-131
Civic IV 1.6V		10/91→11/95					DV020
CRX III 1.6 Esi		03/92→12/98					EV020
							GV020 [3]
1.6 D16Z7	52						
Civic IV 1.6 4x4		01/92→10/95	1590	4	75.00	SOHC/OHC	BV020 (MLS) 88-92/120-125
Civic IV 1.6V		10/91→11/95					DV020
							EV020
							GV020 [3]
1.6 D16Z9	53						
Civic IV Vtec		01/94→03/96	1590	4	75.00	SOHC/OHC	BV020 (MLS) 92/125
							DV022
							EV020
1.7 4EE-2 Diesel	54						
Civic VII CTDi		01/02→09/05	1686	4	79.00	SOHC/OHC	AE5520 (MLS), 1.450mm, 1 Hole
							AE5530 (MLS), 1.500mm, 2 Holes
							AE5540 (MLS), 1.550mm, 3 Notches

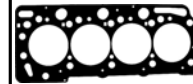
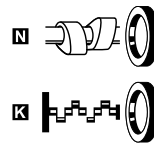
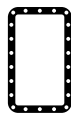
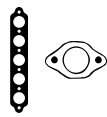

AE5520, AE5530,
AE5540



BS880



BV020



BV350



JC745



JD052



JD5331

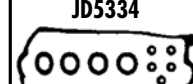

JD5334



JN857

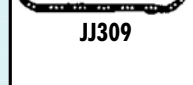

JJ309



cc



kW/PS



1.7	D17A2	1668	4	75.00	SOHC/OHC	92-94/ 125-128	55	AD5230 (MLS), 0.700mm	CG5792	
FR-V 1.7	08/04→									
FR-V Vtec	08/04→09/06									
Stream 1.7 16V	05/01→									
1.7	D17A5	1668	4	75.00	SOHC/OHC	92-96/ 125-131	56	AD5230 (MLS), 0.700mm		
Civic VII	05/01→12/05							06/01→		
1.7	D17A6	1668	4	75.00	SOHC/OHC	85-92/ 116-125	57	AD5230 (MLS), 0.700mm	CG5790	
Civic IV 1.7	11/97→03/01									
Civic VII	01/00→09/05									
1.7	D17A8	1668	4	75.00	SOHC/OHC	88/120	58	AD5230 (MLS), 0.700mm	CG5790	
Civic VII 1.7 i	05/01→12/05									
1.7	D17A9	1668	4	75.00	SOHC/OHC	92/125	59	AD5230 (MLS), 0.700mm	CG5792	
Civic VII	05/01→12/05							06/01→	06/01→	
1.8	B18C4	1797	4	81.00	DOHC	124/169	60	BV040 (MLS)	DV041	EV050
Civic IV	01/97→02/01							→12/00	→12/00	→12/00
1.8	B18C6	1797	4	81.00	DOHC	140/190	61	BV040 (MLS)		
Integra Type R	11/97→10/01									
1.8	R18A1	1798	4	81.00	SOHC/OHC	97-103/ 132-140	62	AH5760 (MLS)	CH5760	EH5760
Civic VIII 1.8	09/05→02/12									
FR-V 1.8	01/07→									
1.8	R18A2	1799	4	81.00	SOHC/OHC	103/140	63	AH5760 (MLS)	CH5760	EH5760
Civic VIII 1.8	01/06→									
Crossroad VTEC	02/07→08/10									
Stream 1.8 Vtec	10/05→									
1.8	XUD7T Diesel	1769	4	80.00	SOHC/OHC	58-65/ 79-88	64	BR780 (Fibre), 1.650mm, 2 Notches ☞0.650→0.770mm BR790 (Fibre), 1.800mm, 3 Notches ☞0.770→0.820mm	DJ720 ▲	EL890 [3] GJ720 ▲
City Saloon D	02/97→11/99									
Concerto 1.8 TD	08/94→10/96									
1.9	F18A3	1850	4	85.00	SOHC/OHC	85/116	65	BS700 (MLS)	DS700 [3]	
Accord V 1.9 i	02/96→10/98									
1.9	F18B2	1850	4	85.00	SOHC/OHC	100/136	66	BV830 (MLS)		
Accord VII 1.8 i	10/98→12/02									

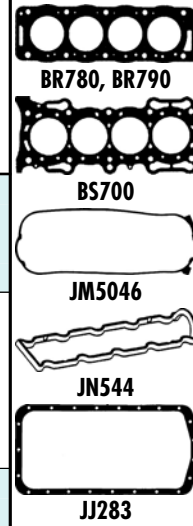
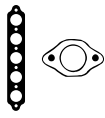

	JD6035 ■ 0.25mm				NJ313 [1] 29.00x45.00x8.00mm, ACM NJ312 ■ [2] 80.00x100.00x10.00mm, MVQ	
					NJ313 [1] 29.00x45.00x8.00mm, ACM NB884 ■ [2] 38.00x50.00x5.50mm, FPM NJ312 ■ [2] 80.00x100.00x10.00mm, MVQ	
	JD5240 ■ (MLS)		HR397	PB355 ■ PB356 ■	NB884 [2] 38.00x50.00x5.50mm, FPM NJ313 [1] 29.00x45.00x8.00mm, ACM	
	JD5240 ■ (MLS)		HR397	PB355 ■ PB356 ■	NB884 [2] 38.00x50.00x5.50mm, FPM NJ313 ■ [1] 29.00x45.00x8.00mm, ACM	
					NJ313 [1] 29.00x45.00x8.00mm, ACM NB884 ■ [2] 38.00x50.00x5.50mm, FPM NJ312 ■ [2] 80.00x100.00x10.00mm, MVQ	
		HM5228 ■				
		HM5228 ■				
HBS527 ☉ [22]	JD5985 ■ (x4) (FPM) JD5984 ■ (MLS)	JM7083 (ACM)			NA5320 ■ [2] 43.00x58.00x7.00mm, ACM NB698 ■ [1] 80.00x98.00x10.00mm, FPM	
HBS527 ☉ [22]	JD5985 ■ (x4) (FPM) JD5984 ■ (MLS)	JM7083 (ACM)			NA5320 ■ [2] 43.00x58.00x7.00mm, ACM NB698 ■ [1] 80.00x98.00x10.00mm, FPM	
HBS084 ☉ [22] M12x1.50x120.00mm (x10)		JN544 [4]	JJ283 [62]	HR569 ■	NF841 [1][2] 35.00x50.00x8.00mm, FPM NA5191 ■ [2] 42.00x62.00x7.00mm, PTFE NA5192 ■ [1] 90.00x110.00x7.00mm, PTFE	KA611 [15]
HBS284 ☉ [22] M12x1.50x198.00mm (x1)		JM5046 (Elastomer)			NJ134 ■ [1][2] 28.00x42.00x8.00mm, MVQ NA5242 ■ [1] 40.00x52.00x7.00mm, FPM NJ312 ■ [2] 80.00x100.00x10.00mm, MVQ	
HBS281 ☉ [22] M12x1.50x198.00mm (x1)		JN918			NJ134 ■ [1][2] 28.00x42.00x8.00mm, MVQ NJ312 ■ [2] 80.00x100.00x10.00mm, MVQ	



cc



kW/PS



2.0	20T2N Diesel					67	BZ440 (MLS), 1.050mm, 1 Hole BZ450 (MLS), 1.200mm, 2 Holes BZ460 (MLS), 1.350mm, 3 Holes	DZ440 ▲ [3]	EZ440
Accord 7 TDi	02/99→12/02	1994	4	84.50	SOHC/OHC	74-77/ 101-105			
Accord V 2.0 TDi	04/96→10/98								
Civic IV	04/98→02/01								
2.0	A20A1					68	BN450 (Graphite)	DN450	GN450
Accord 3 2.0 EX	11/85→12/89	1955	4	82.70	SOHC/OHC	73-76/ 99-103			
Accord 3 12V	01/86→03/88								
2.0	A20A2					69	BN450 (Graphite)	DN450	GN450
Accord 3 2.0 EX	11/85→05/89	1955	4	82.70	SOHC/OHC	78-101/ 106-137			
2.0	A20A3					70	BN450 (Graphite)	DN451 [3]	GN451
Accord 3 2.0EXi	01/86→12/89	1955	4	82.70	SOHC/OHC	85-90/ 116-122	10/87→	01/88→	01/88→
Accord 3 12V	01/87→12/89								
2.0	B20A3					71	BS110 (Graphite)	DS111	
Prelude III	04/87→01/92	1958	4	81.00	SOHC/OHC	80/109			
2.0	B20A4					72	BS110 (Graphite)	DS111	
Prelude III	08/87→01/92	1958	4	81.00	SOHC/OHC	84/114			
2.0	B20A7					73	BS110 (Graphite)	DS111	GS111 [3]
Prelude III	10/87→12/90	1958	4	81.00	DOHC	110/150			
2.0	B20A8					74	BS110 (Graphite)	DS111	
Accord 3 2.0 EX	10/87→12/89	1958	4	81.00	DOHC	98/133			
2.0	B20A9					75	BS110 (Graphite)	DS111	GS111 [3]
Prelude III	04/90→01/92	1958	4	81.00	DOHC	103/140			
2.0	B20B					76	BV050 (MLS)	DV050	EV050
CR-V I 2.0 16V	10/95→01/99	1973	4	84.00	DOHC	94-96/ 128-131	01/97→	01/97→	01/97→
2.0	B20Z1					77	BV050 (MLS)	DV050	EV050
CR-V I 2.0	04/99→02/02	1973	4	84.00	DOHC	98-108/ 133-147			
CR-V I 2.0 16V	01/99→02/02								

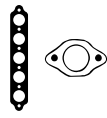

BN450



BS110



BZ440, BZ450,
BZ460



JC404



JC405



JC652



JC688



JN649



JJ271



JJ390

HBS282 [22]
M11x1.50x230.00mm (x10)

HR5051

NB775 (x2) [1] [2]
40.00x52.00x7.00mm, FPM
NB774 [2]
35.00x45.00x8.00mm, FPM
LK5002 [1] [7]
136.00x153.00x21.000mm, PTFE
NB843 [1]
128.00x145.00x28.00mm, FPM

JC652
JC404
JC405 (x2)
JE625

JN605 [4]

JJ271

PA529 (x4)
PA528 (x8)

NJ313 [1]
29.00x45.00x8.00mm, ACM
NJ311 [1]
35.00x54.00x8.00mm, NBR
NJ312 [2]
80.00x100.00x10.00mm, MVQ

JC652
JC404
JC405 (x2)
JE625

JN605 [4]

JJ271

PA529 (x4)
PA528 (x8)

NJ313 [1]
29.00x45.00x8.00mm, ACM
NJ311 [1]
35.00x54.00x8.00mm, NBR
NJ312 [2]
80.00x100.00x10.00mm, MVQ

JC652
01/88→
JC404
10/87→
JC405 (x2)
10/87→
JF021
01/88→

JN605 [4]
10/87→

JJ271
01/88→

PA313 (x4)
10/87→
PA528 (x8)
10/87→

NJ313 [1]
29.00x45.00x8.00mm, ACM
10/87→
NJ312 [2]
80.00x100.00x10.00mm, MVQ
10/87→

NJ313 [1]
29.00x45.00x8.00mm, ACM

NJ313 [1]
29.00x45.00x8.00mm, ACM

JC688
JF024 (x2)

JN649 [4]

JJ390

PA531 (x8)
PA528 (x8)

NJ254 [1]
27.00x43.00x9.00mm, NBR
NJ982 [2]
38.00x53.00x7.00mm, FPM
NJ312 [2]
80.00x100.00x10.00mm, MVQ

JN649 [4]

NJ254 [1]
27.00x43.00x9.00mm, NBR
NJ982 [2]
38.00x53.00x7.00mm, FPM
NJ312 [2]
80.00x100.00x10.00mm, MVQ

JC688
JF024 (x2)

JN649 [4]

JJ390

PA531 (x8)
PA528 (x8)

NJ254 [1]
27.00x43.00x9.00mm, NBR
NJ982 [2]
38.00x53.00x7.00mm, FPM
NJ312 [2]
80.00x100.00x10.00mm, MVQ

HM5246

NJ254 [1]
27.00x43.00x9.00mm, NBR

HM5246

NJ254 [1]
27.00x43.00x9.00mm, NBR



cc



kW/PS



2.0	F20A2	78	BS700 (MLS)	DS700 [3]					
Accord 4 16V	01/90→03/93	1997	4	85.00	SOHC/OHC	81/110			
2.0	F20A3	79	BS700 (MLS)	DS700 [3]					
Accord 4 16V	01/90→03/93	1997	4	85.00	SOHC/OHC	81/110			
2.0	F20A4	80	BS700 (MLS)	DS700 [3]					
Accord 4 16V	01/90→03/93	1997	4	85.00	SOHC/OHC	98/133			
Prelude IV	02/92→09/96								
Prelude V	10/96→10/00								
2.0	F20A6	81	BS700 (MLS)	DS700 [3]					
Accord 4 16V	01/90→03/93	1997	4	85.00	SOHC/OHC	66/90			
2.0	F20A7	82	BS700 (MLS)						
Accord 4 16V	01/92→09/93	1997	4	85.00	DOHC	98/133			
2.0	F20A8	83	BS700 (MLS)	DS700 [3]					
Accord 4 16V	01/90→03/93	1997	4	85.00	DOHC	98/133			
2.0	F20B3	84	BV830 (MLS)	CG5350	GV830				
Accord 5 Coupe	09/93→12/97	1997	4	85.00	SOHC/OHC	98-100/ 133-136			
Accord 5 LS	09/93→02/98								
2.0	F20B5	85	BV360 (MLS)						
Accord 7 Coupe	02/98→06/03	1997	4	85.00	SOHC/OHC	108/147			
2.0	F20B6	86	BV830 (MLS)		EG6210 (Elastomer)				
Accord VII 2.0	12/99→12/02	1997	4	85.00	SOHC/OHC	108/147			
Accord VII 2.0 i	10/98→01/01								
2.0	F20B7	87	BV360 (MLS)		EG6210 (Elastomer)				
Accord 7 Coupe	02/98→06/03	1997	4	85.00	SOHC/OHC	107-108/ 145-147			

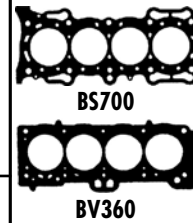
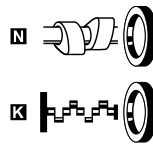
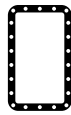
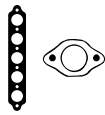

HBS284 ☉ [22] M12x1.50x198.00mm (x1)				PB355 ■ (x8) PB356 ■ (x8)	NJ134 ■ [1][2] 28.00x42.00x8.00mm, MVQ NA5242 ■ [1] 40.00x52.00x7.00mm, FPM NJ312 ■ [2] 80.00x100.00x10.00mm, MVQ	
HBS284 ☉ [22] M12x1.50x198.00mm (x1)				PB355 ■ (x8) PB356 ■ (x8)	NJ134 ■ [1][2] 28.00x42.00x8.00mm, MVQ NA5242 ■ [1] 40.00x52.00x7.00mm, FPM NJ312 ■ [2] 80.00x100.00x10.00mm, MVQ	
HBS284 ☉ [22] M12x1.50x198.00mm (x1)				PB355 ■ (x8) PB356 ■ (x8)	NJ134 ■ [1][2] 28.00x42.00x8.00mm, MVQ NA5242 ■ [1] 40.00x52.00x7.00mm, FPM NJ312 ■ [2] 80.00x100.00x10.00mm, MVQ	
HBS284 ☉ [22] M12x1.50x198.00mm (x1)				PB355 ■ (x8) PB356 ■ (x8)	NJ134 ■ [1][2] 28.00x42.00x8.00mm, MVQ NA5242 ■ [1] 40.00x52.00x7.00mm, FPM NJ312 ■ [2] 80.00x100.00x10.00mm, MVQ	
HBS284 ☉ [22] M12x1.50x198.00mm (x1)	JD5749 ■			PB355 ■ (x8) PB356 ■ (x8)	NJ134 ■ [1][2] 28.00x42.00x8.00mm, MVQ NJ312 ■ [2] 80.00x100.00x10.00mm, MVQ	
HBS284 ☉ [22] M12x1.50x198.00mm (x1)				PB355 ■ (x8) PB356 ■ (x8)	NJ134 ■ [1][2] 28.00x42.00x8.00mm, MVQ NA5242 ■ [1] 40.00x52.00x7.00mm, FPM NJ312 ■ [2] 80.00x100.00x10.00mm, MVQ	
HBS284 ☉ [22] M12x1.50x198.00mm (x1)	JD5749 ■			PB355 ■ (x8) PB356 ■ (x8) HR5088 ■	NJ134 ■ [1][2] 28.00x42.00x8.00mm, MVQ NA5223 ■ [2] 40.00x52.00x7.00mm, FPM NA5242 ■ [1] 40.00x52.00x7.00mm, FPM NJ312 ■ [2] 80.00x100.00x10.00mm, MVQ	KK5646 [17]
HBS281 ☉ [22] M12x1.50x198.00mm (x1)	JD5749 ■	JN918		PB355 ■ (x8) PB356 ■ (x8)	NJ134 ■ [1][2] 28.00x42.00x8.00mm, MVQ NA5242 ■ [1] 40.00x52.00x7.00mm, FPM NJ312 ■ [2] 80.00x100.00x10.00mm, MVQ	
HBS281 ☉ [22] M12x1.50x198.00mm (x1)		JN918		PB355 ■ (x8) PB356 ■ (x8)	NJ134 ■ [1][2] 28.00x42.00x8.00mm, MVQ NA5242 ■ [1] 40.00x52.00x7.00mm, FPM NJ312 ■ [2] 80.00x100.00x10.00mm, MVQ	
HBS281 ☉ [22] M12x1.50x198.00mm (x1)	JD5749 ■	JN918		PB355 ■ (x8) PB356 ■ (x8)	NJ134 ■ [1][2] 28.00x42.00x8.00mm, MVQ NA5242 ■ [1] 40.00x52.00x7.00mm, FPM NJ312 ■ [2] 80.00x100.00x10.00mm, MVQ	



cc



kW/PS



2.0	F20C VTEC	88	AG8010 (MLS)	CG8010	FG8010				
S2000 2.0	06/99→	1997	4	87.00	DOHC	177/240			
2.0	F20Z1	89	BS700 (MLS)	DS705					
Accord 5 LS	02/96→10/98	1997	4	85.00	SOHC/OHC	96/131			
Accord V 2.0 i S	03/93→01/96								
2.0	F20Z2	90	BS700 (MLS)	DS705					
Accord V 2.0 i	03/93→01/96	1997	4	85.00	SOHC/OHC	85/116	→01/96	→01/96	
Torneo 2.0	04/94→12/97								
2.0	F20Z3	91	BS700 (MLS)	DS705					
Accord 4 16V	03/93→12/93	1997	4	85.00	SOHC/OHC	98/133			
2.0	K20A1	92	AG5810 (MLS)	CG5810	EG5810				
Stream 2.0 16V	05/01→	1998	4	86.00		114-118/ 155-160			
2.0	K20A2	93	AG8130 (MLS)	CG8130	FG8130				
Civic VII	09/01→09/05	1998	4	86.00	DOHC	147/200			
Integra 2.0	10/04→								
2.0	K20A3	94	AG8130 (MLS)	CG8130	FG8130				
Civic VII	01/04→09/05	1998	4	86.00	DOHC	114-118/ 155-160			
Civic VII 2.0	10/03→09/05								
Civic VIII 2.0	02/06→02/12								
Integra 2.0	02/02→								
2.0	K20A4	95	AG5810 (MLS)	CG5811	FG8131				
CR-V II 2.0	07/02→09/06	1998	4	86.00	DOHC	110/150			
2.0	K20A6	96	AG5810 (MLS)	CG5810	EG5810				
Accord 7 2.0	02/03→	1998	4	86.00	DOHC	114/155			
Accord 7 AWD	02/03→								
Stepwagon 2.0	10/05→								
2.0	K20A9	97	AG5810 (MLS)	CG5511	FG8131				
FR-V 2.0	08/04→09/06	1998	4	86.00	DOHC	110-118/ 150-160			
FR-V 2.0 4x4	08/04→09/06								
Stepwagon	10/00→09/05								
Stepwagon 2.0	10/00→09/05								
2.0	K20Z1	98							
Integra Type R	02/02→	1998	4	86.00	DOHC	154-162/ 209-220			



BS700



JM5046



JJ417

		HM5258					
HBS284 [22] M12x1.50x198.00mm (x1)	JD5750	JM5046 (Elastomer)	JJ417	PB355 (x8) PB356 (x8)	NA5320 [2] 43.00x58.00x7.00mm, ACM NB698 [1] 80.00x98.00x10.00mm, FPM		
HBS284 [22] M12x1.50x198.00mm (x1) →01/96	JD5750 →01/96	JM5046 (Elastomer) →01/96	JJ417 →01/96	PB355 (x8) PB356 (x8) →01/96	NJ134 [1][2] 28.00x42.00x8.00mm, MVQ NA5242 [1] 40.00x52.00x7.00mm, FPM NJ312 [2] 80.00x100.00x10.00mm, MVQ		
HBS284 [22] M12x1.50x198.00mm (x1)	JD5750	JM5046 (Elastomer)		PB355 (x8) PB356 (x8)	NJ134 [1][2] 28.00x42.00x8.00mm, MVQ NA5242 [1] 40.00x52.00x7.00mm, FPM NJ312 [2] 80.00x100.00x10.00mm, MVQ		
	JD5384 0.25mm JD6045 (MLS) 0.4mm	HM5267			NA5320 [2] 43.00x58.00x7.00mm, ACM NB698 [1] 80.00x98.00x10.00mm, FPM		
HBS528 [22]	JD5384 0.25mm JD6045 (MLS) 0.4mm	HM5267			NA5320 [2] 43.00x58.00x7.00mm, ACM NB698 [1] 80.00x98.00x10.00mm, FPM		
HBS528 [22]	JD5384 0.25mm JD6045 (MLS) 0.4mm	HM5267			NA5320 [2] 43.00x58.00x7.00mm, ACM NB698 [1] 80.00x98.00x10.00mm, FPM		
HBS528 [22]	JD5384 0.25mm JD6045 (MLS) 0.4mm	HM5267			NA5320 [2] 43.00x58.00x7.00mm, ACM NB698 [1] 80.00x98.00x10.00mm, FPM		
HBS528 [22]	JD6045 (MLS) 0.4mm	HM5267			NA5320 [2] 43.00x58.00x7.00mm, ACM NB698 [1] 80.00x98.00x10.00mm, FPM		
HBS528 [22]	JD5384 0.25mm JD6045 (MLS) 0.4mm				NA5320 [2] 43.00x58.00x7.00mm, ACM NB698 [1] 80.00x98.00x10.00mm, FPM		
	JD6045 (MLS) 0.4mm		HR397		NA5320 [2] 43.00x58.00x7.00mm, ACM NB698 [1] 80.00x98.00x10.00mm, FPM		



kW/PS

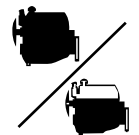

2.0	R20A3	99					AH5760 (MLS)	CH5760	EH5760
Accord 8 2.0 i	07/08→	1997	4	81.00	DOHC	115/156			
2.2	F22A3	100					BS700 (MLS)	DS700 [3]	GS700 [3]
Accord 4 16V	01/90→03/93	2156	4	85.00	SOHC/OHC	108-110/ 147-150			
2.2	F22A7	101					BS700 (MLS)	DS700 [3]	GS700 [3]
Accord 4 16V Ascot 2.2 EX	01/91→12/93 11/90→10/96	2156	4	85.00	SOHC/OHC	110/150	01/91→	01/91→	01/91→
2.2	F22A8	102					BS700 (MLS)	DS700 [3]	GS700 [3]
Accord 4 16V Ascot 2.2 EX	01/91→12/93 11/90→10/96	2156	4	85.00	SOHC/OHC	108/147	01/91→	01/91→	01/91→
2.2	F22B5	103					BV830 (MLS)	CG5350	GV830
Accord 5 ES	09/93→02/98	2156	4	85.00	SOHC/OHC	110/150			
2.2	F22B8	104						CG5350	
Shuttle 2.2 16V	10/94→02/98	2156	4	85.00	SOHC/OHC	110/150		02/95→	
2.2	F22Z2	105					BV360 (MLS)	DV360 [3]	
Accord 5 VTEC Accord V 2.2	02/96→10/98 04/96→12/97	2156	4	85.00	SOHC/OHC	103-110/ 140-150			
2.2	H22A2	106					BV340 (MLS)	DV340 [3]	
Prelude IV	02/93→09/96	2157	4	87.00	DOHC	136/185			

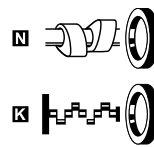
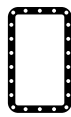
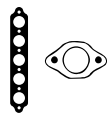

BS700

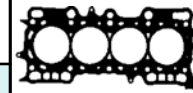

BV340



BV360

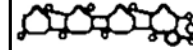

JC883



JC885



JD175



JD176

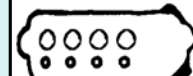

JN755

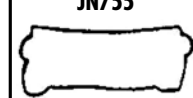

JN904



JJ417



cc



kW/PS



2.2	H22A5	107	AG5760 (MLS)		FG5760				
Prelude V	10/96→10/00	2157	4	87.00	DOHC	136/185	01/97→		
2.2	H22A7	108	AG5760 (MLS)		FG5761				
Accord 7 Type-R	02/99→12/02	2157	4	87.00	DOHC	156/212			
2.2	N22A1 Diesel	109	AH5660 (MLS), 1.300mm AH5661 (MLS), 1.350mm AH5662 (MLS), 1.400mm AH5663 (MLS), 1.450mm AH5664 (MLS), 1.500mm	CH5660 ▲	EH5660				
Accord 7 i-CTDi FR-V 2.2 i-CTDi	01/04→ 07/05→	2204	4	85.00	DOHC	103/140			
2.2	N22A2 Diesel	110	AH5660 (MLS), 1.300mm AH5661 (MLS), 1.350mm AH5662 (MLS), 1.400mm AH5663 (MLS), 1.450mm AH5664 (MLS), 1.500mm	CH5660 ▲	EH5660				
Civic VIII CR-V II 2.2 CTDi CR-V III 4WD	01/06→ 02/05→09/06 01/07→	2204	4	85.00	DOHC	103/140			
2.3	F23A1	111	AG5780 (MLS)	CG5780	EG6210 (Elastomer)				
Accord 7 2.3	01/01→06/03	2254	4	86.00	SOHC/OHC	110-113/ 150-154			
2.3	F23A3	112	BV030 (MLS)	DV030 [3]	GV030				
Accord 7 VTi	02/98→10/02	2254	4	86.00	SOHC/OHC	113/154			
2.3	F23A7	113	AG5780 (MLS)	CG5780	EG6210 (Elastomer)				
Accord 7 1.6V Shuttle 3344 A	02/98→ 10/97→06/04	2254	4	86.00	SOHC/OHC	110-118/ 150-160			
2.3	F23Z5	114	AG5780 (MLS)	CG5780	EG6210 (Elastomer)				
Accord 7 2.3	11/00→06/03	2254	4	86.00	DOHC	104-113/ 141-154			
2.3	H23A2	115	BV030 (MLS)	DV030 [3]	GV030				
Prelude IV	02/92→09/96	2259	4	87.00	DOHC	118/160			
2.3	H23A3	116	BV030 (MLS)	DV030 [3]	GV030				
Accord 5 SR	03/93→01/96	2259	4	87.00	DOHC	116/158			

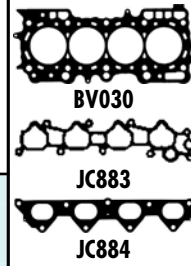
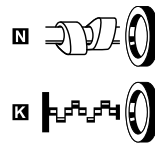

HBS284 ☉ [22] M12x1.50x198.00mm (x1)		JN860 [4] HM5266 ☒ 01/97 →		PB355 ☒ (x8) PB356 ☒ (x8)	NA5245 (x2) [1][2] 29.00x43.00x8.00mm NA5242 ☒ [1] 40.00x52.00x7.00mm, FPM NJ312 ☒ [2] 80.00x100.00x10.00mm, MVQ	
HBS284 ☉ [22] M12x1.50x198.00mm (x1)		HM5266 ☒		PB355 ☒ (x8) PB356 ☒ (x8)	NA5245 (x2) [1][2] 29.00x43.00x8.00mm NA5242 ☒ [1] 40.00x52.00x7.00mm, FPM NJ312 ☒ [2] 80.00x100.00x10.00mm, MVQ	
HBS532 ☉ (x10) [5][21]	JD5989 ☒ (SE) JD5990 ☒ (MLS)				NA5320 ☒ [2] 43.00x58.00x7.00mm, ACM	
HBS532 ☉ (x10) [5][21]	JD5989 ☒ (SE) JD5990 ☒ (MLS)				NA5320 ☒ [2] 43.00x58.00x7.00mm, ACM	
HBS281 ☉ [22] M12x1.50x198.00mm (x1)	JD5749 ☒	JN918		PB355 ☒ (x8) PB356 ☒ (x8)	NJ134 [1][2] 28.00x42.00x8.00mm, MVQ NA5242 ☒ [1] 40.00x52.00x7.00mm, FPM NJ312 ☒ [2] 80.00x100.00x10.00mm, MVQ	
HBS284 ☉ [22] M12x1.50x198.00mm (x1)	JC883 ☒ JC884 ☒ ☉: JF024 (x2)	JN918		PB354 PB355 ☒	NJ134 [1][2] 28.00x42.00x8.00mm, MVQ NA5242 ☒ [1] 40.00x52.00x7.00mm, FPM NJ312 ☒ [2] 80.00x100.00x10.00mm, MVQ	
HBS281 ☉ [22] M12x1.50x198.00mm (x1)	JD5749 ☒	JN918		PB355 ☒ (x8) PB356 ☒ (x8)	NJ134 ☒ [1][2] 28.00x42.00x8.00mm, MVQ NA5242 ☒ [1] 40.00x52.00x7.00mm, FPM NJ312 ☒ [2] 80.00x100.00x10.00mm, MVQ	
HBS281 ☉ [22] M12x1.50x198.00mm (x1)	JD5749 ☒	JN918		PB355 ☒ (x8) PB356 ☒ (x8)	NJ134 [1][2] 28.00x42.00x8.00mm, MVQ NA5242 ☒ [1] 40.00x52.00x7.00mm, FPM NJ312 ☒ [2] 80.00x100.00x10.00mm, MVQ	
HBS284 ☉ [22] M12x1.50x198.00mm (x1)	JC883 ☒ JC884 ☒ ☉: JF024 ☒ (x2)	JN860 [4]		PA096 (x16) [96] 12.30/14.49 PB354 ☒ (x8) PB353 ☒ (x8)	NJ134 ☒ [1][2] 28.00x42.00x8.00mm, MVQ NA5242 ☒ [1] 40.00x52.00x7.00mm, FPM NJ312 ☒ [2] 80.00x100.00x10.00mm, MVQ	
HBS284 ☉ [22] M12x1.50x198.00mm (x1)	JC883 ☒ JC884 ☒ ☉: JF024 ☒ (x2)	JN860 [4]		PB354 ☒ (x8) PB353 ☒ (x8)	NJ134 ☒ [1][2] 28.00x42.00x8.00mm, MVQ NA5242 ☒ [1] 40.00x52.00x7.00mm, FPM NJ312 ☒ [2] 80.00x100.00x10.00mm, MVQ	



cc



kW/PS



2.4	K24A						117			
Accord 7 2.4	02/03→	2354	4	87.00	DOHC		124-147/			
CR-V III 2.4 4WD	09/07→						168-200			
Odyssey i-Vtec	11/08→									
2.4	K24A1						118			
Accord 7 Vtec	09/03→	2354	4	87.00	DOHC		118-147/			
CR-V II Vtec	03/02→09/06						160-200			
CR-V III 2.4	04/07→									
Elysion Vtec	05/04→									
2.4	K24A2						119			
Accord 7 Vtec	02/03→09/05	2354	4	87.00	DOHC		118/160			
Accord 7 Vtec E	09/03→09/05									
2.4	K24A3						120			
Accord 7 2.4	02/03→	2354	4	87.00	DOHC		110-150/			
Stepwagon	10/05→						150-204			
Stepwagon 2.4	10/00→09/05									
2.4	K24A4						121			
Accord 7 Vtec	02/03→09/05	2354	4	87.00	DOHC		118-140/			
Odyssey 2.4	10/05→						160-190			
2.4	K24A6						122	AG5810 (MLS)	CG5810	EG5810
Element 2.4 Vtec	07/02→	2354	4	87.00	DOHC		118/160			
Element Vtec	07/02→									
2.4	K24A8						123			
Accord VII 2.4	09/06→	2354	4	87.00	DOHC		113-124/			
							154-169			
2.4	K24Z1						124			
CR-V III Vtec	09/09→	2354	4	87.00	DOHC		118-125/			
							160-170			
2.5	C25A2						125	BP640 (Graphite) (x2)		
Legend I 2.5 i	02/87→06/88	2494	6	84.00	SOHC/OHC, V		124-127/			
							169-173			
2.7	C27A1						126	BR650 (Graphite)	DR650 [3]	
Legend I 24V	01/88→12/90	2675	6	87.00	SOHC/OHC, V		124/169			
Legend I 24V	10/87→12/90									
3.0	C30A3						127	AG7860 (SMG)		FG7860
NSX Vtec	06/90→09/05	2977	6	90.00	DOHC, V		201/274			
3.0	C30A4						128	AG7860 (SMG)		FG7860
NSX Vtec	06/90→09/05	2977	6	90.00	DOHC		188/256			
3.0	J30A1						129	AG9170 (MLS)	CG9170	EG5770
Accord 7 V6 24V	02/98→06/03	2997	6	86.00	SOHC/OHC, V		147-149/			
Accord 7 Vtec	10/98→12/02						200-203			

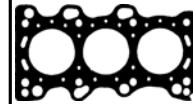

BP640

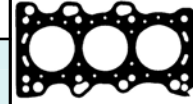

BR650



JC687



JC791

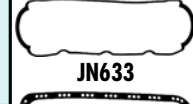

JN633



JJ364

HBS528 ☉ [22]	JD6045 ☒ (MLS) 0.4mm	HM5267 ☒			☒ NA5320 ☒ [2] 43.00x58.00x7.00mm, ACM ☒ NB698 ☒ [1] 80.00x98.00x10.00mm, FPM	
	JD5384 ☒ 0.25mm JD6045 ☒ (MLS) 0.4mm				☒ NA5320 ☒ [2] 43.00x58.00x7.00mm, ACM ☒ NB698 ☒ [1] 80.00x98.00x10.00mm, FPM	
HBS528 ☉ [22]	JD6045 ☒ (MLS) 0.4mm	HM5267 ☒			☒ NA5320 ☒ [2] 43.00x58.00x7.00mm, ACM ☒ NB698 ☒ [1] 80.00x98.00x10.00mm, FPM	
HBS528 ☉ [22]	JD6045 ☒ (MLS) 0.4mm	HM5267 ☒			☒ NA5320 ☒ [2] 43.00x58.00x7.00mm, ACM ☒ NB698 ☒ [1] 80.00x98.00x10.00mm, FPM	
HBS528 ☉ [22]	JD6045 ☒ (MLS) 0.4mm	HM5267 ☒			☒ NA5320 ☒ [2] 43.00x58.00x7.00mm, ACM ☒ NB698 ☒ [1] 80.00x98.00x10.00mm, FPM	
HBS528 ☉ [22]	JD6045 ☒ (MLS) 0.4mm				☒ NA5320 ☒ [2] 43.00x58.00x7.00mm, ACM ☒ NB698 ☒ [1] 80.00x98.00x10.00mm, FPM	
HBS528 ☉ [22]	JD6045 ☒ (MLS) 0.4mm	HM5267 ☒		PB355 ☒ PA969 ☒ PB356 ☒	☒ NA5320 ☒ [2] 43.00x58.00x7.00mm, ACM ☒ NB698 ☒ [1] 80.00x98.00x10.00mm, FPM	
HBS528 ☉ [22]	JD6045 ☒ (MLS) 0.4mm	HM5267 ☒			☒ NA5320 ☒ [2] 43.00x58.00x7.00mm, ACM ☒ NB698 ☒ [1] 80.00x98.00x10.00mm, FPM	
	JC687 ☒ (x2) ☉JE625	JN633 (x2)[4]	JJ364	PA528 ☒ (x12)	☒ NJ933 (x2)[2] 35.00x50.00x8.00mm, FPM ☒ NK023 ☒ [2] 41.00x56.00x8.00mm, ACM ☒ NJ675 ☒ [1] 80.00x98.00x10.00mm, NBR	
	JC791 ☒ (x2) JC687 ☒ (x2) ☉JE625	JN633 (x2)[4]	JJ364	PA528 ☒ (x12)	☒ NJ933 (x2)[2] 35.00x50.00x8.00mm, FPM ☒ NK023 ☒ [2] 41.00x56.00x8.00mm, ACM ☒ NJ675 ☒ [1] 80.00x98.00x10.00mm, NBR	
		HM5247 ☒			☒ NB698 ☒ [1] 80.00x98.00x10.00mm, FPM	
		HM5247 ☒			☒ NB698 ☒ [1] 80.00x98.00x10.00mm, FPM	
					☒ NB698 ☒ [1] 80.00x98.00x10.00mm, FPM	

HONDA









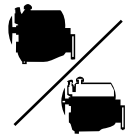



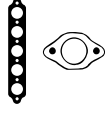

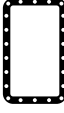

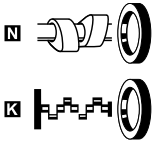

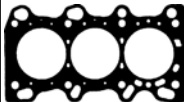
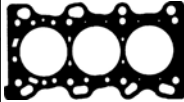

cc



kW/PS



3.2		C32A2				130	BV090 (Graphite)		DV090 [3]
Legend II 24v	01/91→02/96	3206	6	90.00	DOHC, V	151/205	BV100 (Graphite)		
Legend II 24v	01/91→02/96								
3.2		C32B2				131	AG7870 (MLS)		
NSX 180.08/B	01/97→09/05	3179	6	93.00	V	206/280			
NSX 180.10/B	01/97→09/05								

							 <p>BV090</p>  <p>BV100</p>
		<p>HM5248  (x2)</p>		<p>PB355  PB356 </p>	<p> NJ933 [2] 35.00x50.00x8.00mm, FPM  NK023  [2] 41.00x56.00x8.00mm, ACM  NB698  [1] 80.00x98.00x10.00mm, FPM  NJ675  [1] 80.00x98.00x10.00mm, NBR</p>		
					<p> NB698  [1] 80.00x98.00x10.00mm, FPM</p>		



Ltr







CC



9

Model	Ltr	Year Range	Engine	Fuel	CC	Seats	9
ACCENT I (X-3)	1.3	10/99→01/00	G4EH	Petrol	1341	4	9
ACCENT I (X-3)	1.5	10/99→01/00	G4EK	Petrol	1495	4	17
ACCENT I (X-3)	1.5	12/99→01/00	G4ER	Petrol	1495	4	19
ACCENT II (LC)	1.3	01/00→11/00	G4EA	Petrol	1341	4	8
ACCENT II (LC)	1.3	08/00→11/00	G4EH	Petrol	1341	4	9
ACCENT II (LC)	1.5	04/00→11/00	D3EA	Diesel	1493	3	11
ACCENT II (LC)	1.5	01/00→11/00	G4EB	Petrol	1495	4	15
ACCENT II (LC)	1.5	09/00→11/00	G4EC-G	Petrol	1495	4	16
ACCENT II (LC)	1.6	12/00→11/00	G4ED-G	Petrol	1599	4	24
ACCENT III (MC)	1.4	11/00→11/01	G4EE	Petrol	1399	4	10
ACCENT III (MC)	1.5	11/00→11/01	D4FA	Diesel	1493	4	12
ACCENT III (MC)	1.6	11/00→11/01	G4ED	Petrol	1599	4	23
ACCENT Saloon (LC)	1.3	01/00→11/00	G4EA	Petrol	1341	4	8
ACCENT Saloon (LC)	1.5	01/00→11/00	D3EA	Diesel	1493	3	11
ACCENT Saloon (LC)	1.5	01/00→11/00	G4EB	Petrol	1495	4	15
ACCENT Saloon (LC)	1.5	09/99→10/00	G4FK	Petrol	1495	4	20
ACCENT Saloon (LC)	1.6	12/00→11/00	G4ED-G	Petrol	1599	4	24
ACCENT Saloon (MC)	1.4	11/00→11/01	G4EE	Petrol	1399	4	10
ACCENT Saloon (MC)	1.5	11/00→11/01	D4FA	Diesel	1493	4	12
ACCENT Saloon (MC)	1.6	11/00→11/01	G4ED	Petrol	1599	4	23
ACCENT Saloon (X-3)	1.3	10/99→01/00	G4EH	Petrol	1341	4	9
ACCENT Saloon (X-3)	1.5	10/99→01/00	G4EK	Petrol	1495	4	17
ACCENT Saloon (X-3)	1.5	10/99→01/00	G4ER	Petrol	1495	4	19
ATOS (MX)	1.0	02/99→03/00	G4HC	Petrol	999	4	1
ATOS (MX)	1.0	03/00→	G4HCE	Petrol	999	4	2
ATOS (MX)	1.1	08/00→05/00	G4HD	Petrol	1086	4	4
ATOS (MX)	1.1	03/00→	G4HG	Petrol	1086	4	5
ATOS (MX)	1.3	08/00→08/00	G4EA	Petrol	1341	4	8
ATOS PRIME (MX)	1.0	08/99→	G4HC	Petrol	999	4	1
ATOS PRIME (MX)	1.0	03/00→	G4HCE	Petrol	999	4	2
ATOS PRIME (MX)	1.1	06/00→	G4HD	Petrol	1086	4	4
ATOS PRIME (MX)	1.1	09/00→	G4HG	Petrol	1086	4	5
COUPE (GK)	1.6	03/00→08/00	G4ED-G	Petrol	1599	4	24
COUPE (GK)	2.0	08/00→08/00	G4GCG	Petrol	1975	4	43
COUPE (GK)	2.7	03/00→08/00	G6BA-G	Petrol	2656	6	59
COUPE (RD)	1.6	12/99→04/00	4G61	Petrol	1599	4	21
COUPE (RD)	1.6	03/99→04/00	G4GR	Petrol	1599	4	25
COUPE (RD)	1.8	07/99→04/00	G4GM	Petrol	1795	4	31
COUPE (RD)	2.0	08/99→04/00	G4DF	Petrol	1975	4	41
COUPE (RD)	2.0	08/99→04/00	G4GF	Petrol	1975	4	44
ELANTRA (XD)	1.6	06/00→07/00	G4ED-G	Petrol	1599	4	24
ELANTRA (XD)	1.6	06/00→07/00	G4GR	Petrol	1599	4	25
ELANTRA (XD)	1.8	06/00→07/00	G4BB	Petrol	1795	4	27
ELANTRA (XD)	2.0	04/00→07/00	D4EA	Diesel	1991	4	33
ELANTRA (XD)	2.0	06/00→07/00	G4GC	Petrol	1975	4	42
ELANTRA (XD)	2.0	06/00→07/00	G4GCG	Petrol	1975	4	43
ELANTRA Saloon (HD)	2.0	06/00→06/01	G4GC	Petrol	1975	4	42
ELANTRA Saloon (XD)	1.6	06/00→07/00	G4ED-G	Petrol	1599	4	24
ELANTRA Saloon (XD)	1.6	06/00→07/00	G4GR	Petrol	1599	4	25
ELANTRA Saloon (XD)	1.8	06/00→07/00	G4BB	Petrol	1795	4	27
ELANTRA Saloon (XD)	2.0	04/00→07/00	D4EA	Diesel	1991	4	33
ELANTRA Saloon (XD)	2.0	06/00→07/00	G4GC	Petrol	1975	4	42
ELANTRA Saloon (XD)	2.0	06/00→07/00	G4GCG	Petrol	1975	4	43
GALLOPER I	2.5	08/99→07/99	4D56T	Diesel	2477	4	52
GALLOPER I	3.0	08/99→07/99	6G72	Petrol	2972	6	61
GALLOPER II (JK-01)	2.5	08/99→12/00	D4BA	Diesel	2477	4	53
GALLOPER II (JK-01)	2.5	08/99→12/00	D4BH	Diesel	2476	4	55
GALLOPER II (JK-01)	2.6	08/99→06/00	D4BB	Diesel	2607	4	58
GALLOPER II (JK-01)	3.0	08/99→12/00	G6AT	Petrol	2972	6	62
GETZ (TB)	1.1	09/00→06/00	G4HD	Petrol	1086	4	4
GETZ (TB)	1.3	09/00→09/00	G4EA	Petrol	1341	4	8
GETZ (TB)	1.4	08/00→06/00	G4EE	Petrol	1399	4	10
GETZ (TB)	1.5	03/00→09/00	D3EA	Diesel	1493	3	11
GETZ (TB)	1.5	07/00→06/00	D4FA	Diesel	1493	4	12
GETZ (TB)	1.5	03/00→09/00	G4ER	Petrol	1495	4	19
GETZ (TB)	1.6	09/00→06/00	G4ED-G	Petrol	1599	4	24
GRACE Bus	2.5	07/99→06/99	D4BA	Diesel	2477	4	53
GRACE Bus	2.5	06/99→10/00	D4BF	Diesel	2476	4	54
GRANDEUR (TG)	3.3	04/00→	G6DB	Petrol	3342	6	64
H-1 / STAREX	2.4	06/99→04/00	G4CS	Petrol	2351	4	49

	Ltr				CC		9
H-1 / STAREX	2.5	06/99 → 04/00	D4BF	Diesel	2476	4	54
H-1 / STAREX	2.5	10/99 → 12/00	D4BH	Diesel	2476	4	55
H-1 / STAREX	2.6	10/99 → 04/00	D4BB	Diesel	2607	4	58
H-1 Box	2.4	03/00 → 04/00	G4CS	Petrol	2351	4	49
H-1 Box	2.5	03/00 → 09/00	D4BF	Diesel	2476	4	54
H-1 Box	2.5	03/00 → 04/00	D4BH	Diesel	2476	4	55
H-1 Platform/Chassis	2.5	06/00 → 10/00	D4BH	Diesel	2476	4	55
H100 Box	2.4	10/99 → 12/00	G4CS	Petrol	2351	4	49
H100 Box	2.5	07/99 → 03/00	D4BA	Diesel	2477	4	53
H100 Box	2.5	06/99 → 10/00	D4BF	Diesel	2476	4	54
H100 Box	2.5	07/99 → 12/99	D4BX	Diesel	2477	4	56
H100 Bus (P)	2.4	07/99 → 03/00	G4CS	Petrol	2351	4	49
H100 Bus (P)	2.5	07/99 → 03/00	D4BA	Diesel	2477	4	53
H100 Bus (P)	2.5	07/99 → 03/00	D4BF	Diesel	2476	4	54
H100 Bus (P)	2.5	07/99 → 12/99	D4BX	Diesel	2477	4	56
H100 Pickup	2.5	05/99 → 10/00	D4BA	Diesel	2477	4	53
H100 Platform/Chassis	2.4	05/99 → 12/99	G4CS	Petrol	2351	4	49
H100 Platform/Chassis	2.5	07/99 → 12/99	D4BA	Diesel	2477	4	53
H100 Platform/Chassis	2.5	05/99 → 12/99	D4BF	Diesel	2476	4	54
i10 (PA)	1.1	01/00 →	D3FA	Diesel	1120	3	3
i10 (PA)	1.1	12/00 →	G4HG	Petrol	1086	4	5
i20 (PB, PBT)	1.1	03/01 →	D3FA	Diesel	1120	3	3
i30 (FD)	2.0	10/00 → 11/01	D4EA	Diesel	1991	4	33
i30 (FD)	2.0	10/00 → 11/01	G4GC	Petrol	1975	4	42
i30 (FD)	2.0	10/00 → 11/01	G4GCG	Petrol	1975	4	43
i30 CW (FD)	2.0	02/00 → 06/01	D4EA	Diesel	1991	4	33
i30 CW (FD)	2.0	02/00 → 06/01	G4GC	Petrol	1975	4	42
i30 CW (FD)	2.0	02/00 → 06/01	G4GCG	Petrol	1975	4	43
ix35 (LM, EL, ELH)	2.0	01/01 →	G4KD	Petrol	1998	4	47
LANTRA I (J-1)	1.5	10/99 → 11/99	G15B	Petrol	1468	4	13
LANTRA I (J-1)	1.5	10/99 → 11/99	G4DJ	Petrol	1468	4	14
LANTRA I (J-1)	1.6	10/99 → 11/99	G4CR	Petrol	1596	4	22
LANTRA I (J-1)	1.8	10/99 → 11/99	G4CN	Petrol	1836	4	29
LANTRA II (J-2)	1.5	12/99 → 09/00	G4EK	Petrol	1495	4	17
LANTRA II (J-2)	1.6	11/99 → 09/00	4G61	Petrol	1599	4	21
LANTRA II (J-2)	1.6	11/99 → 09/00	G4GR	Petrol	1599	4	25
LANTRA II (J-2)	1.8	11/99 → 09/00	G4GM	Petrol	1795	4	31
LANTRA II (J-2)	1.9	03/99 → 09/00	DJY	Diesel	1905	4	32
LANTRA II (J-2)	2.0	08/99 → 09/00	G4GF	Petrol	1975	4	44
LANTRA II Wagon (J-2)	1.5	04/99 → 10/00	G4EK	Petrol	1495	4	17
LANTRA II Wagon (J-2)	1.6	02/99 → 10/00	4G61	Petrol	1599	4	21
LANTRA II Wagon (J-2)	1.6	02/99 → 10/00	G4GR	Petrol	1599	4	25
LANTRA II Wagon (J-2)	1.8	02/99 → 10/00	G4GM	Petrol	1795	4	31
LANTRA II Wagon (J-2)	1.9	03/99 → 10/00	DJY	Diesel	1905	4	32
LANTRA II Wagon (J-2)	2.0	12/99 → 10/00	G4GF	Petrol	1975	4	44
MATRIX (FC)	1.5	10/00 → 08/01	D3EA	Diesel	1493	3	11
MATRIX (FC)	1.5	12/00 → 08/01	D4FA	Diesel	1493	4	12
MATRIX (FC)	1.6	06/00 → 08/01	G4ED-G	Petrol	1599	4	24
MATRIX (FC)	1.8	06/00 → 08/01	G4GB-G	Petrol	1795	4	30
PONY (X-1)	1.3	10/98 → 09/98	G13B	Petrol	1299	4	6
PONY (X-2)	1.3	10/98 → 01/99	G4DG	Petrol	1299	4	7
PONY (X-2)	1.5	10/98 → 01/99	G15B	Petrol	1468	4	13
PONY (X-2)	1.5	10/98 → 01/99	G4DJ	Petrol	1468	4	14
PONY / EXCEL Saloon (X-2)	1.3	01/99 → 01/99	G4DG	Petrol	1299	4	7
PONY / EXCEL Saloon (X-2)	1.5	01/99 → 01/99	G15B	Petrol	1468	4	13
PONY / EXCEL Saloon (X-2)	1.5	01/99 → 01/99	G4DJ	Petrol	1468	4	14
PONY Saloon (X-1)	1.3	10/98 → 09/98	G13B	Petrol	1299	4	6
PORTER Box	2.4	03/99 → 04/00	G4CS	Petrol	2351	4	49
PORTER Box	2.5	07/99 → 04/00	D4BA	Diesel	2477	4	53
PORTER Box	2.5	07/99 →	D4BH	Diesel	2476	4	55
PORTER Box	2.6	07/99 → 04/00	D4BB	Diesel	2607	4	58
PORTER Bus	2.4	03/99 → 04/00	G4CS	Petrol	2351	4	49
PORTER Bus	2.5	07/99 → 04/00	D4BA	Diesel	2477	4	53
PORTER Bus	2.5	07/99 → 04/00	D4BH	Diesel	2476	4	55
PORTER Pickup	2.4	03/99 → 04/00	G4CS	Petrol	2351	4	49
PORTER Pickup	2.5	07/99 → 04/00	D4BA	Diesel	2477	4	53
PORTER Pickup	2.5	07/99 → 04/00	D4BH	Diesel	2476	4	55
PORTER Pickup	2.6	07/99 → 04/00	D4BB	Diesel	2607	4	58
S COUPE (SLC)	1.5	02/99 → 05/99	G15B	Petrol	1468	4	13
S COUPE (SLC)	1.5	02/99 → 05/99	G4DJ	Petrol	1468	4	14



Ltr











CC



9

	Ltr				CC		
S COUPE (SLC)	1.5	04/99→05/99	G4EK	Petrol	1495	4	17
S COUPE (SLC)	1.5	04/99→05/99	G4EK-TC	Petrol	1495	4	18
SANTA FÉ I (SM)	2.0	04/00→03/00	D4EA	Diesel	1991	4	33
SANTA FÉ I (SM)	2.0	08/00→03/00	G4BP	Petrol	1997	4	36
SANTA FÉ I (SM)	2.4	02/00→03/00	G4JS-G	Petrol	2351	4	50
SANTA FÉ I (SM)	2.7	02/00→03/00	G6BA-G	Petrol	2656	6	59
SANTA FÉ II (CM)	3.3	03/00→	G6DB	Petrol	3342	6	64
SANTAMO	2.0	05/99→	G4CP	Petrol	1997	4	37
SONATA II (Y-2)	1.8	09/98→10/99	4G62	Petrol	1796	4	26
SONATA II (Y-2)	2.0	09/98→08/99	G4CP	Petrol	1997	4	37
SONATA II (Y-2)	2.0	01/99→10/99	G4CP-D	Petrol	1997	4	38
SONATA II (Y-2)	2.0	01/99→10/99	G4CP-U	Petrol	1997	4	40
SONATA II (Y-2)	2.4	09/98→08/99	G4CS	Petrol	2351	4	49
SONATA II (Y-2)	3.0	01/99→10/99	G6AT	Petrol	2972	6	62
SONATA III (Y-3)	1.8	05/99→06/99	G4CM	Petrol	1796	4	28
SONATA III (Y-3)	2.0	06/99→08/99	G4CP	Petrol	1997	4	37
SONATA III (Y-3)	2.0	05/99→06/99	G4CP-D	Petrol	1997	4	38
SONATA III (Y-3)	2.0	06/99→06/99	G4CP-DM	Petrol	1997	4	39
SONATA III (Y-3)	3.0	05/99→06/99	G6AT	Petrol	2972	6	62
SONATA IV (EF)	2.0	10/00→11/00	D4EA	Diesel	1991	4	33
SONATA IV (EF)	2.0	10/00→11/00	G4JP-EG	Petrol	1997	4	45
SONATA IV (EF)	2.0	06/99→10/00	G4JP-G	Petrol	1997	4	46
SONATA IV (EF)	2.4	03/99→10/00	G4BS	Petrol	2351	4	48
SONATA IV (EF)	2.5	06/99→10/00	G6BV-G	Petrol	2493	6	57
SONATA IV (EF)	2.7	10/00→11/00	G6BA-G	Petrol	2656	6	59
SONATA V (NF)	2.0	02/00→	D4EA	Diesel	1991	4	33
SONATA V (NF)	2.0	01/00→	G4KD	Petrol	1998	4	47
SONATA V (NF)	2.4	01/00→	G4KC	Petrol	2359	4	51
SONATA V (NF)	3.3	01/00→	G6DB	Petrol	3342	6	64
SONATA VI (YF)	2.4	01/00→	G4KC	Petrol	2359	4	51
TERRACAN (HP)	2.5	06/00→12/00	D4BH	Diesel	2476	4	55
TERRACAN (HP)	2.9	11/00→12/00	J3	Diesel	2902	4	60
TIBURON Coupe	1.6	10/00→	G4ED-G	Petrol	1599	4	24
TIBURON Coupe	2.0	10/00→12/00	G4GC	Petrol	1975	4	42
TRAJET (FO)	2.0	04/00→07/00	D4EA	Diesel	1991	4	33
TRAJET (FO)	2.0	11/00→07/00	G4GC	Petrol	1975	4	42
TRAJET (FO)	2.0	01/00→07/00	G4GCC-G	Petrol	1975	4	43
TRAJET (FO)	2.0	03/00→07/00	G4JP-G	Petrol	1997	4	46
TRAJET (FO)	2.7	09/00→07/00	G6BA-G	Petrol	2656	6	59
TUCSON (JM)	2.0	08/00→03/01	D4EA	Diesel	1991	4	33
TUCSON (JM)	2.0	01/00→03/01	D4EA-F	Diesel	1991	4	34
TUCSON (JM)	2.0	01/00→03/01	D4EA-V	Diesel	1991	4	35
TUCSON (JM)	2.0	08/00→03/01	G4GC	Petrol	1975	4	42
TUCSON (JM)	2.7	08/00→03/01	G6BA-G	Petrol	2656	6	59
XG (XG)	3.0	12/99→12/00	G6CT-G	Petrol	2972	6	63

		CC			9			CC			9
4D56T	Diesel	2477	4	91.10	52						
4G61	Petrol	1599	4	82.30	21						
4G62	Petrol	1796	4	80.60	26						
6G72	Petrol	2972	6	91.10	61						
D3EA	Diesel	1493	3	83.00	11						
D3FA	Diesel	1120	3	75.00	3						
D4BA	Diesel	2477	4	91.10	53						
D4BB	Diesel	2607	4	91.10	58						
D4BF	Diesel	2476	4	91.10	54						
D4BH	Diesel	2476	4	91.10	55						
D4BX	Diesel	2477	4	91.10	56						
D4EA	Diesel	1991	4	83.00	33						
D4EA-F	Diesel	1991	4	83.00	34						
D4EA-V	Diesel	1991	4	83.00	35						
D4FA	Diesel	1493	4	75.00	12						
DJY	Diesel	1905	4	83.00	32						
G13B	Petrol	1299	4	71.00	6						
G15B	Petrol	1468	4	75.50	13						
G4BB	Petrol	1795	4	82.00	27						
G4BP	Petrol	1997	4	85.00	36						
G4BS	Petrol	2351	4	86.50	48						
G4CM	Petrol	1796	4	80.60	28						
G4CN	Petrol	1836	4	81.50	29						
G4CP	Petrol	1997	4	85.00	37						
G4CP-D	Petrol	1997	4	85.00	38						
G4CP-DM	Petrol	1997	4	85.00	39						
G4CP-U	Petrol	1997	4	85.00	40						
G4CR	Petrol	1596	4	82.30	22						
G4CS	Petrol	2351	4	86.50	49						
G4DF	Petrol	1975	4	82.00	41						
G4DG	Petrol	1299	4	71.00	7						
G4DJ	Petrol	1468	4	75.50	14						
G4EA	Petrol	1341	4	71.50	8						
G4EB	Petrol	1495	4	75.50	15						
G4EC-G	Petrol	1495	4	75.50	16						
G4ED	Petrol	1599	4	76.50	23						
G4ED-G	Petrol	1599	4	76.50	24						
G4EE	Petrol	1399	4	75.50	10						
G4EH	Petrol	1341	4	71.50	9						
G4EK	Petrol	1495	4	75.50	17						
G4EK-TC	Petrol	1495	4	75.50	18						
G4ER	Petrol	1495	4	75.50	19						
G4FK	Petrol	1495	4	75.50	20						
G4GB-G	Petrol	1795	4	82.00	30						
G4GC	Petrol	1975	4	82.00	42						
G4GCC-G	Petrol	1975	4	82.00	43						
G4GF	Petrol	1975	4	82.00	44						
G4GM	Petrol	1795	4	82.00	31						
G4GR	Petrol	1599	4	77.40	25						
G4HC	Petrol	999	4	66.00	1						
G4HCE	Petrol	999	4	66.00	2						
G4HD	Petrol	1086	4	67.00	4						
G4HG	Petrol	1086	4	67.00	5						
G4JP-EG	Petrol	1997	4	85.00	45						
G4JP-G	Petrol	1997	4	85.00	46						
G4JS-G	Petrol	2351	4	86.50	50						
G4KC	Petrol	2359	4	88.00	51						
G4KD	Petrol	1998	4	86.00	47						
G6AT	Petrol	2972	6	91.10	62						
G6BA-G	Petrol	2656	6	86.70	59						
G6BV-G	Petrol	2493	6	84.00	57						
G6CT-G	Petrol	2972	6	91.10	63						
G6DB	Petrol	3342	6	92.00	64						
I3	Diesel	2902	4	97.10	60						



cc



kW/PS



1.0		G4HC					1	AG8050 (Fibre)	CG5360	FG8050
Atos 1.0 i	02/98→03/02	999	4	66.00	SOHC/OHC	40/54				
Atos Prime 1.0 i	08/99→									
1.0		G4HC-E					2	AG8050 (Fibre)	CG5360	FG8050
Atos 1.0 i	03/01→	999	4	66.00	SOHC/OHC	43/58				
Atos prime 1.0 i	03/01→									
1.1		D3FA Diesel					3			
i10 1.1 CRDi	01/08→	1120	3	75.00	DOHC	55/75				
i20 1.1 CRDi	03/12→									
1.1		G4HD					4	AG8060 (MLS)	CG8060	FG8060
Atos 1.1	08/03→05/05	1086	4	67.00	SOHC/OHC	43-49/ 58-67				
Atos prime 1.1	06/03→									
Getz 1.1	09/02→06/09									
1.1		G4HG					5	AG9900 (MLS)	CG9900	
Atos 1.1	03/04→	1086	4	67.00	SOHC/OHC	45-51/ 62-69				
Atos prime 1.1	09/05→									
i10 1.1	12/07→									
1.3		G13B					6	BN330 (Graphite)	DN330	
Pony 1.3	10/85→09/89	1299	4	71.00	SOHC/OHC	50-55/ 68-75				
1.3		G4DG					7	BN330 (Graphite)	DN332	
Pony 1.3	10/89→01/95	1299	4	71.00	SOHC/OHC	43-49/ 58-67				
1.3		G4EA					8	BY730 (MLS), 0.850mm	DY730	GY735
Accent 1.3	01/00→11/05	1341	4	71.50	SOHC/OHC	55-63/ 75-86				
Accent II 1.3	01/00→11/05									
Atos 1.3	08/03→08/08									
Getz 1.3	09/03→09/05									
Getz 1.3 i	09/02→03/04									
1.3		G4EH					9	BY730 (MLS), 0.850mm	DY730	GY735
Accent 1.3	10/94→01/00	1341	4	71.50	SOHC/OHC	44-62/ 60-84				
Accent 12V	10/94→01/00									
Accent I 1.3	10/94→01/00									
Accent I 12V	10/94→01/00									
Accent II 1.3	08/02→11/05									
1.4		G4EE					10	AH6240 (MLS)	CH6240 (MLS)	FH6240
Accent 1.4 GL	11/05→11/10	1399	4	75.50	DOHC	71/97				
Accent III GL	11/05→11/10									
Getz 1.4 i	08/05→06/09									
1.5		D3EA Diesel					11	AG7910 (MLS)	CG7910	FG7910
Accent 1.5 CRDi	01/02→11/05	1493	3	83.00	SOHC/OHC	60/82				
Accent II CRDi	04/02→11/05									
Getz 1.5 CRDi	03/03→09/05									
Matrix 1.5 CRDi	10/01→08/10									

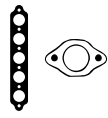

BN330



BY730



JN317



JJ098

HBS378 [5] M10x1.25x106.50mm (x10)	JD5900 [1] JD5899 [1] (MLS)	JM5305	HR397		NJ933 [2] 35.00x50.00x8.00mm, FPM NF678 [2] 35.00x50.00x8.00mm, ACM	
HBS378 [5] M10x1.25x106.50mm (x10)	JD5900 [1] JD5899 [1] (MLS)	JM5305	HR397		NJ933 [2] 35.00x50.00x8.00mm, FPM NF678 [2] 35.00x50.00x8.00mm, ACM	
			HR397			
HBS378 [5] M10x1.25x106.50mm (x10)	JD5900 [1] JD6003 [1] (MLS)	JM5306 (x2)	HR397		NJ933 [2] 35.00x50.00x8.00mm, FPM NF678 [2] 35.00x50.00x8.00mm, ACM	
HBS378 [5] M10x1.25x106.50mm (x10)	JD5900 [1] JD6003 [1] (MLS)	JM5306	HR397		NJ933 [2] 35.00x50.00x8.00mm, FPM NF678 [2] 35.00x50.00x8.00mm, ACM	
HBS440 [5] M10x1.25x100.00mm (x10)		JN317 [4]	JJ098		NJ933 [2] 35.00x50.00x8.00mm, FPM NF678 [2] 35.00x50.00x8.00mm, ACM NJ006 [1] 72.00x96.00x9.00mm, MVQ	
HBS440 [5] M10x1.25x100.00mm (x10)		JN317 [4]	HR397		NJ933 [2] 35.00x50.00x8.00mm, FPM NF678 [2] 35.00x50.00x8.00mm, ACM NJ006 [1] 72.00x96.00x9.00mm, MVQ	
HBS387 [5]	JD5949 [1] JD5751 [1]	JM5277	HR397		NC006 [2] 35.00x48.00x7.00mm, MVQ NF678 [2] 35.00x50.00x8.00mm, ACM NJ006 [1] 72.00x96.00x9.00mm, MVQ	
HBS387 [5]	JD5949 [1] JD5751 [1]	JM5277	HR397		NC006 [2] 35.00x48.00x7.00mm, MVQ NF678 [2] 35.00x50.00x8.00mm, ACM NJ006 [1] 72.00x96.00x9.00mm, MVQ	
HBS454 [5] M10x1.25x95.00mm (x10)	JD5179 [1] (SMG) JD5983 [1] (MLS)	HM5374 [1]	HR397		NC006 [2] 35.00x48.00x7.00mm, MVQ NF678 [2] 35.00x50.00x8.00mm, ACM NJ006 [1] 72.00x96.00x9.00mm, MVQ	
HBS483 [22]	JD5964 [1] (SE) JD5963 [1] (MLS)	HM5250 [1]	HR397			



cc



kW/PS



1.5		D4FA Diesel					12				
Accent GLS	11/05→11/10	1493	4	75.00	DOHC	65-81/ 88-110					
Accent III GLS	11/05→11/10										
Getz 1.5 CRDi	08/05→06/09										
Getz CRDi GLS	07/04→06/09										
Matrix 1.5 CRDi	12/04→08/10										
Matrix CRDi	08/05→08/10										
1.5		G15B					13		BN230 (Graphite)	DN231 [3]	
Lantra I 1.5	10/90→11/95	1468	4	75.50	SOHC/OHC	53-63/ 72-86					
Pony 1.5	10/89→01/95										
Pony 1.5 i	10/89→01/95										
S Coupe 1.5 i	02/90→05/96										
1.5		G4DJ					14		BN230 (Graphite)	DN231 [3]	
Lantra I 1.5	10/90→11/95	1468	4	75.50	SOHC/OHC	53-63/ 72-86					
Pony 1.5	10/89→01/95										
Pony 1.5 i	10/89→01/95										
S Coupe 1.5 GS	03/90→12/92										
S Coupe 1.5 i	02/90→05/96										
1.5		G4EB					15		AH6340 (MLS)		
Accent 1.5	01/00→11/05	1495	4	75.50	SOHC/OHC	66/90					
Accent II 1.5	01/00→11/05										
1.5		G4EC-G					16		AG6040 (MLS)	CG6040	FG6040
Accent II 1.5	09/00→11/05	1495	4	75.50	DOHC	75/102					
1.5		G4EK					17		BY730 (MLS), 0.850mm	DY730	
Accent 12V	10/94→01/00	1495	4	75.50	SOHC/OHC	65-70/ 88-95					
Accent I 12V	10/94→01/00										
Lantra II 12V	12/96→10/00										
S Coupe 1.5 i	04/92→05/96										
1.5		G4EK-TC					18		BY730 (MLS), 0.850mm	DY730	
S Coupe 1.5 i T	04/91→05/96	1495	4	75.50	SOHC/OHC	85/116					
1.5		G4ER					19		AG6040 (MLS) 01/96→	CG6040 01/96→	FG6040 01/96→
Accent 1.6V	10/95→01/00	1495	4	75.50	DOHC	73/99					
Accent I 1.6V	12/95→01/00										
Getz 1.5 i	03/03→09/05										
1.5		G4FK					20		AG6040 (MLS)		
Accent 1.5	09/99→10/02	1495	4	75.50	DOHC	73-77/ 99-105					



BN230



BY730



HA414



JC023



JN317



JJ098

HBS525 [21][94]

JD6032 [E]
(MLS)

HBS440 [5]
M10x1.25x100.00mm (x10)

HA414 [E]
JC023 [E]

JN317 [4]

JJ098

[E] NJ933 [2]
35.00x50.00x8.00mm, FPM
[E] NF678 [2]
35.00x50.00x8.00mm, ACM
[E] NJ006 [1]
72.00x96.00x9.00mm, MVQ

HBS440 [5]
M10x1.25x100.00mm (x10)

HA414 [E]
JC023 [E]

JN317 [4]

JJ098

[E] NJ933 [2]
35.00x50.00x8.00mm, FPM
[E] NF678 [2]
35.00x50.00x8.00mm, ACM
[E] NJ006 [1]
72.00x96.00x9.00mm, MVQ

HBS454 [5]
M10x1.25x95.00mm (x10)

JD5776 [E] (x4)
JD5751 [E]

JM5277

HR397

[E] NC006 [2]
35.00x48.00x7.00mm, MVQ
[E] NF678 [2]
35.00x50.00x8.00mm, ACM
[E] NJ006 [1]
72.00x96.00x9.00mm, MVQ

HBS454 [5]
M10x1.25x95.00mm (x10)

JD5776 [E] (x4)

HM5259 [E]

HR397

[E] NC006 [2]
35.00x48.00x7.00mm, MVQ
[E] NF678 [2]
35.00x50.00x8.00mm, ACM
[E] NJ006 [1]
72.00x96.00x9.00mm, MVQ

HBS387 [5]

JD5949 [E]
JD5751 [E]

JM5277

HR397

[E] NC006 [2]
35.00x48.00x7.00mm, MVQ
[E] NF678 [2]
35.00x50.00x8.00mm, ACM
[E] NJ006 [1]
72.00x96.00x9.00mm, MVQ

HBS387 [5]

JD5949 [E]
JD5751 [E]

JM5277

HR397

[E] NC006 [2]
35.00x48.00x7.00mm, MVQ
[E] NF678 [2]
35.00x50.00x8.00mm, ACM
[E] NJ006 [1]
72.00x96.00x9.00mm, MVQ

HBS454 [5]
M10x1.25x95.00mm (x10)

JD5776 [E] (x4)

HM5259 [E]
01/96 →

HR397

[E] NC006 [2]
35.00x48.00x7.00mm, MVQ
[E] NF678 [2]
35.00x50.00x8.00mm, ACM
[E] NJ006 [1]
72.00x96.00x9.00mm, MVQ

HR397

[E] NC006 [2]
35.00x48.00x7.00mm, MVQ
[E] NF678 [2]
35.00x50.00x8.00mm, ACM
[E] NJ006 [1]
72.00x96.00x9.00mm, MVQ



cc



kW/PS



1.6	4G61	21	BS240 (Graphite)	DS240 [3]	GS240 [3]
Coupe 1.6 i 16V Lantra II 16V	12/96→04/02 11/95→10/00	1599 4 82.30 DOHC	84/114		
1.6	G4CR	22	BS240 (Graphite)	DS240 [3] →12/92 DS241 [3] 01/93→	GS240 [3] →12/92 GS241 [3] 01/93→
Lantra I 16V	10/90→11/95	1596 4 82.30 DOHC	78-84/ 106-114		
1.6	G4ED	23			
Accent 1.6 GLS Accent III GLS	11/05→11/10 11/05→11/10	1599 4 76.50 DOHC	77-82/ 105-112		
1.6	G4ED-G	24	AG8290 (SE), 1.400mm	CG8291	FG8291
Accent 1.6 Accent II 1.6 Coupe 1.6 16V Elantra 1.6 Getz 1.6 Matrix 1.6 Tiburon	12/02→11/05 12/02→11/05 03/02→08/09 06/00→07/06 09/02→06/09 06/01→08/10 10/06→	1599 4 76.50 DOHC	76-79/ 103-107		
1.6	G4GR	25	AG8040 (MLS)	CG8040	FG8040
Coupe 1.6 16V Elantra 1.6 Lantra II 1.6 i	03/98→04/02 06/00→07/06 11/95→10/00	1599 4 77.40 DOHC	66-85/ 90-116		
1.8	4G62	26	BL450 (Graphite)	DL450	
Sonata II 1.8 i	09/88→10/93	1796 4 80.60 SOHC/OHC	60-87/ 82-118		
1.8	G4BB	27	AG8030 (MLS)	CG8030	
Elantra 1.8	06/00→07/06	1795 4 82.00	97/132		
1.8	G4CM	28	BL450 (Graphite)	DL450	
Sonata III 1.8 i	05/93→06/98	1796 4 80.60 SOHC/OHC	70-73/ 95-99		
1.8	G4CN	29	BS240 (Graphite)	DS240 [3]	
Lantra I 16V	10/90→11/95	1836 4 81.50 DOHC	93/127		
1.8	G4GB-G	30	AG8030 (MLS)	CG8030	
Matrix 1.8	06/01→08/10	1795 4 82.00	90/122 09/01→		
1.8	G4GM	31	AG5070 (MLS), 0.800mm	CG5950	
Coupe 1.8 SX Lantra II 16V	07/96→04/02 11/95→10/00	1795 4 82.00 DOHC	94/128		

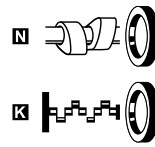

BL450



BS240

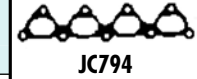

JC794



JM875



JN715



JJ274

HBS308 [5] M10x1.25x99.00mm (x8)	JD5777 [1] JD5778 [3]	JM875 [4]	JJ274	KJ570 (x16)	NJ933 [2] 35.00x50.00x8.00mm, FPM NF678 [2] 35.00x50.00x8.00mm, ACM	
HBS308 [5] M10x1.25x99.00mm (x8)	JC795 [1] JC794 [3]	JN715 [4]		KJ570	NJ242 [2] 35.00x50.00x8.00mm, NBR NJ005 [2] 44.00x60.00x7.00mm, NBR NJ251 [1] 80.00x96.00x9.00mm, MVQ	
HBS454 [5] M10x1.25x95.00mm (x10)			HR397		NC006 [2] 35.00x48.00x7.00mm, MVQ NF678 [2] 35.00x50.00x8.00mm, ACM NJ006 [1] 72.00x96.00x9.00mm, MVQ	
HBS454 [5] M10x1.25x95.00mm (x10)	JD5777 [1] JD5778 [3]	HM5260 [3] HM5261 [3]	HR397		NC006 [2] 35.00x48.00x7.00mm, MVQ NF678 [2] 35.00x50.00x8.00mm, ACM NJ006 [1] 72.00x96.00x9.00mm, MVQ	
HBS308 [5] M10x1.25x99.00mm (x8)	JD5777 [1] JD5778 [3]		HR397		NJ933 [2] 35.00x50.00x8.00mm, FPM NF678 [2] 35.00x50.00x8.00mm, ACM NJ006 [1] 72.00x96.00x9.00mm, MVQ	
		JN788 [4]			NJ933 [2] 35.00x50.00x8.00mm, FPM NF678 [2] 35.00x50.00x8.00mm, ACM	
HBS308 [5] M10x1.25x99.00mm (x8)	JD5777 [1] JD5778 [3]		HR397		NJ933 [2] 35.00x50.00x8.00mm, FPM NF678 [2] 35.00x50.00x8.00mm, ACM	
		JN788 [4]			NJ933 [2] 35.00x50.00x8.00mm, FPM NF678 [2] 35.00x50.00x8.00mm, ACM	
HBS308 [5] M10x1.25x99.00mm (x8)					NJ933 [2] 35.00x50.00x8.00mm, FPM NF678 [2] 35.00x50.00x8.00mm, ACM	
HBS308 [5] M10x1.25x99.00mm (x8)	JD5777 [1] JD5778 [3]		HR397		NJ933 [2] 35.00x50.00x8.00mm, FPM NF678 [2] 35.00x50.00x8.00mm, ACM	
HBS308 [5] M10x1.25x99.00mm (x8)	JD5777 [1] JD5778 [3]		HR397		NJ933 [2] 35.00x50.00x8.00mm, FPM NF678 [2] 35.00x50.00x8.00mm, ACM	



cc



kW/PS



1.9		DJY Diesel					32	BX880 (Fibre), 1.360mm, 1 Notch BX890 (Fibre), 1.400mm, 2 Notches BX900 (Fibre), 1.440mm, 3 Notches BX910 (Fibre), 1.480mm, 4 Notches BX920 (Fibre), 1.520mm, 5 Notches		DJ720 ▲
Lantra II 1.9 D	03/98→10/00	1905	4	83.00	SOHC/OHC	50-52/ 68-71	0.560→0.670mm 0.680→0.710mm 0.720→0.750mm 0.760→0.790mm 0.800→0.830mm			
2.0		D4EA Diesel					33	AG7920 (MLS), 1.100mm AG7930 (MLS), 1.200mm AG7940 (MLS), 1.300mm		CG7920 ▲
Elantra 2.0 CRDi	04/01→07/06	1991	4	83.00	SOHC/OHC	83-110/ 113-150				
i30 2.0 CRDi	10/07→11/11									
i30 CW 2.0 CRDi	02/08→06/12									
Santa Fé I CRDi	04/01→03/06									
Sonata IV CRDi	10/01→11/04									
Sonata V CRDi	02/06→									
Trajet 2.0 CRDi	04/01→07/08									
Tucson 2.0 CRDi	08/04→03/10									
Tucson CRDi	08/04→03/10									
2.0		D4EA-F Diesel					34	AG7920 (MLS), 1.100mm AG7930 (MLS), 1.200mm AG7940 (MLS), 1.300mm		CG7920 ▲
Tucson CRDi	01/06→03/10	1991	4	83.00	DOHC	103/140				
2.0		D4EA-V Diesel					35	AG7920 (MLS), 1.100mm AG7930 (MLS), 1.200mm AG7940 (MLS), 1.300mm		CG7920 ▲
Tucson 2.0 CRDi	01/06→03/10	1991	4	83.00	SOHC/OHC	103/140				
Tucson CRDi	01/06→03/10									
2.0		G4BP					36	AF5430 (MLS)		CF5430
Santa Fé I 2.0	08/01→03/06	1997	4	85.00	DOHC	99/135				
2.0		G4CP					37	BS120 (Graphite)		DS120
Santamo 1.6V	05/99→	1997	4	85.00	OHV	74-102/ 101-139				
Sonata II 2.0 i	09/88→08/91									
Sonata III 2.0 i	06/94→08/96									
2.0		G4CP-D					38	BS120 (Graphite)		DS120
Sonata II 1.6V	01/91→10/93	1997	4	85.00	DOHC	96-103/ 131-140				
Sonata III 1.6V	05/93→06/98									
2.0		G4CP-DM					39	BS120 (Graphite)		DS120
Sonata III 1.6V	06/96→06/98	1997	4	85.00	DOHC	92/125				
2.0		G4CP-U					40	BS120 (Graphite)		DS120
Sonata II 2.0 i	01/91→10/93	1997	4	85.00	SOHC/OHC	80/109				
2.0		G4DF					41	AG8030 (MLS)		CG8030
Coupe 2.0	08/99→01/02	1975	4	82.00	DOHC	99-102/ 135-139				
Coupe 2.0 1.6V	03/01→04/02									

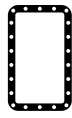

BS120



BX880, BX890,
BX900, BX910,
BX920



JC795

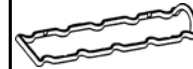

JN544

HBS084 [22] M12x1.50x120.00mm (x10)		JN544 [4]			NA5191 [2] 42.00x62.00x7.00mm, PTFE	
HBS382 [22] M12x1.50x183.00mm (x10)	JD6025 [1] JD6046 [2] (MLS) 1.0mm	HM5251 [2]	HR397			
HBS382 [22] M12x1.50x183.00mm (x10)	JD6025 [1] JD6046 [2] (MLS) 1.0mm	HM5251 [2]	HR397			
HBS382 [22] M12x1.50x183.00mm (x10)	JD6025 [1] JD6046 [2] (MLS) 1.0mm	HM5251 [2]	HR397			
		HM5272 [2]	HR397		NJ933 [2] 35.00x50.00x8.00mm, FPM NF678 [2] 35.00x50.00x8.00mm, ACM NK143 [1] 85.00x103.00x8.00mm, FPM	
HBS307 [5] M12x1.25x104.00mm (x10)	JC795 [1]	JN788 [4]	HR397	KJ570	NJ242 [2] 35.00x50.00x8.00mm, NBR NJ933 [2] 35.00x50.00x8.00mm, FPM NF678 [2] 35.00x50.00x8.00mm, ACM	
HBS307 [5] M12x1.25x104.00mm (x10)		JN788 [4]			NJ933 [2] 35.00x50.00x8.00mm, FPM NF678 [2] 35.00x50.00x8.00mm, ACM	KA294 [15]
HBS307 [5] M12x1.25x104.00mm (x10)		JN788 [4]			NJ933 [2] 35.00x50.00x8.00mm, FPM NF678 [2] 35.00x50.00x8.00mm, ACM	
HBS307 [5] M12x1.25x104.00mm (x10)		JN788 [4]			NJ933 [2] 35.00x50.00x8.00mm, FPM NF678 [2] 35.00x50.00x8.00mm, ACM	
HBS308 [5] M10x1.25x99.00mm (x8)	JD5777 [1] JD5778 [2]	HM5272 [2]	HR397		NJ933 [2] 35.00x50.00x8.00mm, FPM NF678 [2] 35.00x50.00x8.00mm, ACM	



cc



kW/PS



2.0		G4GC					42	AG8030 (MLS)	CG8030	FG8040
Elantra 2.0	06/00→07/06	1975	4	82.00	DOHC	102-105/ 139-143				
Elantra 2.0 CVT	06/06→06/11									
i30 2.0	10/07→11/11									
i30 CW 2.0	02/08→06/12									
Tiburon CVT	10/06→									
Trajet 2.0	11/03→07/08									
Tucson	08/04→03/10									
Tucson 2.0	08/04→03/10									
2.0		G4GC-G					43	AG8030 (MLS)	CG8030	
Coupe 2.0	08/01→08/09	1975	4	82.00	DOHC	100-105/ 136-143				
Coupe 2.0 GLS	02/03→08/09									
Elantra 2.0	06/00→07/06									
i30 2.0	10/07→11/11									
i30 CW 2.0	02/08→06/12									
Trajet 2.0	01/04→07/08									
2.0		G4GF					44	AG5070 (MLS), 0.800mm	CG5950	
Coupe 2.0 16V	08/96→04/02	1975	4	82.00	DOHC	102/139				
Lantra II 16V	08/96→10/00									
2.0		G4JP-EG					45	AF5430 (MLS)	CF5430	
Sonata IV 16V	10/01→11/04	1997	4	85.00	DOHC	96/131				
2.0		G4JP-G					46	AF5430 (MLS)	CF5430	
Sonata IV 16V	06/98→10/01	1997	4	85.00	DOHC	100-102/ 136-139				
Trajet 2.0	03/00→07/08									
2.0		G4KD					47	AH6310 (MLS) AH6320 (MLS)		
ix35 2.0	01/10→	1998	4	86.00	DOHC	120-131/ 163-178				
ix35 2.0 4WD	01/10→									
Sonata V VVTi	01/08→									
2.4		G4BS					48	AF5070 (MLS)	CF5070 ▲	FF5070
Sonata IV 16V	03/98→10/01	2351	4	86.50	DOHC	84-106/ 114-144				
2.4		G4CS					49	BT880 (Graphite)		
H-1 2.4	03/00→04/04	2351	4	86.50	SOHC/OHC	82-90/ 112-122				
H-1 / Starex	02/98→04/04									
H-1 / Starex 2.4	06/97→04/04									
H100 2.4	07/93→12/04									
Porter 2.4	03/96→04/04									
Sonata II 2.4 i	09/88→08/91									
2.4		G4JS-G					50	AF5070 (MLS)	CF5070 ▲	FF5070
Santa Fé I 16V	02/01→03/06	2351	4	86.50	DOHC	100-107/ 136-146				

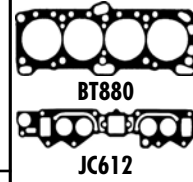
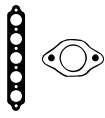

HBS308 [5] M10x1.25x99.00mm (x8)	JD5777 [1] JD5778 [1]	HM5272 [1]	HR397		NJ933 [2] 35.00x50.00x8.00mm, FPM NF678 [2] 35.00x50.00x8.00mm, ACM
HBS308 [5] M10x1.25x99.00mm (x8)	JD5777 [1] JD5778 [1]	HM5272 [1]	HR397		NJ933 [2] 35.00x50.00x8.00mm, FPM NF678 [2] 35.00x50.00x8.00mm, ACM
HBS308 [5] M10x1.25x99.00mm (x8)	JD5777 [1] JD5778 [1]		HR397		NJ933 [2] 35.00x50.00x8.00mm, FPM NF678 [2] 35.00x50.00x8.00mm, ACM
HBS354 [5] M11x1.25x97.00mm (x10)		HM5272 [1]			NJ933 [2] 35.00x50.00x8.00mm, FPM NF678 [2] 35.00x50.00x8.00mm, ACM NK143 [1] 85.00x103.00x8.00mm, FPM
HBS354 [5] M11x1.25x97.00mm (x10)		HM5272 [1]			NJ933 [2] 35.00x50.00x8.00mm, FPM NF678 [2] 35.00x50.00x8.00mm, ACM NK143 [1] 85.00x103.00x8.00mm, FPM
			HR397		NA5108 [2] 42.00x55.00x7.00mm, FPM/ACM NK143 [1] 85.00x103.00x8.00mm, FPM
		HM5272 [1]			NK143 [1] 85.00x103.00x8.00mm, FPM
HBS440 [5] M10x1.25x100.00mm (x10)	JC612 [1]	JN788 [4]	HR397		NJ933 [2] 35.00x50.00x8.00mm, FPM NF678 [2] 35.00x50.00x8.00mm, ACM
		HM5272 [1]			NJ933 [2] 35.00x50.00x8.00mm, FPM NF678 [2] 35.00x50.00x8.00mm, ACM NK143 [1] 85.00x103.00x8.00mm, FPM



cc



kW/PS



2.4		G4KC					51	AF5070 (MLS)	CF5070 ▲	FF5070
Sonata V 2.4	01/05→	2359	4	88.00	DOHC	119-148/ 162-201				
Sonata VI 2.4	01/09→									
2.5		4D56T Diesel					52	BS130 (Graphite), 1.500mm	DS130 [3]	
Galloper I	08/91→07/98	2477	4	91.10	SOHC/OHC	62-74/ 84-101				
2.5		D4BA Diesel					53	BS130 (Graphite), 1.500mm	DS130 [3]	
Galloper II	08/98→12/03	2477	4	91.10	SOHC/OHC	55-65/ 75-88				
Grace 2.5 D	07/93→06/94									
H100 2.5 D	07/93→10/01									
H100 Van 2.5 D	07/93→12/94									
Porter 2.5 TD	07/94→04/04									
2.5		D4BF Diesel					54	BS130 (Graphite), 1.500mm	DS130 [3]	
Grace 2.5 TD	06/98→10/01	2476	4	91.10	SOHC/OHC	57-65/ 78-88				
H-1 2.5 TD	03/00→09/00									
H-1 / Starex D	10/97→04/04									
H-1 / Starex TD	06/97→04/04									
H100 2.5 D	05/96→12/97									
H100 2.5 TD	07/93→03/00									
H100 2.5 TDiC	06/98→10/03									
2.5		D4BH Diesel					55	BS130 (Graphite), 1.500mm	DS130 [3]	GS130
Galloper II	08/98→12/03	2476	4	91.10	SOHC/OHC	59-78/ 80-106				
H-1 2.5 D	06/00→10/05									
H-1 2.5 TD	10/01→04/04									
H-1 Van 2.5 TD	03/00→04/04									
H-1 / Starex	10/97→12/07									
H-1 / Starex TD	03/01→04/04									
Porter 2.5 TCi	05/04→									
Porter 2.5 TD	07/94→04/04									
Terracan 2.5 D	06/01→10/03									
Terracan 2.5 TD	12/01→12/06									
2.5		D4BX Diesel					56	BS130 (Graphite), 1.500mm	DS130 [3]	GS130
H100 2.5 D	07/93→12/94	2477	4	91.10	SOHC/OHC	54-55/ 73-75				
H100 Van 2.5 D	07/93→12/94									
2.5		G6BV-G					57	BZ280 (MLS)	DZ280	
Sonata IV 24V	06/98→10/01	2493	6	84.00	DOHC, V	118/160				
2.6		D4BB Diesel					58	BS130 (Graphite), 1.500mm	DS130 [3]	
Galloper II	08/98→06/03	2607	4	91.10	SOHC/OHC	57-63/ 78-86				
H-1 / Starex TD	10/97→04/04									
Porter 2.6 TD	07/94→04/04									
2.7		G6BA-G					59	AG5690 (MLS)	CG5690	FG5690
Coupe 2.7 V6	03/02→08/09	2656	6	86.70	DOHC, V	121-129/ 165-175				
Santa Fé I V6	02/01→03/06									
Sonata IV 2.7 V6	10/01→11/04									
Trajet 2.7 V6	09/00→07/08									
Tucson	08/04→03/10									
2.9		J3 Diesel					60	AH6540 (MLS), 1.0mm	CH6540 (MLS)	
Terracan	11/01→12/06	2902	4	97.10	DOHC	110-120/ 150-163				



BS130

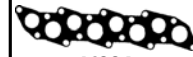

JC224



JN403



JJ072

		HM5272			<input checked="" type="checkbox"/> NA5108 [2] 42.00x55.00x7.00mm, FPM/ACM <input checked="" type="checkbox"/> NF678 [2] 35.00x50.00x8.00mm, ACM <input checked="" type="checkbox"/> NK143 [1] 85.00x103.00x8.00mm, FPM	
HBS295 [5] [97] M12x1.25x104.00mm (x18)	JC224	JN403 [4]	HR397	KJ211	<input checked="" type="checkbox"/> NJ933 [2] 35.00x50.00x8.00mm, FPM <input checked="" type="checkbox"/> NF678 [2] 35.00x50.00x8.00mm, ACM	
HBS295 [5] [97] M12x1.25x104.00mm (x18)	JC224	JN403 [4]	HR397 JJ072	KJ211	<input checked="" type="checkbox"/> NJ933 [2] 35.00x50.00x8.00mm, FPM <input checked="" type="checkbox"/> NF678 [2] 35.00x50.00x8.00mm, ACM	
HBS295 [5] [97] M12x1.25x104.00mm (x18)	JC224	JN403 [4]	HR397	KJ211	<input checked="" type="checkbox"/> NJ933 [2] 35.00x50.00x8.00mm, FPM <input checked="" type="checkbox"/> NF678 [2] 35.00x50.00x8.00mm, ACM	
HBS295 [5] [97] M12x1.25x104.00mm (x18)	JC224	JN403 [4]	JJ072	KJ211	<input checked="" type="checkbox"/> NJ933 [2] 35.00x50.00x8.00mm, FPM <input checked="" type="checkbox"/> NF678 [2] 35.00x50.00x8.00mm, ACM	
HBS295 [5] [97] M12x1.25x104.00mm (x18)	JC224	JN403 [4]	HR397 JJ072	KJ211	<input checked="" type="checkbox"/> NJ933 [2] 35.00x50.00x8.00mm, FPM <input checked="" type="checkbox"/> NF678 [2] 35.00x50.00x8.00mm, ACM	
HBS446 [22] M11x1.50x147.75mm (x16) 01/99 →	JD5795 [x2] (SE)					
HBS295 [5] [97] M12x1.25x104.00mm (x18)	JC224	JN403 [4]	HR397	KJ211	<input checked="" type="checkbox"/> NJ933 [2] 35.00x50.00x8.00mm, FPM <input checked="" type="checkbox"/> NF678 [2] 35.00x50.00x8.00mm, ACM	
HBS446 [22] M11x1.50x147.75mm (x16)		HM5265 [x2]				
HBS379 [5] M12x1.25x131.00mm (x10)		JM5310	HR397		<input checked="" type="checkbox"/> NC048 [2] 38.00x52.00x6.00mm, FPM	

HYUNDAI



cc



kW/PS

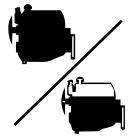

3.0	6G72						61	BR600 (Graphite)		GR600 [3]
Galloper I	08/91→07/98	2972	6	91.10	SOHC/OHC, V	104/141				
3.0	G6AT						62	BR600 (Graphite)		GR600 [3]
Galloper II	08/98→12/03	2972	6	91.10	SOHC/OHC, V	103-107/ 140-146				
Sonata II V6	01/91→10/93									
Sonata III V6	05/93→06/98									
3.0	G6CT-G						63		CG8090 04/99→	FG8090 04/99→
XG 30/300	12/98→	2972	6	91.10	DOHC, V	138/188				
3.3	G6DB						64			
Grandeur 3.3	04/05→	3342	6	92.00	DOHC, V	171-198/ 233-269				
Santa Fé II	03/06→									
Sonata V 3.3	01/05→									

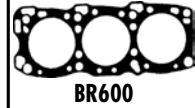
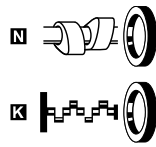
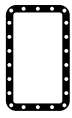
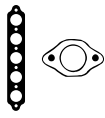

BR600

HBS402 [5]
M12x1.25x102.00mm (x16)

HBS402 [5]
M12x1.25x102.00mm (x16)

HM5264 (x2)
04/99 →

HR397

NJ933 [2]
35.00x50.00x8.00mm, FPM
 NF678 [2]
35.00x50.00x8.00mm, ACM

NJ933 [2]
35.00x50.00x8.00mm, FPM
 NF678 [2]
35.00x50.00x8.00mm, ACM



Ltr



CC



9

	Ltr			CC		
FX	3.5	01/00→12/00	VQ35DE	3498	6	3
G Saloon	3.5	10/00→	VQ35DE	3498	6	3
M30 Convertible	3.0	01/99→12/99	VG30E	2960	6	1
M30 Coupe	3.0	01/98→12/99	VG30E	2960	6	1
M35	3.5	01/00→	VQ35DE	3498	6	3
Q45	4.1	01/99→	VH41DE	4130	8	4
Q45	4.5	01/98→12/99	VH45DE	4494	8	5
QX4	3.3	01/99→	VG33E	3275	6	2



cc



kW/PS



3.0		VG30E					1	BM570 (Graphite)		
M30 Cabrio 3.0	01/90→12/93	2960	6	87.00	SOHC/OHC, V	95-125/ 129-170				
M30 Coupe 3.0	01/89→12/93									
3.3		VG33E					2	AF5690 (Graphite) (x2)	CF5690	FF5690
QX4 3.3	01/97→	3275	6	91.50	SOHC/OHC, V	110-125/ 150-170				
3.5		VQ35DE					3	AE5910 (MLS)	CG5882	EG8230
FX 3.5	02/03→12/08	3498	6	95.50	DOHC, V	188-206/ 256-280				
FX 35	01/03→12/08									
G Saloon 35	10/02→									
M35 3.5 Luxury	01/05→									
M35 AWD	01/05→									
4.1		VH41DE					4	BS840 (Graphite)		
Q45 4.1	01/93→	4130	8	93.00	DOHC, V	201-206/ 273-280				
							→02/96			
							BS830 (Graphite)			
							→02/96			
4.5		VH45DE					5	BS840 (Graphite)		
Q45 4.5	01/89→12/93	4494	8	93.00	DOHC, V	205-207/ 278-282				
							BS830 (Graphite)			

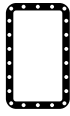
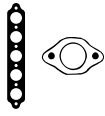

AE5910



BM570



BS830



BS840

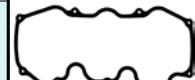

JN570



JP070

		JN570 [4]		PA079	<input checked="" type="checkbox"/> NJ285 [2] 34.00x48.00x8.00mm, NBR	
HBS443 ☉ [22]				PA079	<input checked="" type="checkbox"/> NJ765 [2] 40.00x52.00x7.00mm, NBR <input checked="" type="checkbox"/> NJ933 [2] 35.00x50.00x8.00mm, FPM <input checked="" type="checkbox"/> NJ765 <input checked="" type="checkbox"/> [2] 40.00x52.00x7.00mm, NBR	
HBS404 ☉ [5]		JM7037 JM5316 <input checked="" type="checkbox"/> JM5317 <input checked="" type="checkbox"/>				
		JP070 <input checked="" type="checkbox"/> [4] →02/96				
		JP070 <input checked="" type="checkbox"/> [4]				



Ltr



CC



9

Model	Ltr	Year Range	Engine Code	Fuel Type	CC	Gear	Power (kW)
ASKA	1.8	07/98→09/99	4ZB1	Petrol	1817	4	8
ASKA	2.0	07/98→09/99	4ZC1-T	Petrol	1995	4	11
ASKA	2.0	10/99→09/00	F20B	Petrol	1997	4	12
ASKA	2.3	10/99→09/00	4ZD1	Petrol	2254	4	16
CAMPO (KB)	2.0	01/98→03/98	4ZC1	Petrol	1994	4	10
CAMPO (KB)	2.0	06/98→12/98	G200Z	Petrol	1949	4	9
CAMPO (KB)	2.2	01/98→12/99	4ZD1	Petrol	2254	4	16
CAMPO (KB)	2.2	01/98→12/99	C223	Diesel	2238	4	14
CAMPO (KB)	2.5	01/98→12/99	4JA1	Diesel	2499	4	18
D-MAX (8DH)	3.5	05/00→	6VE1	Petrol	3494	6	28
ELF Box (NHR5_)	2.8	10/98→09/00	4JB1	Diesel	2771	4	20
ELF Box (NHR5_)	2.8	10/98→09/99	4JB1T	Diesel	2771	4	21
ELF Box (NHR6_, NKR6_, NKR7_, NKS7_)	3.1	09/99→09/00	4JG2	Diesel	3059	4	25
ELF Box (NKR8_)	2.8	10/00→	4JB1-TC	Diesel	2771	4	22
ELF Platform/Chassis (NHR5_)	2.8	10/98→09/00	4JB1	Diesel	2771	4	20
ELF Platform/Chassis (NHR5_)	2.8	10/98→09/99	4JB1T	Diesel	2771	4	21
ELF Platform/Chassis (NHR6_, NKR6_, NKR7_, NKS7_)	2.8	10/98→09/00	4JB1	Diesel	2771	4	20
ELF Platform/Chassis (NHR6_, NKR6_, NKR7_, NKS7_)	3.1	09/99→09/00	4JG2	Diesel	3059	4	25
ELF Platform/Chassis (NKR8_, NKQ8_)	2.8	10/00→	4JB1-TC	Diesel	2771	4	22
FARGO Bus	2.0	01/98→12/98	4ZC1	Petrol	1994	4	10
GEMINI (JT)	1.5	02/98→12/99	4EC1	Diesel	1488	4	1
GEMINI (JT)	1.5	02/98→12/99	4EC1T	Diesel	1488	4	2
GEMINI (JT)	1.5	02/98→12/99	4XC1U Kat.	Petrol	1481	4	4
GEMINI (JT)	1.5	02/98→06/99	4XC1UT	Petrol	1471	4	5
GEMINI (JT)	1.6	08/98→12/99	4XE1	Petrol	1588	4	6
GEMINI Saloon (JT)	1.5	02/98→12/99	4EC1	Diesel	1488	4	1
GEMINI Saloon (JT)	1.5	02/98→12/99	4EC1T	Diesel	1488	4	2
GEMINI Saloon (JT)	1.5	02/98→12/99	4XC1U Kat.	Petrol	1481	4	4
GEMINI Saloon	1.5	01/99→12/99	4XC1	Petrol	1471	4	3
GEMINI Saloon	1.7	01/99→12/99	4EE1	Diesel	1686	4	7
GEMINI	1.5	01/99→12/99	4XC1	Petrol	1471	4	3
GEMINI	1.7	01/99→12/99	4EE1	Diesel	1686	4	7
MIDI Box (98000N)	2.0	06/98→	4ZC1	Petrol	1994	4	10
MIDI Box (98000N)	2.2	09/98→	4FD1	Diesel	2189	4	13
MIDI Box (98000N)	2.4	02/99→	4FG1T	Diesel	2380	4	17
MIDI Bus (94000, 98000)	2.0	01/98→	4ZC1	Petrol	1994	4	10
MIDI Bus (94000, 98000)	2.2	01/98→	4FD1	Diesel	2189	4	13
MIDI Bus (94000, 98000)	2.4	01/99→	4FG1T	Diesel	2380	4	17
MIDI Van (94000, 98000)	2.0	01/98→	4ZC1	Petrol	1994	4	10
MIDI Van (94000, 98000)	2.2	01/98→	4FD1	Diesel	2189	4	13
MIDI Van (94000, 98000)	2.4	01/99→	4FG1T	Diesel	2380	4	17
PIAZZA (JR_)	2.0	06/98→12/99	4ZC1-T	Petrol	1995	4	11
PICK UP	2.3	10/98→08/99	4ZD1	Petrol	2254	4	16
PICK UP	2.6	10/98→08/99	4ZE1	Petrol	2559	4	19
TFR/TFS Pickup (TF_)	2.8	09/99→08/99	4JB1	Diesel	2771	4	20
TROOPER (UB)	3.1	08/99→07/99	4JG2 T	Diesel	3059	4	26
TROOPER (UB)	3.2	08/99→07/99	6VD1	Petrol	3165	6	27
TROOPER (UBS)	2.2	05/98→12/98	C223	Diesel	2238	4	14
TROOPER (UBS)	2.6	11/98→07/99	4ZE1	Petrol	2559	4	19
TROOPER (UBS)	2.8	10/98→12/99	4JB1T	Diesel	2771	4	21
TROOPER (UBS)	2.8	10/98→12/99	4JB1-TC	Diesel	2771	4	22
TROOPER Open Off-Road Vehicle (UB)	3.1	08/99→07/99	4JG2 T	Diesel	3059	4	26
TROOPER Open Off-Road Vehicle (UB)	3.2	08/99→07/99	6VD1	Petrol	3165	6	27
TROOPER Open Off-Road Vehicle (UBS)	2.2	05/98→07/98	C223	Diesel	2238	4	14
TROOPER Open Off-Road Vehicle (UBS)	2.2	03/98→12/99	C223T	Diesel	2238	4	15
TROOPER Open Off-Road Vehicle (UBS)	2.3	11/98→12/99	4ZD1	Petrol	2254	4	16
TROOPER Open Off-Road Vehicle (UBS)	2.6	10/98→12/99	4ZE1	Petrol	2559	4	19
TROOPER Open Off-Road Vehicle	3.0	04/00→	4JX1T	Diesel	2999	4	24
TROOPER Open Off-Road Vehicle	3.5	04/00→	6VE1	Petrol	3494	6	28
TROOPER	3.0	04/00→	4JX1	Diesel	2999	4	23
TROOPER	3.5	04/00→	6VE1	Petrol	3494	6	28



cc



kW/PS



1.5	4EC1 Diesel					1			
Gemini 1.5 D	02/88→12/90	1488	4	76.00	SOHC/OHC	37/50	AY840 (MLS), 1.400mm →Eng.975024/975025-178581 AY850 (MLS), 1.450mm, 1 Hole →Eng.975024/975025-178581 AY860 (MLS), 1.500mm, 2 Holes →Eng.975024/975025-178581 AY900 (MLS), 1.400mm Eng.975024/975025-178582→ AY910 (MLS), 1.450mm, 1 Hole Eng.975024/975025-178582→ AY920 (MLS), 1.500mm, 2 Holes Eng.975024/975025-178582→	CY811 ▲[13]	FY811 ▲[3]
1.5	4EC1T Diesel					2			
Gemini 1.5 TD	02/88→12/90	1488	4	76.00	SOHC/OHC	49-54/ 67-73	AY840 (MLS), 1.400mm →Eng.975024/975025-178581 AY850 (MLS), 1.450mm, 1 Hole →Eng.975024/975025-178581 AY860 (MLS), 1.500mm, 2 Holes →Eng.975024/975025-178581 AY900 (MLS), 1.400mm Eng.975024/975025-178582→ AY910 (MLS), 1.450mm, 1 Hole Eng.975024/975025-178582→ AY920 (MLS), 1.500mm, 2 Holes Eng.975024/975025-178582→	CY811 ▲[13]	FY811 ▲[3]
1.5	4XC1					3			
Gemini 1.5	01/90→12/93	1471	4	77.00	SOHC/OHC	73/99			
1.5	4XC1U Kat.					4			
Gemini 1.5	02/88→12/90	1481	4			52/71			
1.5	4XC1UT					5			
Gemini 1.5	02/88→06/90	1471	4	77.00	SOHC/OHC	88/120			
1.6	4XE1					6			
Gemini GTI	08/88→12/90	1588	4	80.00	DOHC	84-99/ 114-135	BS230 (Graphite)		
1.7	4EE1 Diesel					7			
Gemini 1.7 TD	01/90→12/93	1686	4	79.00	SOHC/OHC	65/88	AB5010 (MLS), 1.400mm →Eng.320552 AB5020 (MLS), 1.450mm, 1 Hole →Eng.320552 AB5030 (MLS), 1.500mm, 2 Holes →Eng.320552	CY811 ▲[13]	FY811 ▲[3]
1.8	4ZB1					8			
Aska 1.8	07/89→09/95	1817	4	84.00	SOHC/OHC	56-77/ 76-105	BM330 (Graphite)	DM330 [13]	
1.9	G200Z					9			
Campo 2.0	06/85→12/88	1949	4	87.00	SOHC/OHC	58/79			
Campo 2.0 4WD	06/85→12/88								
2.0	4ZC1					10			
Campo 2.0	01/83→03/88	1994	4	88.00	SOHC/OHC	52-81/ 71-110			
Campo 2.0 4WD	01/83→03/88								
Farga 2.0	01/86→12/88								
Midi 2.0	06/88→								
Midi 2.0 4WD	09/88→								



AB5010, AB5020,
AB5030



AY840, AY850,
AY860



AY900, AY910,
AY920



BM330



BS230



JC060

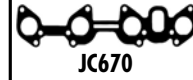

JC670

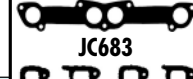

JC683



JD303



JD304

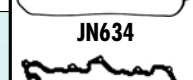

JN634

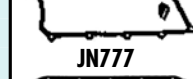

JN777



JH5058



JJ358



cc



kW/PS



2.0		4ZC1-T					11				
Aska 2.0 ZL	07/89→09/95	1995	4	88.00	SOHC/OHC	104-110/					
Piazza 2.0 Turbo	06/85→12/90					141-150					
2.0		F20B					12				
Aska 2.0 LF	10/95→09/96	1997	4	85.00	SOHC/OHC	100-110/					
Aska 2.0 LJ	10/96→09/01					136-150					
2.2		4FD1 Diesel					13		BR190 (Graphite)	DR190 [3]	GR190 [3]
Midi 2.2 D	01/89→	2189	4	88.00	SOHC/OHC	45-54/					
Midi 2.2 D 4WD	09/88→					61-73					
2.2		C223 Diesel					14		BM370 (Fibre) BR200 (Steel)	DM370 ○ [3] DR200 [3]	GM370 ○ [3] GM372 [13]
Campo 2.2 D	01/83→12/91	2238	4	88.00	SOHC/OHC	39-54/					
Campo 2.2 D 4WD	01/83→12/90					53-73					
Trooper 2.2 D	05/84→12/89										
2.2		C223T Diesel					15		BM370 (Fibre) BR200 (Steel)	DM370 ○ [3] DR200 [3]	GM370 ○ [3] GM372 [13]
Trooper 2.2 TD	03/84→12/91	2238	4	88.00	SOHC/OHC	45-53/					
						61-72					
2.3		4ZD1					16		BP920 (Graphite)	DP920 [3]	GP920 [3]
Aska 2.3	10/97→09/01	2254	4	89.30	SOHC/OHC	64-75/					
Campo 2.2	01/89→12/90					87-102					
Pick up 2.3	10/87→08/96										
Pick up 2.3 4x4	10/87→08/96										
Trooper 2.3	11/85→12/91										
2.4		4FG1T Diesel					17		BR190 (Graphite)	DR190 [3]	
Midi 2.4 D	01/94→	2380	4	89.30	SOHC/OHC	56/76					
Midi 2.4 TD	01/94→										
2.5		4JA1 Diesel					18		BR990 (MLS)	DR990 [3]	GR990 [3]
Campo 3346 AK	01/83→12/90	2499	4	93.00	OHV	50-58/					
Campo 3348 AK	01/83→12/90					68-79					
2.6		4ZE1					19		BR940 (Graphite)	DR940 [3]	GR940 [3]
Pick up 2.6 LS	10/87→08/96	2559	4	92.60	SOHC/OHC	66-90/					
Trooper 2.6 4x4	11/86→07/91					90-122					
Trooper 2.6 i	10/87→12/91										
2.8		4JB1 Diesel					20		BR990 (MLS)	DR990 [3]	GR990 [3]
Elf 2.8 D	10/85→09/03	2771	4	93.00	OHV	42-74/					
TFR 2.8 D	09/91→08/99					57-101					
TFR 2.8 D AWD	09/91→08/99										

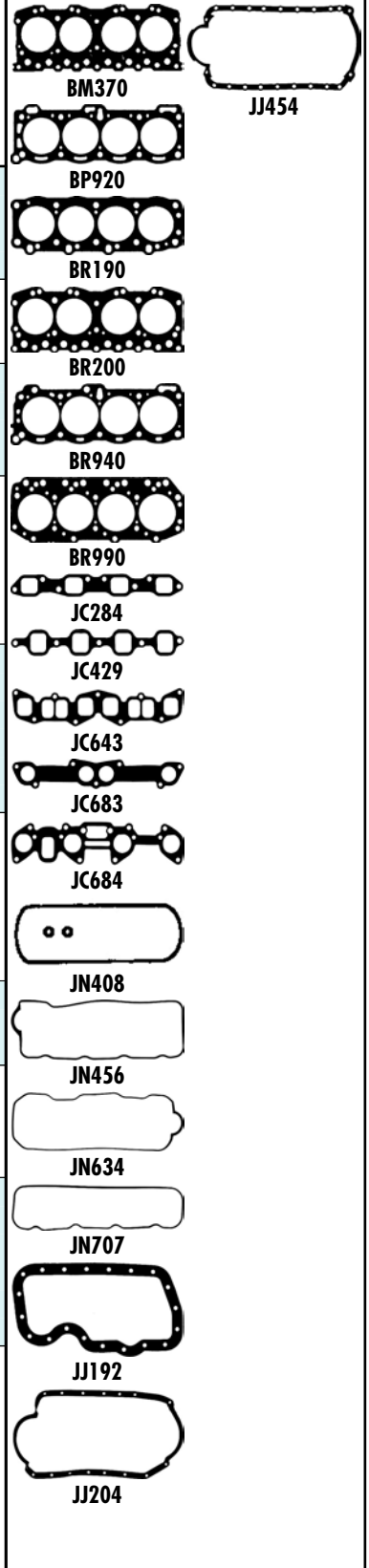

					<p>NJ454 [1][2] 30.00x45.00x8.00mm, NBR</p> <p>NJ322 [1] 95.00x118.00x10.00mm, NBR</p>	
					<p>NJ134 [1][2] 28.00x42.00x8.00mm, MVQ</p>	
	<p>JC429 [1] JC284 [1]</p>	<p>JN456 [4]</p>	<p>JJ204</p>	<p>PA933 (x8)</p>	<p>NJ321 [2] 28.00x47.00x8.00mm, NBR</p> <p>NJ322 [1] 95.00x118.00x10.00mm, NBR</p>	
<p>HBS286 [22] M11x1.50x116.00mm (x16)</p>	<p>JC643 JE751</p>	<p>JN408 [4]</p>	<p>JH016 JJ192</p>	<p>PA418 (x8)</p>	<p>NJ267 [2] 42.00x55.00x9.00mm, NBR</p> <p>NJ266 [2] 65.00x84.00x9.00mm, NBR</p> <p>NJ265 [1] 82.00x105.00x13.00mm, MVQ</p>	
<p>HBS286 [22] M11x1.50x116.00mm (x16)</p>	<p>JC643 JE751</p>	<p>JN408 [4]</p>	<p>JH016 JJ192</p>	<p>PA418 (x8)</p>	<p>NJ267 [2] 42.00x55.00x9.00mm, NBR</p> <p>NJ266 [2] 65.00x84.00x9.00mm, NBR</p> <p>NJ265 [1] 82.00x105.00x13.00mm, MVQ</p>	
	<p>JC684 [1] JC683 [1]</p>	<p>JN634 [4] HL532 [1]</p>		<p>PA933 (x8)</p>	<p>NJ454 [1][2] 30.00x45.00x8.00mm, NBR</p> <p>NJ323 [2] 40.00x56.00x7.00mm, NBR</p> <p>NJ322 [1] 95.00x118.00x10.00mm, NBR</p>	
		<p>JN456 [4]</p>		<p>PA933 (x8)</p>		
			<p>JJ454</p>		<p>NA5051 [2] 40.00x56.00x7.00mm, FPM</p> <p>NF843 [2] 50.00x68.00x10.00mm, FPM/ACM</p>	
	<p>JC683 [1]</p>	<p>JN634 [4] HL532 [1]</p>		<p>PA933 (x8)</p>	<p>NJ454 [1][2] 30.00x45.00x8.00mm, NBR</p> <p>NJ323 [2] 40.00x56.00x7.00mm, NBR</p> <p>NJ322 [1] 95.00x118.00x10.00mm, NBR</p>	
<p>HBS287 [22] M11x1.50x121.00mm (x18)</p>	<p>JD470 [1]</p>	<p>JN707 [4]</p>	<p>JJ454</p>	<p>PA418</p>	<p>NJ267 [2] 42.00x55.00x9.00mm, NBR</p> <p>NJ014 [2] 50.00x68.00x9.00mm, NBR</p> <p>NF843 [2] 50.00x68.00x10.00mm, FPM/ACM</p> <p>NJ322 [1] 95.00x118.00x10.00mm, NBR</p>	



cc



kW/PS



2.8		4JB1T Diesel					21	BR990 (MLS)	CD5400 ▲	ER993
Elf 2.8 TD	10/85→09/92	2771	4	93.00	OHV	57-81/ 77-110				
Trooper 2.8 TD	10/87→12/91									
2.8		4JB1-TC Diesel					22	BR990 (MLS)	CD5400 ▲	ER993
Elf 2.8 TD	10/03→	2771	4	93.00	SOHC/OHC	67-85/ 91-116				
Trooper 2.8 TD	10/88→12/91									
3.0		4JX1 Diesel					23	AG5090 (MLS), 1.250mm, 3 Holes	CG5090 ▲	
Trooper 3.0 DTI	04/00→	2999	4	95.40	DOHC	117-118/ 159-160				
3.0		4JX1T Diesel					24	AG5090 (MLS), 1.250mm, 3 Holes	CG5090 ▲	
Trooper 3.0 DTI	04/00→	2999	4	95.40		118/160				
3.1		4JG2 Diesel					25			
Elf 3.1 TD	09/93→09/01	3059	4	95.40	SOHC/OHC	72/98				
Elf 3.1 TD AWD	09/93→09/01									
3.1		4JG2 T Diesel					26			
Trooper 3.1	08/91→07/98	3059	4	95.40	OHV	80-85/ 109-116				
3.2		6VD1					27			
Trooper 3.2	08/91→07/98	3165	6	93.40	DOHC, V	130-158/ 177-215				
3.5		6VE1					28	AB5780 (MLS) ☒ AB5781 (MLS) ☒	CG5781	EG6240
D-Max V6 24V	05/02→	3494	6	93.40	DOHC, V	147-169/ 200-230				
Trooper V6 24V	04/00→									

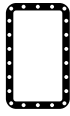
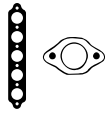

BR990



JN707



JJ454

HBS287 [22] M11x1.50x121.00mm (x18)	JD470	JN707 [4]	JJ454	PA418 (x8)	NJ267 [2] 42.00x55.00x9.00mm, NBR NJ014 [2] 50.00x68.00x9.00mm, NBR NF843 [2] 50.00x68.00x10.00mm, FPM/ACM NJ322 [1] 95.00x118.00x10.00mm, NBR	
HBS287 [22] M11x1.50x121.00mm (x18)	JD470	JN707 [4]	JJ454	PA418 (x8)	NA5051 [2] 40.00x56.00x7.00mm, FPM NF843 [2] 50.00x68.00x10.00mm, FPM/ACM NJ321 [2] 28.00x47.00x8.00mm, NBR	
					NJ321 [2] 28.00x47.00x8.00mm, NBR	
					NF843 [2] 50.00x68.00x10.00mm, FPM/ACM	
					NA5051 [2] 40.00x56.00x7.00mm, FPM NF843 [2] 50.00x68.00x10.00mm, FPM/ACM	
					NA5108 [2] 42.00x55.00x7.00mm, FPM/ACM	
		JM5078 (x2)			NA5108 [2] 42.00x55.00x7.00mm, FPM/ACM	



Ltr















CC



9

Model	Ltr	Year Range	Code	Fuel	CC	Signature	Index
DAILY I Box Body / Estate	2.4	01/98→12/98	8140.21.200	Diesel	2445	4	7
DAILY I Box Body / Estate	2.4	01/97→12/98	8140.61.200	Diesel	2445	4	9
DAILY I Box Body / Estate	2.5	01/98→12/98	8140.27 S	Diesel	2445	4	8
DAILY I Platform/Chassis	2.4	01/98→12/98	8140.21.200	Diesel	2445	4	7
DAILY I Platform/Chassis	2.4	01/97→12/98	8140.61.200	Diesel	2445	4	9
DAILY I Platform/Chassis	2.5	01/98→12/98	8140.27 S	Diesel	2445	4	8
DAILY II Box Body / Estate	2.5	01/98→08/99	8140.07.2700	Diesel	2499	4	10
DAILY II Box Body / Estate	2.5	01/98→08/99	8140.07.2712	Diesel	2499	4	11
DAILY II Box Body / Estate	2.5	01/98→04/99	8140.27.2700	Diesel	2499	4	12
DAILY II Box Body / Estate	2.5	01/98→04/99	8140.27.2720	Diesel	2499	4	13
DAILY II Box Body / Estate	2.5	01/99→04/99	8140.47.2700	Diesel	2499	4	14
DAILY II Box Body / Estate	2.5	06/99→04/99	8140.47.2711	Diesel	2499	4	15
DAILY II Box Body / Estate	2.5	06/99→04/99	8140.47.2721	Diesel	2499	4	16
DAILY II Box Body / Estate	2.5	01/98→08/99	8140.47R	Diesel	2499	4	17
DAILY II Box Body / Estate	2.5	01/98→08/99	8140.47R.2790	Diesel	2499	4	18
DAILY II Box Body / Estate	2.5	01/98→08/99	8140.67F.	Diesel	2499	4	19
DAILY II Box Body / Estate	2.5	09/99→08/99	8140.97.2781	Diesel	2499	4	20
DAILY II Box Body / Estate	2.8	01/99→05/99	8140.23.	Diesel	2798	4	21
DAILY II Box Body / Estate	2.8	05/99→05/99	8140.43.	Diesel	2798	4	22
DAILY II Box Body / Estate	2.8	09/99→05/99	8140.63.	Diesel	2798	4	28
DAILY II Bus	2.5	01/99→12/99	8140.27.2720	Diesel	2499	4	13
DAILY II Bus	2.5	06/99→04/99	8140.47.2711	Diesel	2499	4	15
DAILY II Bus	2.5	06/99→04/99	8140.47.2721	Diesel	2499	4	16
DAILY II Bus	2.8	05/99→05/99	8140.23.	Diesel	2798	4	21
DAILY II Bus	2.8	05/99→05/99	8140.43.	Diesel	2798	4	22
DAILY II Dumptruck	2.5	01/98→04/99	8140.27.2700	Diesel	2499	4	12
DAILY II Dumptruck	2.5	01/99→04/99	8140.27.2720	Diesel	2499	4	13
DAILY II Dumptruck	2.5	05/99→04/99	8140.47.2700	Diesel	2499	4	14
DAILY II Dumptruck	2.5	06/99→04/99	8140.47.2711	Diesel	2499	4	15
DAILY II Dumptruck	2.5	06/99→04/99	8140.47.2721	Diesel	2499	4	16
DAILY II Dumptruck	2.5	01/98→04/99	8140.47R.2790	Diesel	2499	4	18
DAILY II Dumptruck	2.8	05/99→05/99	8140.23.	Diesel	2798	4	21
DAILY II Dumptruck	2.8	05/99→05/99	8140.43.	Diesel	2798	4	22
DAILY II Dumptruck	2.8	09/99→05/99	8140.63.	Diesel	2798	4	28
DAILY II Platform/Chassis	2.5	01/98→08/99	8140.07.2700	Diesel	2499	4	10
DAILY II Platform/Chassis	2.5	01/98→08/99	8140.07.2712	Diesel	2499	4	11
DAILY II Platform/Chassis	2.5	01/98→04/99	8140.27.2700	Diesel	2499	4	12
DAILY II Platform/Chassis	2.5	01/98→04/99	8140.27.2720	Diesel	2499	4	13
DAILY II Platform/Chassis	2.5	01/99→04/99	8140.47.2700	Diesel	2499	4	14
DAILY II Platform/Chassis	2.5	06/99→04/99	8140.47.2711	Diesel	2499	4	15
DAILY II Platform/Chassis	2.5	06/99→04/99	8140.47.2721	Diesel	2499	4	16
DAILY II Platform/Chassis	2.5	01/98→12/99	8140.47R	Diesel	2499	4	17
DAILY II Platform/Chassis	2.5	01/98→12/99	8140.47R.2790	Diesel	2499	4	18
DAILY II Platform/Chassis	2.5	01/98→08/99	8140.67F.	Diesel	2499	4	19
DAILY II Platform/Chassis	2.5	01/98→12/99	8140.97.2781	Diesel	2499	4	20
DAILY II Platform/Chassis	2.8	01/99→05/99	8140.23.	Diesel	2798	4	21
DAILY II Platform/Chassis	2.8	05/99→05/99	8140.43.	Diesel	2798	4	22
DAILY II Platform/Chassis	2.8	09/99→05/99	8140.63.	Diesel	2798	4	28
DAILY III Box Body / Estate	2.3	09/00→	F1AE0481A	Diesel	2287	4	1
DAILY III Box Body / Estate	2.3	09/00→	F1AE0481B	Diesel	2287	4	2
DAILY III Box Body / Estate	2.3	01/00→04/00	F1AE0481M	Diesel	2287	4	6
DAILY III Box Body / Estate	2.8	05/99→	8140.43C	Diesel	2798	4	24
DAILY III Box Body / Estate	2.8	01/00→	8140.43N	Diesel	2798	4	25
DAILY III Box Body / Estate	2.8	11/00→04/00	8140.43R	Diesel	2798	4	26
DAILY III Box Body / Estate	2.8	05/99→	8140.43S	Diesel	2798	4	27
DAILY III Box Body / Estate	2.8	05/99→	8140.63.	Diesel	2798	4	28
DAILY III Box Body / Estate	3.0	09/00→04/00	F1CE0481A	Diesel	2998	4	29
DAILY III Box Body / Estate	3.0	09/00→04/00	F1CE0481B	Diesel	2998	4	30
DAILY III Platform/Chassis	2.3	09/00→	F1AE0481A	Diesel	2287	4	1
DAILY III Platform/Chassis	2.3	09/00→	F1AE0481B	Diesel	2287	4	2
DAILY III Platform/Chassis	2.3	01/00→	F1AE0481M	Diesel	2287	4	6
DAILY III Platform/Chassis	2.8	05/99→	8140.43B	Diesel	2798	4	23
DAILY III Platform/Chassis	2.8	05/99→	8140.43C	Diesel	2798	4	24
DAILY III Platform/Chassis	2.8	01/00→	8140.43N	Diesel	2798	4	25
DAILY III Platform/Chassis	2.8	11/00→04/00	8140.43R	Diesel	2798	4	26
DAILY III Platform/Chassis	2.8	05/99→	8140.43S	Diesel	2798	4	27
DAILY III Platform/Chassis	2.8	05/99→	8140.63.	Diesel	2798	4	28
DAILY III Platform/Chassis	3.0	09/00→04/00	F1CE0481A	Diesel	2998	4	29
DAILY III Platform/Chassis	3.0	09/00→04/00	F1CE0481B	Diesel	2998	4	30
DAILY IV Box Body / Estate	2.3	05/00→	F1AE0481FA	Diesel	2287	4	3

	Ltr				CC		9
DAILY IV Box Body / Estate	2.3	05/00 →	F1AE0481GA	Diesel	2287	4	4
DAILY IV Box Body / Estate	2.3	05/00 →	F1AE0481HA	Diesel	2287	4	5
DAILY IV Box Body / Estate	3.0	05/00 →	F1CE0481FA	Diesel	2998	4	31
DAILY IV Box Body / Estate	3.0	05/00 →	F1CE0481HA	Diesel	2998	4	32
DAILY IV Box Body / Estate	3.0	05/00 →	F1CE0481HC	Diesel	2998	4	33
DAILY IV Box Body / Estate	3.0	07/00 →	F1CE3481LC	Diesel	2998	4	34
DAILY IV Bus	2.3	05/00 →	F1AE0481HA	Diesel	2287	4	5
DAILY IV Dumptruck	2.3	05/00 →	F1AE0481FA	Diesel	2287	4	3
DAILY IV Dumptruck	2.3	05/00 →	F1AE0481GA	Diesel	2287	4	4
DAILY IV Dumptruck	2.3	07/00 →	F1AE0481HA	Diesel	2287	4	5
DAILY IV Dumptruck	3.0	05/00 →	F1CE0481FA	Diesel	2998	4	31
DAILY IV Dumptruck	3.0	05/00 →	F1CE0481HA	Diesel	2998	4	32
DAILY IV Dumptruck	3.0	05/00 →	F1CE0481HC	Diesel	2998	4	33
DAILY IV Dumptruck	3.0	07/00 →	F1CE3481LC	Diesel	2998	4	34
DAILY IV Platform/Chassis	2.3	05/00 →	F1AE0481FA	Diesel	2287	4	3
DAILY IV Platform/Chassis	2.3	05/00 →	F1AE0481GA	Diesel	2287	4	4
DAILY IV Platform/Chassis	2.3	05/00 →	F1AE0481HA	Diesel	2287	4	5
DAILY IV Platform/Chassis	3.0	05/00 →	F1CE0481FA	Diesel	2998	4	31
DAILY IV Platform/Chassis	3.0	05/00 →	F1CE0481HA	Diesel	2998	4	32
DAILY IV Platform/Chassis	3.0	05/00 →	F1CE0481HC	Diesel	2998	4	33
DAILY IV Platform/Chassis	3.0	07/00 →	F1CE3481LC	Diesel	2998	4	34
MASSIF Pickup	3.0	10/00 →	F1CE0481FA	Diesel	2998	4	31
MASSIF Pickup	3.0	10/00 →	F1CE0481HA	Diesel	2998	4	32
MASSIF Single Cab	3.0	10/00 →	F1CE0481FA	Diesel	2998	4	31
MASSIF Single Cab	3.0	10/00 →	F1CE0481HA	Diesel	2998	4	32
MASSIF Station Wagon	3.0	10/00 →	F1CE0481FA	Diesel	2998	4	31
MASSIF Station Wagon	3.0	10/00 →	F1CE0481HA	Diesel	2998	4	32

		CC			9			CC			9
8140.07.2700	Diesel	2499	4	93.00	10						
8140.07.2712	Diesel	2499	4	93.00	11						
8140.21.200	Diesel	2445	4	93.00	7						
8140.23.	Diesel	2798	4	94.40	21						
8140.27 S	Diesel	2445	4	93.00	8						
8140.27.2700	Diesel	2499	4	93.00	12						
8140.27.2720	Diesel	2499	4	93.00	13						
8140.43.	Diesel	2798	4	94.40	22						
8140.43B	Diesel	2798	4	94.40	23						
8140.43C	Diesel	2798	4	94.40	24						
8140.43N	Diesel	2798	4	94.40	25						
8140.43R	Diesel	2798	4	94.40	26						
8140.43S	Diesel	2798	4	94.40	27						
8140.47.2700	Diesel	2499	4	93.00	14						
8140.47.2711	Diesel	2499	4	93.00	15						
8140.47.2721	Diesel	2499	4	93.00	16						
8140.47R	Diesel	2499	4	93.00	17						
8140.47R.2790	Diesel	2499	4	93.00	18						
8140.61.200	Diesel	2445	4	93.00	9						
8140.63.	Diesel	2798	4	94.40	28						
8140.67F.	Diesel	2499	4	93.00	19						
8140.97.2781	Diesel	2499	4	93.00	20						
F1AE0481A	Diesel	2287	4	88.00	1						
F1AE0481B	Diesel	2287	4	88.00	2						
F1AE0481FA	Diesel	2287	4	88.00	3						
F1AE0481GA	Diesel	2287	4	88.00	4						
F1AE0481HA	Diesel	2287	4	88.00	5						
F1AE0481M	Diesel	2287	4	88.00	6						
F1CE0481A	Diesel	2998	4	95.80	29						
F1CE0481B	Diesel	2998	4	95.80	30						
F1CE0481FA	Diesel	2998	4	95.80	31						
F1CE0481HA	Diesel	2998	4	95.80	32						
F1CE0481HC	Diesel	2998	4	95.80	33						
F1CE3481LC	Diesel	2998	4	95.80	34						













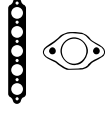

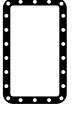

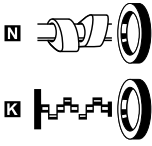



cc



kW/PS

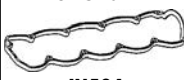

2.3		F1AE0481A Diesel		1						
Daily III	09/02→	2287	4	88.00		70/95	AB5720 (MLS), 1.100mm AB5730 (MLS), 1.200mm AB5740 (MLS), 1.300mm	CB5720 ▲ [13]	FB5721 ▲ [13]	
2.3		F1AE0481B Diesel		2						
Daily III	09/02→	2287	4	88.00		85/116	AB5720 (MLS), 1.100mm AB5730 (MLS), 1.200mm AB5740 (MLS), 1.300mm	CB5720 ▲ [13]	FB5721 ▲ [13]	
2.3		F1AE0481FA Diesel		3						
Daily IV 29L10	05/06→	2287	4	88.00	DOHC	70-78/	AB5720 (MLS), 1.100mm AB5730 (MLS), 1.200mm AB5740 (MLS), 1.300mm			
Daily IV 29L10 V	05/06→					95-106				
Daily IV 35C10	05/06→									
Daily IV 35C10 K	05/06→									
Daily IV 35C11	07/07→									
Daily IV 40C10	05/06→									
Daily IV 40C10V	05/06→									
Daily IV 40C11	07/07→									
2.3		F1AE0481GA Diesel		4						
Daily IV 29L12	05/06→	2287	4	88.00	DOHC	85-93/	AB5720 (MLS), 1.100mm AB5730 (MLS), 1.200mm AB5740 (MLS), 1.300mm			
Daily IV 29L12V	05/06→					116-126				
Daily IV 35C12	05/06→									
Daily IV 35C13	07/07→									
Daily IV 40C12	05/06→									
Daily IV 40C12V	05/06→									
Daily IV 40C13	07/07→									
2.3		F1AE0481HA Diesel		5						
Daily IV 29L14	05/06→	2287	4	88.00	DOHC	100/136	AB5720 (MLS), 1.100mm AB5730 (MLS), 1.200mm AB5740 (MLS), 1.300mm			
Daily IV 29L14C	05/06→									
Daily IV 35C14	05/06→									
Daily IV 35S14	05/06→									
2.3		F1AE0481M Diesel		6						
Daily III	01/05→04/06	2287	4	88.00		100/136	AB5720 (MLS), 1.100mm AB5730 (MLS), 1.200mm AB5740 (MLS), 1.300mm			
2.4		8140.21.200 Diesel		7						
Daily I 35-10	01/85→12/89	2445	4	93.00		68/92	AB5100 (Fibre), 1.200mm AY580 (Fibre), 1.300mm AY590 (Fibre), 1.400mm AB5110 (Fibre), 1.500mm	DS381 ▲ [3]	ES381 FB5100 ▲ [16]	
Daily I 45-10	01/85→12/89									
Daily I 45-10 V	01/85→12/89									
Daily I 49-10	01/85→12/89									
Daily I 49-10 V	01/85→12/89									
2.4		8140.27 S Diesel		8						
Daily I 40-10	01/85→12/89	2445	4	93.00		68/92	AB5100 (Fibre), 1.200mm AY580 (Fibre), 1.300mm AY590 (Fibre), 1.400mm AB5110 (Fibre), 1.500mm	DS381 ▲ [3]	ES381 FB5100 ▲ [16]	
Daily I 40-10 V	01/85→12/89									

								
HBS251 [22] M11x1.50x133.00mm (x4)	JD5338 [1] JD5337 [3]	JM5201 (SE) JM5202 (Elastomer)	JH5077	HR602 [3]	NA5201 [2] 34.00x60.00x10.00mm, FPM			 AB5100, AB5110  AB5720, AB5730, AB5740
HBS251 [22] M11x1.50x133.00mm (x4)	JD5338 [1] JD5337 [3]	JM5201 (SE) JM5202 (Elastomer)	JH5077	HR602 [3]	NA5201 [2] 34.00x60.00x10.00mm, FPM			 AY580, AY590
HBS251 [22] M11x1.50x133.00mm (x4)	JD5338 [1] JD5337 [3]	JM5201 (SE) JM5202 (Elastomer)	JH5077	HR602 [3]	NA5201 [2] 34.00x60.00x10.00mm, FPM			 JC054  JC055
HBS251 [22] M11x1.50x133.00mm (x4)	JD5338 [1] JD5337 [3]	JM5201 (SE) JM5202 (Elastomer)	JH5077	HR602 [3]	NA5201 [2] 34.00x60.00x10.00mm, FPM			 JD5338  JF123
HBS251 [22] M11x1.50x133.00mm (x4)	JD5338 [1] JD5337 [3]	JM5201 (SE) JM5202 (Elastomer)	JH5077	HR602 [3]	NA5201 [2] 34.00x60.00x10.00mm, FPM			 JM5201  JM5202
HBS251 [22] M11x1.50x133.00mm (x4)	JD5338 [1] JD5337 [3]	JM5201 (SE) JM5202 (Elastomer)	JH5077	HR602 [3]	NA5201 [2] 34.00x60.00x10.00mm, FPM			 JN594
HBS011 [5] M12x1.25x119.00mm (x12)	JC054 [1] JC055 [3] 	JN594 [4]	JH5178 (SMG) JJ519	HR602 [3]	NP068 [2] 55.00x70.00x8.00mm, FPM NP067 [2] 50.00x70.00x10.00mm, FPM NF853 [1] 100.00x118.00x10.00mm, FPM NP067 [2] 50.00x70.00x10.00mm, FPM NF883 [1] 114.00x177.00x13.00mm, FPM NF886 [1] 100.00x179.00x15.80mm, FPM NF885 [2] 70.00x179.00x16.00mm, FPM	HJ271 [8] [3] KD929 [68] [69] KK5599 [17] KV927 [76]	 JJ519	
HBS011 [5] M12x1.25x119.00mm (x12)	JC054 [1] JC055 [3] 	JN594 [4]	JH5178 (SMG) JJ519	HR602 [3]	NP068 [2] 55.00x70.00x8.00mm, FPM NF833 [1] 90.00x115.00x13.00mm, FPM	HJ271 [8] [3] KD929 [68] [69] KK5599 [17] KV927 [76]		









cc

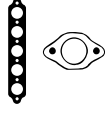

kW/PS

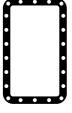

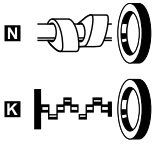
2.4	8140.61.200	Diesel	9					BE580 (Fibre), 1.350mm		FY291 ▲ [16]
Daily I 30-8	01/78→12/89	2445	4	93.00		53/72				
Daily I 35-8	01/78→12/89									
Daily I 40-8	01/83→06/89									
Daily I 40-8 V	01/83→06/89									
2.5	8140.07.2700	Diesel	10					AB5100 (Fibre), 1.200mm AY580 (Fibre), 1.300mm AY590 (Fibre), 1.400mm AB5110 (Fibre), 1.500mm	DS381 ▲ [3]	FB5101 ▲ [16]
Daily II 30-8	01/89→08/98	2499	4	93.00		55/75				
Daily II 35-8	01/89→08/98									
2.5	8140.07.2712	Diesel	11					AB5100 (Fibre), 1.200mm AY580 (Fibre), 1.300mm AY590 (Fibre), 1.400mm AB5110 (Fibre), 1.500mm	DS381 ▲ [3]	FB5101 ▲ [16]
Daily II 30-8	01/89→08/98	2499	4	93.00		55/75				
Daily II 35-8	01/89→08/98									
2.5	8140.27.2700	Diesel	12					AB5100 (Fibre), 1.200mm AY580 (Fibre), 1.300mm AY590 (Fibre), 1.400mm AB5110 (Fibre), 1.500mm	DS381 ▲ [3]	FB5101 ▲ [16]
Daily II 49-10	01/89→04/96	2499	4	93.00		76/103				
Daily II 49-10 K	01/89→04/96									
Daily II 49-10 V	01/89→04/96									
2.5	8140.27.2720	Diesel	13					AB5100 (Fibre), 1.200mm AY580 (Fibre), 1.300mm AY590 (Fibre), 1.400mm AB5110 (Fibre), 1.500mm	DS381 ▲ [3]	FB5101 ▲ [16]
Daily II 40-10 V	01/90→04/96	2499	4	93.00		76/103				
Daily II 45-10	01/89→04/96									
Daily II A 40-10	01/91→12/96									
2.5	8140.47.2700	Diesel	14					AB5100 (Fibre), 1.200mm AY580 (Fibre), 1.300mm AY590 (Fibre), 1.400mm AB5110 (Fibre), 1.500mm	DS381 ▲ [3]	FB5101 ▲ [16]
Daily II 35-12	01/90→04/96	2499	4	93.00		85/116				
Daily II 40-12	10/90→04/96									
Daily II 40-12 V	10/90→04/96									
Daily II 59-12	05/91→04/96									
Daily II 59-12 K	05/91→04/96									
Daily II 59-12 V	05/91→04/96									
2.5	8140.47.2711	Diesel	15					AB5100 (Fibre), 1.200mm AY580 (Fibre), 1.300mm AY590 (Fibre), 1.400mm AB5110 (Fibre), 1.500mm	DS381 ▲ [3]	FB5101 ▲ [16]
Daily II 49-12	06/90→04/96	2499	4	93.00		85/116				
Daily II 49-12 K	06/90→04/96									
Daily II 49-12 V	06/90→04/96									
Daily II 59-12	05/91→04/96									
Daily II 59-12 K	05/91→04/96									
Daily II 59-12 V	05/91→04/96									
Daily II A 45-12	06/90→04/96									

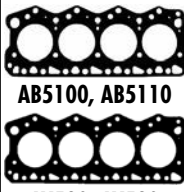
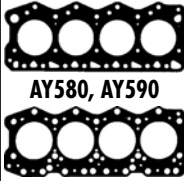
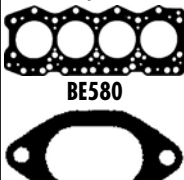
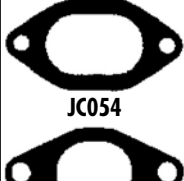
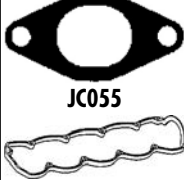
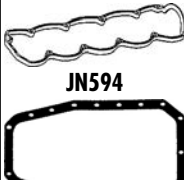
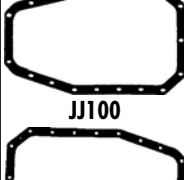
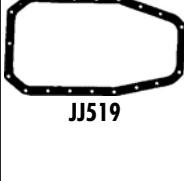
      						 AB5100, AB5110  AY580, AY590  BE580  JC054  JC055  JN594  JJ100  JJ519	
HBS011 [5] M12x1.25x119.00mm (x12)	JC054 [1] JC055 [2]	JN594 [4]	JJ100 (Cork)	HR602 [2]	N NPO67 [2] 50.00x70.00x10.00mm, FPM K NPO67 [2] 50.00x70.00x10.00mm, FPM K NF833 [1] 90.00x115.00x13.00mm, FPM	HJ271 [8] S KK5599 [17] KV927 [76]	
HBS011 [5] M12x1.25x119.00mm (x12)	JC054 [1] JC055 [2]	JN594 [4]	JH5178 (SMG) JJ519	HR602 [2]	N NPO68 [2] 55.00x70.00x8.00mm, FPM N NPO67 [2] 50.00x70.00x10.00mm, FPM K NPO67 [2] 50.00x70.00x10.00mm, FPM K NF883 [1] 114.00x177.00x13.00mm, FPM K NF886 [1] 100.00x179.00x15.80mm, FPM K NF885 [2] 70.00x179.00x16.00mm, FPM		
HBS011 [5] M12x1.25x119.00mm (x12)	JC054 [1] JC055 [2]	JN594 [4]	JH5178 (SMG) JJ519	HR602 [2]	N NPO68 [2] 55.00x70.00x8.00mm, FPM K NPO67 [2] 50.00x70.00x10.00mm, FPM	KK5599 [17] Eng.2921820→	
HBS011 [5] M12x1.25x119.00mm (x12)	JC054 [1] JC055 [2]	JN594 [4]	JH5178 (SMG) JJ519	HR602 [2]	N NPO68 [2] 55.00x70.00x8.00mm, FPM K NF833 [1] 90.00x115.00x13.00mm, FPM		
HBS011 [5] M12x1.25x119.00mm (x12)	JC054 [1] JC055 [2]	JN594 [4]	JH5178 (SMG) JJ519	HR602 [2]	N NPO68 [2] 55.00x70.00x8.00mm, FPM K NPO67 [2] 50.00x70.00x10.00mm, FPM K NF833 [1] 90.00x115.00x13.00mm, FPM K NF886 [1] 100.00x179.00x15.80mm, FPM K NF885 [2] 70.00x179.00x16.00mm, FPM	KD929 [68][69] KD931 [68][69] KK5599 [17] KV927 [76]	
HBS011 [5] M12x1.25x119.00mm (x12)	JC054 [1] JC055 [2]	JN594 [4]	JH5178 (SMG) JJ519	HR602 [2]	N NPO68 [2] 55.00x70.00x8.00mm, FPM N NPO67 [2] 50.00x70.00x10.00mm, FPM K NPO67 [2] 50.00x70.00x10.00mm, FPM K NF883 [1] 114.00x177.00x13.00mm, FPM K NF886 [1] 100.00x179.00x15.80mm, FPM K NF885 [2] 70.00x179.00x16.00mm, FPM	KD929 [68][69] KD931 [68][69] KK5599 [17] KV927 [76]	
HBS011 [5] M12x1.25x119.00mm (x12)	JC054 [1] JC055 [2]	JN594 [4]	JH5178 (SMG) JJ519	HR602 [2]	N NPO68 [2] 55.00x70.00x8.00mm, FPM K NF853 [1] 100.00x118.00x10.00mm, FPM	KK5599 [17] Eng.2921820→	



cc



kW/PS



2.5		8140.47.2721		Diesel		16			
Daily II 49-12	06/90→04/96	2499	4	93.00		85/116	AB5100 (Fibre), 1.200mm AY580 (Fibre), 1.300mm AY590 (Fibre), 1.400mm AB5110 (Fibre), 1.500mm	DS381 ▲[3]	FB5101 ▲[16]
Daily II 49-12 K	06/90→04/96								
Daily II 49-12 V	06/90→04/96								
Daily II A 45-12	06/90→04/96								
2.5		8140.47R		Diesel		17			
Daily II 35-10	01/89→08/98	2499	4	93.00		80/109	AB5100 (Fibre), 1.200mm AY580 (Fibre), 1.300mm AY590 (Fibre), 1.400mm AB5110 (Fibre), 1.500mm	DS381 ▲[3]	FB5101 ▲[16]
2.5		8140.47R.2790		Diesel		18			
Daily II 35-10	01/89→08/98	2499	4	93.00	SOHC/OHC	76-80/ 103-109	AB5100 (Fibre), 1.200mm AY580 (Fibre), 1.300mm AY590 (Fibre), 1.400mm AB5110 (Fibre), 1.500mm	DS381 ▲[3]	ES381 FB5101 ▲[16]
Daily II 49-10	01/89→04/96								
Daily II 49-10 K	01/89→04/96								
Daily II 49-10 V	01/89→04/96								
2.5		8140.67F.		Diesel		19			
Daily II 30-8	01/89→08/98	2499	4	93.00	SOHC/OHC	60/82	AB5100 (Fibre), 1.200mm AY580 (Fibre), 1.300mm AY590 (Fibre), 1.400mm AB5110 (Fibre), 1.500mm AY300 (Fibre), 1.700mm	DS381 ▲[3]	EW091
Daily II 35-8	01/89→08/98								
2.5		8140.97.2781		Diesel		20			
Daily II 35-10	01/89→08/98	2499	4	93.00	SOHC/OHC	68/92			
2.8		8140.23.		Diesel		21			
Daily II	01/97→05/99	2798	4	94.40		76/103	BX400 (Fibre), 1.300mm BX410 (Fibre), 1.400mm BX420 (Fibre), 1.500mm	DX390 ▲[13] DX391 ▲[3]	
Daily II 30-10	01/97→05/99								
Daily II 30-10 C	01/97→05/99								
Daily II 35-10	01/96→05/99								
Daily II 45-10	05/96→05/99								
Daily II 49-10	05/96→05/99								
Daily II 49-10 K	05/96→05/99								
Daily II A 40-10	09/96→05/99								



cc



kW/PS



2.8	8140.43	Diesel	22					BX400 (Fibre), 1.300mm BX410 (Fibre), 1.400mm BX420 (Fibre), 1.500mm	DX390 ▲[13]	
Daily II 35-12	05/96→05/99	2798	4	94.40			90/122			
Daily II 35-12 K	09/96→08/98									
Daily II 49-12	05/96→05/99									
Daily II 49-12 K	05/96→05/99									
Daily II 49-12 V	05/96→05/99									
Daily II 59-12	05/96→05/99									
Daily II 59-12 K	05/96→05/99									
Daily II 59-12 V	05/96→05/99									
Daily II A 40-12	05/96→05/99									
Daily II A 45-12	05/96→05/99									
2.8	8140.43B	Diesel	23					BX400 (Fibre), 1.300mm BX410 (Fibre), 1.400mm BX420 (Fibre), 1.500mm	DX400 ▲[3]	
Daily III	05/99→	2798	4	94.40	SOHC/OHC		78/105			
2.8	8140.43C	Diesel	24					BX390 (Fibre), 1.200mm BX400 (Fibre), 1.300mm BX410 (Fibre), 1.400mm BX420 (Fibre), 1.500mm	DX391 ▲[3]	GX390 ▲[3]
Daily III	05/99→	2798	4	94.40			78/106			
2.8	8140.43N	Diesel	25					BX390 (Fibre), 1.200mm BX400 (Fibre), 1.300mm BX410 (Fibre), 1.400mm BX420 (Fibre), 1.500mm	DX392 ▲	GX392 ▲[3]
Daily III	01/01→04/06	2798	4	94.40	SOHC/OHC		107/146			
2.8	8140.43R	Diesel	26					BX390 (Fibre), 1.200mm BX400 (Fibre), 1.300mm BX410 (Fibre), 1.400mm BX420 (Fibre), 1.500mm	DX391 ▲[3]	GX392 ▲[3]
Daily III	11/01→04/06	2798	4	94.40	SOHC/OHC		66/90			
Daily III 29 L 9	11/01→04/06									
2.8	8140.43S	Diesel	27					BX390 (Fibre), 1.200mm BX400 (Fibre), 1.300mm BX410 (Fibre), 1.400mm BX420 (Fibre), 1.500mm	DX391 ▲[3]	GX390 ▲[3]
Daily III	05/99→04/06	2798	4	94.40	SOHC/OHC		92/125			
2.8	8140.63	Diesel	28					AY680 (Fibre), 1.600mm AY690 (Fibre), 1.700mm AY700 (Fibre), 1.800mm	CY680 ▲[3]	
Daily II 30-8	09/98→05/99	2798	4	94.40	SOHC/OHC		62/84			
Daily II 35-8	09/98→05/99									
Daily III	05/99→									
Daily III 29 L 9	05/99→									
3.0	F1CE0481A	Diesel	29						CG7300 ▲	
Daily III	09/04→04/06	2998	4	95.80			100/136			



AY680, AY690,
AY700



BX400, BX410,
BX420, BX390



JC054



JC055



JF123



JN956



JJ519



JJ613



cc





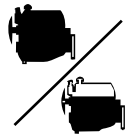



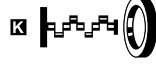
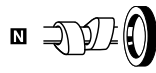
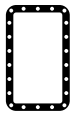
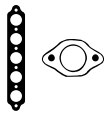

kW/PS



3.0		FICE0481B Diesel			30			CG7300 ▲																							
Daily III	09/04→04/06	2998	4	95.80		122/166																									
3.0		FICE0481FA Diesel			31		AG6050 (MLS), 1.100mm AG6060 (MLS), 1.200mm AG7300 (MLS), 1.300mm	CG7300 ▲																							
Daily IV 35C15	05/06→	2998	4	95.80	DOHC	107/146																									
Daily IV 40C12V	05/06→																														
Daily IV 40C15	05/06→																														
Daily IV 45C15	05/06→																														
Daily IV 45C15V	05/06→																														
Daily IV 50C15	05/06→																														
Daily IV 50C15V	05/06→																														
Daily IV 60C15	05/06→																														
Daily IV 60C15 V	05/06→																														
Daily IV 65C15	05/06→																														
Massif 3.0 HPI	10/08→																														
3.0									FICE0481HA Diesel			32		AG6050 (MLS), 1.100mm AG6060 (MLS), 1.200mm AG7300 (MLS), 1.300mm	CG7300 ▲																
Daily IV 35C17	07/07→								2998	4	95.80	DOHC	125-130/ 170-177																		
Daily IV 35C18	05/06→																														
Daily IV 35S17	07/07→																														
Daily IV 40C17	07/07→																														
Daily IV 40C18	05/06→																														
Daily IV 40C18V	05/06→																														
Daily IV 45C17	07/07→																														
Daily IV 45C18	05/06→																														
Daily IV 50C17	07/07→																														
Daily IV 50C18	05/06→																														
Daily IV 55S17	07/07→																														
Daily IV 60C17	07/07→																														
Daily IV 65C17	07/07→																														
Daily IV 70C17	07/07→																														
Massif 3.0 HPT	10/08→																														
3.0		FICE0481HC Diesel			33		AG6050 (MLS), 1.100mm AG6060 (MLS), 1.200mm AG7300 (MLS), 1.300mm	CG7300 ▲																							
Daily IV 60C18	05/06→	2998	4	95.80	DOHC	130/176																									
Daily IV 65C18	05/06→								3.0		FICE3481LC Diesel			34				Daily IV 35C14	07/07→	2998	4	95.80		103/140			Daily IV 40C14	07/07→	Daily IV 45C14	07/07→	Daily IV 50C14
3.0		FICE3481LC Diesel			34																										
Daily IV 35C14	07/07→	2998	4	95.80		103/140																									
Daily IV 40C14	07/07→																														
Daily IV 45C14	07/07→																														
Daily IV 50C14	07/07→																														
Daily IV 60C14	07/07→																														
Daily IV 65C14	07/07→																														
Daily IV 70C14	07/07→																														



	JD5981  (SMG)					
HBS464  [22]	JD5981  (SMG)					
HBS464  [22]	JD5981  (SMG)					
HBS464  [22]	JD5981  (SMG)					
	JD5981  (SMG)					



Ltr



CC



9

	Ltr				CC		
S-TYPE (CCX)	2.7	06/00→10/00	AJD	Diesel	2720	6	5
S-TYPE (CCX)	3.0	01/99→10/00	AJ-V6	Petrol	2967	6	6
S-TYPE (CCX)	4.0	01/99→04/00	AJ-V8	Petrol	3996	8	11
XF (_J05_, CC9)	2.7	03/00→	AJD	Diesel	2720	6	5
XF (_J05_, CC9)	3.0	03/00→	AJV6D	Diesel	2993	6	7
XF SPORTBRAKE (CC9)	3.0	09/01→	AJV6D	Diesel	2993	6	7
XJ (NAW, NBW)	4.0	07/99→05/00	BC	Petrol	3996	8	12
XJ (NAW, NBW)	4.0	07/99→05/00	DC	Petrol	3996	8	15
XJ (X35_, _J12_, _J24_)	3.0	01/01→	AJ-V6	Petrol	2967	6	6
XJ (X35_, _J12_, _J24_)	3.0	10/00→	AJV6D	Diesel	2993	6	7
XJ (X300)	3.2	11/99→07/99	9JPGRB	Petrol	3239	6	9
XJ (X300)	4.0	11/99→07/99	9KPDRB	Petrol	3980	6	10
XJ (X350, X358)	2.7	10/00→03/00	AJD	Diesel	2720	6	5
XJ (X350, X358)	3.0	05/00→03/00	AJ-V6	Petrol	2967	6	6
XJ (XJ 40, 81)	3.2	09/99→11/99	9BPMNA	Petrol	3239	6	8
XK 8 Convertible (QDV)	4.0	03/99→07/00	CC	Petrol	3996	8	13
XK 8 Convertible (QDV)	4.0	03/99→07/00	CE	Petrol	3996	8	14
XK 8 Convertible (QDV)	4.0	02/99→07/00	EC	Petrol	3996	8	16
XK 8 Coupe (QEV)	4.0	03/99→07/00	CC	Petrol	3996	8	13
XK 8 Coupe (QEV)	4.0	03/99→07/00	CE	Petrol	3996	8	14
XK 8 Coupe (QEV)	4.0	02/99→07/00	EC	Petrol	3996	8	16
X-TYPE (CF1)	2.0	07/00→11/00	FMBA	Diesel	1998	4	1
X-TYPE (CF1)	2.0	07/00→11/00	FMBB	Diesel	1998	4	2
X-TYPE (CF1)	2.0	07/00→11/00	R4-X404	Diesel	1998	4	3
X-TYPE (CF1)	2.2	10/00→11/00	LJ46G	Diesel	2198	4	4
X-TYPE (CF1)	3.0	06/00→11/00	AJ-V6	Petrol	2967	6	6
X-TYPE Estate	2.0	02/00→12/00	FMBA	Diesel	1998	4	1
X-TYPE Estate	2.0	02/00→12/00	FMBB	Diesel	1998	4	2
X-TYPE Estate	2.0	02/00→12/00	R4-X404	Diesel	1998	4	3
X-TYPE Estate	2.2	10/00→12/00	LJ46G	Diesel	2198	4	4
X-TYPE Estate	3.0	02/00→12/00	AJ-V6	Petrol	2967	6	6

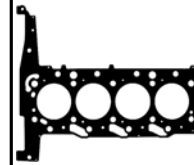
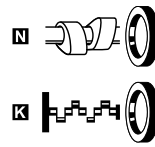
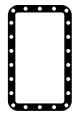

AA5970, AA5980,
AA5990



AC5260

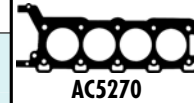

AC5270



AC5390



AC5400



AC5500

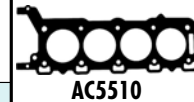

AC5510

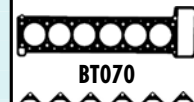

BT070



JC241

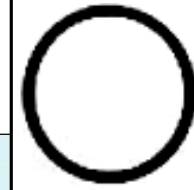

JE231



JN539



JN927

HBS296 [22]
M10x1.50x159.00mm (x10)

JD5999 [E]

HR5111 [S]

NA5031 [F] [2]
50.00x86.50x13.70mm, PTFE
NA5030 [R] [1]
106.00x196.00x15.20mm, FPM

NA5318 [T] [2]
26.0x45.0x8.0mm, FPM

NA5318 [T] [2]
26.0x45.0x8.0mm, FPM

JC241 [I] [98]
09/94 →
HA5010 [E] [S]
HA5011 [E] [S] [98]
09/94 →

JN539 [4]
HL702 [S]

HR299 [S] (x2)

NB720 [R] [1]
99.30x120.00x12.00mm, PTFE

JC241 [I]
HA5011 [E] [S]
JE231 (x2)

JN927
(Elastomer)

HR5050 [S]

NB720 [R] [1]
99.30x120.00x12.00mm, PTFE

JC241 [I]
HA5011 [E] [S]
JE231 (x2)

JN927
(Elastomer)

HR5050 [S]

NB720 [R] [1]
99.30x120.00x12.00mm, PTFE



Ltr



CC



9

	Ltr	12	12		CC	9	9
CHEROKEE (XJ)	2.1	10/98→09/99	J8S 742	Diesel	2068	4	2
COMPASS (MK49)	2.0	08/00→	ECE	Diesel	1968	4	1
GRAND CHEROKEE I (ZJ)	5.2	10/99→04/99	Y01	Petrol	5216	8	4
GRAND CHEROKEE II (WJ, WG)	2.7	10/00→09/00	ENF	Diesel	2685	5	3
PATRIOT (MK74)	2.0	02/00→	ECE	Diesel	1968	4	1



cc



kW/PS

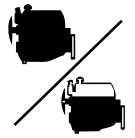

2.0		ECE Diesel					1		
Compass 2.0 CRD	08/06→	1968	4	81.00	DOHC	103/140	AG8810 (MLS)		
Compass CRD 4x4	09/06→						AG8970 (MLS), 1.550mm, 1 Hole		
Patriot 2.0 CRD	02/07→						AG8800 (MLS), 1.630mm, 2 Holes		
Patriot CRD	02/07→								
2.1		J8S 742 Diesel					2		
Cherokee 2.1D	10/86→09/92	2068	4	86.00	SOHC/OHC	59/80	BH080 (Fibre), 1.600mm, 1 Hole →0.960mm	DH080 ▲ [3]	EG176 [3] [14] GH080 ▲ [3] [14]
							BG900 (Fibre), 1.700mm →0.960→1.040mm		
							BH090 (Fibre), 1.800mm, 2 Holes →1.040mm→		
2.7		ENF Diesel					3		
Gr. Cherokee 2	10/01→09/05	2685	5	88.00	DOHC	120/163	AD5720 (MLS), 1.200mm	CD5720 ☒	
5.2		Y01					4		
Gr. Cherokee I	10/95→04/99	5216	8			156/212	AG9690 (SMG) [4]		EG9690

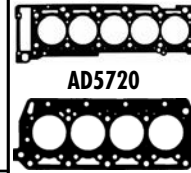
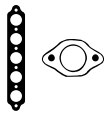

AD5720



BG900



BH080, BH090



JD245



JN697



JJ558



Ltr







CC



9

Model	Ltr	Year Range	Engine	Fuel	CC	Seats	Class
AVELLA Hatchback	1.3	11/99→12/00	B3	Petrol	1324	4	4
AVELLA	1.3	11/99→12/00	B3	Petrol	1324	4	4
BESTA Box	2.2	02/99→	R2	Diesel	2184	4	24
BONGO Bus	2.4	10/00→	D4BH	Diesel	2477	4	26
BONGO Bus	2.7	10/00→	J2	Diesel	2665	4	31
BONGO MPV	2.4	10/00→	D4BH	Diesel	2477	4	26
BONGO MPV	2.7	10/00→	J2	Diesel	2665	4	31
BONGO Platform/Chassis	2.4	10/00→	D4BH	Diesel	2477	4	26
BONGO Platform/Chassis	2.7	03/99→09/00	J2	Diesel	2665	4	31
CARENS I (FC)	1.8	11/00→07/00	T8	Petrol	1793	4	14
CARENS II (FJ)	1.6	07/00→	G46D	Petrol	1594	4	11
CARENS II (FJ)	2.0	07/00→	D4EA	Diesel	1991	4	15
CARENS II (FJ)	2.0	08/00→	G4GC	Petrol/Petroleum Gas (LPG)	1975	4	19
CARENS II (FJ)	2.0	08/00→	G4GC	Petrol	1975	4	19
CARENS III (UN)	2.0	09/00→	D4EA	Diesel	1991	4	15
CARENS III (UN)	2.0	09/00→	G4KA	Petrol	1998	4	21
CARNIVAL / GRAND CARNIVAL III (VQ)	2.9	06/00→	J3	Diesel	2902	4	32
CARNIVAL I (UP)	2.5	08/99→10/00	KRV6	Petrol	2497	6	30
CARNIVAL I (UP)	2.9	08/99→10/00	J3	Diesel	2902	4	32
CARNIVAL II (GQ)	2.5	10/00→	K5	Petrol	2497	6	29
CARNIVAL II (GQ)	2.9	01/99→	J3	Diesel	2902	4	32
CEE'D Hatchback (ED)	2.0	12/00→	G4GC	Petrol/Petroleum Gas (LPG)	1975	4	19
CEE'D Hatchback (ED)	2.0	12/00→	G4GC	Petrol	1975	4	19
CEE'D SW (ED)	2.0	09/00→	G4GC	Petrol/Petroleum Gas (LPG)	1975	4	19
CEE'D SW (ED)	2.0	09/00→	G4GC	Petrol	1975	4	19
CERATO (LD)	1.5	07/00→	D4FA	Diesel	1493	4	7
CERATO (LD)	1.6	07/00→	G4ED	Petrol	1599	4	10
CERATO (LD)	2.0	04/00→	D4EA	Diesel	1991	4	15
CERATO (LD)	2.0	04/00→	G4GC	Petrol/Petroleum Gas (LPG)	1975	4	19
CERATO (LD)	2.0	04/00→	G4GC	Petrol	1975	4	19
CERATO II Saloon (TD)	2.0	01/00→	G4KD	Petrol	1998	4	22
CERATO KOUP (TD)	2.0	01/00→	G4KD	Petrol	1998	4	22
CERATO Saloon (LD)	1.5	07/00→	D4FA	Diesel	1493	4	7
CERATO Saloon (LD)	1.6	04/00→	G4ED	Petrol	1599	4	10
CERATO Saloon (LD)	2.0	04/00→	D4EA	Diesel	1991	4	15
CERATO Saloon (LD)	2.0	04/00→	G4GC	Petrol/Petroleum Gas (LPG)	1975	4	19
CERATO Saloon (LD)	2.0	04/00→	G4GC	Petrol	1975	4	19
CLARUS (K9A)	1.8	07/99→	T8	Petrol	1793	4	14
CLARUS (K9A)	2.0	07/99→	FE (16V)	Petrol	1998	4	16
CLARUS Estate (GC)	1.8	05/99→	T8	Petrol	1793	4	14
CLARUS Estate (GC)	2.0	05/99→	FE (16V)	Petrol	1998	4	16
JOICE	2.0	02/00→	G4CP	Petrol	1997	4	18
K2500 (SD)	2.5	01/00→	D4BH	Diesel	2477	4	26
K2700 (K62W)	2.7	03/99→09/99	J2	Diesel	2665	4	31
K2700 (SD)	2.7	10/99→	J2	Diesel	2665	4	31
K2900	2.9	01/00→	J3	Diesel	2902	4	32
MAGENTIS (GD)	2.0	05/00→	G4JP	Petrol	1997	4	20
MAGENTIS (GD)	2.5	05/00→	G6BV	Petrol	2493	6	28
MAGENTIS (MG)	2.0	11/00→	D4EA	Diesel	1991	4	15
MAGENTIS (MG)	2.0	11/00→	G4KA	Petrol	1998	4	21
MAGENTIS (MG)	2.0	07/00→	G4KD	Petrol	1998	4	22
OPTIMA	2.0	03/01→	G4KD	Petrol	1998	4	22
PICANTO (BA)	1.0	09/00→	G4HE	Petrol	999	4	1
PICANTO (BA)	1.1	04/00→	G4HG	Petrol	1086	4	3
PREGIO Box (TB)	2.5	09/00→	D4BH	Diesel	2477	4	26
PREGIO Box (TB)	2.7	10/99→	J2	Diesel	2665	4	31
PREGIO Bus	2.5	08/99→09/00	D4BH	Diesel	2477	4	26
PRIDE (DA)	1.1	01/99→	B1	Petrol	1139	4	2
PRIDE (DA)	1.3	01/99→	B3	Petrol	1324	4	4
PRIDE (DA)	1.4	03/00→	G4EE	Petrol	1399	4	5
PRIDE (DA)	1.5	03/00→	D4FA	Diesel	1493	4	7
PRIDE (DA)	1.6	03/00→	G4ED	Petrol	1599	4	10
PRIDE Van (DA)	1.3	04/99→06/99	B3	Petrol	1324	4	4
PRO CEE'D (ED)	2.0	02/00→	G4GC	Petrol/Petroleum Gas (LPG)	1975	4	19
PRO CEE'D (ED)	2.0	02/00→	G4GC	Petrol	1975	4	19
RETONA (CE)	2.0	05/00→	FE (16V)	Petrol	1998	4	16
RETONA (CE)	2.0	06/99→	RF	Diesel	1998	4	23
RIO II (JB)	1.4	03/00→	G4EE	Petrol	1399	4	5
RIO II (JB)	1.5	03/00→	D4FA	Diesel	1493	4	7
RIO II (JB)	1.6	03/00→	G4ED	Petrol	1599	4	10

	Ltr				CC		9
RIO II Saloon (JB)	1.4	03/00 →	G4EE	Petrol	1399	4	5
RIO II Saloon (JB)	1.5	03/00 →	D4FA	Diesel	1493	4	7
RIO II Saloon (JB)	1.6	03/00 →	G4ED	Petrol	1599	4	10
SEPHIA (FA)	1.5	02/99 → 10/99	B5	Petrol	1498	4	6
SEPHIA (FA)	1.6	01/99 → 10/99	B6	Petrol	1598	4	9
SEPHIA (FA)	1.8	01/99 → 10/99	OK24N	Petrol	1793	4	12
SEPHIA (FA)	1.8	01/99 → 10/99	OK26Y	Petrol	1793	4	13
SEPHIA Saloon (FA)	1.5	02/99 → 10/99	B5	Petrol	1498	4	6
SEPHIA Saloon (FA)	1.6	09/99 → 10/99	B6	Petrol	1598	4	9
SEPHIA Saloon (FA)	1.8	01/99 → 10/99	OK24N	Petrol	1793	4	12
SEPHIA Saloon (FA)	1.8	01/99 → 10/99	OK26Y	Petrol	1793	4	13
SHUMA (FB)	1.6	01/00 → 12/00	GA6D	Petrol	1594	4	11
SHUMA (FB)	1.8	10/99 → 03/00	T8	Petrol	1793	4	14
SHUMA II (FB)	1.6	05/00 → 08/00	GA6D	Petrol	1594	4	11
SHUMA II (FB)	1.8	05/00 → 08/00	T8	Petrol	1793	4	14
SHUMA II Saloon (FB)	1.6	05/00 → 05/00	GA6D	Petrol	1594	4	11
SHUMA Saloon (FB)	1.5	03/99 → 12/99	OK280	Petrol	1498	4	8
SORENTO I (JC)	2.4	08/00 →	G4JS	Petrol	2351	4	25
SORENTO I (JC)	2.5	08/00 →	D4CB	Diesel	2497	4	27
SPORTAGE (JE_)	2.0	09/00 →	D4EA	Diesel	1991	4	15
SPORTAGE (JE_)	2.0	09/00 →	G4GC	Petrol/Petroleum Gas (LPG)	1975	4	19
SPORTAGE (JE_)	2.0	09/00 →	G4GC	Petrol	1975	4	19
SPORTAGE (KOO)	2.0	04/99 → 08/00	FE (16V)	Petrol	1998	4	16
SPORTAGE (KOO)	2.0	04/99 → 08/99	FE (8V)	Petrol	1998	4	17
SPORTAGE (KOO)	2.0	10/99 → 08/00	RF	Diesel	1998	4	23
SPORTAGE (SL)	2.0	07/01 →	G4KD	Petrol	1998	4	22



CC



9



CC



9

B1	Petrol	1139	4	68.00	2
B3	Petrol	1324	4	71.00	4
B5	Petrol	1498	4	78.00	6
B6	Petrol	1598	4	78.00	9
D4BH	Diesel	2477	4	91.10	26
D4CB	Diesel	2497	4	91.00	27
D4EA	Diesel	1991	4	83.00	15
D4FA	Diesel	1493	4	75.00	7
FE (16V)	Petrol	1998	4	86.00	16
FE (8V)	Petrol	1998	4	86.00	17
G4CP	Petrol	1997	4	85.00	18
G4ED	Petrol	1599	4	76.50	10
G4EE	Petrol	1399	4	75.50	5
G4GC	Petrol/ Petroleum Gas (LPG)	1975	4	82.00	19
G4GC	Petrol	1975	4	82.00	19
G4HE	Petrol	999	4	66.00	1
G4HG	Petrol	1086	4	67.00	3
G4JP	Petrol	1997	4	85.00	20
G4JS	Petrol	2351	4	86.50	25
G4KA	Petrol	1998	4	86.00	21
G4KD	Petrol	1998	4	86.00	22
G6BV	Petrol	2493	6	84.00	28
GA6D	Petrol	1594	4	78.00	11
J2	Diesel	2665	4	94.50	31
J3	Diesel	2902	4	97.10	32
K5	Petrol	2497	6	80.00	29
KRV6	Petrol	2497	6	80.00	30
OK24N	Petrol	1793	4	81.00	12
OK26Y	Petrol	1793	4	81.00	13
OK280	Petrol	1498	4	78.00	8
R2	Diesel	2184	4	86.00	24
RF	Diesel	1998	4	86.00	23
T8	Petrol	1793	4	81.00	14

KIA



cc



kW/PS



Model	Year	CC	Cyls	Power (kW/PS)	Configuration	Code	Part No.	Accessories
1.0 G4HE 1						AG9900 (MLS)	CG9900	
Picanto 1.0	09/05→	999	4	66.00		45-46/ 61-63		
1.1 B1 2						BR960 (Graphite)		
Pride 1.1 i	01/91→	1139	4	68.00	SOHC/OHC	38/52		
1.1 G4HG 3						AG9900 (MLS)	CG9900	FG8060
Picanto 1.1	04/04→	1086	4	67.00	SOHC/OHC	48/65		
1.3 B3 4						BV430 (Graphite)	DV431	GV431
Avella 1.3	11/95→12/01	1324	4	71.00	SOHC/OHC	44-55/ 60-75		
Pride 1.3 16V	01/90→06/99							
1.4 G4EE 5						AH6240 (MLS)	CH6240 (MLS)	FH6240
Pride 1.4 LX	03/05→	1399	4	75.50	DOHC	71/97		
Rio II 1.4 16V	03/05→							
1.5 B5 6						BV110 (Fibre)	DV110	GV110
Sephia 1.5 i	02/96→10/97	1498	4	78.00	SOHC/OHC	59/80		
1.5 D4FA Diesel 7								
Cerato 1.5 CRDi	07/05→	1493	4	75.00	DOHC	75-81/ 102-110		
Pride 1.5 CRDi	03/05→							
Rio II 1.5 CRDi	03/05→							
1.5 OK280 8						AG7840 (Fibre)	CG7840	FG7840
Shuma 1.5	03/96→12/98	1498	4	78.00	SOHC/OHC	59/80		
1.6 B6 9						BV110 (Fibre)	DV110	GV110
Sephia 1.6 i	09/93→10/97	1598	4	78.00	SOHC/OHC	59/80		
1.6 G4ED 10								
Cerato 1.6	04/04→	1599	4	76.50	DOHC	77-82/ 105-112		
Pride 1.6 CVVT	03/05→							
Rio II 1.6 16V	03/05→							
Rio II 1.6 CVVT	03/05→							
1.6 GA6D 11						AG8260 (MLS)	CG8261	FG8260
Carens II 1.6	07/02→	1594	4	78.00	DOHC	75-77/ 102-105		
Shuma 1.6	01/01→12/01							
Shuma II 1.6	05/01→08/04							
1.8 OK24N 12						AG8200 (MLS), 0.8mm [99]	CG8200	FG8200
Sephia 1.8i 16V	01/95→10/97	1793	4	81.00	DOHC	81/110	01/96→	01/96→

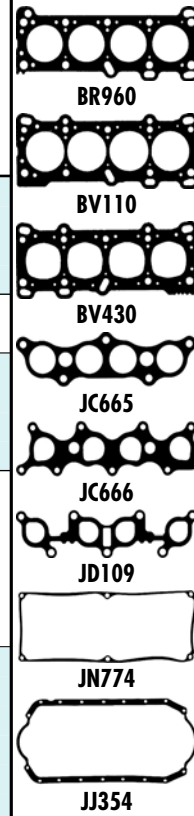
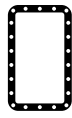
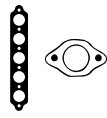

HBS378 [5] M10x1.25x106.50mm (x10)		JM5306	HR397		NJ933 [2] 35.00x50.00x8.00mm, FPM NF678 [2] 35.00x50.00x8.00mm, ACM	
	JD109		JJ354	PA883	NJ448 [2] 30.00x44.00x7.00mm, NBR	
HBS378 [5] M10x1.25x106.50mm (x10)	JD5900 JD6003 (MLS)	JM5306	HR397		NJ933 [2] 35.00x50.00x8.00mm, FPM NF678 [2] 35.00x50.00x8.00mm, ACM	
	JC666 JD109 JD5753 JE101	JN774 [4]	JJ354	PA956	NJ448 [2] 30.00x44.00x7.00mm, NBR NK158 [2] 37.00x50.50x7.00mm, ACM NJ650 [1] 83.00x100.00x9.00mm, ACM	
HBS454 [5] M10x1.25x95.00mm (x10)	JD5179 (SMG) JD5983 (MLS)	HM5374	HR397		NCO06 [2] 35.00x48.00x7.00mm, MVQ NF678 [2] 35.00x50.00x8.00mm, ACM NJ006 [1] 72.00x96.00x9.00mm, MVQ	
	JC665 JE102	JN774 [4]	HC5009 JJ354	PA883 (x8)	NJ448 [2] 30.00x44.00x7.00mm, NBR NJ448 [2] 30.00x44.00x7.00mm, NBR NK158 [2] 37.00x50.50x7.00mm, ACM NJ650 [1] 83.00x100.00x9.00mm, ACM	
HBS525 [21][94]	JD6032 (MLS)					
		JM5296	HC5009	PA883	NJ448 [2] 30.00x44.00x7.00mm, NBR NK158 [2] 37.00x50.50x7.00mm, ACM	
	JC665 JE102	JN774 [4]	HC5009 JJ354	PA883 (x8)	NJ448 [2] 30.00x44.00x7.00mm, NBR NJ448 [2] 30.00x44.00x7.00mm, NBR NK158 [2] 37.00x50.50x7.00mm, ACM NJ650 [1] 83.00x100.00x9.00mm, ACM	
HBS454 [5] M10x1.25x95.00mm (x10)			HR397		NJ933 [2] 35.00x50.00x8.00mm, FPM NF678 [2] 35.00x50.00x8.00mm, ACM NJ006 [1] 72.00x96.00x9.00mm, MVQ	
		JM5320	HC5009 HR397		NK158 [2] 37.00x50.50x7.00mm, ACM	
		JM7038 (Elastomer)	HR397		NJ324 [2] 34.00x48.00x7.00mm, ACM	



cc



kW/PS



1.8		OK26Y					13		AG8200 (MLS), 0.8mm [99]		CG8200	FG8200
Sephia 1.8i 16V	01/95→10/97	1793	4	81.00	DOHC	81/110	01/96→			01/96→	01/96→	
1.8		T8					14		AG8200 (MLS), 0.8mm [99]		CG8200	FG8200
Carens I 1.8 i	11/00→07/02	1793	4	81.00	DOHC	81-85/ 110-116						
Clarus 1.8i 16V	07/96→											
Shuma 1.8 i 16V	10/97→03/01											
Shuma II 1.8	05/01→08/04											
2.0		D4EA Diesel					15		AG7920 (MLS), 1.100mm AG7930 (MLS), 1.200mm AG7940 (MLS), 1.300mm		CG7920 ▲	
Carens II CRDi	07/02→	1991	4	83.00	SOHC/OHC	83-110/ 113-150						
Carens III 2.0	09/06→											
Cerato 2.0 CRDi	04/04→											
Magentis 2.0	11/05→12/08											
Sportage 2.0	09/04→											
2.0		FE (16V)					16		BR850 (Graphite)		DR850 [3]	GR850 [3]
Clarus 2.0i 16V	07/96→	1998	4	86.00	DOHC	94-98/ 128-133						
Retona 2.0 16V	05/00→											
Sportage 2.0	04/94→08/03											
2.0		FE (8V)					17		BL320 (Fibre)		DL321	GL321 [3]
Sportage 2.0	04/94→08/99	1998	4	86.00	SOHC/OHC	70/95						
2.0		G4CP					18		BS120 (Graphite)		DS120	
Joice 2.0	02/00→	1997	4	85.00	DOHC	102/139						
2.0		G4GC					19		AG8030 (MLS)		CG8030	FG8040
Carens II CVT	08/04→	1975	4	82.00	DOHC	102-105/ 139-143						
Cee'd 2.0	12/06→											
Cee'd SW 2.0	09/07→											
Cerato 2.0	04/04→											
Pro Cee'd 2.0	02/08→12/09											
Sportage 2.0	09/04→											
2.0		G4JP					20		AF5430 (MLS)		CF5430	
Magentis 2.0	05/01→	1997	4	85.00	DOHC	100-103/ 136-140						
2.0		G4KA					21		AH6310 (MLS) →12/07 AH6320 (MLS) →12/07			
Carens III 2.0	09/06→	1998	4	86.00	DOHC	106-107/ 144-145						
Magentis 2.0	11/05→											
2.0		G4KD					22		AH6310 (MLS) AH6320 (MLS)			
Cerato 2.0	01/09→	1998	4	86.00	DOHC	115-131/ 156-178						
Cerato II 2.0	01/09→											
Magentis 2.0	07/09→											
Optima 2.0	03/12→											
Optima 2.0 CVVL	03/12→											
Sportage 2.0	07/10→											



BL320



BR850



BS120



JC400



JC401

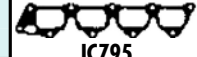

JC795



JN533



JN717



JJ268

		JM7038 (Elastomer)	HR397		N NJ324 [2] 34.00x48.00x7.00mm, ACM	
		JM7038 (Elastomer)			N NJ324 [2] 34.00x48.00x7.00mm, ACM K NK158 F [2] 37.00x50.50x7.00mm, ACM	
HBS382 [22] M12x1.50x183.00mm (x10)	JD6025 F JD6046 F (MLS) 1.0mm	HM5251 F	HR397			
HBS455 [5] M12x1.25x95.00mm (x10)		JN717 [4]	JJ268	PA956 (x16)	N NJ324 [2] 34.00x48.00x7.00mm, ACM K NJ324 F [2] 34.00x48.00x7.00mm, ACM K NJ325 F [1] 90.00x110.00x9.00mm, MVQ	
HBS455 [5] M12x1.25x95.00mm (x10)	JC401 F HA399 F JC400 F	JN533 [4]	JJ268	PA883	N NJ324 [2] 34.00x48.00x7.00mm, ACM K NJ324 F [2] 34.00x48.00x7.00mm, ACM K NJ325 F [1] 90.00x110.00x9.00mm, MVQ	
HBS307 [5] M12x1.25x104.00mm (x10)	JC795 F	JN788 [4]	HR397	KJ570	N NJ242 [2] 35.00x50.00x8.00mm, NBR N NJ933 [2] 35.00x50.00x8.00mm, FPM K NF678 F [2] 35.00x50.00x8.00mm, ACM	
HBS308 [5] M10x1.25x99.00mm (x8)	JD5777 F JD5778 F	HM5272 F	HR397		N NJ933 [2] 35.00x50.00x8.00mm, FPM K NF678 F [2] 35.00x50.00x8.00mm, ACM	
					N NJ933 [2] 35.00x50.00x8.00mm, FPM K NF678 F [2] 35.00x50.00x8.00mm, ACM K NK143 F [1] 85.00x103.00x8.00mm, FPM	
			HR397		K NA5108 F [2] 42.00x55.00x7.00mm, FPM/ACM K NK143 F [1] 85.00x103.00x8.00mm, FPM	
			HR397		K NA5108 F [2] 42.00x55.00x7.00mm, FPM/ACM K NK143 F [1] 85.00x103.00x8.00mm, FPM	



cc



kW/PS



2.0		RF Diesel					23	AG5130 (MLS), 1.500mm	CG5460	GN622 [3]
Refona 2.0 TD	06/99→	1998	4	86.00	SOHC/OHC	61/83				
Sportage 2.0	10/97→08/03									
2.2		R2 Diesel					24	BN620 (Fibre) BS460 (Graphite)	DN621	GN621 [3]
Besta Van 2.2 D	02/96→	2184	4	86.00	SOHC/OHC	48/65				
2.4		G4JS					25	AH5630 (MLS)	CH5630	
Sorento 2.4	08/02→	2351	4	86.50	DOHC	102/139				
2.5		D4BH Diesel					26	BS130 (Graphite), 1.500mm	DS130 [3]	GS130
Bongo 2.4 TDCi	10/03→	2477	4	91.10	SOHC/OHC	69/94				
K2500 2.5 D	01/03→									
Pregio 2.5 D	08/95→09/04									
Pregio 2.5 TCiD	09/02→									
2.5		D4CB Diesel					27	AG9870 (MLS), 0.800mm, 0 Notches AG9880 (MLS), 0.850mm, 1 Notch AG9890 (MLS), 0.900mm, 2 Notches	CG9870 ▲	EG9870
Sorento 2.5CRDi	08/02→	2497	4	91.00		98-131/ 133-178				
2.5		G6BV					28	BZ280 (MLS) ☒ BZ290 (MLS) ☒	DZ280	
Magentis 2.5 V6	05/01→	2493	6	84.00	DOHC, V	124/169				
2.5		K5					29	AB5080 (SE)	CB5080 [3] →03/02	
Carnival II 2.5	10/01→	2497	6	80.00	DOHC	110/150				
2.5		KRV6					30	AB5080 (SE)	CB5080 [3]	
Carnival 2.5 V6	08/99→10/01	2497	6	80.00	DOHC, V	121-129/ 165-175				
2.7		J2 Diesel					31	AE5470 (MLS)	CE5470 [13]	FE5470
Bongo 2.7 D	03/97→09/03	2665	4	94.50	OHV	59-61/ 80-83				
K2700 2.7 D	03/97→09/99									
Pregio 2.7 D	10/97→									
2.9		J3 Diesel					32	AH6540 (MLS), 1.0mm	CH6540 (MLS)	
Carnival 2.9 TD	08/99→10/01	2902	4	97.10	DOHC	92-136/ 125-185				
Carnival II 2.9	01/99→									
K2900 2.9 D	01/08→									

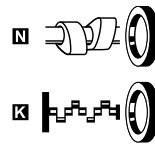
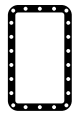

AB5080



AE5470



BN620



BS130



BS460



JC224



JC477



JC598

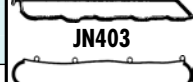

JN403

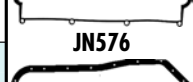

JN576



JJ072



JJ268

HBS211 [22] M12x1.50x113.00mm (x10)		JN576 [4]			NJ324 [2] 34.00x48.00x7.00mm, ACM	
HBS211 [22] M12x1.50x113.00mm (x10)	JC598 [1] JC477 [1] JE102	JN576 [4]	JJ268	PA659 (x8)	NJ448 [2] 30.00x44.00x7.00mm, NBR NJ324 [2] 34.00x48.00x7.00mm, ACM NJ325 [1] 90.00x110.00x9.00mm, MVQ	
					NJ933 [2] 35.00x50.00x8.00mm, FPM NF678 [2] 35.00x50.00x8.00mm, ACM NK143 [1] 85.00x103.00x8.00mm, FPM	
HBS295 [5][97] M12x1.25x104.00mm (x18)	JC224	JN403 [4]	JJ072	KJ211	NJ933 [2] 35.00x50.00x8.00mm, FPM NF678 [2] 35.00x50.00x8.00mm, ACM	
HBS434 [5] M12x1.25x152.00mm (x18)	JD5960 [1]				NA5330 [2] 48.00x62.00x8.00mm, FPM	
HBS446 [22] M11x1.50x147.75mm (x16)	JD5795 [2] (SE)					
HBS423 [5] M9x1.25x200.00mm (x16)			HR397		NC065 [2] 30.00x40.00x7.00mm, FPM NB998 [1] 30.00x40.00x7.00mm, FPM Brown NA5083 [2] 32.50x45.00x7.70mm, FPM LK5000 [1][7] 89.00x116.00x10.20mm, FPM	
HBS423 [5] M9x1.25x200.00mm (x16)			HR397		NC065 [2] 30.00x40.00x7.00mm, FPM NB998 [1] 30.00x40.00x7.00mm, FPM Brown NA5083 [2] 32.50x45.00x7.70mm, FPM LK5000 [1][7] 89.00x116.00x10.20mm, FPM	
	JD5328 [1] JD5327 [1]	JM5196 (Elastomer)			NA5196 [1][2] 90.00x110.00x9.00mm, ACM NA5197 [2] 53.00x69.85x11.00mm, MVQ	
HBS379 [5] M12x1.25x131.00mm (x10)		JM5310	HR397		NC048 [2] 38.00x52.00x6.00mm, FPM	



Ltr



CC



9

	Ltr				CC		
110	1.5	01/99→	VAZ-2111	Petrol	1499	4	11
110	1.6	01/00→	VAZ-21114	Petrol	1596	4	14
110	1.6	01/00→	VAZ-21124	Petrol	1596	4	15
110	2.0	08/99→	C 20 XE	Petrol	1998	4	19
111	1.5	01/99→	VAZ-2111	Petrol	1499	4	11
111	1.6	03/00→	VAZ-21124	Petrol	1596	4	15
112	1.5	01/99→	VAZ-2111	Petrol	1499	4	11
112	1.6	03/00→	VAZ-21124	Petrol	1596	4	15
GRANTA (2190)	1.6	10/01→	VAZ-21126	Petrol	1597	4	16
KALINA Estate (1117)	1.4	11/00→	VAZ-11194	Petrol/Petroleum Gas (LPG)	1390	4	6
KALINA Estate (1117)	1.4	11/00→	VAZ-11194	Petrol	1390	4	6
KALINA Estate (1117)	1.6	10/00→	VAZ-21114	Petrol	1596	4	14
KALINA Hatchback (1119)	1.4	11/00→	VAZ-11194	Petrol/Petroleum Gas (LPG)	1390	4	6
KALINA Hatchback (1119)	1.4	11/00→	VAZ-11194	Petrol	1390	4	6
KALINA Hatchback (1119)	1.6	10/00→	VAZ-21114	Petrol	1596	4	14
KALINA Saloon (1118)	1.4	11/00→	VAZ-11194	Petrol/Petroleum Gas (LPG)	1390	4	6
KALINA Saloon (1118)	1.4	11/00→	VAZ-11194	Petrol	1390	4	6
KALINA Saloon (1118)	1.6	10/00→	VAZ-21114	Petrol	1596	4	14
KALINA Saloon (1118)	1.6	10/00→	VAZ-21124	Petrol	1596	4	15
NIVA (2121)	1.6	01/98→03/99	BA3 2121	Petrol	1569	4	13
NIVA (2121)	1.9	01/99→	XUD9A	Diesel	1905	4	17
NIVA (2121)	1.9	01/99→	XUD9SD	Diesel	1905	4	18
NOVA (2105)	1.3	05/98→	BA3 2105	Petrol	1294	4	3
NOVA (2105)	1.4	03/98→	BA3 2103	Petrol	1452	4	7
NOVA (2105)	1.5	05/99→04/00	BA3 2103 (KAT)	Petrol	1451	4	8
NOVA (2105)	1.5	06/98→	BA3 21083	Petrol	1499	4	9
NOVA (2105)	1.6	01/98→10/00	BA3 2106	Petrol	1570	4	12
NOVA Estate (2104)	1.3	09/98→12/99	BA3 2105	Petrol	1294	4	3
NOVA Estate (2104)	1.4	09/98→02/99	BA3 2103	Petrol	1452	4	7
NOVA Estate (2104)	1.5	10/98→04/99	BA3 2103	Petrol	1452	4	7
NOVA Estate (2104)	1.5	08/99→	BA3 2103 (KAT)	Petrol	1451	4	8
PRIORA Estate (2171)	1.6	10/00→	VAZ-21126	Petrol	1597	4	16
PRIORA Hatchback (2172)	1.6	12/00→	VAZ-21126	Petrol	1597	4	16
PRIORA Saloon (2170)	1.6	12/00→	VAZ-21126	Petrol	1597	4	16
SAMARA (2108, 2109)	1.1	02/98→12/99	BA3 21081	Petrol	1100	4	1
SAMARA (2108, 2109)	1.1	02/99→	BA3 21081 (KAT)	Petrol	1099	4	2
SAMARA (2108, 2109)	1.3	01/98→	BA3 2108	Petrol	1288	4	4
SAMARA (2108, 2109)	1.3	09/99→	BA3 2108 (KAT)	Petrol	1288	4	5
SAMARA (2108, 2109)	1.5	01/98→	BA3 21083	Petrol	1499	4	9
SAMARA (2108, 2109)	1.5	09/99→	BA3 21083 (KAT)	Petrol	1500	4	10
SAMARA (2108, 2109)	1.5	04/99→	VAZ-2111	Petrol	1499	4	11
SAMARA FORMA (21099)	1.1	07/99→	BA3 21081 (KAT)	Petrol	1099	4	2
SAMARA FORMA (21099)	1.3	05/98→	BA3 2108	Petrol	1288	4	4
SAMARA FORMA (21099)	1.5	09/99→	BA3 21083	Petrol	1499	4	9
SAMARA FORMA (21099)	1.5	07/99→	BA3 21083 (KAT)	Petrol	1500	4	10
SAMARA FORMA (21099)	1.5	01/00→	VAZ-2111	Petrol	1499	4	11
TOSCANA (2107)	1.3	12/98→05/01	BA3 2105	Petrol	1294	4	3
TOSCANA (2107)	1.4	09/98→02/99	BA3 2103	Petrol	1452	4	7

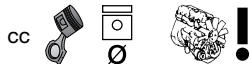

kW/PS

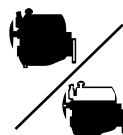

Model	Year Range	CC	Cyls	Power (kW/PS)	Configuration	Engine Code	Transmission	Drive
1.1	BA3 21081	1						
Samara 1100	02/88→12/94	1100	4	76.00	SOHC/OHC	39/53	→12/93	BS620 (Fibre)
								DS620
								→12/93
1.1	BA3 21081 (KAT)	2						
Samara 1100	07/91→	1099	4	76.00	SOHC/OHC	39-43/ 53-58	01/93→	BS620 (Fibre)
								DS620
								01/93→
1.3	BA3 2105	3						
Nova 1300	05/81→12/90	1294	4	79.00	SOHC/OHC	48-51/ 65-70	→12/93	BH700 (Fibre)
								DH700 [13]
								→12/93
Toscana 1300	12/85→05/12							GH700 [3]
								→12/93
1.3	BA3 2108	4						
Samara 1300	01/86→07/97	1288	4	76.00	SOHC/OHC	45-48/ 61-65		BS620 (Fibre)
								DS620
1.3	BA3 2108 (KAT)	5						
Samara 1300	09/91→	1288	4	76.00	SOHC/OHC	44-45/ 60-62		BS620 (Fibre)
								DS620
1.4	VAZ-11194	6						
Kalina 1.4 16V	11/08→	1390	4	76.50	DOHC	60-66/ 82-90		AH5260 (MLS)
Kalina 1.4 LPG	11/08→							
1.5	BA3 2103	7						
Nova 1.5 1500	10/86→04/98	1452	4	76.00	SOHC/OHC	54-55/ 73-75		
Nova 1500	03/85→02/93							
Toscana 1500	09/83→02/93							
1.5	BA3 2103 (KAT)	8						
Nova 1500	05/93→04/04	1451	4	76.00	SOHC/OHC	49-55/ 67-75		
1.5	BA3 21083	9						
Nova 1500	06/89→	1499	4	82.00	SOHC/OHC	53/72	→12/93	BS630 (Fibre)
								DS630
								→12/93
Samara 1500	01/88→							
1.5	BA3 21083 (KAT)	10						
Samara 1500	07/91→	1500	4	82.00	SOHC/OHC	50/68		BS630 (Fibre)
								DS630
1.5	VAZ-2111	11						
110 1.5	01/95→	1499	4	82.00	SOHC/OHC	56-59/ 76-80		BS630 (Fibre)
111 1.5	10/00→							DS630
111 1500	01/96→							
112 1.5	01/95→							
Samara 1.5	04/96→							
1.6	BA3 2106	12						
Nova 1600	01/88→10/01	1570	4	79.00	SOHC/OHC	56-58/ 76-79		BH700 (Fibre)
								DH700 [13]
								GH700 [3]
1.6	BA3 2121	13						
Niva 1600	01/87→03/95	1569	4	79.00	SOHC/OHC	54-56/ 73-76	→12/93	BH700 (Fibre)
								DH700 [13]
								→12/93
								GH700 [3]
								→12/93
1.6	VAZ-21114	14						
110 1.6	01/00→	1596	4	82.00	SOHC/OHC	60/82		AH5270 (MLS)
Kalina 1.6	10/04→							
1.6	VAZ-21124	15						
110 1.6	01/00→	1596	4	82.00	SOHC/OHC	60-66/ 82-90		AH5270 (MLS)
111 1.6	03/06→							
112 1.6	03/06→							
Kalina 1.6	10/04→							
1.6	VAZ-21126	16						
Granta 1.6	10/11→	1597	4	82.00		72/98		AH5270 (MLS)
Priora 1.6	12/08→							

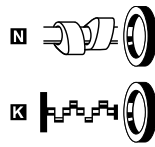

BH700



BS620



BS630



JC872



JM077



JH881



JJ412

			JJ412 →12/93				
			JJ412 01/93→				
		JM077 [4] →12/93	JH5183 →12/93				
			JJ412				
			JJ412				
	JD5950						
	JC872 →12/93	JM077 [4] →12/93	JH881 →12/93	HR569			
	JC872	JM077 [4]	JH881	HR569			
	JC872 →12/93		JJ412 →12/93				
	JC872		JJ412	HR569			
		JM077 [4]	JH881				
		JM077 [4] →12/93	JH881 →12/93				
	JD5950						
	JD5950						
	JD5950						

LADA









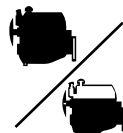



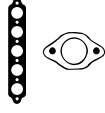

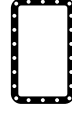

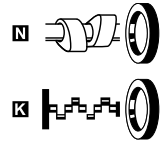







cc

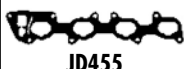

kW/PS

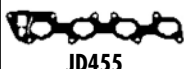

1.9		XUD9A Diesel				17			
Niva 1900 D	01/93→	1905	4	83.00	SOHC/OHC	47-52/ 64-71	BX880 (Fibre), 1.360mm, 1 Notch -0.560→0.670mm BX890 (Fibre), 1.400mm, 2 Notches -0.680→0.710mm BX900 (Fibre), 1.440mm, 3 Notches -0.720→0.750mm BX910 (Fibre), 1.480mm, 4 Notches -0.760→0.790mm BX920 (Fibre), 1.520mm, 5 Notches -0.800→0.830mm	DJ720 ▲	EL890 [3] GJ720 ▲
1.9		XUD9SD Diesel				18			
Niva 1900 D	01/99→	1905	4	83.00	SOHC/OHC	55/75	BX880 (Fibre), 1.360mm, 1 Notch -0.560→0.670mm BX890 (Fibre), 1.400mm, 2 Notches -0.680→0.710mm BX900 (Fibre), 1.440mm, 3 Notches -0.720→0.750mm BX910 (Fibre), 1.480mm, 4 Notches -0.760→0.790mm BX920 (Fibre), 1.520mm, 5 Notches -0.800→0.830mm	DJ720 ▲	EL890 [3] GJ720 ▲
2.0		C 20 XE				19			
110 2.0 i	08/96→	1998	4	86.00	DOHC	110/150	BS720 (Fibre)	DS720	ES720

      		 					
HBS084 [22] M12x1.50x120.00mm (x10)	JD5972 [1] JC423 [x2] 	JN544 [4]	JJ283 [62] PA349 22.00x16.00x2.000mm	HR569 [5]	NF841 [1][2] 35.00x50.00x8.00mm, FPM NA5191 [2] 42.00x62.00x7.00mm, PTFE NA5192 [1] 90.00x110.00x7.00mm, PTFE	HL5010 [100][5] KA611 [15]	         
HBS084 [22] M12x1.50x120.00mm (x10)	JC759 (Steel) JC423 [x2] 	JN544 [4]	JJ283 [62] PA349 22.00x16.00x2.000mm	HR569 [5]	NF841 [1][2] 35.00x50.00x8.00mm, FPM NA5191 [2] 42.00x62.00x7.00mm, PTFE NA5192 [1] 90.00x110.00x7.00mm, PTFE	HL5010 [100][5] KA611 [15]	  
HBS035 [5] M11x1.25x110.00mm (x10) →Eng.14137011 HBS054 [5] M11x1.25x105.00mm (x10) Eng.14137012→	JD455 [1] JD5980 [5]	JM950 [4]	JJ459 (x2)	PA565 (x16) HR342 [5]	NC006 [2] 35.00x48.00x7.00mm, MVQ NB884 [2] 38.00x50.00x5.50mm, FPM NB806 [1] 90.00x104.00x11.00mm, FPM		



Ltr







CC



9

Model	Ltr	Year Range	Price	Fuel	CC	Gear	9
DEDRA (835)	1.6	01/99→07/99	182 A4.000	Petrol	1581	4	34
DEDRA (835)	1.6	08/98→06/99	835 A1.000	Petrol	1581	4	40
DEDRA (835)	1.8	03/99→07/99	182 A2.000	Petrol	1747	4	43
DEDRA (835)	1.8	03/99→07/99	183 A1.000	Petrol	1747	4	44
DEDRA (835)	1.8	09/98→07/99	835 A2.046	Petrol	1756	4	48
DEDRA (835)	1.8	07/99→07/99	836 A5.000	Petrol	1756	4	51
DEDRA (835)	1.9	04/98→07/99	160 D1.000	Diesel	1929	4	52
DEDRA (835)	1.9	04/98→07/99	835 A4.000	Diesel	1929	4	56
DEDRA (835)	1.9	04/98→07/99	835 A4.046	Diesel	1929	4	57
DEDRA (835)	2.0	09/98→07/99	835 A5.000	Petrol	1995	4	71
DEDRA (835)	2.0	09/98→07/99	835 A5.046	Petrol	1995	4	72
DEDRA (835)	2.0	05/99→07/99	835 A7.000	Petrol	1995	4	73
DEDRA (835)	2.0	11/99→06/99	835 A8.000	Petrol	1995	4	74
DEDRA (835)	2.0	04/99→07/99	835 A8.046	Petrol	1995	4	75
DEDRA (835)	2.0	07/99→07/99	836 A3.000	Petrol	1995	4	77
DEDRA SW (835)	1.6	01/99→07/99	182 A4.000	Petrol	1581	4	34
DEDRA SW (835)	1.8	03/99→07/99	182 A2.000	Petrol	1747	4	43
DEDRA SW (835)	1.8	03/99→07/99	183 A1.000	Petrol	1747	4	44
DEDRA SW (835)	1.8	07/99→07/99	836 A5.000	Petrol	1756	4	51
DEDRA SW (835)	1.9	07/99→07/99	160 D1.000	Diesel	1929	4	52
DEDRA SW (835)	1.9	07/99→07/99	835 A4.000	Diesel	1929	4	56
DEDRA SW (835)	2.0	07/99→07/99	836 A3.000	Petrol	1995	4	77
DELTA I (831ABO)	1.3	09/97→08/99	831 A2.000	Petrol	1301	4	19
DELTA I (831ABO)	1.3	09/97→08/99	831 B.000	Petrol	1301	4	20
DELTA I (831ABO)	1.5	09/97→12/99	831 A1.000	Petrol	1498	4	31
DELTA I (831ABO)	1.5	09/97→12/99	831 B1.000	Petrol	1498	4	32
DELTA I (831ABO)	1.6	05/98→08/99	149 C2.000	Petrol	1585	4	33
DELTA I (831ABO)	1.9	10/98→12/98	831 D1.000	Diesel	1929	4	55
DELTA I (831ABO)	2.0	12/98→12/99	831 C5.046	Petrol	1995	4	64
DELTA I (831ABO)	2.0	06/99→01/99	831 E5.000	Petrol	1995	4	65
DELTA I (831ABO)	2.0	06/99→01/99	831 E5.046	Petrol	1995	4	66
DELTA II (836)	1.4	10/99→08/99	160 A1.046	Petrol	1372	4	21
DELTA II (836)	1.4	10/99→08/99	836 A4.000	Petrol	1372	4	27
DELTA II (836)	1.6	01/99→08/99	182 A4.000	Petrol	1581	4	34
DELTA II (836)	1.6	03/99→08/99	182 A6.000	Petrol	1581	4	35
DELTA II (836)	1.8	03/99→08/99	182 A2.000	Petrol	1747	4	43
DELTA II (836)	1.8	03/99→08/99	183 A1.000	Petrol	1747	4	44
DELTA II (836)	1.8	06/99→08/99	835 C2.000	Petrol	1756	4	49
DELTA II (836)	1.8	07/99→08/99	835 C4.000	Petrol	1756	4	50
DELTA II (836)	1.9	10/99→08/99	160 D1.000	Diesel	1929	4	52
DELTA II (836)	1.9	10/99→08/99	835 A4.000	Diesel	1929	4	56
DELTA II (836)	2.0	06/99→08/99	836 A2.000	Petrol	1995	4	76
DELTA II (836)	2.0	06/99→08/99	836 A3.000	Petrol	1995	4	77
DELTA III (844)	1.4	09/00→	198 A1.000	Petrol	1368	4	23
DELTA III (844)	1.4	09/00→	198 A4.000	Petrol	1368	4	24
DELTA III (844)	1.4	09/00→	198 A4.000	LPG	1368	4	24
DELTA III (844)	1.4	07/01→	198 A7.000	Petrol	1368	4	25
DELTA III (844)	1.6	09/00→	198 A2.000	Diesel	1598	4	37
DELTA III (844)	1.6	04/01→	944 A 3.000	Diesel	1598	4	41
DELTA III (844)	1.6	08/00→	955 A4.000	Diesel	1598	4	42
KAPPA (838A)	2.0	06/99→10/00	175 A3.000	Petrol	1998	5	61
KAPPA (838A)	2.0	10/99→10/00	838 A1.000	Petrol	1998	5	78
KAPPA (838A)	2.0	02/99→10/00	838 A4.000	Petrol	1995	4	79
KAPPA (838A)	2.0	07/99→10/00	838 A6.000	Petrol	1998	5	80
KAPPA (838A)	2.4	08/99→10/00	838 A2.000	Petrol	2446	5	89
KAPPA (838A)	2.4	08/99→10/00	838 A2.027	Petrol	2446	5	90
KAPPA (838A)	2.4	08/99→10/00	838 A3.000	Diesel	2387	5	91
KAPPA (838A)	2.4	08/99→10/00	838 A7.000	Diesel	2387	5	92
KAPPA (838A)	2.4	06/99→10/00	838 A8.000	Diesel	2387	5	93
KAPPA Coupe (838)	2.0	06/99→03/00	175 A3.000	Petrol	1998	5	61
KAPPA Coupe (838)	2.0	11/99→03/00	838 A4.000	Petrol	1995	4	79
KAPPA Coupe (838)	2.0	07/99→03/00	838 A6.000	Petrol	1998	5	80
KAPPA Coupe (838)	2.4	11/99→03/00	838 A2.000	Petrol	2446	5	89
KAPPA SW (838B)	2.0	06/99→10/00	175 A3.000	Petrol	1998	5	61
KAPPA SW (838B)	2.0	07/99→10/00	838 A4.000	Petrol	1995	4	79
KAPPA SW (838B)	2.0	07/99→10/00	838 A6.000	Petrol	1998	5	80
KAPPA SW (838B)	2.4	07/99→10/00	838 A2.000	Petrol	2446	5	89
KAPPA SW (838B)	2.4	07/99→10/00	838 A3.000	Diesel	2387	5	91
KAPPA SW (838B)	2.4	07/99→10/00	838 A7.000	Diesel	2387	5	92
KAPPA SW (838B)	2.4	06/99→10/00	838 A8.000	Diesel	2387	5	93

	Ltr				CC		9
LYBRA (839AX)	1.6	07/99→10/00	182 A4.000	Petrol	1581	4	34
LYBRA (839AX)	1.6	10/00→10/00	182 B6.000	Petrol	1596	4	36
LYBRA (839AX)	1.8	07/99→10/00	839 A4.000	Petrol	1747	4	45
LYBRA (839AX)	1.8	07/99→10/00	839 A7.000	Petrol	1747	4	46
LYBRA (839AX)	1.8	07/99→10/00	839 A9.000	Petrol	1747	4	47
LYBRA (839AX)	1.9	05/00→10/00	937 A2.000	Diesel	1910	4	58
LYBRA (839AX)	1.9	07/99→09/00	AR 32302	Diesel	1910	4	59
LYBRA (839AX)	1.9	09/00→05/00	AR 37101	Diesel	1910	4	60
LYBRA (839AX)	2.0	07/99→09/00	182 B7.000	Petrol	1998	5	62
LYBRA (839AX)	2.0	09/00→10/00	185 A8.000	Petrol	1998	5	63
LYBRA (839AX)	2.4	07/99→02/00	839 A5.000	Diesel	2387	5	94
LYBRA (839AX)	2.4	09/00→05/00	839 A6.000	Diesel	2387	5	95
LYBRA (839AX)	2.4	05/00→10/00	841 C.000	Diesel	2387	5	96
LYBRA (839AX)	2.4	07/99→02/00	AR 32501	Diesel	2387	5	103
LYBRA SW (839BX)	1.6	07/99→10/00	182 A4.000	Petrol	1581	4	34
LYBRA SW (839BX)	1.6	10/00→10/00	182 B6.000	Petrol	1596	4	36
LYBRA SW (839BX)	1.8	07/99→10/00	839 A4.000	Petrol	1747	4	45
LYBRA SW (839BX)	1.8	07/99→10/00	839 A7.000	Petrol	1747	4	46
LYBRA SW (839BX)	1.9	05/00→10/00	937 A2.000	Diesel	1910	4	58
LYBRA SW (839BX)	1.9	07/99→09/00	AR 32302	Diesel	1910	4	59
LYBRA SW (839BX)	1.9	09/00→05/00	AR 37101	Diesel	1910	4	60
LYBRA SW (839BX)	2.0	07/99→09/00	182 B7.000	Petrol	1998	5	62
LYBRA SW (839BX)	2.0	09/00→10/00	185 A8.000	Petrol	1998	5	63
LYBRA SW (839BX)	2.4	10/99→09/00	839 A5.000	Diesel	2387	5	94
LYBRA SW (839BX)	2.4	09/00→10/00	839 A6.000	Diesel	2387	5	95
LYBRA SW (839BX)	2.4	05/00→10/00	841 C.000	Diesel	2387	5	96
LYBRA SW (839BX)	2.4	10/99→09/00	AR 32501	Diesel	2387	5	103
MUSA (350)	1.3	10/00→	188 A9.000	Diesel	1248	4	12
MUSA (350)	1.3	09/00→	199 A3.000	Diesel	1248	4	14
MUSA (350)	1.3	03/00→	199 B1.000	Diesel	1248	4	15
MUSA (350)	1.4	10/00→	192 B2.000	Petrol	1368	4	22
MUSA (350)	1.4	09/00→	350 A1.000	Petrol/Petroleum Gas (LPG)	1368	4	26
MUSA (350)	1.4	09/00→	350 A1.000	Petrol	1368	4	26
MUSA (350)	1.4	10/00→	843 A 1.000	Petrol	1368	4	30
MUSA (350)	1.6	07/00→	350 A2.000	Diesel	1598	4	38
MUSA (350)	1.6	07/00→	350 A3.000	Diesel	1598	4	39
MUSA (350)	1.9	10/00→	188 B2.000	Diesel	1910	4	53
PHEDRA (179)	2.0	09/00→11/01	RFN (EW10J4)	Petrol	1997	4	83
PHEDRA (179)	2.0	09/00→11/01	RHW (DW10ATED4)	Diesel	1997	4	85
PHEDRA (179)	2.2	09/00→11/01	4HW(DW12ATED4)	Diesel	2179	4	88
PRISMA (831AB0)	1.3	01/98→02/99	831 A2.000	Petrol	1301	4	19
PRISMA (831AB0)	1.5	08/98→02/99	831 B1.000	Petrol	1498	4	32
PRISMA (831AB0)	1.6	05/98→12/98	149 C2.000	Petrol	1585	4	33
PRISMA (831AB0)	1.9	01/98→02/99	831 D.000	Diesel	1911	4	54
PRISMA (831AB0)	1.9	05/98→12/98	831 D1.000	Diesel	1929	4	55
THEMA (834)	2.0	05/98→08/99	834 B2.000	Petrol	1995	4	67
THEMA (834)	2.0	12/98→06/99	834 C1.000	Petrol	1995	4	68
THEMA (834)	2.0	08/99→12/99	834 F1.000	Petrol	1995	4	69
THEMA (834)	2.0	10/99→07/99	834 F2.000	Petrol	1995	4	70
THEMA (834)	2.4	11/98→09/98	8144.91	Diesel	2445	4	102
THEMA (834)	2.5	05/98→07/99	8144.97S	Diesel	2500	4	104
THEMA (834)	2.5	06/98→05/99	8144.97	Diesel	2499	4	105
THEMA (834)	2.5	05/99→07/99	8144.97 Y	Diesel	2500	4	106
THEMA SW (834)	2.0	05/98→08/99	834 B2.000	Petrol	1995	4	67
THEMA SW (834)	2.0	12/98→06/99	834 C1.000	Petrol	1995	4	68
THEMA SW (834)	2.0	05/99→07/99	834 F1.000	Petrol	1995	4	69
THEMA SW (834)	2.0	11/99→07/99	834 F2.000	Petrol	1995	4	70
THEMA SW (834)	2.4	03/98→09/99	8144.91	Diesel	2445	4	102
THEMA SW (834)	2.5	05/98→07/99	8144.97S	Diesel	2500	4	104
THEMA SW (834)	2.5	06/98→05/99	8144.97	Diesel	2499	4	105
THEMA SW (834)	2.5	09/99→07/99	8144.97 Y	Diesel	2500	4	106
THESIS (841AX)	2.0	07/00→07/00	841 E.000	Petrol	1998	5	81
THESIS (841AX)	2.4	07/00→07/00	841 C.000	Diesel	2387	5	96
THESIS (841AX)	2.4	07/00→07/00	841 D.000	Petrol	2446	5	97
THESIS (841AX)	2.4	05/00→07/00	841 G.000	Diesel	2387	5	98
THESIS (841AX)	2.4	09/00→07/00	841 M.000	Diesel	2387	5	99
THESIS (841AX)	2.4	09/00→07/00	841 N.000	Diesel	2387	5	100
THESIS (841AX)	2.4	04/00→07/00	841 P.000	Diesel	2387	5	101
THESIS (841AX)	3.0	07/00→07/00	841 A.000	Petrol	2959	6	107
Y (840A)	1.1	11/99→09/00	176 B2.000	Petrol	1108	4	7



Ltr











CC



9

	Ltr				CC		
Y (840A)	1.2	04/99→09/00	176 B9.000	Petrol	1242	4	9
Y (840A)	1.2	03/99→09/00	188 A4.000	Petrol	1242	4	10
Y (840A)	1.2	10/00→09/00	188 A5.000	Petrol	1242	4	11
Y (840A)	1.2	03/99→09/00	840 A3.000	Petrol	1242	4	16
Y (840A)	1.4	10/99→09/00	840 A2.000	Petrol	1370	4	28
Y (840A)	1.4	03/99→09/00	840 A4.000	Petrol	1370	4	29
Y10 (156)	1.0	03/98→02/98	156 A1.000	Petrol	1049	4	1
Y10 (156)	1.0	03/98→02/99	156 A2.000	Petrol	999	4	2
Y10 (156)	1.0	06/98→06/99	156 A2.100	Petrol	999	4	3
Y10 (156)	1.0	10/98→02/99	156 A2.246	Petrol	999	4	4
Y10 (156)	1.1	08/98→06/99	156 C.000	Petrol	1108	4	5
Y10 (156)	1.1	07/98→12/99	156 C.046	Petrol	1108	4	6
Y10 (156)	1.1	01/99→12/99	176 B2.000	Petrol	1108	4	7
Y10 (156)	1.3	02/98→12/99	146 A 5.046	Petrol	1297	4	17
Y10 (156)	1.3	11/98→12/99	156 B.000	Petrol	1301	4	18
YPSILON (843)	1.2	08/01→12/01	169 A4.000	Petrol	1242	4	8
YPSILON (843)	1.2	08/01→12/01	169 A4.000	Bi-Fuel	1242	4	8
YPSILON (843)	1.2	10/00→12/01	188 A4.000	Petrol	1242	4	10
YPSILON (843)	1.2	10/00→12/01	188 A5.000	Petrol	1242	4	11
YPSILON (843)	1.3	10/00→12/01	188 A9.000	Diesel	1248	4	12
YPSILON (843)	1.3	09/00→12/01	199 A2.000	Diesel	1248	4	13
YPSILON (843)	1.3	09/00→12/01	199 A3.000	Diesel	1248	4	14
YPSILON (843)	1.4	02/00→12/01	350 A1.000	Petrol/Petroleum Gas (LPG)	1368	4	26
YPSILON (843)	1.4	02/00→12/01	350 A1.000	Petrol	1368	4	26
YPSILON (843)	1.4	10/00→12/01	843 A 1.000	Petrol	1368	4	30
YPSILON (846)	1.2	05/01→	169 A4.000	Petrol	1242	4	8
YPSILON (846)	1.2	05/01→	169 A4.000	Bi-Fuel	1242	4	8
YPSILON (846)	1.3	05/01→	199 B1.000	Diesel	1248	4	15
ZETA (220)	2.0	07/00→09/00	RFN	Petrol	1997	4	82
ZETA (220)	2.0	05/99→07/00	RFV (XU10J4R)	Petrol	1998	4	84
ZETA (220)	2.0	09/99→09/00	RHW (DW10ATED4)	Diesel	1997	4	85
ZETA (220)	2.0	04/00→09/00	RHZ (DW10ATED)	Diesel	1997	4	86
ZETA (220)	2.1	05/99→09/99	P 8 C	Diesel	2088	4	87

		CC			9			CC			9
146 A 5.046	Petrol	1297	4	76.00	17	835 C4.000	Petrol	1756	4	84.00	50
149 C2.000	Petrol	1585	4	84.00	33	836 A2.000	Petrol	1995	4	84.00	76
156 A1.000	Petrol	1049	4	76.00	1	836 A3.000	Petrol	1995	4	84.00	77
156 A2.000	Petrol	999	4	70.00	2	836 A4.000	Petrol	1372	4	80.50	27
156 A2.100	Petrol	999	4	70.00	3	836 A5.000	Petrol	1756	4	84.00	51
156 A2.246	Petrol	999	4	70.00	4	838 A1.000	Petrol	1998	5	82.00	78
156 B.000	Petrol	1301	4	76.10	18	838 A2.000	Petrol	2446	5	83.00	89
156 C.000	Petrol	1108	4	70.00	5	838 A2.027	Petrol	2446	5	83.00	90
156 C.046	Petrol	1108	4	70.00	6	838 A3.000	Diesel	2387	5	82.00	91
160 A1.046	Petrol	1372	4	80.50	21	838 A4.000	Petrol	1995	4	84.00	79
160 D1.000	Diesel	1929	4	82.60	52	838 A6.000	Petrol	1998	5	82.00	80
169 A4.000	Petrol	1242	4	70.80	8	838 A7.000	Diesel	2387	5	82.00	92
169 A4.000	Bi-Fuel	1242	4	70.80	8	838 A8.000	Diesel	2387	5	82.00	93
175 A3.000	Petrol	1998	5	82.00	61	839 A4.000	Petrol	1747	4	82.00	45
176 B2.000	Petrol	1108	4	70.00	7	839 A5.000	Diesel	2387	5	82.00	94
176 B9.000	Petrol	1242	4	70.80	9	839 A6.000	Diesel	2387	5	82.00	95
182 A2.000	Petrol	1747	4	82.00	43	839 A7.000	Petrol	1747	4	82.00	46
182 A4.000	Petrol	1581	4	86.40	34	839 A9.000	Petrol	1747	4	82.00	47
182 A6.000	Petrol	1581	4	86.40	35	840 A2.000	Petrol	1370	4	82.00	28
182 B6.000	Petrol	1596	4	80.50	36	840 A3.000	Petrol	1242	4	70.80	16
182 B7.000	Petrol	1998	5	82.00	62	840 A4.000	Petrol	1370	4	82.00	29
183 A1.000	Petrol	1747	4	82.00	44	841 A.000	Petrol	2959	6	93.00	107
185 A8.000	Petrol	1998	5	82.00	63	841 C.000	Diesel	2387	5	82.00	96
188 A4.000	Petrol	1242	4	70.80	10	841 D.000	Petrol	2446	5	83.00	97
188 A5.000	Petrol	1242	4	70.80	11	841 E.000	Petrol	1998	5	82.00	81
188 A9.000	Diesel	1248	4	69.60	12	841 G.000	Diesel	2387	5	82.00	98
188 B2.000	Diesel	1910	4	82.00	53	841 M.000	Diesel	2387	5	82.00	99
192 B2.000	Petrol	1368	4	72.00	22	841 N.000	Diesel	2387	5	82.00	100
198 A1.000	Petrol	1368	4	72.00	23	841 P.000	Diesel	2387	5	82.00	101
198 A2.000	Diesel	1598	4	79.50	37	843 A 1.000	Petrol	1368	4	72.00	30
198 A4.000	Petrol	1368	4	72.00	24	937 A2.000	Diesel	1910	4	82.00	58
198 A4.000	LPG	1368	4	72.00	24	944 A 3.000	Diesel	1598	4	79.50	41
198 A7.000	Petrol	1368	4	72.00	25	955 A4.000	Diesel	1598	4	79.50	42
199 A2.000	Diesel	1248	4	69.60	13	AR 32302	Diesel	1910	4	82.00	59
199 A3.000	Diesel	1248	4	69.60	14	AR 32501	Diesel	2387	5	82.00	103
199 B1.000	Diesel	1248	4	69.60	15	AR 37101	Diesel	1910	4	82.00	60
350 A1.000	Petrol/ Petroleum Gas (LPG)	1368	4	72.00	26	P 8 C	Diesel	2088	4	85.00	87
350 A1.000	Petrol	1368	4	72.00	26	RFN	Petrol	1997	4	85.00	82
350 A2.000	Diesel	1598	4	79.50	38	RFN (EW10J4)	Petrol	1997	4	85.00	83
350 A3.000	Diesel	1598	4	79.50	39	RFV (XU10J4R)	Petrol	1998	4	86.00	84
4HW(DW12ATED4)	Diesel	2179	4	85.00	88	RHW (DW10ATED4)	Diesel	1997	4	85.00	85
8144. 97S	Diesel	2500	4	93.00	104	RHZ (DW10ATED)	Diesel	1997	4	85.00	86
8144.91	Diesel	2445	4	93.00	102						
8144.97	Diesel	2499	4	93.00	105						
8144.97 Y	Diesel	2500	4	93.00	106						
831 A1.000	Petrol	1498	4	86.40	31						
831 A2.000	Petrol	1301	4	86.40	19						
831 B.000	Petrol	1301	4	86.40	20						
831 B1.000	Petrol	1498	4	86.40	32						
831 C5.046	Petrol	1995	4	84.00	64						
831 D.000	Diesel	1911	4	82.60	54						
831 D1.000	Diesel	1929	4	82.60	55						
831 E5.000	Petrol	1995	4	84.00	65						
831 E5.046	Petrol	1995	4	84.00	66						
834 B2.000	Petrol	1995	4	84.00	67						
834 C1.000	Petrol	1995	4	84.00	68						
834 F1.000	Petrol	1995	4	84.00	69						
834 F2.000	Petrol	1995	4	84.00	70						
835 A1.000	Petrol	1581	4	86.40	40						
835 A2.046	Petrol	1756	4	84.00	48						
835 A4.000	Diesel	1929	4	82.60	56						
835 A4.046	Diesel	1929	4	82.60	57						
835 A5.000	Petrol	1995	4	84.00	71						
835 A5.046	Petrol	1995	4	84.00	72						
835 A7.000	Petrol	1995	4	84.00	73						
835 A8.000	Petrol	1995	4	84.00	74						
835 A8.046	Petrol	1995	4	84.00	75						
835 C2.000	Petrol	1756	4	84.00	49						



cc



kW/PS



1.0		156 A1.000					1	BP290 (Fibre)	DP294 [3]	
Y10 1.0 Fire	03/85→02/89	1049	4	76.00	SOHC/OHC	62/84				
1.0		156 A2.000					2	BP280 (Fibre), 1.650mm BV940 (Fibre), 2.000mm	DV675	GP282 [3]
Y10 1.0 Fire	03/85→02/90	999	4	70.00	SOHC/OHC	33-37/ 45-50				
1.0		156 A2.100					3	BP280 (Fibre), 1.650mm BV940 (Fibre), 2.000mm	DV675	GP282 [3]
Y10 1.0 Fire	06/85→06/91	999	4	70.00	SOHC/OHC	32/44				
1.0		156 A2.246					4	BP280 (Fibre), 1.650mm BV940 (Fibre), 2.000mm	DV675	GP282 [3]
Y10 1.0 Fire	10/87→02/92	999	4	70.00	SOHC/OHC	33/45				
1.1		156 C.000					5	BP280 (Fibre), 1.650mm BV940 (Fibre), 2.000mm	DV675	GP282 [3]
Y10 1.1 Fire	08/89→06/92	1108	4	70.00	SOHC/OHC	42/57				
Y10 1.1 i.e	08/89→06/92									
1.1		156 C.046					6	BP280 (Fibre), 1.650mm BV940 (Fibre), 2.000mm	DV675	GP282 [3]
Y10 1.1 Fire	07/89→12/95	1108	4	70.00	SOHC/OHC	37-40/ 50-54				
1.1		176 B2.000					7	BP280 (Fibre), 1.650mm BV940 (Fibre), 2.000mm	DV675	GP285
Y 1.1	11/95→09/03	1108	4	70.00	SOHC/OHC	40/54				
Y10 1.1 Fire	01/95→12/95									
1.2		169 A4.000					8	AG7380 (MLS)	CG7380	EE5242
Ypsilon 1.2	08/10→12/11	1242	4	70.80	SOHC/OHC	49-51/ 67-69				
Ypsilon 1.2 Bi	05/11→									
1.2		176 B9.000					9	AD5830 (MLS) BY380 (Fibre), 1.650mm	DY382 →Eng.0616937 CE5180 Eng.0616937→	EE5242 GY383
Y 1.2 16V	04/97→09/03	1242	4	70.80	DOHC	63/86				

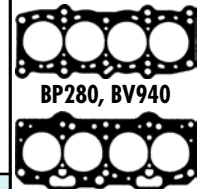

BP280, BV940



BP290

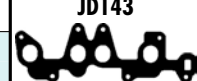

BY380



JD143



JD148



JD464

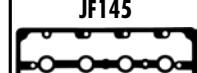

JD465



JD5155



JD5375



JF145



JM5176



JN587



JN667



JJ078

	JD143 JD5155	JN587 [4]	JJ078				
HBS052 [5] M9x1.25x95.00mm (x10)	JD148 ■ JD5375 ■ ☉ JF145 (MLS)	JN667 [4]	HR354	HR599 ■	☒ NA5053 [2] 30.00x42.00x7.00mm, FPM ☒ NB815 ■ [2] 23.00x35.00x7.00mm, FPM ☒ NB814 ■ [1] 70.00x88.00x8.00mm, FPM	JR673 [6]	
HBS052 [5] M9x1.25x95.00mm (x10)	JD148 ■ JD5375 ■ ☉ JF145 (MLS)	JN667 [4]	HR354	HR599 ■	☒ NA5053 [2] 30.00x42.00x7.00mm, FPM ☒ NB815 ■ [2] 23.00x35.00x7.00mm, FPM ☒ NB814 ■ [1] 70.00x88.00x8.00mm, FPM	KA5032 [41] JR673 [6]	
HBS052 [5] M9x1.25x95.00mm (x10)	JD148 ■ JD5375 ■ ☉ JF145 (MLS)	JN667 [4]	HR354	HR599 ■	☒ NA5053 [2] 30.00x42.00x7.00mm, FPM ☒ NB815 ■ [2] 23.00x35.00x7.00mm, FPM ☒ NB814 ■ [1] 70.00x88.00x8.00mm, FPM	KA5032 [41] JR673 [6]	
HBS052 [5] M9x1.25x95.00mm (x10)	JD148 ■ JD5375 ■ ☉ JF145 (MLS)	JN667 [4]	HR354	HR599 ■	☒ NA5053 [2] 30.00x42.00x7.00mm, FPM ☒ NB815 ■ [2] 23.00x35.00x7.00mm, FPM ☒ NB814 ■ [1] 70.00x88.00x8.00mm, FPM		
HBS052 [5] M9x1.25x95.00mm (x10)	JD148 ■ JD5375 ■ (x2) ☉ JF145 (MLS)	JN667 [4]	HR354	HR599 ■	☒ NA5053 [2] 30.00x42.00x7.00mm, FPM ☒ NB815 ■ [2] 23.00x35.00x7.00mm, FPM ☒ NB814 ■ [1] 70.00x88.00x8.00mm, FPM	KA5032 [41] JR673 [6]	
HBS052 [5] M9x1.25x95.00mm (x10)	JD148 ■ JD5375 ■ ☉ JF145 (MLS)	JN667 [4]	HR354	HR599 ■	☒ NA5053 [2] 30.00x42.00x7.00mm, FPM ☒ NB815 ■ [2] 23.00x35.00x7.00mm, FPM ☒ NA5061 ■ [1] 74.00x88.00x8.00mm, FPM	KA5032 [41] JR673 [6] →02/02 KK5001 [17] 03/02→	
HBS052 [5] M9x1.25x95.00mm (x10)	HA5053 ■ ■ JD5375 ■	JM7099 [4] (SMG)			☒ NA5058 [2] 40.00x55.00x7.00mm, FPM ☒ NA5057 ■ [2] 27.00x37.00x7.00mm, FPM ☒ NA5061 ■ [1] 74.00x88.00x8.00mm, FPM		
HBS247 ☉ [5] M9x1.25x87.00mm (x10)	JD464 ■ JD465 ■	JM5176		HR814 ■	☒ NA5058 [2] 40.00x55.00x7.00mm, FPM ☒ NA5057 ■ [2] 27.00x37.00x7.00mm, FPM ☒ NA5061 ■ [1] 74.00x88.00x8.00mm, FPM	KA5032 [41] JR673 [6] →02/02 KK5001 [17] 03/02→	



cc



kW/PS



1.2	188 A4.000					10			
Y 1.2	03/96→09/03	1242	4	70.80	SOHC/OHC	44/60	AE5240 (MLS)	DV672 [3]	EE5242
Ypsilon 1.2	10/03→12/11						BV670 (Fibre), 1.650mm 10/00→08/03 AE5550 (Fibre), 1.850mm 10/00→08/03	10/00→ →Eng.1890665 CG7381 10/00→ Eng.1890666→ →Eng.2533528 CE5241 10/00→ Eng.2533529→ →Eng.2939661 CE5242 10/00→ Eng.2939662→	10/00→
1.2	188 A5.000					11			
Y 1.2 16V	10/00→09/03	1242	4	70.80	DOHC	59/80	AD5830 (MLS)	DY383	EE5242
Ypsilon 1.2	10/03→12/11						BY380 (Fibre), 1.650mm	→Eng.0613937 CE5181 Eng.0616937→	GY383 →Eng.0616937
1.2	188 A9.000	Diesel				12			
Musa 1.3 MTJ	10/04→	1248	4	69.60	DOHC	51/70	AD5800 (MLS), 0.720mm	CD5810 ▲	ED5800
Ypsilon 1.3 JTD	10/03→12/11						AD5810 (MLS), 0.820mm, 1 Hole AD5820 (MLS), 0.920mm, 2 Holes		FD5810
1.2	199 A2.000	Diesel				13			
Ypsilon 1.3D	09/06→12/11	1248	4	69.60	DOHC	55/75	AD5800 (MLS), 0.720mm	CD5810 ▲	FD5810
							AD5810 (MLS), 0.820mm, 1 Hole AD5820 (MLS), 0.920mm, 2 Holes		
1.2	199 A3.000	Diesel				14			
Musa 1.3 D MTJ	09/06→	1248	4	69.60	DOHC	66-77/ 90-105	AD5800 (MLS), 0.720mm	CD5820 ▲	ED5820
Ypsilon 1.3D	09/06→12/11						AD5810 (MLS), 0.820mm, 1 Hole AD5820 (MLS), 0.920mm, 2 Holes		FD5820 ▲
1.2	199 B1.000	Diesel				15			
Musa 1.3 D MTJ	03/09→	1248	4	69.60	DOHC	70/95	AD5800 (MLS), 0.720mm	CD5810 ▲	ED5800
Ypsilon Agora	05/11→						AD5810 (MLS), 0.820mm, 1 Hole AD5820 (MLS), 0.920mm, 2 Holes		
1.2	840 A3.000					16			
Y 1.2	03/96→09/03	1242	4	70.80	SOHC/OHC	44/60	BV670 (Fibre), 1.650mm	DV672 [3]	EE5242
							AE5550 (Fibre), 1.850mm		
1.3	146 A 5.046					17			
Y10 1.3 Fire	02/89→12/95	1297	4	76.00	SOHC/OHC	53/72	BP290 (Fibre)	DP292	
1.3	156 B.000					18			
Y10 1.3 Fire	11/87→12/95	1301	4	76.10	SOHC/OHC	53-56/ 72-76	BP290 (Fibre)	DP292	
1.3	831 A2.000					19			
Delta I 1.3	09/79→08/92	1301	4	86.40	SOHC/OHC	55-58/ 75-79	BP110 (Fibre)		
Prisma 1.3	01/83→02/92								
1.3	831 B.000					20			
Delta I 1.3	09/79→08/92	1301	4	86.40	SOHC/OHC	55/75	BP110 (Fibre)		
1.4	160 A1.046					21			
Delta II 1.4	10/94→08/99	1372	4	80.50	SOHC/OHC	51/69	BR620 (Fibre)		
1.4	192 B2.000					22			
Musa 1.4	10/07→	1368	4	72.00	DOHC	66/90	AG7310 (MLS)	CG7310	EE5242

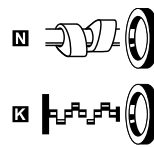
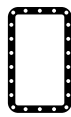
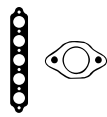

HBS052 [5] M9x1.25x95.00mm (x10) 10/00→	JA5010 ■ 10/00→ JD5375 ■ 10/00→	JM5019 (Elastomer) 10/00→ JM7099 [4] (SMG) 10/00→ Eng.2935743→	HR354 10/00→	HR599 ■ 10/00→	NA5053 [2] 30.00x42.00x7.00mm, FPM 10/00→ NB815 ■ [2] 23.00x35.00x7.00mm, FPM 10/00→ →Eng.2939661 NA5061 ■ [1] 74.00x88.00x8.00mm, FPM 10/00→ NA5057 ■ [2] 27.00x37.00x7.00mm, FPM 10/00→ Eng.2939662→	KA5032 [41]
HBS247 ⊗ [5] M9x1.25x87.00mm (x10)	JA5005 ■ (Elastomer) JA5006 ■	JM5176		HR814 ■	NA5058 [2] 40.00x55.00x7.00mm, FPM NA5057 ■ [2] 27.00x37.00x7.00mm, FPM LK5001 ■ [1][2][7] 74.00x187.50x17.000mm, FPM	KA5032 [41]
HBS353 ⊗ [5] M10x1.25x119.00mm (x10)	JD5411 ■ JD5412 ■ ⊗ JD5413 ■ (MLS)	JM5259 (SE)		HR5088 ■	NA5223 ■ [2] 40.00x52.00x7.00mm, FPM NA5230 ■ [2] 78.00x100.00x9.00mm, PTFE	KK5646 [17]
HBS353 ⊗ [5] M10x1.25x119.00mm (x10)	JD5411 ■ JD5413 ■ (MLS)	JM5299			NA5223 ■ [2] 40.00x52.00x7.00mm, FPM NA5230 ■ [2] 78.00x100.00x9.00mm, PTFE	
HBS353 ⊗ [5] M10x1.25x119.00mm (x10)	JD5411 ■ JD5413 ■ (MLS)	JM5259 (SE)			NA5223 ■ [2] 40.00x52.00x7.00mm, FPM NA5230 ■ [2] 78.00x100.00x9.00mm, PTFE	
HBS353 ⊗ [5] M10x1.25x119.00mm (x10)	JD5411 ■ JD5413 ■ (MLS)	JM5259 (SE)			NA5223 ■ [2] 40.00x52.00x7.00mm, FPM NA5230 ■ [2] 78.00x100.00x9.00mm, PTFE	
HBS052 [5] M9x1.25x95.00mm (x10)	JA5010 ■ JD5375 ■	JN667 [4]	HR354	HR599 ■	NA5053 [2] 30.00x42.00x7.00mm, FPM NB815 ■ [2] 23.00x35.00x7.00mm, FPM NA5061 ■ [1] 74.00x88.00x8.00mm, FPM	KA5032 [41]
	JD143			JJ078		
	JD143			JJ078		
		JN805 ■ [4]				
		JP049 ■ (Cork) JN805 ■ [4]				KA294 [15]
HBS052 [5] M9x1.25x95.00mm (x10)	HA5053 ■ ■ ■	JM5176			NA5058 [2] 40.00x55.00x7.00mm, FPM NA5057 ■ [2] 27.00x37.00x7.00mm, FPM LK5001 ■ [1][2][7] 74.00x187.50x17.000mm, FPM	

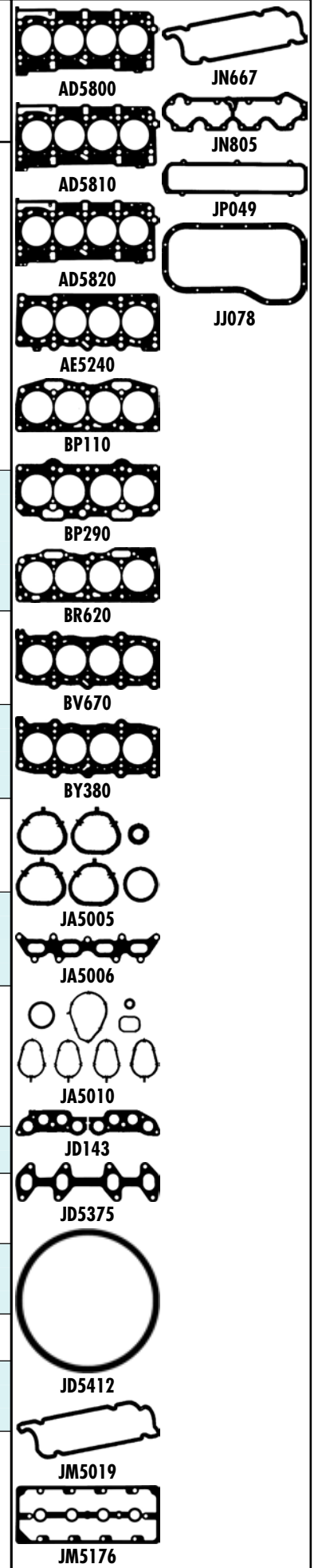



cc



kW/PS



1.4	198 A1.000	23	AH6510 (MLS)		EE5242					
Delta 3 1.4	09/08→	1368	4	72.00	DOHC	110/150				
1.4	198 A4.000	24	AH6510 (MLS)		EE5242					
Delta 3 1.4	09/08→	1368	4	72.00	DOHC	88/120				
1.4	198 A7.000	25	AH6510 (MLS)		EE5242					
Delta 3 1.4 16V	07/10→	1368	4	72.00	DOHC	103/140				
1.4	350 A1.000	26	AG7380 (MLS)	CG7380	EE5242					
Musa 1.4	09/05→	1368	4	72.00	SOHC/OHC	55-57/ 75-78				
Musa 1.4 LPG	11/10→									
Ypsilon 1.4	02/06→12/11									
Ypsilon 1.4 LPG	11/10→12/11									
1.4	836 A4.000	27	BR620 (Fibre)							
Delta II 1.4	10/94→08/99	1372	4	80.50	SOHC/OHC	51/69				
1.4	840 A2.000	28	AY480 (Fibre) BX040 (Fibre), 1.200mm	DX040 [3]	GX041					
Y 1.4 12V	10/96→09/03	1370	4	82.00	SOHC/OHC	55-59/ 75-80				
1.4	840 A4.000	29	AY480 (Fibre) BX040 (Fibre), 1.200mm	DX040 [3]	GX041					
Y 1.4 12V	03/96→09/03	1370	4	82.00	SOHC/OHC	55/75				
1.4	843 A 1.000	30	AG6220 (MLS) →04/06 AG7310 (MLS) 05/06→	CG6220 →04/06 CG7310 05/06→	EE5242					
Musa 1.4	10/04→	1368	4	72.00	DOHC	70/95				
Ypsilon 1.4	10/03→12/11									
1.5	831 A1.000	31	BP860 (Fibre)	DP860	GP861					
Delta I 1.5	09/79→12/92	1498	4	86.40	DOHC	63/86				
1.5	831 B1.000	32	BP860 (Fibre)	DP871 →Eng.5750056 DJ851 ▲ Eng.5750056→ DP861 Eng.5750056→	GP861					
Delta I 1.5	09/79→12/92	1498	4	86.40	DOHC	59-63/ 80-86				
Prisma 1.5	08/86→02/92									
1.6	149 C2.000	33	BT410 (Fibre)	DT411 [16] DT423 [13]						
Delta I 1.6	05/87→08/92	1585	4	84.00		66/90				
Prisma 1.6	05/87→12/89									

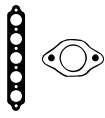

AY480, BX040



BP860



BR620



BT410



JD342



JD343



JD5375

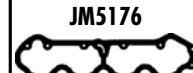

JM5176



JN805

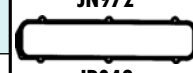

JN972



JP049



cc



kW/PS



1.6	182 A4.000					34	BX030 (Fibre), 1.650mm AY470 (Fibre), 1.850mm	CY470 [3] DX030 [3]	
Dedra 1.6 16V	01/96→07/99	1581	4	86.40	DOHC	76/103			
Delta II 1.6	01/96→08/99								
Lybra 1.6 16V	07/99→10/05								
1.6	182 A6.000					35	BX030 (Fibre), 1.650mm AY470 (Fibre), 1.850mm	CY470 [3] DX030 [3]	
Delta II 1.6	03/96→08/99	1581	4	86.40	DOHC	66/90			
1.6	182 B6.000					36	AB5150 (Fibre) →Eng.505168 AD5970 (MLS) Eng.505169→	CB5150 [3] →Eng.505168 CD5970 [3] (MLS) Eng.505169→	EB5150
Lybra 1.6	10/00→10/05	1596	4	80.50	DOHC	76/103			
1.6	198 A2.000	Diesel				37	AH6880 (MLS), 0.82mm AH6890 (MLS), 0.92mm, 1 Hole		
Delta 3 1.6 MTJ	09/08→	1598	4	79.50	DOHC	88/120			
1.6	350 A2.000	Diesel				38	AH6880 (MLS), 0.82mm AH6890 (MLS), 0.92mm, 1 Hole		
Musa 1.6 D MTJ	07/08→	1598	4	79.50	DOHC	85-88/ 116-120			
1.6	350 A3.000	Diesel				39	AH6880 (MLS), 0.82mm AH6890 (MLS), 0.92mm, 1 Hole		
Musa 1.6 D MTJ	07/08→	1598	4	79.50	DOHC	85/116			
1.6	835 A1.000					40	AY460 (Fibre) BR630 (Fibre)	DR632 [3] →12/92 DR630 [3] 01/93→	
Dedra 1.6 i.e.	08/89→06/94	1581	4	86.40	SOHC/OHC	65-66/ 88-90			
1.6	944 A 3.000	Diesel				41	AH6880 (MLS), 0.82mm AH6890 (MLS), 0.92mm, 1 Hole		
Delta 3 1.6 MTJ	04/11→	1598	4	79.50	DOHC	77/105			
1.6	955 A4.000	Diesel				42	AH6880 (MLS), 0.82mm AH6890 (MLS), 0.92mm, 1 Hole		
Delta 3 1.6 MTJ	08/08→	1598	4	79.50	DOHC	85/116			
1.7	182 A2.000					43	AY500 (Fibre), 1.85mm	DW720	GW724 [3]
Dedra 1.8	03/96→07/99	1747	4	82.00	DOHC	83/113			
Delta II 1.8	03/96→08/99								
1.7	183 A1.000					44	BW720 (Fibre), 1.650mm AY500 (Fibre), 1.85mm	DW723 [13]	EA5420 [3] GW723 [3]
Dedra 1.8	03/96→07/99	1747	4	82.00	DOHC	96/131			
Delta II 1.8	03/96→08/99								
1.7	839 A4.000					45	BW720 (Fibre), 1.650mm AY500 (Fibre), 1.85mm	CA5421 [3] DW723 [13]	
Lybra 1.8 16V	07/99→10/05	1747	4	82.00	DOHC	96/131			
1.7	839 A7.000					46	AA5420 (MLS), 0.380mm BW720 (Fibre), 1.650mm AY500 (Fibre), 1.85mm	CA5421 [3] DW723 [13]	
Lybra 1.8 16V	07/99→10/05	1747	4	82.00	DOHC	96/131			



AB5150



AD5970



AY460, BR630



AY500



BW720, AA5420



BX030, AY470



HA5005



JA5007



JD271

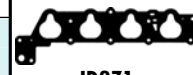

JD273



JD5143

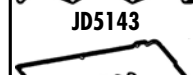

HL701



JN805

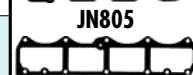

JN973

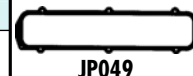

JP049



cc



kW/PS



1.7	839 A9.000					47	AA5420 (MLS), 0.380mm BW720 (Fibre), 1.650mm AY500 (Fibre), 1.85mm	DW723 [13]	GW723 [3]
Lybra 1.8 16V	07/99→10/05	1747	4	82.00	DOHC	96/131			
1.8	835 A2.046					48	BT410 (Fibre) BT420 (Fibre)	DT410	GT410
Dedra 1.8 i.e.	09/89→07/99	1756	4	84.00	DOHC	74-77/ 101-105			
1.8	835 C2.000					49	BT440 (Fibre)	DT449 [3]	
Delta II 1.8	06/93→08/99	1756	4	84.00	DOHC	76/103			
1.8	835 C4.000					50	BR620 (Fibre)		
Delta II 1.8	07/94→08/99	1756	4	84.00	DOHC	66/90			
1.8	836 A5.000					51	BT440 (Fibre) AY500 (Fibre), 1.85mm	DT449 [3]	
Dedra 1.8 i.e.	07/94→07/99	1756	4	84.00	DOHC	74/101			
1.9	160 D1.000 Diesel					52	BR680 (Graphite), 1.650mm BR690 (Graphite), 1.800mm, 1 Notch BR700 (Graphite), 1.950mm, 2 Notches	DV680 ▲[3]	GV680 ▲
Dedra 1.9 TDS	04/89→07/99	1929	4	82.60	SOHC/OHC	66/90			
Delta II 1.9TD	10/94→08/99								
1.9	188 B2.000 Diesel					53	AG7310 (MLS)	CA5560 ▲[3] →Eng.4081111 CA5561 ▲ Eng.4081111→	EE5242
Musa 1.9 D MTJ	10/04→	1910	4	82.00	SOHC/OHC	74/101			
1.9	831 D.000 Diesel					54	BR690 (Graphite), 1.800mm, 1 Notch BR700 (Graphite), 1.950mm, 2 Notches	DT290 ▲[3]	
Prisma 1.9 D	01/83→02/92	1911	4	82.60	SOHC/OHC	48/65			
1.9	831 D1.000 Diesel					55	BR680 (Graphite), 1.650mm BR690 (Graphite), 1.800mm, 1 Notch BR700 (Graphite), 1.950mm, 2 Notches	DT290 ▲[3]	GV680 ▲
Delta I 1.9	10/86→12/89	1929	4	82.60		48-59/ 55-80			
Prisma 1.9 TD	05/85→12/89								
1.9	835 A4.000 Diesel					56	BR680 (Graphite), 1.650mm BR690 (Graphite), 1.800mm, 1 Notch BR700 (Graphite), 1.950mm, 2 Notches	DV680 ▲[3]	GV680 ▲
Dedra 1.9 TDS	04/89→07/99	1929	4	82.60	SOHC/OHC	66/90			
Delta II 1.9TD	10/94→08/99								
1.9	835 A4.046 Diesel					57	BR680 (Graphite), 1.650mm BR690 (Graphite), 1.800mm, 1 Notch BR700 (Graphite), 1.950mm, 2 Notches	DV680 ▲[3]	GV680 ▲
Dedra 1.9 TDS	04/89→07/99	1929	4	82.60	DOHC	66/90			
1.9	937 A2.000 Diesel					58	AA5560 (MLS), 0.820mm, 0 Holes AA5570 (MLS), 0.920mm, 1 Hole AA5580 (MLS), 1.020mm, 2 Holes	CA5560 ▲[3] →Eng.4081110 CA5561 ▲ Eng.4081111→	EE5181 [3] FA5560 ▲[3]
Lybra 1.9 JTD	05/01→10/05	1910	4	82.00	SOHC/OHC	85/116			
1.9	AR 32302 Diesel					59	AY520 (MLS), 1.600mm, 0 Holes AY530 (MLS), 1.700mm, 1 Hole AY540 (MLS), 1.800mm, 2 Holes	CY550 ▲[3]	FY550 ▲[3]
Lybra 1.9 JTD	07/99→09/00	1910	4	82.00	SOHC/OHC	77/105			



HBS132 [5] M10x1.25x254.00mm (x10)	JA5007 [1] JD273 [2] (MLS)	HL701 [2]		HR599 [2]	NA5053 [2] 30.00x42.00x7.00mm, FPM NA5070 [2] 31.00x41.00x7.00mm, FPM NF888 [1] 93.00x172.00x12.00mm, FPM	
HBS092 [5] M10x1.25x115.00mm (x10)	JC662 [1] JA757 [2]	JN643 (x2)[4] JN948 [4]		HR363 [2]		
HBS092 [5] M10x1.25x115.00mm (x10)	JC662 [1] JD019 [2]					
HBS092 [5] M10x1.25x115.00mm (x10)						
HBS095 [5] M12x1.25x133.00mm (x10)	JC738	JN459 [4]	JJ298		NA5187 [2] 30.00x52.00x7.00mm, ACM NB742 [2] 30.00x43.00x8.00mm, ACM NB732 [1] 74.00x90.00x10.00mm, FPM	
HBS227 [5] M12x1.25x218.00mm (x10)	JA5035 [1]	JM5204 (Elastomer)			NA5053 [2] 30.00x42.00x7.00mm, FPM NA5070 [2] 31.00x41.00x7.00mm, FPM	
HBS095 [5] M12x1.25x133.00mm (x10)			JJ298			
HBS095 [5] M12x1.25x133.00mm (x10)	JC738	JN568 [4]		HR596 [2]	NA5187 [2] 30.00x52.00x7.00mm, ACM NB742 [2] 30.00x43.00x8.00mm, ACM NB732 [1] 74.00x90.00x10.00mm, FPM	LV583 [41]
HBS095 [5] M12x1.25x133.00mm (x10)	JC738	JN459 [4]	JJ298		NA5187 [2] 30.00x52.00x7.00mm, ACM NB742 [2] 30.00x43.00x8.00mm, ACM NB732 [1] 74.00x90.00x10.00mm, FPM	
HBS095 [5] M12x1.25x133.00mm (x10)	JC738	JN459 [4]	JJ298		NA5187 [2] 30.00x52.00x7.00mm, ACM NB742 [2] 30.00x43.00x8.00mm, ACM NB732 [1] 74.00x90.00x10.00mm, FPM	
HBS227 [5] M12x1.25x218.00mm (x10)	JA5035 [1] JD468 [2] (MLS)	JM5028 (Elastomer) →Eng.4081110 JM5204 (Elastomer) Eng.4081111→		HR363 [2]	NA5053 [2] 30.00x42.00x7.00mm, FPM NA5070 [2] 31.00x41.00x7.00mm, FPM NF888 [1] 93.00x172.00x12.00mm, FPM	
HBS227 [5] M12x1.25x218.00mm (x10)	JA5035 [1] JD468 [2] (MLS)	JP063 [4]		HR363 [2]	NA5053 [2] 30.00x42.00x7.00mm, FPM NA5070 [2] 31.00x41.00x7.00mm, FPM NF888 [1] 93.00x172.00x12.00mm, FPM	KL476 [10] KA845 [15]

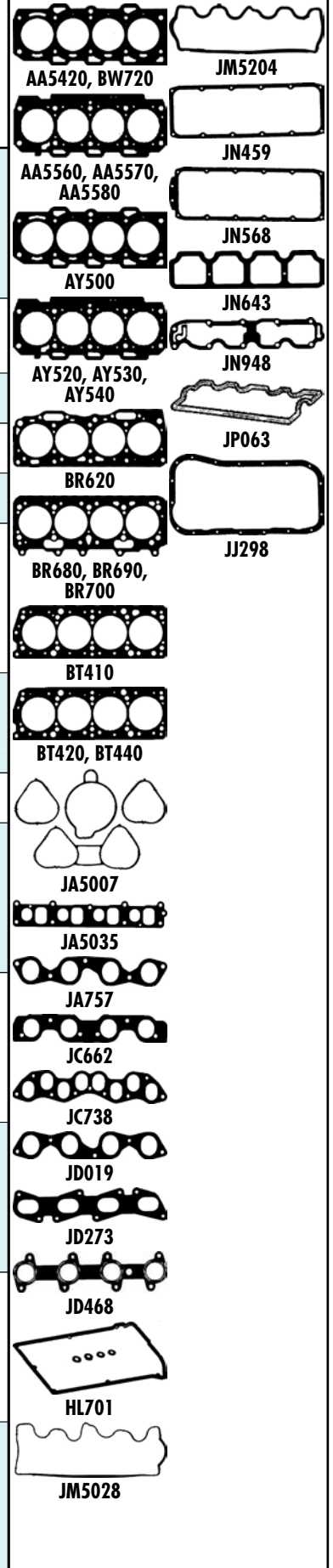



cc



kW/PS

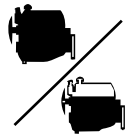

1.9	AR 37101 Diesel	60	AA5560 (MLS), 0.820mm, 0 Holes	CA5560 ▲ [3]	EE5181 [3]
Lybra 1.9 JTD	09/00→05/01	1910 4 82.00 SOHC/OHC	80-85/ 109-116	→Eng.4081111	FA5560 ▲ [3]
2.0	175 A3.000	61	AY320 (MLS), 1.800mm	CY320	FY320
Kappa 2.0 16V	06/98→10/01	1998 5 82.00 DOHC	162/220		
2.0	182 B7.000	62	BW321 (Fibre)	DW322 [3]	
Lybra 2.0 20V	07/99→09/00	1998 5 82.00 DOHC	113/154		
2.0	185 A8.000	63	AA5590 (MLS), 0.490mm	CA5590 [3]	ED5960
Lybra 2.0 20V	09/00→10/05	1998 5 82.00 DOHC	110/150		
2.0	831 C5.046	64	BT420 (Fibre)	DT423 [13]	GT423
Delta I 2.0	12/86→12/92	1995 4 84.00 DOHC	130/177		
2.0	831 E5.000	65	BT440 (Fibre)	DT447	GT447 [3]
Delta I 2.0	06/93→01/94	1995 4 84.00 DOHC	155/211		
2.0	831 E5.046	66	BT440 (Fibre)	DT447	GT447 [3]
Delta I 2.0	06/93→01/94	1995 4 84.00 DOHC	155/211		
2.0	834 B2.000	67	BT440 (Fibre)	DT441	GT441
Thema 2000	05/88→08/92	1995 4 84.00 DOHC	108/147		
2.0	834 C1.000	68	BT440 (Fibre)	DT442	GT442
Thema 2000	12/88→06/90	1995 4 84.00 DOHC	133/181		
2.0	834 F1.000	69	BT440 (Fibre)	DT443	
Thema 2000	05/92→07/94	1995 4 84.00 DOHC	110-112/ 150-152	DT448	
Thema 2000 16V	08/92→12/93				
2.0	834 F2.000	70	BT440 (Fibre)	DT442	
Thema 2000	10/92→07/94	1995 4 84.00 DOHC	148/202		
2.0	835 A5.000	71	BT440 (Fibre)	DT440 [3]	GT440 [3]
Dedra 2.0	09/89→07/92	1995 4 84.00 DOHC	86/117		
2.0	835 A5.046	72	BT440 (Fibre)	DT446	GT446 [16]
Dedra 2.0 i.e.	09/89→07/99	1995 4 84.00 DOHC	82-83/ 112-113		
2.0	835 A7.000	73	BT420 (Fibre)	DT423 [13]	GT423
Dedra 2.0	05/90→07/94	1995 4 84.00 DOHC	121/165		

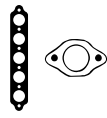



cc



kW/PS

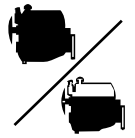

Model	Year Range	Year	Cylinders	Displacement (cc)	Configuration	Power (kW/PS)	Part Number	Accessories
2.0 835 A8.000 74							BT240 (Fibre), 1.950mm, 2 Notches	DT423 [13]
Dedra 2.0	11/90→06/94	1995	4	84.00	DOHC	130-132/ 177-180		
2.0 835 A8.046 75							BT440 (Fibre)	DT440 [3]
Dedra 2.0	04/91→07/99	1995	4	84.00	DOHC	119/162		
2.0 836 A2.000 76							BT440 (Fibre)	DT447
Delta II 2.0	06/93→08/99	1995	4	84.00	DOHC	137/186		
2.0 836 A3.000 77							BT440 (Fibre)	DT443
Dedra 2.0	07/94→07/99	1995	4	84.00	DOHC	102-108/ 139-147		
Dedra 2.0 16V	07/94→07/99							
Delta II 2.0	06/93→08/99							
2.0 838 A1.000 78							BW321 (Fibre)	DW320
Kappa 2.0 20V	10/94→10/01	1998	5	82.00	DOHC	107/146		
2.0 838 A4.000 79							BT440 (Fibre)	DT448
Kappa 2.0 16V	02/95→10/01	1995	4	84.00	DOHC	151/205		
2.0 838 A6.000 80							BW321 (Fibre)	DW322 [3]
Kappa 2.0 16V	07/96→03/01	1998	5	82.00	DOHC	114/155		
Kappa 2.0 20V	07/96→10/01							
2.0 841 E.000 81							AD5960 (MLS)	CD5960
Thesis 2.0 T	07/02→07/09	1998	5	82.00	DOHC	136/185		
2.0 RFN 82							AD5300 (MLS)	
Zeta 2.0 JTD	07/00→09/02	1997	4	85.00	DOHC	100/136		
2.0 RFN (EW10J4) 83							AD5300 (MLS)	
Phedra 2.0	09/02→11/10	1997	4	85.00	DOHC	100/136		
2.0 RFV (XU10J4R) 84							BV140 (Fibre), 1.250mm	
Zeta 2.0 16V	05/98→07/00	1998	4	86.00	DOHC	97/132		
2.0 RHW (DW10ATED4) Diesel 85							AD5490 (MLS), 1.250mm, 2 Notches AD5500 (MLS), 1.300mm, 3 Holes AD5510 (MLS), 1.350mm, 4 Holes AD5520 (MLS), 1.400mm, 5 Holes	
Phedra 2.0 JTD	09/02→11/10	1997	4	85.00	DOHC	80/109		
Zeta 2.0 JTD	09/99→09/02							
2.0 RHZ (DW10ATED) Diesel 86							AC5011 (MLS), 1.300mm, 1 Hole -0.470→0.605mm AC5020 (MLS), 1.350mm, 2 Holes -0.605→0.655mm AC5031 (MLS), 1.400mm, 3 Holes -0.655→0.705mm AC5040 (MLS), 1.450mm, 4 Holes -0.705→0.755mm AC5051 (MLS), 1.500mm, 5 Holes -0.755→0.830mm	CC5010 ▲ [3]
Zeta 2.0 JTD	04/00→09/02	1997	4	85.00	SOHC/OHC	80/109		

HBS092 [5] M10x1.25x115.00mm (x10)	JC662 [1] JD019 [1]	JN643 [4]	JH111		NA5187 [2] 30.00x52.00x7.00mm, ACM NB742 [2] 30.00x43.00x8.00mm, ACM NB732 [1] 74.00x90.00x10.00mm, FPM			AC5020, AC5040 AD5490, AD5500, AD5510, AD5520 AD5960 BT240 BT440 BV140 JC662 JD019 JD151 JD152 JD153 JD225 JD226 JD536 JM5018 JN643 JN928 JH111 JJ413 	
HBS092 [5] M10x1.25x115.00mm (x10)			JH111						
HBS093 [5] M10x1.25x172.00mm (x10)	JD151 JD152 [1]	JN928 [4]	JJ413	HR599 [1]	NA5053 [2] 30.00x42.00x7.00mm, FPM				
HBS093 [5] M10x1.25x172.00mm (x10)	JD153 [1] JD151 JD5997 [1]	JN928 [4]	JJ413	HR599 [1]	NA5053 [2] 30.00x42.00x7.00mm, FPM NB742 [2] 30.00x43.00x8.00mm, ACM NB732 [1] 74.00x90.00x10.00mm, FPM				
HBS133 [5] M10x1.25x254.00mm (x12)	JD225 [1] JD226 [1]				NA5053 [2] 30.00x42.00x7.00mm, FPM NA5069 [2] 55.00x68.00x8.00mm, FPM NA5070 [2] 31.00x41.00x7.00mm, FPM				
HBS093 [5] M10x1.25x172.00mm (x10)	JD153 [1] JD151 JD5997 [1]	JN928 [4]	JJ413		NA5053 [2] 30.00x42.00x7.00mm, FPM NB742 [2] 30.00x43.00x8.00mm, ACM NA5062 [1] 74.00x90.00x10.00mm, ACM NB732 [1] 74.00x90.00x10.00mm, FPM	HJ283 [8] [1]			
HBS133 [5] M10x1.25x254.00mm (x12)	JD226 [1]	JM5018 (Elastomer)		HR800 [1]	NA5053 [2] 30.00x42.00x7.00mm, FPM NA5070 [2] 31.00x41.00x7.00mm, FPM NF888 [1] 93.00x172.00x12.00mm, FPM	HJ283 [8] [1]			
HBS133 [5] M10x1.25x254.00mm (x12)					NA5053 [2] 30.00x42.00x7.00mm, FPM NA5070 [2] 31.00x41.00x7.00mm, FPM				
HBS259 [22] M11x1.50x144.50mm (x10)					NA5256 [2] 40.00x55.00x6.50mm, FPM				
HBS259 [22] M11x1.50x144.50mm (x10)					NA5256 [2] 40.00x55.00x6.50mm, FPM				
HBS087 [22] M12x1.50x110.00mm (x10)	JD536 [1]	JM7121 [1] (Elastomer)							
HBS261 [22] M12x1.50x126.00mm (x10)		JM5141 (Elastomer)			NA5035 [2] 27.00x47.00x7.00mm, FPM NA5191 [2] 42.00x62.00x7.00mm, PTFE				
HBS261 [22] M12x1.50x126.00mm (x10)	JD5191 [1] JD5190 [1]				NA5035 [2] 27.00x47.00x7.00mm, FPM				



cc



kW/PS



2.1	P 8 C Diesel					87			
Zeta 2.1 TD	05/96→09/99	2088	4	85.00	SOHC/OHC	80/109	BY941 (MLS), 1.520mm →0.650→0.760mm BY950 (MLS), 1.570mm →0.770→0.810mm BY961 (MLS), 1.620mm →0.820→0.860mm BY970 (MLS), 1.670mm BY981 (MLS), 1.720mm →0.920→0.960mm	DV150 ▲[3]	EV150 [3]
2.2	4HW(DW12ATED4) Diesel					88			
Phedra 2.2 JTD	09/02→11/10	2179	4	85.00	DOHC	94/128	AD5490 (MLS), 1.250mm, 2 Notches AD5500 (MLS), 1.300mm, 3 Holes AD5510 (MLS), 1.350mm, 4 Holes AD5520 (MLS), 1.400mm, 5 Holes	CD5490 ▲	ED5490
2.4	838 A2.000					89			
Kappa 2.4 20V	08/94→10/01	2446	5	83.00	DOHC	129/175	BW330 (Fibre)		ED5960
2.4	838 A2.027					90			
Kappa 2.4 20V	08/94→10/01	2446	5	83.00	DOHC	129/175	BW330 (Fibre)		ED5960
2.4	838 A3.000 Diesel					91			
Kappa 2.4 T.DS	08/94→10/01	2387	5	82.00	SOHC/OHC	91/124	BW340 (Fibre), 1.600mm →Eng.0345336 BW350 (Fibre), 1.700mm, 1 Notch →Eng.0345336 BW360 (Fibre), 1.800mm, 2 Notches →Eng.0345336 AA5720 (MLS), 1.600mm Eng.0345337→ AA5730 (MLS), 1.700mm, 1 Notch Eng.0345337→ AA5740 (MLS), 1.800mm, 2 Notches Eng.0345337→	DW340 ▲[3]	GW341 ▲[3]
2.4	838 A7.000 Diesel					92			
Kappa 2.4 T.DS	08/94→10/01	2387	5	82.00	SOHC/OHC	91/124	BW340 (Fibre), 1.600mm →Eng.0345336 BW350 (Fibre), 1.700mm, 1 Notch →Eng.0345336 BW360 (Fibre), 1.800mm, 2 Notches →Eng.0345336 AA5720 (MLS), 1.600mm Eng.0345337→ AA5730 (MLS), 1.700mm, 1 Notch Eng.0345337→ AA5740 (MLS), 1.800mm, 2 Notches Eng.0345337→	DW340 ▲[3]	GW341 ▲[3]
2.4	838 A8.000 Diesel					93			
Kappa 2.4 JTD	06/98→10/01	2387	5	82.00	SOHC/OHC	100/136	AY550 (MLS), 1.600mm AY560 (MLS), 1.700mm, 1 Hole AY570 (MLS), 1.800mm, 2 Holes	CY520 ▲[3]	FY520 ▲[3]
2.4	839 A5.000 Diesel					94			
Lybra 2.4 JTD	07/99→02/01	2387	5	82.00		96-99/ 131-135	AY550 (MLS), 1.600mm AY560 (MLS), 1.700mm, 1 Hole AY570 (MLS), 1.800mm, 2 Holes	CY520 ▲[3]	FY520 ▲[3]

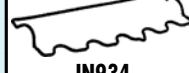
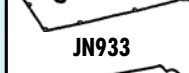
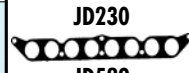
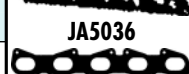
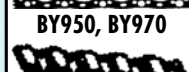
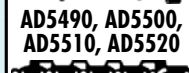
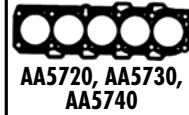

HBS125 [22]
M12x1.50x150.50mm (x10)

JD529 [1]
JD230 [1]

NF841 [1][2]
35.00x50.00x8.00mm, FPM
NA5191 [2]
42.00x62.00x7.00mm, PTFE

AA5720, AA5730, AA5740

AD5490, AD5500, AD5510, AD5520

AY550, AY560, AY570

BW330

BW340, BW350, BW360

HBS261 [22]
M12x1.50x126.00mm (x10)

JM5141
(Elastomer)

NA5035 [2]
27.00x47.00x7.00mm, FPM
NA5191 [2]
42.00x62.00x7.00mm, PTFE

BY950, BY970

HBS133 [5]
M10x1.25x254.00mm (x12)

JD226 [1]

JN933 [4]

HR800 [1]

NA5053 [2]
30.00x42.00x7.00mm, FPM
NA5070 [2]
31.00x41.00x7.00mm, FPM
NF888 [1]
93.00x172.00x12.00mm, FPM

KL477 [10]
KA845 [15]

JA5036

HBS133 [5]
M10x1.25x254.00mm (x12)

JD226 [1]

JN933 [4]

HR800 [1]

NA5053 [2]
30.00x42.00x7.00mm, FPM
NA5070 [2]
31.00x41.00x7.00mm, FPM
NF888 [1]
93.00x172.00x12.00mm, FPM

JD226

JD228

JD230

HBS257 [5]
M12x1.25x218.00mm (x12)

JD228 [1]

JN934 [4]

HR363 [1]

NA5053 [2]
30.00x42.00x7.00mm, FPM
NA5070 [2]
31.00x41.00x7.00mm, FPM
NF888 [1]
93.00x172.00x12.00mm, FPM

JD529

JN933

HBS257 [5]
M12x1.25x218.00mm (x12)

JD228 [1]

JN934 [4]

HR363 [1]

NA5053 [2]
30.00x42.00x7.00mm, FPM
NA5070 [2]
31.00x41.00x7.00mm, FPM
NF888 [1]
93.00x172.00x12.00mm, FPM

HBS257 [5]
M12x1.25x218.00mm (x12)

JA5036 [1]
JD228 [1]

NA5053 [2]
30.00x42.00x7.00mm, FPM
NA5070 [2]
31.00x41.00x7.00mm, FPM
NF888 [1]
93.00x172.00x12.00mm, FPM

HBS257 [5]
M12x1.25x218.00mm (x12)

JA5036 [1]
JD228 [1]

NA5053 [2]
30.00x42.00x7.00mm, FPM
NA5070 [2]
31.00x41.00x7.00mm, FPM
NF888 [1]
93.00x172.00x12.00mm, FPM



cc



kW/PS



2.4	839 A6.000	Diesel					95	AA5780 (MLS), 0.820mm AA5790 (MLS), 0.920mm AA5800 (MLS), 1.020mm	CA5780 ▲ [3]	EA5780
Lybra 2.4 JTD	09/00→10/05	2387	5	82.00	SOHC/OHC		103/140			
2.4	841 C.000	Diesel					96	AA5780 (MLS), 0.820mm AA5790 (MLS), 0.920mm AA5800 (MLS), 1.020mm	CA5780 ▲ [3]	EA5780
Lybra 2.4 JTD	05/02→10/05	2387	5	82.00	SOHC/OHC		110/150			
Thesis 2.4 JTD	07/02→07/09									
2.4	841 D.000						97	AD5960 (MLS)		
Thesis 2.4	07/02→07/09	2446	5	83.00	DOHC		125/170			
2.4	841 G.000	Diesel					98	AD5190 (Fibre) AD5920 (MLS), 0.920mm AD5930 (MLS), 1.020mm	CD5910	ED5910 [3]
Thesis 2.4 JTD	05/03→07/09	2387	5	82.00	DOHC		129/175			
2.4	841 M.000	Diesel					99	AD5190 (Fibre) AD5920 (MLS), 0.920mm AD5930 (MLS), 1.020mm	CD5910	ED5910 [3]
Thesis 2.4 JTD	09/03→07/09	2387	5	82.00	DOHC		120-147/ 163-200			
2.4	841 N.000	Diesel					100	AD5190 (Fibre) AD5920 (MLS), 0.920mm AD5930 (MLS), 1.020mm	CD5910	ED5910 [3]
Thesis 2.4 JTD	09/03→07/09	2387	5	82.00	DOHC		120/163			
2.4	841 P.000	Diesel					101	AG7410 (MLS), 0.820mm, 0 Holes AG7420 (MLS), 0.920mm, 1 Hole AG7430 (MLS), 1.020mm, 2 Holes		
Thesis 2.4D Mtj	04/06→07/09	2387	5	82.00	DOHC		136/185			
2.4	8144.91	Diesel					102	BR090 (Fibre), 1.800mm	DP273 ▲	FB5722 ▲
Thema 2500 T	11/84→09/90	2445	4	93.00	SOHC/OHC		74/101			
2.4	AR 32501	Diesel					103	AY550 (MLS), 1.600mm AY560 (MLS), 1.700mm, 1 Hole AY570 (MLS), 1.800mm, 2 Holes	CY520 ▲ [3]	FY520 ▲ [3]
Lybra 2.4 JTD	07/99→02/01	2387	5	82.00	SOHC/OHC		99-100/ 135-136			
2.5	8144.97S	Diesel					104	AY290 (Fibre), 1.600mm AY300 (Fibre), 1.700mm AY310 (Fibre), 1.800mm	DP273 ▲	
Thema 2000	05/88→07/92	2500	4	93.00			77/105			
Thema 2500 T	05/88→07/92									
2.5	8144.97	Diesel					105	AY290 (Fibre), 1.600mm AY300 (Fibre), 1.700mm AY310 (Fibre), 1.800mm	DP273 ▲ DT752 ▲ [3]	
Thema 2500 T	06/88→05/92	2499	4	93.00	SOHC/OHC		85/115			
2.5	8144.97 Y	Diesel					106	AY290 (Fibre), 1.600mm AY300 (Fibre), 1.700mm AY310 (Fibre), 1.800mm		
Thema 2500 T	05/92→07/94	2500	4	93.00	SOHC/OHC		85/115			



HBS257 [5] M12x1.25x218.00mm (x12)	JA5036 [1] JD228 [1]	JM5029 (Elastomer)		HR363 [1]	NA5053 [2] 30.00x42.00x7.00mm, FPM NA5070 [2] 31.00x41.00x7.00mm, FPM NF888 [1] 93.00x172.00x12.00mm, FPM	KL477 [10] KA845 [15]
HBS257 [5] M12x1.25x218.00mm (x12)	JA5036 [1] JD228 [1]	JM5029 (Elastomer)		HR363 [1]	NA5053 [2] 30.00x42.00x7.00mm, FPM NA5070 [2] 31.00x41.00x7.00mm, FPM NF888 [1] 93.00x172.00x12.00mm, FPM	KL477 [10] KA845 [15]
HBS133 [5] M10x1.25x254.00mm (x12)					NA5053 [2] 30.00x42.00x7.00mm, FPM NA5070 [2] 31.00x41.00x7.00mm, FPM	
HBS371 [5] M12x1.25x225.00mm (x12)		JM7117 (Steel)			NA5070 [2] 31.00x41.00x7.00mm, FPM	
HBS371 [5] M12x1.25x225.00mm (x12)		JM7117 (Steel)				
HBS371 [5] M12x1.25x225.00mm (x12)		JM7117 (Steel)				
		JM7117 (Steel)			NA5070 [2] 31.00x41.00x7.00mm, FPM	
HBS011 [5] M12x1.25x119.00mm (x12)	JC054 [1] JC055 [1]	JN585 [4]		HR602 [1]	NF841 [1][2] 35.00x50.00x8.00mm, FPM NP068 [2] 55.00x70.00x8.00mm, FPM NP068 [2] 55.00x70.00x8.00mm, FPM NF853 [1] 100.00x118.00x10.00mm, FPM	
HBS257 [5] M12x1.25x218.00mm (x12)	JA5036 [1] JD228 [1]				NA5053 [2] 30.00x42.00x7.00mm, FPM NA5070 [2] 31.00x41.00x7.00mm, FPM	
HBS011 [5] M12x1.25x119.00mm (x12)	JC055 [1]	JN585 [4]			NF841 [1][2] 35.00x50.00x8.00mm, FPM NP068 [2] 55.00x70.00x8.00mm, FPM NP068 [2] 55.00x70.00x8.00mm, FPM NF853 [1] 100.00x118.00x10.00mm, FPM	
HBS011 [5] M12x1.25x119.00mm (x12)	JC054 [1]	JN585 [4]			NF841 [1][2] 35.00x50.00x8.00mm, FPM NP068 [2] 55.00x70.00x8.00mm, FPM NF853 [1] 100.00x118.00x10.00mm, FPM	
HBS011 [5] M12x1.25x119.00mm (x12)	JC054 [1] JC055 [1]	JN969 [4]	JJ549		NP068 [2] 55.00x70.00x8.00mm, FPM NP068 [2] 55.00x70.00x8.00mm, FPM NF853 [1] 100.00x118.00x10.00mm, FPM	

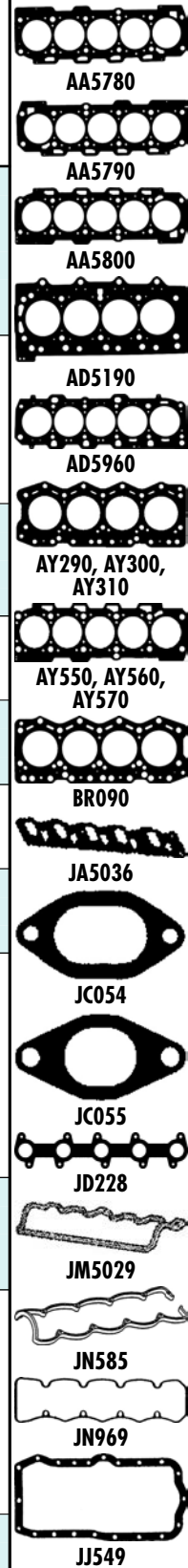

LANCIA



cc



kW/PS

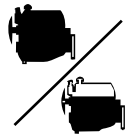

3.0

841 A.000

107

BT380 (Fibre), 1.650mm

CY640 [3]

FY640

Thesis 3.0

07/02→07/09

2959









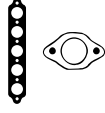

6

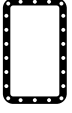
93.00

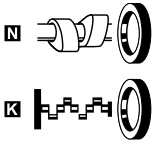
DOHC, V6

158/215

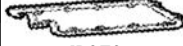
AY640 (Fibre), 1.650mm

							 AY640  BT380  JP070  JP071
HBS272 [22] M10x1.50x147.00mm (x16)		JP071 [4] JP070 [4]		HR662 [4]			



Ltr



CC



9

	Ltr				CC		
DEFENDER Cabrio (LD)	2.4	05/00→	244DT	Diesel	2402	4	3
DEFENDER Cabrio (LD)	2.5	06/99→	10 P	Diesel	2495	5	4
DEFENDER Cabrio (LD)	2.5	09/99→	11 L	Diesel	2495	4	5
DEFENDER Cabrio (LD)	2.5	06/99→	14 P	Diesel	2495	5	8
DEFENDER Cabrio (LD)	2.5	09/99→	16 L	Diesel	2495	4	9
DEFENDER Cabrio (LD)	2.5	09/99→	23 L	Diesel	2495	4	14
DEFENDER Pickup (LD_)	2.4	05/00→	244DT	Diesel	2402	4	3
DEFENDER Pickup (LD_)	2.5	06/99→	10 P	Diesel	2495	5	4
DEFENDER Station Wagon (LD)	2.4	05/00→	244DT	Diesel	2402	4	3
DEFENDER Station Wagon (LD)	2.5	06/99→	10 P	Diesel	2495	5	4
DEFENDER Station Wagon (LD)	2.5	09/99→12/99	11 L	Diesel	2495	4	5
DEFENDER Station Wagon (LD)	2.5	06/99→	14 P	Diesel	2495	5	8
DEFENDER Station Wagon (LD)	2.5	09/99→12/99	16 L	Diesel	2495	4	9
DEFENDER Station Wagon (LD)	2.5	09/99→12/99	23 L	Diesel	2495	4	14
DISCOVERY I (LJ, LG)	2.5	10/98→10/99	12 L	Diesel	2496	4	6
DISCOVERY I (LJ, LG)	2.5	10/98→10/99	17 L	Diesel	2495	4	10
DISCOVERY I (LJ, LG)	2.5	10/98→10/99	19 L	Diesel	2496	4	11
DISCOVERY I (LJ, LG)	2.5	10/98→10/99	21 L	Diesel	2495	4	12
DISCOVERY I (LJ, LG)	2.5	07/99→10/99	22 L	Diesel	2495	4	13
DISCOVERY II (LJ, LI)	2.5	01/99→06/00	10 P	Diesel	2495	5	4
DISCOVERY III (TAA)	2.7	07/00→09/00	276DT	Diesel	2720	6	17
DISCOVERY III (TAA)	4.4	07/00→09/00	448PN	Petrol	4394	8	23
DISCOVERY IV (LA)	2.7	09/00→	276DT	Diesel	2720	6	17
DISCOVERY IV (LA)	3.0	09/00→	306DT	Diesel	2993	6	19
DISCOVERY IV (LA)	3.0	09/00→	30DDTX	Diesel	2993	6	18
FREELANDER (LN)	2.5	11/00→10/00	25 K4F	Petrol	2497	6	16
FREELANDER 2 (FA_)	2.2	10/00→	224DT	Diesel	2179	4	1
FREELANDER 2 (FA_)	2.2	10/00→	DW12BTED4	Diesel	2179	4	2
RANGE ROVER EVOQUE (LV)	2.2	06/01→	224DT	Diesel	2179	4	1
RANGE ROVER I (AE, AN, HAA, HAB, HAM, HBM, RE, RN)	2.5	09/99→04/99	14 L	Diesel	2495	4	7
RANGE ROVER I (AE, AN, HAA, HAB, HAM, HBM, RE, RN)	3.9	11/98→07/99	37 D	Petrol	3950	8	21
RANGE ROVER I (AE, AN, HAA, HAB, HAM, HBM, RE, RN)	3.9	11/98→07/99	38 D	Petrol	3950	8	22
RANGE ROVER II (LP)	2.5	08/99→03/00	14 L	Diesel	2495	4	7
RANGE ROVER II (LP)	2.5	07/99→03/00	25 6T (BMW)	Diesel	2497	6	15
RANGE ROVER II (LP)	3.9	07/99→03/00	42 D	Petrol	3947	8	20
RANGE ROVER III (LM)	4.4	05/00→08/01	448PN	Petrol	4394	8	23
RANGE ROVER IV (LG)	3.0	08/01→	306DT	Diesel	2993	6	19
RANGE ROVER SPORT (LS)	2.7	02/00→	276DT	Diesel	2720	6	17
RANGE ROVER SPORT (LS)	3.0	08/01→	306DT	Diesel	2993	6	19
RANGE ROVER SPORT (LS)	3.0	09/00→	30DDTX	Diesel	2993	6	18
RANGE ROVER SPORT (LS)	4.4	02/00→	448PN	Petrol	4394	8	23
RANGE ROVER SPORT (LW)	3.0	04/01→	30DDTX	Diesel	2993	6	18

LAND ROVER



cc



kW/PS



2.2		224DT Diesel					1			
Evoque 2.2 SD4	06/11→	2179	4	85.00	DOHC	110-140/150-190				
Evoque 2.2 TD4	06/11→									
Freelander 2	10/06→									
2.2		DW12BTED4 Diesel					2			
Freelander 2	10/06→	2179	4	85.00	DOHC	110/150				
2.4		244DT Diesel					3	AA5940 (MLS), 1.100mm, 1 Hole		
Defender 2.4	05/07→	2402	4	89.90	DOHC	90/122		AA5950 (MLS), 1.150mm, 2 Holes		
								AA5960 (MLS), 1.200mm, 3 Holes		
2.5		10 P Diesel					4			
Defender 2.5	06/98→	2495	5	84.50	SOHC/OHC	90-102/122-139				
Discovery II 2.5	01/99→06/04									
2.5		11 L Diesel					5	BY470 (Fibre), 1.300mm, 1 Hole	DV720 ▲ ^[13]	EV720 ^[3]
Defender 2.5	09/90→12/98	2495	4	90.48		79-83/107-113	BY480 (Fibre), 1.400mm, 2 Holes	DY470 ▲ ^[13]	EY470	
							BY490 (Fibre), 1.500mm, 3 Holes			
							BY500 (Fibre), 1.600mm			
2.5		12 L Diesel					6	BY470 (Fibre), 1.300mm, 1 Hole	DV720 ▲ ^[13]	EV720 ^[3]
Discovery I 2.5	10/89→10/98	2496	4	90.50		83/113	BY480 (Fibre), 1.400mm, 2 Holes	DY470 ▲ ^[13]	EY470	
							BY490 (Fibre), 1.500mm, 3 Holes			
							BY500 (Fibre), 1.600mm			
2.5		14 L Diesel					7			EV720 ^[3]
Range Rover I	09/91→04/94	2495	4	90.50	OHV	83/113			EY470	
Range Rover II	08/94→03/02									
2.5		14 P Diesel					8	AB5900 (MLS), 1.200mm, 2 Holes		
Defender 2.5	06/98→	2495	5	84.50	SOHC/OHC	90/122	AB5910 (MLS), 1.270mm, 1 Hole			
							AB5920 (MLS), 1.350mm, 3 Holes			
2.5		16 L Diesel					9	BY470 (Fibre), 1.300mm, 1 Hole	DV720 ▲ ^[13]	EV720 ^[3]
Defender 2.5	09/90→12/98	2495	4	90.48		83/113	BY480 (Fibre), 1.400mm, 2 Holes	DY470 ▲ ^[13]	EY470	
							BY490 (Fibre), 1.500mm, 3 Holes			
							BY500 (Fibre), 1.600mm			
2.5		17 L Diesel					10	BY470 (Fibre), 1.300mm, 1 Hole	DV720 ▲ ^[13]	EV720 ^[3]
Discovery I 2.5	10/89→10/98	2495	4	90.48		83/113	BY480 (Fibre), 1.400mm, 2 Holes		EY470	
							BY490 (Fibre), 1.500mm, 3 Holes			
							BY500 (Fibre), 1.600mm			
2.5		19 L Diesel					11	BY470 (Fibre), 1.300mm, 1 Hole	DV720 ▲ ^[13]	EV720 ^[3]
Discovery I 2.5	10/89→10/98	2496	4	90.50	OHV	83-90/113-122	BY480 (Fibre), 1.400mm, 2 Holes		EY470	
							BY490 (Fibre), 1.500mm, 3 Holes			
							BY500 (Fibre), 1.600mm			
2.5		21 L Diesel					12	BY480 (Fibre), 1.400mm, 2 Holes	DV720 ▲ ^[13]	EV720 ^[3]
Discovery I 2.5	10/89→10/98	2495	4	90.50	OHV	83/113	BY490 (Fibre), 1.500mm, 3 Holes		EY470	
							BY500 (Fibre), 1.600mm			

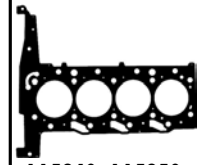
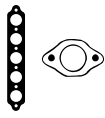

AA5940, AA5950,
AA5960

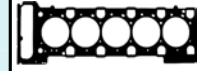

AB5900, AB5910,
AB5920



BY470, BY480,
BY490, BY500



JC886



JD471



JM5034



JM5037

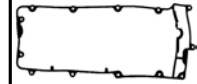

JM5074



JN872



JP020

LAND ROVER



cc



kw/PS



2.5	22 L Diesel					13			
Discovery I 2.5	07/94→10/98	2495	4	90.48		83-92/ 113-125	BY470 (Fibre), 1.300mm, 1 Hole BY480 (Fibre), 1.400mm, 2 Holes BY490 (Fibre), 1.500mm, 3 Holes BY500 (Fibre), 1.600mm	DY470 ▲ [13]	EY470
2.5	23 L Diesel					14			
Defender 2.5	09/90→12/98	2495	4	90.48		83-86/ 113-117	BY470 (Fibre), 1.300mm, 1 Hole BY480 (Fibre), 1.400mm, 2 Holes BY490 (Fibre), 1.500mm, 3 Holes BY500 (Fibre), 1.600mm	DY470 ▲ [13]	EV720 [3] EY470
2.5	25 6T (BMW) Diesel					15			
Range Rover II	07/94→03/02	2497	6		SOHC/OHC	100/136	BZ111 (Fibre), 1.680mm, 2 Holes		
2.5	25 K4F					16			
Freelander 2.5	11/00→10/06	2497	6	80.00	DOHC, V	129-130/ 175-177	AA5920 (MLS) (x2) KM5002 (Metal)	CA5920 [3]	EA5920
2.7	276DT Diesel					17			
Discovery III	07/04→09/09	2720	6	81.00	V	140/190		CH5730	
Discovery IV	09/09→								
Range Rover Sp	02/05→								
3.0	30DDTX Diesel					18			
Discovery IV	09/09→	2993	6	84.00	DOHC, V	155-200/ 211-272			
Range Rover Sp	09/09→								
3.0	306DT Diesel					19			
Discovery IV	09/09→	2993	6	84.00	V	180-190/ 245-258			
Range Rover 4	08/12→								
Range Rover Sp	08/12→								
3.9	42 D					20			
Range Rover II	07/94→03/02	3947	8		V	140/190	AY200 (Fibre)	CY200 [13]	EY200 [3]
4.0	37 D					21			
Range Rover I	11/88→07/94	3950	8	94.00	OHV, V	127/173	AB5490 (Fibre)	DR290 [13]	EG914 [3]
4.0	38 D					22			
Range Rover I	11/88→07/94	3950	8	94.00	OHV, V	127/173	BR290 (Steel)	DR290 [13]	EG914 [3]
4.4	448PN					23			
Discovery III	07/04→09/09	4394	8	88.00	DOHC, V	220-225/ 299-306	AD5610 (MLS), 2 Notches ☒ AD5600 (MLS), 2 Notches ☒		
Range Rover 3	05/05→08/12								
Range Rover Sp	02/05→								

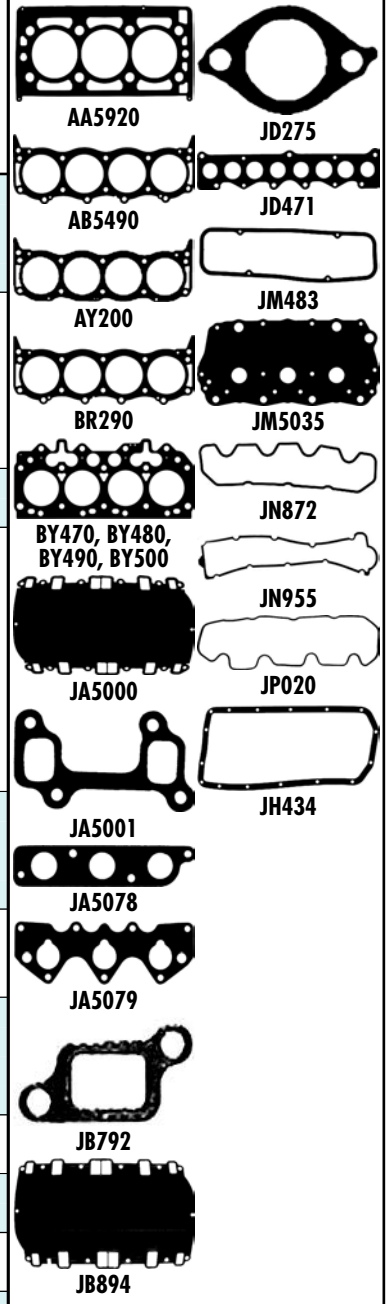



Ltr



CC



9

	Ltr				CC		
200 Box	1.9	10/99→03/99	XUD9	Diesel	1905	4	2
200 Pickup	1.9	10/99→03/99	XUD9	Diesel	1905	4	2
400 Box	2.5	04/98→03/99	EN 55	Diesel	2498	4	5
400 Box	2.5	04/98→03/99	ET 70	Diesel	2498	4	6
400 Bus	2.5	04/98→03/99	EN 55	Diesel	2498	4	5
400 Bus	2.5	11/99→10/99	ET 70	Diesel	2498	4	6
400 Platform/Chassis	2.5	04/98→10/99	EN 55	Diesel	2498	4	5
400 Platform/Chassis	2.5	11/99→10/99	ET 70	Diesel	2498	4	6
CONVOY Box	2.5	04/99→04/00	EN 55	Diesel	2498	4	5
CONVOY Box	2.5	10/99→04/00	ET 70	Diesel	2496	4	6
CONVOY Box	2.5	04/99→09/99	ET 70	Diesel	2498	4	6
CONVOY Bus	2.5	10/99→04/00	4EB	Diesel	2496	4	3
CONVOY Bus	2.5	10/99→04/00	4HB	Diesel	2496	4	4
CONVOY Bus	2.5	04/99→02/00	EN 55	Diesel	2498	4	5
CONVOY Bus	2.5	04/99→02/00	ET 70	Diesel	2498	4	6
CONVOY Platform/Chassis	2.5	04/99→04/00	EN 55	Diesel	2498	4	5
CONVOY Platform/Chassis	2.5	10/99→04/00	ET 70	Diesel	2496	4	6
CONVOY Platform/Chassis	2.5	04/99→09/99	ET 70	Diesel	2498	4	6
SHERPA Bus (FR)	1.6	01/98→09/98	G16A		1598	4	1



cc



kW/PS



1.6		G16A					1			
Sherpa 1.6	01/83→09/88	1598	4	75.00	SOHC/OHC	48/65			EG5260	
1.9		XUD9 Diesel					2			
200 1.9 D	10/94→03/96	1905	4	83.00	SOHC/OHC	47/64				
2.5		4EB Diesel					3			
Convoy 2.5 D	10/97→04/09	2496	4	93.70	SOHC/OHC	74/101				
2.5		4HB Diesel					4			
Convoy 2.5 D	10/97→04/09	2496	4	93.67	OHV	56/76				
2.5		EN 55 Diesel					5	BT800 (Fibre)	DT802 DT806	ET800
400 2.5 D	04/89→10/96	2498	4	94.00	SOHC/OHC	56/76				
Convoy 2.5 D	04/96→02/02									
Convoy 2.5 DI	10/98→04/09									
Convoy 26.414	10/98→04/09									
2.5		ET 70 Diesel					6			
Convoy 2.5 TDI	10/98→04/09	2498	4	94.00	SOHC/OHC	71/97				
400 2.5 D	04/89→03/96									
400 2.5 TD	11/95→10/96									
C 2.5 TD	11/95→10/98									
Convoy 2.5 D	04/96→02/02									

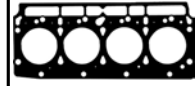

BT800



JD064



JD065



JD066



JM5027



JN821



JJ484

					<input checked="" type="checkbox"/> NF841 [1][2] 35.00x50.00x8.00mm, FPM		
					<input checked="" type="checkbox"/> NB856 [2] 47.62x66.50x11.00mm, PTFE		
					<input checked="" type="checkbox"/> NB856 [2] 47.62x66.50x11.00mm, PTFE		
HBS008 [19] M12x1.75x92.00mm (x18)	JD064 <input checked="" type="checkbox"/> JD066 <input checked="" type="checkbox"/>	JM5027 (SE) JN821 [87] (Cork)	JJ484	HR5064 <input checked="" type="checkbox"/>	<input checked="" type="checkbox"/> NB856 [2] 47.62x66.50x11.00mm, PTFE <input checked="" type="checkbox"/> NF780 <input checked="" type="checkbox"/> [2] 45.00x60.00x7.00mm, ACM <input checked="" type="checkbox"/> NB854 <input checked="" type="checkbox"/> [1] 79.00x99.00x9.50mm, PTFE <input checked="" type="checkbox"/> NB855 <input checked="" type="checkbox"/> [2] 67.00x86.00x9.50mm, PTFE		
HBS008 [19] M12x1.75x92.00mm (x18)	JD065 <input checked="" type="checkbox"/> JD066 <input checked="" type="checkbox"/>	JM5027 (SE) JN821 [87] (Cork)	JJ484	HR5064 <input checked="" type="checkbox"/>	<input checked="" type="checkbox"/> NB856 [2] 47.62x66.50x11.00mm, PTFE <input checked="" type="checkbox"/> NF780 <input checked="" type="checkbox"/> [2] 45.00x60.00x7.00mm, ACM <input checked="" type="checkbox"/> NB854 <input checked="" type="checkbox"/> [1] 79.00x99.00x9.50mm, PTFE <input checked="" type="checkbox"/> NB855 <input checked="" type="checkbox"/> [2] 67.00x86.00x9.50mm, PTFE		



Ltr



CC



9

	Ltr				CC		
ES (F1, F2)	3.0	09/99→12/99	3VZ-FE	Petrol	2959	6	6
ES (MCV_, VZV_)	3.0	10/99→06/00	1MZ-FE	Petrol	2995	6	4
GS (GRL_, GWL1_)	2.5	01/01→	4GR-FSE	Petrol	2499	6	3
GS (JZS147)	3.0	03/99→08/99	2JZ-GE	Petrol	2997	6	5
GS (UZS161, JZS160)	3.0	08/99→03/00	2JZ-GE	Petrol	2997	6	5
GS (UZS161, JZS160)	4.0	12/99→11/00	1UZ-FE	Petrol	3969	8	7
IS C (GSE2_)	2.5	04/00→	4GR-FSE	Petrol	2499	6	3
IS I (JCE1_, GXE1_)	2.0	04/99→07/00	1G-FE	Petrol	1988	6	1
IS I (JCE1_, GXE1_)	3.0	09/00→07/00	2JZ-GE	Petrol	2997	6	5
IS II (GSE2_, ALE2_, USE2_)	2.2	10/00→	2AD-FHV	Diesel	2231	4	2
IS II (GSE2_, ALE2_, USE2_)	2.5	10/00→	4GR-FSE	Petrol	2499	6	3
IS III (GSE3_, AVE3_)	2.5	04/01→	4GR-FSE	Petrol	2499	6	3
IS SportCross	2.0	10/00→10/00	1G-FE	Petrol	1988	6	1
IS SportCross	3.0	10/00→10/00	2JZ-GE	Petrol	2997	6	5
LS (UCF10)	4.0	12/98→12/99	1UZ-FE	Petrol	3969	8	7
LS (UCF20)	4.0	12/99→10/00	1UZ-FE	Petrol	3969	8	7
RX (MCU15)	3.0	07/00→05/00	1MZ-FE	Petrol	2995	6	4
RX (MHU3_, GSU3_, MCU3_)	3.0	05/00→12/00	1MZ-FE	Petrol	2995	6	4



cc



kW/PS



2.0		1G-FE					1	AG9990 (MLS)	
IS I 200	04/99→07/05	1988	6	75.00	DOHC	114/155			
IS SportX 200	10/02→10/05								
2.2		2AD-FHV Diesel					2		
IS II 220d	10/05→	2231	4	86.00	DOHC	130/177			
2.5		4GR-FSE					3	AH6710 (MLS) [102] AH6700 (MLS) [102]	
GS 250	01/12→	2499	6	83.00	DOHC, V	150-158/ 204-215			
IS C 250	04/09→								
IS II 250	10/05→								
IS II 250 AWD	10/05→								
IS III 250	04/13→								
3.0		1MZ-FE					4	BZ350 (Fibre), 1.300mm [102] BZ340 (Fibre), 1.300mm [102] AG9280 (MLS) [102] 01/98→06/00 AG9270 (MLS) [102] 01/98→06/00 AG9100 (MLS) [102] 07/00→ AG9090 (MLS) [102] 07/00→	
ES 3.0	10/96→06/08	2995	6	87.50	DOHC, V	135-164/ 184-223	DZ350 [103] →01/97	EG9270 01/98→	
RX 300	07/00→12/08						CD9270		
RX 300 AWD	10/00→05/03						01/98→06/00		
3.0		2JZ-GE					5	AG5100 (MLS), 0.300mm	
GS 300	03/93→03/05	2997	6	86.00	DOHC	156-163/ 212-222		FG5100	
GS 300 T3	08/97→10/00								
IS I 300	09/01→07/05								
IS SportX 300	10/01→10/05								
3.0		3VZ-FE					6	BS300 (Graphite) [102] BS290 (Graphite) [102]	
ES 300	09/91→12/97	2959	6	87.50	DOHC, V	138/188	DS292 [3]		
4.0		1UZ-FE					7	AF5031 (MLS) [102] AG7640 (Graphite) [102] AF5030 (MLS) [102] AG7630 (Graphite) [102]	
GS 400	12/97→11/00	3969	8	87.50	DOHC, V	180-216/ 245-294	CF5030	FF5030	
LS 400	12/89→10/00								



BS290



BS300

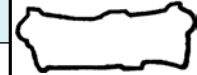

JN792

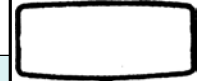

JN936

			HR397			
HBS531 [21][22]	JD6004 (Steel) JD5988 (MLS)	JM7106 (ACM)	HR397	PA6055 (FPM)	NA5319 [2] 48x63.0x6.5mm, FPM	
			HR397			
		JN936 [4] HM5242 (NBR)	HR397		NJ347 [2] 38.00x50.00x8.00mm, NBR	
HBS450 [5] M11x1.25x91.00mm (x14)		JN831 [4]	HR397			
HBS394 (x16)[5] M11x1.25x96.00mm (x16)		JN792 (x2)[4]		PB281 (x12)	NJ347 (x2)[2] 38.00x50.00x8.00mm, NBR	
		HM5243	HR397			



Ltr



CC



9

	Ltr				CC		
2 ELEVEN	1.8	04/00 →	2ZZ-GE	Petrol	1796	4	1
ELISE	1.8	03/99 → 11/00	18 K4K	Petrol	1796	4	2
ELISE	1.8	11/00 →	2ZZ-GE	Petrol	1796	4	1
EUROPA S	2.0	07/00 →	Z 20 LER	Petrol	1998	4	3
EXIGE (SCC_)	1.8	09/00 → 06/01	2ZZ-GE	Petrol	1796	4	1









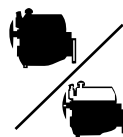

cc

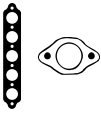

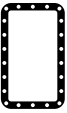
kW/PS

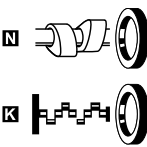

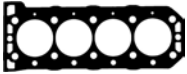
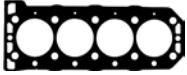
1.8		2ZZ-GE					1			
2 Eleven 1.8	04/07→	1796	4	82.00	DOHC	132-202/ 180-275				
Elise 1.8	11/02→									
Exige 1.8 16V	09/01→06/12									
Exige 1.8 240	04/06→06/12									
Exige 1.8 260	04/06→06/12									
Exige 1.8 GT3	08/06→06/12									
1.8		18 K4K					2	BW5750 (MLS) BW750 (SE)	DW5757 (MLS) DW754 [3] (SE)	ER322 [3]
Elise 1.8 16V	03/99→11/00	1796	4	80.00	DOHC	107-110/ 146-150				
2.0		Z 20 LER					3			
Europa S 2.0 T	07/06→	1998	4	86.00	DOHC	147/200				

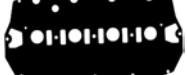
								 BW5750  BW750  JD563  JD564  JN963
					<p>NA5260 [2] 38.00x50.00x6.00mm, FPM</p> <p>NJ347 [2] 38.00x50.00x8.00mm, NBR</p> <p>NA5260 [2] 38.00x50.00x6.00mm, FPM</p> <p>NJ215 [1] 85.00x105.00x10.00mm, FPM</p>			
HBS005 [5]	JD563 JD564	JN963 [4]		HR752				
					<p>NC006 [2] 35.00x48.00x7.00mm, MVQ</p> <p>NB700 [2] 31.00x50.00x8.00mm, MVQ</p> <p>NB806 [1] 90.00x104.00x11.00mm, FPM</p>			



Ltr







CC



9

	Ltr				CC		
2 (DE)	1.3	10/00→	ZJ-VE	Petrol	1349	4	17
2 (DE)	1.5	10/00→	ZY-DE	Petrol	1498	4	29
2 (DE)	1.5	10/00→	ZY-VE	Petrol	1498	4	30
2 (DY)	1.2	02/00→	FUJA	Petrol	1242	4	6
2 (DY)	1.3	04/00→	FUJA	Petrol	1242	4	6
2 (DY)	1.4	04/00→	F6JA	Diesel	1399	4	18
2 (DY)	1.4	04/00→	F6JB	Diesel	1399	4	19
2 (DY)	1.4	02/00→	FXJA	Petrol	1388	4	20
2 (DY)	1.5	04/00→	ZY-VE	Petrol	1498	4	30
2 (DY)	1.6	02/00→	FYJA	Petrol	1596	4	43
3 (BK)	1.4	02/00→06/00	FXJA	Petrol	1388	4	20
3 (BK)	1.4	10/00→06/00	ZJ-VE	Petrol	1349	4	17
3 (BK)	1.6	10/00→06/00	B6ZE	Petrol	1598	4	42
3 (BK)	1.6	06/00→06/00	Y601	Diesel	1560	4	44
3 (BK)	2.0	10/00→06/00	LF17	Petrol	1999	4	83
3 (BK)	2.0	12/00→06/00	RF7J	Diesel	1998	4	92
3 (BL)	1.6	06/00→	Y601	Diesel	1560	4	44
3 (BL)	1.6	06/00→	Z6	Petrol	1598	4	45
3 (BL)	2.0	06/00→	LF17	Petrol	1999	4	83
3 (BL)	2.0	06/00→	LF-DE	Petrol	1999	4	85
3 Saloon (BK)	1.6	06/00→	Y601	Diesel	1560	4	44
3 Saloon (BK)	1.6	02/00→	Z6	Petrol	1598	4	45
3 Saloon (BK)	2.0	02/00→	LF17	Petrol	1999	4	83
3 Saloon (BK)	2.0	12/00→	RF7J	Diesel	1998	4	92
3 Saloon (BL)	1.6	06/00→	Z6	Petrol	1598	4	45
3 Saloon (BL)	2.0	06/00→	LF17	Petrol	1999	4	83
3 Saloon (BL)	2.0	06/00→	LF-DE	Petrol	1999	4	85
5 (CR19)	1.8	03/00→	L823	Petrol	1798	4	67
5 (CR19)	2.0	03/00→	LFF7	Petrol	1999	4	86
5 (CR19)	2.0	06/00→	RF7J	Diesel	1998	4	92
6 (GG)	1.8	08/00→08/00	L813	Petrol	1798	4	66
6 (GG)	2.0	06/00→08/00	LF17	Petrol	1999	4	83
6 (GG)	2.0	06/00→08/00	LF18	Petrol	1999	4	84
6 (GG)	2.0	03/00→08/00	LFF7	Petrol	1999	4	86
6 (GG)	2.0	06/00→08/00	RF5C	Diesel	1998	4	91
6 (GG)	2.0	06/00→08/00	RF7J	Diesel	1998	4	92
6 (GG)	2.3	06/00→08/00	L3C1	Petrol	2261	4	108
6 (GG)	2.5	08/00→	L5-VE	Petrol	2488	4	111
6 (GH)	1.8	08/00→	L813	Petrol	1798	4	66
6 (GH)	2.0	08/00→	LF17	Petrol	1999	4	83
6 (GH)	2.0	01/01→	LF-DE	Petrol	1999	4	85
6 (GH)	2.0	08/00→	RF7J	Diesel	1998	4	92
6 (GH)	2.5	08/00→	L5-VE	Petrol	2488	4	111
6 Estate (GH)	1.8	02/00→	L813	Petrol	1798	4	66
6 Estate (GH)	2.0	02/00→	LF17	Petrol	1999	4	83
6 Estate (GH)	2.0	01/01→	LF-DE	Petrol	1999	4	85
6 Estate (GH)	2.0	02/00→	RF7J	Diesel	1998	4	92
6 Estate (GH)	2.5	02/00→	L5-VE	Petrol	2488	4	111
6 Hatchback (GG)	1.8	08/00→08/00	L813	Petrol	1798	4	66
6 Hatchback (GG)	2.0	08/00→08/00	LF17	Petrol	1999	4	83
6 Hatchback (GG)	2.0	08/00→08/00	LF18	Petrol	1999	4	84
6 Hatchback (GG)	2.0	03/00→08/00	LFF7	Petrol	1999	4	86
6 Hatchback (GG)	2.0	08/00→08/00	RF5C	Diesel	1998	4	91
6 Hatchback (GG)	2.0	06/00→08/00	RF7J	Diesel	1998	4	92
6 Hatchback (GG)	2.3	08/00→08/00	L3C1	Petrol	2261	4	108
6 Hatchback (GG)	2.5	08/00→	L5-VE	Petrol	2488	4	111
6 Hatchback (GH)	1.8	08/00→	L813	Petrol	1798	4	66
6 Hatchback (GH)	2.0	08/00→	LF17	Petrol	1999	4	83
6 Hatchback (GH)	2.0	01/01→	LF-DE	Petrol	1999	4	85
6 Hatchback (GH)	2.0	08/00→	RF7J	Diesel	1998	4	92
6 Hatchback (GH)	2.5	08/00→	L5-VE	Petrol	2488	4	111
6 Station Wagon (GY)	1.8	08/00→08/00	L813	Petrol	1798	4	66
6 Station Wagon (GY)	2.0	08/00→08/00	LF17	Petrol	1999	4	83
6 Station Wagon (GY)	2.0	08/00→08/00	LF18	Petrol	1999	4	84
6 Station Wagon (GY)	2.0	03/00→08/00	LFF7	Petrol	1999	4	86
6 Station Wagon (GY)	2.0	08/00→08/00	RF5C	Diesel	1998	4	91
6 Station Wagon (GY)	2.0	06/00→08/00	RF7J	Diesel	1998	4	92
6 Station Wagon (GY)	2.3	08/00→08/00	L3C1	Petrol	2261	4	108
121 I (DA)	1.1	10/98→10/99	B1	Petrol	1139	4	1
121 I (DA)	1.1	10/98→10/99	B116	Petrol	1139	4	2

	Ltr				CC		9
121 I (DA)	1.3	10/98→11/99	B3	Petrol	1324	4	7
121 II (DB)	1.1	11/99→10/99	B1	Petrol	1139	4	1
121 II (DB)	1.3	11/99→03/99	B3 (16V)	Petrol	1324	4	8
121 III (JASM, JBSM)	1.3	03/99→04/00	DHF	Petrol	1242	4	4
121 III (JASM, JBSM)	1.3	03/99→04/00	DHG	Petrol	1242	4	5
121 III (JASM, JBSM)	1.3	03/99→04/00	J4R	Petrol	1299	4	13
121 III (JASM, JBSM)	1.3	03/99→04/00	J4T	Petrol	1299	4	14
121 III (JASM, JBSM)	1.3	03/99→04/00	JJK	Petrol	1299	4	15
121 III (JASM, JBSM)	1.3	03/99→04/00	JJM	Petrol	1299	4	16
121 III (JASM, JBSM)	1.8	03/99→04/00	RTJ	Diesel	1753	4	70
121 III (JASM, JBSM)	1.8	03/99→04/00	RTK	Diesel	1753	4	71
323 C IV (BG)	1.3	09/98→07/99	B3 (16V)	Petrol	1324	4	8
323 C IV (BG)	1.3	09/98→07/99	B3E	Petrol	1324	4	11
323 C IV (BG)	1.6	03/99→10/99	B6	Petrol	1598	4	31
323 C IV (BG)	1.6	09/98→06/99	B6E	Petrol	1598	4	40
323 C IV (BG)	1.7	08/98→07/99	PN54	Diesel	1720	4	51
323 C IV (BG)	1.8	11/99→12/99	BP	Petrol	1840	4	53
323 C IV (BG)	1.8	09/98→03/99	BP (DOHC)	Petrol	1840	4	54
323 C IV (BG)	1.8	09/98→03/99	BP22	Petrol	1840	4	55
323 C IV (BG)	1.8	09/98→03/99	BP31	Petrol	1840	4	56
323 C V (BA)	1.3	08/99→09/99	B3 (16V)	Petrol	1324	4	8
323 C V (BA)	1.5	08/99→09/99	Z5-DE	Petrol	1489	4	28
323 C V (BA)	1.8	08/99→09/99	BP-ZE	Petrol	1840	4	61
323 F IV (BG)	1.6	03/99→10/99	B6	Petrol	1598	4	31
323 F IV (BG)	1.6	09/98→06/99	B6E	Petrol	1598	4	40
323 F IV (BG)	1.8	08/98→07/99	BP	Petrol	1840	4	53
323 F IV (BG)	1.8	08/98→07/99	BP (DOHC)	Petrol	1840	4	54
323 F IV (BG)	1.8	09/98→03/99	BP31	Petrol	1840	4	56
323 F IV (BG)	1.8	01/99→04/99	BPC	Petrol	1840	4	58
323 F V (BA)	1.5	07/99→09/99	Z5-DE	Petrol	1489	4	28
323 F V (BA)	1.8	08/99→09/99	BP-ZE	Petrol	1840	4	61
323 F V (BA)	2.0	08/99→09/99	KF	Petrol	1995	6	81
323 F VI (BJ)	1.4	01/00→05/00	B3 (16V)	Petrol	1324	4	8
323 F VI (BJ)	1.4	09/99→01/00	B3 ME	Petrol	1324	4	9
323 F VI (BJ)	1.6	01/00→05/00	ZM	Petrol	1598	4	46
323 F VI (BJ)	2.0	01/00→05/00	FS7E	Petrol	1991	4	78
323 F VI (BJ)	2.0	01/00→05/00	FS7G	Petrol	1991	4	79
323 F VI (BJ)	2.0	09/99→05/00	RF1G	Diesel	1998	4	88
323 F VI (BJ)	2.0	01/00→05/00	RF4F	Diesel	1998	4	90
323 II (BD)	1.3	11/98→10/98	E3	Petrol	1296	4	12
323 II Hatchback (BD)	1.3	11/98→10/98	E3	Petrol	1296	4	12
323 III (BF)	1.1	08/98→04/99	E1	Petrol	1071	4	3
323 III (BF)	1.3	08/98→05/98	E3	Petrol	1296	4	12
323 III (BF)	1.4	04/98→07/98	B3	Petrol	1324	4	7
323 III (BF)	1.5	09/98→10/98	B5	Petrol	1498	4	21
323 III (BF)	1.5	08/98→05/98	E5	Petrol	1490	4	25
323 III (BF)	1.5	08/98→05/98	E5E2	Petrol	1490	4	26
323 III (BF)	1.5	08/98→05/98	E5E3	Petrol	1490	4	27
323 III (BF)	1.6	01/98→10/98	B6 (SOHC)	Petrol	1598	4	33
323 III (BF)	1.6	10/98→11/99	B6T	Petrol	1598	4	41
323 III (BF)	1.7	09/98→05/98	PN27	Diesel	1720	4	49
323 III (BF)	1.7	01/98→05/98	PN46	Diesel	1720	4	50
323 III Hatchback (BF)	1.1	09/98→10/98	E1	Petrol	1071	4	3
323 III Hatchback (BF)	1.3	09/98→08/98	B3E	Petrol	1324	4	11
323 III Hatchback (BF)	1.4	09/98→10/98	B3	Petrol	1324	4	7
323 III Hatchback (BF)	1.5	09/98→10/98	B5	Petrol	1498	4	21
323 III Hatchback (BF)	1.5	08/98→05/98	E5	Petrol	1490	4	25
323 III Hatchback (BF)	1.5	08/98→05/98	E5E2	Petrol	1490	4	26
323 III Hatchback (BF)	1.5	08/98→05/98	E5E3	Petrol	1490	4	27
323 III Hatchback (BF)	1.6	08/98→08/99	B6 (SOHC)	Petrol	1598	4	33
323 III Hatchback (BF)	1.6	09/98→10/98	B68	Petrol	1597	4	36
323 III Hatchback (BF)	1.6	10/98→08/99	B6T	Petrol	1598	4	41
323 III Hatchback (BF)	1.7	04/98→05/98	PN27	Diesel	1720	4	49
323 III Hatchback (BF)	1.7	01/98→05/98	PN46	Diesel	1720	4	50
323 III Station Wagon (BW)	1.3	07/98→04/99	E3	Petrol	1296	4	12
323 III Station Wagon (BW)	1.5	01/98→09/99	B5	Petrol	1498	4	21
323 III Station Wagon (BW)	1.5	05/98→05/98	B50	Petrol	1498	4	23
323 III Station Wagon (BW)	1.5	05/98→05/98	B53	Petrol	1498	4	24
323 III Station Wagon (BW)	1.5	05/98→05/98	E5	Petrol	1490	4	25
323 III Station Wagon (BW)	1.6	09/98→10/99	B6 (SOHC)	Petrol	1598	4	33



Ltr







CC



9

Model	Ltr	Year Range	Engine	Fuel	CC	Seats	Price
323 III Station Wagon (BW)	1.6	09/98→10/99	B65M	Petrol	1598	4	35
323 III Station Wagon (BW)	1.6	09/98→10/98	B68	Petrol	1597	4	36
323 III Station Wagon (BW)	1.6	09/98→10/99	B6E	Petrol	1598	4	40
323 III Station Wagon (BW)	1.7	11/98→03/99	PN26	Diesel	1720	4	48
323 III Station Wagon (BW)	1.7	11/98→03/99	PN54	Diesel	1720	4	51
323 P V (BA)	1.3	10/99→	B3 (16V)	Petrol	1324	4	8
323 P V (BA)	1.5	10/99→	Z5-DE	Petrol	1489	4	28
323 P V (BA)	2.0	10/99→	RF1G	Diesel	1998	4	88
323 S IV (BG)	1.3	04/99→07/99	B3 (16V)	Petrol	1324	4	8
323 S IV (BG)	1.3	09/98→06/99	B383	Petrol	1324	4	10
323 S IV (BG)	1.3	09/98→06/99	B3E	Petrol	1324	4	11
323 S IV (BG)	1.6	08/98→10/99	B6	Petrol	1598	4	31
323 S IV (BG)	1.6	09/98→06/99	B6E	Petrol	1598	4	40
323 S IV (BG)	1.7	08/98→07/99	PN46	Diesel	1720	4	50
323 S IV (BG)	1.7	08/98→07/99	PN54	Diesel	1720	4	51
323 S IV (BG)	1.7	08/98→07/99	PN62	Diesel	1720	4	52
323 S IV (BG)	1.8	06/98→07/99	BP (DOHC)	Petrol	1840	4	54
323 S IV (BG)	1.8	08/98→07/99	BP52	Petrol	1840	4	57
323 S V (BA)	1.3	08/99→09/99	B3 (16V)	Petrol	1324	4	8
323 S V (BA)	1.5	08/99→09/99	Z5-DE	Petrol	1489	4	28
323 S V (BA)	1.6	05/99→09/99	4EE1-T	Diesel	1686	4	47
323 S V (BA)	1.6	08/99→09/99	B6 (DOHC)	Petrol	1598	4	32
323 S V (BA)	1.8	07/99→09/99	BP (DOHC)	Petrol	1840	4	54
323 S V (BA)	1.8	08/99→09/99	BP-ZE	Petrol	1840	4	61
323 S V (BA)	2.0	10/99→09/99	RF1G	Diesel	1998	4	88
323 S VI (BJ)	1.4	01/00→05/00	B3 (16V)	Petrol	1324	4	8
323 S VI (BJ)	1.4	09/99→01/00	B3 ME	Petrol	1324	4	9
323 S VI (BJ)	1.6	09/99→02/00	B6 (DOHC)	Petrol	1598	4	32
323 S VI (BJ)	1.6	01/00→05/00	ZM	Petrol	1598	4	46
323 S VI (BJ)	2.0	02/00→05/00	FS	Petrol	1991	4	76
323 S VI (BJ)	2.0	01/00→05/00	FS7E	Petrol	1991	4	78
323 S VI (BJ)	2.0	01/00→05/00	FS7G	Petrol	1991	4	79
323 S VI (BJ)	2.0	09/99→05/00	RF1G	Diesel	1998	4	88
323 S VI (BJ)	2.0	09/99→05/00	RF3F	Diesel	1998	4	89
323 S VI (BJ)	2.0	10/00→10/00	RF4F	Diesel	1998	4	90
626 III (GD)	1.8	11/98→05/99	F8 (12V)	Petrol	1789	4	62
626 III (GD)	2.0	09/98→05/99	FE (12V)	Petrol	1998	4	72
626 III (GD)	2.0	07/98→05/99	FE (16V)	Petrol	1998	4	73
626 III (GD)	2.0	07/98→07/99	RF-N	Diesel	1998	4	95
626 III (GD)	2.2	11/98→05/99	F2	Petrol	2184	4	96
626 III Coupe (GD)	1.8	09/98→08/99	F8 (12V)	Petrol	1789	4	62
626 III Coupe (GD)	2.0	09/98→12/98	FE (12V)	Petrol	1998	4	72
626 III Coupe (GD)	2.0	06/98→10/99	FE (16V)	Petrol	1998	4	73
626 III Coupe (GD)	2.0	09/98→10/99	FE (8V)	Petrol	1998	4	74
626 III Coupe (GD)	2.2	04/98→12/99	F2	Petrol	2184	4	96
626 III Hatchback (GD)	1.8	11/98→05/99	F8 (12V)	Petrol	1789	4	62
626 III Hatchback (GD)	2.0	11/98→05/99	FE (12V)	Petrol	1998	4	72
626 III Hatchback (GD)	2.0	06/98→10/99	FE (16V)	Petrol	1998	4	73
626 III Hatchback (GD)	2.0	09/98→10/99	FE (8V)	Petrol	1998	4	74
626 III Hatchback (GD)	2.0	07/98→07/99	RF-N	Diesel	1998	4	95
626 III Hatchback (GD)	2.2	11/98→04/99	F2	Petrol	2184	4	96
626 III Station Wagon (GV)	1.8	01/98→03/99	F8 (12V)	Petrol	1789	4	62
626 III Station Wagon (GV)	2.0	09/98→01/99	FE (12V)	Petrol	1998	4	72
626 III Station Wagon (GV)	2.0	01/98→03/99	FE (16V)	Petrol	1998	4	73
626 III Station Wagon (GV)	2.0	10/98→09/99	FE (8V)	Petrol	1998	4	74
626 III Station Wagon (GV)	2.0	04/99→02/99	FS	Petrol	1991	4	76
626 III Station Wagon (GV)	2.0	05/99→11/99	RF-CX	Diesel	1998	4	93
626 III Station Wagon (GV)	2.0	11/99→09/99	RF65	Diesel	1998	4	94
626 III Station Wagon (GV)	2.0	09/98→07/99	RF-N	Diesel	1998	4	95
626 III Station Wagon (GV)	2.2	03/98→11/99	F2	Petrol	2184	4	96
626 III Station Wagon (GV)	2.2	05/99→11/99	F2L1	Petrol	2184	4	101
626 IV (GE)	1.8	01/99→04/99	FP	Petrol	1840	4	63
626 IV (GE)	2.0	01/99→04/99	FS	Petrol	1991	4	76
626 IV (GE)	2.0	10/99→04/99	RF OHC	Diesel	1998	4	87
626 IV Hatchback (GE)	1.8	08/99→04/99	FP	Petrol	1840	4	63
626 IV Hatchback (GE)	2.0	08/99→04/99	FS	Petrol	1991	4	76
626 IV Hatchback (GE)	2.0	01/99→04/99	RF OHC	Diesel	1998	4	87
626 IV Hatchback (GE)	2.5	01/99→04/99	KL	Petrol	2497	6	110
626 V (GF)	1.8	12/99→10/00	FP9A	Petrol	1840	4	64
626 V (GF)	1.8	05/99→12/99	FPY3	Petrol	1840	4	65

	Ltr				CC		9
626 V (GF)	2.0	05/99→10/00	FS	Petrol	1991	4	76
626 V (GF)	2.0	04/99→10/00	FS2C	Petrol	1991	4	77
626 V (GF)	2.0	04/99→10/00	RF3F	Diesel	1998	4	89
626 V Hatchback (GF)	1.8	12/99→10/00	FP	Petrol	1840	4	63
626 V Hatchback (GF)	1.8	05/99→12/99	FPY3	Petrol	1840	4	65
626 V Hatchback (GF)	2.0	05/99→10/00	FS	Petrol	1991	4	76
626 V Hatchback (GF)	2.0	02/99→10/00	FS2C	Petrol	1991	4	77
626 V Hatchback (GF)	2.0	04/99→10/00	RF3F	Diesel	1998	4	89
626 V Station Wagon (GW)	1.8	01/00→10/00	FP9A	Petrol	1840	4	64
626 V Station Wagon (GW)	1.8	02/99→01/00	FPY3	Petrol	1840	4	65
626 V Station Wagon (GW)	2.0	02/99→10/00	FS	Petrol	1991	4	76
626 V Station Wagon (GW)	2.0	02/99→10/00	FS2C	Petrol	1991	4	77
626 V Station Wagon (GW)	2.0	09/99→10/00	RF3F	Diesel	1998	4	89
626 V Station Wagon (GW)	2.0	04/99→10/00	RF4F	Diesel	1998	4	90
929 III (HC)	2.0	06/98→12/98	FE (8V)	Petrol	1998	4	74
929 III (HC)	2.0	06/98→12/98	FEFA	Petrol	1998	4	75
929 III (HC)	2.2	01/98→04/98	F2	Petrol	2184	4	96
929 III (HC)	2.2	01/98→04/98	F21	Petrol	2184	4	97
929 III (HC)	2.2	04/98→06/99	F2-C	Petrol	2184	4	98
929 III (HC)	2.2	01/98→04/98	F2E	Petrol	2184	4	99
929 III (HC)	2.2	05/98→12/98	F2-EGI	Petrol	2184	4	100
929 III (HC)	3.0	06/98→06/99	JE	Petrol	2954	6	117
929 III (HC)	3.0	01/98→06/99	JE3	Petrol	2954	6	118
B-SERIE (UF)	2.0	01/98→03/99	FE (8V)	Petrol	1998	4	74
B-SERIE (UF)	2.2	03/98→10/98	R2	Diesel	2184	4	102
B-SERIE (UF)	2.2	01/98→03/99	R290	Diesel	2184	4	105
B-SERIE (UN)	2.2	02/99→	R5A2	Petrol	2184	4	106
B-SERIE (UN)	2.5	06/99→	MD25NA	Diesel	2500	4	112
B-SERIE (UN)	2.5	06/99→07/00	MD25TI	Diesel	2499	4	113
B-SERIE (UN)	2.5	11/99→	WLE7	Diesel	2500	4	114
B-SERIE (UN)	2.5	02/99→03/00	WLT (12 V)	Diesel	2499	4	116
DEMIO (DW)	1.3	08/99→04/00	B3 (16V)	Petrol	1324	4	8
DEMIO (DW)	1.3	08/99→	B3 ME	Petrol	1324	4	9
DEMIO (DW)	1.5	04/00→	B5 E	Petrol	1498	4	22
E-SERIE Box (SG)	2.0	04/00→07/00	FE (8V)	Petrol	1998	4	74
E-SERIE Box (SR2)	2.0	01/98→05/00	FE (8V)	Petrol	1998	4	74
E-SERIE Box (SR2)	2.2	02/99→05/00	R2	Diesel	2184	4	102
E-SERIE Box (SR2)	2.2	03/99→05/00	R203	Diesel	2184	4	103
E-SERIE Box (SR2)	2.2	03/99→05/00	R207	Diesel	2184	4	104
E-SERIE MPV (SG)	2.0	08/99→10/00	FE (12V)	Petrol	1998	4	72
E-SERIE Platform/Chassis (SD1)	2.2	04/99→07/99	R2	Diesel	2184	4	102
MPV I (LV)	2.5	05/99→09/99	WLT	Diesel	2499	4	115
MPV I (LV)	3.0	03/99→09/99	JE94	Petrol	2954	6	119
MPV II (LW)	2.0	08/00→07/00	FS	Petrol	1991	4	76
MPV II (LW)	2.0	09/99→08/00	FS-DS	Petrol	1991	4	80
MPV II (LW)	2.0	07/00→02/00	RF5C	Diesel	1998	4	91
MPV II (LW)	2.5	09/99→03/00	GY-DE	Petrol	2495	6	109
MX-3 (EC)	1.6	07/99→	B69	Petrol	1598	4	37
MX-3 (EC)	1.6	01/99→	B6D	Petrol	1598	4	39
MX-5 I (NA)	1.6	05/99→01/99	B64F	Petrol	1598	4	34
MX-5 I (NA)	1.8	02/99→04/99	BP (DOHC)	Petrol	1840	4	54
MX-5 I (NA)	1.8	09/99→04/99	BPF1	Petrol	1840	4	60
MX-5 II (NB)	1.6	05/99→10/00	B6D	Petrol	1598	4	39
MX-5 II (NB)	1.8	01/99→10/00	BPD	Petrol	1840	4	59
MX-5 II (NB)	1.8	05/99→10/00	BP-ZE	Petrol	1840	4	61
MX-5 III (NC)	1.8	03/00→	L828	Petrol	1798	4	68
MX-5 III (NC)	1.8	03/00→	L8-DE	Petrol	1798	4	69
MX-5 III (NC)	2.0	03/00→	LF-DE	Petrol	1999	4	85
MX-6 (GE)	1.8	12/99→02/99	FP9A	Petrol	1840	4	64
MX-6 (GE)	2.0	02/99→02/99	FS	Petrol	1991	4	76
MX-6 (GE)	2.5	02/99→02/99	KL	Petrol	2497	6	110
PREMACY (CP)	1.9	07/99→03/00	FP	Petrol	1840	4	63
PREMACY (CP)	2.0	11/00→03/00	FS7E	Petrol	1991	4	78
PREMACY (CP)	2.0	11/00→03/00	FS7G	Petrol	1991	4	79
PREMACY (CP)	2.0	02/00→03/00	LFF7	Petrol	1999	4	86
PREMACY (CP)	2.0	10/99→07/00	RF3F	Diesel	1998	4	89
PREMACY (CP)	2.0	07/00→03/00	RF4F	Diesel	1998	4	90
SPECTRON	2.2	08/98→10/99	R2	Diesel	2184	4	102
XEDOS 6 (CA)	1.6	06/99→10/99	B6 (DOHC)	Petrol	1598	4	32
XEDOS 6 (CA)	1.6	08/99→05/99	B69	Petrol	1598	4	38



Ltr











CC



9

	Ltr	01/99→10/99	KF1	Petrol	1995	6	82
XEDOS 6 (CA)	2.0	01/99→10/99	KF1	Petrol	1995	6	82
XEDOS 9 (TA)	2.0	08/99→01/00	KF	Petrol	1995	6	81
XEDOS 9 (TA)	2.3	02/99→01/00	KJ-ZEM	Petrol	2255	6	107
XEDOS 9 (TA)	2.5	07/99→09/00	KL	Petrol	2497	6	110

		CC			9			CC			9
4EE1-T	Diesel	1686	4	79.00	47	JJK	Petrol	1299	4	74.00	15
B1	Petrol	1139	4	68.00	1	JJM	Petrol	1299	4	74.00	16
B116	Petrol	1139	4	68.00	2	KF	Petrol	1995	6	78.00	81
B3	Petrol	1324	4	71.00	7	KF1	Petrol	1995	6	78.00	82
B3 (16V)	Petrol	1324	4	71.00	8	KJ-ZEM	Petrol	2255	6	80.30	107
B3 ME	Petrol	1324	4	71.00	9	KL	Petrol	2497	6	84.50	110
B383	Petrol	1324	4	71.00	10	L3C1	Petrol	2261	4	87.50	108
B3E	Petrol	1324	4	71.00	11	L5-VE	Petrol	2488	4	89.00	111
B5	Petrol	1498	4	78.00	21	L813	Petrol	1798	4	83.00	66
B5 E	Petrol	1498	4	78.00	22	L823	Petrol	1798	4	83.00	67
B50	Petrol	1498	4	78.00	23	L828	Petrol	1798	4	83.00	68
B53	Petrol	1498	4	78.00	24	L8-DE	Petrol	1798	4	83.00	69
B6	Petrol	1598	4	78.00	31	LF17	Petrol	1999	4	87.50	83
B6 (DOHC)	Petrol	1598	4	78.00	32	LF18	Petrol	1999	4	87.50	84
B6 (SOHC)	Petrol	1598	4	78.00	33	LF-DE	Petrol	1999	4	87.50	85
B64F	Petrol	1598	4	78.00	34	LFF7	Petrol	1999	4	87.50	86
B65M	Petrol	1598	4	78.00	35	MD25NA	Diesel	2500	4	94.00	112
B68	Petrol	1597	4	78.00	36	MD25TI	Diesel	2499	4	94.00	113
B69	Petrol	1598	4	78.00	37	PN26	Diesel	1720	4	78.00	48
B69	Petrol	1598	4	78.00	38	PN27	Diesel	1720	4	78.00	49
B6D	Petrol	1598	4	78.00	39	PN46	Diesel	1720	4	78.00	50
B6E	Petrol	1598	4	78.00	40	PN54	Diesel	1720	4	78.00	51
B6T	Petrol	1598	4	78.00	41	PN62	Diesel	1720	4	78.00	52
B6ZE	Petrol	1598	4	78.00	42	R2	Diesel	2184	4	86.00	102
BP	Petrol	1840	4	83.00	53	R203	Diesel	2184	4	86.00	103
BP (DOHC)	Petrol	1840	4	83.00	54	R207	Diesel	2184	4	86.00	104
BP22	Petrol	1840	4	83.00	55	R290	Diesel	2184	4	86.00	105
BP31	Petrol	1840	4	83.00	56	R5A2	Petrol	2184	4	86.00	106
BP52	Petrol	1840	4	83.00	57	RF OHC	Diesel	1998	4	86.00	87
BPC	Petrol	1840	4	83.00	58	RF1G	Diesel	1998	4	86.00	88
BPD	Petrol	1840	4	83.00	59	RF3F	Diesel	1998	4	86.00	89
BPF1	Petrol	1840	4	83.00	60	RF4F	Diesel	1998	4	86.00	90
BP-ZE	Petrol	1840	4	83.00	61	RF5C	Diesel	1998	4	86.00	91
DHF	Petrol	1242	4	71.90	4	RF7J	Diesel	1998	4	86.00	92
DHG	Petrol	1242	4	71.90	5	RF-CX	Diesel	1998	4	86.00	93
E1	Petrol	1071	4	70.00	3	RF65	Diesel	1998	4	86.00	94
E3	Petrol	1296	4	77.00	12	RF-N	Diesel	1998	4	86.00	95
E5	Petrol	1490	4	77.00	25	RTJ	Diesel	1753	4	82.50	70
E5E2	Petrol	1490	4	77.00	26	RTK	Diesel	1753	4	82.50	71
E5E3	Petrol	1490	4	77.00	27	WLE7	Diesel	2500	4	93.00	114
F2	Petrol	2184	4	86.00	96	WLT	Diesel	2499	4	93.00	115
F21	Petrol	2184	4	86.00	97	WLT (12 V)	Diesel	2499	4	93.00	116
F2-C	Petrol	2184	4	86.00	98	Y601	Diesel	1560	4	75.00	44
F2E	Petrol	2184	4	86.00	99	Z5-DE	Petrol	1489	4	75.30	28
F2-EGI	Petrol	2184	4	86.00	100	Z6	Petrol	1598	4	78.00	45
F2L1	Petrol	2184	4	86.00	101	ZJ-VE	Petrol	1349	4	74.00	17
F6JA	Diesel	1399	4	73.70	18	ZM	Petrol	1598	4	78.00	46
F6JB	Diesel	1399	4	73.70	19	ZY-DE	Petrol	1498	4	78.00	29
F8 (12V)	Petrol	1789	4	86.00	62	ZY-VE	Petrol	1498	4	78.00	30
FE (12V)	Petrol	1998	4	86.00	72						
FE (16V)	Petrol	1998	4	86.00	73						
FE (8V)	Petrol	1998	4	86.00	74						
FEFA	Petrol	1998	4	86.00	75						
FP	Petrol	1840	4	83.00	63						
FP9A	Petrol	1840	4	83.00	64						
FPY3	Petrol	1840	4	83.00	65						
FS	Petrol	1991	4	83.00	76						
FS2C	Petrol	1991	4	83.00	77						
FS7E	Petrol	1991	4	83.00	78						
FS7G	Petrol	1991	4	83.00	79						
FS-DS	Petrol	1991	4	83.00	80						
FUJA	Petrol	1242	4	71.90	6						
FXJA	Petrol	1388	4	76.00	20						
FYJA	Petrol	1596	4	79.00	43						
GY-DE	Petrol	2495	6	81.60	109						
J4R	Petrol	1299	4	74.00	13						
J4T	Petrol	1299	4	74.00	14						
JE	Petrol	2954	6	90.00	117						
JE3	Petrol	2954	6	90.00	118						
JE94	Petrol	2954	6	90.00	119						



cc



kw/PS



1.1		B1					1	BR960 (Graphite)		
121 I 1.1	10/87→10/90	1139	4	68.00	SOHC/OHC	38-42/ 52-57				
121 II 1.1	11/90→10/93									
1.1		B116					2	BR960 (Graphite)		
121 I 1.1	10/87→10/90	1139	4	68.00	SOHC/OHC	38-42/ 52-57				
1.1		E1					3	BJ420 (Fibre)	DJ420	
323 III 1.1	08/85→04/90	1071	4	70.00	SOHC/OHC	40/54				
1.2		DHF					4	BY650 (MLS) →05/98 AB5120 (MLS) 05/98→	DY650 ☒ [3] 05/98→ DY651 05/98→	EY650 [3]
121 III M/420	03/96→04/03	1242	4	71.90	DOHC	55/75				
1.2		DHG					5	BY650 (MLS) →05/98 AB5120 (MLS) 05/98→	DY650 ☒ [3] 05/98→ DY651 05/98→	EY650 [3]
121 III M/420	03/96→04/03	1242	4	71.90	DOHC	55/75				
1.2		FUJA					6	AG8310 (Steel)	CB5120	EB5120
2 1.2	02/03→	1242	4	71.90	DOHC	55/75				
2 1.25	04/03→									
1.3		B3					7	BR960 (Graphite)	DR961	GR961
121 I 1.3	10/87→11/90	1324	4	71.00	SOHC/OHC	40-44/ 54-60				
323 III 1.4	04/87→10/89									
1.3		B3 (16V)					8	BV430 (Graphite) AG9080 (MLS), 1.200mm	DV431	GV431
121 II 1.3 16V	11/90→03/96	1324	4	71.00	SOHC/OHC	39-54/ 53-73				
121 II 1.3i 16V	11/90→03/96									
323 C IV 1.3	09/89→09/98									
323 F V 1.4	01/01→05/04									
323 P V 1.3 16V	10/96→									
323 S IV 1.3	04/91→07/94									
323 S V 1.3 16V	08/94→09/98									
323 S VI 1.4	01/01→05/04									
Demio 1.3 i 16V	08/98→04/00									
1.3		B3 ME					9	AG9080 (MLS), 1.200mm		
323 F V 1.4 16V	09/98→01/01	1324	4	71.00	SOHC/OHC	46-54/ 63-73				
323 S VI 1.4	09/98→01/01									
Demio 1.3 16V	08/98→									
1.3		B383					10	BR960 (Graphite)	DR961	
323 S IV 1.3	09/89→06/91	1324	4	71.00	SOHC/OHC	49/67				
1.3		B3E					11	BR960 (Graphite)	DR961	
323 C IV 1.3	09/89→07/94	1324	4	71.00	SOHC/OHC	49/67				
323 III 1.3 i	09/85→08/89									
323 S IV 1.3	09/89→06/91									

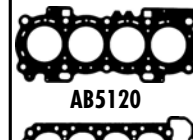
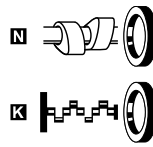
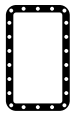
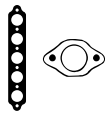

AB5120



BJ420



BR960



BV430



BY650



JC163

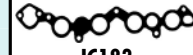

JC183



JD109



JD5164

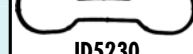

JD5230



JM5155



JN396

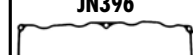

JN628



JN774



JE5025



JJ149



JJ354

MAZDA













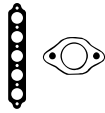

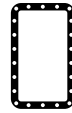

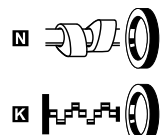













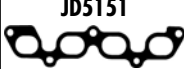

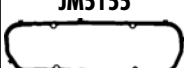
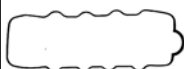

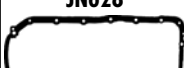

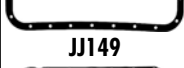



















































cc



kW/PS



1.3	E3						12	BJ430 (Graphite)	DJ430 →12/82 DJ431 [13] 12/82→12/84 DJ432 [13] 01/85→	GJ430 →12/82 GJ431 12/82→12/84 GJ432 01/85→
323 II 1.3 323 III 1.3	11/80→10/89 08/85→04/90	1296	4	77.00	SOHC/OHC	44-55/ 60-75				
1.3	J4R						13	BT140 (Fibre)	DY671 [13]	EY671
121 III E/420	03/96→04/03	1299	4	74.00		44/60				
1.3	J4T						14	BT140 (Fibre)	DY671 [13]	EY671
121 III E/420	03/96→04/03	1299	4	74.00		44/60				
1.3	JJK						15	BT140 (Fibre)	DY671 [13]	EY671
121 III H/420	03/96→04/03	1299	4	74.00		37/50				
1.3	JJM						16	BT140 (Fibre)	DY671 [13]	EY671
121 III H/420	03/96→04/03	1299	4	74.00	SOHC/OHC	37/50				
1.3	ZJ-VE						17			
2 1.3 3 1.4	10/07→ 10/03→06/09	1349	4	74.00	DOHC	55-67/ 75-91				
1.4	F6JA Diesel						18	AH6560 (MLS), 1.25mm, 2 Notches AH6570 (MLS), 1.3mm, 3 Notches AH6580 (MLS), 1.35mm, 1 Notch AH6590 (MLS), 1.4mm, 4 Notches AH6600 (MLS), 1.45mm, 5 Notches	CD5130 ▲	ED5130
2 1.4 CD	04/03→	1399	4	73.70	SOHC/OHC	50/68				
1.4	F6JB Diesel						19	AH6560 (MLS), 1.25mm, 2 Notches AH6570 (MLS), 1.3mm, 3 Notches AH6580 (MLS), 1.35mm, 1 Notch AH6590 (MLS), 1.4mm, 4 Notches AH6600 (MLS), 1.45mm, 5 Notches	CD5130 ▲	ED5130
2 1.4 CD	04/03→	1399	4	73.70	SOHC/OHC	50/68				
1.4	FXJA						20	AB5133 (MLS)	CB5133 ☒	EB5120
2 1.4 3 1.4	02/03→ 02/04→06/09	1388	4	76.00	DOHC	59/80				
1.5	B5						21	BP600 (Graphite)	DP602 [3]	GP602 [3]
323 III 1.5	01/87→09/91	1498	4	78.00	SOHC/OHC	54-55/ 73-75				
1.5	B5 E						22	AG7850 (MLS)	CG7850	
Demio 1.5 16V	04/00→	1498	4	78.00	SOHC/OHC	55/75				
1.5	B50						23	BP600 (Graphite)	DP602 [3]	GP602 [3]
323 III 1.5	05/86→05/89	1498	4	78.00	SOHC/OHC	54-55/ 73-75				

									
		JC163  JC250 	JN396 [4] HL508 	JJ149		NA5058 [2] 40.00x55.00x7.00mm, FPM NB384  [2] 40.00x55.00x8.00mm, NBR NJ099  [1] 70.00x88.00x12.00mm, MVQ			 BJ430  BP600  BT140  HA497  JC163  JC250  JC974  JD5151  JD5164  JD545  JM5155  JN105  JN396  JN628  JH5015  JJ149  JJ354
HBS050  [22] M11x1.50x120.00mm (x10)	JD5151  JD545  HA497  	JN105 [4]	JH5015	HR655 	NA576 [2] 36.50x52.30x8.00mm, MVQ NB788  [1] 79.40x95.30x11.10mm, PTFE				
HBS050  [22] M11x1.50x120.00mm (x10)	JD5151  JD545  (x4) HA497  	JN105 [4]	JH5015	HR655 	NA576 [2] 36.50x52.30x8.00mm, MVQ NB788  [1] 79.40x95.30x11.10mm, PTFE				
HBS050  [22] M11x1.50x120.00mm (x10)	JD5151  JD545  HA497  	JN105 [4]	JH5015	HR655 	NA576 [2] 36.50x52.30x8.00mm, MVQ NA576  [2] 36.50x52.30x8.00mm, MVQ NB788  [1] 79.40x95.30x11.10mm, PTFE				
HBS050  [22] M11x1.50x120.00mm (x10)	JD5151  JD545  (x4) HA497  	JN105 [4]	JH5015	HR655 	NA576  [2] 36.50x52.30x8.00mm, MVQ NB788  [1] 79.40x95.30x11.10mm, PTFE				
HBS523  [5] [21]	JD6036  (x4) (FPM)		HR397		NA5246  [2] 42.50x54.50x6.00mm, MVQ NK157  [1] [2] 84.00x100.00x10.00mm, FPM				
HBS359  [22] M11x1.50x147.00mm (x10)	HA5029   JD5829 	JM5299			NA5258 [2] 27.00x47.00x7.00mm, PTFE NA5259  [2] 40.00x55.00x6.40mm, PTFE				
HBS359  [22] M11x1.50x147.00mm (x10)	HA5029   JD5829 	JM5299			NA5258 [2] 27.00x47.00x7.00mm, PTFE NA5259  [2] 40.00x55.00x6.40mm, PTFE				
HBS078  [22] M10x1.50x143.00mm (x10)	JD5866  JD5164  →10/03 JD5865  11/03→	JM5155 [78] (Elastomer) JM7060 [79] (Elastomer)		HR808  HR809  	NC048 [2] 38.00x52.00x6.00mm, FPM NA5137  [2] 32.90x47.40x5.00mm, FPM LK5004  [1] [7] 80.00x182.00x19.40mm, PTFE				
	JC974 	JN628 [4]	JJ354	PA883 (x8)	NJ448 [2] 30.00x44.00x7.00mm, NBR NJ448  [2] 30.00x44.00x7.00mm, NBR NJ650  [1] 83.00x100.00x9.00mm, ACM				
	JD5753 				NJ448 [2] 30.00x44.00x7.00mm, NBR NK158  [2] 37.00x50.50x7.00mm, ACM				
	JC974 	JN628 [4]	JJ354	PA883 (x8)	NJ448 [2] 30.00x44.00x7.00mm, NBR NJ448  [2] 30.00x44.00x7.00mm, NBR NJ650  [1] 83.00x100.00x9.00mm, ACM				



cc



kW/PS



1.5	B53						24	BP600 (Graphite)	DP602 [3]	GP602 [3]
323 III 1.5	05/86→05/89	1498	4	78.00	SOHC/OHC	54-55/ 73-75				
1.5	E5						25	BP600 (Graphite)	DP602 [3]	GP602 [3]
323 III 1.5	08/85→05/89	1490	4	77.00	SOHC/OHC	47-65/ 64-88				
1.5	E5E2						26	BP540 (Graphite)	DP540	
323 III 1.5i T	08/85→05/89	1490	4	77.00		85/115				
1.5	E5E3						27	BP540 (Graphite)	DP540	
323 III 1.5 i	08/85→05/89	1490	4	77.00		70/95				
1.5	Z5-DE						28	AG5120 (MLS), 0.450mm	CG5380	
323 C IV 1.5	08/94→09/98	1489	4	75.30	DOHC	65/88				
323 F V 1.5 16V	07/94→09/98									
323 P V 1.5 16V	10/96→									
323 S V 1.5 16V	08/94→09/98									
1.5	ZY-DE						29	AG8170 (MLS)		
2 1.5	10/07→	1498	4	78.00	DOHC	76/103				
1.5	ZY-VE						30	AG8170 (MLS)		
2 1.5	04/03→	1498	4	78.00	DOHC	76-84/ 103-114				
1.6	B6						31	BS940 (Graphite)	DS940	
323 C IV 1.6	03/91→10/94	1598	4	78.00	DOHC	64-65/ 87-88	10/89→	10/89→		
323 F V 1.6 16V	03/91→10/94									
323 S IV 1.6	08/89→10/94									
1.6	B6 (DOHC)						32	BS940 (Graphite)		
323 S V 1.6	08/94→09/98	1598	4	78.00	DOHC	79-80/ 107-109				
323 S VI 1.6	09/98→02/01									
Xedos 6 1.6 16V	06/94→10/99									
1.6	B6 (SOHC)						33	BP600 (Graphite)		
323 III 1.6	09/86→10/95	1598	4	78.00	SOHC/OHC	63-77/ 86-105	→01/90			
323 III 1.6 GT	08/85→08/93						AJ270 (Graphite) 02/90→			
1.6	B64F						34	BS940 (Graphite)		GS941
MX-5 1.6	05/90→01/94	1598	4	78.00	DOHC	85/115				
1.6	B65M						35	BV110 (Fibre)	DV110	
323 III 1.6	09/86→10/95	1598	4	78.00	SOHC/OHC	63-66/ 86-90				
323 III FL 608	05/90→03/93									

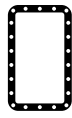

AJ270



BP540



BP600



BS940



BV110



JC664



JC974



JN628

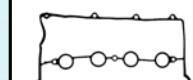

JN752



JN774



JJ354

	JC974	JN628 [4]	JJ354	PA883 (x8)	NJ448 [2] 30.00x44.00x7.00mm, NBR NJ448 [2] 30.00x44.00x7.00mm, NBR NJ650 [1] 83.00x100.00x9.00mm, ACM	
	JC974	JN628 [4]	JJ354	PA883 (x8)	NJ448 [2] 30.00x44.00x7.00mm, NBR NJ448 [2] 30.00x44.00x7.00mm, NBR NJ650 [1] 83.00x100.00x9.00mm, ACM	
					NA5058 [2] 40.00x55.00x7.00mm, FPM	
					NA5058 [2] 40.00x55.00x7.00mm, FPM	
HBS420 [22] M11x1.50x100.00mm (x10)	JD6040 0.35mm JD6044 (MLS) 0,7mm	JM5287	HC5009	PB353 (x16) PB354 (x16)	NJ324 [2] 34.00x48.00x7.00mm, ACM NK158 [2] 37.00x50.50x7.00mm, ACM	
	JD6036 (x4) (FPM)		HR397		NA5246 [2] 42.50x54.50x6.00mm, MVQ NK157 [1] [2] 84.00x100.00x10.00mm, FPM	
	JD6036 (x4) (FPM)		HR397		NA5246 [2] 42.50x54.50x6.00mm, MVQ NK157 [1] [2] 84.00x100.00x10.00mm, FPM	
	JD5753 10/89→	JN774 [4] 10/89→	HC5009 10/89→ HR397 10/89→		NJ448 [2] 30.00x44.00x7.00mm, NBR 10/89→ NJ285 [2] 34.00x48.00x8.00mm, NBR 10/89→ NK157 [1] [2] 84.00x100.00x10.00mm, FPM 10/89→	
		JN752 [4]	HC5009		NJ448 [2] 30.00x44.00x7.00mm, NBR NJ285 [2] 34.00x48.00x8.00mm, NBR NK157 [1] [2] 84.00x100.00x10.00mm, FPM	
	JC664 01/90→	JN774 [4]	HC5009	PA883 (x8)	NJ448 [2] 30.00x44.00x7.00mm, NBR NJ448 [2] 30.00x44.00x7.00mm, NBR NK157 [1] [2] 84.00x100.00x10.00mm, FPM	
					NJ324 [2] 34.00x48.00x7.00mm, ACM	
				PA883 (x8)	NJ448 [2] 30.00x44.00x7.00mm, NBR	

MAZDA



cc



kW/PS



Engine Model	Year Range	CC	Cyls	Power (kW/PS)	Configuration	Stroke (mm)	Accessories	Notes
1.6 B68							36	
323 III 1.6	09/87→10/89	1597	4	78.00		54/74	BP600 (Graphite)	DP601 [3] GP601 01/88→
1.6 B69							37	
MX-3 1.6 i	07/91→	1598	4	78.00	SOHC/OHC	65-66/ 88-90	BV110 (Fibre) BV510 (Graphite)	
1.6 B69							38	
Xedos 6 1.6 16V	08/92→05/94	1598	4	78.00	DOHC	83-85/ 113-115	BS940 (Graphite)	DS940
1.6 B6D							39	
MX-3 1.6 i MX-5 II 1.6 16V	01/94→ 05/98→10/05	1598	4	78.00	DOHC	79-81/ 107-110	BP570 (Graphite)	DP570 [3] GP570
1.6 B6E							40	
323 C IV 1.6 323 F V 1.6 323 III 1.6 323 III FL 608 323 S IV 1.6	09/89→06/91 09/89→06/91 09/86→10/95 05/90→03/93 09/89→06/91	1598	4	78.00	SOHC/OHC	62-63/ 84-86	BP600 (Graphite) →07/89 BS940 (Graphite) 07/89→	
1.6 B6T							41	
323 III 1.6 GT	10/85→08/93	1598	4	78.00	DOHC	100-103/ 136-140	BP570 (Graphite)	DP570 [3]
1.6 B6ZE							42	
3 1.6	10/03→06/09	1598	4	78.00	DOHC	77-88/ 104-120	AG8170 (MLS)	CG8170 FG8170
1.6 FYJA							43	
2 1.6	02/03→	1596	4	79.00	DOHC	74/100	AC5860 (MLS), 0.500mm 10/03→	EB5120
1.6 Y601 Diesel							44	
3 1.6 DI Turbo 3 1.6 MZR CD	06/04→06/09 06/09→	1560	4	75.00	DOHC	80-81/ 109-110	AD5130 (MLS), 1.250mm, 2 Notches AD5140 (MLS), 1.300mm, 3 Notches AD5150 (MLS), 1.350mm, 1 Notch AD5160 (MLS), 1.400mm, 4 Notches AD5170 (MLS), 1.450mm, 5 Notches	CD5140 ▲
1.6 Z6							45	
3 1.6 3 1.6 MZR	02/04→ 06/09→	1598	4	78.00	DOHC	77/105	AG8170 (MLS)	CG8170
1.6 ZM							46	
323 F V 1.6 323 S VI 1.6	01/01→05/04 01/01→05/04	1598	4	78.00	DOHC	70-72/ 95-98	BV380 (MLS)	DV380 [3]
1.7 4EE1-T Diesel							47	
323 S V 1.6 TD	05/94→09/98	1686	4	79.00	SOHC/OHC	60-65/ 82-88	AB5010 (MLS), 1.400mm 04/95→ →Eng.320552 AB5020 (MLS), 1.450mm, 1 Hole 04/95→ →Eng.320552 AB5030 (MLS), 1.500mm, 2 Holes 04/95→ →Eng.320552	CY811 ▲ [3] 04/95→ FY811 ▲ [3] 04/95→

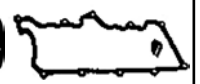
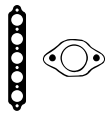

AB5010, AB5020,
AB5030

JN777



AC5860

JJ354



AD5130, AD5140,
AD5150, AD5160,
AD5170



BP570



BP600



BS940



BV110



BV380

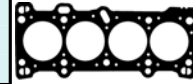

BV510



JC666



JC781



JC784

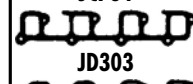

JD303



JD304



JM5155



JN628

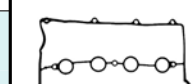

JN752



JN774

MAZDA



cc



kW/PS



1.7	PN26 Diesel					48	BS070 (Graphite)	DS070 [3]	GS070
323 III 1.7 D	10/89→03/93	1720	4	78.00	SOHC/OHC	40-44/ 54-60			
323 III FL 608	11/86→10/89								
1.7	PN27 Diesel					49	BS070 (Graphite)	DS070 [3]	GS070
323 III 1.7 D	04/86→05/89	1720	4	78.00	SOHC/OHC	40-44/ 54-60			
1.7	PN46 Diesel					50	BS070 (Graphite)	DS070 [3]	GS070
323 III 1.7 D	01/87→05/89	1720	4	78.00	SOHC/OHC	41-42/ 56-57			
323 S IV 1.7 D	08/89→07/94								
1.7	PN54 Diesel					51	BS070 (Graphite)	DS070 [3]	GS070
323 C IV 1.7 D	08/89→07/94	1720	4	78.00	SOHC/OHC	40-44/ 54-60			
323 III 1.7 D	10/89→03/93								
323 III FL 608	11/86→10/89								
323 S IV 1.7 D	08/89→07/94								
1.7	PN62 Diesel					52	BS070 (Graphite)	DS070 [3]	GS070
323 S IV 1.7 D	08/89→07/94	1720	4	78.00	SOHC/OHC	41-43/ 56-58			
1.8	BP					53	BS950 (MLS)	DS950	GS950 [3]
323 C IV 1.8	11/91→12/93	1840	4	83.00	SOHC/OHC	76-78/ 103-106			
323 F V 1.8 16V	08/89→07/94								
1.8	BP (DOHC)					54	BS950 (MLS)	DS950	GS950 [3]
323 C IV 1.8 GT	09/89→03/93	1840	4	83.00	DOHC	92-96/ 125-130	01/91→12/94	01/91→12/94	01/91→12/94
323 F V 1.8 GT	08/89→07/94								
323 S IV 1.8	06/89→07/94								
323 S V 1.8	07/94→09/98								
MX-5 1.8	02/94→04/98								
1.8	BP22					55	BS950 (MLS)	DS950	GS953
323 C IV 1.8	09/89→03/93	1840	4	83.00	DOHC	103/140			
1.8	BP31					56	BS950 (MLS)	DS950	GS953
323 C IV 1.8	09/89→03/93	1840	4	83.00	DOHC	103/140			
323 F V 1.8 16V	09/89→03/93								

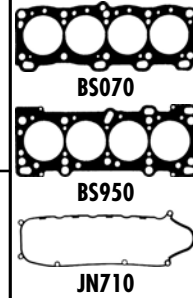
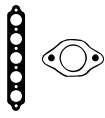

HBS211 [22]
M12x1.50x113.00mm (x10)

JN710 [4]

PA883 (x8)

NJ448 [2]
30.00x44.00x7.00mm, NBR
NJ448 [2]
30.00x44.00x7.00mm, NBR
NJ650 [1]
83.00x100.00x9.00mm, ACM

HBS211 [22]
M12x1.50x113.00mm (x10)

JN710 [4]

PA883 (x8)

NJ448 [2]
30.00x44.00x7.00mm, NBR
NJ448 [2]
30.00x44.00x7.00mm, NBR
NJ650 [1]
83.00x100.00x9.00mm, ACM

HBS211 [22]
M12x1.50x113.00mm (x10)

JN710 [4]

PA883 (x8)

NJ448 [2]
30.00x44.00x7.00mm, NBR
NJ448 [2]
30.00x44.00x7.00mm, NBR
NJ650 [1]
83.00x100.00x9.00mm, ACM

HBS211 [22]
M12x1.50x113.00mm (x10)

JN710 [4]

PA883 (x8)

NJ448 [2]
30.00x44.00x7.00mm, NBR
NJ448 [2]
30.00x44.00x7.00mm, NBR
NJ650 [1]
83.00x100.00x9.00mm, ACM

HBS211 [22]
M12x1.50x113.00mm (x10)

JN710 [4]

PA883 (x8)

NJ448 [2]
30.00x44.00x7.00mm, NBR
NJ448 [2]
30.00x44.00x7.00mm, NBR
NJ650 [1]
83.00x100.00x9.00mm, ACM

HBS136 [22]
M11x1.50x104.50mm (x10)

JN775 [4]

PA956 (x16)

NJ324 (x2) [2]
34.00x48.00x7.00mm, ACM
NJ448 [2]
30.00x44.00x7.00mm, NBR
NJ650 [1]
83.00x100.00x9.00mm, ACM

HBS136 [22]
M11x1.50x104.50mm (x10)
01/91→12/94

JN775 [4]
01/91→12/94

PA956 (x16)
01/91→12/94

NJ324 (x2) [2]
34.00x48.00x7.00mm, ACM
01/91→12/94
NJ448 [2]
30.00x44.00x7.00mm, NBR
01/91→12/94
NJ650 [1]
83.00x100.00x9.00mm, ACM
01/91→12/94

HBS136 [22]
M11x1.50x104.50mm (x10)

JN775 [4]

HC5009

NJ324 [2]
34.00x48.00x7.00mm, ACM
NJ448 [2]
30.00x44.00x7.00mm, NBR
NJ650 [1]
83.00x100.00x9.00mm, ACM

HBS136 [22]
M11x1.50x104.50mm (x10)

JN775 [4]

HC5009

NJ324 [2]
34.00x48.00x7.00mm, ACM
NJ448 [2]
30.00x44.00x7.00mm, NBR
NJ650 [1]
83.00x100.00x9.00mm, ACM



cc



kW/PS



1.8	BP52	57	BS950 (MLS)	DS950	GS950 [3]
323 S IV 1.8	08/89→07/94	1840 4 83.00 DOHC 76/103	09/91→	09/91→	09/91→
1.8	BPC	58	BS950 (MLS)	DS950	GS950 [3]
323 F V 1.8	01/91→04/94	1840 4 83.00 DOHC 76-78/103-106			
1.8	BPD	59	BS953 (MLS)		
MX-5 II 1.8	01/98→07/02	1840 4 83.00 102-107/139-146			
MX-5 II 1.8 16V	11/00→10/05				
1.8	BPF1	60	BS950 (MLS)	CG5370	
MX-5 1.8	09/93→04/98	1840 4 83.00 DOHC 92-98/125-133			
1.8	BP-ZE	61	BS950 (MLS)	CG5370	GS950 [3]
323 C IV 1.8	08/94→09/98	1840 4 83.00 DOHC 84-103/114-140	05/98→	05/98→	05/98→
323 F V 1.8 16V	08/94→09/98				
323 S V 1.8 16V	08/94→09/98				
MX-5 II 1.8 16V	05/98→10/05				
1.8	F8 (12V)	62	BR730 (Graphite)	DR736 [3]	
626 III 1.8	09/87→05/92	1789 4 86.00 SOHC/OHC 58-65/79-88			
1.8	FP	63	BV380 (MLS)	CG5390	GV380
626 IV 1.8	08/91→04/97	1840 4 83.00 DOHC 74-84/100-114			
626 IV 1.8 i	01/92→04/97				
626 V 1.8	12/99→10/02				
Premacy 1.9	07/99→03/05				
1.8	FP9A	64	BV380 (MLS)	CG5390	GV380
626 V 1.8	12/99→10/02	1840 4 83.00 74/100			
MX-6 1.8	12/95→02/97				
1.8	FPY3	65	BV380 (MLS)	CG5390	GV380
626 V 1.8	05/97→01/00	1840 4 83.00 DOHC 66/90			

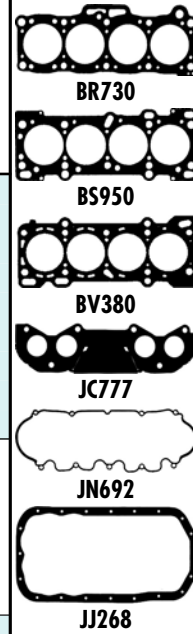

HBS136 [22]
M11x1.50x104.50mm (x10)
09/91→

JN775 [4]
09/91→

PA956 (x16)
09/91→

NJ324 (x2) [2]
34.00x48.00x7.00mm, ACM
09/91→
NJ448 [2]
30.00x44.00x7.00mm, NBR
09/91→
NJ650 [1]
83.00x100.00x9.00mm, ACM
09/91→

HBS136 [22]
M11x1.50x104.50mm (x10)

JN775 [4]

PA956 (x16)

NJ324 [2]
34.00x48.00x7.00mm, ACM
NJ448 [2]
30.00x44.00x7.00mm, NBR
NJ650 [1]
83.00x100.00x9.00mm, ACM

HR397

NJ324 [2]
34.00x48.00x7.00mm, ACM

JN775 [4]

HC5009
HR397

NJ324 [2]
34.00x48.00x7.00mm, ACM
NK158 [2]
37.00x50.50x7.00mm, ACM

JN775 [4]
05/98→

HC5009
05/98→
HR397
05/98→

PA956 (x16)
05/98→

NJ324 (x2) [2]
34.00x48.00x7.00mm, ACM
05/98→
NJ448 [2]
30.00x44.00x7.00mm, NBR
05/98→
NK158 [2]
37.00x50.50x7.00mm, ACM
05/98→
NJ650 [1]
83.00x100.00x9.00mm, ACM
05/98→

JC777

JN692 [4]

JJ268

PA883 (x12)

NJ324 [2]
34.00x48.00x7.00mm, ACM
NJ324 [2]
34.00x48.00x7.00mm, ACM
NJ325 [1]
90.00x110.00x9.00mm, MVQ

HBS136 [22]
M11x1.50x104.50mm (x10)

JD331

HR397

NJ324 [2]
34.00x48.00x7.00mm, ACM
NAS246 [2]
42.50x54.50x6.00mm, MVQ
NK205 [1][104]
89.00x109.00x9.00mm, MVQ

HBS136 [22]
M11x1.50x104.50mm (x10)

JD331

HR397

NJ324 [2]
34.00x48.00x7.00mm, ACM
NAS246 [2]
42.50x54.50x6.00mm, MVQ

HBS136 [22]
M11x1.50x104.50mm (x10)

JD331

HR397

NJ324 [2]
34.00x48.00x7.00mm, ACM
NAS246 [2]
42.50x54.50x6.00mm, MVQ
NK205 [1][104]
89.00x109.00x9.00mm, MVQ



cc



kW/PS



1.8	L813					66	AC5940 (MLS)		
6 1.8 6 1.8 MZR	08/02→08/07 08/07→	1798	4	83.00	DOHC	88/120			
1.8	L823					67	AD5220 (MLS) →08/07 AH6680 (MLS) [105] 08/07→		
5 1.8	03/05→	1798	4	83.00	DOHC	85/116			
1.8	L828					68	AC5940 (MLS)		
MX-5 III 1.8	03/05→	1798	4	83.00	DOHC	93/126			
1.8	L8-DE					69	AC5940 (MLS)		
MX-5 III 1.8	03/05→	1798	4	83.00	DOHC	91-93/ 124-126			
1.8	RTJ Diesel					70	BW010 (Fibre), 1.360mm, 2 Notches ☒-0.430→0.680mm AB5800 (Fibre), 1.360mm, 2 Teeth ☒-0.430→0.680mm BW020 (Fibre), 1.420mm, 3 Notches ☒-0.681→0.740mm AB5810 (Fibre), 1.420mm, 3 Teeth ☒-0.681→0.740mm BW030 (Fibre), 1.520mm, 4 Notches ☒-0.741→0.860mm AB5820 (Fibre), 1.520mm, 4 Teeth ☒-0.741→0.860mm		ET192 [3]
121 III H/420	03/96→04/03	1753	4	82.50		44/60			
1.8	RTK Diesel					71	BW010 (Fibre), 1.360mm, 2 Notches ☒-0.430→0.680mm AB5800 (Fibre), 1.360mm, 2 Teeth ☒-0.430→0.680mm BW020 (Fibre), 1.420mm, 3 Notches ☒-0.681→0.740mm AB5810 (Fibre), 1.420mm, 3 Teeth ☒-0.681→0.740mm BW030 (Fibre), 1.520mm, 4 Notches ☒-0.741→0.860mm AB5820 (Fibre), 1.520mm, 4 Teeth ☒-0.741→0.860mm		ET192 [3]
121 III H/420	03/96→04/03	1753	4	82.50		44/60			
2.0	FE (12V)					72	BL320 (Fibre) BR850 (Graphite)	DR850 [3]	GR850 [3]
626 III 2.0 626 III 2.0 12V E-Serie 2.0 i	09/87→10/90 09/87→05/92 08/99→10/01	1998	4	86.00	SOHC/OHC	66-81/ 90-110			
2.0	FE (16V)					73	BR850 (Graphite)	DR850 [3]	GR850 [3]
626 III 2.0 16V	06/87→05/92	1998	4	86.00	DOHC	103-109/ 140-148			

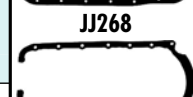
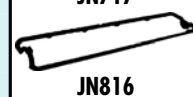
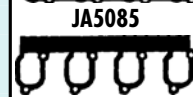
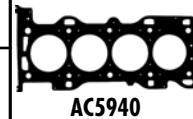
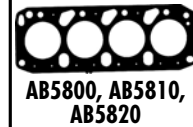

HBS369 [5]
M10x1.50x145.50mm (x10)

JD5299 [1]
JE5037 [1]

JM5153 [78]
(Elastomer)
JM5158 [79]
(Elastomer)

HR397

HR5063 [1]

NA5157 [2]
37.00x50.00x8.00mm, PTFE
NA5157 [2]
37.00x50.00x8.00mm, PTFE
LK5005 [1] [7]
88.00x188.00x15.000mm, PTFE

AC5940

HBS369 [5]
M10x1.50x145.50mm (x10)

JD5299 [1]
JE5037 [1]

JM5153 [78]
(Elastomer)

HR397

HR5063 [1]

NA5157 [2]
37.00x50.00x8.00mm, PTFE
NA5157 [2]
37.00x50.00x8.00mm, PTFE
LK5005 [1] [7]
88.00x188.00x15.000mm, PTFE

AD5220

HBS369 [5]
M10x1.50x145.50mm (x10)

JM5153 [78]
(Elastomer)

HR397

HR5063 [1]

NA5157 [2]
37.00x50.00x8.00mm, PTFE
NA5157 [2]
37.00x50.00x8.00mm, PTFE
LK5005 [1] [7]
88.00x188.00x15.000mm, PTFE

BL320

HBS369 [5]
M10x1.50x145.50mm (x10)

JM5153 [78]
(Elastomer)

HR397

HR5063 [1]

NA5157 [2]
37.00x50.00x8.00mm, PTFE
NA5157 [2]
37.00x50.00x8.00mm, PTFE
LK5005 [1] [7]
88.00x188.00x15.000mm, PTFE

BR850

HBS033 [19]
M12x1.75x136.00mm (x10)

JD240 [1]
JD310 [1]

JN816 [4]

JJ463

PB180 (x8)
8.00x12.0/15.40x9.50
866N W (FPM)
HR801 [1]

NB785 [2]
28.00x38.00x7.00mm, FPM
NB984 [2]
66.67x89.30x10.00mm, FPM
NB788 [1]
79.40x95.30x11.10mm, PTFE

BW010, BW020,
BW030

HBS033 [19]
M12x1.75x136.00mm (x10)

JD240 [1]
JA5085 [1]
JD310 [1]

JN816 [4]

JJ463

PB180 (x8)
8.00x12.0/15.40x9.50
866N W (FPM)
HR801 [1]

NB785 [2]
28.00x38.00x7.00mm, FPM
NB984 [2]
66.67x89.30x10.00mm, FPM
NB788 [1]
79.40x95.30x11.10mm, PTFE

JA5085

JD240

JD310

JD5299

JE5037

JN717

JN816

JJ268

JN717 [4]

JJ268

PA883 (x12)

NJ324 [2]
34.00x48.00x7.00mm, ACM
NJ324 [2]
34.00x48.00x7.00mm, ACM
NJ325 [1]
90.00x110.00x9.00mm, MVQ

JJ463

JN717 [4]

JJ268

PA956 (x16)

NJ324 (x2) [2]
34.00x48.00x7.00mm, ACM
NJ324 [2]
34.00x48.00x7.00mm, ACM
NJ325 [1]
90.00x110.00x9.00mm, MVQ

MAZDA

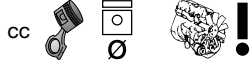

kW/PS

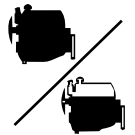

2.0	FE (8V)					74	BL320 (Fibre) BR850 (Graphite)	DR850 [3]	GR850 [3]
626 III 2.0	09/87→09/97	1998	4	86.00	SOHC/OHC	60-88/ 82-120			
929 III 2.0	06/87→12/88								
B-Serie 2.0	01/85→03/96								
E-Serie E2000	01/84→07/06								
2.0	FEFA					75	BL320 (Fibre) BR850 (Graphite)	DR850 [3]	GR850 [3]
929 III 2.0	06/87→12/88	1998	4	86.00	SOHC/OHC	85/116			
2.0	FS					76	BV380 (MLS)	DV380 [3]	
323 S VI 2.0	02/00→05/04	1991	4	83.00	DOHC	85-98/ 116-133			
626 III 2.0 GLX	04/92→02/95								
626 IV 2.0 i	08/91→04/97								
626 IV 2.0i 4WD	04/92→04/97								
626 V 2.0	05/97→10/02								
MPV II 2.0	08/00→07/02								
MX-6 2.0	02/92→02/97								
2.0	FS2C					77	BV380 (MLS)	DV380 [3]	
626 V 2.0	04/98→10/02	1991	4	83.00	DOHC	100/136			
626 V 2.0 H.P.	02/98→10/02								
2.0	FS7E					78	BV380 (MLS)	DV380 [3]	
323 F V 2.0	01/01→05/04	1991	4	83.00	DOHC	96/131			
323 S VI 2.0	01/01→05/04								
Premacy 2.0	11/01→03/05								
2.0	FS7G					79	BV380 (MLS)	DV380 [3]	
323 F V 2.0	01/01→05/04	1991	4	83.00	DOHC	96/131			
323 S VI 2.0	01/01→05/04								
Premacy 2.0	11/01→03/05								
2.0	FS-DS					80	BV380 (MLS)	DV380 [3]	
MPV II 2.0	09/99→08/00	1991	4	83.00	DOHC	90/122			
2.0	KF					81	BX790 (MLS) BX780 (MLS)		
323 F V 2.0 24V	08/94→09/98	1995	6	78.00	DOHC, V	104-106/ 141-144			
Xedos 9 2.0 24V	08/93→01/00								
2.0	KF1					82	BX790 (MLS) BX780 (MLS)		
Xedos 6 2.0 V6	01/92→10/99	1995	6	78.00	DOHC, V	103-106/ 140-144			
2.0	LF17					83	AD5220 (MLS) →08/07 AH6680 (MLS) [105] 08/07→		
3 2.0	10/03→06/09	1999	4	87.50	DOHC	104-110/ 141-150			
3 2.0 MZR	06/09→								
6 2.0	06/02→08/07								
6 2.0 MZR	08/07→								



AD5220



BL320



BR850

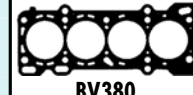

BV380

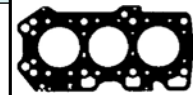

BX780



BX790

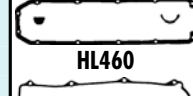

HL460



JN717



JJ268

		JN717 [4]	JJ268	PA883 (x8)	NJ324 [2] 34.00x48.00x7.00mm, ACM NJ325 [1] 90.00x110.00x9.00mm, MVQ
		JN717 [4]	JJ268	PA883 (x8) PA956 (x8)	NJ324 [2] 34.00x48.00x7.00mm, ACM NJ325 [1] 90.00x110.00x9.00mm, MVQ
HBS136 [22] M11x1.50x104.50mm (x10)	JD331	JN877 [4]	HR397		NJ324 [2] 34.00x48.00x7.00mm, ACM NAS246 [2] 42.50x54.50x6.00mm, MVQ NK205 [1][104] 89.00x109.00x9.00mm, MVQ
HBS136 [22] M11x1.50x104.50mm (x10)	JD331	JN877 [4]	HR397		NJ324 [2] 34.00x48.00x7.00mm, ACM NAS246 [2] 42.50x54.50x6.00mm, MVQ NK205 [1][104] 89.00x109.00x9.00mm, MVQ
HBS136 [22] M11x1.50x104.50mm (x10)	JD331		HR397		NJ324 [2] 34.00x48.00x7.00mm, ACM NAS246 [2] 42.50x54.50x6.00mm, MVQ
HBS136 [22] M11x1.50x104.50mm (x10)	JD331	JN775 [4]			NJ324 [2] 34.00x48.00x7.00mm, ACM NAS246 [2] 42.50x54.50x6.00mm, MVQ
HBS136 [22] M11x1.50x104.50mm (x10)	JD331	JN775 [4]			NJ324 [2] 34.00x48.00x7.00mm, ACM NAS246 [2] 42.50x54.50x6.00mm, MVQ NK205 [1][104] 89.00x109.00x9.00mm, MVQ
	JD5756 JD5755	JN438 (Elastomer) HL460 (Cork)	HR397		NJ448 [2] 30.00x44.00x7.00mm, NBR NAS246 [2] 42.50x54.50x6.00mm, MVQ
	JD5756 JD5755	JN438 (Elastomer) HL460 (Cork)	HR397		NJ448 [2] 30.00x44.00x7.00mm, NBR NAS246 [2] 42.50x54.50x6.00mm, MVQ
HBS369 [5] M10x1.50x145.50mm (x10)		JM5153 [78] (Elastomer) JM5158 [79] (Elastomer)	HR397		NA5157 [2] 37.00x50.00x8.00mm, PTFE NAS157 [2] 37.00x50.00x8.00mm, PTFE LK5005 [1][7] 88.00x188.00x15.00mm, PTFE

MAZDA



cc



kW/PS



2.0	LF18						84	AD5220 (MLS)		
6 2.0	06/02→08/07	1999	4	87.50	DOHC	104/141				
2.0	LF-DE						85	AD5220 (MLS)		
3 2.0 MZR	06/09→	1999	4	87.50	DOHC	104-118/	→08/07			
6 2.0 MZR	01/10→					141-160	AH6680 (MLS) [105]			
MX-5 III 2.0	03/05→						08/07→			
2.0	LFF7						86	AD5220 (MLS)		
5 2.0	03/05→	1999	4	87.50	DOHC	107/146				
6 2.0	03/05→08/07									
Premacy 2.0	02/05→03/05									
2.0	RF OHC Diesel						87	AG5130 (MLS), 1.500mm	CG5460	
626 IV 2.0D GLX	10/92→04/97	1998	4	86.00	SOHC/OHC	55/75				
2.0	RF1G Diesel						88	AG5130 (MLS), 1.500mm		
323 F V 2.0 D	09/98→05/04	1998	4	86.00	SOHC/OHC	52/71				
323 P V 2.0 D	10/96→									
323 S V 2.0 D	10/96→09/98									
323 S VI 2.0 D	09/98→05/04									
2.0	RF3F Diesel						89	AG8190 (MLS)	CG8191	
323 S VI 2.0 TD	09/98→05/04	1998	4	86.00	SOHC/OHC	66/90				
626 V 2.0 DITD	04/98→10/02									
Premacy 2.0 TD	10/99→07/00									
2.0	RF4F Diesel						90	AG8190 (MLS)	CG8191	
323 F V 2.0 TD	01/01→05/04	1998	4	86.00		74/101				
323 S VI 2.0 TD	10/00→10/02									
626 V 2.0 TDI	04/98→10/02									
Premacy 2.0 TD	07/00→03/05									
2.0	RF5C Diesel						91	AG8190 (MLS)	CG8190	FG8190
6 2.0 GiTD 4x4	10/02→02/05	1998	4	86.00		89-100/				
6 2.0 DI	06/02→08/07					121-136				
MPV II 2.0 II	07/02→02/06									
2.0	RF7J Diesel						92	AG8190 (MLS)		
3 2.0 MZR-CD	12/06→06/09	1998	4	86.00	SOHC/OHC	103-105/				
5 2.0 CD	06/05→					140-143				
6 2.0 DI	06/05→08/07									
6 2.0 MZR-CD	08/07→									
2.0	RF-CX Diesel						93	AG5130 (MLS), 1.500mm	CG5460	EG5130 FG5130
626 III 2.0 D	05/93→11/96	1998	4	86.00		55/75				
2.0	RFG5 Diesel						94	AG5130 (MLS), 1.500mm	CG5460	
626 III 2.0 D	11/94→09/97	1998	4	86.00	SOHC/OHC	55-60/ 75-82				
2.0	RF-N Diesel						95	AG5130 (MLS), 1.500mm		
626 III 2.0 D	07/87→07/91	1998	4	86.00		44/60				

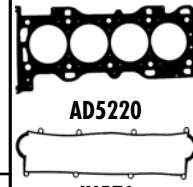
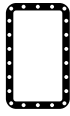
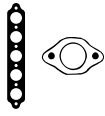

HBS369 [5] M10x1.50x145.50mm (x10)		JM5153 [78] (Elastomer) JM5158 [79] (Elastomer)	HR397		NA5157 [2] 37.00x50.00x8.00mm, PTFE NA5157 [2] 37.00x50.00x8.00mm, PTFE LK5005 [1][7] 88.00x188.00x15.000mm, PTFE	
HBS369 [5] M10x1.50x145.50mm (x10)		JM5153 [78] (Elastomer)	HR397		LK5005 [1][7] 88.00x188.00x15.000mm, PTFE	
HBS369 [5] M10x1.50x145.50mm (x10)		JM5153 [78] (Elastomer) JM5158 [79] (Elastomer)	HR397		NA5157 [2] 37.00x50.00x8.00mm, PTFE NA5157 [2] 37.00x50.00x8.00mm, PTFE LK5005 [1][7] 88.00x188.00x15.000mm, PTFE	
HBS211 [22] M12x1.50x113.00mm (x10)		JN576 [4]			NJ324 [2] 34.00x48.00x7.00mm, ACM	
HBS211 [22] M12x1.50x113.00mm (x10)		JN576 [4]	HR397		NJ448 [2] 30.00x44.00x7.00mm, NBR	
HBS289 [22] M12x1.50x113.00mm (x10)	JD6026 [1] 0.35mm JD6027 [3] (MLS) 0.55mm	JM5315	HR397		NJ448 [2] 30.00x44.00x7.00mm, NBR	
HBS289 [22] M12x1.50x113.00mm (x10)	JD6026 [1] 0.35mm JD6027 [3] (MLS) 0.55mm	JM5315	HR397		NJ448 [2] 30.00x44.00x7.00mm, NBR	
HBS494 [22] M12x1.50x160.00mm (x10)	JD6026 [1] 0.35mm JD6027 [3] (MLS) 0.55mm	JM5314 (Elastomer)	HR397		NJ448 [2] 30.00x44.00x7.00mm, NBR	
	JD6026 [1] 0.35mm JD6027 [3] (MLS) 0.55mm		HR397		NJ448 [2] 30.00x44.00x7.00mm, NBR	
HBS211 [22] M12x1.50x113.00mm (x10)		JN576 [4]			NJ324 [2] 34.00x48.00x7.00mm, ACM	
HBS211 [22] M12x1.50x113.00mm (x10)		JN576 [4]			NJ324 [2] 34.00x48.00x7.00mm, ACM	
HBS211 [22] M12x1.50x113.00mm (x10)		JN576 [4]			NJ324 [2] 34.00x48.00x7.00mm, ACM	

MAZDA



cc



kW/PS



2.2	F2	96	BR730 (Graphite)	DR732 [3] →12/90 DR734 [3] 01/91→	GR732 →12/90 GR734 [3] 01/91→				
626 III 2.2 12V	11/87→11/96	2184	4	86.00	SOHC/OHC	85/115			
626 III 2.2 4WD	11/87→11/92								
929 III 2.2 12V	01/88→04/89								
2.2	F21	97	BR730 (Graphite)	DR732 [3]	GR730 [3] GR732				
929 III 2.2 12V	01/88→04/89	2184	4	86.00	SOHC/OHC	85/115			
2.2	F2-C	98	BR730 (Graphite)	DR730 [3]	GR730 [3]				
929 III 2.2 12V	04/89→06/91	2184	4	86.00	SOHC/OHC	94/128			
2.2	F2E	99	BR730 (Graphite)	DR730 [3]	GR730 [3]				
929 III 2.2 12V	01/88→04/89	2184	4	86.00	SOHC/OHC	85/116			
2.2	F2-EGI	100	BR730 (Graphite)	DR732 [3]					
929 III 2.2 i	05/87→12/88	2184	4	86.00	SOHC/OHC	100/136			
2.2	F2L1	101	BR730 (Graphite)	DR734 [3]	GR734 [3]				
626 III 2.2 4WD	05/91→11/92	2184	4	86.00	SOHC/OHC	85/115			
2.2	R2 Diesel	102	BN620 (Fibre)	DN621	GN620 GN621 [3] 11/86→				
B-Serie 2.2 D	03/85→10/89	2184	4	86.00	SOHC/OHC	47-52/ 64-71			
E-Serie 2.2D	02/97→05/03								
E-Serie E2200	04/97→07/99								
Spectron 2.2 TD	08/86→10/95								
2.2	R203 Diesel	103	BN620 (Fibre) BS460 (Graphite)	DN621	GN620				
E-Serie 4WD	03/91→05/03	2184	4	86.00	SOHC/OHC	46-47/ 63-64			
E-Serie E2200 D	03/91→05/03								
2.2	R207 Diesel	104	BN620 (Fibre) BS460 (Graphite)	DN621	GN620				
E-Serie 4WD	03/91→05/03	2184	4	86.00	SOHC/OHC	46-47/ 63-64			
E-Serie E2200 D	03/91→05/03								
2.2	R290 Diesel	105	BN620 (Fibre) BS460 (Graphite)	DN621	GN620				
B-Serie 2.2 D	01/85→03/96	2184	4	86.00	SOHC/OHC	44-47/ 60-64			
2.2	R5A2	106	BR730 (Graphite)						
B-Serie 2.2 4WD	02/99→	2184	4	86.00	SOHC/OHC	60/82			

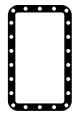
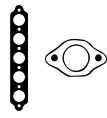

BN620



BR730



BS460



JC400



JC477



JC598



JC777



JC778



JC779



JN576



JN692



JJ268

MAZDA



cc



kW/PS

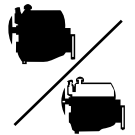

2.3	KJ -ZEM	107					AG8160 (MLS) 	CG8150	FG8150
Xedos 9 2.3 24V	02/95→01/00	2255	6	80.30	DOHC, V	155/211	06/96→ AG8150 (MLS) 		
							06/96→		
2.3	L3C1	108					AD5220 (MLS)	CD5220 [3]	
6 2.3	06/02→08/07	2261	4	87.50	DOHC	119-122/ 162-166			
6 2.3 AWD	11/02→08/07								
2.5	GY-DE	109					AC5880 (MLS) 	CG7850	
MPV II 2.5 V6	09/99→03/02	2495	6	81.60	DOHC, V	125/170	AC5870 (MLS) 		
2.5	KL	110					BV410 (MLS) 	DV410 [3]	
626 IV 2.5 24V	01/92→04/97	2497	6	84.50	DOHC, V	120-123/ 163-167	BV420 (MLS) 		
MX-6 2.5 24V	02/92→02/97								
MX-6 2.5 i 24V	08/94→02/97								
Xedos 9 2.5 24V	07/93→07/00								
Xedos 9 2.5 V6	07/00→09/02								
2.5	L5-VE	111					AH6350 (MLS)	CH6350	EH6350
6 2.5	08/07→12/07	2488	4	89.00	DOHC	120-125/ 163-170			
6 2.5 MZR	08/07→								
2.5	MD25NA Diesel	112					AA5130 (MLS)	CA5130 [3]	FA5130 [3]
B-Serie 2.5 D	06/99→	2500	4	94.00	SOHC/OHC	57/78			
B-Serie 2.5D	06/99→								
2.5	MD25TI Diesel	113					AA5130 (MLS)	CA5130 [3]	FA5130 [3]
B-Serie 2.4TD	06/99→07/06	2499	4	94.00	SOHC/OHC	80/109			
2.5	WLE7 Diesel	114					AA5130 (MLS)	CA5130 [3]	FA5130 [3]
B-Serie 2.5 D	11/99→12/01	2500	4	93.00	SOHC/OHC	61-63/ 83-86			
2.5	WL-T Diesel	115					AA5130 (MLS)	CA5130 [3]	FA5130 [3]
MPV I 2.5 TD	05/96→09/99	2499	4	93.00	SOHC/OHC	81-86/ 110-117			
2.5	WL-T (12 V) Diesel	116					AA5130 (MLS)	CA5130 [3]	FA5130 [3]
B-Serie 2.5 TD	02/99→03/05	2499	4	93.00	SOHC/OHC	85-92/ 116-125			
3.0	JE	117					BR970 (MLS) 		
929 III 3.0	06/87→06/91	2954	6	90.00	SOHC/OHC, V	140/190	BR980 (MLS) 		
3.0	JE3	118					BR970 (MLS) 		
929 III 3.0	01/88→12/89	2954	6	90.00	SOHC/OHC, V	123-125/ 167-170	BR980 (MLS) 		
929 III 3.0 i	01/90→06/91								
3.0	JE94	119					BR970 (MLS) 		
MPV I 3.0 i V6	03/95→09/99	2954	6	90.00	V	109-113/ 148-154	BR980 (MLS) 		



AC5870



AC5880

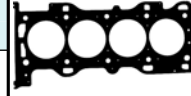

AD5220



BR970, BR980



BV410, BV420



JC931



JE5037



JN714



JH5065



Ltr







CC



9

Model	Ltr	Year Range	OM Code	Fuel Type	CC	Gear	Index
100 Box (631)	2.4	02/98→02/99	OM 616.963	Diesel	2399	4	141
100 Bus (631)	2.0	04/98→08/99	OM 615.963	Diesel	1988	4	64
100 Bus (631)	2.4	12/99→02/99	OM 616	Diesel	2399	4	134
100 Bus (631)	2.4	02/98→02/99	OM 616.963	Diesel	2399	4	141
100 Platform/Chassis (631)	2.4	02/98→02/99	OM 616.963	Diesel	2399	4	141
190 (W201)	1.8	04/99→08/99	M 102.910	Petrol	1797	4	12
190 (W201)	2.0	09/98→05/99	M 102.924	Petrol	1996	4	36
190 (W201)	2.0	10/98→06/99	M 102.961	Petrol	1996	4	37
190 (W201)	2.0	10/98→08/99	M 102.962	Petrol	1996	4	38
190 (W201)	2.0	08/98→08/99	OM 601.911	Diesel	1997	4	59
190 (W201)	2.3	09/98→08/98	M 102.983	Petrol	2298	4	109
190 (W201)	2.3	10/98→08/99	M 102.985	Petrol	2298	4	110
190 (W201)	2.5	09/98→08/99	M 102.990	Petrol	2498	4	142
190 (W201)	2.5	03/98→08/99	M 102.991	Petrol	2498	4	143
190 (W201)	2.5	05/99→08/99	M 102.992	Petrol	2498	4	144
190 (W201)	2.5	04/98→08/99	OM 602.911	Diesel	2497	5	145
190 (W201)	2.5	02/98→08/99	OM 602.961	Diesel	2497	5	150
190 (W201)	2.6	10/98→08/99	M 103.942	Petrol	2597	6	159
A-CLASS (W168)	1.4	07/99→08/00	M 166.940	Petrol	1397	4	1
A-CLASS (W168)	1.6	07/99→08/00	M 166.960	Petrol	1598	4	3
A-CLASS (W168)	1.7	07/99→08/00	OM 668.940	Diesel	1689	4	9
A-CLASS (W168)	1.7	07/99→02/00	OM 668.941	Diesel	1689	4	10
A-CLASS (W168)	1.7	02/00→08/00	OM 668.942	Diesel	1689	4	11
A-CLASS (W168)	1.9	03/99→08/00	M 166.990	Petrol	1898	4	33
A-CLASS (W168)	2.1	03/00→08/00	M 166.995	Petrol	2084	4	68
A-CLASS (W169)	1.5	09/00→06/01	M 266.920	Petrol	1498	4	2
A-CLASS (W169)	1.7	09/00→06/01	M 266.940	Petrol	1699	4	7
A-CLASS (W169)	2.0	09/00→06/01	M 266.960	Petrol	2034	4	57
A-CLASS (W169)	2.0	09/00→06/01	M 266.960	Bi-Fuel	2034	4	57
A-CLASS (W169)	2.0	09/00→06/01	M 266.980	Petrol	2034	4	58
A-CLASS (W169)	2.0	09/00→06/01	OM 640.940	Diesel	1991	4	65
A-CLASS (W169)	2.0	09/00→06/01	OM 640.941	Diesel	1991	4	66
A-CLASS (W169)	2.0	09/00→06/01	OM 640.942	Diesel	1991	4	67
A-CLASS (W176)	1.8	06/01→	OM 651.901	Diesel	1796	4	32
B-CLASS (W245)	1.5	03/00→11/01	M 266.920	Petrol	1498	4	2
B-CLASS (W245)	1.7	03/00→11/01	M 266.940	Petrol	1699	4	7
B-CLASS (W245)	2.0	03/00→11/01	M 266.960	Petrol	2034	4	57
B-CLASS (W245)	2.0	03/00→11/01	M 266.960	Bi-Fuel	2034	4	57
B-CLASS (W245)	2.0	03/00→11/01	M 266.980	Petrol	2034	4	58
B-CLASS (W245)	2.0	03/00→11/01	OM 640.940	Diesel	1991	4	65
B-CLASS (W245)	2.0	03/00→11/01	OM 640.941	Diesel	1991	4	66
B-CLASS (W246)	1.8	11/01→	OM 651.901	Diesel	1796	4	32
CABRIOLET (A124)	3.0	04/99→06/99	M 104.980	Petrol	2960	6	200
C-CLASS (W202)	1.8	03/99→05/00	M 111.920	Petrol	1799	4	13
C-CLASS (W202)	1.8	03/99→05/00	M 111.921	Petrol	1799	4	14
C-CLASS (W202)	2.0	01/99→05/00	M 111.941	Petrol	1998	4	42
C-CLASS (W202)	2.0	10/99→05/00	M 111.944	Petrol	1998	4	45
C-CLASS (W202)	2.0	01/99→05/00	M 111.945	Petrol	1998	4	46
C-CLASS (W202)	2.0	03/99→05/00	OM 601.913	Diesel	1997	4	61
C-CLASS (W202)	2.0	10/99→05/00	OM 604.915	Diesel	1997	4	62
C-CLASS (W202)	2.2	03/99→05/00	M 111.961	Petrol	2199	4	95
C-CLASS (W202)	2.2	08/99→05/00	OM 604.910	Diesel	2155	4	96
C-CLASS (W202)	2.2	09/99→05/00	OM 611.960	Diesel	2151	4	98
C-CLASS (W202)	2.3	06/99→06/99	M 111.974	Petrol	2295	4	116
C-CLASS (W202)	2.3	10/99→05/00	M 111.975	Petrol	2295	4	117
C-CLASS (W202)	2.4	06/99→05/00	M 112.910	Petrol	2398	6	132
C-CLASS (W202)	2.5	05/99→05/00	OM 605.910	Diesel	2497	5	152
C-CLASS (W202)	2.5	10/99→05/00	OM 605.960	Diesel	2497	5	155
C-CLASS (W202)	2.8	05/99→05/00	M 104.941	Petrol	2799	6	177
C-CLASS (W202)	2.8	06/99→05/00	M 112.920	Petrol	2799	6	182
C-CLASS (W202)	3.6	05/99→05/00	M 104.941 (AMG 3.6)	Petrol	3606	6	289
C-CLASS (W203)	1.8	05/00→02/00	M 271.940	Petrol	1796	4	19
C-CLASS (W203)	1.8	07/00→02/00	M 271.942	Petrol	1796	4	21
C-CLASS (W203)	1.8	05/00→02/00	M 271.946	Petrol	1796	4	23
C-CLASS (W203)	1.8	02/00→02/00	M 271.948	Petrol	1796	4	24
C-CLASS (W203)	2.0	10/00→05/00	M 111.951	Petrol	1998	4	51
C-CLASS (W203)	2.0	05/00→05/00	M 111.955	Petrol	1998	4	53
C-CLASS (W203)	2.2	05/00→02/00	OM 611.962	Diesel	2148	4	70
C-CLASS (W203)	2.2	02/00→02/00	OM 646.962	Diesel	2148	4	79
C-CLASS (W203)	2.2	02/00→02/00	OM 646.963	Diesel	2148	4	80

	Ltr				CC		9
GCLASS (W203)	2.6	05/00 → 02/00	M 112.912	Petrol	2597	6	161
GCLASS (W203)	2.6	07/00 → 02/00	M 112.916	Petrol	2597	6	165
GCLASS (W203)	2.7	12/00 → 02/00	OM 612.962	Diesel	2685	5	169
GCLASS (W203)	3.0	01/00 → 02/00	M 272.940	Petrol	2996	6	202
GCLASS (W203)	3.0	01/00 → 02/00	M 272.941	Petrol	2996	6	203
GCLASS (W203)	3.0	01/00 → 02/00	OM 612.990	Diesel	2950	5	221
GCLASS (W203)	3.0	01/00 → 02/00	OM 642.910	Diesel	2987	6	228
GCLASS (W203)	3.2	05/00 → 02/00	M 112.946	Petrol	3199	6	251
GCLASS (W203)	3.2	07/00 → 02/00	M 112.953	Petrol	3199	6	255
GCLASS (W203)	3.2	02/00 → 02/00	M 112.961	Petrol	3199	6	259
GCLASS (W203)	3.5	01/00 → 02/00	M 272.960	Petrol	3498	6	266
GCLASS (W203)	3.5	01/00 → 02/00	M 272.970	Petrol	3498	6	274
GCLASS (W204)	1.6	01/00 →	M 271.910	Petrol	1597	4	5
GCLASS (W204)	1.8	01/00 →	M 271.820	Petrol	1796	4	15
GCLASS (W204)	1.8	07/00 →	M 271.860	Petrol	1796	4	16
GCLASS (W204)	1.8	01/00 →	M 271.950	Petrol	1796	4	25
GCLASS (W204)	1.8	01/00 →	M 271.952	Petrol	1796	4	27
GCLASS (W204)	2.1	01/00 →	OM 646.811	Diesel	2148	4	73
GCLASS (W204)	2.1	01/00 →	OM 646.812	Diesel	2148	4	74
GCLASS (W204)	2.1	01/01 →	OM 651.912	Diesel	2143	4	90
GCLASS (W204)	2.1	01/01 →	OM 651.913	Diesel	2143	4	91
GCLASS (W204)	3.0	01/00 →	M 272.947	Petrol	2996	6	207
GCLASS (W204)	3.0	07/00 →	M 272.948	Petrol	2996	6	208
GCLASS (W204)	3.0	10/00 →	OM 642.830	Diesel	2987	6	226
GCLASS (W204)	3.0	10/00 →	OM 642.832	Diesel	2987	6	227
GCLASS (W204)	3.0	01/00 →	OM 642.960	Diesel	2987	6	234
GCLASS (W204)	3.0	07/00 →	OM 642.961	Diesel	2987	6	235
GCLASS (W204)	3.5	01/00 →	M 272.961	Petrol	3498	6	267
GCLASS (W204)	3.5	07/00 →	M 272.971	Petrol	3498	6	275
GCLASS (W204)	3.5	09/00 →	M 272.982	Petrol	3498	6	283
GCLASS (W204)	6.2	02/00 →	M 156.985	Petrol	6208	8	311
GCLASS Coupe (C204)	1.8	06/01 →	M 271.820	Petrol	1796	4	15
GCLASS Coupe (C204)	1.8	06/01 →	M 271.860	Petrol	1796	4	16
GCLASS Coupe (C204)	6.2	06/01 →	M 156.985	Petrol	6208	8	311
GCLASS Coupe (CL203)	1.8	05/00 → 05/00	M 271.921	Petrol	1796	4	18
GCLASS Coupe (CL203)	1.8	05/00 → 05/00	M 271.940	Petrol	1796	4	19
GCLASS Coupe (CL203)	1.8	03/00 → 05/00	M 271.942	Petrol	1796	4	21
GCLASS Coupe (CL203)	1.8	05/00 → 05/00	M 271.946	Petrol	1796	4	23
GCLASS Coupe (CL203)	1.8	05/00 → 05/00	M 271.948	Petrol	1796	4	24
GCLASS Coupe (CL203)	2.0	03/00 → 05/00	M 111.951	Petrol	1998	4	51
GCLASS Coupe (CL203)	2.0	03/00 → 05/00	M 111.955	Petrol	1998	4	53
GCLASS Coupe (CL203)	2.2	03/00 → 05/00	OM 611.962	Diesel	2148	4	70
GCLASS Coupe (CL203)	2.2	03/00 → 05/00	OM 646.962	Diesel	2148	4	79
GCLASS Coupe (CL203)	2.2	02/00 → 05/00	OM 646.963	Diesel	2148	4	80
GCLASS Coupe (CL203)	2.3	03/00 → 05/00	M 111.981	Petrol	2295	4	121
GCLASS Coupe (CL203)	3.0	09/00 → 05/00	OM 612.990	Diesel	2950	5	221
GCLASS Coupe (CL203)	3.2	09/00 → 05/00	M 112.946	Petrol	3199	6	251
GCLASS Coupe (CL203)	3.2	05/00 → 05/00	M 112.961	Petrol	3199	6	259
GCLASS Coupe (CL203)	3.5	01/00 → 05/00	M 272.960	Petrol	3498	6	266
GCLASS Estate (S202)	1.8	06/99 → 09/00	M 111.920	Petrol	1799	4	13
GCLASS Estate (S202)	1.8	06/99 → 09/00	M 111.921	Petrol	1799	4	14
GCLASS Estate (S202)	2.0	06/99 → 03/00	M 111.941	Petrol	1998	4	42
GCLASS Estate (S202)	2.0	11/99 → 03/00	M 111.944	Petrol	1998	4	45
GCLASS Estate (S202)	2.0	06/99 → 03/00	M 111.945	Petrol	1998	4	46
GCLASS Estate (S202)	2.0	09/00 → 03/00	M 111.952	Petrol	1998	4	52
GCLASS Estate (S202)	2.0	09/00 → 03/00	M 111.956	Petrol	1998	4	54
GCLASS Estate (S202)	2.0	10/99 → 03/00	OM 604.915	Diesel	1997	4	62
GCLASS Estate (S202)	2.2	06/99 → 03/00	OM 604.910	Diesel	2155	4	96
GCLASS Estate (S202)	2.2	09/99 → 03/00	OM 611.960	Diesel	2151	4	98
GCLASS Estate (S202)	2.3	06/99 → 06/99	M 111.974	Petrol	2295	4	116
GCLASS Estate (S202)	2.3	06/99 → 09/00	M 111.975	Petrol	2295	4	117
GCLASS Estate (S202)	2.4	06/99 → 09/00	M 112.910	Petrol	2398	6	132
GCLASS Estate (S202)	2.5	06/99 → 03/00	OM 605.960	Diesel	2497	5	155
GCLASS Estate (S202)	2.6	09/00 → 03/00	M 112.915	Petrol	2597	6	164
GCLASS Estate (S202)	2.8	06/99 → 03/00	M 112.920	Petrol	2799	6	182
GCLASS T-Model (S203)	1.8	05/00 → 08/00	M 271.940	Petrol	1796	4	19
GCLASS T-Model (S203)	1.8	07/00 → 08/00	M 271.942	Petrol	1796	4	21
GCLASS T-Model (S203)	1.8	05/00 → 08/00	M 271.946	Petrol	1796	4	23
GCLASS T-Model (S203)	1.8	02/00 → 08/00	M 271.948	Petrol	1796	4	24
GCLASS T-Model (S203)	2.0	03/00 → 05/00	M 111.951	Petrol	1998	4	51



Ltr







CC



9

Model	Ltr	Year Range	OM	Fuel	CC	Gear	Price
G-CLASS T-Model (S203)	2.0	03/00→05/00	M 111.955	Petrol	1998	4	53
G-CLASS T-Model (S203)	2.2	03/00→08/00	OM 611.962	Diesel	2148	4	70
G-CLASS T-Model (S203)	2.2	03/00→08/00	OM 646.962	Diesel	2148	4	79
G-CLASS T-Model (S203)	2.2	02/00→08/00	OM 646.963	Diesel	2148	4	80
G-CLASS T-Model (S203)	2.6	03/00→08/00	M 112.912	Petrol	2597	6	161
G-CLASS T-Model (S203)	2.6	07/00→08/00	M 112.916	Petrol	2597	6	165
G-CLASS T-Model (S203)	2.7	03/00→08/00	OM 612.962	Diesel	2685	5	169
G-CLASS T-Model (S203)	3.0	01/00→08/00	M 272.940	Petrol	2996	6	202
G-CLASS T-Model (S203)	3.0	01/00→08/00	M 272.941	Petrol	2996	6	203
G-CLASS T-Model (S203)	3.0	01/00→08/00	OM 612.990	Diesel	2950	5	221
G-CLASS T-Model (S203)	3.0	06/00→08/00	OM 642.910	Diesel	2987	6	228
G-CLASS T-Model (S203)	3.2	03/00→08/00	M 112.946	Petrol	3199	6	251
G-CLASS T-Model (S203)	3.2	07/00→08/00	M 112.953	Petrol	3199	6	255
G-CLASS T-Model (S203)	3.2	03/00→08/00	M 112.961	Petrol	3199	6	259
G-CLASS T-Model (S203)	3.5	01/00→08/00	M 272.960	Petrol	3498	6	266
G-CLASS T-Model (S203)	3.5	01/00→08/00	M 272.970	Petrol	3498	6	274
G-CLASS T-Model (S204)	1.8	08/00→	M 271.820	Petrol	1796	4	15
G-CLASS T-Model (S204)	1.8	08/00→	M 271.860	Petrol	1796	4	16
G-CLASS T-Model (S204)	1.8	01/00→	M 271.910	Petrol	1597	4	5
G-CLASS T-Model (S204)	1.8	08/00→	M 271.950	Petrol	1796	4	25
G-CLASS T-Model (S204)	1.8	08/00→	M 271.952	Petrol	1796	4	27
G-CLASS T-Model (S204)	2.1	08/00→	OM 646.811	Diesel	2148	4	73
G-CLASS T-Model (S204)	2.1	04/01→	OM 651.912	Diesel	2143	4	90
G-CLASS T-Model (S204)	2.1	08/01→	OM 651.913	Diesel	2143	4	91
G-CLASS T-Model (S204)	3.0	08/00→	M 272.947	Petrol	2996	6	207
G-CLASS T-Model (S204)	3.0	10/00→	OM 642.830	Diesel	2987	6	226
G-CLASS T-Model (S204)	3.0	10/00→	OM 642.832	Diesel	2987	6	227
G-CLASS T-Model (S204)	3.0	08/00→	OM 642.960	Diesel	2987	6	234
G-CLASS T-Model (S204)	3.0	08/00→	OM 642.961	Diesel	2987	6	235
G-CLASS T-Model (S204)	3.5	08/00→	M 272.961	Petrol	3498	6	267
G-CLASS T-Model (S204)	6.2	02/00→	M 156.985	Petrol	6208	8	311
CLC-CLASS (CL203)	1.6	02/00→06/01	M 271.911	Petrol	1597	4	6
CLC-CLASS (CL203)	1.8	05/00→06/01	M 271.946	Petrol	1796	4	23
CLC-CLASS (CL203)	1.8	05/00→06/01	M 271.955	Petrol	1796	4	29
CLC-CLASS (CL203)	2.1	05/00→06/01	OM 646.962	Diesel	2148	4	79
CLC-CLASS (CL203)	2.1	05/00→06/01	OM 646.963	Diesel	2148	4	80
CLC-CLASS (CL203)	3.5	05/00→06/01	M 272.960	Petrol	3498	6	266
CLK (C208)	2.0	06/99→06/00	M 111.944	Petrol	1998	4	45
CLK (C208)	2.0	06/99→06/00	M 111.945	Petrol	1998	4	46
CLK (C208)	2.0	06/00→06/00	M 111.956	Petrol	1998	4	54
CLK (C208)	2.3	06/99→06/00	M 111.973	Petrol	2295	4	115
CLK (C208)	2.3	06/99→06/00	M 111.975	Petrol	2295	4	117
CLK (C208)	2.3	06/00→06/00	M 111.982	Petrol	2295	4	122
CLK (C208)	3.2	06/99→06/00	M 112.940	Petrol	3199	6	245
CLK (C209)	1.8	09/00→05/00	M 271.940	Petrol	1796	4	19
CLK (C209)	1.8	07/00→05/00	M 271.942	Petrol	1796	4	21
CLK (C209)	1.8	10/00→05/00	M 271.955	Petrol	1796	4	29
CLK (C209)	2.2	01/00→05/00	OM 646.966	Diesel	2148	4	81
CLK (C209)	2.6	06/00→05/00	M 112.912	Petrol	2597	6	161
CLK (C209)	2.7	10/00→05/00	OM 612.962	Diesel	2685	5	169
CLK (C209)	2.7	10/00→05/00	OM 612.967	Diesel	2685	5	173
CLK (C209)	3.0	01/00→05/00	M 272.940	Petrol	2996	6	202
CLK (C209)	3.0	01/00→05/00	OM 642.910	Diesel	2987	6	228
CLK (C209)	3.2	06/00→05/00	M 112.955	Petrol	3199	6	257
CLK (C209)	3.5	01/00→05/00	M 272.960	Petrol	3498	6	266
CLK (C209)	5.5	06/00→05/00	M 273.965	Petrol	5461	8	300
CLK (C209)	6.2	04/00→05/00	M 156.982	Petrol	6208	8	308
CLK Convertible (A208)	2.0	03/99→03/00	M 111.941	Petrol	1998	4	42
CLK Convertible (A208)	2.0	03/99→06/00	M 111.944	Petrol	1998	4	45
CLK Convertible (A208)	2.0	03/99→03/00	M 111.945	Petrol	1998	4	46
CLK Convertible (A208)	2.0	06/00→03/00	M 111.956	Petrol	1998	4	54
CLK Convertible (A208)	2.3	03/99→06/00	M 111.973	Petrol	2295	4	115
CLK Convertible (A208)	2.3	03/99→06/00	M 111.975	Petrol	2295	4	117
CLK Convertible (A208)	2.3	06/00→03/00	M 111.982	Petrol	2295	4	122
CLK Convertible (A208)	3.2	03/99→03/00	M 112.940	Petrol	3199	6	245
CLK Convertible (A209)	1.8	02/00→03/01	M 271.940	Petrol	1796	4	19
CLK Convertible (A209)	1.8	07/00→03/01	M 271.942	Petrol	1796	4	21
CLK Convertible (A209)	1.8	10/00→03/01	M 271.955	Petrol	1796	4	29
CLK Convertible (A209)	2.6	02/00→03/01	M 112.912	Petrol	2597	6	161
CLK Convertible (A209)	3.0	01/00→03/01	M 272.940	Petrol	2996	6	202

	Ltr				CC		9
CLK Convertible (A209)	3.0	03/00 → 03/01	OM 642.910	Diesel	2987	6	228
CLK Convertible (A209)	3.2	02/00 → 03/01	M 112.955	Petrol	3199	6	257
CLK Convertible (A209)	3.5	01/00 → 03/01	M 272.960	Petrol	3498	6	266
CLK Convertible (A209)	5.5	06/00 → 03/01	M 273.967	Petrol	5461	8	302
CLK Convertible (A209)	6.2	04/00 → 03/01	M 156.982	Petrol	6208	8	308
CLS (C218)	2.1	04/01 →	OM 651.924	Diesel	2143	4	93
CLS (C219)	3.0	07/00 → 12/01	M 272.943	Petrol	2996	6	205
CLS (C219)	3.0	01/00 → 12/01	OM 642.920	Diesel	2987	6	229
CLS (C219)	3.5	10/00 → 12/01	M 272.964	Petrol	3498	6	269
CLS (C219)	3.5	04/00 → 12/01	M 272.985	Petrol	3498	6	286
CLS (C219)	5.5	04/00 → 12/01	M 273.960	Petrol	5461	8	296
CLS (C219)	6.2	04/00 → 12/01	M 156.983	Petrol	6208	8	309
CLS Shooting Brake (X218)	2.1	10/01 →	OM 651.924	Diesel	2143	4	93
COUPE (C124)	2.2	10/99 → 05/99	M 111.960	Petrol	2199	4	94
COUPE (C124)	2.3	03/98 → 12/99	M 102.982	Petrol	2298	4	108
COUPE (C124)	3.0	03/98 → 05/99	M 103.983	Petrol	2960	6	196
COUPE (C124)	3.0	09/98 → 12/99	M 104.980	Petrol	2960	6	200
COUPE (C124)	3.2	10/99 → 05/99	M 104.992	Petrol	3199	6	241
E-CLASS (W124)	2.0	06/99 → 06/99	M 111.940	Petrol	1998	4	41
E-CLASS (W124)	2.0	06/99 → 06/99	OM 601.912	Diesel	1997	4	60
E-CLASS (W124)	2.2	06/99 → 06/99	M 111.960	Petrol	2199	4	94
E-CLASS (W124)	2.5	06/99 → 06/99	OM 602.962	Diesel	2497	5	151
E-CLASS (W124)	2.5	07/99 → 06/99	OM 605.911	Diesel	2497	5	153
E-CLASS (W124)	2.8	06/99 → 06/99	M 104.942	Petrol	2799	6	178
E-CLASS (W124)	3.0	06/99 → 06/99	M 103.985	Petrol	2960	6	198
E-CLASS (W124)	3.0	06/99 → 06/99	OM 603.960	Diesel	2996	6	214
E-CLASS (W124)	3.0	06/99 → 06/99	OM 603.963	Diesel	2996	6	215
E-CLASS (W124)	3.0	07/99 → 06/99	OM 606.910	Diesel	2996	6	216
E-CLASS (W124)	3.2	06/99 → 06/99	M 104.992	Petrol	3199	6	241
E-CLASS (W124)	3.6	07/99 → 01/99	M 104.992 (AMG 3.6)	Petrol	3606	6	290
E-CLASS (W210)	2.0	06/99 → 08/00	M 111.942	Petrol	1998	4	43
E-CLASS (W210)	2.0	06/99 → 03/00	M 111.947	Petrol	1998	4	48
E-CLASS (W210)	2.0	08/00 → 03/00	M 111.957	Petrol	1998	4	55
E-CLASS (W210)	2.0	01/99 → 03/00	OM 604.917	Diesel	1997	4	63
E-CLASS (W210)	2.2	06/99 → 03/00	OM 604.912	Diesel	2155	4	97
E-CLASS (W210)	2.2	06/99 → 03/00	OM 611.961	Diesel	2148	4	69
E-CLASS (W210)	2.3	06/99 → 06/99	M 111.970	Petrol	2295	4	114
E-CLASS (W210)	2.4	06/99 → 08/00	M 112.911	Petrol	2398	6	133
E-CLASS (W210)	2.5	06/99 → 07/99	OM 605.912	Diesel	2497	5	154
E-CLASS (W210)	2.5	06/99 → 07/99	OM 605.962	Diesel	2497	5	156
E-CLASS (W210)	2.6	08/00 → 03/00	M 112.914	Petrol	2597	6	163
E-CLASS (W210)	2.7	07/99 → 03/00	OM 612.961	Diesel	2685	5	168
E-CLASS (W210)	2.8	01/99 → 06/99	M 104.945	Petrol	2799	6	181
E-CLASS (W210)	2.8	12/99 → 03/00	M 112.921	Petrol	2799	6	183
E-CLASS (W210)	2.9	03/99 → 07/99	OM 602.982	Diesel	2874	5	190
E-CLASS (W210)	3.0	06/99 → 06/99	OM 606.912	Diesel	2996	6	217
E-CLASS (W210)	3.0	12/99 → 07/99	OM 606.962	Diesel	2996	6	219
E-CLASS (W210)	3.2	06/99 → 06/99	M 104.995	Petrol	3199	6	243
E-CLASS (W210)	3.2	06/99 → 03/00	M 112.941	Petrol	3199	6	246
E-CLASS (W210)	3.2	07/99 → 03/00	OM 613.961	Diesel	3226	6	261
E-CLASS (W211)	1.8	11/00 → 12/00	M 271.941	Petrol	1796	4	20
E-CLASS (W211)	1.8	11/00 → 12/00	M 271.941	Bi-Fuel	1796	4	20
E-CLASS (W211)	1.8	11/00 → 12/00	M 271.946	Petrol	1796	4	23
E-CLASS (W211)	1.8	04/00 → 12/00	M 271.956	Petrol	1796	4	30
E-CLASS (W211)	2.1	04/00 → 12/00	OM 646.820	Diesel	2148	4	75
E-CLASS (W211)	2.1	03/00 → 12/00	OM 646.821	Diesel	2148	4	76
E-CLASS (W211)	2.1	03/00 → 12/00	OM 646.961	Diesel	2148	4	78
E-CLASS (W211)	2.1	08/00 → 12/00	OM 651.924	Diesel	2143	4	93
E-CLASS (W211)	2.2	07/00 → 12/00	OM 646.951	Diesel	2148	4	77
E-CLASS (W211)	2.6	03/00 → 12/00	M 112.913	Petrol	2597	6	162
E-CLASS (W211)	2.6	03/00 → 12/00	M 112.917	Petrol	2597	6	166
E-CLASS (W211)	2.7	03/00 → 12/00	OM 647.961	Diesel	2685	5	175
E-CLASS (W211)	3.0	03/00 → 12/00	M 272.943	Petrol	2996	6	205
E-CLASS (W211)	3.0	03/00 → 12/00	OM 642.910	Diesel	2987	6	228
E-CLASS (W211)	3.0	03/00 → 12/00	OM 642.920	Diesel	2987	6	229
E-CLASS (W211)	3.0	03/00 → 12/00	OM 642.921	Diesel	2987	6	230
E-CLASS (W211)	3.2	03/00 → 12/00	M 112.949	Petrol	3199	6	253
E-CLASS (W211)	3.2	03/00 → 12/00	M 112.954	Petrol	3199	6	256
E-CLASS (W211)	3.2	11/00 → 12/00	OM 648.961	Diesel	3222	6	263
E-CLASS (W211)	3.5	03/00 → 12/00	M 272.964	Petrol	3498	6	269



Ltr







CC



9

Model	Ltr	Date Range	Model Code	Fuel Type	CC	Gearbox	Price
E-CLASS (W211)	3.5	08/00→12/00	M 272.972	Petrol	3498	6	276
E-CLASS (W211)	3.5	09/00→12/00	M 272.985	Petrol	3498	6	286
E-CLASS (W211)	5.5	04/00→12/00	M 273.960	Petrol	5461	8	296
E-CLASS (W211)	5.5	04/00→12/00	M 273.962	Petrol	5461	8	298
E-CLASS (W211)	6.2	03/00→12/00	M 156.983	Petrol	6208	8	309
E-CLASS (W212)	1.8	08/00→	M 271.820	Petrol	1796	4	15
E-CLASS (W212)	1.8	01/00→	M 271.860	Petrol	1796	4	16
E-CLASS (W212)	1.8	03/01→	M 271.958	Bi-Fuel	1796	4	31
E-CLASS (W212)	2.1	12/01→	OM 651.924	Diesel/Electro	2143	4	93
E-CLASS (W212)	2.1	01/00→	OM 651.924	Diesel	2143	4	93
E-CLASS (W212)	3.0	01/00→	M 272.952	Petrol	2996	6	210
E-CLASS (W212)	3.5	01/00→08/01	M 272.977	Petrol	3498	6	279
E-CLASS (W212)	3.5	01/00→	M 272.980	Petrol	3498	6	282
E-CLASS (W212)	3.5	01/00→08/01	M 272.983	Petrol	3498	6	284
E-CLASS (W212)	5.5	01/00→	M 273.970	Petrol	5461	8	304
E-CLASS (W212)	5.5	01/00→	M 273.971	Petrol	5461	8	305
E-CLASS (W212)	6.2	12/00→	M 156.985	Petrol	6208	8	311
E-CLASS Convertible (A124)	2.0	06/99→03/99	M 111.940	Petrol	1998	4	41
E-CLASS Convertible (A124)	2.2	06/99→03/99	M 111.960	Petrol	2199	4	94
E-CLASS Convertible (A124)	3.2	06/99→03/99	M 104.992	Petrol	3199	6	241
E-CLASS Convertible (A124)	3.2	06/99→03/99	M 104.995	Petrol	3199	6	243
E-CLASS Convertible (A124)	3.6	05/99→03/99	M 104.992 (AMG 3.6)	Petrol	3606	6	290
E-CLASS Convertible (A207)	1.8	01/01→	M 271.820	Petrol	1796	4	15
E-CLASS Convertible (A207)	1.8	01/01→	M 271.860	Petrol	1796	4	16
E-CLASS Convertible (A207)	3.5	01/01→	M 272.982	Petrol	3498	6	283
E-CLASS Convertible (A207)	3.5	01/01→	M 272.984	Petrol	3498	6	285
E-CLASS Convertible (A207)	5.5	01/01→	M 273.966	Petrol	5461	8	301
E-CLASS Coupe (C124)	2.0	06/99→06/99	M 111.940	Petrol	1998	4	41
E-CLASS Coupe (C124)	2.2	06/99→06/99	M 111.960	Petrol	2199	4	94
E-CLASS Coupe (C124)	3.2	06/99→06/99	M 104.992	Petrol	3199	6	241
E-CLASS Coupe (C124)	3.6	06/99→06/99	M 104.992 (AMG 3.6)	Petrol	3606	6	290
E-CLASS Coupe (C207)	1.8	01/01→	M 271.820	Petrol	1796	4	15
E-CLASS Coupe (C207)	1.8	01/00→	M 271.860	Petrol	1796	4	16
E-CLASS Coupe (C207)	3.5	01/00→	M 272.982	Petrol	3498	6	283
E-CLASS Coupe (C207)	3.5	01/00→	M 272.984	Petrol	3498	6	285
E-CLASS Coupe (C207)	5.5	01/00→	M 273.966	Petrol	5461	8	301
E-CLASS Estate (S124)	2.0	06/99→06/99	M 111.940	Petrol	1998	4	41
E-CLASS Estate (S124)	2.2	06/99→06/99	M 111.960	Petrol	2199	4	94
E-CLASS Estate (S124)	2.5	06/99→06/99	OM 602.962	Diesel	2497	5	151
E-CLASS Estate (S124)	2.5	06/99→06/99	OM 605.911	Diesel	2497	5	153
E-CLASS Estate (S124)	2.8	06/99→06/99	M 104.942	Petrol	2799	6	178
E-CLASS Estate (S124)	3.0	06/99→06/99	M 103.985	Petrol	2960	6	198
E-CLASS Estate (S124)	3.0	06/99→06/99	M 104.980	Petrol	2960	6	200
E-CLASS Estate (S124)	3.0	06/99→06/99	OM 603.960	Diesel	2996	6	214
E-CLASS Estate (S124)	3.0	06/99→06/99	OM 603.963	Diesel	2996	6	215
E-CLASS Estate (S124)	3.0	06/99→06/99	OM 606.910	Diesel	2996	6	216
E-CLASS Estate (S124)	3.2	06/99→06/99	M 104.992	Petrol	3199	6	241
E-CLASS Estate (S124)	3.6	05/99→06/99	M 104.992 (AMG 3.6)	Petrol	3606	6	290
E-CLASS Estate (S210)	2.0	06/99→08/00	M 111.942	Petrol	1998	4	43
E-CLASS Estate (S210)	2.0	06/99→03/00	M 111.947	Petrol	1998	4	48
E-CLASS Estate (S210)	2.0	08/00→03/00	M 111.957	Petrol	1998	4	55
E-CLASS Estate (S210)	2.2	06/99→03/00	OM 611.961	Diesel	2148	4	69
E-CLASS Estate (S210)	2.3	06/99→06/99	M 111.970	Petrol	2295	4	114
E-CLASS Estate (S210)	2.4	06/99→03/00	M 112.911	Petrol	2398	6	133
E-CLASS Estate (S210)	2.5	06/99→07/99	OM 605.912	Diesel	2497	5	154
E-CLASS Estate (S210)	2.5	06/99→07/99	OM 605.962	Diesel	2497	5	156
E-CLASS Estate (S210)	2.6	08/00→03/00	M 112.914	Petrol	2597	6	163
E-CLASS Estate (S210)	2.7	07/99→03/00	OM 612.961	Diesel	2685	5	168
E-CLASS Estate (S210)	2.8	12/99→03/00	M 112.921	Petrol	2799	6	183
E-CLASS Estate (S210)	2.9	06/99→07/99	OM 602.982	Diesel	2874	5	190
E-CLASS Estate (S210)	3.0	12/99→07/99	OM 606.962	Diesel	2996	6	219
E-CLASS Estate (S210)	3.2	12/99→03/00	M 112.941	Petrol	3199	6	246
E-CLASS Estate (S210)	3.2	07/99→03/00	OM 613.961	Diesel	3226	6	261
E-CLASS T-Model (S211)	1.8	03/00→07/00	M 271.941	Petrol	1796	4	20
E-CLASS T-Model (S211)	1.8	03/00→07/00	M 271.941	Bi-Fuel	1796	4	20
E-CLASS T-Model (S211)	1.8	04/00→07/00	M 271.956	Petrol	1796	4	30
E-CLASS T-Model (S211)	2.1	03/00→07/00	OM 646.821	Diesel	2148	4	76
E-CLASS T-Model (S211)	2.1	03/00→07/00	OM 646.961	Diesel	2148	4	78
E-CLASS T-Model (S211)	2.6	03/00→07/00	M 112.913	Petrol	2597	6	162
E-CLASS T-Model (S211)	2.6	07/00→07/00	M 112.917	Petrol	2597	6	166

	Ltr				CC		9
E-CLASS T-Model (S211)	2.7	03/00→07/00	OM 647.961	Diesel	2685	5	175
E-CLASS T-Model (S211)	3.0	03/00→07/00	M 272.943	Petrol	2996	6	205
E-CLASS T-Model (S211)	3.0	03/00→07/00	OM 642.920	Diesel	2987	6	229
E-CLASS T-Model (S211)	3.0	03/00→07/00	OM 642.921	Diesel	2987	6	230
E-CLASS T-Model (S211)	3.2	03/00→07/00	M 112.949	Petrol	3199	6	253
E-CLASS T-Model (S211)	3.2	07/00→07/00	M 112.954	Petrol	3199	6	256
E-CLASS T-Model (S211)	3.2	03/00→07/00	OM 648.961	Diesel	3222	6	263
E-CLASS T-Model (S211)	3.5	03/00→07/00	M 272.967	Petrol	3498	6	272
E-CLASS T-Model (S211)	3.5	03/00→07/00	M 272.972	Petrol	3498	6	276
E-CLASS T-Model (S211)	3.5	05/00→07/00	M 272.985	Petrol	3498	6	286
E-CLASS T-Model (S211)	5.5	04/00→07/00	M 273.960	Petrol	5461	8	296
E-CLASS T-Model (S211)	5.5	04/00→07/00	M 273.962	Petrol	5461	8	298
E-CLASS T-Model (S211)	6.2	03/00→07/00	M 156.983	Petrol	6208	8	309
E-CLASS T-Model (S212)	1.8	11/00→	M 271.820	Petrol	1796	4	15
E-CLASS T-Model (S212)	1.8	11/00→	M 271.860	Petrol	1796	4	16
E-CLASS T-Model (S212)	2.1	12/01→	OM 651.924	Diesel/Electro	2143	4	93
E-CLASS T-Model (S212)	2.1	11/00→	OM 651.924	Diesel	2143	4	93
E-CLASS T-Model (S212)	3.0	11/00→	M 272.952	Petrol	2996	6	210
E-CLASS T-Model (S212)	3.5	11/00→	M 272.977	Petrol	3498	6	279
E-CLASS T-Model (S212)	3.5	08/00→	M 272.980	Petrol	3498	6	282
E-CLASS T-Model (S212)	3.5	11/00→	M 272.983	Petrol	3498	6	284
E-CLASS T-Model (S212)	5.5	11/00→	M 273.971	Petrol	5461	8	305
E-CLASS T-Model (S212)	6.2	08/00→	M 156.985	Petrol	6208	8	311
G-CLASS (W460)	2.3	05/98→08/99	M 102.979	Petrol	2299	4	106
G-CLASS (W460)	2.3	04/98→08/99	M 102.981	Petrol	2299	4	107
G-CLASS (W460)	2.3	04/98→08/99	M 102.987	Petrol	2299	4	111
G-CLASS (W460)	2.3	04/98→08/99	M 102.989	Petrol	2298	4	112
G-CLASS (W460)	2.3	03/97→07/99	M 115.973	Petrol	2307	4	126
G-CLASS (W460)	2.5	10/98→12/99	OM 602.930	Diesel	2497	5	147
G-CLASS (W460)	2.7	11/97→08/98	M 110.994	Petrol	2746	6	167
G-CLASS (W460)	3.0	03/97→07/99	OM 603.912	Diesel	2996	6	211
G-CLASS (W460)	3.0	12/97→12/99	OM 617.931	Diesel	2998	5	223
G-CLASS (W461)	2.3	02/99→	M 102.979	Petrol	2299	4	106
G-CLASS (W461)	2.3	06/99→	M 102.996	Petrol	2298	4	113
G-CLASS (W461)	2.5	02/99→	OM 602.939	Diesel	2497	5	149
G-CLASS (W461)	2.7	01/00→	OM 612.966	Diesel	2685	5	172
G-CLASS (W461)	2.9	04/99→	OM 602.942	Diesel	2874	5	188
G-CLASS (W461)	2.9	07/99→	OM 602.983	Diesel	2874	5	191
G-CLASS (W463)	2.0	01/99→07/99	M 102.965	Petrol	1996	4	40
G-CLASS (W463)	2.3	06/99→06/99	M 102.989	Petrol	2298	4	112
G-CLASS (W463)	2.5	06/99→	OM 602.931	Diesel	2497	5	148
G-CLASS (W463)	2.7	10/00→	OM 612.965	Diesel	2685	5	171
G-CLASS (W463)	3.0	06/99→	M 103.987	Petrol	2960	6	199
G-CLASS (W463)	3.0	09/98→	OM 603.931	Diesel	2996	6	213
G-CLASS (W463)	3.0	08/99→	OM 606.964	Diesel	2996	6	220
G-CLASS (W463)	3.0	09/00→	OM 642.970	Diesel	2987	6	236
G-CLASS (W463)	3.2	09/99→12/99	M 104.996	Petrol	3199	6	244
G-CLASS (W463)	3.2	07/99→	M 112.945	Petrol	3199	6	250
G-CLASS (W463)	3.4	09/99→	OM 603.972	Diesel	3449	6	265
G-CLASS (W463)	5.5	05/00→	M 273.963	Petrol	5461	8	299
G-CLASS Cabrio (W463)	2.0	01/99→07/99	M 102.965	Petrol	1996	4	40
G-CLASS Cabrio (W463)	2.3	06/99→02/99	M 102.989	Petrol	2298	4	112
G-CLASS Cabrio (W463)	3.0	09/98→09/99	M 103.987	Petrol	2960	6	199
G-CLASS Cabrio (W463)	3.0	12/99→09/99	OM 603.931	Diesel	2996	6	213
G-CLASS Cabrio (W463)	3.0	09/99→	OM 606.964	Diesel	2996	6	220
G-CLASS Cabrio (W463)	3.0	09/00→	OM 642.970	Diesel	2987	6	236
G-CLASS Cabrio (W463)	3.2	09/99→11/99	M 104.996	Petrol	3199	6	244
G-CLASS Cabrio (W463)	3.2	11/99→	M 112.945	Petrol	3199	6	250
G-CLASS Cabrio (W463)	3.4	09/99→09/99	OM 603.972	Diesel	3449	6	265
G-CLASS Cabrio (W463)	5.5	12/00→	M 273.963	Petrol	5461	8	299
GL-CLASS (X164)	3.0	12/00→	OM 642.820	Diesel	2987	6	224
GL-CLASS (X164)	3.0	10/01→	OM 642.822	Diesel	2987	6	225
GL-CLASS (X164)	3.0	09/00→	OM 642.940	Diesel	2987	6	232
GL-CLASS (X164)	5.5	09/00→	M 273.963	Petrol	5461	8	299
GLK-CLASS (X204)	2.1	12/00→	OM 651.912	Diesel	2143	4	90
GLK-CLASS (X204)	2.1	07/01→	OM 651.913	Diesel	2143	4	91
GLK-CLASS (X204)	2.1	12/00→	OM 651.916	Diesel	2143	4	92
GLK-CLASS (X204)	3.0	06/00→04/01	M 272.948	Petrol	2996	6	208
GLK-CLASS (X204)	3.0	07/00→05/01	OM 642.832	Diesel	2987	6	227
GLK-CLASS (X204)	3.0	06/00→	OM 642.961	Diesel	2987	6	235



Ltr







CC



9

Model	Ltr	Year Range	Engine Code	Fuel	CC	Gears	Price
GLK-CLASS (X204)	3.5	06/00→04/01	M 272.971	Petrol	3498	6	275
GLK-CLASS (X204)	3.5	04/00→	M 272.991	Petrol	3498	6	287
KOMBI Estate (S124)	2.0	09/98→05/99	M 102.922	Petrol	1996	4	35
KOMBI Estate (S124)	2.0	09/98→12/98	M 102.962	Petrol	1996	4	38
KOMBI Estate (S124)	2.0	09/98→08/99	M 102.963	Petrol	1996	4	39
KOMBI Estate (S124)	2.0	10/99→06/99	M 111.940	Petrol	1998	4	41
KOMBI Estate (S124)	2.0	09/98→08/99	OM 601.912	Diesel	1997	4	60
KOMBI Estate (S124)	2.2	10/99→05/99	M 111.960	Petrol	2199	4	94
KOMBI Estate (S124)	2.3	09/98→08/99	M 102.982	Petrol	2298	4	108
KOMBI Estate (S124)	2.5	09/98→06/99	OM 602.912	Diesel	2497	5	146
KOMBI Estate (S124)	2.5	03/98→07/99	OM 602.962	Diesel	2497	5	151
KOMBI Estate (S124)	2.6	09/98→08/99	M 103.940	Petrol	2597	6	157
KOMBI Estate (S124)	2.8	10/99→06/99	M 104.942	Petrol	2799	6	178
KOMBI Estate (S124)	3.0	01/98→08/99	M 103.983	Petrol	2960	6	196
KOMBI Estate (S124)	3.0	09/98→06/99	M 103.985	Petrol	2960	6	198
KOMBI Estate (S124)	3.0	09/98→08/99	M 104.980	Petrol	2960	6	200
KOMBI Estate (S124)	3.0	09/98→06/99	OM 603.912	Diesel	2996	6	211
KOMBI Estate (S124)	3.0	09/98→06/99	OM 603.960	Diesel	2996	6	214
KOMBI Estate (S124)	3.0	09/98→01/98	OM 603.963	Diesel	2996	6	215
KOMBI Estate (S124)	3.2	10/99→06/99	M 104.992	Petrol	3199	6	241
M-CLASS (W163)	2.3	02/99→06/00	M 111.977	Petrol	2295	4	118
M-CLASS (W163)	2.7	12/99→06/00	OM 612.963	Diesel	2685	5	170
M-CLASS (W163)	3.2	02/99→08/00	M 112.942	Petrol	3199	6	247
M-CLASS (W163)	3.7	08/00→06/00	M 112.970	Petrol	3724	6	291
M-CLASS (W164)	3.0	09/00→	OM 642.820	Diesel	2987	6	224
M-CLASS (W164)	3.0	02/01→	OM 642.832	Diesel	2987	6	227
M-CLASS (W164)	3.0	07/00→	OM 642.940	Diesel	2987	6	232
M-CLASS (W164)	3.5	07/00→	M 272.967	Petrol	3498	6	272
M-CLASS (W164)	5.5	12/00→	M 273.963	Petrol	5461	8	299
M-CLASS (W164)	6.2	01/00→	M 156.980	Petrol	6208	8	306
R-CLASS (W251, V251)	3.0	01/00→	M 272.945	Petrol	2996	6	206
R-CLASS (W251, V251)	3.0	01/00→	OM 642.950	Diesel	2987	6	233
R-CLASS (W251, V251)	3.5	01/00→	M 272.967	Petrol	3498	6	272
R-CLASS (W251, V251)	3.5	01/00→	M 276.958	Petrol	3498	6	288
R-CLASS (W251, V251)	5.5	01/00→	M 273.963	Petrol	5461	8	299
R-CLASS (W251, V251)	6.2	02/00→	M 156.980	Petrol	6208	8	306
Saloon (W124)	2.0	12/98→05/99	M 102.922	Petrol	1996	4	35
Saloon (W124)	2.0	09/98→08/99	M 102.963	Petrol	1996	4	39
Saloon (W124)	2.0	10/99→06/99	M 111.940	Petrol	1998	4	41
Saloon (W124)	2.0	12/98→06/99	OM 601.912	Diesel	1997	4	60
Saloon (W124)	2.2	10/99→06/99	M 111.960	Petrol	2199	4	94
Saloon (W124)	2.3	12/98→06/99	M 102.982	Petrol	2298	4	108
Saloon (W124)	2.5	04/98→06/99	OM 602.912	Diesel	2497	5	146
Saloon (W124)	2.5	09/98→06/99	OM 602.962	Diesel	2497	5	151
Saloon (W124)	2.6	09/98→08/99	M 103.940	Petrol	2597	6	157
Saloon (W124)	2.6	09/98→08/99	M 103.943	Petrol	2597	6	160
Saloon (W124)	2.8	10/99→06/99	M 104.942	Petrol	2799	6	178
Saloon (W124)	3.0	06/98→08/99	M 103.983	Petrol	2960	6	196
Saloon (W124)	3.0	09/98→06/99	M 103.985	Petrol	2960	6	198
Saloon (W124)	3.0	09/98→08/99	M 104.980	Petrol	2960	6	200
Saloon (W124)	3.0	12/98→06/99	OM 603.912	Diesel	2996	6	211
Saloon (W124)	3.0	09/98→06/99	OM 603.913	Diesel	2996	6	212
Saloon (W124)	3.0	09/98→06/99	OM 603.960	Diesel	2996	6	214
Saloon (W124)	3.0	09/98→06/99	OM 603.963	Diesel	2996	6	215
Saloon (W124)	3.2	10/99→06/99	M 104.992	Petrol	3199	6	241
Saloon (W124)	3.4	06/99→05/99	OM 603.971	Diesel	3449	6	264
S-CLASS (W126)	2.5	09/98→06/99	M 103.941	Petrol	2597	6	158
S-CLASS (W126)	3.0	09/98→06/99	M 103.981	Petrol	2960	6	194
S-CLASS (W140)	2.8	01/99→10/99	M 104.944	Petrol	2799	6	180
S-CLASS (W140)	3.0	05/99→10/99	OM 606.961	Diesel	2996	6	218
S-CLASS (W140)	3.2	03/99→10/99	M 104.990	Petrol	3199	6	239
S-CLASS (W140)	3.2	03/99→10/99	M 104.994	Petrol	3199	6	242
S-CLASS (W140)	3.4	01/99→10/99	OM 603.971	Diesel	3449	6	264
S-CLASS (W220)	2.8	10/99→08/00	M 112.922	Petrol	2799	6	184
S-CLASS (W220)	3.2	10/99→08/00	M 112.944	Petrol	3199	6	249
S-CLASS (W220)	3.2	08/99→09/00	OM 613.960	Diesel	3222	6	260
S-CLASS (W220)	3.2	09/00→08/00	OM 648.960	Diesel	3222	6	262
S-CLASS (W220)	3.7	09/00→08/00	M 112.972	Petrol	3724	6	292
S-CLASS (W220)	3.7	06/00→08/00	M 112.975	Petrol	3724	6	294
S-CLASS (W220)	6.3	09/00→08/00	M 137.980	Petrol	6258	12	313

	Ltr				CC		9
S-CLASS (W221)	3.0	10/00 →	OM 642.930	Diesel	2987	6	231
S-CLASS (W221)	3.5	10/00 →	M 272.965	Petrol	3498	6	270
S-CLASS (W221)	3.5	01/00 →	M 272.974	Petrol/Electro	3498	6	277
S-CLASS (W221)	3.5	02/00 →	M 272.975	Petrol	3498	6	278
S-CLASS (W221)	5.5	10/00 →	M 273.961	Petrol	5461	8	297
S-CLASS (W221)	5.5	10/00 →	M 273.968	Petrol	5461	8	303
S-CLASS (W221)	6.2	10/00 →	M 156.984	Petrol	6208	8	310
S-CLASS Coupe (C215)	6.3	09/00 → 03/00	M 137.980	Petrol	6258	12	313
S-CLASS Coupe (C216)	5.5	06/00 →	M 273.961	Petrol	5461	8	297
S-CLASS Coupe (C216)	5.5	02/00 →	M 273.968	Petrol	5461	8	303
S-CLASS Coupe (C216)	6.2	10/00 →	M 156.984	Petrol	6208	8	310
SL (R107)	2.9	09/98 → 08/98	M 103.982	Petrol	2960	6	195
SL (R129)	2.8	08/99 → 10/00	M 104.943	Petrol	2799	6	179
SL (R129)	2.8	05/99 → 10/00	M 112.923	Petrol	2799	6	185
SL (R129)	2.8	05/99 → 10/00	M 112.925	Petrol	2799	6	186
SL (R129)	3.0	03/98 → 08/99	M 103.984	Petrol	2960	6	197
SL (R129)	3.0	03/98 → 07/99	M 104.981	Petrol	2960	6	201
SL (R129)	3.2	09/99 → 10/00	M 104.991	Petrol	3199	6	240
SL (R129)	3.2	05/99 → 10/00	M 112.943	Petrol	3199	6	248
SL (R230)	3.0	03/00 → 01/01	M 272.949	Petrol	2996	6	209
SL (R230)	3.5	03/00 → 01/01	M 272.966	Petrol	3498	6	271
SL (R230)	3.7	03/00 → 01/01	M 112.973	Petrol	3724	6	293
SL (R230)	5.5	03/00 → 01/01	M 273.965	Petrol	5461	8	300
SL (R230)	6.2	03/00 → 01/01	M 156.981	Petrol	6208	8	307
SLK (R170)	2.0	10/99 → 03/00	M 111.943	Petrol	1998	4	44
SLK (R170)	2.0	09/99 → 03/00	M 111.946	Petrol	1998	4	47
SLK (R170)	2.0	03/00 → 04/00	M 111.958	Petrol	1998	4	56
SLK (R170)	2.3	09/99 → 03/00	M 111.973	Petrol	2295	4	115
SLK (R170)	2.3	03/00 → 04/00	M 111.983	Petrol	2295	4	123
SLK (R170)	3.2	03/00 → 04/00	M 112.947	Petrol	3199	6	252
SLK (R170)	3.2	03/00 → 04/00	M 112.960	Petrol	3199	6	258
SLK (R171)	1.8	03/00 → 02/01	M 271.944	Petrol	1795	4	22
SLK (R171)	1.8	01/00 → 02/01	M 271.954	Petrol	1796	4	28
SLK (R171)	3.0	01/00 → 02/01	M 272.942	Petrol	2996	6	204
SLK (R171)	3.5	06/00 → 02/01	M 272.963	Petrol	3498	6	268
SLK (R171)	3.5	01/00 → 02/01	M 272.969	Petrol	3498	6	273
SLK (R172)	1.8	02/01 →	M 271.860	Petrol	1796	4	16
SLK (R172)	1.8	02/01 →	M 271.861	Petrol	1796	4	17
SLS AMG (C197)	6.2	03/01 →	M 159.980	Petrol	6208	8	312
SLS AMG Convertible (A197)	6.2	06/01 →	M 159.980	Petrol	6208	8	312
SPRINTER 2+ Box (901, 902)	2.1	04/00 → 05/00	OM 611.981	Diesel	2148	4	71
SPRINTER 2+ Box (901, 902)	2.1	04/00 → 05/00	OM 611.987	Diesel	2148	4	72
SPRINTER 2+ Box (901, 902)	2.3	02/99 → 05/00	M 111.979	Petrol	2295	4	120
SPRINTER 2+ Box (901, 902)	2.3	02/99 → 05/00	M 111.984	Petrol	2295	4	124
SPRINTER 2+ Box (901, 902)	2.3	02/99 → 05/00	M 111.984	Gas	2295	4	124
SPRINTER 2+ Box (901, 902)	2.3	02/99 → 04/00	OM 601.943	Diesel	2299	4	130
SPRINTER 2+ Box (901, 902)	2.7	04/00 → 05/00	OM 612.981	Diesel	2685	5	174
SPRINTER 2+ Box (901, 902)	2.9	02/99 → 04/00	OM 602.980	Diesel	2874	5	189
SPRINTER 2+ Bus (901, 902)	2.1	04/00 → 05/00	OM 611.981	Diesel	2148	4	71
SPRINTER 2+ Bus (901, 902)	2.1	04/00 → 05/00	OM 611.987	Diesel	2148	4	72
SPRINTER 2+ Bus (901, 902)	2.3	02/99 → 05/00	M 111.979	Petrol	2295	4	120
SPRINTER 2+ Bus (901, 902)	2.3	04/00 → 05/00	M 111.984	Petrol	2295	4	124
SPRINTER 2+ Bus (901, 902)	2.3	04/00 → 05/00	M 111.984	Gas	2295	4	124
SPRINTER 2+ Bus (901, 902)	2.3	02/99 → 04/00	OM 601.943	Diesel	2299	4	130
SPRINTER 2+ Bus (901, 902)	2.7	04/00 → 05/00	OM 612.981	Diesel	2685	5	174
SPRINTER 2+ Bus (901, 902)	2.9	02/99 → 04/00	OM 602.980	Diesel	2874	5	189
SPRINTER 2+ Platform/Chassis (901, 902)	2.1	04/00 → 05/00	OM 611.981	Diesel	2148	4	71
SPRINTER 2+ Platform/Chassis (901, 902)	2.1	04/00 → 05/00	OM 611.987	Diesel	2148	4	72
SPRINTER 2+ Platform/Chassis (901, 902)	2.3	02/99 → 05/00	M 111.979	Petrol	2295	4	120
SPRINTER 2+ Platform/Chassis (901, 902)	2.3	01/99 → 04/00	OM 601.943	Diesel	2299	4	130
SPRINTER 2+ Platform/Chassis (901, 902)	2.7	04/00 → 05/00	OM 612.981	Diesel	2685	5	174
SPRINTER 2+ Platform/Chassis (901, 902)	2.9	02/99 → 04/00	OM 602.980	Diesel	2874	5	189
SPRINTER 3+ Box (903)	2.1	04/00 → 05/00	OM 611.981	Diesel	2148	4	71
SPRINTER 3+ Box (903)	2.1	04/00 → 05/00	OM 611.987	Diesel	2148	4	72
SPRINTER 3+ Box (903)	2.3	02/99 → 05/00	M 111.979	Petrol	2295	4	120
SPRINTER 3+ Box (903)	2.3	02/99 → 05/00	M 111.984	Petrol	2295	4	124
SPRINTER 3+ Box (903)	2.3	02/99 → 05/00	M 111.984	Gas	2295	4	124
SPRINTER 3+ Box (903)	2.3	02/99 → 04/00	OM 601.943	Diesel	2299	4	130
SPRINTER 3+ Box (903)	2.7	04/00 → 05/00	OM 612.981	Diesel	2685	5	174
SPRINTER 3+ Box (903)	2.9	02/99 → 08/00	OM 602.980	Diesel	2874	5	189



Ltr







CC



9

Model	Ltr	Year Range	Price (M)	Fuel Type	CC	Oil	9
SPRINTER 3-t Box (906)	1.8	09/00→	M 271.951	Petrol/Petroleum Gas (LPG)	1796	4	26
SPRINTER 3-t Box (906)	1.8	09/00→	M 271.951	Petrol/Natural Gas (CNG)	1796	4	26
SPRINTER 3-t Box (906)	1.8	09/00→	M 271.951	Petrol	1796	4	26
SPRINTER 3-t Box (906)	1.8	09/00→	M 271.951	Natural Gas	1796	4	26
SPRINTER 3-t Box (906)	2.1	06/00→	OM 646.984	Diesel	2148	4	86
SPRINTER 3-t Box (906)	2.1	06/00→	OM 646.985	Diesel	2148	4	87
SPRINTER 3-t Box (906)	2.1	06/00→	OM 646.986	Diesel	2148	4	88
SPRINTER 3-t Box (906)	2.1	06/00→	OM 646.990	Diesel	2148	4	89
SPRINTER 3-t Box (906)	3.0	06/00→	OM 642.992	Diesel	2987	6	238
SPRINTER 3-t Box (906)	3.5	06/00→	M 272.979	Petrol	3498	6	281
SPRINTER 3-t Bus (903)	2.1	04/00→05/00	OM 611.981	Diesel	2148	4	71
SPRINTER 3-t Bus (903)	2.1	04/00→05/00	OM 611.987	Diesel	2148	4	72
SPRINTER 3-t Bus (903)	2.3	02/99→05/00	M 111.984	Petrol	2295	4	124
SPRINTER 3-t Bus (903)	2.3	02/99→05/00	M 111.984	Gas	2295	4	124
SPRINTER 3-t Bus (903)	2.3	02/99→04/00	OM 601.943	Diesel	2299	4	130
SPRINTER 3-t Bus (903)	2.7	04/00→05/00	OM 612.981	Diesel	2685	5	174
SPRINTER 3-t Bus (903)	2.9	02/99→08/00	OM 602.980	Diesel	2874	5	189
SPRINTER 3-t Bus (906)	1.8	09/00→	M 271.951	Petrol/Petroleum Gas (LPG)	1796	4	26
SPRINTER 3-t Bus (906)	1.8	09/00→	M 271.951	Petrol/Natural Gas (CNG)	1796	4	26
SPRINTER 3-t Bus (906)	1.8	09/00→	M 271.951	Petrol	1796	4	26
SPRINTER 3-t Bus (906)	1.8	09/00→	M 271.951	Natural Gas	1796	4	26
SPRINTER 3-t Bus (906)	2.1	06/00→	OM 646.985	Diesel	2148	4	87
SPRINTER 3-t Bus (906)	2.1	06/00→	OM 646.990	Diesel	2148	4	89
SPRINTER 3-t Bus (906)	3.5	06/00→	M 272.979	Petrol	3498	6	281
SPRINTER 3-t Platform/Chassis (903)	2.1	04/00→05/00	OM 611.981	Diesel	2148	4	71
SPRINTER 3-t Platform/Chassis (903)	2.1	04/00→05/00	OM 611.987	Diesel	2148	4	72
SPRINTER 3-t Platform/Chassis (903)	2.3	02/99→05/00	M 111.984	Petrol	2295	4	124
SPRINTER 3-t Platform/Chassis (903)	2.3	02/99→05/00	M 111.984	Gas	2295	4	124
SPRINTER 3-t Platform/Chassis (903)	2.3	02/99→04/00	OM 601.943	Diesel	2299	4	130
SPRINTER 3-t Platform/Chassis (903)	2.7	04/00→05/00	OM 612.981	Diesel	2685	5	174
SPRINTER 3-t Platform/Chassis (903)	2.9	02/99→04/00	OM 602.980	Diesel	2874	5	189
SPRINTER 3-t Platform/Chassis (906)	1.8	09/00→	M 271.951	Petrol/Petroleum Gas (LPG)	1796	4	26
SPRINTER 3-t Platform/Chassis (906)	1.8	09/00→	M 271.951	Petrol/Natural Gas (CNG)	1796	4	26
SPRINTER 3-t Platform/Chassis (906)	1.8	09/00→	M 271.951	Petrol	1796	4	26
SPRINTER 3-t Platform/Chassis (906)	2.1	06/00→	OM 646.984	Diesel	2148	4	86
SPRINTER 3-t Platform/Chassis (906)	2.1	06/00→	OM 646.985	Diesel	2148	4	87
SPRINTER 3-t Platform/Chassis (906)	2.1	06/00→	OM 646.986	Diesel	2148	4	88
SPRINTER 3-t Platform/Chassis (906)	2.1	06/00→	OM 646.990	Diesel	2148	4	89
SPRINTER 3-t Platform/Chassis (906)	3.0	06/00→	OM 642.992	Diesel	2987	6	238
SPRINTER 3-t Platform/Chassis (906)	3.5	06/00→	M 272.979	Petrol	3498	6	281
SPRINTER 4-t Box (904)	2.1	04/00→05/00	OM 611.981	Diesel	2148	4	71
SPRINTER 4-t Box (904)	2.1	04/00→05/00	OM 611.987	Diesel	2148	4	72
SPRINTER 4-t Box (904)	2.3	02/99→05/00	M 111.979	Petrol	2295	4	120
SPRINTER 4-t Box (904)	2.3	02/99→05/00	OM 601.943	Diesel	2299	4	130
SPRINTER 4-t Box (904)	2.7	04/00→05/00	OM 612.981	Diesel	2685	5	174
SPRINTER 4-t Box (904)	2.9	02/99→05/00	OM 602.980	Diesel	2874	5	189
SPRINTER 4-t Bus (904)	2.1	04/00→05/00	OM 611.981	Diesel	2148	4	71
SPRINTER 4-t Bus (904)	2.1	04/00→05/00	OM 611.987	Diesel	2148	4	72
SPRINTER 4-t Bus (904)	2.3	02/99→05/00	M 111.979	Petrol	2295	4	120
SPRINTER 4-t Bus (904)	2.7	04/00→05/00	OM 612.981	Diesel	2685	5	174
SPRINTER 4-t Platform/Chassis (904)	2.1	04/00→05/00	OM 611.981	Diesel	2148	4	71
SPRINTER 4-t Platform/Chassis (904)	2.1	04/00→05/00	OM 611.987	Diesel	2148	4	72
SPRINTER 4-t Platform/Chassis (904)	2.3	02/99→05/00	M 111.979	Petrol	2295	4	120
SPRINTER 4-t Platform/Chassis (904)	2.3	02/99→05/00	OM 601.943	Diesel	2299	4	130
SPRINTER 4-t Platform/Chassis (904)	2.7	04/00→05/00	OM 612.981	Diesel	2685	5	174
SPRINTER 4-t Platform/Chassis (904)	2.9	02/99→05/00	OM 602.980	Diesel	2874	5	189
SPRINTER 5-t Box (906)	2.1	06/00→	OM 646.984	Diesel	2148	4	86
SPRINTER 5-t Box (906)	2.1	06/00→	OM 646.985	Diesel	2148	4	87
SPRINTER 5-t Box (906)	2.1	06/00→	OM 646.986	Diesel	2148	4	88
SPRINTER 5-t Box (906)	2.1	06/00→	OM 646.990	Diesel	2148	4	89
SPRINTER 5-t Box (906)	3.0	06/00→	OM 642.992	Diesel	2987	6	238
SPRINTER 5-t Box (906)	3.5	06/00→	M 272.979	Petrol	3498	6	281
SPRINTER 5-t Platform/Chassis (905)	2.7	04/00→05/00	OM 612.981	Diesel	2685	5	174
SPRINTER 5-t Platform/Chassis (906)	1.8	09/00→	M 271.951	Petrol/Petroleum Gas (LPG)	1796	4	26
SPRINTER 5-t Platform/Chassis (906)	1.8	09/00→	M 271.951	Petrol/Natural Gas (CNG)	1796	4	26
SPRINTER 5-t Platform/Chassis (906)	1.8	09/00→	M 271.951	Petrol	1796	4	26
SPRINTER 5-t Platform/Chassis (906)	1.8	09/00→	M 271.951	Natural Gas	1796	4	26
SPRINTER 5-t Platform/Chassis (906)	2.1	06/00→	OM 646.984	Diesel	2148	4	86
SPRINTER 5-t Platform/Chassis (906)	2.1	06/00→	OM 646.985	Diesel	2148	4	87

	Ltr				CC		9
SPRINTER 5+ Platform/Chassis (906)	2.1	06/00 →	OM 646.986	Diesel	2148	4	88
SPRINTER 5+ Platform/Chassis (906)	2.1	06/00 →	OM 646.990	Diesel	2148	4	89
SPRINTER 5+ Platform/Chassis (906)	3.0	06/00 →	OM 642.992	Diesel	2987	6	238
SPRINTER 5+ Platform/Chassis (906)	3.5	06/00 →	M 272.979	Petrol	3498	6	281
SPRINTER 3,5 Platform/Chassis (906)	1.8	09/00 →	M 271.951	Petrol/Petroleum Gas (LPG)	1796	4	26
SPRINTER 3,5 Platform/Chassis (906)	1.8	09/00 →	M 271.951	Petrol/Natural Gas (CNG)	1796	4	26
SPRINTER 3,5 Platform/Chassis (906)	1.8	09/00 →	M 271.951	Petrol	1796	4	26
SPRINTER 3,5 Platform/Chassis (906)	1.8	09/00 →	M 271.951	Natural Gas	1796	4	26
SPRINTER 3,5 Platform/Chassis (906)	2.1	06/00 →	OM 646.984	Diesel	2148	4	86
SPRINTER 3,5 Platform/Chassis (906)	2.1	06/00 →	OM 646.985	Diesel	2148	4	87
SPRINTER 3,5 Platform/Chassis (906)	2.1	06/00 →	OM 646.986	Diesel	2148	4	88
SPRINTER 3,5 Platform/Chassis (906)	2.1	06/00 →	OM 646.990	Diesel	2148	4	89
SPRINTER 3,5 Platform/Chassis (906)	3.0	06/00 →	OM 642.992	Diesel	2987	6	238
SPRINTER 3,5 Platform/Chassis (906)	3.5	06/00 →	M 272.979	Petrol	3498	6	281
SPRINTER 3,5+ Box (906)	1.8	09/00 →	M 271.951	Petrol/Petroleum Gas (LPG)	1796	4	26
SPRINTER 3,5+ Box (906)	1.8	09/00 →	M 271.951	Petrol/Natural Gas (CNG)	1796	4	26
SPRINTER 3,5+ Box (906)	1.8	09/00 →	M 271.951	Petrol	1796	4	26
SPRINTER 3,5+ Box (906)	1.8	09/00 →	M 271.951	Natural Gas	1796	4	26
SPRINTER 3,5+ Box (906)	2.1	06/00 →	OM 646.984	Diesel	2148	4	86
SPRINTER 3,5+ Box (906)	2.1	06/00 →	OM 646.985	Diesel	2148	4	87
SPRINTER 3,5+ Box (906)	2.1	06/00 →	OM 646.986	Diesel	2148	4	88
SPRINTER 3,5+ Box (906)	2.1	06/00 →	OM 646.990	Diesel	2148	4	89
SPRINTER 3,5+ Box (906)	3.0	06/00 →	OM 642.992	Diesel	2987	6	238
SPRINTER 3,5+ Box (906)	3.5	06/00 →	M 272.979	Petrol	3498	6	281
SPRINTER 3,5+ Bus (906)	1.8	09/00 →	M 271.951	Petrol/Petroleum Gas (LPG)	1796	4	26
SPRINTER 3,5+ Bus (906)	1.8	09/00 →	M 271.951	Petrol/Natural Gas (CNG)	1796	4	26
SPRINTER 3,5+ Bus (906)	1.8	09/00 →	M 271.951	Petrol	1796	4	26
SPRINTER 3,5+ Bus (906)	1.8	09/00 →	M 271.951	Natural Gas	1796	4	26
SPRINTER 3,5+ Bus (906)	2.1	06/00 →	OM 646.985	Diesel	2148	4	87
SPRINTER 3,5+ Bus (906)	2.1	06/00 →	OM 646.990	Diesel	2148	4	89
SPRINTER 3,5+ Bus (906)	3.0	02/00 →	OM 642.992	Diesel	2987	6	238
SPRINTER 3,5+ Bus (906)	3.5	06/00 →	M 272.979	Petrol	3498	6	281
SPRINTER 4,6+ Box (906)	2.1	06/00 →	OM 646.985	Diesel	2148	4	87
SPRINTER 4,6+ Box (906)	2.1	06/00 →	OM 646.986	Diesel	2148	4	88
SPRINTER 4,6+ Box (906)	2.1	06/00 →	OM 646.990	Diesel	2148	4	89
SPRINTER 4,6+ Box (906)	3.0	03/00 →	OM 642.992	Diesel	2987	6	238
SPRINTER 4,6+ Box (906)	3.5	06/00 →	M 272.979	Petrol	3498	6	281
SPRINTER 4,6+ Platform/Chassis (906)	2.1	06/00 →	OM 646.985	Diesel	2148	4	87
SPRINTER 4,6+ Platform/Chassis (906)	2.1	06/00 →	OM 646.986	Diesel	2148	4	88
SPRINTER 4,6+ Platform/Chassis (906)	2.1	06/00 →	OM 646.990	Diesel	2148	4	89
SPRINTER 4,6+ Platform/Chassis (906)	3.0	06/00 →	OM 642.992	Diesel	2987	6	238
SPRINTER 4,6+ Platform/Chassis (906)	3.5	06/00 →	M 272.979	Petrol	3498	6	281
SPRINTER Dumptruck (905)	2.7	04/00 →	OM 612.981	Diesel	2685	5	174
T1 Box (601)	2.3	07/98 → 02/99	M 102.942	Petrol	2298	4	102
T1 Box (601)	2.3	05/98 → 02/99	M 102.945	Petrol	2298	4	104
T1 Box (601)	2.3	07/98 → 02/99	M 102.946	Petrol	2298	4	105
T1 Box (601)	2.3	10/98 → 02/99	OM 601.940	Diesel	2299	4	127
T1 Box (601)	2.4	06/98 → 01/99	OM 616.937	Diesel	2399	4	139
T1 Box (601)	2.4	06/98 → 01/99	OM 616.939	Diesel	2399	4	140
T1 Box (601)	2.8	10/98 → 02/99	OM 602.940	Diesel	2874	5	187
T1 Box (601)	2.9	12/98 → 01/99	OM 617.913	Diesel	2998	5	222
T1 Box (602)	2.3	11/98 → 02/99	OM 601.940	Diesel	2299	4	127
T1 Box (602)	2.4	10/98 → 01/99	OM 616.937	Diesel	2399	4	139
T1 Box (602)	2.4	10/98 → 01/99	OM 616.939	Diesel	2399	4	140
T1 Box (602)	2.9	06/98 → 02/99	OM 602.940	Diesel	2874	5	187
T1 Box (602)	3.0	10/98 → 01/99	OM 617.913	Diesel	2998	5	222
T1 Bus (601)	2.3	07/98 → 01/99	M 102.942	Petrol	2298	4	102
T1 Bus (601)	2.3	05/98 → 02/99	M 102.945	Petrol	2298	4	104
T1 Bus (601)	2.3	10/98 → 02/99	OM 601.940	Diesel	2299	4	127
T1 Bus (601)	2.8	11/98 → 02/99	OM 602.940	Diesel	2874	5	187
T1 Bus (601)	2.9	12/98 → 01/99	OM 617.913	Diesel	2998	5	222
T1 Bus (602)	2.3	06/98 → 02/99	OM 601.940	Diesel	2299	4	127
T1 Bus (602)	2.9	06/98 → 02/99	OM 602.940	Diesel	2874	5	187
T1 Platform/Chassis (601)	2.3	04/97 → 10/98	M 102.942	Petrol	2298	4	102
T1 Platform/Chassis (601)	2.3	04/97 → 10/98	M 115.955	Petrol	2307	4	125
T1 Platform/Chassis (601)	2.3	11/98 → 02/99	OM 601.940	Diesel	2299	4	127
T1 Platform/Chassis (601)	2.4	12/97 → 10/98	OM 616.937	Diesel	2399	4	139
T1 Platform/Chassis (601)	2.8	11/98 → 02/99	OM 602.940	Diesel	2874	5	187
T1 Platform/Chassis (601)	2.9	11/98 → 02/99	OM 602.940	Diesel	2874	5	187
T1 Platform/Chassis (601)	2.9	12/98 → 01/99	OM 617.913	Diesel	2998	5	222



Ltr















CC











9

	Ltr				CC		
T1 Platform/Chassis (602)	2.3	01/98→12/99	M 102.942	Petrol	2298	4	102
T1 Platform/Chassis (602)	2.3	06/98→02/99	OM 601.940	Diesel	2299	4	127
T1 Platform/Chassis (602)	2.4	01/97→12/99	OM 616.917	Diesel	2404	4	138
T1 Platform/Chassis (602)	2.4	06/98→01/99	OM 616.937	Diesel	2399	4	139
T1 Platform/Chassis (602)	2.4	06/98→01/99	OM 616.939	Diesel	2399	4	140
T1 Platform/Chassis (602)	2.9	06/98→02/99	OM 602.940	Diesel	2874	5	187
T1 Platform/Chassis (602)	3.0	10/98→01/99	OM 617.913	Diesel	2998	5	222
T1/TN Box Body / Estate	2.3	08/98→06/99	M 102.942	Petrol	2298	4	102
T1/TN Box Body / Estate	2.3	08/98→06/99	M 102.945	Petrol	2298	4	104
T1/TN Box Body / Estate	2.3	11/98→06/99	OM 601.940	Diesel	2299	4	127
T1/TN Box Body / Estate	2.4	07/98→01/98	OM 616.913	Diesel	2398	4	136
T1/TN Box Body / Estate	2.4	07/98→01/98	OM 616.939	Diesel	2399	4	140
T1/TN Box Body / Estate	2.8	11/98→06/99	OM 602.940	Diesel	2874	5	187
T1/TN Box Body / Estate	2.9	04/98→01/98	OM 617.913	Diesel	2998	5	222
T1/TN Platform/Chassis	2.3	08/98→06/99	M 102.942	Petrol	2298	4	102
T1/TN Platform/Chassis	2.3	08/98→06/99	M 102.945	Petrol	2298	4	104
T1/TN Platform/Chassis	2.3	11/98→06/99	OM 601.940	Diesel	2299	4	127
T1/TN Platform/Chassis	2.4	07/98→01/98	OM 616.913	Diesel	2398	4	136
T1/TN Platform/Chassis	2.4	07/98→01/98	OM 616.939	Diesel	2399	4	140
T1/TN Platform/Chassis	2.8	11/98→06/99	OM 602.940	Diesel	2874	5	187
T1/TN Platform/Chassis	2.9	04/98→01/98	OM 617.913	Diesel	2998	5	222
T2/L Box Body / Estate	2.3	08/98→12/98	M 102.943	Petrol	2299	4	103
T2/L Box Body / Estate	2.4	01/97→12/98	OM 616.910	Diesel	2400	4	135
T2/L Platform/Chassis	2.3	08/98→12/98	M 102.943	Petrol	2299	4	103
T2/L Platform/Chassis	2.4	01/97→12/98	OM 616.910	Diesel	2400	4	135
T2/L Platform/Chassis	2.4	01/97→12/98	OM 616.917	Diesel	2404	4	138
T2/LN1 Box Body / Estate	2.3	04/98→12/99	M 102.946	Petrol	2298	4	105
T2/LN1 Box Body / Estate	2.3	03/98→12/99	OM 601.941	Diesel	2299	4	128
T2/LN1 Box Body / Estate	2.4	04/98→04/98	OM 616.914	Diesel	2399	4	137
T2/LN1 Dumptruck	2.3	03/98→12/99	OM 601.941	Diesel	2299	4	128
T2/LN1 Dumptruck	2.4	04/98→04/98	OM 616.914	Diesel	2399	4	137
T2/LN1 Platform/Chassis	2.3	04/98→12/99	M 102.946	Petrol	2298	4	105
T2/LN1 Platform/Chassis	2.4	04/98→04/98	OM 616.914	Diesel	2399	4	137
VANEO (414)	1.4	06/00→07/00	M 166.940	Petrol	1397	4	1
VANEO (414)	1.6	02/00→07/00	M 166.961	Petrol	1598	4	4
VANEO (414)	1.7	02/00→07/00	OM 668.914	Diesel	1689	4	8
VANEO (414)	1.9	02/00→07/00	M 166.991	Petrol	1898	4	34
VARIO Box Body / Estate	2.9	09/99→	OM 602.984	Diesel	2874	5	192
VARIO Box Body / Estate	2.9	09/99→	OM 602.985	Diesel	2874	5	193
VARIO Bus	2.9	09/99→	OM 602.984	Diesel	2874	5	192
VARIO Bus	2.9	09/99→	OM 602.985	Diesel	2874	5	193
VARIO Dumptruck	2.9	09/99→	OM 602.984	Diesel	2874	5	192
VARIO Dumptruck	2.9	09/99→	OM 602.985	Diesel	2874	5	193
VARIO Platform/Chassis	2.9	09/99→	OM 602.984	Diesel	2874	5	192
VARIO Platform/Chassis	2.9	09/99→	OM 602.985	Diesel	2874	5	193
V-CLASS (638/2)	2.0	02/99→07/00	M 111.948	Petrol	1998	4	49
V-CLASS (638/2)	2.0	02/99→07/00	M 111.950	Petrol	1998	4	50
V-CLASS (638/2)	2.2	03/99→07/00	OM 611.980	Diesel	2151	4	99
V-CLASS (638/2)	2.3	10/99→07/00	M 111.978	Petrol	2295	4	119
V-CLASS (638/2)	2.3	09/99→07/00	OM 601.970	Diesel	2299	4	131
V-CLASS (638/2)	2.8	08/99→07/00	M 104.900	Petrol	2792	6	176
VIANO (W639)	2.0	09/00→	OM 646.982	Diesel	2148	4	84
VIANO (W639)	2.2	09/00→	OM 646.982	Diesel	2148	4	84
VIANO (W639)	3.0	03/00→	OM 642.990	Diesel	2987	6	237
VIANO (W639)	3.2	09/00→	M 112.951	Petrol	3199	6	254
VIANO (W639)	3.5	09/00→	M 272.979	Petrol	3498	6	281
VIANO (W639)	3.7	06/00→	M 112.976	Petrol	3724	6	295
VITO / MIXTO Box (W639)	2.2	08/00→	OM 646.981	Diesel	2148	4	83
VITO / MIXTO Box (W639)	2.2	09/00→	OM 646.982	Diesel	2148	4	84
VITO / MIXTO Box (W639)	2.2	09/00→	OM 646.983	Diesel	2148	4	85
VITO / MIXTO Box (W639)	3.0	07/00→	OM 642.990	Diesel	2987	6	237
VITO / MIXTO Box (W639)	3.2	09/00→	M 112.951	Petrol	3199	6	254
VITO / MIXTO Box (W639)	3.5	09/00→	M 272.978	Petrol	3498	6	280
VITO / MIXTO Box (W639)	3.7	06/00→07/00	M 112.976	Petrol	3724	6	295
VITO Box (638)	2.0	03/99→07/00	M 111.948	Petrol	1998	4	49
VITO Box (638)	2.0	03/99→07/00	M 111.950	Petrol	1998	4	50
VITO Box (638)	2.2	03/99→07/00	OM 611.980	Diesel	2151	4	99
VITO Box (638)	2.2	03/99→07/00	OM 611A (60 KW CDI)	Diesel	2151	4	100
VITO Box (638)	2.2	03/99→07/00	OM 611LA (75 KW CDI)	Diesel	2151	4	101
VITO Box (638)	2.3	03/99→07/00	M 111.978	Petrol	2295	4	119

	Ltr				CC		9
VITO Box (638)	2.3	03/99 → 07/00	OM 601.942	Diesel	2299	4	129
VITO Box (638)	2.3	03/99 → 07/00	OM 601.970	Diesel	2299	4	131
VITO Bus (638)	2.0	02/99 → 07/00	M 111.948	Petrol	1998	4	49
VITO Bus (638)	2.0	02/99 → 07/00	M 111.950	Petrol	1998	4	50
VITO Bus (638)	2.2	03/99 → 07/00	OM 611.980	Diesel	2151	4	99
VITO Bus (638)	2.2	03/99 → 07/00	OM 611A (60 KW CDI)	Diesel	2151	4	100
VITO Bus (638)	2.2	03/99 → 07/00	OM 611LA (75 KW CDI)	Diesel	2151	4	101
VITO Bus (638)	2.3	12/99 → 07/00	M 111.978	Petrol	2295	4	119
VITO Bus (638)	2.3	02/99 → 07/00	OM 601.942	Diesel	2299	4	129
VITO Bus (638)	2.3	02/99 → 07/00	OM 601.970	Diesel	2299	4	131
VITO Bus (W639)	2.2	09/00 →	OM 646.980	Diesel	2148	4	82
VITO Bus (W639)	2.2	09/00 →	OM 646.981	Diesel	2148	4	83
VITO Bus (W639)	2.2	09/00 →	OM 646.982	Diesel	2148	4	84
VITO Bus (W639)	2.2	09/00 →	OM 646.983	Diesel	2148	4	85
VITO Bus (W639)	3.0	09/00 →	M 112.951	Petrol	3199	6	254
VITO Bus (W639)	3.0	07/00 →	OM 642.990	Diesel	2987	6	237
VITO Bus (W639)	3.2	09/00 →	M 112.951	Petrol	3199	6	254
VITO Bus (W639)	3.5	09/00 →	M 272.978	Petrol	3498	6	280
VITO Bus (W639)	3.7	06/00 →	M 112.976	Petrol	3724	6	295

		CC			9			CC			9
M 102.910	Petrol	1797	4	89.00	12	M 111.973	Petrol	2295	4	90.90	115
M 102.922	Petrol	1996	4	89.00	35	M 111.974	Petrol	2295	4	90.90	116
M 102.924	Petrol	1996	4	89.00	36	M 111.975	Petrol	2295	4	90.90	117
M 102.942	Petrol	2298	4	95.50	102	M 111.977	Petrol	2295	4	90.90	118
M 102.943	Petrol	2299	4	95.50	103	M 111.978	Petrol	2295	4	90.90	119
M 102.945	Petrol	2298	4	95.50	104	M 111.979	Petrol	2295	4	90.90	120
M 102.946	Petrol	2298	4	95.50	105	M 111.981	Petrol	2295	4	90.90	121
M 102.961	Petrol	1996	4	89.00	37	M 111.982	Petrol	2295	4	90.90	122
M 102.962	Petrol	1996	4	89.00	38	M 111.983	Petrol	2295	4	90.90	123
M 102.963	Petrol	1996	4	89.00	39	M 111.984	Petrol	2295	4	90.90	124
M 102.965	Petrol	1996	4	89.00	40	M 111.984	Gas	2295	4	90.90	124
M 102.979	Petrol	2299	4	95.50	106	M 112.910	Petrol	2398	6	83.20	132
M 102.981	Petrol	2299	4	95.50	107	M 112.911	Petrol	2398	6	83.20	133
M 102.982	Petrol	2298	4	95.50	108	M 112.912	Petrol	2597	6	89.90	161
M 102.983	Petrol	2298	4	95.50	109	M 112.913	Petrol	2597	6	89.90	162
M 102.985	Petrol	2298	4	95.50	110	M 112.914	Petrol	2597	6	89.90	163
M 102.987	Petrol	2299	4	95.50	111	M 112.915	Petrol	2597	6	89.90	164
M 102.989	Petrol	2298	4	95.50	112	M 112.916	Petrol	2597	6	89.90	165
M 102.990	Petrol	2498	4	95.50	142	M 112.917	Petrol	2597	6	89.90	166
M 102.991	Petrol	2498	4	95.50	143	M 112.920	Petrol	2799	6	89.90	182
M 102.992	Petrol	2498	4	95.50	144	M 112.921	Petrol	2799	6	89.90	183
M 102.996	Petrol	2298	4	95.50	113	M 112.922	Petrol	2799	6	89.90	184
M 103.940	Petrol	2597	6	82.90	157	M 112.923	Petrol	2799	6	89.90	185
M 103.941	Petrol	2597	6	82.90	158	M 112.925	Petrol	2799	6	89.90	186
M 103.942	Petrol	2597	6	82.90	159	M 112.940	Petrol	3199	6	89.90	245
M 103.943	Petrol	2597	6	82.90	160	M 112.941	Petrol	3199	6	89.90	246
M 103.981	Petrol	2960	6	88.50	194	M 112.942	Petrol	3199	6	89.90	247
M 103.982	Petrol	2960	6	88.50	195	M 112.943	Petrol	3199	6	89.90	248
M 103.983	Petrol	2960	6	88.50	196	M 112.944	Petrol	3199	6	89.90	249
M 103.984	Petrol	2960	6	88.50	197	M 112.945	Petrol	3199	6	89.90	250
M 103.985	Petrol	2960	6	88.50	198	M 112.946	Petrol	3199	6	89.90	251
M 103.987	Petrol	2960	6	88.50	199	M 112.947	Petrol	3199	6	89.90	252
M 104.900	Petrol	2792	6	81.00	176	M 112.949	Petrol	3199	6	89.90	253
M 104.941	Petrol	2799	6	89.90	177	M 112.951	Petrol	3199	6	89.90	254
M 104.941 (AMG 3.6)	Petrol	3606	6	91.00	289	M 112.953	Petrol	3199	6	89.90	255
M 104.942	Petrol	2799	6	89.90	178	M 112.954	Petrol	3199	6	89.90	256
M 104.943	Petrol	2799	6	89.90	179	M 112.955	Petrol	3199	6	89.90	257
M 104.944	Petrol	2799	6	89.90	180	M 112.960	Petrol	3199	6	89.90	258
M 104.945	Petrol	2799	6	89.90	181	M 112.961	Petrol	3199	6	89.90	259
M 104.980	Petrol	2960	6	88.50	200	M 112.970	Petrol	3724	6	97.00	291
M 104.981	Petrol	2960	6	88.50	201	M 112.972	Petrol	3724	6	97.00	292
M 104.990	Petrol	3199	6	89.90	239	M 112.973	Petrol	3724	6	97.00	293
M 104.991	Petrol	3199	6	89.90	240	M 112.975	Petrol	3724	6	97.00	294
M 104.992	Petrol	3199	6	89.90	241	M 112.976	Petrol	3724	6	97.00	295
M 104.992 (AMG 3.6)	Petrol	3606	6	91.00	290	M 115.955	Petrol	2307	4	93.75	125
M 104.994	Petrol	3199	6	89.90	242	M 115.973	Petrol	2307	4	93.75	126
M 104.995	Petrol	3199	6	89.90	243	M 137.980	Petrol	6258	12	84.50	313
M 104.996	Petrol	3199	6	89.90	244	M 156.980	Petrol	6208	8	102.20	306
M 110.994	Petrol	2746	6	86.00	167	M 156.981	Petrol	6208	8	102.00	307
M 111.920	Petrol	1799	4	85.30	13	M 156.982	Petrol	6208	8	102.20	308
M 111.921	Petrol	1799	4	85.30	14	M 156.983	Petrol	6208	8	102.20	309
M 111.940	Petrol	1998	4	89.90	41	M 156.984	Petrol	6208	8	102.20	310
M 111.941	Petrol	1998	4	89.90	42	M 156.985	Petrol	6208	8	102.00	311
M 111.942	Petrol	1998	4	89.90	43	M 159.980	Petrol	6208	8	102.20	312
M 111.943	Petrol	1998	4	89.90	44	M 166.940	Petrol	1397	4	80.00	1
M 111.944	Petrol	1998	4	89.90	45	M 166.960	Petrol	1598	4	80.00	3
M 111.945	Petrol	1998	4	89.90	46	M 166.961	Petrol	1598	4	80.00	4
M 111.946	Petrol	1998	4	89.90	47	M 166.990	Petrol	1898	4	84.00	33
M 111.947	Petrol	1998	4	89.90	48	M 166.991	Petrol	1898	4	84.00	34
M 111.948	Petrol	1998	4	89.90	49	M 166.995	Petrol	2084	4	84.00	68
M 111.950	Petrol	1998	4	89.90	50	M 266.920	Petrol	1498	4	83.00	2
M 111.951	Petrol	1998	4	89.90	51	M 266.940	Petrol	1699	4	83.00	7
M 111.952	Petrol	1998	4	89.90	52	M 266.960	Petrol	2034	4	83.00	57
M 111.955	Petrol	1998	4	89.90	53	M 266.960	Bi-Fuel	2034	4	83.00	57
M 111.956	Petrol	1998	4	89.90	54	M 266.980	Petrol	2034	4	83.00	58
M 111.957	Petrol	1998	4	89.90	55	M 271.820	Petrol	1796	4	82.00	15
M 111.958	Petrol	1998	4	89.90	56	M 271.860	Petrol	1796	4	82.00	16
M 111.960	Petrol	2199	4	89.90	94	M 271.861	Petrol	1796	4	82.00	17
M 111.961	Petrol	2199	4	89.90	95	M 271.910	Petrol	1597	4	80.00	5
M 111.970	Petrol	2295	4	90.90	114	M 271.911	Petrol	1597	4	80.00	6

		CC			9			CC			9
M 271.921	Petrol	1796	4	82.00	18	OM 601.943	Diesel	2299	4	89.00	130
M 271.940	Petrol	1796	4	82.00	19	OM 601.970	Diesel	2299	4	89.00	131
M 271.941	Petrol	1796	4	82.00	20	OM 602.911	Diesel	2497	5	87.00	145
M 271.941	Bi-Fuel	1796	4	82.00	20	OM 602.912	Diesel	2497	5	87.00	146
M 271.942	Petrol	1796	4	82.00	21	OM 602.930	Diesel	2497	5	87.00	147
M 271.944	Petrol	1795	4	82.00	22	OM 602.931	Diesel	2497	5	87.00	148
M 271.946	Petrol	1796	4	82.00	23	OM 602.939	Diesel	2497	5	87.00	149
M 271.948	Petrol	1796	4	82.00	24	OM 602.940	Diesel	2874	5	89.00	187
M 271.950	Petrol	1796	4	82.00	25	OM 602.942	Diesel	2874	5	89.00	188
M 271.951	Petrol/ Petroleum Gas (LPG)	1796	4	82.00	26	OM 602.961	Diesel	2497	5	87.00	150
M 271.951	Petrol/ Natural Gas (CNG)	1796	4	82.00	26	OM 602.962	Diesel	2497	5	87.00	151
M 271.951	Petrol	1796	4	82.00	26	OM 602.980	Diesel	2874	5	89.00	189
M 271.951	Natural Gas	1796	4	82.00	26	OM 602.982	Diesel	2874	5	89.00	190
M 271.952	Petrol	1796	4	82.00	27	OM 602.983	Diesel	2874	5	89.00	191
M 271.954	Petrol	1796	4	82.00	28	OM 602.984	Diesel	2874	5	89.00	192
M 271.955	Petrol	1796	4	82.00	29	OM 602.985	Diesel	2874	5	89.00	193
M 271.956	Petrol	1796	4	82.00	30	OM 603.912	Diesel	2996	6	87.00	211
M 271.958	Bi-Fuel	1796	4	82.00	31	OM 603.913	Diesel	2996	6	87.00	212
M 272.940	Petrol	2996	6	88.00	202	OM 603.931	Diesel	2996	6	87.00	213
M 272.941	Petrol	2996	6	88.00	203	OM 603.960	Diesel	2996	6	87.00	214
M 272.942	Petrol	2996	6	88.00	204	OM 603.963	Diesel	2996	6	87.00	215
M 272.943	Petrol	2996	6	88.00	205	OM 603.971	Diesel	3449	6	89.00	264
M 272.945	Petrol	2996	6	88.00	206	OM 603.972	Diesel	3449	6	89.00	265
M 272.947	Petrol	2996	6	88.00	207	OM 604.910	Diesel	2155	4	89.00	96
M 272.948	Petrol	2996	6	88.00	208	OM 604.912	Diesel	2155	4	89.00	97
M 272.949	Petrol	2996	6	88.00	209	OM 604.915	Diesel	1997	4	87.00	62
M 272.952	Petrol	2996	6	88.00	210	OM 604.917	Diesel	1997	4	87.00	63
M 272.960	Petrol	3498	6	92.90	266	OM 605.910	Diesel	2497	5	87.00	152
M 272.961	Petrol	3498	6	92.90	267	OM 605.911	Diesel	2497	5	87.00	153
M 272.963	Petrol	3498	6	92.90	268	OM 605.912	Diesel	2497	5	87.00	154
M 272.964	Petrol	3498	6	92.90	269	OM 605.960	Diesel	2497	5	87.00	155
M 272.965	Petrol	3498	6	92.90	270	OM 605.962	Diesel	2497	5	87.00	156
M 272.966	Petrol	3498	6	92.90	271	OM 606.910	Diesel	2996	6	87.00	216
M 272.967	Petrol	3498	6	92.90	272	OM 606.912	Diesel	2996	6	87.00	217
M 272.969	Petrol	3498	6	92.90	273	OM 606.961	Diesel	2996	6	87.00	218
M 272.970	Petrol	3498	6	92.90	274	OM 606.962	Diesel	2996	6	87.00	219
M 272.971	Petrol	3498	6	92.90	275	OM 606.964	Diesel	2996	6	87.00	220
M 272.972	Petrol	3498	6	92.90	276	OM 611.960	Diesel	2151	4	88.00	98
M 272.974	Petrol/Electro	3498	6	92.90	277	OM 611.961	Diesel	2148	4	88.00	69
M 272.975	Petrol	3498	6	92.90	278	OM 611.962	Diesel	2148	4	88.00	70
M 272.977	Petrol	3498	6	92.90	279	OM 611.980	Diesel	2151	4	88.00	99
M 272.978	Petrol	3498	6	92.90	280	OM 611.981	Diesel	2148	4	88.00	71
M 272.979	Petrol	3498	6	92.90	281	OM 611.987	Diesel	2148	4	88.00	72
M 272.980	Petrol	3498	6	92.90	282	OM 611A (60 KW CDI)	Diesel	2151	4	88.00	100
M 272.982	Petrol	3498	6	92.90	283	OM 611LA (75 KW CDI)	Diesel	2151	4	88.00	101
M 272.983	Petrol	3498	6	92.90	284	OM 612.961	Diesel	2685	5	88.00	168
M 272.984	Petrol	3498	6	92.90	285	OM 612.962	Diesel	2685	5	88.00	169
M 272.985	Petrol	3498	6	92.90	286	OM 612.963	Diesel	2685	5	88.00	170
M 272.991	Petrol	3498	6	92.90	287	OM 612.965	Diesel	2685	5	88.00	171
M 273.960	Petrol	5461	8	98.00	296	OM 612.966	Diesel	2685	5	88.00	172
M 273.961	Petrol	5461	8	98.00	297	OM 612.967	Diesel	2685	5	88.00	173
M 273.962	Petrol	5461	8	98.00	298	OM 612.981	Diesel	2685	5	88.00	174
M 273.963	Petrol	5461	8	98.00	299	OM 612.990	Diesel	2950	5	88.00	221
M 273.965	Petrol	5461	8	98.00	300	OM 613.960	Diesel	3222	6	88.00	260
M 273.966	Petrol	5461	8	98.00	301	OM 613.961	Diesel	3226	6	88.00	261
M 273.967	Petrol	5461	8	98.00	302	OM 615.963	Diesel	1988	4	87.00	64
M 273.968	Petrol	5461	8	98.00	303	OM 616	Diesel	2399	4	90.90	134
M 273.970	Petrol	5461	8	98.00	304	OM 616.910	Diesel	2400	4	91.00	135
M 273.971	Petrol	5461	8	98.00	305	OM 616.913	Diesel	2398	4	91.00	136
M 276.958	Petrol	3498	6	92.90	288	OM 616.914	Diesel	2399	4	91.00	137
OM 601.911	Diesel	1997	4	87.00	59	OM 616.917	Diesel	2404	4	91.00	138
OM 601.912	Diesel	1997	4	87.00	60	OM 616.937	Diesel	2399	4	91.00	139
OM 601.913	Diesel	1997	4	87.00	61	OM 616.939	Diesel	2399	4	91.00	140
OM 601.940	Diesel	2299	4	89.00	127	OM 616.963	Diesel	2399	4	91.00	141
OM 601.941	Diesel	2299	4	89.00	128	OM 617.913	Diesel	2998	5	91.00	222
OM 601.942	Diesel	2299	4	89.00	129	OM 617.931	Diesel	2998	5	90.90	223
						OM 640.940	Diesel	1991	4	83.00	65
						OM 640.941	Diesel	1991	4	83.00	66
						OM 640.942	Diesel	1991	4	83.00	67
						OM 642.820	Diesel	2987	6	83.00	224



CC



9



CC



9

OM 642.822	Diesel	2987	6	83.00	225
OM 642.830	Diesel	2987	6	83.00	226
OM 642.832	Diesel	2987	6	83.00	227
OM 642.910	Diesel	2987	6	83.00	228
OM 642.920	Diesel	2987	6	83.00	229
OM 642.921	Diesel	2987	6	83.00	230
OM 642.930	Diesel	2987	6	83.00	231
OM 642.940	Diesel	2987	6	83.00	232
OM 642.950	Diesel	2987	6	83.00	233
OM 642.960	Diesel	2987	6	83.00	234
OM 642.961	Diesel	2987	6	83.00	235
OM 642.970	Diesel	2987	6	83.00	236
OM 642.990	Diesel	2987	6	83.00	237
OM 642.992	Diesel	2987	6	83.00	238
OM 646.811	Diesel	2148	4	88.00	73
OM 646.812	Diesel	2148	4	88.00	74
OM 646.820	Diesel	2148	4	88.00	75
OM 646.821	Diesel	2148	4	88.00	76
OM 646.951	Diesel	2148	4	88.00	77
OM 646.961	Diesel	2148	4	88.00	78
OM 646.962	Diesel	2148	4	88.00	79
OM 646.963	Diesel	2148	4	88.00	80
OM 646.966	Diesel	2148	4	88.00	81
OM 646.980	Diesel	2148	4	88.00	82
OM 646.981	Diesel	2148	4	88.00	83
OM 646.982	Diesel	2148	4	88.00	84
OM 646.983	Diesel	2148	4	88.00	85
OM 646.984	Diesel	2148	4	88.00	86
OM 646.985	Diesel	2148	4	88.00	87
OM 646.986	Diesel	2148	4	88.00	88
OM 646.990	Diesel	2148	4	88.00	89
OM 647.961	Diesel	2685	5	88.00	175
OM 648.960	Diesel	3222	6	88.00	262
OM 648.961	Diesel	3222	6	88.00	263
OM 651.901	Diesel	1796	4	83.00	32
OM 651.912	Diesel	2143	4	83.00	90
OM 651.913	Diesel	2143	4	83.00	91
OM 651.916	Diesel	2143	4	83.00	92
OM 651.924	Diesel/Electro	2143	4	83.00	93
OM 651.924	Diesel	2143	4	83.00	93
OM 668.914	Diesel	1689	4	80.00	8
OM 668.940	Diesel	1689	4	80.00	9
OM 668.941	Diesel	1689	4	80.00	10
OM 668.942	Diesel	1689	4	80.00	11

MERCEDES-BENZ



cc



kW/PS

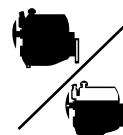

1.4		M 166.940					1	AB5550 (MLS)	CB5550 [13]	EB5550 [3]
A-Class 140	07/97→08/04	1397	4	80.00	SOHC/OHC	60/82				
Vaneo 1.4	06/02→07/05									
1.5		M 266.920					2	AG8500 (SE)	CG8500	EG8500
A-Class 150	09/04→06/12	1498	4	83.00	SOHC/OHC	70/95				
A-Class 160 CDI	04/09→06/12									
B-Class 150	03/05→11/11									
B-Class 160	04/09→11/11									
1.6		M 166.960					3	AB5550 (MLS)	CB5550 [13]	EB5550 [3]
A-Class 140	01/01→08/04	1598	4	80.00	SOHC/OHC	60-75/ 82-102				
A-Class 160	07/97→08/04									
1.6		M 166.961					4	AB5550 (MLS)	CB5550 [13]	EB5550 [3]
Vaneo 1.6	02/02→07/05	1598	4	80.00	SOHC/OHC	60-75/ 82-102				
1.6		M 271.910					5			
C-Class 180	01/08→	1597	4	80.00	DOHC	105-115/ 143-156				
1.6		M 271.911					6			
CLC 160	02/09→06/11	1597	4	80.00	DOHC	95/129				
1.7		M 266.940					7	AG8500 (SE)	CG8500	EG8500
A-Class 170	09/04→06/12	1699	4	83.00	SOHC/OHC	85/116				
A-Class 180	04/09→06/12									
B-Class 170 CDI	03/05→11/11									
B-Class 180	04/09→11/11									
1.7		OM 668.914 Diesel					8	AB5560 (MLS), 1.200mm	CB5560 [13]	
Vaneo 1.7 CDI	02/02→07/05	1689	4	80.00	DOHC	55-67/ 75-91				
1.7		OM 668.940 Diesel					9	AB5560 (MLS), 1.200mm	CB5560 [13]	
A-Class 160 CDI	02/01→08/04	1689	4	80.00	DOHC	55-66/ 75-90	09/98→			
A-Class 170 CDI	07/98→02/01									
1.7		OM 668.941 Diesel					10	AB5560 (MLS), 1.200mm	CB5560 [13]	
A-Class 160 CDI	07/98→02/01	1689	4	80.00	DOHC	44/60				
1.7		OM 668.942 Diesel					11	AB5560 (MLS), 1.200mm	CB5560 [13]	
A-Class 170 CDI	02/01→08/04	1689	4	80.00	DOHC	70/95				
1.8		M 102.910					12	BH870 (Fibre)	DH873 DH876 [106]	EH872
190 E 1.8	04/90→08/93	1797	4	89.00	SOHC/OHC	80/109				



AB5550



AB5560



BH870



JD182



JD292



JD293



JD5135



JD5136

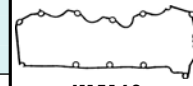

JM5163



JM5164

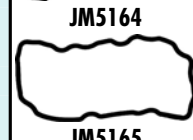

JM5165

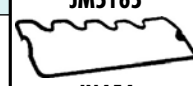

JN454

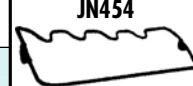

JN607

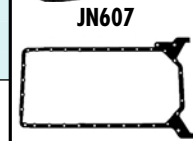

JJ488

HBS457 [22] M10x1.50x180.00mm (x10)	JD5804 [1] JD5135 [3]	JM5163 (Elastomer)	HR397	PA5041 [1] (x4) 6.00/12.20x10.00 (FPM) HR5097 [3]	NA5109 [2] 40.00x62.00x8.00mm, PTFE NA5107 [1] 90.00x167.00x10.50mm, PTFE	
HBS457 [22] M10x1.50x180.00mm (x10)	JD5799 [1] JD5802 [3]	HR397 [3]	HR397	HR5097 [3]	NA5109 [2] 40.00x62.00x8.00mm, PTFE	
HBS457 [22] M10x1.50x180.00mm (x10)	JD5804 [1] JD5135 [3]	JM5163 (Elastomer)	HR397	PA5041 [1] (x4) 6.00/12.20x10.00 (FPM) HR5097 [3]	NA5109 [2] 40.00x62.00x8.00mm, PTFE NA5107 [1] 90.00x167.00x10.50mm, PTFE	
HBS457 [22] M10x1.50x180.00mm (x10)	JD5804 [1] JD5135 [3]	JM5163 (Elastomer)	HR397	PA5041 [1] (x4) 6.00/12.20x10.00 (FPM) HR5097 [3]	NA5109 [2] 40.00x62.00x8.00mm, PTFE NA5107 [1] 90.00x167.00x10.50mm, PTFE	
					NA5131 [2] 45.00x67.00x8.00mm, PTFE	
HBS457 [22] M10x1.50x180.00mm (x10)	JD5799 [1] JD5802 [3]			PA5041 (x4) 6.00/12.20x10.00 (FPM) HR5097 [3]		
HBS291 [19] M12x1.75x185.00mm (x10) HBS457 [22] M10x1.50x180.00mm (x10)	JD5834 [1] JD5136 [3]	JM5165 [3] (Elastomer) JM5164 [3] (Elastomer)		PA5041 [1] (x8) 6.00/12.20x10.00 (FPM) HR5056 [3]	NA5109 [2] 40.00x62.00x8.00mm, PTFE NA5107 [1] 90.00x167.00x10.50mm, PTFE	
HBS291 [19] M12x1.75x185.00mm (x10) 09/98→ HBS457 [22] M10x1.50x180.00mm (x10) 09/98→	JD5834 [1] 09/98→ JD5136 [3] 09/98→	JM5165 [3] (Elastomer) 09/98→ JM5164 [3] (Elastomer) 09/98→		PA5041 [1] (x8) 6.00/12.20x10.00 (FPM) 09/98→ HR5056 [3] 09/98→	NA5109 [2] 40.00x62.00x8.00mm, PTFE 09/98→ NA5107 [1] 90.00x167.00x10.50mm, PTFE 09/98→	
HBS291 [19] M12x1.75x185.00mm (x10) HBS457 [22] M10x1.50x180.00mm (x10)	JD5834 [1] JD5136 [3]	JM5165 [3] (Elastomer) JM5164 [3] (Elastomer)		PA5041 [1] (x8) 6.00/12.20x10.00 (FPM) HR5056 [3]	NA5109 [2] 40.00x62.00x8.00mm, PTFE NA5107 [1] 90.00x167.00x10.50mm, PTFE	
HBS291 [19] M12x1.75x185.00mm (x10) HBS457 [22] M10x1.50x180.00mm (x10)	JD5834 [1] JD5136 [3]	JM5165 [3] (Elastomer) JM5164 [3] (Elastomer)		PA5041 [1] (x8) 6.00/12.20x10.00 (FPM) HR5056 [3]	NA5109 [2] 40.00x62.00x8.00mm, PTFE NA5107 [1] 90.00x167.00x10.50mm, PTFE	
HBS047 [19] M12x1.75x120.00mm (x10)	JD182 [1] JD292 [3] (x3) JD293 [3] (x1)	JN454 [4] [107] JN607 [4] [106]	JJ488	HR756 [3]	NB971 [2] 45.00x67.00x10.00mm, FPM NB972 [1] 93.00x117.00x12.00mm, FPM NB975 [2] 45.00x74.50x12.00mm, FPM NB974 [1] 93.00x114.00x13.00mm, FPM NA5266 [1] 93.00x114.00x14.00mm, FPM NA5074 [1] 93.00x133.50x15.50mm, PTFE	

MERCEDES-BENZ



cc



kW/PS

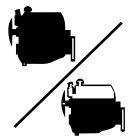

1.8		M 111.920					13		BZ850 (Fibre)	DV820	EV810
C-Class 180	03/93→05/00	1799	4	85.30	DOHC	90/122					
C-Class 180 T	06/96→09/00										
1.8		M 111.921					14		BZ850 (Fibre)	DV820	EV810
C-Class 180	03/93→05/00	1799	4	85.30	SOHC/OHC	89-90/ 121-122					
C-Class 180 T	06/96→09/00										
1.8		M 271.820					15				
C-Class 180	06/11→	1796	4	82.00	DOHC	115-137/ 156-186					
C-Class 180 CGI	01/07→										
C-Class 200	05/11→										
C-Class 200 CGI	01/07→										
E-class (W212)	08/09→										
E 200 CGI (212.048, 212.148)											
E-class Convertible (A207) 01/10→											
E 200 CGI (207.448)											
E-class Coupe (C207) 01/10→											
E 200 CGI (207.348)											
E-class T-Model (S212) 11/09→											
E 200 CGI (212.248)											
1.8		M 271.860					16				
C-Class 200 CGI	08/07→	1796	4	82.00	DOHC	135-150/ 184-204					
C-Class 250	06/11→										
C-Class 250 CGI	07/09→										
E-class (W212)	08/09→										
E 200 CGI (212.048, 212.148)											
E-class (W212) 01/09→											
E 250 CGI (212.047, 212.147)											
E-class Convertible (A207) 01/10→											
E 200 CGI (207.448)											
E-class Convertible (A207) 01/10→											
E 250 CGI (207.447)											
E-class Coupe (C207) 01/10→											
E 200 CGI (207.348)											
E-class Coupe (C207) 01/09→											
E 250 CGI (207.347)											
E-class T-Model (S212) 11/09→											
E 200 CGI (212.248)											
E-class T-Model (S212) 11/09→											
E 250 CGI (212.247)											
SLK 200	02/11→										
SLK 250	02/11→										
1.8		M 271.861					17				
SLK 200	02/11→	1796	4	82.00	DOHC	135-150/ 184-204					
SLK 250	02/11→										
1.8		M 271.921					18		AG8790 (MLS)	CG8790	EG8790
C-Class 160	05/02→05/08	1796	4	82.00	DOHC	90-95/ 122-129					
1.8		M 271.940					19		AG8790 (MLS)	CG8790	EG8790
C-Class 200	05/02→05/08	1796	4	82.00	DOHC	120/163					
C-Class 220	05/02→05/08										
C-Class C 200	05/02→08/07										
CLK 200 Komp	09/02→03/10										

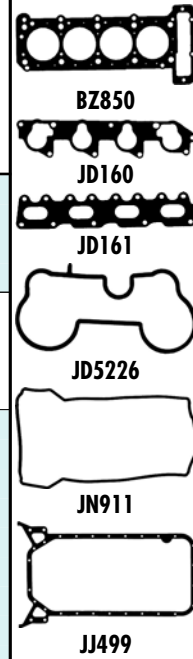

HBS150 Ⓞ [19]
M12x1.75x102.00mm (x10)

JD160 ■
JD161 ■

JN911 [4]

JJ499

HR5055 ■

☒ NB973 ■ [2]
45.00x67.00x8.00mm, FPM
☒ NB974 ■ [1]
93.00x114.00x13.00mm, FPM

JM5111 (x4) [108]

HBS150 Ⓞ [19]
M12x1.75x102.00mm (x10)

JD160 ■
JD5226 ■ (x2)
JD161 ■

JN911 [4]

JJ499

HR5055 ■

☒ NB973 ■ [2]
45.00x67.00x8.00mm, FPM
☒ NB974 ■ [1]
93.00x114.00x13.00mm, FPM

JM5111 (x4) [108]

☒ NA5131 ■ [2]
45.00x67.00x8.00mm, PTFE

☒ NA5131 ■ [2]
45.00x67.00x8.00mm, PTFE

☒ NA5131 ■ [2]
45.00x67.00x8.00mm, PTFE

HBS459 Ⓞ [22]
M10x1.50x165.00mm (x10)

JD5835 ■
(FPM)
JD5801 ■

JM7026
(Elastomer)

☒ NA5131 ■ [2]
45.00x67.00x8.00mm, PTFE

HBS459 Ⓞ [22]
M10x1.50x165.00mm (x10)

JD5835 ■
(FPM)
JD5801 ■

JM7026
(Elastomer)

☒ NA5131 ■ [2]
45.00x67.00x8.00mm, PTFE

MERCEDES-BENZ



cc



kW/PS



1.8	M 271.941	20	AG8790 (MLS)	CG8790	EG8790				
E-class E 200 (W211)	03/04→12/08	1796	4	82.00	DOHC	120/163			
E-class E 200	11/02→12/08								
Kompressor (W211)									
E-class T-Model	03/03→07/09								
E 200 Kompressor (W211)									
1.8	M 271.942	21	AG8790 (MLS)		EG8790				
C-Class 200 CGI	03/03→05/08	1796	4	82.00	DOHC	125/170			
C-Class C200 CGI	07/03→02/07								
CLK 200 CGI	07/03→03/10								
1.8	M 271.944	22	AG8790 (MLS)	CG8790	EG8790				
SLK Cabrio 200	03/04→02/11	1795	4	82.00	DOHC	120/163			
1.8	M 271.946	23	AG8790 (MLS)	CG8790 DZ881 ☒○ [13]	EG8790				
C-Class 180	05/02→05/08	1796	4	82.00	DOHC	105-125/ 143-170			
C-Class C 180	05/02→08/07								
CLC 180 Komp	05/08→06/11								
E-class E 200 (W211)	11/02→12/08								
1.8	M 271.948	24	AG8790 (MLS)	CG8790	EG8790				
C-Class 230	05/02→05/08	1796	4	82.00	DOHC	141/192			
C-Class C 230	02/04→08/07								
1.8	M 271.950	25	AG8790 (MLS)	CG8790	EG8790				
C-Class 200	01/07→	1796	4	82.00	DOHC	120-135/ 163-184			
1.8	M 271.951	26	AG8790 (MLS)	CG8790	EG8790				
Sprinter 3.5 316	09/08→	1796	4	82.00	DOHC	115/156			
Sprinter 3t 216	09/08→								
Sprinter 5t 516	09/08→								
1.8	M 271.952	27		CG8790					
C-Class 180	01/07→	1796	4	82.00	DOHC	115/156			
1.8	M 271.954	28							
SLK 200 Komp	01/08→02/11	1796	4	82.00	DOHC	135/184			
1.8	M 271.955	29							
CLC 200 Komp	05/08→06/11	1796	4	82.00	DOHC	135/184			
CLK 200 Komp	10/06→03/10								
1.8	M 271.956	30							
E-class E 200	04/06→12/08	1796	4	82.00	DOHC	135/184			
Kompressor (W211)									
E-class T-Model	04/06→07/09								
E 200 Kompressor (W211)									
1.8	M 271.958	31							
E-class (W212)	03/11→	1796	4	82.00	DOHC	120-135/ 163-184			
E 200 NGT (212.041)									
1.8	OM 651.901 Diesel	32							
A-Class 180 CDI	06/12→	1796	4	83.00		80-100/ 109-136			
A-Class 200 CDI	06/12→								
B-Class 180 CDI	11/11→								
B-Class 200 CDI	11/11→								
1.9	M 166.990	33	AB5570 (MLS), 0.700mm	CB5570 [13]	EB5550 [3]				
A-Class 190	03/99→08/04	1898	4	84.00	SOHC/OHC	92/125			
1.9	M 166.991	34	AB5570 (MLS), 0.700mm	CB5570 [13]	EB5550 [3]				
Vaneo 1.9	02/02→07/05	1898	4	84.00	SOHC/OHC	92/125			

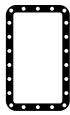
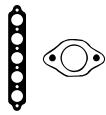

AB5570



JD5135

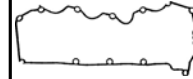

JM5163

HBS459 [22] M10x1.50x165.00mm (x10)	JD5835 [1] (FPM) JD5801 [2]	JM7026 (Elastomer)			NA5131 [2] 45.00x67.00x8.00mm, PTFE	
HBS459 [22] M10x1.50x165.00mm (x10)	JD5801 [2]	JM7026 (Elastomer)			NA5131 [2] 45.00x67.00x8.00mm, PTFE NA5168 [1] 93.00x114.00x11.50mm, PTFE	
HBS459 [22] M10x1.50x165.00mm (x10)	JD5835 [1] (FPM) JD5801 [2]	JM7026 (Elastomer)			NA5131 [2] 45.00x67.00x8.00mm, PTFE	
HBS459 [22] M10x1.50x165.00mm (x10)	JD5835 [1] (FPM) JD5801 [2]	JM7026 (Elastomer)		HR5055 [2]	NA5131 [2] 45.00x67.00x8.00mm, PTFE	
HBS459 [22] M10x1.50x165.00mm (x10)	JD5835 [1] (FPM) JD5801 [2]	JM7026 (Elastomer)			NA5131 [2] 45.00x67.00x8.00mm, PTFE	
HBS459 [22] M10x1.50x165.00mm (x10)	JD5835 [1] (FPM) JD5801 [2]	JM7026 (Elastomer)			NA5131 [2] 45.00x67.00x8.00mm, PTFE	
HBS459 [22] M10x1.50x165.00mm (x10)	JD5835 [1] (FPM) JD5801 [2]	JM7026 (Elastomer)			NA5131 [2] 45.00x67.00x8.00mm, PTFE	
		JM7026 (Elastomer)			NA5131 [2] 45.00x67.00x8.00mm, PTFE	
					NA5131 [2] 45.00x67.00x8.00mm, PTFE	
HBS459 [22] M10x1.50x165.00mm (x10)					NA5131 [2] 45.00x67.00x8.00mm, PTFE	
					NA5131 [2] 45.00x67.00x8.00mm, PTFE	
					NA5131 [2] 45.00x67.00x8.00mm, PTFE	
HBS534 [22]						
HBS457 [22] M10x1.50x180.00mm (x10)	JD5135 [2]	JM5163 (Elastomer)		PA5041 [1] (x4) 6.00/12.20x10.00 (FPM) HR5097 [2]	NA5109 [2] 40.00x62.00x8.00mm, PTFE NA5107 [1] 90.00x167.00x10.50mm, PTFE	
HBS457 [22] M10x1.50x180.00mm (x10)		JM5163 (Elastomer)		PA5041 (x4) 6.00/12.20x10.00 (FPM) HR5097 [2]	NA5109 [2] 40.00x62.00x8.00mm, PTFE NA5107 [1] 90.00x167.00x10.50mm, PTFE	

MERCEDES-BENZ



cc



kW/PS

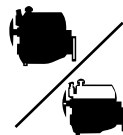

2.0	M 102.922						35	BH870 (Fibre)	CB5570 [13]	EH872
E-class 200 E	12/85→05/93	1996	4	89.00	SOHC/OHC	75-80/ 102-109				
Kombi 200 E	11/92→05/93									
Kombi 200 T	09/85→05/90									
2.0	M 102.924						36	BH870 (Fibre)	CB5570 [13]	EH872
190 E 2.0	09/84→05/90	1996	4	89.00	SOHC/OHC	75-77/ 102-105				
2.0	M 102.961						37	BH870 (Fibre)		
190 E 2.0	10/82→06/93	1996	4	89.00	SOHC/OHC	83-93/ 113-126				
2.0	M 102.962						38	BH870 (Fibre)	DH873 DH876 [106]	EH872
190 E 2.0	10/82→08/93	1996	4	89.00	SOHC/OHC	83-90/ 115-122				
Kombi 200 TE	09/88→12/89									
2.0	M 102.963						39	BH870 (Fibre)	DH873 DH876 [106]	EH872
E-class 200 E	09/88→08/92	1996	4	89.00	SOHC/OHC	87-90/ 118-122				
Kombi 200 TE	09/88→08/92									
2.0	M 102.965						40			
G-Class 200 GE	01/90→07/93	1996	4	89.00	SOHC/OHC	80-85/ 109-116				

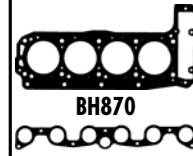
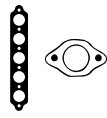

BH870



JD182



JD291



JD292



JD293



JE5026



JN454

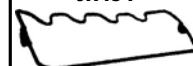

JN607



JJ488

MERCEDES-BENZ



cc



kW/PS

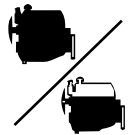

2.0	M 111.940	41	BZ880 (Fibre)	DV810 ☒○ [13]	EV810				
E-class 200 E	10/92→06/93	1998	4	89.90	DOHC	100/136			
E-class Coupe	06/93→06/97								
E 200 (C124)									
E-class E 200	06/93→06/95								
E-class E 200 T (S124)	06/93→06/96								
E-class Cabriolet	06/93→03/98								
Convertible E 200 (A124)									
Kombi 200 TE	10/92→06/93								
2.0	M 111.941	42	BZ880 (Fibre)	DV810 ☒○ [13]	EV810				
C-Class 200	01/94→05/00	1998	4	89.90	DOHC	100/136			
C-Class 200 T	06/96→03/01								
CLK 200	03/98→03/02								
2.0	M 111.942	43	BZ880 (Fibre)	DZ881 ☒○ [13]	EV810				
E-class E 200 (W210)	06/95→08/00	1998	4	89.90	DOHC	100/136			
E-class E 200 T (S210)	06/96→08/00								
2.0	M 111.943	44	BZ880 (Fibre)	DZ881 ☒○ [13]	EV810				
SLK Cabrio 200	10/96→03/00	1998	4	89.90	DOHC	132-141/ 180-192			
2.0	M 111.944	45	BZ880 (Fibre)	DV810 ☒○ [13]	EV810				
C-Class 200	10/95→05/00	1998	4	89.90	DOHC	132-141/ 180-192			
C-Class 200 T	11/96→03/01								
CLK 200 Komp	06/97→06/00								
2.0	M 111.945	46	BZ880 (Fibre)	DZ881 ☒○ [13]	EV810				
C-Class 200	01/94→05/00	1998	4	89.90	DOHC	100/136			
C-Class 200 T	06/96→03/01								
CLK 200	06/97→06/02								
2.0	M 111.946	47	BZ880 (Fibre)	DZ881 ☒○ [13]	EV810				
SLK Cabrio 200	09/96→03/00	1998	4	89.90	DOHC	100/136			
2.0	M 111.947	48	BZ880 (Fibre)	DZ881 ☒○ [13]	EV810				
E-class E 200 K ompressor (W210)	06/97→03/02	1998	4	89.90	DOHC	137/186			
E-class E 200 T Kompressor (S210)	06/97→03/03								
2.0	M 111.948	49	BZ880 (Fibre)	DV810 ☒○ [13]	EV810				
V-Class 200	02/97→07/03	1998	4	89.90	DOHC	95/129			
Vito 113	02/96→07/03								
2.0	M 111.950	50							
V-Class 200	02/97→07/03	1998	4	89.90	DOHC	95/129			
Vito 113	02/96→07/03								
2.0	M 111.951	51	BZ880 (Fibre)	DZ881 ☒○ [13]	EV810				
C-Class 180	03/01→05/02	1998	4	89.90	DOHC	95/129			
C-Class C 180	10/00→05/02								
2.0	M 111.952	52	BZ880 (Fibre)	DZ881 ☒○ [13]	EV810				
C-Class 180 T	09/00→03/01	1998	4	89.90	DOHC	95/129			
2.0	M 111.955	53	BZ880 (Fibre)	DZ881 ☒○ [13]	EV810				
C-Class 200	03/01→05/02	1998	4	89.90	DOHC	120/163			
C-Class C 200	05/00→05/02								
2.0	M 111.956	54	BZ880 (Fibre)	DZ881 ☒○ [13]	EV810				
C-Class 200 T	09/00→03/01	1998	4	89.90	DOHC	120/163			
CLK 200 Komp	06/00→06/02								

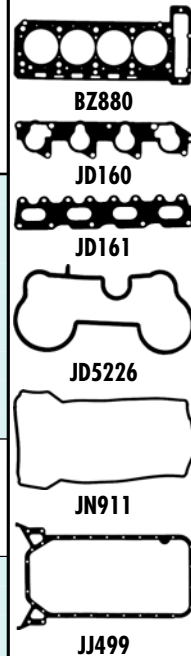
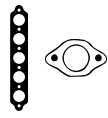

HBS150 [19] M12x1.75x102.00mm (x10)	JD160 JD161	JN911 [4] HM5057	JJ499	HR5055	NB973 [2] 45.00x67.00x8.00mm, FPM NB974 [1] 93.00x114.00x13.00mm, FPM	JM5111 (x4)[108]
HBS150 [19] M12x1.75x102.00mm (x10)	JD160 JD161	JN911 [4] HM5057	JJ499	HR5055	NB973 [2] 45.00x67.00x8.00mm, FPM NB974 [1] 93.00x114.00x13.00mm, FPM	JM5111 (x4)[108]
HBS150 [19] M12x1.75x102.00mm (x10)	JD5226 (x2) JD161	JN911 [4]	JJ499	HR5055	NB973 [2] 45.00x67.00x8.00mm, FPM NB974 [1] 93.00x114.00x13.00mm, FPM	JM5111 (x4)[108]
HBS150 [19] M12x1.75x102.00mm (x10)	JD5226 (x2) JD161	HM5057	JJ499	HR5055	NB973 [2] 45.00x67.00x8.00mm, FPM NB974 [1] 93.00x114.00x13.00mm, FPM	
HBS150 [19] M12x1.75x102.00mm (x10)	JD160 (x1) JD5226 (x2) JD161	JN911 [4] HM5057	JJ499	HR5055	NB973 [2] 45.00x67.00x8.00mm, FPM NB974 [1] 93.00x114.00x13.00mm, FPM	JM5111 (x4)[108]
HBS150 [19] M12x1.75x102.00mm (x10)	JD5226 (x2) JD161	JN911 [4]	JJ499	HR5055	NB973 [2] 45.00x67.00x8.00mm, FPM NB974 [1] 93.00x114.00x13.00mm, FPM	JM5111 (x4)[108]
HBS150 [19] M12x1.75x102.00mm (x10)	JD5226 (x2) JD161	HM5057	JJ499	HR5055	NB973 [2] 45.00x67.00x8.00mm, FPM NB974 [1] 93.00x114.00x13.00mm, FPM	
HBS150 [19] M12x1.75x102.00mm (x10)	JD160 JD161	HM5057	JJ499	HR5055	NB973 [2] 45.00x67.00x8.00mm, FPM NB974 [1] 93.00x114.00x13.00mm, FPM	
					NB973 [2] 45.00x67.00x8.00mm, FPM NB974 [1] 93.00x114.00x13.00mm, FPM	
HBS150 [19] M12x1.75x102.00mm (x10)	JD161				NB973 [2] 45.00x67.00x8.00mm, FPM	
HBS150 [19] M12x1.75x102.00mm (x10)	JD161				NB973 [2] 45.00x67.00x8.00mm, FPM	
HBS150 [19] M12x1.75x102.00mm (x10)					NB973 [2] 45.00x67.00x8.00mm, FPM	
HBS150 [19] M12x1.75x102.00mm (x10)	JD5402				NB973 [2] 45.00x67.00x8.00mm, FPM	

MERCEDES-BENZ



cc



kW/PS



2.0	M 111.957					55	BZ880 (Fibre)	DZ881 ☒○ [13]	EV810
E-class E 200 Kompressor (W210)	08/00→03/02	1998	4	89.90	DOHC	120/163			
E-class E 200 T Kompressor (S210)	08/00→03/03								
2.0	M 111.958					56	BZ880 (Fibre)	DZ881 ☒○ [13]	
SLK Cabrio 200	03/00→04/04	1998	4	89.90	DOHC	120/163			
2.0	M 266.960					57	AH5000 (MLS)		EG8500
A-Class 200	09/04→06/12	2034	4	83.00	SOHC/OHC	85-100/116-136			
B-Class 170	04/08→11/11								
B-Class 180	04/08→11/11								
B-Class 200 CDI	03/05→11/11								
2.0	M 266.980					58	AH5000 (MLS)		EG8500
A-Class 200	09/05→06/12	2034	4	83.00	SOHC/OHC	142/193			
B-Class 200 CDI	03/05→11/11								
2.0	OM 601.911	Diesel				59	BT540 (Fibre)	DT540 ☒ DT541	EM720
190 E 2.0 D	08/83→08/93	1997	4	87.00	SOHC/OHC	53-55/ 72-75			
2.0	OM 601.912	Diesel				60	BT540 (Fibre)	DT540 ☒ DT541	EM720
E-class 200 D	12/84→06/93	1997	4	87.00	SOHC/OHC	53-55/ 72-75			
E-class E 200 D	06/93→06/95								
Kombi 200 T D	09/85→08/91								
2.0	OM 601.913	Diesel				61	BT540 (Fibre)	DT540 ☒ DT541	EM720
C-Class 200 D	03/93→05/00	1997	4	87.00	SOHC/OHC	55/75			
2.0	OM 604.915	Diesel				62			
C-Class 200 D	10/96→05/00	1997	4	87.00	DOHC	65-85/ 88-116			
C-Class 200 T D	10/96→03/01								

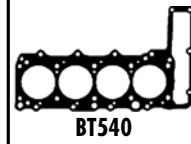
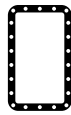
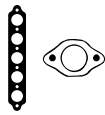

BT540

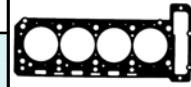

BZ880



JD158



JD159

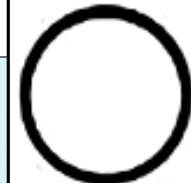

JD475



JN572



JN619



JJ498

HBS150 [19]
M12x1.75x102.00mm (x10)

HBS150 [19]
M12x1.75x102.00mm (x10)

HBS457 [22]
M10x1.50x180.00mm (x10)

HBS457 [22]
M10x1.50x180.00mm (x10)

HBS058 [22]
M10x1.50x115.00mm (x5)

JD158 [1]
JD159 [1]

JD158 [1]
JD159 [1]

HBS061 [22]
M10x1.50x115.00mm (x4)

JD5799 [1]
JD5802 [1]

JD5799 [1]

JD158 [1]
JD159 [1]

JD158 [1]
JD159 [1]

JD158 [1]
JD159 [1]

JD475 [1]

JN572 [4][106]
JN619 [4][107]

JN572 [4][106]
JN619 [4][107]

JN572 [4][106]
JN619 [4][107]

JJ498

JJ498

JJ498

PA5041 (x4)
6.00/12.20x10.00
(FPM)
HR5097 [1]

PA5041 (x4)
6.00/12.20x10.00
(FPM)
HR5097 [1]

HR757 [1]

HR757 [1]

HR757 [1]

NB973 [2]
45.00x67.00x8.00mm, FPM
NB974 [1]
93.00x114.00x13.00mm, FPM

NB973 [2]
45.00x67.00x8.00mm, FPM
NB974 [1]
93.00x114.00x13.00mm, FPM

NB973 [2]
45.00x67.00x8.00mm, FPM
NB975 [2]
45.00x74.50x12.00mm, FPM
NB974 [1]
93.00x114.00x13.00mm, FPM
NA5266 [1]
93.00x114.00x14.00mm, FPM
NA5074 [1]
93.00x133.50x15.50mm, PTFE

NA5131 [2]
45.00x67.00x8.00mm, PTFE
NB973 [2]
45.00x67.00x8.00mm, FPM
NB971 [2]
45.00x67.00x10.00mm, FPM
NB975 [2]
45.00x74.50x12.00mm, FPM
NB974 [1]
93.00x114.00x13.00mm, FPM
NA5266 [1]
93.00x114.00x14.00mm, FPM
NA5074 [1]
93.00x133.50x15.50mm, PTFE

NA5131 [2]
45.00x67.00x8.00mm, PTFE
NB973 [2]
45.00x67.00x8.00mm, FPM
NB971 [2]
45.00x67.00x10.00mm, FPM
NB975 [2]
45.00x74.50x12.00mm, FPM
NB974 [1]
93.00x114.00x13.00mm, FPM
NA5266 [1]
93.00x114.00x14.00mm, FPM
NA5074 [1]
93.00x133.50x15.50mm, PTFE

NA5131 [2]
45.00x67.00x8.00mm, PTFE

KK5683 [109]

KK5683 [109]

KK5683 [109]

MERCEDES-BENZ



cc



kW/PS

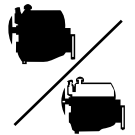

2.0	OM 604.917	Diesel	63				
E-class E 200 D (W210)	01/96→03/02	1997	4	87.00	DOHC	65/88	
2.0	OM 615.963	Diesel	64				
100 2.0 D	04/88→08/93	1988	4	87.00	SOHC/OHC	43/58	
2.0	OM 640.940	Diesel	65				
A-Class 180 CDI	09/04→06/12	1991	4	83.00	DOHC	80/109	AG8501 (MLS)
B-Class 180 CDI	03/05→11/11						CG8501
2.0	OM 640.941	Diesel	66				
A-Class 200 CDI	09/04→06/12	1991	4	83.00	DOHC	100-103/ 136-140	AG8501 (MLS)
B-Class 200 CDI	03/05→11/11						CG8501
2.0	OM 640.942	Diesel	67				
A-Class 160 CDI	09/04→06/12	1991	4	83.00	DOHC	60/82	AG8501 (MLS)
							CG8501
2.1	M 166.995		68				
A-Class 210	03/02→08/04	2084	4	84.00	SOHC/OHC	103/140	AB5570 (MLS), 0.700mm
							CB5570 [13]
2.1	OM 611.961	Diesel	69				
E-class E 200 CDI (W210)	06/98→03/02	2148	4	88.00	DOHC	75-105/ 102-143	AC5620 (MLS), 1.200mm
E-class E 220 CDI (W210)	06/98→03/02						CC5620
E-class E 220 T CDI (S210)	06/98→03/03						EC5620 [3]
E-class (W210) E 220 CDI	07/99→03/02						
2.1	OM 611.962	Diesel	70				
C-Class 200 CDI	03/01→08/07	2148	4	88.00	DOHC	85-105/ 116-143	AC5620 (MLS), 1.200mm
C-Class 220 CDI	03/01→05/08						CC5620
C-Class C200 CDI	09/00→02/07						EC5620 [3]
C-Class C220 CDI	05/00→02/07						
2.1	OM 611.981	Diesel	71				
Sprinter 2t 211	04/00→05/06	2148	4	88.00	DOHC	80-95/ 109-129	AC5620 (MLS), 1.200mm
Sprinter 2t 213	04/00→05/06						CC5620
Sprinter 3t 311	04/00→05/06						EC5620 [3]
Sprinter 3t 313	04/00→05/06						
Sprinter 4t 411	04/00→05/06						
Sprinter 4t 413	04/00→05/06						
2.1	OM 611.987	Diesel	72				
Sprinter 2t 208	04/00→05/06	2148	4	88.00	DOHC	60/82	AC5620 (MLS), 1.200mm
Sprinter 3t 308	04/00→05/06						CC5620
Sprinter 4t 408	04/00→05/06						EC5620 [3]
2.1	OM 646.811	Diesel	73				
C-Class 200 CDI	01/07→	2148	4	88.00	DOHC	100-125/ 136-170	AH6460 (MLS), 1.200mm, 2 Holes
C-Class 220 CDI	01/07→						AH6470 (MLS), 1.400mm, 1 Hole
							AH6450 (MLS), 1.400mm, 3 Holes
2.1	OM 646.812	Diesel	74				
C-Class 200 CDI	01/07→	2148	4	88.00	DOHC	100/136	AH6460 (MLS), 1.200mm, 2 Holes
							AH6470 (MLS), 1.400mm, 1 Hole
							AH6450 (MLS), 1.400mm, 3 Holes
2.1	OM 646.820	Diesel	75				
E-class E 200 CDI (W211)	04/06→12/08	2148	4	88.00	DOHC	100/136	AH6460 (MLS), 1.200mm, 2 Holes
							AH6470 (MLS), 1.400mm, 1 Hole
							AH6450 (MLS), 1.400mm, 3 Holes



AB5570



AC5620

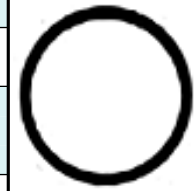

JD475



JD5135

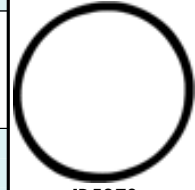

JD5378



JD5379

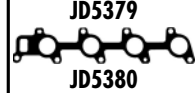

JD5380

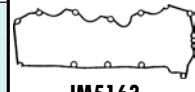

JM5163

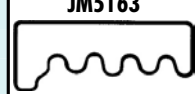

JM848

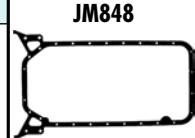

JH5082

HBS061 [22] M10x1.50x115.00mm (x4)	JD475				NA5131 [2] 45.00x67.00x8.00mm, PTFE	
	JB162	JM848 [4]			PA815 [1] [2] 78.00x94.00x8.00mm	
HBS458 [19] M12x1.75x115.00mm (x10)	JD5800 JD5803	JM7027 (Elastomer) HM5286		PA5041 (x16) 6.00/12.20x10.00 (FPM)		
HBS458 [19] M12x1.75x115.00mm (x10)	JD5800 JD5803	JM7027 (Elastomer) HM5286		PA5041 (x16) 6.00/12.20x10.00 (FPM)		
HBS458 [19] M12x1.75x115.00mm (x10)	JD5800 JD5803	JM7027 (Elastomer) HM5286		PA5041 (x16) 6.00/12.20x10.00 (FPM)		
HBS457 [22] M10x1.50x180.00mm (x10)	JD5135	JM5163 (Elastomer)		PA5041 (x4) 6.00/12.20x10.00 (FPM) HR5097	NA5109 [2] 40.00x62.00x8.00mm, PTFE NA5107 [1] 90.00x167.00x10.50mm, PTFE	
HBS292 [19] M12x1.75x102.00mm (x10)	JD5380 (MLS)	HM5170	JH5082 [62] (Steel)	HR5055 HR5085 (x4)	NA5131 [2] 45.00x67.00x8.00mm, PTFE NA5074 [1] 93.00x133.50x15.50mm, PTFE	KA5035 [15] KA5036 [15]
HBS292 [19] M12x1.75x102.00mm (x10)	JD5378 JD5380 (MLS)	HM5170	JH5082 [62] (Steel)	HR5055 HR5085 (x4)	NA5131 [2] 45.00x67.00x8.00mm, PTFE NA5074 [1] 93.00x133.50x15.50mm, PTFE	KA5035 [15] KA5036 [15]
HBS292 [19] M12x1.75x102.00mm (x10)	JD5379 (Elastomer) JD5380 (MLS)	HM5170	JH5082 [62] (Steel)	HR5085 (x4)	NA5131 [2] 45.00x67.00x8.00mm, PTFE NA5074 [1] 93.00x133.50x15.50mm, PTFE	KA5035 [15] KA5036 [15]
HBS292 [19] M12x1.75x102.00mm (x10)	JD5379 (Elastomer) JD5380 (MLS)	HM5170	JH5082 [62] (Steel)	HR5085 (x4)	NA5131 [2] 45.00x67.00x8.00mm, PTFE NA5074 [1] 93.00x133.50x15.50mm, PTFE	KA5035 [15] KA5036 [15]
			JH5082 (Steel)		NA5131 [2] 45.00x67.00x8.00mm, PTFE NA5074 [1] 93.00x133.50x15.50mm, PTFE	KA5036 [15]
			JH5082 (Steel)		NA5131 [2] 45.00x67.00x8.00mm, PTFE NA5074 [1] 93.00x133.50x15.50mm, PTFE	KA5036 [15]
			JH5082 (Steel)		NA5131 [2] 45.00x67.00x8.00mm, PTFE NA5074 [1] 93.00x133.50x15.50mm, PTFE	KA5036 [15]

MERCEDES-BENZ



cc



kw/PS

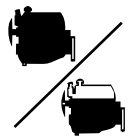

2.1	OM 646.821	Diesel	76	AH6460 (MLS), 1.200mm, 2 Holes 09/03→ AH6470 (MLS), 1.400mm, 1 Hole 09/03→ AH6450 (MLS), 1.400mm, 3 Holes 09/03→			
E-class E 220 CDI (W211) 04/06→12/08	2148	4	88.00	DOHC	100-125/ 136-170		
E-class (W211) E 220 CDI 03/03→12/08							
E-class T-Model 04/06→07/09							
E 200 CDI (S211)							
E-class T-Model (S211) 03/03→07/09							
E 220 T CDI							
E-class T-Model (S211) 04/06→07/09							
E 220 T CDI (211.208)							
2.1	OM 646.951	Diesel	77	AC5620 (MLS), 1.200mm			
E-class E 200 CDI (W211) 07/02→12/08	2148	4	88.00	DOHC	75-90/ 102-122		EC5620 [3]
2.1	OM 646.961	Diesel	78	AC5620 (MLS), 1.200mm			
E-class E 220 CDI (W211) 03/02→12/08	2148	4	88.00	DOHC	100-110/ 136-150		EC5620 [3]
E-class T-Model 03/03→07/09							
E 220 CDI (S211)							
E-class T-Model 03/03→07/09							
E 220 T CDI (S211)							
2.1	OM 646.962	Diesel	79	AC5620 (MLS), 1.200mm			
C-Class 200 CDI 03/01→05/08	2148	4	88.00	DOHC	75-110/ 102-150		EC5620 [3]
C-Class C200 CDI 02/01→02/07							
CLC 200 CDI 05/08→06/11							
2.1	OM 646.963	Diesel	80	AC5620 (MLS), 1.200mm			
C-Class 220 CDI 02/04→05/08	2148	4	88.00	DOHC	110/150	CC5620	EC5620 [3]
C-Class C220 CDI 02/04→02/07							
CLC 220 CDI 05/08→06/11							
2.1	OM 646.966	Diesel	81	AC5620 (MLS), 1.200mm			
CLK 220 CDI 01/05→05/09	2148	4	88.00	DOHC	110/150	CC5620	EC5620 [3]
2.1	OM 646.980	Diesel	82	AH6460 (MLS), 1.200mm, 2 Holes AH6470 (MLS), 1.400mm, 1 Hole AH6450 (MLS), 1.400mm, 3 Holes			
Vito 109 CDI 09/06→	2148	4	88.00	DOHC	70/95		
2.1	OM 646.981	Diesel	83	AH6460 (MLS), 1.200mm, 2 Holes AH6470 (MLS), 1.400mm, 1 Hole AH6450 (MLS), 1.400mm, 3 Holes			
Vito 109 CDI 08/06→	2148	4	88.00	DOHC	70/95		
2.1	OM 646.982	Diesel	84	AC5620 (MLS), 1.200mm AH6460 (MLS), 1.200mm, 2 Holes AH6470 (MLS), 1.400mm, 1 Hole AH6450 (MLS), 1.400mm, 3 Holes			
Viano CDI 2.0 09/03→	2148	4	88.00	DOHC	80-110/ 109-150		
Viano CDI 2.2 09/03→							
Vito 111 CDI 09/03→							
Vito 115 CDI 09/03→							
2.1	OM 646.983	Diesel	85	AH6460 (MLS), 1.200mm, 2 Holes AH6470 (MLS), 1.400mm, 1 Hole AH6450 (MLS), 1.400mm, 3 Holes			
Vito 109 CDI 09/03→	2148	4	88.00	DOHC	65-80/ 88-109		
2.1	OM 646.984	Diesel	86	AH6460 (MLS), 1.200mm, 2 Holes AH6470 (MLS), 1.400mm, 1 Hole AH6450 (MLS), 1.400mm, 3 Holes			
Sprinter 3.5 309 06/06→	2148	4	88.00	DOHC	65/88		
Sprinter 3t 209 06/06→							
Sprinter 5t 509 06/06→							
2.1	OM 646.985	Diesel	87	AH6460 (MLS), 1.200mm, 2 Holes AH6470 (MLS), 1.400mm, 1 Hole AH6450 (MLS), 1.400mm, 3 Holes			
Sprint 4,6t 411 06/09→	2148	4	88.00	DOHC	80/109		
Sprinter 3.5 311 06/06→							
Sprinter 3t 211 06/06→							
Sprinter 5t 511 06/06→							

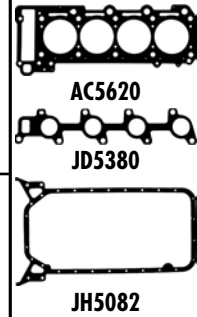

					<input checked="" type="checkbox"/> NA5131 [2] 45.00x67.00x8.00mm, PTFE <input checked="" type="checkbox"/> NA5074 [1] 93.00x133.50x15.50mm, PTFE	KA5036 [15]
HBS292 [19] M12x1.75x102.00mm (x10)	JD5380 [15] (MLS)	HM5170 [15]	JH5082 [62] (Steel)		<input checked="" type="checkbox"/> NA5131 [2] 45.00x67.00x8.00mm, PTFE <input checked="" type="checkbox"/> NA5074 [1] 93.00x133.50x15.50mm, PTFE	KA5036 [15]
HBS292 [19] M12x1.75x102.00mm (x10)	JD5380 [15] (MLS)	HM5170 [15]	JH5082 [62] (Steel)	HR5055 [15]	<input checked="" type="checkbox"/> NA5131 [2] 45.00x67.00x8.00mm, PTFE <input checked="" type="checkbox"/> NA5074 [1] 93.00x133.50x15.50mm, PTFE	KA5036 [15]
HBS292 [19] M12x1.75x102.00mm (x10)	JD5380 [15] (MLS)	HM5170 [15]	JH5082 [62] (Steel)	HR5055 [15]	<input checked="" type="checkbox"/> NA5131 [2] 45.00x67.00x8.00mm, PTFE <input checked="" type="checkbox"/> NA5074 [1] 93.00x133.50x15.50mm, PTFE	KA5036 [15]
HBS292 [19] M12x1.75x102.00mm (x10)	JD5380 [15] (MLS)	HM5170 [15]	JH5082 [62] (Steel)	HR5055 [15]	<input checked="" type="checkbox"/> NA5131 [2] 45.00x67.00x8.00mm, PTFE <input checked="" type="checkbox"/> NA5074 [1] 93.00x133.50x15.50mm, PTFE	KA5036 [15]
HBS292 [19] M12x1.75x102.00mm (x10)	JD5380 [15] (MLS)		JH5082 [62] (Steel)	HR5085 [15]	<input checked="" type="checkbox"/> NA5131 [2] 45.00x67.00x8.00mm, PTFE <input checked="" type="checkbox"/> NA5074 [1] 93.00x133.50x15.50mm, PTFE	KA5036 [15]
HBS292 [19] M12x1.75x102.00mm (x10)	JD5380 [15] (MLS)			HR5085 [15]	<input checked="" type="checkbox"/> NA5131 [2] 45.00x67.00x8.00mm, PTFE <input checked="" type="checkbox"/> NA5074 [1] 93.00x133.50x15.50mm, PTFE	KA5036 [15]
HBS292 [19] M12x1.75x102.00mm (x10)	JD5380 [15] (MLS)			HR5085 [15]	<input checked="" type="checkbox"/> NA5131 [2] 45.00x67.00x8.00mm, PTFE <input checked="" type="checkbox"/> NA5074 [1] 93.00x133.50x15.50mm, PTFE	KA5036 [15]
HBS292 [19] M12x1.75x102.00mm (x10)	JD5380 [15] (MLS)			HR5085 [15]	<input checked="" type="checkbox"/> NA5131 [2] 45.00x67.00x8.00mm, PTFE <input checked="" type="checkbox"/> NA5074 [1] 93.00x133.50x15.50mm, PTFE	KA5036 [15]
HBS292 [19] M12x1.75x102.00mm (x10)	JD5380 [15] (MLS)			HR5085 [15]	<input checked="" type="checkbox"/> NA5131 [2] 45.00x67.00x8.00mm, PTFE <input checked="" type="checkbox"/> NA5074 [1] 93.00x133.50x15.50mm, PTFE	KA5036 [15]
HBS292 [19] M12x1.75x102.00mm (x10)	JD5380 [15] (MLS)			HR5085 [15]	<input checked="" type="checkbox"/> NA5131 [2] 45.00x67.00x8.00mm, PTFE <input checked="" type="checkbox"/> NA5074 [1] 93.00x133.50x15.50mm, PTFE	KA5036 [15]

MERCEDES-BENZ



cc



kW/PS

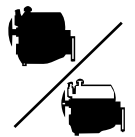

2.1	OM 646.986	Diesel	88	AH6460 (MLS), 1.200mm, 2 Holes AH6470 (MLS), 1.400mm, 1 Hole AH6450 (MLS), 1.400mm, 3 Holes				
Sprint 4,6t 413	06/06→	2148	4	88.00	DOHC	95-110/ 129-150		
Sprinter 3.5 313	06/06→							
Sprinter 3t 213	06/06→							
Sprinter 5t 513	06/06→							
2.1	OM 646.990	Diesel	89	AH6460 (MLS), 1.200mm, 2 Holes AH6470 (MLS), 1.400mm, 1 Hole AH6450 (MLS), 1.400mm, 3 Holes				
Sprint 4,6t 415	06/06→	2148	4	88.00	DOHC	110/150		
Sprinter 3.5 315	06/06→							
Sprinter 3t 215	06/06→							
Sprinter 5t 515	06/06→							
2.1	OM 651.912	Diesel	90					
C-Class 26.480	01/11→	2143	4	83.00	DOHC	120-150/ 163-204		
C-Class 220 CDI	02/13→							
C-Class 250 CDI	04/10→							
GLK 220 CDI	12/08→							
GLK 250 CDI	09/09→							
2.1	OM 651.913	Diesel	91					
C-Class 26.480	01/11→	2143	4	83.00	DOHC	88-105/ 120-143		
C-Class 180 CDI	01/11→							
C-Class 200 CDI	08/10→							
GLK 200 CDI	07/10→							
2.1	OM 651.916	Diesel	92					
GLK 200 CDI	07/10→	2143	4	83.00	DOHC	105-125/ 143-170		
GLK 220 CDI	12/08→							
2.1	OM 651.924	Diesel	93					
CLS 250 CDI	04/11→	2143	4	83.00	DOHC	120-150/ 163-204		
E-class (W211) E 250 CDI	08/08→12/08							
E-class (W212) E 220 CDI	01/09→							
E-class (W212)	01/09→							
E 220 CDI / BlueTEC (212.001, 212.002)								
E-class (W212)	01/09→							
E 250 CDI (212.003)								
E-class (W212)	01/09→							
E 250 CDI 4-matic (212.082)								
E-class (W212) E 300	12/11→							
Hybrid/BlueTEC Hybrid (212.098)								
E-class T-Model (S212)	11/09→							
E 220 CDI (212.202)								
E-class T-Model (S212)	11/09→							
E 250 CDI (212.203)								
E-class T-Model (S212)	12/11→							
E 300 Hybrid (212.298)								
NL NL 313	07/10→							
2.2	M 111.960		94	BZ880 (Fibre)	DV810 ☒ ○ [13]	EV810		
Coupe 220 CE	10/92→05/93	2199	4	89.90	DOHC	110/150		
E-class 220 E	10/92→06/93							
E-class Coupe	06/93→06/97							
E 220 (C124)								
E-class E 220	06/93→06/95							
E-class E 220 T (S124)	06/93→06/96							
E-class Cabriolet	06/93→03/98							
Convertible E 220 (A124)								
Kombi 220 TE	10/92→05/93							

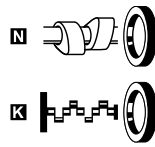
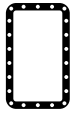
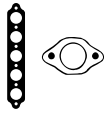

BZ880



JD160



JD161



JD5380



JN911



JJ499

HBS292 [19]
M12x1.75x102.00mm (x10)

JD5380 [15]
(MLS)

HR5085 [15]

NA5131 [2]
45.00x67.00x8.00mm, PTFE
NA5074 [1]
93.00x133.50x15.50mm, PTFE

KA5036 [15]

HBS292 [19]
M12x1.75x102.00mm (x10)

JD5380 [15]
(MLS)

HR5085 [15]

NA5131 [2]
45.00x67.00x8.00mm, PTFE
NA5074 [1]
93.00x133.50x15.50mm, PTFE

KA5036 [15]

HBS534 [22]

HBS534 [22]

HBS534 [22]

HBS534 [22]

HBS150 [19]
M12x1.75x102.00mm (x10)

JD160 [4]
JD161 [4]

JN911 [4]
HM5057 [4]

JJ499

HR5055 [4]

NB973 [2]
45.00x67.00x8.00mm, FPM
NB974 [1]
93.00x114.00x13.00mm, FPM

JM5111 (x4) [108]

MERCEDES-BENZ



kW/PS

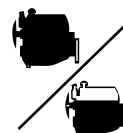

2.2	M 111.961						95	BZ880 (Fibre)	DV810 ☒○ [13]	EV810
C-Class 220	03/93→05/00	2199	4	89.90	DOHC	110/150				
2.2	OM 604.910	Diesel					96	BZ860 (Fibre)	DZ860 ○ [13]	HC5005
C-Class 220 D	08/93→05/00	2155	4	89.00	DOHC	55-70/ 75-95				
C-Class 220 T D	06/96→03/01									
2.2	OM 604.912	Diesel					97	BZ860 (Fibre)	DZ860 ○ [13]	HC5005
E-Class E 220 D (W210)	06/95→03/02	2155	4	89.00	DOHC	55-70/ 75-95				
2.2	OM 611.960	Diesel					98	AC5620 (MLS), 1.200mm	CC5620	EC5620 [3]
C-Class 200 CDI	03/98→03/01	2151	4	88.00	DOHC	75-92/ 102-125				
C-Class 220 CDI	09/97→03/01									
2.2	OM 611.980	Diesel					99	AC5620 (MLS), 1.200mm	CC5620	EC5620 [3]
V-Class 200 CDI	03/99→07/03	2151	4	88.00	DOHC	60-90/ 82-122				
V-Class 220 CDI	03/99→07/03									
Vito 112 CDI	03/99→07/03									
2.2	OM 611A (60 KW CDI)	Diesel					100	AC5620 (MLS), 1.200mm	CC5620	EC5620 [3]
Vito 108 CDI	03/99→07/03	2151	4	88.00	DOHC	60/82				
2.2	OM 611LA (75 KW CDI)	Diesel					101	AC5620 (MLS), 1.200mm	CC5620	EC5620 [3]
Vito 110 CDI	03/99→07/03	2151	4	88.00	DOHC	75/102				
2.3	M 102.942						102	BH880 (Fibre)	DH882 ☒	
T1 210 2.3	04/77→02/96	2298	4	95.50	SOHC/OHC	70/95				
T1 310 2.3	01/82→12/94									
T1 410	08/82→06/95									
2.3	M 102.943						103	BH880 (Fibre)		
T2/L L 410	08/82→12/88	2299	4	95.50	SOHC/OHC	70/95				

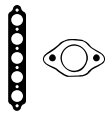

HBS150 [19] M12x1.75x102.00mm (x10)	JD160 [1] JD161 [1]	JN911 [4] HM5057 [1]	JJ499	HR5055 [1]	NA973 [2] 45.00x67.00x8.00mm, FPM NA974 [1] 93.00x114.00x13.00mm, FPM	JM5111 (x4)[108]
HBS061 [22] M10x1.50x115.00mm (x4)	JD475 [x8] JD5225 [1]		JJ498	PA5041 [x16] 6.00/12.20x10.00 (FPM) →Eng.0.031329 →Eng.2.006455	NA131 [2] 45.00x67.00x8.00mm, PTFE NB973 [2] 45.00x67.00x8.00mm, FPM NB974 [1] 93.00x114.00x13.00mm, FPM	
HBS061 [22] M10x1.50x115.00mm (x4)	JD475 [x8] JD5225 [1]		JJ498	PA5041 [x8] 6.00/12.20x10.00 (FPM)	NA131 [2] 45.00x67.00x8.00mm, PTFE NB973 [2] 45.00x67.00x8.00mm, FPM NB974 [1] 93.00x114.00x13.00mm, FPM	
HBS292 [19] M12x1.75x102.00mm (x10)	JD5377 [1] JD5380 [1] (MLS)	HM5170 [1]	JH5082 [62] (Steel)	HR5055 [1] HR5085 [x4]	NA131 [2] 45.00x67.00x8.00mm, PTFE NA5074 [1] 93.00x133.50x15.50mm, PTFE	KA5035 [15] KA5036 [15] KB5050 [68][110]
HBS292 [19] M12x1.75x102.00mm (x10)	JD5379 [1] (Elastomer) JD5380 [1] (MLS)	HM5170 [1]	JH5082 [62] (Steel)	HR5055 [1] HR5085 [x4]	NA131 [2] 45.00x67.00x8.00mm, PTFE NA5074 [1] 93.00x133.50x15.50mm, PTFE	KA5035 [15] KA5036 [15]
HBS292 [19] M12x1.75x102.00mm (x10)	JD5379 [1] (Elastomer) JD5380 [1] (MLS)	HM5170 [1]	JH5082 [62] (Steel)	HR5085 [x4]	NA131 [2] 45.00x67.00x8.00mm, PTFE NA5074 [1] 93.00x133.50x15.50mm, PTFE	KA5035 [15] KA5036 [15]
HBS292 [19] M12x1.75x102.00mm (x10)	JD5379 [1] (Elastomer) JD5380 [1] (MLS)	HM5170 [1]	JH5082 [62] (Steel)	HR5055 [1] HR5085 [x4]	NA131 [2] 45.00x67.00x8.00mm, PTFE NA5074 [1] 93.00x133.50x15.50mm, PTFE	KA5035 [15] KA5036 [15]
HBS047 [19] M12x1.75x120.00mm (x10)	JD292 [x4]	JN454 [4][107] JN607 [4][106]	JJ488	HR756 [1]	NB973 [2] 45.00x67.00x8.00mm, FPM NB975 [2] 45.00x74.50x12.00mm, FPM NB974 [1] 93.00x114.00x13.00mm, FPM NA5266 [1] 93.00x114.00x14.00mm, FPM NA5074 [1] 93.00x133.50x15.50mm, PTFE	
	JD292 [x4]	JN454 [4][107] JN607 [4][106]	JJ488	HR756 [1]	NB973 [2] 45.00x67.00x8.00mm, FPM NB975 [2] 45.00x74.50x12.00mm, FPM NB974 [1] 93.00x114.00x13.00mm, FPM NA5266 [1] 93.00x114.00x14.00mm, FPM NA5074 [1] 93.00x133.50x15.50mm, PTFE	

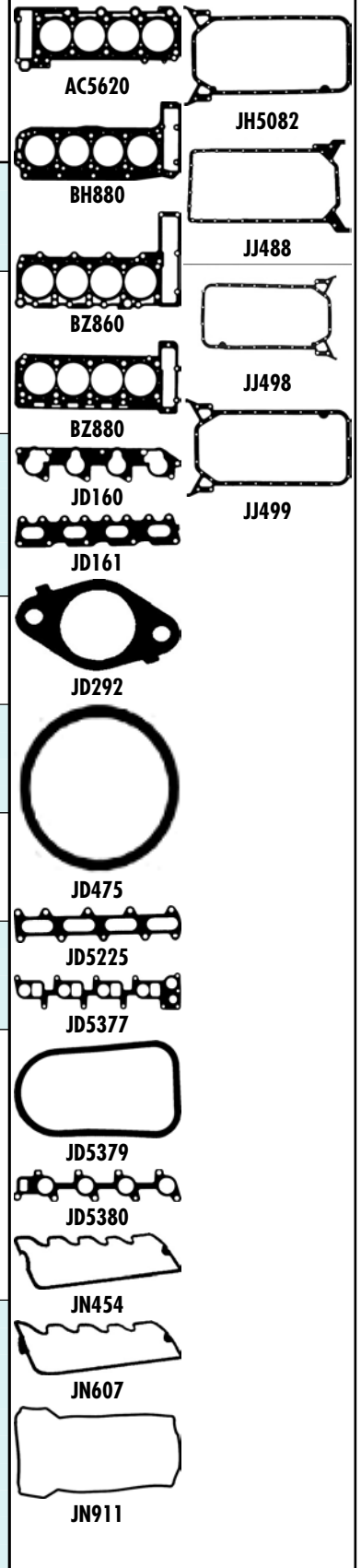

MERCEDES-BENZ



cc



kW/PS

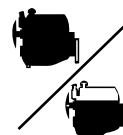

2.3	M 102.945					104	BH880 (Fibre)	DH882 ☒	
T1 210 2.3 T1 410	05/89→02/96 08/82→06/95	2298	4	95.50	SOHC/OHC	77/105			
2.3	M 102.946					105	BH880 (Fibre)		
T1 210 2.3 T2/LN1 510	07/82→02/96 04/86→12/94	2298	4	95.50	SOHC/OHC	70-77/ 95-105			
2.3	M 102.979					106	BH880 (Fibre)		EH872
G-Class 230 GE	05/87→08/92	2299	4	95.50	SOHC/OHC	90/122			
2.3	M 102.981					107	BH880 (Fibre)		
G-Class 230 GE	04/82→08/92	2299	4	95.50	SOHC/OHC	92/125			
2.3	M 102.982					108	BH880 (Fibre)	DH882 ☒	EH872
Coupe 230 CE E-class 230 E Kombi 230 TE	03/87→12/92 12/84→06/93 09/85→08/92	2298	4	95.50	SOHC/OHC	97-100/ 132-136			

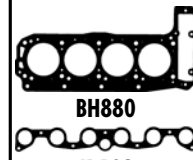
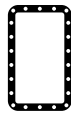
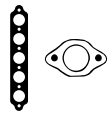

BH880

JD182



JD292



JD293



JN454



JN607



JJ488

MERCEDES-BENZ

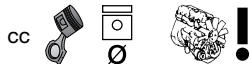

kW/PS

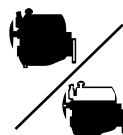

2.3		M 102.983				109				
190 E 2.3-16	09/85→08/88	2298	4	95.50	DOHC	125-136/ 170-185				
2.3		M 102.985				110		BH880 (Fibre)	DH882 ☒	EH872
190 2.3 (W201)	09/87→09/88	2298	4	95.50	SOHC/OHC	97-100/ 132-136				
190 2.3 E	10/82→09/88									
190 E 2.3	09/86→08/93									
2.3		M 102.987				111		BH880 (Fibre)		
G-Class 230 GE	04/82→08/92	2299	4	95.50	SOHC/OHC	90-92/ 122-125				
2.3		M 102.989				112		BH880 (Fibre)		EH872
G-Class 230 GE	04/82→06/93	2298	4	95.50	SOHC/OHC	93/126				
2.3		M 102.996				113		BH880 (Fibre)		EH872
G-Class 230 GE	06/93→	2298	4	95.50	SOHC/OHC	92/125				
2.3		M 111.970				114		BZ900 (Fibre)	DZ900 ○ [13]	EV810
E-class E 230 (W210)	06/95→06/97	2295	4	90.90	DOHC	110/150				
E-class E 230 T (S210)	06/96→06/97									

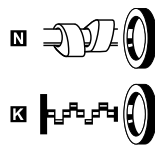
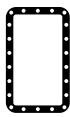
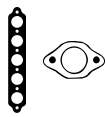

BH880

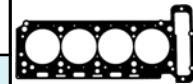

BZ900



JD161



JD182



JD292



JD293

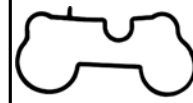

JD5226



JN454



JN607



JN911



JJ488

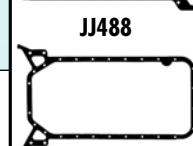

JJ499

MERCEDES-BENZ









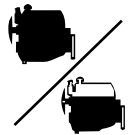



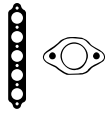

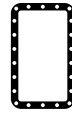

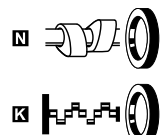



















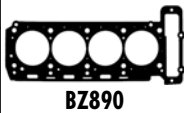









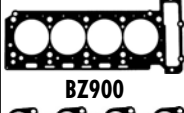























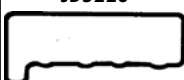





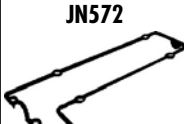



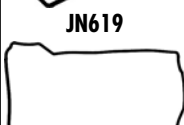



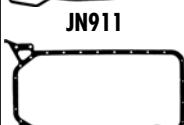

cc



kW/PS



2.3	M 111.973					115						
CLK 230 Komp SLK Cabrio 230	06/97→06/00 09/96→03/00	2295	4	90.90	DOHC	142/193						EV810
2.3	M 111.974					116	BZ900 (Fibre)		DZ900 ○ [13]			EV810
C-Class 230 C-Class 230 T	06/96→06/97 06/96→06/98	2295	4	90.90	DOHC	110/150						
2.3	M 111.975					117	BZ890 (Fibre)		DZ891 ☒ ○ [13]			EV810
C-Class 230 C-Class 230 T CLK 230 Komp	10/95→05/00 06/97→09/00 06/97→06/00	2295	4	90.90	DOHC	142/193						
2.3	M 111.977					118	BZ900 (Fibre)		DZ900 ○ [13]			EV810
M ML 230	02/98→06/05	2295	4	90.90	DOHC	110/150						
2.3	M 111.978					119	BZ900 (Fibre)		DZ160 ○			EV810
V-Class 230 Vito 114	10/96→07/03 12/96→07/03	2295	4	90.90	DOHC	105/143						
2.3	M 111.979					120	BZ900 (Fibre)		DZ160 ○			EV810
Sprinter 2t 214 Sprinter 3t 314 Sprinter 4t 414	02/95→05/06 02/95→05/06 02/96→05/06	2295	4	90.90	DOHC	105/143						
2.3	M 111.981					121	BZ890 (Fibre)		DZ891 ☒ ○ [13]			
C-Class 230	03/01→05/02	2295	4	90.90	DOHC	145/197						
2.3	M 111.982					122	BZ890 (Fibre)					
CLK 230 Komp	06/00→06/02	2295	4	90.90	DOHC	145/197						
2.3	M 111.983					123	BZ890 (Fibre)					
SLK Cabrio 230	03/00→04/04	2295	4	90.90	DOHC	145/197						
2.3	M 111.984					124	BZ900 (Fibre)		DZ160 ○			
Sprinter 2t 214 Sprinter 3t 314	02/95→05/06 02/95→05/06	2295	4	90.90	DOHC	92-105/ 125-143	Eng.000 740→ Eng.003 501→					
2.3	M 115.955					125						
T1 210 2.3	04/77→10/89	2307	4	93.75	SOHC/OHC	62-63/ 84-86						
2.3	M 115.973					126						
G-Class 230 G	03/79→07/93	2307	4	93.75	SOHC/OHC	66-75/ 90-102						
2.3	OM 601.940 Diesel					127	BW370 (Fibre)		DW370 ☒ ○ [13] →06/95 DW372 [13][106] →06/95 DW373 [13][107] →06/95			EM720 →06/95
T1 208 D 2.3 T1 308 D 2.3 T1 408 D	10/88→02/96 11/88→02/96 11/88→06/95	2299	4	89.00	SOHC/OHC	58-60/ 79-82	→06/95					

									
HBS150  [19] M12x1.75x102.00mm (x10)	JD5226  (x2) JD161 	JN911 [4] HM5057 	JJ499	HR5055 	NB973  [2] 45.00x67.00x8.00mm, FPM NB974  [1] 93.00x114.00x13.00mm, FPM	JM5111 (x4) [108]	 BW370  JJ498		
HBS150  [19] M12x1.75x102.00mm (x10)	JD5226  (x2) JD161 	JN911 [4] HM5057 	JJ499	HR5055 	NB973  [2] 45.00x67.00x8.00mm, FPM NB974  [1] 93.00x114.00x13.00mm, FPM NA5074  [1] 93.00x133.50x15.50mm, PTFE	JM5111 (x4) [108]	 BZ890  JJ499		
HBS150  [19] M12x1.75x102.00mm (x10)	JD160  (x1) JD5226  (x2) JD161 	JN911 [4] HM5057 	JJ499	HR5055 	NB973  [2] 45.00x67.00x8.00mm, FPM NB974  [1] 93.00x114.00x13.00mm, FPM	JM5111 [108]	 BZ900  JD158  JD159  JD160		
HBS150  [19] M12x1.75x102.00mm (x10)	JD5226  (x2) JD161 	JN911 [4]	JJ499	HR5055 	NB973  [2] 45.00x67.00x8.00mm, FPM NB974  [1] 93.00x114.00x13.00mm, FPM	JM5111 (x4) [108]	 JD161		
HBS150  [19] M12x1.75x102.00mm (x10)	JD160  JD161 	JN911 [4] HM5057 	JJ499	HR5055 	NB973  [2] 45.00x67.00x8.00mm, FPM NB974  [1] 93.00x114.00x13.00mm, FPM	JM5111 (x4) [108]	 JD5226		
HBS150  [19] M12x1.75x102.00mm (x10)	JD160  JD161 	JN911 [4] HM5274  Eng.50813931→	JJ499		NB973  [2] 45.00x67.00x8.00mm, FPM NB974  [1] 93.00x114.00x13.00mm, FPM	JM5111 (x4) [108]	 JM850		
HBS150  [19] M12x1.75x102.00mm (x10)					NB973  [2] 45.00x67.00x8.00mm, FPM		 JN572		
HBS150  [19] M12x1.75x102.00mm (x10)					NB973  [2] 45.00x67.00x8.00mm, FPM		 JN619		
HBS150  [19] M12x1.75x102.00mm (x10)	JD160 				NB973  [2] 45.00x67.00x8.00mm, FPM		 JM850		
		JM850 [4]	JH683	HL196 	PA815  (x1) [1] [2] 78.00x94.00x8.00mm NB975  [2] 45.00x74.50x12.00mm, FPM NB978  [2] 65.00x90.00x13.00mm, FPM		 JN911		
		JM850 [4]	JH683	HL196 	PA815  (x1) [1] [2] 78.00x94.00x8.00mm NB975  [2] 45.00x74.50x12.00mm, FPM NB978  [2] 65.00x90.00x13.00mm, FPM		 JH5082		
	JD158  →06/95 JD159  →06/95	JN572 [4] [106] →06/95 JN619 [4] [107] →06/95	JH5082 (Steel) →06/95 JJ498 →06/95	HR757  →06/95	NA5131  [2] 45.00x67.00x8.00mm, PTFE →06/95 NB974  [1] 93.00x114.00x13.00mm, FPM →06/95	KK5683 [109]	 JH683		

MERCEDES-BENZ



cc



kW/PS

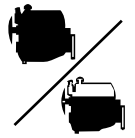

2.3	OM 601.941	Diesel		128	BW370 (Fibre)	DW370 ☒○ [13]	EM720
T2/LN1 508 D	03/89→12/94	2299	4	89.00	SOHC/OHC	58-60/ 79-82	
2.3	OM 601.942	Diesel		129	BW370 (Fibre)	DW370 ☒○ [13] DW372 [13][106] DW373 [13][107]	EM720
Vito 108 D	02/96→07/03	2299	4	89.00	SOHC/OHC	58/79	
2.3	OM 601.943	Diesel		130	BW370 (Fibre)	DW370 ☒○ [13] DW372 [13][106] DW373 [13][107]	EM720
Sprinter 2t 208	01/95→04/00	2299	4	89.00	SOHC/OHC	58-60/ 79-82	
Sprinter 3t 308	02/95→04/00						
Sprinter 4t 408	02/96→05/06						
2.3	OM 601.970	Diesel		131			EM720
V-Class 230TD	09/96→07/03	2299	4	89.00	SOHC/OHC	72/98	
Vito 110 D	03/97→07/03						
Vito 110 TD	02/96→07/03						
2.4	M 112.910			132	AE5730 (MLS), 0.650mm, 2 Notches ☒ [111] AE5760 (MLS) ☒ (x6) AE5740 (MLS), 0.650mm, 2 Notches ☒ [111]		
C-Class 2648 AK	06/97→05/00	2398	6	83.20	DOHC, V	125/170	
C-Class 2648 AS	06/97→09/00						
2.4	M 112.911			133	AE5730 (MLS), 0.650mm, 2 Notches ☒ [111] AE5740 (MLS), 0.650mm, 2 Notches ☒ [111]		
E-class E 240 (W210)	06/97→08/00	2398	6	83.20	DOHC, V	125/170	
E-class E 240 T (S210)	06/97→03/03						
2.4	OM 616	Diesel		134	BC790 (Fibre)	DC790 [13]	
T00 2.4 D	12/90→02/96	2399	4	90.90	SOHC/OHC	41-55/ 56-75	
2.4	OM 616.910	Diesel		135	BC790 (Fibre)	DC790 [13]	EC790 GC790
T2/L L 407 D	01/75→12/88	2400	4	91.00	SOHC/OHC	48-53/ 65-72	

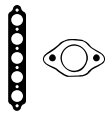

AE5740



BC790



BW370



JD158



JD159



JD5385



JD5386

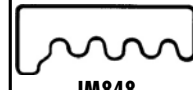

JM848



JN572



JN619

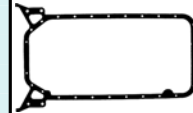

JH5082

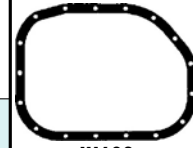

JH683

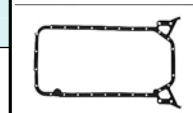

JJ498

MERCEDES-BENZ



cc



kW/PS

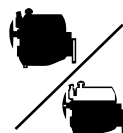

2.4	OM 616.913	Diesel	136	BC790 (Fibre)	DC790 [13]	EC790 GC790
T1 407 D	07/81→01/89	2398 4 91.00	SOHC/OHC 53/72			
2.4	OM 616.914	Diesel	137	BC790 (Fibre)	DC790 [13]	EC790 GC790
T2/LN1 507 D T2/LN1 507 DK	04/86→04/89 04/86→04/89	2399 4 91.00	SOHC/OHC 53/72			
2.4	OM 616.917	Diesel	138	BC790 (Fibre)	DC790 [13]	EC790 GC790
T1 307 D 2.4 T2/L L 407 D	01/77→12/90 01/75→12/88	2404 4 91.00	SOHC/OHC 48/65	05/77→08/82	05/77→08/82	05/77→08/82 05/77→08/82
2.4	OM 616.937	Diesel	139	BC790 (Fibre)	DC790 [13]	EC790 GC790
T1 207 D 2.4 T1 307 D 2.4	12/77→01/90 06/82→01/90	2399 4 91.00	SOHC/OHC 48-53/ 65-72			
2.4	OM 616.939	Diesel	140	BC790 (Fibre)	DC790 [13]	EC790 GC790
T1 207 D 2.4 T1 307 D 2.4 T1 407 D	06/82→01/90 06/82→01/90 07/81→01/89	2399 4 91.00	SOHC/OHC 53/72	09/82→02/89	09/82→02/89	09/82→02/89 09/82→02/89
2.4	OM 616.963	Diesel	141	BC790 (Fibre)	DC790 [13]	EC797
T00 2.4 D	02/88→02/96	2399 4 91.00	SOHC/OHC 53-56/ 72-76			
2.5	M 102.990		142			
T90 E 2.5-16	09/88→08/93	2498 4 95.50	DOHC 143-150/ 195-204			
2.5	M 102.991		143			
T90 1932 AK	03/89→08/93	2498 4 95.50	DOHC 143/195			
2.5	M 102.992		144			
T90 E Evoll 2.5	05/90→08/93	2498 4 95.50	DOHC 173/235			



BC790

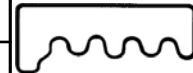

JM848

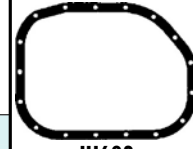

JH683



JJ488

HBS045 [19] M12x1.75x145.00mm (x6)	JB162	JM848 [4]	JH683		PA815 [x1][1][2] 78.00x94.00x8.00mm NB975 [2] 45.00x74.50x12.00mm, FPM NB978 [2] 65.00x90.00x13.00mm, FPM	
HBS045 [19] M12x1.75x145.00mm (x6)	JB162	JM848 [4]	JH683		PA815 [x1][1][2] 78.00x94.00x8.00mm NB975 [2] 45.00x74.50x12.00mm, FPM NB978 [2] 65.00x90.00x13.00mm, FPM	
HBS045 [19] M12x1.75x145.00mm (x6) 05/77→08/82	JB162 05/77→08/82	JM848 [4] 05/77→08/82	JH683 05/77→08/82		PA815 [x1][1][2] 78.00x94.00x8.00mm 05/77→08/82 NB975 [2] 45.00x74.50x12.00mm, FPM 05/77→08/82	
HBS045 [19] M12x1.75x145.00mm (x6)	JB162	JM848 [4]	JH683		PA815 [x1][1][2] 78.00x94.00x8.00mm NB975 [2] 45.00x74.50x12.00mm, FPM	
HBS045 [19] M12x1.75x145.00mm (x6) 09/82→02/89	JB162 09/82→02/89	JM848 [4] 09/82→02/89	JH683 09/82→02/89		PA815 [x1][1][2] 78.00x94.00x8.00mm 09/82→02/89 NB975 [2] 45.00x74.50x12.00mm, FPM 09/82→02/89	
HBS045 [19] M12x1.75x145.00mm (x6)	JB162	JM848 [4]			PA815 [x1][1][2] 78.00x94.00x8.00mm NB975 [2] 45.00x74.50x12.00mm, FPM NB978 [2] 65.00x90.00x13.00mm, FPM	
HBS150 [19] M12x1.75x102.00mm (x10)			JJ488		NB973 [2] 45.00x67.00x8.00mm, FPM NB975 [2] 45.00x74.50x12.00mm, FPM NB974 [1] 93.00x114.00x13.00mm, FPM NA5266 [1] 93.00x114.00x14.00mm, FPM NA5074 [1] 93.00x133.50x15.50mm, PTFE	
HBS150 [19] M12x1.75x102.00mm (x10)					NB973 [2] 45.00x67.00x8.00mm, FPM NB974 [1] 93.00x114.00x13.00mm, FPM	
HBS150 [19] M12x1.75x102.00mm (x10)					NB973 [2] 45.00x67.00x8.00mm, FPM NB469 [1] 77.00x100.00x11.50mm, FPM	

MERCEDES-BENZ



cc



kW/PS

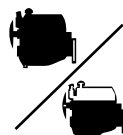

2.5	OM 602.911	Diesel		145	BN720 (Fibre), 1.740mm		EN720 [3]
190 E 2.0 D	04/85→08/93	2497	5	87.00	SOHC/OHC	66-69/ 90-94	
2.5	OM 602.912	Diesel		146	BN720 (Fibre), 1.740mm		EN720 [3]
E-class 250 D Kombi 250 T D	04/85→06/93 09/85→06/93	2497	5	87.00	SOHC/OHC	66-69/ 90-94	
2.5	OM 602.930	Diesel		147	BN720 (Fibre), 1.740mm		EN720 [3]
G-Class 250 GD	10/87→12/92	2497	5	87.00	SOHC/OHC	62-69/ 84-94	
2.5	OM 602.931	Diesel		148	BN720 (Fibre), 1.740mm		EN720 [3]
G-Class 250 GD	06/90→	2497	5	87.00	SOHC/OHC	69/94	

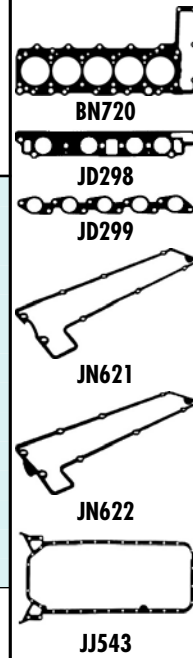
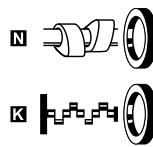
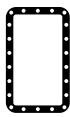
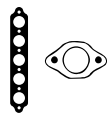

	JD298 ■ JD299 ■	JN621 [4][107] JN622 [4][106]	JJ543	HR758 ■	<input checked="" type="checkbox"/> NA5131 ■ [2] 45.00x67.00x8.00mm, PTFE <input checked="" type="checkbox"/> NB973 ■ [2] 45.00x67.00x8.00mm, FPM <input checked="" type="checkbox"/> NB971 ■ [2] 45.00x67.00x10.00mm, FPM <input checked="" type="checkbox"/> NB975 ■ [2] 45.00x74.50x12.00mm, FPM <input checked="" type="checkbox"/> NB974 ■ [1] 93.00x114.00x13.00mm, FPM <input checked="" type="checkbox"/> NA5266 ■ [1] 93.00x114.00x14.00mm, FPM <input checked="" type="checkbox"/> NA5074 ■ [1] 93.00x133.50x15.50mm, PTFE
HBS059 ⊕ [22] M10x1.50x115.00mm (x6)	JD298 ■ JD299 ■	JN621 [4][107] JN622 [4][106]	JJ543	HR758 ■	<input checked="" type="checkbox"/> NA5131 ■ [2] 45.00x67.00x8.00mm, PTFE <input checked="" type="checkbox"/> NB973 ■ [2] 45.00x67.00x8.00mm, FPM <input checked="" type="checkbox"/> NB971 ■ [2] 45.00x67.00x10.00mm, FPM <input checked="" type="checkbox"/> NB975 ■ [2] 45.00x74.50x12.00mm, FPM <input checked="" type="checkbox"/> NB974 ■ [1] 93.00x114.00x13.00mm, FPM <input checked="" type="checkbox"/> NA5266 ■ [1] 93.00x114.00x14.00mm, FPM <input checked="" type="checkbox"/> NA5074 ■ [1] 93.00x133.50x15.50mm, PTFE
HBS059 ⊕ [22] M10x1.50x115.00mm (x6)	JD298 ■ JD299 ■	JN621 [4][107] JN622 [4][106]	JJ543	HR758 ■	<input checked="" type="checkbox"/> NA5131 ■ [2] 45.00x67.00x8.00mm, PTFE <input checked="" type="checkbox"/> NB973 ■ [2] 45.00x67.00x8.00mm, FPM <input checked="" type="checkbox"/> NB975 ■ [2] 45.00x74.50x12.00mm, FPM <input checked="" type="checkbox"/> NB974 ■ [1] 93.00x114.00x13.00mm, FPM <input checked="" type="checkbox"/> NA5266 ■ [1] 93.00x114.00x14.00mm, FPM <input checked="" type="checkbox"/> NA5074 ■ [1] 93.00x133.50x15.50mm, PTFE
HBS059 ⊕ [22] M10x1.50x115.00mm (x6)	JD298 ■ JD299 ■	JN621 [4][107] JN622 [4][106]	JJ543	HR758 ■	<input checked="" type="checkbox"/> NA5131 ■ [2] 45.00x67.00x8.00mm, PTFE <input checked="" type="checkbox"/> NB973 ■ [2] 45.00x67.00x8.00mm, FPM <input checked="" type="checkbox"/> NB975 ■ [2] 45.00x74.50x12.00mm, FPM <input checked="" type="checkbox"/> NB974 ■ [1] 93.00x114.00x13.00mm, FPM <input checked="" type="checkbox"/> NA5266 ■ [1] 93.00x114.00x14.00mm, FPM <input checked="" type="checkbox"/> NA5074 ■ [1] 93.00x133.50x15.50mm, PTFE







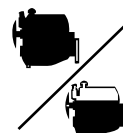



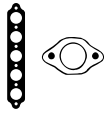

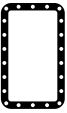

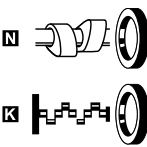

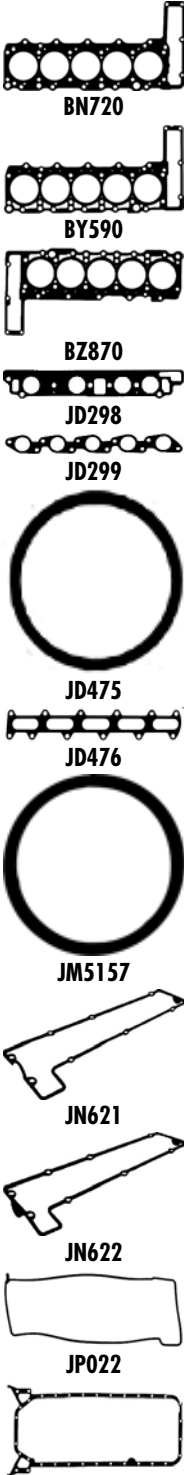











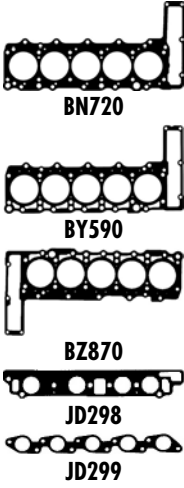











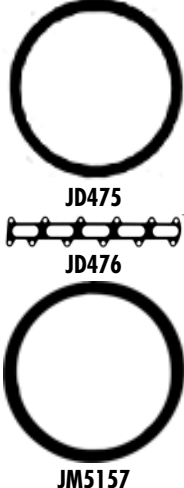











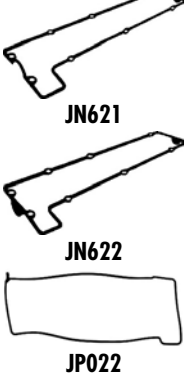











MERCEDES-BENZ



kW/PS



2.5	OM 602.939	Diesel		149		BN720 (Fibre), 1.740mm		EN720 [3]
G-Class 250 GD	02/90→	2497	5	87.00	OHV	68/92		
2.5	OM 602.961	Diesel		150		BN720 (Fibre), 1.740mm		EN720 [3]
190 E 2.5 TD	02/88→08/93	2497	5	87.00	SOHC/OHC	90-93/ 122-126		
2.5	OM 602.962	Diesel		151		BN720 (Fibre), 1.740mm		EN720 [3]
E-class 250 TD	09/88→06/93	2497	5	87.00	SOHC/OHC	93/126		
E-class E 250 Turbo D (S124)	06/93→06/96							
E-class E 250 Turbo-D	06/93→06/95							
Kombi 250 TD	03/88→07/93							
2.5	OM 605.910	Diesel		152		BY590 (Fibre) BZ870 (MLS)	DY590 ☒○ [13]	EY590 [3]
C-Class 250 D	05/93→05/00	2497	5	87.00	DOHC	83/113		
2.5	OM 605.911	Diesel		153		BY590 (Fibre)	DY590 ☒○ [13]	EY590 [3]
E-class E 250 D	07/93→06/95	2497	5	87.00	DOHC	83/113		
E-class E 250 T D (S124)	06/93→06/96							
2.5	OM 605.912	Diesel		154		BY590 (Fibre)	DY590 ☒○ [13]	EY590 [3]
E-class E 250 D (W210)	06/95→07/99	2497	5	87.00	DOHC	83/113		
E-class E 250 T D (S210)	06/96→07/99							

							
HBS059  [22] M10x1.50x115.00mm (x6)	JD298  JD299 	JN621 [4][107] JN622 [4][106]	JJ543	HR758 	NA5131  [2] 45.00x67.00x8.00mm, PTFE NB973  [2] 45.00x67.00x8.00mm, FPM NB971  [2] 45.00x67.00x10.00mm, FPM NB975  [2] 45.00x74.50x12.00mm, FPM NB974  [1] 93.00x114.00x13.00mm, FPM NA5266  [1] 93.00x114.00x14.00mm, FPM NA5074  [1] 93.00x133.50x15.50mm, PTFE		
HBS059  [22] M10x1.50x115.00mm (x6)	JD298  JD299 	JN621 [4][107] JN622 [4][106]	JJ543	HR758 	NA5131  [2] 45.00x67.00x8.00mm, PTFE NB973  [2] 45.00x67.00x8.00mm, FPM NB971  [2] 45.00x67.00x10.00mm, FPM NB975  [2] 45.00x74.50x12.00mm, FPM NB974  [1] 93.00x114.00x13.00mm, FPM NA5266  [1] 93.00x114.00x14.00mm, FPM NA5074  [1] 93.00x133.50x15.50mm, PTFE		
HBS059  [22] M10x1.50x115.00mm (x6)	JD298  JD299 	JN621 [4][107] JN622 [4][106]	JJ543	HR758 	NA5131  [2] 45.00x67.00x8.00mm, PTFE NB973  [2] 45.00x67.00x8.00mm, FPM NB971  [2] 45.00x67.00x10.00mm, FPM NB975  [2] 45.00x74.50x12.00mm, FPM NB974  [1] 93.00x114.00x13.00mm, FPM NA5266  [1] 93.00x114.00x14.00mm, FPM NA5074  [1] 93.00x133.50x15.50mm, PTFE		
HBS062  [22] M10x1.50x115.00mm (x5)	JD475  (x10) JD476 	JM5157 (Elastomer) JP022 (x1)[4]	JJ543	PA5041  (x10) 6.00/12.20x10.00 (FPM)	NA5131  [2] 45.00x67.00x8.00mm, PTFE NB973  [2] 45.00x67.00x8.00mm, FPM NB974  [1] 93.00x114.00x13.00mm, FPM		
HBS062  [22] M10x1.50x115.00mm (x5)	JD475  (x10) JD476 	JM5157 (Elastomer) JP022 (x1)[4]	JJ543	PA5041  (x10) 6.00/12.20x10.00 (FPM)	NA5131  [2] 45.00x67.00x8.00mm, PTFE NB973  [2] 45.00x67.00x8.00mm, FPM NB974  [1] 93.00x114.00x13.00mm, FPM		
HBS062  [22] M10x1.50x115.00mm (x5)	JD475  (x10) JD476 	JM5157 (Elastomer) JP022 (x1)[4]	JJ543	PA5041  (x10) 6.00/12.20x10.00 (FPM)	NA5131  [2] 45.00x67.00x8.00mm, PTFE NB973  [2] 45.00x67.00x8.00mm, FPM NB974  [1] 93.00x114.00x13.00mm, FPM		

MERCEDES-BENZ



cc



kW/PS

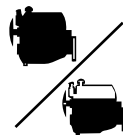

2.5		OM 605.960		Diesel		155		BZ870 (MLS)	DZ870 ○ [13]	EY590 [3]
C-Class 250 T	10/95→03/01	2497	5	87.00	SOHC/OHC	110/150				
2.5		OM 605.962		Diesel		156		BZ870 (MLS)	DZ870 ○ [13]	EY590 [3]
E-class E 250 T Turbo-D (S210)	06/97→07/99	2497	5	87.00	DOHC	110/150				
E-class E 250 Turbo-D (W210)	06/97→07/99									
2.6		M 103.940				157				
E-class 260 E	09/85→08/92	2597	6	82.90	SOHC/OHC	118-122/ 160-166				
Kombi 260 TE	09/89→08/92									
Kombi 1824 K	09/85→12/89									
2.6		M 103.941				158				
S-Class 260 SE	09/85→06/91	2597	6	82.90	SOHC/OHC	118-122/ 160-166				
2.6		M 103.942				159				
190 2.6 (W201)	10/82→09/88	2597	6	82.90	SOHC/OHC	118-122/ 160-166				
190 E 2.6	09/86→08/93									



BZ870



JD121

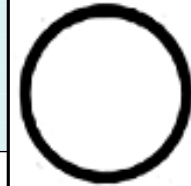

JD475



JD476

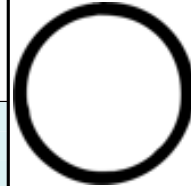

JM5157

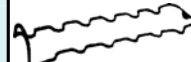

JN623



JP022



JJ543

MERCEDES-BENZ



cc



kw/PS



2.6		M 103.943					160			
E-class 260 E	09/86→08/92	2597	6	82.90	SOHC/OHC	118/160				
2.6		M 112.912					161	AE5750 (MLS) ☒ AE5760 (MLS) ☒	CE5760 ☒☒	
C-Class C 240 CLK 240	05/00→08/07 06/02→03/10	2597	6	89.90	DOHC, V	120-125/ 163-170				
2.6		M 112.913					162	AE5750 (MLS) ☒ AE5760 (MLS) ☒	CE5760 ☒☒	
E-class E 240 (W211) E-class T-Model E 240 T (S211)	03/02→12/08 03/03→07/09	2597	6	89.90	SOHC/OHC, V	130/177				
2.6		M 112.914					163	AE5750 (MLS) ☒ AE5760 (MLS) ☒	CE5760 ☒☒	
E-class E 240 (W210) E-class E 240 T (S210)	08/00→03/02 08/00→03/03	2597	6	89.90	DOHC, V	125/170				
2.6		M 112.915					164	AE5750 (MLS) ☒ AE5760 (MLS) ☒	CE5760 ☒☒	
C-Class 240 T	09/00→03/01	2597	6	89.90	SOHC/OHC, V	125/170				
2.6		M 112.916					165	AE5750 (MLS) ☒ AE5760 (MLS) ☒	CE5760 ☒☒	
C-Class C 240	07/02→08/07	2597	6	89.90	SOHC/OHC, V	125/170				
2.6		M 112.917					166	AE5750 (MLS) ☒ AE5760 (MLS) ☒	CE5760 ☒☒	
E-class E 240 (W211) E-class (W211) E 240 4-matic (211.080) E-class T-Model (S211) E 240 T 4-matic (211.280)	03/02→12/08 03/03→12/08 07/03→07/09	2597	6	89.90	SOHC/OHC, V	130/177				
2.7		M 110.994					167			
G-Class 280 GE	11/79→08/89	2746	6	86.00	DOHC	110-115/ 150-156				
2.7		OM 612.961 Diesel					168	AD5720 (MLS), 1.200mm	CD5720 ☒	ED5720
E-class E 270 CDI (W210) E-class E 270 T CDI (S210) E-class G 300.19	07/99→03/02 07/99→03/03 07/99→03/03	2685	5	88.00	DOHC	120-125/ 163-170				
2.7		OM 612.962 Diesel					169	AD5720 (MLS), 1.200mm	CD5720 ☒	ED5720
C-Class 270 CDI C-Class C270 CDI CLK 270 CDI	03/01→08/07 12/00→02/07 10/02→05/09	2685	5	88.00	DOHC	125/170				
2.7		OM 612.963 Diesel					170	AD5720 (MLS), 1.200mm	CC5620 CD5720 ☒	ED5720
M ML 270 CDI	12/99→06/05	2685	5	88.00	DOHC	120/163				

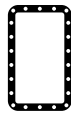
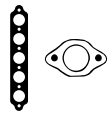

AD5720



AE5750



JD121

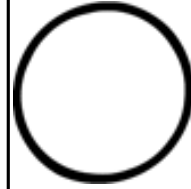

JD5378



JD5385



JD5386

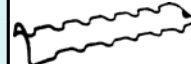

JN623



JJ543

MERCEDES-BENZ









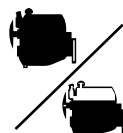

cc

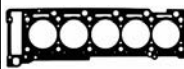

kW/PS

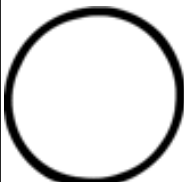
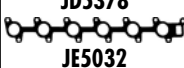

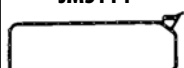
2.7	OM 612.965	Diesel	171				
G-Class 270 CDI	10/01→	2685	5	88.00	DOHC	115-120/ 156-163	
2.7	OM 612.966	Diesel	172				
G-Class 270 CDI	01/03→	2685	5	88.00	DOHC	115/156	AD5720 (MLS), 1.200mm CD5720 ☒ ED5720
2.7	OM 612.967	Diesel	173				
CLK 270 CDI	10/02→05/09	2685	5	88.00	DOHC	120-125/ 163-170	AD5720 (MLS), 1.200mm CD5720 ☒ ED5720
2.7	OM 612.981	Diesel	174				
Sprinter 616 CDI	04/01→	2685	5	88.00	DOHC	110-115/ 150-156	AD5720 (MLS), 1.200mm CD5720 ☒ ED5720
Sprinter 2t 216	04/00→05/06						
Sprinter 3t 316	04/00→05/06						
Sprinter 4t 416	04/00→05/06						
Sprinter 5t 616	04/01→05/06						
2.7	OM 647.961	Diesel	175				
E-class E 270 CDI (W211)	03/02→12/08	2685	5	88.00	DOHC	130/177	AD5720 (MLS), 1.200mm CD5720 ☒ ED5720
E-class T-Model	03/03→07/09						
E 270 T CDI (S211)							
2.8	M 104.900		176				
V-Class 280	08/97→07/03	2792	6	81.00	SOHC/OHC, VR	128/174	AA5430 (Fibre) CA5430 [13]
2.8	M 104.941		177				
C-Class 280	05/93→05/00	2799	6	89.90	DOHC	142/193	AE5330 (Fibre), 1.240mm CE5330 ○ [3]
2.8	M 104.942		178				
E-class 280 E	10/92→06/93	2799	6	89.90	DOHC	142-145/ 193-197	AE5330 (Fibre), 1.240mm CE5330 ○ [3]
E-class E 280	06/93→06/95						
E-class E 280 long	06/93→06/95						
E-class E 280 T (S124)	06/93→06/96						
Kombi 280 TE	10/92→06/93						

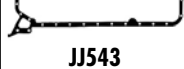
				JJ543		<input checked="" type="checkbox"/> NA5131 [2] 45.00x67.00x8.00mm, PTFE <input checked="" type="checkbox"/> NA5074 [1] 93.00x133.50x15.50mm, PTFE	KA5036 [15]			 AA5430  AD5720  AE5330  JD167  JD169  JE5032  JD5378  JE5032  JM5114  JJ500  JJ543	
HBS293 [19] M12x1.75x102.00mm (x12)	JD5378 [x5] JD5797 [1] JD5798 [1]	JM7028 (Elastomer) HM5274 [1] Eng.50813931→	JJ543				KA5036 [15]				
HBS293 [19] M12x1.75x102.00mm (x12)	JD5798 [1]	JM7028 (Elastomer) HM5274 [1] Eng.50813931→	JJ543			<input checked="" type="checkbox"/> NA5131 [2] 45.00x67.00x8.00mm, PTFE <input checked="" type="checkbox"/> NA5074 [1] 93.00x133.50x15.50mm, PTFE	KA5036 [15]				
HBS293 [19] M12x1.75x102.00mm (x12)	JD5797 [1] JD5798 [1]	JM7028 (Elastomer) HM5274 [1] Eng.50813931→	JJ543			<input checked="" type="checkbox"/> NA5131 [2] 45.00x67.00x8.00mm, PTFE <input checked="" type="checkbox"/> NA5074 [1] 93.00x133.50x15.50mm, PTFE	KA5036 [15]				
HBS293 [19] M12x1.75x102.00mm (x12)	JD5378 [x5] JD5797 [1] JD5798 [1] JE5032 [1] (MLS)	JM7028 (Elastomer) HM5274 [1] Eng.50813931→	JJ543			<input checked="" type="checkbox"/> NA5131 [2] 45.00x67.00x8.00mm, PTFE <input checked="" type="checkbox"/> NA5074 [1] 93.00x133.50x15.50mm, PTFE	KA5036 [15]				
HBS077 [22] M11x1.50x144.00mm (x3)				HR662 [1]		<input checked="" type="checkbox"/> NB716 [2] 35.00x48.00x10.00mm, FPM <input checked="" type="checkbox"/> NA5133 [1] 85.00x105.00x11.00mm, FPM	KK5683 [109]				
HBS152 [19] M12x1.75x160.00mm (x14)	JD167 [x6] JD169 [x2]	JM5114 (Elastomer)	JJ500	HR5055 [1]		<input checked="" type="checkbox"/> NB971 [2] 45.00x67.00x10.00mm, FPM <input checked="" type="checkbox"/> NB972 [1] 93.00x117.00x12.00mm, FPM <input checked="" type="checkbox"/> NB975 [2] 45.00x74.50x12.00mm, FPM <input checked="" type="checkbox"/> NB974 [1] 93.00x114.00x13.00mm, FPM <input checked="" type="checkbox"/> NA5266 [1] 93.00x114.00x14.00mm, FPM <input checked="" type="checkbox"/> NA5074 [1] 93.00x133.50x15.50mm, PTFE	JR5040 [17] KK5683 [109]				
HBS152 [19] M12x1.75x160.00mm (x14)	JD167 [x6] JD169 [x2]	JM5114 (Elastomer)	JJ500	HR5055 [1]		<input checked="" type="checkbox"/> NB971 [2] 45.00x67.00x10.00mm, FPM <input checked="" type="checkbox"/> NB972 [1] 93.00x117.00x12.00mm, FPM <input checked="" type="checkbox"/> NB975 [2] 45.00x74.50x12.00mm, FPM <input checked="" type="checkbox"/> NB974 [1] 93.00x114.00x13.00mm, FPM <input checked="" type="checkbox"/> NA5266 [1] 93.00x114.00x14.00mm, FPM <input checked="" type="checkbox"/> NA5074 [1] 93.00x133.50x15.50mm, PTFE	JR5040 [17] KK5683 [109]				

MERCEDES-BENZ



cc



kW/PS

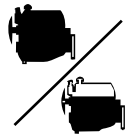

2.8	M 104.943					179			
SL Cabrio 280	08/93→10/01	2799	6	89.90	DOHC	142-150/ 193-204	AE5330 (Fibre), 1.240mm	CE5330 ○ [3]	
2.8	M 104.944					180			
S-Class 300 SE	01/93→10/98	2799	6	89.90	DOHC	142-145/ 193-197	AE5330 (Fibre), 1.240mm	CE5330 ○ [3]	
S-Class S 280	02/93→10/98								
2.8	M 104.945					181			
3 - series T 143 H/420	01/96→06/97	2799	6	89.90	DOHC	142/193	AE5330 (Fibre), 1.240mm	CE5330 ○ [3]	
2.8	M 112.920					182			
C-Class 2650 AK	06/97→03/01	2799	6	89.90	DOHC, V	145-150/ 197-204	AE5750 (MLS) ☒ AE5760 (MLS) ☒	CE5760 ☒☒	
C-Class 2650 AS	06/97→05/00								
2.8	M 112.921					183			
E-class E 280 (W210)	12/96→03/02	2799	6	89.90	DOHC, V	150/204	AE5750 (MLS) ☒ AE5760 (MLS) ☒	CE5760 ☒☒	
E-class E 280 T (S210)	12/96→03/03								
NG 2444 LS	12/96→03/03								
2.8	M 112.922					184			
S-Class S 280	10/98→08/05	2799	6	89.90	SOHC/OHC, V	150/204	AE5750 (MLS) ☒ AE5760 (MLS) ☒	CE5760 ☒☒	
2.8	M 112.923					185			
SL Cabrio 280	05/98→10/01	2799	6	89.90	SOHC/OHC, V	150/204	AE5750 (MLS) ☒ AE5760 (MLS) ☒	CE5760 ☒☒	
2.8	M 112.925					186			
SL Cabrio 280	05/98→10/01	2799	6	89.90	DOHC, V	150/204	AE5750 (MLS) ☒ AE5760 (MLS) ☒	CE5760 ☒☒	



AE5330



AE5750

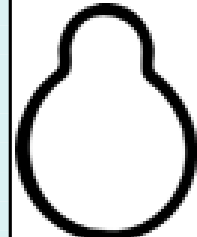

JD167



JD169



JD5385



JD5386



JM5114

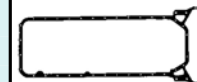

JJ500

HBS152 [19]
M12x1.75x160.00mm (x14)

JD167 (x6)
JD169 (x2)

JM5114
(Elastomer)

JJ500

HR5055

NB971 [2]
45.00x67.00x10.00mm, FPM
 NB972 [1]
93.00x117.00x12.00mm, FPM
 NB975 [2]
45.00x74.50x12.00mm, FPM
 NB974 [1]
93.00x114.00x13.00mm, FPM
 NA5266 [1]
93.00x114.00x14.00mm, FPM
 NA5074 [1]
93.00x133.50x15.50mm, PTFE

JR5040 [17]
KK5683 [109]

HBS152 [19]
M12x1.75x160.00mm (x14)

JD167 (x6)
JD169 (x2)

JM5114
(Elastomer)

JJ500

HR5055

NB971 [2]
45.00x67.00x10.00mm, FPM
 NB972 [1]
93.00x117.00x12.00mm, FPM
 NB975 [2]
45.00x74.50x12.00mm, FPM
 NB974 [1]
93.00x114.00x13.00mm, FPM
 NA5266 [1]
93.00x114.00x14.00mm, FPM
 NA5074 [1]
93.00x133.50x15.50mm, PTFE

JR5040 [17]
KK5683 [109]

HBS152 [19]
M12x1.75x160.00mm (x14)

JD167 (x6)
JD169 (x2)

JM5114
(Elastomer)

JJ500

HR5055

NB971 [2]
45.00x67.00x10.00mm, FPM
 NB972 [1]
93.00x117.00x12.00mm, FPM
 NB975 [2]
45.00x74.50x12.00mm, FPM
 NB974 [1]
93.00x114.00x13.00mm, FPM
 NA5266 [1]
93.00x114.00x14.00mm, FPM
 NA5074 [1]
93.00x133.50x15.50mm, PTFE

JR5040 [17]
KK5683 [109]

JD5385 (x2)
JD5386 (x6)

JM5236
(Elastomer)
JM5237
(Elastomer)

NA5131 [2]
45.00x67.00x8.00mm, PTFE
 NA5168 [1]
93.00x114.00x11.50mm, PTFE

JD5385 (x2)
JD5386 (x6)

JM5236
(Elastomer)
JM5237
(Elastomer)

NA5131 [2]
45.00x67.00x8.00mm, PTFE
 NA5168 [1]
93.00x114.00x11.50mm, PTFE

JD5385 (x2)
JD5386

JM5236
(Elastomer)
JM5237
(Elastomer)

NA5131 [2]
45.00x67.00x8.00mm, PTFE
 NA5168 [1]
93.00x114.00x11.50mm, PTFE

JD5385 (x2)
JD5386

JM5236
(Elastomer)
JM5237
(Elastomer)

NA5131 [2]
45.00x67.00x8.00mm, PTFE
 NA5168 [1]
93.00x114.00x11.50mm, PTFE

JD5385 (x2)
JD5386

JM5236
(Elastomer)
JM5237
(Elastomer)

NA5131 [2]
45.00x67.00x8.00mm, PTFE
 NA5168 [1]
93.00x114.00x11.50mm, PTFE

MERCEDES-BENZ



cc



kW/PS

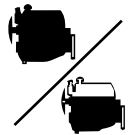

2.9	OM 602.940	Diesel	187				BW380 (Fibre), 1.800mm	DW380 ☒○	EN720 [3]
T1 210 D 2.8	10/88→02/96	2874	5	89.00		70-72/ 95-98			
T1 210 D 2.9	11/88→02/96								
T1 310 D 2.9	06/89→02/96								
T1 410 D	11/88→06/95								
2.9	OM 602.942	Diesel	188				BW380 (Fibre), 1.800mm	DW380 ☒○	EN720 [3]
G-Class 290GD/G	04/92→	2874	5	89.00	SOHC/OHC	70-72/ 95-98			
2.9	OM 602.980	Diesel	189				BW380 (Fibre), 1.800mm	DW381 ☒○ [13]	EN720 [3]
Sprinter 2t 210	01/97→04/00	2874	5	89.00	SOHC/OHC	75-90/ 102-122			
Sprinter 2t 212	02/95→04/00								
Sprinter 3t 2.9	01/97→12/99								
Sprinter 3t 310	02/95→08/02								
Sprinter 3t 312	02/95→08/02								
Sprinter 4t 410	02/96→05/06								
Sprinter 4t 412	02/96→05/06								
2.9	OM 602.982	Diesel	190				BW380 (Fibre), 1.800mm	DW381 ☒○ [13]	EN720 [3]
E-class E 290 T Turbo-D (S210)	06/96→07/99	2874	5	89.00	SOHC/OHC	95/129			
E-class E 290 Turbo-D (W210)	03/96→07/99								
2.9	OM 602.983	Diesel	191				BW380 (Fibre), 1.800mm	DW381 ☒○ [13]	EN720 [3]
G-Class 290 TD	07/97→	2874	5	89.00	SOHC/OHC	88/120			
2.9	OM 602.984	Diesel	192				BW380 (Fibre), 1.800mm	DW381 ☒○ [13]	EN720 [3]
Vario 512 D	09/96→	2874	5	89.00	SOHC/OHC	90/122			
Vario 612 D	09/96→								
Vario 812 D	09/96→								
Vario O 812	09/96→								
2.9	OM 602.985	Diesel	193				BW380 (Fibre), 1.800mm	DW381 ☒○ [13]	EN720 [3]
Vario 612 D	09/96→	2874	5	89.00	SOHC/OHC	90/122			
Vario 812 D	09/96→								
Vario O 812	09/96→								



BW380



JD298

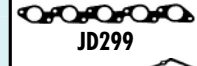

JD299



JN621



JN622



JJ543

MERCEDES-BENZ



cc



kW/PS

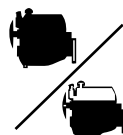

3.0	M 103.981					194	BN740 (Fibre)	HL657	
S-Class 2629 A	09/85→06/91	2960	6	88.50	SOHC/OHC	132-138/ 180-188			
3.0	M 103.982					195	BN740 (Fibre)	HL657	
SL Cabrio 300	09/85→08/89	2960	6	88.50	SOHC/OHC	132-138/ 180-188			
3.0	M 103.983					196	BN740 (Fibre)	HL657	
Coupe 300 CE	03/87→05/93	2960	6	88.50	SOHC/OHC	132-138/ 179-188			
E-class 300 E	06/85→08/92								
Kombi 300 TE	01/86→08/92								
3.0	M 103.984					197	BN740 (Fibre)	HL657	
SL Cabrio 300	03/89→08/93	2960	6	88.50	SOHC/OHC	140/190			



BN740



JD121

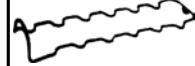

JN623

MERCEDES-BENZ



kW/PS

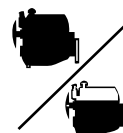

3.0	M 103.985					198	BN740 (Fibre)	HL657	
E-class 300 E	09/86→06/93	2960	6	88.50	SOHC/OHC	132/180			
E-class E 300	06/93→06/95								
E-class E 300 T (S124)	06/93→06/96								
Kombi 300 TE	09/86→06/93								
3.0	M 103.987					199	BN740 (Fibre)	HL657	
G-Class 300 GE	09/89→09/97	2960	6	88.50	SOHC/OHC	125-128/ 170-174			
3.0	M 104.980					200	AC5520 (Fibre) AE5330 (Fibre), 1.240mm	CC5520 [3]	
Cabrio 300 CE24	04/92→06/93	2960	6	88.50	DOHC	162-170/ 220-231			
Coupe 300 CE-24	09/89→12/92								
E-class 300 E24	09/88→08/92								
E-class E 300 TE-24 AMG (S124)	06/93→06/96								
Kombi 300 TE-24	09/89→08/92								
3.0	M 104.981					201	AC5520 (Fibre) AE5330 (Fibre), 1.240mm	CC5520 [3]	
SL Cabrio 300	03/89→07/93	2960	6	88.50	DOHC	170/231			
3.0	M 272.940					202	AG8400 (MLS)		
C-Class 280	01/05→08/07	2996	6	88.00	DOHC, V	170/231	AG8390 (MLS)		
C-Class C280	01/05→02/07								
CLK 280	01/05→03/10								
3.0	M 272.941					203	AG8400 (MLS)		
C-Class 280	01/05→08/07	2996	6	88.00	DOHC, V	170/231	AG8390 (MLS)		
C-Class C280	01/05→02/07								
3.0	M 272.942					204	AG8400 (MLS)		
SLK 280	01/05→02/11	2996	6	88.00	DOHC, V	170/231	AG8390 (MLS)		
SLK 300	04/09→02/11								

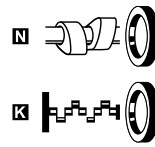
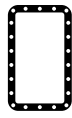
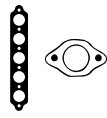

AC5520



AE5330



BN740



JD121



JD169



JE5018

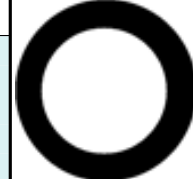

JM5115



JN623



JJ500

MERCEDES-BENZ



cc



kW/PS

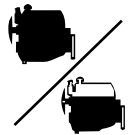

3.0	M 272.943					205	AG8400 (MLS)		
CLS 280	07/08→12/10	2996	6	88.00	DOHC, V	170/231	AG8390 (MLS)		
CLS 300	04/09→12/10								
E-class (W211) E 280 (211.054)	03/05→12/08								
E-class (W211) E 280 4-matic (211.092)	01/06→12/08								
E-class T-Model (S211) E 280 T (211.254)	03/05→07/09								
E-class T-Model (S211) E 280 T 4-matic (211.292)	03/05→07/09								
3.0	M 272.945					206	AG8400 (MLS)		
R 280	01/07→	2996	6	88.00	DOHC, V	170/231	AG8390 (MLS)		
R 300	07/09→								
3.0	M 272.947					207	AG8400 (MLS)		
C-Class 280	01/07→	2996	6	88.00	DOHC, V	170/231	AG8390 (MLS)		
C-Class 300	07/09→								
3.0	M 272.948					208	AG8400 (MLS)		
C-Class 280	07/07→	2996	6	88.00	DOHC, V	170/231	AG8390 (MLS)		
C-Class 300	07/07→								
GLK 280	06/08→06/09								
GLK 300	07/09→04/11								
3.0	M 272.949					209	AG8400 (MLS)		
SL 280	03/08→01/12	2996	6	88.00	DOHC, V	170/231	AG8390 (MLS)		
SL 300	04/09→01/12								
3.0	M 272.952					210	AG8400 (MLS)		
E-class (W212) E 300 (212.054)	01/09→	2996	6	88.00	DOHC, V	170/231	AG8390 (MLS)		
E-class T-Model (S212) E 300	11/09→								
3.0	OM 603.912 Diesel					211	BT550 (Fibre)		
E-class 300 D	12/84→06/93	2996	6	87.00	SOHC/OHC	80-83/109-113			
G-Class 300 GD	03/79→07/93								
Kombi 300 T D	09/86→06/93								
3.0	OM 603.913 Diesel					212	BT550 (Fibre)		
E-class 300 D	09/86→06/93	2996	6	87.00	SOHC/OHC	80-83/109-113			

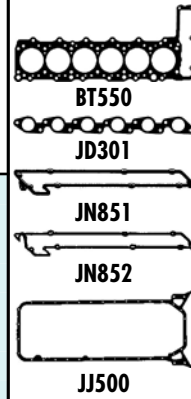
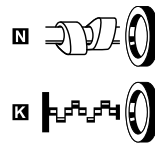
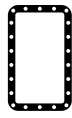

HBS511 [22]		HR397	HR397		NA5131 [2] 45.00x67.00x8.00mm, PTFE	
HBS511 [22]		HR397	HR397		NA5131 [2] 45.00x67.00x8.00mm, PTFE	
HBS511 [22]		HR397	HR397		NA5131 [2] 45.00x67.00x8.00mm, PTFE	
HBS511 [22]		HR397	HR397		NA5131 [2] 45.00x67.00x8.00mm, PTFE	
HBS511 [22]		HR397	HR397		NA5131 [2] 45.00x67.00x8.00mm, PTFE	
HBS511 [22]		HR397	HR397		NA5131 [2] 45.00x67.00x8.00mm, PTFE	
HBS060 [22] M10x1.50x115.00mm (x7)	JD301	JN851 [4][106] JN852 [4][107]	JJ500	HR760	NA5131 [2] 45.00x67.00x8.00mm, PTFE NB973 [2] 45.00x67.00x8.00mm, FPM NB971 [2] 45.00x67.00x10.00mm, FPM NB975 [2] 45.00x74.50x12.00mm, FPM NB974 [1] 93.00x114.00x13.00mm, FPM NAS266 [1] 93.00x114.00x14.00mm, FPM NAS074 [1] 93.00x133.50x15.50mm, PTFE	
HBS060 [22] M10x1.50x115.00mm (x7)	JD301	JN851 [4][106] JN852 [4][107]	JJ500	HR760	NA5131 [2] 45.00x67.00x8.00mm, PTFE NB973 [2] 45.00x67.00x8.00mm, FPM NB971 [2] 45.00x67.00x10.00mm, FPM NB975 [2] 45.00x74.50x12.00mm, FPM NB974 [1] 93.00x114.00x13.00mm, FPM NAS266 [1] 93.00x114.00x14.00mm, FPM NAS074 [1] 93.00x133.50x15.50mm, PTFE	

MERCEDES-BENZ

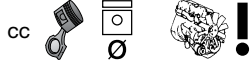

kW/PS

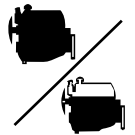

3.0	OM 603.931	Diesel	213	BT550 (Fibre)		
G-Class 300 GD	09/89→09/97	2996 6	87.00	SOHC/OHC	83/113	
3.0	OM 603.960	Diesel	214	BT550 (Fibre)		
E-class 300 TD	09/86→06/93	2996 6	87.00	SOHC/OHC	100-108/ 136-147	
E-class E 300 T Turbo-D (S124)	06/93→06/96					
E-class E 300 Turbo-D	06/93→06/95					
Kombi 300 T	09/86→06/93					
Kombi 300 TD T	06/92→05/93					
3.0	OM 603.963	Diesel	215	BT550 (Fibre)		
E-class 300 TD	09/86→06/93	2996 6	87.00	SOHC/OHC	105-108/ 143-147	
E-class E 300 T Turbo-D (S124)	06/93→06/96					
E-class E 300 Turbo-D	06/93→06/95					
Kombi 300 T	09/86→01/89					
3.0	OM 606.910	Diesel	216	BY580 (Fibre)	DY580 ☒○ [13]	EY580 [3]
E-class E 300 D	07/93→06/95	2996 6	87.00	DOHC	100/136	
E-class E 300 TD (S124)	06/93→06/96					
3.0	OM 606.912	Diesel	217	BY580 (Fibre)	DY580 ☒○ [13]	EY580 [3]
E-class E 300 D (W210)	06/95→06/97	2996 6	87.00	DOHC	100/136	
3.0	OM 606.961	Diesel	218	BY580 (Fibre)	DY580 ☒○ [13]	EY580 [3]
S-Class 300 TD	05/96→10/98	2996 6	87.00	DOHC	130/177	



BT550

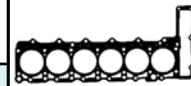

BY580



JD301



JD478

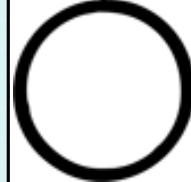

JM5157

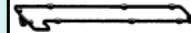

JN851



JN852

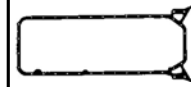

JJ500

MERCEDES-BENZ



cc



kW/PS



3.0	OM 606.962	Diesel	219	BY580 (Fibre)	DY580 ☒○ [13]	EY580 [3]	
E-class E 300 T Turbo-D (S210)	12/96→07/99	2996 6	87.00	DOHC	130/177	03/97→	03/97→
E-class E 300 Turbo-D (W210)	12/96→07/99						
3.0	OM 606.964	Diesel	220	BY580 (Fibre)	DY580 ☒○ [13]	EY580 [3]	
G-Class 300 TD	08/96→	2996 6	87.00	DOHC	130/177	09/96→	09/96→
3.0	OM 612.990	Diesel	221	AD5720 (MLS), 1.200mm	CD5720 ☒	ED5720	
C-Class 30 AMG	09/02→05/08	2950 5	88.00	DOHC	170/231		
C-Class C30 CDI	01/03→02/07						
3.0	OM 617.913	Diesel	222	BC800 (Fibre)	DC800	EC791	
T1 209 D 2.9	12/82→01/90	2998 5	91.00	SOHC/OHC	65/88	→01/89	→01/89
T1 309 D 3.0	10/82→01/90						
T1 409 D	04/82→01/89						
3.0	OM 617.931	Diesel	223	BC800 (Fibre)	DC800	EC791	
G-Class 300 GD	12/79→12/91	2998 5	90.90	SOHC/OHC	65/88		
3.0	OM 642.820	Diesel	224	AH5010 (MLS) ☒ AH5020 (MLS) ☒			
G-Class GL 350	12/09→	2987 6	83.00	DOHC, V	150-155/ 204-211		
M ML 300 CDI	02/10→						
M ML 350 CDI	09/09→						
3.0	OM 642.822	Diesel	225	AH5010 (MLS) ☒ AH5020 (MLS) ☒			
G-Class GL 350	10/10→	2987 6	83.00	DOHC, V	165-195/ 224-265		
3.0	OM 642.830	Diesel	226	AH5010 (MLS) ☒ AH5020 (MLS) ☒			
C-Class 350 CDI	10/09→	2987 6	83.00	DOHC, V	165-170/ 224-231		
C-Class 350 CDI	10/09→						
3.0	OM 642.832	Diesel	227	AH5010 (MLS) ☒ AH5020 (MLS) ☒			
C-Class 26.480	01/11→	2987 6	83.00	DOHC, V	150-170/ 204-231		
C-Class 350 CDI	10/09→						
GLk 350 CDI	07/09→05/10						
M ML 300 CDI	02/10→						
M ML 350 CDI	02/10→						
3.0	OM 642.910	Diesel	228	AH5010 (MLS) ☒ AH5020 (MLS) ☒	CH5010		
C-Class 320 CDI	06/05→08/07	2987 6	83.00	DOHC	165/224		
C-Class C320 CDI	01/05→02/07						
CLK 320 CDI	01/05→03/10						
E-class E 320 CDI 4-matic (W211)	03/05→12/08						



AD5720



BC800



BY580

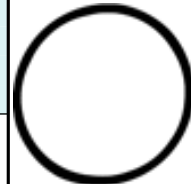

JD5378

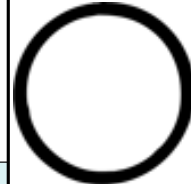

JM5157

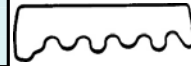

JN273



JH683



JJ500

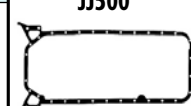

JJ543

HBS063 [22] M10x1.50x115.00mm (x6) 03/97→		JM5157 (Elastomer) 03/97→	JJ500 03/97→	PA5041 [x12] 6.00/12.20x10.00 (FPM) 03/97→ HR5057 03/97→	NA5131 [2] 45.00x67.00x8.00mm, PTFE 03/97→ NB973 [2] 45.00x67.00x8.00mm, FPM 03/97→ NB974 [1] 93.00x114.00x13.00mm, FPM 03/97→	
HBS063 [22] M10x1.50x115.00mm (x6) 09/96→		JM5157 (Elastomer) 09/96→	JJ500 09/96→	PA5041 [x12] 6.00/12.20x10.00 (FPM) 09/96→ HR5057 09/96→	NA5131 [2] 45.00x67.00x8.00mm, PTFE 09/96→ NB973 [2] 45.00x67.00x8.00mm, FPM 09/96→ NB974 [1] 93.00x114.00x13.00mm, FPM 09/96→	
HBS293 [19] M12x1.75x102.00mm (x12)	JD5378 [x5] JD5797 JD5798	JM7028 (Elastomer) HM5274 Eng.50813931→	JJ543		NA5131 [2] 45.00x67.00x8.00mm, PTFE NA5074 [1] 93.00x133.50x15.50mm, PTFE	KA5036 [15]
HBS046 [19] M12x1.75x145.00mm (x8) →01/89	JD297 →01/89	JN273 [4] →01/89	JH683 →01/89		PA815 [x1][1][2] 78.00x94.00x8.00mm →01/89 NB975 [2] 45.00x74.50x12.00mm, FPM →01/89	
HBS046 [19] M12x1.75x145.00mm (x8)	JD297	JN273 [4]	JH683		PA815 [x1][1][2] 78.00x94.00x8.00mm NB975 [2] 45.00x74.50x12.00mm, FPM	
HBS474 [19] M12x1.75x205.00mm (x16)			HR397		NA5131 [2] 45.00x67.00x8.00mm, PTFE	
HBS474 [19] M12x1.75x205.00mm (x16)			HR397		NA5131 [2] 45.00x67.00x8.00mm, PTFE	
HBS474 [19] M12x1.75x205.00mm (x16)			HR397		NA5131 [2] 45.00x67.00x8.00mm, PTFE	
HBS474 [19] M12x1.75x205.00mm (x16)	JD5902 [x2] (MLS) JE5067 JE5068	HR397	HR397		NA5131 [2] 45.00x67.00x8.00mm, PTFE	

MERCEDES-BENZ



cc



kw/PS

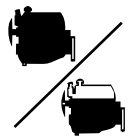

3.0	OM 642.920	Diesel	229	AH5010 (MLS) <input checked="" type="checkbox"/>		
CLS 320 CDI	01/05→12/10	2987	6	83.00	DOHC, V	140-165/ 190-224
CLS 350 CDI	04/09→12/10					
E-class E 280 CDI (W211)	03/05→12/08					
E-class E 300 (W211)	09/07→12/08					
E-class E 320 CDI (W211)	03/05→12/08					
E-class T-Model	03/05→07/09					
E 280 T CDI (S211)						
E-class T-Model	03/05→07/09					
E 320 T CDI (S211)						
E-class T-Model	03/05→07/09					
E 320 T CDI 4-matic (S211)						
3.0	OM 642.921	Diesel	230	AH5010 (MLS) <input checked="" type="checkbox"/>		
E-class E 280 CDI	03/05→12/08	2987	6	83.00	DOHC, V	140/190
4-matic (W211)						
E-class T-Model	03/05→07/09					
E 280 T CDI 4-matic (S211)						
3.0	OM 642.930	Diesel	231	AH5010 (MLS) <input checked="" type="checkbox"/>		CH5010
S-Class 320 CDI	10/05→	2987	6	83.00	DOHC, V	155-173/ 211-235
S-Class 350 CDI	05/11→					
3.0	OM 642.940	Diesel	232	AH5010 (MLS) <input checked="" type="checkbox"/>		CH5010
G-Class GL 320	09/06→05/09	2987	6	83.00	DOHC, V	140-170/ 190-231
G-Class GL 350	05/09→					
M ML 280 CDI	07/05→07/09					
M ML 300 CDI	07/09→					
M ML 320 CDI	07/05→07/09					
M ML 350 CDI	07/09→					
3.0	OM 642.950	Diesel	233	AH5010 (MLS) <input checked="" type="checkbox"/>		CH5010
R 280 CDI	05/06→	2987	6	83.00	DOHC, V	140-165/ 190-224
R 300 CDI	07/09→					
R 320 CDI	01/06→					
R 350 BlueTEC	01/06→					
R 350 CDI	07/09→					
3.0	OM 642.960	Diesel	234	AH5010 (MLS) <input checked="" type="checkbox"/>		CH5010
C-Class 320 CDI	01/07→	2987	6	83.00	DOHC, V	165/224
C-Class 350 CDI	07/09→					
3.0	OM 642.961	Diesel	235	AH5010 (MLS) <input checked="" type="checkbox"/>		CH5010
C-Class 320 CDI	07/07→	2987	6	83.00	DOHC, V	165/224
C-Class 350 CDI	07/09→					
GLk 320 CDI	06/08→					
3.0	OM 642.970	Diesel	236	AH5010 (MLS) <input checked="" type="checkbox"/>		CH5010
G-Class 320 CDI	09/06→	2987	6	83.00	DOHC, V	165/224
3.0	OM 642.990	Diesel	237			CH5010
Viano CDI 3.0	03/06→	2987	6	83.00	DOHC, V	150-165/ 204-224
Vito 120 CDI	07/06→					
3.0	OM 642.992	Diesel	238	AH5010 (MLS) <input checked="" type="checkbox"/>		CH5010
Sprint 4,6t 418	06/06→	2987	6	83.00	DOHC, V	135-140/ 184-190
Sprint 4,6t 419	03/09→					
Sprinter 3.5 318	06/06→					
Sprinter 3.5 319	03/09→					
Sprinter 3t 218	06/06→					
Sprinter 3t 219	03/09→					
Sprinter 5t 518	06/06→					
Sprinter 5t 519	03/09→					



HBS474 [19] M12x1.75x205.00mm (x16)	JD5902 [x2] (MLS)	HR397 [x]	HR397		NA5131 [2] 45.00x67.00x8.00mm, PTFE	
HBS474 [19] M12x1.75x205.00mm (x16)	JD5902 [x2] (MLS)	HR397 [x]	HR397		NA5131 [2] 45.00x67.00x8.00mm, PTFE	
HBS474 [19] M12x1.75x205.00mm (x16)	JD5902 [x2] (MLS)	HR397 [x]	HR397		NA5131 [2] 45.00x67.00x8.00mm, PTFE	
HBS474 [19] M12x1.75x205.00mm (x16)	JD5902 [x2] (MLS)	HR397 [x]	HR397		NA5131 [2] 45.00x67.00x8.00mm, PTFE	
HBS474 [19] M12x1.75x205.00mm (x16)	JD5902 [x2] (MLS)	HR397 [x]	HR397		NA5131 [2] 45.00x67.00x8.00mm, PTFE	
HBS474 [19] M12x1.75x205.00mm (x16)	JD5902 [x2] (MLS) JE5067 [x] JE5068 [x]	HR397 [x]	HR397		NA5131 [2] 45.00x67.00x8.00mm, PTFE	
HBS474 [19] M12x1.75x205.00mm (x16)	JD5902 [x2] (MLS) JE5067 [x] JE5068 [x]	HR397 [x]	HR397		NA5131 [2] 45.00x67.00x8.00mm, PTFE	
HBS474 [19] M12x1.75x205.00mm (x16)	JD5902 [x2] (MLS)	HR397 [x]	HR397		NA5131 [2] 45.00x67.00x8.00mm, PTFE	
HBS474 [19] M12x1.75x205.00mm (x16)	JD5902 [x2] (MLS)	HR397 [x]	HR397		NA5131 [2] 45.00x67.00x8.00mm, PTFE	
HBS474 [19] M12x1.75x205.00mm (x16)	JD5902 [x2] (MLS)	HR397 [x]	HR397		NA5131 [2] 45.00x67.00x8.00mm, PTFE	

MERCEDES-BENZ

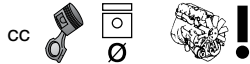

kW/PS

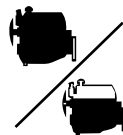

3.2	M 104.990					239	AE5330 (Fibre), 1.240mm	CE5330 ○ [3] CE5331 [3]
S-Class 300/320	03/91→10/98	3199	6	89.90	DOHC	162-170/ 220-231		
3.2	M 104.991					240	AE5330 (Fibre), 1.240mm	CE5330 ○ [3]
SL Cabrio 320	09/93→10/01	3199	6	89.90	DOHC	170/231		
3.2	M 104.992					241	AE5330 (Fibre), 1.240mm	CE5330 ○ [3]
Coupe 320 CE	10/92→05/93	3199	6	89.90	DOHC	162/220		
E-class 320 E	10/92→06/93							
E-class Coupe	06/93→06/97							
E 320 (C124)								
E-class E 320	06/93→06/95							
E-class E 320 T (S124)	06/93→06/96							
E-class Cabriolet	06/93→03/98							
Convertible E 320 (A124)								
Kombi 320 TE	10/92→06/93							
3.2	M 104.994					242	AE5330 (Fibre), 1.240mm	CE5330 ○ [3] CE5331 [3]
S-Class 300/320	03/91→10/98	3199	6	89.90	DOHC	170/231		
3.2	M 104.995					243	AE5330 (Fibre), 1.240mm	CE5330 ○ [3]
E-class E 320 (W210)	06/95→06/97	3199	6	89.90	DOHC	162/220		
E-class Cabriolet	06/93→03/98							
Convertible E 320 (A124)								

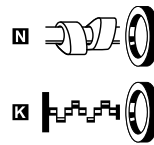
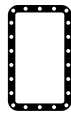
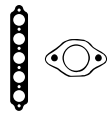

AE5330

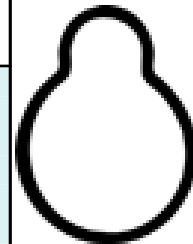

JD167



JD169



JE5028

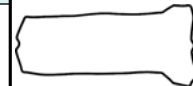

JM5114

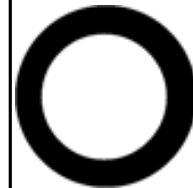

JM5115



JJ500

HBS152 [19] M12x1.75x160.00mm (x14)	JE5028 [1] JD169 [2] (x2)	JM5113 (Elastomer) JM5115 (x6) (Elastomer)	JJ500	HR5055 [3]	NB971 [2] (2) 45.00x67.00x10.00mm, FPM NB972 [1] (1) 93.00x117.00x12.00mm, FPM NB975 [2] (2) 45.00x74.50x12.00mm, FPM NB974 [1] (1) 93.00x114.00x13.00mm, FPM NA5266 [1] (1) 93.00x114.00x14.00mm, FPM NA5074 [1] (1) 93.00x133.50x15.50mm, PTFE	JR5040 [17] KK5683 [109]
HBS152 [19] M12x1.75x160.00mm (x14)	JD167 [1] (x6) JD169 [2] (x2)	JM5114 (Elastomer)	JJ500	HR5055 [3]	NB971 [2] (2) 45.00x67.00x10.00mm, FPM NB972 [1] (1) 93.00x117.00x12.00mm, FPM NB975 [2] (2) 45.00x74.50x12.00mm, FPM NB974 [1] (1) 93.00x114.00x13.00mm, FPM NA5266 [1] (1) 93.00x114.00x14.00mm, FPM NA5074 [1] (1) 93.00x133.50x15.50mm, PTFE	JR5040 [17] KK5683 [109]
HBS152 [19] M12x1.75x160.00mm (x14)	JD167 [1] (x6) JD169 [2] (x2)	JM5114 (Elastomer)	JJ500	HR5055 [3]	NB971 [2] (2) 45.00x67.00x10.00mm, FPM NB972 [1] (1) 93.00x117.00x12.00mm, FPM NB975 [2] (2) 45.00x74.50x12.00mm, FPM NB974 [1] (1) 93.00x114.00x13.00mm, FPM NA5266 [1] (1) 93.00x114.00x14.00mm, FPM NA5074 [1] (1) 93.00x133.50x15.50mm, PTFE	JR5040 [17] KK5683 [109]
HBS152 [19] M12x1.75x160.00mm (x14)	JD167 [1] (x6) JD169 [2] (x2)	JM5113 (Elastomer) JM5115 (x6) (Elastomer)	JJ500	HR5055 [3]	NB971 [2] (2) 45.00x67.00x10.00mm, FPM NB972 [1] (1) 93.00x117.00x12.00mm, FPM NB975 [2] (2) 45.00x74.50x12.00mm, FPM NB974 [1] (1) 93.00x114.00x13.00mm, FPM NA5266 [1] (1) 93.00x114.00x14.00mm, FPM NA5074 [1] (1) 93.00x133.50x15.50mm, PTFE	JR5040 [17] KK5683 [109]
HBS152 [19] M12x1.75x160.00mm (x14)	JD167 [1] JD169 [2]		JJ500	HR5055 [3]	NB973 [2] (2) 45.00x67.00x8.00mm, FPM NB971 [2] (2) 45.00x67.00x10.00mm, FPM NB974 [1] (1) 93.00x114.00x13.00mm, FPM	JR5040 [17] KK5683 [109]

MERCEDES-BENZ



kw/PS

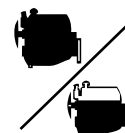

3.2	M 104.996					244	AE5330 (Fibre), 1.240mm	CE5330 ○ [3]	
G-Class 320 GE	09/94→11/97	3199	6	89.90	DOHC	155/211			
G-Class G 320	09/94→12/97								
3.2	M 112.940					245	AE5750 (MLS) ☒ AE5760 (MLS) ☒	CE5760 ☒☒	
CLK 320	03/98→03/02	3199	6	89.90	SOHC/OHC, V	160-162/ 218-220			
CLK 3535 K	06/97→06/02								
3.2	M 112.941					246	AE5750 (MLS) ☒ AE5760 (MLS) ☒	CE5760 ☒☒	
E-class E 320 (W210)	06/97→03/02	3199	6	89.90	DOHC, V	165/224			
E-class E 320 T (S210)	12/96→03/03								
3.2	M 112.942					247	AE5750 (MLS) ☒ AE5760 (MLS) ☒	CE5760 ☒☒	
M ML 320	02/98→08/02	3199	6	89.90	DOHC, V	160/218			
3.2	M 112.943					248	AE5750 (MLS) ☒ AE5760 (MLS) ☒	CE5760 ☒☒	
SL Cabrio 320	05/98→10/01	3199	6	89.90	SOHC/OHC, V	165/224			
3.2	M 112.944					249	AE5750 (MLS) ☒ AE5760 (MLS) ☒	CE5760 ☒☒	
S-Class S 320	10/98→08/05	3199	6	89.90	SOHC/OHC, V	165/224			
3.2	M 112.945					250	AE5750 (MLS) ☒ AE5760 (MLS) ☒	CE5760 ☒☒	
G-Class G 320	07/97→	3199	6	89.90	DOHC, V	158/215			
3.2	M 112.946					251	AE5750 (MLS) ☒ AE5760 (MLS) ☒	CE5760 ☒☒	
C-Class 320	09/02→05/08	3199	6	89.90	DOHC, V	160/218			
C-Class C 320	05/00→08/07								
3.2	M 112.947					252	AE5750 (MLS) ☒ AE5760 (MLS) ☒	CE5760 ☒☒	
SLK Cabrio 320	03/00→04/04	3199	6	89.90	SOHC/OHC, V	160/218			
3.2	M 112.949					253	AE5750 (MLS) ☒ AE5760 (MLS) ☒	CE5760 ☒☒	
E-class E 320 (W211)	03/02→12/08	3199	6	89.90	DOHC, V	165/224			
E-class T-Model E 320 T (S211)	03/03→07/09								
3.2	M 112.951					254	AE5750 (MLS) ☒ AE5760 (MLS) ☒	CE5760 ☒☒	
Viano 3.0	09/03→	3199	6	89.90	DOHC, V	140-160/ 190-218			
Viano 3.2	09/03→								
Vito 119	09/03→								
Vito 122	09/03→								
3.2	M 112.953					255	AE5750 (MLS) ☒ AE5760 (MLS) ☒	CE5760 ☒☒	
C-Class C 320	07/02→08/07	3199	6	89.90	SOHC/OHC, V	160/218			



AE5330



AE5750

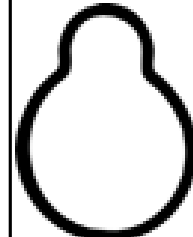

JD167



JD169



JD5385



JD5386

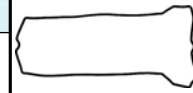

JM5114



JJ500

HBS152 [19] M12x1.75x160.00mm (x14)	JD167 [x6] JD169 [x2]	JM5114 (Elastomer)	JJ500	HR5055	NB971 [2] 45.00x67.00x10.00mm, FPM NB972 [1] 93.00x117.00x12.00mm, FPM NB975 [2] 45.00x74.50x12.00mm, FPM NB974 [1] 93.00x114.00x13.00mm, FPM NA5266 [1] 93.00x114.00x14.00mm, FPM NA5074 [1] 93.00x133.50x15.50mm, PTFE	JR5040 [17] KK5683 [109]
HBS463 [22] M11x1.50x141.00mm (x8)	JD5385 [x2] JD5386	JM5236 [x6] (Elastomer) JM5237 (Elastomer)	HR397		NA5131 [2] 45.00x67.00x8.00mm, PTFE NA5168 [1] 93.00x114.00x11.50mm, PTFE	
HBS463 [22] M11x1.50x141.00mm (x8)	JD5385 [x2] JD5386 [x6]	JM5236 (Elastomer) JM5237 (Elastomer)	HR397		NA5131 [2] 45.00x67.00x8.00mm, PTFE NA5168 [1] 93.00x114.00x11.50mm, PTFE	
HBS463 [22] M11x1.50x141.00mm (x8)	JD5385 [x2] JD5386	JM5236 (Elastomer) JM5237 (Elastomer)	HR397		NA5131 [2] 45.00x67.00x8.00mm, PTFE NA5168 [1] 93.00x114.00x11.50mm, PTFE	
HBS463 [22] M11x1.50x141.00mm (x8)	JD5385 [x2] JD5386	JM5236 (Elastomer) JM5237 (Elastomer)	HR397		NA5131 [2] 45.00x67.00x8.00mm, PTFE NA5168 [1] 93.00x114.00x11.50mm, PTFE	
HBS463 [22] M11x1.50x141.00mm (x8)	JD5385 [x2] JD5386	JM5236 (Elastomer) JM5237 (Elastomer)	HR397		NA5131 [2] 45.00x67.00x8.00mm, PTFE NA5168 [1] 93.00x114.00x11.50mm, PTFE	
HBS463 [22] M11x1.50x141.00mm (x8)	JD5385 [x2] JD5386	JM5236 (Elastomer) JM5237 (Elastomer)	HR397		NA5131 [2] 45.00x67.00x8.00mm, PTFE NA5168 [1] 93.00x114.00x11.50mm, PTFE	
HBS463 [22] M11x1.50x141.00mm (x8)	JD5385 [x2] JD5386	JM5236 (Elastomer) JM5237 (Elastomer)	HR397		NA5131 [2] 45.00x67.00x8.00mm, PTFE NA5168 [1] 93.00x114.00x11.50mm, PTFE	
HBS463 [22] M11x1.50x141.00mm (x8)	JD5385 [x2] JD5386	JM5236 (Elastomer) JM5237 (Elastomer)	HR397		NA5131 [2] 45.00x67.00x8.00mm, PTFE NA5168 [1] 93.00x114.00x11.50mm, PTFE	
HBS463 [22] M11x1.50x141.00mm (x8)	JD5385 [x2] JD5386	JM5236 (Elastomer) JM5237 (Elastomer)	HR397		NA5131 [2] 45.00x67.00x8.00mm, PTFE NA5168 [1] 93.00x114.00x11.50mm, PTFE	
HBS463 [22] M11x1.50x141.00mm (x8)	JD5385 [x2] JD5386	JM5236 (Elastomer) JM5237 (Elastomer)	HR397		NA5131 [2] 45.00x67.00x8.00mm, PTFE NA5168 [1] 93.00x114.00x11.50mm, PTFE	
HBS463 [22] M11x1.50x141.00mm (x8)	JD5385 [x2] JD5386	JM5236 (Elastomer) JM5237 (Elastomer)	HR397		NA5131 [2] 45.00x67.00x8.00mm, PTFE NA5168 [1] 93.00x114.00x11.50mm, PTFE	
HBS463 [22] M11x1.50x141.00mm (x8)	JD5385 [x2] JD5386	JM5236 (Elastomer) JM5237 (Elastomer)	HR397		NA5131 [2] 45.00x67.00x8.00mm, PTFE NA5168 [1] 93.00x114.00x11.50mm, PTFE	

MERCEDES-BENZ



cc



kW/PS

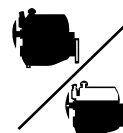

3.2	M 112.954						256	AE5750 (MLS) AE5760 (MLS)	CE5760	
E-class E 320 (W211)	03/03→12/08	3199	6	89.90	SOHC/OHC, V	165/224				
E-class T-Model E 320 T (S211)	07/03→07/09									
3.2	M 112.955						257	AE5750 (MLS) AE5760 (MLS)	CE5760	
CLK 320	06/02→03/10	3199	6	89.90	SOHC/OHC, V	160/218				
3.2	M 112.960						258	AE5750 (MLS) AE5760 (MLS)	CE5760	
SLK Cabrio AMG	03/01→04/04	3199	6	89.90	DOHC, V	260/354				
3.2	M 112.961						259	AE5750 (MLS) AE5760 (MLS)	CE5760	
C-Class 32 AMG	03/01→05/08	3199	6	89.90	DOHC, V	260/354				
C-Class C 32 AMG	02/01→02/07									
3.2	OM 613.960	Diesel					260	AG8490 (MLS)		
S-Class 320 CDI	08/99→09/02	3222	6	88.00	DOHC	145/197				
3.2	OM 613.961	Diesel					261	AG8490 (MLS)		
E-class E 320 CDI (W210)	07/99→03/02	3226	6	88.00	DOHC	145/197				
E-class E 320 T CDI (S210)	07/99→03/03									
3.2	OM 648.960	Diesel					262	AG8490 (MLS)		
S-Class 320 CDI	09/02→08/05	3222	6	88.00	DOHC	150/204				
3.2	OM 648.961	Diesel					263	AG8490 (MLS)		
E-class E 280 CDI (W211)	05/04→12/08	3222	6	88.00	DOHC	130-150/ 177-204				
E-class E 320 CDI (W211)	11/02→12/08									
E-class T-Model)	05/04→07/09									
E 280 T CDI (S211)										
E-class T-Model	03/03→07/09									
E 320 T CDI (S211)										
3.4	OM 603.971	Diesel					264		DY601 [13]	
E-class 300 TD	06/91→05/93	3449	6	89.00	SOHC/OHC	100-110/ 136-150				
S-Class 350 TD	01/93→10/98									
3.4	OM 603.972	Diesel					265			
G-Class 350 G	09/91→	3449	6	89.00	SOHC/OHC	100/136				
G-Class 350 T	09/91→09/97									
3.5	M 272.960						266			
C-Class 350	01/05→05/08	3498	6	92.90	DOHC, V	200/272				
C-Class C350	01/05→02/07									
CLC 350	05/08→06/11									
CLK 350	01/05→03/10									
3.5	M 272.961						267			
C-Class 350	01/07→	3498	6	92.90	DOHC, V	200/272				

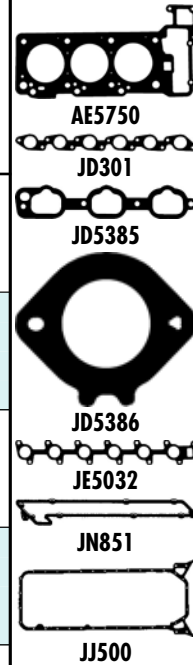
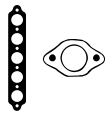

HBS463 [22] M11x1.50x141.00mm (x8)	JD5385 [x2] JD5386 [x6]	JM5236 [x] (Elastomer) JM5237 [x] (Elastomer)	HR397		NA5131 [2] 45.00x67.00x8.00mm, PTFE NA5168 [1] 93.00x114.00x11.50mm, PTFE	
HBS463 [22] M11x1.50x141.00mm (x8)	JD5385 [x2] JD5386 [x]	JM5236 [x] (Elastomer) JM5237 [x] (Elastomer)	HR397		NA5131 [2] 45.00x67.00x8.00mm, PTFE NA5168 [1] 93.00x114.00x11.50mm, PTFE	
HBS463 [22] M11x1.50x141.00mm (x8)	JD5385 [x2] JD5386 [x]	JM5236 [x] (Elastomer) JM5237 [x] (Elastomer)	HR397		NA5131 [2] 45.00x67.00x8.00mm, PTFE NA5168 [1] 93.00x114.00x11.50mm, PTFE	
HBS463 [22] M11x1.50x141.00mm (x8)	JD5385 [x2] JD5386 [x]	JM5236 [x] (Elastomer) JM5237 [x] (Elastomer)	HR397		NA5131 [2] 45.00x67.00x8.00mm, PTFE NA5168 [1] 93.00x114.00x11.50mm, PTFE	
HBS294 [19] M12x1.75x102.00mm (x14)	JE5032 [x] (MLS)			HR5055 [x]	NA5131 [2] 45.00x67.00x8.00mm, PTFE NA5074 [1] 93.00x133.50x15.50mm, PTFE	
HBS294 [19] M12x1.75x102.00mm (x14)	JE5032 [x] (MLS)			HR5055 [x]	NA5131 [2] 45.00x67.00x8.00mm, PTFE NA5074 [1] 93.00x133.50x15.50mm, PTFE	
HBS294 [19] M12x1.75x102.00mm (x14)	JE5032 [x] (MLS)			HR5055 [x]	NA5131 [2] 45.00x67.00x8.00mm, PTFE NA5074 [1] 93.00x133.50x15.50mm, PTFE	
HBS294 [19] M12x1.75x102.00mm (x14)	JE5032 [x] (MLS)			HR5055 [x]	NA5131 [2] 45.00x67.00x8.00mm, PTFE NA5074 [1] 93.00x133.50x15.50mm, PTFE	
HBS060 [22] M10x1.50x115.00mm (x7)	JD301 [x]	JN851 [4]	JJ500	HR760 [x]	NA5131 [2] 45.00x67.00x8.00mm, PTFE NB973 [2] 45.00x67.00x8.00mm, FPM NB975 [2] 45.00x74.50x12.00mm, FPM NB974 [1] 93.00x114.00x13.00mm, FPM NA5266 [1] 93.00x114.00x14.00mm, FPM NA5074 [1] 93.00x133.50x15.50mm, PTFE	
HBS060 [22] M10x1.50x115.00mm (x7)	JD301 [x]	JN851 [4]	JJ500	HR760 [x]	NA5131 [2] 45.00x67.00x8.00mm, PTFE NB973 [2] 45.00x67.00x8.00mm, FPM NB974 [1] 93.00x114.00x13.00mm, FPM	
HBS511 [22]		HR397 [x]	HR397	HR280 [x]	NA5131 [2] 45.00x67.00x8.00mm, PTFE	
					NA5131 [2] 45.00x67.00x8.00mm, PTFE	

MERCEDES-BENZ



cc



kW/PS

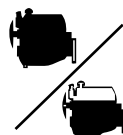

3.5	M 272.963						268
SLK 350	06/04→02/11	3498	6	92.90	DOHC, V		200/272
3.5	M 272.964						269
CLS 350	10/04→12/10	3498	6	92.90	DOHC, V		200/272
E-class (W211)	03/05→12/08						
E 350 (211.056)							
3.5	M 272.965						270
S-Class S 350	10/05→	3498	6	92.90	DOHC, V		200/272
3.5	M 272.966						271
SL 350	03/06→01/12	3498	6	92.90	DOHC, V		200/272
3.5	M 272.967						272
R 350	01/06→	3498	6	92.90	DOHC, V		200/272
E-class T-Model (S211)	03/05→07/09						
E 350 T (211.256)							
M ML 350	07/05→						
3.5	M 272.969						273
SLK 350	01/08→02/11	3498	6	92.90	DOHC		224/305
3.5	M 272.970						274
C-Class 350	01/05→08/07	3498	6	92.90	DOHC, V		200/272
C-Class C350	01/05→02/07						
3.5	M 272.971						275
C-Class 350	07/07→	3498	6	92.90	DOHC, V		200/272
GLK 350	06/08→04/11						
3.5	M 272.972						276
E-class (W211)	08/04→08/06	3498	6	92.90	DOHC, V		200-205/ 272-279
E 350 4-matic							
E-class (W211)	03/05→12/08						
E 350 4-matic (211.087)							
E-class T-Model (S211)	03/05→07/09						
E 350 T 4-matic (211.287)							
3.5	M 272.974						277
S-Class S 400	01/09→	3498	6	92.90	DOHC, V		200-205/ 272-279
3.5	M 272.975						278
S-Class S 350	02/08→	3498	6	92.90	DOHC, V		200/272
3.5	M 272.977						279
E-class (W212)	01/09→08/11	3498	6	92.90	DOHC, V		200/272
E 350 4-matic (212.087)							
E-class T-Model (S212)	11/09→						
E 350 4-matic (212.287)							
3.5	M 272.978						280
Vito 126	09/07→	3498	6	92.90	DOHC		190/258
3.5	M 272.979						281
Sprint 4,6t 424	06/06→	3498	6	92.90	DOHC		190/258
Sprinter 3.5 324	06/06→						
Sprinter 3t 224	06/06→						
Sprinter 5t 524	06/06→						
Viano 3.5	09/07→						
3.5	M 272.980						282
E-class (W212)	01/09→	3498	6	92.90	DOHC, V		200/272
E 350 (212.056)							
E-class T-Model (S212)	08/09→						
E 350 (212.256)							
3.5	M 272.982						283
C-Class 350 CGI	09/08→	3498	6	92.90	DOHC, V		215/292
E-class Convertible (A207)	01/10→						
E 350 CGI (207.457)							
E-class Coupe (C207)	01/09→						
E 350 CGI (207.357)							

MERCEDES-BENZ



cc



kW/PS

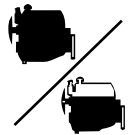

Model	Period	cc	Cyl	Power (kW/PS)	Configuration	Power (kW/PS)	Notes	Options
3.5	M 272.983					284		
E-class (W212)	01/09→08/11	3498	6	92.90	DOHC, V	215/292		
E 350 CGI (212.057)								
E-class T-Model (S212)	11/09→							
E 350 CGI (212.257)								
3.5	M 272.984					285		
E-class Convertible (A207)	01/10→	3498	6	92.90	DOHC, V	215/292		
CGI (207.457)								
E-class Coupe (C207)	01/09→							
(207.357)								
3.5	M 272.985					286		
CLS 350	04/06→12/10	3498	6	92.90	DOHC, V	215/292		
CLS 350 CGI	04/09→12/10							
E-class (W211)	09/07→12/08							
E 350 CGI (211.057)								
E-class T-Model (S211)	05/06→07/09							
350 CGI (211.257)								
3.5	M 272.991					287		
GLK 350	04/09→	3498	6	92.90	DOHC, V	200/272		
3.5	M 276.958					288		
R 350	01/06→	3498	6	92.90	DOHC, V	225/306		
3.6	M 104.941 (AMG 3.6)					289	AE5330 (Fibre), 1.240mm	CE5330 ○ [3]
C-Class C36 AMG	05/94→05/00	3606	6	91.00	DOHC, V	206/280		
3.6	M 104.992 (AMG 3.6)					290	AE5330 (Fibre), 1.240mm	CE5330 ○ [3]
E-class E 36 AMG	07/94→01/95	3606	6	91.00	DOHC, V	195-200/ 265-272		
E-class Coupe	06/93→04/95							
E 36 AMG (C124)								
Premium Route	05/94→06/97							
385.19T,400.19T								
Premium Route	05/94→06/96							
385.24T,400.24T								
Premium Route	05/94→03/98							
385.26,400.26								
3.7	M 112.970					291		
M ML 350	08/02→06/05	3724	6	97.00	SOHC/OHC, V	173-180/ 235-245		
3.7	M 112.972					292		
S-Class S 350	09/02→08/05	3724	6	97.00	DOHC, V	180/245		
3.7	M 112.973					293		
SL Cabrio 350	03/03→01/12	3724	6	97.00	SOHC/OHC, V	180/245		
3.7	M 112.975					294		
S-Class S 350	06/03→08/05	3724	6	97.00	DOHC, V	180/245		
3.7	M 112.976					295		
Viano 3.7	06/04→	3724	6	97.00	DOHC, V	165-170/ 224-231		
Vito 123	06/04→07/08							
5.5	M 273.960					296	AG8440 (MLS)	AG8430 (MLS)
CLS 500	04/06→12/10	5461	8	98.00	DOHC, V	285/388		
E-class (W211)	04/06→12/08							
E 500 (211.072)								
E-class T-Model (S211)	04/06→07/09							
E 500 T (211.272)								
5.5	M 273.961					297	AG8440 (MLS)	AG8430 (MLS)
S-Class CL 500	06/06→	5461	8	98.00	DOHC, V	271-285/ 369-388		
S-Class S 500	10/05→							

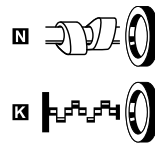
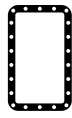

AE5330

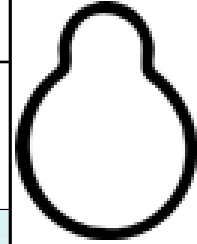

JD167



JD169



JD5385



JD5386

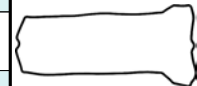

JM5114

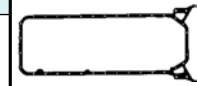

JJ500

HBS511 [22]		HR397 [5]	HR397	HR5062 [5]	NA5131 [2] 45.00x67.00x8.00mm, PTFE	
HBS511 [22]		HR397 [5]	HR397	HR5062 [5]	NA5131 [2] 45.00x67.00x8.00mm, PTFE	
HBS511 [22]		HR397 [5]	HR397	HR5062 [5]	NA5131 [2] 45.00x67.00x8.00mm, PTFE	
HBS511 [22]		HR397 [5]	HR397	HR5062 [5]	NA5131 [2] 45.00x67.00x8.00mm, PTFE	
HBS152 [19] M12x1.75x160.00mm (x14)	JD167 [1] JD169 [5]	JM5114 (Elastomer)	JJ500	HR5055 [5]	NB973 [2] 45.00x67.00x8.00mm, FPM	JR5040 [17] KK5683 [109]
HBS152 [19] M12x1.75x160.00mm (x14)	JD167 [1] JD169 [5]	JM5114 (Elastomer)	JJ500	HR5055 [5]	NB973 [2] (xNB975) 45.00x67.00x8.00mm, FPM	JR5040 [17] KK5683 [109]
HBS463 [22] M11x1.50x141.00mm (x8)	JD5385 [2] JD5386 [5]	JM5236 [5] (Elastomer) JM5237 [5] (Elastomer)	HR397		NA5131 [2] 45.00x67.00x8.00mm, PTFE NA5168 [1] 93.00x114.00x11.50mm, PTFE	
HBS463 [22] M11x1.50x141.00mm (x8)	JD5385 [2] JD5386 [5]	JM5236 [5] (Elastomer) JM5237 [5] (Elastomer)	HR397		NA5131 [2] 45.00x67.00x8.00mm, PTFE NA5168 [1] 93.00x114.00x11.50mm, PTFE	
HBS463 [22] M11x1.50x141.00mm (x8)		JM5236 [5] (Elastomer) JM5237 [5] (Elastomer)			NA5131 [2] 45.00x67.00x8.00mm, PTFE NA5168 [1] 93.00x114.00x11.50mm, PTFE	
HBS463 [22] M11x1.50x141.00mm (x8)	JD5385 [2] JD5386 [5]	JM5236 [5] (Elastomer) JM5237 [5] (Elastomer)	HR397		NA5131 [2] 45.00x67.00x8.00mm, PTFE NA5168 [1] 93.00x114.00x11.50mm, PTFE	
HBS463 [22] M11x1.50x141.00mm (x8)	JD5385 [2] JD5386 [5]	JM5236 [5] (Elastomer) JM5237 [5] (Elastomer)	HR397		NA5131 [2] 45.00x67.00x8.00mm, PTFE NA5168 [1] 93.00x114.00x11.50mm, PTFE	
HBS511 [22]		HR397 [5]	HR397	HR791 [5]	NA5131 [2] 45.00x67.00x8.00mm, PTFE	
HBS511 [22]		HR397 [5]	HR397	HR791 [5]	NA5131 [2] 45.00x67.00x8.00mm, PTFE	

MERCEDES-BENZ



cc



kW/PS

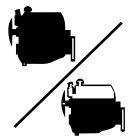

Model	Year Range	cc	Cylinders	Power (kW/PS)	Configuration	Max Torque (kgm)	Max Power (kW/PS)	AG8440 (MLS)	AG8430 (MLS)
5.5	M 273.962						298		
E-class (W211)	04/06→12/08	5461	8	98.00	DOHC, V	285/388		AG8440 (MLS) <input checked="" type="checkbox"/>	AG8430 (MLS) <input checked="" type="checkbox"/>
E 500 4-matic (211.090)									
E-class T-Model (S211)	04/06→07/09								
E 500 T 4-matic (211.290)									
5.5	M 273.963						299		
R 500	01/07→	5461	8	98.00	DOHC, V	285/388		AG8440 (MLS) <input checked="" type="checkbox"/>	AG8430 (MLS) <input checked="" type="checkbox"/>
G-Class G 500	05/08→								
G-Class GL 500	09/06→								
M ML 500	12/07→								
5.5	M 273.965						300		
CLK 500	06/06→05/09	5461	8	98.00	DOHC, V	285/388		AG8440 (MLS) <input checked="" type="checkbox"/>	AG8430 (MLS) <input checked="" type="checkbox"/>
SL 500	03/06→01/12								
5.5	M 273.966						301		
E-class Convertible (A207)	01/10→	5461	8	98.00	DOHC, V	285/388		AG8440 (MLS) <input checked="" type="checkbox"/>	AG8430 (MLS) <input checked="" type="checkbox"/>
E 500 (207.472)									
E-class Coupe (C207)	01/09→								
E 500 (207.372)									
5.5	M 273.967						302		
CLK 500	06/06→03/10	5461	8	98.00	DOHC, V	285/388		AG8440 (MLS) <input checked="" type="checkbox"/>	AG8430 (MLS) <input checked="" type="checkbox"/>
5.5	M 273.968						303		
S-Class CL 500	02/08→	5461	8	98.00	DOHC, V	285/388		AG8440 (MLS) <input checked="" type="checkbox"/>	AG8430 (MLS) <input checked="" type="checkbox"/>
S-Class S 500	10/05→								
5.5	M 273.970						304		
E-class (W212) E 500 4-matic	01/09→	5461	8	98.00	DOHC, V	285/388		AG8440 (MLS) <input checked="" type="checkbox"/>	AG8430 (MLS) <input checked="" type="checkbox"/>
(212.090)									
5.5	M 273.971						305		
E-class (W212)	01/09→	5461	8	98.00	DOHC, V	285/388		AG8440 (MLS) <input checked="" type="checkbox"/>	AG8430 (MLS) <input checked="" type="checkbox"/>
E 500 (212.072)									
E-class T-Model (S212)	11/09→								
E 500 (212.272)									
6.2	M 156.980						306		
R 63 AMG	02/06→	6208	8	102.20	DOHC, V	375/510			
M ML 63 AMG	01/06→								
6.2	M 156.981						307		
SL 63AMG	03/08→01/12	6208	8	102.00	DOHC, V	386/525			
6.2	M 156.982						308		
CLK 63 AMG	04/06→03/10	6208	8	102.20	DOHC, V	354-373/ 481-507			
6.2	M 156.983						309		
CLS 63 AMG	04/06→12/10	6208	8	102.20	DOHC, V	378/514			
E-class (W211)	03/06→12/08								
E 63 AMG (211.077)									
E-class T-Model (S211)	03/06→07/09								
E 63 AMG (211.277)									
6.2	M 156.984						310		
S-Class 63 AMG	10/06→	6208	8	102.20	DOHC, V	386/525			
S-Class CL63 AMG	10/06→								
6.2	M 156.985						311		
C-Class 63 AMG	02/08→	6208	8	102.00	DOHC, V	336-410/ 457-558			
E-class (W212)	12/09→								
E 63 AMG (212.077)									
E-class T-Model (S212)	08/09→								
E 63 AMG (212.277)									

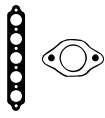

HBS511 [22]		HR397 [5]	HR397	HR791 [5]	<input checked="" type="checkbox"/> NAS131 [2] 45.00x67.00x8.00mm, PTFE	
HBS511 [22]		HR397 [5]	HR397	HR791 [5]	<input checked="" type="checkbox"/> NAS131 [2] 45.00x67.00x8.00mm, PTFE	
HBS511 [22]		HR397 [5]	HR397	HR791 [5]	<input checked="" type="checkbox"/> NAS131 [2] 45.00x67.00x8.00mm, PTFE	
HBS511 [22]		HR397 [5]	HR397	HR791 [5]	<input checked="" type="checkbox"/> NAS131 [2] 45.00x67.00x8.00mm, PTFE	
HBS511 [22]		HR397 [5]	HR397	HR791 [5]	<input checked="" type="checkbox"/> NAS131 [2] 45.00x67.00x8.00mm, PTFE	
HBS511 [22]		HR397 [5]	HR397	HR791 [5]	<input checked="" type="checkbox"/> NAS131 [2] 45.00x67.00x8.00mm, PTFE	
HBS511 [22]		HR397 [5]	HR397	HR791 [5]	<input checked="" type="checkbox"/> NAS131 [2] 45.00x67.00x8.00mm, PTFE	
					<input checked="" type="checkbox"/> NAS131 [2] 45.00x67.00x8.00mm, PTFE <input checked="" type="checkbox"/> NAS168 [1] 93.00x114.00x11.50mm, PTFE	
					<input checked="" type="checkbox"/> NAS131 [2] 45.00x67.00x8.00mm, PTFE <input checked="" type="checkbox"/> NAS168 [1] 93.00x114.00x11.50mm, PTFE	
					<input checked="" type="checkbox"/> NAS131 [2] 45.00x67.00x8.00mm, PTFE <input checked="" type="checkbox"/> NAS168 [1] 93.00x114.00x11.50mm, PTFE	
					<input checked="" type="checkbox"/> NAS131 [2] 45.00x67.00x8.00mm, PTFE <input checked="" type="checkbox"/> NAS168 [1] 93.00x114.00x11.50mm, PTFE	
					<input checked="" type="checkbox"/> NAS131 [2] 45.00x67.00x8.00mm, PTFE <input checked="" type="checkbox"/> NAS168 [1] 93.00x114.00x11.50mm, PTFE	
					<input checked="" type="checkbox"/> NAS131 [2] 45.00x67.00x8.00mm, PTFE <input checked="" type="checkbox"/> NAS168 [1] 93.00x114.00x11.50mm, PTFE	

MERCEDES-BENZ



kW/PS

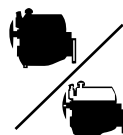









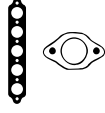

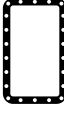
6.2 M 159.980 312

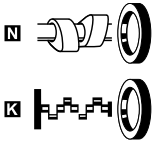
SLS Amg 6.2	06/13→	6208	8	102.20	DOHC, V	420-464/ 571-631
SLS Amg 6.2 GT	06/13→					
SLS Amg 6.2 Kom	03/10→					

6.3 M 137.980 313

S-Class 63 AMG	09/01→08/05	6258	12	84.50	V	326/444
S-Class CL63	09/01→03/06					

							
						<p> <input checked="" type="checkbox"/> NA5131  [2] 45.00x67.00x8.00mm, PTFE <input checked="" type="checkbox"/> NA5168  [1] 93.00x114.00x11.50mm, PTFE </p>	
						<p> <input checked="" type="checkbox"/> NA5131  [2] 45.00x67.00x8.00mm, PTFE <input checked="" type="checkbox"/> NA5168  [1] 93.00x114.00x11.50mm, PTFE </p>	



Ltr



CC



9

	Ltr				CC		
EXPRESS Box	1.4	03/00 → 05/00	14 K4F	Petrol	1396	4	1
EXPRESS Box	1.8	03/00 → 05/00	18 K4F	Petrol	1796	4	3
EXPRESS Box	1.8	03/00 → 05/00	18 K4K	Petrol	1796	4	4
MG TF	1.6	03/00 →	16 K4F	Petrol	1588	4	2
MG TF	1.8	03/00 →	18 K4F	Petrol	1796	4	3
MG TF	1.8	03/00 →	18 K4K	Petrol	1796	4	4
MG ZR	1.4	06/00 → 04/00	14 K4F	Petrol	1396	4	1
MG ZR	1.8	06/00 → 04/00	18 K4F	Petrol	1796	4	3
MG ZR	1.8	06/00 → 04/00	18 K4K	Petrol	1796	4	4
MG ZS Hatchback	1.6	11/00 → 10/00	16 K4F	Petrol	1588	4	2
MG ZS Hatchback	1.8	07/00 → 10/00	18 K4F	Petrol	1796	4	3
MG ZS Hatchback	2.5	07/00 → 10/00	25 K4F	Petrol	2497	6	6
MG ZS	1.6	07/00 → 04/00	16 K4F	Petrol	1588	4	2
MG ZS	1.8	07/00 → 04/00	18 K4F	Petrol	1796	4	3
MG ZS	2.5	07/00 → 04/00	25 K4F	Petrol	2497	6	6
MG ZT-T	1.8	01/00 → 07/00	18 K4F	Petrol	1796	4	3
MG ZT-T	2.0	06/00 → 07/00	204D2	Diesel	1951	4	5
MG ZT-T	2.5	10/00 → 07/00	25 K4F	Petrol	2497	6	6
MG ZT	1.8	01/00 → 07/00	18 K4F	Petrol	1796	4	3
MG ZT	2.0	06/00 → 07/00	204D2	Diesel	1951	4	5
MG ZT	2.5	06/00 → 07/00	25 K4F	Petrol	2497	6	6
MGF (RD)	1.6	02/00 → 03/00	16 K4F	Petrol	1588	4	2
MGF (RD)	1.8	03/99 → 03/00	18 K4F	Petrol	1796	4	3
MGF (RD)	1.8	03/99 → 03/00	18 K4K	Petrol	1796	4	4



cc



kW/PS



1.4		14 K4F					1	BW5750 (MLS) BW750 (SE)		DW5757 (MLS) DW757 (SE)	ER321 [3][112]
Express 1.4	03/03→05/05	1396	4	75.00	DOHC	76/103					
MG ZR 105	06/01→04/05										
1.6		16 K4F					2	BW5750 (MLS) BW750 (SE) KM5021 0.5mm, (Metal) [113]		DW5757 (MLS) DW757 (SE)	ER322 [3]
MG TF 115	03/02→	1588	4	80.00	DOHC	79-86/ 107-117					
MG ZS 1.6	11/01→10/05										
MGF 1.6	02/00→03/02										
1.8		18 K4F					3	BW5750 (MLS) BW750 (SE) KM5021 0.5mm, (Metal) [113]		DW5757 (MLS) DW757 (SE)	ER322 [3]
Express 1.8	03/03→05/05	1796	4	80.00	DOHC	86-100/ 117-136					
MG TF 120	03/02→										
MG TF 135	03/02→										
MG ZR 120	06/01→04/05										
MG ZS 120	07/01→10/05										
MG ZT 1.8 16V	01/03→07/05										
MG ZT+ 1.8 16V	01/03→07/05										
MGF 1.8 i 16V	03/95→03/02										
1.8		18 K4K					4	BW5750 (MLS) BW750 (SE) KM5021 0.5mm, (Metal) [113]		DW754 [3] (SE)	ER322 [3]
Express 160	03/03→05/05	1796	4	80.00	DOHC	107-118/ 146-160					
MG TF 160	03/02→										
MG ZR 160	06/01→04/05										
MGF 1.8 i VVC	10/01→03/02										
MGF 1.8 i VVC	03/95→03/02										
2.0		204D2 Diesel					5	BZ690 (MLS), 1.450mm, 1 Hole BZ700 (MLS), 1.550mm, 2 Holes BZ710 (MLS), 1.650mm, 3 Holes		DZ690 ▲ [13]	EZ690 [3]
MG ZT 2.0 CDTi	06/02→07/05	1951	4	84.00		85-96/ 116-131					
MG ZT+ 2.0 CDT	06/02→07/05										
2.5		25 K4F					6	AA5920 (MLS) (x2) KM5002 (Metal)		CA5920 [3]	EA5920
MG ZS 180	07/01→10/05	2497	6	80.00	DOHC, V	118-140/ 160-190					
MG ZT 160	06/01→07/05										
MG ZT 180	01/03→07/05										
MG ZT 190	06/01→07/05										
MG ZT+ 160	10/01→07/05										
MG ZT+ 180	01/03→07/05										
MG ZT+ 190	10/01→07/05										

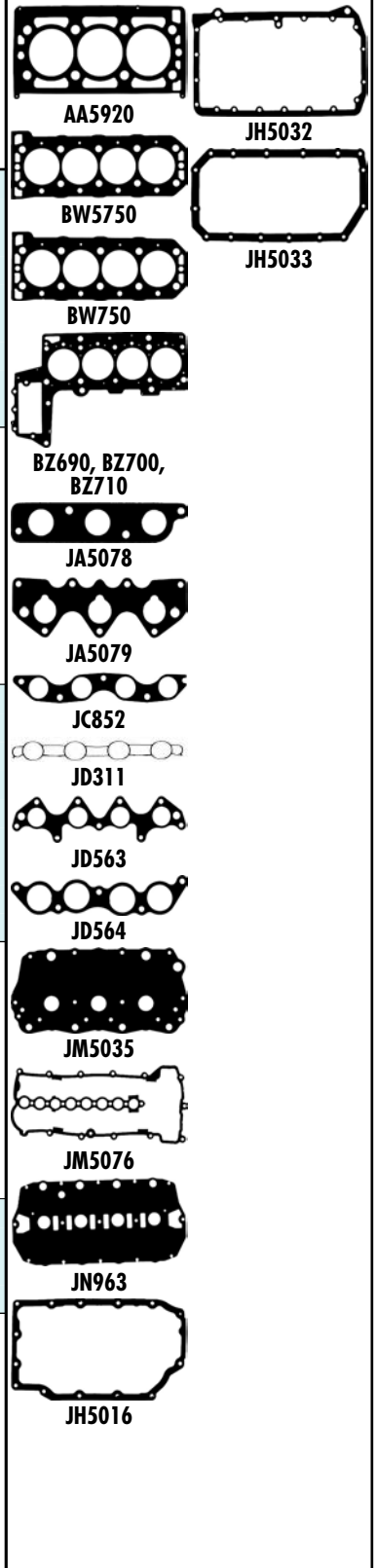



Ltr



CC



9

Model	Ltr	Year Range	Engine	Fuel	CC	Seats	Index
MINI (R50, R53)	1.4	06/00→09/00	1ND	Diesel	1364	4	1
MINI (R50, R53)	1.4	06/00→09/00	1ND-TV	Diesel	1364	4	2
MINI (R50, R53)	1.6	06/00→09/00	W10B16A	Petrol	1598	4	10
MINI (R50, R53)	1.6	03/00→09/00	W11B16A	Petrol	1598	4	11
MINI (R56)	1.4	03/00→	N12B14A	Petrol	1397	4	3
MINI (R56)	1.6	03/00→	9HZ (DV6TED4)	Diesel	1560	4	4
MINI (R56)	1.6	10/00→	N12B16A	Petrol	1598	4	5
MINI (R56)	1.6	10/00→	N14 B16 A	Petrol	1598	4	6
MINI (R56)	1.6	03/00→	N14 B16 C	Petrol	1598	4	7
MINI (R56)	1.6	03/01→	N16 B16 A	Petrol	1598	4	8
MINI (R56)	1.6	03/01→	N18 B16 A	Petrol	1598	4	9
MINI CLUBMAN (R55)	1.4	03/00→02/01	N12B14A	Petrol	1397	4	3
MINI CLUBMAN (R55)	1.6	10/00→	9HZ (DV6TED4)	Diesel	1560	4	4
MINI CLUBMAN (R55)	1.6	10/00→	N12B16A	Petrol	1598	4	5
MINI CLUBMAN (R55)	1.6	10/00→	N14 B16 A	Petrol	1598	4	6
MINI CLUBMAN (R55)	1.6	03/00→	N14 B16 C	Petrol	1598	4	7
MINI CLUBMAN (R55)	1.6	10/00→	N16 B16 A	Petrol	1598	4	8
MINI CLUBMAN (R55)	1.6	03/01→	N18 B16 A	Petrol	1598	4	9
MINI CLUBVAN (R55)	1.6	12/01→	N16 B16 A	Petrol	1598	4	8
MINI Convertible (R52)	1.6	07/00→11/00	W10B16A	Petrol	1598	4	10
MINI Convertible (R52)	1.6	07/00→11/00	W11B16A	Petrol	1598	4	11
MINI Convertible (R57)	1.6	03/00→	N12B16A	Petrol	1598	4	5
MINI Convertible (R57)	1.6	03/00→	N14 B16 A	Petrol	1598	4	6
MINI Convertible (R57)	1.6	03/00→	N14 B16 C	Petrol	1598	4	7
MINI Convertible (R57)	1.6	03/00→	N16 B16 A	Petrol	1598	4	8
MINI Convertible (R57)	1.6	03/01→	N18 B16 A	Petrol	1598	4	9
MINI COUNTRYMAN (R60)	1.6	06/01→	N16 B16 A	Petrol	1598	4	8
MINI COUNTRYMAN (R60)	1.6	06/01→	N18 B16 A	Petrol	1598	4	9
MINI Coupe (R58)	1.6	09/01→	N14 B16 C	Petrol	1598	4	7
MINI Coupe (R58)	1.6	09/01→	N16 B16 A	Petrol	1598	4	8
MINI Coupe (R58)	1.6	09/01→	N18 B16 A	Petrol	1598	4	9
MINI PACEMAN (R61)	1.6	04/01→	N16 B16 A	Petrol	1598	4	8
MINI PACEMAN (R61)	1.6	04/01→	N18 B16 A	Petrol	1598	4	9
MINI Roadster (R59)	1.6	02/01→	N14 B16 C	Petrol	1598	4	7
MINI Roadster (R59)	1.6	02/01→	N16 B16 A	Petrol	1598	4	8
MINI Roadster (R59)	1.6	02/01→	N18 B16 A	Petrol	1598	4	9



cc



kW/PS



1.4 1ND Diesel 1							AG7600 (MLS), 0.850mm →09/05	CG7600 ▲ →09/05	FG7600 ▲ →09/05
Mini One D	06/03→09/06	1364	4	73.00		55/75	AG7610 (MLS), 0.900mm →09/05		
							AG7620 (MLS), 0.950mm →09/05		
1.4 1ND-TV Diesel 2							AG7600 (MLS), 0.850mm →09/05	CG7600 ▲ →09/05	FG7600 ▲ →09/05
Mini One D	06/03→09/06	1364	4	73.00	SOHC/OHC	55-65/ 75-88	AG7610 (MLS), 0.900mm →09/05		
							AG7620 (MLS), 0.950mm →09/05		
1.4 N12B14A 3							AH6440 (MLS), 0.900mm	CH6440 (MLS)	
Clubman One	03/09→02/10	1397	4	77.00	DOHC	55-70/ 75-95			
Mini One	03/07→								
1.6 9HZ (DV6TED4) Diesel 4							AD5130 (MLS), 1.250mm, 2 Notches	CD5140 ▲	
Clubman CooperD	10/07→	1560	4	75.00	DOHC	66-80/ 90-109	AD5140 (MLS), 1.300mm, 3 Notches		
Mini Cooper D	03/07→						AD5150 (MLS), 1.350mm, 1 Notch		
Mini One D	06/09→07/10						AD5160 (MLS), 1.400mm, 4 Notches		
							AD5170 (MLS), 1.450mm, 5 Notches		
1.6 N12B16A 5							AH6440 (MLS), 0.900mm	CH6440 (MLS)	
Clubman Cooper	10/07→	1598	4	77.00	DOHC	85-88/ 116-120			
Mini Cooper	10/06→								
Mini C Cooper	03/09→								
1.6 N14 B16 A 6							AH6730 (MLS), 0.9mm	CH6730 (MLS)	
Clubman CooperS	10/07→	1598	4		DOHC	120-141/ 163-192			
Mini Cooper S	10/06→								
Mini J Cooper	01/12→								
Mini C Cooper S	03/09→								
1.6 N14 B16 C 7							AH6730 (MLS), 0.9mm	CH6730 (MLS)	
Clubman Cooper	03/08→	1598	4	77.00	DOHC	155/211			
Mini J Cooper	03/08→								
Mini C JC Works	03/08→								
Mini Coupe JC W	09/11→								
Mini Roadster	02/12→								
1.6 N16 B16 A 8							AH6440 (MLS), 0.900mm	CH6440 (MLS)	
Clubman Cooper	10/07→	1598	4	77.00	DOHC	55-90/ 75-122			
Clubman One	03/10→								
Clubvan Cooper	12/12→								
Clubvan One	12/12→								
Countryman	06/10→								
Countryman One	06/10→								
Mini Cooper	03/10→								
Mini One	03/10→								
Mini C Cooper	03/09→								
Mini C One	03/10→								
Mini Coupe	09/11→								
Mini Paceman	04/12→								
Mini Roadster	02/12→								

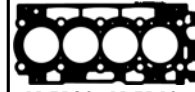

AD5130, AD5140,
AD5150, AD5160,
AD5170

	JD5959 (MLS)	JM5288			NA5260 [2] 38.00x50.00x6.00mm, FPM NA5088 [1] 75.00x107.00x8.00mm, FPM	
HBS490 [19] M12x1.75x180.00mm (x10)	JD5959 (MLS)	JM5288			NA5260 [2] 38.00x50.00x6.00mm, FPM NA5088 [1] 75.00x107.00x8.00mm, FPM	
HBS522 [21][57]	JD6034 (x4) (Elastomer)					
HBS359 [22] M11x1.50x147.00mm (x10)	JD5830 HA5031 HA5030 JD5829	JM7034 (Elastomer)			NA5258 [2] 27.00x47.00x7.00mm, PTFE NA5259 [2] 40.00x55.00x6.40mm, PTFE	
HBS522 [21][57]	JD6034 (x4) (Elastomer)					
HBS522 [21][57]						
HBS522 [21][57]						
HBS522 [21][57]	JD6034 (x4) (Elastomer)					



cc



kW/PS



1.6		N18 B16 A				9		AH6730 (MLS), 0.9mm		
Clubman CooperS	03/10→	1598	4	77.00	DOHC	120-160/ 163-218				
Countryman S	06/10→									
Countryman S 4	06/10→									
Countryman SJCW	09/12→									
Mini Cooper S	03/10→									
Mini C Cooper S	03/10→									
Mini Coupe S	09/11→									
Mini Paceman S	04/12→									
Mini Paceman S4	04/12→									
Mini Roadster S	02/12→									
1.6		W10B16A				10		AC5920 (MLS), 0.650mm		
Mini C Cooper	07/04→11/07	1598	4	77.00		66-85/ 90-116		CC5920 [3]	EC5921 →07/04	
Mini C One	07/04→11/07									
Mini Cooper	06/01→09/06									
Mini One	06/01→09/06									
1.6		W11B16A				11		AC5920 (MLS), 0.650mm		
Mini C Cooper S	07/04→11/07	1598	4	77.00		120-160/ 163-218		CC5921 [13]	EC5921 →07/04	
Mini Cooper S	03/02→09/06									
Mini J Cooper	03/06→09/06									
Mini JC Works	07/04→11/07									
Mini S Works	11/03→06/05									
Mini Works	11/03→09/06									

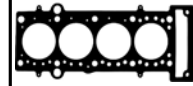
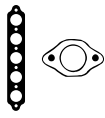

AC5920



JM5119



JH5051

HBS522 [21][57]

PA349
22.00x16.00x2.000mm

HBS496 [22]

JD5826 [1]
(Elastomer)
JD5827 [3]
(SE)

JM5119
(Elastomer)

JH5051

HR5061 [5]

NA5139 [2]
32.00x45.00x6.00mm, FPM
NA5140 [1]
91.00x111.00x10.00mm, FPM

HBS496 [22]

JD5827 [3]
(SE)

JM5119
(Elastomer)

JH5051

HR5061 [5]

NA5139 [2]
32.00x45.00x6.00mm, FPM
NA5140 [1]
91.00x111.00x10.00mm, FPM



Ltr







CC



9

Model	Ltr	Year Range	Engine	Fuel	CC	Seats	Price
380 (DB)	3.8	04/00→04/00	6G75	Petrol	3828	6	69
3000 GT (Z16A)	3.0	06/99→08/99	6G72 (DOHC 24V)	Petrol	2972	6	64
ASX (GA_W_)	1.6	05/01→	4A92	Petrol	1590	4	15
CANTER Platform/Chassis (FB_, FE_, FG_)	2.4	08/00→11/01	4G64 (8V)	Petrol	2351	4	51
CANTER Platform/Chassis (FB4_, FE4_)	2.5	09/99→09/99	4D56 (8V)	Diesel	2477	4	53
CANTER Platform/Chassis (FB6_, FE5_, FE6_)	2.8	10/99→07/00	4M40-2AT	Diesel	2835	4	61
CANTER Platform/Chassis (FB6_, FE5_, FE6_)	2.8	10/99→07/00	4M40-A	Diesel	2835	4	62
CARISMA (DA_)	1.6	07/99→06/00	4G92	Petrol	1597	4	20
CARISMA (DA_)	1.8	07/99→06/00	4G93	Petrol	1834	4	26
CARISMA (DA_)	1.8	09/99→06/00	4G93 (GDI)	Petrol	1834	4	27
CARISMA (DA_)	1.9	10/99→09/00	F8QT	Diesel	1870	4	30
CARISMA (DA_)	1.9	09/00→06/00	F9Q1	Diesel	1870	4	31
CARISMA (DA_)	1.9	09/00→06/00	F9Q2	Diesel	1870	4	32
CARISMA Saloon (DA_)	1.3	09/00→10/00	4G13 (12V)	Petrol	1299	4	4
CARISMA Saloon (DA_)	1.6	09/99→06/00	4G92	Petrol	1597	4	20
CARISMA Saloon (DA_)	1.8	09/99→06/00	4G93	Petrol	1834	4	26
CARISMA Saloon (DA_)	1.8	09/99→06/00	4G93 (GDI)	Petrol	1834	4	27
CARISMA Saloon (DA_)	1.9	10/99→09/00	F8QT	Diesel	1870	4	30
CARISMA Saloon (DA_)	1.9	09/00→06/00	F9Q1	Diesel	1870	4	31
CARISMA Saloon (DA_)	1.9	09/00→06/00	F9Q2	Diesel	1870	4	32
COLT CZC Convertible (RG)	1.5	05/00→07/00	4A91	Petrol	1499	4	9
COLT CZC Convertible (RG)	1.5	05/00→07/00	4A91	LPG	1499	4	9
COLT II (C1_A)	1.2	09/98→04/98	4G16	Petrol	1198	4	2
COLT II (C1_A)	1.3	06/98→04/98	G13B	Petrol	1299	4	7
COLT II (C1_A)	1.5	09/98→04/98	4G15	Petrol	1468	4	10
COLT II (C1_A)	1.5	09/98→04/98	G15B	Petrol	1468	4	14
COLT II (C1_A)	1.6	02/98→04/98	4G32 T/C	Petrol	1597	4	18
COLT II (C1_A)	1.6	07/98→04/98	G32BT	Petrol	1597	4	21
COLT II (C1_A)	1.8	09/98→04/98	4D65	Diesel	1796	4	22
COLT III (C5_A)	1.3	04/98→05/99	4G13 (12V)	Petrol	1299	4	4
COLT III (C5_A)	1.3	04/98→05/99	4G13 (8V)	Petrol	1299	4	6
COLT III (C5_A)	1.5	04/98→05/99	4G15	Petrol	1468	4	11
COLT III (C5_A)	1.5	07/99→05/99	4G15 (12V)	Petrol	1468	4	12
COLT III (C5_A)	1.6	04/98→05/99	4G61	Petrol	1596	4	19
COLT III (C5_A)	1.8	04/98→05/99	4D65	Diesel	1796	4	22
COLT III (C5_A)	1.8	06/99→05/99	4G67	Petrol	1836	4	25
COLT IV (CA_A)	1.3	04/99→04/99	4G13 (12V)	Petrol	1299	4	4
COLT IV (CA_A)	1.6	04/99→04/99	4G92	Petrol	1597	4	20
COLT IV (CA_A)	1.8	04/99→04/99	4G93	Petrol	1834	4	26
COLT PLUS VII (Z2_W)	1.3	08/00→	4A90	Petrol	1332	4	3
COLT PLUS VII (Z2_W)	1.3	08/00→	4A90	LPG	1332	4	3
COLT PLUS VII (Z2_W)	1.5	08/00→	4A91	Petrol	1499	4	9
COLT PLUS VII (Z2_W)	1.5	08/00→	4A91	LPG	1499	4	9
COLT V (CJ_, CP_)	1.3	05/99→09/00	4G13 (12V)	Petrol	1299	4	4
COLT V (CJ_, CP_)	1.3	09/00→09/00	4G13 (16V)	Petrol	1299	4	5
COLT V (CJ_, CP_)	1.5	09/99→09/00	4G15 (16V)	Petrol	1468	4	13
COLT V (CJ_, CP_)	1.6	05/99→09/00	4G92	Petrol	1597	4	20
COLT V (CJ_, CP_)	1.8	11/99→07/00	4G93	Petrol	1834	4	26
COLT VI (Z3_A, Z2_A)	1.1	10/00→06/01	3A91	Petrol	1124	3	1
COLT VI (Z3_A, Z2_A)	1.1	10/00→06/01	3A91	Bi-Fuel	1124	3	1
COLT VI (Z3_A, Z2_A)	1.3	06/00→	4A90	Petrol	1332	4	3
COLT VI (Z3_A, Z2_A)	1.3	06/00→	4A90	LPG	1332	4	3
COLT VI (Z3_A, Z2_A)	1.5	06/00→	4A91	Petrol	1499	4	9
COLT VI (Z3_A, Z2_A)	1.5	06/00→	4A91	LPG	1499	4	9
COLT VI (Z3_A, Z2_A)	1.5	09/00→02/00	4G15 (16V)	Petrol	1468	4	13
DEBONAIR (S1_A)	3.0	09/98→08/99	6G72 (DOHC 24V)	Petrol	2972	6	64
DEBONAIR (S1_A)	3.0	07/98→08/99	6G72 (SOHC 12V)	Petrol	2972	6	65
DEBONAIR (S2_A)	3.0	09/99→10/99	6G72 (SOHC 12V)	Petrol	2972	6	65
DIAMANTE Estate (F_W)	3.0	06/99→03/99	6G72 (SOHC 24V)	Petrol	2972	6	66
DIAMANTE Saloon (F2_A, F1_A)	2.5	05/99→07/99	6G73	Petrol	2497	6	57
DIAMANTE Saloon (F2_A, F1_A)	3.0	10/99→07/99	6G72 (DOHC 24V)	Petrol	2972	6	64
DIAMANTE Saloon (F4_A, F3_A)	2.5	09/00→11/00	6A13	Petrol	2498	6	56
DIAMANTE Saloon (F4_A, F3_A)	2.5	09/99→08/00	6G73	Petrol	2497	6	57
DIAMANTE Saloon (F4_A, F3_A)	3.0	06/99→08/00	6G72 (DOHC 24V)	Petrol	2972	6	64
DION MPV (CR_W)	2.0	12/99→10/00	4G94 (GDI)	Petrol	1999	4	42
ECLIPSE Convertible (D5_A)	1.8	05/99→03/00	4G93	Petrol	1834	4	26
ECLIPSE Convertible (D5_A)	2.4	05/99→03/00	4G64 (SOHC 16V)	Petrol/Petroleum Gas (LPG)	2351	4	49
ECLIPSE Convertible (D5_A)	2.4	05/99→03/00	4G64 (SOHC 16V)	Petrol	2351	4	49
ECLIPSE Convertible (D5_A)	2.4	05/99→03/00	4G64 (SOHC 16V)	CNG	2351	4	49
ECLIPSE Convertible (D5_A)	3.0	05/99→03/00	6G72 (DOHC 24V)	Petrol	2972	6	64

	Ltr				CC		9
ECLIPSE Convertible	1.8	12/98→03/99	4G37	Petrol	1755	4	24
ECLIPSE Convertible	1.8	04/99→04/99	4G93	Petrol	1834	4	26
ECLIPSE I (D2_A)	1.8	12/98→03/99	4G37	Petrol	1755	4	24
ECLIPSE I (D2_A)	2.0	04/99→11/99	4G63 (DOHC 16V)	Petrol	1997	4	37
ECLIPSE II (D3_A)	2.0	12/99→04/99	4G63 (DOHC 16V)	Petrol	1997	4	37
ECLIPSE II (D3_A)	2.0	04/99→04/99	4G63 T (DOHC 16V)	Petrol	1997	4	39
ECLIPSE III (D5_A)	2.4	05/99→03/00	4G64 (SOHC 16V)	Petrol/Petroleum Gas (LPG)	2351	4	49
ECLIPSE III (D5_A)	2.4	05/99→03/00	4G64 (SOHC 16V)	Petrol	2351	4	49
ECLIPSE III (D5_A)	2.4	05/99→03/00	4G64 (SOHC 16V)	CNG	2351	4	49
ECLIPSE III (D5_A)	3.0	05/99→03/00	6G72 (DOHC 24V)	Petrol	2972	6	64
ENDEAVOR (D8_W, D7_W)	3.8	01/00→08/01	6G75	Petrol	3828	6	69
FTO Coupe (DE_A)	1.8	09/99→07/00	4G93	Petrol	1834	4	26
GALANT III (E1_A)	1.6	06/98→04/99	4G32	Petrol	1597	4	17
GALANT III (E1_A)	1.8	06/98→04/99	4D65 T	Diesel	1796	4	23
GALANT III (E1_A)	2.0	06/98→04/99	4G63 (SOHC 8V)	Petrol	1997	4	38
GALANT III (E1_A)	2.0	06/98→04/99	4G63 T (SOHC 8V)	Petrol	1997	4	40
GALANT III (E1_A)	2.0	06/98→04/99	6G3B	Petrol	1997	4	47
GALANT III (E1_A)	2.4	06/98→04/99	4G64 (8V)	Petrol	2351	4	51
GALANT III (E1_A)	2.4	07/98→04/99	6G4B	Petrol	2351	4	52
GALANT IV (E3_A)	1.8	11/98→10/99	4D65 T	Diesel	1796	4	23
GALANT IV (E3_A)	1.8	11/98→10/99	4G37	Petrol	1755	4	24
GALANT IV (E3_A)	2.0	11/98→12/99	4G63 (DOHC 16V)	Petrol	1997	4	37
GALANT IV (E3_A)	2.0	04/98→12/99	4G63 (SOHC 8V)	Petrol	1997	4	38
GALANT IV Saloon (E3_A)	1.6	01/98→10/99	4G32	Petrol	1597	4	17
GALANT IV Saloon (E3_A)	1.8	01/98→10/99	4D65	Diesel	1796	4	22
GALANT IV Saloon (E3_A)	1.8	12/98→10/99	4D65 T	Diesel	1796	4	23
GALANT IV Saloon (E3_A)	1.8	11/98→10/99	4G37	Petrol	1755	4	24
GALANT IV Saloon (E3_A)	2.0	11/98→10/99	4G63 (DOHC 16V)	Petrol	1997	4	37
GALANT IV Saloon (E3_A)	2.0	11/98→12/99	4G63 (SOHC 8V)	Petrol	1997	4	38
GALANT Saloon (DJ_, ED_, EF_)	2.0	10/00→	4G94 (GDI)	Petrol	1999	4	42
GALANT Saloon (DJ_, ED_, EF_)	3.8	10/00→	6G75	Petrol	3828	6	69
GALANT V (E5_A, E7_A, E8_A)	1.8	02/99→08/99	4G93	Petrol	1834	4	26
GALANT V (E5_A, E7_A, E8_A)	1.8	11/99→08/99	4G93 (GDI)	Petrol	1834	4	27
GALANT V (E5_A, E7_A, E8_A)	2.0	11/99→08/99	4D68 T	Diesel	1998	4	35
GALANT V (E5_A, E7_A, E8_A)	2.0	11/99→08/99	4G63 (SOHC 8V)	Petrol	1997	4	38
GALANT V (E5_A, E7_A, E8_A)	2.0	11/99→08/99	6A12	Petrol	1999	6	43
GALANT V (E5_A, E7_A, E8_A)	2.5	11/99→09/99	6G73	Petrol	2497	6	57
GALANT V Saloon (E5_A, E7_A, E8_A)	1.8	02/99→08/99	4G93	Petrol	1834	4	26
GALANT V Saloon (E5_A, E7_A, E8_A)	1.8	11/99→08/99	4G93 (GDI)	Petrol	1834	4	27
GALANT V Saloon (E5_A, E7_A, E8_A)	2.0	11/99→08/99	4D68 T	Diesel	1998	4	35
GALANT V Saloon (E5_A, E7_A, E8_A)	2.0	11/99→08/99	4G63 (SOHC 8V)	Petrol	1997	4	38
GALANT V Saloon (E5_A, E7_A, E8_A)	2.0	11/99→08/99	6A12	Petrol	1999	6	43
GALANT V Saloon (E5_A, E7_A, E8_A)	2.5	11/99→08/99	6G73	Petrol	2497	6	57
GALANT VI (EA_)	1.8	11/99→10/00	4G93 (GDI)	Petrol	1834	4	27
GALANT VI (EA_)	2.0	09/99→10/00	4D68 (SOHC)	Diesel	1998	4	34
GALANT VI (EA_)	2.0	09/99→10/00	4D68 T	Diesel	1998	4	35
GALANT VI (EA_)	2.0	10/99→10/00	4G94 (GDI)	Petrol	1999	4	42
GALANT VI (EA_)	2.4	02/99→10/00	4G64 (GDI)	Petrol	2351	4	48
GALANT VI (EA_)	2.5	09/99→10/00	6A13	Petrol	2498	6	56
GALANT VI Estate (EA_)	2.0	09/99→10/00	4D68 (SOHC)	Diesel	1998	4	34
GALANT VI Estate (EA_)	2.4	02/99→10/00	4G64 (GDI)	Petrol	2351	4	48
GALANT VI Estate (EA_)	2.5	09/99→10/00	6A13	Petrol	2498	6	56
GALANT VI Estate (EA_)	2.8	10/99→07/00	4M40T	Diesel	2835	4	63
GALLOPER (JK-01)	2.5	09/99→12/00	D4BF	Diesel	2476	4	58
GALLOPER (JK-01)	2.5	09/99→12/00	D4BH	Diesel	2476	4	59
GRANDIS (N9_, N8_)	2.0	11/99→05/00	4G63 (SOHC 8V)	Petrol	1997	4	38
GRANDIS (N9_, N8_)	2.4	11/99→05/00	4G64 (GDI)	Petrol	2351	4	48
GRANDIS (N9_, N8_)	3.0	05/00→05/00	6G72 (DOHC 24V)	Petrol	2972	6	64
GRANDIS (NA_W)	2.0	09/00→	BSY	Diesel	1968	4	45
GRANDIS (NA_W)	2.0	02/00→	BWC	Diesel	1968	4	46
GTO Coupe (Z1_A)	3.0	06/98→08/00	6G72 (DOHC 24V)	Petrol	2972	6	64
GTO Coupe (Z1_A)	3.0	06/99→09/00	6G72T	Petrol	2972	6	67
KUDA (D05W)	1.8	06/99→04/00	4G37	Petrol	1755	4	24
L 200 (K3_T, K2_T, K1_T, KO_T)	1.6	04/98→10/99	4G32	Petrol	1597	4	17
L 200 (K3_T, K2_T, K1_T, KO_T)	2.0	11/98→08/99	4G63 (SOHC 8V)	Petrol	1997	4	38
L 200 (K3_T, K2_T, K1_T, KO_T)	2.4	11/98→05/99	4G64 (8V)	Petrol	2351	4	51
L 200 (K3_T, K2_T, K1_T, KO_T)	2.5	11/98→10/99	4D56 (8V)	Diesel	2477	4	53
L 200 (K3_T, K2_T, K1_T, KO_T)	2.5	11/99→08/99	4D56 T	Diesel	2477	4	54
L 200 (K3_T, K2_T, K1_T, KO_T)	3.0	11/98→08/99	6G72 (SOHC 12V)	Petrol	2972	6	65
L 200 (K7_T, K6_T)	2.0	06/99→12/00	4G63 (SOHC 8V)	Petrol	1997	4	38



Ltr







CC



9

Model	Ltr	Year Range	Engine	Fuel	CC	Gear	Price
L 200 (K7_T, K6_T)	2.4	06/99→12/00	4G64 (SOHC 16V)	Petrol/Petroleum Gas (LPG)	2351	4	49
L 200 (K7_T, K6_T)	2.4	06/99→12/00	4G64 (SOHC 16V)	Petrol	2351	4	49
L 200 (K7_T, K6_T)	2.4	06/99→12/00	4G64 (SOHC 16V)	CNG	2351	4	49
L 200 (K7_T, K6_T)	2.5	06/99→12/00	4D56 (8V)	Diesel	2477	4	53
L 200 (K7_T, K6_T)	2.5	08/00→12/00	4D56 T	Diesel	2477	4	54
L 200 (K7_T, K6_T)	2.5	06/99→12/00	4D56 TD	Diesel	2477	4	55
L 200 (K7_T, K6_T)	3.0	08/00→11/00	6G72 (DOHC 24V)	Petrol	2972	6	64
L 200 (KB_T, KA_T)	2.4	11/00→	4G64 (SOHC 16V)	Petrol/Petroleum Gas (LPG)	2351	4	49
L 200 (KB_T, KA_T)	2.4	11/00→	4G64 (SOHC 16V)	Petrol	2351	4	49
L 200 (KB_T, KA_T)	2.4	11/00→	4G64 (SOHC 16V)	CNG	2351	4	49
L 200 (KB_T, KA_T)	2.8	05/00→	4M40-A	Diesel	2835	4	62
L 200 (KB_T, KA_T)	3.2	07/00→	4M41	Diesel	3200	4	68
L 200 Platform/Chassis (K3_T, KO_T, K1_T, K2_T)	2.5	10/98→10/99	4D56 (8V)	Diesel	2477	4	53
L 200 Platform/Chassis (K3_T, KO_T, K1_T, K2_T)	2.5	09/99→10/99	4D56 T	Diesel	2477	4	54
L 200 Platform/Chassis (K3_T, KO_T, K1_T, K2_T)	3.0	09/99→10/99	6G72 (SOHC 12V)	Petrol	2972	6	65
L 200 Platform/Chassis (K6_T, K7_T)	2.4	10/99→12/00	4G64 (SOHC 16V)	Petrol/Petroleum Gas (LPG)	2351	4	49
L 200 Platform/Chassis (K6_T, K7_T)	2.4	10/99→12/00	4G64 (SOHC 16V)	Petrol	2351	4	49
L 200 Platform/Chassis (K6_T, K7_T)	2.4	10/99→12/00	4G64 (SOHC 16V)	CNG	2351	4	49
L 200 Platform/Chassis (K6_T, K7_T)	2.8	10/99→03/00	4M40-A	Diesel	2835	4	62
L 200 Platform/Chassis (K6_T, K7_T)	2.8	04/00→12/00	4M40-T	Diesel	2835	4	63
L 200 Platform/Chassis (K6_T, K7_T)	3.0	10/99→12/00	6G72 (SOHC 24V)	Petrol	2972	6	66
L 200 Platform/Chassis (KA_T, KB_T)	2.4	12/00→	4G64 (SOHC 16V)	Petrol/Petroleum Gas (LPG)	2351	4	49
L 200 Platform/Chassis (KA_T, KB_T)	2.4	12/00→	4G64 (SOHC 16V)	Petrol	2351	4	49
L 200 Platform/Chassis (KA_T, KB_T)	2.4	12/00→	4G64 (SOHC 16V)	CNG	2351	4	49
L 300 Box (PO_W, P1_W)	1.4	04/99→05/99	4G33	Petrol	1439	4	8
L 300 Box (PO_W, P1_W)	1.6	11/98→05/99	4G32	Petrol	1597	4	17
L 300 Box (PO_W, P1_W)	2.0	06/99→08/99	4G63 (DOHC 16V)	Petrol	1997	4	37
L 300 Box (PO_W, P1_W)	2.0	08/98→05/00	4G63 (SOHC 8V)	Petrol	1997	4	38
L 300 Box (PO_W, P1_W)	2.0	11/98→	G63B	Petrol	1997	4	47
L 300 Box (PO_W, P1_W)	2.4	09/99→	4G64 (SOHC 16V)	Petrol/Petroleum Gas (LPG)	2351	4	49
L 300 Box (PO_W, P1_W)	2.4	09/99→	4G64 (SOHC 16V)	Petrol	2351	4	49
L 300 Box (PO_W, P1_W)	2.4	09/99→	4G64 (SOHC 16V)	CNG	2351	4	49
L 300 Box (PO_W, P1_W)	2.4	11/98→08/99	4G64 (8V)	Petrol	2351	4	51
L 300 Box (PO_W, P1_W)	2.4	11/98→08/99	G64B	Petrol	2351	4	52
L 300 Box (PO_W, P1_W)	2.5	11/98→02/00	4D56 (8V)	Diesel	2477	4	53
L 300 Box (PO_W, P1_W)	2.5	02/98→05/00	4D56 T	Diesel	2477	4	54
L 300 Box (PO_W, P1_W)	2.8	09/99→10/99	4M40	Diesel	2835	4	60
L 300 Box (PO_W, P1_W)	3.0	06/99→05/00	6G72 (DOHC 24V)	Petrol	2972	6	64
L 300 Bus (PO_W, P1_W, P2_W)	1.6	11/98→	4G32	Petrol	1597	4	17
L 300 Bus (PO_W, P1_W, P2_W)	2.0	06/99→	4G63 (DOHC 16V)	Petrol	1997	4	37
L 300 Bus (PO_W, P1_W, P2_W)	2.0	11/98→	4G63 (SOHC 8V)	Petrol	1997	4	38
L 300 Bus (PO_W, P1_W, P2_W)	2.0	11/98→	G63B	Petrol	1997	4	47
L 300 Bus (PO_W, P1_W, P2_W)	2.4	09/99→05/00	4G64 (SOHC 16V)	Petrol/Petroleum Gas (LPG)	2351	4	49
L 300 Bus (PO_W, P1_W, P2_W)	2.4	09/99→05/00	4G64 (SOHC 16V)	Petrol	2351	4	49
L 300 Bus (PO_W, P1_W, P2_W)	2.4	09/99→05/00	4G64 (SOHC 16V)	CNG	2351	4	49
L 300 Bus (PO_W, P1_W, P2_W)	2.4	11/99→	4G64 (12V)	Petrol	2351	4	50
L 300 Bus (PO_W, P1_W, P2_W)	2.4	11/98→08/99	4G64 (8V)	Petrol	2351	4	51
L 300 Bus (PO_W, P1_W, P2_W)	2.4	11/98→12/99	G64B	Petrol	2351	4	52
L 300 Bus (PO_W, P1_W, P2_W)	2.5	11/98→	4D56 (8V)	Diesel	2477	4	53
L 300 Bus (PO_W, P1_W, P2_W)	2.5	02/98→	4D56 T	Diesel	2477	4	54
L 300 Bus (PO_W, P1_W, P2_W)	2.5	09/99→	4D56 TD	Diesel	2477	4	55
L 300 Bus (PO_W, P1_W, P2_W)	3.0	06/99→05/00	6G72 (DOHC 24V)	Petrol	2972	6	64
L 300 Platform/Chassis (LO3_P)	1.6	04/98→04/99	4G32	Petrol	1597	4	17
L 300 Platform/Chassis (LO3_P)	2.5	11/98→04/99	4D56 (8V)	Diesel	2477	4	53
L 300 Platform/Chassis (P1_T)	2.0	06/99→04/00	4G63 (DOHC 16V)	Petrol	1997	4	37
L 300 Platform/Chassis (P1_T)	2.5	11/99→04/00	4D56 T	Diesel	2477	4	54
L 400 / SPACE GEAR Bus (PD_W, PC_W, PA_V, PB_V)	2.0	05/99→10/00	4G63 (DOHC 16V)	Petrol	1997	4	37
L 400 / SPACE GEAR Bus (PD_W, PC_W, PA_V, PB_V)	2.4	05/99→06/00	4G64 (SOHC 16V)	Petrol/Petroleum Gas (LPG)	2351	4	49
L 400 / SPACE GEAR Bus (PD_W, PC_W, PA_V, PB_V)	2.4	05/99→06/00	4G64 (SOHC 16V)	Petrol	2351	4	49
L 400 / SPACE GEAR Bus (PD_W, PC_W, PA_V, PB_V)	2.4	05/99→06/00	4G64 (SOHC 16V)	CNG	2351	4	49
L 400 / SPACE GEAR Bus (PD_W, PC_W, PA_V, PB_V)	2.5	05/99→06/00	4D56 T	Diesel	2477	4	54
L 400 / SPACE GEAR Bus (PD_W, PC_W, PA_V, PB_V)	2.5	05/99→05/00	4D56 TD	Diesel	2477	4	55
L 400 Box (PD_W, PC_W, PB_V, PA_W, PA_V)	1.6	06/99→10/00	4G32	Petrol	1597	4	17
L 400 Box (PD_W, PC_W, PB_V, PA_W, PA_V)	2.0	06/99→10/00	4G63 (DOHC 16V)	Petrol	1997	4	37
L 400 Box (PD_W, PC_W, PB_V, PA_W, PA_V)	2.0	06/99→03/00	4G63 (SOHC 8V)	Petrol	1997	4	38
L 400 Box (PD_W, PC_W, PB_V, PA_W, PA_V)	2.4	06/99→10/00	4G64 (SOHC 16V)	Petrol/Petroleum Gas (LPG)	2351	4	49
L 400 Box (PD_W, PC_W, PB_V, PA_W, PA_V)	2.4	06/99→10/00	4G64 (SOHC 16V)	Petrol	2351	4	49
L 400 Box (PD_W, PC_W, PB_V, PA_W, PA_V)	2.4	06/99→10/00	4G64 (SOHC 16V)	CNG	2351	4	49
L 400 Box (PD_W, PC_W, PB_V, PA_W, PA_V)	2.5	09/99→06/00	4D56 T	Diesel	2477	4	54

	Ltr				CC		9
LANCER Coupe (CC)	1.8	09/99→07/99	4G93	Petrol	1834	4	26
LANCER Estate (CS_W)	1.6	09/00→10/00	4G18	Petrol	1584	4	16
LANCER Estate (CS_W)	2.0	09/00→12/00	4G63 (DOHC 16V)	Petrol	1997	4	37
LANCER Estate (CS_W)	2.0	08/00→10/00	4G94	Petrol	1999	4	41
LANCER Estate (CS_W)	2.4	09/00→10/00	4G64 (GDI)	Petrol	2351	4	48
LANCER III (C1_A, C6_A)	1.2	08/98→04/98	4G16	Petrol	1198	4	2
LANCER III (C1_A, C6_A)	1.5	11/98→04/98	4G15	Petrol	1468	4	10
LANCER III (C1_A, C6_A)	1.5	06/98→04/98	G15B	Petrol	1468	4	14
LANCER III (C1_A, C6_A)	1.8	09/98→04/98	4D65	Diesel	1796	4	22
LANCER III Station Wagon (C1_V, C3_V)	1.3	07/99→08/99	4G13 (12V)	Petrol	1299	4	4
LANCER III Station Wagon (C1_V, C3_V)	1.3	05/98→06/99	G13B	Petrol	1299	4	7
LANCER III Station Wagon (C1_V, C3_V)	1.5	09/98→12/99	4G15	Petrol	1468	4	11
LANCER III Station Wagon (C1_V, C3_V)	1.5	08/98→08/99	4G15 (12V)	Petrol	1468	4	12
LANCER III Station Wagon (C1_V, C3_V)	1.5	09/98→08/98	G15B	Petrol	1468	4	14
LANCER III Station Wagon (C1_V, C3_V)	1.8	08/98→06/99	4D65	Diesel	1796	4	22
LANCER III Station Wagon (C1_V, C3_V)	1.8	03/98→06/99	4G37	Petrol	1755	4	24
LANCER III Station Wagon (C1_V, C3_V)	1.8	01/98→08/98	G37B	Petrol	1755	4	29
LANCER IV (C6_A, C7_A)	1.3	06/99→05/99	4G13 (12V)	Petrol	1299	4	4
LANCER IV (C6_A, C7_A)	1.5	06/98→05/99	4G15	Petrol	1468	4	11
LANCER IV (C6_A, C7_A)	1.5	09/98→05/99	4G15 (12V)	Petrol	1468	4	12
LANCER IV (C6_A, C7_A)	1.6	05/98→09/99	4G61	Petrol	1596	4	19
LANCER IV (C6_A, C7_A)	1.6	06/99→05/99	4G92	Petrol	1597	4	20
LANCER IV (C6_A, C7_A)	1.8	04/98→05/99	4D65	Diesel	1796	4	22
LANCER IV (C6_A, C7_A)	1.8	09/98→07/99	4G37	Petrol	1755	4	24
LANCER IV (C6_A, C7_A)	1.8	11/98→05/99	4G67	Petrol	1836	4	25
LANCER IV (C6_A, C7_A)	1.8	06/99→12/99	4G93	Petrol	1834	4	26
LANCER IV (C6_A, C7_A)	2.0	06/99→07/99	4D68	Diesel	1998	4	33
LANCER IV Saloon (C6_A)	1.2	05/98→08/99	4G16	Petrol	1198	4	2
LANCER IV Saloon (C6_A)	1.3	07/99→06/99	4G13 (12V)	Petrol	1299	4	4
LANCER IV Saloon (C6_A)	1.3	04/98→05/99	4G13 (8V)	Petrol	1299	4	6
LANCER IV Saloon (C6_A)	1.3	05/98→05/99	G13B	Petrol	1299	4	7
LANCER IV Saloon (C6_A)	1.5	04/98→05/99	4G15	Petrol	1468	4	11
LANCER IV Saloon (C6_A)	1.5	09/98→08/99	4G15 (12V)	Petrol	1468	4	12
LANCER IV Saloon (C6_A)	1.6	05/98→08/99	4G61	Petrol	1596	4	19
LANCER IV Saloon (C6_A)	1.8	04/98→05/99	4D65	Diesel	1796	4	22
LANCER Saloon (CS_A)	1.3	09/00→	4G13 (16V)	Petrol	1299	4	5
LANCER Saloon (CS_A)	1.6	09/00→	4G18	Petrol	1584	4	16
LANCER Saloon (CS_A)	1.8	09/00→	4G93	Petrol	1834	4	26
LANCER Saloon (CS_A)	2.0	09/00→	4G63 (DOHC 16V)	Petrol	1997	4	37
LANCER Saloon (CS_A)	2.0	08/00→	4G94	Petrol	1999	4	41
LANCER Saloon (CS_A)	2.0	09/00→	4G94 (GDI)	Petrol	1999	4	42
LANCER Saloon (CS_A)	2.4	09/00→	4G64 (GDI)	Petrol	2351	4	48
LANCER Saloon (CY/Z_A)	1.5	06/00→	4A91	Petrol	1499	4	9
LANCER Saloon (CY/Z_A)	1.5	06/00→	4A91	LPG	1499	4	9
LANCER Saloon (CY/Z_A)	1.6	05/01→	4A92	Petrol	1590	4	15
LANCER Saloon (CY/Z_A)	2.0	01/00→	BKD	Diesel	1968	4	44
LANCER Saloon (CY/Z_A)	2.0	01/00→	BWC	Diesel	1968	4	46
LANCER SPORTBACK (CX_A)	1.5	06/00→	4A91	Petrol	1499	4	9
LANCER SPORTBACK (CX_A)	1.5	06/00→	4A91	LPG	1499	4	9
LANCER SPORTBACK (CX_A)	1.6	05/01→	4A92	Petrol	1590	4	15
LANCER SPORTBACK (CX_A)	2.0	06/00→	BKD	Diesel	1968	4	44
LANCER SPORTBACK (CX_A)	2.0	06/00→	BWC	Diesel	1968	4	46
LANCER V (CB/D_A)	1.3	06/99→12/99	4G13 (12V)	Petrol	1299	4	4
LANCER V (CB/D_A)	1.5	09/99→07/99	4G15 (12V)	Petrol	1468	4	12
LANCER V (CB/D_A)	1.6	06/99→12/99	4G92	Petrol	1597	4	20
LANCER V (CB/D_A)	1.8	06/99→07/99	4G37	Petrol	1755	4	24
LANCER V (CB/D_A)	1.8	06/99→12/99	4G93	Petrol	1834	4	26
LANCER V (CB/D_A)	2.0	06/99→12/99	4D68	Diesel	1998	4	33
LANCER V Station Wagon (CB_W, CD_W)	1.3	09/99→08/00	4G13 (12V)	Petrol	1299	4	4
LANCER V Station Wagon (CB_W, CD_W)	1.5	03/99→10/00	4G15 (12V)	Petrol	1468	4	12
LANCER V Station Wagon (CB_W, CD_W)	1.6	12/99→10/00	4G92	Petrol	1597	4	20
LANCER V Station Wagon (CB_W, CD_W)	1.8	03/99→10/00	4G93	Petrol	1834	4	26
LANCER V Station Wagon (CB_W, CD_W)	2.0	12/99→10/00	4D68	Diesel	1998	4	33
LANCER V Station Wagon (CB_W, CD_W)	2.0	03/99→10/00	4D68 T	Diesel	1998	4	35
LANCER VI (CJ-CP_)	1.3	12/99→08/00	4G13 (12V)	Petrol	1299	4	4
LANCER VI (CJ-CP_)	1.5	09/99→08/99	4G15 (12V)	Petrol	1468	4	12
LANCER VI (CJ-CP_)	1.5	12/99→08/00	4G15 (16V)	Petrol	1468	4	13
LANCER VI (CJ-CP_)	1.6	12/99→08/00	4G92	Petrol	1597	4	20
LANCER VI (CJ-CP_)	1.8	09/99→08/00	4G93	Petrol	1834	4	26



Ltr







CC



9

Model	Ltr	Year Range	Engine	Fuel	CC	Gear	Price
LANCER VI (CJ-CP_)	1.8	06/00→08/00	4G93 (GDI)	Petrol	1834	4	27
LANCER VI (CJ-CP_)	1.8	09/99→08/00	4G93T	Petrol	1834	4	28
LANCER VI (CJ-CP_)	2.0	09/99→08/00	4D68	Diesel	1998	4	33
LANCER VI (CJ-CP_)	2.0	09/99→08/00	4G94 (GDI)	Petrol	1999	4	42
LANCER VI (CJ-CP_)	2.4	09/99→08/00	4G64 (GDI)	Petrol	2351	4	48
MAGNA Estate (TE)	3.0	04/99→06/99	6G72 (SOHC 24V)	Petrol	2972	6	66
MAGNA Estate (TW, TJ, TF, TL, TH, TE)	3.0	06/99→05/00	6G72 (DOHC 24V)	Petrol	2972	6	64
MAGNA Saloon (TL, TJ, TH, TE, TW, TF)	2.4	04/99→03/99	4G64 (SOHC 16V)	Petrol/Petroleum Gas (LPG)	2351	4	49
MAGNA Saloon (TL, TJ, TH, TE, TW, TF)	2.4	04/99→03/99	4G64 (SOHC 16V)	Petrol	2351	4	49
MAGNA Saloon (TL, TJ, TH, TE, TW, TF)	2.4	04/99→03/99	4G64 (SOHC 16V)	CNG	2351	4	49
MAGNA Saloon (TL, TJ, TH, TE, TW, TF)	3.0	06/99→05/00	6G72 (DOHC 24V)	Petrol	2972	6	64
MAGNA Saloon (TL, TJ, TH, TE, TW, TF)	3.0	04/99→07/00	6G72 (SOHC 24V)	Petrol	2972	6	66
MAGNA Saloon (TS, TR)	2.5	04/99→06/99	6G73	Petrol	2497	6	57
MAGNA Saloon (TS, TR)	3.0	05/99→06/99	6G72 (DOHC 24V)	Petrol	2972	6	64
MAGNA Saloon (TS, TR)	3.0	05/99→06/99	6G72 (SOHC 24V)	Petrol	2972	6	66
MAVEN	1.5	09/00→	4G15 (12V)	Petrol	1468	4	12
MIRAGE Coupe	1.3	12/99→08/99	4G13 (12V)	Petrol	1299	4	4
MIRAGE Coupe	1.5	12/99→08/99	4G15 (12V)	Petrol	1468	4	12
MIRAGE Estate	1.8	08/00→07/00	4G93	Petrol	1834	4	26
MIRAGE Hatchback	1.3	05/98→07/00	4G13 (12V)	Petrol	1299	4	4
MIRAGE Hatchback	1.3	05/98→11/99	4G13 (8V)	Petrol	1299	4	6
MIRAGE Hatchback	1.5	05/98→08/99	4G15 (12V)	Petrol	1468	4	12
MIRAGE Hatchback	1.5	05/98→06/99	G15B	Petrol	1468	4	14
MIRAGE Hatchback	1.6	06/98→11/99	4G61	Petrol	1596	4	19
MIRAGE Hatchback	1.6	12/99→07/00	4G92	Petrol	1597	4	20
MIRAGE Hatchback	1.8	12/99→07/00	4G93	Petrol	1834	4	26
MIRAGE Hatchback	2.0	09/99→07/00	4D68 T	Diesel	1998	4	35
MIRAGE Hatchback	2.0	09/99→08/99	4G63 (SOHC 8V)	Petrol	1997	4	38
MIRAGE Saloon	1.3	07/99→08/99	4G13 (12V)	Petrol	1299	4	4
MIRAGE Saloon	1.3	05/98→11/99	4G13 (8V)	Petrol	1299	4	6
MIRAGE Saloon	1.5	05/98→08/99	4G15 (12V)	Petrol	1468	4	12
MIRAGE Saloon	1.5	05/98→11/99	G15B	Petrol	1468	4	14
MIRAGE Saloon	1.8	05/98→11/99	4D65	Diesel	1796	4	22
MIRAGE Saloon	1.8	12/99→08/99	4D65 T	Diesel	1796	4	23
MIRAGE Saloon	1.8	12/99→10/99	4G93	Petrol	1834	4	26
MIRAGE Saloon	1.8	09/99→08/99	4G93T	Petrol	1834	4	28
MIRAGE Saloon	2.0	12/99→08/99	4D68	Diesel	1998	4	33
MIRAGE Saloon	2.0	12/99→07/00	4D68 T	Diesel	1998	4	35
MIRAGE Saloon	2.0	09/99→08/99	4G63 (SOHC 8V)	Petrol	1997	4	38
MIRAGE Saloon	2.0	09/99→08/99	4G63 (SOHC 8V)	Petrol	1997	4	37
OUTLANDER I (CU_W)	2.0	05/00→10/00	4G63 (DOHC 16V)	Petrol	1997	4	39
OUTLANDER I (CU_W)	2.0	04/00→10/00	4G63 T (DOHC 16V)	Petrol	1997	4	39
OUTLANDER I (CU_W)	2.4	05/00→10/00	4G64 (SOHC 16V)	Petrol/Petroleum Gas (LPG)	2351	4	49
OUTLANDER I (CU_W)	2.4	05/00→10/00	4G64 (SOHC 16V)	Petrol	2351	4	49
OUTLANDER I (CU_W)	2.4	05/00→10/00	4G64 (SOHC 16V)	CNG	2351	4	49
OUTLANDER II (CW_W)	2.0	02/00→	BSY	Diesel	1968	4	45
OUTLANDER II Van (CW_W)	2.0	12/00→	BSY	Diesel	1968	4	45
PAJERO CLASSIC (V2_W)	2.5	07/00→	4D56 T	Diesel	2477	4	54
PAJERO CLASSIC (V2_W)	2.8	06/00→	4M40-T	Diesel	2835	4	63
PAJERO CLASSIC (V2_W)	3.0	08/00→	6G72 (DOHC 24V)	Petrol	2972	6	64
PAJERO CLASSIC (V2_W)	3.2	05/00→	4M41	Diesel	3200	4	68
PAJERO CLASSIC (V2_W)	3.8	06/00→	6G75	Petrol	3828	6	69
PAJERO I (L04_G, L14_G)	2.0	01/98→02/99	G63B	Petrol	1997	4	47
PAJERO I (L04_G, L14_G)	2.5	10/98→12/99	4D56 T	Diesel	2477	4	54
PAJERO I (L04_G, L14_G)	3.0	05/98→05/99	6G72 (SOHC 12V)	Petrol	2972	6	65
PAJERO I Canvas Top (L04_G)	2.5	05/98→11/99	4D56 T	Diesel	2477	4	54
PAJERO II (V3_W, V2_W, V4_W)	2.4	04/99→10/99	4G64 (12V)	Petrol	2351	4	50
PAJERO II (V3_W, V2_W, V4_W)	2.5	03/99→08/99	4D56 T	Diesel	2477	4	54
PAJERO II (V3_W, V2_W, V4_W)	2.5	12/99→10/99	4D56 TD	Diesel	2477	4	55
PAJERO II (V3_W, V2_W, V4_W)	2.8	11/99→07/99	4M40-A	Diesel	2835	4	62
PAJERO II (V3_W, V2_W, V4_W)	2.8	06/99→10/99	4M40-T	Diesel	2835	4	63
PAJERO II (V3_W, V2_W, V4_W)	3.0	12/99→12/99	6G72 (SOHC 12V)	Petrol	2972	6	65
PAJERO II (V3_W, V2_W, V4_W)	3.0	06/99→10/99	6G72 (SOHC 24V)	Petrol	2972	6	66
PAJERO II Canvas Top (V2_W, V4_W)	1.8	06/99→04/00	4G93 (GDI)	Petrol	1834	4	27
PAJERO II Canvas Top (V2_W, V4_W)	2.4	04/99→04/00	4G64 (12V)	Petrol	2351	4	50
PAJERO II Canvas Top (V2_W, V4_W)	2.5	03/99→08/99	4D56 T	Diesel	2477	4	54
PAJERO II Canvas Top (V2_W, V4_W)	2.5	12/99→04/00	4D56 TD	Diesel	2477	4	55
PAJERO II Canvas Top (V2_W, V4_W)	3.0	12/99→12/99	6G72 (SOHC 12V)	Petrol	2972	6	65
PAJERO II Canvas Top (V2_W, V4_W)	3.0	06/99→04/00	6G72 (SOHC 24V)	Petrol	2972	6	66
PAJERO III (V7_W, V6_W)	2.5	04/00→12/00	4D56 T	Diesel	2477	4	54

	Ltr				CC		9
PAJERO III (V7_W, V6_W)	3.2	04/00→12/00	4M41	Diesel	3200	4	68
PAJERO III Canvas Top (V6_W, V7_W)	2.5	04/00→12/00	4D56 T	Diesel	2477	4	54
PAJERO III Canvas Top (V6_W, V7_W)	3.0	10/00→12/00	6G72 (SOHC 24V)	Petrol	2972	6	66
PAJERO III Canvas Top (V6_W, V7_W)	3.2	04/00→12/00	4M41	Diesel	3200	4	68
PAJERO IV (V8_W, V9_W)	3.0	02/00→	6G72 (SOHC 24V)	Petrol	2972	6	66
PAJERO IV (V8_W, V9_W)	3.2	02/00→	4M41	Diesel	3200	4	68
PAJERO IV (V8_W, V9_W)	3.8	02/00→	6G75	Petrol	3828	6	69
PAJERO IV Van (V90, V80)	3.2	11/00→	4M41	Diesel	3200	4	68
PAJERO PININ (H6_W, H7_W)	1.8	11/00→06/00	4G93	Petrol	1834	4	26
PAJERO PININ (H6_W, H7_W)	1.8	10/99→06/00	4G93 (GDI)	Petrol	1834	4	27
PAJERO PININ (H6_W, H7_W)	2.0	10/00→06/00	4G94 (GDI)	Petrol	1999	4	42
PAJERO SPORT (K90)	1.8	03/00→02/00	4G93	Petrol	1834	4	26
PAJERO SPORT (K90)	1.8	05/99→02/00	4G93 (GDI)	Petrol	1834	4	27
PAJERO SPORT (K90)	2.0	10/00→02/00	4G94 (GDI)	Petrol	1999	4	42
PAJERO SPORT (K90)	2.5	11/99→	4D56 T	Diesel	2477	4	54
PAJERO SPORT (K90)	2.8	11/99→10/00	4M40-T	Diesel	2835	4	63
PAJERO SPORT (K90)	3.0	03/00→	6G72 (DOHC 24V)	Petrol	2972	6	64
PAJERO SPORT (K90)	3.0	11/99→	6G72 (SOHC 24V)	Petrol	2972	6	66
PAJERO SPORT (K90)	3.2	11/99→	4M41	Diesel	3200	4	68
PAJERO SPORT II (KG_, KH_)	2.4	07/00→	4G64 (SOHC 16V)	Petrol/Petroleum Gas (LPG)	2351	4	49
PAJERO SPORT II (KG_, KH_)	2.4	07/00→	4G64 (SOHC 16V)	Petrol	2351	4	49
PAJERO SPORT II (KG_, KH_)	2.4	07/00→	4G64 (SOHC 16V)	CNG	2351	4	49
PAJERO SPORT II (KG_, KH_)	2.5	09/00→	4D56 T	Diesel	2477	4	54
PAJERO SPORT II (KG_, KH_)	3.2	07/00→	4M41	Diesel	3200	4	68
PAJERO SPORT VAN (K90)	2.5	12/99→01/00	4D56 T	Diesel	2477	4	54
PAJERO SPORT VAN (K90)	3.0	12/99→01/00	6G72 (DOHC 24V)	Petrol	2972	6	64
SANTAMO	2.0	05/99→12/00	4G63 (DOHC 16V)	Petrol	1997	4	37
SAPORO III (E16A)	2.4	06/98→08/99	4G64 (8V)	Petrol	2351	4	51
SAVRIN	2.0	01/00→12/00	4G63 (DOHC 16V)	Petrol	1997	4	37
SIGMA (F2_A, F1_A)	3.0	12/99→07/99	6G72 (DOHC 24V)	Petrol	2972	6	64
SIGMA (F2_A, F1_A)	3.0	12/99→07/99	6G72 (SOHC 12V)	Petrol	2972	6	65
SIGMA Station Wagon (FO_W)	3.0	06/99→10/99	6G72 (SOHC 12V)	Petrol	2972	6	65
SPACE RUNNER (N1_W, N2_W)	1.8	10/99→08/99	4G93	Petrol	1834	4	26
SPACE RUNNER (N1_W, N2_W)	2.0	10/99→08/99	4D68 T	Diesel	1998	4	35
SPACE RUNNER (N1_W, N2_W)	2.0	06/99→08/99	4G63 (DOHC 16V)	Petrol	1997	4	37
SPACE RUNNER (N6_W)	2.0	08/99→08/00	4G63 (DOHC 16V)	Petrol	1997	4	37
SPACE RUNNER (N6_W)	2.4	08/99→08/00	4G64 (GDI)	Petrol	2351	4	48
SPACE STAR (DG_A)	1.3	06/99→12/00	4G13 (16V)	Petrol	1299	4	5
SPACE STAR (DG_A)	1.6	01/00→12/00	4G18	Petrol	1584	4	16
SPACE STAR (DG_A)	1.6	04/00→12/00	4G92	Petrol	1597	4	20
SPACE STAR (DG_A)	1.8	10/00→12/00	4G93	Petrol	1834	4	26
SPACE STAR (DG_A)	1.8	06/99→12/00	4G93 (GDI)	Petrol	1834	4	27
SPACE STAR (DG_A)	1.9	02/00→12/00	F9Q1	Diesel	1870	4	31
SPACE STAR (DG_A)	1.9	10/00→12/00	F9Q2	Diesel	1870	4	32
SPACE WAGON (DO_V/W)	1.8	06/98→04/99	4D65 T	Diesel	1796	4	23
SPACE WAGON (DO_V/W)	1.8	01/98→12/98	4G37	Petrol	1755	4	24
SPACE WAGON (DO_V/W)	1.8	09/98→04/99	G37B	Petrol	1755	4	29
SPACE WAGON (DO_V/W)	2.0	03/98→01/99	4G63 (SOHC 8V)	Petrol	1997	4	38
SPACE WAGON (DO_V/W)	2.0	06/98→05/98	G63B	Petrol	1997	4	47
SPACE WAGON (N3_W, N4_W)	1.8	10/99→10/99	4D65 T	Diesel	1796	4	23
SPACE WAGON (N3_W, N4_W)	1.8	10/99→10/99	4G93	Petrol	1834	4	26
SPACE WAGON (N3_W, N4_W)	2.0	10/99→10/99	4D68 T	Diesel	1998	4	36
SPACE WAGON (N3_W, N4_W)	2.0	10/99→10/99	4G63 (DOHC 16V)	Petrol	1997	4	37
SPACE WAGON (N3_W, N4_W)	2.4	10/99→10/99	4G64 (SOHC 16V)	Petrol/Petroleum Gas (LPG)	2351	4	49
SPACE WAGON (N3_W, N4_W)	2.4	10/99→10/99	4G64 (SOHC 16V)	Petrol	2351	4	49
SPACE WAGON (N3_W, N4_W)	2.4	10/99→10/99	4G64 (SOHC 16V)	CNG	2351	4	49
SPACE WAGON (N9_W, N8_W)	1.8	05/00→08/00	4G93	Petrol	1834	4	26
SPACE WAGON (N9_W, N8_W)	2.0	10/99→12/00	4G63 (DOHC 16V)	Petrol	1997	4	37
SPACE WAGON (N9_W, N8_W)	2.4	10/99→12/00	4G64 (GDI)	Petrol	2351	4	48
SPACE WAGON (N9_W, N8_W)	2.4	11/99→04/00	4G64 (SOHC 16V)	Petrol/Petroleum Gas (LPG)	2351	4	49
SPACE WAGON (N9_W, N8_W)	2.4	11/99→04/00	4G64 (SOHC 16V)	Petrol	2351	4	49
SPACE WAGON (N9_W, N8_W)	2.4	11/99→04/00	4G64 (SOHC 16V)	CNG	2351	4	49
SPACE WAGON (N9_W, N8_W)	3.0	05/00→05/00	6G72 (DOHC 24V)	Petrol	2972	6	64
TREDIA (A21_)	2.0	10/98→03/98	4G63 (SOHC 8V)	Petrol	1997	4	38
VERADA Estate (KR, KS)	3.0	10/99→09/99	6G72 (DOHC 24V)	Petrol	2972	6	64
VERADA Estate (KR, KS)	3.0	03/99→09/99	6G72 (SOHC 24V)	Petrol	2972	6	66
VERADA Saloon (KR, KS)	3.0	10/99→05/99	6G72 (DOHC 24V)	Petrol	2972	6	64
VERADA Saloon (KR, KS)	3.0	07/99→05/99	6G72 (SOHC 12V)	Petrol	2972	6	65
VERADA Saloon (KR, KS)	3.0	03/99→05/99	6G72 (SOHC 24V)	Petrol	2972	6	66



Ltr











CC



9

	Ltr				CC		
VERADA Saloon (KW, KJ, KF, KE, KL, KH)	3.0	06/99→09/00	6G72 (DOHC 24V)	Petrol	2972	6	64
VERADA Saloon (KW, KJ, KF, KE, KL, KH)	3.0	06/99→09/00	6G72 (SOHC 12V)	Petrol	2972	6	65
VERYCA Box Body / Estate (CA9_W, CA8_W)	1.3	10/01→	4G13 (16V)	Petrol	1299	4	5
ZINGER MPV (KBO_A)	2.4	10/00→	4G64 (SOHC 16V)	Petrol/Petroleum Gas (LPG)	2351	4	49
ZINGER MPV (KBO_A)	2.4	10/00→	4G64 (SOHC 16V)	Petrol	2351	4	49
ZINGER MPV (KBO_A)	2.4	10/00→	4G64 (SOHC 16V)	CNG	2351	4	49

		CC			9			CC			9
3A91	Petrol	1124	3	75.00	1	G13B	Petrol	1299	4	71.00	7
3A91	Bi-Fuel	1124	3	75.00	1	G15B	Petrol	1468	4	75.50	14
4A90	Petrol	1332	4	75.00	3	G32BT	Petrol	1597	4	76.90	21
4A90	LPG	1332	4	75.00	3	G37B	Petrol	1755	4	80.60	29
4A91	Petrol	1499	4	75.00	9	G63B	Petrol	1997	4	85.00	47
4A91	LPG	1499	4	75.00	9	G64B	Petrol	2351	4	86.50	52
4A92	Petrol	1590	4	75.00	15						
4D56 (8V)	Diesel	2477	4	91.10	53						
4D56 T	Diesel	2477	4	91.10	54						
4D56 TD	Diesel	2477	4	91.10	55						
4D65	Diesel	1796	4	80.60	22						
4D65 T	Diesel	1796	4	80.60	23						
4D68	Diesel	1998	4	82.70	33						
4D68 (SOHC)	Diesel	1998	4	82.70	34						
4D68 T	Diesel	1998	4	82.70	35						
4D68 T	Diesel	1998	4	82.70	36						
4G13 (12V)	Petrol	1299	4	71.00	4						
4G13 (16V)	Petrol	1299	4	71.00	5						
4G13 (8V)	Petrol	1299	4	71.00	6						
4G15	Petrol	1468	4	75.50	10						
4G15	Petrol	1468	4	75.50	11						
4G15 (12V)	Petrol	1468	4	75.50	12						
4G15 (16V)	Petrol	1468	4	75.50	13						
4G16	Petrol	1198	4	68.20	2						
4G18	Petrol	1584	4	76.00	16						
4G32	Petrol	1597	4	76.90	17						
4G32 T/C	Petrol	1597	4		18						
4G33	Petrol	1439	4	73.00	8						
4G37	Petrol	1755	4	80.60	24						
4G61	Petrol	1596	4	82.30	19						
4G63 (DOHC 16V)	Petrol	1997	4	85.00	37						
4G63 (SOHC 8V)	Petrol	1997	4	85.00	38						
4G63 T (DOHC 16V)	Petrol	1997	4	85.00	39						
4G63 T (SOHC 8V)	Petrol	1997	4	85.00	40						
4G64 (GDI)	Petrol	2351	4	86.50	48						
4G64 (SOHC 16V)	Petrol/ Petroleum Gas (LPG)	2351	4	86.50	49						
4G64 (SOHC 16V)	Petrol	2351	4	86.50	49						
4G64 (SOHC 16V)	CNG	2351	4	86.50	49						
4G64 (12V)	Petrol	2351	4	86.50	50						
4G64 (8V)	Petrol	2351	4	86.50	51						
4G67	Petrol	1836	4	81.50	25						
4G92	Petrol	1597	4	82.30	20						
4G93	Petrol	1834	4	81.00	26						
4G93 (GDI)	Petrol	1834	4	81.00	27						
4G93T	Petrol	1834	4	81.00	28						
4G94	Petrol	1999	4	81.50	41						
4G94 (GDI)	Petrol	1999	4	81.50	42						
4M40	Diesel	2835	4	95.00	60						
4M40-2AT	Diesel	2835	4	95.00	61						
4M40-A	Diesel	2835	4	95.00	62						
4M40-T	Diesel	2835	4	95.00	63						
4M41	Diesel	3200	4	98.50	68						
6A12	Petrol	1999	6	78.40	43						
6A13	Petrol	2498	6	81.00	56						
6G72 (DOHC 24V)	Petrol	2972	6	91.10	64						
6G72 (SOHC 12V)	Petrol	2972	6	91.10	65						
6G72 (SOHC 24V)	Petrol	2972	6	91.10	66						
6G72T	Petrol	2972	6	91.10	67						
6G73	Petrol	2497	6	83.50	57						
6G75	Petrol	3828	6	95.00	69						
BKD	Diesel	1968	4	81.00	44						
BSY	Diesel	1968	4	81.00	45						
BWC	Diesel	1968	4	81.00	46						
D4BF	Diesel	2476	4	91.10	58						
D4BH	Diesel	2476	4	91.10	59						
F8QT	Diesel	1870	4	80.00	30						
F9Q1	Diesel	1870	4	80.00	31						
F9Q2	Diesel	1870	4	80.00	32						



cc



kW/PS



1.1		3A91					1	AH7130 (MLS)			
Colt VI 1.1	10/04→	1124	3	75.00	DOHC	55/75					
Colt VI 1.1 Bi	10/04→										
1.2		4G16					2	BE060 (Graphite)			
Colt II 1.2	09/86→04/88	1198	4	68.20	SOHC/OHC	40-44/ 55-60					
Lancer III 1.2	08/86→04/88										
Lancer IV 1.2	05/88→08/92										
1.3		4A90					3	AG9920 (MLS)			
Colt VI 1.3	06/04→	1332	4	75.00	DOHC	67-70/ 91-95					
Colt VI 1.3 Bi	06/04→										
Colt VII 1.3	08/04→										
1.3		4G13 (12V)					4	BT430 (Graphite)		DT430	GT430
Carisma 1.3	09/00→10/04	1299	4	71.00	SOHC/OHC	44-58/ 60-79	→12/96	→12/96	→12/96		
Colt III 1.3	04/88→05/92										
COLT IV 1.3 Gli	04/92→04/96										
Colt V 1300	05/96→09/00										
Lancer III 1.3	07/90→08/92										
Lancer IV 1.3	07/90→05/94										
Lancer V 1.3	06/92→08/03										
Lancer VI 1.3	12/95→08/03										
Mirage 1.3	05/88→07/03										
Mirage 1.3 12V	07/90→11/91										
Mirage 1.3 GS	07/90→11/91										
1.3		4G13 (16V)					5	AG7690 (MLS)		CG7691	FG7690
Colt V 1300	09/00→09/03	1299	4	71.00	SOHC/OHC	60-64/ 82-87					
Lancer 1.3	09/03→										
Space star 1.3	06/98→12/04										
Veryca 1.3	10/11→										
1.3		4G13 (8V)					6	BN330 (Graphite)		DN332	
Colt III 1.3	04/88→05/92	1299	4	71.00	SOHC/OHC	44-51/ 60-69					
Colt III 1.3 GL	04/88→12/90										
Lancer IV 1.3	04/88→05/92										
Mirage 1.3	05/88→11/91										
Mirage 1.3 GS	07/90→11/91										
1.3		G13B					7	BN330 (Graphite)		DN330	
Colt II 1.3	06/86→04/88	1299	4	71.00	SOHC/OHC	44-57/ 60-78					
Lancer III 1.3	05/88→06/90										
Lancer IV 1.3	05/88→05/92										
1.4		4G33					8	BK420 (Graphite)		DK420	GK420 [3]
L300 1.4	04/90→05/94	1439	4	73.00	SOHC/OHC	50-56/ 68-76					



BE060



BK420



BN330



BT430



JC122



JC123



JC124



JC719



JD023



JN317



JN365

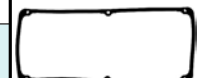

JN897

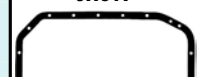

JJ075



JJ098

	JD6031 (x4) (Elastomer) JD5871 (MLS)		HR397					
HBS440 [5] M10x1.25x100.00mm (x10) →12/88		JN317 [4] →12/88						
HBS537 [5] [21]	JD6031 (x4) (Elastomer) JD5905 (MLS)	JM7124 [4] (ACM)	HR397	HR5048				
HBS440 [5] M10x1.25x100.00mm (x10)	JD5757 JD023	JN897 [4] →12/96 JM5022 [4] (ACM) 01/97→	HR397	KJ570 (x12)	NJ933 [2] 35.00x50.00x8.00mm, FPM NF678 [2] 35.00x50.00x8.00mm, ACM NJ006 [1] 72.00x96.00x9.00mm, MVQ			
HBS477 [5]	JD5966 (SMG)	HM5244 (NBR)	HR397		NJ933 [2] 35.00x50.00x8.00mm, FPM NF678 [2] 35.00x50.00x8.00mm, ACM NJ006 [1] 72.00x96.00x9.00mm, MVQ			
HBS440 [5] M10x1.25x100.00mm (x10)	JC122 (x1) JC123 (x2) JC719	JN317 [4]	HR397		NJ933 [2] 35.00x50.00x8.00mm, FPM NF678 [2] 35.00x50.00x8.00mm, ACM NJ006 [1] 72.00x96.00x9.00mm, MVQ			
HBS440 [5] M10x1.25x100.00mm (x10)		JN317 [4]	JJ098		NJ933 [2] 35.00x50.00x8.00mm, FPM NF678 [2] 35.00x50.00x8.00mm, ACM NJ006 [1] 72.00x96.00x9.00mm, MVQ			
	JC124 JE011	JN365 [4]	JJ075		NJ242 [2] 35.00x50.00x8.00mm, NBR NJ005 [2] 44.00x60.00x7.00mm, NBR NJ006 [1] 72.00x96.00x9.00mm, MVQ NJ008 [1] 72.00x96.00x9.00mm, NBR NJ007 [2] 44.00x65.00x11.00mm, NBR	NJ255 [2] [10]		



cc



kW/PS



1.5	4A91						9	AG9920 (MLS)		
Colt CZC 1.5	05/06→07/09	1499	4	75.00	DOHC	75-80/ 102-109				
Colt VI 1.5	06/04→									
Colt VII 1.5	08/04→									
Lancer 1.5	06/08→									
Lancer 1.8	02/10→									
1.5	4G15						10	BN230 (Graphite)	DN231 [3]	
Colt II 1.5 GLX	09/84→04/88	1468	4	75.50	SOHC/OHC	55/75				
Lancer III 1.5	11/83→04/88									
1.5	4G15						11	BT430 (Graphite)		GT430
Colt III 1.5	04/88→05/92	1468	4	75.50	SOHC/OHC	55-66/ 75-90				
Lancer III 1.5	09/88→12/90									
Lancer IV 1.5	04/88→05/92									
1.5	4G15 (12V)						12	BT430 (Graphite)		GT430
Colt III 1.5	07/90→05/92	1468	4	75.50	SOHC/OHC	56-81/ 76-110	→12/96			
Lancer III 1.5	08/89→08/92									
Lancer IV 1.5	09/88→08/92									
Lancer V 1.5	09/92→10/03									
Lancer VI 1.5	09/95→08/99									
Maven 1.5	09/05→									
Mirage 1.5	05/88→08/99									
Mirage 1.5 12V	05/88→06/90									
Mirage 1.5 E	05/88→06/90									
Mirage 1.5 GE	12/91→08/95									
1.5	4G15 (16V)						13	AF5470 (MLS)		
Colt V 1.5	09/95→09/03	1468	4	75.50	DOHC	69-81/ 94-110				
Colt V 1500	11/95→09/03									
Colt VI 1.5	09/04→02/06									
Lancer VI 1.5	12/95→08/03									
1.5	G15B						14	BN230 (Graphite)	DN233	
Colt II 1.5 GLX	09/85→04/88	1468	4	75.50		51-64/ 70-87				
Lancer III 1.5	06/85→08/89									
Mirage 1.5	05/88→11/91									
Mirage 1.5 4WD	05/88→11/91									
Mirage 1.5 E	05/88→06/90									
1.6	4A92						15	AG9920 (MLS)		
ASX 1.6	05/10→	1590	4	75.00	DOHC	85-86/ 116-117				
Lancer 1.6	05/10→									
1.6	4G18						16	AF5480 (MLS)	CF5481	FF5481
Lancer 1.6	09/03→10/08	1584	4	76.00	DOHC	72-77/ 98-105				
Space star 1.6	01/01→12/04									
1.6	4G32						17	BD040 (Graphite)	DD040	GD040 [3]
Galant III 1.6	06/84→04/90	1597	4	76.90	SOHC/OHC	48-60/ 65-82				
Galant IV 1.6	01/88→10/92									
L200 1.6	04/87→10/96									
L300 1.6	04/83→05/94									
L400 1.6	06/96→10/02									



BD040



BN230



BT430



JC122



JC123



JC719



JN276



JN317

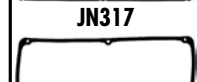

JN897

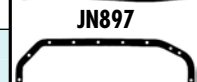

JJ075



JJ098

HBS537 [5] [21]	JD6031 [x4] (Elastomer) JD5905 [E] (MLS)	JM7124 (ACM)	HR397	HR5048 [E]		
HBS440 [5] M10x1.25x100.00mm (x10)	JC122 [E] JC123 [E] (x2) JC719 [E]	JN317 [4]	JJ098		NJ933 [2] 35.00x50.00x8.00mm, FPM NF678 [E] [2] 35.00x50.00x8.00mm, ACM NJ006 [E] [1] 72.00x96.00x9.00mm, MVQ	
HBS440 [5] M10x1.25x100.00mm (x10)	JD5757 [E]	JN897 [4]			NJ933 [2] 35.00x50.00x8.00mm, FPM NF678 [E] [2] 35.00x50.00x8.00mm, ACM NJ006 [E] [1] 72.00x96.00x9.00mm, MVQ	
HBS440 [5] M10x1.25x100.00mm (x10)	JD5757 [E]	JN897 [4]			NJ933 [2] 35.00x50.00x8.00mm, FPM NF678 [E] [2] 35.00x50.00x8.00mm, ACM NJ006 [E] [1] 72.00x96.00x9.00mm, MVQ	
		JM5022 (ACM)	HR397	PA425 (x16)	NF678 [E] [2] 35.00x50.00x8.00mm, ACM NJ006 [E] [1] 72.00x96.00x9.00mm, MVQ	
HBS440 [5] M10x1.25x100.00mm (x10)	JC122 [E] JC123 [E] (x2) JC719 [E]	JN317 [4]	JJ098		NJ933 [2] 35.00x50.00x8.00mm, FPM NF678 [E] [2] 35.00x50.00x8.00mm, ACM NJ006 [E] [1] 72.00x96.00x9.00mm, MVQ	
HBS537 [5] [21]			HR397			
HBS477 [5]	JD5966 [E] (SMG)	JM7124 (ACM)	HR397		NJ933 [2] 35.00x50.00x8.00mm, FPM NF678 [E] [2] 35.00x50.00x8.00mm, ACM NJ006 [E] [1] 72.00x96.00x9.00mm, MVQ	
HBS440 [5] M10x1.25x100.00mm (x10)		JN276 [4]	JJ075	KJ211	NJ242 [2] 35.00x50.00x8.00mm, NBR NJ005 [E] [2] 44.00x60.00x7.00mm, NBR NJ006 [E] [1] 72.00x96.00x9.00mm, MVQ	NJ255 [2] [10]









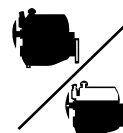



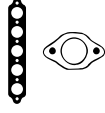

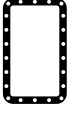

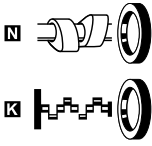





























cc

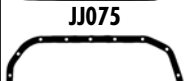

kW/PS



1.6		4G32 T/C					18	BK410 (Graphite)	DK412	
Colt II 1.6 T	02/84→04/88	1597	4			92/125				
1.6		4G61					19	BS240 (Graphite)	DS240 [3]	GS240 [3]
Colt III 1.6 Gt	04/88→05/90	1596	4	82.30	DOHC	90-100/ 122-136				
Lancer IV 1.6	05/88→08/92									
Lancer IV 1.6 i	09/90→09/92									
Mirage 1.6 Gti	06/88→11/91									
1.6		4G92					20	BT890 (Graphite)	DT890	GT890 [3]
Carisma 1.6	07/95→06/06	1597	4	82.30	SOHC/OHC	66-88/ 90-119				
COLT IV 1.6	02/94→04/96									
COLT IV 1.6 4WD	08/93→08/95									
COLT IV 1.6 GLX	04/92→04/96									
Colt V 1600	05/96→09/03									
Lancer IV 1.6	06/92→05/94									
Lancer V 1.6	06/92→10/03									
Lancer VI 1.6	12/95→08/03									
Mirage 1.6	12/91→07/03									
Mirage 1.6 4WD	12/91→08/95									
Space star 1.6	04/01→12/04									
1.6		G32BT					21	BK410 (Graphite)		
Colt II 1.6 T	07/86→04/88	1597	4	76.90	SOHC/OHC	77/105				
1.8		4D65 Diesel					22	BN220 (Graphite)	DN220	GN220
Colt II 1.8 GLD	09/86→04/88	1796	4	80.60	SOHC/OHC	43-48/ 58-65				
Colt III 1.8 D	04/88→05/92									
Galant IV 1.8 D	01/88→10/92									
Lancer III 1.8D	08/86→06/92									
Lancer IV 1.8	04/88→05/92									
Lancer IV 1.8D	04/88→05/92									
Mirage 1.8 D	05/88→11/91									
1.8		4D65 T Diesel					23	BN220 (Graphite)	DN221 [3]	GN221
Galant III 1.8	06/84→04/90	1796	4	80.60	SOHC/OHC	55-60/ 75-82				
Galant IV 1.8	12/87→10/92									
Mirage 1.8 TD	12/91→08/95									
Space Wagon 1.8	06/86→10/98									
1.8		4G37					24	BM830 (Fibre)	DM830	GM830 [3]
Eclipse 1.8	12/89→03/94	1755	4	80.60	SOHC/OHC	63-71/ 86-97	→03/93	→03/93	→03/93	
Galant IV 1.8	11/87→10/92									
Kuda 1.8	06/98→04/03									
Lancer III 1.8	03/89→06/92									
Lancer IV 1.8	09/89→07/93									
Lancer V 1.8	06/92→07/93									
Space Wagon 1.8	01/84→12/88									

										
HBS440  [5] M10x1.25x100.00mm (x10)							NJ933 [2] 35.00x50.00x8.00mm, FPM NF678  [2] 35.00x50.00x8.00mm, ACM NJ006  [1] 72.00x96.00x9.00mm, MVQ		 BK410	 BM830
HBS308  [5] M10x1.25x99.00mm (x8)	JD5777  JD5778 	JM875 [4]	JJ274	KJ570			NJ933 [2] 35.00x50.00x8.00mm, FPM NF678  [2] 35.00x50.00x8.00mm, ACM		 BN220	 BS240
HBS215  [5] M10x1.25x95.00mm (x10)	JD007  JD5372  0.2mm (Steel)	JN800 [4]	HR397				NJ242 [2] 35.00x50.00x8.00mm, NBR NF678  [2] 35.00x50.00x8.00mm, ACM NK143  [1] 85.00x103.00x8.00mm, FPM		 BT890	 JC554
HBS440  [5] M10x1.25x100.00mm (x10)		JN365 [4]	HR397				NJ933 [2] 35.00x50.00x8.00mm, FPM NF678  [2] 35.00x50.00x8.00mm, ACM NJ006  [1] 72.00x96.00x9.00mm, MVQ		 JM875	 JN365
HBS307  [5] M12x1.25x104.00mm (x10)	JC554 	JN599 [4]	HR397	KJ211 (x8)			NJ242 [2] 35.00x50.00x8.00mm, NBR NJ005  [2] 44.00x60.00x7.00mm, NBR NJ251  [1] 80.00x96.00x9.00mm, MVQ	NJ255 [2][10] NJ610 [2][56]	 JN599	 JJ075
HBS307  [5] M12x1.25x104.00mm (x10)	JC632 	JN599 [4]	HR397	KJ211 (x8)			NJ242 [2] 35.00x50.00x8.00mm, NBR NF678  [2] 35.00x50.00x8.00mm, ACM NJ251  [1] 80.00x96.00x9.00mm, MVQ	NJ255 [2][10] NJ655 [2][10]	 JJ075	 JJ274
HBS440  [5] M10x1.25x100.00mm (x10) →03/93	JC968  →03/93 JC627  →03/93	JN365 [4] →03/93	JJ075 →03/93				NJ933 [2] 35.00x50.00x8.00mm, FPM →03/93 NF678  [2] 35.00x50.00x8.00mm, ACM →03/93 NJ006  [1] 72.00x96.00x9.00mm, MVQ →03/93	NJ255 [2][10]		



cc



kW/PS

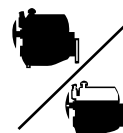

1.8		4G67				25		BS240 (Graphite)		DS240 [3]	
Colt III 1.8 GT	06/90→05/92	1836	4	81.50	DOHC	100/136					
Lancer IV 1.8	11/89→05/92										
1.8		4G93				26		BT890 (Graphite)		DT890	
Carisma 1.8	07/95→06/06	1834	4	81.00	SOHC/OHC	81-103/ 110-140					GT890 [3]
Carisma 1.8 16V	07/95→06/06										
COLT IV 1.8 Gti	04/92→04/96										
Colt V 1.8	11/97→07/01										
Eclipse 1.8	04/94→03/05										
FTO 1.8	09/94→07/01										
Galant V 1.8	02/94→08/96										
Lancer 1.8	09/92→07/96										
Lancer IV 1.8	06/92→12/93										
Lancer V 1.8	06/92→10/03										
Lancer V 1.8 i	03/95→10/03										
Lancer VI 1.8	09/95→08/03										
Mirage 1.8	09/95→07/03										
Mirage 1.8 Gsi	12/91→08/95										
Mirage 1.8 Gti	12/91→07/03										
Pajero 1.8	11/01→06/07										
Pajero 1.8 4WD	03/01→02/05										
Space runner	10/91→08/99										
Space star 1.8	10/02→12/04										
Space Wagon 1.8	10/91→08/04										
1.8		4G93 (GDI)				27		AE5610 (MIS)		CE5612	
Carisma 1.8 GDI	09/97→06/06	1834	4	81.00	DOHC	87-110/ 118-150					
Galant V 1.8	11/92→08/96										
Galant VI 1.8	11/97→10/01										
Lancer VI 1.8	06/00→08/03										
Pajero 1.8	05/99→02/01										
Pajero 1.8 GDI	10/99→06/07										
Pajero II 1.8D	06/98→04/00										
Space star 1.8	06/98→12/04										
1.8		4G93T				28		BT890 (Graphite)			
Lancer VI 1.8	09/95→08/03	1834	4	81.00	DOHC	141-152/ 192-207					
Mirage 1.8 4WD	09/95→08/99										
1.8		G37B				29		BM830 (Fibre)		DM831 [3]	
Lancer III 1.8	01/87→08/89	1755	4	80.60	SOHC/OHC	61-62/ 83-84		→08/89		→08/89	
Space Wagon 1.8	09/88→04/91										

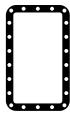
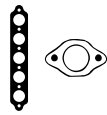

BM830



BS240



BT890

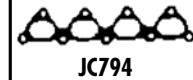

JC794



JC795

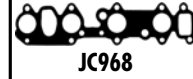

JC968

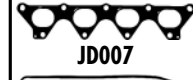

JD007

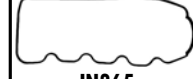

JN365



JJ075



JJ274



cc



kW/PS

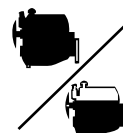

1.9		F8QT Diesel					30				
Carisma 1.9 TD	10/96→09/00	1870	4	80.00	SOHC/OHC	66/90	AD5030 (Fibre), 1.400mm, 2 Holes AD5040 (Fibre), 1.500mm, 1 Hole AD5050 (Fibre), 1.600mm, 3 Holes	DY040 ▲ [3]	EL960 [3] [18]		
1.9		F9Q1 Diesel					31				
Carisma 1.9 DID Space star 1.9	09/00→06/06 02/01→12/04	1870	4	80.00	SOHC/OHC	75/102	AC5061 (MLS), 1.320mm	CC5060 ▲ [3]			
1.9		F9Q2 Diesel					32				
Carisma 1.9 DID Space star 1.9	09/00→06/06 10/02→12/04	1870	4	80.00	SOHC/OHC	85/116	AC5061 (MLS), 1.320mm	CC5060 ▲ [3]			
2.0		4D68 Diesel					33				
Lancer IV 2.0 D Lancer V 2.0 D Lancer VI 2.0 D Mirage 2.0 GD	06/92→07/93 06/92→10/03 09/95→08/03 12/91→08/95	1998	4	82.70	SOHC/OHC	50-54/ 68-73	AG5302 (Graphite), 1.400mm, 1 Hole AG5300 (Graphite), 1.450mm, 2 Holes AG5301 (Graphite), 1.500mm, 3 Notches	CG5520 ▲			
2.0		4D68 (SOHC) Diesel					34				
Galant VI 2.0	09/96→10/04	1998	4	82.70	SOHC/OHC	66/90	AG5302 (Graphite), 1.400mm, 1 Hole AG5300 (Graphite), 1.450mm, 2 Holes AG5301 (Graphite), 1.500mm, 3 Notches	CG5520 ▲			
2.0		4D68 T Diesel					35				
Galant V 2.0 Galant VI 2.0 Lancer V 2.0 D Mirage 2.0 D Mirage 2.0 TD Space runner	11/92→08/96 09/96→10/04 03/95→10/03 09/95→07/03 12/91→07/03 10/92→08/99	1998	4	82.70	SOHC/OHC	60-69/ 82-94	AG5302 (Graphite), 1.400mm, 1 Hole AG5300 (Graphite), 1.450mm, 2 Holes AG5301 (Graphite), 1.500mm, 3 Notches	CG5520 ▲			
2.0		4D68 T Diesel					36				
Space Wagon 2.0	10/92→10/98	1998	4	82.70	SOHC/OHC	60/82	AG5302 (Graphite), 1.400mm, 1 Hole AG5300 (Graphite), 1.450mm, 2 Holes AG5301 (Graphite), 1.500mm, 3 Notches	CG5520 ▲			

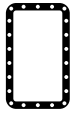
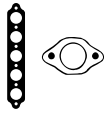

AD5030, AD5040,
AD5050



JC632



JD463



JN599



JN732



JJ557

HBS120 [22] M12x1.50x118.00mm (x10)	JD463	JN732 [4]	JJ557	NF846 [2] 25.00x42.00x7.00mm, FPM/ACM NF850 [1] 85.00x105.00x8.00mm, FPM NF843 [2] 50.00x68.00x10.00mm, FPM/ACM NA5037 [1] 85.00x105.00x11.00mm, ACM	
HBS120 [22] M12x1.50x118.00mm (x10)	JD5189	JM5086 (Elastomer)	JH5041	NF846 [2] 25.00x42.00x7.00mm, FPM/ACM NA5036 [2] 42.00x54.00x6.00mm, FPM NF850 [1] 85.00x105.00x8.00mm, FPM	
HBS120 [22] M12x1.50x118.00mm (x10)	JD5189	JM5086 (Elastomer)	JH5041	NF846 [2] 25.00x42.00x7.00mm, FPM/ACM NA5036 [2] 42.00x54.00x6.00mm, FPM NF850 [1] 85.00x105.00x8.00mm, FPM	
HBS421 [5] M11x1.25x118.00mm (x10)	JC632	JN599 [4]	HR397	NJ933 [2] 35.00x50.00x8.00mm, FPM NF678 [2] 35.00x50.00x8.00mm, ACM NK143 [1] 85.00x103.00x8.00mm, FPM	
HBS421 [5] M11x1.25x118.00mm (x10)	JC632	JN599 [4]	HR397	NJ933 [2] 35.00x50.00x8.00mm, FPM NF678 [2] 35.00x50.00x8.00mm, ACM NK143 [1] 85.00x103.00x8.00mm, FPM	
HBS421 [5] M11x1.25x118.00mm (x10)	JC632	JN599 [4]	HR397	NJ933 [2] 35.00x50.00x8.00mm, FPM NF678 [2] 35.00x50.00x8.00mm, ACM NK143 [1] 85.00x103.00x8.00mm, FPM	
HBS421 [5] M11x1.25x118.00mm (x10)	JC632	JN599 [4]	HR397	NJ933 [2] 35.00x50.00x8.00mm, FPM NF678 [2] 35.00x50.00x8.00mm, ACM NK143 [1] 85.00x103.00x8.00mm, FPM	



cc



kW/PS



2.0		4G63 (DOHC 16V)					37	BS120 (Graphite)	DS120	GS120 →12/93
Eclipse 2.0 i	04/91→11/95	1997	4	85.00	DOHC	78-110/ 106-150				
Eclipse II 2000	12/95→04/99									
Galant IV 2.0	11/87→12/92									
L300 2.0	06/94→04/00									
L300 2.0 GLS	06/94→05/96									
L300 41.272 VF	07/96→									
L400 2.0	09/95→10/02									
L400 2.0 16V	05/95→05/00									
Lancer 2.0	09/03→12/07									
Outlander I 2.0	05/03→10/06									
Santamo 2.0 16V	05/99→12/04									
Savrin 2.0	01/01→12/04									
Space runner	06/97→08/02									
Space Wagon 2.0	10/92→12/04									
2.0		4G63 (SOHC 8V)					38	BH060 (Graphite)	DH061	GH061
Galant III 2.0	06/84→04/90	1997	4	85.00	SOHC/OHC	63-101/ 86-137				
Galant IV 2.0	11/87→12/92									
Galant V 2.0	11/92→08/96									
Grandis 2.0	11/97→05/03									
L200 2.0	11/86→12/07									
L300 2.0	06/94→05/02									
L300 2.0 4WD	12/86→05/03									
L300 FH 12/420	11/86→									
L300 FH 12/460	11/86→									
L400 2.0	06/96→03/01									
Mirage 2.0	09/95→08/99									
Space Wagon 2.0	03/85→01/92									
Tredia 2.0 GLXi	10/86→03/88									
2.0		4G63 T (DOHC 16V)					39	BS120 (Graphite)		
Eclipse II 2.0T	04/94→04/99	1997	4	85.00	DOHC	110-157/ 150-213				
Outlander I 2.0	04/04→10/06									
2.0		4G63 T (SOHC 8V)					40	BH060 (Graphite)	DH064 [3]	GH064 [3]
Galant III 2.0 T	06/84→04/90	1997	4	85.00	SOHC/OHC	107-148/ 145-201				
2.0		4G94					41	AG7710 (MLS)		
Lancer 2.0	08/03→10/08	1999	4	81.50	SOHC/OHC	84-103/ 115-140				
2.0		4G94 (GDI)					42	AG7700 (MLS)		
Dion 2.0 16V	12/99→10/05	1999	4	81.50	DOHC	85-107/ 116-146				
Dion 2.0 4WD	12/99→10/05									
Galant 2.0 Gdi	10/03→									
Galant VI 2.0	10/99→10/04									
Lancer 2.0 GDi	09/03→									
Lancer VI 2.0	09/95→08/03									
Pajero 2.0 GDI	10/00→06/07									

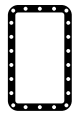
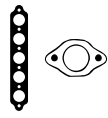

BH060



BS120



JC441



JC493



JC611



JC612



JN715



JJ274



cc



kW/PS



2.0		6A12					43		AF5500 (Graphite) (x2)		CF5500
Galant V 2.0	11/92→08/96	1999	6	78.40	SOHC/OHC, V	108-110/ 147-150					
2.0		BKD Diesel					44		AG8970 (MLS), 1.550mm, 1 Hole AG8800 (MLS), 1.630mm, 2 Holes AG8960 (MLS), 1.710mm, 3 Holes		CG8410 ▲ EF5380
Lancer 2.0 DI-D	01/08→	1968	4	81.00	DOHC	103/140					
2.0		BSY Diesel					45		AG8970 (MLS), 1.550mm, 1 Hole AG8800 (MLS), 1.630mm, 2 Holes AG8960 (MLS), 1.710mm, 3 Holes		EF5380
Grandis 2.0 DI-D	09/05→	1968	4	81.00	DOHC	100-103/ 136-140					
Outlander 2 2.0	12/06→										
2.0		BWC Diesel					46		AG8970 (MLS), 1.550mm, 1 Hole AG8800 (MLS), 1.630mm, 2 Holes AG8960 (MLS), 1.710mm, 3 Holes		EF5380
Grandis 2.0 DID	02/07→	1968	4	81.00	SOHC/OHC	103/140					
Lancer 2.0 DI-D	01/08→										
2.0		G63B					47		BH060 (Graphite) 01/86→12/88		DH061 01/86→12/88
Galant III 2.0	06/86→04/90	1997	4	85.00	SOHC/OHC	62-81/ 84-110					
L300 2.0	11/86→07/88										
Pajero I 2.0	01/83→02/91										
Space Wagon 2.0	06/86→05/88										
2.4		4G64 (GDI)					48		AG9130 (MLS), 0.400mm 10/98→ AG9120 (SMG), 1.3mm, (Graphite) [114] 09/00→12/03		CG9130 10/98→09/00 CG9120 09/00→12/03
Galant VI 2.4	02/99→10/04	2351	4	86.50	DOHC	84-121/ 114-165					
Grandis 2.4 GDi	11/97→05/03										
Lancer 2.4 GDI	09/03→10/08										
Lancer VI 2.4	09/95→08/03										
Space runner	08/99→08/02										
Space Wagon 2.4	10/98→12/04										

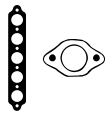

BH060



JC441



JD600

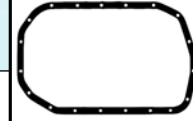

JJ274



cc



kW/PS



2.4		4G64 (SOHC 16V)				49		AG8080 (Graphite) AG9130 (MLS, 0.400mm)		CG8080 [115] CG9130	
Eclipse 2.4 RS	05/99→03/05	2351	4	86.50	SOHC/OHC	85-110/ 116-150					
Eclipse III 2.4	05/99→03/05										
L200 2.4	06/96→12/07										
L200 2.4 CNG	12/09→										
L200 2.4 i	10/96→12/06										
L300 2.4	09/97→05/03										
L300 2.4 i	03/06→										
L400 2.4	05/95→06/05										
L400 2.4 4WD	09/96→06/05										
L400 2.4 i 4WD	05/95→05/00										
Magna 2.4	04/96→03/99										
Outlander I 2.4	05/03→10/06										
Pajero 2.4	07/08→										
Space Wagon 2.4	10/91→04/04										
Zinger 2.4	10/05→										
2.4		4G64 (12V)				50					
L300 FH 12/420	11/90→	2351	4	86.50	DOHC	82-87/ 112-118					
L300 FH 12/460	11/90→										
Pajero II 2.4	04/91→04/00										
2.4		4G64 (8V)				51		BT880 (Graphite)		DT880 [3]	
Canter 2.4	08/01→11/10	2351	4	86.50	SOHC/OHC	82-97/ 111-132					
Galant III 2.4	06/85→04/90										
L200 2.4	11/86→05/92										
L300 2.4	11/86→08/97										
L300 2.4 4WD	11/86→08/97										
Sapporo III 2.4	06/87→08/90										
2.4		G64B				52		BT880 (Graphite)		DT880 [3]	
Galant III 2.4	07/85→04/90	2351	4	86.50	SOHC/OHC	80-82/ 109-112	02/86→02/90			02/86→02/90	GT880 [3] 02/86→02/90
L300 2.4	11/86→08/97										
L300 2.4 4WD	11/86→08/97										
L300 FH 12/420	11/86→12/90										
2.5		4D56 (8V) Diesel				53		BJ600 (Graphite)		DJ600	
Canter 2.5 D	09/92→09/96	2477	4	91.10	SOHC/OHC	51-55/ 69-75					GJ600
L200 2.5 D	10/86→12/07										
L300 2.5 D	11/86→09/03										
L300 Van 2.5 D	11/86→02/06										

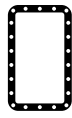

BJ600



BT880



JC224



JC611



JC612



JN403



JJ072



JJ274



cc



kW/PS



2.5		4D56 T Diesel				54		AH6480 (MLS), 1.450mm, 0 Holes		DS130 [3]	GS130
L200 2.5 TD	09/90→12/07	2477	4	91.10	SOHC/OHC	62-110/ 84-150	BS130 (Graphite), 1.500mm				
L300 2.5 D	11/94→04/00					AH6490 (MLS), 1.500mm, 1 Hole					
L300 2.5 TD	02/87→05/03					AH6500 (MLS), 1.550mm, 2 Holes					
L300 2.5 TD 4WD	11/88→										
L300 2.5 TD 4x4	11/91→05/03										
L400 2500 TD	05/95→06/05										
Pajero 2.5 D	11/97→10/98										
Pajero 2.5 TD	11/98→01/08										
Pajero 3 2.5	04/00→12/06										
Pajero 3 2.5D	04/00→12/06										
Pajero I 2.5 TD	05/86→12/91										
Pajero II 2.5	03/91→08/99										
2.5		4D56 TD Diesel				55		BS130 (Graphite), 1.500mm		DS130 [3]	GS130
L200 2.5 TD	06/96→12/07	2477	4	91.10	SOHC/OHC	73/99	05/91→		05/91→	05/91→	
L300 2.5 TD	09/94→										
L400 2.5 TD	05/95→05/00										
L400 2.5 TD 4x4	05/95→05/00										
Pajero II 2.5TD	12/90→04/00										
2.5		6A13				56		AG9150 (Fibre), (SMG) (x2)		CG9150	
Diamante 2.5	09/03→11/05	2498	6	81.00	DOHC, V	118-125/ 160-170					
Galant VI 2.5	09/96→10/04										
2.5		6G73				57		AG9150 (Fibre), (SMG) (x2)		CG9150	
Diamante 2.5	05/90→08/04	2497	6	83.50	DOHC, V	125-147/ 170-200	01/93→		01/93→		
Galant V 2.5	11/92→09/96										
Magna 2.5	04/91→06/96										
2.5		D4BF Diesel				58		BS130 (Graphite), 1.500mm		DS130 [3]	
Galopper 2.5 TD	09/98→12/03	2476	4	91.10	SOHC/OHC	59-65/ 80-88					
2.5		D4BH Diesel				59		BS130 (Graphite), 1.500mm		DS130 [3]	GS130
Galopper 2.5 TD	09/98→12/03	2476	4	91.10	SOHC/OHC	59-78/ 80-106					
2.8		4M40 Diesel				60		AG5160 (Fibre), 1.350mm, 2 Holes AA5020 (Fibre), 1.450mm, 4 Holes		CA5021 ▲	EA5020
L300 2.8 D	09/95→10/98	2835	4	95.00	SOHC/OHC	69-71/ 94-97					
2.8		4M40-2AT Diesel				61		AG5160 (Fibre), 1.350mm, 2 Holes AA5020 (Fibre), 1.450mm, 4 Holes		CA5021 ▲	EA5020
Canter 2.8 TDi	10/98→07/01	2835	4	95.00	SOHC/OHC	85/116					
2.8		4M40-A Diesel				62		AG5160 (Fibre), 1.350mm, 2 Holes AA5020 (Fibre), 1.450mm, 4 Holes		CA5021 ▲	EA5020 →02/96
Canter 2.8 D	10/96→07/01	2835	4	95.00	SOHC/OHC	69-71/ 94-97					
L200 2.8 D	10/96→03/03										
Pajero II 2.8 D	11/93→07/97										

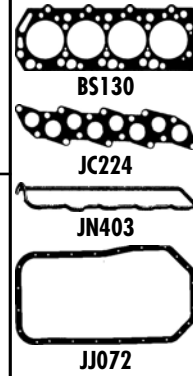

HBS295 [5] [97] M12x1.25x104.00mm (x18)	JC224	JN403 [4]	HR397	KJ211 (x8)	NJ242 [2] 35.00x50.00x8.00mm, NBR NJ005 [2] 44.00x60.00x7.00mm, NBR NJ251 [1] 80.00x96.00x9.00mm, MVQ	NJ255 [2] [10] NJ610 [2] [56]
HBS295 [5] [97] M12x1.25x104.00mm (x18) 05/91→	JC224 05/91→	JN403 [4] 05/91→	HR397 05/91→	KJ211 (x8) 05/91→	NJ242 [2] 35.00x50.00x8.00mm, NBR 05/91→ NJ005 [2] 44.00x60.00x7.00mm, NBR 05/91→ NJ251 [1] 80.00x96.00x9.00mm, MVQ 05/91→	
		JM7039 (Elastomer)	HR397		NJ933 [2] 35.00x50.00x8.00mm, FPM NF678 [2] 35.00x50.00x8.00mm, ACM NK143 [1] 85.00x103.00x8.00mm, FPM	
		JM7039 (Elastomer) 01/93→	HR397 01/93→		NJ933 [2] 35.00x50.00x8.00mm, FPM 01/93→ NF678 [2] 35.00x50.00x8.00mm, ACM 01/93→ NK143 [1] 85.00x103.00x8.00mm, FPM 01/93→	
HBS295 [5] [97] M12x1.25x104.00mm (x18)	JC224	JN403 [4]	HR397	KJ211	NJ933 [2] 35.00x50.00x8.00mm, FPM NF678 [2] 35.00x50.00x8.00mm, ACM	
HBS295 [5] [97] M12x1.25x104.00mm (x18)	JC224	JN403 [4]	JJ072	KJ211	NJ933 [2] 35.00x50.00x8.00mm, FPM NF678 [2] 35.00x50.00x8.00mm, ACM	
HBS216 [5] M12x1.25x104.00mm (x14)	JA5014	HM5230	HR397		NA5243 [2] 50.00x74.00x11.00mm, FPM NA5244 [1] 91.00x114.00x12.00mm, FPM	
HBS216 [5] M12x1.25x104.00mm (x14)	JA5014	HM5230	HR397		NA5243 [2] 50.00x74.00x11.00mm, FPM NA5244 [1] 91.00x114.00x12.00mm, FPM	
HBS216 [5] M12x1.25x104.00mm (x14)	JA5014	HM5230	HR397		NA5243 [2] 50.00x74.00x11.00mm, FPM NA5244 [1] 91.00x114.00x12.00mm, FPM	



cc



kW/PS



2.8		4M40-T Diesel			63		AG5160 (Fibre), 1.350mm, 2 Holes	CA5021 ▲	EA5020 →02/96
Galant VI 2.8	10/96→07/01	2835	4	95.00	SOHC/OHC	80-92/ 109-125	AA5020 (Fibre), 1.450mm, 4 Holes		
L200 2.8 TD	04/03→12/06								
Pajero 2.8 TD	06/02→								
Pajero 2.8 TDi	11/98→10/03								
Pajero II 2.8TD	06/94→10/99								
3.0		6G72 (DOHC 24V)			64		BV010 (Graphite)	DV010 (Graphite)	
3000 GT 24V 4WD	06/92→08/99	2972	6	91.10	DOHC, V	105-210/ 143-286			
Debonair 3.0	09/89→08/92								
Diamante 3.0	10/92→08/04								
Eclipse 3.0	05/99→03/05								
Eclipse III 3.0	05/99→03/05								
Grandis 3.0 GDi	05/00→05/03								
GTO coupe 3.0	06/89→08/00								
L200 3.0	08/01→11/05								
L300 3.0	06/94→05/03								
L300 3.0 4WD	10/00→05/03								
Magna 3.0 GDi	06/98→05/03								
Magna 3.0 i	05/91→06/96								
Pajero 3.0 V6	12/99→01/08								
Pajero 3.0 ZR	08/03→								
Sigma 3.0 V6	12/90→07/96								
Space Wagon 3.0	05/00→05/03								
Verada 3.0	10/95→09/96								
Verada 3.0 24V	10/92→05/96								
Verada 3.0 Ei	06/99→09/02								
3.0		6G72 (SOHC 12V)			65		BR600 (Graphite)	DR601 [3]	GR600 [3]
Debonair 3.0	07/86→10/97	2972	6	91.10	SOHC/OHC, V	104-151/ 141-205			
L200 3.0	11/86→08/96								
L200 3.0 i	09/90→10/96								
Pajero I 3.0	11/88→11/90								
Pajero I 3.0 i	05/88→05/91								
Pajero II 3.0	12/90→12/95								
Sigma 3.0	06/92→10/96								
Sigma 3.0 V6	12/90→07/96								
Verada 3.0	10/92→05/96								
Verada 3.0 Ei	06/99→09/02								
Verada 3.0 i	07/91→03/94								
3.0		6G72 (SOHC 24V)			66		BV010 (Graphite)	DV010 (Graphite)	
Diamante 3.0	06/92→03/98	2972	6	91.10	SOHC/OHC, V	114-150/ 155-204			
L200 3.0	10/96→12/06								
Magna 3.0	08/00→07/02								
Magna 3.0 i	05/91→07/02								
Pajero 3.0 V6	11/98→								
Pajero 3 3.0	10/01→12/06								
Pajero 4 3.0	02/07→								
Pajero II 3.0	06/94→04/00								
Verada 3.0	03/94→09/96								
3.0		6G72T			67		BV010 (Graphite)	DV010 (Graphite)	
GTO coupe 3.0	06/92→09/00	2972	6	91.10	DOHC, V	206-238/ 280-324			

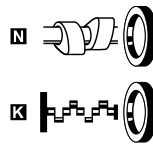
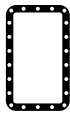
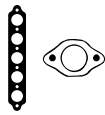

BR600



BV010

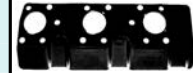

JC751

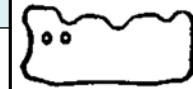

JN713

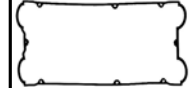

JN889



cc



kW/PS

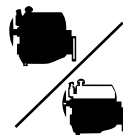

3.2		4M41 Diesel				68			
L200 3.2 Di-D	07/06→	3200	4	98.50	DOHC	118-147/ 160-200	AG7740 (MLS), 0.500mm, 1 Notch	FF5490 ▲	
Pajero 3.2 DiD	09/06→						AG7750 (MLS), 0.550mm, 2 Notches		
Pajero 3.2 Di-D	05/05→						AF5490 (MLS), 0.600mm, 3 Notches		
Pajero 3.2 TDi	11/98→						AG7760 (MLS), 0.650mm, 4 Notches		
Pajero 3 3.2D	04/00→12/06								
Pajero 4 3.2D	11/06→								
3.8		6G75				69			
380 3.8 i	04/05→04/08	3828	6	95.00	SOHC/OHC, V	149-192/ 202-261			
Endeavor 3.8	01/03→08/11								
Galant 3.8 Gdi	10/03→								
Pajero 3.8	09/06→								
Pajero 3.8 GDi	06/02→08/06								
Pajero 4 3.8	02/07→								

HBS491 © [5]					NA5243 [2] 50.00x74.00x11.00mm, FPM	
	JD5759 [1]				NJ242 (x2) [2] 35.00x50.00x8.00mm, NBR NJ874 [2] 37.00x50.00x6.00mm, ACM NJ873 [1] 91.00x111.00x9.00mm, FPM	



Ltr







CC



9

Model	Ltr	Year Range	Engine Code	Fuel Type	CC	Power (kW)	0-100 (s)
100 NX (B13)	1.6	09/99→10/99	GA16DE	Petrol	1597	4	37
100 NX (B13)	1.6	03/99→10/99	GA16DS	Petrol	1597	4	39
100 NX (B13)	2.0	10/99→10/99	SR20DE	Petrol	1998	4	72
180 SX Coupe (S13)	1.8	04/98→06/99	CA18DET	Petrol	1809	4	48
180 SX Coupe (S13)	2.0	04/99→03/99	SR20DET	Petrol	1998	4	74
200 SX (S13)	1.8	09/98→03/99	CA18DE	Petrol	1809	4	47
200 SX (S13)	1.8	07/98→11/99	CA18DET	Petrol	1809	4	48
200 SX (S13)	2.0	07/98→11/99	SR20DE	Petrol	1998	4	72
200 SX (S14)	2.0	10/99→12/99	SR20DE	Petrol	1998	4	72
200 SX (S14)	2.0	10/99→12/99	SR20DET	Petrol	1998	4	74
240 SX	2.4	04/99→08/99	KA24DE	Petrol	2389	4	84
300 ZX (Z31)	3.0	05/98→10/99	VG30ET	Petrol	2960	6	115
300 ZX (Z31)	3.0	04/98→10/99	VG30T	Petrol	2959	6	117
300 ZX (Z32)	3.0	05/99→09/99	VG30DETT	Petrol	2960	6	113
350 Z (Z33)	3.5	09/00→	VQ35DE	Petrol	3498	6	126
350 Z (Z33)	3.5	09/00→	VQ35HR	Petrol	3498	6	127
350 Z Roadster (Z33)	3.5	03/00→	VQ35DE	Petrol	3498	6	126
350 Z Roadster (Z33)	3.5	09/00→	VQ35HR	Petrol	3498	6	127
AD Van	1.3	10/98→08/98	E13S	Petrol	1269	4	13
AD Van	1.5	10/98→08/98	E15S	Petrol	1488	4	20
AD Van	1.6	06/98→04/99	E16S	Petrol	1597	4	36
AD Van	1.7	10/98→	CD17	Diesel	1681	4	45
AD Van	2.0	10/99→04/99	CD20	Diesel	1974	4	60
AD Van	2.0	10/99→04/99	SR20DE	Petrol	1998	4	72
AD Wagon	1.5	05/99→08/00	QG15DE	Petrol	1498	4	30
AD Wagon	1.6	05/99→08/00	GA16DE	Petrol	1597	4	37
AD Wagon	1.6	10/99→04/99	GA16DS	Petrol	1597	4	39
AD Wagon	1.7	10/99→08/00	CD17	Diesel	1681	4	45
AD Wagon	1.8	05/99→08/00	QG18DE	Petrol	1769	4	53
AD Wagon	2.0	05/99→08/00	SR20DE	Petrol	1998	4	72
ALMERA Classic (B10)	1.6	03/00→	QG16DE	Petrol	1597	4	44
ALMERA I (N15)	1.4	09/99→07/00	GA14DE	Petrol	1392	4	16
ALMERA I (N15)	1.5	07/99→05/00	GA15DE	Petrol	1498	4	21
ALMERA I (N15)	1.6	07/99→07/00	GA16DE	Petrol	1597	4	37
ALMERA I (N15)	1.8	07/99→05/00	QG18DE	Petrol	1769	4	53
ALMERA I (N15)	2.0	11/99→07/00	CD20	Diesel	1974	4	60
ALMERA I Hatchback (N15)	1.4	09/99→03/00	GA14DE	Petrol	1392	4	16
ALMERA I Hatchback (N15)	1.5	07/99→03/00	GA15DE	Petrol	1498	4	21
ALMERA I Hatchback (N15)	1.6	07/99→03/00	GA16DE	Petrol	1597	4	37
ALMERA I Hatchback (N15)	2.0	11/99→03/00	CD20	Diesel	1974	4	60
ALMERA I Hatchback (N15)	2.0	07/99→03/00	SR20DE	Petrol	1998	4	72
ALMERA II (N16)	1.5	03/00→	GA15DE	Petrol	1498	4	21
ALMERA II (N16)	1.5	01/00→	K9K 722	Diesel	1461	4	28
ALMERA II (N16)	1.5	07/00→	QG15DE	Petrol	1498	4	30
ALMERA II (N16)	1.6	07/00→02/00	GA16DE	Petrol	1597	4	37
ALMERA II (N16)	1.6	07/00→02/00	QG16DE	Petrol	1597	4	44
ALMERA II (N16)	1.8	07/00→	QG18DE	Petrol	1769	4	53
ALMERA II (N16)	2.0	08/00→	SR20DE	Petrol	1998	4	72
ALMERA II (N16)	2.2	07/00→	YD22DDT	Diesel	2184	4	79
ALMERA II (N16)	2.2	09/00→	YD22DDTi	Diesel	2184	4	80
ALMERA II Hatchback (N16)	1.5	01/00→	K9K 722	Diesel	1461	4	28
ALMERA II Hatchback (N16)	1.5	03/00→	QG15DE	Petrol	1498	4	30
ALMERA II Hatchback (N16)	1.6	07/00→02/00	GA16DE	Petrol	1597	4	37
ALMERA II Hatchback (N16)	1.8	01/00→	QG18DE	Petrol	1769	4	53
ALMERA II Hatchback (N16)	2.0	08/00→	SR20DE	Petrol	1998	4	72
ALMERA II Hatchback (N16)	2.2	03/00→	YD22DDT	Diesel	2184	4	79
ALMERA II Hatchback (N16)	2.2	09/00→	YD22DDTi	Diesel	2184	4	80
ALMERA TINO (V10)	1.8	08/00→	QG18DE	Petrol	1769	4	53
ALMERA TINO (V10)	2.0	08/00→	SR20DE	Petrol	1998	4	72
ALMERA TINO (V10)	2.2	09/00→	YD22DDT	Diesel	2184	4	79
ALMERA TINO (V10)	2.2	08/00→	YD22DDTi	Diesel	2184	4	80
ALTIMA Coupe	2.5	10/00→	QR25DE	Petrol/Electro	2488	4	93
ALTIMA Coupe	2.5	10/00→	QR25DE	Petrol	2488	4	93
ALTIMA	2.4	06/99→09/00	KA24DE	Petrol	2389	4	84
ALTIMA	2.5	08/00→	QR25DE	Petrol/Electro	2488	4	93
ALTIMA	2.5	08/00→	QR25DE	Petrol	2488	4	93
ALTIMA	3.5	08/00→	VQ35DE	Petrol	3498	6	126
ATLAS	2.4	10/99→10/00	KA24E	Petrol	2389	4	85
ATLAS	2.5	10/99→10/99	TD25	Diesel	2494	4	96
ATLAS	2.7	07/99→10/00	TD27Ti	Diesel	2664	4	104

	Ltr				CC		9
AUSTER	1.8	04/98→10/98	CA18T	Petrol	1809	4	51
AUSTER	2.0	06/98→10/98	CA20S	Petrol	1974	4	59
AVENIR	1.6	11/99→	QG16DE	Petrol	1597	4	44
AVENIR	1.8	11/99→	QG18DE	Petrol	1769	4	53
AVENIR	2.0	10/98→10/99	CA20E	Petrol	1974	4	58
AVENIR	2.0	06/98→10/99	CA20S	Petrol	1974	4	59
AVENIR	2.0	11/99→09/99	CD20T	Diesel	1974	4	61
AVENIR	2.0	10/98→10/99	LD20T	Diesel	1952	4	66
AVENIR	2.0	09/00→	QR20DE	Petrol	1998	4	68
AVENIR	2.0	11/99→08/00	SR20DE	Petrol	1998	4	72
BASSARA	2.4	11/99→08/00	KA24DE	Petrol	2389	4	84
BASSARA	2.5	06/00→08/00	QR25DE	Petrol/Electro	2488	4	93
BASSARA	2.5	06/00→08/00	QR25DE	Petrol	2488	4	93
BASSARA	2.5	11/99→08/00	YD25DDTi	Diesel	2488	4	99
BASSARA	3.0	11/99→08/00	VG30DE	Petrol	2988	6	118
BE	1.0	12/98→07/99	MA10S	Petrol	988	4	4
BLUEBIRD (T72, T12)	1.6	12/98→06/99	CA16S	Petrol	1598	4	33
BLUEBIRD (T72, T12)	1.8	02/98→12/99	CA18D	Petrol	1809	4	46
BLUEBIRD (T72, T12)	1.8	11/98→04/99	CA18S	Petrol	1809	4	50
BLUEBIRD (T72, T12)	1.8	12/98→05/99	CA18T	Petrol	1809	4	51
BLUEBIRD (T72, T12)	2.0	12/98→12/99	CA20E	Petrol	1974	4	58
BLUEBIRD (T72, T12)	2.0	12/98→02/99	CA20S	Petrol	1974	4	59
BLUEBIRD (U11)	1.6	12/98→02/99	CA16S	Petrol	1598	4	33
BLUEBIRD (U11)	1.8	11/98→06/98	CA18S	Petrol	1809	4	50
BLUEBIRD (U11)	1.8	04/98→05/99	CA18T	Petrol	1809	4	51
BLUEBIRD (U11)	2.0	12/98→02/99	CA20S	Petrol	1974	4	59
BLUEBIRD Hatchback (T72, T12)	1.6	03/98→06/99	CA16S	Petrol	1598	4	33
BLUEBIRD Hatchback (T72, T12)	1.8	02/98→12/99	CA18D	Petrol	1809	4	46
BLUEBIRD Hatchback (T72, T12)	1.8	12/98→11/99	CA18T	Petrol	1809	4	51
BLUEBIRD Hatchback (T72, T12)	2.0	12/98→12/99	CA20E	Petrol	1974	4	58
BLUEBIRD Station Wagon (WU11)	1.6	12/98→02/99	CA16S	Petrol	1598	4	33
BLUEBIRD Station Wagon (WU11)	1.8	09/98→04/99	CA18ET	Petrol	1809	4	49
BLUEBIRD Station Wagon (WU11)	1.8	11/98→04/99	CA18S	Petrol	1809	4	50
BLUEBIRD Station Wagon (WU11)	2.0	04/98→12/99	CA20E	Petrol	1974	4	58
BLUEBIRD Station Wagon (WU11)	2.0	12/98→09/99	CA20S	Petrol	1974	4	59
BLUEBIRD SYLPHY	1.5	08/00→08/00	QG15DE	Petrol	1498	4	30
BLUEBIRD SYLPHY	1.6	08/00→08/00	QG16DE	Petrol	1597	4	44
BLUEBIRD SYLPHY	1.8	08/00→08/00	QG18DE	Petrol	1769	4	53
BLUEBIRD SYLPHY	2.0	09/00→08/01	MR20DE	Petrol	1997	4	67
BLUEBIRD SYLPHY	2.0	08/00→08/00	SR20DE	Petrol	1998	4	72
BLUEBIRD	3.0	11/99→03/99	VG30E	Petrol	2960	6	114
BOBBY Box	1.5	11/98→11/99	A15S	Petrol	1488	4	19
BOBBY Bus	1.5	11/98→11/99	A15S	Petrol	1488	4	19
CABSTAR Platform/Chassis (F22, H40)	2.3	01/98→12/98	TD23	Diesel	2289	4	83
CABSTAR Platform/Chassis (F22, H40)	2.4	09/98→09/99	Z24	Petrol	2388	4	86
CABSTAR Platform/Chassis (F22, H40)	2.5	01/98→12/99	TD25	Diesel	2494	4	96
CABSTAR Platform/Chassis (F23, H41, H42)	2.5	01/99→12/00	TD25	Diesel	2494	4	96
CARAVAN	2.4	05/00→	KA24DE	Petrol	2389	4	84
CEDRIC WAGON	3.0	04/98→08/99	VG30E	Petrol	2960	6	114
CEDRIC	2.5	06/99→04/99	VQ25DE	Petrol	2496	6	98
CEDRIC	2.8	09/98→05/99	LD28	Diesel	2792	6	107
CEDRIC	2.8	06/99→10/99	RD28	Diesel	2826	6	108
CEDRIC	2.8	06/99→04/99	RD28T	Diesel	2826	6	109
CEDRIC	3.0	09/98→10/99	VG30E	Petrol	2960	6	114
CEDRIC	3.0	09/98→05/99	VG30T	Petrol	2959	6	117
CEDRIC	3.0	06/99→02/99	VQ30DE	Petrol	2988	6	118
CEFIRO I Saloon (J31)	2.0	01/00→	VQ20DE	Petrol	1995	6	76
CEFIRO I Saloon (J31)	2.5	01/00→	VQ25DE	Petrol	2496	6	98
CEFIRO I Saloon (J31)	3.0	01/00→	VQ30DE	Petrol	2988	6	118
CEFIRO I Saloon (J31)	3.5	01/00→	VQ35DE	Petrol	3498	6	126
CEFIRO Saloon	2.0	10/99→12/99	VQ20DE	Petrol	1995	6	76
CEFIRO Saloon	2.5	10/99→12/99	VQ25DE	Petrol	2496	6	98
CEFIRO Saloon	3.0	10/99→12/99	VQ30DE	Petrol	2988	6	118
CIMA	2.0	07/99→02/00	SR20DE	Petrol	1998	4	72
CIMA	3.0	01/98→06/99	VG30DET	Petrol	2960	6	112
CIMA	3.0	01/98→08/99	VG30DE	Petrol	2988	6	118
CREW	2.8	04/98→08/00	RD28	Diesel	2826	6	108
CUBE (Z10)	1.3	03/99→08/00	CG13DE	Petrol	1275	4	10
CUBE (Z10)	1.3	09/00→12/00	CGA3DE	Petrol	1348	4	11
CUBE (Z11)	1.4	01/00→09/00	CR14DE	Petrol	1386	4	15



Ltr







CC



9

Model	Ltr	Year Range	Engine	Fuel	CC	Gears	Power (kW)
CUBE (Z11)	1.5	01/00→09/00	QG15DE	Petrol	1498	4	30
CUBE (Z12)	1.6	03/01→	HR16DE	Petrol	1598	4	42
ELGRAND (E50)	3.2	10/99→08/00	QD32ETI	Diesel	3153	4	122
ELGRAND (E50)	3.3	04/99→08/00	VG33E	Petrol	3275	6	124
ELGRAND (E51)	3.0	04/00→12/01	ZD30	Diesel	2953	4	119
ELGRAND (E51)	3.5	05/00→12/01	VQ35DE	Petrol	3498	6	126
ELGRAND (E52)	2.5	11/01→	QR25DE	Petrol/Electro	2488	4	93
ELGRAND (E52)	2.5	11/01→	QR25DE	Petrol	2488	4	93
ELGRAND (E52)	3.5	11/01→	VQ35DE	Petrol	3498	6	126
EXPERT	1.8	10/99→04/00	QG18DE	Petrol	1769	4	53
FAIRLADY Z (Z31)	3.0	01/98→12/98	VG30T	Petrol	2959	6	117
GLORIA Estate	3.0	04/98→08/99	VG30E	Petrol	2960	6	114
GLORIA	2.4	05/99→08/00	KA24DE	Petrol	2389	4	84
GLORIA	2.5	05/99→08/00	RB25DET	Petrol	2498	6	95
GLORIA	2.5	06/99→04/99	VQ25DE	Petrol	2496	6	98
GLORIA	2.8	06/99→10/99	RD28	Diesel	2826	6	108
GLORIA	3.0	06/99→10/99	VG30DET	Petrol	2960	6	112
GLORIA	3.0	09/98→10/99	VG30E	Petrol	2960	6	114
GLORIA	3.0	09/98→08/00	VG30T	Petrol	2959	6	117
GLORIA	3.0	06/99→04/99	VQ30DE	Petrol	2988	6	118
HOMY Box	2.4	05/99→10/99	KA24E	Petrol	2389	4	85
HOMY Box	2.5	05/99→10/99	TD25	Diesel	2494	4	96
HOMY Box	3.0	10/99→10/99	VG30E	Petrol	2960	6	114
HOMY Box	3.0	05/99→10/99	VG30S	Petrol	2960	6	116
HOMY Platform/Chassis	2.5	05/99→10/99	TD25	Diesel	2494	4	96
INTERSTAR Box (X70)	1.9	07/00→	F9Q 772	Diesel	1870	4	57
INTERSTAR Box (X70)	2.2	07/00→	G9T 722	Diesel	2188	4	78
INTERSTAR Box (X70)	2.5	09/00→	G9U 632	Diesel	2464	4	89
INTERSTAR Box (X70)	2.5	09/00→	G9U 650	Diesel	2464	4	90
INTERSTAR Box (X70)	2.5	07/00→	G9U 720	Diesel	2463	4	91
INTERSTAR Box (X70)	3.0	11/00→	ZD30	Diesel	2953	4	119
INTERSTAR Bus (X70)	1.9	07/00→	F9Q 772	Diesel	1870	4	57
INTERSTAR Bus (X70)	2.2	07/00→	G9T 722	Diesel	2188	4	78
INTERSTAR Bus (X70)	2.5	09/00→	G9U 632	Diesel	2464	4	89
INTERSTAR Bus (X70)	2.5	04/00→	G9U 650	Diesel	2464	4	90
INTERSTAR Bus (X70)	2.5	07/00→	G9U 720	Diesel	2463	4	91
INTERSTAR Bus (X70)	3.0	11/00→	ZD30	Diesel	2953	4	119
INTERSTAR Platform/Chassis	2.5	08/00→	G9U 632	Diesel	2464	4	89
INTERSTAR Platform/Chassis	2.5	08/00→	G9U 650	Diesel	2464	4	90
INTERSTAR Platform/Chassis	2.5	08/00→	G9U 720	Diesel	2463	4	91
INTERSTAR Platform/Chassis	3.0	11/00→	ZD30	Diesel	2953	4	119
JUKE (F15)	1.6	06/01→	HR16DE	Petrol	1598	4	42
KUBISTAR (X76)	1.2	04/00→	D4F 712	Petrol	1149	4	5
KUBISTAR (X76)	1.2	08/00→	D7F 764	Petrol	1149	4	6
KUBISTAR (X76)	1.5	04/00→	K9K 276	Diesel	1461	4	22
KUBISTAR (X76)	1.5	04/00→	K9K 700	Diesel	1461	4	23
KUBISTAR (X76)	1.5	08/00→	K9K 704	Diesel	1461	4	24
KUBISTAR (X76)	1.5	08/00→	K9K 710	Diesel	1461	4	26
KUBISTAR (X76)	1.5	08/00→	K9K 714	Diesel	1461	4	27
KUBISTAR (X76)	1.5	08/00→	K9K 722	Diesel	1461	4	28
KUBISTAR (X76)	1.6	08/00→	K4M 752	Petrol	1598	4	43
KUBISTAR Box	1.2	04/00→	D4F 712	Petrol	1149	4	5
KUBISTAR Box	1.2	08/00→	D7F 764	Petrol	1149	4	6
KUBISTAR Box	1.5	08/00→	K9K 704	Diesel	1461	4	24
KUBISTAR Box	1.5	08/00→	K9K 710	Diesel	1461	4	26
KUBISTAR Box	1.5	08/00→	K9K 714	Diesel	1461	4	27
KUBISTAR Box	1.5	08/00→	K9K 722	Diesel	1461	4	28
KUBISTAR Box	1.6	08/00→	K4M 752	Petrol	1598	4	43
LAFESTA	2.0	07/00→	MR20DE	Petrol	1997	4	67
LATIO Saloon	1.6	03/00→	HR16DE	Petrol	1598	4	42
LAUREL (JC32)	2.8	01/98→12/98	RD28	Diesel	2826	6	108
LAUREL	2.0	07/99→10/00	RB20DE	Petrol	1998	6	69
LAUREL	2.0	07/99→01/99	RB20DET	Petrol	1998	6	70
LAUREL	2.0	07/99→06/99	RB20E	Petrol	1998	6	71
LAUREL	2.5	02/99→10/00	RB25DE	Petrol	2498	6	94
LAUREL	2.5	02/99→10/00	RB25DET	Petrol	2498	6	95
LEOPARD Coupe	3.0	04/98→09/99	VG30DET	Petrol	2960	6	112
LEOPARD Estate	2.4	10/99→08/00	KA24DE	Petrol	2389	4	84
LEOPARD Estate	3.0	10/99→08/00	VQ30DE	Petrol	2988	6	118
LEOPARD	2.4	10/99→08/00	KA24DE	Petrol	2389	4	84

	Ltr				CC		9
LEOPARD	3.0	10/99→08/00	VG30E	Petrol	2960	6	114
LEOPARD	3.0	10/99→08/00	VQ30DE	Petrol	2988	6	118
LIVINA /GRAND LIVINA (L10)	1.6	02/00→	HR16DE	Petrol	1598	4	42
LUCINO Hatchback	1.4	09/99→01/00	GA14DE	Petrol	1392	4	16
LUCINO Hatchback	1.6	10/99→01/00	GA16DE	Petrol	1597	4	37
LUCINO Hatchback	1.6	09/99→10/99	GA16DS	Petrol	1597	4	39
LUCINO Hatchback	1.8	11/99→01/00	SR18DE	Petrol	1838	4	54
LUCINO Hatchback	2.0	10/99→01/00	SR20DE	Petrol	1998	4	72
LUCINO Hatchback	2.0	10/99→10/99	SR20DET	Petrol	1998	4	74
LUCINO Saloon	1.3	11/99→01/00	GA13DE	Petrol	1295	4	14
LUCINO Saloon	1.4	11/99→01/00	GA14DE	Petrol	1392	4	16
LUCINO Saloon	1.5	11/99→01/00	GA15DE	Petrol	1498	4	21
LUCINO Saloon	1.6	11/99→01/00	GA16DE	Petrol	1597	4	37
LUCINO Saloon	2.0	11/99→01/00	CD20	Diesel	1974	4	60
MAXIMA II (J30)	3.0	10/98→06/99	VG30E	Petrol	2960	6	114
MAXIMA QX (A32)	2.0	02/99→08/00	VQ20DE	Petrol	1995	6	76
MAXIMA QX (A32)	2.5	02/99→08/00	VQ25DE	Petrol	2496	6	98
MAXIMA QX (A32)	3.0	01/99→08/00	VQ30DE	Petrol	2988	6	118
MAXIMA QX (A33)	2.0	03/00→11/00	VQ20DE	Petrol	1995	6	76
MAXIMA QX (A33)	2.5	03/00→11/00	VQ25DE	Petrol	2496	6	98
MAXIMA QX (A33)	3.0	03/00→11/00	VQ30DE	Petrol	2988	6	118
MAXIMA QX (A33)	3.5	08/00→11/00	VQ35DE	Petrol	3498	6	126
MAXIMA Station Wagon	2.0	10/99→	VQ20DE	Petrol	1995	6	76
MAXIMA Station Wagon	2.5	10/99→	VQ25DE	Petrol	2496	6	98
MAXIMA Station Wagon	3.0	10/99→	VQ30DE	Petrol	2988	6	118
MICRA C+C (K12)	1.4	08/00→	CR14DE	Petrol	1386	4	15
MICRA C+C (K12)	1.6	08/00→	HR16DE	Petrol	1598	4	42
MICRA I (K10)	1.0	12/98→12/98	MA10S	Petrol	988	4	4
MICRA I (K10)	1.2	07/98→07/99	MA12S	Petrol	1235	4	9
MICRA II (K11)	1.0	08/99→02/00	CG10DE	Petrol	998	4	1
MICRA II (K11)	1.3	08/99→09/00	CG13DE	Petrol	1275	4	10
MICRA II (K11)	1.4	09/00→02/00	CGA3DE	Petrol	1348	4	11
MICRA II (K11)	1.5	02/99→02/00	TD15	Diesel	1527	4	31
MICRA III (K12)	1.0	01/00→06/01	CG10DE	Petrol	998	4	1
MICRA III (K12)	1.2	01/00→06/01	CG12DE	Petrol	1240	4	7
MICRA III (K12)	1.2	01/00→06/01	CR12DE	Petrol	1240	4	8
MICRA III (K12)	1.4	01/00→06/01	CR14DE	Petrol	1386	4	15
MICRA III (K12)	1.5	06/00→06/01	K9K 276	Diesel	1461	4	22
MICRA III (K12)	1.5	01/00→06/01	K9K 704	Diesel	1461	4	24
MICRA III (K12)	1.5	06/00→06/01	K9K 708	Diesel	1461	4	25
MICRA III (K12)	1.5	09/00→06/01	K9K 722	Diesel	1461	4	28
MICRA III (K12)	1.6	05/00→06/01	HR16DE	Petrol	1598	4	42
MURANO (Z50)	3.5	08/00→	VQ35DE	Petrol	3498	6	126
MURANO (Z51)	3.5	11/00→	VQ35DE	Petrol	3498	6	126
NAVARA (D21)	2.4	06/99→02/99	Z24i	Petrol	2389	4	87
NAVARA (D21)	2.7	06/99→02/99	TD27	Diesel	2664	4	101
NAVARA (D22)	3.0	05/00→	VG30E	Petrol	2960	6	114
NAVARA (D40)	2.5	07/00→	YD25DDTi	Diesel	2488	4	99
NOTE (E11)	1.4	03/00→	CR14DE	Petrol	1386	4	15
NOTE (E11)	1.5	03/00→	K9K 276	Diesel	1461	4	22
NOTE (E11)	1.5	03/00→	K9K 700	Diesel	1461	4	23
NOTE (E11)	1.6	03/00→	HR16DE	Petrol	1598	4	42
NP300	2.5	04/00→	YD25DDTi	Diesel	2488	4	99
NV200 Box	1.6	02/01→	HR16DE	Petrol	1598	4	42
NV200 EVALIA	1.6	07/01→	HR16DE	Petrol	1598	4	42
PATHFINDER (R50)	2.4	09/99→02/00	KA24E	Petrol	2389	4	85
PATHFINDER (R50)	2.7	09/99→12/00	TD27ETi	Diesel	2664	4	102
PATHFINDER (R50)	3.2	09/99→12/00	QD32ETi	Diesel	3153	4	122
PATHFINDER (R50)	3.3	09/99→12/00	VG33E	Petrol	3275	6	124
PATHFINDER (R50)	3.5	11/00→12/00	VQ35	Petrol	3498	6	125
PATHFINDER (R51)	2.5	01/00→	YD25DDTi	Diesel	2488	4	99
PATHFINDER (R51)	4.0	09/00→	VQ40DE	Petrol	3954	6	128
PATHFINDER	2.4	07/98→10/99	Z24i	Petrol	2389	4	87
PATHFINDER	3.0	07/98→08/99	VG30E	Petrol	2960	6	114
PATROL GR I (Y60, GR)	2.8	09/98→02/99	RD28T	Diesel	2826	6	109
PATROL GR I (Y60, GR)	4.2	02/98→02/99	TB42E	Petrol	4169	6	129
PATROL GR II Wagon (Y61)	2.7	05/99→06/00	TD27T	Diesel	2664	4	103
PATROL GR II Wagon (Y61)	2.8	06/99→05/00	RD28Ti	Diesel	2826	6	110
PATROL GR II Wagon (Y61)	3.0	05/00→	ZD30DDTi	Diesel	2953	4	120
PATROL GR II Wagon (Y61)	4.2	03/00→08/00	TB42E	Petrol	4169	6	129



Ltr







CC



9

Model	Ltr	Year Range	Engine Code	Fuel Type	CC	Seats	Price
PATROL GR II Wagon (Y61)	4.2	06/99→	TD42T	Diesel	4169	6	130
PATROL Hardtop (K160)	2.8	07/98→08/98	L28	Petrol	2753	6	106
PATROL Hardtop (K160)	3.2	07/98→08/98	SD33T	Diesel	3246	6	123
PATROL Hardtop (K260)	2.8	05/98→06/99	L28	Petrol	2753	6	106
PATROL Hardtop (K260)	2.8	03/98→03/99	RD28	Diesel	2826	6	108
PATROL Hardtop (K260)	2.8	05/98→06/99	RD28T	Diesel	2826	6	109
PATROL Hardtop (K260)	3.0	03/98→09/99	RB30S	Petrol	2962	6	111
PATROL Hardtop (K260)	3.2	08/98→06/99	SD33T	Diesel	3246	6	123
PATROL II (GU)	3.0	09/00→	ZD30DDTi	Diesel	2953	4	120
PATROL Station Wagon (W160)	2.8	07/98→08/98	L28	Petrol	2753	6	106
PATROL Station Wagon (W160)	3.2	07/98→08/98	SD33T	Diesel	3246	6	123
PATROL Station Wagon (W260)	2.8	01/99→01/99	RD28	Diesel	2826	6	108
PATROL Station Wagon (W260)	2.8	06/98→11/99	RD28T	Diesel	2826	6	109
PATROL Station Wagon (W260)	3.2	08/98→06/99	SD33T	Diesel	3246	6	123
PICK UP (D21)	2.0	09/98→08/99	Z20	Petrol	1952	4	77
PICK UP (D21)	2.4	04/99→02/99	KA24E	Petrol	2389	4	85
PICK UP (D21)	2.4	01/99→12/99	Z24	Petrol	2388	4	86
PICK UP (D21)	2.4	09/98→12/99	Z24i	Petrol	2389	4	87
PICK UP (D21)	2.5	08/98→02/99	TD25	Diesel	2494	4	96
PICK UP (D21)	2.7	08/98→02/99	TD27	Diesel	2663	4	101
PICK UP (D21)	2.7	09/98→12/99	TD27T	Diesel	2664	4	103
PICK UP (D21)	3.0	09/98→02/99	VG30E	Petrol	2960	6	114
PICK UP (D22)	2.0	01/99→08/00	SR20DE	Petrol	1998	4	72
PICK UP (D22)	2.4	11/00→	KA24DE	Petrol	2389	4	84
PICK UP (D22)	2.4	02/99→	KA24E	Petrol	2389	4	85
PICK UP (D22)	2.4	01/99→12/00	Z24	Petrol	2388	4	86
PICK UP (D22)	2.4	01/99→12/00	Z24S	Petrol	2389	4	88
PICK UP (D22)	2.5	02/99→	TD25	Diesel	2494	4	96
PICK UP (D22)	2.5	05/99→	TD25Ti	Diesel	2494	4	97
PICK UP (D22)	2.5	03/00→	YD25DDTi	Diesel	2488	4	99
PICK UP (D22)	2.7	02/99→	TD27	Diesel	2663	4	101
PICK UP (D22)	2.7	01/99→10/00	TD27T	Diesel	2664	4	103
PICK UP (D22)	3.0	01/99→10/00	VG30E	Petrol	2960	6	114
PICK UP (D22)	3.0	11/00→	ZD30	Diesel	2953	4	119
PICK UP (D22)	3.2	01/99→	QD32	Diesel	3153	4	121
PICK UP (D22)	3.3	01/00→	VG33E	Petrol	3275	6	124
PIXO (UAO)	1.0	06/00→	K10 B	Petrol	996	3	3
PRAIRIE (M10, NM10)	2.0	01/98→09/98	CA20E	Petrol	1974	4	58
PRAIRIE (M10, NM10)	2.0	01/98→09/98	CA20S	Petrol	1974	4	59
PRAIRIE PRO (M11)	2.0	10/98→12/99	CA20E	Petrol	1974	4	58
PRAIRIE PRO (M11)	2.0	10/98→03/99	CA20S	Petrol	1974	4	59
PRAIRIE PRO (M11)	2.4	04/99→07/99	KA24E	Petrol	2389	4	85
PRIMASTAR Box (X83)	1.9	09/00→	F9Q 760	Diesel	1870	4	55
PRIMASTAR Box (X83)	1.9	09/00→	F9Q 762	Diesel	1870	4	56
PRIMASTAR Box (X83)	2.0	02/00→	F4R 720	Petrol	1998	4	62
PRIMASTAR Box (X83)	2.5	09/00→	G9U 632	Diesel	2464	4	89
PRIMASTAR Box (X83)	2.5	09/00→	G9U 720	Diesel	2463	4	91
PRIMASTAR Box (X83)	2.5	07/00→	G9U 730	Diesel	2463	4	92
PRIMASTAR Bus (X83)	1.9	03/00→	F9Q 760	Diesel	1870	4	55
PRIMASTAR Bus (X83)	1.9	03/00→	F9Q 762	Diesel	1870	4	56
PRIMASTAR Bus (X83)	2.0	03/00→	F4R 720	Petrol	1998	4	62
PRIMASTAR Bus (X83)	2.0	03/00→	F4R 722	Petrol	1998	4	63
PRIMASTAR Bus (X83)	2.5	09/00→	G9U 632	Diesel	2464	4	89
PRIMASTAR Bus (X83)	2.5	09/00→	G9U 720	Diesel	2463	4	91
PRIMASTAR Bus (X83)	2.5	07/00→	G9U 730	Diesel	2463	4	92
PRIMERA (P10)	1.6	06/99→01/99	GA16DE	Petrol	1597	4	37
PRIMERA (P10)	1.6	06/99→01/99	GA16DS	Petrol	1597	4	39
PRIMERA (P10)	2.0	01/99→01/99	CD20	Diesel	1974	4	60
PRIMERA (P10)	2.0	06/99→06/99	SR20DE	Petrol	1998	4	72
PRIMERA (P10)	2.0	06/99→06/99	SR20DI	Petrol	1998	4	75
PRIMERA (P11)	1.6	09/99→12/00	GA16DE	Petrol	1597	4	37
PRIMERA (P11)	1.6	06/99→12/00	QG16DE	Petrol	1597	4	44
PRIMERA (P11)	1.8	08/99→12/00	QG18DE	Petrol	1769	4	53
PRIMERA (P11)	2.0	09/99→12/00	CD20T	Diesel	1974	4	61
PRIMERA (P11)	2.0	09/99→12/00	SR20DE	Petrol	1998	4	72
PRIMERA (P11)	2.0	09/99→12/00	SR20De	Petrol	1998	4	73
PRIMERA (P12)	1.6	01/00→	QG16DE	Petrol	1597	4	44
PRIMERA (P12)	1.8	03/00→	QG18DE	Petrol	1769	4	53
PRIMERA (P12)	2.0	03/00→	QR20DE	Petrol	1998	4	68
PRIMERA (P12)	2.2	03/00→	YD22DDT	Diesel	2184	4	79

	Ltr				CC		9
PRIMERA (P12)	2.5	01/00 →	QR25DE	Petrol/Electro	2488	4	93
PRIMERA (P12)	2.5	01/00 →	QR25DE	Petrol	2488	4	93
PRIMERA Estate (WP12)	1.6	01/00 →	QG16DE	Petrol	1597	4	44
PRIMERA Estate (WP12)	1.8	03/00 →	QG18DE	Petrol	1769	4	53
PRIMERA Estate (WP12)	2.0	03/00 →	QR20DE	Petrol	1998	4	68
PRIMERA Estate (WP12)	2.2	03/00 →	YD22DDT	Diesel	2184	4	79
PRIMERA Hatchback (P10)	1.6	06/99 → 01/99	GA16DE	Petrol	1597	4	37
PRIMERA Hatchback (P10)	1.6	06/99 → 01/99	GA16DS	Petrol	1597	4	39
PRIMERA Hatchback (P10)	2.0	01/99 → 01/99	CD20	Diesel	1974	4	60
PRIMERA Hatchback (P10)	2.0	06/99 → 06/99	SR20DE	Petrol	1998	4	72
PRIMERA Hatchback (P10)	2.0	06/99 → 06/99	SR20DI	Petrol	1998	4	75
PRIMERA Hatchback (P11)	1.6	09/99 → 07/00	GA16DE	Petrol	1597	4	37
PRIMERA Hatchback (P11)	1.6	09/00 → 07/00	QG16DE	Petrol	1597	4	44
PRIMERA Hatchback (P11)	1.8	08/99 → 07/00	QG18DE	Petrol	1769	4	53
PRIMERA Hatchback (P11)	2.0	09/99 → 07/00	CD20T	Diesel	1974	4	61
PRIMERA Hatchback (P11)	2.0	09/99 → 07/00	SR20DE	Petrol	1998	4	72
PRIMERA Hatchback (P11)	2.0	09/99 → 07/00	SR20De	Petrol	1998	4	73
PRIMERA Hatchback (P12)	1.6	07/00 →	QG16DE	Petrol	1597	4	44
PRIMERA Hatchback (P12)	1.8	07/00 →	QG18DE	Petrol	1769	4	53
PRIMERA Hatchback (P12)	2.0	07/00 →	QR20DE	Petrol	1998	4	68
PRIMERA Hatchback (P12)	2.2	07/00 →	YD22DDT	Diesel	2184	4	79
PRIMERA Hatchback (P12)	2.5	01/00 →	QR25DE	Petrol/Electro	2488	4	93
PRIMERA Hatchback (P12)	2.5	01/00 →	QR25DE	Petrol	2488	4	93
PRIMERA Traveller (W10)	1.6	03/99 → 03/99	GA16DE	Petrol	1597	4	37
PRIMERA Traveller (W10)	1.6	07/99 → 03/99	GA16DS	Petrol	1597	4	39
PRIMERA Traveller (W10)	2.0	07/99 → 12/99	CD20	Diesel	1974	4	60
PRIMERA Traveller (W10)	2.0	07/99 → 01/99	SR20DE	Petrol	1998	4	72
PRIMERA Traveller (W10)	2.0	07/99 → 03/99	SR20DI	Petrol	1998	4	75
PRIMERA Traveller (WP11)	1.6	04/99 → 12/00	GA16DE	Petrol	1597	4	37
PRIMERA Traveller (WP11)	1.6	04/99 → 12/00	QG16DE	Petrol	1597	4	44
PRIMERA Traveller (WP11)	1.8	08/99 → 12/00	QG18DE	Petrol	1769	4	53
PRIMERA Traveller (WP11)	2.0	04/99 → 12/00	CD20T	Diesel	1974	4	61
PRIMERA Traveller (WP11)	2.0	04/99 → 12/00	SR20DE	Petrol	1998	4	72
PRIMERA Traveller (WP11)	2.0	06/99 → 12/00	SR20De	Petrol	1998	4	73
QASHQAI / QASHQAI +2 (J10, JJ10)	1.6	02/00 →	HR16DE	Petrol	1598	4	42
QASHQAI / QASHQAI +2 (J10, JJ10)	2.0	02/00 →	MR20DE	Petrol	1997	4	67
QUEST (V40)	3.0	05/99 → 09/99	VG30E	Petrol	2960	6	114
QUEST (V42)	3.5	05/00 →	VQ35DE	Petrol	3498	6	126
SENTRA	1.8	01/00 → 08/00	QG18DE	Petrol	1769	4	53
SENTRA	2.0	01/00 →	SR20DE	Petrol	1998	4	72
SENTRA	2.5	06/00 → 08/00	QR25DE	Petrol/Electro	2488	4	93
SENTRA	2.5	06/00 → 08/00	QR25DE	Petrol	2488	4	93
SERENA (C23M)	1.6	02/99 → 09/00	GA16DE	Petrol	1597	4	37
SERENA (C23M)	2.0	11/99 → 09/00	SR20DE	Petrol	1998	4	72
SERENA (C23M)	2.3	01/99 → 09/00	LD23	Diesel	2283	4	82
SERENA (C23M)	2.4	07/99 → 08/00	KA24E	Petrol	2389	4	85
SERENA (C24)	2.0	09/00 →	SR20DE	Petrol	1998	4	72
SERENA (C24)	2.5	06/99 →	YD25DDTi	Diesel	2488	4	99
SERENA (C25)	2.0	04/00 →	MR20DE	Petrol	1997	4	67
SERENA (C25)	2.5	02/00 →	QR25DE	Petrol/Electro	2488	4	93
SERENA (C25)	2.5	02/00 →	QR25DE	Petrol	2488	4	93
SILVIA (S12)	1.8	07/98 → 04/98	CA18ET	Petrol	1809	4	49
SILVIA (S12)	2.0	04/98 → 09/98	FJ20E	Petrol	1991	4	64
SKYLINE (R32)	2.0	03/98 → 06/99	RB20DE	Petrol	1998	6	69
SKYLINE (R32)	2.0	03/98 → 06/99	RB20DET	Petrol	1998	6	70
SKYLINE (R32)	2.0	03/98 → 06/99	RB20E	Petrol	1998	6	71
SKYLINE (R32)	2.5	03/98 → 06/99	RB25DE	Petrol	2498	6	94
SKYLINE (R33)	2.0	07/99 → 05/99	RB20E	Petrol	1998	6	71
SKYLINE (R33)	2.5	07/99 → 05/99	RB25DE	Petrol	2498	6	94
SKYLINE (R34)	2.0	06/99 → 07/00	RB20DE	Petrol	1998	6	69
SKYLINE Coupe (R32)	2.0	03/98 → 06/99	RB20DE	Petrol	1998	6	69
SKYLINE Coupe (R32)	2.0	03/98 → 06/99	RB20DET	Petrol	1998	6	70
SKYLINE Coupe (R32)	2.6	04/98 → 06/99	RB26DETT	Petrol	2568	6	100
SKYLINE Coupe (R33)	2.0	07/99 → 05/99	RB20E	Petrol	1998	6	71
SKYLINE Coupe (R33)	2.5	07/99 → 05/99	RB25DE	Petrol	2498	6	94
SKYLINE Coupe (R33)	2.5	01/99 → 07/00	RB25DET	Petrol	2498	6	95
SKYLINE Coupe (R33)	2.6	07/99 → 09/99	RB26DETT	Petrol	2568	6	100
SKYLINE Coupe (R34)	2.0	06/99 → 07/00	RB20DE	Petrol	1998	6	69
SKYLINE Coupe (V35)	3.5	08/00 →	VQ35DE	Petrol	3498	6	126
STAGEA (M35)	3.5	04/00 → 12/00	VQ35DE	Petrol	3498	6	126



Ltr















CC



9

Model	Ltr	Year Range	Engine Code	Fuel Type	CC	Gear	Price
STAGEA (WC34)	2.0	09/99→08/99	RB20E	Petrol	1998	6	71
STAGEA (WC34)	2.5	09/99→10/00	RB25DE	Petrol	2498	6	94
STAGEA (WC34)	2.5	09/99→10/00	RB25DET	Petrol	2498	6	95
STAGEA (WC34)	2.6	09/99→10/00	RB26DETT	Petrol	2568	6	100
SUNNY Box (Y10)	1.6	10/99→03/00	GA16DE	Petrol	1597	4	37
SUNNY Box (Y10)	1.7	11/99→03/00	CD17	Diesel	1681	4	45
SUNNY Coupe	1.8	04/00→09/00	QG18DE	Petrol	1769	4	53
SUNNY Hatchback	1.5	04/00→08/00	QG15DE	Petrol	1498	4	30
SUNNY Hatchback	1.8	04/00→09/00	QG18DE	Petrol	1769	4	53
SUNNY I (B11)	1.6	07/98→10/98	E16I	Petrol	1597	4	34
SUNNY I (B11)	1.6	07/98→10/98	E16S	Petrol	1597	4	36
SUNNY I Traveller (B11)	1.3	08/98→08/99	E13	Petrol	1269	4	12
SUNNY II (N13)	1.3	07/98→10/99	E13S	Petrol	1269	4	13
SUNNY II (N13)	1.4	10/98→08/99	GA14S	Petrol	1392	4	18
SUNNY II (N13)	1.5	06/98→10/98	E15S	Petrol	1488	4	20
SUNNY II (N13)	1.6	02/98→10/98	CA16D	Petrol	1598	4	32
SUNNY II (N13)	1.6	06/98→10/99	E16i	Petrol	1597	4	35
SUNNY II (N13)	1.6	06/98→10/98	E16S	Petrol	1597	4	36
SUNNY II (N13)	1.6	02/98→10/98	GA16DE	Petrol	1597	4	37
SUNNY II (N13)	1.6	10/98→06/99	GA16i	Petrol	1597	4	40
SUNNY II (N13)	1.6	07/98→10/98	GA16S	Petrol	1597	4	41
SUNNY II (N13)	1.7	06/98→05/98	CD17	Diesel	1681	4	45
SUNNY II Coupe (B12)	1.5	06/98→10/98	E15S	Petrol	1488	4	20
SUNNY II Coupe (B12)	1.6	05/98→05/98	CA16D	Petrol	1598	4	32
SUNNY II Coupe (B12)	1.6	06/98→05/98	E16i	Petrol	1597	4	35
SUNNY II Coupe (B12)	1.6	06/98→10/98	E16S	Petrol	1597	4	36
SUNNY II Coupe (B12)	1.6	10/98→06/99	GA16i	Petrol	1597	4	40
SUNNY II Coupe (B12)	1.8	01/98→06/99	CA18D	Petrol	1809	4	46
SUNNY II Hatchback (N13)	1.0	07/98→09/99	E10S	Petrol	988	4	2
SUNNY II Hatchback (N13)	1.3	06/98→10/98	E13S	Petrol	1269	4	13
SUNNY II Hatchback (N13)	1.4	01/98→08/99	GA14S	Petrol	1392	4	18
SUNNY II Hatchback (N13)	1.5	06/98→10/98	E15S	Petrol	1488	4	20
SUNNY II Hatchback (N13)	1.6	06/98→05/98	CA16D	Petrol	1598	4	32
SUNNY II Hatchback (N13)	1.6	07/98→10/98	E16I	Petrol	1597	4	34
SUNNY II Hatchback (N13)	1.6	06/98→10/99	E16i	Petrol	1597	4	35
SUNNY II Hatchback (N13)	1.6	06/98→10/98	E16S	Petrol	1597	4	36
SUNNY II Hatchback (N13)	1.6	02/98→10/98	GA16DE	Petrol	1597	4	37
SUNNY II Hatchback (N13)	1.6	06/98→10/99	GA16i	Petrol	1597	4	40
SUNNY II Hatchback (N13)	1.7	06/98→01/99	CD17	Diesel	1681	4	45
SUNNY II Hatchback (N13)	1.8	01/98→06/99	CA18D	Petrol	1809	4	46
SUNNY II Traveller (B12)	1.5	06/98→10/98	E15S	Petrol	1488	4	20
SUNNY II Traveller (B12)	1.6	06/98→05/98	E16i	Petrol	1597	4	35
SUNNY II Traveller (B12)	1.6	06/98→10/98	E16S	Petrol	1597	4	36
SUNNY II Traveller (B12)	1.6	10/98→06/99	GA16i	Petrol	1597	4	40
SUNNY II Traveller (B12)	1.7	01/98→06/99	CD17	Diesel	1681	4	45
SUNNY III (N14)	1.4	10/99→06/99	GA14DE	Petrol	1392	4	16
SUNNY III (N14)	1.4	10/99→06/99	GA14DS	Petrol	1392	4	17
SUNNY III (N14)	1.6	08/99→05/99	GA16DE	Petrol	1597	4	37
SUNNY III (N14)	1.6	10/99→06/99	GA16DEL	Petrol	1597	4	38
SUNNY III (N14)	1.6	10/99→05/99	GA16DS	Petrol	1597	4	39
SUNNY III (N14)	2.0	10/99→05/99	CD20	Diesel	1974	4	60
SUNNY III (N14)	2.0	08/99→12/99	SR20DE	Petrol	1998	4	72
SUNNY III Hatchback (N14)	1.4	10/99→05/99	GA14DE	Petrol	1392	4	16
SUNNY III Hatchback (N14)	1.4	10/99→06/99	GA14DS	Petrol	1392	4	17
SUNNY III Hatchback (N14)	1.6	10/99→05/99	GA16DE	Petrol	1597	4	37
SUNNY III Hatchback (N14)	1.6	10/99→06/99	GA16DEL	Petrol	1597	4	38
SUNNY III Hatchback (N14)	1.6	10/99→05/99	GA16DS	Petrol	1597	4	39
SUNNY III Hatchback (N14)	2.0	10/99→05/99	CD20	Diesel	1974	4	60
SUNNY III Hatchback (N14)	2.0	10/99→05/99	SR20DE	Petrol	1998	4	72
SUNNY III Hatchback (N14)	2.0	10/99→05/99	SR20DET	Petrol	1998	4	74
SUNNY III Liftback (N14)	1.4	10/99→06/99	GA14DE	Petrol	1392	4	16
SUNNY III Liftback (N14)	1.4	10/99→06/99	GA14DS	Petrol	1392	4	17
SUNNY III Liftback (N14)	1.6	10/99→05/99	GA16DE	Petrol	1597	4	37
SUNNY III Liftback (N14)	1.6	10/99→06/99	GA16DEL	Petrol	1597	4	38
SUNNY III Liftback (N14)	1.6	10/99→05/99	GA16DS	Petrol	1597	4	39
SUNNY III Liftback (N14)	2.0	10/99→05/99	CD20	Diesel	1974	4	60
SUNNY III Liftback (N14)	2.0	10/99→05/99	SR20DE	Petrol	1998	4	72
SUNNY III Traveller (Y10)	1.6	06/99→03/00	GA16DE	Petrol	1597	4	37
SUNNY III Traveller (Y10)	1.6	11/99→03/00	GA16DS	Petrol	1597	4	39
SUNNY III Traveller (Y10)	2.0	06/99→03/00	CD20	Diesel	1974	4	60

	Ltr				CC		9
SUNNY Saloon	1.5	07/99→03/00	QG15DE	Petrol	1498	4	30
SUNNY Saloon	1.8	04/00→09/00	QG18DE	Petrol	1769	4	53
SUNNY Saloon	2.0	01/00→05/00	SR20DE	Petrol	1998	4	72
SYLPHY (B17)	1.6	08/01→	HR16DE	Petrol	1598	4	42
TEANA I (J31)	2.0	10/00→06/00	QR20DE	Petrol	1998	4	68
TEANA I (J31)	3.5	10/00→06/00	VQ35DE	Petrol	3498	6	126
TEANA II (J32)	2.5	07/00→	VQ25DE	Petrol	2496	6	98
TEANA II (J32)	3.5	07/00→	VQ35DE	Petrol	3498	6	126
TERRANO I (WD21)	2.4	10/98→02/99	Z24i	Petrol	2389	4	87
TERRANO I (WD21)	2.7	02/98→02/99	TD27T	Diesel	2664	4	103
TERRANO I (WD21)	3.0	01/99→12/99	VG30E	Petrol	2960	6	114
TERRANO II (R20)	2.4	02/99→	KA24E	Petrol	2389	4	85
TERRANO II (R20)	2.7	02/99→01/00	TD27T	Diesel	2664	4	103
TERRANO II (R20)	2.7	05/99→	TD27TI	Diesel	2664	4	104
TERRANO II (R20)	3.0	05/00→	ZD30	Diesel	2953	4	119
TERRANO II (R20)	3.0	10/99→06/00	ZD30DDTi	Diesel	2953	4	120
TERRANO II (R20)	3.2	10/99→10/99	QD32ETI	Diesel	3153	4	122
TERRANO II (R20)	3.3	10/99→10/99	VG33E	Petrol	3275	6	124
TERRANO II (R20)	3.5	10/99→06/00	VQ35DE	Petrol	3498	6	126
TERRANO Van (R20)	2.7	06/99→	TD27TI	Diesel	2664	4	104
TERRANO Van (R20)	3.0	04/00→	ZD30	Diesel	2953	4	119
TIIDA Hatchback (C11X)	1.5	09/00→	K9K 728	Diesel	1461	4	29
TIIDA Hatchback (C11X)	1.6	09/00→	HR16DE	Petrol	1598	4	42
TIIDA Hatchback (C11X)	1.8	09/00→	MR18DE	Petrol	1797	4	52
TIIDA Hatchback	1.8	05/00→02/00	MR18DE	Petrol	1797	4	52
TIIDA Saloon (SC11X)	1.6	09/00→	HR16DE	Petrol	1598	4	42
TIIDA Saloon (SC11X)	1.8	09/00→	MR18DE	Petrol	1797	4	52
TRADE Box Body / Estate	2.3	05/99→12/00	LD23	Diesel	2283	4	82
TRADE Platform/Chassis	2.3	06/99→10/00	LD23	Diesel	2283	4	82
TRADE Platform/Chassis	2.7	11/99→09/00	TD27T	Diesel	2664	4	103
TRADE Platform/Chassis	2.8	12/98→06/99	A428II	Diesel	2820	4	105
URVAN Box (E24)	2.0	05/98→05/99	Z20	Petrol	1952	4	77
URVAN Box (E24)	2.3	01/98→05/99	TD23	Diesel	2289	4	83
URVAN Box (E24)	2.4	02/99→05/99	Z24i	Petrol	2389	4	87
URVAN Box (E24)	2.5	12/98→05/99	TD25	Diesel	2494	4	96
URVAN Box (E24)	3.0	02/99→04/99	VG30S	Petrol	2960	6	116
URVAN Box (E24)	3.2	02/99→04/99	SD33T	Diesel	3246	6	123
URVAN Box (E25)	2.4	05/00→	KA24DE	Petrol	2389	4	84
URVAN Bus (E23)	2.0	12/98→11/98	Z20	Petrol	1952	4	77
URVAN Bus (E24)	2.4	05/98→09/99	Z24i	Petrol	2389	4	87
URVAN Bus (E24)	2.5	05/98→10/99	TD25	Diesel	2494	4	96
URVAN Bus (E24)	3.0	02/99→04/99	VG30S	Petrol	2960	6	116
URVAN Bus (E24)	3.2	02/99→04/99	SD33T	Diesel	3246	6	123
URVAN Bus (V2_)	2.4	05/00→	KA24DE	Petrol	2389	4	84
URVAN Bus (V2_)	3.0	10/99→08/00	VG30E	Petrol	2960	6	114
VANETTE Box (C22)	1.5	10/98→12/99	A15S	Petrol	1488	4	19
VANETTE Box (C22)	2.0	07/99→01/99	LD20II	Diesel	1952	4	65
VANETTE Bus (C22)	1.5	10/98→12/99	A15S	Petrol	1488	4	19
VANETTE Bus (C22)	2.4	10/98→12/99	Z24i	Petrol	2389	4	87
VANETTE CARGO Box (HC 23)	1.6	01/99→	GA16DE	Petrol	1597	4	37
VANETTE CARGO Box (HC 23)	2.3	01/99→	LD23	Diesel	2283	4	82
VANETTE CARGO Bus (HC 23)	1.6	01/99→	GA16DE	Petrol	1597	4	37
VANETTE CARGO Bus (HC 23)	2.3	01/99→	LD23	Diesel	2283	4	82
X-TRAIL (T30)	2.0	07/00→	QR20DE	Petrol	1998	4	68
X-TRAIL (T30)	2.2	06/00→	YD22DDTi	Diesel	2184	4	80
X-TRAIL (T30)	2.2	07/00→	YD22ETI	Diesel	2184	4	81
X-TRAIL (T30)	2.5	09/00→	QR25DE	Petrol/Electro	2488	4	93
X-TRAIL (T30)	2.5	09/00→	QR25DE	Petrol	2488	4	93
X-TRAIL (T31)	2.0	03/00→	MR20DE	Petrol	1997	4	67
X-TRAIL (T31)	2.5	06/00→	QR25DE	Petrol/Electro	2488	4	93
X-TRAIL (T31)	2.5	06/00→	QR25DE	Petrol	2488	4	93

		CC			9			CC			9
A15S	Petrol	1488	4	76.00	19	MA12S	Petrol	1235	4	71.00	9
A428H	Diesel	2820	4	94.00	105	MR18DE	Petrol	1797	4	84.00	52
CA16D	Petrol	1598	4	78.00	32	MR20DE	Petrol	1997	4	84.00	67
CA16S	Petrol	1598	4	78.00	33	QD32	Diesel	3153	4	99.20	121
CA18D	Petrol	1809	4	83.00	46	QD32ETI	Diesel	3153	4	99.20	122
CA18DE	Petrol	1809	4	83.00	47	QG15DE	Petrol	1498	4	73.60	30
CA18DET	Petrol	1809	4	83.00	48	QG16DE	Petrol	1597	4	76.00	44
CA18ET	Petrol	1809	4	83.00	49	QG18DE	Petrol	1769	4	80.00	53
CA18S	Petrol	1809	4	83.00	50	QR20DE	Petrol	1998	4	89.00	68
CA18T	Petrol	1809	4	83.60	51	QR25DE	Petrol/Electro	2488	4	89.00	93
CA20E	Petrol	1974	4	84.50	58	QR25DE	Petrol	2488	4	89.00	93
CA20S	Petrol	1974	4	84.50	59	RB20DE	Petrol	1998	6	78.00	69
CD17	Diesel	1681	4	80.00	45	RB20DET	Petrol	1998	6	78.00	70
CD20	Diesel	1974	4	84.50	60	RB20E	Petrol	1998	6	78.00	71
CD20T	Diesel	1974	4	84.50	61	RB25DE	Petrol	2498	6	86.00	94
CG10DE	Petrol	998	4	71.00	1	RB25DET	Petrol	2498	6	86.00	95
CG12DE	Petrol	1240	4	71.00	7	RB26DETT	Petrol	2568	6	86.00	100
CG13DE	Petrol	1275	4	71.00	10	RB30S	Petrol	2962	6	86.00	111
CGA3DE	Petrol	1348	4	72.00	11	RD28	Diesel	2826	6	85.00	108
CR12DE	Petrol	1240	4	71.00	8	RD28T	Diesel	2826	6	85.00	109
CR14DE	Petrol	1386	4	73.00	15	RD28Ti	Diesel	2826	6	85.00	110
D4F 712	Petrol	1149	4	69.00	5	SD33T	Diesel	3246	6	83.00	123
D7F 764	Petrol	1149	4	69.00	6	SRI8DE	Petrol	1838	4	82.50	54
E10S	Petrol	988	4	73.00	2	SR20DE	Petrol	1998	4	86.00	72
E13	Petrol	1269	4	76.00	12	SR20De	Petrol	1998	4	86.00	73
E13S	Petrol	1269	4	76.00	13	SR20DET	Petrol	1998	4	86.00	74
E15S	Petrol	1488	4	76.00	20	SR20Di	Petrol	1998	4	86.00	75
E16i	Petrol	1597	4	76.00	34	TB42E	Petrol	4169	6	96.00	129
E16i	Petrol	1597	4	76.00	35	TD15	Diesel	1527	4	77.00	31
E16S	Petrol	1597	4	76.00	36	TD23	Diesel	2289	4	89.00	83
F4R 720	Petrol	1998	4	82.70	62	TD25	Diesel	2494	4	92.90	96
F4R 722	Petrol	1998	4	82.70	63	TD25Ti	Diesel	2494	4	92.90	97
F9Q 760	Diesel	1870	4	80.00	55	TD27	Diesel	2663	4	96.00	101
F9Q 762	Diesel	1870	4	80.00	56	TD27ETi	Diesel	2664	4	96.00	102
F9Q 772	Diesel	1870	4	80.00	57	TD27T	Diesel	2664	4	96.00	103
FI20E	Petrol	1991	4	89.00	64	TD27Ti	Diesel	2664	4	96.00	104
G9T 722	Diesel	2188	4	87.00	78	TD42T	Diesel	4169	6	96.00	130
G9U 632	Diesel	2464	4	89.00	89	VG30DET	Petrol	2960	6	87.00	112
G9U 650	Diesel	2464	4	89.00	90	VG30DETT	Petrol	2960	6	87.00	113
G9U 720	Diesel	2463	4	89.00	91	VG30E	Petrol	2960	6	87.00	114
G9U 730	Diesel	2463	4	89.00	92	VG30ET	Petrol	2960	6	87.00	115
GA13DE	Petrol	1295	4	71.00	14	VG30S	Petrol	2960	6	87.00	116
GA14DE	Petrol	1392	4	73.60	16	VG30T	Petrol	2959	6	87.00	117
GA14DS	Petrol	1392	4	73.60	17	VG33E	Petrol	3275	6	91.50	124
GA14S	Petrol	1392	4	73.60	18	VQ20DE	Petrol	1995	6	76.00	76
GA15DE	Petrol	1498	4	73.60	21	VQ25DE	Petrol	2496	6	85.00	98
GA16DE	Petrol	1597	4	76.00	37	VQ30DE	Petrol	2988	6	93.00	118
GA16DEL	Petrol	1597	4	76.00	38	VQ35	Petrol	3498	6	95.50	125
GA16DS	Petrol	1597	4	76.00	39	VQ35DE	Petrol	3498	6	95.50	126
GA16i	Petrol	1597	4	76.00	40	VQ35HR	Petrol	3498	6	95.50	127
GA16S	Petrol	1597	4	76.00	41	VQ40DE	Petrol	3954	6	95.50	128
HRI6DE	Petrol	1598	4	78.00	42	YD22DDT	Diesel	2184	4	86.00	79
K10 B	Petrol	996	3	73.40	3	YD22DDTi	Diesel	2184	4	86.00	80
K4M 752	Petrol	1598	4	79.50	43	YD22ETI	Diesel	2184	4	86.00	81
K9K 276	Diesel	1461	4	76.00	22	YD25DDTi	Diesel	2488	4	89.00	99
K9K 700	Diesel	1461	4	76.00	23	Z20	Petrol	1952	4	85.00	77
K9K 704	Diesel	1461	4	76.00	24	Z24	Petrol	2388	4	89.00	86
K9K 708	Diesel	1461	4	76.00	25	Z24i	Petrol	2389	4	89.00	87
K9K 710	Diesel	1461	4	76.00	26	Z24S	Petrol	2389	4	89.00	88
K9K 714	Diesel	1461	4	76.00	27	ZD30	Diesel	2953	4	96.00	119
K9K 722	Diesel	1461	4	76.00	28	ZD30DDTi	Diesel	2953	4	96.00	120
K9K 728	Diesel	1461	4	76.00	29						
KA24DE	Petrol	2389	4	89.00	84						
KA24E	Petrol	2389	4	89.00	85						
L28	Petrol	2753	6	86.00	106						
LD20H	Diesel	1952	4	85.00	65						
LD20T	Diesel	1952	4	85.00	66						
LD23	Diesel	2283	4	87.00	82						
LD28	Diesel	2792	6	84.50	107						
MA10S	Petrol	988	4	68.00	4						



kW/PS

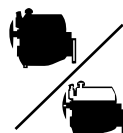

Model	Year Range	CC	Cyls	Power (kW/PS)	Configuration	Code	Engine	Accessories
1.0 CG10DE 1								
Micra II 1.0 i	08/92→02/03	998	4	71.00	DOHC	40-48/54-65	BY900 (Fibre) →02/03 AG7880 (MLS) 03/03→	DY900 [3] →02/03 CG7880 03/03→
Micra III 1.0	01/03→06/10							FG7880
1.0 E10S 2								
Sunny II 1.0	07/86→09/90	988	4	73.00	SOHC/OHC	37/50	BJ690 (Fibre)	DJ690
1.0 K10 B 3								
Pixo 1.0	06/09→	996	3	73.40	DOHC, V	50/68	AH6620 (MLS)	
1.0 MA10S 4								
BE 1.0	12/82→07/92	988	4	68.00	SOHC/OHC	37-40/50-54	BL760 (Graphite)	DL761
Micra I 1.0	12/82→12/89							GL761 [3]
1.1 D4F 712 5								
Kubistar 1.2	04/06→	1149	4	69.00		55/75	AD5980 (MLS) AG7950 (MLS)	CD5980 CD5981 →Eng.030820
1.1 D7F 764 6								
Kubistar 1.2	08/03→	1149	4	69.00	SOHC/OHC	44/60	BX630 (Fibre)	DX630
1.2 CG12DE 7								
Micra III 1.2	01/03→06/10	1240	4	71.00	DOHC	48-66/65-90	AG7880 (MLS)	CG7880
1.2 CR12DE 8								
Micra III 1.2	01/03→06/10	1240	4	71.00	DOHC	48-59/65-80	AG7880 (MLS)	CG7880
1.2 MA12S 9								
Micra I 1.2	07/86→07/92	1235	4	71.00	SOHC/OHC	40-44/54-60	BR160 (Graphite)	
1.3 CG13DE 10								
Cube 1.3	03/98→08/00	1275	4	71.00	DOHC	55/75	BY900 (Fibre)	DY900 [3]
Micra II 1.3 i	08/92→09/00							
1.3 CGA3DE 11								
Cube 1.3	09/00→12/02	1348	4	72.00	DOHC	60-74/82-101	BY900 (Fibre) →01/03	DY900 [3]
Cube 1.3 AWD	09/00→12/02							
Micra II 1.4 i	09/00→02/03							
1.3 E13 12								
Sunny I 1.3	08/82→08/90	1269	4	76.00	SOHC/OHC	44/60	BK440 (Graphite)	GK444 [3]
1.3 E13S 13								
AD 1.3	10/81→08/88	1269	4	76.00	SOHC/OHC	44/60	BK440 (Graphite)	GK444 [3]
Sunny II 1.3	06/86→10/91							
1.3 GA13DE 14								
Lucino 1.3	11/96→01/00	1295	4	71.00	DOHC	63/86		
1.4 CR14DE 15								
Cube 1.4	01/03→09/05	1386	4	73.00	DOHC	65-72/88-98	AH6300 (MLS), 0.6mm	CH6300
Cube 1.4 4x4	01/03→09/05							
Micra C+C 1.4	08/05→							
Micra III 1.4	01/03→06/10							
Note 1.4	03/06→							

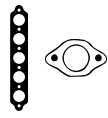

BJ690



BK440



BL760



BR160



BX630



BY900



JC459



JC460



JC875

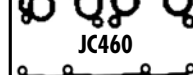

JC876

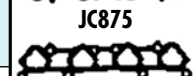

JD420



JD421



JN494

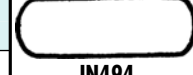

JN840

HBS110 [22] M10x1.50x146.00mm (x10)	JC875 [1] →12/00 JD5841 [1] (FPM) 02/03→ JC876 [x2]	JM5281	HR397	PB681	NJ765 [2] 40.00x52.00x7.00mm, NBR NJ933 [2] 35.00x50.00x8.00mm, FPM NJ765 [2] 40.00x52.00x7.00mm, NBR NJ287 [1] 80.00x100.00x10.00mm, MVQ	
	JC460 [1] JC459 [1]	JN840 [4]	HC443 [1]	PA079 HR5112 [1][6]		
HBS283 [5] M9x1.25x122.00mm (x10)	JD5885 [1] JD5884 [1]	JM5185			NA5261 [2] 28.00x47.00x8.00mm, PTFE/ACM	
HBS241 [5] M9x1.25x103.00mm (x10)	JD421 [1] JD420 [1]	JM5131 (Elastomer)			NA5053 [2] 30.00x42.00x7.00mm, FPM NF856 [2] 32.00x44.00x6.00mm, FPM	
HBS506 [22] (FPM)	JD5841 [1] (FPM)			PB681	NJ765 [2] 40.00x52.00x7.00mm, NBR NJ765 [2] 40.00x52.00x7.00mm, NBR	
HBS506 [22] (FPM)	JD5841 [1] (FPM)			PB681	NJ765 [2] 40.00x52.00x7.00mm, NBR NJ765 [2] 40.00x52.00x7.00mm, NBR	
	JC460 [1] JC459 [1]	JN840 [4]	HC443 [1]	PA079 HR5112 [1][6]		
HBS110 [22] M10x1.50x146.00mm (x10)	JC875 [1] JC876 [x2]	JM5281	HC5010 [1]	PB681	NJ765 [2] 40.00x52.00x7.00mm, NBR NJ933 [2] 35.00x50.00x8.00mm, FPM NJ765 [2] 40.00x52.00x7.00mm, NBR	
HBS110 [22] M10x1.50x146.00mm (x10) HBS506 [22]	JC875 [1] JC876 [x2]	JM5298 (ACM) 02/03→	HR397	PB681	NJ765 [2] 40.00x52.00x7.00mm, NBR NJ765 [2] 40.00x52.00x7.00mm, NBR	
HBS409 [22]	HA371 [1][1]	JN494 [4]	HC442 [1]		NJ288 [1] 40.00x55.00x9.00mm, NBR NJ287 [1] 80.00x100.00x10.00mm, MVQ	
HBS409 [22]	HA371 [1][1]	JN494 [4]	HC442 [1]		NJ288 [1] 40.00x55.00x9.00mm, NBR NJ287 [1] 80.00x100.00x10.00mm, MVQ	
				PB681	NJ765 [2] 40.00x52.00x7.00mm, NBR NJ765 [2] 40.00x52.00x7.00mm, NBR	
HBS506 [22] (FPM)	JD5841 [1] (FPM)	HR397 [1]	HR397	PB681	NJ765 [2] 40.00x52.00x7.00mm, NBR NJ765 [2] 40.00x52.00x7.00mm, NBR	

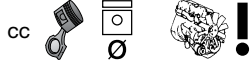

kW/PS

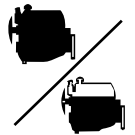

1.4	GA14DE	16	BP950 (Graphite)	DP951					
Almera I 1.4	09/95→07/00	1392	4	73.60	DOHC	55-64/ 75-87			
Lucino 1.4	09/91→01/00								
Sunny III 1.4 i	10/90→06/95								
1.4	GA14DS	17	BP950 (Graphite)						
Sunny III 1.4	10/90→06/95	1392	4	73.60	DOHC	55-63/ 75-86			
Sunny III 1.4 i	10/90→05/95								
1.4	GA14S	18	BV990 (Graphite)	DV990	GV990				
Sunny II 1.4 LX	10/88→08/91	1392	4	73.60	SOHC/OHC	55-60/ 75-82			
1.5	A15S	19	BC270 (Graphite)	DC270 [13]	GC275 [3]				
Bobby 1.5	11/87→11/94	1488	4	76.00	SOHC/OHC	49-60/ 67-82			
Vanette 1.5	10/86→12/95								
1.5	E15S	20	BK440 (Graphite)	DK440					
AD 1.5	10/81→08/88	1488	4	76.00	SOHC/OHC	52-55/ 71-75			
Sunny II 1.5	06/86→10/88								
1.5	GA15DE	21							
Almera 2 1.5	03/01→	1498	4	73.60	DOHC	77/105			
Almera I 1.5	07/95→05/00								
Lucino 1.5	11/97→01/00								
1.5	K9K 276 Diesel	22	AG9490 (MLS), 0.75mm [70][71]	CE5200 ▲	EE5200				
Kubistar 1.5	04/06→	1461	4	76.00	SOHC/OHC	62-66/ 84-90			
Micra III 1.5 d	06/05→06/10								
Note 1.5 dCi	03/06→								
1.5	K9K 700 Diesel	23	AG9490 (MLS), 0.75mm [70][71]	CE5200 ▲	EE5200				
Kubistar 1.5	04/06→	1461	4	76.00	SOHC/OHC	48-50/ 65-68			
Note 1.5 dCi	03/06→								
1.5	K9K 704 Diesel	24	AE5200 (MLS) →05/04 AG9490 (MLS), 0.75mm [70][71] 05/04→	CE5200 ▲	EE5200				
Kubistar 1.5	08/03→	1461	4	76.00	SOHC/OHC	48/65			
Micra III 1.5 d	01/03→06/10								
1.5	K9K 708 Diesel	25	AG9490 (MLS), 0.75mm [70][71]	CE5200 ▲	EE5200				
Micra III 1.5 d	06/05→06/10	1461	4	76.00	SOHC/OHC	48-50/ 65-68			
1.5	K9K 710 Diesel	26	AE5200 (MLS) →05/04 AG9490 (MLS), 0.75mm [70][71] 05/04→	CE5200 ▲	EE5200				
Kubistar 1.5	08/03→	1461	4	76.00	SOHC/OHC	42-45/ 57-61			

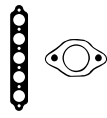

AE5200



BC270



BK440



BP950



BV990

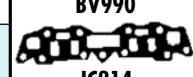

JC214



JC761

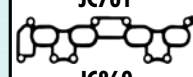

JC869



JD169

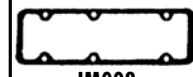

JM008

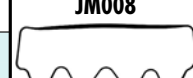

JN665



JN838

HBS187 [22] M10x1.50x97.00mm (x10)	JC761 JD169	JN838 [4]	HR397	PB681 (x16)	NJ765 [2] 40.00x52.00x7.00mm, NBR NJ284 [1] 84.00x104.00x11.00mm, FPM	
HBS187 [22] M10x1.50x97.00mm (x10)	JD093 JC761	JN838 [4]	HR397	PB681	NJ765 [2] 40.00x52.00x7.00mm, NBR NJ765 [2] 40.00x52.00x7.00mm, NBR	
	JC869 JC870			PB071 (x4) PA874 (x8)	NJ765 [2] 40.00x52.00x7.00mm, NBR NJ284 [1] 84.00x104.00x11.00mm, FPM	
	JC214	JM008 [4]	HC259		NJ022 [2] 38.00x55.00x9.00mm, FPM/ACM NJ021 [1] 60.00x82.00x12.00mm, FPM/ACM	
HBS409 [22] 01/86 →		JN665 [4]	HC442		NJ288 [1] 40.00x55.00x9.00mm, NBR NJ287 [1] 80.00x100.00x10.00mm, MVQ	
				PB681	NJ765 [2] 40.00x52.00x7.00mm, NBR NJ765 [2] 40.00x52.00x7.00mm, NBR	
HBS299 [22] M11x1.50x125.00mm (x10)	JD5402 KK5643	JM7054 (NBR)	JH5109 (NBR)	HR817	NA5215 [2] 28.00x42.00x5.00mm, FPM NA5255 [2] 35.00x47.00x7.00mm, PTFE/ACM NA5118 [1][2] 80.00x100.00x9.00mm, PTFE	
HBS299 [22] M11x1.50x125.00mm (x10)	JD5402 KK5643	JM7054 (NBR)	JH5109 (NBR)	HR817	NA5215 [2] 28.00x42.00x5.00mm, FPM NA5255 [2] 35.00x47.00x7.00mm, PTFE/ACM NA5118 [1][2] 80.00x100.00x9.00mm, PTFE	
HBS299 [22] M11x1.50x125.00mm (x10)	JD5402 KK5643	JM7054 (NBR)	JH5109 (NBR)	HR817	NA5215 [2] 28.00x42.00x5.00mm, FPM NA5255 [2] 35.00x47.00x7.00mm, PTFE/ACM NA5118 [1][2] 80.00x100.00x9.00mm, PTFE	
HBS299 [22] M11x1.50x125.00mm (x10)	JD5402 KK5643	JM7054 (NBR)	JH5109 (NBR)	HR817	NA5215 [2] 28.00x42.00x5.00mm, FPM NA5255 [2] 35.00x47.00x7.00mm, PTFE/ACM NA5118 [1][2] 80.00x100.00x9.00mm, PTFE	
HBS299 [22] M11x1.50x125.00mm (x10)	JD5402 KK5643	JM7054 (NBR)	JH5109 (NBR)	HR817	NA5215 [2] 28.00x42.00x5.00mm, FPM NA5255 [2] 35.00x47.00x7.00mm, PTFE/ACM NA5118 [1][2] 80.00x100.00x9.00mm, PTFE	













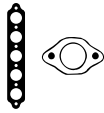

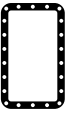

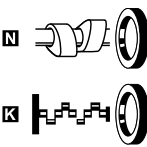

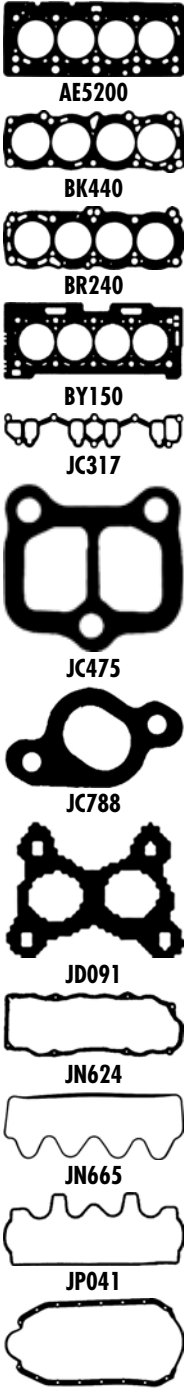























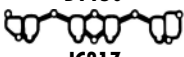















































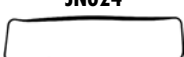
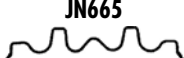

cc



kW/PS



1.5	K9K 714 Diesel	27	AE5200 (MLS)	CE5200 ▲	EE5200
Kubistar 1.5	08/03→	1461 4 76.00 SOHC/OHC	42-45/ 57-61 →05/04 AG9490 (MLS), 0.75mm [70][71] 05/04→		
1.5	K9K 722 Diesel	28	AE5200 (MLS)	CE5200 ▲	EE5200
Almera 2 1.5d	01/03→	1461 4 76.00 SOHC/OHC	60/82 →05/04 AG9490 (MLS), 0.75mm [70][71] 05/04→		
Almera 2 1.5dCi	01/03→				
Kubistar 1.5	08/03→				
Micra III 1.5 d	09/03→06/10				
1.5	K9K 728 Diesel	29	AG9490 (MLS), 0.75mm [70][71]	CE5200 ▲	EE5200
Tiida 1.5 dCi	09/07→	1461 4 76.00 SOHC/OHC	74-78/ 101-106		
1.5	QG15DE	30	AD5250 (MLS), 0.600mm	CD5250	
AD 1.5	05/99→08/04	1498 4 73.60 DOHC	66-80/ 90-109		
Almera 2 1.5	03/00→				
Bluebird 1.5	08/00→08/05				
Cube 1.5	01/03→09/05				
Cube 1.5 4x4	01/03→09/05				
Sunny 1.5	07/95→08/03				
Sunny 1.5 4x4	07/95→03/00				
1.5	TD15 Diesel	31	BY150 (Fibre), 1.750mm	DY150 ▲[3]	
Micra II 1.5D	02/98→02/03	1527 4 77.00	42/57		
1.6	CA16D	32	BR240 (Graphite)	DR240	ER241 GR240
Sunny II 1.6	02/87→05/89	1598 4 78.00 DOHC	79-81/ 107-110		
1.6	CA16S	33		DK831 DM596 [3]	GM596 [3]
Bluebird 1.6	12/85→06/91	1598 4 78.00 SOHC/OHC	60-66/ 82-90		
1.6	E16I	34	BK440 (Graphite)	DK446	GK447 [3]
Sunny I 1.6 4x4	07/86→10/88	1597 4 76.00 SOHC/OHC	62-66/ 84-90		
Sunny II 1.6	07/86→10/88				
1.6	E16i	35	BK440 (Graphite)		
Sunny II 1.6 i	06/86→10/90	1597 4 76.00 SOHC/OHC	54/73		
1.6	E16S	36	BK440 (Graphite)		
AD 1.6	06/87→04/90	1597 4 76.00 SOHC/OHC	62/84		
Sunny I 1.6 SLX	07/86→10/88				
Sunny II 1.6	06/86→10/88				

							
HBS299  [22] M11x1.50x125.00mm (x10)	JD5402   KK5643	JM7054 (NBR)	JH5109 (NBR)	HR817 	 NA5215 [2] 28.00x42.00x5.00mm, FPM  NA5255  [2] 35.00x47.00x7.00mm, PTFE/ACM  NA5118  [1][2] 80.00x100.00x9.00mm, PTFE		 AE5200  BK440  BR240 
HBS299  [22] M11x1.50x125.00mm (x10)	JD5402   KK5643	JM7054 (NBR)	JH5109 (NBR)	HR817 	 NA5215 [2] 28.00x42.00x5.00mm, FPM  NA5255  [2] 35.00x47.00x7.00mm, PTFE/ACM  NA5118  [1][2] 80.00x100.00x9.00mm, PTFE		 BY150  JC317
HBS299  [22] M11x1.50x125.00mm (x10)	JD5402   KK5643	JM7054 (NBR)	JH5109 (NBR)	HR817 	 NA5215 [2] 28.00x42.00x5.00mm, FPM  NA5255  [2] 35.00x47.00x7.00mm, PTFE/ACM  NA5118  [1][2] 80.00x100.00x9.00mm, PTFE		 JC475
HBS422  [22] M10x1.50x92.00mm (x10)	JD5977   (SE) JD091  (x2)	JM5064 (Elastomer)	HR397	PB681	 NJ765 [2] 40.00x52.00x7.00mm, NBR  NJ765  [2] 40.00x52.00x7.00mm, NBR		 JC788 
HBS113  [22] M11x1.50x185.00mm (x10)		JPO41 [4]	HR397		 NF870  [2] 42.00x66.00x6.00mm, FPM/ACM  NF850  [1] 85.00x105.00x8.00mm, FPM		 JD091 
HBS495  [22]	JC788  (x4)		HC459 	PA874  (x8)	 NJ765  [2] 40.00x52.00x7.00mm, NBR  NJ284  [1] 84.00x104.00x11.00mm, FPM		 JN624 
	JC317   JC475  (x2)  JE747	JN624 [4]	HC459  JJ265	PA079  (x8) HR5112  [1][6]	 NJ285 [2] 34.00x48.00x8.00mm, NBR  NJ280  [2] 33.00x47.00x8.00mm, NBR  NJ284  [1] 84.00x104.00x11.00mm, FPM		 JN665  JP041 
					 NJ287  [1] 80.00x100.00x10.00mm, MVQ		 JJ265
HBS409  [22]		JN665 [4]			 NJ288 [1] 40.00x55.00x9.00mm, NBR  NJ287  [1] 80.00x100.00x10.00mm, MVQ		
HBS409  [22]		JN665 [4]			 NJ288 [1] 40.00x55.00x9.00mm, NBR  NJ287  [1] 80.00x100.00x10.00mm, MVQ		













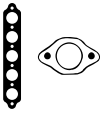

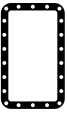

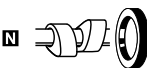
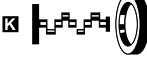



























cc



kW/PS



1.6		GA16DE					37	BV440 (Fibre)	DV440	GV440
100 NX 1.6 SR	09/93→10/94	1597	4	76.00	DOHC	60-88/ 82-120				
AD 1.6	05/99→08/04									
Almera 2 1.6	07/00→02/03									
Almera 1 1.6	07/95→07/00									
Lucino 1.6	10/92→01/00									
Primera 1.6	06/93→01/96									
Primera 1.6 16V	09/96→07/02									
Primera 1.6 i	03/94→03/98									
Serena 1.6	10/94→08/00									
Serena 1.6 16V	02/93→09/01									
Sunny 1.6 L	11/92→04/96									
Sunny Van 1.6i	10/92→03/00									
Sunny II 1.6	02/87→10/88									
Sunny III 1.6	08/90→05/95									
Sunny III 1.6 i	10/90→03/00									
Sunny III 1.6i	10/92→03/00									
Vanette 1.6 i	01/95→									
1.6		GA16DEL					38	BV440 (Fibre)	DV440	GV440
Sunny III 1.6 i	10/90→05/95	1597	4	76.00	DOHC	66/90				
Sunny III 1.6SR	01/92→06/95									
1.6		GA16DS					39	BP970 (Graphite)	DV440	GP970 [3]
100 NX 1.6	03/90→10/94	1597	4	76.00	DOHC	64-75/ 87-102				
AD 1.6	10/90→04/99									
Lucino 1.6	09/91→10/92									
Primera 1.6	06/90→01/96									
Primera 1.6 i	07/90→03/98									
Sunny III 1.6	11/90→05/95									
Sunny III 1.6 i	10/90→03/00									
1.6		GA16i					40	BS610 (Graphite)	DS610 [3]	GS610 [3]
Sunny II 1.6	10/88→08/90	1597	4	76.00	SOHC/OHC	66/90				
Sunny II 1.6 i	06/86→06/91									
1.6		GA16S					41			
Sunny II 1.6	07/86→10/88	1597	4	76.00	SOHC/OHC	62-70/ 84-95				
1.6		HR16DE					42	AH6280 (MLS)		
Cube 1.6 16V	03/10→	1598	4	78.00	DOHC	69-86/ 94-117				
Juke 1.6	06/10→									
Latio 1.6	03/07→									
Livina 1.6	02/07→									
MICRA C+C 160SR	08/05→									
Micra III 160SR	05/05→06/10									
Note 1.6	03/06→									
NV200 1.6 16V	02/10→									
QASHQAI 1.6	02/07→									
Sylphy 1.6	08/12→									
Tiida 1.6	09/07→									

						 	!	 BP970  BS610  BV440  JC869  JD091  JN829  JN838
HBS187  [22] M10x1.50x97.00mm (x10)		JN829 [4] JN838 [4][117]	HR397	PB681	 NJ765 [2] 40.00x52.00x7.00mm, NBR  NJ765  [2] 40.00x52.00x7.00mm, NBR			
HBS187  [22] M10x1.50x97.00mm (x10)		JN829 [4] JN838 [4]	HR397	PB681	 NJ765 [2] 40.00x52.00x7.00mm, NBR  NJ765  [2] 40.00x52.00x7.00mm, NBR			
HBS187  [22] M10x1.50x97.00mm (x10)	JD093  [22] JD091  (x2)	JN838 [4]	HR397	PB681 (x16)	 NJ207 [1][2] 27.00x49.00x7.50mm, ACM  NJ765  [2] 40.00x52.00x7.00mm, NBR  NJ284  [1] 84.00x104.00x11.00mm, FPM			
	JC869  [22] JC870  [22]		HR397	PB071  (x4) PA874  (x8)	 NJ765  [2] 40.00x52.00x7.00mm, NBR  NJ284  [1] 84.00x104.00x11.00mm, FPM			
					 NJ765 [2] 40.00x52.00x7.00mm, NBR  NJ765  [2] 40.00x52.00x7.00mm, NBR			
HBS516  [22]					 NA5223  [2] 40.00x52.00x7.00mm, FPM			

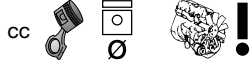

kW/PS

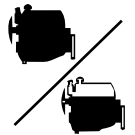

1.6		K4M 752					43	AC5100 (MLS), 1.200mm	CC5100 [3]	
Kubistar 1.6	08/03→	1598	4	79.50	DOHC	70/95				
1.6		QG16DE					44	AB5630 (MLS)	CB5630	
Almera 1.6 16V	03/06→	1597	4	76.00	DOHC	75-87/ 102-118				
Almera 2 1.6	07/00→02/03									
Avenir 1.6	11/97→									
Bluebird 1.6	08/00→08/05									
Primera 1.6	01/02→									
Primera 1.6 16V	06/96→07/02									
1.7		CD17 Diesel					45	BP580 (Graphite), 1.200mm	DP580 [3]	GP580
AD 1.7 D	05/99→	1681	4	80.00	SOHC/OHC	40/54				
AD 1.7 D	10/84→08/04									
Sunny Van 1.7 D	11/90→03/00									
Sunny II 1.7 D	01/86→06/91									
1.8		CA18D					46	BS050 (Graphite)	DS050 [3]	GS050 [3]
Bluebird 1.8 i	02/89→12/90	1809	4	83.00	DOHC	92-95/ 125-129				
Sunny II 1.8	01/89→06/91									
1.8		CA18DE					47	BS050 (Graphite)	DS050 [3]	GS050 [3]
200 SX 1.8	09/88→03/94	1809	4	83.00	DOHC	94-99/ 128-135				
1.8		CA18DET					48	BS050 (Graphite)	DS051 [3]	
180 SX 1.8 T II	04/89→06/92	1809	4	83.00	DOHC	124-148/ 169-201				
200 SX 1.8T	07/88→11/93									
1.8		CA18ET					49	BK840 (Graphite)	DM593 [3]	
Bluebird 1.8	09/84→04/90	1809	4	83.00	SOHC/OHC	90-100/ 122-136				
Silvia 1.8	07/86→04/88									
1.8		CA18S					50	BK480 (Fibre)	DM593 [3]	
Bluebird 1.8	11/83→04/90	1809	4	83.00	SOHC/OHC	65-74/ 88-101				
1.8		CA18T					51	BM590 (Graphite)		
Auster 1.8 T	04/87→10/89	1809	4	83.60	SOHC/OHC	99/135				
Bluebird 1.8	04/84→11/92									
1.8		MR18DE					52	AH6330 (MLS)		
Tiida 1.8	05/04→02/07	1797	4	84.00	DOHC	78-95/ 106-129				

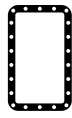
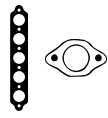

AC5100



BK480



BK840



BM590



BP580



BS050



JC788



JN528



JN624



JN653

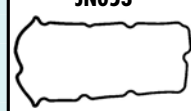

JN654



JJ265

HBS301 [22]
M10x1.50x117.00mm (x10)

JD5393 [1]
JD5394 [1]
KK5643

HR397
JH5108

PA5013

NA5215 [2]
28.00x42.00x5.00mm, FPM
NA5016
35.00x47.00x7.00mm, FPM/ACM
NA5016 [2]
35.00x47.00x7.00mm, FPM/ACM
NF835 [1]
80.00x100.00x8.00mm, FPM/ACM

HBS422 [22]
M10x1.50x92.00mm (x10)

JD5977 [1]
(SE)

JM5245

HR397

PB681

NJ765 [2]
40.00x52.00x7.00mm, NBR
NJ765 [2]
40.00x52.00x7.00mm, NBR

JN528 [4]

JJ265

PA079
HR5112 [116]

NJ285 [2]
34.00x48.00x8.00mm, NBR

HBS495 [22]

JC788 [x4]

JN653 [4]
JN654 [4]

HR397

PA874 [x16]

NJ765 [2]
40.00x52.00x7.00mm, NBR
NJ765 [2]
40.00x52.00x7.00mm, NBR
NJ284 [1]
84.00x104.00x11.00mm, FPM

HBS495 [22]

JC788 [x4]

JN653 [4]
JN654 [4]

HR397

PA874 [x16]

NJ765 [2]
40.00x52.00x7.00mm, NBR
NJ765 [2]
40.00x52.00x7.00mm, NBR
NJ284 [1]
84.00x104.00x11.00mm, FPM

HBS495 [22]

JC788 [x4]

JN653 [4]
JN654 [4]

HR397

PA874 [x16]

NJ765 [2]
40.00x52.00x7.00mm, NBR
NJ765 [2]
40.00x52.00x7.00mm, NBR

JN624 [4]

JJ265

PA079
HR5112 [116]

NJ285 [2]
34.00x48.00x8.00mm, NBR

JN624 [4]

JJ265

PA079
HR5112 [116]

NJ285 [2]
34.00x48.00x8.00mm, NBR

JJ265

PA079
HR5112 [116]

NJ285 [2]
34.00x48.00x8.00mm, NBR



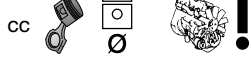



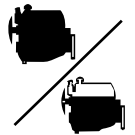



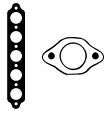

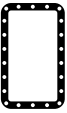

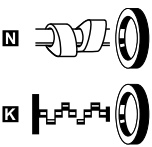

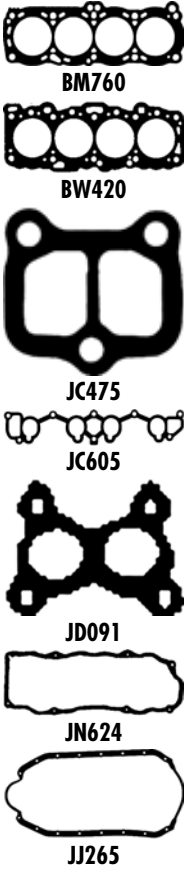















































HR397



kW/PS



1.8		QG18DE					53	AB5690 (MLS)		FB5610
AD 1.8	05/99→08/04	1769	4	80.00	DOHC	84-94/ 114-128				
Almera 2 1.8	01/00→									
Almera I 1.8	07/95→05/00									
Almera Tino 1.8	08/00→									
Avenir 1.8	11/97→									
Bluebird 1.8	08/00→08/05									
Expert 1.8	10/98→04/04									
Primera 1.8	03/02→									
Primera 16V	08/99→07/02									
Sentra 1.8	01/00→08/06									
Sunny 1.8	04/00→09/03									
Sunny Coupe 1.8	04/00→09/03									
1.8		SR18DE					54			
Lucino 1.8 T	11/95→01/00	1838	4	82.50	DOHC	92-104/ 125-141				
1.9		F9Q 760 Diesel					55	AC5062 (MLS) AC5061 (MLS), 1.320mm	CC5060 ▲ [3]	EC5060 →Eng.C000156 EC5063 Eng.C000156→
Primastar	03/01→	1870	4	80.00	SOHC/OHC	74/101				
1.9		F9Q 762 Diesel					56	AC5062 (MLS) AC5061 (MLS), 1.320mm	CC5060 ▲ [3]	EC5060
Primastar	03/01→	1870	4	80.00	SOHC/OHC	60/82				
1.9		F9Q 772 Diesel					57	AC5062 (MLS) AC5061 (MLS), 1.320mm	CC5060 ▲ [3]	EC5060
Interstar	07/02→	1870	4	80.00	SOHC/OHC	60/82				
2.0		CA20E					58	BM760 (Graphite)	DM766	GM766 [3]
Avenir 2.0	10/89→10/97	1974	4	84.50	SOHC/OHC	72-85/ 98-116				
Bluebird 2.0 i	04/84→12/90									
Bluebird 2.0 iT	12/85→12/90									
Prairie 2.0	01/86→03/92									
Prairie 2.0 4x4	01/86→03/92									
Prairie 2.0 i	10/88→12/92									
2.0		CA20S					59	BM760 (Graphite)	DM766	GM765 [3]
Auster 2.0	06/86→10/89	1974	4	84.50	SOHC/OHC	66-81/ 90-110				
Avenir 2.0	06/86→10/90									
Bluebird 2.0	12/85→09/90									
Bluebird 2.0 LX	12/85→02/90									
Prairie 2.0	01/86→03/92									
Prairie 2.0 4x4	01/86→03/92									
2.0		CD20 Diesel					60	BW420 (MLS) →12/97 AD5280 (MLS), 1.150mm, 1 Hole 01/98→ AD5281 (MLS), 1.250mm, 3 Notches 01/98→	DW420 →12/97 CD5280 ▲ 01/98→	GW420 [3] GW421 ▲
AD 2.0 D	10/94→04/99	1974	4	84.50	SOHC/OHC	55/75				
Almera I 2.0 D	11/95→07/00									
Lucino 2.0 D	11/97→01/00									
Primera 2.0 D	07/90→01/96									
Sunny III 2.0 D	10/90→03/00									
2.0		CD20T Diesel					61	AD5280 (MLS), 1.150mm, 1 Hole AD5281 (MLS), 1.250mm, 3 Notches	CD5280 ▲	GW421 ▲
Avenir 2.0 TD	11/92→09/99	1974	4	84.50	SOHC/OHC	66/90				
Primera 2.0 TD	09/96→07/02									

							
HBS422  [22] M10x1.50x92.00mm (x10)	JD5977  (SE) JD091 	JM5245	HR397	PB681	 NJ765 [2] 40.00x52.00x7.00mm, NBR  NJ765  [2] 40.00x52.00x7.00mm, NBR		
				PA874			
HBS372  [22] M12x1.50x121.00mm (x10)	JD5189	JM5086 (Elastomer)	JH5041	HR646 	 NF846 [2] 25.00x42.00x7.00mm, FPM/ACM  NA5036  [2] 42.00x54.00x6.00mm, FPM  NA5037  [1] 85.00x105.00x11.00mm, ACM		JD091 JN624
HBS372  [22] M12x1.50x121.00mm (x10)	JD5189	JM5086 (Elastomer)	JH5041	HR646 	 NA5036  [2] 42.00x54.00x6.00mm, FPM		JJ265
HBS372  [22] M12x1.50x121.00mm (x10)	JD5189	JM5086 (Elastomer)	JH5041	HR646 	 NF846 [2] 25.00x42.00x7.00mm, FPM/ACM  NA5036  [2] 42.00x54.00x6.00mm, FPM  NA5037  [1] 85.00x105.00x11.00mm, ACM		
	JC605  JC475  (x2)  JE747	JN624 [4]	HC459  JJ265	PA079  (x8) HR5112  [116]	 NJ285 [2] 34.00x48.00x8.00mm, NBR  NJ280  [2] 33.00x47.00x8.00mm, NBR  NJ284  [1] 84.00x104.00x11.00mm, FPM		
	JC605  JC475  (x2)  JE747	JN624 [4]	HC459  JJ265	PA079  (x8) HR5112  [116]	 NJ285 [2] 34.00x48.00x8.00mm, NBR  NJ280  [2] 33.00x47.00x8.00mm, NBR  NJ284  [1] 84.00x104.00x11.00mm, FPM		
HBS505  [22]		JM5138		PA079 HR5112  [116]	 NJ765 [2] 40.00x52.00x7.00mm, NBR  NJ285 [2] 34.00x48.00x8.00mm, NBR  NJ765  [2] 40.00x52.00x7.00mm, NBR		
HBS505  [22]				PA079 HR5112  [116]	 NJ765 [2] 40.00x52.00x7.00mm, NBR  NJ285 [2] 34.00x48.00x8.00mm, NBR  NJ765  [2] 40.00x52.00x7.00mm, NBR		



cc



kW/PS



2.0	F4R 720	62	AD5990 (MLS)	CD5991	ED5991				
Primastar	03/01→	1998	4	82.70	DOHC	88/120			
2.0	F4R 722	63	AD5990 (MLS)	CD5991	ED5991				
Primastar	03/01→	1998	4	82.70	DOHC	88/120			
2.0	FJ20E	64							
Silvia 2.0 GP	04/84→09/88	1991	4	89.00		107/146			
2.0	LD20II Diesel	65	BR360 (Graphite)	DR360	GR360				
Vanette 2.0 D	07/91→01/95	1952	4	85.00	SOHC/OHC	44-49/ 60-67			
2.0	LD20T Diesel	66	BL310 (Graphite)	DL310					
Avenir 2.0 TD	10/87→10/92	1952	4	85.00	SOHC/OHC	57-62/ 78-84			
2.0	MR20DE	67	AH6330 (MLS)						
Bluebird 2.0	09/05→08/12	1997	4	84.00	DOHC	98-108/ 133-147			
Lafesta 2.0 CVT	07/05→								
QASHQAI 2.0	02/07→								
QASHQAI 2.0 AWD	02/07→								
Serena 2.0	04/05→								
Serena 2.0 4x4	04/05→								
X-Trail 2.0	03/07→								
2.0	QR20DE	68	AF5540 (MLS)	CF5541	FF5541				
Avenir 2.0	09/01→	1998	4	89.00	DOHC	103/140			
Avenir 2.0 4x4	09/01→								
Primera 2.0	03/02→								
Teana 1 2.0	10/03→06/08								
X-Trail 2.0	07/01→								
2.0	RB20DE	69							
Laurel 2.0	07/90→10/01	1998	6	78.00	DOHC	110-114/ 150-155			
Skyline 2.0	03/89→07/00								
Skyline 2.0 4x4	03/89→06/93								
2.0	RB20DET	70							
Laurel 2.0 T	07/90→01/93	1998	6	78.00	DOHC	151-160/ 205-218			
Skyline 2.0	03/89→06/93								
Skyline 2.0 4x4	03/89→06/93								
2.0	RB20E	71							
Laurel 2.0	07/90→06/97	1998	6	78.00	SOHC/OHC	92-96/ 125-131			
Skyline 2.0	03/89→05/98								
Stagea 2.0	09/96→08/98								

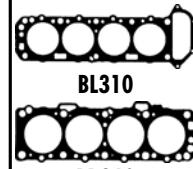

HBS310 [22] M12x1.50x117.00mm (x10)	JD5908 ■ JD5910 ■		HR397 JH5041	PA5013	<input checked="" type="checkbox"/> NA5257 [2] 28.00x47.00x5.50mm, FPM <input checked="" type="checkbox"/> NA5036 ■ [2] 42.00x54.00x6.00mm, FPM <input checked="" type="checkbox"/> NA5037 ■ [1] 85.00x105.00x11.00mm, ACM
HBS310 [22] M12x1.50x117.00mm (x10)	JD5908 ■ JD5910 ■		HR397 JH5041	PA5013	<input checked="" type="checkbox"/> NA5257 [2] 28.00x47.00x5.50mm, FPM <input checked="" type="checkbox"/> NA5036 ■ [2] 42.00x54.00x6.00mm, FPM <input checked="" type="checkbox"/> NA5037 ■ [1] 85.00x105.00x11.00mm, ACM <input checked="" type="checkbox"/> NJ287 ■ [1] 80.00x100.00x10.00mm, MVQ
		JN722 [4]			<input checked="" type="checkbox"/> NJ045 ■ [2] 48.00x70.00x9.00mm, NBR <input checked="" type="checkbox"/> NJ287 ■ [1] 80.00x100.00x10.00mm, MVQ
					<input checked="" type="checkbox"/> NJ287 ■ [1] 80.00x100.00x10.00mm, MVQ
	JD5891 ■ JD5892	HM5290 ■	HR397	PB681	
HBS504 [19]		JM5267	HR397		
					<input checked="" type="checkbox"/> NJ765 [2] 40.00x52.00x7.00mm, NBR <input checked="" type="checkbox"/> NJ933 [2] 35.00x50.00x8.00mm, FPM <input checked="" type="checkbox"/> NJ765 ■ [2] 40.00x52.00x7.00mm, NBR <input checked="" type="checkbox"/> NJ287 ■ [1] 80.00x100.00x10.00mm, MVQ
					<input checked="" type="checkbox"/> NJ765 [2] 40.00x52.00x7.00mm, NBR <input checked="" type="checkbox"/> NJ765 ■ [2] 40.00x52.00x7.00mm, NBR <input checked="" type="checkbox"/> NJ287 ■ [1] 80.00x100.00x10.00mm, MVQ
					<input checked="" type="checkbox"/> NJ765 [2] 40.00x52.00x7.00mm, NBR <input checked="" type="checkbox"/> NJ765 ■ [2] 40.00x52.00x7.00mm, NBR <input checked="" type="checkbox"/> NJ287 ■ [1] 80.00x100.00x10.00mm, MVQ

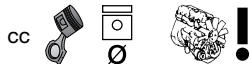

kW/PS

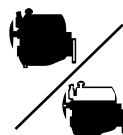

2.0		SR20DE					72	BV540 (Fibre)	DT050 [3]	EV540 GT050 [3]
100 NX 2.0	10/90→10/94	1998	4	86.00	DOHC	92-119/ 125-162				
200 SX 2.0i	07/88→12/99									
AD 2.0	10/94→08/01									
Almera 2 2.0	08/02→									
Almera I 2.0 GT	07/96→03/00									
Almera Tino 2.0	08/00→									
Avenir 2.0	11/97→08/01									
Avenir 2.0 4x4	11/97→08/01									
Bluebird 2.0	08/00→08/02									
Cima 2.0	07/96→02/01									
Lucino 2.0	10/91→01/00									
Pick Up 2.0	01/97→08/01									
Primera 2.0	06/90→01/98									
Primera 2.0 16V	09/96→07/02									
Primera 2.0 4x4	03/91→04/93									
Primera 2.0 GT	06/90→01/96									
Primera 2.0 i	01/95→06/96									
Primera GT	03/91→04/93									
Sentra 2.0	01/00→									
Serena 2.0 16V	11/92→09/01									
Serena 2.0 SGX	09/00→									
Sunny 2.0	01/00→05/02									
Sunny III 2.0	08/90→12/96									
Sunny III 2.0 i	10/90→05/95									
2.0		SR20De					73	BV540 (Fibre)	DV541	EV540
Primera 2.0 16V	06/96→12/01	1998	4	86.00	DOHC	85/115				
Primera N 4416	09/96→12/01									
Primera N 4421	09/96→07/02									
2.0		SR20DET					74	BV540 (Fibre)	DV540 [13]	EV540
180 SX 2.0 T	04/91→03/94	1998	4	86.00	DOHC	147-162/ 200-220				
200 SX 2.0i	10/93→12/99									
Lucino 2.0	10/91→10/95									
Silvia 2.0 T	04/94→09/99									
Sunny III 2.0	10/90→05/95									
2.0		SR20DI					75	BV540 (Fibre)	DV541	EV540
Primera 2.0 16V	06/90→06/96	1998	4	86.00	DOHC	85/115				
Primera 2.0 i	07/90→03/98									
2.0		VQ20DE					76	AG8240 (MLS)		EG8230
Cefiro 2.0	10/94→12/99	1995	6	76.00	DOHC, V	103/140				
Maxima 2.0 QX	10/97→									
Maxima QX 2.0	02/95→11/03									
2.0		Z20					77	BG720 (Graphite)	DG724	GG724 [3]
Pick Up 2.0	09/85→08/91	1992	4	85.00	SOHC/OHC	64-66/ 87-90				
Urvan 2.0	12/82→05/97									
2.2		G9T 722 Diesel					78	AE5210 (MLS), 1.240mm	CE5210	EE5220 [3]
Interstar	07/02→	2188	4	87.00	DOHC	66/90				

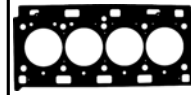

AE5210



BG720



BV540



JC760



JC955



JD134



JD135



JM086

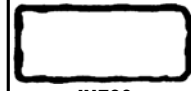

JN798



JN830



JJ568



cc



kW/PS



2.2	YD22DDT Diesel	79	AD5260 (MLS), 0.800mm, 1 Hole	CD5260 ▲				
Almera 2 2.2dCi	09/03→	2184	4	86.00	DOHC	81-102/ 110-139		
Almera 2 2.2Di	03/00→							
Almera Tino 2.2	09/03→							
Primera 2.2 dCi	04/03→							
Primera 2.2 Di	03/02→							
2.2	YD22DDTi Diesel	80	AD5260 (MLS), 0.800mm, 1 Hole	CD5260 ▲				
Almera 2 2.2dCi	09/03→	2184	4	86.00	DOHC	84-100/ 114-136		
Almera Tino 2.2	08/00→							
X-Trail 2.2	06/01→09/03							
X-Trail 2.2 DCi	12/03→							
2.2	YD22ETI Diesel	81	AG9930 (MLS), 0.900mm, 0 Holes AG9940 (MLS), 0.920mm, 1 Hole AG9950 (MLS), 0.950mm, 2 Holes AG9960 (MLS), 0.970mm, 3 Holes AG9970 (MLS), 1.000mm, 4 Holes AG9980 (MLS), 1.020mm, 5 Holes	CD5260 ▲				
X-Trail 2.2 Di	07/01→	2184	4	86.00		84/114		
2.3	LD23 Diesel	82	AG5170 (MLS), 1.400mm, 1 Hole AG5180 (MLS), 1.450mm, 2 Holes AG5250 (MLS), 1.500mm, 3 Holes	CG5530 ▲				
Serena 2.3 D	01/95→09/01	2283	4	87.00	SOHC/OHC	55/75		
Trada 2.3 D	06/96→10/01							
Trada 75	05/97→12/00							
Vanette 2.3 D	01/95→							
2.3	TD23 Diesel	83	BS760 (MLS), 1.400mm	DS760 [13]				
Cabstar 2.3 D	01/87→12/89	2289	4	89.00		51-56/ 69-76		GS760 [3]
Urvan 2.3 D	01/88→05/97							
2.4	KA24DE	84		GP960 [3]				
240 SX 2.4	04/93→08/97	2389	4	89.00	DOHC	98-115/ 133-156		
Altima 2.4	06/93→09/01							
Bassara 2.4	11/99→08/02							
Caravan 2.4	05/01→							
Gloria 2.4	05/99→08/04							
Leopard 2.4	10/95→08/01							
Pick Up 2.4	11/01→04/05							
Pick Up 2.4 i	03/02→							
Urvan 2.4	05/01→							
2.4	KA24E	85	BS770 (Graphite)	DS771 [13]				
Atlas 2.4	10/95→10/04	2389	4	89.00	SOHC/OHC	85-98/ 116-133		
Homy 2.4	05/92→10/95							
Pathfinder	09/99→02/02							
Pick Up 2.4 i	02/98→							
Pick Up 2046 AS	04/92→02/98							
Pick Up 2048 AK	04/92→02/98							
Prairie 2.4 i	04/92→07/94							
Prairie 2636 B	04/92→07/94							
Serena 2.4	07/94→08/00							
Terrano II 2.4	05/96→01/02							
Terrano II 2.4i	02/93→06/96							
2.4	Z24	86	BR660 (Graphite)	DR660 [13]				
Cabstar 2.4	09/85→09/93	2388	4	89.00	SOHC/OHC	74-79/ 101-107		GR661
Pick Up 2.4	01/92→12/02							
Pick Up 2.4 4WD	01/97→12/02							



BR660



BS760



BS770



JC133



JC580



JC900



JC901



JM086



JN724



JH005



cc



kW/PS



2.4		Z24i					87	BR660 (Graphite)	DR660 [13]	GR661
Navara 2.4	06/92→02/97	2389	4	89.00	SOHC/OHC	72-91/ 98-124				
Pathfinder	07/86→10/95									
Pick Up 2.4	09/85→12/96									
Pick Up 2.4 i	03/86→04/92									
Terrano I 2.4 i	10/87→02/93									
Urvan 2.4	02/92→05/97									
Urvan 2.4 i	05/89→09/93									
Vanette 2.4 i	10/86→12/95									
2.4		Z24S					88	BR660 (Graphite)	DR660 [13]	GR661
Pick Up 2.4	01/97→12/02	2389	4	89.00	SOHC/OHC	74-79/ 101-107				
Pick Up 2.4 4WD	01/97→12/02									
2.5		G9U 632 Diesel					89	AE5220 (MLS)	CE5210	EE5220 [3]
Interstar	08/06→	2464	4	89.00	DOHC	88-107/ 120-146				
Primostar	09/06→									
2.5		G9U 650 Diesel					90	AE5220 (MLS)	CE5210	EE5220 [3]
Interstar	04/06→	2464	4	89.00	DOHC	74-88/ 101-120				
2.5		G9U 720 Diesel					91	AE5220 (MLS)	CE5210	EE5220 [3]
Interstar	07/02→	2463	4	89.00	DOHC	73-84/ 99-114				
Primostar	09/08→									
2.5		G9U 730 Diesel					92	AE5220 (MLS)	CE5210	EE5220 [3]
Primostar	07/03→	2463	4	89.00	DOHC	99/135				
2.5		QR25DE					93	AH7080 (MLS), 0.5mm		
Alhima 2.5	08/01→09/06	2488	4	89.00	DOHC	108-134/ 147-182				
Alhima 2.5 Hy	10/06→									
Bassara 2.5	06/02→08/03									
Elgrand 2.5	11/10→									
Elgrand 2.5 AWD	11/10→									
Primera 2.5	01/02→									
Sentra 2.5	06/02→08/06									
Serena 2.5	02/06→									
Serena 2.5 4x4	02/06→									
X-Trail 2.5	09/02→									
2.5		RB25DE					94			
Laurel 2.5	02/93→10/02	2498	6	86.00	DOHC	132-147/ 180-200				
Laurel 2.5 4x4	02/93→10/02									
Skyline 2.5	03/89→05/98									
Skyline 2.5 4x4	07/93→05/98									
Stagea 2.5	09/96→10/01									
Stagea 2.5 AWD	09/96→10/01									
2.5		RB25DET					95			
Gloria 2.5 T	05/99→08/04	2498	6	86.00	DOHC	172-206/ 234-280				
Laurel 2.5	02/93→10/00									
Laurel 2.5 4x4	02/93→10/00									
Skyline 2.5	01/94→07/00									
Stagea 2.5T AWD	09/96→10/01									

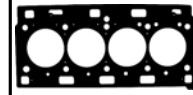
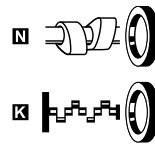
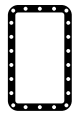
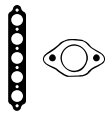

AE5220



BR660



JC133

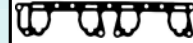

JC580



JM086



JH005



JJ568

	JC580 ■ JC133 ■ (x2) ⊕JE747	JM086 [4]	JH005	PA933 ■ (x8)	<input checked="" type="checkbox"/> NJ045 ■ [2] 48.00x70.00x9.00mm, NBR <input checked="" type="checkbox"/> NJ056 ■ [1] 80.00x100.00x13.00mm, MVQ	
	JC580 ■ JC133 ■ ⊕JE747	JM086 [4]	JH005	PA933	<input checked="" type="checkbox"/> NJ045 ■ [2] 48.00x70.00x9.00mm, NBR <input checked="" type="checkbox"/> NJ056 ■ [1] 80.00x100.00x13.00mm, MVQ	
HBS373 ⊕ [22] M12x1.50x131.00mm (x10)	JD5891 ■ (x4) JD5892	HM5290 ■	JJ568	HR791 ■	<input checked="" type="checkbox"/> NA5053 [2] 30.00x42.00x7.00mm, FPM <input checked="" type="checkbox"/> NF860 ■ [1] 93.00x108.00x7.00mm, FPM/ACM	
HBS373 ⊕ [22] M12x1.50x131.00mm (x10)	JD5891 ■ (x4) JD5892	HM5290 ■	JJ568	HR791 ■	<input checked="" type="checkbox"/> NA5053 [2] 30.00x42.00x7.00mm, FPM <input checked="" type="checkbox"/> NF860 ■ [1] 93.00x108.00x7.00mm, FPM/ACM	
HBS373 ⊕ [22] M12x1.50x131.00mm (x10)	JD5891 ■ (x4) JD5892	HM5290 ■	JJ568	HR791 ■	<input checked="" type="checkbox"/> NA5053 [2] 30.00x42.00x7.00mm, FPM <input checked="" type="checkbox"/> NF860 ■ [1] 93.00x108.00x7.00mm, FPM/ACM	
HBS373 ⊕ [22] M12x1.50x131.00mm (x10)		HM5290 ■	JJ568	HR791 ■	<input checked="" type="checkbox"/> NA5053 [2] 30.00x42.00x7.00mm, FPM <input checked="" type="checkbox"/> NF860 ■ [1] 93.00x108.00x7.00mm, FPM/ACM	
HBS504 ⊕ [19]		JM5267	HR397			
					<input checked="" type="checkbox"/> NJ765 [2] 40.00x52.00x7.00mm, NBR <input checked="" type="checkbox"/> NJ765 ■ [2] 40.00x52.00x7.00mm, NBR <input checked="" type="checkbox"/> NJ287 ■ [1] 80.00x100.00x10.00mm, MVQ	
					<input checked="" type="checkbox"/> NJ765 [2] 40.00x52.00x7.00mm, NBR <input checked="" type="checkbox"/> NJ765 ■ [2] 40.00x52.00x7.00mm, NBR	



cc



kW/PS



2.5	TD25 Diesel					96	BW540 (MLS), 1.400mm	DW540 [13]	
Atlas 2.5 D	10/93→10/97	2494	4	92.90		55-62/ 75-84			
Cabstar 2.5 D	01/89→12/00								
Homy 2.5 TD	05/92→10/95								
Pick Up 2.5 D	08/87→02/98								
Urvan 2.5 D	12/88→05/97								
2.5	TD25Ti Diesel					97	BW540 (MLS), 1.400mm	DW540 [13]	
Pick Up 2.5 TD	05/98→	2494	4	92.90		76/103			
Pick Up 2.5 Tdi	05/98→10/01								
2.5	VQ25DE					98			
Cedric 2.5	06/96→04/99	2496	6	85.00	DOHC, V	134-154/ 182-209			
Cefiro 2.5	10/94→12/99								
Gloria 2.5	06/96→04/99								
Maxima 2.5 V6	10/97→								
Maxima QX 2.5	02/95→11/03								
Teana II 2.5	07/08→								
2.5	YD25DDTi Diesel					99	AH5340 (MLS), 0.900mm, 1 Notch 01/10→ AH5350 (MLS), 0.970mm, 4 Notches 01/10→ AH5360 (MLS), 1.000mm, 5 Notches 01/10→		
Bassara 2.5 DCi	11/99→08/03	2488	4	89.00	DOHC	96-140/ 131-190			
Navara 2.5 dCi	07/05→								
NP300 2.5 dCi	04/08→								
Pathfinder	01/05→								
Pick Up 2.5 Di	03/02→								
Serena 2.0 SGX	06/99→								
Serena 2.5 SGX	06/99→								
2.6	RB26DET					100			
Skyline 2.6 4x4	04/89→09/99	2568	6	86.00	DOHC	206/280			
Stagea 2.6T T	09/96→10/01								
2.7	TD27 Diesel					101	BS760 (MLS), 1.400mm		
Navara 2.7D 4x4	06/92→02/97	2663	4	96.00	OHV	58-73/ 79-99			
Pick Up 2.7 D	08/87→02/98								
Pick Up 2.7 TD	02/98→								
2.7	TD27ETi Diesel					102			
Pathfinder	09/97→12/04	2664	4	96.00		96/131			
2.7	TD27T Diesel					103	AC5750 (MLS), 1.200mm, 1 Notch AC5760 (MLS), 1.250mm, 2 Notches AC5770 (MLS), 1.300mm, 3 Notches	CC5750 ▲	
Patrol GR II	05/98→06/01	2664	4	96.00	OHV	66-74/ 90-101			
Pick Up 2.7 TD	09/87→10/01								
Terrano I 2.7TD	02/89→02/96								
Terrano II 2.7D	02/93→01/02								
Trada 2.7 TD	11/98→09/04								
2.7	TD27Ti Diesel					104	AC5750 (MLS), 1.200mm, 1 Notch AC5760 (MLS), 1.250mm, 2 Notches AC5770 (MLS), 1.300mm, 3 Notches	CC5750 ▲	
Atlas 2.7 TDiC	07/96→10/04	2664	4	96.00	SOHC/OHC	92/125			
Terrano II 2.7D	05/96→								
Terrano Van 2.7	06/98→								
2.8	A428II Diesel					105			
Trada 2.8 D	12/86→06/94	2820	4	94.00	SOHC/OHC	57-62/ 78-84			
2.8	L28					106	BC380 (Graphite)	DC380 [13]	GC383
Patrol 2.8	07/80→06/90	2753	6	86.00	SOHC/OHC	88-89/ 120-121			

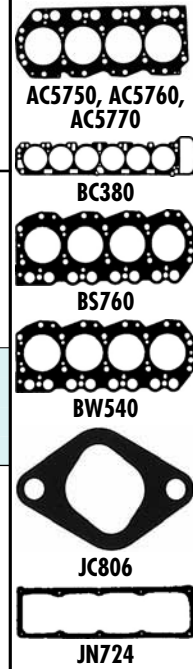

HBS194 [22] M12x1.50x113.00mm (x18)	JC805 [1] JC806 [1]	JN724 [4]		PA378 (x8)	NJ829 [1][2] 86.00x100.00x10.00mm, MVQ NJ831 [2] 58.00x80.00x10.00mm, NBR	
HBS194 [22] M12x1.50x113.00mm (x18)	JC805 [1] JC806 [4]	JN724 [4]		PA378 (x8)	NJ829 [1][2] 86.00x100.00x10.00mm, MVQ NJ831 [2] 58.00x80.00x10.00mm, NBR	
				PA874		
HBS374 [5] M11x1.25x118mm (x18)	JD6028 [1] 0.35mm JD6029 [1] (MLS) 0.6mm		HR397			
					NJ765 [2] 40.00x52.00x7.00mm, NBR NJ933 [2] 35.00x50.00x8.00mm, FPM NJ765 [2] 40.00x52.00x7.00mm, NBR	
HBS194 [22] M12x1.50x113.00mm (x18)	JC805 [1] JC806 [1]	JN724 [4]		PA378	NJ829 [1][2] 86.00x100.00x10.00mm, MVQ NJ831 [2] 58.00x80.00x10.00mm, NBR	
				PA378		
HBS194 [22] M12x1.50x113.00mm (x18)	JC805 [1] JC806 [1]	JN724 [4]		PA378	NJ829 [1][2] 86.00x100.00x10.00mm, MVQ NJ831 [2] 58.00x80.00x10.00mm, NBR	
HBS194 [22] M12x1.50x113.00mm (x18)	JC805 [1] JC806 [4]	JN724 [4]		PA378 (x8)	NJ829 [1][2] 86.00x100.00x10.00mm, MVQ NJ831 [2] 58.00x80.00x10.00mm, NBR	
HBS189 [19] M12x1.75x105.50mm (x18)						
	JB776					



cc



kW/PS



2.8	LD28 Diesel					107	BK080 (Graphite)		GK081
Cedric 2.8 D	09/87→05/91	2792	6	84.50	SOHC/OHC	60-67/ 82-91			
2.8	RD28 Diesel					108	BW620 (MLS)	DW620 [3] 10/86→12/92	GW620 [3] 10/86→12/92
Cedric 2.8 TD	06/91→10/95	2826	6	85.00	SOHC/OHC	66-69/ 90-94			
Crew 2.8 D	04/86→08/03								
Gloria 2.8 TD	06/91→10/95								
Laurel 2.8 D	01/85→12/89								
Patrol 2.8 D	03/89→03/96								
Patrol 2.8D 4x4	01/90→01/91								
2.8	RD28T Diesel					109	BV250 (MLS), 1.500mm	DV250 08/95→	GV250 08/95→
Cedric 2.8 D	06/91→04/99	2826	6	85.00	SOHC/OHC	74-86/ 101-117			
Patrol 2.8 TD	05/86→11/95								
Patrol 2.8TD	03/92→06/93								
Patrol GR I	09/88→02/98								
2.8	RD28Ti Diesel					110	BV250 (MLS), 1.500mm	DV250	GV250
Patrol GR II	06/97→05/00	2826	6	85.00	SOHC/OHC	95/129			
3.0	RB30S					111	BP550 (Graphite)		
Patrol 3.0	03/89→09/93	2962	6	86.00	SOHC/OHC	99-100/ 135-136			
3.0	VG30DET					112			
Cima 3.0	09/91→06/96	2960	6	87.00	DOHC, V	136-244/ 185-332			
Cima 3.0 Turbo	01/88→08/91								
Gloria 3.0	06/91→10/95								
Leopard 3.0	04/86→09/88								
Leopard 3.0 SC	10/88→09/91								
3.0	VG30DETT					113	BS910 (Graphite) (x2)	DS910	GS910 [3]
300 ZX F 12/320	05/90→09/95	2960	6	87.00	DOHC, V	197-208/ 268-283			
3.0	VG30E					114	BM570 (Graphite)	DM574 [3]	
Bluebird 3.0	11/91→03/97	2960	6	87.00	SOHC/OHC, V	95-147/ 129-200			
Cedric 3.0	04/87→10/97								
Gloria 3.0	04/87→10/97								
Homy 3.0	10/94→10/97								
Leopard 3.0	10/91→08/01								
Maxima II 3.0 i	10/88→06/94								
Navara 3.0	05/00→								
Navara 3.0 4x4	05/00→								
Pathfinder	07/86→08/95								
Pick Up 3.0	09/85→09/01								
Pick Up 3.0 4WD	02/98→10/01								
Pick Up 2051 AS	09/90→02/98								
Se 3.0	05/92→09/98								
Terrano I 3.0 i	01/90→12/95								
Urvan 3.0	10/95→08/00								

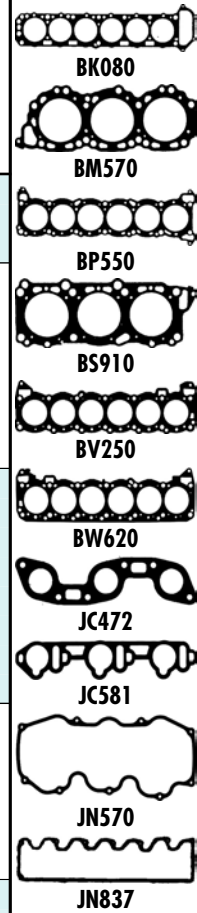

			JH031		NJ045 [2] 48.00x70.00x9.00mm, NBR	
HBS190 [19] M12x1.75x112.00mm (x14)		JN837 [4]		PA079 (x12)	NJ285 [2] 34.00x48.00x8.00mm, NBR NJ765 [2] 40.00x52.00x7.00mm, NBR NJ287 [1] 80.00x100.00x10.00mm, MVQ	
HBS190 [19] M12x1.75x112.00mm (x14)		JN837 [4]	HR397	PA079	NJ765 [2] 40.00x52.00x7.00mm, NBR NJ285 [2] 34.00x48.00x8.00mm, NBR NJ765 [2] 40.00x52.00x7.00mm, NBR NJ287 [1] 80.00x100.00x10.00mm, MVQ	
HBS190 [19] M12x1.75x112.00mm (x14)		JN837 [4]	HR397	PA079	NJ765 [2] 40.00x52.00x7.00mm, NBR NJ285 [2] 34.00x48.00x8.00mm, NBR NJ765 [2] 40.00x52.00x7.00mm, NBR	
				PA874	NJ765 [2] 40.00x52.00x7.00mm, NBR NJ765 [2] 40.00x52.00x7.00mm, NBR	
			HC460	PA874 (x24)	NJ765 [2] 40.00x52.00x7.00mm, NBR NJ765 [2] 40.00x52.00x7.00mm, NBR NJ284 [1] 84.00x104.00x11.00mm, FPM	
	JC581 JC472	JN570 [4]	JJ299	PA079	NJ285 [2] 34.00x48.00x8.00mm, NBR	KA675 [15]



cc



kW/PS



3.0	VG30ET	115	BM570 (Graphite) (x2)		DM574 [3]			
300 ZX F 12/320	05/87→10/90	2960	6	87.00	SOHC/OHC, V	149/203		
3.0	VG30S	116						
Homy 3.0	05/92→10/95	2960	6	87.00	SOHC/OHC, V	92-122/ 125-166		
Urvan 3.0	02/92→04/97							
3.0	VG30T	117	BM570 (Graphite)					
300 ZX 3.0 T	04/84→10/90	2959	6	87.00	SOHC/OHC, V	143-190/ 194-258		
Cedric 3.0	09/87→05/91							
Fairlady 3.0 T	01/84→12/89							
Gloria 3.0	09/87→08/04							
3.0	VQ30DE	118	AF5710 (MLS), 0.700mm					
Bassara 3.0	11/99→08/03	2988	6	93.00	DOHC, V	140-168/ 190-228		
Cedric 3.0	06/91→02/96							
Cefiro 3.0	10/94→12/99							
Cima 3.0	01/88→08/91							
Gloria 3.0	06/91→10/95							
Gloria 3.0 SV	11/95→04/99							
Leopard 3.0	10/95→08/01							
Maxima 3.0 QX	10/97→							
Maxima QX 2.0	03/00→11/03							
Maxima QX 3.0	01/95→08/00							
3.0	ZD30 Diesel	119	AF5740 (MLS), 0.650mm, 1 Notch		CF5740 ▲	FF5740 ▲		
Elgrand 3.0 D	04/03→12/10	2953	4	96.00	DOHC	100-113/ 136-154		
Interstar	11/03→							
Pick Up 3.0 TD	11/01→							
Terrano II 3.0D	05/02→							
Terrano Van 3.0	04/03→							
3.0	ZD30DDTi Diesel	120	AF5740 (MLS), 0.650mm, 1 Notch		CF5740 ▲	FF5740 ▲		
Patrol GR II	05/00→09/04	2953	4	96.00	DOHC	96-125/ 131-170		
Patrol II 3.0D	09/07→							
Terrano II 3.0D	10/97→06/03							
3.2	QD32 Diesel	121				GS200		
Pick Up 3.2 D	12/98→	3153	4	99.20	OHV	70-76/ 95-103		
Pick Up 3.2 TD	01/97→10/01							
3.2	QD32ETI Diesel	122						
Elgrand 3.2 4x4	10/95→08/01	3153	4	99.20	SOHC/OHC	110/150		
Elgrand 3.2 D	10/95→08/01							
Pathfinder	09/97→12/04							
Terrano II 3.2D	10/92→10/97							
3.2	SD33T Diesel	123	BR260 (MLS)		DR260 [13]			
Patrol 3.2 D	08/88→06/90	3246	6	83.00		81-88/ 110-120		
Patrol 3.2 TD	07/83→08/88							
Patrol 3.2D	08/88→06/90							
Patrol 3.2TD	07/83→08/88							
Urvan 3.2 TD	02/92→04/97							
3.3	VG33E	124	AF5690 (Graphite) (x2)		CF5690	FF5690		
Elgrand 3.3	04/96→08/01	3275	6	91.50	SOHC/OHC, V	110-125/ 150-170		
Elgrand 3.3 4x4	04/96→08/01							
Pathfinder	09/97→12/04							
Pick Up 3.3 4WD	01/03→							
Terrano II 3.3	10/92→10/97							



BM570



BR260



JC472



JC581

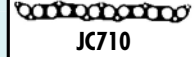

JC710



JN570

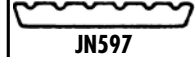

JN597



JN724



JJ151



cc







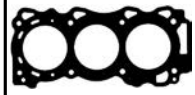
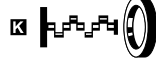
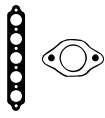

kW/PS



3.5		VQ35				125		AE5890 (MLS)		CG5882	
Pathfinder	11/00→12/04	3498	6	95.50	DOHC, V	162-191/ 220-260		AE5880 (MLS)			
3.5		VQ35DE				126		AE5910 (MLS)			
350 Z 3.5	09/02→	3498	6	95.50	DOHC, V	170-221/ 231-301		AG6130 (MLS)			
Altima 3.5	08/01→09/06										
Cefiro 3.5	01/00→09/03										
Elgrand 3.5	05/02→12/10										
Elgrand 3.5 AWD	11/10→										
Maxima QX 3.5	08/01→11/03										
Murano 3.5	08/03→										
Quest 3.5	05/03→										
Skyline 3.5 4x4	08/03→										
Stagea 3.5	04/06→12/07										
Stagea 3.5 AWD	04/06→12/07										
Teana 1 3.5	10/03→06/08										
Teana II 3.5	07/08→										
Terrano II 3.5	10/94→06/03										
3.5		VQ35HR				127		AH6760 (MLS), 0.58mm [119]			
350 Z 3.5	09/05→	3498	6	95.50	DOHC, V	228-230/ 310-313		AH6770 (MLS), 0.58mm [119]			
4.0		VQ40DE				128		AE5910 (MLS)			
Pathfinder	09/05→	3954	6	95.50	DOHC, V	198-217/ 269-295		AG6130 (MLS)			
4.2		TB42E				129		AF5600 (Fibre)		CF5600	
Patrol GR I	02/88→02/98	4169	6	96.00		121-129/ 165-175		01/92→			FF5600
Patrol GR II	03/00→08/02										
4.2		TD42T Diesel				130					
Patrol GR II	06/97→09/04	4169	6	96.00	SOHC/OHC	85-118/ 116-160					



AE5910

		JM5316  JM5317 				
HBS404  [5]		JM5316  JM5317 	HR397			
			HR397			
				PA874		
HBS433  [22] M12x1.50x113.00mm (x26)				PA378		



Ltr







CC



9

Model	Ltr	Year Range	Engine	Fuel	CC	Seats	Power
AGILA (A) (H00)	1.0	09/00→12/00	Z 10 XE	Petrol	973	3	4
AGILA (A) (H00)	1.0	08/00→12/00	Z 10 XEP	Petrol	998	3	5
AGILA (A) (H00)	1.2	09/00→12/00	Z 12 XE	Petrol	1199	4	20
AGILA (A) (H00)	1.2	07/00→12/00	Z 12 XEP	Petrol/Petroleum Gas (LPG)	1229	4	21
AGILA (A) (H00)	1.2	07/00→12/00	Z 12 XEP	Petrol	1229	4	21
AGILA (A) (H00)	1.3	08/00→12/00	Z 13 DT	Diesel	1248	4	22
AGILA (B) (H08)	1.0	04/00→	K10B	Petrol/Petroleum Gas (LPG)	996	3	2
AGILA (B) (H08)	1.0	04/00→	K10B	Petrol	996	3	2
AGILA (B) (H08)	1.3	04/00→	Z 13 DTJ	Diesel	1248	4	25
ANTARA	2.0	09/00→	Z 20 DM	Diesel	1991	4	158
ANTARA	2.0	05/00→	Z 20 DMH	Diesel	1991	4	159
ANTARA	2.0	05/00→	Z 20 S	Diesel	1991	4	166
ARENA Box (TB, TF)	1.9	03/99→08/00	F8Q 600	Diesel	1870	4	115
ARENA Box (TB, TF)	1.9	03/99→08/00	F8Q 606	Diesel	1870	4	116
ARENA Box (TB, TF)	2.5	03/99→08/00	S8U 758	Diesel	2499	4	202
ARENA Box (TB, TF)	2.5	03/99→08/00	S8U 780	Diesel	2499	4	205
ARENA Box (TB, TF)	2.5	03/99→08/00	S8U 782	Diesel	2499	4	206
ARENA Combi (THB)	1.9	03/99→08/00	F8Q 600	Diesel	1870	4	115
ARENA Combi (THB)	1.9	03/99→08/00	F8Q 606	Diesel	1870	4	116
ARENA Combi (THB)	2.5	03/99→08/00	S8U 758	Diesel	2499	4	202
ARENA Combi (THB)	2.5	03/99→08/00	S8U 780	Diesel	2499	4	205
ARENA Combi (THB)	2.5	03/99→08/00	S8U 782	Diesel	2499	4	206
ASCONA C (81_, 86_, 87_, 88_)	1.3	09/98→08/98	13 S	Petrol	1297	4	28
ASCONA C (81_, 86_, 87_, 88_)	1.6	03/98→08/98	16 D	Diesel	1598	4	47
ASCONA C (81_, 86_, 87_, 88_)	1.6	03/98→08/98	16 DA	Diesel	1598	4	48
ASCONA C (81_, 86_, 87_, 88_)	1.6	09/98→08/98	16 SV	Petrol	1598	4	51
ASCONA C (81_, 86_, 87_, 88_)	1.6	09/98→08/98	C 16 LZ	Petrol	1598	4	59
ASCONA C (81_, 86_, 87_, 88_)	1.6	09/98→08/98	C 16 NZ	Petrol	1598	4	60
ASCONA C (81_, 86_, 87_, 88_)	1.6	09/98→08/98	E 16 LZ	Petrol	1598	4	66
ASCONA C (81_, 86_, 87_, 88_)	1.6	09/98→08/98	E 16 NZ	Petrol	1598	4	67
ASCONA C (81_, 86_, 87_, 88_)	1.8	09/98→08/98	E 18 NV	Petrol	1796	4	107
ASCONA C (81_, 86_, 87_, 88_)	2.0	09/98→08/98	20 NE	Petrol	1998	4	127
ASCONA C (81_, 86_, 87_, 88_)	2.0	03/98→08/98	20 SEH	Petrol	1998	4	130
ASCONA C (81_, 86_, 87_, 88_)	2.0	09/98→08/98	C 20 NE	Petrol	1998	4	142
ASCONA C (81_, 86_, 87_, 88_)	2.0	08/98→08/98	C 20 NEF	Petrol	1998	4	143
ASCONA C Hatchback (84_, 89_)	1.3	09/98→08/98	13 S	Petrol	1297	4	28
ASCONA C Hatchback (84_, 89_)	1.6	03/98→08/98	16 D	Diesel	1598	4	47
ASCONA C Hatchback (84_, 89_)	1.6	03/98→08/98	16 DA	Diesel	1598	4	48
ASCONA C Hatchback (84_, 89_)	1.6	09/98→08/98	16 N	Petrol	1598	4	49
ASCONA C Hatchback (84_, 89_)	1.6	09/98→08/98	16 SV	Petrol	1598	4	51
ASCONA C Hatchback (84_, 89_)	1.6	09/98→08/98	C 16 LZ	Petrol	1598	4	59
ASCONA C Hatchback (84_, 89_)	1.6	09/98→08/98	C 16 NZ	Petrol	1598	4	60
ASCONA C Hatchback (84_, 89_)	1.6	09/98→08/98	E 16 NZ	Petrol	1598	4	67
ASCONA C Hatchback (84_, 89_)	1.8	09/98→08/98	E 18 NV	Petrol	1796	4	107
ASCONA C Hatchback (84_, 89_)	2.0	09/98→08/98	20 NE	Petrol	1998	4	127
ASCONA C Hatchback (84_, 89_)	2.0	03/98→08/98	20 SEH	Petrol	1998	4	130
ASCONA C Hatchback (84_, 89_)	2.0	09/98→08/98	C 20 NE	Petrol	1998	4	142
ASTRA F (56_, 57_)	1.4	09/99→09/99	14 NV	Petrol	1389	4	31
ASTRA F (56_, 57_)	1.4	09/99→09/99	14 SE	Petrol	1389	4	32
ASTRA F (56_, 57_)	1.4	09/99→09/99	C 14 NZ	Petrol	1389	4	35
ASTRA F (56_, 57_)	1.4	03/99→09/99	C 14 SE	Petrol	1389	4	36
ASTRA F (56_, 57_)	1.4	09/99→09/99	X 14 NZ	Petrol	1389	4	38
ASTRA F (56_, 57_)	1.4	02/99→09/99	X 14 XE	Petrol	1389	4	40
ASTRA F (56_, 57_)	1.6	03/99→09/99	C 16 NZ	Petrol	1598	4	60
ASTRA F (56_, 57_)	1.6	05/99→12/99	C 16 SE	Petrol	1598	4	62
ASTRA F (56_, 57_)	1.6	05/99→07/99	X 16 SZ	Petrol	1598	4	69
ASTRA F (56_, 57_)	1.6	03/99→09/99	X 16 SZR	Petrol	1598	4	70
ASTRA F (56_, 57_)	1.6	08/99→09/99	X 16 XEL	Petrol	1598	4	72
ASTRA F (56_, 57_)	1.7	03/99→09/99	17 D	Diesel	1700	4	85
ASTRA F (56_, 57_)	1.7	07/99→09/99	17 DR	Diesel	1700	4	87
ASTRA F (56_, 57_)	1.7	03/99→09/99	17 DT (TC4EE1)	Diesel	1686	4	88
ASTRA F (56_, 57_)	1.7	03/99→09/99	X 17 DT (TC4EE1)	Diesel	1686	4	90
ASTRA F (56_, 57_)	1.7	11/99→09/99	X 17 DTL	Diesel	1700	4	91
ASTRA F (56_, 57_)	1.8	09/99→09/99	18 SE	Petrol	1796	4	98
ASTRA F (56_, 57_)	1.8	03/99→09/99	C 18 NZ	Petrol	1796	4	104
ASTRA F (56_, 57_)	1.8	06/99→10/99	C 18 XE	Petrol	1799	4	105
ASTRA F (56_, 57_)	1.8	11/99→09/99	C 18 XEL	Petrol	1799	4	106
ASTRA F (56_, 57_)	1.8	11/99→09/99	X 18 XE	Petrol	1799	4	110
ASTRA F (56_, 57_)	2.0	03/99→09/99	C 20 NE	Petrol	1998	4	142
ASTRA F (56_, 57_)	2.0	02/99→09/99	X 20 XEV	Petrol	1998	4	155

	Ltr				CC		9
ASTRA F CLASSIC Estate	1.4	01/99→01/00	X 14 NZ	Petrol	1389	4	38
ASTRA F CLASSIC Estate	1.6	01/99→01/00	X 16 SZR	Petrol	1598	4	70
ASTRA F CLASSIC Estate	1.6	01/99→01/00	X 16 XEL	Petrol	1598	4	72
ASTRA F CLASSIC Estate	1.8	02/00→07/00	Z 18 XEL	Petrol	1796	4	113
ASTRA F CLASSIC Hatchback	1.2	03/99→08/00	X 12 XE	Petrol	1199	4	18
ASTRA F CLASSIC Hatchback	1.4	01/99→08/00	X 14 NZ	Petrol	1389	4	38
ASTRA F CLASSIC Hatchback	1.4	03/99→08/00	X 14 XE	Petrol	1389	4	40
ASTRA F CLASSIC Hatchback	1.6	01/99→08/00	X 16 SZR	Petrol	1598	4	70
ASTRA F CLASSIC Hatchback	1.6	01/99→08/00	X 16 XEL	Petrol	1598	4	72
ASTRA F CLASSIC Hatchback	1.7	03/99→08/00	X 17 DTL	Diesel	1700	4	91
ASTRA F CLASSIC Hatchback	1.8	03/99→08/00	X 18 XE1	Petrol	1796	4	111
ASTRA F CLASSIC Hatchback	2.0	08/99→08/00	X 20 DTH	Diesel	1995	4	151
ASTRA F CLASSIC Hatchback	2.0	03/99→08/00	X 20 DTL	Diesel	1995	4	152
ASTRA F CLASSIC Hatchback	2.0	10/99→08/00	X 20 XER	Petrol	1998	4	154
ASTRA F CLASSIC Hatchback	2.0	03/99→08/00	X 20 XEV	Petrol	1998	4	155
ASTRA F CLASSIC Saloon	1.4	01/99→08/00	X 14 NZ	Petrol	1389	4	38
ASTRA F CLASSIC Saloon	1.6	01/99→08/00	X 16 SZR	Petrol	1598	4	70
ASTRA F CLASSIC Saloon	1.6	01/99→08/00	X 16 XEL	Petrol	1598	4	72
ASTRA F Convertible (53_B)	1.4	05/99→03/00	C 14 SE	Petrol	1389	4	36
ASTRA F Convertible (53_B)	1.4	01/99→03/00	X 14 XE	Petrol	1389	4	40
ASTRA F Convertible (53_B)	1.6	03/99→08/99	X 16 SZ	Petrol	1598	4	69
ASTRA F Convertible (53_B)	1.6	01/99→03/00	X 16 SZR	Petrol	1598	4	70
ASTRA F Convertible (53_B)	1.8	11/99→03/00	C 18 XEL	Petrol	1799	4	106
ASTRA F Convertible (53_B)	1.8	11/99→03/00	X 18 XE	Petrol	1799	4	110
ASTRA F Convertible (53_B)	2.0	03/99→10/99	C 20 NE	Petrol	1998	4	142
ASTRA F Estate (51_, 52_)	1.4	09/99→09/99	14 NV	Petrol	1389	4	31
ASTRA F Estate (51_, 52_)	1.4	09/99→01/99	14 SE	Petrol	1389	4	32
ASTRA F Estate (51_, 52_)	1.4	09/99→01/99	C 14 NZ	Petrol	1389	4	35
ASTRA F Estate (51_, 52_)	1.4	03/99→01/99	C 14 SE	Petrol	1389	4	36
ASTRA F Estate (51_, 52_)	1.4	02/99→01/99	X 14 XE	Petrol	1389	4	40
ASTRA F Estate (51_, 52_)	1.6	09/99→01/99	C 16 NZ	Petrol	1598	4	60
ASTRA F Estate (51_, 52_)	1.6	03/99→12/99	C 16 SE	Petrol	1598	4	62
ASTRA F Estate (51_, 52_)	1.6	05/99→07/99	X 16 SZ	Petrol	1598	4	69
ASTRA F Estate (51_, 52_)	1.6	09/99→01/99	X 16 SZR	Petrol	1598	4	70
ASTRA F Estate (51_, 52_)	1.6	08/99→01/99	X 16 XEL	Petrol	1598	4	72
ASTRA F Estate (51_, 52_)	1.7	12/99→09/99	17 D	Diesel	1700	4	85
ASTRA F Estate (51_, 52_)	1.7	07/99→01/99	17 DR	Diesel	1700	4	87
ASTRA F Estate (51_, 52_)	1.7	12/99→01/99	17 DT (TC4EE1)	Diesel	1686	4	88
ASTRA F Estate (51_, 52_)	1.7	12/99→01/99	X 17 DT (TC4EE1)	Diesel	1686	4	90
ASTRA F Estate (51_, 52_)	1.7	11/99→01/99	X 17 DTL	Diesel	1700	4	91
ASTRA F Estate (51_, 52_)	1.8	09/99→01/99	C 18 NZ	Petrol	1796	4	104
ASTRA F Estate (51_, 52_)	1.8	06/99→01/99	C 18 XE	Petrol	1799	4	105
ASTRA F Estate (51_, 52_)	1.8	07/99→01/99	C 18 XEL	Petrol	1799	4	106
ASTRA F Estate (51_, 52_)	1.8	07/99→01/99	X 18 XE	Petrol	1799	4	110
ASTRA F Estate (51_, 52_)	2.0	09/99→07/99	C 20 NE	Petrol	1998	4	142
ASTRA F Estate (51_, 52_)	2.0	03/99→01/99	C 20 XE	Petrol	1998	4	146
ASTRA F Estate (51_, 52_)	2.0	02/99→01/99	X 20 XEV	Petrol	1998	4	155
ASTRA F Hatchback (53_, 54_, 58_, 59_)	1.4	09/99→09/99	14 NV	Petrol	1389	4	31
ASTRA F Hatchback (53_, 54_, 58_, 59_)	1.4	09/99→01/99	14 SE	Petrol	1389	4	32
ASTRA F Hatchback (53_, 54_, 58_, 59_)	1.4	03/99→01/99	C 14 NZ	Petrol	1389	4	35
ASTRA F Hatchback (53_, 54_, 58_, 59_)	1.4	03/99→01/99	C 14 SE	Petrol	1389	4	36
ASTRA F Hatchback (53_, 54_, 58_, 59_)	1.4	01/99→01/99	X 14 XE	Petrol	1389	4	40
ASTRA F Hatchback (53_, 54_, 58_, 59_)	1.6	09/99→01/99	C 16 NZ	Petrol	1598	4	60
ASTRA F Hatchback (53_, 54_, 58_, 59_)	1.6	03/99→12/99	C 16 SE	Petrol	1598	4	62
ASTRA F Hatchback (53_, 54_, 58_, 59_)	1.6	05/99→07/99	X 16 SZ	Petrol	1598	4	69
ASTRA F Hatchback (53_, 54_, 58_, 59_)	1.6	09/99→01/99	X 16 SZR	Petrol	1598	4	70
ASTRA F Hatchback (53_, 54_, 58_, 59_)	1.6	08/99→01/99	X 16 XEL	Petrol	1598	4	72
ASTRA F Hatchback (53_, 54_, 58_, 59_)	1.7	12/99→09/99	17 D	Diesel	1700	4	85
ASTRA F Hatchback (53_, 54_, 58_, 59_)	1.7	07/99→01/99	17 DR	Diesel	1700	4	87
ASTRA F Hatchback (53_, 54_, 58_, 59_)	1.7	12/99→01/99	17 DT (TC4EE1)	Diesel	1686	4	88
ASTRA F Hatchback (53_, 54_, 58_, 59_)	1.7	12/99→01/99	X 17 DT (TC4EE1)	Diesel	1686	4	90
ASTRA F Hatchback (53_, 54_, 58_, 59_)	1.7	11/99→01/99	X 17 DTL	Diesel	1700	4	91
ASTRA F Hatchback (53_, 54_, 58_, 59_)	1.8	09/99→01/99	C 18 NZ	Petrol	1796	4	104
ASTRA F Hatchback (53_, 54_, 58_, 59_)	1.8	06/99→08/99	C 18 XE	Petrol	1799	4	105
ASTRA F Hatchback (53_, 54_, 58_, 59_)	1.8	09/99→01/99	C 18 XEL	Petrol	1799	4	106
ASTRA F Hatchback (53_, 54_, 58_, 59_)	1.8	09/99→01/99	X 18 XE	Petrol	1799	4	110
ASTRA F Hatchback (53_, 54_, 58_, 59_)	2.0	09/99→01/99	C 20 NE	Petrol	1998	4	142
ASTRA F Hatchback (53_, 54_, 58_, 59_)	2.0	09/99→01/99	C 20 XE	Petrol	1998	4	146
ASTRA F Hatchback (53_, 54_, 58_, 59_)	2.0	02/99→01/99	X 20 XEV	Petrol	1998	4	155
ASTRA F Van (55_)	1.4	10/99→01/99	C 14 NZ	Petrol	1389	4	35



Ltr







CC



9

Model	Ltr	Period	Engine	Fuel	CC	Seats	Price
ASTRA F Van (55_)	1.6	10/99→04/99	C 16 NZ	Petrol	1598	4	60
ASTRA F Van (55_)	1.6	02/99→07/99	X 16 SZ	Petrol	1598	4	69
ASTRA F Van (55_)	1.6	08/99→03/99	X 16 XEL	Petrol	1598	4	72
ASTRA F Van (55_)	1.7	12/99→09/99	17 D	Diesel	1700	4	85
ASTRA F Van (55_)	1.7	07/99→01/99	17 DR	Diesel	1700	4	87
ASTRA F Van (55_)	1.7	03/99→02/99	X 17 DT (TC4EE1)	Diesel	1686	4	90
ASTRA F Van (55_)	1.7	08/99→01/99	X 17 DTL	Diesel	1700	4	91
ASTRA G Box (F70)	1.6	01/99→09/00	X 16 SZR	Petrol	1598	4	70
ASTRA G Box (F70)	1.6	09/00→04/00	Z 16 SE	Petrol	1598	4	78
ASTRA G Box (F70)	1.7	01/99→04/00	X 17 DTL	Diesel	1700	4	91
ASTRA G Box (F70)	2.0	01/99→04/00	X 20 DTL	Diesel	1995	4	152
ASTRA G Convertible	1.6	03/00→10/00	Z 16 XE	Petrol	1598	4	79
ASTRA G Convertible	1.6	01/00→10/00	Z 16 XEP	Petrol	1598	4	81
ASTRA G Convertible	1.8	03/00→10/00	Z 18 XE	Petrol	1796	4	112
ASTRA G Convertible	2.0	03/00→10/00	Z 20 LET	Petrol	1998	4	163
ASTRA G Convertible	2.2	09/00→10/00	Y 22 DTR	Diesel	2172	4	175
ASTRA G Convertible	2.2	03/00→10/00	Z 22 SE	Petrol	2198	4	178
ASTRA G Coupe (F07_)	1.6	03/00→05/00	Z 16 XE	Petrol	1598	4	79
ASTRA G Coupe (F07_)	1.6	03/00→05/00	Z 16 XEP	Petrol	1598	4	81
ASTRA G Coupe (F07_)	1.8	03/00→10/00	X 18 XE1	Petrol	1796	4	111
ASTRA G Coupe (F07_)	1.8	09/00→05/00	Z 18 XE	Petrol	1796	4	112
ASTRA G Coupe (F07_)	2.0	09/00→05/00	Z 20 LET	Petrol	1998	4	163
ASTRA G Coupe (F07_)	2.2	09/00→05/00	Y 22 DTR	Diesel	2172	4	175
ASTRA G Coupe (F07_)	2.2	09/00→05/00	Z 22 SE	Petrol	2198	4	178
ASTRA G Estate (F35_)	1.2	02/99→09/00	X 12 XE	Petrol	1199	4	18
ASTRA G Estate (F35_)	1.2	09/00→07/00	Z 12 XE	Petrol	1199	4	20
ASTRA G Estate (F35_)	1.4	06/99→07/00	X 14 XE	Petrol	1389	4	40
ASTRA G Estate (F35_)	1.4	06/99→07/00	Z 14 XE	Petrol	1389	4	41
ASTRA G Estate (F35_)	1.4	09/00→12/00	Z 14 XEP	Petrol/Petroleum Gas (LPG)	1364	4	43
ASTRA G Estate (F35_)	1.4	09/00→12/00	Z 14 XEP	Petrol	1364	4	43
ASTRA G Estate (F35_)	1.6	02/99→09/00	X 16 SZR	Petrol	1598	4	70
ASTRA G Estate (F35_)	1.6	02/99→07/00	X 16 XEL	Petrol	1598	4	72
ASTRA G Estate (F35_)	1.6	09/00→07/00	Z 16 SE	Petrol	1598	4	78
ASTRA G Estate (F35_)	1.6	02/99→07/00	Z 16 XE	Petrol	1598	4	79
ASTRA G Estate (F35_)	1.6	12/00→07/00	Z 16 XEP	Petrol	1598	4	81
ASTRA G Estate (F35_)	1.6	03/00→07/00	Z 16 YNG	Petrol/Natural Gas (CNG)	1598	4	84
ASTRA G Estate (F35_)	1.6	03/00→07/00	Z 16 YNG	Petrol	1598	4	84
ASTRA G Estate (F35_)	1.6	03/00→07/00	Z 16 YNG	Gas	1598	4	84
ASTRA G Estate (F35_)	1.6	03/00→07/00	Z 16 YNG	CNG	1598	4	84
ASTRA G Estate (F35_)	1.7	02/99→08/00	X 17 DTL	Diesel	1700	4	91
ASTRA G Estate (F35_)	1.7	02/00→07/00	Y 17 DT	Diesel	1686	4	92
ASTRA G Estate (F35_)	1.7	04/00→07/00	Z 17 DTL	Diesel	1686	4	96
ASTRA G Estate (F35_)	1.8	02/99→09/00	X 18 XE1	Petrol	1796	4	111
ASTRA G Estate (F35_)	1.8	09/00→07/00	Z 18 XE	Petrol	1796	4	112
ASTRA G Estate (F35_)	2.0	08/99→07/00	X 20 DTH	Diesel	1995	4	151
ASTRA G Estate (F35_)	2.0	02/99→07/00	X 20 DTL	Diesel	1995	4	152
ASTRA G Estate (F35_)	2.0	02/99→07/00	X 20 XEV	Petrol	1998	4	155
ASTRA G Estate (F35_)	2.0	08/99→07/00	Y 20 DTH	Diesel	1995	4	156
ASTRA G Estate (F35_)	2.0	02/99→07/00	Y 20 DTL	Diesel	1995	4	157
ASTRA G Estate (F35_)	2.0	09/00→07/00	Z 20 LET	Petrol	1998	4	163
ASTRA G Estate (F35_)	2.2	09/00→07/00	Y 22 DTR	Diesel	2172	4	175
ASTRA G Estate (F35_)	2.2	03/00→07/00	Z 22 SE	Petrol	2198	4	178
ASTRA G Hatchback (F48_, F08_)	1.0	08/00→05/00	Z 10 XEP	Petrol	998	3	5
ASTRA G Hatchback (F48_, F08_)	1.2	02/99→09/00	X 12 XE	Petrol	1199	4	18
ASTRA G Hatchback (F48_, F08_)	1.2	09/00→01/00	Z 12 XE	Petrol	1199	4	20
ASTRA G Hatchback (F48_, F08_)	1.4	02/99→01/00	X 14 XE	Petrol	1389	4	40
ASTRA G Hatchback (F48_, F08_)	1.4	02/99→01/00	Z 14 XE	Petrol	1389	4	41
ASTRA G Hatchback (F48_, F08_)	1.4	09/00→12/00	Z 14 XEP	Petrol/Petroleum Gas (LPG)	1364	4	43
ASTRA G Hatchback (F48_, F08_)	1.4	09/00→12/00	Z 14 XEP	Petrol	1364	4	43
ASTRA G Hatchback (F48_, F08_)	1.6	02/99→01/00	C 16 SEL	Petrol	1598	4	64
ASTRA G Hatchback (F48_, F08_)	1.6	02/99→09/00	X 16 SZR	Petrol	1598	4	70
ASTRA G Hatchback (F48_, F08_)	1.6	02/99→01/00	X 16 XEL	Petrol	1598	4	72
ASTRA G Hatchback (F48_, F08_)	1.6	09/00→01/00	Z 16 SE	Petrol	1598	4	78
ASTRA G Hatchback (F48_, F08_)	1.6	02/99→01/00	Z 16 XE	Petrol	1598	4	79
ASTRA G Hatchback (F48_, F08_)	1.6	12/00→12/00	Z 16 XEP	Petrol	1598	4	81
ASTRA G Hatchback (F48_, F08_)	1.6	06/00→03/00	Z 16 YNG	Petrol/Natural Gas (CNG)	1598	4	84
ASTRA G Hatchback (F48_, F08_)	1.6	06/00→03/00	Z 16 YNG	Petrol	1598	4	84
ASTRA G Hatchback (F48_, F08_)	1.6	06/00→03/00	Z 16 YNG	Gas	1598	4	84
ASTRA G Hatchback (F48_, F08_)	1.6	06/00→03/00	Z 16 YNG	CNG	1598	4	84
ASTRA G Hatchback (F48_, F08_)	1.7	02/99→08/00	X 17 DTL	Diesel	1700	4	91

	Ltr				CC		9
ASTRA G Hatchback (F48_, F08_)	1.7	02/00→01/00	Y 17 DT	Diesel	1686	4	92
ASTRA G Hatchback (F48_, F08_)	1.7	04/00→01/00	Z 17 DTL	Diesel	1686	4	96
ASTRA G Hatchback (F48_, F08_)	1.8	02/99→09/00	X 18 XE1	Petrol	1796	4	111
ASTRA G Hatchback (F48_, F08_)	1.8	09/00→01/00	Z 18 XE	Petrol	1796	4	112
ASTRA G Hatchback (F48_, F08_)	2.0	02/99→01/00	C 20 SEL	Petrol	1998	4	145
ASTRA G Hatchback (F48_, F08_)	2.0	08/99→01/00	X 20 DTH	Diesel	1995	4	151
ASTRA G Hatchback (F48_, F08_)	2.0	02/99→01/00	X 20 DTL	Diesel	1995	4	152
ASTRA G Hatchback (F48_, F08_)	2.0	11/99→09/00	X 20 XER	Petrol	1998	4	154
ASTRA G Hatchback (F48_, F08_)	2.0	02/99→01/00	X 20 XEV	Petrol	1998	4	155
ASTRA G Hatchback (F48_, F08_)	2.0	08/99→01/00	Y 20 DTH	Diesel	1995	4	156
ASTRA G Hatchback (F48_, F08_)	2.0	02/99→01/00	Y 20 DTL	Diesel	1995	4	157
ASTRA G Hatchback (F48_, F08_)	2.0	09/00→01/00	Z 20 LET	Petrol	1998	4	163
ASTRA G Hatchback (F48_, F08_)	2.2	09/00→01/00	Y 22 DTR	Diesel	2172	4	175
ASTRA G Hatchback (F48_, F08_)	2.2	03/00→01/00	Z 22 SE	Petrol	2198	4	178
ASTRA G Saloon (F69_)	1.2	09/99→09/00	X 12 XE	Petrol	1199	4	18
ASTRA G Saloon (F69_)	1.2	09/00→01/00	Z 12 XE	Petrol	1199	4	20
ASTRA G Saloon (F69_)	1.4	09/99→01/00	X 14 XE	Petrol	1389	4	40
ASTRA G Saloon (F69_)	1.4	09/99→01/00	Z 14 XE	Petrol	1389	4	41
ASTRA G Saloon (F69_)	1.4	09/00→12/00	Z 14 XEP	Petrol/Petroleum Gas (LPG)	1364	4	43
ASTRA G Saloon (F69_)	1.4	09/00→12/00	Z 14 XEP	Petrol	1364	4	43
ASTRA G Saloon (F69_)	1.6	09/99→09/00	X 16 SZR	Petrol	1598	4	70
ASTRA G Saloon (F69_)	1.6	09/99→01/00	X 16 XEL	Petrol	1598	4	72
ASTRA G Saloon (F69_)	1.6	09/00→01/00	Z 16 SE	Petrol	1598	4	78
ASTRA G Saloon (F69_)	1.6	09/99→01/00	Z 16 XE	Petrol	1598	4	79
ASTRA G Saloon (F69_)	1.6	12/00→01/00	Z 16 XEP	Petrol	1598	4	81
ASTRA G Saloon (F69_)	1.7	09/99→08/00	X 17 DTL	Diesel	1700	4	91
ASTRA G Saloon (F69_)	1.7	02/00→01/00	Y 17 DT	Diesel	1686	4	92
ASTRA G Saloon (F69_)	1.7	04/00→01/00	Z 17 DTL	Diesel	1686	4	96
ASTRA G Saloon (F69_)	1.8	09/99→09/00	X 18 XE1	Petrol	1796	4	111
ASTRA G Saloon (F69_)	1.8	09/00→01/00	Z 18 XE	Petrol	1796	4	112
ASTRA G Saloon (F69_)	2.0	08/99→01/00	X 20 DTH	Diesel	1995	4	151
ASTRA G Saloon (F69_)	2.0	09/99→01/00	X 20 DTL	Diesel	1995	4	152
ASTRA G Saloon (F69_)	2.0	09/99→01/00	X 20 XEV	Petrol	1998	4	155
ASTRA G Saloon (F69_)	2.0	08/99→01/00	Y 20 DTH	Diesel	1995	4	156
ASTRA G Saloon (F69_)	2.0	09/99→01/00	Y 20 DTL	Diesel	1995	4	157
ASTRA G Saloon (F69_)	2.2	09/00→01/00	Y 22 DTR	Diesel	2172	4	175
ASTRA G Saloon (F69_)	2.2	03/00→01/00	Z 22 SE	Petrol	2198	4	178
ASTRA GTC J	1.6	10/01→	A 16 LET	Petrol	1598	4	56
ASTRA GTC J	1.8	10/01→	A 18 XER	Petrol/Petroleum Gas (LPG)	1796	4	102
ASTRA GTC J	1.8	10/01→	A 18 XER	Petrol	1796	4	102
ASTRA GTC J	2.0	10/01→	A 20 DTH	Diesel	1956	4	135
ASTRA GTC J	2.0	10/01→	A 20 DTR	Diesel	1956	4	138
ASTRA GTC J	2.0	04/01→	A 20 NFT	Petrol	1998	4	139
ASTRA H Estate	1.3	08/00→	Z 13 DTH	Diesel	1248	4	24
ASTRA H Estate	1.4	08/00→	Z 14 XEL	Petrol	1364	4	42
ASTRA H Estate	1.4	08/00→	Z 14 XEP	Petrol/Petroleum Gas (LPG)	1364	4	43
ASTRA H Estate	1.4	08/00→	Z 14 XEP	Petrol	1364	4	43
ASTRA H Estate	1.6	12/00→	A 16 XER	Petrol/Petroleum Gas (LPG)	1598	4	57
ASTRA H Estate	1.6	12/00→	A 16 XER	Petrol	1598	4	57
ASTRA H Estate	1.6	02/00→	Z 16 LET	Petrol	1598	4	77
ASTRA H Estate	1.6	08/00→	Z 16 XEP	Petrol	1598	4	81
ASTRA H Estate	1.6	12/00→	Z 16 XER	Petrol/Petroleum Gas (LPG)	1598	4	82
ASTRA H Estate	1.6	12/00→	Z 16 XER	Petrol	1598	4	82
ASTRA H Estate	1.7	08/00→	Z 17 DTH	Diesel	1686	4	95
ASTRA H Estate	1.7	08/00→	Z 17 DTL	Diesel	1686	4	96
ASTRA H Estate	1.8	08/00→	A 18 XER	Petrol/Petroleum Gas (LPG)	1796	4	102
ASTRA H Estate	1.8	08/00→	A 18 XER	Petrol	1796	4	102
ASTRA H Estate	1.8	08/00→	Z 18 XE	Petrol	1796	4	112
ASTRA H Estate	1.8	08/00→	Z 18 XER	Petrol	1796	4	114
ASTRA H Estate	1.9	09/00→	Z 19 DT	Diesel	1910	4	122
ASTRA H Estate	1.9	09/00→	Z 19 DTH	Diesel	1910	4	123
ASTRA H Estate	1.9	08/00→	Z 19 DTJ	Diesel	1910	4	124
ASTRA H Estate	1.9	09/00→	Z 19 DTL	Diesel	1910	4	125
ASTRA H Estate	2.0	08/00→	Z 20 LEL	Petrol	1998	4	161
ASTRA H Estate	2.0	09/00→	Z 20 LER	Petrol	1998	4	162
ASTRA H GTC	1.2	10/00→	X 12 XE	Petrol	1199	4	18
ASTRA H GTC	1.2	08/00→	Z 12 XEP	Petrol/Petroleum Gas (LPG)	1229	4	21
ASTRA H GTC	1.2	08/00→	Z 12 XEP	Petrol	1229	4	21
ASTRA H GTC	1.3	04/00→	Z 13 DTH	Diesel	1248	4	24
ASTRA H GTC	1.4	03/00→	Z 14 XEL	Petrol	1364	4	42



Ltr







CC



9

Model	Ltr	Year	Engine	Fuel	CC	Seats	Price
ASTRA H GTC	1.4	03/00→	Z 14 XEP	Petrol/Petroleum Gas (LPG)	1364	4	43
ASTRA H GTC	1.4	03/00→	Z 14 XEP	Petrol	1364	4	43
ASTRA H GTC	1.6	02/00→	Z 16 LET	Petrol	1598	4	77
ASTRA H GTC	1.6	03/00→	Z 16 XEP	Petrol	1598	4	81
ASTRA H GTC	1.6	12/00→	Z 16 XER	Petrol/Petroleum Gas (LPG)	1598	4	82
ASTRA H GTC	1.6	12/00→	Z 16 XER	Petrol	1598	4	82
ASTRA H GTC	1.7	03/00→	Z 17 DTH	Diesel	1686	4	95
ASTRA H GTC	1.7	03/00→	Z 17 DTL	Diesel	1686	4	96
ASTRA H GTC	1.8	03/00→	Z 18 XE	Petrol	1796	4	112
ASTRA H GTC	1.8	01/00→	Z 18 XER	Petrol	1796	4	114
ASTRA H GTC	1.9	09/00→	Z 19 DT	Diesel	1910	4	122
ASTRA H GTC	1.9	03/00→	Z 19 DTH	Diesel	1910	4	123
ASTRA H GTC	1.9	03/00→	Z 19 DTJ	Diesel	1910	4	124
ASTRA H GTC	1.9	01/00→	Z 19 DTL	Diesel	1910	4	125
ASTRA H GTC	2.0	08/00→	Z 20 LEH	Petrol	1998	4	160
ASTRA H GTC	2.0	03/00→	Z 20 LEL	Petrol	1998	4	161
ASTRA H GTC	2.0	03/00→	Z 20 LER	Petrol	1998	4	162
ASTRA H Saloon	1.3	02/00→	Z 13 DTH	Diesel	1248	4	24
ASTRA H Saloon	1.6	02/00→	Z 16 XER	Petrol/Petroleum Gas (LPG)	1598	4	82
ASTRA H Saloon	1.6	02/00→	Z 16 XER	Petrol	1598	4	82
ASTRA H Saloon	1.7	02/00→	Z 17 DTH	Diesel	1686	4	95
ASTRA H Saloon	1.8	02/00→	A 18 XER	Petrol/Petroleum Gas (LPG)	1796	4	102
ASTRA H Saloon	1.8	02/00→	A 18 XER	Petrol	1796	4	102
ASTRA H Saloon	1.8	02/00→	Z 18 XER	Petrol	1796	4	114
ASTRA H TwinTop	1.6	02/00→	Z 16 LET	Petrol	1598	4	77
ASTRA H TwinTop	1.6	09/00→	Z 16 XE1	Petrol	1598	4	80
ASTRA H TwinTop	1.6	09/00→	Z 16 XEP	Petrol	1598	4	81
ASTRA H TwinTop	1.6	12/00→	Z 16 XER	Petrol/Petroleum Gas (LPG)	1598	4	82
ASTRA H TwinTop	1.6	12/00→	Z 16 XER	Petrol	1598	4	82
ASTRA H TwinTop	1.8	09/00→	A 18 XER	Petrol/Petroleum Gas (LPG)	1796	4	102
ASTRA H TwinTop	1.8	09/00→	A 18 XER	Petrol	1796	4	102
ASTRA H TwinTop	1.8	09/00→	Z 18 XE	Petrol	1796	4	112
ASTRA H TwinTop	1.8	09/00→	Z 18 XER	Petrol	1796	4	114
ASTRA H TwinTop	1.9	09/00→	Z 19 DTH	Diesel	1910	4	123
ASTRA H TwinTop	2.0	09/00→	Z 20 LEL	Petrol	1998	4	161
ASTRA H TwinTop	2.0	09/00→	Z 20 LER	Petrol	1998	4	162
ASTRA H Van	1.3	08/00→	Z 13 DTH	Diesel	1248	4	24
ASTRA H Van	1.7	03/00→	Z 17 DTH	Diesel	1686	4	95
ASTRA H Van	1.9	09/00→	Z 19 DT	Diesel	1910	4	122
ASTRA H Van	1.9	09/00→	Z 19 DTH	Diesel	1910	4	123
ASTRA H Van	1.9	08/00→	Z 19 DTJ	Diesel	1910	4	124
ASTRA H	1.2	10/00→	X 12 XE	Petrol	1199	4	18
ASTRA H	1.2	08/00→	Z 12 XEP	Petrol/Petroleum Gas (LPG)	1229	4	21
ASTRA H	1.2	08/00→	Z 12 XEP	Petrol	1229	4	21
ASTRA H	1.3	08/00→	Z 13 DTH	Diesel	1248	4	24
ASTRA H	1.4	04/00→10/00	Z 14 XEL	Petrol	1364	4	42
ASTRA H	1.4	03/00→	Z 14 XEP	Petrol/Petroleum Gas (LPG)	1364	4	43
ASTRA H	1.4	03/00→	Z 14 XEP	Petrol	1364	4	43
ASTRA H	1.6	12/00→	A 16 XER	Petrol/Petroleum Gas (LPG)	1598	4	57
ASTRA H	1.6	12/00→	A 16 XER	Petrol	1598	4	57
ASTRA H	1.6	02/00→	Z 16 LET	Petrol	1598	4	77
ASTRA H	1.6	03/00→	Z 16 XEP	Petrol	1598	4	81
ASTRA H	1.6	12/00→	Z 16 XER	Petrol/Petroleum Gas (LPG)	1598	4	82
ASTRA H	1.6	12/00→	Z 16 XER	Petrol	1598	4	82
ASTRA H	1.7	03/00→	Z 17 DTH	Diesel	1686	4	95
ASTRA H	1.7	03/00→	Z 17 DTL	Diesel	1686	4	96
ASTRA H	1.8	01/00→	A 18 XER	Petrol/Petroleum Gas (LPG)	1796	4	102
ASTRA H	1.8	01/00→	A 18 XER	Petrol	1796	4	102
ASTRA H	1.8	03/00→	Z 18 XE	Petrol	1796	4	112
ASTRA H	1.8	01/00→	Z 18 XER	Petrol	1796	4	114
ASTRA H	1.9	06/00→	Z 19 DT	Diesel	1910	4	122
ASTRA H	1.9	09/00→	Z 19 DTH	Diesel	1910	4	123
ASTRA H	1.9	04/00→	Z 19 DTJ	Diesel	1910	4	124
ASTRA H	1.9	09/00→	Z 19 DTL	Diesel	1910	4	125
ASTRA H	2.0	03/00→	Z 20 LEH	Petrol	1998	4	160
ASTRA H	2.0	03/00→	Z 20 LEL	Petrol	1998	4	161
ASTRA H	2.0	09/00→	Z 20 LER	Petrol	1998	4	162
ASTRA J Saloon	1.3	06/01→	A 13 DTE	Diesel	1248	4	12
ASTRA J Saloon	1.6	06/01→	A 16 LET	Petrol	1598	4	56
ASTRA J Saloon	1.6	06/01→	A 16 XER	Petrol/Petroleum Gas (LPG)	1598	4	57

	Ltr				CC		9
ASTRA J Saloon	1.6	06/01→	A 16 XER	Petrol	1598	4	57
ASTRA J Sports Tourer	1.3	10/01→	A 13 DTE	Diesel	1248	4	12
ASTRA J Sports Tourer	1.6	10/01→	A 16 LET	Petrol	1598	4	56
ASTRA J Sports Tourer	1.6	10/01→	A 16 XER	Petrol/Petroleum Gas (LPG)	1598	4	57
ASTRA J Sports Tourer	1.6	10/01→	A 16 XER	Petrol	1598	4	57
ASTRA J Sports Tourer	2.0	10/01→	A 20 DTH	Diesel	1956	4	135
ASTRA J Sports Tourer	2.0	12/01→	A 20 DTR	Diesel	1956	4	138
ASTRA J	1.3	12/00→	A 13 DTE	Diesel	1248	4	12
ASTRA J	1.6	12/00→	A 16 LET	Petrol	1598	4	56
ASTRA J	1.6	12/00→	A 16 XER	Petrol/Petroleum Gas (LPG)	1598	4	57
ASTRA J	1.6	12/00→	A 16 XER	Petrol	1598	4	57
ASTRA J	2.0	12/00→	A 20 DTH	Diesel	1956	4	135
ASTRA J	2.0	12/01→	A 20 DTR	Diesel	1956	4	138
CALIBRA A (85_)	2.0	03/99→07/99	C 20 LET	Petrol	1998	4	141
CALIBRA A (85_)	2.0	06/99→07/99	C 20 NE	Petrol	1998	4	142
CALIBRA A (85_)	2.0	06/99→02/99	C 20 XE	Petrol	1998	4	146
CALIBRA A (85_)	2.0	02/99→07/99	X 20 XEV	Petrol	1998	4	155
CALIBRA A (85_)	2.5	04/99→07/99	C 25 XE	Petrol	2498	6	192
CALIBRA A (85_)	2.5	04/99→07/99	X 25 XE	Petrol	2498	6	209
CAMPO (TF_)	2.2	08/98→09/99	C223	Diesel	2238	4	167
CAMPO (TF_)	2.3	08/99→09/99	23 P	Petrol	2254	4	183
CAMPO (TF_)	2.3	08/99→09/99	4 ZD1	Petrol	2255	4	181
CAMPO (TF_)	2.5	08/99→	4 JA1	Diesel	2499	4	187
CAMPO (TF_)	2.5	07/99→	4 JA1T	Diesel	2499	4	188
CAMPO (TF_)	3.1	12/99→	4 JG2T	Diesel	3059	4	225
CASCADA (W13)	2.0	03/01→	A 20 DTH	Diesel	1956	4	135
CASCADA (W13)	2.0	03/01→	A 20 DTR	Diesel	1956	4	138
COMBO (71_)	1.2	07/99→10/00	C 12 NZ	Petrol	1196	4	15
COMBO (71_)	1.2	07/99→10/00	X 12 SZ	Petrol	1195	4	17
COMBO (71_)	1.4	07/99→10/00	C 14 NZ	Petrol	1389	4	35
COMBO (71_)	1.4	07/99→10/00	C 14 SE	Petrol	1389	4	36
COMBO (71_)	1.4	07/99→10/00	X 14 SZ	Petrol	1389	4	39
COMBO (71_)	1.4	08/99→10/00	X 14 XE	Petrol	1389	4	40
COMBO (71_)	1.7	07/99→10/00	17 D (4EE1)	Diesel	1686	4	86
COMBO (71_)	1.7	07/99→10/00	X 17 D (4EE1)	Diesel	1686	4	89
COMBO Box Body / Estate (X12)	1.3	02/01→	A 13 FD	Diesel	1248	4	14
COMBO Box Body / Estate (X12)	1.4	02/01→	A 14 FC	Petrol/Natural Gas (CNG)	1368	4	33
COMBO Box Body / Estate (X12)	1.4	02/01→	A 14 FC	Petrol	1368	4	33
COMBO Box Body / Estate (X12)	1.4	02/01→	A 14 FC	CNG	1368	4	33
COMBO Box Body / Estate (X12)	1.4	02/01→	A 14 FP	Petrol	1368	4	34
COMBO Box Body / Estate (X12)	1.6	02/01→	A 16 FDH	Diesel	1598	4	52
COMBO Box Body / Estate (X12)	1.6	02/01→	A 16 FDL	Diesel	1598	4	53
COMBO Box Body / Estate	1.3	08/00→	Z 13 DT	Diesel	1248	4	22
COMBO Box Body / Estate	1.3	10/00→	Z 13 DTJ	Diesel	1248	4	25
COMBO Box Body / Estate	1.4	08/00→	Z 14 XEP	Petrol/Petroleum Gas (LPG)	1364	4	43
COMBO Box Body / Estate	1.4	08/00→	Z 14 XEP	Petrol	1364	4	43
COMBO Box Body / Estate	1.6	10/00→	Z 16 SE	Petrol	1598	4	78
COMBO Box Body / Estate	1.6	04/00→	Z 16 YNG	Petrol/Natural Gas (CNG)	1598	4	84
COMBO Box Body / Estate	1.6	04/00→	Z 16 YNG	Petrol	1598	4	84
COMBO Box Body / Estate	1.6	04/00→	Z 16 YNG	Gas	1598	4	84
COMBO Box Body / Estate	1.6	04/00→	Z 16 YNG	CNG	1598	4	84
COMBO Box Body / Estate	1.7	10/00→	Y 17 DT	Diesel	1686	4	92
COMBO Box Body / Estate	1.7	10/00→	Y 17 DTL	Diesel	1686	4	93
COMBO Box Body / Estate	1.7	12/00→	Z 17 DTH	Diesel	1686	4	95
COMBO Tour (X12)	1.3	02/01→	A 13 FD	Diesel	1248	4	14
COMBO Tour (X12)	1.4	02/01→	A 14 FC	Petrol/Natural Gas (CNG)	1368	4	33
COMBO Tour (X12)	1.4	02/01→	A 14 FC	Petrol	1368	4	33
COMBO Tour (X12)	1.4	02/01→	A 14 FC	CNG	1368	4	33
COMBO Tour (X12)	1.4	02/01→	A 14 FP	Petrol	1368	4	34
COMBO Tour (X12)	1.6	02/01→	A 16 FDH	Diesel	1598	4	52
COMBO Tour (X12)	1.6	02/01→	A 16 FDL	Diesel	1598	4	53
COMBO Tour	1.3	10/00→	Y 13 DT	Diesel	1248	4	19
COMBO Tour	1.3	10/00→	Z 13 DT	Diesel	1248	4	22
COMBO Tour	1.3	10/00→	Z 13 DTJ	Diesel	1248	4	25
COMBO Tour	1.4	10/00→	Z 14 XEP	Petrol/Petroleum Gas (LPG)	1364	4	43
COMBO Tour	1.4	10/00→	Z 14 XEP	Petrol	1364	4	43
COMBO Tour	1.6	10/00→	Z 16 SE	Petrol	1598	4	78
COMBO Tour	1.6	04/00→	Z 16 YNG	Petrol/Natural Gas (CNG)	1598	4	84
COMBO Tour	1.6	04/00→	Z 16 YNG	Petrol	1598	4	84
COMBO Tour	1.6	04/00→	Z 16 YNG	Gas	1598	4	84



Ltr







CC



9

Model	Ltr	Year Range	Engine	Fuel	CC	Seats	Price
COMBO Tour	1.6	04/00→	Z 16 YNG	CNG	1598	4	84
COMBO Tour	1.7	10/00→	Y 17 DT	Diesel	1686	4	92
COMBO Tour	1.7	10/00→	Y 17 DTL	Diesel	1686	4	93
COMBO Tour	1.7	12/00→	Z 17 DTH	Diesel	1686	4	95
CORSA A Box	1.0	02/98→04/98	10 S	Petrol	993	4	1
CORSA A Box	1.2	02/98→04/98	12 NC	Petrol	1196	4	6
CORSA A Box	1.2	02/98→07/99	12 S	Petrol	1196	4	9
CORSA A Box	1.2	02/98→04/98	12 ST	Petrol	1196	4	10
CORSA A Box	1.2	02/98→04/98	E 12 GV	Petrol	1196	4	16
CORSA A Box	1.3	02/98→04/98	13 NB	Petrol	1297	4	27
CORSA A Box	1.3	02/98→04/98	13 SB	Petrol	1297	4	29
CORSA A Box	1.5	06/98→04/98	15 D (4EC1)	Diesel	1488	4	44
CORSA A Hatchback (93, 94, 98, 99)	1.0	09/98→03/99	10 S	Petrol	993	4	1
CORSA A Hatchback (93, 94, 98, 99)	1.2	09/98→08/99	12 NC	Petrol	1196	4	6
CORSA A Hatchback (93, 94, 98, 99)	1.2	01/99→03/99	12 NV	Petrol	1196	4	7
CORSA A Hatchback (93, 94, 98, 99)	1.2	09/98→08/99	12 S	Petrol	1196	4	9
CORSA A Hatchback (93, 94, 98, 99)	1.2	09/98→02/99	12 ST	Petrol	1196	4	10
CORSA A Hatchback (93, 94, 98, 99)	1.2	09/98→03/99	C 12 NZ	Petrol	1196	4	15
CORSA A Hatchback (93, 94, 98, 99)	1.2	09/98→08/99	E 12 GV	Petrol	1196	4	16
CORSA A Hatchback (93, 94, 98, 99)	1.3	09/98→10/98	13 NB	Petrol	1297	4	27
CORSA A Hatchback (93, 94, 98, 99)	1.3	09/98→03/99	13 S	Petrol	1297	4	28
CORSA A Hatchback (93, 94, 98, 99)	1.3	09/98→10/98	13 SB	Petrol	1297	4	29
CORSA A Hatchback (93, 94, 98, 99)	1.3	09/98→09/99	C 13 N	Petrol	1297	4	30
CORSA A Hatchback (93, 94, 98, 99)	1.4	01/99→03/99	14 NV	Petrol	1389	4	31
CORSA A Hatchback (93, 94, 98, 99)	1.4	01/98→03/99	C 14 NZ	Petrol	1389	4	35
CORSA A Hatchback (93, 94, 98, 99)	1.4	09/99→03/99	C 14 SE	Petrol	1389	4	36
CORSA A Hatchback (93, 94, 98, 99)	1.5	09/98→03/99	15 D (4EC1)	Diesel	1488	4	44
CORSA A Hatchback (93, 94, 98, 99)	1.5	03/98→03/99	15 DT (T4EC1)	Diesel	1488	4	45
CORSA A Hatchback (93, 94, 98, 99)	1.6	08/98→09/99	C 16 NZ	Petrol	1598	4	60
CORSA A Hatchback (93, 94, 98, 99)	1.6	02/99→03/99	C 16 SE	Petrol	1598	4	62
CORSA A Hatchback (93, 94, 98, 99)	1.6	09/98→03/99	C 16 SEI	Petrol	1598	4	63
CORSA A Hatchback (93, 94, 98, 99)	1.6	05/98→03/99	E 16 SE	Petrol	1598	4	68
CORSA A TR (91, 92, 96, 97)	1.0	09/98→09/99	10 S	Petrol	993	4	1
CORSA A TR (91, 92, 96, 97)	1.2	09/98→03/99	12 ST	Petrol	1196	4	10
CORSA A TR (91, 92, 96, 97)	1.2	09/98→03/99	C 12 NZ	Petrol	1196	4	15
CORSA A TR (91, 92, 96, 97)	1.3	09/98→03/99	13 S	Petrol	1297	4	28
CORSA A TR (91, 92, 96, 97)	1.4	09/98→03/99	14 NV	Petrol	1389	4	31
CORSA A TR (91, 92, 96, 97)	1.4	10/98→03/99	C 14 NZ	Petrol	1389	4	35
CORSA A TR (91, 92, 96, 97)	1.5	10/98→11/99	15 D (4EC1)	Diesel	1488	4	44
CORSA A TR (91, 92, 96, 97)	1.5	10/98→03/99	15 DT (T4EC1)	Diesel	1488	4	45
CORSA B (73, 78, 79)	1.0	11/99→09/00	X 10 XE	Petrol	973	3	3
CORSA B (73, 78, 79)	1.2	03/99→09/00	12 NZ	Petrol	1195	4	8
CORSA B (73, 78, 79)	1.2	03/99→09/00	C 12 NZ	Petrol	1196	4	15
CORSA B (73, 78, 79)	1.2	03/99→09/00	X 12 SZ	Petrol	1195	4	17
CORSA B (73, 78, 79)	1.2	03/99→09/00	X 12 XE	Petrol	1199	4	18
CORSA B (73, 78, 79)	1.4	03/99→09/00	C 14 NZ	Petrol	1389	4	35
CORSA B (73, 78, 79)	1.4	03/99→09/00	C 14 SE	Petrol	1389	4	36
CORSA B (73, 78, 79)	1.4	08/99→09/00	C 14 SEL	Petrol	1389	4	37
CORSA B (73, 78, 79)	1.4	03/99→09/00	X 14 SZ	Petrol	1389	4	39
CORSA B (73, 78, 79)	1.4	09/99→09/00	X 14 XE	Petrol	1389	4	40
CORSA B (73, 78, 79)	1.5	03/99→09/00	15 D (4EC1)	Diesel	1488	4	44
CORSA B (73, 78, 79)	1.5	03/99→09/00	15 DT (T4EC1)	Diesel	1488	4	45
CORSA B (73, 78, 79)	1.5	03/99→09/00	X 15 DT (T4EC1)	Diesel	1488	4	46
CORSA B (73, 78, 79)	1.6	08/99→09/00	C 16 SEL	Petrol	1598	4	64
CORSA B (73, 78, 79)	1.6	03/99→09/00	C 16 XE	Petrol	1598	4	65
CORSA B (73, 78, 79)	1.6	09/99→09/00	X 16 XE	Petrol	1598	4	71
CORSA B (73, 78, 79)	1.7	02/99→09/00	17 D (4EE1)	Diesel	1686	4	86
CORSA B (73, 78, 79)	1.7	02/99→09/00	X 17 D (4EE1)	Diesel	1686	4	89
CORSA B Box (73)	1.4	08/99→09/00	X 14 SZ	Petrol	1389	4	39
CORSA B Box (73)	1.7	08/99→09/00	17 D (4EE1)	Diesel	1686	4	86
CORSA B Box (73)	1.7	08/99→09/00	X 17 D (4EE1)	Diesel	1686	4	89
CORSA B Estate (F35)	1.4	01/99→	X 14 XE	Petrol	1389	4	40
CORSA B Estate (F35)	1.7	01/99→	X 17 D (4EE1)	Diesel	1686	4	89
CORSA C (F08, F68)	1.0	09/00→12/00	Z 10 XE	Petrol	973	3	4
CORSA C (F08, F68)	1.0	06/00→12/00	Z 10 XEP	Petrol	998	3	5
CORSA C (F08, F68)	1.2	09/00→12/00	Z 12 XE	Petrol	1199	4	20
CORSA C (F08, F68)	1.2	07/00→12/00	Z 12 XEP	Petrol/Petroleum Gas (LPG)	1229	4	21
CORSA C (F08, F68)	1.2	07/00→12/00	Z 12 XEP	Petrol	1229	4	21
CORSA C (F08, F68)	1.3	06/00→12/00	Z 13 DT	Diesel	1248	4	22
CORSA C (F08, F68)	1.4	09/00→12/00	Z 14 XE	Petrol	1389	4	41

	Ltr				CC		9
CORSA C (F08, F68)	1.4	06/00→12/00	Z 14 XEP	Petrol/Petroleum Gas (LPG)	1364	4	43
CORSA C (F08, F68)	1.4	06/00→12/00	Z 14 XEP	Petrol	1364	4	43
CORSA C (F08, F68)	1.6	05/00→12/00	Y 16 YNG	CNG	1598	4	74
CORSA C (F08, F68)	1.7	09/00→12/00	Y 17 DT	Diesel	1686	4	92
CORSA C (F08, F68)	1.7	09/00→12/00	Y 17 DTL	Diesel	1686	4	93
CORSA C (F08, F68)	1.7	06/00→12/00	Z 17 DTH	Diesel	1686	4	95
CORSA C (F08, F68)	1.8	09/00→12/00	Z 18 XE	Petrol	1796	4	112
CORSA C Box (F08, W5L)	1.2	09/00→	Z 12 XE	Petrol	1199	4	20
CORSA C Box (F08, W5L)	1.2	07/00→	Z 12 XEP	Petrol/Petroleum Gas (LPG)	1229	4	21
CORSA C Box (F08, W5L)	1.2	07/00→	Z 12 XEP	Petrol	1229	4	21
CORSA C Box (F08, W5L)	1.3	08/00→	Z 13 DT	Diesel	1248	4	22
CORSA C Box (F08, W5L)	1.4	08/00→	Z 14 XEP	Petrol/Petroleum Gas (LPG)	1364	4	43
CORSA C Box (F08, W5L)	1.4	08/00→	Z 14 XEP	Petrol	1364	4	43
CORSA C Box (F08, W5L)	1.7	09/00→	Y 17 DT	Diesel	1686	4	92
CORSA C Box (F08, W5L)	1.7	09/00→	Y 17 DTL	Diesel	1686	4	93
CORSA C Box (F08, W5L)	1.7	08/00→	Z 17 DTH	Diesel	1686	4	95
CORSA D Van	1.2	07/00→	Z 12 XEP	Petrol/Petroleum Gas (LPG)	1229	4	21
CORSA D Van	1.2	07/00→	Z 12 XEP	Petrol	1229	4	21
CORSA D Van	1.3	07/00→	A 13 DTC	Diesel	1248	4	11
CORSA D Van	1.3	06/01→	A 13 DTR	Diesel	1248	4	13
CORSA D Van	1.3	06/01→	Z 13 DTE	Diesel	1248	4	23
CORSA D Van	1.3	07/00→	Z 13 DTH	Diesel	1248	4	24
CORSA D Van	1.3	07/00→	Z 13 DTJ	Diesel	1248	4	25
CORSA D	1.0	07/00→	Z 10 XEP	Petrol	998	3	5
CORSA D	1.2	07/00→	Z 12 XEP	Petrol/Petroleum Gas (LPG)	1229	4	21
CORSA D	1.2	07/00→	Z 12 XEP	Petrol	1229	4	21
CORSA D	1.3	07/00→	A 13 DTC	Diesel	1248	4	11
CORSA D	1.3	06/01→	A 13 DTE	Diesel	1248	4	12
CORSA D	1.3	06/01→	A 13 DTR	Diesel	1248	4	13
CORSA D	1.3	06/01→	Z 13 DTE	Diesel	1248	4	23
CORSA D	1.3	07/00→	Z 13 DTH	Diesel	1248	4	24
CORSA D	1.3	07/00→	Z 13 DTJ	Diesel	1248	4	25
CORSA D	1.4	07/00→	Z 14 XEP	Petrol/Petroleum Gas (LPG)	1364	4	43
CORSA D	1.4	07/00→	Z 14 XEP	Petrol	1364	4	43
CORSA D	1.6	02/00→	A 16 LEL	Petrol	1598	4	54
CORSA D	1.6	02/00→	A 16 LER	Petrol	1598	4	55
CORSA D	1.6	02/00→	Z 16 LEL	Petrol	1598	4	75
CORSA D	1.6	02/00→	Z 16 LER	Petrol	1598	4	76
FRONTERA A (5_MWL4)	2.2	03/99→10/99	X 22 XE	Petrol	2198	4	173
FRONTERA A (5_MWL4)	2.3	03/99→10/99	23 DTR	Diesel	2260	4	182
FRONTERA A (5_MWL4)	2.4	03/99→10/99	C 24 NE	Petrol	2410	4	186
FRONTERA A (5_MWL4)	2.5	09/99→10/99	25TDS (VM41B)	Diesel	2499	4	191
FRONTERA A (5_MWL4)	2.8	03/99→10/99	28 TDI (4JB1T)	Diesel	2771	4	213
FRONTERA A Sport (5_SUD2)	2.0	03/99→10/99	C 20 NE	Petrol	1998	4	142
FRONTERA A Sport (5_SUD2)	2.0	03/99→10/99	X 20 SE	Petrol	1998	4	153
FRONTERA A Sport (5_SUD2)	2.5	09/99→10/99	25TDS (VM41B)	Diesel	2499	4	191
FRONTERA A Sport (5_SUD2)	2.8	03/99→08/99	28 TDI (4JB1T)	Diesel	2771	4	213
FRONTERA B (6B_)	2.2	10/99→09/00	X 22 DTH	Diesel	2171	4	171
FRONTERA B (6B_)	2.2	10/99→	X 22 SE	Petrol	2198	4	172
FRONTERA B (6B_)	2.2	10/99→	Y 22 DTH	Diesel	2171	4	174
FRONTERA B (6B_)	2.2	10/99→	Y 22 SE	Petrol	2198	4	176
FRONTERA B (6B_)	3.2	10/99→	6 VDI	Petrol	3165	6	227
FRONTERA B (6B_)	3.2	10/99→	Y 32 NE	Petrol	3165	6	228
GT Convertible	2.0	06/00→	LNF	Petrol	1998	4	149
GT Convertible	2.0	06/00→	Z 20 NHH	Petrol	1998	4	165
INSIGNIA Saloon	1.6	01/00→	A 16 LET	Petrol	1598	4	56
INSIGNIA Saloon	1.6	07/00→	A 16 XER	Petrol/Petroleum Gas (LPG)	1598	4	57
INSIGNIA Saloon	1.6	07/00→	A 16 XER	Petrol	1598	4	57
INSIGNIA Saloon	1.8	07/00→	A 18 XER	Petrol/Petroleum Gas (LPG)	1796	4	102
INSIGNIA Saloon	1.8	07/00→	A 18 XER	Petrol	1796	4	102
INSIGNIA Saloon	2.0	07/00→	A 20 DT	Diesel	1956	4	133
INSIGNIA Saloon	2.0	07/00→	A 20 DTC	Diesel	1956	4	134
INSIGNIA Saloon	2.0	07/00→	A 20 DTH	Diesel	1956	4	135
INSIGNIA Saloon	2.0	07/00→	A 20 DTJ	Diesel	1956	4	136
INSIGNIA Saloon	2.0	07/00→	A 20 DTL	Diesel	1956	4	137
INSIGNIA Saloon	2.0	07/00→	A 20 DTR	Diesel	1956	4	138
INSIGNIA Saloon	2.0	09/01→	A 20 NFT	Petrol	1998	4	139
INSIGNIA Saloon	2.0	07/00→	A 20 NHT	Petrol	1998	4	140
INSIGNIA Saloon	2.0	07/00→	A 20 NHT	Flexfuel	1998	4	140
INSIGNIA Sports Tourer	1.6	01/00→	A 16 LET	Petrol	1598	4	56



Ltr







CC



9

INSIGNIA Sports Tourer	1.6	07/00→	A 16 XER	Petrol/Petroleum Gas (LPG)	1598	4	57
INSIGNIA Sports Tourer	1.6	07/00→	A 16 XER	Petrol	1598	4	57
INSIGNIA Sports Tourer	1.8	07/00→	A 18 XER	Petrol/Petroleum Gas (LPG)	1796	4	102
INSIGNIA Sports Tourer	1.8	07/00→	A 18 XER	Petrol	1796	4	102
INSIGNIA Sports Tourer	2.0	07/00→	A 20 DT	Diesel	1956	4	133
INSIGNIA Sports Tourer	2.0	07/00→	A 20 DTC	Diesel	1956	4	134
INSIGNIA Sports Tourer	2.0	07/00→	A 20 DTH	Diesel	1956	4	135
INSIGNIA Sports Tourer	2.0	07/00→	A 20 DTJ	Diesel	1956	4	136
INSIGNIA Sports Tourer	2.0	07/00→	A 20 DTL	Diesel	1956	4	137
INSIGNIA Sports Tourer	2.0	07/00→	A 20 DTR	Diesel	1956	4	138
INSIGNIA Sports Tourer	2.0	09/01→	A 20 NFT	Petrol	1998	4	139
INSIGNIA Sports Tourer	2.0	07/00→	A 20 NHT	Petrol	1998	4	140
INSIGNIA Sports Tourer	2.0	07/00→	A 20 NHT	Flexfuel	1998	4	140
INSIGNIA	1.6	07/00→	A 16 LET	Petrol	1598	4	56
INSIGNIA	1.6	07/00→	A 16 XER	Petrol/Petroleum Gas (LPG)	1598	4	57
INSIGNIA	1.6	07/00→	A 16 XER	Petrol	1598	4	57
INSIGNIA	1.8	07/00→	A 18 XER	Petrol/Petroleum Gas (LPG)	1796	4	102
INSIGNIA	1.8	07/00→	A 18 XER	Petrol	1796	4	102
INSIGNIA	2.0	07/00→	A 20 DT	Diesel	1956	4	133
INSIGNIA	2.0	07/00→	A 20 DTC	Diesel	1956	4	134
INSIGNIA	2.0	07/00→	A 20 DTH	Diesel	1956	4	135
INSIGNIA	2.0	07/00→	A 20 DTJ	Diesel	1956	4	136
INSIGNIA	2.0	07/00→	A 20 DTL	Diesel	1956	4	137
INSIGNIA	2.0	07/00→	A 20 DTR	Diesel	1956	4	138
INSIGNIA	2.0	09/01→	A 20 NFT	Petrol	1998	4	139
INSIGNIA	2.0	07/00→	A 20 NHT	Petrol	1998	4	140
INSIGNIA	2.0	07/00→	A 20 NHT	Flexfuel	1998	4	140
KADETT E (39_, 49_)	1.3	09/98→08/98	13 N	Petrol	1297	4	26
KADETT E (39_, 49_)	1.3	09/98→08/98	13 NB	Petrol	1297	4	27
KADETT E (39_, 49_)	1.3	09/98→08/99	C 13 N	Petrol	1297	4	30
KADETT E (39_, 49_)	1.4	01/99→08/99	14 NV	Petrol	1389	4	31
KADETT E (39_, 49_)	1.4	01/99→08/99	C 14 NZ	Petrol	1389	4	35
KADETT E (39_, 49_)	1.5	07/98→08/99	15 DT (T4EC1)	Diesel	1488	4	45
KADETT E (39_, 49_)	1.6	09/98→01/98	16 D	Diesel	1598	4	47
KADETT E (39_, 49_)	1.6	09/98→01/98	16 DA	Diesel	1598	4	48
KADETT E (39_, 49_)	1.6	09/98→08/99	16 SV	Petrol	1598	4	51
KADETT E (39_, 49_)	1.6	09/98→08/99	C 16 LZ	Petrol	1598	4	59
KADETT E (39_, 49_)	1.6	09/98→08/99	C 16 NZ	Petrol	1598	4	60
KADETT E (39_, 49_)	1.6	09/98→08/99	E 16 NZ	Petrol	1598	4	67
KADETT E (39_, 49_)	1.6	09/98→08/99	E 16 SE	Petrol	1598	4	68
KADETT E (39_, 49_)	1.7	02/98→08/99	17 D	Diesel	1700	4	85
KADETT E (39_, 49_)	1.8	09/98→08/99	18 E	Petrol	1796	4	97
KADETT E (39_, 49_)	1.8	09/99→08/99	18 SV	Petrol	1796	4	100
KADETT E (39_, 49_)	1.8	09/99→08/99	C 18 NT	Petrol	1796	4	103
KADETT E (39_, 49_)	1.8	09/99→08/99	C 18 NZ	Petrol	1796	4	104
KADETT E (39_, 49_)	1.8	09/98→08/99	E 18 NV	Petrol	1796	4	107
KADETT E (39_, 49_)	2.0	03/98→08/99	20 NE	Petrol	1998	4	127
KADETT E (39_, 49_)	2.0	03/98→08/99	20 SE	Petrol	1998	4	129
KADETT E (39_, 49_)	2.0	03/98→08/99	C 20 NE	Petrol	1998	4	142
KADETT E Box (37_, 47_)	1.3	09/98→07/98	13 N	Petrol	1297	4	26
KADETT E Box (37_, 47_)	1.3	09/98→07/98	13 NB	Petrol	1297	4	27
KADETT E Box (37_, 47_)	1.4	01/99→08/99	C 14 NZ	Petrol	1389	4	35
KADETT E Box (37_, 47_)	1.6	08/98→08/98	16 D	Diesel	1598	4	47
KADETT E Box (37_, 47_)	1.6	08/98→08/98	16 DA	Diesel	1598	4	48
KADETT E Box (37_, 47_)	1.6	08/98→09/99	C 16 NZ	Petrol	1598	4	60
KADETT E Box (37_, 47_)	1.7	08/98→09/99	17 D	Diesel	1700	4	85
KADETT E Box (37_, 47_)	1.8	08/98→09/99	C 18 NT	Petrol	1796	4	103
KADETT E Combo (38_, 48_)	1.3	01/98→12/98	13 N	Petrol	1297	4	26
KADETT E Combo (38_, 48_)	1.3	01/98→12/98	13 S	Petrol	1297	4	28
KADETT E Combo (38_, 48_)	1.4	07/98→08/99	14 NV	Petrol	1389	4	31
KADETT E Combo (38_, 48_)	1.4	08/99→07/99	C 14 NZ	Petrol	1389	4	35
KADETT E Combo (38_, 48_)	1.6	01/98→12/98	16 DA	Diesel	1598	4	48
KADETT E Combo (38_, 48_)	1.6	09/98→06/99	16 SH	Petrol	1598	4	50
KADETT E Combo (38_, 48_)	1.6	09/98→12/99	16 SV	Petrol	1598	4	51
KADETT E Combo (38_, 48_)	1.6	08/99→07/99	C 16 NZ	Petrol	1598	4	60
KADETT E Combo (38_, 48_)	1.7	01/98→07/99	17 D	Diesel	1700	4	85
KADETT E Combo (38_, 48_)	1.7	07/99→07/99	17 DR	Diesel	1700	4	87
KADETT E Convertible (43B_)	1.3	03/98→02/99	13 S	Petrol	1297	4	28
KADETT E Convertible (43B_)	1.4	08/99→02/99	14 NV	Petrol	1389	4	31
KADETT E Convertible (43B_)	1.4	01/99→08/99	C 14 NZ	Petrol	1389	4	35

	Ltr				CC		9
KADETT E Convertible (43B_)	1.6	07/98→02/99	16 SV	Petrol	1598	4	51
KADETT E Convertible (43B_)	1.6	10/98→02/99	C 16 LZ	Petrol	1598	4	59
KADETT E Convertible (43B_)	1.6	10/98→02/99	C 16 NZ	Petrol	1598	4	60
KADETT E Convertible (43B_)	1.6	10/98→02/99	E 16 NZ	Petrol	1598	4	67
KADETT E Convertible (43B_)	2.0	10/98→02/99	20 NE	Petrol	1998	4	127
KADETT E Convertible (43B_)	2.0	10/98→02/99	C 20 NE	Petrol	1998	4	142
KADETT E Convertible (43B_)	2.0	09/99→05/99	C 20 XE	Petrol	1998	4	146
KADETT E Estate (35_, 36_, 45_, 46_)	1.3	09/98→08/99	13 N	Petrol	1297	4	26
KADETT E Estate (35_, 36_, 45_, 46_)	1.3	09/98→08/99	C 13 N	Petrol	1297	4	30
KADETT E Estate (35_, 36_, 45_, 46_)	1.4	01/99→08/99	14 NV	Petrol	1389	4	31
KADETT E Estate (35_, 36_, 45_, 46_)	1.4	01/99→08/99	C 14 NZ	Petrol	1389	4	35
KADETT E Estate (35_, 36_, 45_, 46_)	1.5	07/98→08/99	15 DT (T4EC1)	Diesel	1488	4	45
KADETT E Estate (35_, 36_, 45_, 46_)	1.6	09/98→01/98	16 D	Diesel	1598	4	47
KADETT E Estate (35_, 36_, 45_, 46_)	1.6	09/98→01/98	16 DA	Diesel	1598	4	48
KADETT E Estate (35_, 36_, 45_, 46_)	1.6	09/98→08/99	16 SV	Petrol	1598	4	51
KADETT E Estate (35_, 36_, 45_, 46_)	1.6	09/98→08/99	C 16 LZ	Petrol	1598	4	59
KADETT E Estate (35_, 36_, 45_, 46_)	1.6	09/98→08/99	C 16 NZ	Petrol	1598	4	60
KADETT E Estate (35_, 36_, 45_, 46_)	1.6	09/98→08/99	E 16 NZ	Petrol	1598	4	67
KADETT E Estate (35_, 36_, 45_, 46_)	1.7	02/98→08/99	17 D	Diesel	1700	4	85
KADETT E Estate (35_, 36_, 45_, 46_)	1.8	12/98→08/99	18 SE	Petrol	1796	4	98
KADETT E Estate (35_, 36_, 45_, 46_)	1.8	06/98→08/99	C 18 NT	Petrol	1796	4	103
KADETT E Estate (35_, 36_, 45_, 46_)	1.8	06/98→08/99	C 18 NZ	Petrol	1796	4	104
KADETT E Estate (35_, 36_, 45_, 46_)	1.8	09/98→08/99	E 18 NV	Petrol	1796	4	107
KADETT E Estate (35_, 36_, 45_, 46_)	2.0	09/98→08/99	20 NE	Petrol	1998	4	127
KADETT E Estate (35_, 36_, 45_, 46_)	2.0	09/98→08/99	C 20 NE	Petrol	1998	4	142
KADETT E Hatchback (33_, 34_, 43_, 44_)	1.3	09/98→08/99	13 N	Petrol	1297	4	26
KADETT E Hatchback (33_, 34_, 43_, 44_)	1.3	09/98→08/99	13 NB	Petrol	1297	4	27
KADETT E Hatchback (33_, 34_, 43_, 44_)	1.3	09/98→08/99	C 13 N	Petrol	1297	4	30
KADETT E Hatchback (33_, 34_, 43_, 44_)	1.4	01/99→08/99	14 NV	Petrol	1389	4	31
KADETT E Hatchback (33_, 34_, 43_, 44_)	1.4	01/99→08/99	C 14 NZ	Petrol	1389	4	35
KADETT E Hatchback (33_, 34_, 43_, 44_)	1.4	09/98→08/99	C 14 SE	Petrol	1389	4	36
KADETT E Hatchback (33_, 34_, 43_, 44_)	1.5	07/98→08/99	15 DT (T4EC1)	Diesel	1488	4	45
KADETT E Hatchback (33_, 34_, 43_, 44_)	1.6	09/98→01/98	16 D	Diesel	1598	4	47
KADETT E Hatchback (33_, 34_, 43_, 44_)	1.6	09/98→01/98	16 DA	Diesel	1598	4	48
KADETT E Hatchback (33_, 34_, 43_, 44_)	1.6	09/98→08/99	16 SV	Petrol	1598	4	51
KADETT E Hatchback (33_, 34_, 43_, 44_)	1.6	09/98→08/99	C 16 LZ	Petrol	1598	4	59
KADETT E Hatchback (33_, 34_, 43_, 44_)	1.6	09/98→08/99	C 16 NZ	Petrol	1598	4	60
KADETT E Hatchback (33_, 34_, 43_, 44_)	1.6	09/98→08/99	E 16 NZ	Petrol	1598	4	67
KADETT E Hatchback (33_, 34_, 43_, 44_)	1.7	02/98→08/99	17 D	Diesel	1700	4	85
KADETT E Hatchback (33_, 34_, 43_, 44_)	1.8	06/98→08/99	C 18 NT	Petrol	1796	4	103
KADETT E Hatchback (33_, 34_, 43_, 44_)	1.8	06/98→08/99	C 18 NZ	Petrol	1796	4	104
KADETT E Hatchback (33_, 34_, 43_, 44_)	1.8	09/98→08/99	E 18 NV	Petrol	1796	4	107
KADETT E Hatchback (33_, 34_, 43_, 44_)	1.8	06/98→08/99	S 18 NV	Petrol	1796	4	109
KADETT E Hatchback (33_, 34_, 43_, 44_)	2.0	09/98→08/99	20 NE	Petrol	1998	4	127
KADETT E Hatchback (33_, 34_, 43_, 44_)	2.0	09/98→08/99	20 SEH	Petrol	1998	4	130
KADETT E Hatchback (33_, 34_, 43_, 44_)	2.0	12/98→08/99	20 XE	Petrol	1998	4	131
KADETT E Hatchback (33_, 34_, 43_, 44_)	2.0	03/98→08/99	20 XEJ	Petrol	1998	4	132
KADETT E Hatchback (33_, 34_, 43_, 44_)	2.0	09/98→08/99	C 20 NE	Petrol	1998	4	142
KADETT E Hatchback (33_, 34_, 43_, 44_)	2.0	03/98→08/99	C 20 XE	Petrol	1998	4	146
MANTA B (58_, 59_)	2.0	08/97→08/98	20 E	Petrol	1979	4	126
MANTA B CC (53_, 55_)	2.0	08/97→08/98	20 E	Petrol	1979	4	126
MERIVA B	1.3	06/01→	A 13 DTC	Diesel	1248	4	11
MERIVA B	1.3	06/01→	A 13 DTE	Diesel	1248	4	12
MERIVA	1.3	04/00→05/01	Y 13 DT	Diesel	1248	4	19
MERIVA	1.3	04/00→05/01	Z 13 DT	Diesel	1248	4	22
MERIVA	1.3	09/00→05/01	Z 13 DTJ	Diesel	1248	4	25
MERIVA	1.4	07/00→05/01	Z 14 XEP	Petrol/Petroleum Gas (LPG)	1364	4	43
MERIVA	1.4	07/00→05/01	Z 14 XEP	Petrol	1364	4	43
MERIVA	1.6	09/00→05/01	Z 16 LET	Petrol	1598	4	77
MERIVA	1.6	05/00→05/01	Z 16 SE	Petrol	1598	4	78
MERIVA	1.6	05/00→01/00	Z 16 XE	Petrol	1598	4	79
MERIVA	1.6	01/00→05/01	Z 16 XEP	Petrol	1598	4	81
MERIVA	1.7	09/00→05/01	Y 17 DT	Diesel	1686	4	92
MERIVA	1.7	09/00→05/01	Y 17 DTL	Diesel	1686	4	93
MERIVA	1.7	09/00→05/01	Z 17 DT	Diesel	1686	4	94
MERIVA	1.7	09/00→05/01	Z 17 DTH	Diesel	1686	4	95
MERIVA	1.8	05/00→05/01	Z 18 XE	Petrol	1796	4	112
MOKKA	1.6	06/01→	A 16 XER	Petrol/Petroleum Gas (LPG)	1598	4	57
MOKKA	1.6	06/01→	A 16 XER	Petrol	1598	4	57
MOKKA	1.8	01/01→	A 18 XER	Petrol/Petroleum Gas (LPG)	1796	4	102



Ltr







CC



9

Model	Ltr	Year	Engine	Fuel	CC	Gear	Price
MOKKA	1.8	01/01→	A 18 XER	Petrol	1796	4	102
MONTEREY A (UBS_)	3.1	09/99→07/99	4 JG2TC	Diesel	3059	4	226
MONTEREY A (UBS_)	3.2	06/99→07/99	6 VD1	Petrol	3165	6	227
MONTEREY B	3.0	07/99→08/99	4 JX1	Diesel	2999	4	216
MONTEREY B	3.5	07/99→08/99	6 VE1	Petrol	3494	6	230
MOVANO Box (F9)	1.9	09/00→10/00	F9Q 770	Diesel	1870	4	119
MOVANO Box (F9)	1.9	10/00→	F9Q 772	Diesel	1870	4	120
MOVANO Box (F9)	1.9	10/00→	F9Q 774	Diesel	1870	4	121
MOVANO Box (F9)	2.2	09/00→	G9T 720	Diesel	2188	4	168
MOVANO Box (F9)	2.2	09/00→	G9T 722	Diesel	2188	4	169
MOVANO Box (F9)	2.2	09/00→	G9T 750	Diesel	2188	4	170
MOVANO Box (F9)	2.5	10/00→	G9U 632	Diesel	2464	4	195
MOVANO Box (F9)	2.5	10/00→	G9U 650	Diesel	2464	4	196
MOVANO Box (F9)	2.5	10/00→	G9U 720	Diesel	2463	4	197
MOVANO Box (F9)	2.5	10/00→	G9U 724	Diesel	2463	4	198
MOVANO Box (F9)	2.5	10/00→	G9U 754	Diesel	2463	4	201
MOVANO Box (F9)	2.5	01/99→09/00	S8U 770	Diesel	2499	4	203
MOVANO Box (F9)	2.5	01/99→09/00	S8U 772	Diesel	2499	4	204
MOVANO Box (F9)	2.8	01/99→10/00	S9W 700	Diesel	2799	4	214
MOVANO Box (F9)	2.8	01/99→10/00	S9W 702	Diesel	2799	4	215
MOVANO Combi (J9)	1.9	09/00→10/00	F9Q 770	Diesel	1870	4	119
MOVANO Combi (J9)	1.9	10/00→	F9Q 772	Diesel	1870	4	120
MOVANO Combi (J9)	1.9	10/00→	F9Q 774	Diesel	1870	4	121
MOVANO Combi (J9)	2.2	09/00→	G9T 720	Diesel	2188	4	168
MOVANO Combi (J9)	2.2	09/00→	G9T 722	Diesel	2188	4	169
MOVANO Combi (J9)	2.2	09/00→	G9T 750	Diesel	2188	4	170
MOVANO Combi (J9)	2.5	08/00→	G9U 632	Diesel	2464	4	195
MOVANO Combi (J9)	2.5	08/00→	G9U 650	Diesel	2464	4	196
MOVANO Combi (J9)	2.5	10/00→	G9U 720	Diesel	2463	4	197
MOVANO Combi (J9)	2.5	10/00→	G9U 724	Diesel	2463	4	198
MOVANO Combi (J9)	2.5	10/00→	G9U 750	Diesel	2463	4	200
MOVANO Combi (J9)	2.5	10/00→	G9U 754	Diesel	2463	4	201
MOVANO Combi (J9)	2.5	07/99→09/00	S8U 770	Diesel	2499	4	203
MOVANO Combi (J9)	2.5	07/99→09/00	S8U 772	Diesel	2499	4	204
MOVANO Combi (J9)	2.8	07/99→10/00	S9W 700	Diesel	2799	4	214
MOVANO Combi (J9)	2.8	07/99→10/00	S9W 702	Diesel	2799	4	215
MOVANO Dumphtruck (H9)	2.2	09/00→	G9T 720	Diesel	2188	4	168
MOVANO Dumphtruck (H9)	2.2	09/00→	G9T 722	Diesel	2188	4	169
MOVANO Dumphtruck (H9)	2.2	09/00→	G9T 750	Diesel	2188	4	170
MOVANO Dumphtruck (H9)	2.5	08/00→	G9U 632	Diesel	2464	4	195
MOVANO Dumphtruck (H9)	2.5	08/00→	G9U 650	Diesel	2464	4	196
MOVANO Dumphtruck (H9)	2.5	10/00→	G9U 720	Diesel	2463	4	197
MOVANO Dumphtruck (H9)	2.5	10/00→	G9U 724	Diesel	2463	4	198
MOVANO Dumphtruck (H9)	2.5	10/00→	G9U 750	Diesel	2463	4	200
MOVANO Dumphtruck (H9)	2.5	10/00→	G9U 754	Diesel	2463	4	201
MOVANO Dumphtruck (H9)	2.5	01/99→09/00	S8U 770	Diesel	2499	4	203
MOVANO Dumphtruck (H9)	2.5	01/99→09/00	S8U 772	Diesel	2499	4	204
MOVANO Dumphtruck (H9)	2.8	01/99→10/00	S9W 700	Diesel	2799	4	214
MOVANO Dumphtruck (H9)	2.8	01/99→10/00	S9W 702	Diesel	2799	4	215
MOVANO Platform/Chassis (U9, E9)	2.2	09/00→	G9T 720	Diesel	2188	4	168
MOVANO Platform/Chassis (U9, E9)	2.2	09/00→	G9T 722	Diesel	2188	4	169
MOVANO Platform/Chassis (U9, E9)	2.2	09/00→	G9T 750	Diesel	2188	4	170
MOVANO Platform/Chassis (U9, E9)	2.5	08/00→	G9U 632	Diesel	2464	4	195
MOVANO Platform/Chassis (U9, E9)	2.5	08/00→	G9U 650	Diesel	2464	4	196
MOVANO Platform/Chassis (U9, E9)	2.5	10/00→	G9U 720	Diesel	2463	4	197
MOVANO Platform/Chassis (U9, E9)	2.5	10/00→	G9U 724	Diesel	2463	4	198
MOVANO Platform/Chassis (U9, E9)	2.5	10/00→	G9U 750	Diesel	2463	4	200
MOVANO Platform/Chassis (U9, E9)	2.5	10/00→	G9U 754	Diesel	2463	4	201
MOVANO Platform/Chassis (U9, E9)	2.5	07/99→09/00	S8U 770	Diesel	2499	4	203
MOVANO Platform/Chassis (U9, E9)	2.5	07/99→09/00	S8U 772	Diesel	2499	4	204
MOVANO Platform/Chassis (U9, E9)	2.8	07/99→10/00	S9W 700	Diesel	2799	4	214
MOVANO Platform/Chassis (U9, E9)	2.8	07/99→10/00	S9W 702	Diesel	2799	4	215
OMEGA A (16_, 17_, 19_)	1.8	09/98→03/99	18 SEH	Petrol	1796	4	99
OMEGA A (16_, 17_, 19_)	1.8	09/98→03/99	18 SV	Petrol	1796	4	100
OMEGA A (16_, 17_, 19_)	1.8	09/98→03/99	E 18 NVR	Petrol	1796	4	108
OMEGA A (16_, 17_, 19_)	2.0	09/98→03/99	20 SE	Petrol	1998	4	129
OMEGA A (16_, 17_, 19_)	2.0	09/98→03/99	C 20 NE	Petrol	1998	4	142
OMEGA A (16_, 17_, 19_)	2.0	09/99→03/99	C 20 NEJ	Petrol	1998	4	144
OMEGA A (16_, 17_, 19_)	2.3	08/98→03/99	23 DTR	Diesel	2260	4	182
OMEGA A (16_, 17_, 19_)	2.3	10/98→03/99	23 YD	Diesel	2260	4	184

	Ltr				CC		9
OMEGA A (16_, 17_, 19_)	2.3	10/98 → 08/98	23 YDT	Diesel	2260	4	185
OMEGA A (16_, 17_, 19_)	2.4	09/98 → 03/99	C 24 NE	Petrol	2410	4	186
OMEGA A (16_, 17_, 19_)	2.6	09/99 → 03/99	C 26 NE	Petrol	2594	6	211
OMEGA A (16_, 17_, 19_)	3.0	03/98 → 09/99	30 NE	Petrol	2969	6	217
OMEGA A (16_, 17_, 19_)	3.0	03/98 → 03/99	C 30 NE	Petrol	2969	6	219
OMEGA A (16_, 17_, 19_)	3.0	09/98 → 03/99	C 30 SE	Petrol	2969	6	220
OMEGA A (16_, 17_, 19_)	3.0	09/98 → 03/99	C 30 SEJ	Petrol	2969	6	221
OMEGA A Estate (66_, 67_)	1.8	09/98 → 03/99	18 SEH	Petrol	1796	4	99
OMEGA A Estate (66_, 67_)	1.8	09/98 → 03/99	18 SV	Petrol	1796	4	100
OMEGA A Estate (66_, 67_)	1.8	09/98 → 03/99	E 18 NVR	Petrol	1796	4	108
OMEGA A Estate (66_, 67_)	2.0	09/98 → 03/99	20 SE	Petrol	1998	4	129
OMEGA A Estate (66_, 67_)	2.0	09/98 → 04/99	C 20 NE	Petrol	1998	4	142
OMEGA A Estate (66_, 67_)	2.0	09/99 → 03/99	C 20 NEJ	Petrol	1998	4	144
OMEGA A Estate (66_, 67_)	2.3	09/98 → 03/99	23 DTR	Diesel	2260	4	182
OMEGA A Estate (66_, 67_)	2.3	09/98 → 03/99	23 YD	Diesel	2260	4	184
OMEGA A Estate (66_, 67_)	2.3	09/98 → 08/98	23 YDT	Diesel	2260	4	185
OMEGA A Estate (66_, 67_)	2.4	09/98 → 03/99	C 24 NE	Petrol	2410	4	186
OMEGA A Estate (66_, 67_)	2.6	09/99 → 03/99	C 26 NE	Petrol	2594	6	211
OMEGA A Estate (66_, 67_)	3.0	03/98 → 09/99	30 NE	Petrol	2969	6	217
OMEGA A Estate (66_, 67_)	3.0	03/98 → 03/99	C 30 LE	Petrol	2969	6	218
OMEGA A Estate (66_, 67_)	3.0	03/98 → 03/99	C 30 NE	Petrol	2969	6	219
OMEGA A Estate (66_, 67_)	3.0	09/98 → 04/99	C 30 SE	Petrol	2969	6	220
OMEGA A Estate (66_, 67_)	3.0	09/98 → 03/99	C 30 SEJ	Petrol	2969	6	221
OMEGA B (25_, 26_, 27_)	2.0	03/99 → 12/00	20 SE	Petrol	1998	4	129
OMEGA B (25_, 26_, 27_)	2.0	09/99 → 09/00	X 20 DTH	Diesel	1995	4	151
OMEGA B (25_, 26_, 27_)	2.0	03/99 → 09/99	X 20 SE	Petrol	1998	4	153
OMEGA B (25_, 26_, 27_)	2.0	03/99 → 09/99	X 20 XEV	Petrol	1998	4	155
OMEGA B (25_, 26_, 27_)	2.2	09/00 → 07/00	Y 22 DTH	Diesel	2171	4	174
OMEGA B (25_, 26_, 27_)	2.2	09/99 → 07/00	Y 22 XE	Petrol	2198	4	177
OMEGA B (25_, 26_, 27_)	2.2	09/99 → 07/00	Z 22 XE	Petrol	2198	4	179
OMEGA B (25_, 26_, 27_)	2.5	04/99 → 07/00	25 DT	Diesel	2497	6	189
OMEGA B (25_, 26_, 27_)	2.5	04/99 → 07/00	X 25 DT	Diesel	2497	6	207
OMEGA B (25_, 26_, 27_)	2.5	04/99 → 07/00	X 25 TD	Diesel	2498	6	208
OMEGA B (25_, 26_, 27_)	2.5	03/99 → 09/00	X 25 XE	Petrol	2498	6	209
OMEGA B (25_, 26_, 27_)	2.5	09/00 → 07/00	Y 25 DT	Diesel	2497	6	210
OMEGA B (25_, 26_, 27_)	2.6	09/00 → 07/00	Y 26 SE	Petrol	2597	6	212
OMEGA B (25_, 26_, 27_)	3.0	04/99 → 02/00	X 30 XE	Petrol	2962	6	222
OMEGA B Estate (21_, 22_, 23_)	2.0	09/99 → 09/00	X 20 DTH	Diesel	1995	4	151
OMEGA B Estate (21_, 22_, 23_)	2.0	03/99 → 09/99	X 20 SE	Petrol	1998	4	153
OMEGA B Estate (21_, 22_, 23_)	2.0	03/99 → 09/99	X 20 XEV	Petrol	1998	4	155
OMEGA B Estate (21_, 22_, 23_)	2.2	09/00 → 07/00	Y 22 DTH	Diesel	2171	4	174
OMEGA B Estate (21_, 22_, 23_)	2.2	09/99 → 07/00	Y 22 XE	Petrol	2198	4	177
OMEGA B Estate (21_, 22_, 23_)	2.2	09/99 → 07/00	Z 22 XE	Petrol	2198	4	179
OMEGA B Estate (21_, 22_, 23_)	2.5	04/99 → 07/00	25 DT	Diesel	2497	6	189
OMEGA B Estate (21_, 22_, 23_)	2.5	04/99 → 07/00	X 25 DT	Diesel	2497	6	207
OMEGA B Estate (21_, 22_, 23_)	2.5	04/99 → 07/00	X 25 TD	Diesel	2498	6	208
OMEGA B Estate (21_, 22_, 23_)	2.5	03/99 → 09/00	X 25 XE	Petrol	2498	6	209
OMEGA B Estate (21_, 22_, 23_)	2.5	09/00 → 07/00	Y 25 DT	Diesel	2497	6	210
OMEGA B Estate (21_, 22_, 23_)	2.6	09/00 → 07/00	Y 26 SE	Petrol	2597	6	212
OMEGA B Estate (21_, 22_, 23_)	3.0	04/99 → 02/00	X 30 XE	Petrol	2962	6	222
SENATOR B (29_)	2.5	09/99 → 09/99	25 NE	Petrol	2490	6	190
SENATOR B (29_)	2.6	09/99 → 09/99	C 26 NE	Petrol	2594	6	211
SENATOR B (29_)	3.0	01/98 → 09/99	30 NE	Petrol	2969	6	217
SENATOR B (29_)	3.0	09/98 → 09/99	C 30 LE	Petrol	2969	6	218
SENATOR B (29_)	3.0	01/98 → 09/99	C 30 NE	Petrol	2969	6	219
SENATOR B (29_)	3.0	09/98 → 09/99	C 30 SE	Petrol	2969	6	220
SIGNUM	1.8	05/00 →	Z 18 XE	Petrol	1796	4	112
SIGNUM	1.8	09/00 →	Z 18 XER	Petrol	1796	4	114
SIGNUM	1.9	04/00 →	Z 19 DT	Diesel	1910	4	122
SIGNUM	1.9	04/00 →	Z 19 DTH	Diesel	1910	4	123
SIGNUM	2.0	05/00 →	Y 20 DTH	Diesel	1995	4	156
SIGNUM	2.0	05/00 →	Z 20 NET	Petrol	1998	4	164
SIGNUM	2.2	05/00 →	Y 22 DTR	Diesel	2172	4	175
SIGNUM	2.2	05/00 →	Z 22 YH	Petrol	2198	4	180
SIGNUM	3.0	05/00 →	Y 30 DT	Diesel	2958	6	223
SIGNUM	3.0	09/00 →	Z 30 DT	Diesel	2958	6	224
SIGNUM	3.2	05/00 →	Z 32 SE	Petrol	3175	6	229
SINTRA	2.2	07/99 → 04/99	X 22 DTH	Diesel	2171	4	171
SINTRA	2.2	11/99 → 04/99	X 22 XE	Petrol	2198	4	173
SINTRA	3.0	11/99 → 04/99	X 30 XE	Petrol	2962	6	222



Ltr







CC



9

Model	Ltr	Period	Engine	Fuel	CC	Seats	Price
SPEEDSTER	2.0	04/00→	Z 20 LET	Petrol	1998	4	163
SPEEDSTER	2.2	09/00→	Z 22 SE	Petrol	2198	4	178
TIGRA (95_)	1.4	07/99→12/00	X 14 XE	Petrol	1389	4	40
TIGRA (95_)	1.6	08/99→08/99	C 16 SEL	Petrol	1598	4	64
TIGRA (95_)	1.6	07/99→08/99	X 16 XE	Petrol	1598	4	71
TIGRA TwinTop	1.3	06/00→	Z 13 DT	Diesel	1248	4	22
TIGRA TwinTop	1.4	06/00→	Z 14 XEP	Petrol/Petroleum Gas (LPG)	1364	4	43
TIGRA TwinTop	1.4	06/00→	Z 14 XEP	Petrol	1364	4	43
TIGRA TwinTop	1.8	06/00→	Z 18 XE	Petrol	1796	4	112
VECTRA A (86_, 87_)	1.4	09/98→06/99	14 NV	Petrol	1389	4	31
VECTRA A (86_, 87_)	1.6	09/98→05/99	16 SV	Petrol	1598	4	51
VECTRA A (86_, 87_)	1.6	09/98→11/99	C 16 NZ	Petrol	1598	4	60
VECTRA A (86_, 87_)	1.6	09/98→11/99	C 16 NZ2	Petrol	1598	4	61
VECTRA A (86_, 87_)	1.6	09/98→11/99	E 16 NZ	Petrol	1598	4	67
VECTRA A (86_, 87_)	1.6	09/99→11/99	X 16 SZ	Petrol	1598	4	69
VECTRA A (86_, 87_)	1.7	10/98→09/99	17 D	Diesel	1700	4	85
VECTRA A (86_, 87_)	1.7	07/99→11/99	17 DR	Diesel	1700	4	87
VECTRA A (86_, 87_)	1.7	03/99→11/99	17 DT (TC4EE1)	Diesel	1686	4	88
VECTRA A (86_, 87_)	1.7	03/99→11/99	X 17 DT (TC4EE1)	Diesel	1686	4	90
VECTRA A (86_, 87_)	1.8	09/98→10/99	18 SV	Petrol	1796	4	100
VECTRA A (86_, 87_)	1.8	03/99→11/99	C 18 NZ	Petrol	1796	4	104
VECTRA A (86_, 87_)	1.8	09/98→07/98	E 18 NVR	Petrol	1796	4	108
VECTRA A (86_, 87_)	2.0	09/98→10/99	20 NE	Petrol	1998	4	127
VECTRA A (86_, 87_)	2.0	09/98→09/99	20 SEH	Petrol	1998	4	130
VECTRA A (86_, 87_)	2.0	01/98→06/99	20 XEJ	Petrol	1998	4	132
VECTRA A (86_, 87_)	2.0	06/99→11/99	C 20 LET	Petrol	1998	4	141
VECTRA A (86_, 87_)	2.0	09/98→11/99	C 20 NE	Petrol	1998	4	142
VECTRA A (86_, 87_)	2.0	09/98→09/98	C 20 NEF	Petrol	1998	4	143
VECTRA A (86_, 87_)	2.0	02/99→11/99	C 20 XE	Petrol	1998	4	146
VECTRA A (86_, 87_)	2.0	06/99→11/99	X 20 XEV	Petrol	1998	4	155
VECTRA A (86_, 87_)	2.5	08/99→11/99	C 25 XE	Petrol	2498	6	192
VECTRA A Hatchback (88_, 89_)	1.4	04/98→06/99	14 NV	Petrol	1389	4	31
VECTRA A Hatchback (88_, 89_)	1.6	09/98→05/99	16 SV	Petrol	1598	4	51
VECTRA A Hatchback (88_, 89_)	1.6	09/98→11/99	C 16 NZ	Petrol	1598	4	60
VECTRA A Hatchback (88_, 89_)	1.6	09/98→11/99	C 16 NZ2	Petrol	1598	4	61
VECTRA A Hatchback (88_, 89_)	1.6	09/99→11/99	X 16 SZ	Petrol	1598	4	69
VECTRA A Hatchback (88_, 89_)	1.7	09/98→09/99	17 D	Diesel	1700	4	85
VECTRA A Hatchback (88_, 89_)	1.7	07/99→11/99	17 DR	Diesel	1700	4	87
VECTRA A Hatchback (88_, 89_)	1.7	03/99→11/99	17 DT (TC4EE1)	Diesel	1686	4	88
VECTRA A Hatchback (88_, 89_)	1.7	03/99→11/99	X 17 DT (TC4EE1)	Diesel	1686	4	90
VECTRA A Hatchback (88_, 89_)	1.8	09/98→10/99	18 SV	Petrol	1796	4	100
VECTRA A Hatchback (88_, 89_)	1.8	03/99→11/99	C 18 NZ	Petrol	1796	4	104
VECTRA A Hatchback (88_, 89_)	1.8	09/98→07/98	E 18 NVR	Petrol	1796	4	108
VECTRA A Hatchback (88_, 89_)	2.0	09/98→10/99	20 NE	Petrol	1998	4	127
VECTRA A Hatchback (88_, 89_)	2.0	09/98→11/99	20 SEH	Petrol	1998	4	130
VECTRA A Hatchback (88_, 89_)	2.0	02/98→10/99	20 XEJ	Petrol	1998	4	132
VECTRA A Hatchback (88_, 89_)	2.0	09/98→11/99	C 20 NE	Petrol	1998	4	142
VECTRA A Hatchback (88_, 89_)	2.0	04/98→09/98	C 20 NEF	Petrol	1998	4	143
VECTRA A Hatchback (88_, 89_)	2.0	02/99→11/99	C 20 XE	Petrol	1998	4	146
VECTRA A Hatchback (88_, 89_)	2.0	06/99→11/99	X 20 XEV	Petrol	1998	4	155
VECTRA A Hatchback (88_, 89_)	2.5	02/99→11/99	C 25 XE	Petrol	2498	6	192
VECTRA B (36_)	1.6	09/99→08/99	16 SV	Petrol	1598	4	51
VECTRA B (36_)	1.6	10/99→04/00	X 16 SZR	Petrol	1598	4	70
VECTRA B (36_)	1.6	10/99→04/00	X 16 XEL	Petrol	1598	4	72
VECTRA B (36_)	1.6	10/99→04/00	Y 16 XE	Petrol	1598	4	73
VECTRA B (36_)	1.6	10/99→04/00	Z 16 XE	Petrol	1598	4	79
VECTRA B (36_)	1.7	10/99→12/99	X 17 DT (TC4EE1)	Diesel	1686	4	90
VECTRA B (36_)	1.8	10/99→09/00	X 18 XE	Petrol	1799	4	110
VECTRA B (36_)	1.8	10/99→09/00	X 18 XE1	Petrol	1796	4	111
VECTRA B (36_)	1.8	09/00→04/00	Z 18 XE	Petrol	1796	4	112
VECTRA B (36_)	1.8	10/99→09/00	Z 18 XEL	Petrol	1796	4	113
VECTRA B (36_)	2.0	10/99→04/00	20 NEJ	Petrol	1998	4	128
VECTRA B (36_)	2.0	10/99→09/00	C 20 SEL	Petrol	1998	4	145
VECTRA B (36_)	2.0	06/99→04/00	X 20 DTH	Diesel	1995	4	151
VECTRA B (36_)	2.0	11/99→04/00	X 20 DTL	Diesel	1995	4	152
VECTRA B (36_)	2.0	10/99→09/00	X 20 XEV	Petrol	1998	4	155
VECTRA B (36_)	2.0	06/99→04/00	Y 20 DTH	Diesel	1995	4	156
VECTRA B (36_)	2.2	09/00→04/00	Y 22 DTR	Diesel	2172	4	175
VECTRA B (36_)	2.2	09/00→04/00	Z 22 SE	Petrol	2198	4	178
VECTRA B (36_)	2.5	10/99→09/00	X 25 XE	Petrol	2498	6	209

	Ltr				CC		9
VECTRA B (36_)	2.6	09/00→04/00	Y 26 SE	Petrol	2597	6	212
VECTRA B Estate (31_)	1.6	11/99→06/00	X 16 SZR	Petrol	1598	4	70
VECTRA B Estate (31_)	1.6	11/99→07/00	X 16 XEL	Petrol	1598	4	72
VECTRA B Estate (31_)	1.6	11/99→07/00	Y 16 XE	Petrol	1598	4	73
VECTRA B Estate (31_)	1.6	11/99→07/00	Z 16 XE	Petrol	1598	4	79
VECTRA B Estate (31_)	1.7	11/99→12/99	X 17 DT (TC4EE1)	Diesel	1686	4	90
VECTRA B Estate (31_)	1.8	11/99→09/00	X 18 XE	Petrol	1799	4	110
VECTRA B Estate (31_)	1.8	11/99→09/00	X 18 XE1	Petrol	1796	4	111
VECTRA B Estate (31_)	1.8	09/00→07/00	Z 18 XE	Petrol	1796	4	112
VECTRA B Estate (31_)	1.8	11/99→09/00	Z 18 XEL	Petrol	1796	4	113
VECTRA B Estate (31_)	2.0	11/99→02/00	20 NEJ	Petrol	1998	4	128
VECTRA B Estate (31_)	2.0	11/99→09/00	C 20 SEL	Petrol	1998	4	145
VECTRA B Estate (31_)	2.0	06/99→07/00	X 20 DTH	Diesel	1995	4	151
VECTRA B Estate (31_)	2.0	11/99→06/00	X 20 DTL	Diesel	1995	4	152
VECTRA B Estate (31_)	2.0	11/99→09/00	X 20 XEV	Petrol	1998	4	155
VECTRA B Estate (31_)	2.0	06/99→07/00	Y 20 DTH	Diesel	1995	4	156
VECTRA B Estate (31_)	2.2	09/00→07/00	Y 22 DTR	Diesel	2172	4	175
VECTRA B Estate (31_)	2.2	09/00→07/00	Z 22 SE	Petrol	2198	4	178
VECTRA B Estate (31_)	2.5	11/99→09/00	X 25 XE	Petrol	2498	6	209
VECTRA B Estate (31_)	2.6	09/00→07/00	Y 26 SE	Petrol	2597	6	212
VECTRA B Hatchback (38_)	1.6	10/99→07/00	X 16 SZR	Petrol	1598	4	70
VECTRA B Hatchback (38_)	1.6	10/99→07/00	X 16 XEL	Petrol	1598	4	72
VECTRA B Hatchback (38_)	1.6	10/99→07/00	Y 16 XE	Petrol	1598	4	73
VECTRA B Hatchback (38_)	1.6	10/99→07/00	Z 16 XE	Petrol	1598	4	79
VECTRA B Hatchback (38_)	1.7	10/99→12/99	X 17 DT (TC4EE1)	Diesel	1686	4	90
VECTRA B Hatchback (38_)	1.8	10/99→09/00	X 18 XE	Petrol	1799	4	110
VECTRA B Hatchback (38_)	1.8	10/99→09/00	X 18 XE1	Petrol	1796	4	111
VECTRA B Hatchback (38_)	1.8	09/00→07/00	Z 18 XE	Petrol	1796	4	112
VECTRA B Hatchback (38_)	1.8	10/99→09/00	Z 18 XEL	Petrol	1796	4	113
VECTRA B Hatchback (38_)	2.0	10/99→02/00	20 NEJ	Petrol	1998	4	128
VECTRA B Hatchback (38_)	2.0	10/99→09/00	C 20 SEL	Petrol	1998	4	145
VECTRA B Hatchback (38_)	2.0	06/99→07/00	X 20 DTH	Diesel	1995	4	151
VECTRA B Hatchback (38_)	2.0	11/99→06/00	X 20 DTL	Diesel	1995	4	152
VECTRA B Hatchback (38_)	2.0	10/99→09/00	X 20 XEV	Petrol	1998	4	155
VECTRA B Hatchback (38_)	2.0	06/99→07/00	Y 20 DTH	Diesel	1995	4	156
VECTRA B Hatchback (38_)	2.2	09/00→07/00	Y 22 DTR	Diesel	2172	4	175
VECTRA B Hatchback (38_)	2.2	09/00→07/00	Z 22 SE	Petrol	2198	4	178
VECTRA B Hatchback (38_)	2.5	10/99→09/00	X 25 XE	Petrol	2498	6	209
VECTRA B Hatchback (38_)	2.6	09/00→07/00	Y 26 SE	Petrol	2597	6	212
VECTRA C Estate	1.6	06/00→	Z 16 XE	Petrol	1598	4	79
VECTRA C Estate	1.6	01/00→	Z 16 XEP	Petrol	1598	4	81
VECTRA C Estate	1.8	10/00→	Z 18 XE	Petrol	1796	4	112
VECTRA C Estate	1.8	01/00→	Z 18 XER	Petrol	1796	4	114
VECTRA C Estate	1.9	04/00→	Z 19 DT	Diesel	1910	4	122
VECTRA C Estate	1.9	04/00→	Z 19 DTH	Diesel	1910	4	123
VECTRA C Estate	1.9	10/00→	Z 19 DTL	Diesel	1910	4	125
VECTRA C Estate	2.0	10/00→	Y 20 DTH	Diesel	1995	4	156
VECTRA C Estate	2.0	10/00→	Z 20 NET	Petrol	1998	4	164
VECTRA C Estate	2.2	10/00→	Y 22 DTR	Diesel	2172	4	175
VECTRA C Estate	2.2	10/00→	Z 22 YH	Petrol	2198	4	180
VECTRA C Estate	3.0	10/00→	Y 30 DT	Diesel	2958	6	223
VECTRA C Estate	3.0	08/00→	Z 30 DT	Diesel	2958	6	224
VECTRA C Estate	3.2	10/00→	Z 32 SE	Petrol	3175	6	229
VECTRA C GTS	1.6	08/00→	Z 16 XE	Petrol	1598	4	79
VECTRA C GTS	1.6	01/00→	Z 16 XEP	Petrol	1598	4	81
VECTRA C GTS	1.8	08/00→	Z 18 XE	Petrol	1796	4	112
VECTRA C GTS	1.8	08/00→12/00	Z 18 XEL	Petrol	1796	4	113
VECTRA C GTS	1.8	01/00→	Z 18 XER	Petrol	1796	4	114
VECTRA C GTS	1.9	04/00→	Z 19 DT	Diesel	1910	4	122
VECTRA C GTS	1.9	04/00→	Z 19 DTH	Diesel	1910	4	123
VECTRA C GTS	2.0	08/00→	Y 20 DTH	Diesel	1995	4	156
VECTRA C GTS	2.0	03/00→	Z 20 NET	Petrol	1998	4	164
VECTRA C GTS	2.2	08/00→	Y 22 DTR	Diesel	2172	4	175
VECTRA C GTS	2.2	08/00→	Z 22 SE	Petrol	2198	4	178
VECTRA C GTS	2.2	10/00→	Z 22 YH	Petrol	2198	4	180
VECTRA C GTS	3.0	06/00→	Y 30 DT	Diesel	2958	6	223
VECTRA C GTS	3.0	08/00→	Z 30 DT	Diesel	2958	6	224
VECTRA C GTS	3.2	08/00→	Z 32 SE	Petrol	3175	6	229
VECTRA C	1.6	06/00→	Z 16 XE	Petrol	1598	4	79
VECTRA C	1.6	01/00→	Z 16 XEP	Petrol	1598	4	81



Ltr















CC











9

Model	Ltr	Year	Engine	Fuel	CC	Chassis	Price
VECTRA C	1.8	04/00→	Z 18 XE	Petrol	1796	4	112
VECTRA C	1.8	04/00→	Z 18 XEL	Petrol	1796	4	113
VECTRA C	1.8	01/00→	Z 18 XER	Petrol	1796	4	114
VECTRA C	1.9	04/00→	Z 19 DT	Diesel	1910	4	122
VECTRA C	1.9	04/00→	Z 19 DTH	Diesel	1910	4	123
VECTRA C	2.0	04/00→	Y 20 DTH	Diesel	1995	4	156
VECTRA C	2.0	03/00→	Z 20 NET	Petrol	1998	4	164
VECTRA C	2.2	04/00→	Y 22 DTR	Diesel	2172	4	175
VECTRA C	2.2	04/00→	Z 22 SE	Petrol	2198	4	178
VECTRA C	2.2	10/00→	Z 22 YH	Petrol	2198	4	180
VECTRA C	3.0	06/00→	Y 30 DT	Diesel	2958	6	223
VECTRA C	3.0	08/00→	Z 30 DT	Diesel	2958	6	224
VECTRA C	3.2	08/00→	Z 32 SE	Petrol	3175	6	229
VIVARO Box (F7)	1.9	08/00→	F9Q 760	Diesel	1870	4	117
VIVARO Box (F7)	1.9	08/00→	F9Q 762	Diesel	1870	4	118
VIVARO Box (F7)	2.0	08/00→	F4R 720	Petrol	1998	4	147
VIVARO Box (F7)	2.0	08/00→	F4R 820	Petrol	1998	4	148
VIVARO Box (F7)	2.0	08/00→	M9R 780	Diesel	1995	4	150
VIVARO Box (F7)	2.5	08/00→	G9MB6	Diesel	2463	4	193
VIVARO Box (F7)	2.5	08/00→	G9U 630	Diesel	2464	4	194
VIVARO Box (F7)	2.5	05/00→	G9U 730	Diesel	2463	4	199
VIVARO Combi (J7)	1.9	08/00→	F9Q 760	Diesel	1870	4	117
VIVARO Combi (J7)	1.9	08/00→	F9Q 762	Diesel	1870	4	118
VIVARO Combi (J7)	1.9	08/00→	F9Q 774	Diesel	1870	4	121
VIVARO Combi (J7)	2.0	08/00→	F4R 720	Petrol	1998	4	147
VIVARO Combi (J7)	2.0	08/00→	F4R 820	Petrol	1998	4	148
VIVARO Combi (J7)	2.0	08/00→	M9R 780	Diesel	1995	4	150
VIVARO Combi (J7)	2.5	08/00→	G9U 630	Diesel	2464	4	194
VIVARO Combi (J7)	2.5	05/00→	G9U 730	Diesel	2463	4	199
VIVARO Platform/Chassis (E7)	1.9	08/00→	F9Q 760	Diesel	1870	4	117
VIVARO Platform/Chassis (E7)	1.9	08/00→	F9Q 762	Diesel	1870	4	118
VIVARO Platform/Chassis (E7)	2.0	08/00→	F4R 720	Petrol	1998	4	147
VIVARO Platform/Chassis (E7)	2.0	08/00→	F4R 820	Petrol	1998	4	148
VIVARO Platform/Chassis (E7)	2.0	08/00→	M9R 780	Diesel	1995	4	150
VIVARO Platform/Chassis (E7)	2.5	08/00→	G9U 630	Diesel	2464	4	194
VIVARO Platform/Chassis (E7)	2.5	08/00→	G9U 730	Diesel	2463	4	199
ZAFIRA A (F75_)	1.6	04/99→06/00	X 16 XEL	Petrol	1598	4	72
ZAFIRA A (F75_)	1.6	04/99→06/00	Z 16 XE	Petrol	1598	4	79
ZAFIRA A (F75_)	1.6	09/00→06/00	Z 16 YNG	Petrol/Natural Gas (CNG)	1598	4	84
ZAFIRA A (F75_)	1.6	09/00→06/00	Z 16 YNG	Petrol	1598	4	84
ZAFIRA A (F75_)	1.6	09/00→06/00	Z 16 YNG	Gas	1598	4	84
ZAFIRA A (F75_)	1.6	09/00→06/00	Z 16 YNG	CNG	1598	4	84
ZAFIRA A (F75_)	1.8	04/99→09/00	X 18 XE1	Petrol	1796	4	111
ZAFIRA A (F75_)	1.8	09/00→06/00	Z 18 XE	Petrol	1796	4	112
ZAFIRA A (F75_)	2.0	10/99→06/00	X 20 DTL	Diesel	1995	4	152
ZAFIRA A (F75_)	2.0	09/00→06/00	Y 20 DTH	Diesel	1995	4	156
ZAFIRA A (F75_)	2.0	11/00→06/00	Y 20 DTL	Diesel	1995	4	157
ZAFIRA A (F75_)	2.0	11/00→06/00	Z 20 LER	Petrol	1998	4	162
ZAFIRA A (F75_)	2.0	09/00→06/00	Z 20 LET	Petrol	1998	4	163
ZAFIRA A (F75_)	2.2	01/00→06/00	Y 22 DTR	Diesel	2172	4	175
ZAFIRA A (F75_)	2.2	09/00→06/00	Z 22 SE	Petrol	2198	4	178
ZAFIRA B (A05)	1.6	01/00→	A 16 XER	Petrol/Petroleum Gas (LPG)	1598	4	57
ZAFIRA B (A05)	1.6	01/00→	A 16 XER	Petrol	1598	4	57
ZAFIRA B (A05)	1.6	02/00→	A 16 XNT	CNG	1598	4	58
ZAFIRA B (A05)	1.6	07/00→	Z 16 XE1	Petrol	1598	4	80
ZAFIRA B (A05)	1.6	07/00→	Z 16 XEP	Petrol	1598	4	81
ZAFIRA B (A05)	1.6	01/00→	Z 16 XER	Petrol/Petroleum Gas (LPG)	1598	4	82
ZAFIRA B (A05)	1.6	01/00→	Z 16 XER	Petrol	1598	4	82
ZAFIRA B (A05)	1.6	02/00→	Z 16 XNT	CNG	1598	4	83
ZAFIRA B (A05)	1.6	01/00→	Z 16 YNG	Petrol/Natural Gas (CNG)	1598	4	84
ZAFIRA B (A05)	1.6	01/00→	Z 16 YNG	Petrol	1598	4	84
ZAFIRA B (A05)	1.6	01/00→	Z 16 YNG	Gas	1598	4	84
ZAFIRA B (A05)	1.6	01/00→	Z 16 YNG	CNG	1598	4	84
ZAFIRA B (A05)	1.8	07/00→	A 18 XER	Petrol/Petroleum Gas (LPG)	1796	4	102
ZAFIRA B (A05)	1.8	07/00→	A 18 XER	Petrol	1796	4	102
ZAFIRA B (A05)	1.8	07/00→	Z 18 XER	Petrol	1796	4	114
ZAFIRA B (A05)	1.9	07/00→	Z 19 DT	Diesel	1910	4	122
ZAFIRA B (A05)	1.9	07/00→	Z 19 DTH	Diesel	1910	4	123
ZAFIRA B (A05)	1.9	07/00→	Z 19 DTL	Diesel	1910	4	125
ZAFIRA B (A05)	2.0	01/00→	Z 20 LEH	Petrol	1998	4	160

	Ltr				CC		9
ZAFIRA B (A05)	2.0	07/00 →	Z 20 LEL	Petrol	1998	4	161
ZAFIRA B (A05)	2.0	07/00 →	Z 20 LER	Petrol	1998	4	162
ZAFIRA B (A05)	2.2	07/00 →	Z 22 YH	Petrol	2198	4	180
ZAFIRA B Van	1.6	02/00 →	A 16 XNT	CNG	1598	4	58
ZAFIRA B Van	1.6	02/00 →	Z 16 XNT	CNG	1598	4	83
ZAFIRA B Van	1.8	07/00 →	A 18 XER	Petrol/Petroleum Gas (LPG)	1796	4	102
ZAFIRA B Van	1.8	07/00 →	A 18 XER	Petrol	1796	4	102
ZAFIRA B Van	1.8	07/00 →	Z 18 XER	Petrol	1796	4	114
ZAFIRA C (P12)	1.6	10/01 →	A 16 XNT	CNG	1598	4	58
ZAFIRA C (P12)	1.8	10/01 →	A 18 XEL	Petrol	1796	4	101
ZAFIRA C (P12)	1.8	10/01 →	A 18 XER	Petrol/Petroleum Gas (LPG)	1796	4	102
ZAFIRA C (P12)	1.8	10/01 →	A 18 XER	Petrol	1796	4	102
ZAFIRA C (P12)	2.0	10/01 →	A 20 DT	Diesel	1956	4	133
ZAFIRA C (P12)	2.0	10/01 →	A 20 DTH	Diesel	1956	4	135
ZAFIRA C (P12)	2.0	10/01 →	A 20 DTL	Diesel	1956	4	137
ZAFIRA C (P12)	2.0	01/01 →	A 20 DTR	Diesel	1956	4	138

		CC			9			CC			9
10 S	Petrol	993	4	72.00	1	A 16 XNT	CNG	1598	4	79.00	58
12 NC	Petrol	1196	4	79.00	6	A 18 XEL	Petrol	1796	4	80.50	101
12 NV	Petrol	1196	4	77.80	7	A 18 XER	Petrol/ Petroleum Gas (LPG)	1796	4	80.50	102
12 NZ	Petrol	1195	4	72.00	8						
12 S	Petrol	1196	4	79.00	9						
12 ST	Petrol	1196	4	77.80	10	A 18 XER	Petrol	1796	4	80.50	102
13 N	Petrol	1297	4	75.00	26	A 20 DT	Diesel	1956	4	83.00	133
13 NB	Petrol	1297	4	75.00	27	A 20 DTC	Diesel	1956	4	83.00	134
13 S	Petrol	1297	4	75.00	28	A 20 DTH	Diesel	1956	4	83.00	135
13 SB	Petrol	1297	4	75.00	29	A 20 DTJ	Diesel	1956	4	83.00	136
14 NV	Petrol	1389	4	77.60	31	A 20 DTL	Diesel	1956	4	83.00	137
14 SE	Petrol	1389	4	77.60	32	A 20 DTR	Diesel	1956	4	83.00	138
15 D (4EC1)	Diesel	1488	4	76.00	44	A 20 NFT	Petrol	1998	4	86.00	139
15 DT (T4EC1)	Diesel	1488	4	76.00	45	A 20 NHT	Petrol	1998	4	86.00	140
16 D	Diesel	1598	4	80.00	47	A 20 NHT	Flexfuel	1998	4	86.00	140
16 DA	Diesel	1598	4	80.00	48	C 12 NZ	Petrol	1196	4	72.00	15
16 N	Petrol	1598	4	80.00	49	C 13 N	Petrol	1297	4	75.00	30
16 SH	Petrol	1598	4	80.00	50	C 14 NZ	Petrol	1389	4	77.60	35
16 SV	Petrol	1598	4	79.00	51	C 14 SE	Petrol	1389	4	77.60	36
17 D	Diesel	1700	4	82.50	85	C 14 SEL	Petrol	1389	4	77.60	37
17 D (4EE1)	Diesel	1686	4	79.00	86	C 16 LZ	Petrol	1598	4	80.00	59
17 DR	Diesel	1700	4	82.50	87	C 16 NZ	Petrol	1598	4	79.00	60
17 DT (T4EE1)	Diesel	1686	4	79.00	88	C 16 NZ2	Petrol	1598	4	79.00	61
18 E	Petrol	1796	4	84.80	97	C 16 SE	Petrol	1598	4	79.00	62
18 SE	Petrol	1796	4	84.80	98	C 16 SEI	Petrol	1598	4	79.00	63
18 SEH	Petrol	1796	4	84.80	99	C 16 SEL	Petrol	1598	4	79.00	64
18 SV	Petrol	1796	4	84.80	100	C 16 XE	Petrol	1598	4	79.00	65
20 E	Petrol	1979	4	95.00	126	C 18 NT	Petrol	1796	4	84.80	103
20 NE	Petrol	1998	4	86.00	127	C 18 NZ	Petrol	1796	4	84.80	104
20 NEJ	Petrol	1998	4	86.00	128	C 18 XE	Petrol	1799	4	81.60	105
20 SE	Petrol	1998	4	86.00	129	C 18 XEL	Petrol	1799	4	81.60	106
20 SEH	Petrol	1998	4	86.00	130	C 20 LET	Petrol	1998	4	86.00	141
20 XE	Petrol	1998	4	86.00	131	C 20 NE	Petrol	1998	4	86.00	142
20 XEJ	Petrol	1998	4	86.00	132	C 20 NEF	Petrol	1998	4	86.00	143
23 DTR	Diesel	2260	4	92.00	182	C 20 NEJ	Petrol	1998	4	86.00	144
23 P	Petrol	2254	4	89.30	183	C 20 SEL	Petrol	1998	4	86.00	145
23 YD	Diesel	2260	4	92.00	184	C 20 XE	Petrol	1998	4	86.00	146
23 YDT	Diesel	2260	4	92.00	185	C 24 NE	Petrol	2410	4	95.00	186
25 DT	Diesel	2497	6	80.00	189	C 25 XE	Petrol	2498	6	81.60	192
25 NE	Petrol	2490	6	87.00	190	C 26 NE	Petrol	2594	6	88.80	211
25TDS (VM41B)	Diesel	2499	4	92.00	191	C 30 LE	Petrol	2969	6	95.00	218
28 TDI (4JB1T)	Diesel	2771	4	93.00	213	C 30 NE	Petrol	2969	6	95.00	219
30 NE	Petrol	2969	6	95.00	217	C 30 SE	Petrol	2969	6	95.00	220
4 JA1	Diesel	2499	4	93.00	187	C 30 SEJ	Petrol	2969	6	95.00	221
4 JA1T	Diesel	2499	4	93.00	188	C223	Diesel	2238	4	88.00	167
4 JG2T	Diesel	3059	4	95.40	225	E 12 GV	Petrol	1196	4	79.00	16
4 JG2TC	Diesel	3059	4	95.40	226	E 16 LZ	Petrol	1598	4	79.00	66
4 JX1	Diesel	2999	4	95.40	216	E 16 NZ	Petrol	1598	4	79.00	67
4 ZD1	Petrol	2255	4	89.50	181	E 16 SE	Petrol	1598	4	79.00	68
6 VD1	Petrol	3165	6	93.40	227	E 18 NV	Petrol	1796	4	84.80	107
6 VE1	Petrol	3494	6	93.40	230	E 18 NWR	Petrol	1796	4	84.80	108
A 13 DTC	Diesel	1248	4	69.60	11	F4R 720	Petrol	1998	4	82.70	147
A 13 DTE	Diesel	1248	4	69.60	12	F4R 820	Petrol	1998	4	82.70	148
A 13 DTR	Diesel	1248	4	69.60	13	F8Q 600	Diesel	1870	4	80.00	115
A 13 FD	Diesel	1248	4	69.60	14	F8Q 606	Diesel	1870	4	80.00	116
A 14 FC	Petrol/ Natural Gas (CNG)	1368	4	72.00	33	F9Q 760	Diesel	1870	4	80.00	117
A 14 FC	Petrol	1368	4	72.00	33	F9Q 762	Diesel	1870	4	80.00	118
A 14 FC	CNG	1368	4	72.00	33	F9Q 770	Diesel	1870	4	80.00	119
A 14 FP	Petrol	1368	4	72.00	34	F9Q 772	Diesel	1870	4	80.00	120
A 16 FDH	Diesel	1598	4	79.50	52	F9Q 774	Diesel	1870	4	80.00	121
A 16 FDL	Diesel	1598	4	79.50	53	G9MB6	Diesel	2463	4	89.00	193
A 16 LEL	Petrol	1598	4	79.00	54	G9T 720	Diesel	2188	4	87.00	168
A 16 LER	Petrol	1598	4	79.00	55	G9T 722	Diesel	2188	4	87.00	169
A 16 LET	Petrol	1598	4	79.00	56	G9T 750	Diesel	2188	4	87.00	170
A 16 XER	Petrol/ Petroleum Gas (LPG)	1598	4	79.00	57	G9U 630	Diesel	2464	4	89.00	194
A 16 XER	Petrol	1598	4	79.00	57	G9U 632	Diesel	2464	4	89.00	195
						G9U 650	Diesel	2464	4	89.00	196
						G9U 720	Diesel	2463	4	89.00	197
						G9U 724	Diesel	2463	4	89.00	198
						G9U 730	Diesel	2463	4	89.00	199

		CC			9			CC			9
G9U 750	Diesel	2463	4	89.00	200	Z 14 XE	Petrol	1389	4	77.60	41
G9U 754	Diesel	2463	4	89.00	201	Z 14 XEL	Petrol	1364	4	73.40	42
K10B	Petrol/ Petroleum Gas (LPG)	996	3	73.00	2	Z 14 XEP	Petrol/ Petroleum Gas (LPG)	1364	4	73.40	43
K10B	Petrol	996	3	73.00	2	Z 14 XEP	Petrol	1364	4	73.40	43
LNF	Petrol	1998	4	86.00	149	Z 16 LEL	Petrol	1598	4	79.00	75
M9R 780	Diesel	1995	4	84.00	150	Z 16 LER	Petrol	1598	4	79.00	76
S 18 NV	Petrol	1796	4	84.80	109	Z 16 LET	Petrol	1598	4	79.00	77
S8U 758	Diesel	2499	4	93.00	202	Z 16 SE	Petrol	1598	4	79.00	78
S8U 770	Diesel	2499	4	93.00	203	Z 16 XE	Petrol	1598	4	79.00	79
S8U 772	Diesel	2499	4	93.00	204	Z 16 XE1	Petrol	1598	4	79.00	80
S8U 780	Diesel	2499	4	93.00	205	Z 16 XEP	Petrol	1598	4	79.00	81
S8U 782	Diesel	2499	4	93.00	206	Z 16 XER	Petrol/ Petroleum Gas (LPG)	1598	4	79.00	82
S9W 700	Diesel	2799	4	94.40	214	Z 16 XER	Petroleum Gas (LPG)	1598	4	79.00	82
S9W 702	Diesel	2799	4	94.40	215	Z 16 XNT	CNG	1598	4	79.00	83
X 10 XE	Petrol	973	3	72.50	3	Z 16 YNG	Petrol/ Natural Gas (CNG)	1598	4	79.00	84
X 12 SZ	Petrol	1195	4	72.00	17	Z 16 YNG	Petrol	1598	4	79.00	84
X 12 XE	Petrol	1199	4	72.50	18	Z 17 DT	Diesel	1686	4	79.00	94
X 14 NZ	Petrol	1389	4	77.60	38	Z 17 DTH	Diesel	1686	4	79.00	95
X 14 SZ	Petrol	1389	4	77.60	39	Z 17 DTL	Diesel	1686	4	79.00	96
X 14 XE	Petrol	1389	4	77.60	40	Z 18 XE	Petrol	1796	4	80.50	112
X 15 DT (T4EC1)	Diesel	1488	4	76.00	46	Z 18 XE1	Petrol	1796	4	80.50	113
X 16 SZ	Petrol	1598	4	79.00	69	Z 18 XER	Petrol	1796	4	80.50	114
X 16 SZR	Petrol	1598	4	79.00	70	Z 19 DT	Diesel	1910	4	82.00	122
X 16 XE	Petrol	1598	4	79.00	71	Z 19 DTH	Diesel	1910	4	82.00	123
X 16 XEL	Petrol	1598	4	79.00	72	Z 19 DTJ	Diesel	1910	4	82.00	124
X 17 D (4EE1)	Diesel	1686	4	79.00	89	Z 19 DTL	Diesel	1910	4	82.00	125
X 17 DT (TC4EE1)	Diesel	1686	4	79.00	90	Z 20 DM	Diesel	1991	4	83.00	158
X 17 DTL	Diesel	1700	4	82.50	91	Z 20 DMH	Diesel	1991	4	83.00	159
X 18 XE	Petrol	1799	4	81.60	110	Z 20 LEH	Petrol	1998	4	86.00	160
X 18 XE1	Petrol	1796	4	80.50	111	Z 20 LEL	Petrol	1998	4	86.00	161
X 20 DTH	Diesel	1995	4	84.00	151	Z 20 LER	Petrol	1998	4	86.00	162
X 20 DTL	Diesel	1995	4	84.00	152	Z 20 LET	Petrol	1998	4	86.00	163
X 20 SE	Petrol	1998	4	86.00	153	Z 20 NET	Petrol	1998	4	86.00	164
X 20 XER	Petrol	1998	4	86.00	154	Z 20 NHH	Petrol	1998	4	86.00	165
X 20 XEV	Petrol	1998	4	86.00	155	Z 20 S	Diesel	1991	4	83.00	166
X 22 DTH	Diesel	2171	4	84.00	171	Z 22 SE	Petrol	2198	4	86.00	178
X 22 SE	Petrol	2198	4	86.00	172	Z 22 XE	Petrol	2198	4	86.00	179
X 22 XE	Petrol	2198	4	86.00	173	Z 22 YH	Petrol	2198	4	86.00	180
X 25 DT	Diesel	2497	6	80.00	207	Z 30 DT	Diesel	2958	6	87.50	224
X 25 TD	Diesel	2498	6	80.00	208	Z 32 SE	Petrol	3175	6	88.50	229
X 25 XE	Petrol	2498	6	81.60	209						
X 30 XE	Petrol	2962	6	86.00	222						
Y 13 DT	Diesel	1248	4	69.60	19						
Y 16 XE	Petrol	1598	4	79.00	73						
Y 16 YNG	CNG	1598	4	79.00	74						
Y 17 DT	Diesel	1686	4	79.00	92						
Y 17 DTL	Diesel	1686	4	79.00	93						
Y 20 DTH	Diesel	1995	4	84.00	156						
Y 20 DTL	Diesel	1995	4	84.00	157						
Y 22 DTH	Diesel	2171	4	84.00	174						
Y 22 DTR	Diesel	2172	4	84.00	175						
Y 22 SE	Petrol	2198	4	86.00	176						
Y 22 XE	Petrol	2198	4	86.00	177						
Y 25 DT	Diesel	2497	6	80.00	210						
Y 26 SE	Petrol	2597	6	83.20	212						
Y 30 DT	Diesel	2958	6	87.50	223						
Y 32 NE	Petrol	3165	6	93.40	228						
Z 10 XE	Petrol	973	3	72.50	4						
Z 10 XEP	Petrol	998	3	73.40	5						
Z 12 XE	Petrol	1199	4	72.50	20						
Z 12 XEP	Petrol/ Petroleum Gas (LPG)	1229	4	73.40	21						
Z 12 XEP	Petrol	1229	4	73.40	21						
Z 13 DT	Diesel	1248	4	69.60	22						
Z 13 DTE	Diesel	1248	4	69.60	23						
Z 13 DTH	Diesel	1248	4	69.60	24						
Z 13 DTJ	Diesel	1248	4	69.60	25						



cc



kW/PS



1.0	10 S							1	BN010 (Fibre)	DN010	ET820
Corso A 1.0	09/82→03/93	993	4	72.00	OHV	33-37/					
Corso A Van 1.0	02/86→04/89					45-50					
1.0	K10B							2	AH6620 (MLS)		
Agila 1.0	04/08→	996	3	73.00	DOHC	48-50/					
Agila 1.0 LPG	01/10→					65-68					
1.0	X 10 XE							3	AB5140 (MLS)	CB5140 [13]	EB5140 [3]
Corso B 1.0i	11/96→09/00	973	3	72.50	DOHC	40/54					
1.0	Z 10 XE							4	AB5140 (MLS)	CB5141 <input type="checkbox"/> [13]	EB5140 [3]
Agila 1.0 12V	09/00→12/07	973	3	72.50	DOHC	43/58					
Corso C 1.0	09/00→12/09										
1.0	Z 10 XEP							5	AE5950 (Steel)	CE5950	
Agila 1.0	08/03→12/07	998	3	73.40	DOHC	44/60					
Astra G 1.0	08/03→05/04										
Corso C 1.0	06/03→12/09										
Corso D 1.0	07/06→										
1.2	12 NC							6	BN040 (Fibre), 1.360mm	DN041 [13]	ET820
Corso A 1.2	09/82→08/90	1196	4	79.00	OHV	33/45					
Corso A Van 1.2	02/86→04/89										
1.2	12 NV							7	BL550 (Fibre)	DL550 →Eng.125T-19230854 DL551 Eng.125T-19230855→	EK470 [3]
Corso A 1.2 N	01/90→03/93	1196	4	77.80		38/52					
1.2	12 NZ							8	BW170 (Fibre)	DW170	
Corso B 1.2i	03/93→09/00	1195	4	72.00	SOHC/OHC	33/45					
1.2	12 S							9	BN040 (Fibre), 1.360mm	DN041 [13] DN042	ET820
Corso A 1.2	09/82→08/90	1196	4	79.00	OHV	40-44/ 54-60					
Corso A Van 1.2	02/86→07/90										
1.2	12 ST							10	BL550 (Fibre)	DL550 →Eng.125T-19230854 DL551 Eng.125T-19230855→	EK470 [3]
Corso A 1.2 S	09/82→03/93	1196	4	77.80	SOHC/OHC	40-43/ 55-58					
Corso A Van 1.2	02/86→04/89										
1.2	A 13 DTC Diesel							11	AD5800 (MLS), 0.720mm AD5810 (MLS), 0.820mm, 1 Hole AD5820 (MLS), 0.920mm, 2 Holes	CD5810 ▲	ED5800 FD5810
Corso D 1.3CDTI	07/06→	1248	4	69.60	DOHC	55/75					
Meriva B 1.3	06/10→										
1.2	A 13 DTE Diesel							12	AD5800 (MLS), 0.720mm AD5810 (MLS), 0.820mm, 1 Hole AD5820 (MLS), 0.920mm, 2 Holes		
Astra J 1.3CDTI	12/09→	1248	4	69.60	DOHC	70/95					
Astra Sport 1.3	10/10→										
Corso D 1.3CDTI	06/10→										
Meriva B 1.3	06/10→										
1.2	A 13 DTR Diesel							13	AD5800 (MLS), 0.720mm AD5810 (MLS), 0.820mm, 1 Hole AD5820 (MLS), 0.920mm, 2 Holes		
Corso D 1.3CDTI	06/10→	1248	4	69.60	DOHC	70/95					

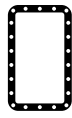

HBS112 [5] M9x1.25x100.00mm (x5)	JD5979 [1] JA415 [1]	JN068 [4]	HC288 [1]	HR291 [1]	NB691 [1] [1] 54.00x82.00x9.00mm, ACM	
HBS253 [5] M8x1.25x119.00mm (x10)	JD5223 [1] JE5017 [1]	JM5085 (Elastomer)	JH5037	PA5025 (x12) HR5096 [1]	NA5108 [2] [2] 42.00x55.00x7.00mm, FPM/ACM NB698 [1] [1] 80.00x98.00x10.00mm, FPM	JR5030 [6]
HBS253 [5] M8x1.25x119.00mm (x10)	JD5117 [1] (x3) JE5017 [1]	JM5121 (Elastomer)	JH5037	PA5025 (x12) HR5096 [1]	NA5108 [2] [2] 42.00x55.00x7.00mm, FPM/ACM NB698 [1] [1] 80.00x98.00x10.00mm, FPM	JR5030 [6]
HBS253 [5] M8x1.25x119.00mm (x10)	JD5904 [1] (x4) JE5017 [1]	JM5121 (Elastomer)	JH5037	PA5025 (x12)	NA5108 [2] [2] 42.00x55.00x7.00mm, FPM/ACM NB698 [1] [1] 80.00x98.00x10.00mm, FPM	JR5030 [6]
HBS112 [5] M9x1.25x100.00mm (x5)	JD5979 [1] JA415 [1]	JN068 [4]	HC288 [1]	HR291 [1]	NB691 [1] [1] 54.00x82.00x9.00mm, ACM	
HBS002 [5] M10x1.25x140.00mm (x10)	JC280 [1] JC281 [1]	JN344 [4] →Eng.12ST-19391635 JN626 [4] Eng.12ST-19391636→	JH5005 (Cork) JJ120 (Cork)	PA565 (x8) Eng.12ST-19230855→ HR342 [1]	NC006 [2] 35.00x48.00x7.00mm, MVQ NB697 [2] [2] 26.00x42.00x8.00mm, FPM NB698 [1] [1] 80.00x98.00x10.00mm, FPM	
HBS002 [5] M10x1.25x140.00mm (x10)	JC824 [1] JC281 [1]	JN626 [4]	JH5005 (Cork) JJ120 (Cork)	PA565 (x8) HR342 (x1)	NC006 [2] 35.00x48.00x7.00mm, MVQ NB697 [2] [2] 26.00x42.00x8.00mm, FPM NB698 [1] [1] 80.00x98.00x10.00mm, FPM	
HBS112 [5] M9x1.25x100.00mm (x5)	JD5979 [1] JA415 [1]	JN068 [4]	HC288 [1]	PA619 (x8) 9.00/17.00x14.20 (ACM) HR291 [1]	NC006 [2] 35.00x48.00x7.00mm, MVQ NB628 [2] [2] 45.00x60.00x9.00mm, ACM NB691 [1] [1] 54.00x82.00x9.00mm, ACM	
HBS002 [5] M10x1.25x140.00mm (x10)	JC280 [1] JC281 [1]	JN344 [4] →Eng.12ST-19391635 JN626 [4] Eng.12ST-19391636→	JH5005 (Cork) JJ120 (Cork)	PA565 (x8) Eng.12ST-19230855→ HR342 [1]	NC006 [2] 35.00x48.00x7.00mm, MVQ NB697 [2] [2] 26.00x42.00x8.00mm, FPM NB698 [1] [1] 80.00x98.00x10.00mm, FPM	
HBS353 [5] M10x1.25x119.00mm (x10)	JD5411 [1] JD5412 [1] [1] JD5413 [1] (MLS)	JM5259 (SE)	HR397	HR5088 [1]	NA5223 [2] [2] 40.00x52.00x7.00mm, FPM NA5230 [2] [2] 78.00x100.00x9.00mm, PTFE	
HBS353 [5] M10x1.25x119.00mm (x10)		JM5259 (SE)			NA5223 [2] [2] 40.00x52.00x7.00mm, FPM NA5230 [2] [2] 78.00x100.00x9.00mm, PTFE	
HBS353 [5] M10x1.25x119.00mm (x10)		JM5259 (SE)			NA5223 [2] [2] 40.00x52.00x7.00mm, FPM NA5230 [2] [2] 78.00x100.00x9.00mm, PTFE	

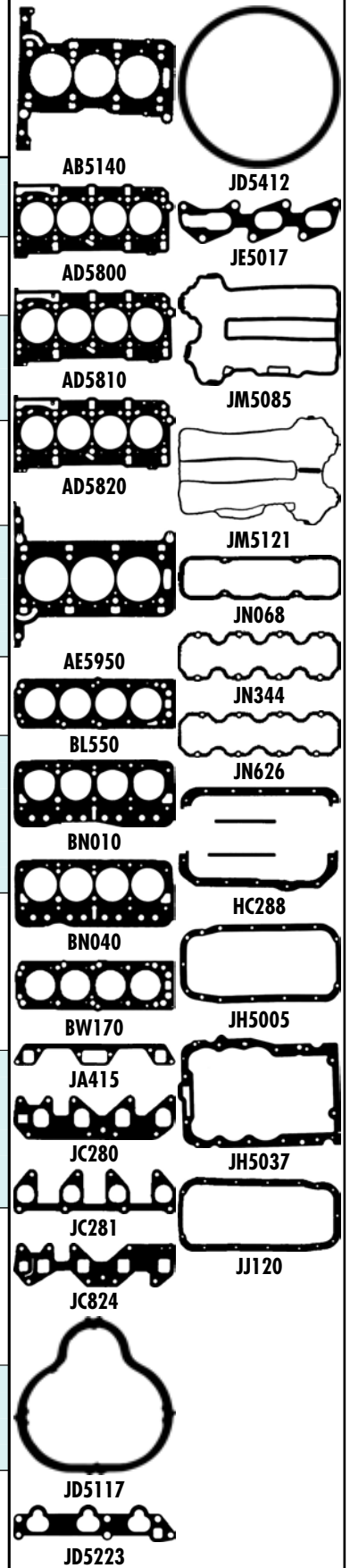



cc



kW/PS



1.2	A 13 FD Diesel						14	AD5800 (MLS), 0.720mm AD5810 (MLS), 0.820mm, 1 Hole AD5820 (MLS), 0.920mm, 2 Holes		
Combo 1.3	02/12→	1248	4	69.60	DOHC	66/90				
1.2	C 12 NZ						15	BW170 (Fibre)	DW170	ES260
Combo 1.2	07/94→10/01	1196	4	72.00	SOHC/OHC	33/45				
Corsa A 1.2 i	09/89→03/93									
Corsa B 1.2i	03/93→09/00									
1.2	E 12 GV						16	BN040 (Fibre), 1.360mm	DN041 [13]	ET820
Corsa A 1.2	09/82→08/90	1196	4	79.00	OHV	33/45				
Corsa A Van 1.2	02/86→04/89									
1.2	X 12 SZ						17	BW170 (Fibre)	DW170	ES260
Combo 1.2	07/94→10/01	1195	4	72.00	SOHC/OHC	33/45				
Corsa B 1.2i	03/93→09/00									
1.2	X 12 XE						18	AB5240 (MLS)	CB5241 [13]	EB5240 [3]
Astra F 1.2 i	03/98→08/00	1199	4	72.50	DOHC	48/65				
Astra G 1.2 16V	02/98→09/00									
Astra H 1.2	10/06→									
Corsa B 1.2i	03/98→09/00									
1.2	Y 13 DT Diesel						19	AD5800 (MLS), 0.720mm AD5810 (MLS), 0.820mm, 1 Hole AD5820 (MLS), 0.920mm, 2 Holes	CD5810 ▲	ED5800
Combo 1.3 16V	10/04→	1248	4	69.60	DOHC	51/70				
Meriva 1.3 CDTI	04/05→05/10									
1.2	Z 12 XE						20	AB5240 (MLS) →Ch.3G9999999 AH5030 (MLS) Ch.4G000001→	CB5240 [13][151][152] [153] →Ch.3G9999999 CH5030 [151][152][153] Ch.4G000001→	EB5240 [3]
Agila 1.2 16V	09/00→12/07	1199	4	72.50	DOHC	55/75				
Astra G 1.2 16V	09/00→01/05									
Corsa C 1.2	09/00→12/09									
Corsa C 1.2 16V	09/00→									
1.2	Z 12 XEP						21	AH5030 (MLS)	CH5031	EH5030
Agila 1.2 16V	07/04→12/07	1229	4	73.40	DOHC	59/80				
Astra H 1.2	08/05→									
Corsa C 1.2	07/04→12/09									
Corsa C Van 1.2	07/05→									
Corsa D 1.2	07/06→									
Corsa D 1.2 LPG	09/09→									
1.2	Z 13 DT Diesel						22	AD5800 (MLS), 0.720mm AD5810 (MLS), 0.820mm, 1 Hole AD5820 (MLS), 0.920mm, 2 Holes	CD5810 ▲	ED5800
Agila 1.3 CDTI	08/03→12/07	1248	4	69.60	DOHC	51/70				
Combo 1.3 16V	10/04→									
Corsa C 1.3 CDTI	06/03→12/09									
Meriva 1.3 CDTI	04/05→05/10									
Tigra 1.3 CDTI	06/04→									
1.2	Z 13 DTE Diesel						23	AD5800 (MLS), 0.720mm AD5810 (MLS), 0.820mm, 1 Hole AD5820 (MLS), 0.920mm, 2 Holes		
Corsa D 1.3 CDTI	06/10→	1248	4	69.60	DOHC	70/95				
1.2	Z 13 DTH Diesel						24	AD5800 (MLS), 0.720mm AD5810 (MLS), 0.820mm, 1 Hole AD5820 (MLS), 0.920mm, 2 Holes	CD5820 ▲	ED5820 FD5820 ▲
Astra H 1.3 CDTI	04/05→	1248	4	69.60	DOHC	66-74/ 90-101				
Corsa D 1.3 CDTI	07/06→									

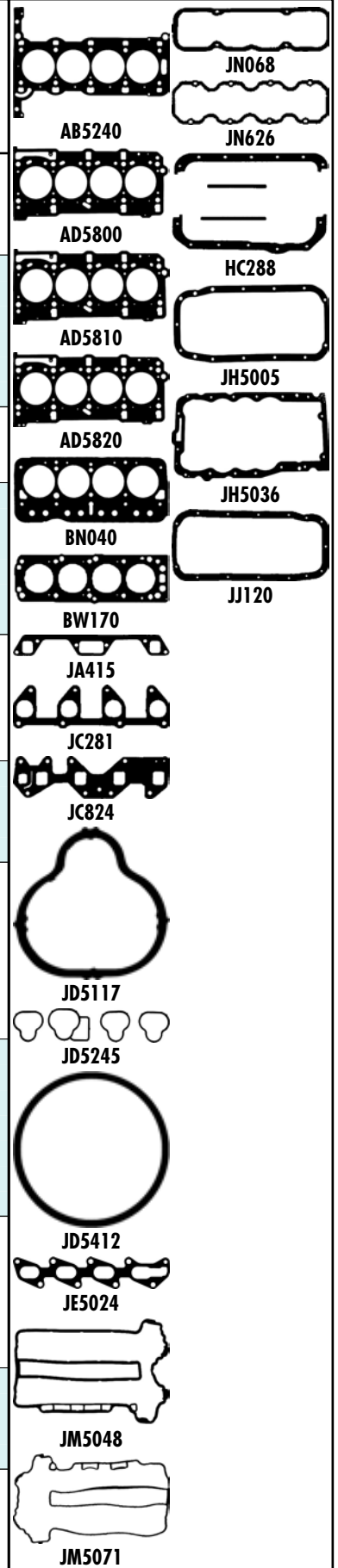

HBS353 [5] M10x1.25x119.00mm (x10)		JM5259 (SE)			NA5223 [2] 40.00x52.00x7.00mm, FPM NA5230 [2] 78.00x100.00x9.00mm, PTFE	
HBS002 [5] M10x1.25x140.00mm (x10)	JC824 [1] JC281 [1]	JN626 [4]	JH5005 (Cork) JJ120 (Cork)	PA565 (x8) HR342 [x1]	NC006 [2] 35.00x48.00x7.00mm, MVQ NB697 [2] 26.00x42.00x8.00mm, FPM NB698 [1] 80.00x98.00x10.00mm, FPM	
HBS112 [5] M9x1.25x100.00mm (x5)	JD5979 [1] JA415 [1]	JN068 [4]	HC288 [1]	HR291 [1]	NB691 [1] 54.00x82.00x9.00mm, ACM	
HBS002 [5] M10x1.25x140.00mm (x10)	JC824 [1] JC281 [1]	JN626 [4]	JH5005 (Cork) JJ120 (Cork)	PA565 (x8) HR342 [x1]	NC006 [2] 35.00x48.00x7.00mm, MVQ NB697 [2] 26.00x42.00x8.00mm, FPM NB698 [1] 80.00x98.00x10.00mm, FPM	
HBS252 [5] M8x1.25x119.00mm (x12)	JD5245 [1] JE5024 [1]	JM5048 (Elastomer)	JH5036	PA5025 (x16) HR5048 [1]	NA5108 [2] 42.00x55.00x7.00mm, FPM/ACM NB698 [1] 80.00x98.00x10.00mm, FPM	JR5030 [6]
HBS353 [5] M10x1.25x119.00mm (x10)	JD5411 [1] JD5412 [1] JD5413 [1] (MLS)	JM5259 (SE)	HR397	HR5088 [1]	NA5223 [2] 40.00x52.00x7.00mm, FPM NA5230 [2] 78.00x100.00x9.00mm, PTFE	
HBS252 [5] M8x1.25x119.00mm (x12)	JD5117 [1] (x4) [151][152][153] →Ch.369999999 JD5904 [1] (x4) [151][152][153] (FPM) Ch.46000001→ JE5024 [1]	JM5048 (Elastomer) →Eng.1G001502 JM5071 (Elastomer) Eng.1G001503→	JH5036	PA5025 (x16) HR5048 [1]	NA5108 [2] 42.00x55.00x7.00mm, FPM/ACM NB698 [1] 80.00x98.00x10.00mm, FPM	JR5030 [6]
HBS252 [5] M8x1.25x119.00mm (x12)	JD5904 [1] (x4) (FPM)	JM5048 (Elastomer) →Eng.1G001502 JM5071 (Elastomer) Eng.1G001503→	JH5036	HR5048 [1]	NA5108 [2] 42.00x55.00x7.00mm, FPM/ACM NB698 [1] 80.00x98.00x10.00mm, FPM	JR5030 [6]
HBS353 [5] M10x1.25x119.00mm (x10)	JD5411 [1] JD5413 [1] (MLS)	JM5259 (SE)	HR397	HR5088 [1]	NA5223 [2] 40.00x52.00x7.00mm, FPM NA5230 [2] 78.00x100.00x9.00mm, PTFE	KK5646 [17]
HBS353 [5] M10x1.25x119.00mm (x10)	JD5413 [1] (MLS)	JM5259 (SE)	HR397	HR5088 [1]	NA5223 [2] 40.00x52.00x7.00mm, FPM NA5230 [2] 78.00x100.00x9.00mm, PTFE	
HBS353 [5] M10x1.25x119.00mm (x10)	JD5993 [1] JD5413 [1] (MLS)	JM5259 (SE)	HR397	HR5088 [1]	NA5223 [2] 40.00x52.00x7.00mm, FPM NA5230 [2] 78.00x100.00x9.00mm, PTFE	



cc



kW/PS



1.2		Z 13 DTJ Diesel				25	AD5800 (MLS), 0.720mm AD5810 (MLS), 0.820mm, 1 Hole AD5820 (MLS), 0.920mm, 2 Holes		CD5810 ▲	ED5800 FD5810
Agila 1.3 CDTI	04/08→	1248	4	69.60	DOHC	55/75				
Combo 1.3 16V	10/05→									
Corsa D 1.3CDTI	07/06→									
Meriva 1.3 CDTI	09/03→05/10									
1.3		13 N				26	BK470 (Fibre) →08/86		DK470 →08/86 →Eng.13N-1535880 DK471 →08/86 Eng.13N-1535881→	EK470 [3] →08/86 GK470 →08/86
Kadett E 1.3 N	09/84→08/91	1297	4	75.00	SOHC/OHC	39-44/ 53-60				
1.3		13 NB				27	BK470 (Fibre)		DK470 →12/86 DK471 01/87→	EK470 [3] GK470
Corsa A 1.3	09/85→10/89	1297	4	75.00	SOHC/OHC	44/60				
Corsa A Van 1.3	02/86→04/89									
Kadett E 1.3 N	09/84→08/91									
1.3		13 S				28	BK470 (Fibre) →08/89		DK470 →12/86 DK471 01/87→08/89	EK470 [3] →08/89 GK470 →08/89
Ascona C 1.3 S	09/81→08/88	1297	4	75.00	SOHC/OHC	42-55/ 57-75				
Corsa A 1.3 GL	09/82→03/93									
Kadett E 1.3 S	01/86→02/93									
1.3		13 SB				29	BK470 (Fibre)		DK470 →12/86 DK471 01/87→	EK470 [3] GK470
Corsa A 1.3 S	09/82→10/89	1297	4	75.00	SOHC/OHC	51/70				
Corsa A Van 1.3	02/86→04/89									
1.3		C 13 N				30	BK470 (Fibre)		DK470 →12/86 DK471 01/87→	EK470 [3]
Corsa A 1.3 i	09/86→09/90	1297	4	75.00	SOHC/OHC	44/60				
Kadett E 1.3 i	09/85→08/91									
1.4		14 NV				31	BS260 (Fibre)		DS260	EK470 [3] ES260
Astra F 1.4	09/91→09/93	1389	4	77.60	SOHC/OHC	53-55/ 72-75				
Corsa A 1.4 S	09/89→03/93									
Kadett E 1.4 S	07/89→02/93									
Vectra A 1.4 S	04/88→06/92									
1.4		14 SE				32	BS260 (Fibre)		DS261 [3]	ES260
Astra F 1.4	09/92→09/98	1389	4	77.60	SOHC/OHC	60/82				
1.4		A 14 FC				33	AH6510 (MLS)			
Combo 1.4	02/12→	1368	4	72.00	DOHC	88/120				
Combo 1.4 CNG	02/12→									

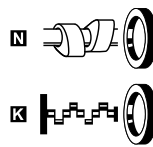
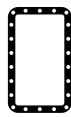
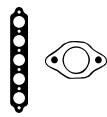

HBS353 [5] M10x1.25x119.00mm (x10)	JD5411 [1] JD5413 [5] (MLS)	JM5259 (SE)	HR397	HR5088 [5]	NA5223 [2] 40.00x52.00x7.00mm, FPM NA5230 [2] 78.00x100.00x9.00mm, PTFE	
HBS002 [5] M10x1.25x140.00mm (x10) →08/86	JC280 [1] →08/86 JC281 [5] →08/86 JE119 →08/86	JN344 [4] →08/86 →Eng.13N-1535880 JN626 [4] →08/86 Eng.13N-1535881 →	JH5005 (Cork) →08/86 JJ120 (Cork) →08/86	PA565 (x8) →08/86 HR342 [5] (x1) →08/86	NC006 [2] 35.00x48.00x7.00mm, MVQ →08/86 NB697 [2] 26.00x42.00x8.00mm, FPM →08/86 NB698 [1] 80.00x98.00x10.00mm, FPM →08/86	
HBS002 [5] M10x1.25x140.00mm (x10)	JC280 [1] JC281 [5] JE119	JN344 [4] →12/86 JN626 [4] 01/87 →	JH5005 (Cork) JJ120 (Cork)	PA565 (x8) HR342 [5]	NC006 [2] 35.00x48.00x7.00mm, MVQ NB697 [2] 26.00x42.00x8.00mm, FPM NB698 [1] 80.00x98.00x10.00mm, FPM	
HBS002 [5] M10x1.25x140.00mm (x10) →08/89	JC280 [1] →08/89 JC281 [5] →08/89 JE119 →08/89	JN344 [4] →12/86 JN626 [4] 01/87 →08/89	JH5005 (Cork) →08/89 JJ120 (Cork) →08/89	PA565 (x8) →08/89 HR342 [5] (x1) →08/89	NC006 [2] 35.00x48.00x7.00mm, MVQ →08/89 NB697 [2] 26.00x42.00x8.00mm, FPM →08/89 NB698 [1] 80.00x98.00x10.00mm, FPM →08/89	
HBS002 [5] M10x1.25x140.00mm (x10)	JC280 [1] JC281 [5] JE119	JN344 [4] →12/86 JN626 [4] 01/87 →	JH5005 (Cork) JJ120 (Cork)	PA565 HR342 [5]	NC006 [2] 35.00x48.00x7.00mm, MVQ NB697 [2] 26.00x42.00x8.00mm, FPM NB698 [1] 80.00x98.00x10.00mm, FPM	
HBS002 [5] M10x1.25x140.00mm (x10)	JC280 [1] JC281 [5] JE119	JN344 [4] →12/86 JN626 [4] 01/87 →	JH5005 (Cork) JJ120 (Cork)	PA565 (x8) HR342 [5] (x1)	NC006 [2] 35.00x48.00x7.00mm, MVQ NB697 [2] 26.00x42.00x8.00mm, FPM NB698 [1] 80.00x98.00x10.00mm, FPM	
HBS002 [5] M10x1.25x140.00mm (x10)	JC824 [1] JC281 [5] JE120	JN626 [4]	JH5005 (Cork) JJ120 (Cork)	PA565 (x8) HR342 [5] (x1)	NC006 [2] 35.00x48.00x7.00mm, MVQ NB697 [2] 26.00x42.00x8.00mm, FPM NB698 [1] 80.00x98.00x10.00mm, FPM	
HBS002 [5] M10x1.25x140.00mm (x10)	JC823 [1] JC281 [5] JE120 [120]	JN929 [4]	JH5005 (Cork) JJ120 (Cork)	PA565 (x8) HR342 [5] (x1)	NC006 [2] 35.00x48.00x7.00mm, MVQ NB697 [2] 26.00x42.00x8.00mm, FPM NB698 [1] 80.00x98.00x10.00mm, FPM	
					NA5057 [2] 27.00x37.00x7.00mm, FPM LK5001 [1] [2] [7] 74.00x187.50x17.00mm, FPM	

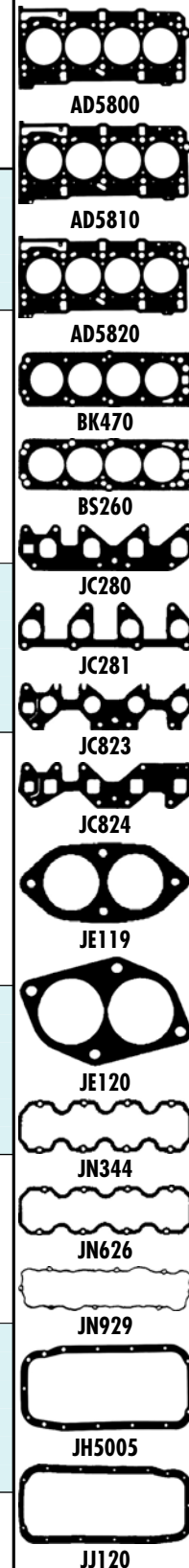



cc



kW/PS



1.4		A 14 FP					34	AG7310 (MLS)	CG7310	EE5180 [3]
Combo 1.4	02/12→	1368	4	72.00	DOHC	70/95				
1.4		C 14 NZ					35	BS260 (Fibre)	DS260	EK470 [3]
Astra F 1.4 i	09/91→01/99	1389	4	77.60	SOHC/OHC	40-44/ 54-60				
Combo 1.4	07/94→10/01									
Corsa A 1.4 i	01/85→03/93									
Corsa B 1.4i	03/93→09/00									
Kadett E 1.4 i	01/90→07/94									
1.4		C 14 SE					36	BS260 (Fibre)	DS261 [3]	ES260
Astra F 1.4 Si	03/92→03/01	1389	4	77.60	SOHC/OHC	54-60/ 73-82				
Combo 1.4	07/94→10/01									
Corsa A 1.4 Si	09/91→03/93									
Corsa B 1.4	04/93→08/94									
Corsa B 1.4 Si	03/93→09/00									
Kadett E 1.4 S	09/89→08/91									
1.4		C 14 SEL					37	AY210 (Fibre)	CY210 [3]	EY230
Corsa B 1.4i	08/97→09/00	1389	4	77.60	DOHC	63/86				
1.4		X 14 NZ					38	BS260 (Fibre)	DS260 →Eng.19489817 DS261 [3] Eng.19489818→	ES260
Astra F 1.4 i	09/91→01/05	1389	4	77.60	SOHC/OHC	44/60				
1.4		X 14 SZ					39	BS260 (Fibre)	DS261 [3]	ES260
Combo 1.4	07/94→10/01	1389	4	77.60	SOHC/OHC	40-44/ 54-60				
Corsa B 1.4i	03/93→09/00									
1.4		X 14 XE					40	AY210 (Fibre)	CY210 [3][121][122][123] CY211 [3] 02/98→	EY230
Astra F 1.4 i	03/98→08/00	1389	4	77.60	DOHC	63-69/ 86-94				
Astra F 1.4i	01/96→03/01									
Astra G 1.4 16V	02/98→01/05									
Combo 1.4 16V	08/99→10/01									
Corsa B 1.4i	09/94→09/00									
Tigra 1.4 16V	07/94→12/00									
1.4		Z 14 XE					41	AB5360 (MLS)	CB5360 [3] →Eng.02M25254 EB5541 [18] Eng.02M25255→	EB5360 [3] →Eng.02M25254 EB5541 [18] Eng.02M25255→
Astra G 1.4 16V	02/98→01/05	1389	4	77.60	DOHC	66/90				
Corsa C 1.4	09/00→12/09									
1.4		Z 14 XEL					42	AH5030 (MLS)	CH5030	EH5030
Astra H 1.4	04/04→10/04	1364	4	73.40	DOHC	55-59/ 75-80				

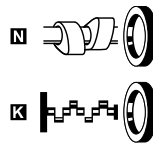
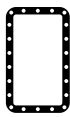
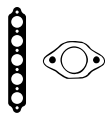

HBS247 [5] M9x1.25x87.00mm (x10)		JM5176			NA5057 [2] 27.00x37.00x7.00mm, FPM LK5001 [1][2][7] 74.00x187.50x17.00mm, FPM	
HBS002 [5] M10x1.25x140.00mm (x10)	JC824 [1] JC281 [1] JE120	JN626 [4]	JH5005 (Cork) JJ120 (Cork)	PA565 (x8) HR342 (x1)	NC006 [2] 35.00x48.00x7.00mm, MVQ NB697 [2] 26.00x42.00x8.00mm, FPM NB698 [1] 80.00x98.00x10.00mm, FPM	
HBS002 [5] M10x1.25x140.00mm (x10)	JC823 [1] JC281 [1] JE120 [120]	JN929 [4]	JH5005 (Cork) JJ120 (Cork)	PA565 (x8) HR342 (x1)	NC006 [2] 35.00x48.00x7.00mm, MVQ NB697 [2] 26.00x42.00x8.00mm, FPM NB698 [1] 80.00x98.00x10.00mm, FPM	
HBS055 [5] M10x1.25x153.00mm (x10)	JD445 [1] JD444 [1]		JJ575	PA5041 6.00/12.20x10.00 (FPM) HR791 [1]	NC006 [2] 35.00x48.00x7.00mm, MVQ NB697 [2] 26.00x42.00x8.00mm, FPM NB698 [1] 80.00x98.00x10.00mm, FPM	
HBS002 [5] M10x1.25x140.00mm (x10)	JC824 [1] JC281 [1] JE120	JN626 [4] →Eng.19489817 JN929 [4] Eng.19489818→	JH5005 (Cork) JJ120 (Cork)	PA565 (x8) HR342 [1]	NC006 [2] 35.00x48.00x7.00mm, MVQ NB697 [2] 26.00x42.00x8.00mm, FPM NB698 [1] 80.00x98.00x10.00mm, FPM	
HBS002 [5] M10x1.25x140.00mm (x10)	JC823 [1] JC281 [1] JE120	JN929 [4]	JH5005 (Cork) JJ120 (Cork)	PA565 (x8) HR342 [1]	NC006 [2] 35.00x48.00x7.00mm, MVQ NB697 [2] 26.00x42.00x8.00mm, FPM NB698 [1] 80.00x98.00x10.00mm, FPM	
HBS055 [5] M10x1.25x153.00mm (x10)	JD445 [1] [122] [123] JD5147 [1] [124] →01/98 JD5149 [1] [123] [124] JD5269 [1] [121][122] 02/98→ JD444 [1]	JM5059 (Elastomer)	JH5005 (Cork) JJ120 (Cork) JJ575	PA5041 6.00/12.20x10.00 (FPM) HR791 [1]	NC006 [2] 35.00x48.00x7.00mm, MVQ NB697 [2] 26.00x42.00x8.00mm, FPM NB698 [1] 80.00x98.00x10.00mm, FPM	
HBS055 [5] M10x1.25x153.00mm (x10)	JD5147 [1] JD5149 [1] [124] JD5148 [1]	JM5059 (Elastomer)	JJ120 (Cork) JJ575	PA5041 (x16) 6.00/12.20x10.00 (FPM) HR791 [1]	NC006 (x2) [2] 35.00x48.00x7.00mm, MVQ NB697 [2] 26.00x42.00x8.00mm, FPM NB698 [1] 80.00x98.00x10.00mm, FPM	
HBS252 [5] M8x1.25x119.00mm (x12)	JD5904 [1] (x4) (FPM) JE5024 [1]	JM5071 (Elastomer)	JH5036	HR5048 [1]	NA5108 [2] 42.00x55.00x7.00mm, FPM/ACM NB698 [1] 80.00x98.00x10.00mm, FPM	JR5030 [6]

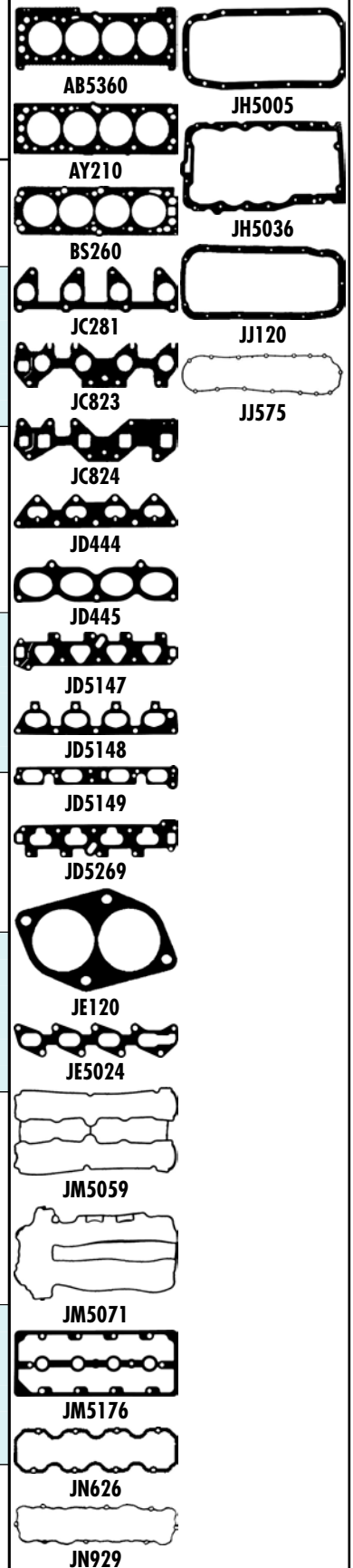



cc



kW/PS

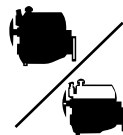

1.4		Z 14 XEP				43		AH5030 (MLS)	CH5030	EH5030
Astra G 1.4	09/07→12/09	1364	4	73.40	DOHC	66/90				
Astra H 1.4	03/04→									
Astra H 1.4 LPG	08/09→									
Combo 1.4	10/04→									
Combo 1.4 16V	08/05→									
Corsa C 1.4	06/03→12/09									
Corsa D 1.4	07/06→									
Meriva 1.4 16V	07/04→05/10									
Tigra 1.4	06/04→									
1.5		15 D (4EC1) Diesel				44		AY840 (MLS), 1.400mm →Eng.975024	CY811 ▲[13]	FY811 ▲[3]
Corsa A 1.5 D	09/87→03/93	1488	4	76.00	SOHC/OHC	37/50	AY850 (MLS), 1.450mm, 1 Hole →Eng.975024			
Corsa A 1.5D	06/87→04/89						AY860 (MLS), 1.500mm, 2 Holes →Eng.975024			
Corsa B 1.5 D	03/93→09/00						AY900 (MLS), 1.400mm Eng.975025→			
							AY910 (MLS), 1.450mm, 1 Hole Eng.975025→			
							AY920 (MLS), 1.500mm, 2 Holes Eng.975025→			
1.5		15 DT (T4EC1) Diesel				45		AY840 (MLS), 1.400mm 02/88→ →Eng.975024	CY811 ▲[13] 02/88→	FY811 ▲[3] 02/88→
Corsa A 1.5 TD	10/87→03/93	1488	4	76.00	SOHC/OHC	49-53/ 67-72	AY850 (MLS), 1.450mm, 1 Hole 02/88→ →Eng.975024			
Corsa B 1.5 TD	03/93→09/00						AY860 (MLS), 1.500mm, 2 Holes 02/88→ →Eng.975024			
Kadett E 1.5 TD	07/88→08/91						AY900 (MLS), 1.400mm 02/88→ Eng.975025→			
							AY910 (MLS), 1.450mm, 1 Hole 02/88→ Eng.975025→			
							AY920 (MLS), 1.500mm, 2 Holes 02/88→ Eng.975025→			

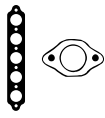

AY840, AY850,
AY860



AY900, AY910,
AY920



JD304



JE5024



JM5071

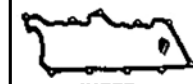

JN777



JH5036



JH5058



kW/PS

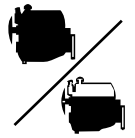

1.5		X 15 DT (T4EC1) Diesel			46				
Corso B 1.5 TD	03/93→09/00	1488	4	76.00	SOHC/OHC	49/67	AY840 (MLS), 1.400mm 01/96→ →Eng.975024 AY850 (MLS), 1.450mm, 1 Hole 01/96→ →Eng.975024 AY860 (MLS), 1.500mm, 2 Holes 01/96→ →Eng.975024 AY900 (MLS), 1.400mm 01/96→ Eng.975025→ AY910 (MLS), 1.450mm, 1 Hole 01/96→ Eng.975025→ AY920 (MLS), 1.500mm, 2 Holes 01/96→ Eng.975025→	CY811 ▲ [13] 01/96→	FY811 ▲ [3] 01/96→
1.6		16 D Diesel			47				
Ascona C 1.6 D Kadett E 1.6 D	03/82→08/88 08/84→01/89	1598	4	80.00	SOHC/OHC	40/54	BLO10 (Fibre), 1.400mm ☞→0.750mm BLO20 (Fibre), 1.500mm, 1 Notch ☞0.750→0.850mm BLO30 (Fibre), 1.600mm, 2 Notches ☞0.850mm→	DL010 ▲ →12/85 DL011 ▲ 01/86→	EK481 [3] →12/85 EK485 01/86→
1.6		16 DA Diesel			48				
Ascona C 1.6 D Kadett E 1.6 D	03/82→08/88 08/84→12/89	1598	4	80.00	SOHC/OHC	40/54	BLO10 (Fibre), 1.400mm ☞→0.750mm BLO20 (Fibre), 1.500mm, 1 Notch ☞0.750→0.850mm BLO30 (Fibre), 1.600mm, 2 Notches ☞0.850mm→	DL010 ▲ →12/85 DL011 ▲ 01/86→	EK481 [3] →12/85 EK485 01/86→
1.6		16 N			49				
Ascona C 1.6	09/81→08/88	1598	4	80.00	SOHC/OHC	51-55/ 69-75	BK480 (Fibre)	DK480	EJ160
1.6		16 SH			50				
Kadett E 1.6	09/86→06/93	1598	4	80.00	SOHC/OHC	66/90	BK480 (Fibre)	DK480	
1.6		16 SV			51				
Ascona C 1.6 Kadett E 1.6 Kadett E 1.6 i Kadett E 1.6 S Vectra A 1.6 Vectra A 1.6 S Vectra B 1.6 GL	09/86→08/88 09/86→12/91 07/89→02/93 09/86→08/91 09/88→05/93 09/88→05/93 09/95→08/96	1598	4	79.00	SOHC/OHC	60/82	BP800 (Fibre)	DP800	EK484

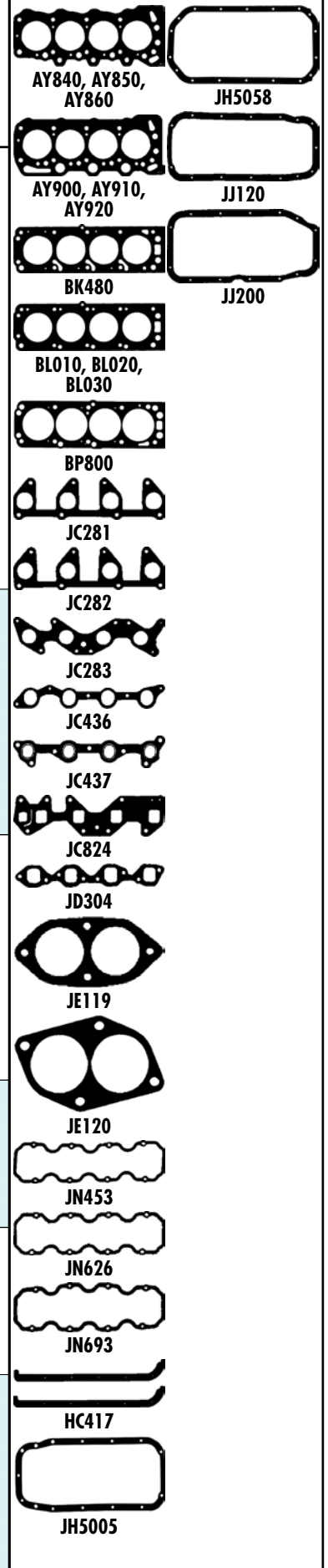
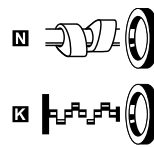
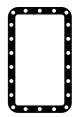
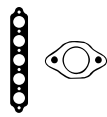

HBS036 [22]
M12x1.50x102.00mm (x10)
01/96→

JD5914 ■
01/96→
JD304 ■
01/96→
☉JE5029
01/96→

JN776 [4]
01/96→

JH5058
01/96→

PA658 (x8)
01/96→

NJ449 [2]
40.00x52.00x6.00mm, NBR
01/96→
NJ449 ■ [2]
40.00x52.00x6.00mm, NBR
01/96→
NK103 ■ [1]
87.00x100.00x8.50mm, FPM
01/96→

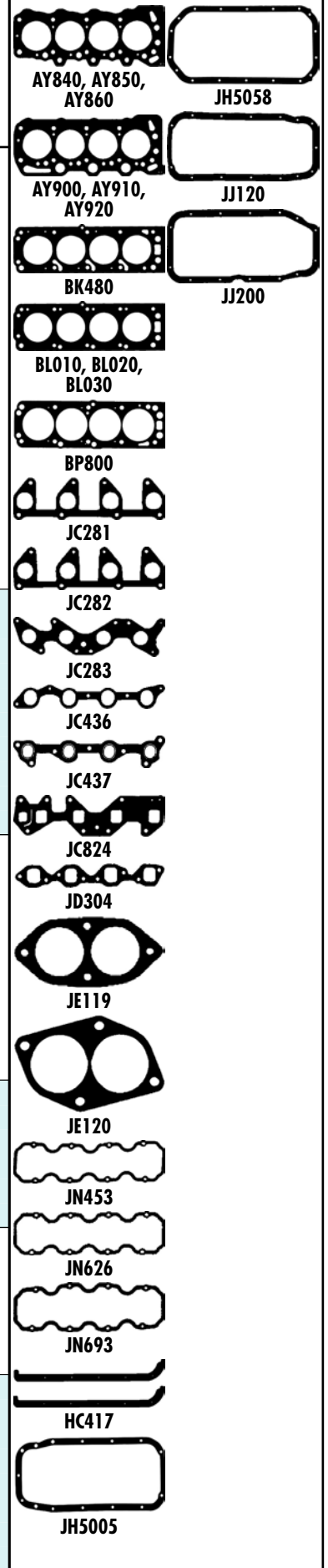

HBS074 [5]
M11x1.25x154.00mm (x10)

JC436 ■
JC437 ■
☉JE119

JN453 [4]
→12/85
JN693 [4]
01/86→

JJ200

HR343 ■

NC006 ■ [2]
35.00x48.00x7.00mm, MVQ
NB734 ■ [2]
35.00x50.00x8.00mm, FPM
NB701 ■ [1]
86.00x104.00x11.00mm, FPM
→Eng.16DA-14498630
NB806 ■ [1]
90.00x104.00x11.00mm, FPM
Eng.16DA-14498631→

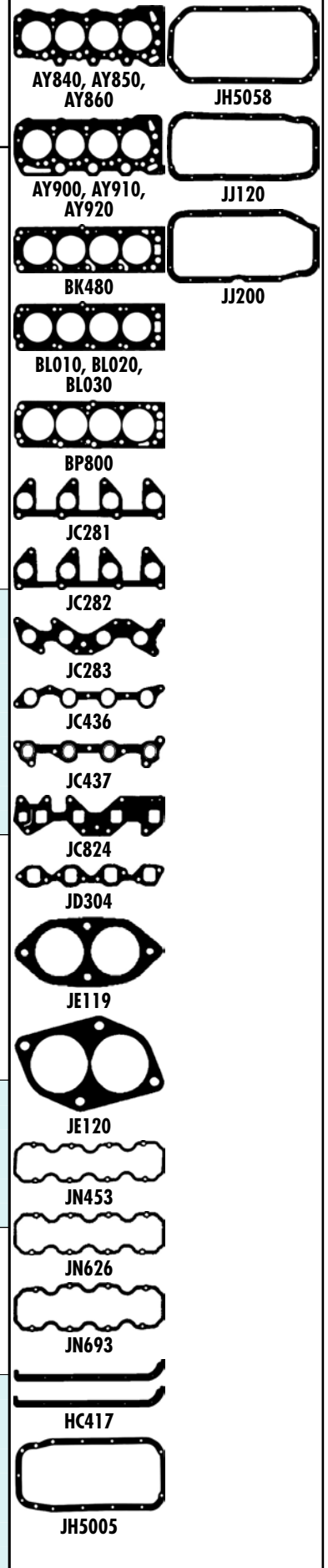

HBS074 [5]
M11x1.25x154.00mm (x10)

JC436 ■
JC437 ■
☉JE119

JN693 [4][125]
Eng.16DA-14498632→
JN453 [4][125]
Eng.16DA-14503756→
→Eng.16DA-14498630

JJ200

HR343 ■

NC006 [2]
35.00x48.00x7.00mm, MVQ
NB734 ■ [2]
35.00x50.00x8.00mm, FPM
NB701 ■ [1]
86.00x104.00x11.00mm, FPM
→Eng.16DA-14498630
NB806 ■ [1]
90.00x104.00x11.00mm, FPM
Eng.16DA-14498631→

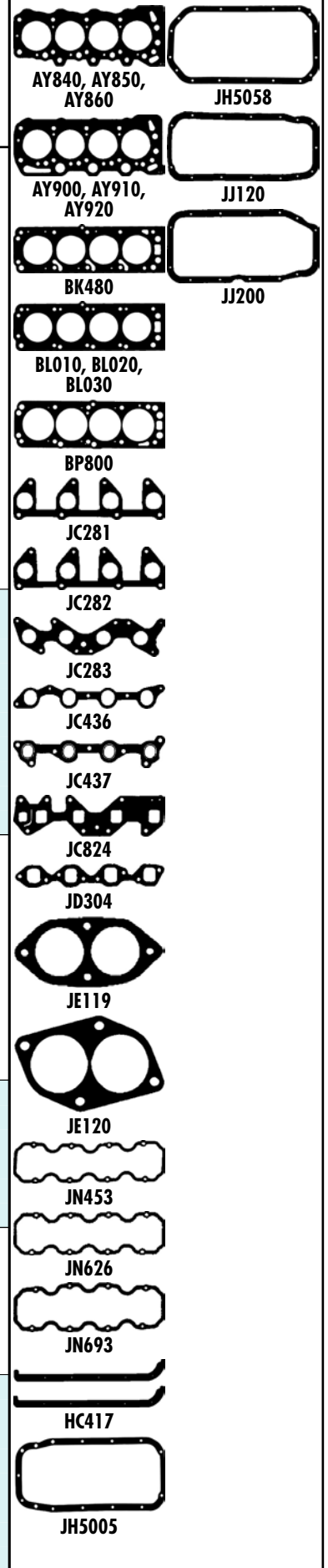

HBS053 [5]
M11x1.25x140.00mm (x10)

JC283 ■
JC282 ■
☉JE120

JN453 [4]

HC417 ■
JJ200

PA619 ■ (x4)
9.00/17.00x14.20
(ACM)
Eng.16N300001→
HR343 ■

NC006 ■ [2]
35.00x48.00x7.00mm, MVQ
NB700 ■ [2]
31.00x50.00x8.00mm, MVQ
NB701 ■ [1]
86.00x104.00x11.00mm, FPM

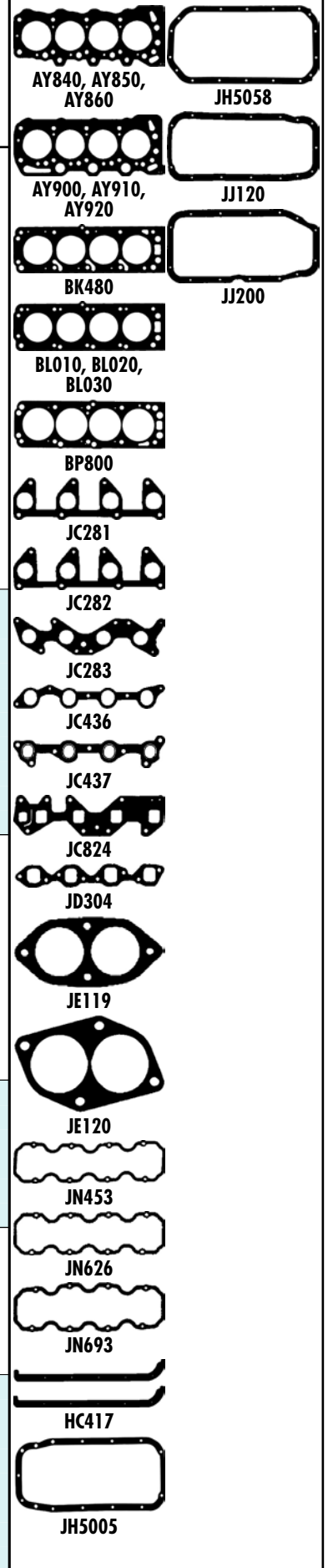

HBS053 [5]
M11x1.25x140.00mm (x10)

JC283 ■
JC282 ■
☉JE120

JN453 [4]

JJ200

HR343 ■

NC006 [2]
35.00x48.00x7.00mm, MVQ
NB700 ■ [2]
31.00x50.00x8.00mm, MVQ
NB701 ■ [1]
86.00x104.00x11.00mm, FPM

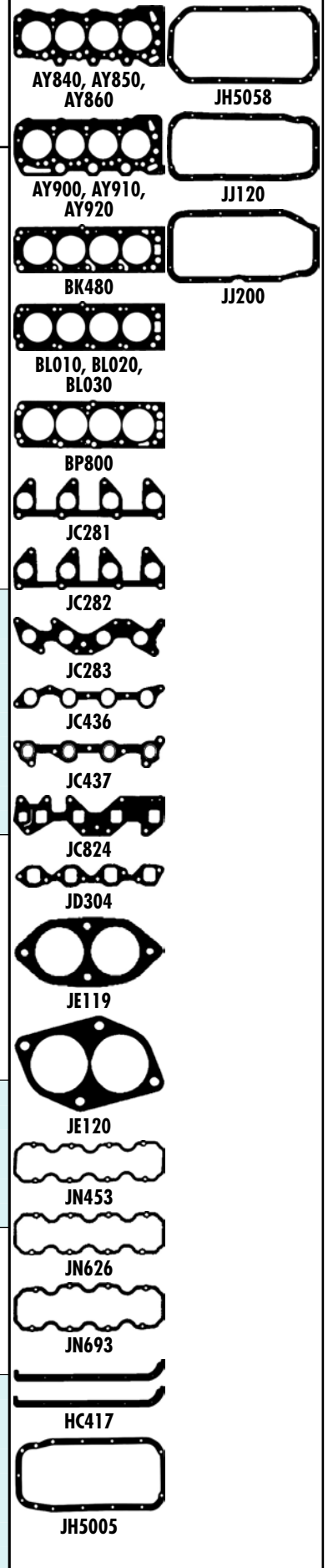

HBS002 [5]
M10x1.25x140.00mm (x10)

JC824 ■
JC281 ■
☉JE120 [126]

JN626 [4]

JH5005
(Cork)
JJ120 (x2)
(Cork)

PA565 (x8)
HR342 (x1)

NC006 [2]
35.00x48.00x7.00mm, MVQ
NB697 ■ [2]
26.00x42.00x8.00mm, FPM
NB698 ■ [1]
80.00x98.00x10.00mm, FPM

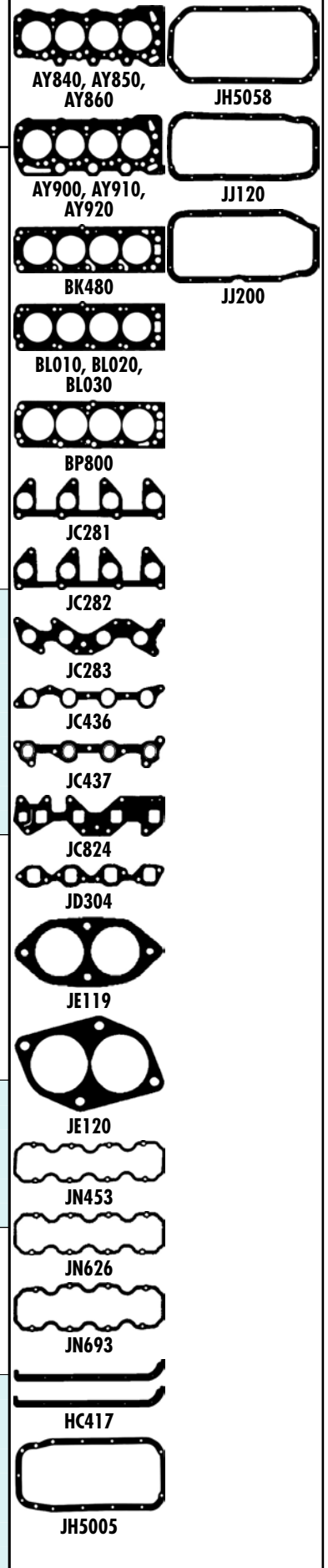



cc



kW/PS



1.6		A 16 FDH Diesel				52		AH6880 (MLS), 0.82mm AH6890 (MLS), 0.92mm, 1 Hole AH6900 (MLS), 1.02mm, 2 Holes		
Combo 1.6	02/12→	1598	4	79.50	DOHC	74-77/ 101-105				
1.6		A 16 FDL Diesel				53		AH6880 (MLS), 0.82mm AH6890 (MLS), 0.92mm, 1 Hole AH6900 (MLS), 1.02mm, 2 Holes		
Combo 1.6	02/12→	1598	4	79.50	DOHC	66/90				
1.6		A 16 LEL				54		AH5240 (MLS)		
Corsa D 1.6T	02/07→	1598	4	79.00	DOHC	110/150		CH5241 (MLS)	EH5240	
1.6		A 16 LER				55		AH5240 (MLS)		
Corsa D 1.6T	02/07→	1598	4	79.00	DOHC	141/192		CH5241 (MLS)	EH5240	
1.6		A 16 LET				56		AH5240 (MLS)		
Astra GTC J 1.6	10/11→	1598	4	79.00	DOHC	132/180		CH5241 (MLS)	EH5240	
Astra J 1.6T	12/09→									
Astra Sport Tur	10/10→									
Insignia 1.6T	07/08→									
1.6		A 16 XER				57		AH5240 (MLS)		
Astra H 1.6	12/06→	1598	4	79.00	DOHC	84-85/ 114-116		CH5242 (MLS)	EH5240	
Astra J 1.6	12/09→									
Astra Sport 1.6	10/10→									
Insignia 1.6	07/08→									
Mokka 1.6	06/12→									
Zafira 1.6	01/08→									
1.6		A 16 XNT				58		AH5240 (MLS)		
Zafira 1.6 CNG	02/09→	1598	4	79.00	DOHC	110/150		CH5241 (MLS)	EH5240	
1.6		C 16 LZ				59		BP800 (Fibra)		
Ascona C 1.6 i	09/86→08/88	1598	4	80.00	SOHC/OHC	55/75		DP802	EK484	
Kadett E 1.6 i	09/86→02/93									
1.6		C 16 NZ				60		BP800 (Fibra)		
Ascona C 1.6 i	09/86→08/88	1598	4	79.00	SOHC/OHC	55-60/ 75-82		DP802	EK484 →10/91 ES260 11/91→	
Astra F 1.6 i	09/91→09/98									
Corsa A 1.6 GSI	08/88→09/92									
Kadett E 1.6 i	09/86→07/94									
Vectra A 1.6 i	09/88→11/95									
1.6		C 16 NZ2				61		BP800 (Fibra)		
Vectra A 1.6 i	09/88→11/95	1598	4	79.00	SOHC/OHC	55/75	09/92→	DP802 09/92→	EK484 09/92→	
1.6		C 16 SE				62		BP800 (Fibra)		
Astra F 1.6 Si	03/92→12/94	1598	4	79.00	SOHC/OHC	74/100		DP803	EK484	
Corsa A 1.6 GSI	02/92→03/93									

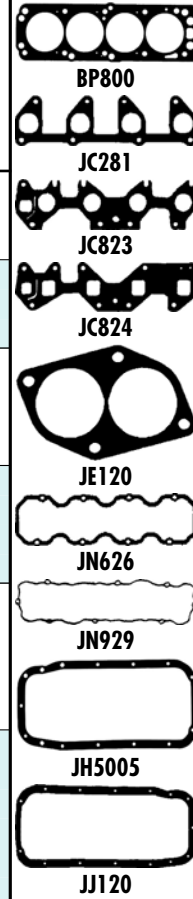
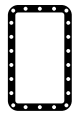

					NA5070 [2] 31.00x41.00x7.00mm, FPM	
					NA5070 [2] 31.00x41.00x7.00mm, FPM	
HBS055 [5] M10x1.25x153.00mm (x10)		JM7103 (Elastomer)			NC006 [2] 35.00x48.00x7.00mm, MVQ NA5174 [2] 31.50x42.00x7.00mm, FPM	NA5174 [2][10]
HBS055 [5] M10x1.25x153.00mm (x10)		JM7103 (Elastomer)			NC006 [2] 35.00x48.00x7.00mm, MVQ NA5174 [2] 31.50x42.00x7.00mm, FPM	NA5174 [2][10]
HBS055 [5] M10x1.25x153.00mm (x10)		JM7103 (Elastomer)			NC006 [2] 35.00x48.00x7.00mm, MVQ NA5174 [2] 31.50x42.00x7.00mm, FPM	NA5174 [2][10]
HBS055 [5] M10x1.25x153.00mm (x10)		JM7103 (Elastomer)			NC006 [2] 35.00x48.00x7.00mm, MVQ NA5174 [2] 31.50x42.00x7.00mm, FPM	NA5174 [2][10]
HBS055 [5] M10x1.25x153.00mm (x10)		JM7103 (Elastomer)			NC006 [2] 35.00x48.00x7.00mm, MVQ NA5174 [2] 31.50x42.00x7.00mm, FPM	NA5174 [2][10]
HBS002 [5] M10x1.25x140.00mm (x10)	JC824 [1] JC281 [1] JE120	JN626 [4]	JH5005 (Cork) JJ120 (x2) (Cork)	PA565 (x8) HR342 [1]	NC006 [2] 35.00x48.00x7.00mm, MVQ NB697 [2] 26.00x42.00x8.00mm, FPM NB698 [1] 80.00x98.00x10.00mm, FPM	
HBS002 [5] M10x1.25x140.00mm (x10)	JC824 [1] JC281 [1] JE120 [127]	JN626 [4]	JH5005 (Cork) JJ120 (Cork)	PA565 (x8) HR342 [1]	NC006 [2] 35.00x48.00x7.00mm, MVQ NB697 [2] 26.00x42.00x8.00mm, FPM NB698 [1] 80.00x98.00x10.00mm, FPM	
HBS002 [5] M10x1.25x140.00mm (x10) 09/92→	JC824 [1] 09/92→ JC281 [1] 09/92→ JE120 [127] 09/92→	JN626 [4] 09/92→	JH5005 (Cork) 09/92→ JJ120 (x2) (Cork) 09/92→	PA565 (x8) 09/92→ HR342 [1] 09/92→	NC006 [2] 35.00x48.00x7.00mm, MVQ 09/92→ NB697 [2] 26.00x42.00x8.00mm, FPM 09/92→ NB698 [1] 80.00x98.00x10.00mm, FPM 09/92→	
HBS002 [5] M10x1.25x140.00mm (x10)	JC823 [1] JC281 [1] JE120	JN929 [4]	JH5005 (Cork) JJ120 (Cork)	PA565 (x8) HR342 [1]	NC006 [2] 35.00x48.00x7.00mm, MVQ NB697 [2] 26.00x42.00x8.00mm, FPM NB698 [1] 80.00x98.00x10.00mm, FPM	



cc



kW/PS



1.6		C 16 SEI					63	BP800 (Fibre)	DP803	EK484
Corsa A 1.6 GSI	09/89→03/93	1598	4	79.00	SOHC/OHC	72/98	01/90→12/92	01/90→12/92	01/90→12/92	
1.6		C 16 SEL					64	AY220 (Fibre)	DY231 [3]	EY230
Astra G 1.6 16V	02/98→01/05	1598	4	79.00	DOHC	74/100				
Corsa B 1.6i	08/97→09/00									
Tigra 1.6 16V	08/97→08/98									
1.6		C 16 XE					65	AY220 (Fibre)	DY231 [3]	EY230
Corsa B 1.6 GSI	03/93→09/00	1598	4	79.00	DOHC	80/109				
1.6		E 16 LZ					66	BP800 (Fibre)	DP802	EK484
Ascona C 1.6 i	09/87→08/88	1598	4	79.00	SOHC/OHC	55/75				
1.6		E 16 NZ					67	BP800 (Fibre)	DP802	EK484
Ascona C 1.6 i	09/87→08/88	1598	4	79.00	SOHC/OHC	55-65/ 75-88				
Kadett E 1.6 i	09/86→02/93									
Vectra A 1.6	08/92→06/94									
Vectra A 1.6 i	09/88→11/95									
1.6		E 16 SE					68	BP800 (Fibre)	DP802	EK484
Corsa A 1.6 GSI	05/88→03/92	1598	4	79.00	SOHC/OHC	74-75/ 100-102				
Kadett E 1.6	09/87→08/91									
1.6		X 16 SZ					69	BP800 (Fibre)	DP802	EK484
Astra F 1.6 i	02/93→08/96	1598	4	79.00	SOHC/OHC	52/71				
Vectra A 1.6 i	09/93→11/95									
1.6		X 16 SZR					70	BP800 (Fibre)	DP806 [3]	EC040 [3]
Astra F 1.6 i	09/91→01/05	1598	4	79.00	SOHC/OHC	55/75				
Astra G 1.6	02/98→09/00									
Astra G Van 1.6	01/99→09/00									
Vectra B 1.6 i	10/95→07/03									
1.6		X 16 XE					71	AY220 (Fibre)	CY220 [3]	EY230
Corsa B 1.6i	09/94→09/00	1598	4	79.00	DOHC	78/106				
Tigra 1.6 16V	07/94→08/98									



AY220



BP800



JC281



JC823

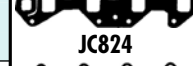

JC824



JD444

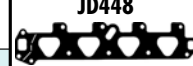

JD448



JD5147



JD5269



JE120



JM5059

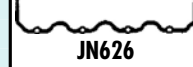

JN626



JN929



JP008

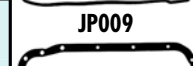

JP009



JH5005



JJ120

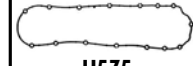

JJ575













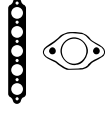

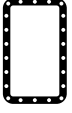

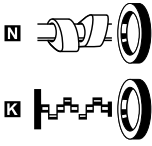





cc



kW/PS

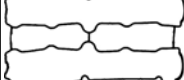
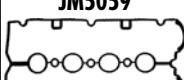
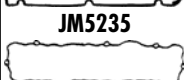
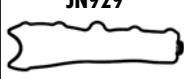

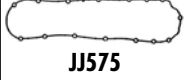
1.6		X 16 XEL					72	AY220 (Fibre)	CY220 [3][121][130] →09/98 DY232 [3][124][131] 10/98→	EY230
Astra F 1.6i	08/94→01/05	1598	4	79.00	DOHC	74/100				
Astra G 1.6 16V	02/98→01/05									
Vectra B 1.6i	10/95→07/02									
Zafira 1.6 16V	04/99→06/05									
1.6		Y 16 XE					73	AB5540 (MLS)	CB5540 [3]	EB5541 [18]
Vectra B 1.6i	10/95→07/02	1598	4	79.00	DOHC	74/101				
1.6		Y 16 YNG					74	AB5540 (MLS)	CB5540 [3]	EB5541 [18]
Corsa C 1.6 CNG	05/03→12/09	1598	4	79.00	DOHC	69-71/ 94-97				
1.6		Z 16 LEL					75	AH5240 (MLS)	CH5241 (MLS)	EH5240
Corsa D 1.6T	02/07→	1598	4	79.00	DOHC	110/150				
1.6		Z 16 LER					76	AH5240 (MLS)	CH5241 (MLS)	EH5240
Corsa D 1.6T	02/07→	1598	4	79.00	DOHC	141/192				
1.6		Z 16 LET					77	AH5240 (MLS)	CH5241 (MLS)	EH5240
Astra H 1.6T	02/07→	1598	4	79.00	DOHC	132/180				
Meriva 1.6 T	09/05→05/10									
1.6		Z 16 SE					78	AE5920 (Steel)	CE5920 [3]	EB5541 [18]
Astra G 1.6	09/00→01/05	1598	4	79.00	SOHC/OHC	62-64/ 84-87				
Astra G Van 1.6	09/00→04/05									
Combo 1.6	10/01→									
Meriva 1.6	05/03→05/10									
1.6		Z 16 XE					79	AB5540 (MLS)	CB5540 [3]	EB5541 [18]
Astra G 1.6 16V	02/98→10/05	1598	4	79.00	DOHC	74/101				
Meriva 1.6 16V	05/03→05/10									
Vectra B 1.6i	10/95→07/02									
Vectra C 1.6	06/04→									
Zafira 1.6 16V	04/99→06/05									
1.6		Z 16 XE1					80	AE5930 (MLS)	CE5930 [3]	
Astra H 1.6	09/05→	1598	4	79.00	DOHC	77/105				
Zafira 1.6	07/05→									

      							
HBS055 [5] M10x1.25x153.00mm (x10)	JD5147 ■ JD444 ■	JM5059 [124][131] (Elastomer) JP008 [4][121][130] JP009 [4][121][130]	JJ575	PA5041 (x16) 6.00/12.20x10.00 (FPM) HR791 ■ (x1)	NC006 [2] 35.00x48.00x7.00mm, MVQ NB697 ■ [2] 26.00x42.00x8.00mm, FPM NB698 ■ [1] 80.00x98.00x10.00mm, FPM		 AB5540  AE5920  AE5930  AY220  JD444  JD5147  JD5148  JD5269  JD5398  JD5399  JD5400  JD5401  JM5059  JM5235  JN929  JP008  JP009  JJ575
HBS055 [5] M10x1.25x153.00mm (x10)	JD5269 ■ JD5148 ■	JM5059 (Elastomer)	JJ575	PA5041 (x16) 6.00/12.20x10.00 (FPM) HR791 ■	NC006 (x4) [2] 35.00x48.00x7.00mm, MVQ NB697 ■ [2] 26.00x42.00x8.00mm, FPM NB698 ■ [1] 80.00x98.00x10.00mm, FPM		
HBS055 [5] M10x1.25x153.00mm (x10)	JD5269 ■ JD5148 ■	JM5059 (Elastomer)	JJ575	PA5041 6.00/12.20x10.00 (FPM) HR791 ■	NC006 [2] 35.00x48.00x7.00mm, MVQ NB697 ■ [2] 26.00x42.00x8.00mm, FPM NB698 ■ [1] 80.00x98.00x10.00mm, FPM NA5327 ■ [1] 80.00x98.00x14.50mm, PTFE		
HBS055 [5] M10x1.25x153.00mm (x10)		JM7103 (Elastomer)			NC006 [2] 35.00x48.00x7.00mm, MVQ NA5174 ■ [2] 31.50x42.00x7.00mm, FPM	NA5174 [2][10]	
HBS055 [5] M10x1.25x153.00mm (x10)		JM7103 (Elastomer)			NC006 [2] 35.00x48.00x7.00mm, MVQ NA5174 ■ [2] 31.50x42.00x7.00mm, FPM	NA5174 [2][10]	
HBS055 [5] M10x1.25x153.00mm (x10)		JM7103 (Elastomer)			NC006 [2] 35.00x48.00x7.00mm, MVQ NA5174 ■ [2] 31.50x42.00x7.00mm, FPM	NA5174 [2][10]	
HBS002 [5] M10x1.25x140.00mm (x10)	JD5398 ■ JD5399 ■	JN929 [4]		HR342 ■	NC006 (x2) [2] 35.00x48.00x7.00mm, MVQ NB697 ■ [2] 26.00x42.00x8.00mm, FPM NB698 ■ [1] 80.00x98.00x10.00mm, FPM		
HBS055 [5] M10x1.25x153.00mm (x10)	JD5147 ■ JD5148 ■	JM5059 (Elastomer)	JJ575	PA5041 (x16) 6.00/12.20x10.00 (FPM) HR791 ■	NC006 (x2) [2] 35.00x48.00x7.00mm, MVQ NB697 ■ [2] 26.00x42.00x8.00mm, FPM NB698 ■ [1] 80.00x98.00x10.00mm, FPM		
HBS055 [5] M10x1.25x153.00mm (x10)	JD5400 ■ JD5401 ■	JM5235 (Elastomer)		HR5087 ■	NC006 [2] 35.00x48.00x7.00mm, MVQ NA5174 ■ [2] 31.50x42.00x7.00mm, FPM NB698 ■ [1] 80.00x98.00x10.00mm, FPM NA5327 ■ [1] 80.00x98.00x14.50mm, PTFE	NA5174 [2][10]	



cc



kW/PS

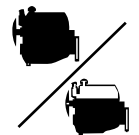

1.6		Z 16 XEP				81	AE5930 (MLS)	CE5930 [3]	
Astra G 1.6	12/02→12/09	1598	4	79.00	DOHC	74-77/ 101-105			
Astra G 1.6 16V	03/00→05/05								
Astra H 1.6	03/04→								
Meriva 1.6	01/06→05/10								
Vectra C 1.6	01/06→								
Zafira 1.6	07/05→								
1.6		Z 16 XER				82	AH5240 (MLS)	CH5242 (MLS)	EH5240
Astra H 1.6	12/06→	1598	4	79.00	DOHC	85/116			
Astra H 1.6 LPG	08/09→								
Zafira 1.6	01/08→								
1.6		Z 16 XNT				83	AH5240 (MLS)	CH5241 (MLS)	EH5240
Zafira 1.6 CNG	02/09→	1598	4	79.00	DOHC	110/150			
1.6		Z 16 YNG				84	AB5540 (MLS)	CB5540 [3]	
Astra G 1.6	06/02→03/04	1598	4	79.00	DOHC	69-74/ 94-101			
Astra G 1.6 CNG	03/03→07/04								
Combo 1.6 CNG	04/05→								
Zafira 1.6 CNG	09/01→06/05								
1.7		17 D Diesel				85	BY330 (Fibre), 1.300mm BY340 (Fibre), 1.400mm, 1 Notch BY350 (Fibre), 1.500mm, 2 Notches	DL011 ▲	EK485
Astra F 1.7 D	12/91→09/92	1700	4	82.50	SOHC/OHC	42/57			
Kadett E 1.7 D	08/88→07/94								
Vectra A 1.7 D	09/88→09/92								
1.7		17 D (4EE1) Diesel				86	AB5010 (MLS), 1.400mm 01/96→ →Eng.320552 AB5020 (MLS), 1.450mm, 1 Hole 01/96→ →Eng.320552 AB5030 (MLS), 1.500mm, 2 Holes 01/96→ →Eng.320552	CY811 ▲ [13] 01/96→	FY811 ▲ [3] 01/96→
Combo 1.7 D	07/94→10/01	1686	4	79.00	SOHC/OHC	44/60			
Corsa B 1.7 D	02/96→09/00								
1.7		17 DR Diesel				87	BY330 (Fibre), 1.300mm BY340 (Fibre), 1.400mm, 1 Notch BY350 (Fibre), 1.500mm, 2 Notches	DL011 ▲	EK485
Astra F 1.7 D	07/92→01/99	1700	4	82.50	SOHC/OHC	42-44/ 57-60			
Kadett E 1.7 D	07/92→07/94								
Vectra A 1.7 D	07/92→11/95								

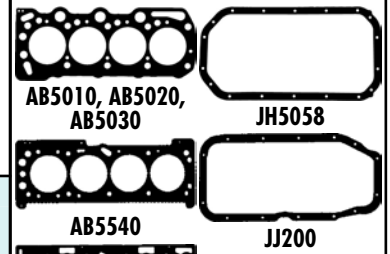

HBS055 [5]
M10x1.25x153.00mm (x10)

JD5400 [1]
JD5401 [1]

JM5235
(Elastomer)

HR5087 [1]

NC006 (x2) [2]
35.00x48.00x7.00mm, MVQ
NA5174 [2] [2]
31.50x42.00x7.00mm, FPM
NB698 [1] [1]
80.00x98.00x10.00mm, FPM
NA5327 [1] [1]
80.00x98.00x14.50mm, PTFE

NA5174 [2][10]

HBS055 [5]
M10x1.25x153.00mm (x10)

JM7103
(Elastomer)

NC006 [2]
35.00x48.00x7.00mm, MVQ
NA5174 [2] [2]
31.50x42.00x7.00mm, FPM
NB698 [1] [1]
80.00x98.00x10.00mm, FPM

NA5174 [2][10]

HBS055 [5]
M10x1.25x153.00mm (x10)

JM7103
(Elastomer)

NC006 [2]
35.00x48.00x7.00mm, MVQ
NA5174 [2] [2]
31.50x42.00x7.00mm, FPM
NB698 [1] [1]
80.00x98.00x10.00mm, FPM

NA5174 [2][10]

HBS055 [5]
M10x1.25x153.00mm (x10)

JD5147 [1]
JD5148 [1]

JM5059
(Elastomer)

HR280 [1]

NC006 [2]
35.00x48.00x7.00mm, MVQ
NB697 [2] [2]
26.00x42.00x8.00mm, FPM
NB698 [1] [1]
80.00x98.00x10.00mm, FPM
NA5327 [1] [1]
80.00x98.00x14.50mm, PTFE

NA5271 [2][10]

HBS074 [5]
M11x1.25x154.00mm (x10)

JC436 [1]
JC437 [1]
JE119 [1]

JN693 [4]

JJ200

HR343 [1]

NC006 [2]
35.00x48.00x7.00mm, MVQ
NB734 [2] [2]
35.00x50.00x8.00mm, FPM
NB806 [1] [1]
90.00x104.00x11.00mm, FPM

NA5271 [2][10]

HBS036 [22]
M12x1.50x102.00mm (x10)
01/96→

JD5914 [1]
01/96→
JD304 [1]
01/96→
JE5029 [1]
01/96→

JN777 [4]

JH5058

PA658 (x8)

NJ449 [2]
40.00x52.00x6.00mm, NBR
01/96→
NJ449 [2] [2]
40.00x52.00x6.00mm, NBR
01/96→
NJ450 [1][2]
45.00x68.00x12.00mm, NBR
01/96→

NA5271 [2][10]

HBS074 [5]
M11x1.25x154.00mm (x10)

JC436 [1]
JD474 [1]
JC437 [1]
JE119 [1]

JN693 [4]

JJ200

HR343 [1]

NC006 [2]
35.00x48.00x7.00mm, MVQ
NB734 [2] [2]
35.00x50.00x8.00mm, FPM
NB806 [1] [1]
90.00x104.00x11.00mm, FPM

NA5271 [2][10]

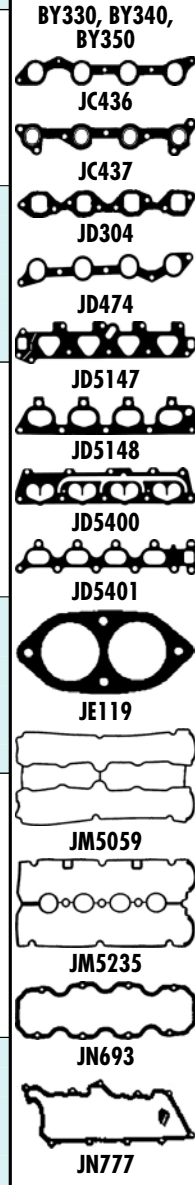



cc



kW/PS



1.7		17 DT (TC4EE1) Diesel			88				
Astra F 1.7 TDS	12/91→09/98	1686	4	79.00	SOHC/OHC	60/82	AB5010 (MLS), 1.400mm →08/94 →Eng.320552	CY811 ▲ [13] →08/94	FY811 ▲ [3] →08/94
Vectra A 1.7 TD	03/90→11/95						AB5020 (MLS), 1.450mm, 1 Hole →08/94 →Eng.320552		
							AB5030 (MLS), 1.500mm, 2 Holes →08/94 →Eng.320552		
1.7		X 17 D (4EE1) Diesel			89				
Combo 1.7 D	07/94→10/01	1686	4	79.00	SOHC/OHC	42-44/ 57-60	AB5010 (MLS), 1.400mm →Eng.320552	CY811 ▲ [13]	FY811 ▲ [3]
Corsa B 1.7 D	02/96→09/00						AB5020 (MLS), 1.450mm, 1 Hole →Eng.320552		
							AB5030 (MLS), 1.500mm, 2 Holes →Eng.320552		
1.7		X 17 DT (TC4EE1) Diesel			90				
Astra F 1.7 TD	03/95→02/98	1686	4	79.00	SOHC/OHC	60/82	AB5010 (MLS), 1.400mm →Eng.320552	CY811 ▲ [13]	FY811 ▲ [3]
Astra F 1.7 TDS	12/91→09/98						AB5020 (MLS), 1.450mm, 1 Hole →Eng.320552		
Vectra A 1.7 TD	03/90→11/95						AB5030 (MLS), 1.500mm, 2 Holes →Eng.320552		
Vectra B 1.7 TD	10/95→12/98								
1.7		X 17 DTL Diesel			91				
Astra F 1.7 TD	08/94→08/00	1700	4	82.50	SOHC/OHC	50/68	AY160 (MLS), 1.300mm	DL012 ▲ [3]	EK486 [3][62]
Astra G 1.7 TD	02/98→04/05						AY170 (MLS), 1.400mm, 1 Notch AY180 (MLS), 1.500mm, 2 Notches		
1.7		Y 17 DT Diesel			92				
Astra G 1.7	02/00→01/05	1686	4	79.00	DOHC	55/75	AE5520 (MLS), 1.450mm, 1 Hole	CE5521 ▲ [3]	EE5520 [3]
Combo 1.7 DTI	10/01→						AE5530 (MLS), 1.500mm, 2 Holes		
Corsa C 1.7 DTI	09/00→12/09						AE5540 (MLS), 1.550mm, 3 Notches		
Meriva 1.7 DTI	09/03→05/10								
1.7		Y 17 DTL Diesel			93				
Combo 1.7 DI	10/01→	1686	4	79.00	DOHC	48/65	AE5520 (MLS), 1.450mm, 1 Hole	CE5521 ▲ [3] Eng.721439→	EE5520 [3]
Corsa C 1.7 DI	09/00→12/09						AE5530 (MLS), 1.500mm, 2 Holes		
Meriva 1.7 DTI	09/03→05/10						AE5540 (MLS), 1.550mm, 3 Notches		
1.7		Z 17 DT Diesel			94				
Meriva 1.7 CDTI	09/03→05/10	1686	4	79.00	DOHC	74/101	AE5520 (MLS), 1.450mm, 1 Hole	CE5523 ▲ [3]	EE5520 [3]
							AE5530 (MLS), 1.500mm, 2 Holes		
							AE5540 (MLS), 1.550mm, 3 Notches		
1.7		Z 17 DTH Diesel			95				
Astra H 1.7 CDTI	03/04→	1686	4	79.00	DOHC	74/100	AE5520 (MLS), 1.450mm, 1 Hole	CE5523 ▲ [3]	EE5520 [3]
Combo 1.7 16V	12/04→						AE5530 (MLS), 1.500mm, 2 Holes		
Corsa C 1.7 CDTI	06/03→12/09						AE5540 (MLS), 1.550mm, 3 Notches		
Meriva 1.7 CDTI	09/03→05/10								
1.7		Z 17 DTL Diesel			96				
Astra G 1.7 CDTI	04/03→07/09	1686	4	79.00	DOHC	59/80	AE5520 (MLS), 1.450mm, 1 Hole	CE5522 ▲ [3]	EE5520 [3]
Astra H 1.7 CDTI	03/04→						AE5530 (MLS), 1.500mm, 2 Holes		
							AE5540 (MLS), 1.550mm, 3 Notches		



AB5010, AB5020,
AB5030



AE5520, AE5530,
AE5540



AY160, AY170,
AY180



JC437

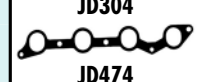

JD304



JD474



JD5329



JD5330

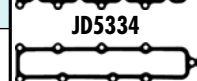

JD5331

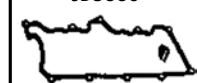

JD5332



JD5334



JD5336



JN777

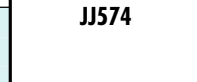

JP018



JH5058



JJ574

HBS036 [22]
M12x1.50x102.00mm (x10)
→08/94

JD5914 [1]
→08/94
JD304 [1]
→08/94
 JE5029
→08/94

JN777 [4]
→08/94

PA658 (x8)
→08/94

NJ449 [2]
40.00x52.00x6.00mm, NBR
→08/94
 NJ449 [2]
40.00x52.00x6.00mm, NBR
→08/94
 NK103 [1]
87.00x100.00x8.50mm, FPM
→08/94

HBS036 [22]
M12x1.50x102.00mm (x10)

JD5914 [1]
JD304 [1]
 JE5029

JN777 [4]

JH5058

PA658 (x8)

NJ449 [2]
40.00x52.00x6.00mm, NBR
 NK103 [1]
87.00x100.00x8.50mm, FPM
 NJ450 [1][2]
45.00x68.00x12.00mm, NBR

HBS036 [22]
M12x1.50x102.00mm (x10)

JD5914 [1]
JD304 [1]
 JE5029

JN777 [4]

PA658 (x8)

NJ449 [2]
40.00x52.00x6.00mm, NBR
 NJ449 [2]
40.00x52.00x6.00mm, NBR
 NK103 [1]
87.00x100.00x8.50mm, FPM

HBS074 [5]
M11x1.25x154.00mm (x10)

JD474 [1]
JC437 [1]

JP018 [4]

JJ574

HR343 [1]

NCO06 [2]
35.00x48.00x7.00mm, MVQ
 NB734 [2]
35.00x50.00x8.00mm, FPM
 NB806 [1]
90.00x104.00x11.00mm, FPM

HBS036 [22]
M12x1.50x102.00mm (x10)

JD5332 [1]
→Eng.721438
JD5336 [1] [2]
JD5333 [1]
Eng.721439→
JD5329 [1]

JM5197
(Elastomer)

HR791 [1]

NB884 [2]
38.00x50.00x5.50mm, FPM
 NJ449 [2]
40.00x52.00x6.00mm, NBR
 NK103 [1]
87.00x100.00x8.50mm, FPM

HBS036 [22]
M12x1.50x102.00mm (x10)

JD5332 [1]
→Eng.721438
JD5336 [1] [2]
JD5333 [1]
Eng.721439→
JD5329 [1]

JM5197
(Elastomer)

HR791 [1]

NB884 [2]
38.00x50.00x5.50mm, FPM
 NJ449 [2]
40.00x52.00x6.00mm, NBR
 NK103 [1]
87.00x100.00x8.50mm, FPM

HBS036 [22]
M12x1.50x102.00mm (x10)

JD5334 [1]
JD5331 [1] (x2)

JM5198
(Elastomer)

HR791 [1]

NB884 [2]
38.00x50.00x5.50mm, FPM
 NJ449 [2]
40.00x52.00x6.00mm, NBR
 NK103 [1]
87.00x100.00x8.50mm, FPM

HBS036 [22]
M12x1.50x102.00mm (x10)

JD5334 [1]
JD5331 [1]

JM5198
(Elastomer)

HR791 [1]

NB884 [2]
38.00x50.00x5.50mm, FPM
 NJ449 [2]
40.00x52.00x6.00mm, NBR
 NK103 [1]
87.00x100.00x8.50mm, FPM

HBS036 [22]
M12x1.50x102.00mm (x10)

JD5334 [1]
JD5330 [1]

JM5198
(Elastomer)

HR791 [1]

NB884 [2]
38.00x50.00x5.50mm, FPM
 NJ449 [2]
40.00x52.00x6.00mm, NBR
 NK103 [1]
87.00x100.00x8.50mm, FPM



cc



kW/PS

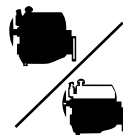

1.8	18 E	97	BM380 (Fibre)		DM381 [3]	EK482
Kadett E 1.8	09/87→08/90	1796	4	84.80	SOHC/OHC	82-85/ 112-115
1.8	18 SE	98	BM380 (Fibre)		DM381 [3]	EK482
Astra F 1.8i Kadett E 1.8	09/95→09/96 12/88→08/91	1796	4	84.80	SOHC/OHC	82-85/ 112-116
1.8	18 SEH	99	BP810 (Fibre)		DP811 [3]	EK482
Omega A 1.8	09/86→03/94	1796	4	84.80	SOHC/OHC	85/115
1.8	18 SV	100	BP810 (Fibre)		DP810	EK482
Kadett E 1.8 i Omega A 1.8 N Omega A 1.8 S Vectra A 1.8 i Vectra A 1.8 S	09/90→08/91 11/86→09/88 09/86→03/94 09/88→10/90 09/89→10/90	1796	4	84.80	SOHC/OHC	63-66/ 86-90
1.8	A 18 XEL	101	AH5240 (MLS)		CH5240	EH5240
Zafira 1.8	10/11→	1796	4	80.50	DOHC	85-88/ 116-120
1.8	A 18 XER	102	AH5240 (MLS)		CH5240	EH5240
Astra GTC J 1.8 Astra H 1.8 Insignia 1.8 Mokka 1.8 Mokka 1.8 4x4 Zafira 1.8 Zafira 1.8 LPG	10/11→ 08/05→ 07/08→ 01/13→ 01/13→ 07/05→ 10/11→	1796	4	80.50	DOHC	101-103/ 137-140
1.8	C 18 NT	103	BM380 (Fibre)		DM381 [3]	
Kadett E 1.8 i	08/84→09/92	1796	4	84.80	SOHC/OHC	66/90
1.8	C 18 NZ	104	BP810 (Fibre)		DP810	EK482
Astra F 1.8 i Kadett E 1.8 i Vectra A 1.8 i	09/91→09/98 06/85→08/91 03/90→11/95	1796	4	84.80	SOHC/OHC	66/90

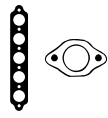

BM380



BP810



JC282



JC283



JC756



JC757



JE120

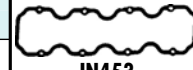

JN453



JN693

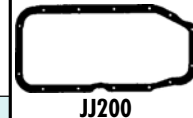

JJ200

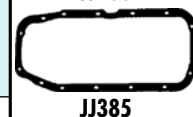

JJ385

OPEL



cc



kW/PS



1.8	C 18 XE	105	BY240 (Fibre)	DY241 [3]	EC130				
Astra F 1.8i	06/93→01/98	1799	4	81.60	DOHC	92/125			
1.8	C 18 XEL	106	BY240 (Fibre)	DY241 [3]	EC130				
Astra F 1.8i	07/94→03/01	1799	4	81.60	DOHC	85/116			
1.8	E 18 NV	107	BP810 (Fibre)	DP810	EK482				
Ascona C 1.8	09/87→08/88	1796	4	84.80	SOHC/OHC	62/84			
Kadett E 1.8 S	09/87→08/91								
1.8	E 18 NVR	108	BP810 (Fibre)	DP810	EK482				
Omega A 1.8	09/87→03/94	1796	4	84.80	SOHC/OHC	65/88			
Vectra A 1.8 S	09/88→07/89								
1.8	S 18 NV	109	BP810 (Fibre)	DP810	EK482				
Kadett E 1.8 i	06/85→08/91	1796	4	84.80	SOHC/OHC	62-74/ 84-101			
Kadett E 1.8 S	09/87→08/91								
1.8	X 18 XE	110	BY240 (Fibre)	DY241 [3]	EC130				
Astra F 1.8i	07/94→03/01	1799	4	81.60	DOHC	85/115			
Vectra B 1.8i	10/95→09/00								

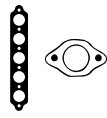

BP810



BY240



JC282



JC757



JD451



JE120



JN693



JP016



JJ385



JJ615



cc



kW/PS

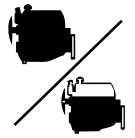

1.8 X 18 XE1		111					AC5460 (MLS)	CC5460 [3]	HC5007
Astra F 1.8 i	03/98→08/00	1796	4	80.50	DOHC	85/115	02/98→	02/98→	
Astra G 1.8 16V	02/98→10/00								
Vectra B 1.8i	10/95→09/00								
Zafira 1.8 16V	04/99→09/00								
1.8 Z 18 XE		112					AC5460 (MLS)	CC5460 [3]	
Astra G 1.8 16V	09/00→10/05	1796	4	80.50	DOHC	90-92/ 122-125			
Astra H 1.8	03/04→								
Corsa C 1.8	09/00→12/09								
Meriva 1.8	05/03→05/10								
Signum 1.8	05/03→								
Tigra 1.8	06/04→								
Vectra B 1.8i	09/00→07/03								
Vectra C 1.8	04/02→								
Zafira 1.8 16V	09/00→06/05								



AC5460



JD5196

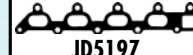

JD5197



JE120

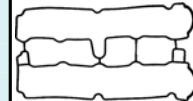

JM5092



cc



kW/PS



1.8		Z 18 XEL				113		AC5460 (MLS)	CC5460 [3]	
Astra F 1.8	02/03→07/04	1796	4	80.50	DOHC	79-85/ 107-116				
Vectra B 1.8i	10/95→09/00									
Vectra C 1.8	04/02→12/06									
1.8		Z 18 XER				114		AH5240 (MLS)	CH5240	EH5240
Astra H 1.8	08/05→	1796	4	80.50	DOHC	103/140				
Signum 1.8	09/05→									
Vectra C 1.8	01/06→									
Zafira 1.8	07/05→									
1.9		F8Q 600 Diesel				115		AY710 (SE), 1.360mm, 2 Notches, 2 Holes →+0.073mm AY720 (SE), 1.440mm, 1 Notch, 1 Hole →0.073→0.206mm AY730 (SE), 1.520mm, 3 Notches, 3 Holes →0.206mm→	DL961 ▲ [3]	EL960 [3] [18]
Arena 1.9 D	03/98→08/01	1870	4	80.00	SOHC/OHC	44/60				
Arena Van 1.9 D	03/98→08/01									
1.9		F8Q 606 Diesel				116		AY710 (SE), 1.360mm, 2 Notches, 2 Holes →+0.073mm AY720 (SE), 1.440mm, 1 Notch, 1 Hole →0.073→0.206mm AY730 (SE), 1.520mm, 3 Notches, 3 Holes →0.206mm→	DL961 ▲ [3]	EL960 [3] [18]
Arena 1.9 D	03/98→08/01	1870	4	80.00	SOHC/OHC	44/60				
Arena Van 1.9 D	03/98→08/01									
1.9		F9Q 760 Diesel				117		AC5061 (MLS), 1.320mm AC5070 (Fibre), 1.350mm, 2 Notches →+0.653mm AC5080 (Fibre), 1.450mm, 1 Notch →0.653→0.786mm AC5090 (Fibre), 1.550mm, 3 Notches →0.786mm→	CC5060 ▲ [3]	EC5060
Vivaro 1.9 DTI	08/01→	1870	4	80.00	SOHC/OHC	74/101				
1.9		F9Q 762 Diesel				118		AC5070 (Fibre), 1.350mm, 2 Notches →+0.653mm AC5080 (Fibre), 1.450mm, 1 Notch →0.653→0.786mm AC5090 (Fibre), 1.550mm, 3 Notches →0.786mm→	CC5060 ▲ [3]	EC5060 EC5063
Vivaro 1.9 DI	08/01→	1870	4	80.00	SOHC/OHC	59-60/ 80-82				
Vivaro 1.9 DTI	08/01→									
Vivaro FM 9/340	08/06→									
1.9		F9Q 770 Diesel				119		AC5070 (Fibre), 1.350mm, 2 Notches →+0.653mm AC5080 (Fibre), 1.450mm, 1 Notch →0.653→0.786mm AC5090 (Fibre), 1.550mm, 3 Notches →0.786mm→	CC5060 ▲ [3]	EC5060
Movano 1.9 DTI	09/00→10/01	1870	4	80.00	SOHC/OHC	59/80				

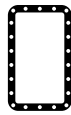
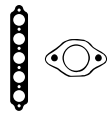

AC5070, AC5080,
AC5090



AC5460



AY710, AY720,
AY730



JD409



JD5196



JD5197



JE120

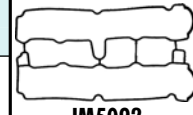

JM5092



JN732



JJ557

HBS055 [5]
M10x1.25x153.00mm (x10)

JD5196 ■
JD5197 ■
☉JE120

JM5092
(Elastomer)

PA5025 (x16)
HR5048 ■ (x1)

☒ NC006 (x2) [2]
35.00x48.00x7.00mm, MVQ
☒ NC065 ■ [2]
30.00x40.00x7.00mm, FPM
→Ch.22999999
→Ch.25999999
→Ch.26999999
→Ch.28999999
→Ch.28999999
→Ch.2H999999

NA5174 [2] [10]

HBS055 [5]
M10x1.25x153.00mm (x10)

JD5982 ■

JM7103
(Elastomer)

☒ NC006 [2]
35.00x48.00x7.00mm, MVQ
☒ NA5174 ■ [2]
31.50x42.00x7.00mm, FPM

NA5174 [2] [10]

HBS244 [22]
M12x1.50x111.00mm (x10)

JD409

JN732 [4]

JJ557

HR569 ■

☒ NF846 [2]
25.00x42.00x7.00mm, FPM/ACM
☒ NA5036 ■ [2]
42.00x54.00x6.00mm, FPM
☒ NF850 ■ [1]
85.00x105.00x8.00mm, FPM

HBS244 [22]
M12x1.50x111.00mm (x10)

JD409

JN732 [4]

JJ557

HR569 ■

☒ NF846 [2]
25.00x42.00x7.00mm, FPM/ACM
☒ NA5036 ■ [2]
42.00x54.00x6.00mm, FPM
☒ NF850 ■ [1]
85.00x105.00x8.00mm, FPM

HBS372 [22]
M12x1.50x121.00mm (x10)

JD5189

JM5086
(Elastomer)

JH5041

HR646 ■

☒ NF846 [2]
25.00x42.00x7.00mm, FPM/ACM
☒ NA5036 ■ [2]
42.00x54.00x6.00mm, FPM
☒ NA5037 ■ [1]
85.00x105.00x11.00mm, ACM

HBS372 [22]
M12x1.50x121.00mm (x10)

JD5189

JM5086
(Elastomer)

JH5041
=KG5012
16.00x23.00x1.500mm

HR646 ■

☒ NF846 [2]
25.00x42.00x7.00mm, FPM/ACM
☒ NA5036 ■ [2]
42.00x54.00x6.00mm, FPM
☒ NA5037 ■ [1]
85.00x105.00x11.00mm, ACM

HBS372 [22]
M12x1.50x121.00mm (x10)

JD5189

JM5086
(Elastomer)

JH5041
=KG5012
16.00x23.00x1.500mm

HR646 ■

☒ NF846 [2]
25.00x42.00x7.00mm, FPM/ACM
☒ NA5036 ■ [2]
42.00x54.00x6.00mm, FPM
☒ NA5037 ■ [1]
85.00x105.00x11.00mm, ACM



cc



kW/PS



1.9	F9Q 772 Diesel	1870	4	80.00	SOHC/OHC	120	60/82	AC5070 (Fibre), 1.350mm, 2 Notches →0.653mm AC5080 (Fibre), 1.450mm, 1 Notch →0.653→0.786mm AC5090 (Fibre), 1.550mm, 3 Notches →0.786mm→	CC5060 ▲ [3]	EC5060
Movano 1.9 DTI	10/01→									
1.9	F9Q 774 Diesel	1870	4	80.00	SOHC/OHC	121	60/82	AC5070 (Fibre), 1.350mm, 2 Notches →0.653mm AC5080 (Fibre), 1.450mm, 1 Notch →0.653→0.786mm AC5090 (Fibre), 1.550mm, 3 Notches →0.786mm→	CC5060 ▲ [3]	EC5060 EC5063
Movano 1.9 DTI	10/01→									
Vivaro 1.9 DI	08/01→									
1.9	Z 19 DT Diesel	1910	4	82.00	SOHC/OHC	122	88/120	AG7440 (MLS) AG7390 (MLS), 0.820mm AG7400 (MLS), 0.920mm, 1 Hole	CA5561 ▲ →Eng.4244825 CG7390 ▲ Eng.4244826→	EE5181 [3]
Astra H 1.9 CDTI	06/04→									
Signum 1.9 CDTI	04/04→									
Vectra C 1.9	04/04→									
Zafira 1.9 CDTI	07/05→									
1.9	Z 19 DTH Diesel	1910	4	82.00	DOHC	123	110/150	AD5840 (MLS), 0.820mm, 0 Holes AD5850 (MLS), 0.920mm, 1 Hole AD5860 (MLS), 1.020mm, 2 Holes	CD5840 ▲	EE5181 [3]
Astra H 1.9 CDTI	09/04→									
Signum 1.9 CDTI	04/04→									
Vectra C 1.9	04/04→									
Zafira 1.9 CDTI	07/05→									
1.9	Z 19 DTJ Diesel	1910	4	82.00	DOHC	124	88/120	AD5840 (MLS), 0.820mm, 0 Holes AD5850 (MLS), 0.920mm, 1 Hole AD5860 (MLS), 1.020mm, 2 Holes	CD5840 ▲	EE5181 [3]
Astra H 1.9 CDTI	04/04→									
1.9	Z 19 DTL Diesel	1910	4	82.00	DOHC	125	74/101	AG7440 (MLS) AG7390 (MLS), 0.820mm AG7400 (MLS), 0.920mm, 1 Hole	CG7390 ▲	EE5181 [3]
Astra H 1.9 CDTI	09/05→									
Vectra C 1.9	10/05→									
Zafira 1.9 CDTI	07/05→									
2.0	20 E	1979	4	95.00	CIH	126	81/110	BJ170 (Fibre)		EJ160
Manta B 2.0 E	08/77→08/88									
2.0	20 NE	1998	4	86.00	SOHC/OHC	127	85-95/ 115-129	BP820 (Fibre)	DP820 [3]	EK482
Ascona C 2.0 i	09/86→08/88									
Kadett E 2.0 i	10/86→02/93									
Kadett E 2.0 GSI	09/86→08/91									
Vectra A 2.0 i	09/88→10/90									
2.0	20 NEJ	1998	4	86.00	SOHC/OHC	128	82/112	BP820 (Fibre)	DP820 [3]	HC5007
Vectra B 2.0 i	10/95→04/02									

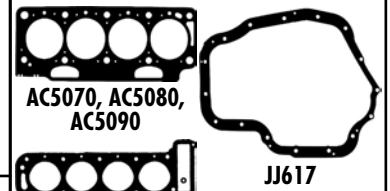
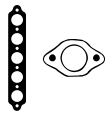

HBS372 [22]
M12x1.50x121.00mm (x10)

JD5189

JM5086
(Elastomer)

JH5041
=KG5012
16.00x23.00x1.500mm

HR646

NF846 [2]
25.00x42.00x7.00mm, FPM/ACM
NA5036 [2]
42.00x54.00x6.00mm, FPM
NA5037 [1]
85.00x105.00x11.00mm, ACM

HBS372 [22]
M12x1.50x121.00mm (x10)

JD5189

JM5086
(Elastomer)

JH5041
=KG5012
16.00x23.00x1.500mm

HR646

NF846 [2]
25.00x42.00x7.00mm, FPM/ACM
NA5036 [2]
42.00x54.00x6.00mm, FPM
NA5037 [1]
85.00x105.00x11.00mm, ACM

HBS227 [5]
M12x1.25x218.00mm (x10)

JA5035
JD468
(MLS)

JM5028
(Elastomer)
→Eng.4244825
JM5204
(Elastomer)
Eng.4244826 →

HR397

HR363

NA5053 [2]
30.00x42.00x7.00mm, FPM
NA5070 [2]
31.00x41.00x7.00mm, FPM
NF888 [1]
93.00x172.00x12.00mm, FPM

HBS370 [5]
M12x1.25x225.00mm (x10)

JD5376
JD468
(MLS)

JM7055
(SE)

HR5095
→Eng.17180894

NA5053 [2]
30.00x42.00x7.00mm, FPM
NA5070 [2]
31.00x41.00x7.00mm, FPM
NF888 [1]
93.00x172.00x12.00mm, FPM

HBS370 [5]
M12x1.25x225.00mm (x10)

JD5376
JD468
(MLS)

JM7055
(SE)

HR5095

NA5053 [2]
30.00x42.00x7.00mm, FPM
NA5070 [2]
31.00x41.00x7.00mm, FPM
NF888 [1]
93.00x172.00x12.00mm, FPM

HBS227 [5]
M12x1.25x218.00mm (x10)

JD5376
JD468
(MLS)

JM5204
(Elastomer)

HR363

NA5053 [2]
30.00x42.00x7.00mm, FPM
NA5070 [2]
31.00x41.00x7.00mm, FPM
NF888 [1]
93.00x172.00x12.00mm, FPM

HBS161 [22]
M12x1.50x64.00mm (x5)

JC155

JN041 [4]

HC417

PA619 (x4)
9.00/17.00x14.20
(ACM)
HR336

NB628 [2]
45.00x60.00x9.00mm, ACM
NB469 [1]
77.00x100.00x11.50mm, FPM

HBS053 [5]
M11x1.25x140.00mm (x10)

JC756
JC282
⊕JE120

JN693 [4]

JJ385

PA565 (x8)
HR342 (x1)

NC006 [2]
35.00x48.00x7.00mm, MVQ
NB807 [1]
55.00x70.10x8.00mm, FPM
NB700 [2]
31.00x50.00x8.00mm, MVQ
NB806 [1]
90.00x104.00x11.00mm, FPM

HBS053 [5]
M11x1.25x140.00mm (x10)

JC756
JC282
⊕JE120

JN693 [4]

JJ616
JJ617

PA565
HR342

NC006 [2]
35.00x48.00x7.00mm, MVQ
NB700 [2]
31.00x50.00x8.00mm, MVQ
NB806 [1]
90.00x104.00x11.00mm, FPM

BJ170

BP820

JA5035

JC155

JC282

JC756

JD468

JD5376

JE120

JM5028

JM5204

JN041

JN693

HC417

JJ385

JJ616



cc



kW/PS



2.0		20 SE				129		BP820 (Fibre)	DP820 [3]	EK482
Kadett E 2.0 i	03/87→08/91	1998	4	86.00	SOHC/OHC	85-90/	115-122			
Omega A 2.0	09/86→03/94									
Omega B 2.0	03/94→12/00									
2.0		20 SEH				130		BP820 (Fibre)	DP820 [3]	EK482
Ascona C 2.0GT	03/87→08/88	1998	4	86.00	SOHC/OHC	95/129				
Kadett E 2.0GSI	09/86→08/91									
Vectra A 2.0 GT	09/88→11/95									
Vectra A 2.0 i	09/88→09/92									
2.0		20 XE				131		BS720 (Fibre)	DS720	ES720
Kadett E 2.0GSI	12/87→08/91	1998	4	86.00	DOHC	115/156				
2.0		20 XEJ				132		BS720 (Fibre)	DS720	ES720
Kadett E 2.0GSI	03/88→08/91	1998	4	86.00	DOHC	110/150				
Vectra A 2.0 i	02/89→10/90									
Vectra A 2000	01/89→10/90									
Vectra A GT	01/89→06/94									
2.0		A 20 DT Diesel				133		AH7170 (MLS), 0.95mm, 0 Notches AH7180 1.05mm, 1 Notch AH7190 (MLS), 1.15mm, 2 Notches		
Insignia 2.0	07/08→	1956	4	83.00	DOHC	96/131				
Zafira 2.0 CDTi	10/11→									
2.0		A 20 DTC Diesel				134		AH7170 (MLS), 0.95mm, 0 Notches AH7180 1.05mm, 1 Notch AH7190 (MLS), 1.15mm, 2 Notches		
Insignia 2.0	07/08→	1956	4	83.00	DOHC	81/110				
2.0		A 20 DTH Diesel				135		AH7170 (MLS), 0.95mm, 0 Notches AH7180 1.05mm, 1 Notch AH7190 (MLS), 1.15mm, 2 Notches		
Astra GTC J 2.0	10/11→	1956	4	83.00	DOHC	118-121/	160-165			
Astra J 2.0CDTi	12/09→									
Astra Sport 2.0	10/10→									
Cascada 2.0CDTi	03/13→									
Insignia 2.0	07/08→									
Zafira 2.0 CDTi	10/11→									
2.0		A 20 DTJ Diesel				136		AH7170 (MLS), 0.95mm, 0 Notches AH7180 1.05mm, 1 Notch AH7190 (MLS), 1.15mm, 2 Notches		
Insignia 2.0	07/08→	1956	4	83.00	DOHC	96/131				
2.0		A 20 DTL Diesel				137		AH7170 (MLS), 0.95mm, 0 Notches AH7180 1.05mm, 1 Notch AH7190 (MLS), 1.15mm, 2 Notches		
Insignia 2.0	07/08→	1956	4	83.00	DOHC	81/110				
Zafira 2.0 CDTi	10/11→									



BP820



BS720



JC282



JC756

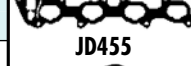

JD455



JE120



JM950



JN693



JJ385



JJ459

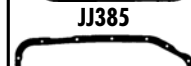

NA5070



NF888



cc



kW/PS



2.0	A 20 DTR Diesel						138	AH7170 (MLS), 0.95mm, 0 Notches AH7180 1.05mm, 1 Notch AH7190 (MLS), 1.15mm, 2 Notches		
Astra GTC J 2.0	10/12→	1956	4	83.00	DOHC	140-143/ 190-195				
Astra J 2.0CDTI	12/12→									
Astra Sport 2.0	12/12→									
Cascada 2.0CDTI	03/13→									
Insignia 2.0	07/08→									
Insignia 60-94	01/12→									
Zafira 2.0 CDTI	01/13→									
2.0	A 20 NFT						139	AH6380 (MLS), 0.64mm [132]		
Astra GTC J 2.0	04/12→	1998	4	86.00	DOHC	162-206/ 220-280				
Insignia 2.0T	09/11→									
2.0	A 20 NHT						140	AH6380 (MLS), 0.64mm [132]		
Insignia 2.0T	07/08→	1998	4	86.00	DOHC	162/220				
2.0	C 20 LET						141	BY260 (Fibre)	DY260	ES720
Calibra A 2.0iT	03/92→07/97	1998	4	86.00	DOHC	150/204				
Vectra A 2.0T	06/94→11/95									
2.0	C 20 NE						142	BP820 (Fibre)	DP820 [3]	EK482
Ascona C 2.0 i	09/86→08/88	1998	4	86.00	SOHC/OHC	85/115				
Astra F 2.0 i	09/91→09/98									
Calibra A 2.0 i	06/90→07/97									
Frontera A	03/92→10/98									
Kadett E 2.0 i	10/86→02/93									
Kadett E 2.0GSI	09/86→08/91									
Omega A 2.0	09/87→04/94									
Omega A 2.0 i	09/86→03/94									
Vectra A 2.0 i	09/88→11/95									
2.0	C 20 NEF						143	BP820 (Fibre) 01/88→12/88	DP820 [3] 01/88→12/88	EK482 01/88→12/88
Ascona C 2.0 i	08/87→08/88	1998	4	86.00	SOHC/OHC	74/100				
Vectra A 2.0	04/88→09/89									
2.0	C 20 NEJ						144	BP820 (Fibre)	DP820 [3]	EK482
Omega A 2.0	09/90→03/94	1998	4	86.00	SOHC/OHC	73-74/ 99-100				
Omega A 2.0 i	09/90→03/94									
2.0	C 20 SEL						145	BY250 (Fibre)	DY250 [3]	HC5007
Astra G 2.0 16V	02/98→01/05	1998	4	86.00	DOHC	100/136				
Vectra B 2.0i	10/95→09/00									

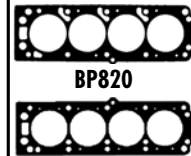

BP820



BY250



BY260



JC282



JC756



JD451



JD455



JD456



JE120



JM950



JN693



JP016



JJ385

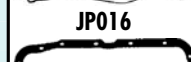

JJ459



JJ616

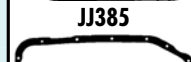

JJ617

					<p>☒ NA5070 ☒ [2] 31.00x41.00x7.00mm, FPM</p> <p>☒ NF888 ☒ [1] 93.00x172.00x12.00mm, FPM</p>	
<p>HBS416 [22] M11x1.50x163.00mm (x10)</p>					<p>☒ NA5108 ☒ [2] 42.00x55.00x7.00mm, FPM/ACM</p>	
<p>HBS416 [22] M11x1.50x163.00mm (x10)</p>					<p>☒ NA5108 ☒ [2] 42.00x55.00x7.00mm, FPM/ACM</p>	
<p>HBS035 ☉ [5] M11x1.25x110.00mm (x10) →Eng.14137011</p> <p>HBS054 ☉ [5] M11x1.25x105.00mm (x10) Eng.14003805→</p>	<p>JD455 ■ JD456 ■</p>	<p>JM950 [4]</p>	<p>JJ459 (x2)</p>	<p>PA565 (x16) HR342 ☒ (x2)</p>	<p>☒ NC006 (x2) [2] 35.00x48.00x7.00mm, MVQ</p> <p>☒ NB884 ☒ [2] 38.00x50.00x5.50mm, FPM</p> <p>☒ NB806 ☒ [1] 90.00x104.00x11.00mm, FPM</p>	
<p>HBS053 ☉ [5] M11x1.25x140.00mm (x10) 01/97→12/96</p>	<p>JC756 ■ JC282 ■ ☉ JE120</p>	<p>JN693 [4]</p>	<p>JJ385</p>	<p>PA565 (x8) HR342 ☒ (x1)</p>	<p>☒ NC006 [2] 35.00x48.00x7.00mm, MVQ</p> <p>☒ NB807 [1] 55.00x70.10x8.00mm, FPM</p> <p>☒ NB700 ☒ [2] 31.00x50.00x8.00mm, MVQ</p> <p>☒ NB806 ☒ [1] 90.00x104.00x11.00mm, FPM</p>	
<p>HBS053 ☉ [5] M11x1.25x140.00mm (x10) 01/88→12/88</p>	<p>JC756 ■ 01/88→12/88 JC282 ■ 01/88→12/88 ☉ JE120 01/88→12/88</p>	<p>JN693 [4] 01/88→12/88</p>	<p>JJ385 01/88→12/88</p>	<p>PA565 (x8) HR342 ☒ 01/88→12/88</p>	<p>☒ NC006 [2] 35.00x48.00x7.00mm, MVQ 01/88→12/88</p> <p>☒ NB807 [1] 55.00x70.10x8.00mm, FPM 01/88→12/88</p> <p>☒ NB700 ☒ [2] 31.00x50.00x8.00mm, MVQ 01/88→12/88</p> <p>☒ NB806 ☒ [1] 90.00x104.00x11.00mm, FPM 01/88→12/88</p>	
<p>HBS053 ☉ [5] M11x1.25x140.00mm (x10)</p>	<p>JC756 ■ JC282 ■</p>	<p>JN693 [4]</p>	<p>JJ385</p>	<p>PA565 HR342 ☒</p>	<p>☒ NC006 [2] 35.00x48.00x7.00mm, MVQ</p> <p>☒ NB807 [1] 55.00x70.10x8.00mm, FPM</p> <p>☒ NB700 ☒ [2] 31.00x50.00x8.00mm, MVQ</p> <p>☒ NB806 ☒ [1] 90.00x104.00x11.00mm, FPM</p>	
<p>HBS054 ☉ [5] M11x1.25x105.00mm (x10)</p>	<p>JD451 ■ JD5300 ■ (MLS) ☉ JE120</p>	<p>JP016 [4]</p>	<p>JJ616 ☒ [133] JJ617 ☒ [133]</p>	<p>PA5041 (x16) 6.00/12.20x10.00 (FPM) HR791 ☒</p>	<p>☒ NC006 [2] 35.00x48.00x7.00mm, MVQ</p> <p>☒ NB700 ☒ [2] 31.00x50.00x8.00mm, MVQ</p> <p>☒ NB806 ☒ [1] 90.00x104.00x11.00mm, FPM</p>	









cc

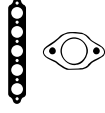

kw/PS

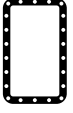

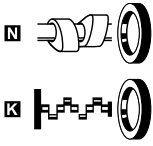
2.0	C 20 XE	146			BS720 (Fibre)	DS720	ES720
Astra F 2.0 GSI	09/91→01/98	1998	4	86.00	DOHC	110/150	
Astra F 2.0i	03/93→01/98						
Calibra A 2.0 i	06/90→02/94						
Kadett E 2.0	09/90→05/92						
Kadett E 2.0GSI	03/88→08/91						
Vectra A 2.0 GT	02/90→11/95						
Vectra A 2.0 i	02/90→11/95						
2.0	F4R 720	147			AD5990 (MLS)	CD5991	ED5991
Vivaro 2.0 16V	08/01→	1998	4	82.70	DOHC	88/120	
2.0	F4R 820	148			AD5990 (MLS)	CD5991	ED5991
Vivaro 2.0 ECO	08/06→	1998	4	82.70	DOHC	86/117	
2.0	LNF	149			AH6380 (MLS), 0.64mm [132]		
GT Cabrio 2.0	06/07→	1998	4	86.00	DOHC	194/264	
2.0	M9R 780 Diesel	150			AG9760 (MLS)		
Vivaro 2.0 CDTI	08/06→	1995	4	84.00	DOHC	66-84/ 90-114	
2.0	X 20 DTH Diesel	151			AB5670 (MLS), 1.300mm, 1 Notch AB5680 (MLS), 1.400mm, 2 Notches	CB5670 ▲ [13]	EB5670 [3]
Astra F 2.0 DTi	08/99→08/00	1995	4	84.00	SOHC/OHC	74/101	
Astra G 2.0	08/99→01/05						
Omega B 2.0 16V	09/97→09/00						
Vectra B 2.0	06/97→07/03						
2.0	X 20 DTL Diesel	152			AB5670 (MLS), 1.300mm, 1 Notch AB5680 (MLS), 1.400mm, 2 Notches	CB5670 ▲ [13]	EB5670 [3]
Astra F 2.0 Di	03/98→08/00	1995	4	84.00	SOHC/OHC	60/82	
Astra G 2.0 DI	02/98→04/05						
Vectra B 2.0 DI	11/96→04/02						
Zafira 2.0 DI	10/99→06/05						
2.0	X 20 SE	153			BP820 (Fibre)	DP823 [3]	EC130
Frontera A	03/92→10/98	1998	4	86.00	SOHC/OHC	85/115	
Omega B 2.0	03/94→09/99						
2.0	X 20 XER	154			BY250 (Fibre)	DY250 [3]	HC5007
Astra F 2.0 i	10/99→08/00	1998	4	86.00	DOHC	118/160	
Astra G 2.0	11/99→09/02						
2.0	X 20 XEV	155			BY250 (Fibre)	DY250 [3]	EC130 HC5007 [133]
Astra F 2.0 i	03/98→08/00	1998	4	86.00	DOHC	100/136	
Astra F 2.0i	02/95→09/98						
Astra G 2.0 16V	02/98→01/05						
Calibra A 2.0 i	02/94→07/97						
Omega B 2.0 16V	03/94→09/99						
Vectra A 2.0 i	06/94→11/95						
Vectra B 2.0i	10/95→09/00						

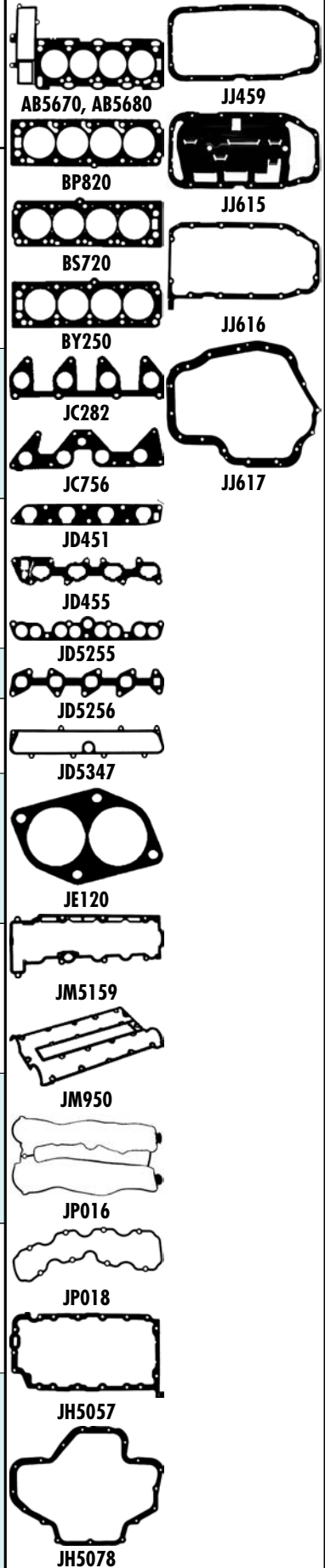
								
HBS035 [5] M11x1.25x110.00mm (x10) →Eng.14137011 HBS054 [5] M11x1.25x105.00mm (x10) Eng.14137012→	JD455 [1] JD5980 [1]	JM950 [4]	JJ459 (x2)	PA565 (x16) HR342 [x2]	NC006 (x2) [2] 35.00x48.00x7.00mm, MVQ NB884 [2] 38.00x50.00x5.50mm, FPM NB806 [1] 90.00x104.00x11.00mm, FPM			AB5670, AB5680 BP820 BS720 BY250 JC282 JC756 JD451 JD455 JD5255 JD5256 JD5347 JE120 JM5159 JM950 JP016 JP018 JH5078
HBS310 [22] M12x1.50x117.00mm (x10)		HR397 [1]	JH5041	PA5013 (x16)	NA5257 [2] 28.00x47.00x5.50mm, FPM NA5036 [2] 42.00x54.00x6.00mm, FPM NA5037 [1] 85.00x105.00x11.00mm, ACM			JJ459 JJ615 JJ616 JJ617
HBS310 [22] M12x1.50x117.00mm (x10)		HR397 [1]	JH5041		NA5257 [2] 28.00x47.00x5.50mm, FPM NA5036 [2] 42.00x54.00x6.00mm, FPM NA5037 [1] 85.00x105.00x11.00mm, ACM			JJ616 JJ617
	JD5867 [1] (SE)				NA5108 [2] 42.00x55.00x7.00mm, FPM/ACM			
	JD5937 [1] (MLS)							
HBS298 [22] M12x1.50x235.00mm (x10)	JD5255 [1] JD5347 [1] [2] JD5256 [1]	JM5159 (SE)	JH5057 JH5078 [2]	PA5041 (x16) 6.00/12.20x10.00 (FPM) HR791 [1]	NA5069 [2] 55.00x68.00x8.00mm, FPM NA5209 [1] 99.00x114.00x11.00mm, FPM NB469 [1] 77.00x100.00x11.50mm, FPM	JR5029 [6]		JR5029 [6]
HBS298 [22] M12x1.50x235.00mm (x10)	JD5255 [1] JD5347 [1] [2] JD5256 [1]	JM5159 (SE)	JH5057	PA5041 (x16) 6.00/12.20x10.00 (FPM) HR791 [1]	NA5069 [2] 55.00x68.00x8.00mm, FPM NA5209 [1] 99.00x114.00x11.00mm, FPM NB469 [1] 77.00x100.00x11.50mm, FPM	JR5029 [6]		JR5029 [6]
HBS053 [5] M11x1.25x140.00mm (x10) 01/97→	JC756 [1] JC282 [1] ⊙JE120	JP018 [4]	JJ615	PA565 (x8) HR342 [x1]	NC006 [2] 35.00x48.00x7.00mm, MVQ NB700 [2] 31.00x50.00x8.00mm, MVQ NB806 [1] 90.00x104.00x11.00mm, FPM			JM950 JP016 JP018
HBS054 [5] M11x1.25x105.00mm (x10)		JP016 [4]	JJ616 [2] JJ617 [2]	HR791 [1]	NC006 [x2] [2] 35.00x48.00x7.00mm, MVQ NB700 [2] 31.00x50.00x8.00mm, MVQ NB806 [1] 90.00x104.00x11.00mm, FPM			JP016 JP018
HBS054 [5] M11x1.25x105.00mm (x10)	JD451 [1] JD5300 [1] (MLS) ⊙JE120	JP016 [4]	JJ615 JJ616 [1] [3] JJ617 [2]	PA5041 (x16) 6.00/12.20x10.00 (FPM) HR791 [x1]	NC006 (x2) [2] 35.00x48.00x7.00mm, MVQ NB700 [2] 31.00x50.00x8.00mm, MVQ NB806 [1] 90.00x104.00x11.00mm, FPM			JH5078



cc



kW/PS



2.0	Y 20 DTH Diesel	156	AB5670 (MLS), 1.300mm, 1 Notch	CB5670 ▲ [13]	EB5670 [3]				
Astra G 2.0	08/99→01/05	1995	4	84.00	SOHC/OHC	74/101	AB5680 (MLS), 1.400mm, 2 Notches		
Signum 2.0 DTI	05/03→								
Vectra B 2.0	06/97→07/03								
Vectra C 2.0	04/02→								
Zafira 2.0 DTI	09/00→06/05								
2.0	Y 20 DTL Diesel	157	AB5670 (MLS), 1.300mm, 1 Notch	CB5670 ▲ [13]	EB5670 [3]				
Astra G 2.0 DI	02/98→01/05	1995	4	84.00	SOHC/OHC	60-63/ 82-86	AB5680 (MLS), 1.400mm, 2 Notches		
Zafira 2.0 DTI	11/03→06/05								
2.0	Z 20 DM Diesel	158	AH5690 (MLS)	CH5690					
Antara 2.0 CDTI	09/08→	1991	4	83.00	DOHC	93/126	AH5700 (MLS), 1.200mm, 2 Holes AH5710 (MLS), 1.300mm, 3 Holes		
2.0	Z 20 DMH Diesel	159	AH5690 (MLS)	CH5690					
Antara 2.0	05/06→	1991	4	83.00	DOHC	110/150	AH5700 (MLS), 1.200mm, 2 Holes AH5710 (MLS), 1.300mm, 3 Holes		
Antara 2.0 CDTI	05/06→								
2.0	Z 20 LEH	160							EG9570
Astra H 2.0T	03/05→	1998	4	86.00	DOHC	177/240			
Zafira 2.0	01/06→								
2.0	Z 20 LEL	161	AG9570 (MLS)	CG9570	EG9570				
Astra H 2.0T	03/04→	1998	4	86.00	DOHC	125/170			
Zafira 2.0	07/05→								
2.0	Z 20 LER	162	AG9570 (MLS)	CG9570	EG9570				
Astra H 2.0T	09/04→	1998	4	86.00	DOHC	147/200			
Zafira 2.0	07/05→								
Zafira 2.0 OPC	11/02→06/05								
2.0	Z 20 LET	163	AG9570 (MLS)	CG9570	EG9570				
Astra G 2.0 OPC	03/02→10/05	1998	4	86.00	DOHC	140-162/ 190-220			
Astra G 2.0 T	09/00→10/05								
Speedster 2.0	10/03→08/06								
Speedster 2.0 T	04/03→								
Zafira 2.0 OPC	09/01→06/05								
2.0	Z 20 NET	164	AG9580 (MLS)	CG9581					
Signum 2.0 T	05/03→	1998	4	86.00	DOHC	129/175			
Vectra C 2.0T	03/03→								
2.0	Z 20 NHH	165	AH6380 (MLS), 0.64mm [132]						
GT Cabrio 2.0	06/07→	1998	4	86.00	DOHC	194/264			
2.0	Z 20 S Diesel	166	AH5690 (MLS)	CH5690					
Antara 2.0	05/06→	1991	4	83.00	DOHC	93-110/ 126-150	AH5700 (MLS), 1.200mm, 2 Holes AH5710 (MLS), 1.300mm, 3 Holes		
Antara 2.0 CDTI	05/06→								
2.2	C223 Diesel	167	BM370 (Fibre) BR200 (Steel)	DM370 ○ [3] DR200 [3]	GM370 ○ [3] GM372 [13]				
Campo 2.2 D	08/87→09/96	2238	4	88.00	SOHC/OHC	39-54/ 53-73			

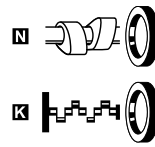
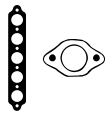

AB5670, AB5680



BM370



BR200



JC643



JD451

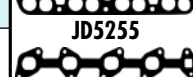

JD5255

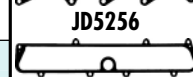

JD5256

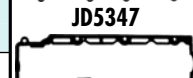

JD5347

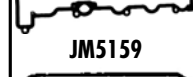

JM5159

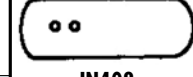

JN408



JP016



JH5057



JJ616



JJ617



HBS298 [22]
M12x1.50x235.00mm (x10)

JD5347 [1] [2]
JD5255 [1] [2]
JD5256 [1]

JM5159
(SE)

JH5057

PA5041 (x16)
6.00/12.20x10.00
(FPM)
HR791 [1]

[1] NA5069 [1] [2]
55.00x68.00x8.00mm, FPM
[1] NA5209 [1] [1]
99.00x114.00x11.00mm, FPM
[1] NB469 [1] [1]
77.00x100.00x11.50mm, FPM

JR5029 [6]

HBS298 [22]
M12x1.50x235.00mm (x10)

JD5255 [1]
JD5347 [1] [2]
JD5256 [1]

JM5159
(SE)

JH5057

PA5041 (x16)
6.00/12.20x10.00
(FPM)
HR791 [1]

[1] NA5069 [1] [2]
55.00x68.00x8.00mm, FPM
[1] NA5209 [1] [1]
99.00x114.00x11.00mm, FPM
[1] NB469 [1] [1]
77.00x100.00x11.50mm, FPM

JR5029 [6]

JM7115
(NBR)

JM7115
(NBR)

HBS054 [5]
M11x1.25x105.00mm (x10)

JD451 [1]
JD5903 [1]
(MLS)

JP016 [4]

JJ616 [2]
JJ617 [2]

HR791 [1]

[1] NC006 [2]
35.00x48.00x7.00mm, MVQ
[1] NB700 [1] [2]
31.00x50.00x8.00mm, MVQ
[1] NB806 [1] [1]
90.00x104.00x11.00mm, FPM

HBS054 [5]
M11x1.25x105.00mm (x10)

JD451 [1]
JD5903 [1]
(MLS)

JP016 [4]

JJ616 [2]
JJ617 [2]

HR791 [1]

[1] NC006 [2]
35.00x48.00x7.00mm, MVQ
[1] NB700 [1] [2]
31.00x50.00x8.00mm, MVQ
[1] NB806 [1] [1]
90.00x104.00x11.00mm, FPM

HBS054 [5]
M11x1.25x105.00mm (x10)

JD451 [1]
JD5903 [1]
(MLS)

JP016 [4]

JJ616 [2]
JJ617 [2]

HR791 [1]

[1] NC006 [2]
35.00x48.00x7.00mm, MVQ
[1] NB700 [1] [2]
31.00x50.00x8.00mm, MVQ
[1] NB806 [1] [1]
90.00x104.00x11.00mm, FPM

HBS054 [5]
M11x1.25x105.00mm (x10)

JD451 [1]
JD5903 [1]
(MLS)

JP016 [4]

JJ616 [2]
JJ617 [2]

HR791 [1]

[1] NC006 (x2) [2]
35.00x48.00x7.00mm, MVQ
[1] NB700 [1] [2]
31.00x50.00x8.00mm, MVQ
[1] NB806 [1] [1]
90.00x104.00x11.00mm, FPM

HBS416 [22]
M11x1.50x163.00mm (x10)

JD5867 [1]
(SE)

HM5370 [1]

HR397

[1] NAS108 [1] [2]
42.00x55.00x7.00mm, FPM/ACM
[1] NB806 [1] [1]
90.00x104.00x11.00mm, FPM
[1] NAS108 [1] [2]
42.00x55.00x7.00mm, FPM/ACM

JM7115
(NBR)

HBS286 [22]
M11x1.50x116.00mm (x16)

JC643
JE019

JN408 [4]

[1] NJ267 [2]
42.00x55.00x9.00mm, NBR
[1] NJ266 [1] [2]
65.00x84.00x9.00mm, NBR
[1] NJ265 [1] [1]
82.00x105.00x13.00mm, MVQ



cc



kW/PS



2.2	G9T 720 Diesel	168	AE5210 (MLS), 1.240mm		CE5210	EE5220 [3]
Movano 2.2 DTI	09/00→	2188	4	87.00 DOHC	66/90	
2.2	G9T 722 Diesel	169	AE5210 (MLS), 1.240mm		CE5210	EE5220 [3]
Movano 2.2 DTI	09/00→	2188	4	87.00 DOHC	66/90	
2.2	G9T 750 Diesel	170	AE5210 (MLS), 1.240mm		CE5210	EE5220 [3]
Movano 2.2 DTI	09/00→	2188	4	87.00 DOHC	66/90	
2.2	X 22 DTH Diesel	171	AB5670 (MLS), 1.300mm, 1 Notch AB5680 (MLS), 1.400mm, 2 Notches		CB5670 ▲ [13] →Eng.2V599999 CB5671 ▲ [13] Eng.3V500001→	EB5670 [3][134] EB5671 [3][135]
Frontera B	10/98→09/02	2171	4	84.00 SOHC/OHC	85/116	
Sintra 2.2 DTI	07/97→04/99					
2.2	X 22 SE	172	BY250 (Fibre)		DY254	EC102
Frontera B	10/98→	2198	4	86.00 DOHC	100-104/ 136-141	
2.2	X 22 XE	173	BY250 (Fibre)		DY251 [3]	EC100 [3]
Frontera A	03/95→10/98	2198	4	86.00 DOHC	100-104/ 136-141	
Sintra 2.2i 16V	11/96→04/99					
2.2	Y 22 DTH Diesel	174	AB5670 (MLS), 1.300mm, 1 Notch AB5680 (MLS), 1.400mm, 2 Notches		CB5670 ▲ [13] →Eng.2V599999 CB5671 ▲ [13] Eng.3V500001→	EB5670 [3][136] EB5671 [3][135]
Frontera B	10/98→09/02	2171	4	84.00 SOHC/OHC	81-88/ 110-120	
Omega B 2.2 16V	09/00→07/03					
2.2	Y 22 DTR Diesel	175	AB5670 (MLS), 1.300mm, 1 Notch AB5680 (MLS), 1.400mm, 2 Notches		CB5670 ▲ [13]	EB5670 [3]
Astra G 2.2 DTI	09/02→10/05	2172	4	84.00 SOHC/OHC	86-92/ 117-125	
Signum 2.2	05/03→06/08					
Signum 2.2 DTI	05/03→					
Vectra B 2.2	09/00→07/03					
Vectra C 2.2	04/02→06/08					
Zafira 2.2 DTI	01/02→06/05					
2.2	Y 22 SE	176	BY250 (Fibre)		DY255	EC102
Frontera B	10/98→	2198	4	86.00 DOHC	100/136	
2.2	Y 22 XE	177	BY250 (Fibre)		DY253	EC101
Omega B 2.2 16V	09/99→07/03	2198	4	86.00 DOHC	106/144	
2.2	Z 22 SE	178	AG9580 (MLS)		CG9580	
Astra G 16V	09/00→10/05	2198	4	86.00 DOHC	108/147	
Speedster 2.2	09/00→					
Vectra B 2.2i	09/00→07/03					
Vectra C 2.2	04/02→					
Zafira 2.2 16V	09/00→06/05					

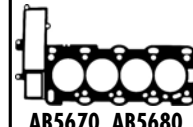

AB5670, AB5680



AE5210



BY250



JD451



JD5255



JD5256

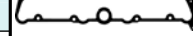

JD5277

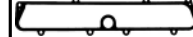

JD5347



JM5159



JP016



JH5079



JH5080



JH5096



JJ459



JJ568

HBS373 [22] M12x1.50x131.00mm (x10)	JD5891 [1] JD5892	HM5290 [3]	JJ568		NA5053 [2] 30.00x42.00x7.00mm, FPM NF860 [1] 93.00x108.00x7.00mm, FPM/ACM		
HBS373 [22] M12x1.50x131.00mm (x10)	JD5891 [1] JD5892	HM5290 [3]	JJ568		NA5053 [2] 30.00x42.00x7.00mm, FPM		
HBS373 [22] M12x1.50x131.00mm (x10)	JD5891 [1] JD5892	HM5290 [3]	JJ568		NA5053 [2] 30.00x42.00x7.00mm, FPM		
HBS298 [22] M12x1.50x235.00mm (x10)	JD5255 [1] JD5347 [1] [2] →Eng.2V599999 JD5277 [1] [2] Eng.3V500001 → JD5256 [3]	JM5159 (SE)	JH5079 JH5080	PA5041 (x16) 6.00/12.20x10.00 (FPM) HR791 [3]	NA5069 [2] 55.00x68.00x8.00mm, FPM NA5209 [1] 99.00x114.00x11.00mm, FPM	JR5029 [6]	
HBS054 [5] M11x1.25x105.00mm (x10)	JD451 [1] JD5300 [3] (MLS)	JP016 [4]	JH5096 (SE)	HR791 [3]	NC006 [2] 35.00x48.00x7.00mm, MVQ NB700 [2] 31.00x50.00x8.00mm, MVQ NB806 [1] 90.00x104.00x11.00mm, FPM		
HBS054 [5] M11x1.25x105.00mm (x10)	JD451 [1]	JP016 [4]	JJ459	PA5041 (x16) 6.00/12.20x10.00 (FPM) HR791 [3] (x1)	NC006 (x2) [2] 35.00x48.00x7.00mm, MVQ NB700 [2] 31.00x50.00x8.00mm, MVQ NB806 [1] 90.00x104.00x11.00mm, FPM		
HBS298 [22] M12x1.50x235.00mm (x10)	JD5255 [1] JD5347 [1] [2] →Eng.2V599999 JD5277 [1] [2] Eng.3V500001 → JD5256 [3]	JM5159 (SE)	JH5079 JH5080	HR791 [3]	NA5069 [2] 55.00x68.00x8.00mm, FPM NA5209 [1] 99.00x114.00x11.00mm, FPM	JR5029 [6]	
HBS298 [22] M12x1.50x235.00mm (x10)	JD5255 [1] JD5277 [1] [2] JD5256 [3]	JM5159 (SE)	JH5057	PA5041 (x16) 6.00/12.20x10.00 (FPM) HR791 [3]	NA5069 [2] 55.00x68.00x8.00mm, FPM NA5209 [1] 99.00x114.00x11.00mm, FPM	JR5029 [6]	
HBS054 [5] M11x1.25x105.00mm (x10)	JD5737 [3] (MLS)	JP016 [4]	JH5096 (SE)	HR791 [3]	NC006 [2] 35.00x48.00x7.00mm, MVQ NB700 [2] 31.00x50.00x8.00mm, MVQ NB806 [1] 90.00x104.00x11.00mm, FPM		
HBS054 [5] M11x1.25x105.00mm (x10)	JD5300 [3] (MLS)	JP016 [4]	JH5119	HR791 [3]	NC006 [2] 35.00x48.00x7.00mm, MVQ NB700 [2] 31.00x50.00x8.00mm, MVQ NB806 [1] 90.00x104.00x11.00mm, FPM		
HBS416 [22] M11x1.50x163.00mm (x10)	KG5337 [1] (MVQ) JD5868 [3]	JM7102 (Elastomer) HM5300 [3] (NBR)			NC006 [2] 35.00x48.00x7.00mm, MVQ NA5108 [2] 42.00x55.00x7.00mm, FPM/ACM NB806 [1] 90.00x104.00x11.00mm, FPM		



cc



kW/PS



2.2	Z 22 XE	179	BY250 (Fibre)		DY253	EC101
Omega B 2.2 16V	09/99→07/03	2198	4	86.00	DOHC	106/144
2.2	Z 22 YH	180	AG9590 (MLS)		CG9590	
Signum 2.2 D	05/03→	2198	4	86.00	DOHC	110-114/ 150-155
Vectra C 2.2	10/03→					
Zafira 2.2	07/05→					
2.3	4 ZD1	181	BP920 (Graphite)		DP920 [3]	GP920 [3][137] GP921 [3][138]
Campo 2.3	08/94→09/96	2255	4	89.50	SOHC/OHC	69-72/ 94-98
						09/94→ 09/94→
2.3	23 DTR Diesel	182	BR010 (Fibre), 1.300mm, 1 Hole		DR010 ▲	EJ161
Frontera A	03/92→10/98	2260	4	92.00	SOHC/OHC	74/100
Omega A 2.3 TD	08/88→03/94					
						BR020 (Fibre), 1.400mm, 2 Holes BR030 (Fibre), 1.500mm, 3 Holes
2.3	23 P	183	BP920 (Graphite)		DP920 [3]	GP920 [3][137] GP921 [3][138]
Campo 2.3	08/94→09/96	2254	4	89.30	SOHC/OHC	72/98
2.3	23 YD Diesel	184	BR010 (Fibre), 1.300mm, 1 Hole		DR010 ▲	EJ161
Omega A 2.3 D	09/86→03/94	2260	4	92.00	SOHC/OHC	54/73
						BR020 (Fibre), 1.400mm, 2 Holes BR030 (Fibre), 1.500mm, 3 Holes
2.3	23 YDT Diesel	185	BR010 (Fibre), 1.300mm, 1 Hole		DR010 ▲	EJ161
Omega A 2.3 TD	09/86→08/88	2260	4	92.00	SOHC/OHC	66/90
						BR020 (Fibre), 1.400mm, 2 Holes BR030 (Fibre), 1.500mm, 3 Holes
2.4	C 24 NE	186	BJ170 (Fibre)			
Frontera A	03/92→10/98	2410	4	95.00		92/125
Omega A 2.4 i	09/88→03/94					
2.5	4 JA1 Diesel	187	BR990 (MLS)		DR990 [3]	GR990 [3]
Campo 2.5	08/91→06/94	2499	4	93.00	SOHC/OHC	56-74/ 76-101
Campo 2.5 DTI	12/01→					
2.5	4 JA1T Diesel	188	BR990 (MLS)		DR990 [3]	GR990 [3]
Campo 2.5 TD	07/94→	2499	4	93.00	OHV	56/76
2.5	25 DT Diesel	189	BZ111 (Fibre), 1.680mm, 2 Holes		DW731 ▲ [13]	EY280
Omega B 2.5 TD	04/94→07/03	2497	6	80.00	SOHC/OHC	96/130
						BZ120 (Fibre), 1.870mm, 3 Holes
2.5	25 NE	190	BT530 (Fibre)			
Senator B 2.5 i	09/90→09/93	2490	6	87.00	SOHC/OHC	103/140

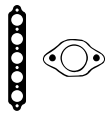

HBS054 [5] M11x1.25x105.00mm (x10)	JD5300 [MLS]	JP016 [4]	JH5119	HR791 [5]	NC006 [2] 35.00x48.00x7.00mm, MVQ NB700 [2] 31.00x50.00x8.00mm, MVQ NB806 [1] 90.00x104.00x11.00mm, FPM	
HBS416 [22] M11x1.50x163.00mm (x10)	JD5869 [x3] JD5870 [x1] JD5868	JM7102 (Elastomer)	HR397		NA5108 [2] 42.00x55.00x7.00mm, FPM/ACM NB806 [1] 90.00x104.00x11.00mm, FPM	
	JC684 [09/94→] JC683 [09/94→]	JN634 [4] [09/94→] HL532 [09/94→]	JJ358 [137] [09/94→]	PA933 [x8] [09/94→]	NJ454 [1][2] 30.00x45.00x8.00mm, NBR [09/94→] NJ323 [2] 40.00x56.00x7.00mm, NBR [09/94→] NJ322 [1] 95.00x118.00x10.00mm, NBR [09/94→]	
HBS163 [22] M13x1.50x134.00mm (x10)	JD5765	JN523 [4] JN521 [4]	HC417 [5] JH5019	PA543 HR794 [x1]	NB628 [2] 45.00x60.00x9.00mm, ACM NB690 [1] 81.00x100.10x11.50mm, FPM	
	JC684 [1] JC683 [5]	JN634 [4] HL532 [5]	JJ358 [137]	PA933 [x8]	NJ454 [1][2] 30.00x45.00x8.00mm, NBR NJ323 [2] 40.00x56.00x7.00mm, NBR NJ322 [1] 95.00x118.00x10.00mm, NBR	
HBS160 [22] M13x1.50x134.00mm (x10)	JD5765	JN523 [4] JN521 [4]	HC417 [5]	PA543 PA619 [x8] 9.00/17.00x14.20 (ACM) HR794 [5]	NB628 [2] 45.00x60.00x9.00mm, ACM NB690 [1] 81.00x100.10x11.50mm, FPM	
HBS163 [22] M13x1.50x134.00mm (x10)	JD5765	JN523 [4] JN521 [4]	HC417 [5]	PA543 HR794 [x1]	NB628 [2] 45.00x60.00x9.00mm, ACM NB690 [1] 81.00x100.10x11.50mm, FPM	
HBS161 [22] M12x1.50x64.00mm (x5)	JD187	JN923 [4] JN924 [x2][4]	JH5019 [5]	PA619 [x8] 9.00/17.00x14.20 (ACM) HR336 [x1]	NB628 [2] 45.00x60.00x9.00mm, ACM NB469 [1] 77.00x100.00x11.50mm, FPM	
		JN707 [4]	JJ470	PA418 [x8]	NA5051 [2] 40.00x56.00x7.00mm, FPM NJ322 [1] 95.00x118.00x10.00mm, NBR	
		JN707 [4]	JJ470	PA418 [x8]	NA5051 [2] 40.00x56.00x7.00mm, FPM NJ322 [1] 95.00x118.00x10.00mm, NBR	
HBS066 [22] M12x1.50x146.50mm (x14)	JD274 [x6] JD276 [x1] JD5134	JN955 [4]	JJ536	PA5041 [x12] 6.00/12.20x10.00 (FPM) HR280 [x1]	NF637 [2] 48.00x65.00x10.00mm, FPM NA5104 [1] 90.00x110.00x12.00mm, PTFE NB431 [1] 90.00x110.00x12.00mm, FPM	
		JM956 [4] →Eng.25E45754	HC295 [5]	HR336 [x3]	NB628 [2] 45.00x60.00x9.00mm, ACM NB469 [1] 77.00x100.00x11.50mm, FPM	

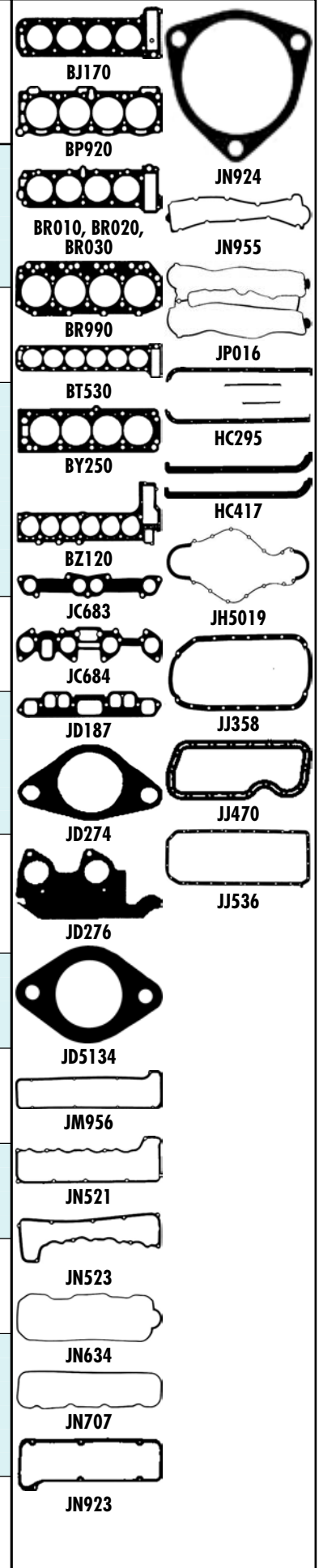



cc



kW/PS



2.5	25TDS (VM41B) Diesel	191	AY400 (MLS), 1.420mm, 0 Notches (x4) BK570 (Fibre), 1.420mm, 0 Notches (x4) AY410 (MLS), 1.520mm, 2 Notches (x4) BP260 (Fibre), 1.520mm, 2 Notches AY420 (MLS), 1.620mm, 1 Notch (x4) BK580 (Fibre), 1.620mm, 1 Notch (x4)	DK570 ▲	GK572 ▲ [18]	
Frontera A	09/96→10/98	2499	4	92.00	OHV	85/115
2.5	C 25 XE	192	BY270 (Fibre) (x2)	DY270 [3]	EC230 [3]	
Calibra A 2.5 i	04/93→07/97	2498	6	81.60	DOHC, V	125/170
Vectra A 2.5 CD	08/92→08/95					
Vectra A 2.5 V6	02/93→11/95					
2.5	G9MB6 Diesel	193	AE5220 (MLS)		EE5220 [3]	
Vivaro 2.5 CDTI	08/06→	2463	4	89.00		107/146
2.5	G9U 630 Diesel	194	AE5220 (MLS)	CE5210	EE5220 [3]	
Vivaro 2.5 CDTI	08/06→	2464	4	89.00	DOHC	84-107/ 114-146
2.5	G9U 632 Diesel	195	AE5220 (MLS)	CE5210	EE5220 [3]	
Movano 2.5 CDTI	10/03→	2464	4	89.00	DOHC	88-107/ 120-146
2.5	G9U 650 Diesel	196	AE5220 (MLS)	CE5210	EE5220 [3]	
Movano 2.5 CDTI	10/03→	2464	4	89.00	DOHC	74-107/ 101-146
2.5	G9U 720 Diesel	197	AE5220 (MLS)	CE5210	EE5220 [3]	
Movano 2.5 DTI	10/01→	2463	4	89.00	DOHC	84-85/ 114-116
2.5	G9U 724 Diesel	198	AE5220 (MLS)	CE5210	EE5220 [3]	
Movano 2.5 DTI	10/01→	2463	4	89.00	DOHC	84/115
2.5	G9U 730 Diesel	199	AE5220 (MLS)	CE5210	EE5220 [3]	
Vivaro 2.5 DTI	05/03→	2463	4	89.00	DOHC	99/135
2.5	G9U 750 Diesel	200	AE5220 (MLS)	CE5210	EE5220 [3]	
Movano 2.5 DTI	10/01→	2463	4	89.00	DOHC	84/115
2.5	G9U 754 Diesel	201	AE5220 (MLS)		EE5220 [3]	
Movano 2.5 DTI	10/01→	2463	4	89.00	DOHC	73-84/ 99-115
2.5	S8U 758 Diesel	202	AY290 (Fibre), 1.600mm AY300 (Fibre), 1.700mm AY310 (Fibre), 1.800mm	DE588 ▲ [3]	FY291 ▲ [16]	
Arena 2.5 D	03/98→08/01	2499	4	93.00	SOHC/OHC	55-58/ 75-79
Arena Van 2.5 D	03/98→08/01					



HBS108 [12] M14x1.75x137.00mm (x10)	JC928 [x4] JD025 [x4] ◀JF123	JPO67 [4] JPO68 [4] [93]				
HBS164 [5] M11x1.25x105.00mm (x16)	JD5201 [x2] JD458 [x2] JD457 [x2] JD459 [x2]	JM5094 [x2] [139] (Elastomer) JM5095 [x2] [139] (Elastomer) HM5294	JH5052	PA5041 (x24) 6.00/12.20x10.00 (FPM) HR5062 [x1]	NA5006 (x4) [2] 35.00x48.00x7.00mm, MVQ NB884 [2] 38.00x50.00x5.50mm, FPM NB806 [1] 90.00x104.00x11.00mm, FPM	
HBS373 [22] M12x1.50x131.00mm (x10)			JJ568		NA5053 [2] 30.00x42.00x7.00mm, FPM NF860 [1] 93.00x108.00x7.00mm, FPM/ACM	
HBS373 [22] M12x1.50x131.00mm (x10)			JJ568		NA5053 [2] 30.00x42.00x7.00mm, FPM NF860 [1] 93.00x108.00x7.00mm, FPM/ACM	
HBS373 [22] M12x1.50x131.00mm (x10)			JJ568		NA5053 [2] 30.00x42.00x7.00mm, FPM NF860 [1] 93.00x108.00x7.00mm, FPM/ACM	
HBS373 [22] M12x1.50x131.00mm (x10)			JJ568		NA5053 [2] 30.00x42.00x7.00mm, FPM NF860 [1] 93.00x108.00x7.00mm, FPM/ACM	
HBS373 [22] M12x1.50x131.00mm (x10)			JJ568		NA5053 [2] 30.00x42.00x7.00mm, FPM NF860 [1] 93.00x108.00x7.00mm, FPM/ACM	
HBS373 [22] M12x1.50x131.00mm (x10)			JJ568		NA5053 [2] 30.00x42.00x7.00mm, FPM NF860 [1] 93.00x108.00x7.00mm, FPM/ACM	
HBS373 [22] M12x1.50x131.00mm (x10)			JJ568		NA5053 [2] 30.00x42.00x7.00mm, FPM NF860 [1] 93.00x108.00x7.00mm, FPM/ACM	
HBS373 [22] M12x1.50x131.00mm (x10)			JJ568		NA5053 [2] 30.00x42.00x7.00mm, FPM NF860 [1] 93.00x108.00x7.00mm, FPM/ACM	
HBS011 [5] M12x1.25x119.00mm (x12)	JC054 [x1] JC055 [x1]	JN956 [4]	JJ100 (Cork) JJ519		NPO68 [2] 55.00x70.00x8.00mm, FPM NPO67 [2] 50.00x70.00x10.00mm, FPM NF883 [1] 114.00x177.00x13.00mm, FPM NF885 [2] 70.00x179.00x16.00mm, FPM	

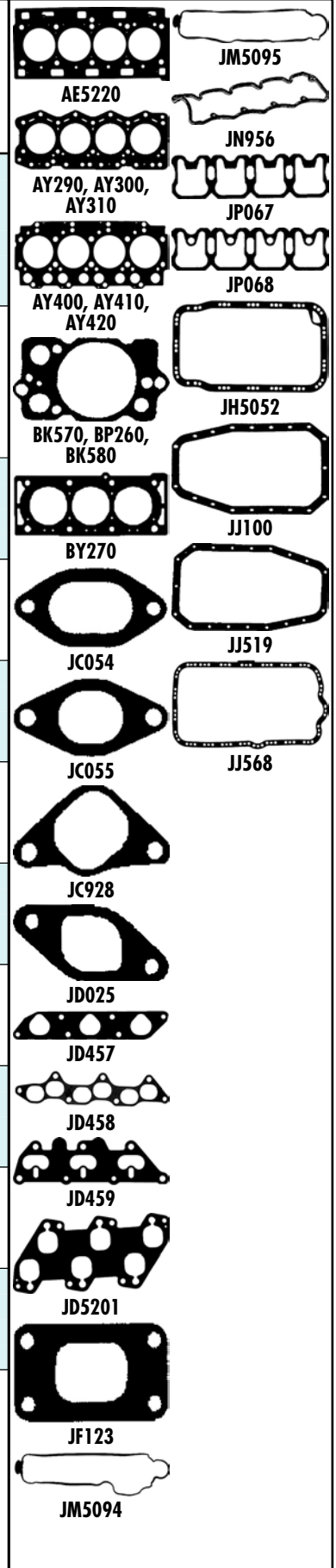



cc



kW/PS

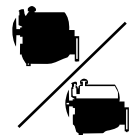

2.5	S8U 770 Diesel	203	AY290 (Fibre), 1.600mm AY300 (Fibre), 1.700mm AY310 (Fibre), 1.800mm	DE588 ▲[3]	FY291 ▲[16]	
Movano 2.5 D	07/98→09/00	2499	4	93.00	SOHC/OHC	59/80
2.5	S8U 772 Diesel	204	AY290 (Fibre), 1.600mm AY300 (Fibre), 1.700mm AY310 (Fibre), 1.800mm	DE588 ▲[3]	FY291 ▲[16]	
Movano 2.5 D	07/98→09/00	2499	4	93.00	SOHC/OHC	59/80
2.5	S8U 780 Diesel	205	AY290 (Fibre), 1.600mm AY300 (Fibre), 1.700mm AY310 (Fibre), 1.800mm	DE588 ▲[3]	FY291 ▲[16]	
Arena 2.5 D	03/98→08/01	2499	4	93.00	SOHC/OHC	55/75
Arena Van 2.5 D	03/98→08/01					
2.5	S8U 782 Diesel	206	AY290 (Fibre), 1.600mm AY300 (Fibre), 1.700mm AY310 (Fibre), 1.800mm	DE588 ▲[3]	FY291 ▲[16]	
Arena 2.5 D	03/98→08/01	2499	4	93.00	SOHC/OHC	55/75
Arena Van 2.5 D	03/98→08/01					
2.5	X 25 DT Diesel	207	BZ111 (Fibre), 1.680mm, 2 Holes BZ120 (Fibre), 1.870mm, 3 Holes	DW731 ▲[13]	EY280	
Omega B 2.5 TD	04/94→07/03	2497	6	80.00	SOHC/OHC	96/130
2.5	X 25 TD Diesel	208	BZ111 (Fibre), 1.680mm, 2 Holes BZ120 (Fibre), 1.870mm, 3 Holes	DW731 ▲[13]	EY280	
Omega B 2.5 D	05/94→05/99	2498	6	80.00	SOHC/OHC	96/131
Omega B 2.5 TD	04/94→07/03					
2.5	X 25 XE	209	BY270 (Fibre) (x2)	DY271 [3] DY272	EC230 [3]	
Calibra A 2.5 i	04/93→07/97	2498	6	81.60	DOHC, V	125-144/ 170-196
Omega B 2.5 V6	03/94→09/00					
Vectra B 2.5	10/99→06/00					
Vectra B 2.5i	10/95→09/00					
2.5	Y 25 DT Diesel	210	AC5320 (MLS), 1.450mm, 1 Hole AC5330 (MLS), 1.550mm, 2 Holes AC5340 (MLS), 1.650mm, 3 Holes	DZ660 ▲[13]		
Omega B 2.5 DTI	09/01→07/03	2497	6	80.00	DOHC	110/150
2.6	C 26 NE	211	BT530 (Fibre)			
Omega A 2.6 i	09/90→03/94	2594	6	88.80		110/150
Senator B 2.6 i	09/90→09/93					
2.6	Y 26 SE	212				
Omega B 2.6 V6	09/00→07/03	2597	6	83.20	DOHC, V	125-132/ 170-180
Vectra B 2.6i	09/00→07/03					
2.8	28 TDI (4JB1T) Diesel	213	BR990 (MLS)	CD5400 ▲	ER993	
Frontera A	03/95→10/98	2771	4	93.00	OHV	83/113

HBS011 [5] M12x1.25x119.00mm (x12)	JC054 ■ JC055 ■	JN956 [4] JN969 [4]	JJ519		■ NPO68 [2] 55.00x70.00x8.00mm, FPM ■ NF883 ■ [1] 114.00x177.00x13.00mm, FPM ■ NF885 ■ [2] 70.00x179.00x16.00mm, FPM		AC5320, AC5330 AC5340 AY290, AY300, AY310 BR990 BT530 BY270 BZ120 JC054 JC055 JD274 JD276 JD5202 ■ (x2) JD5203 ■ (x3) JD459 ■ (x2) JD5108 ■ (x6) JD5107 ■ (x6) JD5183 ■ (x3) JD5202 ■ (x2) JD5203 ■ (x3) JD470 ■	JD5203 JD5204 JM5094 JM5095 JM5106 JN707 JN955 JN956 JN969 HC295 JH5052 JJ100 JJ454 JJ519 JJ536 JJ572 JD5202 JJ573	
HBS011 [5] M12x1.25x119.00mm (x12)	JC054 ■ JC055 ■	JN969 [4]	JJ519		■ NPO68 [2] 55.00x70.00x8.00mm, FPM ■ NF883 ■ [1] 114.00x177.00x13.00mm, FPM ■ NF885 ■ [2] 70.00x179.00x16.00mm, FPM		AC5340 AY290, AY300, AY310 BR990 BT530 BY270 BZ120 JC054 JC055 JD274 JD276 JD5202 ■ (x2) JD5203 ■ (x3) JD459 ■ (x2) JD5108 ■ (x6) JD5107 ■ (x6) JD5183 ■ (x3) JD5202 ■ (x2) JD5203 ■ (x3) JD470 ■	JD5203 JD5204 JM5094 JM5095 JM5106 JN707 JN955 JN956 JN969 HC295 JH5052 JJ100 JJ454 JJ519 JJ536 JJ572 JD5202 JJ573	
HBS011 [5] M12x1.25x119.00mm (x12)	JC054 ■ JC055 ■	JN956 [4]	JJ100 (Cork) JJ519		■ NPO68 [2] 55.00x70.00x8.00mm, FPM ■ NF883 ■ [1] 114.00x177.00x13.00mm, FPM ■ NF885 ■ [2] 70.00x179.00x16.00mm, FPM		AC5340 AY290, AY300, AY310 BR990 BT530 BY270 BZ120 JC054 JC055 JD274 JD276 JD5202 ■ (x2) JD5203 ■ (x3) JD459 ■ (x2) JD5108 ■ (x6) JD5107 ■ (x6) JD5183 ■ (x3) JD5202 ■ (x2) JD5203 ■ (x3) JD470 ■	JD5203 JD5204 JM5094 JM5095 JM5106 JN707 JN955 JN956 JN969 HC295 JH5052 JJ100 JJ454 JJ519 JJ536 JJ572 JD5202 JJ573	
HBS011 [5] M12x1.25x119.00mm (x12)	JC054 ■ JC055 ■ (x4)	JN956 [4]	JJ100 (Cork) JJ519		■ NPO68 [2] 55.00x70.00x8.00mm, FPM ■ NF883 ■ [1] 114.00x177.00x13.00mm, FPM ■ NF885 ■ [2] 70.00x179.00x16.00mm, FPM		AC5340 AY290, AY300, AY310 BR990 BT530 BY270 BZ120 JC054 JC055 JD274 JD276 JD5202 ■ (x2) JD5203 ■ (x3) JD459 ■ (x2) JD5108 ■ (x6) JD5107 ■ (x6) JD5183 ■ (x3) JD5202 ■ (x2) JD5203 ■ (x3) JD470 ■	JD5203 JD5204 JM5094 JM5095 JM5106 JN707 JN955 JN956 JN969 HC295 JH5052 JJ100 JJ454 JJ519 JJ536 JJ572 JD5202 JJ573	
HBS066 ⊕ [22] M12x1.50x146.50mm (x14)	JD274 ■ (x6) JD276 ■	JN955 [4]	JJ536	PA5041 (x12) 6.00/12.20x10.00 (FPM) HR280 ■	■ NF637 ■ [2] 48.00x65.00x10.00mm, FPM ■ NB431 ■ [1] 90.00x110.00x12.00mm, FPM		AC5340 AY290, AY300, AY310 BR990 BT530 BY270 BZ120 JC054 JC055 JD274 JD276 JD5202 ■ (x2) JD5203 ■ (x3) JD459 ■ (x2) JD5108 ■ (x6) JD5107 ■ (x6) JD5183 ■ (x3) JD5202 ■ (x2) JD5203 ■ (x3) JD470 ■	JD5203 JD5204 JM5094 JM5095 JM5106 JN707 JN955 JN956 JN969 HC295 JH5052 JJ100 JJ454 JJ519 JJ536 JJ572 JD5202 JJ573	
HBS066 ⊕ [22] M12x1.50x146.50mm (x14)	JD274 ■ (x6) JD276 ■	JN955 [4]	JJ536	PA5041 (x12) 6.00/12.20x10.00 (FPM) HR280 ■	■ NF637 ■ [2] 48.00x65.00x10.00mm, FPM ■ NB431 ■ [1] 90.00x110.00x12.00mm, FPM		AC5340 AY290, AY300, AY310 BR990 BT530 BY270 BZ120 JC054 JC055 JD274 JD276 JD5202 ■ (x2) JD5203 ■ (x3) JD459 ■ (x2) JD5108 ■ (x6) JD5107 ■ (x6) JD5183 ■ (x3) JD5202 ■ (x2) JD5203 ■ (x3) JD470 ■	JD5203 JD5204 JM5094 JM5095 JM5106 JN707 JN955 JN956 JN969 HC295 JH5052 JJ100 JJ454 JJ519 JJ536 JJ572 JD5202 JJ573	
HBS164 ⊕ [5] M11x1.25x105.00mm (x16)	JD5202 ■ (x2) JD5203 ■ (x3) JD459 ■ (x2)	JD5204 (x2) (Elastomer) JM5094 ■ (x2)[139] (Elastomer) JM5095 ■ (x2)[139] (Elastomer) HM5294 ■	JH5052 JJ573 ■ JJ572 ■	PA5041 (x24) 6.00/12.20x10.00 (FPM) HR5062 ■ (x1)	■ NC006 (x4)[2] 35.00x48.00x7.00mm, MVQ ■ NB884 ■ [2] 38.00x50.00x5.50mm, FPM ■ NB806 ■ [1] 90.00x104.00x11.00mm, FPM		AC5340 AY290, AY300, AY310 BR990 BT530 BY270 BZ120 JC054 JC055 JD274 JD276 JD5202 ■ (x2) JD5203 ■ (x3) JD459 ■ (x2) JD5108 ■ (x6) JD5107 ■ (x6) JD5183 ■ (x3) JD5202 ■ (x2) JD5203 ■ (x3) JD470 ■	JD5203 JD5204 JM5094 JM5095 JM5106 JN707 JN955 JN956 JN969 HC295 JH5052 JJ100 JJ454 JJ519 JJ536 JJ572 JD5202 JJ573	
HBS066 ⊕ [22] M12x1.50x146.50mm (x14)	JD5108 ■ (x6) JD5107 ■ (x6) JD5183 ■ (x3)	JM5106 (Elastomer)		PA5016 (x24)	■ NA5104 ■ [1] 90.00x110.00x12.00mm, PTFE		AC5340 AY290, AY300, AY310 BR990 BT530 BY270 BZ120 JC054 JC055 JD274 JD276 JD5202 ■ (x2) JD5203 ■ (x3) JD459 ■ (x2) JD5108 ■ (x6) JD5107 ■ (x6) JD5183 ■ (x3) JD5202 ■ (x2) JD5203 ■ (x3) JD470 ■	JD5203 JD5204 JM5094 JM5095 JM5106 JN707 JN955 JN956 JN969 HC295 JH5052 JJ100 JJ454 JJ519 JJ536 JJ572 JD5202 JJ573	
			HC295 ■	PA619 (x12) 9.00/17.00x14.20 (ACM) HR336 ■ (x3)	■ NB628 ■ [2] 45.00x60.00x9.00mm, ACM ■ NB469 ■ [1] 77.00x100.00x11.50mm, FPM		AC5340 AY290, AY300, AY310 BR990 BT530 BY270 BZ120 JC054 JC055 JD274 JD276 JD5202 ■ (x2) JD5203 ■ (x3) JD459 ■ (x2) JD5108 ■ (x6) JD5107 ■ (x6) JD5183 ■ (x3) JD5202 ■ (x2) JD5203 ■ (x3) JD470 ■	JD5203 JD5204 JM5094 JM5095 JM5106 JN707 JN955 JN956 JN969 HC295 JH5052 JJ100 JJ454 JJ519 JJ536 JJ572 JD5202 JJ573	
HBS164 ⊕ [5] M11x1.25x105.00mm (x16)	JD5202 ■ (x2) JD5203 ■ (x3)	JD5204 (x2) (Elastomer) JM5094 ■ (x2)[139] (Elastomer) JM5095 ■ (x2)[139] (Elastomer)		HR5062 ■	■ NC006 (x4)[2] 35.00x48.00x7.00mm, MVQ ■ NB884 ■ [2] 38.00x50.00x5.50mm, FPM ■ NB806 ■ [1] 90.00x104.00x11.00mm, FPM		AC5340 AY290, AY300, AY310 BR990 BT530 BY270 BZ120 JC054 JC055 JD274 JD276 JD5202 ■ (x2) JD5203 ■ (x3) JD459 ■ (x2) JD5108 ■ (x6) JD5107 ■ (x6) JD5183 ■ (x3) JD5202 ■ (x2) JD5203 ■ (x3) JD470 ■	JD5203 JD5204 JM5094 JM5095 JM5106 JN707 JN955 JN956 JN969 HC295 JH5052 JJ100 JJ454 JJ519 JJ536 JJ572 JD5202 JJ573	
HBS287 ⊕ [22] M11x1.50x121.00mm (x18)	JD470 ■	JN707 [4]	JJ454	PA418 (x8)	■ NJ267 [2] 42.00x55.00x9.00mm, NBR ■ NJ014 ■ [2] 50.00x68.00x9.00mm, NBR ■ NJ322 ■ [1] 95.00x118.00x10.00mm, NBR		AC5340 AY290, AY300, AY310 BR990 BT530 BY270 BZ120 JC054 JC055 JD274 JD276 JD5202 ■ (x2) JD5203 ■ (x3) JD459 ■ (x2) JD5108 ■ (x6) JD5107 ■ (x6) JD5183 ■ (x3) JD5202 ■ (x2) JD5203 ■ (x3) JD470 ■	JD5203 JD5204 JM5094 JM5095 JM5106 JN707 JN955 JN956 JN969 HC295 JH5052 JJ100 JJ454 JJ519 JJ536 JJ572 JD5202 JJ573	



cc



kW/PS



2.8	S9W 700 Diesel					214	BX400 (Fibre), 1.300mm BX410 (Fibre), 1.400mm BX420 (Fibre), 1.500mm	DX391 ▲ [3]	GX410 ▲ [3]
Movano 2.8 DTI	07/98→10/01	2799	4	94.40	SOHC/OHC	84/114			
2.8	S9W 702 Diesel					215	BX400 (Fibre), 1.300mm BX410 (Fibre), 1.400mm BX420 (Fibre), 1.500mm	DX391 ▲ [3]	GX410 ▲ [3]
Movano 2.8 DTI	07/98→10/01	2799	4	94.40	SOHC/OHC	84/114			
3.0	4 JX1 Diesel					216	AG5090 (MLS), 1.250mm, 3 Holes	CG5090 ▲	
Monterey B 3.0	07/98→08/99	2999	4	95.40	DOHC	117-118/ 159-160			
3.0	30 NE					217			EW870
Omega A 3.0	03/87→09/90	2969	6	95.00	CIH	130/177			
Senator B 3.0	01/88→09/90								
3.0	C 30 LE					218			EW870
Omega A 3.0	03/87→03/94	2969	6	95.00		115/156			
Senator B 3.0	09/87→09/93								
3.0	C 30 NE					219			EW870
Omega A 3.0 CAT	03/87→03/94	2969	6	95.00		130/177			
Senator B 3.0 i	01/88→09/93								
3.0	C 30 SE					220	BV950 (Fibre)	DV951	EB950 [3]
Omega A 3.0	09/88→04/94	2969	6	95.00	DOHC	150/204			
Omega A 3.0 24V	09/89→03/94								
Senator B 3.0	09/89→09/93								
3.0	C 30 SEJ					221	BV950 (Fibre)	DV951	EB950 [3]
Omega A 3.0 24V	09/89→03/94	2969	6	95.00	DOHC	147/200			
3.0	X 30 XE					222	BY300 (Fibre) (x2)	DY300 [3]	EC230 [3] Eng.08178989→
Omega B 3.0 V6	04/94→02/01	2962	6	86.00	DOHC, V	148-155/ 201-211			
Sintra 3.0i 24V	11/96→04/99								
3.0	Y 30 DT Diesel					223	AG9770 (MLS), 0.600mm, 1 Hole <input checked="" type="checkbox"/> AG9780 (MLS), 0.650mm, 2 Holes <input checked="" type="checkbox"/> AG9790 (MLS), 0.700mm, 3 Holes <input checked="" type="checkbox"/> AG9800 (MLS), 0.600mm, 1 Hole <input checked="" type="checkbox"/> AG9810 (MLS), 0.650mm, 2 Holes <input checked="" type="checkbox"/> AG9820 (MLS), 0.700mm, 3 Holes <input checked="" type="checkbox"/>	CG9770 ▲	EG9770 FG9770 ▲
Signum 3.0	05/03→	2958	6	87.50	DOHC, V	130/177			
Vectra C 3.0	06/03→								
Vectra C 3.0 V6	10/03→								
3.0	Z 30 DT Diesel					224	AG9770 (MLS), 0.600mm, 1 Hole <input checked="" type="checkbox"/> AG9780 (MLS), 0.650mm, 2 Holes <input checked="" type="checkbox"/> AG9790 (MLS), 0.700mm, 3 Holes <input checked="" type="checkbox"/> AG9800 (MLS), 0.600mm, 1 Hole <input checked="" type="checkbox"/> AG9810 (MLS), 0.650mm, 2 Holes <input checked="" type="checkbox"/> AG9820 (MLS), 0.700mm, 3 Holes <input checked="" type="checkbox"/>	CG9770 ▲	EG9770 FG9770 ▲
Signum 3.0	09/05→	2958	6	87.50	DOHC, V	135/184			
Vectra C 3.0	08/05→								
Vectra C 3.0 V6	08/05→								
3.1	4 JG2T Diesel					225	AG7720 (Steel), 1.600mm, 1 Notch 01/93→ AG7730 (Steel), 1.650mm, 2 Notches 01/93→ AD5400 (Fibre), 1.700mm, 3 Holes 01/93→	CD5400 ▲ 01/93→	ER993 01/93→
Campero 3.1 TD	12/92→	3059	4	95.40	OHV	80/109			

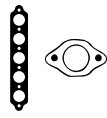

HBS011 [5] M12x1.25x119.00mm (x12)	JC054 [1] JC055 [4]	JN956 [4]	JJ613	HR602 [5]	N NP068 [2] 55.00x70.00x8.00mm, FPM K NF883 [1] 114.00x177.00x13.00mm, FPM K NF885 [2] 70.00x179.00x16.00mm, FPM	
HBS011 [5] M12x1.25x119.00mm (x12)	JC054 [1] JC055 [4]	JN956 [4]	JH5178 (SMG) JJ613	HR602 [5]	N NP068 [2] 55.00x70.00x8.00mm, FPM K NF883 [1] 114.00x177.00x13.00mm, FPM K NF885 [2] 70.00x179.00x16.00mm, FPM	
HBS419 [22] M11x1.50x110.00mm (x18)					N NJ321 [2] 28.00x47.00x8.00mm, NBR	
			HC295 [5]	PA619 (x12) 9.00/17.00x14.20 (ACM) HR336 [x3]	K NB628 [2] 45.00x60.00x9.00mm, ACM K NB469 [1] 77.00x100.00x11.50mm, FPM	
			HC295 [5]	PA619 (x12) 9.00/17.00x14.20 (ACM) HR336 [x3]	K NB628 [2] 45.00x60.00x9.00mm, ACM K NB469 [1] 77.00x100.00x11.50mm, FPM	
			HC295 [5]	PA619 (x12) 9.00/17.00x14.20 (ACM) HR336 [x3]	K NB628 [2] 45.00x60.00x9.00mm, ACM K NB469 [1] 77.00x100.00x11.50mm, FPM	
HBS417 [22] M12x1.50x88.00mm (x14)			JJ508 (Elastomer)	PA565 (x24) HR342 [x3]	K NB690 [1] 81.00x100.10x11.50mm, FPM	
HBS417 [22] M12x1.50x88.00mm (x14)			JJ508 (Elastomer)	PA565 (x24) HR342 [x3]	K NB690 [1] 81.00x100.10x11.50mm, FPM	
HBS164 [5] M11x1.25x105.00mm (x16)	JD5202 [x2] JD5203 [x3] JD459 [x2]	JM5094 [x2][139] (Elastomer) JM5095 [x2][139] (Elastomer) HM5294 [x1]	JJ573 [x] JJ572 [x]	PA5041 (x24) 6.00/12.20x10.00 (FPM) HR5062 [x1]	N NC006 (x4) [2] 35.00x48.00x7.00mm, MVQ K NB884 [2] 38.00x50.00x5.50mm, FPM K NB806 [1] 90.00x104.00x11.00mm, FPM	
HBS502 [22] (SE)	JD5897 [1] (SE) JD5896 [1] JE5064 (Steel)	HM5292 [1]		HR5094 [1]		
HBS502 [22] (SE)	JD5897 [1] (SE) JD5896 [1] JE5064 (Steel)	HM5292 [1]		HR5094 [1]		
HBS287 [22] M11x1.50x121.00mm (x18) 01/93 →			JJ555 01/93 →		K NA5051 [2] 40.00x56.00x7.00mm, FPM 01/93 →	

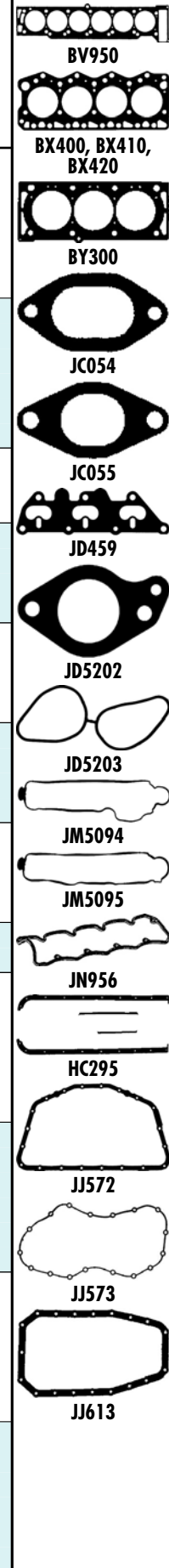



cc



kW/PS



3.1		4 JG2TC Diesel				226					
Monterey A 3.1T	09/91→07/98	3059	4	95.40	OHV	84/114	AG7720 (Steel), 1.600mm, 1 Notch AG7730 (Steel), 1.650mm, 2 Notches AD5400 (Fibre), 1.700mm, 3 Holes	CD5400 ▲	ER993		
3.2		6 VD1				227					
Frontera B	10/98→	3165	6	93.40	DOHC, V	130-151/ 177-205	AB5780 (MLS) ☒ AB5781 (MLS) ☒	CG5781	EG6240		
Monterey A 3.2	06/92→07/98										
3.2		Y 32 NE				228					
Frontera B	10/98→	3165	6	93.40	DOHC, V	151/205	AB5780 (MLS) ☒ AB5781 (MLS) ☒	CG5500	EG6240		
3.2		Z 32 SE				229					
Signum 3.2 V6	05/03→	3175	6	88.50	DOHC, V	155/211	AB5670 (MLS), 1.300mm, 1 Notch AB5680 (MLS), 1.400mm, 2 Notches	CB5671 ▲ [13]	EB5671 [3]		
Vectra C 3.2 V6	08/02→										
3.5		6 VE1				230					
Monterey B 3.5	07/98→08/99	3494	6	93.40	DOHC, V	158/215	AB5780 (MLS) ☒ (x2) AB5781 (MLS) ☒	CG5781	EG6240		

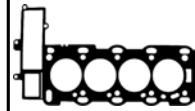
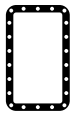
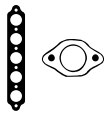

AB5670, AB5680



JM5071



JM5094



JM5095

HBS287 [22]
M11x1.50x121.00mm (x18)

JJ555

NA5051 [2]
40.00x56.00x7.00mm, FPM
NF843 [2]
50.00x68.00x10.00mm, FPM/ACM

JM5078 (x2)

NA5108 [2]
42.00x55.00x7.00mm, FPM/ACM

JM5078 (x2)

NA5108 [2]
42.00x55.00x7.00mm, FPM/ACM

HBS164 [5]
M11x1.25x105.00mm (x16)

JM5071
(Elastomer)
JM5094 [x2][139]
(Elastomer)
JM5095 [x2][139]
(Elastomer)

HR397

HR280 [x2]

NC006 [2]
35.00x48.00x7.00mm, MVQ
NB884 [2]
38.00x50.00x5.50mm, FPM
NB806 [1]
90.00x104.00x11.00mm, FPM

JM5078 (x2)

NA5108 [2]
42.00x55.00x7.00mm, FPM/ACM



Ltr







CC



9

	Ltr				CC		
104	1.0	09/98→06/98	108C (XV8)	Petrol	954	4	2
104	1.1	08/98→06/98	109F (XW7)	Petrol	1124	4	6
104 Coupe	1.1	08/97→06/98	109F (XW7)	Petrol	1124	4	6
106 I (1A, 1C)	1.0	09/99→04/99	CDY (TU9M)	Petrol	954	4	3
106 I (1A, 1C)	1.0	09/99→04/99	CDZ (TU9M)	Petrol	954	4	4
106 I (1A, 1C)	1.0	09/99→04/99	TU9	Petrol	954	4	5
106 I (1A, 1C)	1.1	09/99→04/99	HDZ (TU1M)	Petrol	1124	4	10
106 I (1A, 1C)	1.3	10/99→04/99	TU2J2	Petrol	1294	4	20
106 I (1A, 1C)	1.4	08/99→03/99	K5A (TU3)	Petrol	1360	4	34
106 I (1A, 1C)	1.4	09/99→04/99	K9Y (TUD3Y)	Diesel	1361	4	35
106 I (1A, 1C)	1.4	09/99→04/99	KDX (TU3MC)	Petrol	1361	4	37
106 I (1A, 1C)	1.4	09/99→04/99	KDY (TU3M)	Petrol	1361	4	38
106 I (1A, 1C)	1.4	09/99→04/99	KFZ (TU3J2/Z)	Petrol	1361	4	47
106 I (1A, 1C)	1.5	06/99→04/99	VJY (TUD5)	Diesel	1527	4	52
106 I (1A, 1C)	1.6	01/99→04/99	NFY (TU5J2)	Petrol	1587	4	88
106 I (1A, 1C)	1.6	06/99→04/99	NFZ (TU5JP)	Petrol	1587	4	89
106 II (1)	1.0	05/99→	CDY (TU9M)	Petrol	954	4	3
106 II (1)	1.0	01/99→	CDZ (TU9M)	Petrol	954	4	4
106 II (1)	1.1	01/99→	HDY (TU1M)	Petrol	1124	4	9
106 II (1)	1.1	05/99→	HDZ (TU1M)	Petrol	1124	4	10
106 II (1)	1.1	05/99→	HFX (TU1JP)	Petrol	1124	4	12
106 II (1)	1.4	05/99→	KFW (TU3JP)	Petrol	1360	4	45
106 II (1)	1.4	05/99→	KFX (TU3JP)	Bi-Fuel	1360	4	45
106 II (1)	1.4	05/99→	KFX (TU3JP)	Petrol	1361	4	46
106 II (1)	1.5	04/99→	VJX (TUD5)	Diesel	1527	4	51
106 II (1)	1.5	05/99→	VJY (TUD5)	Diesel	1527	4	52
106 II (1)	1.6	05/99→	NFW (TU5J2)	Petrol	1587	4	86
106 II (1)	1.6	05/99→	NFX (TU5J4)	Petrol	1587	4	87
106 II (1)	1.6	05/99→	NFY (TU5J2)	Petrol	1587	4	88
106 II (1)	1.6	05/99→	NFZ (TU5JP)	Petrol	1587	4	89
106 Van (1_)	1.0	09/99→03/00	CDY (TU9M)	Petrol	954	4	3
106 Van (1_)	1.0	09/99→03/00	TU9	Petrol	954	4	5
106 Van (1_)	1.5	10/00→03/00	VJX (TUD5)	Diesel	1527	4	51
106 Van (1_)	1.5	05/99→03/00	VJY (TUD5)	Diesel	1527	4	52
107	1.0	06/00→	1KR (384 F)	Petrol	998	3	1
107	1.4	06/00→	8HT (DV4TD)	Diesel	1398	4	23
205 Box	1.1	08/98→07/99	H1B (TU1)	Petrol	1124	4	8
205 Box	1.7	03/99→	161A (XUD7)	Diesel	1769	4	92
205 Box	1.8	02/98→07/99	A9A (XUD7)	Diesel	1769	4	96
205 I Convertible (741B, 20D)	1.1	10/98→12/99	HDZ (TU1M)	Petrol	1124	4	10
205 I Convertible (741B, 20D)	1.4	04/98→12/98	150B (XY8)	Petrol	1360	4	27
205 I Convertible (741B, 20D)	1.4	03/98→05/98	150D (XY7)	Petrol	1360	4	28
205 I Convertible (741B, 20D)	1.4	03/98→05/98	150G (XY7)	Petrol	1360	4	29
205 I Convertible (741B, 20D)	1.4	04/98→12/98	150H (XY8)	Petrol	1360	4	30
205 I Convertible (741B, 20D)	1.4	03/98→12/99	K1D (TU3A)	Petrol	1361	4	32
205 I Convertible (741B, 20D)	1.4	08/98→06/99	K2B (TU3S)	Petrol	1360	4	33
205 I Convertible (741B, 20D)	1.4	01/98→09/99	KAY (TU3CP)	Petrol	1361	4	36
205 I Convertible (741B, 20D)	1.4	05/99→12/99	KDY (TU3M)	Petrol	1361	4	38
205 I Convertible (741B, 20D)	1.4	05/99→12/99	KDZ (TU3M)	Petrol	1361	4	39
205 I Convertible (741B, 20D)	1.6	04/98→10/99	180A (XU5J)	Petrol	1580	4	68
205 I Convertible (741B, 20D)	1.6	04/98→10/99	180Z (XU5J)	Petrol	1580	4	69
205 I Convertible (741B, 20D)	1.6	08/99→12/99	BDY (XU5M3Z)	Petrol	1580	4	77
205 I Convertible (741B, 20D)	1.9	08/98→12/99	DFZ (XU9J1)	Petrol	1905	4	118
205 II (20A/C)	1.0	08/99→05/99	CDZ (TU9M)	Petrol	954	4	4
205 II (20A/C)	1.0	10/98→09/99	TU9	Petrol	954	4	5
205 II (20A/C)	1.1	07/98→10/98	E1	Petrol	1118	4	7
205 II (20A/C)	1.1	10/98→10/99	H1B (TU1)	Petrol	1124	4	8
205 II (20A/C)	1.1	07/98→09/99	HDZ (TU1M)	Petrol	1124	4	10
205 II (20A/C)	1.2	01/98→12/99	F1	Petrol	1204	4	17
205 II (20A/C)	1.3	08/99→07/99	G1A	Petrol	1294	4	18
205 II (20A/C)	1.3	10/98→10/99	TU24	Petrol	1294	4	19
205 II (20A/C)	1.4	01/98→07/98	150 (XY6B)	Petrol	1360	4	26
205 II (20A/C)	1.4	07/98→05/98	150B (XY8)	Petrol	1360	4	27
205 II (20A/C)	1.4	10/98→05/98	150D (XY7)	Petrol	1360	4	28
205 II (20A/C)	1.4	10/98→05/98	150G (XY7)	Petrol	1360	4	29
205 II (20A/C)	1.4	07/98→05/98	150H (XY8)	Petrol	1360	4	30
205 II (20A/C)	1.4	10/98→10/99	K1D (TU3A)	Petrol	1361	4	32
205 II (20A/C)	1.4	06/98→12/98	K2B (TU3S)	Petrol	1360	4	33
205 II (20A/C)	1.4	08/98→09/99	KAY (TU3CP)	Petrol	1361	4	36
205 II (20A/C)	1.4	08/99→07/99	KDX (TU3MC)	Petrol	1361	4	37

	Ltr				CC		9
205 II (20A/C)	1.4	07/98 → 09/99	KDY (TU3M)	Petrol	1361	4	38
205 II (20A/C)	1.4	07/98 → 09/99	KDZ (TU3M)	Petrol	1361	4	39
205 II (20A/C)	1.4	07/98 → 09/99	KFX (TU3JP)	Petrol	1361	4	46
205 II (20A/C)	1.4	08/99 → 07/99	TU32	Petrol	1361	4	48
205 II (20A/C)	1.4	06/98 → 12/98	Y2/K	Petrol	1442	4	49
205 II (20A/C)	1.6	08/99 → 07/99	171 (XU5S)	Petrol	1580	4	67
205 II (20A/C)	1.6	10/98 → 12/98	180A (XU5J)	Petrol	1580	4	68
205 II (20A/C)	1.6	10/98 → 12/98	180Z (XU5J)	Petrol	1580	4	69
205 II (20A/C)	1.6	10/98 → 09/99	B1A (XU51C)	Petrol	1580	4	71
205 II (20A/C)	1.6	10/98 → 09/99	B1E (XU51C)	Petrol	1580	4	72
205 II (20A/C)	1.6	10/98 → 09/99	BAZ (XU5CP)	Petrol	1580	4	75
205 II (20A/C)	1.6	05/99 → 09/99	BDY (XU5M2Z)	Petrol	1580	4	76
205 II (20A/C)	1.6	05/99 → 09/99	BDY (XU5M3Z)	Petrol	1580	4	77
205 II (20A/C)	1.7	07/98 → 09/99	161A (XUD7)	Diesel	1769	4	92
205 II (20A/C)	1.7	01/99 → 09/99	A8B (XUD7TE)	Diesel	1769	4	95
205 II (20A/C)	1.8	08/99 → 05/99	XUD7T	Diesel	1769	4	103
205 II (20A/C)	1.9	10/98 → 05/98	D2A (XU92C)	Petrol	1905	4	105
205 II (20A/C)	1.9	10/98 → 09/99	D6B (XU9JA)	Petrol	1905	4	109
205 II (20A/C)	1.9	10/98 → 05/99	DFZ (XU9J1)	Petrol	1905	4	118
205 II (20A/C)	1.9	10/98 → 09/99	DJZ (XUD9Y)	Diesel	1905	4	124
205 II (20A/C)	1.9	10/98 → 05/99	DKZ (XU9JAZ)	Petrol	1905	4	125
206 CC (2D)	1.6	04/00 →	9HZ (DV6TED4)	Diesel	1560	4	66
206 CC (2D)	1.6	09/00 →	NFU (TU5JP4)	Petrol/Ethanol	1587	4	85
206 CC (2D)	1.6	09/00 →	NFU (TU5JP4)	Petrol	1587	4	85
206 CC (2D)	1.6	09/00 →	NFU (TU5JP4)	Flexfuel	1587	4	85
206 CC (2D)	2.0	09/00 →	RFN (EW10J4)	Petrol	1997	4	142
206 Hatchback (2A/C)	1.1	09/99 →	HFX (TU1JP)	Petrol	1124	4	12
206 Hatchback (2A/C)	1.1	09/99 →	HFZ (TU1JP)	Petrol	1124	4	13
206 Hatchback (2A/C)	1.4	09/00 →	8HX (DV4TD)	Diesel	1398	4	24
206 Hatchback (2A/C)	1.4	09/00 →	8HZ (DV4TD)	Diesel	1398	4	25
206 Hatchback (2A/C)	1.4	10/00 →	KFU (ET3J4)	Petrol	1360	4	41
206 Hatchback (2A/C)	1.4	05/00 → 09/00	KFV (TU3JP)	Petrol/Petroleum Gas (LPG)	1360	4	43
206 Hatchback (2A/C)	1.4	05/00 → 09/00	KFV (TU3JP)	Petrol	1360	4	43
206 Hatchback (2A/C)	1.4	09/99 →	KFW (TU3JP)	Petrol	1360	4	45
206 Hatchback (2A/C)	1.4	09/99 →	KFW (TU3JP)	Bi-Fuel	1360	4	45
206 Hatchback (2A/C)	1.4	09/99 →	KFX (TU3JP)	Petrol	1361	4	46
206 Hatchback (2A/C)	1.6	05/00 →	9HY (DV6TED4)	Diesel	1560	4	65
206 Hatchback (2A/C)	1.6	05/00 →	9HZ (DV6TED4)	Diesel	1560	4	66
206 Hatchback (2A/C)	1.6	12/00 →	NFU (TU5JP4)	Petrol/Ethanol	1587	4	85
206 Hatchback (2A/C)	1.6	12/00 →	NFU (TU5JP4)	Petrol	1587	4	85
206 Hatchback (2A/C)	1.6	12/00 →	NFU (TU5JP4)	Flexfuel	1587	4	85
206 Hatchback (2A/C)	1.6	09/99 → 12/00	NFZ (TU5JP)	Petrol	1587	4	89
206 Hatchback (2A/C)	1.9	09/99 → 11/00	WJZ (DW8)	Diesel	1868	4	127
206 Hatchback (2A/C)	2.0	07/00 →	RFK (EW10J4S)	Petrol	1997	4	140
206 Hatchback (2A/C)	2.0	10/00 →	RFN (EW10J4)	Petrol	1997	4	142
206 Hatchback (2A/C)	2.0	04/99 → 10/00	RFR (DEW10J4)	Petrol	1997	4	143
206 Hatchback (2A/C)	2.0	12/99 →	RHY (DW10TD)	Diesel	1997	4	166
206 Saloon	1.4	09/00 →	8HZ (DV4TD)	Diesel	1398	4	25
206 Saloon	1.4	03/00 →	KFV (TU3A)	Petrol	1360	4	42
206 Saloon	1.4	03/00 →	KFW (TU3JP)	Petrol	1360	4	45
206 Saloon	1.4	03/00 →	KFW (TU3JP)	Bi-Fuel	1360	4	45
206 Saloon	1.6	03/00 →	NFU (TU5JP4)	Petrol/Ethanol	1587	4	85
206 Saloon	1.6	03/00 →	NFU (TU5JP4)	Petrol	1587	4	85
206 Saloon	1.6	03/00 →	NFU (TU5JP4)	Flexfuel	1587	4	85
206 SW (2E/K)	1.1	07/00 →	HFX (TU1JP)	Petrol	1124	4	12
206 SW (2E/K)	1.4	07/00 →	8HX (DV4TD)	Diesel	1398	4	24
206 SW (2E/K)	1.4	10/00 →	KFU (ET3J4)	Petrol	1360	4	41
206 SW (2E/K)	1.4	07/00 →	KFV (TU3A)	Petrol	1360	4	42
206 SW (2E/K)	1.4	07/00 →	KFW (TU3JP)	Petrol	1360	4	45
206 SW (2E/K)	1.4	07/00 →	KFW (TU3JP)	Bi-Fuel	1360	4	45
206 SW (2E/K)	1.6	05/00 →	9HZ (DV6TED4)	Diesel	1560	4	66
206 SW (2E/K)	1.6	07/00 →	NFU (TU5JP4)	Petrol/Ethanol	1587	4	85
206 SW (2E/K)	1.6	07/00 →	NFU (TU5JP4)	Petrol	1587	4	85
206 SW (2E/K)	1.6	07/00 →	NFU (TU5JP4)	Flexfuel	1587	4	85
206 SW (2E/K)	2.0	07/00 →	RFN (EW10J4)	Petrol	1997	4	142
206 SW (2E/K)	2.0	07/00 →	RHY (DW10TD)	Diesel	1997	4	166
206 Van	1.4	09/00 → 03/00	8HX (DV4TD)	Diesel	1398	4	24
206 Van	1.4	09/00 → 03/00	8HZ (DV4TD)	Diesel	1398	4	25
206 Van	1.9	04/99 → 05/00	WJZ (DW8)	Diesel	1868	4	127
206+ (T3E)	1.1	01/00 →	HFX (TU1A)	Petrol	1124	4	11



Ltr







CC



9

Model	Ltr	Year	Engine	Fuel	CC	Gears	Power
206+ (T3E)	1.1	01/00→	HFX (TU1JP)	Petrol	1124	4	12
206+ (T3E)	1.1	01/00→	TU1AE5	Petrol	1124	4	14
206+ (T3E)	1.4	01/00→	8HX (DV4TD)	Diesel	1398	4	24
206+ (T3E)	1.4	01/00→	8HZ (DV4TD)	Diesel	1398	4	25
206+ (T3E)	1.4	09/01→	KFT (TU3A)	Petrol	1360	4	40
206+ (T3E)	1.4	01/00→	KFV (TU3A)	Petrol	1360	4	42
206+ (T3E)	1.4	01/00→	KFW (TU3A)	Petrol	1360	4	44
206+ (T3E)	1.4	01/00→	KFW (TU3A)	Flexfuel	1360	4	44
207 (WA, WC)	1.4	06/00→	8FS (EP3)	Petrol	1397	4	21
207 (WA, WC)	1.4	02/00→	8HZ (DV4TD)	Diesel	1398	4	25
207 (WA, WC)	1.4	06/00→	EP3	Petrol	1397	4	31
207 (WA, WC)	1.4	02/00→	KFU (ET3J4)	Petrol	1360	4	41
207 (WA, WC)	1.4	02/00→	KFV (TU3A)	Petrol	1360	4	42
207 (WA, WC)	1.4	08/00→	KFW (TU3A)	Petrol	1360	4	44
207 (WA, WC)	1.4	08/00→	KFW (TU3A)	Flexfuel	1360	4	44
207 (WA, WC)	1.6	10/00→	5FR (EP6DT)	Petrol	1598	4	53
207 (WA, WC)	1.6	02/00→	5FS (EP6C)	Petrol	1598	4	54
207 (WA, WC)	1.6	02/00→	5FX (EP6DT)	Petrol	1598	4	57
207 (WA, WC)	1.6	02/00→	5FY (EP6DTS)	Petrol	1598	4	58
207 (WA, WC)	1.6	02/00→	9HV (DV6ATED4)	Diesel	1560	4	62
207 (WA, WC)	1.6	02/00→	9HX (DV6ATED4)	Diesel	1560	4	64
207 (WA, WC)	1.6	02/00→	9HY (DV6TED4)	Diesel	1560	4	65
207 (WA, WC)	1.6	02/00→	9HZ (DV6TED4)	Diesel	1560	4	66
207 (WA, WC)	1.6	02/00→	EP6	Petrol	1598	4	80
207 (WA, WC)	1.6	02/00→	NFU (TU5JP4)	Petrol/Ethanol	1587	4	85
207 (WA, WC)	1.6	02/00→	NFU (TU5JP4)	Petrol	1587	4	85
207 (WA, WC)	1.6	02/00→	NFU (TU5JP4)	Flexfuel	1587	4	85
207 CC (WD)	1.6	10/00→	5FR (EP6DT)	Petrol	1598	4	53
207 CC (WD)	1.6	02/00→	5FX (EP6DT)	Petrol	1598	4	57
207 CC (WD)	1.6	08/00→	9HR (DV6C)	Diesel	1560	4	59
207 CC (WD)	1.6	02/00→	9HZ (DV6TED4)	Diesel	1560	4	66
207 CC (WD)	1.6	02/00→	EP6	Petrol	1598	4	80
207 Saloon	1.4	12/00→	KFV (TU3A)	Petrol	1360	4	42
207 Saloon	1.4	11/00→	KFW (TU3A)	Petrol	1360	4	44
207 Saloon	1.4	11/00→	KFW (TU3A)	Flexfuel	1360	4	44
207 SW (WK)	1.4	06/00→	8FS (EP3)	Petrol	1397	4	21
207 SW (WK)	1.4	06/00→	EP3	Petrol	1397	4	31
207 SW (WK)	1.4	06/00→	KFV (TU3A)	Petrol	1360	4	42
207 SW (WK)	1.6	02/00→	5FY (EP6DTS)	Petrol	1598	4	58
207 SW (WK)	1.6	08/00→	9HR (DV6C)	Diesel	1560	4	59
207 SW (WK)	1.6	06/00→	9HX (DV6ATED4)	Diesel	1560	4	64
207 SW (WK)	1.6	06/00→	9HZ (DV6TED4)	Diesel	1560	4	66
207 SW (WK)	1.6	06/00→	EP6	Petrol	1598	4	80
207 Van	1.4	04/00→	8HZ (DV4TD)	Diesel	1398	4	25
207 Van	1.6	04/00→	9HX (DV6ATED4)	Diesel	1560	4	64
208	1.4	03/01→	8FS (EP3)	Petrol	1397	4	21
208	1.6	03/01→	EP6CDT	Petrol	1598	4	81
305 II (581M)	1.1	11/98→12/98	XK5	Petrol	1127	4	15
305 II (581M)	1.5	09/98→07/99	142 (XR5A)	Petrol	1472	4	50
305 II (581M)	1.6	10/98→06/98	171 (XU5S)	Petrol	1580	4	67
305 II (581M)	1.6	10/98→07/98	B1A (XU51C)	Petrol	1580	4	71
305 II (581M)	1.6	11/98→12/98	BAZ (XU5CP)	Petrol	1580	4	75
305 II (581M)	1.8	11/98→12/98	161A (XUD7)	Diesel	1769	4	92
305 II (581M)	1.9	10/98→07/98	162 (XUD9)	Diesel	1905	4	104
305 II (581M)	1.9	10/98→07/98	D9A (XUD9)	Diesel	1905	4	113
305 II (581M)	1.9	11/98→12/98	DFZ (XU9J1)	Petrol	1905	4	118
305 II Break (581E)	1.6	02/98→12/98	B1A (XU51C)	Petrol	1580	4	71
305 II Break (581E)	1.6	11/98→12/98	BAZ (XU5CP)	Petrol	1580	4	75
305 II Break (581E)	1.8	11/98→12/98	161A (XUD7)	Diesel	1769	4	92
305 II Break (581E)	1.9	10/98→12/98	162 (XUD9)	Diesel	1905	4	104
305 II Break (581E)	1.9	10/98→12/98	D9A (XUD9)	Diesel	1905	4	113
305 II Break (581E)	1.9	11/98→12/98	DFZ (XU9J1)	Petrol	1905	4	118
306 (7B, N3, N5)	1.1	06/99→05/00	HDZ (TU1M)	Petrol	1124	4	10
306 (7B, N3, N5)	1.4	06/99→05/00	KDX (TU3MC)	Petrol	1361	4	37
306 (7B, N3, N5)	1.4	06/99→05/00	KFW (TU3JP)	Petrol	1360	4	45
306 (7B, N3, N5)	1.4	06/99→05/00	KFW (TU3JP)	Bi-Fuel	1360	4	45
306 (7B, N3, N5)	1.4	06/99→05/00	KFX (TU3JP)	Petrol	1361	4	46
306 (7B, N3, N5)	1.6	10/00→05/00	NFT	Petrol	1587	4	84
306 (7B, N3, N5)	1.6	06/99→10/00	NFZ (TU5JP)	Petrol	1587	4	89
306 (7B, N3, N5)	1.8	03/99→05/00	LFY (XU7JP4)	Petrol	1761	4	100

	Ltr				CC		9
306 (7B, N3, N5)	1.8	06/99→05/00	LFZ (XU7JP)	Petrol	1762	4	101
306 (7B, N3, N5)	1.9	03/99→05/00	DHV (XUD9BSD)	Diesel	1905	4	119
306 (7B, N3, N5)	1.9	06/99→05/00	DHY (XUD9TE)	Diesel	1905	4	122
306 (7B, N3, N5)	1.9	06/99→05/00	DJY (XUD9A)	Diesel	1905	4	123
306 (7B, N3, N5)	1.9	06/99→05/00	DJZ (XUD9Y)	Diesel	1905	4	124
306 (7B, N3, N5)	1.9	09/99→05/00	WJY (DW8B)	Diesel	1868	4	126
306 (7B, N3, N5)	1.9	09/99→05/00	WJZ (DW8)	Diesel	1868	4	127
306 (7B, N3, N5)	1.9	02/99→10/99	XUD9	Diesel	1905	4	129
306 (7B, N3, N5)	1.9	02/99→04/99	XUD9TE	Diesel	1905	4	130
306 (7B, N3, N5)	2.0	06/99→05/00	RFT (XU10J4)	Petrol	1998	4	145
306 (7B, N3, N5)	2.0	03/99→05/00	RFV (XU10J4R)	Petrol	1998	4	147
306 (7B, N3, N5)	2.0	07/99→05/00	RFX (XU10J2)	Petrol	1998	4	149
306 (7B, N3, N5)	2.0	06/99→05/00	RFY (XU10J4Z)	Petrol	1998	4	150
306 (7B, N3, N5)	2.0	06/99→05/00	RHY (DW10TD)	Diesel	1997	4	166
306 Break (7E, N3, N5)	1.4	03/99→04/00	KFW (TU3JP)	Petrol	1360	4	45
306 Break (7E, N3, N5)	1.4	03/99→04/00	KFW (TU3JP)	Bi-Fuel	1360	4	45
306 Break (7E, N3, N5)	1.4	03/99→04/00	KFX (TU3JP)	Petrol	1361	4	46
306 Break (7E, N3, N5)	1.6	10/00→04/00	NFT	Petrol	1587	4	84
306 Break (7E, N3, N5)	1.6	03/99→10/00	NFZ (TU5JP)	Petrol	1587	4	89
306 Break (7E, N3, N5)	1.8	03/99→04/00	LFY (XU7JP4)	Petrol	1761	4	100
306 Break (7E, N3, N5)	1.8	03/99→04/00	LFZ (XU7JP)	Petrol	1762	4	101
306 Break (7E, N3, N5)	1.9	03/99→04/00	DHV (XUD9BSD)	Diesel	1905	4	119
306 Break (7E, N3, N5)	1.9	02/99→04/00	DHY (XUD9TE)	Diesel	1905	4	122
306 Break (7E, N3, N5)	1.9	03/99→04/00	DJY (XUD9A)	Diesel	1905	4	123
306 Break (7E, N3, N5)	1.9	09/99→04/00	WJY (DW8B)	Diesel	1868	4	126
306 Break (7E, N3, N5)	1.9	09/99→04/00	WJZ (DW8)	Diesel	1868	4	127
306 Break (7E, N3, N5)	2.0	03/99→04/00	RFV (XU10J4R)	Petrol	1998	4	147
306 Break (7E, N3, N5)	2.0	06/99→04/00	RHY (DW10TD)	Diesel	1997	4	166
306 Convertible (7D, N3, N5)	1.6	10/00→04/00	NFT	Petrol	1587	4	84
306 Convertible (7D, N3, N5)	1.6	04/99→10/00	NFZ (TU5JP)	Petrol	1587	4	89
306 Convertible (7D, N3, N5)	1.8	07/00→04/00	LFY (XU7JP4)	Petrol	1761	4	100
306 Convertible (7D, N3, N5)	1.8	03/99→04/00	LFZ (XU7JP)	Petrol	1762	4	101
306 Convertible (7D, N3, N5)	2.0	03/99→04/00	RFV (XU10J4R)	Petrol	1998	4	147
306 Convertible (7D, N3, N5)	2.0	03/99→04/00	RFX (XU10J2)	Petrol	1998	4	149
306 Hatchback (7A, 7C, N3, N5)	1.1	05/99→05/00	HDZ (TU1M)	Petrol	1124	4	10
306 Hatchback (7A, 7C, N3, N5)	1.4	05/99→05/00	KDX (TU3MC)	Petrol	1361	4	37
306 Hatchback (7A, 7C, N3, N5)	1.4	05/99→05/00	KFW (TU3JP)	Petrol	1360	4	45
306 Hatchback (7A, 7C, N3, N5)	1.4	05/99→05/00	KFW (TU3JP)	Bi-Fuel	1360	4	45
306 Hatchback (7A, 7C, N3, N5)	1.4	05/99→05/00	KFX (TU3JP)	Petrol	1361	4	46
306 Hatchback (7A, 7C, N3, N5)	1.6	10/00→05/00	NFT	Petrol	1587	4	84
306 Hatchback (7A, 7C, N3, N5)	1.6	05/99→10/00	NFZ (TU5JP)	Petrol	1587	4	89
306 Hatchback (7A, 7C, N3, N5)	1.8	05/99→05/00	A9A (XUD7)	Diesel	1769	4	96
306 Hatchback (7A, 7C, N3, N5)	1.8	03/99→05/00	LFY (XU7JP4)	Petrol	1761	4	100
306 Hatchback (7A, 7C, N3, N5)	1.8	05/99→05/00	LFZ (XU7JP)	Petrol	1762	4	101
306 Hatchback (7A, 7C, N3, N5)	1.9	03/99→05/00	DHV (XUD9BSD)	Diesel	1905	4	119
306 Hatchback (7A, 7C, N3, N5)	1.9	05/99→05/00	DHY (XUD9TE)	Diesel	1905	4	122
306 Hatchback (7A, 7C, N3, N5)	1.9	06/99→05/00	DJY (XUD9A)	Diesel	1905	4	123
306 Hatchback (7A, 7C, N3, N5)	1.9	05/99→05/00	DJZ (XUD9Y)	Diesel	1905	4	124
306 Hatchback (7A, 7C, N3, N5)	1.9	09/99→05/00	WJY (DW8B)	Diesel	1868	4	126
306 Hatchback (7A, 7C, N3, N5)	1.9	09/99→05/00	WJZ (DW8)	Diesel	1868	4	127
306 Hatchback (7A, 7C, N3, N5)	1.9	04/99→05/99	XUD9	Diesel	1905	4	129
306 Hatchback (7A, 7C, N3, N5)	1.9	04/99→04/99	XUD9TE	Diesel	1905	4	130
306 Hatchback (7A, 7C, N3, N5)	2.0	03/99→05/00	RFS (XU10J4RS)	Petrol	1998	4	144
306 Hatchback (7A, 7C, N3, N5)	2.0	06/99→05/00	RFT (XU10J4)	Petrol	1998	4	145
306 Hatchback (7A, 7C, N3, N5)	2.0	03/99→05/00	RFV (XU10J4R)	Petrol	1998	4	147
306 Hatchback (7A, 7C, N3, N5)	2.0	05/99→05/00	RFX (XU10J2)	Petrol	1998	4	149
306 Hatchback (7A, 7C, N3, N5)	2.0	05/99→05/00	RFY (XU10J4Z)	Petrol	1998	4	150
306 Hatchback (7A, 7C, N3, N5)	2.0	06/99→05/00	RHY (DW10TD)	Diesel	1997	4	166
306 Van (N., 7.)	1.9	02/99→10/99	XUD9	Diesel	1905	4	129
306 Van (N., 7.)	1.9	02/99→04/99	XUD9TE	Diesel	1905	4	130
307 (3A/C)	1.4	10/00→	8HX (DV4TD)	Diesel	1398	4	24
307 (3A/C)	1.4	10/00→	8HZ (DV4TD)	Diesel	1398	4	25
307 (3A/C)	1.4	11/00→	KFU (ET3J4)	Petrol	1360	4	41
307 (3A/C)	1.4	08/00→	KFW (TU3JP)	Petrol	1360	4	45
307 (3A/C)	1.4	08/00→	KFW (TU3JP)	Bi-Fuel	1360	4	45
307 (3A/C)	1.6	04/00→	9HV (DV6ATED4)	Diesel	1560	4	62
307 (3A/C)	1.6	02/00→	9HY (DV6TED4)	Diesel	1560	4	65
307 (3A/C)	1.6	02/00→	9HZ (DV6TED4)	Diesel	1560	4	66
307 (3A/C)	1.6	08/00→	NFU (TU5JP4)	Petrol/Ethanol	1587	4	85
307 (3A/C)	1.6	08/00→	NFU (TU5JP4)	Petrol	1587	4	85



Ltr







CC



9

Model	Ltr	Year	Engine	Fuel	CC	Seats	Price
307 (3A/C)	1.6	08/00→	NFU (TU5JP4)	Flexfuel	1587	4	85
307 (3A/C)	2.0	03/00→	RFJ (EW10A)	Petrol/Ethanol	1997	4	139
307 (3A/C)	2.0	03/00→	RFJ (EW10A)	Petrol	1997	4	139
307 (3A/C)	2.0	03/00→	RFJ (EW10A)	Flexfuel	1997	4	139
307 (3A/C)	2.0	06/00→	RFK (EW10J4S)	Petrol	1997	4	140
307 (3A/C)	2.0	08/00→	RFN (EW10J4)	Petrol	1997	4	142
307 (3A/C)	2.0	10/00→	RHR (DW10BTED4)	Diesel	1997	4	159
307 (3A/C)	2.0	08/00→	RHS (DW10ATED)	Diesel	1997	4	160
307 (3A/C)	2.0	08/00→	RHY (DW10TD)	Diesel	1997	4	166
307 Break (3E)	1.4	03/00→	8HZ (DV4TD)	Diesel	1398	4	25
307 Break (3E)	1.4	11/00→	KFU (ET3J4)	Petrol	1360	4	41
307 Break (3E)	1.4	04/00→09/00	KFW (TU3JP)	Petrol	1360	4	45
307 Break (3E)	1.4	04/00→09/00	KFW (TU3JP)	Bi-Fuel	1360	4	45
307 Break (3E)	1.6	04/00→	9HV (DV6ATED4)	Diesel	1560	4	62
307 Break (3E)	1.6	02/00→	9HY (DV6TED4)	Diesel	1560	4	65
307 Break (3E)	1.6	02/00→	9HZ (DV6TED4)	Diesel	1560	4	66
307 Break (3E)	1.6	03/00→	NFU (TU5JP4)	Petrol/Ethanol	1587	4	85
307 Break (3E)	1.6	03/00→	NFU (TU5JP4)	Petrol	1587	4	85
307 Break (3E)	1.6	03/00→	NFU (TU5JP4)	Flexfuel	1587	4	85
307 Break (3E)	2.0	03/00→	RFJ (EW10A)	Petrol/Ethanol	1997	4	139
307 Break (3E)	2.0	03/00→	RFJ (EW10A)	Petrol	1997	4	139
307 Break (3E)	2.0	03/00→	RFJ (EW10A)	Flexfuel	1997	4	139
307 Break (3E)	2.0	06/00→	RFK (EW10J4S)	Petrol	1997	4	140
307 Break (3E)	2.0	03/00→	RFN (EW10J4)	Petrol	1997	4	142
307 Break (3E)	2.0	02/00→	RHR (DW10BTED4)	Diesel	1997	4	159
307 Break (3E)	2.0	03/00→	RHS (DW10ATED)	Diesel	1997	4	160
307 Break (3E)	2.0	03/00→	RHY (DW10TD)	Diesel	1997	4	166
307 CC (3B)	1.6	02/00→	NFU (TU5JP4)	Petrol/Ethanol	1587	4	85
307 CC (3B)	1.6	02/00→	NFU (TU5JP4)	Petrol	1587	4	85
307 CC (3B)	1.6	02/00→	NFU (TU5JP4)	Flexfuel	1587	4	85
307 CC (3B)	2.0	03/00→	RFJ (EW10A)	Petrol/Ethanol	1997	4	139
307 CC (3B)	2.0	03/00→	RFJ (EW10A)	Petrol	1997	4	139
307 CC (3B)	2.0	03/00→	RFJ (EW10A)	Flexfuel	1997	4	139
307 CC (3B)	2.0	10/00→	RFK (EW10J4S)	Petrol	1997	4	140
307 CC (3B)	2.0	10/00→	RFN (EW10J4)	Petrol	1997	4	142
307 CC (3B)	2.0	06/00→	RHR (DW10BTED4)	Diesel	1997	4	159
307 SW (3H)	1.4	03/00→01/00	8HZ (DV4TD)	Diesel	1398	4	25
307 SW (3H)	1.4	11/00→	KFU (ET3J4)	Petrol	1360	4	41
307 SW (3H)	1.4	04/00→09/00	KFW (TU3JP)	Petrol	1360	4	45
307 SW (3H)	1.4	04/00→09/00	KFW (TU3JP)	Bi-Fuel	1360	4	45
307 SW (3H)	1.6	12/00→	9HV (DV6ATED4)	Diesel	1560	4	62
307 SW (3H)	1.6	12/00→	9HX (DV6ATED4)	Diesel	1560	4	64
307 SW (3H)	1.6	02/00→	9HY (DV6TED4)	Diesel	1560	4	65
307 SW (3H)	1.6	02/00→	9HZ (DV6TED4)	Diesel	1560	4	66
307 SW (3H)	1.6	03/00→	NFU (TU5JP4)	Petrol/Ethanol	1587	4	85
307 SW (3H)	1.6	03/00→	NFU (TU5JP4)	Petrol	1587	4	85
307 SW (3H)	1.6	03/00→	NFU (TU5JP4)	Flexfuel	1587	4	85
307 SW (3H)	2.0	03/00→	RFJ (EW10A)	Petrol/Ethanol	1997	4	139
307 SW (3H)	2.0	03/00→	RFJ (EW10A)	Petrol	1997	4	139
307 SW (3H)	2.0	03/00→	RFJ (EW10A)	Flexfuel	1997	4	139
307 SW (3H)	2.0	03/00→	RFN (EW10J4)	Petrol	1997	4	142
307 SW (3H)	2.0	02/00→	RHR (DW10BTED4)	Diesel	1997	4	159
307 SW (3H)	2.0	03/00→	RHS (DW10ATED)	Diesel	1997	4	160
307 SW (3H)	2.0	03/00→	RHY (DW10TD)	Diesel	1997	4	166
308 (4A_, 4C_)	1.4	09/00→	8FS (EP3)	Petrol	1397	4	21
308 (4A_, 4C_)	1.4	09/00→	EP3	Petrol	1397	4	31
308 (4A_, 4C_)	1.6	09/00→	5FT (EP6DT)	Petrol	1598	4	55
308 (4A_, 4C_)	1.6	01/01→	5FV (EP6DT)	Petrol	1598	4	56
308 (4A_, 4C_)	1.6	09/00→	5FX (EP6DT)	Petrol	1598	4	57
308 (4A_, 4C_)	1.6	03/00→	5FY (EP6DTS)	Petrol	1598	4	58
308 (4A_, 4C_)	1.6	12/00→	9HR (DV6C)	Diesel	1560	4	59
308 (4A_, 4C_)	1.6	09/00→	9HZ (DV6TED4)	Diesel	1560	4	66
308 (4A_, 4C_)	1.6	09/00→	EP6	Petrol	1598	4	80
308 (4A_, 4C_)	1.6	10/00→	EP6CDT	Petrol	1598	4	81
308 (4A_, 4C_)	1.6	07/01→	EP6CDTX	Petrol	1598	4	82
308 (4A_, 4C_)	1.6	04/00→	NFU (TU5JP4)	Petrol/Ethanol	1587	4	85
308 (4A_, 4C_)	1.6	04/00→	NFU (TU5JP4)	Petrol	1587	4	85
308 (4A_, 4C_)	1.6	04/00→	NFU (TU5JP4)	Flexfuel	1587	4	85
308 (4A_, 4C_)	2.0	10/01→	RHE (DW10CTED4)	Diesel	1997	4	155
308 (4A_, 4C_)	2.0	04/01→	RHH (DW10CTED4)	Diesel	1997	4	156

	Ltr				CC		9
308 (4A, 4C)	2.0	09/00 →	RHR (DW10BTE4)	Diesel	1997	4	159
308 CC	1.6	06/00 →	5FT (EP6DT)	Petrol	1598	4	55
308 CC	1.6	06/00 →	5FX (EP6DT)	Petrol	1598	4	57
308 CC	1.6	06/00 →	9HR (DV6C)	Diesel	1560	4	59
308 CC	1.6	06/00 →	EP6	Petrol	1598	4	80
308 CC	1.6	06/00 →	EP6CDT	Petrol	1598	4	81
308 CC	1.6	10/01 →	EP6CDTX	Petrol	1598	4	82
308 CC	2.0	06/00 →	RHH (DW10CTED4)	Diesel	1997	4	156
308 CC	2.0	04/00 →	RHR (DW10BTE4)	Diesel	1997	4	159
308 SW	1.4	09/00 →	8FS (EP3)	Petrol	1397	4	21
308 SW	1.6	09/00 →	5FT (EP6DT)	Petrol	1598	4	55
308 SW	1.6	09/00 →	5FX (EP6DT)	Petrol	1598	4	57
308 SW	1.6	03/00 →	5FY (EP6DTS)	Petrol	1598	4	58
308 SW	1.6	12/00 →	9HR (DV6C)	Diesel	1560	4	59
308 SW	1.6	09/00 →	9HV (DV6ATED4)	Diesel	1560	4	62
308 SW	1.6	09/00 →	9HX (DV6ATED4)	Diesel	1560	4	64
308 SW	1.6	09/00 →	9HZ (DV6TED4)	Diesel	1560	4	66
308 SW	1.6	09/00 →	EP6	Petrol	1598	4	80
308 SW	1.6	10/00 →	EP6CDT	Petrol	1598	4	81
308 SW	1.6	03/00 →	NFU (TU5JP4)	Petrol/Ethanol	1587	4	85
308 SW	1.6	03/00 →	NFU (TU5JP4)	Petrol	1587	4	85
308 SW	1.6	03/00 →	NFU (TU5JP4)	Flexfuel	1587	4	85
308 SW	2.0	01/00 →	RFJ (EW10A)	Petrol/Ethanol	1997	4	139
308 SW	2.0	01/00 →	RFJ (EW10A)	Petrol	1997	4	139
308 SW	2.0	01/00 →	RFJ (EW10A)	Flexfuel	1997	4	139
308 SW	2.0	04/01 →	RHE (DW10CTED4)	Diesel	1997	4	155
308 SW	2.0	06/00 →	RHH (DW10CTED4)	Diesel	1997	4	156
308 SW	2.0	09/00 →	RHR (DW10BTE4)	Diesel	1997	4	159
309 I (10C, 10A)	1.1	10/98 → 07/98	E1	Petrol	1118	4	7
309 I (10C, 10A)	1.3	10/98 → 07/98	G1A	Petrol	1294	4	18
309 I (10C, 10A)	1.4	03/98 → 07/98	K1D (TU3A)	Petrol	1361	4	32
309 I (10C, 10A)	1.4	03/98 → 07/98	K2B (TU3S)	Petrol	1360	4	33
309 I (10C, 10A)	1.4	03/98 → 07/98	KDY (TU3M)	Petrol	1361	4	38
309 I (10C, 10A)	1.4	03/98 → 07/98	KDZ (TU3M)	Petrol	1361	4	39
309 I (10C, 10A)	1.5	06/98 → 12/98	Y2/K	Petrol	1442	4	49
309 I (10C, 10A)	1.6	11/98 → 09/98	180Z (XU5J)	Petrol	1580	4	69
309 I (10C, 10A)	1.6	10/98 → 07/98	B1A (XU51C)	Petrol	1580	4	71
309 I (10C, 10A)	1.6	08/98 → 07/98	B1E (XU51C)	Petrol	1580	4	72
309 I (10C, 10A)	1.6	11/98 → 09/98	B6B (XU5J)	Petrol	1580	4	74
309 I (10C, 10A)	1.6	09/98 → 12/98	BAZ (XU5CP)	Petrol	1580	4	75
309 I (10C, 10A)	1.9	06/98 → 07/98	16Z (XUD9)	Diesel	1905	4	104
309 I (10C, 10A)	1.9	10/98 → 07/98	D2B (XU9S)	Petrol	1905	4	106
309 I (10C, 10A)	1.9	10/98 → 07/98	D6B (XU9JA)	Petrol	1905	4	109
309 I (10C, 10A)	1.9	06/98 → 07/98	D9A (XUD9)	Diesel	1905	4	113
309 I (10C, 10A)	1.9	07/98 → 07/98	DDZ (XU9M)	Petrol	1905	4	116
309 I (10C, 10A)	1.9	03/98 → 07/98	DFZ (XU9J1)	Petrol	1905	4	118
309 I (10C, 10A)	1.9	07/98 → 07/98	DKZ (XU9JAZ)	Petrol	1905	4	125
309 II (3C, 3A)	1.1	09/98 → 10/99	H1B (TU1)	Petrol	1124	4	8
309 II (3C, 3A)	1.1	08/99 → 12/99	HDZ (TU1M)	Petrol	1124	4	10
309 II (3C, 3A)	1.4	07/99 → 12/99	K1D (TU3A)	Petrol	1361	4	32
309 II (3C, 3A)	1.4	07/98 → 12/99	KDY (TU3M)	Petrol	1361	4	38
309 II (3C, 3A)	1.4	07/98 → 12/99	KDZ (TU3M)	Petrol	1361	4	39
309 II (3C, 3A)	1.6	07/98 → 12/99	B2A (XU52C/K)	Petrol	1580	4	73
309 II (3C, 3A)	1.6	07/98 → 12/99	BDY (XU5M2Z)	Petrol	1580	4	76
309 II (3C, 3A)	1.6	07/98 → 12/99	BDY (XU5M3Z)	Petrol	1580	4	77
309 II (3C, 3A)	1.6	07/98 → 12/99	BDZ (XU5M)	Petrol	1580	4	78
309 II (3C, 3A)	1.8	07/98 → 12/99	161A (XUD7)	Diesel	1769	4	92
309 II (3C, 3A)	1.8	08/98 → 12/99	A8B (XUD7TE)	Diesel	1769	4	95
309 II (3C, 3A)	1.9	07/98 → 12/99	16Z (XUD9)	Diesel	1905	4	104
309 II (3C, 3A)	1.9	08/98 → 07/99	D6C (XU9J4)	Petrol	1905	4	110
309 II (3C, 3A)	1.9	07/98 → 12/99	D9A (XUD9)	Diesel	1905	4	113
309 II (3C, 3A)	1.9	10/99 → 12/99	DDZ (XU9M)	Petrol	1905	4	116
309 II (3C, 3A)	1.9	10/99 → 12/99	DFW (XU9J4Z)	Petrol	1905	4	117
309 II (3C, 3A)	1.9	08/98 → 12/99	DFZ (XU9J1)	Petrol	1905	4	118
309 II (3C, 3A)	1.9	07/98 → 12/99	DJZ (XUD9Y)	Diesel	1905	4	124
309 II (3C, 3A)	1.9	07/98 → 12/99	DKZ (XU9JAZ)	Petrol	1905	4	125
405 I (15B)	1.4	01/98 → 07/99	K5A (TU3)	Petrol	1360	4	34
405 I (15B)	1.6	07/98 → 12/99	B1E (XU51C)	Petrol	1580	4	72
405 I (15B)	1.6	01/98 → 12/99	B2A (XU52C/K)	Petrol	1580	4	73
405 I (15B)	1.6	07/98 → 06/98	BAZ (XU5CP)	Petrol	1580	4	75



Ltr







CC



9

Model	Ltr	Year	Engine	Fuel	CC	Gear	Price
405 I (15B)	1.6	07/98→12/99	BDY (XU5M2Z)	Petrol	1580	4	76
405 I (15B)	1.6	07/98→12/99	BDZ (XU5M)	Petrol	1580	4	78
405 I (15B)	1.8	03/98→12/99	A8A (XUD7TE)	Diesel	1769	4	94
405 I (15B)	1.8	03/98→12/99	AJZ (XUD7TEY)	Diesel	1769	4	97
405 I (15B)	1.9	07/98→12/99	D2C (XU92C)	Petrol	1905	4	107
405 I (15B)	1.9	01/98→12/99	D6A (XU9JZ)	Petrol	1905	4	108
405 I (15B)	1.9	06/98→07/99	D6C (XU9J4)	Petrol	1905	4	110
405 I (15B)	1.9	03/98→12/99	D9B (XUD9A)	Diesel	1905	4	114
405 I (15B)	1.9	07/98→12/99	DDZ (XU9M)	Petrol	1905	4	116
405 I (15B)	1.9	04/98→12/99	DFW (XU9J4Z)	Petrol	1905	4	117
405 I (15B)	1.9	07/98→12/99	DFZ (XU9J1)	Petrol	1905	4	118
405 I (15B)	1.9	07/98→09/99	DJZ (XUD9Y)	Diesel	1905	4	124
405 I (15B)	1.9	06/98→12/99	DKZ (XU9JAZ)	Petrol	1905	4	125
405 I Break (15E)	1.4	05/98→07/99	K5A (TU3)	Petrol	1360	4	34
405 I Break (15E)	1.6	10/98→08/99	B1E (XU51C)	Petrol	1580	4	72
405 I Break (15E)	1.6	05/98→07/99	B2A (XU52C/K)	Petrol	1580	4	73
405 I Break (15E)	1.6	10/98→08/99	BAZ (XU5CP)	Petrol	1580	4	75
405 I Break (15E)	1.6	10/98→08/99	BDY (XU5M2Z)	Petrol	1580	4	76
405 I Break (15E)	1.6	10/98→08/99	BDY (XU5M3Z)	Petrol	1580	4	77
405 I Break (15E)	1.6	04/98→08/99	BDZ (XU5M)	Petrol	1580	4	78
405 I Break (15E)	1.8	10/98→08/99	A8A (XUD7TE)	Diesel	1769	4	94
405 I Break (15E)	1.8	10/98→08/99	AJZ (XUD7TEY)	Diesel	1769	4	97
405 I Break (15E)	1.9	10/98→08/99	D2C (XU92C)	Petrol	1905	4	107
405 I Break (15E)	1.9	06/98→07/99	D6C (XU9J4)	Petrol	1905	4	110
405 I Break (15E)	1.9	10/98→08/99	D9B (XUD9A)	Diesel	1905	4	114
405 I Break (15E)	1.9	10/98→08/99	DDZ (XU9M)	Petrol	1905	4	116
405 I Break (15E)	1.9	05/98→08/99	DFZ (XU9J1)	Petrol	1905	4	118
405 I Break (15E)	1.9	10/98→08/99	DJY (XUD9A)	Diesel	1905	4	123
405 I Break (15E)	1.9	10/98→08/99	DJZ (XUD9Y)	Diesel	1905	4	124
405 I Break (15E)	1.9	10/98→08/99	DKZ (XU9JAZ)	Petrol	1905	4	125
405 II (4B)	1.4	08/99→10/99	KDX (TU3MC)	Petrol	1361	4	37
405 II (4B)	1.6	08/99→10/99	BDY (XU5M2Z)	Petrol	1580	4	76
405 II (4B)	1.6	08/99→10/99	BDY (XU5M3Z)	Petrol	1580	4	77
405 II (4B)	1.6	08/99→10/99	BDZ (XU5M)	Petrol	1580	4	78
405 II (4B)	1.6	08/99→10/99	BFZ (XU5JP)	Petrol	1580	4	79
405 II (4B)	1.8	08/99→10/99	LFZ (XU7JP)	Petrol	1762	4	101
405 II (4B)	1.9	08/99→10/99	DHY (XUD9TE)	Diesel	1905	4	122
405 II (4B)	1.9	06/99→10/99	DJY (XUD9A)	Diesel	1905	4	123
405 II (4B)	1.9	08/99→10/99	DJZ (XUD9Y)	Diesel	1905	4	124
405 II (4B)	2.0	06/99→10/99	RFT (XU10J4)	Petrol	1998	4	145
405 II (4B)	2.0	08/99→10/99	RFX (XU10J2)	Petrol	1998	4	149
405 II (4B)	2.0	08/99→10/99	RFY (XU10J4Z)	Petrol	1998	4	150
405 II (4B)	2.0	08/99→10/99	RGZ (XU10J4TE/Z)	Petrol	1998	4	154
405 II Break (4E)	1.4	08/99→10/99	KDX (TU3MC)	Petrol	1361	4	37
405 II Break (4E)	1.6	08/99→10/99	BDY (XU5M2Z)	Petrol	1580	4	76
405 II Break (4E)	1.6	08/99→10/99	BDY (XU5M3Z)	Petrol	1580	4	77
405 II Break (4E)	1.6	08/99→10/99	BDZ (XU5M)	Petrol	1580	4	78
405 II Break (4E)	1.6	08/99→10/99	BFZ (XU5JP)	Petrol	1580	4	79
405 II Break (4E)	1.8	08/99→10/99	LFZ (XU7JP)	Petrol	1762	4	101
405 II Break (4E)	1.9	08/99→10/99	DHY (XUD9TE)	Diesel	1905	4	122
405 II Break (4E)	1.9	06/99→10/99	DJY (XUD9A)	Diesel	1905	4	123
405 II Break (4E)	1.9	08/99→10/99	DJZ (XUD9Y)	Diesel	1905	4	124
405 II Break (4E)	1.9	09/99→12/99	XUD9	Diesel	1905	4	129
405 II Break (4E)	2.0	08/99→10/99	RFX (XU10J2)	Petrol	1998	4	149
405 II Break (4E)	2.0	08/99→12/99	RGZ (XU10J4TE/Z)	Petrol	1998	4	154
406 (8B)	1.6	11/99→05/00	BFZ (XU5JP)	Petrol	1580	4	79
406 (8B)	1.8	10/00→05/00	6FZ (EW7J4)	Petrol	1749	4	91
406 (8B)	1.8	05/99→05/00	LFX (XU7JB)	Petrol	1761	4	99
406 (8B)	1.8	11/99→10/00	LFY (XU7JP4)	Petrol	1761	4	100
406 (8B)	1.9	10/99→05/00	DHW (XUD9SD)	Diesel	1905	4	120
406 (8B)	1.9	01/99→05/00	DHX (XUD9TE)	Diesel	1905	4	121
406 (8B)	1.9	01/99→05/00	DHY (XUD9TE)	Diesel	1905	4	122
406 (8B)	2.0	08/00→06/00	RFN (EW10J4)	Petrol	1997	4	142
406 (8B)	2.0	01/99→08/00	RFR (DEW10J4)	Petrol	1997	4	143
406 (8B)	2.0	11/99→05/00	RFV (XU10J4R)	Petrol	1998	4	147
406 (8B)	2.0	04/99→05/00	RGX (XU10J2TE)	Petrol	1998	4	152
406 (8B)	2.0	11/99→03/99	RGY (XU10J2TE)	Petrol	1998	4	153
406 (8B)	2.0	08/00→05/00	RHS (DW10ATED)	Diesel	1997	4	160
406 (8B)	2.0	02/99→05/00	RHY (DW10TD)	Diesel	1997	4	166
406 (8B)	2.0	06/99→05/00	RHZ (DW10ATED)	Diesel	1997	4	167

	Ltr				CC		9
406 (8B)	2.0	05/00 → 05/00	RLZ (EW10D)	Petrol	1997	4	168
406 (8B)	2.1	01/99 → 05/00	P8C (XUD11BTE)	Diesel	2088	4	170
406 (8B)	2.2	07/00 → 05/00	3FZ (EW12J4)	Petrol	2230	4	174
406 (8B)	2.2	03/00 → 05/00	4HX (DW12TED4/FAP)	Diesel	2179	4	181
406 (8B)	3.0	03/00 → 05/00	XFX (ES9J4S)	Petrol	2946	6	207
406 (8B)	3.0	10/99 → 05/00	XFZ (ES9J4)	Petrol	2946	6	208
406 Break (8E/F)	1.8	10/00 → 10/00	6FZ (EW7J4)	Petrol	1749	4	91
406 Break (8E/F)	1.8	05/99 → 10/00	LFX (XU7JB)	Petrol	1761	4	99
406 Break (8E/F)	1.8	10/99 → 10/00	LFY (XU7JP4)	Petrol	1761	4	100
406 Break (8E/F)	1.9	10/99 → 10/00	DHW (XUD9SD)	Diesel	1905	4	120
406 Break (8E/F)	1.9	10/99 → 10/00	DHX (XUD9TE)	Diesel	1905	4	121
406 Break (8E/F)	2.0	10/00 → 10/00	RFN (EW10J4)	Petrol	1997	4	142
406 Break (8E/F)	2.0	01/99 → 10/00	RFR (DEW10J4)	Petrol	1997	4	143
406 Break (8E/F)	2.0	10/99 → 10/00	RFV (XU10J4R)	Petrol	1998	4	147
406 Break (8E/F)	2.0	10/99 → 10/00	RGX (XU10J2TE)	Petrol	1998	4	152
406 Break (8E/F)	2.0	11/99 → 03/99	RGY (XU10J2TE)	Petrol	1998	4	153
406 Break (8E/F)	2.0	08/00 → 10/00	RHS (DW10ATED)	Diesel	1997	4	160
406 Break (8E/F)	2.0	02/99 → 10/00	RHY (DW10TD)	Diesel	1997	4	166
406 Break (8E/F)	2.0	02/99 → 10/00	RHZ (DW10ATED)	Diesel	1997	4	167
406 Break (8E/F)	2.0	05/00 → 10/00	RLZ (EW10D)	Petrol	1997	4	168
406 Break (8E/F)	2.1	10/99 → 10/00	P8C (XUD11BTE)	Diesel	2088	4	170
406 Break (8E/F)	2.2	07/00 → 10/00	3FZ (EW12J4)	Petrol	2230	4	174
406 Break (8E/F)	2.2	03/00 → 10/00	4HX (DW12TED4/FAP)	Diesel	2179	4	181
406 Break (8E/F)	3.0	03/00 → 10/00	XFX (ES9J4S)	Petrol	2946	6	207
406 Break (8E/F)	3.0	10/99 → 10/00	XFZ (ES9J4)	Petrol	2946	6	208
406 Coupe (8C)	2.0	10/00 → 12/00	RFN (EW10J4)	Petrol	1997	4	142
406 Coupe (8C)	2.0	01/99 → 10/00	RFR (DEW10J4)	Petrol	1997	4	143
406 Coupe (8C)	2.0	03/99 → 12/00	RFV (XU10J4R)	Petrol	1998	4	147
406 Coupe (8C)	2.2	03/00 → 12/00	3FZ (EW12J4)	Petrol	2230	4	174
406 Coupe (8C)	2.2	03/00 → 12/00	4HX (DW12TED4/FAP)	Diesel	2179	4	181
406 Coupe (8C)	3.0	03/00 → 12/00	XFX (ES9J4S)	Petrol	2946	6	207
406 Coupe (8C)	3.0	03/99 → 12/00	XFZ (ES9J4)	Petrol	2946	6	208
407 (6D_)	1.6	05/00 →	9HY (DV6TED4)	Diesel	1560	4	65
407 (6D_)	1.8	09/00 →	6FY (EW7A)	Petrol	1749	4	90
407 (6D_)	1.8	05/00 →	6FZ (EW7J4)	Petrol	1749	4	91
407 (6D_)	2.0	09/00 →	RFJ (EW10A)	Petrol/Ethanol	1997	4	139
407 (6D_)	2.0	09/00 →	RFJ (EW10A)	Petrol	1997	4	139
407 (6D_)	2.0	09/00 →	RFJ (EW10A)	Flexfuel	1997	4	139
407 (6D_)	2.0	05/00 →	RFN (EW10J4)	Petrol	1997	4	142
407 (6D_)	2.0	02/01 →	RHE (DW10CTED4)	Diesel	1997	4	155
407 (6D_)	2.0	07/00 →	RHH (DW10CTED4)	Diesel	1997	4	156
407 (6D_)	2.0	05/00 →	RHR (DW10BTED4)	Diesel	1997	4	159
407 (6D_)	2.2	09/00 →	3FY (EW12J4)	Petrol	2230	4	173
407 (6D_)	2.2	05/00 →	3FZ (EW12J4)	Petrol	2230	4	174
407 (6D_)	2.2	06/00 →	4HP (DW12BTED4)	Diesel	2179	4	177
407 (6D_)	2.2	05/00 →	4HT (DW12BTED4)	Diesel	2179	4	178
407 (6D_)	2.7	10/00 →	UHZ (DT17)	Diesel	2720	6	201
407 (6D_)	3.0	05/00 →	XFV (ES9A)	Petrol	2946	6	206
407 Coupe (6C_)	2.0	02/01 →	RHE (DW10CTED4)	Diesel	1997	4	155
407 Coupe (6C_)	2.0	06/00 →	RHH (DW10CTED4)	Diesel	1997	4	156
407 Coupe (6C_)	2.0	10/00 →	RHR (DW10BTED4)	Diesel	1997	4	159
407 Coupe (6C_)	2.2	10/00 →	3FY (EW12J4)	Petrol	2230	4	173
407 Coupe (6C_)	2.7	10/00 →	UHZ (DT17)	Diesel	2720	6	201
407 Coupe (6C_)	3.0	06/00 →	DT20C	Diesel	2993	6	209
407 Coupe (6C_)	3.0	10/00 →	XFV (ES9A)	Petrol	2946	6	206
407 SW (6E_)	1.6	05/00 →	9HY (DV6TED4)	Diesel	1560	4	65
407 SW (6E_)	1.8	09/00 →	6FY (EW7A)	Petrol	1749	4	90
407 SW (6E_)	1.8	05/00 →	6FZ (EW7J4)	Petrol	1749	4	91
407 SW (6E_)	2.0	09/00 →	RFJ (EW10A)	Petrol/Ethanol	1997	4	139
407 SW (6E_)	2.0	09/00 →	RFJ (EW10A)	Petrol	1997	4	139
407 SW (6E_)	2.0	09/00 →	RFJ (EW10A)	Flexfuel	1997	4	139
407 SW (6E_)	2.0	05/00 →	RFN (EW10J4)	Petrol	1997	4	142
407 SW (6E_)	2.0	02/01 →	RHE (DW10CTED4)	Diesel	1997	4	155
407 SW (6E_)	2.0	07/00 →	RHH (DW10CTED4)	Diesel	1997	4	156
407 SW (6E_)	2.0	05/00 →	RHR (DW10BTED4)	Diesel	1997	4	159
407 SW (6E_)	2.2	09/00 →	3FY (EW12J4)	Petrol	2230	4	173
407 SW (6E_)	2.2	05/00 →	3FZ (EW12J4)	Petrol	2230	4	174
407 SW (6E_)	2.2	06/00 →	4HP (DW12BTED4)	Diesel	2179	4	177
407 SW (6E_)	2.2	05/00 →	4HT (DW12BTED4)	Diesel	2179	4	178
407 SW (6E_)	2.7	10/00 →	UHZ (DT17)	Diesel	2720	6	201



Ltr







CC



9

Model	Ltr	Year	Engine	Fuel	CC	Seats	Price
407 SW (6E_)	3.0	05/00→	XFV (ES9A)	Petrol	2946	6	206
504 Pickup (E_)	1.8	07/98→12/98	XM7	Petrol	1796	4	102
504 Pickup (E_)	1.9	01/98→12/98	XD4x88	Diesel	1948	4	128
504 Pickup (E_)	2.3	01/98→12/98	134 (XD2)	Diesel	2304	4	187
505 (551A)	2.0	09/98→09/99	106E (XN1A)	Petrol	1971	4	132
505 (551A)	2.2	03/98→10/98	176B (N9TE)	Petrol	2155	4	183
505 (551A)	2.2	06/98→12/98	176W (N9TEA)	Petrol	2155	4	184
505 (551A)	2.2	08/98→12/99	851B (ZDJL)	Petrol	2165	4	185
505 (551A)	2.2	03/98→12/99	851X (ZDJL)	Petrol	2165	4	186
505 (551A)	2.5	10/98→12/99	152A (XD3T)	Diesel	2498	4	192
505 (551A)	2.5	10/98→12/99	152B (XD3TE)	Diesel	2498	4	193
505 (551A)	2.5	06/98→12/99	155 (XD3)	Diesel	2498	4	194
505 (551A)	2.5	10/98→12/99	XD3T	Diesel	2497	4	199
505 (551A)	2.8	06/98→12/99	154X (ZN3J)	Petrol	2849	6	202
505 Break (551D)	2.0	10/98→09/98	829 (ZEJ)	Petrol	1995	4	136
505 Break (551D)	2.2	01/98→12/99	851X (ZDJL)	Petrol	2165	4	186
505 Break (551D)	2.5	10/98→12/99	152B (XD3TE)	Diesel	2498	4	193
505 Break (551D)	2.5	08/98→12/99	155 (XD3)	Diesel	2498	4	194
508	1.6	11/01→	5FS (EP6C)	Petrol	1598	4	54
508	1.6	11/01→	9HR (DV6C)	Diesel	1560	4	59
508	1.6	11/01→	EP6CDT	Petrol	1598	4	81
508	2.0	11/01→	RHH (DW10CTED4)	Diesel	1997	4	156
508	2.0	11/01→	RHR (DW10BTED4)	Diesel	1997	4	159
508	2.2	11/01→	4HL (DW12C)	Diesel	2179	4	175
508 SW	1.6	11/01→	5FS (EP6C)	Petrol	1598	4	54
508 SW	1.6	11/01→	5FX (EP6DT)	Petrol	1598	4	57
508 SW	1.6	11/01→	9HR (DV6C)	Diesel	1560	4	59
508 SW	1.6	11/01→	EP6CDT	Petrol	1598	4	81
508 SW	2.0	12/01→	RHH (DW10CTED4)	Diesel/Electro	1997	4	156
508 SW	2.0	11/01→	RHH (DW10CTED4)	Diesel	1997	4	156
508 SW	2.0	11/01→	RHR (DW10BTED4)	Diesel	1997	4	159
508 SW	2.2	11/01→	4HL (DW12C)	Diesel	2179	4	175
605 (6B)	2.0	06/98→09/99	RSA (XU102C)	Petrol	1998	4	137
605 (6B)	2.0	07/99→09/99	RFV (XU10J4R)	Petrol	1998	4	147
605 (6B)	2.0	06/98→09/99	RFZ (XU10J2Z)	Petrol	1998	4	151
605 (6B)	2.0	07/99→09/99	RGX (XU10J2TE)	Petrol	1998	4	152
605 (6B)	2.0	07/99→09/99	RGY (XU10J2TE)	Petrol	1998	4	153
605 (6B)	2.1	08/99→09/99	P8C (XUD11BTE)	Diesel	2088	4	170
605 (6B)	2.1	06/98→07/99	P9A (XUD11A)	Diesel	2138	4	171
605 (6B)	2.1	06/98→09/99	PHZ (XUD11ATE)	Diesel	2088	4	172
605 (6B)	2.5	07/99→09/99	THY (DK5ATE)	Diesel	2446	4	191
605 (6B)	3.0	10/98→09/99	UFZ (ZPJ)	Petrol	2963	6	210
605 (6B)	3.0	08/98→09/99	UKZ (ZPJ4/Z)	Petrol	2963	6	211
605 (6B)	3.0	04/99→09/99	XFZ (ES9J4)	Petrol	2946	6	208
607 (9D, 9U)	2.0	02/00→	RFN (EW10J4)	Petrol	1997	4	142
607 (9D, 9U)	2.0	09/00→	RHR (DW10BTED4)	Diesel	1997	4	159
607 (9D, 9U)	2.0	03/00→07/00	RHS (DW10ATED)	Diesel	1997	4	160
607 (9D, 9U)	2.0	05/00→	RHZ (DW10ATED)	Diesel	1997	4	167
607 (9D, 9U)	2.2	09/00→	3FY (EW12J4)	Petrol	2230	4	173
607 (9D, 9U)	2.2	02/00→	3FZ (EW12J4)	Petrol	2230	4	174
607 (9D, 9U)	2.2	05/00→	4HT (DW12BTED4)	Diesel	2179	4	178
607 (9D, 9U)	2.2	02/00→	4HX (DW12TED4/FAP)	Diesel	2179	4	181
607 (9D, 9U)	2.7	12/00→	DT17TED4	Diesel	2721	6	200
607 (9D, 9U)	3.0	03/00→	XFV (ES9A)	Petrol	2946	6	206
607 (9D, 9U)	3.0	02/00→	AFX (ES9J4S)	Petrol	2946	6	207
806 (221)	1.8	07/99→08/00	LFW (XU7JP)	Petrol	1761	4	98
806 (221)	1.9	07/99→08/00	DHX (XUD9TE)	Diesel	1905	4	121
806 (221)	1.9	05/99→08/00	DHY (XUD9TE)	Diesel	1905	4	122
806 (221)	2.0	09/00→08/00	RFN (EW10J4)	Petrol	1997	4	142
806 (221)	2.0	06/99→08/00	RFU (XU10J2)	Petrol	1998	4	146
806 (221)	2.0	05/99→09/00	RFV (XU10J4R)	Petrol	1998	4	147
806 (221)	2.0	06/99→08/00	RGX (XU10J2TE)	Petrol	1998	4	152
806 (221)	2.0	08/99→08/00	RHW (DW10ATED4)	Diesel	1997	4	164
806 (221)	2.0	08/99→08/00	RHZ (DW10ATED)	Diesel	1997	4	167
806 (221)	2.1	06/99→08/99	P8C (XUD11BTE)	Diesel	2088	4	170
807 (E)	2.0	09/00→	RFJ (EW10A)	Petrol/Ethanol	1997	4	139
807 (E)	2.0	09/00→	RFJ (EW10A)	Petrol	1997	4	139
807 (E)	2.0	09/00→	RFJ (EW10A)	Flexfuel	1997	4	139
807 (E)	2.0	06/00→	RFN (EW10J4)	Petrol	1997	4	142
807 (E)	2.0	06/00→	RHH (DW10CTED4)	Diesel	1997	4	156

	Ltr				CC		9
807 (E)	2.0	02/00 →	RHK (DW10UTED4)	Diesel	1997	4	157
807 (E)	2.0	06/00 →	RHM (DW10ATED4)	Diesel	1997	4	158
807 (E)	2.0	06/00 →	RHR (DW10BTED4)	Diesel	1997	4	159
807 (E)	2.0	06/00 →	RHT (DW10ATED4)	Diesel	1997	4	161
807 (E)	2.0	06/00 →	RHW (DW10ATED4)	Diesel	1997	4	164
807 (E)	2.2	06/00 →	3FZ (EW12J4)	Petrol	2230	4	174
807 (E)	2.2	06/00 →	4HT (DW12BTED4)	Diesel	2179	4	178
807 (E)	2.2	06/00 →	4HX (DW12TED4/FAP)	Diesel	2179	4	181
807 (E)	3.0	06/00 →	XFX (ES9J4S)	Petrol	2946	6	207
1007 (KM_)	1.4	04/00 →	8HX (DV4TD)	Diesel	1398	4	24
1007 (KM_)	1.4	04/00 →	8HZ (DV4TD)	Diesel	1398	4	25
1007 (KM_)	1.4	10/00 →	KFU (ET3J4)	Petrol	1360	4	41
1007 (KM_)	1.4	04/00 →	KFV (TU3JP)	Petrol/Petroleum Gas (LPG)	1360	4	43
1007 (KM_)	1.4	04/00 →	KFV (TU3JP)	Petrol	1360	4	43
1007 (KM_)	1.6	06/00 →	9HZ (DV6TED4)	Diesel	1560	4	66
1007 (KM_)	1.6	04/00 →	NFU (TU5JP4)	Petrol/Ethanol	1587	4	85
1007 (KM_)	1.6	04/00 →	NFU (TU5JP4)	Petrol	1587	4	85
1007 (KM_)	1.6	04/00 →	NFU (TU5JP4)	Flexfuel	1587	4	85
2008	1.6	03/01 →	5FS (EP6C)	Petrol	1598	4	54
3008	1.6	06/00 →	5FS (EP6C)	Petrol	1598	4	54
3008	1.6	06/00 →	5FV (EP6DT)	Petrol	1598	4	56
3008	1.6	06/00 →	5FX (EP6DT)	Petrol	1598	4	57
3008	1.6	08/01 →	9HR (DV6C)	Diesel	1560	4	59
3008	1.6	06/00 →	9HZ (DV6TED4)	Diesel	1560	4	66
3008	1.6	06/00 →	EP6	Petrol	1598	4	80
3008	2.0	06/00 →	RHE (DW10CTED4)	Diesel	1997	4	155
3008	2.0	06/00 →	RHH (DW10CTED4)	Diesel	1997	4	156
4007 (GP_)	2.0	11/01 →	4B11	Petrol	1998	4	131
4007 (GP_)	2.2	02/00 →	4HN (DW12MTED4)	Diesel	2179	4	176
5008	1.6	09/00 →	5FS (EP6C)	Petrol	1598	4	54
5008	1.6	08/01 →	9HR (DV6C)	Diesel	1560	4	59
5008	1.6	09/00 →	9HZ (DV6TED4)	Diesel	1560	4	66
5008	1.6	09/00 →	EP6	Petrol	1598	4	80
5008	1.6	09/00 →	EP6CDT	Petrol	1598	4	81
5008	2.0	06/00 →	RHE (DW10CTED4)	Diesel	1997	4	155
5008	2.0	09/00 →	RHH (DW10CTED4)	Diesel	1997	4	156
BIPPER (AA_)	1.3	10/01 →	199 A9.000	Diesel	1248	4	16
BIPPER (AA_)	1.4	02/00 →	8HS (DV4TD)	Diesel	1398	4	22
BIPPER (AA_)	1.4	02/00 →	KFV (TU3A)	Petrol	1360	4	42
BIPPER Tepee	1.3	10/01 →	199 A9.000	Diesel	1248	4	16
BIPPER Tepee	1.4	04/00 →	8HS (DV4TD)	Diesel	1398	4	22
BIPPER Tepee	1.4	04/00 →	KFV (TU3A)	Petrol	1360	4	42
BOXER Box (230L)	1.9	03/99 → 04/00	D8C (XUD9UTF)	Diesel	1905	4	112
BOXER Box (230L)	1.9	03/99 → 04/00	D9B (XUD9AU)	Diesel	1905	4	115
BOXER Box (230L)	1.9	07/99 → 04/00	DJY (XUD9A)	Diesel	1905	4	123
BOXER Box (230L)	1.9	03/99 → 04/00	XUD9TE	Diesel	1905	4	130
BOXER Box (230L)	2.0	06/99 → 04/00	RFW (XU10J2)	Petrol	1998	4	148
BOXER Box (230L)	2.0	08/00 → 04/00	RHV (DW10UTD)	Diesel	1997	4	163
BOXER Box (230L)	2.5	03/99 → 04/00	T8A (DJ5T)	Diesel	2446	4	188
BOXER Box (230L)	2.5	03/99 → 04/00	T9A (DJ5)	Diesel	2446	4	189
BOXER Box (230L)	2.5	01/99 → 04/00	THX (DJ5TED)	Diesel	2446	4	190
BOXER Box (230L)	2.8	10/00 → 04/00	8140.43S (F28DTCR)	Diesel	2798	4	204
BOXER Box (230L)	2.8	01/99 → 02/00	8140.63 (F28D)	Diesel	2798	4	205
BOXER Box (244)	2.0	04/00 →	RFL (XU10J2U)	Petrol	1998	4	141
BOXER Box (244)	2.0	04/00 →	RHV (DW10TD)	Diesel	1997	4	162
BOXER Box (244)	2.0	04/00 →	RHV (DW10UTD)	Diesel	1997	4	163
BOXER Box (244)	2.2	04/00 →	4HY (DW12UTED)	Diesel	2179	4	182
BOXER Box (244)	2.8	04/00 →	8140.43N	Diesel	2798	4	203
BOXER Box (244)	2.8	04/00 →	8140.43S (F28DTCR)	Diesel	2798	4	204
BOXER Box	2.2	04/00 →	4HU (P22DTE)	Diesel	2198	4	179
BOXER Box	2.2	04/00 →	4HV (P22DTE)	Diesel	2198	4	180
BOXER Bus (230P)	1.9	03/99 → 04/00	D8C (XUD9UTF)	Diesel	1905	4	112
BOXER Bus (230P)	1.9	03/99 → 04/00	D9B (XUD9AU)	Diesel	1905	4	115
BOXER Bus (230P)	1.9	08/99 → 04/00	DHY (XUD9TE)	Diesel	1905	4	122
BOXER Bus (230P)	2.0	03/99 → 04/00	RFW (XU10J2)	Petrol	1998	4	148
BOXER Bus (230P)	2.5	07/99 → 04/00	T8A (DJ5T)	Diesel	2446	4	188
BOXER Bus (230P)	2.5	08/99 → 04/00	T9A (DJ5)	Diesel	2446	4	189
BOXER Bus (230P)	2.5	01/99 → 04/00	THX (DJ5TED)	Diesel	2446	4	190
BOXER Bus (230P)	2.8	10/00 → 04/00	8140.43S (F28DTCR)	Diesel	2798	4	204
BOXER Bus (230P)	2.8	01/99 → 02/00	8140.63 (F28D)	Diesel	2798	4	205



Ltr







CC



9

Model	Ltr	Year	Engine	Fuel	CC	Power	CV
BOXER Bus (244, Z_)	2.0	04/00→	RFL (XU10J2U)	Petrol	1998	4	141
BOXER Bus (244, Z_)	2.0	04/00→	RHV (DW10TD)	Diesel	1997	4	162
BOXER Bus (244, Z_)	2.0	04/00→	RHV (DW10UTD)	Diesel	1997	4	163
BOXER Bus (244, Z_)	2.2	04/00→	4HY (DW12UTED)	Diesel	2179	4	182
BOXER Bus (244, Z_)	2.8	04/00→	8140.43N	Diesel	2798	4	203
BOXER Bus (244, Z_)	2.8	04/00→	8140.43S (F28DTCR)	Diesel	2798	4	204
BOXER Bus	2.2	04/00→	4HU (P22DTE)	Diesel	2198	4	179
BOXER Bus	2.2	04/00→	4HV (P22DTE)	Diesel	2198	4	180
BOXER Platform/Chassis (244)	2.0	04/00→	RHV (DW10TD)	Diesel	1997	4	162
BOXER Platform/Chassis (244)	2.0	04/00→	RHV (DW10UTD)	Diesel	1997	4	163
BOXER Platform/Chassis (244)	2.2	04/00→	4HY (DW12UTED)	Diesel	2179	4	182
BOXER Platform/Chassis (244)	2.8	04/00→	8140.43N	Diesel	2798	4	203
BOXER Platform/Chassis (244)	2.8	04/00→	8140.43S (F28DTCR)	Diesel	2798	4	204
BOXER Platform/Chassis (ZCT_)	1.9	07/99→04/00	D8C (XUD9UTF)	Diesel	1905	4	112
BOXER Platform/Chassis (ZCT_)	1.9	12/99→04/00	DHY (XUD9TE)	Diesel	1905	4	122
BOXER Platform/Chassis (ZCT_)	2.0	12/00→04/00	RFL (XU10J2U)	Petrol	1998	4	141
BOXER Platform/Chassis (ZCT_)	2.0	06/99→04/00	RFW (XU10J2)	Petrol	1998	4	148
BOXER Platform/Chassis (ZCT_)	2.5	03/99→04/00	T8A (DJ5T)	Diesel	2446	4	188
BOXER Platform/Chassis (ZCT_)	2.5	03/99→04/00	T9A (DJ5)	Diesel	2446	4	189
BOXER Platform/Chassis (ZCT_)	2.5	01/99→04/00	THX (DJ5TED)	Diesel	2446	4	190
BOXER Platform/Chassis (ZCT_)	2.8	10/00→04/00	8140.43S (F28DTCR)	Diesel	2798	4	204
BOXER Platform/Chassis (ZCT_)	2.8	01/99→02/00	8140.63 (F28D)	Diesel	2798	4	205
BOXER Platform/Chassis	2.2	04/00→	4HU (P22DTE)	Diesel	2198	4	179
BOXER Platform/Chassis	2.2	04/00→	4HV (P22DTE)	Diesel	2198	4	180
EXPERT (224)	1.6	02/99→	222A2 (1580 SPI)	Petrol	1581	4	70
EXPERT (224)	1.8	10/99→09/00	LFZ (XU7JP)	Petrol	1762	4	101
EXPERT (224)	1.9	02/99→	D8B (XUD9TE)	Diesel	1905	4	111
EXPERT (224)	1.9	02/99→	D9B (XUD9AU)	Diesel	1905	4	115
EXPERT (224)	1.9	02/99→	DHX (XUD9TE)	Diesel	1905	4	121
EXPERT (224)	1.9	12/00→	WJY (DW8B)	Diesel	1868	4	126
EXPERT (224)	1.9	12/00→	WJZ (DW8)	Diesel	1868	4	127
EXPERT (224)	2.0	07/00→	RFN (EW10J4)	Petrol	1997	4	142
EXPERT (224)	2.0	07/00→	RHW (DW10ATED4)	Diesel	1997	4	164
EXPERT (224)	2.0	10/00→11/00	RHX (DW10BTED)	Diesel	1997	4	165
EXPERT (224)	2.0	07/00→	RHZ (DW10ATED)	Diesel	1997	4	167
EXPERT Box (222)	1.6	02/99→	222A2 (1580 SPI)	Petrol	1581	4	70
EXPERT Box (222)	1.8	10/99→09/00	LFZ (XU7JP)	Petrol	1762	4	101
EXPERT Box (222)	1.9	02/99→	D8B (XUD9TE)	Diesel	1905	4	111
EXPERT Box (222)	1.9	02/99→	D9B (XUD9AU)	Diesel	1905	4	115
EXPERT Box (222)	1.9	02/99→	DHX (XUD9TE)	Diesel	1905	4	121
EXPERT Box (222)	1.9	12/99→	WJY (DW8B)	Diesel	1868	4	126
EXPERT Box (222)	1.9	12/99→	WJZ (DW8)	Diesel	1868	4	127
EXPERT Box (222)	2.0	09/00→	RFN (EW10J4)	Petrol	1997	4	142
EXPERT Box (222)	2.0	07/00→	RHW (DW10ATED4)	Diesel	1997	4	164
EXPERT Box (222)	2.0	07/00→	RHX (DW10BTED)	Diesel	1997	4	165
EXPERT Box (222)	2.0	07/00→	RHZ (DW10ATED)	Diesel	1997	4	167
EXPERT Box (222)	1.6	01/00→	9HU (DV6UTED4)	Diesel	1560	4	61
EXPERT Box (VF3A_, VF3U_, VF3X_)	2.0	01/00→	RFH (EW10A)	Petrol	1997	4	138
EXPERT Box (VF3A_, VF3U_, VF3X_)	2.0	01/00→	RFJ (EW10A)	Petrol/Ethanol	1997	4	139
EXPERT Box (VF3A_, VF3U_, VF3X_)	2.0	01/00→	RFJ (EW10A)	Petrol	1997	4	139
EXPERT Box (VF3A_, VF3U_, VF3X_)	2.0	01/00→	RFJ (EW10A)	Flexfuel	1997	4	139
EXPERT Box (VF3A_, VF3U_, VF3X_)	2.0	09/00→	RHH (DW10CTED4)	Diesel	1997	4	156
EXPERT Box (VF3A_, VF3U_, VF3X_)	2.0	01/00→	RHK (DW10UTED4)	Diesel	1997	4	157
EXPERT Box (VF3A_, VF3U_, VF3X_)	2.0	01/00→	RHR (DW10BTED4)	Diesel	1997	4	159
EXPERT Platform/Chassis (223)	1.6	02/99→	222A2 (1580 SPI)	Petrol	1581	4	70
EXPERT Platform/Chassis (223)	1.9	02/99→	D8B (XUD9TE)	Diesel	1905	4	111
EXPERT Platform/Chassis (223)	1.9	02/99→	D9B (XUD9AU)	Diesel	1905	4	115
EXPERT Platform/Chassis (223)	1.9	02/99→	DHX (XUD9TE)	Diesel	1905	4	121
EXPERT Platform/Chassis (223)	1.9	06/99→11/00	WJY (DW8B)	Diesel	1868	4	126
EXPERT Platform/Chassis (223)	1.9	06/99→11/00	WJZ (DW8)	Diesel	1868	4	127
EXPERT Platform/Chassis (223)	2.0	10/00→10/00	RHW (DW10ATED4)	Diesel	1997	4	164
EXPERT Platform/Chassis	1.6	01/00→	9HU (DV6UTED4)	Diesel	1560	4	61
EXPERT Platform/Chassis	2.0	01/00→	RHK (DW10UTED4)	Diesel	1997	4	157
EXPERT Platform/Chassis	2.0	01/00→	RHR (DW10BTED4)	Diesel	1997	4	159
EXPERT Tepee (VF3V_)	1.6	01/00→	9HU (DV6UTED4)	Diesel	1560	4	61
EXPERT Tepee (VF3V_)	2.0	01/00→	RFH (EW10A)	Petrol	1997	4	138
EXPERT Tepee (VF3V_)	2.0	01/00→	RFJ (EW10A)	Petrol/Ethanol	1997	4	139
EXPERT Tepee (VF3V_)	2.0	01/00→	RFJ (EW10A)	Petrol	1997	4	139
EXPERT Tepee (VF3V_)	2.0	01/00→	RFJ (EW10A)	Flexfuel	1997	4	139
EXPERT Tepee (VF3V_)	2.0	09/00→	RHH (DW10CTED4)	Diesel	1997	4	156

	Ltr				CC		9
EXPERT Tepee (VF3V_)	2.0	01/00 →	RHK (DW10UTED4)	Diesel	1997	4	157
EXPERT Tepee (VF3V_)	2.0	01/00 →	RHR (DW10BTED4)	Diesel	1997	4	159
J5 Box (280L)	1.8	01/98 →11/98	169B (XM7T)	Petrol	1796	4	93
J5 Box (280L)	2.0	09/98 →08/99	XN1P	Petrol	1971	4	169
J5 Box (280L)	2.5	09/98 →08/99	CRD93	Diesel	2498	4	195
J5 Box (280L)	2.5	09/98 →08/99	CRD93L	Diesel	2498	4	197
J5 Box (280L)	2.5	09/98 →08/99	CRD93LS (U25/673)	Diesel	2498	4	198
J5 Box (290L)	1.8	09/99 →01/99	169B (XM7T)	Petrol	1796	4	93
J5 Box (290L)	1.9	10/99 →03/99	D9B (XUD9A)	Diesel	1905	4	114
J5 Box (290L)	2.0	09/99 →01/99	170D (XN1TACP)	Petrol	1971	4	135
J5 Box (290L)	2.5	09/99 →01/99	CRD93	Diesel	2498	4	195
J5 Box (290L)	2.5	10/99 →03/99	CRD93 (U25/661)	Diesel	2498	4	196
J5 Box (290L)	2.5	09/99 →01/99	CRD93L	Diesel	2498	4	197
J5 Box (290L)	2.5	10/99 →03/99	CRD93LS (U25/673)	Diesel	2498	4	198
J5 Bus (280P)	2.0	01/98 →09/99	170 (XN1T)	Petrol	1971	4	133
J5 Bus (280P)	2.0	09/98 →09/99	170B (XN1T)	Petrol	1971	4	134
J5 Bus (280P)	2.5	09/98 →09/99	CRD93 (U25/661)	Diesel	2498	4	196
J5 Bus (290P)	1.9	10/99 →02/99	D9B (XUD9A)	Diesel	1905	4	114
J5 Bus (290P)	2.0	10/99 →02/99	170D (XN1TACP)	Petrol	1971	4	135
J5 Bus (290P)	2.5	10/99 →02/99	CRD93 (U25/661)	Diesel	2498	4	196
J5 Bus (290P)	2.5	10/99 →02/99	CRD93LS (U25/673)	Diesel	2498	4	198
J5 Platform/Chassis (280L)	2.0	01/98 →11/98	170 (XN1T)	Petrol	1971	4	133
J5 Platform/Chassis (280L)	2.0	01/98 →11/98	170B (XN1T)	Petrol	1971	4	134
J5 Platform/Chassis (280L)	2.5	09/98 →08/99	CRD93	Diesel	2498	4	195
J5 Platform/Chassis (280L)	2.5	09/98 →09/99	CRD93 (U25/661)	Diesel	2498	4	196
J5 Platform/Chassis (280L)	2.5	09/98 →08/99	CRD93L	Diesel	2498	4	197
J5 Platform/Chassis (290L)	1.9	10/99 →02/99	D9B (XUD9A)	Diesel	1905	4	114
J5 Platform/Chassis (290L)	2.0	10/99 →02/99	170D (XN1TACP)	Petrol	1971	4	135
J5 Platform/Chassis (290L)	2.5	10/99 →02/99	CRD93 (U25/661)	Diesel	2498	4	196
J5 Platform/Chassis (290L)	2.5	10/99 →02/99	CRD93LS (U25/673)	Diesel	2498	4	198
PARTNER Box (5)	1.1	06/99 →	HDZ (TU1M)	Petrol	1124	4	10
PARTNER Box (5)	1.4	11/00 →10/00	KFV (TU3A)	Petrol	1360	4	42
PARTNER Box (5)	1.4	04/00 →	KFW (TU3JP)	Petrol	1360	4	45
PARTNER Box (5)	1.4	04/00 →	KFW (TU3JP)	Bi-Fuel	1360	4	45
PARTNER Box (5)	1.4	06/99 →	KFX (TU3JP)	Petrol	1361	4	46
PARTNER Box (5)	1.4	06/99 →	TU32	Petrol	1361	4	48
PARTNER Box (5)	1.6	02/00 →	9HW (DV6BTED4)	Diesel	1560	4	63
PARTNER Box (5)	1.6	02/00 →	9HX (DV6ATED4)	Diesel	1560	4	64
PARTNER Box (5)	1.6	09/00 →10/00	NFU (TU5JP4)	Petrol/Ethanol	1587	4	85
PARTNER Box (5)	1.6	09/00 →10/00	NFU (TU5JP4)	Petrol	1587	4	85
PARTNER Box (5)	1.6	09/00 →10/00	NFU (TU5JP4)	Flexfuel	1587	4	85
PARTNER Box (5)	1.8	06/99 →	A9A (XUD7)	Diesel	1769	4	96
PARTNER Box (5)	1.9	05/99 →	DJY (XUD9A)	Diesel	1905	4	123
PARTNER Box (5)	1.9	06/99 →	WJY (DW8B)	Diesel	1868	4	126
PARTNER Box (5)	1.9	06/99 →	WJZ (DW8)	Diesel	1868	4	127
PARTNER Box (5)	2.0	04/00 →	RHY (DW10TD)	Diesel	1997	4	166
PARTNER Box	1.6	04/00 →	9HT (DV6BTED4)	Diesel	1560	4	60
PARTNER Box	1.6	04/00 →	9HX (DV6ATED4)	Diesel	1560	4	64
PARTNER Box	1.6	04/00 →	9HZ (DV6TED4)	Diesel	1560	4	66
PARTNER Box	1.6	04/00 →	NFR (TU5JP4B)	Petrol	1587	4	83
PARTNER Box	1.6	04/00 →	NFU (TU5JP4)	Petrol/Ethanol	1587	4	85
PARTNER Box	1.6	04/00 →	NFU (TU5JP4)	Petrol	1587	4	85
PARTNER Box	1.6	04/00 →	NFU (TU5JP4)	Flexfuel	1587	4	85
PARTNER Combispac (5F)	1.1	06/99 →	HDZ (TU1M)	Petrol	1124	4	10
PARTNER Combispac (5F)	1.1	06/99 →	HFX (TU1JP)	Petrol	1124	4	12
PARTNER Combispac (5F)	1.4	06/99 →	KFW (TU3JP)	Petrol	1360	4	45
PARTNER Combispac (5F)	1.4	06/99 →	KFW (TU3JP)	Bi-Fuel	1360	4	45
PARTNER Combispac (5F)	1.4	06/99 →	KFX (TU3JP)	Petrol	1361	4	46
PARTNER Combispac (5F)	1.4	06/99 →	TU32	Petrol	1361	4	48
PARTNER Combispac (5F)	1.6	02/00 →	9HW (DV6BTED4)	Diesel	1560	4	63
PARTNER Combispac (5F)	1.6	02/00 →	9HX (DV6ATED4)	Diesel	1560	4	64
PARTNER Combispac (5F)	1.6	07/00 →	NFU (TU5JP4)	Petrol/Ethanol	1587	4	85
PARTNER Combispac (5F)	1.6	07/00 →	NFU (TU5JP4)	Petrol	1587	4	85
PARTNER Combispac (5F)	1.6	07/00 →	NFU (TU5JP4)	Flexfuel	1587	4	85
PARTNER Combispac (5F)	1.8	05/99 →	LFX (XU7JB)	Petrol	1761	4	99
PARTNER Combispac (5F)	1.9	06/99 →	DJY (XUD9A)	Diesel	1905	4	123
PARTNER Combispac (5F)	1.9	12/99 →	WJY (DW8B)	Diesel	1868	4	126
PARTNER Combispac (5F)	1.9	12/99 →	WJZ (DW8)	Diesel	1868	4	127
PARTNER Combispac (5F)	1.9	05/99 →12/99	XUD9	Diesel	1905	4	129
PARTNER Combispac (5F)	2.0	02/00 →	RHY (DW10TD)	Diesel	1997	4	166



Ltr



















CC



9

	Ltr				CC		
PARTNER Platform/Chassis	1.6	01/00→	9HT (DV6BTED4)	Diesel	1560	4	60
PARTNER Platform/Chassis	1.6	01/00→	9HX (DV6ATED4)	Diesel	1560	4	64
PARTNER Tepee	1.6	04/01→	5FS (EP6C)	Petrol	1598	4	54
PARTNER Tepee	1.6	04/00→	9HT (DV6BTED4)	Diesel	1560	4	60
PARTNER Tepee	1.6	04/00→	9HX (DV6ATED4)	Diesel	1560	4	64
PARTNER Tepee	1.6	04/00→	9HZ (DV6TED4)	Diesel	1560	4	66
PARTNER Tepee	1.6	04/00→	NFR (TU5JP4B)	Petrol	1587	4	83
PARTNER Tepee	1.6	04/00→	NFU (TU5JP4)	Petrol/Ethanol	1587	4	85
PARTNER Tepee	1.6	04/00→	NFU (TU5JP4)	Petrol	1587	4	85
PARTNER Tepee	1.6	04/00→	NFU (TU5JP4)	Flexfuel	1587	4	85
RCZ	1.6	03/01→	EP6CDT	Petrol	1598	4	81
RCZ	1.6	06/01→	EP6CDTX	Petrol	1598	4	82
RCZ	2.0	03/01→	RHH (DW10CTED4)	Diesel	1997	4	156

		CC			9			CC			9
106E (XN1A)	Petrol	1971	4	88.00	132	B1A (XU51C)	Petrol	1580	4	83.00	71
108C (XV8)	Petrol	954	4	70.00	2	B1E (XU51C)	Petrol	1580	4	83.00	72
109F (XW7)	Petrol	1124	4	72.00	6	B2A (XU52C/K)	Petrol	1580	4	83.00	73
134 (XD2)	Diesel	2304	4	94.00	187	B6B (XU5J)	Petrol	1580	4	83.00	74
142 (XR5A)	Petrol	1472	4	78.00	50	BAZ (XU5CP)	Petrol	1580	4	83.00	75
150 (XY6B)	Petrol	1360	4	75.00	26	BDY (XU5M2Z)	Petrol	1580	4	83.00	76
150B (XY8)	Petrol	1360	4	75.00	27	BDY (XU5M3Z)	Petrol	1580	4	83.00	77
150D (XY7)	Petrol	1360	4	75.00	28	BDZ (XU5M)	Petrol	1580	4	83.00	78
150G (XY7)	Petrol	1360	4	75.00	29	BFZ (XU5JP)	Petrol	1580	4	83.00	79
150H (XY8)	Petrol	1360	4	75.00	30	CDY (TU9M)	Petrol	954	4	70.00	3
152A (XD3T)	Diesel	2498	4	94.00	192	CDZ (TU9M)	Petrol	954	4	70.00	4
152B (XD3TE)	Diesel	2498	4	94.00	193	CRD93	Diesel	2498	4	93.00	195
154X (ZN3J)	Petrol	2849	6	91.00	202	CRD93 (U25/661)	Diesel	2498	4	93.00	196
155 (XD3)	Diesel	2498	4	94.00	194	CRD93L	Diesel	2498	4	94.00	197
161A (XUD7)	Diesel	1769	4	80.00	92	CRD93LS (U25/673)	Diesel	2498	4	93.00	198
162 (XUD9)	Diesel	1905	4	83.00	104	D2A (XU92C)	Petrol	1905	4	83.00	105
169B (XM7T)	Petrol	1796	4	84.00	93	D2B (XU9S)	Petrol	1905	4	83.00	106
170 (XN1T)	Petrol	1971	4	88.00	133	D2C (XU92C)	Petrol	1905	4	83.00	107
170B (XN1T)	Petrol	1971	4	88.00	134	D6A (XU9J2)	Petrol	1905	4	83.00	108
170D (XN1TACP)	Petrol	1971	4	88.00	135	D6B (XU9JA)	Petrol	1905	4	83.00	109
171 (XU5S)	Petrol	1580	4	83.00	67	D6C (XU9JA)	Petrol	1905	4	83.00	110
176B (N9TE)	Petrol	2155	4	91.70	183	D8B (XUD9TE)	Diesel	1905	4	83.00	111
176W (N9TEA)	Petrol	2155	4	91.70	184	D8C (XUD9UTF)	Diesel	1905	4	83.00	112
180A (XU5J)	Petrol	1580	4	83.00	68	D9A (XUD9)	Diesel	1905	4	83.00	113
180Z (XU5J)	Petrol	1580	4	83.00	69	D9B (XUD9A)	Diesel	1905	4	83.00	114
199 A9.000	Diesel	1248	4	69.60	16	D9B (XUD9AU)	Diesel	1905	4	83.00	115
1KR (384 F)	Petrol	998	3	71.00	1	DDZ (XU9M)	Petrol	1905	4	83.00	116
222A2 (1580 SPI)	Petrol	1581	4		70	DFW (XU9JAZ)	Petrol	1905	4	83.00	117
3FY (EW12J4)	Petrol	2230	4	86.00	173	DFZ (XU9J1)	Petrol	1905	4	83.00	118
3FZ (EW12J4)	Petrol	2230	4	86.00	174	DHV (XUD9BSD)	Diesel	1905	4	83.00	119
4B11	Petrol	1998	4	86.00	131	DHW (XUD9SD)	Diesel	1905	4	83.00	120
4HL (DW12C)	Diesel	2179	4	85.00	175	DHX (XUD9TE)	Diesel	1905	4	83.00	121
4HN (DW12MTED4)	Diesel	2179	4	85.00	176	DHY (XUD9TE)	Diesel	1905	4	83.00	122
4HP (DW12BTED4)	Diesel	2179	4		177	DJY (XUD9A)	Diesel	1905	4	83.00	123
4HT (DW12BTED4)	Diesel	2179	4	85.00	178	DJZ (XUD9Y)	Diesel	1905	4	83.00	124
4HU (P22DTE)	Diesel	2198	4	86.00	179	DKZ (XU9JAZ)	Petrol	1905	4	83.00	125
4HV (P22DTE)	Diesel	2198	4	86.00	180	DT17TED4	Diesel	2721	6	81.00	200
4HX (DW12TED4/FAP)	Diesel	2179	4	85.00	181	DT20C	Diesel	2993	6	84.00	209
4HY (DW12UTED)	Diesel	2179	4	85.00	182	E1	Petrol	1118	4	74.00	7
5FR (EP6DT)	Petrol	1598	4	77.00	53	EP3	Petrol	1397	4	76.00	31
5FS (EP6C)	Petrol	1598	4	77.00	54	EP6	Petrol	1598	4	77.00	80
5FT (EP6DT)	Petrol	1598	4	77.00	55	EP6CDT	Petrol	1598	4	77.00	81
5FV (EP6DT)	Petrol	1598	4	77.00	56	EP6CDTX	Petrol	1598	4	77.00	82
5FX (EP6DT)	Petrol	1598	4	77.00	57	F1	Petrol	1204	4	74.00	17
5FY (EP6DTS)	Petrol	1598	4	77.00	58	G1A	Petrol	1294	4	76.70	18
6FY (EW7A)	Petrol	1749	4	82.70	90	H1B (TU1)	Petrol	1124	4	72.00	8
6FZ (EW7J4)	Petrol	1749	4	82.70	91	HDY (TU1M)	Petrol	1124	4	72.00	9
8140.43N	Diesel	2798	4	94.40	203	HDZ (TU1M)	Petrol	1124	4	72.00	10
8140.43S (F28DTCR)	Diesel	2798	4	94.40	204	HFX (TU1A)	Petrol	1124	4	72.00	11
8140.63 (F28D)	Diesel	2798	4	94.40	205	HFX (TU1JP)	Petrol	1124	4	72.00	12
829 (ZEJ)	Petrol	1995	4	88.00	136	HFZ (TU1JP)	Petrol	1124	4	72.00	13
851B (ZDJL)	Petrol	2165	4	88.00	185	K1D (TU3A)	Petrol	1361	4	75.00	32
851X (ZDJL)	Petrol	2165	4	88.00	186	K2B (TU3S)	Petrol	1360	4	75.00	33
8FS (EP3)	Petrol	1397	4	77.00	21	K5A (TU3)	Petrol	1360	4	75.00	34
8HS (DV4TD)	Diesel	1398	4	73.70	22	K9Y (TUD3Y)	Diesel	1361	4	75.00	35
8HT (DV4TD)	Diesel	1398	4	73.70	23	KAY (TU3CP)	Petrol	1361	4	75.00	36
8HX (DV4TD)	Diesel	1398	4	73.70	24	KDX (TU3MC)	Petrol	1361	4	75.00	37
8HZ (DV4TD)	Diesel	1398	4	73.70	25	KDY (TU3M)	Petrol	1361	4	75.00	38
9HR (DV6C)	Diesel	1560	4	75.00	59	KDZ (TU3M)	Petrol	1361	4	75.00	39
9HT (DV6BTED4)	Diesel	1560	4	75.00	60	KFT (TU3A)	Petrol	1360	4	75.00	40
9HU (DV6UTED4)	Diesel	1560	4	75.00	61	KFU (ET3J4)	Petrol	1360	4	75.00	41
9HV (DV6ATED4)	Diesel	1560	4	75.00	62	KFV (TU3A)	Petrol	1360	4	75.00	42
9HW (DV6BTED4)	Diesel	1560	4	75.00	63	KFV (TU3JP)	Petrol/ Petroleum Gas (LPG)	1360	4	75.00	43
9HX (DV6ATED4)	Diesel	1560	4	75.00	64						
9HY (DV6TED4)	Diesel	1560	4	75.00	65	KFV (TU3JP)	Petrol	1360	4	75.00	43
9HZ (DV6TED4)	Diesel	1560	4	75.00	66	KFW (TU3A)	Petrol	1360	4	75.00	44
A8A (XUD7TE)	Diesel	1769	4	80.00	94	KFW (TU3A)	Flexfuel	1360	4	75.00	44
A8B (XUD7TE)	Diesel	1769	4	80.00	95	KFW (TU3JP)	Petrol	1360	4	75.00	45
A9A (XUD7)	Diesel	1769	4	80.00	96	KFW (TU3JP)	Bi-Fuel	1360	4	75.00	45
AJZ (XUD7TEY)	Diesel	1769	4	80.00	97						

		CC			9			CC			9
KFX (TU3JP)	Petrol	1361	4	75.00	46	XD4x88	Diesel	1948	4	88.00	128
KFZ (TU3J2/Z)	Petrol	1361	4	75.00	47	XFV (ES9A)	Petrol	2946	6	87.00	206
LFW (XU7JP)	Petrol	1761	4	83.00	98	XFX (ES9J4S)	Petrol	2946	6	87.00	207
LFX (XU7JB)	Petrol	1761	4	83.00	99	XFZ (ES9J4)	Petrol	2946	6	87.00	208
LFY (XU7JP4)	Petrol	1761	4	83.00	100	XK5	Petrol	1127	4	78.00	15
LFZ (XU7JP)	Petrol	1762	4	83.00	101	XM7	Petrol	1796	4	84.00	102
NFR (TU5JP4B)	Petrol	1587	4	78.50	83	XN1P	Petrol	1971	4	88.00	169
NFT	Petrol	1587	4	78.50	84	XUD7T	Diesel	1769	4	80.00	103
NFU (TU5JP4)	Petrol/Ethanol	1587	4	78.50	85	XUD9	Diesel	1905	4	83.00	129
NFU (TU5JP4)	Petrol	1587	4	78.50	85	XUD9TE	Diesel	1905	4	83.00	130
NFU (TU5JP4)	Flexfuel	1587	4	78.50	85	Y2/K	Petrol	1442	4	76.70	49
NFW (TU5J2)	Petrol	1587	4	78.50	86						
NFX (TU5J4)	Petrol	1587	4	78.50	87						
NFY (TU5J2)	Petrol	1587	4	78.50	88						
NFZ (TU5JP)	Petrol	1587	4	78.50	89						
P8C (XUD11BTE)	Diesel	2088	4	85.00	170						
P9A (XUD11A)	Diesel	2138	4	86.00	171						
PHZ (XUD11ATE)	Diesel	2088	4	85.00	172						
R5A (XU102C)	Petrol	1998	4	86.00	137						
RFH (EW10A)	Petrol	1997	4	85.00	138						
RFJ (EW10A)	Petrol/Ethanol	1997	4	85.00	139						
RFJ (EW10A)	Petrol	1997	4	85.00	139						
RFJ (EW10A)	Flexfuel	1997	4	85.00	139						
RFK (EW10J4S)	Petrol	1997	4	85.00	140						
RFL (XU10J2U)	Petrol	1998	4	86.00	141						
RFN (EW10J4)	Petrol	1997	4	85.00	142						
RFR (DEW10J4)	Petrol	1997	4	85.00	143						
RFS (XU10J4RS)	Petrol	1998	4	86.00	144						
RFT (XU10J4)	Petrol	1998	4	86.00	145						
RFU (XU10J2)	Petrol	1998	4	86.00	146						
RFV (XU10J4R)	Petrol	1998	4	86.00	147						
RFW (XU10J2)	Petrol	1998	4	86.00	148						
RFX (XU10J2)	Petrol	1998	4	86.00	149						
RFY (XU10J4Z)	Petrol	1998	4	86.00	150						
RFZ (XU10J2Z)	Petrol	1998	4	86.00	151						
RGX (XU10J2TE)	Petrol	1998	4	86.00	152						
RGY (XU10J2TE)	Petrol	1998	4	86.00	153						
RGZ (XU10J4TE/Z)	Petrol	1998	4	86.00	154						
RHE (DW10CTED4)	Diesel	1997	4	85.00	155						
RHH (DW10CTED4)	Diesel/Electro	1997	4	85.00	156						
RHH (DW10CTED4)	Diesel	1997	4	85.00	156						
RHK (DW10UTED4)	Diesel	1997	4	85.00	157						
RHM (DW10ATED4)	Diesel	1997	4	85.00	158						
RHR (DW10BTED4)	Diesel	1997	4	85.00	159						
RHS (DW10ATED)	Diesel	1997	4	85.00	160						
RHT (DW10ATED4)	Diesel	1997	4	85.00	161						
RHV (DW10TD)	Diesel	1997	4	85.00	162						
RHV (DW10UTD)	Diesel	1997	4	85.00	163						
RHW (DW10ATED4)	Diesel	1997	4	85.00	164						
RHX (DW10BTED)	Diesel	1997	4	85.00	165						
RHY (DW10TD)	Diesel	1997	4	85.00	166						
RHZ (DW10ATED)	Diesel	1997	4	85.00	167						
RLZ (EW10D)	Petrol	1997	4	85.00	168						
T8A (DJ5T)	Diesel	2446	4	92.00	188						
T9A (DJ5)	Diesel	2446	4	92.00	189						
THX (DJ5TED)	Diesel	2446	4	92.00	190						
THY (DK5ATE)	Diesel	2446	4	92.00	191						
TU1AE5	Petrol	1124	4	72.00	14						
TU24	Petrol	1294	4	75.00	19						
TU2J2	Petrol	1294	4	75.00	20						
TU32	Petrol	1361	4	75.00	48						
TU9	Petrol	954	4	70.00	5						
UFZ (ZPJ)	Petrol	2963	6	93.00	210						
UHZ (DT17)	Diesel	2720	6	81.00	201						
UKZ (ZPJ4/Z)	Petrol	2963	6	93.00	211						
VJX (TUD5)	Diesel	1527	4	77.00	51						
VJY (TUD5)	Diesel	1527	4	77.00	52						
WJY (DW8B)	Diesel	1868	4	82.20	126						
WJZ (DW8)	Diesel	1868	4	82.20	127						
XD3T	Diesel	2497	4	94.00	199						

Sommaire

Type Mines OU C.N.I.T.*	9	Type Mines OU C.N.I.T.*	9	Type Mines OU C.N.I.T.*	9	Type Mines OU C.N.I.T.*	9
104		1SH1A1	10	1AHDZE/GPL	10	MPE000AB8022	4
104A11	6	1SH1A2	10	1AHFXF	10	MPE000ABC026	10
104A17	6	1SH3A1	10	1AK5A2	45	MPE000ABD027	10
104A41	2	1SHDZ2	10	1AKFWF	45	MPE000ABE028	10
104C01	2	1SK9B1	35	1AKFXE	45	MPE000ABG066	89
104C07	2	1SK9B2	35	1AKFXE/IF	45	MPE000ABJ032	45
104C11	6	1SK9B9	35	1AKFXL	45	MPE000ABJ068	89
104C17	6	1SK9Y2	35	1AKFXS	45	MPE000ABK034	45
104S01	2	1SVJY2	52	1AKFXT	45	MPE000ABM036	45
104S11	6	MPE000AB0050	52	1AKFXT/IF	45	MPE000ABM072	89
		MPE000AB5213	37	1AKFXU/IFL4	45	MPE000ABP074	89
		MPE000AB6214	37	1ANFZE	89	MPE000ABP075	52
		MPE000AB7215	37	1ANFZL	89	MPE000ABS078	52
106		MPE000AB8022	4	1ANFZT	89	MPE000ABS721	45
1SC1A1	3	MPE000ABC026	10	1AVJUF	52	MPE000ABW046	86
1SVJXF	51	MPE000ABD027	10	1AVJXF	51	MPE000ABW082	52
1SVJYE	52	MPE000ABE028	10	1AVJYE	52	MPE000ABX047	87
		MPE000ABG066	89	1AVJYF	52	MPE1001BJ569	4
106 I		MPE000ABJ032	34	1AVJZD	52	MPE1001BK570	10
1AC1A1	3	MPE000ABJ068	89	1AVJZE	52	MPE1001BP053	4
1ACDY1	3	MPE000ABK034	37	1AVJZF	52	MPE1001BR056	4
1ACDY2	3	MPE000ABM036	34	1CCDYE	3	MPE1001BS057	4
1ACDZ1	4	MPE000ABM072	89	1CCDZD	4	MPE1001BX062	10
1ACDZ2	4	MPE000ABP074	89	1CCDZE	4	MPE1001BY063	10
1AH1A1	10	MPE000ABP075	52	1CCDZW	4	MPE1002BK568	4
1AH1A2	10	MPE000ABS078	52	1CH3A2	9	MPE1002BN571	10
1AH3A1	10	MPE000ABS721	37	1CHDYE	9	MPE1002BR054	4
1AH3A2	10	MPE000ABW046	88	1CHDZD	10	MPE1002BS055	4
1AHDY2	10	MPE1001BJ569	4	1CHDZE	10	MPE1002BX060	10
1AHDZ1	10	MPE1001BK570	10	1CHDZE/GPL	10	MPE1002BY061	10
1AHDZ2	10	MPE1001BP053	4	1CHFXF	10	MPE1101B0407	45
1AHDZ8	10	MPE1001BR056	4	1CK5A2	45	MPE1101BE069	45
1AK2D2	37	MPE1001BX062	10	1CKFWF	45	MPE1101BG071	45
1AK3A2	34	MPE1001BY063	10	1CKFWU	45	MPE1101BK075	45
1AK9B1	35	MPE1002BN571	10	1CKFXD	45	MPE1101BM077	45
1AK9B2	35	MPE1002BX060	10	1CKFXE	45	MPE1101BP759	45
1AK9B9	35	MPE1002BY061	10	1CKFXE/IF	45	MPE1101BQ760	45
1AK9Y2	35	MPE1101B0407	37	1CKFXL	45	MPE1101BW572	45
1AKDX8	37	MPE1101BE069	37	1CKFXS	45	MPE1101BX573	45
1AKDY2	37	MPE1101BG071	37	1CKFXT	45	MPE1102B0574	45
1ANFZ2	89	MPE1101BK075	37	1CKFXT/IF	45	MPE1102BE067	45
1ANFZ4	89	MPE1101BM077	37	1CKFXU/IFL4	45	MPE1102BL074	45
1AVJY2	52	MPE1101BW572	37	1CNFWE	86	MPE1102BT761	45
1CC1A1	3	MPE1101BX573	37	1CNFX2	87	MPE1201B8089	89
1CC1A2	3	MPE1102B0574	37	1CNFXE	87	MPE1401BJ661	87
1CCDY1	3	MPE1102BE067	37	1CNFXE/D3	87	MPE1401BU382	87
1CCDY2	3	MPE1102BL074	37	1CNFXF	87	MPE1401BV092	87
1CCDZ1	4	MPE1201B8089	89	1CNFZE	89	MPE3101BR076	45
1CCDZ2	4	MPE1301BK091	88	1CNFZL	89	MPE3102BQ073	45
1CH1A1	10	MPE3201BC087	89	1CNFZT	89	MPE3201BC087	89
1CH1A2	10	MPE5002BC415	52	1CVJUF	52	MPE5001B9414	52
1CH3A1	10	MPE5002BL097	52	1CVJXF	51	MPE5001BN101	52
1CHDY1	10	MPE5002BM098	52	1CVJYE	52	MPE5001BP102	52
1CHDY2	10	MPE5002BN099	52	1CVJYF	52	MPE5001BP103	52
1CHDZ1	10	MPE5002BP100	52	1CVJZD	52	MPE5001BR662	51
1CHDZ2	10	MPE5002BU663	52	1CVJZE	52	MPE5002BC415	52
1CHDZ8	10	VPE1001B7063	10	1CVJZF	52	MPE5002BL097	52
1CK2D2	37	VPE1001BS569	10	1SCDZD	4	MPE5002BM098	52
1CK3A2	34	VPE1001BT570	10	1SCDZE	4	MPE5002BN099	52
1CK6B2	47	VPE5001BX102	52	1SHDZD	10	MPE5002BP100	52
1CK9B1	35	VPE5001BZ104	52	1SHDZE	10	MPE5002BU663	51
1CK9B2	35			1SHFXF	10	MPEZ001BF063	10
1CK9Y2	35			1SVJZD	52	MPEZ002BF061	10
1CKDX2	37			1SVJZE	52	VPE000AB5082	52
1CKDX8	37			MPE000AB0050	52	VPE1001B1057	4
1CKDY2	37			MPE000AB2052	52	VPE1001B7063	10
1CKFZ2	47			MPE000AB2210	45	VPE1001BS569	10
1CMFZ2	20			MPE000AB3211	45	VPE1001BT570	10
1CNFY2	88			MPE000AB5213	45	VPE5001BX102	52
1CNFZ2	89			MPE000AB6020	4	VPE5001BZ104	52
1CNFZ4	89			MPE000AB6214	45		
1CVJY2	52			MPE000AB7215	45		
1SCDY1	3						
1SCDZ2	4						
		106 II					
		1ACDYE	3				
		1ACDZD	4				
		1ACDZE	4				
		1ACDZW	4				
		1AH3A2	9				
		1AH3A8	9				
		1AHDYE	9				
		1AHDZD	10				
		1AHDZE	10				

* C.N.I.T. = Code National d'Identification du Type (code D2.1 sur nouvelles cartes grises)

Type Mines OU C.N.I.T.*	9	Type Mines OU C.N.I.T.*	9	Type Mines OU C.N.I.T.*	9	Type Mines OU C.N.I.T.*	9
107		20CB141	71	MPE000AJH314	37	2CNFZP	89
MPE1011SG160	1	20CB62	68	MPE000AJJ315	27	2CNFZW	89
MPE1011SH355	1	20CBD2	76	MPE1101JQ231	27	2CRFKA	140
MPE1011SX784	1	20CBD21	76	MPE1102JQ229	32	2CRFNF	142
MPE1012S1786	1	20CBD4	76	MPE5001JR230	92	2CRFRE	143
MPE1012SK162	1	20CBD41	76	MPE5002JR228	92	2CRFRE/IF	143
MPE1012SL357	1	20CC11	5	VPE000AJP313	92	2CRFRE/IFWRC	143
MPE3011SP356	1	20CC12	5	VPE000AJR315	36	2CRFRE/WRC	143
MPE3012SS358	1	20CCD1	5	VPE5001JQ230	92	2CRHYE	166
MPE5011SK213	23	20CCD2	5			2CRHYF	166
MPE5011SS354	23	20CD62	109	206		2CRHYU	166
MPE5012SN214	23	20CDF2	109	2A8HXF	24	2CRHYX	166
PM8HTC	23	20CDF2A	109	2A8HZA	24	2CWJYF	127
PMCFAC	1	20CDF4	109	2A8HZF	24	2CWJZT	127
PMCFB4	1	20CDJ2	124	2AHFXA	12	2CWJZW	127
PMCFB0/P	1	20CDK2	125	2AHFXA/IF	12	2D9HZA	66
PN8HTC	23	20CDK4	125	2AHFXF	12	2DKFWA	42
PNCFCAC	1	20CG12	18	2AHFYE	12	2DNFU	85
PNCFB4	1	20CH11	8	2AHFZ2	12	2DNFUB	85
PNCFB0/P	1	20CH12	8	2AHFZE	12	2DNFUA	85
UPE1011SG160	1	20CH31	8	2AHFZW	12	2DNFUF	85
UPE1011SH355	1	20CHD2	10	2AK6C2	45	2DNFUR	85
UPE1012SK162	1	20CK12	36	2AK6C8	45	2DRFNF	142
UPE1012SL357	1	20CK121	32	2AKFUA	41	2E8HXF	24
UPE3011SP356	1	20CK22	33	2AKFUF	41	2E8HZA	24
UPE3012SS358	1	20CK221	37	2AKFWA	45	2E8HZF	24
UPE5011SK213	23	20CK32	36	2AKFWF	45	2EHFXF	12
UPE5011SS354	23	20CKA2	36	2AKFWR	43	2EKFUA	41
UPE5012SN214	23	20CKD2	27	2AKFX4	45	2EKFUF	41
		20CKD21	27	2AKFXE	45	2EKFWA	42
		20CL11	5	2AKFXF	45	2EKFWA/IFL5	42
		20CM11	8	2AKFXP	45	2EKFWF	42
		20CM22	19	2AKFXW	45	2ERFNF	142
		20CN11	5	2ANFUA	85	2ERHYF	166
		20CN12	5	2ANFUF	85	2H9HYA	65
		20DBA2	77	2ANFUR	85	2H9HZA	65
		20DBD2	77	2ANFUU	85	2HKFUA	41
		20DDF2	118	2ANFZE	89	2HKFUF	41
		20DH12	10	2ANFZP	89	2HNFUA	85
		20DH2	10	2ANFZW	89	2HNFUB	85
		20DK12	32	2ARHYE	166	2HNFUF	85
		20DK22	33	2ARHYF	166	2HNFUR	85
		20DK221	27	2ARHYU	166	2HRHYF	166
		20DKA2	36	2AWJYF	127	2J9HYA	65
		20DKD2	38	2AWJYU	127	2J9HZA	65
		20DT12	28	2AWJZT	127	2JNFUA	85
		20SA82	95	2AWJZW	127	2JNFUB	85
		20SA91	92	2B8HZA	25	2JNFUF	85
		20SA92	92	2B8HZF	25	2JNFUR	85
		20SC11	5	2C8HXF	24	2JRHYP	166
		20SDJ2	124	2C8HZA	24	2K9HYA	66
		20SE11	7	2C8HZF	24	2K9HZA	66
		20SE12	7	2CHFAXA	12	2KKFUA	41
		20SG12	18	2CHFAXA/IF	12	2KKFUF	41
		20SH11	8	2CHFEXF	12	2KNFUA	85
		20SH12	8	2CHFYE	12	2KNFUB	85
		20SHD2	10	2CHFZ2	12	2KNFUF	85
		20SK11	36	2CHFZE	12	2KNFUR	85
		20SK12	36	2CHFZW	12	2KRHYF	166
		20SK31	36	2CK6C2	45	2L8HRO	24
		20SL11	28	2CKFUF	41	2L8HZA	24
		20SL12	28	2CKFWA	45	2LHFV0	11
		20TA92	92	2CKFWF	45	2LHFXA	11
		741B57	27	2CKFWR	45	2LKFTO	40
		741B66	68	2CKFXE	45	2LKFWA	42
		741B86	118	2CKFXF	45	2M8HRO	24
		741C37	26	2CKFXP	45	2M8HZA	24
		741C47	26	2CKFXW	45	2MHFV0	11
		742A52	49	2CNFUF	85	2MHFXA	11
		742A57	49	2CNFUR	85	2MKFTO	40
		MPE000AJF312	92	2CNFUU	85	2MKFWA	42
		MPE000AJG313	92	2CNFZE	89	2S8HXF	24
205							
20AA82	103						
20AA91	92						
20AA92	92						
20AB14	71						
20AB141	67						
20ABD2	76						
20ABD21	76						
20ABD4	76						
20ABD41	76						
20AC11	5						
20AC12	5						
20AC27	71						
20ACD1	5						
20ACD2	5						
20ADF4	109						
20ADJ2	124						
20AF12	17						
20AG12	18						
20AH11	8						
20AH12	8						
20AH31	8						
20AH32	8						
20AHD2	10						
20AK11	32						
20AK12	32						
20AK121	32						
20AK22	33						
20AK221	33						
20AK31	36						
20AK32	36						
20AKA2	36						
20AKD2	38						
20AKD21	38						
20AKD22	38						
20AKH1	32						
20AN11	5						
20AN12	5						
20CA82	103						
20CA91	92						
20CA92	92						
20CB14	71						

* C.N.I.T. = Code National d'Identification du Type (code D2.1 sur nouvelles cartes grises)

Sommaire

Type Mines OU C.N.I.T.*	9	Type Mines OU C.N.I.T.*	9	Type Mines OU C.N.I.T.*	9	Type Mines OU C.N.I.T.*	9
2S8HZA	24	MPE1312K3123	85	MPE5212K4061	166	MPE1212TK432	21
2S8HZF	24	MPE1312K4124	85	MPE5311KR295	65	MPE1212TL275	41
2SHFXU	12	MPE1312K5064	85	MPE5311KS077	65	MPE1212T0729	21
2SHFZW	12	MPE1312K9129	85	MPE5312KU296	65	MPE1212TX736	41
2SRHYE	166	MPE1312KA130	85	MPE5312KV078	65	MPE1214T4484	21
2SRHYF	166	MPE1314KF131	85	MPE5314K0079	66	MPE1214T9744	21
2SWJYU	127	MPE1314KG132	85	MPE5314KZ297	66	MPE1214TK755	21
2SWJZW	127	MPE1315KJ133	85	MPE5315KB149	66	MPE1214TP856	21
2TWJYU	127	MPE1315KK134	85	UPE1111K9248	45	MPE1214TT437	21
2TWJZW	127	MPE1501KJ412	142	UPE1112KA247	45	MPE1214TZ443	21
2U8HZA	24	MPE1501KJ413	142	UPE1114KG249	42	MPE1311TG323	85
M10PGTVP000E314	11	MPE1501KM646	142	UPE1201KH987	41	MPE1311TP271	85
M10PGTVP000H317	11	MPE1501KN647	142	UPE1204KP988	41	MPE1312TR332	85
MPE000AK2431	89	MPE1501KT459	142	UPE1311K5127	85	MPE1312TW276	85
MPE000AK4433	127	MPE1501KU460	142	UPE1314KF131	85	MPE1411T7340	54
MPE000AK5434	127	MPE1504KF888	142	UPE3311K4253	85	MPE1411TH314	54
MPE000AK6435	45	MPE1505KW648	142	UPE3312K7254	85	MPE1412T7726	54
MPE000AK7436	45	MPE1515K3266	142	UPE3314KC255	85	MPE1412TT324	54
MPE000AKW425	12	MPE1701KX928	140	UPE5011K3107	24	MPE1414TA434	80
MPE000AKX426	12	MPE1711KB262	140	UPE5011KH387	24	MPE1414TJ442	80
MPE1001K6317	12	MPE3101K1393	45	UPE5011KR264	24	MPE1414TM482	80
MPE1001K8743	12	MPE3101KD768	45	UPE5012K4106	24	MPE1415TF376	80
MPE1001KD324	12	MPE3101KN706	45	UPE5012KJ386	24	MPE1611TF292	57
MPE1001KF362	12	MPE3102K2392	45	UPE5012KS263	24	MPE1611TH427	57
MPE1001KR593	12	MPE3102KE767	45	UPE5014KA108	24	MPE1611TK660	57
MPE1002K6315	12	MPE3102KP705	45	UPE5014KY265	24	MPE1611TL625	57
MPE1002KB744	12	MPE3201KF494	89	UPE5201K1546	166	MPE1611TS341	57
MPE1002KG361	12	MPE3202KG493	89	UPE5201K9748	166	MPE1612TN431	57
MPE1002KU594	12	MPE3301K1700	85	UPE5204K0891	166	MPE1612TR629	57
MPE1004KY885	12	MPE3301KX696	85	UPE5204K1892	166	MPE1612TY381	57
MPE1011XJ775	11	MPE3302K0697	85	UPE5311KR295	65	MPE1615T0377	57
MPE1012XY778	11	MPE3304K3890	85	UPE5311KS077	65	MPE1711T7382	58
MPE1101KD641	45	MPE3305K7698	85	UPE5312KU296	65	MPE1714T6436	58
MPE1101KG741	45	MPE3311K4253	85	UPE5312KV078	65	MPE3411T2426	54
MPE1101KJ222	45	MPE3312K3250	85	UPE5314K0079	66	MPE3411TC339	54
MPE1101KU367	45	MPE3312K7254	85	UPE5314KZ297	66	MPE3412T2654	54
MPE1101KV368	45	MPE3312KC065	85	VPE1001KF317	12	MPE3412TJ343	54
MPE1102KG642	45	MPE3314KC255	85	VPE5101K6322	127	MPE3414T9657	80
MPE1102KJ221	45	MPE3315KB252	85	VPE5101KJ564	127	MPE3414TH435	80
MPE1102KJ742	45	MPE5001KA794	24			MPE3414TZ453	80
MPE1102KU365	45	MPE5002JR228	127			MPE3415TP380	80
MPE1102KV366	45	MPE5002KB793	24	207		MPE5011T3267	25
MPE1104K9886	42	MPE5004KJ893	24	M10PGTVP0000203	21	MPE5011TR316	25
MPE1104KA887	42	MPE5011K3107	24	M10PGTVP0001240	80	MPE5012T2325	25
MPE1111K9248	45	MPE5011KH387	24	M10PGTVP0002180	42	MPE5012TA272	25
MPE1111X4776	42	MPE5011KR264	24	M10PGTVP0004243	80	MPE5012TJ730	25
MPE1112KA247	45	MPE5011XT774	24	M10PGTVP0005244	21	MPE5211T4478	62
MPE1112X9779	42	MPE5012K4106	24	M10PGTVP000A188	80	MPE5211TC317	62
MPE1114KG249	42	MPE5012KJ386	24	M10PGTVP000C190	80	MPE5211TP268	62
MPE1201K7370	89	MPE5012KS263	24	M10PGTVP000C215	42	MPE5211TR429	62
MPE1201K9566	89	MPE5012X9777	24	M10PGTVP000D191	80	MPE5211TR480	62
MPE1201KE984	41	MPE5014KA108	24	M10PGTVP000E192	57	MPE5212TN840	62
MPE1201KH987	41	MPE5014KY265	24	M10PGTVP000F218	41	MPE5212TN326	62
MPE1201KJ989	41	MPE5010K9564	127	M10PGTVP000J161	54	MPE5212TP655	62
MPE1201KM992	41	MPE5010KF437	127	M10PGTVP000J221	80	MPE5212TV273	62
MPE1201KT320	89	MPE5010KH694	127	M10PGTVP000N226	80	MPE5212TX433	62
MPE1202K8369	89	MPE5010KX322	127	M10PGTVP000P167	57	MPE5214T6438	64
MPE1202KC567	89	MPE5010KX322	127	M10PGTVP000R168	21	MPE5214T6632	64
MPE1202KH985	41	MPE5010KX322	127	M10PGTVP000R229	21	MPE5214T7439	64
MPE1202KM990	41	MPE5010KX322	127	M10PGTVP000T196	54	MPE5214TD445	64
MPE1202KU319	89	MPE5010KX322	127	M10PGTVP000V198	54	MPE5214TN746	64
MPE1204KM986	41	MPE5010KX322	127	M10PGTVP000V234	42	MPE5214TS485	64
MPE1204KP988	41	MPE5010KX322	127	M10PGTVP000Z202	57	MPE5214TT486	64
MPE1204KR991	41	MPE5010KX322	127	M10PGTVP000Z238	58	MPE5214TW658	64
MPE1204KT993	41	MPE5201K1546	166	MPE1111TV322	42	MPE5311T3661	65
MPE1301KU699	85	MPE5201K9748	166	MPE1112T6331	42	MPE5311T9304	65
MPE1301KZ643	85	MPE5201KG658	166	MPE1112TP738	42	MPE5311TB342	65
MPE1302K2644	85	MPE5201KZ411	166	MPE1114TN441	42	MPE5311TF479	65
MPE1304KW889	85	MPE5202K0410	166	MPE1211T3320	41	MPE5311TN318	65
MPE1305K9645	85	MPE5202K2545	166	MPE1211T6711	21	MPE5311TP319	65
MPE1311K5127	85	MPE5202KH657	166	MPE1211TE270	41	MPE5311TV653	65
MPE1311K6128	85	MPE5204K0891	166	MPE1211TE428	21	MPE5311TY717	65
		MPE5204K1892	166	MPE1212TE329	41	MPE5311TZ269	65

* C.N.I.T. = Code National d'Identification du Type (code D2.1 sur nouvelles cartes grises)

Sommaire

Type Mines OU C.N.I.T.*	9	Type Mines OU C.N.I.T.*	9	Type Mines OU C.N.I.T.*	9	Type Mines OU C.N.I.T.*	9
MPE5312T0656	65	WA9HR8	59	305 II		7ARFVW	147
MPE5312T6274	65	WA9HXC	62	581AA1	15	7ARFX2	149
MPE5312TC305	65	WA9HYC	65	581M27	71	7ARFX4	149
MPE5312TJ481	65	WA9HZC	65	581M40	104	7ARFX8	149
MPE5312TY327	65	WAKFT0	42	581M48	104	7ARFY2	150
MPE5312TZ328	65	WAKFUC	41	581M54	67	7ARHYE	166
MPE5314T4487	66	WAKFVC	42	581M56	67	7ARHYF	166
MPE5314T7659	66	WANFUC	85	581M68	92	7AWJYF	126
MPE5314TJ440	66	WANFUF	85	581M84	118	7AWJZT	126
MPE5314TP446	66	WB5FR8	53	581M86	118	7BD8A2	122
MPE5314TZ748	66	WB5FS0	80	581MA1	15	7BD8AD	122
MPE5315TE628	66	WB5FS9	80	581U27	71	7BD9B2	123
MPE5315TJ378	66	WB5FWC	80	581U40	104	7BD9BD	123
UPE1111TV322	42	WB5FWF	80	581U48	104	7BDHVE	119
UPE1114TN441	42	WB5FXC	57	581U60	92	7BDHY2	122
UPE1211TE270	41	WB9HR8	59	581U68	92	7BDHYE	122
UPE1211TE428	21	WB9HZC	66	306		7BDJY2	124
UPE1212TK432	21	WC5FR8	53	7AA9A2	96	7BDJYE	123
UPE1212TL275	41	WC5FS0	54	7AA9AT	96	7BDJYT	123
UPE1214TT437	21	WC5FS9	54	7AD8A2	122	7BK2D2	37
UPE1311TP271	85	WC5FWC	54	7AD8AD	122	7BK2D9	37
UPE1312TW276	85	WC5FWF	54	7AD9B2	123	7BK5A2	37
UPE1411TH314	54	WC5FXC	57	7AD9BD	123	7BKDX2	37
UPE1412TT324	54	WC8FP0	21	7ADHVE	119	7BKDX9	37
UPE1414TM482	80	WC8FR0	21	7ADHY2	122	7BKFWF	37
UPE1611TF292	57	WC8FSC	21	7ADHYE	122	7BKFX2	37
UPE1611TH427	57	WC8HR0/1	25	7ADJY2	123	7BKFXE	37
UPE1611TL625	57	WC8HZC	25	7ADJYE	123	7BKFXT	37
UPE1612TN431	57	WC9HR8	59	7ADJYT	123	7BKFXT/GPL	37
UPE1711T7382	58	WC9HXC	62	7ADJZ2	124	7BKFXT/IF	37
UPE3411T2426	54	WC9HYC	65	7AHDY2	10	7BKFXW	37
UPE3412T2654	54	WC9HZC	65	7AHDZ2	10	7BL6A2	101
UPE3412TJ343	54	WCKFT0	42	7AK2D2	37	7BL6A4	101
UPE5011T3267	25	WCKFUC	41	7AK5A2	37	7BL6A9	101
UPE5011TA626	25	WCKFVC	42	7AK6D8	37	7BLFYE	100
UPE5011TR316	25	WCNFUC	85	7AKDX2	37	7BLFYE/GPL	100
UPE5012T2325	25	WE5FS0	80	7AKDX9	37	7BLFYF	100
UPE5012TA272	25	WE5FS9	80	7AKFX2	37	7BLFYF/D4	100
UPE5211TC317	62	WE5FWC	80	7AKFXE	37	7BLFYT	100
UPE5211TP268	62	WE5FWF	80	7AKFXT	37	7BLFYT/GPL	100
UPE5211TV627	62	WE5FYC	58	7AKFXU	37	7BLFYW	100
UPE5212TN326	62	WE8FP0	21	7AKFXW	37	7BLFZ2	101
UPE5212TV273	62	WE8FR0	21	7AL6A2	101	7BLFZ4	101
UPE5214T6632	64	WE8FSC	21	7AL6A4	101	7BLFZ8	101
UPE5214T7439	64	WE9HR8	59	7AL6A9	101	7BLFZ9	101
UPE5214T486	64	WE9HXC	64	7ALFYE	100	7BLFZP	101
UPE5311T9304	65	WE9HYC	66	7ALFYE/GPL	100	7BLFZW	101
UPE5311TF479	65	WE9HZC	66	7ALFYF	100	7BNFTF	84
UPE5311TN318	65	WEKFT0	42	7ALFYF/D4	100	7BNFTR	84
UPE5311TP319	65	WEKFVC	42	7ALFYT	100	7BNFZ2	89
UPE5311TV653	65	WM5FYC	58	7ALFYT/GPL	100	7BNFZ8	89
UPE5311TZ269	65	WU5FS0	80	7ALFYW	100	7BNFZ9	89
UPE5312T0656	65	WU5FWC	80	7ALFZ2	101	7BNFZE	89
UPE5312T6274	65	WU8FR0	21	7ALFZ4	101	7BNFZP	89
UPE5312TC305	65	WU8FSC	21	7ALFZ8	101	7BNFZW	89
UPE5312TJ481	65	WU9HR8	59	7ALFZ9	101	7BRFVE	147
UPE5312TY327	65	WU9HXC	64	7ALFZP	101	7BRFVP	147
UPE5312TZ328	65	WU9HZC	66	7ANFTF	84	7BRFVW	147
UPE5314T4487	66	208		7ANFTR	84	7BRFX2	149
UPE5314T7659	66	CA5FV0	81	7ANFZ2	89	7BRFX4	149
UPE5314TJ440	66	CA5FV8	81	7ANFZ9	89	7BRFX8	149
UPE5314TP446	66	CA8FP0	21	7ANFZE	89	7BRHYE	166
WA5FR8	53	CC8FP0	21	7ANFZP	89	7BRHYF	166
WA5FS0	54	M10PGTVP0028960	21	7ANFZW	89	7BWJYF	126
WA5FWC	54	M10PGTVP002E966	21	7AR6D2	149	7BWJZT	126
WA5FWF	54	M10PGTVP0043432	81	7ARFT2	145	7CA9A2	96
WA5FXC	57	M10PGTVP0064140	81	7ARFV2	147	7CA9AT	96
WA8FP0	21			7ARFVE	147	7CD8A2	122
WA8FR0	21			7ARFVP	147	7CD9B2	123
WA8FSC	21					7CDHVE	119
WA8HR0/1	25					7CDHY2	122
WA8HZC	25					7CDHYE	122

* C.N.I.T. = Code National d'Identification du Type (code D2.1 sur nouvelles cartes grises)

Sommaire

Type Mines OU C.N.I.T.*	9	Type Mines OU C.N.I.T.*	9	Type Mines OU C.N.I.T.*	9	Type Mines OU C.N.I.T.*	9
7CDJY2	123	7EKFWF	45	MPE000ADQ717	144	MPE3302D6164	101
7CDJYE	123	7EKFXE	45	MPE000ADR136	123	MPE3302DB618	84
7CDJYT	123	7EKFXT	45	MPE000ADS137	123	MPE3302DC619	84
7CDJZ2	124	7EKFXT/GPL	45	MPE000ADS173	147	MPE3304DD167	101
7CHDY2	10	7EKFXW	45	MPE000ADT138	123	MPE3304DJ622	84
7CHDZ2	10	7EL6A2	101	MPE000ADT174	147	MPE3305DE166	101
7CKZD2	37	7EL6A4	101	MPE000ADU139	37	MPE3305DK621	84
7CK5A2	37	7ELFYE	100	MPE000ADV140	37	MPE3501D2178	147
7CKDX2	37	7ELFYE/GPL	100	MPE000ADV176	147	MPE3502D0174	147
7CKDX9	37	7ELFYF	100	MPE000ADW177	144	MPE3502D2176	147
7CKFWF	37	7ELFYF/D4	100	MPE000ADX142	37	MPE3504DC182	147
7CKFX2	37	7ELFYT	100	MPE000ADZ144	37	MPE3504MJ883	147
7CKFXE	37	7ELFYT/GPL	100	MPE1101D0150	37	MPE3504MS929	147
7CKFXT	37	7ELFYW	100	MPE1101D6386	37	MPE3505DC180	147
7CKFXU	37	7ELFZP	101	MPE1101DQ625	37	MPE5001DT141	123
7CKFXW	37	7ENFTF	84	MPE1101DT373	37	MPE5001DU142	123
7CL6A2	101	7ENFTR	84	MPE1101DZ149	37	MPE5002DR137	123
7CLFYE	100	7ENFZE	89	MPE1102D0148	37	MPE5002DS138	123
7CLFYF	100	7ENFZP	89	MPE1102D6384	37	MPE5002DT139	123
7CLFZ2	101	7ENFZW	89	MPE1102DQ623	37	MPE5002DU140	123
7CLFZ4	101	7ERFVE	147	MPE1102DR624	37	MPE5004D1143	123
7CLFZ8	101	7ERFVP	147	MPE1102DT371	37	MPE5004D2144	123
7CLFZ9	101	7ERFVW	147	MPE1102DU372	37	MPE5101D7727	126
7CLFZP	101	7ERHYE	166	MPE1102DX145	37	MPE5101DW389	123
7CNFTF	84	7ERHYF	166	MPE1102DY146	37	MPE5101DW558	126
7CNFZ2	89	7EWJYF	126	MPE1102DZ147	37	MPE5102D7725	126
7CNFZ9	89	7EWJZT	126	MPE1104D0374	45	MPE5102D8726	126
7CNFZE	89	7HRHYE	166	MPE1104D7151	45	MPE5102DW556	123
7CR6D2	149	7HRHYF	166	MPE1104D8152	45	MPE5102DX388	126
7CR6E2	147	7JRHYF	166	MPE1104DD387	45	MPE5102DX557	126
7CRFS2	144	7SA9A2	96	MPE1104DX626	45	MPE5102DZ390	126
7CRFSH	144	7SA9AE	96	MPE1201D9379	89	MPE5104D3559	126
7CRFSW	144	7SD9B2	129	MPE1201DU170	89	MPE5104D4391	123
7CRFT2	145	7SDJY2	129	MPE1202D9377	89	MPE5104DE728	126
7CRFV2	147	7SDJYE	123	MPE1202DA378	89	MPE5201D2712	166
7CRFVE	147	7SDJYT	123	MPE1202DU168	89	MPE5201D3458	166
7CRFVP	147	7SDJZ2	124	MPE1202DV169	89	MPE5201D7135	122
7CRFX2	149	7SHDY2	10	MPE1204D2172	89	MPE5201DL476	166
7CRFX4	149	7SHDZ2	10	MPE1204DH381	89	MPE5201DP443	166
7CRFX8	149	7SKZD2	37	MPE1205D3171	89	MPE5202D0708	166
7CRFY2	150	7SKDX2	37	MPE1205DJ380	89	MPE5202D3711	166
7CRHYE	166	7SKFXE	37	MPE1301D0615	84	MPE5202D7133	122
7CWJYF	126	7SWJYF	126	MPE1302D0613	84	MPE5202D8134	122
7CWJZT	126	7SWJZT	126	MPE1302D1614	84	MPE5202DJ472	166
7DL6A2	101	7TA9AE	96	MPE1304D8617	84	MPE5202DK473	166
7DL6A4	101	7TDJYE	123	MPE1305D9616	84	MPE5202DP441	166
7DLFYE	100	7TWJZT	126	MPE1401D1157	100	MPE5202DP442	166
7DLFYF	100	MPE000AD0145	45	MPE1401DU671	100	MPE5202DP477	166
7DLFYT	100	MPE000AD0242	144	MPE1401DY542	100	MPE5202DZ707	166
7DLFZ2	101	MPE000AD1146	45	MPE1402D0154	100	MPE5204D6710	166
7DLFZ4	101	MPE000AD2147	100	MPE1402D1155	100	MPE5204DE136	122
7DLFZ8	101	MPE000AD4149	100	MPE1402D2156	100	MPE5204DQ475	166
7DLFZP	101	MPE000AD8153	101	MPE1402DU669	100	MPE5204DV444	166
7DNFTF	84	MPE000AD9154	100	MPE1402DV670	100	MPE000ADV139	37
7DNFTR	84	MPE000ADA155	100	MPE1402DZ153	100	MPEZ102D6146	37
7DNFZ2	89	MPE000ADC157	101	MPE1404D2673	100	MPEZ102D8148	37
7DNFZE	89	MPE000ADD158	101	MPE1404DB161	100	VPE000AD0136	129
7DNFZE/IF	89	MPE000ADF160	101	MPE1404DC162	100	VPE000ADR127	129
7DNFZP	89	MPE000ADG161	101	MPE1405D3672	100	VPE000ADT129	124
7DR6D2	149	MPE000ADH162	89	MPE1405DB159	100	VPE000ADV131	129
7DR6E2	147	MPE000ADJ128	122	MPE1405DC160	100	VPE000ADW132	129
7DRFVE	147	MPE000ADJ163	89	MPE1501DV177	147	VPE000ADZ135	129
7DRFVP	147	MPE000ADJ164	89	MPE1502DT173	147	VPE1101D9150	37
7DRFVW	147	MPE000ADK165	89	MPE1505D5179	147	VPE5001D2141	124
7DRFX2	149	MPE000ADL130	122	MPE1701DK376	144	VPE5001D3142	124
7DRFX4	149	MPE000ADL166	89	MPE1701DL183	144	VPE5101D5389	129
7ED9BD	123	MPE000ADM167	145	MPE1701DM184	144		
7EDHVE	119	MPE000ADN168	147	MPE1701DN185	144		
7EDHYE	122	MPE000ADN423	122	MPE3202DM481	89		
7EDJYE	123	MPE000ADP170	147	MPE3202DP483	89		
7EDJYT	123	MPE000ADP424	122	MPE3205D7485	89		
7EK5A2	45	MPE000ADQ171	147	MPE3302D5163	101		

307

3A8HZB	24
3A8HZB/T	24
3A9HXC	62
3A9HXC/T	62

* C.N.I.T. = Code National d'Identification du Type (code D2.1 sur nouvelles cartes grises)

Sommaire

Type Mines OU C.N.I.T.*	9	Type Mines OU C.N.I.T.*	9	Type Mines OU C.N.I.T.*	9	Type Mines OU C.N.I.T.*	9
3A9HYB	65	3EKFUB	41	MPE1312MS049	85	MPE5214MY243	62
3A9HYB/T	65	3EKFUC	41	MPE1312MT050	85	MPE5216MU138	62
3A9HYC	65	3EKFWB	45	MPE1314MP199	85	MPE5216MY178	62
3A9HZB	65	3ENFUB	85	MPE1314MU144	85	MPE5301M3827	160
3A9HZB/T	65	3ENFUC	85	MPE1316M1147	85	MPE5301M8771	160
3A9HZC	65	3ENFUC/FF	85	MPE1316MV202	85	MPE5302M6828	160
3AK6DY	45	3ENFUE	85	MPE1501M2818	142	MPE5302MB772	160
3AKFUB	41	3ENFUJ	85	MPE1501ME733	142	MPE5304MX876	160
3AKFUC	41	3ERFJC	139	MPE1502M5819	142	MPE5306MF829	160
3AKFUC/T	41	3ERFJF	139	MPE1502MH734	142	MPE5311M6186	65
3AKFWB	45	3ERFNB	142	MPE1504M2873	142	MPE5311M9286	65
3AKFWB/T	45	3ERFNC	142	MPE1506MP831	142	MPE5311MP035	65
3AN6A5	85	3ERFNE	142	MPE1516MG009	142	MPE5311MX080	65
3ANFUB	85	3ERFNF	142	MPE1611M3165	139	MPE5311MZ179	65
3ANFUC	85	3ERHRH	159	MPE1611MP150	139	MPE5312M0081	65
3ANFUE	85	3ERHSB	160	MPE1612M7167	142	MPE5312M2180	65
3ANFUF	85	3ERHY	166	MPE1612MS152	142	MPE5312M9187	65
3ANFUK	85	3ERHYB	166	MPE1614MD169	139	MPE5312MC287	65
3ANFUL	85	3G8HZB	24	MPE1614MY154	139	MPE5312MR036	65
3ANFUL/FF	85	3G9HXC	62	MPE1616M2384	139	MPE5314M5082	65
3ARFJC	139	3G9HYB	65	MPE1616M6158	139	MPE5314M7181	65
3ARFJF	139	3GKFUC	41	MPE1616ML173	139	MPE5314ME188	65
3ARFKC	140	3H9HXC	62	MPE1711MV183	140	MPE5314MH288	65
3ARFN8	142	3H9HYB	65	MPE1712MY184	140	MPE5314MW037	65
3ARFNB	142	3H9HYC	65	MPE3301M9900	85	MPE5316M1038	65
3ARFNE	142	3H9HZB	65	MPE3301MP757	85	MPE5316M3076	65
3ARHRH	159	3H9HZC	65	MPE3302MC901	85	MPE5316MA083	65
3ARHRJ	159	3HNFUB	85	MPE3302MR758	85	MPE5316MC182	65
3ARHSB	160	3HNFUC	85	MPE3304MH902	85	MPE5316MJ189	65
3ARHY	166	3HNFUC/FF	85	MPE3304MW881	85	MPE5501MW994	159
3ARHYB	166	3HNFUE	85	MPE3306M1882	85	MPE5502M2995	159
3ARHYB/T	166	3HNFUF	85	MPE3306MM903	85	MPE5504M4996	159
3ARHYM	166	3HNFUN	85	MPE3311MJ194	85	MPE5506M9997	159
3BRHRH	159	3HRFJC	139	MPE3311MR141	85	MPE5511MV216	159
3C8HZB	24	3HRFJF	139	MPE3312MP197	85	MPE5512MC425	159
3C8HZM	24	3HRFNB	142	MPE3312MV143	85	MPE5512M2218	159
3C9HXC	62	3HRFNC	142	MPE3314M1145	85	MPE5512M2290	159
3C9HYB	65	3HRFNE	142	MPE3314MV200	85	MPE5514M5220	159
3C9HYC	65	3HRFNF	142	MPE3316M2203	85	MPE5515M8221	159
3C9HZB	65	3HRHRH	159	MPE3316M8148	85	MPE5516MC223	159
3C9HZC	65	3HRHRJ	159	MPE3501M7781	142	MPE7511MX309	159
3CKFUB	41	3HRHSB	160	MPE3501M9916	142	MPE7512M0310	159
3CKFUC	41	3HRHY	166	MPE3502MA782	142	MPE7516MA312	159
3CKFWB	45	3HRHYB	166	MPE3502MC917	142	MPE9312M2520	85
3CN6A5	85	MPE1101MT752	45	MPE3506M4937	142	MPE9316MC522	85
3CNFUB	85	MPE1102MW753	45	MPE3506MB908	142	UPE1214MW192	41
3CNFUC	85	MPE1104M0875	45	MPE3506MN884	142	UPE1311ME195	85
3CNFUE	85	MPE1201MA978	41	MPE3506MX930	142	UPE1312MJ198	85
3CNFUF	85	MPE1201MD981	41	MPE3611MA166	139	UPE1616ML173	139
3CNFUK	85	MPE1202MD979	41	MPE3611MV151	139	UPE1711MV183	140
3CNFUL	85	MPE1202MG982	41	MPE3612ME168	142	UPE3312MP197	85
3CNFUL/FF	85	MPE1204MJ980	41	MPE3612MZ153	142	UPE3611MA166	139
3CRFJC	139	MPE1204ML983	41	MPE3614M5155	139	UPE5211ML175	62
3CRFKC	140	MPE1211MP190	41	MPE3614MK170	139	UPE5212MP176	62
3CRFN8	142	MPE1212MR191	41	MPE3616MD159	139	UPE5214MP137	62
3CRFNB	142	MPE1214MW192	41	MPE3616MS174	139	UPE5214MT177	62
3CRFNC	142	MPE1301M3900	85	MPE5001MG773	24	UPE5216MY178	62
3CRFNE	142	MPE1301MS731	85	MPE5002MJ774	24	UPE5311M6186	65
3CRFNF	142	MPE1301MU769	85	MPE5004M7880	25	UPE5311M9286	65
3CRHRH	159	MPE1302MV732	85	MPE5201MS729	166	UPE5311MZ179	65
3CRHRJ	159	MPE1302MX770	85	MPE5202MV730	166	UPE5312M2180	65
3CRHSB	160	MPE1304MM877	85	MPE5204ML874	166	UPE5312M9187	65
3CRHY	166	MPE1304MN878	85	MPE5206M6830	166	UPE5312MC287	65
3CRHYB	166	MPE1306M6832	85	MPE5211MH135	62	UPE5312MR036	65
3CRHYM	166	MPE1306MS879	85	MPE5211ML175	62	UPE5314M7181	65
3E8HZB	25	MPE1311ME195	85	MPE5211MQ241	62	UPE5314ME188	65
3E9HVC	62	MPE1311MK140	85	MPE5212MK136	62	UPE5314MH288	65
3E9HXC	62	MPE1311MM045	85	MPE5212MP176	62	UPE5316MA083	65
3E9HYB	65	MPE1311MN046	85	MPE5212MT242	62	UPE5316MC182	65
3E9HYC	65	MPE1312MJ198	85	MPE5212MV244	62	UPE5316MJ189	65
3E9HZB	65	MPE1312MP142	85	MPE5214MP137	62	UPE5511MV216	159
3E9HZC	65	MPE1312MR048	85	MPE5214MT177	62	UPE5512MZ218	159

* C.N.I.T. = Code National d'Identification du Type (code D2.1 sur nouvelles cartes grises)

Sommaire

Type Mines OU C.N.I.T.*	9	Type Mines OU C.N.I.T.*	9	Type Mines OU C.N.I.T.*	9	Type Mines OU C.N.I.T.*	9
UPE5514M5220	159	4E5FWF	80	MPE5311V0610	66	309 I	
UPE5516MC223	159	4E8FSC	21	MPE5311VR611	66	10AB62	69
UPE7511MX309	159	4E9HPO	62	MPE5312VB762	66	10ABA2	71
UPE7512M0310	159	4E9HR8	59	MPE5312VF475	66	10ABA4	72
UPE7516MA312	159	4E9HXC	62	MPE5312VG476	66	10AD22	118
UPE9316MC522	85	4E9HZH	66	MPE5312VX615	66	10AD62	109
307 CC		4ERHF8	159	MPE5312VY616	66	10AD64	109
3BNFU	85	4ERHRH	159	MPE5314V5619	66	10AD92	104
3BNFUC	85	4H5FS0/1	80	MPE5314V6620	66	10ADD2	116
3BRFJC	139	4H5FS9/1	80	MPE5316V8582	66	10ADF2	109
3BRFJF	139	4H5FTF	55	MPE5316V9583	66	10ADF4	109
3BRFKC	140	4H5FV8	81	MPE5316VK763	66	10ADJ2	104
3BRFNC	142	4H5FVA	81	MPE5511V0662	159	10ADK2	125
3BRFNF	142	4H5FVC	80	MPE5511VU472	159	10AE11	7
MPE1305MA935	85	4H5FWC/1	80	MPE5512V1477	159	10AE12	7
MPE1315MS201	85	4H5FWF	80	MPE5512V2663	159	10AG12	18
MPE1315MY146	85	4H5FWF/1	80	MPE5516VU584	159	10AG22	18
MPE1505MX938	142	4H5FXH	57	MPE7311VH534	66	10AK12	32
MPE1615M2156	139	4H5FYH	58	MPE7312V6618	66	10AK22	33
MPE1615MH171	139	4H9HR8	59	MPE7511V2535	159	10AKD2	38
MPE1705MV977	140	4H9HR8/1	59	MPE7512VE545	159	10AY22	49
MPE1715M5185	140	4H9HR8/1P	59	MPE7516V1585	159	10CB62	109
MPE1715MF256	140	4H9HXC	62	MPE9612VL694	55	10CBA2	69
MPE1715MS075	140	4H9HXC/1	62	UPE1211VJ528	21	10CBA4	72
MPE3505M4939	142	4H9HZH	66	UPE1411V4468	80	10CD22	118
MPE3615M9157	139	4H9HZH/1	59	UPE1412VB473	80	10CD62	109
MPE3615MP172	139	4HNFUC/1FF	85	UPE3412VJ536	80	10CD92	104
308		4HRHE8	155	UPE5214VG640	62	10CDD2	116
4A5FTF	55	4HRHE8/1	155	UPE5216VN643	62	10CDE2	109
4A5FWC	80	4HRHF8	159	UPE5311V8470	66	10CDF2	109
4A5FWF	80	4HRHF8/1	159	UPE5311V9471	66	10CDF4	109
4A5FXC	57	4HRHHA	156	UPE5311VQ610	66	10CDJ2	104
4A5FXH	57	4HRHRH	159	UPE5311VR611	66	10CDK2	125
4A8FSC	21	4HRHRJ	159	UPE5312VF475	66	10CE11	7
4A9HZC	66	M10PGTVP0003048	55	UPE5312VG476	66	10CE12	7
4A9HZC/1	66	M10PGTVP0004049	80	UPE5312VX615	66	10CG10	7
4A9HZH	66	M10PGTVP0006051	80	UPE5312VY616	66	10CG12	18
4ARHRH	159	M10PGTVP0008053	57	UPE5314V6620	66	10CG22	71
4ARHRJ	159	M10PGTVP0009054	57	UPE5316V8582	66	10CK12	32
4B5FU8	82	M10PGTVP000B056	21	UPE5316V9583	66	10CK22	33
4C5FS0/1	80	M10PGTVP000B092	55	UPE5511V0662	159	10CKD2	38
4C5FS9/1	80	M10PGTVP000D094	80	UPE5511VU472	159	10SD92	104
4C5FTF	55	M10PGTVP000E095	80	UPE5512V1477	159	10SE11	18
4C5FU8	82	M10PGTVP000R097	57	UPE5512VT663	159	10SE12	18
4C5FV8	81	M10PGTVP000Y079	80	UPE5516VU584	159	10SG11	18
4C5FV8/1	81	MPE1211VJ528	21	UPE7312V6618	66	10SG12	18
4C5FVA	81	MPE1212VV538	21	UPE7511V2535	159	3AD2A2	106
4C5FVC	80	MPE1214V3639	21	UPE7512VE545	159	3AD2H2	106
4C5FVC/1	80	MPE1411V4468	80	UPE7516V1585	159	3AE1A2	7
4C5FWF	80	MPE1412VB473	80	308 CC			
4C5FWF/1	80	MPE1416VR578	80	4B5FS0	80	3AG1A2	18
4C5FXC	57	MPE1611V7609	57	4B5FSC	80	3AK2B2	33
4C5FXH	57	MPE1611VP469	57	4B5FTF	55	3AY2A2	49
4C5FYH	58	MPE1611VP759	57	4B5FV8	81	3CB2A2	7
4C8FSC	21	MPE1612VE614	57	4B5FVA	81	3CD2A2	106
4C9HR8	59	MPE1612VS761	57	4B5FXH	57	3CD2H2	106
4C9HR8/1	59	MPE1612VW474	57	4B9HR8	59	3CE1A2	7
4C9HR8/1P	59	MPE1614V2595	57	4BRHF8	159	3CG1A2	18
4C9HZC	66	MPE1616VD580	57	4BRHHA	156	3CK2B2	33
4C9HZC/1	66	MPE3411V7526	80	4BRHHB	156	3SE1A2	7
4C9HZH	66	MPE3412VJ536	80	4BRHRJ	159	3SG1A2	18
4CNFUC/1FF	85	MPE3414VS638	80	M10PGTVP000V040	80	309 II	
4CRHF8	159	MPE3416V0642	80	M10PGTVP000X042	55	10AA92	92
4CRHF8/1	159	MPE3611VQ586	55	M10PGTVP000Y043	57	10AB51	73
4CRHHA	156	MPE3612VU588	55	M10PGTVP001K355	156	10CA92	92
4CRHRH	159	MPE3616V4590	55	MPE5615V5781	159	10CB22	73
4CRHRJ	159	MPE5214VG640	62	MPE7515VX680	159	10SA92	92
4CRHRJ/1	159	MPE5216VN643	62				
4E5FS0	80	MPE5311V7760	66				
4E5FWC	80	MPE5311V8470	66				
		MPE5311V9471	66				

* C.N.I.T. = Code National d'Identification du Type (code D2.1 sur nouvelles cartes grises)

Sommaire

Type Mines OU C.N.I.T.*	9	Type Mines OU C.N.I.T.*	9	Type Mines OU C.N.I.T.*	9	Type Mines OU C.N.I.T.*	9
3AB2B42	73	15BD62	108	4ED2H4	107	8BL6A2	100
3AB5A2	76	15BD62/1	108	4ED2H8	107	8BLFXE	99
3ABDY2	76	15BD62/2	108	4ED5A2	107	8BLFY2	100
3ABDY4	76	15BD621	110	4ED6D2	107	8BLFY8	100
3ABDZ2	76	15BD64	108	4SB2A2	73	8BLFYD	100
3AD6B2	125	15BD64/1	108			8BLFYE	100
3AD9A2	104	15BD64/2	108	405 II		8BLFYE/GPL	100
3ADDZ2	116	15BD671	117	15BK21	37	8BLFYF/IF	100
3ADFZ4	118	15BD92	114	15BK22	37	8BLFYF	100
3ADJZ2	104	15BD02	116	4BB5A2	76	8BLFYF/IF	100
3ADKZ2	125	15BD07	116	4BBDY2	76	8BLFYS	100
3ADKZ4	125	15BDF2	110	4BBDY4	76	8BLFYT	100
3AH1A1	8	15BDF2/1	117	4BBFZ2	76	8BLFYT/GPL	100
3AH1A2	8	15BDF21	110	4BBFZ4	76	8BLFYW	100
3AHDZ2	10	15BDF4/2	118	4BD8A2	122	8BP8C2	170
3AK1D2	32	15BDF7/1	117	4BD9B2	123	8BP8CD	170
3AK1G2	32	15BDJ2	124	4BDHY2	122	8BP8CE	170
3AK2D2	38	15BDK2	125	4BDJY2	124	8BR6E2	147
3AK3A1	32	15BDK4	125	4BDJZ2	124	8BR6E4	147
3AK3AZ	32	15BK11	34	4BK2D2	37	8BRFNA	142
3AKDY2	38	15BK11/1	34	4BKDX2	37	8BRFNR	142
3AKDZ2	38	15BK11BC	34	4BL6A2	101	8BRFRE	143
3CA8B2	95	15BK12	34	4BLFZ2	101	8BRFRE/IF	143
3CA9A2	92	15BK121	34	4BLFZ4	101	8BRFRR/IF	143
3CA9A9	92	15BK31	34	4BRFT2	150	8BRFV2	142
3CB2A4	73	15BK32	34	4BRFX2	149	8BRFV4	142
3CB2B2	73	15EA82	94	4BRFX4	149	8BRFVD	147
3CB2B4	73	15EA92	94	4BRFX7	149	8BRFVE	147
3CBDY2	76	15EAJ2	94	4BRFY2	150	8BRFVN	147
3CBDY4	76	15EB12	72	4BRGZ7	154	8BRFVP	147
3CBDZ2	76	15EB12/31	72	4EB5A2	76	8BRFVT	142
3CD6B2	125	15EB22	73	4EBDY2	76	8BRFVW	142
3CD6C2	110	15EB24	73	4EBDY4	76	8BRGX2	152
3CD9A2	104	15EB32	75	4EBFZ2	76	8BRGX6	152
3CDDZ2	116	15EB52	78	4EBFZ4	76	8BRHSF	160
3CDFW2	117	15EBD2	76	4ED8A2	122	8BRHYE	166
3CDFZ4	118	15EBD4/1	76	4ED9B2	129	8BRHYF	166
3CDJZ2	104	15ED22	125	4EDHY2	122	8BRHZE	167
3CDKZ2	125	15ED22/1	125	4EDJY2	129	8BRHZF	167
3CDKZ4	125	15ED22/31	107	4EDJZ2	124	8BRHZR	167
3CH1A1	8	15ED24	125	4EKDX2	37	8BRLZF	168
3CH1A2	8	15ED24/1	125	4EL6A2	101	8BXFXA	207
3CHDZ2	10	15ED24/31	107	4ELFZ2	101	8BXFXB	207
3CK1D2	32	15ED27	125	4ELFZ4	101	8BXFXF	207
3CK1G2	32	15ED27/1	125	4ER6D2	149	8BXFXR	207
3CK2D2	38	15ED52	107	4ER6D4	149	8BXFZ2	208
3CKDY2	38	15ED54	107	4ERFX2	149	8BXFZ4	208
3CKDZ2	38	15ED62	125	4ERFX4	149	8BXFZE	208
3SA9A2	92	15ED62/2	125	4ERFX7	149	8BXFZP	208
3SD9A2	104	15ED64	125	4SBDY2	76	8C3FZA	174
3SH1A1	8	15ED64/2	125	4SBFZ2	76	8C4HXF	181
3SH1A2	8	15ED92	114	4SD9B2	123	8CRFNA	142
3SK1G2	32	15EDD2	116			8CRFNR	142
		15EDD2/2	116	406		8CRFR6	143
		15EDD7	116	8B3FZA	174	8CRFRE	143
		15EDF2	118	8B3FZE	174	8CRFRE/IF	143
		15EDF4	118	8B3FZF	174	8CRFRF	143
		15EDF4/2	118	8B4HXF	181	8CRFRR	143
		15EDJ2	124	8B6FZF	91	8CRFV2	147
		15EDK2	125	8B6FZF/GPL	91	8CRFV8	147
		15EDK4	125	8B6FZR	91	8CRFVE	147
		15SB22	73	8BBFZ2	79	8CRFVP	147
		15SD92	114	8BBFZD	79	8CRFVT	147
		4BB2A2	73	8BBFZE	79	8CXFX3	207
		4BB2A4	73	8BD8B	122	8CXFX6	207
		4BD5A2	107	8BD8B2	121	8CXFX9	207
		4BD5A4	107	8BD8BD	121	8CXFXA	207
		4BD6D2	118	8BDHVF	120	8CXFXB	207
		4BD6D4	118	8BDHWE	120	8CXFXF	207
		4EB2A2	73	8BDHX2	121	8CXFXR	207
		4EB2A4	73	8BDHXE	121	8CXFZ4	208
		4ED2H2	107	8BDHXP	121	8CXFZE	208
405 I							
15B8A2	72						
15BA82	94						
15BA92	94						
15BAJ2	94						
15BB12	72						
15BB12/31	72						
15BB22	73						
15BB24	73						
15BB32	72						
15BB52	76						
15BBD2	78						
15BBD4	78						
15BBD4/1	78						
15BD22/31	107						
15BD24/31	107						
15BD52	107						
15BD54	107						

* C.N.I.T. = Code National d'Identification du Type (code D2.1 sur nouvelles cartes grises)

Sommaire

Type Mines OU C.N.I.T.*	9	Type Mines OU C.N.I.T.*	9	Type Mines OU C.N.I.T.*	9	Type Mines OU C.N.I.T.*	9
8CXFZP	208	8FRHZE	167	MPE1202A9186	99	MPE3402AJ036	100
8E3FZE	174	8FRHZF	167	MPE1204A5433	99	MPE3404AJ420	100
8E3FZF	174	MPE000AA0015	147	MPE1204AE187	99	MPE3404AL750	91
8E4HXF	181	MPE000AA0087	152	MPE1402A4416	100	MPE3404AP038	100
8E6FZF	91	MPE000AA0112	100	MPE1402A5029	100	MPE3404AQ040	100
8E6FZF/GPL	91	MPE000AA0184	147	MPE1402A6030	100	MPE3501A6537	142
8E6FZR	91	MPE000AA0245	100	MPE1402A6418	100	MPE3501A7017	143
8ED8BD	121	MPE000AA0403	100	MPE1402A7031	100	MPE3501AD023	143
8EDHWE	120	MPE000AA1113	100	MPE1402AD037	100	MPE3501AW721	142
8EDHX2	121	MPE000AA1185	147	MPE1402AD425	100	MPE3501AY468	143
8EDHXE	121	MPE000AA1246	100	MPE1402AL627	91	MPE3502A2010	147
8EDHXP	121	MPE000AA1404	100	MPE1402AP049	100	MPE3502A5534	147
8ELFXE	99	MPE000AA2114	100	MPE1402AP630	100	MPE3502AE022	147
8ELFYE	100	MPE000AA2186	208	MPE1404AB419	100	MPE3502AV718	142
8ELFYE/1	100	MPE000AA2405	147	MPE1404AC032	100	MPE3502AX465	147
8ELFYE/GPL	100	MPE000AA3054	152	MPE1404AD033	100	MPE3504A0719	142
8ELFYE/IF	100	MPE000AA3115	100	MPE1404AD421	100	MPE3504A2466	147
8ELFYP	100	MPE000AA3187	208	MPE1404AE034	100	MPE3504A3467	147
8ELFYR/IF	100	MPE000AA4116	100	MPE1404AE422	100	MPE3504A8012	147
8ELFYT	100	MPE000AA4188	208	MPE1404AF035	100	MPE3504AA535	147
8ELFYT/GPL	100	MPE000AA4407	142	MPE1404AG424	100	MPE3504AB960	142
8ELFYW	100	MPE000AA5056	147	MPE1404AJ039	100	MPE3504AE963	142
8EP8CE	170	MPE000AA5092	147	MPE1404AJ427	100	MPE3504AK024	147
8ER6E2	147	MPE000AA5117	208	MPE1404AL041	100	MPE3801AA450	208
8ERFNA	142	MPE000AA5408	143	MPE1404AP953	91	MPE3801AC125	208
8ERFNF	142	MPE000AA6057	147	MPE1404AT631	100	MPE3802AA448	208
8ERFNR	142	MPE000AA6093	147	MPE1404AU632	100	MPE3802AC123	208
8ERFRE	143	MPE000AA6118	208	MPE1501A0016	147	MPE3804AF449	208
8ERFRE/IF	143	MPE000AA7094	147	MPE1501AE612	142	MPE3804AJ126	208
8ERFV2	147	MPE000AA7410	143	MPE1501AH457	143	MPE3901A7656	207
8ERFV4	147	MPE000AA8411	147	MPE1502A1015	147	MPE3901A9949	207
8ERFVE	147	MPE000AA9096	170	MPE1502A6020	147	MPE3902A7654	207
8ERFVP	147	MPE000AAA413	147	MPE1502AD609	147	MPE3904AC655	207
8ERFVW	147	MPE000AAL097	170	MPE1502AG454	143	MPE5102AW002	120
8ERGXE	152	MPE000AAM098	170	MPE1502AN461	147	MPE5104A1003	120
8ERHSF	160	MPE000AAN002	100	MPE1502AU820	142	MPE5202AS813	166
8ERHYE	166	MPE000AAN099	170	MPE1504A1011	147	MPE5202AA042	121
8ERHYE/1	166	MPE000AAP004	147	MPE1504A3013	147	MPE5202AB043	121
8ERHYF	166	MPE000AAP100	120	MPE1504A4959	142	MPE5202AG691	166
8ERHZE	167	MPE000AAP101	120	MPE1504A8018	147	MPE5202AM478	166
8ERHZE/1	167	MPE000AAQ005	170	MPE1504AF025	147	MPE5202AV451	166
8ERHZF	167	MPE000AAQ102	120	MPE1504AJ610	142	MPE5204A0452	166
8ERHZR	167	MPE000AAQ235	208	MPE1504AJ611	147	MPE5204A1453	166
8ERLZF	168	MPE000AAR006	121	MPE1504AL455	147	MPE5204AA814	166
8EXFXA	207	MPE000AAR236	208	MPE1504AM456	147	MPE5204AB815	166
8EXFXB	207	MPE000AAS007	170	MPE1504AS462	147	MPE5204AG044	121
8EXFXF	207	MPE000AAS104	79	MPE1504AZ821	142	MPE5204AH045	121
8EXFXR	207	MPE000AAS237	208	MPE1602AF116	152	MPE5204AL692	166
8EXFZE	208	MPE000AAT008	170	MPE1602AG117	152	MPE5204AR479	166
8EXFZP	208	MPE000AAT105	121	MPE1602AK775	142	MPE5204AS480	166
8F6FZF	91	MPE000AAT238	208	MPE1604A0776	142	MPE5302A8357	167
8F6FZR	91	MPE000AAT396	100	MPE1604AL118	152	MPE5302AJ974	167
8FDHWE	120	MPE000AAU009	100	MPE1701AJ862	174	MPE5302AL783	160
8FDHXE	121	MPE000AAU106	121	MPE1702AJ824	174	MPE5302AN469	167
8FDHXP	121	MPE000AAU178	147	MPE1702AK596	174	MPE5302AN688	167
8FLFXE	99	MPE000AAU239	208	MPE1704AA970	174	MPE5302AP046	170
8FLFXE/1	99	MPE000AAU397	100	MPE1704AN825	174	MPE5302AP047	170
8FLFYE	100	MPE000AAV010	100	MPE1801A1447	208	MPE5302AQ048	170
8FLFYE/IF	100	MPE000AAV107	121	MPE1801A3122	208	MPE5302AR049	170
8FLFYP	100	MPE000AAV179	147	MPE1801A5124	208	MPE5302AX964	167
8FLFYT	100	MPE000AAV240	208	MPE1802A1445	208	MPE5304A3966	167
8FP8CE	170	MPE000AAV398	100	MPE1802A3120	208	MPE5304AD358	167
8FRFNA	142	MPE000AAW180	147	MPE1804A6446	208	MPE5304AE359	167
8FRFNR	142	MPE000AAW399	100	MPE1804A8121	208	MPE5304AN975	167
8FRFRE/1	143	MPE000AAX181	147	MPE1901AL554	207	MPE5304AP976	167
8FRFRE/IF	143	MPE000AAX400	100	MPE1901AN653	207	MPE5304AQ784	167
8FRFVE	147	MPE000AAY085	152	MPE1901AR585	207	MPE5304AS470	167
8FRFVP	147	MPE000AAY110	100	MPE1901AR948	207	MPE5304AS689	167
8FRFVT	147	MPE000AAY401	100	MPE1902AN651	207	MPE5304AT435	167
8FRHSF	160	MPE000AAZ086	152	MPE1904AS652	207	MPE5304AT471	167
8FRHYE	166	MPE000AAZ402	100	MPE3402AB417	100	MPE5304AT532	167
8FRHYF	166	MPE1202A0432	99	MPE3402AG749	91	MPE5304AT690	167

* C.N.I.T. = Code National d'Identification du Type (code D2.1 sur nouvelles cartes grises)

Sommaire

Type Mines OU C.N.I.T.*	9	Type Mines OU C.N.I.T.*	9	Type Mines OU C.N.I.T.*	9	Type Mines OU C.N.I.T.*	9
MPE5304AU436	167	6JX8ZA	209	MPE9612PV649	139	BA82R	186
MPE5304AU533	167	6JXFVH	206	UPE1514PH338	90	BA916	202
MPE5304AW050	170	6JXFVJ	206	UPE1614PF229	142	BA917	202
MPE5304AX051	170	M10PGTVP000L321	159	UPE5314P0523	65	BA919	202
MPE5501AL704	181	MPE1412PB055	91	UPE5314P3102	65	BA91F	202
MPE5502AK701	181	MPE1412PC056	91	UPE5314PC208	65	BA91J	202
MPE5504A7950	181	MPE1414PH057	91	UPE5314PG054	65	BA91R	202
MPE5504AP702	181	MPE1512P2230	90	UPE5514PP007	159	BD815	186
MPE7302A4965	167	MPE1512P4002	142	UPE5514PV110	159	BD81E	186
MPE7302AF904	167	MPE1512P6004	142	UPE5614PK707	139	BF327	186
MPE7302AN754	167	MPE1512PC337	90	UPE5714PA299	178	BF816	186
MPE7302AU955	167	MPE1514P7231	90	UPE7514PG258	159	BF81F	186
MPE7304AK905	167	MPE1514P9003	142	UPE7814P3301	201	CF221	186
MPE7304AS755	167	MPE1514PB005	142	UPE7814PW621	201	CF327	186
MPE7304AZ956	167	MPE1514PH338	90				
		MPE1612PA228	142	504		508	
407		MPE1614PF229	142	504R48	187	8D4HLA	175
6D3FYF	173	MPE1711PT239	173	504U20	128	8D5FS8/P	54
6D3FYH	173	MPE1712PH225	173	504V40	187	8D5FV8	81
6D3FZF	174	MPE1712PM000	174	504V48	187	8D5FVA	81
6D3FZH	174	MPE1714PM226	173	504V57	102	8D9HR8/PS	59
6D4HPPH	177	MPE1714PR001	174	504V58	187	8DRHDA	159
6D4HTH	178	MPE1911PF205	206			8DRHH8	156
6D6FVC	90	MPE3512P2066	142	505		8DRHHA	156
6D6FZB	91	MPE3512P3067	142	551A17	132	8DRHR8	159
6D9HYB	65	MPE3512PV095	142	551A18	132	8E4HLA	175
6D9HYC	65	MPE3512PW096	142	551A50	194	8E5FS8/P	54
6D9HZC	65	MPE3514P8068	142	551A53	194	8E5FV8	81
6D9HZC/1	65	MPE3514PC097	142	551A54	192	8E5FVA	81
6DRFJC	139	MPE3612PB259	142	551A55	194	8E9HR8/PS	59
6DRFJF	139	MPE3614PG260	142	551A56	193	8ERHDA	159
6DRFNB	142	MPE3712PX041	174	551A56/A	192	8ERHH8	156
6DRFNC	142	MPE3712PY236	173	551A57	194	8ERHHA	156
6DRFNE	142	MPE3714P2042	174	551A58	194	8ERHR8	159
6DRHF8	159	MPE3714P3237	173	551A58A	194	8URHC8/P	156
6DRHHA	156	MPE3902PE998	206	551A59	192	M10PGTVP0011178	54
6DRHLH	159	MPE3904PJ999	206	551A66	183	M10PGTVP0014206	81
6DRHR8	159	MPE3911PX206	206	551A76	202	M10PGTVP001B504	81
6DRHRE	159	MPE3912PP099	206	551A79	202	M10PGTVP001E507	156
6DRHRG	159	MPE3914PU100	206	551A84	186	M10PGTVP001R167	175
6DRHRH	159	MPE5312P7207	65	551A89	185	M10PGTVP002L125	159
6DRHRJ	159	MPE5312PB053	65	551A96	183	M10PGTVP0030297	156
6DUHZJ	201	MPE5312PQ359	65	551A99	183	M10PGTVP0032299	81
6DXFVJ	206	MPE5312PY101	65	551D16	136	M10PGTVP0033178	156
6E3FYF	173	MPE5314P0523	65	551D50	194	M10PGTVP0033300	156
6E3FYH	173	MPE5314P3102	65	551D53	193	M10PGTVP003G288	175
6E3FZF	174	MPE5314PC208	65	551D55	194	M10PGTVP003H289	81
6E3FZH	174	MPE5314PG054	65	551D57	194	M10PGTVP003U291	159
6E4HPPH	177	MPE5511PJ467	159	551D58	194	M10PGTVP003W293	54
6E4HTH	178	MPE5512PK006	159	551D58DG	194	M10PGTVP003X294	159
6E6FVC	90	MPE5512PS086	159	551D59	193	M10PGTVP003Y295	156
6E6FZB	91	MPE5514PP007	159	551D86	186	M10PGTVP003Z296	159
6E9HYB	65	MPE5514PV110	159	551D89	186	M10PGTVP004P550	54
6E9HYC	65	MPE5614PK707	139	551D8H	194	M10PGTVP004R552	54
6E9HZC	65	MPE5712P3623	178	551F16	136	M10PGTVP004V388	59
6E9HZC/1	65	MPE5712P5298	178	551F50	194	M10PGTVP004V909	156
6ERFJC	139	MPE5712P6335	178	551F55	194	M10PGTVP004X390	59
6ERFJF	139	MPE5714PA299	178	551F56	193	M10PGTVP006W132	156
6ERFNB	142	MPE5714PB336	178	551F57	194	M10PGTVP0075819	175
6ERFNE	142	MPE7512P7059	159	551F58	194	M10PGTVP0076820	81
6ERHF8	159	MPE7512PB257	159	551F58DG	194	M10PGTVP0078822	159
6ERHHA	156	MPE7512PQ103	159	551F86	186	M10PGTVP0079823	175
6ERHRE	159	MPE7512PY111	159	551F89	186	M10PGTVP007A824	81
6ERHRG	159	MPE7514P3112	159	551FD1	136	M10PGTVP007C826	159
6ERHRH	159	MPE7514PC060	159	551G58	194	M10PGTVP007E828	54
6ERHRJ	159	MPE7514PG258	159	551H58	194	M10PGTVP007F829	159
6EUHZJ	201	MPE7514PV104	159	551S50	194	M10PGTVP007G830	156
6EXFVJ	206	MPE7811PR622	201	551S58	194	M10PGTVP007J832	54
6J3FYH	173	MPE7811PX204	201	BA815	186	M10PGTVP007J833	159
6JRHH8	156	MPE7812PY300	201	BA816	186	M10PGTVP007K834	156
6JRHRH	159	MPE7814P3301	201	BA81E	186	M10PGTVP007M836	81
6JUHZJ	201	MPE7814PW621	201	BA82F	186	M10PGTVP007P838	81

* C.N.I.T. = Code National d'Identification du Type (code D2.1 sur nouvelles cartes grises)

Type Mines OU C.N.I.T.*	9	Type Mines OU C.N.I.T.*	9	Type Mines OU C.N.I.T.*	9	Type Mines OU C.N.I.T.*	9			
M10PGTVP007P839	156	605 6BP8A2 172 6BP8A4 172 6BP8B2 172 6BP8B2/1 172 6BP8B4 172 6BP8B4/1 172 6BP8C2 170 6BP8C4 170 6BP8CE 170 6BP8CE/IF 170 6BP8CP 170 6BP9A2 171 6BPHZ2 172 6BPHZ4 172 6BPJZ2 171 6BR2A2 137 6BR2A8 137 6BR6A2 151 6BR6A4 151 6BR6A8 151 6BR6E2 147 6BR6E4 147 6BRFV2 147 6BRFV4 147 6BRFV9 147 6BRFV2 147 6BRFZ2 151 6BRFZ4 151 6BRFZ8 151 6BRFZ9 151 6BRGX2 152 6BRGX4 152 6BRGXE 152 6BRGXP 152 6BRGY2 153 6BRGY4 153 6BSFZ2 210 6BSFZ4 210 6BSKZ2 211 6BTHY2 191 6BTHYE 191 6BUFZ2 210 6BUFZ4 210 6BUKZ2 211 6BXFZ2 208 6BXFZ4 208 6BXFZE 208 6BXFZP 208 MPE000AF1205 147 MPE000AF2206 147 MPE000AF3207 191 MPE000AF4208 208 MPE000AF5209 208 MPE000AFX201 170 MPE000AFY202 170 MPE000AFZ203 147 MPE1502FD191 147 MPE1602FP193 152 MPE1802FN196 208 MPE3602F7194 152 MPE3802FU197 208 MPE5302F3189 170 MPE5502F4195 191 MPE7302FA190 170	174 174 174 174 174 181 181 142 142 160 167 207 207 207 207 207 173 174 174 178 178 181 181 159 167 200 206 142 142 174 174 174 174 174 173 207 207 174 174 173 207 207 174 174 173 207 207 174 174 174 173 207 207 174 174 174 173 164 164 164 164 164 164 167 167 181 181 181 181 159 159 159 181 178 178 181 181 200	607 9D3FZ2 174 9D3FZ6 174 9D3FZB 174 9D3FZC 174 9D3FZE 174 9D3FZF 174 9D4HXB 181 9D4HXE 181 9D4HXG 181 9DRFN5 142 9DRFN6 142 9DRFNC 142 9DRHSB 160 9DRHZB 167 9DXFX2 207 9DXFX5 207 9DXFX6 207 9DXFXB 207 9DXFXC 207 9DXFXE 207 9DXFXF 207 9U3FVH 173 9U3FZC 174 9U3FZF 174 9U4HPH 178 9U4HTH 178 9U4HXE 181 9U4HXG 181 9URHRH 159 9URHSB 167 9UUHZJ 200 9UXFVJ 206 MPE1502LJ833 142 MPE1502LV713 142 MPE1702L9549 174 MPE1702LG714 174 MPE1702LZ575 174 MPE1712L1116 174 MPE1712LV279 173 MPE1902L5683 207 MPE1902LR547 207 MPE3702L6576 174 MPE3702LS562 174 MPE3702LX786 174 MPE3712L8117 174 MPE3902L9548 207 MPE3902LN684 207 MPE3912L8122 206 MPE5302L0787 167 MPE5302LB579 167 MPE5312LD120 167 MPE5502LB947 181 MPE5502LF563 181 MPE5502LT577 181 MPE5512LD524 159 MPE5512LP280 159 MPE5512LP281 159 MPE5512LW119 181 MPE5712LG313 178 MPE5712LG385 178 MPE7502LO578 181 MPE7512L1118 181 MPE7812L9121 200	98 98 170 170 170 170 152 152 146 146 146 146 142 142 147 164 167 167 146 98 146 152 121 121 98 98 146 142 142 146 146 146 146 146 142 142 146 152 142 142 121 121 170 170 164 164 164 164 164 164 167 146 146 146 121 170 170 170	221LA2 221LA2/1 221PA2 221PA2/8S 221PA2/S 221RA2 221RA2/8S 221RB2 221RB2/7S 221RB2/S 221RB9 AFRFNC AFRFNF AFRFVB/IF AFRHWB AFRHZ AFRHZ/S MPE000AH9441 MPE000AHE216 MPE000AHG218 MPE000AHH219 MPE000AHJ220 MPE000AHJ221 MPE000AHK222 MPE1306HN200 MPE1306HP201 MPE1406H1204 MPE1506HD763 MPE1506HL796 MPE1506HP581 MPE1506HU223 MPE1606HK203 MPE3506H7582 MPE3506HK764 MPE3506HS797 MPE5206HN198 MPE5206HP199 MPE5306H1202 MPE5306H4762 MPE5306H7765 MPE5306HC795 MPE5306HF798 MPE5306HP649 MPE5306HP650 MPE5306HU486 VPE000AHP218 VPE000AHQ219 VPE000AHS221 VPE000AHT222 VPE1406HA204 VPE5206HX199 VPE5306H3486 VPE5306HA202	98 98 170 170 170 152 152 146 146 146 146 142 142 147 164 167 167 146 98 146 152 121 121 98 98 146 142 142 146 146 146 142 142 146 152 142 142 121 121 170 170 164 164 164 164 164 164 167 146 146 146 121 170 170 170	EBRFNC 142 EBRFNE 142 EBRFNF 142 EBRH08 159 EBRHH8 156 EBRHHA 156 EBRHKH 157 EBRHME 158 EBRHRR 159 EBRHTB 158 EBRHWB 158 EBXFWF 207 M10PGTVP004J969 159 M10PGTVP008Y944 159 MPE1506NV800 142 MPE1616NK232 139 MPE1616NM234 139 MPE1706NG801 174 MPE1706NH802 174 MPE3506NU926 142 MPE3506NV927 142 MPE3616NF451 139 MPE3616NG452 139 MPE3616NR233 139 MPE3616NT235 139 MPE5306NQ803 158 MPE5306NR804 158 MPE5306NT806 158 MPE5416NL302 157 MPE5416NM303 157 MPE5506NE807 181 MPE5506NF808 181 MPE5516N0052 181 MPE5516NQ333 159 MPE5516NR334 159 MPE5516NZ051 181 MPE5716NU511 178 MPE5716NW513 178 MPE5716NY515 178 MPE5716NZ516 178 MPE7306N945 158 MPE7306N946 158 MPE7716NA557 178 UPE3616NT235 139 UPE5306NR804 158 UPE5416NM303 157 UPE5516N0052 181 UPE5516NR334 159 UPE5716NZ516 178 UPE7306N946 158		
605			606 221DA2 122 221DA2/8S 122 221DC2 121 221DH2 121 221DH2/8S 121 221DH2/S 121		807 EA3FZC 174 EA4HWB 181 EA4HWG 181 EARFJC 139 EARFNC 142 EARFNE 142 EARHME 158 EARHTB 158 EARHWB 158 EAXFWF 207 EB3FZC 174 EB4HSJ 178 EB4HTH 178 EB4HWB 181 EB4HWG 181 EBRFJC 139 EBRFJF 139		1007 KM8HXB 24 KM8HZB 24 KM8HZC 24 KM9HZC 66 KMKFUC 41 KMKFVB 43 KMKFVC 43 KMKFVC/P 43 KMNFUC 85 MPE1111R2367 43 MPE1111R4685 43 MPE1111R6090 43 MPE1111R J092 43 MPE1111RV227 43 MPE1211R J277 41 MPE1311RQ687 85 MPE1311RX306 85 MPE3111RG278 43 MPE3311RX688 85 MPE5011R3682 24			

* C.N.I.T. = Code National d'Identification du Type (code D2.1 sur nouvelles cartes grises)

Type Mines OU C.N.I.T.*	9	Type Mines OU C.N.I.T.*	9	Type Mines OU C.N.I.T.*	9	Type Mines OU C.N.I.T.*	9
MPE5011RG088	24	M10PGTVP0049959	56	5008		MPE5012WG591	22
MPE5011RG113	24	M10PGTVP004A439	54	0A5FS0/1	54	Boxer	
MPE5011RH114	24	M10PGTVP004A960	56	0A5FV8	81	231A22	148
MPE5311RR360	66	M10PGTVP004B440	54	0A5FV8/1	81	231A32	123
MPE5311RY683	66	M10PGTVP004B961	56	0A5FVA	81	231A42	190
UPE1111R2367	43	M10PGTVP004C441	59	0A5FW0/1	54	231A52	189
UPE1111RG090	43	M10PGTVP004C962	56	0A9HR8/1	59	231A62	115
UPE1111RV227	43	M10PGTVP004D442	59	0A9HR8/1P	59	231A72	112
UPE1211RJ277	41	M10PGTVP004E443	59	0A9HR8/P	59	231A82	130
UPE1311RX306	85	M10PGTVP004E964	155	0A9HZH	66	231AJ2	163
UPE3311RX688	85	M10PGTVP004F444	59	0A9HZH/1	66	231AL2	204
UPE5011R3682	24	M10PGTVP004F965	155	0A9HZH/1P	66	231B02	188
UPE5011RG113	24	M10PGTVP004H446	59	0A9HZH/P	66	231B12	148
UPE5011RH114	24	M10PGTVP004J447	59	0ARHE8	155	231B22	148
UPE5311RR360	66	M10PGTVP004J448	59	0ARHE8/1	155	231B42	190
UPE5311RY683	66	M10PGTVP004K449	59	0ARHHA	156	231B44	190
2008		M10PGTVP004M451	59	0E5FV8	81	231B52	189
CU5FS0	54	M10PGTVP004N452	59	0E5FV8/1	81	231B54	189
3008		M10PGTVP004P453	59	0E5FW0/1	54	231B59	188
OU5FS0/1	54	M10PGTVP004P454	59	0E9HR8/1	59	231B72	112
OU5FS8	54	M10PGTVP004R455	59	0E9HR8/1P	59	231B82	130
OU5FV8	56	M10PGTVP004U459	155	0E9HZH	66	231B92	188
OU5FV8/1	56	M10PGTVP004V460	155	0E9HZH/1	66	231B94	190
OU5FVA	56	M10PGTVP004X462	155	0E9HZH/1P	66	231BJ2	163
OU5FVA/1	56	M10PGTVP004Y463	156	0E9HZH/P	66	231BL2	204
OU5FW0	54	M10PGTVP004Z464	156	0ERHE8	155	231BL4	204
OU5FW0/1	54	M10PGTVP004Z877	156	0ERHE8/1	155	231C02	188
OU5FXH	57	M10PGTVP0050816	59	0ERHHA	156	231C22	148
OU9HR8	59	M10PGTVP0051817	59	M10PGTVP0000372	156	231C24	148
OU9HR8/1	59	M10PGTVP0052818	59	M10PGTVP0002374	156	231C32/D	115
OU9HR8/1M	59	M10PGTVP005J410	156	M10PGTVP0004728	155	231C42	190
OU9HR8/1P	59	M10PGTVP005J411	156	M10PGTVP0007731	155	231C44	190
OU9HR8/1PS	59	M10PGTVP005K412	156	M10PGTVP000C736	66	231C62	115
OU9HR8/1PSM	59	M10PGTVP005Z815	59	M10PGTVP000D737	66	231C72	112
OU9HR8/2	59	M10PGTVP006S128	156	M10PGTVP000G122	66	231C72/E	112
OU9HR8/2PS	59	M10PGTVP006T129	156	M10PGTVP000H123	66	231C82	122
OU9HR8/2PSM	59	M10PGTVP006U130	156	M10PGTVP000J125	66	231C92	188
OU9HR8/M	59	M10PGTVP0070875	59	M10PGTVP000J742	66	231CH2/E	204
OU9HR8/P	59	M10PGTVP0071876	59	M10PGTVP000J743	66	231CL2/E	204
OU9HR8/PS	59	M10PGTVP0073878	59	M10PGTVP000K126	155	231G22	148
OU9HR8/PSM	59	M10PGTVP0074879	59	M10PGTVP000L127	155	231G42	190
OU9HZH	66	M10PGTVP0075855	54	M10PGTVP000R132	66	231G52	189
OU9HZH/1	66	M10PGTVP0076856	54	M10PGTVP000S134	66	231G82	112
OU9HZH/1P	66	M10PGTVP0076881	59	M10PGTVP000T135	66	231G92	189
OU9HZH/P	66	M10PGTVP0077857	56	M10PGTVP000U136	155	231GH2	204
OU9RHE8/1M	155	M10PGTVP0078858	56	M10PGTVP000V137	155	231GL2	204
OURHE8	155	M10PGTVP0078883	59	M10PGTVP000W368	66	231H22	148
OURHE8/1	155	M10PGTVP0079859	56	M10PGTVP000X369	66	231H42	190
OURHHA	156	M10PGTVP007A860	56	M10PGTVP000Y370	66	231H52	189
OURHHA/1	156	M10PGTVP007A885	156	M10PGTVP000Z371	66	231H82	112
OURHHA/1M	156	M10PGTVP007B886	156	M10PGTVP001G096	66	231HL2	204
OURHHA/M	156	M10PGTVP007C887	156	M10PGTVP001U099	66	231J42	190
HURHC8/1P	156	M10PGTVP007D888	156	M10PGTVP001V100	66	231J52	189
HURHC8/2P	156	M10PGTVP007Y873	59	M10PGTVP001W101	66	231JL2	204
HURHC8/P	156	M10PGTVP007Z874	59	M10PGTVP001X102	66	231U42	190
M10PGTVP0002011	155	MPE1414XH764	54	Bipper		231U82	112
M10PGTVP0003012	155	MPE1414XJ765	54	AA8HSC	22	231V22/D	148
M10PGTVP000K356	156	MPE1614X3766	57	AA8HSC/P	22	231V24	148
M10PGTVP000L357	156	MPE5314XN768	66	AAFHZ	16	231V42	190
M10PGTVP000S001	56	MPE5314XP769	66	AAFHZ/S	16	231V52	189
M10PGTVP000T002	56	4007		AAKFT	42	231V52/D	189
M10PGTVP000V004	54	MPE6714U5455	176	AAKFT	42	231V54/D	189
M10PGTVP001H510	56	MPE6714U6456	176	AJ8HSC	22	231V82	122
M10PGTVP001J511	56	MPE6714U7457	176	AJ8HSC/P	22	231V92	188
M10PGTVP001J512	56	MPE6714U8458	176	AJ8HSL	22	231V94	188
M10PGTVP001K513	56	UPE6714U7457	176	AJFHZO	16	231VH2/D	204
M10PGTVP0040465	156	UPE6714U8458	176	AJFHZO/S	16	231VJ2/D	162
M10PGTVP0040878	156	VU4HNNH	176	AJFHZO/SH	16	231VL2/D	204
M10PGTVP0041466	156	VU4HNNH/1	176	AJKFTO	42	232	205
M10PGTVP0041879	156	VV4HNNH	176	AJKFVC	42	232B02	188
		VV4HNNH/1	176	MPE1112WF592	42	232B22	148

* C.N.I.T. = Code National d'Identification du Type (code D2.1 sur nouvelles cartes grises)

Sommaire

Type Mines OU C.N.I.T.*	9	Type Mines OU C.N.I.T.*	9	Type Mines OU C.N.I.T.*	9	Type Mines OU C.N.I.T.*	9
232B22/1	148	232V94	188	MPE000AE6283	188	VPE5303EP516	190
232B42	190	232VH2/D	204	MPE000AE8285	188	YAAMF	180
232B42/1	190	232VH2/G	204	MPE000AE9286	148	YAAMFA	180
232B44	190	232VH2/H	204	MPE000AEA190	148	YAAMFAAX	180
232B52	189	232VL2/D	204	MPE000AEA251	148	YAAMFB	180
232B52/1	189	232VL2/G	204	MPE000AEA287	148	YAAMFBAX	180
232B54	189	232VL2/H	204	MPE000AEB252	188	YAAMFBX	180
232B72	112	233B22	148	MPE000AEC192	112	YAAMM	180
232B82	130	233B42	190	MPE000AEC253	188	YAAMRA	180
232B92	188	233B52	189	MPE000AEC289	148	YABMF	179
232B94	190	233B92	188	MPE000AED254	112	YABMFA	179
232BH2/1	204	233BL2	204	MPE000AEE255	112	YABMFABX	179
232BJ2	163	233F42	190	MPE000AEV200	188	YABMFB	179
232BL2	204	233F82	112	MPE000AEX274	188	YABMFBBX	179
232BL2/1	204	233G22	148	MPE000AEX299	188	YBAMD	180
232BL4/1	204	233G42	190	MPE000AEY275	188	YBAMF	180
232F42	190	233G42/1	190	MPE000AEZ276	188	YBAMFA	180
232F82	112	233G52	189	MPE000AEZ301	188	YBAMFAAX	180
232G22	148	233G52/1	189	MPE1303E1514	148	YBAMFB	180
232G42	190	233G82	112	MPE1303EJ496	148	YBAMFBAX	180
232G42/1	190	233GH2	204	MPE1303EQ503	148	YBAMFBBX	180
232G52	189	233GL2	204	MPE1303EZ512	148	YBAMFC	180
232G82	112	233GL2/1	204	MPE1403E4834	141	YBAMFCBX	180
232GH2	204	233H22	148	MPE1403E5835	141	YBAMG	180
232GL2	204	233H42	190	MPE1403EE844	141	YBBMAB	179
232GL4	204	233H42/1	190	MPE5203E8325	122	YBBMABAX	179
232H22	148	233H52	189	MPE5203E8846	162	YBBMD	179
232H42	190	233H82	112	MPE5203E9520	189	YBBMF	179
232H42/1	190	233HL2	204	MPE5203EA521	189	YBBMFA	179
232H44	190	233J22	148	MPE5203EN789	162	YBBMFAAX	179
232H52	189	233J42	190	MPE5203EP342	189	YBBMFB	179
232H82	112	233J44	190	MPE5203EP791	162	YBBMFBX	179
232H92	188	233J52	189	MPE5203EQ343	189	YBBMFC	179
232HL2	204	233J54	189	MPE5203EQ792	162	YBBMFCBX	179
232HL4	204	233J92	188	MPE5203ER344	189	YBBMG	179
232J02	188	233JH2	204	MPE5203ER502	122	YBBMP	179
232J12	148	233JL2	204	MPE5203EW507	189	YCAMAB	180
232J22	148	233JL4	204	MPE5203EY836	162	YCAMABAX	180
232J42	190	233K22	148	MPE5203EZ837	162	YCAMD	180
232J44	190	233K4	190	MPE5303E4505	188	YCAMDC	180
232J52	189	233K52	189	MPE5303E5348	188	YCAMDCAX	180
232J54	189	233K52/1	189	MPE5303E6349	188	YCAMF	180
232J92	188	233K54	189	MPE5303E7350	188	YCAMFB	180
232J94	190	233K92	188	MPE5303E8351	188	YCAMFBX	180
232JH2	204	233KH2	204	MPE5303E9352	188	YCAMFC	180
232JL2	204	233KL2	204	MPE5303EF516	188	YCAMFCBX	180
232JL4	204	233KL2/1	204	MPE5303EG517	188	YCAMG	180
232K22	148	233KL4	204	MPE5303EH518	188	YCAMHC	180
232K42	190	233L22	148	MPE5303EK909	182	YCAMHCAX	180
232K52	189	233L42	190	MPE5303EL910	182	YCBMD	179
232K54	189	233L42/1	190	MPE5303EM911	182	YCBMF	179
232KH2	204	233L44	190	MPE5303EN912	182	YCBMFB	179
232KL2	204	233L52	189	MPE5303EP913	182	YCBMFBX	179
232KL4	204	233L52/1	189	MPE5303EY499	188	YCBMFC	179
232L22	148	233L54	189	MPE5503E4679	204	YCBMFCBX	179
232L44	190	233LL2	204	MPE5503E5680	204	YCBMFCCX	179
232L52	189	233LL2/1	204	MPE5503E6850	204	YCBMG	179
232L54	189	233LL4	204	MPE5503E8852	204	YCBMHC	179
232L92	188	233N42	190	MPE5503E9853	204	YCBMHACAX	179
232L2	204	233N44	190	MPE5503EP675	204	YDBMAC	179
232LL4	204	233N52	189	MPE5503ER677	204	YDBMACAXL	179
232N42	190	233N92	188	MPE5503EW840	204	YDBMFC	179
232N44	190	234G42	190	MPE5503EY842	204	YDBMHC	179
232N52	189	234G52	189	MPE6203EW346	189	ZAAMFA	162
232V22/D	148	234GH2	204	MPE6303E2500	188	ZAAMFABX	162
232V24	148	234GL2	204	MPE6303E8506	188	ZAAMP	162
232V44	190	234K42	190	MPE6303EL519	190	ZAAMRA	162
232V52	189	234K52	189	MPE6306EP261	188	ZAPAP	204
232V52/D	189	234KH2	204	MPE7503ED851	204	ZAPMF	204
232V52/G	189	234KL2	204	MPE7503EH855	204	ZAPMP	204
232V52/H	189	MPE000AE0277	188	N10PGTCT001R844	179	ZARMF	182
232V54/D	189	MPE000AE5282	188	N10PGTCT002G020	179	ZARMFAX	182

* C.N.I.T. = Code National d'Identification du Type (code D2.1 sur nouvelles cartes grises)

Sommaire

Type Mines OU C.N.I.T.*	9	Type Mines OU C.N.I.T.*	9	Type Mines OU C.N.I.T.*	9	Type Mines OU C.N.I.T.*	9
ZARMFABX	182	ZCZMG	203	BYDHXA	121	XERHKK	157
ZARMP	182	ZCZMH	203	BYRHXA	165	XERHRH	159
ZARMRA	182	ZCZMN	203	BYRHXB	165	XFRHGH	157
ZARMRB	182	ZCZMNC	203	BYRHZB	167	XFRHKK	157
ZATMF	141	ZCZMNCAY	203	BZDHXA	121	XGRHGH	157
ZBAMD	162			BZRFNC	142	XGRHKK	157
ZBAMFA	162			BZRHWB	164	XS9HUC	61
ZBAMFAAX	162	Expert		BZRHXA	165	XSRFHC	138
ZBAMNB	162	222AA2	70	BZRHXB	165	XSRHKK	157
ZBAMP	162	222DA2	111	BZWJYB	126	XT9HUC	61
ZBPAF	204	222DB2	115	BZWJZA	126	XTRHH8	156
ZBPAP	204	222LA9	101	MPE1503G1589	142	XTRHKK	157
ZBPMD	204	222LB9	101	MPE1503G2590	142	XTRHRH	159
ZBPMFB	204	223AA2	70	MPE1503G9863	142	XU9HUC	61
ZBPMFBAY	204	223DA2	111	MPE1513G5010	142	XURHH8	156
ZBPMH	204	223DB2	115	MPE1513G6011	142	XURHKK	157
ZBPMNBAY	204	223DH2	121	MPE1513G8013	142	XURHRH	159
ZBPMNC	204	224AA2/5	70	MPE1513G9014	142	XV9HUC	61
ZBPMNCAY	204	224AA2/6	70	MPE1614G5A09	138	XVRHKK	157
ZBPMP	204	224AA2/8	70	MPE3503GG634	142	XW9HUC	61
ZBPMRB	204	224AA2/9	70	MPE3503GH635	142	XWRHKK	157
ZBPWF	204	224DA2	111	MPE3513G0071	142		
ZBPWN	204	224DB2	115	MPE3513G1072	142	J5	
ZBRMD	182	224DH2	121	MPE3513G2073	142	280A11	93
ZBRMF	182	224LA9	101	MPE3513G2073	142	280A11M	93
ZBRMH	182	224LB9	101	MPE3513GG015	142	280A51	195
ZBRMN	182	225DA2	111	MPE3513G2070	142	280B22	169
ZBRMNB	182	226DA2	111	MPE5103GX225	115	280B221	169
ZBRMP	182	BARFNC	142	MPE5213G2025	165	280B222	169
ZBTMF	141	BARFNF	142	MPE5213G3026	165	280B22M	169
ZBTMP	141	BARHWB	164	MPE5213G5028	165	280B52	195
ZBZMA	203	BARHZB	167	MPE5213G6029	165	280B521	195
ZBZMD	203	BAWJZA	126	MPE5213GC459	61	280B522	195
ZBZMF	203	BBRFNC	142	MPE5214GY346	61	280B62	114
ZBZMG	203	BBRFNF	142	MPE5303G3865	164	280B92	197
ZBZMH	203	BBRHXB	165	MPE5303G5637	167	280B921	197
ZBZMN	203	BBRHZB	167	MPE5303G6638	167	280B922	197
ZCPAF	204	BBWJZA	126	MPE5303G7639	164	280C22	133
ZCPMD	204	BCRHZB	167	MPE5313G7020	167	280C221	133
ZCPMF	204	BDDHXA	111	MPE5313G9022	167	280C51	196
ZCPMH	204	BDRFNC	142	MPE5313GA023	167	280C511	196
ZCPMM	204	BDRFNF	142	MPE5313GH030	167	280C52	196
ZCPWA	204	BDRHWB	164	MPE5313GJ031	167	280C521	196
ZCPWC	204	BDRHXA	165	MPE5313GJ032	167	280C52DG	195
ZCPWD	204	BDRHXB	165	MPE5313GK033	167	280C82	114
ZCPWN	204	BDRHZ	167	MPE5313GL034	167	280C92	198
ZCRMCB	182	BDRHZA	167	MPE5414GL349	157	280C94	198
ZCRMCBAX	182	BDRHZB	167	MPE5514GK399	159	280D22	169
ZCRMDC	182	BDWJYB	126	XA9HUC	61	280D52	195
ZCRMDCAX	182	BDWJZA	126	XARHGH	157	280G22	133
ZCRMFA	182	BEDHXA	111	XARHKK	157	280G221	133
ZCRMFBAX	182	BERFNC	142	XARHRH	159	280G222	133
ZCRMH	182	BERFNF	142	XB9HUC	61	280G223	133
ZCRMMA	182	BERHWB	164	XC9HUC	61	280G224	133
ZCRMNB	182	BERHXA	165	XC9HUC/SC	61	280G225	133
ZCRMNBAX	182	BERHXB	165	XCRHGH	157	280G226	133
ZCRMNBX	182	BERHZB	167	XCRHGH/SC	157	280G227	133
ZCTMF	141	BEWJZA	126	XCRHH8	156	280G22M	133
ZCTMM	141	BHRHZB	167	XCRHHA	156	280G52	196
ZCTMNB	141	BSDHXA	121	XCRHKK	157	280G521	196
ZCTMNBAX	141	BSRHXA	165	XCRHKK/SC	157	280G522	196
ZCTMNC	141	BSRHXB	165	XCRHRH	159	280G523	196
ZCTMNCAX	141	BSRHZB	167	XD9HUC/SC	61	280G524	196
ZCZMA	203	BTRHWB	164	XDRHGH	157	280G525	196
ZCZMAG	203	BTWJYB	126	XDRHGH/SC	157	280G526	196
ZCZMAGAY	203	BTWJZA	126	XDRHGH/SG	157	280G527	196
ZCZMC	203	BURHZB	164	XDRHH8	156	280G92	197
ZCZMD	203	BVRHWB	164	XDRHHA	156	280G921	197
ZCZMF	203	BVWJYB	126	XDRHHA	156	280G922	197
ZCZMFA	203	BWDHXA	121	XDRHKK	157	280G923	197
ZCZMFAAY	203	BWRHXB	164	XDRHKK/SC	157	280G924	197
		BXRHWB	164	XDRHRH	159		
		BXWJYB	126	XERFJC	138		
				XERHGH	157		

* C.N.I.T. = Code National d'Identification du Type (code D2.1 sur nouvelles cartes grises)

Sommaire

Type Mines OU C.N.I.T.*	9	Type Mines OU C.N.I.T.*	9	Type Mines OU C.N.I.T.*	9	Type Mines OU C.N.I.T.*	9
280G926	197	Partner		7F9HXC	64	MPE1204CS127	99
280G927	197	5AHDZA	10	7J6FS0	54	MPE1214CJ602	83
280H22	133	5AHDZE	10	7J9HPO	64	MPE1303CJ922	85
280H52	196	5AHDZE/GPL	10	7J9HTC	60	MPE1303CK923	85
280H92	198	5AHFXF	10	7J9HVC	64	MPE1312CQ603	85
280J32	135	5BA9A2	96	7J9HXC	64	MPE1313CN246	85
280J52	195	5BA9AD	96	7J9HZC	66	MPE5103C7918	126
280J92	197	5BA9AG	96	7JNFRC	83	MPE5103C8919	126
280K32	135	5BD9BD	123	7JNFUC	85	MPE5104C0715	126
280K92	197	5BDJYE	123	7S9HPO	64	MPE5104C3330	126
280L92	197	5BHDZD	10	7S9HXC	64	MPE5104C4331	126
280X54	195	5BHDZE	10	GB9HW	63	MPE5104CC400	126
28B52D6	195	5BHDZE/GPL	10	GB9HWC	63	MPE5104CD401	126
28B92D6	197	5BHFXX	10	GB9HXC	64	MPE5113C5139	126
28G224M	133	5BK5A2	46	GBHFVB	10	MPE5113C9240	63
290A11	93	5BK5AG	46	GBKFVC	42	MPE5114CJ599	60
290A42	135	5BK6C2	46	GBKFWB	42	MPE5203CN924	166
290A62	114	5BKFWF	46	GBKFWBGL	45	MPE5203CP925	166
290B22	169	5BKFXD	46	GBKFWC	45	MPE5204CC778	166
290B221	169	5BKFXE	46	GBKFWCGN	45	MPE5204CD779	166
290B222	169	5BKFXE/GPL	46	GBNFUB	85	MPE5204CE780	166
290B42	135	5BRHYE	166	GBRHYB	166	MPE5204CM666	166
290B52	195	5BRHYF	166	GBWJYB	126	MPE5204CX605	166
290B521	195	5BWJYF	126	GBWJYBDG	126	MPE5212CR771	64
290B522	195	5BWJZE	126	GBWJYBDGL	126	MPE5213CY449	64
290B523	195	5BWJZT	126	GC9HWC	63	MPE5214C6164	64
290B54	196	5CA9AD	96	GC9HXC	64	MPE5214CR307	64
290B62	114	5CD9BD	123	GCKFWB	45	MPE5312C2772	66
290B92	197	5CKFXD	46	GCKFWBGNV	45	MPE6204AL010	166
290B921	197	5CKFXE	46	GCKFWBGPL	45	MPE6204AP013	166
290B922	197	5CKFXE/GPL	46	GCNFUB	85	MPE9013CV224	45
290B923	197	5CRHYE	166	GCRHYB	166	MPE9103CY933	45
290B94	198	5CRHYF	166	GCRHYBDG	166	MPE9113CE039	45
290C02	114	5CWJYF	126	GCRHYBDGL	166	N10PGTCT0001952	60
290C22	135	5CWJZE	126	GCWJYB	126	UPE5114CJ599	60
290C42	135	5DD9BD	123	GERHYB	166	VPE000ACL122	126
290C52	196	5DHDZE	10	GJ9HWC	63	VPE5004CF113	123
290C54	196	5EK5AG	45	GJ9HXC	64		
290C92	198	5FA9AD	96	GJKFVC	45	RCZ	
290C94	198	5FD9BD	129	GJKFWB	45	4J5FU8	82
290D42	135	5FDJYE	123	GJKFWBGNV	45	4J5FV8	81
290G221	135	5FHDZD	10	GJKFWBGPL	45	4J5FVA	81
290G222	135	5FHDZE	10	GJKFWC	45	4JRH88	156
290G223	135	5FK5A2	45	GJNFUB	85	M10PGTVP0008502	156
290G224	135	5FK5AG	45	GJNFUC	85		
290G42	135	5FK6C2	45	GJRHY	166		
290G52	196	5FKFWF	45	GJRHYB	166		
290G521	196	5FKFWF/GPL	45	GJRHYK	166		
290G522	196	5FKFXD	45	GJWJYB	126		
290G523	196	5FKFXE	45	GJWJYBDG	126		
290G524	196	5FKFXE/GPL	45	GJWJYBDGL	126		
290G525	196	5FKFXF	45	M10PGTVP000R945	64		
290G526	196	5FLFXE	99	M10PGTVP000Z335	85		
290G527	196	5FNFUF	85	MPE000AC1244	99		
290G541	196	5FNFUU	85	MPE000ACA120	45		
290G62	114	5FRHYE	166	MPE000ACB121	123		
290G921	198	5FRHYF	166	MPE000ACC061	45		
290G922	198	5FRHYU	166	MPE000ACC122	123		
290G923	198	5FWJYF	126	MPE000ACD062	123		
290G924	198	5FWJZE	126	MPE000ACG417	45		
290G926	198	7A9HTC	60	MPE1103CX920	45		
290G941	198	7A9HVC	64	MPE1103CY921	45		
290J32	135	7A9HXC	64	MPE1104C0109	45		
290J52	195	7ANFRC	83	MPE1104C5599	45		
290J92	197	7B9HTC	60	MPE1104CW396	45		
290K32	135	7B9HXC	64	MPE1104CX106	45		
290K42	135	7BNFRC	83	MPE1104CY107	45		
290K52	196	7C9HTC	60	MPE1104CY664	45		
290M62	114	7C9HXC	64	MPE1113C2245	45		
290R62	114	7CNFRC	83	MPE1204CC402	99		
26921D6	195	7D9HTC	60	MPE1204CD403	99		
		7E9HXC	64	MPE1204CJ603	99		

* C.N.I.T. = Code National d'Identification du Type (code D2.1 sur nouvelles cartes grises)

IDENTIFICATION JOINTS DE CULASSE - Moteur Diesel CYLINDER HEAD GASKET IDENTIFICATION - Diesel Engine PEUGEOT - CITROËN - Moteur XUD7 Atmo / XUD7 N.A. Engine

Moteurs / Engines XUD7 Atmo / N.A. → Alésage / Bore = 80 mm - 1769 cm³

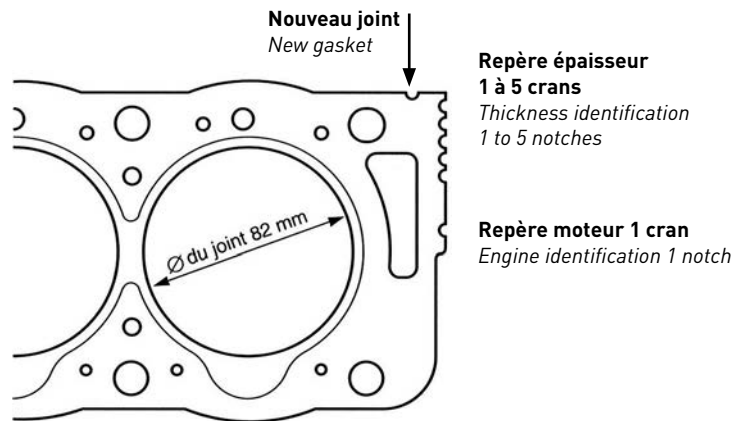
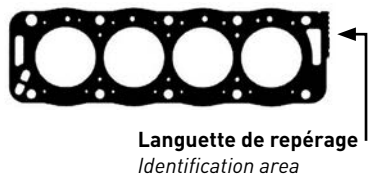

ANCIENS JOINTS FIBREUX (3 épaisseurs différentes) OLD FIBER GASKETS (3 different thicknesses)

} 1 Cran / Notch
} 2 Crans / Notches
} 3 Crans / Notches

NOUVEAUX JOINTS FIBREUX (5 épaisseurs différentes) NEW FIBER GASKETS (5 different thicknesses)

} 1 Cran / Notch	BX 830 Ép. / Thick. = 1,36 mm*
} 2 Crans / Notches	BX 840 Ép. / Thick. = 1,40 mm*
} 3 Crans / Notches	BX 850 Ép. / Thick. = 1,44 mm*
} 4 Crans / Notches	BX 860 Ép. / Thick. = 1,48 mm*
} 5 Crans / Notches	BX 870 Ép. / Thick. = 1,52 mm*

* L'épaisseur correspond à l'épaisseur serrée sur moteur.
* The above thickness refers to the assembled thickness.



Attention: mesurer systématiquement les dépassements de pistons au PMH pour déterminer le joint de culasse d'épaisseur optimale (voir les notes techniques en fin de catalogue pour identifier la correspondance entre le dépassement du piston et la réf. de joint).

Warning: it is strongly recommended that the gasket selection be made after measuring the UDC piston protrusion; see the technical notes at the end of the catalogue to have the link between the piston protrusion and the gasket part number.

IDENTIFICATION JOINTS DE CULASSE - Moteur Diesel CYLINDER HEAD GASKET IDENTIFICATION - Diesel Engine PEUGEOT - CITROËN - Moteur XUD7 Turbo / XUD7 T.C. Engine

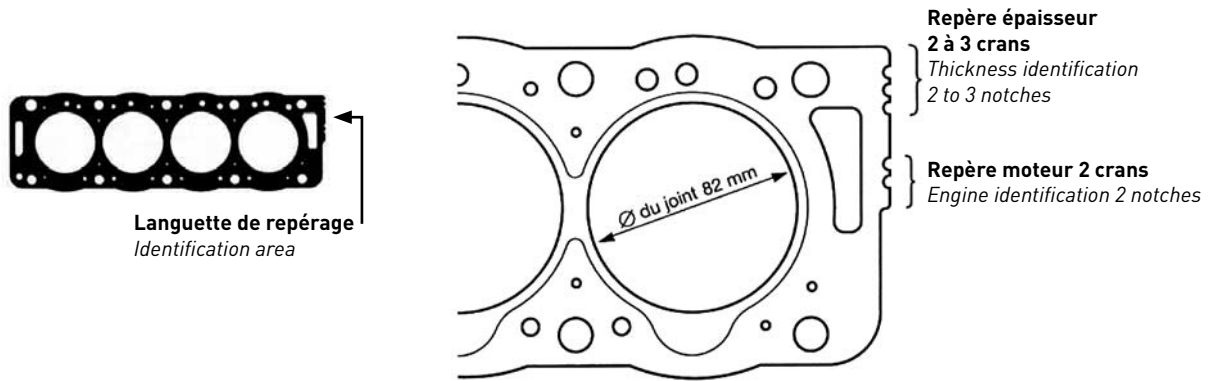
Moteurs / Engines XUD7 Turbo / T.C. → Alésage / Bore = 80 mm - 1769 cm³



	
2 Crans / Notches	3 Crans / Notches
BX 780 Ép. / Thick. = 1,65 mm*	BX 790 Ép. / Thick. = 1,80 mm*
<p>* L'épaisseur indiquée correspond à l'épaisseur libre (avant montage). * The above thickness refers to the thickness before the assembly of the engine.</p>	

Attention: mesurer systématiquement les dépassements de pistons au PMH pour déterminer le joint de culasse d'épaisseur optimale (voir les notes techniques en fin de catalogue pour identifier la correspondance entre le dépassement du piston et la réf. de joint).

Warning: it is strongly recommended that the gasket selection be made after measuring the UDC piston protrusion; see the technical notes at the end of the catalogue to have the link between the piston protrusion and the gasket part number.

IDENTIFICATION JOINTS DE CULASSE - Moteur Diesel CYLINDER HEAD GASKET IDENTIFICATION - Diesel Engine PEUGEOT - CITROËN - Moteur XUD9 Atmo / XUD9 N.A. Engine

Moteurs / Engines XUD9 Atmo / N.A. → Alésage / Bore = 83 mm - 1905 cm³

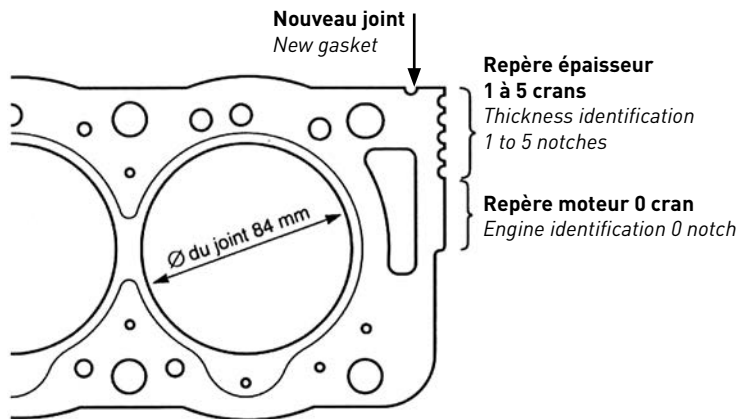



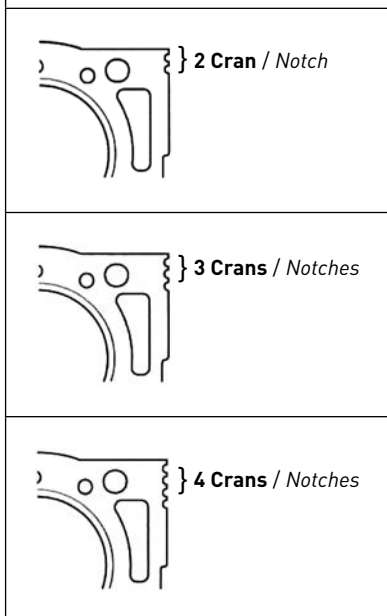

ANCIENS JOINTS FIBREUX (3 épaisseurs différentes) OLD FIBER GASKETS (3 different thicknesses)



Ces joints ne sont plus disponibles.
The gaskets are deleted.

NOUVEAUX JOINTS FIBREUX (5 épaisseurs différentes) NEW FIBER GASKETS (5 different thicknesses)

 } 1 Cran / Notch	BX 880 Ép. / Thick. = 1,36 mm*
 } 2 Crans / Notches	BX 890 Ép. / Thick. = 1,40 mm*
 } 3 Crans / Notches	BX 900 Ép. / Thick. = 1,44 mm*
 } 4 Crans / Notches	BX 910 Ép. / Thick. = 1,48 mm*
 } 5 Crans / Notches	BX 920 Ép. / Thick. = 1,52 mm*

* L'épaisseur correspond à l'épaisseur serrée sur moteur.
* The above thickness refers to the assembled thickness.

Attention: mesurer systématiquement les dépassements de pistons au PMH pour déterminer le joint de culasse d'épaisseur optimale (voir les notes techniques en fin de catalogue pour identifier la correspondance entre le dépassement du piston et la réf. de joint).

Warning: it is strongly recommended that the gasket selection be made after measuring the UDC piston protrusion; see the technical notes at the end of the catalogue to have the link between the piston protrusion and the gasket part number.

IDENTIFICATION JOINTS DE CULASSE - Moteur Diesel CYLINDER HEAD GASKET IDENTIFICATION - Diesel Engine PEUGEOT - CITROËN - Moteur XUD9 Turbo / XUD9 T.C. Engine

Moteurs / Engines XUD9 Turbo / T.C. → Alésage / Bore = 83 mm - 1905 cm³

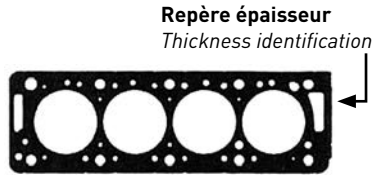



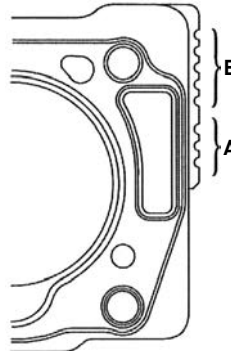

Joint métal-élastomère PAYEN
Steel elastomer gasket PAYEN
A = Repère moteur = 3 crans
A = Engine identification = 3 notches
B = Repère épaisseur = 1 à 5 crans
B = Thickness identification = 1 to 5 notches

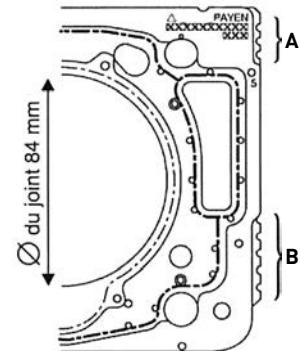



Joint métallique multifeuille
Multi-layer steel gasket
(ELRING)

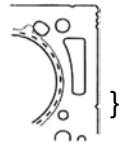
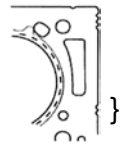
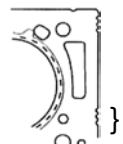

Joint métal-élastomère
Steel elastomer gasket
PAYEN

ANCIENS JOINTS FIBREUX OLD FIBER GASKETS	
 } 1 Cran / Notch	
 } 2 Crans / Notches	BV 920
 } 3 Crans / Notches	BV 930
 } 4 Crans / Notches	

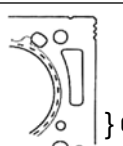
NOUVEAUX JOINTS METAL-ELASTOMERE (5 + 1 épaisseurs différentes) STEEL ELASTOMER GASKETS (5 + 1 different thicknesses)	
 } 1 Cran / Notch	BX 930 Ép. / Thick. = 1,36 mm*
 } 2 Crans / Notches	BX 940 Ép. / Thick. = 1,40 mm*
 } 3 Crans / Notches	BX 950 Ép. / Thick. = 1,44 mm*
 } 4 Crans / Notches	BX 960 Ép. / Thick. = 1,48 mm*
 } 5 Crans / Notches	BX 970 Ép. / Thick. = 1,52 mm*
 } 0 Cran / Notch	BX 980 Ép. / Thick. = 1,59 mm* Pour bloc rectifié For resurfaced block

* L'épaisseur indiquée correspond à l'épaisseur serrée sur moteur.
* The above thickness refers to the assembled thickness.







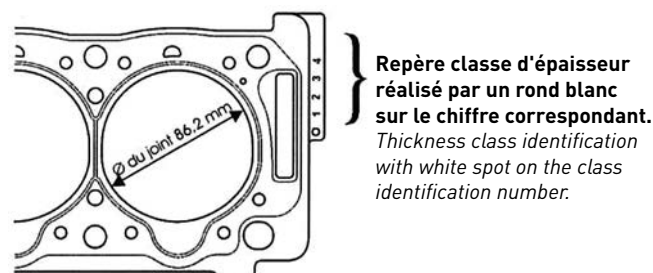
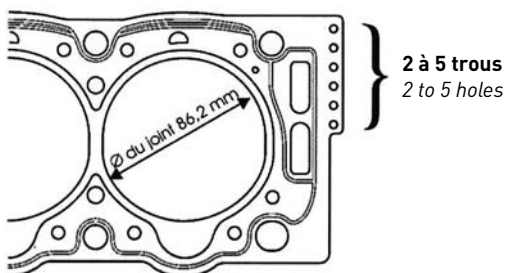

IDENTIFICATION JOINTS DE CULASSE - Moteur Diesel CYLINDER HEAD GASKET IDENTIFICATION - Diesel Engine PEUGEOT - CITROËN - Moteur / Engine XUD11 ATA et / and BTE

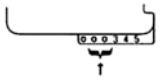
Moteurs / Engines XUD11 ATE et / and BTE → Alésage / Bore = 85 mm - 2088 cm³

Anciens joints de culasse fibreux 4 épaisseurs
Old fiber gaskets (4 different thicknesses)

Nouveaux joints métalliques multifeuilles (5+2 classes)
New multi-layer steel gaskets

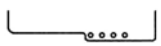
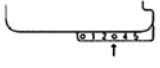

ANCIENS JOINTS FIBREUX (4 épaisseurs différentes) <i>OLD FIBER GASKETS</i> <i>(4 different thicknesses)</i>	ANCIENS JOINTS FIBREUX (5 classes) <i>OLD FIBER GASKETS</i> <i>(3 classes)</i>	NOUVEAUX JOINTS MÉTALLIQUES MULTIFEUILLES (3 + 2 classes) <i>NEW MULTI-LAYER STEEL GASKETS</i> <i>(3 + 2 classes)</i>	
 2 Trous / Holes			BY 930 Classe / Class 0 (1 + 2 trous / holes) Ép. / Thick. = 1,35 mm*
 3 Trous / Holes			BY 941 Classe / Class 1 Ép. / Thick. = 1,52 mm*
 4 Trous / Holes	 1 Classe <i>1 Class</i>		BY 961 Classe / Class 2 Ép. / Thick. = 1,62 mm*
 5 Trous / Holes	 2 Classes <i>2 Classes</i>		BY 981 Classe / Class 3 Ép. / Thick. = 1,72 mm*
	 3 Classes <i>3 Classes</i>		BY 990 Classe / Class 6 (1 + 4 trous / holes) Ép. / Thick. = 1,77 mm*
<p>* L'épaisseur correspond à l'épaisseur serrée sur moteur. * The above thickness refers to the assembled thickness.</p>			

Attention: mesurer systématiquement les dépassements de pistons au PMH pour déterminer le joint de culasse d'épaisseur optimale (voir les notes techniques en fin de catalogue pour identifier la correspondance entre le dépassement du piston et la réf. de joint).

Warning: it is strongly recommended that the gasket selection be made after measuring the UDC piston protrusion; see the technical notes at the end of the catalogue to have the link between the piston protrusion and the gasket part number.

IDENTIFICATION JOINTS DE CULASSE - Moteur Diesel CYLINDER HEAD GASKET IDENTIFICATION - Diesel Engine PEUGEOT - CITROËN - Moteur DW8 Atmo / DW8 N.A. Engine

Moteurs / Engines DW8 Atmo / DW8 N.A.

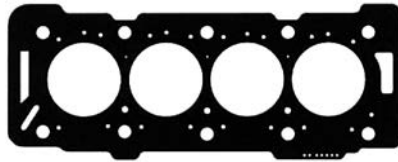

Languette de repérage
Identification area

	1 Trou /Hole	AA5830 Ép. / Thick. = 1,26 mm*
	2 Trous /Holes	AA5840 Ép. / Thick. = 1,30 mm*
	3 Trous /Holes	AA5850 Ép. / Thick. = 1,34 mm*
	4 Trous /Holes	AA5860 Ép. / Thick. = 1,38 mm*
	5 Trous /Holes	AA5870 Ép. / Thick. = 1,42 mm*
	2 Trous /Holes	AA5880 Ép. / Thick. = 1,46 mm*
<p>* L'épaisseur correspond à l'épaisseur serrée sur moteur. * The above thickness refers to the assembled thickness.</p>		

Attention: mesurer systématiquement les dépassements de pistons au PMH pour déterminer le joint de culasse d'épaisseur optimale (voir les notes techniques en fin de catalogue pour identifier la correspondance entre le dépassement du piston et la réf. de joint).



Warning: it is strongly recommended that the gasket selection be made after measuring the UDC piston protrusion; see the technical notes at the end of the catalogue to have the link between the piston protrusion and the gasket part number.

IDENTIFICATION JOINTS DE CULASSE - Moteur Diesel CYLINDER HEAD GASKET IDENTIFICATION - Diesel Engine PEUGEOT - CITROËN - Moteur DW10 Turbo / DW10 T.C. Engine

Moteurs / Engines DW10 Turbo / DW10 T.C.

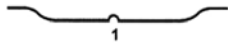
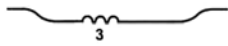

Languette de repérage
Identification area

	1 Cran /Noth	AC5011 Ép. / Thick. = 1,30 mm*
	3 Crans /Nothes	AC5031 Ép. / Thick. = 1,40 mm*
	5 Crans /Nothes	AC5051 Ép. / Thick. = 1,50 mm*
<p>* L'épaisseur correspond à l'épaisseur serrée sur moteur. * The above thickness refers to the assembled thickness.</p>		

Attention: mesurer systématiquement les dépassements de pistons au PMH pour déterminer le joint de culasse d'épaisseur optimale (voir les notes techniques en fin de catalogue pour identifier la correspondance entre le dépassement du piston et la réf. de joint).

Warning: it is strongly recommended that the gasket selection be made after measuring the UDC piston protrusion; see the technical notes at the end of the catalogue to have the link between the piston protrusion and the gasket part number.











cc

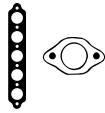

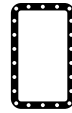
kW/PS

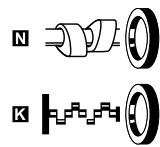

1.0		1KR (384 F)					1	AG9310 (MLS)	CG9310	EG9310
107 1.0	06/05→	998	3	71.00		50/68				
1.0		108C (XV8)					2			
104 1.0	09/83→06/88	954	4	70.00	SOHC/OHC	32-33/44-45				
1.0		CDY (TU9M)					3	BS810 (Fibre), 1.300mm BR490 (Fibre), 1.500mm	DS810 DT012 ▲	EH951 [14][18] EH952 [3]
106 1.0	09/91→03/01	954	4	70.00	SOHC/OHC	33/45				
106 I 1.0	09/91→04/96									
106 II 1.0 i	05/96→									
1.0		CDZ (TU9M)					4	BS810 (Fibre), 1.300mm 01/97→ BR490 (Fibre), 1.500mm 01/97→	DS810 01/97→ DT012 ▲ 01/97→	EH951 [14][18] 01/97→ EH952 [3] 01/97→
106 I 1.0	09/91→04/96	954	4	70.00	SOHC/OHC	37/50				
106 II 1.0 i	01/97→									
205 1.0	08/92→05/97									
1.0		TU9					5	BS810 (Fibre), 1.300mm BR490 (Fibre), 1.500mm	DS810 DT012 ▲	EH951 [14][18] EH952 [3]
106 1.0	09/91→03/01	954	4	70.00	SOHC/OHC	33/45				
106 I 1.0	09/91→04/96									
205 1.0	10/87→09/98									
1.1		109F (XW7)					6	BN580 (Fibre), 1.200mm BH950 (Fibre), 1.200mm, 1 Notch BL620 (Fibre), 1.400mm BP720 (Fibre), 1.400mm	DN571 ▲	EH950 [3][14]
104 1.1	08/79→06/88	1124	4	72.00	SOHC/OHC	37/50				
1.1		EI					7	BF100 (Fibre), 1.300mm BG480 (Fibre), 1.800mm	DF106 ▲○ [13] DF107 ▲ [13]	EF102
205 1.1 XA	07/87→10/88	1118	4	74.00	OHV	40/54				
309 I 1.1	10/85→07/89									
1.1		H1B (TU1)					8	AD5700 (Fibre), 1.250mm AD5710 (Fibre), 1.500mm	DT010 DT012 ▲	EH951 [14][18] EH952 [3]
205 1.1	08/87→10/90	1124	4	72.00	SOHC/OHC	40/54				
309 II 1.1	09/89→10/93									
1.1		HDY (TU1M)					9	AD5700 (Fibre), 1.250mm 02/97→ BS810 (Fibre), 1.300mm 02/97→	DT010 02/97→ DT012 ▲ 02/97→	EH951 [14][18] 02/97→ EH952 [3] 02/97→
106 II 1.1 i	01/97→	1124	4	72.00	SOHC/OHC	40/54				

      						 	
HBS508 [22]	JD5845 [NBR] JD5846 [MLS] JD5863 [SE]	JM7042 [ACM]			NA5260 [2] 38.00x50.00x6.00mm, FPM NA5260 [2] 38.00x50.00x6.00mm, FPM NA5324 [1] 74.00x89.00x8.50mm, FPM		AD5710 BF100, BG480 BH950, BL620 BN580, BP720 BS810, BR490 JB836 JB837 JC702 JD551 JE189 JE647 JN238 JN596 JN658 HC341
					NF678 [2] 35.00x50.00x8.00mm, ACM NF641 [1] 78.00x100.00x10.00mm, MVQ		
HBS039 [22] M10x1.50x175.00mm (x10)	JD551 [x2] JC702 [x2] JE189	JN658 [4]	JJ586 = PB852 16.00x24.00x1.500mm = PA349 22.00x16.00x2.000mm	PA858 HR599 HR642	NF870 [2] 42.00x66.00x6.00mm, FPM/ACM NF850 [1] 85.00x105.00x8.00mm, FPM NF857 [1] 85.00x105.00x9.00mm, FPM/ACM	HR564 [55]	
HBS039 [22] M10x1.50x175.00mm (x10) 01/97→	JD551 [x2] 01/97→ JC702 [x2] 01/97→ JE189 01/97→	JN658 [4] 01/97→	= PB852 16.00x24.00x1.500mm = PA349 22.00x16.00x2.000mm JJ586 01/97→	PA858 01/97→ HR599 01/97→ HR642 01/97→	NF870 [2] 42.00x66.00x6.00mm, FPM/ACM 01/97→ NF850 [1] 85.00x105.00x8.00mm, FPM 01/97→ NF857 [1] 85.00x105.00x9.00mm, FPM/ACM 01/97→	HR564 [55]	
HBS039 [22] M10x1.50x175.00mm (x10)	JD551 [x2] JC702 [x2] JE189	JN658 [4]	JJ586 = PB852 16.00x24.00x1.500mm = PA349 22.00x16.00x2.000mm	PA858 HR599 HR642	NF870 [2] 42.00x66.00x6.00mm, FPM/ACM NF850 [1] 85.00x105.00x8.00mm, FPM NF857 [1] 85.00x105.00x9.00mm, FPM/ACM	HR564 [55]	
	JE647	JN596 [4]		HR300	NF678 [2] 35.00x50.00x8.00mm, ACM NF641 [1] 78.00x100.00x10.00mm, MVQ		
	JB836 JB837	JN238 [4]	HC341 = KG5290 20.40x27.00x3.000mm		NF692 [1] 71.00x88.00x8.00mm, MVQ NF694 [2] 40.00x58.00x8.00mm, ACM		
HBS039 [22] M10x1.50x175.00mm (x10)	JD551 [x2] JC702 [x2] JE189	JN658 [4]	JJ586 = PB852 16.00x24.00x1.500mm = PA349 22.00x16.00x2.000mm	HR642	NF870 [2] 42.00x66.00x6.00mm, FPM/ACM NF850 [1] 85.00x105.00x8.00mm, FPM NF857 [1] 85.00x105.00x9.00mm, FPM/ACM	HR564 [55]	
HBS039 [22] M10x1.50x175.00mm (x10) 02/97→	JD551 [x2] 02/97→ JC702 [x2] 02/97→ JE189 02/97→	JN658 [4] 02/97→	= PB852 16.00x24.00x1.500mm = PA349 22.00x16.00x2.000mm JJ586 02/97→	HR642 02/97→	NF870 [2] 42.00x66.00x6.00mm, FPM/ACM 02/97→ NF850 [1] 85.00x105.00x8.00mm, FPM 02/97→ NF857 [1] 85.00x105.00x9.00mm, FPM/ACM 02/97→	HR564 [55]	



cc



kw/PS



1.1	HDZ (TU1M)	10					AD5700 (Fibre), 1.250mm BS810 (Fibre), 1.300mm AD5710 (Fibre), 1.500mm BR490 (Fibre), 1.500mm	DT010 DT012 ▲	EH951 [14][18] EH952 [3]
106 I 1.1	09/91→04/96	1124	4	72.00	SOHC/OHC	44/60			
106 II 1.1 i	05/96→								
205 1.1	07/89→09/98								
205 1.1 CI	10/89→12/94								
306 1.1	05/93→05/01								
309 II 1.1	08/90→12/93								
Partner 1.1	06/96→								
1.1	HFX (TU1A)	11					AC5700 (Fibre), 1.260mm AC5710 (Fibre), 1.46mm	CC5700	EC5700
206 1.1	01/09→	1124	4	72.00	SOHC/OHC	44/60			
1.1	HFX (TU1JP)	12					AC5700 (Fibre), 1.260mm AC5710 (Fibre), 1.46mm	CC5700	EC5700
106 II 1.1 i	05/96→	1124	4	72.00	SOHC/OHC	44/60			
206 1.1	07/02→								
206 1.1 i	09/98→								
Partner 1.1	06/96→								
1.1	HFZ (TU1JP)	13					AC5700 (Fibre), 1.260mm AC5710 (Fibre), 1.46mm	CC5700	EC5700
206 1.1 i	09/98→	1124	4	72.00	SOHC/OHC	44/60			
1.1	TU1AE5	14					AC5700 (Fibre), 1.260mm AC5710 (Fibre), 1.46mm		EH951 [14][18]
206 1.1	01/09→	1124	4	72.00	SOHC/OHC	44/60			
1.1	XK5	15					BF570 (Fibre), 1.200mm BP760 (Fibre), 1.400mm	DF572 ▲○	GF570 ▲○ [13]
305 II 1.1	11/82→12/88	1127	4	78.00	SOHC/OHC	43/58			
1.2	199 A9.000 Diesel	16							
Bipper 1.3 75	10/10→	1248	4	69.60	DOHC	55/75			
1.2	F1	17					BF100 (Fibre), 1.300mm BG480 (Fibre), 1.800mm	DF106 ▲○ [13] DF107 ▲ [13]	EF102
205 1.2	01/87→12/90	1204	4	74.00	OHV	47/64			
1.3	G1A	18					BF170 (Fibre), 1.300mm BG490 (Fibre), 1.800mm	DF106 ▲○ [13] DF107 ▲ [13]	EF102
205 1.3	08/90→07/92	1294	4	76.70	SOHC/OHC	47-48/ 64-65			
309 I 1.3	10/85→07/89								
1.3	TU24	19					AD5700 (Fibre), 1.250mm AD5710 (Fibre), 1.500mm	DT013 ▲ [3]	EH951 [14][18] EH952 [3]
205 1.3 Rallye	10/87→10/90	1294	4	75.00	SOHC/OHC	74-76/ 101-103			
1.3	TU2J2	20						DY130 ▲ [3]	EH951 [14][18] EH952 [3]
106 I 1.3	10/93→04/96	1294	4	75.00	SOHC/OHC	72-74/ 98-101			
1.4	8FS (EP3)	21					AH6440 (MLS), 0.900mm	CH6440 (MLS)	
207 1.4 16V	06/07→	1397	4	77.00	DOHC	70/95			
208 1.4	03/12→								
308 1.4 16V	09/07→								

HBS039 [22] M10x1.50x175.00mm (x10)	JD551 [x2] HA5028 [x2] JC702 [x2] JE189	JN658 [4]	JJ586 PB852 16.00x24.00x1.500mm PA349 22.00x16.00x2.000mm	HR599 [x]	NF870 [2] 42.00x66.00x6.00mm, FPM/ACM NF850 [1] 85.00x105.00x8.00mm, FPM NF857 [1] 85.00x105.00x9.00mm, FPM/ACM	HR564 [55] [x]	AC5700 JN658 AD5710 HC341 BF100, BG480 JJ057 BF170, BG490 JJ586 BF570, BP760 BS810, BR490 JB836 JB837 JB875 JC702 JD551 JE189 JE647 LT634 JN238		
HBS039 [22] M10x1.50x175.00mm (x10)	HA5028 [x2]	JN658 [4]	JJ586 PB852 16.00x24.00x1.500mm PA349 22.00x16.00x2.000mm	HR599 [x]	NF870 [2] 42.00x66.00x6.00mm, FPM/ACM NF850 [1] 85.00x105.00x8.00mm, FPM NF857 [1] 85.00x105.00x9.00mm, FPM/ACM	HR564 [55] [x]	BS810, BR490 JB836 JB837 JB875 JC702 KA525 [15] HG088 [60] [x]		
HBS039 [22] M10x1.50x175.00mm (x10)	HA5028 [x2]	JN658 [4]	JJ586 PB852 16.00x24.00x1.500mm PA349 22.00x16.00x2.000mm	HR599 [x]	NF870 [2] 42.00x66.00x6.00mm, FPM/ACM NF850 [1] 85.00x105.00x8.00mm, FPM NF857 [1] 85.00x105.00x9.00mm, FPM/ACM				
HBS039 [22] M10x1.50x175.00mm (x10)	HA5028 [x2] JE647 LT634		JJ057 PA349 22.00x16.00x2.000mm	HR300 [x]	NF870 [2] 42.00x66.00x6.00mm, FPM/ACM NF640 [2] 60.50x78.00x9.00mm, MVQ	HR573 [55] [x] KA525 [15] HG088 [60] [x]			
			JJ586		NF870 [2] 42.00x66.00x6.00mm, FPM/ACM NF692 [1] 71.00x88.00x8.00mm, MVQ NF694 [2] 40.00x58.00x8.00mm, ACM				
	JB875 [x] JE647 LT634		JJ057 PA349 22.00x16.00x2.000mm	HR300 [x]	NAS230 [2] 78.00x100.00x9.00mm, PTFE NF692 [1] 71.00x88.00x8.00mm, MVQ NF694 [2] 40.00x58.00x8.00mm, ACM				
	JB836 [x] JB837 [x]	JN238 [4]	HC341 [x] KG5290 20.40x27.00x3.000mm		NF692 [1] 71.00x88.00x8.00mm, MVQ NF694 [2] 40.00x58.00x8.00mm, ACM				
	JB836 [x] JB837 [x]	JN238 [4]	HC341 [x] PA349 22.00x16.00x2.000mm	HR569 [x]	NF692 [1] 71.00x88.00x8.00mm, MVQ NF694 [2] 40.00x58.00x8.00mm, ACM				
HBS039 [22] M10x1.50x175.00mm (x10)	JC702 [x2] JE189	JN658 [4]	JJ586 PB852 16.00x24.00x1.500mm	PA858 HR569 [x]	NF870 [2] 42.00x66.00x6.00mm, FPM/ACM NF850 [1] 85.00x105.00x8.00mm, FPM NF857 [1] 85.00x105.00x9.00mm, FPM/ACM	HR564 [55] [x]			
HBS039 [22] M10x1.50x175.00mm (x10)	JC702 [x2] JE189	JN658 [4]	JJ586 PB852 16.00x24.00x1.500mm PA349 22.00x16.00x2.000mm	HR642 [x]	NF870 [2] 42.00x66.00x6.00mm, FPM/ACM NF850 [1] 85.00x105.00x8.00mm, FPM NF857 [1] 85.00x105.00x9.00mm, FPM/ACM	HR564 [55] [x]			
HBS522 [21] [57]	JD6034 [x4] (Elastomer)								



cc



kW/PS



1.4	8HS (DV4TD)	Diesel				22	AH6560 (MLS), 1.25mm, 2 Notches AH6570 (MLS), 1.3mm, 3 Notches AH6580 (MLS), 1.35mm, 1 Notch AH6590 (MLS), 1.4mm, 4 Notches AH6600 (MLS), 1.45mm, 5 Notches	CD5130 ▲	
Bipper 1.4 HDi	02/08→	1398	4	73.70		50/68			
1.4	8HT (DV4TD)	Diesel				23	AH6560 (MLS), 1.25mm, 2 Notches AH6570 (MLS), 1.3mm, 3 Notches AH6580 (MLS), 1.35mm, 1 Notch AH6590 (MLS), 1.4mm, 4 Notches AH6600 (MLS), 1.45mm, 5 Notches	CD5130 ▲	ED5130
107 1.4 HDi	06/05→	1398	4	73.70	SOHC/OHC	40/54			
1.4	8HX (DV4TD)	Diesel				24	AH6560 (MLS), 1.25mm, 2 Notches AH6570 (MLS), 1.3mm, 3 Notches AH6580 (MLS), 1.35mm, 1 Notch AH6590 (MLS), 1.4mm, 4 Notches AH6600 (MLS), 1.45mm, 5 Notches	CD5130 ▲	ED5130
206 1.4 HDi	09/01→03/09	1398	4	73.70	SOHC/OHC	50-51/ 68-69			
206 1.4 HDi eco	09/01→								
307 1.4 HDi	10/01→								
1007 1.4 HDi	04/05→								
1.4	8HZ (DV4TD)	Diesel				25	AH6560 (MLS), 1.25mm, 2 Notches AH6570 (MLS), 1.3mm, 3 Notches AH6580 (MLS), 1.35mm, 1 Notch AH6590 (MLS), 1.4mm, 4 Notches AH6600 (MLS), 1.45mm, 5 Notches	CD5130 ▲	ED5130
206 1.4 HDi	09/01→03/09	1398	4	73.70		50-51/ 68-69			
206 1.4 HDi eco	09/01→								
207 1.4 HDi	02/06→								
307 1.4 HDi	10/01→								
307 1.4 HDi 70	03/02→01/05								
1007 1.4 HDi	04/05→								
1.4	150 (XY6B)					26			
205 1.4	01/87→07/88	1360	4	75.00	SOHC/OHC	53/72			
1.4	150B (XY8)					27	BN580 (Fibre), 1.200mm BP720 (Fibre), 1.400mm	DN582 ▲	EH950 [3][14]
205 1.4	07/88→05/89	1360	4	75.00	SOHC/OHC	58-59/ 79-80			
205 1.4 CT	04/86→12/88								
1.4	150D (XY7)					28	BP720 (Fibre), 1.400mm →Eng.3281 BN580 (Fibre), 1.200mm Eng.3280→		EH950 [3][14]
205 1.4	10/87→05/89	1360	4	75.00	SOHC/OHC	44/60			
205 1.4 CJ	03/88→05/89								
1.4	150G (XY7)					29	BN580 (Fibre), 1.200mm BP720 (Fibre), 1.400mm		EH950 [3][14]
205 1.4	10/87→05/89	1360	4	75.00	SOHC/OHC	44/60			
205 1.4 CJ	03/88→05/89								
1.4	150H (XY8)					30			EH950 [3][14]
205 1.4	07/88→05/89	1360	4	75.00	SOHC/OHC	58/79			
205 1.4 CT	04/86→12/88								
1.4	EP3					31	AH6440 (MLS), 0.900mm	CH6440 (MLS)	
207 1.4 16V	06/07→	1397	4	76.00	DOHC	70/95			
308 1.4 16V	09/07→								
1.4	K1D (TU3A)					32	AD5700 (Fibre), 1.250mm AD5710 (Fibre), 1.500mm	DT010 DT012 ▲	EH951 [14][18] EH952 [3]
205 1.4	10/87→10/90	1361	4	75.00	SOHC/OHC	49/67			
205 1.4 CJ	03/89→12/94								
309 I 1.4	03/89→07/89								
309 II 1.4	07/90→12/93								
1.4	K2B (TU3S)					33		DT010	
205 1.4	06/87→06/94	1360	4	75.00	SOHC/OHC	62/85			
309 I 1.4	03/89→07/89								



AD5710



BN580, BP720



JC702



JD551



JE189

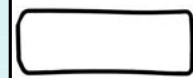

JN596



JN658



JJ586

HBS359 [22] M11x1.50x147.00mm (x10)	HA5029 [1] [5] JD5829 [5]	JM5299			NA5258 [2] 27.00x47.00x7.00mm, PTFE	
HBS359 [22] M11x1.50x147.00mm (x10)	HA5029 [1] [5] JD5829 [5]	JM5299	KG5157 10.00x20.00x2.000mm		NA5258 [2] 27.00x47.00x7.00mm, PTFE	
HBS359 [22] M11x1.50x147.00mm (x10)	HA5029 [1] [5] JD5829 [5]	JM5299	KG5157 10.00x20.00x2.000mm		NA5258 [2] 27.00x47.00x7.00mm, PTFE NA5259 [2] 40.00x55.00x6.40mm, PTFE	
HBS359 [22] M11x1.50x147.00mm (x10)	HA5029 [1] [5] JD5829 [5]	JM5299	KG5157 10.00x20.00x2.000mm		NA5258 [2] 27.00x47.00x7.00mm, PTFE NA5259 [2] 40.00x55.00x6.40mm, PTFE	
					NF678 [2] 35.00x50.00x8.00mm, ACM NF641 [1] 78.00x100.00x10.00mm, MVQ	
HBS011 [5] M12x1.25x119.00mm (x12)		JN596 [4]		HR300 [5]	NF678 [2] 35.00x50.00x8.00mm, ACM NF641 [1] 78.00x100.00x10.00mm, MVQ	
					NF678 [2] 35.00x50.00x8.00mm, ACM NF641 [1] 78.00x100.00x10.00mm, MVQ	
					NF678 [2] 35.00x50.00x8.00mm, ACM NF641 [1] 78.00x100.00x10.00mm, MVQ	
HBS011 [5] M12x1.25x119.00mm (x12)					NF678 [2] 35.00x50.00x8.00mm, ACM NF641 [1] 78.00x100.00x10.00mm, MVQ	
HBS522 [21] [57]	JD6034 [1] (x4) (Elastomer)					
HBS039 [22] M10x1.50x175.00mm (x10)	JD551 [1] (x2) HA5028 [1] [5] JC702 [1] (x2) JE189	JN658 [4]	JJ586 PB852 16.00x24.00x1.500mm PA349 22.00x16.00x2.000mm	HR599 [5] HR642 [5]	NF870 [2] 42.00x66.00x6.00mm, FPM/ACM NF850 [1] 85.00x105.00x8.00mm, FPM NF857 [1] 85.00x105.00x9.00mm, FPM/ACM	HR564 [5] [5] NF836 [1] [2] [53] NF826 [2] [53] [5]
HBS011 [5] M12x1.25x119.00mm (x12)	JD551 [1] (x2) HA5028 [1] [5] JC702 [1] (x2)	JN658 [4]		HR599 [5]	NF870 [2] 42.00x66.00x6.00mm, FPM/ACM NF850 [1] 85.00x105.00x8.00mm, FPM NF857 [1] 85.00x105.00x9.00mm, FPM/ACM	



cc



kW/PS



1.4		K5A (TU3)					34	AD5700 (Fibre), 1.250mm AD5710 (Fibre), 1.500mm		DT010 DT012 ▲	EH951 [14][18] EH952 [3]
106 I 1.4	08/91→03/96	1360	4	75.00	SOHC/OHC	47-51/ 64-69					
405 I 1.4	01/87→07/92										
1.4		K9Y (TUD3Y) Diesel					35	BS730 (SE), 1.800mm BY120 (Fibre), 1.800mm		DS731 ▲	EH951 [14][18] EH952 [3]
106 I 1.4 D	09/92→04/96	1361	4	75.00	SOHC/OHC	37/50					
1.4		KAY (TU3CP)					36	AD5700 (Fibre), 1.250mm AD5710 (Fibre), 1.500mm		DT010 DT012 ▲	EH951 [14][18] EH952 [3]
205 1.4	08/87→09/93	1361	4	75.00	SOHC/OHC	44/60					
205 1.4 CJ	01/89→09/93										
1.4		KDX (TU3MC)					37	AY110 (Fibre) AD5700 (Fibre), 1.250mm AD5710 (Fibre), 1.500mm		DT010	EH951 [14][18] EH952 [3]
106 I 1.4	09/91→04/96	1361	4	75.00	SOHC/OHC	55-58/ 75-79					
205 1.4	08/90→07/98										
306 1.4	05/93→05/01										
306 1.4 SL	06/94→05/01										
405 II 1.4	08/92→10/96										
1.4		KDY (TU3M)					38	AY110 (Fibre) AD5700 (Fibre), 1.250mm AD5710 (Fibre), 1.500mm		DT010 DT012 ▲	EH951 [14][18] EH952 [3]
106 I 1.4	09/91→04/96	1361	4	75.00	SOHC/OHC	55-58/ 75-79					
205 1.4	07/88→09/98										
205 1.4 CJ	05/91→12/94										
309 I 1.4	03/89→07/89										
309 II 1.4	07/89→12/93										
1.4		KDZ (TU3M)					39	AY110 (Fibre) AD5700 (Fibre), 1.250mm AD5710 (Fibre), 1.500mm		DT010	EH951 [14][18] EH952 [3]
205 1.4	07/88→09/98	1361	4	75.00	SOHC/OHC	55/75					
205 1.4 CJ	05/91→12/94										
309 I 1.4	03/89→07/89										
309 II 1.4	07/89→12/93										
1.4		KFT (TU3A)					40	AD5700 (Fibre), 1.250mm AD5710 (Fibre), 1.500mm			
206 1.4 i	09/10→	1360	4	75.00	SOHC/OHC	54/73					
1.4		KFU (ET3JA)					41	AG9030 (Fibre), 1.400mm		CG9030	EG9030
206 1.4 16V	10/03→	1360	4	75.00	DOHC	65/88					
207 1.4 16V	02/06→										
307 1.4 16V	11/03→										
1007 1.4 16V	10/05→										
1.4		KFV (TU3A)					42	AD5700 (Fibre), 1.250mm AD5710 (Fibre), 1.500mm			
206 1.4	07/02→	1360	4	75.00	SOHC/OHC	54-60/ 73-82					
206 1.4 i	01/09→										
207 1.4	02/06→										
Biipper 1.4	02/08→										
Partner 1.4	11/02→10/06										
1.4		KFV (TU3JP)					43	AD5700 (Fibre), 1.250mm AD5710 (Fibre), 1.500mm		DT012 ▲	EH951 [14][18]
206 1.4 LPG	05/06→09/07	1360	4	75.00	SOHC/OHC	48-55/ 65-75					
1007 1.4	04/05→										

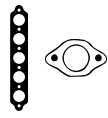

AD5710



BS730, BY120



JC702

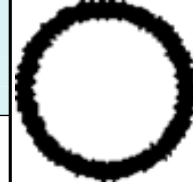

JD538



JD551

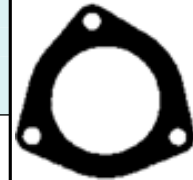

JE189

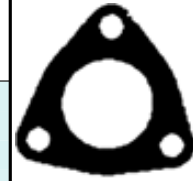

JF067



JN658

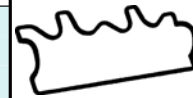

JN758

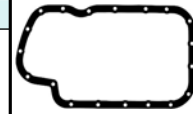

JJ586



cc



kw/PS

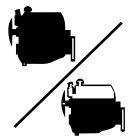

1.4		KFW (TU3A)					44	AD5700 (Fibre), 1.250mm	DT012 ▲	EH951 [14][18]
206 1.4 i	01/09→	1360	4	75.00	SOHC/OHC	55-60/	AD5710 (Fibre), 1.500mm			
207 1.4	08/08→					75-82				
207 1.4 Bioflex	11/08→									
1.4		KFW (TU3JP)					45	AD5700 (Fibre), 1.250mm	DT012 ▲	EH951 [14][18]
106 II 1.4 i	05/96→	1360	4	75.00	SOHC/OHC	47-55/	AD5710 (Fibre), 1.500mm			
206 1.4	07/02→					64-75				
206 1.4 i	09/98→									
306 1.4	05/93→04/02									
306 1.4 SL	06/94→05/01									
307 1.4	08/00→09/03									
Partner 1.4	06/96→10/06									
Partner 1.4 Bif	04/03→									
1.4		KFX (TU3JP)					46	AY110 (Fibre)	DT010	EH951 [14][18]
106 II 1.4 i	05/96→	1361	4	75.00	SOHC/OHC	49-55/	01/96→	01/96→	01/96→	
205 1.4	07/88→09/98					67-75	AD5700 (Fibre), 1.250mm	DT012 ▲	EH952 [3]	
206 1.4 i	09/98→						01/96→	01/96→	01/96→	
306 1.4	05/93→04/02						BY130 (Fibre), 1.280mm			
306 1.4 SL	06/94→05/01						01/96→			
Partner 1.4	06/96→						AD5710 (Fibre), 1.500mm			
							01/96→			
1.4		KFZ (TU3J2/Z)					47	AY110 (Fibre)	DT010	EH951 [14][18]
106 I 1.4	09/91→04/96	1361	4	75.00	SOHC/OHC	69/94	AD5700 (Fibre), 1.250mm	DT012 ▲		
								DY130 ▲ [3]		
1.4		TU32					48			
205 1.4	08/90→07/98	1361	4	75.00	SOHC/OHC	51-55/				
Partner 1.4	06/96→					70-75				
1.4		Y2/K					49	BF170 (Fibre), 1.300mm	DF106 ▲○ [13]	EF102
205 1.4	06/87→12/89	1442	4	76.70	OHV	61-63/	BG490 (Fibre), 1.800mm	DF107 ▲ [13]		
309 I 1.5	06/87→12/89					83-86				
1.5		142 (XR5A)					50	BF570 (Fibre), 1.200mm	DF572 ▲○	GF570 ▲○ [13]
305 II 1.5	09/85→07/90	1472	4	78.00	SOHC/OHC	50/68	BP760 (Fibre), 1.400mm		→Eng.9285506	
1.5		VJX (TUD5) Diesel					51	BY150 (Fibre), 1.750mm	DY150 ▲ [3]	
106 1.5 D	10/00→03/01	1527	4	77.00	SOHC/OHC	42/57				
106 II 1.5 D	10/00→									
1.5		VJY (TUD5) Diesel					52	BY150 (Fibre), 1.750mm	DY150 ▲ [3]	
106 1.5 D	05/96→03/01	1527	4	77.00	SOHC/OHC	40/54				
106 I 1.5 D	06/94→04/96									
106 II 1.5 D	05/96→									

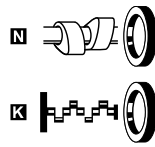
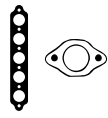

HBS039 [22] M10x1.50x175.00mm (x10)	JD538 [x4] HA5028 [x2] JC702 [x2]	JN658 [4]		HR646 [x]	NF870 [2] 42.00x66.00x6.00mm, FPM/ACM NF850 [1] 85.00x105.00x8.00mm, FPM	
HBS039 [22] M10x1.50x175.00mm (x10)	HA5028 [x2] JC702 [x2] JE5072 (MLS)	JN658 [4]		HR599 [x]	NF870 [2] 42.00x66.00x6.00mm, FPM/ACM NF850 [1] 85.00x105.00x8.00mm, FPM NF857 [1] 85.00x105.00x9.00mm, FPM/ACM	
HBS039 [22] M10x1.50x175.00mm (x10) 01/96→	JD538 [x4] 01/96→ JD551 [x2] 01/96→ HA5028 [x2] 01/96→ JC702 [x2] 01/96→ JE189 01/96→ JE5072 (MLS) 01/96→	JN658 [4] 01/96→	PB852 16.00x24.00x1.500mm PA349 22.00x16.00x2.000mm JJ586 01/96→	HR599 [x] 01/96→ HR642 [x] 01/96→	NF870 [2] 42.00x66.00x6.00mm, FPM/ACM 01/96→ NF850 [1] 85.00x105.00x8.00mm, FPM 01/96→ NF857 [1] 85.00x105.00x9.00mm, FPM/ACM 01/96→	HR564 [55] [x] NF836 [1] [2] [53] [x] NF826 [2] [53] [x]
HBS039 [22] M10x1.50x175.00mm (x10)	JD551 [x2] HA5028 [x2] JC702 [x2] JE189	JN658 [4]	PB852 16.00x24.00x1.500mm PA349 22.00x16.00x2.000mm	HR642 [x]	NF870 [2] 42.00x66.00x6.00mm, FPM/ACM NF850 [1] 85.00x105.00x8.00mm, FPM NF857 [1] 85.00x105.00x9.00mm, FPM/ACM	HR564 [55] [x]
	HA5028 [x2]			HR599 [x]	NF870 [2] 42.00x66.00x6.00mm, FPM/ACM NF850 [1] 85.00x105.00x8.00mm, FPM	
	JB836 [x] JB837 [x]	JN238 [4]	HC341 [x] PA349 22.00x16.00x2.000mm	HR569 [x]	NF692 [1] 71.00x88.00x8.00mm, MVQ NF694 [2] 40.00x58.00x8.00mm, ACM	
	JB875 [x] JE145 LT634		JJ057 PA349 22.00x16.00x2.000mm	HR300 [x]	NF640 [2] 60.50x78.00x9.00mm, MVQ	HR573 [55] [x] Paper → Eng. 9285506 KA525 [15] HG088 [60] [x]
HBS113 [22] M11x1.50x185.00mm (x10)	JF067	JPO41 [4]	JJ587 PB907 14.00x21.00x2.000mm	HR642 [x]	NF870 [2] 42.00x66.00x6.00mm, FPM/ACM NF850 [1] 85.00x105.00x8.00mm, FPM NF857 [1] 85.00x105.00x9.00mm, FPM/ACM	PB259 [45]
HBS113 [22] M11x1.50x185.00mm (x10)	JD498 [x] JF067	JPO41 [4]	JJ587 PB907 14.00x21.00x2.000mm	HR599 [x] HR642 [x]	NF870 [2] 42.00x66.00x6.00mm, FPM/ACM NF850 [1] 85.00x105.00x8.00mm, FPM NF857 [1] 85.00x105.00x9.00mm, FPM/ACM	PB259 [45]

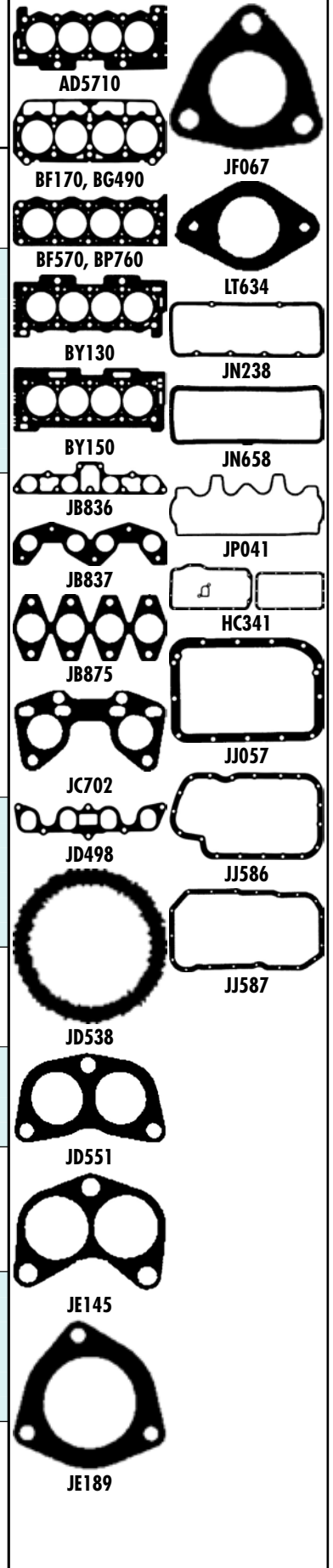



cc



kW/PS



1.6		5FR (EP6DT)				53		AH6730 (MLS), 0.9mm	CH6730 (MLS)
207 1.6 16V T	10/09→	1598	4	77.00	DOHC	115/156			
1.6		5FS (EP6C)				54		AH6440 (MLS), 0.900mm	CH6440 (MLS)
207 1.6 16V VTi	02/07→	1598	4	77.00	DOHC	88/120			
508 1.6 VTi	11/10→								
2008 1.6 VTi	03/13→								
3008 1.6 VTi	06/09→								
5008 1.6 16V	09/09→								
Partner 1.6	04/10→								
1.6		5FT (EP6DT)				55		AH6730 (MLS), 0.9mm	CH6730 (MLS)
308 1.6 16V	09/07→	1598	4	77.00	DOHC	103/140			
308 CC 1.6 16V	06/09→								
1.6		5FV (EP6DT)				56		AH6730 (MLS), 0.9mm	CH6730 (MLS)
308 1.6	01/12→	1598	4	77.00	DOHC	115-120/ 156-163			
3008 1.6 THP	06/09→								
1.6		5FX (EP6DT)				57		AH6730 (MLS), 0.9mm	CH6730 (MLS)
207 1.6 16V T	02/06→	1598	4	77.00	DOHC	110/150			
308 1.6 16V	09/07→								
308 CC 1.6 16V	06/09→								
508 1.6 THP	11/10→								
3008 1.6 THP	06/09→								
1.6		5FY (EP6DTS)				58		AH6730 (MLS), 0.9mm	CH6730 (MLS)
207 1.6 16V RC	02/07→	1598	4	77.00	DOHC	128/175			
308 1.6 16V	03/08→								
1.6		9HR (DV6C) Diesel				59			
207 1.6 HDi	08/09→	1560	4	75.00	SOHC/OHC	82/112			
308 1.6 HDi	12/09→								
308 CC 1.6 HDi	06/09→								
508 1.6 HDi	11/10→								
3008 1.6 HDi	08/10→								
5008 1.6 HDi	08/10→								
1.6		9HT (DV6BTED4) Diesel				60		AD5130 (MLS), 1.250mm, 2 Notches AD5140 (MLS), 1.300mm, 3 Notches AD5150 (MLS), 1.350mm, 1 Notch AD5160 (MLS), 1.400mm, 4 Notches AD5170 (MLS), 1.450mm, 5 Notches	CD5140 ▲
Partner 1.6 HDi	04/08→	1560	4	75.00	DOHC	55/75			
1.6		9HU (DV6UTED4) Diesel				61			
Expert 1.6 90	01/07→	1560	4	75.00	DOHC	66/90			
1.6		9HV (DV6ATED4) Diesel				62		AD5130 (MLS), 1.250mm, 2 Notches AD5140 (MLS), 1.300mm, 3 Notches AD5150 (MLS), 1.350mm, 1 Notch AD5160 (MLS), 1.400mm, 4 Notches AD5170 (MLS), 1.450mm, 5 Notches	CD5140 ▲
207 1.6 HDi	02/06→	1560	4	75.00	DOHC	66/90			
307 1.6 HDi	04/05→								
307 1.6 HDi 90	12/06→								
308 1.6 HDi	09/07→								
1.6		9HW (DV6BTED4) Diesel				63			
Partner 1.6 75	02/06→	1560	4	75.00	DOHC	55/75			
1.6		9HX (DV6ATED4) Diesel				64		AD5130 (MLS), 1.250mm, 2 Notches AD5140 (MLS), 1.300mm, 3 Notches AD5150 (MLS), 1.350mm, 1 Notch AD5160 (MLS), 1.400mm, 4 Notches AD5170 (MLS), 1.450mm, 5 Notches	CD5140 ▲
207 1.6 HDi	02/06→	1560	4	75.00	DOHC	66-68/ 90-92			
307 1.6 HDi 90	12/06→								
308 1.6 HDi	09/07→								
Partner 1.6 4x4	04/12→								
Partner 1.6 90	02/06→								
Partner 1.6 HDi	04/08→								

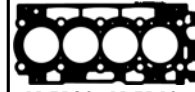

AD5130, AD5140,
AD5150, AD5160,
AD5170

HBS522 [21][57]		HM5371 [S]				
HBS522 [21][57]	JD6034 [I] (x4) (Elastomer)					
HBS522 [21][57]		HM5371 [S]				
HBS522 [21][57]		HM5371 [S]				
HBS522 [21][57]		HM5371 [S]				
HBS522 [21][57]		HM5371 [S]				
					NA5258 [2] 27.00x47.00x7.00mm, PTFE	
HBS359 [22] M11x1.50x147.00mm (x10)	JD5830 [I] [Z] HA5031 [I] [X] [S] HA5030 [I] [X] [S] JD5829 [E]				NA5258 [2] 27.00x47.00x7.00mm, PTFE NA5259 [E] [2] 40.00x55.00x6.40mm, PTFE	
					NA5258 [2] 27.00x47.00x7.00mm, PTFE	
HBS359 [22] M11x1.50x147.00mm (x10)	JD5830 [I] [Z] HA5031 [I] [X] [S] HA5030 [I] [X] [S] JD5829 [E]	JM7034 (Elastomer)			NA5258 [2] 27.00x47.00x7.00mm, PTFE NA5259 [E] [2] 40.00x55.00x6.40mm, PTFE	
					NA5258 [2] 27.00x47.00x7.00mm, PTFE	
HBS359 [22] M11x1.50x147.00mm (x10)	JD5830 [I] [Z] HA5031 [I] [X] [S] HA5030 [I] [X] [S] JD5829 [E]	JM7034 (Elastomer)	KG5157 10.00x20.00x2.000mm		NA5258 [2] 27.00x47.00x7.00mm, PTFE NA5259 [E] [2] 40.00x55.00x6.40mm, PTFE	









cc

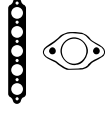

kW/PS

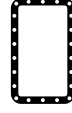

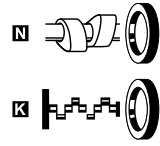
1.6		9HY (DV6TED4) Diesel				65													
206 1.6 HDi 110	05/04→	1560	4	75.00	DOHC	80/109	AD5130 (MLS), 1.250mm, 2 Notches	CD5140 ▲											
207 1.6 HDi	02/06→						AD5140 (MLS), 1.300mm, 3 Notches												
307 1.6 110 FAP	02/04→						AD5150 (MLS), 1.350mm, 1 Notch												
407 1.6 110 FAP	05/04→						AD5160 (MLS), 1.400mm, 4 Notches												
1.6		9HZ (DV6TED4) Diesel				66													
206 1.6 HDi 110	05/04→	1560	4	75.00	DOHC	80-82/ 109-112	AD5130 (MLS), 1.250mm, 2 Notches	CD5140 ▲											
207 1.6 HDi	02/06→						AD5140 (MLS), 1.300mm, 3 Notches												
307 1.6 110 FAP	02/04→						AD5150 (MLS), 1.350mm, 1 Notch												
308 1.6 HDi	09/07→						AD5160 (MLS), 1.400mm, 4 Notches												
1007 1.6 HDi	06/07→						AD5170 (MLS), 1.450mm, 5 Notches												
3008 1.6 HDi	06/09→																		
5008 1.6 HDi	09/09→																		
Partner 1.6 HDi	04/08→																		
1.6							171 (XU5S)				67								
205 1.6	08/90→07/92	1580	4	83.00	SOHC/OHC	66-71/ 90-97	BL650 (Fibre), 1.200mm	DL650	DN590 ▲ [3]	EL650 [3]	GL650 [3]								
305 II 1.6	10/82→06/88						BR510 (Fibre), 1.440mm												
1.6		180A (XU5J)				68													
205 1.6 CTI	04/86→10/90	1580	4	83.00	SOHC/OHC	76/104	BL650 (Fibre), 1.200mm	DL650	DN590 ▲ [3]	EL650 [3]	GL650 [3]								
205 1.6 GTI	10/87→12/89						BR510 (Fibre), 1.440mm												
1.6		180Z (XU5J)				69													
205 1.6 CTI	04/86→10/90	1580	4	83.00		76/103	BL650 (Fibre), 1.200mm	DL650	DN590 ▲ [3]	EL650 [3]	GL650 [3]								
205 1.6 GTI	10/87→12/89						BR510 (Fibre), 1.440mm												
309 I 1.6	11/85→09/88																		
1.6		222A2 (1580 SPI)				70													
Expert 1.6	02/96→	1581	4			58/79	AY460 (Fibre)	DR630 [3]		GR630 [3]									
						BR630 (Fibre)													
1.6		B1A (XU51C)				71													
205 1.6	10/87→09/98	1580	4	83.00	SOHC/OHC	55/75	BL650 (Fibre), 1.200mm	DN590 ▲ [3]		EL650 [3]	GL650 [3]								
305 II 1.6	10/82→12/88						BR510 (Fibre), 1.440mm												
309 I 1.6	10/85→07/89																		
1.6		B1E (XU51C)				72													
205 1.6	10/87→09/98	1580	4	83.00	SOHC/OHC	53-55/ 72-75	BL650 (Fibre), 1.200mm	DL650	DN590 ▲ [3]	EL650 [3]	GL650 [3]								
309 I 1.6	08/87→07/89						BR510 (Fibre), 1.440mm												
405 I 1.6	07/87→12/92																		
1.6		B2A (XU52C/K)				73													
309 II 1.6	07/89→12/93	1580	4	83.00	SOHC/OHC	66-68/ 90-92	BL650 (Fibre), 1.200mm	DL650	DN590 ▲ [3]	EL650 [3]	GL650 [3]								
405 I 1.6	01/87→12/92						BR510 (Fibre), 1.440mm												
1.6		B6B (XU5J)				74													
309 I 1.6	11/85→09/88	1580	4	83.00	SOHC/OHC	76/103	BL650 (Fibre), 1.200mm			EL650 [3]									
1.6		BAZ (XU5CP)				75													
205 1.6	10/87→09/98	1580	4	83.00		54-55/ 74-75	BL650 (Fibre), 1.200mm	DL650	DN590 ▲ [3]	EL650 [3]	GL650 [3]								
305 II 1.6	11/86→12/88						BR510 (Fibre), 1.440mm												
309 I 1.6	09/86→12/89																		
405 I 1.6	07/87→08/92																		

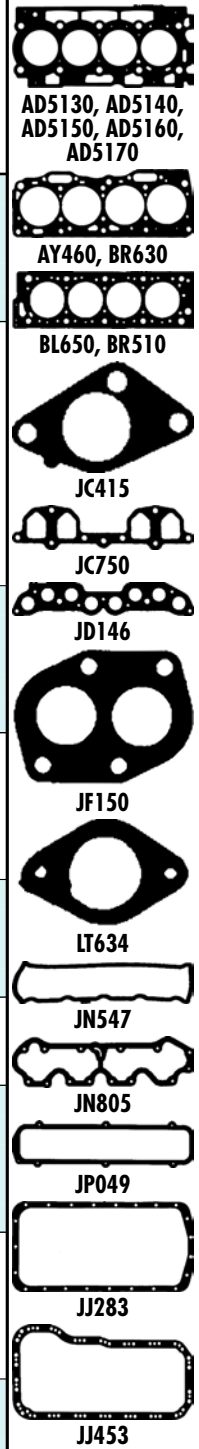
								
HBS359 [22] M11x1.50x147.00mm (x10)	JD5830 [1] [2] HA5031 [1] [2] [3] [4] HA5030 [1] [2] [3] [4] JD5829 [5]	JM7034 (Elastomer)	KG5157 10.00x20.00x2.000mm		NA5258 [2] 27.00x47.00x7.00mm, PTFE NA5259 [2] 40.00x55.00x6.40mm, PTFE			AD5130, AD5140, AD5150, AD5160, AD5170 AY460, BR630 BL650, BR510 JC415 JC750 JD146 JF150 KA611 [15] LC292 (x2)[45] LT634 JN547 JN805 JP049 JJ283 JJ453 JJ547 JJ805 JP049 JJ283 JJ453
HBS359 [22] M11x1.50x147.00mm (x10)	JD5830 [1] [2] HA5031 [1] [2] [3] [4] HA5030 [1] [2] [3] [4] JD5829 [5]	JM7034 (Elastomer)	KG5157 10.00x20.00x2.000mm		NA5258 [2] 27.00x47.00x7.00mm, PTFE NA5259 [2] 40.00x55.00x6.40mm, PTFE			AD5130, AD5140, AD5150, AD5160, AD5170 AY460, BR630 BL650, BR510 JC415 JC750 JD146 JF150 KA611 [15] LC292 (x2)[45] LT634 JN547 JN805 JP049 JJ283 JJ453 JJ547 JJ805 JP049 JJ283 JJ453
	JC750 [1] JC415 [5] (x4) LT634	JN547 [4]	JJ283 [62] PA349 22.00x16.00x2.000mm PB907 14.00x21.00x2.000mm	HR569 [5]	NA5191 [2] 42.00x62.00x7.00mm, PTFE NA5192 [1] 90.00x110.00x7.00mm, PTFE	HR566 [55] [5] KA611 [15] LC292 (x2)[45]		AD5130, AD5140, AD5150, AD5160, AD5170 AY460, BR630 BL650, BR510 JC415 JC750 JD146 JF150 KA611 [15] LC292 (x2)[45] LT634 JN547 JN805 JP049 JJ283 JJ453 JJ547 JJ805 JP049 JJ283 JJ453
HBS083 [22] M11x1.50x168.00mm (x10)	JC750 [1] JC415 [5] (x4) LT634	JN547 [4]	JJ283 [62] PA349 22.00x16.00x2.000mm PB907 14.00x21.00x2.000mm	HR569 [5]	NA5191 [2] 42.00x62.00x7.00mm, PTFE NA5192 [1] 90.00x110.00x7.00mm, PTFE	HR566 [55] [5] KA611 [15] LC292 (x2)[45]		AD5130, AD5140, AD5150, AD5160, AD5170 AY460, BR630 BL650, BR510 JC415 JC750 JD146 JF150 KA611 [15] LC292 (x2)[45] LT634 JN547 JN805 JP049 JJ283 JJ453 JJ547 JJ805 JP049 JJ283 JJ453
HBS083 [22] M11x1.50x168.00mm (x10)	JC750 [1] JC415 [5] (x4) LT634	JN547 [4]	JJ283 [62] PA349 22.00x16.00x2.000mm PB907 14.00x21.00x2.000mm	HR569 [5]	NA5191 [2] 42.00x62.00x7.00mm, PTFE NA5192 [1] 90.00x110.00x7.00mm, PTFE	KA611 [15]		AD5130, AD5140, AD5150, AD5160, AD5170 AY460, BR630 BL650, BR510 JC415 JC750 JD146 JF150 KA611 [15] LC292 (x2)[45] LT634 JN547 JN805 JP049 JJ283 JJ453 JJ547 JJ805 JP049 JJ283 JJ453
HBS051 [5] M10x1.25x98.00mm (x5)	JD146 JF150	JP049 [4] (Cork) JN805 [4]	JJ453	HR363 [5]		LA378 [41]		AD5130, AD5140, AD5150, AD5160, AD5170 AY460, BR630 BL650, BR510 JC415 JC750 JD146 JF150 KA611 [15] LC292 (x2)[45] LT634 JN547 JN805 JP049 JJ283 JJ453 JJ547 JJ805 JP049 JJ283 JJ453
HBS083 [22] M11x1.50x168.00mm (x10)	JC750 [1] JC415 [5] (x4) LT634	JN547 [4]	JJ283 [62] PA349 22.00x16.00x2.000mm PB907 14.00x21.00x2.000mm	HR569 [5]	NA5191 [2] 42.00x62.00x7.00mm, PTFE NA5192 [1] 90.00x110.00x7.00mm, PTFE	HR566 [55] [5] KA611 [15] LC292 (x2)[45]		AD5130, AD5140, AD5150, AD5160, AD5170 AY460, BR630 BL650, BR510 JC415 JC750 JD146 JF150 KA611 [15] LC292 (x2)[45] LT634 JN547 JN805 JP049 JJ283 JJ453 JJ547 JJ805 JP049 JJ283 JJ453
HBS083 [22] M11x1.50x168.00mm (x10)	JC750 [1] JC415 [5] (x4) LT634	JN547 [4]	JJ283 [62] PA349 22.00x16.00x2.000mm PB907 14.00x21.00x2.000mm	HR569 [5]	NA5191 [2] 42.00x62.00x7.00mm, PTFE NA5192 [1] 90.00x110.00x7.00mm, PTFE	HR566 [55] [5] KA611 [15] LC292 (x2)[45]		AD5130, AD5140, AD5150, AD5160, AD5170 AY460, BR630 BL650, BR510 JC415 JC750 JD146 JF150 KA611 [15] LC292 (x2)[45] LT634 JN547 JN805 JP049 JJ283 JJ453 JJ547 JJ805 JP049 JJ283 JJ453
HBS038 [22] M11x1.50x175.00mm (x10) HBS083 [22] M11x1.50x168.00mm (x10)	JC750 [1] JC415 [5] (x4)	JN547 [4]	JJ283 [62] PA349 22.00x16.00x2.000mm PB907 14.00x21.00x2.000mm	HR569 [5]	NA5191 [2] 42.00x62.00x7.00mm, PTFE NA5192 [1] 90.00x110.00x7.00mm, PTFE	HR566 [55] [5] KA611 [15]		AD5130, AD5140, AD5150, AD5160, AD5170 AY460, BR630 BL650, BR510 JC415 JC750 JD146 JF150 KA611 [15] LC292 (x2)[45] LT634 JN547 JN805 JP049 JJ283 JJ453 JJ547 JJ805 JP049 JJ283 JJ453
			JJ283 [62]		NA5191 [2] 42.00x62.00x7.00mm, PTFE NA5192 [1] 90.00x110.00x7.00mm, PTFE	KA611 [15]		AD5130, AD5140, AD5150, AD5160, AD5170 AY460, BR630 BL650, BR510 JC415 JC750 JD146 JF150 KA611 [15] LC292 (x2)[45] LT634 JN547 JN805 JP049 JJ283 JJ453 JJ547 JJ805 JP049 JJ283 JJ453
HBS038 [22] M11x1.50x175.00mm (x10) HBS083 [22] M11x1.50x168.00mm (x10)	JC750 [1] JC415 [5] (x4) LT634	JN547 [4]	JJ283 [62] PA349 22.00x16.00x2.000mm PB907 14.00x21.00x2.000mm	HR569 [5]	NA5191 [2] 42.00x62.00x7.00mm, PTFE NA5192 [1] 90.00x110.00x7.00mm, PTFE	HR566 [55] [5] KA611 [15] LC292 (x2)[45]		AD5130, AD5140, AD5150, AD5160, AD5170 AY460, BR630 BL650, BR510 JC415 JC750 JD146 JF150 KA611 [15] LC292 (x2)[45] LT634 JN547 JN805 JP049 JJ283 JJ453 JJ547 JJ805 JP049 JJ283 JJ453













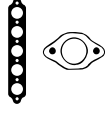

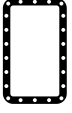

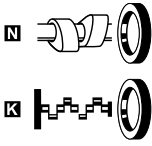



cc

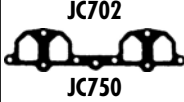

kW/PS

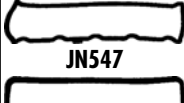
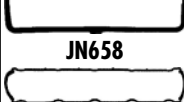

1.6		BDY (XU5M2Z)					76	BL650 (Fibre), 1.200mm BR510 (Fibre), 1.440mm	DL650 DN590 ▲ [3]	EL650 [3] GL650 [3]
205 1.6 Aut.	05/90→09/98	1580	4	83.00	SOHC/OHC	65-71/ 88-97				
309 II 1.6	07/89→12/93									
405 I 1.6	07/87→12/92									
405 II 1.6	08/92→10/96									
1.6		BDY (XU5M3Z)					77	BL650 (Fibre), 1.200mm BR510 (Fibre), 1.440mm	DL650 DN590 ▲ [3]	EL650 [3] GL650 [3]
205 1.6 Aut.	05/90→09/98	1580	4	83.00	SOHC/OHC	65-66/ 88-90				
205 1.6 CJ	08/92→12/94									
309 II 1.6	07/89→12/93									
405 I 1.6	10/88→08/92									
405 II 1.6	08/92→10/96									
1.6		BDZ (XU5M)					78	BL650 (Fibre), 1.200mm BR510 (Fibre), 1.440mm	DL650 DN590 ▲ [3]	EL650 [3] GL650 [3]
309 II 1.6	07/89→12/93	1580	4	83.00	SOHC/OHC	65-66/ 88-90				
405 I 1.6	07/87→12/92									
405 I 1.6 4x4	04/88→07/92									
405 I 1.6 Sri	04/88→07/92									
405 II 1.6	08/92→10/96									
1.6		BFZ (XU5JP)					79	BL650 (Fibre), 1.200mm BR510 (Fibre), 1.440mm	CY130 ▲ [3]	EL650 [3]
405 II 1.6	08/92→10/96	1580	4	83.00	SOHC/OHC	65-66/ 88-90				
406 1.6	11/95→05/04									
1.6		EP6					80	AH6440 (MLS), 0.900mm	CH6440 (MLS)	
207 1.6 16V	02/07→	1598	4	77.00	DOHC	88/120				
207 1.6 16V VTi	02/07→									
308 1.6 16V	09/07→									
308 CC 1.6 16V	06/09→									
3008 1.6 VTi	06/09→									
5008 1.6 16V	09/09→									
1.6		EP6CDT					81	AH6730 (MLS), 0.9mm	CH6730 (MLS)	
208 1.6	03/12→	1598	4	77.00	DOHC	115/156				
308 1.6 16V	10/09→									
308 CC 1.6 16V	06/09→									
508 1.6 THP	11/10→									
5008 1.6 16V	09/09→									
RCZ 1.6 16V	03/10→									
1.6		EP6CDTX					82	AH6730 (MLS), 0.9mm	CH6730 (MLS)	
308 1.6 GTi	07/10→	1598	4	77.00	DOHC	147/200				
308 G 280.24	10/10→									
RCZ 1.6 16V	06/10→									
1.6		NFR (TU5JP4B)					83	AD5180 (MLS), 0.620mm		
Partner 1.6	04/08→	1587	4	78.50	DOHC	66/90				
1.6		NFT					84	BY180 (Fibre), 1.50mm AY120 (Fibre), 1.70mm	DY130 ▲ [3]	EY130 [3]
306 1.6	10/00→04/02	1587	4	78.50	SOHC/OHC	72/98				

								 AD5180  JJ587  AY120  BL650, BR510  BY180  JC415  JC702  JC750  JD519  JD520  JE189  JN547  JN658  JP043  JJ283
	JC750 ■ JC415 ■ (x4)	JN547 [4]	JJ283 [62]	HR569 ■	☒ NA5191 ■ [2] 42.00x62.00x7.00mm, PTFE ☒ NA5192 ■ [1] 90.00x110.00x7.00mm, PTFE	KA611 [15]		
	JC750 ■ JC415 ■ (x4)	JN547 [4]	JJ283 [62] =PA349 22.00x16.00x2.000mm =PB907 14.00x21.00x2.000mm	HR569 ■	☒ NA5191 ■ [2] 42.00x62.00x7.00mm, PTFE ☒ NA5192 ■ [1] 90.00x110.00x7.00mm, PTFE	HR566 [55] ■ KA611 [15] LC292 (x2) [45]		
	JC750 ■ JC415 ■ (x4)	JN547 [4]	JJ283 [62] =PA349 22.00x16.00x2.000mm =PB907 14.00x21.00x2.000mm	HR569 ■	☒ NA5191 ■ [2] 42.00x62.00x7.00mm, PTFE ☒ NA5192 ■ [1] 90.00x110.00x7.00mm, PTFE	HR566 [55] ■ KA611 [15]		
HBS038 ⊕ [22] M11x1.50x175.00mm (x10) HBS260 ⊕ [22] M11x1.50x168.00mm (x10) Eng.07448 →	JD519 ■ (x2) JD520 ■ (x4)	JP043 [4]	JJ283 [62] =PA349 22.00x16.00x2.000mm =PB907 14.00x21.00x2.000mm	HR569 ■	☒ NA5191 ■ [2] 42.00x62.00x7.00mm, PTFE ☒ NA5192 ■ [1] 90.00x110.00x7.00mm, PTFE	HR566 [55] ■ KA611 [15]		
HBS522 ⊕ [21] [57]	JD6034 ■ (x4) (Elastomer)							
HBS522 ⊕ [21] [57]		HM5371 ■						
HBS522 ⊕ [21] [57]		HM5371 ■						
HBS254 ⊕ [22] M10x1.50x122.00mm (x10)	⊕ JE5072 (MLS)				☒ NF870 ■ [2] 42.00x66.00x6.00mm, FPM/ACM ☒ NA5089 ■ [2] 38.00x50.00x8.00mm, NBR ☒ NF850 ■ [1] 85.00x105.00x8.00mm, FPM			
HBS039 ⊕ [22] M10x1.50x175.00mm (x10)	JD530 ■ (x4) JC702 ■ (x2) ⊕ JE189	JN658 [4]	JJ587 =PB852 16.00x24.00x1.500mm =PA349 22.00x16.00x2.000mm	HR642 ■	☒ NF870 ■ [2] 42.00x66.00x6.00mm, FPM/ACM ☒ NF850 ■ [1] 85.00x105.00x8.00mm, FPM ☒ NF857 ■ [1] 85.00x105.00x9.00mm, FPM/ACM			



cc



kW/PS



1.6		NFU (TU5JP4)				85		AD5180 (MLS), 0.620mm		CD5180	ED5180
206 1.6 16V	09/00→	1587	4	78.50	DOHC	78-90/ 106-122					
207 1.6 16V	02/06→										
307 1.6 16V	08/00→										
307 1.6 BioFlex	09/07→										
307 CC 1.6 16V	03/05→										
308 1.6 Bioflex	04/08→										
1007 1.6 16V	04/05→										
Partner 1.6	09/00→10/02										
Partner 1.6 16V	07/01→										
1.6		NFW (TU5J2)				86		BY180 (Fibre), 1.50mm AY120 (Fibre), 1.70mm			
106 II 1.6 i	05/96→				SOHC/OHC	74/101					
1.6		NFX (TU5J4)				87		AE5010 (MLS), 1.370mm AE5020 (MLS), 1.570mm AE5030 (MLS), 1.770mm		CE5010	
106 II 1.6 S16	05/96→				DOHC	87/118					
1.6		NFY (TU5J2)				88		BY180 (Fibre), 1.50mm AY120 (Fibre), 1.70mm		DY130 ▲ [3]	EY130 [3]
106 I 1.6	01/94→04/96	1587	4	78.50	SOHC/OHC	74-76/ 101-104					
106 II 1.6 i	05/96→										
1.6		NFZ (TU5JP)				89		BY180 (Fibre), 1.50mm AY120 (Fibre), 1.70mm		DY130 ▲ [3]	EY130 [3]
106 I 1.6	06/93→04/96	1587	4	78.50	SOHC/OHC	65/88					
106 II 1.6 i	05/96→										
206 1.6 i	09/98→12/00										
306 1.6	05/93→10/00										
306 1.6 SR	06/94→10/00										
1.7		6FY (EW7A)				90		AH6530 (MLS)		CH6530	
407 1.8 16V	09/05→	1749	4	82.70	DOHC	92/125					
1.7		6FZ (EW7J4)				91		AD5310 (MLS), 0.750mm		CD5310	ED5300
406 1.8 16V	10/00→10/04	1749	4	82.70	DOHC	85/116					
407 1.8	05/04→										
1.8		161A (XUD7) Diesel				92		BX830 (Fibre), 1.360mm, 1 Notch ☞0.560→0.670mm BX840 (Fibre), 1.400mm, 2 Notches ☞0.680→0.710mm BX850 (Fibre), 1.440mm, 3 Notches ☞0.720→0.750mm BX860 (Fibre), 1.480mm, 4 Notches ☞0.760→0.790mm BX870 (Fibre), 1.520mm, 5 Notches ☞0.800→0.830mm		DJ720 ▲	EL890 [3] GJ720 ▲
205 1.7 D	07/87→09/98	1769	4	80.00	SOHC/OHC	44/60					
205 Van 1.7 D	03/94→										
305 II 1.8 D	11/82→12/88										
309 II 1.8 D	07/89→12/93										
1.8		169B (XM7T)				93				DM533 ▲ [3]	EM531 [3]
J5 1.8	01/83→01/94	1796	4	84.00		49-51/ 67-69					

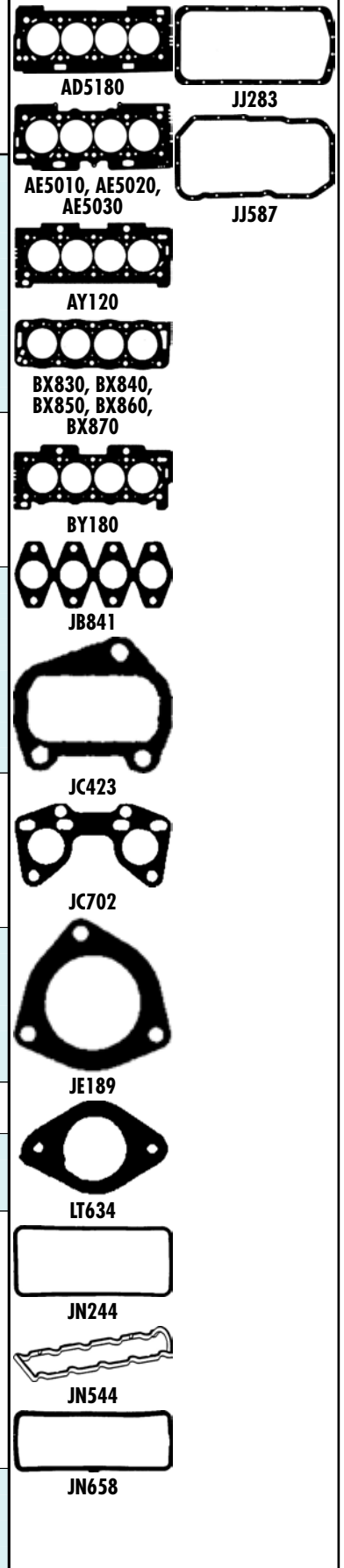
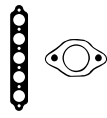

HBS254 [22] M10x1.50x122.00mm (x10)	HA5032 [1] [3] JE5072 (MLS)	JM7035 (Elastomer)	JH5107 (ACM)	NA5260 [2] 38.00x50.00x6.00mm, FPM NA5260 [2] 38.00x50.00x6.00mm, FPM NF870 [2] 42.00x66.00x6.00mm, FPM/ACM NF850 [1] 85.00x105.00x8.00mm, FPM NF857 [1] 85.00x105.00x9.00mm, FPM/ACM	AD5180 JJ283 AE5010, AE5020, AE5030 JJ587 AY120 BX830, BX840, BX850, BX860, BX870 BY180 JB841 JC423 JC702 JE189 LT634 JN244 JN544 JN658
HBS039 [22] M10x1.50x175.00mm (x10)				HR599 [3] NF870 [2] 42.00x66.00x6.00mm, FPM/ACM NF850 [1] 85.00x105.00x8.00mm, FPM NF857 [1] 85.00x105.00x9.00mm, FPM/ACM	
HBS254 [22] M10x1.50x122.00mm (x10)	JE5044 (MLS)			HR599 [3] HR642 [3] NA5260 [2] 38.00x50.00x6.00mm, FPM NF870 [2] 42.00x66.00x6.00mm, FPM/ACM NF850 [1] 85.00x105.00x8.00mm, FPM NF857 [1] 85.00x105.00x9.00mm, FPM/ACM	
HBS039 [22] M10x1.50x175.00mm (x10)	JD530 [1] (x4) JC702 [1] (x2) JE189	JN658 [4]	JJ587 PB852 16.00x24.00x1.500mm PA349 22.00x16.00x2.000mm	HR642 [3] NF870 [2] 42.00x66.00x6.00mm, FPM/ACM NF850 [1] 85.00x105.00x8.00mm, FPM NF857 [1] 85.00x105.00x9.00mm, FPM/ACM	
HBS039 [22] M10x1.50x175.00mm (x10)	JD530 [1] (x4) JC702 [1] (x2) JE189	JN658 [4]	JJ587 PB852 16.00x24.00x1.500mm PA349 22.00x16.00x2.000mm	HR642 [3] NF870 [2] 42.00x66.00x6.00mm, FPM/ACM NF850 [1] 85.00x105.00x8.00mm, FPM NF857 [1] 85.00x105.00x9.00mm, FPM/ACM	
HBS535 [22]		JM5139 [1] JM5283 [1]	PB907 14.00x21.00x2.000mm	NA5256 [2] 40.00x55.00x6.50mm, FPM	
HBS259 [22] M11x1.50x144.50mm (x10)		JM5139 [1] JM5283 [1]	PB907 14.00x21.00x2.000mm	HR5080 [3] NA5256 [2] 40.00x55.00x6.50mm, FPM	
HBS084 [22] M12x1.50x120.00mm (x10) →Eng.08469 HBS245 [22] M12x1.50x125.00mm (x10) Eng.08470→	JD5972 [1] JC423 [1] (x2) LT634	JN544 [4]	JJ283 [62] PA349 22.00x16.00x2.000mm	HR569 [3] NF841 (x2)[1][2] 35.00x50.00x8.00mm, FPM NA5191 [2] 42.00x62.00x7.00mm, PTFE NA5192 [1] 90.00x110.00x7.00mm, PTFE	KA611 [15]
HBS038 [22] M11x1.50x175.00mm (x10)	JB841 [1]	JN244 [4]	PA349 22.00x16.00x2.000mm	HR569 [3] NA5191 [2] 42.00x62.00x7.00mm, PTFE NA5192 [1] 90.00x110.00x7.00mm, PTFE	HL472 [55] [3]



cc



kW/PS



1.8	A8A (XUD7TE)	Diesel	94	BR780 (Fibre), 1.650mm, 2 Notches -0.650→0.770mm BR790 (Fibre), 1.800mm, 3 Notches -0.770→0.820mm		
405 I 1.8 TD	03/88→12/92	1769	4	80.00		66/90
405 I 1.8 TD	10/88→08/92					
1.8	A8B (XUD7TE)	Diesel	95	BR780 (Fibre), 1.650mm, 2 Notches -0.650→0.770mm BR790 (Fibre), 1.800mm, 3 Notches -0.770→0.820mm		
205 1.7 TD	01/90→09/98	1769	4	80.00	SOHC/OHC	57/78
309 II 1.8 TD	08/89→12/93					
1.8	A9A (XUD7)	Diesel	96	BX830 (Fibre), 1.360mm, 1 Notch -0.560→0.670mm BX840 (Fibre), 1.400mm, 2 Notches -0.680→0.710mm BX850 (Fibre), 1.440mm, 3 Notches -0.720→0.750mm BX860 (Fibre), 1.480mm, 4 Notches -0.760→0.790mm BX870 (Fibre), 1.520mm, 5 Notches -0.800→0.830mm	DJ720 ▲	EL890 [3] GJ720 ▲
205 1.8 D	02/83→07/90	1769	4	80.00		43-44/ 58-60
306 1.8 D	05/93→05/01					
Partner 1.8 D	06/96→02/98					
1.8	AJZ (XUD7TEY)	Diesel	97	BR780 (Fibre), 1.650mm, 2 Notches -0.650→0.770mm BR790 (Fibre), 1.800mm, 3 Notches -0.770→0.820mm		
405 I 1.8 TD	03/88→12/92	1769	4	80.00	SOHC/OHC	66/90
405 I 1.8 TD	10/88→08/92					
1.8	LFW (XU7JP)		98	BL650 (Fibre), 1.200mm BR510 (Fibre), 1.440mm		EL650 [3]
806 1.8	07/95→08/02	1761	4	83.00	SOHC/OHC	73/99
1.8	LFX (XU7JB)		99	BL650 (Fibre), 1.200mm BR510 (Fibre), 1.440mm	DL651 ▲	EL650 [3]
406 1.8	05/97→10/04	1761	4	83.00	SOHC/OHC	66/90
Partner 1.8	05/97→					
1.8	LFY (XU7JP4)		100	AD5100 (Fibre)	CD5100 →Eng.7965	
306 1.8 16V	03/97→04/02	1761	4	83.00	DOHC	81-86/ 110-117
406 1.8 16V	11/95→10/00					
1.8	LFZ (XU7JP)		101	BL650 (Fibre), 1.200mm BR510 (Fibre), 1.440mm	CY130 ▲ [3] CY131 ▲ [3]	EL650 [3]
306 1.8	05/93→04/02	1762	4	83.00	SOHC/OHC	74-76/ 101-103
306 1.8 ST	06/94→05/01					
405 II 1.8	08/92→10/96					
Expert 1.8	10/96→09/00					
1.8	XM7		102			
504 1.8	07/87→12/89	1796	4	84.00		53-58/ 72-79
1.8	XUD7T Diesel		103	BR780 (Fibre), 1.650mm, 2 Notches -0.650→0.770mm BR790 (Fibre), 1.800mm, 3 Notches -0.770→0.820mm		
205 1.8 XDT	08/90→05/97	1769	4	80.00	SOHC/OHC	58/79
1.9	162 (XUD9)	Diesel	104	BX880 (Fibre), 1.360mm, 1 Notch -0.560→0.670mm BX890 (Fibre), 1.400mm, 2 Notches -0.680→0.710mm BX900 (Fibre), 1.440mm, 3 Notches -0.720→0.750mm BX910 (Fibre), 1.480mm, 4 Notches -0.760→0.790mm BX920 (Fibre), 1.520mm, 5 Notches -0.800→0.830mm	DJ720 ▲	EL890 [3] GJ720 ▲
305 II 1.9 D	10/82→12/88	1905	4	83.00	SOHC/OHC	47-48/ 64-65
309 I 1.9 D	06/86→07/89					
309 II 1.9 D	07/89→12/93					

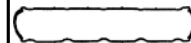
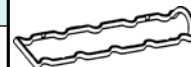
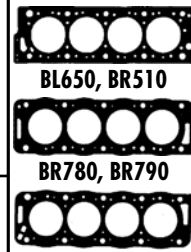
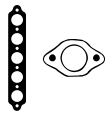

					NF841 [1][2] 35.00x50.00x8.00mm, FPM NA5191 [2] 42.00x62.00x7.00mm, PTFE	KA611 [15]
					NF841 [1][2] 35.00x50.00x8.00mm, FPM NA5191 [2] 42.00x62.00x7.00mm, PTFE	KA611 [15]
HBS084 [22] M12x1.50x120.00mm (x10) →Eng.08469 HBS245 [22] M12x1.50x125.00mm (x10) Eng.08470→	JD5972 [1] JC423 [2] (x2) LT634	JN544 [4]	JJ283 [62] PA349 22.00x16.00x2.000mm	HR569 [5]	NF841 (x2)[1][2] 35.00x50.00x8.00mm, FPM NA5191 [2] 42.00x62.00x7.00mm, PTFE NA5192 [1] 90.00x110.00x7.00mm, PTFE	KA611 [15]
					NF841 [1][2] 35.00x50.00x8.00mm, FPM NA5191 [2] 42.00x62.00x7.00mm, PTFE	
HBS260 [22] M11x1.50x168.00mm (x10) Eng.07448→	JD519 [1] (x2)		JJ283 [62] PA349 PB907 14.00x21.00x2.000mm	HR569 [5]	NA5191 [2] 42.00x62.00x7.00mm, PTFE NA5192 [1] 90.00x110.00x7.00mm, PTFE	HR566 [55] [5] KA611 [15]
HBS260 [22] M11x1.50x168.00mm (x10)	JD5254 [1] (x4) JD520 [2]	JP043 [4]	JJ283 [62]	HR569 [5]	NA5191 [2] 42.00x62.00x7.00mm, PTFE	KA611 [15]
HBS089 [22] M11x1.50x159.00mm (x10)		JM7121 [2] (Elastomer)	PB907 14.00x21.00x2.000mm →Eng.07359 HR5081 [2] →Eng.07360→ →Eng.07965	HR5080 [2] →Eng.07359 HR5081 [2] →Eng.07360→ →Eng.07965	NA5191 [2] 42.00x62.00x7.00mm, PTFE NA5192 [1] 90.00x110.00x7.00mm, PTFE	HR566 [55] [5] KA611 [15]
HBS260 [22] M11x1.50x168.00mm (x10) Eng.07448→	JD519 [1] (x2) JD520 [2] (x4)	JP043 [4]	JJ283 [62] PA349 PB907 14.00x21.00x2.000mm	HR569 [5]	NA5191 [2] 42.00x62.00x7.00mm, PTFE NA5192 [1] 90.00x110.00x7.00mm, PTFE	HR566 [55] [5] KA611 [15]
					NA5191 [2] 42.00x62.00x7.00mm, PTFE NA5192 [1] 90.00x110.00x7.00mm, PTFE	
					NF841 [1][2] 35.00x50.00x8.00mm, FPM NA5191 [2] 42.00x62.00x7.00mm, PTFE	KA611 [15]
HBS084 [22] M12x1.50x120.00mm (x10)	JD5972 [1] JC759 (Steel) JC423 [2] (x2)	JN544 [4]	JJ283 [62]	HR569 [5]	NF841 [1][2] 35.00x50.00x8.00mm, FPM NA5191 [2] 42.00x62.00x7.00mm, PTFE NA5192 [1] 90.00x110.00x7.00mm, PTFE	KA611 [15]













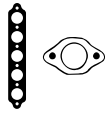

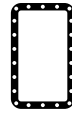

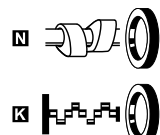













cc

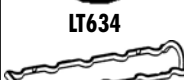

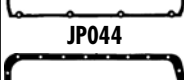
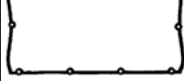
kw/PS

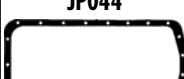

1.9	D2A (XU92C)	105	BL650 (Fibre), 1.200mm	DL650	EL650 [3]
205 1.9 GTI	10/87→05/89	1905 4 83.00 SOHC/OHC 75/102	BR510 (Fibre), 1.440mm	DN590 ▲ [3]	GL650 [3]
1.9	D2B (XU9S)	106	BL650 (Fibre), 1.200mm	DN590 ▲ [3]	EL650 [3]
309 1.9	10/85→07/89	1905 4 83.00 SOHC/OHC 75/102	BR510 (Fibre), 1.440mm		GL650 [3]
1.9	D2C (XU92C)	107	BL650 (Fibre), 1.200mm	DN590 ▲ [3]	EL650 [3]
405 1.9	07/87→12/92	1905 4 83.00 SOHC/OHC 70/95	BR510 (Fibre), 1.440mm		GL650 [3]
1.9	D6A (XU9J2)	108	BL650 (Fibre), 1.200mm	DL650	EL650 [3]
405 1.9	01/89→12/92	1905 4 83.00 SOHC/OHC 90-92/122-125	BR510 (Fibre), 1.440mm	DN590 ▲ [3]	GL650 [3]
1.9	D6B (XU9JA)	109	BL650 (Fibre), 1.200mm	DN590 ▲ [3]	EL650 [3]
205 1.9 GTI	10/87→09/98	1905 4 83.00 SOHC/OHC 94-96/128-131	BR510 (Fibre), 1.440mm	DN590 ▲ [3]	GL650 [3]
309 1.9 GTI	10/86→07/89				
1.9	D6C (XU9J4)	110	BR510 (Fibre), 1.440mm	DF180 ○ [13]	EL650 [3]
309 II 1.9 GTI	08/89→07/90	1905 4 83.00 DOHC 116-118/158-160		DF180 ○ [13] DR510 [3]	
405 1.9 4x4	06/87→07/92				
405 1.9 AWD	06/87→07/92				
405 1.9 MI-16	07/87→11/91				
1.9	D8B (XUD9TE) Diesel	111	BX930 (SE), 1.360mm, 1 Notch	DJ720 ▲	EL890 [3]
Expert 1.9 TD	02/96→	1905 4 83.00 SOHC/OHC 68-69/92-94	BX940 (SE), 1.400mm, 2 Notches BX950 (SE), 1.440mm, 3 Notches BX960 (SE), 1.480mm, 4 Notches BX970 (SE), 1.520mm, 5 Notches BX980 (SE), 1.590mm ☞0.830mm→		GJ720 ▲
1.9	D8C (XUD9UTF) Diesel	112	BX930 (SE), 1.360mm, 1 Notch	DJ720 ▲	EL890 [3]
Boxer 1.9 TD	03/94→04/02	1905 4 83.00 SOHC/OHC 68/92	BX940 (SE), 1.400mm, 2 Notches BX950 (SE), 1.440mm, 3 Notches BX960 (SE), 1.480mm, 4 Notches BX970 (SE), 1.520mm, 5 Notches BX980 (SE), 1.590mm ☞0.830mm→		GJ720 ▲
1.9	D9A (XUD9) Diesel	113	BX880 (Fibre), 1.360mm, 1 Notch	DJ720 ▲	EL890 [3]
305 II 1.9 D	10/82→12/88	1905 4 83.00 SOHC/OHC 47/64	☞0.560→0.670mm BX890 (Fibre), 1.400mm, 2 Notches ☞0.680→0.710mm BX900 (Fibre), 1.440mm, 3 Notches ☞0.720→0.750mm BX910 (Fibre), 1.480mm, 4 Notches ☞0.760→0.790mm BX920 (Fibre), 1.520mm, 5 Notches ☞0.800→0.830mm	DJ720 ▲	GL650 [3] GJ720 ▲
309 1.9 D	06/86→07/89				
309 II 1.9 D	07/89→12/93				

								
HBS083 [22] M11x1.50x168.00mm (x10)	JC750 [1] JC415 [x4] 	JN547 [4]	JJ283 [62] =PA349 22.00x16.00x2.000mm =PB907 14.00x21.00x2.000mm	HR569 [5]	NA5191 [2] 42.00x62.00x7.00mm, PTFE NA5192 [1] 90.00x110.00x7.00mm, PTFE	HR566 [55] KA611 [15] LC292 (x2)[45]	 BL650, BR510  BX880, BX890, BX900, BX910, BX920 	
HBS083 [22] M11x1.50x168.00mm (x10)	JC750 [1] JC415 [x4] 	JN547 [4]	JJ283 [62] =PA349 22.00x16.00x2.000mm =PB907 14.00x21.00x2.000mm	HR569 [5]	NA5191 [2] 42.00x62.00x7.00mm, PTFE NA5192 [1] 90.00x110.00x7.00mm, PTFE	HR566 [55] KA611 [15]	 JC415  JC423	
HBS038 [22] M11x1.50x175.00mm (x10) HBS083 [22] M11x1.50x168.00mm (x10)	JC750 [1] JC415 [x4] 	JN547 [4]	JJ283 [62] =PA349 22.00x16.00x2.000mm =PB907 14.00x21.00x2.000mm	HR569 [5]	NA5191 [2] 42.00x62.00x7.00mm, PTFE NA5192 [1] 90.00x110.00x7.00mm, PTFE	HR566 [55] KA611 [15]	 JC423  JC750  JC759  JC991	
HBS083 [22] M11x1.50x168.00mm (x10)	JC750 [1] JC415 [x4] 	JN547 [4]	JJ283 [62] =PA349 22.00x16.00x2.000mm =PB907 14.00x21.00x2.000mm	HR569 [5]	NA5191 [2] 42.00x62.00x7.00mm, PTFE NA5192 [1] 90.00x110.00x7.00mm, PTFE	HR566 [55] KA611 [15] LC292 (x2)[45]	 JC991  LT634  JN544  JN547	
HBS038 [22] M11x1.50x175.00mm (x10)	JD5763 [x2] JD5764 [1]	JPO44 [4]	JJ283 [62] =PA349 22.00x16.00x2.000mm	HR599 [5]	NF869 [x2][1] 32.00x45.00x8.00mm, FPM NA5191 [2] 42.00x62.00x7.00mm, PTFE NA5192 [1] 90.00x110.00x7.00mm, PTFE	HR566 [55] KA611 [15] LC292 (x2)[45]	 JN544  JN547  JP044  JJ283	
HBS277 [22] M12x1.50x148.00mm (x10)	JC759 (Steel)	JN544 [4]	JJ283 [62] =PA349 22.00x16.00x2.000mm =PB907 14.00x21.00x2.000mm	HR569 [5]	NB959 [2] 35.00x50.00x7.00mm, FPM NF841 [1][2] 35.00x50.00x8.00mm, FPM NA5191 [2] 42.00x62.00x7.00mm, PTFE NA5192 [1] 90.00x110.00x7.00mm, PTFE	KA611 [15]	 JP044  JJ283	
HBS277 [22] M12x1.50x148.00mm (x10)	JC991	JN544 [4]	JJ283 [62] =PA349 22.00x16.00x2.000mm =PB907 14.00x21.00x2.000mm	HR569 [5]	NF841 [1][2] 35.00x50.00x8.00mm, FPM NB959 [2] 35.00x50.00x7.00mm, FPM NA5191 [2] 42.00x62.00x7.00mm, PTFE NA5192 [1] 90.00x110.00x7.00mm, PTFE	KA611 [15]	 JJ283	
HBS084 [22] M12x1.50x120.00mm (x10)	JD5972 [1] JC759 (Steel) JC423 [x2]	JN544 [4]	JJ283 [62]	HR569 [5]	NF841 [1][2] 35.00x50.00x8.00mm, FPM NA5191 [2] 42.00x62.00x7.00mm, PTFE NA5192 [1] 90.00x110.00x7.00mm, PTFE	KA611 [15]		



cc



kW/PS



1.9	D9B (XUD9A)	Diesel	114	BX880 (Fibre), 1.360mm, 1 Notch -0.560→0.670mm BX890 (Fibre), 1.400mm, 2 Notches -0.680→0.710mm BX900 (Fibre), 1.440mm, 3 Notches -0.720→0.750mm BX910 (Fibre), 1.480mm, 4 Notches -0.760→0.790mm BX920 (Fibre), 1.520mm, 5 Notches -0.800→0.830mm	DJ720 ▲	EL890 [3] GJ720 ▲
405 I 1.9 D J5 1.9 D	03/88→12/92 10/90→03/94	1905 4 83.00	SOHC/OHC 51-52/ 69-71			
1.9	D9B (XUD9AU)	Diesel	115	BX880 (Fibre), 1.360mm, 1 Notch -0.560→0.670mm BX890 (Fibre), 1.400mm, 2 Notches -0.680→0.710mm BX900 (Fibre), 1.440mm, 3 Notches -0.720→0.750mm BX910 (Fibre), 1.480mm, 4 Notches -0.760→0.790mm BX920 (Fibre), 1.520mm, 5 Notches -0.800→0.830mm	DJ720 ▲	EL890 [3] GJ720 ▲
Boxer 1.9 D Expert 1.9 D	03/94→04/02 02/96→	1905 4 83.00	SOHC/OHC 51/70			
1.9	DDZ (XU9M)		116	BL650 (Fibre), 1.200mm BR510 (Fibre), 1.440mm	DL650 DN590 ▲ [3]	EL650 [3] GL650 [3]
309 I 1.9 309 II 1.9 405 I 1.9 405 I 1.9 4x4	07/88→07/89 10/90→12/93 07/88→12/92 07/88→12/92	1905 4 83.00	SOHC/OHC 80/109			
1.9	DFW (XU9J4Z)		117	BR510 (Fibre), 1.440mm	DF180 ○ [3] DR510 [3]	EL650 [3]
309 II 1.9 GTI 405 I 1.9 MI-16	10/90→12/93 04/88→12/92	1905 4 83.00	DOHC 108/147			
1.9	DFZ (XU9J1)		118	BL650 (Fibre), 1.200mm BR510 (Fibre), 1.440mm	DL650 DN590 ▲ [3]	EL650 [3] GL650 [3]
205 1.9 205 1.9 CTi 205 1.9 GTI 305 II 1.9 309 I 1.9 309 II 1.9 405 I 1.9 405 I 1.9 AWD 405 I 1.9 Inj	08/92→05/97 08/87→12/94 10/87→07/94 11/86→12/88 03/86→07/89 08/89→12/93 05/88→08/92 09/88→07/92 07/87→12/92	1905 4 83.00	SOHC/OHC 72-77/ 98-105			
1.9	DHV (XUD9BSD)	Diesel	119	BX930 (SE), 1.360mm, 1 Notch BX940 (SE), 1.400mm, 2 Notches BX950 (SE), 1.440mm, 3 Notches BX960 (SE), 1.480mm, 4 Notches BX970 (SE), 1.520mm, 5 Notches BX980 (SE), 1.590mm -0.830mm→	DJ720 ▲	EL890 [3] GJ720 ▲
306 1.9 D	03/98→04/02	1905 4 83.00	SOHC/OHC 55/75			

HBS084 [22] M12x1.50x120.00mm (x10)	JC759 (Steel) JC423	JN544 [4]	JJ283 [62]	HR569	NB959 [2] 35.00x50.00x7.00mm, FPM NF841 [1][2] 35.00x50.00x8.00mm, FPM NA5191 [2] 42.00x62.00x7.00mm, PTFE NA5192 [1] 90.00x110.00x7.00mm, PTFE	KA611 [15]	
HBS084 [22] M12x1.50x120.00mm (x10)	JC759 (Steel) JC423	JN544 [4]	JJ283 [62] PA349 22.00x16.00x2.000mm PB907 14.00x21.00x2.000mm	HR569	NB959 [2] 35.00x50.00x7.00mm, FPM NF841 [1][2] 35.00x50.00x8.00mm, FPM NA5191 [2] 42.00x62.00x7.00mm, PTFE NA5192 [1] 90.00x110.00x7.00mm, PTFE	KA611 [15]	
HBS083 [22] M11x1.50x168.00mm (x10)	JC750 JC415 (x4) LT634	JN547 [4]	JJ283 [62] PA349 22.00x16.00x2.000mm PB907 14.00x21.00x2.000mm	HR569	NA5191 [2] 42.00x62.00x7.00mm, PTFE NA5192 [1] 90.00x110.00x7.00mm, PTFE	HR566 [55] KA611 [15]	
HBS038 [22] M11x1.50x175.00mm (x10)	JD5763 (x2) JD5764	JP044 [4]	JJ283 [62] PA349 22.00x16.00x2.000mm	HR599	NF869 (x2)[1] 32.00x45.00x8.00mm, FPM NA5191 [2] 42.00x62.00x7.00mm, PTFE NA5192 [1] 90.00x110.00x7.00mm, PTFE	HR566 [55] KA611 [15] LC292 (x2)[45]	
HBS083 [22] M11x1.50x168.00mm (x10)	JC750 JC415 (x4) LT634	JN547 [4]	JJ283 [62] PA349 22.00x16.00x2.000mm PB907 14.00x21.00x2.000mm	HR569	NA5191 [2] 42.00x62.00x7.00mm, PTFE NA5192 [1] 90.00x110.00x7.00mm, PTFE	HR566 [55] KA611 [15] LC292 (x2)[45]	
HBS084 [22] M12x1.50x120.00mm (x10)	JC759 (Steel) JC991	JN544 [4]	JJ283 [62] PA349 22.00x16.00x2.000mm PB907 14.00x21.00x2.000mm	HR569	NF841 [1][2] 35.00x50.00x8.00mm, FPM NB959 [2] 35.00x50.00x7.00mm, FPM NA5191 [2] 42.00x62.00x7.00mm, PTFE NA5192 [1] 90.00x110.00x7.00mm, PTFE	KA611 [15]	



cc



kW/PS

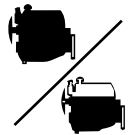

1.9	DHW (XUD9SD)	Diesel	120	BX930 (SE), 1.360mm, 1 Notch	DJ720 ▲	EL890 [3]				
406 1.9 D	10/96→10/04	1905	4	83.00	SOHC/OHC	55/75	12/96→	12/96→	12/96→	GJ720 ▲
				12/96→			BX940 (SE), 1.400mm, 2 Notches			
				12/96→			BX950 (SE), 1.440mm, 3 Notches			
				12/96→			BX960 (SE), 1.480mm, 4 Notches			
				12/96→			BX970 (SE), 1.520mm, 5 Notches			
				12/96→			BX980 (SE), 1.590mm			
				12/96→			0.830mm→			
1.9	DHX (XUD9TE)	Diesel	121	BX930 (SE), 1.360mm, 1 Notch	DJ720 ▲	EL890 [3]				
406 1.9 TD	01/96→10/04	1905	4	83.00	SOHC/OHC	66/90	12/96→	12/96→	12/96→	GJ720 ▲
806 1.9 TD	07/95→08/02									
Expert 1.9 TD	02/96→									
				12/96→			BX940 (SE), 1.400mm, 2 Notches			
				12/96→			BX950 (SE), 1.440mm, 3 Notches			
				12/96→			BX960 (SE), 1.480mm, 4 Notches			
				12/96→			BX970 (SE), 1.520mm, 5 Notches			
				12/96→			BX980 (SE), 1.590mm			
				12/96→			0.830mm→			
1.9	DHY (XUD9TE)	Diesel	122	BX930 (SE), 1.360mm, 1 Notch	DJ720 ▲	EL890 [3]				
306 1.9 DT	05/93→05/01	1905	4	83.00		66-69/ 90-93	12/96→	12/96→	12/96→	GJ720 ▲
306 1.9 SRDT	06/94→05/01									
306 1.9 TD	02/97→04/02									
405 II 1.9 TD	08/92→10/96									
406 1.9 TD	01/96→05/04									
806 1.9 TD	05/97→08/02									
Boxer 1.9 TD	08/94→04/02									
				12/96→			BX940 (SE), 1.400mm, 2 Notches			
				12/96→			BX950 (SE), 1.440mm, 3 Notches			
				12/96→			BX960 (SE), 1.480mm, 4 Notches			
				12/96→			BX970 (SE), 1.520mm, 5 Notches			
				12/96→			BX980 (SE), 1.590mm			
				12/96→			0.830mm→			
1.9	DJY (XUD9A)	Diesel	123	BX880 (Fibre), 1.360mm, 1 Notch	DJ720 ▲	EL890 [3]				
306 1.9 D	06/94→04/02	1905	4	83.00	SOHC/OHC	50-51/ 68-69	12/96→	12/96→	12/96→	GJ720 ▲
306 1.9 SLD	06/94→05/01									
405 I 1.9 D	10/88→08/92									
405 II 1.9 D	06/94→10/96									
Boxer 1.9 D	07/99→04/02									
Partner 1.9 D	05/96→12/98									
				12/96→			BX890 (Fibre), 1.400mm, 2 Notches			
				12/96→			0.680→0.710mm			
				12/96→			BX900 (Fibre), 1.440mm, 3 Notches			
				12/96→			0.720→0.750mm			
				12/96→			BX910 (Fibre), 1.480mm, 4 Notches			
				12/96→			0.760→0.790mm			
				12/96→			BX920 (Fibre), 1.520mm, 5 Notches			
				12/96→			0.800→0.830mm			
1.9	DJZ (XUD9Y)	Diesel	124	BX880 (Fibre), 1.360mm, 1 Notch	DJ720 ▲	EL890 [3]				
205 1.9 D	10/87→09/98	1905	4	83.00	SOHC/OHC	47/64	12/96→	12/96→	12/96→	GJ720 ▲
306 1.9 D	05/93→05/01									
306 1.9 SLD	06/94→05/01									
309 II 1.9 D	07/89→12/93									
405 I 1.9 D	07/88→09/92									
405 II 1.9 D	08/92→10/96									
				12/96→			BX890 (Fibre), 1.400mm, 2 Notches			
				12/96→			0.680→0.710mm			
				12/96→			BX900 (Fibre), 1.440mm, 3 Notches			
				12/96→			0.720→0.750mm			
				12/96→			BX910 (Fibre), 1.480mm, 4 Notches			
				12/96→			0.760→0.790mm			
				12/96→			BX920 (Fibre), 1.520mm, 5 Notches			
				12/96→			0.800→0.830mm			
1.9	DKZ (XU9JAZ)	Diesel	125	BL650 (Fibre), 1.200mm	DN590 ▲ [3]	EL650 [3]				
205 1.9	08/90→05/97	1905	4	83.00	SOHC/OHC	88-90/ 120-122	12/96→	12/96→	12/96→	GL650 [3]
205 1.9 GTI	10/87→10/94									
309 I 1.9 GTI	07/88→07/89									
309 II 1.9 GTI	07/89→12/93									
405 I 1.9	07/88→12/92									
405 I 1.9 4x4	06/87→07/92									
				12/96→			BR510 (Fibre), 1.440mm			

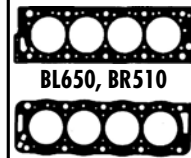
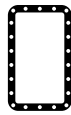
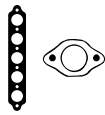

BL650, BR510



BX880, BX890,
BX900, BX910,
BX920



BX930, BX940,
BX950, BX960,
BX970, BX980



JC415



JC423



JC750



JC759

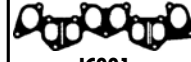

JC991



LT634



JN544

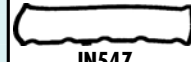

JN547



JJ283

HBS084 [22] M12x1.50x120.00mm (x10) 12/96→	JC759 (Steel) 12/96→ JC991 12/96→	JN544 [4] 12/96→	PA349 22.00x16.00x2.000mm PB907 14.00x21.00x2.000mm JJ283 [62] 12/96→	HR569 [5] 12/96→	NF841 [1][2] 35.00x50.00x8.00mm, FPM 12/96→ NB959 [2] 35.00x50.00x7.00mm, FPM 12/96→ NA5191 [2] 42.00x62.00x7.00mm, PTFE 12/96→ NA5192 [1] 90.00x110.00x7.00mm, PTFE 12/96→	KA611 [15]
HBS277 [22] M12x1.50x148.00mm (x10)	JC759 (Steel)	JN544 [4]	JJ283 [62] PA349 22.00x16.00x2.000mm PB907 14.00x21.00x2.000mm	HR569 [5]	NF841 [1][2] 35.00x50.00x8.00mm, FPM NB959 [2] 35.00x50.00x7.00mm, FPM NA5191 [2] 42.00x62.00x7.00mm, PTFE NA5192 [1] 90.00x110.00x7.00mm, PTFE	KA611 [15]
HBS277 [22] M12x1.50x148.00mm (x10)	JC759 (Steel) JC991 JC423 [x2]	JN544 [4]	JJ283 [62] PA349 22.00x16.00x2.000mm PB907 14.00x21.00x2.000mm	HR569 [5]	NF841 [1][2] 35.00x50.00x8.00mm, FPM NB959 [2] 35.00x50.00x7.00mm, FPM NA5191 [2] 42.00x62.00x7.00mm, PTFE NA5192 [1] 90.00x110.00x7.00mm, PTFE	KA611 [15]
HBS084 [22] M12x1.50x120.00mm (x10)	JC759 (Steel) JC991 JC423 [x2]	JN544 [4]	JJ283 [62]	HR569 [5]	NF841 [1][2] 35.00x50.00x8.00mm, FPM NA5191 [2] 42.00x62.00x7.00mm, PTFE NA5192 [1] 90.00x110.00x7.00mm, PTFE	KA611 [15]
HBS084 [22] M12x1.50x120.00mm (x10)	JD5972 [1] JC759 (Steel) JC991 JC423 [x2]	JN544 [4]	JJ283 [62]	HR569 [5]	NF841 [1][2] 35.00x50.00x8.00mm, FPM NA5191 [2] 42.00x62.00x7.00mm, PTFE NA5192 [1] 90.00x110.00x7.00mm, PTFE NB959 [2] 35.00x50.00x7.00mm, FPM	KA611 [15]
HBS038 [22] M11x1.50x175.00mm (x10) HBS083 [22] M11x1.50x168.00mm (x10)	JC750 [1] JC415 [x4] LT634	JN547 [4]	JJ283 [62] PA349 22.00x16.00x2.000mm PB907 14.00x21.00x2.000mm	HR569 [5]	NA5191 [2] 42.00x62.00x7.00mm, PTFE NA5192 [1] 90.00x110.00x7.00mm, PTFE	HR566 [55] [5] KA611 [15] LC292 [x2] [45]



cc



kw/PS



1.9	WJY (DW8B)	Diesel				126	AA5830 (SE), 1.260mm, 1 Hole ☒-0.510→0.540mm AA5840 (SE), 1.300mm, 2 Holes ☒-0.550→0.580mm AA5850 (SE), 1.340mm, 3 Holes ☒-0.590→0.620mm AA5860 (SE), 1.380mm, 4 Holes ☒-0.630→0.660mm AA5870 (SE), 1.420mm, 5 Holes ☒-0.670→0.700mm AA5880 (SE), 1.460mm, 6 Holes ☒-0.710→0.750mm	CA5830 ▲ [3]	EA5830
306 1.9 D	09/98→04/02	1868	4	82.20	SOHC/OHC	51/69			
Expert 1.9 D	06/98→11/03								
Expert 1.9 D 70	12/98→								
Partner 1.9 D	06/96→08/05								
1.9	WJZ (DW8)	Diesel				127	AA5830 (SE), 1.260mm, 1 Hole ☒-0.510→0.540mm AA5840 (SE), 1.300mm, 2 Holes ☒-0.550→0.580mm AA5850 (SE), 1.340mm, 3 Holes ☒-0.590→0.620mm AA5860 (SE), 1.380mm, 4 Holes ☒-0.630→0.660mm AA5870 (SE), 1.420mm, 5 Holes ☒-0.670→0.700mm AA5880 (SE), 1.460mm, 6 Holes ☒-0.710→0.750mm	CA5830 ▲ [3]	EA5830
206 1.9 D	09/98→05/07	1868	4	82.20	SOHC/OHC	51/69			
306 1.9 D	09/98→04/02								
Expert 1.9 D	06/98→11/03								
Expert 1.9 D 70	12/98→								
Partner 1.9 D	06/96→								
1.9	XD4x88	Diesel				128		DG050 ▲ [13]	EF580
504 1.9 D	01/80→12/89	1948	4	88.00	SOHC/OHC	40/54			
1.9	XUD9	Diesel				129			EL890 [3]
306 1.9 D	04/93→05/99	1905	4	83.00	SOHC/OHC	47-52/ 64-71			
306 1.9 STD	02/94→10/95								
405 II 1.9 D	09/93→12/95								
Partner 1.9 D	05/96→12/98								
1.9	XUD9TE	Diesel				130			EL890 [3]
306 1.9 D	04/93→04/99	1905	4	83.00	SOHC/OHC	66-69/ 90-94			
Boxer 1.9 DT	03/96→09/98								
Boxer 1.9 TD	07/99→04/02								
2.0	4B11					131			
4007 2.0	11/10→	1998	4	86.00	DOHC	108-118/ 147-160			
4007 2.0 4x4	11/10→								
2.0	106E (XN1A)					132	BM530 (Fibre), 1.400mm BN780 (Fibre), 1.600mm	DM530 [13] DM533 ▲ [3]	GM533 ○ [13]
505 2.0	09/85→09/95	1971	4	88.00		72/98			
2.0	170 (XN1T)					133	BM530 (Fibre), 1.400mm BN780 (Fibre), 1.600mm	DM530 [13] DM533 ▲ [3]	EM531 [3]
J5 2.0	01/83→09/90	1971	4	88.00		58/79			
2.0	170B (XN1T)					134	BM530 (Fibre), 1.400mm BN780 (Fibre), 1.600mm	DM530 [13] DM533 ▲ [3]	EM531 [3]
J5 2.0	09/81→09/90	1971	4	88.00		55/75			
2.0	170D (XN1TACP)					135	BM530 (Fibre), 1.400mm		
J5 2.0	09/90→02/94	1971	4	88.00	OHV	62/84			
J5 2426	10/90→02/94								

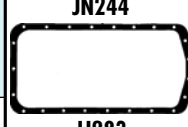
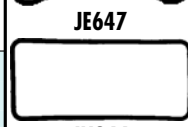
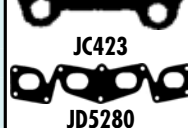
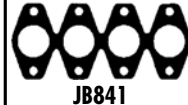
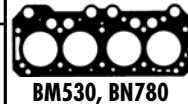
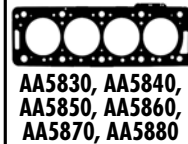
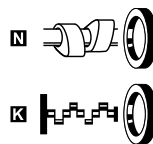
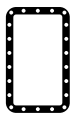
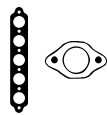

PEUGEOT



cc



kW/PS



2.0		829 (ZEJ)					136	BG170 (Fibre), 1.200mm	DG171 ○	
505 2.0	10/85→09/89	1995	4	88.00	SOHC/OHC	77-81/ 105-110				
2.0		R5A (XU102C)					137	BS820 (Fibre), 1.250mm	DS820 ▲ [3]	ES820 [3]
605 2.0	06/89→09/99	1998	4	86.00	SOHC/OHC	84/114				
2.0		RFH (EW10A)					138	AH6630 (MLS)		
Expert 2.0 16V	01/07→	1997	4	85.00	DOHC	103/140				
2.0		RFJ (EW10A)					139	AD5300 (MLS) AH6630 (MLS)		
307 2.0 16V	03/05→	1997	4	85.00	DOHC	103-111/ 140-151				
307 CC 2.0 16V	03/05→									
308 2.0 Bioflex	01/08→									
407 2.0 16V	09/05→									
407 2.0 Bioflex	09/07→									
807 2.0 16V	09/05→									
Expert 2.0 16V	01/07→									
2.0		RFK (EW10J4S)					140	AD5300 (MLS)	CD5300	ED5300
206 2.0 RC	07/03→	1997	4	85.00	DOHC	130/177				
307 2.0 16V	06/05→									
307 CC 2.0 16V	10/03→									
2.0		RFL (XU10J2U)					141	BV140 (Fibre), 1.250mm BY320 (Fibre), 1.450mm	CY081 ▲ [3]	ES820 [3]
Boxer 2.0	12/01→04/02	1998	4	86.00	SOHC/OHC	81/110				
2.0		RFN (EW10J4)					142	AD5300 (MLS)	CD5300	ED5300
206 2.0 16V	07/02→	1997	4	85.00	DOHC	100-105/ 136-143				
206 2.0 S16	09/00→									
307 2.0	03/02→									
307 2.0 16V	08/00→									
307 CC 2.0 16V	10/03→									
406 2.0 16V	08/00→12/04									
407 2.0	05/04→									
607 2.0	02/00→									
806 2.0 16V	09/00→08/02									
807 2.0	06/02→									
Expert 2.0	07/00→									
2.0		RFR (DEW10J4)					143		CD5300	ED5300
206 2.0 S16	04/99→10/00	1997	4	85.00	DOHC	99/135				
406 2.0 16V	01/99→10/00									
2.0		RFS (XU10J4RS)					144	AY070 (Fibre)	CY070	
306 2.0 S16	03/96→05/01	1998	4	86.00	DOHC	120-123/ 163-167				

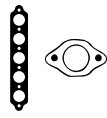

AY070



BG170



BS820



BV140, BY320



JB954



JC415



JM5139
JM5283



JD519

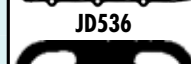

JD536



JD539

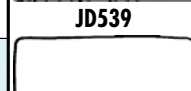

JN292



JN547



JJ283



JJ558

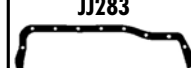

KA611



NA5205
NA5204

HBS116 [22] M12x1.50x243.00mm (x10)	JB954 [E]	JN292 [4]	JJ558 (Felt) =PA349 22.00x16.00x2.000mm	HR569 [E]	NA5016 35.00x47.00x7.00mm, FPM/ACM NF687 [2] 35.00x47.00x7.00mm, FPM NF648 [2] 50.00x68.00x10.00mm, MVQ NF843 [2] 50.00x68.00x10.00mm, FPM/ACM NF844 [1] 90.00x110.00x11.00mm, FPM/ACM	NF849 [2] [56]
HBS084 [22] M12x1.50x120.00mm (x10)	JC415 [E] (x4)	JN547 [4]	JJ283 [62] =PA349 22.00x16.00x2.000mm =PB907 14.00x21.00x2.000mm	HR569 [E]	NA5191 [2] 42.00x62.00x7.00mm, PTFE NA5192 [1] 90.00x110.00x7.00mm, PTFE	KA611 [15]
HBS535 [22]						
HBS259 [22] M11x1.50x144.50mm (x10) HBS535 [22]	JD5971 [I]	JM5139 [I] JM5283 [E]	=PB907 14.00x21.00x2.000mm		NA5256 [2] 40.00x55.00x6.50mm, FPM	NA5205 [1] [2] [53] NA5204 [2] [53]
HBS259 [22] M11x1.50x144.50mm (x10) HBS535 [22]	JD5971 [I]	JM5139 [I] JM5283 [E]	=PB907 14.00x21.00x2.000mm		NA5256 [2] 40.00x55.00x6.50mm, FPM	
HBS084 [22] M12x1.50x120.00mm (x10)	JD519 [I] (x2) JC415 [E] (x4)	JN547 [4]	JJ283 [62] =PA349 22.00x16.00x2.000mm =PB907 14.00x21.00x2.000mm	HR569 [E]	NA5191 [2] 42.00x62.00x7.00mm, PTFE NA5192 [1] 90.00x110.00x7.00mm, PTFE	KA611 [15]
HBS259 [22] M11x1.50x144.50mm (x10)		JM5139 [I] JM5283 [E]	=PB907 14.00x21.00x2.000mm		NA5256 [2] 40.00x55.00x6.50mm, FPM NF844 [1] 90.00x110.00x11.00mm, FPM/ACM	
HBS259 [22] M11x1.50x144.50mm (x10)		JM5139 [I] JM5283 [E]	=PB907 14.00x21.00x2.000mm		NA5256 [2] 40.00x55.00x6.50mm, FPM	
HBS087 [22] M12x1.50x110.00mm (x10) →Eng.08581	JD536 [I] JD539 [E]		=PB907 14.00x21.00x2.000mm	HR5080 [E] →Eng.07359 HR5081 [E] Eng.07360 → →Eng.07965	NA5191 [2] 42.00x62.00x7.00mm, PTFE NA5192 [1] 90.00x110.00x7.00mm, PTFE	KA611 [15]



cc



kW/PS



2.0 RFT (XU10J4)							145	AY090 (Fibre), 1.250mm AY100 (Fibre), 1.450mm	CY090 ▲ [3]	ES820 [3]
306 2.0 S16	06/94→05/01	1998	4	86.00	DOHC	110-112/ 150-152				
405 II 2.0 16V	06/94→10/95									
2.0 RFU (XU10J2)							146	BV140 (Fibre), 1.250mm BY320 (Fibre), 1.450mm	CY082 ▲ [3]	ES820 [3]
806 2.0	06/94→08/02	1998	4	86.00	SOHC/OHC	89-90/ 121-123				
2.0 RFV (XU10J4R)							147	AY070 (Fibre) BV140 (Fibre), 1.250mm	CY070	
306 2.0	03/97→04/02	1998	4	86.00	DOHC	97-99/ 132-135				
306 2.0 16V	03/97→04/02									
406 2.0 16V	11/95→12/04									
605 2.0 16V	07/94→09/99									
806 2.0 16V	05/98→09/00									
2.0 RFW (XU10J2)							148	BV140 (Fibre), 1.250mm BY320 (Fibre), 1.450mm	CY081 ▲ [3]	ES820 [3]
Boxer 2.0 i	03/94→04/02	1998	4	86.00	SOHC/OHC	80/109				
Boxer 2.0 i 4x4	08/96→04/02									
2.0 RFX (XU10J2)							149	BV140 (Fibre), 1.250mm BY320 (Fibre), 1.450mm	CY080 ▲ [3]	ES820 [3]
306 2.0	03/94→04/02	1998	4	86.00	SOHC/OHC	89-96/ 121-131				
306 2.0 ST	07/94→05/01									
306 2.0 XSi	05/93→05/01									
405 II 2.0	08/92→10/96									
405 II 2.0 4x4	08/92→10/96									
405 II 2.0 X4	08/92→10/95									
2.0 RFY (XU10J4Z)							150	AY090 (Fibre), 1.250mm AY100 (Fibre), 1.450mm	CY090 ▲ [3]	ES820 [3]
306 2.0 S16	05/93→05/01	1998	4	86.00	DOHC	112/152				
405 II 2.0 MI16	08/92→10/95									
2.0 RFZ (XU10J2Z)							151	BV140 (Fibre), 1.250mm BY320 (Fibre), 1.450mm	DS820 ▲ [3]	ES820 [3]
605 2.0	06/89→09/99	1998	4	86.00	SOHC/OHC	89-90/ 121-123				
2.0 RGX (XU10J2TE)							152	BY310 (Fibre), 1.250mm BY320 (Fibre), 1.450mm	DY310 ▲ [3]	ES820 [3]
406 2.0 Turbo	04/96→10/04	1998	4	86.00		108/147				
605 2.0 T	07/91→09/99									
806 2.0 T	06/94→08/02									
2.0 RGY (XU10J2TE)							153	BV140 (Fibre), 1.250mm BY310 (Fibre), 1.250mm BY320 (Fibre), 1.450mm	DY310 ▲ [3]	ES820 [3]
406 2.0	11/96→03/99	1998	4	86.00	SOHC/OHC	104/141				
605 2.0 T	07/92→09/99									
2.0 RGZ (XU10J4TE/Z)							154	AY090 (Fibre), 1.250mm AY100 (Fibre), 1.450mm	CY090 ▲ [3]	ES820 [3]
405 II 2.0 4x4	08/92→12/95	1998	4	86.00	DOHC	144/196				
405 II 2.0 T	08/92→10/95									
2.0 RHE (DW10CTED4) Diesel							155			EA5830
308 2.0 HDi	04/11→	1997	4	85.00	DOHC	110/150				
407 2.0 HDi	02/10→									
3008 2.0 HDi	06/09→									
5008 2.0 HDi	06/09→									

HBS087 [22] M12x1.50x110.00mm (x10) →Eng.08581	JD536 [1] JD535 [1]	JPO44 [4]	PA349 22.00x16.00x2.000mm PB907 14.00x21.00x2.000mm	HR642 [1]	NA5191 [2] 42.00x62.00x7.00mm, PTFE NA5192 [1] 90.00x110.00x7.00mm, PTFE	KA611 [15]
HBS084 [22] M12x1.50x120.00mm (x10)	HA510 [1] [1] JC415 [1] (x4)	JN547 [4]	JJ283 [62] PA349 22.00x16.00x2.000mm PB907 14.00x21.00x2.000mm	HR569 [1]	NA5191 [2] 42.00x62.00x7.00mm, PTFE NA5192 [1] 90.00x110.00x7.00mm, PTFE	KA611 [15]
HBS087 [22] M12x1.50x110.00mm (x10) →Eng.08581	JD536 [1] JD539 [1]	JM7121 [1] (Elastomer)	PB907 14.00x21.00x2.000mm	HR5080 [1] →Eng.07359 HR5081 [1] Eng.07360→ →Eng.07965	NA5191 [2] 42.00x62.00x7.00mm, PTFE NA5192 [1] 90.00x110.00x7.00mm, PTFE	KA611 [15]
HBS084 [22] M12x1.50x120.00mm (x10)	JD519 [1] (x2) JC415 [1] (x4)	JN547 [4]	JJ283 [62] PA349 22.00x16.00x2.000mm PB907 14.00x21.00x2.000mm	HR569 [1]	NA5191 [2] 42.00x62.00x7.00mm, PTFE NA5192 [1] 90.00x110.00x7.00mm, PTFE	KA611 [15]
HBS084 [22] M12x1.50x120.00mm (x10)	HA510 [1] [1] JD520 [1] (x4)	JPO43 [4]	JJ283 [62] PA349 22.00x16.00x2.000mm PB907 14.00x21.00x2.000mm	HR569 [1]	NA5191 [2] 42.00x62.00x7.00mm, PTFE NA5192 [1] 90.00x110.00x7.00mm, PTFE	KA611 [15]
HBS087 [22] M12x1.50x110.00mm (x10) →Eng.08581	JD536 [1] JD535 [1]	JPO44 [4]	JJ283 [62] PA349 22.00x16.00x2.000mm PB907 14.00x21.00x2.000mm	HR599 [1]	NA5191 [2] 42.00x62.00x7.00mm, PTFE NA5192 [1] 90.00x110.00x7.00mm, PTFE	KA611 [15]
HBS084 [22] M12x1.50x120.00mm (x10)	JC415 [1] (x4)	JN547 [4]	JJ283 [62] PA349 22.00x16.00x2.000mm PB907 14.00x21.00x2.000mm	HR569 [1]	NA5191 [2] 42.00x62.00x7.00mm, PTFE NA5192 [1] 90.00x110.00x7.00mm, PTFE	KA611 [15]
HBS084 [22] M12x1.50x120.00mm (x10)	HA512 [1] [1]	JN547 [4]	JJ283 [62] PA349 22.00x16.00x2.000mm PB907 14.00x21.00x2.000mm	HR569 [1]	NA5191 [2] 42.00x62.00x7.00mm, PTFE NA5192 [1] 90.00x110.00x7.00mm, PTFE	KA611 [15]
HBS084 [22] M12x1.50x120.00mm (x10)	HA512 [1] [1]	JN547 [4]	JJ283 [62] PA349 22.00x16.00x2.000mm PB907 14.00x21.00x2.000mm	HR569 [1]	NA5191 [2] 42.00x62.00x7.00mm, PTFE NA5192 [1] 90.00x110.00x7.00mm, PTFE	KA611 [15]
HBS087 [22] M12x1.50x110.00mm (x10) →Eng.08581	JD536 [1] JD535 [1]	JPO44 [4]	JJ283 [62] PA349 22.00x16.00x2.000mm PB907 14.00x21.00x2.000mm	HR599 [1] HR642 [1] (x2)	NA5191 [2] 42.00x62.00x7.00mm, PTFE NA5192 [1] 90.00x110.00x7.00mm, PTFE	KA611 [15]
					NA5035 [2] 27.00x47.00x7.00mm, FPM NA5191 [2] 42.00x62.00x7.00mm, PTFE NA5192 [1] 90.00x110.00x7.00mm, PTFE	

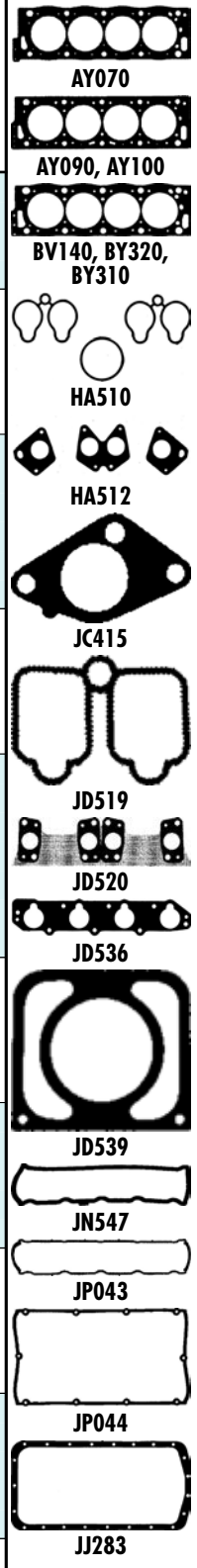



cc



kW/PS



2.0		RHH (DW10CTED4)		Diesel		156				
308 2.0 HDi	06/09→	1997	4	85.00	DOHC	120/163				EA5830
308 CC 2.0 HDi	06/09→									
407 2.0 HDi	06/09→									
508 2.0 HDi	11/10→									
508 2.0 HDi AWC	11/10→									
508 2.0 HDi RXH	12/11→									
807 2.0 HDi	06/09→									
3008 2.0 HDi	06/09→									
5008 2.0 HDi	09/09→									
Expert 2.0 165	09/09→									
RCZ 2.0 HDi	03/10→									
2.0		RHK (DW10UTED4)		Diesel		157		AD5490 (MLS), 1.250mm, 2 Notches	CD5500 ▲	EA5830
807 2.0 HDi	02/06→	1997	4	85.00	DOHC	79-88/ 107-120	AD5500 (MLS), 1.300mm, 3 Holes			
Expert 2.0 120	01/07→						AD5510 (MLS), 1.350mm, 4 Holes			
							AD5520 (MLS), 1.400mm, 5 Holes			
2.0		RHM (DW10ATED4)		Diesel		158		AC5011 (MLS), 1.300mm, 1 Hole	CC5010 ▲ [3]	EA5830
807 2.0 HDi FAP	06/02→	1997	4	85.00	DOHC	79/107	→0.470→0.605mm	CC5011 ▲		
							AC5020 (MLS), 1.350mm, 2 Holes			
							→0.605→0.655mm			
							AC5031 (MLS), 1.400mm, 3 Holes			
							→0.655→0.705mm			
							AC5040 (MLS), 1.450mm, 4 Holes			
							→0.705→0.755mm			
							AC5051 (MLS), 1.500mm, 5 Holes			
							→0.755→0.830mm			
2.0		RHR (DW10BTED4)		Diesel		159		AD5490 (MLS), 1.250mm, 2 Notches	CD5500 ▲	ED5500
307 2.0 135 FAP	10/03→	1997	4	85.00	DOHC	100-103/ 136-140	AD5500 (MLS), 1.300mm, 3 Holes			
308 2.0 HDi	09/07→						AD5510 (MLS), 1.350mm, 4 Holes			
308 CC 2.0 HDi	04/09→						AD5520 (MLS), 1.400mm, 5 Holes			
407 2.0 135 FAP	05/04→									
407 2.0 HDi	10/05→									
508 2.0 HDi	11/10→									
607 2.0 HDi	09/05→									
807 2.0 HDi	06/06→									
Expert 2.0 140	01/07→									
2.0		RHS (DW10ATED)		Diesel		160		AC5011 (MLS), 1.300mm, 1 Hole	CC5010 ▲ [3]	EA5830
307 2.0 110 FAP	08/00→	1997	4	85.00	SOHC/OHC	79/107	→0.470→0.605mm	→Eng.8331		
406 2.0 110 FAP	08/01→10/04						AC5020 (MLS), 1.350mm, 2 Holes			
607 2.0 HDi	03/01→07/04						→0.605→0.655mm			
							AC5031 (MLS), 1.400mm, 3 Holes			
							→0.655→0.705mm			
							AC5040 (MLS), 1.450mm, 4 Holes			
							→0.705→0.755mm			
							AC5051 (MLS), 1.500mm, 5 Holes			
							→0.755→0.830mm			

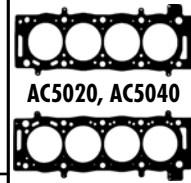
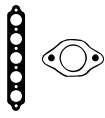

						<p>NA5035 [2] 27.00x47.00x7.00mm, FPM</p> <p>NA5191 [2] 42.00x62.00x7.00mm, PTFE</p> <p>NA5192 [1] 90.00x110.00x7.00mm, PTFE</p>	
<p>HBS261 [22] M12x1.50x126.00mm (x10)</p>	<p>JD5881 [2]</p>	<p>HM5289 [2]</p>	<p>KG5157 10.00x20.00x2.000mm</p> <p>PB907 14.00x21.00x2.000mm</p>	<p>HR5046 [2]</p>	<p>NA5035 [2] 27.00x47.00x7.00mm, FPM</p> <p>NA5191 [2] 42.00x62.00x7.00mm, PTFE</p> <p>NA5192 [1] 90.00x110.00x7.00mm, PTFE</p>		
<p>HBS261 [22] M12x1.50x126.00mm (x10)</p>	<p>JD5191 [2] JD5190 [2]</p>	<p>JM5087 (Elastomer)</p> <p>JM5141 (Elastomer)</p>		<p>HR5046 [2]</p>	<p>NA5035 [2] 27.00x47.00x7.00mm, FPM</p> <p>NA5191 [2] 42.00x62.00x7.00mm, PTFE</p> <p>NA5192 [1] 90.00x110.00x7.00mm, PTFE</p>		
<p>HBS261 [22] M12x1.50x126.00mm (x10)</p>	<p>JD5881 [2]</p>	<p>JM5141 (Elastomer)</p> <p>HM5289 [2]</p>	<p>KG5157 10.00x20.00x2.000mm</p> <p>PB907 14.00x21.00x2.000mm</p>	<p>HR5046 [2]</p>	<p>NA5035 [2] 27.00x47.00x7.00mm, FPM</p> <p>NA5191 [2] 42.00x62.00x7.00mm, PTFE</p> <p>NA5192 [1] 90.00x110.00x7.00mm, PTFE</p>	<p>NA5205 [1][2][53]</p> <p>NA5204 [2][53]</p>	
<p>HBS261 [22] M12x1.50x126.00mm (x10)</p>	<p>JD5191 [2] JD5190 [2]</p>	<p>JM5141 (Elastomer)</p>	<p>KG5157 10.00x20.00x2.000mm</p> <p>PB907 14.00x21.00x2.000mm</p>	<p>HR5046 [2]</p>	<p>NA5035 [2] 27.00x47.00x7.00mm, FPM</p> <p>NA5191 [2] 42.00x62.00x7.00mm, PTFE</p> <p>NA5192 [1] 90.00x110.00x7.00mm, PTFE</p>	<p>NA5205 [1][2][53]</p> <p>NA5204 [2][53]</p>	

PEUGEOT



cc









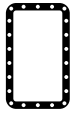
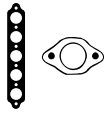

























kW/PS



2.0	RHT (DW10ATED4)	Diesel	161	AC5011 (MLS), 1.300mm, 1 Hole -0.470 → -0.605mm AC5020 (MLS), 1.350mm, 2 Holes -0.605 → -0.655mm AC5031 (MLS), 1.400mm, 3 Holes -0.655 → -0.705mm AC5040 (MLS), 1.450mm, 4 Holes -0.705 → -0.755mm AC5051 (MLS), 1.500mm, 5 Holes -0.755 → -0.830mm	CC5010 ▲ [3] CC5011 ▲	EA5830
807 2.0 HDI FAP	06/02 →	1997 4 85.00 DOHC	79/107			
2.0	RHV (DW10TD)	Diesel	162			EA5830
Boxer 2.0 HDI	04/02 →	1997 4 85.00 SOHC/OHC	62/84			
2.0	RHV (DW10UTD)	Diesel	163	AC5011 (MLS), 1.300mm, 1 Hole -0.470 → -0.605mm AC5020 (MLS), 1.350mm, 2 Holes -0.605 → -0.655mm AC5031 (MLS), 1.400mm, 3 Holes -0.655 → -0.705mm AC5040 (MLS), 1.450mm, 4 Holes -0.705 → -0.755mm AC5051 (MLS), 1.500mm, 5 Holes -0.755 → -0.830mm	CC5010 ▲ [3]	EA5830
Boxer 2.0 HDI	08/01 → 04/02	1997 4 85.00 SOHC/OHC	62/84			
2.0	RHW (DW10ATED4)	Diesel	164	AC5011 (MLS), 1.300mm, 1 Hole -0.470 → -0.605mm AC5020 (MLS), 1.350mm, 2 Holes -0.605 → -0.655mm AC5031 (MLS), 1.400mm, 3 Holes -0.655 → -0.705mm AC5040 (MLS), 1.450mm, 4 Holes -0.705 → -0.755mm AC5051 (MLS), 1.500mm, 5 Holes -0.755 → -0.830mm	CC5010 ▲ [3] CC5011 ▲	EA5830
806 2.0 HDI 16V 807 2.0 HDi 807 2.0 HDI FAP Expert 2.0 HDI	08/99 → 08/02 04/04 → 05/06 06/02 → 07/00 → 10/06	1997 4 85.00 DOHC	79-80/ 107-109			
2.0	RHX (DW10BTED)	Diesel	165	AC5011 (MLS), 1.300mm, 1 Hole -0.470 → -0.605mm AC5020 (MLS), 1.350mm, 2 Holes -0.605 → -0.655mm AC5031 (MLS), 1.400mm, 3 Holes -0.655 → -0.705mm AC5040 (MLS), 1.450mm, 4 Holes -0.705 → -0.755mm AC5051 (MLS), 1.500mm, 5 Holes -0.755 → -0.830mm	CC5010 ▲ [3]	EA5830
Expert 2.0 HDI	07/00 → 11/03	1997 4 85.00 SOHC/OHC	69/94			
2.0	RHY (DW10TD)	Diesel	166	AC5011 (MLS), 1.300mm, 1 Hole -0.470 → -0.605mm AC5020 (MLS), 1.350mm, 2 Holes -0.605 → -0.655mm AC5031 (MLS), 1.400mm, 3 Holes -0.655 → -0.705mm AC5040 (MLS), 1.450mm, 4 Holes -0.705 → -0.755mm AC5051 (MLS), 1.500mm, 5 Holes -0.755 → -0.830mm	CC5010 ▲ [3]	EA5830
206 2.0 HDI 206 2.0 HDI 90 306 2.0 HDI 90 307 2.0 HDI 90 406 2.0 HDI 90 Partner 2.0 4x4 Partner 2.0 HDI	07/02 → 12/99 → 06/99 → 04/02 08/00 → 02/99 → 10/04 04/04 → 08/05 02/00 →	1997 4 85.00 SOHC/OHC	66/90			



AC5020, AC5040

<p>HBS261  [22] M12x1.50x126.00mm (x10)</p>	<p>JD5191  JD5190 </p>	<p>JM5087 (Elastomer) JM5141 (Elastomer)</p>		<p>HR5046 </p>	<p>NA5035 [2] 27.00x47.00x7.00mm, FPM NA5191  [2] 42.00x62.00x7.00mm, PTFE NA5192  [1] 90.00x110.00x7.00mm, PTFE</p>	
					<p>NA5035 [2] 27.00x47.00x7.00mm, FPM NA5191  [2] 42.00x62.00x7.00mm, PTFE NA5192  [1] 90.00x110.00x7.00mm, PTFE</p>	
<p>HBS261  [22] M12x1.50x126.00mm (x10)</p>	<p>JD5191  JD5190 </p>	<p>JM5087 (Elastomer)</p>	<p>KG5157 10.00x20.00x2.000mm PB907 14.00x21.00x2.000mm</p>	<p>HR5046 </p>	<p>NA5035 [2] 27.00x47.00x7.00mm, FPM NA5191  [2] 42.00x62.00x7.00mm, PTFE NA5192  [1] 90.00x110.00x7.00mm, PTFE</p>	
<p>HBS261  [22] M12x1.50x126.00mm (x10)</p>	<p>JD5191  JD5190 </p>	<p>JM5087 (Elastomer) JM5141 (Elastomer)</p>	<p>KG5157 10.00x20.00x2.000mm PB907 14.00x21.00x2.000mm</p>	<p>HR5046 </p>	<p>NA5035 [2] 27.00x47.00x7.00mm, FPM NA5191  [2] 42.00x62.00x7.00mm, PTFE NA5192  [1] 90.00x110.00x7.00mm, PTFE</p>	
<p>HBS261  [22] M12x1.50x126.00mm (x10)</p>	<p>JD5191  JD5190 </p>	<p>JM5087 (Elastomer)</p>	<p>KG5157 10.00x20.00x2.000mm PB907 14.00x21.00x2.000mm</p>	<p>HR5046 </p>	<p>NA5035 [2] 27.00x47.00x7.00mm, FPM NA5191  [2] 42.00x62.00x7.00mm, PTFE NA5192  [1] 90.00x110.00x7.00mm, PTFE</p>	
<p>HBS261  [22] M12x1.50x126.00mm (x10)</p>	<p>JD5191  JD5190 </p>	<p>JM5087 (Elastomer)</p>	<p>KG5157 10.00x20.00x2.000mm PB907 14.00x21.00x2.000mm</p>	<p>HR5046 </p>	<p>NA5035 [2] 27.00x47.00x7.00mm, FPM NA5191  [2] 42.00x62.00x7.00mm, PTFE NA5192  [1] 90.00x110.00x7.00mm, PTFE</p>	



cc



kW/PS



2.0	RHZ (DW10ATED)	Diesel	167	AC5011 (MLS), 1.300mm, 1 Hole →0.470→0.605mm AC5020 (MLS), 1.350mm, 2 Holes →0.605→0.655mm AC5031 (MLS), 1.400mm, 3 Holes →0.655→0.705mm AC5040 (MLS), 1.450mm, 4 Holes →0.705→0.755mm AC5051 (MLS), 1.500mm, 5 Holes →0.755→0.830mm	CC5010 ▲ [3] →Eng.8331 CC5011 ▲ Eng.8332→	EA5830
406 2.0 110 FAP 406 2.0 HDI 110 607 2.0 HDI 806 2.0 HDI Expert 2.0 HDI	08/01→10/04 06/98→04/04 05/00→ 08/99→08/02 07/00→	1997	4 85.00 SOHC/OHC 79-80/ 107-109			
2.0	RLZ (EW10D)	168	AD5300 (MLS)	CD5300	ED5300	
406 2.0 16V HPi	05/01→10/04	1997	4 85.00 DOHC 103/140			
2.0	XN1P	169	BM530 (Fibre), 1.400mm BN780 (Fibre), 1.600mm	DM530 [13] DM533 ▲ [3]	GM533 ○ [13]	
J5 2.0	09/81→08/90	1971	4 88.00 OHV 57/78			
2.1	P8C (XUD11BTE)	Diesel	170	BY930 (MLS), 1.350mm →0.540→0.640mm BY941 (MLS), 1.520mm →0.650→0.760mm BY950 (MLS), 1.570mm →0.770→0.810mm BY961 (MLS), 1.620mm →0.820→0.860mm BY970 (MLS), 1.670mm BY981 (MLS), 1.720mm →0.920→0.960mm	DV150 ▲ [3]	EV150 [3]
406 2.1 TD 12V 605 2.1 TD 12V 806 2.1 td 12V	01/96→10/04 08/94→09/99 06/96→08/99	2088	4 85.00 SOHC/OHC 80/109			
2.1	P9A (XUD11A)	Diesel	171	BV150 (Fibre), 1.580mm, 2 Notches →0.650→0.770mm BV160 (Fibre), 1.700mm, 3 Notches →0.770→0.820mm	DV150 ▲ [3]	EV150 [3]
605 2.1 D	06/89→07/95	2138	4 86.00 SOHC/OHC 60/82			
2.1	PHZ (XUD11ATE)	Diesel	172	BY930 (MLS), 1.350mm →0.540→0.640mm BY941 (MLS), 1.520mm →0.650→0.760mm BY950 (MLS), 1.570mm →0.770→0.810mm BY961 (MLS), 1.620mm →0.820→0.860mm BY970 (MLS), 1.670mm BY981 (MLS), 1.720mm →0.920→0.960mm	DV150 ▲ [3]	EV150 [3]
605 2.1 TD	06/89→09/99	2088	4 85.00 SOHC/OHC 80/109			
2.2	3FY (EW12J4)	173	AG9750 (MLS)	CG9750	EG9750	
407 2.2 16V 407 Coupe 2.2 607 2.2 16V	09/05→ 10/05→ 09/05→	2230	4 86.00 DOHC 120/163			
2.2	3FZ (EW12J4)	174	AG9750 (MLS)	CG9750	EG9750	
406 2.2 406 Coupe 2.2 407 2.2 607 2.2 16V 807 2.2	07/00→10/04 03/02→12/04 05/04→ 02/00→ 06/02→	2230	4 86.00 DOHC 116/158			



AC5020, AC5040



BM530, BN780



BV150



BV160



BY930, BY950,
BY970



JB841



JD230



JD529

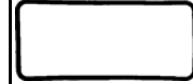

JN244



JP045



JJ283



HBS261 [22]
M12x1.50x126.00mm (x10)

JD5191 [1]
JD5190 [1]

JM5087
(Elastomer)

KG5157
10.00x20.00x2.000mm
PB907
14.00x21.00x2.000mm

HR5046 [1]

NA5035 [2]
27.00x47.00x7.00mm, FPM
NA5191 [2]
42.00x62.00x7.00mm, PTFE
NA5192 [1]
90.00x110.00x7.00mm, PTFE

HBS259 [22]
M11x1.50x144.50mm (x10)

PB907
14.00x21.00x2.000mm

NA5256 [2]
40.00x55.00x6.50mm, FPM

HBS038 [22]
M11x1.50x175.00mm (x10)

JB841 [1]

JN244 [4]

PA349
22.00x16.00x2.000mm

HR569 [1]

NF387 [1][2]
42.00x60.00x10.00mm, NBR

HL472 [55] [1]
HR574 [55] [1]

HBS125 [22]
M12x1.50x150.50mm (x10)

JD529 [1]
JD230 [1]

JP045 [4]

JJ283 [62]
PB907
14.00x21.00x2.000mm

HR805 [1]

NF841 [1][2]
35.00x50.00x8.00mm, FPM
NA5191 [2]
42.00x62.00x7.00mm, PTFE
NA5192 [1]
90.00x110.00x7.00mm, PTFE

KA611 [15]

HBS115 [22]
M12x1.50x145.00mm (x10)

JD529 [1]
JD230 [1]

JP045 [4]

JJ283 [62]
PA349
22.00x16.00x2.000mm

HR805 [1]

NF841 [1][2]
35.00x50.00x8.00mm, FPM
NA5191 [2]
42.00x62.00x7.00mm, PTFE
NA5192 [1]
90.00x110.00x7.00mm, PTFE

KA611 [15]

HBS115 [22]
M12x1.50x145.00mm (x10)
→Eng.05571
HBS125 [22]
M12x1.50x150.50mm (x10)
Eng.05572→

JD529 [1]
JD230 [1]

JP045 [4]

JJ283 [62]
PA349
22.00x16.00x2.000mm
PB907
14.00x21.00x2.000mm

HR805 [1]

NF841 [1][2]
35.00x50.00x8.00mm, FPM
NA5191 [2]
42.00x62.00x7.00mm, PTFE
NA5192 [1]
90.00x110.00x7.00mm, PTFE

KA611 [15]

HBS309 [22]
M11x1.50x127.00mm (x10)

JD5883 [1]
(SMG)

JM5139 [1]
JM5283 [1]

PB907
14.00x21.00x2.000mm

NA5256 [2]
40.00x55.00x6.50mm, FPM

HBS309 [22]
M11x1.50x127.00mm (x10)

JD5883 [1]
(SMG)

JM5139 [1]
JM5283 [1]

PB907
14.00x21.00x2.000mm

NA5256 [2]
40.00x55.00x6.50mm, FPM

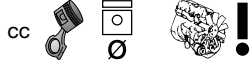

kW/PS

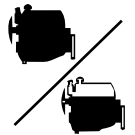

2.2	4HL (DW12C)	Diesel					175			
508 2.2 HDi	11/10→	2179	4	85.00	DOHC	147-150/ 200-204				
2.2	4HN (DW12MTED4)	Diesel					176			EH6520
4007 2.2 HDi	02/07→	2179	4	85.00	DOHC	115/156				
2.2	4HP (DW12BTED4)	Diesel					177			EH6520
407 2.2 HDi	06/08→	2179	4			120/163				
2.2	4HT (DW12BTED4)	Diesel					178			ED5490 EH6520
407 2.2 HDi 170	05/06→	2179	4	85.00	DOHC	120-125/ 163-170		CD5490 ▲		
607 2.2 HDi	05/06→									
807 2.2 HDi	06/06→									
2.2	4HU (P22DTE)	Diesel					179	AH6390 (MLS), 1.100mm, 1 Notch AH6400 (MLS), 1.150mm, 2 Notches AH6410 (MLS), 1.200mm, 3 Notches	CH6390 ▲	EA5970 [3]
Boxer 2.2 120	04/06→	2198	4	86.00	DOHC	88/120				
2.2	4HV (P22DTE)	Diesel					180	AH6390 (MLS), 1.100mm, 1 Notch AH6400 (MLS), 1.150mm, 2 Notches AH6410 (MLS), 1.200mm, 3 Notches	CH6390 ▲	EA5970 [3]
Boxer 2.2 100	04/06→	2198	4	86.00	DOHC	74/101				
2.2	4HX (DW12TED4/FAP)	Diesel					181	AD5490 (MLS), 1.250mm, 2 Notches AD5500 (MLS), 1.300mm, 3 Holes AD5510 (MLS), 1.350mm, 4 Holes AD5520 (MLS), 1.400mm, 5 Holes	CD5490 ▲	ED5490
406 2.2 HDi	03/00→12/04	2179	4	85.00	DOHC	94-98/ 128-133				
607 2.2 HDi	02/00→									
807 2.2 HDi	06/02→									
2.2	4HY (DW12UTED)	Diesel					182	AH5080 (MLS), 1.250mm, 1 Hole AH5090 (MLS), 1.300mm, 2 Holes AH5100 (MLS), 1.350mm, 3 Holes AH5110 (MLS), 1.400mm, 4 Holes		
Boxer 2.2 HDi	04/02→	2179	4	85.00	SOHC/OHC	74/101				
2.2	176B (N9TE)					183	BL610 (Fibre), 1.350mm			
505 2.2T	03/84→10/88	2155	4	91.70	SOHC/OHC	114/155				
2.2	176W (N9TEA)					184	BL610 (Fibre), 1.350mm			
505 2.2T	06/87→12/88	2155	4	91.70	SOHC/OHC	128/174				
2.2	851B (ZDJL)					185	BG170 (Fibre), 1.200mm	DG171 ○		
505 2.2 GTI	08/83→12/93	2165	4	88.00	SOHC/OHC	90/122				



AD5490, AD5500,
AD5510, AD5520



BG170



BL610



JB954



JC712



JM5037

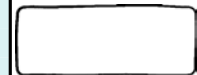

JN292

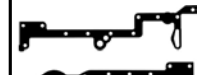

HC5004



JJ558



cc



kw/PS



Model	Year Range	CC	Cyls	Power (kW/PS)	Configuration	Code	Accessories	Options
2.2 851X (ZDJL)				186				
505 2.2	01/86→12/93	2165	4	88.00	SOHC/OHC	84/114	BG170 (Fibre), 1.200mm	DG171 ○
2.3 134 (XD2) Diesel				187				
504 2.3 D	01/80→12/89	2304	4	94.00	OHV	51/69	BP890 (Fibre), 1.530mm, 2 Notches BP900 (Fibre), 1.630mm, 3 Notches BP910 (Fibre), 1.730mm, 4 Notches	DG050 ▲ [3] GG050 ▲ ○
2.4 T8A (DJ5T) Diesel				188				
Boxer 2.5 TD	03/94→04/02	2446	4	92.00		76/103	BY140 (Fibre)	DY140 ▲ [3] EY140
2.4 T9A (DJ5) Diesel				189				
Boxer 2.5 D	03/94→04/02	2446	4	92.00	SOHC/OHC	63/86	BY140 (Fibre)	DY140 ▲ [3] EY140
Boxer 2.5 D 4x4	07/96→04/02							
2.4 THX (DJ5TED) Diesel				190				
Boxer 2.5 TDI	01/97→04/02	2446	4	92.00		79/107	AE5050 (MLS)	CE5050 ▲ [3] EY140
2.4 THY (DK5ATE) Diesel				191				
605 2.5 TD	07/94→09/99	2446	4	92.00	SOHC/OHC	95/129	BY140 (Fibre)	DY140 ▲ [3] EY140
2.5 152A (XD3T) Diesel				192				
505 2.5 TD	10/83→12/93	2498	4	94.00		66/90		DG052 ▲ GG052 ▲ ○ [3]
2.5 152B (XD3TE) Diesel				193				
505 2.5 TD	10/86→12/93	2498	4	94.00		77/105	BP890 (Fibre), 1.530mm, 2 Notches BP900 (Fibre), 1.630mm, 3 Notches BP910 (Fibre), 1.730mm, 4 Notches	DG052 ▲ GG052 ▲ ○ [3] GM310 ▲ [3]
2.5 155 (XD3) Diesel				194				
505 2.5 D	06/81→12/93	2498	4	94.00		51-55/ 70-75		DH890 ▲ [13]
2.5 CRD93 Diesel				195				
J5 2.5 D	09/81→01/94	2498	4	93.00	OHV	54/73		
J5 2.5 D 4x4	09/81→08/90							
2.5 CRD93 (U25/661) Diesel				196				
J5 2.5 D	09/81→02/94	2498	4	93.00	OHV	54/73	BG450 (Fibre), 1.350mm	
J5 2.5 D 4x4	10/90→03/94							
J5 12.36 DB2	10/90→02/94							
J5 280 E 23 T	09/81→09/90							
J5 2431	10/90→02/94							
2.5 CRD93L Diesel				197				
J5 2.5 DT	09/81→01/94	2498	4	94.00	OHV	70/95		

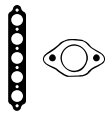

AE5050



BG170



BG450



BP890, BP900,
BP910



BY140



JB842



JB869

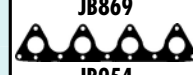

JB954



JC091

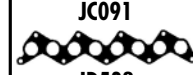

JD532

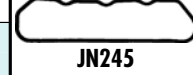

JN245

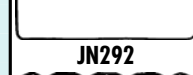

JN292



JN426



HC346



JJ558

HBS302 [22]
M12x1.50x204.00mm (x10)

JB954 [1]

JN292 [4]

JJ558
(Felt)
=PA349
22.00x16.00x2.000mm

HR569 [1]

NA5016
35.00x47.00x7.00mm, FPM/ACM
NF687 [2]
35.00x47.00x7.00mm, FPM
NF648 [2]
50.00x68.00x10.00mm, MVQ
NF843 [2]
50.00x68.00x10.00mm, FPM/ACM
NF844 [1]
90.00x110.00x11.00mm, FPM/ACM

NF849 [2][56]

HBS015 [22]
M11x1.50x120.00mm (x7)

JB842 [x2]

JN245 [4]

=PA349
22.00x16.00x2.000mm

HR662 [1]

NF780 [2]
45.00x60.00x7.00mm, ACM
NF387 [1][2]
42.00x60.00x10.00mm, NBR

KA606 [15]

JD532 [1]
JD531 [1]

JJ588

HR662 [1]

NB645 [2]
35.00x50.00x7.00mm, MVQ
NB645 [2]
35.00x50.00x7.00mm, MVQ
NF867 [1]
98.00x120.00x7.00mm, FPM/ACM

JD532 [1]
JD531 [1]

JJ588

HR662 [1]

NB645 [2]
35.00x50.00x7.00mm, MVQ
NB645 [2]
35.00x50.00x7.00mm, MVQ
NF867 [1]
98.00x120.00x7.00mm, FPM/ACM

HBS273 [22]
M10x1.50x174.00mm (x8)

JJ588
=PA349
22.00x16.00x2.000mm

HR642 [1]

NB959 [2]
35.00x50.00x7.00mm, FPM
NF866 [2]
64.00x88.00x6.00mm, FPM/ACM
NF867 [1]
98.00x120.00x7.00mm, FPM/ACM

KA835 [15]

HBS114 [22]
M10x1.50x148.00mm (x8)

JD532 [1]
JD531 [1]

JJ588
=PA349
22.00x16.00x2.000mm

HR788 [1]

NB959 [2]
35.00x50.00x7.00mm, FPM
NF866 [2]
64.00x88.00x6.00mm, FPM/ACM
NF867 [1]
98.00x120.00x7.00mm, FPM/ACM

JC091 [1]

NF780 [2]
45.00x60.00x7.00mm, ACM

HBS015 [22]
M11x1.50x120.00mm (x7)

JC091 [1]

JN245 [4]

HC346 [1]
=PA349
22.00x16.00x2.000mm

PA229 (x8)

NF780 [2]
45.00x60.00x7.00mm, ACM

KA606 [15]

NF780 [2]
45.00x60.00x7.00mm, ACM

JB869 [1]

JN426 [4]

NF776 [2]
75.00x90.00x11.50mm, FPM/ACM
NF752 [1]
95.00x112.00x12.50mm, FPM

HBS017 [22]
M12x1.50x145.00mm (x8)

JB869 [1]

JN426 [4]

NF776 [2]
75.00x90.00x11.50mm, FPM/ACM
NF752 [1]
95.00x112.00x12.50mm, FPM

JB869 [1]

JN426 [4]

NF776 [2]
75.00x90.00x11.50mm, FPM/ACM
NF752 [1]
95.00x112.00x12.50mm, FPM

PEUGEOT



cc



kw/PS



2.5	CRD93LS (U25/673)	Diesel	198	BL830 (Fibra), 1.800mm	DL831 ▲ [13]	GL830 [3]	
J5 2.5 DT	09/81→08/90	2498	4	93.00	OHV	70/95	
J5 2.5 TD	10/90→02/94						
J5 2.5 TD 4x4	10/90→03/94						
2.5	XD3T Diesel		199		DG052 ▲	GG052 ▲○ [3]	
505 2.5 TD	10/83→12/90	2497	4	94.00	SOHC/OHC	66-70/ 90-95	
2.7	DT17TED4 Diesel		200	AH5730 (MLS), 1.17mm, 2 Notches (x2)	CH5730		
607 2.7 HDi 24V	12/04→	2721	6	81.00		150/204	
				AH5731 (MLS), 1.22mm, 3 Notches (x2) [67]			
				AH5732 (MLS), 1.27mm, 4 Notches (x2) [67]			
				AH5733 (MLS), 1.32mm, 5 Notches (x2) [67]			
2.7	UHZ (DT17) Diesel		201	AH5730 (MLS), 1.17mm, 2 Notches (x2)	CH5730		
407 2.7 HDi	10/05→	2720	6	81.00	DOHC, V	150/204	
				AH5731 (MLS), 1.22mm, 3 Notches (x2) [67]			
				AH5732 (MLS), 1.27mm, 4 Notches (x2) [67]			
				AH5733 (MLS), 1.32mm, 5 Notches (x2) [67]			
2.8	154X (ZN3J)		202				
505 2.8 GTI V6	06/86→12/93	2849	6	91.00	SOHC/OHC, V	105/143	
2.8	8140.43N Diesel		203	BX390 (Fibra), 1.200mm		GX392 ▲ [3]	
Boxer 2.8 HDi	04/04→	2798	4	94.40	SOHC/OHC	107/146	
				BX400 (Fibra), 1.300mm			
				BX410 (Fibra), 1.400mm			
				BX420 (Fibra), 1.500mm			
2.8	8140.43S (F28DTCR) Diesel		204	BX390 (Fibra), 1.200mm	DX392 ▲	GX392 ▲ [3]	
Boxer 2.8 AWD	10/00→11/01	2798	4	94.40	SOHC/OHC	92-125/ 125-170	
Boxer 2.8 HDi	10/00→04/02						
				BX400 (Fibra), 1.300mm			
				BX410 (Fibra), 1.400mm			
				BX420 (Fibra), 1.500mm			
2.8	8140.63 (F28D) Diesel		205	BX390 (Fibra), 1.200mm	DX392 ▲	GX392 ▲ [3]	
Boxer 2.8 D	01/99→02/02	2798	4	94.40		64/87	
				BX400 (Fibra), 1.300mm			
				BX410 (Fibra), 1.400mm			
				BX420 (Fibra), 1.500mm			
2.9	XFV (ES9A)		206	AH5060 (MLS), 0.740mm ☒	CH5040 ☒		
407 3.0	05/04→	2946	6	87.00	DOHC, V	155/211	
407 3.0 V6	10/05→						
607 3.0 V6 24V	03/04→						
				AH5050 (MLS), 0.950mm ☒	CH5060 ☒		
				AH5040 (MLS), 0.740mm ☒			
				AH5070 (MLS), 0.950mm ☒			

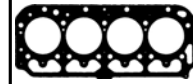

BL830



BX390, BX400,
BX410, BX420



JB868



JB869



JC054



JC055



JC091



JF123

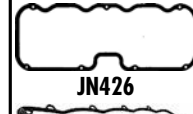

JN426

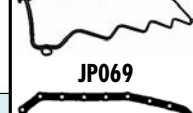

JP069



JJ613

PEUGEOT

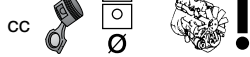

kW/PS

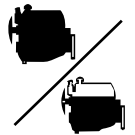

2.9	XFX (ES9J4S)					207			
406 3.0 V6	03/00→12/04	2946	6	87.00	DOHC, V	150-152/ 204-207	AH5060 (MLS), 0.740mm	CH5040	
607 3.0 V6 24V	02/00→						AH5050 (MLS), 0.950mm	CH5060	
807 3.0 V6	06/02→						AH5040 (MLS), 0.740mm		
							AH5070 (MLS), 0.950mm		
2.9	XFZ (ES9J4)					208			
406 3.0 24V	10/96→05/04	2946	6	87.00	DOHC, V	140-150/ 190-204	AG9710 (MLS), 1.400mm	CG9710	EG9710
406 24V	10/96→10/04						AG9720 (MLS), 1.650mm	CG9720	
406 V6 24V	03/97→12/04						AG9730 (MLS), 1.400mm	CG9740	
605 3.0 V6	04/97→09/99						AG9740 (MLS), 1.650mm		
3.0	DT20C Diesel					209			
407 3.0 HDi	06/09→	2993	6	84.00	DOHC, V	177/241			
3.0	UFZ (ZPJ)					210			
605 3.0	10/89→09/99	2963	6	93.00	SOHC/OHC, V	123/167			
3.0	UKZ (ZPJ4/Z)					211			
605 3.0 SV 24	08/89→09/99	2963	6	93.00	DOHC, V	147/200			

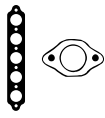

HBS272 [22] M10x1.50x147.00mm (x16)	JD5906 [1] JD5907 [1] (x2)		⇒PB852 16.00x24.00x1.500mm	HR5062 [5]	N NA5260 [2] 38.00x50.00x6.00mm, FPM N NA5177 [2] 42.00x56.00x7.00mm, FPM K NA5177 [2] 42.00x56.00x7.00mm, FPM K NF867 [1] 98.00x120.00x7.00mm, FPM/ACM
HBS272 [22] M10x1.50x147.00mm (x16)	JD5879 [1] JD5880 [1] (SE) JD5878 [1] (MLS)		⇒PB852 16.00x24.00x1.500mm	HR5062 [5]	N NA5260 [2] 38.00x50.00x6.00mm, FPM N NA5177 [2] 42.00x56.00x7.00mm, FPM K NA5177 [2] 42.00x56.00x7.00mm, FPM K NF867 [1] 98.00x120.00x7.00mm, FPM/ACM
	JD5999 [1]		⇒PA349 22.00x16.00x2.000mm	HR5111 [5]	N NA5318 [1][2] 26.00x45.00x8.00mm, FPM K NA5323 [2] 35.00x50.00x7.00mm, PTFE
HBS127 [22] M12x1.50x178.00mm (x16)			⇒PA349 22.00x16.00x2.000mm		N NF869 (x2)[1] 32.00x45.00x8.00mm, FPM K NA5191 [2] 42.00x62.00x7.00mm, PTFE K NF835 [1] 80.00x100.00x8.00mm, FPM/ACM K NF634 [1] 80.00x100.00x13.00mm, MVQ
HBS127 [22] M12x1.50x178.00mm (x16)			⇒PA349 22.00x16.00x2.000mm		N NF869 (x2)[1] 32.00x45.00x8.00mm, FPM K NA5191 [2] 42.00x62.00x7.00mm, PTFE K NF835 [1] 80.00x100.00x8.00mm, FPM/ACM K NF634 [1] 80.00x100.00x13.00mm, MVQ



Ltr



CC



9

Model	Ltr	Year Range	Engine	Fuel	CC	Doors	Seats
AEROBACK Hatchback (C2_A, C9_L)	1.3	10/98→11/99	4 G 13	Petrol	1299	4	1
AEROBACK Hatchback (C2_A, C9_L)	1.5	01/99→09/99	4 G 15	Petrol	1468	4	4
AEROBACK Hatchback (C2_A, C9_L)	1.5	10/98→11/99	4 G 15 M	Petrol	1468	4	5
AEROBACK Hatchback (C2_A, C9_L)	1.6	10/98→11/99	4 G 92	Petrol	1597	4	7
JUMBUCK Pickup	1.5	05/00→	4 G 15	Petrol	1468	4	4
PERSONA 300 (C9_M)	1.3	08/00→	4 G 13 M	Petrol	1299	4	2
PERSONA 300 (C9_M)	1.3	03/99→	G 13 B	Petrol	1299	4	3
PERSONA 300 (C9_M)	1.5	03/99→	4 G 15 M	Petrol	1468	4	5
PERSONA 300 (C9_M)	1.5	09/99→	G 15 B	Petrol	1468	4	6
PERSONA 300 (C9_M)	1.6	03/99→	4 G 92	Petrol	1597	4	7
PERSONA 400 (C9_S)	1.3	10/00→	4 G 13 M	Petrol	1299	4	2
PERSONA 400 (C9_S)	1.5	01/99→	4 G 15	Petrol	1468	4	4
PERSONA 400 (C9_S)	1.5	05/99→	4 G 15 M	Petrol	1468	4	5
PERSONA 400 (C9_S)	1.6	01/99→	4 G 92	Petrol	1597	4	7
PERSONA 400 (C9_S)	2.0	05/99→	4 D 68	Diesel	1998	4	8
PERSONA 400 (C9_S)	2.0	09/99→	4 D 68 T	Diesel	1998	4	9
PERSONA 400 Hatchback (C9_C, C9_S)	1.3	01/99→	4 G 13	Petrol	1299	4	1
PERSONA 400 Hatchback (C9_C, C9_S)	1.3	10/00→	4 G 13 M	Petrol	1299	4	2
PERSONA 400 Hatchback (C9_C, C9_S)	1.5	01/99→	4 G 15	Petrol	1468	4	4
PERSONA 400 Hatchback (C9_C, C9_S)	1.5	10/00→	4 G 15 M	Petrol	1468	4	5
PERSONA 400 Hatchback (C9_C, C9_S)	1.6	01/99→	4 G 92	Petrol	1597	4	7
PERSONA 400 Hatchback (C9_C, C9_S)	2.0	05/99→	4 D 68	Diesel	1998	4	8
PERSONA 400 Hatchback (C9_C, C9_S)	2.0	09/99→	4 D 68 T	Diesel	1998	4	9
PERSONA Saloon	1.6	03/00→	4 G 92	Petrol	1597	4	7
SAGA Hatchback	1.3	01/99→06/99	4 G 13	Petrol	1299	4	1
SAGA Hatchback	1.5	01/99→06/99	4 G 15	Petrol	1468	4	4
SAGA Saloon	1.3	10/98→06/99	4 G 13	Petrol	1299	4	1
SAGA Saloon	1.5	01/99→06/99	4 G 15	Petrol	1468	4	4
SALOON Saloon (C2_S)	1.3	01/99→09/99	4 G 13	Petrol	1299	4	1
SALOON Saloon (C2_S)	1.3	10/99→06/99	4 G 13 M	Petrol	1299	4	2
SALOON Saloon (C2_S)	1.5	01/99→09/99	4 G 15	Petrol	1468	4	4
SATRIA (C9_M)	1.3	07/99→	4 G 13	Petrol	1299	4	1
SATRIA (C9_M)	1.3	08/00→	4 G 13 M	Petrol	1299	4	2
SATRIA (C9_M)	1.5	04/99→	4 G 15	Petrol	1468	4	4
SATRIA (C9_M)	1.6	07/99→	4 G 92	Petrol	1597	4	7
WIRA Hatchback	1.3	08/00→	4 G 13	Petrol	1299	4	1
WIRA Hatchback	1.3	10/00→	4 G 13 M	Petrol	1299	4	2
WIRA Hatchback	1.5	08/00→	4 G 15 M	Petrol	1468	4	5
WIRA Hatchback	2.0	01/00→	4 D 68	Diesel	1998	4	8
WIRA	1.3	08/00→	4 G 13	Petrol	1299	4	1
WIRA	1.3	10/00→	4 G 13 M	Petrol	1299	4	2
WIRA	1.5	08/00→	4 G 15	Petrol	1468	4	4
WIRA	1.5	10/00→	4 G 15 M	Petrol	1468	4	5
WIRA	1.6	08/00→02/00	4 G 92	Petrol	1597	4	7
WIRA	2.0	01/00→	4 D 68	Diesel	1998	4	8

PROTON



cc



kW/PS



1.3		4 G 13					1	BT430 (Graphite)	DT430	
Aeroback 1.3	10/88→11/96	1299	4	71.00	SOHC/OHC	50-56/ 68-76	→12/96			
Persona 413GLSi	01/94→									
Saga 1.3 GLE	10/88→06/96									
Saga 1.3 GLS	01/91→06/96									
Saloon 1.3	01/91→09/93									
Satria 1.3	07/96→									
Wira 1.3	08/00→									
1.3		4 G 13 M					2	BT430 (Graphite)	DT430	
Persona 1.3	08/00→	1299	4	71.00	SOHC/OHC	55-57/ 75-78				
Saloon 1.3	10/92→06/96									
Satria 1.3	08/00→									
Wira 1.3	10/05→									
1.3		G 13 B					3	BT430 (Graphite)	DT430	
Persona 313i	03/96→	1299	4	71.00	SOHC/OHC	55/75	→12/96			
1.5		4 G 15					4	BT430 (Graphite)	DT430	
Aeroback 1.5	01/91→09/93	1468	4	75.50	SOHC/OHC	55-66/ 75-90	→12/96			
Jumbuck 1.5	05/02→									
Persona 415GLSi	01/94→									
Saga 1.5 GLE	01/91→06/96									
Saga 1.5 GLS	01/91→06/96									
Saloon 1.5	01/91→09/93									
Satria 1.5	04/96→									
Wira 1.5	08/00→									
1.5		4 G 15 M					5	BT430 (Graphite)	DT430	
Aeroback 1.5 LX	10/88→11/96	1468	4	75.50	SOHC/OHC	64-67/ 87-91				
Persona 1.5	05/95→									
Persona 315GLSi	03/96→									
Wira 1.5	08/00→									
1.5		G 15 B					6	BT430 (Graphite)	DT430	
Persona 315GLSi	09/96→	1468	4	75.50	SOHC/OHC	55-66/ 75-90	→12/96			
1.6		4 G 92					7	BT890 (Graphite)	DT890	GT890 [3]
Aeroback 1.6 EX	10/88→11/96	1597	4	81.00	SOHC/OHC	70-83/ 95-113				
Persona 1.6	03/08→									
Persona 316	03/96→									
Persona 316GLXi	03/96→									
Persona 416	08/00→02/02									
Persona 416 i	12/95→									
Persona 416GLXi	01/94→									
Satria 1.6	07/97→									
Wira 1.6	08/00→02/02									

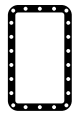

BT430



BT890



JD007



JD023



JN897

PROTON



cc



kW/PS



2.0 4 D 68 Diesel 8

Persona 420GLSD	05/96→	1998	4	82.70	SOHC/OHC	48/65
Wira 2.0 D	01/00→					

2.0 4 D 68 T Diesel 9

Persona 420 D	09/96→	1998	4	82.70	SOHC/OHC	60/82
Persona 420 TD	09/96→					

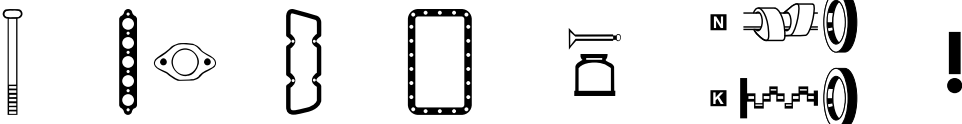
							
						<p>N NJ933 [2] 35.00x50.00x8.00mm, FPM</p> <p>K NF678 [2] 35.00x50.00x8.00mm, ACM</p> <p>K NK143 [1] 85.00x103.00x8.00mm, FPM</p>	
						<p>N NJ933 [2] 35.00x50.00x8.00mm, FPM</p> <p>K NF678 [2] 35.00x50.00x8.00mm, ACM</p> <p>K NK143 [1] 85.00x103.00x8.00mm, FPM</p>	



Ltr







CC



9

Model	Ltr	Period	Code	Fuel	CC	9
4 (112_)	0.8	09/97→12/98	800 01	Petrol	845	1
4 (112_)	0.8	10/98→10/98	800 705	Petrol	845	2
4 (112_)	0.8	10/98→10/98	B1B 707	Petrol	845	3
4 (112_)	1.0	12/98→06/99	689 710	Petrol	956	5
4 (112_)	1.0	06/98→06/99	C1C 708	Petrol	956	7
4 (112_)	1.1	06/97→06/99	688 712	Petrol	1108	10
4 (112_)	1.1	06/97→06/99	C1E 714	Petrol	1108	12
4 (112_)	1.1	06/97→06/99	C1E 719	Petrol	1108	14
4 Box (R21_, R23_)	0.8	09/96→12/98	800 01	Petrol	845	1
4 Box (R21_, R23_)	0.8	04/98→07/98	800 705	Petrol	845	2
4 Box (R21_, R23_)	0.8	04/98→07/98	B1B 707	Petrol	845	3
4 Box (R21_, R23_)	1.0	06/98→12/99	C1C 708	Petrol	956	7
4 Box (R21_, R23_)	1.1	10/97→07/98	688 711	Petrol	1108	9
4 Box (R21_, R23_)	1.1	10/97→07/98	688 712	Petrol	1108	10
4 Box (R21_, R23_)	1.1	10/97→07/98	C1E 714	Petrol	1108	12
4 Box (R21_, R23_)	1.1	10/97→07/98	C1E 718	Petrol	1108	13
4 Box (R21_, R23_)	1.1	10/97→07/98	C1E 719	Petrol	1108	14
9 (L42_)	1.2	09/98→12/98	C1G 700	Petrol	1237	54
9 (L42_)	1.2	09/98→12/98	C1G 710	Petrol	1237	56
9 (L42_)	1.4	12/98→12/98	C1J 715	Petrol	1397	76
9 (L42_)	1.4	12/98→12/98	C1J 760	Petrol	1397	78
9 (L42_)	1.4	12/98→12/98	C1J 764	Petrol	1397	79
9 (L42_)	1.4	12/98→12/98	C1J 792	Petrol	1397	86
9 (L42_)	1.4	12/98→12/98	C1J 796	Petrol	1397	87
9 (L42_)	1.4	09/98→12/98	C2J 720	Petrol	1397	89
9 (L42_)	1.4	12/98→12/98	C2J 730	Petrol	1397	90
9 (L42_)	1.4	09/98→12/98	C2J 766	Petrol	1397	91
9 (L42_)	1.4	09/98→12/98	C2J 767	Petrol	1397	92
9 (L42_)	1.4	09/98→12/98	C2J 768	Petrol	1397	93
9 (L42_)	1.6	10/98→12/98	F8M 700	Diesel	1596	190
9 (L42_)	1.6	10/98→12/98	F8M 720	Diesel	1596	191
9 (L42_)	1.6	10/98→12/98	F8M 730	Diesel	1596	192
9 (L42_)	1.7	09/98→12/98	F2N 700	Petrol	1721	257
9 (L42_)	1.7	09/98→12/98	F2N 704	Petrol	1721	258
9 (L42_)	1.7	10/98→12/98	F2N 708	Petrol	1721	259
9 (L42_)	1.7	10/98→12/98	F2N 710	Petrol	1721	260
9 (L42_)	1.7	10/98→12/98	F2N 730	Petrol	1721	266
9 (L42_)	1.7	10/98→12/98	F2N 798	Petrol	1721	274
9 (L42_)	1.7	06/98→12/98	F3N 708	Petrol	1721	276
9 (L42_)	1.7	10/98→12/98	F3N 718	Petrol	1721	279
11 (B/C37_)	1.2	10/98→12/98	C1G 700	Petrol	1237	54
11 (B/C37_)	1.2	10/98→12/98	C1G 710	Petrol	1237	56
11 (B/C37_)	1.4	03/98→12/98	C1J 715	Petrol	1397	76
11 (B/C37_)	1.4	10/98→12/98	C1J 770	Petrol	1397	81
11 (B/C37_)	1.4	10/98→12/98	C1J 782	Petrol	1397	83
11 (B/C37_)	1.4	03/98→12/98	C2J 720	Petrol	1397	89
11 (B/C37_)	1.4	03/98→12/98	C2J 730	Petrol	1397	90
11 (B/C37_)	1.4	03/98→12/98	C2J 766	Petrol	1397	91
11 (B/C37_)	1.4	03/98→12/98	C2J 767	Petrol	1397	92
11 (B/C37_)	1.4	03/98→12/98	C2J 768	Petrol	1397	93
11 (B/C37_)	1.6	08/98→12/98	F8M 700	Diesel	1596	190
11 (B/C37_)	1.6	08/98→12/98	F8M 720	Diesel	1596	191
11 (B/C37_)	1.6	08/98→12/98	F8M 730	Diesel	1596	192
11 (B/C37_)	1.7	10/98→12/98	F2N 708	Petrol	1721	259
11 (B/C37_)	1.7	10/98→12/98	F2N 710	Petrol	1721	260
11 (B/C37_)	1.7	10/98→12/98	F2N 730	Petrol	1721	266
11 (B/C37_)	1.7	06/98→12/98	F2N 732	Petrol	1721	267
11 (B/C37_)	1.7	06/98→12/98	F2N 742	Petrol	1721	269
11 (B/C37_)	1.7	10/98→12/98	F2N 798	Petrol	1721	274
11 (B/C37_)	1.7	06/98→12/98	F3N 708	Petrol	1721	276
11 (B/C37_)	1.7	10/98→12/98	F3N 718	Petrol	1721	279
11 Box (S37_)	1.2	10/98→12/98	C1G 700	Petrol	1237	54
11 Box (S37_)	1.2	10/98→12/98	C1G 710	Petrol	1237	56
11 Box (S37_)	1.6	08/98→12/98	F8M 700	Diesel	1596	190
11 Box (S37_)	1.6	08/98→12/98	F8M 720	Diesel	1596	191
11 Box (S37_)	1.6	08/98→12/98	F8M 730	Diesel	1596	192
19 I (B/C53_)	1.2	01/98→12/99	C1G 730	Petrol	1237	60
19 I (B/C53_)	1.4	01/98→12/98	C2J 772	Petrol	1397	95
19 I (B/C53_)	1.4	01/98→04/99	C3J 710	Petrol	1397	105
19 I (B/C53_)	1.4	01/98→12/99	E6J 700	Petrol	1390	108

	Ltr				CC		9
19 I (B/C53_)	1.4	01/98→12/99	E6J 701	Petrol	1390	4	109
19 I (B/C53_)	1.4	09/99→04/99	E7J 700	Petrol	1390	4	115
19 I (B/C53_)	1.7	09/98→04/99	F3N 740	Petrol	1721	4	283
19 I (B/C53_)	1.7	09/98→04/99	F3N 741	Petrol	1721	4	284
19 I (B/C53_)	1.7	09/98→04/99	F3N 742	Petrol	1721	4	285
19 I (B/C53_)	1.7	09/98→04/99	F3N 743	Petrol	1721	4	286
19 I (B/C53_)	1.8	06/98→04/99	F7P 704	Petrol	1764	4	319
19 I (B/C53_)	1.9	09/99→04/99	F8Q 610	Diesel	1870	4	322
19 I (B/C53_)	1.9	09/98→04/99	F8Q 706	Diesel	1870	4	335
19 I (B/C53_)	1.9	09/98→04/99	F8Q 742	Diesel	1870	4	342
19 I Box (S53_)	1.2	01/98→12/99	C1G 730	Petrol	1237	4	60
19 I Box (S53_)	1.4	01/98→12/99	E6J 700	Petrol	1390	4	108
19 I Box (S53_)	1.9	01/98→12/99	F8Q 706	Diesel	1870	4	335
19 I Box (S53_)	1.9	01/98→12/99	F8Q 742	Diesel	1870	4	342
19 I Cabriolet (D53_)	1.7	07/99→04/99	F2N 724	Petrol	1721	4	265
19 I Cabriolet (D53_)	1.7	07/99→04/99	F3N 742	Petrol	1721	4	285
19 I Cabriolet (D53_)	1.7	07/99→04/99	F3N 743	Petrol	1721	4	286
19 I Cabriolet (D53_)	1.8	07/99→04/99	F7P 704	Petrol	1764	4	319
19 I Chamade (L53_)	1.2	01/98→12/99	C1G 730	Petrol	1237	4	60
19 I Chamade (L53_)	1.4	07/98→04/99	C2J 772	Petrol	1397	4	95
19 I Chamade (L53_)	1.4	07/98→04/99	C3J 710	Petrol	1397	4	105
19 I Chamade (L53_)	1.4	07/98→08/99	E6J 700	Petrol	1390	4	108
19 I Chamade (L53_)	1.4	07/98→08/99	E6J 701	Petrol	1390	4	109
19 I Chamade (L53_)	1.4	09/99→04/99	E7J 700	Petrol	1390	4	115
19 I Chamade (L53_)	1.7	09/98→12/99	F2N 720	Petrol	1721	4	263
19 I Chamade (L53_)	1.7	09/98→12/99	F2N 721	Petrol	1721	4	264
19 I Chamade (L53_)	1.7	10/98→04/99	F3N 740	Petrol	1721	4	283
19 I Chamade (L53_)	1.7	10/98→04/99	F3N 741	Petrol	1721	4	284
19 I Chamade (L53_)	1.7	07/98→04/99	F3N 742	Petrol	1721	4	285
19 I Chamade (L53_)	1.7	07/98→04/99	F3N 743	Petrol	1721	4	286
19 I Chamade (L53_)	1.7	08/98→12/99	F3N 746	Petrol	1721	4	287
19 I Chamade (L53_)	1.8	10/98→04/99	F7P 704	Petrol	1764	4	319
19 I Chamade (L53_)	1.9	10/98→04/99	F8Q 706	Diesel	1870	4	335
19 I Chamade (L53_)	1.9	09/99→04/99	F8Q 740	Diesel	1870	4	341
19 I Chamade (L53_)	1.9	10/98→04/99	F8Q 742	Diesel	1870	4	342
19 II (B/C53_)	1.2	04/99→12/99	C1G 730	Petrol	1237	4	60
19 II (B/C53_)	1.2	05/99→09/99	E7F 730	Petrol	1171	4	70
19 II (B/C53_)	1.4	04/99→12/99	C3J 710	Petrol	1397	4	105
19 II (B/C53_)	1.4	01/99→12/99	E6J 700	Petrol	1390	4	108
19 II (B/C53_)	1.4	01/99→12/99	E7J 706	Petrol	1390	4	116
19 II (B/C53_)	1.4	01/99→12/99	E7J 742	Petrol	1390	4	125
19 II (B/C53_)	1.7	04/99→12/99	F3N 740	Petrol	1721	4	283
19 II (B/C53_)	1.7	04/99→12/99	F3N 741	Petrol	1721	4	284
19 II (B/C53_)	1.7	04/99→12/99	F3N 743	Petrol	1721	4	286
19 II (B/C53_)	1.7	05/99→09/99	F3N 746	Petrol	1721	4	287
19 II (B/C53_)	1.8	05/99→12/99	F3P 682	Petrol	1783	4	292
19 II (B/C53_)	1.8	04/99→05/99	F3P 700	Petrol	1794	4	293
19 II (B/C53_)	1.8	04/99→12/99	F3P 706	Petrol	1794	4	296
19 II (B/C53_)	1.8	04/99→12/99	F3P 707	Petrol	1794	4	297
19 II (B/C53_)	1.8	04/99→12/99	F3P 708	Petrol	1794	4	298
19 II (B/C53_)	1.8	04/99→12/99	F3P 760	Petrol	1794	4	307
19 II (B/C53_)	1.8	05/99→12/99	F3P 765	Petrol	1794	4	309
19 II (B/C53_)	1.8	04/99→12/99	F7P 704	Petrol	1764	4	319
19 II (B/C53_)	1.9	04/99→12/99	F8Q 742	Diesel	1870	4	342
19 II (B/C53_)	1.9	04/99→12/99	F8Q 744	Diesel	1870	4	343
19 II Box (S53_)	1.2	03/99→12/99	C1G 730	Petrol	1237	4	60
19 II Box (S53_)	1.4	03/99→12/99	E6J 700	Petrol	1390	4	108
19 II Box (S53_)	1.9	03/99→12/99	F8Q 706	Diesel	1870	4	335
19 II Box (S53_)	1.9	03/99→12/99	F8Q 740	Diesel	1870	4	341
19 II Box (S53_)	1.9	03/99→12/99	F8Q 742	Diesel	1870	4	342
19 II Cabriolet (D53_ , 853_)	1.7	04/99→09/99	F3N 742	Petrol	1721	4	285
19 II Cabriolet (D53_ , 853_)	1.7	04/99→09/99	F3N 743	Petrol	1721	4	286
19 II Cabriolet (D53_ , 853_)	1.8	07/99→06/99	F3P 682	Petrol	1783	4	292
19 II Cabriolet (D53_ , 853_)	1.8	04/99→06/99	F3P 704	Petrol	1794	4	294
19 II Cabriolet (D53_ , 853_)	1.8	04/99→06/99	F3P 705	Petrol	1794	4	295
19 II Cabriolet (D53_ , 853_)	1.8	04/99→06/99	F3P 706	Petrol	1794	4	296
19 II Cabriolet (D53_ , 853_)	1.8	04/99→06/99	F3P 707	Petrol	1794	4	297
19 II Cabriolet (D53_ , 853_)	1.8	04/99→06/99	F3P 708	Petrol	1794	4	298
19 II Cabriolet (D53_ , 853_)	1.8	04/99→06/99	F3P 760	Petrol	1794	4	307
19 II Cabriolet (D53_ , 853_)	1.8	07/99→06/99	F3P 764	Petrol	1783	4	308



Ltr



CC



9

19 II Cabriolet (D53_853_)	1.8	07/99→06/99	F3P 765	Petrol	1794	4	309
19 II Cabriolet (D53_853_)	1.8	04/99→06/99	F7P 704	Petrol	1764	4	319
19 II Chamade (L53_)	1.4	05/99→09/99	C1J 742	Petrol	1397	4	77
19 II Chamade (L53_)	1.4	05/99→09/99	C2J 772	Petrol	1397	4	95
19 II Chamade (L53_)	1.4	04/99→12/99	C3J 710	Petrol	1397	4	105
19 II Chamade (L53_)	1.4	10/99→11/99	E6J 700	Petrol	1390	4	108
19 II Chamade (L53_)	1.4	10/99→11/99	E7J 706	Petrol	1390	4	116
19 II Chamade (L53_)	1.4	11/99→12/99	E7J 742	Petrol	1390	4	125
19 II Chamade (L53_)	1.7	01/99→08/99	F2N 720	Petrol	1721	4	263
19 II Chamade (L53_)	1.7	01/99→08/99	F2N 721	Petrol	1721	4	264
19 II Chamade (L53_)	1.7	04/99→12/99	F3N 740	Petrol	1721	4	283
19 II Chamade (L53_)	1.7	04/99→12/99	F3N 741	Petrol	1721	4	284
19 II Chamade (L53_)	1.7	04/99→12/99	F3N 742	Petrol	1721	4	285
19 II Chamade (L53_)	1.7	04/99→12/99	F3N 743	Petrol	1721	4	286
19 II Chamade (L53_)	1.8	05/99→12/99	F3P 682	Petrol	1783	4	292
19 II Chamade (L53_)	1.8	04/99→11/99	F3P 700	Petrol	1794	4	293
19 II Chamade (L53_)	1.8	04/99→12/99	F3P 704	Petrol	1794	4	294
19 II Chamade (L53_)	1.8	04/99→12/99	F3P 705	Petrol	1794	4	295
19 II Chamade (L53_)	1.8	04/99→12/99	F3P 706	Petrol	1794	4	296
19 II Chamade (L53_)	1.8	04/99→12/99	F3P 707	Petrol	1794	4	297
19 II Chamade (L53_)	1.8	04/99→12/99	F3P 708	Petrol	1794	4	298
19 II Chamade (L53_)	1.8	04/99→12/99	F3P 760	Petrol	1794	4	307
19 II Chamade (L53_)	1.8	05/99→09/99	F3P 765	Petrol	1794	4	309
19 II Chamade (L53_)	1.8	04/99→12/99	F7P 704	Petrol	1764	4	319
19 II Chamade (L53_)	1.9	04/99→12/99	F8Q 742	Diesel	1870	4	342
19 II Chamade (L53_)	1.9	04/99→12/99	F8Q 744	Diesel	1870	4	343
21 (B48_)	1.4	09/98→05/99	C2J 770	Petrol	1397	4	94
21 (B48_)	1.7	07/98→05/99	F2N 711	Petrol	1721	4	261
21 (B48_)	1.7	07/98→05/99	F2N 712	Petrol	1721	4	262
21 (B48_)	1.7	07/98→05/99	F2N 754	Petrol	1721	4	272
21 (B48_)	1.7	09/98→06/99	F3N 722	Petrol	1721	4	280
21 (B48_)	1.7	09/98→06/99	F3N 723	Petrol	1721	4	281
21 (B48_)	1.7	07/98→05/99	F3N 726	Petrol	1721	4	282
21 (B48_)	1.9	09/98→01/99	F8Q 710	Diesel	1870	4	336
21 (B48_)	2.0	07/98→05/99	J7R 740	Petrol	1995	4	498
21 (B48_)	2.0	09/98→12/99	J7R 746	Petrol	1995	4	499
21 (B48_)	2.0	09/98→12/99	J7R 747	Petrol	1995	4	500
21 (B48_)	2.0	07/98→06/99	J7R 750	Petrol	1995	4	501
21 (B48_)	2.0	07/98→06/99	J7R 751	Petrol	1995	4	502
21 (B48_)	2.0	07/98→05/99	J7R 754	Petrol	1995	4	504
21 (B48_)	2.1	09/98→12/99	J8S 600	Diesel	2068	4	526
21 (B48_)	2.1	07/98→05/99	J8S 704	Diesel	2068	4	530
21 (B48_)	2.1	09/98→06/99	J8S 714	Diesel	2068	4	533
21 (B48_)	2.1	09/98→12/99	J8S 740	Diesel	2068	4	536
21 (B48_)	2.1	07/98→06/99	J8S 784	Diesel	2068	4	544
21 (B48_)	2.1	09/98→06/99	J8S 786	Diesel	2068	4	545
21 (B48_)	2.1	09/98→06/99	J8S 788	Diesel	2068	4	546
21 (B48_)	2.2	09/98→06/99	J7T 754	Petrol	2165	4	582
21 (B48_)	2.2	07/98→06/99	J7T 755	Petrol	2165	4	583
21 Box (S48_)	1.7	06/98→04/99	F2N 710	Petrol	1721	4	260
21 Box (S48_)	1.9	06/98→08/99	F8Q 710	Diesel	1870	4	336
21 Box (S48_)	2.1	06/98→08/99	J8S 704	Diesel	2068	4	530
21 Estate (K48_)	1.7	10/98→12/98	F2N 710	Petrol	1721	4	260
21 Estate (K48_)	1.7	06/98→03/99	F2N 712	Petrol	1721	4	262
21 Estate (K48_)	1.7	06/98→12/98	F2N 750	Petrol	1721	4	270
21 Estate (K48_)	1.7	06/98→04/98	F2N 752	Petrol	1721	4	271
21 Estate (K48_)	1.7	06/98→12/99	F3N 722	Petrol	1721	4	280
21 Estate (K48_)	1.7	06/98→12/99	F3N 723	Petrol	1721	4	281
21 Estate (K48_)	1.7	05/98→06/99	F3N 726	Petrol	1721	4	282
21 Estate (K48_)	1.9	03/98→08/99	F8Q 710	Diesel	1870	4	336
21 Estate (K48_)	2.0	06/99→05/99	J6R 758	Petrol	1995	4	482
21 Estate (K48_)	2.0	06/99→05/99	J6R 759	Petrol	1995	4	483
21 Estate (K48_)	2.0	06/99→05/99	J6R 792	Petrol	1995	4	487
21 Estate (K48_)	2.0	06/99→02/99	J7R 740	Petrol	1995	4	498
21 Estate (K48_)	2.0	03/98→12/99	J7R 746	Petrol	1995	4	499
21 Estate (K48_)	2.0	03/98→12/99	J7R 747	Petrol	1995	4	500
21 Estate (K48_)	2.0	06/98→06/99	J7R 750	Petrol	1995	4	501
21 Estate (K48_)	2.0	06/98→06/99	J7R 751	Petrol	1995	4	502
21 Estate (K48_)	2.1	08/98→12/99	J8S 600	Diesel	2068	4	526
21 Estate (K48_)	2.1	10/98→05/99	J8S 704	Diesel	2068	4	530



Ltr



CC



9

21 Estate (K48_)	2.1	10/98 → 11/99	J8S 714	Diesel	2068	4	533
21 Estate (K48_)	2.1	08/98 → 12/99	J8S 740	Diesel	2068	4	536
21 Estate (K48_)	2.1	02/99 → 09/99	J8S 784	Diesel	2068	4	544
21 Estate (K48_)	2.1	10/98 → 11/99	J8S 786	Diesel	2068	4	545
21 Estate (K48_)	2.1	10/98 → 11/99	J8S 788	Diesel	2068	4	546
21 Estate (K48_)	2.2	06/98 → 12/99	J7T 754	Petrol	2165	4	582
21 Estate (K48_)	2.2	06/98 → 12/99	J7T 755	Petrol	2165	4	583
21 Saloon (L48_)	1.4	06/98 → 10/99	C2J 770	Petrol	1397	4	94
21 Saloon (L48_)	1.7	03/98 → 03/99	F2N 710	Petrol	1721	4	260
21 Saloon (L48_)	1.7	07/98 → 02/99	F2N 750	Petrol	1721	4	270
21 Saloon (L48_)	1.7	06/98 → 04/98	F2N 752	Petrol	1721	4	271
21 Saloon (L48_)	1.7	03/98 → 02/99	F3N 722	Petrol	1721	4	280
21 Saloon (L48_)	1.7	03/98 → 02/99	F3N 723	Petrol	1721	4	281
21 Saloon (L48_)	1.7	07/98 → 02/99	F3N 726	Petrol	1721	4	282
21 Saloon (L48_)	1.9	08/98 → 10/99	F8Q 710	Diesel	1870	4	336
21 Saloon (L48_)	2.0	03/98 → 10/99	J6R 758	Petrol	1995	4	482
21 Saloon (L48_)	2.0	03/98 → 10/99	J6R 759	Petrol	1995	4	483
21 Saloon (L48_)	2.0	03/98 → 10/99	J6R 792	Petrol	1995	4	487
21 Saloon (L48_)	2.0	03/98 → 10/99	J6R 793	Petrol	1995	4	488
21 Saloon (L48_)	2.0	12/98 → 06/99	J7R 740	Petrol	1995	4	498
21 Saloon (L48_)	2.0	03/98 → 12/99	J7R 746	Petrol	1995	4	499
21 Saloon (L48_)	2.0	03/98 → 12/99	J7R 747	Petrol	1995	4	500
21 Saloon (L48_)	2.0	03/98 → 06/98	J7R 750	Petrol	1995	4	501
21 Saloon (L48_)	2.0	03/98 → 06/98	J7R 751	Petrol	1995	4	502
21 Saloon (L48_)	2.0	04/98 → 10/99	J7R 752	Petrol	1995	4	503
21 Saloon (L48_)	2.0	02/99 → 10/99	J7R 756	Petrol	1995	4	505
21 Saloon (L48_)	2.1	05/98 → 06/99	J8S 600	Diesel	2068	4	526
21 Saloon (L48_)	2.1	03/98 → 12/98	J8S 704	Diesel	2068	4	530
21 Saloon (L48_)	2.1	03/98 → 06/99	J8S 714	Diesel	2068	4	533
21 Saloon (L48_)	2.1	05/98 → 06/99	J8S 740	Diesel	2068	4	536
21 Saloon (L48_)	2.1	10/99 → 06/99	J8S 784	Diesel	2068	4	544
21 Saloon (L48_)	2.1	03/98 → 06/99	J8S 786	Diesel	2068	4	545
21 Saloon (L48_)	2.1	03/98 → 06/99	J8S 788	Diesel	2068	4	546
21 Saloon (L48_)	2.2	07/98 → 02/99	J7T 754	Petrol	2165	4	582
21 Saloon (L48_)	2.2	04/98 → 02/99	J7T 755	Petrol	2165	4	583
25 (B29_)	2.0	04/98 → 12/99	J6R 706	Petrol	1995	4	479
25 (B29_)	2.0	04/98 → 12/99	J6R 707	Petrol	1995	4	480
25 (B29_)	2.0	04/98 → 12/99	J6R 760	Petrol	1995	4	484
25 (B29_)	2.0	04/98 → 12/99	J6R 762	Petrol	1995	4	485
25 (B29_)	2.0	04/98 → 12/99	J6R 763	Petrol	1995	4	486
25 (B29_)	2.0	06/98 → 12/99	J7R 720	Petrol	1995	4	489
25 (B29_)	2.0	06/98 → 12/99	J7R 721	Petrol	1995	4	490
25 (B29_)	2.0	03/98 → 12/99	J7R 722	Petrol	1995	4	491
25 (B29_)	2.0	03/98 → 12/99	J7R 723	Petrol	1995	4	492
25 (B29_)	2.0	06/98 → 12/99	J7R 726	Petrol	1995	4	493
25 (B29_)	2.1	04/98 → 05/98	J8S 706	Diesel	2068	4	531
25 (B29_)	2.1	04/98 → 12/99	J8S 708	Diesel	2068	4	532
25 (B29_)	2.1	06/98 → 12/99	J8S 736	Diesel	2068	4	534
25 (B29_)	2.1	04/98 → 12/99	J8S 738	Diesel	2068	4	535
25 (B29_)	2.2	04/98 → 12/98	J7T 706	Petrol	2165	4	573
25 (B29_)	2.2	04/98 → 12/98	J7T 707	Petrol	2165	4	574
25 (B29_)	2.2	09/98 → 12/99	J7T 708	Petrol	2165	4	575
25 (B29_)	2.2	04/98 → 12/98	J7T 714	Petrol	2165	4	576
25 (B29_)	2.2	04/98 → 12/98	J7T 715	Petrol	2165	4	577
25 (B29_)	2.2	04/98 → 12/98	J7T 730	Petrol	2165	4	578
25 (B29_)	2.2	04/98 → 12/98	J7T 731	Petrol	2165	4	579
25 (B29_)	2.2	09/98 → 12/99	J7T 732	Petrol	2165	4	580
25 (B29_)	2.2	09/98 → 12/99	J7T 733	Petrol	2165	4	581
25 (B29_)	2.4	10/98 → 05/99	Z7U 702	Petrol	2458	6	640
25 (B29_)	2.5	01/99 → 12/99	Z7U 700	Petrol	2458	6	639
25 (B29_)	2.7	04/98 → 08/98	Z7V 708	Petrol	2664	6	641
25 (B29_)	2.7	04/98 → 08/98	Z7V 709	Petrol	2664	6	642
25 (B29_)	2.7	04/98 → 08/98	Z7V 711	Petrol	2664	6	643
25 (B29_)	2.8	06/98 → 02/99	Z7W 700	Petrol	2849	6	645
25 (B29_)	2.8	06/98 → 12/99	Z7W 706	Petrol	2849	6	646
25 (B29_)	2.8	06/98 → 12/99	Z7W 707	Petrol	2849	6	647
25 (B29_)	2.8	06/98 → 12/99	Z7W 709	Petrol	2849	6	648
AVANTIME (DEO_)	2.0	11/00 → 05/00	F4R 760	Petrol	1998	4	429
AVANTIME (DEO_)	2.0	11/00 → 05/00	F4R 761	Petrol	1998	4	430
AVANTIME (DEO_)	2.2	05/00 → 05/00	G9T 712	Diesel	2188	4	566



Ltr







CC



9

Model	Ltr	Year Range	Engine Code	Fuel Type	CC	Power (kW)	Power (HP)
AVANTIME (DEO _)	3.0	09/00→05/00	L7X 720	Petrol	2946	6	655
AVANTIME (DEO _)	3.0	09/00→05/00	L7X 721	Petrol	2946	6	656
CLIO Grandtour (KRO/1 _)	1.2	02/00→	D4F 740	Petrol	1149	4	31
CLIO Grandtour (KRO/1 _)	1.2	02/00→	D4F 740	Flexfuel	1149	4	31
CLIO Grandtour (KRO/1 _)	1.2	02/00→	D4F 764	Petrol	1149	4	33
CLIO Grandtour (KRO/1 _)	1.2	02/00→	D4F 784	Petrol	1149	4	37
CLIO Grandtour (KRO/1 _)	1.4	02/01→	K4J 780	Petrol	1390	4	142
CLIO Grandtour (KRO/1 _)	1.5	02/00→	K9K 714	Diesel	1461	4	151
CLIO Grandtour (KRO/1 _)	1.5	02/01→	K9K 752	Diesel	1461	4	162
CLIO Grandtour (KRO/1 _)	1.5	02/00→	K9K 764	Diesel	1461	4	165
CLIO Grandtour (KRO/1 _)	1.5	02/00→	K9K 766	Diesel	1461	4	166
CLIO Grandtour (KRO/1 _)	1.5	02/00→	K9K 768	Diesel	1461	4	167
CLIO Grandtour (KRO/1 _)	1.5	08/01→	K9K 770	Diesel	1461	4	168
CLIO Grandtour (KRO/1 _)	1.5	02/00→	K9K 772	Diesel	1461	4	169
CLIO Grandtour (KRO/1 _)	1.6	02/00→	K4M 800	Petrol	1598	4	226
CLIO Grandtour (KRO/1 _)	1.6	02/00→	K4M 801	Petrol	1598	4	227
CLIO Grandtour (KRO/1 _)	1.6	11/00→	K4M 862	Petrol	1598	4	238
CLIO Grandtour IV	1.2	01/01→	D4F 740	Petrol	1149	4	31
CLIO Grandtour IV	1.2	01/01→	D4F 740	Flexfuel	1149	4	31
CLIO I (B/C57_ 5/357_)	1.1	01/99→09/99	C1E 700	Petrol	1108	4	11
CLIO I (B/C57_ 5/357_)	1.2	01/99→12/99	C3G 720	Petrol	1239	4	65
CLIO I (B/C57_ 5/357_)	1.2	01/99→09/99	D7F 730	Petrol	1149	4	48
CLIO I (B/C57_ 5/357_)	1.2	05/99→03/99	E5F 710	Petrol	1171	4	66
CLIO I (B/C57_ 5/357_)	1.2	05/99→09/99	E7F 700	Petrol	1171	4	67
CLIO I (B/C57_ 5/357_)	1.2	01/99→06/99	E7F 706	Petrol	1171	4	68
CLIO I (B/C57_ 5/357_)	1.2	05/99→09/99	E7F 708	Petrol	1171	4	69
CLIO I (B/C57_ 5/357_)	1.2	05/99→09/99	E7F 750	Petrol	1171	4	71
CLIO I (B/C57_ 5/357_)	1.4	01/99→09/99	E7J 601	Petrol	1390	4	110
CLIO I (B/C57_ 5/357_)	1.4	01/99→09/99	E7J 710	Petrol	1390	4	117
CLIO I (B/C57_ 5/357_)	1.4	01/99→09/99	E7J 711	Petrol	1390	4	118
CLIO I (B/C57_ 5/357_)	1.4	01/99→09/99	E7J 718	Petrol	1390	4	119
CLIO I (B/C57_ 5/357_)	1.4	01/99→09/99	E7J 719	Petrol	1390	4	120
CLIO I (B/C57_ 5/357_)	1.4	01/99→09/99	E7J 754	Petrol	1390	4	126
CLIO I (B/C57_ 5/357_)	1.4	01/99→09/99	E7J 756	Petrol	1390	4	127
CLIO I (B/C57_ 5/357_)	1.4	01/99→09/99	E7J 757	Petrol	1390	4	128
CLIO I (B/C57_ 5/357_)	1.7	01/99→12/99	F2N 770	Petrol	1721	4	273
CLIO I (B/C57_ 5/357_)	1.8	01/99→09/99	F3P 710	Petrol	1794	4	299
CLIO I (B/C57_ 5/357_)	1.8	01/99→08/99	F3P 712	Petrol	1794	4	300
CLIO I (B/C57_ 5/357_)	1.8	01/99→09/99	F3P 714	Petrol	1794	4	301
CLIO I (B/C57_ 5/357_)	1.8	08/99→09/99	F3P 754	Petrol	1794	4	304
CLIO I (B/C57_ 5/357_)	1.8	08/99→09/99	F3P 755	Petrol	1783	4	305
CLIO I (B/C57_ 5/357_)	1.8	08/99→09/99	F3P 758	Petrol	1783	4	306
CLIO I (B/C57_ 5/357_)	1.8	01/99→03/99	F7P 722	Petrol	1764	4	320
CLIO I (B/C57_ 5/357_)	1.9	05/99→02/99	F8Q 676	Diesel	1870	4	331
CLIO I (B/C57_ 5/357_)	1.9	01/99→09/99	F8Q 678	Diesel	1870	4	332
CLIO I (B/C57_ 5/357_)	1.9	05/99→02/99	F8Q 696	Diesel	1870	4	334
CLIO I (B/C57_ 5/357_)	1.9	01/99→09/99	F8Q 730	Diesel	1870	4	339
CLIO I (B/C57_ 5/357_)	1.9	01/99→09/99	F8Q 732	Diesel	1870	4	340
CLIO I (B/C57_ 5/357_)	2.0	01/99→09/99	F7R 700	Petrol	1998	4	469
CLIO I Box (S57_)	1.1	01/99→09/99	C1E 700	Petrol	1108	4	11
CLIO I Box (S57_)	1.2	06/99→02/99	C3G 720	Petrol	1239	4	65
CLIO I Box (S57_)	1.2	01/99→09/99	E7F 706	Petrol	1171	4	68
CLIO I Box (S57_)	1.2	01/99→09/99	E7F 750	Petrol	1171	4	71
CLIO I Box (S57_)	1.9	04/99→02/99	F8Q 678	Diesel	1870	4	332
CLIO I Box (S57_)	1.9	01/99→09/99	F8Q 730	Diesel	1870	4	339
CLIO I Box (S57_)	1.9	01/99→09/99	F8Q 732	Diesel	1870	4	340
CLIO II (BBO/1/2_ CBO/1/2_)	1.0	02/00→05/00	CG10DE	Petrol	998	4	8
CLIO II (BBO/1/2_ CBO/1/2_)	1.2	06/00→	D4F 706	Petrol	1149	4	23
CLIO II (BBO/1/2_ CBO/1/2_)	1.2	06/00→	D4F 712	Petrol	1149	4	25
CLIO II (BBO/1/2_ CBO/1/2_)	1.2	06/00→	D4F 714	Petrol	1149	4	26
CLIO II (BBO/1/2_ CBO/1/2_)	1.2	06/00→	D4F 722	Petrol	1149	4	28
CLIO II (BBO/1/2_ CBO/1/2_)	1.2	06/00→	D4F 728	Petrol	1149	4	29
CLIO II (BBO/1/2_ CBO/1/2_)	1.2	09/99→	D7F 720	Petrol	1149	4	45
CLIO II (BBO/1/2_ CBO/1/2_)	1.2	03/99→05/00	D7F 722	Petrol	1149	4	46
CLIO II (BBO/1/2_ CBO/1/2_)	1.2	09/99→	D7F 726	Petrol	1149	4	47
CLIO II (BBO/1/2_ CBO/1/2_)	1.2	09/99→	D7F 746	Petrol	1149	4	50
CLIO II (BBO/1/2_ CBO/1/2_)	1.2	09/99→	D7F 764	Petrol/Petroleum Gas (LPG)	1149	4	51
CLIO II (BBO/1/2_ CBO/1/2_)	1.2	09/99→	D7F 764	Petrol	1149	4	51
CLIO II (BBO/1/2_ CBO/1/2_)	1.2	09/99→	D7F 766	Petrol/Petroleum Gas (LPG)	1149	4	52
CLIO II (BBO/1/2_ CBO/1/2_)	1.2	09/99→	D7F 766	Petrol	1149	4	52

	Ltr				CC		9
CLIO II (BBO/1/2_, CBO/1/2_)	1.4	09/99→05/00	E7J 780	Petrol	1390	4	131
CLIO II (BBO/1/2_, CBO/1/2_)	1.4	08/00→	K4J 710	Petrol	1390	4	132
CLIO II (BBO/1/2_, CBO/1/2_)	1.4	08/00→	K4J 711	Petrol	1390	4	133
CLIO II (BBO/1/2_, CBO/1/2_)	1.4	10/99→	K4J 712	Petrol	1390	4	134
CLIO II (BBO/1/2_, CBO/1/2_)	1.4	10/99→	K4J 713	Petrol	1390	4	135
CLIO II (BBO/1/2_, CBO/1/2_)	1.5	06/00→	K9K 700	Diesel	1461	4	146
CLIO II (BBO/1/2_, CBO/1/2_)	1.5	06/00→	K9K 702	Diesel	1461	4	147
CLIO II (BBO/1/2_, CBO/1/2_)	1.5	06/00→	K9K 704	Diesel	1461	4	148
CLIO II (BBO/1/2_, CBO/1/2_)	1.5	01/00→	K9K 712	Diesel	1461	4	150
CLIO II (BBO/1/2_, CBO/1/2_)	1.5	08/00→	K9K 714	Diesel	1461	4	151
CLIO II (BBO/1/2_, CBO/1/2_)	1.5	02/00→	K9K 718	Diesel	1461	4	153
CLIO II (BBO/1/2_, CBO/1/2_)	1.5	06/00→	K9K 740	Diesel	1461	4	160
CLIO II (BBO/1/2_, CBO/1/2_)	1.6	09/99→	K4M 708	Petrol	1598	4	201
CLIO II (BBO/1/2_, CBO/1/2_)	1.6	09/99→	K4M 740	Petrol	1598	4	208
CLIO II (BBO/1/2_, CBO/1/2_)	1.6	09/99→	K4M 742	Petrol	1598	4	209
CLIO II (BBO/1/2_, CBO/1/2_)	1.6	09/99→	K4M 743	Petrol	1598	4	210
CLIO II (BBO/1/2_, CBO/1/2_)	1.6	09/99→	K4M 744	Petrol	1598	4	211
CLIO II (BBO/1/2_, CBO/1/2_)	1.6	09/99→	K4M 745	Petrol	1598	4	212
CLIO II (BBO/1/2_, CBO/1/2_)	1.6	09/99→	K4M 748	Petrol	1598	4	213
CLIO II (BBO/1/2_, CBO/1/2_)	1.6	09/99→	K4M 748	Flexfuel	1598	4	213
CLIO II (BBO/1/2_, CBO/1/2_)	1.6	09/99→05/00	K7M 744	Petrol	1598	4	249
CLIO II (BBO/1/2_, CBO/1/2_)	1.6	09/99→05/00	K7M 745	Petrol	1598	4	250
CLIO II (BBO/1/2_, CBO/1/2_)	1.9	09/99→05/00	F8Q 630	Diesel	1870	4	326
CLIO II (BBO/1/2_, CBO/1/2_)	1.9	02/00→05/00	F8Q 632	Diesel	1870	4	327
CLIO II (BBO/1/2_, CBO/1/2_)	1.9	12/99→05/00	F9Q 780	Diesel	1870	4	378
CLIO II (BBO/1/2_, CBO/1/2_)	2.0	02/00→	F4R 730	Petrol	1998	4	423
CLIO II (BBO/1/2_, CBO/1/2_)	2.0	01/00→	F4R 738	Petrol	1998	4	424
CLIO II (BBO/1/2_, CBO/1/2_)	3.0	11/00→12/00	L7X 760	Petrol	2946	6	660
CLIO II (BBO/1/2_, CBO/1/2_)	3.0	12/00→	L7X 762	Petrol	2946	6	661
CLIO II Box (SBO/1/2_)	1.1	09/99→	D7F 720	Petrol	1149	4	45
CLIO II Box (SBO/1/2_)	1.1	09/99→	D7F 726	Petrol	1149	4	47
CLIO II Box (SBO/1/2_)	1.1	09/99→	D7F 746	Petrol	1149	4	50
CLIO II Box (SBO/1/2_)	1.2	03/99→10/00	D7F 722	Petrol	1149	4	46
CLIO II Box (SBO/1/2_)	1.2	03/99→10/00	D7F 726	Petrol	1149	4	47
CLIO II Box (SBO/1/2_)	1.2	03/99→10/00	D7F 746	Petrol	1149	4	50
CLIO II Box (SBO/1/2_)	1.5	06/00→	K9K 700	Diesel	1461	4	146
CLIO II Box (SBO/1/2_)	1.5	06/00→	K9K 702	Diesel	1461	4	147
CLIO II Box (SBO/1/2_)	1.5	06/00→	K9K 704	Diesel	1461	4	148
CLIO II Box (SBO/1/2_)	1.5	11/00→	K9K 710	Diesel	1461	4	149
CLIO II Box (SBO/1/2_)	1.5	04/00→	K9K 714	Diesel	1461	4	151
CLIO II Box (SBO/1/2_)	1.5	11/00→	K9K 716	Diesel	1461	4	152
CLIO II Box (SBO/1/2_)	1.9	09/99→	F8Q 630	Diesel	1870	4	326
CLIO II Box (SBO/1/2_)	1.9	02/00→05/00	F8Q 632	Diesel	1870	4	327
CLIO II Box (SBO/1/2_)	1.9	02/00→05/00	F9Q 780	Diesel	1870	4	378
CLIO III (BRO/1, CRO/1)	1.2	06/00→	D4F 740	Petrol	1149	4	31
CLIO III (BRO/1, CRO/1)	1.2	06/00→	D4F 740	Flexfuel	1149	4	31
CLIO III (BRO/1, CRO/1)	1.2	07/00→	D4F 742	Flexfuel	1149	4	32
CLIO III (BRO/1, CRO/1)	1.2	06/00→	D4F 764	Petrol	1149	4	33
CLIO III (BRO/1, CRO/1)	1.2	05/00→	D4F 784	Petrol	1149	4	37
CLIO III (BRO/1, CRO/1)	1.4	06/00→	K4J 780	Petrol	1390	4	142
CLIO III (BRO/1, CRO/1)	1.5	06/00→	K9K 714	Diesel	1461	4	151
CLIO III (BRO/1, CRO/1)	1.5	11/00→	K9K 750	Diesel	1461	4	161
CLIO III (BRO/1, CRO/1)	1.5	05/00→	K9K 752	Diesel	1461	4	162
CLIO III (BRO/1, CRO/1)	1.5	06/00→	K9K 764	Diesel	1461	4	165
CLIO III (BRO/1, CRO/1)	1.5	06/00→	K9K 766	Diesel	1461	4	166
CLIO III (BRO/1, CRO/1)	1.5	06/00→	K9K 768	Diesel	1461	4	167
CLIO III (BRO/1, CRO/1)	1.5	08/01→	K9K 770	Diesel	1461	4	168
CLIO III (BRO/1, CRO/1)	1.5	06/00→	K9K 772	Diesel	1461	4	169
CLIO III (BRO/1, CRO/1)	1.6	05/00→02/01	K4M 748	Petrol	1598	4	213
CLIO III (BRO/1, CRO/1)	1.6	05/00→02/01	K4M 748	Flexfuel	1598	4	213
CLIO III (BRO/1, CRO/1)	1.6	06/00→	K4M 800	Petrol	1598	4	226
CLIO III (BRO/1, CRO/1)	1.6	06/00→	K4M 801	Petrol	1598	4	227
CLIO III (BRO/1, CRO/1)	1.6	06/00→	K4M 804	Petrol	1598	4	228
CLIO III (BRO/1, CRO/1)	1.6	06/00→	K4M 862	Petrol	1598	4	238
CLIO III (BRO/1, CRO/1)	2.0	02/00→	F4R 830	Petrol	1998	4	454
CLIO III (BRO/1, CRO/1)	2.0	09/00→	M4R 700	Petrol	1997	4	508
CLIO III (BRO/1, CRO/1)	2.0	09/00→	M4R 701	Petrol	1997	4	509
CLIO IV	1.2	11/01→	D4F 740	Petrol	1149	4	31
CLIO IV	1.2	11/01→	D4F 740	Flexfuel	1149	4	31
ESPACE I (J11_)	2.0	07/98→12/99	J6R 234	Petrol	1995	4	477



Ltr







CC



9

Model	Ltr	Year	Engine	Fuel	CC	Gear	Price
ESPACE I (J11 _)	2.0	07/98→12/99	J6R 236	Petrol	1995	4	478
ESPACE I (J11 _)	2.0	01/98→12/99	J6R 734	Petrol	1995	4	481
ESPACE I (J11 _)	2.0	03/98→12/99	J7R 760	Petrol	1995	4	506
ESPACE I (J11 _)	2.1	10/98→12/99	J8S 240	Diesel	2068	4	524
ESPACE I (J11 _)	2.1	10/98→12/99	J8S 774	Diesel	2068	4	541
ESPACE I (J11 _)	2.2	07/98→12/99	J7T 770	Petrol	2165	4	587
ESPACE II (J/S63 _)	2.0	01/99→10/99	J7R 768	Petrol	1995	4	507
ESPACE II (J/S63 _)	2.1	01/99→10/99	J8S 610	Diesel	2068	4	527
ESPACE II (J/S63 _)	2.1	11/99→10/99	J8S 612	Diesel	2068	4	528
ESPACE II (J/S63 _)	2.1	01/99→10/99	J8S 772	Diesel	2068	4	540
ESPACE II (J/S63 _)	2.1	01/99→10/99	J8S 776	Diesel	2068	4	542
ESPACE II (J/S63 _)	2.1	01/99→10/99	J8S 778	Diesel	2068	4	543
ESPACE II (J/S63 _)	2.2	01/99→12/99	J7T 772	Petrol	2165	4	588
ESPACE II (J/S63 _)	2.2	01/99→12/99	J7T 773	Petrol	2165	4	589
ESPACE II (J/S63 _)	2.2	01/99→10/99	J7T 776	Petrol	2165	4	590
ESPACE II (J/S63 _)	2.8	01/99→10/99	Z7W 712	Petrol	2849	6	649
ESPACE II (J/S63 _)	2.8	01/99→10/99	Z7W 713	Petrol	2849	6	650
ESPACE II (J/S63 _)	2.8	01/99→10/99	Z7W 717	Petrol	2849	6	651
ESPACE III (JEO _)	1.9	02/99→10/00	F9Q 722	Diesel	1870	4	357
ESPACE III (JEO _)	2.0	11/99→10/00	F3R 728	Petrol	1998	4	403
ESPACE III (JEO _)	2.0	11/99→10/00	F3R 729	Petrol	1998	4	404
ESPACE III (JEO _)	2.0	11/99→10/00	F3R 742	Petrol	1998	4	405
ESPACE III (JEO _)	2.0	11/99→10/00	F3R 768	Petrol	1998	4	409
ESPACE III (JEO _)	2.0	11/99→10/00	F3R 769	Petrol	1998	4	410
ESPACE III (JEO _)	2.0	10/99→10/00	F4R 700	Petrol	1998	4	415
ESPACE III (JEO _)	2.0	10/99→10/00	F4R 701	Petrol	1998	4	416
ESPACE III (JEO _)	2.2	11/99→10/00	G8T 714	Diesel	2188	4	548
ESPACE III (JEO _)	2.2	11/99→10/00	G8T 716	Diesel	2188	4	549
ESPACE III (JEO _)	2.2	11/99→10/00	G8T 760	Diesel	2188	4	552
ESPACE III (JEO _)	2.2	10/00→10/00	G9T 642	Diesel	2188	4	558
ESPACE III (JEO _)	2.2	07/00→10/00	G9T 710	Diesel	2188	4	565
ESPACE III (JEO _)	3.0	10/99→10/00	L7X 727	Petrol	2946	6	657
ESPACE III (JEO _)	3.0	11/99→10/99	Z7X 775	Petrol	2963	6	669
ESPACE IV (JKO/1 _)	1.9	11/00→	F9Q 680	Diesel	1870	4	352
ESPACE IV (JKO/1 _)	1.9	11/00→	F9Q 820	Diesel	1870	4	388
ESPACE IV (JKO/1 _)	1.9	11/00→	F9Q 826	Diesel	1870	4	389
ESPACE IV (JKO/1 _)	2.0	11/00→02/00	F4R 790	Petrol	1998	4	445
ESPACE IV (JKO/1 _)	2.0	11/00→	F4R 792	Petrol	1998	4	446
ESPACE IV (JKO/1 _)	2.0	11/00→	F4R 794	Petrol	1998	4	447
ESPACE IV (JKO/1 _)	2.0	11/00→	F4R 795	Petrol	1998	4	448
ESPACE IV (JKO/1 _)	2.0	11/00→	F4R 796	Petrol	1998	4	449
ESPACE IV (JKO/1 _)	2.0	11/00→	F4R 797	Petrol	1998	4	450
ESPACE IV (JKO/1 _)	2.0	04/00→	F4R 896	Petrol	1998	4	461
ESPACE IV (JKO/1 _)	2.0	04/00→	F4R 897	Petrol	1998	4	462
ESPACE IV (JKO/1 _)	2.0	01/00→	M9R 740	Diesel	1995	4	517
ESPACE IV (JKO/1 _)	2.0	01/00→	M9R 750	Diesel	1995	4	518
ESPACE IV (JKO/1 _)	2.0	01/00→	M9R 815	Diesel	1995	4	521
ESPACE IV (JKO/1 _)	2.2	02/00→	G9T 645	Diesel	2188	4	559
ESPACE IV (JKO/1 _)	2.2	11/00→	G9T 742	Diesel	2188	4	569
ESPACE IV (JKO/1 _)	2.2	11/00→	G9T 743	Diesel	2188	4	570
ESPACE IV (JKO/1 _)	3.0	11/00→	P9X 701	Diesel	2958	6	662
ESPACE IV (JKO/1 _)	3.5	11/00→	V4Y 711	Petrol	3498	6	671
ESPACE IV (JKO/1 _)	3.5	11/00→	V4Y 715	Petrol	3498	6	673
FLUENCE (L30 _)	1.5	02/01→	K9K 830	Diesel	1461	4	179
FLUENCE (L30 _)	1.5	06/00→	K9K 832	Diesel	1461	4	180
FLUENCE (L30 _)	1.5	02/01→	K9K 834	Diesel	1461	4	181
FLUENCE (L30 _)	1.5	02/01→	K9K 836	Diesel	1461	4	182
FLUENCE (L30 _)	1.5	02/01→	K9K 837	Diesel	1461	4	183
FLUENCE (L30 _)	1.6	02/01→	K4M 838	Petrol	1598	4	234
FLUENCE (L30 _)	1.6	02/01→	K4M 839	Petrol	1598	4	235
GRAND SCÉNIC II (JMO/1 _)	1.5	04/00→	K9K 728	Diesel	1461	4	156
GRAND SCÉNIC II (JMO/1 _)	1.5	05/00→	K9K P 732	Diesel	1461	4	189
GRAND SCÉNIC II (JMO/1 _)	1.6	04/00→	K4M 761	Petrol	1598	4	218
GRAND SCÉNIC II (JMO/1 _)	1.6	04/00→	K4M 782	Petrol	1598	4	221
GRAND SCÉNIC II (JMO/1 _)	1.6	06/00→	K4M 788	Petrol	1598	4	222
GRAND SCÉNIC II (JMO/1 _)	1.6	06/00→	K4M 788	Flexfuel	1598	4	222
GRAND SCÉNIC II (JMO/1 _)	1.9	04/00→	F9Q 812	Diesel	1870	4	385
GRAND SCÉNIC II (JMO/1 _)	1.9	05/00→	F9Q 816	Diesel	1870	4	386
GRAND SCÉNIC II (JMO/1 _)	1.9	05/00→	F9Q 818	Diesel	1870	4	387
GRAND SCÉNIC II (JMO/1 _)	1.9	05/00→	F9Q E 804	Diesel	1870	4	392

	Ltr				CC		9
GRAND SCÉNIC II (JMO/1_)	1.9	05/00→	F9Q EE 804	Diesel	1870	4	393
GRAND SCÉNIC II (JMO/1_)	1.9	05/00→	F9Q J 803	Diesel	1870	4	394
GRAND SCÉNIC II (JMO/1_)	2.0	04/00→	F4R 770	Petrol	1998	4	437
GRAND SCÉNIC II (JMO/1_)	2.0	04/00→	F4R 771	Petrol	1998	4	438
GRAND SCÉNIC II (JMO/1_)	2.0	04/00→	F4R 776	Petrol	1998	4	440
GRAND SCÉNIC II (JMO/1_)	2.0	09/00→	M9R 700	Diesel	1995	4	514
GRAND SCÉNIC II (JMO/1_)	2.0	09/00→	M9R 721	Diesel	1995	4	515
GRAND SCÉNIC II (JMO/1_)	2.0	09/00→	M9R 722	Diesel	1995	4	516
GRAND SCÉNIC III (JZO/1_)	1.5	04/00→	K9K 830	Diesel	1461	4	179
GRAND SCÉNIC III (JZO/1_)	1.5	02/00→	K9K 832	Diesel	1461	4	180
GRAND SCÉNIC III (JZO/1_)	1.5	04/00→	K9K 836	Diesel	1461	4	182
GRAND SCÉNIC III (JZO/1_)	1.5	04/00→	K9K 837	Diesel	1461	4	183
GRAND SCÉNIC III (JZO/1_)	1.5	11/01→	K9K 846	Diesel	1461	4	184
GRAND SCÉNIC III (JZO/1_)	1.6	02/00→	K4M 858	Petrol	1598	4	237
GRAND SCÉNIC III (JZO/1_)	1.6	02/00→	K4M 866	Petrol	1598	4	239
GRAND SCÉNIC III (JZO/1_)	1.6	02/00→	K4M 866	Flexfuel	1598	4	239
GRAND SCÉNIC III (JZO/1_)	1.6	02/00→	K4M 866	Bi-Fuel	1598	4	239
GRAND SCÉNIC III (JZO/1_)	1.9	02/00→	F9Q 870	Diesel	1870	4	390
GRAND SCÉNIC III (JZO/1_)	1.9	02/00→	F9Q 872	Diesel	1870	4	391
GRAND SCÉNIC III (JZO/1_)	2.0	02/00→	M4R 711	Petrol	1997	4	511
KANGOO (KCO/1_)	1.2	06/00→	D4F 712	Petrol	1149	4	25
KANGOO (KCO/1_)	1.2	06/00→	D4F 714	Petrol	1149	4	26
KANGOO (KCO/1_)	1.2	06/00→	D4F 716	Petrol	1149	4	27
KANGOO (KCO/1_)	1.2	08/99→	D7F 710	Petrol	1149	4	44
KANGOO (KCO/1_)	1.2	08/99→	D7F 720	Petrol	1149	4	45
KANGOO (KCO/1_)	1.2	08/99→	D7F 722	Petrol	1149	4	46
KANGOO (KCO/1_)	1.2	08/99→	D7F 726	Petrol	1149	4	47
KANGOO (KCO/1_)	1.2	08/99→	D7F 744	Petrol	1149	4	49
KANGOO (KCO/1_)	1.2	08/99→	D7F 746	Petrol	1149	4	50
KANGOO (KCO/1_)	1.4	08/99→	E7J 634	Petrol	1390	4	113
KANGOO (KCO/1_)	1.4	08/99→	E7J 635	Petrol	1390	4	114
KANGOO (KCO/1_)	1.4	08/99→	E7J 780	Petrol	1390	4	131
KANGOO (KCO/1_)	1.4	08/99→	K7J 700	Petrol	1390	4	143
KANGOO (KCO/1_)	1.4	08/99→	K7J 701	Petrol	1390	4	144
KANGOO (KCO/1_)	1.5	12/00→	K9K 700	Diesel	1461	4	146
KANGOO (KCO/1_)	1.5	07/00→	K9K 702	Diesel	1461	4	147
KANGOO (KCO/1_)	1.5	12/00→	K9K 704	Diesel	1461	4	148
KANGOO (KCO/1_)	1.5	07/00→	K9K 710	Diesel	1461	4	149
KANGOO (KCO/1_)	1.5	06/00→	K9K 714	Diesel	1461	4	151
KANGOO (KCO/1_)	1.5	06/00→	K9K 718	Diesel	1461	4	153
KANGOO (KCO/1_)	1.6	06/00→	K4M 750	Petrol	1598	4	214
KANGOO (KCO/1_)	1.6	06/00→	K4M 752	Petrol	1598	4	215
KANGOO (KCO/1_)	1.6	06/00→	K4M 753	Petrol	1598	4	216
KANGOO (KCO/1_)	1.6	09/99→06/00	K7M 746	Petrol	1598	4	251
KANGOO (KCO/1_)	1.9	08/99→	F8Q 630	Diesel	1870	4	326
KANGOO (KCO/1_)	1.9	08/99→	F8Q 632	Diesel	1870	4	327
KANGOO (KCO/1_)	1.9	08/99→	F8Q 662	Diesel	1870	4	330
KANGOO (KCO/1_)	1.9	02/00→	F9Q 780	Diesel	1870	4	378
KANGOO (KCO/1_)	1.9	10/00→	F9Q 782	Diesel	1870	4	379
KANGOO (KCO/1_)	1.9	10/00→	F9Q 790	Diesel	1870	4	380
KANGOO / GRAND KANGOO (KWO/1_)	1.5	02/00→	K9K 800	Diesel	1461	4	173
KANGOO / GRAND KANGOO (KWO/1_)	1.5	02/00→	K9K 802	Diesel	1461	4	174
KANGOO / GRAND KANGOO (KWO/1_)	1.5	02/00→	K9K 804	Diesel	1461	4	175
KANGOO / GRAND KANGOO (KWO/1_)	1.5	02/00→	K9K 806	Diesel	1461	4	176
KANGOO / GRAND KANGOO (KWO/1_)	1.5	11/01→	K9K 808	Diesel	1461	4	177
KANGOO / GRAND KANGOO (KWO/1_)	1.6	02/00→	K4M 830	Petrol	1598	4	232
KANGOO / GRAND KANGOO (KWO/1_)	1.6	02/00→	K7M 750	Petrol	1598	4	252
KANGOO BE BOP (KWO/1_)	1.5	09/01→	K9K 802	Diesel	1461	4	174
KANGOO BE BOP (KWO/1_)	1.5	06/00→	K9K 804	Diesel	1461	4	175
KANGOO BE BOP (KWO/1_)	1.5	02/00→	K9K 806	Diesel	1461	4	176
KANGOO BE BOP (KWO/1_)	1.5	06/00→	K9K 808	Diesel	1461	4	177
KANGOO BE BOP (KWO/1_)	1.6	02/00→	K4M 830	Petrol	1598	4	232
KANGOO Express (FCO/1_)	1.0	07/00→	CG10DE	Petrol	998	4	8
KANGOO Express (FCO/1_)	1.2	10/00→	D4F 712	Petrol	1149	4	25
KANGOO Express (FCO/1_)	1.2	10/00→	D4F 714	Petrol	1149	4	26
KANGOO Express (FCO/1_)	1.2	10/00→	D4F 730	Petrol	1149	4	30
KANGOO Express (FCO/1_)	1.2	08/99→	D7F 710	Petrol	1149	4	44
KANGOO Express (FCO/1_)	1.2	08/99→	D7F 720	Petrol	1149	4	45
KANGOO Express (FCO/1_)	1.2	08/99→	D7F 722	Petrol	1149	4	46
KANGOO Express (FCO/1_)	1.2	08/99→	D7F 726	Petrol	1149	4	47



Ltr







CC



9

Model	Ltr	Year	Engine	Fuel	CC	Power	Price
KANGOO Express (FCO/1_)	1.2	08/99→	D7F 744	Petrol	1149	4	49
KANGOO Express (FCO/1_)	1.2	08/99→	D7F 746	Petrol	1149	4	50
KANGOO Express (FCO/1_)	1.2	07/99→07/00	D7F 764	Petrol/Petroleum Gas (LPG)	1149	4	51
KANGOO Express (FCO/1_)	1.2	07/99→07/00	D7F 764	Petrol	1149	4	51
KANGOO Express (FCO/1_)	1.2	07/99→07/00	D7F 766	Petrol/Petroleum Gas (LPG)	1149	4	52
KANGOO Express (FCO/1_)	1.2	07/99→07/00	D7F 766	Petrol	1149	4	52
KANGOO Express (FCO/1_)	1.4	08/99→	E7J 634	Petrol	1390	4	113
KANGOO Express (FCO/1_)	1.4	08/99→	E7J 635	Petrol	1390	4	114
KANGOO Express (FCO/1_)	1.4	08/99→	E7J 780	Petrol	1390	4	131
KANGOO Express (FCO/1_)	1.4	08/99→	K7J 701	Petrol	1390	4	144
KANGOO Express (FCO/1_)	1.5	12/00→	K9K 700	Diesel	1461	4	146
KANGOO Express (FCO/1_)	1.5	12/00→	K9K 702	Diesel	1461	4	147
KANGOO Express (FCO/1_)	1.5	12/00→	K9K 704	Diesel	1461	4	148
KANGOO Express (FCO/1_)	1.5	04/00→	K9K 710	Diesel	1461	4	149
KANGOO Express (FCO/1_)	1.5	06/00→	K9K 714	Diesel	1461	4	151
KANGOO Express (FCO/1_)	1.5	06/00→	K9K 718	Diesel	1461	4	153
KANGOO Express (FCO/1_)	1.6	10/00→	K4M 750	Petrol	1598	4	214
KANGOO Express (FCO/1_)	1.6	10/00→	K4M 752	Petrol	1598	4	215
KANGOO Express (FCO/1_)	1.6	10/00→	K4M 753	Petrol	1598	4	216
KANGOO Express (FCO/1_)	1.9	08/99→	F8Q 630	Diesel	1870	4	326
KANGOO Express (FCO/1_)	1.9	08/99→	F8Q 632	Diesel	1870	4	327
KANGOO Express (FCO/1_)	1.9	08/99→	F8Q 662	Diesel	1870	4	330
KANGOO Express (FCO/1_)	1.9	02/00→	F9Q 780	Diesel	1870	4	378
KANGOO Express (FCO/1_)	1.9	10/00→	F9Q 782	Diesel	1870	4	379
KANGOO Express (FCO/1_)	1.9	10/00→	F9Q 790	Diesel	1870	4	380
KANGOO Express (FWO/1_)	1.5	02/00→	K9K 800	Diesel	1461	4	173
KANGOO Express (FWO/1_)	1.5	02/00→	K9K 802	Diesel	1461	4	174
KANGOO Express (FWO/1_)	1.5	09/01→	K9K 804	Diesel	1461	4	175
KANGOO Express (FWO/1_)	1.5	02/00→	K9K 806	Diesel	1461	4	176
KANGOO Express (FWO/1_)	1.5	06/00→	K9K 808	Diesel	1461	4	177
KANGOO Express (FWO/1_)	1.6	02/00→	K4M 830	Petrol	1598	4	232
KANGOO Express (FWO/1_)	1.6	02/00→	K4M 834	Petrol/Petroleum Gas (LPG)	1598	4	233
KANGOO Express (FWO/1_)	1.6	02/00→	K7M 750	Petrol	1598	4	252
LAGUNA Coupe (DTO/1)	1.5	03/01→	K9K 846	Diesel	1461	4	184
LAGUNA Coupe (DTO/1)	2.0	09/00→	F4R 811	Petrol	1998	4	452
LAGUNA Coupe (DTO/1)	2.0	09/00→	F4Rt 800	Petrol	1998	4	464
LAGUNA Coupe (DTO/1)	2.0	09/00→	F4Rt 811	Petrol	1998	4	465
LAGUNA Coupe (DTO/1)	2.0	09/00→	M9R 815	Diesel	1995	4	521
LAGUNA Coupe (DTO/1)	3.5	09/00→	V4Y 713	Petrol	3498	6	672
LAGUNA I (B56_, 556_)	1.6	11/99→03/00	K4M 720	Petrol	1598	4	207
LAGUNA I (B56_, 556_)	1.8	08/99→03/00	F3P 670	Petrol	1783	4	288
LAGUNA I (B56_, 556_)	1.8	06/99→02/00	F3P 674	Petrol	1783	4	289
LAGUNA I (B56_, 556_)	1.8	06/99→06/99	F3P 676	Petrol	1794	4	290
LAGUNA I (B56_, 556_)	1.8	08/99→03/00	F3P 678	Petrol	1783	4	291
LAGUNA I (B56_, 556_)	1.8	11/99→03/00	F3P 720	Petrol	1794	4	302
LAGUNA I (B56_, 556_)	1.8	11/99→03/00	F3P 724	Petrol	1794	4	303
LAGUNA I (B56_, 556_)	1.8	04/99→03/00	F4P 760	Petrol	1783	4	312
LAGUNA I (B56_, 556_)	1.9	10/99→03/00	F9Q 710	Diesel	1870	4	353
LAGUNA I (B56_, 556_)	1.9	10/99→03/00	F9Q 716	Diesel	1870	4	354
LAGUNA I (B56_, 556_)	1.9	10/99→03/00	F9Q 717	Diesel	1870	4	355
LAGUNA I (B56_, 556_)	1.9	09/99→03/00	F9Q 718	Diesel	1870	4	356
LAGUNA I (B56_, 556_)	2.0	03/99→03/00	F3R 611	Petrol	1998	4	400
LAGUNA I (B56_, 556_)	2.0	11/99→03/00	F3R 722	Petrol	1998	4	401
LAGUNA I (B56_, 556_)	2.0	11/99→03/00	F3R 723	Petrol	1998	4	402
LAGUNA I (B56_, 556_)	2.0	06/99→02/00	F3R 768	Petrol	1998	4	409
LAGUNA I (B56_, 556_)	2.0	09/99→03/00	F4R 780	Petrol	1998	4	441
LAGUNA I (B56_, 556_)	2.0	06/99→03/00	N7Q 700	Petrol	1948	4	395
LAGUNA I (B56_, 556_)	2.0	06/99→03/00	N7Q 704	Petrol	1948	4	396
LAGUNA I (B56_, 556_)	2.2	11/99→03/00	G8T 706	Diesel	2188	4	547
LAGUNA I (B56_, 556_)	2.2	11/99→03/00	G8T 752	Diesel	2188	4	551
LAGUNA I (B56_, 556_)	2.2	03/99→03/00	G8T 760	Diesel	2188	4	552
LAGUNA I (B56_, 556_)	2.2	11/99→03/00	G8T 790	Diesel	2188	4	553
LAGUNA I (B56_, 556_)	2.2	11/99→03/00	G8T 794	Diesel	2188	4	554
LAGUNA I (B56_, 556_)	3.0	03/99→03/00	L7X 700	Petrol	2946	6	652
LAGUNA I (B56_, 556_)	3.0	03/99→03/00	L7X 701	Petrol	2946	6	653
LAGUNA I (B56_, 556_)	3.0	11/99→03/00	Z7X 760	Petrol	2963	6	667
LAGUNA I (B56_, 556_)	3.0	11/99→03/00	Z7X 765	Petrol	2963	6	668
LAGUNA I Grandtour (K56_)	1.6	11/99→03/00	K4M 720	Petrol	1598	4	207
LAGUNA I Grandtour (K56_)	1.8	09/99→03/00	F3P 670	Petrol	1783	4	288
LAGUNA I Grandtour (K56_)	1.8	09/99→03/00	F3P 678	Petrol	1783	4	291

	Ltr				CC		9
LAGUNA I Grandtour (K56_)	1.8	09/99→03/00	F3P 720	Petrol	1794	4	302
LAGUNA I Grandtour (K56_)	1.8	09/99→03/00	F3P 724	Petrol	1794	4	303
LAGUNA I Grandtour (K56_)	1.8	04/99→03/00	F4P 760	Petrol	1783	4	312
LAGUNA I Grandtour (K56_)	1.9	10/99→03/00	F9Q 710	Diesel	1870	4	353
LAGUNA I Grandtour (K56_)	1.9	10/99→03/00	F9Q 716	Diesel	1870	4	354
LAGUNA I Grandtour (K56_)	1.9	10/99→03/00	F9Q 717	Diesel	1870	4	355
LAGUNA I Grandtour (K56_)	1.9	09/99→03/00	F9Q 718	Diesel	1870	4	356
LAGUNA I Grandtour (K56_)	2.0	09/99→03/00	F3R 722	Petrol	1998	4	401
LAGUNA I Grandtour (K56_)	2.0	09/99→03/00	F3R 723	Petrol	1998	4	402
LAGUNA I Grandtour (K56_)	2.0	10/99→01/00	F3R 768	Petrol	1998	4	409
LAGUNA I Grandtour (K56_)	2.0	09/99→03/00	F4R 780	Petrol	1998	4	441
LAGUNA I Grandtour (K56_)	2.0	09/99→03/00	N7Q 700	Petrol	1948	4	395
LAGUNA I Grandtour (K56_)	2.0	09/99→03/00	N7Q 704	Petrol	1948	4	396
LAGUNA I Grandtour (K56_)	2.2	09/99→03/00	G8T 706	Diesel	2188	4	547
LAGUNA I Grandtour (K56_)	2.2	09/99→03/00	G8T 752	Diesel	2188	4	551
LAGUNA I Grandtour (K56_)	2.2	03/99→03/00	G8T 760	Diesel	2188	4	552
LAGUNA I Grandtour (K56_)	2.2	09/99→03/00	G8T 790	Diesel	2188	4	553
LAGUNA I Grandtour (K56_)	2.2	09/99→03/00	G8T 794	Diesel	2188	4	554
LAGUNA I Grandtour (K56_)	3.0	03/99→03/00	L7X 700	Petrol	2946	6	652
LAGUNA I Grandtour (K56_)	3.0	03/99→03/00	L7X 701	Petrol	2946	6	653
LAGUNA I Grandtour (K56_)	3.0	02/99→03/00	Z7X 765	Petrol	2963	6	668
LAGUNA II (BGO/1_)	1.6	03/00→	K4M 710	Petrol	1598	4	203
LAGUNA II (BGO/1_)	1.6	03/00→	K4M 714	Petrol	1598	4	204
LAGUNA II (BGO/1_)	1.6	02/00→	K4M 716	Petrol	1598	4	205
LAGUNA II (BGO/1_)	1.8	03/00→	F4P 770	Petrol	1783	4	313
LAGUNA II (BGO/1_)	1.8	03/00→	F4P 771	Petrol	1783	4	314
LAGUNA II (BGO/1_)	1.8	03/00→	F4P 772	Petrol	1783	4	315
LAGUNA II (BGO/1_)	1.8	03/00→	F4P 773	Petrol	1783	4	316
LAGUNA II (BGO/1_)	1.8	03/00→	F4P 774	Petrol	1783	4	317
LAGUNA II (BGO/1_)	1.8	03/00→	F4P 775	Petrol	1783	4	318
LAGUNA II (BGO/1_)	1.9	03/00→	F9Q 664	Diesel	1870	4	349
LAGUNA II (BGO/1_)	1.9	03/00→	F9Q 670	Diesel	1870	4	350
LAGUNA II (BGO/1_)	1.9	03/00→	F9Q 674	Diesel	1870	4	351
LAGUNA II (BGO/1_)	1.9	03/00→	F9Q 718	Diesel	1870	4	356
LAGUNA II (BGO/1_)	1.9	03/00→	F9Q 750	Diesel	1870	4	368
LAGUNA II (BGO/1_)	1.9	06/00→	F9Q 752	Diesel	1870	4	369
LAGUNA II (BGO/1_)	1.9	03/00→	F9Q 754	Diesel	1870	4	370
LAGUNA II (BGO/1_)	1.9	01/00→	F9Q 758	Diesel	1870	4	371
LAGUNA II (BGO/1_)	1.9	05/00→	F9Q 759	Diesel	1870	4	372
LAGUNA II (BGO/1_)	2.0	08/00→	F4R 712	Petrol	1998	4	417
LAGUNA II (BGO/1_)	2.0	08/00→	F4R 713	Petrol	1998	4	418
LAGUNA II (BGO/1_)	2.0	08/00→	F4R 714	Petrol	1998	4	419
LAGUNA II (BGO/1_)	2.0	08/00→	F4R 715	Petrol	1998	4	420
LAGUNA II (BGO/1_)	2.0	01/00→	F4R 764	Petrol	1998	4	433
LAGUNA II (BGO/1_)	2.0	01/00→	F4R 765	Petrol	1998	4	434
LAGUNA II (BGO/1_)	2.0	01/00→	F4R 784	Petrol	1998	4	442
LAGUNA II (BGO/1_)	2.0	01/00→	F4R 786	Petrol	1998	4	443
LAGUNA II (BGO/1_)	2.0	01/00→	F4R 787	Petrol	1998	4	444
LAGUNA II (BGO/1_)	2.0	01/00→	F4R 886	Petrol	1998	4	459
LAGUNA II (BGO/1_)	2.0	01/00→	F4R 887	Petrol	1998	4	460
LAGUNA II (BGO/1_)	2.0	04/00→	F5R 700	Petrol	1998	4	466
LAGUNA II (BGO/1_)	2.0	04/00→	F5R 701	Petrol	1998	4	467
LAGUNA II (BGO/1_)	2.0	08/00→	M9R 740	Diesel	1995	4	517
LAGUNA II (BGO/1_)	2.2	04/00→	G9T 600	Diesel	2188	4	555
LAGUNA II (BGO/1_)	2.2	05/00→	G9T 605	Diesel	2188	4	556
LAGUNA II (BGO/1_)	2.2	10/00→	G9T 700	Diesel	2188	4	560
LAGUNA II (BGO/1_)	2.2	10/00→	G9T 702	Diesel	2188	4	561
LAGUNA II (BGO/1_)	2.2	05/00→	G9T 706	Diesel	2188	4	563
LAGUNA II (BGO/1_)	2.2	05/00→	G9T 707	Diesel	2188	4	564
LAGUNA II (BGO/1_)	3.0	03/00→	L7X 731	Petrol	2946	6	658
LAGUNA II Grandtour (KGO/1_)	1.6	03/00→	K4M 710	Petrol	1598	4	203
LAGUNA II Grandtour (KGO/1_)	1.6	03/00→	K4M 714	Petrol	1598	4	204
LAGUNA II Grandtour (KGO/1_)	1.6	02/00→	K4M 716	Petrol	1598	4	205
LAGUNA II Grandtour (KGO/1_)	1.6	06/00→10/00	K4M 718	Petrol	1598	4	206
LAGUNA II Grandtour (KGO/1_)	1.8	03/00→	F4P 770	Petrol	1783	4	313
LAGUNA II Grandtour (KGO/1_)	1.8	03/00→	F4P 771	Petrol	1783	4	314
LAGUNA II Grandtour (KGO/1_)	1.8	03/00→	F4P 773	Petrol	1783	4	316
LAGUNA II Grandtour (KGO/1_)	1.8	03/00→	F4P 774	Petrol	1783	4	317
LAGUNA II Grandtour (KGO/1_)	1.8	03/00→	F4P 775	Petrol	1783	4	318
LAGUNA II Grandtour (KGO/1_)	1.9	03/00→	F9Q 664	Diesel	1870	4	349



Ltr







CC



9

Model	Ltr	Year	Engine	Fuel	CC	Power	Price
LAGUNA II Grandtour (KGO/1_)	1.9	03/00→	F9Q 670	Diesel	1870	4	350
LAGUNA II Grandtour (KGO/1_)	1.9	03/00→	F9Q 674	Diesel	1870	4	351
LAGUNA II Grandtour (KGO/1_)	1.9	03/00→	F9Q 718	Diesel	1870	4	356
LAGUNA II Grandtour (KGO/1_)	1.9	03/00→	F9Q 750	Diesel	1870	4	368
LAGUNA II Grandtour (KGO/1_)	1.9	06/00→	F9Q 752	Diesel	1870	4	369
LAGUNA II Grandtour (KGO/1_)	1.9	03/00→	F9Q 754	Diesel	1870	4	370
LAGUNA II Grandtour (KGO/1_)	1.9	01/00→	F9Q 758	Diesel	1870	4	371
LAGUNA II Grandtour (KGO/1_)	1.9	05/00→	F9Q 759	Diesel	1870	4	372
LAGUNA II Grandtour (KGO/1_)	2.0	08/00→	F4R 712	Petrol	1998	4	417
LAGUNA II Grandtour (KGO/1_)	2.0	08/00→	F4R 713	Petrol	1998	4	418
LAGUNA II Grandtour (KGO/1_)	2.0	08/00→	F4R 714	Petrol	1998	4	419
LAGUNA II Grandtour (KGO/1_)	2.0	08/00→	F4R 715	Petrol	1998	4	420
LAGUNA II Grandtour (KGO/1_)	2.0	01/00→	F4R 764	Petrol	1998	4	433
LAGUNA II Grandtour (KGO/1_)	2.0	01/00→	F4R 765	Petrol	1998	4	434
LAGUNA II Grandtour (KGO/1_)	2.0	01/00→	F4R 784	Petrol	1998	4	442
LAGUNA II Grandtour (KGO/1_)	2.0	01/00→	F4R 786	Petrol	1998	4	443
LAGUNA II Grandtour (KGO/1_)	2.0	01/00→	F4R 787	Petrol	1998	4	444
LAGUNA II Grandtour (KGO/1_)	2.0	01/00→	F4R 886	Petrol	1998	4	459
LAGUNA II Grandtour (KGO/1_)	2.0	01/00→	F4R 887	Petrol	1998	4	460
LAGUNA II Grandtour (KGO/1_)	2.0	04/00→	F5R 700	Petrol	1998	4	466
LAGUNA II Grandtour (KGO/1_)	2.0	04/00→	F5R 701	Petrol	1998	4	467
LAGUNA II Grandtour (KGO/1_)	2.0	08/00→	M9R 740	Diesel	1995	4	517
LAGUNA II Grandtour (KGO/1_)	2.2	04/00→	G9T 600	Diesel	2188	4	555
LAGUNA II Grandtour (KGO/1_)	2.2	10/00→	G9T 702	Diesel	2188	4	561
LAGUNA II Grandtour (KGO/1_)	2.2	05/00→	G9T 706	Diesel	2188	4	563
LAGUNA II Grandtour (KGO/1_)	2.2	05/00→	G9T 707	Diesel	2188	4	564
LAGUNA II Grandtour (KGO/1_)	3.0	03/00→	L7X 731	Petrol	2946	6	658
LAGUNA III (BTO/1)	1.5	10/00→	K9K 780	Diesel	1461	4	170
LAGUNA III (BTO/1)	1.6	10/00→	K4M 824	Petrol	1598	4	231
LAGUNA III (BTO/1)	2.0	03/00→	F4R 800	Petrol	1998	4	451
LAGUNA III (BTO/1)	2.0	10/00→	F4R 811	Petrol	1998	4	452
LAGUNA III (BTO/1)	2.0	10/00→	M4R 704	Petrol	1997	4	510
LAGUNA III (BTO/1)	2.0	10/00→	M4R 704	Flexfuel	1997	4	510
LAGUNA III (BTO/1)	2.0	10/00→	M4R 726	Flexfuel	1997	4	513
LAGUNA III (BTO/1)	2.0	01/00→	M9R 815	Diesel	1995	4	521
LAGUNA III (BTO/1)	3.5	04/00→	V4Y 713	Petrol	3498	6	672
LAGUNA III Grandtour (KTO/1)	1.5	10/00→	K9K 780	Diesel	1461	4	170
LAGUNA III Grandtour (KTO/1)	1.6	10/00→	K4M 824	Petrol	1598	4	231
LAGUNA III Grandtour (KTO/1)	2.0	03/00→	F4R 800	Petrol	1998	4	451
LAGUNA III Grandtour (KTO/1)	2.0	10/00→	F4R 811	Petrol	1998	4	452
LAGUNA III Grandtour (KTO/1)	2.0	10/00→	M4R 704	Petrol	1997	4	510
LAGUNA III Grandtour (KTO/1)	2.0	10/00→	M4R 704	Flexfuel	1997	4	510
LAGUNA III Grandtour (KTO/1)	2.0	10/00→	M4R 726	Flexfuel	1997	4	513
LAGUNA III Grandtour (KTO/1)	2.0	01/00→	M9R 815	Diesel	1995	4	521
LAGUNA III Grandtour (KTO/1)	3.5	04/00→	V4Y 713	Petrol	3498	6	672
LOGAN (LS_)	1.4	09/00→	K7J 710	Petrol	1390	4	145
LOGAN (LS_)	1.5	04/00→	K9K 792	Diesel	1461	4	171
LOGAN (LS_)	1.5	02/00→	K9K 796	Diesel	1461	4	172
LOGAN (LS_)	1.6	04/00→	K4M 690	Petrol	1598	4	195
LOGAN (LS_)	1.6	09/00→	K7M 710	Petrol	1598	4	246
LOGAN Estate (KS_)	1.4	10/00→	K7J 710	Petrol	1390	4	145
LOGAN Estate (KS_)	1.5	04/00→	K9K 792	Diesel	1461	4	171
LOGAN Estate (KS_)	1.5	02/00→	K9K 796	Diesel	1461	4	172
LOGAN Estate (KS_)	1.6	04/00→	K4M 697	Petrol	1598	4	196
LOGAN Estate (KS_)	1.6	04/00→	K7M 710	Petrol	1598	4	246
MASTER I Box (T_)	2.0	06/98→10/98	829 730	Petrol	1995	4	399
MASTER I Box (T_)	2.0	10/98→07/99	J5R 718	Petrol	1995	4	473
MASTER I Box (T_)	2.0	06/98→10/98	J5R 728	Petrol	1995	4	476
MASTER I Box (T_)	2.0	08/98→07/99	J8S 330	Diesel	2068	4	525
MASTER I Box (T_)	2.2	08/98→07/99	J7T 782	Petrol	2165	4	592
MASTER I Box (T_)	2.2	08/98→07/99	J7T 788	Petrol	2165	4	593
MASTER I Box (T_)	2.4	08/98→08/98	8140.61.2300	Diesel	2445	4	605
MASTER I Box (T_)	2.4	09/98→12/99	S8U 730	Diesel	2445	4	611
MASTER I Box (T_)	2.4	08/98→08/98	S8U 731	Diesel	2445	4	612
MASTER I Box (T_)	2.5	08/98→07/99	8140.27.2500	Diesel	2499	4	613
MASTER I Box (T_)	2.5	08/98→07/99	8140.27.2510	Diesel	2499	4	614
MASTER I Box (T_)	2.5	08/98→07/99	8140.27.2580	Diesel	2499	4	615
MASTER I Box (T_)	2.5	08/98→07/99	8140.67.2510	Diesel	2499	4	617
MASTER I Box (T_)	2.5	08/98→07/99	S8U 742	Diesel	2499	4	628
MASTER I Box (T_)	2.5	08/98→07/99	S9U 702	Diesel	2499	4	636

	Ltr				CC		9
MASTER I Box (T__)	2.5	08/98→07/99	S9U 714	Diesel	2499	4	637
MASTER I Bus (T__)	2.0	10/98→07/99	J5R 718	Petrol	1995	4	473
MASTER I Bus (T__)	2.0	06/98→10/98	J5R 728	Petrol	1995	4	476
MASTER I Bus (T__)	2.0	08/98→07/99	J8S 330	Diesel	2068	4	525
MASTER I Bus (T__)	2.1	11/98→04/99	J8S 330	Diesel	2068	4	525
MASTER I Bus (T__)	2.2	08/98→07/99	J7T 782	Petrol	2165	4	592
MASTER I Bus (T__)	2.2	08/98→07/99	J7T 788	Petrol	2165	4	593
MASTER I Bus (T__)	2.4	08/98→08/98	8140.61.2300	Diesel	2445	4	605
MASTER I Bus (T__)	2.4	08/98→10/98	S8U 731	Diesel	2445	4	612
MASTER I Bus (T__)	2.5	08/98→07/99	8140.27.2500	Diesel	2499	4	613
MASTER I Bus (T__)	2.5	08/98→07/99	8140.27.2510	Diesel	2499	4	614
MASTER I Bus (T__)	2.5	08/98→07/99	8140.27.2580	Diesel	2499	4	615
MASTER I Bus (T__)	2.5	08/98→07/99	8140.67.2510	Diesel	2499	4	617
MASTER I Bus (T__)	2.5	08/98→07/99	S8U 742	Diesel	2499	4	628
MASTER I Bus (T__)	2.5	08/98→07/99	S9U 702	Diesel	2499	4	636
MASTER I Bus (T__)	2.5	08/98→07/99	S9U 714	Diesel	2499	4	637
MASTER I Platform/Chassis (P__)	2.0	11/98→12/99	J5R 716	Petrol	1995	4	472
MASTER I Platform/Chassis (P__)	2.0	11/98→07/99	J5R 718	Petrol	1995	4	473
MASTER I Platform/Chassis (P__)	2.0	10/98→07/99	J5R 728	Petrol	1995	4	476
MASTER I Platform/Chassis (P__)	2.1	11/98→07/99	J8S 330	Diesel	2068	4	525
MASTER I Platform/Chassis (P__)	2.2	08/99→02/99	J7T 788	Petrol	2165	4	593
MASTER I Platform/Chassis (P__)	2.4	08/99→02/99	S8U 730	Diesel	2445	4	611
MASTER I Platform/Chassis (P__)	2.5	09/98→07/99	8140.61.2300	Diesel	2445	4	605
MASTER I Platform/Chassis (P__)	2.5	09/98→07/99	S8U 731	Diesel	2445	4	612
MASTER I Platform/Chassis (P__)	2.5	07/98→10/98	S8U 742	Diesel	2499	4	628
MASTER I Platform/Chassis (P__)	2.5	11/98→10/99	S9U 702	Diesel	2499	4	636
MASTER I Platform/Chassis (P__)	2.5	08/99→02/99	S9U 740	Diesel	2499	4	638
MASTER II Box (FD)	1.9	09/00→	F9Q 770	Diesel	1870	4	375
MASTER II Box (FD)	1.9	11/00→	F9Q 772	Diesel	1870	4	376
MASTER II Box (FD)	1.9	11/00→	F9Q 774	Diesel	1870	4	377
MASTER II Box (FD)	2.2	09/00→	G9T 720	Diesel	2188	4	567
MASTER II Box (FD)	2.2	09/00→	G9T 722	Diesel	2188	4	568
MASTER II Box (FD)	2.2	09/00→	G9T 750	Diesel	2188	4	571
MASTER II Box (FD)	2.5	08/00→	G9U 632	Diesel	2464	4	621
MASTER II Box (FD)	2.5	08/00→	G9U 650	Diesel	2464	4	622
MASTER II Box (FD)	2.5	10/00→	G9U 720	Diesel	2463	4	623
MASTER II Box (FD)	2.5	10/00→	G9U 724	Diesel	2463	4	624
MASTER II Box (FD)	2.5	01/00→	G9U 750	Diesel	2463	4	626
MASTER II Box (FD)	2.5	10/00→	G9U 754	Diesel	2463	4	627
MASTER II Box (FD)	2.5	07/99→01/00	S8U 770	Diesel	2499	4	634
MASTER II Box (FD)	2.8	07/99→10/00	S9W 702	Diesel	2799	4	644
MASTER II Bus (JD)	1.9	09/00→	F9Q 770	Diesel	1870	4	375
MASTER II Bus (JD)	1.9	11/00→	F9Q 772	Diesel	1870	4	376
MASTER II Bus (JD)	1.9	11/00→	F9Q 774	Diesel	1870	4	377
MASTER II Bus (JD)	2.2	09/00→	G9T 720	Diesel	2188	4	567
MASTER II Bus (JD)	2.2	09/00→	G9T 722	Diesel	2188	4	568
MASTER II Bus (JD)	2.2	09/00→	G9T 750	Diesel	2188	4	571
MASTER II Bus (JD)	2.5	08/00→	G9U 632	Diesel	2464	4	621
MASTER II Bus (JD)	2.5	08/00→	G9U 650	Diesel	2464	4	622
MASTER II Bus (JD)	2.5	10/00→	G9U 720	Diesel	2463	4	623
MASTER II Bus (JD)	2.5	01/00→	G9U 750	Diesel	2463	4	626
MASTER II Bus (JD)	2.5	10/00→	G9U 754	Diesel	2463	4	627
MASTER II Bus (JD)	2.5	07/99→01/00	S8U 770	Diesel	2499	4	634
MASTER II Bus (JD)	2.8	07/99→10/00	S9W 702	Diesel	2799	4	644
MASTER II Platform/Chassis (ED/HD/UD)	2.2	09/00→	G9T 720	Diesel	2188	4	567
MASTER II Platform/Chassis (ED/HD/UD)	2.2	09/00→	G9T 722	Diesel	2188	4	568
MASTER II Platform/Chassis (ED/HD/UD)	2.2	09/00→	G9T 750	Diesel	2188	4	571
MASTER II Platform/Chassis (ED/HD/UD)	2.5	08/00→	G9U 632	Diesel	2464	4	621
MASTER II Platform/Chassis (ED/HD/UD)	2.5	08/00→	G9U 650	Diesel	2464	4	622
MASTER II Platform/Chassis (ED/HD/UD)	2.5	10/00→	G9U 720	Diesel	2463	4	623
MASTER II Platform/Chassis (ED/HD/UD)	2.5	01/00→	G9U 750	Diesel	2463	4	626
MASTER II Platform/Chassis (ED/HD/UD)	2.5	10/00→	G9U 754	Diesel	2463	4	627
MASTER II Platform/Chassis (ED/HD/UD)	2.5	07/99→01/00	S8U 770	Diesel	2499	4	634
MASTER II Platform/Chassis (ED/HD/UD)	2.8	07/99→10/00	S9W 702	Diesel	2799	4	644
MASTER III Box (FV)	2.3	02/01→	M9T 670	Diesel	2298	4	594
MASTER III Box (FV)	2.3	02/01→	M9T 672	Diesel	2298	4	595
MASTER III Box (FV)	2.3	02/01→	M9T 676	Diesel	2298	4	596
MASTER III Box (FV)	2.3	02/01→	M9T 678	Diesel	2298	4	597
MASTER III Box (FV)	2.3	02/01→	M9T 680	Diesel	2298	4	598
MASTER III Box (FV)	2.3	02/01→	M9T 686	Diesel	2298	4	599



Ltr







CC



9

Model	Ltr	Year	Engine	Fuel	CC	Chassis	Price
MASTER III Box (FV)	2.3	02/01→	M9T 690	Diesel	2298	4	600
MASTER III Box (FV)	2.3	02/01→	M9T 692	Diesel	2298	4	601
MASTER III Box (FV)	2.3	02/01→	M9T 694	Diesel	2298	4	602
MASTER III Box (FV)	2.3	02/01→	M9T 696	Diesel	2298	4	603
MASTER III Box (FV)	2.3	02/01→	M9T 698	Diesel	2298	4	604
MASTER III Bus (JV)	2.3	02/01→	M9T 670	Diesel	2298	4	594
MASTER III Bus (JV)	2.3	02/01→	M9T 672	Diesel	2298	4	595
MASTER III Bus (JV)	2.3	02/01→	M9T 676	Diesel	2298	4	596
MASTER III Bus (JV)	2.3	02/01→	M9T 680	Diesel	2298	4	598
MASTER III Platform/Chassis (EV, HV, UV)	2.3	02/01→	M9T 670	Diesel	2298	4	594
MASTER III Platform/Chassis (EV, HV, UV)	2.3	02/01→	M9T 672	Diesel	2298	4	595
MASTER III Platform/Chassis (EV, HV, UV)	2.3	02/01→	M9T 676	Diesel	2298	4	596
MASTER III Platform/Chassis (EV, HV, UV)	2.3	02/01→	M9T 678	Diesel	2298	4	597
MASTER III Platform/Chassis (EV, HV, UV)	2.3	02/01→	M9T 680	Diesel	2298	4	598
MASTER III Platform/Chassis (EV, HV, UV)	2.3	02/01→	M9T 686	Diesel	2298	4	599
MASTER III Platform/Chassis (EV, HV, UV)	2.3	02/01→	M9T 690	Diesel	2298	4	600
MASTER III Platform/Chassis (EV, HV, UV)	2.3	02/01→	M9T 692	Diesel	2298	4	601
MASTER III Platform/Chassis (EV, HV, UV)	2.3	02/01→	M9T 694	Diesel	2298	4	602
MASTER III Platform/Chassis (EV, HV, UV)	2.3	02/01→	M9T 696	Diesel	2298	4	603
MASTER III Platform/Chassis (EV, HV, UV)	2.3	02/01→	M9T 698	Diesel	2298	4	604
MEGANE CC (EZO/1_)	1.5	06/01→	K9K 836	Diesel	1461	4	182
MEGANE CC (EZO/1_)	1.6	06/01→	K4M 858	Petrol	1598	4	237
MEGANE CC (EZO/1_)	1.9	06/01→	F9Q 870	Diesel	1870	4	390
MEGANE CC (EZO/1_)	2.0	06/01→	F4R 870	Petrol	1998	4	456
MEGANE CC (EZO/1_)	2.0	06/01→	F4R 872	Petrol	1998	4	457
MEGANE CC (EZO/1_)	2.0	10/01→	F4R 874	Petrol	1998	4	458
MEGANE CC (EZO/1_)	2.0	06/01→	M4R 711	Petrol	1997	4	511
MEGANE CC (EZO/1_)	2.0	06/01→	M4R 713	Petrol	1997	4	512
MEGANE I (BAO/1_)	1.4	01/99→03/99	E7J 624	Petrol	1390	4	111
MEGANE I (BAO/1_)	1.4	01/99→08/00	E7J 626	Petrol	1390	4	112
MEGANE I (BAO/1_)	1.4	01/99→08/00	E7J 764	Petrol	1390	4	129
MEGANE I (BAO/1_)	1.4	03/99→08/00	K4J 714	Petrol	1390	4	136
MEGANE I (BAO/1_)	1.4	03/99→08/00	K4J 750	Petrol	1390	4	140
MEGANE I (BAO/1_)	1.6	03/99→08/00	K4M 700	Petrol	1598	4	197
MEGANE I (BAO/1_)	1.6	03/99→08/00	K4M 701	Petrol	1598	4	198
MEGANE I (BAO/1_)	1.6	03/99→08/00	K4M 704	Petrol	1598	4	199
MEGANE I (BAO/1_)	1.6	03/99→08/00	K4M 708	Petrol	1598	4	201
MEGANE I (BAO/1_)	1.6	01/99→03/99	K7M 702	Petrol	1598	4	244
MEGANE I (BAO/1_)	1.6	01/99→03/99	K7M 703	Petrol	1598	4	245
MEGANE I (BAO/1_)	1.6	01/99→03/99	K7M 720	Petrol	1598	4	248
MEGANE I (BAO/1_)	1.6	01/99→03/99	K7M 790	Petrol	1598	4	253
MEGANE I (BAO/1_)	1.8	01/00→08/00	F4P 720	Petrol	1783	4	310
MEGANE I (BAO/1_)	1.8	01/00→08/00	F4P 722	Petrol	1783	4	311
MEGANE I (BAO/1_)	1.9	01/99→08/00	F8Q 620	Diesel	1870	4	323
MEGANE I (BAO/1_)	1.9	01/99→08/00	F8Q 624	Diesel	1870	4	325
MEGANE I (BAO/1_)	1.9	01/99→08/00	F8Q 784	Diesel	1870	4	346
MEGANE I (BAO/1_)	1.9	01/99→08/00	F8Q 786	Diesel	1870	4	347
MEGANE I (BAO/1_)	1.9	03/99→02/00	F9Q 730	Diesel	1870	4	358
MEGANE I (BAO/1_)	1.9	03/99→02/00	F9Q 731	Diesel	1870	4	359
MEGANE I (BAO/1_)	1.9	02/00→08/00	F9Q 732	Diesel	1870	4	360
MEGANE I (BAO/1_)	1.9	02/00→08/00	F9Q 733	Diesel	1870	4	361
MEGANE I (BAO/1_)	1.9	03/99→02/00	F9Q 734	Diesel	1870	4	362
MEGANE I (BAO/1_)	1.9	03/99→02/00	F9Q 736	Diesel	1870	4	363
MEGANE I (BAO/1_)	1.9	02/00→08/00	F9Q 744	Diesel	1870	4	366
MEGANE I (BAO/1_)	2.0	01/99→08/00	F3R 750	Petrol	1998	4	406
MEGANE I (BAO/1_)	2.0	01/99→08/00	F3R 751	Petrol	1998	4	407
MEGANE I (BAO/1_)	2.0	07/99→08/00	F7R 710	Petrol	1998	4	470
MEGANE I (BAO/1_)	2.0	07/99→08/00	F7R 714	Petrol	1998	4	471
MEGANE I Cabriolet (EAO/1_)	1.4	03/99→08/00	K4J 714	Petrol	1390	4	136
MEGANE I Cabriolet (EAO/1_)	1.4	03/99→08/00	K4J 750	Petrol	1390	4	140
MEGANE I Cabriolet (EAO/1_)	1.6	03/99→08/00	K4M 700	Petrol	1598	4	197
MEGANE I Cabriolet (EAO/1_)	1.6	03/99→08/00	K4M 701	Petrol	1598	4	198
MEGANE I Cabriolet (EAO/1_)	1.6	03/99→08/00	K4M 708	Petrol	1598	4	201
MEGANE I Cabriolet (EAO/1_)	1.6	10/99→03/99	K7M 702	Petrol	1598	4	244
MEGANE I Cabriolet (EAO/1_)	1.6	10/99→03/99	K7M 703	Petrol	1598	4	245
MEGANE I Cabriolet (EAO/1_)	2.0	04/99→08/00	F3R 750	Petrol	1998	4	406
MEGANE I Cabriolet (EAO/1_)	2.0	03/99→08/00	F3R 791	Petrol	1998	4	411
MEGANE I Cabriolet (EAO/1_)	2.0	03/99→08/00	F3R 796	Petrol	1998	4	412
MEGANE I Cabriolet (EAO/1_)	2.0	01/00→08/00	F4R 746	Petrol	1998	4	428
MEGANE I Cabriolet (EAO/1_)	2.0	01/00→08/00	F4R 770	Petrol	1998	4	437

	Ltr				CC		9
MEGANE I Cabriolet (EAO/1_)	2.0	11/99→08/00	F5R 740	Petrol	1998	4	468
MEGANE I Cabriolet (EAO/1_)	2.0	10/99→11/99	F7R 710	Petrol	1998	4	470
MEGANE I Cabriolet (EAO/1_)	2.0	10/99→11/99	F7R 714	Petrol	1998	4	471
MEGANE I Classic (LAO/1_)	1.4	09/99→08/00	E7J 626	Petrol	1390	4	112
MEGANE I Classic (LAO/1_)	1.4	09/99→08/00	E7J 764	Petrol	1390	4	129
MEGANE I Classic (LAO/1_)	1.4	03/99→08/00	K4J 714	Petrol	1390	4	136
MEGANE I Classic (LAO/1_)	1.4	03/99→08/00	K4J 750	Petrol	1390	4	140
MEGANE I Classic (LAO/1_)	1.6	03/99→08/00	K4M 700	Petrol	1598	4	197
MEGANE I Classic (LAO/1_)	1.6	03/99→08/00	K4M 701	Petrol	1598	4	198
MEGANE I Classic (LAO/1_)	1.6	03/99→08/00	K4M 708	Petrol	1598	4	201
MEGANE I Classic (LAO/1_)	1.6	09/99→03/99	K7M 702	Petrol	1598	4	244
MEGANE I Classic (LAO/1_)	1.6	09/99→03/99	K7M 703	Petrol	1598	4	245
MEGANE I Classic (LAO/1_)	1.6	09/99→03/99	K7M 720	Petrol	1598	4	248
MEGANE I Classic (LAO/1_)	1.6	09/99→03/99	K7M 790	Petrol	1598	4	253
MEGANE I Classic (LAO/1_)	1.8	01/00→08/00	F4P 720	Petrol	1783	4	310
MEGANE I Classic (LAO/1_)	1.8	01/00→08/00	F4P 722	Petrol	1783	4	311
MEGANE I Classic (LAO/1_)	1.9	09/99→08/00	F8Q 620	Diesel	1870	4	323
MEGANE I Classic (LAO/1_)	1.9	09/99→08/00	F8Q 624	Diesel	1870	4	325
MEGANE I Classic (LAO/1_)	1.9	09/99→08/00	F8Q 784	Diesel	1870	4	346
MEGANE I Classic (LAO/1_)	1.9	09/99→08/00	F8Q 786	Diesel	1870	4	347
MEGANE I Classic (LAO/1_)	1.9	03/99→02/00	F9Q 730	Diesel	1870	4	358
MEGANE I Classic (LAO/1_)	1.9	03/99→02/00	F9Q 731	Diesel	1870	4	359
MEGANE I Classic (LAO/1_)	1.9	02/00→08/00	F9Q 732	Diesel	1870	4	360
MEGANE I Classic (LAO/1_)	1.9	02/00→08/00	F9Q 733	Diesel	1870	4	361
MEGANE I Classic (LAO/1_)	1.9	03/99→02/00	F9Q 734	Diesel	1870	4	362
MEGANE I Classic (LAO/1_)	1.9	03/99→02/00	F9Q 736	Diesel	1870	4	363
MEGANE I Classic (LAO/1_)	1.9	02/00→08/00	F9Q 738	Diesel	1870	4	364
MEGANE I Classic (LAO/1_)	1.9	02/00→08/00	F9Q 744	Diesel	1870	4	366
MEGANE I Classic (LAO/1_)	2.0	09/99→08/00	F3R 750	Petrol	1998	4	406
MEGANE I Classic (LAO/1_)	2.0	09/99→08/00	F3R 751	Petrol	1998	4	407
MEGANE I Classic (LAO/1_)	2.0	09/99→08/00	F3R 752	Petrol	1998	4	408
MEGANE I Classic (LAO/1_)	2.0	09/99→08/00	F3R 791	Petrol	1998	4	411
MEGANE I Classic (LAO/1_)	2.0	09/99→08/00	F3R 796	Petrol	1998	4	412
MEGANE I Classic (LAO/1_)	2.0	09/99→08/00	F3R 797	Petrol	1998	4	413
MEGANE I Classic (LAO/1_)	2.0	09/99→08/00	F3R 798	Petrol	1998	4	414
MEGANE I Coach (DAO/1_)	1.4	03/99→08/00	K4J 714	Petrol	1390	4	136
MEGANE I Coach (DAO/1_)	1.4	03/99→08/00	K4J 750	Petrol	1390	4	140
MEGANE I Coach (DAO/1_)	1.6	03/99→08/00	K4M 700	Petrol	1598	4	197
MEGANE I Coach (DAO/1_)	1.6	03/99→08/00	K4M 701	Petrol	1598	4	198
MEGANE I Coach (DAO/1_)	1.6	03/99→08/00	K4M 708	Petrol	1598	4	201
MEGANE I Coach (DAO/1_)	1.6	03/99→03/99	K7M 702	Petrol	1598	4	244
MEGANE I Coach (DAO/1_)	1.6	03/99→03/99	K7M 703	Petrol	1598	4	245
MEGANE I Coach (DAO/1_)	1.9	03/99→02/00	F9Q 731	Diesel	1870	4	359
MEGANE I Coach (DAO/1_)	1.9	02/00→08/00	F9Q 732	Diesel	1870	4	360
MEGANE I Coach (DAO/1_)	1.9	02/00→08/00	F9Q 733	Diesel	1870	4	361
MEGANE I Coach (DAO/1_)	1.9	03/99→02/00	F9Q 734	Diesel	1870	4	362
MEGANE I Coach (DAO/1_)	1.9	03/99→02/00	F9Q 736	Diesel	1870	4	363
MEGANE I Coach (DAO/1_)	2.0	03/99→08/00	F3R 750	Petrol	1998	4	406
MEGANE I Coach (DAO/1_)	2.0	03/99→08/00	F3R 751	Petrol	1998	4	407
MEGANE I Coach (DAO/1_)	2.0	03/99→08/00	F3R 791	Petrol	1998	4	411
MEGANE I Coach (DAO/1_)	2.0	03/99→08/00	F3R 796	Petrol	1998	4	412
MEGANE I Coach (DAO/1_)	2.0	01/00→08/00	F4R 746	Petrol	1998	4	428
MEGANE I Coach (DAO/1_)	2.0	11/99→08/00	F5R 740	Petrol	1998	4	468
MEGANE I Coach (DAO/1_)	2.0	03/99→11/99	F7R 710	Petrol	1998	4	470
MEGANE I Coach (DAO/1_)	2.0	03/99→11/99	F7R 714	Petrol	1998	4	471
MEGANE I Grandtour (KAO/1_)	1.4	03/99→08/00	E7J 626	Petrol	1390	4	112
MEGANE I Grandtour (KAO/1_)	1.4	03/99→08/00	K4J 714	Petrol	1390	4	136
MEGANE I Grandtour (KAO/1_)	1.4	03/99→08/00	K4J 750	Petrol	1390	4	140
MEGANE I Grandtour (KAO/1_)	1.6	03/99→08/00	K4M 700	Petrol	1598	4	197
MEGANE I Grandtour (KAO/1_)	1.6	03/99→08/00	K4M 701	Petrol	1598	4	198
MEGANE I Grandtour (KAO/1_)	1.6	03/99→08/00	K4M 704	Petrol	1598	4	199
MEGANE I Grandtour (KAO/1_)	1.6	03/99→08/00	K4M 708	Petrol	1598	4	201
MEGANE I Grandtour (KAO/1_)	1.6	03/99→08/00	K7M 702	Petrol	1598	4	244
MEGANE I Grandtour (KAO/1_)	1.6	03/99→08/00	K7M 703	Petrol	1598	4	245
MEGANE I Grandtour (KAO/1_)	1.8	01/00→08/00	F4P 720	Petrol	1783	4	310
MEGANE I Grandtour (KAO/1_)	1.8	01/00→08/00	F4P 722	Petrol	1783	4	311
MEGANE I Grandtour (KAO/1_)	1.9	04/99→08/00	F8Q 622	Diesel	1870	4	324
MEGANE I Grandtour (KAO/1_)	1.9	04/99→08/00	F8Q 790	Diesel	1870	4	348
MEGANE I Grandtour (KAO/1_)	1.9	03/99→02/00	F9Q 731	Diesel	1870	4	359
MEGANE I Grandtour (KAO/1_)	1.9	02/00→08/00	F9Q 732	Diesel	1870	4	360



Ltr







CC



9

Model	Ltr	Year Range	Engine	Fuel	CC	Seats	Price
MEGANE I Grandtour (KAO/1_)	1.9	02/00→08/00	F9Q 733	Diesel	1870	4	361
MEGANE I Grandtour (KAO/1_)	1.9	03/99→02/00	F9Q 736	Diesel	1870	4	363
MEGANE I Grandtour (KAO/1_)	1.9	02/00→08/00	F9Q 738	Diesel	1870	4	364
MEGANE I Grandtour (KAO/1_)	1.9	02/00→08/00	F9Q 744	Diesel	1870	4	366
MEGANE II (BMO/1_ CMO/1_)	1.4	11/00→	K4J 730	Petrol	1390	4	137
MEGANE II (BMO/1_ CMO/1_)	1.4	10/00→	K4J 732	Petrol	1390	4	138
MEGANE II (BMO/1_ CMO/1_)	1.4	11/00→	K4J 740	Petrol	1390	4	139
MEGANE II (BMO/1_ CMO/1_)	1.5	11/00→	K9K 722	Diesel	1461	4	154
MEGANE II (BMO/1_ CMO/1_)	1.5	05/00→	K9K 724	Diesel	1461	4	155
MEGANE II (BMO/1_ CMO/1_)	1.5	10/00→	K9K 728	Diesel	1461	4	156
MEGANE II (BMO/1_ CMO/1_)	1.5	10/00→	K9K 729	Diesel	1461	4	157
MEGANE II (BMO/1_ CMO/1_)	1.5	05/00→	K9K 732	Diesel	1461	4	158
MEGANE II (BMO/1_ CMO/1_)	1.5	05/00→	K9K 734	Diesel	1461	4	159
MEGANE II (BMO/1_ CMO/1_)	1.6	11/00→	K4M 760	Petrol	1598	4	217
MEGANE II (BMO/1_ CMO/1_)	1.6	06/00→	K4M 788	Petrol	1598	4	222
MEGANE II (BMO/1_ CMO/1_)	1.6	06/00→	K4M 788	Flexfuel	1598	4	222
MEGANE II (BMO/1_ CMO/1_)	1.6	01/00→	K4M 812	Petrol	1598	4	229
MEGANE II (BMO/1_ CMO/1_)	1.6	01/00→	K4M 813	Petrol	1598	4	230
MEGANE II (BMO/1_ CMO/1_)	1.9	11/00→	F9Q 800	Diesel	1870	4	381
MEGANE II (BMO/1_ CMO/1_)	1.9	05/00→	F9Q 803	Diesel	1870	4	382
MEGANE II (BMO/1_ CMO/1_)	1.9	11/00→	F9Q 804	Diesel	1870	4	383
MEGANE II (BMO/1_ CMO/1_)	1.9	11/00→	F9Q 808	Diesel	1870	4	384
MEGANE II (BMO/1_ CMO/1_)	1.9	11/00→	F9Q 816	Diesel	1870	4	386
MEGANE II (BMO/1_ CMO/1_)	1.9	11/00→	F9Q 818	Diesel	1870	4	387
MEGANE II (BMO/1_ CMO/1_)	2.0	11/00→	F4R 770	Petrol	1998	4	437
MEGANE II (BMO/1_ CMO/1_)	2.0	05/00→	F4R 774	Petrol	1998	4	439
MEGANE II (BMO/1_ CMO/1_)	2.0	05/00→	F4R 776	Petrol	1998	4	440
MEGANE II (BMO/1_ CMO/1_)	2.0	05/00→	F4Rt 774	Petrol	1998	4	463
MEGANE II (BMO/1_ CMO/1_)	2.0	09/00→	M9R 700	Diesel	1995	4	514
MEGANE II (BMO/1_ CMO/1_)	2.0	09/00→	M9R 722	Diesel	1995	4	516
MEGANE II Coupé-Cabriolet (EMO/1_)	1.5	03/00→	K9K 732	Diesel	1461	4	158
MEGANE II Coupé-Cabriolet (EMO/1_)	1.5	01/00→	K9K 734	Diesel	1461	4	159
MEGANE II Coupé-Cabriolet (EMO/1_)	1.6	09/00→	K4M 760	Petrol	1598	4	217
MEGANE II Coupé-Cabriolet (EMO/1_)	1.6	09/00→	K4M 761	Petrol	1598	4	218
MEGANE II Coupé-Cabriolet (EMO/1_)	1.6	01/00→	K4M 812	Petrol	1598	4	229
MEGANE II Coupé-Cabriolet (EMO/1_)	1.6	01/00→	K4M 813	Petrol	1598	4	230
MEGANE II Coupé-Cabriolet (EMO/1_)	1.6	01/00→	K4M C 813	Petrol	1598	4	241
MEGANE II Coupé-Cabriolet (EMO/1_)	1.6	01/00→	K4M D 812	Petrol	1598	4	242
MEGANE II Coupé-Cabriolet (EMO/1_)	1.9	09/00→	F9Q 800	Diesel	1870	4	381
MEGANE II Coupé-Cabriolet (EMO/1_)	1.9	05/00→	F9Q 803	Diesel	1870	4	382
MEGANE II Coupé-Cabriolet (EMO/1_)	1.9	09/00→	F9Q 804	Diesel	1870	4	383
MEGANE II Coupé-Cabriolet (EMO/1_)	1.9	09/00→	F9Q 816	Diesel	1870	4	386
MEGANE II Coupé-Cabriolet (EMO/1_)	1.9	09/00→	F9Q 818	Diesel	1870	4	387
MEGANE II Coupé-Cabriolet (EMO/1_)	2.0	09/00→	F4R 770	Petrol	1998	4	437
MEGANE II Coupé-Cabriolet (EMO/1_)	2.0	09/00→	F4R 771	Petrol	1998	4	438
MEGANE II Coupé-Cabriolet (EMO/1_)	2.0	05/00→	F4R 776	Petrol	1998	4	440
MEGANE II Coupé-Cabriolet (EMO/1_)	2.0	09/00→	M9R 700	Diesel	1995	4	514
MEGANE II Coupé-Cabriolet (EMO/1_)	2.0	09/00→	M9R 722	Diesel	1995	4	516
MEGANE II Estate (KMO/1_)	1.4	08/00→	K4J 730	Petrol	1390	4	137
MEGANE II Estate (KMO/1_)	1.4	08/00→	K4J 740	Petrol	1390	4	139
MEGANE II Estate (KMO/1_)	1.5	08/00→	K9K 722	Diesel	1461	4	154
MEGANE II Estate (KMO/1_)	1.5	05/00→	K9K 724	Diesel	1461	4	155
MEGANE II Estate (KMO/1_)	1.5	02/00→	K9K 728	Diesel	1461	4	156
MEGANE II Estate (KMO/1_)	1.5	02/00→	K9K 729	Diesel	1461	4	157
MEGANE II Estate (KMO/1_)	1.5	05/00→	K9K 732	Diesel	1461	4	158
MEGANE II Estate (KMO/1_)	1.5	05/00→	K9K 734	Diesel	1461	4	159
MEGANE II Estate (KMO/1_)	1.6	08/00→	K4M 760	Petrol	1598	4	217
MEGANE II Estate (KMO/1_)	1.6	08/00→	K4M 761	Petrol	1598	4	218
MEGANE II Estate (KMO/1_)	1.6	02/00→	K4M 762	Petrol	1598	4	219
MEGANE II Estate (KMO/1_)	1.6	02/00→	K4M 762	Flexfuel	1598	4	219
MEGANE II Estate (KMO/1_)	1.6	01/00→	K4M 812	Petrol	1598	4	229
MEGANE II Estate (KMO/1_)	1.6	01/00→	K4M 813	Petrol	1598	4	230
MEGANE II Estate (KMO/1_)	1.6	01/00→	K4M D 812	Petrol	1598	4	242
MEGANE II Estate (KMO/1_)	1.9	08/00→	F9Q 800	Diesel	1870	4	381
MEGANE II Estate (KMO/1_)	1.9	05/00→	F9Q 803	Diesel	1870	4	382
MEGANE II Estate (KMO/1_)	1.9	05/00→	F9Q 804	Diesel	1870	4	383
MEGANE II Estate (KMO/1_)	1.9	03/00→	F9Q 808	Diesel	1870	4	384
MEGANE II Estate (KMO/1_)	1.9	05/00→	F9Q 818	Diesel	1870	4	387
MEGANE II Estate (KMO/1_)	2.0	08/00→	F4R 770	Petrol	1998	4	437
MEGANE II Estate (KMO/1_)	2.0	08/00→	F4R 771	Petrol	1998	4	438

	Ltr				CC		9
MEGANE II Estate (KMO/1_)	2.0	09/00 →	M9R 700	Diesel	1995	4	514
MEGANE II Estate (KMO/1_)	2.0	09/00 →	M9R 722	Diesel	1995	4	516
MEGANE II Saloon (LMO/1_)	1.4	09/00 →	K4J 730	Petrol	1390	4	137
MEGANE II Saloon (LMO/1_)	1.4	09/00 →	K4J 732	Petrol	1390	4	138
MEGANE II Saloon (LMO/1_)	1.4	09/00 →	K4J 740	Petrol	1390	4	139
MEGANE II Saloon (LMO/1_)	1.5	09/00 →	K9K 722	Diesel	1461	4	154
MEGANE II Saloon (LMO/1_)	1.5	05/00 →	K9K 724	Diesel	1461	4	155
MEGANE II Saloon (LMO/1_)	1.5	02/00 →	K9K 728	Diesel	1461	4	156
MEGANE II Saloon (LMO/1_)	1.5	02/00 →	K9K 729	Diesel	1461	4	157
MEGANE II Saloon (LMO/1_)	1.5	05/00 →	K9K 732	Diesel	1461	4	158
MEGANE II Saloon (LMO/1_)	1.5	01/00 →	K9K 734	Diesel	1461	4	159
MEGANE II Saloon (LMO/1_)	1.6	09/00 →	K4M 760	Petrol	1598	4	217
MEGANE II Saloon (LMO/1_)	1.6	09/00 →	K4M 761	Petrol	1598	4	218
MEGANE II Saloon (LMO/1_)	1.6	05/00 →	K4M 762	Petrol	1598	4	219
MEGANE II Saloon (LMO/1_)	1.6	05/00 →	K4M 762	Flexfuel	1598	4	219
MEGANE II Saloon (LMO/1_)	1.6	09/00 →	K4M 768	Petrol	1598	4	220
MEGANE II Saloon (LMO/1_)	1.6	01/00 →	K4M 812	Petrol	1598	4	229
MEGANE II Saloon (LMO/1_)	1.6	01/00 →	K4M 813	Petrol	1598	4	230
MEGANE II Saloon (LMO/1_)	1.6	01/00 →	K4M D 812	Petrol	1598	4	242
MEGANE II Saloon (LMO/1_)	1.9	09/00 →	F9Q 800	Diesel	1870	4	381
MEGANE II Saloon (LMO/1_)	1.9	05/00 →	F9Q 803	Diesel	1870	4	382
MEGANE II Saloon (LMO/1_)	1.9	05/00 →	F9Q 804	Diesel	1870	4	383
MEGANE II Saloon (LMO/1_)	1.9	09/00 →	F9Q 808	Diesel	1870	4	384
MEGANE II Saloon (LMO/1_)	1.9	05/00 →	F9Q 816	Diesel	1870	4	386
MEGANE II Saloon (LMO/1_)	1.9	05/00 →	F9Q 818	Diesel	1870	4	387
MEGANE II Saloon (LMO/1_)	2.0	09/00 →	F4R 770	Petrol	1998	4	437
MEGANE II Saloon (LMO/1_)	2.0	09/00 →	F4R 771	Petrol	1998	4	438
MEGANE II Saloon (LMO/1_)	2.0	09/00 →	M9R 700	Diesel	1995	4	514
MEGANE II Saloon (LMO/1_)	2.0	09/00 →	M9R 722	Diesel	1995	4	516
MEGANE III Coupe (DZO/1_)	1.5	11/00 →	K9K F 830	Diesel	1461	4	185
MEGANE III Coupe (DZO/1_)	1.5	02/00 →	K9K G 832	Diesel	1461	4	186
MEGANE III Coupe (DZO/1_)	1.5	11/00 →	K9K H 834	Diesel	1461	4	187
MEGANE III Coupe (DZO/1_)	1.5	02/00 →	K9K J 836	Diesel	1461	4	188
MEGANE III Coupe (DZO/1_)	1.6	11/00 →	K4M 858	Petrol	1598	4	237
MEGANE III Coupe (DZO/1_)	1.6	11/00 →	K4M 866	Petrol	1598	4	239
MEGANE III Coupe (DZO/1_)	1.6	11/00 →	K4M 866	Flexfuel	1598	4	239
MEGANE III Coupe (DZO/1_)	1.6	11/00 →	K4M 866	Bi-Fuel	1598	4	239
MEGANE III Coupe (DZO/1_)	1.6	11/00 →	K4M P 848	Petrol	1598	4	243
MEGANE III Coupe (DZO/1_)	1.9	11/00 →	F9Q 870	Diesel	1870	4	390
MEGANE III Coupe (DZO/1_)	1.9	11/00 →	F9Q 872	Diesel	1870	4	391
MEGANE III Coupe (DZO/1_)	2.0	11/00 →	F4R 870	Petrol	1998	4	456
MEGANE III Coupe (DZO/1_)	2.0	11/00 →	F4R 874	Petrol	1998	4	458
MEGANE III Coupe (DZO/1_)	2.0	05/00 →	M4R 711	Petrol	1997	4	511
MEGANE III Grandtour (KZO/1)	1.5	05/00 →	K9K 834	Diesel	1461	4	181
MEGANE III Grandtour (KZO/1)	1.5	02/00 →	K9K 836	Diesel	1461	4	182
MEGANE III Grandtour (KZO/1)	1.5	02/00 →	K9K 837	Diesel	1461	4	183
MEGANE III Grandtour (KZO/1)	1.5	02/00 →	K9K 846	Diesel	1461	4	184
MEGANE III Grandtour (KZO/1)	1.6	05/00 →	K4M 858	Petrol	1598	4	237
MEGANE III Grandtour (KZO/1)	1.6	11/00 →	K4M 866	Petrol	1598	4	239
MEGANE III Grandtour (KZO/1)	1.6	11/00 →	K4M 866	Flexfuel	1598	4	239
MEGANE III Grandtour (KZO/1)	1.6	11/00 →	K4M 866	Bi-Fuel	1598	4	239
MEGANE III Grandtour (KZO/1)	1.9	05/00 →	F9Q 870	Diesel	1870	4	390
MEGANE III Grandtour (KZO/1)	1.9	05/00 →	F9Q 872	Diesel	1870	4	391
MEGANE III Grandtour (KZO/1)	2.0	11/00 →	F4R 870	Petrol	1998	4	456
MEGANE III Grandtour (KZO/1)	2.0	11/00 →	F4R 872	Petrol	1998	4	457
MEGANE III Grandtour (KZO/1)	2.0	05/00 →	M4R 711	Petrol	1997	4	511
MEGANE III Hatchback (BZO_)	1.5	12/00 →	K9K 830	Diesel	1461	4	179
MEGANE III Hatchback (BZO_)	1.5	02/00 →	K9K 836	Diesel	1461	4	182
MEGANE III Hatchback (BZO_)	1.5	02/00 →	K9K G 832	Diesel	1461	4	186
MEGANE III Hatchback (BZO_)	1.5	11/00 →	K9K H 834	Diesel	1461	4	187
MEGANE III Hatchback (BZO_)	1.6	11/00 →	K4M 760	Petrol	1598	4	217
MEGANE III Hatchback (BZO_)	1.6	11/00 →	K4M 858	Petrol	1598	4	237
MEGANE III Hatchback (BZO_)	1.6	11/00 →	K4M 866	Petrol	1598	4	239
MEGANE III Hatchback (BZO_)	1.6	11/00 →	K4M 866	Flexfuel	1598	4	239
MEGANE III Hatchback (BZO_)	1.6	11/00 →	K4M 866	Bi-Fuel	1598	4	239
MEGANE III Hatchback (BZO_)	1.9	11/00 →	F9Q 870	Diesel	1870	4	390
MEGANE III Hatchback (BZO_)	1.9	11/00 →	F9Q 872	Diesel	1870	4	391
MEGANE III Hatchback (BZO_)	2.0	11/00 →	F4R 870	Petrol	1998	4	456
MEGANE III Hatchback (BZO_)	2.0	02/00 →	M4R 711	Petrol	1997	4	511
MEGANE III Hatchback (BZO_)	2.0	02/00 →	M4R 713	Petrol	1997	4	512



Ltr







CC



9

Model	Ltr	Period	Engine	Fuel	CC	Seats	Price
MEGANE III Saloon	1.6	06/00→	K4M 866	Petrol	1598	4	239
MEGANE III Saloon	1.6	06/00→	K4M 866	Flexfuel	1598	4	239
MEGANE III Saloon	1.6	06/00→	K4M 866	Bi-Fuel	1598	4	239
MEGANE III Saloon	1.9	06/00→	F9Q 870	Diesel	1870	4	390
MEGANE III Saloon	1.9	06/00→	F9Q 872	Diesel	1870	4	391
MEGANE Scenic (JAO/1_)	1.4	01/99→09/99	E7J 764	Petrol	1390	4	129
MEGANE Scenic (JAO/1_)	1.6	04/99→10/99	K4M 700	Petrol	1598	4	197
MEGANE Scenic (JAO/1_)	1.6	04/99→10/99	K4M 701	Petrol	1598	4	198
MEGANE Scenic (JAO/1_)	1.6	04/99→10/99	K4M 704	Petrol	1598	4	199
MEGANE Scenic (JAO/1_)	1.6	04/99→10/99	K4M 708	Petrol	1598	4	201
MEGANE Scenic (JAO/1_)	1.6	10/99→10/99	K7M 702	Petrol	1598	4	244
MEGANE Scenic (JAO/1_)	1.6	10/99→10/99	K7M 703	Petrol	1598	4	245
MEGANE Scenic (JAO/1_)	1.6	01/99→09/99	K7M 720	Petrol	1598	4	248
MEGANE Scenic (JAO/1_)	1.9	01/99→09/99	F8Q 784	Diesel	1870	4	346
MEGANE Scenic (JAO/1_)	1.9	01/99→09/99	F8Q 786	Diesel	1870	4	347
MEGANE Scenic (JAO/1_)	1.9	03/99→09/99	F8Q 790	Diesel	1870	4	348
MEGANE Scenic (JAO/1_)	1.9	04/99→09/99	F9Q 730	Diesel	1870	4	358
MEGANE Scenic (JAO/1_)	1.9	04/99→09/99	F9Q 734	Diesel	1870	4	362
MEGANE Scenic (JAO/1_)	2.0	01/99→10/99	F3R 750	Petrol	1998	4	406
MEGANE Scenic (JAO/1_)	2.0	01/99→09/99	F3R 751	Petrol	1998	4	407
MEGANE Scenic (JAO/1_)	2.0	01/99→09/99	F3R 796	Petrol	1998	4	412
MODUS / GRAND MODUS (F/JPO_)	1.2	12/00→	D4F 740	Petrol	1149	4	31
MODUS / GRAND MODUS (F/JPO_)	1.2	12/00→	D4F 740	Flexfuel	1149	4	31
MODUS / GRAND MODUS (F/JPO_)	1.2	12/00→	D4F 764	Petrol	1149	4	33
MODUS / GRAND MODUS (F/JPO_)	1.2	05/00→	D4F 784	Petrol	1149	4	37
MODUS / GRAND MODUS (F/JPO_)	1.4	12/00→	K4J 770	Petrol	1390	4	141
MODUS / GRAND MODUS (F/JPO_)	1.5	09/00→	K9K 750	Diesel	1461	4	161
MODUS / GRAND MODUS (F/JPO_)	1.5	12/00→	K9K 752	Diesel	1461	4	162
MODUS / GRAND MODUS (F/JPO_)	1.5	12/00→	K9K 760	Diesel	1461	4	163
MODUS / GRAND MODUS (F/JPO_)	1.5	12/00→	K9K 762	Diesel	1461	4	164
MODUS / GRAND MODUS (F/JPO_)	1.5	05/00→	K9K 764	Diesel	1461	4	165
MODUS / GRAND MODUS (F/JPO_)	1.5	12/00→	K9K 766	Diesel	1461	4	166
MODUS / GRAND MODUS (F/JPO_)	1.5	12/00→	K9K 768	Diesel	1461	4	167
MODUS / GRAND MODUS (F/JPO_)	1.5	10/01→	K9K 770	Diesel	1461	4	168
MODUS / GRAND MODUS (F/JPO_)	1.5	05/00→	K9K 772	Diesel	1461	4	169
MODUS / GRAND MODUS (F/JPO_)	1.6	12/00→	K4M 790	Petrol	1598	4	223
MODUS / GRAND MODUS (F/JPO_)	1.6	12/00→	K4M 791	Petrol	1598	4	224
MODUS / GRAND MODUS (F/JPO_)	1.6	12/00→	K4M 794	Petrol	1598	4	225
MODUS / GRAND MODUS (F/JPO_)	1.6	12/00→	K4M 800	Petrol	1598	4	226
MODUS / GRAND MODUS (F/JPO_)	1.6	12/00→	K4M 801	Petrol	1598	4	227
RAPID Box (F40_, G40_)	1.0	09/98→05/99	C1C 706	Petrol	949	4	4
RAPID Box (F40_, G40_)	1.1	07/98→04/99	C1E 750	Petrol	1108	4	15
RAPID Box (F40_, G40_)	1.1	07/98→04/99	C1E 752	Petrol	1108	4	16
RAPID Box (F40_, G40_)	1.1	07/98→04/99	C1E 754	Petrol	1108	4	17
RAPID Box (F40_, G40_)	1.1	06/98→09/99	C1E 756	Petrol	1108	4	18
RAPID Box (F40_, G40_)	1.1	07/98→04/99	C1E 760	Petrol	1108	4	19
RAPID Box (F40_, G40_)	1.1	07/98→04/99	C1E 762	Petrol	1108	4	20
RAPID Box (F40_, G40_)	1.1	07/98→04/99	C1E 792	Petrol	1108	4	21
RAPID Box (F40_, G40_)	1.2	09/99→08/99	C1G 726	Petrol	1237	4	59
RAPID Box (F40_, G40_)	1.2	09/99→03/99	C3G 710	Petrol	1239	4	63
RAPID Box (F40_, G40_)	1.2	09/99→03/99	C3G 712	Petrol	1239	4	64
RAPID Box (F40_, G40_)	1.2	05/99→11/99	E7F 708	Petrol	1171	4	69
RAPID Box (F40_, G40_)	1.4	07/98→08/99	C1J 768	Petrol	1397	4	80
RAPID Box (F40_, G40_)	1.4	07/98→08/99	C1J 780	Petrol	1397	4	82
RAPID Box (F40_, G40_)	1.4	03/98→08/99	C2J 784	Petrol	1397	4	99
RAPID Box (F40_, G40_)	1.4	08/98→03/99	C3J 700	Petrol	1397	4	103
RAPID Box (F40_, G40_)	1.4	08/98→03/99	C3J 702	Petrol	1397	4	104
RAPID Box (F40_, G40_)	1.4	08/98→03/99	C3J 760	Petrol	1397	4	106
RAPID Box (F40_, G40_)	1.4	08/98→03/99	C3J 762	Petrol	1397	4	107
RAPID Box (F40_, G40_)	1.4	09/99→03/99	E7J 720	Petrol	1390	4	121
RAPID Box (F40_, G40_)	1.4	09/99→03/99	E7J 724	Petrol	1390	4	122
RAPID Box (F40_, G40_)	1.4	09/99→03/99	E7J 726	Petrol	1390	4	123
RAPID Box (F40_, G40_)	1.4	01/99→03/99	E7J 728	Petrol	1390	4	124
RAPID Box (F40_, G40_)	1.4	09/99→03/99	E7J 773	Petrol	1390	4	130
RAPID Box (F40_, G40_)	1.6	03/98→08/99	F8M 720	Diesel	1596	4	191
RAPID Box (F40_, G40_)	1.6	03/98→08/99	F8M 730	Diesel	1596	4	192
RAPID Box (F40_, G40_)	1.6	03/98→08/99	F8M 736	Diesel	1596	4	193
RAPID Box (F40_, G40_)	1.6	03/98→08/99	F8M 760	Diesel	1596	4	194
RAPID Box (F40_, G40_)	1.9	09/99→03/99	F8Q 640	Diesel	1870	4	328
RAPID Box (F40_, G40_)	1.9	09/99→03/99	F8Q 646	Diesel	1870	4	329

	Ltr				CC		9
RAPID Box (F40_, G40_)	1.9	09/99→03/99	F8Q 682	Diesel	1870	4	333
RAPID Box (F40_, G40_)	1.9	09/99→03/99	F8Q 722	Diesel	1870	4	337
RAPID Box (F40_, G40_)	1.9	09/99→03/99	F8Q 724	Diesel	1870	4	338
RAPID Box (F40_, G40_)	1.9	09/99→03/99	F8Q 774	Diesel	1870	4	344
RAPID Box (F40_, G40_)	1.9	09/99→03/99	F8Q 776	Diesel	1870	4	345
SAFRANE I (B54_)	2.0	11/99→07/99	J7R 732	Petrol	1995	4	494
SAFRANE I (B54_)	2.0	11/99→07/99	J7R 733	Petrol	1995	4	495
SAFRANE I (B54_)	2.0	04/99→07/99	J7R 734	Petrol	1995	4	496
SAFRANE I (B54_)	2.0	04/99→07/99	J7R 735	Petrol	1995	4	497
SAFRANE I (B54_)	2.1	11/99→07/99	J8S 760	Diesel	2068	4	539
SAFRANE I (B54_)	2.2	04/99→07/99	J7T 760	Petrol	2165	4	584
SAFRANE I (B54_)	2.2	04/99→07/99	J7T 761	Petrol	2165	4	585
SAFRANE I (B54_)	2.2	04/99→07/99	J7T 762	Petrol	2165	4	586
SAFRANE I (B54_)	2.5	12/99→07/99	S8U 762	Diesel	2500	4	632
SAFRANE I (B54_)	2.5	12/99→07/99	S8U 763	Diesel	2500	4	633
SAFRANE I (B54_)	3.0	12/99→07/99	Z7X 721	Petrol	2963	6	663
SAFRANE I (B54_)	3.0	12/99→07/99	Z7X 722	Petrol	2963	6	664
SAFRANE I (B54_)	3.0	12/99→07/99	Z7X 723	Petrol	2963	6	665
SAFRANE I (B54_)	3.0	02/99→07/99	Z7X 726	Petrol	2963	6	666
SAFRANE II (B54_)	2.0	07/99→12/00	N7Q 710	Petrol	1948	4	397
SAFRANE II (B54_)	2.0	07/99→12/00	N7Q 711	Petrol	1948	4	398
SAFRANE II (B54_)	2.2	07/99→12/00	G8T 740	Diesel	2188	4	550
SAFRANE II (B54_)	2.5	07/99→12/00	N7U 700	Petrol	2435	5	607
SAFRANE II (B54_)	2.5	07/99→12/00	N7U 701	Petrol	2435	5	608
SAFRANE II (B54_)	2.9	03/99→12/00	L7X 713	Petrol	2946	6	654
SANDERO/STEPWAY	1.4	02/00→	K7J 710	Petrol	1390	4	145
SANDERO/STEPWAY	1.6	12/00→	K7M 710	Petrol	1598	4	246
SANDERO/STEPWAY	1.6	11/01→	K7M 718	Petrol	1598	4	247
SCÉNIC I (JAO/1_)	1.4	09/99→08/00	K4J 714	Petrol	1390	4	136
SCÉNIC I (JAO/1_)	1.4	09/99→08/00	K4J 750	Petrol	1390	4	140
SCÉNIC I (JAO/1_)	1.6	09/99→09/00	K4M 700	Petrol	1598	4	197
SCÉNIC I (JAO/1_)	1.6	09/99→09/00	K4M 706	Petrol	1598	4	200
SCÉNIC I (JAO/1_)	1.6	03/00→08/00	K4M 708	Petrol	1598	4	201
SCÉNIC I (JAO/1_)	1.6	03/00→08/00	K4M 709	Petrol	1598	4	202
SCÉNIC I (JAO/1_)	1.8	01/00→08/00	F4P 720	Petrol	1783	4	310
SCÉNIC I (JAO/1_)	1.8	07/00→08/00	F4P 722	Petrol	1783	4	311
SCÉNIC I (JAO/1_)	1.9	09/99→03/00	F8Q 790	Diesel	1870	4	348
SCÉNIC I (JAO/1_)	1.9	09/99→08/00	F9Q 731	Diesel	1870	4	359
SCÉNIC I (JAO/1_)	1.9	09/99→08/00	F9Q 732	Diesel	1870	4	360
SCÉNIC I (JAO/1_)	1.9	09/99→08/00	F9Q 733	Diesel	1870	4	361
SCÉNIC I (JAO/1_)	1.9	09/99→08/00	F9Q 734	Diesel	1870	4	362
SCÉNIC I (JAO/1_)	1.9	09/99→08/00	F9Q 736	Diesel	1870	4	363
SCÉNIC I (JAO/1_)	1.9	11/00→08/00	F9Q 740	Diesel	1870	4	365
SCÉNIC I (JAO/1_)	1.9	02/00→08/00	F9Q 744	Diesel	1870	4	366
SCÉNIC I (JAO/1_)	1.9	12/00→08/00	F9Q 748	Diesel	1870	4	367
SCÉNIC I (JAO/1_)	2.0	09/99→08/00	F4R 740	Petrol	1998	4	425
SCÉNIC I (JAO/1_)	2.0	09/99→08/00	F4R 741	Petrol	1998	4	426
SCÉNIC I (JAO/1_)	2.0	09/99→08/00	F4R 744	Petrol	1998	4	427
SCÉNIC I (JAO/1_)	2.0	06/00→08/00	F4R 746	Petrol	1998	4	428
SCÉNIC II (JMO/1_)	1.4	06/00→	K4J 730	Petrol	1390	4	137
SCÉNIC II (JMO/1_)	1.4	06/00→	K4J 740	Petrol	1390	4	139
SCÉNIC II (JMO/1_)	1.4	06/00→	K4J 770	Petrol	1390	4	141
SCÉNIC II (JMO/1_)	1.5	06/00→	K9K 722	Diesel	1461	4	154
SCÉNIC II (JMO/1_)	1.5	05/00→	K9K 724	Diesel	1461	4	155
SCÉNIC II (JMO/1_)	1.5	11/00→	K9K 728	Diesel	1461	4	156
SCÉNIC II (JMO/1_)	1.5	11/00→	K9K 729	Diesel	1461	4	157
SCÉNIC II (JMO/1_)	1.5	05/00→	K9K 732	Diesel	1461	4	158
SCÉNIC II (JMO/1_)	1.5	01/00→	K9K 734	Diesel	1461	4	159
SCÉNIC II (JMO/1_)	1.6	06/00→	K4M 761	Petrol	1598	4	218
SCÉNIC II (JMO/1_)	1.6	06/00→	K4M 782	Petrol	1598	4	221
SCÉNIC II (JMO/1_)	1.6	06/00→	K4M 788	Petrol	1598	4	222
SCÉNIC II (JMO/1_)	1.6	06/00→	K4M 788	Flexfuel	1598	4	222
SCÉNIC II (JMO/1_)	1.6	01/00→	K4M 812	Petrol	1598	4	229
SCÉNIC II (JMO/1_)	1.6	01/00→	K4M 9 766	Petrol	1598	4	240
SCÉNIC II (JMO/1_)	1.6	01/00→	K4M C 813	Petrol	1598	4	241
SCÉNIC II (JMO/1_)	1.9	06/00→	F9Q 804	Diesel	1870	4	383
SCÉNIC II (JMO/1_)	1.9	06/00→	F9Q 812	Diesel	1870	4	385
SCÉNIC II (JMO/1_)	1.9	05/00→	F9Q 816	Diesel	1870	4	386
SCÉNIC II (JMO/1_)	1.9	05/00→	F9Q 818	Diesel	1870	4	387
SCÉNIC II (JMO/1_)	1.9	05/00→	F9Q J 803	Diesel	1870	4	394



Ltr



CC



9

Model	Ltr	Year Range	Engine Code	Fuel Type	CC	Seats	Price
SCÉNIC II (JMO/1_)	2.0	06/00→	F4R 770	Petrol	1998	4	437
SCÉNIC II (JMO/1_)	2.0	06/00→	F4R 771	Petrol	1998	4	438
SCÉNIC II (JMO/1_)	2.0	05/00→	F4R 776	Petrol	1998	4	440
SCÉNIC II (JMO/1_)	2.0	09/00→	M9R 700	Diesel	1995	4	514
SCÉNIC II (JMO/1_)	2.0	09/00→	M9R 721	Diesel	1995	4	515
SCÉNIC II (JMO/1_)	2.0	09/00→	M9R 722	Diesel	1995	4	516
SCÉNIC III (JZO/1_)	1.5	04/00→	K9K 830	Diesel	1461	4	179
SCÉNIC III (JZO/1_)	1.5	02/00→	K9K 832	Diesel	1461	4	180
SCÉNIC III (JZO/1_)	1.5	04/00→	K9K 836	Diesel	1461	4	182
SCÉNIC III (JZO/1_)	1.5	04/00→	K9K 837	Diesel	1461	4	183
SCÉNIC III (JZO/1_)	1.5	11/01→	K9K 846	Diesel	1461	4	184
SCÉNIC III (JZO/1_)	1.6	02/00→	K4M 858	Petrol	1598	4	237
SCÉNIC III (JZO/1_)	1.6	02/00→	K4M 866	Petrol	1598	4	239
SCÉNIC III (JZO/1_)	1.6	02/00→	K4M 866	Flexfuel	1598	4	239
SCÉNIC III (JZO/1_)	1.6	02/00→	K4M 866	Bi-Fuel	1598	4	239
SCÉNIC III (JZO/1_)	1.9	02/00→	F9Q 870	Diesel	1870	4	390
SCÉNIC III (JZO/1_)	1.9	02/00→	F9Q 872	Diesel	1870	4	391
SCÉNIC III (JZO/1_)	2.0	02/00→	M4R 711	Petrol	1997	4	511
SPORT SPIDER (EFO_)	2.0	03/99→10/99	F7R 710	Petrol	1998	4	470
SUPER 5 (B/C40_)	1.0	10/98→10/98	C1C 700	Petrol	956	4	6
SUPER 5 (B/C40_)	1.1	10/98→03/99	C1E 750	Petrol	1108	4	15
SUPER 5 (B/C40_)	1.1	10/98→03/99	C1E 752	Petrol	1108	4	16
SUPER 5 (B/C40_)	1.1	10/98→10/98	C1E 754	Petrol	1108	4	17
SUPER 5 (B/C40_)	1.1	01/98→03/99	C1E 756	Petrol	1108	4	18
SUPER 5 (B/C40_)	1.1	01/98→03/99	C1E 760	Petrol	1108	4	19
SUPER 5 (B/C40_)	1.2	01/98→08/99	C1G 702	Petrol	1237	4	55
SUPER 5 (B/C40_)	1.2	01/98→08/99	C1G 720	Petrol	1237	4	57
SUPER 5 (B/C40_)	1.2	01/98→08/99	C1G 722	Petrol	1237	4	58
SUPER 5 (B/C40_)	1.4	01/98→05/99	840 730	Petrol	1397	4	72
SUPER 5 (B/C40_)	1.4	10/98→06/98	C1J 768	Petrol	1397	4	80
SUPER 5 (B/C40_)	1.4	10/98→06/98	C1J 780	Petrol	1397	4	82
SUPER 5 (B/C40_)	1.4	04/98→08/99	C1J 782	Petrol	1397	4	83
SUPER 5 (B/C40_)	1.4	04/98→08/99	C1J 784	Petrol	1397	4	84
SUPER 5 (B/C40_)	1.4	04/98→08/99	C1J 788	Petrol	1397	4	85
SUPER 5 (B/C40_)	1.4	10/98→07/98	C2J 700	Petrol	1397	4	88
SUPER 5 (B/C40_)	1.4	10/98→07/98	C2J 780	Petrol	1397	4	96
SUPER 5 (B/C40_)	1.4	10/98→07/98	C2J 781	Petrol	1397	4	97
SUPER 5 (B/C40_)	1.4	06/98→07/98	C2J 782	Petrol	1397	4	98
SUPER 5 (B/C40_)	1.4	06/98→08/99	C2J 784	Petrol	1397	4	99
SUPER 5 (B/C40_)	1.4	10/98→07/98	C2J 788	Petrol	1397	4	100
SUPER 5 (B/C40_)	1.4	10/98→07/98	C2J 789	Petrol	1397	4	101
SUPER 5 (B/C40_)	1.4	10/98→07/98	C2J 798	Petrol	1397	4	102
SUPER 5 (B/C40_)	1.4	10/98→12/99	C3J 700	Petrol	1397	4	103
SUPER 5 (B/C40_)	1.4	10/98→12/99	C3J 702	Petrol	1397	4	104
SUPER 5 (B/C40_)	1.4	10/98→12/99	C3J 760	Petrol	1397	4	106
SUPER 5 (B/C40_)	1.6	08/98→12/99	F8M 720	Diesel	1596	4	191
SUPER 5 (B/C40_)	1.6	04/98→12/99	F8M 730	Diesel	1596	4	192
SUPER 5 (B/C40_)	1.7	06/98→03/99	F2N 740	Petrol	1721	4	268
SUPER 5 (B/C40_)	1.7	06/98→03/99	F2N 742	Petrol	1721	4	269
SUPER 5 (B/C40_)	1.7	10/98→08/99	F3N 702	Petrol	1721	4	275
SUPER 5 (B/C40_)	1.7	10/98→03/99	F3N 716	Petrol	1721	4	277
SUPER 5 (B/C40_)	1.7	10/98→03/99	F3N 717	Petrol	1721	4	278
SUPER 5 (B/C40_)	1.7	10/98→08/99	F3N 722	Petrol	1721	4	280
SUPER 5 Box (S40_)	1.0	10/98→10/98	C1C 700	Petrol	956	4	6
SUPER 5 Box (S40_)	1.1	10/98→12/99	C1E 750	Petrol	1108	4	15
SUPER 5 Box (S40_)	1.1	10/98→12/99	C1E 752	Petrol	1108	4	16
SUPER 5 Box (S40_)	1.1	10/98→12/99	C1E 754	Petrol	1108	4	17
SUPER 5 Box (S40_)	1.2	01/98→12/99	C1G 702	Petrol	1237	4	55
SUPER 5 Box (S40_)	1.6	10/98→12/99	F8M 720	Diesel	1596	4	191
THALIA (LBO/1/2_)	1.2	02/99→10/00	D7F 744	Petrol	1149	4	49
THALIA (LBO/1/2_)	1.2	02/99→10/00	D7F 746	Petrol	1149	4	50
THALIA (LBO/1/2_)	1.6	03/99→	K7M 746	Petrol	1598	4	251
THALIA (LBO/1/2_)	2.0	09/00→	F4R 738	Petrol	1998	4	424
THALIA (LBO/1/2_)	3.0	04/00→09/00	L7X 732	Petrol	2946	6	659
THALIA (LBO/1/2_)	3.0	06/00→	L7X 762	Petrol	2946	6	661
THALIA I (LBO/1/2_)	1.2	04/00→	D4F 712	Petrol	1149	4	25
THALIA I (LBO/1/2_)	1.4	08/00→	K4J 712	Petrol	1390	4	134
THALIA I (LBO/1/2_)	1.4	08/00→	K7J 700	Petrol	1390	4	143
THALIA I (LBO/1/2_)	1.5	04/00→	K9K 700	Diesel	1461	4	146
THALIA I (LBO/1/2_)	1.5	06/00→	K9K 702	Diesel	1461	4	147



Ltr



CC



9

THALIA I (LBO/1/2_)	1.5	02/00 →	K9K 714	Diesel	1461	4	151
THALIA I (LBO/1/2_)	1.5	06/00 →	K9K 740	Diesel	1461	4	160
THALIA I (LBO/1/2_)	1.6	04/00 →	K4M 740	Petrol	1598	4	208
THALIA I (LBO/1/2_)	1.9	02/99 → 05/00	F8Q 630	Diesel	1870	4	326
THALIA II (LU1/2_)	1.2	09/00 →	D4F 728	Petrol	1149	4	29
THALIA II (LU1/2_)	1.5	01/00 →	K9K 700	Diesel	1461	4	146
THALIA II (LU1/2_)	1.5	09/00 →	K9K 718	Diesel	1461	4	153
THALIA II (LU1/2_)	1.5	09/00 →	K9K 740	Diesel	1461	4	160
THALIA II (LU1/2_)	1.6	09/00 →	K4M 743	Petrol	1598	4	210
TRAFIC Box (T1, T3, T4)	1.4	03/98 → 04/98	847 700	Petrol	1397	4	73
TRAFIC Box (T1, T3, T4)	1.4	03/98 → 04/98	847 701	Petrol	1397	4	74
TRAFIC Box (T1, T3, T4)	1.4	03/98 → 04/98	C1J 700	Petrol	1397	4	75
TRAFIC Box (T1, T3, T4)	1.7	06/98 → 04/98	F1N 724	Petrol	1721	4	256
TRAFIC Box (T1, T3, T4)	2.0	05/98 → 04/98	J5R 716	Petrol	1995	4	472
TRAFIC Box (T1, T3, T4)	2.0	06/98 → 04/98	J5R 722	Petrol	1995	4	474
TRAFIC Box (T1, T3, T4)	2.0	06/98 → 04/98	J5R 726	Petrol	1995	4	475
TRAFIC Box (T1, T3, T4)	2.1	09/98 → 04/98	852 750	Diesel	2068	4	523
TRAFIC Box (TXX)	1.4	05/98 → 06/99	C1J 700	Petrol	1397	4	75
TRAFIC Box (TXX)	1.7	08/99 → 08/99	F1N 720	Petrol	1721	4	254
TRAFIC Box (TXX)	1.9	06/99 → 03/00	F8Q 606	Diesel	1870	4	321
TRAFIC Box (TXX)	2.0	05/98 → 08/99	J5R 716	Petrol	1995	4	472
TRAFIC Box (TXX)	2.1	05/98 → 06/99	852 750	Diesel	2068	4	523
TRAFIC Box (TXX)	2.1	06/99 → 10/99	J8S 620	Diesel	2068	4	529
TRAFIC Box (TXX)	2.1	06/99 → 10/99	J8S 758	Diesel	2068	4	538
TRAFIC Box (TXX)	2.2	06/99 → 10/99	J7T 600	Petrol	2165	4	572
TRAFIC Box (TXX)	2.2	05/98 → 06/99	J7T 780	Petrol	2165	4	591
TRAFIC Box (TXX)	2.5	05/98 → 03/00	8140.67.2500	Diesel	2499	4	616
TRAFIC Box (TXX)	2.5	05/98 → 03/00	8140.67.2550	Diesel	2499	4	618
TRAFIC Box (TXX)	2.5	05/98 → 03/00	8140.67.2580	Diesel	2499	4	619
TRAFIC Box (TXX)	2.5	03/98 → 03/00	S8U 750	Diesel	2499	4	629
TRAFIC Box (TXX)	2.5	05/98 → 03/00	S8U 752	Diesel	2499	4	630
TRAFIC Box (TXX)	2.5	05/98 → 03/00	S8U 758	Diesel	2499	4	631
TRAFIC Bus (T5, T6, T7)	1.4	03/98 → 04/98	847 700	Petrol	1397	4	73
TRAFIC Bus (T5, T6, T7)	1.4	03/98 → 04/98	847 701	Petrol	1397	4	74
TRAFIC Bus (T5, T6, T7)	1.4	03/98 → 04/98	C1J 700	Petrol	1397	4	75
TRAFIC Bus (T5, T6, T7)	1.7	06/98 → 04/98	F1N 724	Petrol	1721	4	256
TRAFIC Bus (T5, T6, T7)	2.0	06/98 → 04/98	J5R 716	Petrol	1995	4	472
TRAFIC Bus (T5, T6, T7)	2.0	06/98 → 04/98	J5R 722	Petrol	1995	4	474
TRAFIC Bus (T5, T6, T7)	2.0	06/98 → 04/98	J5R 726	Petrol	1995	4	475
TRAFIC Bus (T5, T6, T7)	2.1	03/98 → 04/98	852 750	Diesel	2068	4	523
TRAFIC Bus (T5, T6, T7)	2.5	03/98 → 08/99	S8U 750	Diesel	2499	4	629
TRAFIC Bus (TXW)	1.7	08/99 → 08/99	F1N 724	Petrol	1721	4	256
TRAFIC Bus (TXW)	1.9	06/99 → 03/00	F8Q 606	Diesel	1870	4	321
TRAFIC Bus (TXW)	2.0	05/98 → 08/99	J5R 726	Petrol	1995	4	475
TRAFIC Bus (TXW)	2.1	05/98 → 06/99	852 720	Diesel	2068	4	522
TRAFIC Bus (TXW)	2.1	05/98 → 06/99	852 750	Diesel	2068	4	523
TRAFIC Bus (TXW)	2.1	06/99 → 10/99	J8S 620	Diesel	2068	4	529
TRAFIC Bus (TXW)	2.1	06/99 → 10/99	J8S 758	Diesel	2068	4	538
TRAFIC Bus (TXW)	2.2	06/99 → 10/99	J7T 600	Petrol	2165	4	572
TRAFIC Bus (TXW)	2.2	05/98 → 06/99	J7T 780	Petrol	2165	4	591
TRAFIC Bus (TXW)	2.5	05/98 → 03/00	8140.67.2500	Diesel	2499	4	616
TRAFIC Bus (TXW)	2.5	05/98 → 03/00	8140.67.2550	Diesel	2499	4	618
TRAFIC Bus (TXW)	2.5	05/98 → 03/00	8140.67.2580	Diesel	2499	4	619
TRAFIC Bus (TXW)	2.5	05/98 → 03/00	S8U 750	Diesel	2499	4	629
TRAFIC Bus (TXW)	2.5	05/98 → 03/00	S8U 752	Diesel	2499	4	630
TRAFIC Bus (TXW)	2.5	05/98 → 03/00	S8U 758	Diesel	2499	4	631
TRAFIC II Box (FL)	1.9	03/00 →	F9Q 760	Diesel	1870	4	373
TRAFIC II Box (FL)	1.9	03/00 →	F9Q 762	Diesel	1870	4	374
TRAFIC II Box (FL)	2.0	03/00 →	F4R 720	Petrol	1998	4	421
TRAFIC II Box (FL)	2.0	03/00 →	F4R 722	Petrol	1998	4	422
TRAFIC II Box (FL)	2.0	08/00 →	F4R 820	Petrol	1998	4	453
TRAFIC II Box (FL)	2.0	08/00 →	M9R 780	Diesel	1995	4	519
TRAFIC II Box (FL)	2.0	08/00 →	M9R 782	Diesel	1995	4	520
TRAFIC II Box (FL)	2.5	08/00 →	G9U 630	Diesel	2464	4	620
TRAFIC II Box (FL)	2.5	03/00 →	G9U 730	Diesel	2464	4	625
TRAFIC II Bus (JL)	1.9	03/00 →	F9Q 760	Diesel	1870	4	373
TRAFIC II Bus (JL)	1.9	03/00 →	F9Q 762	Diesel	1870	4	374
TRAFIC II Bus (JL)	2.0	03/00 →	F4R 720	Petrol	1998	4	421
TRAFIC II Bus (JL)	2.0	03/00 →	F4R 722	Petrol	1998	4	422
TRAFIC II Bus (JL)	2.0	08/00 →	F4R 820	Petrol	1998	4	453



Ltr















CC















9









	Ltr				CC		
TRAFIC II Bus (JL)	2.0	08/00→	M9R 780	Diesel	1995	4	519
TRAFIC II Bus (JL)	2.0	08/00→	M9R 782	Diesel	1995	4	520
TRAFIC II Bus (JL)	2.5	08/00→	G9U 630	Diesel	2464	4	620
TRAFIC II Bus (JL)	2.5	03/00→	G9U 730	Diesel	2464	4	625
TRAFIC II Platform/Chassis (EL)	1.9	03/00→	F9Q 760	Diesel	1870	4	373
TRAFIC II Platform/Chassis (EL)	1.9	03/00→	F9Q 762	Diesel	1870	4	374
TRAFIC II Platform/Chassis (EL)	2.0	03/00→	F4R 720	Petrol	1998	4	421
TRAFIC II Platform/Chassis (EL)	2.0	08/00→	M9R 780	Diesel	1995	4	519
TRAFIC II Platform/Chassis (EL)	2.0	08/00→	M9R 782	Diesel	1995	4	520
TRAFIC II Platform/Chassis (EL)	2.5	08/00→	G9U 630	Diesel	2464	4	620
TRAFIC II Platform/Chassis (EL)	2.5	03/00→	G9U 730	Diesel	2464	4	625
TRAFIC Platform/Chassis (P6)	1.4	03/98→04/98	847 700	Petrol	1397	4	73
TRAFIC Platform/Chassis (P6)	1.4	03/98→04/98	C1J 700	Petrol	1397	4	75
TRAFIC Platform/Chassis (P6)	1.7	06/98→04/98	FIN 722	Petrol	1721	4	255
TRAFIC Platform/Chassis (P6)	2.0	05/98→02/98	J5R 716	Petrol	1995	4	472
TRAFIC Platform/Chassis (P6)	2.0	03/98→04/98	J5R 726	Petrol	1995	4	475
TRAFIC Platform/Chassis (P6)	2.1	03/98→04/98	852 720	Diesel	2068	4	522
TRAFIC Platform/Chassis (P6)	2.1	05/98→02/98	852 750	Diesel	2068	4	523
TRAFIC Platform/Chassis (P6)	2.1	05/98→02/98	J8S 750	Diesel	2068	4	537
TRAFIC Platform/Chassis (P6)	2.5	03/98→04/98	8140.61.240	Diesel	2445	4	606
TRAFIC Platform/Chassis (P6)	2.5	03/98→04/98	S8U 720	Diesel	2445	4	609
TRAFIC Platform/Chassis (P6)	2.5	03/98→04/98	S8U 722	Diesel	2445	4	610
TRAFIC Platform/Chassis (PXX)	1.7	05/98→08/99	FIN 722	Petrol	1721	4	255
TRAFIC Platform/Chassis (PXX)	2.0	03/98→10/99	J5R 726	Petrol	1995	4	475
TRAFIC Platform/Chassis (PXX)	2.1	05/98→06/99	852 720	Diesel	2068	4	522
TRAFIC Platform/Chassis (PXX)	2.1	06/99→04/99	J8S 620	Diesel	2068	4	529
TRAFIC Platform/Chassis (PXX)	2.1	06/99→10/99	J8S 758	Diesel	2068	4	538
TRAFIC Platform/Chassis (PXX)	2.2	09/99→04/99	J7T 600	Petrol	2165	4	572
TRAFIC Platform/Chassis (PXX)	2.2	05/98→06/99	J7T 780	Petrol	2165	4	591
TRAFIC Platform/Chassis (PXX)	2.5	05/98→03/00	8140.61.240	Diesel	2445	4	606
TRAFIC Platform/Chassis (PXX)	2.5	05/98→03/00	S8U 720	Diesel	2445	4	609
TRAFIC Platform/Chassis (PXX)	2.5	05/98→03/00	S8U 722	Diesel	2445	4	610
TRAFIC Platform/Chassis (PXX)	2.5	03/98→08/99	S8U 750	Diesel	2499	4	629
TRAFIC Platform/Chassis (PXX)	2.5	09/99→03/00	S8U 758	Diesel	2499	4	631
TRAFIC Platform/Chassis (PXX)	2.5	05/99→03/00	S8U 780	Diesel	2499	4	635
TWINGO (CO6_)	1.2	09/99→08/00	D7F 702	Petrol	1149	4	40
TWINGO (CO6_)	1.2	09/99→08/00	D7F 703	Petrol	1149	4	41
TWINGO (CO6_)	1.2	09/99→08/00	D7F 704	Petrol	1149	4	42
TWINGO I (CO6_)	1.2	03/99→10/99	C3G 700	Petrol	1239	4	61
TWINGO I (CO6_)	1.2	03/99→10/99	C3G 702	Petrol	1239	4	62
TWINGO I (CO6_)	1.2	01/00→	D4F 702	Petrol	1149	4	22
TWINGO I (CO6_)	1.2	08/00→	D4F 708	Petrol	1149	4	24
TWINGO I (CO6_)	1.2	05/99→	D7F 700	Petrol	1149	4	38
TWINGO I (CO6_)	1.2	05/99→	D7F 701	Petrol	1149	4	39
TWINGO I (CO6_)	1.2	05/99→	D7F 702	Petrol	1149	4	40
TWINGO I (CO6_)	1.2	05/99→	D7F 703	Petrol	1149	4	41
TWINGO I (CO6_)	1.2	05/99→	D7F 704	Petrol	1149	4	42
TWINGO I Box (SO6_)	1.2	03/99→05/99	C3G 700	Petrol	1239	4	61
TWINGO I Box (SO6_)	1.2	03/99→05/99	C3G 702	Petrol	1239	4	62
TWINGO I Box (SO6_)	1.2	05/99→	D7F 700	Petrol	1149	4	38
TWINGO I Box (SO6_)	1.2	05/99→	D7F 701	Petrol	1149	4	39
TWINGO I Box (SO6_)	1.2	05/99→	D7F 702	Petrol	1149	4	40
TWINGO I Box (SO6_)	1.2	05/99→	D7F 703	Petrol	1149	4	41
TWINGO I Box (SO6_)	1.2	05/99→	D7F 704	Petrol	1149	4	42
TWINGO I Box (SO6_)	1.2	05/99→	D7F 706	Petrol	1149	4	43
TWINGO II (CNO_)	1.2	03/00→	D4F 772	Petrol	1149	4	34
TWINGO II (CNO_)	1.2	03/00→	D4F 780	Petrol	1149	4	35
TWINGO II (CNO_)	1.2	03/00→	D4F 782	Petrol	1149	4	36
TWINGO II (CNO_)	1.2	03/00→	D7F 800	Petrol	1149	4	53
TWINGO II (CNO_)	1.5	04/00→	K9K 718	Diesel	1461	4	153
TWINGO II (CNO_)	1.5	03/00→	K9K 740	Diesel	1461	4	160
TWINGO II (CNO_)	1.5	10/01→	K9K 820	Diesel	1461	4	178
TWINGO II (CNO_)	1.5	10/01→	K9K 830	Diesel	1461	4	179
TWINGO II (CNO_)	1.6	05/00→	K4M 854	Petrol	1598	4	236
VEL SATIS (BJO_)	2.0	06/00→	F4R 762	Petrol	1998	4	431
VEL SATIS (BJO_)	2.0	06/00→	F4R 763	Petrol	1998	4	432
VEL SATIS (BJO_)	2.0	04/00→	F4R 766	Petrol	1998	4	435
VEL SATIS (BJO_)	2.0	04/00→	F4R 767	Petrol	1998	4	436
VEL SATIS (BJO_)	2.0	04/00→	F4R 867	Petrol	1998	4	455
VEL SATIS (BJO_)	2.2	04/00→	G9T 600	Diesel	2188	4	555







	Ltr				CC		9
VEL SATIS (BJO_)	2.2	09/00 →	G9T 606	Diesel	2188	4	557
VEL SATIS (BJO_)	2.2	09/00 →	G9T 700	Diesel	2188	4	560
VEL SATIS (BJO_)	2.2	06/00 →	G9T 702	Diesel	2188	4	561
VEL SATIS (BJO_)	2.2	06/00 →	G9T 703	Diesel	2188	4	562
VEL SATIS (BJO_)	3.0	06/00 →	P9X 701	Diesel	2958	6	662
VEL SATIS (BJO_)	3.5	06/00 →	V4Y 701	Petrol	3498	6	670
VEL SATIS (BJO_)	3.5	06/00 →	V4Y 711	Petrol	3498	6	671
VEL SATIS (BJO_)	3.5	10/00 →	V4Y 715	Petrol	3498	6	673
WIND (E4M_)	1.2	02/01 →	D4F 780	Petrol	1149	4	35
WIND (E4M_)	1.2	07/01 →	D4F 782	Petrol	1149	4	36
WIND (E4M_)	1.6	07/01 →	K4M 854	Petrol	1598	4	236

		CC			9			CC			9
688 711	Petrol	1108	4	70.00	9	C3G 700	Petrol	1239	4	74.00	61
688 712	Petrol	1108	4	70.00	10	C3G 702	Petrol	1239	4	74.00	62
689 710	Petrol	956	4	65.00	5	C3G 710	Petrol	1239	4	74.00	63
800 01	Petrol	845	4	58.00	1	C3G 712	Petrol	1239	4	74.00	64
800 705	Petrol	845	4	58.00	2	C3G 720	Petrol	1239	4	74.00	65
8140.27.2500	Diesel	2499	4	93.00	613	C3J 700	Petrol	1397	4	76.00	103
8140.27.2510	Diesel	2499	4	93.00	614	C3J 702	Petrol	1397	4	76.00	104
8140.27.2580	Diesel	2499	4	93.00	615	C3J 710	Petrol	1397	4	76.00	105
8140.61.2300	Diesel	2445	4	93.00	605	C3J 760	Petrol	1397	4	76.00	106
8140.61.240	Diesel	2445	4	93.00	606	C3J 762	Petrol	1397	4	76.00	107
8140.67.2500	Diesel	2499	4	93.00	616	CG10DE	Petrol	998	4	71.00	8
8140.67.2510	Diesel	2499	4	93.00	617	D4F 702	Petrol	1149	4	69.00	22
8140.67.2550	Diesel	2499	4	93.00	618	D4F 706	Petrol	1149	4	69.00	23
8140.67.2580	Diesel	2499	4	93.00	619	D4F 708	Petrol	1149	4	69.00	24
829 730	Petrol	1995	4	88.00	399	D4F 712	Petrol	1149	4	69.00	25
840 730	Petrol	1397	4	76.00	72	D4F 714	Petrol	1149	4	69.00	26
847 700	Petrol	1397	4	76.00	73	D4F 716	Petrol	1149	4	69.00	27
847 701	Petrol	1397	4	76.00	74	D4F 722	Petrol	1149	4	69.00	28
852 720	Diesel	2068	4	86.00	522	D4F 728	Petrol	1149	4	69.00	29
852 750	Diesel	2068	4	86.00	523	D4F 730	Petrol	1149	4	69.00	30
B1B 707	Petrol	845	4	58.00	3	D4F 740	Petrol	1149	4	69.00	31
C1C 700	Petrol	956	4	65.00	6	D4F 740	Flexfuel	1149	4	69.00	31
C1C 706	Petrol	949	4	65.00	4	D4F 742	Flexfuel	1149	4	69.00	32
C1C 708	Petrol	956	4	65.00	7	D4F 764	Petrol	1149	4	69.00	33
C1E 700	Petrol	1108	4	70.00	11	D4F 772	Petrol	1149	4	69.00	34
C1E 714	Petrol	1108	4	70.00	12	D4F 780	Petrol	1149	4	69.00	35
C1E 718	Petrol	1108	4	70.00	13	D4F 782	Petrol	1149	4	69.00	36
C1E 719	Petrol	1108	4	70.00	14	D4F 784	Petrol	1149	4	69.00	37
C1E 750	Petrol	1108	4	70.00	15	D7F 700	Petrol	1149	4	69.00	38
C1E 752	Petrol	1108	4	70.00	16	D7F 701	Petrol	1149	4	69.00	39
C1E 754	Petrol	1108	4	70.00	17	D7F 702	Petrol	1149	4	69.00	40
C1E 756	Petrol	1108	4	70.00	18	D7F 703	Petrol	1149	4	69.00	41
C1E 760	Petrol	1108	4	70.00	19	D7F 704	Petrol	1149	4	69.00	42
C1E 762	Petrol	1108	4	70.00	20	D7F 706	Petrol	1149	4	69.00	43
C1E 792	Petrol	1108	4	70.00	21	D7F 710	Petrol	1149	4	69.00	44
C1G 700	Petrol	1237	4	71.50	54	D7F 720	Petrol	1149	4	69.00	45
C1G 702	Petrol	1237	4	71.50	55	D7F 722	Petrol	1149	4	69.00	46
C1G 710	Petrol	1237	4	71.50	56	D7F 726	Petrol	1149	4	69.00	47
C1G 720	Petrol	1237	4	71.50	57	D7F 730	Petrol	1149	4	69.00	48
C1G 722	Petrol	1237	4	71.50	58	D7F 744	Petrol	1149	4	69.00	49
C1G 726	Petrol	1237	4	71.50	59	D7F 746	Petrol	1149	4	69.00	50
C1G 730	Petrol	1237	4	71.50	60	D7F 764	Petrol/ Petroleum Gas (LPG)	1149	4	69.00	51
C1J 700	Petrol	1397	4	76.00	75						
C1J 715	Petrol	1397	4	76.00	76						
C1J 742	Petrol	1397	4	76.00	77	D7F 764	Petrol	1149	4	69.00	51
C1J 760	Petrol	1397	4	76.00	78	D7F 766	Petrol/ Petroleum Gas (LPG)	1149	4	69.00	52
C1J 764	Petrol	1397	4	76.00	79						
C1J 768	Petrol	1397	4	76.00	80						
C1J 770	Petrol	1397	4	76.00	81	D7F 766	Petrol	1149	4	69.00	52
C1J 780	Petrol	1397	4	76.00	82	D7F 800	Petrol	1149	4	69.00	53
C1J 782	Petrol	1397	4	76.00	83	E5F 710	Petrol	1171	4	75.80	66
C1J 784	Petrol	1397	4	76.00	84	E6J 700	Petrol	1390	4	75.80	108
C1J 788	Petrol	1397	4	76.00	85	E6J 701	Petrol	1390	4	75.80	109
C1J 792	Petrol	1397	4	76.00	86	E7F 700	Petrol	1171	4	75.80	67
C1J 796	Petrol	1397	4	76.00	87	E7F 706	Petrol	1171	4	75.80	68
C2J 700	Petrol	1397	4	76.00	88	E7F 708	Petrol	1171	4	75.80	69
C2J 720	Petrol	1397	4	76.00	89	E7F 730	Petrol	1171	4	75.80	70
C2J 730	Petrol	1397	4	76.00	90	E7F 750	Petrol	1171	4	75.80	71
C2J 766	Petrol	1397	4	76.00	91	E7J 601	Petrol	1390	4	75.80	110
C2J 767	Petrol	1397	4	76.00	92	E7J 624	Petrol	1390	4	75.80	111
C2J 768	Petrol	1397	4	76.00	93	E7J 626	Petrol	1390	4	75.80	112
C2J 770	Petrol	1397	4	76.00	94	E7J 634	Petrol	1390	4	75.80	113
C2J 772	Petrol	1397	4	76.00	95	E7J 635	Petrol	1390	4	75.80	114
C2J 780	Petrol	1397	4	76.00	96	E7J 700	Petrol	1390	4	75.80	115
C2J 781	Petrol	1397	4	76.00	97	E7J 706	Petrol	1390	4	75.80	116
C2J 782	Petrol	1397	4	76.00	98	E7J 710	Petrol	1390	4	75.80	117
C2J 784	Petrol	1397	4	76.00	99	E7J 711	Petrol	1390	4	75.80	118
C2J 788	Petrol	1397	4	76.00	100	E7J 718	Petrol	1390	4	75.80	119
C2J 789	Petrol	1397	4	76.00	101	E7J 719	Petrol	1390	4	75.80	120
C2J 798	Petrol	1397	4	76.00	102	E7J 720	Petrol	1390	4	75.80	121

		CC			9			CC			9
E7J 724	Petrol	1390	4	75.80	122	F3R 729	Petrol	1998	4	82.70	404
E7J 726	Petrol	1390	4	75.80	123	F3R 742	Petrol	1998	4	82.70	405
E7J 728	Petrol	1390	4	75.80	124	F3R 750	Petrol	1998	4	82.70	406
E7J 742	Petrol	1390	4	75.80	125	F3R 751	Petrol	1998	4	82.70	407
E7J 754	Petrol	1390	4	75.80	126	F3R 752	Petrol	1998	4	82.70	408
E7J 756	Petrol	1390	4	75.80	127	F3R 768	Petrol	1998	4	82.70	409
E7J 757	Petrol	1390	4	75.80	128	F3R 769	Petrol	1998	4	82.70	410
E7J 764	Petrol	1390	4	75.80	129	F3R 791	Petrol	1998	4	82.70	411
E7J 773	Petrol	1390	4	75.80	130	F3R 796	Petrol	1998	4	82.70	412
E7J 780	Petrol	1390	4	75.80	131	F3R 797	Petrol	1998	4	82.70	413
FIN 720	Petrol	1721	4	81.00	254	F3R 798	Petrol	1998	4	82.70	414
FIN 722	Petrol	1721	4	81.00	255	F4P 720	Petrol	1783	4	82.70	310
FIN 724	Petrol	1721	4	81.00	256	F4P 722	Petrol	1783	4	82.70	311
F2N 700	Petrol	1721	4	81.00	257	F4P 760	Petrol	1783	4	82.70	312
F2N 704	Petrol	1721	4	81.00	258	F4P 770	Petrol	1783	4	82.70	313
F2N 708	Petrol	1721	4	81.00	259	F4P 771	Petrol	1783	4	82.70	314
F2N 710	Petrol	1721	4	81.00	260	F4P 772	Petrol	1783	4	82.70	315
F2N 711	Petrol	1721	4	81.00	261	F4P 773	Petrol	1783	4	82.70	316
F2N 712	Petrol	1721	4	81.00	262	F4P 774	Petrol	1783	4	82.70	317
F2N 720	Petrol	1721	4	81.00	263	F4P 775	Petrol	1783	4	82.70	318
F2N 721	Petrol	1721	4	81.00	264	F4R 700	Petrol	1998	4	82.70	415
F2N 724	Petrol	1721	4	81.00	265	F4R 701	Petrol	1998	4	82.70	416
F2N 730	Petrol	1721	4	81.00	266	F4R 712	Petrol	1998	4	82.70	417
F2N 732	Petrol	1721	4	81.00	267	F4R 713	Petrol	1998	4	82.70	418
F2N 740	Petrol	1721	4	81.00	268	F4R 714	Petrol	1998	4	82.70	419
F2N 742	Petrol	1721	4	81.00	269	F4R 715	Petrol	1998	4	82.70	420
F2N 750	Petrol	1721	4	81.00	270	F4R 720	Petrol	1998	4	82.70	421
F2N 752	Petrol	1721	4	81.00	271	F4R 722	Petrol	1998	4	82.70	422
F2N 754	Petrol	1721	4	81.00	272	F4R 730	Petrol	1998	4	82.70	423
F2N 770	Petrol	1721	4	81.00	273	F4R 738	Petrol	1998	4	82.70	424
F2N 798	Petrol	1721	4	81.00	274	F4R 740	Petrol	1998	4	82.70	425
F3N 702	Petrol	1721	4	81.00	275	F4R 741	Petrol	1998	4	82.70	426
F3N 708	Petrol	1721	4	81.00	276	F4R 744	Petrol	1998	4	82.70	427
F3N 716	Petrol	1721	4	81.00	277	F4R 746	Petrol	1998	4	82.70	428
F3N 717	Petrol	1721	4	81.00	278	F4R 760	Petrol	1998	4	82.70	429
F3N 718	Petrol	1721	4	81.00	279	F4R 761	Petrol	1998	4	82.70	430
F3N 722	Petrol	1721	4	81.00	280	F4R 762	Petrol	1998	4	82.70	431
F3N 723	Petrol	1721	4	81.00	281	F4R 763	Petrol	1998	4	82.70	432
F3N 726	Petrol	1721	4	81.00	282	F4R 764	Petrol	1998	4	82.70	433
F3N 740	Petrol	1721	4	81.00	283	F4R 765	Petrol	1998	4	82.70	434
F3N 741	Petrol	1721	4	81.00	284	F4R 766	Petrol	1998	4	82.70	435
F3N 742	Petrol	1721	4	81.00	285	F4R 767	Petrol	1998	4	82.70	436
F3N 743	Petrol	1721	4	81.00	286	F4R 770	Petrol	1998	4	82.70	437
F3N 746	Petrol	1721	4	81.00	287	F4R 771	Petrol	1998	4	82.70	438
F3P 670	Petrol	1783	4	82.70	288	F4R 774	Petrol	1998	4	82.70	439
F3P 674	Petrol	1783	4	82.70	289	F4R 776	Petrol	1998	4	82.70	440
F3P 676	Petrol	1794	4	82.70	290	F4R 780	Petrol	1998	4	82.70	441
F3P 678	Petrol	1783	4	82.70	291	F4R 784	Petrol	1998	4	82.70	442
F3P 682	Petrol	1783	4	82.70	292	F4R 786	Petrol	1998	4	82.70	443
F3P 700	Petrol	1794	4	82.70	293	F4R 787	Petrol	1998	4	82.70	444
F3P 704	Petrol	1794	4	82.70	294	F4R 790	Petrol	1998	4	82.70	445
F3P 705	Petrol	1794	4	82.70	295	F4R 792	Petrol	1998	4	82.70	446
F3P 706	Petrol	1794	4	82.70	296	F4R 794	Petrol	1998	4	82.70	447
F3P 707	Petrol	1794	4	82.70	297	F4R 795	Petrol	1998	4	82.70	448
F3P 708	Petrol	1794	4	82.70	298	F4R 796	Petrol	1998	4	82.70	449
F3P 710	Petrol	1794	4	82.70	299	F4R 797	Petrol	1998	4	82.70	450
F3P 712	Petrol	1794	4	82.70	300	F4R 800	Petrol	1998	4	82.70	451
F3P 714	Petrol	1794	4	82.70	301	F4R 811	Petrol	1998	4	82.70	452
F3P 720	Petrol	1794	4	82.70	302	F4R 820	Petrol	1998	4	82.70	453
F3P 724	Petrol	1794	4	82.70	303	F4R 830	Petrol	1998	4	82.70	454
F3P 754	Petrol	1794	4	82.70	304	F4R 867	Petrol	1998	4	82.70	455
F3P 755	Petrol	1783	4	82.70	305	F4R 870	Petrol	1998	4	82.70	456
F3P 758	Petrol	1783	4	82.70	306	F4R 872	Petrol	1998	4	82.70	457
F3P 760	Petrol	1794	4	82.70	307	F4R 874	Petrol	1998	4	82.70	458
F3P 764	Petrol	1783	4	82.70	308	F4R 886	Petrol	1998	4	82.70	459
F3P 765	Petrol	1794	4	82.70	309	F4R 887	Petrol	1998	4	82.70	460
F3R 611	Petrol	1998	4	82.70	400	F4R 896	Petrol	1998	4	82.70	461
F3R 722	Petrol	1998	4	82.70	401	F4R 897	Petrol	1998	4	82.70	462
F3R 723	Petrol	1998	4	82.70	402	F4Rt 774	Petrol	1998	4	82.70	463
F3R 728	Petrol	1998	4	82.70	403	F4Rt 800	Petrol	1998	4	82.70	464

		CC			9			CC			9
F4Rt 811	Petrol	1998	4	82.70	465	F9Q 774	Diesel	1870	4	80.00	377
F5R 700	Petrol	1998	4	86.00	466	F9Q 780	Diesel	1870	4	80.00	378
F5R 701	Petrol	1998	4	86.00	467	F9Q 782	Diesel	1870	4	80.00	379
F5R 740	Petrol	1998	4	82.70	468	F9Q 790	Diesel	1870	4	80.00	380
F7P 704	Petrol	1764	4	82.00	319	F9Q 800	Diesel	1870	4	80.00	381
F7P 722	Petrol	1764	4	82.00	320	F9Q 803	Diesel	1870	4	80.00	382
F7R 700	Petrol	1998	4	82.70	469	F9Q 804	Diesel	1870	4	80.00	383
F7R 710	Petrol	1998	4	82.70	470	F9Q 808	Diesel	1870	4	80.00	384
F7R 714	Petrol	1998	4	82.70	471	F9Q 812	Diesel	1870	4	80.00	385
F8M 700	Diesel	1596	4	78.00	190	F9Q 816	Diesel	1870	4	80.00	386
F8M 720	Diesel	1596	4	78.00	191	F9Q 818	Diesel	1870	4	80.00	387
F8M 730	Diesel	1596	4	78.00	192	F9Q 820	Diesel	1870	4	80.00	388
F8M 736	Diesel	1596	4	78.00	193	F9Q 826	Diesel	1870	4	80.00	389
F8M 760	Diesel	1596	4	78.00	194	F9Q 870	Diesel	1870	4	80.00	390
F8Q 606	Diesel	1870	4	80.00	321	F9Q 872	Diesel	1870	4	80.00	391
F8Q 610	Diesel	1870	4	80.00	322	F9Q E 804	Diesel	1870	4	80.00	392
F8Q 620	Diesel	1870	4	80.00	323	F9Q EE 804	Diesel	1870	4	80.00	393
F8Q 622	Diesel	1870	4	80.00	324	F9Q J 803	Diesel	1870	4	80.00	394
F8Q 624	Diesel	1870	4	80.00	325	G8T 706	Diesel	2188	4	87.00	547
F8Q 630	Diesel	1870	4	80.00	326	G8T 714	Diesel	2188	4	87.00	548
F8Q 632	Diesel	1870	4	80.00	327	G8T 716	Diesel	2188	4	87.00	549
F8Q 640	Diesel	1870	4	80.00	328	G8T 740	Diesel	2188	4	87.00	550
F8Q 646	Diesel	1870	4	80.00	329	G8T 752	Diesel	2188	4	87.00	551
F8Q 662	Diesel	1870	4	80.00	330	G8T 760	Diesel	2188	4	87.00	552
F8Q 676	Diesel	1870	4	80.00	331	G8T 790	Diesel	2188	4	87.00	553
F8Q 678	Diesel	1870	4	80.00	332	G8T 794	Diesel	2188	4	87.00	554
F8Q 682	Diesel	1870	4	80.00	333	G9T 600	Diesel	2188	4	87.00	555
F8Q 696	Diesel	1870	4	80.00	334	G9T 605	Diesel	2188	4	87.00	556
F8Q 706	Diesel	1870	4	80.00	335	G9T 606	Diesel	2188	4	87.00	557
F8Q 710	Diesel	1870	4	80.00	336	G9T 642	Diesel	2188	4	87.00	558
F8Q 722	Diesel	1870	4	80.00	337	G9T 645	Diesel	2188	4	87.00	559
F8Q 724	Diesel	1870	4	80.00	338	G9T 700	Diesel	2188	4	87.00	560
F8Q 730	Diesel	1870	4	80.00	339	G9T 702	Diesel	2188	4	87.00	561
F8Q 732	Diesel	1870	4	80.00	340	G9T 703	Diesel	2188	4	87.00	562
F8Q 740	Diesel	1870	4	80.00	341	G9T 706	Diesel	2188	4	87.00	563
F8Q 742	Diesel	1870	4	80.00	342	G9T 707	Diesel	2188	4	87.00	564
F8Q 744	Diesel	1870	4	80.00	343	G9T 710	Diesel	2188	4	87.00	565
F8Q 774	Diesel	1870	4	80.00	344	G9T 712	Diesel	2188	4	87.00	566
F8Q 776	Diesel	1870	4	80.00	345	G9T 720	Diesel	2188	4	87.00	567
F8Q 784	Diesel	1870	4	80.00	346	G9T 722	Diesel	2188	4	87.00	568
F8Q 786	Diesel	1870	4	80.00	347	G9T 742	Diesel	2188	4	87.00	569
F8Q 790	Diesel	1870	4	80.00	348	G9T 743	Diesel	2188	4	87.00	570
F9Q 664	Diesel	1870	4	80.00	349	G9T 750	Diesel	2188	4	87.00	571
F9Q 670	Diesel	1870	4	80.00	350	G9U 630	Diesel	2464	4	89.00	620
F9Q 674	Diesel	1870	4	80.00	351	G9U 632	Diesel	2464	4	89.00	621
F9Q 680	Diesel	1870	4	80.00	352	G9U 650	Diesel	2464	4	89.00	622
F9Q 710	Diesel	1870	4	80.00	353	G9U 720	Diesel	2463	4	89.00	623
F9Q 716	Diesel	1870	4	80.00	354	G9U 724	Diesel	2463	4	89.00	624
F9Q 717	Diesel	1870	4	80.00	355	G9U 730	Diesel	2464	4	89.00	625
F9Q 718	Diesel	1870	4	80.00	356	G9U 750	Diesel	2463	4	89.00	626
F9Q 722	Diesel	1870	4	80.00	357	G9U 754	Diesel	2463	4	89.00	627
F9Q 730	Diesel	1870	4	80.00	358	JSR 716	Petrol	1995	4	88.00	472
F9Q 731	Diesel	1870	4	80.00	359	JSR 718	Petrol	1995	4	88.00	473
F9Q 732	Diesel	1870	4	80.00	360	JSR 722	Petrol	1995	4	88.00	474
F9Q 733	Diesel	1870	4	80.00	361	JSR 726	Petrol	1995	4	88.00	475
F9Q 734	Diesel	1870	4	80.00	362	JSR 728	Petrol	1995	4	88.00	476
F9Q 736	Diesel	1870	4	80.00	363	J6R 234	Petrol	1995	4	88.00	477
F9Q 738	Diesel	1870	4	80.00	364	J6R 236	Petrol	1995	4	88.00	478
F9Q 740	Diesel	1870	4	80.00	365	J6R 706	Petrol	1995	4	88.00	479
F9Q 744	Diesel	1870	4	80.00	366	J6R 707	Petrol	1995	4	88.00	480
F9Q 748	Diesel	1870	4	80.00	367	J6R 734	Petrol	1995	4	88.00	481
F9Q 750	Diesel	1870	4	80.00	368	J6R 758	Petrol	1995	4	88.00	482
F9Q 752	Diesel	1870	4	80.00	369	J6R 759	Petrol	1995	4	88.00	483
F9Q 754	Diesel	1870	4	80.00	370	J6R 760	Petrol	1995	4	88.00	484
F9Q 758	Diesel	1870	4	80.00	371	J6R 762	Petrol	1995	4	88.00	485
F9Q 759	Diesel	1870	4	80.00	372	J6R 763	Petrol	1995	4	88.00	486
F9Q 760	Diesel	1870	4	80.00	373	J6R 792	Petrol	1995	4	88.00	487
F9Q 762	Diesel	1870	4	80.00	374	J6R 793	Petrol	1995	4	88.00	488
F9Q 770	Diesel	1870	4	80.00	375	J7R 720	Petrol	1995	4	88.00	489
F9Q 772	Diesel	1870	4	80.00	376	J7R 721	Petrol	1995	4	88.00	490

		CC			9			CC			9
J7R 722	Petrol	1995	4	88.00	491	K4J 750	Petrol	1390	4	79.50	140
J7R 723	Petrol	1995	4	88.00	492	K4J 770	Petrol	1390	4	79.50	141
J7R 726	Petrol	1995	4	88.00	493	K4J 780	Petrol	1390	4	79.50	142
J7R 732	Petrol	1995	4	88.00	494	K4M 690	Petrol	1598	4	79.50	195
J7R 733	Petrol	1995	4	88.00	495	K4M 697	Petrol	1598	4	79.50	196
J7R 734	Petrol	1995	4	88.00	496	K4M 700	Petrol	1598	4	79.50	197
J7R 735	Petrol	1995	4	88.00	497	K4M 701	Petrol	1598	4	79.50	198
J7R 740	Petrol	1995	4	88.00	498	K4M 704	Petrol	1598	4	79.50	199
J7R 746	Petrol	1995	4	88.00	499	K4M 706	Petrol	1598	4	79.50	200
J7R 747	Petrol	1995	4	88.00	500	K4M 708	Petrol	1598	4	79.50	201
J7R 750	Petrol	1995	4	88.00	501	K4M 709	Petrol	1598	4	79.50	202
J7R 751	Petrol	1995	4	88.00	502	K4M 710	Petrol	1598	4	79.50	203
J7R 752	Petrol	1995	4	88.00	503	K4M 714	Petrol	1598	4	79.50	204
J7R 754	Petrol	1995	4	88.00	504	K4M 716	Petrol	1598	4	79.50	205
J7R 756	Petrol	1995	4	88.00	505	K4M 718	Petrol	1598	4	79.50	206
J7R 760	Petrol	1995	4	88.00	506	K4M 720	Petrol	1598	4	79.50	207
J7R 768	Petrol	1995	4	88.00	507	K4M 740	Petrol	1598	4	79.50	208
J7T 600	Petrol	2165	4	88.00	572	K4M 742	Petrol	1598	4	79.50	209
J7T 706	Petrol	2165	4	88.00	573	K4M 743	Petrol	1598	4	79.50	210
J7T 707	Petrol	2165	4	88.00	574	K4M 744	Petrol	1598	4	79.50	211
J7T 708	Petrol	2165	4	88.00	575	K4M 745	Petrol	1598	4	79.50	212
J7T 714	Petrol	2165	4	88.00	576	K4M 748	Petrol	1598	4	79.50	213
J7T 715	Petrol	2165	4	88.00	577	K4M 748	Flexfuel	1598	4	79.50	213
J7T 730	Petrol	2165	4	88.00	578	K4M 750	Petrol	1598	4	79.50	214
J7T 731	Petrol	2165	4	88.00	579	K4M 752	Petrol	1598	4	79.50	215
J7T 732	Petrol	2165	4	88.00	580	K4M 753	Petrol	1598	4	79.50	216
J7T 733	Petrol	2165	4	88.00	581	K4M 760	Petrol	1598	4	79.50	217
J7T 754	Petrol	2165	4	88.00	582	K4M 761	Petrol	1598	4	79.50	218
J7T 755	Petrol	2165	4	88.00	583	K4M 762	Petrol	1598	4	79.50	219
J7T 760	Petrol	2165	4	88.00	584	K4M 762	Flexfuel	1598	4	79.50	219
J7T 761	Petrol	2165	4	88.00	585	K4M 768	Petrol	1598	4	79.50	220
J7T 762	Petrol	2165	4	88.00	586	K4M 782	Petrol	1598	4	79.50	221
J7T 770	Petrol	2165	4	88.00	587	K4M 788	Petrol	1598	4	79.50	222
J7T 772	Petrol	2165	4	88.00	588	K4M 788	Flexfuel	1598	4	79.50	222
J7T 773	Petrol	2165	4	88.00	589	K4M 790	Petrol	1598	4	79.50	223
J7T 776	Petrol	2165	4	88.00	590	K4M 791	Petrol	1598	4	79.50	224
J7T 780	Petrol	2165	4	88.00	591	K4M 794	Petrol	1598	4	79.50	225
J7T 782	Petrol	2165	4	88.00	592	K4M 800	Petrol	1598	4	79.50	226
J7T 788	Petrol	2165	4	88.00	593	K4M 801	Petrol	1598	4	79.50	227
J8S 240	Diesel	2068	4	86.00	524	K4M 804	Petrol	1598	4	79.50	228
J8S 330	Diesel	2068	4	86.00	525	K4M 812	Petrol	1598	4	79.50	229
J8S 600	Diesel	2068	4	86.00	526	K4M 813	Petrol	1598	4	79.50	230
J8S 610	Diesel	2068	4	86.00	527	K4M 824	Petrol	1598	4	79.50	231
J8S 612	Diesel	2068	4	86.00	528	K4M 830	Petrol	1598	4	79.50	232
J8S 620	Diesel	2068	4	86.00	529	K4M 834	Petrol/ Petroleum Gas (LPG)	1598	4	79.50	233
J8S 704	Diesel	2068	4	86.00	530						
J8S 706	Diesel	2068	4	86.00	531						
J8S 708	Diesel	2068	4	86.00	532	K4M 838	Petrol	1598	4	79.50	234
J8S 714	Diesel	2068	4	86.00	533	K4M 839	Petrol	1598	4	79.50	235
J8S 736	Diesel	2068	4	86.00	534	K4M 854	Petrol	1598	4	79.50	236
J8S 738	Diesel	2068	4	86.00	535	K4M 858	Petrol	1598	4	79.50	237
J8S 740	Diesel	2068	4	86.00	536	K4M 862	Petrol	1598	4	79.50	238
J8S 750	Diesel	2068	4	86.00	537	K4M 866	Petrol	1598	4	79.50	239
J8S 758	Diesel	2068	4	86.00	538	K4M 866	Flexfuel	1598	4	79.50	239
J8S 760	Diesel	2068	4	86.00	539	K4M 866	Bi-Fuel	1598	4	79.50	239
J8S 772	Diesel	2068	4	86.00	540	K4M 9 766	Petrol	1598	4	79.50	240
J8S 774	Diesel	2068	4	86.00	541	K4M C 813	Petrol	1598	4	79.50	241
J8S 776	Diesel	2068	4	86.00	542	K4M D 812	Petrol	1598	4	79.50	242
J8S 778	Diesel	2068	4	86.00	543	K4M P 848	Petrol	1598	4	79.50	243
J8S 784	Diesel	2068	4	86.00	544	K7J 700	Petrol	1390	4	75.80	143
J8S 786	Diesel	2068	4	86.00	545	K7J 701	Petrol	1390	4	75.80	144
J8S 788	Diesel	2068	4	86.00	546	K7J 710	Petrol	1390	4	79.50	145
K4J 710	Petrol	1390	4	79.50	132	K7M 702	Petrol	1598	4	79.50	244
K4J 711	Petrol	1390	4	79.50	133	K7M 703	Petrol	1598	4	79.50	245
K4J 712	Petrol	1390	4	79.50	134	K7M 710	Petrol	1598	4	79.50	246
K4J 713	Petrol	1390	4	79.50	135	K7M 718	Petrol	1598	4	79.50	247
K4J 714	Petrol	1390	4	79.50	136	K7M 720	Petrol	1598	4	79.50	248
K4J 730	Petrol	1390	4	79.50	137	K7M 744	Petrol	1598	4	79.50	249
K4J 732	Petrol	1390	4	79.50	138	K7M 745	Petrol	1598	4	79.50	250
K4J 740	Petrol	1390	4	79.50	139	K7M 746	Petrol	1598	4	79.50	251

		CC			9			CC			9
K7M 750	Petrol	1598	4	79.50	252	M9R 815	Diesel	1995	4	84.00	521
K7M 790	Petrol	1598	4	79.50	253	M9T 670	Diesel	2298	4	85.00	594
K9K 700	Diesel	1461	4	76.00	146	M9T 672	Diesel	2298	4	85.00	595
K9K 702	Diesel	1461	4	76.00	147	M9T 676	Diesel	2298	4	85.00	596
K9K 704	Diesel	1461	4	76.00	148	M9T 678	Diesel	2298	4	85.00	597
K9K 710	Diesel	1461	4	76.00	149	M9T 680	Diesel	2298	4	85.00	598
K9K 712	Diesel	1461	4	76.00	150	M9T 686	Diesel	2298	4	85.00	599
K9K 714	Diesel	1461	4	76.00	151	M9T 690	Diesel	2298	4	85.00	600
K9K 716	Diesel	1461	4	76.00	152	M9T 692	Diesel	2298	4	85.00	601
K9K 718	Diesel	1461	4	76.00	153	M9T 694	Diesel	2298	4	85.00	602
K9K 722	Diesel	1461	4	76.00	154	M9T 696	Diesel	2298	4	85.00	603
K9K 724	Diesel	1461	4	76.00	155	M9T 698	Diesel	2298	4	85.00	604
K9K 728	Diesel	1461	4	76.00	156	N7Q 700	Petrol	1948	4	83.00	395
K9K 729	Diesel	1461	4	76.00	157	N7Q 704	Petrol	1948	4	83.00	396
K9K 732	Diesel	1461	4	76.00	158	N7Q 710	Petrol	1948	4	83.00	397
K9K 734	Diesel	1461	4	76.00	159	N7Q 711	Petrol	1948	4	83.00	398
K9K 740	Diesel	1461	4	76.00	160	N7U 700	Petrol	2435	5	83.00	607
K9K 750	Diesel	1461	4	76.00	161	N7U 701	Petrol	2435	5	83.00	608
K9K 752	Diesel	1461	4	76.00	162	P9X 701	Diesel	2958	6	87.50	662
K9K 760	Diesel	1461	4	76.00	163	S8U 720	Diesel	2445	4	93.00	609
K9K 762	Diesel	1461	4	76.00	164	S8U 722	Diesel	2445	4	93.00	610
K9K 764	Diesel	1461	4	76.00	165	S8U 730	Diesel	2445	4	93.00	611
K9K 766	Diesel	1461	4	76.00	166	S8U 731	Diesel	2445	4	93.00	612
K9K 768	Diesel	1461	4	76.00	167	S8U 742	Diesel	2499	4	93.00	628
K9K 770	Diesel	1461	4	76.00	168	S8U 750	Diesel	2499	4	93.00	629
K9K 772	Diesel	1461	4	76.00	169	S8U 752	Diesel	2499	4	93.00	630
K9K 780	Diesel	1461	4	76.00	170	S8U 758	Diesel	2499	4	93.00	631
K9K 792	Diesel	1461	4	76.00	171	S8U 762	Diesel	2500	4	93.00	632
K9K 796	Diesel	1461	4	76.00	172	S8U 763	Diesel	2500	4	93.00	633
K9K 800	Diesel	1461	4	76.00	173	S8U 770	Diesel	2499	4	93.00	634
K9K 802	Diesel	1461	4	76.00	174	S8U 780	Diesel	2499	4	93.00	635
K9K 804	Diesel	1461	4	76.00	175	S9U 702	Diesel	2499	4	93.00	636
K9K 806	Diesel	1461	4	76.00	176	S9U 714	Diesel	2499	4	93.00	637
K9K 808	Diesel	1461	4	76.00	177	S9U 740	Diesel	2499	4	93.00	638
K9K 820	Diesel	1461	4	76.00	178	S9W 702	Diesel	2799	4	94.40	644
K9K 830	Diesel	1461	4	76.00	179	V4Y 701	Petrol	3498	6	95.50	670
K9K 832	Diesel	1461	4	76.00	180	V4Y 711	Petrol	3498	6	95.50	671
K9K 834	Diesel	1461	4	76.00	181	V4Y 713	Petrol	3498	6	95.50	672
K9K 836	Diesel	1461	4	76.00	182	V4Y 715	Petrol	3498	6	95.50	673
K9K 837	Diesel	1461	4	76.00	183	Z7U 700	Petrol	2458	6	91.00	639
K9K 846	Diesel	1461	4	76.00	184	Z7U 702	Petrol	2458	6	91.00	640
K9K F 830	Diesel	1461	4	76.00	185	Z7V 708	Petrol	2664	6	88.00	641
K9K G 832	Diesel	1461	4	76.00	186	Z7V 709	Petrol	2664	6	88.00	642
K9K H 834	Diesel	1461	4	76.00	187	Z7V 711	Petrol	2664	6	88.00	643
K9K J 836	Diesel	1461	4	76.00	188	Z7W 700	Petrol	2849	6	91.00	645
K9K P 732	Diesel	1461	4	76.00	189	Z7W 706	Petrol	2849	6	91.00	646
L7X 700	Petrol	2946	6	87.00	652	Z7W 707	Petrol	2849	6	91.00	647
L7X 701	Petrol	2946	6	87.00	653	Z7W 709	Petrol	2849	6	91.00	648
L7X 713	Petrol	2946	6	87.00	654	Z7W 712	Petrol	2849	6	91.00	649
L7X 720	Petrol	2946	6	87.00	655	Z7W 713	Petrol	2849	6	91.00	650
L7X 721	Petrol	2946	6	87.00	656	Z7W 717	Petrol	2849	6	91.00	651
L7X 727	Petrol	2946	6	87.00	657	Z7X 721	Petrol	2963	6	93.00	663
L7X 731	Petrol	2946	6	87.00	658	Z7X 722	Petrol	2963	6	93.00	664
L7X 732	Petrol	2946	6	87.00	659	Z7X 723	Petrol	2963	6	93.00	665
L7X 760	Petrol	2946	6	87.00	660	Z7X 726	Petrol	2963	6	93.00	666
L7X 762	Petrol	2946	6	87.00	661	Z7X 760	Petrol	2963	6	93.00	667
M4R 700	Petrol	1997	4	84.00	508	Z7X 765	Petrol	2963	6	93.00	668
M4R 701	Petrol	1997	4	84.00	509	Z7X 775	Petrol	2963	6	93.00	669
M4R 704	Petrol	1997	4	84.00	510						
M4R 704	Flexfuel	1997	4	84.00	510						
M4R 711	Petrol	1997	4	84.00	511						
M4R 713	Petrol	1997	4	84.00	512						
M4R 726	Flexfuel	1997	4	84.00	513						
M9R 700	Diesel	1995	4	84.00	514						
M9R 721	Diesel	1995	4	84.00	515						
M9R 722	Diesel	1995	4	84.00	516						
M9R 740	Diesel	1995	4	84.00	517						
M9R 750	Diesel	1995	4	84.00	518						
M9R 780	Diesel	1995	4	84.00	519						
M9R 782	Diesel	1995	4	84.00	520						

Sommaire

Type Mines OU C.N.I.T.*	9	Type Mines OU C.N.I.T.*	9	Type Mines OU C.N.I.T.*	9	Type Mines OU C.N.I.T.*	9
4		S37400	190	C53205	105	L53T05	343
112300	1	S37S00	54	C53302	286	L53V02	309
112302A	1	19		C53305	286	L53Y02	293
112800	10	353A05	296	C53405	335	L53Y05	293
112890	10	353C05	292	C53505	125	L53Z05	343
112C00	7	353D05	292	C53701	108	S53004	60
210600	1	353F02	296	C53705	108	S53005	60
210B00	13	453A05	294	C53805	293	S53205	105
210B90	10	453C05	292	C53905	319	S53405	335
237090	10	453D05	292	C53A01	125	S53705	108
239B00	13	453F02	296	C53A05	125	S53105	335
3C2370	10	453H02	296	C53B01	283	S53J05	335
R1123	1	453H05	292	C53B05	283	S53K05	335
R1128	10	553A05	296	C53C02	286		
R112C	7	553C05	292	C53C05	285	21	
R2106	1	553D05	292	C53D05	319	B48005	533
R210B	10	553F02	296	C53E05	283	B48104	262
R2370	10	553H02	296	C53F05	287	B48105	262
R2391	2	553H05	292	C53I05	342	B48202	261
R239B	13	853A05	294	C53J05	335	B48204	280
R2430	10	853C05	292	C53K05	322	B48205	280
		853F02	294	C53M05	285	B48205A	280
9		B53004	60	C53P04	95	B48302	499
L42200	76	B53005	60	C53P05	95	B48305	499
L42202	76	B53104	105	C53T05	343	B48405	261
L42300	89	B53105	105	C53V02	296	B48605	530
L42301	89	B53204	105	C53W04	70	B48705	533
L42302	89	B53205	105	C53W05	70	B48805	533
L42400	190	B53302	286	C53W05	70	B48805	533
L42500	78	B53305	286	C53Y02	293	B48C02	499
L42600	257	B53405	335	C53Y05	293	B48C05	499
L42601	257	B53405A	335	C53Z05	343	B48D05	94
L42C00	76	B53505	125	D53C02	265	B48E02	280
L42C02	76	B53605	283	D53C05	285	B48E05	280
L42E00	276	B53701	108	D53D05	319	B48E05A	280
L42F	279	B53704	108	D53V02	294	B48F05	282
L42F00	279	B53705	108	D53Y02	296	B48H04	336
L42J00	89	B53705BC	108	D53Y05	296	B48H05	336
L42L00	266	B53805	293	D53Y42	294	B48K02	582
L42N00	259	B53905	319	D53Y45	294	B48K05	582
L42R00	89	B53A01	125	L53004	60	B48P05	533
L42S00	54	B53B01	283	L53005	60	B48R05	498
		B53B05	283	L53104	105	B48R08	498
11		B53C02	285	L53105	105	B48U02	94
B37200	76	B53C05	285	L53204	105	B48V05	526
B37300	89	B53D05	319	L53205	105	B48W05	533
B37300A	89	B53E05	283	L53302	263	B48Y05	498
B37301	89	B53F05	287	L53305	263	B48Y08	498
B37400	190	B53G05	108	L53305A	263	K48005	544
B37500	81	B53H04	105	L53405	335	K481	262
B37A	76	B53H05	105	L53505	125	K48104	262
B37A00	76	B53I05	342	L53605	283	K48105	262
B37D00	267	B53J05	335	L53701	108	K481F4	262
B37E00	276	B53K05	322	L53704	108	K481F5	262
B37F00	279	B53M05	285	L53705	108	K482	260
B37L00	266	B53P04	95	L53805	293	K48204	260
B37N00	259	B53P05	95	L53905	319	K48205	260
B37R00	89	B53T05	343	L53A01	116	K48205A	260
B37S00	54	B53V02	296	L53A05	115	K482F5	260
C37200	76	B53W04	70	L53B01	283	K482F5A	260
C37300	89	B53W05	70	L53B05	283	K483	499
C37400	190	B53Y02	296	L53C02	285	K48302	499
C3750087	81	B53Y05	296	L53C05	285	K48305	499
C37A00	76	B53Y42	296	L53D05	319	K48308	499
C37C00	76	B53Y45	296	L53F05	287	K483F2	499
C37D00	267	B53Z05	343	L53G05	108	K483F5	499
C37E00	276	C53004	60	L53H04	105	K483K2	499
C37F00	279	C53005	60	L53H05	105	K483K5	499
C37L00	266	C53104	105	L53I05	342	K48405	280
C37N00	259	C53105	105	L53J05	335	K486	530
C37R00	89	C53204	105	L53K05	341	K48605	530
C37S00	54			L53P04	105	K48608	530
				L53P05	105	K486F5	530

* C.N.I.T. = Code National d'Identification du Type (code D2.1 sur nouvelles cartes grises)

Type Mines OU C.N.I.T.*	9	Type Mines OU C.N.I.T.*	9	Type Mines OU C.N.I.T.*	9	Type Mines OU C.N.I.T.*	9
K48705	533	L48S02	499	Clio		B57CBC	299
K48805	533	L48S05	499	357A02	304	B57I05	339
K488F5	533	L48U01	94	357D02	304	B57I85	339
K488K5	533	L48U05	94	357D02A	304	B57J01	127
K488K5E	533	L48V05	526	357F04	67	B57J05	127
K48902	499	L48V05E	526	357F05	67	B57L05	339
K48905	499	L48W05	533	357G05	67	B57N04	66
K48A	533	L48Y05	498	357J05	67	B57N05	66
K48C02	499	L48Y08	498	357K05	48	B57P05	117
K48C05	499	S48005	544	357K0C	48	B57R05	68
K48E05	280	S48104	262	357K0F	48	B57S04	67
K48F05	282	S48105	262	357L05	67	B57S05	67
K48H05	336	S48205	260	357N05	331	B57T	110
K48HF5	336	S48605	530	357U02	304	B57T01	110
K48K02	582	S48H05	336	357U05	299	B57T05	110
K48K05	582	S48V05	526	357V05	306	B57U05	299
K48K08	582			357Y05	48	B57Y	110
K48M	270	25		557A02	304	B57YK5	117
K48M04	270	B29005	532	557B05	127	C57I04	11
K48M05	270	B290A5	532	557D02	304	C57I05	11
K48N05	271	B290E5	532	557D02A	304	C57204	66
K480	530	B29202	489	557F04	67	C57205	66
K48P05	533	B29205	489	557F05	67	C57205A	66
K48R05	498	B29302	645	557G05	67	C57301	117
K48S02	499	B29305	645	557J05	67	C57305	117
K48S05	499	B29405	489	557K05	48	C57305A	117
K48V05	526	B29505	640	557K0C	48	C57405	273
K48V08	530	B29605	531	557K0F	48	C57405A	273
K48VF5	526	B29701	479	557L05	67	C57505	320
K48VK5E	530	B29705	479	557N05	331	C57605	339
K48W05	533	B29705A	479	557R05	67	C576B5	339
L48005	544	B29801	641	557U02	304	C57705	65
L48202	260	B29805	641	557U05	299	C57802	304
L48204	260	B29B02	575	557U0C	299	C57905	300
L48205	260	B29B05	575	557Y	48	C57A04	67
L48205A	260	B29E	573	557Y05	48	C57A05	67
L48301	501	B29E01	573	657H05	332	C57A05A	67
L48302	501	B29E01/1A	573	657HB5	332	C57AB5	67
L48305	501	B29E01A	573	657K05	48	C57ABC	67
L48405	280	B29E02	573	657K0F	48	C57AK5	67
L48505	503	B29E05	573	657N05	331	C57B01	117
L48508	503	B29E05A	573	B57I04	11	C57B02	117
L48605	530	B29F02	646	B57I05	11	C57B05	117
L48705	533	B29F05	646	B57204	66	C57B05A	117
L48805	533	B29G05	639	B57205	66	C57BB1	117
L48805E	533	B29H02	489	B57205A	66	C57BB5	117
L48902	482	B29H05	489	B57301	117	C57BK1	117
L48905	482	B29W05	532	B57305	117	C57BK5	117
L48A05	533			B57405	273	C57C05	299
L48C02	499	Avantime		B57405A	273	C57C05A	299
L48C05	499	DE01	566	B57605	339	C57CB5	299
L48D05	94	DE0106	566	B57605A	339	C57D05	320
L48E05	280	DE04	655	B576B5	339	C57H05	304
L48F05	270	DE0T	655	B57705	65	C57HB5	306
L48H05	336	DE0T02	655	B57802	304	C57I05	339
L48I05	336	DE0T06	655	B57A04	67	C57I85	339
L48J05	482	DE0U	429	B57A05	67	C57J01	127
L48K	582	DE0U02	429	B57A05A	67	C57J05	127
L48K02	583	DE0U06	429	B57ABC	67	C57J0E	127
L48K05	582	DE0V	429	B57B01	117	C57L05	339
L48K08	582	DE0V06	429	B57B02	117	C57M05	469
L48L05	505	MRE1711PR100	429	B57B05	117	C57R04	68
L48L08	505	MRE1711PS101	429	B57B05A	117	C57R05	67
L48M04	270	MRE1901P8946	655	B57BB1	117	C57S04	67
L48M05	270	MRE1911PA099	655	B57BB5	117	C57S05	67
L48N05	271	MRE3911PY142	655	B57BB8	117	C57T02	110
L48O05	526	MRE3911PZ143	655	B57BK1	117	C57T05	110
L48P05	533	MRE5611P1144	566	B57BK2	117	C57T05A	110
L48Q05	498			B57BK5	117	C57U05	299
L48Q08	498			B57C05	299	C57Y05	117
L48R05	498			B57C05A	299	KR02	31
L48R08	498			B57CB5	299	KR04	37

* C.N.I.T. = Code National d'Identification du Type (code D2.1 sur nouvelles cartes grises)

Sommaire

Type Mines OU C.N.I.T.*	9	Type Mines OU C.N.I.T.*	9	Type Mines OU C.N.I.T.*	9	Type Mines OU C.N.I.T.*	9
KROA	142	M10RENV000T105	168	MRE1334EP661	37	BB07CF	146
KROB	226	M10RENV000U106	31	MRE1424E5924	226	BB07EF	146
KROE	31	M10RENV000V107	31	MRE1434E6633	226	BB08	147
KROF	166	M10RENV000W108	37	MRE1434EF121	226	BB080F	147
KROG	151	M10RENV000X109	238	MRE1434ER654	226	BB08EF	147
KROH	165	M10RENV000Y110	168	MRE1701EE753	469	BB0A	45
KROJ	31	M10RENV0010923	168	MRE3101EQ032	127	BB0A0C	45
KROP	37	M10RENV001Y181	168	MRE3102ET712	110	BB0A0F	45
KROS	31	M10RENV001Z182	168	MRE3424EA923	226	BB0B	131
KR10	238	M10RENV0029385	168	MRE3434EB632	226	BB0B0F	45
KR140H	37	M10RENV002B387	168	MRE3434EK120	226	BB0C	131
KR16	226	M10RENV002P390	168	MRE3434EW653	226	BB0C0F	131
KR17	166	MRE000AE7790	48	MRE5024EJ929	151	BB0D	249
KR1A0H	142	MRE000AE8791	48	MRE5034EJ638	151	BB0D0A	249
KR1B0A	226	MRE000AE9792	48	MRE5034EP317	151	BB0D0F	249
KR1B0H	226	MRE000AEA793	48	MRE5224E1928	166	BB0E	326
KR1C	169	MRE000AEG580	48	MRE5224E8935	166	BB0E0E	326
KR1E05	33	MRE000AEH412	331	MRE5234E2637	166	BB0E0F	326
KR1F05	166	MRE000AEJ802	117	MRE5234E9123	166	BB0F	45
KR1F0H	166	MRE000AEK803	117	MRE5234EM657	166	BB0F0F	46
KR1G0H	151	MRE000AEL804	117	MRE5324ED930	169	BB0FCF	45
KR1H	168	MRE000AEM805	117	MRE5324EH934	165	BB0H	201
KR1H06	165	MRE000AEP807	117	MRE5334EC116	165	BB0H0F	201
KR1J0H	31	MRE000AET266	48	MRE5334EE639	165	BB0J	326
KR1N	166	MRE000AEW269	48	MRE5334EJ644	165	BB0JOE	326
KR1P0H	37	MRE000AEY817	339	MRE5334EK124	165	BB0J0F	326
KR1S	169	MRE000AEZ818	331	MRE5334EY659	165	BB0L	134
KR1S0H	31	MRE001AE0139	48	S57104	11	BB0LOA	134
KR1T	151	MRE001AE0466	110	S57105	11	BB0LOF	134
KR1U	31	MRE001AE1140	48	S57205	71	BB0P	132
KR1V	168	MRE001AE1467	117	S576	339	BB0PEA	132
KR21	31	MRE001AE2141	48	S57605	339	BB0PEG	132
KR260A	226	MRE001AE3142	48	S576B5	339	BB0S	131
KR270E	166	MRE001AE4046	127	S57705	65	BB0S0A	131
KR2C06	169	MRE001AE4143	110	S57A05	67	BB0S0F	131
KR2H0H	168	MRE001AE4337	48	S57105	339	BB0T	201
KR2HDH	168	MRE001AE5144	117	S571B5	339	BB0T0F	201
KR2T0H	151	MRE001AE5338	48	S57L	339	BB0U0F	378
KR2V0H	168	MRE001AE6339	48	S57L05	339	BB0V	378
KRA60A	226	MRE001AE7340	48	S57R05	68	BB0W	23
KRAC06	169	MRE001AE8341	110	URE1324E4933	37	BB0WEH	23
KRAH0H	168	MRE001AE9342	117	URE1334EH133	37	BB0Y	8
KRAN06	169	MRE001AEW462	48	URE5024EJ929	151	BB10	45
KRAS36	169	MRE001AEX463	48	URE5224E1928	166	BB11	23
KRC40H	37	MRE001AEY464	48	URE5234E9123	166	BB13	132
KRCF05	166	MRE001AEZ465	48	URE5324ED930	169	BB14	201
KRCF0H	166	MRE1001ED362	48	URE5324EH934	165	BB17	131
KRCH06	165	MRE1001EF001	48	URE5334EK124	165	BB19	23
KRCP0H	37	MRE1001EG002	48	VRE000AEG790	48	BB1D0F	201
M10RENV00001113	238	MRE1001EH003	48	VRE000AEJ792	48	BB1DEA	201
M10RENV00002114	168	MRE1001EK042	48	VRE000AEJ793	48	BB1DEF	201
M10RENV00003115	168	MRE1001EL043	48	VRE001AEE338	48	BB1J	201
M10RENV00006118	142	MRE1002ED360	48	VRE1001EP002	11	BB1K	45
M10RENV00007119	226	MRE1002EG036	48	VRE1001ET042	48	BB1KEF	45
M10RENV00008120	226	MRE1002EH037	48	VRE1001EU043	48	BB1L	132
M10RENV00009121	31	MRE1002EW016	48	VRE5001E4005	339	BB1LOF	132
M10RENV0000A122	168	MRE1002EX017	48	VRE5001E9046	339	BB1LEA	132
M10RENV0000B123	168	MRE1101EJ613	117	VRE5001EA047	339	BB1LEF	132
M10RENV0000C124	168	MRE1101EW044	117	VRE5001EB727	339	BB1R	201
M10RENV0000D125	168	MRE1102E3013	110	VRE5001ED729	339	BB1W	146
M10RENV0000E126	31	MRE1102EJ029	110	VRE5001EJ698	339	BB24	146
M10RENV0000F127	37	MRE1102EK612	110	VRE5001EK700	331	BB26	201
M10RENV0000J810	37	MRE1102ES038	110			BB27	23
M10RENV0000K811	37	MRE1124EJ931	31			BB28	45
M10RENV0000L097	142	MRE1124EJ932	31			BB2C	378
M10RENV0000M098	226	MRE1134EJ640	31			BB2D	45
M10RENV0000N099	226	MRE1202EN023	299			BB2DEF	45
M10RENV0000P100	31	MRE1324E4933	37			BB2G	150
M10RENV0000Q101	31	MRE1334E5642	37			BB2G05	150
M10RENV0000R102	168	MRE1334E9125	37			BB2H	45
M10RENV0000R103	168	MRE1334EH133	37			BB2J	151
M10RENV0000S104	168	MRE1334EJ134	37			BB2J05	151
				Clio 2			
				BB00	249		
				BB000F	249		
				BB01	201		
				BB02	326		
				BB020F	326		
				BB05	23		
				BB05CF	23		
				BB07	146		

* C.N.I.T. = Code National d'Identification du Type (code D2.1 sur nouvelles cartes grises)

Sommaire

Type Mines OU C.N.I.T.*	9	Type Mines OU C.N.I.T.*	9	Type Mines OU C.N.I.T.*	9	Type Mines OU C.N.I.T.*	9
BB2K	201	CBOWEF	23	MRE000AEA793	45	MRE1101EU976	23
BB2L	23	CBOWEH	23	MRE000AEG580	45	MRE1101EW044	131
BB2L05	23	CB0Y	8	MRE000AEH412	326	MRE1102E3013	131
BB2T	23	CB10	45	MRE000AET266	45	MRE1102E4959	23
BB2T05	23	CB11	23	MRE000AEW269	45	MRE1102E7926	23
BB2U	23	CB13	132	MRE000AEY817	326	MRE1102EA893	131
BB2U05	23	CB14	201	MRE000AEZ818	326	MRE1102EJ029	131
BB2V	23	CB15	423	MRE001AE0139	45	MRE1102EK612	131
BB2Y	8	CB17	131	MRE001AE0466	131	MRE1102ES038	131
BB3A0C	45	CB19	23	MRE001AE1140	45	MRE1102ET973	23
BB3A0F	45	CB1A	660	MRE001AE1467	131	MRE1102EV975	23
BB3E	201	CB1A06	660	MRE001AE2141	45	MRE1111E0981	23
BB3G	201	CB1C	423	MRE001AE2468	249	MRE1111E1472	23
BB3H	201	CB1DOF	201	MRE001AE3142	45	MRE1111EA481	23
BB3KCF	45	CB1DEA	201	MRE001AE3469	249	MRE1111EF741	23
BB3KEF	45	CB1DEF	201	MRE001AE4143	131	MRE1111EG742	23
BB3M	160	CB1G	423	MRE001AE4337	45	MRE1111EL068	23
BB3M05	160	CB1H	661	MRE001AE4470	326	MRE1111EL650	23
BB3N	153	CB1K	45	MRE001AE5144	131	MRE1111EM651	23
BB3N05	153	CB1KCF	45	MRE001AE5338	45	MRE1111ES682	23
BB8M05	160	CB1KEF	45	MRE001AE5471	326	MRE1112EL648	23
BBR7CF	146	CB1L	132	MRE001AE6145	249	MRE1112EM067	23
BBR7EF	146	CB1LOA	132	MRE001AE6339	45	MRE1201E7045	249
BBTJ05	151	CB1LOF	132	MRE001AE6472	326	MRE1201EE731	249
CB01	201	CB1LEA	132	MRE001AE7146	249	MRE1202E3039	249
CB05	23	CB1LEF	132	MRE001AE7340	45	MRE1301EA365	201
CB05CF	23	CB1NOF	423	MRE001AE7473	326	MRE1301EA778	134
CB05EF	23	CB1S	423	MRE001AE8147	326	MRE1301EJ859	201
CB07	146	CB1T	423	MRE001AE8341	131	MRE1301EJ980	201
CB07CF	146	CB1U	661	MRE001AE9148	326	MRE1301EL861	132
CB07EF	146	CB1W	146	MRE001AE9342	131	MRE1302EB777	134
CB08	147	CB20	424	MRE001AEA149	326	MRE1302EJ979	201
CB080F	147	CB21	424	MRE001AEA343	249	MRE1302EK858	201
CB08EF	147	CB220F	424	MRE001AEA476	249	MRE1302EM860	132
CB0A	45	CB26	201	MRE001AEB150	326	MRE1311EA001	132
CB0A0C	45	CB27	23	MRE001AEB344	249	MRE1311EQ017	132
CB0A0F	45	CB2C	378	MRE001AEB477	249	MRE1311EX484	201
CB0B	131	CB2D	45	MRE001AEC345	326	MRE1311EZ062	201
CB0B0F	45	CB2DEF	45	MRE001AED346	326	MRE1312E0061	201
CB0C	131	CB2G	150	MRE001AEE347	326	MRE1312EB000	132
CB0CDF	131	CB2G05	150	MRE001AEF348	326	MRE1312EG465	201
CB0D	249	CB2H	45	MRE001AEJ352	249	MRE1312EH466	201
CB0DOA	249	CB2J	151	MRE001AEW462	45	MRE1312ER016	132
CB0DOF	249	CB2J05	151	MRE001AEX463	45	MRE1411ER978	201
CB0E	326	CB2L	23	MRE001AEY464	45	MRE1411EW983	201
CB0E0E	326	CB2L05	23	MRE001AEZ465	45	MRE1412E9969	201
CB0E0F	326	CB2P	424	MRE1001E5997	45	MRE1412EP974	201
CB0F	45	CB2T	23	MRE1001ED362	46	MRE1701EE753	423
CB0F0F	46	CB2T05	23	MRE1001EF001	46	MRE1701EG913	423
CB0FCF	45	CB2U	23	MRE1001EF910	45	MRE1711EG003	423
CB0H	201	CB2U05	23	MRE1001EG002	46	MRE1711ER208	423
CB0H0F	201	CB2V	23	MRE1001EH003	46	MRE1711ES209	423
CB0J	326	CB2Y	8	MRE1001EK042	46	MRE1811E8603	424
CB0JOE	326	CB3A0C	45	MRE1001EL043	46	MRE1911E0391	661
CB0JOF	326	CB3A0F	45	MRE1002E6996	45	MRE3201E0359	249
CB0L	134	CB3E	201	MRE1002ED360	46	MRE3201EL696	249
CB0LOA	134	CB3G	201	MRE1002EG036	46	MRE3202E0357	249
CB0LOF	134	CB3H	201	MRE1002EG909	45	MRE3202ES701	249
CB0M	423	CB3KEF	45	MRE1002EH037	46	MRE3301E0798	132
CB0M0F	423	CB3M	160	MRE1002EW016	46	MRE3301E3898	132
CB0P	132	CB3N	153	MRE1002EX017	46	MRE3302E1797	132
CB0POG	132	CB8M05	160	MRE1011E7064	45	MRE3302E4897	132
CB0PEG	132	CB8N05	153	MRE1011EF485	45	MRE3311E1482	201
CB0S	131	CB8M05	160	MRE1011EW477	45	MRE3311E2483	201
CB0S0F	131	CB8N05	153	MRE1012E8063	45	MRE3311EA031	132
CB0T	201	CB3J05	151	MRE1012EE457	45	MRE3311EB262	132
CB0T0F	201	CB3U05	23	MRE1012EP467	45	MRE3311EC033	201
CB0U	378	CB3R7EF	146	MRE1101E3960	23	MRE3311EG486	132
CB0U0F	378	M10RENV0018313	45	MRE1101E6927	23	MRE3311EX478	132
CB0V	378	MRE000AE7790	45	MRE1101E9894	131	MRE3312EB030	132
CB0W	23	MRE000AE8791	45	MRE1101EJ613	131	MRE3312EC261	132
CB0W0H	23	MRE000AE9792	45	MRE1101ES974	23	MRE3312ED032	201

* C.N.I.T. = Code National d'Identification du Type (code D2.1 sur nouvelles cartes grises)

Sommaire

Type Mines OU C.N.I.T.*	9	Type Mines OU C.N.I.T.*	9	Type Mines OU C.N.I.T.*	9	Type Mines OU C.N.I.T.*	9
MRE3312EF458	132	SBOE0F	326	BR0U	228	CR03	33
MRE3312EG459	132	SBOF	45	BR0V	161	CR04	37
MRE3312EK463	201	SBOFBF	46	BR0W	162	CR05	226
MRE3312EL464	201	SBOFCF	45	BR0Y	226	CR06	508
MRE3312EP468	132	SBOJ	326	BR10	238	CR07	508
MRE3312EQ469	132	SBOJOE	327	BR11	31	CR09	228
MRE3421E1011	201	SBOJOF	327	BR140H	37	CR0A	142
MRE3421E2012	201	SBOR0F	326	BR15	226	CR0B	226
MRE5001E0046	326	SBOU	378	BR16	226	CROC	508
MRE5001E1047	326	SBOU0F	378	BR17	166	CROE	31
MRE5001E2727	326	SB10	45	BR1A	161	CROF	166
MRE5001E4729	326	SB1K	45	BR1A0H	142	CROG	151
MRE5001E9698	326	SB2D	46	BR1B	162	CROH	165
MRE5001EB700	326	SB2DEF	46	BR1B0A	226	CROJ	31
MRE5001ED896	146	SB2H	46	BR1B0H	226	CROK	508
MRE5001EJ999	146	SB2J	151	BR1C	169	CRON	454
MRE5001EV005	326	SB3A	147	BR1D	31	CROP	37
MRE5002E3726	326	SB3ADF	45	BR1E	142	CROPOH	37
MRE5002E5728	326	SB3KEF	45	BR1E05	31	CROQ	31
MRE5002EA697	326	SB3M	160	BR1EB5	33	CROK	31
MRE5002EB019	326	SB8M05	160	BR1F	162	CROS	31
MRE5002EC699	326	SBR7CF	146	BR1F05	166	CROT	228
MRE5002EE895	146	SBR7EF	146	BR1F0H	166	CROU	228
MRE5002EK998	146	SBR8EF	147	BR1G	161	CROV	161
MRE5002EW040	326	SBR9EF	146	BR1G0H	151	CROW	162
MRE5002EX041	326	URE1011EF485	45	BR1H	168	CROY	226
MRE5011E4473	146	URE1111E0981	23	BR1H06	165	CR10	238
MRE5011E7573	146	URE1111EL650	23	BR1J	226	CR11	31
MRE5011E8574	146	URE1411ER978	201	BR1J0H	31	CR140H	37
MRE5011EK999	146	URE1412EP974	201	BR1JBH	31	CR15	226
MRE5012E8572	146	URE3421E1011	201	BR1L	31	CR16	226
MRE5012EJ996	146	URE3421E2012	201	BR1M	226	CR17	166
MRE5012EL452	146	URE5011E8574	146	BR1N	166	CR18	454
MRE5012EM453	146	URE5011EK999	146	BR1POH	37	CR190H	228
MRE5021EU135	146	URE5012E8572	146	BR1ROH	31	CR1A0H	142
MRE5022EU133	146	URE5021EU135	146	BR1S	33	CR1B0A	226
MRE5101E3912	378	URE5111EM578	147	BR1SOH	31	CR1B0H	226
MRE5101EW711	378	URE9011EN602	45	BR1T	151	CR1C	169
MRE5102E4911	378	VRE1001EP002	45	BR1U	31	CR1E	142
MRE5102EX710	378	VRE1001ET042	45	BR1U0H	31	CR1E05	31
MRE5111EF474	147	VRE1001EU043	45	BR1V	168	CR1EB5	33
MRE5111EG475	147	VRE5001E4005	326	BR1Y	226	CR1F05	166
MRE5111EK576	147	VRE5001EB727	326	BR21	31	CR1F0H	166
MRE5111EM578	147	VRE5001ED729	326	BR270E	166	CR1G	161
MRE5111ET125	147	VRE5001EJ698	326	BR2C06	169	CR1G0H	151
MRE5111EU029	147	VRE5001EK700	326	BR2HOH	168	CR1H	168
MRE5112EL575	147			BR2HAH	168	CR1H06	165
MRE5112EN577	147			BR2N06	166	CR1J	226
MRE5112EU124	147			BR2V0H	168	CR1J0H	31
MRE5112EV028	147			BR3U0H	31	CR1JBH	31
MRE5112EX454	147			BRA006	238	CR1L	31
MRE5112EY455	147			BRA0T6	142	CR1M	226
MRE5311E1476	150			BRA60A	226	CR1N	166
MRE5312EJ456	150			BRAC06	169	CR1N06	454
MRE9011EJ148	45			BRAH0H	168	CR1POH	37
MRE9011EN602	45			BRAND6	166	CR1Q0H	31
MRE9012EJ147	45			BRAS36	33	CR1ROH	31
MRE9012EP601	45			BRAS6	33	CR1ROH	31
MREZ001E2043	45			BRC40H	37	CR1S	169
MREZ002EY037	45			BRCA0H	142	CR1SOH	31
SB07	146			BRCBOA	226	CR1T	151
SB070F	146			BRCC06	508	CR1U	31
SB07CF	146			BRCC0A	508	CR1U0H	31
SB08	147			BRCF05	166	CR1V	168
SB09	146			BRCF0H	166	CR1Y	226
SB090F	146			BRCH06	165	CR1Y0A	226
SBOA	45			BRCPOH	37	CR1Y0H	226
SBOA0	45			BREU0H	31	CR21	31
SBOADF	45			BREUBH	31	CR270E	166
SBOADFBC	45			BRR0T6	238	CR2C06	169
SBOE	326			CR00	142	CR2D0H	31
SBOE0E	326			CR02	31	CR2E0H	142
		Clio 3					
		BR00	142				
		BR01	31				
		BR02	31				
		BR03	31				
		BR04	37				
		BR05	226				
		BR06	508				
		BR07	508				
		BR09	228				
		BR0A	142				
		BR0B	226				
		BR0C	508				
		BR0E	31				
		BR0F	166				
		BR0G	151				
		BR0H	165				
		BR0J	31				
		BR0K	508				
		BR0P	37				
		BR0POH	37				
		BR0Q	31				
		BR0R	31				
		BR0S	31				
		BR0T	228				

* C.N.I.T. = Code National d'Identification du Type (code D2.1 sur nouvelles cartes grises)

Sommaire

Type Mines OU C.N.I.T.*	9	Type Mines OU C.N.I.T.*	9	Type Mines OU C.N.I.T.*	9	Type Mines OU C.N.I.T.*	9
CR2H0H	168	M10RENV000G067	238	M10RENV002P364	168	MRE1332EZ579	37
CR2H4H	168	M10RENV000H032	31	M10RENV002P365	165	MRE1421E3504	226
CR2JOA	226	M10RENV000H068	238	M10RENV002T369	168	MRE1421E3576	226
CR2N06	166	M10RENV000J033	168	M10RENV002X373	168	MRE1421E7508	226
CR2V0H	168	M10RENV000J034	168	M10RENV003A579	31	MRE1421EW569	226
CR2V4H	168	M10RENV000J069	165	MRE1021E4387	31	MRE1422E0499	226
CR3S0H	31	M10RENV000J748	37	MRE1021EQ761	31	MRE1422E3502	226
CR3U0H	31	M10RENV000K035	168	MRE1021EZ055	31	MRE1422EL556	226
CRA006	238	M10RENV000L036	165	MRE1022EM755	31	MRE1422ES563	226
CRA0T6	238	M10RENV000L072	228	MRE1022EZ053	31	MRE1432EW566	226
CRA60A	226	M10RENV000M001	228	MRE1022EZ380	31	MRE1621E7269	508
CRAC06	169	M10RENV000M037	165	MRE1101EU976	31	MRE1622E3263	508
CRAH0H	168	M10RENV000M073	142	MRE1102EV975	31	MRE1632EH567	508
CRAS36	169	M10RENV000N002	142	MRE1111E0981	31	MRE1821E9506	454
CRASS6	169	M10RENV000N038	31	MRE1111E1472	31	MRE1821EQ268	454
CRAST6	169	M10RENV000P003	226	MRE1111EA481	31	MRE1831E3596	454
CRAV0H	168	M10RENV000P004	226	MRE1111EF741	31	MRE3421E1568	226
CRC40H	37	M10RENV000P039	508	MRE1111EG742	31	MRE3421E8575	226
CRC90H	228	M10RENV000P040	508	MRE1111EL068	31	MRE3422E1009	226
CRCB0A	226	M10RENV000P075	226	MRE1111EL650	31	MRE3422E2010	226
CRCC06	508	M10RENV000P076	508	MRE1111EM651	31	MRE3422E0555	226
CRCC0A	508	M10RENV000P779	37	MRE1111ES682	31	MRE3422EX562	226
CRCF05	166	M10RENV000R005	31	MRE1112EF678	31	MRE3432E1565	226
CRCF0H	166	M10RENV000R006	31	MRE1112EF739	31	MRE3432ED541	226
CRCHT6	165	M10RENV000R041	508	MRE1112EG740	31	MRE3621EE270	508
CRCK06	508	M10RENV000R042	37	MRE1112EJ451	31	MRE3622EA264	508
CRCP0H	37	M10RENV000R077	508	MRE1112EL648	31	MRE5001EJ999	151
CREU0H	31	M10RENV000R078	508	MRE1112EM067	31	MRE5002EK998	151
CREUBH	31	M10RENV000R103	168	MRE1112EM649	31	MRE5011E4473	151
CRJN06	454	M10RENV000R757	168	MRE1112ET462	31	MRE5011E7573	151
CRK806	454	M10RENV000R782	226	MRE1112ET972	31	MRE5011E8574	151
CRR0T6	238	M10RENV000S007	168	MRE1121ED386	31	MRE5011EK999	151
M10RENV0000015	31	M10RENV000S043	31	MRE1121EY759	31	MRE5012EJ996	151
M10RENV0000051	31	M10RENV000S079	31	MRE1122E8379	31	MRE5012EL452	151
M10RENV0000087	508	M10RENV000T008	168	MRE1122EU753	31	MRE5012EM453	151
M10RENV0001016	238	M10RENV000T080	168	MRE1132EL549	31	MRE5021E7572	151
M10RENV0001052	31	M10RENV000U009	168	MRE1132ET194	31	MRE5021EC505	151
M10RENV0001088	508	M10RENV000U081	168	MRE1132EU195	31	MRE5021EK161	162
M10RENV0002017	165	M10RENV000V010	165	MRE1211ER998	228	MRE5021EP748	162
M10RENV0002053	168	M10RENV000V082	168	MRE1212EQ995	228	MRE5021EQ749	162
M10RENV0002089	37	M10RENV000W011	31	MRE1221E0000	228	MRE5021ET134	151
M10RENV0002114	165	M10RENV000W047	228	MRE1221E9566	228	MRE5021EU135	151
M10RENV0002768	37	M10RENV000W083	165	MRE1221EG573	228	MRE5021EZ758	151
M10RENV0003018	168	M10RENV000X012	31	MRE1222E5560	228	MRE5022E9500	151
M10RENV0003054	168	M10RENV000X048	142	MRE1222EY553	228	MRE5022EP746	162
M10RENV0003090	31	M10RENV000X084	165	MRE1311EB487	142	MRE5022EQ747	162
M10RENV0003769	228	M10RENV000Y013	37	MRE1311EG977	142	MRE5022ET132	151
M10RENV0004055	168	M10RENV000Y085	31	MRE1311EL982	142	MRE5022EU133	151
M10RENV0005020	238	M10RENV000Z014	31	MRE1311EQ017	142	MRE5022EV752	151
M10RENV0005056	165	M10RENV000Z050	226	MRE1311ES479	142	MRE5022EW559	151
M10RENV0006021	238	M10RENV000Z086	508	MRE1312EB460	142	MRE5031E3592	151
M10RENV0006057	31	M10RENV0010305	168	MRE1312EE973	142	MRE5032EL547	151
M10RENV0007022	165	M10RENV0011306	168	MRE1312EL470	142	MRE5211EK979	166
M10RENV0007058	31	M10RENV0012307	168	MRE1312ER010	142	MRE5211EP984	166
M10RENV0007094	454	M10RENV0013308	168	MRE1312ES599	142	MRE5212ED970	166
M10RENV0008023	168	M10RENV0019411	168	MRE1312EY968	142	MRE5212EJ975	166
M10RENV0008059	454	M10RENV001E319	168	MRE1321E5552	142	MRE5221ED389	161
M10RENV0008095	454	M10RENV001R173	168	MRE1321EF756	37	MRE5221EF391	166
M10RENV0008799	37	M10RENV001R587	168	MRE1321EJ760	37	MRE5221EQ571	166
M10RENV0009060	37	M10RENV001S175	168	MRE1321EK567	142	MRE5221ET768	166
M10RENV000A025	228	M10RENV001T916	165	MRE1321ER574	142	MRE5221EU769	166
M10RENV000A061	31	M10RENV001U177	168	MRE1322E6651	142	MRE5221EX578	166
M10RENV000B026	142	M10RENV001W179	168	MRE1322E9554	142	MRE5222EF558	166
M10RENV000B062	31	M10RENV001X920	165	MRE1322EB750	37	MRE5222EM565	166
M10RENV000B123	168	M10RENV001Y181	168	MRE1322EF754	37	MRE5222ET766	161
M10RENV000C027	226	M10RENV0023379	168	MRE1322EG561	142	MRE5222EU767	166
M10RENV000C063	238	M10RENV0024380	165	MRE1331E9131	37	MRE5222EX382	166
M10RENV000C803	226	M10RENV0025381	168	MRE1331EA132	37	MRE5222EZ384	166
M10RENV000D028	226	M10RENV0026382	454	MRE1331EJ625	37	MRE5231ED618	166
M10RENV000E029	508	M10RENV002E354	168	MRE1332E7551	37	MRE5231EM591	166
M10RENV000F030	508	M10RENV002J358	168	MRE1332E9129	37	MRE5232E4546	166
M10RENV000G031	508	M10RENV002M362	226	MRE1332EA130	37	MRE5232EU572	166

* C.N.I.T. = Code National d'Identification du Type (code D2.1 sur nouvelles cartes grises)

Type Mines OU C.N.I.T.*	9	Type Mines OU C.N.I.T.*	9	Type Mines OU C.N.I.T.*	9	Type Mines OU C.N.I.T.*	9
MRE5311E0985	165	URE5022E9500	151	Espace 3		Espace 4	
MRE5311EV980	165	URE5022EP746	162	JE0A02	403	JK00	671
MRE5312EP971	165	URE5022EQ747	162	JE0A05	403	JK00AB	671
MRE5312ET976	165	URE5022ET132	151	JE0AL5	403	JK00CB	671
MRE5321EM388	165	URE5022EU133	151	JE0D02	669	JK01	517
MRE5321EP390	165	URE5022EW559	151	JE0E05	549	JK01A6	517
MRE5322E6381	165	URE5211EK979	166	JE0EL5	549	JK01B6	517
MRE5322E8383	165	URE5211EP984	166	JE0G02	657	JK01C6	517
MRE5331EP620	165	URE5212ED970	166	JE0GL2	657	JK01D6	517
MRE5332E6574	165	URE5212EJ975	166	JE0H05	548	JK04	517
MRE5332EG548	165	URE5221EQ571	166	JE0HL5	548	JK04A6	517
MRE9131EU112	31	URE5221ET768	166	JE0K05	558	JK04AC	517
MRE9131EW114	31	URE5221EX578	166	JE0KL5	558	JK04BC	517
MRE9132E5581	31	URE5222EF558	166	JE0L02	415	JK04C6	517
MRE9132ER107	31	URE5222EM565	166	JE0L05	415	JK04CC	517
MRE9132ET109	31	URE5222ET766	161	JE0LL5	415	JK07	559
SROA	142	URE5311E0985	165	JE0M05	357	JK07AB	559
SROF	166	URE5311EV980	165	JE0N05	415	JK07CB	559
SROG	151	URE5312EP971	165	JE0NL5	415	JK08	449
SROH	165	URE5312ET976	165	JE0P05	548	JK09	446
SROJ	31	URE5321EM388	165	JE0PL5	548	JK09A6	446
SROP	37	URE5321EP390	165	JE0S05	558	JK09B6	446
SROS	33			JE0SL5	558	JK0A	449
SR17	151	Clio 4		MRE000AH0658	403	JK0AA6	449
SR1FOH	166	5R0G0H	31	MRE000AH1659	549	JK0AAB	449
SR1G0H	151	7R0G0H	31	MRE000AH2660	669	JK0AB6	449
SR1H	168	BHMG	31	MRE000AH3661	403	JK0ABB	449
SR1J0H	31	BHMK	31	MRE000AH4662	549	JK0AC6	449
SR1U	31	KHMG	31	MRE000AHJ119	549	JK0AD6	449
SR1V	168	M10RENV1399866	31	MRE000AHR516	403	JK0ADB	449
SR21	31			MRE000AHS517	549	JK0B	447
SR2H0H	168	Espace I		MRE000AHT518	669	JK0D	447
SR2V0H	168	J11205	477	MRE001AHB499	403	JK0F	671
U10RENV001R173	168	J11405	524	MRE001AHC500	549	JK0G	352
URE1111E0981	31	J11505	524	MRE001AHE502	403	JK0H	569
URE1111EL650	31	J11605	506	MRE001AHG504	403	JK0HA6	569
URE1112ET972	31	J11608	506	MRE001AHH505	548	JK0HAB	569
URE1311EG977	142	J11705	587	MRE001AHJ118	403	JK0HB6	569
URE1311EL982	142	J11708	587	MRE001AHJ119	549	JK0HC6	569
URE1312EY968	142	S11205	477	MRE001AHK120	669	JK0HCB	569
URE1321E5552	142	S11205T	481	MRE001AHK508	657	JK0J	662
URE1321EF756	37	S11505	524	MRE001AHL121	403	JK0JBB	662
URE1321EJ760	37			MRE001AHL509	657	JK0JCB	662
URE1321EK567	142	Espace II		MRE001AHM122	549	JK0JDB	662
URE1322E6551	142	J63305	527	MRE001AHN123	403	JK0K	446
URE1322EB750	37	J63325	527	MRE001AHP124	548	JK0L	446
URE1322EG561	142	J63405	527	MRE001AHP125	548	JK0N	447
URE1331E9131	37	J63505	527	MRE1406HY488	403	JK0P	671
URE1332E9129	37	J63508	540	MRE1406HZ489	403	JK0S	671
URE1332EA130	37	J63525	527	MRE1406NF499	403	JK0T	569
URE1422EL556	226	J63555	527	MRE1606HA807	415	JK0U	388
URE1621E7269	508	J63605	507	MRE1606HB614	415	JK0V	662
URE1821E9506	454	J63615	507	MRE1606HB808	415	JK0VCB	662
URE1821EQ268	454	J63705	588	MRE1606HC615	415	JK0Y	662
URE3421E1568	226	J63708	588	MRE1616HJ038	415	JK0YAC	662
URE3421E8575	226	J63712	588	MRE3406H3487	403	JK0YCC	662
URE3422E1009	226	J63805	649	MRE3606HJ809	415	JK1CC	517
URE3422E2010	226	J63845	649	MRE3606HJ810	415	JK1D	449
URE3422EQ555	226	J63D05	527	MRE3806HF495	657	JK1J	517
URE3422EX562	226	J63E05	528	MRE3806HG496	657	JK1JA6	517
URE3622EA264	508	J63G05	588	MRE5306NK502	357	JK1JAC	517
URE5011E8574	151	J63J22	649	MRE5406HE492	548	JK1JC6	517
URE5011EK999	151	MRE001AHJ118	507	MRE5406HG494	548	JKAFAB	671
URE5012EJ996	151	S63505	527	MRE5406HM863	565	JKAFCB	671
URE5021E7572	151	S63525	527	MRE5406HP503	548	M10RENV0009678	517
URE5021EC505	151	S63535	527	MRE5406HP865	548	M10RENV000J651	671
URE5021EK161	162	S63705	588	MRE5406HQ504	548	M10RENV000K653	671
URE5021EP748	162	S63D05	527	MRE5506HX864	558	M10RENV000P683	446
URE5021EQ749	162					M10RENV000R685	449
URE5021ET134	151					M10RENV000S686	449
URE5021EU135	151					M10RENV000T687	449
URE5021EZ758	151					M10RENV000U688	449

* C.N.I.T. = Code National d'Identification du Type (code D2.1 sur nouvelles cartes grises)

Sommaire

Type Mines OU C.N.I.T.*	9	Type Mines OU C.N.I.T.*	9	Type Mines OU C.N.I.T.*	9	Type Mines OU C.N.I.T.*	9
M10RENV000V689	449	MRE5416HL279	352	MRE7716H1223	662	F401K5	15
M10RENV000W690	449	MRE5416HM280	352	MRE7716H2224	662	F401M4	15
M10RENV000X691	449	MRE5426HM279	352	MRE7716H3225	662	F401M5	15
M10RENV000Y692	449	MRE5426HN280	352	MRE7716H4226	662	F401P4	15
M10RENV000Y861	517	MRE5426HQ283	388	MRE7716H8291	662	F401P5	15
MRE1616HJ038	446	MRE5426HR284	388	MRE7716H9292	662	F402	80
MRE1616HJ039	446	MRE5426HS285	388	MRE7716HC295	662	F40205	80
MRE1716H9188	447	MRE5426HT286	388	MRE7716HV289	662	F402M5	80
MRE1716H9285	447	MRE5506HV862	569	MRE7716HV835	662	F404	191
MRE1716HA189	447	MRE5616H2204	569	MRE7716HW290	662	F40404	191
MRE1716HA286	447	MRE5616H3205	569	MRE7716H2803	662	F40404A	191
MRE1716HA868	449	MRE5616H4206	569	MRE7726HQ247	662	F40405	191
MRE1716HB190	447	MRE5616H5207	569	MRE7726HR248	662	F40405A	191
MRE1716HB287	447	MRE5616H7281	569	URE1726HP228	449	F404K5	191
MRE1716HC191	447	MRE5616H8282	569	URE3726HA764	449	F404M4	191
MRE1716HC288	447	MRE5616H9283	569	URE3726HW229	449	F404M4A	191
MRE1716HC870	449	MRE5616H9793	569	URE3726HY231	449	F404M5	191
MRE1716HE872	449	MRE5616HA284	569	URE3916H8308	671	F404P4	191
MRE1716HF219	447	MRE5616HA794	569	URE3926H0238	671	F404P5	191
MRE1716HH221	447	MRE5616HJ512	569	URE3926H1239	671	F40604	63
MRE1716HP265	447	MRE5616HK513	569	URE5416HJ277	388	F40605	63
MRE1716HQ266	447	MRE5616HM515	569	URE5416HK278	388	F406M5	63
MRE1716HR267	447	MRE5626H6534	517	URE5426HQ283	388	F406V4	63
MRE1716HR874	449	MRE5626H7535	517	URE5426HR284	388	F406V5	63
MRE1716HS268	447	MRE5626H8536	517	MRE5626HS285	388	F40705	103
MRE1726H0882	449	MRE5626H9537	517	URE5616H7281	569	F407M5	103
MRE1726H1883	449	MRE5626HB212	569	URE5616H8282	569	F40A05	130
MRE1726H2884	449	MRE5626HC213	569	URE5616H9793	569	F40AM5	130
MRE1726H3885	449	MRE5626HD214	569	URE5626H6534	517	F40AP5	130
MRE1726HP228	449	MRE5626HE215	569	URE5626H7535	517	F40D	130
MRE1726HR230	449	MRE5626HL258	517	URE5626H8536	517	F40DM5	124
MRE1726HT232	449	MRE5626HM259	517	URE5626H9537	517	F40E05	329
MRE1726HV234	449	MRE5626HN260	517	URE5626HB212	569	F40EK5	328
MRE3616HQ040	446	MRE5626HP261	517	URE5626HC213	569	F40EM5	329
MRE3716HO270	447	MRE5636H0430	517	URE5626HD214	569	F40EP5	329
MRE3716H1271	447	MRE5636H1431	517	URE5626HE215	569	F40F04	59
MRE3716H2272	447	MRE5636H2202	517	URE5626HL258	517	F40F05	59
MRE3716H4299	447	MRE5636HE444	517	URE5626HM259	517	F40FM4	59
MRE3716H5300	447	MRE5636HG446	517	URE5626HN260	517	F40FM5	59
MRE3716H6301	447	MRE5636HH253	517	URE5626HP261	517	F40H04	18
MRE3716H7302	447	MRE5636HJ254	517	URE5636H0430	517	F40H05	18
MRE3716HH869	449	MRE5636HJ255	517	URE5636H2202	517	F40HM5	18
MRE3716HJ871	449	MRE5636HJ448	517	URE5636HY428	517	F40M05	99
MRE3716HW873	449	MRE5636HK256	517	URE5636HZ429	517	F40N	329
MRE3716HY875	449	MRE5636HK450	517	URE7616HN607	569	F40N05	329
MRE3716HZ269	447	MRE5636HY428	517	URE7616HP608	569	F40NK5	329
MRE3726H0233	449	MRE5636HZ429	517	URE7616HP609	569	F40NM5	329
MRE3726H2235	449	MRE7616HA303	569	URE7626H0716	517	F40NP5	329
MRE3726H8762	449	MRE7616HB304	569	URE7626HK251	559	F40P	329
MRE3726H9763	449	MRE7616HC305	569	URE7626HL216	569	F40P05	329
MRE3726HA764	449	MRE7616HD306	569	URE7626HL252	559	F40P35	329
MRE3726HB765	449	MRE7616HN607	569	URE7626HM217	569	F40PK5	329
MRE3726HW229	449	MRE7616HP608	569	URE7626HM253	559	F40PL5	329
MRE3726HY231	449	MRE7616HP609	569	URE7626HN218	569	F40PM5	329
MRE3916H8308	671	MRE7616HQ610	569	URE7626HP219	569	F40PN5	329
MRE3916H9309	671	MRE7626H0716	517	URE7626HX713	517	F40PP5	329
MRE3916HA310	671	MRE7626HJ250	559	URE7626HY714	517	F40PS5	329
MRE3926H0238	671	MRE7626HK251	559	URE7626HZ715	517	F40R04	328
MRE3926H1239	671	MRE7626HL216	569	URE7716HV289	662	F40R05	328
MRE3926H2240	671	MRE7626HL252	559	URE7716HV835	662	F40RM5	328
MRE3926H3047	671	MRE7626HM217	569	URE7716HW290	662	F40RP5	328
MRE3926H3241	671	MRE7626HM253	559	URE7716H2803	662	F40RV5	328
MRE3926H4048	671	MRE7626HN218	569			F40RW5	328
MRE5416HE200	388	MRE7626HP219	569			F40S01	121
MRE5416HF201	388	MRE7626HX713	517			F40S05	121
MRE5416HF273	388	MRE7626HY714	517			F40SM1	121
MRE5416HG202	352	MRE7626HZ715	517			F40SM5	121
MRE5416HG274	388	MRE7636HL445	517			F40T04	15
MRE5416HH275	352	MRE7636HN447	517			F40T05	15
MRE5416HJ276	352	MRE7636HP449	517			F40TM5	15
MRE5416HJ277	388	MRE7636HR451	517			F40U	130
MRE5416HK278	388	MRE7716H0804	662			F40U05	121
				Express			
				F400	4		
				F40004	4		
				F40004A	4		
				F400M4	4		
				F401	15		
				F40104	15		
				F40105	15		
				F401K4	15		

* C.N.I.T. = Code National d'Identification du Type (code D2.1 sur nouvelles cartes grises)

Type Mines OU C.N.I.T.*	9	Type Mines OU C.N.I.T.*	9	Type Mines OU C.N.I.T.*	9	Type Mines OU C.N.I.T.*	9
F40UM5	121	JM16	189	MRE5336A1141	189	Gr. Scenic 3	
F40UP2	121	JM17	392	MRE5336A2142	189	JZ03	237
F40UP5	121	JM1D	392	MRE5336A7147	156	JZ03B6	237
F40UV5	121	JM1E	189	MRE5336AY138	189	JZ07	180
F40V	130	JM1K	514	MRE5416AC593	385	JZ09	182
F40V05	121	JM1R	218	MRE5416AJ344	385	JZ0A	179
F40VM5	121	JM1RD6	218	MRE5421AU171	386	JZ0AA6	179
F40VP5	121	JM1RN6	218	MRE5426A4426	386	JZ0B	180
F40Y05	130	JM1U	437	MRE5426A4681	392	JZ0BB6	180
F40YM5	130	JMAUN6	437	MRE5426AX164	386	JZ0G	511
G40A05	63	JMAUNA	437	MRE5426AZ166	386	JZ0GBT	511
G40AM5	63	JMAWN6	440	MRE5516AE876	386	JZ0J	390
G40B05	328	JMG4D6	386	MRE5516AG878	386	JZ0JA6	390
G40BM5	328	JMG4DA	386	MRE5526A0678	386	JZ0N	390
G40BP5	328	JMG4N6	386	MRE5526AC424	386	JZ0NA6	390
G40BV5	328	JMG4NA	386	MRE5526AC679	386	JZ0U	237
G40BW5	328	JMG5D6	392	MRE5526AF682	386	JZ0VB6	237
G40C05	329	JMG6D6	189	MRE5526AG816	386	JZ1B	237
G40CM5	329	JMG6N6	189	MRE5526AK820	386	JZ1D	511
G40CP5	329	JMGED6	189	MRE5526AM822	386	JZ1E	511
MRE000AGU653	328	JMGEN6	189	MRE5536AN143	386	JZ1G	182
MRE5004GJ384	328	JMGKD6	514	MRE5536AP144	386	JZ1H	237
VRE5004GR383	328	JMGKDB	514	MRE5536AS148	386	JZ1J	390
		JMGKN6	514	MRE5626A5770	514	JZ1K	390
		JMGKNB	514	MRE5626A6771	514	JZ1M	182
Fluence		JMJ4N6	386	MRE5626A7772	514	JZ1P	511
L300	234	JMJ4NA	386	MRE5626AJ165	514	JZ1S	390
L301	234	JMJ6N6	189	MRE5626AL423	514	JZ1SA6	390
L306	182	JMJEN6	189	MRE5626AR429	514	JZ1U	237
L30A	179	JMJKN6	514	MRE7526AE517	386	JZ1U06	237
L30B	180	JMJKNB	514	MRE7526AM525	386	JZ1W	182
L30D	182	JMJRN6	218	MRE7526AR530	386	JZ1Y	237
L30F	234	JMK4D6	386	MRE7626A3532	514	M10RENVPO00R199	511
L30H	234	JMKDD6	392	MRE7626AU523	514	M10RENVPO00R200	511
L30J	179	JMPKD6	514	MRE7626AZ528	514		
L30K	179	JMT4N6	386	URE1426AA056	218	Kangoo	
L30L	182	MRE1416A1594	218	URE1426AC058	218	FC00	251
L30M	179	MRE1416AS621	218	URE1426AK454	218	FC01	44
L30P	234	MRE1416AY397	218	URE1516AB400	437	FC05	25
L30R	234	MRE1426AA056	218	URE1716AP623	440	FC07	146
L30S	181	MRE1426AC058	218	URE3526AY416	437	FC07AF	146
LZB105	234	MRE1426AJ513	218	URE5316AV913	189	FC07BF	147
LZB10A	234	MRE1426AK454	218	URE5326AG581	189	FC07GF	146
LZBA05	179	MRE1426AM129	218	URE5326AN940	189	FC07HF	146
LZBB06	180	MRE1426AN130	218	URE5326AQ810	189	FC07TF	147
LZBD06	182	MRE1426AY529	218	URE5326AQ943	189	FC08	147
LZBF05	234	MRE1436A5377	218	URE5326AS521	189	FC084F	147
LZBF0A	234	MRE1516AB400	437	URE5326AS582	189	FC08BF	147
LZBL0E	182	MRE1516AC401	437	URE5326AV815	189	FC08GF	147
LZBS05	181	MRE1516AC595	437	URE5326AY527	189	FC09	148
M10RENVPO00T856	181	MRE1516AD596	437	URE5416AC593	385	FC094F	148
M10RENVPO00U857	182	MRE1526AQ511	437	URE5516AE876	386	FC09AF	148
M10RENVPO00V858	180	MRE1526AV516	437	URE5516AG878	386	FC09GF	148
M10RENVPO012792	182	MRE1716AP623	440	URE5526A0678	386	FC0A	44
M10RENVPO015795	181	MRE1726AD417	440	URE5526AC424	386	FC0AAF	44
M10RENVPO17D787	234	MRE3516AL598	437	URE5526AC679	386	FC0AAFBC	51
M10RENVPO316R731	234	MRE3526AY416	437	URE5526AF682	386	FC0B	113
		MRE5316A0591	156	URE5526AG816	386	FC0BAA	113
		MRE5316AV913	189	URE5526AK820	386	FC0BAF	113
		MRE5326A1591	156	URE5526AM822	386	FC0C	113
		MRE5326A4594	189	URE5536AN143	386	FC0CAF	113
		MRE5326A5595	189	URE5536AP144	386	FC0CBF	113
		MRE5326A6596	156	URE5536AS148	386	FC0D	330
		MRE5326AG581	189	URE5626A0086	514	FC0DAF	330
		MRE5326AN940	189	URE5626AJ165	514	FC0E	326
		MRE5326AQ810	189	URE5626AR429	514	FC0EAF	326
		MRE5326AQ943	189	URE7526AE517	386	FC0EBF	326
		MRE5326AS521	189	URE7526AM525	386	FC0EHF	327
		MRE5326AS582	189	URE7526AR530	386	FC0F	44
		MRE5326AV815	189	URE7626A3532	514	FC0FAF	44
		MRE5326AW428	189	URE7626AU523	514	FC0HBF	113
		MRE5326AY527	189	URE7626AZ528	514	FC0J	326
Gr. Scenic 2							
JM02D5	156						
JM0CDH	218						
JM0G	385						
JM0GD6	385						
JM0L	386						
JM0U	437						
JM0UD6	437						
JM0UDA	437						
JM0UN6	437						
JM0UNA	437						
JM0W	440						
JM0WN6	440						
JM14	386						
JM15	392						

* C.N.I.T. = Code National d'Identification du Type (code D2.1 sur nouvelles cartes grises)

Sommaire

Type Mines OU C.N.I.T.*	9	Type Mines OU C.N.I.T.*	9	Type Mines OU C.N.I.T.*	9	Type Mines OU C.N.I.T.*	9
FCOJ4F	326	FWOF	176	KCOJCF	326	KWOF	175
FCOJAF	326	FWOFB6	176	KCOJEF	326	KWOFB6	175
FCOJAG	326	FWOFC6	176	KCOK	44	KWOFD6	175
FCOJBF	326	FWOFK6	176	KCOL	214	KWOG	177
FCOJHF	326	FWOG	177	KCOM	113	KWOGB5	177
FCOL	214	FWOGB5	177	KCOMCF	113	KW0H	175
FCON	113	FWOGC5	177	KCON	326	KW0HB6	175
FCON	326	FWOGF5	177	KCOP	214	KW0HH6	175
FCONAF	326	FWOH	175	KCOPA8	214	KW0N	252
FCONAG	326	FWON	252	KCOPAF	214	KW0NJ5	252
FCOP	214	FWOP	252	KCOS	214	KW0P	252
FCOPA8	214	FWOU	232	KCOSA8	214	KW0UB5	232
FCOS	214	FWOW	232	KCOSAF	214	KW0Y	252
FCOSA8	214	FWOWB5	232	KCOSHA	214	KW24B5	174
FCOT	25	FWOWC5	232	KCOT	25	KW25B5	177
FCOU	378	FWOY	252	KCOU	378	KW25G5	177
FCOUBF	378	FW14B5	173	KCOUAF	378	KW26B6	175
FCOV	378	FW14C5	177	KCOUGF	378	KW27B5	174
FCOVA8	379	FW14F5	173	KCOV	378	KW28B5	177
FCOVAF	378	FW15B5	177	KCOVA8	379	KW2BS5	174
FCOVBF	378	FW15C5	177	KCOVAF	378	KW2C	176
FCOW	25	FW15F5	177	KCOVEF	378	KW2CG6	176
FCOWAF	25	FW15H5	177	KCOVGF	378	KW2D	232
FCOWGF	25	FW15M5	177	KCOW	25	KW2DG5	232
FC1D	25	FW15T5	177	KCOWEF	25	KW2F	176
FC1DAF	25	FW1AB5	173	KCOWGF	25	KW2FG6	176
FC1DBF	25	FW1AC5	173	KC1D	25	KW2HG6	175
FC1DGF	25	FW1AE5	173	KC1DGF	25	KW2UBA	232
FC1E	151	FW1AF5	173	KC1E	151	KWX6B6	175
FC1EAF	151	FW1AK5	173	KC1EGF	151	KWX7B5	174
FC1EBF	151	FW1BE5	173	KC1F	151	KWX8B5	177
FC1ECF	151	FW1BF5	173	KC1FGF	151	M10RENV0006542	232
FC1EGF	151	FW1BH5	173	KC1G	153	M10RENV0007543	232
FC1EHF	151	FW1BM5	173	KC1GGF	153	M10RENV000S528	232
FC1F	148	FW1CH6	176	KC1N	214	M10RENV000T529	232
FC1FAF	148	FW1CM6	176	KC1R	146	M10RENV000U530	232
FC1FGF	148	FW1HM6	175	KC1RGF	146	M10RENV000V531	252
FC1FHF	148	FW1UBA	232	KC1S	147	M10RENV000W532	252
FC1G	153	FW1UC5	232	KC4AAF	44	M10RENV001T201	177
FC1GAF	153	FW58B5	177	KCAPA8	214	MRE000APN964	44
FC1GBF	153	KCO0	251	KCASA8	214	MRE000APP965	113
FC1GGF	153	KCO1	44	KCAVA8	379	MRE000APQ967	330
FC1N	214	KCO5	25	KCAVAK	380	MRE000APR968	326
FC1R	146	KCO7	146	KCE8EF	147	MRE001APK112	44
FC1S	147	KCO74F	146	KCE9EF	148	MRE001APL113	113
FC4AAF	44	KCO7BF	146	KCEDEF	25	MRE001APN115	330
FCASA8	214	KCO8	147	KCEWEF	25	MRE001APN151	44
FCAVA8	380	KCO8EF	147	KCR7EF	146	MRE001APP116	326
FCAVAK	380	KCO8GF	147	KCR7GF	146	MRE001APP152	113
FCOUGF	378	KCO9	148	KCR8EF	147	MRE001APQ154	330
FW00	252	KCOA	44	KCR8GF	147	MRE001APR155	326
FW04	173	KCOAAF	44	KCTEEF	151	MRE001APT157	44
FW05	177	KCOAAG	44	KCTFEF	151	MRE001APV159	326
FW08	177	KCOB	113	KCTGEF	153	MRE1002K6638	44
FW0A	173	KCOBAA	113	KW00	252	MRE1002K7639	44
FW0B	173	KCOBEA	113	KW04	174	MRE1002KR393	44
FW0BB5	173	KCOBEF	113	KW04B5	174	MRE1002KX399	44
FW0BC5	173	KCOBGF	113	KW04J5	174	MRE1002KX981	44
FW0BD5	173	KCOCAF	113	KW05	177	MRE1002KY400	44
FW0BK5	173	KCOCBF	113	KW05D5	177	MRE1004KE387	44
FW0C	176	KCODAF	330	KW0A	173	MRE1012KU686	44
FW0CB6	176	KCOEAF	326	KW0B	174	MRE1102K5627	113
FW0CK6	176	KCOEAG	326	KW0BB5	174	MRE1102K6628	113
FW0D	232	KCOEBF	326	KW0BD5	174	MRE1102K9401	113
FW0DB5	232	KCOF	44	KW0C	176	MRE1102KA402	113
FW0DBA	232	KCOFEF	44	KW0D	232	MRE1102KB985	113
FW0DC5	232	KCOH01	113	KW0DB5	232	MRE1102KJ640	113
FW0E	252	KCOHAF	113	KW0DBA	232	MRE1102KJ641	113
FW0EB5	252	KCOHGF	113	KW0DD5	232	MRE1102KR904	113
FW0EC5	252	KCOJ	326	KW0E	252	MRE1102KS905	113
FW0EE5	252	KCOJAF	326	KW0EB5	252	MRE1102KT906	113
FW0EF5	252	KCOJAG	326	KW0EE5	252	MRE1112K6663	113

* C.N.I.T. = Code National d'Identification du Type (code D2.1 sur nouvelles cartes grises)

Sommaire

Type Mines OU C.N.I.T.*	9	Type Mines OU C.N.I.T.*	9	Type Mines OU C.N.I.T.*	9	Type Mines OU C.N.I.T.*	9
MRE1112K7664	25	MRE5222KT045	153	K56205	547	M10RENV0002244	521
MRE1112K6055	25	MRE5222UL936	153	K56305	312	M10RENV0002341	452
MRE1112KJ021	25	MRE5232K2089	153	K563F5	312	M10RENV002N654	521
MRE1112KJ022	25	MRE5232K4479	153	K56405	312	M10RENV002V662	521
MRE1112KU130	25	MRE5322UW937	175	K564F5	312	M10RENV002W724	521
MRE1112KU615	25	MRE5332KD090	175	K56502	668	M10RENV002Y726	521
MRE1122K4078	25	MRE5332KF092	175	K56605	547	MRE000AB0470	547
MRE1122K5079	25	MRE5332KF480	175	K566F5	547	MRE000AB0689	288
MRE1122K8082	25	MRE5332KW486	175	K56805	207	MRE000AB1011	288
MRE1122KN025	25	MRE6112K0060	379	K568F5	207	MRE000AB1471	288
MRE1212KF687	214	MRE6212KQ489	380	K56905	552	MRE000AB1859	288
MRE1212KH689	215	MRE9012KM690	44	K5690E	552	MRE000AB1884	401
MRE1212KW025	214	MRE9012KV153	44	K569FE	552	MRE000AB2472	288
MRE1232KX484	252	MRE9012KZ606	44	K569HE	552	MRE000AB2885	401
MRE1322UL938	232	MSM1304AN003	232	K569JE	552	MRE000AB3013	288
MRE1332K2091	232	MSM5304AY002	175	K56C02	401	MRE000AB3049	401
MRE1332K4481	232	N10RENT000X469	174	K56C0C	401	MRE000AB3473	288
MRE2212KM691	214	N10RENT0134876	177	K56C6C	401	MRE000AB4183	547
MRE2212KN692	214	N10RENT0137854	175	K56C6K	401	MRE000AB4474	288
MRE2212KX059	214	URE2212KN692	214	K56CKE	401	MRE000AB4499	401
MRE3102KJ986	113	URE3212KM688	214	K56D05	395	MRE000AB5051	401
MRE3102KW903	113	URE5022KT029	151	K56F05	547	MRE000AB5087	401
MRE3212KC132	214	URE5022KV031	148	K56FF5	547	MRE000AB5184	547
MRE3212KM688	214	URE5032K4488	148	K56H01	401	MRE000AB5500	401
MRE5002K6396	326	URE5222K3116	153	K56HGC	401	MRE000AB6185	288
MRE5002K6723	326	URE5222KR104	153	K56J	353	MRE000AB6501	401
MRE5002K7397	326	URE5232K2089	153	K56J02	353	MRE000AB7089	401
MRE5002K8725	326	URE5232K4479	153	K56J05	353	MRE000AB7186	288
MRE5002KA957	146	URE5332KD090	175	K56JF5	353	MRE000AB7211	401
MRE5002KA982	326	URE5332KF480	175	K56L02	401	MRE000AB7477	288
MRE5002KB958	146	VRE000APW964	44	K56L0A	401	MRE000AB7502	401
MRE5002KB983	326	VRE000APZ967	326	K56L0C	401	MRE000AB7696	288
MRE5002KD403	326	VRE001AP0155	326	K56L0G	401	MRE000AB8187	288
MRE5002KE404	326	VRE001APW151	44	K56L3G	401	MRE000AB8478	288
MRE5002KF405	326	VRE001APX116	326	K56L4F	409	MRE000AB8503	401
MRE5002KF987	146	VRE001APX152	113	K56L5F	409	MRE000AB9188	288
MRE5002KG406	326	VRE001APZ154	326	K56LFE	401	MRE000AB9213	401
MRE5002KY848	326	VRE1002K6399	44	K56LGC	401	MRE000AB9443	288
MRE5004K4390	326	VRE1102KE627	113	K56LHF	409	MRE000AB9892	547
MRE5004K5391	326	VRE1102KJ401	113	K56LJF	409	MRE000ABA092	401
MRE5012K0619	146	VRE5002KM403	326	K56M05	395	MRE000ABA214	401
MRE5012K2657	146	VRE5002KP405	326	K56MHE	395	MRE000ABA444	288
MRE5012K5563	146			K56MJE	395	MRE000ABB021	401
MRE5012K6564	146	Laguna		K56N02	401	MRE000ABB215	401
MRE5012KB109	146	A56A	441	K56N05	401	MRE000ABB506	395
MRE5012KC570	146	DT06	452	K56R02	668	MRE000ABB700	401
MRE5012KD111	146	DT0C	672	K56S0C	288	MRE000ABB869	288
MRE5012KE112	326	DT0G	464	K56SG5	288	MRE000ABB894	547
MRE5012KX616	146	DT0H	452	K56T	288	MRE000ABC216	401
MRE5022KJ018	151	DT0M	521	K56TF5	288	MRE000ABC701	401
MRE5022KJ019	148	DT0P	672	K56TG5	288	MRE000ABD023	401
MRE5022KN023	146	DT0V	672	K56TGE	288	MRE000ABD217	401
MRE5022KT029	151	DT0Y	452	K56V02	652	MRE000ABD508	547
MRE5022KV031	148	DT19	521	K56V05	652	MRE000ABD896	552
MRE5032K4488	148	DT1F	521	K56VJ2	652	MRE000ABE096	395
MRE5032K5489	148	DT1G06	464	K56VJ5	652	MRE000ABE157	288
MRE5032KM093	148	DT1H0E	452	K56W05	356	MRE000ABE678	288
MRE5102K2709	378	DT1M06	521	K56WF5	356	MRE000ABE703	401
MRE5102KF916	378	DT1P0E	672	K56WR5	356	MRE000ABE897	552
MRE5102KH918	378	DT1U	464	K56Y05	312	MRE000ABF025	401
MRE5102KM984	378	DTBG06	464	K56YF5	312	MRE000ABF061	547
MRE5112K9133	147	DTD90E	521	K56Z	302	MRE000ABF158	288
MRE5112K9618	147	DTDU06	464	M10RENV000C318	464	MRE000ABF510	547
MRE5112KB135	147	DTEH0E	452	M10RENV000D319	452	MRE000ABF704	401
MRE5112KC136	147	DTF30E	672	M10RENV000H323	672	MRE000ABG062	547
MRE5112KE659	147	K560	302	M10RENV000L291	521	MRE000ABG220	395
MRE5112KJ567	147	K5600C	288	M10RENV000M292	521	MRE000ABG511	547
MRE5112KK568	147	K560G5	288	M10RENV000R332	464	MRE000ABG705	401
MRE5122KJ105	147	K560GC	288	M10RENV000R333	672	MRE000ABH512	552
MRE5122KQ113	147	K560PF	302	M10RENV000S334	521	MRE000ABH900	652
MRE5222K3116	153	K56105	207	M10RENV000T335	521	MRE000ABJ064	288
MRE5222KR104	153	K561F5	207	M10RENV000Y340	464	MRE000ABJ065	288

* C.N.I.T. = Code National d'Identification du Type (code D2.1 sur nouvelles cartes grises)

Sommaire

Type Mines OU C.N.I.T.*	9	Type Mines OU C.N.I.T.*	9	Type Mines OU C.N.I.T.*	9	Type Mines OU C.N.I.T.*	9
MRE000ABJ513	552	MRE1304BP596	207	B56F05	547	MRE000AC0423	288
MRE000ABJ999	288	MRE1304BQ597	207	B56F25	547	MRE000ACS971	288
MRE000ABK066	288	MRE1304BR282	207	B56H02	401	MRE000ACU427	401
MRE000ABM226	552	MRE1304BS283	207	B56HKC	401	MRE000ACV234	288
MRE000ABN033	547	MRE1404B0633	312	B56J	353	MRE000ACV852	395
MRE000ABN227	552	MRE1404B1634	312	B56J02	353	MRE000ACW429	401
MRE000ABN712	547	MRE1404BU300	401	B56J05	353	MRE000ACX103	288
MRE000ABP035	288	MRE1404BV301	312	B56L	409	MRE000ACX854	547
MRE000ABP714	547	MRE1404BW302	312	B56L02	401	MRE000ACY855	552
MRE000ABQ036	288	MRE1404BY595	312	B56L05	401	MRE000ACY977	288
MRE000ABQ072	288	MRE1604B7717	395	B56LOF	409	MRE000ACZ856	667
MRE000ABQ194	288	MRE1831C1341	464	B56L0G	400	MRE001AC0396	207
MRE000ABQ679	288	MRE1831C1474	464	B56L3F	409	MRE001AC2398	401
MRE000ABR716	552	MRE3404BB286	401	B56L3G	400	MRE001AC4242	288
MRE000ABS717	552	MRE3731C3347	452	B56LDA	401	MRE001AC4375	401
MRE000ABU173	401	MRE3731CN331	452	B56LDE	401	MRE001AC5207	288
MRE000ABY881	401	MRE3804BJ289	652	B56LK5	409	MRE001AC8379	400
MRE000ABZ469	547	MRE3931CM335	672	B56M05	395	MRE001ACA248	401
MRE000ABZ688	288	MRE3931CT342	672	B56MLE	395	MRE001ACB213	288
MRE000AC0433	401	MRE5204BR086	547	B56N02	401	MRE001ACC250	401
MRE000AC9248	401	MRE5304B1280	353	B56N05	401	MRE001ACC383	395
MRE001AB0009	288	MRE5304B2281	353	B56P05	547	MRE001ACD251	401
MRE001AB2435	547	MRE5304BM714	353	B56R02	667	MRE001ACE252	400
MRE001AB4304	547	MRE5304BN715	353	B56S05	288	MRE001ACE385	547
MRE001AB4437	547	MRE5304BQ754	353	B56SJC	288	MRE001ACF253	400
MRE001AB5183	401	MRE5304BR755	353	B56SK5	288	MRE001ACF386	552
MRE001AB5402	288	MRE5304BU589	353	B56T05	288	MRE001ACH219	401
MRE001AB6281	288	MRE5304BW821	356	B56U0G	400	MRE001ACJ221	401
MRE001AB6306	547	MRE5404B0294	552	B56V02	652	MRE001ACJ256	395
MRE001AB6439	552	MRE5404B2296	552	B56V05	652	MRE001ACK222	401
MRE001AB7016	288	MRE5404B3297	552	B56VL2	652	MRE001ACK258	547
MRE001AB8308	552	MRE5404B5590	552	B56VL5	652	MRE001ACL223	400
MRE001AB9187	401	MRE5404BF090	552	B56W05	356	MRE001ACL259	552
MRE001AB9309	552	MRE5404BG285	552	B56Y05	312	MRE001ACL550	353
MRE001ABC021	401	S56605	547	B56YOC	312	MRE001ACM224	400
MRE001ABC445	353	S56F05	547	B56ZK5	289	MRE001ACN261	652
MRE001ABD446	353	S56J05	353	MRE000AC0857	652	MRE001ACN552	395
MRE001ABE314	353			MRE000AC1107	288	MRE001ACP227	395
MRE001ABE447	552			MRE000AC2435	547	MRE001ACP262	652
MRE001ABF024	401			MRE000AC3109	288	MRE001ACP263	353
MRE001ABF315	353			MRE000AC3436	552	MRE001ACP553	552
MRE001ABF412	288			MRE000AC3727	288	MRE001ACR229	547
MRE001ABF448	552			MRE000AC4437	667	MRE001ACR265	395
MRE001ABG025	401			MRE000AC4983	401	MRE001ACR556	401
MRE001ABG316	552			MRE000AC5244	401	MRE001ACS230	552
MRE001ABJ161	288			MRE000AC6245	401	MRE001ACS266	552
MRE001ABJ610	353			MRE000AC6985	401	MRE001ACS363	288
MRE001ABK611	353			MRE000AC7731	288	MRE001ACT267	652
MRE001ABL454	207			MRE000AC7986	401	MRE001ACT558	401
MRE001ABL612	552			MRE000AC8987	400	MRE001ACU232	652
MRE001ABM455	207			MRE000AC9988	400	MRE001ACU390	353
MRE001ABM613	552			MRE000ACB117	401	MRE001ACV233	652
MRE001ABN032	547			MRE000ACB250	547	MRE001ACV269	207
MRE001ABN323	207			MRE000ACC251	552	MRE001ACW234	353
MRE001ABP034	547			MRE000ACC991	395	MRE001ACW392	395
MRE001ABR036	552			MRE000ACE993	547	MRE001ACX393	552
MRE001ABR194	547			MRE000ACF739	395	MRE001ACY236	288
MRE001ABS037	552			MRE000ACF994	552	MRE001ACY394	652
MRE001ABS619	207			MRE000ACH741	547	MRE001ACZ395	652
MRE001ABT171	288			MRE000ACH838	288	MRE1202CE052	288
MRE001ABT196	547			MRE000ACH996	652	MRE1202CF053	288
MRE001ABT293	401			MRE000ACJ415	288	MRE1202CH055	288
MRE001ABT620	207			MRE000ACJ742	552	MRE1202CL314	288
MRE001ABV198	552			MRE000ACJ743	667	MRE1202CN316	288
MRE001ABV428	401			MRE000ACJ997	652	MRE1202CP318	288
MRE001ABW199	552			MRE000ACK744	395	MRE1302C1611	207
MRE001ABW271	288			MRE000ACL745	395	MRE1302C3322	207
MRE001ABX297	401			MRE000ACM419	288	MRE1302CU604	207
MRE001ABY007	288			MRE000ACM746	652	MRE1402C0636	312
MRE1204B8079	288			MRE000ACN420	288	MRE1402C5350	401
MRE1204BD084	288			MRE000ACN844	401	MRE1402C5799	312
MRE1304BL592	207			MRE000ACP421	288	MRE1402C6606	401

Laguna I

556A	441
B560	302
B5600C	288
B5600F	302
B560KE	288
B560PF	302
B56105	207
B56205	547
B563	312
B56305	312
B5630E	312
B56405	312
B5640C	312
B56502	667
B5660E	547
B56805C	207
B56905	552
B569LE	552
B56AK5	302
B56B05	302
B56BJC	302
B56BK5	302
B56C02	401
B56C05	401
B56C0C	401
B56C0D	401
B56C05	401
B56CDD	401
B56CK2	401
B56CK5	401
B56CKC	401
B56D05	395
B56E05	667

* C.N.I.T. = Code National d'Identification du Type (code D2.1 sur nouvelles cartes grises)

Sommaire

Type Mines OU C.N.I.T.*	9	Type Mines OU C.N.I.T.*	9	Type Mines OU C.N.I.T.*	9	Type Mines OU C.N.I.T.*	9
MRE1402C6642	312	BG0K05	417	BGETB6	517	KG1W	351
MRE1402C7352	312	BG0K0A	417	BGEVB6	371	KG1Y	442
MRE1402C7643	312	BG0L	203	BGEWB6	351	KG1ZB6	442
MRE1402CA610	312	BG0L05	203	BGRF06	560	KG42B6	371
MRE1402CB065	401	BG0M	313	BGRF0B	560	KG42BA	371
MRE1402CN332	401	BG0M0A	313	BGRG06	350	KG43B6	371
MRE1402CP333	401	BG0N	466	BGRRO6	356	KG4AB6	351
MRE1602C8721	395	BG0N05	466	KG00	417	KG4NBB	555
MRE1602CA335	395	BG0N0A	466	KG01	658	KG4TB6	517
MRE1602CC337	395	BG0P	417	KG02	658	KG4VB6	371
MRE1602CH306	395	BG0R	351	KG03	433	KG4VBA	371
MRE1602CK600	395	BG0R06	351	KG04	313	KG4WB6	351
MRE1802C2343	652	BG0S	433	KG0405	313	KGCCB6	350
MRE1802C3308	652	BG0S06	433	KG05	349	KG CZB6	442
MRE1802C4345	652	BG0S0B	433	KG06	313	KG E3B6	371
MRE1802C6602	652	BG0T	459	KG08	371	KG ENBB	555
MRE3402C5599	400	BG0U	203	KG09	555	KG EVB6	371
MRE3402CD607	400	BG0V	313	KG0A	203	KG RF0B	561
MRE3402CQ329	400	BG0V05	313	KG0A05	203	KG RG06	350
MRE3802C7342	652	BG0W	417	KG0A0A	203	MRE1302C6907	203
MRE3802C9344	652	BG0Y	658	KG0B	313	MRE1302C869	203
MRE3802CA309	652	BG0Z	442	KG0C	313	MRE1304CB908	203
MRE3802CD603	652	BG10	371	KG0C05	313	MRE1304CC970	203
MRE5202C4321	547	BG12	371	KG0D	658	MRE1304CE875	203
MRE5202CW058	547	BG13	371	KG0DOB	658	MRE1402C3930	313
MRE5302C0598	353	BG15B6	349	KG0DOB	658	MRE1402C4870	313
MRE5302C3310	353	BG19B6	555	KG0E	369	MRE1402C5799	313
MRE5302CJ325	353	BG1A	351	KG0E05	356	MRE1402C5871	313
MRE5302CP719	353	BG1FB6	560	KG0F	555	MRE1402CJ874	313
MRE5302CQ757	353	BG1FBB	560	KG0F06	561	MRE1404C3962	313
MRE5302CV823	353	BG1G	205	KG0G	350	MRE1404C4963	313
MRE5402CD601	552	BG1GB6	350	KG0G06	350	MRE1404C6965	313
MRE5402CF348	552	BG1H	205	KG0J	313	MRE1404C8931	313
MRE5402CG349	552	BG1K	658	KG0JOA	313	MRE1404CP876	313
MRE5402CH059	552	BG1L	433	KG0K	417	MRE1404CQ877	313
MRE5402CL354	552	BG1M	433	KG0K05	417	MRE1404CT880	313
MRE5402CQ323	552	BG1N	555	KG0K0A	417	MRE1412C3117	313
MRE5402CR324	552	BG1P	433	KG0L	203	MRE1412C6932	203
MRE7302CV720	353	BG1PBA	417	KG0L05	203	MRE1412CD939	203
		BG1PBE	417	KG0M	313	MRE1412CG069	313
		BG1T	517	KG0M0A	313	MRE1412CP174	313
		BG1TB6	459	KG0N	466	MRE1414C8118	313
		BG1V	371	KG0N05	466	MRE1414CL070	313
		BG1W	351	KG0N0A	466	MRE1414CP946	203
		BG1Y	442	KG0P	417	MRE1512C1856	417
		BG1ZB6	442	KG0R	351	MRE1512C5145	417
		BG1ZBB	442	KG0R06	351	MRE1512CC928	417
		BG3L05	205	KG0S	433	MRE1512CJ935	417
		BG42B6	371	KG0S06	433	MRE1512CY853	417
		BG42BA	371	KG0S0B	433	MRE1514C1949	417
		BG43B6	371	KG0T	459	MRE1514CA146	417
		BG4AB6	351	KG0TB6	459	MRE1514CU942	417
		BG4HBE	205	KG0U	203	MRE1602C3971	417
		BG4KBB	658	KG0V	313	MRE1604B7717	417
		BG4NBB	555	KG0W	417	MRE1604C8972	417
		BG4TB6	517	KG0Y	658	MRE1712C3317	433
		BG4VB6	371	KG0Z	442	MRE1712CS888	433
		BG4VBA	371	KG10	371	MRE1712CW892	433
		BG4WB6	351	KG12	371	MRE1714C6898	442
		BGCFB6	560	KG13	371	MRE1714C8318	433
		BGCFBB	560	KG15B6	349	MRE1812C1959	442
		BGCCB6	350	KG1A	351	MRE1814C8962	442
		BGCPBA	417	KG1FB6	561	MRE3402CB968	313
		BGCPBE	417	KG1FBB	561	MRE3404CG969	313
		BGCTB6	459	KG1G	205	MRE3512CH927	417
		BGCZB6	442	KG1GB6	350	MRE3512CP122	417
		BGCZBB	442	KG1H	205	MRE3512CP934	417
		BGE2B6	371	KG1K	658	MRE3514CT123	417
		BGE3B6	371	KG1L	459	MRE3514C2941	417
		BGEAB6	351	KG1N	555	MRE3712C3893	442
		BGEHBE	205	KG1T	517	MRE3712C8449	433
		BGEKBB	658	KG1V	371	MRE3712C2889	442
Laguna II							
OB	658						
BG00	417						
BG01	658						
BG02	658						
BG03	442						
BG04	313						
BG0405	313						
BG05	349						
BG06	313						
BG0606	313						
BG08	371						
BG09	555						
BG0A	203						
BG0A05	203						
BG0A0A	203						
BG0B	313						
BG0B05	313						
BG0C	313						
BG0C05	313						
BG0D	658						
BG0DOB	658						
BG0E	369						
BG0E05	356						
BG0F	560						
BG0F06	560						
BG0F0B	560						
BG0G	350						
BG0G06	350						
BG0J	313						
BG0JOA	313						
BG0K	417						

* C.N.I.T. = Code National d'Identification du Type (code D2.1 sur nouvelles cartes grises)

Sommaire

Type Mines OU C.N.I.T.*	9	Type Mines OU C.N.I.T.*	9	Type Mines OU C.N.I.T.*	9	Type Mines OU C.N.I.T.*	9
MRE3714CD450	433	MRE7522C1122	371	BTBG06	451	MRE1422CW957	231
MRE3714CD899	433	MRE7522CY119	371	BTD90E	521	MRE1622C9950	510
MRE3714CH903	433	MRE7612C8253	560	BTEM06	521	MRE1622CC978	510
MRE3902C1872	658	MRE7612CJ554	560	KTOA	170	MRE1622CJ959	510
MRE3904CM878	658	MRE7612CN850	560	KTOA06	170	MRE1622U0826	510
MRE3912CV890	658	MRE7614C1860	561	KTOAE6	170	MRE1622U5831	510
MRE3912CZ894	658	MRE7614CD254	561	KTOD	231	MRE1624C0998	510
MRE3914C9900	658	MRE7614CN555	561	KTOF	510	MRE1624CT991	510
MRE3914CD904	658	MRE7624CK127	555	KTOF06	510	MRE1624U7865	510
MRE5212CN885	349	MRE9312C6178	205	KTOFE6	510	MRE1624UX855	510
MRE5214C1895	349	MRE9314CN252	205	KTOG	451	MRE1632CP310	510
MRE5302C5966	356	MREZ304BF596	205	KTOH	452	MRE1634C0017	510
MRE5302C7932	356	URE3514CZ941	417	KTOM	521	MRE1634CT311	510
MRE5302CV823	356	URE5212CN885	349	KTOM06	521	MRE1832C1472	451
MRE5304BW821	356	URE5214C1895	349	KTOR	170	MRE1832CP097	451
MRE5304CA967	356	URE5412C1854	351	KTOW	510	MRE1834CB478	451
MRE5312CA546	349	URE5412CH931	351	KTOY	452	MRE1834CE312	451
MRE5312CC548	356	URE5412CY851	350	KT19	521	MRE1834CW100	451
MRE5312CK071	356	URE5414CC861	350	KT1A06	170	MRE3722C0961	452
MRE5314C5088	356	URE5414CF864	351	KT1F	521	MRE3722UM832	452
MRE5314CF547	349	URE5414CG865	350	KT1H	510	MRE3722UW842	452
MRE5314CH549	356	URE5414CZ945	351	KT1H0E	452	MRE3724UE856	452
MRE5402CA961	350	URE5512C0930	350	KT1M06	521	MRE3732C5153	452
MRE5402CU873	350	URE5512CT933	350	KT1RG6	170	MRE3732CK168	452
MRE5404C4879	350	URE5514C8944	350	KT390E	521	MRE3734C7018	452
MRE5404CH964	350	URE5514CB947	350	KT3F06	521	MRE3734CP000	452
MRE5412C1854	351	URE5514CF951	350	KT3H06	510	MRE5422C7956	170
MRE5412C2855	350	URE5514CJ954	350	KTBG06	451	MRE5422C2948	170
MRE5412C4857	351	URE5522C6194	350	KTD90E	521	MRE5422UR825	170
MRE5412C8667	350	URE5612CG849	560	KTEH0E	452	MRE5422UW830	170
MRE5412CF929	350	URE5622CH001	517	KTEM06	521	MRE5424CR997	170
MRE5412CH931	351	URE5622CJ002	517	KTFF06	521	MRE5424UJ849	170
MRE5412CW231	350	URE5624CN003	517	KTR06	170	MRE5424UP854	170
MRE5412CY851	350	URE5624CP004	517	KYBG06	451	MRE5432C7470	170
MRE5414C1232	350	URE7612CN850	560	M10RENV0000403	521	MRE5432C8471	170
MRE5414C6952	351	URE7614C1860	561	M10RENV0003284	451	MRE5432CX072	170
MRE5414CC861	350			M10RENV0006251	231	MRE5434C2073	170
MRE5414CE669	350	Laguna 3		M10RENV0006409	510	MRE5434CH476	170
MRE5414CF864	351	BT00	170	M10RENV0007410	452	MRE5434CJ477	170
MRE5414CG865	350	BT04	231	M10RENV0008253	510	MRE5722C3983	521
MRE5414CJ867	351	BT05	510	M10RENV0009351	170	MRE5722CA965	521
MRE5414CZ945	351	BT06	452	M10RENV000A255	452	MRE5732CA152	521
MRE5422CH190	350	BT0A	170	M10RENV000B256	452	MRE5732CF157	521
MRE5422CK193	350	BT0A06	170	M10RENV000B353	510	MRE5732CU172	521
MRE5422CY196	351	BT0D	231	M10RENV000K362	170	MRE5734C5179	521
MRE5424C5199	350	BT0D06	231	M10RENV000L291	521	MRE5734C7533	521
MRE5424C8202	350	BT0F	510	M10RENV000M292	521	MRE5734C8182	521
MRE5512C0940	350	BT0F06	510	M10RENV000M364	510	MRE5734C8534	521
MRE5512CQ930	350	BT0G	451	M10RENV000P366	452	MRE5734CH022	521
MRE5512CT933	350	BT0H	452	M10RENV000P367	452	MRE5734CH191	521
MRE5514C8944	350	BTOM	521	M10RENV000S298	510	MRE5734C2004	521
MRE5514CB947	350	BTOR	170	M10RENV000S334	521	URE5422C7956	170
MRE5514CF951	350	BTOT	170	M10RENV000S395	451	URE5424CR997	170
MRE5514CJ954	350	BT0U	231	M10RENV000T299	452	URE5432C7470	170
MRE5522C6194	350	BT0W	510	M10RENV000T335	521	URE5432CX072	170
MRE5522CA198	350	BT0Y	452	M10RENV000V240	231	URE5434C2073	170
MRE5612CA552	560	BT19	521	M10RENV000W241	510	URE5434CH476	170
MRE5612CF848	560	BT1A06	170	M10RENV000Z244	521	URE5734CH191	521
MRE5612CG849	560	BT1F	521	M10RENV0016117	170		
MRE5612CW089	560	BT1F06	510	M10RENV002J746	170	Logan	
MRE5614C1090	561	BT1H	513	M10RENV002J807	521	KS00	171
MRE5614C1212	561	BT1H0E	452	M10RENV002M811	521	KS03	246
MRE5614C6605	555	BT1J	170	M10RENV002N654	521	KS04	172
MRE5614CF553	561	BT1M06	521	M10RENV002R815	521	KS0A	145
MRE5614CT858	555	BT1R06	170	M10RENV002U758	170	KS0B	246
MRE5614CU859	561	BT1U0D	231	M10RENV002V662	521	KS0C	145
MRE5622C2191	517	BT1W0D	510	M10RENV002W724	521	KS0D	246
MRE5622CH001	517	BT1Y0E	452	M10RENV002X786	521	KS0E	145
MRE5622CJ002	517	BT1YDE	452	M10RENV002Y726	521	KS0F	246
MRE5624CN003	517	BT290E	521	M10RENV0075049	170	KS0G	145
MRE5624CP004	517	BT3F06	521	M10RENV009N223	170	KS0H	246
MRE5624CQ200	517	BT3H06	513	MRE1422CP949	231	KS0J	171

* C.N.I.T. = Code National d'Identification du Type (code D2.1 sur nouvelles cartes grises)

Sommaire

Type Mines OU C.N.I.T.*	9	Type Mines OU C.N.I.T.*	9	Type Mines OU C.N.I.T.*	9	Type Mines OU C.N.I.T.*	9
KSOL	196	QH92	476	RJ5E	592	EDCVG5	627
KSOM	196	QH94	605	RJ5G	617	EDCVH5	627
KSOP	196	QHA4	605	RJ5H	613	EDCVK5	627
KSOW	172	QJ74	605	RJ5J	613	EDCVL5	627
KS0Y	171	QJ92	476	RJ5L	617	FD01	622
KS11	246	QJ94	605	RJ92	476	FD02	627
KS12	145	R8D2	473	RJ95	636	FD03	621
KS1E	246	R8D5	613	RJ9E	593	FD0A	634
KS1L	172	R8D6	617	RJ9G	628	FD0C	644
KS1Y	196	R8DE	592	RJ9H	636	FD0E	634
KSOK	171	R8DG	617	RJ9J	638	FD0G	567
LS00	171	RC7E	593	RL7E	593	FD0L	375
LS03	246	RC7G	628	RL7H	636	FD0M	623
LS09	195	RC7H	636	RL7J	638	FD0N	567
LS0A	145	RC92	473	RL92	473	FD0P	376
LS0B	246	RC9E	593	RL9E	593	FD0U	626
LS0C	145	RC9G	628	RL9G	628	FD0V	627
LS0D	246	RC9H	636	RL9H	636	FD0W	627
LS0E	145	RC9J	638	RL9J	638	FD0Y	621
LS0F	246	RD8H	613	VRE5103MH517	617	FD1M	623
LS0G	145	RD8J	613			FD1N	567
LS0H	246	RD9E	593	Master II		FD21	622
LS0J	171	RD9G	628	ED01	621	FD22	627
LS0K	171	RD9H	636	ED02	627	FD2G	567
LS0L	195	RF12	473	ED0A	634	FD2Y	621
LS0M	195	RF13	525	ED0C	644	FD31	622
LS0P	195	RF16	617	ED0E	634	FD32	627
LS0T	246	RF1E	592	ED0G	567	FD3E	634
LS0V	195	RF1G	617	ED0M	623	FD3G	567
LS0W	172	RF1L	617	ED0N	567	FD3U	623
LS0Y	171	RH12	473	ED0O	623	FD3Y	621
LS11	246	RH15	613	ED0V	627	FD71	622
LS12	145	RH16	617	ED0Y	621	FD72	627
LS18	195	RH1E	592	ED41	621	FD7Y	621
LS1A	246	RH1G	617	ED42	627	FD81	622
LS1E	246	RH1H	613	ED4Y	621	FD82	627
LS1F	145	RH1J	613	ED81	622	FD8W	626
LS1H	246	RH1K	613	ED82	627	FD8Y	621
LS1S	195	RH2E	592	ED8Y	621	FD91	622
LS1V	195	RH2G	617	ED91	621	FD92	627
LS1Y	195	RH2H	613	ED92	627	FD9Y	621
		RH52	473	ED9Y	621	FDA1D6	622
Master I		RH55	613	EDC1G6	622	FDA2D6	627
FB30A1	473	RH56	617	EDC1K6	622	FDA2DH	627
FB30A2	473	RH5E	592	EDC1L6	622	FDA3D6	621
FB30A5	617	RH5G	617	EDC3KH	621	FDAAD5	634
FB30A7	613	RH5H	613	EDCAH5	634	FDACD5	644
FB30AE	592	RH92	476	EDCAK5	634	FDAED5	634
FB30AG	617	RH95	636	EDCCG5	644	FDAGD5	567
FB30AH	613	RH9E	593	EDCCH5	644	FDAJD5	567
FB30AJ	613	RH9G	628	EDCCK5	644	FDAKD5	376
FB30AK	613	RH9H	636	EDCCL5	644	FDAMD5	623
FB30AL	617	RH9J	638	EDCEG5	634	FDAND5	567
FB30B2	473	RJ12	473	EDCEH5	634	FDAPD5	376
FB30B3	525	RJ15	613	EDCEK5	634	FDAUD6	626
FB30B5	617	RJ16	617	EDCEL5	634	FDAVD5	627
FB30BE	592	RJ1E	592	EDCGH5	567	FDAWD6	627
FB30BG	617	RJ1G	617	EDCGK5	567	FDAWDH	626
FB30BL	617	RJ1H	613	EDCMG5	623	FDB1D6	622
FB30C1	473	RJ1J	613	EDCMH5	623	FDB1DH	622
FB30C2	473	RJ1L	617	EDCMK5	623	FDB1E6	622
FB30C5	617	RJ22	473	EDCMKH	623	FDB1H6	622
FB30C7	613	RJ25	613	EDCML5	623	FDB1HH	622
FB30CE	592	RJ26	617	EDCNG5	567	FDB2D6	627
FB30CG	617	RJ27	617	EDCNK5	567	FDB2E6	627
FB30CH	613	RJ2E	592	EDCNL5	567	FDB2H6	627
FB30CJ	613	RJ2G	617	EDCUG5	626	FDB3D6	621
FB30DH	613	RJ2H	613	EDCUG6	623	FDB3E6	621
FB30DL	617	RJ2J	613	EDCUH6	623	FDB3H6	621
FC30A1	605	RJ52	473	EDCUK6	623	FDB3HH	621
FC30A2	476	RJ55	613	EDCUL5	626	FDBAD5	634
QH74	605	RJ56	617	EDCUL6	623	FDBAE5	634

* C.N.I.T. = Code National d'Identification du Type [code D2.1 sur nouvelles cartes grises]

Sommaire

Type Mines OU C.N.I.T.*	9	Type Mines OU C.N.I.T.*	9	Type Mines OU C.N.I.T.*	9	Type Mines OU C.N.I.T.*	9
FDBAH5	634	FDCMJ6	626	JD11	622	MRE5213MW724	567
FDBCD5	644	FDCML5	623	JD12	627	MRE5213MX725	567
FDBCE5	644	FDCMM5	623	JD1A	634	MRE5323M2295	627
FDBCH5	644	FDCNE5	567	JD1B	644	MRE5323M3332	627
FDBED5	634	FDCNH5	567	JD1E	634	MRE5323M4297	627
FDBEE5	634	FDCNJ5	567	JD1F	644	MRE5323M7433	627
FDBEH5	634	FDCNL5	567	JD1G	567	MRE5323MC341	627
FDBGD5	567	FDCNM5	567	JD1L	375	MRE5323ME307	627
FDBGE5	567	FDCUD6	626	JD1M	623	MRE5323MH443	627
FDBGH5	567	FDCUE5	626	JD1N	567	MRE5323MJ347	627
FDBJD5	567	FDCUE6	626	JD1P	376	MRE5323MY327	627
FDBJE5	567	FDCUH5	626	JD1Y	621	MRE5333MJ213	627
FDBJH5	567	FDCUH6	626	JD2E	634	MRE5333MM217	627
FDBMD5	623	FDCUJ6	626	JD2M	623	MRE5403M8523	644
FDBME5	623	FDCUL5	626	JD2N	567	MRE5403MW511	644
FDBMH5	623	FDCUL6	626	JDA1D6	626	MRE5413M8425	626
FDBMH6	626	FDCUM5	626	JDA1H6	626	MRE5413MA427	626
FDBMHH	626	FDCUM6	626	JDA206	627	MRE5413MD006	623
FDBND5	567	FDCVD5	627	JDA2D6	627	MRE5413MD430	626
FDBNE5	567	FDCVE5	627	JDA2H6	627	MRE5413MH434	626
FDBNH5	567	FDCVH5	627	JDAAD5	634	MRE5413MJ727	626
FDBUD6	626	FDCVJ5	627	JDABD5	644	MRE5413MK013	626
FDBUH6	626	FDCVM5	627	JDAED5	634	MRE5413MK728	626
FDBVD5	627	FDCWH6	627	JDAFD5	644	MRE5413MM730	626
FDBVE5	627	FDCWJ6	627	JDAGD5	567	MRE5413MQ734	626
FDBVH5	627	FDCWL6	627	JDAJD5	567	MRE5413MR735	626
FDBWD6	627	FDCWM6	627	JDAKD5	376	MRE5413MT737	626
FDBWE6	627	FDCYH6	621	JDAMD5	623	MRE5413MU411	626
FDBWH6	627	FDCYL6	621	JDAMD6	626	MRE5413MV412	626
FDBYH6	621	FDCYM6	621	JDAMH6	626	MRE5413MZ416	626
FDC1D6	626	GDCCG5	644	JDAND5	567	MRE5423M6325	622
FDC1E6	622	HD01	622	JDANH5	567	MRE5423MA293	622
FDC1H6	622	HD02	627	JDAPD5	376	MRE5423MB330	622
FDC1HH	622	HD0A	634	JDAYD6	621	MRE5423MF431	622
FDC1L6	622	HD0C	644	JDAYH6	621	MRE5423MH627	622
FDC1LH	622	HD0E	634	JDC2H6	627	MRE5423MJ337	622
FDC1M6	622	HD0G	567	JDCMH6	626	MRE5423MM305	622
FDC1MH	622	HD0M	644	JDCNH5	567	MRE5423MP441	622
FDC2D6	627	HD0N	567	JDEM06	626	MRE5423MQ345	622
FDC2E6	627	HD0U	623	JDEMH6	626	MRE5423MT639	622
FDC2H6	627	HD0V	627	JDEND5	567	MRE5433MR212	622
FDC2L6	627	HD0Y	621	JDENH5	567	MRE5433MV216	622
FDC3D6	621	HD11	622	JDEPD5	376	MRE5623M3435	621
FDC3H6	621	HD12	627	JDGMH6	626	MRE5623M7730	621
FDC3HH	621	HD1E	634	JDGNH5	567	MRE5623M9732	621
FDCAE5	634	HD1G	567	JDKMD6	626	MRE5623MA309	621
FDCAL5	634	HD1Y	621	JDKND5	567	MRE5623MB734	621
FDCAM5	634	HD3C	644	JDNED5	634	MRE5623MF738	621
FDCCE5	644	HDC1K6	622	JDNJD5	567	MRE5623MV718	621
FDCCH5	644	HDC2K6	627	JDNM	623	MRE5623MX720	621
FDCCL5	644	HDC3K6	621	JDNMD5	623	MRE5623MZ334	621
FDCCM5	644	HDCCK5	644	JDNMD6	623	MRE5623M2722	621
FDCCEH5	634	HDCEK5	634	JDNN	567	NDDCL5	644
FDCCEJ5	634	HDCJK5	567	JDNND5	567	NDEL5	634
FDCEL5	634	HDCMK5	644	JDSMH6	626	NDDUL6	623
FDCGH5	567	HDCN65	567	MRE5113M4415	376	UD01	622
FDCGL5	567	HDCNK5	567	MRE5113MM433	376	UD02	627
FDCJD5	567	HDCUG6	623	MRE5113MP726	376	UD0A	634
FDCJE5	567	HDCUK6	623	MRE5203M5989	567	UD0C	644
FDCJH5	567	HDCVG5	627	MRE5203M6990	567	UD0E	634
FDCJJ5	567	HDCVK5	627	MRE5203MB995	567	UD0G	567
FDCJL5	567	JD01	622	MRE5203ME840	567	UD0N	567
FDCJM5	567	JD02	627	MRE5213M1729	567	UD0U	623
FDCMD5	623	JD0A	634	MRE5213M4732	567	UD0V	627
FDCMD6	626	JD0B	644	MRE5213M8736	567	UD0Y	621
FDCME5	623	JD0E	634	MRE5213MC413	567	UD11	622
FDCME6	626	JD0G	567	MRE5213MD414	567	UD12	627
FDCMH5	623	JD0L	375	MRE5213MG417	567	UD1G	567
FDCMH6	626	JD0M	623	MRE5213MP426	567	UD1Y	621
FDCMHH	626	JD0N	567	MRE5213MR428	567	UD41	622
FDCMHJ5	623	JD0P	376	MRE5213MU431	567	UD42	627
FDCMJ5	623	JD0Y	621	MRE5213MV432	567	UD4C	644

* C.N.I.T. = Code National d'Identification du Type (code D2.1 sur nouvelles cartes grises)

Sommaire

Type Mines OU C.N.I.T.*	9	Type Mines OU C.N.I.T.*	9	Type Mines OU C.N.I.T.*	9	Type Mines OU C.N.I.T.*	9
UD4Y	621	MAA7FC	597	MAFDFA	602	VAE4FX	597
UD51	622	MAA7FG	597	MAFEAC	594	VAE4FZ	597
UD52	627	MAA7JC	599	MAFEBA	594	VAE4J1	594
UD5Y	621	MAA7JG	599	MAFEBC	594	VAE4J2	594
UD61	622	MAF2BB	594	MAFECC	599	VAE4JA	594
UD62	627	MAF2CC	599	MAFEDA	599	VAE4JC	594
UD6Y	621	MAF2DB	599	MAFEDC	599	VAE4JE	594
UD81	622	MAF2FB	602	MAFEEC	602	VAE4JX	594
UD82	627	MAF3DB	599	MAFEFA	602	VAE5F1	597
UD8Y	621	MAF3FB	602	MAFEJA	599	VAE5F2	597
UDCCK5	644	MAF4AE	594	MAFFDA	599	VAE5FA	597
UDCEG5	634	MAF4BB	594	MAFFDC	599	VAE5FC	597
UDCJG5	567	MAF4BE	594	MAFFFA	602	VAE5FE	597
UDCNK5	567	MAF4CC	599	MAFFFC	602	VAE5FX	597
UDCUG6	623	MAF4CE	599	MAFGFG	602	VAEA1	594
UDCUK5	626	MAF4DB	599	MAFGJG	599	VBH4B1	594
UDCUK6	623	MAF4DE	599	MAFMAC	594	VBH4B2	594
UDCVG5	627	MAF4EC	602	MBM4J1	597	VBH4D1	594
UDCVK5	627	MAF4EE	602	MCF8FH	597	VBH4D2	594
		MAF4FB	602	MCF8FJ	597	VBH4F1	597
		MAF4FC	602	MCF8FK	597	VBH4F2	597
		MAF4FE	602	MCF8JG	599	VBH4J1	594
		MAF6AC	600	MCF8JH	599	VBH4J2	594
		MAF6AG	600	MCF8JJ	599	VBH5F1	597
		MAF6BC	600	MCF8JK	599	VBH5F2	597
		MAF6BD	594	MCF9FG	597	VBH6F1	602
		MAF6CC	599	MCF9FH	597	VBH6F2	602
		MAF6CG	599	MCF9FJ	597	VBH6F3	602
		MAF6CJ	599	MCF9FK	597	VBH6F4	602
		MAF6DC	599	MCF9JG	599	VBH6J1	599
		MAF6DD	599	MCF9JH	599	VBH6J2	599
		MAF6DG	599	MCF9JJ	599	VBH6J3	599
		MAF6DJ	599	MCF9JK	599	VBH6J4	599
		MAF6EC	602	MFF6FK	597	VBH7F1	597
		MAF6EG	602	MFF6JK	599	VBH7F2	597
		MAF6EJ	602	MLJ0BA	594	VBH7F3	602
		MAF6FC	602	MLJ1DA	594	VBH7J1	599
		MAF6FD	597	MLJ4BC	594	VBH7J2	602
		MAF6FH	597	N10RENT0014439	599	VBH7J3	599
		MAF6FJ	602	N10RENT001A445	599	VBH7J4	599
		MAF6JC	599	N10RENT001B834	602	VBH8F4	602
		MAF6JD	599	UV0A	594	VBH9F4	602
		MAF6JG	599	UV0B	594	VBH9J3	599
		MAF6JH	599	UV0C	594	VBU4A1	594
		MAF6JJ	599	UV0D	594	VBU4A2	594
		MAF7FC	597	UV0E	597	VBU4B1	594
		MAF7FD	597	UV0F	597	VBU4B2	594
		MAF7FH	597	UV0J	594	VBU4C1	594
		MAF7FJ	597	VAE4A2	594	VBU4C2	594
		MAF7FK	597	VAE4AC	594	VBU4D1	594
		MAF7JC	599	VAE4AE	594	VBU4D2	594
		MAF7JD	599	VAE4B1	594	VBU4E1	597
		MAF7JG	599	VAE4B2	594	VBU4E2	597
		MAF7JH	599	VAE4BC	594	VBU4F1	597
		MAF7JJ	599	VAE4BE	594	VBU4F2	597
		MAF7JK	599	VAE4C1	594	VBU4J1	594
		MAFABA	594	VAE4C2	594	VBU4J2	594
		MAFADA	599	VAE4CC	594	VBU5F1	597
		MAFAFA	602	VAE4CE	594	VBU5F2	597
		MAFAJB	599	VAE4D1	594	VBU5J1	594
		MAFBDA	599	VAE4D2	594	VBU5J2	594
		MAFBFA	602	VAE4DC	594	VBU6A1	600
		MAFCAC	594	VAE4DE	594	VBU6A2	600
		MAFCBA	594	VAE4E1	597	VBU6A3	600
		MAFCBC	594	VAE4E2	597	VBU6A4	600
		MAFCCC	599	VAE4EC	597	VBU6B1	600
		MAFCDA	599	VAE4EE	597	VBU6B2	600
		MAFCDC	599	VAE4F1	597	VBU6B3	600
		MAFCCE	602	VAE4F2	597	VBU6B4	600
		MAFCFA	602	VAE4FA	597	VBU6C1	599
		MAFCFC	602	VAE4FC	597	VBU6C2	599
		MAFDDA	599	VAE4FE	597	VBU6C3	599

* C.N.I.T. = Code National d'Identification du Type (code D2.1 sur nouvelles cartes grises)

Sommaire

Type Mines OU C.N.I.T.*	9	Type Mines OU C.N.I.T.*	9	Type Mines OU C.N.I.T.*	9	Type Mines OU C.N.I.T.*	9
VBU6C4	599	BA0N	358	EA0B02	197	LA0L	248
VBU6D1	599	BA0N05	358	EA0B05	197	LA0L05	248
VBU6D2	599	BA0NM2	358	EA0C	428	LA0N	358
VBU6D3	599	BA0NM5	358	EA0D	136	LA0N05	358
VBU6D4	599	BA0R	323	EA0D05	136	LA0NM5	358
VBU6E1	602	BA0R05	323	EA0F	244	LA0R	323
VBU6E2	602	BA0S	244	EA0F0G	244	LA0S	244
VBU6E3	602	BA0S05	244	EA0G	406	LA0U	323
VBU6E4	602	BA0T	111	EA0G0A	411	LA0V	112
VBU6F1	602	BA0T05	111	EA0G0C	406	LA0W	136
VBU6F2	602	BA0U	323	EA0H	470	LA0Y	346
VBU6F3	602	BA0U05	323	EA0H05	470	LA0Y05	346
VBU6F4	602	BA0V	112	EA0P	468	LA10	136
VBU6J1	599	BA0VM5	112	EA0P05	468	LA11	197
VBU6J2	599	BA0W	136	EA0W	136	LA12	310
VBU6J3	599	BA0W05	136	EA0W05	136	LA1A	310
VBU6J4	599	BA0Y	346	EA11	197	LA1C	197
VBU7F1	602	BA0Y05	346	EA13	428	LA1H	136
VBU7F3	602	BA10	136	EA1H	136	LA1J	197
VBU7F4	602	BA11	197	EA1J	197	LA1K	197
VBU7J1	599	BA12	310	EA1S	428	LA1M	310
VBU7J2	599	BA1A	310	KA01	360	LA1R	310
VBU7J3	599	BA1A05	310	KA04	197	LA1U	366
VBU8J3	599	BA1D	470	KA0402	197	MRE000AA0144	323
VBU9J3	599	BA1F	360	KA0405	197	MRE000AA1145	112
VBUSF3	602	BA1H	136	KA05	360	MRE000AA2922	358
VDH8F3	602	BA1J	197	KA0505	360	MRE000AA4766	112
VDH8J3	599	BA1K	197	KA0B	197	MRE000AA5149	323
VDH8J4	599	BA1M	310	KA0D	136	MRE000AA6150	244
VDH9F3	602	BA1R	310	KA0F	244	MRE000AA6768	244
VDH9J4	599	BA1U	366	KA0J	324	MRE000AA8152	346
VDU8F3	602	DA03	411	KA0J05	324	MRE000AAA287	244
VDU8F4	602	DA0305	411	KA0N	359	MRE000AAA772	346
VDU8J4	599	DA04	197	KA0N02	359	MRE000AAB288	136
VDU9F3	602	DA0402	197	KA0N05	359	MRE000AAC289	411
VDU9F4	602	DA0405	197	KA0R	324	MRE000AAC350	244
VDU9J4	599	DA05	360	KA0V	112	MRE000AAD351	406
		DA0B	197	KA0V05	112	MRE000AAE122	244
		DA0B05	197	KA0W	136	MRE000AAE316	323
		DA0C	428	KA0W05	136	MRE000AAE352	411
		DA0D	136	KA10	136	MRE000AAF123	244
		DA0F	244	KA11	197	MRE000AAF317	112
		DA0F02	244	KA12	310	MRE000AAG124	244
		DA0F0D	244	KA1A	310	MRE000AAG318	244
		DA0F0F	244	KA1H	136	MRE000AAH125	406
		DA0F0G	244	KA1J	197	MRE000AAH319	244
		DA0G	406	KA1R	310	MRE000AAH355	323
		DA0G02	406	KA1U	366	MRE000AAH549	323
		DA0G05	406	LA00	197	MRE000AAJ126	411
		DA0G0A	406	LA01	360	MRE000AAJ320	406
		DA0G0C	406	LA04	197	MRE000AAJ321	406
		DA0H	470	LA05	360	MRE000AAJ356	112
		DA0H05	470	LA0505	360	MRE000AAJ357	244
		DA0N	359	LA07	406	MRE000AAJ550	112
		DA0N05	359	LA08	358	MRE000AAJ902	112
		DA0NM5	359	LA0A	323	MRE000AAK128	112
		DA0P	468	LA0A05	323	MRE000AAK358	244
		DA0W	136	LA0A0E	323	MRE000AAL129	244
		DA0W05	136	LA0B	197	MRE000AAL359	406
		DA10	136	LA0B02	197	MRE000AAM324	323
		DA11	197	LA0B05	197	MRE000AAM554	323
		DA13	428	LA0D	136	MRE000AAN361	323
		DA1F	360	LA0E	112	MRE000AAN519	323
		DA1H	136	LA0E05	112	MRE000AAN555	244
		DA1J	197	LA0F	244	MRE000AAP132	323
		DA1S	428	LA0F02	244	MRE000AAP133	244
		EA03	468	LA0F0F	244	MRE000AAP362	244
		EA0305	468	LA0F0G	244	MRE000AAP363	323
		EA04	197	LA0G	406	MRE000AAP520	112
		EA0402	197	LA0G05	406	MRE000AAP557	346
		EA04B5	197	LA0G0C	406	MRE000AAP617	244
		EA0B	197	LA0K	346	MRE000AAP618	244

Megane

BA00	197
BA04	197
BA0402	197
BA0405	197
BA05	360
BA07	406
BA08	358
BA09	346
BA0905	346
BA0A	323
BA0A05	323
BA0A0E	323
BA0B	197
BA0D	136
BA0D05	136
BA0E	112
BA0E05	112
BA0F	244
BA0F02	244
BA0F05	244
BA0F0F	244
BA0G	406
BA0G02	406
BA0G05	406
BA0G0C	406
BA0GLA	406
BA0GLC	406
BA0H	470
BA0H05	470
BA0K	346
BA0K05	346
BA0L	248
BA0L05	248

* C.N.I.T. = Code National d'Identification du Type (code D2.1 sur nouvelles cartes grises)

Sommaire

Type Mines OU C.N.I.T.*	9	Type Mines OU C.N.I.T.*	9	Type Mines OU C.N.I.T.*	9	Type Mines OU C.N.I.T.*	9
MRE000AAP776	244	MRE001AA2084	323	MRE1301AG788	197	MRE5004A8767	324
MRE000AAP909	323	MRE001AA3085	111	MRE1301AJ766	197	MRE5004AR653	324
MRE000AAQ134	346	MRE001AA5087	244	MRE1301AN831	197	MRE5102AV942	366
MRE000AAQ558	346	MRE001AA6088	244	MRE1302A8656	197	MRE5104AU937	366
MRE000AAR293	112	MRE001AA7089	406	MRE1302AC951	197	MRE5202A5166	346
MRE000AAR559	346	MRE001AA9091	358	MRE1302AE953	197	MRE5202AK181	346
MRE000AAR620	411	MRE001AAA092	406	MRE1302AH762	197	MRE5301AQ240	359
MRE000AAR778	323	MRE001AAV077	112	MRE1302AJ764	197	MRE5301AQ664	359
MRE000AAS524	323	MRE001AAW078	244	MRE1302AK668	197	MRE5301AR787	359
MRE000AAS621	406	MRE001AAZ081	406	MRE1302AR833	197	MRE5301AT789	359
MRE000AAT525	244	MRE001AJL058	406	MRE1302AT835	197	MRE5301AV572	359
MRE000AAT622	244	MRE001AJN060	244	MRE1304A0838	197	MRE5302A9221	358
MRE000AAU296	406	MRE001AJP061	406	MRE1304A7651	197	MRE5302AE165	358
MRE000AAU562	244	MRE001AJD062	411	MRE1304AK955	197	MRE5302AJ582	358
MRE000AAU623	244	MRE001AK0072	406	MRE1304AR768	197	MRE5302AM658	358
MRE000AAU781	244	MRE001AK3075	323	MRE1305A0836	197	MRE5302AP564	358
MRE000AAU914	323	MRE001AK4076	406	MRE1305A5647	197	MRE5302AP782	358
MRE000AAV297	323	MRE001AKR063	112	MRE1305AL954	197	MRE5302AR785	358
MRE000AAV527	346	MRE001AKT065	244	MRE1305AV770	197	MRE5302AS179	358
MRE000AAV624	406	MRE001AKY070	323	MRE1401AM238	406	MRE5302AY670	358
MRE000AAW140	244	MRE001AKZ071	244	MRE1401AS571	406	MRE5304AK652	359
MRE000AAW298	244	MRE001ANJ051	411	MRE1402A3217	406	MRE5304AT783	359
MRE000AAW528	346	MRE001ANJ052	406	MRE1402AL174	406	MRE7302A0763	358
MRE000AAW564	323	MRE001ANL054	244	MRE1402AR920	310	MRE7302AY761	358
MRE000AAX141	406	MRE001ANM055	406	MRE1404AU919	310	MRE9304AG769	197
MRE000AAX917	244	MRE001ANN056	359	MRE1405AE452	406	SA05	360
MRE000AAY142	411	MRE001ANP057	406	MRE1405AJ456	406	SA0505	360
MRE000AAY300	346	MRE1102A3211	112	MRE1412AW051	310	SA09	346
MRE000AAY918	244	MRE1102A3574	112	MRE1414A2053	310	SA0905	346
MRE000AAZ301	346	MRE1102AJ554	112	MRE1414AM037	310	SA0A	323
MRE000AAZ531	111	MRE1102AL168	112	MRE1601A4660	468	SA0A05	323
MRE000AJ5625	406	MRE1102AN655	112	MRE1601A7239	411	SA0N	358
MRE000AJ6626	244	MRE1102AP559	112	MRE1601A8567	411	SA0N05	358
MRE000AJ7627	244	MRE1102AQ622	112	MRE1601AG733	411	SA0R	323
MRE000AJ9762	406	MRE1102AR562	112	MRE1601AN122	411	SA0R05	323
MRE000AJA763	244	MRE1102AV178	112	MRE1601AR902	411	SA0U	323
MRE000AJB764	244	MRE1102AX180	112	MRE1602A6175	470	SA0U05	323
MRE000AJS939	406	MRE1102AZ667	112	MRE1605A3457	468	SA0Y	346
MRE000AJU941	244	MRE1104AL649	112	MRE1605AN732	468	SA0Y05	346
MRE000AK1753	323	MRE1201A3663	136	MRE1605AW450	470	SA1U	366
MRE000AK3755	323	MRE1201A3882	136	MRE1605AW644	468	SA1U05	366
MRE000AK4756	323	MRE1201A7570	244	MRE1605AX900	428		
MRE000AK5757	244	MRE1201AR227	244	MRE1615AF105	428		
MRE000AK6758	406	MRE1201AY234	244	MRE1615AK085	428		
MRE000AK7759	244	MRE1201AZ235	244	MRE3201A3233	244	BM00	381
MRE000AK9628	323	MRE1202A0198	244	MRE3202A0555	244	BM02	156
MRE000AKA629	112	MRE1202A0561	244	MRE3202A2169	244	BM05	437
MRE000AKB630	244	MRE1202A0816	136	MRE3202AK212	244	BM08	138
MRE000AKC631	244	MRE1202A1781	136	MRE3202AK575	244	BM080H	138
MRE000AKD632	406	MRE1202A7884	136	MRE3301A1706	197	BM0B	137
MRE000AKE924	112	MRE1202AB888	136	MRE3301AJ881	197	BM0BOH	137
MRE000AKG926	244	MRE1202AG214	244	MRE3302A0703	197	BM0C	217
MRE000AKH636	323	MRE1202AJ579	244	MRE3302A1704	197	BM0COA	217
MRE000AKJ637	323	MRE1202AQ939	136	MRE3302A1704	197	BM0COH	217
MRE000AKJ928	406	MRE1202AV132	244	MRE3302AM883	197	BM0F	154
MRE000AKK639	406	MRE1202AX170	244	MRE3302AS889	197	BM0F05	154
MRE000AKL931	323	MRE1202AY171	244	MRE3305A0891	197	BM0G	381
MRE000AKM641	323	MRE1202AZ657	136	MRE3305A5702	197	BM0H	137
MRE000AKM932	323	MRE1204AR936	136	MRE3401A0573	406	BM0J	217
MRE000AKN933	244	MRE1204AS901	136	MRE3401AR237	406	BM0JOH	217
MRE000AKP934	406	MRE1204AW650	136	MRE3402A8216	406	BM0L	382
MRE000AKP935	244	MRE1205AJ890	136	MRE3402AQ173	406	BM0M	439
MRE000AKS938	323	MRE1205AR449	244	MRE3405AN455	411	BM0M06	439
MRE000AKW748	112	MRE1205AT451	244	MRE5002A4210	323	BM0T	154
MRE000AKX749	244	MRE1205AU646	136	MRE5002A5671	323	BM0U	437
MRE000AKY750	244	MRE1205AV938	136	MRE5002A9578	323	BM0U06	437
MRE000AN3946	406	MRE1205AW454	244	MRE5002AH126	323	BM0U0A	437
MRE000AN4947	411	MRE1212AJ119	136	MRE5002AM167	323	BM0W	440
MRE000AN5948	406	MRE1212AK120	136	MRE5002AN811	323	BM0W06	440
MRE000AN6949	244	MRE1301AB952	197	MRE5002AP558	323	BM0Y	219
MRE000AN7950	244	MRE1301AC662	197	MRE5002AP812	323	BM11	439
MRE000AN8951	406	MRE1301AE786	197	MRE5002AR815	323	BM13	156
				MRE5002AT659	323	BM14	382

Megane 2

BM00	381
BM02	156
BM05	437
BM08	138
BM080H	138
BM0B	137
BM0BOH	137
BM0C	217
BM0COA	217
BM0COH	217
BM0F	154
BM0F05	154
BM0G	381
BM0H	137
BM0J	217
BM0JOH	217
BM0L	382
BM0M	439
BM0M06	439
BM0T	154
BM0U	437
BM0U06	437
BM0U0A	437
BM0W	440
BM0W06	440
BM0Y	219
BM11	439
BM13	156
BM14	382

* C.N.I.T. = Code National d'Identification du Type (code D2.1 sur nouvelles cartes grises)

Sommaire

Type Mines OU C.N.I.T.*	9	Type Mines OU C.N.I.T.*	9	Type Mines OU C.N.I.T.*	9	Type Mines OU C.N.I.T.*	9
BM16	159	CM1SOH	137	KMOJOA	217	LM1G06	381
BM17	382	CM1U	437	KMOL	382	LM1K	514
BM1A	137	CM1Y	222	KMOT	154	LM1M	437
BM1B	217	CM2H	439	KMOU	437	LM1N	437
BM1C	381	CM2HB6	439	KMOU06	437	LM1N06	437
BM1D	382	CMK406	382	KMOU0A	437	LM1R	229
BM1E	158	CMR205	156	KMOY	217	LM1ROA	229
BM1F	155	CMR20A	156	KM13	156	LM1ROH	229
BM1G	381	CMRG06	381	KM14	382	LM1S	137
BM1K	514	CMS406	382	KM16	156	LM1SOH	137
BM1M	437	CMS40A	382	KM17	383	LM1U	437
BM1N	437	CMSD06	383	KM1B	217	LMK406	382
BM1N06	437	CMSE06	158	KM1C	381	LMR20A	156
BM1R	217	CMSF05	155	KM1D	382	LMR2C5	159
BM1ROA	217	CMSK06	514	KM1E	156	LMRG06	381
BM1ROH	217	EM05	437	KM1F	155	LMS406	382
BM1S	137	EM0C	217	KM1G	381	LMS40A	382
BM1SOH	137	EM0COH	217	KM1K	514	LMSD06	382
BM1T	440	EM0G	381	KM1M	437	LMSEC6	158
BM1U	437	EM0J	217	KM1M06	437	LMSFB5	155
BM1U06	437	EMOJOA	217	KM1N	437	LMSK06	514
BM1V	439	EMOJH	217	KM1R	217	MRE1111A4637	138
BM1Y	222	EMOU	437	KM1ROA	217	MRE1111A6312	138
BM2K	222	EMOU06	437	KM1ROH	217	MRE1112A7311	138
BMK406	382	EMOU0A	437	KM1S	137	MRE1112AZ630	138
BMMJOA	217	EMOW	440	KM1SOH	137	MRE1201AS943	137
BMR205	156	EMOWOC	440	KM1U	437	MRE1202AS941	137
BMR20A	156	EM14	382	KM2K	219	MRE1204AR936	137
BMRG06	381	EM16	159	KM2K0H	219	MRE1311AP638	137
BMS406	382	EM17	383	KMK406	382	MRE1312AB367	137
BMS40A	382	EM1B	217	KMR205	156	MRE1312AE237	137
BMSD06	383	EM1C	381	KMR20A	156	MRE1312AF626	137
BMSD0A	383	EM1D	383	KMRG06	381	MRE1312AG239	137
BMSEA6	158	EM1E	158	KMS406	382	MRE1312AG627	137
BMSF05	155	EM1G	381	KMS40A	382	MRE1312AK631	137
CM00	381	EM1K	514	KMS6B6	156	MRE1312AL632	137
CM02	156	EM1M	437	KMSD06	383	MRE1314AU382	137
CM05	437	EM1N	437	KMSEB6	156	MRE1314AV383	137
CM080H	138	EM1N06	437	KMSFB5	155	MRE1321A5071	137
CM0B	137	EM1R	217	KMSK06	514	MRE1322A3067	137
CM0B0H	137	EM1ROA	217	LM00	381	MRE1322AZ063	137
CM0C	217	EM1ROH	217	LM02	156	MRE1324AE074	137
CM0COH	217	EM1T	440	LM05	437	MRE1411AR242	217
CM0F	154	EM1U	437	LM08	138	MRE1412AP370	217
CM0G	381	EMK406	382	LM0B	137	MRE1412AP371	217
CM0H	137	EMK40A	382	LM0B0H	137	MRE1412AS241	217
CM0J	217	EMKD06	383	LM0C	217	MRE1412AU243	217
CM0JOA	217	EMPK06	514	LM0C0H	217	MRE1414A6384	217
CM0L	382	EMRG06	381	LM0F	154	MRE1414A7385	217
CM0M	439	EMS406	382	LM0FC5	154	MRE1415AT491	217
CM0M06	439	EMS40A	382	LM0G	381	MRE1415AU492	217
CM0U	437	EMS06	383	LM0H	137	MRE1421AD069	217
CM0U06	437	EMS0A	383	LM0J	217	MRE1422A2153	229
CM0W	440	EMSE06	158	LM0J0A	217	MRE1422A8062	229
CM0Y	219	EMSG06	381	LM0J0H	217	MRE1422AB065	217
CM14	382	EMSK06	514	LM0L	382	MRE1422AN138	217
CM16	159	GM02	156	LM0T	154	MRE1424A3150	217
CM17	383	GM0F	155	LM0U	437	MRE1424AN073	217
CM1B	217	GM16	159	LM0U06	437	MRE1425AS076	217
CM1C	381	GM1E	158	LM0U0A	437	MRE1511A8249	437
CM1D	382	GM1F	155	LM0Y	219	MRE1511AJ357	437
CM1E	158	KM00	381	LM13	159	MRE1512A1373	437
CM1F	155	KM02	156	LM14	382	MRE1512A2374	437
CM1G	381	KM05	437	LM16	158	MRE1512A9248	437
CM1G06	381	KM0B	137	LM17	382	MRE1512AK356	437
CM1K	514	KM0B0H	137	LM1A	137	MRE1514AJ387	437
CM1M	437	KM0C	217	LM1B	217	MRE1514AV388	437
CM1N	437	KM0COH	217	LM1C	381	MRE1515A6494	437
CM1R	217	KM0F	154	LM1D	382	MRE1515A7495	437
CM1ROA	217	KM0G	381	LM1E	158	MRE1525A0778	437
CM1ROH	217	KM0H	137	LM1F	155	MRE1525AU032	437
CM1S	137	KM0J	217	LM1G	381	MRE1525AY036	437

* C.N.I.T. = Code National d'Identification du Type (code D2.1 sur nouvelles cartes grises)

Sommaire

Type Mines OU C.N.I.T.*	9	Type Mines OU C.N.I.T.*	9	Type Mines OU C.N.I.T.*	9	Type Mines OU C.N.I.T.*	9
MRE1711AX642	440	MRE5224A5609	154	MRE5521A9395	382	URE5221A9777	155
MRE1712AS635	440	MRE5224AL589	155	MRE5521A9686	382	URE5222AY775	154
MRE1715A9646	440	MRE5224AL783	154	MRE5522A8392	382	URE5224A2509	155
MRE1715AM756	440	MRE5311AN527	156	MRE5522A9684	382	URE5224A3607	154
MRE1721AE586	440	MRE5311AU922	158	MRE5522AB880	382	URE5224A4608	155
MRE1721AW895	440	MRE5312AM366	159	MRE5522AH692	382	URE5224A5609	154
MRE1721AX896	440	MRE5312AM754	159	MRE5522AJ403	382	URE5224AL589	155
MRE1722AE584	440	MRE5312AP526	156	MRE5522AS872	382	URE5224AL783	154
MRE1722AW893	440	MRE5312AQ916	158	MRE5522AD878	382	URE5311AN527	156
MRE1722AX894	440	MRE5312AT919	158	MRE5522AF176	382	URE5311AU922	158
MRE1725AH035	440	MRE5312AU920	158	MRE5524AJ690	382	URE5312AP526	156
MRE1911AY587	439	MRE5312AX535	159	MRE5524AK400	382	URE5312AT919	158
MRE1912A0490	439	MRE5312AY536	159	MRE5525AD039	382	URE5312AU920	158
MRE1921AX585	439	MRE5314A2924	156	MRE5525AD876	382	URE5314A2924	156
MRE1921AZ587	439	MRE5314A7541	156	MRE5525AJ688	382	URE5314AR755	156
MRE1922AX583	439	MRE5314AR755	156	MRE5525AK398	382	URE5321A0600	158
MRE1931A6496	439	MRE5321A0600	158	MRE5621AC776	514	URE5322A0598	158
MRE1931AY136	439	MRE5321A1601	158	MRE5621AJ007	514	URE5322A2597	158
MRE1931AZ137	439	MRE5322A0598	158	MRE5621AL397	514	URE5324AA604	156
MRE1932AZ135	439	MRE5322AE612	158	MRE5621AW602	514	URE5324AB605	156
MRE3411A8314	217	MRE5322AS590	158	MRE5622A1774	514	URE5324AC606	156
MRE3412A9313	217	MRE5322AZ597	158	MRE5622AJ005	514	URE5324AU588	156
MRE3412AB315	217	MRE5324AA604	156	MRE5622AK006	514	URE5411AR521	381
MRE3412AB581	217	MRE5324AB605	156	MRE5622AK394	514	URE5412AS520	381
MRE3412AQ585	217	MRE5324AC606	156	MRE5622AV405	514	URE5414AD537	381
MRE3412AW372	217	MRE5324AU588	156	MRE5622AV599	514	URE5511AA882	382
MRE3414AE386	217	MRE5325AB603	158	MRE5624AN781	514	URE5512AB881	382
MRE3414AV586	217	MRE5325AZ275	158	MRE5624AQ008	514	URE5521A3874	382
MRE3415A1493	217	MRE5411AB965	383	MRE5624AW402	514	URE5521A9395	382
MRE3421AJ068	217	MRE5411AR521	381	MRE5625AN779	514	URE5521A9686	382
MRE3421AK070	217	MRE5411AV525	383	MRE5625AP077	514	URE5522A8392	382
MRE3422A9154	229	MRE5412A2530	381	MRE5631A6065	514	URE5522A9684	382
MRE3422AD061	217	MRE5412A9246	381	MRE5632A7064	514	URE5522AS872	382
MRE3422AG064	217	MRE5412AC964	383	MRE7312A4694	156	URE5524AD878	382
MRE3422AJ066	217	MRE5412AE348	381	MRE7312A5695	156	URE5524AF176	382
MRE3422AU139	217	MRE5412AJ352	381	MRE7314AB697	156	URE5524AJ690	382
MRE3422AW141	217	MRE5412AQ360	381	MRE7422A0169	383	URE5524AK400	382
MRE3424AA151	217	MRE5412AR361	381	MRE7525AK173	382	URE5621AJ007	514
MRE3424AS072	217	MRE5412AS520	381	MRE9311AN842	219	URE5621AL397	514
MRE3425AX075	217	MRE5412AW233	381	MRE9312A5107	219	URE5621AW602	514
MRE3511AG251	437	MRE5412AW524	381	MRE9312AP841	222	URE5622AK006	514
MRE3512A9375	437	MRE5414AB377	381	MRE9321A2274	219	URE5622AK394	514
MRE3512AH250	437	MRE5414AC378	381	MRE9322A3273	222	URE5622AV599	514
MRE3514A2389	437	MRE5414AD537	381	MRE9322AJ773	219	URE5624AQ008	514
MRE3515AE496	437	MRE5414AE538	383	MRE9324A4780	217	URE5624AW402	514
MRE3515AF497	437	MRE5415AC498	381	SM0F	154	URE7312A5695	156
MRE3525A1033	437	MRE5415AD499	381	SM16	159	URE9312AP841	222
MRE5111A3236	154	MRE5415AK542	381	SM1E	158	URE9321A2274	219
MRE5111AL351	154	MRE5415AL543	381	SM1F	155	URE9322A3273	222
MRE5111AZ523	154	MRE5421A0687	383	URE1324AE074	137	URE9322AJ773	219
MRE5112A0364	154	MRE5421AU171	382	URE1421AD069	217	URE5212AH917	154
MRE5112A0522	154	MRE5422A0685	383	URE1422AB065	217	URE5212AL921	154
MRE5112A4235	154	MRE5422A8693	382	URE1424AN073	217	URE5221A9777	155
MRE5112AB533	154	MRE5422AA404	382	URE1511A8249	437	URE5222AK786	154
MRE5112AC534	154	MRE5422AT168	382	URE1721AX896	440	URE5222AZ510	154
MRE5112AM350	154	MRE5422AU873	383	URE1722AX894	440	URE5322AE612	158
MRE5112AZ363	154	MRE5422AZ393	383	URE1911AY587	439		
MRE5114AK380	154	MRE5424A8179	383	URE1921AX585	439		
MRE5114AM540	154	MRE5424A9180	383	URE1921AZ587	439		
MRE5211AL923	154	MRE5424AA691	383	URE1922AX583	439		
MRE5212AH917	154	MRE5424AB401	383	URE1931AY136	439		
MRE5212AJ918	155	MRE5425A2038	381	URE1931AZ137	439		
MRE5212AL921	154	MRE5425A4040	381	URE3421AJ068	217		
MRE5214AJ925	155	MRE5425A5041	381	URE3421AK070	217		
MRE5214AT925	155	MRE5425AA689	383	URE3422AG064	217		
MRE5221A9777	154	MRE5425AB399	383	URE3422AJ066	217		
MRE5222AK786	154	MRE5511AA882	382	URE3511AG251	437		
MRE5222AY775	154	MRE5512AA880	382	URE5112A0522	154		
MRE5222AZ510	154	MRE5512AB881	382	URE5114AM540	154		
MRE5224A2509	155	MRE5514AH883	382	URE5211AL923	154		
MRE5224A3607	154	MRE5515AK884	382	URE5212AL921	154		
MRE5224A4608	155	MRE5521A3874	382	URE5214AT925	155		

Megane 3

BZ03	239
BZ0306	239
BZ09	182
BZ0903	182
BZ090E	182
BZ0A	179
BZ0A05	179
BZ0B	186
BZ0B06	186
BZ0C	187
BZ0C05	187
BZ0C06	187
BZ0D	182
BZ0D06	182

* C.N.I.T. = Code National d'Identification du Type (code D2.1 sur nouvelles cartes grises)

Type Mines OU C.N.I.T.*	9	Type Mines OU C.N.I.T.*	9	Type Mines OU C.N.I.T.*	9	Type Mines OU C.N.I.T.*	9
BZ0G	511	KZ1T	456	DZ090E	188	JA0G05	406
BZ0G0T	511	KZ1T06	456	DZ0A	185	JA0G0A	406
BZ0J	390	KZ1U	237	DZ0A05	185	JA0J	348
BZ0J06	390	KZ1W	182	DZ0B	186	JA0J05	348
BZ0K	456	KZ1W06	182	DZ0B06	186	JA0K	346
BZ0K06	456	KZ1Y	239	DZ0C	187	JA0K05	346
BZ0N	390	KZ1Y02	239	DZ0C05	187	JA0L	248
BZ0N06	390	KZ1Y06	239	DZ0D	188	JA0L05	248
BZ0U	237	KZ5G02	182	DZ0D06	188	JA0N	358
BZ0U06	237	KZ5G06	182	DZ0G	511	JA0N05	358
BZ14	182	M10RENV000R138	511	DZ0G0T	511	JA0Y	346
BZ1406	182	M10RENV000R175	511	DZ0H	243	JA0Y05	346
BZ1A	187	M10RENV000T141	456	DZ0J	390	JA11	197
BZ1A05	187	M10RENV000U178	456	DZ0J06	390	JA1J	197
BZ1A07	187	M10RENV000W144	237	DZ0K	456	JA3B05	197
BZ1B	237	M10RENV000X181	237	DZ0K06	456	M10RENV0009157	511
BZ1E	511	MRE1422AB065	239	DZ0N	390	M10RENV000B159	456
BZ1F	182	MRE1432AC417	237	DZ0N06	390	M10RENV000E162	237
BZ1G	182	MRE1432AP684	237	DZ0T	243	M10RENV000H165	188
BZ1H	237	MRE1832AW494	456	DZ0U	237	M10RENV00059285	458
BZ1J	390	MRE5232A0413	187	DZ0U06	237	M10RENV014P255	187
BZ1K	390	MRE5232AE851	187	DZ14	188	M10RENV020J693	458
BZ1M	182	MRE5232AY411	179	DZ1406	188	MRE000A1278	129
BZ1P	511	MRE5332A9412	186	DZ15	458	MRE000AA2279	244
BZ1P0T	511	MRE5334AJ708	182	DZ1506	458	MRE000AA2340	129
BZ1S	390	MRE5431AX525	182	DZ17	458	MRE000AA3280	244
BZ1S06	390	MRE5432AW522	182	DZ18	458	MRE000AA3341	244
BZ1T	456	MRE5532AW415	390	DZ1802	458	MRE000AA4281	406
BZ1T06	456	MRE5532AX416	390	DZ1A	187	MRE000AA4342	244
BZ1U	237	URE1422AB065	239	DZ1A05	187	MRE000AA5343	406
BZ1W	182	URE5232AY411	179	DZ1B	237	MRE000AA6344	346
BZ1Y	239	URE5332A9412	186	DZ1E	511	MRE000AA7284	346
BZ1Y02	239	URE5532AX416	390	DZ1F	188	MRE000AA8346	346
BZ5G02	182			DZ1G	188	MRE000AL8953	129
BZ5G06	182			DZ1G06	188	MRE000AL9954	244
DZ1N	458	Megane CC		DZ1H	237	MRE000AL9955	244
DZ1N06	458	EZ03	237	DZ1J	390	MRE000ALB956	406
DZ1NS6	458	EZ0306	237	DZ1K	390	MRE000ALC957	346
KZ03	239	EZ07	182	DZ1M	188	MRE000ALD958	244
KZ0306	239	EZ09	182	DZ1M06	188	MRE000ALE959	346
KZ09	182	EZ090E	182	DZ1P	511	MRE000ALJ963	346
KZ0903	182	EZ0B	182	DZ1P0T	511	MRE000ALP642	129
KZ090E	182	EZ0B06	182	DZ1S	390	MRE000ALP643	244
KZ0B	182	EZ0D	182	DZ1S06	390	MRE000ALQ644	244
KZ0B06	182	EZ0D06	182	DZ1T	456	MRE000ALR645	406
KZ0C	181	EZ0G	511	DZ1T02	456	MRE000ALS646	346
KZ0C05	181	EZ0G0T	511	DZ1U	237	MRE000ALT647	244
KZ0D	182	EZ0J	390	DZ1W	188	MRE000ALU648	346
KZ0D06	182	EZ0J06	390	DZ1W06	188	MRE000ALV649	406
KZ0G	511	EZ0K	456	DZ1Y	239	MRE001AL0132	346
KZ0G0T	511	EZ0N	390	DZ5G02	188	MRE001AL1097	346
KZ0J	390	EZ0U	237	FA0J	348	MRE001AL1133	348
KZ0J06	390	EZ1E	511	FA0J05	348	MRE001AL2134	348
KZ0K	456	EZ1G	182	FA0N	358	MRE001AL3099	346
KZ0N	390	EZ1G06	182	FA0Y	346	MRE001AL4136	346
KZ0N06	390	EZ1K	390	FA0Y05	346	MRE001AL6138	406
KZ0U	237	EZ1P	511	JA00	197	MRE001AL7103	346
KZ0V06	237	EZ1P0T	511	JA0202	406	MRE001AL8104	406
KZ14	182	EZ1S	390	JA020C	412	MRE001ALE631	129
KZ1406	182	EZ1S06	390	JA04	197	MRE001ALF632	244
KZ1A	181	EZ1T	456	JA04N5	197	MRE001ALG633	244
KZ1A05	181	EZ1T06	456	JA04N5EG	197	MRE001ALM093	129
KZ1A07	181	EZ1U	237	JA0B	197	MRE001ALM639	346
KZ1B	237	EZ1U06	237	JA0E	129	MRE001ALN094	244
KZ1F	182	EZ1Y	237	JA0E05	129	MRE001ALN640	348
KZ1G	182	EZ1Y06	237	JA0EL5	129	MRE001ALP095	244
KZ1G06	182			JA0F	244	MRE001ALP096	406
KZ1M	182	Megane Scenic		JA0F02	244	MRE001ALP641	358
KZ1P	511	DZ03	239	JA0F05	244	MRE001ALP642	406
KZ1P0T	511	DZ0306	239	JA0FL5	244	MRE001ALQ643	406
KZ1S	390	DZ04	456	JA0G	406	MRE001ALU126	129
KZ1S06	390	DZ09	188	JA0G02	406	MRE001ALV127	244
		DZ0903	188				

* C.N.I.T. = Code National d'Identification du Type (code D2.1 sur nouvelles cartes grises)

Sommaire

Type Mines OU C.N.I.T.*	9	Type Mines OU C.N.I.T.*	9	Type Mines OU C.N.I.T.*	9	Type Mines OU C.N.I.T.*	9
MRE001ALW125	244	VRE5006AM538	348	JPOV	225	MRE5036SN103	164
MRE001ALW128	244	VRE5006AX549	348	JPOV05	225	MRE5036SP044	164
MRE001ALX129	406	VRE5006AY550	348	JPOW	37	MRE5036SP104	164
MRE001ALY130	406			JPOW05	37	MRE5036SQ045	164
MRE001ALZ131	406			JPOWF5	37	MRE5116SK746	161
MRE1102A3247	129	Modus		JP16	223	MRE5216SC825	161
MRE1102AK264	129	FPOC	31	JP17	163	MRE5216SJ990	163
MRE1102AX241	129	FPOC05	31	JP1B	164	MRE5226SC084	163
MRE1106A2529	129	FPOD	161	JP1C	31	MRE5226SK408	163
MRE1106A7534	129	FPOD05	161	JP1CF5	31	MRE5226SP545	163
MRE1106AG543	129	FPOE	162	JP1D	168	MRE5236S3038	163
MRE1202A9146	244	FPOE05	162	JP1E	37	MRE5236S5040	163
MRE1202A9243	244	FPOG	162	JP1F	141	MRE5236S8201	163
MRE1202AK254	244	FPOG05	162	JP1FF5	141	MRE5236ST222	163
MRE1202AW266	244	FPOK	31	JP1RF5	31	MRE5236SV030	163
MRE1206AD530	244	FPOK05	31	JP1SF5	33	MRE5236SV224	163
MRE1206AR544	244	JP01	141	JP360A	223	MRE5236SW031	163
MRE1302AH277	197	JP0105	141	JP36FA	223	MRE5316SP986	165
MRE1306A0773	197	JP02	169	JP3705	163	MRE5326ST407	169
MRE1306A5839	197	JP0206	169	JP37F5	163	MRE5336S3028	169
MRE1306AA747	197	JP02F6	169	JP3B05	164	MRE5336S4029	169
MRE1306AM626	406	JP04	161	JP3BF5	164	MRE5336SF198	165
MRE1306AS923	197	JP0405	161	JP3C05	31	MRE5336SG199	165
MRE1306AY771	197	JP04F5	161	JP3D05	168	MRE5336SL046	165
MRE1306AZ772	197	JP04M5	161	JP3DF5	168	MRE5336SM047	165
MRE1402AJ268	406	JP04N5	161	JP3DM5	168	URE1116S7745	31
MRE1402AK270	406	JP08	162	JP3E05	37	URE1116SB749	31
MRE1406A8541	406	JP0805	162	JP3EF5	37	URE1116SV988	31
MRE1431AF422	239	JP09	163	JP3ES5	37	URE1116SY991	31
MRE1831AV495	456	JP09F6	163	JPDN5	168	URE1316SU748	141
MRE3202A1265	244	JPOA	141	JPGCF5	31	URE1326SJ542	141
MRE3206AK531	244	JPOA05	141	MRE1016SQ993	31	URE1326SL156	141
MRE3206AY545	244	JPOB	223	MRE1026SK210	31	URE1416S0744	223
MRE3306AF746	197	JPOB05	223	MRE1026SP409	31	URE1426SU543	223
MRE3306AW885	197	JPOB0A	223	MRE1026SQ410	31	URE3416S0764	223
MRE3316A4019	197	JPOBFA	223	MRE1116S7745	31	URE3426S1544	223
MRE3402AP269	406	JPOC	31	MRE1116SB749	31	URE3426S0788	223
MRE3406AD540	406	JPOC05	31	MRE1116SV988	31	URE3436SE035	223
MRE3406AP552	406	JPOCF5	31	MRE1116SW989	31	URE5016SB747	162
MRE5002AT271	348	JPOD	161	MRE1116SY991	31	URE5016SC845	162
MRE5002AU272	348	JPOD05	161	MRE1136S1058	31	URE5026S6547	164
MRE5006AC537	348	JPOE	162	MRE1136SV052	31	URE5036SP044	164
MRE5006AD538	348	JPOE05MO	162	MRE1216S1826	225	URE5036SP104	164
MRE5006AP549	348	JPOF	161	MRE1226SH550	225	URE5036SQ045	164
MRE5006AP550	348	JPOF05	161	MRE1316SU748	141	URE5116SK746	161
MRE5202A5263	346	JPOF06	163	MRE1326SJ542	141	URE5216SJ990	161
MRE5202AQ248	346	JPOFOH	163	MRE1326SL156	141	URE5226SC084	163
MRE5231A4419	187	JPOFF5	163	MRE1326ST613	37	URE5226SP545	163
MRE5302A3251	358	JPOFFH	163	MRE1336S0D50	37	URE5236S3038	163
MRE5302AE262	358	JPOG	162	MRE1336SV032	37	URE5236ST222	163
MRE5302AR275	358	JPOG05	164	MRE1336SV226	37	URE5316SP986	165
MRE5306A8539	358	JPOGF5	162	MRE1336SW033	37	URE5336SL046	165
MRE5306AK551	358	JPOH	165	MRE1336SW227	37	URE5336SM047	165
MRE5331AD418	186	JPOH06	165	MRE1416S0744	223	VRE1116S749	31
MRE5531A0421	390	JPOHF6	165	MRE1426SJ787	223	VRE5016S744	162
MRE5531AZ420	390	JPOJ	141	MRE1426SU543	223	VRE5116S746	161
VRE000AAG284	346	JPOJ05	141	MRE1436S0257	223		
VRE000AAH346	346	JPOK	31	MRE1436S2259	223		
VRE000AL3648	346	JPOK05	31	MRE1436S7034	223	Safrane I	
VRE000ALN959	346	JPOL	225	MRE1436S9036	223	B54002	494
VRE000ALR963	346	JPOL05	225	MRE3416S0764	223	B54005	494
VRE001AL9132	346	JPOP	31	MRE3426S1544	223	B54005A	494
VRE001ALA133	346	JPOP05	31	MRE3426S0788	223	B54102	586
VRE001ALC099	346	JPOR	31	MRE3426SU889	223	B54105	586
VRE001ALD136	346	JPOR05	31	MRE3436S6221	223	B54202	496
VRE001ALG103	346	JPOS	33	MRE3436S7258	223	B54205	496
VRE001ALV639	346	JPOS05	33	MRE3436S9260	223	B54302	584
VRE001ALX641	346	JPOS0H	33	MRE3436SE035	223	B54305	584
VRE5002A2271	348	JPOT	31	MRE3436SG037	223	B54402	663
VRE5006A2748	348	JPOT05	31	MRE5016SB747	162	B54405	663
VRE5006A3749	348	JPOU	223	MRE5016SC845	162	B54408	663
VRE5006AL537	348	JPOU05	223	MRE5026S6547	164	B544K2	663
		JPOU0A	223			B54508	666

* C.N.I.T. = Code National d'Identification du Type (code D2.1 sur nouvelles cartes grises)

Sommaire

Type Mines OU C.N.I.T.*	9	Type Mines OU C.N.I.T.*	9	Type Mines OU C.N.I.T.*	9	Type Mines OU C.N.I.T.*	9
B54605	539	JA04N5	201	JM0B	137	MRE1516AC401	437
B54802	632	JA05	360	JM0C	218	MRE1716AN622	440
B54805	632	JA0B	201	JM0C0H	218	MRE3416A3590	218
B54822	632	JA0C	425	JM0F	154	MRE3516AG399	437
B54802	663	JA0D	136	JM0F05	154	MRE5116A3517	154
B54E02	494	JA0D05	136	JM0G	385	MRE5116AC393	154
B54E05	494	JA0J	348	JM0G06	385	MRE5216AN915	155
B54J02	663	JA0JN5	348	JM0H	137	MRE5236AD066	155
MRE000AD4339	663	JA0N	359	JM0J	218	MRE5316AP518	156
MRE000AD7669	663	JA0N02	359	JM0J0A	218	MRE5316AW914	158
MRE000ADD312	494	JA0NN5	359	JM0J0H	218	MRE5326A1591	156
MRE000ADG545	494	JA0W	136	JM0L	383	MRE5326A4594	158
MRE000ADJ548	663	JA0W05	136	JM0T	154	MRE5326A5595	158
MRE000ADZ334	494	JA0WN5	136	JM0U	437	MRE5326A6596	156
Safrane II		JA10	136	JM0U06	437	MRE5326AV815	158
B54F02	607	JA11	201	JM0U0A	437	MRE5326AW428	158
B54F05	607	JA12	310	JM0W	440	MRE5336A1141	158
B54G0E	550	JA13	425	JM0W06	440	MRE5336A2142	158
B54L02	397	JA1A	310	JM0Y	222	MRE5336A7147	156
B54L05	397	JA1B	425	JM12	385	MRE5336AY138	158
B54L0C	397	JA1D	425	JM14	383	MRE5416AB398	383
B54N02	654	JA1F	360	JM15	383	MRE5416AB592	385
MRE000AD0335	607	JA1F05	360	JM16	159	MRE5416AB955	385
MRE000AD1336	607	JA1H	136	JM17	383	MRE5416AJ344	383
MRE000AD1663	397	JA1J	201	JM1A	137	MRE5416AZ519	383
MRE000AD2337	550	JA1L	425	JM1B	218	MRE5421AU171	383
MRE000AD2664	397	JA1M	310	JM1D	383	MRE5426A4426	383
MRE000AD3665	607	JA1R	310	JM1E	158	MRE5426AX164	383
MRE000AD4666	607	JA1S	425	JM1F	155	MRE5426AZ166	383
MRE000AD5667	550	JA1U	366	JM1G	385	MRE5516AG878	383
MRE000AD6668	397	JA1U05	366	JM1G06	385	MRE5526A0678	383
MRE000ADC311	397	JAA50E	365	JM1GE6	385	MRE5526AC424	383
MRE000ADD312	397	JAAC0E	427	JM1K	514	MRE5526AC679	383
MRE000ADD542	607	JABF0E	365	JM1M	437	MRE5526AF682	383
MRE000ADE313	607	MRE1206A3750	136	JM1N	437	MRE5526AM822	383
MRE000ADE543	607	MRE1206A3944	136	JM1R	229	MRE5536AN143	383
MRE000ADF314	607	MRE1206AH886	136	JM1R06	229	MRE5536AP144	383
MRE000ADF544	550	MRE1306A0773	201	JM1R0A	229	MRE5536AS148	383
MRE000ADG315	550	MRE1306A5839	201	JM1R0H	229	MRE5626A0086	514
MRE000ADG545	397	MRE1306AS923	201	JM1S	137	MRE5626A5770	514
MRE000ADH546	397	MRE1306AZ542	136	JM1S0H	137	MRE5626A6771	514
MRE000ADJ256	397	MRE1406A0921	310	JM1T	440	MRE5626A7772	514
MRE000ADJ547	397	MRE1406A4828	310	JM1U	437	MRE7526AR530	383
MRE000ADY333	397	MRE1416AP035	310	JM1Y	222	MRE9316AV840	222
MRE000ADZ334	397	MRE1416AP072	310	JM2A	156	MRE9326AE276	222
MRE1502DG156	397	MRE1606A9752	425	JM2C	385	MRE9326AY163	222
MRE1502DH157	397	MRE1606AN791	425	JM3Y0H	222	MRE9326AY515	222
MRE1702DX153	607	MRE1606AY899	425	JM4Y0H	222	URE1416AX396	218
MRE3502DL155	397	MRE1616AL084	425	JMK406	383	URE1426AA056	229
MRE3702D2152	607	MRE2606AS793	427	JMKD06	385	URE1426AK454	229
MRE3802D9695	654	MRE2616AG137	427	JMPK06	514	URE1516AB400	437
MRE5402DG154	550	MRE3306AF746	201	JMRF05	154	URE5116A3517	154
Sandero		MRE3306AW885	201	JMRG06	385	URE5216AN915	155
B50A	145	MRE3606AR922	425	JMS406	383	URE5236AD066	155
B50B	246	MRE3606AS790	425	JMS40A	383	URE5316AW914	158
B50C	145	MRE3616AT086	425	JMS506	383	URE5326AV815	158
B50D	246	MRE5006AU749	348	JMS606	159	URE5416AB398	383
B50E	145	MRE5106A6945	360	JMS706	383	URE5416AZ519	383
B50F	246	MRE5116A8073	360	JMSD06	383	URE5516AG878	383
B50G	145	MRE5306A5827	360	JMSD0A	383	URE5526A0678	383
B50H	246	MRE5306A6792	360	JMSE06	158	URE5526AC424	383
BS11	246	MRE5306AK551	359	JMSF05	155	URE5526AC679	383
BS12	145	MRE5306AK745	359	JMSK06	514	URE5526AF682	383
BS1F	145	MRE6306A7887	365	JMSK0B	514	URE5526AM822	383
Scenic		MRE6306AB794	365	MRE1316AL394	137	URE5536AN143	383
FADJ	348	MRE7316AZ074	359	MRE1326A3059	137	URE5536AP144	383
FATU05	360	Scenic 2		MRE1326A4060	137	URE5536AS148	383
JA01	360	JM02	156	MRE1416AX396	218	URE5626A0086	514
JA0105	360	JM0205	156	MRE1426AA056	229	URE7526AR530	383
		JM020H	156	MRE1426AK454	229	URE9326AY163	222
		JM05	437	MRE1426AM129	229	URE9326AY515	222
				MRE1516AB400	437		

* C.N.I.T. = Code National d'Identification du Type (code D2.1 sur nouvelles cartes grises)

Sommaire

Type Mines OU C.N.I.T.*	9	Type Mines OU C.N.I.T.*	9	Type Mines OU C.N.I.T.*	9	Type Mines OU C.N.I.T.*	9
Scenic 3		B40404	191	LB27	25	PAY300	522
JZ02	184	B40405	191	LB29	146	PC82	475
JZ03	239	B40705	103	LB2A	134	PC83	522
JZ0306	239	B40801	277	LB2B	134	PC8F	529
JZ07	180	B40805	277	LB2E	147	PC92	475
JZ09	182	B40F04	55	LB2K	208	PC93	522
JZ0903	182	B40F05	55	LB2R	25	PC9F	529
JZ090E	182	B40G05	268	LB2U	25	PCG2	475
JZ09A3	182	B40H04	15	LB2V	25	PCG3	522
JZ09B3	182	B40H05	15	LB3D	134	PCGF	529
JZ09J3	182	B40J01	98	LB3E	208	PCJF	529
JZ0A	179	B40J05	98	LB3G	208	PCTF05	529
JZ0A06	179	B40K05	268	LB3H	208	PCX200	472
JZ0B	180	B40M05	99	LB3K	143	PCX400	629
JZ0B06	180	C40004	6	LB3M	146	PCY200	475
JZ0D	182	C40005	6	LB3N	147	PCY205	475
JZ0D06	182	C40104	15	LB8D05	134	PCY300	522
JZ0DA6	182	C40105	15	LB8K05	143	PCY305	522
JZ0G	511	C40205	80	LBND05	134	PCY400	606
JZ0G0T	511	C40301	100	LBND0A	134	T110	75
JZ0J	390	C40305	100	LBNM05	146	T113	523
JZ0J06	390	C40404	191	LBNN05	153	T118	254
JZ0N	390	C40405	191	LBVU05	25	T11E	572
JZ0N06	390	C40505	83	LU00	251	T11F	529
JZ0U	237	C40705	103	LU01	210	T120	75
JZ0V06	237	C40801	277	LU02	251	T123	523
JZ14	182	C40805	277	LU05	210	T128	254
JZ14J6	182	C40905	275	LU06	210	T12E	572
JZ1B	237	C40F04	55	LU07	251	T12F	529
JZ1D	511	C40F05	55	LU17	143	T1X000	73
JZ1E	511	C40G05	268	LU18	208	T1X000B	73
JZ1G	182	C40H04	15	LU1A	210	T1X000M	73
JZ1G02	182	C40H05	15	LU1B	210	T1X004	75
JZ1GA2	182	C40J01	98	LU1V	210	T1X305	523
JZ1GB2	182	C40J05	98	LU1W	160	T1X805	254
JZ1H	237	C40K05	268	LU24	160	T2B2	475
JZ1J	390	C40M05	99	LU25	160	T2B3	522
JZ1K	390	S40004	6	LU2B	134	T2B4	629
JZ1M	182	S40104	15	LU2M	210	T2B8	256
JZ1S	390	S40105	15	LU2U	29	T2BE	572
JZ1S06	390	S40404	191	LU2V	29	T2BF	529
JZ1U	237	S40405	191	LU2W	29	T2W300	523
JZ1U02	237	S40705	55	LU3D	134	T2W305	522
JZ1U06	237	S40F04	55	LU3K	143	T2W800	256
JZ1UA2	237	S40F05	55	LU3M	160	T2W805	256
JZ1UB2	237			LU3N	153	T318	254
JZ1W	182	Thalia		LU3P	143	T31A	591
JZ1Y	239	L2B1AS	49	LU3R	134	T31E	572
JZ1Y02	239	LB00	251	LU3S	143	T31F	529
JZ2D0D	182	LB01	208	LU3T	134	T323	523
JZ3G04	182	LB02	326	MSS000ABA137	49	T328	254
JZ4206	184	LB03	143	MSS000ABB271	49	T32E	572
JZS4J6	182	LB07	146	MSS6303BP190	49	T32F	529
JZT206	184	LB07CF	146	Trafic		T333	523
M10RENV0003212	237	LB0B	143	F8AJB5	321	T33F	529
M10RENV003P654	184	LB0K	134	F8AMA5	616	T358	254
Sport spider		LB0L	134	F8AMB5	616	T35A	591
EF0H05	470	LB0P	134	F8DMA5	616	T35E	572
MRE000AA6829	470	LB11	25	H8DMC5	629	T35F	529
MRE000AA7830	470	LB13	134	J8BLA5	321	T3V300	475
MRE1605JW477	470	LB17	143	J8BMA5	616	T3X300	523
MRE1605JX478	470	LB18	208	J8BMA5G	616	T3X305	523
Super 5		LB19	25	MRE5103LG587	616	T3X800	256
B40004	6	LB1B	208	P313	523	T3X805	254
B40005	6	LB1J	208	P318	254	T413	523
B40104	15	LB1R	208	P353	523	T414	629
B40105	15	LB1V	208	P358	254	T418	254
B40205	80	LB1W	146	P358	254	T41B	616
B40301	100	LB1Y	25	P3X000	73	T41E	572
B40305	100	LB23	147	P3X310	523	T41F	529
		LB24	146	P3X810	256	T424	629
		LB26	208	PAY200	475	T428	254

* C.N.I.T. = Code National d'Identification du Type (code D2.1 sur nouvelles cartes grises)

Sommaire

Type Mines OU C.N.I.T.*	9	Type Mines OU C.N.I.T.*	9	Type Mines OU C.N.I.T.*	9	Type Mines OU C.N.I.T.*	9
T42B	616	TB3G	616	V2W300	523	ELBLB6	421
T42E	572	TB42	472	V312	472	ELBMB6	519
T42F	529	TB43	523	V313	523	ELBPB6	519
T434	616	TB44	629	V314	616	ELBSB6	519
T43F	529	TB4E	572	V31A	591	ELBVB6	620
T4V800	255	TB4G	616	V31B	616	ELBVBH	620
T4X300	523	TB52	472	V31E	572	FLOA	421
T4X305	523	TB54	629	V31G	616	FLOB	373
T4X405	616	TB5E	572	V31M	616	FLOC	373
T4X800	256	TB5G	616	V3X208	472	FLOD	625
T4X805	254	TB62	472	V3X308	523	FLOH	519
T53M	616	TB63	523	V412	472	FLOJ	620
T552	475	TB64	629	V41A	591	FLOL	453
T553	522	TB6A	591	V422	472	FLDLA6	453
T554	629	TB6E	572	V423	523	FLOM	519
T558	256	TB6G	616	V424	616	FLON	453
T55E	572	TB92	475	V42A	591	FLOP	519
T55F	529	TB93	537	V42B	616	FLOS	519
T55G	616	TB94	606	V42E	572	FLOV	620
T55J	321	TB9A	591	V42G	616	FLOW	453
T55L	321	TB9B	629	V492	472	FLAAA6	421
T55M	616	TB9E	572	V494	616	FLABA5	373
T5B3	522	TB9G	606	V49A	572	FLACA6	373
T5B8	256	TBX200	472	V49B	629	FLADA6	625
T5BA	591	TBX201	472	V49E	572	FLADAH	625
T5BE	572	TBX205	472	V49G	629	FLAHA6	519
T5BF	529	TBX300	523	V4JM	629	FLAHAH	519
T5W300	523	TBX305	523	V4X200	472	FLAJA6	620
T5W800	256	TBX405	629	V4X208	472	FLAJAH	620
T5X000	73	TBXA05	591	V4X300	523	FLAMA6	519
T5X200	472	TBZ200	475	V4X308	523	FLAPA6	519
T5X201	472	TBZ205	475	V4X408	616	FLASA6	519
T5X205	475	TBZ305	537	V4Y208	472	FLAVA6	620
T5X300	523	TBZ405	606	V4Y408	616	FLAVAH	620
T5X305	522	TBZ800	255	V5B2	472	FLBAA6	421
T5X405	629	TBZA05	591	V5B3	523	FLBAB6	421
T5X800	256	TC7G	616	V5B4	616	FLBAC6	421
T5X805	256	TC94	629	V5BA	591	FLBAD6	421
T6W300	523	TC9A	591	V5BB	616	FLBBA5	373
T7B2	475	TC9E	572	V5BE	572	FLBBB5	373
T7B3	522	TC9G	606	V5BG	616	FLBBC5	373
T7B4	629	TC9M	616	V5BM	616	FLBBD5	373
T7BA	591	TCJG	606	V5W208	472	FLBCA6	373
T7BB	616	TCJM	606	V5W300	523	FLBCB6	373
T7BG	616	TCY405	629	V5W408	616	FLBCC6	373
T7CA	591	TE1200	472	V9X200	472	FLBCD6	373
T7CE	572	TE1A	591	V9X300	523	FLBDA6	625
T7W200	472	TE2200	472	VRE5003LN437	321	FLBDAH	625
T7W205	475	TE2A	591	VRE5006LD421	321	FLBDB6	625
T7W300	523	TE92	475			FLBDBH	625
T7W305	522	TE9200	475			FLBDC6	625
T7W405	629	TE9A	591			FLBDCH	625
T7WA05	591	TF1G	616			FLBDD6	625
T9X380	523	TF1J	321			FLBDDH	625
TAX300	523	TF1L	321			FLBHA6	519
TAZ300	537	TF1M	616			FLBHAH	519
TB12	472	TF2G	616			FLBHB6	519
TB13	523	TF2J	321			FLBHBH	519
TB14	629	TF2L	321			FLBHC6	519
TB1A	591	TF2M	616			FLBCH	519
TB1B	616	TF3G	616			FLBHD6	519
TB1E	572	TF3J	321			FLBHDH	519
TB1G	616	TF3L	321			FLBJA6	620
TB22	472	TF3M	616			FLBJAH	620
TB23	523	TG1G	616			FLBJB6	620
TB24	629	TH1G	616			FLBJBH	620
TB2A	591	THBJ	321			FLBJC6	620
TB2B	616	THBL	321			FLBJCH	620
TB2E	572	TJ1G	616			FLBJD6	620
TB2G	616	TMBE	572			FLBJDH	620
TB33	523	TMBF	529			FLBLA6	453
TB34	629	V2W200	472			FLBLC6	453

Trafix 2

ELOA	421	FLBDA6	625
ELOB	374	FLBDAH	625
ELOC	373	FLBDB6	625
ELOD	625	FLBDBH	625
ELOH	519	FLBDC6	625
ELOJ	620	FLBDCH	625
ELOL	421	FLBDD6	625
ELOM	519	FLBDDH	625
ELOP	519	FLBHA6	519
ELOS	519	FLBHAH	519
ELOV	620	FLBHB6	519
ELBAB6	421	FLBHBH	519
ELBBB5	374	FLBHC6	519
ELBCB6	373	FLBCH	519
ELBD6	625	FLBHD6	519
ELBDB6	625	FLBHDH	519
ELBDBH	625	FLBJA6	620
ELBHB6	519	FLBJAH	620
ELBHBH	519	FLBJB6	620
ELJB6	620	FLBJBH	620
ELJBH	620	FLBJC6	620
		FLBJCH	620
		FLBJD6	620
		FLBJDH	620
		FLBLA6	453
		FLBLC6	453

* C.N.I.T. = Code National d'Identification du Type (code D2.1 sur nouvelles cartes grises)

Sommaire

Type Mines OU C.N.I.T.*	9	Type Mines OU C.N.I.T.*	9	Type Mines OU C.N.I.T.*	9	Type Mines OU C.N.I.T.*	9
FLBLD6	453	JLAAA6	421	JLNCA6	373	MRE5513LH328	625
FLBMA6	519	JLABA5	374	JLNDA6	625	MRE5513LJ329	625
FLBMB6	519	JLACA6	373	JLNDAH	625	MRE5623L2471	620
FLBMC6	519	JLADA6	625	JLNHA6	519	MRE5623L7476	620
FLBMD6	519	JLADAH	625	JLNHAH	519	MRE5623LD482	620
FLBPA6	519	JLAEA6	520	JLNJA6	620	MRE5623LF484	620
FLBPB6	519	JLAHA6	519	JLNJAH	620	MRE5623LN456	620
FLBPC6	519	JLAHAH	519	JLNLA6	453	MRE5623LT462	620
FLBPD6	519	JLAJA6	620	JLNRA6	620	MRE5623LV464	620
FLBSA6	519	JLAJAH	620	JLNVA6	620	MRE5623LX491	620
FLBSB6	519	JLALA6	453	JLNVAH	620	MRE5633L0238	620
FLBSC6	519	JLAMA6	520	JLPHB6	519	MRE5633L4242	620
FLBSD6	519	JLAPA6	519	JLPHBH	519	MRE5633L4303	620
FLBVA6	620	JLARA6	620	JLPJB6	620	MRE5633LF289	620
FLBVAH	620	JLARAH	620	JLPJBH	620	MRE5633LQ228	620
FLBVB6	620	JLASA6	520	JLPVB6	620	MRE5633LS230	620
FLBVBH	620	JLATA6	519	JLPVBH	620	MRE5633LU232	620
FLBVC6	620	JLAVA6	620	JLUHA6	519	MRE5633LW234	620
FLBVCH	620	JLAVAH	620	M10RENV001P366	520	MRE5633LZ298	620
FLBVD6	620	JLBAA6	421	M10RENV001S369	519		
FLBVDH	620	JLBAB6	421	MRE1413LD407	421	Twingo	
FLFAA6	421	JLBBA5	374	MRE1413LJ255	421	C06005	22
FLFBA5	373	JLBBA5	374	MRE1413LM319	421	C0600K	22
FLFCA6	373	JLBBA6	373	MRE1413LN320	421	C061CK	24
FLFHA6	519	JLBBA6	373	MRE1423L2467	421	C0620K	22
FLFHAH	519	JLBDA6	625	MRE1423L3493	421	C062CK	22
FLFMA6	519	JLBDAH	625	MRE1423L6496	421	C06305	61
FLFPA6	519	JLBDB6	625	MRE1423L8473	421	C0630P	61
FLFSA6	519	JLBDBH	625	MRE1423LD478	421	C06355	61
FLGAB6	421	JLBEA6	520	MRE1423LT458	421	C0635P	61
FLGAA5	373	JLBHA6	519	MRE5113L2256	374	C06405	61
FLGBB5	373	JLBHAH	519	MRE5113LG076	374	C0640P	61
FLGCA6	373	JLBHB6	519	MRE5113LJ078	374	C06455	61
FLGCB6	373	JLBHBH	519	MRE5113LJ818	374	C06455A	61
FLGDA6	625	JLBHBS	519	MRE5113LP048	374	C0645P	61
FLGDAH	625	JLBJA6	620	MRE5113LU406	374	C0645PA	61
FLGDB6	625	JLBJAH	620	MRE5223L1474	520	C06601	38
FLGDBH	625	JLBJB6	620	MRE5223L6479	520	C06605	38
FLGHA6	519	JLBJBH	620	MRE5223LM459	520	C0660E	38
FLGHAH	519	JLBLB6	453	MRE5223LO488	520	C0660G	38
FLGHB6	519	JLBMA6	520	MRE5223LR489	520	C0660M	38
FLGHBH	519	JLBMB6	520	MRE5223LV468	520	C066M5	38
FLGJA6	620	JLBMB5	520	MRE5223LW469	520	C066M5G	38
FLGJAH	620	JLBPA6	519	MRE5223LW494	520	C066MG	38
FLGJB6	620	JLBPB6	519	MRE5223LZ497	520	C06701	38
FLGJBH	620	JLBRB6	620	MRE5233LJ454	520	C06705	38
FLGLA6	453	JLBSA6	520	MRE5313L1077	373	C0670E	38
FLGLB6	453	JLBSB6	520	MRE5313L3079	373	C0670G	38
FLGMA6	519	JLBTA6	519	MRE5313L3819	373	C068	38
FLGMB6	519	JLBVA6	620	MRE5313L4044	373	C068A5	38
FLGPA6	519	JLBVAH	620	MRE5313L5045	373	C068AE	38
FLGPB6	519	JLBVB6	620	MRE5313LD405	373	C068M5	38
FLGSA6	519	JLBVBH	620	MRE5313LN257	373	C06C05	22
FLGSB6	519	JLCAA6	421	MRE5313LS323	373	C06D	22
FLGVA6	620	JLCCA6	373	MRE5423L2455	519	C06D05	22
FLGVAH	620	JLCDA6	625	MRE5423L7460	519	C06D0K	22
FLGVB6	620	JLCDAH	625	MRE5423L8461	519	C06G0E	38
FLGVBH	620	JLCHA6	519	MRE5423LC490	519	C06GN5	38
FLWHA6	519	JLCHAH	519	MRE5423LH470	519	C06H05	22
JLOA	421	JLCJA6	620	MRE5423LH495	519	C06K	22
JLOB	374	JLCJAH	620	MRE5423LM475	519	C06TAH	38
JLOC	373	JLCLA6	453	MRE5423LR480	519	C06W05	22
JLOD	625	JLCMA6	520	MRE5423LS481	519	C06W0K	22
JLOH	519	JLCRA6	620	MRE5433L1453	519	CN00	179
JLOJ	620	JLCVA6	620	MRE5433LD296	519	CN0005	179
JLOL	453	JLCVAH	620	MRE5433LT287	519	CN0015	179
JLOM	520	JLDCA6	373	MRE5513L0408	625	CN01	34
JLON	453	JLDHA6	519	MRE5513L8707	625	CN03	178
JLOP	519	JLDJA6	620	MRE5513LD324	625	CN0305	178
JLOR	620	JLDLA6	453	MRE5513LE325	625	CN04	34
JLOS	520	JLEJB6	620	MRE5513LF326	625	CN040H	34
JLOV	620	JLNAA6	421	MRE5513LG327	625	CN0415	34

* C.N.I.T. = Code National d'Identification du Type (code D2.1 sur nouvelles cartes grises)

Sommaire

Type Mines OU C.N.I.T.*	9	Type Mines OU C.N.I.T.*	9	Type Mines OU C.N.I.T.*	9	Type Mines OU C.N.I.T.*	9
CND41H	34	MRE1111FE703	22	VRE000AF9369	38	Wind	
CND05	34	MRE1111FG705	22	VRE000AFJ670	38	E4MA	36
CNOA	34	MRE1111FP652	22	VRE000AFP676	38	E4MB	236
CNOA05	34	MRE1111FV138	22	VRE001AF4485	38	E4MC	236
CNOA0H	34	MRE1111FW139	22	VRE001AF9490	38	E4MF	36
CNOB	34	MRE1121FD798	34	VRE001AFA042	38	EN0F05	36
CNOC	35	MRE1121UL694	34	VRE001AFB043	38	EN0N05	236
CNOC05	35	MRE1131FQ458	34	VRE001AFD045	38	EN0R05	236
CNOD	53	MRE1131FY466	34	VRE001AFS484	38	M10RENV007Y042	236
CNOD05	53	MRE1321FZ800	35	VRE1001F7867	38		
CNOE	160	MRE1321US717	35	VRE1001F8868	38		
CNOE05	160	MRE1331F7128	35	VRE1001FF160	38		
CNOF	35	MRE1331FC460	35	VRE1001FM458	38		
CNOF05	35	MRE1531FA305	236	VRE1001FP461	38		
CNOF15	35	MRE1531FZ463	236	VRE1001FR463	38		
CNOK	34	MRE3001FB159	38	VRE1001FT465	38		
CNON	236	MRE3001FL460	38	VRE1001FU466	38		
CNON05	236	MRE3001FP464	38				
CNOP	35	MRE3001FP779	38	Vel Satis			
CNOR	236	MRE3001FP780	38	BJ00	555		
CNOR05	236	MRE3001FT759	38	BJ01	670		
CNOS	236	MRE3011F7700	38	BJ010B	670		
CNOU	153	MRE3011F8701	38	BJ0E	555		
CNOV	34	MRE3011FS757	38	BJ0E06	561		
CNA05	34	MRE3011FT758	38	BJ0F	555		
CNBA05	34	MRE5021FJ802	160	BJ0F0B	561		
CNCA05	34	MRE5021UQ697	160	BJ0G	555		
CND105	34	MRE5031FW462	160	BJ0H	555		
CNE005	179	MRE9011F8173	38	BJ0H06	555		
CNE015	179	MRE9011FA588	38	BJ0J	662		
CNE305	178	MREZ011FZ171	38	BJ0JOB	662		
CNJ105	34	S06305	61	BJ0K	431		
GND1	34	S06405	61	BJ0K06	431		
GND3	178	S0640P	61	BJ0K0B	431		
GND0C	35	S06455	61	BJ0M	555		
GND0D	53	S06455A	61	BJ0M06	555		
GND0E	160	S0645P	61	BJ0N	662		
GND105	34	S0645PA	61	BJ0NOB	662		
GNE305	178	S06601	38	BJ0P	431		
M10RENV001P196	34	S06605	38	BJ0P06	431		
MRE000AF0369	38	S0660E	38	BJ0P0B	431		
MRE000AFA670	38	S0660G	38	BJ0U	670		
MRE000AFU327	38	S066M5	38	BJ0V	670		
MRE000AFY367	38	S066MG	38	BJ0V0B	670		
MRE001AF0490	38	S06805	38	BJ0W	431		
MRE001AF1042	38	S068M5	38	BJ0W06	435		
MRE001AF2043	38	S06C	22	BJ0W0B	431		
MRE001AF4045	38	S06GN5	38	BJR006	555		
MRE001AFJ484	38	S06K	22	BJRF0B	561		
MRE001AFV485	38	URE1011FJ171	38	BJRH0B	555		
MRE1001F6160	38	URE1011FP141	38	BJRM06	555		
MRE1001F9163	38	URE1021F6801	53	MRE1712RB091	431		
MRE1001FD458	38	URE1021UD696	53	MRE1712RQ846	435		
MRE1001FG461	38	URE1031FJ461	53	MRE1712RX102	431		
MRE1001FJ463	38	URE1031FY088	53	MRE3712R4103	431		
MRE1001FK465	38	URE1111F9698	22	MRE3712RD245	431		
MRE1001FL466	38	URE1111FG705	22	MRE3712RX847	431		
MRE1001FS473	38	URE1121FD798	34	MRE3912RU098	670		
MRE1001FT474	38	URE1131FQ458	34	MRE3922R4046	670		
MRE1001FY867	38	URE1131FY466	34	MRE5322RS160	555		
MRE1001FZ868	38	URE1321FZ800	35	MRE5412RV9556	555		
MRE1011FH170	38	URE1331F7128	35	MRE5412RT213	555		
MRE1011FJ171	38	URE1331FC460	35	MRE5612RE214	561		
MRE1011FP141	38	URE1531FA305	236	MRE5612RH095	561		
MRE1011FY115	38	URE1531FZ463	236	MRE5612RU557	555		
MRE1021F6801	53	URE3011FS757	38	MRE5612RV558	561		
MRE1021UD696	53	URE3011FT758	38	MRE7612RA337	561		
MRE1031FJ461	53	URE5021FJ802	160	MRE7622RC277	555		
MRE1031FY088	53	URE5021UQ697	160	MRE7712RD560	662		
MRE1101F7866	22	URE5031FW462	160	MRE7712RU092	662		
MRE1111F9698	22	URE9011FA588	38				
MRE1111FD702	22	VRE000AF1325	38				

* C.N.I.T. = Code National d'Identification du Type (code D2.1 sur nouvelles cartes grises)

IDENTIFICATION JOINTS DE CULASSE - Moteur Diesel CYLINDER HEAD GASKET IDENTIFICATION - Diesel Engine RENAULT - F9Q

Moteurs / Engines **F9Q**



Languette de repérage
Identification area

<p>2 Trous / Holes</p>	<p>1 Trou / Hole</p>	<p>3 Trous / Holes</p>
<p>AC5070 Ép. / Thick. = 1,35 mm*</p>	<p>AC5080 Ép. / Thick. = 1,45 mm*</p>	<p>AC5090 Ép. / Thick. = 1,55 mm*</p>
<p>* L'épaisseur correspond à l'épaisseur serrée sur moteur. * The above thickness refers to the assembled thickness.</p>		

IDENTIFICATION JOINTS DE CULASSE - Moteur Diesel CYLINDER HEAD GASKET IDENTIFICATION - Diesel Engine RENAULT - J8S

Moteurs / Engines J8S

2 types de joints interchangeables / 2 kind of interchangeable gaskets

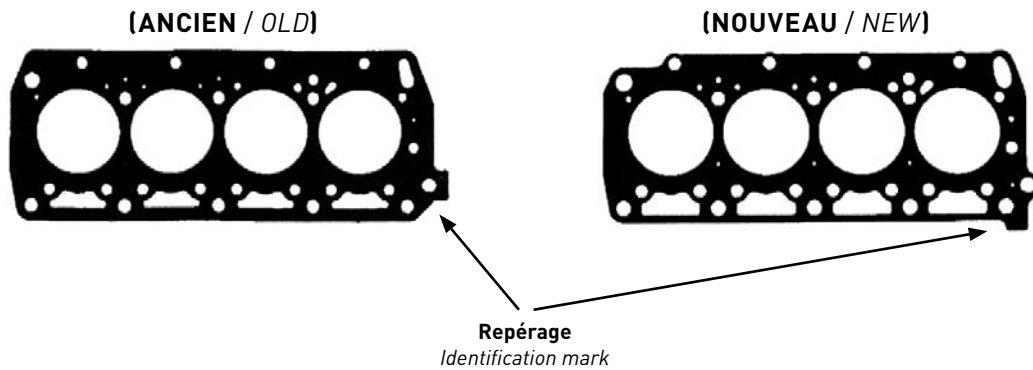

2 possibilités de repérage / 2 ways of identification

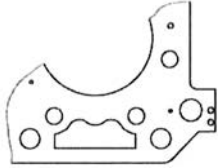
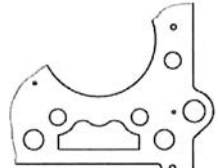
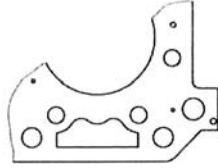
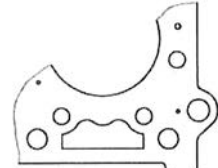
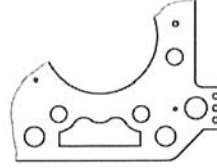
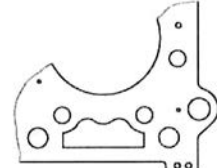
 <p>2 Trous / Holes</p> <p>ou / or</p>  <p>1 Trou / Hole</p>	 <p>1 Trou / Hole</p> <p>ou / or</p>  <p>0 Trou / Hole</p>	 <p>3 Trous / Holes</p> <p>ou / or</p>  <p>2 Trous / Holes</p>
<p>BH 080 Ép. / Thick. = 1,60 mm*</p>	<p>BG 900 Ép. / Thick. = 1,70 mm*</p>	<p>BH 090 Ép. / Thick. = 1,80 mm*</p>
<p>Dépassement pistons: inférieur à 0,960 mm Piston protusion up to 0,960 mm</p>	<p>Dépassement pistons: de 0,960 à 1,040 mm Piston protusion from 0,960 to 1,040 mm</p>	<p>Dépassement pistons: supérieur à 1,040 mm Piston protusion above 1,040 mm</p>







IDENTIFICATION JOINTS DE CULASSE - Moteur Diesel CYLINDER HEAD GASKET IDENTIFICATION - Diesel Engine RENAULT - F8M

Moteurs / Engines **F8M-720** → Avril 1988
F8M-730 → Avril 1988



Repérage /
Identification mark

2 possibilités de repérage / 2 ways of identification

 2 Trous / Holes ou / or  2 Trous / Holes	 0 ou 1 Trou / Hole ou / or  1 Trou / Hole	 3 Trous / Holes ou / or  3 Trous / Holes
<p>BL 960 Ép. / Thick. = 1,65</p>	<p>BL 970 Ép. / Thick. = 1,75</p>	<p>BL 980 Ép. / Thick. = 1,85</p>
<p>Dépassement pistons: inférieur à 0,885 mm Piston protusion up to 0,885 mm</p>	<p>Dépassement pistons: de 0,885 à 0,985 mm Piston protusion from 0,885 to 0,985 mm</p>	<p>Dépassement pistons: supérieur à 985 mm Piston protusion above 0,985 mm</p>

Moteurs / Engines **F8M-730** Avril 1988 →

2 types de joints interchangeables / 2 kind of interchangeable gaskets

(ANCIEN / OLD)

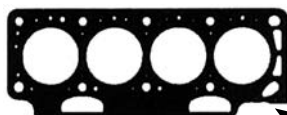







(NOUVEAU / NEW)



Repérage
Identification mark

2 possibilités de repérage / 2 ways of identification

 2 Trous / Holes ou / or  2 Trous / Holes	 0 ou 1 Trou / Hole ou / or  1 Trou / Hole	 3 Trous / Holes ou / or  3 Trous / Holes
<p>Identification moteur 1 trou / Engine identification 1 hole</p>		
<p>BS 010 Ép. / Thick. = 1,65</p>	<p>BS 020 Ép. / Thick. = 1,75</p>	<p>BS 030 Ép. / Thick. = 1,85</p>
<p>Dépassement pistons: inférieur à 0,885 mm Piston protusion up to 0,885 mm</p>	<p>Dépassement pistons: de 0,885 à 0,985 mm Piston protusion from 0,885 to 0,985 mm</p>	<p>Dépassement pistons: supérieur à 985 mm Piston protusion above 0,985 mm</p>

IDENTIFICATION JOINTS DE CULASSE - Moteur Diesel CYLINDER HEAD GASKET IDENTIFICATION - Diesel Engine RENAULT - F8Q

Moteurs / Engines **F8Q Atmo / F8Q N.A.**

2 types de joints interchangeables / 2 kind of interchangeable gaskets

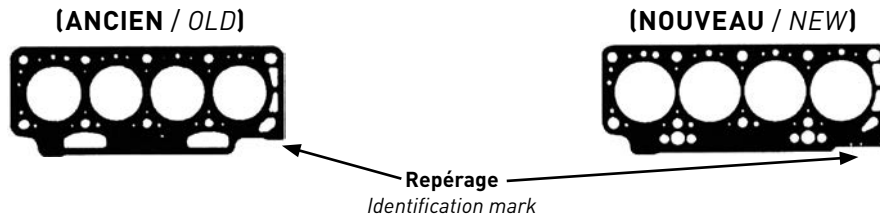

3 possibilités de repérage / 3 ways of identification

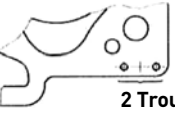
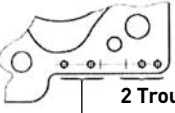
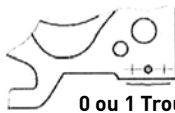
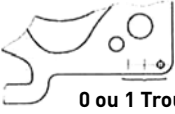
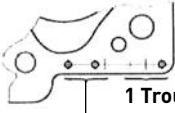
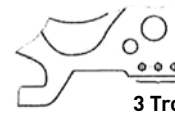
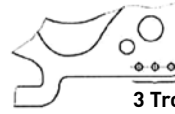
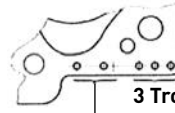
 2 Trous / Holes ou / or  2 Trous / Holes ou / or  2 Trous / Holes Identification moteur 2 trous / Engine identification 2 holes	 0 ou 1 Trou / Hole ou / or  0 ou 1 Trou / Hole ou / or  1 Trou / Hole Identification moteur 2 trous / Engine identification 2 holes	 3 Trous / Holes ou / or  3 Trous / Holes ou / or  3 Trous / Holes Identification moteur 2 trous / Engine identification 2 holes
<p>BS 520 Ép. / Thick. = 1,65</p>	<p>BS 530 Ép. / Thick. = 1,75</p>	<p>BS 540 Ép. / Thick. = 1,85</p>
<p>Dépassement pistons: inférieur à 0,868 mm Piston protusion up to 0,868 mm</p>	<p>Dépassement pistons: de 0,868 à 1,000 mm Piston protusion from 0,868 to 1,000 mm</p>	<p>Dépassement pistons: supérieur à 1,000 mm Piston protusion above 1,000 mm</p>

Moteurs / Engines **F8Q Turbo / F8Q T.C.**

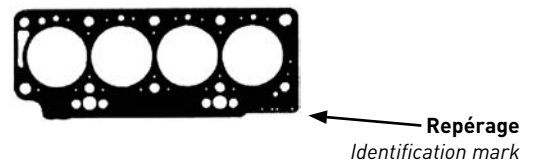

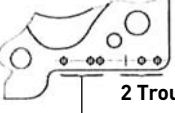
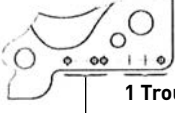
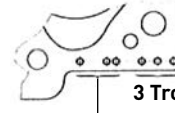
 2 Trous / Holes Identification moteur 3 trous / Engine identification 3 holes	 1 Trou / Hole Identification moteur 3 trous / Engine identification 3 holes	 3 Trous / Holes Identification moteur 3 trous / Engine identification 3 holes
<p>AY 710 Ép. / Thick. = 1,40</p>	<p>AY 720 Ép. / Thick. = 1,50</p>	<p>AY 730 Ép. / Thick. = 1,60</p>
<p>Dépassement pistons: inférieur à 0,073 mm Piston protusion up to 0,073 mm</p>	<p>Dépassement pistons: de 0,073 à 0,206 mm Piston protusion from 0,073 to 0,206 mm</p>	<p>Dépassement pistons: supérieur à 0,206 mm Piston protusion above 0,206 mm</p>

RENAULT



cc



kW/PS



0.8	800 01					1	BF350 (Fibre), 1.500mm		
4 0.8	09/66→12/88	845	4	58.00	OHV	25/34			
0.8	800 705					2	BF350 (Fibre), 1.500mm		
4 0.8	04/83→07/89	845	4	58.00		19-26/ 26-35			
0.8	B1B 707					3	BF350 (Fibre), 1.500mm		
4 0.8	04/83→07/89	845	4	58.00	OHV	21/29			
0.9	C1C 706					4	BH680 (Fibre), 1.200mm BM790 (Fibre), 1.750mm	DH683 ■○ DH687 [13]	EH680
Express 1.0	09/85→05/92	949	4	65.00		27-31/ 37-42			
1.0	689 710					5	BH680 (Fibre), 1.200mm	DH681 ○	GH681 ○ [14][16]
4 1.0	12/85→06/93	956	4	65.00	OHV	32/44			
1.0	C1C 700					6	BH680 (Fibre), 1.200mm BM790 (Fibre), 1.750mm	DH683 ■○ DH687 [13]	EH680
Super 5 1.0 Super 5 Van 1.0	10/84→10/88 10/84→10/88	956	4	65.00		30/41			
1.0	C1C 708					7	BH680 (Fibre), 1.200mm BM790 (Fibre), 1.750mm	DH683 ■○ DH687 [13]	EH680
4 1.0	06/87→12/93	956	4	65.00	OHV	25/34			
1.0	CG10DE					8	BY900 (Fibre)	CG7880 DY900 [3] →12/00	
Clio 2 1.0 Kangoo 1.0	02/00→05/01 07/03→	998	4	71.00	DOHC	40/54			
1.1	688 711					9	BH680 (Fibre), 1.200mm		
4 Van 1.1	10/76→07/89	1108	4	70.00	OHV	25/34			
1.1	688 712					10	BH680 (Fibre), 1.200mm		
4 1.1 4 Van 1.1	06/78→06/90 10/76→07/89	1108	4	70.00		25-35/ 34-48			
1.1	C1E 700					11	BH680 (Fibre), 1.200mm BM790 (Fibre), 1.750mm	DH683 ■○ DH687 [13]	EH680
Clio 1.1	01/91→09/98	1108	4	70.00	OHV	35-36/ 48-49			
1.1	C1E 714					12	BH680 (Fibre), 1.200mm BM790 (Fibre), 1.750mm	DH681 ○ DH687 [13]	GH681 ○ [14][16] GH683 ○ [14]
4 1.1 4 Van 1.1	06/78→06/90 10/76→07/89	1108	4	70.00	OHV	25-32/ 34-44			

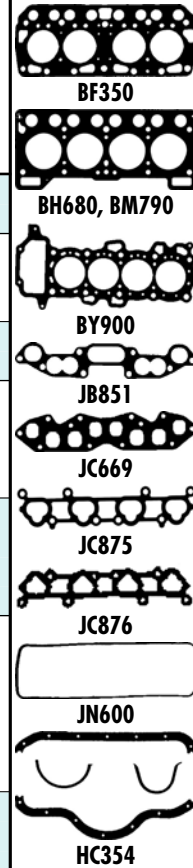
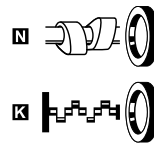
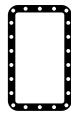
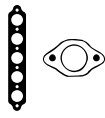

HBS104 [22] M10x1.50x100.00mm (x10)	JC669	JN600 [4]	HC354 [5]	HR646 [5]	NF835 [1] 80.00x100.00x8.00mm, FPM/ACM NF722 [2] 35.00x50.00x10.00mm, MVQ	
HBS104 [22] M10x1.50x100.00mm (x10)	JB851	JN600 [4]	HC354 [5]		NF535 [1] 30.00x42.00x8.00mm, NBR NF835 [1] 80.00x100.00x8.00mm, FPM/ACM	
HBS104 [22] M10x1.50x100.00mm (x10)	JC669	JN600 [4]	HC354 [5] =PA349 22.00x16.00x2.000mm	HR646 [5]	NF834 [2] 35.00x50.00x8.00mm, FPM NF835 [1] 80.00x100.00x8.00mm, FPM/ACM NF722 [2] 35.00x50.00x10.00mm, MVQ	HR350 [55] [5] JR635 [6]
HBS104 [22] M10x1.50x100.00mm (x10)	JC669	JN600 [4]	HC354 [5]	HR646 [5]	NF835 [1] 80.00x100.00x8.00mm, FPM/ACM NF722 [2] 35.00x50.00x10.00mm, MVQ	
HBS110 [22] M10x1.50x146.00mm (x10)	JC875 [1] →12/00 JD5841 [1] (FPM) JC876 [5] (x2)	JM5281		PB681	NJ765 [2] 40.00x52.00x7.00mm, NBR NJ765 [2] 40.00x52.00x7.00mm, NBR	
HBS104 [22] M10x1.50x100.00mm (x10)					NF535 [1] 30.00x42.00x8.00mm, NBR NF835 [1] 80.00x100.00x8.00mm, FPM/ACM	
HBS104 [22] M10x1.50x100.00mm (x10)					NF535 [1] 30.00x42.00x8.00mm, NBR NF835 [1] 80.00x100.00x8.00mm, FPM/ACM	
HBS104 [22] M10x1.50x100.00mm (x10)	JC669	JN600 [4]	HC354 [5] =PA349 22.00x16.00x2.000mm	HR643 [5]	NF535 [1] 30.00x42.00x8.00mm, NBR NF834 [2] 35.00x50.00x8.00mm, FPM NF835 [1] 80.00x100.00x8.00mm, FPM/ACM NF722 [2] 35.00x50.00x10.00mm, MVQ	HR350 [55] [5] NF791 [2] [53] JR635 [6]
HBS104 [22] M10x1.50x100.00mm (x10)	JB851	JN600 [4]	HC354 [5] =KJ647 18.30x24.00x2.000mm		NF535 [1] 30.00x42.00x8.00mm, NBR NF834 [2] 35.00x50.00x8.00mm, FPM NF835 [1] 80.00x100.00x8.00mm, FPM/ACM NF722 [2] 35.00x50.00x10.00mm, MVQ	HR350 [55] [5] NF775 (x2) [1] [53] [2]



cc



kW/PS



1.1		C1E 718				13	BH680 (Fibre), 1.200mm BM790 (Fibre), 1.750mm		DH683 ■○ DH687 [13]	EH680
4 Van 1.1	10/76→07/89	1108	4	70.00	OHV	25-26/ 34-35				
1.1		C1E 719				14	BH680 (Fibre), 1.200mm BM790 (Fibre), 1.750mm		DH683 ■○ DH687 [13]	EH680
4 1.1	06/78→06/90	1108	4	70.00	OHV	25-26/ 34-35				
4 Van 1.1	10/76→07/89									
1.1		C1E 750				15	BH680 (Fibre), 1.200mm →06/90 BM790 (Fibre), 1.750mm →06/90		DH683 ■○ →06/90 DH687 [13] →06/90	EH680 →06/90
Express 1.1	09/85→08/91	1108	4	70.00	OHV	33-35/ 45-48				
Express Van 1.1	07/85→04/95									
Super 5 1.1	10/84→03/95									
Super 5 Van 1.1	10/84→12/96									
1.1		C1E 752				16	BH680 (Fibre), 1.200mm →06/89 BM790 (Fibre), 1.750mm →06/89		DH683 ■○ →06/89 DH687 [13] →06/89	EH680 →06/89
Express Van 1.1	07/85→04/95	1108	4	70.00	OHV	33-34/ 45-46				
Super 5 1.1	10/84→03/95									
Super 5 Van 1.1	10/84→12/96									
1.1		C1E 754				17	BH680 (Fibre), 1.200mm →08/91 BM790 (Fibre), 1.750mm →08/91		DH683 ■○ →08/91 DH687 [13] →08/91	EH680 →08/91
Express Van 1.1	07/85→04/95	1108	4	70.00	OHV	33-34/ 45-46				
Super 5 1.1	10/84→10/88									
Super 5 Van 1.1	10/84→12/96									

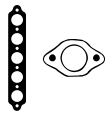

BH680, BM790



JC669



JN600



HC354

<p>HBS104 [22] M10x1.50x100.00mm (x10)</p>	<p>JC669</p>	<p>JN600 [4]</p>	<p>HC354</p>	<p>HR646</p>	<p>NF535 [1] 30.00x42.00x8.00mm, NBR NF834 [2] 35.00x50.00x8.00mm, FPM NF835 [1] 80.00x100.00x8.00mm, FPM/ACM NF722 [2] 35.00x50.00x10.00mm, MVQ</p>	
<p>HBS104 [22] M10x1.50x100.00mm (x10)</p>	<p>JC669</p>	<p>JN600 [4]</p>	<p>HC354</p>	<p>HR646</p>	<p>NF535 [1] 30.00x42.00x8.00mm, NBR NF834 [2] 35.00x50.00x8.00mm, FPM NF835 [1] 80.00x100.00x8.00mm, FPM/ACM NF722 [2] 35.00x50.00x10.00mm, MVQ</p>	
<p>HBS104 [22] M10x1.50x100.00mm (x10) →06/90</p>	<p>JC669 →06/90</p>	<p>JN600 [4] →06/90</p>	<p>HC354 →06/90</p>	<p>HR646 →06/90</p>	<p>NF535 [1] 30.00x42.00x8.00mm, NBR →06/90 NF834 [2] 35.00x50.00x8.00mm, FPM →06/90 NF835 [1] 80.00x100.00x8.00mm, FPM/ACM →06/90 NF722 [2] 35.00x50.00x10.00mm, MVQ →06/90</p>	
<p>HBS104 [22] M10x1.50x100.00mm (x10) →06/89</p>	<p>JC669 →06/89</p>	<p>JN600 [4] →06/89</p>	<p>HC354 →06/89</p>	<p>HR646 →06/89</p>	<p>NF535 [1] 30.00x42.00x8.00mm, NBR →06/89 NF834 [2] 35.00x50.00x8.00mm, FPM →06/89 NF835 [1] 80.00x100.00x8.00mm, FPM/ACM →06/89 NF722 [2] 35.00x50.00x10.00mm, MVQ →06/89</p>	
<p>HBS104 [22] M10x1.50x100.00mm (x10) →08/91</p>	<p>JC669 →08/91</p>	<p>JN600 [4] →08/91</p>	<p>HC354 →08/91</p>	<p>HR646 →08/91</p>	<p>NF535 [1] 30.00x42.00x8.00mm, NBR →08/91 NF834 [2] 35.00x50.00x8.00mm, FPM →08/91 NF835 [1] 80.00x100.00x8.00mm, FPM/ACM →08/91 NF722 [2] 35.00x50.00x10.00mm, MVQ →08/91</p>	



cc



kW/PS



1.1		CIE 756					18			
Express Van 1.1	06/87→09/91	1108	4	70.00	OHV	33/45	BH680 (Fibre), 1.200mm →07/89	DH683 ■○ →07/89	EH680 →07/89	
Super 5 1.1	01/86→03/95						BM790 (Fibre), 1.750mm →07/89	DH687 [13] →07/89		
1.1		CIE 760					19			
Express Van 1.1	07/85→04/95	1108	4	70.00	OHV	33/45	BH680 (Fibre), 1.200mm →08/91	DH683 ■○ →08/91	EH680 →08/91	
Super 5 1.1	01/86→03/95						BM790 (Fibre), 1.750mm →08/91	DH687 [13] →08/91		
1.1		CIE 762					20			
Express 1.1	09/93→04/95	1108	4	70.00	OHV	33-36/ 45-49	BH680 (Fibre), 1.200mm 09/91→	DH683 ■○ 09/91→	EH680 09/91→	
Express Van 1.1	07/85→04/95						BM790 (Fibre), 1.750mm 09/91→	DH687 [13] 09/91→		
1.1		CIE 792					21			
Express Van 1.1	07/85→04/95	1108	4	70.00	OHV	33/45	BH680 (Fibre), 1.200mm	DH683 ■○	EH680	
							BM790 (Fibre), 1.750mm	DH687 [13]		
1.1		D4F 702					22			
Twingo 1.2 16V	01/01→	1149	4	69.00	SOHC/OHC	55/75	AD5980 (MLS)	CD5980 CD5981 →Eng.030820	EG7950 Eng.010102→	
1.1		D4F 706					23			
Clio 2 1.2 16V	06/01→	1149	4	69.00	SOHC/OHC	55/75	AD5980 (MLS)	CD5980 CD5981 →Eng.030820	EG7950	
1.1		D4F 708					24			
Twingo 1.2 16V	08/04→	1149	4	69.00	SOHC/OHC	44/60	AD5980 (MLS)	CD5980 CD5981 →Eng.030820	EG7950	
1.1		D4F 712					25			
Clio 2 1.2 16V	06/01→	1149	4	69.00	DOHC	55/75	AD5980 (MLS)	CD5980 CD5981 →Eng.030820	EG7950	
Kangoo 1.2 16V	06/01→									
Thalia 1.2	04/02→									
1.1		D4F 714					26			
Clio 2 1.2 16V	06/01→	1149	4	69.00		55/75	AD5980 (MLS)	CD5980 CD5981 →Eng.030820	EG7950	
Kangoo 1.2 16V	06/01→									

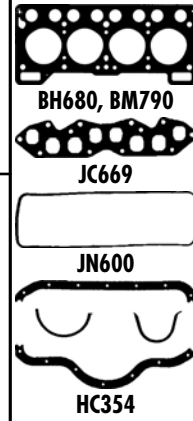

HBS104 [22]
M10x1.50x100.00mm (x10)
→07/89

JC669
→07/89

JN600 [4]
→07/89

HC354 [5]
→07/89
=PA349
22.00x16.00x2.000mm

HR643 [5]
→07/89

NF535 [1]
30.00x42.00x8.00mm, NBR
→07/89
NF834 [2]
35.00x50.00x8.00mm, FPM
→07/89
NF835 [1]
80.00x100.00x8.00mm, FPM/ACM
→07/89
NF722 [2]
35.00x50.00x10.00mm, MVQ
→07/89

HR350 [55] [5]
LT839 [15]
JR635 [6]
→07/89

HBS104 [22]
M10x1.50x100.00mm (x10)
→08/91

JC669
→08/91

JN600 [4]
→08/91

HC354 [5]
→08/91

HR646 [5]
→08/91

NF535 [1]
30.00x42.00x8.00mm, NBR
→08/91
NF834 [2]
35.00x50.00x8.00mm, FPM
→08/91
NF835 [1]
80.00x100.00x8.00mm, FPM/ACM
→08/91
NF722 [2]
35.00x50.00x10.00mm, MVQ
→08/91

HBS104 [22]
M10x1.50x100.00mm (x10)
09/91→

JC669
09/91→

JN600 [4]
09/91→

HC354 [5]
09/91→

HR646 [5]
09/91→

NF535 [1]
30.00x42.00x8.00mm, NBR
09/91→
NF834 [2]
35.00x50.00x8.00mm, FPM
09/91→
NF835 [1]
80.00x100.00x8.00mm, FPM/ACM
09/91→
NF722 [2]
35.00x50.00x10.00mm, MVQ
09/91→

HBS104 [22]
M10x1.50x100.00mm (x10)

JC669

JN600 [4]

HC354 [5]

HR646 [5]

NF535 [1]
30.00x42.00x8.00mm, NBR
NF834 [2]
35.00x50.00x8.00mm, FPM
NF835 [1]
80.00x100.00x8.00mm, FPM/ACM
NF722 [2]
35.00x50.00x10.00mm, MVQ

HBS283 [5]
M9x1.25x122.00mm (x10)

JD5885 [1]
JD5884 [5]

JM5185

NA5261 [2]
28.00x47.00x8.00mm, PTFE/ACM

HBS283 [5]
M9x1.25x122.00mm (x10)

JD5885 [1]
JD5884 [5]

JM5185

NA5261 [2]
28.00x47.00x8.00mm, PTFE/ACM

HBS283 [5]
M9x1.25x122.00mm (x10)

JD5885 [1]
JD5884 [5]

JM5185

NA5261 [2]
28.00x47.00x8.00mm, PTFE/ACM

HBS283 [5]
M9x1.25x122.00mm (x10)

JD5885 [1]
JD5884 [5]

JM5185

NA5261 [2]
28.00x47.00x8.00mm, PTFE/ACM

HBS283 [5]
M9x1.25x122.00mm (x10)

JD5885 [1]
JD5884 [5]

JM5185

NA5261 [2]
28.00x47.00x8.00mm, PTFE/ACM

RENAULT



cc



kW/PS



1.1	D4F 716	27	AD5980 (MLS)	CD5980 CD5981 →Eng.030820	EG7950				
Kangoo 1.2 16V	06/01→	1149	4	69.00	DOHC	55/75			
1.1	D4F 722	28	AD5980 (MLS)	CD5980 CD5981 →Eng.030820	EG7950				
Clio 2 1.2 16V	06/01→	1149	4	69.00	DOHC	55/75			
1.1	D4F 728	29	AD5980 (MLS)	CD5980 CD5981 →Eng.030820	EG7950				
Clio 2 1.2 16V	06/01→	1149	4	69.00	DOHC	55/75			
Thalia 1.2	09/08→								
1.1	D4F 730	30	AD5980 (MLS)	CD5980 CD5981 →Eng.030820	EG7950				
Kangoo 1.2 16V	10/01→	1149	4	69.00	DOHC	55/75			
1.1	D4F 740	31	AD5980 (MLS)	CD5980	EG7950 Eng.010102→				
Clio 1.2 16V	02/08→	1149	4	69.00		48-55/ 65-75			
Clio 3 1.2 16V	06/05→								
Clio 3 Hi-Flex	07/08→								
Clio 4 1.2 16V	11/12→								
Modus 1.2	12/04→								
Modus 1.2 16V	10/08→								
1.1	D4F 742	32	AD5980 (MLS)	CD5980	EG7950 Eng.010102→				
Clio 3 Hi-Flex	07/08→	1149	4	69.00	SOHC/OHC	55/75			
1.1	D4F 764	33	AD5980 (MLS)	CD5980	EG7950 Eng.010102→				
Clio 1.2 16V	02/08→	1149	4	69.00	DOHC	43-58/ 58-79			
Clio 3 1.2 16V	06/05→								
Modus 1.2	12/04→								
1.1	D4F 772	34	AD5980 (MLS)	CD5980	EG7950 Eng.010102→				
Twingo 1.2 16V	03/07→	1149	4	69.00	DOHC	55-56/ 75-76			
1.1	D4F 780	35	AH6780 (MLS), 0.50mm		EG7950 Eng.010102→				
Twingo 1.2 T	03/07→	1149	4	69.00	DOHC	74-75/ 100-102			
Twingo 1.2 Tce	02/11→								
Wind 1.2	02/11→								
1.1	D4F 782	36	AH6780 (MLS), 0.50mm		EG7950 Eng.010102→				
Twingo 1.2 T	03/07→	1149	4	69.00	DOHC	74/101			
Wind 1.2	07/10→								
1.1	D4F 784	37	AH6780 (MLS), 0.50mm		EG7950 Eng.010102→				
Clio 1.2 16V	02/08→	1149	4	69.00	DOHC	74/100			
Clio 3 1.2 16V	05/07→								
Modus 1.2 16V	05/07→								
1.1	D7F 700	38	BX630 (Fibre)	DX630	EA140 [3]				
Twingo 1.2	05/96→	1149	4	69.00	SOHC/OHC	40-43/ 54-58			
Twingo Van 1.2	05/96→								
1.1	D7F 701	39	BX630 (Fibre)	DX630	EA140 [3]				
Twingo 1.2	05/96→	1149	4	69.00	SOHC/OHC	40-43/ 54-58			
Twingo Van 1.2	05/96→								

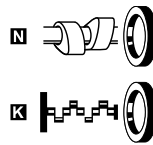
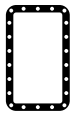
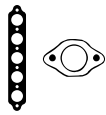

BX630



JD420

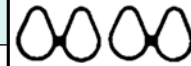

JD421



JN997



JJ565

HBS283 [5] M9x1.25x122.00mm (x10)	JD5885 [1] JD5884 [2]	JM5185			NA5261 [2] 28.00x47.00x8.00mm, PTFE/ACM	
HBS283 [5] M9x1.25x122.00mm (x10)	JD5885 [1] JD5884 [2]	JM5185			NA5261 [2] 28.00x47.00x8.00mm, PTFE/ACM	
HBS283 [5] M9x1.25x122.00mm (x10)	JD5885 [1] JD5884 [2]	JM5185			NA5261 [2] 28.00x47.00x8.00mm, PTFE/ACM	
HBS283 [5] M9x1.25x122.00mm (x10)	JD5885 [1] JD5884 [2]	JM5185			NA5261 [2] 28.00x47.00x8.00mm, PTFE/ACM	
HBS283 [5] M9x1.25x122.00mm (x10)	JD5885 [1] JD5884 [2]	JM7053 (ACM)			NA5261 [2] 28.00x47.00x8.00mm, PTFE/ACM	
HBS283 [5] M9x1.25x122.00mm (x10)	JD5885 [1] JD5884 [2]	JM7053 (ACM)			NA5261 [2] 28.00x47.00x8.00mm, PTFE/ACM	
HBS283 [5] M9x1.25x122.00mm (x10)	JD5885 [1] JD5884 [2]	JM7053 (ACM)			NA5261 [2] 28.00x47.00x8.00mm, PTFE/ACM	
HBS283 [5] M9x1.25x122.00mm (x10)	JD5885 [1] JD5884 [2]	JM7053 (ACM)			NA5261 [2] 28.00x47.00x8.00mm, PTFE/ACM	
	JD6038 [1] (Steel) JD6033 [2] (MLS)	JM7125 (ACM)		HR817 [2]	NA5261 [2] 28.00x47.00x8.00mm, PTFE/ACM	
	JD6038 [1] (Steel) JD6033 [2] (MLS)	JM7125 (ACM)		HR817 [2]	NA5261 [2] 28.00x47.00x8.00mm, PTFE/ACM	
	JD6038 [1] (Steel) JD6033 [2] (MLS)	JM7125 (ACM)		HR817 [2]	NA5261 [2] 28.00x47.00x8.00mm, PTFE/ACM	
HBS241 [5] M9x1.25x103.00mm (x10)	JD421 [1] JD420 [2]	JN997 [4] →01/00 JM5131 (Elastomer) 01/00→	JJ565		NA5053 [2] 30.00x42.00x7.00mm, FPM NA5322 [2] 32.00x44.00x6.00mm, ACM NF856 [2] 32.00x44.00x6.00mm, FPM LK5001 [1] [2] [7] 74.00x187.50x17.000mm, FPM	
HBS241 [5] M9x1.25x103.00mm (x10)	JD421 [1] JD420 [2]	JN997 [4] →01/00 JM5131 (Elastomer) 01/00→	JJ565		NA5053 [2] 30.00x42.00x7.00mm, FPM NA5322 [2] 32.00x44.00x6.00mm, ACM NF856 [2] 32.00x44.00x6.00mm, FPM	

RENAULT



cc



kW/PS

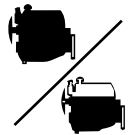

1.1	D7F 702	40	BX630 (Fibre)	DX630	EA140 [3]				
Twingo 1.2 Twingo Van 1.2	05/96→08/00 05/96→	1149	4	69.00	SOHC/OHC	43-44/ 58-60			
1.1	D7F 703	41	BX630 (Fibre)	DX630	EA140 [3]				
Twingo 1.2 Twingo Van 1.2	05/96→08/00 05/96→	1149	4	69.00	SOHC/OHC	43/58			
1.1	D7F 704	42	BX630 (Fibre)	DX630	EA140 [3]				
Twingo 1.2 Twingo Van 1.2	05/96→08/00 05/96→	1149	4	69.00	SOHC/OHC	43-44/ 58-60			
1.1	D7F 706	43	BX630 (Fibre)	DX630	EA140 [3]				
Twingo Van 1.2	05/96→	1149	4	69.00	SOHC/OHC	43/58			
1.1	D7F 710	44	BX630 (Fibre)	DX630	EA140 [3]				
Kangoo 1.2	08/97→	1149	4	69.00	SOHC/OHC	43/58	03/98→	03/98→	EG7950 03/98→
1.1	D7F 720	45	BX630 (Fibre)	DX630	EA140 [3]				
Clio 2 1.2 Clio 2 Van 1.2 Kangoo 1.2	09/98→ 09/98→ 08/97→	1149	4	69.00	SOHC/OHC	43/58			
1.1	D7F 722	46	BX630 (Fibre)	DX630	EA140 [3]				
Clio 2 1.2 Kangoo 1.2	03/99→10/03 08/97→	1149	4	69.00	SOHC/OHC	43-44/ 58-60			
1.1	D7F 726	47	BX630 (Fibre)	DX630	EA140 [3]				
Clio 2 1.2 Clio 2 Van 1.2 Kangoo 1.2	09/98→10/03 09/98→ 08/97→	1149	4	69.00	SOHC/OHC	43/58			
1.1	D7F 730	48	BX630 (Fibre)	DX630	EA140 [3]				
Clio 1.2	01/96→09/98	1149	4	69.00	SOHC/OHC	40-43/ 54-58			
1.1	D7F 744	49	BX630 (Fibre)	DX630	EA140 [3]				
Kangoo 1.2 Thalia 1.2	08/97→ 02/98→10/03	1149	4	69.00	SOHC/OHC	43/58			EG7950

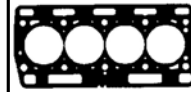
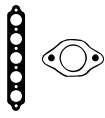

BX630



JD420



JD421



JN997



JJ565

HBS241 [5] M9x1.25x103.00mm (x10)	JD421 [1] JD420 [E]	JN997 [4] →01/00 JM5131 (Elastomer) 01/00→	JJ565	NA5053 [2] 30.00x42.00x7.00mm, FPM NF856 [2] 32.00x44.00x6.00mm, FPM	
HBS241 [5] M9x1.25x103.00mm (x10)	JD421 [1] JD420 [E]	JN997 [4] →01/00 JM5131 (Elastomer) 01/00→	JJ565	NA5053 [2] 30.00x42.00x7.00mm, FPM NF856 [2] 32.00x44.00x6.00mm, FPM	
HBS241 [5] M9x1.25x103.00mm (x10)	JD421 [1] JD420 [E]	JN997 [4] →01/00 JM5131 (Elastomer) 01/00→	JJ565	NA5053 [2] 30.00x42.00x7.00mm, FPM NF856 [2] 32.00x44.00x6.00mm, FPM	
HBS241 [5] M9x1.25x103.00mm (x10)	JD421 [1] JD420 [E]	JN997 [4] →01/00 JM5131 (Elastomer) 01/00→	JJ565	NA5053 [2] 30.00x42.00x7.00mm, FPM NF856 [2] 32.00x44.00x6.00mm, FPM	
HBS241 [5] M9x1.25x103.00mm (x10) 03/98→	JD421 [1] 03/98→ JD420 [E] 03/98→	JN997 [4] 03/98→01/00 JM5131 (Elastomer) 01/00→	PA349 22.00x16.00x2.000mm JJ565 03/98→	NA5053 [2] 30.00x42.00x7.00mm, FPM 03/98→ NA5322 [2] 32.00x44.00x6.00mm, ACM 03/98→ NF856 [2] 32.00x44.00x6.00mm, FPM 03/98→	NF791 [2] [53]
HBS241 [5] M9x1.25x103.00mm (x10)	JD421 [1] JD420 [E]	JN997 [4] →01/00 JM5131 (Elastomer) 01/00→	JJ565	NA5053 [2] 30.00x42.00x7.00mm, FPM NF856 [2] 32.00x44.00x6.00mm, FPM	
HBS241 [5] M9x1.25x103.00mm (x10)	JD421 [1] JD420 [E]	JN997 [4] →01/00 JM5131 (Elastomer) 01/00→	JJ565 PA349 22.00x16.00x2.000mm	NA5053 [2] 30.00x42.00x7.00mm, FPM NF856 [2] 32.00x44.00x6.00mm, FPM	NF791 [2] [53]
HBS241 [5] M9x1.25x103.00mm (x10)	JD421 [1] JD420 [E]	JN997 [4] →01/00 JM5131 (Elastomer) 01/00→	JJ565 PA349 22.00x16.00x2.000mm	NA5053 [2] 30.00x42.00x7.00mm, FPM NF856 [2] 32.00x44.00x6.00mm, FPM	NF791 [2] [53]
HBS241 [5] M9x1.25x103.00mm (x10)	JD421 [1] JD420 [E]	JN997 [4] →01/00 JM5131 (Elastomer) 01/00→	JJ565 PA349 22.00x16.00x2.000mm	NA5053 [2] 30.00x42.00x7.00mm, FPM NA5322 [2] 32.00x44.00x6.00mm, ACM NF856 [2] 32.00x44.00x6.00mm, FPM	
HBS241 [5] M9x1.25x103.00mm (x10)	JD421 [1] JD420 [E]	JN997 [4] →01/00 JM5131 (Elastomer) 01/00→	JJ565 PA349 22.00x16.00x2.000mm	NA5053 [2] 30.00x42.00x7.00mm, FPM NF856 [2] 32.00x44.00x6.00mm, FPM	NF791 [2] [53]

RENAULT



cc



kW/PS



1.1	D7F 746	50	BX630 (Fibre)	DX630	EA140 [3] EG7950				
Clio 2 1.2	09/98→10/03	1149	4	69.00	SOHC/OHC	43/58			
Clio 2 Van 1.2	09/98→								
Kangoo 1.2	08/97→								
Thalia 1.2	02/98→10/03								
1.1	D7F 764	51	BX630 (Fibre)	DX630	EA140 [3]				
Clio 2 1.2	09/98→	1149	4	69.00	SOHC/OHC	43/58			
Clio 2 1.2 LPG	09/98→06/09								
Kangoo 1.2	07/98→07/01								
1.1	D7F 766	52	BX630 (Fibre)	DX630	EA140 [3]				
Clio 2 1.2	09/98→	1149	4	69.00	SOHC/OHC	43/58			
Clio 2 1.2 LPG	09/98→06/09								
Kangoo 1.2	07/98→07/01								
1.1	D7F 800	53	BX630 (Fibre)	DX630	EA140 [3]				
Twingo 1.2	03/07→	1149	4	69.00	SOHC/OHC	43/58			
1.2	C1G 700	54	BH690 (Fibre), 1.200mm	DH687 [13] DH690 ○ [13] DH693 ○ [13]					
9 1.2	09/85→12/88	1237	4	71.50	OHV	40/54			
11 1.2	10/84→12/88								
11 Van 1.2	10/84→12/88								
1.2	C1G 702	55	BH690 (Fibre), 1.200mm	DH687 [13] DH690 ○ [13] DH693 ○ [13]					
Super 5 1.2	01/87→12/96	1237	4	71.50	OHV	40-44/ 54-60			
1.2	C1G 710	56	BH690 (Fibre), 1.200mm	DH687 [13] DH690 ○ [13] DH693 ○ [13]					
9 1.2	09/85→12/88	1237	4	71.50	OHV	40/55			
11 1.2	10/84→12/88								
11 Van 1.2	10/84→12/88								
1.2	C1G 720	57	BH690 (Fibre), 1.200mm	DH687 [13] DH690 ○ [13] DH693 ○ [13]					
Super 5 1.2	01/87→08/90	1237	4	71.50	OHV	40/54			
1.2	C1G 722	58	BH690 (Fibre), 1.200mm	DH687 [13] DH690 ○ [13] DH693 ○ [13]					
Super 5 1.2	01/87→08/90	1237	4	71.50	OHV	40/54			
1.2	C1G 726	59	BH690 (Fibre), 1.200mm	DH687 [13] DH690 ○ [13] DH693 ○ [13]					
Express 1.2	09/91→08/93	1237	4	71.50	OHV	40/54			
1.2	C1G 730	60	BH690 (Fibre), 1.200mm	DH687 [13] DH690 ○ [13] DH693 ○ [13]					
19 1.2	01/88→12/95	1237	4	71.50	OHV	40/54			
19 Van 1.2	01/88→12/95								
1.2	C3G 700	61	BV190 (Fibre), 1.250mm BX740 (Fibre), 1.750mm	DV190 ▲ DX651	EV190 [3][14]				
Twingo 1.2	03/93→10/96	1239	4	74.00	OHV	40/55			
Twingo Van 1.2	03/93→05/96								

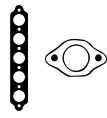

BH690



BV190, BX740



BX630



JC669



JD231



JD420



JD421



JN600

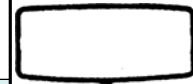

JN936

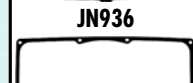

JN997



JJ565

HBS241 [5] M9x1.25x103.00mm (x10)	JD421 [1] JD420 [2]	JN997 [4] →01/00 JM5131 (Elastomer) 01/00→	JJ565 =PA349 22.00x16.00x2.000mm		NA5053 [2] 30.00x42.00x7.00mm, FPM NF856 [2] 32.00x44.00x6.00mm, FPM	NF791 [2] [53]
HBS241 [5] M9x1.25x103.00mm (x10)	JD421 [1] JD420 [2]	JN997 [4] →01/00 JM5131 (Elastomer) 01/00→	JJ565		NA5053 [2] 30.00x42.00x7.00mm, FPM NF856 [2] 32.00x44.00x6.00mm, FPM	
HBS241 [5] M9x1.25x103.00mm (x10)	JD421 [1] JD420 [2]	JN997 [4] →01/00 JM5131 (Elastomer) 01/00→	JJ565		NA5053 [2] 30.00x42.00x7.00mm, FPM NF856 [2] 32.00x44.00x6.00mm, FPM	
HBS241 [5] M9x1.25x103.00mm (x10)	JD421 [1] JD420 [2]	JM5131 (Elastomer)	JJ565		NA5053 [2] 30.00x42.00x7.00mm, FPM NF856 [2] 32.00x44.00x6.00mm, FPM	
HBS104 [22] M10x1.50x100.00mm (x10)	JC669	JN600 [4]		HR646 [2]	NF835 [1] 80.00x100.00x8.00mm, FPM/ACM NF722 [2] 35.00x50.00x10.00mm, MVQ	
HBS104 [22] M10x1.50x100.00mm (x10)	JC669	JN600 [4]		HR646 [2]	NF835 [1] 80.00x100.00x8.00mm, FPM/ACM NF722 [2] 35.00x50.00x10.00mm, MVQ	
HBS104 [22] M10x1.50x100.00mm (x10)	JC669	JN600 [4]		HR646 [2]	NF835 [1] 80.00x100.00x8.00mm, FPM/ACM NF722 [2] 35.00x50.00x10.00mm, MVQ	
HBS104 [22] M10x1.50x100.00mm (x10)	JC669	JN600 [4]		HR646 [2]	NF835 [1] 80.00x100.00x8.00mm, FPM/ACM NF722 [2] 35.00x50.00x10.00mm, MVQ	
HBS104 [22] M10x1.50x100.00mm (x10)	JC669	JN600 [4]		HR646 [2]	NF835 [1] 80.00x100.00x8.00mm, FPM/ACM NF722 [2] 35.00x50.00x10.00mm, MVQ	
HBS104 [22] M10x1.50x100.00mm (x10)	JC669	JN600 [4]		HR646 [2]	NF835 [1] 80.00x100.00x8.00mm, FPM/ACM NF722 [2] 35.00x50.00x10.00mm, MVQ	
HBS104 [22] M10x1.50x100.00mm (x10)	JC669	JN600 [4]		HR646 [2]	NF835 [1] 80.00x100.00x8.00mm, FPM/ACM NF722 [2] 35.00x50.00x10.00mm, MVQ	
HBS104 [22] M10x1.50x100.00mm (x10)	JD231	JN936 [4]		HR599 [2] HR643 [2]	NF835 [1] 80.00x100.00x8.00mm, FPM/ACM NF722 [2] 35.00x50.00x10.00mm, MVQ	



cc



kW/PS

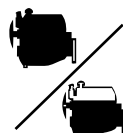

1.2	C3G 702	62	BV190 (Fibre), 1.250mm		DV190 ▲	EV190 [3][14]						
Twingo 1.2	03/93→10/96	1239	4	74.00	OHV	40/55	10/94→	BX740 (Fibre), 1.750mm	10/94→	DX651	10/94→	
Twingo Van 1.2	03/93→05/96											
1.2	C3G 710	63	BV190 (Fibre), 1.250mm		DV190 ▲	EV190 [3][14]						
Express Van 1.2	09/91→03/98	1239	4	74.00	OHV	40/55		BX740 (Fibre), 1.750mm		DX651		
1.2	C3G 712	64	BV190 (Fibre), 1.250mm		DV190 ▲	EV190 [3][14]						
Express Van 1.2	09/91→03/98	1239	4	74.00	OHV	40/55		BX740 (Fibre), 1.750mm		DX651		
1.2	C3G 720	65	BV190 (Fibre), 1.250mm		DV190 ▲	EV190 [3][14]						
Clio 1.2	06/94→02/98	1239	4	74.00	OHV	40/54	01/96→12/96	BX740 (Fibre), 1.750mm	01/96→12/96	DX651	01/96→12/96	
1.2	E5F 710	66	BX720 (Fibre), 1.350mm		DX720 [3]	ES580 [3][14]						
Clio 1.2	05/90→03/96	1171	4	75.80	SOHC/OHC	40-44/ 55-60		BX730 (Fibre), 1.750mm				
1.2	E7F 700	67	BX720 (Fibre), 1.350mm		DX720 [3]	ES580 [3][14]						
Clio 1.2	05/90→09/98	1171	4	75.80	SOHC/OHC	43-44/ 58-60		BX730 (Fibre), 1.750mm				
1.2	E7F 706	68	BX720 (Fibre), 1.350mm		DX720 [3]	ES580 [3][14]						
Clio 1.2	01/91→06/96	1171	4	75.80	SOHC/OHC	40-43/ 54-58		BX730 (Fibre), 1.750mm				
Clio Van 1.2	01/91→09/98											
1.2	E7F 708	69	BX720 (Fibre), 1.350mm		DX720 [3]	ES580 [3][14]						
Clio 1.2	05/90→09/98	1171	4	75.80	SOHC/OHC	43-48/ 58-65		BX730 (Fibre), 1.750mm				
Express 1.2	05/95→11/98											
1.2	E7F 730	70	BX720 (Fibre), 1.350mm		DX720 [3]	ES580 [3][14]						
19 1.2	05/92→09/94	1171	4	75.80	SOHC/OHC	44-46/ 60-63		BX730 (Fibre), 1.750mm				



BV190, BX740



BX720



BX730



JC955



JC956



JD231

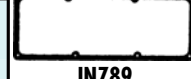

JN789

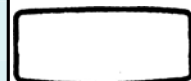

JR635



JN936



JJ407



cc



kW/PS



1.2	E7F 750						71	BX720 (Fibre), 1.350mm 01/94→ BX730 (Fibre), 1.750mm 01/94→	DX720 [3] 01/94→	ES580 [3][14] 01/94→
Clio 1.2 Clio Van 1.2	05/90→09/98 01/91→09/98	1171	4	75.80	SOHC/OHC	43-44/ 58-60				
1.4	840 730						72	BF730 (Fibre), 1.400mm	DF731 ○ [13]	EF731 [3][14]
Super 5 1.4T GT	01/85→05/91	1397	4	76.00	OHV	118/160				
1.4	847 700						73	BH690 (Fibre), 1.200mm	DH690 ○ [13]	
Trafic 1.4	03/80→04/89	1397	4	76.00	OHV	35/48				
1.4	847 701						74	BH690 (Fibre), 1.200mm	DH690 ○ [13]	
Trafic 1.4	03/80→04/89	1397	4	76.00	OHV	35/48				
1.4	C1J 700						75	BH690 (Fibre), 1.200mm	DH690 ○ [13]	EH694 [3][14] GH690 ○ [14][16] GH691 ○ [3][14]
Trafic 1.4	03/80→06/91	1397	4	76.00	OHV	35-36/ 48-50				
1.4	C1J 715						76	BH690 (Fibre), 1.200mm	DH687 [13] DH690 ○ [13] DH692 ○ [13] DH693 ○ [13]	EH680
9 1.4 11 1.4	12/81→12/88 03/83→12/88	1397	4	76.00	OHV	44/60				
1.4	C1J 742						77	BH690 (Fibre), 1.200mm	DH687 [13] DH690 ○ [13] DH692 ○ [13] DH693 ○ [13]	EH680
19 1.4	05/92→09/94	1397	4	76.00	OHV	43-44/ 58-60				
1.4	C1J 760						78	BN360 (Fibre), 1.900mm	DN360 ○ [13] DN361 ▲ ○ [13]	EH682 [3][14]
9 1.4 T	12/86→12/89	1397	4	76.00	OHV	77/105				
1.4	C1J 764						79	BN360 (Fibre), 1.900mm	DN360 ○ [13] DN361 ▲ ○ [13]	EH682 [3][14]
9 1.4 T	12/86→12/89	1397	4	76.00	OHV	77-87/ 105-118				

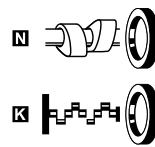
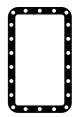
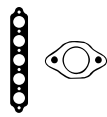

HBS102 [22]
M10x1.50x113.00mm (x5)
01/94→

JC956 [1]
01/94→
JC955 [1]
01/94→

JN789 [4]
01/94→

PA349
22.00x16.00x2.000mm
JJ407
01/94→

HR599 [5]
01/94→
HR646 [5]
01/94→

NA5016
35.00x47.00x7.00mm, FPM/ACM
01/94→
NA5053 [2]
30.00x42.00x7.00mm, FPM
01/94→
NA5016 [2]
35.00x47.00x7.00mm, FPM/ACM
01/94→
NF835 [1]
80.00x100.00x8.00mm, FPM/ACM
01/94→

HR658 [55] [5]



BF730

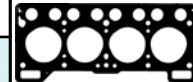

BH690



BN360



BX720



BX730



JB851

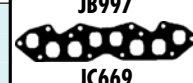

JB997



JC669

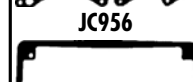

JC955

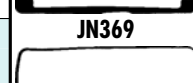

JC956

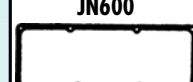

JN369

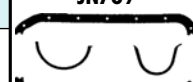

JN600



JN789



HC354

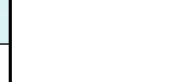

JJ407

HBS104 [22]
M10x1.50x100.00mm (x10)

JB851

JN369 [4]

HC354 [5]
KJ647
18.30x24.00x2.000mm

HR564 [55] [5]

NF535 [1]
30.00x42.00x8.00mm, NBR
NF834 [2]
35.00x50.00x8.00mm, FPM
NF835 [1]
80.00x100.00x8.00mm, FPM/ACM

HR564 [55] [5]
KA533 [15]
JR635 [6]

HBS104 [22]
M10x1.50x100.00mm (x10)

JB851

JN600 [4]

HC354 [5]

HR643 [5]

NF535 [1]
30.00x42.00x8.00mm, NBR
NF722 [2]
35.00x50.00x10.00mm, MVQ
NF634 [1]
80.00x100.00x13.00mm, MVQ

HBS104 [22]
M10x1.50x100.00mm (x10)

JB851

JN600 [4]

HC354 [5]

HR643 [5]

NF535 [1]
30.00x42.00x8.00mm, NBR
NF722 [2]
35.00x50.00x10.00mm, MVQ
NF634 [1]
80.00x100.00x13.00mm, MVQ

HBS104 [22]
M10x1.50x100.00mm (x10)

JB997

JN600 [4]

HC354 [5]
PA349
22.00x16.00x2.000mm

HR646 [5]

NF834 [2]
35.00x50.00x8.00mm, FPM
NF835 [1]
80.00x100.00x8.00mm, FPM/ACM
NF722 [2]
35.00x50.00x10.00mm, MVQ
NF634 [1]
80.00x100.00x13.00mm, MVQ

HR564 [55] [5]

HBS104 [22]
M10x1.50x100.00mm (x10)

JC669

JN600 [4]

HC354 [5]
HC486 [5]

HR646 [5]

NF835 [1]
80.00x100.00x8.00mm, FPM/ACM
NF722 [2]
35.00x50.00x10.00mm, MVQ

HBS104 [22]
M10x1.50x100.00mm (x10)

JC669

JN600 [4]

HC486 [5]

HR646 [5]

NF834 [2]
35.00x50.00x8.00mm, FPM
NF835 [1]
80.00x100.00x8.00mm, FPM/ACM
NF722 [2]
35.00x50.00x10.00mm, MVQ
NF634 [1]
80.00x100.00x13.00mm, MVQ

HBS104 [22]
M10x1.50x100.00mm (x10)

JC669

JN600 [4]

HC486 [5]
PA349
22.00x16.00x2.000mm

HR564 [55] [5]

NF834 [2]
35.00x50.00x8.00mm, FPM
NF835 [1]
80.00x100.00x8.00mm, FPM/ACM

HR564 [55] [5]
NF791 [2] [53]

HBS104 [22]
M10x1.50x100.00mm (x10)

JC669

JN600 [4]

HC486 [5]
PA349
22.00x16.00x2.000mm

HR564 [55] [5]

NF834 [2]
35.00x50.00x8.00mm, FPM
NF835 [1]
80.00x100.00x8.00mm, FPM/ACM

HR564 [55] [5]
NF791 [2] [53]



cc



kW/PS



1.4	C1J 768	80	BH690 (Fibre), 1.200mm	DH687 [13] DH690 ○ [13] DH692 ○ [13] DH693 ○ [13]	EH680
Express Van 1.4 Super 5 1.4	07/85→08/91 10/84→06/88	1397 4 76.00 OHV	43-44/ 58-60		
1.4	C1J 770	81	BN360 (Fibre), 1.900mm	DN360 ○ [13] DN361 ▲ ○ [13]	
11 1.4 Turbo	10/86→12/88	1397 4 76.00 OHV	85/115		
1.4	C1J 780	82	BH690 (Fibre), 1.200mm	DH687 [13] DH690 ○ [13] DH692 ○ [13] DH693 ○ [13]	EH680
Express Van 1.4 Super 5 1.4	07/85→08/91 10/84→06/88	1397 4 76.00 OHV	43/58		
1.4	C1J 782	83	BN360 (Fibre), 1.900mm	DN360 ○ [13] 10/86→ DN361 ▲ ○ [13] 10/86→	
11 1.4 Turbo Super 5 1.4T	10/86→12/88 04/85→08/90	1397 4 76.00 OHV	85-88/ 115-120	10/86→	
1.4	C1J 784	84	BN360 (Fibre), 1.900mm	DN360 ○ [13] 07/86→ DN361 ▲ ○ [13] 07/86→	
Super 5 1.4T	04/85→08/90	1397 4 76.00 OHV	85-88/ 115-120	07/86→	
1.4	C1J 788	85	BN360 (Fibre), 1.900mm	DN360 ○ [13] 06/87→ DN361 ▲ ○ [13] 06/87→	
Super 5 1.4T	04/85→08/90	1397 4 76.00 OHV	85-88/ 115-120	06/87→	
1.4	C1J 792	86	BH690 (Fibre), 1.200mm	DH687 [13] DH690 ○ [13] DH692 ○ [13] DH693 ○ [13]	EH680
9 1.4	12/81→12/88	1397 4 76.00 OHV	44/60		
1.4	C1J 796	87	BH690 (Fibre), 1.200mm	DH687 [13] DH690 ○ [13] DH692 ○ [13] DH693 ○ [13]	EH680
9 1.4	12/81→12/88	1397 4 76.00 OHV	44/60		
1.4	C2J 700	88	BH690 (Fibre), 1.200mm	DH690 ○ [13] 06/87→	EH680 06/87→
Super 5 1.4	10/84→07/89	1397 4 76.00 OHV	52-53/ 71-72	06/87→	
1.4	C2J 720	89	BH690 (Fibre), 1.200mm	DH687 [13] 10/86→11/87 DH690 ○ [13] 10/86→11/87 DH692 ○ [13] 10/86→11/87 DH693 ○ [13] 10/86→11/87	EH680 10/86→11/87
9 1.4 11 1.4	09/85→12/88 03/83→12/88	1397 4 76.00 OHV	43-49/ 58-67	10/86→11/87	
1.4	C2J 730	90	BH690 (Fibre), 1.200mm	DH687 [13] 10/86→ DH690 ○ [13] 10/86→ DH692 ○ [13] 10/86→ DH693 ○ [13] 10/86→	EH680 10/86→
9 1.4 11 1.4	12/81→12/88 03/83→12/88	1397 4 76.00 OHV	44/60	10/86→	

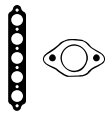

BH690



BN360

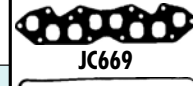

JC669

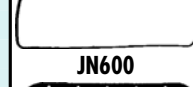

JN600



HC354

HBS104 [22] M10x1.50x100.00mm (x10)	JC669	JN600 [4]	HC486 [5]	HR646 [5]	NF835 [1] 80.00x100.00x8.00mm, FPM/ACM NF722 [2] 35.00x50.00x10.00mm, MVQ	
HBS104 [22] M10x1.50x100.00mm (x10)	JC669	JN600 [4]			NF835 [1] 80.00x100.00x8.00mm, FPM/ACM NF722 [2] 35.00x50.00x10.00mm, MVQ	
HBS104 [22] M10x1.50x100.00mm (x10)	JC669	JN600 [4]	HC354 [5] HC486 [5]	HR646 [5]	NF835 [1] 80.00x100.00x8.00mm, FPM/ACM NF722 [2] 35.00x50.00x10.00mm, MVQ	
HBS104 [22] M10x1.50x100.00mm (x10) 10/86→	JC669 10/86→	JN600 [4] 10/86→			NF835 [1] 80.00x100.00x8.00mm, FPM/ACM 10/86→ NF722 [2] 35.00x50.00x10.00mm, MVQ 10/86→	
HBS104 [22] M10x1.50x100.00mm (x10) 07/86→	JC669 07/86→	JN600 [4] 07/86→			NF835 [1] 80.00x100.00x8.00mm, FPM/ACM 07/86→ NF722 [2] 35.00x50.00x10.00mm, MVQ 07/86→	
HBS104 [22] M10x1.50x100.00mm (x10) 06/87→	JC669 06/87→	JN600 [4] 06/87→			NF835 [1] 80.00x100.00x8.00mm, FPM/ACM 06/87→ NF722 [2] 35.00x50.00x10.00mm, MVQ 06/87→	
HBS104 [22] M10x1.50x100.00mm (x10)	JC669	JN600 [4]		HR646 [5]	NF835 [1] 80.00x100.00x8.00mm, FPM/ACM NF722 [2] 35.00x50.00x10.00mm, MVQ	
HBS104 [22] M10x1.50x100.00mm (x10)	JC669	JN600 [4]		HR646 [5]	NF835 [1] 80.00x100.00x8.00mm, FPM/ACM NF722 [2] 35.00x50.00x10.00mm, MVQ	
HBS104 [22] M10x1.50x100.00mm (x10) 06/87→	JC669 06/87→	JN600 [4] 06/87→	HC354 [5] 06/87→ HC486 [5] 06/87→	HR646 [5] 06/87→	NF835 [1] 80.00x100.00x8.00mm, FPM/ACM 06/87→ NF722 [2] 35.00x50.00x10.00mm, MVQ 06/87→	
HBS104 [22] M10x1.50x100.00mm (x10) 10/86→11/87	JC669 10/86→11/87	JN600 [4] 10/86→11/87		HR646 [5] 10/86→11/87	NF835 [1] 80.00x100.00x8.00mm, FPM/ACM 10/86→11/87 NF722 [2] 35.00x50.00x10.00mm, MVQ 10/86→11/87	
HBS104 [22] M10x1.50x100.00mm (x10) 10/86→	JC669 10/86→	JN600 [4] 10/86→		HR646 [5] 10/86→	NF835 [1] 80.00x100.00x8.00mm, FPM/ACM 10/86→ NF722 [2] 35.00x50.00x10.00mm, MVQ 10/86→	



cc



kW/PS



1.4		C2J 766					91	BH690 (Fibre), 1.200mm	DH687 [13]	EH680
9 1.4	09/85→12/88	1397	4	76.00	OHV	49/67	10/84→	10/84→	EH680	
11 1.4	03/83→12/88							DH690 ○ [13]		
								10/84→		
								DH692 ○ [13]		
								10/84→		
								DH693 ○ [13]		
								10/84→		
1.4		C2J 767					92	BH690 (Fibre), 1.200mm	DH687 [13]	EH680
9 1.4	09/85→12/88	1397	4	76.00	OHV	49/67	10/84→	10/84→	EH680	
11 1.4	03/83→12/88							DH690 ○ [13]		
								10/84→		
								DH692 ○ [13]		
								10/84→		
								DH693 ○ [13]		
								10/84→		
1.4		C2J 768					93	BH690 (Fibre), 1.200mm	DH687 [13]	EH680
9 1.4	09/85→12/88	1397	4	76.00	OHV	49-50/ 67-68	10/85→	10/85→	EH680	
11 1.4	03/83→12/88							DH690 ○ [13]		
								10/85→		
								DH692 ○ [13]		
								10/85→		
								DH693 ○ [13]		
								10/85→		
1.4		C2J 770					94	BH690 (Fibre), 1.200mm	DH687 [13]	EH680
21 1.4	06/88→10/93	1397	4	76.00	OHV	51/69		10/85→	EH680	
								DH690 ○ [13]		
								DH692 ○ [13]		
								DH693 ○ [13]		
1.4		C2J 772					95	BH690 (Fibre), 1.200mm	DH687 [13]	EH680
19 1.4	07/88→09/94	1397	4	76.00	OHV	43-44/ 58-60	01/89→12/89	01/89→12/89	EH680	
								DH690 ○ [13]		
								01/89→12/89		
								DH692 ○ [13]		
								01/89→12/89		
								DH693 ○ [13]		
								01/89→12/89		
1.4		C2J 780					96	BH690 (Fibre), 1.200mm	DH690 ○ [13]	EH680
Super 5 1.4	10/84→07/89	1397	4	76.00	OHV	52-53/ 71-72			EH680	
1.4		C2J 781					97	BH690 (Fibre), 1.200mm	DH690 ○ [13]	EH680
Super 5 1.4	10/84→07/89	1397	4	76.00	OHV	52-53/ 71-72			EH680	

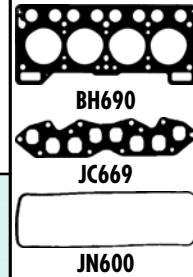
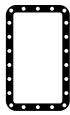
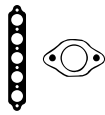

HBS104 [22] M10x1.50x100.00mm (x10) 10/84→	JC669 10/84→	JN600 [4] 10/84→		HR646 [5] 10/84→	NF835 [1] 80.00x100.00x8.00mm, FPM/ACM 10/84→ NF722 [2] 35.00x50.00x10.00mm, MVQ 10/84→	
HBS104 [22] M10x1.50x100.00mm (x10) 10/84→	JC669 10/84→	JN600 [4] 10/84→		HR646 [5] 10/84→	NF835 [1] 80.00x100.00x8.00mm, FPM/ACM 10/84→ NF722 [2] 35.00x50.00x10.00mm, MVQ 10/84→	
HBS104 [22] M10x1.50x100.00mm (x10) 10/85→	JC669 10/85→	JN600 [4] 10/85→	PA349 22.00x16.00x2.000mm HC486 [5] 10/85→	HR646 [5] 10/85→	NF834 [2] 35.00x50.00x8.00mm, FPM 10/85→ NF835 [1] 80.00x100.00x8.00mm, FPM/ACM 10/85→ NF722 [2] 35.00x50.00x10.00mm, MVQ 10/85→	HR564 [55] [5] LT839 [15] JR635 [6] 10/85→
HBS104 [22] M10x1.50x100.00mm (x10)	JC669	JN600 [4]	HC486 [5] PA349 22.00x16.00x2.000mm	HR646 [5]	NF834 [2] 35.00x50.00x8.00mm, FPM NF835 [1] 80.00x100.00x8.00mm, FPM/ACM NF722 [2] 35.00x50.00x10.00mm, MVQ NF634 [1] (x1) 80.00x100.00x13.00mm, MVQ	HR564 [55] [5] LT839 [15] JR635 [6]
HBS104 [22] M10x1.50x100.00mm (x10) 01/89→12/89	JC669 01/89→12/89	JN600 [4] 01/89→12/89	PA349 22.00x16.00x2.000mm HC486 [5] 01/89→12/89	HR646 [5] 01/89→12/89	NF834 [2] 35.00x50.00x8.00mm, FPM 01/89→12/89 NF835 [1] 80.00x100.00x8.00mm, FPM/ACM 01/89→12/89 NF722 [2] 35.00x50.00x10.00mm, MVQ 01/89→12/89 NF634 [1] 80.00x100.00x13.00mm, MVQ 01/89→12/89	HR564 [55] [5] LT839 [15] JR635 [6] 01/89→12/89
HBS104 [22] M10x1.50x100.00mm (x10)	JC669	JN600 [4]			NF835 [1] 80.00x100.00x8.00mm, FPM/ACM NF722 [2] 35.00x50.00x10.00mm, MVQ	
HBS104 [22] M10x1.50x100.00mm (x10)	JC669	JN600 [4]			NF835 [1] 80.00x100.00x8.00mm, FPM/ACM NF722 [2] 35.00x50.00x10.00mm, MVQ	

RENAULT



cc



kW/PS



1.4	C2J 782	1397	4	76.00	OHV	98	BH690 (Fibre), 1.200mm	DH687 [13] 07/87→ DH690 ○ [13] 07/87→ DH692 ○ [13] 07/87→ DH693 ○ [13] 07/87→	EH680 07/87→
Super 5 1.4	06/87→07/89					49/67	07/87→		
1.4	C2J 784	1397	4	76.00	OHV	99	BH690 (Fibre), 1.200mm	DH687 [13] DH690 ○ [13] DH692 ○ [13] DH693 ○ [13]	EH680
Express Van 1.4	03/86→08/91					44/60			
Super 5 1.4	06/87→08/90								
1.4	C2J 788	1397	4	76.00	OHV	100	BH690 (Fibre), 1.200mm	DH690 ○ [13]	EH680
Super 5 1.4	10/84→07/89					52-53/ 71-72			
1.4	C2J 789	1397	4	76.00	OHV	101	BH690 (Fibre), 1.200mm	DH690 ○ [13]	EH680
Super 5 1.4	10/84→07/89					52-53/ 71-72			
1.4	C2J 798	1397	4	76.00	OHV	102	BH690 (Fibre), 1.200mm	DH690 ○ [13] 06/86→06/89	EH680 06/86→06/89
Super 5 1.4	10/84→07/89					52-53/ 71-72	06/86→06/89		
1.4	C3J 700	1397	4	76.00	OHV	103	BH690 (Fibre), 1.200mm	DH687 [13] DH690 ○ [13] DH692 ○ [13] DH693 ○ [13]	EH680
Express Van 1.4	08/88→03/98					43-44/ 58-60			
Super 5 1.4	10/85→12/96								
1.4	C3J 702	1397	4	76.00	OHV	104	BH690 (Fibre), 1.200mm	DH687 [13] 08/88→ DH690 ○ [13] 08/88→ DH692 ○ [13] 08/88→ DH693 ○ [13] 08/88→	EH680 08/88→
Express Van 1.4	08/88→03/98					43-44/ 58-60	08/88→		
Super 5 1.4	10/85→12/96								
1.4	C3J 710	1397	4	76.00	OHV	105	BH690 (Fibre), 1.200mm	DH687 [13] 01/89→ DH690 ○ [13] 01/89→ DH692 ○ [13] 01/89→ DH693 ○ [13] 01/89→	EH680 01/89→
19 1.4	07/88→09/94					43-44/ 58-60	01/89→		
19 1.4 (532)	04/92→12/95								
19 1.4 CAT	01/89→04/92								
19 0 303	04/92→12/95								

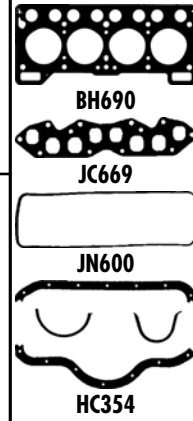
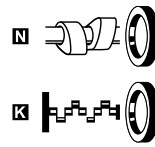

HBS104 [22] M10x1.50x100.00mm (x10) 07/87→	JC669 07/87→	JN600 [4] 07/87→	PA349 22.00x16.00x2.000mm HC486 07/87→	HR646 [5] 07/87→	NF834 [2] 35.00x50.00x8.00mm, FPM 07/87→ NF835 [1] 80.00x100.00x8.00mm, FPM/ACM 07/87→ NF722 [2] 35.00x50.00x10.00mm, MVQ 07/87→	HR564 [55] [5] JR635 [6] 07/87→
HBS104 [22] M10x1.50x100.00mm (x10)	JC669	JN600 [4]	HC486 [5] PA349 22.00x16.00x2.000mm	HR646 [5]	NF834 [2] 35.00x50.00x8.00mm, FPM NF835 [1] 80.00x100.00x8.00mm, FPM/ACM NF722 [2] 35.00x50.00x10.00mm, MVQ	HR564 [55] [5] LT839 [15] JR635 [6]
HBS104 [22] M10x1.50x100.00mm (x10)	JC669	JN600 [4]			NF835 [1] 80.00x100.00x8.00mm, FPM/ACM NF722 [2] 35.00x50.00x10.00mm, MVQ	
HBS104 [22] M10x1.50x100.00mm (x10)	JC669	JN600 [4]			NF835 [1] 80.00x100.00x8.00mm, FPM/ACM NF722 [2] 35.00x50.00x10.00mm, MVQ	
HBS104 [22] M10x1.50x100.00mm (x10) 06/86→06/89	JC669 06/86→06/89	JN600 [4] 06/86→06/89			NF835 [1] 80.00x100.00x8.00mm, FPM/ACM 06/86→06/89 NF722 [2] 35.00x50.00x10.00mm, MVQ 06/86→06/89	
HBS104 [22] M10x1.50x100.00mm (x10)	JC669	JN600 [4]	HC354 [5] HC486 [5]	HR646 [5]	NF835 [1] 80.00x100.00x8.00mm, FPM/ACM NF722 [2] 35.00x50.00x10.00mm, MVQ	
HBS104 [22] M10x1.50x100.00mm (x10) 08/88→	JC669 08/88→	JN600 [4] 08/88→	HC354 [5] 08/88→ HC486 [5] 08/88→	HR646 [5] 08/88→	NF835 [1] 80.00x100.00x8.00mm, FPM/ACM 08/88→ NF722 [2] 35.00x50.00x10.00mm, MVQ 08/88→	
HBS104 [22] M10x1.50x100.00mm (x10) 01/89→	JC669 01/89→	JN600 [4] 01/89→	PA349 22.00x16.00x2.000mm HC486 01/89→	HR646 [5] 01/89→	NF834 [2] 35.00x50.00x8.00mm, FPM 01/89→ NF835 [1] 80.00x100.00x8.00mm, FPM/ACM 01/89→ NF722 [2] 35.00x50.00x10.00mm, MVQ 01/89→ NF634 [1] 80.00x100.00x13.00mm, MVQ 01/89→	HR564 [55] [5] LT839 [15] JR635 [6] 01/89→

RENAULT



kW/PS

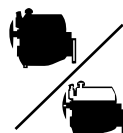

1.4	C3J 760	106					BH690 (Fibre), 1.200mm	DH687 [13]	EH680
Express Van 1.4 Super 5 1.4	08/88→03/98 10/85→12/96	1397	4	76.00	OHV	43-44/ 58-60	→08/91	→08/91 DH690 ○ [13] →08/91 DH692 ○ [13] →08/91 DH693 ○ [13] →08/91	→08/91
1.4	C3J 762	107					BH690 (Fibre), 1.200mm	DH687 [13]	EH680
Express Van 1.4	08/88→03/98	1397	4	76.00	OHV	43-44/ 58-60	09/91→	09/91→ DH690 ○ [13] 09/91→ DH692 ○ [13] 09/91→ DH693 ○ [13] 09/91→	09/91→
1.4	E6J 700	108					BX720 (Fibre), 1.350mm BX730 (Fibre), 1.750mm	DX720 [3]	ES580 [3][14]
19 1.4	01/88→12/95	1390	4	75.80	SOHC/OHC	57-59/ 78-80			
1.4	E6J 701	109					BX720 (Fibre), 1.350mm BX730 (Fibre), 1.750mm	DX720 [3]	ES580 [3][14]
19 1.4	01/88→12/92	1390	4	75.80	SOHC/OHC	57-59/ 78-80			
1.4	E7J 601	110					BX720 (Fibre), 1.350mm BX730 (Fibre), 1.750mm	DX720 [3]	ES580 [3][14]
Clio 1.4	01/91→09/98	1390	4	75.80	SOHC/OHC	58-59/ 80-80			
1.4	E7J 624	111					BX720 (Fibre), 1.350mm BX730 (Fibre), 1.750mm	DX722	EA150
Megane 1.4 Eco	01/96→03/99	1390	4	75.80	SOHC/OHC	52/71			
1.4	E7J 626	112					BX720 (Fibre), 1.350mm BX730 (Fibre), 1.750mm	DX722	EA150
Megane 1.4 Megane 1.4 e	09/96→08/03 01/96→08/03	1390	4	75.80	SOHC/OHC	55/75			
1.4	E7J 634	113					BX720 (Fibre), 1.350mm BX730 (Fibre), 1.750mm		EA150
Kangoo 1.4	08/97→	1390	4	75.80	SOHC/OHC	55/75			

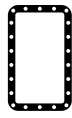
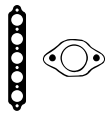

BH690



BX720



BX730



JC669



JC955



JC956

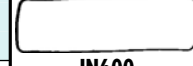

JN600



JN789



HC354



JJ407



cc



kW/PS



1.4	E7J 635	1390	4	75.80	SOHC/OHC	114	BX720 (Fibre), 1.350mm BX730 (Fibre), 1.750mm	EA150
Kangoo 1.4	08/97→					55/75		
1.4	E7J 700	1390	4	75.80	SOHC/OHC	115	BX720 (Fibre), 1.350mm BX730 (Fibre), 1.750mm	DX720 [3]
19 1.4	09/90→04/92					55-59/ 75-80		
1.4	E7J 706	1390	4	75.80	SOHC/OHC, BOXER	116	BX720 (Fibre), 1.350mm BX730 (Fibre), 1.750mm	DX720 [3]
19 1.4	01/92→12/95					55-59/ 75-80		
1.4	E7J 710	1390	4	75.80	SOHC/OHC	117	BX720 (Fibre), 1.350mm BX730 (Fibre), 1.750mm	ES580 [3][14]
Clio 1.4	01/91→09/98					58-59/ 80-80		
1.4	E7J 711	1390	4	75.80	SOHC/OHC	118	BX720 (Fibre), 1.350mm BX730 (Fibre), 1.750mm	ES580 [3][14]
Clio 1.4	01/91→09/98					58-59/ 80-80		
1.4	E7J 718	1390	4	75.80	SOHC/OHC	119	BX720 (Fibre), 1.350mm BX730 (Fibre), 1.750mm	ES580 [3][14]
Clio 1.4	01/91→09/98					58/79		
1.4	E7J 719	1390	4	75.80	SOHC/OHC	120	BX720 (Fibre), 1.350mm BX730 (Fibre), 1.750mm	ES580 [3][14]
Clio 1.4	01/91→09/98					58/79		

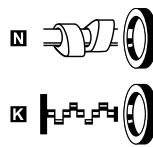
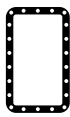
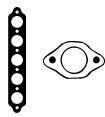

BX720



BX730



JC955



JC956

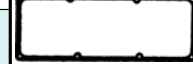

JN789



JJ407

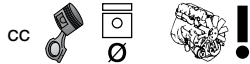

kW/PS

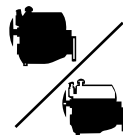

1.4		E7J 720				121	BX720 (Fibre), 1.350mm →09/95		DX720 [3] →09/95
Express 1.4	09/91→08/93	1390	4	75.80	SOHC/OHC	43-59/ 58-80	BX730 (Fibre), 1.750mm →09/95		
Express Van 1.4	09/91→03/98								
1.4		E7J 724				122	BX720 (Fibre), 1.350mm →09/95		DX720 [3] →09/95
Express 1.4	09/91→08/93	1390	4	75.80	SOHC/OHC	54-59/ 73-80	BX730 (Fibre), 1.750mm →09/95		
Express Van 1.4	09/91→03/98								
1.4		E7J 726				123	BX720 (Fibre), 1.350mm →09/95		DX720 [3] →09/95
Express Van 1.4	09/91→03/98	1390	4	75.80	SOHC/OHC	55-59/ 75-80	BX730 (Fibre), 1.750mm →09/95		
1.4		E7J 728				124	BX720 (Fibre), 1.350mm →09/95		DX720 [3] →09/95
Express Van 1.4	01/94→03/98	1390	4	75.80	SOHC/OHC	58-59/ 79-80	BX730 (Fibre), 1.750mm		ES580 [3][14]
1.4		E7J 742				125	BX720 (Fibre), 1.350mm 09/94→		DX720 [3] 09/94→
19 1.4	01/92→12/95	1390	4	75.80	SOHC/OHC	55/75	BX730 (Fibre), 1.750mm 09/94→		ES580 [3][14] 09/94→

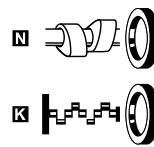
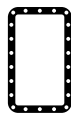
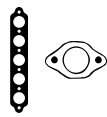

BX720



BX730



JC955



JC956

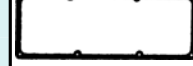

JN789



JJ407

HBS102 [22]
M10x1.50x113.00mm (x5)
→09/95

JC956 [1]
→09/95
JC955 [1]
→09/95

JN789 [4]
→09/95

HR599 [5]
→09/95

NA5016 [2]
35.00x47.00x7.00mm, FPM/ACM
→09/95
NA5053 [2]
30.00x42.00x7.00mm, FPM
→09/95
NA5016 [2]
35.00x47.00x7.00mm, FPM/ACM
→09/95
NF835 [1]
80.00x100.00x8.00mm, FPM/ACM
→09/95

HBS102 [22]
M10x1.50x113.00mm (x5)
→09/95

JC956 [1]
→09/95
JC955 [1]
→09/95

JN789 [4]
→09/95

HR599 [5]
→09/95
HR646 [5]
→09/95

NA5016 [2]
35.00x47.00x7.00mm, FPM/ACM
→09/95
NA5053 [2]
30.00x42.00x7.00mm, FPM
→09/95
NA5016 [2]
35.00x47.00x7.00mm, FPM/ACM
→09/95
NF835 [1]
80.00x100.00x8.00mm, FPM/ACM
→09/95

HBS102 [22]
M10x1.50x113.00mm (x5)
→09/95

JC956 [1]
→09/95
JC955 [1]
→09/95

JN789 [4]
→09/95

HR599 [5]
→09/95
HR646 [5]
→09/95

NA5016 [2]
35.00x47.00x7.00mm, FPM/ACM
→09/95
NA5053 [2]
30.00x42.00x7.00mm, FPM
→09/95
NA5016 [2]
35.00x47.00x7.00mm, FPM/ACM
→09/95
NF835 [1]
80.00x100.00x8.00mm, FPM/ACM
→09/95

HBS102 [22]
M10x1.50x113.00mm (x5)

JC956 [1]
JC955 [1]

JN789 [4]

JJ407
=PA349
22.00x16.00x2.000mm

HR646 [5]

NA5053 [2]
30.00x42.00x7.00mm, FPM
NA5016 [2]
35.00x47.00x7.00mm, FPM/ACM
NF835 [1]
80.00x100.00x8.00mm, FPM/ACM

HR658 [55]

HBS102 [22]
M10x1.50x113.00mm (x5)
09/94→

JC956 [1]
09/94→
JC955 [1]
09/94→

JN789 [4]
09/94→

=PA349
22.00x16.00x2.000mm
JJ407
09/94→

HR646 [5]
09/94→

NA5053 [2]
30.00x42.00x7.00mm, FPM
09/94→
NA5016 [2]
35.00x47.00x7.00mm, FPM/ACM
09/94→
NF835 [1]
80.00x100.00x8.00mm, FPM/ACM
09/94→

HR658 [55]



cc



kW/PS



1.4		E7J 754				126					
Clio 1.4	01/91→09/98	1390	4	75.80	SOHC/OHC	55-59/ 75-80	BX720 (Fibre), 1.350mm 03/94→ BX730 (Fibre), 1.750mm 03/94→	DX720 [3] 03/94→			
1.4		E7J 756				127					
Clio 1.4	01/91→09/98	1390	4	75.80	SOHC/OHC	55/75	BX720 (Fibre), 1.350mm BX730 (Fibre), 1.750mm	DX720 [3]		ES580 [3][14]	
1.4		E7J 757				128					
Clio 1.4	01/91→09/98	1390	4	75.80	SOHC/OHC	55/75	BX720 (Fibre), 1.350mm BX730 (Fibre), 1.750mm	DX720 [3]		ES580 [3][14]	
1.4		E7J 764				129					
Megane 1.4 Megane 1.4 e Megane Scenic	09/96→08/03 01/96→08/03 01/97→09/99	1390	4	75.80	SOHC/OHC	55/75	BX720 (Fibre), 1.350mm BX730 (Fibre), 1.750mm	DX722		EA150	
1.4		E7J 773				130					
Express 1.4 Express Van 1.4	05/95→08/97 09/91→03/98	1390	4	75.80	SOHC/OHC	55-59/ 75-80	BX720 (Fibre), 1.350mm →09/95 BX730 (Fibre), 1.750mm →09/95	DX720 [3] →09/95			
1.4		E7J 780				131					
Clio 2 1.4 Kangoo 1.4	09/98→05/05 08/97→	1390	4	75.80	SOHC/OHC	55/75	BX720 (Fibre), 1.350mm 03/98→ BX730 (Fibre), 1.750mm 03/98→	DX721 03/98→		EA150 03/98→ ES580 [3][14] 03/98→	

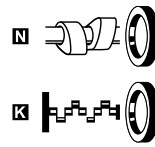
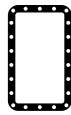
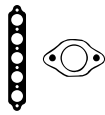

BX720



BX730



JC955



JC956

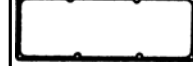

JN789



JJ407



cc



kW/PS

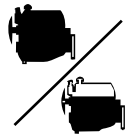

1.4	K4J 710	132	AC5100 (MLS), 1.200mm	CC5100 [3]
Clio 2 1.4 16V	08/00→	1390 4 79.50 DOHC	72/98	
1.4	K4J 711	133	AC5100 (MLS), 1.200mm	CC5100 [3]
Clio 2 1.4 16V	08/00→	1390 4 79.50 DOHC	72/98	
1.4	K4J 712	134	AC5100 (MLS), 1.200mm	CC5100 [3]
Clio 2 1.4 16V Thalia 1.4	10/99→09/04 08/00→	1390 4 79.50 DOHC	70-72/ 95-98	
1.4	K4J 713	135	AC5100 (MLS), 1.200mm	CC5100 [3]
Clio 2 1.4 16V	10/99→09/04	1390 4 79.50 DOHC	70-72/ 95-98	
1.4	K4J 714	136	AC5100 (MLS), 1.200mm	CC5100 [3]
Megane 1.4 16V Scenic 1.4 16V	03/99→08/03 09/99→08/03	1390 4 79.50 DOHC	70/95	
1.4	K4J 730	137	AC5100 (MLS), 1.200mm	CC5100 [3]
Megane 2 1.4 Scenic 2 1.4 16V	11/02→ 06/03→	1390 4 79.50 DOHC	72/98	
1.4	K4J 732	138	AC5100 (MLS), 1.200mm	CC5100 [3]
Megane 2 1.4	09/03→	1390 4 79.50 DOHC	60/82	

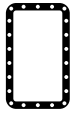
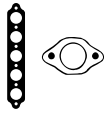

AC5100

HBS301 [22] M10x1.50x117.00mm (x10)	JD5393 JD5893 (FPM) JD5394	HR397	JH5108	PA5013 (x16)	NA5215 [2] 28.00x42.00x5.00mm, FPM NA5016 35.00x47.00x7.00mm, FPM/ACM NA5016 [2] 35.00x47.00x7.00mm, FPM/ACM NF835 [1] 80.00x100.00x8.00mm, FPM/ACM
HBS301 [22] M10x1.50x117.00mm (x10)	JD5393 JD5893 (FPM) JD5394	HR397	JH5108	PA5013 (x16)	NA5215 [2] 28.00x42.00x5.00mm, FPM NA5016 35.00x47.00x7.00mm, FPM/ACM NA5016 [2] 35.00x47.00x7.00mm, FPM/ACM NF835 [1] 80.00x100.00x8.00mm, FPM/ACM
HBS301 [22] M10x1.50x117.00mm (x10)	JD5393 JD5893 (FPM) JD5394	HR397	JH5108	PA5013 (x16)	NA5215 [2] 28.00x42.00x5.00mm, FPM NA5016 35.00x47.00x7.00mm, FPM/ACM NA5016 [2] 35.00x47.00x7.00mm, FPM/ACM NF835 [1] 80.00x100.00x8.00mm, FPM/ACM
HBS301 [22] M10x1.50x117.00mm (x10)	JD5393 JD5893 (FPM) JD5394	HR397	JH5108	PA5013 (x16)	NA5215 [2] 28.00x42.00x5.00mm, FPM NA5016 35.00x47.00x7.00mm, FPM/ACM NA5016 [2] 35.00x47.00x7.00mm, FPM/ACM NF835 [1] 80.00x100.00x8.00mm, FPM/ACM
HBS301 [22] M10x1.50x117.00mm (x10)	JD5393 JD5893 (FPM) JD5394	HR397	JH5108	PA5013 (x16)	NA5215 [2] 28.00x42.00x5.00mm, FPM NA5016 35.00x47.00x7.00mm, FPM/ACM NA5016 [2] 35.00x47.00x7.00mm, FPM/ACM NF835 [1] 80.00x100.00x8.00mm, FPM/ACM
HBS301 [22] M10x1.50x117.00mm (x10)	JD5393 JD5893 (FPM) JD5394	HR397	JH5108	PA5013 (x16)	NA5215 [2] 28.00x42.00x5.00mm, FPM NA5016 35.00x47.00x7.00mm, FPM/ACM NA5016 [2] 35.00x47.00x7.00mm, FPM/ACM NF835 [1] 80.00x100.00x8.00mm, FPM/ACM
HBS301 [22] M10x1.50x117.00mm (x10)	JD5393 JD5893 (FPM) JD5394	HR397	JH5108	PA5013 (x16)	NA5215 [2] 28.00x42.00x5.00mm, FPM NA5016 35.00x47.00x7.00mm, FPM/ACM NA5016 [2] 35.00x47.00x7.00mm, FPM/ACM NF835 [1] 80.00x100.00x8.00mm, FPM/ACM

RENAULT



cc



kW/PS

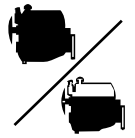

1.4	K4J 740	1390	4	79.50	DOHC	139	AC5100 (MLS), 1.200mm		
Megane 2 1.4 Scenic 2 1.416V	11/02→ 06/03→					72/98			
1.4	K4J 750	1390	4	79.50	DOHC	140	AC5100 (MLS), 1.200mm	CC5100 [3]	
Megane 1.4 16V Scenic 1.4 16V	03/99→08/03 09/99→08/03					70/95			
1.4	K4J 770	1390	4	79.50	DOHC	141	AC5100 (MLS), 1.200mm	CC5100 [3]	
Modus 1.4 Scenic 2 1.416V	12/04→ 06/03→					72/98			
1.4	K4J 780	1390	4	79.50	DOHC	142	AC5100 (MLS), 1.200mm	CC5100 [3]	
Clio 1.4 16V Clio 3 1.4 16V	02/10→ 06/05→					72/98			
1.4	K7J 700	1390	4	75.80	SOHC/OHC	143	BY030 (Fibre)		EA150
Kangoo 1.4 Thalia 1.4	08/97→ 08/00→					55/75			
1.4	K7J 701	1390	4	75.80	SOHC/OHC	144	BY030 (Fibre)		EA150
Kangoo 1.4	08/97→					55/75			
1.4	K7J 710	1390	4	79.50	SOHC/OHC	145	AH5170 (MLS)		
Logan 1.4 Sandero 1.4	09/04→ 02/09→					55/75			

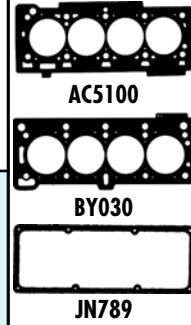

HBS301 [22] M10x1.50x117.00mm (x10)	JD5393 [1] JD5893 [1] (FPM) JD5394 [1]	HR397 [1]		PA5013 (x16)	NA5215 [2] 28.00x42.00x5.00mm, FPM NA5016 35.00x47.00x7.00mm, FPM/ACM NA5016 [2] 35.00x47.00x7.00mm, FPM/ACM NF835 [1] 80.00x100.00x8.00mm, FPM/ACM	
HBS301 [22] M10x1.50x117.00mm (x10)	JD5393 [1] JD5893 [1] (FPM) JD5394 [1]	HR397 [1]	JH5108	PA5013 (x16)	NA5215 [2] 28.00x42.00x5.00mm, FPM NA5016 35.00x47.00x7.00mm, FPM/ACM NA5016 [2] 35.00x47.00x7.00mm, FPM/ACM NF835 [1] 80.00x100.00x8.00mm, FPM/ACM	
HBS301 [22] M10x1.50x117.00mm (x10)	JD5393 [1] JD5893 [1] (FPM) JD5394 [1]	HR397 [1]	JH5108	PA5013 (x16)	NA5215 [2] 28.00x42.00x5.00mm, FPM NA5016 35.00x47.00x7.00mm, FPM/ACM NA5016 [2] 35.00x47.00x7.00mm, FPM/ACM NF835 [1] 80.00x100.00x8.00mm, FPM/ACM	
HBS301 [22] M10x1.50x117.00mm (x10)	JD5393 [1] JD5893 [1] (FPM) JD5394 [1]	HR397 [1]	JH5108	PA5013 (x16)	NA5215 [2] 28.00x42.00x5.00mm, FPM NA5016 35.00x47.00x7.00mm, FPM/ACM NA5016 [2] 35.00x47.00x7.00mm, FPM/ACM NF835 [1] 80.00x100.00x8.00mm, FPM/ACM	
HBS102 [22] M10x1.50x113.00mm (x5)	JD5315 [1] JD418 [1]	JN789 [4]	PA349 22.00x16.00x2.000mm	HR646 [1]	NA5016 35.00x47.00x7.00mm, FPM/ACM NA5053 [2] 30.00x42.00x7.00mm, FPM NA5016 [2] 35.00x47.00x7.00mm, FPM/ACM NF835 [1] 80.00x100.00x8.00mm, FPM/ACM	
HBS102 [22] M10x1.50x113.00mm (x5)	JD5315 [1] JD418 [1]	JN789 [4]	PA349 22.00x16.00x2.000mm	HR646 [1]	NA5016 35.00x47.00x7.00mm, FPM/ACM NA5053 [2] 30.00x42.00x7.00mm, FPM NA5016 [2] 35.00x47.00x7.00mm, FPM/ACM NF835 [1] 80.00x100.00x8.00mm, FPM/ACM	
HBS102 [22] M10x1.50x113.00mm (x5)	JD5315 [1] (x4) JD418 [1]	JN789 [4]		HR646 [1]	NA5016 35.00x47.00x7.00mm, FPM/ACM NA5053 [2] 30.00x42.00x7.00mm, FPM NA5016 [2] 35.00x47.00x7.00mm, FPM/ACM NF835 [1] 80.00x100.00x8.00mm, FPM/ACM	



cc



kW/PS



1.5	K9K 700 Diesel	146	AE5200 (MLS)	CE5200 ▲	EE5200				
Clio 2 1.5 dCi	06/01→	1461	4	76.00	SOHC/OHC	48-50/	→05/04		
Kangoo 1.5 dCi	12/01→					65-68	AG9490 (MLS), 0.75mm [70][71]		
Thalia 1.5dCi	04/02→						05/04→		
1.5	K9K 702 Diesel	147	AE5200 (MLS)	CE5200 ▲	EE5200				
Clio 2 1.5 dCi	06/01→10/04	1461	4	76.00	SOHC/OHC	48-60/	→05/04		
Kangoo 1.5 dCi	12/01→					65-82	AG9490 (MLS), 0.75mm [70][71]		
Thalia 1.5dCi	06/01→						05/04→		
1.5	K9K 704 Diesel	148	AE5200 (MLS)	CE5200 ▲	EE5200				
Clio 2 1.5 dCi	06/01→12/06	1461	4	76.00	SOHC/OHC	42-48/	→05/04		
Kangoo 1.5 dCi	12/01→					57-65	AG9490 (MLS), 0.75mm [70][71]		
							05/04→		
1.5	K9K 710 Diesel	149	AE5200 (MLS)	CE5200 ▲	EE5200				
Clio 2 1.5 dCi	11/03→	1461	4	76.00	SOHC/OHC	60/82	→05/04		
Kangoo 1.5 dCi	07/02→						AG9490 (MLS), 0.75mm [70][71]		
							05/04→		
1.5	K9K 712 Diesel	150	AE5200 (MLS)	CE5200 ▲	EE5200				
Clio 2 1.5 dCi	01/04→	1461	4	76.00	SOHC/OHC	74/100	→05/04		
							AG9490 (MLS), 0.75mm [70][71]		
							05/04→		
1.5	K9K 714 Diesel	151	AE5200 (MLS)	CE5200 ▲	EE5200				
Clio 1.5 dCi	02/08→	1461	4	76.00	SOHC/OHC	50/68	→05/04		
Clio 2 1.5 dCi	04/04→						AG9490 (MLS), 0.75mm [70][71]		
Clio 3 1.5 dCi	06/05→						05/04→		
Kangoo 1.5 dCi	06/05→								
Thalia 1.5dCi	02/03→								
1.5	K9K 716 Diesel	152	AE5200 (MLS)	CE5200 ▲	EE5200				
Clio 2 1.5 dCi	11/03→	1461	4	76.00	SOHC/OHC	60/82	→05/04		
							AG9490 (MLS), 0.75mm [70][71]		
							05/04→		
1.5	K9K 718 Diesel	153	AG9490 (MLS), 0.75mm [70][71]	CE5200 ▲	EE5200				
Clio 2 1.5 dCi	02/07→	1461	4	76.00	SOHC/OHC	62/84			
Kangoo 1.5 dCi	06/05→								
Thalia 1.5dCi	09/08→								
Twingo 1.5 dCi	04/08→								
1.5	K9K 722 Diesel	154	AE5200 (MLS)	CE5200 ▲	EE5200				
Megane 2 1.5	11/02→	1461	4	76.00	SOHC/OHC	60-63/	→05/04		
Scenic 2 1.5dCi	06/03→					82-86	AG9490 (MLS), 0.75mm [70][71]		
							05/04→		

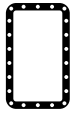
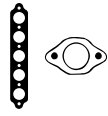

AE5200

HBS299 [22] M11x1.50x125.00mm (x10)	JD5402 [E] [KK5643]	JM7054 (NBR)	JH5109 (NBR)	HR817 [E]	NA5215 [2] 28.00x42.00x5.00mm, FPM NA5255 [2] 35.00x47.00x7.00mm, PTFE/ACM NA5118 [1][2] 80.00x100.00x9.00mm, PTFE
HBS299 [22] M11x1.50x125.00mm (x10)	JD5402 [E] [KK5643]	JM7054 (NBR)	JH5109 (NBR)	HR817 [E]	NA5215 [2] 28.00x42.00x5.00mm, FPM NA5255 [2] 35.00x47.00x7.00mm, PTFE/ACM NA5118 [1][2] 80.00x100.00x9.00mm, PTFE
HBS299 [22] M11x1.50x125.00mm (x10)	JD5402 [E] [KK5643]	JM7054 (NBR)	JH5109 (NBR)	HR817 [E]	NA5215 [2] 28.00x42.00x5.00mm, FPM NA5255 [2] 35.00x47.00x7.00mm, PTFE/ACM NA5118 [1][2] 80.00x100.00x9.00mm, PTFE
HBS299 [22] M11x1.50x125.00mm (x10)	JD5402 [E] [KK5643]	JM7054 (NBR)	JH5109 (NBR)	HR817 [E]	NA5215 [2] 28.00x42.00x5.00mm, FPM NA5255 [2] 35.00x47.00x7.00mm, PTFE/ACM NA5118 [1][2] 80.00x100.00x9.00mm, PTFE
HBS299 [22] M11x1.50x125.00mm (x10)	JD5402 [E] [KK5643]	JM7054 (NBR)	JH5109 (NBR)	HR817 [E]	NA5215 [2] 28.00x42.00x5.00mm, FPM NA5255 [2] 35.00x47.00x7.00mm, PTFE/ACM NA5118 [1][2] 80.00x100.00x9.00mm, PTFE
HBS299 [22] M11x1.50x125.00mm (x10)	JD5402 [E] [KK5643]	JM7054 (NBR)	JH5109 (NBR)	HR817 [E]	NA5215 [2] 28.00x42.00x5.00mm, FPM NA5255 [2] 35.00x47.00x7.00mm, PTFE/ACM NA5118 [1][2] 80.00x100.00x9.00mm, PTFE
HBS299 [22] M11x1.50x125.00mm (x10)	JD5402 [E] [KK5643]	JM7054 (NBR)	JH5109 (NBR)	HR817 [E]	NA5215 [2] 28.00x42.00x5.00mm, FPM NA5255 [2] 35.00x47.00x7.00mm, PTFE/ACM NA5118 [1][2] 80.00x100.00x9.00mm, PTFE
HBS299 [22] M11x1.50x125.00mm (x10)	JD5402 [E] [KK5643]	JM7054 (NBR)	JH5109 (NBR)	HR817 [E]	NA5215 [2] 28.00x42.00x5.00mm, FPM NA5255 [2] 35.00x47.00x7.00mm, PTFE/ACM NA5118 [1][2] 80.00x100.00x9.00mm, PTFE
HBS299 [22] M11x1.50x125.00mm (x10)	JD5402 [E] [KK5643]	JM7054 (NBR)		HR817 [E]	NA5215 [2] 28.00x42.00x5.00mm, FPM NA5255 [2] 35.00x47.00x7.00mm, PTFE/ACM NA5118 [1][2] 80.00x100.00x9.00mm, PTFE

RENAULT



cc



kW/PS



1.5	K9K 724 Diesel	1461	4	76.00	SOHC/OHC	155	AG9490 (MLS), 0.75mm [70][71]	CE5200 ▲	EE5200
Megane 2 1.5 Scenic 2 1.5dCi	05/05→ 05/05→					63/86			
1.5	K9K 728 Diesel	1461	4	76.00	SOHC/OHC	156	AG9490 (MLS), 0.75mm [70][71]	CE5200 ▲	EE5200
Gr. Scenic 2 Megane 2 1.5 Scenic 2 1.5dCi	04/04→ 10/03→ 11/03→					74-78/ 101-106			
1.5	K9K 729 Diesel	1461	4	76.00	SOHC/OHC	157	AG9490 (MLS), 0.75mm [70][71]	CE5200 ▲	EE5200
Megane 2 1.5 Scenic 2 1.5dCi	10/03→ 11/03→					74/101			
1.5	K9K 732 Diesel	1461	4	76.00	SOHC/OHC	158	AG9490 (MLS), 0.75mm [70][71]		EE5200
Megane 2 1.5 Scenic 2 1.5dCi	05/05→ 05/05→					78/106			
1.5	K9K 734 Diesel	1461	4	76.00	SOHC/OHC	159	AG9490 (MLS), 0.75mm [70][71]		
Megane 2 1.5 Scenic 2 1.5dCi	05/05→ 01/07→					74-78/ 103-106			
1.5	K9K 740 Diesel	1461	4	76.00	SOHC/OHC	160	AG9490 (MLS), 0.75mm [70][71]	CE5200 ▲	EE5200
Clio 2 1.5 dCi Thalia 1.5dCi Twingo 1.5 dCi	06/05→ 06/05→ 03/07→					47/64			
1.5	K9K 750 Diesel	1461	4	76.00	SOHC/OHC	161	AG9490 (MLS), 0.75mm [70][71]	CE5200 ▲	EE5200
Clio 3 1.5 dCi Modus 1.5 90 Modus 1.5 dCi	11/07→ 10/10→ 09/04→					57-65/ 78-88			
1.5	K9K 752 Diesel	1461	4	76.00	SOHC/OHC	162	AG9490 (MLS), 0.75mm [70][71]	CE5200 ▲	EE5200
Clio 1.5 dCi Clio 3 1.5 dCi Modus 1.5 dCi	02/10→ 05/05→ 12/04→					47-50/ 64-68			
1.5	K9K 760 Diesel	1461	4	76.00	SOHC/OHC	163	AG9490 (MLS), 0.75mm [70][71]	CE5200 ▲	EE5200
Modus 1.5 dCi	12/04→					50-63/ 68-86			

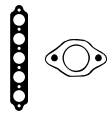

HBS299 [22] M11x1.50x125.00mm (x10)	JD5402 [E] [KK5643]	JM7054 (NBR)	JH5109 (NBR)	HR817 [E]	NA5215 [2] 28.00x42.00x5.00mm, FPM [NA5255] [2] 35.00x47.00x7.00mm, PTFE/ACM [NA5118] [1][2] 80.00x100.00x9.00mm, PTFE	
HBS299 [22] M11x1.50x125.00mm (x10)	JD5402 [E] [KK5643]	JM7054 (NBR)	JH5109 (NBR)	HR817 [E]	NA5215 [2] 28.00x42.00x5.00mm, FPM [NA5255] [2] 35.00x47.00x7.00mm, PTFE/ACM [NA5118] [1][2] 80.00x100.00x9.00mm, PTFE	
HBS299 [22] M11x1.50x125.00mm (x10)	JD5402 [E] [KK5643]	JM7054 (NBR)	JH5109 (NBR)	HR817 [E]	NA5215 [2] 28.00x42.00x5.00mm, FPM [NA5255] [2] 35.00x47.00x7.00mm, PTFE/ACM [NA5118] [1][2] 80.00x100.00x9.00mm, PTFE	
HBS299 [22] M11x1.50x125.00mm (x10)	JD5402 [E] [KK5643]	JM7054 (NBR)	JH5109 (NBR)	HR817 [E]	NA5215 [2] 28.00x42.00x5.00mm, FPM [NA5328] [2] 28.00x42.00x6.00mm, PTFE/ACM [NA5255] [2] 35.00x47.00x7.00mm, PTFE/ACM [NA5118] [1][2] 80.00x100.00x9.00mm, PTFE	
HBS299 [22] M11x1.50x125.00mm (x10)	JD5402 [E] [KK5643]	JM7054 (NBR)	JH5109 (NBR)	HR817 [E]	NA5215 [2] 28.00x42.00x5.00mm, FPM [NA5255] [2] 35.00x47.00x7.00mm, PTFE/ACM [NA5118] [1][2] 80.00x100.00x9.00mm, PTFE	
HBS299 [22] M11x1.50x125.00mm (x10)	JD5402 [E] [KK5643]	JM7054 (NBR)	JH5109 (NBR)	HR817 [E]	NA5215 [2] 28.00x42.00x5.00mm, FPM [NA5255] [2] 35.00x47.00x7.00mm, PTFE/ACM [NA5118] [1][2] 80.00x100.00x9.00mm, PTFE	
HBS299 [22] M11x1.50x125.00mm (x10)	JD5402 [E] [KK5643]	JM7054 (NBR)	JH5109 (NBR)	HR817 [E]	NA5215 [2] 28.00x42.00x5.00mm, FPM [NA5255] [2] 35.00x47.00x7.00mm, PTFE/ACM [NA5118] [1][2] 80.00x100.00x9.00mm, PTFE	
HBS299 [22] M11x1.50x125.00mm (x10)	JD5402 [E] [KK5643]	JM7054 (NBR)	JH5109 (NBR)	HR817 [E]	NA5215 [2] 28.00x42.00x5.00mm, FPM [NA5255] [2] 35.00x47.00x7.00mm, PTFE/ACM [NA5118] [1][2] 80.00x100.00x9.00mm, PTFE	
HBS299 [22] M11x1.50x125.00mm (x10)	JD5402 [E] [KK5643]	JM7054 (NBR)	JH5109 (NBR)	HR817 [E]	NA5215 [2] 28.00x42.00x5.00mm, FPM [NA5255] [2] 35.00x47.00x7.00mm, PTFE/ACM [NA5118] [1][2] 80.00x100.00x9.00mm, PTFE	



cc



kW/PS



1.5	K9K 762	Diesel				164	AG9490 (MLS), 0.75mm [70][71]	CE5200 ▲	EE5200
Modus 1.5 dCi	12/04→	1461	4	76.00	SOHC/OHC	50/68			
1.5	K9K 764	Diesel				165	AG9490 (MLS), 0.75mm [70][71]	CE5200 ▲	EE5200
Clio 1.5 dCi	02/08→	1461	4	76.00	SOHC/OHC	78/106			
Clio 3 1.5 dCi	06/05→								
Modus 1.5 dCi	05/05→								
1.5	K9K 766	Diesel				166	AG9490 (MLS), 0.75mm [70][71]	CE5200 ▲	EE5200
Clio 1.5 dCi	02/08→	1461	4	76.00	SOHC/OHC	63/86			
Clio 3 1.5 dCi	06/05→								
Modus 1.5 dCi	12/04→								
1.5	K9K 768	Diesel				167	AG9490 (MLS), 0.75mm [70][71]	CE5200 ▲	EE5200
Clio 1.5 dCi	02/08→	1461	4	76.00	SOHC/OHC	50/68			
Clio 3 1.5 dCi	06/05→								
Modus 1.5 dCi	12/04→								
1.5	K9K 770	Diesel				168	AG9490 (MLS), 0.75mm [70][71]	CE5200 ▲	EE5200
Clio 1.5 dCi	08/10→	1461	4	76.00	SOHC/OHC	55-65/ 75-88			
Clio 3 1.5 dCi	08/10→								
Modus 1.5 75	10/10→								
1.5	K9K 772	Diesel				169	AG9490 (MLS), 0.75mm [70][71]	CE5200 ▲	EE5200
Clio 1.5 dCi	02/08→	1461	4	76.00	SOHC/OHC	63-76/ 86-103			
Clio 3 1.5 dCi	06/05→								
Modus 1.5 dCi	05/07→								
1.5	K9K 780	Diesel				170	AG9490 (MLS), 0.75mm [70][71]		EE5200
Laguna 3 1.5dCi	10/07→	1461	4	76.00	SOHC/OHC	76-81/ 103-110			
1.5	K9K 792	Diesel				171	AG9490 (MLS), 0.75mm [70][71]	CE5200 ▲	EE5200
Logan 1.5 dCi	04/07→	1461	4	76.00	SOHC/OHC	50/68			

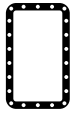
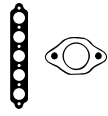

HBS299 [22] M11x1.50x125.00mm (x10)	JD5402 [E] [KK5643]	JM7054 (NBR)	JH5109 (NBR)	HR817 [S]	NA5215 [2] 28.00x42.00x5.00mm, FPM NA5255 [2] 35.00x47.00x7.00mm, PTFE/ACM NA5118 [1][2] 80.00x100.00x9.00mm, PTFE
HBS299 [22] M11x1.50x125.00mm (x10)	JD5402 [E] [KK5643]	JM7054 (NBR)	JH5109 (NBR)	HR817 [S]	NA5215 [2] 28.00x42.00x5.00mm, FPM NA5328 [2] 28.00x42.00x6.00mm, PTFE/ACM NA5255 [2] 35.00x47.00x7.00mm, PTFE/ACM NA5118 [1][2] 80.00x100.00x9.00mm, PTFE
HBS299 [22] M11x1.50x125.00mm (x10)	JD5402 [E] [KK5643]	JM7054 (NBR)	JH5109 (NBR)	HR817 [S]	NA5215 [2] 28.00x42.00x5.00mm, FPM NA5328 [2] 28.00x42.00x6.00mm, PTFE/ACM NA5255 [2] 35.00x47.00x7.00mm, PTFE/ACM NA5118 [1][2] 80.00x100.00x9.00mm, PTFE
HBS299 [22] M11x1.50x125.00mm (x10)	JD5402 [E] [KK5643]	JM7054 (NBR)	JH5109 (NBR)	HR817 [S]	NA5215 [2] 28.00x42.00x5.00mm, FPM NA5255 [2] 35.00x47.00x7.00mm, PTFE/ACM NA5118 [1][2] 80.00x100.00x9.00mm, PTFE
HBS299 [22] M11x1.50x125.00mm (x10)	JD5402 [E] [KK5643]	JM7054 (NBR)	JH5109 (NBR)	HR817 [S]	NA5215 [2] 28.00x42.00x5.00mm, FPM NA5255 [2] 35.00x47.00x7.00mm, PTFE/ACM NA5118 [1][2] 80.00x100.00x9.00mm, PTFE
HBS299 [22] M11x1.50x125.00mm (x10)	JD5402 [E] [KK5643]	JM7054 (NBR)	JH5109 (NBR)	HR817 [S]	NA5215 [2] 28.00x42.00x5.00mm, FPM NA5328 [2] 28.00x42.00x6.00mm, PTFE/ACM NA5255 [2] 35.00x47.00x7.00mm, PTFE/ACM NA5118 [1][2] 80.00x100.00x9.00mm, PTFE
HBS299 [22] M11x1.50x125.00mm (x10)	JD5402 [E] [KK5643]	JM7054 (NBR)	JH5109 (NBR)	HR817 [S]	NA5215 [2] 28.00x42.00x5.00mm, FPM NA5328 [2] 28.00x42.00x6.00mm, PTFE/ACM NA5255 [2] 35.00x47.00x7.00mm, PTFE/ACM NA5118 [1][2] 80.00x100.00x9.00mm, PTFE
HBS299 [22] M11x1.50x125.00mm (x10)	JD5402 [E] [KK5643]	JM7054 (NBR)	JH5109 (NBR)	HR817 [S]	NA5215 [2] 28.00x42.00x5.00mm, FPM NA5255 [2] 35.00x47.00x7.00mm, PTFE/ACM NA5118 [1][2] 80.00x100.00x9.00mm, PTFE

RENAULT



cc



kW/PS



1.5	K9K 796	Diesel	172	AG9490 (MLS), 0.75mm [70][71]	CE5200 ▲			
Logan 1.5 dCi	02/08→	1461	4	76.00	SOHC/OHC	63/86		
1.5	K9K 800	Diesel	173	AG9490 (MLS), 0.75mm [70][71]		EE5200		
Kangoo 1.5 dCi	02/08→	1461	4	76.00	SOHC/OHC	50-63/ 75-86		
Kangoo dCi	02/08→							
Kangoo dCi 75	09/10→							
Kangoo dCi 85	02/08→							
1.5	K9K 802	Diesel	174	AG9490 (MLS), 0.75mm [70][71]		EE5200		
Kangoo 1.5 dCi	11/12→	1461	4	76.00	SOHC/OHC	55-63/ 75-86		
Kangoo dCi	02/08→							
Kangoo dCi 75	09/10→							
Kangoo dCi 85	02/08→							
1.5	K9K 804	Diesel	175	AG9490 (MLS), 0.75mm [70][71]		EE5200		
Kangoo 1.5 dCi	06/09→	1461	4	76.00	SOHC/OHC	76-80/ 103-110		
Kangoo dCi	02/08→							
Kangoo dCi 110	09/10→							
1.5	K9K 806	Diesel	176	AG9490 (MLS), 0.75mm [70][71]		EE5200		
Kangoo dCi	02/08→	1461	4	76.00	SOHC/OHC	76/103		
1.5	K9K 808	Diesel	177	AG9490 (MLS), 0.75mm [70][71]		EE5200		
Kangoo 1.5 dCi	11/12→	1461	4	76.00	SOHC/OHC	66/90		
Kangoo dCi	06/09→							
Kangoo dCi 90	06/09→							
1.5	K9K 820	Diesel	178	AG9490 (MLS), 0.75mm [70][71]	CE5200 ▲			
Twingo 1.5 dCi	10/10→	1461	4	76.00	SOHC/OHC	55/75		
1.5	K9K 830	Diesel	179	AG9490 (MLS), 0.75mm [70][71]	CE5200 ▲			
Fluence 1.5 dCi	02/10→	1461	4	76.00	SOHC/OHC	63/86		
Gr. Scenic 3	04/09→							
Megane 3 1.5dCi	12/09→							
Scenic 3 1.5dCi	04/09→							
Twingo 1.5 dCi	10/10→							

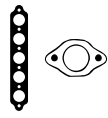

HBS299 [22] M11x1.50x125.00mm (x10)	JD5402 [2] KK5643	JM7054 (NBR)	JH5109 (NBR)	HR817 [5]	NA5215 [2] 28.00x42.00x5.00mm, FPM NA5255 [2] 35.00x47.00x7.00mm, PTFE/ACM NA5118 [1][2] 80.00x100.00x9.00mm, PTFE	
HBS299 [22] M11x1.50x125.00mm (x10)	JD5402 [2]	JM7054 (NBR)	JH5109 (NBR)	HR817 [5]	NA5215 [2] 28.00x42.00x5.00mm, FPM NA5255 [2] 35.00x47.00x7.00mm, PTFE/ACM NA5118 [1][2] 80.00x100.00x9.00mm, PTFE	
HBS299 [22] M11x1.50x125.00mm (x10)	JD5402 [2]	JM7054 (NBR)	JH5109 (NBR)	HR817 [5]	NA5215 [2] 28.00x42.00x5.00mm, FPM NA5255 [2] 35.00x47.00x7.00mm, PTFE/ACM NA5118 [1][2] 80.00x100.00x9.00mm, PTFE	
HBS299 [22] M11x1.50x125.00mm (x10)	JD5402 [2]	JM7054 (NBR)	JH5109 (NBR)	HR817 [5]	NA5215 [2] 28.00x42.00x5.00mm, FPM NA5328 [2] 28.00x42.00x6.00mm, PTFE/ACM NA5255 [2] 35.00x47.00x7.00mm, PTFE/ACM NA5118 [1][2] 80.00x100.00x9.00mm, PTFE	
HBS299 [22] M11x1.50x125.00mm (x10)	JD5402 [2]	JM7054 (NBR)	JH5109 (NBR)	HR817 [5]	NA5215 [2] 28.00x42.00x5.00mm, FPM NA5328 [2] 28.00x42.00x6.00mm, PTFE/ACM NA5255 [2] 35.00x47.00x7.00mm, PTFE/ACM NA5118 [1][2] 80.00x100.00x9.00mm, PTFE	
HBS299 [22] M11x1.50x125.00mm (x10)	JD5402 [2]	JM7054 (NBR)	JH5109 (NBR)	HR817 [5]	NA5215 [2] 28.00x42.00x5.00mm, FPM NA5255 [2] 35.00x47.00x7.00mm, PTFE/ACM NA5118 [1][2] 80.00x100.00x9.00mm, PTFE	
HBS299 [22] M11x1.50x125.00mm (x10)	JD5402 [2]	JM7054 (NBR)	JH5109 (NBR)	HR817 [5]	NA5215 [2] 28.00x42.00x5.00mm, FPM NA5255 [2] 35.00x47.00x7.00mm, PTFE/ACM NA5118 [1][2] 80.00x100.00x9.00mm, PTFE	
HBS299 [22] M11x1.50x125.00mm (x10)	JD5402 [2]	JM7054 (NBR)	JH5109 (NBR)	HR817 [5]	NA5215 [2] 28.00x42.00x5.00mm, FPM NA5255 [2] 35.00x47.00x7.00mm, PTFE/ACM NA5118 [1][2] 80.00x100.00x9.00mm, PTFE	



cc



kW/PS



1.5	K9K 832	Diesel	1461	4	76.00	SOHC/OHC	180	AG9490 (MLS), 0.75mm [70][71]		
Fluence 1.5 dCi	06/05→						78/106			
Gr. Scenic 3	02/09→									
Scenic 3 1.5dCi	02/09→									
1.5	K9K 834	Diesel	1461	4	76.00	SOHC/OHC	181	AG9490 (MLS), 0.75mm [70][71]		
Fluence 1.5 dCi	02/10→						66/90			
Megane 3 1.5dCi	05/09→									
1.5	K9K 836	Diesel	1461	4	76.00	SOHC/OHC	182	AG9490 (MLS), 0.75mm [70][71]		
Fluence 1.5 dCi	02/10→						78-81/ 106-110			
Gr. Scenic 3	04/09→									
Megane 3 1.5dCi	02/09→									
Megane CC 1.5d	06/10→									
Scenic 3 1.5dCi	04/09→									
1.5	K9K 837	Diesel	1461	4	76.00	SOHC/OHC	183			
Fluence 1.5 dCi	02/10→						81/110			
Gr. Scenic 3	04/09→									
Megane 3 1.5dCi	02/09→									
Scenic 3 1.5dCi	04/09→									
1.5	K9K 846	Diesel	1461	4	76.00	SOHC/OHC	184	AG9490 (MLS), 0.75mm [70][71]		
Gr. Scenic 3	11/10→						70-81/ 95-110			
Laguna 1.5 dCi	03/12→									
Megane 3 1.5dCi	02/09→									
Scenic 3 1.5dCi	11/10→									
1.5	K9K F 830	Diesel	1461	4	76.00	SOHC/OHC	185	AG9490 (MLS), 0.75mm [70][71]	CE5200 ▲	
Megane Scenic	11/08→						63/86			
1.5	K9K G 832	Diesel	1461	4	76.00	SOHC/OHC	186	AG9490 (MLS), 0.75mm [70][71]		
Megane 3 1.5dCi	02/09→						78/106			
Megane Scenic	02/09→									
1.5	K9K H 834	Diesel	1461	4	76.00	SOHC/OHC	187			
Megane 3 1.5dCi	11/08→						66/90			
Megane Scenic	11/08→									



HBS299 [22] M11x1.50x125.00mm (x10)	JD5402 [E]		JH5109 (NBR)	HR817 [E]	NA5215 [2] 28.00x42.00x5.00mm, FPM NA5328 [2] 28.00x42.00x6.00mm, PTFE/ACM NA5255 [E] [2] 35.00x47.00x7.00mm, PTFE/ACM NA5118 [E] [1][2] 80.00x100.00x9.00mm, PTFE	
HBS299 [22] M11x1.50x125.00mm (x10)	JD5402 [E]		JH5109 (NBR)	HR817 [E]	NA5215 [2] 28.00x42.00x5.00mm, FPM NA5328 [2] 28.00x42.00x6.00mm, PTFE/ACM NA5255 [E] [2] 35.00x47.00x7.00mm, PTFE/ACM NA5118 [E] [1][2] 80.00x100.00x9.00mm, PTFE	
HBS299 [22] M11x1.50x125.00mm (x10)	JD5402 [E]		JH5109 (NBR)	HR817 [E]	NA5215 [2] 28.00x42.00x5.00mm, FPM NA5328 [2] 28.00x42.00x6.00mm, PTFE/ACM NA5255 [E] [2] 35.00x47.00x7.00mm, PTFE/ACM NA5118 [E] [1][2] 80.00x100.00x9.00mm, PTFE	
	JD5402 [E]		JH5109 (NBR)		NA5215 [2] 28.00x42.00x5.00mm, FPM NA5328 [2] 28.00x42.00x6.00mm, PTFE/ACM NA5255 [E] [2] 35.00x47.00x7.00mm, PTFE/ACM NA5118 [E] [1][2] 80.00x100.00x9.00mm, PTFE	
HBS299 [22] M11x1.50x125.00mm (x10)	JD5402 [E]		JH5109 (NBR)	HR817 [E]	NA5215 [2] 28.00x42.00x5.00mm, FPM NA5255 [E] [2] 35.00x47.00x7.00mm, PTFE/ACM NA5118 [E] [1][2] 80.00x100.00x9.00mm, PTFE	
HBS299 [22] M11x1.50x125.00mm (x10)	JD5402 [E]	JM7054 (NBR)	JH5109 (NBR)	HR817 [E]	NA5215 [2] 28.00x42.00x5.00mm, FPM NA5255 [E] [2] 35.00x47.00x7.00mm, PTFE/ACM NA5118 [E] [1][2] 80.00x100.00x9.00mm, PTFE	
HBS299 [22] M11x1.50x125.00mm (x10)	JD5402 [E]		JH5109 (NBR)	HR817 [E]	NA5215 [2] 28.00x42.00x5.00mm, FPM NA5255 [E] [2] 35.00x47.00x7.00mm, PTFE/ACM NA5118 [E] [1][2] 80.00x100.00x9.00mm, PTFE	
HBS299 [22] M11x1.50x125.00mm (x10)	JD5402 [E]		JH5109 (NBR)	HR817 [E]	NA5215 [2] 28.00x42.00x5.00mm, FPM NA5255 [E] [2] 35.00x47.00x7.00mm, PTFE/ACM NA5118 [E] [1][2] 80.00x100.00x9.00mm, PTFE	



cc



kW/PS



1.5		K9K J 836		Diesel		188		AG9490 (MLS), 0.75mm [70][71]	
Megane Scenic	02/09→	1461	4	76.00	SOHC/OHC	81/110			
1.5		K9K P 732		Diesel		189		AG9490 (MLS), 0.75mm [70][71]	
Gr. Scenic 2	05/05→	1461	4	76.00	SOHC/OHC	78/106			EE5200
1.6		F8M 700		Diesel		190		BL960 (Fibre), 1.650mm, 2 Holes →0.885mm BS010 (Fibre), 1.650mm, 2 Holes →0.885mm BL970 (Fibre), 1.750mm, 1 Hole →0.885→0.985mm BS020 (Fibre), 1.750mm, 1 Hole →0.885→0.985mm BL980 (Fibre), 1.850mm, 3 Holes →0.985mm→ BS030 (Fibre), 1.850mm, 3 Holes →0.985mm→	
9 1.6 D	10/82→12/88	1596	4	78.00	SOHC/OHC	40/55			DL961 ▲ [3]
11 1.6 D	08/83→12/88								
11 Van 1.6 D	08/83→12/88								
1.6		F8M 720		Diesel		191		BL960 (Fibre), 1.650mm, 2 Holes →08/91 →0.885mm BS010 (Fibre), 1.650mm, 2 Holes →08/91 →0.885mm BL970 (Fibre), 1.750mm, 1 Hole →08/91 →0.885→0.985mm BS020 (Fibre), 1.750mm, 1 Hole →08/91 →0.885→0.985mm BL980 (Fibre), 1.850mm, 3 Holes →08/91 →0.985mm→ BS030 (Fibre), 1.850mm, 3 Holes →08/91 →0.985mm→	
9 1.6 D	10/82→12/88	1596	4	78.00	SOHC/OHC	40/55			DL961 ▲ [3]
11 1.6 D	08/83→12/88								→08/91
11 Van 1.6 D	08/83→12/88								
Express 1.6 D	03/86→08/98								
Super 5 1.6 D	10/84→12/96								

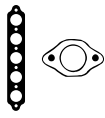

BL960, BL970,
BL980



BS010, BS020,
BS030



JD409

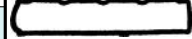

JN732

HBS299 [22]
M11x1.50x125.00mm (x10)

JD5402 [2]

JH5109
(NBR)

HR817 [2]

NA5215 [2]
28.00x42.00x5.00mm, FPM
NA5255 [2]
35.00x47.00x7.00mm, PTFE/ACM
NA5118 [1][2]
80.00x100.00x9.00mm, PTFE

HBS299 [22]
M11x1.50x125.00mm (x10)

JD5402 [2]
KK5643

JM7054
(NBR)

JH5109
(NBR)

HR817 [2]

NA5215 [2]
28.00x42.00x5.00mm, FPM
NA5255 [2]
35.00x47.00x7.00mm, PTFE/ACM
NA5118 [1][2]
80.00x100.00x9.00mm, PTFE

HBS244 [22]
M12x1.50x111.00mm (x10)

JD409

JN732 [4]

NF846 [2]
25.00x42.00x7.00mm, FPM/ACM
NF850 [1]
85.00x105.00x8.00mm, FPM
NF648 [2]
50.00x68.00x10.00mm, MVQ
NF843 [2]
50.00x68.00x10.00mm, FPM/ACM

HBS244 [22]
M12x1.50x111.00mm (x10)
→08/91

JD409
→08/91

JN732 [4]
→08/91

NF846 [2]
25.00x42.00x7.00mm, FPM/ACM
→08/91
NF850 [1]
85.00x105.00x8.00mm, FPM
→08/91
NF648 [2]
50.00x68.00x10.00mm, MVQ
→08/91
NF843 [2]
50.00x68.00x10.00mm, FPM/ACM
→08/91



cc



kW/PS



1.6		F8M 730 Diesel				192			
9 1.6 D	10/82→12/88	1596	4	78.00	SOHC/OHC	40/55	BL960 (Fibre), 1.650mm, 2 Holes →08/91 ☞→0.885mm BS010 (Fibre), 1.650mm, 2 Holes →08/91 ☞→0.885mm BL970 (Fibre), 1.750mm, 1 Hole →08/91 ☞0.885→0.985mm BS020 (Fibre), 1.750mm, 1 Hole →08/91 ☞0.885→0.985mm BL980 (Fibre), 1.850mm, 3 Holes →08/91 ☞0.985mm→ BS030 (Fibre), 1.850mm, 3 Holes →08/91 ☞0.985mm→	DL961 ▲ [3] →08/91	
11 1.6 D	08/83→12/88								
11 Van 1.6 D	08/83→12/88								
Express 1.6 D	03/86→08/98								
Super 5 1.6 D	04/85→12/96								
1.6		F8M 736 Diesel				193			
Express 1.6 D	03/86→08/98	1596	4	78.00	SOHC/OHC	40/55	BL960 (Fibre), 1.650mm, 2 Holes ☞→0.885mm BS010 (Fibre), 1.650mm, 2 Holes ☞→0.885mm BL970 (Fibre), 1.750mm, 1 Hole ☞0.885→0.985mm BS020 (Fibre), 1.750mm, 1 Hole ☞0.885→0.985mm BL980 (Fibre), 1.850mm, 3 Holes ☞0.985mm→ BS030 (Fibre), 1.850mm, 3 Holes ☞0.985mm→	DL961 ▲ [3]	
1.6		F8M 760 Diesel				194			
Express 1.6 D	03/86→08/98	1596	4	78.00	SOHC/OHC	40/55	BL960 (Fibre), 1.650mm, 2 Holes ☞→0.885mm BS010 (Fibre), 1.650mm, 2 Holes ☞→0.885mm BL970 (Fibre), 1.750mm, 1 Hole ☞0.885→0.985mm BS020 (Fibre), 1.750mm, 1 Hole ☞0.885→0.985mm BL980 (Fibre), 1.850mm, 3 Holes ☞0.985mm→ BS030 (Fibre), 1.850mm, 3 Holes ☞0.985mm→	DL961 ▲ [3]	
1.6		K4M 690				195			
Logan 1.6	04/07→	1598	4	79.50	DOHC	77-85/ 105-116	AC5100 (MLS), 1.200mm		
1.6		K4M 697				196			
Logan 1.6	04/07→	1598	4	79.50	DOHC	77-82/ 105-112	AC5100 (MLS), 1.200mm	CC5110	

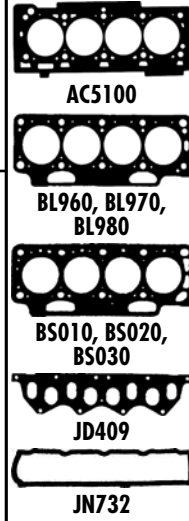
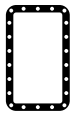
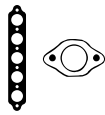

HBS244 [22]
M12x1.50x111.00mm (x10)
→08/91

JD409
→08/91

JN732 [4]
→08/91

NF846 [2]
25.00x42.00x7.00mm, FPM/ACM
→08/91
NF850 [1]
85.00x105.00x8.00mm, FPM
→08/91
NF648 [2]
50.00x68.00x10.00mm, MVQ
→08/91
NF843 [2]
50.00x68.00x10.00mm, FPM/ACM
→08/91

HBS244 [22]
M12x1.50x111.00mm (x10)

JD409

JN732 [4]

NF846 [2]
25.00x42.00x7.00mm, FPM/ACM
NF850 [1]
85.00x105.00x8.00mm, FPM
NF648 [2]
50.00x68.00x10.00mm, MVQ
NF843 [2]
50.00x68.00x10.00mm, FPM/ACM

HBS244 [22]
M12x1.50x111.00mm (x10)

JD409

JN732 [4]

NF846 [2]
25.00x42.00x7.00mm, FPM/ACM
NF850 [1]
85.00x105.00x8.00mm, FPM
NF648 [2]
50.00x68.00x10.00mm, MVQ
NF843 [2]
50.00x68.00x10.00mm, FPM/ACM

HBS301 [22]
M10x1.50x117.00mm (x10)

JD5393 [1]
JD5394 [1]

HR397 [1]

PA5013 (x16)

NA5215 [2]
28.00x42.00x5.00mm, FPM
NA5328 [2]
28.00x42.00x6.00mm, PTFE/ACM
NA5016
35.00x47.00x7.00mm, FPM/ACM
NA5016 [2]
35.00x47.00x7.00mm, FPM/ACM
NF835 [1]
80.00x100.00x8.00mm, FPM/ACM

HBS301 [22]
M10x1.50x117.00mm (x10)

JD5393 [1]
JD5394 [1]

HR397 [1]

PA5013 (x16)

NA5016
35.00x47.00x7.00mm, FPM/ACM
NA5016 [2]
35.00x47.00x7.00mm, FPM/ACM
NF835 [1]
80.00x100.00x8.00mm, FPM/ACM



cc



kW/PS

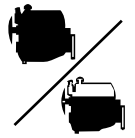

1.6		K4M 700				197	AC5100 (MLS), 1.200mm	CC5100 [3]
Megane 1.6 16V	03/99→08/03	1598	4	79.50	DOHC	79/107		
Megane Scenic	04/98→10/99							
Scenic 1.6	09/99→09/03							
1.6		K4M 701				198	AC5100 (MLS), 1.200mm	CC5100 [3]
Megane 1.6 16V	03/99→08/03	1598	4	79.50	DOHC	79-81/ 107-110		
Megane Scenic	04/98→10/99							
1.6		K4M 704				199	AC5100 (MLS), 1.200mm	CC5100 [3]
Megane 1.6 16V	03/99→08/03	1598	4	79.50	DOHC	79-80/ 107-109		
Megane Scenic	04/98→10/99							
1.6		K4M 706				200	AC5100 (MLS), 1.200mm	CC5100 [3]
Scenic 1.6	09/99→09/03	1598	4	79.50	DOHC	79-80/ 107-109		
1.6		K4M 708				201	AC5100 (MLS), 1.200mm	CC5100 [3]
Clio 2 1.6 16V	09/98→	1598	4	79.50	DOHC	75-79/ 102-107		
Megane 1.6 16V	03/99→08/03							
Megane Scenic	04/98→10/99							
Scenic 1.6	03/01→08/03							
1.6		K4M 709				202	AC5100 (MLS), 1.200mm	CC5100 [3]
Scenic 1.6	03/01→08/03	1598	4	79.50	DOHC	75-79/ 102-107		
1.6		K4M 710				203	AC5100 (MLS), 1.200mm	CC5100 [3]
Laguna II 1.6	03/01→	1598	4	79.50	DOHC	76-79/ 103-107		

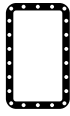
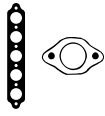

AC5100

HBS301 [22] M10x1.50x117.00mm (x10)	JD5393 [1] JD5394 [1]	HR397 [1]	JH5108	PA5013 (x16)	NA5215 [2] 28.00x42.00x5.00mm, FPM NA5016 35.00x47.00x7.00mm, FPM/ACM NA5016 [2] 35.00x47.00x7.00mm, FPM/ACM NF835 [1] 80.00x100.00x8.00mm, FPM/ACM	
HBS301 [22] M10x1.50x117.00mm (x10)	JD5393 [1] JD5394 [1]	HR397 [1]	JH5108	PA5013 (x16)	NA5215 [2] 28.00x42.00x5.00mm, FPM NA5016 35.00x47.00x7.00mm, FPM/ACM NA5016 [2] 35.00x47.00x7.00mm, FPM/ACM NF835 [1] 80.00x100.00x8.00mm, FPM/ACM	
HBS301 [22] M10x1.50x117.00mm (x10)	JD5393 [1] JD5394 [1]	HR397 [1]	JH5108	PA5013 (x16)	NA5215 [2] 28.00x42.00x5.00mm, FPM NA5016 35.00x47.00x7.00mm, FPM/ACM NA5016 [2] 35.00x47.00x7.00mm, FPM/ACM NF835 [1] 80.00x100.00x8.00mm, FPM/ACM	
HBS301 [22] M10x1.50x117.00mm (x10)	JD5393 [1] JD5394 [1]	HR397 [1]		PA5013 (x16)	NA5215 [2] 28.00x42.00x5.00mm, FPM NA5016 35.00x47.00x7.00mm, FPM/ACM NA5016 [2] 35.00x47.00x7.00mm, FPM/ACM NF835 [1] 80.00x100.00x8.00mm, FPM/ACM	
HBS301 [22] M10x1.50x117.00mm (x10)	JD5393 [1] JD5894 [1]	HR397 [1]	JH5108 → PA349 22.00x16.00x2.000mm	PA5013 (x16)	NA5215 [2] 28.00x42.00x5.00mm, FPM NA5016 35.00x47.00x7.00mm, FPM/ACM NA5016 [2] 35.00x47.00x7.00mm, FPM/ACM NF835 [1] 80.00x100.00x8.00mm, FPM/ACM	
HBS301 [22] M10x1.50x117.00mm (x10)	JD5393 [1] JD5894 [1]	HR397 [1]	JH5108	PA5013 (x16)	NA5215 [2] 28.00x42.00x5.00mm, FPM NA5016 35.00x47.00x7.00mm, FPM/ACM NA5016 [2] 35.00x47.00x7.00mm, FPM/ACM NF835 [1] 80.00x100.00x8.00mm, FPM/ACM	
HBS301 [22] M10x1.50x117.00mm (x10)	JD5393 [1] JD5394 [1]	HR397 [1]	JH5108 → PA349 22.00x16.00x2.000mm	PA5013 (x16)	NA5215 [2] 28.00x42.00x5.00mm, FPM NA5016 35.00x47.00x7.00mm, FPM/ACM NA5016 [2] 35.00x47.00x7.00mm, FPM/ACM NF835 [1] 80.00x100.00x8.00mm, FPM/ACM	



cc



kW/PS



1.6	K4M 714	204	AC5100 (MLS), 1.200mm	CC5100 [3]
Laguna II 1.6	03/01→	1598 4 79.50 DOHC	79/107	
1.6	K4M 716	205	AC5100 (MLS), 1.200mm	CC5100 [3]
Laguna II 1.6	02/05→	1598 4 79.50 DOHC	82/112	
1.6	K4M 718	206	AC5100 (MLS), 1.200mm	CC5100 [3]
Laguna II 1.6	06/01→10/03	1598 4 79.50 DOHC	76/103	
1.6	K4M 720	207	AC5100 (MLS), 1.200mm	CC5100 [3]
Laguna 1.6 16V	11/97→03/01	1598 4 79.50 DOHC	79/107	
Laguna I 1.6	11/97→03/01			
1.6	K4M 740	208	AC5100 (MLS), 1.200mm	CC5100 [3]
Clio 2 1.6 16V	09/98→	1598 4 79.50 DOHC	79/107	
Thalia 1.6	04/02→			
1.6	K4M 742	209	AC5100 (MLS), 1.200mm	CC5100 [3]
Clio 2 1.6 16V	09/98→	1598 4 79.50 DOHC	66-79/ 90-107	
1.6	K4M 743	210	AC5100 (MLS), 1.200mm	CC5100 [3]
Clio 2 1.6 16V	09/98→	1598 4 79.50 DOHC	66-81/ 90-110	
Thalia 1.6	09/08→			

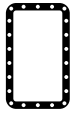
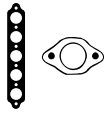

AC5100

HBS301 [22] M10x1.50x117.00mm (x10)	JD5393 [1] JD5394 [1]	HR397 [1]	JH5108 =PA349 22.00x16.00x2.000mm	PA5013 (x16)	NA5215 [2] 28.00x42.00x5.00mm, FPM NA5016 35.00x47.00x7.00mm, FPM/ACM NA5016 [2] 35.00x47.00x7.00mm, FPM/ACM NF835 [1] 80.00x100.00x8.00mm, FPM/ACM
HBS301 [22] M10x1.50x117.00mm (x10)	JD5393 [1] JD5394 [1]	HR397 [1]	JH5108 =PA349 22.00x16.00x2.000mm	PA5013 (x16)	NA5215 [2] 28.00x42.00x5.00mm, FPM NA5016 35.00x47.00x7.00mm, FPM/ACM NA5016 [2] 35.00x47.00x7.00mm, FPM/ACM NF835 [1] 80.00x100.00x8.00mm, FPM/ACM
HBS301 [22] M10x1.50x117.00mm (x10)	JD5393 [1] JD5394 [1]	HR397 [1]		PA5013 (x16)	NA5215 [2] 28.00x42.00x5.00mm, FPM NA5016 35.00x47.00x7.00mm, FPM/ACM NA5016 [2] 35.00x47.00x7.00mm, FPM/ACM NF835 [1] 80.00x100.00x8.00mm, FPM/ACM
HBS301 [22] M10x1.50x117.00mm (x10)	JD5393 [1] JD5394 [1]	HR397 [1]	JH5108 =PA349 22.00x16.00x2.000mm	PA5013 (x16)	NA5215 [2] 28.00x42.00x5.00mm, FPM NA5016 35.00x47.00x7.00mm, FPM/ACM NA5016 [2] 35.00x47.00x7.00mm, FPM/ACM NF835 [1] 80.00x100.00x8.00mm, FPM/ACM
HBS301 [22] M10x1.50x117.00mm (x10)	JD5393 [1] JD5894 [1]	HR397 [1]	JH5108 =PA349 22.00x16.00x2.000mm	PA5013 (x16)	NA5215 [2] 28.00x42.00x5.00mm, FPM NA5016 35.00x47.00x7.00mm, FPM/ACM NA5016 [2] 35.00x47.00x7.00mm, FPM/ACM NF835 [1] 80.00x100.00x8.00mm, FPM/ACM
HBS301 [22] M10x1.50x117.00mm (x10)	JD5393 [1] JD5894 [1]	HR397 [1]	JH5108 =PA349 22.00x16.00x2.000mm	PA5013 (x16)	NA5215 [2] 28.00x42.00x5.00mm, FPM NA5016 35.00x47.00x7.00mm, FPM/ACM NA5016 [2] 35.00x47.00x7.00mm, FPM/ACM NF835 [1] 80.00x100.00x8.00mm, FPM/ACM
HBS301 [22] M10x1.50x117.00mm (x10)	JD5393 [1] JD5894 [1]	HR397 [1]	JH5108 =PA349 22.00x16.00x2.000mm	PA5013 (x16)	NA5215 [2] 28.00x42.00x5.00mm, FPM NA5016 35.00x47.00x7.00mm, FPM/ACM NA5016 [2] 35.00x47.00x7.00mm, FPM/ACM NF835 [1] 80.00x100.00x8.00mm, FPM/ACM



cc



kW/PS



1.6	K4M 744	211	AC5100 (MLS), 1.200mm	CC5100 [3]				
Clio 2 1.6 16V	09/98→	1598	4	79.50	DOHC	55-79/ 75-107		
1.6	K4M 745	212	AC5100 (MLS), 1.200mm	CC5100 [3]				
Clio 2 1.6 16V	09/98→	1598	4	79.50	DOHC	79/107		
1.6	K4M 748	213	AC5100 (MLS), 1.200mm	CC5100 [3]				
Clio 2 1.6 16V	09/98→	1598	4	79.50	DOHC	79-86/ 107-117		
Clio 2 Hi-Flex	01/05→02/10							
Clio 3 Hi-Flex	05/05→02/10							
1.6	K4M 750	214	AC5100 (MLS), 1.200mm	CC5100 [3]				
Kangoo 1.6	10/01→	1598	4	79.50	DOHC	70/95		
Kangoo 1.6 16V	06/01→							
1.6	K4M 752	215	AC5100 (MLS), 1.200mm	CC5100 [3]				
Kangoo 1.6	10/01→	1598	4	79.50	DOHC	70/95		
Kangoo 1.6 16V	06/01→							
1.6	K4M 753	216	AC5100 (MLS), 1.200mm	CC5100 [3]				
Kangoo 1.6	10/01→	1598	4	79.50	DOHC	70/95		
Kangoo 1.6 16V	06/01→							
1.6	K4M 760	217	AC5100 (MLS), 1.200mm	CC5110				
Megane 2 1.6	11/02→	1598	4	79.50	DOHC	82-83/ 112-113		
Megane 3 1.6	11/08→							

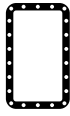
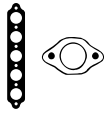

AC5100

HBS301 [22] M10x1.50x117.00mm (x10)	JD5393 [1] JD5894 [1]	HR397 [1]	JH5108 =PA349 22.00x16.00x2.000mm	PA5013 (x16)	NA5215 [2] 28.00x42.00x5.00mm, FPM NA5016 35.00x47.00x7.00mm, FPM/ACM NA5016 [2] 35.00x47.00x7.00mm, FPM/ACM NF835 [1] 80.00x100.00x8.00mm, FPM/ACM
HBS301 [22] M10x1.50x117.00mm (x10)	JD5393 [1] JD5894 [1]	HR397 [1]	JH5108 =PA349 22.00x16.00x2.000mm	PA5013 (x16)	NA5215 [2] 28.00x42.00x5.00mm, FPM NA5016 35.00x47.00x7.00mm, FPM/ACM NA5016 [2] 35.00x47.00x7.00mm, FPM/ACM NF835 [1] 80.00x100.00x8.00mm, FPM/ACM
HBS301 [22] M10x1.50x117.00mm (x10)	JD5393 [1] JD5894 [1]	HR397 [1]	JH5108 =PA349 22.00x16.00x2.000mm	PA5013 (x16)	NA5215 [2] 28.00x42.00x5.00mm, FPM NA5016 35.00x47.00x7.00mm, FPM/ACM NA5016 [2] 35.00x47.00x7.00mm, FPM/ACM NF835 [1] 80.00x100.00x8.00mm, FPM/ACM
HBS301 [22] M10x1.50x117.00mm (x10)	JD5393 [1] JD5394 [1]	HR397 [1]	JH5108 =PA349 22.00x16.00x2.000mm	PA5013 (x16)	NA5215 [2] 28.00x42.00x5.00mm, FPM NA5016 35.00x47.00x7.00mm, FPM/ACM NA5016 [2] 35.00x47.00x7.00mm, FPM/ACM NF835 [1] 80.00x100.00x8.00mm, FPM/ACM
HBS301 [22] M10x1.50x117.00mm (x10)	JD5393 [1] JD5394 [1]	HR397 [1]	JH5108 =PA349 22.00x16.00x2.000mm	PA5013 (x16)	NA5215 [2] 28.00x42.00x5.00mm, FPM NA5016 35.00x47.00x7.00mm, FPM/ACM NA5016 [2] 35.00x47.00x7.00mm, FPM/ACM NF835 [1] 80.00x100.00x8.00mm, FPM/ACM
HBS301 [22] M10x1.50x117.00mm (x10)	JD5393 [1] JD5394 [1]	HR397 [1]	JH5108 =PA349 22.00x16.00x2.000mm	PA5013 (x16)	NA5215 [2] 28.00x42.00x5.00mm, FPM NA5016 35.00x47.00x7.00mm, FPM/ACM NA5016 [2] 35.00x47.00x7.00mm, FPM/ACM NF835 [1] 80.00x100.00x8.00mm, FPM/ACM
HBS301 [22] M10x1.50x117.00mm (x10)	JD5393 [1] JD5894 [1]	HR397 [1]	JH5108 =PA349 22.00x16.00x2.000mm	PA5013 (x16)	NA5215 [2] 28.00x42.00x5.00mm, FPM NA5328 [2] 28.00x42.00x6.00mm, PTFE/ACM NA5016 35.00x47.00x7.00mm, FPM/ACM NA5016 [2] 35.00x47.00x7.00mm, FPM/ACM NF835 [1] 80.00x100.00x8.00mm, FPM/ACM

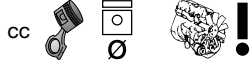

kW/PS

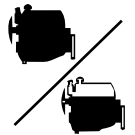

1.6	K4M 761	218	AC5100 (MLS), 1.200mm	CC5110
Gr. Scenic 2 Megane 2 1.6 Scenic 2 1.6	04/04→ 08/03→ 06/03→	1598 4 79.50 DOHC	82-83/ 112-113	
1.6	K4M 762	219	AC5100 (MLS), 1.200mm	
Megane 2 1.6	05/05→	1598 4 79.50 DOHC	77/105	
1.6	K4M 768	220	AC5100 (MLS), 1.200mm	CC5100 [3]
Megane 2 1.6	09/03→	1598 4 79.50 DOHC	75/102	
1.6	K4M 782	221	AC5100 (MLS), 1.200mm	CC5110
Gr. Scenic 2 Scenic 2 1.6	04/04→ 06/03→	1598 4 79.50 DOHC	83/113	
1.6	K4M 788	222	AC5100 (MLS), 1.200mm	CC5100 [3]
Gr. Scenic 2 Megane 2 1.6 Scenic 2 1.6	06/06→ 06/05→ 06/06→	1598 4 79.50 DOHC	77/105	
1.6	K4M 790	223	AC5100 (MLS), 1.200mm	CC5110
Modus 1.6	12/04→	1598 4 79.50 DOHC	82/112	

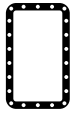
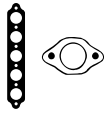

AC5100

HBS301 [22] M10x1.50x117.00mm (x10)	JD5393 [1] JD5894 [1]	HR397 [1]	JH5108 =PA349 22.00x16.00x2.000mm	PA5013 (x16)	NA5215 (x2) [2] 28.00x42.00x5.00mm, FPM NA5328 [2] 28.00x42.00x6.00mm, PTFE/ACM NA5016 35.00x47.00x7.00mm, FPM/ACM NA5016 [2] 35.00x47.00x7.00mm, FPM/ACM NF835 [1] 80.00x100.00x8.00mm, FPM/ACM	
HBS301 [22] M10x1.50x117.00mm (x10)	JD5393 [1] JD5394 [1]	HR397 [1]		PA5013 (x16)	NA5215 [2] 28.00x42.00x5.00mm, FPM NA5016 35.00x47.00x7.00mm, FPM/ACM NA5016 [2] 35.00x47.00x7.00mm, FPM/ACM NF835 [1] 80.00x100.00x8.00mm, FPM/ACM	
HBS301 [22] M10x1.50x117.00mm (x10)	JD5393 [1] JD5394 [1]	HR397 [1]		PA5013 (x16)	NA5215 [2] 28.00x42.00x5.00mm, FPM NA5016 35.00x47.00x7.00mm, FPM/ACM NA5016 [2] 35.00x47.00x7.00mm, FPM/ACM NF835 [1] 80.00x100.00x8.00mm, FPM/ACM	
HBS301 [22] M10x1.50x117.00mm (x10)	JD5393 [1] JD5894 [1]	HR397 [1]	JH5108 =PA349 22.00x16.00x2.000mm	PA5013 (x16)	NA5215 [2] 28.00x42.00x5.00mm, FPM NA5328 [2] 28.00x42.00x6.00mm, PTFE/ACM NA5016 35.00x47.00x7.00mm, FPM/ACM NA5016 [2] 35.00x47.00x7.00mm, FPM/ACM NF835 [1] 80.00x100.00x8.00mm, FPM/ACM	
HBS301 [22] M10x1.50x117.00mm (x10)	JD5393 [1] JD5394 [1]	HR397 [1]		PA5013 (x16)	NA5215 [2] 28.00x42.00x5.00mm, FPM NA5016 35.00x47.00x7.00mm, FPM/ACM NA5016 [2] 35.00x47.00x7.00mm, FPM/ACM NF835 [1] 80.00x100.00x8.00mm, FPM/ACM	
HBS301 [22] M10x1.50x117.00mm (x10)	JD5393 [1] JD5894 [1]	HR397 [1]	JH5109 (NBR)	PA5013 (x16)	NA5215 [2] 28.00x42.00x5.00mm, FPM NA5328 [2] 28.00x42.00x6.00mm, PTFE/ACM NA5016 35.00x47.00x7.00mm, FPM/ACM NA5016 [2] 35.00x47.00x7.00mm, FPM/ACM NF835 [1] 80.00x100.00x8.00mm, FPM/ACM	



cc



kW/PS



1.6	K4M 791	224	AC5100 (MLS), 1.200mm	CC5110
Modus 1.6	12/04→	1598 4 79.50 DOHC	82/112	
1.6	K4M 794	225	AC5100 (MLS), 1.200mm	CC5110
Modus 1.6	12/04→	1598 4 79.50 DOHC	65/88	
1.6	K4M 800	226	AC5100 (MLS), 1.200mm	CC5110
Clio 1.6 16V	02/08→	1598 4 79.50 DOHC	82/112	
Clio 3 1.6 16V	06/05→			
Modus 1.6	12/04→			
1.6	K4M 801	227	AC5100 (MLS), 1.200mm	CC5110
Clio 1.6 16V	02/08→	1598 4 79.50 DOHC	82/112	
Clio 3 1.6 16V	06/05→			
Modus 1.6	12/04→			
1.6	K4M 804	228	AC5100 (MLS), 1.200mm	CC5110
Clio 3 1.6 16V	06/05→	1598 4 79.50 DOHC	65/88	
1.6	K4M 812	229	AC5100 (MLS), 1.200mm	CC5110
Megane 2 1.6	01/06→	1598 4 79.50 DOHC	82/112	
Scenic 2 1.6 16V	01/07→			

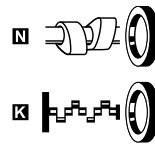
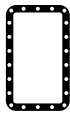
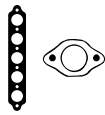

AC5100

<p>HBS301 [22] M10x1.50x117.00mm (x10)</p>	<p>JD5393 [1] JD5894 [1]</p>	<p>HR397 [1]</p>	<p>JH5109 (NBR)</p>	<p>PA5013 (x16)</p>	<p>NA5215 [2] 28.00x42.00x5.00mm, FPM NA5328 [2] 28.00x42.00x6.00mm, PTFE/ACM NA5016 35.00x47.00x7.00mm, FPM/ACM NA5016 [2] 35.00x47.00x7.00mm, FPM/ACM NF835 [1] 80.00x100.00x8.00mm, FPM/ACM</p>
<p>HBS301 [22] M10x1.50x117.00mm (x10)</p>	<p>JD5393 [1] JD5894 [1]</p>	<p>HR397 [1]</p>		<p>PA5013 (x16)</p>	<p>NA5215 [2] 28.00x42.00x5.00mm, FPM NA5328 [2] 28.00x42.00x6.00mm, PTFE/ACM NA5016 35.00x47.00x7.00mm, FPM/ACM NA5016 [2] 35.00x47.00x7.00mm, FPM/ACM NF835 [1] 80.00x100.00x8.00mm, FPM/ACM</p>
<p>HBS301 [22] M10x1.50x117.00mm (x10)</p>	<p>JD5393 [1] JD5894 [1]</p>	<p>HR397 [1]</p>	<p>JH5109 (NBR) = PA349 22.00x16.00x2.000mm</p>	<p>PA5013 (x16)</p>	<p>NA5215 [2] 28.00x42.00x5.00mm, FPM NA5328 [2] 28.00x42.00x6.00mm, PTFE/ACM NA5016 35.00x47.00x7.00mm, FPM/ACM NA5016 [2] 35.00x47.00x7.00mm, FPM/ACM NF835 [1] 80.00x100.00x8.00mm, FPM/ACM</p>
<p>HBS301 [22] M10x1.50x117.00mm (x10)</p>	<p>JD5393 [1] JD5894 [1]</p>	<p>HR397 [1]</p>	<p>JH5109 (NBR) = PA349 22.00x16.00x2.000mm</p>		<p>NA5215 [2] 28.00x42.00x5.00mm, FPM NA5328 [2] 28.00x42.00x6.00mm, PTFE/ACM NA5016 35.00x47.00x7.00mm, FPM/ACM NA5016 [2] 35.00x47.00x7.00mm, FPM/ACM NF835 [1] 80.00x100.00x8.00mm, FPM/ACM</p>
<p>HBS301 [22] M10x1.50x117.00mm (x10)</p>	<p>JD5393 [1] JD5894 [1]</p>	<p>HR397 [1]</p>	<p>JH5109 (NBR) = PA349 22.00x16.00x2.000mm</p>	<p>PA5013 (x16)</p>	<p>NA5215 (x2) [2] 28.00x42.00x5.00mm, FPM NA5328 [2] 28.00x42.00x6.00mm, PTFE/ACM NA5016 35.00x47.00x7.00mm, FPM/ACM NA5016 [2] 35.00x47.00x7.00mm, FPM/ACM NF835 [1] 80.00x100.00x8.00mm, FPM/ACM</p>
<p>HBS301 [22] M10x1.50x117.00mm (x10)</p>	<p>JD5393 [1] JD5894 [1]</p>	<p>HR397 [1]</p>		<p>PA5013 (x16)</p>	<p>NA5328 [2] 28.00x42.00x6.00mm, PTFE/ACM NA5016 35.00x47.00x7.00mm, FPM/ACM NA5016 [2] 35.00x47.00x7.00mm, FPM/ACM NF835 [1] 80.00x100.00x8.00mm, FPM/ACM</p>



cc



kW/PS



1.6	K4M 813	230					AC5100 (MLS), 1.200mm		
Megane 2 1.6	01/06→	1598	4	79.50	DOHC	82/112			
1.6	K4M 824	231					AC5100 (MLS), 1.200mm	CC5110	
Laguna 3 1.6	10/07→	1598	4	79.50	DOHC	81/110			
1.6	K4M 830	232					AC5100 (MLS), 1.200mm	CC5110	
Kangoo 1.6	02/08→	1598	4	79.50	DOHC	70-78/ 95-106			
Kangoo 1.6 16V	02/08→								
1.6	K4M 834	233					AC5100 (MLS), 1.200mm	CC5110	
Kangoo 1.6 LPG	02/08→	1598	4	79.50	DOHC	72/98			
1.6	K4M 838	234					AC5100 (MLS), 1.200mm	CC5110	
Fluence 1.6 16V	02/10→	1598	4	79.50	DOHC	81-82/ 110-112			
1.6	K4M 839	235					AC5100 (MLS), 1.200mm	CC5110	
Fluence 1.6 16V	02/10→	1598	4	79.50	DOHC	81/110			
1.6	K4M 854	236					AC5100 (MLS), 1.200mm	CC5110	
Twingo 1.6 RS	05/08→	1598	4	79.50	DOHC	98/133			
Wind 1.6	07/10→								

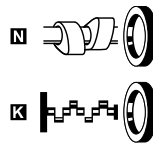
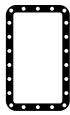
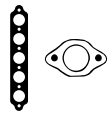

AC5100

HBS301 [22] M10x1.50x117.00mm (x10)	JD5393 [1] JD5394 [1]	HR397 [1]		PA5013 (x16)	NA5328 [2] 28.00x42.00x6.00mm, PTFE/ACM NA5016 35.00x47.00x7.00mm, FPM/ACM NA5016 [2] 35.00x47.00x7.00mm, FPM/ACM NF835 [1] 80.00x100.00x8.00mm, FPM/ACM
HBS301 [22] M10x1.50x117.00mm (x10)	JD5393 [1] JD5394 [1]	HR397 [1]		PA5013 (x16)	NA5328 [2] 28.00x42.00x6.00mm, PTFE/ACM NA5016 35.00x47.00x7.00mm, FPM/ACM NA5016 [2] 35.00x47.00x7.00mm, FPM/ACM NF835 [1] 80.00x100.00x8.00mm, FPM/ACM
HBS301 [22] M10x1.50x117.00mm (x10)	JD5393 [1] JD5394 [1]	HR397 [1]		PA5013 (x16)	NA5328 [2] 28.00x42.00x6.00mm, PTFE/ACM NA5016 35.00x47.00x7.00mm, FPM/ACM NA5016 [2] 35.00x47.00x7.00mm, FPM/ACM NF835 [1] 80.00x100.00x8.00mm, FPM/ACM
HBS301 [22] M10x1.50x117.00mm (x10)	JD5393 [1] JD5394 [1]	HR397 [1]		PA5013 (x16)	NA5328 [2] 28.00x42.00x6.00mm, PTFE/ACM NA5016 35.00x47.00x7.00mm, FPM/ACM NA5016 [2] 35.00x47.00x7.00mm, FPM/ACM NF835 [1] 80.00x100.00x8.00mm, FPM/ACM
HBS301 [22] M10x1.50x117.00mm (x10)	JD5393 [1] JD5394 [1]	HR397 [1]		PA5013 (x16)	NA5328 [2] 28.00x42.00x6.00mm, PTFE/ACM NA5016 35.00x47.00x7.00mm, FPM/ACM NA5016 [2] 35.00x47.00x7.00mm, FPM/ACM NF835 [1] 80.00x100.00x8.00mm, FPM/ACM
HBS301 [22] M10x1.50x117.00mm (x10)	JD5393 [1] JD5394 [1]	HR397 [1]		PA5013 (x16)	NA5328 [2] 28.00x42.00x6.00mm, PTFE/ACM NA5016 35.00x47.00x7.00mm, FPM/ACM NA5016 [2] 35.00x47.00x7.00mm, FPM/ACM NF835 [1] 80.00x100.00x8.00mm, FPM/ACM
HBS301 [22] M10x1.50x117.00mm (x10)	JD5393 [1] JD5394 [1]	HR397 [1]		PA5013 (x16)	NA5328 [2] 28.00x42.00x6.00mm, PTFE/ACM NA5016 35.00x47.00x7.00mm, FPM/ACM NA5016 [2] 35.00x47.00x7.00mm, FPM/ACM NF835 [1] 80.00x100.00x8.00mm, FPM/ACM

RENAULT



cc



kW/PS



1.6		K4M 858				237	AC5100 (MLS), 1.200mm	CC5110	
Gr. Scenic 3	02/09→	1598	4	79.50	DOHC	81/110			
Megane 3 1.6	11/08→								
Megane CC 1.6	06/10→								
Megane Scenic	11/08→								
Scenic 3 1.6	02/09→								
1.6		K4M 862				238	AC5100 (MLS), 1.200mm	CC5110	
Clio 1.6 16V	11/08→	1598	4	79.50	DOHC	94-98/ 128-133			
Clio 3 16V GT	06/09→								
1.6		K4M 866				239	AC5100 (MLS), 1.200mm	CC5110	
Gr. Scenic 3	02/09→	1598	4	79.50	DOHC	81/110			
Megane 3 1.6	11/08→								
Megane Scenic	11/08→								
Scenic 3 1.6	02/09→								
1.6		K4M 9 766				240	AC5100 (MLS), 1.200mm	CC5110	
Scenic 2 1.616V	01/07→	1598	4	79.50	DOHC	81-82/ 109-112			
1.6		K4M C 813				241	AC5100 (MLS), 1.200mm		
Megane 2 1.6	01/06→	1598	4	79.50	DOHC	82/112			
Scenic 2 1.616V	01/07→								
1.6		K4M D 812				242	AC5100 (MLS), 1.200mm		
Megane 2 1.6	01/06→	1598	4	79.50	DOHC	82/112			
1.6		K4M P 848				243	AC5100 (MLS), 1.200mm	CC5110	
Megane Scenic	11/08→	1598	4	79.50	DOHC	74/101			

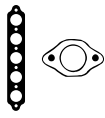

AC5100

HBS301 [22] M10x1.50x117.00mm (x10)	JD5393 [1] JD5394 [1]	HR397 [1]		PA5013 (x16)	NA5328 [2] 28.00x42.00x6.00mm, PTFE/ACM NA5016 35.00x47.00x7.00mm, FPM/ACM NA5016 [2] 35.00x47.00x7.00mm, FPM/ACM NF835 [1] 80.00x100.00x8.00mm, FPM/ACM
HBS301 [22] M10x1.50x117.00mm (x10)	JD5393 [1] JD5394 [1]	HR397 [1]		PA5013 (x16)	NA5016 35.00x47.00x7.00mm, FPM/ACM NA5016 [2] 35.00x47.00x7.00mm, FPM/ACM NF835 [1] 80.00x100.00x8.00mm, FPM/ACM
HBS301 [22] M10x1.50x117.00mm (x10)	JD5393 [1] JD5394 [1]	HR397 [1]		PA5013 (x16)	NA5328 [2] 28.00x42.00x6.00mm, PTFE/ACM NA5016 35.00x47.00x7.00mm, FPM/ACM NA5016 [2] 35.00x47.00x7.00mm, FPM/ACM NF835 [1] 80.00x100.00x8.00mm, FPM/ACM
HBS301 [22] M10x1.50x117.00mm (x10)	JD5393 [1] JD5394 [1]	HR397 [1]		PA5013 (x16)	NA5328 [2] 28.00x42.00x6.00mm, PTFE/ACM NA5016 35.00x47.00x7.00mm, FPM/ACM NA5016 [2] 35.00x47.00x7.00mm, FPM/ACM NF835 [1] 80.00x100.00x8.00mm, FPM/ACM
HBS301 [22] M10x1.50x117.00mm (x10)	JD5393 [1] JD5394 [1]	HR397 [1]		PA5013 (x16)	NA5328 [2] 28.00x42.00x6.00mm, PTFE/ACM NA5016 35.00x47.00x7.00mm, FPM/ACM NA5016 [2] 35.00x47.00x7.00mm, FPM/ACM NF835 [1] 80.00x100.00x8.00mm, FPM/ACM
HBS301 [22] M10x1.50x117.00mm (x10)	JD5393 [1] JD5394 [1]	HR397 [1]		PA5013 (x16)	NA5328 [2] 28.00x42.00x6.00mm, PTFE/ACM NA5016 35.00x47.00x7.00mm, FPM/ACM NA5016 [2] 35.00x47.00x7.00mm, FPM/ACM NF835 [1] 80.00x100.00x8.00mm, FPM/ACM
HBS301 [22] M10x1.50x117.00mm (x10)	JD5393 [1] JD5394 [1]	HR397 [1]		PA5013 (x16)	NA5016 35.00x47.00x7.00mm, FPM/ACM NA5016 [2] 35.00x47.00x7.00mm, FPM/ACM NF835 [1] 80.00x100.00x8.00mm, FPM/ACM

RENAULT



cc



kW/PS



1.6		K7M 702					244	BY030 (Fibre)	DY030 [3]	
Megane 1.6 e	01/96→08/03	1598	4	79.50	SOHC/OHC	66/90				
Megane Scenic	10/96→10/99									
1.6		K7M 703					245	BY030 (Fibre)	DY030 [3]	
Megane 1.6 e	01/96→08/03	1598	4	79.50	SOHC/OHC	66/90				
Megane Scenic	10/96→10/99									
1.6		K7M 710					246	BY030 (Fibre)	DY030 [3]	EA220 [3]
Logan 1.6	09/04→	1598	4	79.50	SOHC/OHC	64-75/ 87-102				
Sandero 1.6	12/07→									
1.6		K7M 718					247	AH5170 (MLS)		
Sandero 1.6	11/10→	1598	4	79.50	SOHC/OHC	62/84				
1.6		K7M 720					248	BY030 (Fibre)	DY030 [3]	EA220 [3]
Megane 1.6 i	01/96→03/99	1598	4	79.50	SOHC/OHC	55/75				
Megane Scenic	01/97→09/99									
1.6		K7M 744					249	BY030 (Fibre)	DY030 [3]	EA220 [3]
Clio 2 1.6	09/98→05/05	1598	4	79.50	SOHC/OHC	66/90				
1.6		K7M 745					250	BY030 (Fibre)	DY030 [3]	EA220 [3]
Clio 2 1.6	09/98→05/05	1598	4	79.50	SOHC/OHC	66/90				

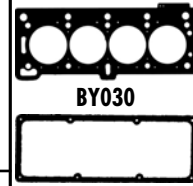
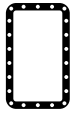
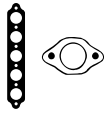

HBS102 [22] M10x1.50x113.00mm (x5)	JD434 [1] JD418 [1]	JN789 [4]		HR646 [1]	NA5016 35.00x47.00x7.00mm, FPM/ACM NA5053 [2] 30.00x42.00x7.00mm, FPM NA5016 [2] 35.00x47.00x7.00mm, FPM/ACM NF835 [1] 80.00x100.00x8.00mm, FPM/ACM	
HBS102 [22] M10x1.50x113.00mm (x5)	JD434 [1] JD418 [1]	JN789 [4]		HR646 [1]	NA5016 35.00x47.00x7.00mm, FPM/ACM NA5053 [2] 30.00x42.00x7.00mm, FPM NA5016 [2] 35.00x47.00x7.00mm, FPM/ACM NF835 [1] 80.00x100.00x8.00mm, FPM/ACM	
HBS102 [22] M10x1.50x113.00mm (x5)	JD434 [1] JD418 [1]	JN789 [4]		HR646 [1]	NA5016 35.00x47.00x7.00mm, FPM/ACM NA5053 [2] 30.00x42.00x7.00mm, FPM NA5016 [2] 35.00x47.00x7.00mm, FPM/ACM NF835 [1] 80.00x100.00x8.00mm, FPM/ACM	
HBS102 [22] M10x1.50x113.00mm (x5)	JD5315 [1] (x4) JD418 [1]	JN789 [4]		HR646 [1]	NA5016 35.00x47.00x7.00mm, FPM/ACM NA5053 [2] 30.00x42.00x7.00mm, FPM NA5016 [2] 35.00x47.00x7.00mm, FPM/ACM NF835 [1] 80.00x100.00x8.00mm, FPM/ACM	
HBS102 [22] M10x1.50x113.00mm (x5)	JD434 [1] JD418 [1]	JN789 [4]	PA349 22.00x16.00x2.000mm	HR646 [1]	NA5016 35.00x47.00x7.00mm, FPM/ACM NA5053 [2] 30.00x42.00x7.00mm, FPM NA5016 [2] 35.00x47.00x7.00mm, FPM/ACM NF835 [1] 80.00x100.00x8.00mm, FPM/ACM	
HBS102 [22] M10x1.50x113.00mm (x5)	JD418 [1]	JN789 [4]	PA349 22.00x16.00x2.000mm	HR646 [1]	NA5016 35.00x47.00x7.00mm, FPM/ACM NA5053 [2] 30.00x42.00x7.00mm, FPM NA5016 [2] 35.00x47.00x7.00mm, FPM/ACM NF835 [1] 80.00x100.00x8.00mm, FPM/ACM	NF791 [2] [53]
HBS102 [22] M10x1.50x113.00mm (x5)	JD418 [1]	JN789 [4]	PA349 22.00x16.00x2.000mm	HR646 [1]	NA5016 35.00x47.00x7.00mm, FPM/ACM NA5053 [2] 30.00x42.00x7.00mm, FPM NA5016 [2] 35.00x47.00x7.00mm, FPM/ACM NF835 [1] 80.00x100.00x8.00mm, FPM/ACM	NF791 [2] [53]



cc



kW/PS



1.6	K7M 746	251	BY030 (Fibre)						
Kangoo 1.6 Thalia 1.6	09/99→06/01 03/98→	1598	4	79.50	SOHC/OHC	66/90			
1.6	K7M 750	252	AH5170 (MLS)						
Kangoo 1.6	02/08→	1598	4	79.50	SOHC/OHC	64/87			
1.6	K7M 790	253	BY030 (Fibre)	DY030 [3]					
Megane 1.6 e	01/96→03/99	1598	4	79.50	SOHC/OHC	66/90			
1.7	F1N 720	254	BL910 (Fibre), 1.200mm	DL910 [3]	EL960 [3] [18]				
Trafic 1.7	08/92→08/94	1721	4	81.00	SOHC/OHC	50/68			
1.7	F1N 722	255	BL910 (Fibre), 1.200mm	DL910 [3]	EL960 [3] [18]				
Trafic 1.7	06/86→08/94	1721	4	81.00	SOHC/OHC	50/68			
1.7	F1N 724	256	BL910 (Fibre), 1.200mm	DL910 [3]	EL960 [3] [18]				
Trafic 1.7	06/86→08/94	1721	4	81.00	SOHC/OHC	50-51/ 68-69			

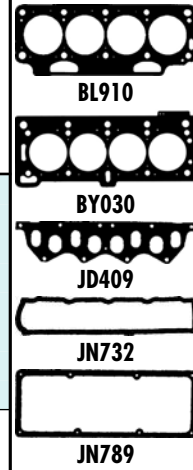

HBS102 [22]
M10x1.50x113.00mm (x5)

JD5315 (x4)
JD418

JN789 [4]

HR646

NA5016
35.00x47.00x7.00mm, FPM/ACM
NA5053 [2]
30.00x42.00x7.00mm, FPM
NA5016 [2]
35.00x47.00x7.00mm, FPM/ACM
NF835 [1]
80.00x100.00x8.00mm, FPM/ACM

HBS102 [22]
M10x1.50x113.00mm (x5)

JD5315 (x4)
JD418

JN789 [4]

HR646

NA5016
35.00x47.00x7.00mm, FPM/ACM
NA5053 [2]
30.00x42.00x7.00mm, FPM
NF835 [1]
80.00x100.00x8.00mm, FPM/ACM

HBS102 [22]
M10x1.50x113.00mm (x5)

JD434
JD418

JN789 [4]

HR646

NA5016
35.00x47.00x7.00mm, FPM/ACM
NA5053 [2]
30.00x42.00x7.00mm, FPM
NA5016 [2]
35.00x47.00x7.00mm, FPM/ACM
NF835 [1]
80.00x100.00x8.00mm, FPM/ACM

HBS244 [22]
M12x1.50x111.00mm (x10)

JD409

JN732 [4]

PA349
22.00x16.00x2.000mm

HR569

NF847 [1]
22.00x45.00x7.00mm, FPM/ACM
NF846 [2]
25.00x42.00x7.00mm, FPM/ACM
NF850 [1]
85.00x105.00x8.00mm, FPM
NF648 [2]
50.00x68.00x10.00mm, MVQ
NF843 [2]
50.00x68.00x10.00mm, FPM/ACM

KA625 [15]
NF849 [2] [56]

HBS244 [22]
M12x1.50x111.00mm (x10)

JD409

JN732 [4]

PA349
22.00x16.00x2.000mm

HR569

NF847 [1]
22.00x45.00x7.00mm, FPM/ACM
NF846 [2]
25.00x42.00x7.00mm, FPM/ACM
NF850 [1]
85.00x105.00x8.00mm, FPM
NF648 [2]
50.00x68.00x10.00mm, MVQ
NF843 [2]
50.00x68.00x10.00mm, FPM/ACM

KA625 [15]
NF849 [2] [56]

HBS244 [22]
M12x1.50x111.00mm (x10)

JD409

JN732 [4]

PA349
22.00x16.00x2.000mm

HR569

NF847 [1]
22.00x45.00x7.00mm, FPM/ACM
NF846 [2]
25.00x42.00x7.00mm, FPM/ACM
NF850 [1]
85.00x105.00x8.00mm, FPM
NF648 [2]
50.00x68.00x10.00mm, MVQ
NF843 [2]
50.00x68.00x10.00mm, FPM/ACM

KA625 [15]
NF849 [2] [56]



cc



kW/PS



1.7		F2N 700				257		BL910 (Fibre), 1.200mm	DL910 [3]	EL960 [3] [18]
9 1.7	09/84→12/88	1721	4	81.00	SOHC/OHC	59/80	→12/87	→12/87	→12/87	
1.7		F2N 704				258		BL910 (Fibre), 1.200mm	DL910 [3]	EL960 [3] [18]
9 1.7	09/84→12/88	1721	4	81.00	SOHC/OHC	59/80	→12/87	→12/87	→12/87	
1.7		F2N 708				259		BL910 (Fibre), 1.200mm	DL910 [3]	EL960 [3] [18]
9 1.7	10/86→12/88	1721	4	81.00	SOHC/OHC	65/88				
11 1.7	10/86→12/88									
1.7		F2N 710				260		BL910 (Fibre), 1.200mm	DL910 [3]	EL960 [3] [18]
9 1.7	10/86→12/88	1721	4	81.00	SOHC/OHC	65/88	06/86→03/92		06/86→03/92	06/86→03/92
11 1.7	10/86→12/88									
21 1.7	03/86→03/93									
21 Van 1.7	06/86→04/95									

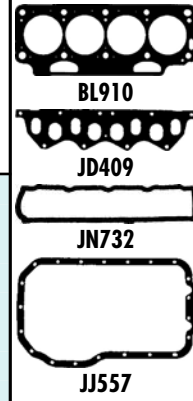
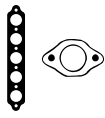

HBS244 [22]
M12x1.50x111.00mm (x10)
→12/87

JD409
→12/87

JN732 [4]
→12/87

JJ557
→12/87

HR569 [5]
→12/87

NF846 [2]
25.00x42.00x7.00mm, FPM/ACM
→12/87
NF847 [1]
22.00x45.00x7.00mm, FPM/ACM
→12/87
NF850 [1]
85.00x105.00x8.00mm, FPM
→12/87
NF648 [2]
50.00x68.00x10.00mm, MVQ
→12/87
NF843 [2]
50.00x68.00x10.00mm, FPM/ACM
→12/87

HBS244 [22]
M12x1.50x111.00mm (x10)
→12/87

JD409
→12/87

JN732 [4]
→12/87

JJ557
→12/87

HR569 [5]
→12/87

NF846 [2]
25.00x42.00x7.00mm, FPM/ACM
→12/87
NF847 [1]
22.00x45.00x7.00mm, FPM/ACM
→12/87
NF850 [1]
85.00x105.00x8.00mm, FPM
→12/87
NF648 [2]
50.00x68.00x10.00mm, MVQ
→12/87
NF843 [2]
50.00x68.00x10.00mm, FPM/ACM
→12/87

HBS244 [22]
M12x1.50x111.00mm (x10)

JD409

JN732 [4]

JJ557

HR569 [5]

NF846 [2]
25.00x42.00x7.00mm, FPM/ACM
NF847 [1]
22.00x45.00x7.00mm, FPM/ACM
NF850 [1]
85.00x105.00x8.00mm, FPM
NF648 [2]
50.00x68.00x10.00mm, MVQ
NF843 [2]
50.00x68.00x10.00mm, FPM/ACM

HBS244 [22]
M12x1.50x111.00mm (x10)
06/86→03/92

JD409
06/86→03/92

JN732 [4]
06/86→03/92

PA349
22.00x16.00x2.000mm
JJ557
06/86→03/92

HR569 [5]
06/86→03/92

NF847 [1]
22.00x45.00x7.00mm, FPM/ACM
06/86→03/92
NF846 [2]
25.00x42.00x7.00mm, FPM/ACM
06/86→03/92
NF850 [1]
85.00x105.00x8.00mm, FPM
06/86→03/92
NF648 [2]
50.00x68.00x10.00mm, MVQ
06/86→03/92
NF843 [2]
50.00x68.00x10.00mm, FPM/ACM
06/86→03/92

KA625 [15]
NF849 [2] [56]



cc



kW/PS

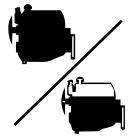

1.7	F2N 711	261	BL910 (Fibre), 1.200mm	DL910 [3]	EL960 [3][18]
21 1.7	07/89→05/93	1721 4 81.00 SOHC/OHC 65/88	→12/89	→12/89	→12/89
1.7	F2N 712	262	BL910 (Fibre), 1.200mm	DL910 [3]	EL960 [3][18]
21 1.7	06/86→05/93	1721 4 81.00 SOHC/OHC 55/75	→12/87	→12/87	→12/87
1.7	F2N 720	263	BL910 (Fibre), 1.200mm	DL910 [3]	EL960 [3][18]
19 1.7	09/88→08/95	1721 4 81.00 SOHC/OHC 65-68/88-92			
1.7	F2N 721	264	BL910 (Fibre), 1.200mm	DL910 [3]	EL960 [3][18]
19 1.7	09/88→08/95	1721 4 81.00 SOHC/OHC 68-69/92-94			
1.7	F2N 724	265	BL910 (Fibre), 1.200mm	DL910 [3]	EL960 [3][18]
19 1.7	07/91→04/92	1721 4 81.00 SOHC/OHC 55-56/75-76			

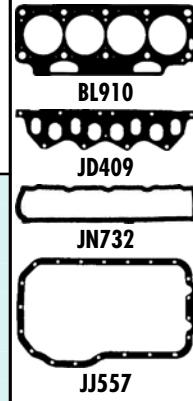
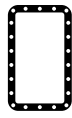

HBS244 [22] M12x1.50x111.00mm (x10) →12/89	JD409 →12/89	JN732 [4] →12/89	JJ557 →12/89	HR569 [5] →12/89	NF846 [2] 25.00x42.00x7.00mm, FPM/ACM →12/89 NF847 [1] 22.00x45.00x7.00mm, FPM/ACM →12/89 NF850 [1] 85.00x105.00x8.00mm, FPM →12/89 NF648 [2] 50.00x68.00x10.00mm, MVQ →12/89 NF843 [2] 50.00x68.00x10.00mm, FPM/ACM →12/89
HBS244 [22] M12x1.50x111.00mm (x10) →12/87	JD409 →12/87	JN732 [4] →12/87	JJ557 →12/87 PA349 22.00x16.00x2.000mm	HR569 [5] →12/87	NF847 [1] 22.00x45.00x7.00mm, FPM/ACM →12/87 NF846 [2] 25.00x42.00x7.00mm, FPM/ACM →12/87 NF850 [1] 85.00x105.00x8.00mm, FPM →12/87 NF648 [2] 50.00x68.00x10.00mm, MVQ →12/87 NF843 [2] 50.00x68.00x10.00mm, FPM/ACM →12/87
HBS244 [22] M12x1.50x111.00mm (x10)	JD409	JN732 [4]	JJ557	HR569 [5]	NF846 [2] 25.00x42.00x7.00mm, FPM/ACM NF847 [1] 22.00x45.00x7.00mm, FPM/ACM NF850 [1] 85.00x105.00x8.00mm, FPM NF648 [2] 50.00x68.00x10.00mm, MVQ NF843 [2] 50.00x68.00x10.00mm, FPM/ACM
HBS244 [22] M12x1.50x111.00mm (x10)	JD409	JN732 [4]	JJ557	HR569 [5]	NF846 [2] 25.00x42.00x7.00mm, FPM/ACM NF847 [1] 22.00x45.00x7.00mm, FPM/ACM NF850 [1] 85.00x105.00x8.00mm, FPM NF648 [2] 50.00x68.00x10.00mm, MVQ NF843 [2] 50.00x68.00x10.00mm, FPM/ACM
HBS244 [22] M12x1.50x111.00mm (x10)	JD409	JN732 [4]	JJ557	HR569 [5]	NF846 [2] 25.00x42.00x7.00mm, FPM/ACM NF847 [1] 22.00x45.00x7.00mm, FPM/ACM NF850 [1] 85.00x105.00x8.00mm, FPM NF648 [2] 50.00x68.00x10.00mm, MVQ NF843 [2] 50.00x68.00x10.00mm, FPM/ACM

RENAULT



cc



kW/PS

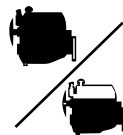

1.7		F2N 730					266	BL910 (Fibre), 1.200mm	DL910 [3]	EL960 [3] [18]
9 1.7	10/86→12/88	1721	4	81.00	SOHC/OHC	54-55/ 73-75				
11 1.7	10/86→12/88									
1.7		F2N 732					267	BL910 (Fibre), 1.200mm	DL910 [3]	EL960 [3] [18]
11 1.7	06/87→12/88	1721	4	81.00	SOHC/OHC	64/87				
1.7		F2N 740					268	BL910 (Fibre), 1.200mm	DL910 [3]	EL960 [3] [18]
Super 5 1.7	06/87→03/95	1721	4	81.00	SOHC/OHC	64-66/ 87-90				
1.7		F2N 742					269	BL910 (Fibre), 1.200mm	DL910 [3]	EL960 [3] [18]
11 1.7	06/87→12/88	1721	4	81.00	SOHC/OHC	64-66/ 87-90				
Super 5 1.7	06/87→03/95									
1.7		F2N 750					270	BL910 (Fibre), 1.200mm	DL910 [3]	EL960 [3] [18]
21 1.7	06/86→02/94	1721	4	81.00	SOHC/OHC	54/73	07/86→12/89	07/86→12/89	07/86→12/89	

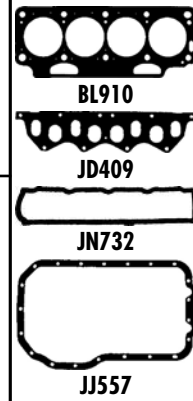
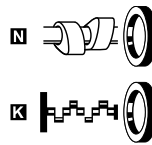
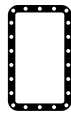
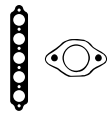

HBS244 [22] M12x1.50x111.00mm (x10)	JD409	JN732 [4]	JJ557 PA349 22.00x16.00x2.000mm	HR569	NF846 [2] 25.00x42.00x7.00mm, FPM/ACM NF847 [1] 22.00x45.00x7.00mm, FPM/ACM NF850 [1] 85.00x105.00x8.00mm, FPM NF648 [2] 50.00x68.00x10.00mm, MVQ NF843 [2] 50.00x68.00x10.00mm, FPM/ACM	KA625 [15] NF849 [2] [56]
HBS244 [22] M12x1.50x111.00mm (x10)	JD409	JN732 [4]	JJ557	HR569	NF846 [2] 25.00x42.00x7.00mm, FPM/ACM NF847 [1] 22.00x45.00x7.00mm, FPM/ACM NF850 [1] 85.00x105.00x8.00mm, FPM NF648 [2] 50.00x68.00x10.00mm, MVQ NF843 [2] 50.00x68.00x10.00mm, FPM/ACM	
HBS244 [22] M12x1.50x111.00mm (x10)	JD409	JN732 [4]	JJ557	HR569	NF846 [2] 25.00x42.00x7.00mm, FPM/ACM NF847 [1] 22.00x45.00x7.00mm, FPM/ACM NF850 [1] 85.00x105.00x8.00mm, FPM NF648 [2] 50.00x68.00x10.00mm, MVQ NF843 [2] 50.00x68.00x10.00mm, FPM/ACM	
HBS244 [22] M12x1.50x111.00mm (x10)	JD409	JN732 [4]	JJ557	HR569	NF846 [2] 25.00x42.00x7.00mm, FPM/ACM NF847 [1] 22.00x45.00x7.00mm, FPM/ACM NF850 [1] 85.00x105.00x8.00mm, FPM NF648 [2] 50.00x68.00x10.00mm, MVQ NF843 [2] 50.00x68.00x10.00mm, FPM/ACM	
HBS244 [22] M12x1.50x111.00mm (x10) 07/86→12/89	JD409 07/86→12/89	JN732 [4] 07/86→12/89	PA349 22.00x16.00x2.000mm JJ557 07/86→12/89	HR569 07/86→12/89	NF847 [1] 22.00x45.00x7.00mm, FPM/ACM 07/86→12/89 NF846 [2] 25.00x42.00x7.00mm, FPM/ACM 07/86→12/89 NF850 [1] 85.00x105.00x8.00mm, FPM 07/86→12/89 NF648 [2] 50.00x68.00x10.00mm, MVQ 07/86→12/89 NF843 [2] 50.00x68.00x10.00mm, FPM/ACM 07/86→12/89	KA625 [15] NF849 [2] [56]

RENAULT



cc



kW/PS



1.7	F2N 752	271	BL910 (Fibre), 1.200mm	DL910 [3]	EL960 [3][18]
21 1.7	06/87→04/89	1721 4 81.00 SOHC/OHC 64/87			
1.7	F2N 754	272	BL910 (Fibre), 1.200mm	DL910 [3]	EL960 [3][18]
21 1.7	07/89→05/93	1721 4 81.00 SOHC/OHC 65/88			
1.7	F2N 770	273	BL910 (Fibre), 1.200mm	DL910 [3]	EL960 [3][18]
Clio 1.7	01/91→12/93	1721 4 81.00 SOHC/OHC 66-68/90-92			
1.7	F2N 798	274	BL910 (Fibre), 1.200mm	DL910 [3]	EL960 [3][18]
9 1.7 11 1.7	10/86→12/88 10/86→12/88	1721 4 81.00 SOHC/OHC, BOXER 65/88			
1.7	F3N 702	275	BL910 (Fibre), 1.200mm	DL910 [3]	EL960 [3][18]
Super 5 1.7 i	10/86→08/91	1721 4 81.00 SOHC/OHC 68-69/92-94			
1.7	F3N 708	276	BL910 (Fibre), 1.200mm	DL910 [3]	EL960 [3][18]
9 1.7 11 1.7 (B/C37E)	06/87→12/88 06/87→12/88	1721 4 81.00 SOHC/OHC 69/94			

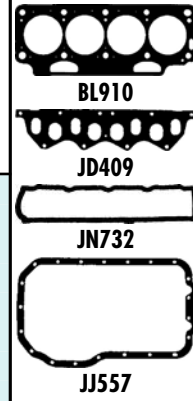

HBS244 [22] M12x1.50x111.00mm (x10)	JD409	JN732 [4]	JJ557 =PA349 22.00x16.00x2.000mm	HR569 [5]	NF847 [1] 22.00x45.00x7.00mm, FPM/ACM NF846 [2] 25.00x42.00x7.00mm, FPM/ACM NF850 [1] 85.00x105.00x8.00mm, FPM NF648 [2] 50.00x68.00x10.00mm, MVQ NF843 [2] 50.00x68.00x10.00mm, FPM/ACM	KA625 [15] NF849 [2] [56]
HBS244 [22] M12x1.50x111.00mm (x10)	JD409	JN732 [4]	JJ557	HR569 [5]	NF846 [2] 25.00x42.00x7.00mm, FPM/ACM NF847 [1] 22.00x45.00x7.00mm, FPM/ACM NF850 [1] 85.00x105.00x8.00mm, FPM NF648 [2] 50.00x68.00x10.00mm, MVQ NF843 [2] 50.00x68.00x10.00mm, FPM/ACM	
HBS244 [22] M12x1.50x111.00mm (x10)	JD409	JN732 [4]	JJ557 =PA349 22.00x16.00x2.000mm	HR569 [5]	NF846 [2] 25.00x42.00x7.00mm, FPM/ACM NF847 [1] 22.00x45.00x7.00mm, FPM/ACM NF850 [1] 85.00x105.00x8.00mm, FPM NF648 [2] 50.00x68.00x10.00mm, MVQ NF843 [2] 50.00x68.00x10.00mm, FPM/ACM	KA625 [15] NF849 [2] [56]
HBS244 [22] M12x1.50x111.00mm (x10)	JD409	JN732 [4]	JJ557	HR569 [5]	NF846 [2] 25.00x42.00x7.00mm, FPM/ACM NF847 [1] 22.00x45.00x7.00mm, FPM/ACM NF850 [1] 85.00x105.00x8.00mm, FPM NF648 [2] 50.00x68.00x10.00mm, MVQ NF843 [2] 50.00x68.00x10.00mm, FPM/ACM	
HBS244 [22] M12x1.50x111.00mm (x10)	JD409	JN732 [4]	JJ557	HR569 [5]	NF846 [2] 25.00x42.00x7.00mm, FPM/ACM NF847 [1] 22.00x45.00x7.00mm, FPM/ACM NF850 [1] 85.00x105.00x8.00mm, FPM NF648 [2] 50.00x68.00x10.00mm, MVQ NF843 [2] 50.00x68.00x10.00mm, FPM/ACM	
HBS244 [22] M12x1.50x111.00mm (x10)	JD409	JN732 [4]	JJ557 =PA349 22.00x16.00x2.000mm	HR569 [5]	NF846 [2] 25.00x42.00x7.00mm, FPM/ACM NF847 [1] 22.00x45.00x7.00mm, FPM/ACM NF850 [1] 85.00x105.00x8.00mm, FPM NF648 [2] 50.00x68.00x10.00mm, MVQ NF843 [2] 50.00x68.00x10.00mm, FPM/ACM	KA625 [15] NF849 [2] [56]



cc



kW/PS

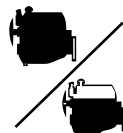

1.7	F3N 716	277						BL910 (Fibre), 1.200mm	DL910 [3]	EL960 [3] [18]
Super 5 1.7	10/86→03/95	1721	4	81.00	SOHC/OHC	54-55/ 73-75				
1.7	F3N 717	278						BL910 (Fibre), 1.200mm	DL910 [3]	EL960 [3] [18]
Super 5 1.7	10/86→03/95	1721	4	81.00	SOHC/OHC	54-55/ 73-75				
1.7	F3N 718	279						BL910 (Fibre), 1.200mm	DL910 [3]	EL960 [3] [18]
9 1.7 11 1.7	10/86→12/88 10/84→12/88	1721	4	81.00	SOHC/OHC	54-55/ 73-75				
1.7	F3N 722	280						BL910 (Fibre), 1.200mm	DL910 [3]	EL960 [3] [18]
21 1.7 Super 5 1.7 i	03/86→06/94 10/86→08/91	1721	4	81.00	SOHC/OHC	66-70/ 90-95	06/86→12/93	06/86→12/93	06/86→12/93	
1.7	F3N 723	281						BL910 (Fibre), 1.200mm	DL910 [3]	EL960 [3] [18]
21 1.7	03/86→06/94	1721	4	81.00	SOHC/OHC	66-70/ 90-95	06/86→12/93	06/86→12/93	06/86→12/93	

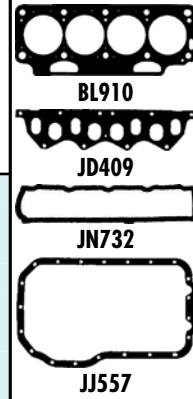
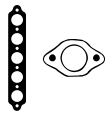

HBS244 [22] M12x1.50x111.00mm (x10)	JD409	JN732 [4]	JJ557	HR569 [5]	NF846 [2] 25.00x42.00x7.00mm, FPM/ACM NF847 [1] 22.00x45.00x7.00mm, FPM/ACM NF850 [1] 85.00x105.00x8.00mm, FPM NF648 [2] 50.00x68.00x10.00mm, MVQ NF843 [2] 50.00x68.00x10.00mm, FPM/ACM	
HBS244 [22] M12x1.50x111.00mm (x10)	JD409	JN732 [4]	JJ557	HR569 [5]	NF846 [2] 25.00x42.00x7.00mm, FPM/ACM NF847 [1] 22.00x45.00x7.00mm, FPM/ACM NF850 [1] 85.00x105.00x8.00mm, FPM NF648 [2] 50.00x68.00x10.00mm, MVQ NF843 [2] 50.00x68.00x10.00mm, FPM/ACM	
HBS244 [22] M12x1.50x111.00mm (x10)	JD409	JN732 [4]	JJ557 PA349 22.00x16.00x2.000mm	HR569 [5]	NF846 [2] 25.00x42.00x7.00mm, FPM/ACM NF847 [1] 22.00x45.00x7.00mm, FPM/ACM NF850 [1] 85.00x105.00x8.00mm, FPM NF648 [2] 50.00x68.00x10.00mm, MVQ NF843 [2] 50.00x68.00x10.00mm, FPM/ACM	KA625 [15] NF849 [2] [56]
HBS244 [22] M12x1.50x111.00mm (x10) 06/86→12/93	JD409 06/86→12/93	JN732 [4] 06/86→12/93	JJ557 06/86→12/93	HR569 [5] 06/86→12/93	NF846 [2] 25.00x42.00x7.00mm, FPM/ACM 06/86→12/93 NF847 [1] 22.00x45.00x7.00mm, FPM/ACM 06/86→12/93 NF850 [1] 85.00x105.00x8.00mm, FPM 06/86→12/93 NF648 [2] 50.00x68.00x10.00mm, MVQ 06/86→12/93 NF843 [2] 50.00x68.00x10.00mm, FPM/ACM 06/86→12/93	
HBS244 [22] M12x1.50x111.00mm (x10) 06/86→12/93	JD409 06/86→12/93	JN732 [4] 06/86→12/93	JJ557 06/86→12/93	HR569 [5] 06/86→12/93	NF846 [2] 25.00x42.00x7.00mm, FPM/ACM 06/86→12/93 NF847 [1] 22.00x45.00x7.00mm, FPM/ACM 06/86→12/93 NF850 [1] 85.00x105.00x8.00mm, FPM 06/86→12/93 NF648 [2] 50.00x68.00x10.00mm, MVQ 06/86→12/93 NF843 [2] 50.00x68.00x10.00mm, FPM/ACM 06/86→12/93	



cc



kW/PS

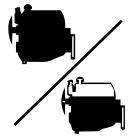

1.7	F3N 726	282							
21 1.7	07/86→02/94	1721	4	81.00	SOHC/OHC	54/73	BL910 (Fibre), 1.200mm 07/89→	DL910 [3] 07/89→	EL960 [3][18] 07/89→
19 1.7	09/88→12/95	1721	4	81.00	SOHC/OHC	54-55/ 73-75	BL910 (Fibre), 1.200mm →06/95	DL910 [3] →06/95	EL960 [3][18] →06/95
19 1.7	09/88→12/95	1721	4	81.00	SOHC/OHC	54-55/ 73-75	BL910 (Fibre), 1.200mm →06/95	DL910 [3] →06/95	EL960 [3][18] →06/95
19 1.7	07/88→12/95 19 Cabrio 1.7 07/91→09/93	1721	4	81.00	SOHC/OHC	66-70/ 90-95	BL910 (Fibre), 1.200mm 03/89→06/95	DL910 [3] 03/89→06/95	EL960 [3][18] 03/89→06/95

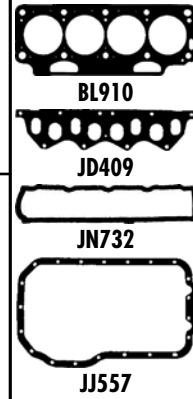
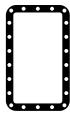
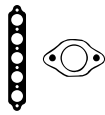

HBS244 [22]
M12x1.50x111.00mm (x10)
07/89→

JD409
07/89→

JN732 [4]
07/89→

PA349
22.00x16.00x2.000mm
JJ557
07/89→

HR569 [5]
07/89→

NF847 [1]
22.00x45.00x7.00mm, FPM/ACM
07/89→
NF846 [2]
25.00x42.00x7.00mm, FPM/ACM
07/89→
NF850 [1]
85.00x105.00x8.00mm, FPM
07/89→
NF648 [2]
50.00x68.00x10.00mm, MVQ
07/89→
NF843 [2]
50.00x68.00x10.00mm, FPM/ACM
07/89→

KA625 [15]
NF849 [2] [56]

HBS244 [22]
M12x1.50x111.00mm (x10)
→06/95

JD409
→06/95

JN732 [4]
→06/95

JJ557
→06/95

HR569 [5]
→06/95

NF846 [2]
25.00x42.00x7.00mm, FPM/ACM
→06/95
NF847 [1]
22.00x45.00x7.00mm, FPM/ACM
→06/95
NF850 [1]
85.00x105.00x8.00mm, FPM
→06/95
NF648 [2]
50.00x68.00x10.00mm, MVQ
→06/95
NF843 [2]
50.00x68.00x10.00mm, FPM/ACM
→06/95

HBS244 [22]
M12x1.50x111.00mm (x10)
→06/95

JD409
→06/95

JN732 [4]
→06/95

JJ557
→06/95

HR569 [5]
→06/95

NF846 [2]
25.00x42.00x7.00mm, FPM/ACM
→06/95
NF847 [1]
22.00x45.00x7.00mm, FPM/ACM
→06/95
NF850 [1]
85.00x105.00x8.00mm, FPM
→06/95
NF648 [2]
50.00x68.00x10.00mm, MVQ
→06/95
NF843 [2]
50.00x68.00x10.00mm, FPM/ACM
→06/95

HBS244 [22]
M12x1.50x111.00mm (x10)
03/89→06/95

JD409
03/89→06/95

JN732 [4]
03/89→06/95

JJ557
03/89→06/95

HR569 [5]
03/89→06/95

NF846 [2]
25.00x42.00x7.00mm, FPM/ACM
03/89→06/95
NF847 [1]
22.00x45.00x7.00mm, FPM/ACM
03/89→06/95
NF850 [1]
85.00x105.00x8.00mm, FPM
03/89→06/95
NF648 [2]
50.00x68.00x10.00mm, MVQ
03/89→06/95
NF843 [2]
50.00x68.00x10.00mm, FPM/ACM
03/89→06/95



cc



kW/PS



1.7		F3N 743					286	BL910 (Fibre), 1.200mm	DL910 [3]	EL960 [3] [18]
19 1.7	07/88→12/95	1721	4	81.00	SOHC/OHC	66/90	03/89→06/95	03/89→06/95	03/89→06/95	
19 Cabrio 1.7	07/91→09/93									
1.7		F3N 746					287	BL910 (Fibre), 1.200mm	DL910 [3]	EL960 [3] [18]
19 1.7	08/88→09/94	1721	4	81.00	SOHC/OHC	66-80/ 90-109				
1.8		F3P 670					288	BX600 (Fibre)	DX600	EL960 [3] [18]
Laguna 1.8	09/95→03/01	1783	4	82.70	SOHC/OHC	66/90				
Laguna I 1.8	08/95→03/01									
1.8		F3P 674					289	BX600 (Fibre)	DX600	EL960 [3] [18]
Laguna I 1.8	06/95→02/01	1783	4	82.70	SOHC/OHC	69/94				
1.8		F3P 676					290	BX600 (Fibre) BS530 (Fibre), 1.750mm, 1 Hole 0.868→1.000mm	DX600	EL960 [3] [18]
Laguna I 1.8	06/95→06/98	1794	4	82.70	SOHC/OHC	69-70/ 94-95				

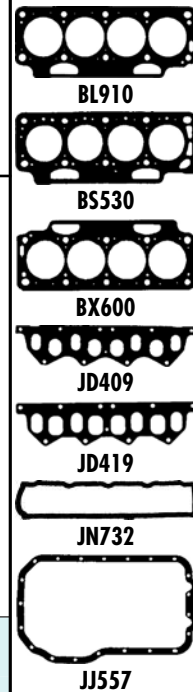
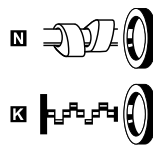
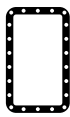
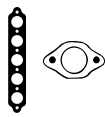

HBS244 [22]
M12x1.50x111.00mm (x10)
03/89→06/95

JD409
03/89→06/95

JN732 [4]
03/89→06/95

PA349
22.00x16.00x2.000mm
JJ557
03/89→06/95

HR569 [5]
03/89→06/95

NF846 [2]
25.00x42.00x7.00mm, FPM/ACM
03/89→06/95
NF847 [1]
22.00x45.00x7.00mm, FPM/ACM
03/89→06/95
NF850 [1]
85.00x105.00x8.00mm, FPM
03/89→06/95
NF648 [2]
50.00x68.00x10.00mm, MVQ
03/89→06/95
NF843 [2]
50.00x68.00x10.00mm, FPM/ACM
03/89→06/95

KA625 [15]
NF849 [2] [56]

HBS244 [22]
M12x1.50x111.00mm (x10)

JD409

JN732 [4]

JJ557

HR569 [5]

NF846 [2]
25.00x42.00x7.00mm, FPM/ACM
NF847 [1]
22.00x45.00x7.00mm, FPM/ACM
NF850 [1]
85.00x105.00x8.00mm, FPM
NF648 [2]
50.00x68.00x10.00mm, MVQ
NF843 [2]
50.00x68.00x10.00mm, FPM/ACM

HBS244 [22]
M12x1.50x111.00mm (x10)

JD419

JN732 [4]

JJ557
PA349
22.00x16.00x2.000mm

HR569 [5]

NF846 [2]
25.00x42.00x7.00mm, FPM/ACM
NF847 [1]
22.00x45.00x7.00mm, FPM/ACM
NF850 [1]
85.00x105.00x8.00mm, FPM
NF843 [2]
50.00x68.00x10.00mm, FPM/ACM
→04/97
NA5037 [1]
85.00x105.00x11.00mm, ACM
NA5036 [2]
42.00x54.00x6.00mm, FPM
04/97→

NF791 [2] [53]
KA625 [15]
NF849 [2] [56]

HBS244 [22]
M12x1.50x111.00mm (x10)

JD419

JN732 [4]

JJ557

HR569 [5]

NF846 [2]
25.00x42.00x7.00mm, FPM/ACM
NF847 [1]
22.00x45.00x7.00mm, FPM/ACM
NF843 [2]
50.00x68.00x10.00mm, FPM/ACM
→04/97
NA5037 [1]
85.00x105.00x11.00mm, ACM
NA5036 [2]
42.00x54.00x6.00mm, FPM
04/97→

HBS244 [22]
M12x1.50x111.00mm (x10)

JD419

JN732 [4]

JJ557

HR569 [5]

NF846 [2]
25.00x42.00x7.00mm, FPM/ACM
NF847 [1]
22.00x45.00x7.00mm, FPM/ACM
NF850 [1]
85.00x105.00x8.00mm, FPM
NF843 [2]
50.00x68.00x10.00mm, FPM/ACM
NA5037 [1]
85.00x105.00x11.00mm, ACM



cc



kW/PS



1.8		F3P 678				291	BX600 (Fibre)	DX600	EL960 [3][18]
Laguna 1.8	09/95→03/01	1783	4	82.70	SOHC/OHC	66/90			
Laguna I 1.8	08/95→03/01								
1.8		F3P 682				292	BX600 (Fibre)	DX600	EL960 [3][18]
19 1.8	05/94→12/95	1783	4	82.70	SOHC/OHC	79/107			
19 Cabrio 1.8	07/94→06/96								
1.8		F3P 700				293	BX600 (Fibre) BS530 (Fibre), 1.750mm, 1 Hole →0.868→1.000mm	DX600	EL960 [3][18]
19 1.8	04/92→11/95	1794	4	82.70	SOHC/OHC	79-81/ 107-110			
1.8		F3P 704				294	BX600 (Fibre) →01/93 BS530 (Fibre), 1.750mm, 1 Hole →01/93 →0.868→1.000mm	DX600 →01/93	EL960 [3][18] →01/93
19 1.8 (L53Y)	04/92→12/95	1794	4	82.70	SOHC/OHC	65-66/ 88-90			
19 Cabrio 1.8	04/92→06/96								
1.8		F3P 705				295	BX600 (Fibre) →01/93 BS530 (Fibre), 1.750mm, 1 Hole →01/93 →0.868→1.000mm	DX600 →01/93	EL960 [3][18] →01/93
19 1.8 (L53Y)	04/92→12/95	1794	4	82.70	SOHC/OHC	65-66/ 88-90			
19 Cabrio 1.8	04/92→06/96								

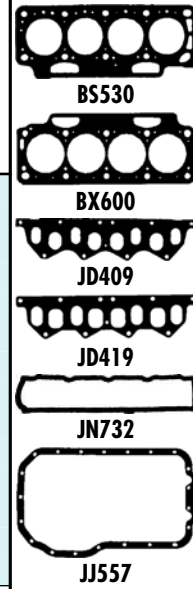
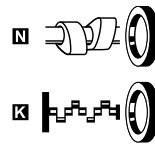
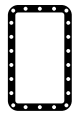

HBS244 [22] M12x1.50x111.00mm (x10)	JD419	JN732 [4]	JJ557 PA349 22.00x16.00x2.000mm	HR569	NF846 [2] 25.00x42.00x7.00mm, FPM/ACM NF847 [1] 22.00x45.00x7.00mm, FPM/ACM NF850 [1] 85.00x105.00x8.00mm, FPM NF843 [2] 50.00x68.00x10.00mm, FPM/ACM →04/97 NA5037 [1] 85.00x105.00x11.00mm, ACM NA5036 [2] 42.00x54.00x6.00mm, FPM 04/97→	NF791 [2][53] KA625 [15] NF849 [2][56]
HBS244 [22] M12x1.50x111.00mm (x10)	JD419	JN732 [4]	JJ557 PA349 22.00x16.00x2.000mm	HR569	NF846 [2] 25.00x42.00x7.00mm, FPM/ACM NF847 [1] 22.00x45.00x7.00mm, FPM/ACM NF850 [1] 85.00x105.00x8.00mm, FPM NF843 [2] 50.00x68.00x10.00mm, FPM/ACM	KA625 [15] NF849 [2][56]
HBS244 [22] M12x1.50x111.00mm (x10)	JD419	JN732 [4]	JJ557 PA349 22.00x16.00x2.000mm	HR569	NF846 [2] 25.00x42.00x7.00mm, FPM/ACM NF847 [1] 22.00x45.00x7.00mm, FPM/ACM NF850 [1] 85.00x105.00x8.00mm, FPM NF843 [2] 50.00x68.00x10.00mm, FPM/ACM	KA625 [15] NF849 [2][56]
HBS244 [22] M12x1.50x111.00mm (x10) →01/93	JD419 →01/93	JN732 [4] →01/93	JJ557 →01/93 PA349 22.00x16.00x2.000mm	HR569 →01/93	NF846 [2] 25.00x42.00x7.00mm, FPM/ACM →01/93 NF847 [1] 22.00x45.00x7.00mm, FPM/ACM →01/93 NF850 [1] 85.00x105.00x8.00mm, FPM →01/93 NF843 [2] 50.00x68.00x10.00mm, FPM/ACM →01/93	KA625 [15] NF849 [2][56]
HBS244 [22] M12x1.50x111.00mm (x10) →01/93	JD409 →01/93	JN732 [4] →01/93	JJ557 →01/93 PA349 22.00x16.00x2.000mm	HR569 →01/93	NF846 [2] 25.00x42.00x7.00mm, FPM/ACM →01/93 NF847 [1] 22.00x45.00x7.00mm, FPM/ACM →01/93 NF850 [1] 85.00x105.00x8.00mm, FPM →01/93 NF843 [2] 50.00x68.00x10.00mm, FPM/ACM →01/93	KA625 [15] NF849 [2][56]



cc



kW/PS



1.8		F3P 706				296		BX600 (Fibre)		DX600	EL960 [3][18]
19 1.8	04/92→12/95	1794	4	82.70	SOHC/OHC	65-79/ 88-107	09/92→	BS530 (Fibre), 1.750mm, 1 Hole	09/92→	09/92→	09/92→
19 1.8 (L53Y)	04/92→12/95							09/92→			
19 Cabrio 1.8	04/92→06/96							→0.868→1.000mm			
1.8		F3P 707				297		BX600 (Fibre)		DX600	EL960 [3][18]
19 1.8	04/92→12/95	1794	4	82.70	SOHC/OHC	65-66/ 88-90	→01/93	BS530 (Fibre), 1.750mm, 1 Hole	→01/93	→01/93	→01/93
19 1.8 (L53Y)	04/92→12/95							→01/93			
19 Cabrio 1.8	04/92→06/96							→0.868→1.000mm			
1.8		F3P 708				298		BX600 (Fibre)		DX600	EL960 [3][18]
19 1.8	04/92→12/95	1794	4	82.70	SOHC/OHC	65-66/ 88-90	01/93→	BS530 (Fibre), 1.750mm, 1 Hole	01/93→	01/93→	01/93→
19 1.8 (L53Y)	04/92→12/95							01/93→			
19 Cabrio 1.8	04/92→06/96							→0.868→1.000mm			
1.8		F3P 710				299		BX600 (Fibre)		DX600	EL960 [3][18]
Clio 1.8	01/91→09/98	1794	4	82.70	SOHC/OHC	65-70/ 88-95		BS530 (Fibre), 1.750mm, 1 Hole			
								→0.868→1.000mm			
1.8		F3P 712				300		BX600 (Fibre)		DX600	EL960 [3][18]
Clio 1.8 Rsi	01/93→08/95	1794	4	82.70	SOHC/OHC	66-80/ 90-109		BS530 (Fibre), 1.750mm, 1 Hole			
								→0.868→1.000mm			

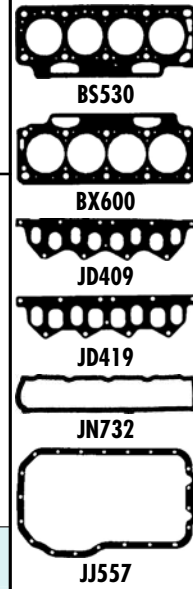

HBS244 [22]
M12x1.50x111.00mm (x10)
09/92→

JD409
09/92→

JN732 [4]
09/92→

PA349
22.00x16.00x2.000mm
JJ557
09/92→

HR569 [5]
09/92→

NF846 [2]
25.00x42.00x7.00mm, FPM/ACM
09/92→
NF847 [1]
22.00x45.00x7.00mm, FPM/ACM
09/92→
NF850 [1]
85.00x105.00x8.00mm, FPM
09/92→
NF843 [2]
50.00x68.00x10.00mm, FPM/ACM
09/92→

KA625 [15]
NF849 [2] [56]

HBS244 [22]
M12x1.50x111.00mm (x10)
→01/93

JD409
→01/93

JN732 [4]
→01/93

JJ557
→01/93
PA349
22.00x16.00x2.000mm

HR569 [5]
→01/93

NF846 [2]
25.00x42.00x7.00mm, FPM/ACM
→01/93
NF847 [1]
22.00x45.00x7.00mm, FPM/ACM
→01/93
NF850 [1]
85.00x105.00x8.00mm, FPM
→01/93
NF843 [2]
50.00x68.00x10.00mm, FPM/ACM
→01/93

KA625 [15]
NF849 [2] [56]

HBS244 [22]
M12x1.50x111.00mm (x10)
01/93→

JD409
01/93→

JN732 [4]
01/93→

PA349
22.00x16.00x2.000mm
JJ557
01/93→

HR569 [5]
01/93→

NF846 [2]
25.00x42.00x7.00mm, FPM/ACM
01/93→
NF847 [1]
22.00x45.00x7.00mm, FPM/ACM
01/93→
NF850 [1]
85.00x105.00x8.00mm, FPM
01/93→
NF843 [2]
50.00x68.00x10.00mm, FPM/ACM
01/93→

KA625 [15]
NF849 [2] [56]

HBS244 [22]
M12x1.50x111.00mm (x10)

JD419

JN732 [4]

JJ557
PA349
22.00x16.00x2.000mm

HR569 [5]

NF846 [2]
25.00x42.00x7.00mm, FPM/ACM
NF847 [1]
22.00x45.00x7.00mm, FPM/ACM
NF850 [1]
85.00x105.00x8.00mm, FPM
NF843 [2]
50.00x68.00x10.00mm, FPM/ACM

NF791 [2] [53]
KA625 [15]
NF849 [2] [56]

HBS244 [22]
M12x1.50x111.00mm (x10)

JD419

JN732 [4]

JJ557
PA349
22.00x16.00x2.000mm

HR569 [5]

NF846 [2]
25.00x42.00x7.00mm, FPM/ACM
NF847 [1]
22.00x45.00x7.00mm, FPM/ACM
NF850 [1]
85.00x105.00x8.00mm, FPM
NF843 [2]
50.00x68.00x10.00mm, FPM/ACM

NF791 [2] [53]
KA625 [15]
NF849 [2] [56]



cc



kW/PS



1.8	F3P 714	301								
Clio 1.8	01/91→09/98	1794	4	82.70	SOHC/OHC	65-70/ 88-95	BX600 (Fibre) BS530 (Fibre), 1.750mm, 1 Hole 0.868→1.000mm	DX600	EL960 [3][18]	
1.8	F3P 720	302								
Laguna 1.8	09/95→03/01	1794	4	82.70	SOHC/OHC	66-69/ 90-94	BX600 (Fibre)	DX600	EL960 [3][18]	
Laguna I 1.8	11/93→03/01									
1.8	F3P 724	303								
Laguna 1.8	09/95→03/01	1794	4	82.70	SOHC/OHC	66-69/ 90-94	BX600 (Fibre)	DX600	EL960 [3][18]	
Laguna I 1.8	11/93→03/01									
1.8	F3P 754	304								
Clio 1.8	08/94→09/98	1794	4	82.70	SOHC/OHC	66/90	BX600 (Fibre)	DX600	EL960 [3][18]	
1.8	F3P 755	305								
Clio 1.8	08/90→09/98	1783	4	82.70	SOHC/OHC	66/90	BX600 (Fibre) 06/94→	DX600 06/94→	EL960 [3][18] 06/94→	

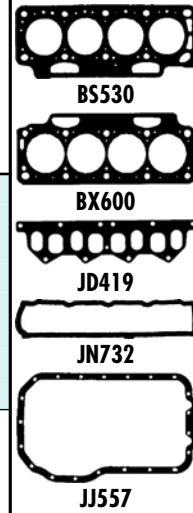
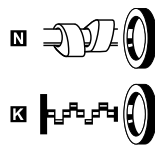
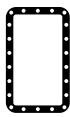
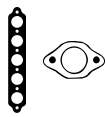

HBS244 [22] M12x1.50x111.00mm (x10)	JD419	JN732 [4]	JJ557 =PA349 22.00x16.00x2.000mm	HR569 [5]	NF846 [2] 25.00x42.00x7.00mm, FPM/ACM NF847 [1] 22.00x45.00x7.00mm, FPM/ACM NF850 [1] 85.00x105.00x8.00mm, FPM NF843 [2] 50.00x68.00x10.00mm, FPM/ACM	NF791 [2][53] KA625 [15] NF849 [2][56]
HBS244 [22] M12x1.50x111.00mm (x10)	JD419	JN732 [4]	JJ557 =PA349 22.00x16.00x2.000mm	HR569 [5]	NF846 [2] 25.00x42.00x7.00mm, FPM/ACM NF847 [1] 22.00x45.00x7.00mm, FPM/ACM NF850 [1] 85.00x105.00x8.00mm, FPM NF843 [2] 50.00x68.00x10.00mm, FPM/ACM →04/97 NA5037 [1] 85.00x105.00x11.00mm, ACM NA5036 [2] 42.00x54.00x6.00mm, FPM 04/97→	NF791 [2][53] KA625 [15] NF849 [2][56]
HBS244 [22] M12x1.50x111.00mm (x10)	JD419	JN732 [4]	JJ557 =PA349 22.00x16.00x2.000mm	HR569 [5]	NF846 [2] 25.00x42.00x7.00mm, FPM/ACM NF847 [1] 22.00x45.00x7.00mm, FPM/ACM NF850 [1] 85.00x105.00x8.00mm, FPM NF843 [2] 50.00x68.00x10.00mm, FPM/ACM →04/97 NA5037 [1] 85.00x105.00x11.00mm, ACM NA5036 [2] 42.00x54.00x6.00mm, FPM 04/97→	NF791 [2][53] KA625 [15] NF849 [2][56]
HBS244 [22] M12x1.50x111.00mm (x10)	JD419	JN732 [4]	JJ557 =PA349 22.00x16.00x2.000mm	HR569 [5]	NF846 [2] 25.00x42.00x7.00mm, FPM/ACM NF847 [1] 22.00x45.00x7.00mm, FPM/ACM NF850 [1] 85.00x105.00x8.00mm, FPM NF843 [2] 50.00x68.00x10.00mm, FPM/ACM	NF791 [2][53] KA625 [15] NF849 [2][56]
HBS244 [22] M12x1.50x111.00mm (x10) 06/94→	JD419 06/94→	JN732 [4] 06/94→	=PA349 22.00x16.00x2.000mm JJ557 06/94→	HR569 [5] 06/94→	NF846 [2] 25.00x42.00x7.00mm, FPM/ACM 06/94→ NF847 [1] 22.00x45.00x7.00mm, FPM/ACM 06/94→ NF850 [1] 85.00x105.00x8.00mm, FPM 06/94→ NF843 [2] 50.00x68.00x10.00mm, FPM/ACM 06/94→	NF791 [2][53] KA625 [15] NF849 [2][56]



cc



kW/PS

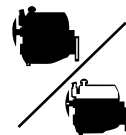

1.8	F3P 758					306	BX600 (Fibre)	DX600	EL960 [3] [18]
Clio 1.8 Rsi	08/95→09/98	1783	4	82.70	SOHC/OHC	79-80/ 107-109			
1.8	F3P 760					307	BX600 (Fibre)	DX600	EL960 [3] [18]
19 1.8	04/92→12/95	1794	4	82.70	SOHC/OHC	65-66/ 88-90	09/92→ BS530 (Fibre) , 1.750mm, 1 Hole 09/92→ 0.868→1.000mm	09/92→	09/92→
19 1.8 (L53Y)	04/92→12/95								
19 Cabrio 1.8	04/92→06/96								
1.8	F3P 764					308	BX600 (Fibre)	DX600	EL960 [3] [18]
19 Cabrio 1.8	07/94→06/96	1783	4	82.70	SOHC/OHC	79/107			
1.8	F3P 765					309	BX600 (Fibre)	DX600	EL960 [3] [18]
19 1.8	05/92→12/95	1794	4	82.70	SOHC/OHC	67-79/ 91-107	04/94→	04/94→	04/94→
19 Cabrio 1.8	07/94→06/96								
1.8	F4P 720					310	AD5990 (MLS)	CD5991	ED5991
Megane 1.8 16V	01/01→08/03	1783	4	82.70	DOHC	85/115			
Scenic 1.8 16V	01/01→08/03								
1.8	F4P 722					311	AD5990 (MLS)	CD5991	ED5991
Megane 1.8 16V	01/01→08/03	1783	4	82.70	DOHC	85/115			
Scenic 1.8 16V	01/01→08/03								
Scenic 1.8 4x4	07/00→04/01								



BS530



BX600



JD409



JD419

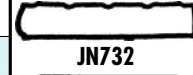

JN732



JJ557

RENAULT

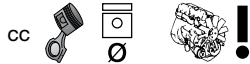

kW/PS

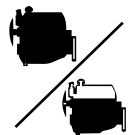

1.8	F4P 760	312	AD5990 (MLS)	CD5991	ED5991				
Laguna 1.8 16V Laguna I 1.8	04/98→03/01 04/98→03/01	1783	4	82.70	DOHC	88/120			
1.8	F4P 770	313	AD5990 (MLS)	CD5991	ED5991				
Laguna II 1.8	03/01→	1783	4	82.70	DOHC	85-89/ 116-121			
1.8	F4P 771	314	AD5990 (MLS)	CD5991	ED5991				
Laguna II 1.8	03/01→	1783	4	82.70	DOHC	85-89/ 116-121			
1.8	F4P 772	315	AD5990 (MLS)	CD5991	ED5991				
Laguna II 1.8	03/01→	1783	4	82.70	DOHC	89/121			
1.8	F4P 773	316	AD5990 (MLS)	CD5991	ED5991				
Laguna II 1.8	03/01→	1783	4	82.70	DOHC	85-89/ 116-121			
1.8	F4P 774	317	AD5990 (MLS)	CD5991	ED5991				
Laguna II 1.8	03/01→	1783	4	82.70	DOHC	85-89/ 116-121			
1.8	F4P 775	318	AD5990 (MLS)	CD5991	ED5991				
Laguna II 1.8	03/01→	1783	4	82.70	DOHC	85-89/ 116-121			

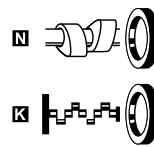
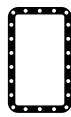
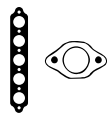

HBS310 [22] M12x1.50x117.00mm (x10)	JD5908 [1] JD5910 [1]	HR397 [1]	JH5041 KG5012 16.00x23.00x1.500mm	PA5013 (x16)	NA5257 [2] 28.00x47.00x5.50mm, FPM NA5036 [2] 42.00x54.00x6.00mm, FPM NF850 [1] 85.00x105.00x8.00mm, FPM NA5037 [1] 85.00x105.00x11.00mm, ACM	
HBS310 [22] M12x1.50x117.00mm (x10)	JD5908 [1] JD5910 [1]	HR397 [1]	JH5041 KG5012 16.00x23.00x1.500mm	PA5013 (x16)	NA5257 [2] 28.00x47.00x5.50mm, FPM NA5036 [2] 42.00x54.00x6.00mm, FPM NF850 [1] 85.00x105.00x8.00mm, FPM NA5037 [1] 85.00x105.00x11.00mm, ACM	
HBS310 [22] M12x1.50x117.00mm (x10)	JD5908 [1] JD5910 [1]	HR397 [1]	JH5041 KG5012 16.00x23.00x1.500mm	PA5013 (x16)	NA5257 [2] 28.00x47.00x5.50mm, FPM NA5036 [2] 42.00x54.00x6.00mm, FPM NF850 [1] 85.00x105.00x8.00mm, FPM NA5037 [1] 85.00x105.00x11.00mm, ACM	
HBS310 [22] M12x1.50x117.00mm (x10)	JD5908 [1] JD5910 [1]	HR397 [1]	JH5041 KG5012 16.00x23.00x1.500mm	PA5013 (x16)	NA5257 [2] 28.00x47.00x5.50mm, FPM NA5036 [2] 42.00x54.00x6.00mm, FPM NF850 [1] 85.00x105.00x8.00mm, FPM NA5037 [1] 85.00x105.00x11.00mm, ACM	
HBS310 [22] M12x1.50x117.00mm (x10)	JD5908 [1] JD5910 [1]	HR397 [1]	JH5041 KG5012 16.00x23.00x1.500mm	PA5013 (x16)	NA5257 [2] 28.00x47.00x5.50mm, FPM NA5036 [2] 42.00x54.00x6.00mm, FPM NF850 [1] 85.00x105.00x8.00mm, FPM NA5037 [1] 85.00x105.00x11.00mm, ACM	
HBS310 [22] M12x1.50x117.00mm (x10)	JD5908 [1] JD5910 [1]	HR397 [1]	JH5041 KG5012 16.00x23.00x1.500mm	PA5013 (x16)	NA5257 [2] 28.00x47.00x5.50mm, FPM NA5036 [2] 42.00x54.00x6.00mm, FPM NF850 [1] 85.00x105.00x8.00mm, FPM NA5037 [1] 85.00x105.00x11.00mm, ACM	
HBS310 [22] M12x1.50x117.00mm (x10)	JD5908 [1] JD5910 [1]	HR397 [1]	JH5041 KG5012 16.00x23.00x1.500mm	PA5013 (x16)	NA5257 [2] 28.00x47.00x5.50mm, FPM NA5036 [2] 42.00x54.00x6.00mm, FPM NF850 [1] 85.00x105.00x8.00mm, FPM NA5037 [1] 85.00x105.00x11.00mm, ACM	



cc



kW/PS

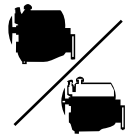

1.8		F7P 704				319		BX610 (Fibre)		DX610 [3]		EL960 [3][18]	
19 1.8 16V	06/89→12/95	1764	4	82.00	DOHC	99-101/	135-137	06/91→		06/91→		06/91→	
19 Cabrio 16V	07/91→06/96												
1.8		F7P 722				320		BX610 (Fibre)		DX610 [3]		EL960 [3][18]	
Clio 1.8 16V	01/91→03/96	1764	4	82.00	DOHC	99/135		08/91→06/94		08/91→06/94		08/91→06/94	
1.9		F8Q 606 Diesel				321		AY710 (SE), 1.360mm, 2 Notches, 2 Holes AY720 (SE), 1.440mm, 1 Notch, 1 Hole AY730 (SE), 1.520mm, 3 Notches, 3 Holes		DL961 ▲ [3]		EC5060	
Trafic 1.9 D	06/97→03/01	1870	4	80.00	SOHC/OHC	44/60		→0.073mm →0.073→0.206mm →0.206mm→					
1.9		F8Q 610 Diesel				322		BS520 (Fibre), 1.650mm, 2 Holes BS530 (Fibre), 1.750mm, 1 Hole BS540 (Fibre), 1.850mm, 3 Holes		DL961 ▲ [3]		EL960 [3][18]	
19 1.9 DT	09/90→04/92	1870	4	80.00	SOHC/OHC	66-69/ 90-94		→0.868mm →0.868→1.000mm →1.000mm→					
1.9		F8Q 620 Diesel				323		BS520 (Fibre), 1.650mm, 2 Holes BS530 (Fibre), 1.750mm, 1 Hole BS540 (Fibre), 1.850mm, 3 Holes		DL961 ▲ [3]		EL960 [3][18]	
Megane 1.9 D	09/96→08/03	1870	4	80.00	SOHC/OHC	47/64		→0.868mm →0.868→1.000mm →1.000mm→					
Megane 1.9D Eco	01/96→08/03												
1.9		F8Q 622 Diesel				324		AY710 (SE), 1.360mm, 2 Notches, 2 Holes AY720 (SE), 1.440mm, 1 Notch, 1 Hole AY730 (SE), 1.520mm, 3 Notches, 3 Holes		DL961 ▲ [3]		EC5060	
Megane 1.9 D	04/99→08/03	1870	4	80.00	SOHC/OHC	47/64		→0.073mm →0.073→0.206mm →0.206mm→					

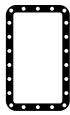
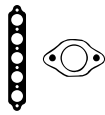

AY710, AY720, AY730



BS520, BS530, BS540



BX610



JD409



JD410



JD411



JD463

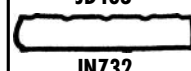

JN732

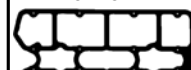

JN996



JJ557

HBS244 [22] M12x1.50x111.00mm (x10) 06/91→	JD411 [1] 06/91→ JD410 [1] 06/91→	JN996 [4] 06/91→	JJ557 06/91→	HR646 [1] 06/91→	NF846 [2] 25.00x42.00x7.00mm, FPM/ACM 06/91→ NF851 [2] 25.00x40.00x7.00mm, FPM/ACM 06/91→ NF850 [1] 85.00x105.00x8.00mm, FPM 06/91→ NF843 [2] 50.00x68.00x10.00mm, FPM/ACM 06/91→	
HBS244 [22] M12x1.50x111.00mm (x10) 08/91→06/94	JD411 [1] 08/91→06/94 JD410 [1] 08/91→06/94	JN996 [4] 08/91→06/94	PB852 16.00x24.00x1.500mm PA349 22.00x16.00x2.000mm JJ557 08/91→06/94	HR646 [x2] 08/91→06/94	NF846 [2] 25.00x42.00x7.00mm, FPM/ACM 08/91→06/94 NF851 [x2] [2] 25.00x40.00x7.00mm, FPM/ACM 08/91→06/94 NF850 [1] 85.00x105.00x8.00mm, FPM 08/91→06/94 NF843 [2] 50.00x68.00x10.00mm, FPM/ACM 08/91→06/94	NF791 [2] [53] KA625 [15] NF849 [2] [56]
HBS120 [22] M12x1.50x118.00mm (x10)	JD463	JN732 [4]	JH5041 KG5012 16.00x23.00x1.500mm	HR569 [1]	NF846 [2] 25.00x42.00x7.00mm, FPM/ACM NA5036 [2] 42.00x54.00x6.00mm, FPM NF850 [1] 85.00x105.00x8.00mm, FPM	
HBS244 [22] M12x1.50x111.00mm (x10)	JD409	JN732 [4]	JJ557	HR569 [1]	NF846 [2] 25.00x42.00x7.00mm, FPM/ACM NF850 [1] 85.00x105.00x8.00mm, FPM NF843 [2] 50.00x68.00x10.00mm, FPM/ACM	
HBS244 [22] M12x1.50x111.00mm (x10)	JD409	JN732 [4]	JJ557	HR569 [1]	NF846 [2] 25.00x42.00x7.00mm, FPM/ACM NF850 [1] 85.00x105.00x8.00mm, FPM NF648 [2] 50.00x68.00x10.00mm, MVQ NF843 [2] 50.00x68.00x10.00mm, FPM/ACM	
HBS120 [22] M12x1.50x118.00mm (x10)	JD409	JN732 [4]	JH5041	HR569 [1]	NF846 [2] 25.00x42.00x7.00mm, FPM/ACM NA5036 [2] 42.00x54.00x6.00mm, FPM NF850 [1] 85.00x105.00x8.00mm, FPM NF843 [2] 50.00x68.00x10.00mm, FPM/ACM	



cc



kW/PS



1.9	F8Q 624 Diesel	1870	4	80.00	SOHC/OHC	325	47/64	BS520 (Fibre), 1.650mm, 2 Holes →0.868mm BS530 (Fibre), 1.750mm, 1 Hole →0.868→1.000mm BS540 (Fibre), 1.850mm, 3 Holes →1.000mm→	DL961 ▲ [3]	EC5060 EL960 [3][18]
Megane 1.9 D Megane 1.9D Eco	09/96→08/03 01/96→08/03									
1.9	F8Q 630 Diesel	1870	4	80.00	SOHC/OHC	326	47/64	AD5030 (Fibre), 1.400mm, 2 Holes AD5040 (Fibre), 1.500mm, 1 Hole AD5050 (Fibre), 1.600mm, 3 Holes	DL961 ▲ [3]	EC5060
Clio 2 1.9 D Clio 2 1.9D Kangoo D 65 1.9 Thalia 1.9D	09/98→05/05 09/98→ 08/97→ 02/98→05/01									
1.9	F8Q 632 Diesel	1870	4	80.00	SOHC/OHC	327	47-48/ 64-65	AD5030 (Fibre), 1.400mm, 2 Holes AD5040 (Fibre), 1.500mm, 1 Hole AD5050 (Fibre), 1.600mm, 3 Holes	DL961 ▲ [3]	EC5060
Clio 2 1.9 D Kangoo 1.9 D Kangoo 1.9 RXED Kangoo D 65 1.9	02/00→05/01 09/99→06/03 09/99→06/01 08/97→									
1.9	F8Q 640 Diesel	1870	4	80.00	SOHC/OHC	328	40/54	BS520 (Fibre), 1.650mm, 2 Holes →0.868mm BS530 (Fibre), 1.750mm, 1 Hole →0.868→1.000mm BS540 (Fibre), 1.850mm, 3 Holes →1.000mm→	DL961 ▲ [3]	EL960 [3][18]
Express 1.9 D	09/94→03/98									
1.9	F8Q 646 Diesel	1870	4	80.00	SOHC/OHC	329	47-66/ 64-90	BS520 (Fibre), 1.650mm, 2 Holes →0.868mm BS530 (Fibre), 1.750mm, 1 Hole →0.868→1.000mm BS540 (Fibre), 1.850mm, 3 Holes →1.000mm→	DL961 ▲ [3]	EL960 [3][18]
Express 1.9 D	09/91→03/98									
1.9	F8Q 662 Diesel	1870	4	80.00	SOHC/OHC	330	40-48/ 54-65	AD5030 (Fibre), 1.400mm, 2 Holes AD5040 (Fibre), 1.500mm, 1 Hole AD5050 (Fibre), 1.600mm, 3 Holes	DL961 ▲ [3]	EC5060
Kangoo D 55 1.9	08/97→									
1.9	F8Q 676 Diesel	1870	4	80.00	SOHC/OHC	331	48/65	BS520 (Fibre), 1.650mm, 2 Holes →0.868mm BS530 (Fibre), 1.750mm, 1 Hole →0.868→1.000mm BS540 (Fibre), 1.850mm, 3 Holes →1.000mm→	DL961 ▲ [3]	EL960 [3][18]
Clio 1.9 D	05/96→02/98									

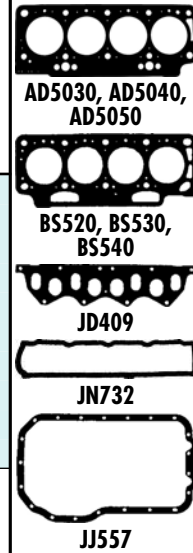
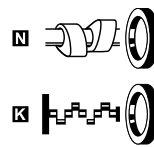
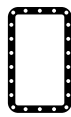
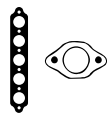



cc



kW/PS

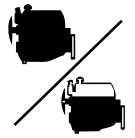

1.9		F8Q 678 Diesel			332				
Clio 1.9 D	01/97→09/98	1870	4	80.00	SOHC/OHC	40-48/ 54-65	BS520 (Fibre), 1.650mm, 2 Holes →0.868mm BS530 (Fibre), 1.750mm, 1 Hole →0.868→1.000mm BS540 (Fibre), 1.850mm, 3 Holes →1.000mm→	DL961 ▲ [3]	EL960 [3] [18]
Clio 1.9 RND	04/96→02/98								
1.9		F8Q 682 Diesel			333				
Express 1.9 D	09/94→03/98	1870	4	80.00	SOHC/OHC	40/54	BS520 (Fibre), 1.650mm, 2 Holes →0.868mm BS530 (Fibre), 1.750mm, 1 Hole →0.868→1.000mm BS540 (Fibre), 1.850mm, 3 Holes →1.000mm→	DL961 ▲ [3]	EC5060
1.9		F8Q 696 Diesel			334				
Clio 1.9 D	05/96→02/98	1870	4	80.00	SOHC/OHC	40-48/ 54-65	BS520 (Fibre), 1.650mm, 2 Holes →0.868mm BS530 (Fibre), 1.750mm, 1 Hole →0.868→1.000mm BS540 (Fibre), 1.850mm, 3 Holes →1.000mm→	DL961 ▲ [3]	EL960 [3] [18]
1.9		F8Q 706 Diesel			335				
19 1.9 D	09/88→04/92	1870	4	80.00	SOHC/OHC	47-48/ 64-65	BS520 (Fibre), 1.650mm, 2 Holes 09/88→ →0.868mm BS530 (Fibre), 1.750mm, 1 Hole 09/88→ →0.868→1.000mm BS540 (Fibre), 1.850mm, 3 Holes 09/88→ →1.000mm→	DL961 ▲ [3] 09/88→	EL960 [3] [18] 09/88→
19 Van 1.9 D	01/88→12/95								
1.9		F8Q 710 Diesel			336				
21 1.9 D	03/86→08/94	1870	4	80.00	SOHC/OHC	47/64	BS520 (Fibre), 1.650mm, 2 Holes →0.868mm BS530 (Fibre), 1.750mm, 1 Hole →0.868→1.000mm BS540 (Fibre), 1.850mm, 3 Holes →1.000mm→	DL961 ▲ [3]	EL960 [3] [18]
21 Van 1.9 D	06/86→08/94								
1.9		F8Q 722 Diesel			337				
Express 1.9 D	09/91→03/98	1870	4	80.00	SOHC/OHC	47-48/ 64-67	BS520 (Fibre), 1.650mm, 2 Holes →0.868mm BS530 (Fibre), 1.750mm, 1 Hole →0.868→1.000mm BS540 (Fibre), 1.850mm, 3 Holes →1.000mm→	DL961 ▲ [3]	EL960 [3] [18]

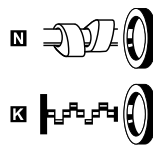
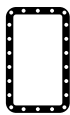
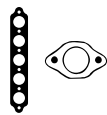

BS520, BS530,
BS540



JD409

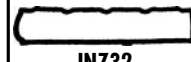

JN732



JJ557



cc



kW/PS



1.9	F8Q 724 Diesel	1870	4	80.00	SOHC/OHC	338	47-48/ 64-67	BS520 (Fibre), 1.650mm, 2 Holes →0.868mm BS530 (Fibre), 1.750mm, 1 Hole →0.868→1.000mm BS540 (Fibre), 1.850mm, 3 Holes →1.000mm→	DL961 ▲ [3]	EL960 [3] [18]
Express 1.9 D	09/91→03/98									
1.9	F8Q 730 Diesel	1870	4	80.00	SOHC/OHC	339	47-48/ 64-65	BS520 (Fibre), 1.650mm, 2 Holes →0.868mm BS530 (Fibre), 1.750mm, 1 Hole →0.868→1.000mm BS540 (Fibre), 1.850mm, 3 Holes →1.000mm→	DL961 ▲ [3]	EL960 [3] [18]
Clio 1.9 D Clio Van 1.9 D	01/91→09/98 01/91→09/98									
1.9	F8Q 732 Diesel	1870	4	80.00	SOHC/OHC	340	47-48/ 64-65	BS520 (Fibre), 1.650mm, 2 Holes →0.868mm BS530 (Fibre), 1.750mm, 1 Hole →0.868→1.000mm BS540 (Fibre), 1.850mm, 3 Holes →1.000mm→	DL961 ▲ [3]	EL960 [3] [18]
Clio 1.9 D Clio Van 1.9 D	01/91→09/98 01/91→09/98									
1.9	F8Q 740 Diesel	1870	4	80.00	SOHC/OHC	341	66-68/ 90-93	AY710 (SE), 1.360mm, 2 Notches, 2 Holes →0.073mm AY720 (SE), 1.440mm, 1 Notch, 1 Hole →0.073→0.206mm AY730 (SE), 1.520mm, 3 Notches, 3 Holes →0.206mm→	DY040 ▲ [3]	EL960 [3] [18]
19 1.9 TD 19 Van 1.9 dT	09/90→04/92 03/92→12/95									
1.9	F8Q 742 Diesel	1870	4	80.00	SOHC/OHC	342	47-48/ 64-65	BS520 (Fibre), 1.650mm, 2 Holes 09/90→ →0.868mm BS530 (Fibre), 1.750mm, 1 Hole 09/90→ →0.868→1.000mm BS540 (Fibre), 1.850mm, 3 Holes 09/90→ →1.000mm→	DL961 ▲ [3] 09/90→	EL960 [3] [18] 09/90→
19 1.9 D 19 Van 1.9 D	09/88→12/95 01/88→12/95									
1.9	F8Q 744 Diesel	1870	4	80.00	SOHC/OHC	343	66-68/ 90-92	AY710 (SE), 1.360mm, 2 Notches, 2 Holes →0.073mm AY720 (SE), 1.440mm, 1 Notch, 1 Hole →0.073→0.206mm AY730 (SE), 1.520mm, 3 Notches, 3 Holes →0.206mm→	DY040 ▲ [3]	EL960 [3] [18]
19 1.9 D 19 1.9 dT	05/92→11/95 04/92→12/95									



AY710, AY720,
AY730



BS520, BS530,
BS540



JD409



JD463



JN732



JJ557



cc



kW/PS

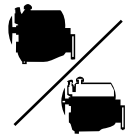

1.9	F8Q 774 Diesel	1870	4	80.00	SOHC/OHC	344	47-48/ 64-67	BS520 (Fibre), 1.650mm, 2 Holes 10/92→ ☞→0.868mm BS530 (Fibre), 1.750mm, 1 Hole 10/92→ ☞0.868→1.000mm BS540 (Fibre), 1.850mm, 3 Holes 10/92→ ☞1.000mm→	DL961 ▲ [3] 10/92→	EL960 [3] [18] 10/92→
Express 1.9 D	09/91→03/98									
1.9	F8Q 776 Diesel	1870	4	80.00	SOHC/OHC	345	47-48/ 64-67	BS520 (Fibre), 1.650mm, 2 Holes ☞→0.868mm BS530 (Fibre), 1.750mm, 1 Hole ☞0.868→1.000mm BS540 (Fibre), 1.850mm, 3 Holes ☞1.000mm→	DL961 ▲ [3]	EL960 [3] [18]
Express 1.9 D	09/91→03/98									
1.9	F8Q 784 Diesel	1870	4	80.00	SOHC/OHC	346	66-69/ 90-94	AY710 (SE), 1.360mm, 2 Notches, 2 Holes ☞→0.073mm AY720 (SE), 1.440mm, 1 Notch, 1 Hole ☞0.073→0.206mm AY730 (SE), 1.520mm, 3 Notches, 3 Holes ☞0.206mm→		EC5060
Megane 1.9 D	04/96→02/01									
Megane 1.9 dT	01/96→08/03									
Megane 1.9 TDI	09/96→08/03									
Megane Scenic	01/97→09/99									
1.9	F8Q 786 Diesel	1870	4	80.00	SOHC/OHC	347	66/90	AY710 (SE), 1.360mm, 2 Notches, 2 Holes ☞→0.073mm AY720 (SE), 1.440mm, 1 Notch, 1 Hole ☞0.073→0.206mm AY730 (SE), 1.520mm, 3 Notches, 3 Holes ☞0.206mm→		EC5060
Megane 1.9 dT	01/96→08/03									
Megane Scenic	01/97→09/99									
1.9	F8Q 790 Diesel	1870	4	80.00	SOHC/OHC	348	47/64	BS520 (Fibre), 1.650mm, 2 Holes ☞→0.868mm BS530 (Fibre), 1.750mm, 1 Hole ☞0.868→1.000mm BS540 (Fibre), 1.850mm, 3 Holes ☞1.000mm→	DL961 ▲ [3]	EL960 [3] [18]
Megane 1.9 D	04/99→08/03									
Megane Scenic	03/97→09/99									
Scenic 1.9 D	09/99→03/01									
1.9	F9Q 664 Diesel	1870	4	80.00	SOHC/OHC	349	68/92	AC5062 (MLS) AC5061 (MLS), 1.320mm	CC5060 ▲ [3]	EC5060 EC5063
Laguna II 1.9	03/04→									

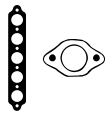

AY710, AY720,
AY730



BS520, BS530,
BS540



JD409



JD463

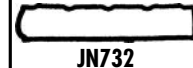

JN732



JJ557

HBS244 [22]
M12x1.50x111.00mm (x10)
10/92→

JD409
10/92→

JJ557
10/92→

HR569 [8]
10/92→

NF846 [2]
25.00x42.00x7.00mm, FPM/ACM
10/92→
NF850 [1]
85.00x105.00x8.00mm, FPM
10/92→
NF648 [2]
50.00x68.00x10.00mm, MVQ
10/92→
NF843 [2]
50.00x68.00x10.00mm, FPM/ACM
10/92→

HBS244 [22]
M12x1.50x111.00mm (x10)

JD409

JJ557

HR569 [8]

NF846 [2]
25.00x42.00x7.00mm, FPM/ACM
NF850 [1]
85.00x105.00x8.00mm, FPM
NF648 [2]
50.00x68.00x10.00mm, MVQ
NF843 [2]
50.00x68.00x10.00mm, FPM/ACM

HBS120 [22]
M12x1.50x118.00mm (x10)

JD463

JN732 [4]

JH5041

HR569 [8]

NF846 [2]
25.00x42.00x7.00mm, FPM/ACM
NA5036 [2]
42.00x54.00x6.00mm, FPM
NF850 [1]
85.00x105.00x8.00mm, FPM
NA5037 [1]
85.00x105.00x11.00mm, ACM

HBS120 [22]
M12x1.50x118.00mm (x10)

JD463

JN732 [4]

JH5041

HR569 [8]

NF846 [2]
25.00x42.00x7.00mm, FPM/ACM
NF850 [1]
85.00x105.00x8.00mm, FPM
NF843 [2]
50.00x68.00x10.00mm, FPM/ACM
→04/97
NA5036 [2]
42.00x54.00x6.00mm, FPM
04/97→

HBS244 [22]
M12x1.50x111.00mm (x10)

JD409

JN732 [4]

JJ557
=PA349
22.00x16.00x2.000mm

HR569 [8]

NF846 [2]
25.00x42.00x7.00mm, FPM/ACM
NA5036 [2]
42.00x54.00x6.00mm, FPM
NF850 [1]
85.00x105.00x8.00mm, FPM
NF843 [2]
50.00x68.00x10.00mm, FPM/ACM

KA625 [15]
NF849 [2] [56]

HBS372 [22]
M12x1.50x121.00mm (x10)

JD5189

JM5086
(Elastomer)

JH5041
=KG5012
16.00x23.00x1.500mm

HR646 [8]

NF846 [2]
25.00x42.00x7.00mm, FPM/ACM
NA5036 [2]
42.00x54.00x6.00mm, FPM
NF850 [1]
85.00x105.00x8.00mm, FPM
NA5037 [1]
85.00x105.00x11.00mm, ACM

RENAULT



cc



kW/PS

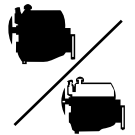

1.9	F9Q 670 Diesel	1870	4	80.00	SOHC/OHC	350	AC5062 (MLS) AC5061 (MLS), 1.320mm	CC5060 ▲ [3]	EC5060 EC5063
Laguna II 1.9	03/01→					88/120			
1.9	F9Q 674 Diesel	1870	4	80.00	SOHC/OHC	351	AC5062 (MLS) AC5061 (MLS), 1.320mm	CC5060 ▲ [3]	EC5060 EC5063
Laguna II 1.9	03/01→					81-88/ 110-120			
1.9	F9Q 680 Diesel	1870	4	80.00	SOHC/OHC	352	AC5062 (MLS) AC5061 (MLS), 1.320mm	CC5060 ▲ [3]	EC5060 EC5063
Espace 4 1.9dCi	11/02→					88/120			
1.9	F9Q 710 Diesel	1870	4	80.00	SOHC/OHC	353	AC5062 (MLS) AC5061 (MLS), 1.320mm AC5070 (Fibre), 1.350mm, 2 Notches ☞→0.653mm AC5080 (Fibre), 1.450mm, 1 Notch ☞0.653→0.786mm AC5090 (Fibre), 1.550mm, 3 Notches ☞0.786mm→	CC5060 ▲ [3]	EC5060 EC5063
Laguna 1.9 dTi Laguna I 1.9	10/97→03/01 10/97→03/01					72/98			
1.9	F9Q 716 Diesel	1870	4	80.00	SOHC/OHC	354	AC5070 (Fibre), 1.350mm, 2 Notches ☞→0.653mm AC5080 (Fibre), 1.450mm, 1 Notch ☞0.653→0.786mm AC5090 (Fibre), 1.550mm, 3 Notches ☞0.786mm→	CC5060 ▲ [3]	EC5060 EC5063
Laguna 1.9 dTi Laguna I 1.9	10/97→03/01 10/97→03/01					72-75/ 98-102			
1.9	F9Q 717 Diesel	1870	4	80.00	SOHC/OHC	355	AC5062 (MLS) AC5061 (MLS), 1.320mm AC5070 (Fibre), 1.350mm, 2 Notches ☞→0.653mm AC5080 (Fibre), 1.450mm, 1 Notch ☞0.653→0.786mm AC5090 (Fibre), 1.550mm, 3 Notches ☞0.786mm→	CC5060 ▲ [3]	EC5060 EC5063
Laguna 1.9 dTi Laguna I 1.9	10/97→03/01 10/97→03/01					72-75/ 98-102			
1.9	F9Q 718 Diesel	1870	4	80.00	SOHC/OHC	356	AC5062 (MLS) AC5061 (MLS), 1.320mm	CC5060 ▲ [3]	EC5060 EC5063
Laguna 1.9 dCi Laguna I 1.9 Laguna II 1.9	09/99→03/01 09/99→03/01 03/01→					79/107			
1.9	F9Q 722 Diesel	1870	4	80.00	SOHC/OHC	357	AC5070 (Fibre), 1.350mm, 2 Notches ☞→0.653mm AC5080 (Fibre), 1.450mm, 1 Notch ☞0.653→0.786mm AC5090 (Fibre), 1.550mm, 3 Notches ☞0.786mm→	CC5060 ▲ [3]	EC5060 EC5063
Espace 3 1.9dTi	02/99→10/02					72/98			

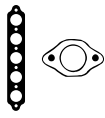

AC5070, AC5080,
AC5090

<p>HBS372 [22] M12x1.50x121.00mm (x10)</p>	<p>JD5189</p>	<p>JM5086 (Elastomer)</p>	<p>JH5041 =KG5012 16.00x23.00x1.500mm</p>	<p>HR646</p>	<p>NF846 [2] 25.00x42.00x7.00mm, FPM/ACM NA5036 [2] 42.00x54.00x6.00mm, FPM NF850 [1] 85.00x105.00x8.00mm, FPM NA5037 [1] 85.00x105.00x11.00mm, ACM</p>
<p>HBS372 [22] M12x1.50x121.00mm (x10)</p>	<p>JD5189</p>	<p>JM5086 (Elastomer)</p>	<p>JH5041 =KG5012 16.00x23.00x1.500mm</p>	<p>HR646</p>	<p>NF846 [2] 25.00x42.00x7.00mm, FPM/ACM NA5036 [2] 42.00x54.00x6.00mm, FPM NF850 [1] 85.00x105.00x8.00mm, FPM NA5037 [1] 85.00x105.00x11.00mm, ACM</p>
<p>HBS372 [22] M12x1.50x121.00mm (x10)</p>	<p>JD5189</p>	<p>JM5086 (Elastomer)</p>	<p>JH5041 =KG5012 16.00x23.00x1.500mm</p>	<p>HR646</p>	<p>NF846 [2] 25.00x42.00x7.00mm, FPM/ACM NA5036 [2] 42.00x54.00x6.00mm, FPM NA5037 [1] 85.00x105.00x11.00mm, ACM</p>
<p>HBS120 [22] M12x1.50x118.00mm (x10) HBS372 [22] M12x1.50x121.00mm (x10)</p>	<p>JD5189</p>	<p>JM5086 (Elastomer)</p>	<p>JH5041</p>	<p>HR646</p>	<p>NF846 [2] 25.00x42.00x7.00mm, FPM/ACM NA5036 [2] 42.00x54.00x6.00mm, FPM NA5037 [1] 85.00x105.00x11.00mm, ACM</p>
<p>HBS120 [22] M12x1.50x118.00mm (x10)</p>	<p>JD5189</p>	<p>JM5086 (Elastomer)</p>	<p>JH5041</p>	<p>HR646</p>	<p>NF846 [2] 25.00x42.00x7.00mm, FPM/ACM NA5036 [2] 42.00x54.00x6.00mm, FPM NA5037 [1] 85.00x105.00x11.00mm, ACM</p>
<p>HBS120 [22] M12x1.50x118.00mm (x10) HBS372 [22] M12x1.50x121.00mm (x10)</p>	<p>JD5189</p>	<p>JM5086 (Elastomer)</p>	<p>JH5041</p>	<p>HR646</p>	<p>NF846 [2] 25.00x42.00x7.00mm, FPM/ACM NA5036 [2] 42.00x54.00x6.00mm, FPM NA5037 [1] 85.00x105.00x11.00mm, ACM</p>
<p>HBS372 [22] M12x1.50x121.00mm (x10)</p>	<p>JD5189</p>	<p>JM5086 (Elastomer)</p>	<p>JH5041 =KG5012 16.00x23.00x1.500mm</p>	<p>HR646</p>	<p>NF846 [2] 25.00x42.00x7.00mm, FPM/ACM NA5036 [2] 42.00x54.00x6.00mm, FPM NF850 [1] 85.00x105.00x8.00mm, FPM NA5037 [1] 85.00x105.00x11.00mm, ACM</p>
<p>HBS120 [22] M12x1.50x118.00mm (x10)</p>	<p>JD5189</p>	<p>JM5086 (Elastomer)</p>	<p>JH5041 =KG5012 16.00x23.00x1.500mm</p>	<p>HR646</p>	<p>NF846 [2] 25.00x42.00x7.00mm, FPM/ACM NA5036 [2] 42.00x54.00x6.00mm, FPM NF850 [1] 85.00x105.00x8.00mm, FPM NA5037 [1] 85.00x105.00x11.00mm, ACM</p>



cc



kW/PS



1.9	F9Q 730 Diesel	1870	4	80.00	SOHC/OHC	358	72/98	AC5070 (Fibre), 1.350mm, 2 Notches →0.653mm AC5080 (Fibre), 1.450mm, 1 Notch →0.653→0.786mm AC5090 (Fibre), 1.550mm, 3 Notches →0.786mm→	CC5060 ▲ [3]	EC5060 EC5063
Megane 1.9 dTi	03/97→02/01									
Megane 1.9 TDI	03/97→02/01									
Megane Scenic	04/97→09/99									
1.9	F9Q 731 Diesel	1870	4	80.00	SOHC/OHC	359	72/98	AC5062 (MLS) AC5061 (MLS), 1.320mm AC5070 (Fibre), 1.350mm, 2 Notches →0.653mm AC5080 (Fibre), 1.450mm, 1 Notch →0.653→0.786mm AC5090 (Fibre), 1.550mm, 3 Notches →0.786mm→	CC5060 ▲ [3]	EC5060 EC5063
Megane 1.9 dTi	03/97→02/01									
Megane 1.9 TDI	03/97→02/01									
Scenic 1.9 dTi	09/99→08/03									
1.9	F9Q 732 Diesel	1870	4	80.00	SOHC/OHC	360	74-77/ 101-105	AC5062 (MLS) AC5061 (MLS), 1.320mm	CC5060 ▲ [3]	EC5060 EC5063
Megane 1.9 dCi	02/01→08/03									
Scenic 1.9 dCi	09/99→08/03									
Scenic 1.9 RX4	12/02→08/03									
1.9	F9Q 733 Diesel	1870	4	80.00	SOHC/OHC	361	75-77/ 102-105	AC5062 (MLS) AC5061 (MLS), 1.320mm	CC5060 ▲ [3]	EC5060 EC5063
Megane 1.9 dCi	02/01→08/03									
Scenic 1.9 dCi	09/99→08/03									
1.9	F9Q 734 Diesel	1870	4	80.00	SOHC/OHC	362	72/98	AC5070 (Fibre), 1.350mm, 2 Notches →0.653mm AC5080 (Fibre), 1.450mm, 1 Notch →0.653→0.786mm AC5090 (Fibre), 1.550mm, 3 Notches →0.786mm→	CC5060 ▲ [3]	EC5060 EC5063
Megane 1.9 dTi	03/97→02/01									
Megane 1.9 TDI	03/97→02/01									
Megane Scenic	04/97→09/99									
Scenic 1.9 dTi	09/99→08/03									
1.9	F9Q 736 Diesel	1870	4	80.00	SOHC/OHC	363	72/98	AC5070 (Fibre), 1.350mm, 2 Notches →0.653mm AC5080 (Fibre), 1.450mm, 1 Notch →0.653→0.786mm AC5090 (Fibre), 1.550mm, 3 Notches →0.786mm→	CC5060 ▲ [3]	EC5060 EC5063
Megane 1.9 dTi	03/97→02/01									
Megane 1.9 TDI	03/97→02/01									
Scenic 1.9 dTi	09/99→08/03									
1.9	F9Q 738 Diesel	1870	4	80.00	SOHC/OHC	364	74-79/ 101-107	AC5062 (MLS) AC5061 (MLS), 1.320mm AC5070 (Fibre), 1.350mm, 2 Notches →0.653mm AC5080 (Fibre), 1.450mm, 1 Notch →0.653→0.786mm AC5090 (Fibre), 1.550mm, 3 Notches →0.786mm→	CC5060 ▲ [3]	EC5060 EC5063
Megane 1.9 dCi	02/01→08/03									
1.9	F9Q 740 Diesel	1870	4	80.00	SOHC/OHC	365	75/102	AC5062 (MLS) AC5061 (MLS), 1.320mm	CC5060 ▲ [3]	EC5060 EC5063
Scenic 1.9 RX4	11/00→08/03									

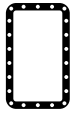
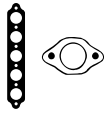

AC5070, AC5080,
AC5090

HBS120 [22] M12x1.50x118.00mm (x10)	JD5189	JM5086 (Elastomer)	JH5041	HR646 [5]	NF846 [2] 25.00x42.00x7.00mm, FPM/ACM NA5036 [2] 42.00x54.00x6.00mm, FPM NF850 [1] 85.00x105.00x8.00mm, FPM NA5037 [1] 85.00x105.00x11.00mm, ACM	
HBS120 [22] M12x1.50x118.00mm (x10) HBS372 [22] M12x1.50x121.00mm (x10)	JD5189	JM5086 (Elastomer)	JH5041	HR646 [5]	NF846 [2] 25.00x42.00x7.00mm, FPM/ACM NA5036 [2] 42.00x54.00x6.00mm, FPM NA5037 [1] 85.00x105.00x11.00mm, ACM	
HBS372 [22] M12x1.50x121.00mm (x10)	JD5189	JM5086 (Elastomer)	JH5041	HR646 [5]	NF846 [2] 25.00x42.00x7.00mm, FPM/ACM NA5036 [2] 42.00x54.00x6.00mm, FPM NA5037 [1] 85.00x105.00x11.00mm, ACM	
HBS372 [22] M12x1.50x121.00mm (x10)	JD5189	JM5086 (Elastomer)	JH5041	HR646 [5]	NF846 [2] 25.00x42.00x7.00mm, FPM/ACM NA5036 [2] 42.00x54.00x6.00mm, FPM NA5037 [1] 85.00x105.00x11.00mm, ACM	
HBS120 [22] M12x1.50x118.00mm (x10)	JD5189	JM5086 (Elastomer)	JH5041	HR646 [5]	NF846 [2] 25.00x42.00x7.00mm, FPM/ACM NA5036 [2] 42.00x54.00x6.00mm, FPM NA5037 [1] 85.00x105.00x11.00mm, ACM	
HBS120 [22] M12x1.50x118.00mm (x10)	JD5189	JM5086 (Elastomer)	JH5041	HR646 [5]	NF846 [2] 25.00x42.00x7.00mm, FPM/ACM NA5036 [2] 42.00x54.00x6.00mm, FPM NA5037 [1] 85.00x105.00x11.00mm, ACM	
HBS120 [22] M12x1.50x118.00mm (x10) HBS372 [22] M12x1.50x121.00mm (x10)	JD5189	JM5086 (Elastomer)	JH5041	HR646 [5]	NF846 [2] 25.00x42.00x7.00mm, FPM/ACM NA5036 [2] 42.00x54.00x6.00mm, FPM NA5037 [1] 85.00x105.00x11.00mm, ACM	
HBS372 [22] M12x1.50x121.00mm (x10)	JD5189	JM5086 (Elastomer)	JH5041 =KG5012 16.00x23.00x1.500mm	HR646 [5]	NF846 [2] 25.00x42.00x7.00mm, FPM/ACM NA5036 [2] 42.00x54.00x6.00mm, FPM NF850 [1] 85.00x105.00x8.00mm, FPM NA5037 [1] 85.00x105.00x11.00mm, ACM	



cc



kW/PS



1.9	F9Q 744 Diesel	1870	4	80.00	SOHC/OHC	366	AC5070 (Fibre), 1.350mm, 2 Notches →0.653mm AC5080 (Fibre), 1.450mm, 1 Notch →0.653→0.786mm AC5090 (Fibre), 1.550mm, 3 Notches →0.786mm→	CC5060 ▲ [3]	EC5060 EC5063
Megane 1.9 dTi Scenic 1.9 dTi	02/01→08/03 02/01→08/03					59/80			
1.9	F9Q 748 Diesel	1870	4	80.00	SOHC/OHC	367	AC5062 (MLS) AC5061 (MLS), 1.320mm	CC5060 ▲ [3]	EC5063
Scenic 1.9 RX4	12/02→08/03					74-79/ 101-107			
1.9	F9Q 750 Diesel	1870	4	80.00	SOHC/OHC	368	AC5062 (MLS) AC5061 (MLS), 1.320mm	CC5060 ▲ [3]	EC5060 EC5063
Laguna II 1.9	03/01→					88/120			
1.9	F9Q 752 Diesel	1870	4	80.00	SOHC/OHC	369	AC5062 (MLS) AC5061 (MLS), 1.320mm	CC5060 ▲ [3]	EC5060 EC5063
Laguna II 1.9	06/01→					74-77/ 101-105			
1.9	F9Q 754 Diesel	1870	4	80.00	SOHC/OHC	370	AC5062 (MLS) AC5061 (MLS), 1.320mm	CC5060 ▲ [3]	EC5060 EC5063
Laguna II 1.9	03/01→					74-79/ 101-107			
1.9	F9Q 758 Diesel	1870	4	80.00	SOHC/OHC	371	AC5062 (MLS) AC5061 (MLS), 1.320mm	CC5060 ▲ [3]	EC5060 EC5063
Laguna II 1.9	01/05→09/07					81-96/ 110-130			
1.9	F9Q 759 Diesel	1870	4	80.00	SOHC/OHC	372	AC5062 (MLS) AC5061 (MLS), 1.320mm	CC5060 ▲ [3]	EC5060 EC5063
Laguna II 1.9	05/05→09/07					85-96/ 116-130			
1.9	F9Q 760 Diesel	1870	4	80.00	SOHC/OHC	373	AC5062 (MLS) AC5061 (MLS), 1.320mm	CC5060 ▲ [3]	EC5060 EC5063
Trafix 2	03/01→					60-75/ 82-102			

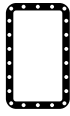
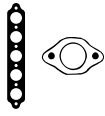

AC5070, AC5080,
AC5090

HBS120 [22] M12x1.50x118.00mm (x10)	JD5189	JM5086 (Elastomer)	JH5041 =KG5012 16.00x23.00x1.500mm	HR646	NF846 [2] 25.00x42.00x7.00mm, FPM/ACM NA5036 [2] 42.00x54.00x6.00mm, FPM NF850 [1] 85.00x105.00x8.00mm, FPM NF843 [2] 50.00x68.00x10.00mm, FPM/ACM NA5037 [1] 85.00x105.00x11.00mm, ACM	
HBS372 [22] M12x1.50x121.00mm (x10)	JD5189	JM5086 (Elastomer)	JH5041 =KG5012 16.00x23.00x1.500mm	HR646	NF846 [2] 25.00x42.00x7.00mm, FPM/ACM	
HBS372 [22] M12x1.50x121.00mm (x10)	JD5189	JM5086 (Elastomer)	JH5041 =KG5012 16.00x23.00x1.500mm	HR646	NF846 [2] 25.00x42.00x7.00mm, FPM/ACM NA5036 [2] 42.00x54.00x6.00mm, FPM NF850 [1] 85.00x105.00x8.00mm, FPM NA5037 [1] 85.00x105.00x11.00mm, ACM	
HBS372 [22] M12x1.50x121.00mm (x10)	JD5189	JM5086 (Elastomer)	JH5041 =KG5012 16.00x23.00x1.500mm	HR646	NF846 [2] 25.00x42.00x7.00mm, FPM/ACM NA5036 [2] 42.00x54.00x6.00mm, FPM NF850 [1] 85.00x105.00x8.00mm, FPM NA5037 [1] 85.00x105.00x11.00mm, ACM	
HBS372 [22] M12x1.50x121.00mm (x10)	JD5189	JM5086 (Elastomer)	JH5041 =KG5012 16.00x23.00x1.500mm	HR646	NF846 [2] 25.00x42.00x7.00mm, FPM/ACM NA5036 [2] 42.00x54.00x6.00mm, FPM NF850 [1] 85.00x105.00x8.00mm, FPM NA5037 [1] 85.00x105.00x11.00mm, ACM	
HBS372 [22] M12x1.50x121.00mm (x10)	JD5189	JM5086 (Elastomer)	JH5041 =KG5012 16.00x23.00x1.500mm	HR646	NF846 [2] 25.00x42.00x7.00mm, FPM/ACM NA5036 [2] 42.00x54.00x6.00mm, FPM NF850 [1] 85.00x105.00x8.00mm, FPM NA5037 [1] 85.00x105.00x11.00mm, ACM	
HBS372 [22] M12x1.50x121.00mm (x10)	JD5189	JM5086 (Elastomer)	JH5041 =KG5012 16.00x23.00x1.500mm	HR646	NF846 [2] 25.00x42.00x7.00mm, FPM/ACM NA5036 [2] 42.00x54.00x6.00mm, FPM NF850 [1] 85.00x105.00x8.00mm, FPM NA5037 [1] 85.00x105.00x11.00mm, ACM	
HBS372 [22] M12x1.50x121.00mm (x10)	JD5189	JM5086 (Elastomer)	JH5041 =KG5012 16.00x23.00x1.500mm	HR646	NF846 [2] 25.00x42.00x7.00mm, FPM/ACM NA5036 [2] 42.00x54.00x6.00mm, FPM NF850 [1] 85.00x105.00x8.00mm, FPM NA5037 [1] 85.00x105.00x11.00mm, ACM	

RENAULT



cc



kW/PS



1.9	F9Q 762	Diesel	374	AC5062 (MLS)	CC5060 ▲ [3]	EC5060 EC5063			
Trafix 2 Trafix 2 1.9dCi	03/01→ 04/01→07/03	1870	4	80.00	SOHC/OHC	60/82	AC5061 (MLS), 1.320mm		
1.9	F9Q 770	Diesel	375	AC5070 (Fibre), 1.350mm, 2 Notches	CC5060 ▲ [3]	EC5060 EC5063			
Master II	09/00→	1870	4	80.00	SOHC/OHC	59/80	AC5080 (Fibre), 1.450mm, 1 Notch AC5090 (Fibre), 1.550mm, 3 Notches	→0.653mm →0.653→0.786mm →0.786mm→	
1.9	F9Q 772	Diesel	376	AC5062 (MLS)	CC5060 ▲ [3]				
Master II	11/01→	1870	4	80.00	SOHC/OHC	60/82	AC5061 (MLS), 1.320mm		
1.9	F9Q 774	Diesel	377	AC5062 (MLS)	CC5060 ▲ [3]	EC5060 EC5063			
Master II	11/01→	1870	4	80.00	SOHC/OHC	60/82	AC5061 (MLS), 1.320mm		
1.9	F9Q 780	Diesel	378	AC5070 (Fibre), 1.350mm, 2 Notches	CC5060 ▲ [3]	EC5060 EC5063			
Clio 2 1.9 DTi Kangoo 1.9 dTi	12/99→05/05 02/00→	1870	4	80.00	SOHC/OHC	59/80	AC5080 (Fibre), 1.450mm, 1 Notch AC5090 (Fibre), 1.550mm, 3 Notches	→0.653mm →0.653→0.786mm →0.786mm→	
1.9	F9Q 782	Diesel	379	AC5070 (Fibre), 1.350mm, 2 Notches	CC5060 ▲ [3]	EC5060 EC5063			
Kangoo 1.9 dCi	10/01→	1870	4	80.00	SOHC/OHC	59-62/ 80-84	AC5080 (Fibre), 1.450mm, 1 Notch AC5090 (Fibre), 1.550mm, 3 Notches	→0.653mm →0.653→0.786mm →0.786mm→	
1.9	F9Q 790	Diesel	380	AC5070 (Fibre), 1.350mm, 2 Notches	CC5060 ▲ [3]	EC5060 EC5063			
Kangoo 1.9 dCi	10/01→	1870	4	80.00	SOHC/OHC	59-62/ 80-84	AC5080 (Fibre), 1.450mm, 1 Notch AC5090 (Fibre), 1.550mm, 3 Notches	→0.653mm →0.653→0.786mm →0.786mm→	

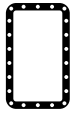
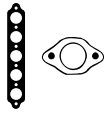

AC5070, AC5080,
AC5090

HBS372 [22] M12x1.50x121.00mm (x10)	JD5189	JM5086 (Elastomer)	JH5041 =KG5012 16.00x23.00x1.500mm	HR646	NF846 [2] 25.00x42.00x7.00mm, FPM/ACM NA5036 [2] 42.00x54.00x6.00mm, FPM NF850 [1] 85.00x105.00x8.00mm, FPM NA5037 [1] 85.00x105.00x11.00mm, ACM	
HBS120 [22] M12x1.50x118.00mm (x10)	JD5189	JM5086 (Elastomer)	JH5041 =KG5012 16.00x23.00x1.500mm	HR646	NF846 [2] 25.00x42.00x7.00mm, FPM/ACM NA5036 [2] 42.00x54.00x6.00mm, FPM NF850 [1] 85.00x105.00x8.00mm, FPM NF843 [2] 50.00x68.00x10.00mm, FPM/ACM NA5037 [1] 85.00x105.00x11.00mm, ACM	
HBS372 [22] M12x1.50x121.00mm (x10)	JD5189	JM5086 (Elastomer)	JH5041 =KG5012 16.00x23.00x1.500mm	HR646	NF846 [2] 25.00x42.00x7.00mm, FPM/ACM NA5036 [2] 42.00x54.00x6.00mm, FPM NF850 [1] 85.00x105.00x8.00mm, FPM NA5037 [1] 85.00x105.00x11.00mm, ACM	
HBS372 [22] M12x1.50x121.00mm (x10)	JD5189	JM5086 (Elastomer)	JH5041	HR646	NF846 [2] 25.00x42.00x7.00mm, FPM/ACM NA5036 [2] 42.00x54.00x6.00mm, FPM NA5037 [1] 85.00x105.00x11.00mm, ACM	
HBS120 [22] M12x1.50x118.00mm (x10)	JD5189	JM5086 (Elastomer)	JH5041 =KG5012 16.00x23.00x1.500mm	HR646	NF846 [2] 25.00x42.00x7.00mm, FPM/ACM NA5036 [2] 42.00x54.00x6.00mm, FPM NF850 [1] 85.00x105.00x8.00mm, FPM NA5037 [1] 85.00x105.00x11.00mm, ACM	
HBS120 [22] M12x1.50x118.00mm (x10)	JD5189	JM5086 (Elastomer)	JH5041 =KG5012 16.00x23.00x1.500mm	HR646	NF846 [2] 25.00x42.00x7.00mm, FPM/ACM NA5036 [2] 42.00x54.00x6.00mm, FPM NF850 [1] 85.00x105.00x8.00mm, FPM NA5037 [1] 85.00x105.00x11.00mm, ACM	
HBS120 [22] M12x1.50x118.00mm (x10)	JD5189	JM5086 (Elastomer)	JH5041 =KG5012 16.00x23.00x1.500mm	HR646	NF846 [2] 25.00x42.00x7.00mm, FPM/ACM NA5036 [2] 42.00x54.00x6.00mm, FPM NF850 [1] 85.00x105.00x8.00mm, FPM NA5037 [1] 85.00x105.00x11.00mm, ACM	



cc



kW/PS



1.9	F9Q 800	Diesel					381	AC5062 (MLS) AC5061 (MLS), 1.320mm	CC5060 ▲ [3]	EC5060 EC5063
Megane 2 1.9	11/02→	1870	4	80.00	SOHC/OHC	88/120				
1.9	F9Q 803	Diesel					382	AC5062 (MLS) AC5061 (MLS), 1.320mm		EC5060 EC5063
Megane 2 1.9	05/05→	1870	4	80.00	SOHC/OHC	72-96/ 98-131				
1.9	F9Q 804	Diesel					383	AC5062 (MLS) AC5061 (MLS), 1.320mm		EC5061
Megane 2 1.9 Scenic 2 1.9dCi	11/02→ 06/03→	1870	4	80.00	SOHC/OHC	81-96/ 110-131				
1.9	F9Q 808	Diesel					384	AC5062 (MLS) AC5061 (MLS), 1.320mm	CC5060 ▲ [3]	EC5060 EC5063
Megane 2 1.9	11/02→12/05	1870	4	80.00	SOHC/OHC	66-75/ 90-102				
1.9	F9Q 812	Diesel					385	AC5062 (MLS) AC5061 (MLS), 1.320mm	CC5060 ▲ [3]	EC5060 EC5061
Gr. Scenic 2 Scenic 2 1.9 D Scenic 2 1.9dCi	04/04→ 06/06→ 06/03→	1870	4	80.00	SOHC/OHC	85-88/ 116-120				
1.9	F9Q 816	Diesel					386	AC5062 (MLS) AC5061 (MLS), 1.320mm	CC5060 ▲ [3]	EC5060 EC5061
Gr. Scenic 2 Megane 2 1.9 Scenic 2 1.9dCi	05/05→ 11/02→ 05/05→	1870	4	80.00	SOHC/OHC	81-96/ 110-131				
1.9	F9Q 818	Diesel					387	AC5062 (MLS) AC5061 (MLS), 1.320mm	CC5060 ▲ [3]	EC5060 EC5061
Gr. Scenic 2 Megane 2 1.9 Scenic 2 1.9dCi	05/05→ 11/02→ 05/05→	1870	4	80.00	SOHC/OHC	81-96/ 110-131				
1.9	F9Q 820	Diesel					388	AC5062 (MLS) AC5061 (MLS), 1.320mm	CC5060 ▲ [3]	EC5060 EC5063
Espace 4 1.9dCi	11/02→02/05	1870	4	80.00	SOHC/OHC	85-88/ 115-120				



HBS372 [22] M12x1.50x121.00mm (x10)	JD5189	JM5086 (Elastomer)	JH5041 =KG5012 16.00x23.00x1.500mm	HR646 [2]	NF846 [2] 25.00x42.00x7.00mm, FPM/ACM NA5036 [2] 42.00x54.00x6.00mm, FPM NF850 [1] 85.00x105.00x8.00mm, FPM NA5037 [1] 85.00x105.00x11.00mm, ACM	
HBS372 [22] M12x1.50x121.00mm (x10)	JD5890 (MLS)	JM5086 (Elastomer)	JH5041	HR646 [2]	NF846 [2] 25.00x42.00x7.00mm, FPM/ACM NA5036 [2] 42.00x54.00x6.00mm, FPM NA5037 [1] 85.00x105.00x11.00mm, ACM	
HBS372 [22] M12x1.50x121.00mm (x10)	JD5890 (MLS)	JM5086 (Elastomer)		HR646 [2]	NF846 [2] 25.00x42.00x7.00mm, FPM/ACM NA5036 [2] 42.00x54.00x6.00mm, FPM NA5037 [1] 85.00x105.00x11.00mm, ACM	
HBS372 [22] M12x1.50x121.00mm (x10)	JD5189	JM5086 (Elastomer)	JH5041	HR646 [2]	NF846 [2] 25.00x42.00x7.00mm, FPM/ACM NA5036 [2] 42.00x54.00x6.00mm, FPM NA5037 [1] 85.00x105.00x11.00mm, ACM	
HBS372 [22] M12x1.50x121.00mm (x10)	JD5189 JD5890 (MLS) JE5061 (MLS) JE5062 (MLS)	JM5086 (Elastomer)	JH5041 =KG5012 16.00x23.00x1.500mm	HR646 [2]	NF846 [2] 25.00x42.00x7.00mm, FPM/ACM NA5036 [2] 42.00x54.00x6.00mm, FPM NF850 [1] 85.00x105.00x8.00mm, FPM NA5037 [1] 85.00x105.00x11.00mm, ACM	
HBS372 [22] M12x1.50x121.00mm (x10)	JD5189 JD5890 (MLS) JE5061 (MLS) JE5062 (MLS)	JM5086 (Elastomer)	JH5041 =KG5012 16.00x23.00x1.500mm	HR646 [2]	NF846 [2] 25.00x42.00x7.00mm, FPM/ACM NA5036 [2] 42.00x54.00x6.00mm, FPM NF850 [1] 85.00x105.00x8.00mm, FPM NA5037 [1] 85.00x105.00x11.00mm, ACM	
HBS372 [22] M12x1.50x121.00mm (x10)	JD5189 JD5890 (MLS) JE5061 (MLS) JE5062 (MLS)	JM5086 (Elastomer)	JH5041 =KG5012 16.00x23.00x1.500mm	HR646 [2]	NF846 [2] 25.00x42.00x7.00mm, FPM/ACM NA5036 [2] 42.00x54.00x6.00mm, FPM NF850 [1] 85.00x105.00x8.00mm, FPM NA5037 [1] 85.00x105.00x11.00mm, ACM	
HBS372 [22] M12x1.50x121.00mm (x10)	JD5189	JM5086 (Elastomer)	JH5041 =KG5012 16.00x23.00x1.500mm	HR646 [2]	NF846 [2] 25.00x42.00x7.00mm, FPM/ACM NA5036 [2] 42.00x54.00x6.00mm, FPM NA5037 [1] 85.00x105.00x11.00mm, ACM	



cc



kW/PS



1.9	F9Q 826 Diesel	1870	4	80.00	SOHC/OHC	389	88/120	AC5062 (MLS) AC5061 (MLS), 1.320mm	CC5060 ▲ [3]	EC5060 EC5063
Espace 4 1.9dCi	11/02→									
1.9	F9Q 870 Diesel	1870	4	80.00	SOHC/OHC	390	96/131			
Gr. Scenic 3	02/09→									
Megane 3 1.9dCi	11/08→									
Megane CC 1.9d	06/10→									
Megane Scenic	11/08→									
Scenic 3 1.9dCi	02/09→									
1.9	F9Q 872 Diesel	1870	4	80.00	SOHC/OHC	391	96/131			
Gr. Scenic 3	02/09→									
Megane 3 1.9dCi	11/08→									
Megane Scenic	11/08→									
Scenic 3 1.9dCi	02/09→									
1.9	F9Q E 804 Diesel	1870	4	80.00	SOHC/OHC	392	81-96/ 110-131	AC5062 (MLS) AC5061 (MLS), 1.320mm	CC5060 ▲ [3]	EC5060 EC5061
Gr. Scenic 2	05/05→									
1.9	F9Q EE 804 Diesel	1870	4	80.00	SOHC/OHC	393	81-96/ 110-131	AC5062 (MLS) AC5061 (MLS), 1.320mm	CC5060 ▲ [3]	EC5060 EC5061
Gr. Scenic 2	05/05→									
1.9	F9Q J 803 Diesel	1870	4	80.00	SOHC/OHC	394	85-96/ 116-131	AC5062 (MLS) AC5061 (MLS), 1.320mm	CC5060 ▲ [3]	EC5060 EC5061
Gr. Scenic 2	05/05→									
Scenic 2 1.9 D	06/06→									
Scenic 2 1.9dCi	05/05→									
1.9	N7Q 700	1948	4	83.00	DOHC	395	102/139	BX651 (Fibre) 08/95→	DX652 08/95→	EA5620 [3] 08/95→
Laguna 2.0 16V	09/95→03/01									
Laguna I 2.0	06/95→03/01									

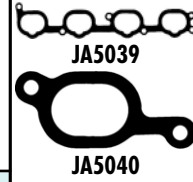
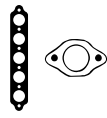

HBS372 [22] M12x1.50x121.00mm (x10)	JD5189	JM5086 (Elastomer)	JH5041 =KG5012 16.00x23.00x1.500mm	HR646 [2]	NF846 [2] 25.00x42.00x7.00mm, FPM/ACM [X] NA5036 [2] 42.00x54.00x6.00mm, FPM [X] NA5037 [1] 85.00x105.00x11.00mm, ACM
					[X] NA5036 [2] 42.00x54.00x6.00mm, FPM
					[X] NA5036 [2] 42.00x54.00x6.00mm, FPM
HBS372 [22] M12x1.50x121.00mm (x10)	JD5189 JD5890 (MLS) [X] JE5061 (MLS) [X] JE5062 (MLS)	JM5086 (Elastomer)	JH5041 =KG5012 16.00x23.00x1.500mm	HR646 [2]	NF846 [2] 25.00x42.00x7.00mm, FPM/ACM [X] NA5036 [2] 42.00x54.00x6.00mm, FPM [X] NF850 [1] 85.00x105.00x8.00mm, FPM [X] NA5037 [1] 85.00x105.00x11.00mm, ACM
HBS372 [22] M12x1.50x121.00mm (x10)	JD5189 JD5890 (MLS) [X] JE5061 (MLS) [X] JE5062 (MLS)	JM5086 (Elastomer)	JH5041 =KG5012 16.00x23.00x1.500mm	HR646 [2]	NF846 [2] 25.00x42.00x7.00mm, FPM/ACM [X] NA5036 [2] 42.00x54.00x6.00mm, FPM [X] NF850 [1] 85.00x105.00x8.00mm, FPM [X] NA5037 [1] 85.00x105.00x11.00mm, ACM
HBS372 [22] M12x1.50x121.00mm (x10)	JD5189 JD5890 (MLS) [X] JE5061 (MLS) [X] JE5062 (MLS)	JM5086 (Elastomer)	JH5041 =KG5012 16.00x23.00x1.500mm	HR646 [2]	NF846 [2] 25.00x42.00x7.00mm, FPM/ACM [X] NA5036 [2] 42.00x54.00x6.00mm, FPM [X] NF850 [1] 85.00x105.00x8.00mm, FPM [X] NA5037 [1] 85.00x105.00x11.00mm, ACM
HBS178 [19] M12x1.75x157.00mm (x10) 08/95→	JA5039 [1] 08/95→ JA5040 [1] 08/95→		=KJ647 18.30x24.00x2.000mm	HR599 [2] 08/95→	NA5138 [2] 44.50x57.20x6.75mm, ACM 08/95→ [X] NA5136 [1] [2] 30.00x47.00x7.00mm, FPM 08/95→ [X] NA5018 [2] 35.00x47.00x5.60mm, FPM 08/95→ [X] NA5017 [1] 98.00x110.00x8.50mm, FPM 08/95→



cc



kW/PS

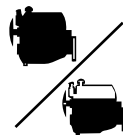

1.9	N7Q 704	396							
Laguna 2.0 16V Laguna I 2.0	09/95→03/01 06/95→03/01	1948	4	83.00	DOHC	102/139	BX651 (Fibre) 08/95→	DX652 08/95→	EA5620 [3] 08/95→
1.9	N7Q 710	397							
Safrane II 2.0	07/96→12/00	1948	4	83.00	DOHC	100/136	BX651 (Fibre)	DX652	
1.9	N7Q 711	398							
Safrane II 2.0	07/96→12/00	1948	4	83.00	DOHC	100/136	BX651 (Fibre)	DX652	
2.0	829 730	399							
Master I 2.0	06/85→10/89	1995	4	88.00	SOHC/OHC	59/80	BG170 (Fibre), 1.200mm	DG173 [3]	EG176 [3][14]
2.0	F3R 611	400							
Laguna I 2.0	03/99→03/01	1998	4	82.70	SOHC/OHC	80-85/ 109-116	BX600 (Fibre) BS530 (Fibre), 1.750mm, 1 Hole -0.868→1.000mm	DX600	EC5060 EC5063
2.0	F3R 722	401							
Laguna 2.0 Laguna I 2.0	09/95→03/01 11/93→03/01	1998	4	82.70	SOHC/OHC	83-84/ 113-114	BX600 (Fibre) 12/93→ BS530 (Fibre), 1.750mm, 1 Hole 12/93→ -0.868→1.000mm	DX600 12/93→	EL960 [3][18] 12/93→

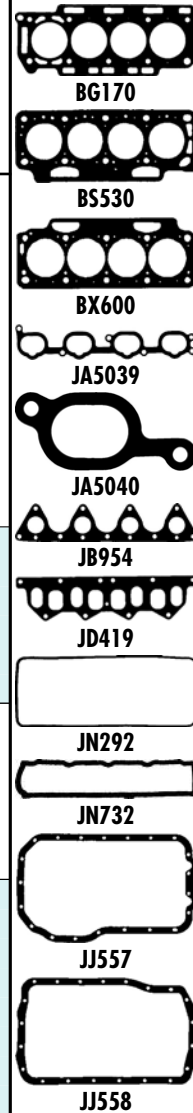
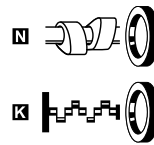
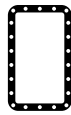
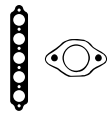



cc



kW/PS



2.0	F3R 723					402	BX600 (Fibre) 12/93→ BS530 (Fibre), 1.750mm, 1 Hole 12/93→ 0.868→1.000mm	DX600 12/93→	EL960 [3][18] 12/93→
Laguna 2.0 Laguna I 2.0	09/95→03/01 11/93→03/01	1998	4	82.70	SOHC/OHC	83-84/ 113-114			
2.0	F3R 728					403	BX600 (Fibre) BS530 (Fibre), 1.750mm, 1 Hole 0.868→1.000mm	DX600	EL960 [3][18]
Espace 3 2.0	11/96→10/00	1998	4	82.70	SOHC/OHC	84/114			
2.0	F3R 729					404	BX600 (Fibre) BS530 (Fibre), 1.750mm, 1 Hole 0.868→1.000mm	DX600	EL960 [3][18]
Espace 3 2.0	11/96→10/00	1998	4	82.70	SOHC/OHC	84/114			
2.0	F3R 742					405	BX600 (Fibre) BS530 (Fibre), 1.750mm, 1 Hole 0.868→1.000mm	DX600	EL960 [3][18]
Espace 3 2.0	11/96→10/00	1998	4	82.70	SOHC/OHC	84/114			
2.0	F3R 750					406	BX600 (Fibre) BS530 (Fibre), 1.750mm, 1 Hole 0.868→1.000mm	DX600	EL960 [3][18]
Megane 2.0 Megane 2.0 i Megane 2.0i Megane Scenic	04/97→08/03 01/96→08/03 03/99→08/03 01/97→10/99	1998	4	82.70	SOHC/OHC	80-84/ 109-114			

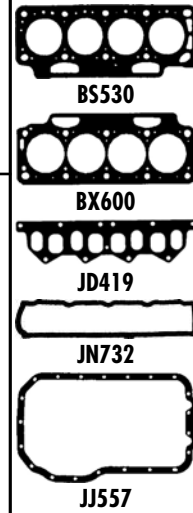
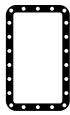
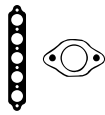

HBS244 [22]
M12x1.50x111.00mm (x10)
12/93→

JD419
12/93→

JN732 [4]
12/93→

PA349
22.00x16.00x2.000mm
JJ557
12/93→

HR569 [5]
12/93→

NF846 [2]
25.00x42.00x7.00mm, FPM/ACM
12/93→
NF847 [1]
22.00x45.00x7.00mm, FPM/ACM
12/93→
NF850 [1]
85.00x105.00x8.00mm, FPM
12/93→
NF843 [2]
50.00x68.00x10.00mm, FPM/ACM
12/93→
NA5037 [1]
85.00x105.00x11.00mm, ACM
12/93→

KA625 [15]
NF849 [2][56]

HBS244 [22]
M12x1.50x111.00mm (x10)

JD419

JN732 [4]

JJ557
PA349
22.00x16.00x2.000mm

HR569 [5]

NF846 [2]
25.00x42.00x7.00mm, FPM/ACM
NF847 [1]
22.00x45.00x7.00mm, FPM/ACM
NF850 [1]
85.00x105.00x8.00mm, FPM
NF843 [2]
50.00x68.00x10.00mm, FPM/ACM
NA5037 [1]
85.00x105.00x11.00mm, ACM

KA625 [15]
NF849 [2][56]

HBS244 [22]
M12x1.50x111.00mm (x10)

JD419

JN732 [4]

JJ557
PA349
22.00x16.00x2.000mm

HR569 [5]

NF846 [2]
25.00x42.00x7.00mm, FPM/ACM
NF847 [1]
22.00x45.00x7.00mm, FPM/ACM
NF850 [1]
85.00x105.00x8.00mm, FPM
NF843 [2]
50.00x68.00x10.00mm, FPM/ACM
NA5037 [1]
85.00x105.00x11.00mm, ACM

KA625 [15]
NF849 [2][56]

HBS244 [22]
M12x1.50x111.00mm (x10)

JD419

JN732 [4]

JJ557
PA349
22.00x16.00x2.000mm

HR569 [5]

NF846 [2]
25.00x42.00x7.00mm, FPM/ACM
NF847 [1]
22.00x45.00x7.00mm, FPM/ACM
NF850 [1]
85.00x105.00x8.00mm, FPM
NF843 [2]
50.00x68.00x10.00mm, FPM/ACM
→04/97
NA5037 [1]
85.00x105.00x11.00mm, ACM
NA5036 [2]
42.00x54.00x6.00mm, FPM
04/97→

KA625 [15]
NF849 [2][56]

HBS244 [22]
M12x1.50x111.00mm (x10)

JD419

JN732 [4]

JJ557
PA349
22.00x16.00x2.000mm

HR569 [5]

NF846 [2]
25.00x42.00x7.00mm, FPM/ACM
NF847 [1]
22.00x45.00x7.00mm, FPM/ACM
NF850 [1]
85.00x105.00x8.00mm, FPM
NF843 [2]
50.00x68.00x10.00mm, FPM/ACM
NA5037 [1]
85.00x105.00x11.00mm, ACM

KA625 [15]
NF849 [2][56]



cc



kW/PS



2.0		F3R 751				407	BX600 (Fibre)		DX600	EL960 [3] [18]
Megane 2.0 i	01/96→08/03	1998	4	82.70	SOHC/OHC	80-84/ 109-114	BS530 (Fibre), 1.750mm, 1 Hole 0.868→1.000mm			
Megane 2.0i	03/99→08/03									
Megane Scenic	01/97→09/99									
2.0		F3R 752				408	BX600 (Fibre)		DX600	EL960 [3] [18]
Megane 2.0 i	09/96→08/03	1998	4	82.70	SOHC/OHC	80-84/ 109-114	BS530 (Fibre), 1.750mm, 1 Hole 0.868→1.000mm			
Megane 2.0i	03/99→08/03									
2.0		F3R 768				409	BX600 (Fibre)		DX600	EL960 [3] [18]
Espace 3 2.0	11/96→10/00	1998	4	82.70	SOHC/OHC	84/114	BS530 (Fibre), 1.750mm, 1 Hole 0.868→1.000mm			
Laguna 2.0	10/98→01/01									
Laguna I 2.0	06/95→02/01									
2.0		F3R 769				410	BX600 (Fibre)		DX600	EL960 [3] [18]
Espace 3 2.0	11/96→10/00	1998	4	82.70	SOHC/OHC	84/114	BS530 (Fibre), 1.750mm, 1 Hole 0.868→1.000mm			
2.0		F3R 791				411	BX600 (Fibre)		DX600	EC5060 EC5063
Megane 2.0 i	09/96→08/03	1998	4	82.70	SOHC/OHC	80-84/ 109-114	BS530 (Fibre), 1.750mm, 1 Hole 0.868→1.000mm			
Megane 2.0i	03/99→08/03									

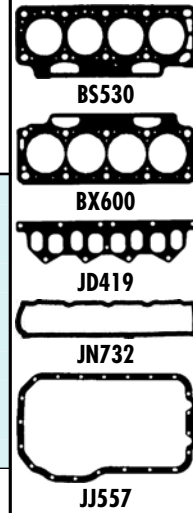

HBS244 [22] M12x1.50x111.00mm (x10)	JD419	JN732 [4]	JJ557	HR569	NF846 [2] 25.00x42.00x7.00mm, FPM/ACM NF847 [1] 22.00x45.00x7.00mm, FPM/ACM NF850 [1] 85.00x105.00x8.00mm, FPM NF843 [2] 50.00x68.00x10.00mm, FPM/ACM NA5037 [1] 85.00x105.00x11.00mm, ACM	
HBS244 [22] M12x1.50x111.00mm (x10)	JD419	JN732 [4]	JJ557	HR569	NF846 [2] 25.00x42.00x7.00mm, FPM/ACM NF847 [1] 22.00x45.00x7.00mm, FPM/ACM NF850 [1] 85.00x105.00x8.00mm, FPM	
HBS244 [22] M12x1.50x111.00mm (x10)	JD419	JN732 [4]	JJ557 PA349 22.00x16.00x2.000mm	HR569	NF846 [2] 25.00x42.00x7.00mm, FPM/ACM NF847 [1] 22.00x45.00x7.00mm, FPM/ACM NA5036 [2] 42.00x54.00x6.00mm, FPM NF850 [1] 85.00x105.00x8.00mm, FPM NF843 [2] 50.00x68.00x10.00mm, FPM/ACM NA5037 [1] 85.00x105.00x11.00mm, ACM	KA625 [15] NF849 [2][56]
HBS244 [22] M12x1.50x111.00mm (x10)	JD419	JN732 [4]	JJ557 PA349 22.00x16.00x2.000mm	HR569	NF846 [2] 25.00x42.00x7.00mm, FPM/ACM NF847 [1] 22.00x45.00x7.00mm, FPM/ACM NA5036 [2] 42.00x54.00x6.00mm, FPM NF850 [1] 85.00x105.00x8.00mm, FPM NF843 [2] 50.00x68.00x10.00mm, FPM/ACM NA5037 [1] 85.00x105.00x11.00mm, ACM	KA625 [15] NF849 [2][56]
HBS244 [22] M12x1.50x111.00mm (x10)	JD419	JN732 [4]	JH5041	HR569	NF846 [2] 25.00x42.00x7.00mm, FPM/ACM NF847 [1] 22.00x45.00x7.00mm, FPM/ACM NA5036 [2] 42.00x54.00x6.00mm, FPM NA5037 [1] 85.00x105.00x11.00mm, ACM	



cc



kW/PS



2.0		F3R 796					412	BX600 (Fibre)	DX600	EL960 [3][18]
Megane 2.0 i	09/96→08/03	1998	4	82.70	SOHC/OHC	80-84/ 109-114	BS530 (Fibre), 1.750mm, 1 Hole -0.868→1.000mm			
Megane 2.0i	03/99→08/03									
Megane Scenic	01/99→09/99									
2.0		F3R 797					413	BX600 (Fibre)	DX600	EC5060 EC5063
Megane 2.0 i	09/96→08/03	1998	4	82.70	SOHC/OHC	80-84/ 109-114	BS530 (Fibre), 1.750mm, 1 Hole -0.868→1.000mm			
Megane 2.0i	03/99→08/03									
2.0		F3R 798					414			EC5060 EC5063
Megane 2.0 i	09/96→08/03	1998	4	82.70	SOHC/OHC	80-84/ 109-114				
Megane 2.0i	03/99→08/03									
2.0		F4R 700					415	AD5990 (MLS)	CD5991	ED5991
Espace 3 2.0	10/98→10/02	1998	4	82.70	DOHC	103/140				
2.0		F4R 701					416	AD5990 (MLS)	CD5991	ED5991
Espace 3 2.0	10/98→10/02	1998	4	82.70	DOHC	103/140				
2.0		F4R 712					417	AD5990 (MLS)	CD5991	ED5991
Laguna II 2.0	08/02→	1998	4	82.70	DOHC	99/135				

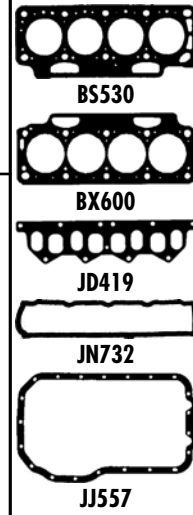
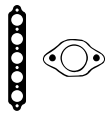

HBS244 [22] M12x1.50x111.00mm (x10)	JD419	JN732 [4]	JJ557 ⇒ PA349 22.00x16.00x2.000mm	HR569 [5]	NF846 [2] 25.00x42.00x7.00mm, FPM/ACM NF847 [1] 22.00x45.00x7.00mm, FPM/ACM NF850 [1] 85.00x105.00x8.00mm, FPM NF843 [2] 50.00x68.00x10.00mm, FPM/ACM →04/97 NA5037 [1] 85.00x105.00x11.00mm, ACM NA5036 [2] 42.00x54.00x6.00mm, FPM 04/97→	KA625 [15] NF849 [2] [56]
HBS244 [22] M12x1.50x111.00mm (x10)	JD419	JN732 [4]	JH5041	HR569 [5]	NF846 [2] 25.00x42.00x7.00mm, FPM/ACM NF847 [1] 22.00x45.00x7.00mm, FPM/ACM NA5036 [2] 42.00x54.00x6.00mm, FPM NA5037 [1] 85.00x105.00x11.00mm, ACM	
HBS244 [22] M12x1.50x111.00mm (x10)			JH5041		NF846 [2] 25.00x42.00x7.00mm, FPM/ACM NF847 [1] 22.00x45.00x7.00mm, FPM/ACM NA5036 [2] 42.00x54.00x6.00mm, FPM NA5037 [1] 85.00x105.00x11.00mm, ACM	
HBS310 [22] M12x1.50x117.00mm (x10)	JD5908 [1] JD5910 [5]	HR397 [5]	JH5041 ⇒ KG5012 16.00x23.00x1.500mm	PA5013 (x16)	NA5257 [2] 28.00x47.00x5.50mm, FPM NA5036 [2] 42.00x54.00x6.00mm, FPM NF850 [1] 85.00x105.00x8.00mm, FPM NA5037 [1] 85.00x105.00x11.00mm, ACM	
HBS310 [22] M12x1.50x117.00mm (x10)	JD5908 [1] JD5910 [5]	HR397 [5]	JH5041 ⇒ KG5012 16.00x23.00x1.500mm	PA5013 (x16)	NA5257 [2] 28.00x47.00x5.50mm, FPM NA5036 [2] 42.00x54.00x6.00mm, FPM NF850 [1] 85.00x105.00x8.00mm, FPM NA5037 [1] 85.00x105.00x11.00mm, ACM	
HBS310 [22] M12x1.50x117.00mm (x10)	JD5908 [1] JD5910 [5]	HR397 [5]	JH5041 ⇒ KG5012 16.00x23.00x1.500mm	PA5013 (x16)	NA5257 [2] 28.00x47.00x5.50mm, FPM NA5036 [2] 42.00x54.00x6.00mm, FPM NF850 [1] 85.00x105.00x8.00mm, FPM NA5037 [1] 85.00x105.00x11.00mm, ACM	

RENAULT



cc



kW/PS



2.0	F4R 713	418	AD5990 (MLS)	CD5991	ED5991
Laguna II 2.0	08/02→	1998 4 82.70 DOHC	95-99/ 129-135		
2.0	F4R 714	419	AD5990 (MLS)	CD5991	ED5991
Laguna II 2.0	08/02→	1998 4 82.70 DOHC	98-99/ 133-135		
2.0	F4R 715	420	AD5990 (MLS)	CD5991	ED5991
Laguna II 2.0	08/02→	1998 4 82.70 DOHC	99/135		
2.0	F4R 720	421	AD5990 (MLS)	CD5991	ED5991
Trafix 2 2.0	03/01→	1998 4 82.70 DOHC	88/120		
2.0	F4R 722	422	AD5990 (MLS)	CD5991	ED5991
Trafix 2 2.0	03/01→	1998 4 82.70 DOHC	88/120		
2.0	F4R 730	423	AD5990 (MLS)	CD5991	ED5991
Clio 2 Sport	02/00→	1998 4 82.70 DOHC	124/169		
2.0	F4R 738	424	AD5990 (MLS)	CD5991	ED5991
Clio 2 Sport Thalia 2.0	01/04→ 09/01→	1998 4 82.70 DOHC	124-132/ 168-180		

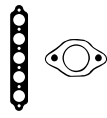

HBS310 [22] M12x1.50x117.00mm (x10)	JD5908 [1] JD5910 [1]	HR397 [1]	JH5041 =KG5012 16.00x23.00x1.500mm	PA5013 (x16)	NA5257 [2] 28.00x47.00x5.50mm, FPM NA5036 [2] 42.00x54.00x6.00mm, FPM NF850 [1] 85.00x105.00x8.00mm, FPM NA5037 [1] 85.00x105.00x11.00mm, ACM	
HBS310 [22] M12x1.50x117.00mm (x10)	JD5908 [1] JD5910 [1]	HR397 [1]	JH5041 =KG5012 16.00x23.00x1.500mm	PA5013 (x16)	NA5257 [2] 28.00x47.00x5.50mm, FPM NA5036 [2] 42.00x54.00x6.00mm, FPM NF850 [1] 85.00x105.00x8.00mm, FPM NA5037 [1] 85.00x105.00x11.00mm, ACM	
HBS310 [22] M12x1.50x117.00mm (x10)	JD5908 [1] JD5910 [1]	HR397 [1]	JH5041 =KG5012 16.00x23.00x1.500mm	PA5013 (x16)	NA5257 [2] 28.00x47.00x5.50mm, FPM NA5036 [2] 42.00x54.00x6.00mm, FPM NF850 [1] 85.00x105.00x8.00mm, FPM NA5037 [1] 85.00x105.00x11.00mm, ACM	
HBS310 [22] M12x1.50x117.00mm (x10)	JD5908 [1] JD5910 [1]	HR397 [1]	JH5041 =KG5012 16.00x23.00x1.500mm	PA5013 (x16)	NA5257 [2] 28.00x47.00x5.50mm, FPM NA5036 [2] 42.00x54.00x6.00mm, FPM NF850 [1] 85.00x105.00x8.00mm, FPM NA5037 [1] 85.00x105.00x11.00mm, ACM	
HBS310 [22] M12x1.50x117.00mm (x10)	JD5908 [1] JD5910 [1]	HR397 [1]	JH5041 =KG5012 16.00x23.00x1.500mm	PA5013 (x16)	NA5257 [2] 28.00x47.00x5.50mm, FPM NA5036 [2] 42.00x54.00x6.00mm, FPM NF850 [1] 85.00x105.00x8.00mm, FPM NA5037 [1] 85.00x105.00x11.00mm, ACM	
HBS310 [22] M12x1.50x117.00mm (x10)	JD5908 [1] JD5910 [1]	HR397 [1]	JH5041 =KG5012 16.00x23.00x1.500mm	PA5013 (x16)	NA5257 [2] 28.00x47.00x5.50mm, FPM NA5036 [2] 42.00x54.00x6.00mm, FPM NF850 [1] 85.00x105.00x8.00mm, FPM NA5037 [1] 85.00x105.00x11.00mm, ACM	
HBS310 [22] M12x1.50x117.00mm (x10)	JD5908 [1] JD5910 [1]	HR397 [1]	JH5041 =KG5012 16.00x23.00x1.500mm	PA5013 (x16)	NA5257 [2] 28.00x47.00x5.50mm, FPM NA5036 [2] 42.00x54.00x6.00mm, FPM NF850 [1] 85.00x105.00x8.00mm, FPM NA5037 [1] 85.00x105.00x11.00mm, ACM	

RENAULT



cc



kW/PS



2.0	F4R 740	425	AD5990 (MLS)	CD5991	ED5991				
Scenic 2.0 16V Scenic 2.0 IDE	07/00→08/03 09/99→08/03	1998	4	82.70	DOHC	99-103/ 135-140			
2.0	F4R 741	426	AD5990 (MLS)	CD5991	ED5991				
Scenic 2.0 16V Scenic 2.0 IDE	07/00→08/03 09/99→08/03	1998	4	82.70	DOHC	99-103/ 135-140			
2.0	F4R 744	427	AD5990 (MLS)	CD5991	ED5991				
Scenic 2.0 IDE Scenic 2.0 RX4	09/99→08/03 06/00→08/03	1998	4	82.70	DOHC	99-103/ 135-140			
2.0	F4R 746	428	AD5990 (MLS)		ED5991				
Megane 2.0 16V Scenic 2.0 16V Scenic 2.0 RX4	01/02→08/03 07/00→08/03 06/00→08/03	1998	4	82.70	DOHC	102-103/ 139-140			
2.0	F4R 760	429	AE5110 (MLS)	CE5110	EE5110				
Avantime 2.0T	11/01→05/03	1998	4	82.70	DOHC	120/163			
2.0	F4R 761	430	AE5110 (MLS)	CE5110	EE5110				
Avantime 2.0T	11/01→05/03	1998	4	82.70	DOHC	120/163			
2.0	F4R 762	431	AE5110 (MLS)	CE5110	EE5110				
Vel Satis	06/02→	1998	4	82.70	DOHC	120/163			
2.0	F4R 763	432	AE5110 (MLS)	CE5110	EE5110				
Vel Satis	06/02→	1998	4	82.70	DOHC	120/163			
2.0	F4R 764	433	AE5110 (MLS)	CE5110	EE5110				
Laguna II 2.0 T	01/03→	1998	4	82.70	DOHC	120/163			

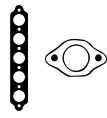

HBS310 [22] M12x1.50x117.00mm (x10)	JD5908 [1] JD5910 [1]	HR397 [1]	JH5041 =KG5012 16.00x23.00x1.500mm	PA5013 (x16)	NA5257 [2] 28.00x47.00x5.50mm, FPM NA5036 [2] 42.00x54.00x6.00mm, FPM NF850 [1] 85.00x105.00x8.00mm, FPM NA5037 [1] 85.00x105.00x11.00mm, ACM	
HBS310 [22] M12x1.50x117.00mm (x10)	JD5908 [1] JD5910 [1]	HR397 [1]	JH5041 =KG5012 16.00x23.00x1.500mm	PA5013 (x16)	NA5257 [2] 28.00x47.00x5.50mm, FPM NA5036 [2] 42.00x54.00x6.00mm, FPM NF850 [1] 85.00x105.00x8.00mm, FPM NA5037 [1] 85.00x105.00x11.00mm, ACM	
HBS310 [22] M12x1.50x117.00mm (x10)	JD5908 [1] JD5910 [1]	HR397 [1]	JH5041 =KG5012 16.00x23.00x1.500mm	PA5013 (x16)	NA5257 [2] 28.00x47.00x5.50mm, FPM NA5036 [2] 42.00x54.00x6.00mm, FPM NF850 [1] 85.00x105.00x8.00mm, FPM NA5037 [1] 85.00x105.00x11.00mm, ACM	
HBS310 [22] M12x1.50x117.00mm (x10)	JD5908 [1] JD5910 [1]		JH5041	PA5013 (x16)	NA5257 [2] 28.00x47.00x5.50mm, FPM NA5036 [2] 42.00x54.00x6.00mm, FPM NA5037 [1] 85.00x105.00x11.00mm, ACM	
HBS310 [22] M12x1.50x117.00mm (x10)	JD5911 [1] JD5910 [1]	HR397 [1]	JH5041	PA5013 (x16)	NA5257 [2] 28.00x47.00x5.50mm, FPM NA5036 [2] 42.00x54.00x6.00mm, FPM NA5037 [1] 85.00x105.00x11.00mm, ACM	
HBS310 [22] M12x1.50x117.00mm (x10)	JD5911 [1] JD5910 [1]	HR397 [1]	JH5041	PA5013 (x16)	NA5257 [2] 28.00x47.00x5.50mm, FPM NA5036 [2] 42.00x54.00x6.00mm, FPM NA5037 [1] 85.00x105.00x11.00mm, ACM	
HBS310 [22] M12x1.50x117.00mm (x10)	JD5911 [1] JD5910 [1]	HR397 [1]	JH5041	PA5013 (x16)	NA5257 [2] 28.00x47.00x5.50mm, FPM NA5036 [2] 42.00x54.00x6.00mm, FPM NA5037 [1] 85.00x105.00x11.00mm, ACM	
HBS310 [22] M12x1.50x117.00mm (x10)	JD5911 [1] JD5910 [1]	HR397 [1]	JH5041	PA5013 (x16)	NA5257 [2] 28.00x47.00x5.50mm, FPM NA5036 [2] 42.00x54.00x6.00mm, FPM NA5037 [1] 85.00x105.00x11.00mm, ACM	
HBS310 [22] M12x1.50x117.00mm (x10)	JD5911 [1] JD5910 [1]		JH5041	PA5013 (x16)	NA5257 [2] 28.00x47.00x5.50mm, FPM NA5036 [2] 42.00x54.00x6.00mm, FPM NA5037 [1] 85.00x105.00x11.00mm, ACM	

RENAULT



cc



kW/PS

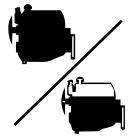

2.0	F4R 765	434	AE5110 (MLS)	CE5110	EE5110				
Laguna II 2.0 T	01/03→	1998	4	82.70	DOHC	120/163			
2.0	F4R 766	435	AE5110 (MLS)	CE5110	EE5110				
Vel Satis	04/04→	1998	4	82.70	DOHC	125/170			
2.0	F4R 767	436	AE5110 (MLS)	CE5110	EE5110				
Vel Satis	04/04→	1998	4	82.70	DOHC	125/170			
2.0	F4R 770	437	AD5990 (MLS)	CD5991	ED5991				
Gr. Scenic 2	04/04→	1998	4	82.70	DOHC	99-103/ 135-140			
Megane 2.0 16V	01/02→08/03								
Megane 2 2.0	11/02→								
Scenic 2 2.0	06/03→								
2.0	F4R 771	438	AD5990 (MLS)	CD5991	ED5991				
Gr. Scenic 2	04/04→	1998	4	82.70	DOHC	99/135			
Megane 2 2.0	08/03→								
Scenic 2 2.0	06/03→								
2.0	F4R 774	439	AE5110 (MLS)	CE5111	EE5110				
Megane 2 2.0	08/06→	1998	4	82.70	DOHC	165-169/ 224-230			
Megane 2 2.0 Sp	05/04→								
2.0	F4R 776	440	AE5110 (MLS)	CE5110	EE5110				
Gr. Scenic 2	04/04→	1998	4	82.70	DOHC	120/163			
Megane 2 2.0 T	05/04→								
Scenic 2 2.0	05/04→								
2.0	F4R 780	441	AD5990 (MLS)	CD5991	ED5991				
Laguna 2.0 16V	09/99→03/01	1998	4	82.70	DOHC	103/140			
Laguna I 2.0	09/99→03/01								

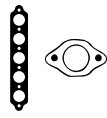

HBS310 [22] M12x1.50x117.00mm (x10)	JD5911 [1] JD5910 [2]		JH5041	PA5013 (x16)	NA5257 [2] 28.00x47.00x5.50mm, FPM NA5036 [2] 42.00x54.00x6.00mm, FPM NA5037 [1] 85.00x105.00x11.00mm, ACM	
HBS310 [22] M12x1.50x117.00mm (x10)	JD5911 [1] JD5910 [2]		JH5041	PA5013 (x16)	NA5257 [2] 28.00x47.00x5.50mm, FPM NA5036 [2] 42.00x54.00x6.00mm, FPM NA5037 [1] 85.00x105.00x11.00mm, ACM	
HBS310 [22] M12x1.50x117.00mm (x10)	JD5911 [1] JD5910 [2]		JH5041	PA5013 (x16)	NA5257 [2] 28.00x47.00x5.50mm, FPM NA5036 [2] 42.00x54.00x6.00mm, FPM NA5037 [1] 85.00x105.00x11.00mm, ACM	
HBS310 [22] M12x1.50x117.00mm (x10)	JD5908 [1] JD5910 [2]	HR397 [2]	JH5041 =KG5012 16.00x23.00x1.500mm	PA5013 (x16)	NA5257 [2] 28.00x47.00x5.50mm, FPM NA5036 [2] 42.00x54.00x6.00mm, FPM NF850 [1] 85.00x105.00x8.00mm, FPM NA5037 [1] 85.00x105.00x11.00mm, ACM	
HBS310 [22] M12x1.50x117.00mm (x10)	JD5908 [1] JD5910 [2]	HR397 [2]	JH5041 =KG5012 16.00x23.00x1.500mm	PA5013 (x16)	NA5257 [2] 28.00x47.00x5.50mm, FPM NA5036 [2] 42.00x54.00x6.00mm, FPM NF850 [1] 85.00x105.00x8.00mm, FPM NA5037 [1] 85.00x105.00x11.00mm, ACM	
HBS310 [22] M12x1.50x117.00mm (x10)	JD5911 [1] JD5910 [2]	HR397 [2]	JH5041		NA5257 [2] 28.00x47.00x5.50mm, FPM NA5036 [2] 42.00x54.00x6.00mm, FPM NA5037 [1] 85.00x105.00x11.00mm, ACM	
HBS310 [22] M12x1.50x117.00mm (x10)	JD5911 [1] JD5910 [2]	HR397 [2]	JH5041 =KG5012 16.00x23.00x1.500mm	PA5013 (x16)	NA5257 [2] 28.00x47.00x5.50mm, FPM NA5036 [2] 42.00x54.00x6.00mm, FPM NF850 [1] 85.00x105.00x8.00mm, FPM NA5037 [1] 85.00x105.00x11.00mm, ACM	
HBS310 [22] M12x1.50x117.00mm (x10)	JD5908 [1] JD5910 [2]	HR397 [2]	JH5041 =KG5012 16.00x23.00x1.500mm	PA5013 (x16)	NA5257 [2] 28.00x47.00x5.50mm, FPM NA5036 [2] 42.00x54.00x6.00mm, FPM NF850 [1] 85.00x105.00x8.00mm, FPM NA5037 [1] 85.00x105.00x11.00mm, ACM	

RENAULT



cc



kW/PS



2.0	F4R 784	442	AE5110 (MLS)	CE5110	EE5110				
Laguna II 2.0	01/05→	1998	4	82.70	DOHC	125/170			
2.0	F4R 786	443	AE5110 (MLS)	CE5110	EE5110				
Laguna II 2.0	01/05→	1998	4	82.70	DOHC	120-125/ 163-170			
Laguna II 2.0 T	01/03→								
2.0	F4R 787	444	AE5110 (MLS)	CE5110	EE5110				
Laguna II 2.0	01/05→	1998	4	82.70	DOHC	120-125/ 163-170			
Laguna II 2.0 T	01/03→								
2.0	F4R 790	445	AD5990 (MLS)		ED5991				
Espace 4 2.0	11/02→02/05	1998	4	82.70	DOHC	98-100/ 133-136			
2.0	F4R 792	446	AD5990 (MLS)	CD5991	ED5991				
Espace 4 2.0	11/02→	1998	4	82.70	DOHC	100/136			
2.0	F4R 794	447	AE5110 (MLS)	CE5110	EE5110				
Espace 4 2.0T	11/02→	1998	4	82.70	DOHC	120/163			
2.0	F4R 795	448	AE5110 (MLS)	CE5110	EE5110				
Espace 4 2.0T	11/02→	1998	4	82.70	DOHC	120/163			
2.0	F4R 796	449	AE5110 (MLS)	CE5110	EE5110				
Espace 4 2.0	04/05→	1998	4	82.70	DOHC	120-125/ 163-170			
Espace 4 2.0T	11/02→								
2.0	F4R 797	450	AE5110 (MLS)	CE5110	EE5110				
Espace 4 2.0	04/05→	1998	4	82.70	DOHC	120-125/ 163-170			
Espace 4 2.0T	11/02→								

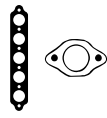

HBS310 [22] M12x1.50x117.00mm (x10)	JD5911 [1] JD5910 [2] JE5060 [1] (Steel)	HR397 [2]	JH5041 KG5012 16.00x23.00x1.500mm	PA5013 (x16)	NA5257 [2] 28.00x47.00x5.50mm, FPM NA5036 [2] 42.00x54.00x6.00mm, FPM NA5037 [1] 85.00x105.00x11.00mm, ACM	
HBS310 [22] M12x1.50x117.00mm (x10)	JD5911 [1] JD5910 [2] JE5060 [1] (Steel)	HR397 [2]	JH5041 KG5012 16.00x23.00x1.500mm	PA5013 (x16)	NA5257 [2] 28.00x47.00x5.50mm, FPM NA5036 [2] 42.00x54.00x6.00mm, FPM NA5037 [1] 85.00x105.00x11.00mm, ACM	
HBS310 [22] M12x1.50x117.00mm (x10)	JD5911 [1] JD5910 [2] JE5060 [1] (Steel)	HR397 [2]	JH5041 KG5012 16.00x23.00x1.500mm	PA5013 (x16)	NA5257 [2] 28.00x47.00x5.50mm, FPM NA5036 [2] 42.00x54.00x6.00mm, FPM NA5037 [1] 85.00x105.00x11.00mm, ACM	
HBS310 [22] M12x1.50x117.00mm (x10)	JD5908 [1] JD5910 [2]	HR397 [2]		PA5013 (x16)	NA5257 [2] 28.00x47.00x5.50mm, FPM NA5036 [2] 42.00x54.00x6.00mm, FPM NA5037 [1] 85.00x105.00x11.00mm, ACM	
HBS310 [22] M12x1.50x117.00mm (x10)	JD5908 [1] JD5910 [2]	HR397 [2]	JH5041 KG5012 16.00x23.00x1.500mm	PA5013 (x16)	NA5257 [2] 28.00x47.00x5.50mm, FPM NA5036 [2] 42.00x54.00x6.00mm, FPM NF850 [1] 85.00x105.00x8.00mm, FPM NA5037 [1] 85.00x105.00x11.00mm, ACM	
HBS310 [22] M12x1.50x117.00mm (x10)	JD5911 [1] JD5910 [2]	HR397 [2]	JH5041 KG5012 16.00x23.00x1.500mm	PA5013 (x16)	NA5257 [2] 28.00x47.00x5.50mm, FPM NA5036 [2] 42.00x54.00x6.00mm, FPM NA5037 [1] 85.00x105.00x11.00mm, ACM	
HBS310 [22] M12x1.50x117.00mm (x10)	JD5911 [1] JD5910 [2]	HR397 [2]	JH5041 KG5012 16.00x23.00x1.500mm	PA5013 (x16)	NA5257 [2] 28.00x47.00x5.50mm, FPM NA5036 [2] 42.00x54.00x6.00mm, FPM NA5037 [1] 85.00x105.00x11.00mm, ACM	
HBS310 [22] M12x1.50x117.00mm (x10)	JD5911 [1] JD5910 [2]	HR397 [2]	JH5041 KG5012 16.00x23.00x1.500mm	PA5013 (x16)	NA5257 [2] 28.00x47.00x5.50mm, FPM NA5036 [2] 42.00x54.00x6.00mm, FPM NA5037 [1] 85.00x105.00x11.00mm, ACM	
HBS310 [22] M12x1.50x117.00mm (x10)	JD5911 [1] JD5910 [2]	HR397 [2]	JH5041 KG5012 16.00x23.00x1.500mm	PA5013 (x16)	NA5257 [2] 28.00x47.00x5.50mm, FPM NA5036 [2] 42.00x54.00x6.00mm, FPM NA5037 [1] 85.00x105.00x11.00mm, ACM	

RENAULT



cc



kW/PS



2.0	F4R 800	451	AE5110 (MLS)	CE5110	EE5110				
Laguna 3 2.0GT	03/08→	1998	4	82.70	DOHC	150/204			
2.0	F4R 811	452	AE5110 (MLS)	CE5110	EE5110				
Laguna 2.0T	09/08→	1998	4	82.70	DOHC	125/170			
Laguna 3 2.0	10/07→								
2.0	F4R 820	453	AD5990 (MLS)	CD5991	EE5110				
Trafix 2 2.0	08/06→	1998	4	82.70	DOHC	86/117			
2.0	F4R 830	454	AD5990 (MLS)	CD5991	ED5991				
Clio 3 Sport	02/06→	1998	4	82.70	DOHC	145-148/ 197-200			
2.0	F4R 867	455	AE5110 (MLS)	CE5110	EE5110				
Vel Satis	04/05→	1998	4	82.70	DOHC	108/147			
2.0	F4R 870	456			ED5991				
Megane 3 2.0TCe	11/08→	1998	4	82.70	DOHC	132/180			
Megane CC 2.0	06/10→								
Megane Scenic	11/08→								
2.0	F4R 872	457			ED5991				
Megane 3 2.0TCe	11/08→	1998	4	82.70	DOHC	132/180			
Megane CC 2.0	06/10→								
2.0	F4R 874	458			ED5991				
Megane 3 2.0TCe	05/09→	1998	4	82.70	DOHC	184-195/ 250-265			
Megane CC 2.0	10/11→								
Megane Scenic	11/08→								
2.0	F4R 886	459	AE5110 (MLS)	CE5110	EE5110				
Laguna II 2.0	01/05→	1998	4	82.70	DOHC	150/204			

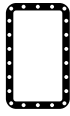
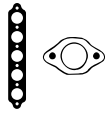

HBS310 [22] M12x1.50x117.00mm (x10)	JD5911 [1] JD5910 [2]	HR397 [2]	JH5041	PA5013 (x16)	NA5257 [2] 28.00x47.00x5.50mm, FPM NA5036 [2] 42.00x54.00x6.00mm, FPM NA5037 [1] 85.00x105.00x11.00mm, ACM	
HBS310 [22] M12x1.50x117.00mm (x10)	JD5911 [1] JD5910 [2]	HR397 [2]	JH5041	PA5013 (x16)	NA5257 [2] 28.00x47.00x5.50mm, FPM NA5036 [2] 42.00x54.00x6.00mm, FPM NA5037 [1] 85.00x105.00x11.00mm, ACM	
HBS310 [22] M12x1.50x117.00mm (x10)	JD5908 [1] JD5910 [2]	HR397 [2]	JH5041	PA5013 (x16)	NA5257 [2] 28.00x47.00x5.50mm, FPM NA5036 [2] 42.00x54.00x6.00mm, FPM NA5037 [1] 85.00x105.00x11.00mm, ACM	
HBS310 [22] M12x1.50x117.00mm (x10)	JD5887 [1] (SE) JD5888 [1] (SE) JD5886 [2]	HR397 [2]	JH5041 KG5012 16.00x23.00x1.500mm	PA5013 (x16)	NA5257 [2] 28.00x47.00x5.50mm, FPM NA5036 [2] 42.00x54.00x6.00mm, FPM NF850 [1] 85.00x105.00x8.00mm, FPM NA5037 [1] 85.00x105.00x11.00mm, ACM	
HBS310 [22] M12x1.50x117.00mm (x10)	JD5911 [1] JD5910 [2]	HR397 [2]	JH5041	PA5013 (x16)	NA5257 [2] 28.00x47.00x5.50mm, FPM NA5036 [2] 42.00x54.00x6.00mm, FPM NA5037 [1] 85.00x105.00x11.00mm, ACM	
			JH5041		NA5036 [2] 42.00x54.00x6.00mm, FPM NA5037 [1] 85.00x105.00x11.00mm, ACM	
			JH5041		NA5036 [2] 42.00x54.00x6.00mm, FPM NA5037 [1] 85.00x105.00x11.00mm, ACM	
			JH5041		NA5036 [2] 42.00x54.00x6.00mm, FPM NA5037 [1] 85.00x105.00x11.00mm, ACM	
HBS310 [22] M12x1.50x117.00mm (x10)	JD5911 [1] JD5910 [2]	HR397 [2]	JH5041 KG5012 16.00x23.00x1.500mm	PA5013 (x16)	NA5257 [2] 28.00x47.00x5.50mm, FPM NA5036 [2] 42.00x54.00x6.00mm, FPM NF850 [1] 85.00x105.00x8.00mm, FPM NA5037 [1] 85.00x105.00x11.00mm, ACM	

RENAULT



cc



kW/PS

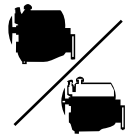

2.0	F4R 887	460	AE5110 (MLS)	CE5110	EE5110
Laguna II 2.0	01/05→	1998 4 82.70 DOHC 150/204			EE5110
2.0	F4R 896	461	AE5110 (MLS)	CE5110	EE5110
Espace 4 2.0	04/05→	1998 4 82.70 DOHC 125/170			EE5110
2.0	F4R 897	462	AE5110 (MLS)	CE5110	EE5110
Espace 4 2.0	04/05→	1998 4 82.70 DOHC 125/170			EE5110
2.0	F4R† 774	463	AE5110 (MLS)	CE5110	
Megane 2 2.0 Sp	05/04→	1998 4 82.70 DOHC 165/224			
2.0	F4R† 800	464	AE5110 (MLS)	CE5110	EE5110
Laguna 2.0 GT	09/08→	1998 4 82.70 DOHC 150/204			EE5110
2.0	F4R† 811	465	AE5110 (MLS)	CE5110	
Laguna 2.0T	09/08→	1998 4 82.70 DOHC 125/170			
2.0	F5R 700	466	AG5420 (MLS)	CG5420	ED5991
Laguna II 2.0	04/01→	1998 4 86.00 DOHC 103/140			ED5991
2.0	F5R 701	467	AG5420 (MLS)	CG5420	ED5991
Laguna II 2.0	04/01→	1998 4 86.00 DOHC 103/140			ED5991

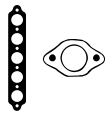

HBS310 [22] M12x1.50x117.00mm (x10)	JD5911 [1] JD5910 [2]	HR397 [2]	JH5041 =KG5012 16.00x23.00x1.500mm	PA5013 (x16)	NA5257 [2] 28.00x47.00x5.50mm, FPM NA5036 [2] 42.00x54.00x6.00mm, FPM NF850 [1] 85.00x105.00x8.00mm, FPM NA5037 [1] 85.00x105.00x11.00mm, ACM	
HBS310 [22] M12x1.50x117.00mm (x10)	JD5911 [1] JD5910 [2]	HR397 [2]	JH5041 =KG5012 16.00x23.00x1.500mm	PA5013 (x16)	NA5257 [2] 28.00x47.00x5.50mm, FPM NA5036 [2] 42.00x54.00x6.00mm, FPM NA5037 [1] 85.00x105.00x11.00mm, ACM	
HBS310 [22] M12x1.50x117.00mm (x10)	JD5911 [1] JD5910 [2]	HR397 [2]	JH5041 =KG5012 16.00x23.00x1.500mm	PA5013 (x16)	NA5257 [2] 28.00x47.00x5.50mm, FPM NA5036 [2] 42.00x54.00x6.00mm, FPM NA5037 [1] 85.00x105.00x11.00mm, ACM	
HBS310 [22] M12x1.50x117.00mm (x10)	JD5911 [1] JD5910 [2]	HR397 [2]		PA5013 (x16)	NA5257 [2] 28.00x47.00x5.50mm, FPM NA5036 [2] 42.00x54.00x6.00mm, FPM NA5037 [1] 85.00x105.00x11.00mm, ACM	
HBS310 [22] M12x1.50x117.00mm (x10)	JD5911 [1] JD5910 [2]	HR397 [2]	JH5041	PA5013 (x16)	NA5257 [2] 28.00x47.00x5.50mm, FPM NA5036 [2] 42.00x54.00x6.00mm, FPM NA5037 [1] 85.00x105.00x11.00mm, ACM	
HBS310 [22] M12x1.50x117.00mm (x10)	JD5911 [1] JD5910 [2]	HR397 [2]		PA5013 (x16)	NA5257 [2] 28.00x47.00x5.50mm, FPM NA5036 [2] 42.00x54.00x6.00mm, FPM NA5037 [1] 85.00x105.00x11.00mm, ACM	
HBS431 [22] M12x1.50x117.00mm (x10)	JD5889 [1] (SE) JD5910 [2]	HR397 [2]	JH5041 =KG5012 16.00x23.00x1.500mm	PA5013 (x16)	NA5257 [2] 28.00x47.00x5.50mm, FPM NA5036 [2] 42.00x54.00x6.00mm, FPM NF850 [1] 85.00x105.00x8.00mm, FPM NA5037 [1] 85.00x105.00x11.00mm, ACM	
HBS431 [22] M12x1.50x117.00mm (x10)	JD5889 [1] (SE) JD5910 [2]	HR397 [2]	JH5041 =KG5012 16.00x23.00x1.500mm	PA5013 (x16)	NA5257 [2] 28.00x47.00x5.50mm, FPM NA5036 [2] 42.00x54.00x6.00mm, FPM NF850 [1] 85.00x105.00x8.00mm, FPM NA5037 [1] 85.00x105.00x11.00mm, ACM	

RENAULT



cc



kW/PS



2.0	F5R 740						468	AG5420 (MLS)	CG5420	ED5991
Megane 2.0 IDE	11/99→08/03	1998	4	82.70	DOHC	103/140				
2.0	F7R 700						469	BX620 (Fibre), 1.350mm	DX620 [3]	EL960 [3][18]
Clio 2.0	01/94→09/98	1998	4	82.70	DOHC	108-110/ 147-150				
2.0	F7R 710						470			EL960 [3][18]
Megane 2.0 16V Sport spider	03/96→08/03 03/95→10/99	1998	4	82.70	DOHC	108-110/ 147-150				
2.0	F7R 714						471			EC5060 EC5063
Megane 2.0 16V	03/96→08/03	1998	4	82.70	DOHC	108/147				
2.0	J5R 716						472	BG170 (Fibre), 1.200mm	DG173 [3]	EG176 [3][14]
Master I 2.0 Trafic 2.0 Trafic 2.0 4x4	11/89→12/95 05/85→08/90 05/85→04/89	1995	4	88.00	SOHC/OHC	59-62/ 80-84				
2.0	J5R 718						473	BG170 (Fibre), 1.200mm	DG173 [3]	EG176 [3][14]
Master I Master I 2.0	10/86→07/98 11/89→07/93	1995	4	88.00	SOHC/OHC	57-60/ 78-82				
2.0	J5R 722						474	BG170 (Fibre), 1.200mm	DG173 [3]	EG176 [3][14]
Trafic 2.0 Trafic 2.0 4x4	06/86→04/89 06/86→04/89	1995	4	88.00	SOHC/OHC	59/80				



BG170



BX620



JB954



JD410



JD411



JN292

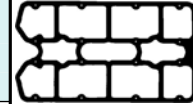

JN996



JJ557



JJ558

RENAULT



cc



kW/PS



2.0	J5R 726					475	BG170 (Fibre), 1.200mm	DG173 [3]	EG176 [3][14]
Trafic 2.0	03/80→10/97	1995	4	88.00	SOHC/OHC	59/80			
Trafic 2.0 4x4	06/86→04/89								
2.0	J5R 728					476	BG170 (Fibre), 1.200mm	DG173 [3]	EG176 [3][14]
Master I	10/86→07/98	1995	4	88.00	SOHC/OHC	58-60/ 79-82			
Master I 2.0	06/85→12/95								
2.0	J6R 234					477	BG170 (Fibre), 1.200mm	DG170 [3] →12/87 DG173 [3] →12/87	EG176 [3][14] →12/87
Espace I 2.0	07/84→12/90	1995	4	88.00	SOHC/OHC	79-81/ 107-110	→12/87		
2.0	J6R 236					478	BG170 (Fibre), 1.200mm	DG170 [3] 01/88→ DG173 [3] 01/88→	EG176 [3][14] 01/88→
Espace I 2.0	07/84→12/90	1995	4	88.00	SOHC/OHC	80/108	01/88→		
2.0	J6R 706					479	BG170 (Fibre), 1.200mm	DG170 [3] →12/89 DG173 [3] →12/89	EG176 [3][14] →12/89
25 2.0	04/84→12/92	1995	4	88.00	SOHC/OHC	74/101	→12/89		

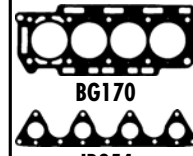
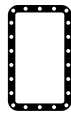
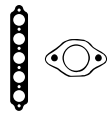

BG170



JB954



JC238

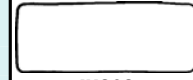

JN292

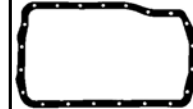

JJ558

<p>HBS116 [22] M12x1.50x243.00mm (x10)</p>	<p>JB954</p>	<p>JN292 [4]</p>	<p>JJ558 (Felt) =PB852 16.00x24.00x1.500mm =PA349 22.00x16.00x2.000mm</p>	<p>HR569</p>	<p>NA5016 35.00x47.00x7.00mm, FPM/ACM ☒ NF648 [2] 50.00x68.00x10.00mm, MVQ ☒ NF843 [2] 50.00x68.00x10.00mm, FPM/ACM ☒ NF844 [1] 90.00x110.00x11.00mm, FPM/ACM</p>	<p>NF849 [2] [56]</p>
<p>HBS116 [22] M12x1.50x243.00mm (x10)</p>	<p>JB954</p>	<p>JN292 [4]</p>	<p>JJ558 (Felt) =PB852 16.00x24.00x1.500mm =PA349 22.00x16.00x2.000mm</p>	<p>HR569</p>	<p>NA5016 35.00x47.00x7.00mm, FPM/ACM ☒ NF648 [2] 50.00x68.00x10.00mm, MVQ ☒ NF843 [2] 50.00x68.00x10.00mm, FPM/ACM ☒ NF844 [1] 90.00x110.00x11.00mm, FPM/ACM</p>	<p>NF849 [2] [56]</p>
<p>HBS116 [22] M12x1.50x243.00mm (x10) →12/87</p>	<p>JB954 →12/87 ☒ JC238 →12/87</p>	<p>JN292 [4] →12/87</p>	<p>JJ558 (Felt) →12/87 =PB852 16.00x24.00x1.500mm =PA349 22.00x16.00x2.000mm</p>	<p>HR569 →12/87</p>	<p>NA5016 35.00x47.00x7.00mm, FPM/ACM →12/87 ☒ NA5016 [2] 35.00x47.00x7.00mm, FPM/ACM →12/87 ☒ NF648 [2] 50.00x68.00x10.00mm, MVQ →12/87 ☒ NF843 [2] 50.00x68.00x10.00mm, FPM/ACM →12/87 ☒ NF844 [1] 90.00x110.00x11.00mm, FPM/ACM →12/87</p>	<p>NF849 [2] [56]</p>
<p>HBS116 [22] M12x1.50x243.00mm (x10) 01/88→</p>	<p>JB954 01/88→ ☒ JC238 01/88→</p>	<p>JN292 [4] 01/88→</p>	<p>=PB852 16.00x24.00x1.500mm =PA349 22.00x16.00x2.000mm JJ558 (Felt) 01/88→</p>	<p>HR569 01/88→</p>	<p>NA5016 35.00x47.00x7.00mm, FPM/ACM 01/88→ ☒ NA5016 [2] 35.00x47.00x7.00mm, FPM/ACM 01/88→ ☒ NF648 [2] 50.00x68.00x10.00mm, MVQ 01/88→ ☒ NF843 [2] 50.00x68.00x10.00mm, FPM/ACM 01/88→ ☒ NF844 [1] 90.00x110.00x11.00mm, FPM/ACM 01/88→</p>	<p>NF849 [2] [56]</p>
<p>HBS116 [22] M12x1.50x243.00mm (x10) →12/89</p>	<p>JB954 →12/89 ☒ JC238 →12/89</p>	<p>JN292 [4] →12/89</p>	<p>JJ558 (Felt) →12/89</p>	<p>HR569 →12/89</p>	<p>NA5016 35.00x47.00x7.00mm, FPM/ACM →12/89 ☒ NF648 [2] 50.00x68.00x10.00mm, MVQ →12/89 ☒ NF843 [2] 50.00x68.00x10.00mm, FPM/ACM →12/89</p>	

RENAULT













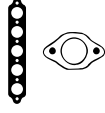

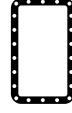

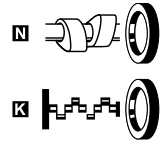





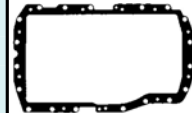

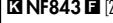



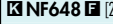
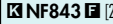
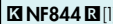



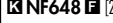

cc

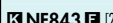
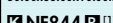

kW/PS

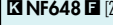
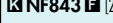

2.0	J6R 707	480	BG170 (Fibre), 1.200mm	DG170 [3] →12/89 DG173 [3] →12/89	EG176 [3][14] →12/89				
25 2.0	04/84→12/92	1995	4	88.00	SOHC/OHC	74/101	→12/89		
2.0	J6R 734	481	BG170 (Fibre), 1.200mm	DG170 [3] DG173 [3]	EG176 [3][14]				
Espace I 2.0	01/88→12/90	1995	4	88.00	SOHC/OHC	74/101			
2.0	J6R 758	482	BG170 (Fibre), 1.200mm	DG170 [3] DG173 [3]	EG176 [3][14]				
21 2.0	03/86→10/93	1995	4	88.00	SOHC/OHC	75-78/ 102-106			
2.0	J6R 759	483	BG170 (Fibre), 1.200mm	DG170 [3] DG173 [3]	EG176 [3][14]				
21 2.0	03/86→10/93	1995	4	88.00	SOHC/OHC	75/102			
2.0	J6R 760	484	BG170 (Fibre), 1.200mm	DG170 [3] →12/89 DG173 [3] →12/89	EG176 [3][14] →12/89				
25 2.0	04/84→12/92	1995	4	88.00	SOHC/OHC	74/101	→12/89		
2.0	J6R 762	485	BG170 (Fibre), 1.200mm	DG170 [3] →12/89 DG173 [3] →12/89	EG176 [3][14] →12/89				
25 2.0	04/84→12/92	1995	4	88.00	SOHC/OHC	74/101	→12/89		
2.0	J6R 763	486	BG170 (Fibre), 1.200mm	DG170 [3] →12/89 DG173 [3] →12/89	EG176 [3][14] →12/89				
25 2.0	04/84→12/92	1995	4	88.00	SOHC/OHC	74/101	→12/89		

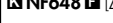
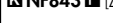
      						 BG170  JB954  JC238  JN292  JJ558  JJ559
HBS116 [22] M12x1.50x243.00mm (x10) →12/89	JB954 →12/89  →12/89	JN292 [4] →12/89	JJ558 (Felt) →12/89	HR569 →12/89	NA5016 35.00x47.00x7.00mm, FPM/ACM →12/89  50.00x68.00x10.00mm, MVQ →12/89  50.00x68.00x10.00mm, FPM/ACM →12/89	
HBS116 [22] M12x1.50x243.00mm (x10)	JB954  JC238	JN292 [4]	JJ558 (Felt)  16.00x24.00x1.500mm  22.00x16.00x2.000mm	HR569	NA5016 35.00x47.00x7.00mm, FPM/ACM  50.00x68.00x10.00mm, MVQ  50.00x68.00x10.00mm, FPM/ACM  90.00x110.00x11.00mm, FPM/ACM	NF849 [2][56]
HBS116 [22] M12x1.50x243.00mm (x10)	JB954  JC238	JN292 [4]	JJ558 (Felt) JJ559 (SE)  16.00x24.00x1.500mm  22.00x16.00x2.000mm	HR569	NA5016 35.00x47.00x7.00mm, FPM/ACM  50.00x68.00x10.00mm, MVQ  50.00x68.00x10.00mm, FPM/ACM  90.00x110.00x11.00mm, FPM/ACM	NF781 (x2)[1][52] [2] NF849 [2][56]
HBS116 [22] M12x1.50x243.00mm (x10)	JB954  JC238	JN292 [4]	JJ558 (Felt) JJ559 (SE)  16.00x24.00x1.500mm  22.00x16.00x2.000mm	HR569	NA5016 35.00x47.00x7.00mm, FPM/ACM  50.00x68.00x10.00mm, MVQ  50.00x68.00x10.00mm, FPM/ACM  90.00x110.00x11.00mm, FPM/ACM	NF781 (x2)[1][52] [2] NF849 [2][56]
HBS116 [22] M12x1.50x243.00mm (x10) →12/89	JB954 →12/89  JC238 →12/89	JN292 [4] →12/89	JJ558 (Felt) →12/89	HR569 →12/89	NA5016 35.00x47.00x7.00mm, FPM/ACM →12/89  50.00x68.00x10.00mm, MVQ →12/89  50.00x68.00x10.00mm, FPM/ACM →12/89	
HBS116 [22] M12x1.50x243.00mm (x10) →12/89	JB954 →12/89  JC238 →12/89	JN292 [4] →12/89	JJ558 (Felt) →12/89	HR569 →12/89	NA5016 35.00x47.00x7.00mm, FPM/ACM →12/89  50.00x68.00x10.00mm, MVQ →12/89  50.00x68.00x10.00mm, FPM/ACM →12/89	
HBS116 [22] M12x1.50x243.00mm (x10) →12/89	JB954 →12/89  JC238 →12/89	JN292 [4] →12/89	JJ558 (Felt) →12/89	HR569 →12/89	NA5016 35.00x47.00x7.00mm, FPM/ACM →12/89  50.00x68.00x10.00mm, MVQ →12/89  50.00x68.00x10.00mm, FPM/ACM →12/89	

RENAULT













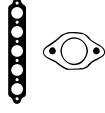

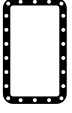

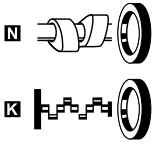



cc

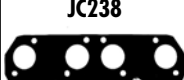

kW/PS

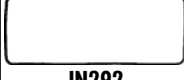

2.0	J6R 792	487	BG170 (Fibre), 1.200mm	DG170 [3] DG173 [3]	EG176 [3][14]				
21 2.0	03/86→10/93	1995	4	88.00	SOHC/OHC	75/102			
2.0	J6R 793	488	BG170 (Fibre), 1.200mm	DG170 [3] DG173 [3]	EG176 [3][14]				
21 2.0	03/86→10/93	1995	4	88.00	SOHC/OHC	75/102			
2.0	J7R 720	489	BX580 (Fibre)	DX580	EG176 [3][14]				
25 2.0 12V	06/88→12/93	1995	4	88.00	SOHC/OHC	103/140			
2.0	J7R 721	490	BX580 (Fibre)	DX580	EG176 [3][14]				
25 2.0 12V	06/88→12/93	1995	4	88.00	SOHC/OHC	103/140			
2.0	J7R 722	491				EG176 [3][14]			
25 2.0	03/87→12/93	1995	4	88.00	SOHC/OHC	88/120			
2.0	J7R 723	492				EG176 [3][14]			
25 2.0	03/87→12/93	1995	4	88.00	SOHC/OHC	88/120			
2.0	J7R 726	493	BX580 (Fibre)	DX580	EG176 [3][14]				
25 2.0 12V	06/89→12/92	1995	4	88.00	SOHC/OHC	99-100/ 135-136			
2.0	J7R 732	494				DX560 [3]	EG176 [3][14]		
Safrane I 2.0	11/92→07/96	1995	4	88.00	SOHC/OHC	77/105			
2.0	J7R 733	495				DX560 [3]	EG176 [3][14]		
Safrane I 2.0	11/92→07/96	1995	4	88.00	SOHC/OHC	77/105			
2.0	J7R 734	496	BX570 (Fibre)	DX570 [3]	EG176 [3][14]				
Safrane I 2.0	04/92→07/96	1995	4	88.00	SOHC/OHC	97-99/ 132-135			
2.0	J7R 735	497	BX570 (Fibre)	DX570 [3]	EG176 [3][14]				
Safrane I 2.0	04/92→07/96	1995	4	88.00	SOHC/OHC	97-99/ 132-135			

								
HBS116 [22] M12x1.50x243.00mm (x10)	JB954 [E] 	JN292 [4]	JJ558 (Felt) JJ559 (SE) =PB852 16.00x24.00x1.500mm =PA349 22.00x16.00x2.000mm	HR569 [E]	NA5016 35.00x47.00x7.00mm, FPM/ACM [X] NF648 [2] 50.00x68.00x10.00mm, MVQ [X] NF843 [2] 50.00x68.00x10.00mm, FPM/ACM [X] NF844 [1] 90.00x110.00x11.00mm, FPM/ACM	NF781 (x2)[1][52] [2][R] NF849 [2][56]	 BG170  BX570  BX580  JB954	
HBS116 [22] M12x1.50x243.00mm (x10)	JB954 [E] 	JN292 [4]	JJ558 (Felt) JJ559 (SE) =PB852 16.00x24.00x1.500mm =PA349 22.00x16.00x2.000mm	HR569 [E]	NA5016 35.00x47.00x7.00mm, FPM/ACM [X] NF648 [2] 50.00x68.00x10.00mm, MVQ [X] NF843 [2] 50.00x68.00x10.00mm, FPM/ACM [X] NF844 [1] 90.00x110.00x11.00mm, FPM/ACM	NF781 (x2)[1][52] [2][R] NF849 [2][56]	 JC238  JD413  JD414  JD416	
HBS116 [22] M12x1.50x243.00mm (x10)	JD414 [I] JD413 [E]	JN995 [4]	JJ558 (Felt)	HR662 [E]	NB866 [2] 28.00x42.00x7.00mm, FPM [X] NF648 [2] 50.00x68.00x10.00mm, MVQ [X] NF843 [2] 50.00x68.00x10.00mm, FPM/ACM		 JN292  JN995	
HBS116 [22] M12x1.50x243.00mm (x10)	JD414 [I] JD413 [E]	JN995 [4]	JJ558 (Felt)	HR662 [E]	NB866 [2] 28.00x42.00x7.00mm, FPM [X] NF648 [2] 50.00x68.00x10.00mm, MVQ [X] NF843 [2] 50.00x68.00x10.00mm, FPM/ACM		 JJ558	
HBS116 [22] M12x1.50x243.00mm (x10)	JD414 [I] JD413 [E]	JN995 [4]	JJ562 (Elastomer) =PB852 16.00x24.00x1.500mm =PA349 22.00x16.00x2.000mm	HR662 [E]	NB866 [2] 28.00x42.00x7.00mm, FPM [X] NF648 [2] 50.00x68.00x10.00mm, MVQ [X] NF843 [2] 50.00x68.00x10.00mm, FPM/ACM [X] NF844 [1] 90.00x110.00x11.00mm, FPM/ACM	NF849 [2][56]	 JJ559  JJ562	
HBS116 [22] M12x1.50x243.00mm (x10)	JD416 [E]	JN292 [4]		HR569 [E]	NA5016 35.00x47.00x7.00mm, FPM/ACM [X] NF843 [2] 50.00x68.00x10.00mm, FPM/ACM			
HBS116 [22] M12x1.50x243.00mm (x10)	JD416 [E]	JN292 [4]		HR569 [E]	NA5016 35.00x47.00x7.00mm, FPM/ACM [X] NF843 [2] 50.00x68.00x10.00mm, FPM/ACM			
HBS116 [22] M12x1.50x243.00mm (x10)	JD416 [E]	JN995 [4]		HR662 [E]	NB866 [2] 28.00x42.00x7.00mm, FPM [X] NF843 [2] 50.00x68.00x10.00mm, FPM/ACM			
HBS116 [22] M12x1.50x243.00mm (x10)	JD416 [E]	JN995 [4]		HR662 [E]	NB866 [2] 28.00x42.00x7.00mm, FPM [X] NF843 [2] 50.00x68.00x10.00mm, FPM/ACM			

RENAULT



cc



kW/PS



2.0		J7R 740				498		BX580 (Fibre)		DX580		EG176 [3][14]	
21 2.0	02/90→06/94	1995	4	88.00	SOHC/OHC	99-100/ 134-136		02/90→02/94		02/90→02/94		02/90→02/94	
21 2.0 4x4	12/89→02/94												
21 2.0 TXi	07/89→05/93												
2.0		J7R 746				499		BG170 (Fibre), 1.200mm		DG173 [3]		EG176 [3][14]	
21 2.0	03/86→12/93	1995	4	88.00	SOHC/OHC	88/120							
21 2.0 (B48C)	09/89→12/93												
21 2.0 4x4	03/89→12/93												
2.0		J7R 747				500		BG170 (Fibre), 1.200mm		DG173 [3]		EG176 [3][14]	
21 2.0	03/86→12/93	1995	4	88.00	SOHC/OHC	88/120							
21 2.0 (B48C)	09/89→12/93												
21 2.0 4x4	03/89→12/93												
2.0		J7R 750				501		BG170 (Fibre), 1.200mm		DG173 [3]		EG176 [3][14]	
21 2.0	03/86→06/92	1995	4	88.00	SOHC/OHC	85-86/ 116-117		→12/88		→12/88		→12/88	
21 2.0 (K483)	06/86→12/88												
2.0		J7R 751				502		BG170 (Fibre), 1.200mm		DG173 [3]		EG176 [3][14]	
21 2.0	03/86→06/92	1995	4	88.00	SOHC/OHC	85-86/ 116-117		→12/88		→12/88		→12/88	
21 2.0 (K483)	06/86→12/88												

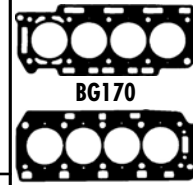
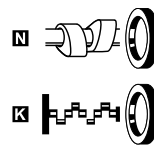
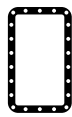
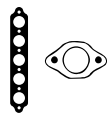

BG170



BX580



JB954



JC238



JD413



JD414

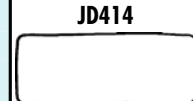

JN292



JN995

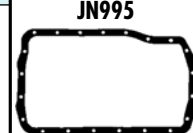

JJ558

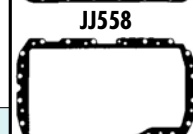

JJ559

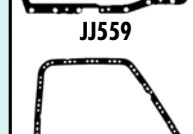

JJ562

HBS116 [22]
M12x1.50x243.00mm (x10)
02/90→02/94

JD414 [1]
02/90→02/94
JD413 [1]
02/90→02/94

JN995 [4]
02/90→02/94

≡PB852
16.00x24.00x1.500mm
≡PA349
22.00x16.00x2.000mm
JJ562
(Elastomer)
02/90→02/94

HR662 [1]
02/90→02/94

☒ NB866 [2]
28.00x42.00x7.00mm, FPM
02/90→02/94
☒ NF648 [2]
50.00x68.00x10.00mm, MVQ
02/90→02/94
☒ NF843 [2]
50.00x68.00x10.00mm, FPM/ACM
02/90→02/94
☒ NF844 [1]
90.00x110.00x11.00mm, FPM/ACM
02/90→02/94

NF849 [2][56]

HBS116 [22]
M12x1.50x243.00mm (x10)

JB954 [1]
JC238

JN292 [4]

JJ558
(Felt)
JJ559
(SE)
≡PB852
16.00x24.00x1.500mm
≡PA349
22.00x16.00x2.000mm

HR569 [1]

☒ NA5016
35.00x47.00x7.00mm, FPM/ACM
☒ NF648 [2]
50.00x68.00x10.00mm, MVQ
☒ NF843 [2]
50.00x68.00x10.00mm, FPM/ACM
☒ NF844 [1]
90.00x110.00x11.00mm, FPM/ACM

NF781 (x2)[1][52]
[2] [R]
NF849 [2][56]

HBS116 [22]
M12x1.50x243.00mm (x10)

JB954 [1]
JC238

JN292 [4]

JJ558
(Felt)
JJ559
(SE)
≡PB852
16.00x24.00x1.500mm
≡PA349
22.00x16.00x2.000mm

HR569 [1]

☒ NA5016
35.00x47.00x7.00mm, FPM/ACM
☒ NF648 [2]
50.00x68.00x10.00mm, MVQ
☒ NF843 [2]
50.00x68.00x10.00mm, FPM/ACM
☒ NF844 [1]
90.00x110.00x11.00mm, FPM/ACM

NF781 (x2)[1][52]
[2] [R]
NF849 [2][56]

HBS116 [22]
M12x1.50x243.00mm (x10)
→12/88

JB954 [1]
→12/88
JC238
→12/88

JN292 [4]
→12/88

JJ558
(Felt)
→12/88
JJ559
(SE)
→12/88
≡PB852
16.00x24.00x1.500mm
≡PA349
22.00x16.00x2.000mm

HR569 [1]
→12/88

☒ NA5016
35.00x47.00x7.00mm, FPM/ACM
→12/88
☒ NF648 [2]
50.00x68.00x10.00mm, MVQ
→12/88
☒ NF843 [2]
50.00x68.00x10.00mm, FPM/ACM
→12/88
☒ NF844 [1]
90.00x110.00x11.00mm, FPM/ACM
→12/88

NF781 (x2)[1][52]
[2] [R]
NF849 [2][56]

HBS116 [22]
M12x1.50x243.00mm (x10)
→12/88

JB954 [1]
→12/88
JC238
→12/88

JN292 [4]
→12/88

JJ558
(Felt)
→12/88
JJ559
(SE)
→12/88
≡PB852
16.00x24.00x1.500mm
≡PA349
22.00x16.00x2.000mm

HR569 [1]
→12/88

☒ NA5016
35.00x47.00x7.00mm, FPM/ACM
→12/88
☒ NF648 [2]
50.00x68.00x10.00mm, MVQ
→12/88
☒ NF843 [2]
50.00x68.00x10.00mm, FPM/ACM
→12/88
☒ NF844 [1]
90.00x110.00x11.00mm, FPM/ACM
→12/88

NF781 (x2)[1][52]
[2] [R]
NF849 [2][56]

RENAULT



cc



kW/PS



2.0		J7R 752				503	BX590 (Fibre)	DX590 [3]	EG176 [3][14]
21 2.0 T 4x4	08/89→10/93	1995	4	88.00	SOHC/OHC	129/175	→03/90	→03/90	→03/90
21 2.0 Turbo	04/87→03/90								
2.0		J7R 754				504	BX580 (Fibre)	DX580	EG176 [3][14]
21 2.0 TXi	07/89→05/93	1995	4	88.00	SOHC/OHC	98-100/ 133-136			
2.0		J7R 756				505	BX590 (Fibre)	DX590 [3]	EG176 [3][14]
21 2.0 T 4x4	02/90→10/92	1995	4	88.00	SOHC/OHC	119/162			
21 2.0 Turbo	02/90→10/92								
2.0		J7R 760				506	BG170 (Fibre), 1.200mm	DG173 [3]	EG176 [3][14]
Espace I 2.0 i	03/88→12/92	1995	4	88.00	SOHC/OHC	87-88/ 118-120	→12/90	→12/90	→12/90
2.0		J7R 768				507	BG170 (Fibre), 1.200mm	DG173 [3]	EG176 [3][14]
Espace II 2.0	01/91→10/96	1995	4	88.00	SOHC/OHC	76/103			
2.0		M4R 700				508	AH6330 (MLS)		
Clio 3 2.0 16V	09/06→	1997	4	84.00	DOHC	102/138			
2.0		M4R 701				509	AH6330 (MLS)		
Clio 3 2.0 16V	09/06→	1997	4	84.00	DOHC	102/138			
2.0		M4R 704				510	AH6330 (MLS)		
Laguna 3 2.0	10/07→	1997	4	84.00	DOHC	103/140			
2.0		M4R 711				511	AH6330 (MLS)		
Gr. Scenic 3	02/09→	1997	4	84.00	DOHC	103/140			
Megane 3 2.0CVT	02/09→								
Megane CC 2.0	06/10→								
Megane Scenic	05/09→								
Scenic 3 2.0	02/09→								

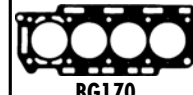

BG170

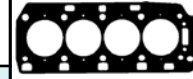

BX580



BX590



JB954



JC238



JD413



JD414

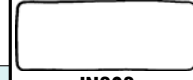

JN292



JN995



JJ558

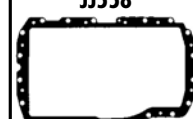

JJ559

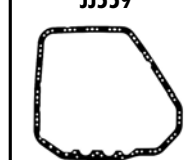

JJ562

RENAULT



cc



kW/PS



2.0	M4R 713					512	AH6330 (MLS)		
Megane 3 2.0CVT	02/09→	1997	4	84.00	DOHC	103/140			
Megane CC 2.0	06/10→								
2.0	M4R 726					513	AH6330 (MLS)		
Laguna 3 2.0	10/07→	1997	4	84.00	DOHC	103/140			
2.0	M9R 700 Diesel					514	AG9760 (MLS)	CG9760	EG9760
Gr. Scenic 2	09/05→	1995	4	84.00	DOHC	110/150			
Megane 2 2.0	09/05→								
Scenic 2 2.0dCi	09/05→								
2.0	M9R 721 Diesel					515	AG9760 (MLS)	CG9760	EG9760
Gr. Scenic 2	09/05→	1995	4	84.00	DOHC	110/150			
Scenic 2 2.0dCi	09/05→								
2.0	M9R 722 Diesel					516	AG9760 (MLS)	CG9760	EG9760
Gr. Scenic 2	09/05→	1995	4	84.00	DOHC	110/150			
Megane 2 2.0	09/05→								
Scenic 2 2.0dCi	09/05→								
2.0	M9R 740 Diesel					517	AG9760 (MLS)	CG9760	EG9760
Espace 4 2.0dCi	01/06→	1995	4	84.00	DOHC	110/150			
Laguna II 2.0	08/05→								
2.0	M9R 750 Diesel					518	AG9760 (MLS)	CG9760	EG9760
Espace 4 2.0dCi	01/06→	1995	4	84.00	DOHC	110/150			
2.0	M9R 780 Diesel					519	AG9760 (MLS)	CG9760	EG9760
Trafix 2	08/06→	1995	4	84.00	DOHC	66-84/ 90-114			
2.0	M9R 782 Diesel					520	AG9760 (MLS)	CG9760	EG9760
Trafix 2	08/06→	1995	4	84.00	DOHC	66-84/ 90-114			
2.0	M9R 815 Diesel					521	AG9760 (MLS)	CG9760	EG9760
Espace 4 2.0dCi	01/06→	1995	4	84.00	DOHC	110-127/ 150-173			
Laguna 2.0 dCi	09/08→								
Laguna 3 2.0dCi	01/08→								
2.1	852 720 Diesel					522	BH080 (Fibre), 1.600mm, 1 Hole →+0.960mm BG900 (Fibre), 1.700mm →0.960→1.040mm BH090 (Fibre), 1.800mm, 2 Holes →1.040mm→	DH080 ▲ [3]	EG176 [3] [14] GH080 ▲ [3] [14]
Traffic 2.1 D	03/80→06/94	2068	4	86.00	SOHC/OHC	43-44/ 58-60			
2.1	852 750 Diesel					523	BH080 (Fibre), 1.600mm, 1 Hole →+0.960mm BG900 (Fibre), 1.700mm →0.960→1.040mm BH090 (Fibre), 1.800mm, 2 Holes →1.040mm→	DH080 ▲ [3]	EG176 [3] [14] GH080 ▲ [3] [14]
Traffic 2.1 D	03/80→06/94	2068	4	86.00	SOHC/OHC	43-44/ 58-60			
Traffic 2.1D 4x4	05/85→04/89								

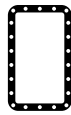
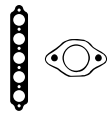

BG900



BH080, BH090



JD245



JN697

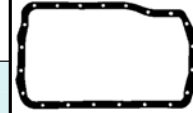

JJ558

HBS373 [22] M12x1.50x131.00mm (x10)	JD5895 [SE] JD5937 [MLS]	HM5291 [S]		HR814 [S]		
HBS373 [22] M12x1.50x131.00mm (x10)	JD5895 [SE] JD5937 [MLS]	HM5291 [S]		HR814 [S]		
HBS373 [22] M12x1.50x131.00mm (x10)	JD5895 [SE] JD5937 [MLS]	HM5291 [S]		HR814 [S]		
HBS373 [22] M12x1.50x131.00mm (x10)	JD5895 [SE] JD5937 [MLS]	HM5291 [S]		HR814 [S]		
HBS373 [22] M12x1.50x131.00mm (x10)	JD5895 [SE] JD5937 [MLS]	HM5291 [S]		HR814 [S]		
HBS373 [22] M12x1.50x131.00mm (x10)	JD5895 [SE] JD5937 [MLS]	HM5291 [S]		HR814 [S]		
HBS373 [22] M12x1.50x131.00mm (x10)	JD5895 [SE] JD5937 [MLS]	HM5291 [S]		HR814 [S]		
HBS373 [22] M12x1.50x131.00mm (x10)	JD5895 [SE] JD5937 [MLS]	HM5291 [S]		HR814 [S]		
HBS373 [22] M12x1.50x131.00mm (x10)	JD5895 [SE] JD5937 [MLS]	HM5291 [S]		HR814 [S]		
HBS010 [22] M12x1.50x134.00mm (x8)	JD245	JN697 [4]	JJ558 (Felt) =PB852 16.00x24.00x1.500mm =PA349 22.00x16.00x2.000mm	HR569 [S]	NA5016 35.00x47.00x7.00mm, FPM/ACM NF648 [2] 50.00x68.00x10.00mm, MVQ NF843 [2] 50.00x68.00x10.00mm, FPM/ACM NF844 [1] 90.00x110.00x11.00mm, FPM/ACM	HR351 [55] [S] NF849 [2] [56]
HBS010 [22] M12x1.50x134.00mm (x8)	JD245	JN697 [4]	JJ558 (Felt) =PB852 16.00x24.00x1.500mm =PA349 22.00x16.00x2.000mm	HR569 [S]	NA5016 35.00x47.00x7.00mm, FPM/ACM NF648 [2] 50.00x68.00x10.00mm, MVQ NF843 [2] 50.00x68.00x10.00mm, FPM/ACM NF844 [1] 90.00x110.00x11.00mm, FPM/ACM	HR351 [55] [S] NF849 [2] [56]

RENAULT



cc



kW/PS



2.1	J8S 240 Diesel	524					BH080 (Fibre), 1.600mm, 1 Hole →→0.960mm BG900 (Fibre), 1.700mm →0.960→1.040mm BH090 (Fibre), 1.800mm, 2 Holes →1.040mm→	DH080 ▲[3]	EG176 [3][14] GH080 ▲[3][14]
Espace I 2.1 TD	10/84→12/90	2068	4	86.00	SOHC/OHC	65/88			
2.1	J8S 330 Diesel	525					BH080 (Fibre), 1.600mm, 1 Hole →→0.960mm BG900 (Fibre), 1.700mm →0.960→1.040mm BH090 (Fibre), 1.800mm, 2 Holes →1.040mm→	DH080 ▲[3]	EG176 [3][14] GH080 ▲[3][14]
Master I	08/80→07/98	2068	4	86.00	SOHC/OHC	44-46/ 60-63			
Master I 2.1 D	11/89→04/95								
2.1	J8S 600 Diesel	526					BH080 (Fibre), 1.600mm, 1 Hole →→0.960mm BG900 (Fibre), 1.700mm →0.960→1.040mm BH090 (Fibre), 1.800mm, 2 Holes →1.040mm→	DH080 ▲[3]	GH080 ▲[3][14]
21 2.1 D	05/89→06/94	2068	4	86.00	SOHC/OHC	53/72			
2.1	J8S 610 Diesel	527					BH080 (Fibre), 1.600mm, 1 Hole →→0.960mm BG900 (Fibre), 1.700mm →0.960→1.040mm BH090 (Fibre), 1.800mm, 2 Holes →1.040mm→	DH080 ▲[3]	EG176 [3][14] GH080 ▲[3][14]
Espace II 2.1TD	01/91→10/96	2068	4	86.00	SOHC/OHC	65/88			
2.1	J8S 612 Diesel	528					BH080 (Fibre), 1.600mm, 1 Hole →→0.960mm BG900 (Fibre), 1.700mm →0.960→1.040mm BH090 (Fibre), 1.800mm, 2 Holes →1.040mm→	DH080 ▲[3]	EG176 [3][14] GH080 ▲[3][14]
Espace II 2.1	11/94→10/96	2068	4	86.00	SOHC/OHC	66/90			
2.1	J8S 620 Diesel	529					BH080 (Fibre), 1.600mm, 1 Hole →→0.960mm BG900 (Fibre), 1.700mm →0.960→1.040mm BH090 (Fibre), 1.800mm, 2 Holes →1.040mm→	DH080 ▲[3]	GH080 ▲[3][14]
Trafic 2.1 D	06/94→04/98	2068	4	86.00	SOHC/OHC	47/64			
2.1	J8S 704 Diesel	530					BH080 (Fibre), 1.600mm, 1 Hole →→0.960mm BG900 (Fibre), 1.700mm →0.960→1.040mm BH090 (Fibre), 1.800mm, 2 Holes →1.040mm→	DH080 ▲[3]	EG176 [3][14] GH080 ▲[3][14]
21 2.1 D	10/86→05/93	2068	4	86.00	SOHC/OHC	48-50/ 65-68			
21 2.1 D (L486)	03/86→12/89								
21 2.1 D 4x4	10/88→05/92								
21 2.1 TD	04/86→06/89								
21 Van 2.1 D	06/86→08/94								
2.1	J8S 706 Diesel	531					BH080 (Fibre), 1.600mm, 1 Hole →→0.960mm BG900 (Fibre), 1.700mm →0.960→1.040mm BH090 (Fibre), 1.800mm, 2 Holes →1.040mm→	DH080 ▲[3]	EG176 [3][14] GH080 ▲[3][14]
25 2.1 D	04/84→05/89	2068	4	86.00	SOHC/OHC	46/63			

HBS010 [22] M12x1.50x134.00mm (x8)	JD245	JN697 [4]	JJ558 (Felt) JJ559 (SE) = PB852 16.00x24.00x1.500mm = PA349 22.00x16.00x2.000mm	HR569	NA5016 35.00x47.00x7.00mm, FPM/ACM ☒ NF648 [2] 50.00x68.00x10.00mm, MVQ ☒ NF843 [2] 50.00x68.00x10.00mm, FPM/ACM ☒ NF844 [1] 90.00x110.00x11.00mm, FPM/ACM	HR351 [55] [S] NF781 [1] [2] [52] ☒ NF849 [2] [56]	BG900 BH080, BH090 NF781 JD245 JN697 JN937 JJ558 JJ559
HBS010 [22] M12x1.50x134.00mm (x8)	JD245	JN697 [4]	JJ558 (Felt) = PB852 16.00x24.00x1.500mm = PA349 22.00x16.00x2.000mm	HR569	NA5016 35.00x47.00x7.00mm, FPM/ACM ☒ NF648 [2] 50.00x68.00x10.00mm, MVQ ☒ NF843 [2] 50.00x68.00x10.00mm, FPM/ACM ☒ NF844 [1] 90.00x110.00x11.00mm, FPM/ACM	HR351 [55] [S] NF849 [2] [56]	JJ558
HBS010 [22] M12x1.50x134.00mm (x8)	JD245	JN697 [4]		HR569	NA5016 35.00x47.00x7.00mm, FPM/ACM ☒ NF648 [2] 50.00x68.00x10.00mm, MVQ ☒ NF843 [2] 50.00x68.00x10.00mm, FPM/ACM		
HBS010 [22] M12x1.50x134.00mm (x8)	JD245		= PB852 16.00x24.00x1.500mm = PA349 22.00x16.00x2.000mm	HR569	NA5016 35.00x47.00x7.00mm, FPM/ACM ☒ NF648 [2] 50.00x68.00x10.00mm, MVQ ☒ NF843 [2] 50.00x68.00x10.00mm, FPM/ACM	HR351 [55] [S] NF781 [1] [2] [52] ☒ NF849 [2] [56]	
HBS010 [22] M12x1.50x134.00mm (x8)	JD245	JN937 [4]	JJ558 (Felt) JJ559 (SE) = PB852 16.00x24.00x1.500mm = PA349 22.00x16.00x2.000mm	HR569	NA5016 35.00x47.00x7.00mm, FPM/ACM ☒ NF648 [2] 50.00x68.00x10.00mm, MVQ ☒ NF843 [2] 50.00x68.00x10.00mm, FPM/ACM ☒ NF844 [1] 90.00x110.00x11.00mm, FPM/ACM	HR351 [55] [S] NF849 [2] [56]	
HBS010 [22] M12x1.50x134.00mm (x8)	JD245	JN937 [4]		HR569	NA5016 35.00x47.00x7.00mm, FPM/ACM ☒ NF648 [2] 50.00x68.00x10.00mm, MVQ ☒ NF843 [2] 50.00x68.00x10.00mm, FPM/ACM		
HBS010 [22] M12x1.50x134.00mm (x8)	JD245	JN697 [4] JN937 [4]	JJ559 (SE) = PB852 16.00x24.00x1.500mm = PA349 22.00x16.00x2.000mm	HR569	NA5016 35.00x47.00x7.00mm, FPM/ACM ☒ NF648 [2] 50.00x68.00x10.00mm, MVQ ☒ NF843 [2] 50.00x68.00x10.00mm, FPM/ACM ☒ NF844 [1] 90.00x110.00x11.00mm, FPM/ACM	HR351 [55] [S] NF849 [2] [56]	
HBS010 [22] M12x1.50x134.00mm (x8)	JD245	JN697 [4]	JJ558 (Felt) JJ559 (SE) = PB852 16.00x24.00x1.500mm = PA349 22.00x16.00x2.000mm	HR569	NA5016 35.00x47.00x7.00mm, FPM/ACM ☒ NF648 [2] 50.00x68.00x10.00mm, MVQ ☒ NF843 [2] 50.00x68.00x10.00mm, FPM/ACM ☒ NF844 [1] 90.00x110.00x11.00mm, FPM/ACM	HR351 [55] [S] NF849 [2] [56]	



cc



kW/PS

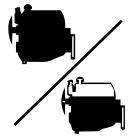

2.1	J8S 708 Diesel	532						BH080 (Fibre), 1.600mm, 1 Hole	DH080 ▲[3]	GH080 ▲[3][14]
25 2.1 Turbo-D	04/84→12/92	2068	4	86.00	SOHC/OHC	63/86	→0.960mm BG900 (Fibre), 1.700mm →0.960→1.040mm BH090 (Fibre), 1.800mm, 2 Holes →1.040mm→			
2.1	J8S 714 Diesel	533						BH080 (Fibre), 1.600mm, 1 Hole	DH080 ▲[3]	
21 2.1 Turbo-D	03/86→06/94	2068	4	86.00	SOHC/OHC	65/88	→12/93 →0.960mm BG900 (Fibre), 1.700mm →12/93 →0.960→1.040mm BH090 (Fibre), 1.800mm, 2 Holes →12/93 →1.040mm→	→12/93		
2.1	J8S 736 Diesel	534						BH080 (Fibre), 1.600mm, 1 Hole	DH080 ▲[3]	EG176 [3][14] GH080 ▲[3][14]
25 2.1 D	06/89→12/92	2068	4	86.00	SOHC/OHC	51/69	→0.960mm BG900 (Fibre), 1.700mm →0.960→1.040mm BH090 (Fibre), 1.800mm, 2 Holes →1.040mm→			
2.1	J8S 738 Diesel	535						BH080 (Fibre), 1.600mm, 1 Hole	DH080 ▲[3]	GH080 ▲[3][14]
25 2.1 Turbo-D	04/84→12/92	2068	4	86.00	SOHC/OHC	63/86	02/90→07/91 →0.960mm BG900 (Fibre), 1.700mm 02/90→07/91 →0.960→1.040mm BH090 (Fibre), 1.800mm, 2 Holes 02/90→07/91 →1.040mm→	02/90→07/91	02/90→07/91	
2.1	J8S 740 Diesel	536						BH080 (Fibre), 1.600mm, 1 Hole	DH080 ▲[3]	GH080 ▲[3][14]
21 2.1 D	05/89→06/94	2068	4	86.00	SOHC/OHC	53/72	08/89→12/92 →0.960mm BG900 (Fibre), 1.700mm 08/89→12/92 →0.960→1.040mm BH090 (Fibre), 1.800mm, 2 Holes 08/89→12/92 →1.040mm→	08/89→12/92	08/89→12/92	
2.1	J8S 750 Diesel	537								
Trafic 2.1 D	05/85→02/89	2068	4	86.00	SOHC/OHC	44/60				
2.1	J8S 758 Diesel	538						BH080 (Fibre), 1.600mm, 1 Hole	DH080 ▲[3]	
Trafic 2.1 D	06/94→10/97	2068	4	86.00	SOHC/OHC	47/64	→0.960mm BG900 (Fibre), 1.700mm →0.960→1.040mm BH090 (Fibre), 1.800mm, 2 Holes →1.040mm→			
2.1	J8S 760 Diesel	539						BH080 (Fibre), 1.600mm, 1 Hole	DH080 ▲[3]	EG176 [3][14]
Safrane I 2.1dT	11/93→07/96	2068	4	86.00	SOHC/OHC	65-66/ 88-90	→0.960mm BG900 (Fibre), 1.700mm →0.960→1.040mm BH090 (Fibre), 1.800mm, 2 Holes →1.040mm→			



BG900



BH080, BH090



JD245



JN697



JN937



JJ558



JJ559



cc



kW/PS



2.1	J8S 772 Diesel	540					BH080 (Fibre), 1.600mm, 1 Hole →0.960mm BG900 (Fibre), 1.700mm →0.960→1.040mm BH090 (Fibre), 1.800mm, 2 Holes →1.040mm→	DH080 ▲[3]	EG176 [3][14] GH080 ▲[3][14]
Espace II 2.1 Espace II 2.1TD	01/91→05/92 01/91→10/96	2068	4	86.00	SOHC/OHC	65/88			
2.1	J8S 774 Diesel	541					BH080 (Fibre), 1.600mm, 1 Hole 01/89→ →0.960mm BG900 (Fibre), 1.700mm 01/89→ →0.960→1.040mm BH090 (Fibre), 1.800mm, 2 Holes 01/89→ →1.040mm→	DH080 ▲[3] 01/89→	EG176 [3][14] 01/89→ GH080 ▲[3][14] 01/89→
Espace I 2.1 TD	10/84→12/90	2068	4	86.00	SOHC/OHC	65/88			
2.1	J8S 776 Diesel	542					BH080 (Fibre), 1.600mm, 1 Hole →0.960mm BG900 (Fibre), 1.700mm →0.960→1.040mm BH090 (Fibre), 1.800mm, 2 Holes →1.040mm→	DH080 ▲[3]	EG176 [3][14] GH080 ▲[3][14]
Espace II 2.1TD	01/91→10/96	2068	4	86.00	SOHC/OHC	65/88			
2.1	J8S 778 Diesel	543					BH080 (Fibre), 1.600mm, 1 Hole →0.960mm BG900 (Fibre), 1.700mm →0.960→1.040mm BH090 (Fibre), 1.800mm, 2 Holes →1.040mm→	DH080 ▲[3]	EG176 [3][14] GH080 ▲[3][14]
Espace II 2.1TD	01/91→10/96	2068	4	86.00	SOHC/OHC	65/88			
2.1	J8S 784 Diesel	544					BH080 (Fibre), 1.600mm, 1 Hole →0.960mm BG900 (Fibre), 1.700mm →0.960→1.040mm BH090 (Fibre), 1.800mm, 2 Holes →1.040mm→	DH080 ▲[3]	EG176 [3][14] GH080 ▲[3][14]
21 2.1 D	07/89→09/95	2068	4	86.00	SOHC/OHC	51/69			
2.1	J8S 786 Diesel	545					BH080 (Fibre), 1.600mm, 1 Hole 08/91→ →0.960mm BG900 (Fibre), 1.700mm 08/91→ →0.960→1.040mm BH090 (Fibre), 1.800mm, 2 Holes 08/91→ →1.040mm→	DH080 ▲[3] 08/91→	
21 2.1 Turbo-D	03/86→06/94	2068	4	86.00	SOHC/OHC	65/88			
2.1	J8S 788 Diesel	546					BH080 (Fibre), 1.600mm, 1 Hole →12/93 →0.960mm BG900 (Fibre), 1.700mm →12/93 →0.960→1.040mm BH090 (Fibre), 1.800mm, 2 Holes →12/93 →1.040mm→	DH080 ▲[3] →12/93	
21 2.1 Turbo-D	03/86→06/94	2068	4	86.00	SOHC/OHC	65/88			

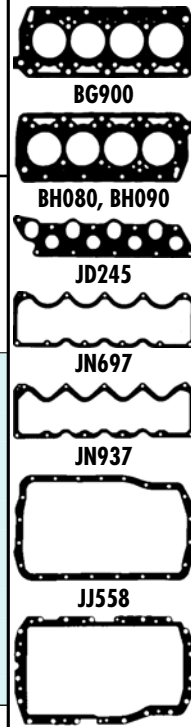
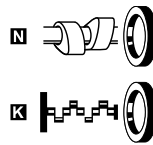
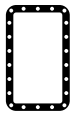
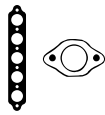

HBS010 [22]
M12x1.50x134.00mm (x8)

JD245

JN937 [4]

⇒**PB852**
16.00x24.00x1.500mm
⇒**PA349**
22.00x16.00x2.000mm

HR569 [5]

NA5016
35.00x47.00x7.00mm, FPM/ACM
☒ **NF648** [2]
50.00x68.00x10.00mm, MVQ
☒ **NF843** [2]
50.00x68.00x10.00mm, FPM/ACM

HR351 [55] [5]
NF781 [1] [2] [52]
☒ **NF849** [2] [56]

HBS010 [22]
M12x1.50x134.00mm (x8)
01/89→

JD245
01/89→

JN697 [4]
01/89→

⇒**PB852**
16.00x24.00x1.500mm
⇒**PA349**
22.00x16.00x2.000mm
JJ558
(Felt)
01/89→
JJ559
(SE)
01/89→

HR569 [5]
01/89→

NA5016
35.00x47.00x7.00mm, FPM/ACM
01/89→
☒ **NF648** [2]
50.00x68.00x10.00mm, MVQ
01/89→
☒ **NF843** [2]
50.00x68.00x10.00mm, FPM/ACM
01/89→
☒ **NF844** [1]
90.00x110.00x11.00mm, FPM/ACM
01/89→

HR351 [55] [5]
NF781 [1] [2] [52]
☒ **NF849** [2] [56]

HBS010 [22]
M12x1.50x134.00mm (x8)

JD245

JN937 [4]

⇒**PB852**
16.00x24.00x1.500mm
⇒**PA349**
22.00x16.00x2.000mm

HR569 [5]

NA5016
35.00x47.00x7.00mm, FPM/ACM
☒ **NF648** [2]
50.00x68.00x10.00mm, MVQ
☒ **NF843** [2]
50.00x68.00x10.00mm, FPM/ACM

HR351 [55] [5]
NF781 [1] [2] [52]
☒ **NF849** [2] [56]

HBS010 [22]
M12x1.50x134.00mm (x8)

JD245

JN937 [4]

⇒**PB852**
16.00x24.00x1.500mm
⇒**PA349**
22.00x16.00x2.000mm

HR569 [5]

NA5016
35.00x47.00x7.00mm, FPM/ACM
☒ **NF648** [2]
50.00x68.00x10.00mm, MVQ
☒ **NF843** [2]
50.00x68.00x10.00mm, FPM/ACM

HR351 [55] [5]
NF781 [1] [2] [52]
☒ **NF849** [2] [56]

HBS010 [22]
M12x1.50x134.00mm (x8)

JD245

JN697 [4]

JJ559
(SE)
⇒**PB852**
16.00x24.00x1.500mm
⇒**PA349**
22.00x16.00x2.000mm

HR569 [5]

NA5016
35.00x47.00x7.00mm, FPM/ACM
☒ **NF648** [2]
50.00x68.00x10.00mm, MVQ
☒ **NF843** [2]
50.00x68.00x10.00mm, FPM/ACM
☒ **NF844** [1]
90.00x110.00x11.00mm, FPM/ACM

HR351 [55] [5]
NF849 [2] [56]

HBS010 [22]
M12x1.50x134.00mm (x8)
08/91→

JD245
08/91→

JN937 [4]
08/91→

HR569 [5]
08/91→

NA5016
35.00x47.00x7.00mm, FPM/ACM
08/91→
☒ **NF648** [2]
50.00x68.00x10.00mm, MVQ
08/91→
☒ **NF843** [2]
50.00x68.00x10.00mm, FPM/ACM
08/91→

HBS010 [22]
M12x1.50x134.00mm (x8)
→12/93

JD245
→12/93

JN937 [4]
→12/93

HR569 [5]
→12/93

NA5016
35.00x47.00x7.00mm, FPM/ACM
→12/93
☒ **NF648** [2]
50.00x68.00x10.00mm, MVQ
→12/93
☒ **NF843** [2]
50.00x68.00x10.00mm, FPM/ACM
→12/93

RENAULT



cc



kW/PS



2.2	G8T 706 Diesel	547							
Laguna 2.2D 12V Laguna I 2.2D	09/95→03/01 11/93→03/01	2188	4	87.00	SOHC/OHC	61/83	BY070 (Fibre) →11/95 BY080 (Fibre) →11/95	DY070 ▲ [3] →11/95	EY070 [3] →11/95
2.2	G8T 714 Diesel	548							
Espace 3 2.2TD	11/96→10/00	2188	4	87.00	SOHC/OHC	83/113	AD5190 (Fibre)	CD5190 [3]	EY070 [3]
2.2	G8T 716 Diesel	549							
Espace 3 2.2 D Espace 3 2.2TD	11/97→01/00 11/96→10/00	2188	4	87.00	SOHC/OHC	83/113	AD5190 (Fibre)	CD5190 [3]	EY070 [3]
2.2	G8T 740 Diesel	550							
Safrane II 2.2	07/96→12/00	2188	4	87.00	SOHC/OHC	83/113	AD5190 (Fibre)	CD5190 [3]	EY070 [3]
2.2	G8T 752 Diesel	551							
Laguna 2.2D 12V Laguna I 2.2D	09/95→03/01 11/93→03/01	2188	4	87.00	SOHC/OHC	61/83	BY070 (Fibre) 11/95→ BY080 (Fibre) 11/95→	DY070 ▲ [3] 11/95→	EY070 [3] 11/95→
2.2	G8T 760 Diesel	552							
Espace 3 2.2TD Laguna 2.2 dT Laguna I 2.2 dT	11/96→10/00 03/96→03/01 03/96→03/01	2188	4	87.00	SOHC/OHC	83/113	AD5190 (Fibre)	CD5190 [3]	EY070 [3]
2.2	G8T 790 Diesel	553							
Laguna 2.2D 12V Laguna I 2.2D	09/95→03/01 11/93→03/01	2188	4	87.00	SOHC/OHC	61/83	BY070 (Fibre) →11/95 BY080 (Fibre) 11/95→	DY070 ▲ [3]	EY070 [3]
2.2	G8T 794 Diesel	554							
Laguna 2.2D 12V Laguna I 2.2D	09/95→03/01 11/93→03/01	2188	4	87.00	SOHC/OHC	61/83	BY070 (Fibre) →11/95 BY080 (Fibre) 11/95→	DY070 ▲ [3]	EY070 [3]
2.2	G9T 600 Diesel	555							
Laguna II 2.2 Vel Satis	04/04→10/05 04/04→	2188	4	87.00	DOHC	85-102/ 116-139	AE5210 (MLS), 1.240mm	CE5210	EE5220 [3]

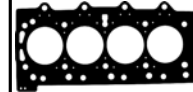
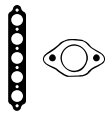

AD5190



AE5210



BY070



BY080

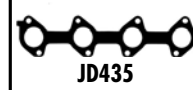

JD435



JD436



JJ568

HBS119 [22] M11x1.50x207.50mm (x4) →11/95	JD436 [1] →11/95 JD5782 [1] →11/95 JD435 [2] →11/95	JP006 [4] →11/95	JJ568 →11/95 PA349 22.00x16.00x2.000mm	HR599 [2] →11/95	NF858 [2] 33.00x43.00x6.00mm, FPM →11/95 NF860 [1] 93.00x108.00x7.00mm, FPM/ACM →11/95 NF861 [2] 46.00x59.00x7.00mm, FPM →11/95	
HBS119 [22] M11x1.50x207.50mm (x4)	JD436 [1] JD435 [2]	JP006 [4]	JJ568 PA349 22.00x16.00x2.000mm	HR788 [2]	NF858 [2] 33.00x43.00x6.00mm, FPM NF860 [1] 93.00x108.00x7.00mm, FPM/ACM NF861 [2] 46.00x59.00x7.00mm, FPM	
HBS119 [22] M11x1.50x207.50mm (x4)	JD436 [1] JD435 [2]	JP006 [4]	JJ568 PA349 22.00x16.00x2.000mm	HR788 [2]	NF858 [2] 33.00x43.00x6.00mm, FPM NF860 [1] 93.00x108.00x7.00mm, FPM/ACM NF861 [2] 46.00x59.00x7.00mm, FPM	
HBS119 [22] M11x1.50x207.50mm (x4)	JD436 [1] JD435 [2]	JP006 [4]	JJ568 PA349 22.00x16.00x2.000mm	HR788 [2]	NF858 [2] 33.00x43.00x6.00mm, FPM NF860 [1] 93.00x108.00x7.00mm, FPM/ACM NF861 [2] 46.00x59.00x7.00mm, FPM	
HBS119 [22] M11x1.50x207.50mm (x4) 11/95→	JD436 [1] 11/95→ JD5782 [1] 11/95→ JD435 [2] 11/95→	JP006 [4] 11/95→	PA349 22.00x16.00x2.000mm JJ568 11/95→	HR599 [2] 11/95→	NF858 [2] 33.00x43.00x6.00mm, FPM 11/95→ NF860 [1] 93.00x108.00x7.00mm, FPM/ACM 11/95→ NF861 [2] 46.00x59.00x7.00mm, FPM 11/95→	
HBS119 [22] M11x1.50x207.50mm (x4)	JD436 [1] JD435 [2]	JP006 [4]	JJ568 PA349 22.00x16.00x2.000mm	HR788 [2]	NF858 [2] 33.00x43.00x6.00mm, FPM NF860 [1] 93.00x108.00x7.00mm, FPM/ACM NF861 [2] 46.00x59.00x7.00mm, FPM	
HBS119 [22] M11x1.50x207.50mm (x4)	JD5782 [1] →11/95 JD436 [1] 01/96→ JD435 [2]	JP006 [4]	JJ568 PA349 22.00x16.00x2.000mm	HR599 [2]	NF858 [2] 33.00x43.00x6.00mm, FPM NF860 [1] 93.00x108.00x7.00mm, FPM/ACM NF861 [2] 46.00x59.00x7.00mm, FPM	
HBS119 [22] M11x1.50x207.50mm (x4)	JD5782 [1] →11/95 JD436 [1] 01/96→ JD435 [2]	JP006 [4]	JJ568 PA349 22.00x16.00x2.000mm	HR599 [2]	NF858 [2] 33.00x43.00x6.00mm, FPM NF860 [1] 93.00x108.00x7.00mm, FPM/ACM NF861 [2] 46.00x59.00x7.00mm, FPM	
HBS373 [22] M12x1.50x131.00mm (x10)	JD5891 [1] JD5892 JD5912 [2] (MLS)	HM5290 [2]	JJ568	HR791 [2]	NA5053 [2] 30.00x42.00x7.00mm, FPM NF860 [1] 93.00x108.00x7.00mm, FPM/ACM	

RENAULT



cc



kW/PS



2.2	G9T 605 Diesel	556	AE5210 (MLS), 1.240mm	CE5210	EE5220 [3]
Laguna II 2.2	05/05→	2188 4 87.00 DOHC	102/139		
2.2	G9T 606 Diesel	557	AE5210 (MLS), 1.240mm	CE5210	EE5220 [3]
Vel Satis	09/04→	2188 4 87.00 DOHC	102/139		
2.2	G9T 642 Diesel	558	AE5210 (MLS), 1.240mm	CE5210	EE5220 [3]
Espace 3 2.2dCi	10/00→10/02	2188 4 87.00 DOHC	95-110/ 129-150		
2.2	G9T 645 Diesel	559	AE5210 (MLS), 1.240mm	CE5210	EE5220 [3]
Espace 4 2.2dCi	02/06→	2188 4 87.00 DOHC	102/139		
2.2	G9T 700 Diesel	560	AE5210 (MLS), 1.240mm	CE5210	EE5220 [3]
Laguna II 2.2	10/01→	2188 4 87.00 DOHC	102-110/ 139-150		
Vel Satis	09/04→				
2.2	G9T 702 Diesel	561	AE5210 (MLS), 1.240mm	CE5210	EE5220 [3]
Laguna II 2.2	10/01→	2188 4 87.00 DOHC	102-110/ 140-150		
Vel Satis	06/02→				
2.2	G9T 703 Diesel	562	AE5210 (MLS), 1.240mm	CE5210	EE5220 [3]
Vel Satis	06/02→	2188 4 87.00 DOHC	110/150		
2.2	G9T 706 Diesel	563	AE5210 (MLS), 1.240mm	CE5210	EE5220 [3]
Laguna II 2.2	05/05→	2188 4 87.00 DOHC	102-110/ 139-150		
2.2	G9T 707 Diesel	564	AE5210 (MLS), 1.240mm	CE5210	EE5220 [3]
Laguna II 2.2	05/05→	2188 4 87.00 DOHC	102-110/ 139-150		
2.2	G9T 710 Diesel	565	AE5210 (MLS), 1.240mm	CE5210	EE5220 [3]
Espace 3 2.2dCi	07/00→10/02	2188 4 87.00 DOHC	85-95/ 115-130		
2.2	G9T 712 Diesel	566	AE5210 (MLS), 1.240mm	CE5210	EE5220 [3]
Avantime 2.2dCi	05/02→05/03	2188 4 87.00 DOHC	110/150		
2.2	G9T 720 Diesel	567	AE5210 (MLS), 1.240mm	CE5210	EE5220 [3]
Master II	09/00→	2188 4 87.00 DOHC	66/90		
2.2	G9T 722 Diesel	568	AE5210 (MLS), 1.240mm	CE5210	EE5220 [3]
Master II	09/00→	2188 4 87.00 DOHC	66/90		
2.2	G9T 742 Diesel	569	AE5210 (MLS), 1.240mm	CE5210	EE5220 [3]
Espace 4 2.2dCi	11/02→	2188 4 87.00 DOHC	110/150		
2.2	G9T 743 Diesel	570	AE5210 (MLS), 1.240mm	CE5210	EE5220 [3]
Espace 4 2.2dCi	11/02→	2188 4 87.00 DOHC	110/150		



cc



kW/PS



2.2	G9T 750 Diesel					571	AE5210 (MLS), 1.240mm	CE5210	EE5220 [3]
Master II	09/00→	2188	4	87.00	DOHC	66/90			
2.2	J7T 600					572	BG170 (Fibre), 1.200mm	DG173 [3]	EG176 [3][14]
Trafic 2.2	06/94→04/98	2165	4	88.00	SOHC/OHC	74/101			
Trafic 2.2 4x4	09/94→04/98								
Trafic 2.2 4x4	06/94→10/97								
2.2	J7T 706					573	BG170 (Fibre), 1.200mm	DG170 [3] DG173 [3]	EG176 [3][14]
25 2.2	04/84→12/89	2165	4	88.00	SOHC/OHC	89/121			
2.2	J7T 707					574	BG170 (Fibre), 1.200mm	DG170 [3] DG173 [3]	EG176 [3][14]
25 2.2	04/84→12/89	2165	4	88.00	SOHC/OHC	89/121			
2.2	J7T 708					575	BG170 (Fibre), 1.200mm	DG170 [3] DG173 [3]	EG176 [3][14]
25 2.2	09/86→12/92	2165	4	88.00	SOHC/OHC	79/107			
2.2	J7T 714					576	BG170 (Fibre), 1.200mm	DG170 [3] DG173 [3]	EG176 [3][14]
25 2.2	04/84→12/89	2165	4	88.00	SOHC/OHC	89-91/ 121-124			
2.2	J7T 715					577	BG170 (Fibre), 1.200mm	DG170 [3] DG173 [3]	EG176 [3][14]
25 2.2	04/84→12/89	2165	4	88.00	SOHC/OHC	89-91/ 121-124			
2.2	J7T 730					578	BG170 (Fibre), 1.200mm	DG170 [3] DG173 [3]	EG176 [3][14]
25 2.2	04/84→12/89	2165	4	88.00	SOHC/OHC	91/124			
2.2	J7T 731					579	BG170 (Fibre), 1.200mm	DG170 [3] DG173 [3]	EG176 [3][14]
25 2.2	04/84→12/89	2165	4	88.00	SOHC/OHC	91/124			
2.2	J7T 732					580	BG170 (Fibre), 1.200mm	DG170 [3] DG173 [3]	EG176 [3][14]
25 2.2	09/86→12/92	2165	4	88.00	SOHC/OHC	79/107			

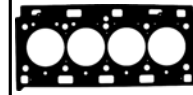
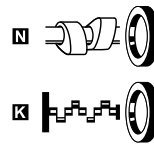
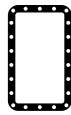
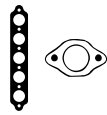

AE5210



BG170



JB954



JC238



JN292



JJ558

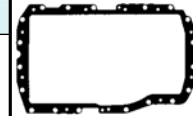

JJ559



JJ568

HBS373 [22] M12x1.50x131.00mm (x10)	JD5891 JD5892 JD5912 (MLS)	HM5290	JJ568	HR791	NA5053 [2] 30.00x42.00x7.00mm, FPM NF860 [1] 93.00x108.00x7.00mm, FPM/ACM	
HBS116 [22] M12x1.50x243.00mm (x10)	JB954 JC238	JN292 [4]	JJ558 (Felt) JJ559 (SE) PB852 16.00x24.00x1.500mm PA349 22.00x16.00x2.000mm	HR569	NA5016 35.00x47.00x7.00mm, FPM/ACM NF648 [2] 50.00x68.00x10.00mm, MVQ NF843 [2] 50.00x68.00x10.00mm, FPM/ACM NF844 [1] 90.00x110.00x11.00mm, FPM/ACM	NF849 [2][56]
	JB954 JC238	JN292 [4]		HR569	NA5016 35.00x47.00x7.00mm, FPM/ACM NF648 [2] 50.00x68.00x10.00mm, MVQ NF843 [2] 50.00x68.00x10.00mm, FPM/ACM	
	JB954 JC238	JN292 [4]		HR569	NA5016 35.00x47.00x7.00mm, FPM/ACM NF648 [2] 50.00x68.00x10.00mm, MVQ NF843 [2] 50.00x68.00x10.00mm, FPM/ACM	
	JB954 JC238	JN292 [4]		HR569	NA5016 35.00x47.00x7.00mm, FPM/ACM NF648 [2] 50.00x68.00x10.00mm, MVQ NF843 [2] 50.00x68.00x10.00mm, FPM/ACM	
	JB954 JC238	JN292 [4]		HR569	NA5016 35.00x47.00x7.00mm, FPM/ACM NF648 [2] 50.00x68.00x10.00mm, MVQ NF843 [2] 50.00x68.00x10.00mm, FPM/ACM	
	JB954 JC238	JN292 [4]		HR569	NA5016 35.00x47.00x7.00mm, FPM/ACM NF648 [2] 50.00x68.00x10.00mm, MVQ NF843 [2] 50.00x68.00x10.00mm, FPM/ACM	
	JB954 JC238	JN292 [4]		HR569	NA5016 35.00x47.00x7.00mm, FPM/ACM NF648 [2] 50.00x68.00x10.00mm, MVQ NF843 [2] 50.00x68.00x10.00mm, FPM/ACM	
	JB954 JC238	JN292 [4]		HR569	NA5016 35.00x47.00x7.00mm, FPM/ACM NF648 [2] 50.00x68.00x10.00mm, MVQ NF843 [2] 50.00x68.00x10.00mm, FPM/ACM	
	JB954 JC238	JN292 [4]		HR569	NA5016 35.00x47.00x7.00mm, FPM/ACM NF648 [2] 50.00x68.00x10.00mm, MVQ NF843 [2] 50.00x68.00x10.00mm, FPM/ACM	
	JB954 JC238	JN292 [4]		HR569	NA5016 35.00x47.00x7.00mm, FPM/ACM NF648 [2] 50.00x68.00x10.00mm, MVQ NF843 [2] 50.00x68.00x10.00mm, FPM/ACM	

RENAULT



cc



kW/PS



2.2	J7T 733	581	BG170 (Fibre), 1.200mm	DG170 [3] DG173 [3]	EG176 [3][14]				
25 2.2	09/86→12/92	2165	4	88.00	SOHC/OHC	79/107			
2.2	J7T 754	582	BG170 (Fibre), 1.200mm	DG170 [3] DG173 [3]	EG176 [3][14]				
21 2.2	06/86→06/94	2165	4	88.00	SOHC/OHC	79/107	08/86→12/93	08/86→12/93	08/86→12/93
21 2.2 4x4	06/86→06/94								
2.2	J7T 755	583	BG170 (Fibre), 1.200mm	DG170 [3] DG173 [3]	EG176 [3][14]				
21 2.2	04/86→06/94	2165	4	88.00	SOHC/OHC	79-81/ 107-110	08/86→12/93	08/86→12/93	08/86→12/93
21 2.2 4x4	06/86→06/94								
2.2	J7T 760	584	BX570 (Fibre)	DX570 [3]	EG176 [3][14]				
Safrane I 2.2	04/92→07/96	2165	4	88.00	SOHC/OHC	101/137	02/94→	02/94→	02/94→
2.2	J7T 761	585	BX570 (Fibre)	DX570 [3]	EG176 [3][14]				
Safrane I 2.2	04/92→07/96	2165	4	88.00	SOHC/OHC	101/137			
2.2	J7T 762	586		DX560 [3]	EG176 [3][14]				
Safrane I 2.2	04/92→07/96	2165	4	88.00	SOHC/OHC	79-81/ 107-110			
2.2	J7T 770	587	BG170 (Fibre), 1.200mm	DG173 [3]	EG176 [3][14]				
Espace I 2.2	07/86→12/90	2165	4	88.00	SOHC/OHC	79-81/ 107-110			

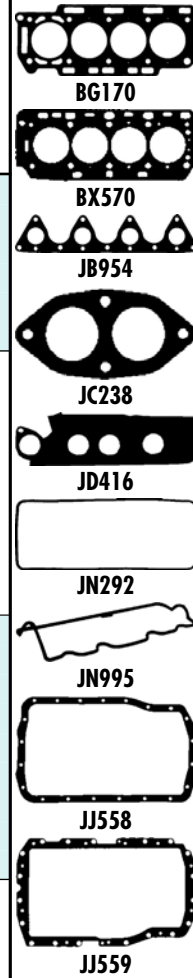
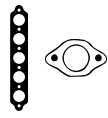

	JB954 JC238	JN292 [4]		HR569	NA5016 35.00x47.00x7.00mm, FPM/ACM NF648 [2] 50.00x68.00x10.00mm, MVQ NF843 [2] 50.00x68.00x10.00mm, FPM/ACM		
	JB954 JC238 08/86→12/93	JN292 [4] 08/86→12/93		HR569 JC238 08/86→12/93	NA5016 35.00x47.00x7.00mm, FPM/ACM 08/86→12/93 NF648 [2] 50.00x68.00x10.00mm, MVQ 08/86→12/93 NF843 [2] 50.00x68.00x10.00mm, FPM/ACM 08/86→12/93		
	JB954 JC238 08/86→12/93	JN292 [4] 08/86→12/93		HR569 JC238 08/86→12/93	NA5016 35.00x47.00x7.00mm, FPM/ACM 08/86→12/93 NF648 [2] 50.00x68.00x10.00mm, MVQ 08/86→12/93 NF843 [2] 50.00x68.00x10.00mm, FPM/ACM 08/86→12/93		
	JD416 JC238 02/94→	JN995 [4] 02/94→		HR662 JC238 02/94→	NB866 [2] 28.00x42.00x7.00mm, FPM 02/94→ NF648 [2] 50.00x68.00x10.00mm, MVQ 02/94→ NF843 [2] 50.00x68.00x10.00mm, FPM/ACM 02/94→		
	JD416 JC238	JN995 [4]		HR662 JC238	NB866 [2] 28.00x42.00x7.00mm, FPM NF648 [2] 50.00x68.00x10.00mm, MVQ NF843 [2] 50.00x68.00x10.00mm, FPM/ACM		
		JN292 [4]	JJ558 (Felt) JJ559 (SE) =PB852 16.00x24.00x1.500mm =PA349 22.00x16.00x2.000mm	HR569	NA5016 35.00x47.00x7.00mm, FPM/ACM NF843 [2] 50.00x68.00x10.00mm, FPM/ACM NF844 [1] 90.00x110.00x11.00mm, FPM/ACM	NF849 [2] [56]	
HBS116 [22] M12x1.50x243.00mm (x10)	JB954 JC238	JN292 [4]	JJ558 (Felt) JJ559 (SE) =PB852 16.00x24.00x1.500mm =PA349 22.00x16.00x2.000mm	HR569	NA5016 35.00x47.00x7.00mm, FPM/ACM NF648 [2] 50.00x68.00x10.00mm, MVQ NF843 [2] 50.00x68.00x10.00mm, FPM/ACM NF844 [1] 90.00x110.00x11.00mm, FPM/ACM	NF849 [2] [56]	

RENAULT



cc



kW/PS



2.2	J7T 772	588	BG170 (Fibre), 1.200mm		DG173 [3]	EG176 [3][14]
Espace II 2.2	01/91→12/96	2165	4	88.00	SOHC/OHC	79-81/ 107-110
2.2	J7T 773	589	BG170 (Fibre), 1.200mm		DG173 [3]	EG176 [3][14]
Espace II 2.2	01/91→12/96	2165	4	88.00	SOHC/OHC	79-81/ 108-110
2.2	J7T 776	590	BG170 (Fibre), 1.200mm		DG173 [3]	EG176 [3][14]
Espace II 2.2	01/91→10/96	2165	4	88.00	SOHC/OHC	79-81/ 107-110
2.2	J7T 780	591	BG170 (Fibre), 1.200mm		DG173 [3]	EG176 [3][14]
Trafic 2.2	05/89→06/94	2165	4	88.00	SOHC/OHC	70/95
Trafic 2.2 4x4	05/89→06/94					
2.2	J7T 782	592	BG170 (Fibre), 1.200mm		DG173 [3]	EG176 [3][14]
Master I 2.2	08/80→07/98	2165	4	88.00	SOHC/OHC	67-69/ 91-94
2.2	J7T 788	593	BG170 (Fibre), 1.200mm		DG173 [3]	EG176 [3][14]
Master I 2.2	08/80→07/98	2165	4	88.00	SOHC/OHC	67-71/ 91-97
2.3	M9T 670 Diesel	594				EG9760
Master 3 2.3dCi	02/10→	2298	4	85.00	DOHC	74-92/ 101-125
2.3	M9T 672 Diesel	595				EG9760
Master 3 2.3dCi	02/10→	2298	4	85.00	DOHC	74-92/ 101-125
2.3	M9T 676 Diesel	596				EG9760
Master 3 2.3dCi	02/10→	2298	4	85.00	DOHC	74-92/ 101-125
2.3	M9T 678 Diesel	597				EG9760
Master 3 2.3dCi	02/10→	2298	4	85.00	DOHC	107/146
2.3	M9T 680 Diesel	598				EG9760
Master 3 2.3dCi	02/10→	2298	4	85.00	DOHC	107/146

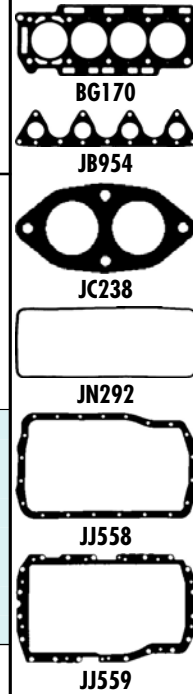
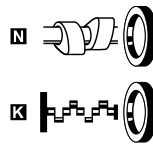
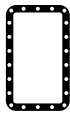
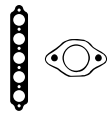

HBS116 [22] M12x1.50x243.00mm (x10)	JB954 	JN292 [4]	JJ558 (Felt) JJ559 (SE) =PB852 16.00x24.00x1.500mm =PA349 22.00x16.00x2.000mm	HR569	NA5016 35.00x47.00x7.00mm, FPM/ACM NF648 [2] 50.00x68.00x10.00mm, MVQ NF843 [2] 50.00x68.00x10.00mm, FPM/ACM NF844 [1] 90.00x110.00x11.00mm, FPM/ACM	NF781 [1][2][52] NF849 [2][56]
HBS116 [22] M12x1.50x243.00mm (x10)	JB954 	JN292 [4]	JJ558 (Felt) JJ559 (SE) =PB852 16.00x24.00x1.500mm =PA349 22.00x16.00x2.000mm	HR569	NA5016 35.00x47.00x7.00mm, FPM/ACM NF648 [2] 50.00x68.00x10.00mm, MVQ NF843 [2] 50.00x68.00x10.00mm, FPM/ACM NF844 [1] 90.00x110.00x11.00mm, FPM/ACM	NF781 [1][2][52] NF849 [2][56]
HBS116 [22] M12x1.50x243.00mm (x10)	JB954 	JN292 [4]	JJ558 (Felt) JJ559 (SE) =PB852 16.00x24.00x1.500mm =PA349 22.00x16.00x2.000mm	HR569	NA5016 35.00x47.00x7.00mm, FPM/ACM NF648 [2] 50.00x68.00x10.00mm, MVQ NF843 [2] 50.00x68.00x10.00mm, FPM/ACM NF844 [1] 90.00x110.00x11.00mm, FPM/ACM	NF781 [1][2][52] NF849 [2][56]
HBS116 [22] M12x1.50x243.00mm (x10)	JB954 	JN292 [4]	JJ558 (Felt) JJ559 (SE) =PB852 16.00x24.00x1.500mm =PA349 22.00x16.00x2.000mm	HR569	NA5016 35.00x47.00x7.00mm, FPM/ACM NF648 [2] 50.00x68.00x10.00mm, MVQ NF843 [2] 50.00x68.00x10.00mm, FPM/ACM NF844 [1] 90.00x110.00x11.00mm, FPM/ACM	NF849 [2][56]
HBS116 [22] M12x1.50x243.00mm (x10)	JB954 	JN292 [4]	JJ558 (Felt) JJ559 (SE) =PB852 16.00x24.00x1.500mm =PA349 22.00x16.00x2.000mm	HR569	NA5016 35.00x47.00x7.00mm, FPM/ACM NF648 [2] 50.00x68.00x10.00mm, MVQ NF843 [2] 50.00x68.00x10.00mm, FPM/ACM NF844 [1] 90.00x110.00x11.00mm, FPM/ACM	NF849 [2][56]
HBS116 [22] M12x1.50x243.00mm (x10)	JB954 	JN292 [4]	JJ558 (Felt) JJ559 (SE) =PB852 16.00x24.00x1.500mm =PA349 22.00x16.00x2.000mm	HR569	NA5016 35.00x47.00x7.00mm, FPM/ACM NF648 [2] 50.00x68.00x10.00mm, MVQ NF843 [2] 50.00x68.00x10.00mm, FPM/ACM NF844 [1] 90.00x110.00x11.00mm, FPM/ACM	NF849 [2][56]

RENAULT



cc



kW/PS

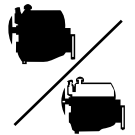

2.3	M9T 686 Diesel						599			EG9760
Master 3 2.3dCi	02/10→	2298	4	85.00	DOHC	92/125				
2.3	M9T 690 Diesel						600			EG9760
Master 3 2.3dCi	02/10→	2298	4	85.00	DOHC	74-92/ 101-125				
2.3	M9T 692 Diesel						601			EG9760
Master 3 2.3dCi	02/10→	2298	4	85.00	DOHC	74-92/ 101-125				
2.3	M9T 694 Diesel						602			EG9760
Master 3 2.3dCi	02/10→	2298	4	85.00	DOHC	107/146				
2.3	M9T 696 Diesel						603			EG9760
Master 3 2.3dCi	02/10→	2298	4	85.00	DOHC	92-107/ 125-146				
2.3	M9T 698 Diesel						604			EG9760
Master 3 2.3dCi	02/10→	2298	4	85.00	DOHC	92-107/ 125-146				
2.4	8140.61.2300 Diesel						605	BE580 (Fibre), 1.350mm AY300 (Fibre), 1.700mm	DE588 ▲ ^[3]	
Master I	08/80→07/98	2445	4	93.00		52/71				
2.4	8140.61.240 Diesel						606	BE580 (Fibre), 1.350mm AY300 (Fibre), 1.700mm	DE588 ▲ ^[3]	
Trafic 2.5 D	03/80→03/01	2445	4	93.00		51/69				
2.4	N7U 700						607	BY361 (Fibre)		
Safrane II 2.5	07/96→12/00	2435	5	83.00	DOHC	121/165				
2.4	N7U 701						608	BY361 (Fibre)		
Safrane II 2.5	07/96→12/00	2435	5	83.00	DOHC	121/165				
2.4	S8U 720 Diesel						609	BE580 (Fibre), 1.350mm 12/82→ AY300 (Fibre), 1.700mm 12/82→	DE588 ▲ ^[3] 12/82→	
Trafic 2.5 D	03/80→03/01	2445	4	93.00	SOHC/OHC	51/69				
2.4	S8U 722 Diesel						610	BE580 (Fibre), 1.350mm 12/82→ AY300 (Fibre), 1.700mm 12/82→	DE588 ▲ ^[3] 12/82→	
Trafic 2.5 D	03/80→03/01	2445	4	93.00	SOHC/OHC	51/69				
2.4	S8U 730 Diesel						611	BE580 (Fibre), 1.350mm AY300 (Fibre), 1.700mm	DE588 ▲ ^[3]	
Master I 2.4 D	09/86→02/98	2445	4	93.00	SOHC/OHC	52/71				

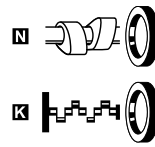
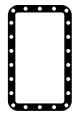

AY300



BE580



BY361



JC054



JC055



JN594



JJ519

HBS011 [5] M12x1.25x119.00mm (x12)	JC054 ■ JC055 ■	JN594 [4]	JJ519		<input checked="" type="checkbox"/> NP068 [2] 55.00x70.00x8.00mm, FPM <input checked="" type="checkbox"/> NF833 ■ [1] 90.00x115.00x13.00mm, FPM <input checked="" type="checkbox"/> NF885 ■ [2] 70.00x179.00x16.00mm, FPM	
HBS011 [5] M12x1.25x119.00mm (x12)	JC054 ■ JC055 ■	JN594 [4]	JJ519		<input checked="" type="checkbox"/> NP068 [2] 55.00x70.00x8.00mm, FPM <input checked="" type="checkbox"/> NA5138 [2] 44.50x57.20x6.75mm, ACM <input checked="" type="checkbox"/> NA5136 [1] [2] 30.00x47.00x7.00mm, FPM <input checked="" type="checkbox"/> NA5018 ■ [2] 35.00x47.00x5.60mm, FPM	
					<input checked="" type="checkbox"/> NA5138 [2] 44.50x57.20x6.75mm, ACM <input checked="" type="checkbox"/> NA5136 [1] [2] 30.00x47.00x7.00mm, FPM <input checked="" type="checkbox"/> NA5018 ■ [2] 35.00x47.00x5.60mm, FPM	
HBS011 [5] M12x1.25x119.00mm (x12) 12/82→	JC054 ■ 12/82→ JC055 ■ 12/82→	JN594 [4] 12/82→	JJ519 12/82→		<input checked="" type="checkbox"/> NP068 [2] 55.00x70.00x8.00mm, FPM 12/82→ <input checked="" type="checkbox"/> NF833 ■ [1] 90.00x115.00x13.00mm, FPM 12/82→ <input checked="" type="checkbox"/> NF885 ■ [2] 70.00x179.00x16.00mm, FPM 12/82→	
HBS011 [5] M12x1.25x119.00mm (x12) 12/82→	JC054 ■ 12/82→ JC055 ■ 12/82→	JN594 [4] 12/82→	JJ519 12/82→		<input checked="" type="checkbox"/> NP068 [2] 55.00x70.00x8.00mm, FPM 12/82→ <input checked="" type="checkbox"/> NF833 ■ [1] 90.00x115.00x13.00mm, FPM 12/82→ <input checked="" type="checkbox"/> NF885 ■ [2] 70.00x179.00x16.00mm, FPM 12/82→	
HBS011 [5] M12x1.25x119.00mm (x12)	JC054 ■ JC055 ■	JN594 [4]	JJ519		<input checked="" type="checkbox"/> NP068 [2] 55.00x70.00x8.00mm, FPM <input checked="" type="checkbox"/> NF833 ■ [1] 90.00x115.00x13.00mm, FPM	



cc



kW/PS



Model	Year Range	CC	Cyls	Power (kW/PS)	Configuration	Code	Options	Accessories	Notes
2.4 S8U 731 Diesel 612									
Master I	08/80→07/98	2445	4	93.00	SOHC/OHC	50-53/ 68-72	BE580 (Fibre), 1.350mm AY300 (Fibre), 1.700mm	DE588 ▲ [3]	
Master I 2.4 D	09/86→10/89								
2.5 8140.27.2500 Diesel 613									
Master I	08/89→07/98	2499	4	93.00		69/94	BR070 (Fibre), 1.200mm AY590 (Fibre), 1.400mm	DS381 ▲ [3]	
2.5 8140.27.2510 Diesel 614									
Master I	08/89→07/98	2499	4	93.00		69/94	BR070 (Fibre), 1.200mm AY590 (Fibre), 1.400mm	DS381 ▲ [3]	
2.5 8140.27.2580 Diesel 615									
Master I	08/89→07/98	2499	4	93.00		72/98	BR070 (Fibre), 1.200mm AY590 (Fibre), 1.400mm	DS381 ▲ [3]	
2.5 8140.67.2500 Diesel 616									
Trafic 2.5 D	05/89→03/01	2499	4	93.00		55/75	BE580 (Fibre), 1.350mm AY300 (Fibre), 1.700mm		
Trafic 2.5D 4x4	05/89→03/01								
2.5 8140.67.2510 Diesel 617									
Master I	08/89→07/98	2499	4	93.00	SOHC/OHC	55/75	BE580 (Fibre), 1.350mm		
2.5 8140.67.2550 Diesel 618									
Trafic 2.5 D	05/89→03/01	2499	4	93.00	SOHC/OHC	55/75	BE580 (Fibre), 1.350mm AY300 (Fibre), 1.700mm		
Trafic 2.5D 4x4	08/89→03/01								
2.5 8140.67.2580 Diesel 619									
Trafic 2.5 D	05/89→03/01	2499	4	93.00		55/75	BE580 (Fibre), 1.350mm AY300 (Fibre), 1.700mm		
Trafic 2.5D 4x4	05/89→03/01								
2.5 G9U 630 Diesel 620									
Trafix 2	08/06→	2464	4	89.00	DOHC	84-107/ 114-146	AE5220 (MLS)	CE5210	EE5220 [3]
Trafix 2 2.5dCi	08/07→								
2.5 G9U 632 Diesel 621									
Master II	08/06→	2464	4	89.00	DOHC	88-107/ 120-146	AE5220 (MLS)	CE5210	EE5220 [3]
2.5 G9U 650 Diesel 622									
Master II	08/06→	2464	4	89.00	DOHC	74-88/ 101-120	AE5220 (MLS)	CE5210	EE5220 [3]
2.5 G9U 720 Diesel 623									
Master II	10/01→	2463	4	89.00	DOHC	84/115	AE5220 (MLS)	CE5210	EE5220 [3]

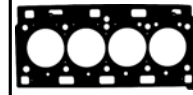

AE5220



AY300



BE580



BR070, AY590



JC054



JC055



JN594



JJ519



JJ568

HBS011 [5] M12x1.25x119.00mm (x12)	JC054 [1] JC055 [2]	JN594 [4]	JJ519		N NPO68 [2] 55.00x70.00x8.00mm, FPM K NF833 [1] 90.00x115.00x13.00mm, FPM K NF885 [2] 70.00x179.00x16.00mm, FPM	
	JC054 [1]		JJ519		N NPO68 [2] 55.00x70.00x8.00mm, FPM K NF833 [1] 90.00x115.00x13.00mm, FPM	
	JC054 [1]		JJ519		N NPO68 [2] 55.00x70.00x8.00mm, FPM K NF833 [1] 90.00x115.00x13.00mm, FPM	
	JC054 [1] JC055 [2]		JJ519		N NPO68 [2] 55.00x70.00x8.00mm, FPM K NPO67 [2] 50.00x70.00x10.00mm, FPM	
	JC054 [1] JC055 [2]	JN594 [4]	JJ519		N NPO68 [2] 55.00x70.00x8.00mm, FPM K NPO67 [2] 50.00x70.00x10.00mm, FPM K NF883 [1] 114.00x177.00x13.00mm, FPM K NF885 [2] 70.00x179.00x16.00mm, FPM	
	JC054 [1]		JJ519			
	JC054 [1] JC055 [2]	JN594 [4]	JJ519		N NPO68 [2] 55.00x70.00x8.00mm, FPM K NPO67 [2] 50.00x70.00x10.00mm, FPM K NF883 [1] 114.00x177.00x13.00mm, FPM K NF885 [2] 70.00x179.00x16.00mm, FPM	
	JC054 [1] JC055 [2]	JN594 [4]	JJ519		N NPO68 [2] 55.00x70.00x8.00mm, FPM K NPO67 [2] 50.00x70.00x10.00mm, FPM K NF883 [1] 114.00x177.00x13.00mm, FPM K NF885 [2] 70.00x179.00x16.00mm, FPM	
HBS373 [22] M12x1.50x131.00mm (x10)	JD5891 [1] (x4) JD5892	HM5290 [2]	JJ568	HR791 [2]	N NA5053 [2] 30.00x42.00x7.00mm, FPM K NF860 [1] 93.00x108.00x7.00mm, FPM/ACM	
HBS373 [22] M12x1.50x131.00mm (x10)	JD5891 [1] (x4) JD5892	HM5290 [2]	JJ568	HR791 [2]	N NA5053 [2] 30.00x42.00x7.00mm, FPM K NF860 [1] 93.00x108.00x7.00mm, FPM/ACM	
HBS373 [22] M12x1.50x131.00mm (x10)	JD5891 [1] (x4) JD5892	HM5290 [2]	JJ568	HR791 [2]	N NA5053 [2] 30.00x42.00x7.00mm, FPM K NF860 [1] 93.00x108.00x7.00mm, FPM/ACM	
HBS373 [22] M12x1.50x131.00mm (x10)	JD5891 [1] (x4) JD5892	HM5290 [2]	JJ568	HR791 [2]	N NA5053 [2] 30.00x42.00x7.00mm, FPM K NF860 [1] 93.00x108.00x7.00mm, FPM/ACM	



cc



kW/PS



2.5	G9U 724 Diesel	624	AE5220 (MLS)	CE5210	EE5220 [3]				
Master II	10/01→	2463	4	89.00	DOHC	84/115			
2.5	G9U 730 Diesel	625	AE5220 (MLS)	CE5210	EE5220 [3]				
Trafix 2	03/01→	2464	4	89.00	DOHC	99/135			
Trafix 2 2.5DTi	03/03→07/03								
2.5	G9U 750 Diesel	626	AE5220 (MLS)	CE5210	EE5220 [3]				
Master II	01/04→	2463	4	89.00	DOHC	84/115			
2.5	G9U 754 Diesel	627	AE5220 (MLS)		EE5220 [3]				
Master II	10/01→	2463	4	89.00	DOHC	73-85/ 99-115			
2.5	S8U 742 Diesel	628	BE580 (Fibre), 1.350mm 05/89→ AY300 (Fibre), 1.700mm 05/89→						
Master I	08/89→07/98	2499	4	93.00	SOHC/OHC	55/75			
Master I 2.5 D	07/80→10/89								
2.5	S8U 750 Diesel	629	BE580 (Fibre), 1.350mm 05/89→ AY300 (Fibre), 1.700mm 05/89→						
Traffic 2.5 D	03/89→03/01	2499	4	93.00	SOHC/OHC	55/75			
Traffic 2.5D 4x4	03/89→03/01								
2.5	S8U 752 Diesel	630	BE580 (Fibre), 1.350mm AY300 (Fibre), 1.700mm						
Traffic 2.5 D	05/89→03/01	2499	4	93.00	SOHC/OHC	55/75			
Traffic 2.5D 4x4	05/89→03/01								
2.5	S8U 758 Diesel	631	BE580 (Fibre), 1.350mm AY300 (Fibre), 1.700mm						
Traffic 2.5 D	05/89→03/01	2499	4	93.00	SOHC/OHC	55-58/ 75-79			
Traffic 2.5D 4x4	08/89→03/01								
2.5	S8U 762 Diesel	632	BE580 (Fibre), 1.350mm AY300 (Fibre), 1.700mm						
Safrane I 2.5dT	12/92→07/96	2500	4	93.00	SOHC/OHC	83/113			
2.5	S8U 763 Diesel	633	BE580 (Fibre), 1.350mm AY300 (Fibre), 1.700mm						
Safrane I 2.5dT	12/92→07/96	2500	4	93.00	SOHC/OHC	83/113			

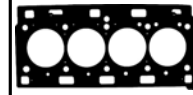
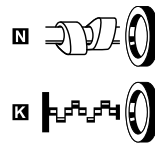
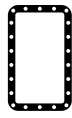
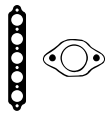

AE5220



AY300



BE580



JC054



JC055



JN594



JN956



JN969



JJ519



JJ549

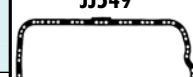

JJ568













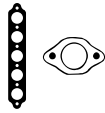

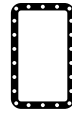

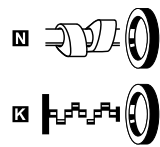



cc



kW/PS



2.5	S8U 770 Diesel	634	BE580 (Fibre), 1.350mm						
Master II 2.5 D	07/98→01/01	2499	4	93.00	SOHC/OHC	59/80	AY300 (Fibre), 1.700mm		
2.5	S8U 780 Diesel	635	BE580 (Fibre), 1.350mm						
Trafic 2.5 D	05/98→03/01	2499	4	93.00	SOHC/OHC	55/75	AY300 (Fibre), 1.700mm		
2.5	S9U 702 Diesel	636	BR070 (Fibre), 1.200mm	DS381 ▲ [3]					
Master I	08/89→07/98	2499	4	93.00	SOHC/OHC	69-72/ 94-98	AY590 (Fibre), 1.400mm		
Master I 2.5 DT	11/89→10/93								
2.5	S9U 714 Diesel	637	BR070 (Fibre), 1.200mm	DS381 ▲ [3]					
Master I	08/89→07/98	2499	4	93.00	SOHC/OHC	69/94	AY590 (Fibre), 1.400mm		
2.5	S9U 740 Diesel	638	BR070 (Fibre), 1.200mm	DS381 ▲ [3]					
Master I 2.5 DT	08/93→02/98	2499	4	93.00	SOHC/OHC	69/94	AY590 (Fibre), 1.400mm		
2.5	Z7U 700	639							
25 2.5 V6 T	01/90→12/92	2458	6	91.00	SOHC/OHC, V	151/205			
2.5	Z7U 702	640							
25 2.4 V6 T	10/84→05/90	2458	6	91.00	SOHC/OHC, V	133/181			
2.7	Z7V 708	641	BG120 (Fibre), 1.200mm ☒						
25 2.7 V6 Inj	04/84→08/89	2664	6	88.00	SOHC/OHC, V	104/141	BG130 (Fibre), 1.200mm ☒		
2.7	Z7V 709	642	BG120 (Fibre), 1.200mm ☒						
25 2.7 V6 Inj	04/84→08/89	2664	6	88.00	SOHC/OHC, V	104/141	BG130 (Fibre), 1.200mm ☒		
2.7	Z7V 711	643	BG120 (Fibre), 1.200mm ☒						
25 2.7 V6 Inj	04/84→08/89	2664	6	88.00	SOHC/OHC, V	104/141	BG130 (Fibre), 1.200mm ☒		
2.8	S9W 702 Diesel	644	BX390 (Fibre), 1.200mm	DX391 ▲ [3]	GX410 ▲ [3]				
Master II	07/98→10/01	2799	4	94.40	SOHC/OHC	84/114	BX400 (Fibre), 1.300mm BX410 (Fibre), 1.400mm BX420 (Fibre), 1.500mm		

									
HBS011 [5] M12x1.25x119.00mm (x12)	JC054 [1] JC055 [1]	JN956 [4]	JJ519		N NP068 [2] 55.00x70.00x8.00mm, FPM K NF883 [1] 114.00x177.00x13.00mm, FPM K NF885 [2] 70.00x179.00x16.00mm, FPM			 AY300  BE580  BG120  BG130  BR070, AY590  BX390, BX400, BX410, BX420	
HBS011 [5] M12x1.25x119.00mm (x12)	JC054 [1] JC055 [1]	JN956 [4]	JJ519		N NP068 [2] 55.00x70.00x8.00mm, FPM K NP067 [2] 50.00x70.00x10.00mm, FPM K NF883 [1] 114.00x177.00x13.00mm, FPM K NF885 [2] 70.00x179.00x16.00mm, FPM			 JC054  JC055  JC876  JN594  JN956  JJ519	
HBS011 [5] M12x1.25x119.00mm (x12)	JC054 [1] JC055 [1]	JN594 [4]	JJ519		N NP068 [2] 55.00x70.00x8.00mm, FPM K NF833 [1] 90.00x115.00x13.00mm, FPM				
HBS011 [5] M12x1.25x119.00mm (x12)	JC054 [1] JC055 [1]	JN594 [4]	JJ519		N NP068 [2] 55.00x70.00x8.00mm, FPM K NF833 [1] 90.00x115.00x13.00mm, FPM				
HBS011 [5] M12x1.25x119.00mm (x12)	JC054 [1] JC055 [1]	JN956 [4]	JJ519		N NP068 [2] 55.00x70.00x8.00mm, FPM K NF883 [1] 114.00x177.00x13.00mm, FPM K NF885 [2] 70.00x179.00x16.00mm, FPM				
HBS127 [22] M12x1.50x178.00mm (x16)				HR569 [x2]	K NF835 [1] 80.00x100.00x8.00mm, FPM/ACM K NF761 [2] 42.00x62.00x10.00mm, FPM/ACM				
HBS127 [22] M12x1.50x178.00mm (x16)				HR569 [x2]	K NF835 [1] 80.00x100.00x8.00mm, FPM/ACM K NF761 [2] 42.00x62.00x10.00mm, FPM/ACM				
HBS127 [22] M12x1.50x178.00mm (x16)	JC876 [1]	JN302 [4] JN303 [4]			K NA5272 [2] ACM K NF634 [1] 80.00x100.00x13.00mm, MVQ				
HBS127 [22] M12x1.50x178.00mm (x16)	JC876 [1]	JN302 [4] JN303 [4]			K NA5272 [2] ACM K NF634 [1] 80.00x100.00x13.00mm, MVQ				
HBS127 [22] M12x1.50x178.00mm (x16)	JC876 [1]	JN302 [4] JN303 [4]			K NA5272 [2] ACM K NF634 [1] 80.00x100.00x13.00mm, MVQ				
HBS011 [5] M12x1.25x119.00mm (x12)	JC054 [x4] JC055 [x4]	JN956 [4]	JH5178 (SMG) JJ519	HR602 [1]	N NP067 [2] 50.00x70.00x10.00mm, FPM K NP067 [2] 50.00x70.00x10.00mm, FPM K NF883 [1] 114.00x177.00x13.00mm, FPM K NF885 [2] 70.00x179.00x16.00mm, FPM		KD929 [68][69] KD931 [68][69] KK5599 [17] KV927 [76]		

RENAULT



cc



kW/PS



2.8	Z7W 700	645	AG5270 (Fibre) ☒	CG5270					
25 2.8 V6	06/87→02/90	2849	6	91.00	SOHC/OHC, V	115/156			
2.8	Z7W 706	646	AG5270 (Fibre) ☒	CG5270					
25 2.8 V6 Inj	06/87→12/92	2849	6	91.00	SOHC/OHC, V	110-112/ 150-153			
2.8	Z7W 707	647	AG5270 (Fibre) ☒	CG5270					
25 2.8 V6 Inj	06/87→12/92	2849	6	91.00	SOHC/OHC, V	110-112/ 150-153			
2.8	Z7W 709	648	AG5270 (Fibre) ☒	CG5270					
25 2.8 V6 Inj	06/87→12/92	2849	6	91.00	SOHC/OHC, V	110/150	06/89→		
2.8	Z7W 712	649	AG5270 (Fibre) ☒	CG5270					
Espace II 2.8	01/91→10/96	2849	6	91.00	SOHC/OHC, V	110/150			
2.8	Z7W 713	650	AG5270 (Fibre) ☒	CG5270					
Espace II 2.8	01/91→10/96	2849	6	91.00	SOHC/OHC, V	110/150			
2.8	Z7W 717	651	AG5270 (Fibre) ☒	CG5270					
Espace II 2.8	01/91→10/96	2849	6	91.00	SOHC/OHC, V	110/150			
2.9	L7X 700	652	AG9710 (MLS), 1.400mm ☒ AG9720 (MLS), 1.650mm ☒ AG9730 (MLS), 1.400mm ☒ AG9740 (MLS), 1.650mm ☒	CG9710 CG9720 ☒ CG9740 ☒	EG9710				
Laguna 3.0 24V Laguna I 3.0	03/97→03/01 03/97→03/01	2946	6	87.00	DOHC, V	140/190			
2.9	L7X 701	653	AG9710 (MLS), 1.400mm ☒ AG9720 (MLS), 1.650mm ☒ AG9730 (MLS), 1.400mm ☒ AG9740 (MLS), 1.650mm ☒	CG9710 CG9720 ☒ CG9740 ☒	EG9710				
Laguna 3.0 24V Laguna I 3.0	03/97→03/01 03/97→03/01	2946	6	87.00	DOHC, V	140/190			



HBS127 [22] M12x1.50x178.00mm (x16)		JN302 [4] JN303 [4]	PA349 22.00x16.00x2.000mm	HR569 [x2]	NF687 [2] 35.00x47.00x7.00mm, FPM NAS272 [2] ACM NF634 [1] 80.00x100.00x13.00mm, MVQ
HBS127 [22] M12x1.50x178.00mm (x16)		JN302 [4] JN303 [4]		HR569 [x2]	NF687 [2] 35.00x47.00x7.00mm, FPM NAS272 [2] ACM NF634 [1] 80.00x100.00x13.00mm, MVQ
HBS127 [22] M12x1.50x178.00mm (x16)		JN302 [4] JN303 [4]		HR569 [x2]	NF687 [2] 35.00x47.00x7.00mm, FPM NAS272 [2] ACM NF634 [1] 80.00x100.00x13.00mm, MVQ
HBS127 [22] M12x1.50x178.00mm (x16) 06/89→		JN302 [4] 06/89→ JN303 [4] 06/89→		HR569 [x2] 06/89→	NF687 [2] 35.00x47.00x7.00mm, FPM 06/89→ NAS272 [2] ACM 06/89→ NF634 [1] 80.00x100.00x13.00mm, MVQ 06/89→
HBS127 [22] M12x1.50x178.00mm (x16)		JN302 [4] JN303 [4]		HR569 [x2]	NF687 [2] 35.00x47.00x7.00mm, FPM NAS272 [2] ACM NF634 [1] 80.00x100.00x13.00mm, MVQ
HBS127 [22] M12x1.50x178.00mm (x16)		JN302 [4] JN303 [4]		HR569 [x2]	NF687 [2] 35.00x47.00x7.00mm, FPM NAS272 [2] ACM NF634 [1] 80.00x100.00x13.00mm, MVQ
HBS127 [22] M12x1.50x178.00mm (x16)		JN302 [4] JN303 [4]		HR569 [x2]	NF687 [2] 35.00x47.00x7.00mm, FPM NAS272 [2] ACM NF634 [1] 80.00x100.00x13.00mm, MVQ
HBS272 [22] M10x1.50x147.00mm (x16)	JD5879 [1] JD5880 [1] (SE) JD5878 [1] (MLS)	HR397 [1]		HR5062 [1]	NA5260 [2] 38.00x50.00x6.00mm, FPM NA5177 [2] 42.00x56.00x7.00mm, FPM NA5177 [2] 42.00x56.00x7.00mm, FPM NF867 [1] 98.00x120.00x7.00mm, FPM/ACM
HBS272 [22] M10x1.50x147.00mm (x16)	JD5879 [1] JD5880 [1] (SE) JD5878 [1] (MLS)	HR397 [1]		HR5062 [1]	NA5260 [2] 38.00x50.00x6.00mm, FPM NA5177 [2] 42.00x56.00x7.00mm, FPM NA5177 [2] 42.00x56.00x7.00mm, FPM NF867 [1] 98.00x120.00x7.00mm, FPM/ACM

RENAULT



cc



kW/PS



2.9	L7X 713					654								
Safrane II 2.9	03/99→12/00	2946	6	87.00	DOHC, V	140/190	AG9710 (MLS), 1.400mm	AG9720 (MLS), 1.650mm	AG9730 (MLS), 1.400mm	AG9740 (MLS), 1.650mm	CG9710 CG9720	CG9740	EG9710	
2.9	L7X 720					655								
Avantime 3.0	09/01→05/03	2946	6	87.00	DOHC	152/207	AH5060 (MLS), 0.740mm	AH5050 (MLS), 0.950mm	AH5040 (MLS), 0.740mm	AH5070 (MLS), 0.950mm	CH5040	CH5060	EG9710	
2.9	L7X 721					656								
Avantime 3.0	09/01→05/03	2946	6	87.00	DOHC	152/207	AH5060 (MLS), 0.740mm	AH5050 (MLS), 0.950mm	AH5040 (MLS), 0.740mm	AH5070 (MLS), 0.950mm	CH5040	CH5060	EG9710	
2.9	L7X 727					657								
Espace 3 V6 24V	10/98→10/02	2946	6	87.00	DOHC, V	140/190	AG9710 (MLS), 1.400mm	AG9720 (MLS), 1.650mm	AG9730 (MLS), 1.400mm	AG9740 (MLS), 1.650mm	CG9710 CG9720	CG9740	EG9710	
2.9	L7X 731					658								
Laguna II 3.0	03/01→	2946	6	87.00	DOHC, V	152/207	AH5060 (MLS), 0.740mm	AH5050 (MLS), 0.950mm	AH5040 (MLS), 0.740mm	AH5070 (MLS), 0.950mm	CH5040	CH5060	EG9710	
2.9	L7X 732					659								
Thalia 3.0	04/00→09/01	2946	6	87.00	DOHC, V	169/230	AH5060 (MLS), 0.740mm	AH5050 (MLS), 0.950mm	AH5040 (MLS), 0.740mm	AH5070 (MLS), 0.950mm	CH5040	CH5060	EG9710	
2.9	L7X 760					660								
Clio 2 V6 Sport	11/00→12/02	2946	6	87.00	DOHC, V	166/226	AH5060 (MLS), 0.740mm	AH5050 (MLS), 0.950mm	AH5040 (MLS), 0.740mm	AH5070 (MLS), 0.950mm	CH5040	CH5060	EG9710	

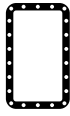
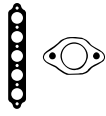

<p>HBS272 [22] M10x1.50x147.00mm (x16)</p>	<p>JD5879 [1] JD5880 [1] (SE) JD5878 [3] (MLS)</p>	<p>HR397 [3]</p>	<p>PA349 22.00x16.00x2.000mm</p>	<p>HR5062 [3]</p>	<p>NA5260 [2] 38.00x50.00x6.00mm, FPM NA5177 [2] 42.00x56.00x7.00mm, FPM NA5177 [2] 42.00x56.00x7.00mm, FPM NF867 [1] 98.00x120.00x7.00mm, FPM/ACM</p>
<p>HBS272 [22] M10x1.50x147.00mm (x16)</p>	<p>JD5906 [1] JD5907 [1] (x2) JD5878 [3] (MLS) JE5069 JE5070 JE5071</p>	<p>HR397 [3]</p>		<p>HR5062 [3]</p>	<p>NA5260 [2] 38.00x50.00x6.00mm, FPM NA5177 [2] 42.00x56.00x7.00mm, FPM NA5177 [2] 42.00x56.00x7.00mm, FPM NF867 [1] 98.00x120.00x7.00mm, FPM/ACM</p>
<p>HBS272 [22] M10x1.50x147.00mm (x16)</p>	<p>JD5906 [1] JD5907 [1] (x2) JD5878 [3] (MLS) JE5069 JE5070 JE5071</p>	<p>HR397 [3]</p>		<p>HR5062 [3]</p>	<p>NA5260 [2] 38.00x50.00x6.00mm, FPM NA5177 [2] 42.00x56.00x7.00mm, FPM NA5177 [2] 42.00x56.00x7.00mm, FPM NF867 [1] 98.00x120.00x7.00mm, FPM/ACM</p>
<p>HBS272 [22] M10x1.50x147.00mm (x16)</p>	<p>JD5879 [1] JD5880 [1] (SE) JD5878 [3] (MLS)</p>	<p>HR397 [3]</p>		<p>HR5062 [3]</p>	<p>NA5260 [2] 38.00x50.00x6.00mm, FPM NA5177 [2] 42.00x56.00x7.00mm, FPM NA5177 [2] 42.00x56.00x7.00mm, FPM NF867 [1] 98.00x120.00x7.00mm, FPM/ACM</p>
<p>HBS272 [22] M10x1.50x147.00mm (x16)</p>	<p>JD5906 [1] JD5907 [1] (x2) JD5878 [3] (MLS) JE5069 JE5070 JE5071</p>	<p>HR397 [3]</p>		<p>HR5062 [3]</p>	<p>NA5260 [2] 38.00x50.00x6.00mm, FPM NA5177 [2] 42.00x56.00x7.00mm, FPM NA5177 [2] 42.00x56.00x7.00mm, FPM NF867 [1] 98.00x120.00x7.00mm, FPM/ACM</p>
<p>HBS272 [22] M10x1.50x147.00mm (x16)</p>	<p>JD5906 [1] JD5907 [1] (x2) JD5878 [3] (MLS) JE5069 JE5070 JE5071</p>	<p>HR397 [3]</p>		<p>HR5062 [3]</p>	<p>NA5260 [2] 38.00x50.00x6.00mm, FPM NA5177 [2] 42.00x56.00x7.00mm, FPM NA5177 [2] 42.00x56.00x7.00mm, FPM NF867 [1] 98.00x120.00x7.00mm, FPM/ACM</p>
<p>HBS272 [22] M10x1.50x147.00mm (x16)</p>	<p>JD5906 [1] JD5907 [1] (x2) JD5878 [3] (MLS) JE5069 JE5070 JE5071</p>	<p>HR397 [3]</p>		<p>HR5062 [3]</p>	<p>NA5260 [2] 38.00x50.00x6.00mm, FPM NA5177 [2] 42.00x56.00x7.00mm, FPM NA5177 [2] 42.00x56.00x7.00mm, FPM NF867 [1] 98.00x120.00x7.00mm, FPM/ACM</p>



cc



kW/PS



2.9	L7X 762					661			
Clio 2 V6 Sport Thalia 3.0	12/02→ 06/02→	2946	6	87.00	DOHC, V	187/254	AH5060 (MLS), 0.740mm ☒ AH5050 (MLS), 0.950mm ☒ AH5040 (MLS), 0.740mm ☒ AH5070 (MLS), 0.950mm ☒	CH5040 ☒ CH5060 ☒	EG9710
3.0	P9X 701 Diesel					662			
Espace 4 3.0dCi Vel Satis	11/02→ 06/02→	2958	6	87.50	DOHC, V	130/177	AG9770 (MLS), 0.600mm, 1 Hole ☒ AG9780 (MLS), 0.650mm, 2 Holes ☒ AG9790 (MLS), 0.700mm, 3 Holes ☒ AG9800 (MLS), 0.600mm, 1 Hole ☒ AG9810 (MLS), 0.650mm, 2 Holes ☒ AG9820 (MLS), 0.700mm, 3 Holes ☒	CG9770 ▲	EG9770
3.0	Z7X 721					663			
Safrane I 3.0	12/92→07/96	2963	6	93.00	SOHC/OHC, V	123-125/ 167-170			
3.0	Z7X 722					664			
Safrane I 3.0	12/92→07/96	2963	6	93.00	SOHC/OHC, V	123/167			
3.0	Z7X 723					665			
Safrane I 3.0	12/92→07/96	2963	6	93.00	SOHC/OHC, V	123/167			
3.0	Z7X 726					666			
Safrane I 3.0	02/93→07/96	2963	6	93.00	SOHC/OHC, V	193/262			
3.0	Z7X 760					667			
Laguna I 3.0	11/93→03/01	2963	6	93.00	SOHC/OHC, V	123/167			
3.0	Z7X 765					668			
Laguna 3.0 Laguna I 3.0	02/96→03/01 11/93→03/01	2963	6	93.00	SOHC/OHC, V	123/167			
3.0	Z7X 775					669			
Espace 3 3.0	11/96→10/98	2963	6	93.00	SOHC/OHC, V	123/167			
3.5	V4Y 701					670	AE5910 (MLS) ☒ AG6130 (MLS) ☒		EG8230
Vel Satis	06/02→	3498	6	95.50	DOHC, V	177/241			
3.5	V4Y 711					671	AE5910 (MLS) ☒ AG6130 (MLS) ☒		EG8230
Espace 4 3.5 V6 Vel Satis	11/02→ 06/02→	3498	6	95.50	DOHC, V	177/241			
3.5	V4Y 713					672	AH6760 (MLS), 0.58mm ☒ [119] AH6770 (MLS), 0.58mm ☒ [119]		
Laguna 3.5 V6 Laguna 3 3.5 Laguna 3 3.5V6	09/08→ 04/08→ 04/08→	3498	6	95.50	DOHC, V	175/238			
3.5	V4Y 715					673	AE5910 (MLS) ☒ AG6130 (MLS) ☒		EG8230
Espace 4 3.5 V6 Vel Satis	11/02→ 10/04→	3498	6	95.50	DOHC, V	170-177/ 231-241			

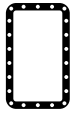
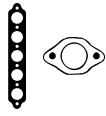

AE5910

HBS272 [22] M10x1.50x147.00mm (x16)	JD5906 [1] JD5907 [1] (x2) JD5878 [1] (MLS) JE5069 JE5070 JE5071	HR397 [1]		HR5062 [1]	NA5260 [2] 38.00x50.00x6.00mm, FPM NA5177 [2] 42.00x56.00x7.00mm, FPM NA5260 [2] 38.00x50.00x6.00mm, FPM NA5177 [2] 42.00x56.00x7.00mm, FPM NF867 [1] 98.00x120.00x7.00mm, FPM/ACM
HBS502 [22] 	JD5897 [1] (SE) JD5896 [1] JE5064 (Steel)	HM5292 [1]		HR5094 [1]	
					NA5191 [2] 42.00x62.00x7.00mm, PTFE NF835 [1] 80.00x100.00x8.00mm, FPM/ACM
					NA5191 [2] 42.00x62.00x7.00mm, PTFE NF835 [1] 80.00x100.00x8.00mm, FPM/ACM
					NA5191 [2] 42.00x62.00x7.00mm, PTFE NF835 [1] 80.00x100.00x8.00mm, FPM/ACM
HBS127 [22] M12x1.50x178.00mm (x16)			PA349 22.00x16.00x2.000mm		NA5191 [2] 42.00x62.00x7.00mm, PTFE NF835 [1] 80.00x100.00x8.00mm, FPM/ACM
					NA5191 [2] 42.00x62.00x7.00mm, PTFE NF835 [1] 80.00x100.00x8.00mm, FPM/ACM
HBS127 [22] M12x1.50x178.00mm (x16)					NA5191 [2] 42.00x62.00x7.00mm, PTFE NF835 [1] 80.00x100.00x8.00mm, FPM/ACM
HBS127 [22] M12x1.50x178.00mm (x16)					NA5191 [2] 42.00x62.00x7.00mm, PTFE NF835 [1] 80.00x100.00x8.00mm, FPM/ACM
		JM5317 [1]			
		JM5317 [1]			
		JM5317			



Ltr







CC



9

Model	Ltr	Year Range	Engine	Fuel	CC	Doors	Price
25 (RF)	1.4	10/99→05/00	14 K4F	Petrol	1396	4	13
25 (RF)	1.4	10/99→05/00	14 K4M	Petrol	1396	4	14
25 (RF)	1.6	10/99→05/00	16 K4F	Petrol	1588	4	18
25 (RF)	1.8	10/99→05/00	18 K4F	Petrol	1796	4	24
25 (RF)	1.8	02/00→05/00	18 K4K	Petrol	1796	4	25
25 (RF)	2.0	10/99→05/00	20 T2N	Diesel	1994	4	35
45 (RT)	1.4	02/00→05/00	14 K4F	Petrol	1396	4	13
45 (RT)	1.6	02/00→05/00	16 K4F	Petrol	1588	4	18
45 (RT)	1.8	02/00→05/00	18 K4F	Petrol	1796	4	24
45 (RT)	2.0	02/00→05/00	20 K4F	Petrol	1997	6	33
45 (RT)	2.0	02/00→05/00	20 T2N	Diesel	1994	4	35
45 Saloon (RT)	1.4	02/00→05/00	14 K4F	Petrol	1396	4	13
45 Saloon (RT)	1.6	02/00→05/00	16 K4F	Petrol	1588	4	18
45 Saloon (RT)	1.8	02/00→05/00	18 K4F	Petrol	1796	4	24
45 Saloon (RT)	2.0	02/00→05/00	20 K4F	Petrol	1997	6	33
45 Saloon (RT)	2.0	02/00→05/00	20 T2N	Diesel	1994	4	35
75 (RJ)	1.8	02/99→05/00	K 1.8	Petrol	1796	4	26
75 (RJ)	2.0	02/99→05/00	20 K4F	Petrol	1997	6	33
75 (RJ)	2.0	02/00→05/00	204D2	Diesel	1951	4	39
75 (RJ)	2.0	02/99→05/00	M 47 R	Diesel	1950	4	43
75 (RJ)	2.5	10/00→05/00	25 K4F	Petrol	2497	6	46
75 (RJ)	2.5	02/99→10/00	KV 6	Petrol	2497	6	51
75 Tourer (RJ)	1.8	08/00→05/00	K 1.8	Petrol	1796	4	26
75 Tourer (RJ)	2.0	08/00→05/00	20 K4F	Petrol	1997	6	33
75 Tourer (RJ)	2.0	02/00→05/00	204D2	Diesel	1951	4	39
75 Tourer (RJ)	2.0	08/00→05/00	M 47 R	Diesel	1950	4	43
75 Tourer (RJ)	2.5	08/00→05/00	KV 6	Petrol	2497	6	51
100 / METRO (XP)	1.1	03/99→12/99	11 K2A	Petrol	1119	4	1
100 / METRO (XP)	1.1	03/99→12/99	11 K2D	Petrol	1119	4	2
100 / METRO (XP)	1.4	03/99→12/99	14 K2A	Petrol	1396	4	8
100 / METRO (XP)	1.4	03/99→12/99	14 K2D	Petrol	1396	4	9
100 / METRO (XP)	1.4	03/99→12/99	14 K4C	Petrol	1396	4	11
100 / METRO (XP)	1.4	03/99→12/99	14 K4D	Petrol	1396	4	12
100 / METRO (XP)	1.4	08/99→12/99	14 K4F	Petrol	1396	4	13
100 / METRO (XP)	1.4	10/99→12/99	TUD 3	Diesel	1361	4	15
100 / METRO (XP)	1.5	12/99→12/99	TUD 5	Diesel	1527	4	16
100 Convertible (XP)	1.1	04/99→10/99	11 K2D	Petrol	1119	4	2
100 Convertible (XP)	1.4	04/99→10/99	14 K2A	Petrol	1396	4	8
100 Convertible (XP)	1.4	04/99→10/99	14 K2D	Petrol	1396	4	9
100 Convertible (XP)	1.4	03/99→10/99	14 K4F	Petrol	1396	4	13
200 (RF)	1.1	01/99→03/00	11 K2D	Petrol	1119	4	2
200 (RF)	1.4	11/99→03/00	14 K2F	Petrol	1396	4	10
200 (RF)	1.4	11/99→03/00	14 K4F	Petrol	1396	4	13
200 (RF)	1.6	11/99→03/00	16 K4F	Petrol	1588	4	18
200 (RF)	1.8	08/99→03/00	18 K4F	Petrol	1796	4	24
200 (RF)	1.8	11/99→03/00	18 K4K	Petrol	1796	4	25
200 (RF)	2.0	11/99→03/00	20 T2N	Diesel	1994	4	35
200 (RF)	2.0	11/99→03/00	20 T2R	Diesel	1994	4	36
200 (XH)	1.3	09/98→09/98	EV 2	Petrol	1342	4	7
200 (XH)	1.6	03/98→09/98	16 H	Petrol	1598	4	17
200 Coupe (XW)	1.6	10/99→06/99	D 16 A8	Petrol	1590	4	20
200 Coupe (XW)	2.0	10/99→06/99	20 T4G	Petrol	1994	4	37
200 Coupe (XW)	2.0	05/99→06/99	20 T4H	Petrol	1994	4	38
200 Hatchback (XW)	1.4	09/99→10/99	14 K2A	Petrol	1396	4	8
200 Hatchback (XW)	1.4	09/99→10/99	14 K2D	Petrol	1396	4	9
200 Hatchback (XW)	1.4	10/98→10/99	14 K4C	Petrol	1396	4	11
200 Hatchback (XW)	1.4	10/98→10/99	14 K4D	Petrol	1396	4	12
200 Hatchback (XW)	1.4	12/99→10/99	14 K4F	Petrol	1396	4	13
200 Hatchback (XW)	1.6	10/98→10/99	D 16 A7	Petrol	1590	4	19
200 Hatchback (XW)	1.6	09/99→10/99	D 16 A8	Petrol	1590	4	20
200 Hatchback (XW)	1.6	09/99→10/99	D 16 A9	Petrol	1590	4	21
200 Hatchback (XW)	1.6	10/98→10/99	D 16 Z2	Petrol	1590	4	23
200 Hatchback (XW)	1.8	09/99→10/99	XUD 7TE	Diesel	1769	4	27
200 Hatchback (XW)	2.0	09/99→10/99	20 M4F	Petrol	1994	4	34
200 Hatchback (XW)	2.0	01/99→10/99	20 T4G	Petrol	1994	4	37
200 Hatchback (XW)	2.0	01/99→10/99	20 T4H	Petrol	1994	4	38
400 (RT)	1.4	03/99→12/99	14 K2F	Petrol	1396	4	10
400 (RT)	1.4	05/99→03/00	14 K4F	Petrol	1396	4	13
400 (RT)	1.6	05/99→03/00	16 K4F	Petrol	1588	4	18
400 (RT)	1.6	05/99→03/00	D 16 Y2	Petrol	1590	4	22

	Ltr				CC		9
400 (RT)	2.0	05/99 → 03/00	20 T2N	Diesel	1994	4	35
400 (RT)	2.0	11/99 → 03/00	20 T2R	Diesel	1994	4	36
400 (RT)	2.0	12/99 → 03/00	20 T4H	Petrol	1994	4	38
400 (XW)	1.4	04/99 → 04/99	14 K4C	Petrol	1396	4	11
400 (XW)	1.4	04/99 → 04/99	14 K4D	Petrol	1396	4	12
400 (XW)	1.4	01/99 → 04/99	14 K4F	Petrol	1396	4	13
400 (XW)	1.6	04/99 → 04/99	D 16 A7	Petrol	1590	4	19
400 (XW)	1.6	04/99 → 04/99	D 16 A8	Petrol	1590	4	20
400 (XW)	1.6	04/99 → 04/99	D 16 A9	Petrol	1590	4	21
400 (XW)	1.6	04/99 → 04/99	D 16 Z2	Petrol	1590	4	23
400 (XW)	1.8	09/99 → 04/99	XUD 7TE	Diesel	1769	4	27
400 (XW)	2.0	02/99 → 04/99	20 M4F	Petrol	1994	4	34
400 (XW)	2.0	01/99 → 04/99	20 T4G	Petrol	1994	4	37
400 (XW)	2.0	01/99 → 04/99	20 T4H	Petrol	1994	4	38
400 Hatchback (RT)	1.4	03/99 → 12/99	14 K2F	Petrol	1396	4	10
400 Hatchback (RT)	1.4	05/99 → 03/00	14 K4F	Petrol	1396	4	13
400 Hatchback (RT)	1.6	05/99 → 03/00	16 K4F	Petrol	1588	4	18
400 Hatchback (RT)	1.6	06/99 → 03/00	D 16 Y2	Petrol	1590	4	22
400 Hatchback (RT)	2.0	05/99 → 03/00	20 T2N	Diesel	1994	4	35
400 Hatchback (RT)	2.0	11/99 → 03/00	20 T2R	Diesel	1994	4	36
400 Hatchback (RT)	2.0	12/99 → 03/00	20 T4H	Petrol	1994	4	38
400 Tourer (XW)	1.6	05/99 → 11/99	D 16 A8	Petrol	1590	4	20
400 Tourer (XW)	1.6	05/99 → 11/99	D 16 Z2	Petrol	1590	4	23
400 Tourer (XW)	1.8	06/99 → 11/99	18 K4K	Petrol	1796	4	25
400 Tourer (XW)	1.8	09/99 → 11/99	XUD 7TE	Diesel	1769	4	27
400 Tourer (XW)	2.0	05/99 → 11/99	20 T4H	Petrol	1994	4	38
600 (RH)	1.9	03/99 → 02/99	F 18 A3	Petrol	1850	4	28
600 (RH)	2.0	12/99 → 02/99	20 T2N	Diesel	1994	4	35
600 (RH)	2.0	07/99 → 02/99	20 T4G	Petrol	1994	4	37
600 (RH)	2.0	08/99 → 02/99	F 20 Z1	Petrol	1997	4	41
600 (RH)	2.0	08/99 → 06/99	F 20 Z2	Petrol	1997	4	42
600 (RH)	2.3	08/99 → 02/99	H 23 A3	Petrol	2259	4	45
800 (XS)	2.0	10/98 → 10/98	20 HD	Petrol	1994	4	30
800 (XS)	2.0	10/98 → 12/99	20 HD M 16	Petrol	1994	4	31
800 (XS)	2.0	10/98 → 12/99	20 HS	Petrol	1994	4	32
800 (XS)	2.0	04/99 → 03/99	20 T4G	Petrol	1994	4	37
800 (XS)	2.0	01/99 → 02/99	20 T4H	Petrol	1994	4	38
800 (XS)	2.0	01/99 → 02/99	T 16	Petrol	1994	4	44
800 (XS)	2.5	04/99 → 02/99	25 K4F	Petrol	2497	6	46
800 (XS)	2.5	01/99 → 02/99	425 SL1RR	Diesel	2500	4	47
800 (XS)	2.5	01/99 → 02/99	492 4 SHIRG	Diesel	2500	4	48
800 (XS)	2.5	10/98 → 12/99	C 25 A1	Petrol	2494	6	49
800 (XS)	2.5	10/98 → 12/99	C 25 A2	Petrol	2494	6	50
800 (XS)	2.7	02/98 → 02/99	C 27 A1	Petrol	2675	6	52
800 (XS)	2.7	02/98 → 12/99	C 27 A2	Petrol	2675	6	53
800 Coupe	2.5	04/99 → 02/99	25 K4F	Petrol	2497	6	46
800 Coupe	2.5	09/99 → 02/99	425 SL1RR	Diesel	2500	4	47
800 Coupe	2.5	09/99 → 02/99	492 4 SHIRG	Diesel	2500	4	48
800 Coupe	2.7	08/99 → 02/99	C 27 A1	Petrol	2675	6	52
800 Hatchback (XS)	2.0	10/98 → 12/99	20 HD	Petrol	1994	4	30
800 Hatchback (XS)	2.0	10/98 → 12/99	20 HD M 16	Petrol	1994	4	31
800 Hatchback (XS)	2.0	10/98 → 12/99	20 HS	Petrol	1994	4	32
800 Hatchback (XS)	2.0	04/99 → 03/99	20 T4G	Petrol	1994	4	37
800 Hatchback (XS)	2.0	08/98 → 02/99	20 T4H	Petrol	1994	4	38
800 Hatchback (XS)	2.0	01/99 → 02/99	T 16	Petrol	1994	4	44
800 Hatchback (XS)	2.5	02/99 → 10/99	25 K4F	Petrol	2497	6	46
800 Hatchback (XS)	2.5	01/99 → 02/99	425 SL1RR	Diesel	2500	4	47
800 Hatchback (XS)	2.5	01/99 → 02/99	492 4 SHIRG	Diesel	2500	4	48
800 Hatchback (XS)	2.5	10/98 → 10/99	C 25 A2	Petrol	2494	6	50
800 Hatchback (XS)	2.7	10/98 → 02/99	C 27 A1	Petrol	2675	6	52
800 Hatchback (XS)	2.7	10/98 → 12/99	C 27 A2	Petrol	2675	6	53
CABRIOLET (XW)	1.4	04/99 → 11/99	14 K4C	Petrol	1396	4	11
CABRIOLET (XW)	1.4	01/99 → 11/99	14 K4D	Petrol	1396	4	12
CABRIOLET (XW)	1.4	01/99 → 11/99	14 K4F	Petrol	1396	4	13
CABRIOLET (XW)	1.6	01/99 → 11/99	16 K4F	Petrol	1588	4	18
CABRIOLET (XW)	1.6	01/99 → 11/99	D 16 A8	Petrol	1590	4	20
CABRIOLET (XW)	1.6	04/99 → 02/99	D 16 Z2	Petrol	1590	4	23
COUPE	1.6	03/99 → 11/99	16 K4F	Petrol	1588	4	18
COUPE	1.8	03/99 → 11/99	18 K4K	Petrol	1796	4	25
MAESTRO	2.0	09/99 → 01/99	BB	Diesel	1996	4	40



Ltr











CC



9

	Ltr				CC		
MINI Convertible (XN)	1.3	09/99→04/99	12 A2E	Petrol	1273	4	6
MINI	1.3	01/99→02/99	12 A2A	Petrol	1273	4	3
MINI	1.3	10/99→11/00	12 A2B	Petrol	1273	4	4
MINI	1.3	01/99→04/99	12 A2D	Petrol	1273	4	5
MINI	1.3	01/99→11/00	12 A2E	Petrol	1273	4	6
MONTEGO Estate (XE)	2.0	10/98→12/99	20 H	Petrol	1994	4	29
MONTEGO Estate (XE)	2.0	01/99→12/99	BB	Diesel	1996	4	40
MONTEGO	2.0	10/98→10/99	20 H	Petrol	1994	4	29
MONTEGO	2.0	10/98→10/99	BB	Diesel	1996	4	40
STREETWISE	1.4	08/00→05/00	14 K4F	Petrol	1396	4	13
STREETWISE	1.4	08/00→05/00	14 K4M	Petrol	1396	4	14
STREETWISE	1.6	01/00→05/00	16 K4F	Petrol	1588	4	18
STREETWISE	1.8	08/00→05/00	18 K4F	Petrol	1796	4	24
STREETWISE	2.0	08/00→05/00	20 T2N	Diesel	1994	4	35

		CC			9			CC			9
11 K2A	Petrol	1119	4	75.00	1						
11 K2D	Petrol	1119	4	75.00	2						
12 A2A	Petrol	1273	4	70.60	3						
12 A2B	Petrol	1273	4		4						
12 A2D	Petrol	1273	4	70.60	5						
12 A2E	Petrol	1273	4	70.60	6						
14 K2A	Petrol	1396	4	75.00	8						
14 K2D	Petrol	1396	4	75.00	9						
14 K2F	Petrol	1396	4	75.00	10						
14 K4C	Petrol	1396	4	75.00	11						
14 K4D	Petrol	1396	4	75.00	12						
14 K4F	Petrol	1396	4	75.00	13						
14 K4M	Petrol	1396	4	75.00	14						
16 H	Petrol	1598	4	76.20	17						
16 K4F	Petrol	1588	4	80.00	18						
18 K4F	Petrol	1796	4	80.00	24						
18 K4K	Petrol	1796	4	80.00	25						
20 H	Petrol	1994	4	84.50	29						
20 HD	Petrol	1994	4	84.50	30						
20 HD M 16	Petrol	1994	4	84.50	31						
20 HS	Petrol	1994	4	84.50	32						
20 K4F	Petrol	1997	6	80.00	33						
20 M4F	Petrol	1994	4	84.50	34						
20 T2N	Diesel	1994	4	84.50	35						
20 T2R	Diesel	1994	4	84.50	36						
20 T4G	Petrol	1994	4	84.45	37						
20 T4H	Petrol	1994	4	84.50	38						
204D2	Diesel	1951	4	84.00	39						
25 K4F	Petrol	2497	6	80.00	46						
425 SL1RR	Diesel	2500	4		47						
492 4 SHIRG	Diesel	2500	4		48						
BB	Diesel	1996	4		40						
C 25 A1	Petrol	2494	6		49						
C 25 A2	Petrol	2494	6		50						
C 27 A1	Petrol	2675	6	87.00	52						
C 27 A2	Petrol	2675	6	87.00	53						
D 16 A7	Petrol	1590	4	75.00	19						
D 16 A8	Petrol	1590	4		20						
D 16 A9	Petrol	1590	4	75.00	21						
D 16 Y2	Petrol	1590	4	75.00	22						
D 16 Z2	Petrol	1590	4	75.00	23						
EV 2	Petrol	1342	4	74.00	7						
F 18 A3	Petrol	1850	4	85.00	28						
F 20 Z1	Petrol	1997	4	85.00	41						
F 20 Z2	Petrol	1997	4	85.00	42						
H 23 A3	Petrol	2259	4	87.00	45						
K 1.8	Petrol	1796	4	80.00	26						
KV 6	Petrol	2497	6	80.00	51						
M 47 R	Diesel	1950	4	84.00	43						
T 16	Petrol	1994	4	84.45	44						
TUD 3	Diesel	1361	4	75.00	15						
TUD 5	Diesel	1527	4	77.00	16						
XUD 7TE	Diesel	1769	4	80.00	27						







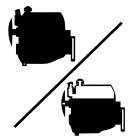

cc

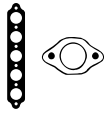

kW/PS

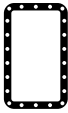

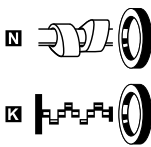
1.1	11 K2A					1	BW5750 (MLS) BW750 (SE) KM5021 0.5mm, (Metal) [113]	DW750 [3] (SE)	ER320 [3][87] ER321 [3][112]
100 111 C/L/S	03/90→12/98	1119	4	75.00	SOHC/OHC	44/60			
1.1	11 K2D					2	BW5750 (MLS) BW750 (SE) KM5021 0.5mm, (Metal) [113]	DW750 [3] (SE)	ER320 [3][87] ER321 [3][112]
100 111 C/L/S	03/90→12/98	1119	4	75.00	SOHC/OHC	44/60			
100 Cabrio 111	04/94→10/97								
200 211	01/98→03/00								
1.3	12 A2A					3	AF470 (Fibre) BK450 (Fibre)	CF474 [13] DK450 [13]	EF464 [3]
Mini 1300	01/91→02/94	1273	4	70.60	OHV	45/61			
1.3	12 A2B					4	AF470 (Fibre) BK450 (Fibre)		EF464 [3]
Mini 1300	10/92→11/00	1273	4			37/50			
1.3	12 A2D					5	AF470 (Fibre) BK450 (Fibre)		EF464 [3]
Mini 1300	01/92→04/95	1273	4	70.60	OHV	39/53			
1.3	12 A2E					6	AF470 (Fibre) BK450 (Fibre)		EF464 [3]
Mini 1300	01/92→11/00	1273	4	70.60	OHV	46/63			
1.3	EV 2					7	BM990 (Graphite)	DM995	EM992 [3] GM990 [3]
200 213 S	09/85→09/89	1342	4	74.00	SOHC/OHC	54/73			
1.4	14 K2A					8	BW5750 (MLS) BW750 (SE) KM5021 0.5mm, (Metal) [113]	DW750 [3] (SE) DW755 [3] (SE)	ER320 [3][87] ER321 [3][112]
100 114 S/L/GTA	03/90→12/98	1396	4	75.00	SOHC/OHC	55/75			
100 Cabrio 114	04/94→10/97								
200 214	09/93→10/95								
1.4	14 K2D					9	BW5750 (MLS) BW750 (SE) KM5021 0.5mm, (Metal) [113]	DW750 [3] (SE) DW755 [3] (SE)	ER320 [3][87] ER321 [3][112]
100 114 S/L/GTA	03/90→12/98	1396	4	75.00	SOHC/OHC	55/75			
100 Cabrio 114	04/94→10/97								
200 214	09/93→10/95								

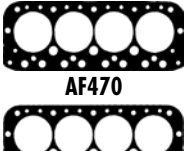
								
HBS005 [5]	LA564 [1] [2] JD656 [1] [2] JD654 [1]	JN736 (Elastomer) JPO65 (SE)	JH5016 [1] [2] JJ404 [8] [7]	HR656 [1]	NB998 [1] 30.00x40.00x7.00mm, FPM Brown NB828 [2] 27.50x39.50x7.00mm, FPM NC065 [2] 30.00x40.00x7.00mm, FPM NB829 [1] 79.95x126.00x11.50mm, FPM			AF470 BK450 BM990 BW5750
HBS005 [5]	LA564 [1] [2] JD656 [1] [2] JD654 [1]	JN736 (Elastomer) JPO65 (SE)	JH5016 [1] [2] JJ404 [8] [7]	HR656 [1]	NC065 [2] 30.00x40.00x7.00mm, FPM NB998 [1] 30.00x40.00x7.00mm, FPM Brown NB828 [2] 27.50x39.50x7.00mm, FPM NB829 [1] 79.95x126.00x11.50mm, FPM			BW750 JA439 JD654 JD656
	JA439	JM302 [4]	HC031 [1]	HR339 [1] (x2)	NA473 [2] 39.70x59.00x9.50mm, NBR NA584 [1] 55.00x70.00x10.00mm, MVQ	HJ013 [8] [5] JR264 [6]		JA439 JD656
	JA439	JM302 [4]	HC031 [1]	HR339 [1] (x2)	NA473 [2] 39.70x59.00x9.50mm, NBR NA584 [1] 55.00x70.00x10.00mm, MVQ	HJ013 [8] [5] JR264 [6]		LA564
	JA439	JM302 [4]	HC031 [1]	HR339 [1] (x2)	NA473 [2] 39.70x59.00x9.50mm, NBR NA584 [1] 55.00x70.00x10.00mm, MVQ	HJ013 [8] [5] JR264 [6]		JM302
	JA439	JM302 [4]	HC031 [1]	HR339 [1] (x2)	NA473 [2] 39.70x59.00x9.50mm, NBR NA584 [1] 55.00x70.00x10.00mm, MVQ	HJ013 [8] [5] JR264 [6]		JN562
		JN562 [4]	JJ309	PA531 [1] (x4) PA528 [1] (x8)	NJ313 [1] 29.00x45.00x8.00mm, ACM NJ381 [1] 31.00x46.00x8.00mm, NBR NJ312 [2] 80.00x100.00x10.00mm, MVQ			JN736 JPO65
HBS005 [5]	LA564 [1] [2] JD656 [1] [2] JD654 [1]	JN736 (Elastomer) JPO65 (SE)	JH5016 [1] [2] JJ404 [8] [7]	HR656 [1]	NB998 [1] 30.00x40.00x7.00mm, FPM Brown NB828 [2] 27.50x39.50x7.00mm, FPM NC065 [2] 30.00x40.00x7.00mm, FPM NB829 [1] 79.95x126.00x11.50mm, FPM			HC031 JH5016
HBS005 [5]	LA564 [1] [2] JD656 [1] [2] JD654 [1]	JN736 (Elastomer) JPO65 (SE)	JH5016 [1] [2] JJ404 [8] [7]	HR656 [1]	NB998 [1] 30.00x40.00x7.00mm, FPM Brown NB828 [2] 27.50x39.50x7.00mm, FPM NC065 [2] 30.00x40.00x7.00mm, FPM NB829 [1] 79.95x126.00x11.50mm, FPM			JJ309 JJ404







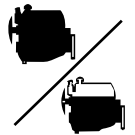

cc

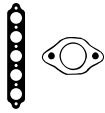

kW/PS

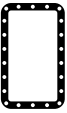

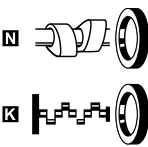
1.4		14 K2F				10					
200 214 i	11/95→03/00	1396	4	75.00	SOHC/OHC	55/75	BW5750 (MLS)	DW756 [3]	ER320 [3][87]	ER321 [3][112]	
400 414	03/96→12/99						BW750 (SE)	(SE)			
							KM5021 0.5mm, (Metal) [113]				
1.4		14 K4C				11					
100 114 16V	03/90→12/98	1396	4	75.00	SOHC/OHC	66-70/90-95	BW5750 (MLS)	DW5757 (MLS)	ER320 [3][87]	ER321 [3][112]	
100 114 GTI 16V	03/90→08/91						BW750 (SE)	DW5759 ☒○ [3]			
200 214 GSi/Si	01/90→10/95						KM5021 0.5mm, (Metal) [113]	(MLS)			
200 214 Si/Gsi	10/89→10/95							DW757 (SE)			
400 414	01/93→04/95							DW759 ☒○ [3]			
400 414 GSi/Si	04/90→04/95							(SE)			
Cabrio 214 1.4	04/90→11/99							(SE)			
1.4		14 K4D				12					
100 114 16V	03/90→12/98	1396	4	75.00	DOHC	66/90	BW5750 (MLS)	DW5757 (MLS)	ER320 [3][87]	ER321 [3][112]	
100 114 GTI 16V	03/90→08/91						BW750 (SE)	DW5759 ☒○ [3]			
200 214 Si/Gsi	10/89→10/95						KM5021 0.5mm, (Metal) [113]	(MLS)			
400 414 GSi/Si	04/90→04/95							DW757 (SE)			
Cabrio 214 1.4	01/92→11/99							DW759 ☒○ [3]			
1.4		14 K4F				13					
25 1.4 16V	10/99→05/05	1396	4	75.00	DOHC	76/103	BW5750 (MLS)	DW5757 (MLS)	ER320 [3][87]	ER321 [3][112]	
45 1.4	02/00→05/05						BW750 (SE)	DW5759 ☒○ [3]			
100 114 GSi	10/94→10/95						KM5021 0.5mm, (Metal) [113]	(MLS)			
100 114 GTI 16V	08/91→12/98							DW757 (SE)			
100 Cabrio 114	03/97→10/98							DW759 ☒○ [3]			
200 214 GSi/Si	12/92→10/95							(SE)			
200 214 Si	11/95→03/00							(SE)			
400 414 GSi/Si	01/93→04/95										
400 414 Si	05/95→03/00										
Cabrio 214 1.4i	01/93→11/99										
Streetwise 1.4	08/03→05/05										
1.4		14 K4M				14					
25 1.4 16V	10/99→05/05	1396	4	75.00	DOHC	62/84	BW5750 (MLS)	DW5757 (MLS)	ER320 [3][87]	ER321 [3][112]	
Streetwise 1.4	08/03→05/05						BW750 (SE)	DW5759 ☒○ [3]			
							KM5021 0.5mm, (Metal) [113]	(MLS)			
								DW757 (SE)			
								DW759 ☒○ [3]			
								(SE)			
1.4		TUD 3 Diesel				15					
100 114 D	10/92→12/94	1361	4	75.00	SOHC/OHC	38/52	BY120 (Fibre), 1.800mm	DS731 ▲			

							
HBS005 [5]	JD655 [1] [2] JD656 [1] [2] JD654 [1]	JP065 (SE)	JH5016 [1] [2] JJ404 [87]	HR656 [5]	N NC065 [2] [1] [101] 30.00x40.00x7.00mm, FPM N NB998 [1] 30.00x40.00x7.00mm, FPM Brown N NB828 [2] 27.50x39.50x7.00mm, FPM N NB829 [1] 79.95x126.00x11.50mm, FPM	!	BW5750 BW750 BY120 JC852 JC852 JC877 JC907 JD311 JD654
HBS005 [5]	JD311 [1] (FPM) JC907 [1] [2] JC877 [1] [2] JC852 [1]	JN963 [4]	JH5016 [1] [2] JJ404 [87]	HR752 [5]	N NC065 [2] [2] 30.00x40.00x7.00mm, FPM N NB998 [2] [1] 30.00x40.00x7.00mm, FPM Brown N NB828 [2] 27.50x39.50x7.00mm, FPM N NB829 [1] 79.95x126.00x11.50mm, FPM		JC877 JC907 JD311 JD654
HBS005 [5]	JC877 [1] JD311 [1] (FPM) JC907 [1] [2] JC852 [1]	JN963 [4]	JH5016 [1] [2] JJ404 [87]	HR752 [5]	N NB998 [1] 30.00x40.00x7.00mm, FPM Brown N NB828 [2] 27.50x39.50x7.00mm, FPM N NC065 [2] 30.00x40.00x7.00mm, FPM N NB829 [1] 79.95x126.00x11.50mm, FPM		JD655 JD656 JN758
HBS005 [5]	JD311 [1] (FPM) JC907 [1] [2] JC877 [1] [2] JC852 [1]	JN963 [4]	JH5016 [1] [2] JJ404 [87]	HR752 [5]	N NC065 [2] [2] 30.00x40.00x7.00mm, FPM N NB998 [2] [1] 30.00x40.00x7.00mm, FPM Brown N NB828 [2] 27.50x39.50x7.00mm, FPM N NB829 [1] 79.95x126.00x11.50mm, FPM		JN963 JP065 JH5016
HBS005 [5]	JD311 [1] (FPM) JC907 [1] [2] JC877 [1] [2] JC852 [1]	JN963 [4]	JH5016 [1] [2] JJ404 [87]	HR752 [5]	N NC065 [2] [2] 30.00x40.00x7.00mm, FPM N NB998 [2] [1] 30.00x40.00x7.00mm, FPM Brown N NB828 [2] 27.50x39.50x7.00mm, FPM N NB829 [1] 79.95x126.00x11.50mm, FPM		JJ404
HBS082 [22] M10x1.50x185.00mm (x10)		JN758 [4]		HR642 [5]	N NF870 [2] 42.00x66.00x6.00mm, FPM/ACM N NF857 [1] 85.00x105.00x9.00mm, FPM/ACM	HR564 [55] [5]	



cc



kw/PS

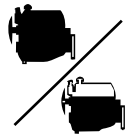

1.5		TUD 5 Diesel				16		BY150 (Fibre), 1.750mm		DY150 ▲ [3]	
100 115 D	12/94→12/98	1527	4	77.00	SOHC/OHC	42/57					
1.6		16 H				17		BL380 (Fibre)		DL381	
200 216	03/85→09/89	1598	4	76.20	SOHC/OHC	61-75/					
200 216 Vitesse	03/85→09/89					83-102					
1.6		16 K4F				18		BW5750 (MLS) BW750 (SE) KM5021 0.5mm, (Metal) [113]		DW5757 (MLS) DW5759 ☒○ [3] (MLS) DW757 (SE) DW759 ☒○ [3] (SE)	
25 1.6 16V	10/99→05/05	1588	4	80.00	DOHC	80-86/					ER322 [3]
45 1.6	02/00→05/05					109-117					
200 216 Si	11/95→03/00										
400 416 Si	05/95→03/00										
Cabrio 216 1.6i	01/96→11/99										
Coupe 1.6 16 V	03/96→11/99										
Streetwise 1.6	01/04→05/05										
1.6		D 16 A7				19		BV350 (Graphite)		DV351 [3] 01/92→ CG7900 01/95→	
200 216 GSi	10/89→10/95	1590	4	75.00	SOHC/OHC	85/116					
400 416 GSi/GSE	04/90→04/95										
1.6		D 16 A8				20		BS880 (Graphite)		DS881 [3] GS881 [3]	
200 216 GTi	09/90→10/95	1590	4		DOHC	90/122					
200 Coupe 216	10/92→06/99										
400 1.6 i	05/94→11/98										
400 416 GTI	04/90→04/95										
Cabrio 216 1.6i	01/92→11/99										
1.6		D 16 A9				21		BS880 (Graphite)		DS881 [3] GS881 [3]	
200 216 GTi	09/90→10/95	1590	4	75.00	DOHC	96/131					
400 416 GTI/GTE	04/90→04/95										
1.6		D 16 Y2				22		BV020 (MLS)		CG7900 EV020	
400 416 Si	05/95→03/00	1590	4	75.00	SOHC/OHC	83/113					
1.6		D 16 Z2				23		BV350 (Graphite)		DV351 [3]	
200 216 GSi	10/89→10/95	1590	4	75.00	SOHC/OHC	82/112					
400 1.6 i	05/94→11/98										
400 416 GSi	04/90→04/95										
Cabrio 1.6	04/90→02/96										
1.8		18 K4F				24		BW5750 (MLS) BW750 (SE) KM5021 0.5mm, (Metal) [113]		DW5757 (MLS) DW5759 ☒○ [3] (MLS) DW757 (SE) DW759 ☒○ [3] (SE)	
25 1.8 16V	10/99→05/05	1796	4	80.00	DOHC	85-88/					ER322 [3]
45 1.8	02/00→05/05					116-120					
200 218 Si	08/99→03/00										
Streetwise 1.8	08/03→05/05										

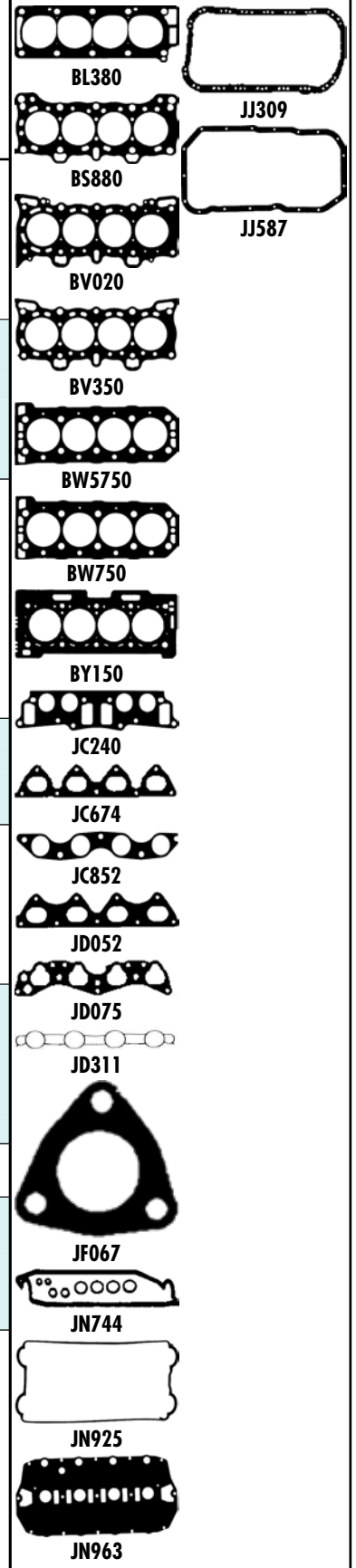
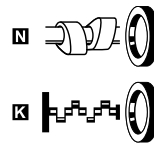
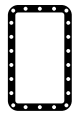
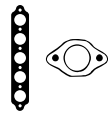

HBS113 [22]
M11x1.50x185.00mm (x10)

JF067

JJ587
PB907
14.00x21.00x2.000mm

HR642

NF870 [2]
42.00x66.00x6.00mm, FPM/ACM
NF850 [1]
85.00x105.00x8.00mm, FPM
NF857 [1]
85.00x105.00x9.00mm, FPM/ACM

JC240

NB775 [1][2]
40.00x52.00x7.00mm, FPM
NB586 [2]
30.00x40.00x7.00mm, MVQ
NB772 [1]
88.90x104.80x9.52mm, MVQ

HBS005 [5]

JD311 (FPM)
JC852

JN963 [4]

HR752

NC065 (x2)[2]
30.00x40.00x7.00mm, FPM
NB998 (x2)[1]
30.00x40.00x7.00mm, FPM
Brown
NB828 [2]
27.50x39.50x7.00mm, FPM
NB829 [1]
79.95x126.00x11.50mm, FPM

JD052
JF024 (x2)
JE625

JN744 [4]

PB355 (x8)
PB356 (x8)

NJ313 [1]
29.00x45.00x8.00mm, ACM
NJ312 [2]
80.00x100.00x10.00mm, MVQ

JC674

JN925 [4]

JJ309

PB156 (x8)

NJ254 [1]
27.00x43.00x9.00mm, NBR
NJ381 [1]
31.00x46.00x8.00mm, NBR
NJ312 [2]
80.00x100.00x10.00mm, MVQ

JC674

JN925 [4]

JJ309

PB156 (x8)

NJ254 [1]
27.00x43.00x9.00mm, NBR
NJ381 [1]
31.00x46.00x8.00mm, NBR
NJ312 [2]
80.00x100.00x10.00mm, MVQ

JD5775

NJ313 [1]
29.00x45.00x8.00mm, ACM

JD075
JD052
JE625
JF024 (x2)

JN744 [4]

PB355
PB356

NJ313 [1]
29.00x45.00x8.00mm, ACM
NK159 [1][2]
40.00x52.00x7.00mm, FPM

HBS005 [5]

JD311 (FPM)
JC852

JN963 [4]

HR752

NC065 (x2)[2]
30.00x40.00x7.00mm, FPM
NB998 (x2)[1]
30.00x40.00x7.00mm, FPM
Brown
NB828 [2]
27.50x39.50x7.00mm, FPM
NB829 [1]
79.95x126.00x11.50mm, FPM

ROVER



cc



kW/PS

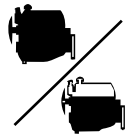

1.8		18 K4K				25					
25 1.8 16V	02/00→05/05	1796	4	80.00	DOHC	107-110/ 146-150	BW5750 (MLS) BW750 (SE) KM5021 0.5mm, (Metal) [113]	DW754 [3] (SE)	ER322 [3]		
200 218 K Vi	11/95→03/00										
400 1.8 i	06/96→11/98										
Coupe 1.8 16 V	03/96→11/99										
1.8		K 1.8				26					
75 1.8 16V	02/99→05/05	1796	4	80.00	DOHC	88/120	BW5750 (MLS) BW750 (SE) KM5021 0.5mm, (Metal) [113]	DW5757 (MLS) DW5759 ☒○ [3] (MLS) DW757 (SE) DW759 ☒○ [3] (SE)	ER322 [3]		
1.8		XUD 7TE Diesel				27					
200 218 TD	09/91→10/95	1769	4	80.00	SOHC/OHC	65/88	BR780 (Fibre), 1.650mm, 2 Notches ☒-0.650→0.770mm BR790 (Fibre), 1.800mm, 3 Notches ☒-0.770→0.820mm	DJ720 ▲	EL890 [3] GJ720 ▲		
400 1.8 TD	09/93→11/98										
400 418 TD	09/91→04/95										
1.9		F 18 A3				28					
600 618 i/Si	03/96→02/99	1850	4	85.00	SOHC/OHC	85/115	BS700 (MLS)	DS700 [3]			
2.0		20 H				29					
Montego 2.0 Gi	10/88→12/93	1994	4	84.50	SOHC/OHC	75-86/ 102-117					
Montego 2.0 i	12/90→10/94										
2.0		20 HD				30					
800 820 16V	10/86→10/88	1994	4	84.50		103/140	BS790 (Fibre)	DS791 [3]	EM682 [3]		
800 820 i/Si	10/88→12/91										
2.0		20 HD M 16				31					
800 330-30 ANW	10/88→12/91	1994	4	84.50	DOHC	98/133	BS790 (Fibre)	DS791 [3]	EM682 [3]		
800 330-30 N	10/88→12/91										

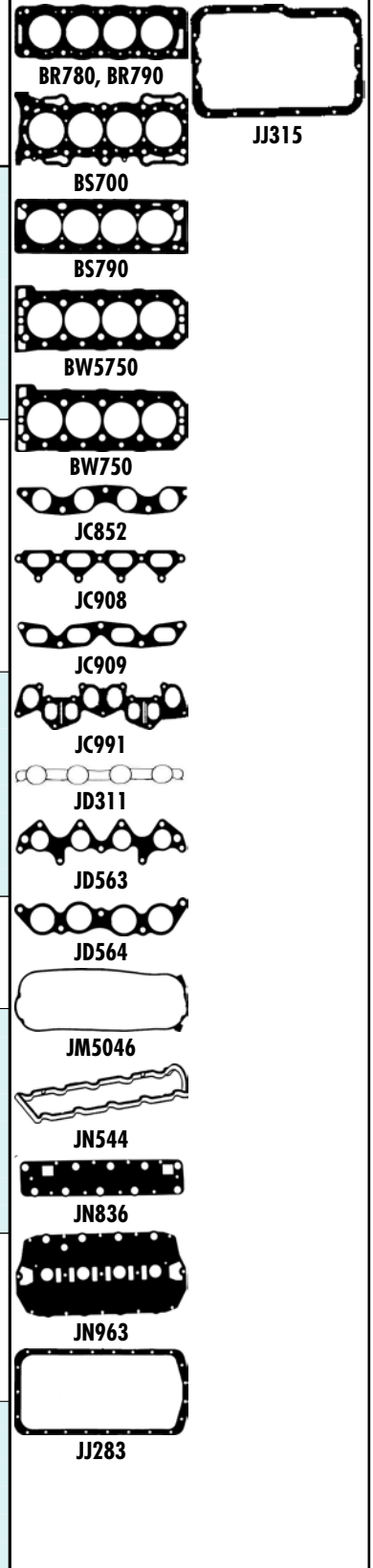
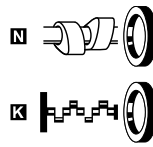
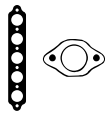

HBS005 [5]	JD564 [1] [2] JD563 [1] [2] JC852 [1]	JN963 [4]		HR752 [1]	<input checked="" type="checkbox"/> NCO65 [1] [2] (x2) [2] 30.00x40.00x7.00mm, FPM <input checked="" type="checkbox"/> NB998 [1] (x2) [1] 30.00x40.00x7.00mm, FPM Brown <input checked="" type="checkbox"/> NB828 [1] [2] 27.50x39.50x7.00mm, FPM <input checked="" type="checkbox"/> NB829 [1] [1] 79.95x126.00x11.50mm, FPM	
HBS005 [5]	JD311 [1] (FPM) JC852 [1]	JN963 [4]		HR752 [1]	<input checked="" type="checkbox"/> NCO65 [1] (x2) [2] 30.00x40.00x7.00mm, FPM <input checked="" type="checkbox"/> NB998 [1] (x2) [1] 30.00x40.00x7.00mm, FPM Brown <input checked="" type="checkbox"/> NB828 [1] [2] 27.50x39.50x7.00mm, FPM <input checked="" type="checkbox"/> NB829 [1] [1] 79.95x126.00x11.50mm, FPM	
HBS084 [22] M12x1.50x120.00mm (x10)	JC991	JN544 [4]	JJ283 [62] =PA349 22.00x16.00x2.000mm	HR569 [1]	<input checked="" type="checkbox"/> NF746 [2] 36.00x50.00x7.00mm, ACM <input checked="" type="checkbox"/> NF841 [1] [2] 35.00x50.00x8.00mm, FPM <input checked="" type="checkbox"/> NA5191 [1] [2] 42.00x62.00x7.00mm, PTFE <input checked="" type="checkbox"/> NA5192 [1] [1] 90.00x110.00x7.00mm, PTFE	KA611 [15]
HBS284 [22] M12x1.50x198.00mm (x1)		JM5046 (Elastomer)			<input checked="" type="checkbox"/> NJ134 [1] [2] 28.00x42.00x8.00mm, MVQ <input checked="" type="checkbox"/> NA5242 [1] [1] 40.00x52.00x7.00mm, FPM	
			JJ315		<input checked="" type="checkbox"/> NB775 [1] [2] 40.00x52.00x7.00mm, FPM <input checked="" type="checkbox"/> NB773 [1] [1] 46.00x60.00x7.00mm, FPM <input checked="" type="checkbox"/> NB774 [1] [2] 35.00x45.00x8.00mm, FPM <input checked="" type="checkbox"/> NB772 [1] [1] 88.90x104.80x9.52mm, MVQ	
HBS305 [22] M11x1.50x162.00mm (x10)	JC908 [1] JC909 [1]	JN836 [4]	JJ315		<input checked="" type="checkbox"/> NB775 [1] [2] 40.00x52.00x7.00mm, FPM <input checked="" type="checkbox"/> NB774 [1] [2] 35.00x45.00x8.00mm, FPM <input checked="" type="checkbox"/> NB772 [1] [1] 88.90x104.80x9.52mm, MVQ	
HBS305 [22] M11x1.50x162.00mm (x10)	JC908 [1] JC909 [1]	JN836 [4]	JJ315		<input checked="" type="checkbox"/> NB775 [1] [2] 40.00x52.00x7.00mm, FPM <input checked="" type="checkbox"/> NB774 [1] [2] 35.00x45.00x8.00mm, FPM <input checked="" type="checkbox"/> NB772 [1] [1] 88.90x104.80x9.52mm, MVQ	

ROVER



cc



kW/PS

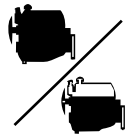

2.0	20 HS						32	BS790 (Fibre)		EM682 [3]
800 820 SE/SI 800 820e	10/86→12/91 10/86→10/91	1994	4	84.50	DOHC	88/120				
2.0	20 K4F						33	AA5920 (MLS) (x2) KM5002 (Metal)	CA5920 [3]	EA5920
45 2.0 V6 75 2.0 V6	02/00→05/05 02/99→05/05	1997	6	80.00	DOHC, V	110/150				
2.0	20 M4F						34	AB5400 (MLS) BS790 (Fibre)		EB5400
200 220 GTi 400 420	09/91→10/95 02/92→04/95	1994	4	84.50	DOHC	103/140				
2.0	20 T2N Diesel						35	BZ440 (MLS), 1.050mm, 1 Hole BZ450 (MLS), 1.200mm, 2 Holes BZ460 (MLS), 1.350mm, 3 Holes	DZ440 ▲ [3]	
25 2.0 iDT 45 2.0 iDT 200 220 SDi 400 420 Di 600 620 Sdi Streetwise 2.0T	10/99→05/05 02/00→05/05 11/95→03/00 05/95→03/00 12/94→02/99 08/03→05/05	1994	4	84.50	SOHC/OHC	74-83/ 101-113				
2.0	20 T2R Diesel						36	BZ440 (MLS), 1.050mm, 1 Hole 04/96→ BZ450 (MLS), 1.200mm, 2 Holes 04/96→ BZ460 (MLS), 1.350mm, 3 Holes 04/96→	DZ440 ▲ [3] 04/96→	
200 220 D/SD 400 420 D	11/95→03/00 11/95→03/00	1994	4	84.50	SOHC/OHC	63/86				
2.0	20 T4G						37	AB5400 (MLS) BS860 (Fibre)	DS863 [3]	EB5400
200 220 Turbo 400 420 Turbo 600 620 Ti 800 820 Sport	10/92→06/99 01/93→04/95 07/94→02/99 04/94→03/96	1994	4	84.45		145-147/ 197-200				

HBS305 [22] M11x1.50x162.00mm (x10)	JC908 [1] JC909 [1]	JN836 [4]	JJ315	HR339 [1] (x4) Eng.20H/E83/104397→ Eng.20H/E85/101990→ →Eng.20H/E84/100120 →Eng.20H/E86/100281 HR802 [1] Eng.20H/E83/104398→ Eng.20H/E84/100121→ Eng.20H/E85/101991→ Eng.20H/E86/100282→	NB775 (x4) [1] [2] 40.00x52.00x7.00mm, FPM NB774 [2] [2] 35.00x45.00x8.00mm, FPM NB772 [1] [1] 88.90x104.80x9.52mm, MVQ	 AA5920	 JJ315
HBS423 [5] M9x1.25x200.00mm (x16)	JA5079 [1] (x2) JA5078 [1] (x2)	JM5035 (x2) (SE)	HR5031 [1] (x2)	NC065 [1] (x2) [2] 30.00x40.00x7.00mm, FPM NB998 [1] (x4) [1] 30.00x40.00x7.00mm, FPM Brown NA5083 [1] [2] 32.50x45.00x7.70mm, FPM LK5000 [1] [7] 89.00x116.00x10.20mm, FPM	 AB5400	 BS790	 BS860
HBS305 [22] M11x1.50x162.00mm (x10)	JC909 [1]	JM5045 [1] (Elastomer) LB161 [1] (SE) LB536 [1] (Elastomer)		NB775 [1] [2] 40.00x52.00x7.00mm, FPM NB774 [2] [2] 35.00x45.00x8.00mm, FPM NB843 [1] [1] 128.00x145.00x28.00mm, FPM	 BZ440, BZ450, BZ460	 JA5078	 JA5079
HBS005 [5] HBS282 [22] M11x1.50x230.00mm (x10)	JD657	JP097 [4]	JH5012	HR5051 [1]	NB775 [1] [2] 40.00x52.00x7.00mm, FPM NB774 [2] [2] 35.00x45.00x8.00mm, FPM LK5002 [1] [7] 136.00x153.00x21.000mm, PTFE NB843 [1] [1] 128.00x145.00x28.00mm, FPM	 JC908	 JC909
HBS282 [22] M11x1.50x230.00mm (x10) 04/96→	JD657 04/96→	JP097 [4] 04/96→	JH5012 04/96→	HR5051 [1] 04/96→	NB775 [1] [2] 40.00x52.00x7.00mm, FPM 04/96→ NB774 [2] [2] 35.00x45.00x8.00mm, FPM 04/96→ LK5002 [1] [7] 136.00x153.00x21.000mm, PTFE 04/96→ NB843 [1] [1] 128.00x145.00x28.00mm, FPM 04/96→	 JD657	 JM5035
HBS305 [22] M11x1.50x162.00mm (x10)	JC909 [1]	JM5045 [1] (Elastomer) LB161 [1] (SE) LB536 [1] (Elastomer)		NB775 [1] [2] 40.00x52.00x7.00mm, FPM NB774 [2] [2] 35.00x45.00x8.00mm, FPM NB843 [1] [1] 128.00x145.00x28.00mm, FPM	 JM5045	 JN836	 JP097
HBS305 [22] M11x1.50x162.00mm (x10)	JC909 [1]	JM5045 [1] (Elastomer) LB161 [1] (SE) LB536 [1] (Elastomer)		NB775 [1] [2] 40.00x52.00x7.00mm, FPM NB774 [2] [2] 35.00x45.00x8.00mm, FPM NB843 [1] [1] 128.00x145.00x28.00mm, FPM	 JM5035	 LB161	 LB536
HBS305 [22] M11x1.50x162.00mm (x10)	JC909 [1]	JM5045 [1] (Elastomer) LB161 [1] (SE) LB536 [1] (Elastomer)		NB775 [1] [2] 40.00x52.00x7.00mm, FPM NB774 [2] [2] 35.00x45.00x8.00mm, FPM NB843 [1] [1] 128.00x145.00x28.00mm, FPM	 JM5045	 JH5012	

ROVER



cc



kW/PS

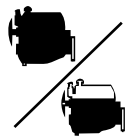

2.0	20 T4H					38	AB5400 (MLS) BS790 (Fibre)		EB5400
200 220 GSi	05/94→06/99	1994	4	84.50	DOHC	100/136			
200 220 GTi	01/93→10/95								
400 2.0 i	05/94→11/98								
400 420	01/93→04/95								
400 420 Si Lux	12/95→03/00								
800 2.0	08/87→09/88								
800 820 I/SI	01/92→02/99								
2.0	204D2 Diesel					39	BZ690 (MLS), 1.450mm, 1 Hole BZ700 (MLS), 1.550mm, 2 Holes BZ710 (MLS), 1.650mm, 3 Holes	DZ690 ▲ [13]	EZ690 [3]
75 2.0 CDTi	02/03→05/05	1951	4	84.00		85-96/ 116-131			
2.0	BB Diesel					40	BP880 (Fibre)		EM685 [3]
Maestro 2.0 TD	09/90→01/95	1996	4			60/82			
Montego 2.0 D	10/88→10/95								
Montego 2.0 T	01/93→12/93								
2.0	F 20 Z1					41	BS700 (MLS)	DS700 [3]	
600 620 Si	08/93→02/99	1997	4	85.00	SOHC/OHC	96/131			
2.0	F 20 Z2					42	BS700 (MLS)	DS700 [3]	
600 620 i	08/93→06/96	1997	4	85.00		85/115			
2.0	M 47 R Diesel					43	BZ690 (MLS), 1.450mm, 1 Hole BZ700 (MLS), 1.550mm, 2 Holes BZ710 (MLS), 1.650mm, 3 Holes	DZ690 ▲ [13]	EZ690 [3]
75 2.0 CDT	02/99→05/05	1950	4	84.00	DOHC	85/116			
2.0	T 16					44	AB5400 (MLS) BS860 (Fibre)	DS863 [3]	EB5400
800 330-30 NW	01/92→02/99	1994	4	84.45	DOHC	100-147/ 136-200			
800 820 T	01/92→02/99								
2.3	H 23 A3					45	BV030 (MLS)	DV030 [3]	GV030
600 623 Si	08/93→02/99	2259	4	87.00	DOHC	116/158			
2.5	25 K4F					46	AA5920 (MLS) (x2) AB5080 (SE) (x2) KM5002 (Metal)		EA5920
75 2.5 V6	10/01→05/05	2497	6	80.00	DOHC, V	129-130/ 175-177			
800 2.5	02/96→10/98								
800 2.5 Si	02/96→10/98								
800 M 200.10/C	04/96→02/99								
800 M 200.12/C	04/96→02/99								
2.5	425 SL1RR Diesel					47	AY400 (MLS), 1.420mm, 0 Notches BK570 (Fibre), 1.420mm, 0 Notches AY410 (MLS), 1.520mm, 2 Notches BP260 (Fibre), 1.520mm, 2 Notches AY420 (MLS), 1.620mm, 1 Notch BK580 (Fibre), 1.620mm, 1 Notch	DK570 ▲	GK572 ▲ [18]
800 330-30 AN	01/90→02/99	2500	4			87/118			
800 825	01/92→02/99								
800 825 SD	09/93→02/99								

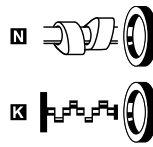
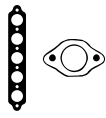

HBS305 [22] M11x1.50x162.00mm (x10)	JC909 [E]	JM5045 [I] (Elastomer) LB161 [E] (SE) LB536 [E] (Elastomer)			NB775 [1][2] 40.00x52.00x7.00mm, FPM NB774 [E] [2] 35.00x45.00x8.00mm, FPM NB843 [I] [1] 128.00x145.00x28.00mm, FPM	
HBS121 [22] M12x1.50x146.50mm (x10)	HA5006 [I][E] JD5183 [E] (x2)	JM5076 [I] (Elastomer)	JH5032 [E] JH5033 [E]	PA5016 (x16) HR5045 [E]	NA5103 [E] [2] 55.00x68.00x8.00mm, PTFE NA5104 [E] [1] 90.00x110.00x12.00mm, PTFE	
			JJ315	HR625 [E]	NB773 [1] 46.00x60.00x7.00mm, FPM NB775 [1][2] 40.00x52.00x7.00mm, FPM NB774 [E] [2] 35.00x45.00x8.00mm, FPM NB772 [E] [1] 88.90x104.80x9.52mm, MVQ	
HBS284 [22] M12x1.50x198.00mm (x1)		JM5046 [I] (Elastomer)			NJ134 [E] [1][2] 28.00x42.00x8.00mm, MVQ NA5242 [E] [1] 40.00x52.00x7.00mm, FPM	
HBS284 [22] M12x1.50x198.00mm (x1)		JM5046 [I] (Elastomer)			NJ134 [E] [1][2] 28.00x42.00x8.00mm, MVQ NA5242 [E] [1] 40.00x52.00x7.00mm, FPM	
HBS121 [22] M12x1.50x146.50mm (x10)	JD5108 [I] HA5006 [I][E] JD5183 [E] (x2)	JM5076 [I] (Elastomer)	JH5032 [E] JH5033 [E]	PA5016 HR5045 [E]	NA5103 [E] [2] 55.00x68.00x8.00mm, PTFE NA5104 [E] [1] 90.00x110.00x12.00mm, PTFE	
HBS305 [22] M11x1.50x162.00mm (x10)	JC909 [E]	JM5045 [I] (Elastomer) LB161 [E] (SE) LB536 [E] (Elastomer)			NB775 [1][2] 40.00x52.00x7.00mm, FPM NB774 [E] [2] 35.00x45.00x8.00mm, FPM NB843 [I] [1] 128.00x145.00x28.00mm, FPM	
HBS284 [22] M12x1.50x198.00mm (x1)	JC883 [I] JC884 [E] [E]JF024 (x2)			PB354 [E] (x8) PB353 [I] (x8)	NJ134 [E] [1][2] 28.00x42.00x8.00mm, MVQ NA5242 [E] [1] 40.00x52.00x7.00mm, FPM	
HBS423 [5] M9x1.25x200.00mm (x16)	JA5079 [I] (x2) JD441 [I][E] (x2) JA5078 [E] (x2)	JM5035 (x2) (SE)		HR5031 [E] (x2)	NC065 [E] (x2) [2] 30.00x40.00x7.00mm, FPM NB998 [E] (x4) [1] 30.00x40.00x7.00mm, FPM Brown NA5083 [E] [2] 32.50x45.00x7.70mm, FPM LK5000 [E] [1][7] 89.00x116.00x10.20mm, FPM	
HBS108 [12] M14x1.75x137.00mm (x10)	JC928 [I] JD5144 JD025 [E] [E]JF123					

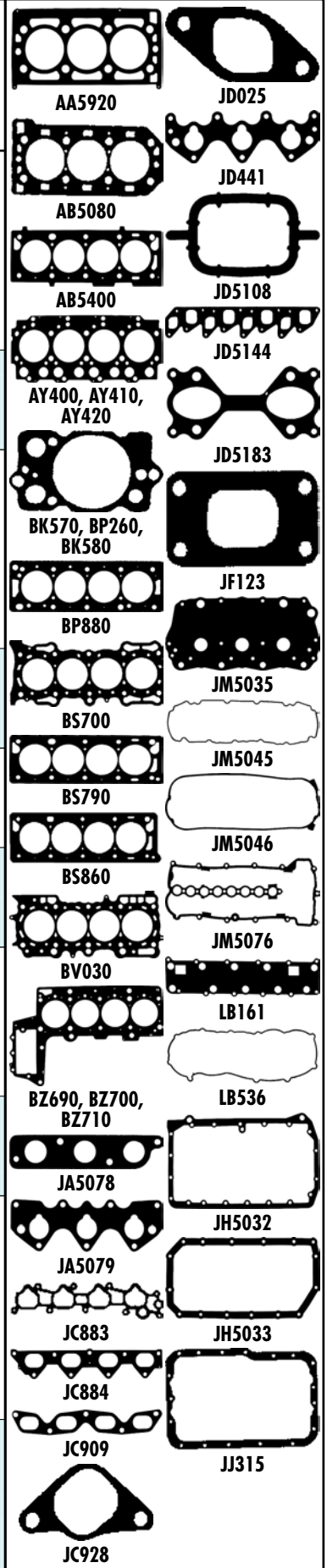

ROVER



cc



kW/PS

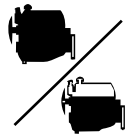

2.5		492 4 SHIRG Diesel					48		DK570 ▲	GK572 ▲ [18]
800 330-30 AN	01/90→02/99	2500	4				87/118	AY400 (MLS), 1.420mm, 0 Notches BK570 (Fibre), 1.420mm, 0 Notches AY410 (MLS), 1.520mm, 2 Notches BP260 (Fibre), 1.520mm, 2 Notches AY420 (MLS), 1.620mm, 1 Notch BK580 (Fibre), 1.620mm, 1 Notch		
800 825	01/92→02/99									
800 825 SD	09/93→02/99									
2.5		C 25 A1					49			
800 825 SI	10/86→12/91	2494	6				110/150	BP640 (Graphite) (x2)		
2.5		C 25 A2					50			
800 2.5	10/88→10/91	2494	6				110-127/ 150-173	BP640 (Graphite) (x2) BR650 (Graphite)		
800 825 SI	10/86→12/91									
2.5		KV 6					51		CA5920 [3]	EA5920
75 2.5 V6	02/99→05/05	2497	6	80.00	DOHC, V		129/175	AA5920 (MLS) (x2) KM5002 (Metal)		
2.7		C 27 A1					52		DR650 [3]	
800 827 24V	01/92→02/99	2675	6	87.00	SOHC/OHC, V		124/169	BR650 (Graphite) (x2)		
800 827 SI	02/88→02/99									
800 827 Vitesse	10/88→12/91									
2.7		C 27 A2					53		DR650 [3]	
800 827	10/88→12/91	2675	6	87.00	SOHC/OHC, V		130/177	BR650 (Graphite)		
800 827 SI	02/88→12/91									

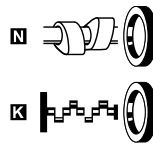
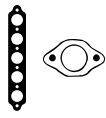

HBS108 [12]
M14x1.75x137.00mm (x10)

JC928 ■
JD5144 ■
JD025 ■
⊙ **JF123**

JC687 ■ (x2)
⊙ **JE625** ■

JC687 ■ (x2)
⊙ **JE625** ■

HBS423 [5]
M9x1.25x200.00mm (x16)

JA5079 ■ (x2)
JA5078 ■ (x2)

JC791 ■ (x2)
JC687 ■ (x2)
⊙ **JE625**
⊙ **JF021** ■

JC791 ■ (x2)
JC687 ■ (x2)
⊙ **JE625**
⊙ **JF021** ■

JN633 (x2)[4]

JN633 (x2)[4]

JM5035 (x2)
(SE)

JN633 (x2)[4]

JN633 (x2)[4]

JJ364

JJ364

JJ364

JJ364

PA528 ■ (x12)

PA528 ■ (x12)

PA528 (x12)

PA528 (x12)

■ **NJ933** (x2)[2]
35.00x50.00x8.00mm, FPM
■ **NK023** ■ [2]
41.00x56.00x8.00mm, ACM
■ **NJ675** ■ [1]
80.00x98.00x10.00mm, NBR

■ **NJ933** (x2)[2]
35.00x50.00x8.00mm, FPM
■ **NK023** ■ [2]
41.00x56.00x8.00mm, ACM
■ **NJ675** ■ [1]
80.00x98.00x10.00mm, NBR

■ **NC065** ■ (x2)[2]
30.00x40.00x7.00mm, FPM
■ **NB998** ■ (x4)[1]
30.00x40.00x7.00mm, FPM
Brown
■ **NA5083** ■ [2]
32.50x45.00x7.70mm, FPM
■ **LK5000** ■ [1][7]
89.00x116.00x10.20mm, FPM

■ **NJ933** (x2)[2]
35.00x50.00x8.00mm, FPM
■ **NK023** ■ [2]
41.00x56.00x8.00mm, ACM
■ **NJ675** ■ [1]
80.00x98.00x10.00mm, NBR

■ **NJ933** (x2)[2]
35.00x50.00x8.00mm, FPM
■ **NK023** ■ [2]
41.00x56.00x8.00mm, ACM
■ **NJ675** ■ [1]
80.00x98.00x10.00mm, NBR



AA5920

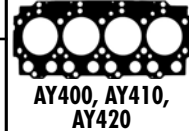

AY400, AY410, AY420



BK570, BP260, BK580



BP640

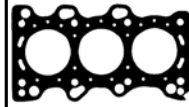

BR650



JA5078



JA5079



JC687

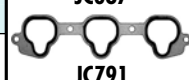

JC791



JC928



JD025

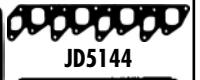

JD5144



JF123



JM5035



JN633



JJ364



Ltr







CC



9

Model	Ltr	Year Range	Engine	Fuel	CC	Seats	Price
9-3 (YS3D)	2.0	10/99→09/00	B204E	Petrol	1985	4	24
9-3 (YS3D)	2.0	02/99→09/00	B204I	Petrol	1985	4	25
9-3 (YS3D)	2.0	02/99→09/00	B204L	Petrol	1985	4	26
9-3 (YS3D)	2.0	02/99→09/00	B204R	Petrol	1985	4	27
9-3 (YS3D)	2.0	01/00→09/00	B205E	Petrol	1985	4	28
9-3 (YS3D)	2.0	01/00→09/00	B205E	Flexfuel	1985	4	28
9-3 (YS3D)	2.0	02/99→09/00	B205L	Petrol	1985	4	29
9-3 (YS3D)	2.0	10/99→09/00	B205R	Petrol	1985	4	30
9-3 (YS3D)	2.2	02/99→09/00	D223L	Diesel	2171	4	39
9-3 (YS3D)	2.2	02/99→11/00	X 22 DTH	Diesel	2171	4	40
9-3 (YS3D)	2.3	02/99→09/00	B234I	Petrol	2290	4	42
9-3 (YS3D)	2.3	10/99→09/00	B235R	Petrol	2290	4	47
9-3 (YS3D)	2.3	10/99→09/00	B235R	Flexfuel	2290	4	47
9-3 (YS3F)	1.8	01/00→	Z 18 XE	Petrol	1796	4	2
9-3 (YS3F)	1.9	12/00→	A 19 DTR	Diesel	1910	4	3
9-3 (YS3F)	1.9	09/00→	Z 19 DT	Diesel	1910	4	4
9-3 (YS3F)	1.9	09/00→	Z 19 DTH	Diesel	1910	4	5
9-3 (YS3F)	1.9	12/00→	Z 19 DTR	Diesel	1910	4	7
9-3 (YS3F)	2.0	01/00→	A 20 NFT	Petrol	1998	4	10
9-3 (YS3F)	2.0	01/00→	A 20 NFT	Flexfuel	1998	4	10
9-3 (YS3F)	2.0	01/00→	A 20 NFT	Bi-Fuel	1998	4	10
9-3 (YS3F)	2.0	09/00→	B207E	Petrol	1998	4	32
9-3 (YS3F)	2.0	09/00→	B207E	Flexfuel	1998	4	32
9-3 (YS3F)	2.0	01/00→	B207G	Petrol	1998	4	33
9-3 (YS3F)	2.0	01/00→	B207H	Flexfuel	1998	4	34
9-3 (YS3F)	2.0	01/00→	B207H	Bi-Fuel	1998	4	34
9-3 (YS3F)	2.0	09/00→	B207L	Petrol	1998	4	35
9-3 (YS3F)	2.0	09/00→	B207L	Flexfuel	1998	4	35
9-3 (YS3F)	2.0	09/00→	B207R	Petrol	1998	4	36
9-3 (YS3F)	2.0	09/00→	B207R	Flexfuel	1998	4	36
9-3 (YS3F)	2.0	09/00→	B207R	Bi-Fuel	1998	4	36
9-3 (YS3F)	2.2	09/00→	D223L	Diesel	2171	4	39
9-3 Cabriolet (YS3D)	2.0	10/99→08/00	B204E	Petrol	1985	4	24
9-3 Cabriolet (YS3D)	2.0	02/99→08/00	B204I	Petrol	1985	4	25
9-3 Cabriolet (YS3D)	2.0	02/99→08/00	B204L	Petrol	1985	4	26
9-3 Cabriolet (YS3D)	2.0	02/99→08/00	B204R	Petrol	1985	4	27
9-3 Cabriolet (YS3D)	2.0	01/00→08/00	B205E	Petrol	1985	4	28
9-3 Cabriolet (YS3D)	2.0	01/00→08/00	B205E	Flexfuel	1985	4	28
9-3 Cabriolet (YS3D)	2.0	02/99→08/00	B205L	Petrol	1985	4	29
9-3 Cabriolet (YS3D)	2.0	10/99→08/00	B205R	Petrol	1985	4	30
9-3 Cabriolet (YS3D)	2.3	02/99→08/00	B234I	Petrol	2290	4	42
9-3 Cabriolet (YS3D)	2.3	09/99→08/00	B235R	Petrol	2290	4	47
9-3 Cabriolet (YS3D)	2.3	09/99→08/00	B235R	Flexfuel	2290	4	47
9-3 Convertible (YS3F)	1.9	12/00→	A 19 DTR	Diesel	1910	4	3
9-3 Convertible (YS3F)	1.9	01/00→	Z 19 DTH	Diesel	1910	4	5
9-3 Convertible (YS3F)	1.9	12/00→	Z 19 DTR	Diesel	1910	4	7
9-3 Convertible (YS3F)	2.0	01/01→	A 20 NFT	Petrol	1998	4	10
9-3 Convertible (YS3F)	2.0	01/01→	A 20 NFT	Flexfuel	1998	4	10
9-3 Convertible (YS3F)	2.0	01/01→	A 20 NFT	Bi-Fuel	1998	4	10
9-3 Convertible (YS3F)	2.0	08/00→	B207E	Petrol	1998	4	32
9-3 Convertible (YS3F)	2.0	08/00→	B207E	Flexfuel	1998	4	32
9-3 Convertible (YS3F)	2.0	01/01→	B207H	Flexfuel	1998	4	34
9-3 Convertible (YS3F)	2.0	01/01→	B207H	Bi-Fuel	1998	4	34
9-3 Convertible (YS3F)	2.0	08/00→	B207L	Petrol	1998	4	35
9-3 Convertible (YS3F)	2.0	08/00→	B207L	Flexfuel	1998	4	35
9-3 Convertible (YS3F)	2.0	08/00→	B207R	Petrol	1998	4	36
9-3 Convertible (YS3F)	2.0	08/00→	B207R	Flexfuel	1998	4	36
9-3 Convertible (YS3F)	2.0	08/00→	B207R	Bi-Fuel	1998	4	36
9-3 Estate	1.8	03/00→	B207E	Petrol	1998	4	32
9-3 Estate	1.8	03/00→	B207E	Flexfuel	1998	4	32
9-3 Estate	1.8	03/00→	Z 18 XE	Petrol	1796	4	2
9-3 Estate	1.9	12/00→	A 19 DTR	Diesel	1910	4	3
9-3 Estate	1.9	03/00→	Z 19 DTH	Diesel	1910	4	5
9-3 Estate	1.9	03/00→	Z 19 DTJ	Diesel	1910	4	6
9-3 Estate	1.9	12/00→	Z 19 DTR	Diesel	1910	4	7
9-3 Estate	2.0	01/01→	A 20 NFT	Petrol	1998	4	10
9-3 Estate	2.0	01/01→	A 20 NFT	Flexfuel	1998	4	10
9-3 Estate	2.0	01/01→	A 20 NFT	Bi-Fuel	1998	4	10
9-3 Estate	2.0	03/00→	B207E	Petrol	1998	4	32
9-3 Estate	2.0	03/00→	B207E	Flexfuel	1998	4	32

	Ltr				CC		9
9-3 Estate	2.0	01/00 →	B207G	Petrol	1998	4	33
9-3 Estate	2.0	01/01 →	B207H	Flexfuel	1998	4	34
9-3 Estate	2.0	01/01 →	B207H	Bi-Fuel	1998	4	34
9-3 Estate	2.0	03/00 →	B207L	Petrol	1998	4	35
9-3 Estate	2.0	03/00 →	B207L	Flexfuel	1998	4	35
9-3 Estate	2.0	03/00 →	B207R	Petrol	1998	4	36
9-3 Estate	2.0	03/00 →	B207R	Flexfuel	1998	4	36
9-3 Estate	2.0	03/00 →	B207R	Bi-Fuel	1998	4	36
9-3X	1.9	02/00 →	A 19 DTR	Diesel	1910	4	3
9-3X	1.9	02/00 →	Z 19 DTR	Diesel	1910	4	7
9-3X	2.0	01/01 →	A 20 NFT	Petrol	1998	4	10
9-3X	2.0	01/01 →	A 20 NFT	Flexfuel	1998	4	10
9-3X	2.0	01/01 →	A 20 NFT	Bi-Fuel	1998	4	10
9-3X	2.0	02/00 →	B207R	Petrol	1998	4	36
9-3X	2.0	02/00 →	B207R	Flexfuel	1998	4	36
9-3X	2.0	02/00 →	B207R	Bi-Fuel	1998	4	36
9-5 (YS3E)	1.9	01/00 →	Z 19 DTH	Diesel	1910	4	5
9-5 (YS3E)	2.0	09/99 →	B205E	Petrol	1985	4	28
9-5 (YS3E)	2.0	09/99 →	B205E	Flexfuel	1985	4	28
9-5 (YS3E)	2.0	07/00 →	B205L	Petrol	1985	4	29
9-5 (YS3E)	2.2	03/00 →	D223L	Diesel	2171	4	39
9-5 (YS3E)	2.3	09/99 →	B235E	Petrol	2290	4	45
9-5 (YS3E)	2.3	09/99 →	B235E	Flexfuel	2290	4	45
9-5 (YS3E)	2.3	07/00 →	B235L	Petrol	2290	4	46
9-5 (YS3E)	2.3	10/99 →	B235R	Petrol	2290	4	47
9-5 (YS3E)	2.3	10/99 →	B235R	Flexfuel	2290	4	47
9-5 (YS3E)	3.0	01/99 →	B308E	Petrol	2962	6	49
9-5 (YS3E)	3.0	07/00 →	D308L	Diesel	2958	6	51
9-5 (YS3G)	1.6	05/01 →	A 16 LET	Petrol	1598	4	1
9-5 (YS3G)	2.0	05/01 →	A 20 DTH	Diesel	1956	4	8
9-5 (YS3G)	2.0	05/01 →	A 20 DTR	Diesel	1956	4	9
9-5 (YS3G)	2.0	05/01 →	A 20 NFT	Petrol	1998	4	10
9-5 (YS3G)	2.0	05/01 →	A 20 NFT	Flexfuel	1998	4	10
9-5 (YS3G)	2.0	05/01 →	A 20 NFT	Bi-Fuel	1998	4	10
9-5 (YS3G)	2.0	05/01 →	A 20 NHT	Petrol	1998	4	11
9-5 (YS3G)	2.0	05/01 →	A 20 NHT	Flexfuel	1998	4	11
9-5 Estate (YS3E)	1.9	01/00 →	Z 19 DTH	Diesel	1910	4	5
9-5 Estate (YS3E)	1.9	01/00 →	Z 19 DTR	Diesel	1910	4	7
9-5 Estate (YS3E)	2.0	01/00 →	A 20 NFT	Petrol	1998	4	10
9-5 Estate (YS3E)	2.0	01/00 →	A 20 NFT	Flexfuel	1998	4	10
9-5 Estate (YS3E)	2.0	01/00 →	A 20 NFT	Bi-Fuel	1998	4	10
9-5 Estate (YS3E)	2.0	10/99 →	B204R	Petrol	1985	4	27
9-5 Estate (YS3E)	2.0	10/99 →	B205E	Petrol	1985	4	28
9-5 Estate (YS3E)	2.0	10/99 →	B205E	Flexfuel	1985	4	28
9-5 Estate (YS3E)	2.0	07/00 → 07/00	B205L	Petrol	1985	4	29
9-5 Estate (YS3E)	2.2	03/00 →	D223L	Diesel	2171	4	39
9-5 Estate (YS3E)	2.3	10/99 →	B235E	Petrol	2290	4	45
9-5 Estate (YS3E)	2.3	10/99 →	B235E	Flexfuel	2290	4	45
9-5 Estate (YS3E)	2.3	07/00 →	B235L	Petrol	2290	4	46
9-5 Estate (YS3E)	2.3	10/99 →	B235R	Petrol	2290	4	47
9-5 Estate (YS3E)	2.3	10/99 →	B235R	Flexfuel	2290	4	47
9-5 Estate (YS3E)	3.0	10/99 →	B308E	Petrol	2962	6	49
9-5 Estate (YS3E)	3.0	07/00 →	D308L	Diesel	2958	6	51
900 I (AC4, AM4)	2.0	09/98 → 08/99	B201	Petrol	1985	4	13
900 I (AC4, AM4)	2.0	07/98 → 12/98	B201XC	Petrol	1985	4	14
900 I (AC4, AM4)	2.0	11/98 → 08/99	B201XI	Petrol	1985	4	15
900 I (AC4, AM4)	2.0	01/98 → 12/98	B201XL	Petrol	1985	4	16
900 I (AC4, AM4)	2.0	10/98 → 12/99	B201XL	Petrol	1985	4	17
900 I (AC4, AM4)	2.0	10/98 → 12/99	B202I	Petrol	1985	4	19
900 I (AC4, AM4)	2.0	07/99 → 12/99	B202S	Petrol	1985	4	21
900 I (AC4, AM4)	2.0	01/98 → 12/98	B202XI	Petrol	1985	4	22
900 I (AC4, AM4)	2.0	01/98 → 12/99	B202XL	Petrol	1985	4	23
900 I (AC4, AM4)	2.0	11/98 → 08/99	BI 20	Petrol	1985	4	37
900 I (AC4, AM4)	2.1	10/98 → 12/99	B212I	Petrol	2119	4	38
900 I Combi Coupe	2.0	09/97 → 12/98	B 20	Petrol	1985	4	12
900 I Combi Coupe	2.0	09/98 → 08/99	B201	Petrol	1985	4	13
900 I Combi Coupe	2.0	09/97 → 12/98	B201XC	Petrol	1985	4	14
900 I Combi Coupe	2.0	11/98 → 12/98	B201XI	Petrol	1985	4	15
900 I Combi Coupe	2.0	01/98 → 12/98	B201XL	Petrol	1985	4	16
900 I Combi Coupe	2.0	10/98 → 12/99	B201XL	Petrol	1985	4	17



Ltr











CC



9

	Ltr				CC		
900 I Combi Coupe	2.0	01/98→08/99	B202I	Petrol	1985	4	19
900 I Combi Coupe	2.0	01/99→06/99	B202L	Petrol	1985	4	20
900 I Combi Coupe	2.0	05/99→10/99	B202S	Petrol	1985	4	21
900 I Combi Coupe	2.0	01/98→12/98	B202XI	Petrol	1985	4	22
900 I Combi Coupe	2.0	02/98→06/99	B202XL	Petrol	1985	4	23
900 I Combi Coupe	2.0	11/98→12/98	BI 20	Petrol	1985	4	37
900 I Combi Coupe	2.1	10/98→07/99	B212I	Petrol	2119	4	38
900 I Convertible	2.0	10/98→09/98	B201	Petrol	1985	4	13
900 I Convertible	2.0	01/99→06/99	B202I	Petrol	1985	4	19
900 I Convertible	2.0	05/99→06/99	B202S	Petrol	1985	4	21
900 I Convertible	2.0	11/98→06/99	B202XL	Petrol	1985	4	23
900 I Convertible	2.1	10/98→06/99	B212I	Petrol	2119	4	38
900 II	2.0	08/99→02/99	B204I	Petrol	1985	4	25
900 II	2.0	07/99→02/99	B204L	Petrol	1985	4	26
900 II	2.0	07/99→07/99	B206I	Petrol	1985	4	31
900 II	2.3	07/99→02/99	B234I	Petrol	2290	4	42
900 II	2.5	07/99→02/99	B258I	Petrol	2498	6	48
900 II Convertible	2.0	12/99→02/99	B204I	Petrol	1985	4	25
900 II Convertible	2.0	12/99→02/99	B204L	Petrol	1985	4	26
900 II Convertible	2.3	12/99→02/99	B234I	Petrol	2290	4	42
900 II Convertible	2.5	12/99→02/99	B258I	Petrol	2498	6	48
900 II Coupe	2.0	08/99→02/99	B204I	Petrol	1985	4	25
900 II Coupe	2.0	12/99→02/99	B204L	Petrol	1985	4	26
900 II Coupe	2.0	12/99→07/99	B206I	Petrol	1985	4	31
900 II Coupe	2.3	12/99→02/99	B234I	Petrol	2290	4	42
900 II Coupe	2.5	12/99→02/99	B258I	Petrol	2498	6	48
9000	2.0	01/98→01/99	B202I	Petrol	1985	4	19
9000	2.0	09/98→12/99	B202L	Petrol	1985	4	20
9000	2.0	09/99→12/99	B202S	Petrol	1985	4	21
9000	2.0	04/98→08/99	B202XL	Petrol	1985	4	23
9000	2.0	09/99→12/99	B204E	Petrol	1985	4	24
9000	2.0	09/99→12/99	B204I	Petrol	1985	4	25
9000	2.3	09/99→12/99	B234E	Petrol	2290	4	41
9000	2.3	08/98→12/99	B234I	Petrol	2290	4	42
9000	2.3	07/99→12/99	B234L	Petrol	2290	4	43
9000	2.3	09/99→10/99	B234R	Petrol	2290	4	44
9000	3.0	07/99→12/99	B308I	Petrol	2962	6	50
9000 Hatchback	2.0	06/98→12/99	B202	Petrol	1985	4	18
9000 Hatchback	2.0	01/98→12/99	B202I	Petrol	1985	4	19
9000 Hatchback	2.0	09/98→12/99	B202L	Petrol	1985	4	20
9000 Hatchback	2.0	09/99→12/99	B202S	Petrol	1985	4	21
9000 Hatchback	2.0	12/98→12/98	B202XI	Petrol	1985	4	22
9000 Hatchback	2.0	09/98→08/99	B202XL	Petrol	1985	4	23
9000 Hatchback	2.0	09/99→12/99	B204E	Petrol	1985	4	24
9000 Hatchback	2.0	09/99→12/99	B204I	Petrol	1985	4	25
9000 Hatchback	2.3	09/99→12/99	B234E	Petrol	2290	4	41
9000 Hatchback	2.3	09/98→12/99	B234I	Petrol	2290	4	42
9000 Hatchback	2.3	09/99→12/99	B234L	Petrol	2290	4	43
9000 Hatchback	2.3	02/99→12/99	B234R	Petrol	2290	4	44
9000 Hatchback	3.0	07/99→12/99	B308I	Petrol	2962	6	50

		CC			9			CC			9
A 16 LET	Petrol	1598	4	79.00	1						
A 19 DTR	Diesel	1910	4	82.00	3						
A 20 DTH	Diesel	1956	4	83.00	8						
A 20 DTR	Diesel	1956	4	83.00	9						
A 20 NFT	Petrol	1998	4	86.00	10						
A 20 NFT	Flexfuel	1998	4	86.00	10						
A 20 NFT	Bi-Fuel	1998	4	86.00	10						
A 20 NHT	Petrol	1998	4	86.00	11						
A 20 NHT	Flexfuel	1998	4	86.00	11						
B 20	Petrol	1985	4	90.00	12						
B201	Petrol	1985	4	90.00	13						
B201XC	Petrol	1985	4	90.00	14						
B201XI	Petrol	1985	4	90.00	15						
B201XL	Petrol	1985	4	90.00	16						
B201XL	Petrol	1985	4		17						
B202	Petrol	1985	4		18						
B202I	Petrol	1985	4	90.00	19						
B202L	Petrol	1985	4	90.00	20						
B202S	Petrol	1985	4	90.00	21						
B202XI	Petrol	1985	4	90.00	22						
B202XL	Petrol	1985	4	90.00	23						
B204E	Petrol	1985	4	90.00	24						
B204I	Petrol	1985	4	90.00	25						
B204L	Petrol	1985	4	90.00	26						
B204R	Petrol	1985	4	90.00	27						
B205E	Petrol	1985	4	90.00	28						
B205E	Flexfuel	1985	4	90.00	28						
B205L	Petrol	1985	4	90.00	29						
B205R	Petrol	1985	4	90.00	30						
B206I	Petrol	1985	4		31						
B207E	Petrol	1998	4	86.00	32						
B207E	Flexfuel	1998	4	86.00	32						
B207G	Petrol	1998	4		33						
B207H	Flexfuel	1998	4		34						
B207H	Bi-Fuel	1998	4		34						
B207L	Petrol	1998	4	86.00	35						
B207L	Flexfuel	1998	4	86.00	35						
B207R	Petrol	1998	4	86.00	36						
B207R	Flexfuel	1998	4	86.00	36						
B207R	Bi-Fuel	1998	4	86.00	36						
B212I	Petrol	2119	4		38						
B234E	Petrol	2290	4	90.00	41						
B234I	Petrol	2290	4	90.00	42						
B234L	Petrol	2290	4	90.00	43						
B234R	Petrol	2290	4	90.00	44						
B235E	Petrol	2290	4	90.00	45						
B235E	Flexfuel	2290	4	90.00	45						
B235L	Petrol	2290	4	90.00	46						
B235R	Petrol	2290	4	90.00	47						
B235R	Flexfuel	2290	4	90.00	47						
B258I	Petrol	2498	6	81.60	48						
B308E	Petrol	2962	6	86.00	49						
B308I	Petrol	2962	6	86.00	50						
BI 20	Petrol	1985	4	90.00	37						
D223L	Diesel	2171	4	84.00	39						
D308L	Diesel	2958	6	87.50	51						
X 22 DTH	Diesel	2171	4	84.00	40						
Z 18 XE	Petrol	1796	4	80.50	2						
Z 19 DT	Diesel	1910	4	82.00	4						
Z 19 DTH	Diesel	1910	4	82.00	5						
Z 19 DTJ	Diesel	1910	4	82.00	6						
Z 19 DTR	Diesel	1910	4	82.00	7						



cc



kW/PS

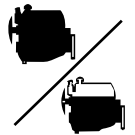

1.6		A 16 LET					1	AH5240 (MLS)	CH5241 (MLS)	EH5240
9-5 1.6T	05/10→	1598	4	79.00	DOHC	132/180				
1.8		Z 18 XE					2	AC5460 (MLS)	CC5460 [3]	
9-3 1.8 i	01/04→	1796	4	80.50	DOHC	90/122				
1.9		A 19 DTR Diesel					3			
9-3 1.9 TtDi	12/07→	1910	4	82.00	DOHC	96-132/ 130-180				
1.9		Z 19 DT Diesel					4	AA5560 (MLS), 0.820mm, 0 Holes AA5570 (MLS), 0.920mm, 1 Hole AA5580 (MLS), 1.020mm, 2 Holes	CA5561 ▲	
9-3 1.9 TiD	09/04→	1910	4	82.00	SOHC/OHC	88/120				
1.9		Z 19 DTH Diesel					5	AD5840 (MLS), 0.820mm, 0 Holes AD5850 (MLS), 0.920mm, 1 Hole AD5860 (MLS), 1.020mm, 2 Holes	CD5840 ▲	EE5181 [3]
9-3 1.9 TiD	09/04→	1910	4	82.00	DOHC	110/150				
9-3 Cabrio 1.9T	01/06→									
9-5 1.9 TiD	01/06→									
1.9		Z 19 DTJ Diesel					6	AD5840 (MLS), 0.820mm, 0 Holes AD5850 (MLS), 0.920mm, 1 Hole AD5860 (MLS), 1.020mm, 2 Holes	CD5840 ▲	EE5181 [3]
9-3 1.9 TiD	03/05→	1910	4	82.00	DOHC	88/120				
1.9		Z 19 DTR Diesel					7			
9-3 1.9 TtDi	12/07→	1910	4	82.00	DOHC	129-132/ 175-180				
9-5 1.9 TiD	01/07→									
2.0		A 20 DTH Diesel					8			
9-5 2.0 TiD	05/10→	1956	4	83.00	DOHC	118/160				
2.0		A 20 DTR Diesel					9			
9-5 2.0 TtDi	05/10→	1956	4	83.00	DOHC	140/190				
2.0		A 20 NFT					10	AH6380 (MLS), 0.64mm [132]		
9-3 2.0 t	01/11→	1998	4	86.00	DOHC	162/220				
9-3 2.0 t Bio	01/11→									
9-3 2.0 t XWD	01/11→									
9-3 2.0T Bio	01/11→									
9-3 3336 K	01/11→									
9-3 3343	01/11→									
9-3 3348 S	01/11→									
9-3 T 144 L/460	01/11→									
9-3 T 144 L/530	01/11→									
9-5 2.0 tBio	01/09→									

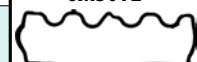
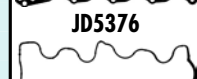
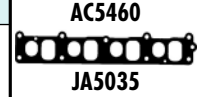
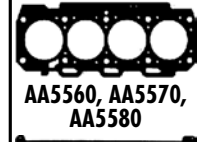
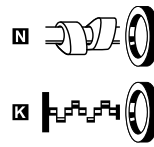
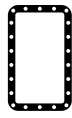
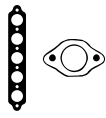



cc



kW/PS

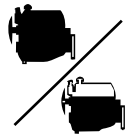

2.0		A 20 NHT					11	AH6380 (MLS), 0.64mm [132]	
9-5 2.0 tBio	05/10→	1998	4	86.00	DOHC	162/220			
9-5 2.0T	05/10→								
9-5 2.0T XWD	05/10→								
2.0		B 20					12	BC650 (Fibre)	
900 I 115-17	09/79→12/88	1985	4	90.00	SOHC/OHC	74/100		EC651 [3] →12/80	
2.0		B201					13	BK610 (Fibre)	
900 I 2.0	10/85→09/89	1985	4	90.00	SOHC/OHC	81/110		DK611 ○ EC651 [3]	
900 I 2.0 i	09/85→08/90								
2.0		B201XC					14	BK610 (Fibre)	
900 I 2.0 c	07/82→12/88	1985	4	90.00	SOHC/OHC	74/100		DK611 ○ 01/81→ EC651 [3] 01/81→	
900 I 115-17	09/79→12/88								
2.0		B201XI					15	BK610 (Fibre)	
900 I 2.0 i	11/80→08/90	1985	4	90.00	SOHC/OHC	85-87/ 115-118		DK611 ○ 01/81→12/88 EC651 [3] 01/81→12/88	
2.0		B201XL					16	BK610 (Fibre)	
900 I 2.0 Turbo	01/86→12/88	1985	4	90.00	SOHC/OHC	110-114/ 150-155			
2.0		B201XL					17	BK610 (Fibre)	
900 I 2.0 Turbo	10/86→12/91	1985	4			103/140		DK611 ○ 01/87→	
2.0		B202					18	BT560 (Fibre)	
9000 2.0-16T	06/89→12/92	1985	4			127/172		DT561 [13] ET560	
2.0		B2021					19	BT560 (Fibre)	
900 I 2.0	10/87→10/91	1985	4	90.00	DOHC	93-98/ 126-133		DT561 [13] 01/89→ ET560 01/89→	
900 I 2.0-16	01/89→06/94								
900 I 2.0 16v	04/90→12/90								
9000 2.0-16	01/89→01/93								
9000 2.0-16 CS	01/89→12/98								

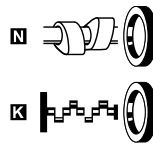
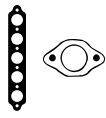

BC650



BK610



BT560



JC305



JD348

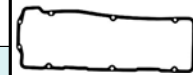

JN285

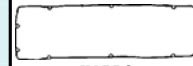

JN513



JJ080

HBS179 [19] M12x1.75x121.50mm (x10) →12/80	JC305 [x2] →12/80	JN285 [4] →12/80	JJ080 →12/80		NB714 [2] 48.00x66.70x10.00mm, MVQ →12/80 NB847 [1] 88.00x108.00x11.00mm, FPM →12/80 NB848 [1] 100.00x120.00x11.00mm, PTFE →12/80	
HBS179 [19] M12x1.75x121.50mm (x10)	JC305 [x2]	JN513 [4]	JJ080		NB714 [2] 48.00x66.70x10.00mm, MVQ NB847 [1] 88.00x108.00x11.00mm, FPM NB848 [1] 100.00x120.00x11.00mm, PTFE	
HBS179 [19] M12x1.75x121.50mm (x10) 01/81→	JC305 [x2] 01/81→	JN513 [4] 01/81→	JJ080 01/81→		NB714 [2] 48.00x66.70x10.00mm, MVQ 01/81→ NB847 [1] 88.00x108.00x11.00mm, FPM 01/81→ NB848 [1] 100.00x120.00x11.00mm, PTFE 01/81→	
HBS179 [19] M12x1.75x121.50mm (x10) 01/81→12/88	JC305 [x2] 01/81→12/88	JN513 [4] 01/81→12/88	JJ080 01/81→12/88		NB714 [2] 48.00x66.70x10.00mm, MVQ 01/81→12/88 NB847 [1] 88.00x108.00x11.00mm, FPM 01/81→12/88 NB848 [1] 100.00x120.00x11.00mm, PTFE 01/81→12/88	
HBS179 [19] M12x1.75x121.50mm (x10)	JC305 [x2]	JN513 [4]	JJ080		NB848 [1] 100.00x120.00x11.00mm, PTFE	
HBS179 [19] M12x1.75x121.50mm (x10) 01/87→	JC305 [x2] 01/87→	JN513 [4] 01/87→	JJ080 01/87→		NB848 [1] 100.00x120.00x11.00mm, PTFE 01/87→	
HBS180 [19] M12x1.75x95.50mm (x10)	JD348	HM5070	JJ080	HR646	NB714 [2] 48.00x66.70x10.00mm, MVQ NB847 [1] 88.00x108.00x11.00mm, FPM NB848 [1] 100.00x120.00x11.00mm, PTFE	
HBS180 [19] M12x1.75x95.50mm (x10) 01/89→	JD348 01/89→	HM5070 01/89→	JJ080 01/89→	HR646 01/89→	NB714 [2] 48.00x66.70x10.00mm, MVQ 01/89→ NB847 [1] 88.00x108.00x11.00mm, FPM 01/89→ NB848 [1] 100.00x120.00x11.00mm, PTFE 01/89→	



cc



kW/PS

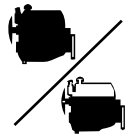

2.0		B202L				20		BT560 (Fibre)	DT561 [13]	ET560 01/91→12/93
900 I 2.0T-16	01/93→06/94	1985	4	90.00	DOHC	132-147/ 180-195				
9000 2.0 16v	09/89→01/90									
9000 2.0-T CD	09/89→12/98									
9000 2.0-T CS	09/88→12/98									
2.0		B202S				21		BT560 (Fibre)	DT561 [13]	ET560
900 I 2.0	05/91→10/93	1985	4	90.00	DOHC	104-110/ 141-150				
900 I 2.0-16	05/91→10/93									
900 I 2.0 ST-16	09/91→06/94									
900 I 2.0T-16	07/91→12/93									
9000 2.0 - NDT	09/93→12/98									
9000 2.0-T CD	09/92→12/98									
2.0		B202XI				22		BT560 (Fibre)	DT561 [13]	ET560
900 I 2.0-16	01/86→12/88	1985	4	90.00	DOHC	92-96/ 125-130				
9000 2.0-16	12/85→12/88									
9000 NG 262	12/85→08/88									
2.0		B202XL				23		BT560 (Fibre)	DT561 [13]	ET560 01/91→07/93
900 I 2.0	10/89→10/93	1985	4	90.00	DOHC	118-132/ 160-180				
900 I 2.0T-16	11/85→06/94									
900 I 2.0T-16 S	01/84→06/94									
9000 2.0-16T	09/84→08/93									
9000 2.0-T CD	09/88→08/93									
2.0		B204E				24		AC5630 (Fibre)	CC5630 [13]	01/96→
9-3 2.0 Turbo	10/98→09/02	1985	4	90.00	DOHC	108-113/ 147-154	01/96→			
9-3 Cabrio 2.0T	10/98→08/03									
9000 2.0 - NDT	09/93→12/98									
9000 2.0-16 CD	09/93→12/98									
9000 2.0-T CD	09/92→12/98									
2.0		B204I				25		AC5630 (Fibre)	CC5630 [13]	
9-3 2.0 i	02/98→09/02	1985	4	90.00	DOHC	96/131				
9-3 Cabrio 2.0i	02/98→08/03									
900 II 2.0 i	12/93→02/98									
900 II 2.0 i	08/94→02/98									
9000 2.0-16 CD	09/93→12/98									
9000 2.0-16 CS	09/93→12/98									
2.0		B204L				26		AC5630 (Fibre)	CC5630 [13]	
9-3 2.0 Turbo	02/98→09/02	1985	4	90.00	DOHC	136-147/ 185-200				
9-3 Cabrio 2.0T	02/98→08/03									
900 II 2.0	07/93→02/98									
900 II 2.0	12/93→02/98									
2.0		B204R				27		AC5630 (Fibre)	CC5630 [13]	
9-3 2.0 SE T	02/98→09/02	1985	4	90.00	DOHC	141-147/ 192-200				
9-3 Cabrio 2.0T	02/98→08/03									
9-5 2.0 t	10/98→									

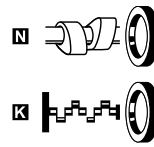
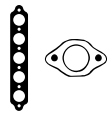

AC5630



BT560



JD348



JD5210



JD5280



JJ080

HBS180 [19] M12x1.75x95.50mm (x10)	JD348	HM5070	JJ080	HR646	NB714 [2] 48.00x66.70x10.00mm, MVQ NB847 [1] 88.00x108.00x11.00mm, FPM NB848 [1] 100.00x120.00x11.00mm, PTFE	
HBS180 [19] M12x1.75x95.50mm (x10)	JD348	HM5070 Eng.652495→	JJ080	HR646	NB714 [2] 48.00x66.70x10.00mm, MVQ NB847 [1] 88.00x108.00x11.00mm, FPM NB848 [1] 100.00x120.00x11.00mm, PTFE	
HBS180 [19] M12x1.75x95.50mm (x10)	JD348	HM5070	JJ080	HR646	NB714 [2] 48.00x66.70x10.00mm, MVQ NB847 [1] 88.00x108.00x11.00mm, FPM NB848 [1] 100.00x120.00x11.00mm, PTFE	
HBS180 [19] M12x1.75x95.50mm (x10)	JD348	HM5070	JJ080	HR646	NB714 [2] 48.00x66.70x10.00mm, MVQ NB847 [1] 88.00x108.00x11.00mm, FPM NB848 [1] 100.00x120.00x11.00mm, PTFE	
HBS180 [19] M12x1.75x95.50mm (x10) 01/96→	JD5210 (x2) 01/96→ JD5280 01/96→	HM5070 01/96→	JJ080 01/96→	HR646 01/96→	NB714 [2] 48.00x66.70x10.00mm, MVQ 01/96→ NB847 [1] 88.00x108.00x11.00mm, FPM 01/96→ NB848 [1] 100.00x120.00x11.00mm, PTFE 01/96→	
HBS180 [19] M12x1.75x95.50mm (x10)	JD5210 (x2) JD5280	HM5070	JJ080	HR646	NB714 [2] 48.00x66.70x10.00mm, MVQ NB847 [1] 88.00x108.00x11.00mm, FPM NB848 [1] 100.00x120.00x11.00mm, PTFE	
HBS180 [19] M12x1.75x95.50mm (x10)	JD5210 (x2) JD5280	HM5070	JJ080	HR646	NB714 [2] 48.00x66.70x10.00mm, MVQ NB847 [1] 88.00x108.00x11.00mm, FPM NB848 [1] 100.00x120.00x11.00mm, PTFE	
HBS180 [19] M12x1.75x95.50mm (x10)	JD5210 (x2) JD5280	HM5070	JJ080	HR646	NB714 [2] 48.00x66.70x10.00mm, MVQ NB847 [1] 88.00x108.00x11.00mm, FPM NB848 [1] 100.00x120.00x11.00mm, PTFE	



kW/PS

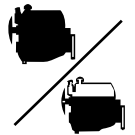

2.0	B205E	28	AE5060 (MLS)	CE5060 [13]				
9-3 2.0 Turbo	01/01→09/02	1985	4	90.00	DOHC	110-141/ 150-192		
9-3 Cabrio 2.0T	01/01→08/03							
9-5 2.0 †	09/97→							
9-5 2.0 †Bio	01/05→							
9-5 2.0T SE	10/98→07/00							
2.0	B205L	29	AC5630 (Fibra)	CC5630 [13]				
9-3 2.0 Turbo	02/98→09/02	1985	4	90.00	DOHC	136/185		
9-3 Cabrio 2.0T	02/98→08/03							
9-5 2.0 †	07/00→07/01							
2.0	B205R	30	AE5060 (MLS)	CE5060 [13]				
9-3 2.0 Turbo	10/99→08/03	1985	4	90.00	DOHC	151/205		
2.0	B206I	31	AC5630 (Fibra)	CC5630 [13]				
900 II 2.0 i	07/93→07/94	1985	4		DOHC	98/133		
2.0	B207E	32	AC5630 (Fibra)	CC5630 [13]				
9-3 1.8t Bio	01/07→	1998	4	86.00	DOHC	110/150		
9-3 1.8 †	09/02→							
9-3 1.8 † Bio	01/07→							
9-3 2.0 †	03/05→							
9-3 Cabrio 1.8T	08/03→							
2.0	B207G	33	AH6380 (MLS), 0.64mm [132]					
9-3 2.0 †	01/07→	1998	4		DOHC	120/163		
9-3 2.0 † XWD	01/07→							
9-3 3348 AK	01/07→							
2.0	B207H	34	AH6380 (MLS), 0.64mm [132]					
9-3 2.0 † Bio	01/11→	1998	4		DOHC	120/163		
9-3 2.0t	01/11→							
9-3 3348	01/07→							
2.0	B207L	35		CG9581				
9-3 1.8t Bio	01/07→	1998	4	86.00	DOHC	129/175		
9-3 2.0 †	09/02→							
9-3 2.0 † Bio	01/07→							
9-3 Cabrio 2.0T	08/03→							
2.0	B207R	36		CG9581				
9-3 2.0 T	09/02→	1998	4	86.00	DOHC	154/210		
9-3 2.0 † Bio	09/02→							
9-3 2.0 † XWD	09/02→							
9-3 2.0t	09/02→							
9-3 2.0T Bio	02/09→							
9-3 Cabrio 2.0T	08/03→							
2.0	BI 20	37	BK610 (Fibra)	DK611 ○				
900 I 2.0 i	11/80→08/90	1985	4	90.00		85-87/ 115-118		EC651 [3]

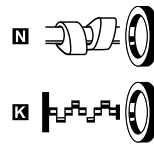
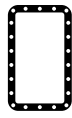
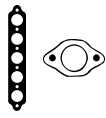

AC5630



AE5060



BK610



JC305



JD5210



JD5280



JD5281



JD5282

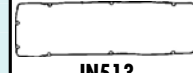

JN513



JJ080



cc



kW/PS

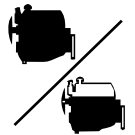

2.1		B212I				38		AC5690 (Fibre)		CC5690 [13]	
900 I 2.1 -16	08/90→06/94	2119	4			100-107/ 136-145	01/92→12/93		01/92→12/93		
900 I 2.1 16 S	10/89→07/92										
2.2		D223L Diesel				39		AB5670 (MLS), 1.300mm, 1 Notch AB5680 (MLS), 1.400mm, 2 Notches		CB5671 ▲ [13] EB5670 [3]	
9-3 2.2 TiD	02/98→09/02	2171	4	84.00	SOHC/OHC	85-92/ 115-125					
9-5 2.2 TiD	03/02→										
2.2		X 22 DTH Diesel				40		AB5670 (MLS), 1.300mm, 1 Notch AB5680 (MLS), 1.400mm, 2 Notches		CB5670 ▲ [13] EB5670 [3]	
9-3 2.2 TiD	02/98→11/00	2171	4	84.00	SOHC/OHC	85/115					
2.3		B234E				41		AC5630 (Fibre)		CC5630 [13]	
9000 2.3 - CDE	09/93→12/98	2290	4	90.00	DOHC	125/170	01/94→		01/94→		
9000 165-24 T	09/93→12/98										
2.3		B234I				42		BT560 (Fibre) AC5630 (Fibre)		DT562 [13] ET560 CC5630 [13]	
9-3 2.3 i	02/98→09/02	2290	4	90.00	DOHC	107-110/ 146-150	01/91→12/93		01/91→12/93	01/91→	
9-3 Cabrio 2.3i	02/98→08/03										
900 II 2.3	07/93→02/98						01/94→		01/94→		
900 II 2.3	12/93→02/98										
9000 2.3	10/89→12/93										
9000 2.3 - CDE	09/93→12/98										
9000 2.3 - CSE	09/93→12/98										
9000 2.3 -16 CD	08/89→12/98										
9000 2.3 -16 CS	09/89→12/98										
2.3		B234L				43		BT560 (Fibre) AC5630 (Fibre)		DT562 [13] ET560 CC5630 [13]	
9000 2.3 - CDT	07/90→12/98	2290	4	90.00	DOHC	143-147/ 195-200	01/91→12/93		01/91→12/93	01/91→	
9000 2.3 -16T	09/90→12/98										
9000 2.3 -T CSE	09/93→12/98						01/94→		01/94→		
2.3		B234R				44		AC5630 (Fibre)		CC5630 [13]	
9000 2.3	09/90→10/98	2290	4	90.00	DOHC	162-165/ 220-225	01/93→		01/93→		
9000 2.3 - CS	02/93→12/98										

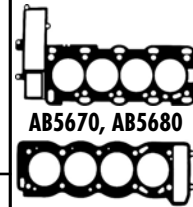
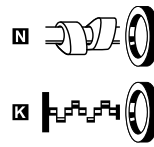
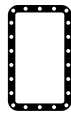
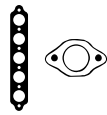

AB5670, AB5680



AC5630



AC5690



BT560



JD348



JD5210



JD5256



JD5280

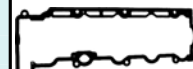

JM5159



JH5057



JJ080

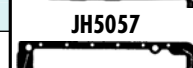

HR5030



NB714



NB847



NB848



NA5069



NA5209









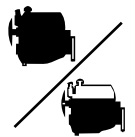

cc

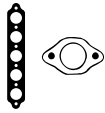

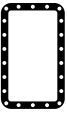
kW/PS

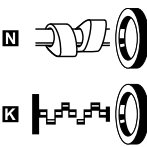

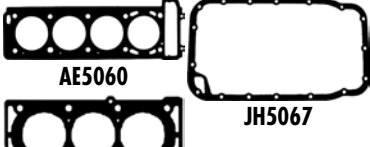
2.3	B235E						45	AE5060 (MLS)	CE5060 [13]	
9-5 2.3 †	09/97→	2290	4	90.00	DOHC	125-136/ 170-185				
9-5 2.3 tBio	01/07→									
9-5 2.3T	04/08→									
2.3	B235L						46	AE5060 (MLS)	CE5060 [13]	
9-5 2.3T	07/03→	2290	4	90.00	DOHC	162-184/ 220				
2.3	B235R						47	AE5060 (MLS)	CE5060 [13]	
9-3 2.3	09/99→01/02	2290	4	90.00	DOHC	152-191/ 207-260				
9-3 2.3 Turbo	10/98→09/02									
9-3 Cabrio 2.3T	10/99→08/03									
9-5 2.3 tBio	11/06→									
9-5 2.3T	10/99→09/01									
2.5	B258I						48	BY270 (Fibre) (x2)	DY270 [3]	EC350
900 II 2.5	07/93→02/98	2498	6	81.60	DOHC, V	125/170				
900 II 2.5	12/93→02/98									
3.0	B308E						49	BY300 (Fibre) (x2)	DY301 [3]	EC350
9-5 3.0 V6t	01/98→	2962	6	86.00	DOHC, V	147/200				
3.0	B308I						50	BY300 (Fibre) (x2)	DY300 [3]	EC350
9000 3.0	07/94→12/98	2962	6	86.00	DOHC, V	155/211	01/95→	01/95→	01/95→	
3.0	D308L Diesel						51	AG9770 (MLS), 0.600mm, 1 Hole <input checked="" type="checkbox"/>	CG9770 ▲	EG9770
9-5 3.0 TiD	07/01→	2958	6	87.50	DOHC, V	130/177				FG9770 ▲
								AG9780 (MLS), 0.650mm, 2 Holes <input checked="" type="checkbox"/>		
								AG9790 (MLS), 0.700mm, 3 Holes <input checked="" type="checkbox"/>		
								AG9800 (MLS), 0.600mm, 1 Hole <input checked="" type="checkbox"/>		
								AG9810 (MLS), 0.650mm, 2 Holes <input checked="" type="checkbox"/>		
								AG9820 (MLS), 0.700mm, 3 Holes <input checked="" type="checkbox"/>		

							
HBS180 ☉ [19] M12x1.75x95.50mm (x10)	JD5282 ■ ■ JD5281 ■ ■ JD5280 ■	HM5070 ■		HR5072 ■	■ NB714 ■ [2] 48.00x66.70x10.00mm, MVQ ■ NB847 ■ [1] 88.00x108.00x11.00mm, FPM ■ NB848 ■ [1] 100.00x120.00x11.00mm, PTFE		AE5060 BY270 BY300 JD457 JD459 JD5202 JD5203 JD5280 JD5281 JD5282 JD5204 JM5094 JM5095 JH5052
HBS180 ☉ [19] M12x1.75x95.50mm (x10)	JD5282 ■ ■ JD5281 ■ ■ JD5280 ■	HM5070 ■		HR5072 ■	■ NB714 ■ [2] 48.00x66.70x10.00mm, MVQ ■ NB847 ■ [1] 88.00x108.00x11.00mm, FPM ■ NB848 ■ [1] 100.00x120.00x11.00mm, PTFE		AE5060 BY270 BY300 JD457 JD459 JD5202 JD5203 JD5280 JD5281 JD5282 JD5204 JM5094 JM5095 JH5052
HBS180 ☉ [19] M12x1.75x95.50mm (x10)	JD5282 ■ ■ JD5281 ■ ■ JD5280 ■	HM5070 ■		HR5072 ■	■ NB714 ■ [2] 48.00x66.70x10.00mm, MVQ ■ NB847 ■ [1] 88.00x108.00x11.00mm, FPM ■ NB848 ■ [1] 100.00x120.00x11.00mm, PTFE		AE5060 BY270 BY300 JD457 JD459 JD5202 JD5203 JD5280 JD5281 JD5282 JD5204 JM5094 JM5095 JH5052
HBS164 ☉ [5] M11x1.25x105.00mm (x16)	JD457 ■ (x2) JD459 ■ (x2)	JM5094 ■ (x2) [139] (Elastomer) JM5095 ■ (x2) [139] (Elastomer)	JH5052	HR5062 ■	■ NC006 (x4) [2] 35.00x48.00x7.00mm, MVQ ■ NB884 ■ [2] 38.00x50.00x5.50mm, FPM ■ NB806 ■ [1] 90.00x104.00x11.00mm, FPM		AE5060 BY270 BY300 JD457 JD459 JD5202 JD5203 JD5280 JD5281 JD5282 JD5204 JM5094 JM5095 JH5052
HBS164 ☉ [5] M11x1.25x105.00mm (x16)	JD5202 ■ (x2) JD5203 ■ (x3) JD459 ■ (x2)	JD5204 (x2) (Elastomer)	JH5067	HR5062 ■	■ NC006 (x4) [2] 35.00x48.00x7.00mm, MVQ ■ NB884 ■ [2] 38.00x50.00x5.50mm, FPM ■ NB806 ■ [1] 90.00x104.00x11.00mm, FPM		AE5060 BY270 BY300 JD457 JD459 JD5202 JD5203 JD5280 JD5281 JD5282 JD5204 JM5094 JM5095 JH5052
HBS164 ☉ [5] M11x1.25x105.00mm (x16) 01/95→	JD5202 ■ (x2) 01/95→ JD5203 ■ (x3) 01/95→ JD459 ■ (x2) 01/95→	JM5094 ■ (x2) [139] (Elastomer) 01/95→ JM5095 ■ (x2) [139] (Elastomer) 01/95→	JH5052 01/95→	HR5062 ■ 01/95→	■ NC006 (x4) [2] 35.00x48.00x7.00mm, MVQ 01/95→ ■ NB884 ■ [2] 38.00x50.00x5.50mm, FPM 01/95→ ■ NB806 ■ [1] 90.00x104.00x11.00mm, FPM 01/95→		AE5060 BY270 BY300 JD457 JD459 JD5202 JD5203 JD5280 JD5281 JD5282 JD5204 JM5094 JM5095 JH5052
HBS502 ☉ [22] (SE) JD5896 ■  JE5064 (Steel)	JD5897 ■ (SE) JD5896 ■  JE5064 (Steel)	HM5292 ■		HR5094 ■			AE5060 BY270 BY300 JD457 JD459 JD5202 JD5203 JD5280 JD5281 JD5282 JD5204 JM5094 JM5095 JH5052



Ltr







CC



9

Model	Ltr	Year Range	Code	Fuel	CC	Seats	Power (kW)
ALHAMBRA (7V8, 7V9)	1.8	10/99→03/01	AJH	Petrol	1781	4	107
ALHAMBRA (7V8, 7V9)	1.8	10/99→03/01	AWC	Petrol	1781	4	115
ALHAMBRA (7V8, 7V9)	1.9	04/99→03/01	IZ	Diesel	1896	4	132
ALHAMBRA (7V8, 7V9)	1.9	08/99→06/00	AFN	Diesel	1896	4	135
ALHAMBRA (7V8, 7V9)	1.9	04/99→03/01	AHU	Diesel	1896	4	139
ALHAMBRA (7V8, 7V9)	1.9	04/99→03/01	ANU	Diesel	1896	4	141
ALHAMBRA (7V8, 7V9)	1.9	05/00→05/00	ARL	Diesel	1896	4	143
ALHAMBRA (7V8, 7V9)	1.9	11/00→11/00	ASZ	Diesel	1896	4	147
ALHAMBRA (7V8, 7V9)	1.9	06/00→03/01	AUY	Diesel	1896	4	149
ALHAMBRA (7V8, 7V9)	1.9	08/99→06/00	AVG	Diesel	1896	4	150
ALHAMBRA (7V8, 7V9)	1.9	05/00→05/00	BTB	Diesel	1896	4	159
ALHAMBRA (7V8, 7V9)	1.9	06/00→03/01	BVK	Diesel	1896	4	161
ALHAMBRA (7V8, 7V9)	2.0	04/99→03/01	ADY	Petrol	1984	4	167
ALHAMBRA (7V8, 7V9)	2.0	04/99→03/01	ATM	Petrol	1984	4	169
ALHAMBRA (7V8, 7V9)	2.0	11/00→03/01	BRT	Diesel	1968	4	178
ALHAMBRA (7V8, 7V9)	2.8	06/00→03/01	AUE	Petrol	2792	6	191
ALHAMBRA (7V8, 7V9)	2.8	06/00→03/01	AYL	Petrol	2792	6	192
ALHAMBRA (710)	1.4	06/01→	CAVA	Petrol	1390	4	57
ALHAMBRA (710)	1.4	06/01→	CNWB	Petrol	1390	4	64
ALHAMBRA (710)	1.8	11/01→	CDAA	Petrol	1798	4	124
ALHAMBRA (710)	2.0	11/01→	CCZA	Petrol	1984	4	184
ALTEA (SP1)	1.2	04/01→	CBZB	Petrol	1197	4	24
ALTEA (SP1)	1.4	05/00→	BXW	Petrol	1390	4	56
ALTEA (SP1)	1.4	11/00→	CAXC	Petrol	1390	4	61
ALTEA (SP1)	1.4	05/00→	CGGB	Petrol	1390	4	62
ALTEA (SP1)	1.6	03/00→	BGU	Petrol	1595	4	86
ALTEA (SP1)	1.6	03/00→	BSE	Petrol	1595	4	87
ALTEA (SP1)	1.6	03/00→	BSF	Petrol	1595	4	88
ALTEA (SP1)	1.6	11/01→	CAYB	Diesel	1598	4	91
ALTEA (SP1)	1.6	10/00→	CAYC	Diesel	1598	4	92
ALTEA (SP1)	1.6	03/00→	CCSA	Petrol/Ethanol	1595	4	93
ALTEA (SP1)	1.6	03/00→	CCSA	Petrol	1595	4	93
ALTEA (SP1)	1.6	09/00→	CHGA	Petrol/Petroleum Gas (LPG)	1595	4	94
ALTEA (SP1)	1.6	03/00→	CMXA	Petrol/Ethanol	1595	4	95
ALTEA (SP1)	1.6	03/00→	CMXA	Petrol	1595	4	95
ALTEA (SP1)	1.8	01/00→	BYT	Petrol	1798	4	122
ALTEA (SP1)	1.8	01/00→	BZB	Petrol	1798	4	123
ALTEA (SP1)	1.8	01/00→	CDAA	Petrol	1798	4	124
ALTEA (SP1)	1.9	04/00→	BJB	Diesel	1896	4	153
ALTEA (SP1)	1.9	04/00→	BKC	Diesel	1896	4	154
ALTEA (SP1)	1.9	04/00→	BLS	Diesel	1896	4	155
ALTEA (SP1)	1.9	04/00→	BXE	Diesel	1896	4	162
ALTEA (SP1)	1.9	08/00→	BXF	Diesel	1896	4	163
ALTEA (SP1)	2.0	03/00→05/00	AZV	Diesel	1968	4	171
ALTEA (SP1)	2.0	03/00→	BKD	Diesel	1968	4	173
ALTEA (SP1)	2.0	05/00→03/00	BLR	Petrol	1984	4	174
ALTEA (SP1)	2.0	05/00→03/00	BLY	Petrol	1984	4	175
ALTEA (SP1)	2.0	11/00→	BMM	Diesel	1968	4	176
ALTEA (SP1)	2.0	03/00→	BMN	Diesel	1968	4	177
ALTEA (SP1)	2.0	05/00→03/00	BVY	Petrol	1984	4	179
ALTEA (SP1)	2.0	05/00→03/00	BVZ	Petrol	1984	4	180
ALTEA (SP1)	2.0	04/00→05/00	BWA	Petrol	1984	4	181
ALTEA (SP1)	2.0	03/00→	CFHC	Diesel	1968	4	188
ALTEA XL (SP5, SP8)	1.2	04/01→	CBZB	Petrol	1197	4	24
ALTEA XL (SP5, SP8)	1.4	10/00→	BXW	Petrol	1390	4	56
ALTEA XL (SP5, SP8)	1.4	11/00→	CAXC	Petrol	1390	4	61
ALTEA XL (SP5, SP8)	1.4	10/00→	CGGB	Petrol	1390	4	62
ALTEA XL (SP5, SP8)	1.6	10/00→	BSE	Petrol	1595	4	87
ALTEA XL (SP5, SP8)	1.6	10/00→	BSF	Petrol	1595	4	88
ALTEA XL (SP5, SP8)	1.6	11/01→	CAYB	Diesel	1598	4	91
ALTEA XL (SP5, SP8)	1.6	10/00→	CAYC	Diesel	1598	4	92
ALTEA XL (SP5, SP8)	1.6	10/00→	CCSA	Petrol/Ethanol	1595	4	93
ALTEA XL (SP5, SP8)	1.6	10/00→	CCSA	Petrol	1595	4	93
ALTEA XL (SP5, SP8)	1.6	09/00→	CHGA	Petrol/Petroleum Gas (LPG)	1595	4	94
ALTEA XL (SP5, SP8)	1.6	10/00→	CMXA	Petrol/Ethanol	1595	4	95
ALTEA XL (SP5, SP8)	1.6	10/00→	CMXA	Petrol	1595	4	95
ALTEA XL (SP5, SP8)	1.8	01/00→	BYT	Petrol	1798	4	122
ALTEA XL (SP5, SP8)	1.8	01/00→	BZB	Petrol	1798	4	123
ALTEA XL (SP5, SP8)	1.8	01/00→	CDAA	Petrol	1798	4	124
ALTEA XL (SP5, SP8)	1.9	10/00→	BKC	Diesel	1896	4	154

	Ltr				CC		9
ALTEA XL (5P5, 5P8)	1.9	10/00 →	BLS	Diesel	1896	4	155
ALTEA XL (5P5, 5P8)	1.9	10/00 →	BXE	Diesel	1896	4	162
ALTEA XL (5P5, 5P8)	1.9	08/00 →	BXF	Diesel	1896	4	163
ALTEA XL (5P5, 5P8)	2.0	11/00 → 03/00	AZV	Diesel	1968	4	171
ALTEA XL (5P5, 5P8)	2.0	10/00 →	BKD	Diesel	1968	4	173
ALTEA XL (5P5, 5P8)	2.0	10/00 →	BMM	Diesel	1968	4	176
ALTEA XL (5P5, 5P8)	2.0	06/00 →	BMN	Diesel	1968	4	177
ALTEA XL (5P5, 5P8)	2.0	10/00 → 03/00	BVY	Petrol	1984	4	179
ALTEA XL (5P5, 5P8)	2.0	10/00 → 03/00	BVZ	Petrol	1984	4	180
ALTEA XL (5P5, 5P8)	2.0	06/00 → 05/00	BWA	Petrol	1984	4	181
ALTEA XL (5P5, 5P8)	2.0	05/00 →	CCZB	Petrol	1984	4	185
ALTEA XL (5P5, 5P8)	2.0	10/00 →	CFHC	Diesel	1968	4	188
AROSA (6H)	1.0	05/99 → 06/00	AER	Petrol	999	4	8
AROSA (6H)	1.0	10/99 → 01/00	AHT	Petrol	997	4	9
AROSA (6H)	1.0	05/99 → 06/00	ALD	Petrol	999	4	10
AROSA (6H)	1.0	05/99 → 06/00	ALL	Petrol	999	4	11
AROSA (6H)	1.0	05/99 → 06/00	ANV	Petrol	999	4	12
AROSA (6H)	1.0	05/99 → 06/00	AUC	Petrol	999	4	14
AROSA (6H)	1.4	05/99 → 06/00	AEX	Petrol	1391	4	33
AROSA (6H)	1.4	01/00 → 06/00	AFK	Petrol	1390	4	35
AROSA (6H)	1.4	05/99 → 06/00	AKK	Petrol	1390	4	37
AROSA (6H)	1.4	05/99 → 06/00	AKV	Petrol	1391	4	38
AROSA (6H)	1.4	01/00 → 06/00	AMF	Diesel	1422	3	39
AROSA (6H)	1.4	05/99 → 06/00	ANW	Petrol	1390	4	40
AROSA (6H)	1.4	05/99 → 06/00	APQ	Petrol	1391	4	43
AROSA (6H)	1.4	01/00 → 06/00	AQQ	Petrol	1390	4	44
AROSA (6H)	1.4	01/00 → 06/00	AUB	Petrol	1390	4	46
AROSA (6H)	1.4	05/99 → 06/00	AUD	Petrol	1390	4	47
AROSA (6H)	1.7	08/99 → 06/00	AKU	Diesel	1716	4	101
CORDOBA (6K1, 6K2)	1.0	09/99 → 06/99	AER	Petrol	999	4	8
CORDOBA (6K1, 6K2)	1.3	02/99 → 08/99	2G	Petrol	1272	4	28
CORDOBA (6K1, 6K2)	1.3	02/99 → 08/99	AAV	Petrol	1272	4	29
CORDOBA (6K1, 6K2)	1.4	06/99 → 06/99	ABD	Petrol	1390	4	32
CORDOBA (6K1, 6K2)	1.4	06/99 → 06/99	AEX	Petrol	1391	4	33
CORDOBA (6K1, 6K2)	1.4	09/99 → 06/99	AFH	Petrol	1390	4	34
CORDOBA (6K1, 6K2)	1.4	06/99 → 06/99	AKV	Petrol	1391	4	38
CORDOBA (6K1, 6K2)	1.4	12/99 → 04/99	ANX	Petrol	1390	4	41
CORDOBA (6K1, 6K2)	1.4	06/99 → 06/99	APQ	Petrol	1391	4	43
CORDOBA (6K1, 6K2)	1.6	05/99 → 06/99	1F	Petrol	1595	4	69
CORDOBA (6K1, 6K2)	1.6	02/99 → 06/99	ABU	Petrol	1598	4	71
CORDOBA (6K1, 6K2)	1.6	02/99 → 06/99	AEE	Petrol	1598	4	72
CORDOBA (6K1, 6K2)	1.6	07/99 → 10/99	AFT	Petrol	1595	4	74
CORDOBA (6K1, 6K2)	1.6	07/99 → 10/99	AKL	Petrol	1595	4	75
CORDOBA (6K1, 6K2)	1.6	02/99 → 06/99	ALM	Petrol	1598	4	76
CORDOBA (6K1, 6K2)	1.7	07/99 → 06/99	AKU	Diesel	1716	4	101
CORDOBA (6K1, 6K2)	1.8	02/99 → 06/99	ABS	Petrol	1781	4	102
CORDOBA (6K1, 6K2)	1.8	02/99 → 06/99	ACC	Petrol	1781	4	103
CORDOBA (6K1, 6K2)	1.8	10/99 → 08/99	ADL	Petrol	1781	4	104
CORDOBA (6K1, 6K2)	1.8	02/99 → 06/99	ADZ	Petrol	1781	4	105
CORDOBA (6K1, 6K2)	1.9	02/99 → 08/99	1Y	Diesel	1896	4	131
CORDOBA (6K1, 6K2)	1.9	08/99 → 06/99	IZ	Diesel	1896	4	132
CORDOBA (6K1, 6K2)	1.9	02/99 → 08/99	AAZ	Diesel	1896	4	133
CORDOBA (6K1, 6K2)	1.9	08/99 → 06/99	AEY	Diesel	1896	4	134
CORDOBA (6K1, 6K2)	1.9	03/99 → 06/99	AFN	Diesel	1896	4	135
CORDOBA (6K1, 6K2)	1.9	08/99 → 06/99	AHU	Diesel	1896	4	139
CORDOBA (6K1, 6K2)	2.0	02/99 → 06/99	2E	Petrol	1984	4	165
CORDOBA (6K1, 6K2)	2.0	08/99 → 06/99	ABF	Petrol	1984	4	166
CORDOBA (6K1, 6K2)	2.0	02/99 → 06/99	AGG	Petrol	1984	4	168
CORDOBA (6K2)	1.0	06/99 → 10/00	ALD	Petrol	999	4	10
CORDOBA (6K2)	1.0	06/99 → 10/00	ANV	Petrol	999	4	12
CORDOBA (6K2)	1.0	06/99 → 10/00	AUC	Petrol	999	4	14
CORDOBA (6K2)	1.4	06/99 → 10/00	AKK	Petrol	1390	4	37
CORDOBA (6K2)	1.4	06/99 → 10/00	ANW	Petrol	1390	4	40
CORDOBA (6K2)	1.4	05/00 → 10/00	APE	Petrol	1390	4	42
CORDOBA (6K2)	1.4	02/00 → 10/00	AQQ	Petrol	1390	4	44
CORDOBA (6K2)	1.4	05/00 → 10/00	AUA	Petrol	1390	4	45
CORDOBA (6K2)	1.4	02/00 → 10/00	AUB	Petrol	1390	4	46
CORDOBA (6K2)	1.4	06/99 → 10/00	AUD	Petrol	1390	4	47
CORDOBA (6K2)	1.6	06/99 → 10/00	AEH	Petrol	1595	4	73
CORDOBA (6K2)	1.6	06/99 → 10/00	AKL	Petrol	1595	4	75



Ltr







CC



9

	Ltr				CC		
CORDOBA (6K2)	1.6	06/99→10/00	ALM	Petrol	1598	4	76
CORDOBA (6K2)	1.6	06/99→10/00	APF	Petrol	1595	4	78
CORDOBA (6K2)	1.6	06/99→10/00	AUR	Petrol	1595	4	80
CORDOBA (6K2)	1.8	07/00→10/00	AQX	Petrol	1781	4	112
CORDOBA (6K2)	1.8	07/00→10/00	AYP	Petrol	1781	4	116
CORDOBA (6K2)	1.9	06/99→10/00	AGP	Diesel	1896	4	136
CORDOBA (6K2)	1.9	06/99→10/00	AGR	Diesel	1896	4	137
CORDOBA (6K2)	1.9	06/99→10/00	AHU	Diesel	1896	4	139
CORDOBA (6K2)	1.9	06/99→10/00	ALH	Diesel	1896	4	140
CORDOBA (6K2)	1.9	06/99→10/00	AQM	Diesel	1896	4	142
CORDOBA (6K2)	1.9	06/99→10/00	ASK	Diesel	1896	4	144
CORDOBA (6K2)	1.9	06/99→10/00	ASV	Diesel	1896	4	145
CORDOBA (6L2)	1.2	10/00→06/00	AZQ	Petrol	1198	3	18
CORDOBA (6L2)	1.2	10/00→06/00	BME	Petrol	1198	3	20
CORDOBA (6L2)	1.2	05/00→11/00	BXV	Petrol	1198	3	21
CORDOBA (6L2)	1.4	10/00→12/00	AMF	Diesel	1422	3	39
CORDOBA (6L2)	1.4	10/00→11/00	AUB	Petrol	1390	4	46
CORDOBA (6L2)	1.4	09/00→12/00	BBY	Petrol	1390	4	49
CORDOBA (6L2)	1.4	10/00→11/00	BBZ	Petrol	1390	4	50
CORDOBA (6L2)	1.4	09/00→12/00	BKY	Petrol	1390	4	52
CORDOBA (6L2)	1.4	06/00→11/00	BMS	Diesel	1422	3	53
CORDOBA (6L2)	1.4	05/00→11/00	BNM	Diesel	1422	3	54
CORDOBA (6L2)	1.4	06/00→11/00	BNV	Diesel	1422	3	55
CORDOBA (6L2)	1.4	05/00→11/00	BXW	Petrol	1390	4	56
CORDOBA (6L2)	1.6	04/00→11/00	BAH	Petrol	1598	4	83
CORDOBA (6L2)	1.6	11/00→11/00	BTS	Petrol	1598	4	89
CORDOBA (6L2)	1.9	09/00→11/00	ASY	Diesel	1896	4	146
CORDOBA (6L2)	1.9	10/00→11/00	ASZ	Diesel	1896	4	147
CORDOBA (6L2)	1.9	09/00→11/00	ATD	Diesel	1896	4	148
CORDOBA (6L2)	1.9	09/00→11/00	AXR	Diesel	1896	4	151
CORDOBA (6L2)	1.9	10/00→11/00	BLT	Diesel	1896	4	156
CORDOBA (6L2)	1.9	09/00→11/00	BMT	Diesel	1896	4	157
CORDOBA (6L2)	2.0	09/00→11/00	AZL	Petrol	1984	4	170
CORDOBA (6L2)	2.0	09/00→11/00	BBX	Petrol	1984	4	172
CORDOBA Vario (6K5)	1.4	09/99→06/99	AEX	Petrol	1391	4	33
CORDOBA Vario (6K5)	1.4	06/99→12/00	AKK	Petrol	1390	4	37
CORDOBA Vario (6K5)	1.4	09/99→06/99	AKV	Petrol	1391	4	38
CORDOBA Vario (6K5)	1.4	06/99→12/00	ANW	Petrol	1390	4	40
CORDOBA Vario (6K5)	1.4	06/99→12/00	APE	Petrol	1390	4	42
CORDOBA Vario (6K5)	1.4	09/99→06/99	APQ	Petrol	1391	4	43
CORDOBA Vario (6K5)	1.4	06/99→12/00	AUA	Petrol	1390	4	45
CORDOBA Vario (6K5)	1.4	06/99→12/00	AUD	Petrol	1390	4	47
CORDOBA Vario (6K5)	1.6	05/99→06/99	1F	Petrol	1595	4	69
CORDOBA Vario (6K5)	1.6	09/99→06/99	AEE	Petrol	1598	4	72
CORDOBA Vario (6K5)	1.6	06/99→12/00	AEH	Petrol	1595	4	73
CORDOBA Vario (6K5)	1.6	09/99→06/99	AFT	Petrol	1595	4	74
CORDOBA Vario (6K5)	1.6	06/99→12/00	AKL	Petrol	1595	4	75
CORDOBA Vario (6K5)	1.6	09/99→12/00	ALM	Petrol	1598	4	76
CORDOBA Vario (6K5)	1.6	06/99→12/00	APF	Petrol	1595	4	78
CORDOBA Vario (6K5)	1.6	06/99→12/00	AUR	Petrol	1595	4	80
CORDOBA Vario (6K5)	1.7	07/99→06/99	AKU	Diesel	1716	4	101
CORDOBA Vario (6K5)	1.9	08/99→06/99	1Z	Diesel	1896	4	132
CORDOBA Vario (6K5)	1.9	09/99→06/99	AEY	Diesel	1896	4	134
CORDOBA Vario (6K5)	1.9	07/99→06/99	AFN	Diesel	1896	4	135
CORDOBA Vario (6K5)	1.9	06/99→12/00	AGP	Diesel	1896	4	136
CORDOBA Vario (6K5)	1.9	06/99→12/00	AGR	Diesel	1896	4	137
CORDOBA Vario (6K5)	1.9	08/99→06/99	AHU	Diesel	1896	4	139
CORDOBA Vario (6K5)	1.9	06/99→12/00	ALH	Diesel	1896	4	140
CORDOBA Vario (6K5)	1.9	06/99→12/00	AQM	Diesel	1896	4	142
CORDOBA Vario (6K5)	1.9	06/99→12/00	ASK	Diesel	1896	4	144
CORDOBA Vario (6K5)	1.9	06/99→12/00	ASV	Diesel	1896	4	145
EXEO (3R2)	1.6	03/00→09/01	ALZ	Petrol	1595	4	77
EXEO (3R2)	1.8	09/01→	CDHA	Petrol	1798	4	125
EXEO (3R2)	1.8	05/01→	CDHB	Petrol	1798	4	126
EXEO (3R2)	1.8	12/00→05/01	CFMA	Petrol	1781	4	127
EXEO (3R2)	2.0	03/00→	BWE	Petrol	1984	4	182
EXEO ST (3R5)	1.6	06/00→09/01	ALZ	Petrol	1595	4	77
EXEO ST (3R5)	1.8	09/01→	CDHA	Petrol	1798	4	125
EXEO ST (3R5)	1.8	05/01→	CDHB	Petrol	1798	4	126
EXEO ST (3R5)	1.8	06/00→05/01	CFMA	Petrol	1781	4	127

	Ltr				CC		9
EXEO ST (3R5)	2.0	06/00 →	BWE	Petrol	1984	4	182
IBIZA I (021A)	0.9	08/99 → 05/99	09 NCA	Petrol	903	4	3
IBIZA I (021A)	0.9	08/98 → 05/99	146 A 000	Petrol	903	4	6
IBIZA I (021A)	1.2	11/98 → 12/99	021 A 1000	Petrol	1193	4	16
IBIZA I (021A)	1.2	01/98 → 05/99	021 C.1000	Petrol	1193	4	17
IBIZA I (021A)	1.5	11/98 → 05/99	021 A 2000	Petrol	1461	4	65
IBIZA I (021A)	1.5	10/98 → 05/99	021 B.2000	Petrol	1461	4	66
IBIZA I (021A)	1.5	10/98 → 05/99	021 C.2000	Petrol	1461	4	67
IBIZA I (021A)	1.5	10/98 → 05/99	021 D.2000	Petrol	1461	4	68
IBIZA I (021A)	1.7	01/99 → 05/99	021 A.3000	Petrol	1675	4	97
IBIZA I (021A)	1.7	01/99 → 05/99	021 B.3000	Petrol	1675	4	98
IBIZA I (021A)	1.7	06/98 → 05/99	022 A.5000	Diesel	1714	4	99
IBIZA II (6K1)	1.0	03/99 → 09/99	AAU	Petrol	1043	4	7
IBIZA II (6K1)	1.0	09/99 → 08/99	AER	Petrol	999	4	8
IBIZA II (6K1)	1.3	03/99 → 08/99	2G	Petrol	1272	4	28
IBIZA II (6K1)	1.3	03/99 → 08/99	AAV	Petrol	1272	4	29
IBIZA II (6K1)	1.4	09/99 → 08/99	ABD	Petrol	1390	4	32
IBIZA II (6K1)	1.4	09/99 → 08/99	AEX	Petrol	1391	4	33
IBIZA II (6K1)	1.4	06/99 → 08/99	AFH	Petrol	1390	4	34
IBIZA II (6K1)	1.4	09/99 → 08/99	AKV	Petrol	1391	4	38
IBIZA II (6K1)	1.4	12/99 → 04/99	ANX	Petrol	1390	4	41
IBIZA II (6K1)	1.4	09/99 → 08/99	APQ	Petrol	1391	4	43
IBIZA II (6K1)	1.6	09/99 → 06/99	1F	Petrol	1595	4	69
IBIZA II (6K1)	1.6	03/99 → 08/99	ABU	Petrol	1598	4	71
IBIZA II (6K1)	1.6	03/99 → 08/99	AEE	Petrol	1598	4	72
IBIZA II (6K1)	1.6	04/99 → 08/99	AFT	Petrol	1595	4	74
IBIZA II (6K1)	1.6	03/99 → 08/99	ALM	Petrol	1598	4	76
IBIZA II (6K1)	1.8	03/99 → 08/99	ABS	Petrol	1781	4	102
IBIZA II (6K1)	1.8	03/99 → 08/99	ACC	Petrol	1781	4	103
IBIZA II (6K1)	1.8	11/99 → 08/99	ADL	Petrol	1781	4	104
IBIZA II (6K1)	1.8	03/99 → 08/99	ADZ	Petrol	1781	4	105
IBIZA II (6K1)	1.9	04/99 → 08/99	1Y	Diesel	1896	4	131
IBIZA II (6K1)	1.9	08/99 → 08/99	1Z	Diesel	1896	4	132
IBIZA II (6K1)	1.9	03/99 → 08/99	AAZ	Diesel	1896	4	133
IBIZA II (6K1)	1.9	08/99 → 08/99	AEY	Diesel	1896	4	134
IBIZA II (6K1)	1.9	02/99 → 08/99	AFN	Diesel	1896	4	135
IBIZA II (6K1)	1.9	08/99 → 08/99	AHU	Diesel	1896	4	139
IBIZA II (6K1)	2.0	03/99 → 08/99	2E	Petrol	1984	4	165
IBIZA II (6K1)	2.0	08/99 → 08/99	ABF	Petrol	1984	4	166
IBIZA II (6K1)	2.0	03/99 → 08/99	AGG	Petrol	1984	4	168
IBIZA III (6K1)	1.0	08/99 → 02/00	ALD	Petrol	999	4	10
IBIZA III (6K1)	1.0	08/99 → 02/00	ANV	Petrol	999	4	12
IBIZA III (6K1)	1.0	10/99 → 02/00	AST	Petrol	999	4	13
IBIZA III (6K1)	1.0	08/99 → 02/00	AUC	Petrol	999	4	14
IBIZA III (6K1)	1.0	10/99 → 02/00	AVZ	Petrol	999	4	15
IBIZA III (6K1)	1.4	08/99 → 02/00	AKK	Petrol	1390	4	37
IBIZA III (6K1)	1.4	08/99 → 02/00	ANW	Petrol	1390	4	40
IBIZA III (6K1)	1.4	05/00 → 02/00	APE	Petrol	1390	4	42
IBIZA III (6K1)	1.4	08/99 → 02/00	AQQ	Petrol	1390	4	44
IBIZA III (6K1)	1.4	05/00 → 02/00	AUA	Petrol	1390	4	45
IBIZA III (6K1)	1.4	08/99 → 02/00	AUB	Petrol	1390	4	46
IBIZA III (6K1)	1.4	08/99 → 02/00	AUD	Petrol	1390	4	47
IBIZA III (6K1)	1.6	08/99 → 02/00	AEH	Petrol	1595	4	73
IBIZA III (6K1)	1.6	08/99 → 02/00	AKL	Petrol	1595	4	75
IBIZA III (6K1)	1.6	08/99 → 02/00	ALM	Petrol	1598	4	76
IBIZA III (6K1)	1.6	08/99 → 02/00	APF	Petrol	1595	4	78
IBIZA III (6K1)	1.6	08/99 → 02/00	AUR	Petrol	1595	4	80
IBIZA III (6K1)	1.8	07/00 → 02/00	AQX	Petrol	1781	4	112
IBIZA III (6K1)	1.8	07/00 → 02/00	AYP	Petrol	1781	4	116
IBIZA III (6K1)	1.9	08/99 → 02/00	AGP	Diesel	1896	4	136
IBIZA III (6K1)	1.9	08/99 → 02/00	AGR	Diesel	1896	4	137
IBIZA III (6K1)	1.9	08/99 → 02/00	ALH	Diesel	1896	4	140
IBIZA III (6K1)	1.9	08/99 → 02/00	AQM	Diesel	1896	4	142
IBIZA III (6K1)	1.9	08/99 → 02/00	ASK	Diesel	1896	4	144
IBIZA III (6K1)	1.9	08/99 → 02/00	ASV	Diesel	1896	4	145
IBIZA IV (6L1)	1.2	02/00 → 06/00	AZQ	Petrol	1198	3	18
IBIZA IV (6L1)	1.2	06/00 → 05/00	BBM	Petrol	1198	3	19
IBIZA IV (6L1)	1.2	02/00 → 06/00	BME	Petrol	1198	3	20
IBIZA IV (6L1)	1.2	05/00 → 11/00	BXV	Petrol	1198	3	21
IBIZA IV (6L1)	1.4	05/00 → 12/00	AMF	Diesel	1422	3	39



Ltr







CC



9

IBIZA IV (6L1)	1.4	02/00→11/00	AUB	Petrol	1390	4	46
IBIZA IV (6L1)	1.4	02/00→12/00	BBY	Petrol	1390	4	49
IBIZA IV (6L1)	1.4	02/00→11/00	BBZ	Petrol	1390	4	50
IBIZA IV (6L1)	1.4	02/00→12/00	BKY	Petrol	1390	4	52
IBIZA IV (6L1)	1.4	06/00→11/00	BMS	Diesel	1422	3	53
IBIZA IV (6L1)	1.4	05/00→11/00	BNM	Diesel	1422	3	54
IBIZA IV (6L1)	1.4	06/00→11/00	BNV	Diesel	1422	3	55
IBIZA IV (6L1)	1.4	05/00→11/00	BXW	Petrol	1390	4	56
IBIZA IV (6L1)	1.6	02/00→11/00	BAH	Petrol	1598	4	83
IBIZA IV (6L1)	1.6	11/00→11/00	BTS	Petrol	1598	4	89
IBIZA IV (6L1)	1.8	01/00→02/00	BBU	Petrol	1781	4	118
IBIZA IV (6L1)	1.8	12/00→05/00	BJX	Petrol	1781	4	119
IBIZA IV (6L1)	1.8	12/00→05/00	BKV	Petrol	1781	4	120
IBIZA IV (6L1)	1.8	01/00→02/00	BLZ	Petrol	1781	4	121
IBIZA IV (6L1)	1.9	02/00→12/00	ASY	Diesel	1896	4	146
IBIZA IV (6L1)	1.9	02/00→11/00	ASZ	Diesel	1896	4	147
IBIZA IV (6L1)	1.9	02/00→11/00	ATD	Diesel	1896	4	148
IBIZA IV (6L1)	1.9	02/00→11/00	AXR	Diesel	1896	4	151
IBIZA IV (6L1)	1.9	02/00→11/00	BLT	Diesel	1896	4	156
IBIZA IV (6L1)	1.9	02/00→11/00	BMT	Diesel	1896	4	157
IBIZA IV (6L1)	1.9	03/00→02/00	BPX	Diesel	1896	4	158
IBIZA IV (6L1)	1.9	03/00→02/00	BUK	Diesel	1896	4	160
IBIZA IV (6L1)	2.0	04/00→11/00	AZL	Petrol	1984	4	170
IBIZA IV (6L1)	2.0	04/00→11/00	BBX	Petrol	1984	4	172
IBIZA V (6J5)	1.2	03/00→	BZG	Petrol	1198	3	22
IBIZA V (6J5)	1.2	08/01→	CBZA	Petrol	1197	4	23
IBIZA V (6J5)	1.2	09/01→	CBZB	Petrol	1197	4	24
IBIZA V (6J5)	1.2	05/01→	CFWA	Diesel	1199	3	25
IBIZA V (6J5)	1.2	03/00→	CGPA	Petrol	1198	3	26
IBIZA V (6J5)	1.2	07/00→	CGPB	Petrol	1198	3	27
IBIZA V (6J5)	1.4	07/00→06/01	BMS	Diesel	1422	3	53
IBIZA V (6J5)	1.4	03/00→	BXW	Petrol	1390	4	56
IBIZA V (6J5)	1.4	06/00→	CAVF	Petrol	1390	4	59
IBIZA V (6J5)	1.4	03/00→	CGGB	Petrol	1390	4	62
IBIZA V (6J5)	1.4	06/00→	CNUB	Petrol	1390	4	63
IBIZA V (6J5)	1.6	05/00→	BTS	Petrol	1598	4	89
IBIZA V (6J5)	1.6	05/01→06/01	CAYA	Diesel	1598	4	90
IBIZA V (6J5)	1.6	05/00→	CAYB	Diesel	1598	4	91
IBIZA V (6J5)	1.6	05/00→	CAYC	Diesel	1598	4	92
IBIZA V (6J5)	1.9	03/00→06/01	BLS	Diesel	1896	4	155
IBIZA V (6J5)	1.9	07/00→06/01	BXJ	Diesel	1896	4	164
IBIZA V SPORTCOUPE (6J1)	1.2	07/00→	BZG	Petrol	1198	3	22
IBIZA V SPORTCOUPE (6J1)	1.2	09/01→	CBZB	Petrol	1197	4	24
IBIZA V SPORTCOUPE (6J1)	1.2	05/01→	CFWA	Diesel	1199	3	25
IBIZA V SPORTCOUPE (6J1)	1.2	07/00→	CGPA	Petrol	1198	3	26
IBIZA V SPORTCOUPE (6J1)	1.2	07/00→	CGPB	Petrol	1198	3	27
IBIZA V SPORTCOUPE (6J1)	1.4	07/00→06/01	BMS	Diesel	1422	3	53
IBIZA V SPORTCOUPE (6J1)	1.4	07/00→	BXW	Petrol	1390	4	56
IBIZA V SPORTCOUPE (6J1)	1.4	06/00→	CAVE	Petrol	1390	4	58
IBIZA V SPORTCOUPE (6J1)	1.4	06/00→	CAVF	Petrol	1390	4	59
IBIZA V SPORTCOUPE (6J1)	1.4	07/00→	CGGB	Petrol	1390	4	62
IBIZA V SPORTCOUPE (6J1)	1.4	06/00→	CNUB	Petrol	1390	4	63
IBIZA V SPORTCOUPE (6J1)	1.6	07/00→	BTS	Petrol	1598	4	89
IBIZA V SPORTCOUPE (6J1)	1.6	05/01→06/01	CAYA	Diesel	1598	4	90
IBIZA V SPORTCOUPE (6J1)	1.6	05/00→	CAYB	Diesel	1598	4	91
IBIZA V SPORTCOUPE (6J1)	1.6	05/00→	CAYC	Diesel	1598	4	92
IBIZA V SPORTCOUPE (6J1)	1.9	07/00→06/01	BLS	Diesel	1896	4	155
IBIZA V SPORTCOUPE (6J1)	1.9	07/00→06/01	BXJ	Diesel	1896	4	164
IBIZA V ST (6J8)	1.2	09/01→	CBZA	Petrol	1197	4	23
IBIZA V ST (6J8)	1.2	09/01→	CBZB	Petrol	1197	4	24
IBIZA V ST (6J8)	1.2	04/01→	CFWA	Diesel	1199	3	25
IBIZA V ST (6J8)	1.2	05/01→	CGPA	Petrol	1198	3	26
IBIZA V ST (6J8)	1.2	05/01→	CGPB	Petrol	1198	3	27
IBIZA V ST (6J8)	1.4	02/01→	CAVF	Petrol	1390	4	59
IBIZA V ST (6J8)	1.4	03/01→	CGGB	Petrol	1390	4	62
IBIZA V ST (6J8)	1.4	02/01→	CNUB	Petrol	1390	4	63
IBIZA V ST (6J8)	1.6	02/01→	BTS	Petrol	1598	4	89
IBIZA V ST (6J8)	1.6	03/01→	CAYB	Diesel	1598	4	91
IBIZA V ST (6J8)	1.6	03/01→	CAYC	Diesel	1598	4	92
INCA (6K9)	1.4	11/99→06/00	AEX	Petrol	1391	4	33

	Ltr				CC		9
INCA (6K9)	1.4	11/99 → 06/00	AKV	Petrol	1391	4	38
INCA (6K9)	1.4	11/99 → 06/00	APQ	Petrol	1391	4	43
INCA (6K9)	1.4	04/00 → 06/00	AUA	Petrol	1390	4	45
INCA (6K9)	1.4	11/99 → 06/00	AUD	Petrol	1390	4	47
INCA (6K9)	1.6	11/99 → 05/99	1F	Petrol	1595	4	69
INCA (6K9)	1.6	06/99 → 09/00	AEE	Petrol	1598	4	72
INCA (6K9)	1.6	06/99 → 09/00	ALM	Petrol	1598	4	76
INCA (6K9)	1.7	09/99 → 06/00	AHB	Diesel	1716	4	100
INCA (6K9)	1.9	11/99 → 06/00	1Y	Diesel	1896	4	131
INCA (6K9)	1.9	11/99 → 06/00	AEY	Diesel	1896	4	134
INCA (6K9)	1.9	09/99 → 06/00	ALH	Diesel	1896	4	140
INCA (6K9)	1.9	11/99 → 06/00	AYQ	Diesel	1896	4	152
LEON (1M1)	1.4	11/99 → 06/00	AHW	Petrol	1390	4	36
LEON (1M1)	1.4	11/99 → 06/00	APE	Petrol	1390	4	42
LEON (1M1)	1.4	11/99 → 06/00	AUA	Petrol	1390	4	45
LEON (1M1)	1.4	11/99 → 06/00	AXP	Petrol	1390	4	48
LEON (1M1)	1.4	11/99 → 06/00	BCA	Petrol	1390	4	51
LEON (1M1)	1.6	11/99 → 06/00	AEH	Petrol	1595	4	73
LEON (1M1)	1.6	11/99 → 06/00	AKL	Petrol	1595	4	75
LEON (1M1)	1.6	11/99 → 06/00	APF	Petrol	1595	4	78
LEON (1M1)	1.6	09/00 → 06/00	ATN	Petrol	1598	4	79
LEON (1M1)	1.6	09/00 → 06/00	AUS	Petrol	1598	4	81
LEON (1M1)	1.6	09/00 → 06/00	AZD	Petrol	1598	4	82
LEON (1M1)	1.6	09/00 → 06/00	BCB	Petrol	1598	4	84
LEON (1M1)	1.6	10/00 → 06/00	BFQ	Petrol	1595	4	85
LEON (1M1)	1.6	10/00 → 06/00	BGU	Petrol	1595	4	86
LEON (1M1)	1.8	11/99 → 06/00	AGN	Petrol	1781	4	106
LEON (1M1)	1.8	11/99 → 06/00	AJQ	Petrol	1781	4	108
LEON (1M1)	1.8	02/00 → 06/00	AMK	Petrol	1781	4	109
LEON (1M1)	1.8	11/99 → 06/00	APG	Petrol	1781	4	110
LEON (1M1)	1.8	11/99 → 06/00	APP	Petrol	1781	4	111
LEON (1M1)	1.8	11/99 → 06/00	ARY	Petrol	1781	4	113
LEON (1M1)	1.8	11/99 → 06/00	AUQ	Petrol	1781	4	114
LEON (1M1)	1.8	07/00 → 06/00	BAM	Petrol	1781	4	117
LEON (1M1)	1.9	11/99 → 06/00	AGR	Diesel	1896	4	137
LEON (1M1)	1.9	11/99 → 06/00	AHF	Diesel	1896	4	138
LEON (1M1)	1.9	11/99 → 06/00	ALH	Diesel	1896	4	140
LEON (1M1)	1.9	11/99 → 06/00	AQM	Diesel	1896	4	142
LEON (1M1)	1.9	02/00 → 06/00	ARL	Diesel	1896	4	143
LEON (1M1)	1.9	11/99 → 06/00	ASV	Diesel	1896	4	145
LEON (1M1)	1.9	05/00 → 06/00	ASZ	Diesel	1896	4	147
LEON (1M1)	1.9	10/00 → 06/00	AXR	Diesel	1896	4	151
LEON (1M1)	2.8	02/00 → 06/00	AUE	Petrol	2792	6	191
LEON (1M1)	2.8	05/00 → 06/00	BDE	Petrol	2792	6	193
LEON (1P1)	1.2	02/01 →	CBZB	Petrol	1197	4	24
LEON (1P1)	1.4	06/00 →	BXW	Petrol	1390	4	56
LEON (1P1)	1.4	11/00 →	CAXC	Petrol	1390	4	61
LEON (1P1)	1.4	06/00 →	CGGB	Petrol	1390	4	62
LEON (1P1)	1.6	07/00 →	BSE	Petrol	1595	4	87
LEON (1P1)	1.6	07/00 →	BSF	Petrol	1595	4	88
LEON (1P1)	1.6	11/01 →	CAYB	Diesel	1598	4	91
LEON (1P1)	1.6	02/01 →	CAYC	Diesel	1598	4	92
LEON (1P1)	1.6	07/00 →	CCSA	Petrol/Ethanol	1595	4	93
LEON (1P1)	1.6	07/00 →	CCSA	Petrol	1595	4	93
LEON (1P1)	1.6	12/00 →	CHGA	Petrol/Petroleum Gas (LPG)	1595	4	94
LEON (1P1)	1.6	07/00 →	CMXA	Petrol/Ethanol	1595	4	95
LEON (1P1)	1.6	07/00 →	CMXA	Petrol	1595	4	95
LEON (1P1)	1.8	06/00 →	BZB	Petrol	1798	4	123
LEON (1P1)	1.8	06/00 →	CDAA	Petrol	1798	4	124
LEON (1P1)	1.9	10/00 →	ASV	Diesel	1896	4	145
LEON (1P1)	1.9	07/00 →	BKC	Diesel	1896	4	154
LEON (1P1)	1.9	07/00 →	BLS	Diesel	1896	4	155
LEON (1P1)	1.9	07/00 →	BXE	Diesel	1896	4	162
LEON (1P1)	1.9	06/00 →	BXF	Diesel	1896	4	163
LEON (1P1)	2.0	07/00 → 05/01	AZV	Diesel	1968	4	171
LEON (1P1)	2.0	07/00 →	BKD	Diesel	1968	4	173
LEON (1P1)	2.0	07/00 → 05/01	BLR	Petrol	1984	4	174
LEON (1P1)	2.0	07/00 → 05/01	BLY	Petrol	1984	4	175
LEON (1P1)	2.0	10/00 →	BMM	Diesel	1968	4	176
LEON (1P1)	2.0	05/00 →	BMN	Diesel	1968	4	177



Ltr















CC











9

Model	Ltr	Year Range	Code	Fuel	CC	Seats	Price
LEON (1P1)	2.0	07/00→05/01	BVY	Petrol	1984	4	179
LEON (1P1)	2.0	07/00→05/01	BVZ	Petrol	1984	4	180
LEON (1P1)	2.0	05/00→03/00	BWA	Petrol	1984	4	181
LEON (1P1)	2.0	11/00→	BWJ	Petrol	1984	4	183
LEON (1P1)	2.0	06/00→	CCZB	Petrol	1984	4	185
LEON (1P1)	2.0	09/00→	CDLA	Petrol	1984	4	186
LEON (1P1)	2.0	11/00→	CDLD	Petrol	1984	4	187
LEON (1P1)	2.0	07/00→	CFHC	Diesel	1968	4	188
MALAGA (O23A)	1.2	11/98→12/99	O21 A.1000	Petrol	1193	4	16
MALAGA (O23A)	1.2	12/98→12/99	O21 C.1000	Petrol	1193	4	17
MALAGA (O23A)	1.5	05/98→12/99	O21 A.2000	Petrol	1461	4	65
MALAGA (O23A)	1.5	01/98→12/99	O21 B.2000	Petrol	1461	4	66
MALAGA (O23A)	1.5	10/98→12/99	O21 C.2000	Petrol	1461	4	67
MALAGA (O23A)	1.5	10/98→12/99	O21 D.2000	Petrol	1461	4	68
MALAGA (O23A)	1.7	05/98→12/99	O22 A.5000	Diesel	1714	4	99
MARBELLA (28)	0.8	08/98→12/99	O8 NCA	Petrol	843	4	1
MARBELLA (28)	0.9	11/99→10/99	O8 NCB	Petrol	899	4	2
MARBELLA (28)	0.9	01/98→12/99	O9 NCA	Petrol	903	4	3
MARBELLA (28)	0.9	01/99→11/99	O9 NCB	Petrol	903	4	4
MARBELLA (28)	0.9	01/98→11/99	100 GL 7000	Petrol	903	4	5
MARBELLA Box (O28A)	0.8	01/98→12/99	O8 NCA	Petrol	843	4	1
MARBELLA Box (O28A)	0.9	01/98→12/99	O9 NCA	Petrol	903	4	3
MARBELLA Box (O28A)	0.9	01/98→12/99	O9 NCB	Petrol	903	4	4
TERRA (24)	0.9	02/98→12/99	O9 NCA	Petrol	903	4	3
TERRA (24)	0.9	02/99→12/99	O9 NCB	Petrol	903	4	4
TERRA (24)	1.3	03/99→12/99	MN	Diesel	1272	4	30
TERRA (24)	1.4	10/99→12/99	1 W	Diesel	1398	4	31
TERRA Box (O24A)	0.9	01/98→12/99	O9 NCA	Petrol	903	4	3
TERRA Box (O24A)	0.9	01/99→12/99	O9 NCB	Petrol	903	4	4
TERRA Box (O24A)	1.3	03/99→02/99	MN	Diesel	1272	4	30
TERRA Box (O24A)	1.4	10/99→02/99	1 W	Diesel	1398	4	31
TOLEDO I (1L)	1.6	05/99→03/99	1F	Petrol	1595	4	69
TOLEDO I (1L)	1.6	05/99→03/99	ABN	Petrol	1595	4	70
TOLEDO I (1L)	1.6	11/99→03/99	AFT	Petrol	1595	4	74
TOLEDO I (1L)	1.6	05/99→03/99	EZ	Petrol	1595	4	96
TOLEDO I (1L)	1.8	11/99→12/99	ABS	Petrol	1781	4	102
TOLEDO I (1L)	1.8	11/99→12/99	ACC	Petrol	1781	4	103
TOLEDO I (1L)	1.8	11/99→12/99	ADZ	Petrol	1781	4	105
TOLEDO I (1L)	1.8	05/99→03/99	KR	Petrol	1781	4	128
TOLEDO I (1L)	1.8	05/99→03/99	PL	Petrol	1781	4	129
TOLEDO I (1L)	1.8	05/99→12/99	RP	Petrol	1781	4	130
TOLEDO I (1L)	1.9	05/99→03/99	1Y	Diesel	1896	4	131
TOLEDO I (1L)	1.9	08/99→03/99	1Z	Diesel	1896	4	132
TOLEDO I (1L)	1.9	05/99→03/99	AAZ	Diesel	1896	4	133
TOLEDO I (1L)	1.9	11/99→03/99	AFN	Diesel	1896	4	135
TOLEDO I (1L)	1.9	08/99→03/99	AHU	Diesel	1896	4	139
TOLEDO I (1L)	2.0	05/99→03/99	2E	Petrol	1984	4	165
TOLEDO I (1L)	2.0	11/99→03/99	ABF	Petrol	1984	4	166
TOLEDO I (1L)	2.0	05/99→03/99	AGG	Petrol	1984	4	168
TOLEDO II (1M2)	1.4	07/99→05/00	AHW	Petrol	1390	4	36
TOLEDO II (1M2)	1.4	07/99→05/00	APE	Petrol	1390	4	42
TOLEDO II (1M2)	1.4	07/99→05/00	AUA	Petrol	1390	4	45
TOLEDO II (1M2)	1.4	07/99→05/00	AXP	Petrol	1390	4	48
TOLEDO II (1M2)	1.4	07/99→05/00	BCA	Petrol	1390	4	51
TOLEDO II (1M2)	1.6	04/99→09/00	AEH	Petrol	1595	4	73
TOLEDO II (1M2)	1.6	04/99→09/00	AKL	Petrol	1595	4	75
TOLEDO II (1M2)	1.6	04/99→09/00	APF	Petrol	1595	4	78
TOLEDO II (1M2)	1.6	09/00→05/00	AUS	Petrol	1598	4	81
TOLEDO II (1M2)	1.6	09/00→05/00	AZD	Petrol	1598	4	82
TOLEDO II (1M2)	1.6	09/00→05/00	BCB	Petrol	1598	4	84
TOLEDO II (1M2)	1.8	04/99→05/00	AGN	Petrol	1781	4	106
TOLEDO II (1M2)	1.8	04/99→05/00	APG	Petrol	1781	4	110
TOLEDO II (1M2)	1.8	05/00→05/00	APP	Petrol	1781	4	111
TOLEDO II (1M2)	1.8	05/00→05/00	AUQ	Petrol	1781	4	114
TOLEDO II (1M2)	1.9	04/99→05/00	AGR	Diesel	1896	4	137
TOLEDO II (1M2)	1.9	04/99→05/00	AHF	Diesel	1896	4	138
TOLEDO II (1M2)	1.9	04/99→05/00	ALH	Diesel	1896	4	140
TOLEDO II (1M2)	1.9	11/99→06/00	AQM	Diesel	1896	4	142
TOLEDO II (1M2)	1.9	10/00→05/00	ARL	Diesel	1896	4	143
TOLEDO II (1M2)	1.9	04/99→05/00	ASV	Diesel	1896	4	145

	Ltr				CC		9
TOLEDO II (1M2)	1.9	05/00 → 05/00	ASZ	Diesel	1896	4	147
TOLEDO II (1M2)	2.3	04/99 → 05/00	AGZ	Petrol	2324	5	189
TOLEDO II (1M2)	2.3	05/00 → 05/00	AQN	Petrol	2324	5	190
TOLEDO III (5P2)	1.6	10/00 → 05/00	BGU	Petrol	1595	4	86
TOLEDO III (5P2)	1.6	10/00 → 05/00	BSE	Petrol	1595	4	87
TOLEDO III (5P2)	1.6	10/00 → 05/00	BSF	Petrol	1595	4	88
TOLEDO III (5P2)	1.6	10/00 → 05/00	CCSA	Petrol/Ethanol	1595	4	93
TOLEDO III (5P2)	1.6	10/00 → 05/00	CCSA	Petrol	1595	4	93
TOLEDO III (5P2)	1.8	01/00 → 05/00	BYT	Petrol	1798	4	122
TOLEDO III (5P2)	1.8	01/00 → 05/00	BZB	Petrol	1798	4	123
TOLEDO III (5P2)	1.8	01/00 → 05/00	CDAA	Petrol	1798	4	124
TOLEDO III (5P2)	1.9	10/00 → 05/00	BJB	Diesel	1896	4	153
TOLEDO III (5P2)	1.9	10/00 → 05/00	BKC	Diesel	1896	4	154
TOLEDO III (5P2)	1.9	10/00 → 05/00	BLS	Diesel	1896	4	155
TOLEDO III (5P2)	1.9	10/00 → 05/00	BXE	Diesel	1896	4	162
TOLEDO III (5P2)	2.0	09/00 → 05/00	AZV	Diesel	1968	4	171
TOLEDO III (5P2)	2.0	04/00 → 05/00	BKD	Diesel	1968	4	173
TOLEDO III (5P2)	2.0	10/00 → 05/00	BLR	Petrol	1984	4	174
TOLEDO III (5P2)	2.0	10/00 → 05/00	BLY	Petrol	1984	4	175
TOLEDO III (5P2)	2.0	11/00 → 05/00	BMM	Diesel	1968	4	176
TOLEDO III (5P2)	2.0	01/00 → 05/00	BMN	Diesel	1968	4	177
TOLEDO III (5P2)	2.0	10/00 → 05/00	BVY	Petrol	1984	4	179
TOLEDO III (5P2)	2.0	10/00 → 05/00	BVZ	Petrol	1984	4	180
TOLEDO III (5P2)	2.0	11/00 → 05/00	BWA	Petrol	1984	4	181
TOLEDO IV (KG3)	1.2	07/01 →	CBZA	Petrol	1197	4	23
TOLEDO IV (KG3)	1.2	07/01 →	CBZB	Petrol	1197	4	24
TOLEDO IV (KG3)	1.4	07/01 →	CAXA	Petrol	1390	4	60
TOLEDO IV (KG3)	1.6	07/01 →	CAYC	Diesel	1598	4	92

		CC			9			CC			9
021 A 1000	Petrol	1193	4	75.00	16	APF	Petrol	1595	4	81.00	78
021 A 2000	Petrol	1461	4	83.00	65	APG	Petrol	1781	4	81.00	110
021 A.3000	Petrol	1675	4	83.00	97	APP	Petrol	1781	4	81.00	111
021 B.2000	Petrol	1461	4	83.00	66	APQ	Petrol	1391	4	76.50	43
021 B.3000	Petrol	1675	4	83.00	98	AQM	Diesel	1896	4	79.50	142
021 C.1000	Petrol	1193	4	75.00	17	AQN	Petrol	2324	5	81.00	190
021 C.2000	Petrol	1461	4	83.00	67	AQQ	Petrol	1390	4	76.50	44
021 D.2000	Petrol	1461	4	83.00	68	AQX	Petrol	1781	4	81.00	112
022 A.5000	Diesel	1714	4	83.00	99	ARL	Diesel	1896	4	79.50	143
08 NCA	Petrol	843	4	65.00	1	ARY	Petrol	1781	4	81.00	113
08 NCB	Petrol	899	4	65.00	2	ASK	Diesel	1896	4	79.50	144
09 NCA	Petrol	903	4	65.00	3	AST	Petrol	999	4	67.10	13
09 NCB	Petrol	903	4	65.00	4	ASV	Diesel	1896	4	79.50	145
1 W	Diesel	1398	4	75.00	31	ASY	Diesel	1896	4	79.50	146
100 GL 7000	Petrol	903	4	65.00	5	ASZ	Diesel	1896	4	79.50	147
146 A 000	Petrol	903	4	65.00	6	ATD	Diesel	1896	4	79.50	148
1F	Petrol	1595	4	81.00	69	ATM	Petrol	1984	4	82.50	169
1Y	Diesel	1896	4	79.50	131	ATN	Petrol	1598	4	76.50	79
1Z	Diesel	1896	4	79.50	132	AUA	Petrol	1390	4	76.50	45
2E	Petrol	1984	4	82.50	165	AUB	Petrol	1390	4	76.50	46
2G	Petrol	1272	4	75.00	28	AUC	Petrol	999	4	67.10	14
AAU	Petrol	1043	4	75.00	7	AUD	Petrol	1390	4	76.50	47
AAV	Petrol	1272	4	75.00	29	AUE	Petrol	2792	6	81.00	191
AAZ	Diesel	1896	4	79.50	133	AUQ	Petrol	1781	4	81.00	114
ABD	Petrol	1390	4	75.00	32	AUR	Petrol	1595	4	81.00	80
ABF	Petrol	1984	4	82.50	166	AUS	Petrol	1598	4	76.50	81
ABN	Petrol	1595	4	81.00	70	AUY	Diesel	1896	4	79.50	149
ABS	Petrol	1781	4	81.00	102	AVG	Diesel	1896	4	79.50	150
ABU	Petrol	1598	4	76.50	71	AVZ	Petrol	999	4	67.10	15
ACC	Petrol	1781	4	81.00	103	AWC	Petrol	1781	4	81.00	115
ADL	Petrol	1781	4	81.00	104	AXP	Petrol	1390	4	76.50	48
ADY	Petrol	1984	4	82.50	167	AXR	Diesel	1896	4	79.50	151
ADZ	Petrol	1781	4	81.00	105	AYL	Petrol	2792	6	81.00	192
AEE	Petrol	1598	4	76.50	72	AYP	Petrol	1781	4	81.00	116
AEH	Petrol	1595	4	81.00	73	AYQ	Diesel	1896	4	79.50	152
AER	Petrol	999	4	67.10	8	AZD	Petrol	1598	4	76.50	82
AEX	Petrol	1391	4	76.50	33	AZL	Petrol	1984	4	82.50	170
AEY	Diesel	1896	4	79.50	134	AZQ	Petrol	1198	3	76.50	18
AFH	Petrol	1390	4	76.50	34	AZV	Diesel	1968	4	81.00	171
AFK	Petrol	1390	4	76.50	35	BAH	Petrol	1598	4	76.50	83
AFN	Diesel	1896	4	79.50	135	BAM	Petrol	1781	4	81.00	117
AFT	Petrol	1595	4	81.00	74	BBM	Petrol	1198	3	76.50	19
AGG	Petrol	1984	4	82.50	168	BBU	Petrol	1781	4	81.00	118
AGN	Petrol	1781	4	81.00	106	BBX	Petrol	1984	4	82.50	172
AGP	Diesel	1896	4	79.50	136	BBY	Petrol	1390	4	76.50	49
AGR	Diesel	1896	4	79.50	137	BBZ	Petrol	1390	4	76.50	50
AGZ	Petrol	2324	5	81.00	189	BCA	Petrol	1390	4	76.50	51
AHB	Diesel	1716	4	79.50	100	BCB	Petrol	1598	4	76.50	84
AHF	Diesel	1896	4	79.50	138	BDE	Petrol	2792	6	81.00	193
AHT	Petrol	997	4	72.00	9	BFQ	Petrol	1595	4	81.00	85
AHU	Diesel	1896	4	79.50	139	BGU	Petrol	1595	4	81.00	86
AHW	Petrol	1390	4	76.50	36	BJB	Diesel	1896	4	79.50	153
AJH	Petrol	1781	4	81.00	107	BJX	Petrol	1781	4	81.00	119
AJQ	Petrol	1781	4	81.00	108	BKC	Diesel	1896	4	79.50	154
AKK	Petrol	1390	4	76.50	37	BKD	Diesel	1968	4	81.00	173
AKL	Petrol	1595	4	81.00	75	BKV	Petrol	1781	4	81.00	120
AKU	Diesel	1716	4	79.50	101	BKY	Petrol	1390	4	76.50	52
AKV	Petrol	1391	4	76.50	38	BLR	Petrol	1984	4	82.50	174
ALD	Petrol	999	4	67.10	10	BLS	Diesel	1896	4	79.50	155
ALH	Diesel	1896	4	79.50	140	BLT	Diesel	1896	4	79.50	156
ALL	Petrol	999	4	67.10	11	BLY	Petrol	1984	4	82.50	175
ALM	Petrol	1598	4	76.50	76	BLZ	Petrol	1781	4	81.00	121
ALZ	Petrol	1595	4	81.00	77	BME	Petrol	1198	3	76.50	20
AMF	Diesel	1422	3	79.50	39	BMM	Diesel	1968	4	81.00	176
AMK	Petrol	1781	4	81.00	109	BMN	Diesel	1968	4	81.00	177
ANU	Diesel	1896	4	79.50	141	BMS	Diesel	1422	3	79.50	53
ANV	Petrol	999	4	67.10	12	BMT	Diesel	1896	4	79.50	157
ANW	Petrol	1390	4	76.50	40	BNM	Diesel	1422	3	79.50	54
ANX	Petrol	1390	4	76.50	41	BNV	Diesel	1422	3	79.50	55
APE	Petrol	1390	4	76.50	42	BPX	Diesel	1896	4	79.50	158

		CC			9			CC			9
BRT	Diesel	1968	4	81.00	178						
BSE	Petrol	1595	4	81.00	87						
BSF	Petrol	1595	4	81.00	88						
BTB	Diesel	1896	4	79.50	159						
BTS	Petrol	1598	4	76.50	89						
BUK	Diesel	1896	4	79.50	160						
BVK	Diesel	1896	4	79.50	161						
BVY	Petrol	1984	4	82.50	179						
BVZ	Petrol	1984	4	82.50	180						
BWA	Petrol	1984	4	82.50	181						
BWE	Petrol	1984	4	82.50	182						
BWJ	Petrol	1984	4	82.50	183						
BXE	Diesel	1896	4	79.50	162						
BXF	Diesel	1896	4	79.50	163						
BXJ	Diesel	1896	4	79.50	164						
BXV	Petrol	1198	3	76.50	21						
BXW	Petrol	1390	4	76.50	56						
BYT	Petrol	1798	4	82.50	122						
BZB	Petrol	1798	4	82.50	123						
BZG	Petrol	1198	3	76.50	22						
CAVA	Petrol	1390	4	76.50	57						
CAVE	Petrol	1390	4	76.50	58						
CAVF	Petrol	1390	4	76.50	59						
CAXA	Petrol	1390	4	76.50	60						
CAXC	Petrol	1390	4	76.50	61						
CAYA	Diesel	1598	4	79.50	90						
CAYB	Diesel	1598	4	79.50	91						
CAYC	Diesel	1598	4	79.50	92						
CBZA	Petrol	1197	4	71.00	23						
CBZB	Petrol	1197	4	71.00	24						
CCSA	Petrol/Ethanol	1595	4	81.00	93						
CCSA	Petrol	1595	4	81.00	93						
CCZA	Petrol	1984	4	82.50	184						
CCZB	Petrol	1984	4	82.50	185						
CDA	Petrol	1798	4	82.50	124						
CDHA	Petrol	1798	4	82.50	125						
CDHB	Petrol	1798	4	82.50	126						
CDLA	Petrol	1984	4	82.50	186						
CDLD	Petrol	1984	4	82.50	187						
CFHC	Diesel	1968	4	81.00	188						
CFMA	Petrol	1781	4	81.00	127						
CFWA	Diesel	1199	3	79.50	25						
CGGB	Petrol	1390	4	76.50	62						
CGPA	Petrol	1198	3	76.50	26						
CGPB	Petrol	1198	3	76.50	27						
CHGA	Petrol/ Petroleum Gas (LPG)	1595	4	81.00	94						
CMXA	Petrol/Ethanol	1595	4	81.00	95						
CMXA	Petrol	1595	4	81.00	95						
CNUB	Petrol	1390	4	76.50	63						
CNWB	Petrol	1390	4	76.50	64						
EZ	Petrol	1595	4	81.00	96						
KR	Petrol	1781	4	81.00	128						
MN	Diesel	1272	4	75.00	30						
PL	Petrol	1781	4	81.00	129						
RP	Petrol	1781	4	81.00	130						



cc



kW/PS

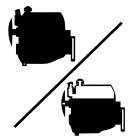

0.8	08 NCA						1	BP520 (Fibre), 1.200mm BP030 (Fibre), 1.800mm	DP011 [13]	
Marbella 0.8	08/86→12/93	843	4	65.00	OHV	25/34				
0.9	08 NCB						2	BP520 (Fibre), 1.200mm BP030 (Fibre), 1.800mm	DP011 [13]	
Marbella 0.9	07/97→10/98	899	4	65.00		30-32/ 41-44				
Marbella 0.9CAT	11/96→10/98									
0.9	09 NCA						3	BP520 (Fibre), 1.200mm BP030 (Fibre), 1.800mm	DP011 [13]	GP011
Ibiza I 0.9	08/90→05/93	903	4	65.00		29/40				
Marbella 0.9	01/87→12/93									
Terra 0.9	01/87→12/96									
0.9	09 NCB						4	BP520 (Fibre), 1.200mm BP030 (Fibre), 1.800mm	DP011 [13]	GP011
Marbella 0.9CAT	01/87→11/96	903	4	65.00	OHV	29/40				
Terra 0.9 CAT	01/90→12/95									
0.9	100 GL 7000						5	BP520 (Fibre), 1.200mm		
Marbella 0.9	01/87→12/93	903	4	65.00	OHV	29/40				
Marbella 0.9CAT	01/90→11/96									
0.9	146 A 000						6	BP520 (Fibre), 1.200mm BP030 (Fibre), 1.800mm	DP011 [13] DR610	GP011
Ibiza I 0.9	08/86→05/93	903	4	65.00	SOHC/OHC	29-32/ 40-43				
1.0	AAU						7	BL570 (Fibre), 1.730mm	DL572 →Ch.80-PW-000000 DL574 Ch.80-PW-000 001→	EV460
Ibiza 2 1.0	03/93→09/96	1043	4	75.00	SOHC/OHC	33/45				
1.0	AER						8	AA5410 (MLS), 0.600mm	CA5410 [3]	EB961 [18]
Arosa 1.0	05/97→06/04	999	4	67.10	SOHC/OHC	37/50				
Cordoba 1.0 i	09/96→06/99									
Ibiza 2 1.0 i	09/96→08/99									
1.0	AHT						9		DT581	
Arosa 1.0	10/98→01/01	997	4	72.00	OHV	37/50				
1.0	ALD						10	AD5630 (MLS), 0.500mm	CD5630	
Arosa 1.0	05/97→06/04	999	4	67.10	SOHC/OHC	37/50				
Cordoba 1.0	06/99→10/02									
Ibiza 3 1.0	08/99→02/02									

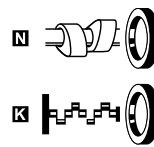
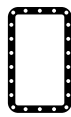
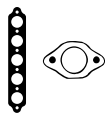

HBS297 [5] M9x1.25x91.00mm (x9)	JC973 [E]	JM333 [4]		HR646 [E]	NA5177 [2] 42.00x56.00x7.00mm, FPM NA5177 [E] [2] 42.00x56.00x7.00mm, FPM	
HBS297 [5] M9x1.25x91.00mm (x9)						
HBS279 [E] [22] M11x1.50x109.00mm (x4)		JM333 [4]	HC027 [E]	HR646 [E]	NB808 [E] [1] 64.00x80.00x8.00mm, FPM	
HBS279 [E] [22] M11x1.50x109.00mm (x4)		JM333 [4]	HC027 [E]	HR646 [E]	NB808 [E] [1] 64.00x80.00x8.00mm, FPM	
					NA5177 [2] 42.00x56.00x7.00mm, FPM NA5177 [E] [2] 42.00x56.00x7.00mm, FPM	
HBS279 [E] [22] M11x1.50x109.00mm (x4)				HR599 [E]	NA5177 [2] 42.00x56.00x7.00mm, FPM NA5177 [E] [2] 42.00x56.00x7.00mm, FPM	
HBS043 [E] [22] M11x1.50x95.00mm (x10)	JD246 [E] JC259 [E] (x2)	JN641 [4]	JJ183	HR569 [E] →Ch.80-NW-500 000 HR816 [E] Ch.80-PW-000 001 →	NA5001 [E] [1][2] 32.00x47.00x10.00mm, FPM NA5001 [E] [E] [1][2] 32.00x47.00x10.00mm, FPM NA5133 [E] [1] 85.00x105.00x11.00mm, FPM	
HBS249 [E] [5] M9x1.25x138.00mm (x10)	JD597 [E] [E] JD601 [E]	JP074 [4] HM5062 [E]	HR397	HR816 [E]	NA5001 [E] [1][2] 32.00x47.00x10.00mm, FPM NA5001 [E] [E] [1][2] 32.00x47.00x10.00mm, FPM NA5133 [E] [1] 85.00x105.00x11.00mm, FPM →Eng.220 083 LK5011 [E] [E] [7][26] 85.00x131.00x15.94mm, PTFE LK5006 [E] [7] 85.00x131.00x16.000mm, PTFE	KA5025 [15]
	JD597 [E] [E] JD5818 [E] [E] (MLS) JD5849 [E] [E] (MLS) JD5817 [E] [E] (MLS)	JM5285		HR646 [E]	NA5133 [E] [1] 85.00x105.00x11.00mm, FPM LK5011 [E] [E] [7][26] 85.00x131.00x15.94mm, PTFE LK5006 [E] [7] 85.00x131.00x16.000mm, PTFE NA5306 [E] [2] 42.00x58.00x8.00mm, ACM 01/99→	KA5025 [15]
HBS362 [E] [5] M9x1.25x162.00mm (x10)	JD5318 [E] JE5076	HR397 [E]	HR397	PA5041 (x8) 6.00/12.20x10.00 (FPM) HR817 [E]	NA5185 [2] 32.00x42.00x7.00mm, FPM NA5185 [E] [2] 32.00x42.00x6.00mm, FPM LK5011 [E] [E] [7][26] 85.00x131.00x15.94mm, PTFE LK5006 [E] [7] 85.00x131.00x16.000mm, PTFE	KA5025 [15]

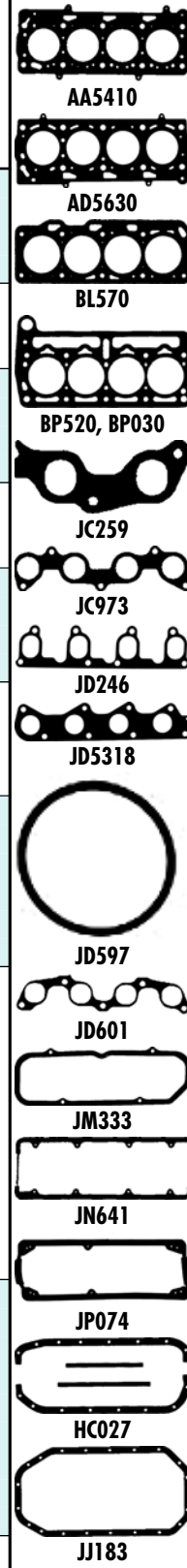



cc



kW/PS

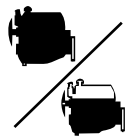

1.0	ALL					11	AA5410 (MLS), 0.600mm	CA5410 [3]	EB961 [18]
Arosa 1.0	05/97→06/04	999	4	67.10	SOHC/OHC	37/50			
1.0	ANV					12	AD5630 (MLS), 0.500mm	CD5630	
Arosa 1.0	05/97→06/04	999	4	67.10	SOHC/OHC	37/50			
Cordoba 1.0	06/99→10/02								
Ibiza 3 1.0	08/99→02/02								
1.0	AST					13			
Ibiza 3 1.0 16V	10/99→02/02	999	4	67.10	SOHC/OHC	51/69			
1.0	AUC					14	AD5630 (MLS), 0.500mm	CD5630	
Arosa 1.0	05/97→06/04	999	4	67.10	SOHC/OHC	37/50			
Cordoba 1.0	06/99→10/02								
Ibiza 3 1.0	08/99→02/02								
1.0	AVZ					15			
Ibiza 3 1.0 16V	10/99→02/02	999	4	67.10	DOHC	51/69			
1.2	021 A 1000					16	AA3130 (Fibre), 1.2mm		EA3130 [3]
Ibiza I 1.2	11/84→12/93	1193	4	75.00		44-47/ 60-63			
Malaga 1.2	11/84→12/93								
1.2	021 C.1000					17	AA3130 (Fibre), 1.2mm		EA3130 [3]
Ibiza I 1.2 i	01/89→05/93	1193	4	75.00	SOHC/OHC	52/71			
Malaga 1.2 i	12/89→12/93								
1.2	AZQ					18	AF5990 (MLS)	CF5990	EF5990
Cordoba 1.2 i	10/02→06/06	1198	3	76.50	DOHC	47/64			
Ibiza 4 1.2	02/02→06/06								
1.2	BBM					19	AG8840 (MLS)	CG8840	EF5990
Ibiza 4 1.2	06/07→05/08	1198	3	76.50	DOHC	44/60			
1.2	BME					20	AF5990 (MLS)	CF5990	EF5990
Cordoba 1.2 i	10/02→06/06	1198	3	76.50	SOHC/OHC	47/64			
Ibiza 4 1.2	02/02→06/06								
1.2	BXV					21	AF5990 (MLS)	CF5990	EF5990
Cordoba 1.2 12V	05/06→11/09	1198	3	76.50	DOHC	51/70			
Ibiza 4 1.2 12V	05/06→11/09								
1.2	BZG					22	AF5990 (MLS)	CF5990	EF5990
Ibiza 5 1.2	03/08→	1198	3	76.50	DOHC	51/70			

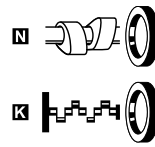
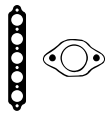

AA5410



AD5630

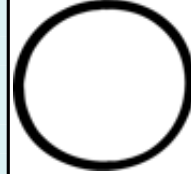

JD5228



JD5318

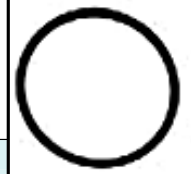

JD597



JD601

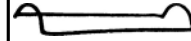

JM2052



JP074

HBS249 [5] M9x1.25x138.00mm (x10)	JD597 [1] [5] JD601 [5]	JP074 [4]	HR397	HR816 [5]	NA5001 [1][2] 32.00x47.00x10.00mm, FPM NA5001 [1][2] 32.00x47.00x10.00mm, FPM LK5011 [7][26] 85.00x131.00x15.94mm, PTFE LK5006 [7] 85.00x131.00x16.000mm, PTFE	KA5025 [15]
HBS362 [5] M9x1.25x162.00mm (x10)	JD5318 [5] JE5076	HR397 [5]	HR397	PA5041 (x8) 6.00/12.20x10.00 (FPM) HR817 [5]	NA5185 [2] 32.00x42.00x7.00mm, FPM NA5185 [2] 32.00x42.00x6.00mm, FPM LK5011 [7][26] 85.00x131.00x15.94mm, PTFE LK5006 [7] 85.00x131.00x16.000mm, PTFE	KA5025 [15]
	JD5228 [1]			PA5041 (x16) 6.00/12.20x10.00 (FPM)	LK5006 [7] 85.00x131.00x16.000mm, PTFE	
HBS362 [5] M9x1.25x162.00mm (x10)	JD5318 [5] JE5076	HR397 [5]	HR397	PA5041 (x8) 6.00/12.20x10.00 (FPM) HR817 [5]	NA5185 [2] 32.00x42.00x7.00mm, FPM NA5185 [2] 32.00x42.00x6.00mm, FPM LK5011 [7][26] 85.00x131.00x15.94mm, PTFE LK5006 [7] 85.00x131.00x16.000mm, PTFE	KA5025 [15]
	JD5228 [1]			PA5041 (x16) 6.00/12.20x10.00 (FPM)	LK5006 [7] 85.00x131.00x16.000mm, PTFE	
HBS044 [19] M12x1.75x115.00mm (x10)		JM2052 [4]		HR599 [5]	NB866 [2] 28.00x42.00x7.00mm, FPM NA784 [1] 70.00x90.00x10.00mm, ACM	
HBS044 [19] M12x1.75x115.00mm (x10)		JM2052 [4]		HR599 [5]	NB866 [2] 28.00x42.00x7.00mm, FPM NA784 [1] 70.00x90.00x10.00mm, ACM	
HBS471 [5] M9x1.25x138.00mm (x8)	JD5811 [1] (x3) JD5816 [5]	HR397 [5]	HR397	PA5041 (x12) 6.00/12.20x10.00 (FPM) HR280 [5]	NA5106 [2] 35.00x48.00x10.00mm, PTFE NA5305 [1][36]	
HBS479 [5] M9x1.25x162.00mm (x8)	JD5808 [1] (x3) JD5819 [5]	HR397 [5]	HR397	PA5041 (x6) 6.00/12.20x10.00 (FPM) HL5002 [5]	NA5106 [2] 35.00x48.00x10.00mm, PTFE NA5305 [1][36]	
HBS471 [5] M9x1.25x138.00mm (x8)	JD5811 [1] (x3) JD5816 [5]	HR397 [5]	HR397	PA5041 (x12) 6.00/12.20x10.00 (FPM) HR280 [5]	NA5106 [2] 35.00x48.00x10.00mm, PTFE	
HBS471 [5] M9x1.25x138.00mm (x8)	JD5811 [1] (x3) JD5816 [5]	HR397 [5]	HR397	PA5041 (x12) 6.00/12.20x10.00 (FPM) HR280 [5]	NA5106 [2] 35.00x48.00x10.00mm, PTFE/ACM NA5106 [2] 35.00x48.00x10.00mm, PTFE	
HBS471 [5] M9x1.25x138.00mm (x8)	JD5811 [1] (x3) JD5816 [5]	HR397 [5]	HR397	PA5041 (x12) 6.00/12.20x10.00 (FPM) HR280 [5]	NA5106 [2] 35.00x48.00x10.00mm, PTFE	



cc



kW/PS

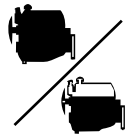

1.2		CBZA					23			
Ibiza 5 1.2 TSI	08/12→	1197	4	71.00	SOHC/OHC	63/86				
Toledo 4 1.2 TSI	07/12→									
1.2		CBZB					24			
Altea 1.2 TSI	04/10→	1197	4	71.00	SOHC/OHC	77/105				
Ibiza 5 1.2 TSI	09/10→									
Leon 1.2 TSI	02/10→									
Toledo 4 1.2 TSI	07/12→									
1.2		CFWA Diesel					25			
Ibiza 5 1.2 TDI	04/10→	1199	3	79.50	DOHC	55/75				
Ibiza 5 2429 S	05/10→									
1.2		CGPA					26	AF5990 (MLS)	CF5990	EF5990
Ibiza 5 1.2	03/08→	1198	3	76.50	DOHC	51/70				
1.2		CGPB					27	AF5990 (MLS)	CF5990	
Ibiza 5 1.2	07/09→	1198	3	76.50	DOHC	44/60				
1.3		2G					28	BL570 (Fibre), 1.730mm	DL572 →Ch.6K-2R-000 100 DL574 Ch.80-PW-000 001→	EV460 Ch.80-PW-000 001→
Cordoba 1.3	02/93→08/94	1272	4	75.00	SOHC/OHC	40/54				
Ibiza 2 1.3 i	03/93→08/99									
1.3		AAV					29	BL570 (Fibre), 1.730mm	DL572 →Ch.6K-2R-000100 →Ch.80-PW-000000 DL574 Ch.6K-2R-000101→ Ch.80-PW-000001→	EV460 Ch.80-PW-000 001→
Cordoba 1.3	02/93→08/94	1272	4	75.00	SOHC/OHC	40/54				
Ibiza 2 1.3 i	03/93→08/99									
1.3		MN Diesel					30	BV460 (Fibre), 1.530mm, 1 Notch BV471 (Fibre), 1.570mm, 2 Notches BV481 (Fibre), 1.610mm, 3 Notches	DV460 ▲	EV460
Terra 1.3 D	03/90→12/94	1272	4	75.00	SOHC/OHC	33/45				
Terra Van 1.3 D	03/90→02/92									
1.4		1 W Diesel					31	BV460 (Fibre), 1.530mm, 1 Notch BV471 (Fibre), 1.570mm, 2 Notches BV481 (Fibre), 1.610mm, 3 Notches	DV460 ▲	EV460
Terra 1.4 D	10/90→12/95	1398	4	75.00	SOHC/OHC	35/48				
1.4		ABD					32	BL570 (Fibre), 1.730mm	DL574 →Eng.ABD558154 DL573 Eng.ABD558155→	EV460
Cordoba 1.4 i	06/94→06/99	1390	4	75.00	SOHC/OHC	44/60				
Ibiza 2 1.4 i	09/93→08/99									

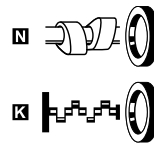
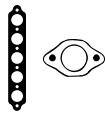

BL570



BV460



JC259



JD246



JN641



JP074



JJ183

		HR397	HR397	PA5041 (x8) 6.00/12.20x10.00 (FPM)		
		HR397	HR397	PA5041 (x8) 6.00/12.20x10.00 (FPM)	NA5124 [2] 32.00x47.00x10.00mm, PTFE/ACM NA5124 [2] 32.00x47.00x10.00mm, PTFE/ACM	
					NA5106 [2] 35.00x48.00x10.00mm, PTFE/ACM NA5106 [2] 35.00x48.00x10.00mm, PTFE	
HBS471 [5] M9x1.25x138.00mm (x8)	JD5811 (x3) JD5816	HR397	HR397	PA5041 (x12) 6.00/12.20x10.00 (FPM) HR280	NA5106 [2] 35.00x48.00x10.00mm, PTFE	
HBS471 [5] M9x1.25x138.00mm (x8)	JD5811 (x3) JD5816	HR397	HR397	PA5041 (x12) 6.00/12.20x10.00 (FPM) HR280	NA5106 [2] 35.00x48.00x10.00mm, PTFE	
HBS043 [22] M11x1.50x95.00mm (x10)	JD246 JC259 (x2)	JN641 [4]	JJ183	HR569 →Ch.80-NW-500 000 HR816 Ch.80-PW-000 001 →	NA5001 [1][2] 32.00x47.00x10.00mm, FPM NA5001 [1][2] 32.00x47.00x10.00mm, FPM NA5133 [1] 85.00x105.00x11.00mm, FPM	
HBS043 [22] M11x1.50x95.00mm (x10)	JD246 JC259 (x2)	JN641 [4]	JJ183	HR569 →Ch.80-NW-500 000 HR816 Ch.80-PW-000 001 →	NA5001 [1][2] 32.00x47.00x10.00mm, FPM NA5001 [1][2] 32.00x47.00x10.00mm, FPM NA5133 [1] 85.00x105.00x11.00mm, FPM	
HBS018 [19] M12x1.75x115.00mm (x10)	JD246 JC259 (x2)	JN641 [4]	JJ183	HR569	NA5001 [1][2] 32.00x47.00x10.00mm, FPM NA5001 [1][2] 32.00x47.00x10.00mm, FPM NA5133 [1] 85.00x105.00x11.00mm, FPM	
HBS018 [19] M12x1.75x115.00mm (x10)	JD246 JC259 (x2)	JN641 [4]	JJ183	HR569 HR816 Ch.80-PW-000 001 →	NA5001 [1][2] 32.00x47.00x10.00mm, FPM NA5001 [1][2] 32.00x47.00x10.00mm, FPM NA5133 [1] 85.00x105.00x11.00mm, FPM	
HBS043 [22] M11x1.50x95.00mm (x10)	JD246 JC259 (x2)	JN641 [4] JP074 [4] HM5062	JJ183	HR569 HR816	NA5001 [1][2] 32.00x47.00x10.00mm, FPM NA5001 [1][2] 32.00x47.00x10.00mm, FPM NA5133 [1] 85.00x105.00x11.00mm, FPM LK5006 [7] 85.00x131.00x16.00mm, PTFE	



cc



kW/PS

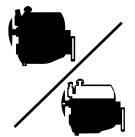

1.4		AEX		33		BZ180 (MLS), 0.500mm	DZ181	EB961 [18]
Arosa 1.4	05/97→06/04	1391	4	76.50	SOHC/OHC	44/60		
Cordoba 1.4 i	06/94→06/99							
Ibiza 2 1.4 i	09/93→08/99							
Inca Van 1.4 i	11/95→06/03							
1.4		AFH		34		AA5500 (MLS)	CA5500 [3]	EB961 [18]
Cordoba 1.4 i	09/96→06/99	1390	4	76.50	DOHC	74/101		
Ibiza 2 1.4 i	06/97→08/99							
1.4		AFK		35		AB5701 (MLS)	CB5700 ☒	EB5700 [3][18]
Arosa 1.4 16V	01/00→06/04	1390	4	76.50	DOHC	74/101		
1.4		AHW		36		AB5701 (MLS)	CB5700 ☒	EB5700 [3][18]
Leon 1.4 16V	11/99→06/06	1390	4	76.50	SOHC/OHC	55/75		
Toledo 2 1.4	07/99→05/06							
1.4		AKK		37		AD5640 (MLS), 0.640mm	CD5640 ☒ [3]	
Arosa 1.4	05/97→06/04	1390	4	76.50	SOHC/OHC	44/60		
Cordoba 1.4	06/99→12/02							
Ibiza 3 1.4	08/99→02/02							
1.4		AKV		38		BZ180 (MLS), 0.500mm	DZ181	EB961 [18]
Arosa 1.4	05/97→06/04	1391	4	76.50	SOHC/OHC	44/60		
Cordoba 1.4 i	06/94→06/99							
Ibiza 2 1.4 i	09/93→08/99							
Inca Van 1.4 i	11/95→06/03							
1.4		AMF Diesel		39		AD5650 (MLS), 1.450mm, 1 Hole AD5660 (MLS), 1.530mm, 2 Holes AD5670 (MLS), 1.610mm, 3 Holes	CD5650 ▲	ED5650 [18]
Arosa 1.4 TDI	01/00→06/04	1422	3	79.50	SOHC/OHC	55/75		
Cordoba 1.4 TDI	10/02→12/05							
Ibiza 4 1.4 TDI	05/02→12/05							

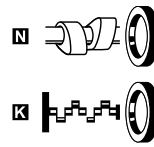
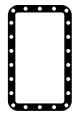
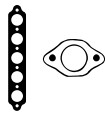

HBS075 [22] M11x1.50x110.00mm (x10)	JD597 [1] [3] JD601 [3]	JP074 [4] HM5062 [3]	HR397	HR816 [3]	NA5001 [1] [2] 32.00x47.00x10.00mm, FPM NA5185 [2] 32.00x42.00x6.00mm, FPM NA5001 [1] [2] 32.00x47.00x10.00mm, FPM NA5133 [1] 85.00x105.00x11.00mm, FPM LK5011 [7] [26] 85.00x131.00x15.94mm, PTFE LK5006 [7] 85.00x131.00x16.000mm, PTFE	KA5025 [15]
HBS360 [22] M11x1.50x142.00mm (x10)	JD5228 [1] (x4) JD5233 [3]	HR397 [3]	HR397	PA5041 (x16) 6.00/12.20x10.00 (FPM) HR791 [3]	NA5001 [1] [2] 32.00x47.00x10.00mm, FPM NA5001 [1] [2] 32.00x47.00x10.00mm, FPM NA5133 [1] 85.00x105.00x11.00mm, FPM LK5006 [7] 85.00x131.00x16.000mm, PTFE Eng.030 001 →	
HBS249 [5] M9x1.25x138.00mm (x10)	JD5228 [1] (x4) JD5298 [3]	HR397 [3]	HR397	PA5041 (x16) 6.00/12.20x10.00 (FPM) HR791 [3]	NA5180 [2] 27.00x42.00x8.00mm, FPM NA5185 [2] 32.00x42.00x6.00mm, FPM	KA5025 [15] KK5551 [20]
HBS249 [5] M9x1.25x138.00mm (x10)	JD5228 [1] JD5298 [3]	HR397 [3]	HR397	PA5041 (x16) 6.00/12.20x10.00 (FPM) HR791 [3]	NA5180 [2] 27.00x42.00x8.00mm, FPM NA5185 [2] 32.00x42.00x6.00mm, FPM LK5011 [7] [26] 85.00x131.00x15.94mm, PTFE	KA5025 [15] KK5551 [20]
HBS362 [5] M9x1.25x162.00mm (x10)	JD5318 [3]	HR397 [3]	HR397	PA5041 (x8) 6.00/12.20x10.00 (FPM) HR817 [3]	NA5185 [2] 32.00x42.00x7.00mm, FPM NA5185 [2] 32.00x42.00x6.00mm, FPM LK5011 [7] [26] 85.00x131.00x15.94mm, PTFE LK5006 [7] 85.00x131.00x16.000mm, PTFE	KA5025 [15]
HBS075 [22] M11x1.50x110.00mm (x10)	JD597 [1] [3] JD601 [3] (x4)	JP074 [4] HM5062 [3]	HR397	PA5041 (x8) 6.00/12.20x10.00 (FPM) HR817 [3]	NA5185 [2] 32.00x42.00x7.00mm, FPM NA5001 [1] [2] 32.00x47.00x10.00mm, FPM NA5185 [2] 32.00x42.00x6.00mm, FPM NA5001 [1] [2] 32.00x47.00x10.00mm, FPM LK5011 [7] [26] 85.00x131.00x15.94mm, PTFE LK5006 [7] 85.00x131.00x16.000mm, PTFE	KA5025 [15]
HBS264 [19] M12x1.75x172.00mm (x8)	JD5278 [1] JD5279 [3]	JM7032 (NBR)	HR397	HR5068 [3]	NA5124 [2] 32.00x47.00x10.00mm, PTFE/ACM NA5106 [2] 35.00x48.00x10.00mm, PTFE LK5003 [1] [7] 85.00x131.00x15.700mm, PTFE	

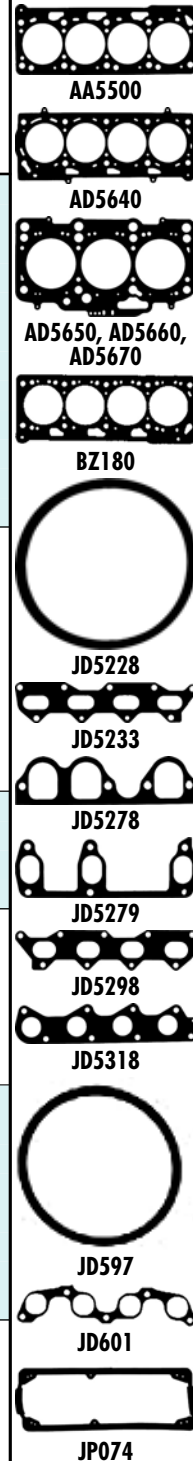









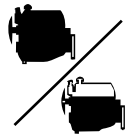





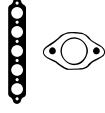

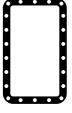

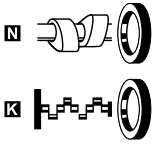



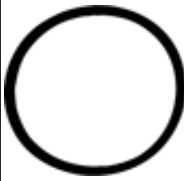

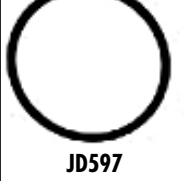

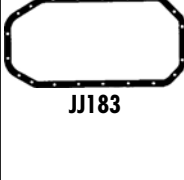
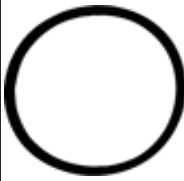

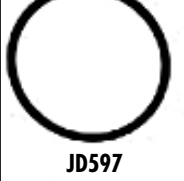

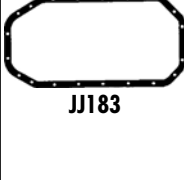
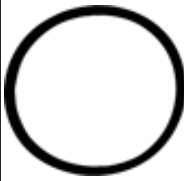

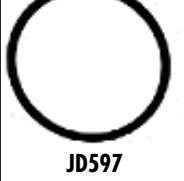

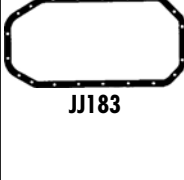
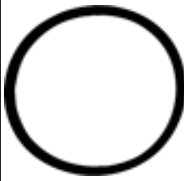

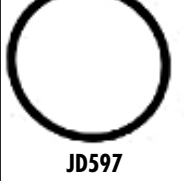

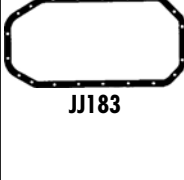
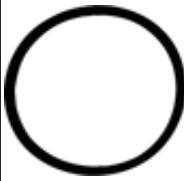

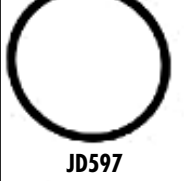
cc

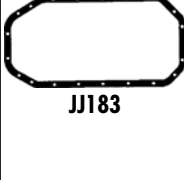
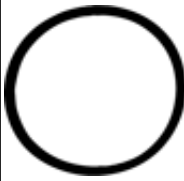

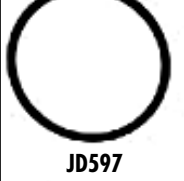
kW/PS

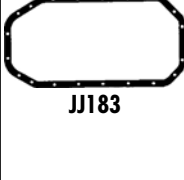
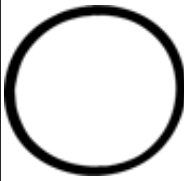

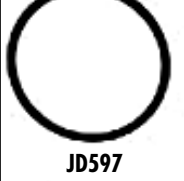
1.4 ANW						40	AD5640 (MLS), 0.640mm	CD5640 ☒ [3]	
Arosa 1.4	05/97→06/04	1390	4	76.50	SOHC/OHC	44/60			
Cordoba 1.4	06/99→12/02								
Ibiza 3 1.4	08/99→02/02								
1.4 ANX						41	BZ180 (MLS), 0.500mm	DZ181	EB961 [18]
Cordoba 1.4	12/97→04/99	1390	4	76.50	SOHC/OHC	40/54			
Ibiza 2 1.4	12/97→04/99								
1.4 APE						42	AB5701 (MLS)	CB5700 ☒	EB5700 [3][18]
Cordoba 1.4	06/99→12/02	1390	4	76.50	SOHC/OHC	55/75			
Cordoba 1.4 16V	05/00→10/02								
Ibiza 3 1.4 16V	05/00→02/02								
Leon 1.4 16V	11/99→06/06								
Toledo 2 1.4	07/99→05/06								
1.4 APQ						43	BZ180 (MLS), 0.500mm	DZ181	EB961 [18]
Arosa 1.4	05/97→06/04	1391	4	76.50	SOHC/OHC	44/60			
Cordoba 1.4 i	06/94→06/99								
Ibiza 2 1.4 i	09/93→08/99								
Inca Van 1.4 i	11/95→06/03								
1.4 AQQ						44	AB5701 (MLS)	CB5700 ☒	EB5700 [3][18]
Arosa 1.4 16V	01/00→06/04	1390	4	76.50	DOHC	74/100			
Cordoba 1.4 16V	02/00→10/02								
Ibiza 3 1.4 16V	08/99→02/02								
1.4 AUA						45	AB5701 (MLS)	CB5700 ☒	EB5700 [3][18]
Cordoba 1.4	06/99→12/02	1390	4	76.50	DOHC	55/75			
Cordoba 1.4 16V	05/00→10/02								
Ibiza 3 1.4 16V	05/00→02/02								
Inca Van 1.4	04/00→06/03								
Leon 1.4 16V	11/99→06/06								
Toledo 2 1.4	07/99→05/06								
1.4 AUB						46	AB5701 (MLS)	CB5700 ☒	EB5700 [3][18]
Arosa 1.4 16V	01/00→06/04	1390	4	76.50	DOHC	74/100			
Cordoba 1.4 16V	02/00→11/09								
Ibiza 3 1.4 16V	08/99→02/02								
Ibiza 4 1.4 16V	02/02→11/09								

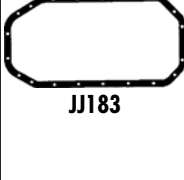
      							
HBS362 [5] M9x1.25x162.00mm (x10)	JD597 [1] [5] JD5318 [5]	HR397 [5]	HR397	PA5041 (x8) 6.00/12.20x10.00 (FPM) HR817 [5]	NA5185 [2] 32.00x42.00x7.00mm, FPM NA5185 [2] 32.00x42.00x6.00mm, FPM LK5011 [7] [26] 85.00x131.00x15.94mm, PTFE LK5006 [7] 85.00x131.00x16.00mm, PTFE	KA5025 [15]	 AD5640  BZ180  JD5228  JD5298  JD5318  JD597  JD601  JP074  JJ183
HBS075 [22] M11x1.50x110.00mm (x10)	JD597 [1] [5] JD601 [5]	JP074 [4] HM5062 [5] HR397 [5]	HR397	HR599 [5]	NA5001 [1] [2] 32.00x47.00x10.00mm, FPM NA5001 [1] [2] 32.00x47.00x10.00mm, FPM LK5011 [7] [26] 85.00x131.00x15.94mm, PTFE LK5006 [7] 85.00x131.00x16.00mm, PTFE	KA5025 [15]	 JD5228  JD5298  JD5318  JD597  JD601  JP074  JJ183
HBS249 [5] M9x1.25x138.00mm (x10)	JD5228 [1] (x4) JD5298 [5]	HR397 [5]	HR397	PA5041 (x16) 6.00/12.20x10.00 (FPM) HR791 [5]	NA5180 [2] 27.00x42.00x8.00mm, FPM NA5185 [2] 32.00x42.00x6.00mm, FPM LK5011 [7] [26] 85.00x131.00x15.94mm, PTFE LK5006 [7] 85.00x131.00x16.00mm, PTFE	KA5025 [15] KK5551 [20]	 JD5228  JD5298  JD5318  JD597  JD601  JP074  JJ183
HBS075 [22] M11x1.50x110.00mm (x10)	JD597 [1] [5] JD601 [5]	JP074 [4] HM5062 [5]	JJ183	HR817 [5]	NA5001 [1] [2] 32.00x47.00x10.00mm, FPM NA5001 [1] [2] 32.00x47.00x10.00mm, FPM LK5011 [7] [26] 85.00x131.00x15.94mm, PTFE LK5006 [7] 85.00x131.00x16.00mm, PTFE	KA5025 [15]	 JD5228  JD5298  JD5318  JD597  JD601  JP074  JJ183
HBS249 [5] M9x1.25x138.00mm (x10)	JD5228 [1] (x4) JD5298 [5]	HR397 [5]	HR397	PA5041 (x16) 6.00/12.20x10.00 (FPM) HR791 [5]	NA5180 [2] 27.00x42.00x8.00mm, FPM NA5185 [2] 32.00x42.00x6.00mm, FPM NB806 [1] 90.00x104.00x11.00mm, FPM	KA5025 [15] KK5551 [20]	 JD5228  JD5298  JD5318  JD597  JD601  JP074  JJ183
HBS249 [5] M9x1.25x138.00mm (x10)	JD5228 [1] (x4) JD5298 [5]	HR397 [5]	HR397	PA5041 (x16) 6.00/12.20x10.00 (FPM) HR791 [5]	NA5180 [2] 27.00x42.00x8.00mm, FPM NA5185 [2] 32.00x42.00x6.00mm, FPM LK5011 [7] [26] 85.00x131.00x15.94mm, PTFE	KA5025 [15] KK5551 [20]	 JD5228  JD5298  JD5318  JD597  JD601  JP074  JJ183
HBS249 [5] M9x1.25x138.00mm (x10)	JD5228 [1] JD5298 [5]	HR397 [5]	HR397	PA5041 (x16) 6.00/12.20x10.00 (FPM) HR791 [5]	NA5180 [2] 27.00x42.00x8.00mm, FPM NA5185 [2] 32.00x42.00x6.00mm, FPM	KA5025 [15] KK5551 [20]	 JD5228  JD5298  JD5318  JD597  JD601  JP074  JJ183



cc



kW/PS

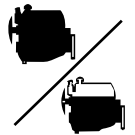

1.4	AUD					47	AD5640 (MLS), 0.640mm	CD5640 ☒ [3]	
Arosa 1.4	05/97→06/04	1390	4	76.50	SOHC/OHC	44/60			
Cordoba 1.4	06/99→12/02								
Ibiza 3 1.4	08/99→02/02								
Inca Van 1.4 i	11/95→06/03								
1.4	AXP					48	AB5701 (MLS)	CB5700 ☒	EB5700 [3][18]
Leon 1.4 16V	11/99→06/06	1390	4	76.50	DOHC	55/75			
Toledo 2 1.4	07/99→05/06								
1.4	BBY					49	AB5701 (MLS)	CB5700 ☒	EB5700 [3][18]
Cordoba 1.4 16V	09/02→12/07	1390	4	76.50	DOHC	55/75			
Ibiza 4 1.4 16V	02/02→12/07								
1.4	BBZ					50	AB5701 (MLS)	CB5700 ☒	EB5700 [3][18]
Cordoba 1.4 16V	10/02→11/09	1390	4	76.50	DOHC	74/100			
Ibiza 4 1.4 16V	02/02→11/09								
1.4	BCA					51	AB5701 (MLS)	CB5700 ☒	EB5700 [3][18]
Leon 1.4 16V	11/99→06/06	1390	4	76.50	DOHC	55/75			
Toledo 2 1.4	07/99→05/06								
1.4	BKY					52	AB5701 (MLS)	CB5700 ☒	EB5700 [3][18]
Cordoba 1.4 16V	09/02→12/07	1390	4	76.50	DOHC	55/75			
Ibiza 4 1.4 16V	02/02→12/07								
1.4	BMS Diesel					53	AD5650 (MLS), 1.450mm, 1 Hole AD5660 (MLS), 1.530mm, 2 Holes AD5670 (MLS), 1.610mm, 3 Holes	CD5650 ▲	ED5650 [18]
Cordoba 1.4 TDI	06/05→11/09	1422	3	79.50	SOHC/OHC	59/80			
Ibiza 4 1.4 TDI	06/05→11/09								
Ibiza 5 1.4 TDI	07/08→06/10								
1.4	BNM Diesel					54	AD5650 (MLS), 1.450mm, 1 Hole AD5660 (MLS), 1.530mm, 2 Holes AD5670 (MLS), 1.610mm, 3 Holes	CD5650 ▲	
Cordoba 1.4 TDI	05/05→11/09	1422	3	79.50	SOHC/OHC	51/70			
Ibiza 4 1.4 TDI	05/05→11/09								
1.4	BNV Diesel					55	AD5650 (MLS), 1.450mm, 1 Hole AD5660 (MLS), 1.530mm, 2 Holes AD5670 (MLS), 1.610mm, 3 Holes	CD5650 ▲	
Cordoba 1.4 TDI	06/05→11/09	1422	3	79.50	SOHC/OHC	59/80			
Ibiza 4 1.4 TDI	06/05→11/09								

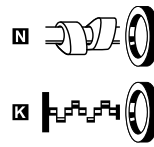
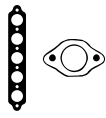

AD5640

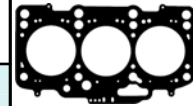

AD5650, AD5660,
AD5670

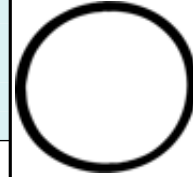

JD5228



JD5278



JD5279



JD5298



JD5318

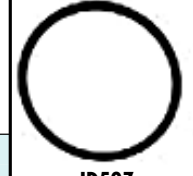

JD597

HBS362 [5] M9x1.25x162.00mm (x10)	JD597 [1] [5] (x4) JD5318 [5]	HR397 [5]	HR397	PA5041 (x8) 6.00/12.20x10.00 (FPM) HR817 [5]	NA5185 [2] 32.00x42.00x7.00mm, FPM NA5185 [2] 32.00x42.00x6.00mm, FPM LK5011 [7] [26] 85.00x131.00x15.94mm, PTFE LK5006 [7] 85.00x131.00x16.000mm, PTFE	KA5025 [15]
HBS249 [5] M9x1.25x138.00mm (x10)	JD5228 [1] JD5298 [5]	HR397 [5]	HR397	PA5041 (x16) 6.00/12.20x10.00 (FPM) HR791 [5]	NA5180 [2] 27.00x42.00x8.00mm, FPM NA5185 [2] 32.00x42.00x6.00mm, FPM LK5011 [7] [26] 85.00x131.00x15.94mm, PTFE	KA5025 [15] KK5551 [20]
HBS249 [5] M9x1.25x138.00mm (x10)	JD5228 [1] (x4) JD5298 [5]	HR397 [5]	HR397	PA5041 (x16) 6.00/12.20x10.00 (FPM) HR791 [5]	NA5180 [2] 27.00x42.00x8.00mm, FPM NA5185 [2] 32.00x42.00x6.00mm, FPM LK5011 [7] [26] 85.00x131.00x15.94mm, PTFE	KA5025 [15] KK5551 [20]
HBS249 [5] M9x1.25x138.00mm (x10)	JD5228 [1] (x4) JD5298 [5]	HR397 [5]	HR397	PA5041 (x16) 6.00/12.20x10.00 (FPM) HR791 [5]	NA5180 [2] 27.00x42.00x8.00mm, FPM NA5185 [2] 32.00x42.00x6.00mm, FPM LK5011 [7] [26] 85.00x131.00x15.94mm, PTFE	KA5025 [15] KK5551 [20]
HBS249 [5] M9x1.25x138.00mm (x10)	JD5228 [1] JD5298 [5]	HR397 [5]	HR397	PA5041 (x16) 6.00/12.20x10.00 (FPM) HR791 [5]	NA5180 [2] 27.00x42.00x8.00mm, FPM NA5185 [2] 32.00x42.00x6.00mm, FPM LK5011 [7] [26] 85.00x131.00x15.94mm, PTFE	KA5025 [15] KK5551 [20]
HBS249 [5] M9x1.25x138.00mm (x10)	JD5228 [1] JD5298 [5]	HR397 [5]	HR397	PA5041 (x16) 6.00/12.20x10.00 (FPM) HR791 [5]	NA5180 [2] 27.00x42.00x8.00mm, FPM NA5185 [2] 32.00x42.00x6.00mm, FPM LK5011 [7] [26] 85.00x131.00x15.94mm, PTFE	KA5025 [15] KK5551 [20]
HBS264 [19] M12x1.75x172.00mm (x8)	JD5278 [1]			HR5068 [5]	NA5124 [2] 32.00x47.00x10.00mm, PTFE/ACM NA5106 [2] 35.00x48.00x10.00mm, PTFE	
HBS264 [19] M12x1.75x172.00mm (x8)	JD5278 [1] JD5279 [5]	JM7032 (NBR)	HR397	HR5068 [5]	NA5124 [2] 32.00x47.00x10.00mm, PTFE/ACM NA5106 [2] 35.00x48.00x10.00mm, PTFE LK5003 [1] [7] 85.00x131.00x15.700mm, PTFE	
HBS264 [19] M12x1.75x172.00mm (x8)	JD5278 [1] JD5279 [5]	JM7032 (NBR)	HR397	HR5068 [5]	NA5124 [2] 32.00x47.00x10.00mm, PTFE/ACM NA5106 [2] 35.00x48.00x10.00mm, PTFE LK5003 [1] [7] 85.00x131.00x15.700mm, PTFE	



cc



kW/PS

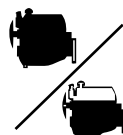

1.4		BXW				56		AB5701 (MLS)	CB5700 ☒	
Altea 1.4 16V	05/06→	1390	4	76.50	DOHC		63/86			
Cordoba 1.4 16V	05/06→11/09									
Ibiza 4 1.4 16V	05/06→11/09									
Ibiza 5 1.4	03/08→									
Leon 1.4 16V	06/06→									
1.4		CAVA				57		AH5960 (MLS), 0.800mm	CH5960	
Alhambra 1.4TSI	06/10→	1390	4	76.50	DOHC		110/150			
1.4		CAVE				58		AH5960 (MLS), 0.800mm	CH5960	
Ibiza 5 1.4 TSI	06/09→	1390	4	76.50	DOHC		132/180			
1.4		CAVF				59		AH5960 (MLS), 0.800mm	CH5960	
Ibiza 5 1.4 TSI	06/09→	1390	4	76.50	DOHC		110/150			
1.4		CAXA				60		AH5960 (MLS), 0.800mm	CH5960	
Toledo 4 1.4TSI	07/12→	1390	4	76.50	DOHC		90/122			
1.4		CAXC				61		AH5960 (MLS), 0.800mm	CH5960	
Altea 1.4 TSI	11/07→	1390	4	76.50	DOHC		92/125			
Leon 1.4 TSI	11/07→									
1.4		CGGB				62		AB5701 (MLS)	CB5700 ☒	
Altea 1.4 16V	05/06→	1390	4	76.50	DOHC		63/85			
Ibiza 5 1.4	03/08→									
Leon 1.4 16V	06/06→									
1.4		CNUB				63				
Ibiza 5 1.4 TSI	06/09→	1390	4	76.50	DOHC		110/150			
1.4		CNWB				64				
Alhambra 1.4TSI	06/10→	1390	4	76.50	DOHC		110/150			
1.5		021 A.2000				65		AA3140 (Fibre), 1.2mm [140]	CA3140 [3]	EA3130 [3]
Ibiza I 1.5	11/84→05/93	1461	4	83.00			63-66/ 85-90			
Malaga 1.5	05/85→12/93									
Malaga 1.5 i	10/86→12/93									
1.5		021 B.2000				66		AA3140 (Fibre), 1.2mm [140]	CA3140 [3]	EA3130 [3]
Ibiza I 1.5 i	10/86→05/93	1461	4	83.00			74/100			
Malaga 1.5 i	01/87→12/93									
1.5		021 C.2000				67		AA3140 (Fibre), 1.2mm [140]	CA3140 [3]	EA3130 [3]
Ibiza I 1.5 i	10/86→05/93	1461	4	83.00	SOHC/OHC		65-66/ 88-90			
Malaga 1.5 i	10/86→12/93									
1.5		021 D.2000				68		AA3140 (Fibre), 1.2mm [140]	CA3140 [3]	EA3130 [3]
Ibiza I 1.5 i	10/86→05/93	1461	4	83.00	SOHC/OHC		65-66/ 89-90			
Malaga 1.5 i	10/86→12/93									

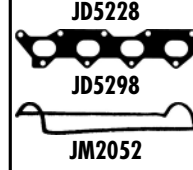
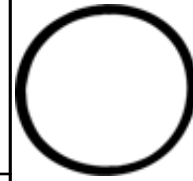
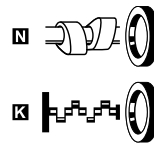
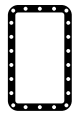
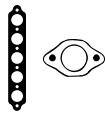

HBS249 [5] M9x1.25x138.00mm (x10)	JD5228 [1] JD5298 [3]	HR397 [3]	HR397	PA5041 (x16) 6.00/12.20x10.00 (FPM) HR791 [3]	NA5180 (x2) [2] 27.00x42.00x8.00mm, FPM NA5185 [2] 32.00x42.00x6.00mm, FPM	
HBS518 [5] [21]	JD5809 [1] JD5814 [3]	HR397 [3]	HR397	PA5041 (x16) 6.00/12.20x10.00 (FPM) HR791 [3]	NA5106 [2] 35.00x48.00x10.00mm, PTFE	JR5048 [6]
HBS518 [5] [21]	JD5809 [1] JD5814 [3]	HR397 [3]	HR397	PA5041 (x16) 6.00/12.20x10.00 (FPM) HR791 [3]	NA5106 [2] 35.00x48.00x10.00mm, PTFE	JR5048 [6]
HBS518 [5] [21]	JD5809 [1]	HR397 [3]	HR397	PA5041 (x16) 6.00/12.20x10.00 (FPM) HR791 [3]	NA5106 [2] 35.00x48.00x10.00mm, PTFE/ACM NA5106 [2] 35.00x48.00x10.00mm, PTFE	JR5048 [6]
HBS518 [5] [21]	JD5809 [1] JD5814 [3]	HR397 [3]	HR397	PA5041 (x16) 6.00/12.20x10.00 (FPM) HR791 [3]	NA5106 [2] 35.00x48.00x10.00mm, PTFE	
HBS518 [5] [21]	JD5809 [1] JD5814 [3]	HR397 [3]	HR397	PA5041 (x16) 6.00/12.20x10.00 (FPM) HR791 [3]	NA5106 [2] 35.00x48.00x10.00mm, PTFE/ACM NA5106 [2] 35.00x48.00x10.00mm, PTFE	JR5048 [6]
HBS249 [5] M9x1.25x138.00mm (x10)	JD5228 [1] (x4) JD5298 [3]	HR397 [3]	HR397	PA5041 (x16) 6.00/12.20x10.00 (FPM) HR791 [3]	NA5180 (x2) [2] 27.00x42.00x8.00mm, FPM NA5185 [2] 32.00x42.00x6.00mm, FPM	
					NA5106 [2] 35.00x48.00x10.00mm, PTFE/ACM NA5106 [2] 35.00x48.00x10.00mm, PTFE	JR5048 [6]
					NA5106 [2] 35.00x48.00x10.00mm, PTFE/ACM NA5106 [2] 35.00x48.00x10.00mm, PTFE	JR5048 [6]
HBS044 [19] M12x1.75x115.00mm (x10)		JM2052 [4]		HR599 [3]	NB866 [2] 28.00x42.00x7.00mm, FPM	
HBS044 [19] M12x1.75x115.00mm (x10)		JM2052 [4]		HR599 [3]	NB866 [2] 28.00x42.00x7.00mm, FPM	
		JM2052 [4]		HR599 [3]	NB866 [2] 28.00x42.00x7.00mm, FPM	
HBS044 [19] M12x1.75x115.00mm (x10)		JM2052 [4]		HR599 [3]	NB866 [2] 28.00x42.00x7.00mm, FPM	



cc



kW/PS

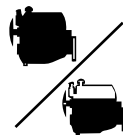

1.6										
1F							69	BM360 (Fibre)	DM368 [3]	EG872
Cordoba 1.6 i	05/94→06/99	1595	4	81.00	SOHC/OHC	52-55/ 71-75				
Ibiza 2 1.6 i	09/94→06/99									
Inca Van 1.6 i	11/95→05/98									
Toledo I 1.6 i	05/91→03/99									
ABN							70	BM360 (Fibre)	DM368 [3]	EG872
Toledo I 1.6 i	05/91→03/99	1595	4	81.00	SOHC/OHC	54-55/ 73-75				
ABU							71	BY620 (Fibre)	DY620 [3]	EV460
Cordoba 1.6 i	02/93→06/99	1598	4	76.50	SOHC/OHC	55/75				
Ibiza 2 1.6 i	03/93→08/99									
AEE							72	BZ180 (MLS), 0.500mm	DZ181	EB961 [18]
Cordoba 1.6 i	02/93→06/99	1598	4	76.50	SOHC/OHC	55/75				
Ibiza 2 1.6 i	03/93→08/99									
Inca Van 1.6 i	06/97→09/00									
AEH							73	AC5220 (MLS)	CY980	EC080 [18] EC5220 [3][18]
Cordoba 1.6	06/99→12/02	1595	4	81.00	SOHC/OHC	74/101				
Ibiza 3 1.6	08/99→02/02									
Leon 1.6	11/99→06/06									
Toledo 2 1.6	04/99→09/00									
AFT							74	AY940 (MLS)	CY941 [3]	EC5220 [3][18]
Cordoba 1.6 i	07/96→10/99	1595	4	81.00	SOHC/OHC	74/101				
Ibiza 2 1.6 i	04/96→08/99									
Toledo I 1.6 i	11/96→03/99									

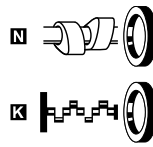
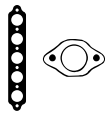

HBS043 [22] M11x1.50x95.00mm (x10)	JC478 [1] PA459 [1] (NBR) JC152 [x4] ☉ JE160	HL457 [23] (Cork) HM5053 [24] (ACM) HM5062 [5]	JJ140 (SMG)	HR569 [5]	NA5001 [1][2] 32.00x47.00x10.00mm, FPM ☒ NA5001 [1][2] 32.00x47.00x10.00mm, FPM ☒ NA5133 [1] 85.00x105.00x11.00mm, FPM ☒ LK5006 [7] 85.00x131.00x16.00mm, PTFE	KA5020 [15]
HBS043 [22] M11x1.50x95.00mm (x10)	JC478 [1] PA459 [1] (NBR) JC152 [x4] ☉ JE160	HL457 [23] (Cork) HM5053 [24] (ACM)		HR569 [5]	NA5001 [1][2] 32.00x47.00x10.00mm, FPM ☒ NA5001 [1][2] 32.00x47.00x10.00mm, FPM ☒ NA5133 [1] 85.00x105.00x11.00mm, FPM	KA5020 [15]
HBS075 [22] M11x1.50x110.00mm (x10)	JD487 [1] JD488 [5]	JN641 [4] HM5062 [5]	JJ183		NA5001 [1][2] 32.00x47.00x10.00mm, FPM ☒ NA5001 [1][2] 32.00x47.00x10.00mm, FPM ☒ NA5133 [1] 85.00x105.00x11.00mm, FPM ☒ LK5006 [7] 85.00x131.00x16.00mm, PTFE	
HBS075 [22] M11x1.50x110.00mm (x10)	JC478 [1] JD597 [1][5] JD601 [5]	JP074 [4] HM5062 [5]	HR397	HR816 [5]	NA5001 [1][2] 32.00x47.00x10.00mm, FPM ☒ NA5001 [1][2] 32.00x47.00x10.00mm, FPM ☒ NA5133 [1] 85.00x105.00x11.00mm, FPM ☒ LK5006 [7] 85.00x131.00x16.00mm, PTFE 32.00x42.00x6.00mm, FPM Eng.562.758→	
HBS246 [22] M10x1.50x120.00mm (x10)	JD607 [x4] JD600 [5] ☉ JF211	JP024 [4]	HR397 JH5117	HR816 [5]	NA5124 [2] 32.00x47.00x10.00mm, PTFE/ACM ☒ NA5001 [1][2] 32.00x47.00x10.00mm, FPM ☒ NA5106 [2] 35.00x48.00x10.00mm, PTFE ☒ NA5124 [2] 32.00x47.00x10.00mm, PTFE/ACM ☒ NB716 [2] 35.00x48.00x10.00mm, FPM ☒ LK5008 [1][7] 85.00x131.00x15.700mm, PTFE	
HBS043 [22] M11x1.50x95.00mm (x10)	JD599 [1][5] JD600 [5] ☉ JF205	JP024 [4]	JH5117 JJ609 (ACM)	HR816 [5]	NA5001 [1][2] 32.00x47.00x10.00mm, FPM ☒ NA5001 [1][2] 32.00x47.00x10.00mm, FPM ☒ NA5133 [1] 85.00x105.00x11.00mm, FPM ☒ LK5008 [1][7] 85.00x131.00x15.700mm, PTFE	

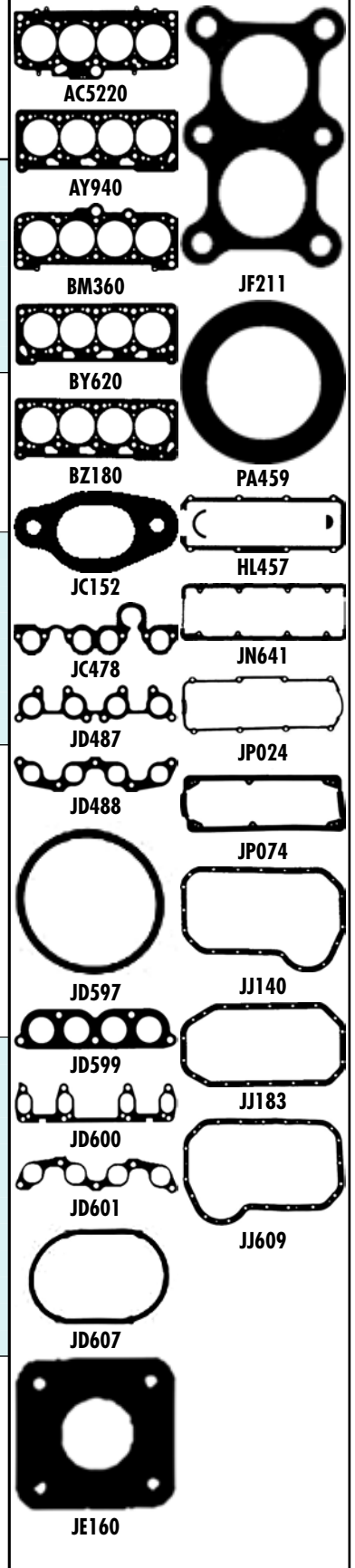



cc



kW/PS

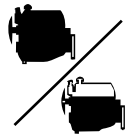

1.6		AKL		75		AC5220 (MLS)	CY980	EC080 [18] EC5220 [3][18]
Cordoba 1.6	06/99→12/02	1595	4	81.00	SOHC/OHC	74/101		
Cordoba 1.6 i	07/96→10/99							
Ibiza 3 1.6	08/99→02/02							
Leon 1.6	11/99→06/06							
Toledo 2 1.6	04/99→09/00							
1.6		ALM		76		BZ180 (MLS), 0.500mm	DZ181	EB961 [18]
Cordoba 1.6	06/99→12/02	1598	4	76.50	SOHC/OHC	55/75		
Cordoba 1.6 i	02/93→06/99							
Ibiza 2 1.6 i	03/93→08/99							
Ibiza 3 1.6	08/99→02/02							
Inca Van 1.6 i	06/97→09/00							
1.6		ALZ		77		AC5220 (MLS)	CC5223	EC5220 [3][18]
EXEO 1.6	03/09→09/10	1595	4	81.00	SOHC/OHC	75/102		
1.6		APF		78		AC5220 (MLS)	CC5221 [3]	EC5220 [3][18]
Cordoba 1.6	06/99→12/02	1595	4	81.00	SOHC/OHC	74/100		
Ibiza 3 1.6	08/99→02/02							
Leon 1.6	11/99→06/06							
Toledo 2 1.6	04/99→09/00							
1.6		ATN		79		AC5280 (MLS)	CC5280 ☒ [59]	
Leon 1.6 16 V	09/00→06/06	1598	4	76.50	DOHC	77/105		
1.6		AUR		80		AC5220 (MLS)	CC5221 [3]	EC5220 [3][18]
Cordoba 1.6	06/99→12/02	1595	4	81.00	SOHC/OHC	74/101		
Ibiza 3 1.6	08/99→02/02							
1.6		AUS		81		AC5280 (MLS)	CC5280 ☒ [59]	EB5700 [3][18]
Leon 1.6 16 V	09/00→06/06	1598	4	76.50	DOHC	77/105		
Toledo 2 1.6	09/00→05/06							

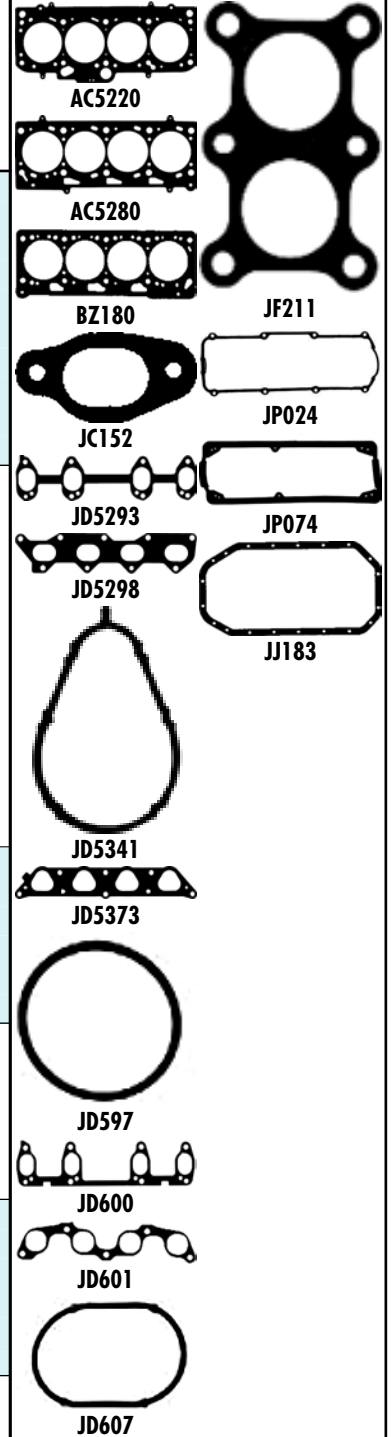
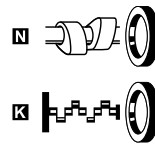
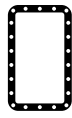
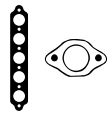



cc



kW/PS

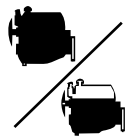

1.6										
AZD							82	AC5280 (MLS)	CC5281 ☒ [3]	EB5700 [3][18]
Leon 1.6 16 V	09/00→06/06	1598	4	76.50	DOHC	77/105				
Toledo 2 1.6	09/00→05/06									
BAH							83			
Cordoba 1.6	04/03→11/09	1598	4	76.50	SOHC/OHC	74/101				
Ibiza 4 1.6	02/03→11/09									
BCB							84	AC5280 (MLS)	CC5281 ☒ [3]	EB5700 [3][18]
Leon 1.6 16 V	09/00→06/06	1598	4	76.50	DOHC	77/105				
Toledo 2 1.6	09/00→05/06									
BFQ							85	AC5220 (MLS)	CC5222 [3]	EC5220 [3][18]
Leon 1.6	10/05→06/06	1595	4	81.00	SOHC/OHC	75/102				
BGU							86	AC5220 (MLS)	CC5222 [3]	EC5220 [3][18]
Altea 1.6	03/04→	1595	4	81.00	SOHC/OHC	75/102				
Leon 1.6	10/05→06/06									
Toledo 3 1.6	10/04→05/09									
BSE							87	AC5220 (MLS)	CC5222 [3]	
Altea 1.6	03/04→	1595	4	81.00	SOHC/OHC	75/102				
Leon 1.6	07/05→									
Toledo 3 1.6	10/04→05/09									
BSF							88	AC5220 (MLS)	CC5222 [3]	
Altea 1.6	03/04→	1595	4	81.00	SOHC/OHC	75/102				
Leon 1.6	07/05→									
Toledo 3 1.6	10/04→05/09									
BTS							89	AG8850 (MLS)		
Cordoba 1.6 16V	11/06→11/09	1598	4	76.50	DOHC	77/105				
Ibiza 4 1.6 16V	11/06→11/09									
Ibiza 5 1.6	05/08→									
CAYA Diesel							90			
Ibiza 5 1.6 TDI	05/10→06/10	1598	4	79.50	DOHC	55/75				
CAYB Diesel							91			
Altea 1.6 TDI	11/10→	1598	4	79.50	DOHC	66/90				
Ibiza 5 1.6 TDI	05/09→									
Leon 1.6 TDI	11/10→									

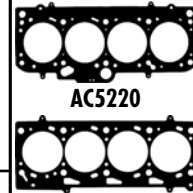
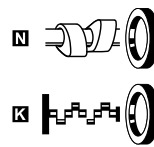
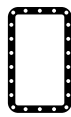
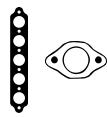

AC5220



AC5280

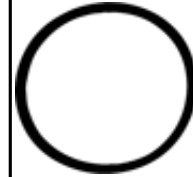

JD5228



JD5293



JD5298



JD5318

HBS316 [5] M9x1.25x97.00mm (x10)	JD5228 [x4] JD5298 JE5076	HR397	HR397	PA5041 (x16) 6.00/12.20x10.00 (FPM) HR791	NA5185 [2] 32.00x42.00x7.00mm, FPM NA5180 [2] 27.00x42.00x8.00mm, FPM NA5185 [2] 32.00x42.00x6.00mm, FPM LK5011 [7][26] 85.00x131.00x15.94mm, PTFE	KK5551 [20]
	JD5835 (FPM) JD5318	HR397	HR397	PA5041 (x8) 6.00/12.20x10.00 (FPM) HR817	NA5185 [2] 32.00x42.00x7.00mm, FPM NA5185 [2] 32.00x42.00x6.00mm, FPM	
HBS316 [5] M9x1.25x97.00mm (x10)	JD5228 [x4] JD5298 JE5076	HR397	HR397	PA5041 (x16) 6.00/12.20x10.00 (FPM) HR791	NA5180 [2] 27.00x42.00x8.00mm, FPM NA5185 [2] 32.00x42.00x6.00mm, FPM LK5011 [7][26] 85.00x131.00x15.94mm, PTFE	KK5551 [20]
HBS246 [22] M10x1.50x120.00mm (x10)	JD5340 [x4] JD5293	JM5205 (Elastomer)	HR397	PA5041 (x8) 6.00/12.20x10.00 (FPM) HR817	NA5124 [2] 32.00x47.00x10.00mm, PTFE/ACM NA5106 [2] 35.00x48.00x10.00mm, PTFE LK5008 [1][7] 85.00x131.00x15.700mm, PTFE	
HBS246 [22] M10x1.50x120.00mm (x10)	JD5340 [x4] JD5293	JM5205 (Elastomer)	HR397	PA5041 (x8) 6.00/12.20x10.00 (FPM) HR817	NA5124 [2] 32.00x47.00x10.00mm, PTFE/ACM NA5106 [2] 35.00x48.00x10.00mm, PTFE NA5124 [2] 32.00x47.00x10.00mm, PTFE/ACM LK5008 [1][7] 85.00x131.00x15.700mm, PTFE	
HBS246 [22] M10x1.50x120.00mm (x10)	JD5340 [x4] JD5293	JM5205 (Elastomer)	HR397	PA5041 (x8) 6.00/12.20x10.00 (FPM) HR817	NA5124 [2] 32.00x47.00x10.00mm, PTFE/ACM NA5106 [2] 35.00x48.00x10.00mm, PTFE LK5008 [1][7] 85.00x131.00x15.700mm, PTFE	
HBS246 [22] M10x1.50x120.00mm (x10)	JD5340 [x4] JD5293	JM5205 (Elastomer)	HR397	PA5041 (x8) 6.00/12.20x10.00 (FPM) HR817	NA5124 [2] 32.00x47.00x10.00mm, PTFE/ACM NA5106 [2] 35.00x48.00x10.00mm, PTFE LK5008 [1][7] 85.00x131.00x15.700mm, PTFE	
HBS249 [5] M9x1.25x138.00mm (x10)	JD5228 JD5814	HR397	HR397	PA5041 (x16) 6.00/12.20x10.00 (FPM)	NA5106 [2] 35.00x48.00x10.00mm, PTFE	JR5048 [6]
		HR397	HR397	PA5041 (x16) 6.00/12.20x10.00 (FPM)	NA5106 [2] 35.00x48.00x10.00mm, PTFE	
		HR397	HR397	PA5041 (x16) 6.00/12.20x10.00 (FPM)	NA5106 [2] 35.00x48.00x10.00mm, PTFE	



cc



kW/PS

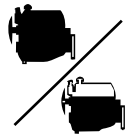

1.6		CAYC Diesel					92			
Altea 1.6 TDI	10/09→	1598	4	79.50	DOHC	77/105				
Ibiza 5 1.6 TDI	05/09→									
Leon 1.6 TDI	02/10→									
Toledo 4 1.6 TDI	07/12→									
1.6		CCSA					93	AC5220 (MLS)	CC5222 [3]	EC5220 [3] [18]
Altea 1.6	03/04→	1595	4	81.00	SOHC/OHC	75/102				
Leon 1.6	07/05→									
Toledo 3 1.6	10/04→05/09									
1.6		CHGA					94	AC5220 (MLS)	CC5222 [3]	EC5220 [3] [18]
Altea 1.6 LPG	09/09→	1595	4	81.00	SOHC/OHC	75/102				
Leon 1.6 LPG	12/09→									
1.6		CMXA					95	AC5220 (MLS)	CC5222 [3]	EC5220 [3] [18]
Altea 1.6	03/04→	1595	4	81.00	SOHC/OHC	75/102				
Leon 1.6	07/05→									
1.6		EZ					96	BM360 (Fibre)	DM368 [3]	EG872
Toledo I 1.6 i	05/91→03/99	1595	4	81.00	SOHC/OHC	52-54/ 71-73				
1.7		021 A.3000					97	AA3140 (Fibre), 1.2mm [140]	CA3140 [3]	EA3130 [3]
Ibiza I 1.7	01/91→05/93	1675	4	83.00	SOHC/OHC	72/98				
1.7		021 B.3000					98	AA3140 (Fibre), 1.2mm [140]	CA3140 [3]	EA3130 [3]
Ibiza I 1.7	01/91→05/93	1675	4	83.00	SOHC/OHC	76/103				
1.7		022 A.5000 Diesel					99	BV680 (Fibre), 1.670mm, 0 Notches BV690 (Fibre), 1.750mm, 1 Notch BV700 (Fibre), 1.850mm, 2 Notches BW980 (Fibre), 1.930mm, 3 Notches BG830 (Fibre), 1.950mm, 2 Notches	DG811 ▲ [3]	
Ibiza I 1.7 D	06/84→05/93	1714	4	83.00	SOHC/OHC	40-42/ 54-57				
Malaga 1.7 D	05/85→12/93									
1.7		AHB Diesel					100	BX800 (MLS), 1.450mm, 1 Hole BX810 (MLS), 1.530mm, 2 Holes BX820 (MLS), 1.610mm, 3 Holes	DX801 ▲	EC030 [18]
Inca Van 1.7 D	09/96→06/03	1716	4	79.50	SOHC/OHC	42/57				
1.7		AKU Diesel					101	BX800 (MLS), 1.450mm, 1 Hole BX810 (MLS), 1.530mm, 2 Holes BX820 (MLS), 1.610mm, 3 Holes	DX801 ▲	EC030 [18] →Eng.013 000
Arosa 1.7 SDI	08/97→06/04	1716	4	79.50	SOHC/OHC	44/60				
Cordoba 1.7 SDI	07/97→06/99									

HBS364 [19] M12x1.75x149.00mm (x10)		HR397 [5]	HR397	PA5041 (x16) 6.00/12.20x10.00 (FPM)	NA5106 [2] 35.00x48.00x10.00mm, PTFE	 AC5220	 JJ140
HBS246 [22] M10x1.50x120.00mm (x10)	JD5340 [4] JD5293 [5]	JM5205 (Elastomer)	HR397	PA5041 (x8) 6.00/12.20x10.00 (FPM) HR817 [5]	NA5124 [2] 32.00x47.00x10.00mm, PTFE/ACM NA5106 [2] 35.00x48.00x10.00mm, PTFE LK5008 [1][7] 85.00x131.00x15.700mm, PTFE	 BG830	 JJ609
HBS246 [22] M10x1.50x120.00mm (x10)	JD5340 [4] JD5293 [5]	JM5205 (Elastomer)	HR397	PA5041 (x8) 6.00/12.20x10.00 (FPM) HR817 [5]	NA5124 [2] 32.00x47.00x10.00mm, PTFE/ACM NA5106 [2] 35.00x48.00x10.00mm, PTFE LK5008 [1][7] 85.00x131.00x15.700mm, PTFE	 BM360	
HBS246 [22] M10x1.50x120.00mm (x10)	JD5340 [4] JD5293 [5]	JM5205 (Elastomer)	HR397	PA5041 (x8) 6.00/12.20x10.00 (FPM) HR817 [5]	NA5106 [2] 35.00x48.00x10.00mm, PTFE/ACM NA5124 [2] 32.00x47.00x10.00mm, PTFE/ACM NA5106 [2] 35.00x48.00x10.00mm, PTFE LK5008 [1][7] 85.00x131.00x15.700mm, PTFE	 BV680, BV690, BV700, BW980	
HBS043 [22] M11x1.50x95.00mm (x10)	JC478 [4] PA459 [4] (NBR) JC152 [5] (x4) JE160	HL457 [23] (Cork) HM5053 [24] (ACM)	JJ140 (SMG)	HR569 [5]	NA5001 [1][2] 32.00x47.00x10.00mm, FPM NA5001 [1][2] 32.00x47.00x10.00mm, FPM NA5133 [1] 85.00x105.00x11.00mm, FPM	 BX800, BX810, BX820	
HBS044 [19] M12x1.75x115.00mm (x10)		JM2052 [4]			NA5106 [2] 35.00x48.00x10.00mm, PTFE/ACM NA5124 [2] 32.00x47.00x10.00mm, PTFE/ACM NA5106 [2] 35.00x48.00x10.00mm, PTFE LK5008 [1][7] 85.00x131.00x15.700mm, PTFE	 JC152	
HBS044 [19] M12x1.75x115.00mm (x10)		JM2052 [4]		HR599 [5]	NA5001 [1][2] 32.00x47.00x10.00mm, FPM NA5001 [1][2] 32.00x47.00x10.00mm, FPM NA5133 [1] 85.00x105.00x11.00mm, FPM	 JC478	
			JJ136		NB866 [2] 28.00x42.00x7.00mm, FPM	 JD170	
HBS018 [19] M12x1.75x115.00mm (x10)	JD170 [4] JC152 [5] (x4) JE5076	JP003 [4] HMS367 [5]	JJ609 (ACM)	HR816 [5]	NA5001 [1][2] 32.00x47.00x10.00mm, FPM NA5001 [1][2] 32.00x47.00x10.00mm, FPM LK5006 [7] 85.00x131.00x16.000mm, PTFE	 JE160	
HBS018 [19] M12x1.75x115.00mm (x10)	JD170 [4] JC152 [5] (x4)	JP003 [4] HMS367 [5]	JJ609 (ACM)	HR816 [5]	NA5001 [1][2] 32.00x47.00x10.00mm, FPM NA5001 [1][2] 32.00x47.00x10.00mm, FPM NA5133 [1] 85.00x105.00x11.00mm, FPM →Eng.013 000 LK5006 [7] 85.00x131.00x16.000mm, PTFE Eng.013 001 →	 JC5293	
					NB866 [2] 28.00x42.00x7.00mm, FPM	 PA459	
						 HL457	
						 JM2052	
						 JP003	
						 JJ136	



cc



kW/PS

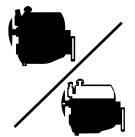

1.8		ABS				102	BM360 (Fibre)	DM367	EM362
Cordoba 1.8 i	02/93→06/99	1781	4	81.00	SOHC/OHC	66/90	→Eng.935 645	→Eng.935 645	ES471
Ibiza 2 1.8 i	03/93→08/99						BZ910 (MLS)	DZ910	
Toledo I 1.8 i	11/93→12/96						Eng.935 646→	Eng.935 646→	
1.8		ACC				103	BZ910 (MLS)	DZ910	
Cordoba 1.8 i	02/93→06/99	1781	4	81.00	SOHC/OHC	66/90			
Ibiza 2 1.8 i	03/93→08/99								
Toledo I 1.8 i	11/93→12/96								
1.8		ADL				104	BM360 (Fibre)	DM365 [3]	ET811
Cordoba 1.8 i	10/93→08/96	1781	4	81.00	DOHC	95/129			
Ibiza 2 1.8 i	11/93→08/96								
1.8		ADZ				105	BM360 (Fibre)	DM367	EB970
Cordoba 1.8 i	02/93→06/99	1781	4	81.00	SOHC/OHC	66/90	→Eng.011 565	→Eng.011 565	EM362
Ibiza 2 1.8 i	03/93→08/99						BZ910 (MLS)	DZ910	
Toledo I 1.8 i	11/93→12/96						Eng.011 566→	Eng.011 566→	
1.8		AGN				106	AY970 (MLS)	CY971	EY841 [3]
Leon 1.8 20V	11/99→06/06	1781	4	81.00	DOHC	92/125			
Toledo 2 1.8	04/99→05/06								
1.8		AJH				107	AY970 (MLS)	CY971	EY841 [3]
Alhambra 1.8T	10/97→03/10	1781	4	81.00	DOHC	110/150			
1.8		AJQ				108	AY970 (MLS)	CY971	EY841 [3]
Leon 1.8	11/99→06/06	1781	4	81.00	DOHC	132/180			

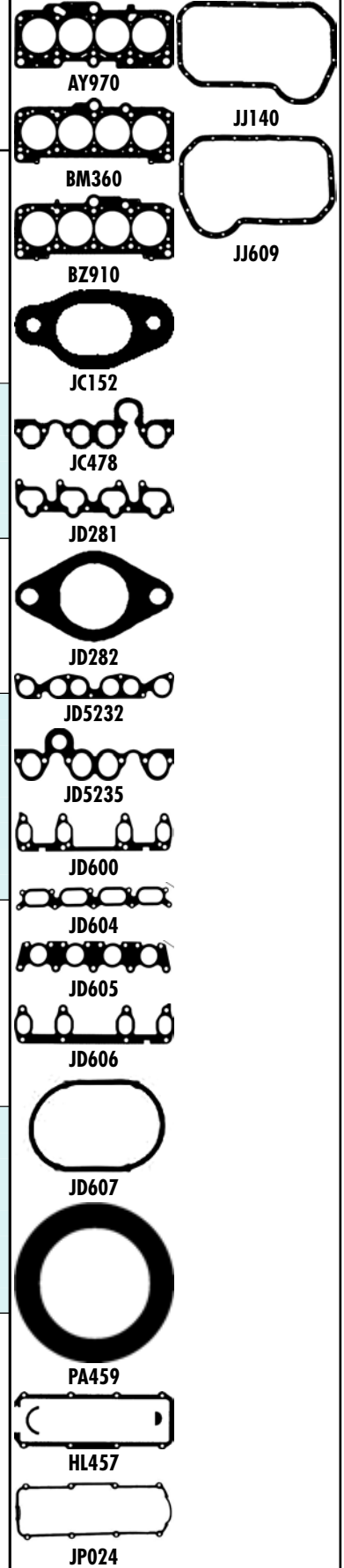
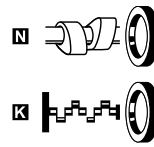
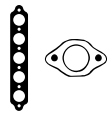

HBS043 [22]
M11x1.50x95.00mm (x10)

JC478 [1]
→Eng.935 645
PA459 [1]
(NBR)
→Eng.935 645
JD5232 [1]
Eng.935 646→
JC152 [x4]
⊕JE5076

JP024 [4]
Eng.935 646→
HL457 [x23]
(Cork)
→Eng.935 645
HM5053 [x24]
(ACM)
→Eng.935 645

JJ140
(SMG)
JJ609
(ACM)

HR569 [x]
→Eng.935 645
HR816 [x]
Eng.935 646→

NA5001 [1][2]
32.00x47.00x10.00mm, FPM
NA5001 [x1][2]
32.00x47.00x10.00mm, FPM
NA5133 [x1]
85.00x105.00x11.00mm, FPM
LK5006 [x7]
85.00x131.00x16.00mm, PTFE

HBS043 [22]
M11x1.50x95.00mm (x10)

JD5235 [1]
JD600 [x]
⊕JE5076

JP024 [4]

JJ609
(ACM)

HR816 [x]

NA5001 [1][2]
32.00x47.00x10.00mm, FPM
NA5001 [x1][2]
32.00x47.00x10.00mm, FPM
NA5133 [x1]
85.00x105.00x11.00mm, FPM

HBS028 [22]
M11x1.50x147.00mm (x10)

JD281 [1]
JD282 [x4]

HL606 [x]

JJ140
(SMG)

HR816 [x2]

NA5001 [1][2]
32.00x47.00x10.00mm, FPM
NA5001 [x1][2]
32.00x47.00x10.00mm, FPM
NA5133 [x1]
85.00x105.00x11.00mm, FPM

HBS043 [22]
M11x1.50x95.00mm (x10)

JC478 [1]
→Eng.011 565
PA459 [1]
(NBR)
→Eng.011 565
JD5235 [1]
Eng.011 566→
JD606 [x]

HL457 [x23]
(Cork)
HM5053 [x24]
(ACM)

JJ609
(ACM)

HR569 [x]
→Eng.011 565
HR816 [x]
Eng.011 566→

NA5001 [1][2]
32.00x47.00x10.00mm, FPM
NA5001 [x1][2]
32.00x47.00x10.00mm, FPM
NA5133 [x1]
85.00x105.00x11.00mm, FPM

HBS268 [22]
M10x1.50x120.00mm (x10)

JD607 [1]
JD605 [x]
⊕JF205

HL732 [x]

HR397

PA5041 (x20)
6.00/12.20x10.00
(FPM)
HR822 [x]

NA5124 (x2)[2]
32.00x47.00x10.00mm, PTFE/ACM
NA5106 [x2]
35.00x48.00x10.00mm, PTFE
NB716 [x2]
35.00x48.00x10.00mm, FPM
LK5003 [x1][7]
85.00x131.00x15.700mm, PTFE

HBS268 [22]
M10x1.50x120.00mm (x10)

JD604 [1]
JD605 [x]
⊕JF205

HL732 [x]

HR397
JH5117

PA5041 (x20)
6.00/12.20x10.00
(FPM)
HR822 [x]

NA5001 [1][2]
32.00x47.00x10.00mm, FPM
NA5124 (x2)[2]
32.00x47.00x10.00mm, PTFE/ACM
NA5106 [x2]
35.00x48.00x10.00mm, PTFE
LK5003 [x1][7]
85.00x131.00x15.700mm, PTFE

HBS268 [22]
M10x1.50x120.00mm (x10)

JD604 [1]
JD605 [x]
⊕JF205

HL732 [x]

HR397
JH5117

PA5041 (x20)
6.00/12.20x10.00
(FPM)
HR822 [x]

NA5001 [1][2]
32.00x47.00x10.00mm, FPM
NA5124 (x2)[2]
32.00x47.00x10.00mm, PTFE/ACM
NA5001 [x1][2]
32.00x47.00x10.00mm, FPM
NB716 [x2]
35.00x48.00x10.00mm, FPM
LK5003 [x1][7]
85.00x131.00x15.700mm, PTFE



cc



kW/PS

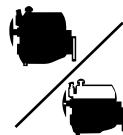

1.8	AMK	109					AY970 (MLS)	CY971	EY841 [3]
Leon 1.8 T	02/02→06/06	1781	4	81.00	DOHC	154/209			
1.8	APG	110					AY970 (MLS)	CY971	EY841 [3]
Leon 1.8 20V Toledo 2 1.8	11/99→06/06 04/99→05/06	1781	4	81.00	DOHC	92/125			
1.8	APP	111					AY970 (MLS)	CY971	EY841 [3]
Leon 1.8 20V T Toledo 2 1.8T	11/99→06/06 05/01→05/06	1781	4	81.00	DOHC	132/180			
1.8	AQX	112					AY970 (MLS)	CY971	EY841 [3]
Cordoba 1.8 T Ibiza 3 1.8 T	07/00→10/02 07/00→02/02	1781	4	81.00	DOHC	115/156			
1.8	ARY	113					AY970 (MLS)	CY971	EY841 [3]
Leon 1.8	11/99→06/06	1781	4	81.00	DOHC	132/180			
1.8	AUQ	114					AY970 (MLS)	CY971	EY841 [3]
Leon 1.8 20V T Toledo 2 1.8T	11/99→06/06 05/01→05/06	1781	4	81.00	DOHC	132/180			
1.8	AWC	115					AY970 (MLS)	CY971	EY841 [3]
Alhambra 1.8T	10/97→03/10	1781	4	81.00	DOHC	110/150			

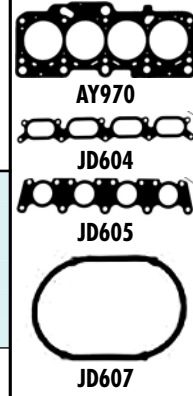
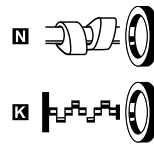
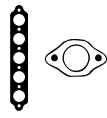



cc



kW/PS

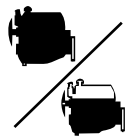

1.8	AYP					116	AY970 (MLS)	CY971	EY841 [3]
Cordoba 1.8 T Ibiza 3 1.8 T	07/00→10/02 07/00→02/02	1781	4	81.00	DOHC	115/156			
1.8	BAM					117	AY970 (MLS)	CY971	EY841 [3]
Leon 1.8 T	07/03→06/06	1781	4	81.00	DOHC	165/225			
1.8	BBU					118	AY970 (MLS)	CY971	EY841 [3]
Ibiza 4 1.8 T	01/04→02/08	1781	4	81.00	DOHC	132/180			
1.8	BJX					119	AY970 (MLS)	CY971	EY841 [3]
Ibiza 4 1.8T FR	12/03→05/08	1781	4	81.00	DOHC	110/150			
1.8	BKV					120	AY970 (MLS)	CY971	EY841 [3]
Ibiza 4 1.8T FR	12/03→05/08	1781	4	81.00		110/150			
1.8	BLZ					121	AY970 (MLS)	CY971	EY841 [3]
Ibiza 4 1.8 T	01/04→02/08	1781	4	81.00	DOHC	132/180			
1.8	BYT					122	AH5380 (MLS)		
Altea 1.8 TFSI Toledo 3 1.8TFS	01/07→ 01/07→05/09	1798	4	82.50	DOHC	118/160			
1.8	BZB					123	AH5380 (MLS)		
Altea 1.8 TFSI Leon 1.8 TSI Toledo 3 1.8TFS	01/07→ 06/07→ 01/07→05/09	1798	4	82.50	DOHC	118/160			
1.8	CDAA					124	AH5380 (MLS)		
Alhambra 1.8T Altea 1.8 TFSI Leon 1.8 TSI Toledo 3 1.8TFS	11/12→ 01/07→ 06/07→ 01/07→05/09	1798	4	82.50	DOHC	118/160			
1.8	CDHA					125	AH5380 (MLS)		
EXEO 1.8 TSI	09/10→	1798	4	82.50	DOHC	88/120			
1.8	CDHB					126	AH5380 (MLS)		
EXEO 1.8 TSI	05/10→	1798	4	82.50	DOHC	118/160			

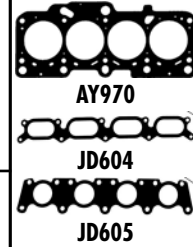
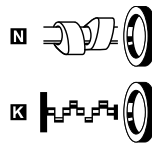
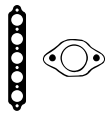

HBS268 [22] M10x1.50x120.00mm (x10)	JD604 [1] JD605 [3]	HL732 [3]	HR397	PA5041 (x20) 6.00/12.20x10.00 (FPM) HR822 [3]	NA5001 [1][2] 32.00x47.00x10.00mm, FPM NA5124 (x2)[2] 32.00x47.00x10.00mm, PTFE/ACM LK5003 [1][7] 85.00x131.00x15.700mm, PTFE
HBS268 [22] M10x1.50x120.00mm (x10)	JD604 [1] JD605 [3]	HL732 [3]	HR397	PA5041 (x20) 6.00/12.20x10.00 (FPM) HR822 [3]	NA5001 [1][2] 32.00x47.00x10.00mm, FPM NA5001 [3] (x2)[1][2] 32.00x47.00x10.00mm, FPM NB716 [2] 35.00x48.00x10.00mm, FPM LK5003 [1][7] 85.00x131.00x15.700mm, PTFE
HBS268 [22] M10x1.50x120.00mm (x10)	JD604 [1] JD605 [3]	HL732 [3]	HR397	PA5041 (x20) 6.00/12.20x10.00 (FPM) HR822 [3]	NA5124 (x2)[2] 32.00x47.00x10.00mm, PTFE/ACM NA5106 [2] 35.00x48.00x10.00mm, PTFE LK5003 [1][7] 85.00x131.00x15.700mm, PTFE
HBS268 [22] M10x1.50x120.00mm (x10)	JD604 [1] JD605 [3]	HL732 [3]	HR397	PA5041 (x20) 6.00/12.20x10.00 (FPM) HR822 [3]	NA5124 (x2)[2] 32.00x47.00x10.00mm, PTFE/ACM NA5106 [2] 35.00x48.00x10.00mm, PTFE LK5003 [1][7] 85.00x131.00x15.700mm, PTFE
HBS268 [22] M10x1.50x120.00mm (x10)	JD604 [1] JD605 [3]	HL732 [3]	HR397	PA5041 (x20) 6.00/12.20x10.00 (FPM) HR822 [3]	NA5001 [1][2] 32.00x47.00x10.00mm, FPM NA5124 (x2)[2] 32.00x47.00x10.00mm, PTFE/ACM LK5003 [1][7] 85.00x131.00x15.700mm, PTFE
HBS268 [22] M10x1.50x120.00mm (x10)	JD604 [1] JD605 [3] (Steel) 1.00mm	HL732 [3]	HR397	PA5041 (x20) 6.00/12.20x10.00 (FPM) HR822 [3]	NA5124 (x2)[2] 32.00x47.00x10.00mm, PTFE/ACM NA5106 [2] 35.00x48.00x10.00mm, PTFE LK5003 [1][7] 85.00x131.00x15.700mm, PTFE
HBS476 [22] M10x1.50x117.00mm (x10)		HR397 [3]	HR397	PA5041 (x16) 6.00/12.20x10.00 (FPM) HR791 [3]	
HBS476 [22] M10x1.50x117.00mm (x10)		HR397 [3]	HR397	PA5041 (x16) 6.00/12.20x10.00 (FPM) HR791 [3]	
HBS476 [22] M10x1.50x117.00mm (x10)		HR397 [3]	HR397	PA5041 (x16) 6.00/12.20x10.00 (FPM) HR791 [3]	NA5124 [2] 32.00x47.00x10.00mm, PTFE/ACM
HBS476 [22] M10x1.50x117.00mm (x10)		HR397 [3]	HR397	PA5041 (x16) 6.00/12.20x10.00 (FPM) HR791 [3]	NA5124 [2] 32.00x47.00x10.00mm, PTFE/ACM
HBS476 [22] M10x1.50x117.00mm (x10)		HR397 [3]	HR397	PA5041 (x16) 6.00/12.20x10.00 (FPM) HR791 [3]	NA5124 [2] 32.00x47.00x10.00mm, PTFE/ACM









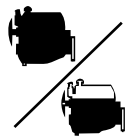



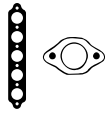

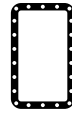

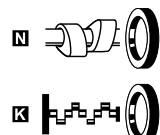



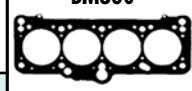



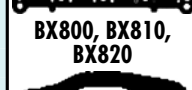



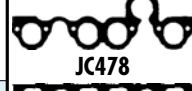
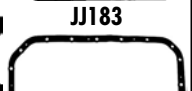

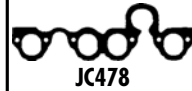
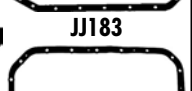







cc



kW/PS



1.8		CFMA					127			
EXEO 1.8 T	12/08→05/10	1781	4	81.00	DOHC	110/150				
1.8		KR					128	BM360 (Fibre)	DM365 [3]	EG875 ET811
Toledo I 1.8	05/91→03/99	1781	4	81.00	DOHC	98-102/ 133-139				
1.8		PL					129	BM360 (Fibre)	DM365 [3]	EG875 ET811
Toledo I 1.8	05/91→03/99	1781	4	81.00	DOHC	92/125				
1.8		RP					130	BM360 (Fibre)	DM368 [3]	EG872 EM362
Toledo I 1.8 i	05/91→12/96	1781	4	81.00		65/88				
1.9		1Y Diesel					131	BV850 (MLS), 1.530mm, 1 Hole BV860 (MLS), 1.570mm, 2 Holes BV870 (MLS), 1.610mm, 3 Holes	DV850 ▲ →Eng.580 000 DV851 ▲ Eng.580 001 →	EC030 [18] →Eng.800000
Cordoba 1.9 D	02/93→08/96	1896	4	79.50	SOHC/OHC	47-50/ 64-68				
Ibiza 2 1.9 D	04/93→08/96									
Inca Van 1.9 D	11/95→06/03									
Toledo I 1.9 D	05/91→03/99									
1.9		1Z Diesel					132	BX800 (MLS), 1.450mm, 1 Hole BX810 (MLS), 1.530mm, 2 Holes BX820 (MLS), 1.610mm, 3 Holes	DX800 ▲ →Eng.1Z-720 000 DX801 ▲ Eng.1Z-720 001 →	EC030 [18]
Alhambra 1.9TDI	04/96→03/10	1896	4	79.50	SOHC/OHC	66/90				
Cordoba 1.9 TDI	08/96→06/99									
Ibiza 2 1.9 TDI	08/96→08/99									
Toledo I 1.9TDI	08/95→03/99									
1.9		AAZ Diesel					133	BV850 (MLS), 1.530mm, 1 Hole BV860 (MLS), 1.570mm, 2 Holes BV870 (MLS), 1.610mm, 3 Holes	DV850 ▲	EC030 [18]
Cordoba 1.9 TD	02/93→08/96	1896	4	79.50	SOHC/OHC	55/75				
Ibiza 2 1.9 TD	03/93→08/96									
Toledo I 1.9 TD	05/91→03/99									
1.9		AEY Diesel					134	BX800 (MLS), 1.450mm, 1 Hole BX810 (MLS), 1.530mm, 2 Holes BX820 (MLS), 1.610mm, 3 Holes	DX801 ▲	EC030 [18] →Eng.050000
Cordoba 1.9 SDI	08/96→06/99	1896	4	79.50	SOHC/OHC	47/64				
Ibiza 2 1.9 SDI	08/96→08/99									
Inca Van 1.9SDI	11/95→06/03									

									
HBS268 [22] M10x1.50x120.00mm (x10)	JD6005 [Steel] 1.00mm JD605		HR397	PA5041 (x20) 6.00/12.20x10.00 (FPM) HR822	NA5106 [2] 35.00x48.00x10.00mm, PTFE/ACM NA5124 [2] 32.00x47.00x10.00mm, PTFE/ACM NA5106 [2] 35.00x48.00x10.00mm, PTFE LK5003 [1][7] 85.00x131.00x15.700mm, PTFE				 BM360  JP003  BV850, BV860, BV870  JH5023  BX800, BX810, BX820  JJ140  JC152  JC478  JD170  JD281  JD282  JE138  JE160  JN914
HBS028 [22] M11x1.50x147.00mm (x10)	JD281 JD282 (x4) JF205	HL606	JJ140 (SMG) JJ183	HR599 (x2) HR816 (x2)	NA5001 [1][2] 32.00x47.00x10.00mm, FPM NA5001 [1][2] 32.00x47.00x10.00mm, FPM NA5133 [1] 85.00x105.00x11.00mm, FPM				 JC478  JD170  JD281  JD282  JE138  JE160
HBS028 [22] M11x1.50x147.00mm (x10)	JD281 JD282 (x4) JF205	HL606	JJ140 (SMG)	HR599 (x2) HR816 (x2)	NA5001 [1][2] 32.00x47.00x10.00mm, FPM NA5001 [1][2] 32.00x47.00x10.00mm, FPM NA5133 [1] 85.00x105.00x11.00mm, FPM				 JD281  JD282  JE138  JE160
HBS043 [22] M11x1.50x95.00mm (x10)	JC478 PA459 (NBR) JC152 (x4) JE160	HL457 [23] (Cork) HM5053 [24] (ACM)	JJ140 (SMG)	HR569	NA5001 (x2)[1][2] 32.00x47.00x10.00mm, FPM NA5001 [1][2] 32.00x47.00x10.00mm, FPM NA5133 [1] 85.00x105.00x11.00mm, FPM	KA5020 [15]			 JD282  JE138  JE160
HBS018 [19] M12x1.75x115.00mm (x10)	JD170 JC152 (x4) JE138 [27] JE5076	JN914 [4] HM5058	JH5023	HR569 →Eng.580 000 HR816 Eng.580 001 →	NA5001 [1][2] 32.00x47.00x10.00mm, FPM NA5001 [1][2] 32.00x47.00x10.00mm, FPM NA5133 [1] 85.00x105.00x11.00mm, FPM LK5006 [7] 85.00x131.00x16.000mm, PTFE				 JE138  JE160
HBS018 [19] M12x1.75x115.00mm (x10)	JD170 JC152 (x4)	JP003 [4] HM5367	JJ609 (ACM)	HR569 →Eng.1Z-720 000 HR816 Eng.1Z-720 001 →	NA5001 [1][2] 32.00x47.00x10.00mm, FPM NA5001 [1][2] 32.00x47.00x10.00mm, FPM NA5133 [1] 85.00x105.00x11.00mm, FPM				 JE160
HBS018 [19] M12x1.75x115.00mm (x10)	JD170 JC152 (x4) JE5076	JN914 [4] HM5058	JH5023	HR569	NA5001 [1][2] 32.00x47.00x10.00mm, FPM NA5001 [1][2] 32.00x47.00x10.00mm, FPM NA5133 [1] 85.00x105.00x11.00mm, FPM				 PA459  HL457
HBS018 [19] M12x1.75x115.00mm (x10)	JD170 JC152 (x4) JE5076	JP003 [4] HM5367	JJ140 (SMG) JJ609 (ACM)	HR816	NA5001 [1][2] 32.00x47.00x10.00mm, FPM NA5001 [1][2] 32.00x47.00x10.00mm, FPM NA5133 [1] 85.00x105.00x11.00mm, FPM LK5006 [7] 85.00x131.00x16.000mm, PTFE				 JN914



cc



kW/PS

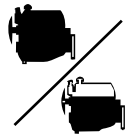

1.9		AFN Diesel				135					
Alhambra 1.9TDI	08/96→06/00	1896	4	79.50	SOHC/OHC	81/110	BX800 (MLS), 1.450mm, 1 Hole BX810 (MLS), 1.530mm, 2 Holes BX820 (MLS), 1.610mm, 3 Holes	DX800 ▲ →Eng.002 000 DX801 ▲ Eng.002 001→	ECOC30 [18] →Eng.576000		
Cordoba 1.9 TDI	03/97→06/99										
Ibiza 2 1.9 TDI	02/97→08/99										
Toledo I 1.9TDI	11/96→03/99										
1.9		AGP Diesel				136					
Cordoba 1.9 SDI	06/99→12/02	1896	4	79.50	SOHC/OHC	50/68	BZ010 (MLS), 1.450mm, 1 Hole →Eng.028 000 BZ020 (MLS), 1.530mm, 2 Holes →Eng.028 000 BZ030 (MLS), 1.610mm, 3 Holes →Eng.028 000 BZ040 (MLS), 1.470mm, 1 Hole Eng.028 001→ BZ050 (MLS), 1.570mm, 2 Holes Eng.028 001→ BZ060 (MLS), 1.670mm, 3 Holes Eng.028 001→	DZ010 ▲☒	ECOC60 [18]		
Ibiza 3 1.9 SDI	08/99→02/02										
1.9		AGR Diesel				137					
Cordoba 1.9 TDI	06/99→12/02	1896	4	79.50	SOHC/OHC	66/90	BZ010 (MLS), 1.450mm, 1 Hole →Eng.151 000 BZ020 (MLS), 1.530mm, 2 Holes →Eng.151 000 BZ030 (MLS), 1.610mm, 3 Holes →Eng.151 000 BZ040 (MLS), 1.470mm, 1 Hole Eng.151 001→ BZ050 (MLS), 1.570mm, 2 Holes Eng.151 001→ BZ060 (MLS), 1.670mm, 3 Holes Eng.151 001→	DZ010 ▲☒	ECOC60 [18]		
Ibiza 3 1.9 TDI	08/99→02/02										
Leon 1.9 TDI	11/99→06/06										
Toledo 2 1.9TDI	04/99→05/06										
1.9		AHF Diesel				138					
Leon 1.9 TDI	11/99→06/06	1896	4	79.50	SOHC/OHC	81/110	BZ010 (MLS), 1.450mm, 1 Hole →Eng.140 000 BZ020 (MLS), 1.530mm, 2 Holes →Eng.140 000 BZ030 (MLS), 1.610mm, 3 Holes →Eng.140 000 BZ040 (MLS), 1.470mm, 1 Hole Eng.140 001→ BZ050 (MLS), 1.570mm, 2 Holes Eng.140 001→ BZ060 (MLS), 1.670mm, 3 Holes Eng.140 001→	DZ010 ▲☒	ECOC60 [18]		
Toledo 2 1.9TDI	04/99→05/06										
1.9		AHU Diesel				139					
Alhambra 1.9TDI	04/96→03/10	1896	4	79.50	SOHC/OHC	66/90	BX800 (MLS), 1.450mm, 1 Hole BX810 (MLS), 1.530mm, 2 Holes BX820 (MLS), 1.610mm, 3 Holes	DX800 ▲ →Eng.720 000 DX801 ▲ Eng.720 001→	ECOC30 [18] →Eng.390000		
Cordoba 1.9 TDI	08/96→10/02										
Ibiza 2 1.9 TDI	08/96→08/99										
Toledo I 1.9TDI	08/95→03/99										

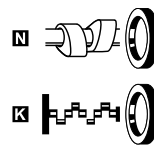
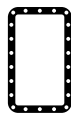
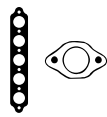

BX800, BX810,
BX820



BZ010, BZ020,
BZ030



BZ040, BZ050,
BZ060



JC152



JD170



JP003



JJ609

HBS018 [19]
M12x1.75x115.00mm (x10)

JD170
JC152 (x4)

JP003 [4]
HM5367

JJ609
(ACM)

HR569
→Eng.002 000
HR816
Eng.002 001 →

NA5001 [1][2]
32.00x47.00x10.00mm, FPM
NA5001 [1][2]
32.00x47.00x10.00mm, FPM
NA5133 [1]
85.00x105.00x11.00mm, FPM
LK5006 [7]
85.00x131.00x16.00mm, PTFE

HBS018 [19]
M12x1.75x115.00mm (x10)

JD170
JC152 (x4)
JE5076

HR397

HR397

HR816

NA5001 [1][2]
32.00x47.00x10.00mm, FPM
NA5106 [2]
35.00x48.00x10.00mm, PTFE/ACM
NA5106 [2]
35.00x48.00x10.00mm, PTFE
LK5003 [1][7]
85.00x131.00x15.700mm, PTFE

HBS018 [19]
M12x1.75x115.00mm (x10)

JD170
JC152 (x4)

HR397

HR397

HR816

NA5001 [1][2]
32.00x47.00x10.00mm, FPM
NB716 [2]
35.00x48.00x10.00mm, FPM
LK5003 [1][7]
85.00x131.00x15.700mm, PTFE
LK5006 [7]
85.00x131.00x16.00mm, PTFE

HBS018 [19]
M12x1.75x115.00mm (x10)

JD170
JC152 (x4)

HR397

HR397

HR816

NA5001 [1][2]
32.00x47.00x10.00mm, FPM
NA5001 [1][2]
32.00x47.00x10.00mm, FPM
NB716 [2]
35.00x48.00x10.00mm, FPM
LK5003 [1][7]
85.00x131.00x15.700mm, PTFE

HBS018 [19]
M12x1.75x115.00mm (x10)

JD170
JC152 (x4)

JP003 [4]
HM5367

JJ609
(ACM)

HR569
→Eng.720 000
HR816
Eng.720 001 →

NA5001 [1][2]
32.00x47.00x10.00mm, FPM
NA5001 [1][2]
32.00x47.00x10.00mm, FPM
NA5133 [1]
85.00x105.00x11.00mm, FPM
LK5006 [7]
85.00x131.00x16.00mm, PTFE



cc



kW/PS

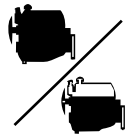

1.9		ALH Diesel					140		DZ010 ▲☒	ECO60 [18]
Cordoba 1.9 TDI	06/99→12/02	1896	4	79.50	SOHC/OHC	66/90	BZ010 (MLS), 1.450mm, 1 Hole →Eng.085 000			
Ibiza 3 1.9 TDI	08/99→02/02						BZ020 (MLS), 1.530mm, 2 Holes →Eng.085 000			
Inca Van 1.9 TDI	09/96→06/03						BZ030 (MLS), 1.610mm, 3 Holes →Eng.085 000			
Leon 1.9 TDI	11/99→06/06						BZ040 (MLS), 1.470mm, 1 Hole Eng.085 001 →			
Toledo 2 1.9 TDI	04/99→05/06						BZ050 (MLS), 1.570mm, 2 Holes Eng.085 001 →			
							BZ060 (MLS), 1.670mm, 3 Holes Eng.085 001 →			
1.9		ANU Diesel					141		CC5230 ▲	ECO60 [18]
Alhambra 1.9 TDI	04/96→03/10	1896	4	79.50	SOHC/OHC	66/90	AF5381 (MLS), 1.490mm, 1 Hole AF5391 (MLS), 1.530mm, 2 Holes AF5401 (MLS), 1.650mm, 3 Holes			
1.9		AQM Diesel					142		DZ010 ▲☒	ECO60 [18]
Cordoba 1.9 SDI	06/99→12/02	1896	4	79.50	SOHC/OHC	50/68	BZ040 (MLS), 1.470mm, 1 Hole BZ050 (MLS), 1.570mm, 2 Holes BZ060 (MLS), 1.670mm, 3 Holes			
Ibiza 3 1.9 SDI	08/99→02/02									
Leon 1.9 SDI	11/99→06/06									
Toledo 2 1.9 SDI	11/99→06/04									
1.9		ARL Diesel					143		CC5231 ▲	ECO60 [18]
Alhambra 1.9 TDI	05/05→05/07	1896	4	79.50	SOHC/OHC	110/150	AF5381 (MLS), 1.490mm, 1 Hole AF5391 (MLS), 1.530mm, 2 Holes AF5401 (MLS), 1.650mm, 3 Holes			
Leon 1.9 TDI	02/01→06/06									
Toledo 2 1.9 TDI	10/00→05/06									
1.9		ASK Diesel					144		DZ010 ▲☒	ECO60 [18]
Cordoba 1.9 TDI	06/99→12/02	1896	4	79.50	SOHC/OHC	81/110	BZ040 (MLS), 1.470mm, 1 Hole BZ050 (MLS), 1.570mm, 2 Holes BZ060 (MLS), 1.670mm, 3 Holes			
Ibiza 3 1.9 TDI	08/99→02/02									
1.9		ASV Diesel					145		DZ010 ▲☒	ECO60 [18]
Cordoba 1.9 TDI	06/99→12/02	1896	4	79.50	SOHC/OHC	81/110	BZ040 (MLS), 1.470mm, 1 Hole BZ050 (MLS), 1.570mm, 2 Holes BZ060 (MLS), 1.670mm, 3 Holes			
Ibiza 3 1.9 TDI	08/99→02/02									
Leon 1.9 TDi	11/99→06/06									
Toledo 2 1.9 TDI	04/99→05/06									

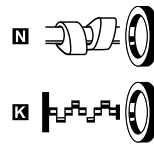
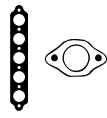

BZ010, BZ020,
BZ030



BZ040, BZ050,
BZ060



JC152



JD170

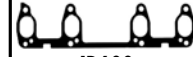

JD600



JD606

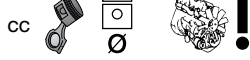

kW/PS

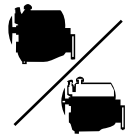

1.9		ASZ Diesel				147	AF5381 (MLS), 1.490mm, 1 Hole AF5391 (MLS), 1.530mm, 2 Holes AF5401 (MLS), 1.650mm, 3 Holes		CC5230 ▲	ECO60 [18]
Cordoba 1.9 SDI	09/02→11/09	1896	4	79.50	SOHC/OHC	47/64	BZ040 (MLS), 1.470mm, 1 Hole BZ050 (MLS), 1.570mm, 2 Holes BZ060 (MLS), 1.670mm, 3 Holes		CC5231 ▲	ECO60 [18]
Ibiza 4 1.9 SDI	02/02→12/05									
1.9		ATD Diesel				148	AF5381 (MLS), 1.490mm, 1 Hole AF5391 (MLS), 1.530mm, 2 Holes AF5401 (MLS), 1.650mm, 3 Holes		CC5230 ▲	ECO60 [18]
Cordoba 1.9 TDI	09/02→11/09	1896	4	79.50	SOHC/OHC	74/100				
Ibiza 4 1.9 TDI	02/02→11/09									
1.9		AUY Diesel				149	AF5381 (MLS), 1.490mm, 1 Hole AF5391 (MLS), 1.530mm, 2 Holes AF5401 (MLS), 1.650mm, 3 Holes		CC5231 ▲	ECO60 [18]
Alhambra 1.9TDI	06/00→03/10	1896	4	79.50	SOHC/OHC	85/115				
1.9		AVG Diesel				150	BX800 (MLS), 1.450mm, 1 Hole BX810 (MLS), 1.530mm, 2 Holes BX820 (MLS), 1.610mm, 3 Holes		DX801 ▲	ECO30 [18]
Alhambra 1.9TDI	08/96→06/00	1896	4	79.50	SOHC/OHC	81/110				
1.9		AXR Diesel				151	AF5381 (MLS), 1.490mm, 1 Hole AF5391 (MLS), 1.530mm, 2 Holes AF5401 (MLS), 1.650mm, 3 Holes		CC5230 ▲	ECO60 [18]
Cordoba 1.9 TDI	09/02→11/09	1896	4	79.50	SOHC/OHC	74/100				
Ibiza 4 1.9 TDI	02/02→11/09									
Leon 1.9 TDI	10/05→06/06									
1.9		AYQ Diesel				152	BZ040 (MLS), 1.470mm, 1 Hole BZ050 (MLS), 1.570mm, 2 Holes BZ060 (MLS), 1.670mm, 3 Holes			ECO60 [18]
Inca Van 1.9SDI	11/95→06/03	1896	4	79.50	SOHC/OHC	47/64				
1.9		BJB Diesel				153	AF5381 (MLS), 1.490mm, 1 Hole AF5391 (MLS), 1.530mm, 2 Holes AF5401 (MLS), 1.650mm, 3 Holes		CC5230 ▲	EF5380
Altea 1.9 TDI	04/04→	1896	4	79.50	SOHC/OHC	77/105				
Toledo 3 1.9TDI	10/04→05/09									

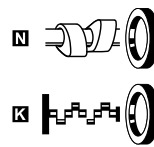
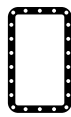
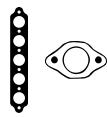

BX800, BX810,
BX820



BZ040, BZ050,
BZ060



JC152



JD170



JD600



JP003



JJ609

HBS018 [19]
M12x1.75x115.00mm (x10)

JD170
JC152 (x4)

JM5203
(Elastomer)

HR397

HR816

NA5001 [1][2]
32.00x47.00x10.00mm, FPM
NA5106 [2]
35.00x48.00x10.00mm, PTFE/ACM
NA5124 [2]
32.00x47.00x10.00mm, PTFE/ACM
NA5106 [2]
35.00x48.00x10.00mm, PTFE
NA5124 [2]
32.00x47.00x10.00mm, PTFE/ACM
NB716 [2]
35.00x48.00x10.00mm, FPM
LK5003 [1][7]
85.00x131.00x15.700mm, PTFE

HBS300 [19]
M12x1.75x166.00mm (x10)

JD170
JC152 (x4)

JM5203
(Elastomer)

HR397

HR816

NA5124 [2]
32.00x47.00x10.00mm, PTFE/ACM
NA5106 [2]
35.00x48.00x10.00mm, PTFE
LK5003 [1][7]
85.00x131.00x15.700mm, PTFE

HBS300 [19]
M12x1.75x166.00mm (x10)

JD170
JD600

JM5203
(Elastomer)

HR397

HR816

NA5124 [2]
32.00x47.00x10.00mm, PTFE/ACM
NA5106 [2]
35.00x48.00x10.00mm, PTFE
LK5003 [1][7]
85.00x131.00x15.700mm, PTFE

HBS300 [19]
M12x1.75x166.00mm (x10)

JD170
JC152 (x4)

JM5203
(Elastomer)

HR397

HR816

NA5124 [2]
32.00x47.00x10.00mm, PTFE/ACM
NA5106 [2]
35.00x48.00x10.00mm, PTFE
LK5003 [1][7]
85.00x131.00x15.700mm, PTFE

HBS018 [19]
M12x1.75x115.00mm (x10)

JD170
JC152 (x4)
JE5075

JP003 [4]
HM5367

HR397
JJ609
(ACM)

HR816

NA5001 [1][2]
32.00x47.00x10.00mm, FPM
NA5001 [1][2]
32.00x47.00x10.00mm, FPM
LK5006 [7]
85.00x131.00x16.000mm, PTFE

HBS300 [19]
M12x1.75x166.00mm (x10)

JD170
JD600

JM5203
(Elastomer)

HR397

HR816

NA5124 [2]
32.00x47.00x10.00mm, PTFE/ACM
NA5106 [2]
35.00x48.00x10.00mm, PTFE
NA5124 [2]
32.00x47.00x10.00mm, PTFE/ACM
LK5003 [1][7]
85.00x131.00x15.700mm, PTFE

HBS018 [19]
M12x1.75x115.00mm (x10)

JD170
JD600
JE5076

JM5203
(Elastomer)

HR397

HR816

NA5001 [1][2]
32.00x47.00x10.00mm, FPM
NA5001 [1][2]
32.00x47.00x10.00mm, FPM
LK5003 [1][7]
85.00x131.00x15.700mm, PTFE

HBS300 [19]
M12x1.75x166.00mm (x10)

JD170
JD600

JM5203
(Elastomer)

HR397

HR816

NA5124 [2]
32.00x47.00x10.00mm, PTFE/ACM
NA5106 [2]
35.00x48.00x10.00mm, PTFE
LK5012 [1][7][28]
85.00x132.00x15.70mm, ACM



cc



kW/PS

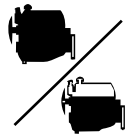

1.9		BKC Diesel				154	AF5381 (MLS), 1.490mm, 1 Hole AF5391 (MLS), 1.530mm, 2 Holes AF5401 (MLS), 1.650mm, 3 Holes	CC5230 ▲	EF5380
Altea 1.9 TDI	04/04→	1896	4	79.50	SOHC/OHC	77/105			
Leon 1.9 TDI	07/05→								
Toledo 3 1.9 TDI	10/04→05/09								
1.9		BLS Diesel				155	AF5381 (MLS), 1.490mm, 1 Hole AF5391 (MLS), 1.530mm, 2 Holes AF5401 (MLS), 1.650mm, 3 Holes	CC5230 ▲	EF5380
Altea 1.9 TDI	04/04→	1896	4	79.50	SOHC/OHC	77/105			
Ibiza 5 1.9 TDI	03/08→06/10								
Leon 1.9 TDI	07/05→								
Toledo 3 1.9 TDI	10/04→05/09								
1.9		BLT Diesel				156	AF5381 (MLS), 1.490mm, 1 Hole AF5391 (MLS), 1.530mm, 2 Holes AF5401 (MLS), 1.650mm, 3 Holes	CC5230 ▲	EB5370 [3][18]
Cordoba 1.9 TDI	10/02→11/09	1896	4	79.50	SOHC/OHC	96/131			
Ibiza 4 1.9 TDI	02/02→11/09								
1.9		BMT Diesel				157	AF5381 (MLS), 1.490mm, 1 Hole AF5391 (MLS), 1.530mm, 2 Holes AF5401 (MLS), 1.650mm, 3 Holes		EF5380
Cordoba 1.9 TDI	09/02→11/09	1896	4	79.50	SOHC/OHC	74/101			
Ibiza 4 1.9 TDI	02/02→11/09								
1.9		BPX Diesel				158	AF5381 (MLS), 1.490mm, 1 Hole AF5391 (MLS), 1.530mm, 2 Holes AF5401 (MLS), 1.650mm, 3 Holes	CC5231 ▲	EC060 [18]
Ibiza 4 1.9 TDI	03/04→02/08	1896	4	79.50	SOHC/OHC	118/160			
1.9		BTB Diesel				159	AF5381 (MLS), 1.490mm, 1 Hole AF5391 (MLS), 1.530mm, 2 Holes AF5401 (MLS), 1.650mm, 3 Holes	CC5230 ▲	EB5370 [3][18]
Alhambra 1.9 TDI	05/05→05/07	1896	4	79.50	SOHC/OHC	110/150			
1.9		BUK Diesel				160	AF5381 (MLS), 1.490mm, 1 Hole AF5391 (MLS), 1.530mm, 2 Holes AF5401 (MLS), 1.650mm, 3 Holes	CC5231 ▲	EC060 [18]
Ibiza 4 1.9 TDI	03/04→02/08	1896	4	79.50	SOHC/OHC	118/160			
1.9		BVK Diesel				161	AF5381 (MLS), 1.490mm, 1 Hole AF5391 (MLS), 1.530mm, 2 Holes AF5401 (MLS), 1.650mm, 3 Holes	CC5231 ▲	EB5370 [3][18]
Alhambra 1.9 TDI	06/00→03/10	1896	4	79.50	SOHC/OHC	85/115			

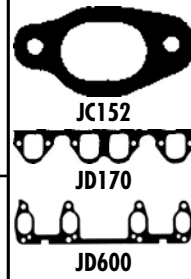
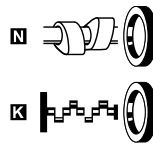
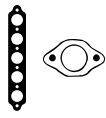

HBS300 [19]
M12x1.75x166.00mm (x10)

JD170
JD600

JM5203
(Elastomer)

HR397

HR816

NA5124 [2]
32.00x47.00x10.00mm, PTFE/ACM
NA5106 [2]
35.00x48.00x10.00mm, PTFE
NA5124 [2]
32.00x47.00x10.00mm, PTFE/ACM
LK5012 [1] [7] [28]
85.00x132.00x15.70mm, ACM

HBS300 [19]
M12x1.75x166.00mm (x10)

JD170
JD5992 [29]
(Steel)

JM7107
(ACM)

HR397

HR816

NA5124 [2]
32.00x47.00x10.00mm, PTFE/ACM
NA5106 [2]
35.00x48.00x10.00mm, PTFE
NA5124 [2]
32.00x47.00x10.00mm, PTFE/ACM
LK5012 [1] [7] [28]
85.00x132.00x15.70mm, ACM

HBS300 [19]
M12x1.75x166.00mm (x10)

JD170
JD600

JM5203
(Elastomer)

HR397

HR816

NA5124 [2]
32.00x47.00x10.00mm, PTFE/ACM
NA5106 [2]
35.00x48.00x10.00mm, PTFE
LK5003 [1] [7]
85.00x131.00x15.70mm, PTFE

HBS300 [19]
M12x1.75x166.00mm (x10)

JD170
JD5992 [29]
(Steel)

JM7107
(ACM)

HR397

HR816

NA5124 [2]
32.00x47.00x10.00mm, PTFE/ACM
NA5106 [2]
35.00x48.00x10.00mm, PTFE
LK5012 [1] [7] [28]
85.00x132.00x15.70mm, ACM

HBS300 [19]
M12x1.75x166.00mm (x10)

JD170
JD600

JM5203
(Elastomer)

HR397

HR816

NA5106 [2]
35.00x48.00x10.00mm, PTFE/ACM
NA5124 [2]
32.00x47.00x10.00mm, PTFE/ACM
NA5106 [2]
35.00x48.00x10.00mm, PTFE
LK5003 [1] [7]
85.00x131.00x15.70mm, PTFE

HBS300 [19]
M12x1.75x166.00mm (x10)

JD170
JD600

JM5203
(Elastomer)

HR397

HR816

NA5124 [2]
32.00x47.00x10.00mm, PTFE/ACM
NA5106 [2]
35.00x48.00x10.00mm, PTFE
LK5003 [1] [7]
85.00x131.00x15.70mm, PTFE

HBS300 [19]
M12x1.75x166.00mm (x10)

JD170
JD600

JM5203
(Elastomer)

HR397

HR816

NA5106 [2]
35.00x48.00x10.00mm, PTFE/ACM
NA5124 [2]
32.00x47.00x10.00mm, PTFE/ACM
NA5106 [2]
35.00x48.00x10.00mm, PTFE
LK5003 [1] [7]
85.00x131.00x15.70mm, PTFE

HBS300 [19]
M12x1.75x166.00mm (x10)

JD170
JC152 (x4)

HR397

HR397

HR816

NA5124 [2]
32.00x47.00x10.00mm, PTFE/ACM
NA5106 [2]
35.00x48.00x10.00mm, PTFE
LK5003 [1] [7]
85.00x131.00x15.70mm, PTFE







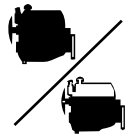

cc

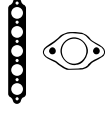

kW/PS

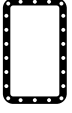

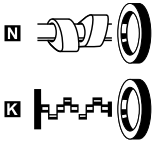
1.9	BXE Diesel	1896	4	79.50	SOHC/OHC	162	77/105	AF5381 (MLS), 1.490mm, 1 Hole AF5391 (MLS), 1.530mm, 2 Holes AF5401 (MLS), 1.650mm, 3 Holes	CC5230 ▲	EF5380
Altea 1.9 TDI	04/04→									
Leon 1.9 TDI	07/05→									
Toledo 3 1.9TDI	10/04→05/09									
1.9	BXF Diesel	1896	4	79.50	SOHC/OHC	163	66/90	AF5381 (MLS), 1.490mm, 1 Hole AF5391 (MLS), 1.530mm, 2 Holes AF5401 (MLS), 1.650mm, 3 Holes	CC5230 ▲	EF5380
Altea 1.9 TDI	08/09→									
Leon 1.9 TDI	06/07→									
1.9	BXJ Diesel	1896	4	79.50	SOHC/OHC	164	66/90	AF5381 (MLS), 1.490mm, 1 Hole AF5391 (MLS), 1.530mm, 2 Holes AF5401 (MLS), 1.650mm, 3 Holes		EF5380
Ibiza 5 1.9 TDI	07/08→06/10									
2.0	2E	1984	4	82.50	SOHC/OHC	165	85/115	BT810 (Fibre)	DT811 →Eng.2E 565 664 DT816 Eng.2E 565 665→	ES471 →Ch.1H-PB-130 001 EB970 Ch.1H-PB-130 001→
Cordoba 2.0 i	02/93→06/99									
Ibiza 2 2.0 i	03/93→08/99									
Toledo I 2.0 i	05/91→03/99									
2.0	ABF	1984	4	82.50	DOHC	166	110/150	BT810 (Fibre) →Ch.4A-S-110 000 BY750 (MLS)	DT81B [3] Eng.031 252→	EB970
Cordoba 2.0 i	08/96→06/99									
Ibiza 2 2.0 i	08/96→08/99									
Toledo I 2.0i	11/93→03/99									
2.0	ADY	1984	4	82.50	SOHC/OHC	167	85/115	BY750 (MLS)	DY753 [3]	EB970
Alhambra 2.0 i	04/96→03/10									
2.0	AGG	1984	4	82.50	SOHC/OHC	168	85/115	BY750 (MLS)	DY753 [3]	EB970
Cordoba 2.0 i	02/93→06/99									
Ibiza 2 2.0 i	03/93→08/99									
Toledo I 2.0 i	05/91→03/99									
2.0	ATM	1984	4	82.50	SOHC/OHC	169	85/115	AB5370 (MLS)		
Alhambra 2.0 i	04/96→03/10									

      							
HBS300 [19] M12x1.75x166.00mm (x10)	JD170 [1] JD600 [1]	JM5203 (Elastomer)	HR397	HR816 [1]	NA5124 [2] 32.00x47.00x10.00mm, PTFE/ACM NA5106 [2] 35.00x48.00x10.00mm, PTFE NA5124 [2] 32.00x47.00x10.00mm, PTFE/ACM LK5012 [1][7][28] 85.00x132.00x15.70mm, ACM		AB5370 BT810 BY750 JC152 JD170 JD281 JD282 JD483 JD5292 JD5293 JD600 HL731 JM5103 JP024 JJ140 JJ609
HBS300 [19] M12x1.75x166.00mm (x10)	JD170 [1] JD600 [1]	JM5203 (Elastomer)	HR397	HR816 [1]	NA5124 [2] 32.00x47.00x10.00mm, PTFE/ACM NA5106 [2] 35.00x48.00x10.00mm, PTFE LK5012 [1][7][28] 85.00x132.00x15.70mm, ACM		AB5370 BT810 BY750 JC152 JD170 JD281 JD282 JD483 JD5292 JD5293 JD600 HL731 JM5103 JP024 JJ140 JJ609
HBS300 [19] M12x1.75x166.00mm (x10)	JD170 [1] JD5992 [29] (Steel)	JM7107 (ACM)	HR397	HR816 [1]	NA5124 [2] 32.00x47.00x10.00mm, PTFE/ACM NA5106 [2] 35.00x48.00x10.00mm, PTFE LK5012 [1][7][28] 85.00x132.00x15.70mm, ACM		AB5370 BT810 BY750 JC152 JD170 JD281 JD282 JD483 JD5292 JD5293 JD600 HL731 JM5103 JP024 JJ140 JJ609
HBS043 [22] M11x1.50x95.00mm (x10)	JD483 [1] JC152 (x4) JF205	JP024 [4]	JJ140 (SMG) JJ609 (ACM)	HR569 [1] →Eng.2E 565 664 HR816 [1] Eng.2E 565 665→	NA5001 [1][2] 32.00x47.00x10.00mm, FPM NA5001 [1][2] 32.00x47.00x10.00mm, FPM NA5133 [1] 85.00x105.00x11.00mm, FPM		AB5370 BT810 BY750 JC152 JD170 JD281 JD282 JD483 JD5292 JD5293 JD600 HL731 JM5103 JP024 JJ140 JJ609
HBS028 [22] M11x1.50x147.00mm (x10)	JD281 [1] JD282 (x4) JF205	HL606 [1] HL731 [1]	JJ609 (ACM)	HR599 [1] HR816 (x2)	NA5001 [1][2] 32.00x47.00x10.00mm, FPM NA5001 [1][2] 32.00x47.00x10.00mm, FPM NA5133 [1] 85.00x105.00x11.00mm, FPM		AB5370 BT810 BY750 JC152 JD170 JD281 JD282 JD483 JD5292 JD5293 JD600 HL731 JM5103 JP024 JJ140 JJ609
HBS043 [22] M11x1.50x95.00mm (x10)	JD483 [1] JD5293 [1] JF205	JP024 [4]	JJ609 (ACM)	HR569 [1] →Eng.000 778 HR816 [1] Eng.000 779→	NA5001 [1][2] 32.00x47.00x10.00mm, FPM NA5124 [2] 32.00x47.00x10.00mm, PTFE/ACM NA5001 [1][2] 32.00x47.00x10.00mm, FPM NA5133 [1] 85.00x105.00x11.00mm, FPM LK5006 [7] 85.00x131.00x16.000mm, PTFE		AB5370 BT810 BY750 JC152 JD170 JD281 JD282 JD483 JD5292 JD5293 JD600 HL731 JM5103 JP024 JJ140 JJ609
HBS043 [22] M11x1.50x95.00mm (x10)	JD483 [1] JC152 (x4) JF205	JP024 [4]	JJ609 (ACM)	HR599 [1]	NA5001 [1][2] 32.00x47.00x10.00mm, FPM NA5001 [1][2] 32.00x47.00x10.00mm, FPM NA5133 [1] 85.00x105.00x11.00mm, FPM LK5006 [7] 85.00x131.00x16.000mm, PTFE		AB5370 BT810 BY750 JC152 JD170 JD281 JD282 JD483 JD5292 JD5293 JD600 HL731 JM5103 JP024 JJ140 JJ609
HBS246 [22] M10x1.50x120.00mm (x10)	JD5292 [1] JD5293 [1]	JM5103 (Elastomer)	HR397	HR816 [1]	NA5124 [2] 32.00x47.00x10.00mm, PTFE/ACM NA5106 [2] 35.00x48.00x10.00mm, PTFE LK5003 [1][7] 85.00x131.00x15.700mm, PTFE		AB5370 BT810 BY750 JC152 JD170 JD281 JD282 JD483 JD5292 JD5293 JD600 HL731 JM5103 JP024 JJ140 JJ609



cc



kW/PS

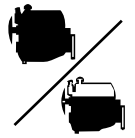

2.0	AZL	170						AB5370 (MLS)	CB5370 [13]	EB5370 [3][18]
Cordoba 2.0	09/02→11/09	1984	4	82.50	SOHC/OHC	85/115				
Ibiza 4 2.0	04/02→11/09									
2.0	AZV Diesel	171						AG8970 (MLS), 1.550mm, 1 Hole AG8800 (MLS), 1.630mm, 2 Holes AG8960 (MLS), 1.710mm, 3 Holes	CG8410 ▲	EF5380
Altea 2.0 TDI	03/04→05/09	1968	4	81.00	DOHC	100/136				
Leon 2.0 TDI	07/05→05/10									
Toledo 3 2.0TDI	09/04→05/09									
2.0	BBX	172						AB5370 (MLS)		EB5370 [3][18]
Cordoba 2.0	09/02→11/09	1984	4	82.50	SOHC/OHC	85/115				
Ibiza 4 2.0	04/02→11/09									
2.0	BKD Diesel	173						AG8970 (MLS), 1.550mm, 1 Hole AG8800 (MLS), 1.630mm, 2 Holes AG8960 (MLS), 1.710mm, 3 Holes	CG8410 ▲	EF5380
Altea 2.0 TDI	03/04→	1968	4	81.00	DOHC	103/140				
Leon 2.0T 16V	07/05→									
Toledo 3 2.0TDI	04/04→05/09									
2.0	BLR	174						AG9600 (MLS)	CG9600	EG9600
Altea 2.0 FSI	05/04→03/09	1984	4	82.50	DOHC	110/150				
Leon 2.0 FSI	07/05→05/10									
Toledo 3 2.0FSI	10/04→05/09									
2.0	BLY	175						AG9600 (MLS)	CG9600	EG9600
Altea 2.0 FSI	05/04→03/09	1984	4	82.50	DOHC	110/150				
Leon 2.0 FSI	07/05→05/10									
Toledo 3 2.0FSI	10/04→05/09									
2.0	BMM Diesel	176						AG9630 (MLS), 1.450mm, 1 Hole AG9640 (MLS), 1.530mm, 2 Holes AG9650 (MLS), 1.610mm, 3 Holes	CG8410 ▲	EF5380
Altea 2.0 TDI	11/05→	1968	4	81.00	SOHC/OHC	103/140				
Leon 2.0 TDI	10/05→									
Toledo 3 2.0TDI	11/05→05/09									
2.0	BMN Diesel	177						AG8970 (MLS), 1.550mm, 1 Hole AG8800 (MLS), 1.630mm, 2 Holes AG8960 (MLS), 1.710mm, 3 Holes	CG8410 ▲	EF5380
Altea 2.0 TDI	03/06→	1968	4	81.00	DOHC	125/170				
Leon 2.0 TDI	05/06→									
Toledo 3 2.0TDI	01/06→05/09									

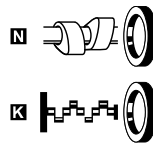
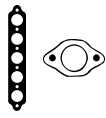

AB5370



JD170



JD5291



JD5293



JD600



LA5204

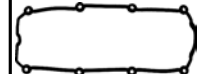

JM5103

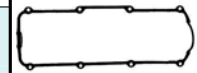

JP024

HBS246 [22] M10x1.50x120.00mm (x10)	JD5291 [1] JD5293 [2]	JPO24 [4]	HR397	HR816 [2]	NA5124 [2] 32.00x47.00x10.00mm, PTFE/ACM NA5106 [2] 35.00x48.00x10.00mm, PTFE NA5124 [2] 32.00x47.00x10.00mm, PTFE/ACM LK5003 [1][7] 85.00x131.00x15.700mm, PTFE	
HBS364 [19] M12x1.75x149.00mm (x10)	JD5805 [1] JD5806 [1] JD5815 [2]	JM7031 (Elastomer)	HR397	PA5041 (x16) 6.00/12.20x10.00 (FPM) HR791 [2]	NA5124 (x2)[2] 32.00x47.00x10.00mm, PTFE/ACM NA5106 [2] 35.00x48.00x10.00mm, PTFE LK5012 [1][7][28] 85.00x132.00x15.70mm, ACM	KK5522 [31]
HBS246 [22] M10x1.50x120.00mm (x10)	LA5204 [1] JD5293 [2]	JM5103 (Elastomer)	HR397	HR642 [2] HR646 [2]	NA5124 [2] 32.00x47.00x10.00mm, PTFE/ACM NA5106 [2] 35.00x48.00x10.00mm, PTFE LK5003 [1][7] 85.00x131.00x15.700mm, PTFE	
HBS364 [19] M12x1.75x149.00mm (x10)	JD5806 [1] →11/06 JD5805 [1] 12/06→ JD5815 [2] JD600 [2]	JM7031 (Elastomer)	HR397	PA5041 (x16) 6.00/12.20x10.00 (FPM) HR791 [2]	NA5124 (x2)[2] 32.00x47.00x10.00mm, PTFE/ACM NA5106 [2] 35.00x48.00x10.00mm, PTFE NA5124 [2] 32.00x47.00x10.00mm, PTFE/ACM LK5012 [1][7][28] 85.00x132.00x15.70mm, ACM	KK5522 [31]
HBS363 [22] M10x1.50x122.00mm (x10)	JD5873 [1] (FPM) JD5813 [2]	JM7078 (Elastomer)	HR397	PA5041 (x16) 6.00/12.20x10.00 (FPM) HR791 [2]	NA5124 [2] 32.00x47.00x10.00mm, PTFE/ACM NA5106 [2] 35.00x48.00x10.00mm, PTFE LK5008 [1][7] 85.00x131.00x15.700mm, PTFE	
HBS363 [22] M10x1.50x122.00mm (x10)	JD5873 [1] (FPM) JD5813 [2]	JM7078 (Elastomer)	HR397	PA5041 (x16) 6.00/12.20x10.00 (FPM) HR791 [2]	NA5124 [2] 32.00x47.00x10.00mm, PTFE/ACM NA5106 [2] 35.00x48.00x10.00mm, PTFE LK5008 [1][7] 85.00x131.00x15.700mm, PTFE	
HBS300 [19] M12x1.75x166.00mm (x10)	JD170 [1] JD5992 [29] (Steel)	JM7031 (Elastomer) JM7107 (ACM)	HR397	HR599 [2] HR816 [2]	NA5124 [2] 32.00x47.00x10.00mm, PTFE/ACM NA5106 [2] 35.00x48.00x10.00mm, PTFE LK5012 [1][7][28] 85.00x132.00x15.70mm, ACM	
HBS364 [19] M12x1.75x149.00mm (x10)	JD5806 [1] (Metal) →11/06 JD5805 [1] (Elastomer) 12/06→ JD5815 [2]	JM7031 (Elastomer)	HR397	PA5041 (x16) 6.00/12.20x10.00 (FPM) HR791 [2]	NA5106 [2] 35.00x48.00x10.00mm, PTFE NA5124 (x2)[2] 32.00x47.00x10.00mm, PTFE/ACM LK5012 [1][7][28] 85.00x132.00x15.70mm, ACM	KK5522 [31]



cc



kW/PS

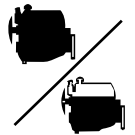

2.0	BRT Diesel	178					AG9630 (MLS), 1.450mm, 1 Hole AG9640 (MLS), 1.530mm, 2 Holes AG9650 (MLS), 1.610mm, 3 Holes		
Alhambra 2.0TDI	11/05→03/10	1968	4	81.00	SOHC/OHC	103/140			
2.0	BVY	179					AG9600 (MLS)	CG9600	EG9600
Altea 2.0 FSI	05/04→03/09	1984	4	82.50	DOHC	110/150			
Leon 2.0 FSI	07/05→05/10								
Toledo 3 2.0FSI	10/04→05/09								
2.0	BVZ	180					AG9600 (MLS)	CG9600	EG9600
Altea 2.0 FSI	05/04→03/09	1984	4	82.50	DOHC	110/150			
Leon 2.0 FSI	07/05→05/10								
Toledo 3 2.0FSI	10/04→05/09								
2.0	BWA	181					AH6930 (MLS)		
Altea 2.0 TFSI	04/06→05/09	1984	4	82.50	DOHC	147/200			
Leon 2.0 TFSI	05/05→03/09								
Toledo 3 2.0TFS	11/05→05/09								
2.0	BWE	182					AH6930 (MLS)		
EXEO 2.0 TFSI	03/09→	1984	4	82.50	DOHC	147/200			
2.0	BWJ	183					AH6930 (MLS)		
Leon 2.0 TFSI	11/06→	1984	4	82.50	DOHC	177/240			
2.0	CCZA	184					AH5380 (MLS)		
Alhambra 2.0TSI	11/10→	1984	4	82.50	DOHC	147/200			
2.0	CCZB	185					AH5380 (MLS)		
Altea 2.0 TFSI	05/09→	1984	4	82.50	DOHC	155/211			
Leon 2.0 TFSI	06/09→								
2.0	CDLA	186					AH6930 (MLS)		
Leon 2.0 TFSI	09/09→	1984	4	82.50	DOHC	195/265			
2.0	CDLD	187					AH6930 (MLS)		
Leon 2.0 TFSI	11/06→	1984	4	82.50	DOHC	177/240			
2.0	CFHC Diesel	188							EF5380
Altea 2.0 TDI	03/04→	1968	4	81.00	DOHC	103/140			
Leon 2.0T 1.6V	07/05→								

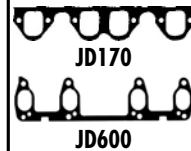
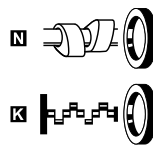
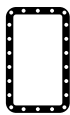
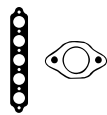

HBS300 [19] M12x1.75x166.00mm (x10)	JD170 [1] JD600 [1]	JM7113 (Elastomer)	HR397	HR599 [1] HR816 [1]	NA5124 [2] 32.00x47.00x10.00mm, PTFE/ACM NA5106 [2] 35.00x48.00x10.00mm, PTFE LK5012 [1] [7] [28] 85.00x132.00x15.70mm, ACM	
HBS363 [22] M10x1.50x122.00mm (x10)	JD5873 [1] (FPM) JD5813 [1]	JM7078 (Elastomer)	HR397	PA5041 (x16) 6.00/12.20x10.00 (FPM) HR791 [1]	NA5124 [2] 32.00x47.00x10.00mm, PTFE/ACM NA5106 [2] 35.00x48.00x10.00mm, PTFE LK5008 [1] [7] 85.00x131.00x15.700mm, PTFE	
HBS363 [22] M10x1.50x122.00mm (x10)	JD5873 [1] (FPM) JD5813 [1]	JM7078 (Elastomer)	HR397	PA5041 (x16) 6.00/12.20x10.00 (FPM) HR791 [1]	NA5124 [2] 32.00x47.00x10.00mm, PTFE/ACM NA5106 [2] 35.00x48.00x10.00mm, PTFE LK5008 [1] [7] 85.00x131.00x15.700mm, PTFE	
HBS476 [22] M10x1.50x117.00mm (x10)			HR397	PA5041 (x16) 6.00/12.20x10.00 (FPM) HR791 [1]	NA5106 [2] 35.00x48.00x10.00mm, PTFE LK5003 [1] [7] 85.00x131.00x15.700mm, PTFE	
HBS476 [22] M10x1.50x117.00mm (x10)			HR397	PA5041 (x16) 6.00/12.20x10.00 (FPM) HR791 [1]	NA5106 [2] 35.00x48.00x10.00mm, PTFE/ACM NA5106 [2] 35.00x48.00x10.00mm, PTFE LK5003 [1] [7] 85.00x131.00x15.700mm, PTFE	
HBS476 [22] M10x1.50x117.00mm (x10)			HR397	PA5041 (x16) 6.00/12.20x10.00 (FPM) HR791 [1]	NA5106 [2] 35.00x48.00x10.00mm, PTFE/ACM NA5106 [2] 35.00x48.00x10.00mm, PTFE LK5003 [1] [7] 85.00x131.00x15.700mm, PTFE	
HBS476 [22] M10x1.50x117.00mm (x10)			HR397	PA5041 (x16) 6.00/12.20x10.00 (FPM) HR791 [1]	NA5124 [2] 32.00x47.00x10.00mm, PTFE/ACM	
HBS476 [22] M10x1.50x117.00mm (x10)			HR397	PA5041 (x16) 6.00/12.20x10.00 (FPM) HR791 [1]		
HBS476 [22] M10x1.50x117.00mm (x10)			HR397	PA5041 (x16) 6.00/12.20x10.00 (FPM) HR791 [1]	NA5124 [2] 32.00x47.00x10.00mm, PTFE/ACM NA5106 [2] 35.00x48.00x10.00mm, PTFE LK5003 [1] [7] 85.00x131.00x15.700mm, PTFE	
HBS476 [22] M10x1.50x117.00mm (x10)			HR397	PA5041 (x16) 6.00/12.20x10.00 (FPM) HR791 [1]	NA5106 [2] 35.00x48.00x10.00mm, PTFE/ACM NA5106 [2] 35.00x48.00x10.00mm, PTFE LK5008 [1] [7] 85.00x131.00x15.700mm, PTFE	
		HR397 [1]	HR397	PA5041 (x16) 6.00/12.20x10.00 (FPM)	NA5106 [2] 35.00x48.00x10.00mm, PTFE	KK5522 [31]



cc



kW/PS

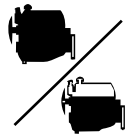

2.3	AGZ	189						AG7800 (MLS)	CG7800	EG7800
Toledo 2 2.3 V5	04/99→05/01	2324	5	81.00	DOHC, VR	110/150				
2.3	AQN	190							CG9620 (MLS)	
Toledo 2 2.3	05/01→05/06	2324	5	81.00	DOHC, V	125/170				
2.8	AUE	191						AG5000 (MLS)	CG5010	EG7800
Alhambra 2.8 V6 Leon Cupra	06/00→03/10 02/01→06/06	2792	6	81.00	DOHC, VR	150/204				
2.8	AYL	192						AG5000 (MLS)	CG5030	EG7800
Alhambra 2.8 V6	06/00→03/10	2792	6	81.00	DOHC, V	150/204				
2.8	BDE	193						AG5000 (MLS)	CG5030	EG7800
Leon 2.8	05/02→06/04	2792	6	81.00	DOHC, V	150/204				

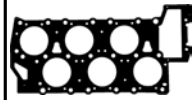
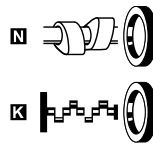
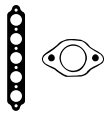

AG5000

HBS461 [22]		HR397 [3]	HR397		NA5106 [2] 35.00x48.00x10.00mm, PTFE/ACM NA5106 [2] 35.00x48.00x10.00mm, PTFE NA5305 [1][36] 01/01 →
HBS513 [22]		JM5234 (MLS) HR397 [3]		PA5041 (x20) 6.00/12.20x10.00 (FPM) HR822 [3]	NA5001 [1][2] 32.00x47.00x10.00mm, FPM NA5106 [2] 35.00x48.00x10.00mm, PTFE NA5305 [1][36]
HBS526 [21][94]	JD5857 [1] (Elastomer)	JM7045 (Elastomer) HR397 [3]	HR397	PA5041 (x24) 6.00/12.20x10.00 (FPM) HR5062 [3]	NA5106 [2] 35.00x48.00x10.00mm, PTFE NA5305 [1][36] 01/01 →
HBS526 [21][94]	JD5857 [1] (Elastomer)	JM7045 (Elastomer)	HR397	PA5041 (x24) 6.00/12.20x10.00 (FPM) HR5062 [3]	NA5106 [2] 35.00x48.00x10.00mm, PTFE NA5305 [1][36] 01/01 →
HBS526 [21][94]	JD5857 [1] (Elastomer)	JM7045 (Elastomer)	HR397	PA5041 (x24) 6.00/12.20x10.00 (FPM) HR5062 [3]	NA5106 [2] 35.00x48.00x10.00mm, PTFE NA5305 [1][36]



Ltr







CC



9

Model	Ltr	Year Range	Code	Fuel	CC	Seats	Index
130	1.3	05/98→10/99	135/8	Petrol	1280	4	19
130	1.3	02/98→10/99	742,13	Petrol	1280	4	24
105,120 (742)	1.2	08/97→12/99	742.12 X	Petrol	1174	4	4
105,120 (744)	1.2	10/98→12/99	742,12	Petrol	1164	4	3
105,120 (744)	1.2	02/98→12/99	742.12 X	Petrol	1174	4	4
FABIA (6Y2)	1.0	12/99→08/00	AQV	Petrol	996	4	1
FABIA (6Y2)	1.0	12/99→08/00	ARV	Petrol	996	4	2
FABIA (6Y2)	1.2	08/00→03/00	AWY	Petrol	1198	3	5
FABIA (6Y2)	1.2	01/00→03/00	AZQ	Petrol	1198	3	6
FABIA (6Y2)	1.2	08/00→03/00	BMD	Petrol	1198	3	8
FABIA (6Y2)	1.2	01/00→03/00	BME	Petrol	1198	3	9
FABIA (6Y2)	1.4	08/99→05/00	AME	Petrol	1397	4	32
FABIA (6Y2)	1.4	04/00→03/00	AMF	Diesel	1422	3	33
FABIA (6Y2)	1.4	08/99→05/00	AQW	Petrol	1397	4	34
FABIA (6Y2)	1.4	08/99→05/00	ATZ	Petrol	1397	4	35
FABIA (6Y2)	1.4	12/99→03/00	AUA	Petrol	1390	4	36
FABIA (6Y2)	1.4	12/99→03/00	AUB	Petrol	1390	4	37
FABIA (6Y2)	1.4	08/00→08/00	AZE	Petrol	1397	4	39
FABIA (6Y2)	1.4	08/00→08/00	AZF	Petrol	1397	4	40
FABIA (6Y2)	1.4	12/99→03/00	BBY	Petrol	1390	4	41
FABIA (6Y2)	1.4	12/99→03/00	BBZ	Petrol	1390	4	42
FABIA (6Y2)	1.4	12/99→03/00	BKY	Petrol	1390	4	44
FABIA (6Y2)	1.4	10/00→03/00	BNM	Diesel	1422	3	46
FABIA (6Y2)	1.4	10/00→03/00	BNV	Diesel	1422	3	47
FABIA (6Y2)	1.9	12/99→03/00	ASY	Diesel	1896	4	90
FABIA (6Y2)	1.9	06/00→03/00	ASZ	Diesel	1896	4	91
FABIA (6Y2)	1.9	01/00→03/00	ATD	Diesel	1896	4	92
FABIA (6Y2)	1.9	01/00→03/00	AXR	Diesel	1896	4	96
FABIA (6Y2)	1.9	06/00→03/00	BLT	Diesel	1896	4	100
FABIA (6Y2)	2.0	12/99→03/00	AQY	Petrol	1984	4	107
FABIA (6Y2)	2.0	12/99→03/00	AZL	Petrol	1984	4	110
FABIA Combi (6Y5)	1.2	07/00→12/00	AWY	Petrol	1198	3	5
FABIA Combi (6Y5)	1.2	01/00→12/00	AZQ	Petrol	1198	3	6
FABIA Combi (6Y5)	1.2	07/00→12/00	BMD	Petrol	1198	3	8
FABIA Combi (6Y5)	1.2	01/00→12/00	BME	Petrol	1198	3	9
FABIA Combi (6Y5)	1.4	04/00→05/00	AME	Petrol	1397	4	32
FABIA Combi (6Y5)	1.4	04/00→12/00	AMF	Diesel	1422	3	33
FABIA Combi (6Y5)	1.4	04/00→05/00	AQW	Petrol	1397	4	34
FABIA Combi (6Y5)	1.4	04/00→05/00	ATZ	Petrol	1397	4	35
FABIA Combi (6Y5)	1.4	05/00→12/00	AUA	Petrol	1390	4	36
FABIA Combi (6Y5)	1.4	04/00→12/00	AUB	Petrol	1390	4	37
FABIA Combi (6Y5)	1.4	04/00→03/00	AZE	Petrol	1397	4	39
FABIA Combi (6Y5)	1.4	04/00→03/00	AZF	Petrol	1397	4	40
FABIA Combi (6Y5)	1.4	05/00→12/00	BBY	Petrol	1390	4	41
FABIA Combi (6Y5)	1.4	04/00→12/00	BBZ	Petrol	1390	4	42
FABIA Combi (6Y5)	1.4	05/00→12/00	BKY	Petrol	1390	4	44
FABIA Combi (6Y5)	1.4	10/00→12/00	BNM	Diesel	1422	3	46
FABIA Combi (6Y5)	1.4	10/00→12/00	BNV	Diesel	1422	3	47
FABIA Combi (6Y5)	1.4	04/00→12/00	BUD	Petrol	1390	4	48
FABIA Combi (6Y5)	1.9	04/00→12/00	ASY	Diesel	1896	4	90
FABIA Combi (6Y5)	1.9	04/00→12/00	ATD	Diesel	1896	4	92
FABIA Combi (6Y5)	1.9	04/00→12/00	AXR	Diesel	1896	4	96
FABIA Combi (6Y5)	2.0	04/00→12/00	AZL	Petrol	1984	4	110
FABIA Combi	1.2	10/00→	BBM	Petrol	1198	3	7
FABIA Combi	1.2	10/00→	BZG	Petrol	1198	3	10
FABIA Combi	1.2	03/01→	CBZA	Petrol	1197	4	11
FABIA Combi	1.2	03/01→	CBZB	Petrol	1197	4	12
FABIA Combi	1.2	10/00→	CEVA	Petrol	1198	3	13
FABIA Combi	1.2	05/01→	CFWA	Diesel	1199	3	14
FABIA Combi	1.2	10/00→	CGPA	Petrol	1198	3	15
FABIA Combi	1.2	11/01→	CGPB	Petrol	1198	3	16
FABIA Combi	1.2	10/00→	CHFA	Petrol	1198	3	17
FABIA Combi	1.2	10/00→	CHTA	Petrol	1198	3	18
FABIA Combi	1.4	10/00→	BMS	Diesel	1422	3	45
FABIA Combi	1.4	10/00→	BNM	Diesel	1422	3	46
FABIA Combi	1.4	10/00→	BNV	Diesel	1422	3	47
FABIA Combi	1.4	10/00→	BXW	Petrol	1390	4	49
FABIA Combi	1.4	05/01→	CAVE	Petrol	1390	4	50
FABIA Combi	1.4	10/00→	CGGB	Petrol	1390	4	54
FABIA Combi	1.6	10/00→	BTS	Petrol	1598	4	64

	Ltr				CC		9
FABIA Combi	1.6	04/01→	CAYA	Diesel	1598	4	65
FABIA Combi	1.6	03/01→	CAYB	Diesel	1598	4	66
FABIA Combi	1.6	03/01→	CAYC	Diesel	1598	4	67
FABIA Combi	1.6	10/00→	CFNA	Petrol	1598	4	69
FABIA Combi	1.9	10/00→	BLS	Diesel	1896	4	99
FABIA Combi	1.9	10/00→	BSW	Diesel	1896	4	103
FABIA Praktik	1.2	07/00→12/00	AWY	Petrol	1198	3	5
FABIA Praktik	1.2	01/00→12/00	AZQ	Petrol	1198	3	6
FABIA Praktik	1.2	07/00→12/00	BMD	Petrol	1198	3	8
FABIA Praktik	1.2	01/00→12/00	BME	Petrol	1198	3	9
FABIA Praktik	1.4	07/00→05/00	AME	Petrol	1397	4	32
FABIA Praktik	1.4	07/00→05/00	AQW	Petrol	1397	4	34
FABIA Praktik	1.4	07/00→05/00	ATZ	Petrol	1397	4	35
FABIA Praktik	1.4	10/00→12/00	BNM	Diesel	1422	3	46
FABIA Praktik	1.9	07/00→12/00	ASY	Diesel	1896	4	90
FABIA Saloon (6Y3)	1.2	07/00→12/00	AWY	Petrol	1198	3	5
FABIA Saloon (6Y3)	1.2	01/00→12/00	AZQ	Petrol	1198	3	6
FABIA Saloon (6Y3)	1.2	07/00→12/00	BMD	Petrol	1198	3	8
FABIA Saloon (6Y3)	1.2	01/00→12/00	BME	Petrol	1198	3	9
FABIA Saloon (6Y3)	1.4	07/00→05/00	AME	Petrol	1397	4	32
FABIA Saloon (6Y3)	1.4	04/00→12/00	AMF	Diesel	1422	3	33
FABIA Saloon (6Y3)	1.4	07/00→05/00	AQW	Petrol	1397	4	34
FABIA Saloon (6Y3)	1.4	07/00→05/00	ATZ	Petrol	1397	4	35
FABIA Saloon (6Y3)	1.4	10/99→12/00	AUA	Petrol	1390	4	36
FABIA Saloon (6Y3)	1.4	12/99→12/00	AUB	Petrol	1390	4	37
FABIA Saloon (6Y3)	1.4	04/00→08/00	AZE	Petrol	1397	4	39
FABIA Saloon (6Y3)	1.4	04/00→08/00	AZF	Petrol	1397	4	40
FABIA Saloon (6Y3)	1.4	10/99→12/00	BBY	Petrol	1390	4	41
FABIA Saloon (6Y3)	1.4	12/99→12/00	BBZ	Petrol	1390	4	42
FABIA Saloon (6Y3)	1.4	10/99→12/00	BKY	Petrol	1390	4	44
FABIA Saloon (6Y3)	1.4	10/00→12/00	BNM	Diesel	1422	3	46
FABIA Saloon (6Y3)	1.4	10/00→12/00	BNV	Diesel	1422	3	47
FABIA Saloon (6Y3)	1.4	04/00→12/00	BUD	Petrol	1390	4	48
FABIA Saloon (6Y3)	1.9	11/99→12/00	ASY	Diesel	1896	4	90
FABIA Saloon (6Y3)	1.9	01/00→12/00	ATD	Diesel	1896	4	92
FABIA Saloon (6Y3)	1.9	01/00→12/00	AXR	Diesel	1896	4	96
FABIA Saloon (6Y3)	2.0	12/99→12/00	AZL	Petrol	1984	4	110
FABIA	1.2	12/00→	BBM	Petrol	1198	3	7
FABIA	1.2	01/00→	BZG	Petrol	1198	3	10
FABIA	1.2	03/01→	CBZA	Petrol	1197	4	11
FABIA	1.2	03/01→	CBZB	Petrol	1197	4	12
FABIA	1.2	01/00→	CEVA	Petrol	1198	3	13
FABIA	1.2	05/01→	CFWA	Diesel	1199	3	14
FABIA	1.2	01/00→	CGPA	Petrol	1198	3	15
FABIA	1.2	11/01→	CGPB	Petrol	1198	3	16
FABIA	1.2	12/00→	CHFA	Petrol	1198	3	17
FABIA	1.2	01/00→	CHTA	Petrol	1198	3	18
FABIA	1.4	01/00→	BMS	Diesel	1422	3	45
FABIA	1.4	02/00→	BNM	Diesel	1422	3	46
FABIA	1.4	01/00→	BNV	Diesel	1422	3	47
FABIA	1.4	01/00→	BXW	Petrol	1390	4	49
FABIA	1.4	05/01→	CAVE	Petrol	1390	4	50
FABIA	1.4	01/00→	CGGB	Petrol	1390	4	54
FABIA	1.6	04/00→	BTS	Petrol	1598	4	64
FABIA	1.6	04/01→	CAYA	Diesel	1598	4	65
FABIA	1.6	03/01→	CAYB	Diesel	1598	4	66
FABIA	1.6	03/01→	CAYC	Diesel	1598	4	67
FABIA	1.6	04/00→	CFNA	Petrol	1598	4	69
FABIA	1.9	04/00→	BLS	Diesel	1896	4	99
FABIA	1.9	04/00→	BSW	Diesel	1896	4	103
FAVORIT (781)	1.3	10/99→09/99	136 L	Petrol	1289	4	21
FAVORIT (781)	1.3	01/99→09/99	136B	Petrol	1289	4	22
FAVORIT (781)	1.3	05/98→09/99	781.135	Petrol	1289	4	25
FAVORIT (781)	1.3	01/99→09/99	781.135E	Petrol	1289	4	26
FAVORIT Forman (785)	1.3	01/99→06/99	136B	Petrol	1289	4	22
FAVORIT Forman (785)	1.3	12/99→06/99	781.135	Petrol	1289	4	25
FAVORIT Forman (785)	1.3	09/99→06/99	781.135E	Petrol	1289	4	26
FAVORIT Forman (785)	1.3	08/99→06/99	OHC	Petrol	1289	4	30
FAVORIT Pickup (787)	1.3	12/99→06/99	135B	Petrol	1289	4	20
FAVORIT Pickup (787)	1.3	12/99→06/99	136B	Petrol	1289	4	22



Ltr







CC



9

Model	Ltr	Year Range	Model Code	Fuel Type	CC	Gear	Price
FAVORIT Pickup (787)	1.3	12/99→06/99	781.135	Petrol	1289	4	25
FELICIA I (6U1)	1.3	10/99→03/99	135B	Petrol	1289	4	20
FELICIA I (6U1)	1.3	10/99→03/99	136B	Petrol	1289	4	22
FELICIA I (6U1)	1.3	10/99→03/99	AMG	Petrol	1289	4	27
FELICIA I (6U1)	1.3	10/99→03/99	AMH	Petrol	1289	4	28
FELICIA I (6U1)	1.3	10/99→03/99	AMJ	Petrol	1289	4	29
FELICIA I (6U1)	1.6	08/99→03/99	AEE	Petrol	1598	4	55
FELICIA I (6U1)	1.6	08/99→03/99	EA111	Petrol	1598	4	72
FELICIA I (6U1)	1.9	10/99→03/99	AEF	Diesel	1896	4	83
FELICIA I Estate (6U5)	1.3	08/99→03/99	135B	Petrol	1289	4	20
FELICIA I Estate (6U5)	1.3	08/99→03/99	136B	Petrol	1289	4	22
FELICIA I Estate (6U5)	1.3	08/99→03/99	AMG	Petrol	1289	4	27
FELICIA I Estate (6U5)	1.3	08/99→03/99	AMH	Petrol	1289	4	28
FELICIA I Estate (6U5)	1.3	08/99→03/99	AMJ	Petrol	1289	4	29
FELICIA I Estate (6U5)	1.6	08/99→03/99	AEE	Petrol	1598	4	55
FELICIA I Estate (6U5)	1.9	10/99→03/99	AEF	Diesel	1896	4	83
FELICIA I Fun (797)	1.3	06/99→04/00	135B	Petrol	1289	4	20
FELICIA I Fun (797)	1.3	06/99→04/00	136B	Petrol	1289	4	22
FELICIA I Fun (797)	1.3	06/99→04/00	136M	Petrol	1289	4	23
FELICIA I Fun (797)	1.6	06/99→04/00	AEE	Petrol	1598	4	55
FELICIA I Fun (797)	1.9	06/99→04/00	AEF	Diesel	1896	4	83
FELICIA II (6U1)	1.3	01/99→06/00	AMG	Petrol	1289	4	27
FELICIA II (6U1)	1.3	01/99→06/00	AMH	Petrol	1289	4	28
FELICIA II (6U1)	1.3	01/99→06/00	AMJ	Petrol	1289	4	29
FELICIA II (6U1)	1.6	01/99→06/00	AEE	Petrol	1598	4	55
FELICIA II (6U1)	1.9	01/99→06/00	AEF	Diesel	1896	4	83
FELICIA II Estate (6U5)	1.3	01/99→06/00	AMH	Petrol	1289	4	28
FELICIA II Estate (6U5)	1.6	01/99→06/00	AEE	Petrol	1598	4	55
FELICIA II Estate (6U5)	1.9	01/99→06/00	AEF	Diesel	1896	4	83
OCTAVIA (1U2)	1.4	04/99→03/00	AMD	Petrol	1397	4	31
OCTAVIA (1U2)	1.4	09/00→12/01	AXP	Petrol	1390	4	38
OCTAVIA (1U2)	1.4	09/00→12/01	BCA	Petrol	1390	4	43
OCTAVIA (1U2)	1.6	09/99→09/00	AEE	Petrol	1598	4	55
OCTAVIA (1U2)	1.6	02/99→12/00	AEH	Petrol	1595	4	56
OCTAVIA (1U2)	1.6	02/99→12/00	AKL	Petrol	1595	4	57
OCTAVIA (1U2)	1.6	11/00→12/01	AVU	Petrol	1595	4	58
OCTAVIA (1U2)	1.6	11/00→12/01	BFQ	Petrol	1595	4	59
OCTAVIA (1U2)	1.8	09/99→07/00	AGN	Petrol	1781	4	73
OCTAVIA (1U2)	1.8	08/99→12/01	AGU	Petrol	1781	4	74
OCTAVIA (1U2)	1.8	08/99→12/01	ARX	Petrol	1781	4	75
OCTAVIA (1U2)	1.8	08/99→12/01	ARZ	Petrol	1781	4	76
OCTAVIA (1U2)	1.8	08/99→12/01	AUM	Petrol	1781	4	77
OCTAVIA (1U2)	1.8	05/00→01/00	AUQ	Petrol	1781	4	78
OCTAVIA (1U2)	1.9	06/99→12/00	AGP	Diesel	1896	4	84
OCTAVIA (1U2)	1.9	09/99→03/01	AGR	Diesel	1896	4	85
OCTAVIA (1U2)	1.9	08/99→01/00	AHF	Diesel	1896	4	86
OCTAVIA (1U2)	1.9	09/99→03/01	ALH	Diesel	1896	4	87
OCTAVIA (1U2)	1.9	06/99→12/00	AQM	Diesel	1896	4	88
OCTAVIA (1U2)	1.9	08/99→01/00	ASV	Diesel	1896	4	89
OCTAVIA (1U2)	1.9	09/00→09/00	ASZ	Diesel	1896	4	91
OCTAVIA (1U2)	1.9	10/00→12/01	AXR	Diesel	1896	4	96
OCTAVIA (1U2)	2.0	04/99→05/00	AEG	Petrol	1984	4	105
OCTAVIA (1U2)	2.0	04/99→05/00	APK	Petrol	1984	4	106
OCTAVIA (1U2)	2.0	04/99→05/00	AQY	Petrol	1984	4	107
OCTAVIA (1U2)	2.0	04/99→05/00	AZH	Petrol	1984	4	108
OCTAVIA (1U2)	2.0	04/99→05/00	AZJ	Petrol	1984	4	109
OCTAVIA (1Z3)	1.2	02/01→	CBZB	Petrol	1197	4	12
OCTAVIA (1Z3)	1.4	05/00→05/00	BCA	Petrol	1390	4	43
OCTAVIA (1Z3)	1.4	06/00→	BUD	Petrol	1390	4	48
OCTAVIA (1Z3)	1.4	11/00→	CAXA	Petrol	1390	4	51
OCTAVIA (1Z3)	1.4	06/00→	CGGA	Petrol	1390	4	53
OCTAVIA (1Z3)	1.6	06/00→	BGU	Petrol	1595	4	60
OCTAVIA (1Z3)	1.6	02/00→10/00	BLF	Petrol	1598	4	61
OCTAVIA (1Z3)	1.6	06/00→	BSE	Petrol	1595	4	62
OCTAVIA (1Z3)	1.6	06/00→	BSF	Petrol	1595	4	63
OCTAVIA (1Z3)	1.6	06/00→	CAYC	Diesel	1598	4	67
OCTAVIA (1Z3)	1.6	06/00→	CCSA	Petrol/Ethanol	1595	4	68
OCTAVIA (1Z3)	1.6	06/00→	CCSA	Petrol	1595	4	68
OCTAVIA (1Z3)	1.6	08/00→	CHGA	Petrol/Petroleum Gas (LPG)	1595	4	70
OCTAVIA (1Z3)	1.6	06/00→	CMXA	Petrol/Ethanol	1595	4	71

	Ltr				CC		9
OCTAVIA (1Z3)	1.6	06/00→	CMXA	Petrol	1595	4	71
OCTAVIA (1Z3)	1.8	06/00→	BZB	Petrol	1798	4	80
OCTAVIA (1Z3)	1.8	06/00→	CDAA	Petrol	1798	4	81
OCTAVIA (1Z3)	1.8	03/00→	CDAB	Petrol	1798	4	82
OCTAVIA (1Z3)	1.9	06/00→12/01	BJB	Diesel	1896	4	97
OCTAVIA (1Z3)	1.9	06/00→12/01	BKC	Diesel	1896	4	98
OCTAVIA (1Z3)	1.9	06/00→12/01	BLS	Diesel	1896	4	99
OCTAVIA (1Z3)	1.9	06/00→12/01	BXE	Diesel	1896	4	104
OCTAVIA (1Z3)	2.0	02/00→05/01	AZV	Diesel	1968	4	112
OCTAVIA (1Z3)	2.0	02/00→	BKD	Diesel	1968	4	113
OCTAVIA (1Z3)	2.0	11/00→	BLR	Petrol	1984	4	114
OCTAVIA (1Z3)	2.0	11/00→	BLY	Petrol	1984	4	116
OCTAVIA (1Z3)	2.0	11/00→	BMM	Diesel	1968	4	117
OCTAVIA (1Z3)	2.0	04/00→	BMN	Diesel	1968	4	118
OCTAVIA (1Z3)	2.0	11/00→	BVY	Petrol	1984	4	122
OCTAVIA (1Z3)	2.0	11/00→	BVZ	Petrol	1984	4	123
OCTAVIA (1Z3)	2.0	10/00→	BWA	Petrol	1984	4	124
OCTAVIA (1Z3)	2.0	10/00→	CCZA	Petrol	1984	4	127
OCTAVIA (1Z3)	2.0	03/01→	CFHF	Diesel	1968	4	128
OCTAVIA Combi (1U5)	1.4	08/00→12/01	AXP	Petrol	1390	4	38
OCTAVIA Combi (1U5)	1.4	08/00→12/01	BCA	Petrol	1390	4	43
OCTAVIA Combi (1U5)	1.6	07/99→09/00	AEE	Petrol	1598	4	55
OCTAVIA Combi (1U5)	1.6	07/99→12/00	AEH	Petrol	1595	4	56
OCTAVIA Combi (1U5)	1.6	07/99→12/00	AKL	Petrol	1595	4	57
OCTAVIA Combi (1U5)	1.6	09/00→12/01	AVU	Petrol	1595	4	58
OCTAVIA Combi (1U5)	1.6	09/00→12/01	BFQ	Petrol	1595	4	59
OCTAVIA Combi (1U5)	1.8	07/99→07/00	AGN	Petrol	1781	4	73
OCTAVIA Combi (1U5)	1.8	07/99→12/01	AGU	Petrol	1781	4	74
OCTAVIA Combi (1U5)	1.8	07/99→12/01	ARX	Petrol	1781	4	75
OCTAVIA Combi (1U5)	1.8	07/99→12/01	ARZ	Petrol	1781	4	76
OCTAVIA Combi (1U5)	1.8	07/99→12/01	AUM	Petrol	1781	4	77
OCTAVIA Combi (1U5)	1.8	08/00→01/00	AUQ	Petrol	1781	4	78
OCTAVIA Combi (1U5)	1.9	07/99→12/00	AGP	Diesel	1896	4	84
OCTAVIA Combi (1U5)	1.9	07/99→03/01	AGR	Diesel	1896	4	85
OCTAVIA Combi (1U5)	1.9	07/99→01/00	AHF	Diesel	1896	4	86
OCTAVIA Combi (1U5)	1.9	07/99→03/01	ALH	Diesel	1896	4	87
OCTAVIA Combi (1U5)	1.9	07/99→12/00	AQM	Diesel	1896	4	88
OCTAVIA Combi (1U5)	1.9	07/99→01/00	ASV	Diesel	1896	4	89
OCTAVIA Combi (1U5)	1.9	09/00→09/00	ASZ	Diesel	1896	4	91
OCTAVIA Combi (1U5)	1.9	08/00→12/01	ATD	Diesel	1896	4	92
OCTAVIA Combi (1U5)	1.9	08/00→12/01	AXR	Diesel	1896	4	96
OCTAVIA Combi (1U5)	2.0	04/99→05/00	AEG	Petrol	1984	4	105
OCTAVIA Combi (1U5)	2.0	04/99→05/00	APK	Petrol	1984	4	106
OCTAVIA Combi (1U5)	2.0	04/99→05/00	AQY	Petrol	1984	4	107
OCTAVIA Combi (1U5)	2.0	04/99→05/00	AZH	Petrol	1984	4	108
OCTAVIA Combi (1U5)	2.0	04/99→05/00	AZJ	Petrol	1984	4	109
OCTAVIA Combi (1Z5)	1.2	02/01→	CBZB	Petrol	1197	4	12
OCTAVIA Combi (1Z5)	1.4	05/00→05/00	BCA	Petrol	1390	4	43
OCTAVIA Combi (1Z5)	1.4	05/00→	BUD	Petrol	1390	4	48
OCTAVIA Combi (1Z5)	1.4	11/00→	CAXA	Petrol	1390	4	51
OCTAVIA Combi (1Z5)	1.4	05/00→	CGGA	Petrol	1390	4	53
OCTAVIA Combi (1Z5)	1.6	09/00→	BGU	Petrol	1595	4	60
OCTAVIA Combi (1Z5)	1.6	02/00→10/00	BLF	Petrol	1598	4	61
OCTAVIA Combi (1Z5)	1.6	09/00→	BSE	Petrol	1595	4	62
OCTAVIA Combi (1Z5)	1.6	09/00→	BSF	Petrol	1595	4	63
OCTAVIA Combi (1Z5)	1.6	06/00→	CAYC	Diesel	1598	4	67
OCTAVIA Combi (1Z5)	1.6	09/00→	CCSA	Petrol/Ethanol	1595	4	68
OCTAVIA Combi (1Z5)	1.6	09/00→	CCSA	Petrol	1595	4	68
OCTAVIA Combi (1Z5)	1.6	08/00→	CHGA	Petrol/Petroleum Gas (LPG)	1595	4	70
OCTAVIA Combi (1Z5)	1.6	09/00→	CMXA	Petrol/Ethanol	1595	4	71
OCTAVIA Combi (1Z5)	1.6	09/00→	CMXA	Petrol	1595	4	71
OCTAVIA Combi (1Z5)	1.8	06/00→	BZB	Petrol	1798	4	80
OCTAVIA Combi (1Z5)	1.8	06/00→	CDAA	Petrol	1798	4	81
OCTAVIA Combi (1Z5)	1.8	03/00→	CDAB	Petrol	1798	4	82
OCTAVIA Combi (1Z5)	1.9	09/00→12/01	BJB	Diesel	1896	4	97
OCTAVIA Combi (1Z5)	1.9	09/00→12/01	BKC	Diesel	1896	4	98
OCTAVIA Combi (1Z5)	1.9	09/00→12/01	BLS	Diesel	1896	4	99
OCTAVIA Combi (1Z5)	1.9	09/00→12/01	BXE	Diesel	1896	4	104
OCTAVIA Combi (1Z5)	2.0	02/00→05/01	AZV	Diesel	1968	4	112
OCTAVIA Combi (1Z5)	2.0	02/00→	BKD	Diesel	1968	4	113



Ltr















CC



9

Model	Ltr	Year	Code	Fuel	CC	Seats	Price
OCTAVIA Combi (1Z5)	2.0	11/00→	BLR	Petrol	1984	4	114
OCTAVIA Combi (1Z5)	2.0	11/00→	BLX	Petrol	1984	4	115
OCTAVIA Combi (1Z5)	2.0	11/00→	BLY	Petrol	1984	4	116
OCTAVIA Combi (1Z5)	2.0	11/00→	BMM	Diesel	1968	4	117
OCTAVIA Combi (1Z5)	2.0	04/00→	BMN	Diesel	1968	4	118
OCTAVIA Combi (1Z5)	2.0	11/00→	BVX	Petrol	1984	4	121
OCTAVIA Combi (1Z5)	2.0	11/00→	BVY	Petrol	1984	4	122
OCTAVIA Combi (1Z5)	2.0	11/00→	BVZ	Petrol	1984	4	123
OCTAVIA Combi (1Z5)	2.0	10/00→	BWA	Petrol	1984	4	124
OCTAVIA Combi (1Z5)	2.0	10/00→	CCZA	Petrol	1984	4	127
OCTAVIA Combi (1Z5)	2.0	03/01→	CFHF	Diesel	1968	4	128
RAPID (120G, 130G, 135G)	1.3	09/98→12/99	135/8	Petrol	1280	4	19
RAPID (120G, 130G, 135G)	1.3	03/98→08/98	742,13	Petrol	1280	4	24
RAPID	1.2	07/01→	CBZA	Petrol	1197	4	11
RAPID	1.2	07/01→	CBZB	Petrol	1197	4	12
RAPID	1.4	07/01→	CAXA	Petrol	1390	4	51
RAPID	1.6	08/01→	CAYB	Diesel	1598	4	66
RAPID	1.6	07/01→	CAYC	Diesel	1598	4	67
RAPID	1.6	07/01→	CFNA	Petrol	1598	4	69
ROOMSTER (5J)	1.2	05/00→01/00	BME	Petrol	1198	3	9
ROOMSTER (5J)	1.2	01/00→	BZG	Petrol	1198	3	10
ROOMSTER (5J)	1.2	03/01→	CBZA	Petrol	1197	4	11
ROOMSTER (5J)	1.2	03/01→	CBZB	Petrol	1197	4	12
ROOMSTER (5J)	1.2	03/01→	CFWA	Diesel	1199	3	14
ROOMSTER (5J)	1.2	01/00→	CGPA	Petrol	1198	3	15
ROOMSTER (5J)	1.4	09/00→03/01	BMS	Diesel	1422	3	45
ROOMSTER (5J)	1.4	07/00→03/01	BNM	Diesel	1422	3	46
ROOMSTER (5J)	1.4	09/00→03/01	BNV	Diesel	1422	3	47
ROOMSTER (5J)	1.4	09/00→	BXW	Petrol	1390	4	49
ROOMSTER (5J)	1.4	09/00→	CGGB	Petrol	1390	4	54
ROOMSTER (5J)	1.6	09/00→	BTS	Petrol	1598	4	64
ROOMSTER (5J)	1.6	03/01→	CAYB	Diesel	1598	4	66
ROOMSTER (5J)	1.6	03/01→	CAYC	Diesel	1598	4	67
ROOMSTER (5J)	1.6	09/00→	CFNA	Petrol	1598	4	69
ROOMSTER (5J)	1.9	03/00→05/00	AXR	Diesel	1896	4	96
ROOMSTER (5J)	1.9	09/00→03/01	BLS	Diesel	1896	4	99
ROOMSTER (5J)	1.9	09/00→03/01	BSW	Diesel	1896	4	103
ROOMSTER Praktik (5J)	1.2	03/00→	BZG	Petrol	1198	3	10
ROOMSTER Praktik (5J)	1.2	03/01→	CBZA	Petrol	1197	4	11
ROOMSTER Praktik (5J)	1.2	03/01→	CFWA	Diesel	1199	3	14
ROOMSTER Praktik (5J)	1.2	03/00→	CGPA	Petrol	1198	3	15
ROOMSTER Praktik (5J)	1.4	03/00→03/01	BMS	Diesel	1422	3	45
ROOMSTER Praktik (5J)	1.4	03/00→03/01	BNM	Diesel	1422	3	46
ROOMSTER Praktik (5J)	1.4	03/00→03/01	BNV	Diesel	1422	3	47
ROOMSTER Praktik (5J)	1.4	03/00→	BXW	Petrol	1390	4	49
ROOMSTER Praktik (5J)	1.4	03/00→	CGGB	Petrol	1390	4	54
ROOMSTER Praktik (5J)	1.6	03/01→	CAYB	Diesel	1598	4	66
SUPERB (3T4)	1.4	07/00→	CAXC	Petrol	1390	4	52
SUPERB (3T4)	1.6	09/01→	CAYC	Diesel	1598	4	67
SUPERB (3T4)	1.8	03/00→	BZB	Petrol	1798	4	80
SUPERB (3T4)	1.8	03/00→	CDAA	Petrol	1798	4	81
SUPERB (3T4)	1.8	03/00→	CDAB	Petrol	1798	4	82
SUPERB (3T4)	1.9	03/00→	BLS	Diesel	1896	4	99
SUPERB (3T4)	1.9	03/00→	BXE	Diesel	1896	4	104
SUPERB (3T4)	2.0	01/00→	BKD	Diesel	1968	4	113
SUPERB (3T4)	2.0	03/00→	BMP	Diesel	1968	4	119
SUPERB (3T4)	2.0	07/00→	CBBB	Diesel	1968	4	125
SUPERB (3T4)	2.0	05/01→	CCZA	Petrol	1984	4	127
SUPERB (3U4)	1.8	12/00→03/00	AWT	Petrol	1781	4	79
SUPERB (3U4)	1.9	08/00→10/00	AVB	Diesel	1896	4	93
SUPERB (3U4)	1.9	12/00→03/00	AVF	Diesel	1896	4	94
SUPERB (3U4)	1.9	12/00→03/00	AWX	Diesel	1896	4	95
SUPERB (3U4)	1.9	01/00→03/00	BPZ	Diesel	1896	4	101
SUPERB (3U4)	1.9	10/00→05/00	BSV	Diesel	1896	4	102
SUPERB (3U4)	2.0	12/00→03/00	AZM	Petrol	1984	4	111
SUPERB (3U4)	2.0	10/00→03/00	BSS	Diesel	1968	4	120
SUPERB (3U4)	2.5	12/00→08/00	AYM	Diesel	2496	6	129
SUPERB (3U4)	2.5	06/00→03/00	BDG	Diesel	2496	6	130
SUPERB Estate (3T5)	1.4	10/00→	CAXC	Petrol	1390	4	52
SUPERB Estate (3T5)	1.6	09/01→	CAYC	Diesel	1598	4	67

	Ltr				CC		9
SUPERB Estate (3T5)	1.8	10/00 →	CDAA	Petrol	1798	4	81
SUPERB Estate (3T5)	1.8	10/00 →	CDAB	Petrol	1798	4	82
SUPERB Estate (3T5)	1.9	10/00 → 11/01	BLS	Diesel	1896	4	99
SUPERB Estate (3T5)	1.9	10/00 → 11/01	BXE	Diesel	1896	4	104
SUPERB Estate (3T5)	2.0	10/00 →	BKD	Diesel	1968	4	113
SUPERB Estate (3T5)	2.0	10/00 → 03/01	BMP	Diesel	1968	4	119
SUPERB Estate (3T5)	2.0	10/00 →	CBBB	Diesel	1968	4	125
SUPERB Estate (3T5)	2.0	05/01 →	CCZA	Petrol	1984	4	127
YETI (5L)	1.2	09/00 →	CBZB	Petrol	1197	4	12
YETI (5L)	1.4	06/01 →	CAXA	Petrol	1390	4	51
YETI (5L)	1.6	11/01 →	CAYC	Diesel	1598	4	67
YETI (5L)	1.8	05/00 →	CDAA	Petrol	1798	4	81
YETI (5L)	1.8	11/00 →	CDAB	Petrol	1798	4	82
YETI (5L)	2.0	05/00 →	CBDB	Diesel	1968	4	126
YETI (5L)	2.0	11/00 →	CFHF	Diesel	1968	4	128

		CC			9			CC			9
135/8	Petrol	1280	4		19	BKD	Diesel	1968	4	81.00	113
135B	Petrol	1289	4		20	BKY	Petrol	1390	4	76.50	44
136 L	Petrol	1289	4		21	BLF	Petrol	1598	4	76.50	61
136B	Petrol	1289	4		22	BLR	Petrol	1984	4	82.50	114
136M	Petrol	1289	4		23	BLS	Diesel	1896	4	79.50	99
742,12	Petrol	1164	4		3	BLT	Diesel	1896	4	79.50	100
742,13	Petrol	1280	4		24	BLX	Petrol	1984	4	82.50	115
742.12 X	Petrol	1174	4		4	BLY	Petrol	1984	4	82.50	116
781.135	Petrol	1289	4	75.50	25	BMD	Petrol	1198	3	76.50	8
781.135E	Petrol	1289	4		26	BME	Petrol	1198	3	76.50	9
AE E	Petrol	1598	4	76.50	55	BMM	Diesel	1968	4	81.00	117
AE F	Diesel	1896	4	79.50	83	BMN	Diesel	1968	4	81.00	118
AE G	Petrol	1984	4	82.50	105	BMP	Diesel	1968	4	81.00	119
AE H	Petrol	1595	4	81.00	56	BMS	Diesel	1422	3	79.50	45
AG N	Petrol	1781	4	81.00	73	BNM	Diesel	1422	3	79.50	46
AG P	Diesel	1896	4	79.50	84	BNV	Diesel	1422	3	79.50	47
AG R	Diesel	1896	4	79.50	85	BPZ	Diesel	1896	4	79.50	101
AG U	Petrol	1781	4	81.00	74	BSE	Petrol	1595	4	81.00	62
AH F	Diesel	1896	4	79.50	86	BSF	Petrol	1595	4	81.00	63
AK L	Petrol	1595	4	81.00	57	BSS	Diesel	1968	4	81.00	120
AL H	Diesel	1896	4	79.50	87	BSV	Diesel	1896	4	79.50	102
AM D	Petrol	1397	4	75.50	31	BSW	Diesel	1896	4	79.50	103
AM E	Petrol	1397	4	75.50	32	BTS	Petrol	1598	4	76.50	64
AM F	Diesel	1422	3	79.50	33	BUD	Petrol	1390	4	76.50	48
AM G	Petrol	1289	4	75.50	27	BVX	Petrol	1984	4	82.50	121
AM H	Petrol	1289	4	75.50	28	BVY	Petrol	1984	4	82.50	122
AM J	Petrol	1289	4	75.50	29	BVZ	Petrol	1984	4	82.50	123
AP K	Petrol	1984	4	82.50	106	BWA	Petrol	1984	4	82.50	124
AQ M	Diesel	1896	4	79.50	88	BXE	Diesel	1896	4	79.50	104
AQ V	Petrol	996	4	72.00	1	BXW	Petrol	1390	4	76.50	49
AQ W	Petrol	1397	4	75.50	34	BZB	Petrol	1798	4	81.00	80
AQ Y	Petrol	1984	4	82.50	107	BZG	Petrol	1198	3	76.50	10
AR V	Petrol	996	4	72.00	2	CAVE	Petrol	1390	4	76.50	50
AR X	Petrol	1781	4	81.00	75	CAXA	Petrol	1390	4	76.50	51
AR Z	Petrol	1781	4	81.00	76	CAXC	Petrol	1390	4	76.50	52
AS V	Diesel	1896	4	79.50	89	CAVA	Diesel	1598	4	79.50	65
AS Y	Diesel	1896	4	79.50	90	CAYB	Diesel	1598	4	79.50	66
AS Z	Diesel	1896	4	79.50	91	CAYC	Diesel	1598	4	79.50	67
AT D	Diesel	1896	4	79.50	92	CBBB	Diesel	1968	4	81.00	125
AT Z	Petrol	1397	4	75.50	35	CBDB	Diesel	1968	4	81.00	126
AU A	Petrol	1390	4	76.50	36	CBZA	Petrol	1197	4	71.00	11
AU B	Petrol	1390	4	76.50	37	CBZB	Petrol	1197	4	71.00	12
AU M	Petrol	1781	4	81.00	77	CCSA	Petrol/Ethanol	1595	4	81.00	68
AU Q	Petrol	1781	4	81.00	78	CCSA	Petrol	1595	4	81.00	68
AV B	Diesel	1896	4	79.50	93	CCCA	Petrol	1984	4	82.50	127
AV F	Diesel	1896	4	79.50	94	CDAA	Petrol	1798	4	82.50	81
AV U	Petrol	1595	4	81.00	58	CDAB	Petrol	1798	4	82.50	82
AW T	Petrol	1781	4	81.00	79	CEVA	Petrol	1198	3	76.50	13
AW X	Diesel	1896	4	79.50	95	CFHF	Diesel	1968	4	81.00	128
AW Y	Petrol	1198	3	76.50	5	CFNA	Petrol	1598	4	76.50	69
AX P	Petrol	1390	4	76.50	38	CFWA	Diesel	1199	3	79.50	14
AX R	Diesel	1896	4	79.50	96	CGGA	Petrol	1390	4	76.50	53
AY M	Diesel	2496	6	78.30	129	CGGB	Petrol	1390	4	76.50	54
AZ E	Petrol	1397	4	75.50	39	CGPA	Petrol	1198	3	76.50	15
AZ F	Petrol	1397	4	75.50	40	CGPB	Petrol	1198	3	76.50	16
AZ H	Petrol	1984	4	82.50	108	CHFA	Petrol	1198	3	76.50	17
AZ J	Petrol	1984	4	82.50	109	CHGA	Petrol/ Petroleum Gas (LPG)	1595	4	81.00	70
AZ L	Petrol	1984	4	82.50	110						
AZ M	Petrol	1984	4	82.50	111						
AZ Q	Petrol	1198	3	76.50	6	CHTA	Petrol	1198	3	76.50	18
AZ V	Diesel	1968	4	81.00	112	CMXA	Petrol/Ethanol	1595	4	81.00	71
BB M	Petrol	1198	3	76.50	7	CMXA	Petrol	1595	4	81.00	71
BB Y	Petrol	1390	4	76.50	41	EAT11	Petrol	1598	4	76.50	72
BB Z	Petrol	1390	4	76.50	42	OHC	Petrol	1289	4	76.50	30
BC A	Petrol	1390	4	76.50	43						
BD G	Diesel	2496	6	78.30	130						
BF Q	Petrol	1595	4	81.00	59						
BG U	Petrol	1595	4	81.00	60						
BJ B	Diesel	1896	4	79.50	97						
BK C	Diesel	1896	4	79.50	98						



cc



kW/PS

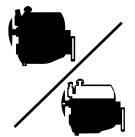

1.0							1				
AQV										DT581	
Fabia 1.0	12/99→08/02	996	4	72.00	OHV	37/50					
1.0							2				
ARV										DT581	
Fabia 1.0	12/99→08/02	996	4	72.00	OHV	37/50					
1.2							3		AX220 (Fibre)		
105, 120	10/83→12/90	1164	4			35-38/ 48-52					
1.2							4		AX220 (Fibre)		
105, 120	08/76→12/90	1174	4			43/58					
1.2							5		AG8840 (MLS)	CG8840	EF5990
AWY											
Fabia 1.2	07/01→03/08	1198	3	76.50	SOHC/OHC	40/54					
1.2							6		AF5990 (MLS)	CF5990	EF5990
AZQ											
Fabia 1.2	01/03→03/08	1198	3	76.50	DOHC	47/64					
1.2							7		AG8840 (MLS)	CG8840	EF5990
BBM											
Fabia 1.2	12/06→	1198	3	76.50	DOHC	44/60					
1.2							8		AG8840 (MLS)	CG8840	EF5990
BMD											
Fabia 1.2	07/01→03/08	1198	3	76.50	SOHC/OHC	40/54					
1.2							9		AF5990 (MLS)	CF5990	EF5990
BME											
Fabia 1.2	01/03→03/08	1198	3	76.50	DOHC	47/64					
Roomster 1.2	05/06→01/07										
1.2							10		AF5990 (MLS)	CF5990	EF5990
BZG											
Fabia 1.2	01/07→	1198	3	76.50	DOHC	51/70					
Roomster 1.2	01/07→										
1.2							11				
CBZA											
Fabia 1.2 TSI	03/10→	1197	4	71.00	SOHC/OHC	63/86					
Rapid 1.2 TSI	07/12→										
Roomster 1.2 TSI	03/10→										
1.2							12				
CBZB											
Fabia 1.2 TSI	03/10→	1197	4	71.00	SOHC/OHC	77/105					
Octavia 1.2 TSI	02/10→										
Rapid 1.2 TSI	07/12→										
Roomster 1.2 TSI	03/10→										
Yeti 1.2 TSI	09/09→										
1.2							13		AF5990 (MLS)	CF5990	EF5990
CEVA											
Fabia 1.2	01/07→	1198	3	76.50	DOHC	51/70					

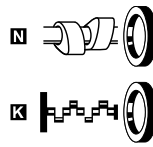
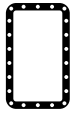
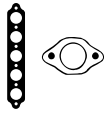

AX220

	<p>JD5818 [E] [K] (MLS) JD5817 [E] (MLS) JD5849 [E] [X] (MLS)</p>	JM5285		HR646 [E]	<p>[K] NA5306 [E] [2] 42.00x58.00x8.00mm, ACM [K] NA5133 [E] [1] 85.00x105.00x11.00mm, FPM</p>	
	<p>JD5818 [E] [K] (MLS) JD5817 [E] (MLS) JD5849 [E] [X] (MLS)</p>	JM5285		HR646 [E]	<p>[K] NA5306 [E] [2] 42.00x58.00x8.00mm, ACM [K] NA5133 [E] [1] 85.00x105.00x11.00mm, FPM</p>	
			JH5184 2.0mm (Rubber with textile reinforcement)		[K] NF634 [E] [1] 80.00x100.00x13.00mm, MVQ	
			JH5184 2.0mm (Rubber with textile reinforcement)		[K] NF634 [E] [1] 80.00x100.00x13.00mm, MVQ	
HBS479 [E] [5] M9x1.25x162.00mm (x8)	JD5807 [E] (x3) JD5819 [E]	HR397 [E]	HR397	PA5041 (x6) 6.00/12.20x10.00 (FPM) HL5002 [E]	[K] NA5106 [E] [2] 35.00x48.00x10.00mm, PTFE [K] NA5305 [E] [1] [36]	
HBS471 [E] [5] M9x1.25x138.00mm (x8)	JD5811 [E] (x3) JD5816 [E]	HR397 [E]	HR397	PA5041 (x12) 6.00/12.20x10.00 (FPM) HR280 [E]	[K] NA5106 [E] [2] 35.00x48.00x10.00mm, PTFE [K] NA5305 [E] [1] [36]	
HBS479 [E] [5] M9x1.25x162.00mm (x8)	JD5808 [E] (x3) JD5819 [E]	HR397 [E]	HR397	PA5041 (x6) 6.00/12.20x10.00 (FPM) HL5002 [E]	[K] NA5106 [E] [2] 35.00x48.00x10.00mm, PTFE [K] NA5305 [E] [1] [36]	
HBS479 [E] [5] M9x1.25x162.00mm (x8)	JD5807 [E] (x3) →Ch.9N 5044100 JD5808 [E] (x3) Ch.9N 5044101→ JD5819 [E]	HR397 [E]	HR397	PA5041 (x6) 6.00/12.20x10.00 (FPM) HL5002 [E]	[K] NA5106 [E] [2] 35.00x48.00x10.00mm, PTFE	
HBS471 [E] [5] M9x1.25x138.00mm (x8)	JD5811 [E] (x3) JD5816 [E]	HR397 [E]	HR397	PA5041 (x12) 6.00/12.20x10.00 (FPM) HR280 [E]	[K] NA5106 [E] [2] 35.00x48.00x10.00mm, PTFE	
HBS471 [E] [5] M9x1.25x138.00mm (x8)	JD5811 [E] (x3) JD5816 [E]	HR397 [E]	HR397	PA5041 (x12) 6.00/12.20x10.00 (FPM) HR280 [E]	[K] NA5106 [E] [2] 35.00x48.00x10.00mm, PTFE	
					[K] NA5124 [E] [2] 32.00x47.00x10.00mm, PTFE/ACM [K] NA5124 [E] [2] 32.00x47.00x10.00mm, PTFE/ACM	
		HR397 [E]	HR397	PA5041 (x8) 6.00/12.20x10.00 (FPM)	[K] NA5124 [E] [2] 32.00x47.00x10.00mm, PTFE/ACM [K] NA5124 [E] [2] 32.00x47.00x10.00mm, PTFE/ACM	
HBS471 [E] [5] M9x1.25x138.00mm (x8)	JD5811 [E] (x3) JD5816 [E]	HR397 [E]		PA5041 (x12) 6.00/12.20x10.00 (FPM) HR280 [E]	[K] NA5106 [E] [2] 35.00x48.00x10.00mm, PTFE/ACM [K] NA5106 [E] [2] 35.00x48.00x10.00mm, PTFE	



kW/PS

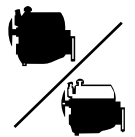

1.2	CFWA Diesel	14						
Fabia 1.2 TDI	05/10→	1199	3	79.50	DOHC	55/75		
Roomster 1.2TDI	03/10→							
1.2	CGPA	15					AF5990 (MLS)	CF5990
Fabia 1.2	01/07→	1198	3	76.50	DOHC	51/70		EF5990
Roomster 1.2	01/07→							
1.2	CGPB	16					AF5990 (MLS)	CF5990
Fabia 1.2 12V	11/11→	1198	3	76.50	DOHC	44/60		
1.2	CHFA	17					AG8840 (MLS)	CG8840
Fabia 1.2	12/06→	1198	3	76.50	DOHC	44/60		EF5990
1.2	CHTA	18					AF5990 (MLS)	CF5990
Fabia 1.2	01/07→	1198	3	76.50	DOHC	51/70		EF5990
1.3	135/8	19					BT580 (Fibre)	DT580
130 GL (S135)	05/88→10/91	1280	4			43/58		
Rapid 1.3 S	09/84→12/90							
1.3	135B	20					BT580 (Fibre)	DT580
Favorit 1.3	12/92→06/97	1289	4			40/54		
Felicia 1.3	10/94→04/02							
Felicia 1.3 LX	08/95→03/98							
1.3	136 L	21					BT580 (Fibre)	DT580
Favorit 1.3 136	10/90→09/94	1289	4			45/61		
1.3	136B	22					BT580 (Fibre)	DT580
Favorit 1.3	12/92→06/97	1289	4			50/68		
Felicia 1.3	10/94→04/02							
Felicia 1.3 LXI	08/95→03/98							
1.3	136M	23					BT580 (Fibre)	
Felicia 1.3	06/97→04/02	1289	4			50/68		
1.3	742,13	24					BT580 (Fibre)	DT580
130 L, GL	02/85→10/91	1280	4			45/61		
Rapid 1.3	03/85→08/88							
1.3	781.135	25					BT580 (Fibre)	DT580
Favorit 1.3	12/91→06/97	1289	4	75.50		42-44/ 57-60		
Favorit 1.3 135	10/90→09/94							
Favorit 135L	05/89→09/94							
1.3	781.135E	26					BT580 (Fibre)	DT580
Favorit 1.3	09/91→06/95	1289	4			40/54		
Favorit 1.3 135	01/90→09/94							
1.3	AMG	27					BT580 (Fibre)	DT580
Felicia 1.3	10/94→03/98	1289	4	75.50		40/54		
Felicia 1.3 LX	08/95→03/98							
Felicia 2 1.3	01/98→06/01							
1.3	AMH	28					BT580 (Fibre)	DT580
Felicia 1.3	10/94→03/98	1289	4	75.50		50/68		
Felicia 1.3 LXI	08/95→03/98							
Felicia 2 1.3	01/98→06/01							

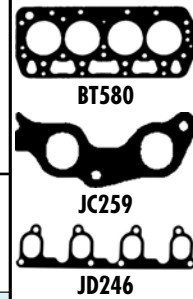
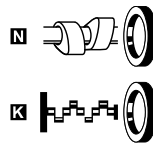
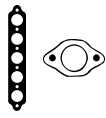

					NA5106 [2] 35.00x48.00x10.00mm, PTFE/ACM NA5106 [2] 35.00x48.00x10.00mm, PTFE	
HBS471 [5] M9x1.25x138.00mm (x8)	JD5811 [x3] JD5816	HR397	HR397	PA5041 (x12) 6.00/12.20x10.00 (FPM) HR280	NA5106 [2] 35.00x48.00x10.00mm, PTFE	
HBS471 [5] M9x1.25x138.00mm (x8)	JD5811 [x3] JD5816	HR397	HR397	PA5041 (x12) 6.00/12.20x10.00 (FPM) HR280	NA5106 [2] 35.00x48.00x10.00mm, PTFE	
HBS479 [5] M9x1.25x162.00mm (x8)	JD5808 [x3] JD5819	HR397	HR397	PA5041 (x6) 6.00/12.20x10.00 (FPM) HL5002	NA5106 [2] 35.00x48.00x10.00mm, PTFE	
HBS471 [5] M9x1.25x138.00mm (x8)	JD5811 [x3] JD5816	HR397	HR397	PA5041 (x12) 6.00/12.20x10.00 (FPM) HR280	NA5106 [2] 35.00x48.00x10.00mm, PTFE/ACM NA5106 [2] 35.00x48.00x10.00mm, PTFE	
HBS173 [22] M11x1.50x182.00mm (x2)	JD5766	JM5285	JH5184 2.0mm (Rubber with textile reinforcement)		NA5133 [1] 85.00x105.00x11.00mm, FPM	
HBS173 [22] M11x1.50x182.00mm (x2)	JD5766	JM5285	JH5184 2.0mm (Rubber with textile reinforcement)	HR569	NA5306 [2] 42.00x58.00x8.00mm, ACM 01/99→	
HBS173 [22] M11x1.50x182.00mm (x2)	JD5766	JM5285	JH5184 2.0mm (Rubber with textile reinforcement)	HR569	NA5133 [1] 85.00x105.00x11.00mm, FPM	
HBS173 [22] M11x1.50x182.00mm (x2)	JD5766	JM5285	JH5184 2.0mm (Rubber with textile reinforcement)	HR569	NA5306 [2] 42.00x58.00x8.00mm, ACM 01/99→	
			JH5184 2.0mm (Rubber with textile reinforcement)	HR569	NA5306 [2] 42.00x58.00x8.00mm, ACM 01/99→	
			JH5184 2.0mm (Rubber with textile reinforcement)		NF634 [1] 80.00x100.00x13.00mm, MVQ	
HBS173 [22] M11x1.50x182.00mm (x2)	JD5766	JM5285	JH5184 2.0mm (Rubber with textile reinforcement)			
HBS173 [22] M11x1.50x182.00mm (x2)	JD5766	JM5285	JH5184 2.0mm (Rubber with textile reinforcement)	HR569		
HBS173 [22] M11x1.50x182.00mm (x2)	JD246 JC259 (x2)	JM5285	JH5184 2.0mm (Rubber with textile reinforcement)	HR569	NA5306 [2] 42.00x58.00x8.00mm, ACM 01/99→	
HBS173 [22] M11x1.50x182.00mm (x2)	JD5766	JM5285	JH5184 2.0mm (Rubber with textile reinforcement)	HR569	NA5306 [2] 42.00x58.00x8.00mm, ACM 01/99→	



cc



kW/PS

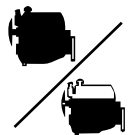

1.3		AMJ					29	BT580 (Fibre)	DT580	
Felicia 1.3	10/94→03/98	1289	4	75.50		43/58				
Felicia 2 1.3	01/98→06/01									
1.3		OHC					30	BT580 (Fibre)	DT580	
Favorit 1.3	08/91→06/95	1289	4			40-45/ 55-61				
1.4		AMD					31	BT580 (Fibre)	DT581	
Octavia 1.4	04/99→03/01	1397	4	75.50	OHV	44/60				
1.4		AME					32	BT580 (Fibre)	DT581	
Fabia 1.4	08/99→05/03	1397	4	75.50	OHV	50/68				
1.4		AMF Diesel					33	AD5650 (MLS), 1.450mm, 1 Hole AD5660 (MLS), 1.530mm, 2 Holes AD5670 (MLS), 1.610mm, 3 Holes	CD5650 ▲	ED5650 [18]
Fabia 1.4 TDI	04/03→03/08	1422	3	79.50	SOHC/OHC	55/75				
1.4		AQW					34	BT580 (Fibre)	DT581	
Fabia 1.4	08/99→05/03	1397	4	75.50	OHV	50/68				
1.4		ATZ					35	BT580 (Fibre)	DT581	
Fabia 1.4	08/99→05/03	1397	4	75.50	OHV	50/68				
1.4		AUA					36	AB5701 (MLS)	CB5700 ☒	EB5700 [3][18]
Fabia 1.4 16V	10/99→03/08	1390	4	76.50	DOHC	55/75				
1.4		AUB					37	AB5701 (MLS)	CB5700 ☒	EB5700 [3][18]
Fabia 1.4 16V	12/99→03/08	1390	4	76.50	DOHC	74/100				
1.4		AXP					38	AB5701 (MLS)	CB5700 ☒	EB5700 [3][18]
Octavia 1.4 16V	08/00→12/10	1390	4	76.50	DOHC	55/75				
1.4		AZE					39	BT580 (Fibre)	DT581	
Fabia 1.4	04/00→03/03	1397	4	75.50	OHV	44/60				

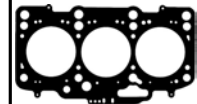
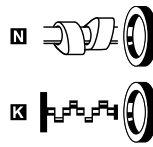
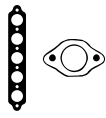

AD5650, AD5660, AD5670



BT580

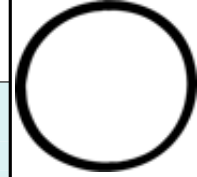

JD5228



JD5278



JD5279



JD5298

HBS173 [22] M11x1.50x182.00mm (x2)		JM5285	JH5184 2.0mm (Rubber with textile reinforcement)	HR569 [5]	NA5306 [2] 42.00x58.00x8.00mm, ACM 01/99→	
HBS173 [22] M11x1.50x182.00mm (x2)	JD5766	JM5285	JH5184 2.0mm (Rubber with textile reinforcement)			
	JD5812 [1] JD5817 [5] (MLS) JD5818 [5] [X] (MLS) JD5849 [5] [X] (MLS)	JM5285		HR599 [5]	NA5306 [2] 42.00x58.00x8.00mm, ACM NA5133 [1] 85.00x105.00x11.00mm, FPM	
	JD5812 [1] JD5818 [5] [X] (MLS) JD5849 [5] [X] (MLS) JD5817 [5] [X] (MLS)	JM5285	HR397	HR599 [5]	NA5306 [2] 42.00x58.00x8.00mm, ACM NA5133 [1] 85.00x105.00x11.00mm, FPM	
HBS264 [19] M12x1.75x172.00mm (x8)	JD5278 [1] JD5279 [5]	JM7032 (NBR)	HR397	HR5068 [5]	NA5124 [2] 32.00x47.00x10.00mm, PTFE/ACM NA5106 [2] 35.00x48.00x10.00mm, PTFE LK5003 [1] [7] 85.00x131.00x15.700mm, PTFE	
	JD5812 [1] JD5818 [5] [X] (MLS) JD5849 [5] [X] (MLS) JD5817 [5] [X] (MLS)	JM5285	HR397	HR599 [5]	NA5306 [2] 42.00x58.00x8.00mm, ACM NA5133 [1] 85.00x105.00x11.00mm, FPM	
	JD5812 [1] JD5818 [5] [X] (MLS) JD5849 [5] [X] (MLS) JD5817 [5] [X] (MLS)	JM5285	HR397	HR599 [5]	NA5306 [2] 42.00x58.00x8.00mm, ACM NA5133 [1] 85.00x105.00x11.00mm, FPM	
HBS249 [5] M9x1.25x138.00mm (x10)	JD5228 [1] (x4) JD5298 [5]	HR397 [5]	HR397	PA5041 (x16) 6.00/12.20x10.00 (FPM) HR791 [5]	NA5180 [2] 27.00x42.00x8.00mm, FPM NA5185 [2] 32.00x42.00x6.00mm, FPM	KA5025 [15] KK5551 [20]
HBS249 [5] M9x1.25x138.00mm (x10)	JD5228 [1] JD5298 [5]	HR397 [5]	HR397	PA5041 (x16) 6.00/12.20x10.00 (FPM) HR791 [5]	NA5180 [2] 27.00x42.00x8.00mm, FPM NA5185 [2] 32.00x42.00x6.00mm, FPM	KA5025 [15] KK5551 [20]
HBS249 [5] M9x1.25x138.00mm (x10)	JD5228 [1] JD5298 [5]	HR397 [5]	HR397	PA5041 (x16) 6.00/12.20x10.00 (FPM) HR791 [5]	NA5180 [2] 27.00x42.00x8.00mm, FPM NA5185 [2] 32.00x42.00x6.00mm, FPM LK5011 [7] [26] 85.00x131.00x15.94mm, PTFE	KA5025 [15] KK5551 [20]
	JD5812 [1] JD5818 [5] [X] (MLS) JD5849 [5] [X] (MLS) JD5817 [5] [X] (MLS)	JM5285		HR599 [5]	NA5306 [2] 42.00x58.00x8.00mm, ACM NA5133 [1] 85.00x105.00x11.00mm, FPM	



cc



kw/PS

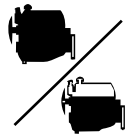

1.4										
AZF							40	BT580 (Fibre)	DT581	
Fabia 1.4	04/00→03/03	1397	4	75.50	OHV	44/60				
BBY							41	AB5701 (MLS)	CB5700 ☒	EB5700 [3][18]
Fabia 1.4 16V	10/99→03/08	1390	4	76.50	DOHC	55/75				
BBZ							42	AB5701 (MLS)	CB5700 ☒	EB5700 [3][18]
Fabia 1.4 16V	12/99→03/08	1390	4	76.50	DOHC	74/100				
BCA							43	AB5701 (MLS)	CB5700 ☒	EB5700 [3][18]
Octavia 1.4	05/04→05/06	1390	4	76.50	DOHC	55/75				
Octavia 1.4 16V	08/00→12/10									
BKY							44	AB5701 (MLS)	CB5700 ☒	EB5700 [3][18]
Fabia 1.4 16V	10/99→03/08	1390	4	76.50	DOHC	55/75				
BMS Diesel							45	AD5650 (MLS), 1.450mm, 1 Hole AD5660 (MLS), 1.530mm, 2 Holes AD5670 (MLS), 1.610mm, 3 Holes		
Fabia 1.4 TDI	01/07→	1422	3	79.50	SOHC/OHC	59/80				
Roomster 1.4TDI	09/06→03/10									
BNM Diesel							46	AD5650 (MLS), 1.450mm, 1 Hole AD5660 (MLS), 1.530mm, 2 Holes AD5670 (MLS), 1.610mm, 3 Holes	CD5650 ▲	
Fabia 1.4 TDI	10/05→03/08	1422	3	79.50	SOHC/OHC	51/70				
Roomster 1.4TDI	07/06→03/10									
BNV Diesel							47	AD5650 (MLS), 1.450mm, 1 Hole AD5660 (MLS), 1.530mm, 2 Holes AD5670 (MLS), 1.610mm, 3 Holes	CD5650 ▲	
Fabia 1.4 TDI	10/05→03/08	1422	3	79.50	SOHC/OHC	59/80				
Roomster 1.4TDI	09/06→03/10									
BUD							48	AB5701 (MLS)	CB5700 ☒	EB5700 [3][18]
Fabia 1.4 16V	04/06→12/07	1390	4	76.50	DOHC	59/80				
Octavia 1.4	06/04→									
BXW							49	AB5701 (MLS)	CB5700 ☒	EB5700 [3][18]
Fabia 1.4	01/07→	1390	4	76.50	DOHC	63/86				
Roomster 1.4	09/06→									

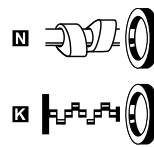
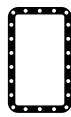
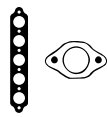

AD5650, AD5660,
AD5670



BT580

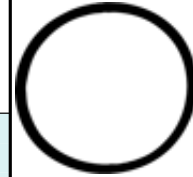

JD5228



JD5278



JD5279



JD5298

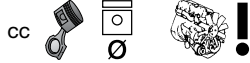

kW/PS

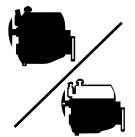

1.4		CAVE					50	AH5960 (MLS), 0.800mm	CH5960	
Fabia 1.4 TSI	05/10→	1390	4	76.50	DOHC	132/180				
1.4		CAXA					51	AH5960 (MLS), 0.800mm	CH5960	
Octavia 1.4 TSI	11/08→	1390	4	76.50	DOHC	90/122				
Rapid 1.4 TSI	07/12→									
Yeti 1.4 TSI	06/10→									
1.4		CAXC					52	AH5960 (MLS), 0.800mm	CH5960	
Superb 1.4 TSI	07/08→	1390	4	76.50	DOHC	92/125				
1.4		CGGA					53	AB5701 (MLS)	CB5700 ☒	
Octavia 1.4	06/04→	1390	4	76.50	DOHC	59/80				
1.4		CGGB					54	AB5701 (MLS)	CB5700 ☒	
Fabia 1.4	01/07→	1390	4	76.50	DOHC	63/85				
Roomster 1.4	09/06→									
1.6		AEE					55	BZ180 (MLS), 0.500mm	DZ181	EB961 [18]
Felicia 1.6	06/97→04/02	1598	4	76.50	SOHC/OHC	55/75				
Felicia 1.6 GLX	08/95→03/98									
Felicia 1.6 LX	08/95→03/98									
Felicia 2 1.6	01/98→06/01									
Octavia 1.6	09/96→09/04									
1.6		AEH					56	AC5220 (MLS)	CY980	EC080 [18] EC5220 [3][18]
Octavia 1.6	02/97→12/07	1595	4	81.00	SOHC/OHC	74/101				
1.6		AKL					57	AC5220 (MLS)	CY980	EC080 [18] EC5220 [3][18]
Octavia 1.6	02/97→12/07	1595	4	81.00	SOHC/OHC	74/101				
1.6		AVU					58	AC5220 (MLS)	CC5222 [3]	EC5220 [3][18]
Octavia 1.6	09/00→12/10	1595	4	81.00	SOHC/OHC	75/102				

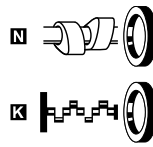
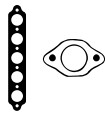

AC5220



BZ180



JC478

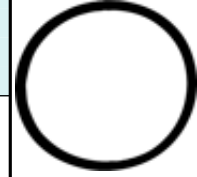

JD5228

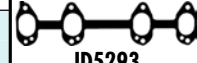

JD5293



JD5298

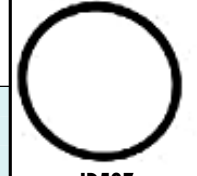

JD597



JD600



JD601

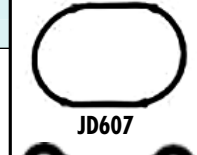

JD607

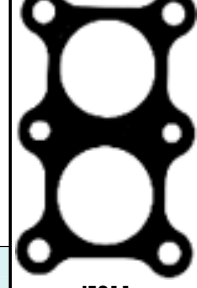

JF211



JP024

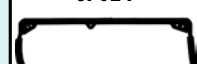

JP074



cc



kW/PS

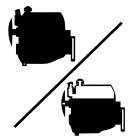

1.6		BFQ					59	AC5220 (MLS)	CC5222 [3]	EC5220 [3] [18]
Octavia 1.6	09/00→12/10	1595	4	81.00	SOHC/OHC	75/102				
1.6		BGU					60	AC5220 (MLS)	CC5222 [3]	EC5220 [3] [18]
Octavia 1.6	06/04→	1595	4	81.00	SOHC/OHC	75/102				
1.6		BLF					61	AG8850 (MLS)	CG8850	
Octavia 1.6 FSI	02/04→10/08	1598	4	76.50	DOHC	85/115				
1.6		BSE					62	AC5220 (MLS)	CC5222 [3]	
Octavia 1.6	06/04→	1595	4	81.00	SOHC/OHC	75/102				
1.6		BSF					63	AC5220 (MLS)	CC5222 [3]	
Octavia 1.6	06/04→	1595	4	81.00	SOHC/OHC	75/102				
1.6		BTS					64	AG8850 (MLS)		
Fabia 1.6	04/07→	1598	4	76.50	DOHC	77/105				
Roomster 1.6	09/06→									
1.6		CAYA Diesel					65			
Fabia 1.6 TDI	04/10→	1598	4	79.50	DOHC	55/75				
1.6		CAYB Diesel					66			
Fabia 1.6 TDI	03/10→	1598	4	79.50	DOHC	66/90				
Rapid 1.6 TDI	08/13→									
Roomster 1.6 TDI	03/10→									
1.6		CAYC Diesel					67			
Fabia 1.6 TDI	03/10→	1598	4	79.50	DOHC	77/105				
Octavia 1.6 TDI	06/09→									
Rapid 1.6 TDI	07/12→									
Roomster 1.6 TDI	03/10→									
Superb 1.6 TDI	09/10→									
Yeti 1.6 TDI	11/10→									
1.6		CCSA					68	AC5220 (MLS)	CC5222 [3]	
Octavia 1.6	06/04→	1595	4	81.00	SOHC/OHC	75/102				
1.6		CFNA					69	AG8850 (MLS)		
Fabia 1.6	04/07→	1598	4	76.50	DOHC	77/105				
Rapid 1.6	07/12→									
Roomster 1.6	09/06→									

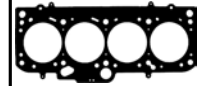
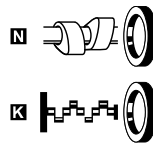
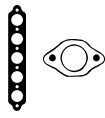

AC5220

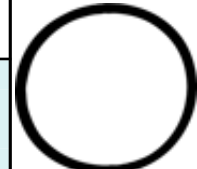

JD5228



JD5293

HBS246 [22] M10x1.50x120.00mm (x10)	JD5340 (x4) JD5293	JM5205 (Elastomer)	HR397	PA5041 (x8) 6.00/12.20x10.00 (FPM) HR817	NA5124 [2] 32.00x47.00x10.00mm, PTFE/ACM NA5106 [2] 35.00x48.00x10.00mm, PTFE LK5008 [1][7] 85.00x131.00x15.700mm, PTFE	
HBS246 [22] M10x1.50x120.00mm (x10)	JD5340 (x4) JD5293	JM5205 (Elastomer)	HR397	PA5041 (x8) 6.00/12.20x10.00 (FPM) HR817	NA5124 [2] 32.00x47.00x10.00mm, PTFE/ACM NA5106 [2] 35.00x48.00x10.00mm, PTFE NA5124 [2] 32.00x47.00x10.00mm, PTFE/ACM LK5008 [1][7] 85.00x131.00x15.700mm, PTFE	
HBS249 [5] M9x1.25x138.00mm (x10)	JD5809 JD5814	HR397		PA5041 (x16) 6.00/12.20x10.00 (FPM) HR791	NA5106 [2] 35.00x48.00x10.00mm, PTFE LK5013 [1][7][25] 85.00x111.00x15.50mm, PTFE LK5011 [7][26] 85.00x131.00x15.94mm, PTFE	JR5048 [6]
HBS246 [22] M10x1.50x120.00mm (x10)	JD5340 (x4) JD5293	JM5205 (Elastomer)	HR397	PA5041 (x8) 6.00/12.20x10.00 (FPM) HR817	NA5124 [2] 32.00x47.00x10.00mm, PTFE/ACM NA5106 [2] 35.00x48.00x10.00mm, PTFE LK5008 [1][7] 85.00x131.00x15.700mm, PTFE	
HBS246 [22] M10x1.50x120.00mm (x10)	JD5340 (x4) JD5293	JM5205 (Elastomer)	HR397	PA5041 (x8) 6.00/12.20x10.00 (FPM) HR817	NA5124 [2] 32.00x47.00x10.00mm, PTFE/ACM NA5106 [2] 35.00x48.00x10.00mm, PTFE LK5008 [1][7] 85.00x131.00x15.700mm, PTFE	
HBS249 [5] M9x1.25x138.00mm (x10)	JD5228 JD5814	HR397	HR397	PA5041 (x16) 6.00/12.20x10.00 (FPM)	NA5106 [2] 35.00x48.00x10.00mm, PTFE	JR5048 [6]
		HR397	HR397	PA5041 (x16) 6.00/12.20x10.00 (FPM)	NA5106 [2] 35.00x48.00x10.00mm, PTFE	
		HR397	HR397	PA5041 (x16) 6.00/12.20x10.00 (FPM)	NA5106 [2] 35.00x48.00x10.00mm, PTFE	
HBS364 [19] M12x1.75x149.00mm (x10)		HR397	HR397	PA5041 (x16) 6.00/12.20x10.00 (FPM)	NA5106 [2] 35.00x48.00x10.00mm, PTFE	
HBS246 [22] M10x1.50x120.00mm (x10)	JD5340 (x4) JD5293	JM5205 (Elastomer)	HR397	PA5041 (x8) 6.00/12.20x10.00 (FPM) HR817	NA5124 [2] 32.00x47.00x10.00mm, PTFE/ACM NA5106 [2] 35.00x48.00x10.00mm, PTFE LK5008 [1][7] 85.00x131.00x15.700mm, PTFE	
					NA5106 [2] 35.00x48.00x10.00mm, PTFE/ACM NA5106 [2] 35.00x48.00x10.00mm, PTFE	JR5048 [6]



kW/PS

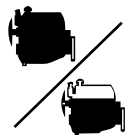

1.6	CHGA	70	AC5220 (MLS)	CC5222 [3]	EC5220 [3][18]
Octavia 1.6 LPG	08/09→	1595 4 81.00 SOHC/OHC 75/102			
1.6	CMXA	71	AC5220 (MLS)	CC5222 [3]	EC5220 [3][18]
Octavia 1.6	06/04→	1595 4 81.00 SOHC/OHC 75/102			
1.6	EA111	72	BZ180 (MLS), 0.500mm	DZ181	
Felicia 1.6 LX	08/95→03/98	1598 4			
1.8	AGN	73	AY970 (MLS)	CY971	EY841 [3]
Octavia 1.8 Octavia 1.8 20V	09/96→07/00 07/98→07/00	1781 4 81.00 DOHC 92/125			
1.8	AGU	74	AY970 (MLS)	CY971	EY841 [3]
Octavia 1.8 T	08/97→12/10	1781 4 81.00 DOHC 110/150			
1.8	ARX	75	AY970 (MLS)	CY971	EY841 [3]
Octavia 1.8 T	08/97→12/10	1781 4 81.00 DOHC 110/150			
1.8	ARZ	76	AY970 (MLS)	CY971	EY841 [3]
Octavia 1.8 T	08/97→12/10	1781 4 81.00 DOHC 110/150			

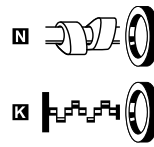
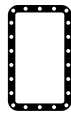
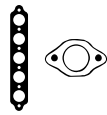

AC5220



AY970



BZ180



JD5293



JD597



JD601



JD604



JD605



JD607



JP074



cc



kW/PS

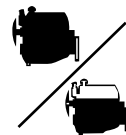

1.8	AUM	77	AY970 (MLS)	CY971	EY841 [3]				
Octavia 1.8 T	08/97→12/10	1781	4	81.00	DOHC	110/150			
1.8	AUG	78	AY970 (MLS)	CY971	EY841 [3]				
Octavia RS 1.8T	05/01→01/06	1781	4	81.00	DOHC	132/180			
1.8	AWT	79	AY970 (MLS)	CY971	EY841 [3]				
Superb 1.8 T	12/01→03/08	1781	4	81.00	DOHC	110/150			
1.8	BZB	80	AH5380 (MLS)						
Octavia 1.8 TSI	06/07→	1798	4	81.00	DOHC	118/160			
Superb 1.8 TSI	03/08→								
1.8	CDAA	81	AH5380 (MLS)						
Octavia 1.8 TSI	06/07→	1798	4	82.50	DOHC	118/160			
Superb 1.8 TSI	03/08→								
Yeti 1.8 TSI	05/09→								
1.8	CDAB	82							
Octavia 1.8 TSI	03/09→	1798	4	82.50	DOHC	112/152			
Superb 1.8 TSI	03/09→								
Yeti 1.8 TSI	11/09→								
1.9	AEF Diesel	83	BV850 (MLS), 1.530mm, 1 Hole	DV850 ▲	ECO30 [18]				
Felicia 1.9 D	10/95→04/02	1896	4	79.50	SOHC/OHC	47/64	BV860 (MLS), 1.570mm, 2 Holes	→Eng.007 000	→Eng.265000
Felicia 2 1.9 D	01/98→06/01						BV870 (MLS), 1.610mm, 3 Holes		
								DV851 ▲	
								Eng.007 001 →	

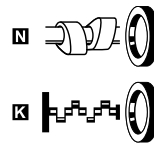
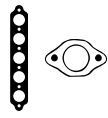

AY970



BV850, BV860, BV870



JC152



JD170

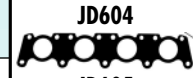

JD604

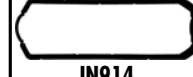

JD605



JN914

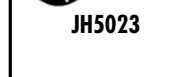

JH5023



cc



kW/PS

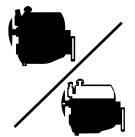

1.9	AGP Diesel					84		DZ010 ▲☒	ECO60 [18]
Octavia 1.9 SDI	06/97→12/03	1896	4	79.50	SOHC/OHC	50/68	BZ010 (MLS), 1.450mm, 1 Hole →Eng.028 000 BZ020 (MLS), 1.530mm, 2 Holes →Eng.028 000 BZ030 (MLS), 1.610mm, 3 Holes →Eng.028 000 BZ040 (MLS), 1.470mm, 1 Hole Eng.028 001→ BZ050 (MLS), 1.570mm, 2 Holes Eng.028 001→ BZ060 (MLS), 1.670mm, 3 Holes Eng.028 001→		
1.9	AGR Diesel					85		DZ010 ▲☒	ECO60 [18]
Octavia 1.9 TDI	09/96→03/10	1896	4	79.50	SOHC/OHC	66/90	BZ010 (MLS), 1.450mm, 1 Hole →Eng.151 000 BZ020 (MLS), 1.530mm, 2 Holes →Eng.151 000 BZ030 (MLS), 1.610mm, 3 Holes →Eng.151 000 BZ040 (MLS), 1.470mm, 1 Hole Eng.151 001→ BZ050 (MLS), 1.570mm, 2 Holes Eng.151 001→ BZ060 (MLS), 1.670mm, 3 Holes Eng.151 001→		
1.9	AHF Diesel					86		DZ010 ▲☒	ECO60 [18]
Octavia 1.9 TDI	08/97→01/06	1896	4	79.50	SOHC/OHC	81/110	BZ010 (MLS), 1.450mm, 1 Hole →Eng.140 000 BZ020 (MLS), 1.530mm, 2 Holes →Eng.140 000 BZ030 (MLS), 1.610mm, 3 Holes →Eng.140 000 BZ040 (MLS), 1.470mm, 1 Hole Eng.140 001→ BZ050 (MLS), 1.570mm, 2 Holes Eng.140 001→ BZ060 (MLS), 1.670mm, 3 Holes Eng.140 001→		
1.9	ALH Diesel					87		DZ010 ▲☒	ECO60 [18]
Octavia 1.9 TDI	09/96→03/10	1896	4	79.50	SOHC/OHC	66/90	BZ010 (MLS), 1.450mm, 1 Hole →Eng.085 000 BZ020 (MLS), 1.530mm, 2 Holes →Eng.085 000 BZ030 (MLS), 1.610mm, 3 Holes →Eng.085 000 BZ040 (MLS), 1.470mm, 1 Hole Eng.085 001→ BZ050 (MLS), 1.570mm, 2 Holes Eng.085 001→ BZ060 (MLS), 1.670mm, 3 Holes Eng.085 001→		
1.9	AQM Diesel					88		DZ010 ▲☒	ECO60 [18]
Octavia 1.9 SDI	06/97→12/03	1896	4	79.50	SOHC/OHC	50/68	BZ040 (MLS), 1.470mm, 1 Hole BZ050 (MLS), 1.570mm, 2 Holes BZ060 (MLS), 1.670mm, 3 Holes		

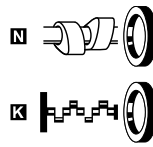
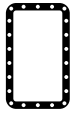
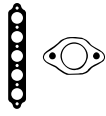

BZ010, BZ020,
BZ030



BZ040, BZ050,
BZ060



JC152



JD170



JD606



cc



kW/PS

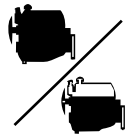

1.9	ASV Diesel					89			
Octavia 1.9 TDI	08/97→01/06	1896	4	79.50	SOHC/OHC	81/110	BZ040 (MLS), 1.470mm, 1 Hole BZ050 (MLS), 1.570mm, 2 Holes BZ060 (MLS), 1.670mm, 3 Holes	DZ010 ▲☒	EC060 [18]
1.9	ASY Diesel					90			
Fabia 1.9 SDI	11/99→03/08	1896	4	79.50	SOHC/OHC	47/64	BZ040 (MLS), 1.470mm, 1 Hole BZ050 (MLS), 1.570mm, 2 Holes BZ060 (MLS), 1.670mm, 3 Holes	CC5231 ▲	EC060 [18]
1.9	ASZ Diesel					91			
Fabia 1.9 TDI RS Octavia 1.9 TDI	06/03→03/08 09/02→09/04	1896	4	79.50	SOHC/OHC	96/130	AF5381 (MLS), 1.490mm, 1 Hole AF5391 (MLS), 1.530mm, 2 Holes AF5401 (MLS), 1.650mm, 3 Holes	CC5230 ▲	EC060 [18]
1.9	ATD Diesel					92			
Fabia 1.9 TDI Octavia 1.9 TDI	01/00→03/08 08/00→12/10	1896	4	79.50	SOHC/OHC	74/100	AF5381 (MLS), 1.490mm, 1 Hole AF5391 (MLS), 1.530mm, 2 Holes AF5401 (MLS), 1.650mm, 3 Holes	CC5230 ▲	EC060 [18]
1.9	AVB Diesel					93			
Superb 1.9 TDI	08/02→10/05	1896	4	79.50	SOHC/OHC	74/101	AF5381 (MLS), 1.490mm, 1 Hole AF5391 (MLS), 1.530mm, 2 Holes AF5401 (MLS), 1.650mm, 3 Holes	CC5230 ▲	EB5370 [3] [18] EC060 [18]
1.9	AVF Diesel					94			
Superb 1.9 TDI	12/01→03/08	1896	4	79.50	SOHC/OHC	96/130	AF5381 (MLS), 1.490mm, 1 Hole AF5391 (MLS), 1.530mm, 2 Holes AF5401 (MLS), 1.650mm, 3 Holes	CC5230 ▲	EC060 [18]
1.9	AWX Diesel					95			
Superb 1.9 TDI	12/01→03/08	1896	4	79.50	SOHC/OHC	96/130	AF5381 (MLS), 1.490mm, 1 Hole AF5391 (MLS), 1.530mm, 2 Holes AF5401 (MLS), 1.650mm, 3 Holes	CC5230 ▲	EC060 [18]

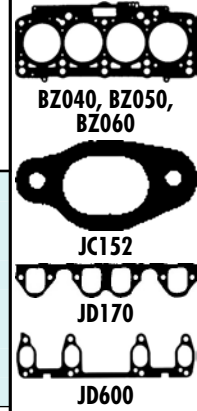
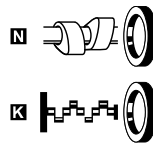
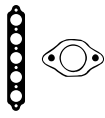

HBS018 [19]
M12x1.75x115.00mm (x10)

JD170 [1]
JC152 [4] (x4)

HR397

HR816 [5]

NA5001 [1][2]
32.00x47.00x10.00mm, FPM
NA5106 [2]
35.00x48.00x10.00mm, PTFE
NB716 [2]
35.00x48.00x10.00mm, FPM
LK5003 [1][7]
85.00x131.00x15.700mm, PTFE

HBS018 [19]
M12x1.75x115.00mm (x10)

JD170 [1]
JC152 [4] (x4)

JM5203
(Elastomer)

HR397

HR816 [5]

NA5001 [1][2]
32.00x47.00x10.00mm, FPM
NA5106 [2]
35.00x48.00x10.00mm, PTFE/ACM
NA5124 [2]
32.00x47.00x10.00mm, PTFE/ACM
NA5106 [2]
35.00x48.00x10.00mm, PTFE
NA5124 [2]
32.00x47.00x10.00mm, PTFE/ACM
NB716 [2]
35.00x48.00x10.00mm, FPM
LK5003 [1][7]
85.00x131.00x15.700mm, PTFE

HBS300 [19]
M12x1.75x166.00mm (x10)

JD170 [1]
JC152 [4] (x4)

JM5203
(Elastomer)

HR397

HR816 [5]

NA5124 [2]
32.00x47.00x10.00mm, PTFE/ACM
NA5106 [2]
35.00x48.00x10.00mm, PTFE
LK5003 [1][7]
85.00x131.00x15.700mm, PTFE

HBS300 [19]
M12x1.75x166.00mm (x10)

JD170 [1]
JD600 [4]

JM5203
(Elastomer)

HR397

HR816 [5]

NA5124 [2]
32.00x47.00x10.00mm, PTFE/ACM
NA5106 [2]
35.00x48.00x10.00mm, PTFE
LK5003 [1][7]
85.00x131.00x15.700mm, PTFE

HBS300 [19]
M12x1.75x166.00mm (x10)

JD170 [1]
JD600 [4]

JM5203
(Elastomer)

HR397

HR816 [5]

NA5124 [2]
32.00x47.00x10.00mm, PTFE/ACM
NA5106 [2]
35.00x48.00x10.00mm, PTFE
LK5003 [1][7]
85.00x131.00x15.700mm, PTFE

HBS300 [19]
M12x1.75x166.00mm (x10)

JD170 [1]
JD600 [4]

JM5203
(Elastomer)

HR397

HR816 [5]

NA5124 [2]
32.00x47.00x10.00mm, PTFE/ACM
NA5106 [2]
35.00x48.00x10.00mm, PTFE
NA5124 [2]
32.00x47.00x10.00mm, PTFE/ACM
LK5003 [1][7]
85.00x131.00x15.700mm, PTFE

HBS300 [19]
M12x1.75x166.00mm (x10)

JD170 [1]
JD600 [4]

JM5203
(Elastomer)

HR397

HR816 [5]

NA5124 [2]
32.00x47.00x10.00mm, PTFE/ACM
NA5106 [2]
35.00x48.00x10.00mm, PTFE
NA5124 [2]
32.00x47.00x10.00mm, PTFE/ACM
LK5003 [1][7]
85.00x131.00x15.700mm, PTFE

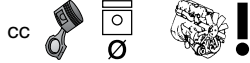

kW/PS

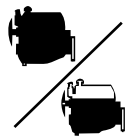

1.9	AXR Diesel					96	AF5381 (MLS), 1.490mm, 1 Hole AF5391 (MLS), 1.530mm, 2 Holes AF5401 (MLS), 1.650mm, 3 Holes	CC5230 ▲	EC060 [18]
Fabia 1.9 TDI	01/00→03/08	1896	4	79.50	SOHC/OHC	74/100			
Octavia 1.9 TDI	08/00→12/10								
Roomster 1.9 TDI	03/06→05/06								
1.9	BJB Diesel					97	AF5381 (MLS), 1.490mm, 1 Hole AF5391 (MLS), 1.530mm, 2 Holes AF5401 (MLS), 1.650mm, 3 Holes	CC5230 ▲	EF5380
Octavia 1.9 TDI	06/04→12/10	1896	4	79.50	SOHC/OHC	77/105			
1.9	BKC Diesel					98	AF5381 (MLS), 1.490mm, 1 Hole AF5391 (MLS), 1.530mm, 2 Holes AF5401 (MLS), 1.650mm, 3 Holes	CC5230 ▲	EF5380
Octavia 1.9 TDI	06/04→12/10	1896	4	79.50	SOHC/OHC	77/105			
1.9	BLS Diesel					99	AF5381 (MLS), 1.490mm, 1 Hole AF5391 (MLS), 1.530mm, 2 Holes AF5401 (MLS), 1.650mm, 3 Holes	CC5230 ▲	EF5380
Fabia 1.9 TDI	04/07→	1896	4	79.50	SOHC/OHC	77/105			
Octavia 1.9 TDI	06/04→12/10								
Roomster 1.9 TDI	09/06→03/10								
Superb 1.9 TDI	03/08→11/10								
1.9	BLT Diesel					100	AF5381 (MLS), 1.490mm, 1 Hole AF5391 (MLS), 1.530mm, 2 Holes AF5401 (MLS), 1.650mm, 3 Holes	CC5230 ▲	EB5370 [3] [18]
Fabia 1.9 TDI RS	06/03→03/08	1896	4	79.50	SOHC/OHC	96/130			
1.9	BPZ Diesel					101	AF5381 (MLS), 1.490mm, 1 Hole AF5391 (MLS), 1.530mm, 2 Holes AF5401 (MLS), 1.650mm, 3 Holes	CC5231 ▲	EB5370 [3] [18]
Superb 1.9 TDI	01/07→03/08	1896	4	79.50	SOHC/OHC	85/115			
1.9	BSV Diesel					102	AF5381 (MLS), 1.490mm, 1 Hole AF5391 (MLS), 1.530mm, 2 Holes AF5401 (MLS), 1.650mm, 3 Holes	CC5231 ▲	EB5370 [3] [18]
Superb 1.9 TDI	10/05→05/07	1896	4	79.50	SOHC/OHC	77/105			
1.9	BSW Diesel					103	AF5381 (MLS), 1.490mm, 1 Hole AF5391 (MLS), 1.530mm, 2 Holes AF5401 (MLS), 1.650mm, 3 Holes	CC5230 ▲	EB5370 [3] [18]
Fabia 1.9 TDI	04/07→	1896	4	79.50	SOHC/OHC	77/105			
Roomster 1.9 TDI	09/06→03/10								

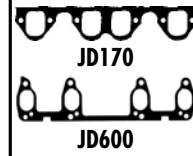
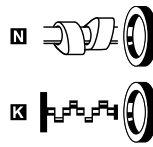
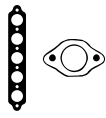

HBS300 [19] M12x1.75x166.00mm (x10)	JD170 JD600	JM5203 (Elastomer)	HR397	HR816	NA5124 [2] 32.00x47.00x10.00mm, PTFE/ACM NA5106 [2] 35.00x48.00x10.00mm, PTFE NA5124 [2] 32.00x47.00x10.00mm, PTFE/ACM LK5003 [1][7] 85.00x131.00x15.700mm, PTFE
HBS300 [19] M12x1.75x166.00mm (x10)	JD170 JD600	JM5203 (Elastomer)	HR397	HR816	NA5124 [2] 32.00x47.00x10.00mm, PTFE/ACM NA5106 [2] 35.00x48.00x10.00mm, PTFE LK5012 [1][7][28] 85.00x132.00x15.700mm, ACM
HBS300 [19] M12x1.75x166.00mm (x10)	JD170 JD600	JM5203 (Elastomer)	HR397	HR816	NA5124 [2] 32.00x47.00x10.00mm, PTFE/ACM NA5106 [2] 35.00x48.00x10.00mm, PTFE NA5124 [2] 32.00x47.00x10.00mm, PTFE/ACM LK5012 [1][7][28] 85.00x132.00x15.700mm, ACM
HBS300 [19] M12x1.75x166.00mm (x10)	JD170 JD5992 [29] (Steel)	JM7107 (ACM)	HR397	HR816	NA5124 [2] 32.00x47.00x10.00mm, PTFE/ACM NA5106 [2] 35.00x48.00x10.00mm, PTFE NA5124 [2] 32.00x47.00x10.00mm, PTFE/ACM LK5012 [1][7][28] 85.00x132.00x15.700mm, ACM
HBS300 [19] M12x1.75x166.00mm (x10)	JD170 JD600	JM5203 (Elastomer)		HR816	NA5124 [2] 32.00x47.00x10.00mm, PTFE/ACM NA5106 [2] 35.00x48.00x10.00mm, PTFE LK5003 [1][7] 85.00x131.00x15.700mm, PTFE
HBS300 [19] M12x1.75x166.00mm (x10)	JD170 JD600	JM5203 (Elastomer)		HR816	NA5106 [2] 35.00x48.00x10.00mm, PTFE/ACM NA5124 [2] 32.00x47.00x10.00mm, PTFE/ACM NA5106 [2] 35.00x48.00x10.00mm, PTFE LK5003 [1][7] 85.00x131.00x15.700mm, PTFE
HBS300 [19] M12x1.75x166.00mm (x10)	JD170 JD600	JM5203 (Elastomer)		HR816	NA5106 [2] 35.00x48.00x10.00mm, PTFE/ACM NA5124 [2] 32.00x47.00x10.00mm, PTFE/ACM NA5106 [2] 35.00x48.00x10.00mm, PTFE LK5003 [1][7] 85.00x131.00x15.700mm, PTFE
HBS300 [19] M12x1.75x166.00mm (x10)	JD170 JD600	JM5203 (Elastomer)		HR816	NA5124 [2] 32.00x47.00x10.00mm, PTFE/ACM NA5106 [2] 35.00x48.00x10.00mm, PTFE LK5003 [1][7] 85.00x131.00x15.700mm, PTFE



cc



kW/PS

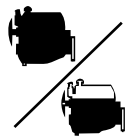

1.9		BXE Diesel					104	AF5381 (MLS), 1.490mm, 1 Hole AF5391 (MLS), 1.530mm, 2 Holes AF5401 (MLS), 1.650mm, 3 Holes	CC5230 ▲	EF5380
Octavia 1.9 TDI	06/04→12/10	1896	4	79.50	SOHC/OHC	77/105				
Superb 1.9 TDI	03/08→11/10									
2.0		AEG					105	AB5370 (MLS)	CB5370 [13]	EB5370 [3][18]
Octavia 2.0	04/99→05/07	1984	4	82.50	SOHC/OHC	85/116				
2.0		APK					106	AB5370 (MLS)	CB5370 [13]	EB5370 [3][18] EY841 [3]
Octavia 2.0	04/99→05/07	1984	4	82.50	SOHC/OHC	85/116				
2.0		AQY					107	AB5370 (MLS)	CB5370 [13]	EB5370 [3][18] EY841 [3]
Fabia 2.0	12/99→03/08	1984	4	82.50	SOHC/OHC	85/116				
Octavia 2.0	04/99→05/07									
2.0		AZH					108	AB5370 (MLS)	CB5370 [13]	EB5370 [3][18] EY841 [3]
Octavia 2.0	04/99→05/07	1984	4	82.50	SOHC/OHC	85/116				
Octavia 2.0 4x4	08/00→09/04									
2.0		AZJ					109	AB5370 (MLS)	CB5370 [13]	EB5370 [3][18]
Octavia 2.0	04/99→05/07	1984	4	82.50	SOHC/OHC	85/116				
Octavia 2.0 4x4	08/00→09/04									
2.0		AZL					110	AB5370 (MLS)	CB5370 [13]	EB5370 [3][18]
Fabia 2.0	12/99→03/08	1984	4	82.50	SOHC/OHC	85/116				
2.0		AZM					111	AB5370 (MLS)	CB5371	EB5370 [3][18]
Superb 2.0	12/01→03/08	1984	4	82.50	SOHC/OHC	85/115				

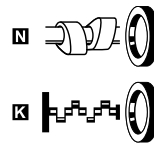
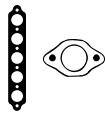

AB5370



JD170



JD5291



JD5293



JD5341



JD600

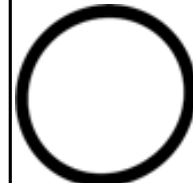

LA5204

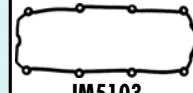

JM5103

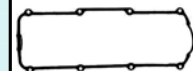

JP024



cc



kW/PS

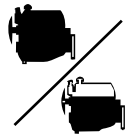

2.0											
2.0	AZV Diesel	112									
Octavia 2.0 TDI	02/04→05/10	1968	4	81.00	DOHC	100/136	AG8970 (MLS), 1.550mm, 1 Hole AG8800 (MLS), 1.630mm, 2 Holes AG8960 (MLS), 1.710mm, 3 Holes	CG8410 ▲	EF5380		
2.0	BKD Diesel	113									
Octavia 2.0 TDI	02/04→	1968	4	81.00	DOHC	103/140	AG8970 (MLS), 1.550mm, 1 Hole AG8800 (MLS), 1.630mm, 2 Holes AG8960 (MLS), 1.710mm, 3 Holes	CG8410 ▲	EF5380		
Superb 2.0 TDI	01/09→										
2.0	BLR	114									
Octavia 2.0 FSI	11/04→	1984	4	82.50	DOHC	110/150	AG9600 (MLS)	CG9600	EG9600		
2.0	BLX	115									
Octavia 2.0 FSI	11/04→	1984	4	82.50	DOHC	110/150	AG9600 (MLS)	CG9600	EG9600		
2.0	BLY	116									
Octavia 2.0 FSI	11/04→	1984	4	82.50	DOHC	110/150	AG9600 (MLS)	CG9600	EG9600		
2.0	BMM Diesel	117									
Octavia 2.0 TDI	11/05→	1968	4	81.00	SOHC/OHC	103/140	AG9630 (MLS), 1.450mm, 1 Hole AG9640 (MLS), 1.530mm, 2 Holes AG9650 (MLS), 1.610mm, 3 Holes	CG8410 ▲	EF5380		
2.0	BMN Diesel	118									
Octavia 2.0 RS	04/06→	1968	4	81.00	DOHC	125/170	AG8970 (MLS), 1.550mm, 1 Hole AG8800 (MLS), 1.630mm, 2 Holes AG8960 (MLS), 1.710mm, 3 Holes	CG8410 ▲	EF5380		
2.0	BMP Diesel	119									
Superb 2.0 TDI	03/08→03/10	1968	4	81.00	SOHC/OHC	103/140	AG9630 (MLS), 1.450mm, 1 Hole AG9640 (MLS), 1.530mm, 2 Holes AG9650 (MLS), 1.610mm, 3 Holes		EF5380		
2.0	BSS Diesel	120									
Superb 2.0 TDI	10/05→03/08	1968	4	81.00	SOHC/OHC	103/140	AG9630 (MLS), 1.450mm, 1 Hole AG9640 (MLS), 1.530mm, 2 Holes AG9650 (MLS), 1.610mm, 3 Holes	CC5231 ▲			

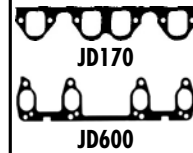
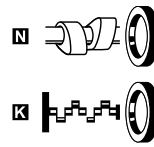
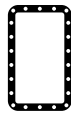
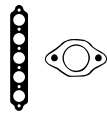

HBS364 [19] M12x1.75x149.00mm (x10)	JD5805 [1] JD5806 [1] JD5815 [5]	JM7031 (Elastomer)		PA5041 (x16) 6.00/12.20x10.00 (FPM) HR791 [5]	NA5124 (x2) [2] 32.00x47.00x10.00mm, PTFE/ACM NA5106 [2] 35.00x48.00x10.00mm, PTFE LK5012 [1] [7] [28] 85.00x132.00x15.70mm, ACM	KK5522 [31]
HBS364 [19] M12x1.75x149.00mm (x10)	JD5806 [1] →11/06 JD5805 [1] 12/06→ JD5815 [5] JD600 [5]	JM7031 (Elastomer)	HR397	PA5041 (x16) 6.00/12.20x10.00 (FPM) HR791 [5]	NA5124 (x2) [2] 32.00x47.00x10.00mm, PTFE/ACM NA5106 [2] 35.00x48.00x10.00mm, PTFE NA5124 [2] 32.00x47.00x10.00mm, PTFE/ACM LK5012 [1] [7] [28] 85.00x132.00x15.70mm, ACM	KK5522 [31]
HBS363 [22] M10x1.50x122.00mm (x10)	JD5873 [1] (FPM) JD5813 [5]	JM7078 (Elastomer)	HR397	PA5041 (x16) 6.00/12.20x10.00 (FPM) HR791 [5]	NA5124 [2] 32.00x47.00x10.00mm, PTFE/ACM NA5106 [2] 35.00x48.00x10.00mm, PTFE LK5008 [1] [7] 85.00x131.00x15.700mm, PTFE	
HBS363 [22] M10x1.50x122.00mm (x10)	JD5873 [1] (FPM) JD5813 [5]	JM7078 (Elastomer)		PA5041 (x16) 6.00/12.20x10.00 (FPM) HR791 [5]	NA5124 [2] 32.00x47.00x10.00mm, PTFE/ACM NA5106 [2] 35.00x48.00x10.00mm, PTFE LK5008 [1] [7] 85.00x131.00x15.700mm, PTFE	
HBS363 [22] M10x1.50x122.00mm (x10)	JD5873 [1] (FPM) JD5813 [5]	JM7078 (Elastomer)	HR397	PA5041 (x16) 6.00/12.20x10.00 (FPM) HR791 [5]	NA5124 [2] 32.00x47.00x10.00mm, PTFE/ACM NA5106 [2] 35.00x48.00x10.00mm, PTFE LK5008 [1] [7] 85.00x131.00x15.700mm, PTFE	
HBS300 [19] M12x1.75x166.00mm (x10)	JD170 [1] JD5992 [5] [29] (Steel)	JM7031 (Elastomer) JM7107 (ACM)	HR397	HR599 [5] HR816 [5]	NA5124 [2] 32.00x47.00x10.00mm, PTFE/ACM NA5106 [2] 35.00x48.00x10.00mm, PTFE LK5012 [1] [7] [28] 85.00x132.00x15.70mm, ACM	
HBS364 [19] M12x1.75x149.00mm (x10)	JD5806 [1] (Metal) →11/06 JD5805 [1] (Elastomer) 12/06→ JD5815 [5]	JM7031 (Elastomer)	HR397	PA5041 (x16) 6.00/12.20x10.00 (FPM) HR791 [5]	NA5124 (x2) [2] 32.00x47.00x10.00mm, PTFE/ACM NA5106 [2] 35.00x48.00x10.00mm, PTFE LK5012 [1] [7] [28] 85.00x132.00x15.70mm, ACM	KK5522 [31]
HBS300 [19] M12x1.75x166.00mm (x10)	JD170 [1] JD5992 [5] [29] (Steel)	JM7107 (ACM)		HR599 [5] HR816 [5]	NA5124 [2] 32.00x47.00x10.00mm, PTFE/ACM NA5106 [2] 35.00x48.00x10.00mm, PTFE LK5012 [1] [7] [28] 85.00x132.00x15.70mm, ACM	
HBS300 [19] M12x1.75x166.00mm (x10)	JD170 [1] JD600 [5] JE5075	JM5203 (Elastomer)		HR599 [5] HR816 [5]	NA5106 [2] 35.00x48.00x10.00mm, PTFE/ACM NA5124 [2] 32.00x47.00x10.00mm, PTFE/ACM NA5106 [2] 35.00x48.00x10.00mm, PTFE LK5003 [1] [7] 85.00x131.00x15.700mm, PTFE	



cc



kW/PS

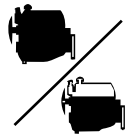

2.0	Model	Year	CC	Cyl	Power (kW/PS)	Engine Type	Part No.	Accessories
2.0	BVX						121	
Octavia 2.0 FSI	11/04→	1984	4	82.50	DOHC	110/150	AG9600 (MLS)	CG9600 EG9600
2.0	BVY						122	
Octavia 2.0 FSI	11/04→	1984	4	82.50	DOHC	110/150	AG9600 (MLS)	CG9600 EG9600
2.0	BVZ						123	
Octavia 2.0 FSI	11/04→	1984	4	82.50	DOHC	110/150	AG9600 (MLS)	CG9600 EG9600
2.0	BWA						124	
Octavia 2.0 RS	10/05→	1984	4	82.50	DOHC	147/200	AH6930 (MLS)	
2.0	CBBB Diesel						125	
Superb 2.0 TDI	07/08→	1968	4	81.00	DOHC	125/170		
2.0	CBDB Diesel						126	
Yeti 2.0 TDI	05/09→	1968	4	81.00	DOHC	103/140		EF5380
2.0	CCZA						127	
Octavia 2.0 RS Superb 2.0 TSI	10/05→ 05/10→	1984	4	82.50	DOHC	147/200	AH5380 (MLS)	
2.0	CFHF Diesel						128	
Octavia 2.0 TDI Yeti 2.0 TDI	03/10→ 11/09→	1968	4	81.00	DOHC	81/110		
2.5	AYM Diesel						129	
Superb 2.5 TDI	12/01→08/03	2496	6	78.30	DOHC, V	114/155	AC5960 (MLS), 1.100mm, 1 Hole (x2) AC5970 (MLS), 1.150mm, 2 Holes (x2) AC5980 (MLS), 1.200mm, 3 Holes (x2)	CC5960 ▲ [33] EC5960
2.5	BDG Diesel						130	
Superb 2.5 TDI	06/03→03/08	2496	6	78.30	DOHC, V	120/163	AC5960 (MLS), 1.100mm, 1 Hole (x2) AC5970 (MLS), 1.150mm, 2 Holes (x2) AC5980 (MLS), 1.200mm, 3 Holes (x2)	CC5960 ▲ [33] EC5960

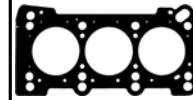
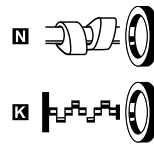
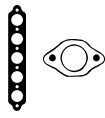

AC5960, AC5970,
AC5980

HBS363 [22] M10x1.50x122.00mm (x10)	JD5873 [1] (FPM) JD5813 [2]	JM7078 (Elastomer)		PA5041 (x16) 6.00/12.20x10.00 (FPM) HR791 [2]	NA5124 [2] 32.00x47.00x10.00mm, PTFE/ACM NA5106 [2] 35.00x48.00x10.00mm, PTFE LK5008 [1][7] 85.00x131.00x15.700mm, PTFE	
HBS363 [22] M10x1.50x122.00mm (x10)	JD5873 [1] (FPM) JD5813 [2]	JM7078 (Elastomer)	HR397	PA5041 (x16) 6.00/12.20x10.00 (FPM) HR791 [2]	NA5124 [2] 32.00x47.00x10.00mm, PTFE/ACM NA5106 [2] 35.00x48.00x10.00mm, PTFE LK5008 [1][7] 85.00x131.00x15.700mm, PTFE	
HBS363 [22] M10x1.50x122.00mm (x10)	JD5873 [1] (FPM) JD5813 [2]	JM7078 (Elastomer)	HR397	PA5041 (x16) 6.00/12.20x10.00 (FPM) HR791 [2]	NA5124 [2] 32.00x47.00x10.00mm, PTFE/ACM NA5106 [2] 35.00x48.00x10.00mm, PTFE LK5008 [1][7] 85.00x131.00x15.700mm, PTFE	
HBS476 [22] M10x1.50x117.00mm (x10)			HR397	PA5041 (x16) 6.00/12.20x10.00 (FPM) HR791 [2]	NA5106 [2] 35.00x48.00x10.00mm, PTFE LK5003 [1][7] 85.00x131.00x15.700mm, PTFE	
	JD5815 [2]			PA5041 (x16) 6.00/12.20x10.00 (FPM) HR791 [2]	NA5124 [2] 32.00x47.00x10.00mm, PTFE/ACM NA5106 [2] 35.00x48.00x10.00mm, PTFE	
		HR397 [2]	HR397	PA5041 (x16) 6.00/12.20x10.00 (FPM) HR791 [2]	NA5106 [2] 35.00x48.00x10.00mm, PTFE	KK5522 [31]
HBS476 [22] M10x1.50x117.00mm (x10)		HR397 [2]		PA5041 (x16) 6.00/12.20x10.00 (FPM) HR791 [2]	NA5124 [2] 32.00x47.00x10.00mm, PTFE/ACM	
				PA5041 (x16) 6.00/12.20x10.00 (FPM) HR791 [2]	NA5124 [2] 32.00x47.00x10.00mm, PTFE/ACM NA5106 [2] 35.00x48.00x10.00mm, PTFE	
HBS265 [22] M12x1.50x155.00mm (x16)	JD5810 [1] (x2) JD5851 [2] (x6) (Fibre)	HM5223 [2] (x2) (ACM)		PA5041 (x24) 6.00/12.20x10.00 (FPM) HR5062 [2]	NA5001 [1][2] 32.00x47.00x10.00mm, FPM	
HBS361 [22] M12x1.50x159.00mm (x16)	JD5810 [1] (x2) JD5851 [2] (x6) (Fibre)	HM5223 [2] (x2) (ACM)		PA5041 (x24) 6.00/12.20x10.00 (FPM) HR5062 [2]	NA5001 [1][2] 32.00x47.00x10.00mm, FPM NA5001 [1][2] 32.00x47.00x10.00mm, FPM NB716 [2] 35.00x48.00x10.00mm, FPM NB928 [2] 105.00x130.00x12.00mm, FPM	



Ltr



CC



9

Model	Ltr	Year Range	Engine	Fuel	CC	Gears	Index
CABRIO (450)	0.6	03/00→01/00	M 160 E6AL B03	Petrol	599	3	1
CABRIO (450)	0.6	01/00→01/00	M 160 E6AL B05	Petrol	599	3	3
CABRIO (450)	0.6	03/00→01/00	M 160.920	Petrol	599	3	4
CABRIO (450)	0.7	01/00→01/00	M 160.910	Petrol	698	3	5
CABRIO (450)	0.8	03/00→01/00	OM 660 DE 8LA	Diesel	799	3	6
CABRIO (450)	0.8	03/00→01/00	OM 660.940	Diesel	799	3	7
CITY-COUPÉ (450)	0.6	07/99→01/00	M 160 E6AL B03	Petrol	599	3	1
CITY-COUPÉ (450)	0.6	07/99→01/00	M 160 E6AL B04	Petrol	599	3	2
CITY-COUPÉ (450)	0.6	01/00→01/00	M 160 E6AL B05	Petrol	599	3	3
CITY-COUPÉ (450)	0.6	07/99→01/00	M 160.920	Petrol	599	3	4
CITY-COUPÉ (450)	0.7	01/00→01/00	M 160.910	Petrol	698	3	5
CITY-COUPÉ (450)	0.8	11/99→01/00	OM 660 DE 8LA	Diesel	799	3	6
CITY-COUPÉ (450)	0.8	11/99→01/00	OM 660.940	Diesel	799	3	7
CROSSBLADE (450)	0.6	06/00→12/00	M 160.920	Petrol	599	3	4
FORFOUR (454)	1.1	01/00→06/00	M 134.910	Petrol	1124	3	11
FORFOUR (454)	1.1	02/00→06/00	M 134.911	Petrol	1124	3	12
FORFOUR (454)	1.3	01/00→06/00	M 135.930	Petrol	1332	4	13
FORFOUR (454)	1.5	01/00→06/00	M 135.950	Petrol	1499	4	14
FORTWO Cabrio (450)	0.7	01/00→01/00	M 160.910	Petrol	698	3	5
FORTWO Cabrio (450)	0.8	01/00→01/00	OM 660 DE 8LA	Diesel	799	3	6
FORTWO Cabrio (450)	0.8	01/00→01/00	OM 660.940	Diesel	799	3	7
FORTWO Cabrio (451)	0.8	01/00→	OM 660.950	Diesel	799	3	8
FORTWO Cabrio (451)	1.0	01/00→	M 132.910	Petrol	999	3	9
FORTWO Cabrio (451)	1.0	01/00→	M 132.930	Petrol	999	3	10
FORTWO Coupe (450)	0.7	01/00→01/00	M 160.910	Petrol	698	3	5
FORTWO Coupe (450)	0.8	01/00→01/00	OM 660 DE 8LA	Diesel	799	3	6
FORTWO Coupe (450)	0.8	01/00→01/00	OM 660.940	Diesel	799	3	7
FORTWO Coupe (451)	0.8	01/00→	OM 660.950	Diesel	799	3	8
FORTWO Coupe (451)	1.0	01/00→	M 132.910	Petrol	999	3	9
FORTWO Coupe (451)	1.0	01/00→	M 132.930	Petrol	999	3	10



cc



kW/PS

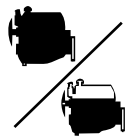

Model	Year Range	CC	Cyl	Power (kW/PS)	Configuration	Code	AC5660 (MLS)	CC5661 [13]	EC5660
0.6 M 160 E6AL B03 1									
Cabrio 0.6	03/00→01/04	599	3	63.50	SOHC/OHC	40/55			
City-Coupe 0.6	07/98→01/04								
0.6 M 160 E6AL B04 2									
City-Coupe 0.6	07/98→01/04	599	3	63.50	SOHC/OHC	33/45	AC5660 (MLS)	CC5661 [13]	EC5660
0.6 M 160 E6AL B05 3									
Cabrio 0.6	01/01→01/04	599	3	63.50	SOHC/OHC	45/61	AC5660 (MLS)	CC5661 [13]	EC5660
City-Coupe 0.6	01/01→01/04								
0.6 M 160.920 4									
Cabrio 0.6	03/00→01/04	599	3	63.50		33-55/	AC5660 (MLS)	CC5661 [13]	EC5660
City-Coupe 0.6	07/98→01/04					45-75			
Crossblade 0.6	06/02→12/03								
0.7 M 160.910 5									
Cabrio 0.7	01/03→01/04	698	3	66.50	SOHC/OHC	33-55/	AG8990 (MLS)		
City-Coupe 0.7	01/03→01/04					45-75			
Fortwo 0.7	01/04→01/07								
0.8 OM 660 DE 8LA Diesel 6									
Cabrio 0.8 CDI	03/01→01/04	799	3	65.50	SOHC/OHC	30/41	AC5670 (MLS)	CC5670	EC5670
City-Coupe CDI	11/99→01/04								
Fortwo 0.8 CDI	01/04→01/07								
0.8 OM 660.940 Diesel 7									
Cabrio 0.8 CDI	03/01→01/04	799	3	65.50	SOHC/OHC	30/41	AC5070 (Fibre), 1.350mm, 2 Notches →+0.653mm	CC5670	EC5670
City-Coupe CDI	11/99→01/04								
Fortwo 0.8 CDI	01/04→01/07								
0.8 OM 660.950 Diesel 8									
Fortwo 0.8 CDI	01/07→	799	3	65.50		33/45	AC5670 (MLS)	CC5670	EC5670
1.0 M 132.910 9									
Fortwo 1.0	01/07→	999	3	72.00	DOHC	45-52/ 61-71	AH6000 (MLS)		
1.0 M 132.930 10									
Fortwo 1.0T	01/07→	999	3	72.00	DOHC	62-75/ 84-102	AH6000 (MLS)		
Fortwo Brabus	01/08→								
1.1 M 134.910 11									
Forfour 1.1	01/04→06/06	1124	3	75.00	DOHC	55/75	AH7130 (MLS)		
1.1 M 134.911 12									
Forfour 1.1	02/05→06/06	1124	3	75.00	DOHC	47/64	AH7130 (MLS)		
1.3 M 135.930 13									
Forfour 1.3	01/04→06/06	1332	4	75.00	DOHC	70/95	AG9920 (MLS)		
1.5 M 135.950 14									
Forfour 1.5	01/04→06/06	1499	4	75.00	DOHC	80-90/ 109-122	AG9920 (MLS)		

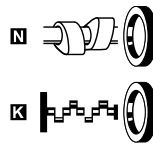
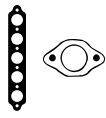

AC5070

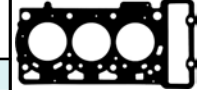

AC5660



AC5670



JM5162



JD5205

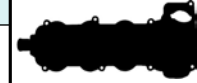

JD5206

HBS349 [5] M9x1.25x145.00mm (x8)	HA5034 [1] [5] JD5205 [5]	HR397 [5]		HL5002 [5]	NA5118 [1] [2] 80.00x100.00x9.00mm, PTFE	
HBS349 [5] M9x1.25x145.00mm (x8)	HA5034 [1] [5] JD5205 [5]			HL5002 [5]	NA5118 [1] [2] 80.00x100.00x9.00mm, PTFE	
HBS349 [5] M9x1.25x145.00mm (x8)	HA5034 [1] [5] JD5205 [5]			HL5002 [5]	NA5118 [1] [2] 80.00x100.00x9.00mm, PTFE	
HBS349 [5] M9x1.25x145.00mm (x8)	HA5034 [1] [5] JD5205 [5]			HL5002 [5]	NA5118 [1] [2] 80.00x100.00x9.00mm, PTFE	
HBS349 [5] M9x1.25x145.00mm (x8)	HA5034 [1] [5] JD5205 [5]				NA5109 [2] 40.00x62.00x8.00mm, PTFE NA5118 [1] [2] 80.00x100.00x9.00mm, PTFE	
HBS460 [22] M10x1.50x154.00mm (x8)	JD5823 [1] (Elastomer) JD5206 [5]	JM5162 (SE)			NA5118 [1] [2] 80.00x100.00x9.00mm, PTFE	
HBS460 [22] M10x1.50x154.00mm (x8)	JD5823 [1] (Elastomer) JD5206 [5]	JM5162 (SE)			NA5118 [1] [2] 80.00x100.00x9.00mm, PTFE	
HBS460 [22] M10x1.50x154.00mm (x8)	JD5823 [1] (Elastomer)	JM5162 (SE)			NA5118 [1] [2] 80.00x100.00x9.00mm, PTFE	
	JD6031 [1] (x4) (Elastomer)					
	JD6031 [1] (x4) (Elastomer)					
HBS537 [5] [21]	JD6031 [1] (x4) (Elastomer) JD5905 [5] (MLS)	JM7124 (ACM)	HR397	HR5048 [5]		
HBS537 [5] [21]	JD6031 [1] (x4) (Elastomer) JD5905 [5] (MLS)	JM7124 (ACM)	HR397	HR5048 [5]		



Ltr



CC



9

	Ltr				CC		
ACTYON I	2.3	11/00→	G23D	Petrol	2295	4	3
CHAIRMAN (HT_)	2.3	07/99→	M 111.970	Petrol	2295	4	4
CHAIRMAN (HT_)	2.3	07/99→	M 111.974	Petrol	2295	4	5
CHAIRMAN (HT_)	2.8	07/99→	M 104.942	Petrol	2799	6	8
CHAIRMAN (HT_)	2.8	08/99→	M 104.945	Petrol	2799	6	9
CHAIRMAN (HT_)	3.2	07/99→	M 104.992	Petrol	3199	6	14
ISTANA Box	2.9	10/99→05/99	OM 602.940	Diesel	2874	5	11
ISTANA Box	2.9	06/99→	OM 602.980	Diesel	2874	5	12
ISTANA Bus	2.9	10/99→05/99	OM 602.940	Diesel	2874	5	11
ISTANA Bus	2.9	06/99→	OM 602.980	Diesel	2874	5	12
KORANDO (K4)	2.2	12/98→12/99	DC23	Diesel	2238	4	2
KORANDO (KJ)	2.3	05/99→	M 111.970	Petrol	2295	4	4
KORANDO (KJ)	2.3	12/99→	OM 601.940	Diesel	2299	4	7
KORANDO (KJ)	2.9	12/99→	MB-OM 662	Diesel	2874	5	10
KORANDO (KJ)	3.2	06/99→	M 104.992	Petrol	3199	6	14
KORANDO (KJ)	3.2	12/99→	M 104.995	Petrol	3199	6	15
KORANDO Cabrio (KJ)	2.9	11/99→	MB-OM 662	Diesel	2874	5	10
KORANDO Cabrio (KJ)	3.2	06/99→	M 104.992	Petrol	3199	6	14
KORANDO Cabrio (KJ)	3.2	01/99→	M 104.995	Petrol	3199	6	15
KYRON	3.2	03/00→	G32D	Petrol	3199	6	13
MUSSO (FJ)	2.0	10/99→	E20	Petrol	1998	4	1
MUSSO (FJ)	2.3	10/99→	M 111.970	Petrol	2295	4	4
MUSSO (FJ)	2.3	10/99→	MB-OM 661	Diesel	2299	4	6
MUSSO (FJ)	2.3	10/99→	OM 601.940	Diesel	2299	4	7
MUSSO (FJ)	2.9	03/99→	MB-OM 662	Diesel	2874	5	10
MUSSO (FJ)	3.2	06/99→	M 104.992	Petrol	3199	6	14
REXTON (GAB_)	2.3	05/00→	G23D	Petrol	2295	4	3
REXTON (GAB_)	3.2	04/00→	G32D	Petrol	3199	6	13
RODIUS	3.2	05/00→	G32D	Petrol	3199	6	13



cc



kW/PS



2.0		E20					1	BZ880 (Fibre)	DZ881 ☒○ [13]	
Musso 2.0	10/96→	1998	4			93/126				
2.2		DC23 Diesel					2	BM370 (Fibre)	DM370 ○ [3]	GM372 [13]
Korando 2.2 D	12/88→12/96	2238	4	88.00	SOHC/OHC	50/68				
2.3		G23D					3	BZ900 (Fibre)	DZ900 ○ [13]	EV810
Actyon 2.3	11/06→	2295	4	90.90	DOHC	110/150				
Actyon 2.3 4x4	11/06→									
Rexton RX230	05/02→									
2.3		M 111.970					4	BZ900 (Fibre)	DZ900 ○ [13]	
Chairman 2.3	07/97→	2295	4	90.90	DOHC	103-110/ 140-150				
Korando 2.3	05/97→									
Musso 2.3 4x4	10/96→									
2.3		M 111.974					5	BZ900 (Fibre)	DZ900 ○ [13]	EV810
Chairman 2.3	07/97→	2295	4	90.90	DOHC	110/150				
2.3		MB-OM 661 Diesel					6	BW370 (Fibre)	DW373 [13]	
Musso 2.3 D 4x4	10/95→	2299	4			59/80				
2.3		OM 601.940 Diesel					7	BW370 (Fibre)	DW370 ☒○ [13] DW372 [13] DW373 [13]	EM720
Korando 2.3 D	12/96→	2299	4	89.00	SOHC/OHC	57-59/ 77-80				
Musso 2.3 D 4x4	10/95→									
2.8		M 104.942					8	AE5330 (Fibre), 1.240mm	CE5330 ○ [3]	
Chairman 2.8	07/97→	2799	6	89.90	DOHC	142-145/ 193-197				
2.8		M 104.945					9	AE5330 (Fibre), 1.240mm	CE5330 ○ [3]	
Chairman 2.8	08/99→	2799	6	89.90	DOHC	142/193				

HBS150 [19] M12x1.75x102.00mm (x10)	JD161 [E]	HM5057 [E]	JJ499					AE5330 	JN572
	JC643 	JN408 [4]	JJ192		NJ267 [2] 42.00x55.00x9.00mm, NBR NJ014 [2] 50.00x68.00x9.00mm, NBR NJ265 [1] 82.00x105.00x13.00mm, MVQ			BM370 	JN619
HBS150 [19] M12x1.75x102.00mm (x10)	JD160 [I] JD161 [E]	HM5057 [E]	JJ498		NB974 [1] 93.00x114.00x13.00mm, FPM NA5074 [1] 93.00x133.50x15.50mm, PTFE			BW370 	JN911
HBS150 [19] M12x1.75x102.00mm (x10)	JD5226 [I] (x2) JD161 [E]	JN911 [4]	JJ499	HR5055 [E]	NB973 [2] 45.00x67.00x8.00mm, FPM NB974 [1] 93.00x114.00x13.00mm, FPM			BZ880 	JH5082
HBS150 [19] M12x1.75x102.00mm (x10)	JD5226 [I] (x2) JD161 [E]	JN911 [4] HM5057 [E]	JJ499	HR5055 [E]	NB973 [2] 45.00x67.00x8.00mm, FPM NB974 [1] 93.00x114.00x13.00mm, FPM NA5074 [1] 93.00x133.50x15.50mm, PTFE			BZ900 	JJ192
HBS058 [22] M10x1.50x115.00mm (x5)	JD158 [I] JD159 [E]		JJ499		NA5131 [2] 45.00x67.00x8.00mm, PTFE NB974 [1] 93.00x114.00x13.00mm, FPM			JC643 	JJ192
	JD158 [I] JD159 [E]	JN572 [4] JN619 [4]	JH5082 (Steel) JJ498	HR757 [E]	NA5131 [2] 45.00x67.00x8.00mm, PTFE NB974 [1] 93.00x114.00x13.00mm, FPM		KK5683 [109]	JD158 	JJ498
HBS152 [19] M12x1.75x160.00mm (x14)	JD167 [I] (x6) JD169 [E] (x2)	JM5114 (Elastomer)	JJ500	HR5055 [E]	NB971 [2] 45.00x67.00x10.00mm, FPM NB972 [1] 93.00x117.00x12.00mm, FPM NB975 [2] 45.00x74.50x12.00mm, FPM NB974 [1] 93.00x114.00x13.00mm, FPM NA5266 [1] 93.00x114.00x14.00mm, FPM NA5074 [1] 93.00x133.50x15.50mm, PTFE			JD160 	JJ499
HBS152 [19] M12x1.75x160.00mm (x14)	JD167 [I] (x6) JD169 [E] (x2)	JM5114 (Elastomer)	JJ500	HR5055 [E]	NB971 [2] 45.00x67.00x10.00mm, FPM NB972 [1] 93.00x117.00x12.00mm, FPM NB975 [2] 45.00x74.50x12.00mm, FPM NB974 [1] 93.00x114.00x13.00mm, FPM NA5266 [1] 93.00x114.00x14.00mm, FPM NA5074 [1] 93.00x133.50x15.50mm, PTFE			JD161 	JJ500
								JD167 	
								JD169 	
								JD5226 	
								JM5114 	
								JN408 	



cc



kW/PS

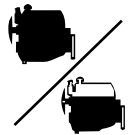

2.9		MB-OM 662 Diesel					10	BW380 (Fibre), 1.800mm	DW380 ☒○ DW381 ☒○ [13]	EN720 [3]
Korando 2.9 D	12/96→10/00	2874	5				72-73/ 98-99			
Musso 2.9 D	03/96→									
2.9		OM 602.940 Diesel					11	BW380 (Fibre), 1.800mm	DW380 ☒○	EN720 [3]
Istina 2.9 D	10/92→05/95	2874	5	89.00	SOHC/OHC		70/95			
Istina 2.9 TD	10/92→05/95									
2.9		OM 602.980 Diesel					12	BW380 (Fibre), 1.800mm	DW381 ☒○ [13]	EN720 [3]
Istina 2.9 D	06/95→	2874	5	89.00	SOHC/OHC		75-90/ 102-122			
3.2		G32D					13	AE5330 (Fibre), 1.240mm	CE5330 ○ [3] →04/06	
Kyron 3.2 M320	03/08→	3199	6	89.90	DOHC		162/220			
Rexton 3.2	04/02→									
Rodius 3.2	05/05→									
Rodius 3.2 4WD	07/07→									
3.2		M 104.992					14	AE5330 (Fibre), 1.240mm	CE5330 ○ [3]	
Chairman 3.2	07/97→	3199	6	89.90	DOHC		162/220			
Korando 3.2	06/97→									
Musso 3.2	06/96→									
3.2		M 104.995					15	AE5330 (Fibre), 1.240mm	CE5330 ○ [3]	
Korando 3.2	12/96→	3199	6	89.90	DOHC		154-156/ 209-212			

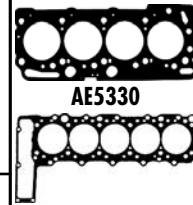

AE5330

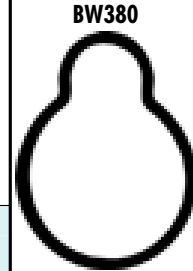

BW380

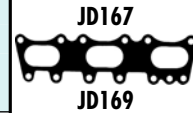

JD167

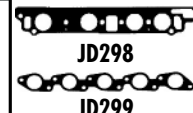

JD169

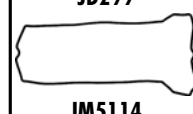

JD298



JD299

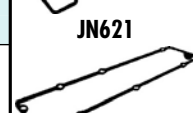

JM5114

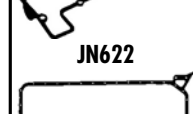

JN621

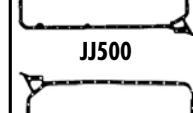

JN622

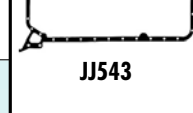

JJ500



JJ543



Ltr







CC



9

Model	Ltr	Year Range	Engine	Fuel	CC	Gear	9
FORESTER (SF)	2.0	08/99→09/00	EJ20	Petrol	1994	4	17
FORESTER (SF)	2.0	04/00→09/00	EJ205	Petrol	1994	4	21
FORESTER (SG)	2.0	09/00→	EJ20	Petrol	1994	4	17
FORESTER (SG)	2.5	11/00→	EJ25	Petrol	2457	4	28
FORESTER (SH)	2.0	01/00→	EJ20	Petrol	1994	4	17
FORESTER (SH)	2.5	01/00→	EJ25	Petrol	2457	4	28
IMPREZA Coupe (GFC)	1.6	12/99→12/00	EJ16I	Petrol	1597	4	10
IMPREZA Coupe (GFC)	1.6	12/99→12/00	EJ16E	Petrol	1597	4	11
IMPREZA Coupe (GFC)	2.0	12/99→12/00	EJ20	Petrol	1994	4	17
IMPREZA Coupe (GFC)	2.0	09/99→09/00	EJ20I	Petrol	1994	4	20
IMPREZA Coupe (GFC)	2.0	09/99→09/00	EJ205P	Petrol	1994	4	22
IMPREZA Coupe (GFC)	2.0	11/99→09/00	EJ20E	Petrol	1994	4	23
IMPREZA Coupe (GFC)	2.0	12/99→12/00	EJ20G	Petrol	1994	4	24
IMPREZA Estate (GD, GG)	2.0	12/00→	EJ20	Petrol	1994	4	17
IMPREZA Estate (GD, GG)	2.0	12/00→	EJ205	Petrol	1994	4	21
IMPREZA Estate (GF)	1.6	06/99→12/00	EJ16I	Petrol	1597	4	10
IMPREZA Estate (GF)	1.6	01/99→08/99	EJ16E	Petrol	1597	4	11
IMPREZA Estate (GF)	1.8	08/99→12/00	EJ18	Petrol	1820	4	14
IMPREZA Estate (GF)	1.8	11/99→06/99	EJ18E	Petrol	1820	4	16
IMPREZA Estate (GF)	2.0	12/99→12/00	EJ20	Petrol	1994	4	17
IMPREZA Estate (GF)	2.0	03/99→12/00	EJ20 (Turbo)	Petrol	1994	4	18
IMPREZA Estate (GF)	2.0	09/99→09/00	EJ20I	Petrol	1994	4	20
IMPREZA Estate (GF)	2.0	06/99→12/00	EJ205	Petrol	1994	4	21
IMPREZA Estate (GF)	2.0	09/99→08/99	EJ20E	Petrol	1994	4	23
IMPREZA Estate (GF)	2.2	11/99→08/99	EJ22	Petrol	2212	4	26
IMPREZA Hatchback	2.0	12/00→12/00	EJ20I	Petrol	1994	4	20
IMPREZA Hatchback	2.0	12/00→09/00	EJ205	Petrol	1994	4	21
IMPREZA Hatchback	2.5	12/00→09/00	EJ25	Petrol	2457	4	28
IMPREZA Saloon (GC)	1.6	06/99→12/00	EJ16I	Petrol	1597	4	10
IMPREZA Saloon (GC)	1.8	08/99→12/00	EJ18	Petrol	1820	4	14
IMPREZA Saloon (GC)	1.8	08/99→12/00	EJ18E	Petrol	1820	4	16
IMPREZA Saloon (GC)	2.0	10/99→12/00	EJ20	Petrol	1994	4	17
IMPREZA Saloon (GC)	2.0	03/99→12/00	EJ20 (Turbo)	Petrol	1994	4	18
IMPREZA Saloon (GC)	2.0	09/99→09/00	EJ20I	Petrol	1994	4	20
IMPREZA Saloon (GC)	2.0	06/99→12/00	EJ205	Petrol	1994	4	21
IMPREZA Saloon (GC)	2.0	09/99→09/00	EJ205P	Petrol	1994	4	22
IMPREZA Saloon (GC)	2.0	07/99→08/99	EJ20E	Petrol	1994	4	23
IMPREZA Saloon (GC)	2.2	11/99→08/99	EJ22	Petrol	2212	4	26
IMPREZA Saloon (GD, GG)	2.0	12/00→	EJ20	Petrol	1994	4	17
IMPREZA Saloon (GD, GG)	2.0	12/00→	EJ205	Petrol	1994	4	21
IMPREZA Saloon (GD, GG)	2.0	10/00→	EJ205P	Petrol	1994	4	22
IMPREZA Saloon (GD, GG)	2.5	03/00→09/00	EJ25I	Petrol	2457	4	29
JUSTY I (KAD)	1.0	11/98→10/99	EF10	Petrol	998	3	6
JUSTY I (KAD)	1.2	10/98→10/99	EF12	Petrol	1189	3	7
JUSTY II (JMA, MS)	1.3	04/00→11/00	G13BB	Petrol	1298	4	8
JUSTY IV	1.0	01/00→	1KR-FE	Petrol	998	3	5
LEGACY I (BC)	1.8	01/98→12/99	EJ18 SPI	Petrol	1820	4	15
LEGACY I (BC)	2.0	08/99→07/99	EJ20 EMPI	Petrol	1994	4	19
LEGACY I (BC)	2.0	08/99→12/99	EJ20E	Petrol	1994	4	23
LEGACY I (BC)	2.0	05/99→07/99	EJ20-GN	Petrol	1994	4	25
LEGACY I (BC)	2.2	01/98→07/99	EJ22 EMPI	Petrol	2212	4	27
LEGACY I Estate (BC, BJF)	1.8	01/98→07/99	EJ18 SPI	Petrol	1820	4	15
LEGACY I Estate (BC, BJF)	2.0	09/99→07/99	EJ20 EMPI	Petrol	1994	4	19
LEGACY I Estate (BC, BJF)	2.0	05/99→07/99	EJ20-GN	Petrol	1994	4	25
LEGACY I Estate (BC, BJF)	2.2	01/98→07/99	EJ22 EMPI	Petrol	2212	4	27
LEGACY II (BD, BG)	1.8	05/99→09/99	EJ18E	Petrol	1820	4	16
LEGACY II (BD, BG)	2.0	09/99→03/99	EJ20	Petrol	1994	4	17
LEGACY II (BD, BG)	2.0	09/99→03/99	EJ20E	Petrol	1994	4	23
LEGACY II (BD, BG)	2.2	07/99→11/99	EJ22	Petrol	2212	4	26
LEGACY II (BD, BG)	2.2	09/99→03/99	EJ22 EMPI	Petrol	2212	4	27
LEGACY II Estate (BD, BG)	2.0	09/99→11/99	EJ20	Petrol	1994	4	17
LEGACY II Estate (BD, BG)	2.0	09/99→11/99	EJ20 EMPI	Petrol	1994	4	19
LEGACY II Estate (BD, BG)	2.2	02/99→12/99	EJ22 EMPI	Petrol	2212	4	27
LEGACY III (BE, BH)	2.0	04/99→08/00	EJ20	Petrol	1994	4	17
LEGACY III (BE, BH)	2.0	06/00→08/00	EJ205P	Petrol	1994	4	22
LEGACY III (BE, BH)	2.5	10/99→08/00	EJ25	Petrol	2457	4	28
LEGACY III (BE, BH)	3.0	08/00→08/00	EZ30	Petrol	3000	6	30
LEGACY III Estate (BE, BH)	2.0	12/99→08/00	EJ20	Petrol	1994	4	17
LEGACY III Estate (BE, BH)	2.0	06/00→08/00	EJ205P	Petrol	1994	4	22
LEGACY III Estate (BE, BH)	2.5	12/99→08/00	EJ25	Petrol	2457	4	28

	Ltr				CC		9
LEGACY III Estate (BE, BH)	3.0	08/00 → 08/00	EZ30	Petrol	3000	6	30
LEGACY IV Estate (B13_)	2.0	09/00 →	EJ20	Petrol	1994	4	17
LEGACY IV Estate (B13_)	2.5	09/00 →	EJ25	Petrol	2457	4	28
LEGACY IV Estate (B13_)	3.0	09/00 →	EZ30	Petrol	3000	6	30
LEGACY IV	2.0	09/00 →	EJ20	Petrol	1994	4	17
LEGACY IV	2.5	09/00 →	EJ25	Petrol	2457	4	28
LEGACY IV	3.0	09/00 →	EZ30	Petrol	3000	6	30
LEONE Hatchback	1.8	01/98 → 12/98	EA82	Petrol	1781	4	13
LEONE II Estate	1.8	11/98 → 02/99	EA82	Petrol	1781	4	13
LEONE II	1.8	08/98 → 07/98	EA81	Petrol	1781	4	12
LEONE II	1.8	11/98 → 09/99	EA82	Petrol	1781	4	13
LIBERO Bus (E10, E12)	1.2	08/98 → 02/00	EF12	Petrol	1189	3	7
OUTBACK (BE, BH)	2.5	10/00 → 08/00	EJ25	Petrol	2457	4	28
OUTBACK (BE, BH)	3.0	10/00 → 08/00	EZ30	Petrol	3000	6	30
OUTBACK (BL, BP)	2.0	09/00 → 10/00	EJ20	Petrol	1994	4	17
OUTBACK (BL, BP)	2.5	09/00 → 09/00	EJ251	Petrol	2457	4	29
OUTBACK (BL, BP)	3.0	11/00 → 09/00	EZ30	Petrol	3000	6	30
REX II	0.5	06/98 → 06/98	EK23 6V	Petrol	544	2	1
REX II	0.5	08/98 → 06/98	EK23 Super Charger	Petrol	544	2	2
REX II	0.7	08/98 → 06/98	EK42	Petrol	665	2	3
REX III	0.7	07/99 → 03/99	EN07E	Petrol	658	4	4
SVX (CX)	3.3	09/99 → 12/99	EG33 DOHC	Petrol	3319	6	31
TREZIA	1.4	03/01 →	1ND-TV	Diesel	1364	4	9
TRIBECA (B9)	3.0	01/00 →	EZ30	Petrol	3000	6	30
VIVIO	0.7	03/99 → 12/99	EN07E	Petrol	658	4	4
XT Coupe (XT)	1.8	11/98 → 12/99	EA82	Petrol	1781	4	13



cc



kW/PS



0.5	EK23 6V	1	BL280 (Graphite)	DL280 [3]	
REX II 550	06/87→06/89	544	2		26/35
REX II 550 4WD	06/87→06/89				
0.5	EK23 Super Charger	2	BL280 (Graphite)	DL280 [3]	
REX II 550 Komp	08/88→06/89	544	2		40/54
0.7	EK42	3	BL280 (Graphite)	DL280 [3]	
Rex II 700	08/82→06/89	665	2	78.00	SOHC/OHC 27/37
0.7	EN07E	4	AG7980 (Graphite)	CG7980	FG7980
Rex III 0.7	07/90→03/92	658	4	56.00	SOHC/OHC 32-35/ 44-48
Rex III 0.7 4WD	07/90→03/92				
Vivio 0.7	08/92→12/98				
Vivio 660 4WD	03/92→10/95				
1.0	1KR-FE	5	AG9310 (MLS)	CG9310	EG9310
Justy IV 1.0	01/07→	998	3	71.00	DOHC 50-51/ 68-70
1.0	EF10	6	BP730 (Graphite)	DP730 [3]	GP730 GP731 [3]
Justy 1000	11/84→10/95	998	3	78.00	SOHC/OHC 37-41/ 50-56
1.2	EF12	7	BR560 (Graphite)	DR560 [3]	GR561 [3]
Justy 1200	10/86→10/95	1189	3	78.00	SOHC/OHC 38-55/ 52-75
Libero 1.2 4WD	08/86→02/00				
Libero 1.2i 4WD	08/91→02/00				
1.3	G13BB	8	BN480 (Graphite)	CG5480	
Justy II 1.3 4x	04/01→11/03	1298	4	74.00	SOHC/OHC 62-63/ 84-86
1.4	1ND-TV Diesel	9	AG7600 (MLS), 0.850mm AG7610 (MLS), 0.900mm AG7620 (MLS), 0.950mm	CG7600 ▲	FG7600 ▲
Trezza 1.4 D	03/11→	1364	4	73.00	SOHC/OHC 55-66/ 75-90
1.6	EJ161	10	AG5590 (MLS) (x2)	CG5590	FG5590
Impreza 1.6	09/98→09/00	1597	4	87.90	SOHC/OHC, BOXER 66-70/ 90-95
Impreza 1.6 4WD	12/96→12/00				
Impreza 1.6 i	06/98→12/00				
Impreza 1.6iT	06/98→12/00				
1.6	EJ16E	11	AG5280 (Fibre), 1.600mm (x2)		EG5280
Impreza 1.6	01/93→12/00	1597	4	87.90	SOHC/OHC, BOXER 66/90
1.8	EA81	12	BG740 (Graphite) (x2)	DG740 [13]	GG740 [3]
Leone II 1.8 GL	08/86→07/89	1781	4	92.00	SOHC/OHC, BOXER 59-60/ 80-82
1.8	EA82	13	BN550 (Graphite) (x2)	DN551 [3]	GN551
Leone 1800 4WD	01/85→12/89	1781	4	92.00	SOHC/OHC, BOXER 66-100/ 90-136
Leone II 1800	11/84→02/92				
Leone II 1800T	11/84→12/90				
XT Coupe 1.8T	11/85→07/90				
XT Coupe T 4WD	11/84→12/90				
1.8	EJ18	14	AG5280 (Fibre), 1.600mm (x2)		EG5280
Impreza 1.8iT	08/92→12/00	1820	4	87.90	SOHC/OHC 76/103
1.8	EJ18 SPI	15	AG5280 (Fibre), 1.600mm (x2)		EG5280
Legacy I 1800	01/89→07/94	1820	4		76/103
1.8	EJ18E	16	AG5280 (Fibre), 1.600mm (x2)		EG5280
Impreza 1.8 i	11/95→06/96	1820	4	87.90	SOHC/OHC 76/103
Impreza 1.8iT	08/92→12/00				
Legacy 2 1.8	05/96→09/98				

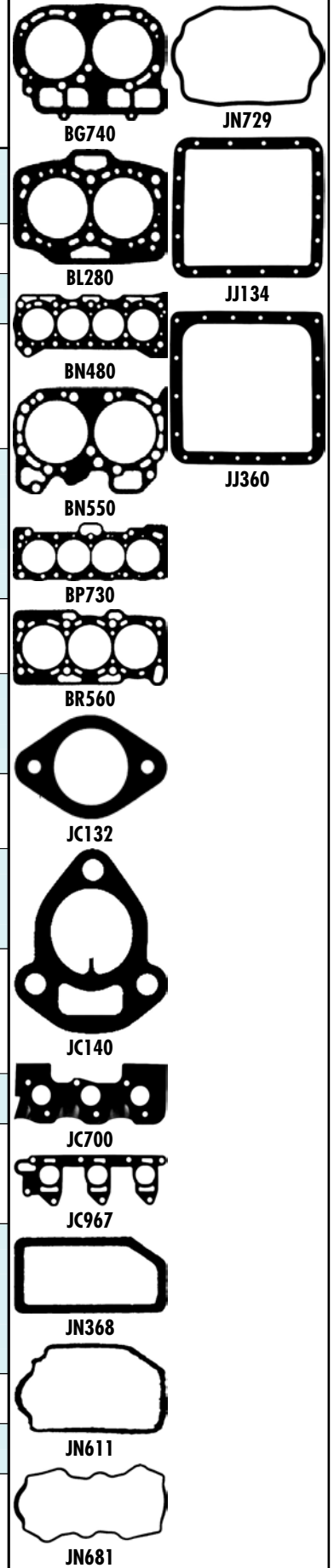

		JN729 [4]			NJ376 [1] 57.00x77.00x10.00mm, MVQ	
	JD5300 (MLS)	HM5257				
HBS508 [22]	JD5845 (NBR) JD5846 (MLS) JD5863 (SE)	JM7042 (ACM)	HR397		NA5260 [2] 38.00x50.00x6.00mm, FPM NA5260 [2] 38.00x50.00x6.00mm, FPM	
					NK243 [1] 68.00x84.00x8.50mm, FPM	
	JC967 JC700		JJ389	PA655 PA656	NK243 [1] 68.00x84.00x8.50mm, FPM	
	JD5770 JD5769	JN886 [4]	HR397	HR5075	NJ336 [2] 32.00x47.00x8.00mm, NBR	
HBS490 [19] M12x1.75x180.00mm (x10)	JD5959 (MLS)	JM5288	HR397		NA5260 [2] 38.00x50.00x6.00mm, FPM NA5260 [2] 38.00x50.00x6.00mm, FPM	
HBS405 [5] M11x1.25x169.00mm (x12) 01/98→					NA5226 [2] 33.0x49.0x8.0mm, FPM	
HBS218 [5] M11x1.25x190.00mm (x12)			JH5101		NA5226 [2] 33.0x49.0x8.0mm, FPM	
	JC140 (x2) JC132 (x2)	JN368 (x2)[4]	JJ134	KJ462 (x4)	NJ341 [2] 38.00x59.00x9.00mm, NBR NJ343 [1] 76.00x93.00x10.00mm, MVQ	
	JC140	JN681 [4] JN611 [4] HL478	JJ360			
HBS218 [5] M11x1.25x190.00mm (x12)			HR397 JH5101			
HBS218 [5] M11x1.25x190.00mm (x12)			HR397 JH5101			
HBS218 [5] M11x1.25x190.00mm (x12)			HR397 JH5101		NA5226 [2] 33.0x49.0x8.0mm, FPM	

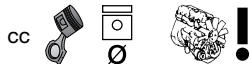

kW/PS

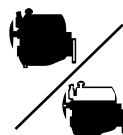

2.0	EJ20	17	AG5290 (Fibre), 1.600mm	CG5450					
Forester 2.0	08/97→09/02	1994	4	92.00	DOHC, BOXER	85-130/ 115-177			
Forester 2.0 ST	06/98→04/01								
Impreza 2.0	12/00→								
Impreza 2.0 16V	06/98→12/00								
Impreza 2.0 4WD	12/95→12/00								
Impreza 2.0 i R	09/05→								
Impreza 2.0iT	10/95→12/00								
Impreza 2.0T	12/95→12/00								
Legacy 2 2.0 i	09/94→03/99								
Legacy 3 2.0	12/98→08/03								
Legacy IV 2.0	09/03→								
Outback 2.0	09/03→10/05								
2.0	EJ20 (Turbo)	18	AG5290 (Fibre), 1.600mm	CG5450					
Impreza 2.0 GTT	03/94→12/00	1994	4	92.00	DOHC, BOXER	155-180/ 211-245			
Impreza 2.0 iTT	03/94→12/00								
2.0	EJ20 EMPI	19	AG5290 (Fibre), 1.600mm	CG5450					
Legacy 2 2.0 i	09/94→11/98	1994	4	92.00	DOHC, BOXER	85/116			
Legacy I 2000	08/91→07/94								
2.0	EJ201	20	AG5580 (MLS)	CG5580					
Impreza 2.0	09/98→09/00	1994	4	92.00	SOHC/OHC, BOXER	92/125			
Impreza 2.0 i	09/98→09/00								
Impreza 2.0i	12/02→12/07								
2.0	EJ205	21	AG5580 (MLS)	CG5581 →02/02 CG5582 03/02→	FG5581				
Forester 2.0 ST	04/01→09/02	1994	4	92.00	DOHC, BOXER	125-169/ 170-230			
Impreza 2.0 GTT	06/98→12/00								
Impreza 2.0i	12/01→09/05								
Impreza 2.0T	12/00→								
Impreza WRX	12/02→09/05								
Impreza WRXT	12/00→								
2.0	EJ205P	22	AG5580 (MLS)	CG5581 CG5582	FG5581				
Impreza 2.0 AWD	09/98→09/00	1994	4	92.00	DOHC, BOXER	206/280			
Legacy 3 2.0	06/02→08/03								
2.0	EJ20E	23	AG5290 (Fibre), 1.600mm	CG5450					
Impreza 2.0	09/96→08/98	1994	4	92.00	SOHC/OHC, BOXER	85-103/ 116-140			
Impreza 2.0 i	11/95→09/00								
Legacy 2 2.0 i	09/94→03/99								
Legacy I 2.0	08/91→12/93								
Legacy I 2.0 GL	08/91→12/93								
2.0	EJ20G	24	AG5210 (Fibre), 1.600mm	CG5440	EG5280				
Impreza 1833 LS	12/96→12/00	1994	4	92.00	DOHC, BOXER	147-155/ 200-211			
2.0	EJ20-GN	25	AG5210 (Fibre), 1.600mm	CG5440	EG5280				
Legacy I 2000 T	05/92→07/94	1994	4		DOHC	147/200			
2.2	EJ22	26	BV450 (Graphite) (x2)						
Impreza GX AWD	11/95→08/98	2212	4	96.90	SOHC/OHC, BOXER	94-100/ 128-136			
Legacy 2 2.2	07/94→11/98								
2.2	EJ22 EMPI	27	BV450 (Graphite) (x2)	DV450 [3]					
Legacy 2 2.2 i	02/94→03/99	2212	4	96.90	SOHC/OHC, BOXER	94-100/ 128-136			
Legacy I 2200	01/89→07/94								

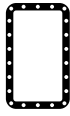
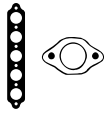

BV450

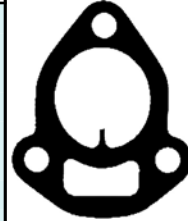

JC140



JD451

HBS405 [5] M11x1.25x169.00mm (x12) 01/95→			JH5101			
HBS405 [5] M11x1.25x169.00mm (x12)	JD5783 [E]	HM5232 [E][K] HM5231 [E][K]	JH5101			
HBS405 [5] M11x1.25x169.00mm (x12) 01/98→	JD5783 [E]	HM5232 [E][K] HM5231 [E][K]	JH5101			
					K NA5226 [F] [2] 33.0x49.0x8.0mm, FPM	
	JC140 [I] (x2) →02/02 JD451 [I] 03/02→ JD5783 [E] (x2)	HM5254 [E][K]			K NA5226 [F] [2] 33.0x49.0x8.0mm, FPM	
	JC140 [I] (x2) JD451 [I] JD5783 [E] (x2)	HM5254 [E][K]			K NA5226 [F] [2] 33.0x49.0x8.0mm, FPM	
HBS405 [5] M11x1.25x169.00mm (x12) 01/98→						
HBS405 [5] M11x1.25x169.00mm (x12)	JD5783 [E]	HM5234 [E][K] HM5233 [E][K]	JH5101		K NA5226 [F] [2] 33.0x49.0x8.0mm, FPM	
HBS405 [5] M11x1.25x169.00mm (x12)	JD5783 [E]	HM5256 [E][K] HM5255 [E][K]	JH5101		K NA5226 [F] [2] 33.0x49.0x8.0mm, FPM	
					K NA5226 [F] [2] 33.0x49.0x8.0mm, FPM	
HBS218 [5] M11x1.25x190.00mm (x12)	JD5783 [E]		JH5101			



cc



kW/PS



2.5		EJ25				28		AG6150 (MLS)	CG6150	
Forester 2.5	12/03→	2457	4	99.50	SOHC/OHC	112-155/ 152-211				
Forester 2.5 RX	11/02→08/05									
Impreza 2.5	12/02→09/05									
Legacy 3 2.5	10/98→08/03									
Legacy IV 2.5	09/03→									
Legacy IV 2.5 i	09/07→									
Outback 2.5	10/00→08/03									
2.5		EJ251				29		AG6150 (MLS)	CG6150	
Impreza 2.5 AWD	03/01→09/05	2457	4	99.50	SOHC/OHC, BOXER	110-130/ 150-177				
Impreza 2.5i	12/02→09/05									
Outback 2.5	09/08→09/09									
3.0		EZ30				30		AG5600 (MLS)	CG5600	FG5600
Legacy 3 3.0 H6	08/00→08/03	3000	6	89.20	DOHC, BOXER	154-184/ 209-250				
Legacy IV 3.0 R	09/03→									
Outback 3.0	11/03→09/09									
Outback 3.0 H6	10/00→08/03									
Tribeca 3.0	01/05→									
3.3		EG33 DOHC				31		AF5760 (Graphite) (x2)	CF5760	FF5760
SVX 3.3 i 24V	09/92→12/97	3319	6		DOHC, BOXER	162-169/ 220-230				

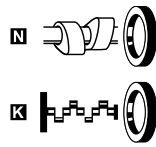
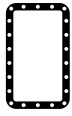
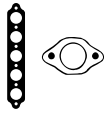

HBS405 [5]
M11x1.25x169.00mm (x12)

HR397

HBS405 [5]
M11x1.25x169.00mm (x12)

HR397

K NA5226 F [2]
33.0x49.0x8.0mm, FPM

HM5253 [K]
(ACM)
HM5252 [K]
(ACM)

K NA5226 F [2]
33.0x49.0x8.0mm, FPM



Ltr







CC



9

Model	Ltr	Year Range	Engine	Fuel	CC	Gears	9
ALTO II (EC)	0.8	01/98→11/99	F8B	Petrol	796	3	1
ALTO III (EF)	1.3	10/99→09/00	G13BB	Petrol	1298	4	15
ALTO III (EF)	1.6	10/99→09/00	G16B	Petrol	1590	4	24
ALTO V (GF)	1.0	01/00→	K10B	Petrol	996	3	5
APV (GD)	1.5	06/00→	G15A	Petrol	1493	4	18
BALENO (EG)	1.3	09/99→05/00	G13BA	Petrol	1298	4	14
BALENO (EG)	1.3	07/99→05/00	G13BB	Petrol	1298	4	15
BALENO (EG)	1.5	03/99→08/99	G15A	Petrol	1493	4	18
BALENO (EG)	1.6	07/99→05/00	G16B	Petrol	1590	4	24
BALENO (EG)	1.8	03/99→05/00	J18A	Petrol	1839	4	26
BALENO Estate (EG)	1.3	03/99→05/00	G13BB	Petrol	1298	4	15
BALENO Estate (EG)	1.6	08/99→05/00	G16B	Petrol	1590	4	24
BALENO Estate (EG)	1.8	08/99→05/00	J18A	Petrol	1839	4	26
BALENO Hatchback (EG)	1.3	09/99→05/00	G13BA	Petrol	1298	4	14
BALENO Hatchback (EG)	1.3	07/99→05/00	G13BB	Petrol	1298	4	15
BALENO Hatchback (EG)	1.6	07/99→05/00	G16B	Petrol	1590	4	24
BALENO Hatchback (EG)	1.8	03/99→05/00	J18A	Petrol	1839	4	26
CARRY Box (FD)	1.3	02/99→	G13BB	Petrol	1298	4	15
CARRY Pickup (FD)	1.5	03/01→	G15A	Petrol	1493	4	18
GRAND VITARA I (FT, GT)	1.3	03/99→07/00	M13A	Petrol	1328	4	16
GRAND VITARA I (FT, GT)	1.6	03/99→07/00	G16B	Petrol	1590	4	24
GRAND VITARA I (FT, GT)	2.0	03/99→08/00	J20A	Petrol	1995	4	32
GRAND VITARA I (FT, GT)	2.0	03/99→07/00	RF	Diesel	1998	4	33
GRAND VITARA I (FT, GT)	2.0	07/00→09/00	RHW	Diesel	1997	4	35
GRAND VITARA I (FT, GT)	2.0	07/00→09/00	RHZ	Diesel	1997	4	36
GRAND VITARA I (FT, GT)	2.5	04/99→07/00	H 25 A	Petrol	2493	6	37
GRAND VITARA I (FT, GT)	2.7	06/00→08/00	H 27 A	Petrol	2736	6	38
GRAND VITARA II (JT)	1.3	05/00→07/00	G13BB	Petrol	1298	4	15
GRAND VITARA II (JT)	1.3	08/00→	M13A	Petrol	1328	4	16
GRAND VITARA II (JT)	1.6	04/00→	M16A	Petrol	1586	4	25
GRAND VITARA II (JT)	1.9	10/00→	F9QB	Diesel	1870	4	27
GRAND VITARA II (JT)	2.0	10/00→	J20A	Petrol	1995	4	32
GRAND VITARA II (JT)	2.7	01/00→	H 27 A	Petrol	2736	6	38
IGNIS (FH)	1.3	10/00→09/00	M13A	Petrol	1328	4	16
IGNIS II	1.3	09/00→	M13A	Petrol	1328	4	16
IGNIS II	1.3	09/00→	Z13DT	Diesel	1248	4	11
IGNIS II	1.5	09/00→	M15A	Petrol	1490	4	21
JIMNY (FJ)	1.3	09/99→	G13BB	Petrol	1298	4	15
JIMNY (FJ)	1.3	09/00→	M13A	Petrol	1328	4	16
JIMNY (FJ)	1.5	08/00→	K9K 266	Diesel	1461	4	19
JIMNY (FJ)	1.5	12/00→	K9K 700	Diesel	1461	4	20
JIMNY (FJ)	1.6	05/00→	M16A	Petrol	1586	4	25
LIANA (ER)	1.3	03/00→	M13A	Petrol	1328	4	16
LIANA (ER)	1.4	04/00→	8HY	Diesel	1398	4	17
LIANA (ER)	1.5	04/00→11/00	M15A	Petrol	1490	4	21
LIANA (ER)	1.6	03/00→	M16A	Petrol	1586	4	25
LIANA Estate (ER)	1.4	04/00→12/00	8HY	Diesel	1398	4	17
LIANA Estate (ER)	1.6	07/00→12/00	M16A	Petrol	1586	4	25
SAMURAI (SJ)	1.0	11/98→12/00	F10A	Petrol	970	4	2
SAMURAI (SJ)	1.3	11/98→12/00	G13A	Petrol	1324	4	12
SAMURAI (SJ)	1.3	11/98→12/00	G13BA	Petrol	1298	4	14
SAMURAI (SJ)	1.9	11/99→12/00	XUD9	Diesel	1905	4	28
SJ 410	1.0	09/98→12/98	F10A	Petrol	970	4	2
SJ 410 Cabrio	1.0	09/98→12/98	F10A	Petrol	970	4	2
SJ 413	1.3	09/98→08/99	G13A	Petrol	1324	4	12
SPLASH	1.0	01/00→	K10B	Petrol	996	3	5
SPLASH	1.3	01/00→	D13A	Diesel	1248	4	7
SPLASH	1.3	01/00→	Z 13 DTJ	Diesel	1248	4	10
SUPER CARRY Bus (ED)	1.0	10/98→03/99	F10A	Petrol	970	4	2
SWIFT Convertible (SF413)	1.3	09/99→10/99	G13BA	Petrol	1298	4	14
SWIFT I (AA)	1.0	10/98→03/98	G10	Petrol	993	3	3
SWIFT I (AA)	1.0	10/98→03/98	G10A	Petrol	993	3	4
SWIFT I (AA)	1.3	10/98→03/98	G13A	Petrol	1324	4	12
SWIFT I (AA)	1.3	08/98→03/98	G13B	Petrol	1298	4	13
SWIFT II Hatchback (EA, MA)	1.0	03/98→05/00	G10A	Petrol	993	3	4
SWIFT II Hatchback (EA, MA)	1.3	03/98→05/00	G13A	Petrol	1324	4	12
SWIFT II Hatchback (EA, MA)	1.3	03/98→05/00	G13B	Petrol	1298	4	13
SWIFT II Hatchback (EA, MA)	1.3	03/98→10/99	G13BA	Petrol	1298	4	14
SWIFT II Hatchback (EA, MA)	1.3	06/00→12/00	G13BB	Petrol	1298	4	15
SWIFT II Hatchback (EA, MA)	1.6	03/98→10/99	G16B	Petrol	1590	4	24

	Ltr				CC		9
SWIFT II Saloon (AH, AJ)	1.3	03/98 → 05/00	G13A	Petrol	1324	4	12
SWIFT II Saloon (AH, AJ)	1.6	11/98 → 05/00	G16B	Petrol	1590	4	24
SWIFT III (MZ, EZ)	1.3	08/00 →	D13A	Diesel	1248	4	7
SWIFT III (MZ, EZ)	1.3	02/00 →	M13A	Petrol	1328	4	16
SWIFT III (MZ, EZ)	1.3	08/00 →	Z 13 DTJ	Diesel	1248	4	10
SWIFT III (MZ, EZ)	1.3	08/00 →	Z13DT	Diesel	1248	4	11
SWIFT III (MZ, EZ)	1.5	02/00 →	M15A	Petrol	1490	4	21
SWIFT III (MZ, EZ)	1.6	05/00 →	M16A	Petrol	1586	4	25
SWIFT IV (FZ, NZ)	1.3	10/01 →	D13A	Diesel	1248	4	7
SWIFT IV (FZ, NZ)	1.6	01/01 →	M16A	Petrol	1586	4	25
SX4 (GY)	1.5	06/00 →	M15A	Petrol	1490	4	21
SX4 (GY)	1.6	04/00 →	9HX	Diesel	1560	4	22
SX4 (GY)	1.6	06/00 →	M16A	Petrol	1586	4	25
SX4 (GY)	2.0	06/00 →	J20A	Petrol	1995	4	32
SX4 Saloon (GY)	1.6	10/00 →	M16A	Petrol	1586	4	25
VITARA (ET, TA)	1.6	07/98 → 03/99	G16A (8V)	Petrol	1590	4	23
VITARA (ET, TA)	1.6	07/99 → 03/99	G16B	Petrol	1590	4	24
VITARA (ET, TA)	1.9	01/99 → 03/99	XUD9A	Diesel	1905	4	29
VITARA (ET, TA)	1.9	08/99 → 03/99	XUD9SD	Diesel	1905	4	30
VITARA (ET, TA)	2.0	12/99 → 03/99	H 20 A	Petrol	1998	6	31
VITARA (ET, TA)	2.0	12/99 → 03/99	J20A	Petrol	1995	4	32
VITARA (ET, TA)	2.0	12/99 → 03/99	RF	Diesel	1998	4	33
VITARA (ET, TA)	2.5	12/99 → 03/99	H 25 A	Petrol	2493	6	37
VITARA (ET)	2.0	12/00 → 12/00	RHP (DW10TD)	Diesel	1997	4	34
VITARA Cabrio (ET, TA)	1.6	07/98 → 01/99	G16A (8V)	Petrol	1590	4	23
VITARA Cabrio (ET, TA)	1.6	07/99 → 03/99	G16B	Petrol	1590	4	24
VITARA Cabrio (ET, TA)	1.9	01/99 → 03/99	XUD9A	Diesel	1905	4	29
VITARA Cabrio (ET, TA)	1.9	08/99 → 03/99	XUD9SD	Diesel	1905	4	30
VITARA Cabrio (ET, TA)	2.0	12/99 → 03/99	J20A	Petrol	1995	4	32
VITARA Cabrio (ET)	2.0	12/00 → 12/00	RHP (DW10TD)	Diesel	1997	4	34
WAGON R+ (EM)	1.2	02/99 → 05/00	K12A	Petrol	1171	4	8
WAGON R+ (MM)	1.3	05/00 →	G13BB	Petrol	1298	4	15
WAGON R+ (MM)	1.3	08/00 →	M13A	Petrol	1328	4	16
WAGON R+ (MM)	1.3	09/00 →	Z13DT	Diesel	1248	4	11
WAGON R	1.0	07/00 → 08/00	G10A	Petrol	993	3	4
WAGON R	1.0	06/00 → 08/00	Z 10 XEP	Petrol	998	3	6
WAGON R	1.2	06/00 → 08/00	Z 12 XEP	Petrol	1229	4	9
X-90 (EL)	1.6	09/99 → 12/99	G16B	Petrol	1590	4	24



CC



9



CC



9

8HY	Diesel	1398	4	73.70	17
9HX	Diesel	1560	4	75.00	22
D13A	Diesel	1248	4	69.60	7
F10A	Petrol	970	4	65.50	2
F8B	Petrol	796	3	68.50	1
F9QB	Diesel	1870	4	80.00	27
G10	Petrol	993	3	74.00	3
G10A	Petrol	993	3	74.00	4
G13A	Petrol	1324	4	74.00	12
G13B	Petrol	1298	4	74.00	13
G13BA	Petrol	1298	4	74.00	14
G13BB	Petrol	1298	4	74.00	15
G15A	Petrol	1493	4	75.00	18
G16A (8V)	Petrol	1590	4	75.00	23
G16B	Petrol	1590	4	75.00	24
H 20 A	Petrol	1998	6	78.00	31
H 25 A	Petrol	2493	6	84.00	37
H 27 A	Petrol	2736	6	88.00	38
J18A	Petrol	1839	4	84.00	26
J20A	Petrol	1995	4	84.00	32
K10B	Petrol	996	3	73.00	5
K12A	Petrol	1171	4	71.00	8
K9K 266	Diesel	1461	4	76.00	19
K9K 700	Diesel	1461	4	76.00	20
M13A	Petrol	1328	4	78.00	16
M15A	Petrol	1490	4	78.00	21
M16A	Petrol	1586	4	78.00	25
RF	Diesel	1998	4	86.00	33
RHP (DW10TD)	Diesel	1997	4	85.00	34
RHW	Diesel	1997	4	85.00	35
RHZ	Diesel	1997	4	85.00	36
XUD9	Diesel	1905	4	83.00	28
XUD9A	Diesel	1905	4	83.00	29
XUD9SD	Diesel	1905	4	83.00	30
Z 10 XEP	Petrol	998	3	73.40	6
Z 12 XEP	Petrol	1229	4	73.40	9
Z 13 DTJ	Diesel	1248	4	69.60	10
Z13DT	Diesel	1248	4	69.60	11

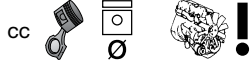

kW/PS

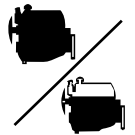

Engine Model	Year Range	CC	Cylinders	Power (kW/PS)	Configuration	Head Gasket	Alternator	Other Parts	
0.8 F8B						1	BM910 (Graphite)	DM910 [3]	
Alto II 0.8	01/86→11/93	796	3	68.50	SOHC/OHC	29/39			
1.0 F10A						2	BL390 (Graphite)	DL391 →02/86 DL390 01/82→01/86	GL390 01/82→01/86 GL391 [3] 02/86→
Samurai 1.0	11/88→12/04	970	4	65.50	SOHC/OHC	30-33/ 41-45			
SJ 410 1.0	09/81→12/88								
SJ 410 Conv 1.0	09/81→12/88								
Super Carry 1.0	10/85→03/99								
1.0 G10						3	BM740 (Graphite) →08/88 BT900 (Graphite) 09/88→	DM740 →08/88 DT900 [3] 09/88→	GT900 [3] 09/88→
Swift I 1.0	10/83→03/89	993	3	74.00	SOHC/OHC	37-40/ 50-54			
1.0 G10A						4	BT900 (Graphite)	DT900 [3]	GT900 [3]
Swift I 1.0	10/83→03/89	993	3	74.00		37-40/ 50-54			
Swift II 1.0	03/89→05/01								
Swift II 1.0 i	03/89→05/01								
WAGON R 1.0	07/03→08/05								
1.0 K10B						5	AH6620 (MLS)		
Alto V (GF) 1.0	01/09→	996	3	73.00	DOHC	48-50/ 65-68			
Splash 1.0	01/08→								
1.0 Z 10 XEP						6	AE5950 (Steel)	CE5950	
WAGON R 1.0	06/04→08/05	998	3	73.40	DOHC	44/60			
1.2 D13A Diesel						7	AD5800 (MLS), 0.720mm AD5810 (MLS), 0.820mm, 1 Hole AD5820 (MLS), 0.920mm, 2 Holes	CD5810 ▲	ED5800
Splash 1.3 CDTI	01/08→	1248	4	69.60	DOHC	55/75			
Swift III 1.3	08/05→								
Swift IV 1.3	10/10→								
1.2 K12A						8	AH6290 (MLS)		
WAGON R+ 1.2	02/98→05/00	1171	4	71.00	DOHC	51/69			
1.2 Z 12 XEP						9	AH5030 (MLS)	CH5031	EH5030
Wagon R 1.2	06/04→08/05	1229	4	73.40	DOHC	59/80			
1.2 Z 13 DTJ Diesel						10	AD5800 (MLS), 0.720mm AD5810 (MLS), 0.820mm, 1 Hole AD5820 (MLS), 0.920mm, 2 Holes	CD5810 ▲	ED5800 FD5810
Splash 1.3 CDTI	01/08→	1248	4	69.60	DOHC	55/75			
Swift III 1.3	08/05→								
1.2 Z13DT Diesel						11	AD5800 (MLS), 0.720mm AD5810 (MLS), 0.820mm, 1 Hole AD5820 (MLS), 0.920mm, 2 Holes	CD5810 ▲	ED5800
Ignis II 1.3	09/03→	1248	4	69.60	DOHC	51/69			
Swift III 1.3	08/05→								
Wagon R+ 1.3	09/03→								

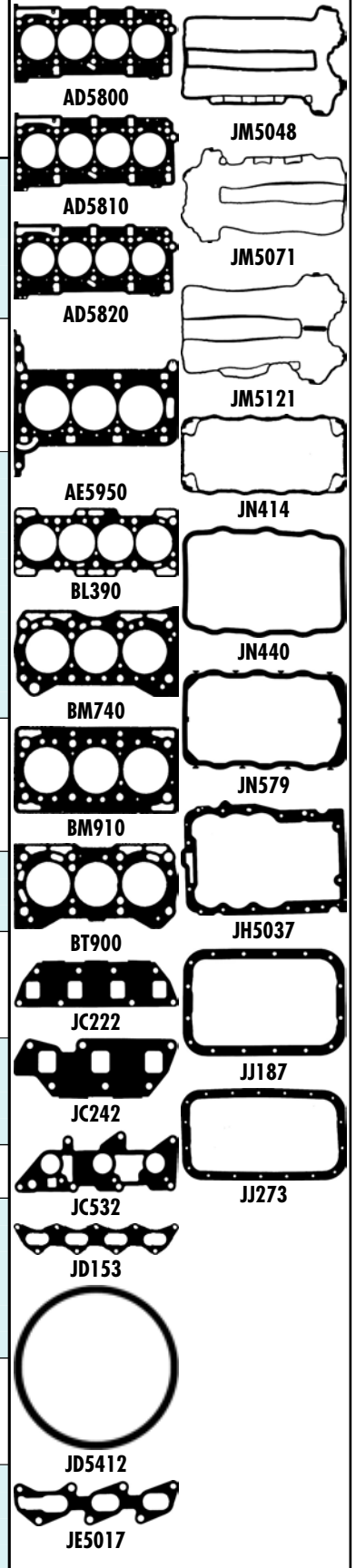

	JC242	JN440 [4]	JJ187		NJ336 [2] 32.00x47.00x8.00mm, NBR NJ377 [2] 32.00x47.00x6.00mm, ACM NJ336 [2] 32.00x47.00x8.00mm, NBR	
	JC420 JC222	JN414 (Elastomer)	JJ273		NJ336 [2] 32.00x47.00x8.00mm, NBR NJ336 [2] 32.00x47.00x8.00mm, NBR	
HBS407 [22] M10x1.50x91.00mm (x8) 01/85→12/88	JC532 JD153	JN579 [4] →08/88	HR397	PA305 →08/88 PA928 (x6) 09/88→	NJ336 [2] 32.00x47.00x8.00mm, NBR →08/88 NJ337 [1] 60.00x80.00x8.00mm, NBR 09/88→ NJ377 [2] 32.00x47.00x6.00mm, ACM NJ378 [1] 68.00x86.00x8.00mm, ACM	
HBS407 [22] M10x1.50x91.00mm (x8) 01/95→12/98		JN579 [4]	HR397		NJ377 [2] 32.00x47.00x6.00mm, ACM	
HBS253 [5] M8x1.25x119.00mm (x10)	JD5904 (x4) (FPM) JE5017	JM5121 (Elastomer)	JH5037	PA5025	NA5108 [2] 42.00x55.00x7.00mm, FPM/ACM NB698 [1] 80.00x98.00x10.00mm, FPM	JR5030 [6]
HBS353 [5] M10x1.25x119.00mm (x10)	JD5411 JD5412 JD5413 (MLS)	JM5259 (SE)	HR397	HR5088	NA5223 [2] 40.00x52.00x7.00mm, FPM NA5230 [2] 78.00x100.00x9.00mm, PTFE	
			HR397			
HBS252 [5] M8x1.25x119.00mm (x12)	JD5904 (x4) (FPM)	JM5048 (Elastomer) →Eng.1G001502 JM5071 (Elastomer) Eng.1G001503→		HR5048	NA5108 [2] 42.00x55.00x7.00mm, FPM/ACM NB698 [1] 80.00x98.00x10.00mm, FPM	
HBS353 [5] M10x1.25x119.00mm (x10)	JD5411 JD5413 (MLS)	JM5259 (SE)	HR397	HR5088	NA5223 [2] 40.00x52.00x7.00mm, FPM NA5230 [2] 78.00x100.00x9.00mm, PTFE	
HBS353 [5] M10x1.25x119.00mm (x10)	JD5411 JD5412 JD5413 (MLS)	JM5259 (SE)		HR5088	NA5223 [2] 40.00x52.00x7.00mm, FPM NA5230 [2] 78.00x100.00x9.00mm, PTFE	KK5646 [17]

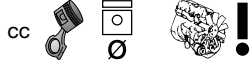

kW/PS

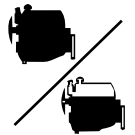

1.3		G13A					12	BN480 (Graphite)	DN480 [13]	GN480 [13]
Samurai 1.3	11/88→12/04	1324	4	74.00	SOHC/OHC	44-54/ 60-73				
SJ 413 1.3	09/84→08/90									
Swift I 1.3	10/84→03/89									
Swift II 1.3	03/89→05/01									
1.3		G13B					13	BN480 (Graphite)	DN484 [3]	GN484 [3]
Swift I 1.3 Gti	08/85→03/89	1298	4	74.00		44-74/ 60-101				
Swift II 1.3	03/89→05/01									
1.3		G13BA					14	BN480 (Graphite)	DN480 [13]	
Baleno 1.3	09/96→05/02	1298	4	74.00	SOHC/OHC	49-59/ 67-80				
Baleno (EG) 1.3	09/96→05/02									
Samurai 1.3	11/88→12/04									
Swift Conv 1.3	09/91→10/96									
Swift II 1.3	03/89→10/96									
1.3		G13BB					15	BN480 (Graphite)	CG5480	EG5220
Alto III 1.3	10/98→09/00	1298	4	74.00	SOHC/OHC	56-63/ 76-86				
Baleno 1.3 16V	03/97→05/02									
Baleno 1.3 i	07/95→05/02									
Carry 1.3 4x4	02/99→09/04									
Carry Van 1.3	03/99→									
Gr Vitara 1.3	05/05→07/06									
Jimny 1.3 16V	09/98→									
Jimny 1.3 4WD	09/98→08/00									
Swift II 1.3	06/01→12/03									
Wagon R+ 1.3	05/00→									
1.3		M13A					16	AG8180 (MLS)	CG8180 →09/03	
Gr Vitara 1.3	03/98→07/03	1328	4	78.00	DOHC	60-69/ 82-94				
Ignis 1.3	10/00→09/03									
Ignis 1.3 4WD	10/00→09/03									
Ignis II 1.3	09/03→									
Jimny 1.3	08/05→									
Jimny 1.3 16V	02/01→									
Jimny 1.3 4WD	02/01→									
Jimny 1.3 4x4	09/00→08/02									
Liana 1.3	03/02→									
Swift III 1.3	02/05→									
Wagon R+ 1.3	08/01→									
1.4		8HY Diesel					17	AH6560 (MLS), 1.25mm, 2 Notches AH6570 (MLS), 1.3mm, 3 Notches AH6580 (MLS), 1.35mm, 1 Notch AH6590 (MLS), 1.4mm, 4 Notches AH6600 (MLS), 1.45mm, 5 Notches AG8100 (MLS)	CD5130 ▲	ED5130
Liana 1.4 DDiS	04/04→12/07	1398	4	73.70		66/90				
1.5		G15A					18			EG5220
APV (GD) 1.5	06/05→	1493	4	75.00	DOHC	57-77/ 77-105				
Baleno (EG) 1.5	03/95→08/98									
Carry 1.5	03/11→									
1.5		K9K 266 Diesel					19	AE5200 (MLS)	CE5200 ▲	
Jimny 1.5 DDiS	08/05→	1461	4	76.00		63/86				

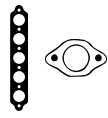

AE5200



BN480



JC641



JC861



JN606

	JC641	JN606 [4]	JJ341		NJ377 [2] 32.00x47.00x6.00mm, ACM	
	JC861	JN606 [4]			NJ377 [2] 32.00x47.00x6.00mm, ACM	
	JC861	JN606 [4]	JJ341		NJ377 [2] 32.00x47.00x6.00mm, ACM	
	JD5770 JD5769	JN886 [4]	HR397		NJ377 [2] 32.00x47.00x6.00mm, ACM	
	JD5994 (SE) JD5965 (MLS)	JM5312 →09/03				
HBS359 [22] M11x1.50x147.00mm (x10)	HA5029 JD5829	JM7034 (Elastomer)	HR397		NA5258 [2] 27.00x47.00x7.00mm, PTFE NA5259 [2] 40.00x55.00x6.40mm, PTFE	
	JD5770 JD5769	JN886 [4]	HR397	PA928 HR5075		
	JD5402	JM7054 (NBR)	HR397		NA5215 [2] 28.00x42.00x5.00mm, FPM NA5118 [1] [2] 80.00x100.00x9.00mm, PTFE	



cc



kW/PS



1.5	K9K 700 Diesel	20	AG9490 (MLS), 0.75mm [70][71]	CE5200 ▲	EE5200
Jimny 1.5 DDiS	12/03→	1461 4 76.00 SOHC/OHC	48-50/ 65-68		
1.5	M15A	21	AG8180 (MLS)		
Ignis II 1.5	09/03→	1490 4 78.00 DOHC	73-83/ 99-113		
Liana (ER) 1.5	04/04→11/07				
Swift III 1.5	02/05→				
SX4 1.5 VVT	07/10→				
SX4 (GY) 1.5	06/06→				
1.6	9HX Diesel	22	AD5130 (MLS), 1.250mm, 2 Notches AD5140 (MLS), 1.300mm, 3 Notches AD5150 (MLS), 1.350mm, 1 Notch AD5160 (MLS), 1.400mm, 4 Notches AD5170 (MLS), 1.450mm, 5 Notches	CD5140 ▲	
SX4 1.6 DDiS	04/07→	1560 4 75.00 DOHC	66/90		
1.6	G16A (8V)	23	BS600 (Graphite)	DS600	EG5260 GS600 [3]
Vitara 1.6	07/88→03/98	1590 4 75.00 SOHC/OHC	50-60/ 68-82		
1.6	G16B	24	AG5260 (Fibre), 1.200mm		EG5260
Alto III 1.6	10/98→09/00	1590 4 75.00 SOHC/OHC	68-73/ 92-99		
Baleno 1.6 i	07/95→05/02				
Gr Vitara 1.6	03/98→07/03				
Gr Vitara I 1.6	02/00→09/02				
Swift II 1.6	03/89→05/01				
Swift II 1.6	11/89→12/91				
Swift II 1.6 i	01/90→05/01				
Vitara 1.6	07/90→03/99				
Vitara 1.6 16V	07/90→03/98				
X-90 1.6 i	09/95→12/97				
X-90 1.6 i 16V	09/95→12/97				
1.6	M16A	25	AG8180 (MLS)		
Gr Vitara 2 1.6	04/05→	1586 4 78.00 DOHC	73-100/ 99-136		
Jimny 1.6 VVT	05/04→				
Liana 1.6	07/01→12/07				
Liana 1.6 4WD	03/02→12/07				
Liana 1.6 i	04/02→12/07				
Liana (ER) 1.6	03/02→				
Swift III 1.6	05/06→				
Swift IV 1.6	01/12→				
SX4 1.6 VVT	06/06→				
SX4 (GY) 1.6	06/06→				
SX4 Saloon 1.6	10/07→				
1.8	J18A	26	AG8020 (MLS)	CG8020	EG8020
Baleno 1.8 GTX	03/96→05/02	1839 4 84.00	89/121		
Baleno 1.8 i	03/96→05/02				
Baleno 1.8i 16V	08/96→05/02				
1.9	F9QB Diesel	27	AC5062 (MLS) AC5061 (MLS), 1.320mm	CC5060 ▲ [3]	
Gr Vitara 2 1.9	10/05→	1870 4 80.00 SOHC/OHC	95/129		

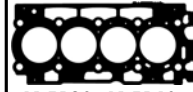

AD5130, AD5140,
AD5150, AD5160,
AD5170



BS600



JC867



JC868



JN606



cc



kW/PS



1.9	XUD9 Diesel					28			
Samurai 1.9 TD	11/98→12/04	1905	4	83.00	SOHC/OHC	46-50/ 63-68	BX880 (Fibre), 1.360mm, 1 Notch ☞0.560→0.670mm BX890 (Fibre), 1.400mm, 2 Notches ☞0.680→0.710mm BX900 (Fibre), 1.440mm, 3 Notches ☞0.720→0.750mm BX910 (Fibre), 1.480mm, 4 Notches ☞0.760→0.790mm BX920 (Fibre), 1.520mm, 5 Notches ☞0.800→0.830mm	DJ720 ▲	GJ720 ▲
1.9	XUD9A Diesel					29			
Vitara 1.9 D	01/95→03/98	1905	4	83.00	SOHC/OHC	50/68	BX880 (Fibre), 1.360mm, 1 Notch ☞0.560→0.670mm BX890 (Fibre), 1.400mm, 2 Notches ☞0.680→0.710mm BX900 (Fibre), 1.440mm, 3 Notches ☞0.720→0.750mm BX910 (Fibre), 1.480mm, 4 Notches ☞0.760→0.790mm BX920 (Fibre), 1.520mm, 5 Notches ☞0.800→0.830mm	DJ720 ▲	EL890 [3] GJ720 ▲
1.9	XUD9SD Diesel					30			
Vitara 1.9 D	08/96→03/99	1905	4	83.00	SOHC/OHC	55/75	BX930 (SE), 1.360mm, 1 Notch BX940 (SE), 1.400mm, 2 Notches BX950 (SE), 1.440mm, 3 Notches BX960 (SE), 1.480mm, 4 Notches BX970 (SE), 1.520mm, 5 Notches BX980 (SE), 1.590mm ☞0.830mm→	DJ720 ▲	EL890 [3] GJ720 ▲
2.0	H 20 A					31			
Vitara 2.0 V6	12/94→03/98	1998	6	78.00	DOHC, V	100/136	AG5720 (Graphite) ☒ 01/95→ AG5710 (Graphite) ☒ 01/95→	CG5710	EG8020
2.0	J20A					32			
Gr Vitara 2.0	03/98→07/03	1995	4	84.00	DOHC	94-107/ 128-146	AG8020 (MLS)	CG8020	EG8020
Gr Vitara 1 2.0	04/98→08/05								
SX4 2.0	06/06→								
SX4 (GY) 2.0	06/06→								
Vitara 2.0	12/96→03/99								
Vitara 2.0 16V	12/96→03/98								
2.0	RF Diesel					33			
Gr Vitara 2.0	03/98→07/03	1998	4	86.00	OHV	52-68/ 71-92	AG5130 (MLS), 1.500mm	CG5460	GN622 [3]
Vitara 2.0 TD	12/94→03/98								
2.0	RHP (DW10TD) Diesel					34			
Vitara 2.0 HDI	12/03→12/05	1997	4	85.00	SOHC/OHC	64/87	AC5011 (MLS), 1.300mm, 1 Hole ☞0.470→0.605mm AC5020 (MLS), 1.350mm, 2 Holes ☞0.605→0.655mm AC5031 (MLS), 1.400mm, 3 Holes ☞0.655→0.705mm AC5040 (MLS), 1.450mm, 4 Holes ☞0.705→0.755mm AC5051 (MLS), 1.500mm, 5 Holes ☞0.755→0.830mm	CC5010 ▲ [3]	EA5830
Vitara (ET) HDI	12/03→12/05								

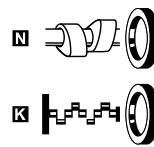
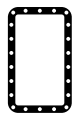
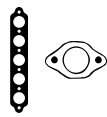

AC5020, AC5040



BX880, BX890,
BX900, BX910,
BX920



BX930, BX940,
BX950, BX960,
BX970, BX980



JC423



JC759



JC991

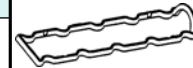

JN544



JN576



JJ283



CC



kW/PS



2.0		RHW Diesel			35				
Gr Vitara 2.0	07/01→07/03	1997	4	85.00	DOHC	80/109	AC5011 (MLS), 1.300mm, 1 Hole ☒-0.470→0.605mm AC5020 (MLS), 1.350mm, 2 Holes ☒-0.605→0.655mm AC5031 (MLS), 1.400mm, 3 Holes ☒-0.655→0.705mm AC5040 (MLS), 1.450mm, 4 Holes ☒-0.705→0.755mm AC5051 (MLS), 1.500mm, 5 Holes ☒-0.755→0.830mm	CC5010 ▲ [3] CC5011 ▲	EA5830
2.0		RHZ Diesel			36				
Gr Vitara 2.0	07/01→07/03	1997	4	85.00	SOHC/OHC	80/109	AC5011 (MLS), 1.300mm, 1 Hole ☒-0.470→0.605mm AC5020 (MLS), 1.350mm, 2 Holes ☒-0.605→0.655mm AC5031 (MLS), 1.400mm, 3 Holes ☒-0.655→0.705mm AC5040 (MLS), 1.450mm, 4 Holes ☒-0.705→0.755mm AC5051 (MLS), 1.500mm, 5 Holes ☒-0.755→0.830mm	CC5010 ▲ [3] CC5011 ▲	EA5830
2.5		H 25 A			37				
Gr Vitara I 2.5	04/98→07/03	2493	6	84.00	DOHC, V	106-118/ 144-160	AG5740 (Graphite) ☒ AG5730 (Graphite) ☒	CG5730 EG8020	
Vitara 2.5 V6	12/95→03/98								
2.7		H 27 A			38				
Gr Vitara 2.7	01/07→	2736	6	88.00	DOHC, V	127-138/ 173-188	AG8110 (MLS) ☒ AG8100 (MLS) ☒	CG8100 EG8020 FG8100	
Gr Vitara I 2.7	06/01→08/06								



AC5020, AC5040

HBS261 [22]
M12x1.50x126.00mm (x10)

JD5191 [1]
JD5190 [3]

JM5087
(Elastomer)
JM5141
(Elastomer)

HR5046 [3]

NA5035 [2]
27.00x47.00x7.00mm, FPM
NA5191 [2]
42.00x62.00x7.00mm, PTFE
NA5192 [1]
90.00x110.00x7.00mm, PTFE

HBS261 [22]
M12x1.50x126.00mm (x10)

JD5191 [1]
JD5190 [3]

JM5087
(Elastomer)

HR5046 [3]

NA5035 [2]
27.00x47.00x7.00mm, FPM
NA5191 [2]
42.00x62.00x7.00mm, PTFE
NA5192 [1]
90.00x110.00x7.00mm, PTFE

JD5929 [1] (x2)
(SE)
JD5933 [3] (x2)
(MLS)
1.000mm

JM5308 [3]
(Elastomer)
JM5307 [3]
(Elastomer)

HR397

PA956 (x24)

NJ336 [2]
32.00x47.00x8.00mm, NBR

JD5929 [1] (x2)
(SE)
JD5933 [3] (x2)
(MLS)
1.000mm

JM5308 [3]
(Elastomer)
JM5307 [3]
(Elastomer)

HR397

PA956 (x24)

NJ336 [2]
32.00x47.00x8.00mm, NBR



Ltr



CC



9

	Ltr	07/98→10/99	Engine	Fuel	CC	Doors	9
EXPRESS 1000-1500 Bus	1.8	07/98→10/99	XM7T	Petrol	1796	4	1
EXPRESS 1000-1500 Bus	1.9	07/98→10/99	XUD9A	Diesel	1905	4	2
EXPRESS 1000-1500 Bus	2.5	07/98→10/99	CRD93	Diesel	2498	4	3
EXPRESS 1000-1500 Bus	2.5	06/98→10/99	CRD93LS	Diesel	2498	4	4
EXPRESS 1000-1500 Platform/Chassis	2.5	07/98→10/99	CRD93	Diesel	2498	4	3
EXPRESS 1000-1500 Platform/Chassis	2.5	06/98→10/99	CRD93LS	Diesel	2498	4	4
EXPRESS 1000-1800 Box	1.8	07/98→10/99	XM7T	Petrol	1796	4	1
EXPRESS 1000-1800 Box	1.9	07/98→10/99	XUD9A	Diesel	1905	4	2
EXPRESS 1000-1800 Box	2.5	07/98→10/99	CRD93	Diesel	2498	4	3
EXPRESS 1000-1800 Box	2.5	06/98→10/99	CRD93LS	Diesel	2498	4	4



cc



kW/PS



1.8 XM7T							1		DM710 ○ [3]	
Express 1.8	07/81→10/90	1796	4	84.00		50-51/ 68-69				
1.9 XUD9A Diesel							2	BX880 (Fibre), 1.360mm, 1 Notch ☞ 0.560→0.670mm BX890 (Fibre), 1.400mm, 2 Notches ☞ 0.680→0.710mm BX900 (Fibre), 1.440mm, 3 Notches ☞ 0.720→0.750mm BX910 (Fibre), 1.480mm, 4 Notches ☞ 0.760→0.790mm BX920 (Fibre), 1.520mm, 5 Notches ☞ 0.800→0.830mm		EL890 [3]
Express 1.9 D	07/87→10/90	1905	4	83.00	SOHC/OHC	51/69				
2.5 CRD93 Diesel							3	BG450 (Fibre), 1.350mm	DG452 ▲ [13]	
Express 2.5 D	07/82→10/94	2498	4	93.00	OHV	54-55/ 73-75				
2.5 CRD93LS Diesel							4	BG450 (Fibre), 1.350mm	DG452 ▲ [13]	
Express 2.5 TD	06/87→10/94	2498	4	93.00	OHV	70/95				

		JB841 [E]	JN244 [4]		HR300 [E]	<input checked="" type="checkbox"/> NA5191 [E] [2] 42.00x62.00x7.00mm, PTFE	
		JD5972 [I] JC423 [E]	JN544 [4]	JJ283 [62]	HR805 [E]	<input checked="" type="checkbox"/> NF841 [I] [2] 35.00x50.00x8.00mm, FPM <input checked="" type="checkbox"/> NA5191 [E] [2] 42.00x62.00x7.00mm, PTFE	
		JB869 [E]	JN426 [4]			<input checked="" type="checkbox"/> NF776 [E] [2] 75.00x90.00x11.50mm, FPM/ACM <input checked="" type="checkbox"/> NF752 [E] [1] 95.00x112.00x12.50mm, FPM	
		JB869 [E]	JN426 [4]			<input checked="" type="checkbox"/> NF776 [E] [2] 75.00x90.00x11.50mm, FPM/ACM <input checked="" type="checkbox"/> NF752 [E] [1] 95.00x112.00x12.50mm, FPM	



Ltr







CC



9

Model	Ltr	Year Range	Engine	Fuel	CC	Seats	Index
4 RUNNER (KZ18_, VZ18_, RZ18_)	3.0	11/99→11/00	1KZ-T	Diesel	2982	4	81
4 RUNNER (RN10_, VZ13_, VZ10_, RN13_)	2.4	08/98→03/99	22REC	Petrol	2366	4	74
4 RUNNER (RN10_, VZ13_, VZ10_, RN13_)	2.4	08/98→11/99	2L-T	Diesel	2446	4	68
4 RUNNER (RN10_, VZ13_, VZ10_, RN13_)	2.7	11/99→03/99	3RZ-FE	Petrol	2694	4	78
4 RUNNER (RN10_, VZ13_, VZ10_, RN13_)	3.0	10/99→03/99	1KZ-T	Diesel	2982	4	81
4 RUNNER (RN10_, VZ13_, VZ10_, RN13_)	3.0	01/99→11/99	3VZ-E	Petrol	2959	6	84
4 RUNNER (RN10_, VZ13_, VZ10_, RN13_)	3.4	11/99→03/99	5VZ-FE	Petrol	3378	6	91
1000 (KP30_)	1.0	04/96→08/98	2K	Petrol	993	4	4
1000 Box (KP36V_)	1.0	04/96→08/98	2K	Petrol	993	4	4
ALLION I (ZZT24_, NZT24_, AZT24_)	1.5	06/00→04/00	1NZ-FE	Petrol/Electro	1497	4	15
ALLION I (ZZT24_, NZT24_, AZT24_)	1.5	06/00→04/00	1NZ-FE	Petrol	1497	4	15
ALLION I (ZZT24_, NZT24_, AZT24_)	1.8	06/00→06/00	1ZZ-FE	Petrol	1794	4	29
ALLION I (ZZT24_, NZT24_, AZT24_)	1.8	06/00→06/00	2ZR-FE	Petrol	1798	4	32
ALLION I (ZZT24_, NZT24_, AZT24_)	2.0	06/00→06/00	1AZ-FSE	Petrol	1998	4	39
ALLION II (NZT26_, ZRT26_)	1.5	07/00→	1NZ-FE	Petrol/Electro	1497	4	15
ALLION II (NZT26_, ZRT26_)	1.5	07/00→	1NZ-FE	Petrol	1497	4	15
ALLION II (NZT26_, ZRT26_)	1.8	07/00→	2ZR-FAE	Petrol	1798	4	31
ALLION II (NZT26_, ZRT26_)	2.0	07/00→	3ZR-FAE	Petrol	1987	4	56
ALPHARD I (ATH1_, MNH1_, ANH1_)	2.4	09/00→04/00	2AZ-FE	Petrol	2362	4	64
ALPHARD I (ATH1_, MNH1_, ANH1_)	2.4	09/00→04/00	2AZ-FXE	Petrol/Electro	2362	4	66
ALPHARD I (ATH1_, MNH1_, ANH1_)	2.4	09/00→04/00	2AZ-FXE	Petrol	2362	4	66
ALPHARD I (ATH1_, MNH1_, ANH1_)	3.0	04/00→04/00	1MZ-FE	Petrol	2995	6	83
ALPHARD II (GGH2_, ANH2_, ATH2_)	2.4	04/00→	2AZ-FE	Petrol	2362	4	64
ALPHARD II (GGH2_, ANH2_, ATH2_)	2.4	12/01→	2AZ-FXE	Petrol/Electro	2362	4	66
ALPHARD II (GGH2_, ANH2_, ATH2_)	2.4	12/01→	2AZ-FXE	Petrol	2362	4	66
ALTEZZA (SXE1_, JCE1_, GXE1_)	2.0	07/00→07/00	1G-FE	Petrol	1988	6	42
AQUA (NHP1_)	1.5	12/01→	1NZ-FXE	Petrol/Electro	1497	4	16
AQUA (NHP1_)	1.5	12/01→	1NZ-FXE	Petrol	1497	4	16
ARISTO (UZS14_, JZS14_)	4.0	10/99→07/99	1UZ-FE	Petrol	3969	8	92
ASCENT Hatchback	1.8	06/00→10/00	7A-FE	Petrol	1762	4	35
ASCENT Saloon	1.8	06/00→10/00	7A-FE	Petrol	1762	4	35
AURION (GSV4_, ACV4_)	2.0	03/00→07/00	1AZ-FSE	Petrol	1998	4	39
AURION (GSV4_, ACV4_)	2.4	03/00→07/00	2AZ-FE	Petrol	2362	4	64
AURION (GSV4_, ACV4_)	2.4	11/00→09/01	2AZ-FXE	Petrol/Electro	2362	4	66
AURION (GSV4_, ACV4_)	2.4	11/00→09/01	2AZ-FXE	Petrol	2362	4	66
AURIS (NRE15_, ZZE15_, ADE15_, ZRE15_, NDE15_)	1.4	03/00→	1ND-TV	Diesel	1364	4	12
AURIS (NRE15_, ZZE15_, ADE15_, ZRE15_, NDE15_)	1.4	03/00→	4ZZ-FE	Petrol	1398	4	13
AURIS (NRE15_, ZZE15_, ADE15_, ZRE15_, NDE15_)	1.5	09/00→	1NZ-FE	Petrol/Electro	1497	4	15
AURIS (NRE15_, ZZE15_, ADE15_, ZRE15_, NDE15_)	1.5	09/00→	1NZ-FE	Petrol	1497	4	15
AURIS (NRE15_, ZZE15_, ADE15_, ZRE15_, NDE15_)	1.8	02/00→	2ZR-FAE	Petrol	1798	4	31
AURIS (NRE15_, ZZE15_, ADE15_, ZRE15_, NDE15_)	1.8	10/00→	2ZR-FE	Petrol	1798	4	32
AURIS (NRE15_, ZZE15_, ADE15_, ZRE15_, NDE15_)	1.8	09/01→	2ZR-FXE	Petrol/Electro	1798	4	33
AURIS (NRE15_, ZZE15_, ADE15_, ZRE15_, NDE15_)	2.0	03/00→	1AD-FTV	Diesel	1998	4	37
AURIS (NRE15_, ZZE15_, ADE15_, ZRE15_, NDE15_)	2.2	03/00→	2AD-FHV	Diesel	2231	4	58
AURIS (NRE15_, ZZE15_, ADE15_, ZRE15_, NDE15_)	2.4	04/00→	2AZ-FE	Petrol	2362	4	64
AURIS (NZE18_, ZRE18_)	1.4	10/01→	1ND-TV	Diesel	1364	4	12
AURIS (NZE18_, ZRE18_)	1.5	10/01→	1NZ-FE	Petrol/Electro	1497	4	15
AURIS (NZE18_, ZRE18_)	1.5	10/01→	1NZ-FE	Petrol	1497	4	15
AURIS (NZE18_, ZRE18_)	1.8	10/01→	2ZR-FAE	Petrol	1798	4	31
AURIS (NZE18_, ZRE18_)	1.8	10/01→	2ZR-FXE	Petrol/Electro	1798	4	33
AURIS (NZE18_, ZRE18_)	2.0	10/01→	1AD-FTV	Diesel	1998	4	37
AURIS TOURING SPORTS (ADE18_, ZWE18_, ZRE18_)	1.4	07/01→	1ND-TV	Diesel	1364	4	12
AURIS TOURING SPORTS (ADE18_, ZWE18_, ZRE18_)	1.8	07/01→	2ZR-FXE	Petrol/Electro	1798	4	33
AURIS TOURING SPORTS (ADE18_, ZWE18_, ZRE18_)	2.0	07/01→	1AD-FTV	Diesel	1998	4	37
AURIS VAN Box (NDE15_)	1.4	03/00→04/01	1ND-TV	Diesel	1364	4	12
AURIS VAN Box (ZRE18_, NZE18_)	1.4	03/01→	1ND-TV	Diesel	1364	4	12
AVALON Saloon (MCX1_)	3.0	03/99→05/00	1MZ-FE	Petrol	2995	6	83
AVALON Saloon (MCX2_)	2.4	08/00→04/00	2AZ-FE	Petrol	2362	4	64
AVALON Saloon (MCX2_)	3.0	08/00→04/00	1MZ-FE	Petrol	2995	6	83
AVENSIS (T22_)	1.6	10/00→02/00	3ZZ-FE	Petrol/Natural Gas (CNG)	1598	4	20
AVENSIS (T22_)	1.6	10/00→02/00	3ZZ-FE	Petrol	1598	4	20
AVENSIS (T22_)	1.6	09/99→10/00	4A-FE	Petrol	1587	4	22
AVENSIS (T22_)	1.8	10/00→02/00	1ZZ-FE	Petrol	1794	4	29
AVENSIS (T22_)	1.8	09/99→10/00	7A-FE	Petrol	1762	4	35
AVENSIS (T22_)	2.0	10/00→02/00	1AZ-FSE	Petrol	1998	4	39
AVENSIS (T22_)	2.0	10/99→02/00	1CD-FTV	Diesel	1995	4	40
AVENSIS (T22_)	2.0	09/99→02/00	2CTE	Diesel	1975	4	47
AVENSIS (T22_)	2.0	09/99→10/00	3S-FE	Petrol	1998	4	49
AVENSIS (T25_)	1.6	04/00→11/00	3ZZ-FE	Petrol/Natural Gas (CNG)	1598	4	20
AVENSIS (T25_)	1.6	04/00→11/00	3ZZ-FE	Petrol	1598	4	20

	Ltr				CC		9
AVENSIS (T25_)	1.8	04/00→11/00	1ZZ-FE	Petrol	1794	4	29
AVENSIS (T25_)	2.0	03/00→11/00	1AD-FTV	Diesel	1998	4	37
AVENSIS (T25_)	2.0	04/00→11/00	1AZ-FSE	Petrol	1998	4	39
AVENSIS (T25_)	2.0	04/00→11/00	1CD-FTV	Diesel	1995	4	40
AVENSIS (T25_)	2.2	07/00→11/00	2AD-FHV	Diesel	2231	4	58
AVENSIS (T25_)	2.2	10/00→11/00	2AD-FTV	Diesel	2231	4	59
AVENSIS (T25_)	2.2	04/00→11/00	3CTE	Diesel	2184	4	60
AVENSIS (T25_)	2.4	09/00→11/00	2AZ-FSE	Petrol	2362	4	65
AVENSIS Estate (T25)	1.6	04/00→11/00	3ZZ-FE	Petrol/Natural Gas (CNG)	1598	4	20
AVENSIS Estate (T25)	1.6	04/00→11/00	3ZZ-FE	Petrol	1598	4	20
AVENSIS Estate (T25)	1.8	04/00→11/00	1ZZ-FE	Petrol	1794	4	29
AVENSIS Estate (T25)	2.0	03/00→11/00	1AD-FTV	Diesel	1998	4	37
AVENSIS Estate (T25)	2.0	04/00→11/00	1AZ-FE	Petrol	1998	4	38
AVENSIS Estate (T25)	2.0	04/00→11/00	1AZ-FSE	Petrol	1998	4	39
AVENSIS Estate (T25)	2.0	04/00→11/00	1CD-FTV	Diesel	1995	4	40
AVENSIS Estate (T25)	2.2	07/00→11/00	2AD-FHV	Diesel	2231	4	58
AVENSIS Estate (T25)	2.2	10/00→11/00	2AD-FTV	Diesel	2231	4	59
AVENSIS Estate (T25)	2.2	04/00→11/00	3CTE	Diesel	2184	4	60
AVENSIS Estate (T25)	2.4	09/00→11/00	2AZ-FSE	Petrol	2362	4	65
AVENSIS Estate (ZRT27, ADT27)	1.8	02/00→	2ZR-FAE	Petrol	1798	4	31
AVENSIS Estate (ZRT27, ADT27)	2.0	02/00→	1AD-FTV	Diesel	1998	4	37
AVENSIS Estate (ZRT27, ADT27)	2.0	02/00→	3ZR-FAE	Petrol	1987	4	56
AVENSIS Estate (ZRT27, ADT27)	2.2	02/00→	2AD-FHV	Diesel	2231	4	58
AVENSIS Estate (ZRT27, ADT27)	2.2	02/00→	2AD-FTV	Diesel	2231	4	59
AVENSIS Liftback (T22_)	1.6	10/00→02/00	3ZZ-FE	Petrol/Natural Gas (CNG)	1598	4	20
AVENSIS Liftback (T22_)	1.6	10/00→02/00	3ZZ-FE	Petrol	1598	4	20
AVENSIS Liftback (T22_)	1.6	09/99→10/00	4A-FE	Petrol	1587	4	22
AVENSIS Liftback (T22_)	1.8	10/00→02/00	1ZZ-FE	Petrol	1794	4	29
AVENSIS Liftback (T22_)	1.8	09/99→10/00	7A-FE	Petrol	1762	4	35
AVENSIS Liftback (T22_)	2.0	10/00→02/00	1AZ-FSE	Petrol	1998	4	39
AVENSIS Liftback (T22_)	2.0	10/99→02/00	1CD-FTV	Diesel	1995	4	40
AVENSIS Liftback (T22_)	2.0	09/99→02/00	2CTE	Diesel	1975	4	47
AVENSIS Liftback (T22_)	2.0	09/99→10/00	3S-FE	Petrol	1998	4	49
AVENSIS Saloon (T25)	1.6	04/00→11/00	3ZZ-FE	Petrol/Natural Gas (CNG)	1598	4	20
AVENSIS Saloon (T25)	1.6	04/00→11/00	3ZZ-FE	Petrol	1598	4	20
AVENSIS Saloon (T25)	1.8	04/00→11/00	1ZZ-FE	Petrol	1794	4	29
AVENSIS Saloon (T25)	2.0	03/00→11/00	1AD-FTV	Diesel	1998	4	37
AVENSIS Saloon (T25)	2.0	04/00→11/00	1AZ-FE	Petrol	1998	4	38
AVENSIS Saloon (T25)	2.0	04/00→11/00	1AZ-FSE	Petrol	1998	4	39
AVENSIS Saloon (T25)	2.0	04/00→11/00	1CD-FTV	Diesel	1995	4	40
AVENSIS Saloon (T25)	2.2	07/00→11/00	2AD-FHV	Diesel	2231	4	58
AVENSIS Saloon (T25)	2.2	10/00→11/00	2AD-FTV	Diesel	2231	4	59
AVENSIS Saloon (T25)	2.2	04/00→11/00	3CTE	Diesel	2184	4	60
AVENSIS Saloon (T25)	2.4	09/00→11/00	2AZ-FSE	Petrol	2362	4	65
AVENSIS Saloon (ZRT27, ADT27)	1.8	02/00→	2ZR-FAE	Petrol	1798	4	31
AVENSIS Saloon (ZRT27, ADT27)	2.0	02/00→	1AD-FTV	Diesel	1998	4	37
AVENSIS Saloon (ZRT27, ADT27)	2.0	02/00→	3ZR-FAE	Petrol	1987	4	56
AVENSIS Saloon (ZRT27, ADT27)	2.2	02/00→	2AD-FHV	Diesel	2231	4	58
AVENSIS Saloon (ZRT27, ADT27)	2.2	02/00→	2AD-FTV	Diesel	2231	4	59
AVENSIS Station Wagon (T22_)	1.6	10/00→02/00	3ZZ-FE	Petrol/Natural Gas (CNG)	1598	4	20
AVENSIS Station Wagon (T22_)	1.6	10/00→02/00	3ZZ-FE	Petrol	1598	4	20
AVENSIS Station Wagon (T22_)	1.6	09/99→10/00	4A-FE	Petrol	1587	4	22
AVENSIS Station Wagon (T22_)	1.8	10/00→02/00	1ZZ-FE	Petrol	1794	4	29
AVENSIS Station Wagon (T22_)	1.8	09/99→10/00	7A-FE	Petrol	1762	4	35
AVENSIS Station Wagon (T22_)	1.9	09/00→02/00	1CD-FTV	Diesel	1995	4	40
AVENSIS Station Wagon (T22_)	1.9	10/99→05/99	2CT	Diesel	1975	4	46
AVENSIS Station Wagon (T22_)	2.0	10/00→02/00	1AZ-FSE	Petrol	1998	4	39
AVENSIS Station Wagon (T22_)	2.0	10/99→02/00	1CD-FTV	Diesel	1995	4	40
AVENSIS Station Wagon (T22_)	2.0	09/99→02/00	2CTE	Diesel	1975	4	47
AVENSIS Station Wagon (T22_)	2.0	09/99→10/00	3S-FE	Petrol	1998	4	49
AVENSIS VERSO (_CLM2_ , _ACM2_)	2.0	08/00→11/00	1AZ-FE	Petrol	1998	4	38
AVENSIS VERSO (_CLM2_ , _ACM2_)	2.0	08/00→08/00	1CD-FTV	Diesel	1995	4	40
AVENSIS VERSO (_CLM2_ , _ACM2_)	2.2	04/00→11/00	2AD-FTV	Diesel	2231	4	59
AVENSIS VERSO (_CLM2_ , _ACM2_)	2.4	10/00→11/00	2AZ-FE	Petrol	2362	4	64
AYGO (WNB1_ , KGB1_)	1.0	07/00→	1KR-FE	Petrol	998	3	2
AYGO (WNB1_ , KGB1_)	1.0	07/00→	1KR-FE	LPG	998	3	2
bB I (NCP3_)	1.5	03/00→12/00	1NZ-FE	Petrol/Electro	1497	4	15
bB I (NCP3_)	1.5	03/00→12/00	1NZ-FE	Petrol	1497	4	15
BLIZZARD (LD2_)	2.0	05/98→10/99	3Y	Petrol	1998	4	54
CALDINA (ST19_ , ET19_ , CT19_ , AT19_)	1.6	02/99→09/99	4A-FE	Petrol	1587	4	22



Ltr







CC



9

Model	Ltr	Year Range	Engine	Fuel	CC	Seats	Price
CALDINA (ST19_, ET19_, CT19_, AT19_)	1.8	02/99→09/99	7A-FE	Petrol	1762	4	35
CALDINA (ST19_, ET19_, CT19_, AT19_)	2.0	02/99→10/99	3S-FE	Petrol	1998	4	49
CALDINA (ST19_, ET19_, CT19_, AT19_)	2.0	07/99→09/99	3S-GE	Petrol	1998	4	50
CALDINA (ST21_, CT21_, AT21_)	1.8	10/99→09/00	7A-FE	Petrol	1762	4	35
CALDINA (ST21_, CT21_, AT21_)	2.0	10/99→09/00	3S-GTE	Petrol	1998	4	53
CALDINA (ST21_, CT21_, AT21_)	2.2	10/99→09/00	3CTE	Diesel	2184	4	60
CALDINA (ZZT24_, ST24_, AZT24_)	2.0	09/00→06/00	1AZ-FSE	Petrol	1998	4	39
CAMRY (_CV1_, _XV1_, _V1_)	2.0	06/99→09/99	3S-FE	Petrol	1998	4	49
CAMRY (_CV1_, _XV1_, _V1_)	2.2	06/99→08/99	5S-FE	Petrol	2164	4	63
CAMRY (_CV1_, _XV1_, _V1_)	3.0	09/99→07/99	1MZ-FE	Petrol	2995	6	83
CAMRY (_CV1_, _XV1_, _V1_)	3.0	06/99→08/99	3VZ-FE	Petrol	2959	6	85
CAMRY (_CV2_, _XV2_)	2.0	08/99→09/99	2CT	Diesel	1975	4	46
CAMRY (_CV2_, _XV2_)	2.2	08/99→11/00	5S-FE	Petrol	2164	4	63
CAMRY (_CV2_, _XV2_)	3.0	08/99→11/00	1MZ-FE	Petrol	2995	6	83
CAMRY (_CV2_, _XV2_)	3.0	08/99→07/00	3VZ-FE	Petrol	2959	6	85
CAMRY (MCV3_, ACV3_, _XV3_)	2.0	08/00→11/00	1AZ-FE	Petrol	1998	4	38
CAMRY (MCV3_, ACV3_, _XV3_)	2.4	11/00→11/00	2AZ-FE	Petrol	2362	4	64
CAMRY (MCV3_, ACV3_, _XV3_)	2.4	01/00→11/00	2AZ-FXE	Petrol/Electro	2362	4	66
CAMRY (MCV3_, ACV3_, _XV3_)	2.4	01/00→11/00	2AZ-FXE	Petrol	2362	4	66
CAMRY (MCV3_, ACV3_, _XV3_)	3.0	11/00→11/00	1MZ-FE	Petrol	2995	6	83
CAMRY (_V2_)	1.8	10/98→08/98	1S-L	Petrol	1832	4	28
CAMRY (_V2_)	2.0	11/98→05/99	2CT	Diesel	1975	4	46
CAMRY (_V2_)	2.0	11/98→05/99	3S-FE	Petrol	1998	4	49
CAMRY (_V2_)	2.5	02/98→05/99	2VZ-FE	Petrol	2508	6	76
CAMRY Estate (_CV2_, _XV2_)	3.0	08/99→07/00	1MZ-FE	Petrol	2995	6	83
CAMRY Saloon (_V1_)	2.0	03/98→07/98	3S-FE	Petrol	1998	4	49
CAMRY Saloon (_XV4_)	2.0	01/00→09/01	1AZ-FE	Petrol	1998	4	38
CAMRY Saloon (_XV4_)	2.4	01/00→09/01	2AZ-FE	Petrol	2362	4	64
CAMRY Saloon (_XV4_)	2.4	01/00→09/01	2AZ-FXE	Petrol/Electro	2362	4	66
CAMRY Saloon (_XV4_)	2.4	01/00→09/01	2AZ-FXE	Petrol	2362	4	66
CAMRY Saloon (XV5_)	2.0	09/01→	1AZ-FE	Petrol	1998	4	38
CAMRY SOLARA Convertible (MCV2_, SXV2_)	2.2	02/00→11/00	5S-FE	Petrol	2164	4	63
CAMRY SOLARA Convertible (MCV2_, SXV2_)	3.0	02/00→11/00	1MZ-FE	Petrol	2995	6	83
CAMRY SOLARA Convertible (MCV3_, ACV3_)	2.4	02/00→11/00	2AZ-FE	Petrol	2362	4	64
CAMRY SOLARA Convertible (MCV3_, ACV3_)	3.0	02/00→11/00	1MZ-FE	Petrol	2995	6	83
CAMRY SOLARA Coupe (MCV2_, SXV2_)	2.2	06/99→06/00	5S-FE	Petrol	2164	4	63
CAMRY SOLARA Coupe (MCV2_, SXV2_)	3.0	06/99→06/00	1MZ-FE	Petrol	2995	6	83
CAMRY SOLARA Coupe (MCV3_, ACV3_)	2.4	07/00→07/00	2AZ-FE	Petrol	2362	4	64
CAMRY SOLARA Coupe (MCV3_, ACV3_)	3.0	07/00→07/00	1MZ-FE	Petrol	2995	6	83
CAMRY Station Wagon (_V2_)	2.0	11/98→05/99	2CT	Diesel	1975	4	46
CAMRY Station Wagon (_V2_)	2.0	11/98→06/99	3S-FE	Petrol	1998	4	49
CAMRY Station Wagon (_V2_)	2.5	01/99→05/99	2VZ-FE	Petrol	2508	6	76
CAMRY Station Wagon (_XV1_, _CV1_, _V10)	2.2	03/99→07/99	5S-FE	Petrol	2164	4	63
CAMRY Station Wagon (_XV1_, _CV1_, _V10)	3.0	03/99→07/99	3VZ-FE	Petrol	2959	6	85
CARIBE Estate	1.3	09/99→08/99	4E-FE	Petrol	1332	4	11
CARIBE Estate	1.6	09/99→08/00	4A-FE	Petrol	1587	4	22
CARINA E (_T19_)	1.6	04/99→09/99	4A-FE	Petrol	1587	4	22
CARINA E (_T19_)	1.8	10/99→09/99	7A-FE	Petrol	1762	4	35
CARINA E (_T19_)	2.0	01/99→09/99	2CT	Diesel	1975	4	46
CARINA E (_T19_)	2.0	04/99→09/99	3S-FE	Petrol	1998	4	49
CARINA E (_T19_)	2.0	04/99→09/99	3S-GE	Petrol	1998	4	50
CARINA E Saloon (_T19_)	1.5	04/99→09/99	5A-FE	Petrol	1497	4	17
CARINA E Saloon (_T19_)	1.6	01/99→09/99	4A-FE	Petrol	1587	4	22
CARINA E Saloon (_T19_)	1.8	04/99→09/99	7A-FE	Petrol	1762	4	35
CARINA E Saloon (_T19_)	2.0	01/99→09/99	2CT	Diesel	1975	4	46
CARINA E Saloon (_T19_)	2.0	12/99→09/99	3S-FE	Petrol	1998	4	49
CARINA E Saloon (_T19_)	2.0	04/99→09/99	3S-GE	Petrol	1998	4	50
CARINA E Sportswagon (_T19_)	1.6	04/99→09/99	4A-FE	Petrol	1587	4	22
CARINA E Sportswagon (_T19_)	1.8	10/99→09/99	7A-FE	Petrol	1762	4	35
CARINA E Sportswagon (_T19_)	2.0	01/99→09/99	2CT	Diesel	1975	4	46
CARINA E Sportswagon (_T19_)	2.0	01/99→09/99	3S-FE	Petrol	1998	4	49
CARINA II (_T15_)	2.0	02/98→05/98	2CL	Diesel	1975	4	45
CARINA II (_T17_)	1.6	12/98→11/98	4A-F	Petrol	1587	4	21
CARINA II (_T17_)	1.6	12/98→03/99	4A-FE	Petrol	1587	4	22
CARINA II (_T17_)	2.0	03/98→06/99	2CL	Diesel	1975	4	45
CARINA II (_T17_)	2.0	12/98→03/99	3S-FE	Petrol	1998	4	49
CARINA II Saloon (_T15_)	2.0	02/98→05/98	2CL	Diesel	1975	4	45
CARINA II Saloon (_T17_)	1.6	12/98→08/99	4A-F	Petrol	1587	4	21
CARINA II Saloon (_T17_)	1.6	12/98→03/99	4A-FE	Petrol	1587	4	22
CARINA II Saloon (_T17_)	2.0	12/98→03/99	3S-FE	Petrol	1998	4	49

	Ltr				CC		9
CARINA II Station Wagon (_T17_)	1.5	12/98 → 03/99	5A-FE	Petrol	1497	4	17
CARINA II Station Wagon (_T17_)	1.6	12/98 → 12/98	4A-F	Petrol	1587	4	21
CARINA II Station Wagon (_T17_)	1.6	12/98 → 03/99	4A-FE	Petrol	1587	4	22
CARINA II Station Wagon (_T17_)	2.0	12/98 → 01/99	2CL	Diesel	1975	4	45
CARINA II Station Wagon (_T17_)	2.0	12/98 → 04/99	3S-FE	Petrol	1998	4	49
CELICA (AT16_ , ST16_)	2.0	01/98 → 08/98	3S-GEL	Petrol	1998	4	51
CELICA (ST20_ , AT20_)	1.8	11/99 → 11/99	7A-FE	Petrol	1762	4	35
CELICA (ST20_ , AT20_)	2.0	11/99 → 11/99	3S-GE	Petrol	1998	4	50
CELICA (ST20_ , AT20_)	2.0	02/99 → 11/99	3S-GTE	Petrol	1998	4	53
CELICA (ST20_ , AT20_)	2.2	11/99 → 08/99	5S-FE	Petrol	2164	4	63
CELICA (ZZT23_)	1.8	08/99 → 07/00	1ZZ-FE	Petrol	1794	4	29
CELICA (ZZT23_)	1.8	08/99 → 09/00	2ZZ-GE	Petrol	1796	4	34
CELICA Convertible (AT18_ , ST18_)	2.0	10/98 → 11/99	3S-GE	Petrol	1998	4	50
CELICA Convertible (AT20_ , ST20_)	2.0	11/99 → 08/99	3S-GE	Petrol	1998	4	50
CELICA Convertible (ST16_ , AT16_)	2.0	10/98 → 08/98	3S-GEL	Petrol	1998	4	51
CELICA Convertible (ST16_ , AT16_)	2.0	08/98 → 08/98	3S-GELC	Petrol	1998	4	52
CELICA Coupe (AT18_ , ST18_)	1.6	10/98 → 11/99	4A-FE	Petrol	1587	4	22
CELICA Coupe (AT18_ , ST18_)	2.0	10/98 → 11/99	3S-GE	Petrol	1998	4	50
CELICA Coupe (AT18_ , ST18_)	2.0	10/98 → 11/99	3S-GTE	Petrol	1998	4	53
CELICA Coupe (AT18_ , ST18_)	2.2	10/98 → 10/99	5S-FE	Petrol	2164	4	63
CELICA Coupe (ST16_ , AT16_)	1.8	08/98 → 08/98	1S-EL	Petrol	1832	4	27
CELICA Coupe (ST16_ , AT16_)	2.0	08/98 → 08/98	3S-GEL	Petrol	1998	4	51
CELICA Coupe (ST16_ , AT16_)	2.0	08/98 → 08/98	3S-GELC	Petrol	1998	4	52
CELICA Coupe (ST16_ , AT16_)	2.0	03/98 → 08/98	3S-GTE	Petrol	1998	4	53
CELICA Hatchback (ST16_ , AT16_)	1.6	08/98 → 08/98	4A-GELC	Petrol	1587	4	24
CELICA Hatchback (ST16_ , AT16_)	2.0	08/98 → 08/98	3S-GEL	Petrol	1998	4	51
CELICA Hatchback (ST16_ , AT16_)	2.0	09/98 → 08/98	3S-GELC	Petrol	1998	4	52
CELSIOR (UCF1_)	4.0	12/98 → 08/00	1UZ-FE	Petrol	3969	8	92
CELSIOR (UCF2_)	4.0	05/99 → 08/00	1UZ-FE	Petrol	3969	8	92
CHASER (_X8_ , _X7_)	2.0	08/98 → 08/99	1G-FE	Petrol	1988	6	42
CHASER (_X8_ , _X7_)	2.0	08/98 → 09/99	21R	Petrol	1972	4	57
CHASER (_X9_)	1.8	10/99 → 08/99	7A-FE	Petrol	1762	4	35
CHASER (_X9_)	2.4	10/99 → 08/99	2L	Diesel	2446	4	67
CHASER (_X10_)	2.2	10/99 → 05/00	5S-FE	Petrol	2164	4	63
COASTER Bus (FB3_ , HB3_ , BB2_ , RB2_)	2.4	05/98 → 09/98	22R	Petrol	2367	4	72
COASTER Bus (FB3_ , HB3_ , BB2_ , RB2_)	4.2	10/98 → 01/99	1H-Z	Diesel	4164	6	97
COASTER Bus (TRB5_ , XZB5_ , RZB4_ , HZB5_ , BZB5_ , BB4_)	2.7	02/99 → 10/00	3RZ-FE	Petrol	2694	4	78
COASTER Bus (TRB5_ , XZB5_ , RZB4_ , HZB5_ , BZB5_ , BB4_)	4.2	02/99 →	1H-Z	Diesel	4164	6	97
COROLLA (_E8_)	1.6	12/98 → 05/98	4A-LC	Petrol	1587	4	25
COROLLA (_E8_)	1.8	07/98 → 05/98	1CL	Diesel	1839	4	26
COROLLA (_E9_)	1.3	05/98 → 12/99	2E	Petrol	1296	4	6
COROLLA (_E9_)	1.3	08/98 → 12/99	2E-E	Petrol	1296	4	7
COROLLA (_E9_)	1.6	08/98 → 04/99	4A-F	Petrol	1587	4	21
COROLLA (_E9_)	1.6	10/98 → 06/99	4A-FE	Petrol	1587	4	22
COROLLA (_E10_)	1.3	07/99 → 04/99	2E	Petrol	1296	4	6
COROLLA (_E10_)	1.3	07/99 → 04/99	4E-FE	Petrol	1332	4	11
COROLLA (_E10_)	1.6	05/99 → 04/99	4A-FE	Petrol	1587	4	22
COROLLA (_E10_)	1.8	11/99 → 09/99	7A-FE	Petrol	1762	4	35
COROLLA (_E11_)	1.3	05/99 → 10/00	2E	Petrol	1296	4	6
COROLLA (_E11_)	1.4	04/99 → 02/00	4E-FE	Petrol	1332	4	11
COROLLA (_E11_)	1.4	02/00 → 11/00	4Z-FE	Petrol	1398	4	13
COROLLA (_E11_)	1.5	09/99 → 10/00	1NZ-FE	Petrol/Electro	1497	4	15
COROLLA (_E11_)	1.5	09/99 → 10/00	1NZ-FE	Petrol	1497	4	15
COROLLA (_E11_)	1.6	02/00 → 11/00	3ZZ-FE	Petrol/Natural Gas (CNG)	1598	4	20
COROLLA (_E11_)	1.6	02/00 → 11/00	3ZZ-FE	Petrol	1598	4	20
COROLLA (_E11_)	1.6	04/99 → 02/00	4A-FE	Petrol	1587	4	22
COROLLA (_E11_)	1.8	10/99 → 12/00	7A-FE	Petrol	1762	4	35
COROLLA (_E11_)	1.9	02/00 → 11/00	1WZ	Diesel	1867	4	36
COROLLA (_E11_)	2.0	08/00 → 11/00	1CD-FTV	Diesel	1995	4	40
COROLLA (_E11_)	2.0	04/99 → 02/00	2CE	Diesel	1975	4	44
COROLLA (_E11_)	2.2	04/99 → 10/00	3CTE	Diesel	2184	4	60
COROLLA (ZZE12_ , NDE12_ , ZDE12_)	1.4	07/00 → 02/00	1ND-TV	Diesel	1364	4	12
COROLLA (ZZE12_ , NDE12_ , ZDE12_)	1.4	01/00 → 12/00	4Z-FE	Petrol	1398	4	13
COROLLA (ZZE12_ , NDE12_ , ZDE12_)	1.6	01/00 → 12/00	3ZZ-FE	Petrol/Natural Gas (CNG)	1598	4	20
COROLLA (ZZE12_ , NDE12_ , ZDE12_)	1.6	01/00 → 12/00	3ZZ-FE	Petrol	1598	4	20
COROLLA (ZZE12_ , NDE12_ , ZDE12_)	1.8	12/00 → 02/00	1ZZ-FE	Petrol	1794	4	29
COROLLA (ZZE12_ , NDE12_ , ZDE12_)	1.8	01/00 → 02/00	2ZZ-GE	Petrol	1796	4	34
COROLLA (ZZE12_ , NDE12_ , ZDE12_)	2.0	01/00 → 02/00	1CD-FTV	Diesel	1995	4	40
COROLLA Compact (_E9_)	1.3	05/98 → 04/99	2E	Petrol	1296	4	6
COROLLA Compact (_E9_)	1.6	08/98 → 04/99	4A-F	Petrol	1587	4	21



Ltr







CC



9

Model	Ltr	Year Range	Engine	Fuel	CC	Seats	Index
COROLLA Compact (_E9_)	1.6	08/98→04/99	4A-FE	Petrol	1587	4	22
COROLLA Compact (_E9_)	1.6	08/98→04/99	4A-GE	Petrol	1587	4	23
COROLLA Compact (_E10_)	1.3	07/99→05/99	2E	Petrol	1296	4	6
COROLLA Compact (_E10_)	1.3	07/99→04/99	4E-FE	Petrol	1332	4	11
COROLLA Compact (_E10_)	1.6	07/99→04/99	4A-FE	Petrol	1587	4	22
COROLLA Compact (_E10_)	1.8	05/99→07/99	7A-FE	Petrol	1762	4	35
COROLLA Compact (_E11_)	1.4	04/99→02/00	4E-FE	Petrol	1332	4	11
COROLLA Compact (_E11_)	1.4	02/00→01/00	4ZZ-FE	Petrol	1398	4	13
COROLLA Compact (_E11_)	1.5	09/99→10/00	1NZ-FE	Petrol/Electro	1497	4	15
COROLLA Compact (_E11_)	1.5	09/99→10/00	1NZ-FE	Petrol	1497	4	15
COROLLA Compact (_E11_)	1.6	02/00→01/00	3ZZ-FE	Petrol/Natural Gas (CNG)	1598	4	20
COROLLA Compact (_E11_)	1.6	02/00→01/00	3ZZ-FE	Petrol	1598	4	20
COROLLA Compact (_E11_)	1.6	04/99→02/00	4A-FE	Petrol	1587	4	22
COROLLA Compact (_E11_)	1.9	02/00→01/00	1WZ	Diesel	1867	4	36
COROLLA Compact (_E11_)	2.0	08/00→01/00	1CD-FTV	Diesel	1995	4	40
COROLLA Compact (_E11_)	2.0	04/99→02/00	2CE	Diesel	1975	4	44
COROLLA Compact (_E11_)	2.2	04/99→10/00	3CTE	Diesel	2184	4	60
COROLLA Estate (_E12J_ , _E12T_)	1.4	07/00→02/00	1ND-TV	Diesel	1364	4	12
COROLLA Estate (_E12J_ , _E12T_)	1.4	01/00→02/00	4ZZ-FE	Petrol	1398	4	13
COROLLA Estate (_E12J_ , _E12T_)	1.6	01/00→02/00	3ZZ-FE	Petrol/Natural Gas (CNG)	1598	4	20
COROLLA Estate (_E12J_ , _E12T_)	1.6	01/00→02/00	3ZZ-FE	Petrol	1598	4	20
COROLLA Estate (_E12J_ , _E12T_)	1.8	12/00→02/00	1ZZ-FE	Petrol	1794	4	29
COROLLA Estate (_E12J_ , _E12T_)	2.0	01/00→02/00	1CD-FTV	Diesel	1995	4	40
COROLLA Estate (_E14_)	1.5	09/00→	1NZ-FE	Petrol/Electro	1497	4	15
COROLLA Estate (_E14_)	1.5	09/00→	1NZ-FE	Petrol	1497	4	15
COROLLA Estate (_E14_)	1.8	09/00→	2ZR-FAE	Petrol	1798	4	31
COROLLA Estate (_NZE16_)	1.5	05/01→	1NZ-FE	Petrol/Electro	1497	4	15
COROLLA Estate (_NZE16_)	1.5	05/01→	1NZ-FE	Petrol	1497	4	15
COROLLA Estate (_NZE16_)	1.8	05/01→	2ZR-FAE	Petrol	1798	4	31
COROLLA Liftback (_E8_)	1.6	04/98→06/98	4A-LC	Petrol	1587	4	25
COROLLA Liftback (_E9_)	1.3	07/98→04/99	2E	Petrol	1296	4	6
COROLLA Liftback (_E9_)	1.3	08/98→04/99	2E-E	Petrol	1296	4	7
COROLLA Liftback (_E9_)	1.6	08/98→04/99	4A-F	Petrol	1587	4	21
COROLLA Liftback (_E9_)	1.6	08/98→04/99	4A-FE	Petrol	1587	4	22
COROLLA Liftback (_E9_)	1.6	07/98→06/99	4A-GE	Petrol	1587	4	23
COROLLA Liftback (_E10_)	1.3	07/99→05/99	2E	Petrol	1296	4	6
COROLLA Liftback (_E10_)	1.3	07/99→04/99	4E-FE	Petrol	1332	4	11
COROLLA Liftback (_E10_)	1.6	07/99→04/99	4A-FE	Petrol	1587	4	22
COROLLA Liftback (_E10_)	1.8	05/99→07/99	7A-FE	Petrol	1762	4	35
COROLLA Liftback (_E11_)	1.4	04/99→02/00	4E-FE	Petrol	1332	4	11
COROLLA Liftback (_E11_)	1.4	02/00→01/00	4ZZ-FE	Petrol	1398	4	13
COROLLA Liftback (_E11_)	1.6	02/00→01/00	3ZZ-FE	Petrol/Natural Gas (CNG)	1598	4	20
COROLLA Liftback (_E11_)	1.6	02/00→01/00	3ZZ-FE	Petrol	1598	4	20
COROLLA Liftback (_E11_)	1.6	04/99→02/00	4A-FE	Petrol	1587	4	22
COROLLA Liftback (_E11_)	1.8	09/99→11/00	7A-FE	Petrol	1762	4	35
COROLLA Liftback (_E11_)	1.9	02/00→01/00	1WZ	Diesel	1867	4	36
COROLLA Liftback (_E11_)	2.0	09/00→01/00	1CD-FTV	Diesel	1995	4	40
COROLLA Liftback (_E11_)	2.0	04/99→02/00	2CE	Diesel	1975	4	44
COROLLA RUMION (_AZE15_ , _NZE15_ , _ZRE15_)	1.5	09/00→	1NZ-FE	Petrol/Electro	1497	4	15
COROLLA RUMION (_AZE15_ , _NZE15_ , _ZRE15_)	1.5	09/00→	1NZ-FE	Petrol	1497	4	15
COROLLA RUMION (_AZE15_ , _NZE15_ , _ZRE15_)	1.8	09/00→	2ZR-FAE	Petrol	1798	4	31
COROLLA Saloon (_E12J_ , _E12T_)	1.3	11/00→05/00	2NZ-FE	Petrol	1299	4	9
COROLLA Saloon (_E12J_ , _E12T_)	1.4	07/00→07/00	1ND-TV	Diesel	1364	4	12
COROLLA Saloon (_E12J_ , _E12T_)	1.4	08/00→07/00	4ZZ-FE	Petrol	1398	4	13
COROLLA Saloon (_E12J_ , _E12T_)	1.5	11/00→07/00	1NZ-FE	Petrol/Electro	1497	4	15
COROLLA Saloon (_E12J_ , _E12T_)	1.5	11/00→07/00	1NZ-FE	Petrol	1497	4	15
COROLLA Saloon (_E12J_ , _E12T_)	1.6	08/00→07/00	3ZZ-FE	Petrol/Natural Gas (CNG)	1598	4	20
COROLLA Saloon (_E12J_ , _E12T_)	1.6	08/00→07/00	3ZZ-FE	Petrol	1598	4	20
COROLLA Saloon (_E12J_ , _E12T_)	1.8	03/00→07/00	1ZZ-FE	Petrol	1794	4	29
COROLLA Saloon (_E12J_ , _E12T_)	2.0	08/00→07/00	1CD-FTV	Diesel	1995	4	40
COROLLA Saloon (E15_)	1.3	03/00→	2NZ-FE	Petrol	1299	4	9
COROLLA Saloon (E15_)	1.4	01/00→	1ND-TV	Diesel	1364	4	12
COROLLA Saloon (E15_)	1.4	01/00→	4ZZ-FE	Petrol	1398	4	13
COROLLA Saloon (E15_)	1.5	08/00→	1NZ-FE	Petrol/Electro	1497	4	15
COROLLA Saloon (E15_)	1.5	08/00→	1NZ-FE	Petrol	1497	4	15
COROLLA Saloon (E15_)	1.6	08/00→	3ZZ-FE	Petrol/Natural Gas (CNG)	1598	4	20
COROLLA Saloon (E15_)	1.6	08/00→	3ZZ-FE	Petrol	1598	4	20
COROLLA Saloon (E15_)	1.8	08/00→	2ZR-FAE	Petrol	1798	4	31
COROLLA Saloon (E15_)	1.8	05/00→	2ZR-FE	Petrol	1798	4	32
COROLLA Saloon (E15_)	2.0	01/00→	1AD-FTV	Diesel	1998	4	37

	Ltr				CC		9
COROLLA Saloon (E15_)	2.2	11/00 →	2AD-FHV	Diesel	2231	4	58
COROLLA Saloon (_NZE16_)	1.5	05/01 →	1NZ-FE	Petrol/Electro	1497	4	15
COROLLA Saloon (_NZE16_)	1.5	05/01 →	1NZ-FE	Petrol	1497	4	15
COROLLA Station Wagon (_E9_)	1.3	05/98 → 04/99	2E	Petrol	1296	4	6
COROLLA Station Wagon (_E9_)	1.3	06/98 → 06/99	2E-E	Petrol	1296	4	7
COROLLA Station Wagon (_E9_)	1.6	12/98 → 08/99	4A-F	Petrol	1587	4	21
COROLLA Station Wagon (_E9_)	1.6	08/98 → 06/99	4A-FE	Petrol	1587	4	22
COROLLA Verso (ZDE12_, CDE12_)	1.4	09/00 → 05/00	1ND-TV	Diesel	1364	4	12
COROLLA Verso (ZDE12_, CDE12_)	1.4	01/00 → 05/00	4ZZ-FE	Petrol	1398	4	13
COROLLA Verso (ZDE12_, CDE12_)	1.6	01/00 → 05/00	3ZZ-FE	Petrol/Natural Gas (CNG)	1598	4	20
COROLLA Verso (ZDE12_, CDE12_)	1.6	01/00 → 05/00	3ZZ-FE	Petrol	1598	4	20
COROLLA Verso (ZDE12_, CDE12_)	1.8	10/00 → 05/00	1ZZ-FE	Petrol	1794	4	29
COROLLA Verso (ZDE12_, CDE12_)	2.0	09/00 → 05/00	1CD-FTV	Diesel	1995	4	40
COROLLA Verso (ZER_, ZZE_, R1_)	1.4	03/00 → 03/00	1ND-TV	Diesel	1364	4	12
COROLLA Verso (ZER_, ZZE_, R1_)	1.5	03/00 → 03/00	1NZ-FE	Petrol/Electro	1497	4	15
COROLLA Verso (ZER_, ZZE_, R1_)	1.5	03/00 → 03/00	1NZ-FE	Petrol	1497	4	15
COROLLA Verso (ZER_, ZZE_, R1_)	1.6	04/00 → 03/00	3ZZ-FE	Petrol/Natural Gas (CNG)	1598	4	20
COROLLA Verso (ZER_, ZZE_, R1_)	1.6	04/00 → 03/00	3ZZ-FE	Petrol	1598	4	20
COROLLA Verso (ZER_, ZZE_, R1_)	1.8	04/00 → 03/00	1ZZ-FE	Petrol	1794	4	29
COROLLA Verso (ZER_, ZZE_, R1_)	2.0	04/00 → 03/00	1CD-FTV	Diesel	1995	4	40
COROLLA Verso (ZER_, ZZE_, R1_)	2.2	10/00 → 03/00	2AD-FHV	Diesel	2231	4	58
COROLLA Verso (ZER_, ZZE_, R1_)	2.2	10/00 → 03/00	2AD-FTV	Diesel	2231	4	59
COROLLA Wagon (_E10_)	1.3	07/99 → 05/99	2E	Petrol	1296	4	6
COROLLA Wagon (_E10_)	1.3	07/99 → 04/99	4E-FE	Petrol	1332	4	11
COROLLA Wagon (_E10_)	1.6	07/99 → 04/99	4A-FE	Petrol	1587	4	22
COROLLA Wagon (_E10_)	1.8	09/99 → 04/99	7A-FE	Petrol	1762	4	35
COROLLA Wagon (_E11_)	1.4	04/99 → 02/00	4E-FE	Petrol	1332	4	11
COROLLA Wagon (_E11_)	1.4	02/00 → 10/00	4ZZ-FE	Petrol	1398	4	13
COROLLA Wagon (_E11_)	1.6	02/00 → 10/00	3ZZ-FE	Petrol/Natural Gas (CNG)	1598	4	20
COROLLA Wagon (_E11_)	1.6	02/00 → 10/00	3ZZ-FE	Petrol	1598	4	20
COROLLA Wagon (_E11_)	1.6	04/99 → 02/00	4A-FE	Petrol	1587	4	22
COROLLA Wagon (_E11_)	1.8	04/99 → 10/00	7A-FE	Petrol	1762	4	35
COROLLA Wagon (_E11_)	1.9	02/00 → 10/00	1WZ	Diesel	1867	4	36
COROLLA Wagon (_E11_)	2.0	04/99 → 10/00	1CD-FTV	Diesel	1995	4	40
COROLLA Wagon (_E11_)	2.0	04/99 → 02/00	2CE	Diesel	1975	4	44
CORONA Estate	1.6	02/99 → 09/99	4A-FE	Petrol	1587	4	22
CORONA Estate	1.8	02/99 → 09/99	7A-FE	Petrol	1762	4	35
CORONA Estate	2.0	07/99 → 09/99	2CT	Diesel	1975	4	46
CORONA Estate	2.0	02/99 → 09/99	3S-FE	Petrol	1998	4	49
CORONA Hatchback	1.6	12/98 → 10/98	4A-F	Petrol	1587	4	21
CORONA Hatchback	1.6	06/98 → 09/99	4A-FE	Petrol	1587	4	22
CORONA Hatchback	1.8	02/99 → 09/99	7A-FE	Petrol	1762	4	35
CORONA Hatchback	2.0	07/99 → 09/99	2CT	Diesel	1975	4	46
CORONA Hatchback	2.0	12/98 → 09/99	3S-FE	Petrol	1998	4	49
CORONA Saloon	1.6	12/98 → 10/98	4A-F	Petrol	1587	4	21
CORONA Saloon	1.6	06/98 → 09/99	4A-FE	Petrol	1587	4	22
CORONA Saloon	1.8	02/99 → 09/99	7A-FE	Petrol	1762	4	35
CORONA Saloon	2.0	07/99 → 09/99	2CT	Diesel	1975	4	46
CORONA Saloon	2.0	12/98 → 09/99	3S-FE	Petrol	1998	4	49
CORSA Hatchback	1.3	11/99 → 09/99	4E-FE	Petrol	1332	4	11
CORSA Hatchback	1.5	11/99 → 09/99	1N	Diesel	1453	4	14
CORSA Saloon	1.3	10/99 → 09/99	4E-FE	Petrol	1332	4	11
CORSA Saloon	1.5	11/99 → 09/99	1N	Diesel	1453	4	14
CORSA Saloon	1.5	10/99 → 10/99	5E-FE	Petrol	1497	4	18
CRESSIDA Estate (RX7_)	2.8	11/98 → 09/98	5M-GE	Petrol	2759	6	79
CRESSIDA Estate	2.0	10/98 → 09/99	1G-FE	Petrol	1988	6	42
CRESSIDA Estate	3.0	10/98 → 09/99	7M-GE	Petrol	2954	6	88
CRESSIDA Saloon (GX7_, MX73)	2.4	01/98 → 10/98	2L-T	Diesel	2446	4	68
CRESSIDA Saloon (GX7_, MX73)	2.8	05/98 → 09/98	5M-GE	Petrol	2759	6	79
CRESSIDA Saloon (_X6_)	2.0	08/98 → 09/99	1G-FE	Petrol	1988	6	42
CRESSIDA Saloon	2.0	10/99 → 09/99	1G-FE	Petrol	1988	6	42
CRESSIDA Saloon	3.0	10/98 → 01/99	7M-GE	Petrol	2954	6	88
CRESTA Estate	2.2	10/99 → 09/00	3CTE	Diesel	2184	4	60
CRESTA Saloon	2.0	08/98 → 09/00	1G-FE	Petrol	1988	6	42
CRESTA Saloon	2.2	10/99 → 09/00	3CTE	Diesel	2184	4	60
CRESTA Saloon	2.4	06/98 → 08/98	22R	Petrol	2367	4	72
CRESTA Saloon	2.4	09/98 → 10/99	2L	Diesel	2446	4	67
CRESTA Saloon	2.8	11/98 → 08/98	5M-GE	Petrol	2759	6	79
CRESTA Saloon	3.0	09/98 → 10/99	7M-GE	Petrol	2954	6	88
CROWN Saloon (CRS_, JZS_, GRS18_, UZS_)	2.5	09/00 → 02/00	4GR-FSE	Petrol	2499	6	77



Ltr







CC



9

Model	Ltr	Year	Engine	Fuel	CC	Chassis	9
CROWN Saloon (GRS20_)	2.5	02/00→11/01	4GR-FSE	Petrol	2499	6	77
CROWN Saloon (GRS21_ , AWS21_)	2.5	12/01→	4GR-FSE	Petrol	2499	6	77
CROWN Saloon (JZS13_ , YS13_ , LS13_ , GS13_)	4.0	08/99→08/99	1UZ-FE	Petrol	3969	8	92
CROWN Saloon (LS13_ , GS13_ , MS13_ , YS13_)	2.0	10/98→07/99	1G-E	Petrol	1988	6	41
CROWN Saloon (LS13_ , GS13_ , MS13_ , YS13_)	3.0	10/98→07/99	7M-GE	Petrol	2954	6	88
CURREN Coupe (ST20_)	1.8	11/99→10/99	7A-FE	Petrol	1762	4	35
CURREN Coupe (ST20_)	2.0	11/99→10/99	3S-GE	Petrol	1998	4	50
CURREN Coupe (ST20_)	2.2	10/99→10/99	5S-FE	Petrol	2164	4	63
CURREN Coupe	1.6	09/98→10/99	4A-FE	Petrol	1587	4	22
CURREN Coupe	2.0	09/98→10/99	3S-GE	Petrol	1998	4	50
CURREN Coupe	2.0	09/98→10/99	3S-GTE	Petrol	1998	4	53
CURREN Coupe	2.2	09/98→09/99	5S-FE	Petrol	2164	4	63
DELIBOY Bus (KXC1_ , CXC1_)	2.2	10/99→10/99	3CTE	Diesel	2184	4	60
DUET (M11_ , M10_)	1.0	09/99→04/00	EJ-VE	Petrol	989	3	5
DYNA 100 Platform/Chassis (YH_)	1.8	08/98→04/99	2Y	Petrol	1812	4	30
DYNA 150 Platform/Chassis	2.0	08/98→08/98	3Y	Petrol	1998	4	54
DYNA 150 Platform/Chassis (LY_)	2.4	05/99→07/00	2L	Diesel	2446	4	67
DYNA 150 Platform/Chassis (LY_)	3.0	09/99→07/00	5L	Diesel	2986	4	86
DYNA 200 Platform/Chassis	2.2	10/99→07/00	4Y	Petrol	2237	4	61
DYNA 200 Platform/Chassis	2.7	06/99→07/00	3RZ-FE	Petrol	2694	4	78
DYNA 200 Platform/Chassis	3.0	08/98→05/99	11B	Diesel	2986	4	90
DYNA 300 Platform/Chassis	2.4	06/99→07/00	2RZ-FE	Petrol	2438	4	70
DYNA Bus (KDY2_)	3.0	08/00→	1KD-FTV	Diesel	2982	4	80
DYNA Bus (LY1_ , H8_)	2.4	08/98→07/00	2L	Diesel	2446	4	67
DYNA Platform/Chassis (KD_ , LY_ , TRY2_ , KDY2_ , XZU4_ , XZU3_)	2.5	08/00→	2KD-FTV	Diesel	2494	4	75
DYNA Platform/Chassis (KD_ , LY_ , TRY2_ , KDY2_ , XZU4_ , XZU3_)	3.0	09/00→	1KD-FTV	Diesel	2982	4	80
DYNA Platform/Chassis (KD_ , LY_ , TRY2_ , KDY2_ , XZU4_ , XZU3_)	3.0	08/00→	5L	Diesel	2986	4	86
DYNA Platform/Chassis (KD_ , LY_ , TRY2_ , KDY2_ , XZU4_ , XZU3_)	3.0	09/00→	1KD-FTV	Diesel	2982	4	80
DYNA Platform/Chassis (LH8_)	2.4	08/98→04/99	2L	Diesel	2446	4	67
ECHO Hatchback (NCP13_ , NCP12_)	1.0	04/00→08/00	1SZ-FE	Petrol	998	4	3
ECHO Hatchback (NCP13_ , NCP12_)	1.3	08/99→03/00	2NZ-FE	Petrol	1299	4	9
ECHO Hatchback (NCP13_ , NCP12_)	1.3	04/00→08/00	2SZ-FE	Petrol	1298	4	10
ECHO Hatchback (NCP13_ , NCP12_)	1.4	01/00→03/00	1ND-TV	Diesel	1364	4	12
ECHO Hatchback (NCP13_ , NCP12_)	1.5	04/00→08/00	1NZ-FE	Petrol/Electro	1497	4	15
ECHO Hatchback (NCP13_ , NCP12_)	1.5	04/00→08/00	1NZ-FE	Petrol	1497	4	15
ECHO Saloon	1.5	04/99→08/00	1NZ-FE	Petrol/Electro	1497	4	15
ECHO Saloon	1.5	04/99→08/00	1NZ-FE	Petrol	1497	4	15
FORTUNER Closed Off-Road Vehicle (TGNS_ , LAN5_ , KUN5_ , GGN5_)	2.5	01/00→	2KD-FTV	Diesel	2494	4	75
FORTUNER Closed Off-Road Vehicle (TGNS_ , LAN5_ , KUN5_ , GGN5_)	3.0	08/00→	1KD-FTV	Diesel	2982	4	80
GAIA (CXM1_ , SXM1_ , ACM1_)	2.0	05/99→10/00	1AZ-FSE	Petrol	1998	4	39
GAIA (CXM1_ , SXM1_ , ACM1_)	2.2	10/99→10/00	3CTE	Diesel	2184	4	60
GRANVIA (H2_ , H1_)	2.7	08/99→	3RZ-FE	Petrol	2694	4	78
GRANVIA (H2_ , H1_)	3.0	08/99→	1KZ-TE	Diesel	2982	4	82
GRANVIA (H2_ , H1_)	3.4	08/99→	5VZ-FE	Petrol	3378	6	91
HARRIER (MCU3_ , MHU3_ , ACU3_ , GSU3_)	2.4	10/00→	2AZ-FE	Petrol	2362	4	64
HARRIER (MCU3_ , MHU3_ , ACU3_ , GSU3_)	3.0	10/00→12/00	1MZ-FE	Petrol	2995	6	83
HARRIER (SXU1_ , MCU1_ , ACU1_)	2.2	03/99→01/00	5S-FE	Petrol	2164	4	63
HARRIER (SXU1_ , MCU1_ , ACU1_)	2.4	06/00→01/00	2AZ-FE	Petrol	2362	4	64
HARRIER (SXU1_ , MCU1_ , ACU1_)	3.0	03/99→01/00	1MZ-FE	Petrol	2995	6	83
HIACE / COMMUTER IV (TRH2_ , KDH2_)	2.5	01/00→	2KD-FTV	Diesel	2494	4	75
HIACE II Box (LH5_ , YH7_ , LH7_ , LH6_ , YH6_ , YH5_)	1.8	03/98→11/98	2Y	Petrol	1812	4	30
HIACE II Box (LH5_ , YH7_ , LH7_ , LH6_ , YH6_ , YH5_)	2.0	01/98→11/98	3Y	Petrol	1998	4	54
HIACE II Box (LH5_ , YH7_ , LH7_ , LH6_ , YH6_ , YH5_)	2.2	09/98→08/98	4Y	Petrol	2237	4	61
HIACE II Box (LH5_ , YH7_ , LH7_ , LH6_ , YH6_ , YH5_)	2.4	05/98→11/98	2L	Diesel	2446	4	67
HIACE II Wagon (LH7_ , LH5_ , LH6_ , YH7_ , YH6_ , YH5_)	1.8	03/98→11/98	2Y	Petrol	1812	4	30
HIACE II Wagon (LH7_ , LH5_ , LH6_ , YH7_ , YH6_ , YH5_)	2.0	01/98→08/98	3Y	Petrol	1998	4	54
HIACE II Wagon (LH7_ , LH5_ , LH6_ , YH7_ , YH6_ , YH5_)	2.4	08/98→08/98	2L	Diesel	2446	4	67
HIACE III Box (YH7_ , LH6_ , LH7_ , LH5_ , YH5_ , YH6_)	2.0	02/99→08/99	1RZ	Petrol	1998	4	43
HIACE III Box (YH7_ , LH6_ , LH7_ , LH5_ , YH5_ , YH6_)	2.4	08/98→08/99	2L	Diesel	2446	4	67
HIACE III Box (YH7_ , LH6_ , LH7_ , LH5_ , YH5_ , YH6_)	2.4	08/98→08/99	2RZ-E	Petrol	2438	4	69
HIACE III Box (YH7_ , LH6_ , LH7_ , LH5_ , YH5_ , YH6_)	2.5	08/00→08/00	2KD-FTV	Diesel	2494	4	75
HIACE III Box (YH7_ , LH6_ , LH7_ , LH5_ , YH5_ , YH6_)	3.0	08/99→08/00	5L	Diesel	2986	4	86
HIACE III Wagon (LH1_ , RZH1_)	2.0	08/98→04/99	1RZ	Petrol	1998	4	43
HIACE III Wagon (LH1_ , RZH1_)	2.4	08/98→08/99	2L	Diesel	2446	4	67

	Ltr				CC		9
HIACE III Wagon (LH1_, RZH1_)	2.4	08/98 → 08/00	2RZ-E	Petrol	2438	4	69
HIACE III Wagon (LH1_, RZH1_)	2.5	08/00 → 08/00	2KD-FTV	Diesel	2494	4	75
HIACE III Wagon (LH1_, RZH1_)	3.0	08/99 → 08/00	5L	Diesel	2986	4	86
HIACE III Wagon (LH1_, RZH1_)	3.4	08/99 → 08/00	5VZ-FE	Petrol	3378	6	91
HIACE IV Box (LH1_)	2.4	08/99 → 08/00	2L	Diesel	2446	4	67
HIACE IV Box (LH1_)	2.4	08/99 → 08/00	2L-T	Diesel	2446	4	68
HIACE IV Box (LH1_)	2.4	08/99 → 02/00	2RZ-E	Petrol	2438	4	69
HIACE IV Box (LH1_)	2.5	11/00 →	2KD-FTV	Diesel	2494	4	75
HIACE IV Box (LH1_)	2.7	04/99 →	3RZ-FE	Petrol	2694	4	78
HIACE IV Box (TRH2_, KDH2_)	2.5	09/00 →	2KD-FTV	Diesel	2494	4	75
HIACE IV Box (TRH2_, KDH2_)	3.0	01/00 →	1KD-FTV	Diesel	2982	4	80
HIACE IV Bus (LH1_)	2.4	08/99 → 08/00	2L	Diesel	2446	4	67
HIACE IV Bus (LH1_)	2.4	08/99 → 08/00	2L-T	Diesel	2446	4	68
HIACE IV Bus (LH1_)	2.4	08/99 → 04/99	2RZ-E	Petrol	2438	4	69
HIACE IV Bus (LH1_)	2.5	11/00 →	2KD-FTV	Diesel	2494	4	75
HIACE IV Bus (LH1_)	2.7	04/99 →	3RZ-FE	Petrol	2694	4	78
HIACE IV Platform/Chassis (LXH1_, RCH1_, KLH1_)	2.4	08/99 → 08/00	2L	Diesel	2446	4	67
HIACE IV Wagon (H100)	2.0	08/99 → 04/99	1RZ	Petrol	1998	4	43
HIACE IV Wagon (TRH2_, KDH2_)	2.5	09/00 →	2KD-FTV	Diesel	2494	4	75
HIACE IV Wagon (TRH2_, KDH2_)	3.0	01/00 →	1KD-FTV	Diesel	2982	4	80
HILUX Closed Off-Road Vehicle (RZN1_, LN1_)	2.4	08/99 → 07/00	2L-T	Diesel	2446	4	68
HILUX Closed Off-Road Vehicle (RZN1_, LN1_)	2.7	08/00 → 07/00	3RZ-FE	Petrol	2694	4	78
HILUX Closed Off-Road Vehicle (RZN1_, LN1_)	3.0	08/00 → 07/00	5L	Diesel	2986	4	86
HILUX Closed Off-Road Vehicle (RZN1_, LN1_)	3.4	11/99 → 07/00	5VZ-FE	Petrol	3378	6	91
HILUX Closed Off-Road Vehicle (ZNT3_, LN9_, RN1_, YN8_, LN8_)	2.4	08/98 → 11/99	2L-T	Diesel	2446	4	68
HILUX Closed Off-Road Vehicle (ZNT3_, LN9_, RN1_, YN8_, LN8_)	3.0	08/99 → 07/99	1KZ-T	Diesel	2982	4	81
HILUX Closed Off-Road Vehicle (ZNT3_, LN9_, RN1_, YN8_, LN8_)	3.0	08/98 → 11/99	3VZ-E	Petrol	2959	6	84
HILUX II Pickup (RN6_, RN5_, LN6_, YN6_, YN5_, LN5_)	1.8	08/98 → 07/99	2Y	Petrol	1812	4	30
HILUX II Pickup (RN6_, RN5_, LN6_, YN6_, YN5_, LN5_)	2.0	08/98 → 07/98	3Y	Petrol	1998	4	54
HILUX II Pickup (RN6_, RN5_, LN6_, YN6_, YN5_, LN5_)	2.2	01/98 → 12/98	4Y	Petrol	2237	4	61
HILUX II Pickup (RN6_, RN5_, LN6_, YN6_, YN5_, LN5_)	2.4	10/98 → 07/00	22R	Petrol	2367	4	72
HILUX II Pickup (RN6_, RN5_, LN6_, YN6_, YN5_, LN5_)	2.4	06/98 → 07/00	22RE	Petrol	2366	4	73
HILUX II Pickup (RN6_, RN5_, LN6_, YN6_, YN5_, LN5_)	2.4	01/98 → 07/00	2L	Diesel	2446	4	67
HILUX II Pickup (RN6_, RN5_, LN6_, YN6_, YN5_, LN5_)	2.4	08/99 → 01/00	2L-T	Diesel	2446	4	68
HILUX II Pickup (RN6_, RN5_, LN6_, YN6_, YN5_, LN5_)	2.4	08/99 → 07/00	2RZ-FE	Petrol	2438	4	70
HILUX II Pickup (RN6_, RN5_, LN6_, YN6_, YN5_, LN5_)	2.5	11/00 → 07/00	2KD-FTV	Diesel	2494	4	75
HILUX II Pickup (RN6_, RN5_, LN6_, YN6_, YN5_, LN5_)	2.7	08/99 → 04/00	3RZ-FE	Petrol	2694	4	78
HILUX II Pickup (RN6_, RN5_, LN6_, YN6_, YN5_, LN5_)	3.0	11/00 → 04/00	1KZ-T	Diesel	2982	4	81
HILUX II Pickup (RN6_, RN5_, LN6_, YN6_, YN5_, LN5_)	3.0	11/99 → 07/00	5L	Diesel	2986	4	86
HILUX II Pickup (RN6_, RN5_, LN6_, YN6_, YN5_, LN5_)	3.0	12/00 → 04/00	5L-E	Diesel	2986	4	87
HILUX II Pickup (RN6_, RN5_, LN6_, YN6_, YN5_, LN5_)	3.4	08/00 → 07/00	5VZ-FE	Petrol	3378	6	91
HILUX II Platform/Chassis (LN6_, LN5_, YN6_, YN5_, VZN1_, RZ)	1.8	08/98 → 07/98	2Y	Petrol	1812	4	30
HILUX II Platform/Chassis (LN6_, LN5_, YN6_, YN5_, VZN1_, RZ)	2.4	10/98 → 12/99	22R	Petrol	2367	4	72
HILUX II Platform/Chassis (LN6_, LN5_, YN6_, YN5_, VZN1_, RZ)	2.4	01/98 → 08/98	2L	Diesel	2446	4	67
HILUX II Platform/Chassis (LN6_, LN5_, YN6_, YN5_, VZN1_, RZ)	2.7	08/99 → 08/00	3RZ-FE	Petrol	2694	4	78
HILUX II Platform/Chassis (LN6_, LN5_, YN6_, YN5_, VZN1_, RZ)	3.0	08/99 → 08/00	1KZ-T	Diesel	2982	4	81
HILUX II Platform/Chassis (LN6_, LN5_, YN6_, YN5_, VZN1_, RZ)	3.0	08/99 → 08/00	5L-E	Diesel	2986	4	87
HILUX III Pickup (TGN1_, GGN2_, GGN1_, KUN2_, KUN1_)	2.0	08/00 →	1AZ-FSE	Petrol	1998	4	39
HILUX III Pickup (TGN1_, GGN2_, GGN1_, KUN2_, KUN1_)	2.5	08/00 →	2KD-FTV	Diesel	2494	4	75
HILUX III Pickup (TGN1_, GGN2_, GGN1_, KUN2_, KUN1_)	3.0	08/00 →	1KD-FTV	Diesel	2982	4	80
HILUX III Platform/Chassis (KUN1_, TGN3_, TGN2_, TGN1_, KUN2)	3.0	02/00 →	1KD-FTV	Diesel	2982	4	80
IQ (KGJ1_, NGJ1_)	1.0	01/00 →	1KR-FE	Petrol	998	3	2
IQ (KGJ1_, NGJ1_)	1.0	01/00 →	1KR-FE	LPG	998	3	2
IQ (KGJ1_, NGJ1_)	1.4	01/00 →	1ND-TV	Diesel	1364	4	12
ISIS (ZNM1_, ANM1_, ZGM1_)	1.8	07/00 →	1ZZ-FE	Petrol	1794	4	29
ISIS (ZNM1_, ANM1_, ZGM1_)	1.8	04/00 →	2ZR-FAE	Petrol	1798	4	31
ISIS (ZNM1_, ANM1_, ZGM1_)	2.0	07/00 →	1AZ-FSE	Petrol	1998	4	39
ISIS (ZNM1_, ANM1_, ZGM1_)	2.0	04/00 →	3ZR-FAE	Petrol	1987	4	56
IST (NCP6_)	1.3	05/00 → 07/00	2NZ-FE	Petrol	1299	4	9
IST (NCP6_)	1.5	05/00 → 07/00	1NZ-FE	Petrol/Electro	1497	4	15



Ltr







CC



9

Model	Ltr	Year Range	Engine	Fuel	CC	Seats	Index
IST (NCP6_)	1.5	05/00→07/00	1NZ-FE	Petrol	1497	4	15
KIJANG Bus	2.0	08/99→08/00	1RZ	Petrol	1998	4	43
KIJANG Bus	2.4	08/98→08/99	2L	Diesel	2446	4	67
KIJANG Bus	2.4	08/99→08/00	2RZ-E	Petrol	2438	4	69
KIJANG Bus	3.0	07/99→07/00	5L	Diesel	2986	4	86
KIJANG INNOVA (TGN4_ , KUN4_)	2.5	08/00→	2KD-FTV	Diesel	2494	4	75
KLUGER (_MCU2_ , _ACU2_)	2.4	06/00→05/00	2AZ-FE	Petrol	2362	4	64
KLUGER (_MCU2_ , _ACU2_)	3.0	06/00→05/00	1MZ-FE	Petrol	2995	6	83
LAND CRUISER (_J6_)	4.0	10/98→12/98	12HT	Diesel	3980	6	93
LAND CRUISER (KDJ12_ , GRJ12_)	2.7	09/00→08/00	3RZ-FE	Petrol	2694	4	78
LAND CRUISER (KDJ12_ , GRJ12_)	3.0	09/00→	1KD-FTV	Diesel	2982	4	80
LAND CRUISER (KDJ12_ , GRJ12_)	3.0	09/00→02/01	1KZ-TE	Diesel	2982	4	82
LAND CRUISER (KDJ12_ , GRJ12_)	3.0	09/00→07/00	5L-E	Diesel	2986	4	87
LAND CRUISER (KDJ12_ , GRJ12_)	3.4	09/00→08/00	5VZ-FE	Petrol	3378	6	91
LAND CRUISER (PZJ7_ , KZJ7_ , HZJ7_ , BJ7_ , LJ7_ , RJ7_)	2.4	11/98→05/99	22R	Petrol	2367	4	72
LAND CRUISER (PZJ7_ , KZJ7_ , HZJ7_ , BJ7_ , LJ7_ , RJ7_)	2.4	12/98→12/99	22RE	Petrol	2366	4	73
LAND CRUISER (PZJ7_ , KZJ7_ , HZJ7_ , BJ7_ , LJ7_ , RJ7_)	2.4	10/98→05/99	2L-T	Diesel	2446	4	68
LAND CRUISER (PZJ7_ , KZJ7_ , HZJ7_ , BJ7_ , LJ7_ , RJ7_)	3.0	05/99→05/99	1KZ-T	Diesel	2982	4	81
LAND CRUISER (PZJ7_ , KZJ7_ , HZJ7_ , BJ7_ , LJ7_ , RJ7_)	4.2	09/00→06/00	1HD-FTE	Diesel	4164	6	95
LAND CRUISER (PZJ7_ , KZJ7_ , HZJ7_ , BJ7_ , LJ7_ , RJ7_)	4.2	01/99→	1H-Z	Diesel	4164	6	97
LAND CRUISER (PZJ7_ , KZJ7_ , HZJ7_ , BJ7_ , LJ7_ , RJ7_)	4.5	11/99→11/99	1FZ-FE	Petrol	4477	6	98
LAND CRUISER (VDJ20_ , UZJ20_)	4.7	08/00→	2UZ-FE	Petrol	4664	8	99
LAND CRUISER 80 (_J8_)	4.2	03/99→12/99	1HD-FT	Diesel	4164	6	94
LAND CRUISER 80 (_J8_)	4.2	01/99→12/99	1HD-T	Diesel	4164	6	96
LAND CRUISER 80 (_J8_)	4.2	01/99→12/99	1H-Z	Diesel	4164	6	97
LAND CRUISER 80 (_J8_)	4.5	08/99→12/99	1FZ-FE	Petrol	4477	6	98
LAND CRUISER 90 (_J9_)	2.7	04/99→07/00	3RZ-FE	Petrol	2694	4	78
LAND CRUISER 90 (_J9_)	3.0	10/00→	1KD-FTV	Diesel	2982	4	80
LAND CRUISER 90 (_J9_)	3.0	04/99→	1KZ-TE	Diesel	2982	4	82
LAND CRUISER 90 (_J9_)	3.4	04/99→	5VZ-FE	Petrol	3378	6	91
LAND CRUISER 90 (_J9_)	4.2	08/99→08/00	1H-Z	Diesel	4164	6	97
LAND CRUISER 90 (_J9_)	4.7	08/00→	2UZ-FE	Petrol	4664	8	99
LAND CRUISER 100 (UZJ100)	4.2	01/99→	1HD-FTE	Diesel	4164	6	95
LAND CRUISER 100 (UZJ100)	4.2	03/99→10/00	1H-Z	Diesel	4164	6	97
LAND CRUISER 100 (UZJ100)	4.7	01/99→	2UZ-FE	Petrol	4664	8	99
LAND CRUISER 150 (KDJ15_ , GRJ15_)	3.0	01/01→	1KD-FTV	Diesel	2982	4	80
LAND CRUISER Hardtop (_J7_)	2.4	07/99→05/99	2L-T	Diesel	2446	4	68
LAND CRUISER Hardtop (_J7_)	3.0	05/99→05/99	1KZ-T	Diesel	2982	4	81
LAND CRUISER Hardtop (_J7_)	4.2	07/99→05/99	1H-Z	Diesel	4164	6	97
LAND CRUISER Pickup (_J7_)	4.2	01/99→	1H-Z	Diesel	4164	6	97
LITEACE Box (CM3_V, KM3_V)	1.5	05/98→09/99	5K	Petrol	1486	4	19
LITEACE Box (CM3_V, KM3_V)	2.0	10/98→07/98	3Y	Petrol	1998	4	54
LITEACE Box (CM3_V, KM3_V)	2.0	08/98→07/98	3Y-C	Petrol	1998	4	55
LITEACE Box (_R2_ V)	1.5	01/99→01/99	5K	Petrol	1486	4	19
LITEACE Box (_R2_ V)	2.2	01/99→01/99	4Y-EC	Petrol	2237	4	62
LITEACE Bus (CM30_G, KM30_G)	1.5	10/98→01/99	5K	Petrol	1486	4	19
LITEACE Bus (CM30_G, KM30_G)	2.0	10/98→07/98	3Y	Petrol	1998	4	54
LITEACE Bus (CM30_G, KM30_G)	2.0	08/98→07/98	3Y-C	Petrol	1998	4	55
LITEACE Bus (_R2_ LG)	1.5	01/99→01/99	5K	Petrol	1486	4	19
LITEACE Bus (_R2_ LG)	2.2	02/99→08/99	3C-TE	Diesel	2184	4	60
LITEACE Bus (_R2_ LG)	2.2	01/99→01/99	4Y-EC	Petrol	2237	4	62
LITEACE Bus	1.8	10/99→08/00	1ZZ-FE	Petrol	1794	4	29
MAJESTA	4.0	09/99→08/00	1UZ-FE	Petrol	3969	8	92
MARK II Estate	2.0	04/98→09/99	1G-FE	Petrol	1988	6	42
MARK II Estate	2.0	11/98→03/98	2S-EL	Petrol	1995	4	48
MARK II Estate	2.2	08/99→07/00	5S-FE	Petrol	2164	4	63
MARK II Estate	2.4	04/98→09/99	2L	Diesel	2446	4	67
MARK II Saloon	1.8	11/98→03/98	1S-L	Petrol	1832	4	28
MARK II Saloon	2.0	04/98→09/00	1G-FE	Petrol	1988	6	42
MARK II Saloon	2.0	11/98→03/98	2S-EL	Petrol	1995	4	48
MARK X I (GRX12_)	2.5	03/00→09/00	4GR-FSE	Petrol	2499	6	77
MARK X II (GRX13_)	2.5	10/00→	4GR-FSE	Petrol	2499	6	77
MARK X ZiO (GGA1_ , ANA1_)	2.4	09/00→	2AZ-FE	Petrol	2362	4	64
MASTER ACE SURF Bus	1.8	02/98→08/99	2Y	Petrol	1812	4	30
MASTER ACE SURF Bus	2.0	02/98→10/99	2CT	Diesel	1975	4	46
MASTER ACE SURF Bus	2.0	02/98→08/99	3Y	Petrol	1998	4	54
MATRIX (ZZE13_)	1.8	09/00→02/00	1ZZ-FE	Petrol	1794	4	29
MODELL F Bus (_R2_ , 31)	2.0	08/98→01/99	3Y	Petrol	1998	4	54
MODELL F Bus (_R2_ , 31)	2.0	08/98→08/98	3Y-C	Petrol	1998	4	55
MODELL F Bus (_R2_ , 31)	2.2	08/98→01/99	4Y-EC	Petrol	2237	4	62

	Ltr				CC		9
MR 2 I (AW1_)	1.6	11/98→06/99	4A-GELC	Petrol	1587	4	24
MR 2 II (SW2_)	2.0	12/98→08/99	3S-FE	Petrol	1998	4	49
MR 2 II (SW2_)	2.0	12/98→05/00	3S-GE	Petrol	1998	4	50
MR 2 III (ZZW3_)	1.8	10/99→06/00	1ZZ-FE	Petrol	1794	4	29
NADIA	2.0	04/99→08/00	3S-FE	Petrol	1998	4	49
NADIA	2.2	04/99→08/00	3CTE	Diesel	2184	4	60
NOAH/VOXY (_AZR6_)	2.0	12/00→06/00	1AZ-FSE	Petrol	1998	4	39
NOAH/VOXY (_ZRR7_)	2.0	06/00→	3ZR-FAE	Petrol	1987	4	56
OPA (ZCT1_ , ACT1_)	1.8	04/00→08/00	1ZZ-FE	Petrol	1794	4	29
OPA (ZCT1_ , ACT1_)	2.0	08/00→04/00	1AZ-FSE	Petrol	1998	4	39
PASEO Convertible (EL54)	1.5	10/99→04/00	5E-FE	Petrol	1497	4	18
PASEO Coupe (EL44_)	1.5	06/98→08/99	5E-FE	Petrol	1497	4	18
PASEO Coupe (EL54)	1.3	08/99→04/00	4E-FE	Petrol	1332	4	11
PASEO Coupe (EL54)	1.5	08/99→04/00	5E-FE	Petrol	1497	4	18
PASSO (_NC1_ , _XC1_)	1.0	06/00→01/01	1KR-FE	Petrol	998	3	2
PASSO (_NC1_ , _XC1_)	1.0	06/00→01/01	1KR-FE	LPG	998	3	2
PASSO (_NGC3_ , _KGC3_)	1.0	02/01→	1KR-FE	Petrol	998	3	2
PASSO (_NGC3_ , _KGC3_)	1.0	02/01→	1KR-FE	LPG	998	3	2
PICNIC (_XM10)	2.0	05/99→01/00	3S-FE	Petrol	1998	4	49
PICNIC (_XM10)	2.2	08/99→12/00	3CTE	Diesel	2184	4	60
PLATZ (NCP1_)	1.0	04/99→08/00	1SZ-FE	Petrol	998	4	3
PLATZ (NCP1_)	1.3	09/00→08/00	2NZ-FE	Petrol	1299	4	9
PLATZ (NCP1_)	1.5	04/99→08/00	1NZ-FE	Petrol/Electro	1497	4	15
PLATZ (NCP1_)	1.5	04/99→08/00	1NZ-FE	Petrol	1497	4	15
PORTE (_NMP1_)	1.3	07/00→07/01	2NZ-FE	Petrol	1299	4	9
PORTE (_NMP1_)	1.5	07/00→07/01	1NZ-FE	Petrol/Electro	1497	4	15
PORTE (_NMP1_)	1.5	07/00→07/01	1NZ-FE	Petrol	1497	4	15
PORTE II (NCP14_)	1.5	08/01→	1NZ-FE	Petrol/Electro	1497	4	15
PORTE II (NCP14_)	1.5	08/01→	1NZ-FE	Petrol	1497	4	15
PREMIO (NZZ26_ , ZRT26_)	1.5	07/00→	1NZ-FE	Petrol/Electro	1497	4	15
PREMIO (NZZ26_ , ZRT26_)	1.5	07/00→	1NZ-FE	Petrol	1497	4	15
PREMIO (NZZ26_ , ZRT26_)	1.8	07/00→	2ZR-FAE	Petrol	1798	4	31
PREMIO (NZZ26_ , ZRT26_)	2.0	07/00→	3ZR-FAE	Petrol	1987	4	56
PREMIO (ZZT24_ , NZT24_ , AZT24_)	1.8	12/00→05/00	7A-FE	Petrol	1762	4	35
PREVIA (MCR3_ , ACR3_ , CLR3_)	2.0	03/00→01/00	1CD-FTV	Diesel	1995	4	40
PREVIA (MCR3_ , ACR3_ , CLR3_)	2.0	10/00→08/00	3S-FE	Petrol	1998	4	49
PREVIA (MCR3_ , ACR3_ , CLR3_)	2.4	08/00→01/00	2AZ-FE	Petrol	2362	4	64
PREVIA (MCR3_ , ACR3_ , CLR3_)	2.4	07/00→01/00	2AZ-FXE	Petrol/Electro	2362	4	66
PREVIA (MCR3_ , ACR3_ , CLR3_)	2.4	07/00→01/00	2AZ-FXE	Petrol	2362	4	66
PREVIA (MCR3_ , ACR3_ , CLR3_)	3.0	08/00→12/00	1MZ-FE	Petrol	2995	6	83
PREVIA (TCR2_ , TCR1_)	2.4	05/99→08/00	2TZ-FE	Petrol	2438	4	71
PREVIA III (ACR5_ , GSR5_)	2.4	10/00→	2AZ-FE	Petrol	2362	4	64
PREVIA III (ACR5_ , GSR5_)	2.4	10/00→	2AZ-FXE	Petrol/Electro	2362	4	66
PREVIA III (ACR5_ , GSR5_)	2.4	10/00→	2AZ-FXE	Petrol	2362	4	66
PRIUS (ZVW3_)	1.8	04/00→	2ZR-FXE	Petrol/Electro	1798	4	33
PRIUS C (NHP10_)	1.5	02/01→	1NZ-FXE	Petrol/Electro	1497	4	16
PRIUS C (NHP10_)	1.5	02/01→	1NZ-FXE	Petrol	1497	4	16
PRIUS Hatchback (NHW20_)	1.5	08/00→03/00	1NZ-FXE	Petrol/Electro	1497	4	16
PRIUS Hatchback (NHW20_)	1.5	08/00→03/00	1NZ-FXE	Petrol	1497	4	16
PRIUS PLUS (ZVW4_)	1.8	03/01→	2ZR-FXE	Petrol/Electro	1798	4	33
PRIUS Saloon (NHW11_)	1.5	05/00→01/00	1NZ-FXE	Petrol/Electro	1497	4	16
PRIUS Saloon (NHW11_)	1.5	05/00→01/00	1NZ-FXE	Petrol	1497	4	16
PROBOX/SUCCEED (_NLP5_ , _NCP5_)	1.3	07/00→	2NZ-FE	Petrol	1299	4	9
PROBOX/SUCCEED (_NLP5_ , _NCP5_)	1.4	07/00→	1ND-TV	Diesel	1364	4	12
PROBOX/SUCCEED (_NLP5_ , _NCP5_)	1.5	07/00→	1NZ-FE	Petrol/Electro	1497	4	15
PROBOX/SUCCEED (_NLP5_ , _NCP5_)	1.5	07/00→	1NZ-FE	Petrol	1497	4	15
PROBOX/SUCCEED (_NLP5_ , _NCP5_)	1.5	07/00→	1NZ-FXE	Petrol/Electro	1497	4	16
PROBOX/SUCCEED (_NLP5_ , _NCP5_)	1.5	07/00→	1NZ-FXE	Petrol	1497	4	16
RACTIS (SCP10_ , NCP10_)	1.3	09/00→08/01	2SZ-FE	Petrol	1298	4	10
RACTIS (SCP10_ , NCP10_)	1.5	09/00→08/01	1NZ-FE	Petrol/Electro	1497	4	15
RACTIS (SCP10_ , NCP10_)	1.5	09/00→08/01	1NZ-FE	Petrol	1497	4	15
RAUM Box	1.5	05/99→10/99	5E-FE	Petrol	1497	4	18
RAUM MPV (EXZ1_)	1.5	05/99→04/00	5E-FE	Petrol	1497	4	18
RAUM MPV (NCZ2_)	1.5	05/00→	1NZ-FE	Petrol/Electro	1497	4	15
RAUM MPV (NCZ2_)	1.5	05/00→	1NZ-FE	Petrol	1497	4	15
RAV 4 I (SXA1_)	2.0	01/99→06/00	3S-FE	Petrol	1998	4	49
RAV 4 I (SXA1_)	2.0	01/99→09/99	3S-GE	Petrol	1998	4	50
RAV 4 I Cabrio (SXA1_)	2.0	12/99→06/00	3S-FE	Petrol	1998	4	49
RAV 4 II (CLA2_ , XA2_ , ZCA2_ , ACA2_)	1.8	02/00→11/00	1ZZ-FE	Petrol	1794	4	29
RAV 4 II (CLA2_ , XA2_ , ZCA2_ , ACA2_)	2.0	06/00→11/00	1AZ-FE	Petrol	1998	4	38



Ltr







CC



9

Model	Ltr	Year	Engine	Fuel	CC	Seats	Power
RAV 4 II (CLA2_, XA2_, ZCA2_, ACA2_)	2.0	09/00→11/00	1CD-FTV	Diesel	1995	4	40
RAV 4 II (CLA2_, XA2_, ZCA2_, ACA2_)	2.4	08/00→11/00	2AZ-FE	Petrol	2362	4	64
RAV 4 III (ACA3_, ACE_, ALA3_, GSA3_, ZSA3_)	2.0	03/00→	1AZ-FE	Petrol	1998	4	38
RAV 4 III (ACA3_, ACE_, ALA3_, GSA3_, ZSA3_)	2.0	12/00→	3ZR-FAE	Petrol	1987	4	56
RAV 4 III (ACA3_, ACE_, ALA3_, GSA3_, ZSA3_)	2.2	03/00→	2AD-FHV	Diesel	2231	4	58
RAV 4 III (ACA3_, ACE_, ALA3_, GSA3_, ZSA3_)	2.2	03/00→	2AD-FTV	Diesel	2231	4	59
RAV 4 III (ACA3_, ACE_, ALA3_, GSA3_, ZSA3_)	2.4	11/00→	2AZ-FE	Petrol	2362	4	64
RAV 4 IV (ZSA4_, ALA4_)	2.0	12/01→	1AD-FTV	Diesel	1998	4	37
RAV 4 IV (ZSA4_, ALA4_)	2.0	12/01→	3ZR-FAE	Petrol	1987	4	56
RAV 4 IV (ZSA4_, ALA4_)	2.2	12/01→	2AD-FHV	Diesel	2231	4	58
REGIUSACE Box (TRH2_, KDH2_)	2.5	08/00→	2KD-FTV	Diesel	2494	4	75
REGIUSACE Box (TRH2_, KDH2_)	3.0	08/00→	1KD-FTV	Diesel	2982	4	80
REGIUSACE Bus (TRH2_, KDH2_)	2.5	08/00→	2KD-FTV	Diesel	2494	4	75
REGIUSACE Bus (TRH2_, KDH2_)	3.0	08/00→	1KD-FTV	Diesel	2982	4	80
SAI (AZK1_)	2.4	11/00→	2AZ-FXE	Petrol/Electro	2362	4	66
SAI (AZK1_)	2.4	11/00→	2AZ-FXE	Petrol	2362	4	66
SCEPTER Coupe (CXV15_, VCV15_)	2.2	10/99→06/99	5S-FE	Petrol	2164	4	63
SCEPTER Estate	2.0	11/99→09/99	2CT	Diesel	1975	4	46
SCEPTER Estate	2.0	10/98→09/99	3S-FE	Petrol	1998	4	49
SCEPTER Estate	2.2	11/99→09/99	5S-FE	Petrol	2164	4	63
SCEPTER Saloon	1.8	04/98→08/98	1S-L	Petrol	1832	4	28
SCEPTER Saloon	2.0	08/98→09/99	2CT	Diesel	1975	4	46
SCEPTER Saloon	2.0	10/98→09/99	3S-FE	Petrol	1998	4	49
SCEPTER Saloon	2.2	11/99→09/99	5S-FE	Petrol	2164	4	63
SEQUOIA (UCK6_, UPK6_, USK6_)	4.7	11/00→	2UZ-FE	Petrol	4664	8	99
SEQUOIA (UCK45_, UCK35_)	4.7	05/00→11/00	2UZ-FE	Petrol	4664	8	99
SIENNA (MCL10_)	3.0	05/99→04/00	1MZ-FE	Petrol	2995	6	83
SIENTA (NCP8_)	1.5	05/00→	1NZ-FE	Petrol/Electro	1497	4	15
SIENTA (NCP8_)	1.5	05/00→	1NZ-FE	Petrol	1497	4	15
SOARER Coupe (MZ2_, GZ2_)	2.0	09/98→03/99	1G-E	Petrol	1988	6	41
SOARER Coupe (_Z3_)	4.0	05/99→09/00	1UZ-FE	Petrol	3969	8	92
SPADE (NCP14_)	1.5	08/01→	1NZ-FE	Petrol/Electro	1497	4	15
SPADE (NCP14_)	1.5	08/01→	1NZ-FE	Petrol	1497	4	15
SPRINTER CARIB	1.3	06/99→04/99	4E-FE	Petrol	1332	4	11
SPRINTER CARIB	1.6	11/98→05/99	4A-F	Petrol	1587	4	21
SPRINTER CARIB	1.6	11/98→10/00	4A-FE	Petrol	1587	4	22
SPRINTER CARIB	1.8	11/99→10/00	7A-FE	Petrol	1762	4	35
SPRINTER Hatchback	1.3	08/98→04/99	2E	Petrol	1296	4	6
SPRINTER Hatchback	1.3	08/98→04/99	2E-E	Petrol	1296	4	7
SPRINTER Hatchback	1.3	06/99→11/00	4E-FE	Petrol	1332	4	11
SPRINTER Hatchback	1.5	06/99→11/00	5A-FE	Petrol	1497	4	17
SPRINTER Hatchback	1.6	08/98→04/99	4A-FE	Petrol	1587	4	22
SPRINTER Hatchback	1.8	11/99→04/99	7A-FE	Petrol	1762	4	35
SPRINTER Saloon	1.3	06/99→11/00	4E-FE	Petrol	1332	4	11
SPRINTER Saloon	1.5	04/99→11/00	5A-FE	Petrol	1497	4	17
SPRINTER Saloon	1.6	06/99→04/99	4A-FE	Petrol	1587	4	22
SPRINTER Saloon	1.8	11/99→04/99	7A-FE	Petrol	1762	4	35
SPRINTER Saloon	2.2	04/99→11/00	3CTE	Diesel	2184	4	60
STARLET (EP91)	1.3	04/99→03/99	4E-FE	Petrol	1332	4	11
STARLET (_P7_)	1.3	10/98→12/98	2E-LC	Petrol	1296	4	8
STARLET (_P7_)	1.5	12/98→12/98	1N	Diesel	1453	4	14
STARLET (_P8_)	1.0	12/98→12/99	1E	Petrol	999	4	1
STARLET (_P8_)	1.3	12/98→12/99	2E	Petrol	1296	4	6
STARLET (_P8_)	1.3	12/98→03/99	2E-E	Petrol	1296	4	7
STARLET (_P8_)	1.5	12/98→03/99	1N	Diesel	1453	4	14
STOUT Pickup (YK11_, RK11_)	2.2	04/98→02/00	4Y	Petrol	2237	4	61
SUPRA (JZA70_, GA70_, MA70)	3.0	01/98→08/99	7M-GE	Petrol	2954	6	88
SUPRA (JZA70_, GA70_, MA70)	3.0	09/98→05/99	7M-GTE	Petrol	2954	6	89
TAMARAW FX (RZF5_, LF5_)	2.4	01/99→10/00	2L	Diesel	2446	4	67
TARAGO Box	2.4	09/98→10/99	2RZ-E	Petrol	2438	4	69
TARAGO Box	2.7	08/99→08/00	3RZ-FE	Petrol	2694	4	78
TARAGO Bus	2.4	09/98→10/99	2RZ-E	Petrol	2438	4	69
TARAGO Bus	2.7	08/99→08/00	3RZ-FE	Petrol	2694	4	78
TERCEL Hatchback	1.3	05/99→09/99	4E-FE	Petrol	1332	4	11
TERCEL Hatchback	1.5	11/99→09/99	1N	Diesel	1453	4	14
TERCEL Hatchback	1.5	11/99→09/99	5E-FE	Petrol	1497	4	18
TERCEL Saloon	1.3	05/99→09/99	4E-FE	Petrol	1332	4	11
TERCEL Saloon	1.5	11/99→09/99	1N	Diesel	1453	4	14
TOWN ACE Box (KM8_, KM7_, CM8_, CM7_)	3.0	10/00→07/00	5L	Diesel	2986	4	86
TOWN ACE Box (YR3_, YR2_)	2.4	04/98→12/99	2L	Diesel	2446	4	67

	Ltr				CC		9
TOWN ACE Box	2.0	04/99→09/00	3Y-C	Petrol	1998	4	55
TOWN ACE Box	2.2	01/99→04/99	4Y-EC	Petrol	2237	4	62
TOWN ACE Bus (CR3_, CR2_)	2.4	04/98→12/99	2L	Diesel	2446	4	67
TOWN ACE Bus (SR5_, SR4_, KR4_, CR5_, CR4_)	2.4	10/00→07/00	2AZ-FE	Petrol	2362	4	64
TOWN ACE Bus (SR5_, SR4_, KR4_, CR5_, CR4_)	3.0	10/00→07/00	5L	Diesel	2986	4	86
TOWN ACE Bus	2.0	05/99→09/00	3Y-C	Petrol	1998	4	55
TOWN ACE Bus	2.2	11/99→04/99	4Y-EC	Petrol	2237	4	62
TOWN ACE Bus	2.4	01/99→04/99	2RZE	Petrol	2438	4	69
TUNDRA Pickup (K4_, K3_)	3.4	04/99→07/00	5VZ-FE	Petrol	3378	6	91
URBAN CRUISER (NSP1_, NLP1_, ZSP1_, NCP11_)	1.4	04/00→	1ND-TV	Diesel	1364	4	12
URBAN CRUISER (NSP1_, NLP1_, ZSP1_, NCP11_)	1.5	07/00→	1NZ-FE	Petrol/Electro	1497	4	15
URBAN CRUISER (NSP1_, NLP1_, ZSP1_, NCP11_)	1.5	07/00→	1NZ-FE	Petrol	1497	4	15
VEROSSA (JZX11_, GX11_)	2.0	10/00→11/00	1G-FE	Petrol	1988	6	42
VERSO (AUR2_, ZGR2_)	1.8	04/00→	2ZR-FAE	Petrol	1798	4	31
VERSO (AUR2_, ZGR2_)	2.0	04/00→	1AD-FTV	Diesel	1998	4	37
VERSO (AUR2_, ZGR2_)	2.2	04/00→	2AD-FHV	Diesel	2231	4	58
VERSO S (NLP12_, NCP12_, NSP12_)	1.4	11/01→	1ND-TV	Diesel	1364	4	12
VERSO S (NLP12_, NCP12_, NSP12_)	1.5	11/01→	1NZ-FE	Petrol/Electro	1497	4	15
VERSO S (NLP12_, NCP12_, NSP12_)	1.5	11/01→	1NZ-FE	Petrol	1497	4	15
VIOS (SCP4_, NCP4_, AXP4_)	1.5	07/00→01/00	1NZ-FE	Petrol/Electro	1497	4	15
VIOS (SCP4_, NCP4_, AXP4_)	1.5	07/00→01/00	1NZ-FE	Petrol	1497	4	15
VIOS (SCP4_, NCP4_, AXP4_)	1.5	07/00→01/00	5A-FE	Petrol	1497	4	17
VIOS/YARIS Saloon (ZSP9_, NCP9_)	1.0	08/00→	1KR-FE	Petrol	998	3	2
VIOS/YARIS Saloon (ZSP9_, NCP9_)	1.0	08/00→	1KR-FE	LPG	998	3	2
VIOS/YARIS Saloon (ZSP9_, NCP9_)	1.3	08/00→	2NZ-FE	Petrol	1299	4	9
VIOS/YARIS Saloon (ZSP9_, NCP9_)	1.3	08/00→	2SZ-FE	Petrol	1298	4	10
VIOS/YARIS Saloon (ZSP9_, NCP9_)	1.5	08/00→	1NZ-FE	Petrol/Electro	1497	4	15
VIOS/YARIS Saloon (ZSP9_, NCP9_)	1.5	08/00→	1NZ-FE	Petrol	1497	4	15
VIOS/YARIS Saloon	1.5	05/01→	1NZ-FE	Petrol/Electro	1497	4	15
VIOS/YARIS Saloon	1.5	05/01→	1NZ-FE	Petrol	1497	4	15
VISTA Estate (CV2_, SV2_)	2.0	11/98→06/99	2CT	Diesel	1975	4	46
VISTA Estate (CV2_, SV2_)	2.0	11/98→06/99	3S-FE	Petrol	1998	4	49
VISTA Saloon (SV2_, CV2_)	2.0	11/98→06/99	2CT	Diesel	1975	4	46
VISTA Saloon (SV2_, CV2_)	2.0	10/98→06/99	3S-FE	Petrol	1998	4	49
VISTA Saloon (SV2_, CV2_)	2.5	10/98→06/99	2VZ-FE	Petrol	2508	6	76
VISTA Saloon (SV4_, CV4_, SV3_, CV3_)	2.0	07/99→05/99	2CT	Diesel	1975	4	46
VISTA Saloon (SV4_, CV4_, SV3_, CV3_)	2.2	07/99→09/99	5S-FE	Petrol	2164	4	63
VISTA Saloon (SV5_, ZV5_)	1.8	06/99→08/00	1ZZ-FE	Petrol	1794	4	29
VISTA Saloon (SV5_, ZV5_)	2.0	06/99→08/00	1AZ-FE	Petrol	1998	4	38
VISTA Saloon (SV5_, ZV5_)	2.0	06/99→08/00	1AZ-FSE	Petrol	1998	4	39
VISTA Saloon (SV5_, ZV5_)	2.4	06/00→08/00	2AZ-FE	Petrol	2362	4	64
VISTA Saloon (SV5_, ZV5_)	3.0	06/99→08/00	1MZ-FE	Petrol	2995	6	83
WILL CYPHA (NCP7_)	1.3	05/00→07/00	2NZ-FE	Petrol	1299	4	9
WILL CYPHA (NCP7_)	1.5	05/00→07/00	1NZ-FE	Petrol/Electro	1497	4	15
WILL CYPHA (NCP7_)	1.5	05/00→07/00	1NZ-FE	Petrol	1497	4	15
WILL VS (ZZE12_, NZE12_)	1.5	03/00→04/00	1NZ-FE	Petrol/Electro	1497	4	15
WILL VS (ZZE12_, NZE12_)	1.5	03/00→04/00	1NZ-FE	Petrol	1497	4	15
WILL VS (ZZE12_, NZE12_)	1.8	03/00→04/00	1ZZ-FE	Petrol	1794	4	29
WINDOM (MCV2_)	2.2	10/99→07/00	3CTE	Diesel	2184	4	60
WINDOM (MCV2_)	2.2	10/99→07/00	5S-FE	Petrol	2164	4	63
WINDOM (MCV2_)	3.0	10/99→07/00	1MZ-FE	Petrol	2995	6	83
WINDOM (MCV3_)	3.0	08/00→07/00	1MZ-FE	Petrol	2995	6	83
WINDOM (VCV1_)	2.2	07/99→09/99	3CTE	Diesel	2184	4	60
WINDOM (VCV1_)	3.0	07/99→09/99	3VZ-FE	Petrol	2959	6	85
WISH MPV (ZGE2_)	1.8	04/00→	2ZR-FAE	Petrol	1798	4	31
WISH MPV (ZGE2_)	2.0	04/00→	3ZR-FAE	Petrol	1987	4	56
WISH MPV (ZNE1_, ANE1_)	1.8	04/00→03/00	1ZZ-FE	Petrol	1794	4	29
WISH MPV (ZNE1_, ANE1_)	2.0	04/00→03/00	1AZ-FSE	Petrol	1998	4	39
YARIS (NLP13_, NSP13_, NCP13_, KSP13_)	1.0	09/01→	1KR-FE	Petrol	998	3	2
YARIS (NLP13_, NSP13_, NCP13_, KSP13_)	1.0	09/01→	1KR-FE	LPG	998	3	2
YARIS (NLP13_, NSP13_, NCP13_, KSP13_)	1.3	12/01→	2NZ-FE	Petrol	1299	4	9
YARIS (NLP13_, NSP13_, NCP13_, KSP13_)	1.4	09/01→	1ND-TV	Diesel	1364	4	12
YARIS (NLP13_, NSP13_, NCP13_, KSP13_)	1.5	12/01→	1NZ-FE	Petrol/Electro	1497	4	15
YARIS (NLP13_, NSP13_, NCP13_, KSP13_)	1.5	12/01→	1NZ-FE	Petrol	1497	4	15
YARIS (NLP13_, NSP13_, NCP13_, KSP13_)	1.5	03/01→	1NZ-FXE	Petrol/Electro	1497	4	16
YARIS (NLP13_, NSP13_, NCP13_, KSP13_)	1.5	03/01→	1NZ-FXE	Petrol	1497	4	16
YARIS (SCP1_, NLP1_, NCP1_)	1.0	04/99→09/00	1SZ-FE	Petrol	998	4	3
YARIS (SCP1_, NLP1_, NCP1_)	1.3	11/99→09/00	2NZ-FE	Petrol	1299	4	9
YARIS (SCP1_, NLP1_, NCP1_)	1.3	04/00→09/00	2SZ-FE	Petrol	1298	4	10
YARIS (SCP1_, NLP1_, NCP1_)	1.4	12/00→09/00	1ND-TV	Diesel	1364	4	12



Ltr











CC



9

	Ltr				CC		
YARIS (SCP1_, NLP1_, NCP1_)	1.5	04/00→09/00	1NZ-FE	Petrol/Electro	1497	4	15
YARIS (SCP1_, NLP1_, NCP1_)	1.5	04/00→09/00	1NZ-FE	Petrol	1497	4	15
YARIS (SCP9_, NSP9_, KSP9_, NCP9_, ZSP9_)	1.0	01/00→	1KR-FE	Petrol	998	3	2
YARIS (SCP9_, NSP9_, KSP9_, NCP9_, ZSP9_)	1.0	01/00→	1KR-FE	LPG	998	3	2
YARIS (SCP9_, NSP9_, KSP9_, NCP9_, ZSP9_)	1.3	11/00→	2NZ-FE	Petrol	1299	4	9
YARIS (SCP9_, NSP9_, KSP9_, NCP9_, ZSP9_)	1.3	01/00→	2SZ-FE	Petrol	1298	4	10
YARIS (SCP9_, NSP9_, KSP9_, NCP9_, ZSP9_)	1.4	01/00→	1ND-TV	Diesel	1364	4	12
YARIS (SCP9_, NSP9_, KSP9_, NCP9_, ZSP9_)	1.5	11/00→	1NZ-FE	Petrol/Electro	1497	4	15
YARIS (SCP9_, NSP9_, KSP9_, NCP9_, ZSP9_)	1.5	11/00→	1NZ-FE	Petrol	1497	4	15
YARIS (SCP9_, NSP9_, KSP9_, NCP9_, ZSP9_)	1.8	11/00→	1ZZ-FE	Petrol	1794	4	29
YARIS (SCP9_, NSP9_, KSP9_, NCP9_, ZSP9_)	1.8	01/00→	2ZR-FE	Petrol	1798	4	32
YARIS VERSO (_NLP2_, _NCP2_)	1.3	11/99→09/00	2NZ-FE	Petrol	1299	4	9
YARIS VERSO (_NLP2_, _NCP2_)	1.4	12/00→09/00	1ND-TV	Diesel	1364	4	12
YARIS VERSO (_NLP2_, _NCP2_)	1.5	03/00→09/00	1NZ-FE	Petrol/Electro	1497	4	15
YARIS VERSO (_NLP2_, _NCP2_)	1.5	03/00→09/00	1NZ-FE	Petrol	1497	4	15

		CC			9			CC			9
11B	Diesel	2986	4	95.00	90	3S-FE	Petrol	1998	4	86.00	49
12HT	Diesel	3980	6	91.00	93	3S-GE	Petrol	1998	4	86.00	50
1AD-FTV	Diesel	1998	4	86.00	37	3S-GEL	Petrol	1998	4	86.00	51
1AZ-FE	Petrol	1998	4	86.00	38	3S-GELC	Petrol	1998	4	86.00	52
1AZ-FSE	Petrol	1998	4	86.00	39	3S-GTE	Petrol	1998	4	86.00	53
1CD-FTV	Diesel	1995	4	82.20	40	3VZ-E	Petrol	2959	6	87.50	84
1CL	Diesel	1839	4	83.00	26	3VZ-FE	Petrol	2959	6	87.50	85
1E	Petrol	999	4	70.50	1	3Y	Petrol	1998	4	86.00	54
1FZ-FE	Petrol	4477	6	100.00	98	3Y-C	Petrol	1998	4	86.00	55
1G-E	Petrol	1988	6	75.00	41	3ZR-FAE	Petrol	1987	4	80.50	56
1G-FE	Petrol	1988	6	75.00	42	3ZZ-FE	Petrol/ Natural Gas (CNG)	1598	4	79.00	20
1HD-FT	Diesel	4164	6	94.00	94	3ZZ-FE	Petrol	1598	4	79.00	20
1HD-FTE	Diesel	4164	6	94.00	95	4A-F	Petrol	1587	4	81.00	21
1HD-T	Diesel	4164	6	94.00	96	4A-FE	Petrol	1587	4	81.00	22
1H-Z	Diesel	4164	6	94.00	97	4A-GE	Petrol	1587	4	81.00	23
1KD-FTV	Diesel	2982	4	96.00	80	4A-GELC	Petrol	1587	4	81.00	24
1KR-FE	Petrol	998	3	71.00	2	4A-IC	Petrol	1587	4	81.00	25
1KR-FE	LPG	998	3	71.00	2	4E-FE	Petrol	1332	4	74.00	11
1KZT	Diesel	2982	4	96.00	81	4GR-FSE	Petrol	2499	6	83.00	77
1KZTE	Diesel	2982	4	96.00	82	4Y	Petrol	2237	4	91.00	61
1MZF-FE	Petrol	2995	6	87.50	83	4Y-EC	Petrol	2237	4	91.00	62
1N	Diesel	1453	4	74.00	14	4ZZ-FE	Petrol	1398	4	79.00	13
1ND-TV	Diesel	1364	4	73.00	12	5A-FE	Petrol	1497	4	78.70	17
1NZ-FE	Petrol/Electro	1497	4	75.00	15	5E-FE	Petrol	1497	4	74.00	18
1NZ-FE	Petrol	1497	4	75.00	15	5K	Petrol	1486	4	80.50	19
1NZ-FXE	Petrol/Electro	1497	4	75.00	16	5L	Diesel	2986	4	99.50	86
1NZ-FXE	Petrol	1497	4	75.00	16	5LE	Diesel	2986	4	99.50	87
1RZ	Petrol	1998	4	86.00	43	5M-GE	Petrol	2759	6	83.00	79
1S-EL	Petrol	1832	4	80.50	27	5S-FE	Petrol	2164	4	87.00	63
1S-L	Petrol	1832	4	80.50	28	5VZ-FE	Petrol	3378	6	93.50	91
1SZ-FE	Petrol	998	4	69.00	3	7A-FE	Petrol	1762	4	81.00	35
1UZ-FE	Petrol	3969	8	87.50	92	7M-GE	Petrol	2954	6	83.00	88
1WZ	Diesel	1867	4	82.20	36	7M-GTE	Petrol	2954	6	83.00	89
1ZZ-FE	Petrol	1794	4	79.00	29	EJ-VE	Petrol	989	3	72.00	5
21R	Petrol	1972	4	84.00	57						
22R	Petrol	2367	4	92.00	72						
22RE	Petrol	2366	4	92.00	73						
22REC	Petrol	2366	4	92.00	74						
2AD-FHV	Diesel	2231	4	86.00	58						
2AD-FTV	Diesel	2231	4	86.00	59						
2AZ-FE	Petrol	2362	4	88.50	64						
2AZ-FSE	Petrol	2362	4	88.50	65						
2AZ-FXE	Petrol/Electro	2362	4	88.50	66						
2AZ-FXE	Petrol	2362	4	88.50	66						
2CE	Diesel	1975	4	86.00	44						
2CL	Diesel	1975	4	86.00	45						
2CT	Diesel	1975	4	86.00	46						
2CTE	Diesel	1975	4	86.00	47						
2E	Petrol	1296	4	73.00	6						
2E-E	Petrol	1296	4	73.00	7						
2E-LC	Petrol	1296	4	73.00	8						
2K	Petrol	993	4	72.00	4						
2KD-FTV	Diesel	2494	4	92.00	75						
2L	Diesel	2446	4	92.00	67						
2LT	Diesel	2446	4	92.00	68						
2NZ-FE	Petrol	1299	4	75.00	9						
2RZ-E	Petrol	2438	4	95.00	69						
2RZ-FE	Petrol	2438	4	95.00	70						
2S-EL	Petrol	1995	4	84.00	48						
2SZ-FE	Petrol	1298	4	72.00	10						
2TZ-FE	Petrol	2438	4	95.00	71						
2UZ-FE	Petrol	4664	8	94.00	99						
2VZ-FE	Petrol	2508	6	87.50	76						
2Y	Petrol	1812	4	86.00	30						
2ZR-FAE	Petrol	1798	4	80.50	31						
2ZR-FE	Petrol	1798	4	80.50	32						
2ZR-FXE	Petrol/Electro	1798	4	80.50	33						
2ZZ-GE	Petrol	1796	4	82.00	34						
3CE	Diesel	2184	4	86.00	60						
3RZ-FE	Petrol	2694	4	95.00	78						



cc



kW/PS



1.0		1E					1			
Starlet 1.0	12/89→12/92	999	4	70.50	SOHC/OHC	40/54	BN530 (Graphite)	DN530	GN530	
1.0		1KR-FE					2			
Aygo 1.0	07/05→	998	3	71.00	DOHC	50-52/ 68-71	AG9310 (MLS)	CG9310	EG9310	
Aygo 1.0 GPL	07/05→									
IQ 1.0	01/09→									
Passo 1.0	06/05→01/10									
Passo 1.0 4WD	02/10→									
Passo 1.0 4x4	06/05→01/10									
Yaris 1.0	08/07→									
Yaris 1.0 GPL	01/06→									
Yaris 1.0 VVTi	01/06→									
1.0		1SZ-FE					3			
Echo 1.0 VVTi	04/03→08/05	998	4	69.00	DOHC	48-50/ 65-68	AD5380 (MLS)	CD5380 02/03→ CD5381 [141] 02/03→	FD5380 [3] 02/03→	
Platz 1.0 VVTi	04/99→08/05									
Yaris 1.0 16V	04/99→09/05									
1.0		2K					4			
1000 1.0	04/69→08/88	993	4	72.00	OHV	33/45	AJ270 (Graphite)	CJ271 [13]	FJ270 [3] FJ271	
1000 Box 1.0	04/69→08/88									
1.0		EJ-VE					5			
Duet 1.0	09/98→04/04	989	3	72.00	SOHC/OHC	43/58	AG5920 (MLS)	CG5290	FG5290	
1.3		2E					6			
Corolla 1.3	05/87→10/01	1296	4	73.00	SOHC/OHC	48-60/ 65-82	BN200 (Graphite)	DN200	GN200	
Corolla 1.3 12V	07/92→04/97									
Corolla 1.3 i	08/87→12/92									
Sprinter 1.3	08/87→04/92									
Starlet 1.3 12V	12/89→12/92									
Starlet 1.3 XL	12/89→12/91									
1.3		2E-E					7			
Corolla 1.3 i	08/87→12/92	1296	4	73.00	SOHC/OHC	55/75	BN200 (Graphite) 11/89→04/92	DN200 11/89→04/92	GN200 11/89→04/92	
Sprinter 1.3	08/87→04/92									
Starlet 1.3 12V	12/89→03/96									
1.3		2E-LC					8			
Starlet 1.3	10/84→12/89	1296	4	73.00	SOHC/OHC	52-55/ 71-75	BN200 (Graphite)	DN200	GN200	

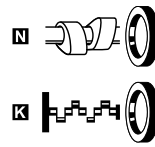
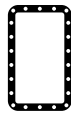
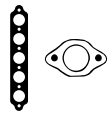

AJ270



BN200



BN530



HA397



JB910



JC558



JC559



JM025

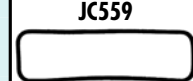

JN598



JJ093



NJ654



cc



kW/PS



1.3		2NZ-FE					9	AB5750 (MLS)	CB5750 [3]	FB5750 [3]
Corolla 1.3	11/01→05/04	1299	4	75.00	DOHC	62-66/ 84-90				
Corolla 1.3VVTi	03/08→									
Echo 1.3 VVTi	08/99→03/03									
Ist 1.3 VVTi	05/04→07/07									
Platz 1.3 VVTi	09/02→08/05									
Porte 1.3 VVTi	07/04→07/12									
Pro/Succeed 1.3	07/02→									
Vios/YARIS 1.3	08/07→									
Will Cypha 1.3	05/01→07/05									
Yaris 1.3	08/07→									
Yaris 1.3 16V	11/99→09/05									
YARIS 1.3 VVTi	11/05→									
Yaris Verso 1.3	11/99→09/05									
1.3		2SZ-FE					10	AG9830 (MLS)		FG9830 (MLS)
Echo 1.3 VVTi	04/03→08/05	1298	4	72.00	DOHC	64/87				
Ractis 1.3	09/05→08/10									
Yaris 1.3	04/02→09/05									
Yaris 1.3 VVTi	01/06→									
1.3		4E-FE					11	BV330 (Graphite)	DV331	GV331
Caribe Est 1.3	09/94→08/96	1332	4	74.00	DOHC	55-65/ 75-88				
Corolla 1.3 XLI	07/92→04/97									
Corolla 1.4	04/97→02/00									
Corsa 1.3	10/90→09/99									
Paseo 1.3	08/95→04/00									
Sprinter 1.3	06/92→11/00									
Sprinter C 1.3	06/92→04/97									
Starlet 1.3	04/96→03/99									
Tercel 1.3	05/92→09/99									
1.4		1ND-TV Diesel					12	AG7600 (MLS), 0.850mm AG7610 (MLS), 0.900mm AG7620 (MLS), 0.950mm	CG7600 ▲	FG7600 ▲
Auris 1.4 D-4D	03/07→04/13	1364	4	73.00	SOHC/OHC	55-66/ 75-90				
Corolla 1.4 D	07/04→07/07									
Corolla 1.4 D4D	09/01→03/09									
Echo 1.4 D4d	01/00→03/03									
IQ 1.4 D-4D	01/09→									
Pro/Succeed 1.4	07/02→									
Urb Cruiser 1.4	04/09→									
Verso S 1.4	11/10→									
YARIS 1.4 D-4D	12/01→09/05									
Yaris Verso 1.4	12/01→09/05									
1.4		4ZZ-FE					13	AB5760 (MLS)	CB5760 [13]	FB5760 [3]
Auris 1.4 VVTi	03/07→	1398	4	79.00	DOHC	71-74/ 97-101				
Corolla 1.4	02/00→01/02									
Corolla 1.4 16V	02/00→11/01									
Corolla 1.4VVTi	01/02→07/07									
1.5		1N Diesel					14	AG7570 (MLS), 1.450mm, 1 Notch AG7580 (MLS), 1.550mm, 2 Notches AG7590 (MLS), 1.650mm, 3 Notches	CG7570 ▲	
Corsa 1.5 D	11/94→09/99	1453	4	74.00	SOHC/OHC	40/54				
Starlet 1.5 D	12/86→03/96									
Tercel 1.5 D	11/94→09/99									

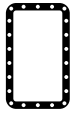
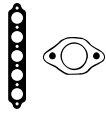

AB5750



AB5760



BV330



JD085

HBS313 [22]
M9x1.50x143.00mm (x10)

JD5159 [1]
JD5738 [1]
(MLS)
0.500mm

JM5072
(Elastomer)

HR397

NA5088 [1]
75.00x107.00x8.00mm, FPM

HBS312 [5]
M9x1.25x84.00mm (x10)

JD5836 [1]
JD5837 [1]
(MLS)
0.500mm

JM5149
(Elastomer)

HR397

NJ353 [2]
35.00x49.00x6.00mm, NBR
NJ353 [2]
35.00x49.00x6.00mm, NBR
NA5324 [1]
74.00x89.00x8.50mm, FPM

HBS306 [5]
M9x1.25x84.00mm (x5)

JD085 [1]

JM5149
(Elastomer)

HR397

NJ353 [2]
35.00x49.00x6.00mm, NBR
NJ353 [2]
35.00x49.00x6.00mm, NBR

HBS490 [19]
M12x1.75x180.00mm (x10)

JD5959 [1]
(MLS)

JM5288

HR397

NA5260 [2]
38.00x50.00x6.00mm, FPM
NA5260 [2]
38.00x50.00x6.00mm, FPM
NA5088 [1]
75.00x107.00x8.00mm, FPM

HBS385 [22]
M10x1.50x147.00mm (x10)

JD5243 [1]
JD5160 [1]
(MLS)

JM5073
(Elastomer)

HR397

PA5019 (x8)
PA5020 (x8)

NJ347 [2]
38.00x50.00x8.00mm, NBR
NA5089 [2]
38.00x50.00x8.00mm, NBR
NA5090 [1]
76.00x94.00x8.50mm, FPM

HR397

NA5260 [2]
38.00x50.00x6.00mm, FPM
NA5260 [2]
38.00x50.00x6.00mm, FPM



cc



kW/PS



1.5		1NZ-FE				15		AB5750 (MLS)	CB5750 [3]	FB5750 [3]
Allion I 1.5	06/01→04/05	1497	4	75.00	DOHC	76-81/ 103-110				
Allion II 1.5	07/07→									
Auris 1.5	09/09→									
Auris 1.5 4WD	09/09→									
bB I 1.5	03/00→12/05									
Corolla 1.5	09/99→03/09									
Corolla 1.5 4WD	09/06→									
Corolla 1.5 G	11/01→05/04									
Echo 1.5 VVTi	04/99→08/05									
Ist 1.5 VVTi	05/04→07/07									
Platz 1.5 VVTi	04/99→08/05									
Porte 1.5 4WD	07/04→07/12									
Porte 1.5 VVTi	07/04→07/12									
Porte 2 1.5	08/12→									
Porte 2 1.5 4WD	08/12→									
Premio 1.5	07/07→									
Pro/Succeed 1.5	07/02→									
Ractis 1.5 VVTi	09/05→08/10									
Raum mpv 1.5	05/03→									
Sienta 1.5	05/03→									
Spade 1.5	08/12→									
Urb Cruiser 1.5	07/07→									
Verso S 1.5	11/10→									
Vios 1.5 VVTi	07/02→01/08									
Vios/YARIS 1.5	08/07→									
Will Cypha 1.5	05/01→07/05									
Will vs 1.5	03/01→04/04									
YARIS 1.5	11/05→									
Yaris 1.5 TS	04/01→09/05									
Yaris Verso 1.5	03/00→09/05									
1.5		1NZ-FXE				16		AB5750 (MLS)	CB5750 [3]	
AQUA 1.5 Hybrid	12/11→	1497	4	75.00	DOHC	53-68/ 72-92				
Prius 1.5	05/00→03/09									
Prius C 1.5	02/12→									
Pro/Succeed 1.5	07/02→									
YARIS 1.5	03/12→									
1.5		5A-FE				17		AG7770 (Fibre), 1.400mm	CG7770	
Carina E 1.5 SG	04/92→09/97	1497	4	78.70	DOHC	63-78/ 86-106				
Carina II 1.5DX	12/87→03/92									
Sprinter 1.5	06/92→11/02									
Vios 1.5	07/02→01/08									
1.5		5E-FE				18		BV330 (Graphite)	DV330 [3]	GV330 [3]
Corso 1.5	10/90→10/94	1497	4	74.00	DOHC	66-85/ 90-116	01/91→	01/91→	01/91→	
Paseo 1.5	06/88→04/00									
Raum Box 1.5	05/93→10/97									
Raum mpv 1.5	05/97→04/03									
Tercel 1.5	11/94→09/99									
1.5		5K				19		BR270 (Graphite)	DR270 [13]	GR270 [3]
Liteace 1.5	10/85→01/95	1486	4	80.50		51-52/ 69-71				



HBS313 [22]
M9x1.50x143.00mm (x10)

JD5159 [1]
JD5738 [3]
(MLS)
0.500mm

JM5072
(Elastomer)

HR397

NA5088 [1]
75.00x107.00x8.00mm, FPM



AB5750



BR270



BV330



JB910



JD085



JD175

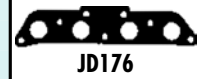

JD176



JM025

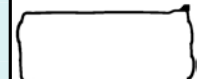

JN865

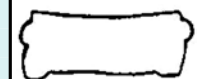

JN904



JJ343

HBS313 [22]
M9x1.50x143.00mm (x10)

JD5159 [1]
JD5738 [3]
(MLS)
0.500mm

HR397

NA5088 [1]
75.00x107.00x8.00mm, FPM

HBS203 [5]
M10x1.25x108.00mm (x5)

JD175 [1]
JD176 [3]

JN904 [4]

HR397

NJ353 [2]
35.00x49.00x6.00mm, NBR

HBS306 [5]
M9x1.25x84.00mm (x5)
01/91→

JD085 [1]
01/91→

JN865 [4]
01/91→

HR397
01/91→

PB341 [1] (x8)
01/91→

NJ353 [2]
35.00x49.00x6.00mm, NBR
01/91→
NJ353 [2]
35.00x49.00x6.00mm, NBR
01/91→

JB910 (x2)

JM025 [4]

JJ343

KJ466 (x8)

NJ001 [1]
70.00x92.00x8.50mm, MVQ
NJ719 [2]
38.50x58.00x8.50mm, NBR

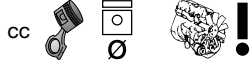

kW/PS

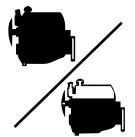

1.6		3ZZ-FE					20	AB5760 (MLS)	CB5760 [13]	FB5760 [3]
Avensis 1.6VVTi	10/00→11/08	1598	4	79.00	DOHC	80-81/ 109-110				
Corolla 1.6	02/00→03/09									
Corolla 1.6 16V	02/00→11/01									
Corolla 1.6 CNG	08/07→									
Corolla 1.6VVTi	01/02→07/07									
1.6		4A-F					21	BR750 (Graphite)	DR750	GR750
Carina II 1.6	12/87→08/90	1587	4	81.00	DOHC	66-74/ 90-101				
Corolla 1.6	08/87→05/92									
Corolla 1.6 4WD	08/87→08/92									
Corolla 1.6 GL	10/87→08/90									
Corolla 1.6 XL	09/89→04/92									
Corona 1.6	12/87→10/89									
Sprinter C 1.6	11/87→05/92									
1.6		4A-FE					22	BR750 (Graphite) 10/87→05/92 BV370 (Graphite) 06/92→	DR750 10/87→05/92 DV370 [3] 06/92→07/94 DV371 08/94→12/97	GR750 →05/92
Avensis 1.6	09/97→10/00	1587	4	81.00	DOHC	66-88/ 90-120				
Caldina 1.6	02/92→09/97									
Caribe Est 1.6	09/94→08/03									
Carina E 1.6	04/92→09/97									
Carina E 1.6 i	02/95→09/97									
Carina E 1.6GLI	04/92→09/97									
Carina II 1.6	12/87→03/92									
Celica 1.6 STI	10/89→11/93									
Corolla 1.6	08/89→02/00									
Corolla 1.6 GLI	07/92→04/97									
Corolla 1.6 i	10/87→06/93									
Corolla 1.6 Si	07/92→04/97									
Corolla 1.6 XLI	08/88→06/92									
Corolla 1.6 Aut	04/97→02/00									
Corona 1.6	06/89→09/97									
Curren 1.6	09/89→10/93									
Sprinter 1.6	08/87→04/97									
Sprinter C 1.6	11/87→10/01									
1.6		4A-GE					23	BN390 (Graphite) →05/89 BR900 (Graphite) 05/89→	DN390 →05/89 DR901 [3] 05/89→	GN390 [3] →05/89 GR901 [3] 05/89→
Corolla 1.6 GTI	07/87→06/93	1587	4	81.00	DOHC	85-96/ 116-131				
1.6		4A-GELC					24	BN390 (Graphite)	DN390	GN390 [3]
Celica 1.6 GT	08/87→08/89	1587	4	81.00	DOHC	85/116				
MR 2 I 1.6	11/84→06/90									
1.6		4A-LC					25	BP530 (Graphite)	DP530	GP530 [3]
Corolla 1.6	04/85→06/89	1587	4	81.00	SOHC/OHC	53-58/ 72-79				
1.8		1C-L Diesel					26	AB5000 (Graphite)	CB5000 [3]	FB5000 [3]
Corolla 1.8 D	07/85→05/88	1839	4	83.00	SOHC/OHC	47/64				

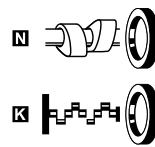
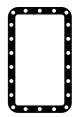
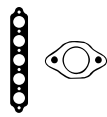

HBS385 [22]
M10x1.50x147.00mm (x10)

JD5243 [1]
JD5160 [1]
(MLS)

JM5073
(Elastomer)

HR397

NJ347 [2]
38.00x50.00x8.00mm, NBR
NA5089 [2]
38.00x50.00x8.00mm, NBR
NA5090 [1]
76.00x94.00x8.50mm, FPM



AB5760



BN390



BP530



BR750



BR900



BV370

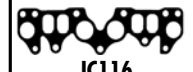

JC116

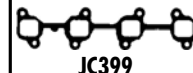

JC399

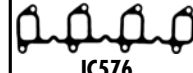

JC576

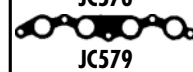

JC579

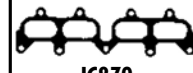

JC879

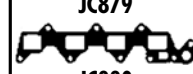

JC880



JC881



JD176

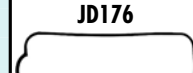

JN356

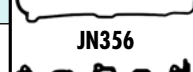

JN532

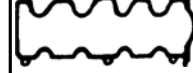

JN603

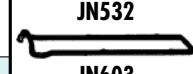

JN706

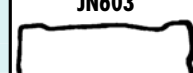

JN904

HBS203 [5]
M10x1.25x108.00mm (x5)

JC880 [1]
JC881 [1]

JN706 [4]

JH5099

PA956 (x8)
PB313 (x8)

NJ353 [2]
35.00x49.00x6.00mm, NBR
NJ349 [2]
32.50x46.00x6.00mm, NBR
NJ001 [1]
70.00x92.00x8.50mm, MVQ

HBS203 [5]
M10x1.25x108.00mm (x5)

JD5978 [1]
(SE)
JC881 [1]
10/87→05/92
JD176 [1]
06/92→

JN706 [4]

→12/92

JN904 [4]

01/92→12/97

HR397

NJ349 [2]
32.50x46.00x6.00mm, NBR
NJ353 [2]
35.00x49.00x6.00mm, NBR
NJ349 [2]
32.50x46.00x6.00mm, NBR
NJ001 [1]
70.00x92.00x8.50mm, MVQ

HBS203 [5]
M10x1.25x108.00mm (x5)

JC879 [1]
05/89→
JC579 [1]
 JE015 [1]

JN603 (x2)[4]

JH5099

PA956 (x8)
PB313 (x8)

NJ353 (x2)[2]
35.00x49.00x6.00mm, NBR
NJ349 [2]
32.50x46.00x6.00mm, NBR
NJ001 [1]
70.00x92.00x8.50mm, MVQ

HBS203 [5]
M10x1.25x108.00mm (x5)

JC579 [1]
 JE015 [1]

JN603 (x2)[4]

JH5099

NJ353 (x2)[2]
35.00x49.00x6.00mm, NBR
NJ349 [2]
32.50x46.00x6.00mm, NBR
NJ001 [1]
70.00x92.00x8.50mm, MVQ

JC116
 JE015 [1]

JN356 [4]

HR397

LT808
NJ353 [2]
35.00x49.00x6.00mm, NBR
NJ349 [2]
32.50x46.00x6.00mm, NBR
NJ001 [1]
70.00x92.00x8.50mm, MVQ

HBS042 [5]
M11x1.25x145.00mm (x10)

JC576 [1]
JC399 [1]

JN532 [4]

HR397

NJ347 [2]
38.00x50.00x8.00mm, NBR



cc



kW/PS



1.8		1S-EL					27	BK670 (Graphite)	DK670	
Celica 1.8	08/87→08/89	1832	4	80.50	SOHC/OHC	67-74/ 91-101				
1.8		1S-L					28	BK670 (Graphite)	DK670	GK671 [3]
Camry 1.8 i	10/86→08/88	1832	4	80.50	SOHC/OHC	66-74/ 90-101				
Mark II 1.8	11/83→03/88									
Scepter 1.8	04/85→08/88									
1.8		1ZZ-FE					29	AB5760 (MLS)	CB5760 [13]	FB5760 [3]
Allion I 1.8	06/01→06/07	1794	4	79.00	DOHC	92-107/ 125-146				
Avenis 1.8	04/03→11/08									
Avenis 1.8VVTi	10/00→02/03									
Celica 1.8 VT-i	08/99→07/05									
Corolla 1.8	03/01→03/09									
Corolla 1.8 4WD	12/01→02/07									
Corolla 1.8VVTi	10/01→05/04									
Isis 1.8VVTi	07/04→									
Liteace 1.8	10/97→08/01									
Matrix 1.8	09/01→02/04									
MR 2 III 1.8	10/99→06/07									
Opa 1.8	04/00→08/03									
Opa 1.8 4WD	04/00→08/03									
RAV 4 II 1.8	02/01→11/05									
Vista 1.8 NT80	06/98→08/03									
Will vs 1.8	03/01→04/04									
WISH MPV 1.8 Hi	04/03→03/09									
YARIS 1.8 VVTi	11/05→									
1.8		2Y					30	BL820 (Graphite) BL822 (Graphite), 1.800mm		
Dyna 100 1.8	08/85→04/95	1812	4	86.00		58-65/ 79-88				
Hiace II 1.8	03/83→11/89									
Hilux II 1.8	08/83→07/94									
Master Ace 1.8	02/85→08/90									
1.8		2ZR-FAE					31	AH6940 (MLS), 0.7mm		
Allion II 1.8	07/07→	1798	4	80.50	DOHC	95-108/ 129-147				
Auris 1.8	02/09→									
Auris 1.8 4WD	02/09→									
Avenis 1.8	02/09→									
Corolla 1.8	09/06→									
Corolla 1.8 4WD	09/06→									
Isis 1.8VVTi	04/07→									
Premio 1.8	07/07→									
Verso 1.8	04/09→									
WISH MPV 1.8	04/09→									
1.8		2ZR-FE					32	AH6940 (MLS), 0.7mm		
Allion I 1.8	06/01→06/07	1798	4	80.50	DOHC	97-106/ 133-144				
Auris 1.8 VVTi	10/06→									
Corolla 1.8	05/07→									
Corolla 1.8VVTi	08/10→									
YARIS 1.8 VVTi	01/07→									

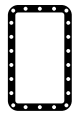
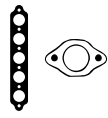

AB5760



BK670



BL820



BL822



JC402



JN469



cc



kW/PS



1.8		2ZR-FXE				33		AH6940 (MLS), 0.7mm	
Auris 1.8 Hybr	09/10→	1798	4	80.50	DOHC	73/99			
Prius 1.8	04/09→								
Prius PLUS 1.8	03/12→								
1.8		2ZZ-GE				34		AG9110 (MLS), 0.400mm	
Celica 1.8 TS	08/99→09/05	1796	4	82.00	DOHC	127-165/ 173-224		CG9110	EG6290
Corolla 1.8 TS	01/02→02/07								
1.8		7A-FE				35		BV360 (MLS)	
Ascent 1.8	06/01→10/03	1762	4	81.00	DOHC	79-106/ 107-144		DV360 [3]	GV360 [3]
Avensis 1.8	09/97→10/00								
Caldina 1.8	02/92→09/01								
Carina E 1.8	04/92→09/97								
Carina E 1.8 GL	10/94→09/97								
Carina E 1.8 i	01/95→09/97								
Celica 1.8i 16V	11/93→11/99								
Chaser 1.8	10/93→08/96								
Corolla 1.8	09/92→12/01								
Corolla 1.8 4WD	09/95→04/97								
Corolla 1.8 AWD	04/97→10/01								
Corolla 1.8 GT	11/92→05/95								
Corolla 1.8 GTi	05/92→07/95								
Corolla 1.8 i	11/92→09/94								
Corolla 1.8 LT	10/97→10/01								
Corolla 1.8 XL	09/92→11/93								
Corolla 1.8GTi	05/92→07/95								
Corona 1.8	02/92→09/97								
Curren 1.8	11/93→10/98								
Premio 1.8	12/01→05/07								
Sprinter 1.8	11/92→04/97								
Sprinter C 1.8	11/92→10/01								
1.9		1WZ Diesel				36		AA5830 (SE), 1.260mm, 1 Hole	
Corolla 1.9 D	02/00→01/02	1867	4	82.20	SOHC/OHC	51/69	AA5830 (SE), 1.260mm, 1 Hole AA5840 (SE), 1.300mm, 2 Holes AA5850 (SE), 1.340mm, 3 Holes AA5860 (SE), 1.380mm, 4 Holes AA5870 (SE), 1.420mm, 5 Holes	CA5830 ▲ [3]	EA5830
2.0		1AD-FTV Diesel				37			
Auris 2.0 D-4D	03/07→	1998	4	86.00	DOHC	91-93/ 124-126			
Avensis 2.0D-4D	03/06→11/08								
Corolla 2.0 D4D	01/07→								
RAV 4 IV 2.0	12/12→								
Verso 2.0 D-4D	04/09→								

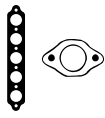

AA5830, AA5840,
AA5850, AA5860,
AA5870



BV360



JD175



JD176



JN904



JJ283

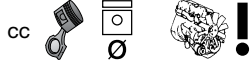

kW/PS

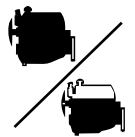

2.0	1AZ-FE					38	AF5780 (MLS)	CF5780	EG6310
Avensis 2.0VVTi	08/01→11/09	1998	4	86.00	DOHC	108-114/ 147-155			
Camry 2.0	09/11→								
Camry 2.0 VVTi	08/01→11/06								
Camry 2.0 VVT-i	01/06→09/11								
RAV 4 II 2.0	06/00→11/05								
RAV 4 III 2.0	03/06→								
Vista 2.0	06/98→08/03								
2.0	1AZ-FSE					39	AF5780 (MLS)	CF5781	FF5781
Allion 1 2.0	06/01→06/07	1998	4	86.00	DOHC	108-114/ 147-155			
Aurion 2.0	03/06→07/09								
Avensis 2.0	04/03→11/08								
Avensis 2.0VVTi	10/00→02/03								
Caldina 2.0	09/02→06/07								
Gaia 2.0VVTi	05/98→10/03								
Hilux III 2.0	08/05→								
Isis 2.0VVTi	07/04→								
Noah/Voxy 2.0	12/01→06/07								
Opa 2.0	08/00→04/05								
Vista 2.0	06/98→08/03								
WISH MPV 2.0 Zi	04/03→03/09								
2.0	1CD-FTV Diesel					40	AD5370 (MLS), 1.000mm, 1 Notch AG7480 (MLS), 1.050mm, 2 Notches AG7490 (MLS), 1.100mm, 3 Notches AG7500 (MLS), 1.150mm, 4 Notches AG7510 (MLS), 1.200mm, 5 Notches	CG7480 ▲ →09/01 CG7491 ▲ 09/01→	FG7480 ▲ →09/01
Avensis 1.9 D	09/02→02/03	1995	4	82.20	DOHC	66-85/ 90-116			
Avensis 2.0 D	09/02→02/03								
Avensis 2.0D-4D	10/99→11/08								
Corolla 2.0 D4D	04/97→03/09								
Previa 2.0 D-4D	03/01→01/06								
RAV 4 2.0 D-4D	09/01→11/05								
2.0	1G-E					41	BK680 (Graphite)	DK680	
Crown 2.0	10/87→07/91	1988	6	75.00	SOHC/OHC	77-80/ 105-109			
Soarer 2.0	09/86→08/90								
2.0	1G-FE					42	AG9990 (MLS)		
Aqua 2.0VVTi	07/01→07/05	1988	6	75.00	DOHC	99-118/ 135-160			
Chaser 2.0 24V	08/86→08/91								
Cressida 2.0	10/88→09/92								
Cressida 2.0 S	10/92→09/96								
Cressida 2.0GLi	08/82→09/92								
Cresta 2.0	08/84→09/01								
Mark II 2.0	04/88→09/96								
Mark II 2.0VVTi	10/96→09/01								
Verossa 2.0	10/00→11/03								
2.0	1RZ					43	BW560 (Graphite)	DW560	GW560 [3]
Hiace III 2.0	08/89→04/98	1998	4	86.00	SOHC/OHC	71-74/ 97-101			
Hiace IV 2.0	08/95→04/98								
Kijang 2.0	08/91→08/01								
2.0	2C-E Diesel					44	AG7650 (MLS), 1.350mm, 2 Holes AG7660 (MLS), 1.450mm, 3 Holes AG7640 (Graphite) ❏		FG7650 ▲
Corolla 2.0 D	04/97→02/00	1975	4	86.00	SOHC/OHC	53/72			
2.0	2C-L Diesel					45	BR580 (Graphite)	DR581 [3]	
Carina II 2.0 D	02/84→06/92	1975	4	86.00	SOHC/OHC	50-54/ 68-73			

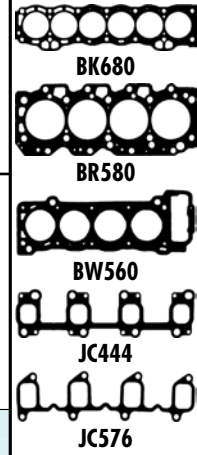

HBS441 [22] M11x1.50x162.00mm (x10) 01/00→	JD5170 ■ JD5171 ■ (MLS) 0.400mm	JM7036 (Elastomer)	HR397		NJ706 [2] 37.50x50.00x6.00mm, ACM NB799 [1][2] 38.00x50.00x7.00mm, FPM NJ347 [2] 38.00x50.00x8.00mm, NBR NJ933 [2] 35.00x50.00x8.00mm, FPM	
HBS441 [22] M11x1.50x162.00mm (x10) 01/00→	JD5973 ■ (SE) JD5171 ■ (MLS) 0.400mm	JM7022 [142]	HR397		NJ347 [2] 38.00x50.00x8.00mm, NBR	
HBS314 [5] M12x1.25x104.00mm (x10)	JD5901 ■ JD5961 ■		HR397		NJ347 [2] 38.00x50.00x8.00mm, NBR NA5282 [2] 45.00x63.00x7.00mm, FPM	
			HR397		NJ347 [2] 38.00x50.00x8.00mm, NBR	
			HR397		NJ353 [2] 35.00x49.00x6.00mm, NBR	
HBS425 [5] M11x1.25x105.00mm (x10)	JE012		HR397	PA136 (x8)		
HBS042 [5] M11x1.25x145.00mm (x10)	JC576 ■				NJ347 [2] 38.00x50.00x8.00mm, NBR	
HBS042 [5] M11x1.25x145.00mm (x10)	JC576 ■ JC444 ■		HR397		NJ347 [2] 38.00x50.00x8.00mm, NBR	













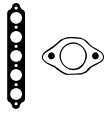

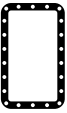

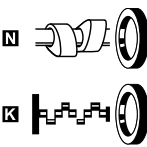



cc



kW/PS

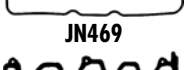
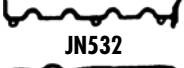

2.0		2C-T Diesel				46		BR580 (Graphite)			
Avensis 1.9 D	10/97→05/98	1975	4	86.00	SOHC/OHC	61-67/ 83-91					
Camry 2.0 TD	11/86→09/99										
Carina E 2.0 TD	01/96→09/97										
Corona 2.0 TD	07/94→09/97										
Master Ace 2.0	02/85→10/93										
Scepter 2.0 TD	08/86→09/96										
Scepter Es 2.0	11/92→09/96										
Vista 2.0 D	07/90→05/98										
Vista 2.0 TD	11/88→06/90										
VistaEs 2.0 TD	11/88→06/91										
2.0		2C-TE Diesel				47		AG7670 (MLS) AD5340 (MLS), 1.250mm, 1 Hole AG5240 (SE), 1.450mm, 3 Holes		CD5340	FG7650 ▲
Avensis 2.0 TD	09/97→02/03	1975	4	86.00	SOHC/OHC	66/90					
2.0		2S-EL				48		BL350 (Graphite)		DL350	
Mark II 2.0	11/83→03/88	1995	4	84.00	SOHC/OHC	79/107					
2.0		3S-FE				49		BR250 (Graphite) →12/96 AD5330 (MLS) 12/96→08/00		DR250 →12/96	GR250 →12/96 FD5330 [3] 12/96→08/00
Avensis 2.0	09/97→10/00	1998	4	86.00	DOHC	88-125/ 120-170					
Caldina 2.0	02/92→10/97										
Camry 2.0	03/83→06/91										
Camry 2.0 Gli	11/86→05/91										
Camry 2000 ZX	06/91→09/97										
Carina E 2.0	01/93→09/97										
Carina E 2.0 i	12/92→09/97										
Carina E 2.0GLI	04/92→09/97										
Carina II 2.0	12/87→04/92										
Corona 2.0	02/92→09/97										
Corona 2.0 EZ	12/87→01/92										
MR 2 II 2.0	12/89→08/92										
Nadia 2.0	04/98→08/03										
Picnic 2.0	06/00→01/03										
Picnic 2.0 16V	05/96→12/01										
Previa 2.0	10/00→08/03										
RAV 4 Conv 2.0	12/97→06/00										
RAV 4 I 2.0	01/94→09/99										
RAV 4 I 2.0 16V	06/94→06/00										
Scepter 2.0	10/86→09/96										
Vista 2.0	10/86→06/91										
2.0		3S-GE				50		BS060 (Graphite)			
Caldina 2.0	07/94→09/97	1998	4	86.00	DOHC	115-129/ 156-175					
Carina E 2.0GTi	04/92→09/97										
Celica 2.0 GTi	10/89→08/99										
Celica 2.0i 16V	11/93→11/99										
Curren 2.0	09/89→10/98										
Curren 2.0 4WD	11/93→10/96										
MR 2 II 2.0	12/89→05/00										
RAV 4 I 2.0	01/94→09/99										

							
HBS042 ☉ [5] M11x1.25x145.00mm (x10)	JC576 ■	JN532 [4]	HR397		NJ347 [2] 38.00x50.00x8.00mm, NBR		 BL350  BR250  BR580  BS060  JC402
HBS042 ☉ [5] M11x1.25x145.00mm (x10)	JC576 ■		HR397		NJ347 [2] 38.00x50.00x8.00mm, NBR		 JC576
	JC402  JE012	JN469 [4]	HR397	KJ466 (x8)	NJ347 [2] 38.00x50.00x8.00mm, NBR NJ344 ■ [2] 42.00x60.00x7.00mm, NBR NJ215 ■ [1] 85.00x105.00x10.00mm, FPM		 JD112  JD194
HBS200 ☉ [5] M10x1.25x94.50mm (x10)	JD194 ■ JD112 ■	JN655 (Elastomer) HM5276 ■ (Elastomer)	HR397		NJ347 [2] 38.00x50.00x8.00mm, NBR NJ215 ■ [1] 85.00x105.00x10.00mm, FPM NK214 ■ [1][2][143] 35.00x63.00x10.00mm, ACM		 JN469  JN532  JN655
HBS198 ☉ [5] M10x1.25x93.00mm (x10)			HR397		NJ353 [2] 35.00x49.00x6.00mm, NBR		



cc



kW/PS



2.0	3S-GEL						51	BR330 (Graphite)	DR330 [3] →Eng.8999999	GR330 [3] →Eng.8999999
Celica 2.0	01/87→08/89	1998	4	86.00	DOHC	103-110/ 140-150		DR332 [3] Eng.8999999→	GR332 [3] Eng.8999999→	
Celica 2.0 GT	08/85→08/89									
2.0	3S-GELC						52	BR330 (Graphite)	DR330 [3] →Eng.8999999	GR330 [3] →Eng.8999999
Celica 2.0	08/87→08/89	1998	4	86.00	DOHC	103/140		DR332 [3] Eng.8999999→	GR332 [3] Eng.8999999→	
Celica 2.0 GT	08/85→08/89									
2.0	3S-GTE						53	BS060 (Graphite)	DS060 [13]	GS060 [3]
Caldina 2.0 4WD	10/97→09/01	1998	4	86.00	DOHC	136-195/ 185-265				
Celica 2.0 i T	02/94→11/99									
Celica 2.0T 4WD	03/88→11/93									
Curren 2.0 T	09/89→10/93									
2.0	3Y						54	BN640 (Graphite)	DN640 [3]	GN640
Blizzard 2.0	05/86→10/95	1998	4	86.00		57-79/ 78-107				
Dyna150 2.0	08/85→08/88									
Hiace II 2.0	01/84→11/89									
Hilux II 2.0	08/85→07/88									
Liteace 2.0	10/85→07/88									
Master Ace 2.0	02/85→08/90									
Modell F 2.0	08/84→01/90									
2.0	3Y-C						55	BN640 (Graphite)	DN640 [3]	GN640
Liteace 2.0	08/88→07/89	1998	4	86.00	OHV	65/88				
Modell F 2.0	08/84→08/88									
Town Ace 2.0	04/92→09/01									
2.0	3ZR-FAE						56	AH6940 (MLS), 0.7mm		
Allion II 2.0	07/07→	1987	4	80.50	DOHC	107-116/ 146-158	03/09→			
Avensis 2.0	02/09→									
Isis 2.0VVTi	04/07→									
Noah/Voxy 2.0	06/07→									
Premio 2.0	07/07→									
RAV 4 III 2.0	12/08→									
RAV 4 IV 2.0	12/12→									
WISH MPV 2.0	04/09→									
2.0	21R						57	BK700 (Graphite)		
Chaser 2.0	08/84→09/91	1972	4	84.00	SOHC/OHC	77/105				
2.2	2AD-FHV Diesel						58			
Auris 2.2 D	03/07→	2231	4	86.00	DOHC	110-130/ 150-177				
Avensis 2.2D	07/05→11/08									
Avensis 2.2D-4D	02/09→									
Corolla 2.2 D4D	10/05→03/09									
RAV 4 III 2.2	12/08→									
RAV 4 III 2.2 D	03/06→									
RAV 4 IV 2.2	12/12→									
Verso 2.2 D-4D	04/09→									
Verso 2.2 D-CAT	04/09→									
2.2	2AD-FTV Diesel						59			
Avensis 2.2D-4D	10/05→11/09	2231	4	86.00	DOHC	100-110/ 136-150				
Corolla 2.2 D4D	10/05→03/09									
RAV 4 III 2.2	03/06→									

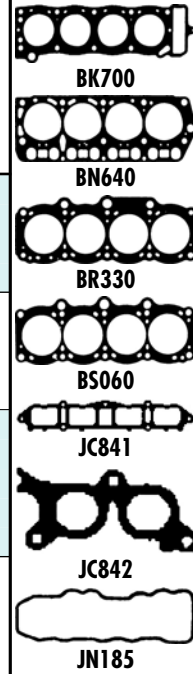

HBS198 Ⓞ [5] M10x1.25x93.00mm (x10)	JC841 ■ JC842 ■		HR397		NJ353 [2] 35.00x49.00x6.00mm, NBR	
HBS198 Ⓞ [5] M10x1.25x93.00mm (x10)	JC841 ■ JC842 ■		HR397		NJ353 [2] 35.00x49.00x6.00mm, NBR	
HBS198 Ⓞ [5] M10x1.25x93.00mm (x10)	JC789 ■ (x2)	JN917 [4]	HR397	PA425 (x16)	NJ353 (x2) [2] 35.00x49.00x6.00mm, NBR NJ215 ■ [1] 85.00x105.00x10.00mm, FPM	
			HR397			
			HR397			
			HR397		NA5260 [2] 38.00x50.00x6.00mm, FPM NA5260 ■ [2] 38.00x50.00x6.00mm, FPM	
		JN185 [4]				
HBS531 Ⓞ [21][22]	JD6004 ■ (Steel) JD5988 ■ (MLS)	JM7106 (ACM)	HR397	PA6055 (FPM)	NA5319 ■ [2] 48x63.0x6.5mm, FPM	
HBS531 Ⓞ [21][22]	JD6004 ■ (Steel) JD5988 ■ (MLS)	JM7106 (ACM)	HR397	PA6055 (FPM)	NA5319 ■ [2] 48x63.0x6.5mm, FPM	



cc



kW/PS



2.2		3C-TE Diesel			60		AG7670 (MLS)		CD5340
Avenis 2.2 TD	04/05→11/08	2184	4	86.00	SOHC/OHC	66-76/ 90-103	AD5340 (MLS), 1.250mm, 1 Hole	AG5240 (SE), 1.450mm, 3 Holes	
Caldina 2.2 TD	10/97→09/01								
Corolla 2.2 TD	04/98→10/01								
Cresta 2.2 TD	10/96→09/01								
Deliboy 2.2 D	10/94→10/95								
Gaia 2.2 TD	10/98→10/03								
Liteace 2.2 D	02/95→08/97								
Nadia 2.2TD 4WD	04/98→08/03								
Picnic 2.2 D	08/97→12/01								
Sprinter 2.2 TD	04/95→11/02								
WINDOM 2.2 TD	07/91→07/01								
2.2		4Y			61		BP650 (Graphite)		DP650 [13]
Dyna200 2.2	10/93→07/01	2237	4	91.00	SOHC/OHC	69/94			GP650 [3]
Hiace II 2.2	09/87→08/89								
Hilux II 2.2	01/87→12/89								
Stout 2.2	04/88→02/00								
2.2		4Y-EC			62		BP650 (Graphite)		DP651 [13]
Liteace 2.2	01/92→01/95	2237	4	91.00	OHV	72-76/ 98-103			
Modell F 2.2	08/87→01/90								
Town Ace 2.2	01/92→04/95								
2.2		5S-FE			63		AG9140 (MLS) BS970 (Graphite)		CG9140
Camry 2.2	06/91→11/01	2164	4	87.00	DOHC	93-103/ 126-140			EG6250
Camry S Con 2.2	02/00→11/02								
Camry S Cpe 2.2	06/98→06/01								
Celica 2.2	10/89→10/93								
Celica 2.2 GT	11/93→08/99								
Chaser 2.2	10/96→05/01								
Curren 2.2	09/89→10/98								
Harrier 2.2	03/98→01/03								
Mark II 2.2	08/96→07/01								
Scepter 2.2	11/92→09/96								
ScepterEs 2.2	11/92→09/96								
Vista 2.2	07/90→09/97								
WINDOM 2.2	10/96→07/01								

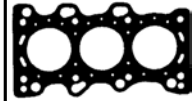
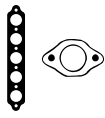

BP650



BS970



JC444



JC576



JC658



JN551

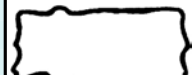

JN655

HBS042 [5]
M11x1.25x145.00mm (x10)

JC576 [1]
JC444 [1]

JM5146

HR397

NJ347 [2]
38.00x50.00x8.00mm, NBR

JC615 [1]
JE012 (x2)

JN551 [4]

NJ344 [2]
42.00x60.00x7.00mm, NBR
NJ360 [1]
80.00x100.00x8.50mm, MVQ
NK214 [1][2][143]
35.00x63.00x10.00mm, ACM

JC658 [1]
JC615 [1]
JE124 (x2)

JN551 [4]

HR397

NJ344 [2]
42.00x60.00x7.00mm, NBR
NJ360 [1]
80.00x100.00x8.50mm, MVQ

HBS200 [5]
M10x1.25x94.50mm (x10)

JN655
(Elastomer)
HM5276 [1]
(Elastomer)

NJ347 [2]
38.00x50.00x8.00mm, NBR
NJ215 [1]
85.00x105.00x10.00mm, FPM



cc



kW/PS



2.4		2AZ-FE				64		AF5840 (MLS), 0.400mm	
Alphard I 2.4	09/03→04/08	2362	4	88.50	DOHC	112-127/ 152-173			
Alphard II 2.4	04/08→								
Aurion 2.4	03/06→07/09								
Auris 2.4 VVTi	04/07→								
Avalon 2.4	08/01→04/05								
Avenis 2.4 VVTi	10/03→11/09								
Camry 2.4 VVTi	01/06→09/11								
Camry 2.4 VVT-i	11/01→11/06								
Camry S Con 2.4	02/04→11/08								
Camry S Cpe 2.4	07/03→07/08								
Harrier 2.4	06/00→01/03								
Kluger 2.4	06/00→05/07								
MARK X ZiO 2.4	09/07→								
Previa 2.4	08/00→01/06								
RAV 4 II 2.4	08/03→11/05								
RAV 4 III 2.4	11/05→								
Town Ace 2.4	10/03→07/07								
Vista 2.4	06/01→08/03								
2.4		2AZ-FSE				65		AF5840 (MLS), 0.400mm	
Avenis 2.4	09/03→11/08	2362	4	88.50	DOHC	120-125/ 163-170			
2.4		2AZ-FXE				66			
Alphard I 2.4	09/03→04/08	2362	4	88.50	DOHC	96-117/ 131-159			
Alphard I 2.4 H	09/03→04/08								
Alphard II 2.4	12/11→								
Aurion 2.4	11/00→09/11								
Camry 2.4 VVTi	01/06→09/11								
Camry 2.4 VVT-i	01/06→09/11								
Previa 2.4	07/02→01/06								
SAI 2.4 Hybrid	11/09→								
2.4		2L Diesel				67		BL950 (Graphite) →08/88 AH6250 (MLS), 1.240mm AH6260 (MLS), 1.550mm BW800 (MLS) 08/00→	
Chaser 2.4 D	10/92→08/96	2446	4	92.00	SOHC/OHC	53-63/ 72-86		DL950 →08/88 DW801 [3] 08/88→08/00	EW801 →12/99 GL950 →08/88 GW801 [3] 08/88→08/00
Cresta 2.4 D	09/88→10/96								
Dyna 2.4 D	08/87→07/01								
Dyna150 2.4 D	05/95→07/01								
Hiace II 2.4 D	05/84→11/89								
Hiace III 2.4 D	08/89→08/95								
Hiace IV 2.4 D	08/95→08/06								
Hilux II 2.4 D	01/84→07/05								
Kijang 2.4 D	08/89→08/95								
Mark II 2.4 D	04/88→09/96								
Tamaraw 2.4 D	01/99→10/04								
Town Ace 2.4 D	04/85→12/91								

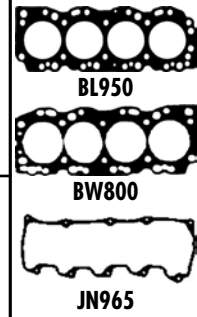
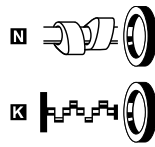
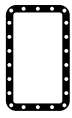

HBS441 [22]
M11x1.50x162.00mm (x10)

JD5170 [1]
JD5171 [5]
(MLS)
0.400mm

JM7036
(Elastomer)

HR397

PA5020

NJ347 [2]
38.00x50.00x8.00mm, NBR

HBS441 [22]
M11x1.50x162.00mm (x10)

JD5973 [1]
(SE)
JD5171 [5]
(MLS)
0.400mm

JM7022

HR397

HBS441 [22]
M11x1.50x162.00mm (x10)

JD5973 [1]
(SE)
JD5171 [5]
(MLS)
0.400mm

JM7022

HR397

HBS315 [5]
M12x1.25x106.00mm (x4)

JE017

JN965 [4]

NJ377 [2]
32.00x47.00x6.00mm, ACM
NJ215 [1]
85.00x105.00x10.00mm, FPM



cc



kW/PS



2.4	2L-T Diesel					68	BL950 (Graphite) →12/88 AH6250 (MLS), 1.240mm 01/89→ AH6260 (MLS), 1.550mm 01/89→	DL951 →12/88	GL951 [3] →12/88
4 Runner 2.4 TD	08/89→11/95	2446	4	92.00	SOHC/OHC	63-92/ 85-125			
Cressida 2.4 TD	01/85→10/88								
Hiace IV 2.4 TD	08/95→08/06								
Hilux 2.4 TD	08/89→07/01								
Hilux II 2.4 TD	08/98→01/02								
LandCruiser 2.4	10/85→05/96								
2.4	2RZ-E					69	BX060 (Graphite)	DX060 [3]	GX060 [3]
Hiace III 2.4	08/89→08/04	2438	4	95.00	SOHC/OHC	81-97/ 115-132			
Hiace IV 2.4	08/95→02/05								
Hiace IV 2.4 i	08/95→02/05								
Kijang 2.4	08/95→08/04								
Tarago Box 2.4	09/89→10/99								
Tarago Bus 2.4	09/89→10/99								
Town Ace 2.4	01/92→04/95								
2.4	2RZ-FE					70	BZ170 (Graphite)		
Dyna300 2.4	06/98→07/01	2438	4	95.00	DOHC	103-107/ 140-146			
Hilux II 2.4	08/94→07/05								
Hilux II 2.4 i	08/97→07/05								
2.4	2TZ-FE					71	BS870 (Graphite)	DS870	GS870
Previa 2.4	05/90→08/00	2438	4	95.00	DOHC	97/132			
Previa 2.4 4WD	05/90→08/00								
2.4	22R					72	BM880 (Graphite)	DM883 [3]	GM881 [3]
Coaster 2.4	05/82→09/89	2367	4	92.00	SOHC/OHC	72-84/ 98-114			
Cresta 2.4	06/87→08/88								
Hilux II 2.4	10/88→12/97								
Hilux II 2.4 i	06/89→07/05								
LandCruiser 2.4	11/84→05/93								
2.4	22RE					73	BM880 (Graphite)	DM883 [3]	
Hilux II 2.4 i	06/89→07/05	2366	4	92.00	SOHC/OHC	84-87/ 114-118			
LandCruiser 2.4	12/88→12/96								
2.4	22REC					74	BM880 (Graphite)	DM883 [3]	
4 Runner 2.4	08/87→03/96	2366	4	92.00	SOHC/OHC	82-87/ 112-118			
2.5	2KD-FTV Diesel					75	AF5980 (MLS), 0.600mm, 0 Notches AF5981 (MLS), 0.640mm, 2 Notches AF5982 (MLS), 0.680mm, 3 Notches AF5983 (MLS), 0.720mm, 4 Notches AF5984 (MLS), 0.750mm, 5 Notches	CF5980 ▲	FF5980 ▲
Dyna 2.5 D4d	08/01→	2494	4	92.00	DOHC	65-106/ 88-144			
Fortuner 2.5	01/09→								
Hiace III 2.5 D	08/01→08/04								
Hiace IV 2.5 D	11/01→08/06								
Hilux II 2.5 D	11/01→07/05								
Hilux III 2.5D	08/05→								
Kijang 2.5 D-4D	08/04→								
Regiusace 2.5	08/04→								
Regiusace 2.5	08/04→								
2.5	2VZ-FE					76	BS300 (Graphite) ☒ BS290 (Graphite) ☒	DS290 [3]	
Camry 2.5	01/90→05/91	2508	6	87.50	DOHC, V	118/161			
Camry 2.5 V6	02/88→05/91								
Vista 2.5	10/88→06/90								

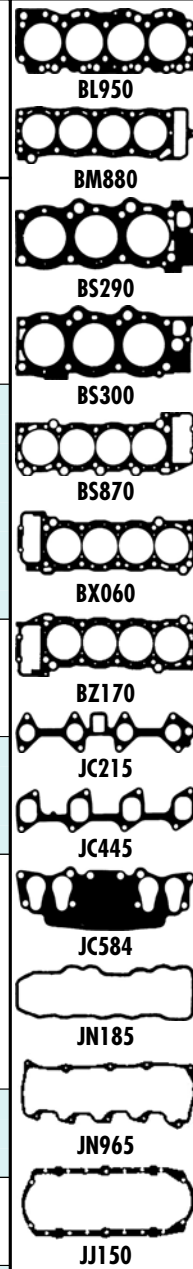
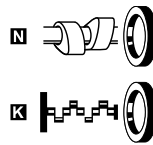
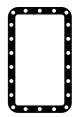
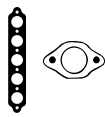

HBS315 [5] M12x1.25x106.00mm (x4)	JC445 [1] →12/88	JN965 [4] 01/89→ HL510 [1] →12/88	JJ150 →12/88 HR397 01/89→		NJ377 [2] 32.00x47.00x6.00mm, ACM NJ215 [1] 85.00x105.00x10.00mm, FPM	
HBS425 [5] M11x1.25x105.00mm (x10)			HR397	PA136 (x8)	NJ200 [2] 48.00x68.00x7.00mm, NBR	
HBS425 [5] M11x1.25x105.00mm (x10)			HR397			
HBS425 [5] M11x1.25x105.00mm (x10)			HR397	PB281 (x16)	NJ200 [2] 48.00x68.00x7.00mm, NBR NK055 [1] 88.00x106.00x8.70mm, FPM	
HBS386 [5] M12x1.25x163.00mm (x10)	JC215 [1] JC584 [1] JE012 (x2)	JN185 [4]		PA136 (x8)	NJ353 [2] 35.00x49.00x6.00mm, NBR NJ360 [1] 80.00x100.00x8.50mm, MVQ NJ243 [1][2] 45.00x68.00x12.00mm, NBR NK214 [1][2][143] 35.00x63.00x10.00mm, ACM	
HBS386 [5] M12x1.25x163.00mm (x10)		JN185 [4]			NJ353 [2] 35.00x49.00x6.00mm, NBR	
HBS386 [5] M12x1.25x163.00mm (x10)		JN185 [4]			NJ353 [2] 35.00x49.00x6.00mm, NBR	
HBS501 [5] M11x1.25x96.00mm (x16)	JD5967 [1] (MLS)	JM7023 (MVQ)	HR397		NJ377 [2] 32.00x47.00x6.00mm, ACM NK251 [2] 50.00x68.00x9.00mm, NBR	
HBS394 [5] M11x1.25x96.00mm (x16)			HR397		NJ347 [2] 38.00x50.00x8.00mm, NBR	



cc



kW/PS



2.5		4GR-FE				77		AH6710 (MLS) [102]	
Crown 2.5	09/03→02/08	2499	6	83.00	DOHC, V	145-158/ 197-215	01/05→		
Crown 2.5	12/12→						AH6700 (MLS) [102]		
Crown 2.5 4WD	12/12→						01/05→		
Crown 2.5 V6	02/08→11/12								
MARK X I 2.5	03/04→09/09								
MARK X II 2.5	10/09→								
2.7		3RZ-FE				78		BZ170 (Graphite)	
4 Runner 2.7 i	11/95→03/96	2694	4	95.00	DOHC	92-112/ 125-152			
Coaster 2.7	02/93→10/03								
Dyna150 2.7	06/95→07/01								
Granvia 2.7	08/95→								
Hiace IV 2.7	04/98→08/06								
Hilux 2.7	08/01→07/04								
Hilux II 2.7	08/94→08/05								
LandCruiser 2.7	04/95→08/04								
Tarago Box 2.7	08/98→08/04								
Tarago Bus 2.7	08/98→08/04								
2.8		5M-GE				79			
Cressida 2.8	11/84→09/88	2759	6	83.00	DOHC	103-125/ 140-170			
Cresta 2.8	11/84→08/88								
3.0		1KD-FTV Diesel				80		AG7520 ▲	
Dyna 3.0 D4d	08/01→	2982	4	96.00	DOHC	75-140/ 102-190	AG7520 (MLS), 0 Notches		CG7520 ▲
Fortuner 3.0	08/09→						AG7530 (MLS), 1 Notch		
Hiace IV 3.0 D	01/05→						AG7540 (MLS), 2 Notches		
Hilux III 3.0	08/05→09/06						AG7550 (MLS), 3 Notches		
Hilux III 3.0D	02/05→						AG7560 (MLS), 4 Notches		
LandCruiser 3.0	10/00→02/10								
Regiusace 3.0	08/04→								
Regiusace 3.0	08/04→								
3.0		1KZ-T Diesel				81		AH5180 ▲	
4 Runner 3.0 T	10/93→11/02	2982	4	96.00	SOHC/OHC	87-92/ 118-125	AH5180 (MLS), 0.750mm		CG5540 ▲
Hilux 3.0 TD	08/93→07/97						AH5230 (MLS), 0.850mm		
Hilux II 3.0 D	08/97→08/05						AG5230 (MLS), 0.950mm, 5 Holes		
LandCruiser 3.0	05/93→05/96								
3.0		1KZ-TE Diesel				82		AH5180 ▲	
Granvia 3.0 TDi	08/95→	2982	4	96.00	SOHC/OHC	85-103/ 116-140	AH5180 (MLS), 0.750mm		CG5540 ▲
LandCruiser 3.0	04/95→02/10						AH5230 (MLS), 0.850mm		
							AG5230 (MLS), 0.950mm, 5 Holes		

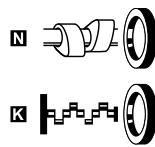
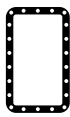
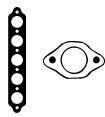

BZ170





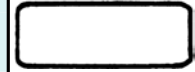



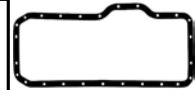





























JC276



JN449



JH024

			HR397			
HBS425  [5] M11x1.25x105.00mm (x10)		JN954 [4]		PA425  (x8)	 NJ200  [2] 48.00x68.00x7.00mm, NBR  NK055  [1] 88.00x106.00x8.70mm, FPM	
	JC277  JC276   JF087	JN449 [4]	JH024	PA136 (x12)	 NJ102 (x2) [2] 38.50x58.00x11.00mm, NBR  NJ344  [2] 42.00x60.00x7.00mm, NBR  NJ030  [1] 80.00x100.00x12.00mm, ACM  NJ042  [2] 48.00x70.00x12.00mm, NBR	
HBS501  [5]	JD5966  (SMG)	JM7023 (MVQ)	HR397		 NJ377  [2] 32.00x47.00x6.00mm, ACM	
HBS209  [5] M12x1.25x127.00mm (x18)	JD5967  (MLS)		HR397		 NJ377  [2] 32.00x47.00x6.00mm, ACM  NK251  [2] 50.00x68.00x9.00mm, NBR  NF843  [2] 50.00x68.00x10.00mm, FPM/ACM	
HBS209  [5] M12x1.25x127.00mm (x18)	JD5967  (MLS)		HR397		 NJ377  [2] 32.00x47.00x6.00mm, ACM  NK251  [2] 50.00x68.00x9.00mm, NBR  NF843  [2] 50.00x68.00x10.00mm, FPM/ACM	



cc



kW/PS



3.0		1MZ-FE				83		BZ350 (Fibre), 1.300mm		DZ350 [144]		EG9270	
Alphard I 3.0	04/03→04/08	2995	6	87.50	DOHC, V	135-164/	→01/97		→01/96		01/00→		
Avalon 3.0	03/95→05/05					184-223		BZ340 (Fibre), 1.300mm		CD9270			
Camry 3.0	09/93→06/06						→01/97			01/98→06/00			
Camry 3.0 24V	08/96→11/01							AG9280 (MLS)					
Camry 3.0 V6	08/96→11/06							01/98→06/00					
Camry S Con 3.0	02/00→11/08							AG9270 (MLS)					
Camry S Cpe 3.0	06/98→07/08							01/98→06/00					
Harrier 3.0	03/98→12/08							AG9100 (MLS)					
Kluger 3.0	06/00→05/07						07/00→						
Previa 3.0 VVTi	08/00→12/05							AG9090 (MLS)					
Sienna 3.0	05/97→04/03						07/00→						
Vista 3.0	06/98→08/02												
WINDOM 3.0	10/96→07/01												
WINDOM 3.0 G	08/01→07/04												
3.0		3VZ-E				84		BS370 (Graphite)		DS360			
4 Runner 3.0	01/90→08/92	2959	6	87.50	SOHC/OHC, V	105-112/							
4 Runner 3.0 V6	07/90→11/95					143-152		BS360 (Graphite)					
Hilux 3.0	08/89→11/95												
3.0		3VZ-FE				85		BS300 (Graphite)		DS292 [3]			
Camry 3.0	06/91→07/01	2959	6	87.50	DOHC, V	138-140/							
WINDOM 3.0	07/91→09/96					188-190		BS290 (Graphite)					
3.0		5L Diesel				86		AY800 (MLS)					
Dyna 3.0 D4d	08/01→	2986	4	99.50	SOHC/OHC	65-67/							
Dyna150 3.0 D	09/98→07/01					88-91							
Hiace III 3.0 D	08/98→08/04												
Hilux 3.0 D	08/02→07/04												
Hilux II 3.0 D	11/97→07/05												
Kijang 3.0 D	07/99→07/01												
Town Ace 3.0 D	10/01→07/07												
3.0		5L-E Diesel				87		AY800 (MLS)					
Hilux II 3.0 D	08/97→08/05	2986	4	99.50	SOHC/OHC	65-71/							
LandCruiser 3.0	09/02→07/09					88-97							
3.0		7M-GE				88		BR300 (Graphite)		DR301 [3]		GR301 [3]	
Cressida 3.0	10/88→09/92	2954	6	83.00	DOHC	140-150/							
Cressida 3.0 i	10/88→01/93					190-204							
Cresta 3.0	09/88→10/96												
Crown 3.0	10/88→07/91												
Supra 3.0	01/86→08/90												
Supra 3.0 24V	01/86→08/88												
3.0		7M-GTE				89		BR300 (Graphite)		DR301 [3]		GR301 [3]	
95 3.0 Turbo	09/87→05/93	2954	6	83.00	DOHC	173-175/							
						235-238							
3.0		11B Diesel				90		AB5200 1.520mm [4]		CB5200 ▲		GR951 [3]	
Dyna200 3.0 D	08/88→05/95	2986	4	95.00	SOHC/OHC	61-75/							
						83-102		BX190 1.700mm [4]					

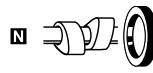

AY800



BR300



BS290



BS300



BS360



BS370



JC276



JC739



JN631

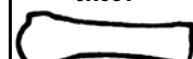

JN712

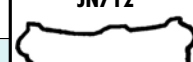

JN792

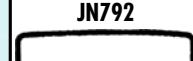

JN936

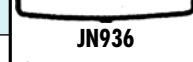

JN965

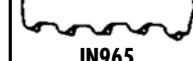

JH024

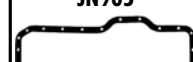

JH024



JH024

JN936 [4]
HM5242 [3]
(NBR)
02/00 → 01/03

HR397

N NJ347 [2]
38.00x50.00x8.00mm, NBR

HBS397 [5]
M11x1.25x115.00mm (x16)
01/95 →

JC838 [3]

JN712 [4]

HBS394 [5]
M11x1.25x96.00mm (x16)

JN792 (x2) [4]

PB281 [1] (x12)

N NJ347 (x2) [2]
38.00x50.00x8.00mm, NBR

HBS315 [5]
M12x1.25x106.00mm (x4)

JN965 [4]

HR397

K NJ377 [2]
32.00x47.00x6.00mm, ACM
K NJ215 [1]
85.00x105.00x10.00mm, FPM

HBS315 [5]
M12x1.25x106.00mm (x4)

JN965 [4]

HR397

N NJ349 [2]
32.50x46.00x6.00mm, NBR
K NJ349 [2]
32.50x46.00x6.00mm, NBR
K NJ377 [2]
32.00x47.00x6.00mm, ACM

JC739 [1]
JC276 [3]
JE015 (x2)

JN631 (x2) [4]

JH024

PA425 (x24)

N NJ353 (x2) [2]
35.00x49.00x6.00mm, NBR
K NJ344 [2]
42.00x60.00x7.00mm, NBR
K NJ645 [2]
52.00x70.00x8.50mm, ACM
K NJ030 [1]
80.00x100.00x12.00mm, ACM

JC739 [1]
JC276 [3]
JE015 (x2)

JN631 (x2) [4]

JH024

PA425 (x24)

N NJ353 [2]
35.00x49.00x6.00mm, NBR
K NJ344 [2]
42.00x60.00x7.00mm, NBR
K NJ645 [2]
52.00x70.00x8.50mm, ACM
K NJ030 [1]
80.00x100.00x12.00mm, ACM



cc



kW/PS



3.4	5VZ-FE					91	BY460 (Graphite) →12/98 BZ340 (Fibre), 1.300mm		
4 Runner 3.4 i	11/95→03/96	3378	6	93.50	DOHC, V	131-142/ 178-193			
Granvia 3.4	08/95→								
Hiace III 3.4	08/95→08/01								
Hilux 3.4	11/95→07/04								
Hilux II 3.4	08/01→07/05								
LandCruiser 3.4	04/96→08/04								
Tundra 3.4	04/99→07/03								
4.0	1UZ-FE					92	AG7640 (Graphite) →08/97 AG7630 (Graphite) →08/97 AF5031 (MLS) 09/97→ AF5030 (MLS) 09/97→	CF5030 09/97→	FF5030 09/97→
Aristo 4.0 4WD	10/92→07/97	3969	8	87.50	DOHC, V	173-216/ 235-294			
Celsior 4.0	12/88→08/00								
Crown 4.0	08/91→08/99								
Crown 4.0 4WD	10/92→08/99								
Majesta 4.0	09/99→08/03								
Soarer 4.0	05/92→09/00								
4.0	12HT Diesel					93	BR890 (Fibre) 10/86→	DR890 [13] 10/86→	GR890 [3] 10/86→
LandCruiser 4.0	10/85→12/89	3980	6	91.00		100/136			
4.2	1HD-FT Diesel					94	AF5800 (MLS), 1.000mm, 1 Notch AF5810 (MLS), 1.100mm, 3 Notches AF5820 (MLS), 1.200mm, 5 Notches	CF5800 ▲ 07/95→	FF5800 ▲ 07/95→
LandCruiser 4.2	03/95→12/97	4164	6	94.00	DOHC	122-125/ 166-170			
4.2	1HD-FTE Diesel					95	AF5800 (MLS), 1.000mm, 1 Notch AF5810 (MLS), 1.100mm, 3 Notches AF5820 (MLS), 1.200mm, 5 Notches	CF5800 ▲	FF5800 ▲
LandCruiser 4.2	01/98→07/08	4164	6	94.00	SOHC/OHC	150/204			
4.2	1HD-T Diesel					96	AH7090 (MLS), 1.2mm, 1 Notch		
LandCruiser 4.2	01/90→12/97	4164	6	94.00	SOHC/OHC	118-123/ 160-167			
4.2	1H-Z Diesel					97	AH7090 (MLS), 1.2mm, 1 Notch		
Coaster 4.2 TD	10/87→10/03	4164	6	94.00	SOHC/OHC	92-123/ 125-167			
LandCruiser 4.2	01/90→10/07								
4.5	1FZ-FE					98	AF5790 (Graphite)	CF5792	
LandCruiser 4.5	08/92→11/99	4477	6	100.00	DOHC	151-173/ 205-235			
4.7	2UZ-FE					99	AF5860 (MLS) AF5870 (MLS)	CF5860	
LandCruiser 4.7	01/98→	4664	8	94.00	DOHC, V	173-212/ 235-288			
Sequoia 4.7	05/00→11/07								

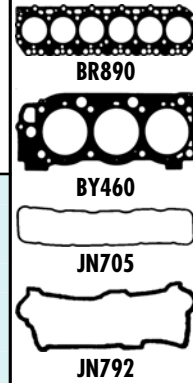
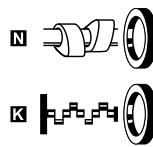
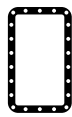
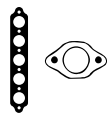

HBS394 © (x16) [5] M11x1.25x96.00mm (x16)	JA5058 ■	JN792 [4]	HR397		NJ347 [2] 38.00x50.00x8.00mm, NBR	
		HM5243 ■	HR397		NJ347 [2] 38.00x50.00x8.00mm, NBR	
		JN705 [4]		PA310 (x12)	NK251 ■ [2] 50.00x68.00x9.00mm, NBR NJ239 ■ [2] 50.00x72.00x12.00mm, NBR NJ240 ■ [1] 95.00x115.00x12.00mm, MVQ	
		HM5241 ■ (ACM) 07/95→	HR397	PA136	NJ377 ■ [2] 32.00x47.00x6.00mm, ACM NK216 ■ [1] 95.00x115.00x9.50mm, MVQ	
		HM5241 ■ (ACM)	HR397	PA136 (x12)	NJ377 ■ [2] 32.00x47.00x6.00mm, ACM NK216 ■ [1] 95.00x115.00x9.50mm, MVQ	
HBS500 © [5]		HM5241 ■ (ACM) 07/95→	HR397		NJ377 ■ [2] 32.00x47.00x6.00mm, ACM	
HBS500 © [5]		HM5241 ■ (ACM) 07/95→	HR397		NJ377 ■ [2] 32.00x47.00x6.00mm, ACM	
		HM5240 ■ (ACM) 01/94→12/95	HR397			
HBS452 © [5] M10x1.25x120.00mm (x10)		HM5243 ■	HR397			



Ltr







CC



9

Model	Ltr	Year Range	Engine	Fuel	CC	Seats	Doors
AGILA Mk I (A)	1.0	09/00→08/00	Z 10 XE	Petrol	973	3	3
AGILA Mk I (A)	1.0	02/00→11/00	Z 10 XEP	Petrol	998	3	4
AGILA Mk I (A)	1.2	09/00→03/00	Z 12 XE	Petrol/Petroleum Gas (LPG)	1199	4	18
AGILA Mk I (A)	1.2	09/00→03/00	Z 12 XE	Petrol	1199	4	18
AGILA Mk I (A)	1.2	07/00→11/00	Z 12 XEP	Petrol/Petroleum Gas (LPG)	1229	4	19
AGILA Mk I (A)	1.2	07/00→11/00	Z 12 XEP	Petrol	1229	4	19
AGILA Mk I (A)	1.3	08/00→03/00	Z 13 DT	Diesel	1248	4	20
AGILA Mk II (B)	1.0	01/00→	K10B	Petrol/Petroleum Gas (LPG)	996	3	1
AGILA Mk II (B)	1.0	01/00→	K10B	Petrol	996	3	1
AGILA Mk II (B)	1.3	01/00→	D13A	Diesel	1248	4	13
AGILA Mk II (B)	1.3	01/00→	Z 13 DTJ	Diesel	1248	4	23
ANTARA (J26, H26)	2.0	08/00→	Z 20 DM	Diesel	1991	4	148
ANTARA (J26, H26)	2.0	08/00→	Z 20 DMH	Diesel	1991	4	149
ARENA Combi	1.9	03/99→08/00	F8Q 600	Diesel	1870	4	108
ARENA Combi	1.9	03/99→08/00	F8Q 606	Diesel	1870	4	109
ARENA Combi	2.5	03/99→08/00	S8U 758	Diesel	2499	4	185
ARENA Combi	2.5	03/99→08/00	S8U 780	Diesel	2499	4	187
ARENA Combi	2.5	03/99→08/00	S8U 782	Diesel	2499	4	188
ARENA Van	1.9	03/99→08/00	F8Q 600	Diesel	1870	4	108
ARENA Van	1.9	03/99→08/00	F8Q 606	Diesel	1870	4	109
ARENA Van	2.5	03/99→08/00	S8U 758	Diesel	2499	4	185
ARENA Van	2.5	03/99→08/00	S8U 780	Diesel	2499	4	187
ARENA Van	2.5	03/99→08/00	S8U 782	Diesel	2499	4	188
ASTRA GTC Mk VI (J)	1.6	10/01→	A 16 LET	Petrol	1598	4	54
ASTRA GTC Mk VI (J)	2.0	10/01→	A 20 DTH	Diesel	1956	4	125
ASTRA GTC Mk VI (J)	2.0	12/01→	A 20 DTR	Diesel	1956	4	128
ASTRA GTC Mk VI (J)	2.0	04/01→	A 20 NFT	Petrol	1998	4	129
ASTRA Mk II Belmont	1.3	09/98→08/99	13 S	Petrol	1297	4	26
ASTRA Mk II Belmont	1.3	09/98→08/99	C 13 N	Petrol	1297	4	28
ASTRA Mk II Belmont	1.4	01/99→12/99	C 14 NZ	Petrol	1389	4	32
ASTRA Mk II Belmont	1.5	01/98→08/98	15 DT	Diesel	1488	4	41
ASTRA Mk II Belmont	1.5	01/98→08/99	15 DT (T4EC1)	Diesel	1488	4	42
ASTRA Mk II Belmont	1.6	09/98→08/99	16 DA	Diesel	1598	4	45
ASTRA Mk II Belmont	1.6	09/98→08/99	16 SH	Petrol	1598	4	47
ASTRA Mk II Belmont	1.6	01/98→12/99	16 SV	Petrol	1598	4	48
ASTRA Mk II Belmont	1.7	01/98→12/99	17 D	Diesel	1699	4	80
ASTRA Mk II Belmont	1.8	09/98→08/99	18 E	Petrol	1796	4	91
ASTRA Mk II Belmont	1.8	09/98→08/99	18 SE	Petrol	1796	4	92
ASTRA Mk II Convertible	1.6	01/98→12/99	16 SV	Petrol	1598	4	48
ASTRA Mk II Convertible	1.6	10/98→02/99	C 16 LZ	Petrol	1598	4	57
ASTRA Mk II Convertible	1.6	10/98→02/99	C 16 NZ	Petrol	1598	4	58
ASTRA Mk II Convertible	1.6	01/99→08/99	E 16 NZ	Petrol	1598	4	63
ASTRA Mk II Convertible	2.0	01/98→12/99	20 NE	Petrol	1998	4	118
ASTRA Mk II Convertible	2.0	01/99→08/99	C 20 NE	Petrol	1998	4	132
ASTRA Mk II Estate	1.2	09/98→12/98	12 S	Petrol	1196	4	7
ASTRA Mk II Estate	1.3	09/98→08/99	13 S	Petrol	1297	4	26
ASTRA Mk II Estate	1.4	01/98→08/99	14 NV	Petrol	1389	4	29
ASTRA Mk II Estate	1.5	01/98→08/99	15 DT (T4EC1)	Diesel	1488	4	42
ASTRA Mk II Estate	1.6	09/98→12/98	16 DA	Diesel	1598	4	45
ASTRA Mk II Estate	1.6	09/98→08/99	16 SV	Petrol	1598	4	48
ASTRA Mk II Estate	1.7	02/98→08/99	17 D	Diesel	1699	4	80
ASTRA Mk II Estate	1.8	01/99→08/99	18 E	Petrol	1796	4	91
ASTRA Mk II Hatchback	1.2	09/98→08/99	12 S	Petrol	1196	4	7
ASTRA Mk II Hatchback	1.3	09/98→08/99	13 S	Petrol	1297	4	26
ASTRA Mk II Hatchback	1.4	01/99→08/99	14 NV	Petrol	1389	4	29
ASTRA Mk II Hatchback	1.4	01/99→08/99	C 14 NZ	Petrol	1389	4	32
ASTRA Mk II Hatchback	1.6	09/98→12/98	16 DA	Diesel	1598	4	45
ASTRA Mk II Hatchback	1.6	09/98→08/99	16 SV	Petrol	1598	4	48
ASTRA Mk II Hatchback	1.8	09/98→08/99	18 E	Petrol	1796	4	91
ASTRA Mk II Hatchback	1.8	09/98→08/99	18 SE	Petrol	1796	4	92
ASTRA Mk II Hatchback	1.9	03/98→08/99	C 20 XE	Petrol	1998	4	135
ASTRA Mk II Hatchback	2.0	09/98→08/99	20 NE	Petrol	1998	4	118
ASTRA Mk II Hatchback	2.0	09/98→08/99	20 SEH	Petrol	1998	4	121
ASTRA Mk II Hatchback	2.0	05/98→08/99	20 XE	Petrol	1998	4	122
ASTRA Mk III (F) Convertible	1.4	09/99→09/99	14 NV	Petrol	1389	4	29
ASTRA Mk III (F) Convertible	1.4	09/99→02/99	C 14 NZ	Petrol	1389	4	32
ASTRA Mk III (F) Convertible	1.4	05/99→03/00	C 14 SE	Petrol	1389	4	33
ASTRA Mk III (F) Convertible	1.4	01/99→03/00	X 14 XE	Petrol	1389	4	36
ASTRA Mk III (F) Convertible	1.6	03/99→08/99	C 16 SE	Petrol	1598	4	59
ASTRA Mk III (F) Convertible	1.6	03/99→08/99	X 16 SZ	Petrol	1598	4	65

	Ltr				CC		9
ASTRA Mk III (F) Convertible	1.6	01/99→03/00	X 16 SZR	Petrol	1598	4	66
ASTRA Mk III (F) Convertible	1.8	09/99→02/99	C 18 NZ	Petrol	1796	4	97
ASTRA Mk III (F) Convertible	1.8	09/99→08/99	C 18 XE	Petrol	1799	4	98
ASTRA Mk III (F) Convertible	1.8	11/99→03/00	C 18 XEL	Petrol	1799	4	99
ASTRA Mk III (F) Convertible	1.8	11/99→03/00	X 18 XE	Petrol	1799	4	103
ASTRA Mk III (F) Convertible	2.0	03/99→10/99	C 20 NE	Petrol	1998	4	132
ASTRA Mk III (F) Convertible	2.0	01/99→02/99	X 20 XEV	Petrol	1998	4	145
ASTRA Mk III (F) Estate	1.4	09/99→02/99	14 NV	Petrol	1389	4	29
ASTRA Mk III (F) Estate	1.4	09/99→02/99	C 14 NZ	Petrol	1389	4	32
ASTRA Mk III (F) Estate	1.4	03/99→02/99	C 14 SE	Petrol	1389	4	33
ASTRA Mk III (F) Estate	1.4	02/99→01/99	X 14 XE	Petrol	1389	4	36
ASTRA Mk III (F) Estate	1.6	09/99→02/99	C 16 NZ	Petrol	1598	4	58
ASTRA Mk III (F) Estate	1.6	03/99→12/99	C 16 SE	Petrol	1598	4	59
ASTRA Mk III (F) Estate	1.6	09/99→02/99	E 16 NZ	Petrol	1598	4	63
ASTRA Mk III (F) Estate	1.6	07/99→02/99	X 16 SZ	Petrol	1598	4	65
ASTRA Mk III (F) Estate	1.6	01/99→02/99	X 16 XEL	Petrol/Petroleum Gas (LPG)	1598	4	68
ASTRA Mk III (F) Estate	1.6	01/99→02/99	X 16 XEL	Petrol	1598	4	68
ASTRA Mk III (F) Estate	1.7	12/99→02/99	17 D	Diesel	1699	4	80
ASTRA Mk III (F) Estate	1.7	03/99→12/99	17 DR	Diesel	1699	4	82
ASTRA Mk III (F) Estate	1.7	12/99→02/99	17 DT (TC4EE1)	Diesel	1686	4	83
ASTRA Mk III (F) Estate	1.7	01/99→02/99	X 17 DTL	Diesel	1699	4	86
ASTRA Mk III (F) Estate	1.8	09/99→02/99	C 18 NZ	Petrol	1796	4	97
ASTRA Mk III (F) Estate	1.8	09/99→02/99	C 18 XE	Petrol	1799	4	98
ASTRA Mk III (F) Estate	1.8	09/99→02/99	C 18 XEL	Petrol	1799	4	99
ASTRA Mk III (F) Estate	1.8	09/99→02/99	X 18 XE	Petrol	1799	4	103
ASTRA Mk III (F) Estate	2.0	09/99→02/99	C 20 NE	Petrol	1998	4	132
ASTRA Mk III (F) Estate	2.0	01/99→02/99	X 20 XEV	Petrol	1998	4	145
ASTRA Mk III (F) Hatchback	1.4	09/99→02/99	14 NV	Petrol	1389	4	29
ASTRA Mk III (F) Hatchback	1.4	09/99→02/99	C 14 NZ	Petrol	1389	4	32
ASTRA Mk III (F) Hatchback	1.4	03/99→02/99	C 14 SE	Petrol	1389	4	33
ASTRA Mk III (F) Hatchback	1.4	02/99→02/99	X 14 XE	Petrol	1389	4	36
ASTRA Mk III (F) Hatchback	1.6	09/99→02/99	C 16 NZ	Petrol	1598	4	58
ASTRA Mk III (F) Hatchback	1.6	03/99→02/99	C 16 SE	Petrol	1598	4	59
ASTRA Mk III (F) Hatchback	1.6	09/99→02/99	E 16 NZ	Petrol	1598	4	63
ASTRA Mk III (F) Hatchback	1.6	07/99→02/99	X 16 SZ	Petrol	1598	4	65
ASTRA Mk III (F) Hatchback	1.6	01/99→02/99	X 16 XEL	Petrol/Petroleum Gas (LPG)	1598	4	68
ASTRA Mk III (F) Hatchback	1.6	01/99→02/99	X 16 XEL	Petrol	1598	4	68
ASTRA Mk III (F) Hatchback	1.7	12/99→02/99	17 D	Diesel	1699	4	80
ASTRA Mk III (F) Hatchback	1.7	09/99→12/99	17 DR	Diesel	1699	4	82
ASTRA Mk III (F) Hatchback	1.7	12/99→02/99	17 DT (TC4EE1)	Diesel	1686	4	83
ASTRA Mk III (F) Hatchback	1.7	08/99→02/99	X 17 DTL	Diesel	1699	4	86
ASTRA Mk III (F) Hatchback	1.8	09/99→02/99	C 18 NZ	Petrol	1796	4	97
ASTRA Mk III (F) Hatchback	1.8	09/99→02/99	C 18 XE	Petrol	1799	4	98
ASTRA Mk III (F) Hatchback	1.8	09/99→02/99	C 18 XEL	Petrol	1799	4	99
ASTRA Mk III (F) Hatchback	2.0	09/99→02/99	C 20 NE	Petrol	1998	4	132
ASTRA Mk III (F) Hatchback	2.0	09/99→02/99	C 20 XE	Petrol	1998	4	135
ASTRA Mk III (F) Hatchback	2.0	01/99→02/99	X 20 XEV	Petrol	1998	4	145
ASTRA Mk III (F)	1.4	04/99→09/99	C 14 NZ	Petrol	1389	4	32
ASTRA Mk III (F)	1.4	04/99→09/99	C 14 SE	Petrol	1389	4	33
ASTRA Mk III (F)	1.4	02/99→09/99	X 14 XE	Petrol	1389	4	36
ASTRA Mk III (F)	1.6	03/99→09/99	C 16 NZ	Petrol	1598	4	58
ASTRA Mk III (F)	1.6	05/99→12/99	C 16 SE	Petrol	1598	4	59
ASTRA Mk III (F)	1.6	08/99→07/99	X 16 SZ	Petrol	1598	4	65
ASTRA Mk III (F)	1.6	03/99→09/99	X 16 SZR	Petrol	1598	4	66
ASTRA Mk III (F)	1.6	08/99→09/99	X 16 XEL	Petrol/Petroleum Gas (LPG)	1598	4	68
ASTRA Mk III (F)	1.6	08/99→09/99	X 16 XEL	Petrol	1598	4	68
ASTRA Mk III (F)	1.7	03/99→09/99	17 D	Diesel	1699	4	80
ASTRA Mk III (F)	1.7	07/99→09/99	17 DR	Diesel	1699	4	82
ASTRA Mk III (F)	1.7	12/99→09/99	17 DT (TC4EE1)	Diesel	1686	4	83
ASTRA Mk III (F)	1.7	08/99→09/99	X 17 DTL	Diesel	1699	4	86
ASTRA Mk III (F)	1.8	09/99→02/99	18 SE	Petrol	1796	4	92
ASTRA Mk III (F)	1.8	03/99→09/99	C 18 NZ	Petrol	1796	4	97
ASTRA Mk III (F)	1.8	06/99→10/99	C 18 XE	Petrol	1799	4	98
ASTRA Mk III (F)	1.8	01/99→12/99	C 18 XEL	Petrol	1799	4	99
ASTRA Mk III (F)	2.0	03/99→09/99	C 20 NE	Petrol	1998	4	132
ASTRA Mk III (F)	2.0	02/99→09/99	X 20 XEV	Petrol	1998	4	145
ASTRA Mk IV (G) Convertible	1.6	03/00→10/00	Z 16 XE	Petrol/Petroleum Gas (LPG)	1598	4	75
ASTRA Mk IV (G) Convertible	1.6	03/00→10/00	Z 16 XE	Petrol	1598	4	75
ASTRA Mk IV (G) Convertible	1.6	03/00→10/00	Z 16 XEP	Petrol	1598	4	77
ASTRA Mk IV (G) Convertible	1.8	03/00→10/00	Z 18 XE	Petrol/Petroleum Gas (LPG)	1796	4	105



Ltr







CC



9

Model	Ltr	Year Range	Engine	Fuel	CC	Seats	Price
ASTRA Mk IV (G) Convertible	1.8	03/00→10/00	Z 18 XE	Petrol	1796	4	105
ASTRA Mk IV (G) Convertible	1.8	03/00→10/00	Z 18 XE	Bi-Fuel	1796	4	105
ASTRA Mk IV (G) Convertible	2.0	03/00→07/00	Z 20 LET	Petrol	1998	4	154
ASTRA Mk IV (G) Convertible	2.2	03/00→10/00	Z 22 SE	Petrol	2198	4	167
ASTRA Mk IV (G) Coupe (F67)	1.6	03/00→08/00	Z 16 XEP	Petrol	1598	4	77
ASTRA Mk IV (G) Coupe (F67)	1.8	03/00→08/00	X 18 XE1	Petrol	1796	4	104
ASTRA Mk IV (G) Coupe (F67)	1.8	09/00→08/00	Z 18 XE	Petrol/Petroleum Gas (LPG)	1796	4	105
ASTRA Mk IV (G) Coupe (F67)	1.8	09/00→08/00	Z 18 XE	Petrol	1796	4	105
ASTRA Mk IV (G) Coupe (F67)	1.8	09/00→08/00	Z 18 XE	Bi-Fuel	1796	4	105
ASTRA Mk IV (G) Coupe (F67)	1.8	03/00→08/00	Z 18 XEL	Petrol	1796	4	106
ASTRA Mk IV (G) Coupe (F67)	2.0	09/00→08/00	Z 20 LET	Petrol	1998	4	154
ASTRA Mk IV (G) Coupe (F67)	2.2	03/00→08/00	Z 22 SE	Petrol	2198	4	167
ASTRA Mk IV (G) Estate	1.2	02/99→09/00	X 12 XE	Petrol	1199	4	16
ASTRA Mk IV (G) Estate	1.2	09/00→05/00	Z 12 XE	Petrol/Petroleum Gas (LPG)	1199	4	18
ASTRA Mk IV (G) Estate	1.2	09/00→05/00	Z 12 XE	Petrol	1199	4	18
ASTRA Mk IV (G) Estate	1.4	02/99→05/00	X 14 XE	Petrol	1389	4	36
ASTRA Mk IV (G) Estate	1.4	02/99→05/00	Z 14 XE	Petrol	1389	4	37
ASTRA Mk IV (G) Estate	1.6	03/99→04/00	X 16 SZR	Petrol	1598	4	66
ASTRA Mk IV (G) Estate	1.6	03/99→04/00	X 16 XEL	Petrol/Petroleum Gas (LPG)	1598	4	68
ASTRA Mk IV (G) Estate	1.6	03/99→04/00	X 16 XEL	Petrol	1598	4	68
ASTRA Mk IV (G) Estate	1.6	03/99→05/00	Z 16 SE	Petrol/Petroleum Gas (LPG)	1598	4	74
ASTRA Mk IV (G) Estate	1.6	03/99→05/00	Z 16 SE	Petrol	1598	4	74
ASTRA Mk IV (G) Estate	1.6	03/99→04/00	Z 16 XE	Petrol/Petroleum Gas (LPG)	1598	4	75
ASTRA Mk IV (G) Estate	1.6	03/99→04/00	Z 16 XE	Petrol	1598	4	75
ASTRA Mk IV (G) Estate	1.6	12/00→05/00	Z 16 XEP	Petrol	1598	4	77
ASTRA Mk IV (G) Estate	1.7	02/99→08/00	X 17 DTL	Diesel	1699	4	86
ASTRA Mk IV (G) Estate	1.7	02/00→05/00	Y 17 DT	Diesel	1686	4	87
ASTRA Mk IV (G) Estate	1.7	04/00→05/00	Z 17 DTL	Diesel	1686	4	90
ASTRA Mk IV (G) Estate	1.8	02/99→08/00	X 18 XE1	Petrol	1796	4	104
ASTRA Mk IV (G) Estate	1.8	09/00→05/00	Z 18 XE	Petrol/Petroleum Gas (LPG)	1796	4	105
ASTRA Mk IV (G) Estate	1.8	09/00→05/00	Z 18 XE	Petrol	1796	4	105
ASTRA Mk IV (G) Estate	1.8	09/00→05/00	Z 18 XE	Bi-Fuel	1796	4	105
ASTRA Mk IV (G) Estate	2.0	03/99→04/00	X 20 DTH	Diesel	1995	4	141
ASTRA Mk IV (G) Estate	2.0	03/99→04/00	X 20 DTL	Diesel	1995	4	142
ASTRA Mk IV (G) Estate	2.0	10/99→05/00	X 20 XER	Petrol	1998	4	144
ASTRA Mk IV (G) Estate	2.0	02/99→05/00	X 20 XEV	Petrol	1998	4	145
ASTRA Mk IV (G) Estate	2.0	03/99→04/00	Y 20 DTH	Diesel	1995	4	146
ASTRA Mk IV (G) Estate	2.0	03/99→04/00	Y 20 DTL	Diesel	1995	4	147
ASTRA Mk IV (G) Estate	2.2	03/00→05/00	Z 22 SE	Petrol	2198	4	167
ASTRA Mk IV (G) Hatchback	1.2	02/99→09/00	X 12 XE	Petrol	1199	4	16
ASTRA Mk IV (G) Hatchback	1.2	09/00→05/00	Z 12 XE	Petrol/Petroleum Gas (LPG)	1199	4	18
ASTRA Mk IV (G) Hatchback	1.2	09/00→05/00	Z 12 XE	Petrol	1199	4	18
ASTRA Mk IV (G) Hatchback	1.4	05/99→05/00	C 14 NZ	Petrol	1389	4	32
ASTRA Mk IV (G) Hatchback	1.4	05/99→05/00	X 14 SZ	Petrol	1389	4	35
ASTRA Mk IV (G) Hatchback	1.4	02/99→05/00	X 14 XE	Petrol	1389	4	36
ASTRA Mk IV (G) Hatchback	1.4	02/99→05/00	Z 14 XE	Petrol	1389	4	37
ASTRA Mk IV (G) Hatchback	1.6	02/99→09/00	X 16 SZR	Petrol	1598	4	66
ASTRA Mk IV (G) Hatchback	1.6	02/99→05/00	X 16 XEL	Petrol/Petroleum Gas (LPG)	1598	4	68
ASTRA Mk IV (G) Hatchback	1.6	02/99→05/00	X 16 XEL	Petrol	1598	4	68
ASTRA Mk IV (G) Hatchback	1.6	07/00→05/00	Z 16 SE	Petrol/Petroleum Gas (LPG)	1598	4	74
ASTRA Mk IV (G) Hatchback	1.6	07/00→05/00	Z 16 SE	Petrol	1598	4	74
ASTRA Mk IV (G) Hatchback	1.6	02/99→05/00	Z 16 XE	Petrol/Petroleum Gas (LPG)	1598	4	75
ASTRA Mk IV (G) Hatchback	1.6	02/99→05/00	Z 16 XE	Petrol	1598	4	75
ASTRA Mk IV (G) Hatchback	1.7	02/99→08/00	X 17 DTL	Diesel	1699	4	86
ASTRA Mk IV (G) Hatchback	1.7	02/00→05/00	Y 17 DT	Diesel	1686	4	87
ASTRA Mk IV (G) Hatchback	1.7	04/00→05/00	Z 17 DTL	Diesel	1686	4	90
ASTRA Mk IV (G) Hatchback	1.8	02/99→09/00	X 18 XE1	Petrol	1796	4	104
ASTRA Mk IV (G) Hatchback	1.8	09/00→05/00	Z 18 XE	Petrol/Petroleum Gas (LPG)	1796	4	105
ASTRA Mk IV (G) Hatchback	1.8	09/00→05/00	Z 18 XE	Petrol	1796	4	105
ASTRA Mk IV (G) Hatchback	1.8	09/00→05/00	Z 18 XE	Bi-Fuel	1796	4	105
ASTRA Mk IV (G) Hatchback	2.0	08/99→05/00	X 20 DTH	Diesel	1995	4	141
ASTRA Mk IV (G) Hatchback	2.0	02/99→05/00	X 20 DTL	Diesel	1995	4	142
ASTRA Mk IV (G) Hatchback	2.0	10/99→08/00	X 20 XER	Petrol	1998	4	144
ASTRA Mk IV (G) Hatchback	2.0	02/99→05/00	X 20 XEV	Petrol	1998	4	145
ASTRA Mk IV (G) Hatchback	2.0	08/99→05/00	Y 20 DTH	Diesel	1995	4	146
ASTRA Mk IV (G) Hatchback	2.0	02/99→05/00	Y 20 DTL	Diesel	1995	4	147
ASTRA Mk IV (G) Hatchback	2.0	07/00→05/00	Z 20 LET	Petrol	1998	4	154
ASTRA Mk IV (G) Hatchback	2.2	03/00→05/00	Z 22 SE	Petrol	2198	4	167
ASTRA Mk IV (G) Saloon	1.2	09/99→09/00	X 12 XE	Petrol	1199	4	16
ASTRA Mk IV (G) Saloon	1.2	09/00→05/00	Z 12 XE	Petrol/Petroleum Gas (LPG)	1199	4	18

	Ltr				CC		9
ASTRA Mk IV (G) Saloon	1.2	09/00 → 05/00	Z 12 XE	Petrol	1199	4	18
ASTRA Mk IV (G) Saloon	1.4	05/99 → 05/00	C 14 NZ	Petrol	1389	4	32
ASTRA Mk IV (G) Saloon	1.4	09/99 → 05/00	X 14 XE	Petrol	1389	4	36
ASTRA Mk IV (G) Saloon	1.4	09/99 → 05/00	Z 14 XE	Petrol	1389	4	37
ASTRA Mk IV (G) Saloon	1.6	09/99 → 05/00	C 16 SEL	Petrol	1598	4	61
ASTRA Mk IV (G) Saloon	1.6	09/99 → 09/00	X 16 SZR	Petrol	1598	4	66
ASTRA Mk IV (G) Saloon	1.6	09/99 → 05/00	X 16 XEL	Petrol/Petroleum Gas (LPG)	1598	4	68
ASTRA Mk IV (G) Saloon	1.6	09/99 → 05/00	X 16 XEL	Petrol	1598	4	68
ASTRA Mk IV (G) Saloon	1.6	07/00 → 05/00	Z 16 SE	Petrol/Petroleum Gas (LPG)	1598	4	74
ASTRA Mk IV (G) Saloon	1.6	07/00 → 05/00	Z 16 SE	Petrol	1598	4	74
ASTRA Mk IV (G) Saloon	1.6	09/99 → 05/00	Z 16 XE	Petrol/Petroleum Gas (LPG)	1598	4	75
ASTRA Mk IV (G) Saloon	1.6	09/99 → 05/00	Z 16 XE	Petrol	1598	4	75
ASTRA Mk IV (G) Saloon	1.6	09/99 → 05/00	Z 16 XEP	Petrol	1598	4	77
ASTRA Mk IV (G) Saloon	1.7	09/99 → 08/00	X 17 DTL	Diesel	1699	4	86
ASTRA Mk IV (G) Saloon	1.7	02/00 → 05/00	Y 17 DT	Diesel	1686	4	87
ASTRA Mk IV (G) Saloon	1.7	04/00 → 05/00	Z 17 DTL	Diesel	1686	4	90
ASTRA Mk IV (G) Saloon	1.8	02/99 → 07/00	X 18 XE1	Petrol	1796	4	104
ASTRA Mk IV (G) Saloon	1.8	02/99 → 07/00	Z 18 XE	Petrol/Petroleum Gas (LPG)	1796	4	105
ASTRA Mk IV (G) Saloon	1.8	02/99 → 07/00	Z 18 XE	Petrol	1796	4	105
ASTRA Mk IV (G) Saloon	1.8	02/99 → 07/00	Z 18 XE	Bi-Fuel	1796	4	105
ASTRA Mk IV (G) Saloon	2.0	02/99 → 07/00	X 20 DTH	Diesel	1995	4	141
ASTRA Mk IV (G) Saloon	2.0	02/99 → 07/00	X 20 DTL	Diesel	1995	4	142
ASTRA Mk IV (G) Saloon	2.0	10/99 → 05/00	X 20 XER	Petrol	1998	4	144
ASTRA Mk IV (G) Saloon	2.0	09/99 → 05/00	X 20 XEV	Petrol	1998	4	145
ASTRA Mk IV (G) Saloon	2.0	02/99 → 07/00	Y 20 DTH	Diesel	1995	4	146
ASTRA Mk IV (G) Saloon	2.0	02/99 → 07/00	Y 20 DTL	Diesel	1995	4	147
ASTRA Mk IV (G) Saloon	2.2	09/00 → 05/00	Y 22 DTR	Diesel	2172	4	164
ASTRA Mk IV (G) Saloon	2.2	03/00 → 05/00	Z 22 SE	Petrol	2198	4	167
ASTRA Mk V (H) Estate	1.2	08/00 → 10/01	Z 12 XEP	Petrol/Petroleum Gas (LPG)	1229	4	19
ASTRA Mk V (H) Estate	1.2	08/00 → 10/01	Z 12 XEP	Petrol	1229	4	19
ASTRA Mk V (H) Estate	1.3	08/00 → 03/00	Z 13 DTH	Diesel	1248	4	22
ASTRA Mk V (H) Estate	1.4	08/00 → 10/01	Z 14 XEL	Petrol	1364	4	38
ASTRA Mk V (H) Estate	1.4	08/00 → 03/00	Z 14 XEP	Petrol/Petroleum Gas (LPG)	1364	4	39
ASTRA Mk V (H) Estate	1.4	08/00 → 03/00	Z 14 XEP	Petrol	1364	4	39
ASTRA Mk V (H) Estate	1.6	08/00 → 03/00	A 16 XER	Petrol	1598	4	55
ASTRA Mk V (H) Estate	1.6	08/00 → 03/00	Z 16 LET	Petrol	1598	4	73
ASTRA Mk V (H) Estate	1.6	08/00 → 03/00	Z 16 XEP	Petrol	1598	4	77
ASTRA Mk V (H) Estate	1.6	08/00 → 03/00	Z 16 XER	Petrol	1598	4	78
ASTRA Mk V (H) Estate	1.7	08/00 → 03/00	Z 17 DTH	Diesel	1686	4	89
ASTRA Mk V (H) Estate	1.7	03/00 → 05/00	Z 17 DTL	Diesel	1686	4	90
ASTRA Mk V (H) Estate	1.8	10/00 → 03/00	A 18 XER	Petrol	1796	4	96
ASTRA Mk V (H) Estate	1.8	10/00 → 03/00	Z 18 XE	Petrol/Petroleum Gas (LPG)	1796	4	105
ASTRA Mk V (H) Estate	1.8	10/00 → 03/00	Z 18 XE	Petrol	1796	4	105
ASTRA Mk V (H) Estate	1.8	10/00 → 03/00	Z 18 XE	Bi-Fuel	1796	4	105
ASTRA Mk V (H) Estate	1.8	10/00 → 03/00	Z 18 XER	Petrol	1796	4	107
ASTRA Mk V (H) Estate	1.9	08/00 → 03/00	Z 19 DT	Diesel	1910	4	114
ASTRA Mk V (H) Estate	1.9	08/00 → 03/00	Z 19 DTH	Diesel	1910	4	115
ASTRA Mk V (H) Estate	1.9	08/00 → 03/00	Z 19 DTL	Diesel	1910	4	117
ASTRA Mk V (H) Estate	2.0	08/00 → 10/01	Z 20 LEL	Petrol	1998	4	152
ASTRA Mk V (H) Estate	2.0	08/00 → 10/01	Z 20 LER	Petrol	1998	4	153
ASTRA Mk V (H) Hatchback	1.2	08/00 → 05/00	Z 12 XEP	Petrol/Petroleum Gas (LPG)	1229	4	19
ASTRA Mk V (H) Hatchback	1.2	08/00 → 05/00	Z 12 XEP	Petrol	1229	4	19
ASTRA Mk V (H) Hatchback	1.3	01/00 → 05/00	Z 13 DTH	Diesel	1248	4	22
ASTRA Mk V (H) Hatchback	1.4	04/00 → 12/00	Z 14 XEL	Petrol	1364	4	38
ASTRA Mk V (H) Hatchback	1.4	01/00 → 05/00	Z 14 XEP	Petrol/Petroleum Gas (LPG)	1364	4	39
ASTRA Mk V (H) Hatchback	1.4	01/00 → 05/00	Z 14 XEP	Petrol	1364	4	39
ASTRA Mk V (H) Hatchback	1.6	09/00 →	Z 16 LET	Petrol	1598	4	73
ASTRA Mk V (H) Hatchback	1.6	01/00 → 05/00	Z 16 XEP	Petrol	1598	4	77
ASTRA Mk V (H) Hatchback	1.6	01/00 → 05/00	Z 16 XER	Petrol	1598	4	78
ASTRA Mk V (H) Hatchback	1.7	01/00 → 05/00	Z 17 DTH	Diesel	1686	4	89
ASTRA Mk V (H) Hatchback	1.7	01/00 → 05/00	Z 17 DTL	Diesel	1686	4	90
ASTRA Mk V (H) Hatchback	1.8	01/00 → 05/00	A 18 XER	Petrol	1796	4	96
ASTRA Mk V (H) Hatchback	1.8	01/00 → 05/00	Z 18 XE	Petrol/Petroleum Gas (LPG)	1796	4	105
ASTRA Mk V (H) Hatchback	1.8	01/00 → 05/00	Z 18 XE	Petrol	1796	4	105
ASTRA Mk V (H) Hatchback	1.8	01/00 → 05/00	Z 18 XE	Bi-Fuel	1796	4	105
ASTRA Mk V (H) Hatchback	1.8	01/00 → 05/00	Z 18 XER	Petrol	1796	4	107
ASTRA Mk V (H) Hatchback	1.9	01/00 → 05/00	Z 19 DT	Diesel	1910	4	114
ASTRA Mk V (H) Hatchback	1.9	01/00 → 05/00	Z 19 DTH	Diesel	1910	4	115
ASTRA Mk V (H) Hatchback	1.9	01/00 → 05/00	Z 19 DTJ	Diesel	1910	4	116
ASTRA Mk V (H) Hatchback	2.0	01/00 → 05/00	Z 20 LEH	Petrol	1998	4	151



Ltr







CC



9

Model	Ltr	Year Range	Engine	Fuel	CC	Seats	Price
ASTRA Mk V (H) Hatchback	2.0	01/00→05/00	Z 20 LEL	Petrol	1998	4	152
ASTRA Mk V (H) Hatchback	2.0	01/00→05/00	Z 20 LER	Petrol	1998	4	153
ASTRA Mk V (H) Sport Hatch	1.3	04/00→11/01	Z 13 DTH	Diesel	1248	4	22
ASTRA Mk V (H) Sport Hatch	1.4	02/00→11/01	Z 14 XEL	Petrol	1364	4	38
ASTRA Mk V (H) Sport Hatch	1.4	03/00→11/01	Z 14 XEP	Petrol/Petroleum Gas (LPG)	1364	4	39
ASTRA Mk V (H) Sport Hatch	1.4	03/00→11/01	Z 14 XEP	Petrol	1364	4	39
ASTRA Mk V (H) Sport Hatch	1.6	10/00→11/01	Z 16 LET	Petrol	1598	4	73
ASTRA Mk V (H) Sport Hatch	1.6	02/00→11/01	Z 16 XEP	Petrol	1598	4	77
ASTRA Mk V (H) Sport Hatch	1.6	12/00→11/01	Z 16 XER	Petrol	1598	4	78
ASTRA Mk V (H) Sport Hatch	1.7	02/00→11/01	Z 17 DTH	Diesel	1686	4	89
ASTRA Mk V (H) Sport Hatch	1.8	03/00→11/01	A 18 XER	Petrol	1796	4	96
ASTRA Mk V (H) Sport Hatch	1.8	02/00→11/01	Z 18 XE	Petrol/Petroleum Gas (LPG)	1796	4	105
ASTRA Mk V (H) Sport Hatch	1.8	02/00→11/01	Z 18 XE	Petrol	1796	4	105
ASTRA Mk V (H) Sport Hatch	1.8	02/00→11/01	Z 18 XE	Bi-Fuel	1796	4	105
ASTRA Mk V (H) Sport Hatch	1.8	03/00→11/01	Z 18 XER	Petrol	1796	4	107
ASTRA Mk V (H) Sport Hatch	1.9	02/00→11/01	Z 19 DT	Diesel	1910	4	114
ASTRA Mk V (H) Sport Hatch	1.9	02/00→11/01	Z 19 DTH	Diesel	1910	4	115
ASTRA Mk V (H) Sport Hatch	1.9	08/00→11/01	Z 19 DTL	Diesel	1910	4	117
ASTRA Mk V (H) Sport Hatch	2.0	02/00→11/01	Z 20 LEH	Petrol	1998	4	151
ASTRA Mk V (H) Sport Hatch	2.0	02/00→11/01	Z 20 LEL	Petrol	1998	4	152
ASTRA Mk VI (J) Saloon	1.3	06/01→	A 13 DTE	Diesel	1248	4	10
ASTRA Mk VI (J) Saloon	1.6	06/01→	A 16 LET	Petrol	1598	4	54
ASTRA Mk VI (J) Saloon	1.6	06/01→	A 16 XER	Petrol	1598	4	55
ASTRA Mk VI (J) Saloon	2.0	12/01→	A 20 DTR	Diesel	1956	4	128
ASTRA Mk VI (J) Sports Tourer	1.3	10/01→	A 13 DTE	Diesel	1248	4	10
ASTRA Mk VI (J) Sports Tourer	1.6	10/01→	A 16 LET	Petrol	1598	4	54
ASTRA Mk VI (J) Sports Tourer	1.6	10/01→	A 16 XER	Petrol	1598	4	55
ASTRA Mk VI (J) Sports Tourer	2.0	10/01→	A 20 DTH	Diesel	1956	4	125
ASTRA Mk VI (J) Sports Tourer	2.0	12/01→	A 20 DTR	Diesel	1956	4	128
ASTRA Mk VI (J)	1.3	12/00→	A 13 DTE	Diesel	1248	4	10
ASTRA Mk VI (J)	1.6	12/00→	A 16 LET	Petrol	1598	4	54
ASTRA Mk VI (J)	1.6	12/00→	A 16 XER	Petrol	1598	4	55
ASTRA Mk VI (J)	1.7	12/00→	Z 17 DTH	Diesel	1686	4	89
ASTRA Mk VI (J)	2.0	12/00→	A 20 DTH	Diesel	1956	4	125
ASTRA Mk VI (J)	2.0	12/01→	A 20 DTR	Diesel	1956	4	128
ASTRA TwinTop Mk V (H)	1.6	10/00→11/01	Z 16 LET	Petrol	1598	4	73
ASTRA TwinTop Mk V (H)	1.6	09/00→11/01	Z 16 XEP	Petrol	1598	4	77
ASTRA TwinTop Mk V (H)	1.6	10/00→11/01	Z 16 XER	Petrol	1598	4	78
ASTRA TwinTop Mk V (H)	1.8	09/00→11/01	Z 18 XE	Petrol/Petroleum Gas (LPG)	1796	4	105
ASTRA TwinTop Mk V (H)	1.8	09/00→11/01	Z 18 XE	Petrol	1796	4	105
ASTRA TwinTop Mk V (H)	1.8	09/00→11/01	Z 18 XE	Bi-Fuel	1796	4	105
ASTRA TwinTop Mk V (H)	1.8	05/00→11/01	Z 18 XER	Petrol	1796	4	107
ASTRA TwinTop Mk V (H)	1.9	01/00→11/01	Z 19 DTH	Diesel	1910	4	115
ASTRA TwinTop Mk V (H)	2.0	02/00→11/01	Z 20 LEL	Petrol	1998	4	152
ASTRA TwinTop Mk V (H)	2.0	01/00→11/01	Z 20 LER	Petrol	1998	4	153
ASTRAMAX	1.3	08/98→12/98	13 N	Petrol	1297	4	24
ASTRAMAX	1.3	08/98→12/98	13 NB	Petrol	1297	4	25
ASTRAMAX	1.3	08/98→12/98	13 S	Petrol	1297	4	26
ASTRAMAX	1.4	07/98→08/99	14 NV	Petrol	1389	4	29
ASTRAMAX	1.4	08/99→07/99	C 14 NZ	Petrol	1389	4	32
ASTRAMAX	1.6	05/98→06/99	16 DA	Diesel	1598	4	45
ASTRAMAX	1.6	09/98→12/99	16 SV	Petrol	1598	4	48
ASTRAMAX	1.6	08/99→10/99	C 16 NZ	Petrol	1598	4	58
ASTRAMAX	1.7	01/98→07/99	17 D	Diesel	1699	4	80
ASTRAVAN Mk III (F)	1.4	01/99→10/99	C 14 NZ	Petrol	1389	4	32
ASTRAVAN Mk III (F)	1.6	01/99→08/99	C 16 NZ	Petrol	1598	4	58
ASTRAVAN Mk III (F)	1.6	02/99→10/99	X 16 SZ	Petrol	1598	4	65
ASTRAVAN Mk III (F)	1.7	01/99→08/99	17 DR	Diesel	1699	4	82
ASTRAVAN Mk III (F)	1.7	01/99→08/99	X 17 DTL	Diesel	1699	4	86
ASTRAVAN Mk IV (G)	1.6	08/99→09/00	X 16 SZR	Petrol	1598	4	66
ASTRAVAN Mk IV (G)	1.6	09/00→08/00	Z 16 SE	Petrol/Petroleum Gas (LPG)	1598	4	74
ASTRAVAN Mk IV (G)	1.6	09/00→08/00	Z 16 SE	Petrol	1598	4	74
ASTRAVAN Mk IV (G)	1.7	08/99→08/00	X 17 DTL	Diesel	1699	4	86
ASTRAVAN Mk IV (G)	1.7	04/00→08/00	Y 17 DT	Diesel	1686	4	87
ASTRAVAN Mk IV (G)	1.7	04/00→08/00	Z 17 DTL	Diesel	1686	4	90
ASTRAVAN Mk IV (G)	2.0	08/99→08/00	X 20 DTL	Diesel	1995	4	142
ASTRAVAN Mk IV (G)	2.0	04/00→08/00	Y 20 DTH	Diesel	1995	4	146
ASTRAVAN Mk V (H)	1.3	08/00→	Z 13 DTH	Diesel	1248	4	22
ASTRAVAN Mk V (H)	1.4	03/00→	Z 14 XEP	Petrol/Petroleum Gas (LPG)	1364	4	39
ASTRAVAN Mk V (H)	1.4	03/00→	Z 14 XEP	Petrol	1364	4	39

	Ltr				CC		9
ASTRAVAN Mk V (H)	1.6	03/00 →	Z 16 XE1	Petrol	1598	4	76
ASTRAVAN Mk V (H)	1.6	03/00 →	Z 16 XEP	Petrol	1598	4	77
ASTRAVAN Mk V (H)	1.7	03/00 →11/01	Z 17 DTH	Diesel	1686	4	89
ASTRAVAN Mk V (H)	1.7	03/00 →07/00	Z 17 DTL	Diesel	1686	4	90
ASTRAVAN Mk V (H)	1.9	03/00 →11/01	Z 19 DT	Diesel	1910	4	114
ASTRAVAN Mk V (H)	1.9	03/00 →11/01	Z 19 DTH	Diesel	1910	4	115
BRAVA Pickup	2.2	08/99 →09/99	C223	Diesel	2238	4	156
BRAVA Pickup	2.5	08/99 →12/00	4 JAI	Diesel	2499	4	174
BRAVA Pickup	2.5	06/99 →12/00	4 JA1T	Diesel	2499	4	175
CALIBRA	2.0	03/99 →07/99	C 20 LET	Petrol	1998	4	131
CALIBRA	2.0	06/99 →07/99	C 20 NE	Petrol	1998	4	132
CALIBRA	2.0	06/99 →02/99	C 20 XE	Petrol	1998	4	135
CALIBRA	2.0	06/99 →07/99	X 20 XEV	Petrol	1998	4	145
CALIBRA	2.5	04/99 →07/99	C 25 XE	Petrol	2498	6	177
CALIBRA	2.5	04/99 →07/99	X 25 XE	Petrol	2498	6	190
CARLTON Mk III Estate	1.8	09/98 →03/99	18 SEH	Petrol	1796	4	93
CARLTON Mk III Estate	1.8	09/98 →03/99	18 SV	Petrol	1796	4	94
CARLTON Mk III Estate	1.8	09/98 →03/99	E 18 NVR	Petrol	1796	4	101
CARLTON Mk III Estate	1.8	09/98 →08/98	S 18 NV	Petrol	1796	4	102
CARLTON Mk III Estate	2.0	09/98 →03/99	20 SE	Petrol	1998	4	120
CARLTON Mk III Estate	2.0	09/98 →03/99	C 20 NE	Petrol	1998	4	132
CARLTON Mk III Estate	2.0	09/99 →03/99	C 20 NEF	Petrol	1998	4	133
CARLTON Mk III Estate	2.0	09/99 →03/99	C 20 NEJ	Petrol	1998	4	134
CARLTON Mk III Estate	2.2	09/98 →08/98	23 YDT	Diesel	2260	4	172
CARLTON Mk III Estate	2.3	09/98 →03/99	23 DTR	Diesel	2260	4	170
CARLTON Mk III Estate	2.3	09/98 →03/99	23 YD	Diesel	2260	4	171
CARLTON Mk III Estate	2.4	09/98 →03/99	C 24 NE	Petrol	2410	4	173
CARLTON Mk III Estate	2.6	09/99 →03/99	C 26 NE	Petrol	2594	6	192
CARLTON Mk III Estate	3.0	03/98 →03/99	C 30 NE	Petrol	2969	6	199
CARLTON Mk III Estate	3.0	09/98 →03/99	C 30 SEJ	Petrol	2969	6	200
CARLTON Mk III	1.8	09/98 →03/99	18 SEH	Petrol	1796	4	93
CARLTON Mk III	1.8	09/98 →03/99	18 SV	Petrol	1796	4	94
CARLTON Mk III	1.8	09/98 →03/99	E 18 NVR	Petrol	1796	4	101
CARLTON Mk III	2.0	09/98 →03/99	20 SE	Petrol	1998	4	120
CARLTON Mk III	2.0	09/98 →03/99	C 20 NE	Petrol	1998	4	132
CARLTON Mk III	2.0	09/99 →03/99	C 20 NEF	Petrol	1998	4	133
CARLTON Mk III	2.0	09/99 →03/99	C 20 NEJ	Petrol	1998	4	134
CARLTON Mk III	2.2	10/98 →08/98	23 YDT	Diesel	2260	4	172
CARLTON Mk III	2.3	08/98 →03/99	23 DTR	Diesel	2260	4	170
CARLTON Mk III	2.3	09/98 →03/99	23 YD	Diesel	2260	4	171
CARLTON Mk III	2.4	09/98 →03/99	C 24 NE	Petrol	2410	4	173
CARLTON Mk III	2.6	09/99 →03/99	C 26 NE	Petrol	2594	6	192
CARLTON Mk III	3.0	03/98 →09/99	30 NE	Petrol	2969	6	197
CARLTON Mk III	3.0	03/98 →03/99	C 30 NE	Petrol	2969	6	199
CARLTON Mk III	3.0	09/98 →03/99	C 30 SEJ	Petrol	2969	6	200
CASCADA Convertible	2.0	02/01 →	A 20 DTH	Diesel	1956	4	125
CASCADA Convertible	2.0	02/01 →	A 20 DTR	Diesel	1956	4	128
CAVALIER Mk II Convertible	1.8	03/98 →10/98	18 SE	Petrol	1796	4	92
CAVALIER Mk II Estate	1.3	09/98 →08/98	13 S	Petrol	1297	4	26
CAVALIER Mk II Estate	1.6	03/98 →08/98	16 DA	Diesel	1598	4	45
CAVALIER Mk II Estate	1.6	10/98 →08/98	16 SH	Petrol	1598	4	47
CAVALIER Mk II Hatchback	1.3	09/98 →08/98	13 NB	Petrol	1297	4	25
CAVALIER Mk II Hatchback	1.3	09/98 →08/98	13 S	Petrol	1297	4	26
CAVALIER Mk II Hatchback	1.6	03/98 →08/98	16 D	Diesel	1598	4	44
CAVALIER Mk II Hatchback	1.6	03/98 →08/98	16 DA	Diesel	1598	4	45
CAVALIER Mk II Hatchback	1.6	09/98 →08/98	16 SH	Petrol	1598	4	47
CAVALIER Mk II Hatchback	1.8	09/98 →08/98	18 E	Petrol	1796	4	91
CAVALIER Mk II Hatchback	1.8	09/98 →08/98	18 SE	Petrol	1796	4	92
CAVALIER Mk II Hatchback	2.0	09/98 →08/98	20 SE	Petrol	1998	4	120
CAVALIER Mk II Hatchback	2.0	03/98 →08/98	20 SEH	Petrol	1998	4	121
CAVALIER Mk II Hatchback	2.0	09/98 →08/98	C 20 NE	Petrol	1998	4	132
CAVALIER Mk II	1.3	09/98 →08/98	13 N	Petrol	1297	4	24
CAVALIER Mk II	1.3	09/98 →08/98	13 S	Petrol	1297	4	26
CAVALIER Mk II	1.6	03/98 →08/98	16 D	Diesel	1598	4	44
CAVALIER Mk II	1.6	09/98 →08/98	16 N	Petrol	1598	4	46
CAVALIER Mk II	1.6	09/98 →08/98	16 SH	Petrol	1598	4	47
CAVALIER Mk II	1.6	08/98 →08/98	C 16 LZ	Petrol	1598	4	57
CAVALIER Mk II	1.6	08/98 →08/98	C 16 NZ	Petrol	1598	4	58
CAVALIER Mk II	1.6	08/98 →08/98	E 16 NZ	Petrol	1598	4	63
CAVALIER Mk II	1.8	09/98 →08/98	18 E	Petrol	1796	4	91



Ltr







CC



9

Model	Ltr	Year Range	Engine	Fuel	CC	Seats	Price
CAVALIER Mk II	1.8	09/98→08/98	18 SE	Petrol	1796	4	92
CAVALIER Mk II	1.8	08/98→08/98	E 18 NV	Petrol	1796	4	100
CAVALIER Mk II	2.0	09/98→08/98	20 NE	Petrol	1998	4	118
CAVALIER Mk II	2.0	09/98→08/98	20 SE	Petrol	1998	4	120
CAVALIER Mk II	2.0	03/98→08/98	20 SEH	Petrol	1998	4	121
CAVALIER Mk II	2.0	09/98→08/98	C 20 NE	Petrol	1998	4	132
CAVALIER Mk III (87)	1.4	09/98→11/99	14 NV	Petrol	1389	4	29
CAVALIER Mk III (87)	1.6	09/98→05/99	16 SV	Petrol	1598	4	48
CAVALIER Mk III (87)	1.6	09/98→11/99	E 16 NZ	Petrol	1598	4	63
CAVALIER Mk III (87)	1.6	09/99→11/99	X 16 SZ	Petrol	1598	4	65
CAVALIER Mk III (87)	1.7	09/98→09/99	17 D	Diesel	1699	4	80
CAVALIER Mk III (87)	1.7	07/99→11/99	17 DR	Diesel	1699	4	82
CAVALIER Mk III (87)	1.7	09/98→11/99	17 DT (TC4EE1)	Diesel	1686	4	83
CAVALIER Mk III (87)	1.8	09/98→08/99	18 SV	Petrol	1796	4	94
CAVALIER Mk III (87)	1.8	09/98→11/99	C 18 NZ	Petrol	1796	4	97
CAVALIER Mk III (87)	2.0	09/98→10/99	20 NE	Petrol	1998	4	118
CAVALIER Mk III (87)	2.0	09/98→09/99	20 SEH	Petrol	1998	4	121
CAVALIER Mk III (87)	2.0	09/98→08/99	20 XE	Petrol	1998	4	122
CAVALIER Mk III (87)	2.0	06/99→11/99	C 20 LET	Petrol	1998	4	131
CAVALIER Mk III (87)	2.0	09/99→11/99	C 20 NE	Petrol	1998	4	132
CAVALIER Mk III (87)	2.0	09/98→11/99	C 20 XE	Petrol	1998	4	135
CAVALIER Mk III (87)	2.0	09/99→11/99	X 20 XEV	Petrol	1998	4	145
CAVALIER Mk III (87)	2.5	08/98→06/99	C 25 XE	Petrol	2498	6	177
CAVALIER Mk III Hatchback	1.4	09/98→11/99	14 NV	Petrol	1389	4	29
CAVALIER Mk III Hatchback	1.6	09/98→05/99	16 SV	Petrol	1598	4	48
CAVALIER Mk III Hatchback	1.6	09/98→11/99	E 16 NZ	Petrol	1598	4	63
CAVALIER Mk III Hatchback	1.6	09/99→11/99	X 16 SZ	Petrol	1598	4	65
CAVALIER Mk III Hatchback	1.7	09/98→09/99	17 D	Diesel	1699	4	80
CAVALIER Mk III Hatchback	1.7	07/99→11/99	17 DR	Diesel	1699	4	82
CAVALIER Mk III Hatchback	1.7	09/98→11/99	17 DT (TC4EE1)	Diesel	1686	4	83
CAVALIER Mk III Hatchback	1.8	09/98→10/99	18 SV	Petrol	1796	4	94
CAVALIER Mk III Hatchback	1.8	09/98→11/99	C 18 NZ	Petrol	1796	4	97
CAVALIER Mk III Hatchback	2.0	09/98→10/99	20 NE	Petrol	1998	4	118
CAVALIER Mk III Hatchback	2.0	09/98→09/99	20 SEH	Petrol	1998	4	121
CAVALIER Mk III Hatchback	2.0	09/98→11/99	C 20 XE	Petrol	1998	4	135
CAVALIER Mk III Hatchback	2.0	09/99→11/99	X 20 XEV	Petrol	1998	4	145
CAVALIER Mk III Hatchback	2.5	09/98→06/99	C 25 XE	Petrol	2498	6	177
COMBO Mk I (B)	1.2	07/99→10/00	C 12 NZ	Petrol	1196	4	12
COMBO Mk I (B)	1.2	07/99→10/00	X 12 SZ	Petrol	1195	4	15
COMBO Mk I (B)	1.4	07/99→10/00	C 14 NZ	Petrol	1389	4	32
COMBO Mk I (B)	1.4	07/99→10/00	C 14 SE	Petrol	1389	4	33
COMBO Mk I (B)	1.4	08/99→10/00	X 14 XE	Petrol	1389	4	36
COMBO Mk I (B)	1.7	07/99→10/00	17 D (4EE1)	Diesel	1686	4	81
COMBO Mk I (B)	1.7	07/99→10/00	X 17 D (4EE1)	Diesel	1686	4	84
COMBO Mk II (C) Box Body / Estate (F25)	1.3	09/00→02/01	Z 13 DT	Diesel	1248	4	20
COMBO Mk II (C) Box Body / Estate (F25)	1.3	10/00→11/01	Z 13 DTJ	Diesel	1248	4	23
COMBO Mk II (C) Box Body / Estate (F25)	1.4	10/00→05/00	Z 14 XE	Petrol	1389	4	37
COMBO Mk II (C) Box Body / Estate (F25)	1.4	01/00→11/01	Z 14 XEP	Petrol/Petroleum Gas (LPG)	1364	4	39
COMBO Mk II (C) Box Body / Estate (F25)	1.4	01/00→11/01	Z 14 XEP	Petrol	1364	4	39
COMBO Mk II (C) Box Body / Estate (F25)	1.6	08/00→11/01	Z 16 SE	Petrol/Petroleum Gas (LPG)	1598	4	74
COMBO Mk II (C) Box Body / Estate (F25)	1.6	08/00→11/01	Z 16 SE	Petrol	1598	4	74
COMBO Mk II (C) Box Body / Estate (F25)	1.6	04/00→02/01	Z 16 YNG	CNG	1598	4	79
COMBO Mk II (C) Box Body / Estate (F25)	1.7	10/00→11/01	Y 17 DT	Diesel	1686	4	87
COMBO Mk II (C) Box Body / Estate (F25)	1.7	09/00→11/01	Y 17 DTL	Diesel	1686	4	88
COMBO Mk II (C) Box Body / Estate (F25)	1.7	12/00→11/01	Z 17 DTH	Diesel	1686	4	89
COMBO Mk III (D) Box Body / Estate	1.3	11/01→	A 13 FD	Diesel	1248	4	11
COMBO Mk III (D) Box Body / Estate	1.4	11/01→	198 A4.000	CNG	1368	4	30
COMBO Mk III (D) Box Body / Estate	1.4	11/01→	843 A1.000	Petrol	1368	4	31
COMBO Mk III (D) Box Body / Estate	1.6	11/01→	A 16 FDH	Diesel	1598	4	49
COMBO Mk III (D) Box Body / Estate	1.6	11/01→	A 16 FDL	Diesel	1598	4	50
COMBO TOUR Mk II (C) (F25)	1.3	09/00→09/00	Y 13 DT	Diesel	1248	4	17
COMBO TOUR Mk II (C) (F25)	1.3	09/00→09/00	Z 13 DT	Diesel	1248	4	20
COMBO TOUR Mk II (C) (F25)	1.3	10/00→09/01	Z 13 DTJ	Diesel	1248	4	23
COMBO TOUR Mk II (C) (F25)	1.4	10/00→09/01	Z 14 XEP	Petrol/Petroleum Gas (LPG)	1364	4	39
COMBO TOUR Mk II (C) (F25)	1.4	10/00→09/01	Z 14 XEP	Petrol	1364	4	39
COMBO TOUR Mk II (C) (F25)	1.6	10/00→06/00	Z 16 SE	Petrol/Petroleum Gas (LPG)	1598	4	74
COMBO TOUR Mk II (C) (F25)	1.6	10/00→06/00	Z 16 SE	Petrol	1598	4	74
COMBO TOUR Mk II (C) (F25)	1.6	04/00→02/01	Z 16 YNG	CNG	1598	4	79
COMBO TOUR Mk II (C) (F25)	1.7	10/00→02/01	Y 17 DT	Diesel	1686	4	87

	Ltr				CC		9
COMBO TOUR Mk II (C) (F25)	1.7	09/00→06/00	Y 17 DTL	Diesel	1686	4	88
COMBO TOUR Mk II (C) (F25)	1.7	12/00→09/01	Z 17 DTH	Diesel	1686	4	89
CORSA Mk I (B)	1.0	11/99→09/00	X 10 XE	Petrol	973	3	2
CORSA Mk I (B)	1.2	03/99→09/00	C 12 NZ	Petrol	1196	4	12
CORSA Mk I (B)	1.2	03/99→09/00	X 12 SZ	Petrol	1195	4	15
CORSA Mk I (B)	1.2	03/99→09/00	X 12 XE	Petrol	1199	4	16
CORSA Mk I (B)	1.4	03/99→09/00	C 14 NZ	Petrol	1389	4	32
CORSA Mk I (B)	1.4	03/99→09/00	C 14 SE	Petrol	1389	4	33
CORSA Mk I (B)	1.4	08/99→09/00	C 14 SEL	Petrol	1389	4	34
CORSA Mk I (B)	1.4	03/99→09/00	X 14 SZ	Petrol	1389	4	35
CORSA Mk I (B)	1.4	09/99→09/00	X 14 XE	Petrol	1389	4	36
CORSA Mk I (B)	1.5	03/99→09/00	15 D	Diesel	1488	4	40
CORSA Mk I (B)	1.5	03/99→10/99	15 DT (T4EC1)	Diesel	1488	4	42
CORSA Mk I (B)	1.5	03/99→10/99	X 15 DT (T4EC1)	Diesel	1488	4	43
CORSA Mk I (B)	1.6	08/99→09/00	C 16 SEL	Petrol	1598	4	61
CORSA Mk I (B)	1.6	03/99→09/00	C 16 XE	Petrol	1598	4	62
CORSA Mk I (B)	1.6	09/99→09/00	X 16 XE	Petrol	1598	4	67
CORSA Mk I (B)	1.7	02/99→09/00	17 D (4EE1)	Diesel	1686	4	81
CORSA Mk I (B)	1.7	02/99→09/00	X 17 D (4EE1)	Diesel	1686	4	84
CORSA Mk II (C) (W5L, F08)	1.0	09/00→10/00	Z 10 XE	Petrol	973	3	3
CORSA Mk II (C) (W5L, F08)	1.0	11/00→10/00	Z 10 XEP	Petrol	998	3	4
CORSA Mk II (C) (W5L, F08)	1.2	09/00→10/00	Z 12 XE	Petrol/Petroleum Gas (LPG)	1199	4	18
CORSA Mk II (C) (W5L, F08)	1.2	09/00→10/00	Z 12 XE	Petrol	1199	4	18
CORSA Mk II (C) (W5L, F08)	1.2	07/00→10/00	Z 12 XEP	Petrol/Petroleum Gas (LPG)	1229	4	19
CORSA Mk II (C) (W5L, F08)	1.2	07/00→10/00	Z 12 XEP	Petrol	1229	4	19
CORSA Mk II (C) (W5L, F08)	1.3	08/00→09/00	Z 13 DT	Diesel	1248	4	20
CORSA Mk II (C) (W5L, F08)	1.3	09/00→09/00	Z 13 DTJ	Diesel	1248	4	23
CORSA Mk II (C) (W5L, F08)	1.4	09/00→10/00	Z 14 XE	Petrol	1389	4	37
CORSA Mk II (C) (W5L, F08)	1.4	06/00→10/00	Z 14 XEP	Petrol/Petroleum Gas (LPG)	1364	4	39
CORSA Mk II (C) (W5L, F08)	1.4	06/00→10/00	Z 14 XEP	Petrol	1364	4	39
CORSA Mk II (C) (W5L, F08)	1.6	05/00→10/00	Y 16 YNG	CNG	1598	4	70
CORSA Mk II (C) (W5L, F08)	1.6	08/00→10/00	Z 16 SE	Petrol/Petroleum Gas (LPG)	1598	4	74
CORSA Mk II (C) (W5L, F08)	1.6	08/00→10/00	Z 16 SE	Petrol	1598	4	74
CORSA Mk II (C) (W5L, F08)	1.6	05/00→10/00	Z 16 YNG	CNG	1598	4	79
CORSA Mk II (C) (W5L, F08)	1.7	08/00→09/00	Y 17 DT	Diesel	1686	4	87
CORSA Mk II (C) (W5L, F08)	1.7	08/00→09/00	Y 17 DTL	Diesel	1686	4	88
CORSA Mk II (C) (W5L, F08)	1.7	08/00→09/00	Z 17 DTH	Diesel	1686	4	89
CORSA Mk II (C) (W5L, F08)	1.8	08/00→09/00	Z 18 XE	Petrol/Petroleum Gas (LPG)	1796	4	105
CORSA Mk II (C) (W5L, F08)	1.8	08/00→09/00	Z 18 XE	Petrol	1796	4	105
CORSA Mk II (C) (W5L, F08)	1.8	08/00→09/00	Z 18 XE	Bi-Fuel	1796	4	105
CORSA Mk III (D) (L_8)	1.0	11/00→	Z 10 XEP	Petrol	998	3	4
CORSA Mk III (D) (L_8)	1.2	11/00→	Z 12 XEP	Petrol/Petroleum Gas (LPG)	1229	4	19
CORSA Mk III (D) (L_8)	1.2	11/00→	Z 12 XEP	Petrol	1229	4	19
CORSA Mk III (D) (L_8)	1.3	11/00→	A 13 DTC	Diesel	1248	4	9
CORSA Mk III (D) (L_8)	1.3	11/00→	A 13 DTE	Diesel	1248	4	10
CORSA Mk III (D) (L_8)	1.3	11/00→	Z 13 DTE	Diesel	1248	4	21
CORSA Mk III (D) (L_8)	1.3	11/00→	Z 13 DTH	Diesel	1248	4	22
CORSA Mk III (D) (L_8)	1.3	11/00→	Z 13 DTJ	Diesel	1248	4	23
CORSA Mk III (D) (L_8)	1.4	07/00→	Z 14 XEP	Petrol/Petroleum Gas (LPG)	1364	4	39
CORSA Mk III (D) (L_8)	1.4	07/00→	Z 14 XEP	Petrol	1364	4	39
CORSA Mk III (D) (L_8)	1.6	05/00→	A 16 LEL	Petrol	1598	4	51
CORSA Mk III (D) (L_8)	1.6	02/00→	A 16 LER	Petrol	1598	4	52
CORSA Mk III (D) (L_8)	1.6	06/01→03/01	A 16 LES	Petrol	1598	4	53
CORSA Mk III (D) (L_8)	1.6	05/00→	Z 16 LEL	Petrol	1598	4	71
CORSA Mk III (D) (L_8)	1.6	02/00→	Z 16 LER	Petrol	1598	4	72
CORSAVAN Mk I (B)	1.4	01/99→09/00	C 14 NZ	Petrol	1389	4	32
CORSAVAN Mk I (B)	1.5	08/99→12/99	15 D	Diesel	1488	4	40
CORSAVAN Mk I (B)	1.7	01/99→09/00	17 D (4EE1)	Diesel	1686	4	81
CORSAVAN Mk I (B)	1.7	01/99→09/00	X 17 D (4EE1)	Diesel	1686	4	84
CORSAVAN Mk II (C)	1.2	09/00→06/00	Z 12 XE	Petrol/Petroleum Gas (LPG)	1199	4	18
CORSAVAN Mk II (C)	1.2	09/00→06/00	Z 12 XE	Petrol	1199	4	18
CORSAVAN Mk II (C)	1.3	04/00→06/00	Z 13 DT	Diesel	1248	4	20
CORSAVAN Mk II (C)	1.4	11/00→06/00	Z 14 XEP	Petrol/Petroleum Gas (LPG)	1364	4	39
CORSAVAN Mk II (C)	1.4	11/00→06/00	Z 14 XEP	Petrol	1364	4	39
CORSAVAN Mk II (C)	1.7	09/00→06/00	Y 17 DT	Diesel	1686	4	87
CORSAVAN Mk II (C)	1.7	09/00→06/00	Y 17 DTL	Diesel	1686	4	88
CORSAVAN Mk III (D)	1.2	07/00→	Z 12 XEP	Petrol/Petroleum Gas (LPG)	1229	4	19
CORSAVAN Mk III (D)	1.2	07/00→	Z 12 XEP	Petrol	1229	4	19
CORSAVAN Mk III (D)	1.3	07/00→	Z 13 DTE	Diesel	1248	4	21
CORSAVAN Mk III (D)	1.3	07/00→	Z 13 DTH	Diesel	1248	4	22



Ltr







CC



9

Model	Ltr	Year Range	Engine	Fuel	CC	Seats	Price
CORSAVAN Mk III (D)	1.3	07/00→	Z 13 DTJ	Diesel	1248	4	23
FRONTERA Mk I (A) Sport	2.0	03/99→10/99	C 20 NE	Petrol	1998	4	132
FRONTERA Mk I (A) Sport	2.0	03/99→10/99	X 20 SE	Petrol	1998	4	143
FRONTERA Mk I (A) Sport	2.8	03/99→08/99	28 TDI (4JB1T)	Diesel	2771	4	194
FRONTERA Mk I (A)	2.0	04/99→08/99	C 20 NE	Petrol	1998	4	132
FRONTERA Mk I (A)	2.0	04/99→08/99	X 20 SE	Petrol	1998	4	143
FRONTERA Mk I (A)	2.2	03/99→10/99	X 22 XE	Petrol	2198	4	162
FRONTERA Mk I (A)	2.3	09/99→06/99	23 DTR	Diesel	2260	4	170
FRONTERA Mk I (A)	2.4	03/99→10/99	C 24 NE	Petrol	2410	4	173
FRONTERA Mk I (A)	2.8	03/99→10/99	28 TDI (4JB1T)	Diesel	2771	4	194
FRONTERA Mk II (B)	2.2	10/99→09/00	X 22 DTH	Diesel	2171	4	160
FRONTERA Mk II (B)	2.2	10/99→10/00	X 22 SE	Petrol	2198	4	161
FRONTERA Mk II (B)	2.2	10/99→09/00	Y 22 DTH	Diesel	2171	4	163
FRONTERA Mk II (B)	2.2	10/99→10/00	Y 22 SE	Petrol	2198	4	165
FRONTERA Mk II (B)	3.2	10/99→10/00	6 VDI	Petrol	3165	6	205
FRONTERA Mk II (B)	3.2	10/99→10/00	Y 32 NE	Petrol	3165	6	206
INSIGNIA Saloon	1.6	01/00→	A 16 LET	Petrol	1598	4	54
INSIGNIA Saloon	1.6	07/00→	A 16 XER	Petrol	1598	4	55
INSIGNIA Saloon	1.8	07/00→09/01	A 18 XER	Petrol	1796	4	96
INSIGNIA Saloon	2.0	07/00→	A 20 DTC	Diesel	1956	4	124
INSIGNIA Saloon	2.0	07/00→	A 20 DTH	Diesel	1956	4	125
INSIGNIA Saloon	2.0	07/00→	A 20 DTJ	Diesel	1956	4	126
INSIGNIA Saloon	2.0	11/00→	A 20 DTR	Diesel	1956	4	128
INSIGNIA Saloon	2.0	09/01→	A 20 NFT	Petrol	1998	4	129
INSIGNIA Saloon	2.0	07/00→	A 20 NHT	Petrol	1998	4	130
INSIGNIA SPORTS TOURER	1.6	01/00→	A 16 LET	Petrol	1598	4	54
INSIGNIA SPORTS TOURER	1.6	07/00→	A 16 XER	Petrol	1598	4	55
INSIGNIA SPORTS TOURER	1.8	07/00→09/01	A 18 XER	Petrol	1796	4	96
INSIGNIA SPORTS TOURER	2.0	07/00→	A 20 DTC	Diesel	1956	4	124
INSIGNIA SPORTS TOURER	2.0	07/00→	A 20 DTH	Diesel	1956	4	125
INSIGNIA SPORTS TOURER	2.0	07/00→	A 20 DTJ	Diesel	1956	4	126
INSIGNIA SPORTS TOURER	2.0	11/00→	A 20 DTR	Diesel	1956	4	128
INSIGNIA SPORTS TOURER	2.0	09/01→	A 20 NFT	Petrol	1998	4	129
INSIGNIA SPORTS TOURER	2.0	07/00→	A 20 NHT	Petrol	1998	4	130
INSIGNIA	1.6	01/00→	A 16 LET	Petrol	1598	4	54
INSIGNIA	1.6	07/00→	A 16 XER	Petrol	1598	4	55
INSIGNIA	1.8	07/00→09/01	A 18 XER	Petrol	1796	4	96
INSIGNIA	2.0	07/00→	A 20 DTC	Diesel	1956	4	124
INSIGNIA	2.0	07/00→	A 20 DTH	Diesel	1956	4	125
INSIGNIA	2.0	07/00→	A 20 DTJ	Diesel	1956	4	126
INSIGNIA	2.0	10/00→	A 20 DTR	Diesel	1956	4	128
INSIGNIA	2.0	09/01→	A 20 NFT	Petrol	1998	4	129
INSIGNIA	2.0	07/00→	A 20 NHT	Petrol	1998	4	130
MERIVA Mk I (A)	1.3	04/00→06/01	Y 13 DT	Diesel	1248	4	17
MERIVA Mk I (A)	1.3	04/00→06/01	Z 13 DT	Diesel	1248	4	20
MERIVA Mk I (A)	1.3	01/00→10/00	Z 13 DTJ	Diesel	1248	4	23
MERIVA Mk I (A)	1.4	01/00→10/00	Z 14 XEP	Petrol/Petroleum Gas (LPG)	1364	4	39
MERIVA Mk I (A)	1.4	01/00→10/00	Z 14 XEP	Petrol	1364	4	39
MERIVA Mk I (A)	1.6	05/00→06/01	Z 16 LET	Petrol	1598	4	73
MERIVA Mk I (A)	1.6	01/00→06/01	Z 16 SE	Petrol/Petroleum Gas (LPG)	1598	4	74
MERIVA Mk I (A)	1.6	01/00→06/01	Z 16 SE	Petrol	1598	4	74
MERIVA Mk I (A)	1.6	01/00→09/00	Z 16 XE	Petrol/Petroleum Gas (LPG)	1598	4	75
MERIVA Mk I (A)	1.6	01/00→09/00	Z 16 XE	Petrol	1598	4	75
MERIVA Mk I (A)	1.6	05/00→06/01	Z 16 XEP	Petrol	1598	4	77
MERIVA Mk I (A)	1.7	06/00→06/01	Y 17 DT	Diesel	1686	4	87
MERIVA Mk I (A)	1.7	09/00→08/00	Z 17 DTH	Diesel	1686	4	89
MERIVA Mk I (A)	1.8	05/00→08/00	Z 18 XE	Petrol/Petroleum Gas (LPG)	1796	4	105
MERIVA Mk I (A)	1.8	05/00→08/00	Z 18 XE	Petrol	1796	4	105
MERIVA Mk I (A)	1.8	05/00→08/00	Z 18 XE	Bi-Fuel	1796	4	105
MERIVA Mk II (B)	1.3	06/01→	A 13 DTC	Diesel	1248	4	9
MERIVA Mk II (B)	1.3	06/01→	A 13 DTE	Diesel	1248	4	10
MOKKA	1.6	06/01→	A 16 XER	Petrol	1598	4	55
MONTEREY Mk II	3.0	07/99→08/99	4 JX1	Diesel	2999	4	196
MONTEREY Mk II	3.5	07/99→08/99	6 VE1	Petrol	3494	6	208
MONTEREY	3.1	09/99→07/99	4 JG2TC	Diesel	3059	4	204
MONTEREY	3.2	06/99→07/99	6 VDI	Petrol	3165	6	205
MOVANO Mk I (A) Chassis/Cab (ED, UD, HD)	2.2	09/00→05/01	G9T 720	Diesel	2188	4	157
MOVANO Mk I (A) Chassis/Cab (ED, UD, HD)	2.2	09/00→05/01	G9T 722	Diesel	2188	4	158
MOVANO Mk I (A) Chassis/Cab (ED, UD, HD)	2.2	09/00→05/01	G9T 750	Diesel	2188	4	159
MOVANO Mk I (A) Chassis/Cab (ED, UD, HD)	2.5	04/00→05/01	G9U 650	Diesel	2464	4	179

	Ltr				CC		9
MOVANO Mk I (A) Chassis/Cab (ED, UD, HD)	2.5	10/00 → 05/01	G9U 720	Diesel	2463	4	180
MOVANO Mk I (A) Chassis/Cab (ED, UD, HD)	2.5	10/00 → 05/01	G9U 724	Diesel	2463	4	181
MOVANO Mk I (A) Chassis/Cab (ED, UD, HD)	2.5	10/00 → 05/01	G9U 754	Diesel	2463	4	184
MOVANO Mk I (A) Chassis/Cab (ED, UD, HD)	2.5	10/99 → 09/00	S8U 770	Diesel	2499	4	186
MOVANO Mk I (A) Chassis/Cab (ED, UD, HD)	2.8	10/99 → 10/00	S9W 702	Diesel	2799	4	195
MOVANO Mk I (A) Combi (JD)	1.9	09/00 → 10/00	F9Q 770	Diesel	1870	4	112
MOVANO Mk I (A) Combi (JD)	1.9	10/00 → 05/01	F9Q 774	Diesel	1870	4	113
MOVANO Mk I (A) Combi (JD)	2.2	09/00 → 05/01	G9T 720	Diesel	2188	4	157
MOVANO Mk I (A) Combi (JD)	2.2	09/00 → 05/01	G9T 750	Diesel	2188	4	159
MOVANO Mk I (A) Combi (JD)	2.5	10/00 → 08/00	G9U 650	Diesel	2464	4	179
MOVANO Mk I (A) Combi (JD)	2.5	10/00 → 08/00	G9U 720	Diesel	2463	4	180
MOVANO Mk I (A) Combi (JD)	2.5	10/00 → 08/00	G9U 750	Diesel	2463	4	183
MOVANO Mk I (A) Combi (JD)	2.5	10/00 → 08/00	G9U 754	Diesel	2463	4	184
MOVANO Mk I (A) Combi (JD)	2.5	10/99 → 09/00	S8U 770	Diesel	2499	4	186
MOVANO Mk I (A) Combi (JD)	2.8	10/99 → 10/00	S9W 702	Diesel	2799	4	195
MOVANO Mk I (A) Van (FD)	1.9	09/00 → 10/00	F9Q 770	Diesel	1870	4	112
MOVANO Mk I (A) Van (FD)	1.9	10/00 → 05/01	F9Q 774	Diesel	1870	4	113
MOVANO Mk I (A) Van (FD)	2.2	09/00 → 05/01	G9T 720	Diesel	2188	4	157
MOVANO Mk I (A) Van (FD)	2.2	09/00 → 05/01	G9T 722	Diesel	2188	4	158
MOVANO Mk I (A) Van (FD)	2.2	09/00 → 05/01	G9T 750	Diesel	2188	4	159
MOVANO Mk I (A) Van (FD)	2.5	04/00 → 05/01	G9U 650	Diesel	2464	4	179
MOVANO Mk I (A) Van (FD)	2.5	10/00 → 05/01	G9U 720	Diesel	2463	4	180
MOVANO Mk I (A) Van (FD)	2.5	10/00 → 05/01	G9U 724	Diesel	2463	4	181
MOVANO Mk I (A) Van (FD)	2.5	10/00 → 05/01	G9U 750	Diesel	2463	4	183
MOVANO Mk I (A) Van (FD)	2.5	10/00 → 05/01	G9U 754	Diesel	2463	4	184
MOVANO Mk I (A) Van (FD)	2.5	10/99 → 09/00	S8U 770	Diesel	2499	4	186
MOVANO Mk I (A) Van (FD)	2.8	10/99 → 10/00	S9W 702	Diesel	2799	4	195
NOVA Hatchback	1.2	01/98 → 10/98	I2 NC	Petrol	1196	4	5
NOVA Hatchback	1.2	01/99 → 03/99	I2 NV	Petrol	1196	4	6
NOVA Hatchback	1.2	01/98 → 02/99	I2 S	Petrol	1196	4	7
NOVA Hatchback	1.2	05/98 → 02/99	I2 ST	Petrol	1196	4	8
NOVA Hatchback	1.2	09/98 → 03/99	C 12 NZ	Petrol	1196	4	12
NOVA Hatchback	1.2	01/98 → 10/98	E 12 GV	Petrol	1196	4	14
NOVA Hatchback	1.3	09/98 → 10/98	I3 NB	Petrol	1297	4	25
NOVA Hatchback	1.3	05/98 → 10/98	I3 SB	Petrol	1297	4	27
NOVA Hatchback	1.3	09/98 → 03/99	C 13 N	Petrol	1297	4	28
NOVA Hatchback	1.4	01/99 → 03/99	I4 NV	Petrol	1389	4	29
NOVA Hatchback	1.4	01/99 → 03/99	C 14 NZ	Petrol	1389	4	32
NOVA Hatchback	1.4	09/99 → 03/99	C 14 SE	Petrol	1389	4	33
NOVA Hatchback	1.5	09/98 → 03/99	I5 D	Diesel	1488	4	40
NOVA Hatchback	1.5	01/99 → 03/99	I5 DT (T4EC1)	Diesel	1488	4	42
NOVA Hatchback	1.6	02/99 → 03/99	C 16 SE	Petrol	1598	4	59
NOVA Hatchback	1.6	09/98 → 03/99	C 16 SEI	Petrol	1598	4	60
NOVA Hatchback	1.6	05/98 → 03/99	E 16 SE	Petrol	1598	4	64
NOVA	1.4	01/99 → 02/99	I4 NV	Petrol	1389	4	29
NOVA	1.4	10/99 → 08/99	C 14 NZ	Petrol	1389	4	32
NOVA	1.4	09/99 → 08/99	C 14 SE	Petrol	1389	4	33
NOVA	1.5	09/98 → 02/99	I5 D	Diesel	1488	4	40
NOVA	1.5	01/99 → 02/99	I5 DT (T4EC1)	Diesel	1488	4	42
NOVAVAN	1.2	01/99 → 10/99	I2 NV	Petrol	1196	4	6
NOVAVAN	1.4	11/99 → 03/99	I4 NV	Petrol	1389	4	29
NOVAVAN	1.5	01/99 → 10/99	I5 D	Diesel	1488	4	40
OMEGA (B) Estate	2.0	01/99 → 09/00	X 20 DTH	Diesel	1995	4	141
OMEGA (B) Estate	2.0	03/99 → 09/99	X 20 SE	Petrol	1998	4	143
OMEGA (B) Estate	2.0	03/99 → 02/00	X 20 XEV	Petrol	1998	4	145
OMEGA (B) Estate	2.2	08/00 → 06/00	Y 22 DTH	Diesel	2171	4	163
OMEGA (B) Estate	2.2	02/99 → 06/00	Y 22 XE	Petrol	2198	4	166
OMEGA (B) Estate	2.2	02/99 → 06/00	Z 22 XE	Petrol	2198	4	168
OMEGA (B) Estate	2.5	04/99 → 07/00	25 DT	Diesel	2497	6	176
OMEGA (B) Estate	2.5	04/99 → 07/00	X 25 DT	Diesel	2497	6	189
OMEGA (B) Estate	2.5	03/99 → 09/00	X 25 XE	Petrol	2498	6	190
OMEGA (B) Estate	2.5	09/00 → 06/00	Y 25 DT	Diesel	2497	6	191
OMEGA (B) Estate	2.6	08/00 → 06/00	Y 26 SE	Petrol	2597	6	193
OMEGA (B) Estate	3.0	07/99 → 07/00	X 30 XE	Petrol	2962	6	201
OMEGA (B)	2.0	09/99 → 09/99	20 SE	Petrol	1998	4	120
OMEGA (B)	2.0	01/99 → 09/00	X 20 DTH	Diesel	1995	4	141
OMEGA (B)	2.0	03/99 → 09/99	X 20 SE	Petrol	1998	4	143
OMEGA (B)	2.0	03/99 → 09/99	X 20 XEV	Petrol	1998	4	145
OMEGA (B)	2.2	08/00 → 07/00	Y 22 DTH	Diesel	2171	4	163
OMEGA (B)	2.2	01/99 → 06/00	Y 22 XE	Petrol	2198	4	166



Ltr







CC



9

Model	Ltr	Year Range	Engine	Fuel	CC	Seats	Price
OMEGA (B)	2.2	01/99→06/00	Z 22 XE	Petrol	2198	4	168
OMEGA (B)	2.5	04/99→07/00	25 DT	Diesel	2497	6	176
OMEGA (B)	2.5	04/99→07/00	X 25 DT	Diesel	2497	6	189
OMEGA (B)	2.5	03/99→09/00	X 25 XE	Petrol	2498	6	190
OMEGA (B)	2.5	09/00→07/00	Y 25 DT	Diesel	2497	6	191
OMEGA (B)	2.6	08/00→07/00	Y 26 SE	Petrol	2597	6	193
OMEGA (B)	3.0	04/99→07/00	X 30 XE	Petrol	2962	6	201
SENATOR Mk II (B)	2.6	09/99→09/99	C 26 NE	Petrol	2594	6	192
SENATOR Mk II (B)	3.0	09/98→09/99	30 NE	Petrol	2969	6	197
SENATOR Mk II (B)	3.0	09/98→09/99	C 30 LE	Petrol	2969	6	198
SENATOR Mk II (B)	3.0	01/98→09/99	C 30 NE	Petrol	2969	6	199
SIGNUM	1.8	06/00→07/00	Z 18 XE	Petrol/Petroleum Gas (LPG)	1796	4	105
SIGNUM	1.8	06/00→07/00	Z 18 XE	Petrol	1796	4	105
SIGNUM	1.8	06/00→07/00	Z 18 XE	Bi-Fuel	1796	4	105
SIGNUM	1.8	08/00→05/00	Z 18 XER	Petrol	1796	4	107
SIGNUM	1.9	04/00→03/00	Z 19 DT	Diesel	1910	4	114
SIGNUM	1.9	04/00→03/00	Z 19 DTH	Diesel	1910	4	115
SIGNUM	1.9	01/00→05/00	Z 19 DTL	Diesel	1910	4	117
SIGNUM	2.0	05/00→05/00	Y 20 DTH	Diesel	1995	4	146
SIGNUM	2.0	01/00→10/00	Z 20 NET	Petrol	1998	4	155
SIGNUM	2.2	05/00→05/00	Y 22 DTR	Diesel	2172	4	164
SIGNUM	2.2	05/00→05/00	Z 22 YH	Petrol	2198	4	169
SIGNUM	3.0	05/00→05/00	Y 30 DT	Diesel	2958	6	202
SIGNUM	3.0	04/00→05/00	Z 30 DT	Diesel	2958	6	203
SIGNUM	3.2	05/00→05/00	Z 32 SE	Petrol	3175	6	207
SINTRA	2.2	07/99→04/99	X 22 DTH	Diesel	2171	4	160
SINTRA	2.2	11/99→04/99	X 22 XE	Petrol	2198	4	162
SINTRA	3.0	11/99→04/99	X 30 XE	Petrol	2962	6	201
SPEEDSTER	2.0	03/00→09/00	Z 20 LET	Petrol	1998	4	154
TIGRA Mk I (F07)	1.4	07/99→12/00	X 14 XE	Petrol	1389	4	36
TIGRA Mk I (F07)	1.6	07/99→12/00	X 16 XE	Petrol	1598	4	67
TIGRA TwinTop	1.3	06/00→08/00	Z 13 DT	Diesel	1248	4	20
TIGRA TwinTop	1.4	06/00→08/00	Z 14 XEP	Petrol/Petroleum Gas (LPG)	1364	4	39
TIGRA TwinTop	1.4	06/00→08/00	Z 14 XEP	Petrol	1364	4	39
TIGRA TwinTop	1.8	06/00→08/00	Z 18 XE	Petrol/Petroleum Gas (LPG)	1796	4	105
TIGRA TwinTop	1.8	06/00→08/00	Z 18 XE	Petrol	1796	4	105
TIGRA TwinTop	1.8	06/00→08/00	Z 18 XE	Bi-Fuel	1796	4	105
VECTRA (B) Estate	1.6	11/99→03/00	X 16 SZR	Petrol	1598	4	66
VECTRA (B) Estate	1.6	11/99→03/00	X 16 XEL	Petrol/Petroleum Gas (LPG)	1598	4	68
VECTRA (B) Estate	1.6	11/99→03/00	X 16 XEL	Petrol	1598	4	68
VECTRA (B) Estate	1.6	11/99→03/00	Y 16 XE	Petrol	1598	4	69
VECTRA (B) Estate	1.6	11/99→03/00	Z 16 XE	Petrol/Petroleum Gas (LPG)	1598	4	75
VECTRA (B) Estate	1.6	11/99→03/00	Z 16 XE	Petrol	1598	4	75
VECTRA (B) Estate	1.7	11/99→12/99	X 17 DT (TC4EE1)	Diesel	1686	4	85
VECTRA (B) Estate	1.8	11/99→09/00	X 18 XE	Petrol	1799	4	103
VECTRA (B) Estate	1.8	11/99→09/00	X 18 XE1	Petrol	1796	4	104
VECTRA (B) Estate	1.8	09/00→03/00	Z 18 XE	Petrol/Petroleum Gas (LPG)	1796	4	105
VECTRA (B) Estate	1.8	09/00→03/00	Z 18 XE	Petrol	1796	4	105
VECTRA (B) Estate	1.8	09/00→03/00	Z 18 XE	Bi-Fuel	1796	4	105
VECTRA (B) Estate	2.0	08/99→10/00	X 20 DTH	Diesel	1995	4	141
VECTRA (B) Estate	2.0	08/99→10/00	X 20 DTL	Diesel	1995	4	142
VECTRA (B) Estate	2.0	10/99→01/00	X 20 XEV	Petrol	1998	4	145
VECTRA (B) Estate	2.0	08/99→10/00	Y 20 DTH	Diesel	1995	4	146
VECTRA (B) Estate	2.2	08/99→10/00	Y 22 DTR	Diesel	2172	4	164
VECTRA (B) Estate	2.2	08/99→10/00	Z 22 SE	Petrol	2198	4	167
VECTRA (B) Estate	2.5	11/99→08/00	X 25 XE	Petrol	2498	6	190
VECTRA (B) Estate	2.6	09/00→03/00	Y 26 SE	Petrol	2597	6	193
VECTRA (B) Hatchback	1.6	08/99→10/00	X 16 SZR	Petrol	1598	4	66
VECTRA (B) Hatchback	1.6	08/99→10/00	X 16 XEL	Petrol/Petroleum Gas (LPG)	1598	4	68
VECTRA (B) Hatchback	1.6	08/99→10/00	X 16 XEL	Petrol	1598	4	68
VECTRA (B) Hatchback	1.6	08/99→10/00	Y 16 XE	Petrol	1598	4	69
VECTRA (B) Hatchback	1.6	08/99→10/00	Z 16 XE	Petrol/Petroleum Gas (LPG)	1598	4	75
VECTRA (B) Hatchback	1.6	08/99→10/00	Z 16 XE	Petrol	1598	4	75
VECTRA (B) Hatchback	1.7	10/99→11/99	X 17 DT (TC4EE1)	Diesel	1686	4	85
VECTRA (B) Hatchback	1.8	10/99→09/00	X 18 XE	Petrol	1799	4	103
VECTRA (B) Hatchback	1.8	10/99→09/00	X 18 XE1	Petrol	1796	4	104
VECTRA (B) Hatchback	1.8	09/00→07/00	Z 18 XE	Petrol/Petroleum Gas (LPG)	1796	4	105
VECTRA (B) Hatchback	1.8	09/00→07/00	Z 18 XE	Petrol	1796	4	105
VECTRA (B) Hatchback	1.8	09/00→07/00	Z 18 XE	Bi-Fuel	1796	4	105
VECTRA (B) Hatchback	2.0	06/99→10/00	X 20 DTH	Diesel	1995	4	141

	Ltr				CC		9
VECTRA (B) Hatchback	2.0	08/99→10/00	X 20 DTL	Diesel	1995	4	142
VECTRA (B) Hatchback	2.0	10/99→01/00	X 20 XEV	Petrol	1998	4	145
VECTRA (B) Hatchback	2.0	06/99→10/00	Y 20 DTH	Diesel	1995	4	146
VECTRA (B) Hatchback	2.2	08/99→10/00	Y 22 DTR	Diesel	2172	4	164
VECTRA (B) Hatchback	2.2	09/00→07/00	Z 22 SE	Petrol	2198	4	167
VECTRA (B) Hatchback	2.5	09/99→08/00	X 25 XE	Petrol	2498	6	190
VECTRA (B) Hatchback	2.6	09/00→07/00	Y 26 SE	Petrol	2597	6	193
VECTRA (B)	1.6	08/99→10/00	X 16 SZR	Petrol	1598	4	66
VECTRA (B)	1.6	08/99→10/00	X 16 XEL	Petrol/Petroleum Gas (LPG)	1598	4	68
VECTRA (B)	1.6	08/99→10/00	X 16 XEL	Petrol	1598	4	68
VECTRA (B)	1.6	08/99→10/00	Y 16 XE	Petrol	1598	4	69
VECTRA (B)	1.6	08/99→10/00	Z 16 XE	Petrol/Petroleum Gas (LPG)	1598	4	75
VECTRA (B)	1.6	08/99→10/00	Z 16 XE	Petrol	1598	4	75
VECTRA (B)	1.7	10/99→11/99	X 17 DT (TC4EE1)	Diesel	1686	4	85
VECTRA (B)	1.8	10/99→09/00	X 18 XE	Petrol	1799	4	103
VECTRA (B)	1.8	10/99→09/00	X 18 XE1	Petrol	1796	4	104
VECTRA (B)	1.8	09/00→03/00	Z 18 XE	Petrol/Petroleum Gas (LPG)	1796	4	105
VECTRA (B)	1.8	09/00→03/00	Z 18 XE	Petrol	1796	4	105
VECTRA (B)	1.8	09/00→03/00	Z 18 XE	Bi-Fuel	1796	4	105
VECTRA (B)	2.0	10/99→03/00	20 NEJ	Petrol	1998	4	119
VECTRA (B)	2.0	08/99→10/00	X 20 DTH	Diesel	1995	4	141
VECTRA (B)	2.0	08/99→10/00	X 20 DTL	Diesel	1995	4	142
VECTRA (B)	2.0	10/99→01/00	X 20 XEV	Petrol	1998	4	145
VECTRA (B)	2.0	08/99→10/00	Y 20 DTH	Diesel	1995	4	146
VECTRA (B)	2.2	08/99→10/00	Y 22 DTR	Diesel	2172	4	164
VECTRA (B)	2.2	08/99→10/00	Z 22 SE	Petrol	2198	4	167
VECTRA (B)	2.5	09/99→08/00	X 25 XE	Petrol	2498	6	190
VECTRA (B)	2.6	09/00→03/00	Y 26 SE	Petrol	2597	6	193
VECTRA Mk II (C) Estate	1.6	06/00→07/00	Z 16 XE	Petrol/Petroleum Gas (LPG)	1598	4	75
VECTRA Mk II (C) Estate	1.6	06/00→07/00	Z 16 XE	Petrol	1598	4	75
VECTRA Mk II (C) Estate	1.8	10/00→08/00	Z 18 XE	Petrol/Petroleum Gas (LPG)	1796	4	105
VECTRA Mk II (C) Estate	1.8	10/00→08/00	Z 18 XE	Petrol	1796	4	105
VECTRA Mk II (C) Estate	1.8	10/00→08/00	Z 18 XE	Bi-Fuel	1796	4	105
VECTRA Mk II (C) Estate	1.8	04/00→07/00	Z 18 XEL	Petrol	1796	4	106
VECTRA Mk II (C) Estate	1.8	01/00→07/00	Z 18 XER	Petrol	1796	4	107
VECTRA Mk II (C) Estate	1.9	04/00→07/00	Z 19 DT	Diesel	1910	4	114
VECTRA Mk II (C) Estate	1.9	04/00→07/00	Z 19 DTH	Diesel	1910	4	115
VECTRA Mk II (C) Estate	1.9	10/00→07/00	Z 19 DTL	Diesel	1910	4	117
VECTRA Mk II (C) Estate	2.0	10/00→07/00	Y 20 DTH	Diesel	1995	4	146
VECTRA Mk II (C) Estate	2.0	10/00→07/00	Z 20 NET	Petrol	1998	4	155
VECTRA Mk II (C) Estate	2.2	10/00→07/00	Y 22 DTR	Diesel	2172	4	164
VECTRA Mk II (C) Estate	2.2	10/00→07/00	Z 22 YH	Petrol	2198	4	169
VECTRA Mk II (C) Estate	3.0	10/00→08/00	Y 30 DT	Diesel	2958	6	202
VECTRA Mk II (C) Estate	3.0	08/00→07/00	Z 30 DT	Diesel	2958	6	203
VECTRA Mk II (C) Estate	3.2	10/00→08/00	Z 32 SE	Petrol	3175	6	207
VECTRA Mk II (C) GTS	1.6	06/00→07/00	Z 16 XE	Petrol/Petroleum Gas (LPG)	1598	4	75
VECTRA Mk II (C) GTS	1.6	06/00→07/00	Z 16 XE	Petrol	1598	4	75
VECTRA Mk II (C) GTS	1.6	01/00→07/00	Z 16 XEP	Petrol	1598	4	77
VECTRA Mk II (C) GTS	1.8	08/00→07/00	Z 18 XE	Petrol/Petroleum Gas (LPG)	1796	4	105
VECTRA Mk II (C) GTS	1.8	08/00→07/00	Z 18 XE	Petrol	1796	4	105
VECTRA Mk II (C) GTS	1.8	08/00→07/00	Z 18 XE	Bi-Fuel	1796	4	105
VECTRA Mk II (C) GTS	1.8	01/00→07/00	Z 18 XER	Petrol	1796	4	107
VECTRA Mk II (C) GTS	1.9	08/00→07/00	Z 19 DT	Diesel	1910	4	114
VECTRA Mk II (C) GTS	1.9	04/00→07/00	Z 19 DTH	Diesel	1910	4	115
VECTRA Mk II (C) GTS	1.9	10/00→07/00	Z 19 DTL	Diesel	1910	4	117
VECTRA Mk II (C) GTS	2.0	08/00→07/00	Y 20 DTH	Diesel	1995	4	146
VECTRA Mk II (C) GTS	2.0	03/00→07/00	Z 20 NET	Petrol	1998	4	155
VECTRA Mk II (C) GTS	2.2	08/00→07/00	Y 22 DTR	Diesel	2172	4	164
VECTRA Mk II (C) GTS	2.2	08/00→07/00	Z 22 SE	Petrol	2198	4	167
VECTRA Mk II (C) GTS	2.2	10/00→08/00	Z 22 YH	Petrol	2198	4	169
VECTRA Mk II (C) GTS	3.0	06/00→08/00	Y 30 DT	Diesel	2958	6	202
VECTRA Mk II (C) GTS	3.0	08/00→07/00	Z 30 DT	Diesel	2958	6	203
VECTRA Mk II (C) GTS	3.2	08/00→07/00	Z 32 SE	Petrol	3175	6	207
VECTRA Mk II (C)	1.6	06/00→07/00	Z 16 XE	Petrol/Petroleum Gas (LPG)	1598	4	75
VECTRA Mk II (C)	1.6	06/00→07/00	Z 16 XE	Petrol	1598	4	75
VECTRA Mk II (C)	1.6	01/00→07/00	Z 16 XEP	Petrol	1598	4	77
VECTRA Mk II (C)	1.8	04/00→07/00	Z 18 XE	Petrol/Petroleum Gas (LPG)	1796	4	105
VECTRA Mk II (C)	1.8	04/00→07/00	Z 18 XE	Petrol	1796	4	105
VECTRA Mk II (C)	1.8	04/00→07/00	Z 18 XE	Bi-Fuel	1796	4	105
VECTRA Mk II (C)	1.8	04/00→07/00	Z 18 XER	Petrol	1796	4	107
VECTRA Mk II (C)	1.8	04/00→07/00	Z 18 XE	Bi-Fuel	1796	4	105
VECTRA Mk II (C)	1.8	04/00→07/00	Z 18 XEL	Petrol	1796	4	106



Ltr



CC



9

	Ltr				CC		
VECTRA Mk II (C)	1.8	01/00→07/00	Z 18 XER	Petrol	1796	4	107
VECTRA Mk II (C)	1.9	04/00→09/00	Z 19 DT	Diesel	1910	4	114
VECTRA Mk II (C)	1.9	04/00→08/00	Z 19 DTH	Diesel	1910	4	115
VECTRA Mk II (C)	1.9	10/00→07/00	Z 19 DTL	Diesel	1910	4	117
VECTRA Mk II (C)	2.0	04/00→10/00	Y 20 DTH	Diesel	1995	4	146
VECTRA Mk II (C)	2.0	01/00→10/00	Z 20 NET	Petrol	1998	4	155
VECTRA Mk II (C)	2.2	04/00→10/00	Y 22 DTR	Diesel	2172	4	164
VECTRA Mk II (C)	2.2	01/00→10/00	Z 22 SE	Petrol	2198	4	167
VECTRA Mk II (C)	2.2	01/00→10/00	Z 22 YH	Petrol	2198	4	169
VECTRA Mk II (C)	3.0	06/00→08/00	Y 30 DT	Diesel	2958	6	202
VECTRA Mk II (C)	3.0	08/00→07/00	Z 30 DT	Diesel	2958	6	203
VECTRA Mk II (C)	3.2	06/00→07/00	Z 32 SE	Petrol	3175	6	207
VIVARO Box (F7)	1.9	08/00→12/00	F9Q 760	Diesel	1870	4	110
VIVARO Box (F7)	1.9	08/00→12/00	F9Q 762	Diesel	1870	4	111
VIVARO Box (F7)	2.0	08/00→12/00	F4R 720	Petrol	1998	4	136
VIVARO Box (F7)	2.0	08/00→	F4R 820	Petrol	1998	4	137
VIVARO Box (F7)	2.0	01/00→	M9R 780	Diesel	1995	4	138
VIVARO Box (F7)	2.0	01/00→	M9R 782	Diesel	1995	4	139
VIVARO Box (F7)	2.5	04/00→	G9U 630	Diesel	2464	4	178
VIVARO Box (F7)	2.5	04/00→	G9U 730	Diesel	2463	4	182
VIVARO Combi (J7)	1.9	08/00→12/00	F9Q 760	Diesel	1870	4	110
VIVARO Combi (J7)	1.9	08/00→12/00	F9Q 762	Diesel	1870	4	111
VIVARO Combi (J7)	2.0	08/00→12/00	F4R 720	Petrol	1998	4	136
VIVARO Combi (J7)	2.0	08/00→	F4R 820	Petrol	1998	4	137
VIVARO Combi (J7)	2.0	01/00→	M9R 780	Diesel	1995	4	138
VIVARO Combi (J7)	2.0	01/00→	M9R 782	Diesel	1995	4	139
VIVARO Combi (J7)	2.0	08/00→	M9R 784	Diesel	1995	4	140
VIVARO Combi (J7)	2.5	04/00→	G9U 630	Diesel	2464	4	178
VIVARO Combi (J7)	2.5	04/00→	G9U 730	Diesel	2463	4	182
VIVARO Platform/Chassis (E7)	1.9	08/00→	F9Q 762	Diesel	1870	4	111
VIVARO Platform/Chassis (E7)	2.0	04/00→	F4R 720	Petrol	1998	4	136
VIVARO Platform/Chassis (E7)	2.0	08/00→	F4R 820	Petrol	1998	4	137
VIVARO Platform/Chassis (E7)	2.0	08/00→	M9R 780	Diesel	1995	4	138
VIVARO Platform/Chassis (E7)	2.0	01/00→	M9R 782	Diesel	1995	4	139
VIVARO Platform/Chassis (E7)	2.5	04/00→	G9U 630	Diesel	2464	4	178
VIVARO Platform/Chassis (E7)	2.5	04/00→	G9U 730	Diesel	2463	4	182
VX220	2.0	03/00→04/00	Z 20 LET	Petrol	1998	4	154
VX220	2.2	09/00→07/00	Z 22 SE	Petrol	2198	4	167
ZAFIRA Mk I (A) (F75)	1.6	11/99→08/00	X 16 XEL	Petrol/Petroleum Gas (LPG)	1598	4	68
ZAFIRA Mk I (A) (F75)	1.6	11/99→08/00	X 16 XEL	Petrol	1598	4	68
ZAFIRA Mk I (A) (F75)	1.6	11/99→08/00	Z 16 XE	Petrol/Petroleum Gas (LPG)	1598	4	75
ZAFIRA Mk I (A) (F75)	1.6	11/99→08/00	Z 16 XE	Petrol	1598	4	75
ZAFIRA Mk I (A) (F75)	1.6	09/00→06/00	Z 16 YNG	CNG	1598	4	79
ZAFIRA Mk I (A) (F75)	1.8	05/99→08/00	X 18 XE1	Petrol	1796	4	104
ZAFIRA Mk I (A) (F75)	1.8	09/00→08/00	Z 18 XE	Petrol/Petroleum Gas (LPG)	1796	4	105
ZAFIRA Mk I (A) (F75)	1.8	09/00→08/00	Z 18 XE	Petrol	1796	4	105
ZAFIRA Mk I (A) (F75)	1.8	09/00→08/00	Z 18 XE	Bi-Fuel	1796	4	105
ZAFIRA Mk I (A) (F75)	2.0	10/99→08/00	X 20 DTL	Diesel	1995	4	142
ZAFIRA Mk I (A) (F75)	2.0	04/99→08/00	Y 20 DTH	Diesel	1995	4	146
ZAFIRA Mk I (A) (F75)	2.0	09/00→06/00	Z 20 LET	Petrol	1998	4	154
ZAFIRA Mk I (A) (F75)	2.2	06/00→06/00	Y 22 DTR	Diesel	2172	4	164
ZAFIRA Mk I (A) (F75)	2.2	11/99→08/00	Z 22 SE	Petrol	2198	4	167
ZAFIRA Mk II (B) (M75)	1.6	12/00→	A 16 XER	Petrol	1598	4	55
ZAFIRA Mk II (B) (M75)	1.6	02/00→	A 16 XNT	CNG	1598	4	56
ZAFIRA Mk II (B) (M75)	1.6	07/00→	Z 16 XE1	Petrol	1598	4	76
ZAFIRA Mk II (B) (M75)	1.6	07/00→	Z 16 XEP	Petrol	1598	4	77
ZAFIRA Mk II (B) (M75)	1.6	12/00→	Z 16 XER	Petrol	1598	4	78
ZAFIRA Mk II (B) (M75)	1.6	07/00→	Z 16 YNG	CNG	1598	4	79
ZAFIRA Mk II (B) (M75)	1.8	04/00→	A 18 XER	Petrol	1796	4	96
ZAFIRA Mk II (B) (M75)	1.8	04/00→	Z 18 XER	Petrol	1796	4	107
ZAFIRA Mk II (B) (M75)	1.9	07/00→	Z 19 DT	Diesel	1910	4	114
ZAFIRA Mk II (B) (M75)	1.9	07/00→	Z 19 DTH	Diesel	1910	4	115
ZAFIRA Mk II (B) (M75)	1.9	07/00→	Z 19 DTL	Diesel	1910	4	117
ZAFIRA Mk II (B) (M75)	2.0	01/00→	Z 20 LEH	Petrol	1998	4	151
ZAFIRA Mk II (B) (M75)	2.0	07/00→	Z 20 LER	Petrol	1998	4	153
ZAFIRA Mk II (B) (M75)	2.2	07/00→	Z 22 YH	Petrol	2198	4	169
ZAFIRA Mk III (P12)	1.6	10/01→	A 16 XNT	CNG	1598	4	56
ZAFIRA Mk III (P12)	1.8	10/01→	A 18 XEL	Petrol	1796	4	95
ZAFIRA Mk III (P12)	1.8	10/01→	A 18 XER	Petrol	1796	4	96
ZAFIRA Mk III (P12)	2.0	10/01→	A 20 DT	Diesel	1956	4	123



Ltr



















CC



9

	Ltr				CC		
ZAFIRA Mk III (P12)	2.0	10/01→	A 20 DTH	Diesel	1956	4	125
ZAFIRA Mk III (P12)	2.0	10/01→	A 20 DTL	Diesel	1956	4	127
ZAFIRA Mk III (P12)	2.0	01/01→	A 20 DTR	Diesel	1956	4	128
ZAFIRA Mk III (P12)	2.0	10/01→	Z 20 DTJ	Diesel	1956	4	150

		CC			9			CC			9
12 NC	Petrol	1196	4	79.00	5	C 16 LZ	Petrol	1598	4	80.00	57
12 NV	Petrol	1196	4	77.80	6	C 16 NZ	Petrol	1598	4	79.00	58
12 S	Petrol	1196	4	79.00	7	C 16 SE	Petrol	1598	4	79.00	59
12 ST	Petrol	1196	4	77.80	8	C 16 SEI	Petrol	1598	4	79.00	60
13 N	Petrol	1297	4	75.00	24	C 16 SEL	Petrol	1598	4	79.00	61
13 NB	Petrol	1297	4	75.00	25	C 16 XE	Petrol	1598	4	79.00	62
13 S	Petrol	1297	4	75.00	26	C 18 NZ	Petrol	1796	4	84.80	97
13 SB	Petrol	1297	4	75.00	27	C 18 XE	Petrol	1799	4	81.60	98
14 NV	Petrol	1389	4	77.60	29	C 18 XEL	Petrol	1799	4	81.60	99
15 D	Diesel	1488	4	76.00	40	C 20 LET	Petrol	1998	4	86.00	131
15 DT	Diesel	1488	4	76.00	41	C 20 NE	Petrol	1998	4	86.00	132
15 DT (T4EC1)	Diesel	1488	4	76.00	42	C 20 NEF	Petrol	1998	4	86.00	133
16 D	Diesel	1598	4	80.00	44	C 20 NEJ	Petrol	1998	4	86.00	134
16 DA	Diesel	1598	4	80.00	45	C 20 XE	Petrol	1998	4	86.00	135
16 N	Petrol	1598	4	80.00	46	C 24 NE	Petrol	2410	4	95.00	173
16 SH	Petrol	1598	4	80.00	47	C 25 XE	Petrol	2498	6	81.60	177
16 SV	Petrol	1598	4	79.00	48	C 26 NE	Petrol	2594	6	88.80	192
17 D	Diesel	1699	4	82.50	80	C 30 LE	Petrol	2969	6	95.00	198
17 D (4EE1)	Diesel	1686	4	79.00	81	C 30 NE	Petrol	2969	6	95.00	199
17 DR	Diesel	1699	4	82.50	82	C 30 SEJ	Petrol	2969	6	95.00	200
17 DT (TC4EE1)	Diesel	1686	4	79.00	83	C223	Diesel	2238	4	88.00	156
18 E	Petrol	1796	4	84.80	91	D13A	Diesel	1248	4	69.60	13
18 SE	Petrol	1796	4	84.80	92	E 12 GV	Petrol	1196	4	79.00	14
18 SEH	Petrol	1796	4	84.80	93	E 16 NZ	Petrol	1598	4	79.00	63
18 SV	Petrol	1796	4	84.80	94	E 16 SE	Petrol	1598	4	79.00	64
198 A4.000	CNG	1368	4	72.00	30	E 18 NV	Petrol	1796	4	84.80	100
20 NE	Petrol	1998	4	86.00	118	E 18 NVR	Petrol	1796	4	84.80	101
20 NEJ	Petrol	1998	4	86.00	119	F4R 720	Petrol	1998	4	82.70	136
20 SE	Petrol	1998	4	86.00	120	F4R 820	Petrol	1998	4	82.70	137
20 SEH	Petrol	1998	4	86.00	121	F8Q 600	Diesel	1870	4	80.00	108
20 XE	Petrol	1998	4	86.00	122	F8Q 606	Diesel	1870	4	80.00	109
23 DTR	Diesel	2260	4	92.00	170	F9Q 760	Diesel	1870	4	80.00	110
23 YD	Diesel	2260	4	92.00	171	F9Q 762	Diesel	1870	4	80.00	111
23 YDT	Diesel	2260	4	92.00	172	F9Q 770	Diesel	1870	4	80.00	112
25 DT	Diesel	2497	6	80.00	176	F9Q 774	Diesel	1870	4	80.00	113
28 TDI (4JB1T)	Diesel	2771	4	93.00	194	G9T 720	Diesel	2188	4	87.00	157
30 NE	Petrol	2969	6	95.00	197	G9T 722	Diesel	2188	4	87.00	158
4 JA1	Diesel	2499	4	93.00	174	G9T 750	Diesel	2188	4	87.00	159
4 JA1T	Diesel	2499	4	93.00	175	G9U 630	Diesel	2464	4	89.00	178
4 JG2TC	Diesel	3059	4	95.40	204	G9U 650	Diesel	2464	4	89.00	179
4 JX1	Diesel	2999	4	95.40	196	G9U 720	Diesel	2463	4	89.00	180
6 VDI	Petrol	3165	6	93.40	205	G9U 724	Diesel	2463	4	89.00	181
6 VE1	Petrol	3494	6	93.40	208	G9U 730	Diesel	2463	4	89.00	182
843 A1.000	Petrol	1368	4	72.00	31	G9U 750	Diesel	2463	4	89.00	183
A 13 DTC	Diesel	1248	4	69.60	9	G9U 754	Diesel	2463	4	89.00	184
A 13 DTE	Diesel	1248	4	69.60	10	K10B	Petrol/ Petroleum Gas (LPG)	996	3	73.00	1
A 13 FD	Diesel	1248	4	69.60	11	K10B	Petrol	996	3	73.00	1
A 16 FDH	Diesel	1598	4	79.50	49	M9R 780	Diesel	1995	4	84.00	138
A 16 FDL	Diesel	1598	4	79.50	50	M9R 782	Diesel	1995	4	84.00	139
A 16 LEL	Petrol	1598	4	79.00	51	M9R 784	Diesel	1995	4	84.00	140
A 16 LER	Petrol	1598	4	79.00	52	S 18 NV	Petrol	1796	4	84.80	102
A 16 LES	Petrol	1598	4	79.00	53	S8U 758	Diesel	2499	4	93.00	185
A 16 LET	Petrol	1598	4	79.00	54	S8U 770	Diesel	2499	4	93.00	186
A 16 XER	Petrol	1598	4	79.00	55	S8U 780	Diesel	2499	4	93.00	187
A 16 XNT	CNG	1598	4	79.00	56	S8U 782	Diesel	2499	4	93.00	188
A 18 XEL	Petrol	1796	4	80.50	95	S9W 702	Diesel	2799	4	94.40	195
A 18 XER	Petrol	1796	4	80.50	96	X 10 XE	Petrol	973	3	72.50	2
A 20 DT	Diesel	1956	4	83.00	123	X 12 SZ	Petrol	1195	4	72.00	15
A 20 DTC	Diesel	1956	4	83.00	124	X 12 XE	Petrol	1199	4	72.50	16
A 20 DTH	Diesel	1956	4	83.00	125	X 14 SZ	Petrol	1389	4	77.60	35
A 20 DTJ	Diesel	1956	4	83.00	126	X 14 XE	Petrol	1389	4	77.60	36
A 20 DTL	Diesel	1956	4	83.00	127	X 15 DT (T4EC1)	Diesel	1488	4	76.00	43
A 20 DTR	Diesel	1956	4	83.00	128	X 16 SZ	Petrol	1598	4	79.00	65
A 20 NFT	Petrol	1998	4	86.00	129	X 16 SZR	Petrol	1598	4	79.00	66
A 20 NHT	Petrol	1998	4	86.00	130	X 16 XE	Petrol	1598	4	79.00	67
C 12 NZ	Petrol	1196	4	72.00	12	X 16 XEL	Petrol/ Petroleum Gas (LPG)	1598	4	79.00	68
C 13 N	Petrol	1297	4	75.00	28						
C 14 NZ	Petrol	1389	4	77.60	32						
C 14 SE	Petrol	1389	4	77.60	33						
C 14 SEL	Petrol	1389	4	77.60	34						

		CC			9			CC			9
X 16 XEL	Petrol	1598	4	79.00	68	Z 18 XE	Petrol/ Petroleum Gas (LPG)	1796	4	80.50	105
X 17 D (4EE1)	Diesel	1686	4	79.00	84	Z 18 XE	Petrol	1796	4	80.50	105
X 17 DT (TC4EE1)	Diesel	1686	4	79.00	85	Z 18 XE	Bi-Fuel	1796	4	80.50	105
X 17 DTL	Diesel	1699	4	82.50	86	Z 18 XEL	Petrol	1796	4	80.50	106
X 18 XE	Petrol	1799	4	81.60	103	Z 18 XER	Petrol	1796	4	80.50	107
X 18 XE1	Petrol	1796	4	80.50	104	Z 19 DT	Diesel	1910	4	82.00	114
X 20 DTH	Diesel	1995	4	84.00	141	Z 19 DTH	Diesel	1910	4	82.00	115
X 20 DTL	Diesel	1995	4	84.00	142	Z 19 DTJ	Diesel	1910	4	82.00	116
X 20 SE	Petrol	1998	4	86.00	143	Z 19 DTL	Diesel	1910	4	82.00	117
X 20 XER	Petrol	1998	4	86.00	144	Z 20 DM	Diesel	1991	4	83.00	148
X 20 XEV	Petrol	1998	4	86.00	145	Z 20 DMH	Diesel	1991	4	83.00	149
X 22 DTH	Diesel	2171	4	84.00	160	Z 20 DTJ	Diesel	1956	4	83.00	150
X 22 SE	Petrol	2198	4	86.00	161	Z 20 LEH	Petrol	1998	4	86.00	151
X 22 XE	Petrol	2198	4	86.00	162	Z 20 LEL	Petrol	1998	4	86.00	152
X 25 DT	Diesel	2497	6	80.00	189	Z 20 LER	Petrol	1998	4	86.00	153
X 25 XE	Petrol	2498	6	81.60	190	Z 20 LET	Petrol	1998	4	86.00	154
X 30 XE	Petrol	2962	6	86.00	201	Z 20 NET	Petrol	1998	4	86.00	155
Y 13 DT	Diesel	1248	4	69.60	17	Z 22 SE	Petrol	2198	4	86.00	167
Y 16 XE	Petrol	1598	4	79.00	69	Z 22 XE	Petrol	2198	4	86.00	168
Y 16 YNG	CNG	1598	4	79.00	70	Z 22 XE	Petrol	2198	4	86.00	168
Y 17 DT	Diesel	1686	4	79.00	87	Z 22 YH	Petrol	2198	4	86.00	169
Y 17 DTL	Diesel	1686	4	79.00	88	Z 30 DT	Diesel	2958	6	87.50	203
Y 20 DTH	Diesel	1995	4	84.00	146	Z 32 SE	Petrol	3175	6	88.50	207
Y 20 DTL	Diesel	1995	4	84.00	147						
Y 22 DTH	Diesel	2171	4	84.00	163						
Y 22 DTR	Diesel	2172	4	84.00	164						
Y 22 SE	Petrol	2198	4	86.00	165						
Y 22 XE	Petrol	2198	4	86.00	166						
Y 25 DT	Diesel	2497	6	80.00	191						
Y 26 SE	Petrol	2597	6	83.20	193						
Y 30 DT	Diesel	2958	6	87.50	202						
Y 32 NE	Petrol	3165	6	93.40	206						
Z 10 XE	Petrol	973	3	72.50	3						
Z 10 XEP	Petrol	998	3	73.40	4						
Z 12 XE	Petrol/ Petroleum Gas (LPG)	1199	4	72.50	18						
Z 12 XE	Petrol	1199	4	72.50	18						
Z 12 XEP	Petrol/ Petroleum Gas (LPG)	1229	4	73.40	19						
Z 12 XEP	Petrol	1229	4	73.40	19						
Z 13 DT	Diesel	1248	4	69.60	20						
Z 13 DTE	Diesel	1248	4	69.60	21						
Z 13 DTH	Diesel	1248	4	69.60	22						
Z 13 DTJ	Diesel	1248	4	69.60	23						
Z 14 XE	Petrol	1389	4	77.60	37						
Z 14 XEL	Petrol	1364	4	73.40	38						
Z 14 XEP	Petrol/ Petroleum Gas (LPG)	1364	4	73.40	39						
Z 14 XEP	Petrol	1364	4	73.40	39						
Z 16 LEL	Petrol	1598	4	79.00	71						
Z 16 LER	Petrol	1598	4	79.00	72						
Z 16 LET	Petrol	1598	4	79.00	73						
Z 16 SE	Petrol/ Petroleum Gas (LPG)	1598	4	79.00	74						
Z 16 SE	Petrol	1598	4	79.00	74						
Z 16 XE	Petrol/ Petroleum Gas (LPG)	1598	4	79.00	75						
Z 16 XE	Petrol	1598	4	79.00	75						
Z 16 XE1	Petrol	1598	4	79.00	76						
Z 16 XEP	Petrol	1598	4	79.00	77						
Z 16 XER	Petrol	1598	4	79.00	78						
Z 16 YNG	CNG	1598	4	79.00	79						
Z 17 DTH	Diesel	1686	4	79.00	89						
Z 17 DTL	Diesel	1686	4	79.00	90						



cc



kW/PS



1.0	K10B						1	AH6620 (MLS)		
Agila 1.0 12V	01/08→	996	3	73.00	DOHC	48-50/				
Agila 1.0 i	08/11→					65-68				
Agila 1.0 LPG	01/08→									
1.0	X 10 XE						2	AB5140 (MLS)	CB5140 [13]	EB5140 [3]
Corsa 1.0 i 12V	11/96→09/00	973	3	72.50	DOHC	40/54				
1.0	Z 10 XE						3	AB5140 (MLS)	CB5141 ☒ [13]	EB5140 [3]
Agila 1.0 12V	09/00→08/05	973	3	72.50	DOHC	43/58				
Corsa 1.0 12V	09/00→10/03									
1.0	Z 10 XEP						4	AE5950 (Steel)	CE5950	
Agila 1.0 12V	02/00→11/06	998	3	73.40	DOHC	44/60				
Corsa 1.0 12V	11/03→10/06									
Corsa 1.0 Mk3	11/06→									
1.2	12 NC						5	BN040 (Fibre), 1.360mm	DN041 [13]	ET820
Nova 1.2 i	01/85→10/89	1196	4	79.00	OHV	33/52				
1.2	12 NV						6	BL550 (Fibre)	DL550 →Eng.12ST-19230854 DL551 Eng.12ST-19230855→	EK470 [3]
Nova 1.2 N	01/90→03/93	1196	4	77.80		38/52				
Novavan 1.2	01/90→10/94									
1.2	12 S						7	BN040 (Fibre), 1.360mm	DN041 [13] DN042	ET820
Astra 1.2	09/84→08/91	1196	4	79.00	OHV	40-44/				
Astra 1.2	09/84→08/91					54-60				
Nova 1.2 S	01/88→02/90									
1.2	12 ST						8	BL550 (Fibre)	DL550 →Eng.12ST-19230854 DL551 Eng.12ST-19230855→	EK470 [3]
Nova 1.2 S	01/88→02/90	1196	4	77.80	SOHC/OHC	40-43/				
Nova 1.2 S	05/83→02/90					54-58				
1.2	A 13 DTC Diesel						9	AD5800 (MLS), 0.720mm AD5810 (MLS), 0.820mm, 1 Hole AD5820 (MLS), 0.920mm, 2 Holes	CD5810 ▲	ED5800 FD5810
Corsa 1.3 CDTi	11/06→	1248	4	69.60	DOHC	55/75				
Meriva 1.3 CDTi	06/10→									
1.2	A 13 DTE Diesel						10	AD5800 (MLS), 0.720mm AD5810 (MLS), 0.820mm, 1 Hole AD5820 (MLS), 0.920mm, 2 Holes		
Astra 1.3 CDTi	12/09→	1248	4	69.60	DOHC	70/95				
Astra 1.3 CDTi	10/10→									
Corsa 1.3 CDTi	11/06→									
Meriva 1.3 CDTi	06/10→									
1.2	A 13 FD Diesel						11	AD5800 (MLS), 0.720mm AD5810 (MLS), 0.820mm, 1 Hole AD5820 (MLS), 0.920mm, 2 Holes		
Combo 1.3 CDTi	11/11→	1248	4	69.60	DOHC	66/90				
1.2	C 12 NZ						12	BW170 (Fibre)	DW170	ES260
Combo 1.2	07/94→10/01	1196	4	72.00	SOHC/OHC	33/45				
Corsa 1.2 i	03/93→09/00									
Nova 1.2 i	09/89→03/93									

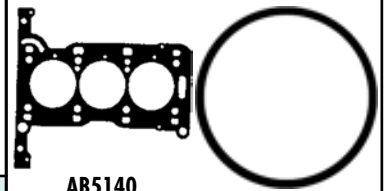
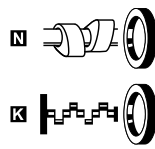
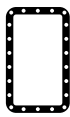
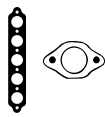

HBS253 [5] M8x1.25x119.00mm (x10)	JD5223 [1] JE5017 [3]	JM5085 (Elastomer)	JH5037	PA5025 (x12) HR5096 [3]	NA5108 [2] 42.00x55.00x7.00mm, FPM/ACM NB698 [1] 80.00x98.00x10.00mm, FPM	JR5030 [6]
HBS253 [5] M8x1.25x119.00mm (x10)	JD5117 [1] (x3) JE5017 [3]	JM5121 (Elastomer)	JH5037	PA5025 (x12) HR5096 [3]	NA5108 [2] 42.00x55.00x7.00mm, FPM/ACM NB698 [1] 80.00x98.00x10.00mm, FPM	
HBS253 [5] M8x1.25x119.00mm (x10)	JD5904 [1] (x4) (FPM) JE5017 [3]	JM5121 (Elastomer)	JH5037	PA5025 (x12) HR5096 [3]	NA5108 [2] 42.00x55.00x7.00mm, FPM/ACM NB698 [1] 80.00x98.00x10.00mm, FPM	JR5030 [6]
HBS112 [5] M9x1.25x100.00mm (x5)	JD5979 [1] JA415 [3]	JN068 [4]	HC288 [3]	HR291 [3]	NB691 [1] 54.00x82.00x9.00mm, ACM	
HBS002 [5] M10x1.25x140.00mm (x10)	JC280 [1] JC281 [3]	JN344 [4] →Eng.12ST-19391635 JN626 [4] Eng.12ST-19391636→	JH5005 (Cork) JJ120 (Cork)	PA565 (x8) Eng.12ST-19230855→ HR342 [3]	NC006 [2] 35.00x48.00x7.00mm, MVQ NB697 [2] 26.00x42.00x8.00mm, FPM NB698 [1] 80.00x98.00x10.00mm, FPM	
HBS112 [5] M9x1.25x100.00mm (x5)	JD5979 [1] JA415 [3]	JN068 [4]	HC288 [3]	PA619 (x8) 9.00/17.00x14.20 (ACM) Eng.12S1154133→ HR291 [3]	NC006 [2] 35.00x48.00x7.00mm, MVQ NB628 [2] 45.00x60.00x9.00mm, ACM NB691 [1] 54.00x82.00x9.00mm, ACM	
HBS002 [5] M10x1.25x140.00mm (x10)	JC280 [1] JC281 [3]	JN344 [4] →Eng.12ST-19391635 JN626 [4] Eng.12ST-19391636→	JH5005 (Cork) JJ120 (Cork)	PA565 (x8) Eng.12ST-19230855→ HR342 [3]	NC006 [2] 35.00x48.00x7.00mm, MVQ NB697 [2] 26.00x42.00x8.00mm, FPM NB698 [1] 80.00x98.00x10.00mm, FPM	
HBS353 [5] M10x1.25x119.00mm (x10)	JD5411 [1] JD5412 [1] [2] JD5413 [3] (MLS)	JM5259 (SE)	HR397	HR5088 [3]	NA5223 [2] 40.00x52.00x7.00mm, FPM NA5230 [2] 78.00x100.00x9.00mm, PTFE	
HBS353 [5] M10x1.25x119.00mm (x10)		JM5259 (SE)			NA5223 [2] 40.00x52.00x7.00mm, FPM NA5230 [2] 78.00x100.00x9.00mm, PTFE	
HBS353 [5] M10x1.25x119.00mm (x10)		JM5259 (SE)			NA5223 [2] 40.00x52.00x7.00mm, FPM NA5230 [2] 78.00x100.00x9.00mm, PTFE	
HBS002 [5] M10x1.25x140.00mm (x10)	JC824 [1] JC281 [3]	JN626 [4]	JH5005 (Cork) JJ120 (Cork)	PA565 (x8) HR342 [3] (x1)	NC006 [2] 35.00x48.00x7.00mm, MVQ NB697 [2] 26.00x42.00x8.00mm, FPM NB698 [1] 80.00x98.00x10.00mm, FPM	

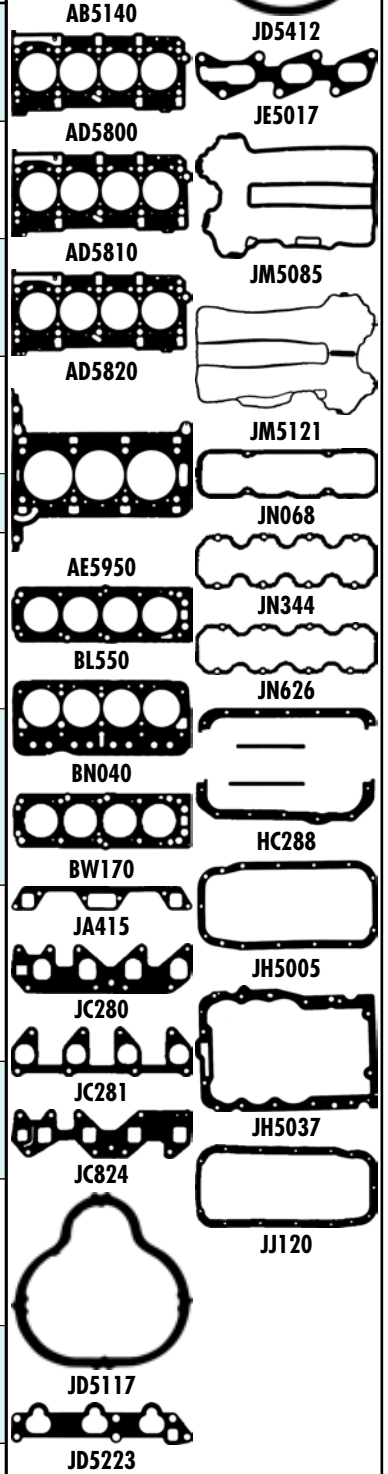



cc



kW/PS



1.2	D13A Diesel					13	AD5800 (MLS), 0.720mm AD5810 (MLS), 0.820mm, 1 Hole AD5820 (MLS), 0.920mm, 2 Holes	CD5810 ▲	ED5800
Agila 1.3 CDTI	01/08→	1248	4	69.60	DOHC	55/75			
1.2	E 12 GV					14	BN040 (Fibre), 1.360mm	DN041 [13]	ET820
Nova 1.2 i	01/85→10/89	1196	4	79.00	OHV	33/45			
1.2	X 12 SZ					15	BW170 (Fibre)	DW170	ES260
Combo 1.2	07/94→10/01	1195	4	72.00	SOHC/OHC	33/45			
Corsa 1.2 i	03/93→09/00								
1.2	X 12 XE					16	AB5240 (MLS)	CB5241 [13]	EB5240 [3]
Astra 1.2 16V	02/98→09/00	1199	4	72.50	DOHC	48/65			
Corsa 1.2 i 16V	03/98→09/00								
1.2	Y 13 DT Diesel					17	AD5800 (MLS), 0.720mm AD5810 (MLS), 0.820mm, 1 Hole AD5820 (MLS), 0.920mm, 2 Holes	CD5810 ▲	ED5800
Combo 1.3 CDTI	09/04→09/06	1248	4	69.60	DOHC	51/70			
Meriva 1.3 CDTI	04/05→06/10								
1.2	Z 12 XE					18	AB5240 (MLS) →Ch.369999999 AH5030 (MLS) Ch.46000001→	CB5240 [13][151][152] [153] →Ch.369999999 CH5030 [151][152][153] Ch.46000001→	EB5240 [3]
Agila 1.2 16V	09/00→03/08	1199	4	72.50	DOHC	55/75			
Astra 1.2 16V	09/00→05/05								
Corsa 1.2 16V	09/00→10/06								
Corsa 1.2 Dual	08/01→10/06								
Corsavan 1.2	09/00→06/06								
1.2	Z 12 XEP					19	AH5030 (MLS)	CH5031	EH5030
Agila 1.2 16V	07/04→11/06	1229	4	73.40	DOHC	59/80			
Astra 1.2	08/05→10/10								
Corsa 1.2	11/06→								
Corsa 1.2 LPG	09/09→								
Corsa 1.2 Twin	07/04→10/06								
Corsavan 1.2	07/09→								
1.2	Z 13 DT Diesel					20	AD5800 (MLS), 0.720mm AD5810 (MLS), 0.820mm, 1 Hole AD5820 (MLS), 0.920mm, 2 Holes	CD5810 ▲	ED5800
Agila 1.3 CDTI	08/03→03/08	1248	4	69.60	DOHC	51-52/ 70-71			
Combo 1.3 CDTI	09/04→02/12								
Corsa 1.3 CDTI	08/00→09/06								
Corsavan 1.3	04/04→06/06								
Meriva 1.3 CDTI	04/05→06/10								
Tigra Twin 1.3	06/04→08/09								
1.2	Z 13 DTE Diesel					21	AD5800 (MLS), 0.720mm AD5810 (MLS), 0.820mm, 1 Hole AD5820 (MLS), 0.920mm, 2 Holes		
Corsa 1.3 CDTI	11/06→	1248	4	69.60	DOHC	70/95			
Corsavan 1.3	07/06→								
1.2	Z 13 DTH Diesel					22	AD5800 (MLS), 0.720mm AD5810 (MLS), 0.820mm, 1 Hole AD5820 (MLS), 0.920mm, 2 Holes	CD5820 ▲	ED5820 FD5820 ▲
Astra 1.3 CDTI	01/04→05/09	1248	4	69.60	DOHC	66-74/ 90-101			
Astra 1.3 CDTi	04/05→11/10								
Astravan 1.3	08/05→								
Corsa 1.3 CDTI	11/06→								
Corsavan 1.3	07/06→								
1.2	Z 13 DTJ Diesel					23	AD5800 (MLS), 0.720mm AD5810 (MLS), 0.820mm, 1 Hole AD5820 (MLS), 0.920mm, 2 Holes	CD5810 ▲	ED5800 FD5810
Agila 1.3 CDTI	01/08→	1248	4	69.60	DOHC	51-55/ 69-75			
Combo 1.3 CDTI	10/05→11/11								
Corsa 1.3 CDTI	09/05→09/06								
Corsavan 1.3	07/06→								
Meriva 1.3 CDTI	01/03→10/09								

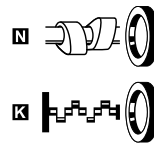
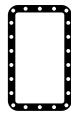
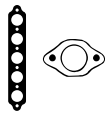

HBS353 [5] M10x1.25x119.00mm (x10)	JD5411 [1] JD5412 [1] [2] JD5413 [3] (MLS)	JM5259 (SE)	HR397	HR5088 [3]	NA5223 [2] [2] 40.00x52.00x7.00mm, FPM NA5230 [2] [2] 78.00x100.00x9.00mm, PTFE	
HBS112 [5] M9x1.25x100.00mm (x5)	JD5979 [1] JA415 [3]	JN068 [4]	HC288 [3]	HR291 [3]	NB691 [1] [1] 54.00x82.00x9.00mm, ACM	
HBS002 [5] M10x1.25x140.00mm (x10)	JC824 [1] JC281 [3]	JN626 [4]	JH5005 (Cork) JJ120 (Cork)	PA565 (x8) HR342 [3] (x1)	NC006 [2] 35.00x48.00x7.00mm, MVQ NB697 [2] [2] 26.00x42.00x8.00mm, FPM NB698 [1] [1] 80.00x98.00x10.00mm, FPM	
HBS252 [5] M8x1.25x119.00mm (x12)	JD5245 [1] [3] JE5024 [3]	JM5048 (Elastomer)	JH5036	PA5025 (x16) HR5048 [3]	NA5108 [2] [2] 42.00x55.00x7.00mm, FPM/ACM NB698 [1] [1] 80.00x98.00x10.00mm, FPM	JR5030 [6]
HBS353 [5] M10x1.25x119.00mm (x10)	JD5411 [1] JD5412 [1] [2] JD5413 [3] (MLS)	JM5259 (SE)	HR397	HR5088 [3]	NA5223 [2] [2] 40.00x52.00x7.00mm, FPM NA5230 [2] [2] 78.00x100.00x9.00mm, PTFE	
HBS252 [5] M8x1.25x119.00mm (x12)	JD5117 [1] (x4) [151][152][153] →Ch.3G999999 JD5904 [1] (x4) [151][152][153] (FPM) Ch.4G000001→ JE5024 [3]	JM5048 (Elastomer) →Eng.1G001502 JM5071 (Elastomer) Eng.1G001503→	JH5036	PA5025 (x16) HR5048 [3]	NA5108 [2] [2] 42.00x55.00x7.00mm, FPM/ACM NB698 [1] [1] 80.00x98.00x10.00mm, FPM	JR5030 [6]
HBS252 [5] M8x1.25x119.00mm (x12)	JD5904 [1] (x4) (FPM)	JM5048 (Elastomer) →Eng.1G001502 JM5071 (Elastomer) Eng.1G001503→	JH5036	HR5048 [3]	NA5108 [2] [2] 42.00x55.00x7.00mm, FPM/ACM NB698 [1] [1] 80.00x98.00x10.00mm, FPM	
HBS353 [5] M10x1.25x119.00mm (x10)	JD5411 [1] JD5413 [3] (MLS)	JM5259 (SE)	HR397	HR5088 [3]	NA5223 [2] [2] 40.00x52.00x7.00mm, FPM NA5230 [2] [2] 78.00x100.00x9.00mm, PTFE	KK5646 [17]
HBS353 [5] M10x1.25x119.00mm (x10)	JD5413 [3] (MLS)	JM5259 (SE)	HR397	HR5088 [3]	NA5223 [2] [2] 40.00x52.00x7.00mm, FPM NA5230 [2] [2] 78.00x100.00x9.00mm, PTFE	
HBS353 [5] M10x1.25x119.00mm (x10)	JD5993 [1] JD5413 [3] (MLS)	JM5259 (SE)	HR397	HR5088 [3]	NA5223 [2] [2] 40.00x52.00x7.00mm, FPM NA5230 [2] [2] 78.00x100.00x9.00mm, PTFE	
HBS353 [5] M10x1.25x119.00mm (x10)	JD5411 [1] JD5413 [3] (MLS)	JM5259 (SE)	HR397	HR5088 [3]	NA5223 [2] [2] 40.00x52.00x7.00mm, FPM NA5230 [2] [2] 78.00x100.00x9.00mm, PTFE	

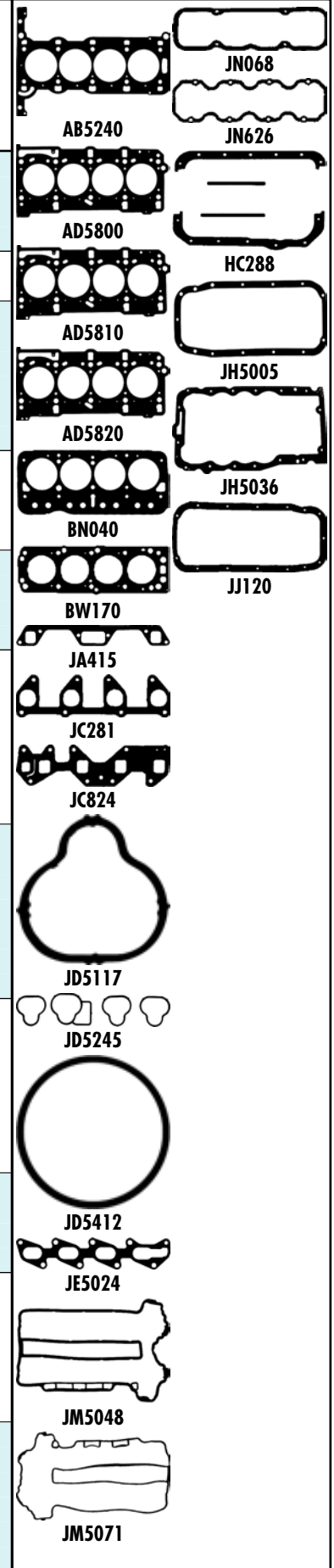



cc



kW/PS



1.3		13 N				24		BK470 (Fibre)		DK470		EK470 [3]	
AstraMAX 1.3 N	08/85→12/89	1297	4	75.00	SOHC/OHC	39-44/ 53-60		→08/86		→08/86 →Eng.13N-1535880		→08/86 GK470 →08/86	
Cavalier 1.3 N	09/81→08/88												
1.3		13 NB				25		BK470 (Fibre)		DK470		EK470 [3]	
AstraMAX 1.3 N	08/85→12/89	1297	4	75.00	SOHC/OHC	44/60				→12/86		GK470	
Cavalier 1.3	09/81→08/88									DK471			
Nova 1.3 i	09/85→10/89									01/87→			
1.3		13 S				26		BK470 (Fibre)		DK470		EK470 [3]	
Astra 1.3	09/84→08/91	1297	4	75.00	SOHC/OHC	42-55/ 57-75				→12/86		GK470	
Astra 1.3	09/84→08/91									DK471			
Astra Belm 1.3	09/85→08/91									01/87→			
AstraMAX 1.3 S	08/85→12/89												
Cavalier 1.3 S	09/81→08/88												
Cavalier 1.3 S	09/81→08/88												
1.3		13 SB				27		BK470 (Fibre)		DK470		EK470 [3]	
Nova 1.3 S	05/83→10/89	1297	4	75.00	SOHC/OHC	51/69				→12/86		GK470	
										DK471			
										01/87→			
1.3		C 13 N				28		BK470 (Fibre)		DK470		EK470 [3]	
Astra 1.3 i CAT	09/85→08/91	1297	4	75.00	SOHC/OHC	44/60				→12/86			
Nova 1.3 i CAT	09/89→03/93									DK471			
										01/87→			
1.4		14 NV				29		BS260 (Fibre)		DS260		EK470 [3]	
Astra 1.4 S	01/89→08/91	1389	4	77.60	SOHC/OHC	53-55/ 72-75							
Astra 1.4 S	09/91→02/98												
Astra Conv 1.4	09/91→09/93												
AstraMAX 1.4 S	07/89→08/91												
Cavalier 1.4 S	09/88→11/95												
Nova 1.4 S	01/90→02/93												
Nova 1.4 S	01/90→03/93												
Novavan 1.4	11/90→03/93												
1.4		198 A4.000				30		AH6510 (MLS)				EE5180 [3]	
Combo 1.4 CNG	11/11→	1368	4	72.00	DOHC	88/120							
1.4		843 A1.000				31		AG7310 (MLS)		CG7310		EE5180 [3]	
Combo 1.4	11/11→	1368	4	72.00	DOHC	70/95							

HBS002 [5] M10x1.25x140.00mm (x10) →08/86	JC280 [1] →08/86 JC281 [1] →08/86 JE119 →08/86	JN344 [4] →08/86 →Eng.13N-1535880 JN626 [4] →08/86 Eng.13N-1535881→	JH5005 (Cork) →08/86 JJ120 (Cork) →08/86	PA565 (x8) →08/86 HR342 [1] (x1) →08/86	NC006 [2] 35.00x48.00x7.00mm, MVQ →08/86 NB697 [2] 26.00x42.00x8.00mm, FPM →08/86 NB698 [1] 80.00x98.00x10.00mm, FPM →08/86	 BK470 BS260 JA5006 JC280 JC281 JC824 JE119 JE120 JM5176 JN344 JN626 JH5005 JJ120	
HBS002 [5] M10x1.25x140.00mm (x10)	JC280 [1] JC281 [1] JE119	JN344 [4] →12/86 JN626 [4] 01/87→	JH5005 (Cork) JJ120 (Cork)	PA565 HR342 [1] (x1)	NC006 [2] 35.00x48.00x7.00mm, MVQ NB697 [2] 26.00x42.00x8.00mm, FPM NB698 [1] 80.00x98.00x10.00mm, FPM	 JC824 JE119 JE120 JM5176 JN344 JN626 JH5005 JJ120	
HBS002 [5] M10x1.25x140.00mm (x10)	JC280 [1] JC281 [1] JE119	JN344 [4] →12/86 JN626 [4] 01/87→	JH5005 (Cork) JJ120 (Cork)	PA565 HR342 [1] (x1)	NC006 [2] 35.00x48.00x7.00mm, MVQ NB697 [2] 26.00x42.00x8.00mm, FPM NB698 [1] 80.00x98.00x10.00mm, FPM	 JM5176 JN344 JN626 JH5005 JJ120	
HBS002 [5] M10x1.25x140.00mm (x10)	JC280 [1] JC281 [1] JE119	JN344 [4] →12/86 JN626 [4] 01/87→	JH5005 (Cork) JJ120 (Cork)	PA565 (x8) HR342 [1] (x1)	NC006 [2] 35.00x48.00x7.00mm, MVQ NB697 [2] 26.00x42.00x8.00mm, FPM NB698 [1] 80.00x98.00x10.00mm, FPM	 JM5176 JN344 JN626 JH5005 JJ120	
HBS002 [5] M10x1.25x140.00mm (x10)	JC280 [1] JC281 [1] JE120	JN626 [4]	JH5005 (Cork) JJ120 (Cork)	PA565 (x8) HR342 [1] (x1)	NC006 [2] 35.00x48.00x7.00mm, MVQ NB697 [2] 26.00x42.00x8.00mm, FPM NB698 [1] 80.00x98.00x10.00mm, FPM	 JM5176 JN344 JN626 JH5005 JJ120	
HBS247 [5] M9x1.25x87.00mm (x10)		JM5176	HR397	HR814 [1]	NA5058 [2] 40.00x55.00x7.00mm, FPM NA5057 [2] 27.00x37.00x7.00mm, FPM LK5001 [1] [2] [7] 74.00x187.50x17.000mm, FPM		
HBS247 [5] M9x1.25x87.00mm (x10)	JA5006 [1]	JM5176	HR397	HR814 [1]	NA5058 [2] 40.00x55.00x7.00mm, FPM NA5057 [2] 27.00x37.00x7.00mm, FPM LK5001 [1] [2] [7] 74.00x187.50x17.000mm, FPM		



cc



kW/PS



1.4		C 14 NZ					32	BS260 (Fibre)	DS260	EK470 [3]
Astra 1.4	05/98→05/05	1389	4	77.60	SOHC/OHC	44/60				
Astra 1.4 i	01/90→09/98									
Astra 1.4 i	09/91→02/98									
Astra Conv 1.4i	09/91→02/98									
AstraMAX 1.4 i	08/91→07/94									
Astravan 1.4 i	01/91→10/94									
Combo 1.4	07/94→10/01									
Corsa 1.4 i	03/93→09/00									
Corsavan 1.4 i	01/94→09/00									
Nova 1.4	10/90→08/92									
Nova 1.4 i	01/90→03/93									
1.4		C 14 SE					33	BS260 (Fibre)	DS261 [3]	ES260
Astra 1.4 i	03/91→09/98	1389	4	77.60	SOHC/OHC	60/82				
Astra 1.4 i	03/92→02/98									
Astra Conv 1.4i	05/93→03/01									
Combo 1.4	07/94→10/01									
Corsa 1.4 i S	03/93→09/00									
Nova 1.4	09/90→08/92									
Nova 1.4 i S	09/91→03/93									
1.4		C 14 SEL					34	AY210 (Fibre)	CY210 [3]	EY230
Corsa 1.4 i 16V	08/97→09/00	1389	4	77.60	DOHC	63/86				
1.4		X 14 SZ					35	BS260 (Fibre)	DS261 [3]	ES260
Astra 1.4	05/98→05/05	1389	4	77.60	SOHC/OHC	40-44/ 54-60				
Corsa 1.4 i	03/93→09/00									
1.4		X 14 XE					36	AY210 (Fibre)	CY210 [3] CY211 [3] 02/98→	EY230
Astra 1.4 16V	02/98→05/05	1389	4	77.60	DOHC	66/90				
Astra 1.4 i 16V	02/96→09/98									
Astra Conv 1.4i	01/96→03/01									
Combo 1.4 16V	08/99→10/01									
Corsa 1.4 i 16V	09/94→09/00									
Tigra Coupe 1.4	07/94→12/00									
1.4		Z 14 XE					37	AB5360 (MLS)	CB5360 [3] →Eng.02M25254 EB5541 [18] Eng.02M25255→	
Astra 1.4 16V	02/98→05/05	1389	4	77.60	DOHC	66/90				
Combo 1.4	10/01→05/07									
Corsa 1.4 i 16V	09/00→10/06									
1.4		Z 14 XEL					38	AH5030 (MLS)	CH5030	EH5030
Astra 1.4	02/05→11/10	1364	4	73.40	DOHC	55-59/ 75-80				
Astra 1.4	04/04→10/10									

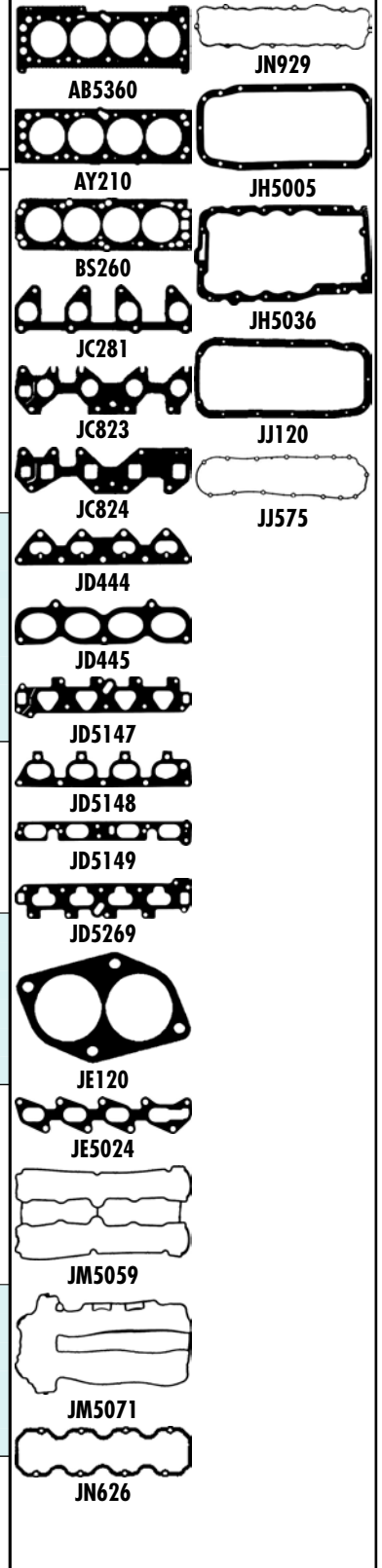
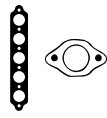

HBS002 [5] M10x1.25x140.00mm (x10)	JC824 [1] JC281 [1] ☉JE120	JN626 [4]	JH5005 (Cork) JJ120 (Cork)	HR342 [x1]	NC006 [2] 35.00x48.00x7.00mm, MVQ NB697 [2] 26.00x42.00x8.00mm, FPM NB698 [1] 80.00x98.00x10.00mm, FPM	
HBS002 [5] M10x1.25x140.00mm (x10)	JC823 [1] JC281 [1] ☉JE120	JN929 [4]	JH5005 (Cork) JJ120 (Cork)	PA565 (x8) HR342 [x1]	NC006 [2] 35.00x48.00x7.00mm, MVQ NB697 [2] 26.00x42.00x8.00mm, FPM NB698 [1] 80.00x98.00x10.00mm, FPM	
HBS055 [5] M10x1.25x153.00mm (x10)	JD445 [1] JD444 [1]		JJ575	PA5041 6.00/12.20x10.00 (FPM) HR791 [1]	NC006 [2] 35.00x48.00x7.00mm, MVQ NB697 [2] 26.00x42.00x8.00mm, FPM NB698 [1] 80.00x98.00x10.00mm, FPM	
HBS002 [5] M10x1.25x140.00mm (x10)	JC823 [1] JC281 [1] ☉JE120	JN929 [4]	JH5005 (Cork) JJ120 (Cork)	PA565 (x8) HR342 [1]	NC006 [2] 35.00x48.00x7.00mm, MVQ NB697 [2] 26.00x42.00x8.00mm, FPM NB698 [1] 80.00x98.00x10.00mm, FPM	
HBS055 [5] M10x1.25x153.00mm (x10)	JD445 [1] JD5147 [1] →01/98 JD5149 [1] JD5269 [1] 02/98→ JD444 [1]	JM5059 (Elastomer)	JH5005 (Cork) JJ120 (Cork) JJ575	PA5041 6.00/12.20x10.00 (FPM) HR791 [1]	NC006 [2] 35.00x48.00x7.00mm, MVQ NB697 [2] 26.00x42.00x8.00mm, FPM NB698 [1] 80.00x98.00x10.00mm, FPM	
HBS055 [5] M10x1.25x153.00mm (x10)	JD5147 [1] JD5149 [1] JD5148 [1]	JM5059 (Elastomer)	JJ120 (Cork) JJ575	PA5041 (x16) 6.00/12.20x10.00 (FPM) HR791 [1]	NC006 (x2) [2] 35.00x48.00x7.00mm, MVQ NB697 [2] 26.00x42.00x8.00mm, FPM NB698 [1] 80.00x98.00x10.00mm, FPM	
HBS252 [5] M8x1.25x119.00mm (x12)	JD5904 [1] (x4) (FPM) JE5024 [1]	JM5071 (Elastomer)	JH5036	PA5025 HR5048 [1]	NA5108 [2] 42.00x55.00x7.00mm, FPM/ACM NB698 [1] 80.00x98.00x10.00mm, FPM	JR5030 [6]



cc



kW/PS



1.4		Z 14 XEP				39		AH5030 (MLS)	CH5030	EH5030
Astra 1.4	01/04→05/09	1364	4	73.40	DOHC	66/90				
Astra 1.4 i 16V	03/05→11/10									
Astravan 1.4 i	03/05→									
Combo 1.4	01/04→11/11									
Corsa 1.4 LPG	07/06→									
Corsa 1.4 Mk3	07/06→									
Corsa 1.4 Twin	06/03→10/06									
Corsavan 1.4	11/03→06/06									
Meriva 1.4	01/03→10/09									
Tigra Twin 1.4	06/04→08/09									
1.5		15 D Diesel				40		AY840 (MLS), 1.400mm →Eng.975024 AY850 (MLS), 1.450mm, 1 Hole →Eng.975024 AY860 (MLS), 1.500mm, 2 Holes →Eng.975024 AY900 (MLS), 1.400mm Eng.975025→ AY910 (MLS), 1.450mm, 1 Hole Eng.975025→ AY920 (MLS), 1.500mm, 2 Holes Eng.975025→	CY811 ▲[13]	FY811 ▲[3]
Corsa 1.5 D	03/93→09/00	1488	4	76.00	SOHC/OHC	37/50				
Corsavan 1.5 D	08/94→12/95									
Nova 1.5 D	09/87→02/93									
Nova 1.5 D	09/87→03/93									
Novavan 1.5 D	01/91→10/94									
1.5		15 DT Diesel				41		AY840 (MLS), 1.400mm →Eng.975024 AY850 (MLS), 1.450mm, 1 Hole →Eng.975024 AY860 (MLS), 1.500mm, 2 Holes →Eng.975024 AY900 (MLS), 1.400mm Eng.975025→ AY910 (MLS), 1.450mm, 1 Hole Eng.975025→ AY920 (MLS), 1.500mm, 2 Holes Eng.975025→	CY811 ▲[13]	FY811 ▲[3]
Astra 1.5 DT	01/87→08/89	1488	4	76.00	SOHC/OHC	53/73				
1.5		15 DT (T4EC1) Diesel				42		AY840 (MLS), 1.400mm 02/88→ →Eng.975024 AY850 (MLS), 1.450mm, 1 Hole 02/88→ →Eng.975024 AY860 (MLS), 1.500mm, 2 Holes 02/88→ →Eng.975024 AY900 (MLS), 1.400mm 02/88→ Eng.975025→ AY910 (MLS), 1.450mm, 1 Hole 02/88→ Eng.975025→ AY920 (MLS), 1.500mm, 2 Holes 02/88→ Eng.975025→	CY811 ▲[13] 02/88→	FY811 ▲[3] 02/88→
Astra 1.5 DT	01/88→08/91	1488	4	76.00	SOHC/OHC	49-53/ 67-72				
Corsa 1.5 TD	03/93→10/96									
Nova 1.5 TD	01/90→02/93									
Nova 1.5 TD	01/90→03/93									

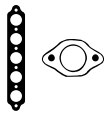

AY840, AY850,
AY860



AY900, AY910,
AY920



JD304



JE5024



JM5071

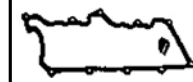

JN777



JH5036



JH5058



cc



kW/PS



1.5		X 15 DT (T4EC1) Diesel			43				
Corsa 1.5 TD	03/93→10/96	1488	4	76.00	SOHC/OHC	49/67	AY840 (MLS), 1.400mm →Eng.975024 AY850 (MLS), 1.450mm, 1 Hole →Eng.975024 AY860 (MLS), 1.500mm, 2 Holes →Eng.975024 AY900 (MLS), 1.400mm Eng.975025→ AY910 (MLS), 1.450mm, 1 Hole Eng.975025→ AY920 (MLS), 1.500mm, 2 Holes Eng.975025→	CY811 ▲[13]	FY811 ▲[3]
1.6		16 D Diesel			44				
Cavalier 1.6 D	03/82→08/88	1598	4	80.00	SOHC/OHC	40/54	BLO10 (Fibre), 1.400mm ☞→0.750mm BLO20 (Fibre), 1.500mm, 1 Notch ☞0.750→0.850mm BLO30 (Fibre), 1.600mm, 2 Notches ☞0.850mm→	DL010 ▲ →12/85 DL011 ▲ 01/86→	EK481 [3] →12/85 EK485 01/86→
1.6		16 DA Diesel			45				
Astra 1.6 D	09/84→12/89	1598	4	80.00	SOHC/OHC	40/54	BLO10 (Fibre), 1.400mm ☞→0.750mm BLO20 (Fibre), 1.500mm, 1 Notch ☞0.750→0.850mm BLO30 (Fibre), 1.600mm, 2 Notches ☞0.850mm→	DL010 ▲ →12/85 DL011 ▲ 01/86→	EK481 [3] →12/85 EK485 01/86→
1.6		16 N			46				
Cavalier 1.6 N	09/81→08/88	1598	4	80.00	SOHC/OHC	51-55/ 69-75	BK480 (Fibre)	DK480	EJ160
1.6		16 SH			47				
Astra Belm 1.6	09/85→08/91	1598	4	80.00	SOHC/OHC	66/90	BK480 (Fibre)	DK480	
Cavalier 1.6	10/83→08/88								
Cavalier 1.6 S	09/81→08/88								
Cavalier 1.6 S	09/81→08/88								
1.6		16 SV			48				
Astra 1.6	09/84→08/91	1598	4	79.00	SOHC/OHC	60/82	BP800 (Fibre)	DP800	EK484
Astra 1.6 S	01/89→12/91								
Astra Conv 1.6i	01/87→12/91								
AstraMAX 1.6	09/85→12/91								
Cavalier 1.6	09/88→05/93								
Cavalier 1.6	09/88→05/93								
1.6		A 16 FDH Diesel			49				
Combo 1.6 CDTi	11/11→	1598	4	79.50	DOHC	74-77/ 101-105	AH6880 (MLS), 0.82mm AH6890 (MLS), 0.92mm, 1 Hole AH6900 (MLS), 1.02mm, 2 Holes		
1.6		A 16 FDL Diesel			50				
Combo 1.6 CDTi	11/11→	1598	4	79.50	DOHC	66/90	AH6880 (MLS), 0.82mm AH6890 (MLS), 0.92mm, 1 Hole AH6900 (MLS), 1.02mm, 2 Holes		

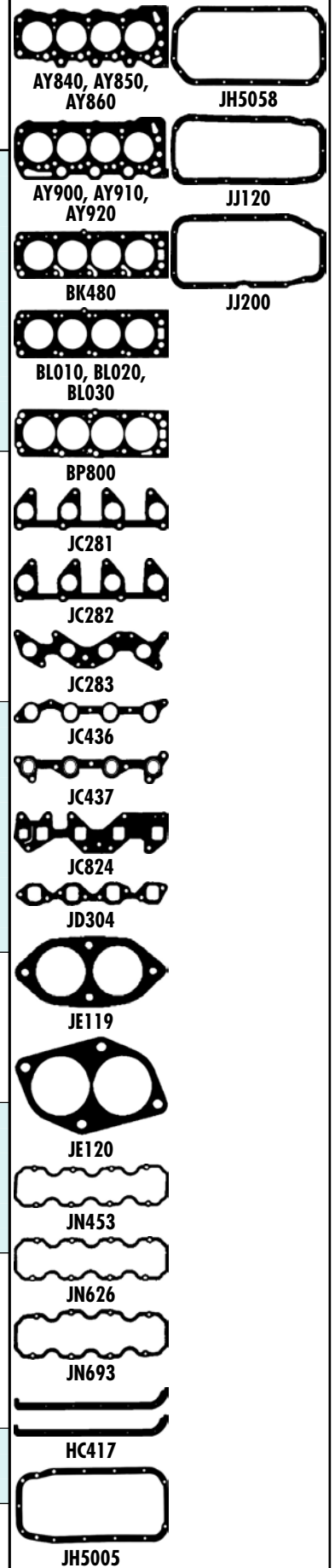
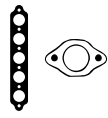

HBS036 [22] M12x1.50x102.00mm (x10)	JD5914 [1] JD304 [1] ☞JE5029	JN776 [4]	JH5058	PA658 (x8)	NJ449 [2] 40.00x52.00x6.00mm, NBR NK103 [1] 87.00x100.00x8.50mm, FPM NJ450 [1][2] 45.00x68.00x12.00mm, NBR	
HBS074 [5] M11x1.25x154.00mm (x10)	JC436 [1] JC437 [1] ☞JE119	JN453 [4] →12/85 JN693 [4] 01/86→	JJ200	HR343 [1]	NC006 [2] 35.00x48.00x7.00mm, MVQ NB734 [2] 35.00x50.00x8.00mm, FPM NB701 [1] 86.00x104.00x11.00mm, FPM →Eng.16DA-14498630 NB806 [1] 90.00x104.00x11.00mm, FPM Eng.16DA-14498631→	
HBS074 [5] M11x1.25x154.00mm (x10)	JC436 [1] JC437 [1] ☞JE119	JN693 [4] Eng.16DA-14498632→ JN453 [4] Eng.16DA-14503756→ →Eng.16DA-14498630	JJ200	HR343 [1]	NC006 [2] 35.00x48.00x7.00mm, MVQ NB734 [2] 35.00x50.00x8.00mm, FPM NB701 [1] 86.00x104.00x11.00mm, FPM →Eng.16DA-14498630 NB806 [1] 90.00x104.00x11.00mm, FPM Eng.16DA-14498631→	
HBS053 [5] M11x1.25x140.00mm (x10)	JC283 [1] JC282 [1] ☞JE120	JN453 [4]	HC417 [1] JJ200	PA619 (x4) 9.00/17.00x14.20 (ACM) Eng.16N300001→ HR343 [1]	NC006 [2] 35.00x48.00x7.00mm, MVQ NB700 [2] 31.00x50.00x8.00mm, MVQ NB701 [1] 86.00x104.00x11.00mm, FPM	
HBS053 [5] M11x1.25x140.00mm (x10)	JC283 [1] JC282 [1] ☞JE120	JN453 [4]	JJ200	HR343 [1]	NC006 [2] 35.00x48.00x7.00mm, MVQ NB700 [2] 31.00x50.00x8.00mm, MVQ NB701 [1] 86.00x104.00x11.00mm, FPM	
HBS002 [5] M10x1.25x140.00mm (x10)	JC824 [1] JC281 [1] ☞JE120	JN626 [4]	JH5005 (x2) (Cork) JJ120 (x2) (Cork)	PA565 (x8) HR342 (x1)	NC006 [2] 35.00x48.00x7.00mm, MVQ NB697 [2] 26.00x42.00x8.00mm, FPM NB698 [1] 80.00x98.00x10.00mm, FPM	
					NA5070 [2] 31.00x41.00x7.00mm, FPM	
					NA5070 [2] 31.00x41.00x7.00mm, FPM	



cc



kW/PS



1.6		A 16 LEL					51	AH5240 (MLS)	CH5241 (MLS)	EH5240
Corso 1.6 SRI	05/07→	1598	4	79.00	DOHC	110/150				
1.6		A 16 LER					52	AH5240 (MLS)	CH5241 (MLS)	EH5240
Corso 1.6 VXR	02/07→	1598	4	79.00	DOHC	141/192				
1.6		A 16 LES					53	AH5240 (MLS)	CH5241 (MLS)	EH5240
Corso 1.6 VXR	06/11→03/12	1598	4	79.00	DOHC	150-155/ 204-211				
1.6		A 16 LET					54	AH5240 (MLS)	CH5241 (MLS)	EH5240
Astra 1.6 Turbo	12/09→	1598	4	79.00	DOHC	132/180				
Astra GTC 1.6	10/11→									
Astra S 1.6 T	10/10→									
Insignia 1.6 T	01/09→									
1.6		A 16 XER					55	AH5240 (MLS)	CH5242 (MLS)	EH5240
Astra 1.6	06/12→	1598	4	79.00	DOHC	85/116				
Astra 1.6	08/04→03/09									
Astra S 1.6	10/10→									
Insignia 1.6	07/08→									
Mokka 1.6	06/12→									
Zafira 1.6	12/07→									
1.6		A 16 XNT					56	AH5240 (MLS)	CH5241 (MLS)	EH5240
Zafira 1.6 CNG	02/09→	1598	4	79.00	DOHC	110/150				
Zafira 1.6 CNG	10/11→									
1.6		C 16 LZ					57	BP800 (Fibre)	DP802	EK484
Astra Conv 1.6i	10/87→02/93	1598	4	80.00	SOHC/OHC	55/75				
Cavalier 1.6 i	08/86→08/88									
1.6		C 16 NZ					58	BP800 (Fibre)	DP802	EK484
Astra 1.6 i	03/92→09/98	1598	4	79.00	SOHC/OHC	55/75	10/87→08/94	10/87→08/94	10/87→10/91	
Astra 1.6 i	09/91→02/98								ES260	
Astra Conv 1.6i	10/87→02/93								11/91→08/94	
AstraMAX 1.6 i	08/91→10/94									
Astravan 1.6 i	01/91→08/98									
Cavalier 1.6 i	08/86→08/88									
1.6		C 16 SE					59	BP800 (Fibre)	DP803	EK484
Astra 1.6 i	03/92→02/98	1598	4	79.00	SOHC/OHC	74/101				
Astra 1.6 i	05/92→12/94									
Astra 1.6 Si	03/91→12/94									
Astra Conv 1.6	03/94→08/95									
Nova 1.6 GSI	02/92→03/93									

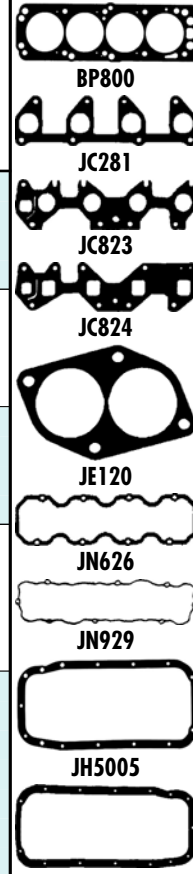
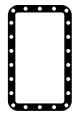

HBS055 [5] M10x1.25x153.00mm (x10)		JM7103 (Elastomer)			NC006 [2] 35.00x48.00x7.00mm, MVQ NA5174 [2] 31.50x42.00x7.00mm, FPM	NA5174 [2][10]
HBS055 [5] M10x1.25x153.00mm (x10)		JM7103 (Elastomer)			NC006 [2] 35.00x48.00x7.00mm, MVQ NA5174 [2] 31.50x42.00x7.00mm, FPM	NA5174 [2][10]
HBS055 [5] M10x1.25x153.00mm (x10)		JM7103 (Elastomer)			NC006 [2] 35.00x48.00x7.00mm, MVQ NA5174 [2] 31.50x42.00x7.00mm, FPM	
HBS055 [5] M10x1.25x153.00mm (x10)		JM7103 (Elastomer)			NC006 [2] 35.00x48.00x7.00mm, MVQ NA5174 [2] 31.50x42.00x7.00mm, FPM	NA5174 [2][10]
HBS055 [5] M10x1.25x153.00mm (x10)		JM7103 (Elastomer)			NC006 [2] 35.00x48.00x7.00mm, MVQ NA5174 [2] 31.50x42.00x7.00mm, FPM	NA5174 [2][10]
HBS055 [5] M10x1.25x153.00mm (x10)		JM7103 (Elastomer)			NC006 [2] 35.00x48.00x7.00mm, MVQ NA5174 [2] 31.50x42.00x7.00mm, FPM	NA5174 [2][10]
HBS002 [5] M10x1.25x140.00mm (x10)	JC824 [1] JC281 [1] ⊕ JE120	JN626 [4]	JH5005 (Cork) JJ120 (x2) (Cork)	PA565 (x8) HR342 [1] (x1)	NC006 [2] 35.00x48.00x7.00mm, MVQ NB697 [2] 26.00x42.00x8.00mm, FPM NB698 [1] 80.00x98.00x10.00mm, FPM	
HBS002 [5] M10x1.25x140.00mm (x10) 10/87→08/94	JC824 [1] 10/87→08/94 JC281 [1] 10/87→08/94 ⊕ JE120 10/87→08/94	JN626 [4] 10/87→08/94	JH5005 (Cork) 10/87→08/94 JJ120 (Cork) 10/87→08/94	PA565 (x8) 10/87→08/94 HR342 [1] (x1) 10/87→08/94	NC006 [2] 35.00x48.00x7.00mm, MVQ 10/87→08/94 NB697 [2] 26.00x42.00x8.00mm, FPM 10/87→08/94 NB698 [1] 80.00x98.00x10.00mm, FPM 10/87→08/94	
HBS002 [5] M10x1.25x140.00mm (x10)	JC823 [1] JC281 [1] ⊕ JE120	JN929 [4]	JH5005 (Cork) JJ120 (Cork)	PA565 (x8) HR342 [1] (x1)	NC006 [2] 35.00x48.00x7.00mm, MVQ NB697 [2] 26.00x42.00x8.00mm, FPM NB698 [1] 80.00x98.00x10.00mm, FPM	



BP800



JC281



JC823



JC824



JE120



JN626

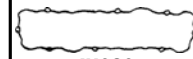

JN929



JH5005

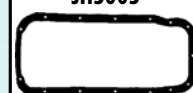

JJ120



cc



kW/PS



1.6		C 16 SEI				60		BP800 (Fibre)	DP803	EK484
Nova 1.6 GSi	09/89→03/93	1598	4	79.00	SOHC/OHC	72/98	01/90→12/92	01/90→12/92	01/90→12/92	
1.6		C 16 SEL				61		AY220 (Fibre)	DY231 [3]	EY230
Astra 1.6 16V	09/98→05/05	1598	4	79.00	DOHC	74/100				
Corsa 1.6 i 16V	08/97→09/00									
1.6		C 16 XE				62		AY220 (Fibre)	DY231 [3]	EY230
Corsa 1.6 GSi	03/93→09/00	1598	4	79.00	DOHC	78-80/ 106-109				
1.6		E 16 NZ				63		BP800 (Fibre)	DP802	EK484
Astra 1.6 i	09/91→02/98	1598	4	79.00	SOHC/OHC	55/75				
Astra Conv 1.6i	01/91→08/93									
Cavalier 1.6 i	08/86→11/95									
1.6		E 16 SE				64		BP800 (Fibre)	DP802	EK484
Nova 1.6	09/88→08/90	1598	4	79.00	SOHC/OHC	60-74/ 81-101				
Nova 1.6 GSi	05/88→03/92									
1.6		X 16 SZ				65		BP800 (Fibre)	DP802	EK484
Astra 1.6 i	07/94→02/98	1598	4	79.00	SOHC/OHC	52/71				
Astra 1.6 i	08/94→07/96									
Astra Conv 1.6i	03/93→08/96									
Astravan 1.6 i	02/94→10/96									
Cavalier 1.6 i	09/93→11/95									
Cavalier 1.6 i	09/93→11/95									
1.6		X 16 SZR				66		BP800 (Fibre)	DP806 [3]	ECO40 [3]
Astra 1.6	02/98→04/04	1598	4	79.00	SOHC/OHC	55/75				
Astra 1.6 i	03/92→09/98									
Astra Conv 1.6i	01/96→03/01									
Astravan 1.6 i	08/98→09/00									
Vectra 1.6 i	08/95→03/02									
1.6		X 16 XE				67		AY220 (Fibre)	CY220 [3]	EY230
Corsa 1.6 i 16V	09/94→09/00	1598	4	79.00	DOHC	78-80/ 106-109				
Tigra Coupe 1.6	07/94→12/00									
1.6		X 16 XEL				68		AY220 (Fibre)	CY220 [3] →09/98 DY232 [3] 10/98→	EY230
Astra 1.6 16V	02/98→05/05	1598	4	79.00	DOHC	74/101				
Astra 1.6 i 16V	01/94→09/98									
Vectra 1.6i 16V	08/95→03/02									
Zafira 1.6 16V	04/99→08/05									
Zafira 1.6 Dual	11/98→08/05									

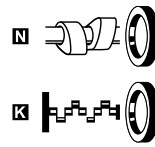
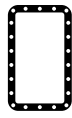
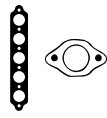

AY220



BP800



JC281



JC823

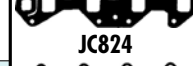

JC824



JD444

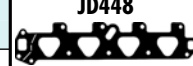

JD448



JD5147



JD5269



JE120



JM5059

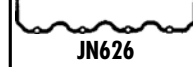

JN626



JN929



JP008

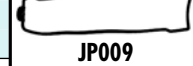

JP009



JH5005



JJ120

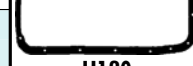

JJ575

HBS002 [5] M10x1.25x140.00mm (x10) 01/90→12/92	JC823 [1] 01/90→12/92 JC281 [1] 01/90→12/92 JE120 01/90→12/92	JN929 [4] 01/90→12/92	JH5005 (Cork) 01/90→12/92 JJ120 (Cork) 01/90→12/92	PA565 (x8) 01/90→12/92 HR342 [1] 01/90→12/92	NC006 [2] 35.00x48.00x7.00mm, MVQ 01/90→12/92 NB697 [2] 26.00x42.00x8.00mm, FPM 01/90→12/92 NB698 [1] 80.00x98.00x10.00mm, FPM 01/90→12/92	
HBS055 [5] M10x1.25x153.00mm (x10)	JD448 [1] JD5147 [1] JD444 [1]	JM5059 (Elastomer) JP008 [4] JP009 [4]	JJ575	PA5041 (x16) 6.00/12.20x10.00 (FPM) HR791 [1]	NC006 (x2) [2] 35.00x48.00x7.00mm, MVQ NB697 [2] 26.00x42.00x8.00mm, FPM NB698 [1] 80.00x98.00x10.00mm, FPM	
HBS055 [5] M10x1.25x153.00mm (x10)	JD448 [1] JD5269 [1] JD444 [1]		JJ575	PA5041 (x16) 6.00/12.20x10.00 (FPM) HR791 [1] (x1)	NC006 (x2) [2] 35.00x48.00x7.00mm, MVQ NB697 [2] 26.00x42.00x8.00mm, FPM NB698 [1] 80.00x98.00x10.00mm, FPM	
HBS002 [5] M10x1.25x140.00mm (x10)	JC824 [1] JC281 [1] JE120	JN626 [4]	JH5005 (Cork) JJ120 (x2) (Cork)	PA565 (x8) HR342 [1] (x1)	NC006 [2] 35.00x48.00x7.00mm, MVQ NB697 [2] 26.00x42.00x8.00mm, FPM NB698 [1] 80.00x98.00x10.00mm, FPM	
HBS002 [5] M10x1.25x140.00mm (x10)	JC823 [1] JC281 [1] JE120	JN626 [4]	JH5005 (Cork) JJ120 (x2) (Cork)	PA565 (x8) HR342 [1] (x1)	NC006 [2] 35.00x48.00x7.00mm, MVQ NB697 [2] 26.00x42.00x8.00mm, FPM NB698 [1] 80.00x98.00x10.00mm, FPM	
HBS002 [5] M10x1.25x140.00mm (x10)	JC824 [1] JC281 [1] JE120	JN929 [4]	JH5005 (Cork) JJ120 (Cork) JJ575	PA565 (x8) HR342 [1] (x1)	NC006 [2] 35.00x48.00x7.00mm, MVQ NB697 [2] 26.00x42.00x8.00mm, FPM NB698 [1] 80.00x98.00x10.00mm, FPM	
HBS002 [5] M10x1.25x140.00mm (x10)	JC824 [1] JC281 [1] JE120	JN929 [4]	JH5005 (Cork) JJ120 (Cork) JJ575	PA565 (x8) HR342 [1] (x1)	NC006 [2] 35.00x48.00x7.00mm, MVQ NB697 [2] 26.00x42.00x8.00mm, FPM NB698 [1] 80.00x98.00x10.00mm, FPM	
HBS055 [5] M10x1.25x153.00mm (x10)	JD448 [1] JD444 [1]		JJ575	PA5041 (x16) 6.00/12.20x10.00 (FPM) HR791 [1] (x1)	NC006 (x2) [2] 35.00x48.00x7.00mm, MVQ NB697 [2] 26.00x42.00x8.00mm, FPM NB698 [1] 80.00x98.00x10.00mm, FPM	
HBS055 [5] M10x1.25x153.00mm (x10)	JD5147 [1] JD444 [1]	JM5059 (Elastomer) JP008 [4] JP009 [4]	JJ575	PA5041 (x16) 6.00/12.20x10.00 (FPM) HR791 [1]	NC006 [2] 35.00x48.00x7.00mm, MVQ NB697 [2] 26.00x42.00x8.00mm, FPM NB698 [1] 80.00x98.00x10.00mm, FPM	













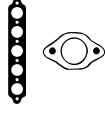

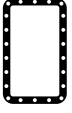

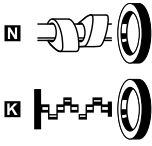





cc



kW/PS



1.6		Y 16 XE				69		AB5540 (MLS)	CB5540 [3]	EB5541 [18]
Vectra 1.6i 16V	08/95→03/02	1598	4	79.00	DOHC	74/101				
1.6		Y 16 YNG				70		AB5540 (MLS)	CB5540 [3]	EB5541 [18]
Corsa 1.6 CNG	05/03→10/06	1598	4	79.00	DOHC	69-71/ 94-97				
1.6		Z 16 LEL				71		AH5240 (MLS)	CH5241 (MLS)	EH5240
Corsa 1.6 SRi	05/07→	1598	4	79.00	DOHC	110/150				
1.6		Z 16 LER				72		AH5240 (MLS)	CH5241 (MLS)	EH5240
Corsa 1.6 VXR	02/07→	1598	4	79.00	DOHC	141/192				
1.6		Z 16 LET				73		AH5240 (MLS)	CH5241 (MLS)	EH5240
Astra 1.6	08/04→03/09	1598	4	79.00	DOHC	132/180				
Astra 1.6	10/06→11/10									
Astra 1.6 Turbo	09/06→									
Astra Twin 1.6	10/06→11/10									
Meriva 1.6 T	05/06→06/10									
1.6		Z 16 SE				74		AE5920 (Steel)	CE5920 [3]	EB5541 [18]
Astra 1.6	03/98→05/05	1598	4	79.00	SOHC/OHC	62-64/ 84-87				
Astra 1.6 Dual	07/00→05/05									
Astravan 1.6 i	09/00→08/06									
Combo 1.6	08/01→10/04									
Combo Van 1.6	10/01→11/11									
Corsa 1.6	08/01→10/04									
Meriva 1.6 i	01/03→10/09									
1.6		Z 16 XE				75		AB5540 (MLS)	CB5540 [3]	EB5541 [18]
Astra 1.6 16V	02/98→05/05	1598	4	79.00	DOHC	63-74/ 85-101				
Astra 1.6 Dual	03/98→05/05									
Astra Conv 1.6	03/01→10/05									
Meriva 1.6i	01/03→10/09									
Vectra 1.6 16V	06/04→07/08									
Vectra 1.6 GTS	06/04→07/08									
Vectra 1.6i 16V	08/95→03/02									
Zafira 1.6 16V	04/99→08/05									
Zafira 1.6 Dual	11/98→08/05									
1.6										Z 16 XE1
Astravan 1.6	03/05→	1598	4	79.00	DOHC	77/105				
Zafira 1.6	07/05→									

      							
HBS055 [5] M10x1.25x153.00mm (x10)	JD5269 [1] JD5148 [3]	JM5059 (Elastomer)	JJ575	PA5041 (x16) 6.00/12.20x10.00 (FPM) HR791 [3]	NC006 (x4) [2] 35.00x48.00x7.00mm, MVQ NB697 [2] 26.00x42.00x8.00mm, FPM NB698 [1] 80.00x98.00x10.00mm, FPM		 AB5540  AE5920  AE5930  JD5147  JD5148  JD5269  JD5398  JD5399  JD5400  JD5401  JM5059  JM5235  JN929  JJ575
HBS055 [5] M10x1.25x153.00mm (x10)	JD5269 [1] JD5148 [3]	JM5059 (Elastomer)	JJ575	PA5041 6.00/12.20x10.00 (FPM) HR791 [3]	NC006 [2] 35.00x48.00x7.00mm, MVQ NB697 [2] 26.00x42.00x8.00mm, FPM NB698 [1] 80.00x98.00x10.00mm, FPM NA5327 [1] 80.00x98.00x14.50mm, PTFE		
HBS055 [5] M10x1.25x153.00mm (x10)		JM7103 (Elastomer)			NC006 [2] 35.00x48.00x7.00mm, MVQ NA5174 [2] 31.50x42.00x7.00mm, FPM	NA5174 [2][10]	
HBS055 [5] M10x1.25x153.00mm (x10)		JM7103 (Elastomer)			NC006 [2] 35.00x48.00x7.00mm, MVQ NA5174 [2] 31.50x42.00x7.00mm, FPM	NA5174 [2][10]	
HBS055 [5] M10x1.25x153.00mm (x10)		JM7103 (Elastomer)			NC006 [2] 35.00x48.00x7.00mm, MVQ NA5174 [2] 31.50x42.00x7.00mm, FPM	NA5174 [2][10]	
HBS002 [5] M10x1.25x140.00mm (x10)	JD5398 [1] JD5399 [3]	JN929 [4]		HR342 [3]	NC006 (x2) [2] 35.00x48.00x7.00mm, MVQ NB697 [2] 26.00x42.00x8.00mm, FPM NB698 [1] 80.00x98.00x10.00mm, FPM		
HBS055 [5] M10x1.25x153.00mm (x10)	JD5147 [1] JD5148 [3]	JM5059 (Elastomer)	JJ575	PA5041 (x16) 6.00/12.20x10.00 (FPM) HR791 [3]	NC006 (x2) [2] 35.00x48.00x7.00mm, MVQ NB697 [2] 26.00x42.00x8.00mm, FPM NB698 [1] 80.00x98.00x10.00mm, FPM		
HBS055 [5] M10x1.25x153.00mm (x10)	JD5400 [1] JD5401 [3]	JM5235 (Elastomer)		HR5087 [3]	NC006 [2] 35.00x48.00x7.00mm, MVQ NA5174 [2] 31.50x42.00x7.00mm, FPM NB698 [1] 80.00x98.00x10.00mm, FPM NA5327 [1] 80.00x98.00x14.50mm, PTFE	NA5174 [2][10]	



cc



kW/PS



1.6		Z 16 XEP				77		AE5930 (MLS)	CE5930 [3]
Astra 1.6	12/02→11/10	1598	4	79.00	DOHC	74-77/ 101-105			
Astra 1.6 16V	09/98→05/05								
Astra Conv 1.6	03/03→10/05								
Astra Coupe 1.6	03/00→08/05								
Astra Twin 1.6	09/05→11/10								
Astravan 1.6	03/05→								
Meriva 1.6i	01/03→10/09								
Vectra 1.6	01/06→07/08								
Zafira 1.6	07/05→								
1.6		Z 16 XER				78		AH5240 (MLS)	CH5242 (MLS)
Astra 1.6	01/04→05/09	1598	4	79.00	DOHC	85/116			
Astra 1.6 i 16V	12/06→11/10								
Astra Twin 1.6i	10/06→11/10								
Zafira 1.6	12/07→								
1.6		Z 16 YNG				79		AB5540 (MLS)	CB5540 [3]
Combo 1.6 CNG	04/05→02/12	1598	4	79.00	DOHC	69-74/ 94-101			
Corsa 1.6 CNG	05/03→10/06								
Zafira 1.6 CNG	09/01→06/05								
1.7		17 D Diesel				80		BY330 (Fibre), 1.300mm →09/92 BY340 (Fibre), 1.400mm, 1 Notch →09/92 BY350 (Fibre), 1.500mm, 2 Notches →09/92	DL011 ▲ →09/92 EK485 →09/92
Astra 1.7 D	01/89→09/92	1699	4	82.50	SOHC/OHC	42/57			
Astra 1.7 D	12/91→02/98								
AstraMAX 1.7 D	01/89→07/94								
Cavalier 1.7 D	09/88→09/92								
Cavalier 1.7 D	09/88→09/92								
1.7		17 D (4EE1) Diesel				81		AB5010 (MLS), 1.400mm 01/96→ →Eng.320552 AB5020 (MLS), 1.450mm, 1 Hole 01/96→ →Eng.320552 AB5030 (MLS), 1.500mm, 2 Holes 01/96→ →Eng.320552	CY811 ▲ [13] 01/96→ FY811 ▲ [3] 01/96→
Combo 1.7 D	07/94→10/01	1686	4	79.00	SOHC/OHC	44/60			
Corsa 1.7 D	02/96→09/00								
Corsavan 1.7 D	01/94→09/00								
1.7		17 DR Diesel				82		BY330 (Fibre), 1.300mm 07/92→ BY340 (Fibre), 1.400mm, 1 Notch 07/92→ BY350 (Fibre), 1.500mm, 2 Notches 07/92→	DL011 ▲ 07/92→ EK485 07/92→
Astra 1.7 D	03/91→09/98	1699	4	82.50	SOHC/OHC	42-44/ 57-60			
Astravan 1.7 D	01/91→08/94								
Cavalier 1.7 D	07/92→11/95								

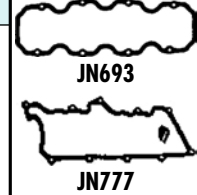
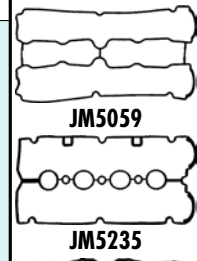
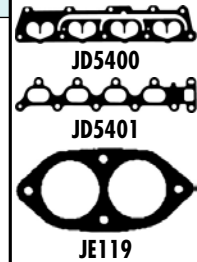
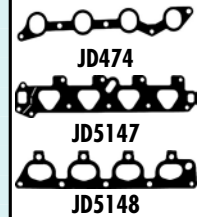
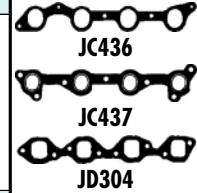
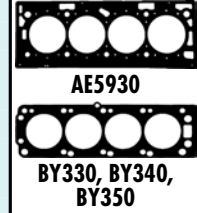
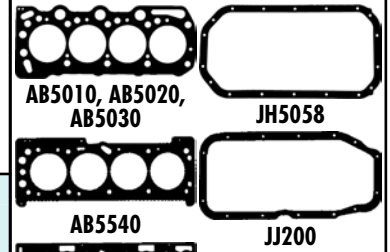



cc



kW/PS



1.7		17 DT (TC4EE1) Diesel			83				
Astra 1.7 TD	12/91→02/98	1686	4	79.00	SOHC/OHC	60/82	AB5010 (MLS), 1.400mm 03/90→08/94 →Eng.320552	CY811 ▲ [13] 03/90→08/94	FY811 ▲ [3] 03/90→08/94
Astra 1.7 TD	12/91→09/98						AB5020 (MLS), 1.450mm, 1 Hole 03/90→08/94 →Eng.320552		
Cavalier 1.7 TD	09/88→11/95						AB5030 (MLS), 1.500mm, 2 Holes 03/90→08/94 →Eng.320552		
1.7		X 17 D (4EE1) Diesel			84				
Combo 1.7 D	07/94→10/01	1686	4	79.00	SOHC/OHC	44/60	AB5010 (MLS), 1.400mm →Eng.320552	CY811 ▲ [13]	FY811 ▲ [3]
Corsa 1.7 D	02/96→09/00						AB5020 (MLS), 1.450mm, 1 Hole →Eng.320552		
Corsavan 1.7 D	01/94→09/00						AB5030 (MLS), 1.500mm, 2 Holes →Eng.320552		
1.7		X 17 DT (TC4EE1) Diesel			85				
Vectra 1.7 TD	10/95→12/97	1686	4	79.00	SOHC/OHC	60/82	AB5010 (MLS), 1.400mm →Eng.320552	CY811 ▲ [13]	FY811 ▲ [3]
							AB5020 (MLS), 1.450mm, 1 Hole →Eng.320552		
							AB5030 (MLS), 1.500mm, 2 Holes →Eng.320552		
1.7		X 17 DTL Diesel			86				
Astra 1.7 TD	01/94→09/98	1699	4	82.50	SOHC/OHC	50/68	AY160 (MLS), 1.300mm	DL012 ▲ [3]	EK486 [3]
Astra 1.7 TD	08/94→08/00						AY170 (MLS), 1.400mm, 1 Notch		
Astravan 1.7 TD	01/94→08/06						AY180 (MLS), 1.500mm, 2 Notches		
1.7		Y 17 DT Diesel			87				
Astra 1.7 DTI	02/00→05/05	1686	4	79.00	DOHC	55/75	AE5520 (MLS), 1.450mm, 1 Hole	CE5521 ▲ [3]	EE5520 [3]
Astravan 1.7	04/01→08/06						AE5530 (MLS), 1.500mm, 2 Holes		
Combo 1.7 DTI	10/01→02/12						AE5540 (MLS), 1.550mm, 3 Notches		
Corsa 1.7 DTI	08/00→09/06								
Corsavan 1.7	09/00→06/06								
Meriva 1.7 DTI	06/03→06/10								
1.7		Y 17 DTL Diesel			88				
Combo 1.7 DI	09/01→11/11	1686	4	79.00	DOHC	48/65	AE5520 (MLS), 1.450mm, 1 Hole	CE5521 ▲ [3] Eng.721439→	EE5520 [3]
Corsa 1.7 DI 16V	08/00→09/06						AE5530 (MLS), 1.500mm, 2 Holes		
Corsavan 1.7 DI	09/00→06/06						AE5540 (MLS), 1.550mm, 3 Notches		
1.7		Z 17 DTH Diesel			89				
Astra 1.7 CDTI	01/04→11/10	1686	4	79.00	DOHC	74/100	AE5520 (MLS), 1.450mm, 1 Hole	CE5523 ▲ [3] 01/01→	EE5520 [3]
Astra 1.7 CDTI	08/04→03/09						AE5530 (MLS), 1.500mm, 2 Holes		
Astravan 1.7	03/05→11/11						AE5540 (MLS), 1.550mm, 3 Notches		
Combo 1.7 CDTI	12/04→11/11								
Corsa 1.7 CDTI	08/00→09/06								
Meriva 1.7 CDTI	09/03→08/05								
1.7		Z 17 DTL Diesel			90				
Astra 1.7 CDTI	04/03→05/09	1686	4	79.00	DOHC	59/80	AE5520 (MLS), 1.450mm, 1 Hole	CE5522 ▲ [3]	EE5520 [3]
Astra 1.7 CDTI	03/04→05/09						AE5530 (MLS), 1.500mm, 2 Holes		
Astravan 1.7	04/04→08/06						AE5540 (MLS), 1.550mm, 3 Notches		

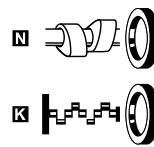
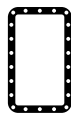
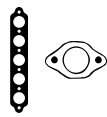

AB5010, AB5020,
AB5030



AE5520, AE5530,
AE5540



AY160, AY170,
AY180



JC437



JD304



JD474



JD5329



JD5330



JD5331



JD5332



JD5334

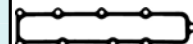

JD5336

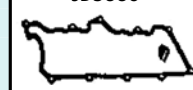

JN777

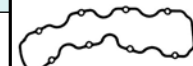

JP018



JH5058



JJ574



cc



kW/PS



1.8	18 E					91	BM380 (Fibre)	DM381 [3]	EK482
Astra 1.8 GTE	09/84→08/91	1796	4	84.80	SOHC/OHC	82-85/ 112-116			
Astra 1.8 i	09/85→08/91								
Cavalier 1.8 i	09/81→08/88								
1.8	18 SE					92	BM380 (Fibre)	DM381 [3]	EK482
Astra 1.8	01/86→12/90	1796	4	84.80	SOHC/OHC	82-85/ 112-116			
Astra 1.8 GTE	09/84→08/91								
Astra 1.8 i	09/85→08/91								
Astra 1.8 i 16V	09/95→02/98								
Cavalier 1.8 i	09/81→08/88								
Cavalier 1800i	03/85→10/88								
1.8	18 SEH					93	BP810 (Fibre)	DP811 [3]	EK482
Carlton 1.8 i	09/86→03/94	1796	4	84.80	SOHC/OHC	85/115			
Carlton 1.8i	09/86→03/94								
1.8	18 SV					94	BP810 (Fibre)	DP810	EK482
Carlton 1.8 S	09/86→03/94	1796	4	84.80	SOHC/OHC	66/90			
Cavalier 1.8	09/88→08/95								
Cavalier 1.8	09/88→10/90								
1.8	A 18 XEL					95	AH5240 (MLS)	CH5240	EH5240
Zafira 1.8	10/11→	1796	4	80.50	DOHC	85-88/ 116-120			
1.8	A 18 XER					96	AH5240 (MLS)	CH5240	EH5240
Astra 1.8	01/04→05/09	1796	4	80.50	DOHC	103/140			
Astra 1.8 i 16V	03/07→11/10								
Insignia 1.8	07/08→09/13								
Zafira 1.8	04/05→								
1.8	C 18 NZ					97	BP810 (Fibre)	DP810	EK482
Astra 1.8 i	03/92→09/98	1796	4	84.80	SOHC/OHC	66/90			
Astra 1.8 i	09/91→02/98								
Astra Conv 1.8i	09/91→02/98								
Cavalier 1.8	09/88→08/95								
Cavalier 1.8	09/88→10/90								
Cavalier 1.8 i	03/90→11/95								
Cavalier 1.8 i	03/90→11/95								
1.8	C 18 XE					98	BY240 (Fibre)	DY241 [3]	EC130
Astra 1.8 i 16V	06/93→02/98	1799	4	81.60	DOHC	92/125			
Astra Conv 1.8	09/94→08/96								
1.8	C 18 XEL					99	BY240 (Fibre)	DY241 [3]	EC130
Astra 1.8 i 16V	01/94→02/98	1799	4	81.60	DOHC	85/116			
Astra Conv 1.8	11/94→03/01								

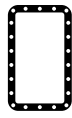
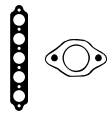

BM380



BP810



BY240



JC282



JC283



JC756



JC757



JD451



JE120

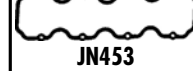

JN453

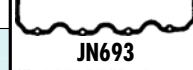

JN693



JP016



JJ200

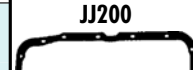

JJ385



JJ615

HBS053 [5] M11x1.25x140.00mm (x10)	JC283 [1] JC282 [2] JE120	JN453 [4]	JJ200	HR343 [2]	NC006 [2] 35.00x48.00x7.00mm, MVQ NB700 [2] 31.00x50.00x8.00mm, MVQ NB701 [1] 86.00x104.00x11.00mm, FPM	
HBS053 [5] M11x1.25x140.00mm (x10)	JC283 [1] JC282 [2] JE120	JN453 [4]	JJ200	HR343 [2]	NC006 [2] 35.00x48.00x7.00mm, MVQ NB700 [2] 31.00x50.00x8.00mm, MVQ NB701 [1] 86.00x104.00x11.00mm, FPM	
HBS053 [5] M11x1.25x140.00mm (x10)	JC756 [1] JC282 [2] JE120	JN693 [4]	JJ385	PA565 (x8) HR342 [x1]	NC006 [2] 35.00x48.00x7.00mm, MVQ NB700 [2] 31.00x50.00x8.00mm, MVQ NB806 [1] 90.00x104.00x11.00mm, FPM	
HBS053 [5] M11x1.25x140.00mm (x10)	JC757 [1] JC282 [2] JE120	JN693 [4]	JJ385 (x2)	PA565 (x8) HR342 [x1]	NC006 [2] 35.00x48.00x7.00mm, MVQ NB807 [1] 55.00x70.10x8.00mm, FPM NB700 [2] 31.00x50.00x8.00mm, MVQ NB806 [1] 90.00x104.00x11.00mm, FPM	
HBS055 [5] M10x1.25x153.00mm (x10)	JD5982 [1]	JM7103 (Elastomer)			NC006 [2] 35.00x48.00x7.00mm, MVQ NA5174 [2] 31.50x42.00x7.00mm, FPM	
HBS055 [5] M10x1.25x153.00mm (x10)	JD5982 [1]	JM7103 (Elastomer)			NC006 [2] 35.00x48.00x7.00mm, MVQ NA5174 [2] 31.50x42.00x7.00mm, FPM	NA5174 [2][10]
HBS053 [5] M11x1.25x140.00mm (x10)	JC757 [1] JC282 [2] JE120	JN693 [4]	JJ385 (x2)	PA565 (x8) HR342 [x1]	NC006 [2] 35.00x48.00x7.00mm, MVQ NB700 [2] 31.00x50.00x8.00mm, MVQ NB806 [1] 90.00x104.00x11.00mm, FPM	
HBS054 [5] M11x1.25x105.00mm (x10)	JD451 [1] JD5300 [2] (MLS) JE120	JP016 [4]	JJ615	PA5041 (x16) 6.00/12.20x10.00 (FPM) HR791 [x1]	NC006 (x2) [2] 35.00x48.00x7.00mm, MVQ NB700 [2] 31.00x50.00x8.00mm, MVQ NB806 [1] 90.00x104.00x11.00mm, FPM	
HBS054 [5] M11x1.25x105.00mm (x10)	JD451 [1] JD5300 [2] (MLS) JE120	JP016 [4]	JJ615	PA5041 (x16) 6.00/12.20x10.00 (FPM) HR791 [x1]	NC006 (x2) [2] 35.00x48.00x7.00mm, MVQ NB700 [2] 31.00x50.00x8.00mm, MVQ NB806 [1] 90.00x104.00x11.00mm, FPM	



cc



kW/PS



1.8		E 18 NV					100	BP810 (Fibre)	DP810	EK482
Cavalier 1.8	08/86→08/88	1796	4	84.80	SOHC/OHC	62/84				
1.8		E 18 NVR					101	BP810 (Fibre)	DP810	EK482
Carlton 1.8	09/87→03/94	1796	4	84.80	SOHC/OHC	65/88				
Carlton 1.8	09/87→03/94									
1.8		S 18 NV					102	BP810 (Fibre)	DP810	EK482
Carlton 1.8	09/86→08/88	1796	4	84.80	SOHC/OHC	62-74/ 84-101				
1.8		X 18 XE					103	BY240 (Fibre)	DY241 [3]	EC130
Astra 1.8 i 16V	09/94→02/98	1799	4	81.60	DOHC	85/116				
Astra Conv 1.8	11/94→03/01									
Vectra 1.8i 16V	10/95→09/00									
1.8		X 18 XE1					104	AC5460 (MLS)	CC5460 [3]	HC5007
Astra 1.8 16V	02/98→07/04	1796	4	80.50	DOHC	85/116				
Astra Coupe 1.8	03/00→08/05									
Vectra 1.8i 16V	10/95→09/00									
Zafira 1.8 16V	05/99→08/00									
1.8		Z 18 XE					105	AC5460 (MLS)	CC5460 [3]	
Astra 1.8	01/04→11/10	1796	4	80.50	DOHC	87-92/ 118-125				
Astra 1.8 16V	02/98→05/05									
Astra 1.8 Dual	02/98→05/05									
Astra Conv 1.8	03/01→10/05									
Astra Coupe 1.8	09/00→08/05									
Astra Twin 1.8	09/05→11/10									
Corsa 1.8 16V	08/00→09/06									
Meriva 1.8i	05/03→08/05									
Signum 1.8	06/03→07/05									
Tigra Twin 1.8	06/04→08/09									
Vectra 1.8 16V	04/02→07/08									
Vectra 1.8 Dual	04/02→07/08									
Vectra 1.8i 16V	09/00→07/03									
Zafira 1.8 16V	09/00→08/05									
Zafira 1.8 Dual	09/00→08/05									

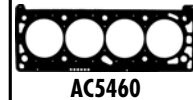
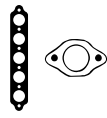

AC5460



BP810



BY240



JC282



JC757



JD451



JD5196



JD5197



JE120



JM5092



JN693



JP016



JJ385



JM5092



JM5092



JM5092



JM5092



JM5092

HBS053 [5]
M11x1.25x140.00mm (x10)

JC757 [1]
JC282 [1]
JE120

JN693 [4]

JJ385 (x2)

PA565 (x8)
HR342 [x1]

NC006 [2]
35.00x48.00x7.00mm, MVQ
NB807 [1]
55.00x70.10x8.00mm, FPM
NB700 [2]
31.00x50.00x8.00mm, MVQ
NB806 [1]
90.00x104.00x11.00mm, FPM

HBS053 [5]
M11x1.25x140.00mm (x10)

JC757 [1]
JC282 [1]
JE120

JN693 [4]

JJ385

PA565 (x8)
HR342 [x1]

NC006 [2]
35.00x48.00x7.00mm, MVQ
NB807 [1]
55.00x70.10x8.00mm, FPM
NB700 [2]
31.00x50.00x8.00mm, MVQ
NB806 [1]
90.00x104.00x11.00mm, FPM

HBS053 [5]
M11x1.25x140.00mm (x10)

JC757 [1]
JC282 [1]
JE120

JN693 [4]

JJ385 (x2)

PA565 (x8)
HR342 [x1]

NC006 [2]
35.00x48.00x7.00mm, MVQ
NB807 [1]
55.00x70.10x8.00mm, FPM
NB700 [2]
31.00x50.00x8.00mm, MVQ
NB806 [1]
90.00x104.00x11.00mm, FPM

HBS054 [5]
M11x1.25x105.00mm (x10)

JD451 [1]
JD5300 [1]
(MLS)
JE120

JP016 [4]

JJ615

PA5041 (x16)
6.00/12.20x10.00
(FPM)
HR791 [x1]

NC006 (x2) [2]
35.00x48.00x7.00mm, MVQ
NB700 [2]
31.00x50.00x8.00mm, MVQ
NB806 [1]
90.00x104.00x11.00mm, FPM

HBS055 [5]
M10x1.25x153.00mm (x10)

JD5196 [1]
JD5197 [1]
JE120

JM5092
(Elastomer)

JJ385

PA5025 (x16)
HR5048 [x1]

NC006 (x2) [2]
35.00x48.00x7.00mm, MVQ
NA5174 [2]
31.50x42.00x7.00mm, FPM
NC065 [2]
30.00x40.00x7.00mm, FPM
NB698 [1]
80.00x98.00x10.00mm, FPM

NA5174 [2] [10]

HBS055 [5]
M10x1.25x153.00mm (x10)

JD5196 [1]
JD5197 [1]
JE120

JM5092
(Elastomer)

JJ385

PA5025 (x16)
HR5048 [x1]

NC006 (x2) [2]
35.00x48.00x7.00mm, MVQ
NB698 [1]
80.00x98.00x10.00mm, FPM
NAS327 [1]
80.00x98.00x14.50mm, PTFE
NA5174 [2]
31.50x42.00x7.00mm, FPM
Ch.32000001 →
Ch.35000001 →
Ch.36000001 →
Ch.38000001 →
Ch.38000001 →
Ch.38000001 →
Ch.3H000001 →
Ch.46000001 →

NA5174 [2] [10]



cc



kW/PS



1.8		Z 18 XEL				106	AC5460 (MLS)	CC5460 [3]	
Astra Coupe 1.8	03/00→08/05	1796	4	80.50	DOHC	81-85/ 110-116			
Vectra 1.8	04/02→07/08								
1.8		Z 18 XER				107	AH5240 (MLS)	CH5240	EH5240
Astra 1.8	01/04→05/09	1796	4	80.50	DOHC	103/140			
Astra 1.8 i 16V	03/07→11/10								
Astra Twin 1.8	05/08→11/10								
Signum 1.8	08/05→05/08								
Vectra 1.8	01/06→07/08								
Zafira 1.8	04/05→								
1.9		F8Q 600 Diesel				108	AY710 (SE), 1.360mm, 2 Notches, 2 Holes →0.073mm AY720 (SE), 1.440mm, 1 Notch, 1 Hole →0.073→0.206mm AY730 (SE), 1.520mm, 3 Notches, 3 Holes →0.206mm→	DL961 ▲ [3]	EL960 [3] [18]
Arena 1.9 D	03/98→08/01	1870	4	80.00	SOHC/OHC	44/60			
1.9		F8Q 606 Diesel				109	AY710 (SE), 1.360mm, 2 Notches, 2 Holes →0.073mm AY720 (SE), 1.440mm, 1 Notch, 1 Hole →0.073→0.206mm AY730 (SE), 1.520mm, 3 Notches, 3 Holes →0.206mm→	DL961 ▲ [3]	EL960 [3] [18]
Arena 1.9 D	03/98→08/01	1870	4	80.00	SOHC/OHC	44/60			
1.9		F9Q 760 Diesel				110	AC5061 (MLS), 1.320mm AC5070 (Fibre), 1.350mm, 2 Notches →0.653mm AC5080 (Fibre), 1.450mm, 1 Notch →0.653→0.786mm AC5090 (Fibre), 1.550mm, 3 Notches →0.786mm→	CC5060 ▲ [3]	EC5060
Vivaro 1.9 DTI	08/01→12/06	1870	4	80.00	SOHC/OHC	74/101			
1.9		F9Q 762 Diesel				111	AC5070 (Fibre), 1.350mm, 2 Notches →0.653mm AC5080 (Fibre), 1.450mm, 1 Notch →0.653→0.786mm AC5090 (Fibre), 1.550mm, 3 Notches →0.786mm→	CC5060 ▲ [3]	EC5060 EC5063
Vivaro 1.9 DI	08/01→12/06	1870	4	80.00	SOHC/OHC	59-60/ 80-82			
1.9		F9Q 770 Diesel				112	AC5070 (Fibre), 1.350mm, 2 Notches →0.653mm AC5080 (Fibre), 1.450mm, 1 Notch →0.653→0.786mm AC5090 (Fibre), 1.550mm, 3 Notches →0.786mm→	CC5060 ▲ [3]	EC5060
Movano 1.9 DTI	09/00→10/01	1870	4	80.00	SOHC/OHC	59/80			
1.9		F9Q 774 Diesel				113	AC5070 (Fibre), 1.350mm, 2 Notches →0.653mm AC5080 (Fibre), 1.450mm, 1 Notch →0.653→0.786mm AC5090 (Fibre), 1.550mm, 3 Notches →0.786mm→	CC5060 ▲ [3]	EC5060 EC5063
Movano 1.9 DTI	10/01→05/10	1870	4	80.00	SOHC/OHC	60/82			
Movano 1.9 DTI	10/01→05/10								

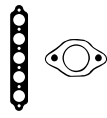

AC5070, AC5080,
AC5090



AC5460



AY710, AY720,
AY730



JD409

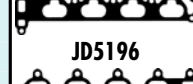

JD5196



JD5197



JE120

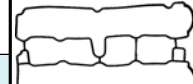

JM5092

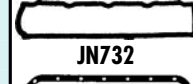

JN732



JJ557

HBS055 [5] M10x1.25x153.00mm (x10)	JD5196 [1] JD5197 [1] JE120	JM5092 (Elastomer)		PA5025 (x16) HR5048 [1] (x1)	NC006 [2] 35.00x48.00x7.00mm, MVQ NA5174 [2] 31.50x42.00x7.00mm, FPM NC065 [2] 30.00x40.00x7.00mm, FPM NB698 [1] 80.00x98.00x10.00mm, FPM	NA5174 [2] [10]
HBS055 [5] M10x1.25x153.00mm (x10)	JD5982 [1]	JM7103 (Elastomer)			NC006 [2] 35.00x48.00x7.00mm, MVQ NA5174 [2] 31.50x42.00x7.00mm, FPM	NA5174 [2] [10]
HBS244 [22] M12x1.50x111.00mm (x10)	JD409	JN732 [4]	JJ557	HR569 [1]	NF846 [2] 25.00x42.00x7.00mm, FPM/ACM NA5036 [2] 42.00x54.00x6.00mm, FPM NF850 [1] 85.00x105.00x8.00mm, FPM	
HBS244 [22] M12x1.50x111.00mm (x10)	JD409	JN732 [4]	JJ557	HR569 [1]	NF846 [2] 25.00x42.00x7.00mm, FPM/ACM NA5036 [2] 42.00x54.00x6.00mm, FPM NF850 [1] 85.00x105.00x8.00mm, FPM	
HBS372 [22] M12x1.50x121.00mm (x10)	JD5189	JM5086 (Elastomer)	JH5041	HR646 [1]	NF846 [2] 25.00x42.00x7.00mm, FPM/ACM NA5036 [2] 42.00x54.00x6.00mm, FPM NA5037 [1] 85.00x105.00x11.00mm, ACM	
HBS372 [22] M12x1.50x121.00mm (x10)	JD5189	JM5086 (Elastomer)	JH5041 =KG5012 16.00x23.00x1.500mm	HR646 [1]	NF846 [2] 25.00x42.00x7.00mm, FPM/ACM NA5036 [2] 42.00x54.00x6.00mm, FPM NA5037 [1] 85.00x105.00x11.00mm, ACM	
HBS372 [22] M12x1.50x121.00mm (x10)	JD5189	JM5086 (Elastomer)	JH5041 =KG5012 16.00x23.00x1.500mm	HR646 [1]	NF846 [2] 25.00x42.00x7.00mm, FPM/ACM NA5036 [2] 42.00x54.00x6.00mm, FPM NA5037 [1] 85.00x105.00x11.00mm, ACM	
HBS372 [22] M12x1.50x121.00mm (x10)	JD5189	JM5086 (Elastomer)	JH5041 =KG5012 16.00x23.00x1.500mm	HR646 [1]	NF846 [2] 25.00x42.00x7.00mm, FPM/ACM NA5036 [2] 42.00x54.00x6.00mm, FPM NA5037 [1] 85.00x105.00x11.00mm, ACM	



cc



kW/PS



1.9		Z 19 DT Diesel			114				
Astra 1.9 CDTI	01/04→11/10	1910	4	82.00	SOHC/OHC	88/120	AA5560 (MLS), 0.820mm, 0 Holes →09/03	CA5561 ▲ →Eng.4244825	EE5181 [3]
Astra 1.9 CDTI	08/04→03/09						AA5570 (MLS), 0.920mm, 1 Hole →09/03	CG7390 ▲ Eng.4244826→	
Astravan 1.9	03/05→11/11						AA5580 (MLS), 1.020mm, 2 Holes →09/03		
Signum 1.9 CDTI	04/04→03/08						AG7440 (MLS) 09/03→		
Vectra 1.9 CDTI	04/02→09/08						AG7390 (MLS), 0.820mm 09/03→		
Zafira 1.9 CDTI	07/05→						AG7400 (MLS), 0.920mm, 1 Hole 09/03→		
1.9		Z 19 DTH Diesel			115				
Astra 1.9 CDTI	01/04→11/10	1910	4	82.00	DOHC	110/150	AD5840 (MLS), 0.820mm, 0 Holes	CD5840 ▲	EE5181 [3]
Astra Twin 1.9	01/06→11/10						AD5850 (MLS), 0.920mm, 1 Hole		
Astravan 1.9	03/05→11/11						AD5860 (MLS), 1.020mm, 2 Holes		
Signum 1.9 CDTI	04/04→03/08								
Vectra 1.9 CDTI	04/04→08/08								
Zafira 1.9 CDTI	07/05→								
1.9		Z 19 DTJ Diesel			116				
Astra 1.9 CDTI	01/04→05/09	1910	4	82.00	DOHC	88/120	AD5840 (MLS), 0.820mm, 0 Holes	CD5840 ▲	EE5181 [3]
							AD5850 (MLS), 0.920mm, 1 Hole		
							AD5860 (MLS), 1.020mm, 2 Holes		
1.9		Z 19 DTL Diesel			117				
Astra 1.9 CDTi	08/04→11/10	1910	4	82.00	DOHC	74/100	AG7440 (MLS)	CG7390 ▲	EE5181 [3]
Signum 1.9 T	01/05→05/08						AG7390 (MLS), 0.820mm		
Vectra 1.9 CDTI	10/05→07/08						AG7400 (MLS), 0.920mm, 1 Hole		
Zafira 1.9 CDTI	07/05→								
2.0		20 NE			118				
Astra 2.0	09/86→08/91	1998	4	86.00	SOHC/OHC	85/116	BP820 (Fibre)	DP820 [3]	EK482
Astra Conv 2.0i	01/87→12/91								
Cavalier 1.8 i	01/91→10/92								
Cavalier 2.0 i	01/91→10/92								
Cavalier 2.0 i	09/86→10/92								
2.0		20 NEJ			119				
Vectra 2.0 i	10/95→03/02	1998	4	86.00	SOHC/OHC	82/112	BP820 (Fibre)	DP820 [3]	HC5007
2.0		20 SE			120				
Carlton 2.0 i	09/86→03/94	1998	4	86.00	SOHC/OHC	85-90/ 116-122	BP820 (Fibre)	DP820 [3]	EK482
Carlton 2.0i	09/86→03/94								
Cavalier 2.0 i	09/86→08/88								
Cavalier 2.0 i	09/86→08/88								
Omega 2.0	09/95→09/96								

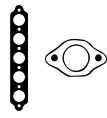

AA5560, AA5570,
AA5580



BP820



JA5035



JC282



JC756



JD468



JD5376



JE120



JM5028

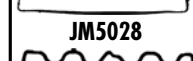

JM5204

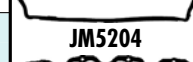

JN693

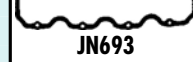

JJ385



JJ616

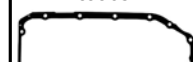

JJ617

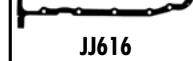

JJ616



JJ617



JJ617



cc



kW/PS



2.0	20 SEH						121	BP820 (Fibre)	DP820 [3]	EK482
Astra 2.0 GTE	09/86→08/91	1998	4	86.00	SOHC/OHC		95/129			
Cavalier 2.0	09/87→08/88									
Cavalier 2.0 i	09/88→09/92									
Cavalier 2.0Sri	03/87→09/92									
2.0	20 XE						122	BS720 (Fibre)	DS720	ES720
Astra 2.0 GTE	05/88→08/91	1998	4	86.00	DOHC		115/156			
Cavalier 2.0GSi	09/89→08/92									
2.0	A 20 DT Diesel						123	AH7170 (MLS), 0.95mm, 0 Notches AH7180 1.05mm, 1 Notch AH7190 (MLS), 1.15mm, 2 Notches		
Zafira 2.0 CDTi	10/11→	1956	4	83.00	DOHC		96/131			
2.0	A 20 DTC Diesel						124	AH7170 (MLS), 0.95mm, 0 Notches AH7180 1.05mm, 1 Notch AH7190 (MLS), 1.15mm, 2 Notches		
Insignia 2.0	07/08→	1956	4	83.00	DOHC		81/110			
2.0	A 20 DTH Diesel						125	AH7170 (MLS), 0.95mm, 0 Notches AH7180 1.05mm, 1 Notch AH7190 (MLS), 1.15mm, 2 Notches		
Astra 2.0 CDTi	12/09→	1956	4	83.00	DOHC		118-121/ 160-165			
Astra 2.0 CDTi	10/10→									
Astra GTC 2.0	10/11→									
Cascada Con 2.0	02/13→									
Insignia 2.0	07/08→									
Zafira 2.0 CDTi	10/11→									
2.0	A 20 DTJ Diesel						126	AH7170 (MLS), 0.95mm, 0 Notches AH7180 1.05mm, 1 Notch AH7190 (MLS), 1.15mm, 2 Notches		
Insignia 2.0	07/08→	1956	4	83.00	DOHC		96/131			
2.0	A 20 DTL Diesel						127	AH7170 (MLS), 0.95mm, 0 Notches AH7180 1.05mm, 1 Notch AH7190 (MLS), 1.15mm, 2 Notches		
Zafira 2.0 CDTi	10/11→	1956	4	83.00	DOHC		81/110			
2.0	A 20 DTR Diesel						128	AH7170 (MLS), 0.95mm, 0 Notches AH7180 1.05mm, 1 Notch AH7190 (MLS), 1.15mm, 2 Notches		
Astra 2.0 CDTi	12/12→	1956	4	83.00	DOHC		140-143/ 190-194			
Astra 2.0CDTi	12/12→									
Astra GTC 2.0	12/12→									
Cascada Con 2.0	02/13→									
Insignia 2.0	10/08→									
Zafira 2.0 CDTi	01/13→									
2.0	A 20 NFT						129	AH6380 (MLS), 0.64mm [132]		
Astra 2.0 VXR	04/12→	1998	4	86.00	DOHC		162-206/ 220-280			
Insignia 2.0 T	09/11→									
2.0	A 20 NHT						130	AH6380 (MLS), 0.64mm [132]		
Insignia 2.0 T	07/08→	1998	4	86.00	DOHC		162/220			
2.0	C 20 LET						131	BY260 (Fibre)	DY260	ES720
Calibra 2.0 i	03/92→07/97	1998	4	86.00	DOHC		150/204			
Cavalier 2.5 V6	06/92→11/94									

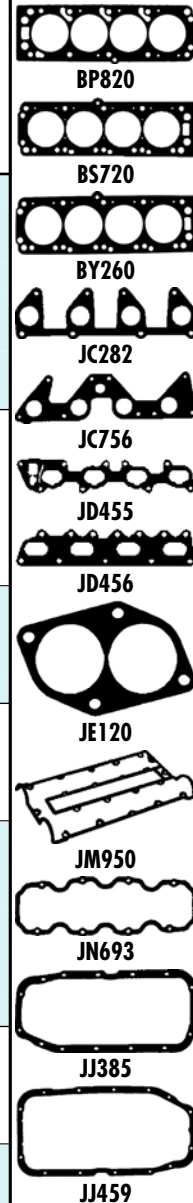
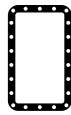
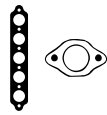

HBS053 [5]
M11x1.25x140.00mm (x10)

JC756 [1]
JC282 [1]
JE120

JN693 [4]

JJ385 (x2)

PA565 (x8)
HR342 (x1)

NA807 [1]
55.00x70.10x8.00mm, FPM
NC006 [2]
35.00x48.00x7.00mm, MVQ
NB700 [2]
31.00x50.00x8.00mm, MVQ
NB806 [1]
90.00x104.00x11.00mm, FPM

HBS035 [5]
M11x1.25x110.00mm (x10)
→Eng.14137011
HBS054 [5]
M11x1.25x105.00mm (x10)
Eng.14137012→

JD455 [1]
JD5980 [1]

JM950 [4]

JJ459

HR342 [1]

NC006 [2]
35.00x48.00x7.00mm, MVQ
NB884 [2]
38.00x50.00x5.50mm, FPM
NB806 [1]
90.00x104.00x11.00mm, FPM

NA5070 [2]
31.00x41.00x7.00mm, FPM
NF888 [1]
93.00x172.00x12.00mm, FPM

NA5070 [2]
31.00x41.00x7.00mm, FPM
NF888 [1]
93.00x172.00x12.00mm, FPM

NA5070 [2]
31.00x41.00x7.00mm, FPM
NF888 [1]
93.00x172.00x12.00mm, FPM

NA5070 [2]
31.00x41.00x7.00mm, FPM
NF888 [1]
93.00x172.00x12.00mm, FPM

NA5070 [2]
31.00x41.00x7.00mm, FPM
NF888 [1]
93.00x172.00x12.00mm, FPM

NA5070 [2]
31.00x41.00x7.00mm, FPM
NF888 [1]
93.00x172.00x12.00mm, FPM

HBS416 [22]
M11x1.50x163.00mm (x10)

NA5108 [2]
42.00x55.00x7.00mm, FPM/ACM

HBS416 [22]
M11x1.50x163.00mm (x10)

NA5108 [2]
42.00x55.00x7.00mm, FPM/ACM

HBS035 [5]
M11x1.25x110.00mm (x10)
→Eng.14137011
HBS054 [5]
M11x1.25x105.00mm (x10)
Eng.14003805→

JD455 [1]
JD456 [1]

JM950 [4]

JJ459 (x2)

PA565 (x16)
HR342 (x2)

NC006 (x2) [2]
35.00x48.00x7.00mm, MVQ
NB884 [2]
38.00x50.00x5.50mm, FPM
NB806 [1]
90.00x104.00x11.00mm, FPM













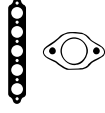

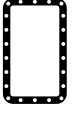

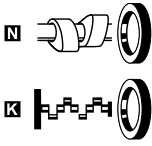

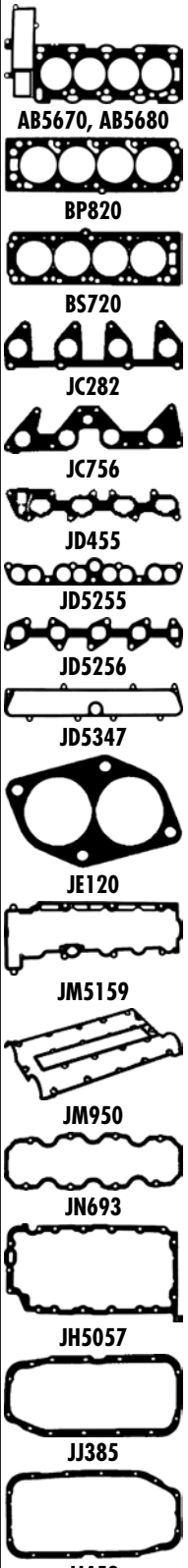







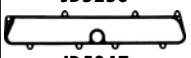

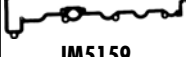

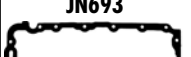



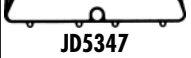







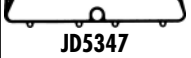







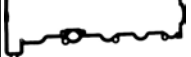





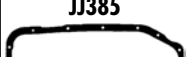











cc

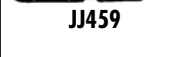

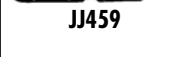
kW/PS

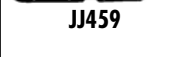

2.0	C 20 NE					132	BP820 (Fibre)	DP820 [3]	EK482
Astra 2.0 i	03/92→09/98	1998	4	86.00	SOHC/OHC	85/115			
Astra 2.0 i	09/91→02/98								
Astra Conv 2.0i	01/91→10/94								
Calibra 2.0 i	06/90→07/97								
Carlton 2.0	09/86→03/94								
Cavalier 2.0 i	09/86→11/95								
Cavalier 2.0 i	09/86→11/95								
Frontera 2.0	04/95→08/98								
Frontera 2.0 i	03/92→10/98								
2.0	C 20 NEF					133	BP820 (Fibre)	DP820 [3]	EK482
Carlton 2.0	09/90→03/94	1998	4	86.00	SOHC/OHC	74/100			
Carlton 2.0	09/90→03/94								
2.0	C 20 NEJ					134	BP820 (Fibre)	DP820 [3]	EK482
Carlton 2.0	09/90→03/94	1998	4	86.00	SOHC/OHC	73-74/ 99-100			
Carlton 2.0 i	09/90→03/94								
2.0	C 20 XE					135	BS720 (Fibre)	DS720	ES720
Astra 1.9	03/88→08/91	1998	4	86.00	DOHC	110/150			
Astra 2.0 i 16V	09/91→02/98								
Calibra 2.0 i	06/90→02/94								
Cavalier 2.0 i	09/88→11/95								
2.0	F4R 720					136	AD5990 (MLS)	CD5991	ED5991
Vivaro 2.0 16V	08/01→12/06	1998	4	82.70	DOHC	88/120			
2.0	F4R 820					137	AD5990 (MLS)	CD5991	ED5991
Vivaro 2.0 ECO	08/06→	1998	4	82.70	DOHC	86/117			
2.0	M9R 780 Diesel					138	AG9760 (MLS)		
Vivaro 2.0 CDTi	01/06→	1995	4	84.00	DOHC	66-84/ 90-114			
2.0	M9R 782 Diesel					139	AG9760 (MLS)		
Vivaro 2.0 CDTi	01/06→	1995	4	84.00	DOHC	66-84/ 90-114			
2.0	M9R 784 Diesel					140	AG9760 (MLS)		
Vivaro 2.0 CDTi	08/06→	1995	4	84.00	DOHC	84/114			
2.0	X 20 DTH Diesel					141	AB5670 (MLS), 1.300mm, 1 Notch AB5680 (MLS), 1.400mm, 2 Notches	CB5670 ▲ [13]	EB5670 [3]
Astra 2.0 DTi	02/98→05/05	1995	4	84.00	SOHC/OHC	74/101			
Omega 2.0 DTi	01/98→09/00								
Vectra 2.0 DTi	08/95→10/01								

								
HBS053 [5] M11x1.25x140.00mm (x10) 01/97→12/96	JC756 [1] JC282 [1] 	JN693 [4]	JJ385	PA565 (x8) HR342 [x1]	NC006 [2] 35.00x48.00x7.00mm, MVQ NB807 [1] 55.00x70.10x8.00mm, FPM NB700 [2] 31.00x50.00x8.00mm, MVQ NB806 [1] 90.00x104.00x11.00mm, FPM			AB5670, AB5680  BP820  BS720  JC282  JC756  JD455  JD5255  JD5256  JD5347  JE120  JM5159  JM950  JN693  JH5057  JJ385  JJ459 
HBS053 [5] M11x1.25x140.00mm (x10)	JC756 [1] JC282 [1] 	JN693 [4]	JJ385	PA565 (x8) HR342 [1]	NC006 [2] 35.00x48.00x7.00mm, MVQ NB807 [1] 55.00x70.10x8.00mm, FPM NB700 [2] 31.00x50.00x8.00mm, MVQ NB806 [1] 90.00x104.00x11.00mm, FPM			 JD5347  JE120  JM5159  JM950  JN693  JH5057  JJ385  JJ459 
HBS053 [5] M11x1.25x140.00mm (x10)	JC756 [1] JC282 [1]	JN693 [4]	JJ385	PA565 HR342 [1]	NC006 [2] 35.00x48.00x7.00mm, MVQ NB807 [1] 55.00x70.10x8.00mm, FPM NB700 [2] 31.00x50.00x8.00mm, MVQ NB806 [1] 90.00x104.00x11.00mm, FPM			 JD5347  JE120  JM5159  JM950  JN693  JH5057  JJ385  JJ459 
HBS035 [5] M11x1.25x110.00mm (x10) →Eng.14137011 HBS054 [5] M11x1.25x105.00mm (x10) Eng.14137012→	JD455 [1] JD5980 [1]	JM950 [4]	JJ459 (x2)	PA565 (x16) HR342 [x2]	NC006 (x2) [2] 35.00x48.00x7.00mm, MVQ NB884 [2] 38.00x50.00x5.50mm, FPM NB806 [1] 90.00x104.00x11.00mm, FPM			 JM5159  JM950  JN693  JH5057  JJ385  JJ459 
HBS310 [22] M12x1.50x117.00mm (x10)		HR397 [1]	JH5041 → KG5012 16.00x23.00x1.500mm	PA5013 (x16)	NA5257 [2] 28.00x47.00x5.50mm, FPM NA5036 [2] 42.00x54.00x6.00mm, FPM NA5037 [1] 85.00x105.00x11.00mm, ACM			 JM950  JN693  JH5057  JJ385  JJ459 
HBS310 [22] M12x1.50x117.00mm (x10)		HR397 [1]	JH5041		NA5257 [2] 28.00x47.00x5.50mm, FPM NA5036 [2] 42.00x54.00x6.00mm, FPM NA5037 [1] 85.00x105.00x11.00mm, ACM			 JM950  JN693  JH5057  JJ385  JJ459 
	JD5937 [1] (MLS)							 JJ385  JJ459 
	JD5937 [1] (MLS)							 JJ385  JJ459 
	JD5937 [1] (MLS)							 JJ385  JJ459 
HBS298 [22] M12x1.50x235.00mm (x10)	JD5347 [1] [2] JD5255 [1] [2] JD5256 [1]	JM5159 (SE)	JH5057	PA5041 (x16) 6.00/12.20x10.00 (FPM) HR791 [1]	NA5069 [2] 55.00x68.00x8.00mm, FPM NA5209 [1] 99.00x114.00x11.00mm, FPM NB469 [1] 77.00x100.00x11.50mm, FPM	JR5029 [6]		 JR5029 



cc



kW/PS



2.0	X 20 DTL Diesel	142			AB5670 (MLS), 1.300mm, 1 Notch AB5680 (MLS), 1.400mm, 2 Notches	CB5670 ▲ [13]	EB5670 [3]
Astra 2.0 DI	02/98→05/05	1995	4	84.00	SOHC/OHC	60/82	
Astravan 2.0 DI	08/98→08/06						
Vectra 2.0 DI	08/95→10/01						
Zafira 2.0 DI	10/99→08/05						
2.0	X 20 SE	143			BP820 (Fibre)	DP823 [3]	EC130
Frontera 2.0	04/95→08/98	1998	4	86.00	SOHC/OHC	85/116	
Frontera 2.0 i	03/92→10/98						
Omega 2.0	03/94→09/99						
Omega 2.0	03/94→09/99						
2.0	X 20 XER	144			BY250 (Fibre)	DY250 [3]	HC5007
Astra 2.0	10/99→08/00	1998	4	86.00	DOHC	118/160	
Astra 2.0 16V	10/99→05/05						
2.0	X 20 XEV	145			BY250 (Fibre)	DY250 [3]	EC130 HC5007
Astra 2.0 16V	02/98→05/05	1998	4	86.00	DOHC	100/136	
Astra 2.0 i 16V	01/94→09/98						
Astra Conv 2.0i	01/94→02/98						
Calibra 2.0 i	06/90→07/97						
Cavalier 2.0 i	09/93→11/95						
Cavalier 2.0SRi	09/93→11/95						
Omega 2.0	03/94→02/01						
Vectra 2.0 i	10/95→01/01						
Vectra 2.0i 16V	10/95→01/01						
2.0	Y 20 DTH Diesel	146			AB5670 (MLS), 1.300mm, 1 Notch AB5680 (MLS), 1.400mm, 2 Notches	CB5670 ▲ [13]	EB5670 [3]
Astra 2.0 DTI	02/98→05/05	1995	4	84.00	SOHC/OHC	74/101	
Astravan 2.0DTI	04/04→08/06						
Signum 2.0 DTI	05/03→05/08						
Vectra 2.0 DTI	08/95→10/08						
Vectra 2.0 GTS	08/02→07/08						
Zafira 2.0 DTI	04/99→08/05						
2.0	Y 20 DTL Diesel	147			AB5670 (MLS), 1.300mm, 1 Notch AB5680 (MLS), 1.400mm, 2 Notches	CB5670 ▲ [13]	EB5670 [3]
Astra 2.0 DI	02/98→05/05	1995	4	84.00	SOHC/OHC	60/82	
2.0	Z 20 DM Diesel	148			AH5690 (MLS) AH5700 (MLS), 1.200mm, 2 Holes AH5710 (MLS), 1.300mm, 3 Holes	CH5690	
Antara 2.0 CDTi	08/06→	1991	4	83.00	DOHC	93/126	
2.0	Z 20 DMH Diesel	149			AH5690 (MLS) AH5700 (MLS), 1.200mm, 2 Holes AH5710 (MLS), 1.300mm, 3 Holes	CH5690	
Antara 2.0 CDTi	08/06→	1991	4	83.00	DOHC	110/150	
2.0	Z 20 DTJ Diesel	150			AB5670 (MLS), 1.300mm, 1 Notch AB5680 (MLS), 1.400mm, 2 Notches	CB5670 ▲ [13]	EB5670 [3]
Zafira 2.0 CDTi	10/11→	1956	4	83.00	DOHC	96/131	

HBS298 [22] M12x1.50x235.00mm (x10)	JD5255 [1] JD5347 [1] JD5256 [1]	JM5159 (SE)	JH5057	PA5041 (x16) 6.00/12.20x10.00 (FPM) HR791 [1]	<input checked="" type="checkbox"/> NA5069 [2] 55.00x68.00x8.00mm, FPM <input checked="" type="checkbox"/> NA5209 [1] 99.00x114.00x11.00mm, FPM <input checked="" type="checkbox"/> NB469 [1] 77.00x100.00x11.50mm, FPM	JR5029 [6]		JJ616 JJ617	
HBS053 [5] M11x1.25x140.00mm (x10) 01/97→	JC756 [1] JC282 [1] 	JP018 [4]	JJ615	PA565 (x8) HR342 [x1]	<input checked="" type="checkbox"/> NC006 [2] 35.00x48.00x7.00mm, MVQ <input checked="" type="checkbox"/> NB700 [2] 31.00x50.00x8.00mm, MVQ <input checked="" type="checkbox"/> NB806 [1] 90.00x104.00x11.00mm, FPM			JJ616 JJ617	
HBS054 [5] M11x1.25x105.00mm (x10)		JP016 [4]	JJ616 [2] JJ617 [2]	HR791 [1]	<input checked="" type="checkbox"/> NC006 [2] 35.00x48.00x7.00mm, MVQ <input checked="" type="checkbox"/> NB700 [2] 31.00x50.00x8.00mm, MVQ <input checked="" type="checkbox"/> NB806 [1] 90.00x104.00x11.00mm, FPM				
HBS054 [5] M11x1.25x105.00mm (x10)	JD451 [1] JD5300 [1] (MLS) 	JP016 [4]	JJ615 JJ616 [2] JJ617 [2]	PA5041 (x16) 6.00/12.20x10.00 (FPM) HR791 [x1]	<input checked="" type="checkbox"/> NC006 (x2) [2] 35.00x48.00x7.00mm, MVQ <input checked="" type="checkbox"/> NB700 [2] 31.00x50.00x8.00mm, MVQ <input checked="" type="checkbox"/> NB806 [1] 90.00x104.00x11.00mm, FPM				
HBS298 [22] M12x1.50x235.00mm (x10)	JD5347 [1] [2] JD5255 [1] [2] JD5256 [1]	JM5159 (SE)	JH5057	PA5041 (x16) 6.00/12.20x10.00 (FPM) HR791 [1]	<input checked="" type="checkbox"/> NA5069 [2] 55.00x68.00x8.00mm, FPM <input checked="" type="checkbox"/> NA5209 [1] 99.00x114.00x11.00mm, FPM <input checked="" type="checkbox"/> NB469 [1] 77.00x100.00x11.50mm, FPM	JR5029 [6]			
HBS298 [22] M12x1.50x235.00mm (x10)	JD5255 [1] JD5347 [1] JD5256 [1]	JM5159 (SE)	JH5057	PA5041 (x16) 6.00/12.20x10.00 (FPM) HR791 [1]	<input checked="" type="checkbox"/> NA5069 [2] 55.00x68.00x8.00mm, FPM <input checked="" type="checkbox"/> NA5209 [1] 99.00x114.00x11.00mm, FPM <input checked="" type="checkbox"/> NB469 [1] 77.00x100.00x11.50mm, FPM	JR5029 [6]			
		JM7115 (NBR)							
		JM7115 (NBR)							
HBS298 [22] M12x1.50x235.00mm (x10)	JD5255 [1] JD5347 [1] JD5256 [1]	JM5159 (SE)	JH5057 JH5078 [2]	PA5041 (x16) 6.00/12.20x10.00 (FPM) HR791 [1]	<input checked="" type="checkbox"/> NA5069 [2] 55.00x68.00x8.00mm, FPM <input checked="" type="checkbox"/> NA5209 [1] 99.00x114.00x11.00mm, FPM <input checked="" type="checkbox"/> NB469 [1] 77.00x100.00x11.50mm, FPM	JR5029 [6]		JJ615	



cc



kW/PS



2.0	Z 20 LEH						151			EG9570
Astra 2.0 Turbo	01/04→05/09	1998	4	86.00	DOHC		176-177/ 240-241			
Astra 2.0 VXR	02/09→11/10									
Zafira 2.0	01/06→									
2.0	Z 20 LEL						152	AG9570 (MLS)	CG9570	EG9570
Astra 2.0 Turbo	01/04→11/10	1998	4	86.00	DOHC		125/170			
Astra Twin 2.0	02/06→11/10									
2.0	Z 20 LER						153	AG9570 (MLS)	CG9570	EG9570
Astra 2.0 Turbo	01/04→10/10	1998	4	86.00	DOHC		147/200			
Astra Twin 2.0T	01/06→11/10									
Zafira 2.0	07/05→									
2.0	Z 20 LET						154	AG9570 (MLS)	CG9570	EG9570
Astra 2.0 SRI T	07/02→05/05	1998	4	86.00	DOHC		140-162/ 190-220			
Astra Conv 2.0	03/02→07/06									
Astra Coupe 2.0	09/00→08/05									
Speedster 2.0	10/03→09/06									
VX220 Conv 2.0i	03/01→04/04									
Zafira 2.0	06/02→06/05									
Zafira 2.0 GSI	09/01→06/05									
2.0	Z 20 NET						155	AG9580 (MLS)	CG9581	
Signum 2.0 i T	01/02→10/08	1998	4	86.00	DOHC		129/175			
Vectra 2.0 T	01/00→10/08									
2.2	C223 Diesel						156	BM370 (Fibre) BR200 (Steel)	DM370 ○ [3] DR200 [3]	GM370 ○ [3] GM372 [13]
Brava 2.2 D	08/91→09/96	2238	4	88.00	SOHC/OHC		39-54/ 53-73			
2.2	G9T 720 Diesel						157	AE5210 (MLS), 1.240mm	CE5210	EE5220 [3]
Movano 2.2 DTI	09/00→05/10	2188	4	87.00	DOHC		66/90			
2.2	G9T 722 Diesel						158	AE5210 (MLS), 1.240mm	CE5210	EE5220 [3]
Movano 2.2 DTI	09/00→05/10	2188	4	87.00	DOHC		66/90			
2.2	G9T 750 Diesel						159	AE5210 (MLS), 1.240mm	CE5210	EE5220 [3]
Movano 2.2 DTI	09/00→05/10	2188	4	87.00	DOHC		66/90			
2.2	X 22 DTH Diesel						160	AB5670 (MLS), 1.300mm, 1 Notch AB5680 (MLS), 1.400mm, 2 Notches	CB5670 ▲ [13] →Eng.2V599999 CB5671 ▲ [13] Eng.3V500001→	EB5670 [3] EB5671 [3][135]
Frontera 2.2DTI	10/98→09/04	2171	4	84.00	SOHC/OHC		85/116			
Sintra 2.2 DTI	07/97→04/99									
2.2	X 22 SE						161	BY250 (Fibre)	DY254	EC102
Frontera 2.2 i	10/98→10/04	2198	4	86.00	DOHC		100-104/ 136-141			

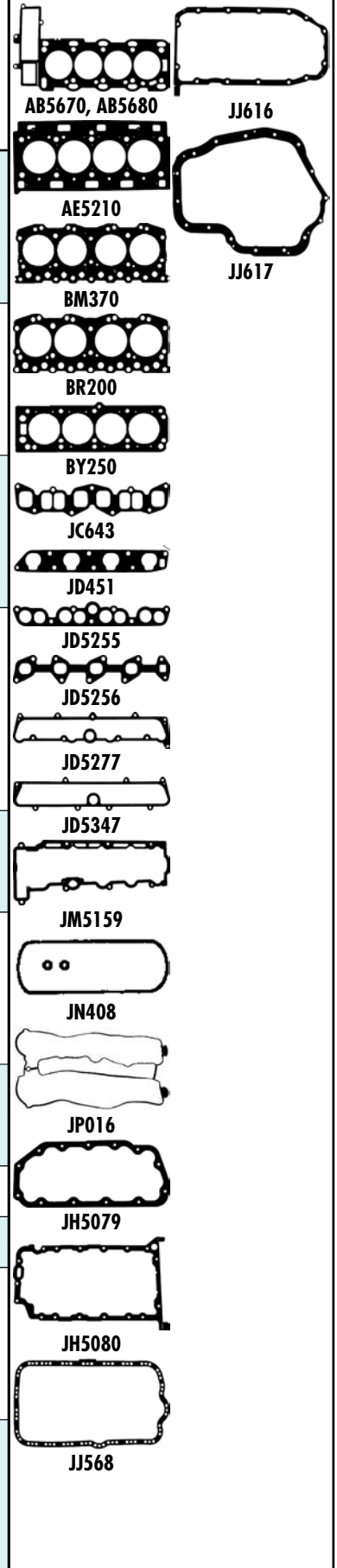

HBS054 [5] M11x1.25x105.00mm (x10)	JD451 [1] JD5903 [3] (MLS)	JP016 [4]	JJ616 [2] JJ617 [2]	HR791 [3]	NC006 [2] 35.00x48.00x7.00mm, MVQ NB700 [2] [2] 31.00x50.00x8.00mm, MVQ NB806 [1] [1] 90.00x104.00x11.00mm, FPM	
HBS054 [5] M11x1.25x105.00mm (x10)	JD451 [1] JD5903 [3] (MLS)	JP016 [4]	JJ616 [2] JJ617 [2]	HR791 [3]	NC006 [2] 35.00x48.00x7.00mm, MVQ NB700 [2] [2] 31.00x50.00x8.00mm, MVQ NB806 [1] [1] 90.00x104.00x11.00mm, FPM	
HBS054 [5] M11x1.25x105.00mm (x10)	JD451 [1] JD5903 [3] (MLS)	JP016 [4]	JJ616 [2] JJ617 [2]	HR791 [3]	NC006 [2] 35.00x48.00x7.00mm, MVQ NB700 [2] [2] 31.00x50.00x8.00mm, MVQ NB806 [1] [1] 90.00x104.00x11.00mm, FPM	
HBS054 [5] M11x1.25x105.00mm (x10)	JD451 [1] JD5903 [3] (MLS)	JP016 [4]	JJ616 [2] JJ617 [2]	HR791 [3]	NC006 (x2) [2] 35.00x48.00x7.00mm, MVQ NB700 [2] [2] 31.00x50.00x8.00mm, MVQ NB806 [1] [1] 90.00x104.00x11.00mm, FPM	
HBS416 [22] M11x1.50x163.00mm (x10)		HM5370 [3]	HR397		NA5108 [2] [2] 42.00x55.00x7.00mm, FPM/ACM NB806 [1] [1] 90.00x104.00x11.00mm, FPM	
HBS286 [22] M11x1.50x116.00mm (x16)	JC643 JE019	JN408 [4]			NJ267 [2] 42.00x55.00x9.00mm, NBR NJ266 [2] [2] 65.00x84.00x9.00mm, NBR NJ265 [1] [1] 82.00x105.00x13.00mm, MVQ	
HBS373 [22] M12x1.50x131.00mm (x10)	JD5891 [1] JD5892	HM5290 [3]	JJ568		NA5053 [2] 30.00x42.00x7.00mm, FPM NF860 [1] [1] 93.00x108.00x7.00mm, FPM/ACM	
HBS373 [22] M12x1.50x131.00mm (x10)	JD5891 [1] JD5892	HM5290 [3]	JJ568		NA5053 [2] 30.00x42.00x7.00mm, FPM	
HBS373 [22] M12x1.50x131.00mm (x10)	JD5891 [1] JD5892	HM5290 [3]	JJ568		NA5053 [2] 30.00x42.00x7.00mm, FPM	
HBS298 [22] M12x1.50x235.00mm (x10)	JD5255 [1] JD5347 [1] →Eng.2V599999 JD5277 [1] Eng.3V500001→ JD5256 [1]	JM5159 (SE)	JH5079 JH5080	PA5041 (x16) 6.00/12.20x10.00 (FPM) HR791 [3]	NA5069 [2] [2] 55.00x68.00x8.00mm, FPM NA5209 [1] [1] 99.00x114.00x11.00mm, FPM	JR5029 [6]
HBS054 [5] M11x1.25x105.00mm (x10)	JD451 [1] JD5300 [3] (MLS)	JP016 [4]	JH5096 (SE)	HR791 [3]	NC006 [2] 35.00x48.00x7.00mm, MVQ NB700 [2] [2] 31.00x50.00x8.00mm, MVQ NB806 [1] [1] 90.00x104.00x11.00mm, FPM	



cc



kW/PS



2.2	X 22 XE					162	BY250 (Fibre)	DY251 [3]	EC100 [3]
Frontera 2.2 i	03/95→10/98	2198	4	86.00	DOHC	100-104/ 136-141			
Sintra 2.2i 16V	11/96→04/99								
2.2	Y 22 DTH Diesel					163	AB5670 (MLS), 1.300mm, 1 Notch AB5680 (MLS), 1.400mm, 2 Notches	CB5670 ▲ [13] →Eng.2V599999 CB5671 ▲ [13] Eng.3V500001→	EB5670 [3] [136] EB5671 [3] [135]
Frontera 2.2DTI	10/98→09/04	2171	4	84.00	SOHC/OHC	85-88/ 116-120			
Omega 2.2 DTI	08/00→07/03								
2.2	Y 22 DTR Diesel					164	AB5670 (MLS), 1.300mm, 1 Notch AB5680 (MLS), 1.400mm, 2 Notches	CB5670 ▲ [13]	EB5670 [3]
Astra 2.2 DTI	09/02→05/05	2172	4	84.00	SOHC/OHC	92/125			
Signum 2.2 DTI	05/03→05/08								
Vectra 2.2 DTI	08/95→10/08								
Vectra 2.2 GTS	08/02→07/08								
Zafira 2.2 D	06/01→06/05								
2.2	Y 22 SE					165	BY250 (Fibre)	DY255	EC102
Frontera 2.2 i	10/98→10/04	2198	4	86.00	DOHC	100/136			
2.2	Y 22 XE					166	BY250 (Fibre)	DY253	EC101
Omega 2.2	01/94→06/03	2198	4	86.00	DOHC	106-108/ 144-147			
Omega 2.2	02/94→06/03								
2.2	Z 22 SE					167	AG9580 (MLS)	CG9580	
Astra 2.2 16V	03/01→05/05	2198	4	86.00	DOHC	106-108/ 144-147			
Astra Conv 2.2	03/01→10/05								
Astra Coupe 2.2	03/00→08/05								
Vectra 2.2 16V	01/02→10/08								
Vectra 2.2i 16V	08/95→07/03								
VX220 Conv 2.2i	09/00→07/05								
Zafira 2.2 16V	11/98→08/04								
2.2	Z 22 XE					168	BY250 (Fibre)	DY253	EC101
Omega 2.2	01/94→06/03	2198	4	86.00	DOHC	106/144			
Omega 2.2	02/94→06/03								
2.2	Z 22 YH					169	AG9590 (MLS)	CG9590	
Signum 2.2 i	05/03→05/08	2198	4	86.00	DOHC	100-114/ 136-155			
Vectra 2.2 dir	01/02→10/08								
Zafira 2.2	07/05→								
2.3	23 DTR Diesel					170	BR010 (Fibre), 1.300mm, 1 Hole BR020 (Fibre), 1.400mm, 2 Holes BR030 (Fibre), 1.500mm, 3 Holes	DR010 ▲	EJ161
Carlton 2.3 TD	08/88→03/94	2260	4	92.00	SOHC/OHC	74/100			
Frontera 2.3 TD	03/92→10/98								
2.3	23 YD Diesel					171	BR010 (Fibre), 1.300mm, 1 Hole BR020 (Fibre), 1.400mm, 2 Holes BR030 (Fibre), 1.500mm, 3 Holes	DR010 ▲	EJ161
Carlton 2.3 D	09/86→03/94	2260	4	92.00	SOHC/OHC	54/73			
Carlton 2.3D	09/86→03/94								



AB5670, AB5680

JJ459



BR010, BR020,
BR030



BY250



JD451



JD5255



JD5256

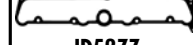

JD5277

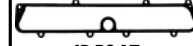

JD5347



JM5159



JN521



JN523



JP016



HC417



JH5019



JH5057



JH5079



JH5080



cc



kw/PS



2.3	23 YDT Diesel	172	BR010 (Fibre), 1.300mm, 1 Hole BR020 (Fibre), 1.400mm, 2 Holes BR030 (Fibre), 1.500mm, 3 Holes		DR010 ▲ DR013 ▲ [13]	EJ161
Carlton 2.3 TD	09/86→08/88	2260	4	92.00 SOHC/OHC	66/90	
2.4	C 24 NE	173	BJ170 (Fibre)			
Carlton 2.4 i	09/88→03/94	2410	4	95.00 SOHC/OHC	92/125	
Carlton 2.4 i	09/88→03/94					
Frontera 2.4 i	03/92→10/98					
2.5	4 JA1 Diesel	174	BR990 (MLS)		DR990 [3]	GR990 [3]
Brava 2.5 D	08/91→06/94	2499	4	93.00 SOHC/OHC	56-74/ 76-101	
Brava 2.5 DTI	08/01→12/02					
2.5	4 JA1T Diesel	175	BR990 (MLS)		DR990 [3]	GR990 [3]
Brava 2.5 D	06/90→06/94	2499	4	93.00 OHV	56/76	01/94→
Brava 2.5 DT	07/94→12/02					01/94→
2.5	25 DT Diesel	176	BZ111 (Fibre), 1.680mm, 2 Holes BZ120 (Fibre), 1.870mm, 3 Holes		DW731 ▲ [13]	EY280
Omega 2.5 TD	04/94→07/01	2497	6	80.00 SOHC/OHC	96/130	
2.5	C 25 XE	177	BY270 (Fibre)		DY270 [3]	EC230 [3]
Calibra 2.5i V6	04/93→07/97	2498	6	81.60 DOHC, V	125/170	
Cavalier 2.5 V6	08/88→06/94					
2.5	G9U 630 Diesel	178	AE5220 (MLS)		CE5210	EE5220 [3]
Vivaro 2.5 CDTI	04/03→07/06	2464	4	89.00 DOHC	84-107/ 114-146	
Vivaro 2.5 DTI	04/04→					
2.5	G9U 650 Diesel	179	AE5220 (MLS)		CE5210	EE5220 [3]
Movano 2.5 CDTI	10/01→05/10	2464	4	89.00 DOHC	74-107/ 101-146	
2.5	G9U 720 Diesel	180	AE5220 (MLS)		CE5210	EE5220 [3]
Movano 2.5 DTI	10/01→05/10	2463	4	89.00 DOHC	84-85/ 115-116	
2.5	G9U 724 Diesel	181	AE5220 (MLS)		CE5210	EE5220 [3]
Movano 2.5 DTI	10/01→05/10	2463	4	89.00 DOHC	84/115	
2.5	G9U 730 Diesel	182	AE5220 (MLS)		CE5210	EE5220 [3]
Vivaro 2.5 CDTI	04/03→07/06	2463	4	89.00 DOHC	99-107/ 135-146	
Vivaro 2.5 DTI	04/04→					
2.5	G9U 750 Diesel	183	AE5220 (MLS)		CE5210	EE5220 [3]
Movano 2.5 DTI	10/01→05/10	2463	4	89.00 DOHC	84/115	
2.5	G9U 754 Diesel	184	AE5220 (MLS)			EE5220 [3]
Movano 2.5 CDTI	10/01→05/10	2463	4	89.00 DOHC	73-84/ 99-115	
Movano 2.5 DTI	10/01→05/10					



HBS163 [22] M13x1.50x134.00mm (x10)	JD5765	JN523 [4] JN521 [4]	HC417	PA543 HR794 (x1)	NB628 [2] 45.00x60.00x9.00mm, ACM NB690 [1] 81.00x100.10x11.50mm, FPM	
HBS161 [22] M12x1.50x64.00mm (x5)	JD187	JN923 [4] JN924 [4]	JH5019	PA619 (x8) 9.00/17.00x14.20 (ACM) HR336 (x1)	NB628 [2] 45.00x60.00x9.00mm, ACM NB469 [1] 77.00x100.00x11.50mm, FPM	
		JN707 [4]	JJ470	PA418 (x8)	NA5051 [2] 40.00x56.00x7.00mm, FPM NJ322 [1] 95.00x118.00x10.00mm, NBR	
		JN707 [4] 01/94→	JJ470 01/94→	PA418 01/94→	NA5051 [2] 40.00x56.00x7.00mm, FPM 01/94→ NJ322 [1] 95.00x118.00x10.00mm, NBR 01/94→	
HBS066 [22] M12x1.50x146.50mm (x14)	JD274 (x6) JD276 (x1) JD5134	JN955 [4]	JJ536	HR280 (x1)	NF637 [2] 48.00x65.00x10.00mm, FPM NA5104 [1] 90.00x110.00x12.00mm, PTFE NB431 [1] 90.00x110.00x12.00mm, FPM	
HBS164 [5] M11x1.25x105.00mm (x16)	JD457 (x2) JD458 JD5201 JD459	JM5094 (x2) [139] (Elastomer) JM5095 (x2) [139] (Elastomer) HM5294	JH5052	PA5041 (x24) 6.00/12.20x10.00 (FPM) HR5062 (x1)	NC006 (x4) [2] 35.00x48.00x7.00mm, MVQ NB884 [2] 38.00x50.00x5.50mm, FPM NB806 [1] 90.00x104.00x11.00mm, FPM	
HBS373 [22] M12x1.50x131.00mm (x10)			JJ568		NA5053 [2] 30.00x42.00x7.00mm, FPM NF860 [1] 93.00x108.00x7.00mm, FPM/ACM	
HBS373 [22] M12x1.50x131.00mm (x10)			JJ568		NA5053 [2] 30.00x42.00x7.00mm, FPM NF860 [1] 93.00x108.00x7.00mm, FPM/ACM	
HBS373 [22] M12x1.50x131.00mm (x10)			JJ568		NA5053 [2] 30.00x42.00x7.00mm, FPM NF860 [1] 93.00x108.00x7.00mm, FPM/ACM	
HBS373 [22] M12x1.50x131.00mm (x10)			JJ568		NA5053 [2] 30.00x42.00x7.00mm, FPM NF860 [1] 93.00x108.00x7.00mm, FPM/ACM	
HBS373 [22] M12x1.50x131.00mm (x10)			JJ568		NA5053 [2] 30.00x42.00x7.00mm, FPM NF860 [1] 93.00x108.00x7.00mm, FPM/ACM	
HBS373 [22] M12x1.50x131.00mm (x10)			JJ568		NA5053 [2] 30.00x42.00x7.00mm, FPM NF860 [1] 93.00x108.00x7.00mm, FPM/ACM	
HBS373 [22] M12x1.50x131.00mm (x10)			JJ568		NA5053 [2] 30.00x42.00x7.00mm, FPM NF860 [1] 93.00x108.00x7.00mm, FPM/ACM	

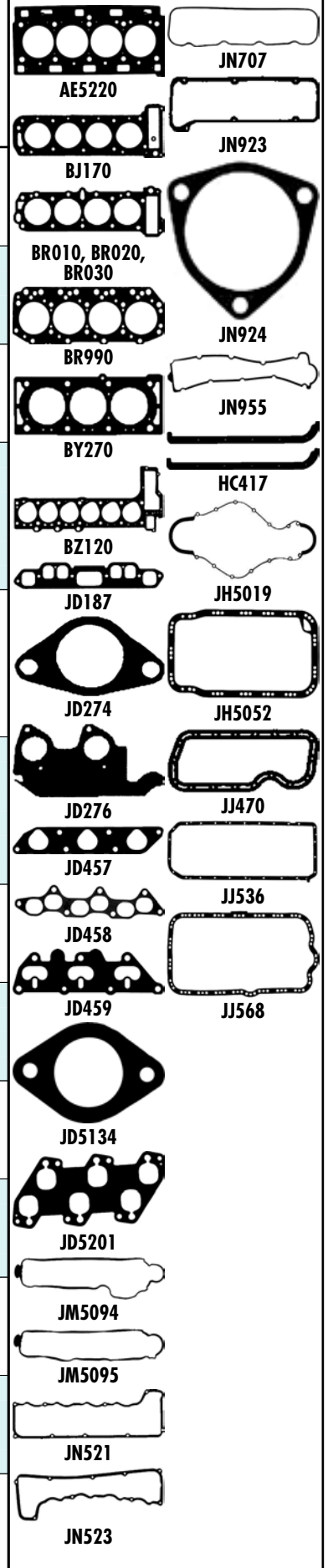



cc



kW/PS

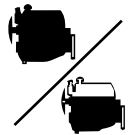

2.5	S8U 758 Diesel	185			AY290 (Fibre), 1.600mm AY300 (Fibre), 1.700mm AY310 (Fibre), 1.800mm	DE588 ▲ [3]	FY291 ▲ [16]
Arena 2.5 D	03/98→08/01	2499	4	93.00	SOHC/OHC	55-58/ 75-79	
2.5	S8U 770 Diesel	186			AY290 (Fibre), 1.600mm AY300 (Fibre), 1.700mm AY310 (Fibre), 1.800mm	DE588 ▲ [3]	FY291 ▲ [16]
Movano 2.5 D	10/98→09/00	2499	4	93.00		59/80	
2.5	S8U 780 Diesel	187			AY290 (Fibre), 1.600mm AY300 (Fibre), 1.700mm AY310 (Fibre), 1.800mm	DE588 ▲ [3]	FY291 ▲ [16]
Arena 2.5 D	03/98→08/01	2499	4	93.00	SOHC/OHC	55/75	
2.5	S8U 782 Diesel	188			AY290 (Fibre), 1.600mm AY300 (Fibre), 1.700mm AY310 (Fibre), 1.800mm	DE588 ▲ [3]	FY291 ▲ [16]
Arena 2.5 D	03/98→08/01	2499	4	93.00	SOHC/OHC	55/75	
2.5	X 25 DT Diesel	189			BZ111 (Fibre), 1.680mm, 2 Holes BZ120 (Fibre), 1.870mm, 3 Holes	DW731 ▲ [13]	EY280
Omega 2.5 TD	04/94→07/01	2497	6	80.00	SOHC/OHC	96/131	
2.5	X 25 XE	190			BY270 (Fibre) (x2)	DY271 [3] DY272	EC230 [3]
Calibra 2.5i V6	04/93→07/97	2498	6	81.60	DOHC, V	125-143/ 170-194	
Omega 2.5 V6	03/94→09/00						
Omega 2.5 V6	03/94→09/00						
Vectra 2.5 i V6	09/95→08/00						
Vectra 2.5i GSi	03/98→07/00						
2.5	Y 25 DT Diesel	191			AC5320 (MLS), 1.450mm, 1 Hole AC5330 (MLS), 1.550mm, 2 Holes AC5340 (MLS), 1.650mm, 3 Holes	DZ660 ▲ [13]	
Omega 2.5 DTi	09/01→06/03	2497	6	80.00	DOHC	110/150	
Omega 2.5 DTi	09/01→07/03						
2.6	C 26 NE	192			BT530 (Fibre)		
Carlton 2.6 i	09/90→03/94	2594	6	88.80	SOHC/OHC	110/150	
Carlton 2.6 i	09/90→03/94						
Senator 2.6 i	09/90→09/93						
2.6	Y 26 SE	193					
Omega 2.6 V6	08/00→07/03	2597	6	83.20	DOHC, V	125-132/ 170-180	
Vectra 2.6 i V6	09/00→07/03						
2.8	28 TDi (4JB1T) Diesel	194			BR990 (MLS)	CD5400 ▲	ER993
Frontera 2.8 TD	03/95→10/98	2771	4	93.00	OHV	83/113	

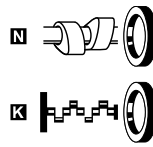
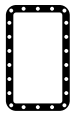
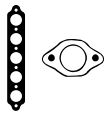

HBS011 [5] M12x1.25x119.00mm (x12)	JC054 ■ JC055 ■	JN956 [4]	JJ100 (Cork) JJ519	N NPO68 [2] 55.00x70.00x8.00mm, FPM N NPO67 ■ [2] 50.00x70.00x10.00mm, FPM N NF883 ■ [1] 114.00x177.00x13.00mm, FPM N NF885 ■ [2] 70.00x179.00x16.00mm, FPM	
HBS011 [5] M12x1.25x119.00mm (x12)	JC054 ■ JC055 ■	JN956 [4] JN969 [4]	JJ519	N NPO68 [2] 55.00x70.00x8.00mm, FPM N NF883 ■ [1] 114.00x177.00x13.00mm, FPM N NF885 ■ [2] 70.00x179.00x16.00mm, FPM	
HBS011 [5] M12x1.25x119.00mm (x12)	JC054 ■ JC055 ■	JN956 [4]	JJ100 (Cork) JJ519	N NPO68 [2] 55.00x70.00x8.00mm, FPM N NF883 ■ [1] 114.00x177.00x13.00mm, FPM N NF885 ■ [2] 70.00x179.00x16.00mm, FPM	
HBS011 [5] M12x1.25x119.00mm (x12)	JC054 ■ JC055 ■ (x4)	JN956 [4]	JJ100 (Cork) JJ519	N NPO68 [2] 55.00x70.00x8.00mm, FPM N NF883 ■ [1] 114.00x177.00x13.00mm, FPM N NF885 ■ [2] 70.00x179.00x16.00mm, FPM	
HBS066 ⊕ [22] M12x1.50x146.50mm (x14)	JD274 ■ JD276 ■	JN955 [4]	JJ536	PA5041 (x12) 6.00/12.20x10.00 (FPM) HR280 ■	N NF637 ■ [2] 48.00x65.00x10.00mm, FPM N NB431 ■ [1] 90.00x110.00x12.00mm, FPM
HBS164 ⊕ [5] M11x1.25x105.00mm (x16)	JD5202 ■ (x2) JD5203 ■ ■ (x3) JD459 ■ (x2)	JD5204 (x2) (Elastomer) JM5094 ■ (x2)[139] (Elastomer) JM5095 ■ (x2)[139] (Elastomer) HMS294 ■	JH5052 JJ573 ■ JJ572 ■	HR5062 ■ (x1)	N NC006 (x4) [2] 35.00x48.00x7.00mm, MVQ N NB884 ■ [2] 38.00x50.00x5.50mm, FPM N NB806 ■ [1] 90.00x104.00x11.00mm, FPM
HBS066 ⊕ [22] M12x1.50x146.50mm (x14)	JD5108 ■ (x6) JD5107 ■ ■ (x6) JD5183 ■ (x3)	JM5106 (Elastomer)		PA5016 (x24)	N NA5104 ■ [1] 90.00x110.00x12.00mm, PTFE
			HC295 ■	PA619 (x12) 9.00/17.00x14.20 (ACM) HR336 ■ (x3)	N NB628 ■ [2] 45.00x60.00x9.00mm, ACM N NB469 ■ [1] 77.00x100.00x11.50mm, FPM
HBS164 ⊕ [5] M11x1.25x105.00mm (x16)	JD5202 ■ (x2) JD5203 ■ ■ (x3)	JD5204 (x2) (Elastomer) JM5094 ■ (x2)[139] (Elastomer) JM5095 ■ (x2)[139] (Elastomer)		HR5062 ■	N NC006 (x4) [2] 35.00x48.00x7.00mm, MVQ N NB884 ■ [2] 38.00x50.00x5.50mm, FPM N NB806 ■ [1] 90.00x104.00x11.00mm, FPM
HBS287 ⊕ [22] M11x1.50x121.00mm (x18)	JD470 ■	JN707 [4]	JJ454	PA418 (x8)	N NJ267 [2] 42.00x55.00x9.00mm, NBR N NJ014 ■ [2] 50.00x68.00x9.00mm, NBR N NJ322 ■ [1] 95.00x118.00x10.00mm, NBR

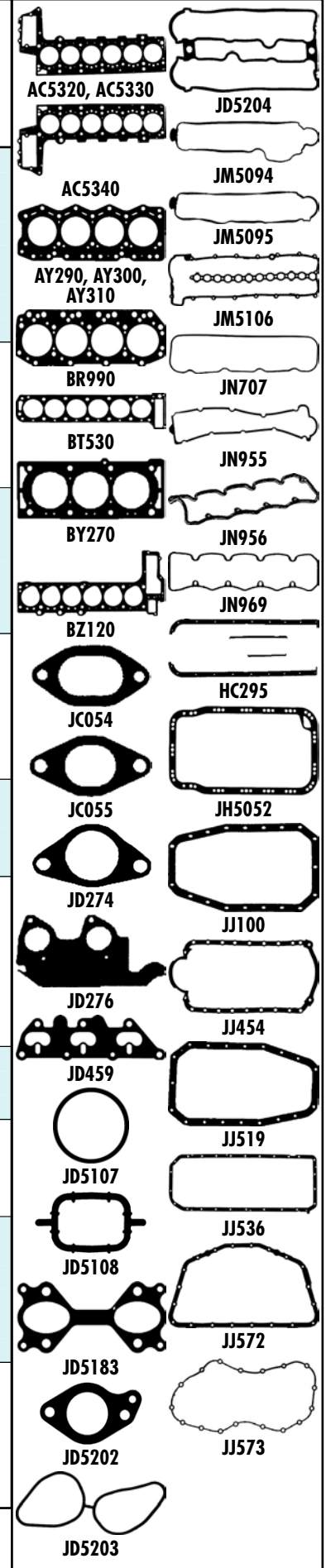













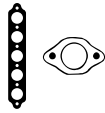

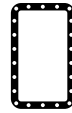

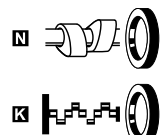

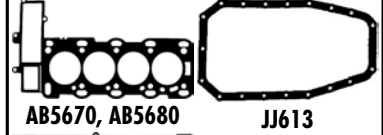
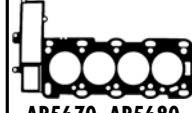



















cc

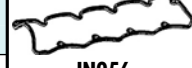

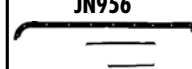
kW/PS

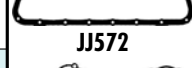

2.8		S9W 702 Diesel				195		BX400 (Fibre), 1.300mm		DX391 ▲ [3]	GX410 ▲ [3]
Movano 2.8 DTI	10/98→10/01	2799	4	94.40	SOHC/OHC	84/114	BX410 (Fibre), 1.400mm				
Movano 2.8 TDI	10/98→10/01						BX420 (Fibre), 1.500mm				
3.0		4 JX1 Diesel				196		AG5090 (MLS), 1.250mm, 3 Holes		CG5090 ▲	
Monterey 3.0DTI	07/98→08/99	2999	4	95.40	DOHC	117-118/ 159-160					
3.0		30 NE				197					EW870
Carlton 3.0	03/87→09/90	2969	6	95.00	CIH	130-135/ 177-184					
Senator 3.0	09/87→09/90										
3.0		C 30 LE				198					EW870
Senator 3.0	09/87→09/93	2969	6	95.00		115/156					
3.0		C 30 NE				199					EW870
Carlton 3.0	03/87→03/94	2969	6	95.00	SOHC/OHC	130/177					
Carlton 3000CAT	03/88→03/94										
Senator 3.0 i	01/88→09/93										
3.0		C 30 SEJ				200		BV950 (Fibre)		DV951	EB950 [3]
Carlton 3.0 24V	09/89→03/94	2969	6	95.00	DOHC	147/200					
Carlton 3000	09/89→03/94										
3.0		X 30 XE				201		BY300 (Fibre) (x2)		DY300 [3]	EC230 [3] Eng.08178989→
Omega 3.0 V6	04/94→07/00	2962	6	86.00	DOHC, V	148-155/ 201-211					
Sintra 3.0i 24V	11/96→04/99										
3.0		Y 30 DT Diesel				202		AG9770 (MLS), 0.600mm, 1 Hole		CG9770 ▲	EG9770 FG9770 ▲
Signum 3.0 CDTi	05/03→05/08	2958	6	87.50	DOHC, V	130/177	AG9780 (MLS), 0.650mm, 2 Holes				
Vectra 3.0 V6	06/03→08/05						AG9790 (MLS), 0.700mm, 3 Holes				
							AG9800 (MLS), 0.600mm, 1 Hole				
							AG9810 (MLS), 0.650mm, 2 Holes				
							AG9820 (MLS), 0.700mm, 3 Holes				
3.0		Z 30 DT Diesel				203		AG9770 (MLS), 0.600mm, 1 Hole		CG9770 ▲	EG9770 FG9770 ▲
Signum 3.0 V6	04/02→05/08	2958	6	87.50	DOHC, V	135/184	AG9780 (MLS), 0.650mm, 2 Holes				
Vectra 3.0 CDTi	08/05→07/08						AG9790 (MLS), 0.700mm, 3 Holes				
							AG9800 (MLS), 0.600mm, 1 Hole				
							AG9810 (MLS), 0.650mm, 2 Holes				
							AG9820 (MLS), 0.700mm, 3 Holes				
3.1		4 JG2TC Diesel				204		AG7720 (Steel), 1.600mm, 1 Notch		CD5400 ▲	ER993
Monterey 3.1 TD	09/91→07/98	3059	4	95.40	SOHC/OHC	84/114	AG7730 (Steel), 1.650mm, 2 Notches				
							AD5400 (Fibre), 1.700mm, 3 Holes				
3.2		6 VD1				205		AB5780 (MLS)		CG5781	EG6240
Frontera 3.2 i	10/98→10/04	3165	6	93.40	DOHC, V	130-151/ 177-205	AB5781 (MLS)				
Monterey 3.2	06/92→07/98										
3.2		Y 32 NE				206		AB5780 (MLS)		CG5500	EG6240
Frontera 3.2 i	10/98→10/04	3165	6	93.40	DOHC, V	151/205	AB5781 (MLS)				
3.2		Z 32 SE				207		AB5670 (MLS), 1.300mm, 1 Notch		CB5671 ▲ [13]	EB5671 [3]
Signum 3.2 V6	05/03→05/08	3175	6	88.50	DOHC, V	155/211	AB5680 (MLS), 1.400mm, 2 Notches				
Vectra 3.2 V6	08/02→07/08										
3.5		6 VE1				208		AB5780 (MLS) (x2)		CG5781	EG6240
Monterey 3.5 V6	07/98→08/99	3494	6	93.40	DOHC, V	158/215	AB5781 (MLS)				

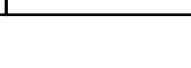
									
HBS011 [5] M12x1.25x119.00mm (x12)	JC054 [1] JC055 [1]		JN956 [4]	JJ613	HR602 [1]	N NP068 [2] 55.00x70.00x8.00mm, FPM K NF883 [1] 114.00x177.00x13.00mm, FPM K NF885 [2] 70.00x179.00x16.00mm, FPM		 AB5670, AB5680  JJ613  BV950  BX400, BX410, BX420	
HBS419 [22] M11x1.50x110.00mm (x18)						N NJ321 [2] 28.00x47.00x8.00mm, NBR		 BY300  JC054  JC055	
				HC295 [1]	PA619 (x12) 9.00/17.00x14.20 (ACM) HR336 [x3]	K NB628 [2] 45.00x60.00x9.00mm, ACM K NB469 [1] 77.00x100.00x11.50mm, FPM		 BY300  JC054  JC055	
				HC295 [1]	PA619 (x12) 9.00/17.00x14.20 (ACM) HR336 [1]	K NB628 [2] 45.00x60.00x9.00mm, ACM K NB469 [1] 77.00x100.00x11.50mm, FPM		 JC055  JD459	
				HC295 [1]	PA619 (x12) 9.00/17.00x14.20 (ACM) HR336 [1]	K NB628 [2] 45.00x60.00x9.00mm, ACM K NB469 [1] 77.00x100.00x11.50mm, FPM		 JD459  JD5202	
HBS417 [22] M12x1.50x88.00mm (x14)				JJ508 (Elastomer)	PA565 (x24) HR342 [x3]	K NB690 [1] 81.00x100.10x11.50mm, FPM		 JD5202  JD5203	
HBS164 [5] M11x1.25x105.00mm (x16)	JD5202 [1] (x2) JD5203 [1] (x3) JD459 [1] (x2)	JM5094 [1] (x2) [139] (Elastomer) JM5095 [1] (x2) [139] (Elastomer) HM5294 [1] (x1)		JJ573 [1] JJ572 [1]	PA5041 (x24) 6.00/12.20x10.00 (FPM) HR5062 [1] (x1)	N NC006 (x4) [2] 35.00x48.00x7.00mm, MVQ K NB884 [2] 38.00x50.00x5.50mm, FPM K NB806 [1] 90.00x104.00x11.00mm, FPM		 JM5071  JM5094  JM5095	
HBS502 [22] (SE) JD5896 [1]  JE5064 (Steel)	JD5897 [1] (SE) JD5896 [1]  JE5064 (Steel)	HM5292 [1]			HR5094 [1]			 JM5071  JM5094  JM5095	
HBS502 [22] (SE) JD5896 [1]  JE5064 (Steel)	JD5897 [1] (SE) JD5896 [1]  JE5064 (Steel)	HM5292 [1]			HR5094 [1]			 JM5095  JN956	
HBS287 [22] M11x1.50x121.00mm (x18)				JJ555		K NA5051 [2] 40.00x56.00x7.00mm, FPM K NF843 [2] 50.00x68.00x10.00mm, FPM/ACM K NA5108 [2] 42.00x55.00x7.00mm, FPM/ACM		 JN956  HC295	
			JM5078 (x2)			K NA5108 [2] 42.00x55.00x7.00mm, FPM/ACM		 HC295  JJ572	
			JM5078 (x2)			K NA5108 [2] 42.00x55.00x7.00mm, FPM/ACM		 JJ572	
HBS164 [5] M11x1.25x105.00mm (x16)		JM5071 (Elastomer) JM5094 [1] (x2) [139] (Elastomer) JM5095 [1] (x2) [139] (Elastomer) JM5078 (x2)		HR397	HR280 [1] (x2)	N NC006 [2] 35.00x48.00x7.00mm, MVQ K NB884 [2] 38.00x50.00x5.50mm, FPM K NB806 [1] 90.00x104.00x11.00mm, FPM K NA5108 [2] 42.00x55.00x7.00mm, FPM/ACM		 JJ572	
		JM5078 (x2)				K NA5108 [2] 42.00x55.00x7.00mm, FPM/ACM			



Ltr



CC



9

	Ltr				CC		
240 (P242, P244)	2.0	09/98→12/99	B 200 E	Petrol	1986	4	43
240 (P242, P244)	2.0	09/98→12/99	B 200 F	Petrol	1986	4	46
240 (P242, P244)	2.3	08/98→12/98	B 23 E	Petrol	2316	4	72
240 (P242, P244)	2.3	08/98→07/99	B 230 F	Petrol	2316	4	75
240 (P242, P244)	2.3	08/98→12/98	B 230 K	Petrol	2316	4	83
240 Kombi (P245)	2.0	08/98→07/99	B 200 E	Petrol	1986	4	43
240 Kombi (P245)	2.0	09/98→12/99	B 200 F	Petrol	1986	4	46
240 Kombi (P245)	2.3	08/98→12/98	B 23 E	Petrol	2316	4	72
240 Kombi (P245)	2.3	08/98→07/99	B 230 F	Petrol	2316	4	75
240 Kombi (P245)	2.3	08/98→12/98	B 230 K	Petrol	2316	4	83
340-360 (343, 345)	1.3	01/98→12/99	B 13	Petrol	1289	4	1
340-360 (343, 345)	1.4	08/98→12/98	B 14.4 S	Petrol	1397	4	2
340-360 (343, 345)	1.6	08/98→07/99	D 16	Diesel	1596	4	8
340-360 (343, 345)	1.7	08/98→07/99	B 17 2 K	Petrol	1721	4	11
340-360 (343, 345)	2.0	08/98→07/98	B 200 E	Petrol	1986	4	43
340-360 (343, 345)	2.0	08/98→07/98	B 200 F	Petrol	1986	4	46
340-360 Saloon (344)	1.3	01/98→12/99	B 13	Petrol	1289	4	1
340-360 Saloon (344)	1.4	08/98→12/98	B 14.4 S	Petrol	1397	4	2
340-360 Saloon (344)	1.6	08/98→07/99	D 16	Diesel	1596	4	8
340-360 Saloon (344)	1.7	08/98→07/99	B 17 2 K	Petrol	1721	4	11
340-360 Saloon (344)	2.0	08/98→07/98	B 200 EA	Petrol	1986	4	44
340-360 Saloon (344)	2.0	08/98→07/98	B 200 F	Petrol	1986	4	46
340-360 Saloon (344)	2.0	08/98→07/99	B 200 K	Petrol	1986	4	49
440 K (445)	1.6	09/98→12/99	B 16 F	Petrol	1596	4	3
440 K (445)	1.6	09/99→08/99	B 16 FI	Petrol	1596	4	4
440 K (445)	1.7	09/98→12/99	B 18 EP	Petrol	1721	4	13
440 K (445)	1.7	08/98→07/98	B 18 F	Petrol	1721	4	14
440 K (445)	1.7	08/98→12/99	B 18 FP	Petrol	1721	4	15
440 K (445)	1.7	08/98→12/99	B 18 FT	Petrol	1721	4	16
440 K (445)	1.7	09/98→08/98	B 18 K	Petrol	1721	4	17
440 K (445)	1.7	09/98→08/99	B 18 KD	Petrol	1721	4	18
440 K (445)	1.7	09/98→12/99	B 18 KP	Petrol	1721	4	19
440 K (445)	1.8	08/99→12/99	B 18 U	Petrol	1794	4	22
440 K (445)	1.9	07/99→12/99	D 19 T	Diesel	1870	4	37
440 K (445)	2.0	08/99→07/99	B 20 F	Petrol	1998	4	42
460 L (464)	1.6	07/99→07/99	B 16 F	Petrol	1596	4	3
460 L (464)	1.7	08/98→07/99	B 18 E	Petrol	1721	4	12
460 L (464)	1.7	08/98→07/99	B 18 EP	Petrol	1721	4	13
460 L (464)	1.7	08/98→07/99	B 18 FT	Petrol	1721	4	16
460 L (464)	1.7	09/98→08/99	B 18 KD	Petrol	1721	4	18
460 L (464)	1.7	09/98→07/99	B 18 KP	Petrol	1721	4	19
460 L (464)	1.8	08/99→07/99	B 18 U	Petrol	1794	4	22
460 L (464)	1.9	07/99→07/99	D 19 T	Diesel	1870	4	37
460 L (464)	2.0	08/99→07/99	B 20 F	Petrol	1998	4	42
480 E	1.7	04/98→07/98	B 18 E	Petrol	1721	4	12
480 E	1.7	08/98→07/99	B 18 EP	Petrol	1721	4	13
480 E	1.7	08/98→07/98	B 18 F	Petrol	1721	4	14
480 E	1.7	08/98→07/99	B 18 FT	Petrol	1721	4	16
480 E	2.0	08/99→09/99	B 20 F	Petrol	1998	4	42
740 (744)	2.0	01/98→08/98	B 200 E	Petrol	1986	4	43
740 (744)	2.0	01/98→08/99	B 200 ET	Petrol	1986	4	45
740 (744)	2.0	09/99→08/99	B 200 F	Petrol	1986	4	46
740 (744)	2.0	09/99→08/99	B 200 FT	Petrol	1986	4	47
740 (744)	2.0	08/98→07/99	B 200 G	Petrol	1986	4	48
740 (744)	2.0	09/98→08/99	B 200 K	Petrol	1986	4	49
740 (744)	2.0	09/98→08/99	B 204 E	Petrol	1986	4	50
740 (744)	2.0	09/99→08/99	B 204 FTE	Petrol	1986	4	52
740 (744)	2.3	08/98→07/99	B 23 A	Petrol	2316	4	71
740 (744)	2.3	08/98→07/98	B 230 E	Petrol	2316	4	73
740 (744)	2.3	08/98→12/98	B 230 ET	Petrol	2316	4	74
740 (744)	2.3	08/98→07/99	B 230 F	Petrol	2316	4	75
740 (744)	2.3	08/98→07/99	B 230 FB	Petrol	2316	4	76
740 (744)	2.3	08/98→08/99	B 230 FT	Petrol	2316	4	79
740 (744)	2.3	08/98→07/98	B 230 K	Petrol	2316	4	83
740 (744)	2.3	08/98→08/99	B 234 F	Petrol	2316	4	84
740 (744)	2.4	08/98→07/99	D 24 T	Diesel	2383	6	111
740 (744)	2.4	08/98→10/98	D 24 TIC	Diesel	2383	6	112
740 Kombi (745)	2.0	08/98→07/99	B 200 E	Petrol	1986	4	43
740 Kombi (745)	2.0	09/98→08/99	B 200 ET	Petrol	1986	4	45
740 Kombi (745)	2.0	08/98→07/99	B 200 F	Petrol	1986	4	46



Ltr



CC



9

Model	Ltr	Year Range	Engine	Fuel	CC	Wheels	Index
740 Kombi (745)	2.0	09/99 → 08/99	B 200 FT	Petrol	1986	4	47
740 Kombi (745)	2.0	08/98 → 07/99	B 200 G	Petrol	1986	4	48
740 Kombi (745)	2.0	09/98 → 08/99	B 200 K	Petrol	1986	4	49
740 Kombi (745)	2.0	09/98 → 08/99	B 204 E	Petrol	1986	4	50
740 Kombi (745)	2.0	09/99 → 08/99	B 204 FTE	Petrol	1986	4	52
740 Kombi (745)	2.3	08/98 → 07/98	B 230 E	Petrol	2316	4	73
740 Kombi (745)	2.3	08/98 → 07/98	B 230 ET	Petrol	2316	4	74
740 Kombi (745)	2.3	08/98 → 07/99	B 230 F	Petrol	2316	4	75
740 Kombi (745)	2.3	08/98 → 07/99	B 230 FB	Petrol	2316	4	76
740 Kombi (745)	2.3	08/98 → 08/99	B 230 FT	Petrol	2316	4	79
740 Kombi (745)	2.3	08/98 → 07/99	B 230 GT	Petrol	2316	4	82
740 Kombi (745)	2.3	09/98 → 07/99	B 230 K	Petrol	2316	4	83
740 Kombi (745)	2.3	08/98 → 08/99	B 234 F	Petrol	2316	4	84
740 Kombi (745)	2.4	09/98 → 07/99	D 24 T	Diesel	2383	6	111
740 Kombi (745)	2.4	08/98 → 07/98	D 24 TIC	Diesel	2383	6	112
760 (704, 764)	2.3	08/98 → 10/98	B 230 ET	Petrol	2316	4	74
760 (704, 764)	2.3	09/98 → 07/99	B 230 FT	Petrol	2316	4	79
760 (704, 764)	2.4	04/98 → 07/99	D 24 T	Diesel	2383	6	111
760 (704, 764)	2.4	08/98 → 07/99	D 24 TIC	Diesel	2383	6	112
760 (704, 764)	2.8	08/98 → 07/98	B 28 E	Petrol	2849	6	141
760 (704, 764)	2.8	08/98 → 08/99	B 280 E	Petrol	2849	6	142
760 (704, 764)	2.8	05/98 → 08/99	B 280 F	Petrol	2849	6	143
760 Kombi (704, 765)	2.3	08/98 → 08/99	B 230 ET	Petrol	2316	4	74
760 Kombi (704, 765)	2.3	09/98 → 08/99	B 230 FT	Petrol	2316	4	79
760 Kombi (704, 765)	2.4	08/98 → 07/99	D 24 TIC	Diesel	2383	6	112
760 Kombi (704, 765)	2.8	08/98 → 08/99	B 28 E	Petrol	2849	6	141
760 Kombi (704, 765)	2.8	08/98 → 08/99	B 280 E	Petrol	2849	6	142
760 Kombi (704, 765)	2.8	05/98 → 08/99	B 280 F	Petrol	2849	6	143
780	2.4	04/98 → 07/99	D 24 TIC	Diesel	2383	6	112
780	2.9	08/98 → 07/99	B 280 F	Petrol	2849	6	143
850 (LS)	2.0	08/99 → 12/99	B 5202 S	Petrol	1984	5	57
850 (LS)	2.0	06/99 → 12/99	B 5204 F	Petrol	1984	5	58
850 (LS)	2.0	08/99 → 12/99	B 5204 FT	Petrol	1984	5	59
850 (LS)	2.0	08/99 → 12/99	B 5204 T	Petrol	1984	5	60
850 (LS)	2.0	09/99 → 10/99	B 5204 T2	Petrol	1984	5	61
850 (LS)	2.3	01/99 → 10/99	B 5234 FS	Petrol	2319	5	86
850 (LS)	2.3	08/99 → 07/99	B 5234 FT	Petrol	2319	5	87
850 (LS)	2.3	04/99 → 10/99	B 5234 T2	Petrol	2319	5	89
850 (LS)	2.3	08/99 → 12/99	B 5234 T4	Petrol	2319	5	91
850 (LS)	2.3	06/99 → 10/99	B 5234 T5	Petrol	2319	5	92
850 (LS)	2.4	09/99 → 10/99	B 5254 T	Petrol	2435	5	110
850 (LS)	2.5	06/99 → 07/99	B 5252	Petrol	2435	5	107
850 (LS)	2.5	08/99 → 12/99	B 5252 FS	Petrol	2435	5	108
850 (LS)	2.5	08/99 → 12/99	B 5254 S	Petrol	2435	5	109
850 (LS)	2.5	08/99 → 12/99	D 5252 T	Diesel	2461	5	140
850 Estate (LW)	2.0	08/99 → 12/99	B 5202 S	Petrol	1984	5	57
850 Estate (LW)	2.0	02/99 → 12/99	B 5204 F	Petrol	1984	5	58
850 Estate (LW)	2.0	02/99 → 12/99	B 5204 FT	Petrol	1984	5	59
850 Estate (LW)	2.0	02/99 → 12/99	B 5204 T	Petrol	1984	5	60
850 Estate (LW)	2.0	09/99 → 10/99	B 5204 T2	Petrol	1984	5	61
850 Estate (LW)	2.3	01/99 → 10/99	B 5234 FS	Petrol	2319	5	86
850 Estate (LW)	2.3	02/99 → 12/99	B 5234 FT	Petrol	2319	5	87
850 Estate (LW)	2.3	04/99 → 10/99	B 5234 T2	Petrol	2319	5	89
850 Estate (LW)	2.3	08/99 → 12/99	B 5234 T4	Petrol	2319	5	91
850 Estate (LW)	2.3	06/99 → 10/99	B 5234 T5	Petrol	2319	5	92
850 Estate (LW)	2.4	09/99 → 10/99	B 5254 T	Petrol	2435	5	110
850 Estate (LW)	2.5	08/99 → 07/99	B 5252	Petrol	2435	5	107
850 Estate (LW)	2.5	08/99 → 12/99	B 5252 FS	Petrol	2435	5	108
850 Estate (LW)	2.5	09/99 → 12/99	B 5254 S	Petrol	2435	5	109
850 Estate (LW)	2.5	04/99 → 12/99	B 5254 T	Petrol	2435	5	110
850 Estate (LW)	2.5	08/99 → 12/99	D 5252 T	Diesel	2461	5	140
940 (944)	2.0	09/99 → 09/99	B 200 E	Petrol	1986	4	43
940 (944)	2.0	01/99 → 07/99	B 200 F	Petrol	1986	4	46
940 (944)	2.0	08/99 → 12/99	B 200 FT	Petrol	1986	4	47
940 (944)	2.0	09/99 → 09/99	B 200 G	Petrol	1986	4	48
940 (944)	2.0	09/99 → 09/99	B 204 FT	Petrol	1986	4	51
940 (944)	2.3	08/99 → 12/99	B 230 E	Petrol	2316	4	73
940 (944)	2.3	08/99 → 12/99	B 230 FB	Petrol	2316	4	76
940 (944)	2.3	08/99 → 07/99	B 230 FD	Petrol	2316	4	77
940 (944)	2.3	08/99 → 07/99	B 230 FT	Petrol	2316	4	79



Ltr







CC



9

Model	Ltr	Year Range	Engine	Fuel	CC	Gear	Price
940 (944)	2.3	08/99→07/99	B 230 FT+	Petrol	2316	4	80
940 (944)	2.3	08/99→12/99	B 230 G	Petrol	2316	4	81
940 (944)	2.3	08/99→07/99	B 234 F	Petrol	2316	4	84
940 (944)	2.3	08/99→07/99	B 234 G	Petrol	2316	4	85
940 (944)	2.4	08/99→12/99	D 24 T	Diesel	2383	6	111
940 (944)	2.4	08/99→12/99	D 24 TIC	Diesel	2383	6	112
940 II (944)	2.0	04/99→10/99	B 200 FT	Petrol	1986	4	47
940 II (944)	2.0	11/99→12/99	B 200 G	Petrol	1986	4	48
940 II (944)	2.0	10/99→05/99	B 204 FT	Petrol	1986	4	51
940 II (944)	2.3	08/99→10/99	B 230 FB	Petrol	2316	4	76
940 II (944)	2.3	08/99→07/99	B 230 FD	Petrol	2316	4	77
940 II (944)	2.3	01/99→10/99	B 230 FK	Petrol	2316	4	78
940 II (944)	2.3	08/99→12/99	B 230 FT	Petrol	2316	4	79
940 II (944)	2.4	08/99→10/99	D 24 TIC	Diesel	2383	6	112
940 II Estate (945)	2.0	04/99→10/99	B 200 FT	Petrol	1986	4	47
940 II Estate (945)	2.0	11/99→12/99	B 200 G	Petrol	1986	4	48
940 II Estate (945)	2.0	10/99→05/99	B 204 FT	Petrol	1986	4	51
940 II Estate (945)	2.3	08/99→10/99	B 230 FB	Petrol	2316	4	76
940 II Estate (945)	2.3	08/99→07/99	B 230 FD	Petrol	2316	4	77
940 II Estate (945)	2.3	01/99→10/99	B 230 FK	Petrol	2316	4	78
940 II Estate (945)	2.3	08/99→10/99	B 230 FT	Petrol	2316	4	79
940 II Estate (945)	2.4	08/99→10/99	D 24 TIC	Diesel	2383	6	112
940 Kombi (945)	2.0	01/99→07/99	B 200 F	Petrol	1986	4	46
940 Kombi (945)	2.0	01/99→07/99	B 200 FT	Petrol	1986	4	47
940 Kombi (945)	2.0	09/99→09/99	B 200 G	Petrol	1986	4	48
940 Kombi (945)	2.3	08/99→12/99	B 230 FB	Petrol	2316	4	76
940 Kombi (945)	2.3	08/99→07/99	B 230 FD	Petrol	2316	4	77
940 Kombi (945)	2.3	08/99→07/99	B 230 FT	Petrol	2316	4	79
940 Kombi (945)	2.3	08/99→07/99	B 230 FT+	Petrol	2316	4	80
940 Kombi (945)	2.3	08/99→07/99	B 234 F	Petrol	2316	4	84
940 Kombi (945)	2.4	08/99→07/99	D 24 T	Diesel	2383	6	111
940 Kombi (945)	2.4	08/99→08/99	D 24 TIC	Diesel	2383	6	112
960 (964)	2.0	09/99→08/99	B 204 E	Petrol	1986	4	50
960 (964)	2.0	08/99→09/99	B 204 FT	Petrol	1986	4	51
960 (964)	2.3	09/99→08/99	B 230 FT	Petrol	2316	4	79
960 (964)	2.4	09/99→07/99	D 24 TIC	Diesel	2383	6	112
960 (964)	2.8	09/99→05/99	B 280 F	Petrol	2849	6	143
960 (964)	2.9	08/99→07/99	B 6304 F	Petrol	2922	6	148
960 II (964)	2.9	07/99→12/99	B 6304 S	Petrol	2922	6	150
960 II Estate (965)	2.9	09/99→12/99	B 6304 S	Petrol	2922	6	150
960 Kombi (965)	2.0	09/99→08/99	B 204 E	Petrol	1986	4	50
960 Kombi (965)	2.0	08/99→09/99	B 204 FT	Petrol	1986	4	51
960 Kombi (965)	2.3	09/99→08/99	B 230 FT	Petrol	2316	4	79
960 Kombi (965)	2.4	09/99→07/99	D 24 TIC	Diesel	2383	6	112
960 Kombi (965)	2.8	09/99→05/99	B 280 E	Petrol	2849	6	142
960 Kombi (965)	2.8	09/99→05/99	B 280 F	Petrol	2849	6	143
960 Kombi (965)	2.9	08/99→07/99	B 6304 F	Petrol	2922	6	148
960 Kombi (965)	2.9	08/99→07/99	B 6304 S	Petrol	2922	6	150
C30	1.6	10/00→12/01	B 4164 S3	Petrol	1596	4	7
C30	1.6	10/01→12/01	D 4162 T	Diesel	1560	4	9
C30	1.6	10/00→12/01	D 4164 T	Diesel	1560	4	10
C30	1.8	10/00→12/01	B 4184 S11	Petrol	1798	4	23
C30	1.8	01/00→12/01	B 4184 S8	Flexfuel	1798	4	25
C30	2.0	10/00→12/01	B 4204 S3	Petrol	1999	4	53
C30	2.0	01/01→12/01	B 4204 S4	Flexfuel	1999	4	54
C30	2.0	10/00→12/01	D 4204 T	Diesel	1998	4	65
C30	2.0	10/01→12/01	D 5204 T	Diesel	1984	5	67
C30	2.0	10/01→12/01	D 5204 T5	Diesel	1984	5	69
C30	2.4	10/00→12/01	B 5244 S4	Petrol	2435	5	98
C30	2.4	10/00→12/01	D 5244 T13	Diesel	2400	5	116
C30	2.4	10/00→12/01	D 5244 T8	Diesel	2400	5	126
C30	2.4	10/00→12/01	D 5244 T9	Diesel	2400	5	127
C30	2.5	10/00→12/01	B 5254 T3	Petrol	2521	5	133
C30	2.5	03/00→12/01	B 5254 T7	Petrol	2521	5	136
C70 I Convertible	2.0	03/99→10/00	B 5204 T2	Petrol	1984	5	61
C70 I Convertible	2.0	03/99→10/00	B 5204 T3	Petrol	1984	5	62
C70 I Convertible	2.0	03/00→10/00	B 5204 T4	Petrol	1984	5	63
C70 I Convertible	2.3	03/99→10/00	B 5234 T3	Petrol	2319	5	90
C70 I Convertible	2.3	07/00→10/00	B 5234 T9	Petrol	2319	5	95
C70 I Convertible	2.4	07/00→10/00	B 5244 T7	Petrol	2435	5	106

	Ltr				CC		9
C70 I Convertible	2.5	03/99→10/00	B 5244 T	Petrol	2435	5	102
C70 I Convertible	2.5	06/99→10/00	B 5254 S	Petrol	2435	5	109
C70 I Convertible	2.5	03/99→10/00	B 5254 T	Petrol	2435	5	110
C70 I Coupe	2.0	03/99→09/00	B 5204 T2	Petrol	1984	5	61
C70 I Coupe	2.0	03/99→09/00	B 5204 T3	Petrol	1984	5	62
C70 I Coupe	2.0	03/00→09/00	B 5204 T4	Petrol	1984	5	63
C70 I Coupe	2.3	03/99→09/00	B 5234 T3	Petrol	2319	5	90
C70 I Coupe	2.5	05/99→09/00	B 5244 S	Petrol	2435	5	96
C70 I Coupe	2.5	03/99→09/00	B 5244 T	Petrol	2435	5	102
C70 I Coupe	2.5	03/99→09/00	B 5254 S	Petrol	2435	5	109
C70 I Coupe	2.5	03/99→09/00	B 5254 T	Petrol	2435	5	110
C70 II Convertible	2.0	01/00→	D 4204 T	Diesel	1998	4	65
C70 II Convertible	2.0	10/01→	D 5204 T	Diesel	1984	5	67
C70 II Convertible	2.0	10/01→	D 5204 T5	Diesel	1984	5	69
C70 II Convertible	2.4	03/00→	B 5244 S4	Petrol	2435	5	98
C70 II Convertible	2.4	03/00→	B 5244 S5	Petrol	2435	5	99
C70 II Convertible	2.4	03/00→	D 5244 T13	Diesel	2400	5	116
C70 II Convertible	2.4	03/00→	D 5244 T8	Diesel	2400	5	126
C70 II Convertible	2.4	03/00→	D 5244 T9	Diesel	2400	5	127
C70 II Convertible	2.5	03/00→	B 5254 T3	Petrol	2521	5	133
C70 II Convertible	2.5	03/00→	B 5254 T7	Petrol	2521	5	136
S40 I (VS)	1.6	09/99→08/99	B 4164 S	Petrol	1588	4	5
S40 I (VS)	1.6	03/99→12/00	B 4164 S2	Petrol	1587	4	6
S40 I (VS)	1.8	07/99→08/99	B 4184 S	Petrol	1731	4	20
S40 I (VS)	1.8	03/99→12/00	B 4184 S2	Petrol	1783	4	24
S40 I (VS)	1.8	03/99→12/00	B 4184 S2	Gas	1783	4	24
S40 I (VS)	1.8	07/99→08/99	B 4184 S3	Petrol	1731	4	21
S40 I (VS)	1.8	03/99→12/00	B 4184 S9	Petrol	1783	4	26
S40 I (VS)	1.8	06/00→12/00	B 4184 SJ	Petrol	1834	4	27
S40 I (VS)	1.8	03/99→12/00	B 4184 SM	Petrol	1834	4	28
S40 I (VS)	1.9	05/99→07/00	B 4194 T	Petrol	1855	4	29
S40 I (VS)	1.9	05/99→07/00	B 4194 T2	Petrol	1855	4	30
S40 I (VS)	1.9	07/99→08/99	D 4192 T	Diesel	1870	4	38
S40 I (VS)	1.9	03/99→07/00	D 4192 T2	Diesel	1870	4	39
S40 I (VS)	1.9	07/00→12/00	D 4192 T3	Diesel	1870	4	40
S40 I (VS)	1.9	07/00→12/00	D 4192 T4	Diesel	1870	4	41
S40 I (VS)	2.0	07/99→12/00	B 4204 S	Petrol	1948	4	31
S40 I (VS)	2.0	07/99→12/00	B 4204 S2	Petrol	1948	4	32
S40 I (VS)	2.0	10/99→12/00	B 4204 T	Petrol	1948	4	33
S40 I (VS)	2.0	07/00→06/00	B 4204 T2	Petrol	1948	4	34
S40 I (VS)	2.0	07/00→12/00	B 4204 T3	Petrol	1948	4	35
S40 I (VS)	2.0	07/00→12/00	B 4204 T5	Petrol	1948	4	36
S40 II (MS)	1.6	01/00→	B 4164 S3	Petrol	1596	4	7
S40 II (MS)	1.6	10/01→	D 4162 T	Diesel	1560	4	9
S40 II (MS)	1.6	01/00→	D 4164 T	Diesel	1560	4	10
S40 II (MS)	1.8	04/00→	B 4184 S11	Petrol	1798	4	23
S40 II (MS)	1.8	01/00→	B 4184 S8	Flexfuel	1798	4	25
S40 II (MS)	2.0	10/00→	B 4204 S3	Petrol	1999	4	53
S40 II (MS)	2.0	10/00→	B 4204 S4	Flexfuel	1999	4	54
S40 II (MS)	2.0	01/00→	D 4204 T	Diesel	1998	4	65
S40 II (MS)	2.0	07/00→	D 4204 T2	Diesel	1998	4	66
S40 II (MS)	2.0	10/01→	D 5204 T	Diesel	1984	5	67
S40 II (MS)	2.0	10/01→	D 5204 T5	Diesel	1984	5	69
S40 II (MS)	2.4	01/00→	B 5244 S	Petrol	2435	5	96
S40 II (MS)	2.4	08/00→	B 5244 S4	Petrol	2435	5	98
S40 II (MS)	2.4	01/00→	B 5244 S5	Petrol	2435	5	99
S40 II (MS)	2.4	03/00→	D 5244 T8	Diesel	2400	5	126
S40 II (MS)	2.5	01/00→	B 5254 T3	Petrol	2521	5	133
S40 II (MS)	2.5	03/00→	B 5254 T7	Petrol	2521	5	136
S60	2.0	09/00→04/01	B 5204 T5	Petrol	1984	5	64
S60	2.3	11/00→04/01	B 5234 T3	Petrol	2319	5	90
S60	2.3	07/00→09/00	B 5234 T7	Petrol	2319	5	93
S60	2.4	11/00→04/01	B 5244 S	Petrol	2435	5	96
S60	2.4	11/00→04/01	B 5244 S2	Petrol	2435	5	97
S60	2.4	11/00→04/01	B 5244 S2	Gas	2435	5	97
S60	2.4	06/00→04/01	B 5244 SG2	Petrol	2435	5	101
S60	2.4	06/00→04/01	B 5244 SG2	Bi-Fuel	2435	5	101
S60	2.4	11/00→04/01	B 5244 T3	Petrol	2435	5	103
S60	2.4	02/00→04/01	B 5244 T5	Petrol	2401	5	105
S60	2.4	07/00→04/01	D 5244 T	Diesel	2401	5	113



Ltr







CC



9

	Ltr				CC		
S60	2.4	12/00→04/01	D 5244 T2	Diesel	2401	5	122
S60	2.4	09/00→04/01	D 5244 T4	Diesel	2400	5	123
S60	2.4	09/00→01/00	D 5244 T5	Diesel	2400	5	124
S60	2.4	09/00→04/01	D 5244 T7	Diesel	2400	5	125
S60	2.5	02/00→04/01	B 5254 T2	Petrol	2521	5	132
S60	2.5	03/00→04/01	B 5254 T4	Petrol	2521	5	134
S60 II	1.6	01/01→	D 4162 T	Diesel	1560	4	9
S60 II	2.0	04/01→	B 4204 T6	Petrol	1999	4	55
S60 II	2.0	04/01→	B 4204 T7	Petrol	1999	4	56
S60 II	2.0	04/01→04/01	D 5204 T2	Diesel	1984	5	68
S60 II	2.0	05/01→	D 5204 T7	Diesel	1984	5	70
S60 II	2.4	04/01→	D 5244 T10	Diesel	2400	5	114
S60 II	2.4	06/01→	D 5244 T11	Diesel	2400	5	115
S60 II	2.4	06/01→	D 5244 T15	Diesel	2400	5	118
S70 (LS)	2.0	01/99→11/00	B 5202 S	Petrol	1984	5	57
S70 (LS)	2.0	01/99→11/00	B 5204 F	Petrol	1984	5	58
S70 (LS)	2.0	01/99→11/00	B 5204 T	Petrol	1984	5	60
S70 (LS)	2.0	01/99→11/00	B 5204 T2	Petrol	1984	5	61
S70 (LS)	2.0	01/99→11/00	B 5204 T3	Petrol	1984	5	62
S70 (LS)	2.0	01/99→11/00	B 5204 T4	Petrol	1984	5	63
S70 (LS)	2.3	01/99→11/00	B 5234 FT+	Petrol	2319	5	88
S70 (LS)	2.3	11/99→11/00	B 5234 T3	Petrol	2319	5	90
S70 (LS)	2.3	07/99→09/00	B 5234 T4	Petrol	2319	5	91
S70 (LS)	2.3	04/99→09/00	B 5234 T7	Petrol	2319	5	93
S70 (LS)	2.4	01/99→11/00	B 5244 S	Petrol	2435	5	96
S70 (LS)	2.4	07/99→11/00	B 5244 S2	Petrol	2435	5	97
S70 (LS)	2.4	07/99→11/00	B 5244 S2	Gas	2435	5	97
S70 (LS)	2.4	07/99→11/00	B 5244 SG	Petrol	2435	5	100
S70 (LS)	2.4	07/99→11/00	B 5244 SG	Gas	2435	5	100
S70 (LS)	2.4	07/99→11/00	B 5244 SG	Bi-Fuel	2435	5	100
S70 (LS)	2.4	01/99→11/00	B 5244 T	Petrol	2435	5	102
S70 (LS)	2.4	11/99→05/99	B 5252 FS	Petrol	2435	5	108
S70 (LS)	2.4	01/99→11/00	B 5254 S	Petrol	2435	5	109
S70 (LS)	2.4	11/99→11/00	B 5254 T	Petrol	2435	5	110
S70 (LS)	2.5	07/99→11/00	B 5244 SG	Petrol	2435	5	100
S70 (LS)	2.5	07/99→11/00	B 5244 SG	Gas	2435	5	100
S70 (LS)	2.5	07/99→11/00	B 5244 SG	Bi-Fuel	2435	5	100
S70 (LS)	2.5	01/99→11/00	B 5252 FS	Petrol	2435	5	108
S70 (LS)	2.5	06/99→11/00	B 5254 S	Petrol	2435	5	109
S70 (LS)	2.5	01/99→11/00	D 5252 T	Diesel	2461	5	140
S70 (LS)	2.5	10/99→11/00	GB 5252 S	Bi-Fuel	2435	5	128
S80 I (TS, XY)	2.0	06/99→07/00	B 5204 T3	Petrol	1984	5	62
S80 I (TS, XY)	2.0	06/99→07/00	B 5204 T4	Petrol	1984	5	63
S80 I (TS, XY)	2.0	12/99→07/00	B 5204 T5	Petrol	1984	5	64
S80 I (TS, XY)	2.4	01/99→07/00	B 5244 S	Petrol	2435	5	96
S80 I (TS, XY)	2.4	01/99→07/00	B 5244 S2	Petrol	2435	5	97
S80 I (TS, XY)	2.4	01/99→07/00	B 5244 S2	Gas	2435	5	97
S80 I (TS, XY)	2.4	09/00→07/00	B 5244 SG2	Petrol	2435	5	101
S80 I (TS, XY)	2.4	09/00→07/00	B 5244 SG2	Bi-Fuel	2435	5	101
S80 I (TS, XY)	2.4	04/00→07/00	B 5244 T3	Petrol	2435	5	103
S80 I (TS, XY)	2.4	06/00→07/00	B 5244 T4	Petrol	2435	5	104
S80 I (TS, XY)	2.4	08/00→07/00	D 5244 T	Diesel	2401	5	113
S80 I (TS, XY)	2.4	10/00→07/00	D 5244 T2	Diesel	2401	5	122
S80 I (TS, XY)	2.5	03/00→07/00	B 5254 T2	Petrol	2521	5	132
S80 I (TS, XY)	2.5	01/99→07/00	D 5252 T	Diesel	2461	5	140
S80 I (TS, XY)	2.8	05/99→07/00	B 6284 T	Petrol	2783	6	144
S80 I (TS, XY)	2.9	03/99→07/00	B 6294 S	Petrol	2922	6	145
S80 I (TS, XY)	2.9	05/99→07/00	B 6304 S3	Petrol	2922	6	152
S80 I (TS, XY)	3.0	06/00→07/00	B 6294 S2	Petrol	2922	6	146
S80 I (TS, XY)	3.0	06/00→07/00	B 6294 T	Petrol	2922	6	147
S80 II (AS)	1.6	06/01→	D 4162 T	Diesel	1560	4	9
S80 II (AS)	1.6	01/01→	D 4164 T	Diesel	1560	4	10
S80 II (AS)	2.0	01/00→	B 4204 S3	Petrol	1999	4	53
S80 II (AS)	2.0	01/00→	B 4204 S4	Flexfuel	1999	4	54
S80 II (AS)	2.0	01/01→	B 4204 T6	Petrol	1999	4	55
S80 II (AS)	2.0	10/01→	B 4204 T7	Petrol	1999	4	56
S80 II (AS)	2.0	02/00→	D 4204 T	Diesel	1998	4	65
S80 II (AS)	2.0	01/01→	D 5204 T2	Diesel	1984	5	68
S80 II (AS)	2.0	05/01→	D 5204 T7	Diesel	1984	5	70
S80 II (AS)	2.4	03/00→	D 5244 T	Diesel	2401	5	113

	Ltr				CC		9
S80 II (AS)	2.4	01/01 →	D 5244 T10	Diesel	2400	5	114
S80 II (AS)	2.4	06/01 →	D 5244 T11	Diesel	2400	5	115
S80 II (AS)	2.4	01/01 →	D 5244 T14	Diesel	2400	5	117
S80 II (AS)	2.4	06/01 →	D 5244 T15	Diesel	2400	5	118
S80 II (AS)	2.4	03/00 →	D 5244 T4	Diesel	2400	5	123
S80 II (AS)	2.4	03/00 →	D 5244 T5	Diesel	2400	5	124
S80 II (AS)	2.5	01/01 →	B 5254 T10	Petrol	2521	5	129
S80 II (AS)	2.5	01/01 →	B 5254 T11	Flexfuel	2521	5	130
S80 II (AS)	2.5	03/00 →	B 5254 T6	Petrol	2521	5	135
S80 II (AS)	2.5	05/00 →	B 5254 T8	Flexfuel	2521	5	137
S90	2.5	11/99 →10/99	B 6244 FS	Petrol	2473	6	138
S90	2.5	11/99 →10/99	B 6254 FS	Petrol	2473	6	139
S90	2.9	01/99 →05/99	B 6304 G	Petrol	2922	6	149
S90	2.9	01/99 →05/99	B 6304 S2	Petrol	2922	6	151
V40 Estate (VW)	1.6	12/99 →08/99	B 4164 S	Petrol	1588	4	5
V40 Estate (VW)	1.6	03/99 →06/00	B 4164 S2	Petrol	1587	4	6
V40 Estate (VW)	1.8	07/99 →08/99	B 4184 S	Petrol	1731	4	20
V40 Estate (VW)	1.8	03/99 →06/00	B 4184 S2	Petrol	1783	4	24
V40 Estate (VW)	1.8	03/99 →06/00	B 4184 S2	Gas	1783	4	24
V40 Estate (VW)	1.8	07/99 →08/99	B 4184 S3	Petrol	1731	4	21
V40 Estate (VW)	1.8	03/99 →06/00	B 4184 S9	Petrol	1783	4	26
V40 Estate (VW)	1.8	06/00 →06/00	B 4184 SJ	Petrol	1834	4	27
V40 Estate (VW)	1.8	03/99 →06/00	B 4184 SM	Petrol	1834	4	28
V40 Estate (VW)	1.9	05/99 →07/00	B 4194 T	Petrol	1855	4	29
V40 Estate (VW)	1.9	07/99 →08/99	D 4192 T	Diesel	1870	4	38
V40 Estate (VW)	1.9	03/99 →07/00	D 4192 T2	Diesel	1870	4	39
V40 Estate (VW)	1.9	07/00 →06/00	D 4192 T3	Diesel	1870	4	40
V40 Estate (VW)	1.9	07/00 →06/00	D 4192 T4	Diesel	1870	4	41
V40 Estate (VW)	2.0	07/99 →06/00	B 4204 S	Petrol	1948	4	31
V40 Estate (VW)	2.0	07/99 →06/00	B 4204 S2	Petrol	1948	4	32
V40 Estate (VW)	2.0	10/99 →07/00	B 4204 T	Petrol	1948	4	33
V40 Estate (VW)	2.0	07/99 →06/00	B 4204 T2	Petrol	1948	4	34
V40 Estate (VW)	2.0	06/00 →06/00	B 4204 T3	Petrol	1948	4	35
V40 Estate (VW)	2.0	07/00 →06/00	B 4204 T5	Petrol	1948	4	36
V40 Hatchback	1.6	03/01 →	D 4162 T	Diesel	1560	4	9
V40 Hatchback	2.5	12/01 →	B 5254 T12	Petrol	2497	5	131
V50 (MW)	1.6	01/00 →	B 4164 S3	Petrol	1596	4	7
V50 (MW)	1.6	01/01 →	D 4162 T	Diesel	1560	4	9
V50 (MW)	1.6	01/00 →	D 4164 T	Diesel	1560	4	10
V50 (MW)	1.8	04/00 →	B 4184 S11	Petrol	1798	4	23
V50 (MW)	1.8	01/00 →	B 4184 S8	Flexfuel	1798	4	25
V50 (MW)	2.0	10/00 →	B 4204 S3	Petrol	1999	4	53
V50 (MW)	2.0	01/01 →	B 4204 S4	Flexfuel	1999	4	54
V50 (MW)	2.0	04/00 →	D 4204 T	Diesel	1998	4	65
V50 (MW)	2.0	10/01 →	D 5204 T	Diesel	1984	5	67
V50 (MW)	2.0	10/01 →	D 5204 T5	Diesel	1984	5	69
V50 (MW)	2.4	04/00 →	B 5244 S	Petrol	2435	5	96
V50 (MW)	2.4	08/00 →	B 5244 S4	Petrol	2435	5	98
V50 (MW)	2.4	04/00 →	B 5244 S5	Petrol	2435	5	99
V50 (MW)	2.4	03/00 →	D 5244 T13	Diesel	2400	5	116
V50 (MW)	2.4	03/00 →	D 5244 T8	Diesel	2400	5	126
V50 (MW)	2.4	05/00 →	D 5244 T9	Diesel	2400	5	127
V50 (MW)	2.5	04/00 →	B 5254 T3	Petrol	2521	5	133
V50 (MW)	2.5	03/00 →	B 5254 T7	Petrol	2521	5	136
V60	1.6	06/01 →	D 4162 T	Diesel	1560	4	9
V60	2.0	09/01 →	B 4204 T6	Petrol	1999	4	55
V60	2.0	09/01 →	B 4204 T7	Petrol	1999	4	56
V60	2.0	09/01 →	D 5204 T2	Diesel	1984	5	68
V60	2.0	12/01 →	D 5204 T7	Diesel	1984	5	70
V60	2.4	09/01 →	D 5244 T10	Diesel	2400	5	114
V60	2.4	06/01 →	D 5244 T11	Diesel	2400	5	115
V60	2.4	06/01 →	D 5244 T15	Diesel/Electro	2400	5	118
V60	2.4	06/01 →	D 5244 T15	Diesel	2400	5	118
V60	2.4	12/01 →	D 5244 T17	Diesel	2400	5	120
V70 I (LV)	2.0	01/99 →03/00	B 5202 S	Petrol	1984	5	57
V70 I (LV)	2.0	01/99 →03/00	B 5204 F	Petrol	1984	5	58
V70 I (LV)	2.0	01/99 →03/00	B 5204 T	Petrol	1984	5	60
V70 I (LV)	2.0	01/99 →03/00	B 5204 T2	Petrol	1984	5	61
V70 I (LV)	2.0	01/99 →03/00	B 5204 T3	Petrol	1984	5	62
V70 I (LV)	2.0	01/99 →03/00	B 5204 T4	Petrol	1984	5	63



Ltr















CC











9

V70 I (LV)	2.3	01/99→03/00	B 5234 FT+	Petrol	2319	5	88
V70 I (LV)	2.3	01/99→03/00	B 5234 T3	Petrol	2319	5	90
V70 I (LV)	2.3	12/99→02/00	B 5234 T7	Petrol	2319	5	93
V70 I (LV)	2.3	12/99→02/00	B 5234 T8	Petrol	2319	5	94
V70 I (LV)	2.4	01/99→05/00	B 5244 S	Petrol	2435	5	96
V70 I (LV)	2.4	08/99→05/00	B 5244 S2	Petrol	2435	5	97
V70 I (LV)	2.4	08/99→05/00	B 5244 S2	Gas	2435	5	97
V70 I (LV)	2.4	08/99→03/00	B 5244 SG	Petrol	2435	5	100
V70 I (LV)	2.4	08/99→03/00	B 5244 SG	Gas	2435	5	100
V70 I (LV)	2.4	08/99→03/00	B 5244 SG	Bi-Fuel	2435	5	100
V70 I (LV)	2.4	08/99→05/00	B 5244 SG2	Petrol	2435	5	101
V70 I (LV)	2.4	08/99→05/00	B 5244 SG2	Bi-Fuel	2435	5	101
V70 I (LV)	2.4	01/99→03/00	B 5244 T	Petrol	2435	5	102
V70 I (LV)	2.4	01/99→05/00	B 5254 S	Petrol	2435	5	109
V70 I (LV)	2.4	01/99→03/00	B 5254 T	Petrol	2435	5	110
V70 I (LV)	2.5	01/99→05/00	B 5244 T	Petrol	2435	5	102
V70 I (LV)	2.5	01/99→03/00	B 5252 FS	Petrol	2435	5	108
V70 I (LV)	2.5	06/99→03/00	B 5254 S	Petrol	2435	5	109
V70 I (LV)	2.5	01/99→05/00	B 5254 T	Petrol	2435	5	110
V70 I (LV)	2.5	11/99→05/00	D 5252 T	Diesel	2461	5	140
V70 I (LV)	2.5	10/99→08/99	GB 5252 S	Bi-Fuel	2435	5	128
V70 II (SW)	2.0	07/00→08/00	B 5204 T5	Petrol	1984	5	64
V70 II (SW)	2.3	03/00→08/00	B 5234 T3	Petrol	2319	5	90
V70 II (SW)	2.3	03/00→08/00	B 5234 T4	Petrol	2319	5	91
V70 II (SW)	2.3	10/00→09/00	B 5234 T7	Petrol	2319	5	93
V70 II (SW)	2.3	10/00→09/00	B 5234 T8	Petrol	2319	5	94
V70 II (SW)	2.4	03/00→08/00	B 5244 S	Petrol	2435	5	96
V70 II (SW)	2.4	03/00→08/00	B 5244 S2	Petrol	2435	5	97
V70 II (SW)	2.4	03/00→08/00	B 5244 S2	Gas	2435	5	97
V70 II (SW)	2.4	09/00→08/00	B 5244 SG	Petrol	2435	5	100
V70 II (SW)	2.4	09/00→08/00	B 5244 SG	Gas	2435	5	100
V70 II (SW)	2.4	09/00→08/00	B 5244 SG	Bi-Fuel	2435	5	100
V70 II (SW)	2.4	09/00→08/00	B 5244 SG2	Petrol	2435	5	101
V70 II (SW)	2.4	09/00→08/00	B 5244 SG2	Bi-Fuel	2435	5	101
V70 II (SW)	2.4	03/00→08/00	B 5244 T3	Petrol	2435	5	103
V70 II (SW)	2.4	04/00→08/00	B 5244 T5	Petrol	2401	5	105
V70 II (SW)	2.4	08/00→08/00	D 5244 T	Diesel	2401	5	113
V70 II (SW)	2.4	12/00→08/00	D 5244 T2	Diesel	2401	5	122
V70 II (SW)	2.4	12/00→08/00	D 5244 T4	Diesel	2400	5	123
V70 II (SW)	2.4	08/00→08/00	D 5244 T5	Diesel	2400	5	124
V70 II (SW)	2.4	05/00→08/00	D 5244 T7	Diesel	2400	5	125
V70 II (SW)	2.5	09/00→08/00	B 5254 T2	Petrol	2521	5	132
V70 II (SW)	2.5	12/00→08/00	B 5254 T4	Petrol	2521	5	134
V70 II (SW)	2.5	03/00→08/00	D 5252 T	Diesel	2461	5	140
V70 III (BW)	1.6	06/01→	D 4162 T	Diesel	1560	4	9
V70 III (BW)	1.6	01/01→	D 4164 T	Diesel	1560	4	10
V70 III (BW)	2.0	10/00→	B 4204 S3	Petrol	1999	4	53
V70 III (BW)	2.0	01/00→	B 4204 S4	Flexfuel	1999	4	54
V70 III (BW)	2.0	01/01→	B 4204 T6	Petrol	1999	4	55
V70 III (BW)	2.0	01/01→	B 4204 T7	Petrol	1999	4	56
V70 III (BW)	2.0	10/00→	D 4204 T	Diesel	1998	4	65
V70 III (BW)	2.0	03/01→	D 5204 T2	Diesel	1984	5	68
V70 III (BW)	2.0	03/01→	D 5204 T7	Diesel	1984	5	70
V70 III (BW)	2.4	12/00→	D 5244 T10	Diesel	2400	5	114
V70 III (BW)	2.4	06/01→	D 5244 T11	Diesel	2400	5	115
V70 III (BW)	2.4	10/00→	D 5244 T14	Diesel	2400	5	117
V70 III (BW)	2.4	06/01→	D 5244 T15	Diesel	2400	5	118
V70 III (BW)	2.4	01/01→	D 5244 T17	Diesel	2400	5	120
V70 III (BW)	2.4	08/00→	D 5244 T4	Diesel	2400	5	123
V70 III (BW)	2.4	08/00→	D 5244 T5	Diesel	2400	5	124
V70 III (BW)	2.5	01/01→	B 5254 T10	Petrol	2521	5	129
V70 III (BW)	2.5	10/00→	B 5254 T11	Flexfuel	2521	5	130
V70 III (BW)	2.5	08/00→	B 5254 T6	Petrol	2521	5	135
V70 III (BW)	2.5	05/00→	B 5254 T8	Flexfuel	2521	5	137
V90 Estate	2.5	11/99→10/99	B 6244 FS	Petrol	2473	6	138
V90 Estate	2.5	11/99→10/99	B 6254 FS	Petrol	2473	6	139
V90 Estate	2.9	01/99→12/99	B 6304 G	Petrol	2922	6	149
V90 Estate	2.9	01/99→12/99	B 6304 S2	Petrol	2922	6	151
XC60	2.0	03/01→	B 4204 T6	Petrol	1999	4	55
XC60	2.0	09/01→	B 4204 T7	Petrol	1999	4	56

	Ltr				CC		9
XC60	2.0	03/01→	D 5204 T2	Diesel	1984	5	68
XC60	2.0	04/01→	D 5204 T7	Diesel	1984	5	70
XC60	2.4	07/00→	D 5244 T10	Diesel	2400	5	114
XC60	2.4	06/01→	D 5244 T11	Diesel	2400	5	115
XC60	2.4	07/00→	D 5244 T14	Diesel	2400	5	117
XC60	2.4	06/01→	D 5244 T15	Diesel	2400	5	118
XC60	2.4	05/00→	D 5244 T16	Diesel	2400	5	119
XC60	2.4	05/00→	D 5244 T17	Diesel	2400	5	120
XC60	2.4	05/00→	D 5244 T4	Diesel	2400	5	123
XC60	2.4	05/00→	D 5244 T5	Diesel	2400	5	124
XC70 CROSS COUNTRY	2.4	03/00→09/00	B 5244 T3	Petrol	2435	5	103
XC70 CROSS COUNTRY	2.4	11/99→09/00	B 5254 T	Petrol	2435	5	110
XC70 CROSS COUNTRY	2.4	09/00→08/00	D 5244 T	Diesel	2401	5	113
XC70 CROSS COUNTRY	2.4	12/00→08/00	D 5244 T4	Diesel	2400	5	123
XC70 CROSS COUNTRY	2.5	09/00→08/00	B 5254 T2	Petrol	2521	5	132
XC70 II	2.0	08/01→	D 5204 T2	Diesel	1984	5	68
XC70 II	2.4	12/00→	D 5244 T10	Diesel	2400	5	114
XC70 II	2.4	06/01→	D 5244 T11	Diesel	2400	5	115
XC70 II	2.4	01/01→	D 5244 T14	Diesel	2400	5	117
XC70 II	2.4	06/01→	D 5244 T15	Diesel	2400	5	118
XC70 II	2.4	08/00→	D 5244 T16	Diesel	2400	5	119
XC70 II	2.4	08/00→	D 5244 T4	Diesel	2400	5	123
XC70 II	2.4	08/00→	D 5244 T5	Diesel	2400	5	124
XC90	2.4	10/00→	D 5244 T	Diesel	2401	5	113
XC90	2.4	01/01→	D 5244 T18	Diesel	2400	5	121
XC90	2.4	05/00→	D 5244 T4	Diesel	2400	5	123
XC90	2.4	10/00→	D 5244 T5	Diesel	2400	5	124
XC90	2.5	10/00→	B 5254 T2	Petrol	2521	5	132
XC90	2.9	10/00→	B 6294 T	Petrol	2922	6	147

		CC			9			CC			9
B 13	Petrol	1289	4	73.00	1	B 5204 T	Petrol	1984	5	81.00	60
B 14.4 S	Petrol	1397	4	76.00	2	B 5204 T2	Petrol	1984	5	81.00	61
B 16 F	Petrol	1596	4	78.00	3	B 5204 T3	Petrol	1984	5	81.00	62
B 16 FI	Petrol	1596	4	78.00	4	B 5204 T4	Petrol	1984	5	81.00	63
B 17 2 K	Petrol	1721	4	81.00	11	B 5204 T5	Petrol	1984	5	81.00	64
B 18 E	Petrol	1721	4	81.00	12	B 5234 FS	Petrol	2319	5	81.00	86
B 18 EP	Petrol	1721	4	81.00	13	B 5234 FT	Petrol	2319	5	81.00	87
B 18 F	Petrol	1721	4	81.00	14	B 5234 FT+	Petrol	2319	5	81.00	88
B 18 FP	Petrol	1721	4	81.00	15	B 5234 T2	Petrol	2319	5	81.00	89
B 18 FT	Petrol	1721	4	81.00	16	B 5234 T3	Petrol	2319	5	81.00	90
B 18 K	Petrol	1721	4	81.00	17	B 5234 T4	Petrol	2319	5	81.00	91
B 18 KD	Petrol	1721	4	81.00	18	B 5234 T5	Petrol	2319	5	81.00	92
B 18 KP	Petrol	1721	4	81.00	19	B 5234 T7	Petrol	2319	5	81.00	93
B 18 U	Petrol	1794	4	82.70	22	B 5234 T8	Petrol	2319	5	81.00	94
B 20 F	Petrol	1998	4	82.70	42	B 5234 T9	Petrol	2319	5	81.00	95
B 200 E	Petrol	1986	4	88.90	43	B 5244 S	Petrol	2435	5	83.00	96
B 200 EA	Petrol	1986	4	88.90	44	B 5244 S2	Petrol	2435	5	83.00	97
B 200 ET	Petrol	1986	4	88.90	45	B 5244 S2	Gas	2435	5	83.00	97
B 200 F	Petrol	1986	4	88.90	46	B 5244 S4	Petrol	2435	5	83.00	98
B 200 FT	Petrol	1986	4	88.90	47	B 5244 S5	Petrol	2435	5	83.00	99
B 200 G	Petrol	1986	4	88.90	48	B 5244 S6	Petrol	2435	5	83.00	100
B 200 K	Petrol	1986	4	88.90	49	B 5244 S6	Gas	2435	5	83.00	100
B 204 E	Petrol	1986	4	88.90	50	B 5244 S6	Bi-Fuel	2435	5	83.00	100
B 204 FT	Petrol	1986	4	88.90	51	B 5244 SG2	Petrol	2435	5	83.00	101
B 204 FTE	Petrol	1986	4	88.90	52	B 5244 SG2	Bi-Fuel	2435	5	83.00	101
B 23 A	Petrol	2316	4	96.00	71	B 5244 T	Petrol	2435	5	83.00	102
B 23 E	Petrol	2316	4	96.00	72	B 5244 T3	Petrol	2435	5	83.00	103
B 230 E	Petrol	2316	4	96.00	73	B 5244 T4	Petrol	2435	5	83.00	104
B 230 ET	Petrol	2316	4	96.00	74	B 5244 T5	Petrol	2401	5	81.00	105
B 230 F	Petrol	2316	4	96.00	75	B 5244 T7	Petrol	2435	5	83.00	106
B 230 FB	Petrol	2316	4	96.00	76	B 5252	Petrol	2435	5	83.00	107
B 230 FD	Petrol	2316	4	96.00	77	B 5252 FS	Petrol	2435	5	83.00	108
B 230 FK	Petrol	2316	4	96.00	78	B 5254 S	Petrol	2435	5	83.00	109
B 230 FT	Petrol	2316	4	96.00	79	B 5254 T	Petrol	2435	5	83.00	110
B 230 FT+	Petrol	2316	4	96.00	80	B 5254 T10	Petrol	2521	5	83.00	129
B 230 G	Petrol	2316	4	96.00	81	B 5254 T11	Flexfuel	2521	5	83.00	130
B 230 GT	Petrol	2316	4	96.00	82	B 5254 T12	Petrol	2497	5	83.00	131
B 230 K	Petrol	2316	4	96.00	83	B 5254 T2	Petrol	2521	5	83.00	132
B 234 F	Petrol	2316	4	96.00	84	B 5254 T3	Petrol	2521	5	83.00	133
B 234 G	Petrol	2316	4	96.00	85	B 5254 T4	Petrol	2521	5	83.00	134
B 28 E	Petrol	2849	6	91.00	141	B 5254 T6	Petrol	2521	5	83.00	135
B 280 E	Petrol	2849	6	91.00	142	B 5254 T7	Petrol	2521	5	83.00	136
B 280 F	Petrol	2849	6	91.00	143	B 5254 T8	Flexfuel	2521	5	83.00	137
B 4164 S	Petrol	1588	4	81.00	5	B 6244 FS	Petrol	2473	6	81.00	138
B 4164 S2	Petrol	1587	4	81.00	6	B 6254 FS	Petrol	2473	6	81.00	139
B 4164 S3	Petrol	1596	4	79.00	7	B 6284 T	Petrol	2783	6	81.00	144
B 4184 S	Petrol	1731	4	83.00	20	B 6294 S	Petrol	2922	6	83.00	145
B 4184 S11	Petrol	1798	4	83.00	23	B 6294 S2	Petrol	2922	6	83.00	146
B 4184 S2	Petrol	1783	4	83.00	24	B 6294 T	Petrol	2922	6	83.00	147
B 4184 S2	Gas	1783	4	83.00	24	B 6304 F	Petrol	2922	6	83.00	148
B 4184 S3	Petrol	1731	4	83.00	21	B 6304 G	Petrol	2922	6	83.00	149
B 4184 S8	Flexfuel	1798	4		25	B 6304 S	Petrol	2922	6	83.00	150
B 4184 S9	Petrol	1783	4	83.00	26	B 6304 S2	Petrol	2922	6	83.00	151
B 4184 SJ	Petrol	1834	4	81.00	27	B 6304 S3	Petrol	2922	6	83.00	152
B 4184 SM	Petrol	1834	4	81.00	28	D 16	Diesel	1596	4	78.00	8
B 4194 T	Petrol	1855	4	81.00	29	D 19 T	Diesel	1870	4	80.00	37
B 4194 T2	Petrol	1855	4	81.00	30	D 24 T	Diesel	2383	6	76.50	111
B 4204 S	Petrol	1948	4	83.00	31	D 24 TIC	Diesel	2383	6	76.50	112
B 4204 S2	Petrol	1948	4	83.00	32	D 4162 T	Diesel	1560	4	75.00	9
B 4204 S3	Petrol	1999	4	87.50	53	D 4164 T	Diesel	1560	4	75.00	10
B 4204 S4	Flexfuel	1999	4	87.50	54	D 4192 T	Diesel	1870	4	80.00	38
B 4204 T	Petrol	1948	4	83.00	33	D 4192 T2	Diesel	1870	4	80.00	39
B 4204 T2	Petrol	1948	4	83.00	34	D 4192 T3	Diesel	1870	4	80.00	40
B 4204 T3	Petrol	1948	4	83.00	35	D 4192 T4	Diesel	1870	4	80.00	41
B 4204 T5	Petrol	1948	4	83.00	36	D 4204 T	Diesel	1998	4	85.00	65
B 4204 T6	Petrol	1999	4	87.50	55	D 4204 T2	Diesel	1998	4	85.00	66
B 4204 T7	Petrol	1999	4	87.50	56	D 5204 T	Diesel	1984	5	81.00	67
B 5202 S	Petrol	1984	5	81.00	57	D 5204 T2	Diesel	1984	5	81.00	68
B 5204 F	Petrol	1984	5	81.00	58	D 5204 T5	Diesel	1984	5	81.00	69
B 5204 FT	Petrol	1984	5	81.00	59	D 5204 T7	Diesel	1984	5	81.00	70

		CC			9			CC			9
D 5244 T	Diesel	2401	5	81.00	113						
D 5244 T10	Diesel	2400	5	81.00	114						
D 5244 T11	Diesel	2400	5	81.00	115						
D 5244 T13	Diesel	2400	5	81.00	116						
D 5244 T14	Diesel	2400	5	81.00	117						
D 5244 T15	Diesel/Electro	2400	5	81.00	118						
D 5244 T15	Diesel	2400	5	81.00	118						
D 5244 T16	Diesel	2400	5	81.00	119						
D 5244 T17	Diesel	2400	5	81.00	120						
D 5244 T18	Diesel	2400	5	81.00	121						
D 5244 T2	Diesel	2401	5	81.00	122						
D 5244 T4	Diesel	2400	5	81.00	123						
D 5244 T5	Diesel	2400	5	81.00	124						
D 5244 T7	Diesel	2400	5	81.00	125						
D 5244 T8	Diesel	2400	5	81.00	126						
D 5244 T9	Diesel	2400	5	81.00	127						
D 5252 T	Diesel	2461	5	81.00	140						
GB 5252 S	Bi-Fuel	2435	5	83.00	128						



cc



kW/PS



1.3		B 13					1			
340-360 1.3	01/89→12/90	1289	4	73.00		49/66	BT080 (Fibre), 1.500mm			
340-360 Sal 1.3	01/89→12/90									
1.4		B 14.4 S					2			
340-360 1.4	08/86→12/88	1397	4	76.00	OHV	50-53/ 68-72	BH690 (Fibre), 1.200mm		DH696 ■	EZ142 [3][14]
340-360 Sal 1.4	08/87→07/88						BM800 (Fibre), 1.750mm			
1.6		B 16 F					3			
440 K 1.6	09/88→12/96	1596	4	78.00	SOHC/OHC	61/83				EL960 [3][18]
460 L 1.6	07/92→07/96									
1.6		B 16 FI					4			
440 K (445) 1.6	09/91→08/93	1596	4	78.00	SOHC/OHC	69/94				EL960 [3][18]
1.6		B 4164 S					5			
S40 1.6	09/95→08/99	1588	4	81.00	DOHC	77/105	AA5620 (Fibre)		CA5620 [3]	EA5620 [3]
V40 1.6	12/95→08/99						AB5431 (Fibre)			
1.6		B 4164 S2					6			
S40 1.6	03/99→12/03	1587	4	81.00	DOHC	80/109	AB5431 (Fibre)		CE5130 [3]	EA5620 [3]
V40 1.6	03/99→06/04						01/00→		01/00→	
									Eng.1818168→	
									CE5131 [3]	
									01/00→	
									Eng.1818169→	
1.6		B 4164 S3					7			
C30 1.6	10/06→12/12	1596	4	79.00	DOHC	74/101	AH7150 (MLS)			EB5120
S40 II 1.6 Mk 2	01/05→						AG9560 (MLS), 0.320mm			
V50 1.6	01/05→						→02/07			

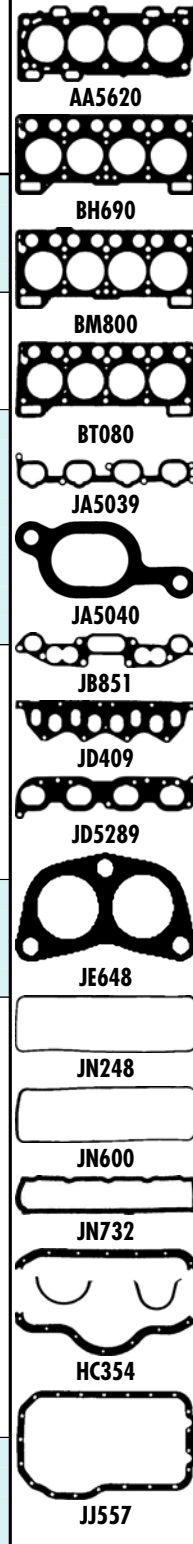
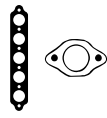

	JB851 	JN600 [4]	HC354		NF722 [2] 35.00x50.00x10.00mm, MVQ NF634 [1] 80.00x100.00x13.00mm, MVQ	
HBS104 [22] M10x1.50x100.00mm (x10)	JB851 (x4)	JN248 [4]	HC354		NF835 [1] 80.00x100.00x8.00mm, FPM/ACM NF722 [2] 35.00x50.00x10.00mm, MVQ	
HBS244 [22] M12x1.50x111.00mm (x10)	JD409	JN732 [4]	JJ557	HR569	NF847 [1] 22.00x45.00x7.00mm, FPM/ACM NF846 [2] 25.00x42.00x7.00mm, FPM/ACM NF850 [1] 85.00x105.00x8.00mm, FPM NF843 [2] 50.00x68.00x10.00mm, FPM/ACM	
HBS244 [22] M12x1.50x111.00mm (x10)	JD409	JN732 [4]	JJ557	HR569	NF846 [2] 25.00x42.00x7.00mm, FPM/ACM NF847 [1] 22.00x45.00x7.00mm, FPM/ACM NF850 [1] 85.00x105.00x8.00mm, FPM NF843 [2] 50.00x68.00x10.00mm, FPM/ACM	
HBS178 [19] M12x1.75x157.00mm (x10)	JA5039			HR599	NA5136 [1][2] 30.00x47.00x7.00mm, FPM NA5017 [1] 98.00x110.00x8.50mm, FPM	
HBS178 [19] M12x1.75x157.00mm (x10) 01/00→	JD5289 01/00→ JA5040 (x4) 01/00→			HR5060 01/00→ →Eng.1818168 HR5076 01/00→ Eng.1818169→	NA5136 [1][2] 30.00x47.00x7.00mm, FPM 01/00→ NA5178 [2] 45.00x65.00x7.00mm, FPM/ACM 01/00→ NA5179 [2] 51.00x65.00x7.00mm, FPM 01/00→ NA5018 [2] 35.00x47.00x5.60mm, FPM 01/00→ NA5017 [1] 98.00x110.00x8.50mm, FPM 01/00→	
HBS078 [22] M10x1.50x143.00mm (x10)	JD5866 JD5865				NC048 [2] 38.00x52.00x6.00mm, FPM	



cc



kW/PS



1.6		D 16 Diesel			8				
340-360 1.6 D	08/84→07/91	1596	4	78.00	SOHC/OHC	40/54	BL960 (Fibre), 1.650mm, 2 Holes →0.885mm BL970 (Fibre), 1.750mm, 1 Hole →Eng.34499 →0.885→0.985mm BL980 (Fibre), 1.850mm, 3 Holes →Eng.34499 →0.985mm→ BS010 (Fibre), 1.650mm, 2 Holes Eng.34500→ →0.885mm BS020 (Fibre), 1.750mm, 1 Hole Eng.34500→ →0.885→0.985mm BS030 (Fibre), 1.850mm, 3 Holes Eng.34500→ →0.985mm→	DL961 ▲ [3]	EL960 [3] [18]
1.6		D 4162 T Diesel			9				
C30 1.6 D2	10/10→12/12	1560	4	75.00	DOHC	84/114			
S40 II 1.6 D2	10/10→								
S60 II DRIVE/D2	01/11→								
S80 II 1.6DRIVE	06/11→								
V40 Hatchb D2	03/12→								
V50 (MW) 1.6 D2	01/10→								
V60 1.6 DRIVE	06/11→								
V70III 1.6DRIVE	06/11→								
1.6		D 4164 T Diesel			10				
C30 1.6 D	10/06→12/12	1560	4	75.00	DOHC	80/109	AD5130 (MLS), 1.250mm, 2 Notches AD5140 (MLS), 1.300mm, 3 Notches AD5150 (MLS), 1.350mm, 1 Notch AD5160 (MLS), 1.400mm, 4 Notches AD5170 (MLS), 1.450mm, 5 Notches	ED5130	
S40 II 1.6 D	01/05→								
S80II 1.6D DRI	01/10→								
V50 1.6 D	01/05→								
V70 III 1.6 D	01/10→								
1.7		B 172 K			11				
340-360 1.7	08/85→07/91	1721	4	81.00	SOHC/OHC	59/80	BL910 (Fibre), 1.200mm	DL910 [3]	EL960 [3] [18]
1.7		B 18 E			12				
460 L (464) 1.7	08/89→07/92	1721	4	81.00	SOHC/OHC	78-80/ 106-109	BL910 (Fibre), 1.200mm	DL910 [3]	EL960 [3] [18]
480 Coupe 1.7	04/86→07/89								

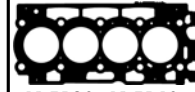
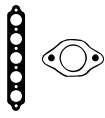

AD5130, AD5140,
AD5150, AD5160,
AD5170



BL910



BL960, BL970,
BL980



BS010, BS020,
BS030



JD409

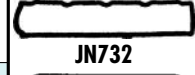

JN732



JJ557



cc



kW/PS

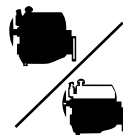

1.7		B 18 EP				13		BL910 (Fibre), 1.200mm	DL910 [3]	EL960 [3] [18] 10/90 →
440 K 1.7	09/88→12/96	1721	4	81.00	SOHC/OHC	75-78/				
460 L 1.7	08/89→07/92					102-106				
480E Coupe 1.7	08/89→07/96									
1.7		B 18 F				14		BL910 (Fibre), 1.200mm	DL910 [3]	EL960 [3] [18]
440 K 1.7	08/88→07/89	1721	4	81.00	SOHC/OHC	70-75/				
480E Coupe 1.7	08/87→07/89					95-102				
1.7		B 18 FP				15		BL910 (Fibre), 1.200mm	DL910 [3]	EL960 [3] [18] 10/90 →
440 K 1.7	08/89→12/96	1721	4	81.00	SOHC/OHC	75/102				
1.7		B 18 FT				16		BX080 (Fibre) BL910 (Fibre), 1.200mm	DL916 [3]	EL960 [3] [18]
440 K 1.7 Turbo	08/88→12/96	1721	4	81.00	SOHC/OHC	88-90/				
460 L 1.7 Turbo	08/89→07/96					120-122				
480E Coupe 1.7T	08/87→07/96									
1.7		B 18 K				17		BL910 (Fibre), 1.200mm	DL910 [3]	EL960 [3] [18]
440 K (445) 1.7	09/88→08/89	1721	4	81.00	SOHC/OHC	58-60/				
						79-82				

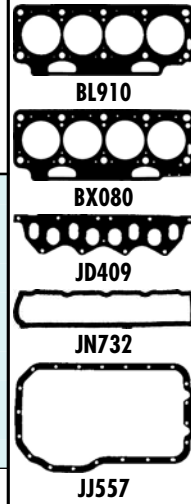
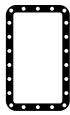
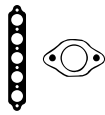

HBS244 [22]
M12x1.50x111.00mm (x10)

JD409

JN732 [4]

JJ557

HR569 [5]

NF846 [2]
25.00x42.00x7.00mm, FPM/ACM
 NF847 [1]
22.00x45.00x7.00mm, FPM/ACM
 NF850 [1]
85.00x105.00x8.00mm, FPM
 NF648 [2]
50.00x68.00x10.00mm, MVQ
 NF843 [2]
50.00x68.00x10.00mm, FPM/ACM

HBS244 [22]
M12x1.50x111.00mm (x10)

JD409

JN732 [4]

JJ557

HR569 [5]

NF846 [2]
25.00x42.00x7.00mm, FPM/ACM
 NF847 [1]
22.00x45.00x7.00mm, FPM/ACM
 NF850 [1]
85.00x105.00x8.00mm, FPM
 NF648 [2]
50.00x68.00x10.00mm, MVQ
 NF843 [2]
50.00x68.00x10.00mm, FPM/ACM

HBS244 [22]
M12x1.50x111.00mm (x10)

JD409

JN732 [4]
10/90 →

JJ557
→ PA349
22.00x16.00x2.00mm

HR569 [5]

NF847 [1]
22.00x45.00x7.00mm, FPM/ACM
 NF846 [2]
25.00x42.00x7.00mm, FPM/ACM
 NF850 [1]
85.00x105.00x8.00mm, FPM
 NF648 [2]
50.00x68.00x10.00mm, MVQ
 NF843 [2]
50.00x68.00x10.00mm, FPM/ACM

HBS244 [22]
M12x1.50x111.00mm (x10)

JD409

JN732 [4]

JJ557

HR805 [5]

NF847 [1]
22.00x45.00x7.00mm, FPM/ACM
 NF846 [2]
25.00x42.00x7.00mm, FPM/ACM
 NF850 [1]
85.00x105.00x8.00mm, FPM
 NF648 [2]
50.00x68.00x10.00mm, MVQ
 NF843 [2]
50.00x68.00x10.00mm, FPM/ACM

HBS244 [22]
M12x1.50x111.00mm (x10)

JD409

JN732 [4]

JJ557

HR569 [5]

NF846 [2]
25.00x42.00x7.00mm, FPM/ACM
 NF847 [1]
22.00x45.00x7.00mm, FPM/ACM
 NF850 [1]
85.00x105.00x8.00mm, FPM
 NF648 [2]
50.00x68.00x10.00mm, MVQ
 NF843 [2]
50.00x68.00x10.00mm, FPM/ACM



cc



kW/PS



1.7	B 18 KD	18	BL910 (Fibre), 1.200mm	DL910 [3]	EL960 [3] [18]
440 K (445) 1.7 460 L (464) 1.7	09/88→08/92 09/89→08/91	1721 4 81.00 SOHC/OHC	58/79		
1.7	B 18 KP	19	BL910 (Fibre), 1.200mm	DL910 [3]	EL960 [3] [18] 10/90→
440 K 1.7 440 K (445) 1.7 460 L (464) 1.7	09/88→12/96 09/88→08/89 09/88→07/96	1721 4 81.00 SOHC/OHC	60-66/ 82-90		
1.7	B 4184 S	20	BX651 (Fibre)	DX652	EA5620 [3] 01/96→
S40 I 1.8 V40 1.8	07/95→08/99 07/95→08/99	1731 4 83.00 DOHC	85/115 01/96→	01/96→	
1.7	B 4184 S3	21	AB5431 (Fibre) BX651 (Fibre)	CE5130 [3] →Eng.1818168 CE5131 [3] Eng.1818169→	EA5620 [3]
S40 I 1.8 V40 1.8	07/95→08/99 07/95→08/99	1731 4 83.00	85/116		
1.8	B 18 U	22	BX600 (Fibre)	DX600	EL960 [3] [18]
440 K 1.8 460 L 1.8	08/91→12/96 08/91→07/96	1794 4 82.70	66/90		
1.8	B 4184 S11	23	AC5940 (MLS)	CB5420 [3] →Eng.1818168 CE5131 [3] Eng.1818169→	
C30 1.8 S40 II 1.8 V50 1.8	10/06→12/12 04/04→ 04/04→	1798 4 83.00	92/125		

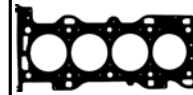

AC5940



BL910



BX600



JA5039



JA5040



JD409



JD419



JD5289



JE5037



JN732



JJ557

HBS244 [22] M12x1.50x111.00mm (x10)	JD409	JN732 [4]	JJ557	HR569 [5]	NF846 [2] 25.00x42.00x7.00mm, FPM/ACM NF847 [1] 22.00x45.00x7.00mm, FPM/ACM NF850 [1] 85.00x105.00x8.00mm, FPM NF648 [2] 50.00x68.00x10.00mm, MVQ NF843 [2] 50.00x68.00x10.00mm, FPM/ACM	
HBS244 [22] M12x1.50x111.00mm (x10)	JD409	JN732 [4]	JJ557	HR569 [5]	NF846 [2] 25.00x42.00x7.00mm, FPM/ACM NF847 [1] 22.00x45.00x7.00mm, FPM/ACM NF850 [1] 85.00x105.00x8.00mm, FPM NF648 [2] 50.00x68.00x10.00mm, MVQ NF843 [2] 50.00x68.00x10.00mm, FPM/ACM	
HBS178 [19] M12x1.75x157.00mm (x10) 01/96→	JA5039 [1] 01/96→ JA5040 [4] (x4) 01/96→			HR5060 [5] 01/96→ →Eng.1818168 HR5076 [5] 01/96→ Eng.1818169→	NA5136 [1][2] 30.00x47.00x7.00mm, FPM 01/96→ NA5017 [1] 98.00x110.00x8.50mm, FPM 01/96→	
HBS178 [19] M12x1.75x157.00mm (x10)	JD5289 [1] JA5040 [4] (x4)			HR5060 [5] →Eng.1818168 HR5076 [5] Eng.1818169→	NA5136 [1][2] 30.00x47.00x7.00mm, FPM NA5178 [2] 45.00x65.00x7.00mm, FPM/ACM NA5179 [2] 51.00x65.00x7.00mm, FPM NA5017 [1] 98.00x110.00x8.50mm, FPM	
HBS244 [22] M12x1.50x111.00mm (x10)	JD419	JN732 [4]	JJ557	HR805 [5]	NF846 [2] 25.00x42.00x7.00mm, FPM/ACM NF847 [1] 22.00x45.00x7.00mm, FPM/ACM NF850 [1] 85.00x105.00x8.00mm, FPM NF648 [2] 50.00x68.00x10.00mm, MVQ NF843 [2] 50.00x68.00x10.00mm, FPM/ACM	
HBS178 [19] M12x1.75x157.00mm (x10) HBS369 [5] M10x1.50x145.50mm (x10)	JA5040 [4] (x4) JE5037 [5]	JM5153 [78] (Elastomer) JM5158 [79] (Elastomer)		HR5060 [5] →Eng.1818168 HR5063 [5] HR5076 [5] Eng.1818169→	NA5178 [2] 45.00x65.00x7.00mm, FPM/ACM NA5179 [2] 51.00x65.00x7.00mm, FPM NA5157 [2] 37.00x50.00x8.00mm, PTFE NA5157 [2] 37.00x50.00x8.00mm, PTFE LK5005 [1][7] 88.00x188.00x15.000mm, PTFE	



cc



kW/PS



1.8		B 4184 S2					24	AB5420 (Fibre)	CB5420 [3] →Eng.1818168 CB5421 [3] Eng.1818169→	EA5620 [3]
S40 I 1.8	03/99→12/03	1783	4	83.00	DOHC	85-90/ 116-122				
S40 I (VS) 1.8	06/01→08/03									
V40 1.8	03/99→06/04									
1.8		B 4184 S8					25	AC5940 (MLS)		
C30 1.8 FlexFl	01/07→12/12	1798	4			92/125				
S40II 1.8 FlxFl	01/06→									
V50 1.8 FlexFl	01/05→									
1.8		B 4184 S9					26	AB5431 (Fibre)	CE5130 [3] →Eng.1818168 CE5131 [3] Eng.1818169→	EA5620 [3]
S40 I 1.8	03/99→12/03	1783	4	83.00	DOHC	88-90/ 120-122				
V40 1.8	03/99→06/04									
1.8		B 4184 SJ					27	AE5610 (MLS)	CE5612	
S40 I 1.8 i	06/01→12/03	1834	4	81.00	DOHC	90/122				
V40 1.8 i	06/01→06/04									
1.8		B 4184 SM					28	AE5610 (MLS)	CE5612	
S40 I 1.8 i	03/98→12/03	1834	4	81.00		92/125				
V40 1.8 i	03/98→06/04									
1.9		B 4194 T					29	AA5620 (Fibre)	CA5620 [3]	EA5620 [3]
S40 I 1.9 T4	05/97→07/00	1855	4	81.00	DOHC	147/200				
V40 Es 1.9 T4	05/97→07/00									
1.9		B 4194 T2					30	AB5431 (Fibre)	CE5130 [3] →Eng.1818168 CE5131 [3] Eng.1818169→	
S40 I 1.9 T4	05/97→07/00	1855	4	81.00	DOHC	147/200				
1.9		B 4204 S					31	BX651 (Fibre)	DX652	EA5620 [3]
S40 I 2.0	07/95→12/03	1948	4	83.00	DOHC	100-103/ 136-140				
V40 2.0	07/95→06/04									

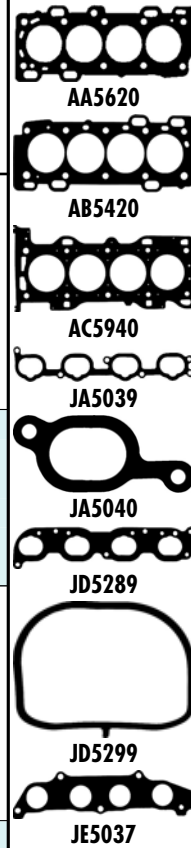

HBS178 [19]
M12x1.75x157.00mm (x10)

JD5289 ■
JA5040 ■ (x4)

HR5060 ■
→Eng.1818168
HR5076 ■
Eng.1818169→

NA5136 [1][2]
30.00x47.00x7.00mm, FPM
NA5178 [2]
45.00x65.00x7.00mm, FPM/ACM
NA5179 [2]
51.00x65.00x7.00mm, FPM
NA5017 ■ [1]
98.00x110.00x8.50mm, FPM

HBS178 [19]
M12x1.75x157.00mm (x10)

JD5299 ■
JE5037 ■

JM5153
(Elastomer)
JM5158
(Elastomer)

HR5063 ■

NA5157 [2]
37.00x50.00x8.00mm, PTFE
NA5157 ■ [2]
37.00x50.00x8.00mm, PTFE
LK5005 ■ [1][7]
88.00x188.00x15.000mm, PTFE

HBS178 [19]
M12x1.75x157.00mm (x10)

JD5289 ■
JA5040 ■ (x4)

HR5060 ■
→Eng.1818168
HR5076 ■
Eng.1818169→

NA5136 [1][2]
30.00x47.00x7.00mm, FPM
NA5178 [2]
45.00x65.00x7.00mm, FPM/ACM
NA5179 [2]
51.00x65.00x7.00mm, FPM
NA5017 ■ [1]
98.00x110.00x8.50mm, FPM

HBS215 [5]
M10x1.25x95.00mm (x10)

JD5372 ■
0.2mm
(Steel)

JM5291
(Elastomer)
JM5290 ■
(Elastomer)

HR5060 ■
→Eng.1818168
HR5076 ■
Eng.1818169→

NJ933 [2]
35.00x50.00x8.00mm, FPM
NF678 ■ [2]
35.00x50.00x8.00mm, ACM
NK143 ■ [1]
85.00x103.00x8.00mm, FPM

HBS215 [5]
M10x1.25x95.00mm (x10)

JD6039 ■
0.35mm
(Steel)
JD5372 ■
0.2mm
(Steel)

JM5232 ■

HR5060 ■
→Eng.1818168
HR5076 ■
Eng.1818169→

NJ933 [2]
35.00x50.00x8.00mm, FPM
NF678 ■ [2]
35.00x50.00x8.00mm, ACM
NK143 ■ [1]
85.00x103.00x8.00mm, FPM

HBS178 [19]
M12x1.75x157.00mm (x10)

JA5039 ■
JA5040 ■ (x4)

HR5060 ■
→Eng.1818168
HR5076 ■
Eng.1818169→

NA5138 (x2)[2]
44.50x57.20x6.75mm, ACM
NA5136 (x2)[1][2]
30.00x47.00x7.00mm, FPM
NA5018 ■ [2]
35.00x47.00x5.60mm, FPM
NA5017 ■ [1]
98.00x110.00x8.50mm, FPM

HBS178 [19]
M12x1.75x157.00mm (x10)

JD5289 ■
JA5040 ■ (x4)

HR5060 ■
→Eng.1818168
HR5076 ■
Eng.1818169→

NA5136 [1][2]
30.00x47.00x7.00mm, FPM
NA5017 ■ [1]
98.00x110.00x8.50mm, FPM

HBS178 [19]
M12x1.75x157.00mm (x10)

JA5039 ■
JA5040 ■ (x4)

HR5060 ■
→Eng.1818168
HR5076 ■
Eng.1818169→

NA5138 (x2)[2]
44.50x57.20x6.75mm, ACM
NA5136 (x2)[1][2]
30.00x47.00x7.00mm, FPM
NA5018 ■ [2]
35.00x47.00x5.60mm, FPM
NA5017 ■ [1]
98.00x110.00x8.50mm, FPM



cc



kW/PS



1.9		B 4204 S2					32	AB5420 (Fibre)	CB5420 [3] →Eng.1818168 CB5421 [3] Eng.1818169→	EA5620 [3]
S40 1.2.0	07/95→12/03	1948	4	83.00	DOHC	100/136				
V40 2.0	07/95→06/04									
1.9		B 4204 T					33	BX651 (Fibre)	DX652	EA5620 [3]
S40 1.2.0 T	10/97→12/03	1948	4	83.00	DOHC	118/160				
V40 2.0 T	10/97→07/00									
1.9		B 4204 T2					34	AB5420 (Fibre)	CB5420 [3] →Eng.1818168 CB5421 [3] Eng.1818169→	EA5620 [3]
S40 1.2.0 T	07/00→06/01	1948	4	83.00	DOHC	118-121/ 160-165				
V40 2.0 T	07/99→06/01									
1.9		B 4204 T3					35	AB5420 (Fibre)	CB5420 [3] →Eng.1818168 CB5421 [3] Eng.1818169→	EA5620 [3]
S40 1.2.0 T	07/00→12/03	1948	4	83.00	DOHC	120-121/ 163-165				
V40 Es 2.0 T	06/01→06/04									
1.9		B 4204 T5					36	AB5420 (Fibre)	CB5420 [3] →Eng.1818168 CB5421 [3] Eng.1818169→	EA5620 [3]
S40 1.2.0 T4	07/00→12/03	1948	4	83.00	DOHC	147/200				
V40 2.0 T4	07/00→06/04									
1.9		D 19 T Diesel					37	AY710 (SE), 1.360mm, 2 Notches, 2 Holes →0.073mm AY720 (SE), 1.440mm, 1 Notch, 1 Hole →0.073→0.206mm AY730 (SE), 1.520mm, 3 Notches, 3 Holes →0.206mm→	DY040 ▲ [3]	EL960 [3] [18]
440 K 1.9 TD	07/94→12/96	1870	4	80.00	SOHC/OHC	66/90				
460 L 1.9 TD	07/94→07/96									

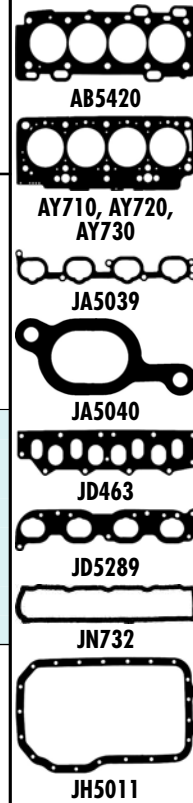

HBS178 [19]
M12x1.75x157.00mm (x10)

JD5289 ■
JA5040 ■ (x4)

HR5060 ■
→Eng.1818168
HR5076 ■
Eng.1818169→

■ **NA5136** [1][2]
30.00x47.00x7.00mm, FPM
■ **NA5178** [2]
45.00x65.00x7.00mm, FPM/ACM
■ **NA5179** [2]
51.00x65.00x7.00mm, FPM
■ **NA5017** ■ [1]
98.00x110.00x8.50mm, FPM

HBS178 [19]
M12x1.75x157.00mm (x10)

JA5039 ■
JA5040 ■ (x4)

HR5060 ■

■ **NA5138** (x2)[2]
44.50x57.20x6.75mm, ACM
■ **NA5136** (x2)[1][2]
30.00x47.00x7.00mm, FPM
■ **NA5018** ■ [2]
35.00x47.00x5.60mm, FPM
■ **NA5017** ■ [1]
98.00x110.00x8.50mm, FPM

HBS178 [19]
M12x1.75x157.00mm (x10)

JA5039 ■
JA5040 ■ (x4)

HR5060 ■
→Eng.1818168
HR5076 ■
Eng.1818169→

■ **NA5136** [1][2]
30.00x47.00x7.00mm, FPM
■ **NA5178** [2]
45.00x65.00x7.00mm, FPM/ACM
■ **NA5179** [2]
51.00x65.00x7.00mm, FPM
■ **NA5018** ■ [2]
35.00x47.00x5.60mm, FPM
■ **NA5017** ■ [1]
98.00x110.00x8.50mm, FPM

HBS178 [19]
M12x1.75x157.00mm (x10)

JA5039 ■
JA5040 ■ (x4)

HR5060 ■
→Eng.1818168
HR5076 ■
Eng.1818169→

■ **NA5136** [1][2]
30.00x47.00x7.00mm, FPM
■ **NA5178** [2]
45.00x65.00x7.00mm, FPM/ACM
■ **NA5179** [2]
51.00x65.00x7.00mm, FPM
■ **NA5018** ■ [2]
35.00x47.00x5.60mm, FPM
■ **NA5017** ■ [1]
98.00x110.00x8.50mm, FPM

HBS178 [19]
M12x1.75x157.00mm (x10)

JD5289 ■
JA5040 ■ (x4)

HR5060 ■
→Eng.1818168
HR5076 ■
Eng.1818169→

■ **NA5136** [1][2]
30.00x47.00x7.00mm, FPM
■ **NA5178** [2]
45.00x65.00x7.00mm, FPM/ACM
■ **NA5179** [2]
51.00x65.00x7.00mm, FPM
■ **NA5018** ■ [2]
35.00x47.00x5.60mm, FPM
■ **NA5017** ■ [1]
98.00x110.00x8.50mm, FPM

HBS120 ⊕ [22]
M12x1.50x118.00mm (x10)

JD463

JN732 [4]

JH5011
⇒**KG5012**
16.00x23.00x1.500mm

HR569 ■

■ **NF846** ■ [2]
25.00x42.00x7.00mm, FPM/ACM
■ **NF850** ■ [1]
85.00x105.00x8.00mm, FPM
■ **NF843** ■ [2]
50.00x68.00x10.00mm, FPM/ACM

KA625 [15]
NF849 [2][56]



cc



kW/PS

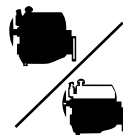

1.9		D 4192 T Diesel			38				
S40 1.9 TD	07/95→08/99	1870	4	80.00	SOHC/OHC	66/90	AY710 (SE), 1.360mm, 2 Notches, 2 Holes →0.073mm	DY040 ▲ [3]	EL960 [3] [18]
V40 1.9 TD	07/95→08/99						AY720 (SE), 1.440mm, 1 Notch, 1 Hole →0.073→0.206mm		
							AY730 (SE), 1.520mm, 3 Notches, 3 Holes →0.206mm→		
1.9		D 4192 T2 Diesel			39				
S40 1.9 DI	03/99→07/00	1870	4	80.00		70/95	AC5070 (Fibre), 1.350mm, 2 Notches →0.653mm	CC5060 ▲ [3]	EC5060
V40 1.9 DI	03/99→07/00						AC5080 (Fibre), 1.450mm, 1 Notch →0.653→0.786mm		
							AC5090 (Fibre), 1.550mm, 3 Notches →0.786mm→		
1.9		D 4192 T3 Diesel			40				
S40 1.9 DI	07/00→12/03	1870	4	80.00	DOHC	85/116	AC5062 (MLS)	CC5060 ▲ [3]	EC5060
V40 1.9 DI	07/00→06/04						AC5061 (MLS), 1.320mm		
1.9		D 4192 T4 Diesel			41				
S40 1.9 DI	07/00→12/03	1870	4	80.00	DOHC	75/102	AC5062 (MLS)	CC5060 ▲ [3]	EC5060
V40 1.9 DI	07/00→06/04						AC5061 (MLS), 1.320mm		
2.0		B 20 F			42				
440 K 2.0	08/92→07/96	1998	4	82.70	SOHC/OHC	80-85/ 108-115	BX600 (Fibre)	DX600	
460 L 2.0	08/92→07/96								
480E Coupe 2.0	08/92→09/95								
2.0		B 200 E			43				
240 2.0	08/83→12/93	1986	4	88.90		82-89/ 112-121	BD070 (Fibre)	DD073 [3]	EH445
340-360 2.0	08/86→07/88								
740 2.0	08/85→07/92								
940 (944) 2.0	09/90→09/93								
2.0		B 200 EA			44				
340-360 Sal 2.0	08/86→07/88	1986	4	88.90	SOHC/OHC	81-82/ 110-112	BD070 (Fibre)	DD073 [3]	EH445
2.0		B 200 ET			45				
740 2.0	01/86→08/90	1986	4	88.90	SOHC/OHC	115-120/ 156-163	BD070 (Fibre)	DD073 [3]	EH445
740 2.0 Turbo	09/87→08/90								
2.0		B 200 F			46				
240 2.0	09/88→12/93	1986	4	88.90	SOHC/OHC	80-82/ 109-112	BD070 (Fibre)	DD073 [3]	EH445
240 Kombi 2.0	09/88→12/93								
340-360 2.0	08/86→07/89								
740 2.0	08/89→08/92								
940 2.0	01/92→07/94								



AC5070, AC5080,
AC5090



AY710, AY720,
AY730



BD070



BX600



JB917

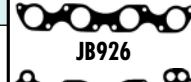

JB926

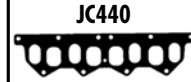

JC440



JD419



JD463

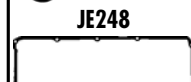

JE248



JN635



JN732

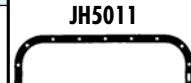

JH5011



JJ065

<p>HBS120 [22] M12x1.50x118.00mm (x10)</p>	<p>JD463</p>	<p>JN732 [4]</p>	<p>JH5011 =KG5012 16.00x23.00x1.500mm</p>	<p>HR569 [5]</p>	<p>NF846 [2] 25.00x42.00x7.00mm, FPM/ACM NF850 [1] 85.00x105.00x8.00mm, FPM NF843 [2] 50.00x68.00x10.00mm, FPM/ACM →04/97 NA5037 [1] 85.00x105.00x11.00mm, ACM NA5036 [2] 42.00x54.00x6.00mm, FPM 04/97→</p>	<p>KA625 [15] NF849 [2] [56]</p>
<p>HBS120 [22] M12x1.50x118.00mm (x10)</p>	<p>JD5189</p>	<p>JM5086 (Elastomer)</p>	<p>JH5041 =KG5012 16.00x23.00x1.500mm</p>	<p>HR646 [5]</p>	<p>NF846 [2] 25.00x42.00x7.00mm, FPM/ACM NA5036 [2] 42.00x54.00x6.00mm, FPM NA5037 [1] 85.00x105.00x11.00mm, ACM</p>	
<p>HBS244 [22] M12x1.50x111.00mm (x10)</p>	<p>JD5189</p>	<p>JM5086 (Elastomer)</p>	<p>JH5041 =KG5012 16.00x23.00x1.500mm</p>	<p>HR646 [5]</p>	<p>NF846 [2] 25.00x42.00x7.00mm, FPM/ACM NA5036 [2] 42.00x54.00x6.00mm, FPM NA5037 [1] 85.00x105.00x11.00mm, ACM</p>	
<p>HBS244 [22] M12x1.50x111.00mm (x10)</p>	<p>JD5189</p>	<p>JM5086 (Elastomer)</p>	<p>JH5041 =KG5012 16.00x23.00x1.500mm</p>	<p>HR646 [5]</p>	<p>NF846 [2] 25.00x42.00x7.00mm, FPM/ACM NA5036 [2] 42.00x54.00x6.00mm, FPM NA5037 [1] 85.00x105.00x11.00mm, ACM</p>	
<p>HBS244 [22] M12x1.50x111.00mm (x10)</p>	<p>JD419</p>	<p>JN732 [4]</p>	<p>JH5011</p>	<p>HR805 [5]</p>	<p>NF847 [1] 22.00x45.00x7.00mm, FPM/ACM NF846 [2] 25.00x42.00x7.00mm, FPM/ACM NF850 [1] 85.00x105.00x8.00mm, FPM NF843 [2] 50.00x68.00x10.00mm, FPM/ACM</p>	
<p>HBS174 [19] M12x1.75x133.00mm (x10)</p>	<p>JB926 [1] JC440 [1] JB917 [x4] ⊕JE248</p>	<p>JN635 [4]</p>	<p>JJ065</p>	<p>HR641 [5]</p>	<p>NA581 [2] 52.00x68.00x10.00mm, MVQ NA869 [1] 92.00x110.00x10.00mm, MVQ</p>	
<p>HBS174 [19] M12x1.75x133.00mm (x10)</p>	<p>JB926 [1] JC440 [1] JB917 [x4] ⊕JE248</p>	<p>JN635 [4]</p>	<p>JJ065</p>	<p>HR641 [5]</p>	<p>NA581 [2] 52.00x68.00x10.00mm, MVQ NA869 [1] 92.00x110.00x10.00mm, MVQ</p>	
<p>HBS174 [19] M12x1.75x133.00mm (x10)</p>	<p>JB926 [1] JC440 [1] JB917 [x4] ⊕JE248</p>	<p>JN635 [4]</p>	<p>JJ065</p>	<p>HR641 [5]</p>	<p>NA581 [2] 52.00x68.00x10.00mm, MVQ NA869 [1] 92.00x110.00x10.00mm, MVQ</p>	
<p>HBS174 [19] M12x1.75x133.00mm (x10)</p>	<p>JB926 [1] JC440 [1] JB917 [x4] ⊕JE248</p>	<p>JN635 [4]</p>	<p>JJ065</p>	<p>HR641 [5]</p>	<p>NA581 [2] 52.00x68.00x10.00mm, MVQ NA869 [1] 92.00x110.00x10.00mm, MVQ</p>	



kW/PS

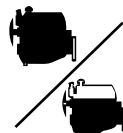

2.0		B 200 FT					47	BD070 (Fibre)	DD073 [3]	EH445
740 2.0 Turbo	09/90→08/91	1986	4	88.90		105-114/ 143-155				
740 Kombi 2.0 T	09/90→08/91									
940 2.0 Turbo	08/90→07/95									
940 II 2.0 T	04/96→10/98									
2.0		B 200 G					48	BD070 (Fibre)	DD073 [3]	EH445
740 2.0	08/85→07/92	1986	4	88.90	SOHC/OHC	80-89/ 109-121				
940 (944) 2.0	09/90→09/93									
940 II 2.0	11/94→12/95									
940 II Es 2.0	11/94→12/95									
940 Kombi 2.0	09/90→09/93									
2.0		B 200 K					49	BD070 (Fibre)	DD072 [3]	EH445
340-360 2.0	08/84→07/90	1986	4	88.90		70-77/ 95-105				
740 2.0	09/88→08/90									
2.0		B 204 E					50	BX090 (Fibre)	DX090 [3]	
740 2.0 16V	09/87→08/90	1986	4	88.90	DOHC	100-103/ 136-140				
740 2.0 GLE	09/87→08/90									
960 2.0	09/90→08/93									
2.0		B 204 FT					51	BX090 (Fibre)	DX090 [3]	EH445
940 2.0	09/90→09/93	1986	4	88.90	DOHC	102-140/ 139-190				
940 II 2.0	10/94→05/97									
960 2.0	08/90→09/93									
2.0		B 204 FTE					52	BX090 (Fibre)		
740 2.0	09/90→08/92	1986	4	88.90	DOHC	147/200				
740 Kombi 2.0	09/90→08/92									
2.0		B 4204 S3					53	AD5220 (MLS)	CD5220 [3]	
C30 2.0	10/06→12/12	1999	4	87.50	DOHC	107/146				
S40 II 2.0	10/06→									
S80 II (AS) 2.0	01/08→									
V50 2.0	10/06→									
V70 III 2.0	10/07→									
2.0		B 4204 S4					54	AD5220 (MLS)	CD5220 [3]	
C30 2.0 FlexFl	01/10→12/12	1999	4	87.50	DOHC	107/146				
S40 II 2.0 F	10/06→									
S80II 2.0 FlxFl	01/08→									
V50 2.0 FlexFl	01/10→									
V70III 2.0FlxFl	01/08→									
2.0		B 4204 T6					55			
S60 II 2.0 T	04/10→	1999	4	87.50	DOHC	149/203				
S80 II 2.0 T	01/10→									
V60 2.0 T	09/10→									
V70 III 2.0 T	01/10→									
XC60 2.0 T	03/10→									
2.0		B 4204 T7					56			
S60 II T5	04/10→	1999	4	87.50	DOHC	176-177/ 239-241				
S80 II T5	10/10→									
V60 T5	09/10→									
V70 III (BW) T5	01/10→									
XC60 T5	09/10→									

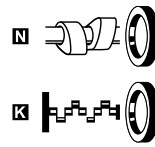
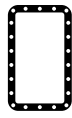

AD5220



BD070



BX090

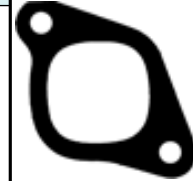

JB917



JB926



JC440

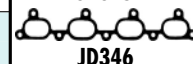

JD345



JD346

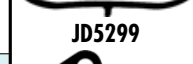

JD5299



JE248



JE5037

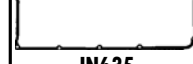

JN635



JJ065

HBS174 [19] M12x1.75x133.00mm (x10)	JB926 ■ JC440 ■ JB917 ■ (x4) ⊕JE248	JN635 [4]	JJ065	HR641 ■	NA581 ■ [2] 52.00x68.00x10.00mm, MVQ NA869 ■ [1] 92.00x110.00x10.00mm, MVQ	
HBS174 [19] M12x1.75x133.00mm (x10)	JB926 ■ JC440 ■ JB917 ■ (x4) ⊕JE248	JN635 [4]	JJ065	HR641 ■	NA581 ■ [2] 52.00x68.00x10.00mm, MVQ NA869 ■ [1] 92.00x110.00x10.00mm, MVQ	
HBS174 [19] M12x1.75x133.00mm (x10)	JB926 ■ JC440 ■ JB917 ■ (x4) ⊕JE248	JN635 [4]	JJ065	HR641 ■	NA581 ■ [2] 52.00x68.00x10.00mm, MVQ NA869 ■ [1] 92.00x110.00x10.00mm, MVQ	
HBS175 ⊕ [19] M12x1.75x115.00mm (x7)	JD345 ■ JD346 ■	HM5293 ■	JJ065	HR599 ■	NA581 ■ [2] 52.00x68.00x10.00mm, MVQ NA869 ■ [1] 92.00x110.00x10.00mm, MVQ	
HBS175 ⊕ [19] M12x1.75x115.00mm (x7)	JD345 ■ JD346 ■	HM5293 ■	JJ065	HR599 ■	NA581 ■ [2] 52.00x68.00x10.00mm, MVQ NA869 ■ [1] 92.00x110.00x10.00mm, MVQ	
HBS175 ⊕ [19] M12x1.75x115.00mm (x7)	JD346 ■	HM5293 ■	JJ065	HR599 ■	NA581 ■ [2] 52.00x68.00x10.00mm, MVQ NA869 ■ [1] 92.00x110.00x10.00mm, MVQ	
HBS369 ⊕ [5] M10x1.50x145.50mm (x10)	JD5299 ■ (x4) JE5037 ■	JM5153 (Elastomer)		HR5063 ■	NA5157 [2] 37.00x50.00x8.00mm, PTFE NA5157 ■ [2] 37.00x50.00x8.00mm, PTFE LK5005 ■ [1][7] 88.00x188.00x15.00mm, PTFE	
HBS369 ⊕ [5] M10x1.50x145.50mm (x10)	JD5299 ■ (x4) JE5037 ■	JM5153 (Elastomer)		HR5063 ■	NA5157 [2] 37.00x50.00x8.00mm, PTFE NA5157 ■ [2] 37.00x50.00x8.00mm, PTFE LK5005 ■ [1][7] 88.00x188.00x15.00mm, PTFE	
				HR5063 ■	NA5157 [2] 37.00x50.00x8.00mm, PTFE NA5157 ■ [2] 37.00x50.00x8.00mm, PTFE LK5005 ■ [1][7] 88.00x188.00x15.00mm, PTFE	
				HR5063 ■	NA5157 [2] 37.00x50.00x8.00mm, PTFE NA5157 ■ [2] 37.00x50.00x8.00mm, PTFE LK5005 ■ [1][7] 88.00x188.00x15.00mm, PTFE	



cc



kW/PS



2.0	B 5202 S	57	BY371 (Fibre)	DY371 [3]	EY370 [3]				
850 2.0	08/94→12/96	1984	5	81.00	DOHC	93/126			
S70 2.0	01/97→11/00								
V70 1.2.0	01/97→03/00								
2.0	B 5204 F	58	BY371 (Fibre)	DY370 [3]	EY370 [3]				
850 2.0	06/91→12/96	1984	5	81.00		96-105/ 131-143		01/96→	
S70 2.0	01/97→11/00								
V70 1.2.0	01/97→03/00								
2.0	B 5204 FT	59	BY371 (Fibre)	CB5440 [3]	EY370 [3]				
850 2.0 Turbo	02/93→12/96	1984	5	81.00	DOHC	150-155/ 204-211			
2.0	B 5204 T	60	BY371 (Fibre)	CB5440 [3]	EY370 [3]				
850 2.0 Turbo	02/93→12/96	1984	5	81.00	DOHC	155/211	08/93→	08/93→	08/93→
S70 2.0 Turbo	01/97→11/00								
V70 1.2.0 Turbo	01/97→03/00								
2.0	B 5204 T2	61	BY371 (Fibre)		EY370 [3]				
850 2.0 Turbo	09/93→10/96	1984	5	81.00	DOHC	132/180	01/97→		01/97→
850 Es 2.0 T	09/93→10/97								EE5250
C70 Conv 2.0	03/98→10/05								01/00→
C70 1 Cpe 2.0	03/97→09/02								Eng.1817653→
S70 2.0	01/97→11/00								
V70 2.0	01/97→03/00								
2.0	B 5204 T3	62	BY371 (Fibre)	DY370 [3]	EY370 [3]				
C70 Conv 2.0 T	03/98→10/05	1984	5	81.00	DOHC	166/226	→12/99	→12/99	
C70 1 Cpe 2.0T	03/97→09/02								EE5250
S70 2.0 Turbo	01/97→11/00								01/00→
S80 2.0 T	06/98→07/06								Eng.1817653→
V70 2.0 T AWD	01/97→03/00								
V70 2.0 Turbo	01/97→03/00								
2.0	B 5204 T4	63	BY371 (Fibre)	DY370 [3]	EY370 [3]				
C70 1 Cpe 2.0T	03/00→09/02	1984	5	81.00	DOHC	120/163	→12/99	→12/99	
C70 1 Conv 2.0 T	03/00→10/05								EE5250
S70 2.0	01/97→11/00								01/01→
S80 2.0	06/98→07/06								Eng.1817653→
V70 1.2.0	01/97→03/00								

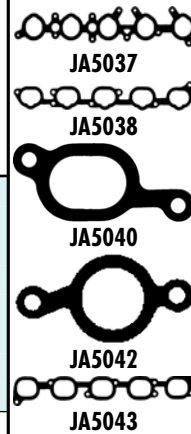
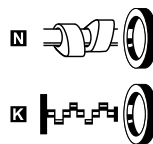
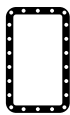
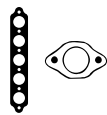

<p>HBS303 [19] M12x1.75x162.00mm (x12) →Eng.131034 HBS185 [19] M12x1.75x157.00mm (x12) Eng.131035→</p>	<p>JA5037 ■ JA5042 ■ (x5) HA5040 ■ ■</p>			<p>HR5030 ■ (x2)</p>	<p>■ NA5138 (x2) [2] 44.50x57.20x6.75mm, ACM ■ NA5149 [1] [145] 30.00x54.00x15.00mm, FPM ■ NA5018 ■ [2] 35.00x47.00x5.60mm, FPM ■ NA5017 ■ [1] 98.00x110.00x8.50mm, FPM</p>
<p>HBS303 [19] M12x1.75x162.00mm (x12) →Eng.131034 HBS185 [19] M12x1.75x157.00mm (x12) Eng.131035→</p>	<p>JA5043 ■ →12/95 JA5038 ■ 01/96→ JA5040 ■ (x5) HA5041 ■ ■</p>			<p>HR5030 ■</p>	<p>■ NA5136 [1] [2] 30.00x47.00x7.00mm, FPM ■ NA5017 ■ [1] 98.00x110.00x8.50mm, FPM</p>
<p>HBS303 [19] M12x1.75x162.00mm (x12) →Eng.131034 HBS185 [19] M12x1.75x157.00mm (x12) Eng.131035→</p>	<p>JA5043 ■ →12/95 JA5038 ■ 01/96→ JA5040 ■ (x5) HA5041 ■ ■</p>			<p>HR5030 ■</p>	<p>■ NA5136 [1] [2] 30.00x47.00x7.00mm, FPM ■ NA5017 ■ [1] 98.00x110.00x8.50mm, FPM</p>
<p>HBS303 [19] M12x1.75x162.00mm (x12) 08/93→ →Eng.131034 HBS185 [19] M12x1.75x157.00mm (x12) 08/93→ Eng.131035→</p>	<p>JA5043 ■ 08/93→12/95 JA5038 ■ 01/96→ JA5040 ■ (x5) HA5041 ■ ■</p>			<p>HR5030 ■ 08/93→</p>	<p>■ NA5136 [1] [2] 30.00x47.00x7.00mm, FPM 08/93→ ■ NA5017 ■ [1] 98.00x110.00x8.50mm, FPM 08/93→</p>
<p>HBS303 [19] M12x1.75x162.00mm (x12) 01/97→ →Eng.131034 HBS185 [19] M12x1.75x157.00mm (x12) 01/97→ Eng.131035→</p>	<p>JA5038 ■ 01/97→ JA5040 ■ (x5) 01/97→ HA5041 ■ ■</p>			<p>HR5030 ■ (x2) 01/97→</p>	<p>■ NA5136 [1] [2] 30.00x47.00x7.00mm, FPM 01/97→ ■ NA5017 ■ [1] 98.00x110.00x8.50mm, FPM 01/97→</p>
<p>HBS303 [19] M12x1.75x162.00mm (x12) →Eng.131034 HBS185 [19] M12x1.75x157.00mm (x12) Eng.131035→</p>	<p>JA5038 ■ JA5040 ■ (x5) HA5041 ■ ■</p>			<p>HR5030 ■ (x2)</p>	<p>■ NA5136 [1] [2] 30.00x47.00x7.00mm, FPM ■ NA5017 ■ [1] 98.00x110.00x8.50mm, FPM</p>
<p>HBS303 [19] M12x1.75x162.00mm (x12) →Eng.131034 HBS185 [19] M12x1.75x157.00mm (x12) Eng.131035→</p>	<p>JA5038 ■ JA5040 ■ (x5) HA5041 ■ ■</p>			<p>HR5030 ■ (x2)</p>	<p>■ NA5136 [1] [2] 30.00x47.00x7.00mm, FPM ■ NA5017 ■ [1] 98.00x110.00x8.50mm, FPM</p>



cc



kW/PS

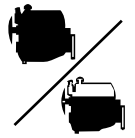

2.0		B 5204 T5				64		AB5440 (Fibre)		CB5440 [3]	EY370 [3] EE5250 01/00→ Eng.1817653→
S60 2.0 T	09/01→04/10	1984	5	81.00	DOHC	132/180					
S80 2.0 T	12/99→07/06										
V70 II 2.0 T	07/01→08/07										
2.0		D 4204 T Diesel				65		AD5490 (MLS), 1.250mm, 2 Notches AD5500 (MLS), 1.300mm, 3 Holes AD5510 (MLS), 1.350mm, 4 Holes AD5520 (MLS), 1.400mm, 5 Holes		CD5500 ▲	ED5500
C30 2.0 D	10/06→12/12	1998	4	85.00	DOHC	100/136					
C70II Conv 2.0D	01/08→										
S40 2.0 D Mk II	01/04→										
S80 II 2.0 TDi	02/08→										
V50 2.0 D	04/04→										
V70III 2.0D Mk3	10/07→										
2.0		D 4204 T2 Diesel				66		AD5490 (MLS), 1.250mm, 2 Notches AD5500 (MLS), 1.300mm, 3 Holes AD5510 (MLS), 1.350mm, 4 Holes AD5520 (MLS), 1.400mm, 5 Holes		CD5500 ▲	ED5500
S40 II 2.0 D4	07/05→	1998	4	85.00	DOHC	96/131					
2.0		D 5204 T Diesel				67					
C30 D4	10/10→12/12	1984	5	81.00	DOHC	130/177					
C70 II Conv D4	10/10→										
S40 II D4	10/10→										
V50 (MW) D4	10/10→										
2.0		D 5204 T2 Diesel				68					
S60 II D3	04/10→04/12	1984	5	81.00	DOHC	120/163					
S80 II (AS) D3	01/10→										
V60 D3 / D4	09/10→										
V70 III D3 / D4	03/10→										
XC60 D3	03/10→										
XC70 II D3	08/11→										
XC70 II D3 AWD	08/11→										
2.0		D 5204 T5 Diesel				69					
C30 D3	10/10→12/12	1984	5	81.00	DOHC	110/150					
C70 II Conv D3	10/10→										
S40 II D3	10/10→										
V50 (MW) D3	10/10→										
2.0		D 5204 T7 Diesel				70					
S60 II D3	05/12→	1984	5	81.00	DOHC	100/136					
S80 II (AS) D3	05/12→										
V60 D3	12/12→										
V70 III (BW) D3	03/10→										
XC60 D3	04/12→										
2.3		B 23 A				71		BK640 (Fibre) →12/84	DK641 →12/84	EH445 →12/84	
740 2.3	08/84→07/90	2316	4	96.00	SOHC/OHC	78-84/ 106-114					

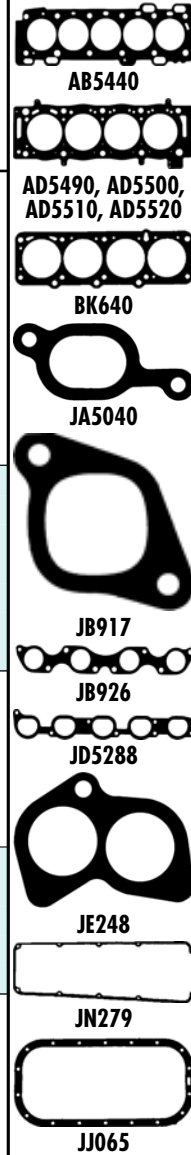
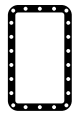

HBS185 [19]
M12x1.75x157.00mm (x12)
→Eng.131034
HBS303 [19]
M12x1.75x162.00mm (x12)
Eng.131035→

JD5288 ■
JA5040 ■ (x5)

HR5030 ■ (x2)

■ **NA5136** (x2)[1][2]
30.00x47.00x7.00mm, FPM
■ **NA5178** [2]
45.00x65.00x7.00mm, FPM/ACM
■ **NA5179** [2]
51.00x65.00x7.00mm, FPM
■ **NA5018** ■ [2]
35.00x47.00x5.60mm, FPM
■ **NA5017** ■ [1]
98.00x110.00x8.50mm, FPM

**AD5490, AD5500,
AD5510, AD5520**

HBS261 ⊕ [22]
M12x1.50x126.00mm (x10)

JD5881 ■

HM5289 ■

HR5046 ■

■ **NA5035** [2]
27.00x47.00x7.00mm, FPM
■ **NA5191** ■ [2]
42.00x62.00x7.00mm, PTFE
■ **NA5192** ■ [1]
90.00x110.00x7.00mm, PTFE



BK640



JA5040



JB917



JB926



JD5288

HBS261 ⊕ [22]
M12x1.50x126.00mm (x10)

JD5881 ■

HM5289 ■

HR5046 ■

■ **NA5035** [2]
27.00x47.00x7.00mm, FPM
■ **NA5191** ■ [2]
42.00x62.00x7.00mm, PTFE
■ **NA5192** ■ [1]
90.00x110.00x7.00mm, PTFE



JE248



JN279



JJ065

HR822 ■

■ **NA5018** ■ [2]
35.00x47.00x5.60mm, FPM

HR822 ■

■ **NA5018** ■ [2]
35.00x47.00x5.60mm, FPM

HR822 ■

■ **NA5018** ■ [2]
35.00x47.00x5.60mm, FPM

HR822 ■

■ **NA5317** [2]
55.5x70.0x6.0mm, FPM

HBS174 [19]
M12x1.75x133.00mm (x10)
→12/84

JB926 ■
→12/84
JB917 ■ (x4)
→12/84
⊕ **JE248**
→12/84

JN279 [4]
→12/84

JJ065
→12/84

HR641 ■
→12/84

■ **NA581** ■ [2]
52.00x68.00x10.00mm, MVQ
→12/84
■ **NA869** ■ [1]
92.00x110.00x10.00mm, MVQ
→12/84



cc



kW/PS



2.3	B 23 E	72	BK640 (Fibre)	DK640	EH445				
240 2.3	08/84→12/89	2316	4	96.00	SOHC/OHC	91-103/ 124-140	→12/84	→12/84	→12/84
2.3	B 230 E	73	BK640 (Fibre)	DK643	EH445				
740 2.3	08/84→07/88	2316	4	96.00	SOHC/OHC	89-98/ 121-133			
940 (944) 2.3	08/90→12/94								
2.3	B 230 ET	74	BK640 (Fibre)	DK643	EH445				
740 2.3 Turbo	08/85→12/88	2316	4	96.00		130-134/ 177-182			
760 2.3 Turbo	08/84→08/90								
2.3	B 230 F	75	BK640 (Fibre)	DK643	EH445				
240 2.3 i	08/86→07/93	2316	4	96.00	SOHC/OHC	81-100/ 110-136	01/85→12/88	01/85→12/88	01/85→12/88
740 2.3	08/84→07/92								
740 Kombi 2.3	01/88→10/90								
2.3	B 230 FB	76	BK640 (Fibre)	DK643	EH445				
740 2.3	08/88→07/90	2316	4	96.00	SOHC/OHC	96/131			
940 2.3	08/90→12/94								
940 II 2.3	08/94→10/98								
2.3	B 230 FD	77	BK640 (Fibre)	DK643	EH445				
940 2.3	08/92→07/94	2316	4	96.00	SOHC/OHC	85-96/ 116-131			
940 II 2.3	08/94→07/95								
2.3	B 230 FK	78	BK640 (Fibre)	DK643	EH445				
940 II 2.3 ti	01/95→10/98	2316	4	96.00	SOHC/OHC	99/135			
2.3	B 230 FT	79	BK640 (Fibre)	DK643	EH445				
740 2.3 Turbo	08/86→08/91	2316	4	96.00	SOHC/OHC	115-151/ 156-205	01/87→	01/87→	01/87→
760 2.3	01/88→07/92								
760 2.3 Turbo	09/87→08/90								
940 2.3 Turbo	08/90→07/94								
940 (944) 2.3	09/90→09/93								
940 II 2.3 T	08/94→12/98								
960 2.3 Turbo	09/90→08/93								
2.3	B 230 FT+	80	BK640 (Fibre)	DK643	EH445				
940 2.3 Turbo	08/91→07/93	2316	4	96.00	SOHC/OHC	140/190			
2.3	B 230 G	81	BK640 (Fibre)	DK643	EH445				
940 2.3	08/90→12/94	2316	4	96.00	SOHC/OHC	90-96/ 122-131			
940 (944) 2.3	08/90→12/94								

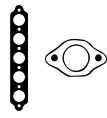

BK640

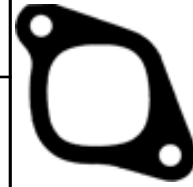

JB917



JB926



JC440



JE248



JN279



JN635

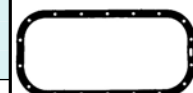

JJ065

HBS174 [19] M12x1.75x133.00mm (x10) →12/84	JB926 ■ →12/84 JB917 ■ (x4) →12/84 ☉ JE248 →12/84	JN279 [4] →12/84	JJ065 →12/84	HR641 ■ →12/84	NA581 ■ [2] 52.00x68.00x10.00mm, MVQ →12/84 NA869 ■ [1] 92.00x110.00x10.00mm, MVQ →12/84	
HBS174 [19] M12x1.75x133.00mm (x10)	JB926 ■ JC440 ■ JB917 ■ (x4) ☉ JE248	JN635 [4]	JJ065	HR641 ■	NA581 ■ [2] 52.00x68.00x10.00mm, MVQ NA869 ■ [1] 92.00x110.00x10.00mm, MVQ	
HBS174 [19] M12x1.75x133.00mm (x10)	JC440 ■ JB917 ■ (x4) ☉ JE248	JN635 [4]	JJ065	HR641 ■	NF846 [2] 25.00x42.00x7.00mm, FPM/ACM NA581 ■ [2] 52.00x68.00x10.00mm, MVQ NA869 ■ [1] 92.00x110.00x10.00mm, MVQ	
HBS174 [19] M12x1.75x133.00mm (x10) 01/85→12/88	JB926 ■ 01/85→12/88 JC440 ■ 01/85→12/88 JB917 ■ (x4) 01/85→12/88 ☉ JE248 01/85→12/88	JN635 [4] 01/85→12/88	JJ065 01/85→12/88	HR641 ■ 01/85→12/88	NA581 ■ [2] 52.00x68.00x10.00mm, MVQ 01/85→12/88 NA869 ■ [1] 92.00x110.00x10.00mm, MVQ 01/85→12/88	
HBS174 [19] M12x1.75x133.00mm (x10)	JC440 ■ JB917 ■ (x4) ☉ JE248	JN635 [4]	JJ065	HR641 ■	NA581 ■ [2] 52.00x68.00x10.00mm, MVQ NA869 ■ [1] 92.00x110.00x10.00mm, MVQ	
HBS174 [19] M12x1.75x133.00mm (x10)	JC440 ■ JB917 ■ (x4) ☉ JE248	JN635 [4]	JJ065	HR641 ■	NA581 ■ [2] 52.00x68.00x10.00mm, MVQ NA869 ■ [1] 92.00x110.00x10.00mm, MVQ	
HBS174 [19] M12x1.75x133.00mm (x10)	JB926 ■ JC440 ■ JB917 ■ (x4) ☉ JE248	JN635 [4]	JJ065	HR641 ■	NF846 ■ [2] 25.00x42.00x7.00mm, FPM/ACM NA581 ■ [2] 52.00x68.00x10.00mm, MVQ NA869 ■ [1] 92.00x110.00x10.00mm, MVQ	
HBS174 [19] M12x1.75x133.00mm (x10) 01/87→	JB926 ■ 01/87→ JC440 ■ 01/87→ JB917 ■ (x4) 01/87→ ☉ JE248 01/87→	JN635 [4] 01/87→	JJ065 01/87→	HR641 ■ 01/87→	NF846 ■ [2] 25.00x42.00x7.00mm, FPM/ACM 01/87→ NA581 ■ [2] 52.00x68.00x10.00mm, MVQ 01/87→ NA869 ■ [1] 92.00x110.00x10.00mm, MVQ 01/87→	
HBS174 [19] M12x1.75x133.00mm (x10)	JC440 ■ JB917 ■ (x4) ☉ JE248	JN635 [4]	JJ065	HR641 ■	NA581 ■ [2] 52.00x68.00x10.00mm, MVQ NA869 ■ [1] 92.00x110.00x10.00mm, MVQ	
HBS174 [19] M12x1.75x133.00mm (x10)	JC440 ■ JB917 ■ (x4) ☉ JE248	JN635 [4]	JJ065	HR641 ■	NA581 ■ [2] 52.00x68.00x10.00mm, MVQ NA869 ■ [1] 92.00x110.00x10.00mm, MVQ	



cc



kW/PS



2.3		B 230 GT					82	BK640 (Fibre)	DK643	EH445
740 2.3 Turbo	08/89→07/90	2316	4	96.00		121/165				
2.3		B 230 K					83	BK640 (Fibre)	DK643	EH445
240 2.3	08/86→12/88	2316	4	96.00	SOHC/OHC	80-86/ 109-117				
740 2.3	09/85→07/90									
2.3		B 234 F					84	BK640 (Fibre)	DK644 [3]	
740 2.3	08/87→08/92	2316	4	96.00	SOHC/OHC	111-117/ 151-159	01/88→	01/88→		
940 2.3	08/90→07/91									
2.3		B 234 G					85	BK640 (Fibre)	DK644 [3]	
940 2.3	08/90→07/91	2316	4	96.00	DOHC	114/155				
2.3		B 5234 FS					86	BY371 (Fibre)		
850 (LS) 2.3	01/96→10/96	2319	5	81.00	DOHC	106/144				
850 Estate 2.3	01/96→10/96									
2.3		B 5234 FT					87	BY371 (Fibre)	DY370 [3]	
850 2.3 T5	02/93→12/96	2319	5	81.00	DOHC	166/225	01/94→	01/94→		
2.3		B 5234 FT+					88	BY371 (Fibre)		
S70 2.3 Turbo	01/97→11/00	2319	5	81.00	DOHC	184/250				
V70 I 2.3 T AWD	04/97→03/00									
V70 I 2.3 Turbo	01/97→03/00									
2.3		B 5234 T2					89	BY371 (Fibre)		
850 2.3 T5 R	04/96→10/96	2319	5	81.00	DOHC	176/239				
850 Es 2.3 T5 R	04/96→10/96									
2.3		B 5234 T3					90	BY371 (Fibre)		EE5250
C70I Conv 2.3T5	03/98→10/05	2319	5	81.00	DOHC	176-184/ 239-250			01/00→ Eng.1817653→	
C70I Cpe 2.3T5	03/97→09/02									
S60 2.3 T5	11/00→04/10									
S70 2.3 T5	01/97→11/00									
S70 2.3 T5 AWD	11/96→09/98									
V70 I 2.3 AWD	04/97→09/98									
V70 I 2.3 T5	01/97→03/00									
V70 I 2.3 T5AWD	01/97→03/00									
V70 II 2.3 T5	03/00→08/07									

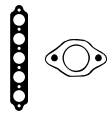

BK640



JA5038



JA5040



JA5043

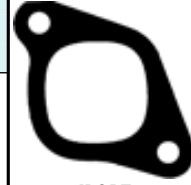

JB917



JC440



JD345



JD346



JD5288



JE248



JN635



JJ065

HBS174 [19]
M12x1.75x133.00mm (x10)

JC440 ■
JB917 ■ (x4)
JE248

JN635 [4]

JJ065

HR641 ■

NA581 ■ [2]
52.00x68.00x10.00mm, MVQ
NA869 ■ [1]
92.00x110.00x10.00mm, MVQ

HBS174 [19]
M12x1.75x133.00mm (x10)

JC440 ■
JB917 ■ (x4)
JE248

JN635 [4]

JJ065

HR641 ■

NA581 ■ [2]
52.00x68.00x10.00mm, MVQ
NA869 ■ [1]
92.00x110.00x10.00mm, MVQ

HBS175 [19]
M12x1.75x115.00mm (x7)
01/88→

JD345 ■
01/88→
JD346 ■
01/88→
JE248
01/88→

HM5293 ■
01/88→

JJ065
01/88→

HR599 ■
01/88→

NA5016 ■ (x2)
35.00x47.00x7.00mm, FPM/ACM
01/88→
NA581 ■ [2]
52.00x68.00x10.00mm, MVQ
01/88→
NA869 ■ [1]
92.00x110.00x10.00mm, MVQ
01/88→

HBS175 [19]
M12x1.75x115.00mm (x7)

JD345 ■
JD346 ■
JE248

HM5293 ■

JJ065

HR599 ■

NA5016 ■ [2]
35.00x47.00x7.00mm, FPM/ACM
NA581 ■ [2]
52.00x68.00x10.00mm, MVQ
NA869 ■ [1]
92.00x110.00x10.00mm, MVQ

HBS185 [19]
M12x1.75x157.00mm (x12)

JA5043 ■

HR599 ■

NA5136 [1][2]
30.00x47.00x7.00mm, FPM
NA5018 ■ [2]
35.00x47.00x5.60mm, FPM

HBS303 [19]
M12x1.75x162.00mm (x12)
01/94→
→Eng.131034

JA5043 ■
01/94→12/95
JA5038 ■
01/96→

HR5030 ■
01/94→

NA5136 [1][2]
30.00x47.00x7.00mm, FPM
01/94→
NA5017 ■ [1]
98.00x110.00x8.50mm, FPM
01/94→

HBS185 [19]
M12x1.75x157.00mm (x12)
01/94→
Eng.131035→

JA5040 ■ (x5)
01/94→
HA5041 ■ ■
01/94→

HBS185 [19]
M12x1.75x157.00mm (x12)

JA5038 ■
JA5040 ■ (x5)
HA5041 ■ ■

HR599 ■

NA5136 [1][2]
30.00x47.00x7.00mm, FPM
NA5017 ■ [1]
98.00x110.00x8.50mm, FPM

HBS185 [19]
M12x1.75x157.00mm (x12)

JA5038 ■
JA5043 ■
JA5040 ■ (x5)

HR599 ■

NA5136 [1][2]
30.00x47.00x7.00mm, FPM
NA5018 ■ [2]
35.00x47.00x5.60mm, FPM

HBS303 [19]
M12x1.75x162.00mm (x12)
→Eng.131034
HBS185 [19]
M12x1.75x157.00mm (x12)
Eng.131035→

JA5038 ■
JD5288 ■
HA5041 ■ ■

HR599 ■

NA5136 [1][2]
30.00x47.00x7.00mm, FPM
NA5017 ■ [1]
98.00x110.00x8.50mm, FPM



cc



kW/PS

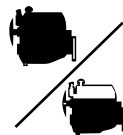

2.3	B 5234 T4	91	BY371 (Fibre)	DY370 [3]					
850 2.3	08/95→12/96	2319	5	81.00	DOHC	176-184/ 239-250			
850 Es 2.3 T5-R	08/95→12/96								
S70 2.3 T5 AWD	07/97→09/00								
V70 II 2.3 T5	03/00→08/07								
2.3	B 5234 T5	92	BY371 (Fibre)	CB5440 [3]					
850 2.3 Turbo R	06/95→10/96	2319	5	81.00	DOHC	177/241			
850 Es 2.3 T R	06/95→10/97								
2.3	B 5234 T7	93	AB5440 (Fibre)		EE5250				
S60 2.3 T5	07/00→09/02	2319	5	81.00	DOHC	195/265			01/00→ Eng.1817653→
S70 (LS) 2.3	04/99→09/00								
V70 I 2.3 AWD	12/98→02/00								
V70 II 2.3 AWD	10/00→09/04								
V70 II 2.3 Mk2	10/00→09/04								
2.3	B 5234 T8	94	AB5440 (Fibre)		EE5250				
V70 I 2.3 AWD	12/98→02/00	2319	5	81.00	DOHC	195/265			01/00→ Eng.1817653→
V70 II 2.3 AWD	10/00→09/04								
2.3	B 5234 T9	95	AB5440 (Fibre)		EE5250				
C70I Conv 2.3T5	07/02→10/05	2319	5	81.00	DOHC	180/245			Eng.1817653→
2.4	B 5244 S	96	AB5450 (Fibre)	CB5452	EE5250				
C70 I Cpe 2.5	05/99→09/02	2435	5	83.00	DOHC	125/170			01/00→ Eng.1817653→
S40 II 2.4	01/04→								
S60 2.4	11/00→04/10								
S70 2.4	01/97→11/00								
S70 2.4 AWD	04/99→09/00								
S80 2.4	01/99→07/06								
V50 2.4	04/04→								
V70 I 2.4	01/97→05/00								
V70 II 2.4	03/00→08/07								
2.4	B 5244 S2	97	AB5450 (Fibre)	CB5452	EE5250				
S60 2.4	11/00→04/10	2435	5	83.00	DOHC	103/140	Eng.1817653→		→Eng.1817652
S70 2.4	08/99→11/00								
S70 2.4 AWD	04/99→09/00								
S70 2.4 Blu-Fl	07/97→09/00								
S80 2.4	01/99→07/06								
V70 I 2.4	08/99→05/00								
V70 II 2.4	03/00→08/07								
2.4	B 5244 S4	98	AG8340 (Fibre)						
C30 2.4 i	10/06→12/12	2435	5	83.00	DOHC	125/170			
C70II Conv 2.4i	03/06→								
S40 II 2.4 AWD	08/06→								
V50 2.4 AWD	08/06→								
2.4	B 5244 S5	99	AG8340 (Fibre)						
C70 II Conv 2.4	03/06→	2435	5	83.00	DOHC	103/140			
S40 II 2.4	01/04→								
V50 2.4	04/04→								

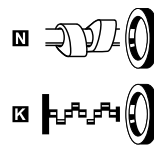
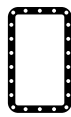
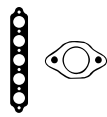

AB5440



AB5450



JA5038



JA5040



JA5043



JD5288



cc



kW/PS



2.4	B 5244 SG	100					AB5450 (Fibre)	CB5452	
S70 2.4	08/99→11/00	2435	5	83.00	DOHC	103/140	Eng.1817653→	→Eng.1817652	
S70 2.4 Blu-Fl	07/97→09/00								
S70 2.5 Bifuel	07/99→11/00								
V70 I 2.4 Bi fl	08/99→03/00								
V70 II 2.4Bi fl	09/01→08/07								
2.4	B 5244 SG2	101					AB5450 (Fibre)	CB5452	
S60 2.4 Bifuel	06/02→04/10	2435	5	83.00	DOHC	103/140	Eng.1817653→		
S80 I 2.4 Bi fl	09/01→07/06								
V70 I 2.4	08/99→05/00								
V70 II 2.4Bi fl	09/01→08/07								
2.4	B 5244 T	102					AB5450 (Fibre)	CB5452	EE5250
C70 I Cpe 2.5T	03/97→09/02	2435	5	83.00	DOHC	142/193		01/00→ Eng.1817653→	
C70I Conv 2.5 T	03/98→10/05								
S70 2.4 Turbo	01/97→11/00								
V70 I 2.4 Turbo	01/97→03/00								
V70 I 2.5 T AWD	01/97→05/00								
2.4	B 5244 T3	103					AB5450 (Fibre)	CB5452	EE5250
S60 2.4 T	11/00→04/10	2435	5	83.00		147/200		Eng.1817653→	
S60 2.4 T AWD	11/01→04/10								
S80 2.4 T	06/00→07/06								
S80 2.4 T5 AWD	04/00→09/03								
V70 II 2.4 T	03/00→08/07								
V70 II 2.4T AWD	09/01→08/07								
XC70 2.4 T AWD	03/00→09/02								
2.4	B 5244 T4	104					AB5440 (Fibre)		EE5250
S80 I 2.4 LTP	06/04→07/06	2435	5	83.00	DOHC	132/180			
2.4	B 5244 T5	105					AB5440 (Fibre)		EE5250
S60 2.4 AWD	02/04→04/10	2401	5	81.00	DOHC	191/260		Eng.1817653→	
S60 2.4 T5	04/04→04/10								
V70 II 2.4 T5	04/04→08/07								
2.4	B 5244 T7	106					AB5440 (Fibre)		EE5250
C70 I Conv 2.4T	07/02→10/05	2435	5	83.00	DOHC	147/200		Eng.1817653→	



AB5440



AB5450

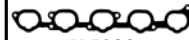

JA5038



JA5040



JD5288



cc



kW/PS

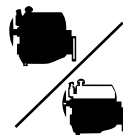

2.4		B 5252				107		BY361 (Fibre)		DY360 [3]		EY370 [3]	
850 2.5	06/91→07/94	2435	5	83.00	SOHC/OHC	103/140		01/92→		01/93→		01/93→	
2.4		B 5252 FS				108		BY361 (Fibre)					
850 2.5	08/94→12/96	2435	5	83.00	SOHC/OHC	106/144							
S70 2.4 AWD	11/96→05/99												
S70 2.5	01/97→11/00												
V70 I 2.5	01/97→03/00												
2.4		B 5254 S				109		BY361 (Fibre)		DY362 [3]		EE5250	
850 2.5	08/91→12/96	2435	5	83.00		121-125/ 165-170		01/92→		01/92→		01/92→	
C70 I Cpe 2.5	05/99→09/02												
C70 I Coupe 2.5	03/99→09/02												
C70I Conv 2.5	06/98→10/05												
S70 2.4	01/97→11/00												
S70 2.4 AWD	10/98→05/99												
S70 2.5	06/98→11/00												
V70 I 2.4	01/97→05/00												
V70 I 2.4 AWD	10/98→05/99												
V70 I 2.5	06/98→03/00												
2.4		B 5254 T				110		BY361 (Fibre)		DY362 [3]		EE5250	
850 2.4 GLE	09/93→10/97	2435	5	83.00	DOHC	142/193		05/96→		05/96→		05/96→	
850 2.5 AWD	04/96→12/96												
850 Es 2.4 GLE	09/93→10/97												
C70 I Cpe 2.5T	03/97→09/02												
C70I Conv 2.5 T	03/98→10/05												
S70 2.4 T5 AWD	11/96→04/99												
S70 2.4 Turbo	01/97→11/00												
V70 I 2.4 Turbo	01/97→03/00												
V70 I 2.5 T AWD	01/97→05/00												
XC70 2.4 T AWD	11/97→09/02												
2.4		D 24 T Diesel				111		BW680 (Fibre), 1.530mm, 1 Notch BZ930 (MLS), 1.570mm, 2 Holes BW690 (Fibre), 1.570mm, 2 Notches BW700 (Fibre), 1.610mm, 3 Notches		DM660 ▲ [3]		EG920	
740 2.4 TD	08/84→07/90	2383	6	76.50	SOHC/OHC	79-83/ 107-113							
740 2.4 Turbo-D	09/85→07/92												
760 2.4 Turbo-D	04/87→07/92												
940 2.4 Turbo-D	08/90→12/94												
2.4		D 24 TIC Diesel				112		BW680 (Fibre), 1.530mm, 1 Notch BZ930 (MLS), 1.570mm, 2 Holes BW690 (Fibre), 1.570mm, 2 Notches BW700 (Fibre), 1.610mm, 3 Notches		DM660 ▲ [3]		EG920	
740 2.4 TD	08/86→10/88	2383	6	76.50	SOHC/OHC	85-95/ 115-129							
740 2.4 TD Ic	08/86→07/88												
760 2.4 TD Ic	08/87→07/92												
780 2.4 D	04/86→07/90												
940 2.4 TD Ic	08/90→10/98												
960 2.4 TD Ic	09/91→07/94												
960 2.4 Tdi	09/90→08/93												

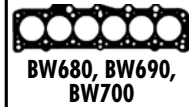
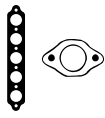

BY361



BZ930



JA5037

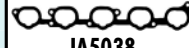

JA5038



JA5040



JA5042



JA5043



JC146



JC152

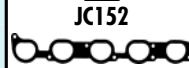

JD5288

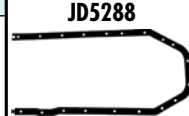

JJ551

HBS303 [19]
M12x1.75x162.00mm (x12)
01/93→
→Eng.131034
HBS185 [19]
M12x1.75x157.00mm (x12)
01/93→
Eng.131035→

JA5037 ■
01/93→
JA5040 ■ (x5)
01/93→
JA5042 ■ (x5)
01/93→

HR5030 ■
01/93→

■ **NA5138** ■ (x2) [2]
44.50x57.20x6.75mm, ACM
01/93→
■ **NA5149** ■ (x2) [1] [145]
30.00x54.00x15.00mm, FPM
01/93→
■ **NA5018** ■ [2]
35.00x47.00x5.60mm, FPM
01/93→
■ **NA5017** ■ [1]
98.00x110.00x8.50mm, FPM
01/93→

HBS185 [19]
M12x1.75x157.00mm (x12)

JA5037 ■
JA5042 ■ (x5)

HR5030 ■

■ **NA5018** ■ [2]
35.00x47.00x5.60mm, FPM

HBS303 [19]
M12x1.75x162.00mm (x12)
01/92→
→Eng.131034
HBS185 [19]
M12x1.75x157.00mm (x12)
01/92→
Eng.131035→

JA5038 ■
JA5043 ■
01/92→
JD5288 ■
01/92→
JA5040 ■ (x5)
01/92→

HR397 ■
01/92→

HR5030 ■ (x2)
01/92→
→Eng.1817652
HR5076 ■ (x2)
01/92→
Eng.1817653→

■ **NA5136** [1] [2]
30.00x47.00x7.00mm, FPM
01/92→
■ **NA5017** ■ [1]
98.00x110.00x8.50mm, FPM
01/92→

HBS303 [19]
M12x1.75x162.00mm (x12)
05/96→
→Eng.131034
HBS185 [19]
M12x1.75x157.00mm (x12)
05/96→
Eng.131035→

JA5038 ■
05/96→
JA5043 ■
05/96→
JD5288 ■
05/96→
JA5040 ■ (x5)
05/96→

HR397 ■
05/96→

HR5030 ■ (x2)
05/96→
→Eng.1817652
HR5076 ■ (x2)
05/96→
Eng.1817653→

■ **NA5136** [1] [2]
30.00x47.00x7.00mm, FPM
05/96→
■ **NA5017** ■ [1]
98.00x110.00x8.50mm, FPM
05/96→

HBS022 ⊕ [19]
M12x1.75x115.00mm (x14)

JC146 ■
JC152 ■ (x6)

JJ551

HR805 ■

■ **NB716** ■ [2]
35.00x48.00x10.00mm, FPM
■ **NA5133** ■ [1]
85.00x105.00x11.00mm, FPM

HBS022 ⊕ [19]
M12x1.75x115.00mm (x14)

JC146 ■
JC152 ■ (x6)

JJ551

HR805 ■

■ **NB716** ■ [2]
35.00x48.00x10.00mm, FPM
■ **NA5133** ■ [1]
85.00x105.00x11.00mm, FPM



cc



kW/PS



2.4		D 5244 T Diesel			113		AE5260 (MLS), 1.020mm, 1 Hole AE5270 (MLS), 1.070mm, 2 Holes AE5280 (MLS), 1.120mm, 3 Holes AE5290 (MLS), 1.170mm, 4 Holes AE5300 (MLS), 1.270mm, 5 Holes	
S60 2.4 D5	07/01→04/10	2401	5	81.00	DOHC	120/163		
S80 2.4 D5	08/01→07/06							
S80 II 2.4 D	03/06→							
V70 II 2.4 D5	08/01→08/07							
XC 90 2.4 D5	10/02→							
XC70 2.4D5 AWD	09/02→08/07							
2.4		D 5244 T10 Diesel			114			
S60 II D5	04/10→	2400	5	81.00	DOHC	151/205		
S60 II D5 AWD	04/10→							
S80 II D5 AWD	01/10→							
S80 II (AS) D5	01/10→							
V60 D5	09/10→							
V60 D5 AWD	09/10→							
V70 III D5 AWD	12/09→							
V70 III (BW) D5	12/09→							
XC60 D5 AWD	07/09→							
XC70 II D5 AWD	12/09→							
2.4		D 5244 T11 Diesel			115			
S60 II D5	06/11→	2400	5	81.00	DOHC	158/215		
S60 II D5 AWD	06/11→							
S80 II D5 AWD	06/11→							
S80 II (AS) D5	06/11→							
V60 2.4 D5	06/11→							
V60 2.4 D5 AWD	06/11→							
V70 III D5 AWD	06/11→							
V70 III (BW) D5	06/11→							
XC60 D5	06/11→							
XC60 D5 AWD	06/11→							
XC70 II D5 AWD	06/11→							
2.4		D 5244 T13 Diesel			116		AE5260 (MLS), 1.020mm, 1 Hole AE5270 (MLS), 1.070mm, 2 Holes AE5280 (MLS), 1.120mm, 3 Holes AE5290 (MLS), 1.170mm, 4 Holes AE5300 (MLS), 1.270mm, 5 Holes	
C30 D5	10/06→12/12	2400	5	81.00	DOHC	132/180		
C70 II Conv D5	03/06→							
V50 (MW) 2.4 D5	03/06→							
2.4		D 5244 T14 Diesel			117			
S80 II 2.4 D	01/10→	2400	5	81.00	DOHC	129/175		
V70 III 2.4 D	10/09→							
XC60 2.4 D	07/09→							
XC70 II 2.4 D	01/10→							
2.4		D 5244 T15			118			
S60 II D5	06/11→	2400	5	81.00	DOHC	158/215		
S60 II D5 AWD	06/11→							
S80 II D5 AWD	06/11→							
S80 II (AS) D5	06/11→							
V60 2.4 D5	06/11→							
V60 2.4 D5 AWD	06/11→							
V60 2.4 Hyb AWD	06/12→							
V70 III D5 AWD	06/11→							
V70 III (BW) D5	06/11→							
XC60 D5 AWD	06/11→							
XC70 II D5 AWD	06/11→							

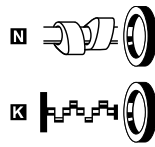
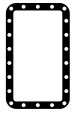
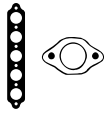

AE5270



AE5300

HBS533 [19][21]

HR822

NA5317 [2]
55.5x70.0x6.0mm, FPM
NA5018 [2]
35.00x47.00x5.60mm, FPM
NA5017 [1]
98.00x110.00x8.50mm, FPM

HR822

NA5317 [2]
55.5x70.0x6.0mm, FPM
NA5018 [2]
35.00x47.00x5.60mm, FPM

HR822

NA5317 [2]
55.5x70.0x6.0mm, FPM

HBS533 [19][21]

HR822

NA5317 [2]
55.5x70.0x6.0mm, FPM
NA5018 [2]
35.00x47.00x5.60mm, FPM

HR822

NA5317 [2]
55.5x70.0x6.0mm, FPM
NA5018 [2]
35.00x47.00x5.60mm, FPM

HR822

NA5317 [2]
55.5x70.0x6.0mm, FPM



cc



kW/PS

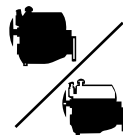

2.4	D 5244 T16	Diesel					119			
XC60 2.4D AWD	05/08→	2400	5	81.00	DOHC	120/163				
XC70II 2.4 DAWD	08/07→									
2.4	D 5244 T17	Diesel					120			
V60 D4 AWD	12/12→	2400	5	81.00	DOHC	120/163				
V70 III D4 AWD	01/13→									
XC60 2.4D AWD	05/08→									
2.4	D 5244 T18	Diesel					121	AE5260 (MLS), 1.020mm, 1 Hole		
XC90 D5	01/11→	2400	5	81.00	DOHC	147/200	AE5270 (MLS), 1.070mm, 2 Holes			
							AE5280 (MLS), 1.120mm, 3 Holes			
							AE5290 (MLS), 1.170mm, 4 Holes			
							AE5300 (MLS), 1.270mm, 5 Holes			
2.4	D 5244 T2	Diesel					122	AE5260 (MLS), 1.020mm, 1 Hole		
S60 2.4 D	12/01→04/10	2401	5	81.00	DOHC	96-120/131-163	AE5270 (MLS), 1.070mm, 2 Holes			
S80 2.4 D	10/01→07/06						AE5280 (MLS), 1.120mm, 3 Holes			
V70 II 2.4 D	12/01→08/07						AE5290 (MLS), 1.170mm, 4 Holes			
V70II 2.4D5 AWD	03/03→08/07						AE5300 (MLS), 1.270mm, 5 Holes			
2.4	D 5244 T4	Diesel					123	AE5260 (MLS), 1.020mm, 1 Hole		
S60 2.4 D5	09/05→04/10	2400	5	81.00	DOHC	136/185	AE5270 (MLS), 1.070mm, 2 Holes			
S80 II D5 AWD	01/07→						AE5280 (MLS), 1.120mm, 3 Holes			
S80 II (AS) D5	03/06→						AE5290 (MLS), 1.170mm, 4 Holes			
V70 II 2.4 D5	12/05→08/07						AE5300 (MLS), 1.270mm, 5 Holes			
V70 III D5 AWD	10/07→									
V70 III (BW) D5	08/07→									
V70II 2.4 D5AWD	12/05→08/07									
XC60 D5 AWD	05/08→									
XC70 2.4D5 AWD	12/05→08/07									
XC70 II D5 AWD	08/07→									
XC90 D5	05/06→									
2.4	D 5244 T5	Diesel					124	AE5260 (MLS), 1.020mm, 1 Hole		
S60 2.4 D	09/05→01/09	2400	5	81.00	DOHC	120/163	AE5270 (MLS), 1.070mm, 2 Holes			
S80 II 2.4 D	03/06→						AE5280 (MLS), 1.120mm, 3 Holes			
V70 II 2.4 D5	08/01→08/07						AE5290 (MLS), 1.170mm, 4 Holes			
V70 III 2.4 D	08/07→						AE5300 (MLS), 1.270mm, 5 Holes			
V70II 2.4D5 AWD	03/03→08/07									
XC 90 2.4 D5	10/02→									
XC60 2.4D AWD	05/08→									
XC70II 2.4 DAWD	08/07→									
XC90 D3 / D5	04/09→									
2.4	D 5244 T7	Diesel					125	AE5260 (MLS), 1.020mm, 1 Hole		
S60 2.4 D	09/05→04/10	2400	5	81.00	DOHC	92/125	AE5270 (MLS), 1.070mm, 2 Holes			
V70 II 2.4 D	05/05→08/07						AE5280 (MLS), 1.120mm, 3 Holes			
							AE5290 (MLS), 1.170mm, 4 Holes			
							AE5300 (MLS), 1.270mm, 5 Holes			
2.4	D 5244 T8	Diesel					126	AE5260 (MLS), 1.020mm, 1 Hole		
C30 D5	10/06→12/12	2400	5	81.00	DOHC	132/180	AE5270 (MLS), 1.070mm, 2 Holes			
C70 II Conv D5	03/06→						AE5280 (MLS), 1.120mm, 3 Holes			
S40 II 2.4 D5	03/06→						AE5290 (MLS), 1.170mm, 4 Holes			
V50 (MW) 2.4 D5	03/06→						AE5300 (MLS), 1.270mm, 5 Holes			

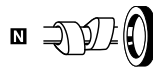
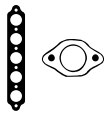

AE5270



AE5300

HR822

NA5317 [2]
55.5x70.0x6.0mm, FPM
 NA5018 [2]
35.00x47.00x5.60mm, FPM

HR822

NA5317 [2]
55.5x70.0x6.0mm, FPM

HBS533 [19][21]

HR822

NA5317 [2]
55.5x70.0x6.0mm, FPM
 NA5018 [2]
35.00x47.00x5.60mm, FPM

HBS533 [19][21]

PA5041 (x16)
6.00/12.20x10.00
(FPM)

NA5018 [2]
35.00x47.00x5.60mm, FPM
 NA5017 [1]
98.00x110.00x8.50mm, FPM

HBS533 [19][21]

HR822

NA5317 [2]
55.5x70.0x6.0mm, FPM
 NA5018 [2]
35.00x47.00x5.60mm, FPM

HBS533 [19][21]

HR822

NA5317 [2]
55.5x70.0x6.0mm, FPM
 NA5018 [2]
35.00x47.00x5.60mm, FPM

HBS533 [19][21]

HR822

NA5317 [2]
55.5x70.0x6.0mm, FPM
 NA5018 [2]
35.00x47.00x5.60mm, FPM

HBS533 [19][21]

HR822

NA5317 [2]
55.5x70.0x6.0mm, FPM
 NA5018 [2]
35.00x47.00x5.60mm, FPM



cc



kW/PS



2.4	D 5244 T9 Diesel	127					AE5260 (MLS), 1.020mm, 1 Hole		
C30 D5	10/06→12/12	2400	5	81.00	DOHC	120/163	AE5270 (MLS), 1.070mm, 2 Holes		
C70II Conv 2.4D	03/07→						AE5280 (MLS), 1.120mm, 3 Holes		
V50 2.4 Tdi	05/07→						AE5290 (MLS), 1.170mm, 4 Holes		
							AE5300 (MLS), 1.270mm, 5 Holes		
2.4	GB 5252 S	128					BY361 (Fibre)		
S70 2.5 Bifuel	10/98→11/00	2435	5	83.00		106/144			
V70 I 2.5 Bi fl	10/98→08/99								
2.5	B 5254 T10	129					AG8320 (MLS)		
S80 II 2.5 T	01/10→	2521	5	83.00	DOHC	170/231			
V70 III 2.5 T	01/10→								
2.5	B 5254 T11	130					AG8320 (MLS)		
S80II 2.5 T Flx	01/10→	2521	5	83.00	DOHC	170/231			
V70III 2.5T Flx	10/09→								
2.5	B 5254 T12	131					AG8320 (MLS)		
V40 Hatchb T5	12/12→	2497	5	83.00	DOHC	187/254			
V40Hatch T5 AWD	01/13→								
2.5	B 5254 T2	132					AE5140 (Fibre)		EE5250
S60 2.5 T	02/04→04/10	2521	5	83.00	DOHC	154/209	AE5560 (MLS)		Eng.1817653→
S60 2.5 T AWD	04/04→04/10								
S80 2.5 T	03/03→07/06								
S80 2.5 T AWD	07/03→07/06								
V70 II 2.5 T	04/04→08/07								
V70 II 2.5T AWD	09/02→08/07								
XC 90 2.5 T	10/02→								
XC70 2.5 T AWD	09/02→08/07								
2.5	B 5254 T3	133					AG8320 (MLS)		
C30 T5	10/06→12/12	2521	5	83.00	DOHC	162/220			
C70 II Conv T5	03/06→								
S40 II T5	01/04→								
S40 II T5 AWD	04/04→								
V50 T5	04/04→								
V50 T5 AWD	04/04→								
2.5	B 5254 T4	134					AE5560 (MLS)		EE5250
S60 R 2.5 T AWD	03/03→04/10	2521	5	83.00	DOHC	220-224/ 299-305			Eng.1817653→
V70 II 2.5 R Sp	12/02→08/07								
V70III R2.5T AWD	03/03→08/07								
2.5	B 5254 T6	135					AG8320 (MLS)		
S80 II 2.5 T	03/06→	2521	5	83.00	DOHC	147/200			
S80 II 2.5T AWD	10/06→								
V70 III 2.5 T	08/07→								
2.5	B 5254 T7	136					AG8320 (MLS)		
C30 T5	03/07→12/12	2521	5	83.00	DOHC	169/230			
C70II Cabrio T5	03/07→								
S40 II T5	03/07→								
S40 II T5 AWD	03/07→								
V50 T5	03/07→								
V50 T5 AWD	03/07→								

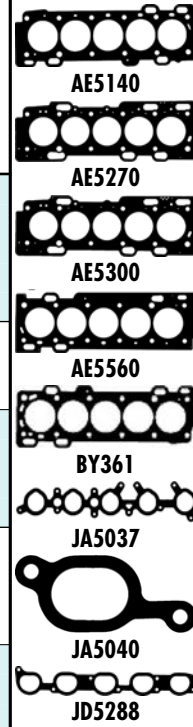
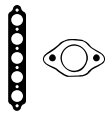

HBS533 [19][21]				HR822 [S]	NA5317 [2] 55.5x70.0x6.0mm, FPM NA5018 [2] 35.00x47.00x5.60mm, FPM	
HBS185 [19] M12x1.75x157.00mm (x12)	JA5037 [I] HA5040 [E][S]			HR599 [S]	NA5018 [E][2] 35.00x47.00x5.60mm, FPM	
HBS185 [19] M12x1.75x157.00mm (x12)				HR5076 [S]	NA5179 [2] 51.00x65.00x7.00mm, FPM NA5018 [E][2] 35.00x47.00x5.60mm, FPM	
HBS185 [19] M12x1.75x157.00mm (x12)				HR5076 [S]	NA5179 [2] 51.00x65.00x7.00mm, FPM NA5018 [E][2] 35.00x47.00x5.60mm, FPM	
HBS185 [19] M12x1.75x157.00mm (x12)				HR5076 [S]	NA5179 [2] 51.00x65.00x7.00mm, FPM	
HBS185 [19] M12x1.75x157.00mm (x12)	JD5288 [I] JA5040 [E] (x5) HA5041 [E][S]			HR5076 [S] (x2)	NA5138 [2] 44.50x57.20x6.75mm, ACM NA5136 [1][2] 30.00x47.00x7.00mm, FPM NA5178 [2] 45.00x65.00x7.00mm, FPM/ACM NA5179 [2] 51.00x65.00x7.00mm, FPM NA5018 [E][2] 35.00x47.00x5.60mm, FPM NA5017 [E][1] 98.00x110.00x8.50mm, FPM	
HBS303 [19] M12x1.75x162.00mm (x12) →Eng.131034 HBS185 [19] M12x1.75x157.00mm (x12) Eng.131035→				HR5113 [90][91][92] [S]	NA5179 [2] 51.00x65.00x7.00mm, FPM NA5018 [E][2] 35.00x47.00x5.60mm, FPM	
HBS185 [19] M12x1.75x157.00mm (x12)	JD5288 [I] JA5040 [E] (x5)			HR5076 [S]	NA5136 [1][2] 30.00x47.00x7.00mm, FPM NA5017 [E][1] 98.00x110.00x8.50mm, FPM	
HBS185 [19] M12x1.75x157.00mm (x12)				HR5076 [S]	NA5179 [2] 51.00x65.00x7.00mm, FPM NA5018 [E][2] 35.00x47.00x5.60mm, FPM	
HBS185 [19] M12x1.75x157.00mm (x12)				HR5076 [S]	NA5179 [2] 51.00x65.00x7.00mm, FPM NA5018 [E][2] 35.00x47.00x5.60mm, FPM	



cc



kW/PS

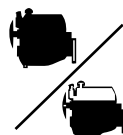

2.5	B 5254 T8	137	AG8320 (MLS)						
S80II 2.5T Flx V70III 2.5T Flx	05/08→ 05/08→	2521	5	83.00	DOHC	147/200			
2.5	B 6244 FS	138	AA5630 (Fibre)						
S90 2.5 V90 Estate 2.5	11/96→10/97 11/96→10/97	2473	6	81.00	DOHC	132/180			
2.5	B 6254 FS	139	AA5630 (Fibre)						
S90 2.5 V90 Estate 2.5	11/96→10/98 11/96→10/98	2473	6	81.00	DOHC	125/170			
2.5	D 5252 T Diesel	140	AF5310 (MLS), 1.510mm, 1 Hole AF5320 (MLS), 1.570mm, 2 Holes AF5330 (MLS), 1.610mm, 3 Holes	DW861 ▲	EW860				
850 2.5 TDI S70 2.5 TDI S70 2.5 TDi AWD S80 2.5 TDI V70 2.5 TDI	08/95→12/96 01/97→11/00 10/99→09/00 01/99→07/06 11/96→08/07	2461	5	81.00	SOHC/OHC	103/140	01/96→ 01/96→ 01/96→	01/96→	01/96→
2.8	B 28 E	141							
760 2.8	08/81→08/90	2849	6	91.00	OHV, V	114-125/ 155-170			
2.8	B 280 E	142							
760 2.8 760 Kombi 2.8 960 Kombi 2.8	08/81→08/90 08/84→08/90 09/90→05/92	2849	6	91.00	SOHC/OHC, V	108-125/ 147-170			
2.8	B 280 F	143							
760 2.8 760 2.8 (765) 780 2.9 960 2.8 GL 960 Kombi 2.8	05/86→08/91 05/86→08/91 08/87→07/90 09/90→05/92 09/90→05/92	2849	6	91.00	SOHC/OHC, V	105-108/ 143-147			
2.8	B 6284 T	144	AA5630 (Fibre) AE5170 (Fibre) AE5150 (Fibre), 1.460mm		EE5150				
S80 2.8 T6	05/98→07/06	2783	6	81.00	DOHC	200/272			
2.9	B 6294 S	145	AE5160 (Fibre)						
S80 I 2.9	03/99→07/06	2922	6	83.00		147/200			
2.9	B 6294 S2	146	AE5160 (Fibre)						
S80 I 3.0	06/01→07/06	2922	6	83.00	DOHC, V	144/196			
2.9	B 6294 T	147	AE5170 (Fibre) AE5150 (Fibre), 1.460mm		EE5150				
S80 3.0 T6 XC90 T6	06/01→07/06 10/02→	2922	6	83.00	DOHC, V	200/272	03/03→		
2.9	B 6304 F	148	AY260 (Fibre)	CY260 [13]	EY370 [3]				
960 2.9	08/90→07/94	2922	6	83.00	DOHC	150/204	01/91→	01/91→	01/91→

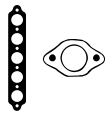

HBS185 [19] M12x1.75x157.00mm (x12)				HR5076	NA5179 [2] 51.00x65.00x7.00mm, FPM NA5018 [2] 35.00x47.00x5.60mm, FPM	
	JA5044 JA5040 (x6)			HR599	NA5136 [1][2] 30.00x47.00x7.00mm, FPM NA5018 [2] 35.00x47.00x5.60mm, FPM	
	JA5044 JA5040 (x6)			HR599	NA5136 [1][2] 30.00x47.00x7.00mm, FPM NA5018 [2] 35.00x47.00x5.60mm, FPM	
HBS021 [19] M12x1.75x115.00mm (x12) 01/96→	JD312 01/96→ JC152 (x5) 01/96→	JN967 [4] 01/96→	JJ184 01/96→	HR805 01/96→	NB716 [2] 35.00x48.00x10.00mm, FPM 01/96→ NA5133 [1] 85.00x105.00x11.00mm, FPM 01/96→	KK5470 [20]
HBS127 [22] M12x1.50x178.00mm (x16)					NA5272 [2] ACM NF634 [1] 80.00x100.00x13.00mm, MVQ	
HBS127 [22] M12x1.50x178.00mm (x16)	JC876	JN302 [4] JN303 [4]		HR300	NA5272 [2] ACM NF634 [1] 80.00x100.00x13.00mm, MVQ	
HBS127 [22] M12x1.50x178.00mm (x16)	JC876	JN302 [4] JN303 [4]		HR300	NA5272 [2] ACM NF634 [1] 80.00x100.00x13.00mm, MVQ	
	JD5297 JD5898 (MLS)			HR5076	NA5136 [1][2] 30.00x47.00x7.00mm, FPM NA5018 [2] 35.00x47.00x5.60mm, FPM	
	JD5297 JD5298			HR5076	NA5136 [1][2] 30.00x47.00x7.00mm, FPM NA5018 [2] 35.00x47.00x5.60mm, FPM	
	JD5297 JD5298			HR5076	NA5136 [1][2] 30.00x47.00x7.00mm, FPM NA5018 [2] 35.00x47.00x5.60mm, FPM	
	JD5297 HA5042			HR5076	NA5136 [1][2] 30.00x47.00x7.00mm, FPM NA5178 [2] 45.00x65.00x7.00mm, FPM/ACM NA5179 [2] 51.00x65.00x7.00mm, FPM NA5017 [1] 98.00x110.00x8.50mm, FPM	
HBS426 [19] M12x1.75x162.00mm (x14) 01/91→	JA5044 01/91→ JA5040 (x6) 01/91→ HA5042 01/91→			HR5076 01/91→	NA5136 [1][2] 30.00x47.00x7.00mm, FPM 01/91→ NA5017 [1] 98.00x110.00x8.50mm, FPM 01/91→	

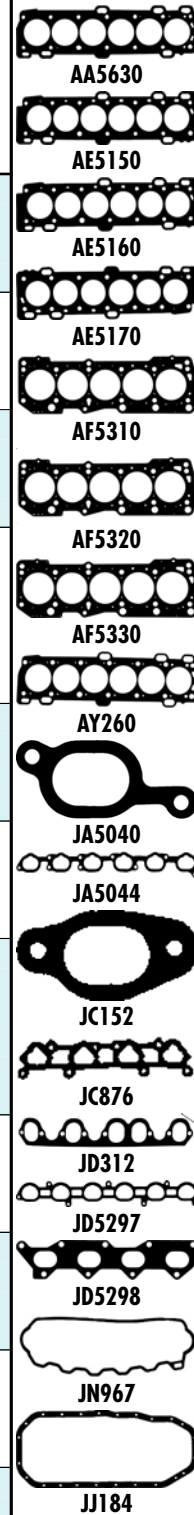



cc



kW/PS



2.9		B 6304 G					149	AY260 (Fibre)	CY260 [13]	EY370 [3]
S90 2.9	01/97→05/98	2922	6	83.00	DOHC	150/204				
V90 2.9	01/97→12/98									
2.9		B 6304 S					150	AY260 (Fibre)	CY260 [13]	EY370 [3]
960 2.9	08/90→12/96	2922	6	83.00	DOHC	150/204				
960 II Es 2.9	09/94→12/96									
2.9		B 6304 S2					151	AY260 (Fibre)	CY260 [13]	EY370 [3]
S90 2.9	01/97→05/98	2922	6	83.00	DOHC	132/180				
V90 Estate 2.9	01/97→12/98									
2.9		B 6304 S3					152	AY260 (Fibre)	CY260 [13]	EY370 [3]
S80 2.9	05/98→07/06	2922	6	83.00	DOHC	150/204				

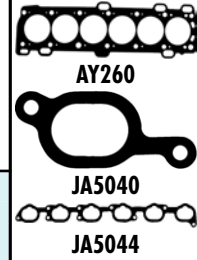

HBS426 [19]
M12x1.75x162.00mm (x14)

JA5044 ■
JA5040 ■ (x6)
HA5042 ■ ■

HR5030 ■ (x2)
→Eng.1818168
HR5076 ■ (x2)
Eng.1818169→

■ **NA5138** (x2)[2]
44.50x57.20x6.75mm, ACM
■ **NA5136** (x2)[1][2]
30.00x47.00x7.00mm, FPM
■ **NA5018** ■ [2]
35.00x47.00x5.60mm, FPM

HBS426 [19]
M12x1.75x162.00mm (x14)

JA5044 ■
JA5040 ■ (x6)
HA5042 ■ ■

HR5030 ■ (x2)

■ **NA5138** (x2)[2]
44.50x57.20x6.75mm, ACM
■ **NA5136** (x2)[1][2]
30.00x47.00x7.00mm, FPM
■ **NA5018** ■ [2]
35.00x47.00x5.60mm, FPM
■ **NA5017** ■ [1]
98.00x110.00x8.50mm, FPM

HBS426 [19]
M12x1.75x162.00mm (x14)

JA5044 ■
JA5040 ■ (x6)
HA5042 ■ ■

HR5030 ■ (x2)
→Eng.1818168
HR5076 ■ (x2)
Eng.1818169→

■ **NA5138** (x2)[2]
44.50x57.20x6.75mm, ACM
■ **NA5136** (x2)[1][2]
30.00x47.00x7.00mm, FPM
■ **NA5018** ■ [2]
35.00x47.00x5.60mm, FPM
■ **NA5017** ■ [1]
98.00x110.00x8.50mm, FPM

HBS426 [19]
M12x1.75x162.00mm (x14)

JA5044 ■
JA5040 ■ (x6)
HA5042 ■ ■

HR5030 ■ (x2)

■ **NA5138** (x2)[2]
44.50x57.20x6.75mm, ACM
■ **NA5136** (x2)[1][2]
30.00x47.00x7.00mm, FPM
■ **NA5018** ■ [2]
35.00x47.00x5.60mm, FPM
■ **NA5017** ■ [1]
98.00x110.00x8.50mm, FPM



Ltr







CC



9

Model	Ltr	Year	Code	Fuel	CC	Price	Power
AMAROK	2.0	09/01→	CDBA	Diesel	1968	4	385
AMAROK	2.0	09/01→	CDCA	Diesel	1968	4	386
AMAROK	2.0	11/01→	CNEA	Diesel	1968	4	409
AMAROK	2.0	11/01→	CSHA	Diesel	1968	4	410
BEETLE (5C1)	1.2	07/01→	CBZB	Petrol	1197	4	23
BEETLE (5C1)	1.4	04/01→	CAVD	Petrol	1390	4	85
BEETLE (5C1)	1.4	04/01→	CNWA	Petrol	1390	4	95
BEETLE (5C1)	1.6	10/01→	CAYC	Diesel	1598	4	144
BEETLE (5C1)	2.0	04/01→	CBFA	Petrol	1984	4	376
BEETLE (5C1)	2.0	04/01→	CCTA	Petrol	1984	4	380
BEETLE (5C1)	2.0	04/01→	CCZA	Petrol	1984	4	382
BEETLE (5C1)	2.0	04/01→	CFFB	Diesel	1968	4	391
BEETLE (5C1)	2.0	04/01→	CJAA	Diesel	1968	4	400
BEETLE (5C1)	2.5	04/01→	CBUA	Petrol	2480	5	477
BEETLE (5C1)	2.5	04/01→	CCCA	Petrol	2480	5	478
BEETLE Convertible (5C7)	1.2	12/01→	CBZB	Petrol	1197	4	23
BEETLE Convertible (5C7)	1.4	12/01→	CAVD	Petrol	1390	4	85
BEETLE Convertible (5C7)	1.4	12/01→	CNWA	Petrol	1390	4	95
BEETLE Convertible (5C7)	1.6	12/01→	CAYC	Diesel	1598	4	144
BEETLE Convertible (5C7)	2.0	12/01→	CBFA	Petrol	1984	4	376
BEETLE Convertible (5C7)	2.0	12/01→	CCTA	Petrol	1984	4	380
BEETLE Convertible (5C7)	2.0	12/01→	CCZA	Petrol	1984	4	382
BEETLE Convertible (5C7)	2.0	12/01→	CFFB	Diesel	1968	4	391
BEETLE Convertible (5C7)	2.0	12/01→	CJAA	Diesel	1968	4	400
BORA (1J2)	1.4	03/00→05/00	AHW	Petrol	1390	4	48
BORA (1J2)	1.4	03/00→05/00	AKQ	Petrol	1390	4	51
BORA (1J2)	1.4	03/00→05/00	APE	Petrol	1390	4	56
BORA (1J2)	1.4	03/00→05/00	AXP	Petrol	1390	4	64
BORA (1J2)	1.4	03/00→05/00	BCA	Petrol	1390	4	69
BORA (1J2)	1.6	10/99→05/00	AEH	Petrol	1595	4	104
BORA (1J2)	1.6	10/99→05/00	AKL	Petrol	1595	4	111
BORA (1J2)	1.6	10/99→05/00	APF	Petrol	1595	4	116
BORA (1J2)	1.6	05/00→05/00	ATN	Petrol	1598	4	119
BORA (1J2)	1.6	05/00→05/00	AUS	Petrol	1598	4	121
BORA (1J2)	1.6	08/00→05/00	AVU	Petrol	1595	4	122
BORA (1J2)	1.6	05/00→05/00	AZD	Petrol	1598	4	126
BORA (1J2)	1.6	01/00→05/00	BAD	Petrol	1598	4	127
BORA (1J2)	1.6	05/00→05/00	BCB	Petrol	1598	4	130
BORA (1J2)	1.6	08/00→05/00	BFQ	Petrol	1595	4	131
BORA (1J2)	1.6	08/00→05/00	BJH	Petrol	1595	4	134
BORA (1J2)	1.8	10/99→05/00	AGN	Petrol	1781	4	188
BORA (1J2)	1.8	05/00→05/00	AGU	Petrol	1781	4	189
BORA (1J2)	1.8	05/00→05/00	ARX	Petrol	1781	4	199
BORA (1J2)	1.8	05/00→05/00	AUM	Petrol	1781	4	201
BORA (1J2)	1.8	03/00→05/00	AUQ	Petrol	1781	4	202
BORA (1J2)	1.8	10/99→05/00	BAF	Petrol	1781	4	211
BORA (1J2)	1.9	10/99→05/00	AGP	Diesel	1896	4	253
BORA (1J2)	1.9	10/99→06/00	AGR	Diesel	1896	4	254
BORA (1J2)	1.9	10/99→06/00	AHF	Diesel	1896	4	255
BORA (1J2)	1.9	12/99→01/00	AJM	Diesel	1896	4	258
BORA (1J2)	1.9	10/99→06/00	ALH	Diesel	1896	4	260
BORA (1J2)	1.9	10/99→05/00	AQM	Diesel	1896	4	262
BORA (1J2)	1.9	05/00→05/00	ARL	Diesel	1896	4	263
BORA (1J2)	1.9	10/99→06/00	ASV	Diesel	1896	4	264
BORA (1J2)	1.9	11/00→05/00	ASZ	Diesel	1896	4	267
BORA (1J2)	1.9	09/00→05/00	ATD	Diesel	1896	4	268
BORA (1J2)	1.9	12/99→01/00	AUY	Diesel	1896	4	270
BORA (1J2)	1.9	09/00→05/00	AXR	Diesel	1896	4	278
BORA (1J2)	2.0	10/99→05/00	APK	Petrol	1984	4	311
BORA (1J2)	2.0	10/99→05/00	AQY	Petrol	1984	4	312
BORA (1J2)	2.0	10/99→05/00	AZG	Petrol	1984	4	321
BORA (1J2)	2.0	10/99→05/00	AZH	Petrol	1984	4	322
BORA (1J2)	2.0	10/99→05/00	AZJ	Petrol	1984	4	323
BORA (1J2)	2.3	10/99→10/00	AGZ	Petrol	2324	5	423
BORA (1J2)	2.3	10/00→05/00	AQN	Petrol	2324	5	424
BORA (1J2)	2.8	03/99→05/00	AQP	Petrol	2792	6	494
BORA (1J2)	2.8	03/99→05/00	AUE	Petrol	2792	6	497
BORA (1J2)	2.8	03/99→05/00	BDE	Petrol	2792	6	502
BORA Estate (1J6)	1.4	09/00→05/00	AHW	Petrol	1390	4	48
BORA Estate (1J6)	1.4	09/00→05/00	AXP	Petrol	1390	4	64

	Ltr				CC		9
BORA Estate (1J6)	1.4	09/00 → 05/00	BCA	Petrol	1390	4	69
BORA Estate (1J6)	1.6	05/99 → 05/00	AEH	Petrol	1595	4	104
BORA Estate (1J6)	1.6	05/99 → 05/00	AKL	Petrol	1595	4	111
BORA Estate (1J6)	1.6	05/99 → 05/00	APF	Petrol	1595	4	116
BORA Estate (1J6)	1.6	02/00 → 05/00	ATN	Petrol	1598	4	119
BORA Estate (1J6)	1.6	02/00 → 05/00	AUS	Petrol	1598	4	121
BORA Estate (1J6)	1.6	08/00 → 05/00	AVU	Petrol	1595	4	122
BORA Estate (1J6)	1.6	02/00 → 05/00	AZD	Petrol	1598	4	126
BORA Estate (1J6)	1.6	01/00 → 05/00	BAD	Petrol	1598	4	127
BORA Estate (1J6)	1.6	02/00 → 05/00	BCB	Petrol	1598	4	130
BORA Estate (1J6)	1.6	08/00 → 05/00	BFQ	Petrol	1595	4	131
BORA Estate (1J6)	1.8	05/99 → 05/00	AGN	Petrol	1781	4	188
BORA Estate (1J6)	1.8	05/00 → 05/00	AGU	Petrol	1781	4	189
BORA Estate (1J6)	1.8	05/00 → 05/00	ARX	Petrol	1781	4	199
BORA Estate (1J6)	1.8	05/00 → 05/00	AUM	Petrol	1781	4	201
BORA Estate (1J6)	1.8	05/00 → 05/00	AUQ	Petrol	1781	4	202
BORA Estate (1J6)	1.9	07/00 → 05/00	AGR	Diesel	1896	4	254
BORA Estate (1J6)	1.9	05/99 → 06/00	AHF	Diesel	1896	4	255
BORA Estate (1J6)	1.9	05/99 → 06/00	AJM	Diesel	1896	4	258
BORA Estate (1J6)	1.9	05/00 → 05/00	ARL	Diesel	1896	4	263
BORA Estate (1J6)	1.9	05/99 → 06/00	ASV	Diesel	1896	4	264
BORA Estate (1J6)	1.9	11/00 → 05/00	ASZ	Diesel	1896	4	267
BORA Estate (1J6)	1.9	09/00 → 05/00	ATD	Diesel	1896	4	268
BORA Estate (1J6)	1.9	05/99 → 06/00	AUY	Diesel	1896	4	270
BORA Estate (1J6)	1.9	09/00 → 05/00	AXR	Diesel	1896	4	278
BORA Estate (1J6)	2.0	05/99 → 05/00	APK	Petrol	1984	4	311
BORA Estate (1J6)	2.0	05/99 → 05/00	AQY	Petrol	1984	4	312
BORA Estate (1J6)	2.0	05/99 → 05/00	AZG	Petrol	1984	4	321
BORA Estate (1J6)	2.0	05/99 → 05/00	AZH	Petrol	1984	4	322
BORA Estate (1J6)	2.0	05/99 → 05/00	AZJ	Petrol	1984	4	323
BORA Estate (1J6)	2.3	05/99 → 10/00	AGZ	Petrol	2324	5	423
BORA Estate (1J6)	2.3	10/00 → 05/00	AQN	Petrol	2324	5	424
BORA Estate (1J6)	2.8	05/99 → 05/00	AQP	Petrol	2792	6	494
BORA Estate (1J6)	2.8	05/99 → 05/00	AUE	Petrol	2792	6	497
BORA Estate (1J6)	2.8	05/99 → 05/00	BDE	Petrol	2792	6	502
CADDY I (14)	1.6	01/98 → 07/99	EW	Petrol	1595	4	154
CADDY I (14)	1.8	08/98 → 07/99	JH	Petrol	1781	4	230
CADDY II Box (9K9A)	1.4	11/99 → 01/00	AEX	Petrol	1390	4	44
CADDY II Box (9K9A)	1.4	11/99 → 01/00	APQ	Petrol	1390	4	57
CADDY II Box (9K9A)	1.4	08/00 → 01/00	AUA	Petrol	1390	4	61
CADDY II Box (9K9A)	1.4	11/99 → 01/00	AUD	Petrol	1390	4	63
CADDY II Box (9K9A)	1.6	11/99 → 05/99	1F	Petrol	1595	4	97
CADDY II Box (9K9A)	1.6	11/99 → 09/00	AEE	Petrol	1598	4	103
CADDY II Box (9K9A)	1.7	07/99 → 09/00	AHB	Diesel	1716	4	169
CADDY II Box (9K9A)	1.9	11/99 → 01/00	1Y	Diesel	1896	4	245
CADDY II Box (9K9A)	1.9	09/99 → 01/00	1Z	Diesel	1896	4	246
CADDY II Box (9K9A)	1.9	11/99 → 01/00	AEY	Diesel	1896	4	250
CADDY II Box (9K9A)	1.9	09/99 → 01/00	AHU	Diesel	1896	4	257
CADDY II Box (9K9A)	1.9	09/99 → 01/00	ALH	Diesel	1896	4	260
CADDY II Box (9K9A)	1.9	11/99 → 01/00	AYQ	Diesel	1896	4	279
CADDY II Estate (9K9B)	1.4	11/99 → 01/00	AEX	Petrol	1390	4	44
CADDY II Estate (9K9B)	1.4	11/99 → 01/00	AKV	Petrol	1390	4	52
CADDY II Estate (9K9B)	1.4	11/99 → 01/00	APQ	Petrol	1390	4	57
CADDY II Estate (9K9B)	1.4	08/00 → 01/00	AUA	Petrol	1390	4	61
CADDY II Estate (9K9B)	1.4	11/99 → 01/00	AUD	Petrol	1390	4	63
CADDY II Estate (9K9B)	1.6	11/99 → 05/99	1F	Petrol	1595	4	97
CADDY II Estate (9K9B)	1.6	06/99 → 09/00	AEE	Petrol	1598	4	103
CADDY II Estate (9K9B)	1.7	07/99 → 09/00	AHB	Diesel	1716	4	169
CADDY II Estate (9K9B)	1.9	11/99 → 01/00	1Y	Diesel	1896	4	245
CADDY II Estate (9K9B)	1.9	11/99 → 01/00	AEY	Diesel	1896	4	250
CADDY II Estate (9K9B)	1.9	10/99 → 01/00	AHU	Diesel	1896	4	257
CADDY II Estate (9K9B)	1.9	10/99 → 01/00	ALE	Diesel	1896	4	259
CADDY II Estate (9K9B)	1.9	10/99 → 01/00	ALH	Diesel	1896	4	260
CADDY II Estate (9K9B)	1.9	11/99 → 01/00	AYQ	Diesel	1896	4	279
CADDY II Pickup (9U7)	1.6	06/99 → 12/00	AEE	Petrol	1598	4	103
CADDY II Pickup (9U7)	1.9	06/99 → 12/00	AEF	Diesel	1896	4	249
CADDY III Box (2KA, 2KH, 2CA, 2CH)	1.2	09/01 →	CBZA	Petrol	1197	4	22
CADDY III Box (2KA, 2KH, 2CA, 2CH)	1.2	09/01 →	CBZB	Petrol	1197	4	23
CADDY III Box (2KA, 2KH, 2CA, 2CH)	1.4	03/00 → 05/00	BCA	Petrol	1390	4	69
CADDY III Box (2KA, 2KH, 2CA, 2CH)	1.4	05/00 → 08/01	BUD	Petrol	1390	4	79



Ltr







CC



9

CADDY III Box (2KA, 2KH, 2CA, 2CH)	1.6	04/00→	BGU	Petrol	1595	4	133
CADDY III Box (2KA, 2KH, 2CA, 2CH)	1.6	04/00→	BSE	Petrol	1595	4	138
CADDY III Box (2KA, 2KH, 2CA, 2CH)	1.6	04/00→	BSF	Petrol	1595	4	139
CADDY III Box (2KA, 2KH, 2CA, 2CH)	1.6	08/01→	CAYD	Diesel	1598	4	145
CADDY III Box (2KA, 2KH, 2CA, 2CH)	1.6	08/01→	CAYE	Diesel	1598	4	146
CADDY III Box (2KA, 2KH, 2CA, 2CH)	1.6	05/01→	CHGA	Petrol/Petroleum Gas (LPG)	1595	4	150
CADDY III Box (2KA, 2KH, 2CA, 2CH)	1.9	04/00→08/01	BJB	Diesel	1896	4	282
CADDY III Box (2KA, 2KH, 2CA, 2CH)	1.9	04/00→08/01	BLS	Diesel	1896	4	284
CADDY III Box (2KA, 2KH, 2CA, 2CH)	1.9	09/00→08/01	BSU	Diesel	1896	4	290
CADDY III Box (2KA, 2KH, 2CA, 2CH)	2.0	03/00→08/01	BDJ	Diesel	1968	4	327
CADDY III Box (2KA, 2KH, 2CA, 2CH)	2.0	09/00→08/01	BMM	Diesel	1968	4	344
CADDY III Box (2KA, 2KH, 2CA, 2CH)	2.0	03/00→08/01	BST	Diesel	1968	4	350
CADDY III Box (2KA, 2KH, 2CA, 2CH)	2.0	04/00→	BSX	Natural Gas	1984	4	351
CADDY III Box (2KA, 2KH, 2CA, 2CH)	2.0	11/01→	CFHC	Diesel	1968	4	396
CADDY III Box (2KA, 2KH, 2CA, 2CH)	2.0	11/01→	CFHE	Diesel	1968	4	397
CADDY III Box (2KA, 2KH, 2CA, 2CH)	2.0	08/01→	CFHF	Diesel	1968	4	398
CADDY III Box (2KA, 2KH, 2CA, 2CH)	2.0	05/01→	CFJA	Diesel	1968	4	399
CADDY III Box (2KA, 2KH, 2CA, 2CH)	2.0	08/01→	CLCA	Diesel	1968	4	406
CADDY III Box (2KA, 2KH, 2CA, 2CH)	2.0	11/01→	CLCB	Diesel	1968	4	407
CADDY III Estate (2KB, 2KJ, 2CB, 2CJ)	1.2	09/01→	CBZA	Petrol	1197	4	22
CADDY III Estate (2KB, 2KJ, 2CB, 2CJ)	1.2	09/01→	CBZB	Petrol	1197	4	23
CADDY III Estate (2KB, 2KJ, 2CB, 2CJ)	1.4	03/00→05/00	BCA	Petrol	1390	4	69
CADDY III Estate (2KB, 2KJ, 2CB, 2CJ)	1.4	05/00→08/01	BUD	Petrol	1390	4	79
CADDY III Estate (2KB, 2KJ, 2CB, 2CJ)	1.6	04/00→	BGU	Petrol	1595	4	133
CADDY III Estate (2KB, 2KJ, 2CB, 2CJ)	1.6	03/00→	BRY	Petrol	1595	4	137
CADDY III Estate (2KB, 2KJ, 2CB, 2CJ)	1.6	04/00→	BSE	Petrol	1595	4	138
CADDY III Estate (2KB, 2KJ, 2CB, 2CJ)	1.6	04/00→	BSF	Petrol	1595	4	139
CADDY III Estate (2KB, 2KJ, 2CB, 2CJ)	1.6	08/01→	CAYD	Diesel	1598	4	145
CADDY III Estate (2KB, 2KJ, 2CB, 2CJ)	1.6	08/01→	CAYE	Diesel	1598	4	146
CADDY III Estate (2KB, 2KJ, 2CB, 2CJ)	1.6	05/01→	CHGA	Petrol/Petroleum Gas (LPG)	1595	4	150
CADDY III Estate (2KB, 2KJ, 2CB, 2CJ)	1.9	04/00→08/01	BJB	Diesel	1896	4	282
CADDY III Estate (2KB, 2KJ, 2CB, 2CJ)	1.9	04/00→08/01	BLS	Diesel	1896	4	284
CADDY III Estate (2KB, 2KJ, 2CB, 2CJ)	1.9	09/00→08/01	BSU	Diesel	1896	4	290
CADDY III Estate (2KB, 2KJ, 2CB, 2CJ)	2.0	03/00→08/01	BDJ	Diesel	1968	4	327
CADDY III Estate (2KB, 2KJ, 2CB, 2CJ)	2.0	09/00→08/01	BMM	Diesel	1968	4	344
CADDY III Estate (2KB, 2KJ, 2CB, 2CJ)	2.0	03/00→08/01	BST	Diesel	1968	4	350
CADDY III Estate (2KB, 2KJ, 2CB, 2CJ)	2.0	04/00→	BSX	Natural Gas	1984	4	351
CADDY III Estate (2KB, 2KJ, 2CB, 2CJ)	2.0	11/01→	CFHC	Diesel	1968	4	396
CADDY III Estate (2KB, 2KJ, 2CB, 2CJ)	2.0	08/01→	CFHF	Diesel	1968	4	398
CADDY III Estate (2KB, 2KJ, 2CB, 2CJ)	2.0	05/01→	CFJA	Diesel	1968	4	399
CADDY III Estate (2KB, 2KJ, 2CB, 2CJ)	2.0	08/01→	CLCA	Diesel	1968	4	406
CADDY III Estate (2KB, 2KJ, 2CB, 2CJ)	2.0	11/01→	CLCB	Diesel	1968	4	407
CC (358)	1.4	11/01→	CKMA	Petrol/Ethanol	1390	4	92
CC (358)	1.4	11/01→	CKMA	Petrol	1390	4	92
CC (358)	1.8	11/01→	CDAA	Petrol	1798	4	218
CC (358)	1.8	11/01→	CDAB	Petrol	1798	4	219
CC (358)	2.0	11/01→	CBFA	Petrol	1984	4	376
CC (358)	2.0	11/01→	CCTA	Petrol	1984	4	380
CC (358)	2.0	11/01→	CCZB	Petrol	1984	4	383
CC (358)	2.0	11/01→	CFFA	Diesel	1968	4	390
CC (358)	2.0	11/01→	CFFB	Diesel	1968	4	391
CC (358)	2.0	11/01→	CFGB	Diesel	1968	4	394
CC (358)	2.0	11/01→	CLLA	Diesel	1968	4	408
CC (358)	3.6	11/01→	BWS	Petrol	3597	6	534
CORRADO (53I)	1.8	04/98→07/99	KR	Petrol	1781	4	234
CORRADO (53I)	1.8	09/98→09/99	PG	Petrol	1781	4	238
CORRADO (53I)	2.0	04/99→12/99	2E	Petrol	1984	4	301
CORRADO (53I)	2.0	08/99→12/99	9A	Petrol	1984	4	302
CORRADO (53I)	2.0	04/99→12/99	ADY	Petrol	1984	4	305
CORRADO (53I)	2.9	08/99→12/99	ABV	Petrol	2861	6	503
CRAFTER 30-35 Bus (2E_)	2.0	05/01→	CKTB	Diesel	1968	4	402
CRAFTER 30-35 Bus (2E_)	2.0	05/01→	CKTC	Diesel	1968	4	403
CRAFTER 30-35 Bus (2E_)	2.0	07/01→	CKUB	Diesel	1968	4	404
CRAFTER 30-35 Bus (2E_)	2.0	10/01→	CKUC	Diesel	1968	4	405
CRAFTER 30-35 Bus (2E_)	2.5	04/00→07/01	BJJ	Diesel	2461	5	467
CRAFTER 30-35 Bus (2E_)	2.5	04/00→	BJK	Diesel	2461	5	468
CRAFTER 30-35 Bus (2E_)	2.5	04/00→	BJL	Diesel	2461	5	469
CRAFTER 30-35 Bus (2E_)	2.5	04/00→07/01	BJM	Diesel	2461	5	470
CRAFTER 30-35 Bus (2E_)	2.5	04/00→07/01	CEBA	Diesel	2461	5	479
CRAFTER 30-35 Bus (2E_)	2.5	04/00→	CEBB	Diesel	2461	5	480

	Ltr				CC		9
CRAFTER 30-35 Bus (2E_)	2.5	04/00 →	CECA	Diesel	2461	5	481
CRAFTER 30-35 Bus (2E_)	2.5	04/00 → 07/01	CECB	Diesel	2461	5	482
CRAFTER 30-50 Box (2E_)	2.0	05/01 →	CKTB	Diesel	1968	4	402
CRAFTER 30-50 Box (2E_)	2.0	05/01 →	CKTC	Diesel	1968	4	403
CRAFTER 30-50 Box (2E_)	2.0	07/01 →	CKUB	Diesel	1968	4	404
CRAFTER 30-50 Box (2E_)	2.0	10/01 →	CKUC	Diesel	1968	4	405
CRAFTER 30-50 Box (2E_)	2.5	04/00 → 07/01	BJJ	Diesel	2461	5	467
CRAFTER 30-50 Box (2E_)	2.5	04/00 →	BJK	Diesel	2461	5	468
CRAFTER 30-50 Box (2E_)	2.5	04/00 →	BJL	Diesel	2461	5	469
CRAFTER 30-50 Box (2E_)	2.5	04/00 → 07/01	BJM	Diesel	2461	5	470
CRAFTER 30-50 Box (2E_)	2.5	04/00 → 07/01	CEBA	Diesel	2461	5	479
CRAFTER 30-50 Box (2E_)	2.5	04/00 →	CEBB	Diesel	2461	5	480
CRAFTER 30-50 Box (2E_)	2.5	04/00 →	CECA	Diesel	2461	5	481
CRAFTER 30-50 Box (2E_)	2.5	04/00 → 07/01	CECB	Diesel	2461	5	482
CRAFTER 30-50 Platform/Chassis (2F_)	2.0	05/01 →	CKTB	Diesel	1968	4	402
CRAFTER 30-50 Platform/Chassis (2F_)	2.0	05/01 →	CKTC	Diesel	1968	4	403
CRAFTER 30-50 Platform/Chassis (2F_)	2.0	07/01 →	CKUB	Diesel	1968	4	404
CRAFTER 30-50 Platform/Chassis (2F_)	2.0	10/01 →	CKUC	Diesel	1968	4	405
CRAFTER 30-50 Platform/Chassis (2F_)	2.5	04/00 → 07/01	BJJ	Diesel	2461	5	467
CRAFTER 30-50 Platform/Chassis (2F_)	2.5	04/00 →	BJK	Diesel	2461	5	468
CRAFTER 30-50 Platform/Chassis (2F_)	2.5	04/00 →	BJL	Diesel	2461	5	469
CRAFTER 30-50 Platform/Chassis (2F_)	2.5	04/00 → 07/01	BJM	Diesel	2461	5	470
CRAFTER 30-50 Platform/Chassis (2F_)	2.5	04/00 → 07/01	CEBA	Diesel	2461	5	479
CRAFTER 30-50 Platform/Chassis (2F_)	2.5	04/00 →	CEBB	Diesel	2461	5	480
CRAFTER 30-50 Platform/Chassis (2F_)	2.5	04/00 →	CECA	Diesel	2461	5	481
CRAFTER 30-50 Platform/Chassis (2F_)	2.5	04/00 → 07/01	CECB	Diesel	2461	5	482
EOS (1F7, 1F8)	1.4	05/00 →	CAVD	Petrol	1390	4	85
EOS (1F7, 1F8)	1.4	11/00 →	CAXA	Petrol	1390	4	87
EOS (1F7, 1F8)	1.6	06/00 → 05/00	BLF	Petrol	1598	4	135
EOS (1F7, 1F8)	2.0	06/00 → 05/00	BMM	Diesel	1968	4	344
EOS (1F7, 1F8)	2.0	03/00 →	BPY	Petrol	1984	4	348
EOS (1F7, 1F8)	2.0	03/00 → 05/00	BVY	Petrol	1984	4	356
EOS (1F7, 1F8)	2.0	03/00 → 05/00	BVZ	Petrol	1984	4	357
EOS (1F7, 1F8)	2.0	03/00 →	BWA	Petrol	1984	4	358
EOS (1F7, 1F8)	2.0	03/00 →	CAWB	Petrol	1984	4	367
EOS (1F7, 1F8)	2.0	05/00 →	CBAB	Diesel	1968	4	369
EOS (1F7, 1F8)	2.0	03/00 →	CBFA	Petrol	1984	4	376
EOS (1F7, 1F8)	2.0	03/00 →	CCTA	Petrol	1984	4	380
EOS (1F7, 1F8)	2.0	03/00 →	CCZA	Petrol	1984	4	382
EOS (1F7, 1F8)	2.0	11/00 →	CCZB	Petrol	1984	4	383
EOS (1F7, 1F8)	2.0	11/01 →	CCFA	Diesel	1968	4	390
EOS (1F7, 1F8)	2.0	05/00 →	CCFB	Diesel	1968	4	391
EOS (1F7, 1F8)	3.2	06/00 → 05/00	BUB	Petrol	3189	6	529
EOS (1F7, 1F8)	3.2	06/00 → 05/00	CBRA	Petrol	3189	6	530
FOX (5Z1, 5Z3)	1.2	04/00 →	BMD	Petrol	1198	3	19
FOX (5Z1, 5Z3)	1.2	09/01 →	CHFA	Petrol	1198	3	28
FOX (5Z1, 5Z3)	1.2	04/00 →	CHFB	Petrol	1198	3	29
FOX (5Z1, 5Z3)	1.4	04/00 →	BKR	Petrol	1390	4	71
FOX (5Z1, 5Z3)	1.4	04/00 →	BNM	Diesel	1422	3	77
FOX (5Z1, 5Z3)	1.6	10/00 →	BAH	Petrol	1598	4	129
FOX (5Z1, 5Z3)	1.6	10/00 →	CCRA	Petrol/Ethanol	1598	4	147
FOX (5Z1, 5Z3)	1.6	10/00 →	CCRA	Petrol	1598	4	147
FOX (5Z1, 5Z3)	1.6	10/00 →	CCRA	Flexfuel	1598	4	147
GOL	1.0	10/00 → 05/00	BTY	Petrol	999	4	11
GOL	1.6	12/99 → 05/00	BWX	Petrol	1596	4	141
GOL	1.8	05/98 → 09/99	RM	Petrol	1781	4	241
GOLF I Cabriolet (155)	1.6	08/98 → 04/99	EW	Petrol	1595	4	154
GOLF I Cabriolet (155)	1.6	08/98 → 04/99	HN	Petrol	1595	4	157
GOLF I Cabriolet (155)	1.6	04/98 → 02/99	RE	Petrol	1595	4	163
GOLF I Cabriolet (155)	1.8	08/98 → 03/99	2H	Petrol	1781	4	178
GOLF I Cabriolet (155)	1.8	08/98 → 12/99	DX	Petrol	1781	4	222
GOLF I Cabriolet (155)	1.8	08/98 → 12/98	EV	Petrol	1781	4	224
GOLF I Cabriolet (155)	1.8	08/98 → 09/99	EX	Petrol	1781	4	225
GOLF I Cabriolet (155)	1.8	08/98 → 04/99	JH	Petrol	1781	4	230
GOLF I Cabriolet (155)	1.8	08/98 → 12/98	PB	Petrol	1781	4	235
GOLF II (19E, 1G1)	1.0	08/98 → 10/99	HZ	Petrol	1043	4	13
GOLF II (19E, 1G1)	1.3	06/98 → 12/99	2G	Petrol	1272	4	30
GOLF II (19E, 1G1)	1.3	06/98 → 12/99	MH	Petrol	1272	4	38
GOLF II (19E, 1G1)	1.3	06/98 → 12/99	NZ	Petrol	1272	4	40
GOLF II (19E, 1G1)	1.6	08/98 → 10/99	1V	Diesel	1589	4	98



Ltr







CC



9

Model	Ltr	Year	Code	Fuel	CC	Checkmark	Price
GOLF II (19E, 1G1)	1.6	08/98→07/99	ABN	Petrol	1595	4	99
GOLF II (19E, 1G1)	1.6	08/98→07/99	EZ	Petrol	1595	4	155
GOLF II (19E, 1G1)	1.6	08/98→07/99	HM	Petrol	1595	4	156
GOLF II (19E, 1G1)	1.6	08/98→10/99	MF	Diesel	1588	4	159
GOLF II (19E, 1G1)	1.6	10/98→12/99	PN	Petrol	1595	4	160
GOLF II (19E, 1G1)	1.6	04/98→10/99	RA	Diesel	1588	4	162
GOLF II (19E, 1G1)	1.6	02/98→10/99	RF	Petrol	1595	4	164
GOLF II (19E, 1G1)	1.6	04/98→10/99	SB	Diesel	1588	4	166
GOLF II (19E, 1G1)	1.8	08/98→12/99	1H	Petrol	1781	4	176
GOLF II (19E, 1G1)	1.8	08/98→07/99	1P	Petrol	1781	4	177
GOLF II (19E, 1G1)	1.8	08/98→10/99	DX	Petrol	1781	4	222
GOLF II (19E, 1G1)	1.8	08/98→10/99	EV	Petrol	1781	4	224
GOLF II (19E, 1G1)	1.8	08/98→10/99	GU	Petrol	1781	4	226
GOLF II (19E, 1G1)	1.8	08/98→10/99	GX	Petrol	1781	4	227
GOLF II (19E, 1G1)	1.8	08/98→10/99	GZ	Petrol	1781	4	228
GOLF II (19E, 1G1)	1.8	08/98→10/99	HV	Petrol	1781	4	229
GOLF II (19E, 1G1)	1.8	02/98→06/99	KR	Petrol	1781	4	234
GOLF II (19E, 1G1)	1.8	08/98→10/99	PB	Petrol	1781	4	235
GOLF II (19E, 1G1)	1.8	01/98→10/99	PF	Petrol	1781	4	237
GOLF II (19E, 1G1)	1.8	08/98→12/99	PG	Petrol	1781	4	238
GOLF II (19E, 1G1)	1.8	02/98→10/99	PL	Petrol	1781	4	239
GOLF II (19E, 1G1)	1.8	08/98→01/99	RH	Petrol	1781	4	240
GOLF II (19E, 1G1)	1.8	08/98→10/99	RP	Petrol	1781	4	242
GOLF III (1H1)	1.3	08/99→07/99	2G	Petrol	1272	4	30
GOLF III (1H1)	1.4	10/99→08/99	ABD	Petrol	1390	4	43
GOLF III (1H1)	1.4	10/99→08/99	AEX	Petrol	1390	4	44
GOLF III (1H1)	1.6	09/99→08/99	ABU	Petrol	1598	4	100
GOLF III (1H1)	1.6	09/99→08/99	AEA	Petrol	1598	4	102
GOLF III (1H1)	1.6	09/99→08/99	AEE	Petrol	1598	4	103
GOLF III (1H1)	1.6	07/99→08/99	AEK	Petrol	1595	4	105
GOLF III (1H1)	1.6	07/99→08/99	AFT	Petrol	1595	4	107
GOLF III (1H1)	1.6	07/99→08/99	AKS	Petrol	1595	4	112
GOLF III (1H1)	1.8	11/99→08/99	AAM	Petrol	1781	4	180
GOLF III (1H1)	1.8	11/99→08/99	ABS	Petrol	1781	4	181
GOLF III (1H1)	1.8	11/99→08/99	ACC	Petrol	1781	4	182
GOLF III (1H1)	1.8	11/99→08/99	ADZ	Petrol	1781	4	185
GOLF III (1H1)	1.9	11/99→08/99	1Y	Diesel	1896	4	245
GOLF III (1H1)	1.9	09/99→08/99	1Z	Diesel	1896	4	246
GOLF III (1H1)	1.9	11/99→08/99	AAZ	Diesel	1896	4	247
GOLF III (1H1)	1.9	07/99→08/99	AEY	Diesel	1896	4	250
GOLF III (1H1)	1.9	04/99→08/99	AFN	Diesel	1896	4	251
GOLF III (1H1)	1.9	09/99→08/99	AHU	Diesel	1896	4	257
GOLF III (1H1)	1.9	09/99→08/99	ALE	Diesel	1896	4	259
GOLF III (1H1)	2.0	11/99→08/99	2E	Petrol	1984	4	301
GOLF III (1H1)	2.0	08/99→08/99	ABF	Petrol	1984	4	304
GOLF III (1H1)	2.0	11/99→08/99	ADY	Petrol	1984	4	305
GOLF III (1H1)	2.0	08/99→09/99	AEP	Petrol	1984	4	307
GOLF III (1H1)	2.0	11/99→08/99	AGG	Petrol	1984	4	308
GOLF III (1H1)	2.0	11/99→08/99	AKR	Petrol	1984	4	309
GOLF III (1H1)	2.8	01/99→09/99	AAA	Petrol	2792	6	483
GOLF III (1H1)	2.9	10/99→08/99	ABV	Petrol	2861	6	503
GOLF III Cabriolet (1E7)	1.6	10/99→05/99	AEK	Petrol	1595	4	105
GOLF III Cabriolet (1E7)	1.6	10/99→05/99	AFT	Petrol	1595	4	107
GOLF III Cabriolet (1E7)	1.6	10/99→05/99	AKS	Petrol	1595	4	112
GOLF III Cabriolet (1E7)	1.8	07/99→05/99	AAM	Petrol	1781	4	180
GOLF III Cabriolet (1E7)	1.8	07/99→05/99	ABS	Petrol	1781	4	181
GOLF III Cabriolet (1E7)	1.8	07/99→05/99	ADZ	Petrol	1781	4	185
GOLF III Cabriolet (1E7)	1.9	08/99→05/99	1Z	Diesel	1896	4	246
GOLF III Cabriolet (1E7)	1.9	07/99→05/99	AFN	Diesel	1896	4	251
GOLF III Cabriolet (1E7)	1.9	08/99→05/99	AHU	Diesel	1896	4	257
GOLF III Cabriolet (1E7)	1.9	08/99→05/99	ALE	Diesel	1896	4	259
GOLF III Cabriolet (1E7)	2.0	07/99→05/99	2E	Petrol	1984	4	301
GOLF III Cabriolet (1E7)	2.0	07/99→05/99	ADY	Petrol	1984	4	305
GOLF III Cabriolet (1E7)	2.0	07/99→05/99	AGG	Petrol	1984	4	308
GOLF III Cabriolet (1E7)	2.0	07/99→05/99	AKR	Petrol	1984	4	309
GOLF III Variant (1H5)	1.4	07/99→04/99	ABD	Petrol	1390	4	43
GOLF III Variant (1H5)	1.4	07/99→04/99	AEX	Petrol	1390	4	44
GOLF III Variant (1H5)	1.4	07/99→04/99	APQ	Petrol	1390	4	57
GOLF III Variant (1H5)	1.6	07/99→04/99	AEK	Petrol	1595	4	105
GOLF III Variant (1H5)	1.6	07/99→04/99	AFT	Petrol	1595	4	107

	Ltr				CC		9
GOLF III Variant (1H5)	1.6	07/99→04/99	AKS	Petrol	1595	4	112
GOLF III Variant (1H5)	1.8	07/99→04/99	AAM	Petrol	1781	4	180
GOLF III Variant (1H5)	1.8	07/99→04/99	ABS	Petrol	1781	4	181
GOLF III Variant (1H5)	1.8	07/99→04/99	ADZ	Petrol	1781	4	185
GOLF III Variant (1H5)	1.8	07/99→04/99	ANN	Petrol	1781	4	192
GOLF III Variant (1H5)	1.8	07/99→04/99	ANP	Petrol	1781	4	193
GOLF III Variant (1H5)	1.9	07/99→04/99	1Y	Diesel	1896	4	245
GOLF III Variant (1H5)	1.9	03/99→04/99	1Z	Diesel	1896	4	246
GOLF III Variant (1H5)	1.9	07/99→04/99	AAZ	Diesel	1896	4	247
GOLF III Variant (1H5)	1.9	07/99→04/99	AEY	Diesel	1896	4	250
GOLF III Variant (1H5)	1.9	04/99→04/99	AFN	Diesel	1896	4	251
GOLF III Variant (1H5)	1.9	03/99→04/99	AHU	Diesel	1896	4	257
GOLF III Variant (1H5)	1.9	03/99→04/99	ALE	Diesel	1896	4	259
GOLF III Variant (1H5)	2.0	07/99→04/99	2E	Petrol	1984	4	301
GOLF III Variant (1H5)	2.0	07/99→04/99	ADY	Petrol	1984	4	305
GOLF III Variant (1H5)	2.0	08/99→04/99	AEP	Petrol	1984	4	307
GOLF III Variant (1H5)	2.0	07/99→04/99	AGG	Petrol	1984	4	308
GOLF III Variant (1H5)	2.0	07/99→04/99	AKR	Petrol	1984	4	309
GOLF III Variant (1H5)	2.9	10/99→04/99	ABV	Petrol	2861	6	503
GOLF IV (1J1)	1.4	08/99→06/00	AHW	Petrol	1390	4	48
GOLF IV (1J1)	1.4	08/99→06/00	AKQ	Petrol	1390	4	51
GOLF IV (1J1)	1.4	08/99→06/00	APE	Petrol	1390	4	56
GOLF IV (1J1)	1.4	08/99→06/00	AXP	Petrol	1390	4	64
GOLF IV (1J1)	1.4	08/99→06/00	BCA	Petrol	1390	4	69
GOLF IV (1J1)	1.6	08/99→05/00	AEH	Petrol	1595	4	104
GOLF IV (1J1)	1.6	08/99→05/00	AKL	Petrol	1595	4	111
GOLF IV (1J1)	1.6	08/99→05/00	APF	Petrol	1595	4	116
GOLF IV (1J1)	1.6	02/00→06/00	ATN	Petrol	1598	4	119
GOLF IV (1J1)	1.6	02/00→06/00	AUS	Petrol	1598	4	121
GOLF IV (1J1)	1.6	08/00→06/00	AVU	Petrol	1595	4	122
GOLF IV (1J1)	1.6	02/00→06/00	AZD	Petrol	1598	4	126
GOLF IV (1J1)	1.6	01/00→06/00	BAD	Petrol	1598	4	127
GOLF IV (1J1)	1.6	02/00→06/00	BAH	Petrol	1598	4	129
GOLF IV (1J1)	1.6	02/00→06/00	BCB	Petrol	1598	4	130
GOLF IV (1J1)	1.6	08/00→06/00	BFQ	Petrol	1595	4	131
GOLF IV (1J1)	1.6	08/00→06/00	BJH	Petrol	1595	4	134
GOLF IV (1J1)	1.8	10/99→09/99	ACC	Petrol	1781	4	182
GOLF IV (1J1)	1.8	08/99→06/00	AGN	Petrol	1781	4	188
GOLF IV (1J1)	1.8	08/99→06/00	AGU	Petrol	1781	4	189
GOLF IV (1J1)	1.8	08/99→06/00	AQA	Petrol	1781	4	197
GOLF IV (1J1)	1.8	08/99→06/00	ARZ	Petrol	1781	4	200
GOLF IV (1J1)	1.8	08/99→06/00	AUM	Petrol	1781	4	201
GOLF IV (1J1)	1.8	08/00→06/00	AUQ	Petrol	1781	4	202
GOLF IV (1J1)	1.8	08/99→06/00	BAF	Petrol	1781	4	211
GOLF IV (1J1)	1.9	10/99→09/99	AAZ	Diesel	1896	4	247
GOLF IV (1J1)	1.9	08/99→06/00	AGP	Diesel	1896	4	253
GOLF IV (1J1)	1.9	10/99→05/00	AGR	Diesel	1896	4	254
GOLF IV (1J1)	1.9	08/99→05/00	AHF	Diesel	1896	4	255
GOLF IV (1J1)	1.9	12/99→06/00	AJM	Diesel	1896	4	258
GOLF IV (1J1)	1.9	10/99→05/00	ALH	Diesel	1896	4	260
GOLF IV (1J1)	1.9	08/99→06/00	AQM	Diesel	1896	4	262
GOLF IV (1J1)	1.9	02/00→06/00	ARL	Diesel	1896	4	263
GOLF IV (1J1)	1.9	08/99→05/00	ASV	Diesel	1896	4	264
GOLF IV (1J1)	1.9	11/00→06/00	ASZ	Diesel	1896	4	267
GOLF IV (1J1)	1.9	09/00→06/00	ATD	Diesel	1896	4	268
GOLF IV (1J1)	1.9	12/99→06/00	AUY	Diesel	1896	4	270
GOLF IV (1J1)	1.9	09/00→06/00	AXR	Diesel	1896	4	278
GOLF IV (1J1)	2.0	07/99→05/00	APK	Petrol	1984	4	311
GOLF IV (1J1)	2.0	07/99→05/00	AQY	Petrol	1984	4	312
GOLF IV (1J1)	2.0	07/99→05/00	AZG	Petrol	1984	4	321
GOLF IV (1J1)	2.0	10/00→06/00	AZH	Petrol	1984	4	322
GOLF IV (1J1)	2.0	07/99→06/00	AZJ	Petrol	1984	4	323
GOLF IV (1J1)	2.3	08/99→10/00	AGZ	Petrol	2324	5	423
GOLF IV (1J1)	2.3	10/00→06/00	AQN	Petrol	2324	5	424
GOLF IV (1J1)	2.8	03/99→06/00	AQP	Petrol	2792	6	494
GOLF IV (1J1)	2.8	03/99→06/00	AUE	Petrol	2792	6	497
GOLF IV (1J1)	2.8	03/99→06/00	BDE	Petrol	2792	6	502
GOLF IV (1J1)	3.2	09/00→06/00	BFH	Petrol	3189	6	519
GOLF IV (1J1)	3.2	09/00→06/00	BML	Petrol	3189	6	524
GOLF IV Cabriolet (1E7)	1.6	06/99→06/00	AFT	Petrol	1595	4	107



Ltr







CC



9

Model	Ltr	Year	Code	Fuel	CC	Power	Price
GOLF IV Cabriolet (1E7)	1.6	06/99→06/00	AKS	Petrol	1595	4	112
GOLF IV Cabriolet (1E7)	1.8	06/99→06/00	AAM	Petrol	1781	4	180
GOLF IV Cabriolet (1E7)	1.8	06/99→06/00	ADZ	Petrol	1781	4	185
GOLF IV Cabriolet (1E7)	1.8	06/99→06/00	ANN	Petrol	1781	4	192
GOLF IV Cabriolet (1E7)	1.8	06/99→06/00	ANP	Petrol	1781	4	193
GOLF IV Cabriolet (1E7)	1.9	06/99→06/00	AFN	Diesel	1896	4	251
GOLF IV Cabriolet (1E7)	1.9	06/99→06/00	AHU	Diesel	1896	4	257
GOLF IV Cabriolet (1E7)	1.9	06/99→06/00	ALE	Diesel	1896	4	259
GOLF IV Cabriolet (1E7)	1.9	06/99→06/00	AVG	Diesel	1896	4	273
GOLF IV Cabriolet (1E7)	2.0	06/99→06/00	AGG	Petrol	1984	4	308
GOLF IV Cabriolet (1E7)	2.0	06/99→06/00	AKR	Petrol	1984	4	309
GOLF IV Cabriolet (1E7)	2.0	06/99→06/00	ATU	Petrol	1984	4	314
GOLF IV Cabriolet (1E7)	2.0	06/99→06/00	AWF	Petrol	1984	4	316
GOLF IV Cabriolet (1E7)	2.0	06/99→06/00	AWG	Petrol	1984	4	317
GOLF IV Variant (1J5)	1.4	05/99→06/00	AHW	Petrol	1390	4	48
GOLF IV Variant (1J5)	1.4	05/99→06/00	AKQ	Petrol	1390	4	51
GOLF IV Variant (1J5)	1.4	05/99→06/00	APE	Petrol	1390	4	56
GOLF IV Variant (1J5)	1.4	05/99→06/00	AXP	Petrol	1390	4	64
GOLF IV Variant (1J5)	1.4	05/99→06/00	BCA	Petrol	1390	4	69
GOLF IV Variant (1J5)	1.6	05/99→04/00	AEH	Petrol	1595	4	104
GOLF IV Variant (1J5)	1.6	05/99→04/00	AKL	Petrol	1595	4	111
GOLF IV Variant (1J5)	1.6	05/99→04/00	APF	Petrol	1595	4	116
GOLF IV Variant (1J5)	1.6	02/00→06/00	ATN	Petrol	1598	4	119
GOLF IV Variant (1J5)	1.6	02/00→06/00	AUS	Petrol	1598	4	121
GOLF IV Variant (1J5)	1.6	08/00→06/00	AVU	Petrol	1595	4	122
GOLF IV Variant (1J5)	1.6	02/00→06/00	AZD	Petrol	1598	4	126
GOLF IV Variant (1J5)	1.6	01/00→06/00	BAD	Petrol	1598	4	127
GOLF IV Variant (1J5)	1.6	02/00→06/00	BCB	Petrol	1598	4	130
GOLF IV Variant (1J5)	1.6	08/00→06/00	BFQ	Petrol	1595	4	131
GOLF IV Variant (1J5)	1.8	05/99→06/00	AGN	Petrol	1781	4	188
GOLF IV Variant (1J5)	1.8	05/00→06/00	AGU	Petrol	1781	4	189
GOLF IV Variant (1J5)	1.8	05/00→06/00	AQA	Petrol	1781	4	197
GOLF IV Variant (1J5)	1.8	05/00→06/00	ARZ	Petrol	1781	4	200
GOLF IV Variant (1J5)	1.8	05/00→06/00	AUM	Petrol	1781	4	201
GOLF IV Variant (1J5)	1.9	05/99→06/00	AGP	Diesel	1896	4	253
GOLF IV Variant (1J5)	1.9	05/99→05/00	AGR	Diesel	1896	4	254
GOLF IV Variant (1J5)	1.9	05/99→06/00	AHF	Diesel	1896	4	255
GOLF IV Variant (1J5)	1.9	05/99→06/00	AJM	Diesel	1896	4	258
GOLF IV Variant (1J5)	1.9	05/99→05/00	ALH	Diesel	1896	4	260
GOLF IV Variant (1J5)	1.9	05/99→06/00	AQM	Diesel	1896	4	262
GOLF IV Variant (1J5)	1.9	05/00→06/00	ARL	Diesel	1896	4	263
GOLF IV Variant (1J5)	1.9	05/99→06/00	ASV	Diesel	1896	4	264
GOLF IV Variant (1J5)	1.9	11/00→06/00	ASZ	Diesel	1896	4	267
GOLF IV Variant (1J5)	1.9	09/00→06/00	ATD	Diesel	1896	4	268
GOLF IV Variant (1J5)	1.9	08/99→06/00	AUY	Diesel	1896	4	270
GOLF IV Variant (1J5)	1.9	09/00→06/00	AXR	Diesel	1896	4	278
GOLF IV Variant (1J5)	2.0	05/99→06/00	APK	Petrol	1984	4	311
GOLF IV Variant (1J5)	2.0	05/99→06/00	AQY	Petrol	1984	4	312
GOLF IV Variant (1J5)	2.0	10/00→06/00	AZH	Petrol	1984	4	322
GOLF IV Variant (1J5)	2.0	05/99→06/00	AZJ	Petrol	1984	4	323
GOLF IV Variant (1J5)	2.0	02/00→06/00	BEH	Bi-Fuel	1984	4	329
GOLF IV Variant (1J5)	2.3	05/99→06/00	AGZ	Petrol	2324	5	423
GOLF IV Variant (1J5)	2.3	10/00→06/00	AQN	Petrol	2324	5	424
GOLF IV Variant (1J5)	2.8	05/99→06/00	AQP	Petrol	2792	6	494
GOLF IV Variant (1J5)	2.8	05/99→06/00	AUE	Petrol	2792	6	497
GOLF IV Variant (1J5)	2.8	05/99→06/00	BDE	Petrol	2792	6	502
GOLF PLUS (5M1, 521)	1.2	05/01→	CBZA	Petrol	1197	4	22
GOLF PLUS (5M1, 521)	1.2	11/00→	CBZB	Petrol	1197	4	23
GOLF PLUS (5M1, 521)	1.4	01/00→	BCA	Petrol	1390	4	69
GOLF PLUS (5M1, 521)	1.4	05/00→06/00	BLG	Petrol	1390	4	73
GOLF PLUS (5M1, 521)	1.4	07/00→	BLN	Petrol	1390	4	74
GOLF PLUS (5M1, 521)	1.4	05/00→06/00	BMY	Petrol	1390	4	76
GOLF PLUS (5M1, 521)	1.4	05/00→	BUD	Petrol	1390	4	79
GOLF PLUS (5M1, 521)	1.4	06/00→	CAVD	Petrol	1390	4	85
GOLF PLUS (5M1, 521)	1.4	06/00→	CAXA	Petrol	1390	4	87
GOLF PLUS (5M1, 521)	1.4	05/00→	CGGA	Petrol	1390	4	90
GOLF PLUS (5M1, 521)	1.4	06/00→	CNWA	Petrol	1390	4	95
GOLF PLUS (5M1, 521)	1.6	01/00→05/00	BLF	Petrol	1598	4	135
GOLF PLUS (5M1, 521)	1.6	05/00→	BSE	Petrol	1595	4	138
GOLF PLUS (5M1, 521)	1.6	05/00→	BSF	Petrol	1595	4	139

	Ltr				CC		9
GOLF PLUS (5M1, 521)	1.6	02/00 →	CAYB	Diesel	1598	4	143
GOLF PLUS (5M1, 521)	1.6	03/00 →	CAYC	Diesel	1598	4	144
GOLF PLUS (5M1, 521)	1.6	05/00 →	CCSA	Petrol/Ethanol	1595	4	148
GOLF PLUS (5M1, 521)	1.6	05/00 →	CCSA	Petrol	1595	4	148
GOLF PLUS (5M1, 521)	1.6	05/00 →	CHGA	Petrol/Petroleum Gas (LPG)	1595	4	150
GOLF PLUS (5M1, 521)	1.6	05/00 →	CMXA	Petrol/Ethanol	1595	4	152
GOLF PLUS (5M1, 521)	1.6	05/00 →	CMXA	Petrol	1595	4	152
GOLF PLUS (5M1, 521)	1.9	01/00 → 01/00	BKC	Diesel	1896	4	283
GOLF PLUS (5M1, 521)	1.9	01/00 → 01/00	BLS	Diesel	1896	4	284
GOLF PLUS (5M1, 521)	1.9	05/00 → 12/00	BRU	Diesel	1896	4	289
GOLF PLUS (5M1, 521)	1.9	01/00 → 01/00	BXE	Diesel	1896	4	294
GOLF PLUS (5M1, 521)	1.9	05/00 → 12/00	BXF	Diesel	1896	4	295
GOLF PLUS (5M1, 521)	1.9	05/00 → 12/00	BXJ	Diesel	1896	4	296
GOLF PLUS (5M1, 521)	2.0	05/00 →	AZV	Diesel	1968	4	325
GOLF PLUS (5M1, 521)	2.0	01/00 →	BKD	Diesel	1968	4	338
GOLF PLUS (5M1, 521)	2.0	05/00 → 06/00	BLR	Petrol	1984	4	340
GOLF PLUS (5M1, 521)	2.0	05/00 → 06/00	BLY	Petrol	1984	4	342
GOLF PLUS (5M1, 521)	2.0	12/00 → 05/00	BMM	Diesel	1968	4	344
GOLF PLUS (5M1, 521)	2.0	05/00 → 06/00	BVY	Petrol	1984	4	356
GOLF PLUS (5M1, 521)	2.0	05/00 → 06/00	BVZ	Petrol	1984	4	357
GOLF PLUS (5M1, 521)	2.0	05/00 →	CBDA	Diesel	1968	4	373
GOLF PLUS (5M1, 521)	2.0	01/00 →	CBDB	Diesel	1968	4	374
GOLF PLUS (5M1, 521)	2.0	01/00 →	CBDC	Diesel	1968	4	375
GOLF PLUS (5M1, 521)	2.0	05/00 →	CFHB	Diesel	1968	4	395
GOLF PLUS (5M1, 521)	2.0	01/00 →	CFHC	Diesel	1968	4	396
GOLF PLUS (5M1, 521)	2.0	01/00 →	CLCA	Diesel	1968	4	406
GOLF V (1K1)	1.4	10/00 → 05/00	BCA	Petrol	1390	4	69
GOLF V (1K1)	1.4	10/00 → 07/00	BKG	Petrol	1390	4	70
GOLF V (1K1)	1.4	11/00 → 11/00	BLG	Petrol	1390	4	73
GOLF V (1K1)	1.4	10/00 → 07/00	BLN	Petrol	1390	4	74
GOLF V (1K1)	1.4	05/00 → 11/00	BMV	Petrol	1390	4	76
GOLF V (1K1)	1.4	05/00 → 11/00	BUD	Petrol	1390	4	79
GOLF V (1K1)	1.4	05/00 → 11/00	CAXA	Petrol	1390	4	87
GOLF V (1K1)	1.6	10/00 → 07/00	BAG	Petrol	1598	4	128
GOLF V (1K1)	1.6	01/00 → 11/00	BGU	Petrol	1595	4	133
GOLF V (1K1)	1.6	10/00 → 07/00	BLF	Petrol	1598	4	135
GOLF V (1K1)	1.6	10/00 → 07/00	BLP	Petrol	1598	4	136
GOLF V (1K1)	1.6	01/00 → 11/00	BSE	Petrol	1595	4	138
GOLF V (1K1)	1.6	01/00 → 11/00	BSF	Petrol	1595	4	139
GOLF V (1K1)	1.6	10/00 → 11/00	CCSA	Petrol/Ethanol	1595	4	148
GOLF V (1K1)	1.6	10/00 → 11/00	CCSA	Petrol	1595	4	148
GOLF V (1K1)	1.9	10/00 → 11/00	BKC	Diesel	1896	4	283
GOLF V (1K1)	1.9	10/00 → 11/00	BLS	Diesel	1896	4	284
GOLF V (1K1)	1.9	05/00 → 11/00	BRU	Diesel	1896	4	289
GOLF V (1K1)	1.9	10/00 → 11/00	BXE	Diesel	1896	4	294
GOLF V (1K1)	1.9	05/00 → 11/00	BXF	Diesel	1896	4	295
GOLF V (1K1)	1.9	05/00 → 11/00	BXJ	Diesel	1896	4	296
GOLF V (1K1)	2.0	01/00 → 11/00	AXW	Petrol	1984	4	319
GOLF V (1K1)	2.0	10/00 → 02/00	AXX	Petrol	1984	4	320
GOLF V (1K1)	2.0	10/00 → 11/00	AZV	Diesel	1968	4	325
GOLF V (1K1)	2.0	01/00 → 11/00	BDK	Diesel	1968	4	328
GOLF V (1K1)	2.0	10/00 → 11/00	BKD	Diesel	1968	4	338
GOLF V (1K1)	2.0	01/00 → 11/00	BLR	Petrol	1984	4	340
GOLF V (1K1)	2.0	01/00 → 11/00	BLX	Petrol	1984	4	341
GOLF V (1K1)	2.0	01/00 → 11/00	BLY	Petrol	1984	4	342
GOLF V (1K1)	2.0	08/00 → 11/00	BMM	Diesel	1968	4	344
GOLF V (1K1)	2.0	11/00 → 11/00	BMN	Diesel	1968	4	345
GOLF V (1K1)	2.0	10/00 → 02/00	BPY	Petrol	1984	4	348
GOLF V (1K1)	2.0	01/00 → 11/00	BVX	Petrol	1984	4	355
GOLF V (1K1)	2.0	01/00 → 11/00	BVY	Petrol	1984	4	356
GOLF V (1K1)	2.0	01/00 → 11/00	BVZ	Petrol	1984	4	357
GOLF V (1K1)	2.0	10/00 → 02/00	BWA	Petrol	1984	4	358
GOLF V (1K1)	2.0	09/00 → 12/00	BYD	Petrol	1984	4	360
GOLF V (1K1)	2.0	10/00 → 02/00	CAWB	Petrol	1984	4	367
GOLF V (1K1)	2.0	10/00 → 11/00	CBDA	Diesel	1968	4	373
GOLF V (1K1)	2.0	10/00 → 02/00	CBFA	Petrol	1984	4	376
GOLF V (1K1)	2.0	10/00 → 02/00	CCTA	Petrol	1984	4	380
GOLF V (1K1)	3.2	01/00 → 11/00	BJS	Petrol	3189	6	520
GOLF V (1K1)	3.2	09/00 → 11/00	BUB	Petrol	3189	6	529
GOLF V (1K1)	3.2	11/00 → 11/00	CBRA	Petrol	3189	6	530



Ltr



CC



9

Model	Ltr	Period	Code	Fuel	CC	Year	Price
GOLF V Variant (1K5)	1.4	06/00→	BLG	Petrol	1390	4	73
GOLF V Variant (1K5)	1.4	06/00→	BMV	Petrol	1390	4	76
GOLF V Variant (1K5)	1.4	06/00→	BUD	Petrol	1390	4	79
GOLF V Variant (1K5)	1.4	07/00→	CAVD	Petrol	1390	4	85
GOLF V Variant (1K5)	1.4	06/00→	CAXA	Petrol	1390	4	87
GOLF V Variant (1K5)	1.6	06/00→	BSE	Petrol	1595	4	138
GOLF V Variant (1K5)	1.6	06/00→	BSF	Petrol	1595	4	139
GOLF V Variant (1K5)	1.6	06/00→	CCSA	Petrol/Ethanol	1595	4	148
GOLF V Variant (1K5)	1.6	06/00→	CCSA	Petrol	1595	4	148
GOLF V Variant (1K5)	1.9	06/00→	BLS	Diesel	1896	4	284
GOLF V Variant (1K5)	1.9	06/00→	BXE	Diesel	1896	4	294
GOLF V Variant (1K5)	2.0	06/00→	AZV	Diesel	1968	4	325
GOLF V Variant (1K5)	2.0	06/00→	BKD	Diesel	1968	4	338
GOLF V Variant (1K5)	2.0	06/00→	BMM	Diesel	1968	4	344
GOLF V Variant (1K5)	2.0	06/00→	BWA	Petrol	1984	4	358
GOLF V Variant (1K5)	2.0	06/00→	CAWB	Petrol	1984	4	367
GOLF V Variant (1K5)	2.0	06/00→	CBDB	Diesel	1968	4	374
GOLF V Variant (1K5)	2.0	06/00→	CCTA	Petrol	1984	4	380
GOLF VI (5K1)	1.2	05/01→11/01	CBZA	Petrol	1197	4	22
GOLF VI (5K1)	1.2	05/00→11/01	CBZB	Petrol	1197	4	23
GOLF VI (5K1)	1.4	10/00→11/01	CAVD	Petrol	1390	4	85
GOLF VI (5K1)	1.4	10/00→11/01	CAXA	Petrol	1390	4	87
GOLF VI (5K1)	1.4	10/00→11/01	CGGA	Petrol	1390	4	90
GOLF VI (5K1)	1.4	10/00→11/01	CNWA	Petrol	1390	4	95
GOLF VI (5K1)	1.6	10/00→11/01	BSE	Petrol	1595	4	138
GOLF VI (5K1)	1.6	10/00→11/01	BSF	Petrol	1595	4	139
GOLF VI (5K1)	1.6	02/00→11/01	CAYB	Diesel	1598	4	143
GOLF VI (5K1)	1.6	02/00→11/01	CAYC	Diesel	1598	4	144
GOLF VI (5K1)	1.6	10/00→11/01	CCSA	Petrol/Ethanol	1595	4	148
GOLF VI (5K1)	1.6	10/00→11/01	CCSA	Petrol	1595	4	148
GOLF VI (5K1)	1.6	03/00→11/01	CHGA	Petrol/Petroleum Gas (LPG)	1595	4	150
GOLF VI (5K1)	1.6	10/00→11/01	CMXA	Petrol/Ethanol	1595	4	152
GOLF VI (5K1)	1.6	10/00→11/01	CMXA	Petrol	1595	4	152
GOLF VI (5K1)	1.8	06/00→01/01	CDAA	Petrol	1798	4	218
GOLF VI (5K1)	2.0	10/00→11/01	CBAA	Diesel	1968	4	368
GOLF VI (5K1)	2.0	10/00→05/01	CBAB	Diesel	1968	4	369
GOLF VI (5K1)	2.0	04/00→11/01	CBBB	Diesel	1968	4	372
GOLF VI (5K1)	2.0	10/00→11/01	CBDC	Diesel	1968	4	375
GOLF VI (5K1)	2.0	06/00→11/01	CBFA	Petrol	1984	4	376
GOLF VI (5K1)	2.0	06/00→11/01	CCTA	Petrol	1984	4	380
GOLF VI (5K1)	2.0	06/00→11/01	CCZA	Petrol	1984	4	382
GOLF VI (5K1)	2.0	04/00→11/01	CCZB	Petrol	1984	4	383
GOLF VI (5K1)	2.0	11/00→05/01	CDLA	Petrol	1984	4	387
GOLF VI (5K1)	2.0	11/00→11/01	CDLC	Petrol	1984	4	388
GOLF VI (5K1)	2.0	11/00→11/01	CDLF	Petrol	1984	4	389
GOLF VI (5K1)	2.0	10/00→11/01	CFFA	Diesel	1968	4	390
GOLF VI (5K1)	2.0	10/00→05/01	CFFB	Diesel	1968	4	391
GOLF VI (5K1)	2.0	04/00→11/01	CFGB	Diesel	1968	4	394
GOLF VI (5K1)	2.0	10/00→05/01	CJAA	Diesel	1968	4	400
GOLF VI (5K1)	2.0	10/00→11/01	CLCA	Diesel	1968	4	406
GOLF VI Convertible (517)	1.2	03/01→11/01	CBZB	Petrol	1197	4	23
GOLF VI Convertible (517)	1.4	03/01→	CAVD	Petrol	1390	4	85
GOLF VI Convertible (517)	1.4	11/01→	CAXA	Petrol	1390	4	87
GOLF VI Convertible (517)	1.4	03/01→	CNWA	Petrol	1390	4	95
GOLF VI Convertible (517)	1.6	03/01→	CAYC	Diesel	1598	4	144
GOLF VI Convertible (517)	2.0	11/01→	CCZB	Petrol	1984	4	383
GOLF VI Convertible (517)	2.0	01/01→	CDLA	Petrol	1984	4	387
GOLF VI Convertible (517)	2.0	11/01→	CFHC	Diesel	1968	4	396
GOLF VI Variant (AJ5)	1.2	07/01→	CBZA	Petrol	1197	4	22
GOLF VI Variant (AJ5)	1.2	08/00→	CBZB	Petrol	1197	4	23
GOLF VI Variant (AJ5)	1.4	07/00→	BUD	Petrol	1390	4	79
GOLF VI Variant (AJ5)	1.4	07/00→	CAVD	Petrol	1390	4	85
GOLF VI Variant (AJ5)	1.4	07/00→	CAXA	Petrol	1390	4	87
GOLF VI Variant (AJ5)	1.4	07/00→	CGGA	Petrol	1390	4	90
GOLF VI Variant (AJ5)	1.4	07/00→	CNWA	Petrol	1390	4	95
GOLF VI Variant (AJ5)	1.6	07/00→	BSE	Petrol	1595	4	138
GOLF VI Variant (AJ5)	1.6	07/00→	BSF	Petrol	1595	4	139
GOLF VI Variant (AJ5)	1.6	12/00→	CAYB	Diesel	1598	4	143
GOLF VI Variant (AJ5)	1.6	07/00→	CAYC	Diesel	1598	4	144
GOLF VI Variant (AJ5)	1.6	07/00→	CCSA	Petrol/Ethanol	1595	4	148



Ltr



CC



9

GOLF VI Variant (AJ5)	1.6	07/00 →	CCSA	Petrol	1595	4	148
GOLF VI Variant (AJ5)	1.6	07/00 →	CMXA	Petrol/Ethanol	1595	4	152
GOLF VI Variant (AJ5)	1.6	07/00 →	CMXA	Petrol	1595	4	152
GOLF VI Variant (AJ5)	2.0	07/00 →	BMM	Diesel	1968	4	344
GOLF VI Variant (AJ5)	2.0	07/00 →	CBDA	Diesel	1968	4	373
GOLF VI Variant (AJ5)	2.0	07/00 →	CBDB	Diesel	1968	4	374
GOLF VI Variant (AJ5)	2.0	07/00 →	CCZA	Petrol	1984	4	382
GOLF VI Variant (AJ5)	2.0	07/00 →	CFHB	Diesel	1968	4	395
GOLF VI Variant (AJ5)	2.0	07/00 →	CFHC	Diesel	1968	4	396
GOLF VI Variant (AJ5)	2.0	07/00 →	CJAA	Diesel	1968	4	400
GOLF VI Variant (AJ5)	2.0	01/01 →	CLCA	Diesel	1968	4	406
GOLF VI Variant (AJ5)	2.0	07/00 →	CLCB	Diesel	1968	4	407
ILTIS (183)	1.6	08/98 →12/98	1C	Diesel	1588	4	96
ILTIS (183)	1.7	03/97 →12/98	WL	Petrol	1714	4	174
ILTIS (183)	1.7	03/97 →12/98	YX	Petrol	1714	4	175
JETTA II (19E, 1G2, 165)	1.3	06/98 →12/99	2G	Petrol	1272	4	30
JETTA II (19E, 1G2, 165)	1.3	06/98 →12/99	MH	Petrol	1272	4	38
JETTA II (19E, 1G2, 165)	1.3	06/98 →12/99	NZ	Petrol	1272	4	40
JETTA II (19E, 1G2, 165)	1.6	01/99 →10/99	IV	Diesel	1589	4	98
JETTA II (19E, 1G2, 165)	1.6	01/98 →07/99	ABN	Petrol	1595	4	99
JETTA II (19E, 1G2, 165)	1.6	01/98 →07/99	EZ	Petrol	1595	4	155
JETTA II (19E, 1G2, 165)	1.6	01/98 →07/99	HM	Petrol	1595	4	156
JETTA II (19E, 1G2, 165)	1.6	01/98 →10/99	MF	Diesel	1588	4	159
JETTA II (19E, 1G2, 165)	1.6	10/98 →10/99	PN	Petrol	1595	4	160
JETTA II (19E, 1G2, 165)	1.6	04/98 →10/99	RA	Diesel	1588	4	162
JETTA II (19E, 1G2, 165)	1.6	03/98 →10/99	RF	Petrol	1595	4	164
JETTA II (19E, 1G2, 165)	1.6	04/98 →10/99	SB	Diesel	1588	4	166
JETTA II (19E, 1G2, 165)	1.8	08/98 →07/99	1P	Petrol	1781	4	177
JETTA II (19E, 1G2, 165)	1.8	01/98 →10/99	EV	Petrol	1781	4	224
JETTA II (19E, 1G2, 165)	1.8	08/98 →10/99	GU	Petrol	1781	4	226
JETTA II (19E, 1G2, 165)	1.8	08/98 →10/99	GX	Petrol	1781	4	227
JETTA II (19E, 1G2, 165)	1.8	01/98 →10/99	GZ	Petrol	1781	4	228
JETTA II (19E, 1G2, 165)	1.8	08/98 →10/99	HV	Petrol	1781	4	229
JETTA II (19E, 1G2, 165)	1.8	06/98 →12/98	KR	Petrol	1781	4	234
JETTA II (19E, 1G2, 165)	1.8	01/98 →10/99	PB	Petrol	1781	4	235
JETTA II (19E, 1G2, 165)	1.8	01/98 →10/99	PF	Petrol	1781	4	237
JETTA II (19E, 1G2, 165)	1.8	08/98 →10/99	PL	Petrol	1781	4	239
JETTA II (19E, 1G2, 165)	1.8	08/98 →01/99	RH	Petrol	1781	4	240
JETTA II (19E, 1G2, 165)	1.8	08/98 →10/99	RP	Petrol	1781	4	242
JETTA III (1K2)	1.4	07/00 →10/01	BLG	Petrol	1390	4	73
JETTA III (1K2)	1.4	07/00 →10/01	BMY	Petrol	1390	4	76
JETTA III (1K2)	1.4	07/00 →10/01	CAVD	Petrol	1390	4	85
JETTA III (1K2)	1.4	05/00 →10/01	CAXA	Petrol	1390	4	87
JETTA III (1K2)	1.6	10/00 →10/01	BGU	Petrol	1595	4	133
JETTA III (1K2)	1.6	09/00 →10/01	BLF	Petrol	1598	4	135
JETTA III (1K2)	1.6	10/00 →10/01	BSE	Petrol	1595	4	138
JETTA III (1K2)	1.6	10/00 →10/01	BSF	Petrol	1595	4	139
JETTA III (1K2)	1.6	12/00 →10/01	CAYB	Diesel	1598	4	143
JETTA III (1K2)	1.6	06/00 →10/01	CAYC	Diesel	1598	4	144
JETTA III (1K2)	1.6	10/00 →10/01	CCSA	Petrol/Ethanol	1595	4	148
JETTA III (1K2)	1.6	10/00 →10/01	CCSA	Petrol	1595	4	148
JETTA III (1K2)	1.9	08/00 →10/01	BKC	Diesel	1896	4	283
JETTA III (1K2)	1.9	08/00 →10/01	BLS	Diesel	1896	4	284
JETTA III (1K2)	1.9	08/00 →10/01	BXE	Diesel	1896	4	294
JETTA III (1K2)	2.0	10/00 →10/01	AXX	Petrol	1984	4	320
JETTA III (1K2)	2.0	09/00 →10/01	AZV	Diesel	1968	4	325
JETTA III (1K2)	2.0	08/00 →10/01	BKD	Diesel	1968	4	338
JETTA III (1K2)	2.0	08/00 →10/01	BLR	Petrol	1984	4	340
JETTA III (1K2)	2.0	08/00 →10/01	BLX	Petrol	1984	4	341
JETTA III (1K2)	2.0	08/00 →10/01	BLY	Petrol	1984	4	342
JETTA III (1K2)	2.0	10/00 →10/01	BMM	Diesel	1968	4	344
JETTA III (1K2)	2.0	10/00 →10/01	BMN	Diesel	1968	4	345
JETTA III (1K2)	2.0	10/00 →10/01	BPY	Petrol	1984	4	348
JETTA III (1K2)	2.0	08/00 →10/01	BVY	Petrol	1984	4	356
JETTA III (1K2)	2.0	08/00 →10/01	BVZ	Petrol	1984	4	357
JETTA III (1K2)	2.0	10/00 →10/01	BWA	Petrol	1984	4	358
JETTA III (1K2)	2.0	03/00 →10/01	CAWA	Petrol	1984	4	366
JETTA III (1K2)	2.0	10/00 →10/01	CAWB	Petrol	1984	4	367
JETTA III (1K2)	2.0	09/00 →10/01	CBDA	Diesel	1968	4	373
JETTA III (1K2)	2.0	08/00 →10/01	CBDB	Diesel	1968	4	374



Ltr







CC



9

JETTA III (1K2)	2.0	10/00→10/01	CBFA	Petrol	1984	4	376
JETTA III (1K2)	2.0	10/00→10/01	CCTA	Petrol	1984	4	380
JETTA III (1K2)	2.0	10/00→10/01	CCZA	Petrol	1984	4	382
JETTA III (1K2)	2.0	08/00→10/01	CJAA	Diesel	1968	4	400
JETTA III (1K2)	2.5	07/00→10/01	CBUA	Petrol	2480	5	477
JETTA III (1K2)	2.5	07/00→10/01	CCCA	Petrol	2480	5	478
JETTA IV (162)	1.2	02/01→	CBZB	Petrol	1197	4	23
JETTA IV (162)	1.4	04/01→	CAVA	Petrol	1390	4	82
JETTA IV (162)	1.4	04/01→	CAVD	Petrol	1390	4	85
JETTA IV (162)	1.4	05/01→	CAXA	Petrol	1390	4	87
JETTA IV (162)	1.6	02/01→	CAYC	Diesel	1598	4	144
JETTA IV (162)	2.0	12/01→	CBFA	Petrol	1984	4	376
JETTA IV (162)	2.0	06/01→	CBPA	Petrol	1984	4	377
JETTA IV (162)	2.0	12/01→	CCTA	Petrol	1984	4	380
JETTA IV (162)	2.0	12/01→	CCZA	Petrol	1984	4	382
JETTA IV (162)	2.0	02/01→	CFFB	Diesel	1968	4	391
JETTA IV (162)	2.0	02/01→	CFHC	Diesel	1968	4	396
JETTA IV (162)	2.0	02/01→	CJAA	Diesel	1968	4	400
JETTA IV (162)	2.0	06/01→	CKJA	Petrol	1984	4	401
JETTA IV (162)	2.0	10/01→	CLCA	Diesel	1968	4	406
JETTA IV (162)	2.0	02/01→	CLCB	Diesel	1968	4	407
JETTA IV (162)	2.5	04/01→	CBUA	Petrol	2480	5	477
JETTA IV (162)	2.5	04/01→	CCCA	Petrol	2480	5	478
KAEFER	1.6	05/97→09/99	AF	Petrol	1584	4	106
LT 28-35 I Box (281-363)	2.4	03/99→06/99	1E	Petrol	2383	6	426
LT 28-35 I Box (281-363)	2.4	08/98→08/99	1G	Diesel	2383	6	427
LT 28-35 I Box (281-363)	2.4	07/99→05/99	1S	Diesel	2383	6	428
LT 28-35 I Box (281-363)	2.4	06/99→05/99	ACL	Diesel	2383	6	430
LT 28-35 I Box (281-363)	2.4	07/99→05/99	ACT	Diesel	2383	6	431
LT 28-35 I Box (281-363)	2.4	01/97→07/99	CP	Diesel	2383	6	433
LT 28-35 I Box (281-363)	2.4	12/98→07/99	DL	Petrol	2383	6	434
LT 28-35 I Box (281-363)	2.4	02/98→08/99	DV	Diesel	2383	6	435
LT 28-35 I Box (281-363)	2.4	01/97→07/99	DW	Diesel	2383	6	436
LT 28-35 I Bus (281-363)	2.4	08/98→06/99	1E	Petrol	2383	6	426
LT 28-35 I Bus (281-363)	2.4	08/98→08/99	1G	Diesel	2383	6	427
LT 28-35 I Bus (281-363)	2.4	08/98→06/99	1S	Diesel	2383	6	428
LT 28-35 I Bus (281-363)	2.4	09/99→06/99	ACL	Diesel	2383	6	430
LT 28-35 I Bus (281-363)	2.4	08/98→06/99	ACT	Diesel	2383	6	431
LT 28-35 I Bus (281-363)	2.4	01/97→07/99	CP	Diesel	2383	6	433
LT 28-35 I Bus (281-363)	2.4	12/98→07/99	DL	Petrol	2383	6	434
LT 28-35 I Bus (281-363)	2.4	12/98→07/98	DV	Diesel	2383	6	435
LT 28-35 I Bus (281-363)	2.4	01/97→07/99	DW	Diesel	2383	6	436
LT 28-35 I Platform/Chassis (281-363)	2.4	08/99→06/99	1E	Petrol	2383	6	426
LT 28-35 I Platform/Chassis (281-363)	2.4	08/99→08/99	1G	Diesel	2383	6	427
LT 28-35 I Platform/Chassis (281-363)	2.4	08/99→06/99	1S	Diesel	2383	6	428
LT 28-35 I Platform/Chassis (281-363)	2.4	08/99→06/99	ACL	Diesel	2383	6	430
LT 28-35 I Platform/Chassis (281-363)	2.4	08/99→06/99	ACT	Diesel	2383	6	431
LT 28-35 I Platform/Chassis (281-363)	2.4	12/97→02/99	CP	Diesel	2383	6	433
LT 28-35 I Platform/Chassis (281-363)	2.4	12/98→07/99	DL	Petrol	2383	6	434
LT 28-35 I Platform/Chassis (281-363)	2.4	12/98→09/99	DV	Diesel	2383	6	435
LT 28-35 I Platform/Chassis (281-363)	2.4	12/97→07/99	DW	Diesel	2383	6	436
LT 28-35 II Bus (2DB, 2DE, 2DK)	2.3	05/99→07/00	AGL	Petrol	2295	4	422
LT 28-35 II Bus (2DB, 2DE, 2DK)	2.5	07/99→07/00	AGX	Diesel	2461	5	444
LT 28-35 II Bus (2DB, 2DE, 2DK)	2.5	05/99→08/99	AHD	Diesel	2461	5	445
LT 28-35 II Bus (2DB, 2DE, 2DK)	2.5	05/99→07/00	ANJ	Diesel	2461	5	449
LT 28-35 II Bus (2DB, 2DE, 2DK)	2.5	05/99→07/00	APA	Diesel	2461	5	450
LT 28-35 II Bus (2DB, 2DE, 2DK)	2.5	05/99→07/00	AVR	Diesel	2461	5	453
LT 28-35 II Bus (2DB, 2DE, 2DK)	2.5	05/00→07/00	BBE	Diesel	2461	5	463
LT 28-35 II Bus (2DB, 2DE, 2DK)	2.5	05/00→07/00	BBF	Diesel	2461	5	464
LT 28-35 II Bus (2DB, 2DE, 2DK)	2.8	02/99→12/99	AGK	Diesel	2799	4	487
LT 28-35 II Bus (2DB, 2DE, 2DK)	2.8	01/99→01/00	ATA	Diesel	2799	4	495
LT 28-35 II Bus (2DB, 2DE, 2DK)	2.8	05/00→06/00	BCQ	Diesel	2798	4	501
LT 28-46 II Box (2DA, 2DD, 2DH)	2.3	05/99→07/00	AGL	Petrol	2295	4	422
LT 28-46 II Box (2DA, 2DD, 2DH)	2.5	09/99→07/00	AGX	Diesel	2461	5	444
LT 28-46 II Box (2DA, 2DD, 2DH)	2.5	05/99→08/99	AHD	Diesel	2461	5	445
LT 28-46 II Box (2DA, 2DD, 2DH)	2.5	05/99→07/00	ANJ	Diesel	2461	5	449
LT 28-46 II Box (2DA, 2DD, 2DH)	2.5	05/99→07/00	APA	Diesel	2461	5	450
LT 28-46 II Box (2DA, 2DD, 2DH)	2.5	05/99→07/00	AVR	Diesel	2461	5	453
LT 28-46 II Box (2DA, 2DD, 2DH)	2.5	05/00→07/00	BBE	Diesel	2461	5	463
LT 28-46 II Box (2DA, 2DD, 2DH)	2.5	05/00→07/00	BBF	Diesel	2461	5	464

	Ltr				CC		9
LT 28-46 II Box (2DA, 2DD, 2DH)	2.8	06/99→12/99	AGK	Diesel	2799	4	487
LT 28-46 II Box (2DA, 2DD, 2DH)	2.8	01/99→07/00	ATA	Diesel	2799	4	495
LT 28-46 II Box (2DA, 2DD, 2DH)	2.8	04/00→07/00	AUH	Diesel	2799	4	498
LT 28-46 II Box (2DA, 2DD, 2DH)	2.8	04/00→07/00	BCQ	Diesel	2798	4	501
LT 28-46 II Platform/Chassis (2DC, 2DF, 2DG, 2DL, 2DM)	2.3	06/99→07/00	AGL	Petrol	2295	4	422
LT 28-46 II Platform/Chassis (2DC, 2DF, 2DG, 2DL, 2DM)	2.5	09/99→07/00	AGX	Diesel	2461	5	444
LT 28-46 II Platform/Chassis (2DC, 2DF, 2DG, 2DL, 2DM)	2.5	06/99→08/99	AHD	Diesel	2461	5	445
LT 28-46 II Platform/Chassis (2DC, 2DF, 2DG, 2DL, 2DM)	2.5	05/99→07/00	ANJ	Diesel	2461	5	449
LT 28-46 II Platform/Chassis (2DC, 2DF, 2DG, 2DL, 2DM)	2.5	05/99→07/00	APA	Diesel	2461	5	450
LT 28-46 II Platform/Chassis (2DC, 2DF, 2DG, 2DL, 2DM)	2.5	05/99→07/00	AVR	Diesel	2461	5	453
LT 28-46 II Platform/Chassis (2DC, 2DF, 2DG, 2DL, 2DM)	2.5	05/00→07/00	BBE	Diesel	2461	5	463
LT 28-46 II Platform/Chassis (2DC, 2DF, 2DG, 2DL, 2DM)	2.5	05/00→07/00	BBF	Diesel	2461	5	464
LT 28-46 II Platform/Chassis (2DC, 2DF, 2DG, 2DL, 2DM)	2.8	06/99→12/99	AGK	Diesel	2799	4	487
LT 28-46 II Platform/Chassis (2DC, 2DF, 2DG, 2DL, 2DM)	2.8	01/99→07/00	ATA	Diesel	2799	4	495
LT 28-46 II Platform/Chassis (2DC, 2DF, 2DG, 2DL, 2DM)	2.8	04/00→07/00	AUH	Diesel	2799	4	498
LT 28-46 II Platform/Chassis (2DC, 2DF, 2DG, 2DL, 2DM)	2.8	04/00→07/00	BCQ	Diesel	2798	4	501
LT 40-55 I Box (291-512)	2.4	01/99→06/99	1E	Petrol	2383	6	426
LT 40-55 I Box (291-512)	2.4	08/98→08/99	1G	Diesel	2383	6	427
LT 40-55 I Box (291-512)	2.4	07/99→05/99	1S	Diesel	2383	6	428
LT 40-55 I Box (291-512)	2.4	06/99→05/99	ACL	Diesel	2383	6	430
LT 40-55 I Box (291-512)	2.4	07/99→05/99	ACT	Diesel	2383	6	431
LT 40-55 I Box (291-512)	2.4	01/97→07/99	CP	Diesel	2383	6	433
LT 40-55 I Box (291-512)	2.4	12/98→07/99	DL	Petrol	2383	6	434
LT 40-55 I Box (291-512)	2.4	08/97→08/99	DV	Diesel	2383	6	435
LT 40-55 I Box (291-512)	2.4	01/97→07/99	DW	Diesel	2383	6	436
LT 40-55 I Platform/Chassis (293-909)	2.4	08/98→06/99	1E	Petrol	2383	6	426
LT 40-55 I Platform/Chassis (293-909)	2.4	08/98→07/99	1G	Diesel	2383	6	427
LT 40-55 I Platform/Chassis (293-909)	2.4	08/99→06/99	1S	Diesel	2383	6	428
LT 40-55 I Platform/Chassis (293-909)	2.4	08/99→06/99	ACL	Diesel	2383	6	430
LT 40-55 I Platform/Chassis (293-909)	2.4	08/99→06/99	ACT	Diesel	2383	6	431
LT 40-55 I Platform/Chassis (293-909)	2.4	12/97→02/99	CP	Diesel	2383	6	433
LT 40-55 I Platform/Chassis (293-909)	2.4	12/98→07/98	DL	Petrol	2383	6	434
LT 40-55 I Platform/Chassis (293-909)	2.4	12/98→09/99	DV	Diesel	2383	6	435
LT 40-55 I Platform/Chassis (293-909)	2.4	12/97→02/99	DW	Diesel	2383	6	436
LUPO (6X1, 6E1)	1.0	09/99→07/00	AER	Petrol	999	4	4
LUPO (6X1, 6E1)	1.0	10/99→05/00	AHT	Petrol	997	4	6
LUPO (6X1, 6E1)	1.0	09/99→07/00	ALD	Petrol	999	4	7
LUPO (6X1, 6E1)	1.0	09/99→07/00	ALL	Petrol	999	4	8
LUPO (6X1, 6E1)	1.0	09/99→07/00	ANV	Petrol	999	4	9
LUPO (6X1, 6E1)	1.0	09/99→07/00	AUC	Petrol	999	4	10
LUPO (6X1, 6E1)	1.2	07/99→07/00	ANY	Diesel	1191	3	14
LUPO (6X1, 6E1)	1.2	07/99→07/00	AYZ	Diesel	1191	3	16
LUPO (6X1, 6E1)	1.4	08/99→07/00	AFK	Petrol	1390	4	46
LUPO (6X1, 6E1)	1.4	09/99→07/00	AHW	Petrol	1390	4	48
LUPO (6X1, 6E1)	1.4	09/99→07/00	AKQ	Petrol	1390	4	51
LUPO (6X1, 6E1)	1.4	01/99→07/00	AMF	Diesel	1422	3	53
LUPO (6X1, 6E1)	1.4	09/99→07/00	APE	Petrol	1390	4	56
LUPO (6X1, 6E1)	1.4	08/99→07/00	AQQ	Petrol	1390	4	58
LUPO (6X1, 6E1)	1.4	02/00→07/00	ARR	Petrol	1390	4	59
LUPO (6X1, 6E1)	1.4	09/99→07/00	AUA	Petrol	1390	4	61
LUPO (6X1, 6E1)	1.4	08/99→07/00	AUB	Petrol	1390	4	62
LUPO (6X1, 6E1)	1.4	10/00→07/00	AUD	Petrol	1390	4	63
LUPO (6X1, 6E1)	1.4	09/99→07/00	BBY	Petrol	1390	4	67
LUPO (6X1, 6E1)	1.6	09/00→07/00	AVY	Petrol	1598	4	123
LUPO (6X1, 6E1)	1.7	09/99→07/00	AKU	Diesel	1716	4	171
MULTIVAN V (7HM, 7HN, 7HF, 7EF, 7EM, 7EN)	1.9	04/00→11/00	AXB	Diesel	1896	4	276
MULTIVAN V (7HM, 7HN, 7HF, 7EF, 7EM, 7EN)	1.9	04/00→11/00	AXC	Diesel	1896	4	277
MULTIVAN V (7HM, 7HN, 7HF, 7EF, 7EM, 7EN)	1.9	01/00→11/00	BRR	Diesel	1896	4	287
MULTIVAN V (7HM, 7HN, 7HF, 7EF, 7EM, 7EN)	1.9	06/00→11/00	BRS	Diesel	1896	4	288
MULTIVAN V (7HM, 7HN, 7HF, 7EF, 7EM, 7EN)	2.0	11/00→	AXA	Petrol	1984	4	318
MULTIVAN V (7HM, 7HN, 7HF, 7EF, 7EM, 7EN)	2.0	09/00→	CAAA	Diesel	1968	4	361
MULTIVAN V (7HM, 7HN, 7HF, 7EF, 7EM, 7EN)	2.0	09/00→	CAAB	Diesel	1968	4	362
MULTIVAN V (7HM, 7HN, 7HF, 7EF, 7EM, 7EN)	2.0	09/00→	CAAC	Diesel	1968	4	363
MULTIVAN V (7HM, 7HN, 7HF, 7EF, 7EM, 7EN)	2.0	05/01→	CAAD	Diesel	1968	4	364
MULTIVAN V (7HM, 7HN, 7HF, 7EF, 7EM, 7EN)	2.0	05/01→	CAAE	Diesel	1968	4	365
MULTIVAN V (7HM, 7HN, 7HF, 7EF, 7EM, 7EN)	2.0	09/00→	CCHA	Diesel	1968	4	378
MULTIVAN V (7HM, 7HN, 7HF, 7EF, 7EM, 7EN)	2.0	05/01→	CCHB	Diesel	1968	4	379
MULTIVAN V (7HM, 7HN, 7HF, 7EF, 7EM, 7EN)	2.5	04/00→11/00	AXD	Diesel	2461	5	455
MULTIVAN V (7HM, 7HN, 7HF, 7EF, 7EM, 7EN)	2.5	04/00→11/00	AXE	Diesel	2461	5	456
MULTIVAN V (7HM, 7HN, 7HF, 7EF, 7EM, 7EN)	2.5	11/00→11/00	BLJ	Diesel	2461	5	471



Ltr







CC



9

MULTIVAN V (7HM, 7HN, 7HF, 7EF, 7EM, 7EN)	2.5	04/00→11/00	BNZ	Diesel	2461	5	473
MULTIVAN V (7HM, 7HN, 7HF, 7EF, 7EM, 7EN)	2.5	04/00→11/00	BPC	Diesel	2461	5	474
MULTIVAN V (7HM, 7HN, 7HF, 7EF, 7EM, 7EN)	3.2	02/00→06/00	BDL	Petrol	3189	6	518
MULTIVAN V (7HM, 7HN, 7HF, 7EF, 7EM, 7EN)	3.2	02/00→11/00	BKK	Petrol	3189	6	522
MULTIVAN V (7HM, 7HN, 7HF, 7EF, 7EM, 7EN)	3.2	02/00→11/00	CFLA	Petrol	3189	6	531
NEW BEETLE (9C1, 1C1)	1.4	11/00→	BCA	Petrol	1390	4	69
NEW BEETLE (9C1, 1C1)	1.6	10/99→09/00	AWH	Petrol	1595	4	124
NEW BEETLE (9C1, 1C1)	1.6	06/00→	AYD	Petrol	1595	4	125
NEW BEETLE (9C1, 1C1)	1.6	06/00→	BFS	Petrol	1595	4	132
NEW BEETLE (9C1, 1C1)	1.8	10/99→	AGU	Petrol	1781	4	189
NEW BEETLE (9C1, 1C1)	1.8	10/99→	APH	Petrol	1781	4	194
NEW BEETLE (9C1, 1C1)	1.8	10/99→	AVC	Petrol	1781	4	203
NEW BEETLE (9C1, 1C1)	1.8	11/00→06/00	AWP	Petrol	1781	4	207
NEW BEETLE (9C1, 1C1)	1.8	10/99→	AWU	Petrol	1781	4	209
NEW BEETLE (9C1, 1C1)	1.8	10/99→	AWV	Petrol	1781	4	210
NEW BEETLE (9C1, 1C1)	1.8	10/99→	BKF	Petrol	1781	4	214
NEW BEETLE (9C1, 1C1)	1.8	11/00→06/00	BNU	Petrol	1781	4	215
NEW BEETLE (9C1, 1C1)	1.9	01/99→06/00	ALH	Diesel	1896	4	260
NEW BEETLE (9C1, 1C1)	1.9	02/00→	ATD	Diesel	1896	4	268
NEW BEETLE (9C1, 1C1)	1.9	02/00→	BEW	Diesel	1896	4	280
NEW BEETLE (9C1, 1C1)	1.9	07/00→	BSW	Diesel	1896	4	291
NEW BEETLE (9C1, 1C1)	2.0	01/99→	AEG	Petrol	1984	4	306
NEW BEETLE (9C1, 1C1)	2.0	01/99→	APK	Petrol	1984	4	311
NEW BEETLE (9C1, 1C1)	2.0	01/99→	AQY	Petrol	1984	4	312
NEW BEETLE (9C1, 1C1)	2.0	01/99→	AVH	Petrol	1984	4	315
NEW BEETLE (9C1, 1C1)	2.0	01/99→	AZG	Petrol	1984	4	321
NEW BEETLE (9C1, 1C1)	2.0	01/99→	AZJ	Petrol	1984	4	323
NEW BEETLE (9C1, 1C1)	2.0	01/99→	BEJ	Petrol	1984	4	330
NEW BEETLE (9C1, 1C1)	2.0	01/99→	BER	Petrol	1984	4	331
NEW BEETLE (9C1, 1C1)	2.0	01/99→	BEV	Petrol	1984	4	332
NEW BEETLE (9C1, 1C1)	2.0	01/99→	BHP	Petrol	1984	4	336
NEW BEETLE (9C1, 1C1)	2.0	01/99→	CBPA	Petrol	1984	4	377
NEW BEETLE (9C1, 1C1)	2.3	10/00→	AQN	Petrol	2324	5	424
NEW BEETLE Convertible (1Y7)	1.4	01/00→09/01	BCA	Petrol	1390	4	69
NEW BEETLE Convertible (1Y7)	1.6	01/00→09/01	BFS	Petrol	1595	4	132
NEW BEETLE Convertible (1Y7)	1.8	01/00→09/01	AWU	Petrol	1781	4	209
NEW BEETLE Convertible (1Y7)	1.8	01/00→09/01	AWV	Petrol	1781	4	210
NEW BEETLE Convertible (1Y7)	1.8	01/00→09/01	BKF	Petrol	1781	4	214
NEW BEETLE Convertible (1Y7)	1.9	06/00→09/01	AXR	Diesel	1896	4	278
NEW BEETLE Convertible (1Y7)	1.9	07/00→09/01	BSW	Diesel	1896	4	291
NEW BEETLE Convertible (1Y7)	2.0	09/00→10/01	AZJ	Petrol	1984	4	323
NEW BEETLE Convertible (1Y7)	2.0	09/00→10/01	BDC	Petrol	1984	4	326
NEW BEETLE Convertible (1Y7)	2.0	09/00→10/01	BEV	Petrol	1984	4	332
NEW BEETLE Convertible (1Y7)	2.0	09/00→10/01	BGD	Petrol	1984	4	334
PARATI	1.8	01/00→05/00	BNY	Petrol	1781	4	216
PARATI	1.8	08/00→	UDH	Petrol	1781	4	243
PARATI	1.9	08/00→	BGG	Diesel	1896	4	281
PASSAT (3A2, 35I)	1.6	02/98→09/99	1F	Petrol	1595	4	97
PASSAT (3A2, 35I)	1.6	02/98→12/98	ABN	Petrol	1595	4	99
PASSAT (3A2, 35I)	1.6	10/99→08/99	AEK	Petrol	1595	4	105
PASSAT (3A2, 35I)	1.6	10/99→08/99	AFT	Petrol	1595	4	107
PASSAT (3A2, 35I)	1.6	02/98→09/99	EZ	Petrol	1595	4	155
PASSAT (3A2, 35I)	1.6	08/98→09/99	RA	Diesel	1588	4	162
PASSAT (3A2, 35I)	1.6	08/98→09/99	SB	Diesel	1588	4	166
PASSAT (3A2, 35I)	1.8	08/99→08/99	AAM	Petrol	1781	4	180
PASSAT (3A2, 35I)	1.8	02/98→08/99	ABS	Petrol	1781	4	181
PASSAT (3A2, 35I)	1.8	02/98→08/99	ADZ	Petrol	1781	4	185
PASSAT (3A2, 35I)	1.8	04/98→09/99	KR	Petrol	1781	4	234
PASSAT (3A2, 35I)	1.8	04/98→07/99	PB	Petrol	1781	4	235
PASSAT (3A2, 35I)	1.8	04/98→07/99	PF	Petrol	1781	4	237
PASSAT (3A2, 35I)	1.8	08/98→08/99	PG	Petrol	1781	4	238
PASSAT (3A2, 35I)	1.8	02/98→08/99	RP	Petrol	1781	4	242
PASSAT (3A2, 35I)	1.9	05/98→10/99	1Y	Diesel	1896	4	245
PASSAT (3A2, 35I)	1.9	10/99→08/99	1Z	Diesel	1896	4	246
PASSAT (3A2, 35I)	1.9	03/99→08/99	AAZ	Diesel	1896	4	247
PASSAT (3A2, 35I)	1.9	03/99→08/99	AFN	Diesel	1896	4	251
PASSAT (3A2, 35I)	1.9	10/99→08/99	AHU	Diesel	1896	4	257
PASSAT (3A2, 35I)	2.0	02/99→08/99	2E	Petrol	1984	4	301
PASSAT (3A2, 35I)	2.0	08/98→09/99	9A	Petrol	1984	4	302
PASSAT (3A2, 35I)	2.0	01/99→08/99	ABF	Petrol	1984	4	304

	Ltr				CC		9
PASSAT (3A2, 35I)	2.0	02/99 → 08/99	ADY	Petrol	1984	4	305
PASSAT (3A2, 35I)	2.0	03/99 → 08/99	AEP	Petrol	1984	4	307
PASSAT (3A2, 35I)	2.0	02/99 → 08/99	AGG	Petrol	1984	4	308
PASSAT (3A2, 35I)	2.8	06/99 → 08/99	AAA	Petrol	2792	6	483
PASSAT (3B2)	1.6	10/99 → 11/00	ADP	Petrol	1595	4	101
PASSAT (3B2)	1.6	10/99 → 11/00	AHL	Petrol	1595	4	108
PASSAT (3B2)	1.6	10/99 → 11/00	ANA	Petrol	1595	4	115
PASSAT (3B2)	1.6	10/99 → 11/00	ARM	Petrol	1595	4	118
PASSAT (3B2)	1.8	10/99 → 11/00	ADR	Petrol	1781	4	184
PASSAT (3B2)	1.8	10/99 → 11/00	AEB	Petrol	1781	4	186
PASSAT (3B2)	1.8	01/99 → 11/00	AFY	Petrol	1781	4	187
PASSAT (3B2)	1.8	10/99 → 11/00	ANB	Petrol	1781	4	191
PASSAT (3B2)	1.8	10/99 → 11/00	APT	Petrol	1781	4	195
PASSAT (3B2)	1.8	10/99 → 11/00	APU	Petrol	1781	4	196
PASSAT (3B2)	1.8	10/99 → 11/00	ARG	Petrol	1781	4	198
PASSAT (3B2)	1.9	10/99 → 11/00	AFN	Diesel	1896	4	251
PASSAT (3B2)	1.9	10/99 → 11/00	AHH	Diesel	1896	4	256
PASSAT (3B2)	1.9	10/99 → 11/00	AHU	Diesel	1896	4	257
PASSAT (3B2)	1.9	08/99 → 11/00	AJM	Diesel	1896	4	258
PASSAT (3B2)	1.9	08/99 → 11/00	ATJ	Diesel	1896	4	269
PASSAT (3B2)	1.9	02/00 → 11/00	AVB	Diesel	1896	4	271
PASSAT (3B2)	1.9	10/99 → 11/00	AVG	Diesel	1896	4	273
PASSAT (3B2)	2.3	10/99 → 11/00	AGZ	Petrol	2324	5	423
PASSAT (3B2)	2.5	07/99 → 11/00	AFB	Diesel	2496	6	443
PASSAT (3B2)	2.5	07/99 → 11/00	AKN	Diesel	2496	6	448
PASSAT (3B2)	2.8	08/99 → 11/00	ACK	Petrol	2771	6	484
PASSAT (3B2)	2.8	05/99 → 09/99	AGE	Petrol	2771	6	486
PASSAT (3B2)	2.8	10/99 → 11/00	ALG	Petrol	2771	6	488
PASSAT (3B2)	2.8	08/99 → 11/00	APR	Petrol	2771	6	492
PASSAT (3B2)	2.8	08/99 → 11/00	AQD	Petrol	2771	6	493
PASSAT (3B2)	2.8	09/99 → 11/00	ATX	Petrol	2771	6	496
PASSAT (3B2)	2.8	09/99 → 11/00	BBG	Petrol	2771	6	500
PASSAT (3B3)	1.6	11/00 → 05/00	ALZ	Petrol	1595	4	114
PASSAT (3B3)	1.8	03/00 → 03/00	APT	Petrol	1781	4	195
PASSAT (3B3)	1.8	11/00 → 05/00	AWL	Petrol	1781	4	205
PASSAT (3B3)	1.8	02/00 → 05/00	AWM	Petrol	1781	4	206
PASSAT (3B3)	1.8	11/00 → 05/00	AWT	Petrol	1781	4	208
PASSAT (3B3)	1.9	11/00 → 05/00	AVB	Diesel	1896	4	271
PASSAT (3B3)	1.9	11/00 → 05/00	AVF	Diesel	1896	4	272
PASSAT (3B3)	1.9	11/00 → 05/00	AWX	Diesel	1896	4	275
PASSAT (3B3)	2.0	11/00 → 05/00	ALT	Petrol	1984	4	310
PASSAT (3B3)	2.0	11/00 → 05/00	AZM	Petrol	1984	4	324
PASSAT (3B3)	2.0	11/00 → 05/00	BFF	Petrol	1984	4	333
PASSAT (3B3)	2.0	12/00 → 05/00	BGW	Diesel	1968	4	335
PASSAT (3B3)	2.0	12/00 → 05/00	BHW	Diesel	1968	4	337
PASSAT (3B3)	2.3	11/00 → 05/00	AZX	Petrol	2324	5	425
PASSAT (3B3)	2.5	11/00 → 05/00	AFB	Diesel	2496	6	443
PASSAT (3B3)	2.5	11/00 → 05/00	AKN	Diesel	2496	6	448
PASSAT (3B3)	2.5	01/00 → 05/00	BAU	Diesel	2496	6	462
PASSAT (3B3)	2.5	05/00 → 05/00	BDG	Diesel	2496	6	465
PASSAT (3B3)	2.5	01/00 → 05/00	BDH	Diesel	2496	6	466
PASSAT (3B3)	2.8	11/00 → 05/00	AMX	Petrol	2771	6	490
PASSAT (3C2)	1.4	05/00 → 07/01	CAXA	Petrol	1390	4	87
PASSAT (3C2)	1.4	01/00 → 07/01	CDGA	Petrol/Natural Gas (CNG)	1390	4	89
PASSAT (3C2)	1.4	01/00 → 07/01	CDGA	Natural Gas	1390	4	89
PASSAT (3C2)	1.4	01/00 → 07/01	CDGA	Bi-Fuel	1390	4	89
PASSAT (3C2)	1.6	03/00 → 06/00	BLF	Petrol	1598	4	135
PASSAT (3C2)	1.6	05/00 → 07/01	BSE	Petrol	1595	4	138
PASSAT (3C2)	1.6	05/00 → 07/01	BSF	Petrol	1595	4	139
PASSAT (3C2)	1.6	08/00 → 07/01	CAYC	Diesel	1598	4	144
PASSAT (3C2)	1.8	05/00 → 07/01	BZB	Petrol	1798	4	217
PASSAT (3C2)	1.8	05/00 → 07/01	CDAA	Petrol	1798	4	218
PASSAT (3C2)	1.8	11/00 → 07/01	CDAB	Petrol	1798	4	219
PASSAT (3C2)	1.8	11/00 → 07/01	CGYA	Petrol	1798	4	220
PASSAT (3C2)	1.9	03/00 → 11/00	BKC	Diesel	1896	4	283
PASSAT (3C2)	1.9	03/00 → 11/00	BLS	Diesel	1896	4	284
PASSAT (3C2)	1.9	03/00 → 11/00	BXE	Diesel	1896	4	294
PASSAT (3C2)	2.0	07/00 → 07/01	AXX	Petrol	1984	4	320
PASSAT (3C2)	2.0	03/00 →	BKP	Diesel	1968	4	339
PASSAT (3C2)	2.0	03/00 → 07/01	BLR	Petrol	1984	4	340



Ltr







CC



9

Model	Ltr	Year Range	Code	Fuel Type	CC	Other	Price
PASSAT (3C2)	2.0	09/00→07/01	BLX	Petrol	1984	4	341
PASSAT (3C2)	2.0	03/00→07/01	BLY	Petrol	1984	4	342
PASSAT (3C2)	2.0	03/00→11/01	BMA	Diesel	1968	4	343
PASSAT (3C2)	2.0	03/00→	BMP	Diesel	1968	4	346
PASSAT (3C2)	2.0	08/00→	BMR	Diesel	1968	4	347
PASSAT (3C2)	2.0	07/00→07/01	BPY	Petrol	1984	4	348
PASSAT (3C2)	2.0	08/00→	BUZ	Diesel	1968	4	352
PASSAT (3C2)	2.0	08/00→07/00	BVE	Diesel	1968	4	353
PASSAT (3C2)	2.0	09/00→07/01	BVX	Petrol	1984	4	355
PASSAT (3C2)	2.0	03/00→07/01	BVY	Petrol	1984	4	356
PASSAT (3C2)	2.0	03/00→07/01	BVZ	Petrol	1984	4	357
PASSAT (3C2)	2.0	07/00→07/01	BWA	Petrol	1984	4	358
PASSAT (3C2)	2.0	11/00→05/00	BWV	Diesel	1968	4	359
PASSAT (3C2)	2.0	07/00→07/01	CAWB	Petrol	1984	4	367
PASSAT (3C2)	2.0	03/00→11/01	CBAA	Diesel	1968	4	368
PASSAT (3C2)	2.0	03/00→	CBAB	Diesel	1968	4	369
PASSAT (3C2)	2.0	01/00→	CBAC	Diesel	1968	4	370
PASSAT (3C2)	2.0	08/00→	CBBB	Diesel	1968	4	372
PASSAT (3C2)	2.0	11/00→07/01	CBDC	Diesel	1968	4	375
PASSAT (3C2)	2.0	07/00→07/01	CBFA	Petrol	1984	4	376
PASSAT (3C2)	2.0	07/00→07/01	CCTA	Petrol	1984	4	380
PASSAT (3C2)	2.0	08/00→07/01	CCTB	Petrol	1984	4	381
PASSAT (3C2)	2.0	07/00→07/01	CCZA	Petrol	1984	4	382
PASSAT (3C2)	3.6	04/00→07/01	BWS	Petrol	3597	6	534
PASSAT (32B)	1.6	08/98→03/98	DT	Petrol	1595	4	153
PASSAT (32B)	1.6	08/98→03/98	PP	Petrol	1595	4	161
PASSAT (32B)	1.6	05/98→03/98	RA	Diesel	1588	4	162
PASSAT (32B)	1.6	02/98→03/98	RL	Petrol	1595	4	165
PASSAT (32B)	1.6	08/98→03/98	WV	Petrol	1588	4	167
PASSAT (32B)	1.6	08/98→03/98	YN	Petrol	1588	4	168
PASSAT (32B)	1.8	01/98→03/98	DS	Petrol	1781	4	221
PASSAT (32B)	1.8	12/98→03/98	DZ	Petrol	1781	4	223
PASSAT (32B)	1.8	01/98→03/98	JN	Petrol	1781	4	232
PASSAT (32B)	1.8	01/98→03/98	JV	Petrol	1781	4	233
PASSAT (32B)	1.8	05/98→03/98	RM	Petrol	1781	4	241
PASSAT (32B)	2.0	08/98→03/98	HP	Petrol	1994	5	411
PASSAT (32B)	2.0	08/98→03/98	JS	Petrol	1994	5	412
PASSAT (32B)	2.2	01/98→03/98	KV	Petrol	2226	5	420
PASSAT (32B)	2.2	08/98→03/98	KX	Petrol	2226	5	421
PASSAT (362)	1.4	08/01→	CAXA	Petrol	1390	4	87
PASSAT (362)	1.4	08/01→	CDGA	Petrol/Natural Gas (CNG)	1390	4	89
PASSAT (362)	1.4	08/01→	CDGA	Natural Gas	1390	4	89
PASSAT (362)	1.4	08/01→	CDGA	Bi-Fuel	1390	4	89
PASSAT (362)	1.4	11/01→	CKMA	Petrol/Ethanol	1390	4	92
PASSAT (362)	1.4	11/01→	CKMA	Petrol	1390	4	92
PASSAT (362)	1.6	08/01→	CAYC	Diesel	1598	4	144
PASSAT (362)	1.8	08/01→	CDA A	Petrol	1798	4	218
PASSAT (362)	1.8	02/01→	CDAB	Petrol	1798	4	219
PASSAT (362)	2.0	11/01→	CCZB	Petrol	1984	4	383
PASSAT (362)	2.0	08/01→	CFFA	Diesel	1968	4	390
PASSAT (362)	2.0	08/01→	CFFB	Diesel	1968	4	391
PASSAT (362)	2.0	08/01→	CFGB	Diesel	1968	4	394
PASSAT (362)	2.0	08/01→	CLLA	Diesel	1968	4	408
PASSAT (362)	3.6	01/01→	BWS	Petrol	3597	6	534
PASSAT ALLTRACK (365)	1.8	01/01→	CDA A	Petrol	1798	4	218
PASSAT ALLTRACK (365)	1.8	01/01→	CDAB	Petrol	1798	4	219
PASSAT ALLTRACK (365)	2.0	01/01→	CCZB	Petrol	1984	4	383
PASSAT ALLTRACK (365)	2.0	01/01→	CFFB	Diesel	1968	4	391
PASSAT ALLTRACK (365)	2.0	01/01→	CFGB	Diesel	1968	4	394
PASSAT CC (357)	1.4	01/01→	CKMA	Petrol/Ethanol	1390	4	92
PASSAT CC (357)	1.4	01/01→	CKMA	Petrol	1390	4	92
PASSAT CC (357)	1.8	06/00→11/01	BZB	Petrol	1798	4	217
PASSAT CC (357)	1.8	06/00→11/01	CDA A	Petrol	1798	4	218
PASSAT CC (357)	1.8	11/00→05/01	CDAB	Petrol	1798	4	219
PASSAT CC (357)	1.8	11/00→05/01	CGYA	Petrol	1798	4	220
PASSAT CC (357)	2.0	06/00→	CAWB	Petrol	1984	4	367
PASSAT CC (357)	2.0	06/00→05/01	CBAA	Diesel	1968	4	368
PASSAT CC (357)	2.0	06/00→	CBAB	Diesel	1968	4	369
PASSAT CC (357)	2.0	05/00→11/01	CBAC	Diesel	1968	4	370
PASSAT CC (357)	2.0	05/00→05/01	CBBA	Diesel	1968	4	371

	Ltr				CC		9
PASSAT CC (357)	2.0	06/00 →	CBBB	Diesel	1968	4	372
PASSAT CC (357)	2.0	06/00 →	CBFA	Petrol	1984	4	376
PASSAT CC (357)	2.0	06/00 →	CCTA	Petrol	1984	4	380
PASSAT CC (357)	2.0	06/00 →	CCZA	Petrol	1984	4	382
PASSAT CC (357)	2.0	11/01 →	CCZB	Petrol	1984	4	383
PASSAT CC (357)	2.0	06/00 → 05/01	CFFA	Diesel	1968	4	390
PASSAT CC (357)	2.0	06/00 →	CFFB	Diesel	1968	4	391
PASSAT CC (357)	2.0	06/00 →	CFGB	Diesel	1968	4	394
PASSAT CC (357)	2.0	06/00 →	CLLA	Diesel	1968	4	408
PASSAT CC (357)	3.6	06/00 →	BLV	Petrol	3597	6	533
PASSAT CC (357)	3.6	06/00 → 05/01	BWS	Petrol	3597	6	534
PASSAT Saloon (32B)	1.6	01/98 → 03/98	DT	Petrol	1595	4	153
PASSAT Saloon (32B)	1.6	08/98 → 03/98	PP	Petrol	1595	4	161
PASSAT Saloon (32B)	1.6	01/98 → 03/98	RL	Petrol	1595	4	165
PASSAT Saloon (32B)	1.8	01/98 → 03/98	DS	Petrol	1781	4	221
PASSAT Saloon (32B)	1.8	01/98 → 03/98	JN	Petrol	1781	4	232
PASSAT Saloon (32B)	1.8	05/98 → 03/98	RM	Petrol	1781	4	241
PASSAT Saloon (32B)	2.2	01/98 → 03/98	KX	Petrol	2226	5	421
PASSAT Variant (3A5, 35I)	1.6	04/98 → 09/99	1F	Petrol	1595	4	97
PASSAT Variant (3A5, 35I)	1.6	07/99 → 12/99	AEK	Petrol	1595	4	105
PASSAT Variant (3A5, 35I)	1.6	07/99 → 12/99	AFT	Petrol	1595	4	107
PASSAT Variant (3A5, 35I)	1.6	04/98 → 09/99	EZ	Petrol	1595	4	155
PASSAT Variant (3A5, 35I)	1.6	08/98 → 09/99	RA	Diesel	1588	4	162
PASSAT Variant (3A5, 35I)	1.6	08/98 → 09/99	SB	Diesel	1588	4	166
PASSAT Variant (3A5, 35I)	1.8	08/99 → 05/99	AAM	Petrol	1781	4	180
PASSAT Variant (3A5, 35I)	1.8	02/98 → 05/99	ABS	Petrol	1781	4	181
PASSAT Variant (3A5, 35I)	1.8	02/98 → 05/99	ADZ	Petrol	1781	4	185
PASSAT Variant (3A5, 35I)	1.8	04/98 → 09/99	KR	Petrol	1781	4	234
PASSAT Variant (3A5, 35I)	1.8	04/98 → 07/99	PB	Petrol	1781	4	235
PASSAT Variant (3A5, 35I)	1.8	04/98 → 07/99	PF	Petrol	1781	4	237
PASSAT Variant (3A5, 35I)	1.8	08/98 → 05/99	PG	Petrol	1781	4	238
PASSAT Variant (3A5, 35I)	1.8	02/98 → 05/99	RP	Petrol	1781	4	242
PASSAT Variant (3A5, 35I)	1.9	05/98 → 10/99	1Y	Diesel	1896	4	245
PASSAT Variant (3A5, 35I)	1.9	10/99 → 05/99	1Z	Diesel	1896	4	246
PASSAT Variant (3A5, 35I)	1.9	03/99 → 05/99	AAZ	Diesel	1896	4	247
PASSAT Variant (3A5, 35I)	1.9	03/99 → 05/99	AFN	Diesel	1896	4	251
PASSAT Variant (3A5, 35I)	1.9	10/99 → 05/99	AHU	Diesel	1896	4	257
PASSAT Variant (3A5, 35I)	2.0	02/99 → 05/99	2E	Petrol	1984	4	301
PASSAT Variant (3A5, 35I)	2.0	08/98 → 09/99	9A	Petrol	1984	4	302
PASSAT Variant (3A5, 35I)	2.0	01/99 → 05/99	ABF	Petrol	1984	4	304
PASSAT Variant (3A5, 35I)	2.0	02/99 → 05/99	ADY	Petrol	1984	4	305
PASSAT Variant (3A5, 35I)	2.0	03/99 → 08/99	AEP	Petrol	1984	4	307
PASSAT Variant (3A5, 35I)	2.0	02/99 → 05/99	AGG	Petrol	1984	4	308
PASSAT Variant (3A5, 35I)	2.8	06/99 → 05/99	AAA	Petrol	2792	6	483
PASSAT Variant (3A5, 35I)	2.9	01/99 → 05/99	ABV	Petrol	2861	6	503
PASSAT Variant (3B5)	1.6	06/99 → 11/00	ADP	Petrol	1595	4	101
PASSAT Variant (3B5)	1.6	06/99 → 11/00	AHL	Petrol	1595	4	108
PASSAT Variant (3B5)	1.6	06/99 → 11/00	ANA	Petrol	1595	4	115
PASSAT Variant (3B5)	1.6	06/99 → 11/00	ARM	Petrol	1595	4	118
PASSAT Variant (3B5)	1.8	06/99 → 11/00	ADR	Petrol	1781	4	184
PASSAT Variant (3B5)	1.8	06/99 → 11/00	AEB	Petrol	1781	4	186
PASSAT Variant (3B5)	1.8	06/99 → 11/00	AFY	Petrol	1781	4	187
PASSAT Variant (3B5)	1.8	06/99 → 11/00	ANB	Petrol	1781	4	191
PASSAT Variant (3B5)	1.8	06/99 → 11/00	APT	Petrol	1781	4	195
PASSAT Variant (3B5)	1.8	06/99 → 11/00	APU	Petrol	1781	4	196
PASSAT Variant (3B5)	1.8	06/99 → 11/00	ARG	Petrol	1781	4	198
PASSAT Variant (3B5)	1.9	06/99 → 11/00	AFN	Diesel	1896	4	251
PASSAT Variant (3B5)	1.9	06/99 → 11/00	AHH	Diesel	1896	4	256
PASSAT Variant (3B5)	1.9	06/99 → 11/00	AHU	Diesel	1896	4	257
PASSAT Variant (3B5)	1.9	08/99 → 11/00	AJM	Diesel	1896	4	258
PASSAT Variant (3B5)	1.9	08/99 → 11/00	ATJ	Diesel	1896	4	269
PASSAT Variant (3B5)	1.9	02/00 → 11/00	AVB	Diesel	1896	4	271
PASSAT Variant (3B5)	1.9	06/99 → 11/00	AVG	Diesel	1896	4	273
PASSAT Variant (3B5)	2.3	06/99 → 11/00	AGZ	Petrol	2324	5	423
PASSAT Variant (3B5)	2.5	07/99 → 11/00	AFB	Diesel	2496	6	443
PASSAT Variant (3B5)	2.5	07/99 → 11/00	AKN	Diesel	2496	6	448
PASSAT Variant (3B5)	2.8	06/99 → 11/00	ACK	Petrol	2771	6	484
PASSAT Variant (3B5)	2.8	05/99 → 09/99	AGE	Petrol	2771	6	486
PASSAT Variant (3B5)	2.8	06/99 → 11/00	ALG	Petrol	2771	6	488
PASSAT Variant (3B5)	2.8	06/99 → 11/00	APR	Petrol	2771	6	492



Ltr







CC



9

	Ltr				CC		
PASSAT Variant (3B5)	2.8	06/99→11/00	AQD	Petrol	2771	6	493
PASSAT Variant (3B5)	2.8	09/99→11/00	ATX	Petrol	2771	6	496
PASSAT Variant (3B5)	2.8	09/99→11/00	BBG	Petrol	2771	6	500
PASSAT Variant (3B6)	1.6	11/00→05/00	ALZ	Petrol	1595	4	114
PASSAT Variant (3B6)	1.8	03/00→08/00	AWM	Petrol	1781	4	206
PASSAT Variant (3B6)	1.8	11/00→05/00	AWT	Petrol	1781	4	208
PASSAT Variant (3B6)	1.9	11/00→05/00	AVB	Diesel	1896	4	271
PASSAT Variant (3B6)	1.9	11/00→05/00	AVF	Diesel	1896	4	272
PASSAT Variant (3B6)	1.9	11/00→05/00	AWX	Diesel	1896	4	275
PASSAT Variant (3B6)	2.0	11/00→05/00	ALT	Petrol	1984	4	310
PASSAT Variant (3B6)	2.0	11/00→05/00	AZM	Petrol	1984	4	324
PASSAT Variant (3B6)	2.0	12/00→05/00	BGW	Diesel	1968	4	335
PASSAT Variant (3B6)	2.0	12/00→05/00	BHW	Diesel	1968	4	337
PASSAT Variant (3B6)	2.3	11/00→05/00	AZX	Petrol	2324	5	425
PASSAT Variant (3B6)	2.5	11/00→05/00	AFB	Diesel	2496	6	443
PASSAT Variant (3B6)	2.5	11/00→05/00	AKN	Diesel	2496	6	448
PASSAT Variant (3B6)	2.5	01/00→05/00	BAU	Diesel	2496	6	462
PASSAT Variant (3B6)	2.5	05/00→05/00	BDG	Diesel	2496	6	465
PASSAT Variant (3B6)	2.5	01/00→05/00	BDH	Diesel	2496	6	466
PASSAT Variant (3B6)	2.8	11/00→05/00	AMX	Petrol	2771	6	490
PASSAT Variant (3C5)	1.4	05/00→11/01	CAXA	Petrol	1390	4	87
PASSAT Variant (3C5)	1.4	01/00→11/01	CDGA	Petrol/Natural Gas (CNG)	1390	4	89
PASSAT Variant (3C5)	1.4	01/00→11/01	CDGA	Natural Gas	1390	4	89
PASSAT Variant (3C5)	1.4	01/00→11/01	CDGA	Bi-Fuel	1390	4	89
PASSAT Variant (3C5)	1.6	08/00→06/00	BLF	Petrol	1598	4	135
PASSAT Variant (3C5)	1.6	08/00→11/01	BSE	Petrol	1595	4	138
PASSAT Variant (3C5)	1.6	08/00→11/01	BSF	Petrol	1595	4	139
PASSAT Variant (3C5)	1.6	08/00→11/01	CAYC	Diesel	1598	4	144
PASSAT Variant (3C5)	1.8	05/00→10/01	BZB	Petrol	1798	4	217
PASSAT Variant (3C5)	1.8	05/00→10/01	CDAA	Petrol	1798	4	218
PASSAT Variant (3C5)	1.8	11/00→11/01	CDAB	Petrol	1798	4	219
PASSAT Variant (3C5)	1.8	11/00→11/01	CGYA	Petrol	1798	4	220
PASSAT Variant (3C5)	1.9	08/00→11/00	BKC	Diesel	1896	4	283
PASSAT Variant (3C5)	1.9	08/00→11/00	BLS	Diesel	1896	4	284
PASSAT Variant (3C5)	1.9	08/00→11/00	BXE	Diesel	1896	4	294
PASSAT Variant (3C5)	2.0	08/00→11/01	AXX	Petrol	1984	4	320
PASSAT Variant (3C5)	2.0	08/00→	BKP	Diesel	1968	4	339
PASSAT Variant (3C5)	2.0	08/00→11/01	BLR	Petrol	1984	4	340
PASSAT Variant (3C5)	2.0	09/00→11/01	BLX	Petrol	1984	4	341
PASSAT Variant (3C5)	2.0	08/00→11/01	BLY	Petrol	1984	4	342
PASSAT Variant (3C5)	2.0	08/00→11/01	BMA	Diesel	1968	4	343
PASSAT Variant (3C5)	2.0	08/00→	BMP	Diesel	1968	4	346
PASSAT Variant (3C5)	2.0	08/00→	BMR	Diesel	1968	4	347
PASSAT Variant (3C5)	2.0	08/00→11/01	BPY	Petrol	1984	4	348
PASSAT Variant (3C5)	2.0	08/00→	BUZ	Diesel	1968	4	352
PASSAT Variant (3C5)	2.0	08/00→02/00	BVE	Diesel	1968	4	353
PASSAT Variant (3C5)	2.0	09/00→11/01	BVX	Petrol	1984	4	355
PASSAT Variant (3C5)	2.0	08/00→11/01	BVY	Petrol	1984	4	356
PASSAT Variant (3C5)	2.0	08/00→11/01	BVZ	Petrol	1984	4	357
PASSAT Variant (3C5)	2.0	08/00→11/01	BWA	Petrol	1984	4	358
PASSAT Variant (3C5)	2.0	11/00→05/00	BWV	Diesel	1968	4	359
PASSAT Variant (3C5)	2.0	08/00→11/01	CAWB	Petrol	1984	4	367
PASSAT Variant (3C5)	2.0	08/00→11/01	CBAA	Diesel	1968	4	368
PASSAT Variant (3C5)	2.0	08/00→	CBAB	Diesel	1968	4	369
PASSAT Variant (3C5)	2.0	01/00→	CBAC	Diesel	1968	4	370
PASSAT Variant (3C5)	2.0	08/00→	CBBB	Diesel	1968	4	372
PASSAT Variant (3C5)	2.0	11/00→11/01	CBDC	Diesel	1968	4	375
PASSAT Variant (3C5)	2.0	08/00→11/01	CBFA	Petrol	1984	4	376
PASSAT Variant (3C5)	2.0	08/00→11/01	CCTA	Petrol	1984	4	380
PASSAT Variant (3C5)	2.0	08/00→11/01	CCTB	Petrol	1984	4	381
PASSAT Variant (3C5)	2.0	08/00→11/01	CCZA	Petrol	1984	4	382
PASSAT Variant (3C5)	3.6	04/00→11/01	BWS	Petrol	3597	6	534
PASSAT Variant (3ZB)	1.6	08/98→03/98	DT	Petrol	1595	4	153
PASSAT Variant (3ZB)	1.6	08/98→03/98	PP	Petrol	1595	4	161
PASSAT Variant (3ZB)	1.6	02/98→03/98	RL	Petrol	1595	4	165
PASSAT Variant (3ZB)	1.6	08/98→03/98	WV	Petrol	1588	4	167
PASSAT Variant (3ZB)	1.6	08/98→03/98	YN	Petrol	1588	4	168
PASSAT Variant (3ZB)	1.8	01/98→03/98	DS	Petrol	1781	4	221
PASSAT Variant (3ZB)	1.8	12/98→03/98	DZ	Petrol	1781	4	223
PASSAT Variant (3ZB)	1.8	01/98→03/98	JN	Petrol	1781	4	232

	Ltr				CC		9
PASSAT Variant (32B)	1.8	01/98 → 03/98	JV	Petrol	1781	4	233
PASSAT Variant (32B)	1.8	05/98 → 03/98	RM	Petrol	1781	4	241
PASSAT Variant (32B)	2.0	08/98 → 03/98	HP	Petrol	1994	5	411
PASSAT Variant (32B)	2.0	08/98 → 03/98	JS	Petrol	1994	5	412
PASSAT Variant (32B)	2.2	08/98 → 07/98	HY	Petrol	2226	5	418
PASSAT Variant (32B)	2.2	08/98 → 03/98	JT	Petrol	2226	5	419
PASSAT Variant (32B)	2.2	01/98 → 03/98	KV	Petrol	2226	5	420
PASSAT Variant (32B)	2.2	08/98 → 03/98	KX	Petrol	2226	5	421
PASSAT Variant (365)	1.4	08/01 →	CAXA	Petrol	1390	4	87
PASSAT Variant (365)	1.4	08/01 →	CDGA	Petrol/Natural Gas (CNG)	1390	4	89
PASSAT Variant (365)	1.4	08/01 →	CDGA	Natural Gas	1390	4	89
PASSAT Variant (365)	1.4	08/01 →	CDGA	Bi-Fuel	1390	4	89
PASSAT Variant (365)	1.4	11/01 →	CKMA	Petrol/Ethanol	1390	4	92
PASSAT Variant (365)	1.4	11/01 →	CKMA	Petrol	1390	4	92
PASSAT Variant (365)	1.6	08/01 →	CAYC	Diesel	1598	4	144
PASSAT Variant (365)	1.8	08/01 →	CDA A	Petrol	1798	4	218
PASSAT Variant (365)	1.8	02/01 →	CDAB	Petrol	1798	4	219
PASSAT Variant (365)	2.0	11/01 →	CCZB	Petrol	1984	4	383
PASSAT Variant (365)	2.0	08/01 →	CFFA	Diesel	1968	4	390
PASSAT Variant (365)	2.0	08/01 →	CFFB	Diesel	1968	4	391
PASSAT Variant (365)	2.0	08/01 →	CFGB	Diesel	1968	4	394
PASSAT Variant (365)	2.0	08/01 →	CLLA	Diesel	1968	4	408
PASSAT Variant (365)	3.6	01/01 →	BWS	Petrol	3597	6	534
PHAETON (3D_)	3.0	09/00 →	BMK	Diesel	2967	6	505
PHAETON (3D_)	3.0	06/00 →	CARA	Diesel	2967	6	507
PHAETON (3D_)	3.0	11/00 →	CEXA	Diesel	2967	6	513
PHAETON (3D_)	3.2	04/00 →	AYT	Petrol	3189	6	515
PHAETON (3D_)	3.2	04/00 →	BKL	Petrol	3189	6	523
PHAETON (3D_)	3.2	02/00 →	BRK	Petrol	3189	6	528
POLO (6N1)	1.0	09/99 → 10/99	AER	Petrol	999	4	4
POLO (6N1)	1.0	10/99 → 09/99	AEV	Petrol	1043	4	5
POLO (6N1)	1.0	09/99 → 10/99	ALL	Petrol	999	4	8
POLO (6N1)	1.3	10/99 → 07/99	ADX	Petrol	1296	4	33
POLO (6N1)	1.4	07/99 → 10/99	AEX	Petrol	1390	4	44
POLO (6N1)	1.4	04/99 → 10/99	AFH	Petrol	1390	4	45
POLO (6N1)	1.4	07/99 → 10/99	AKV	Petrol	1390	4	52
POLO (6N1)	1.4	07/99 → 10/99	APQ	Petrol	1390	4	57
POLO (6N1)	1.6	10/99 → 10/99	AEA	Petrol	1598	4	102
POLO (6N1)	1.6	10/99 → 10/99	AEE	Petrol	1598	4	103
POLO (6N1)	1.6	10/99 → 10/99	AHS	Petrol	1598	4	109
POLO (6N1)	1.6	09/99 → 10/99	AJV	Petrol	1598	4	110
POLO (6N1)	1.7	04/99 → 10/99	AHG	Diesel	1716	4	170
POLO (6N1)	1.7	08/99 → 10/99	AKU	Diesel	1716	4	171
POLO (6N1)	1.9	10/99 → 10/99	AEF	Diesel	1896	4	249
POLO (6N1)	1.9	07/99 → 10/99	AGD	Diesel	1896	4	252
POLO (6N2)	1.0	10/99 → 09/00	ALD	Petrol	999	4	7
POLO (6N2)	1.0	10/99 → 09/00	AUC	Petrol	999	4	10
POLO (6N2)	1.2	04/00 → 10/00	AWY	Petrol	1198	3	15
POLO (6N2)	1.4	10/99 → 09/00	AFK	Petrol	1390	4	46
POLO (6N2)	1.4	10/99 → 09/00	AHW	Petrol	1390	4	48
POLO (6N2)	1.4	10/99 → 09/00	AKK	Petrol	1390	4	49
POLO (6N2)	1.4	10/99 → 09/00	AKP	Petrol	1390	4	50
POLO (6N2)	1.4	10/99 → 09/00	AMF	Diesel	1422	3	53
POLO (6N2)	1.4	10/99 → 09/00	ANX	Petrol	1390	4	55
POLO (6N2)	1.4	10/99 → 09/00	APE	Petrol	1390	4	56
POLO (6N2)	1.4	10/99 → 09/00	AQQ	Petrol	1390	4	58
POLO (6N2)	1.4	01/00 → 10/00	ATL	Diesel	1422	3	60
POLO (6N2)	1.4	10/99 → 09/00	AUA	Petrol	1390	4	61
POLO (6N2)	1.4	10/99 → 09/00	AUB	Petrol	1390	4	62
POLO (6N2)	1.4	10/99 → 09/00	AUD	Petrol	1390	4	63
POLO (6N2)	1.6	10/99 → 09/00	ARC	Petrol	1598	4	117
POLO (6N2)	1.6	10/99 → 09/00	AVY	Petrol	1598	4	123
POLO (6N2)	1.7	10/99 → 09/00	AKU	Diesel	1716	4	171
POLO (6N2)	1.9	10/99 → 09/00	AEF	Diesel	1896	4	249
POLO (6N2)	1.9	10/99 → 09/00	AGD	Diesel	1896	4	252
POLO (6N2)	1.9	10/99 → 09/00	ASX	Diesel	1896	4	265
POLO (6R_)	1.2	11/00 →	CBZB	Petrol	1197	4	23
POLO (6R_)	1.2	05/01 →	CBZC	Petrol	1197	4	24
POLO (6R_)	1.2	10/00 →	CFWA	Diesel	1199	3	25
POLO (6R_)	1.2	06/00 →	CGPA	Petrol	1198	3	26



Ltr













CC







9

Model	Ltr	Period	Code	Fuel	CC	Gear	Price
POLO (6R_)	1.2	06/00→	CGPB	Petrol	1198	3	27
POLO (6R_)	1.4	05/01→	CAVE	Petrol	1390	4	86
POLO (6R_)	1.4	06/00→	CDDA	Petrol	1390	4	88
POLO (6R_)	1.4	06/00→	CGGB	Petrol	1390	4	91
POLO (6R_)	1.4	06/00→	CLPA	Petrol	1390	4	93
POLO (6R_)	1.4	03/01→01/01	CMAA	Petrol/Petroleum Gas (LPG)	1390	4	94
POLO (6R_)	1.6	06/00→	CAYA	Diesel	1598	4	142
POLO (6R_)	1.6	06/00→	CAYB	Diesel	1598	4	143
POLO (6R_)	1.6	06/00→	CAYC	Diesel	1598	4	144
POLO (9N_)	1.2	01/00→05/00	AWY	Petrol	1198	3	15
POLO (9N_)	1.2	10/00→07/00	AZQ	Petrol	1198	3	17
POLO (9N_)	1.2	05/00→11/00	BBM	Petrol	1198	3	18
POLO (9N_)	1.2	01/00→05/00	BMD	Petrol	1198	3	19
POLO (9N_)	1.2	10/00→07/00	BME	Petrol	1198	3	20
POLO (9N_)	1.2	05/00→11/00	BZG	Petrol	1198	3	21
POLO (9N_)	1.4	10/00→06/00	AMF	Diesel	1422	3	53
POLO (9N_)	1.4	10/00→05/00	AUA	Petrol	1390	4	61
POLO (9N_)	1.4	10/00→05/00	AUB	Petrol	1390	4	62
POLO (9N_)	1.4	02/00→07/00	AXU	Petrol	1390	4	65
POLO (9N_)	1.4	10/00→06/00	BAY	Diesel	1422	3	66
POLO (9N_)	1.4	10/00→05/00	BBY	Petrol	1390	4	67
POLO (9N_)	1.4	10/00→05/00	BBZ	Petrol	1390	4	68
POLO (9N_)	1.4	10/00→05/00	BKY	Petrol	1390	4	72
POLO (9N_)	1.4	04/00→11/00	BMS	Diesel	1422	3	75
POLO (9N_)	1.4	04/00→11/00	BNM	Diesel	1422	3	77
POLO (9N_)	1.4	04/00→11/00	BNV	Diesel	1422	3	78
POLO (9N_)	1.4	05/00→11/00	BUD	Petrol	1390	4	79
POLO (9N_)	1.4	04/00→11/00	BWB	Diesel	1422	3	80
POLO (9N_)	1.6	08/00→05/00	BAH	Petrol	1598	4	129
POLO (9N_)	1.6	05/00→11/00	BTS	Petrol	1598	4	140
POLO (9N_)	1.6	06/00→04/00	CCRA	Petrol/Ethanol	1598	4	147
POLO (9N_)	1.6	06/00→04/00	CCRA	Petrol	1598	4	147
POLO (9N_)	1.6	06/00→04/00	CCRA	Flexfuel	1598	4	147
POLO (9N_)	1.8	05/00→11/00	BBU	Petrol	1781	4	212
POLO (9N_)	1.8	09/00→11/00	BJX	Petrol	1781	4	213
POLO (9N_)	1.9	10/00→11/00	ASY	Diesel	1896	4	266
POLO (9N_)	1.9	11/00→11/00	ASZ	Diesel	1896	4	267
POLO (9N_)	1.9	10/00→11/00	ATD	Diesel	1896	4	268
POLO (9N_)	1.9	10/00→11/00	AXR	Diesel	1896	4	278
POLO (9N_)	1.9	11/00→11/00	BLT	Diesel	1896	4	285
POLO (9N_)	1.9	10/00→11/00	BMT	Diesel	1896	4	286
POLO (86C, 80)	1.0	08/98→09/99	AAK	Petrol	1043	4	1
POLO (86C, 80)	1.0	08/98→09/99	AAU	Petrol	1043	4	2
POLO (86C, 80)	1.0	08/98→09/99	ACM	Petrol	1043	4	3
POLO (86C, 80)	1.0	08/98→01/99	HZ	Petrol	1043	4	13
POLO (86C, 80)	1.3	07/98→09/99	2G	Petrol	1272	4	30
POLO (86C, 80)	1.3	10/98→08/99	3F	Petrol	1272	4	31
POLO (86C, 80)	1.3	07/98→09/99	AAV	Petrol	1272	4	32
POLO (86C, 80)	1.3	09/98→09/98	GK	Petrol	1272	4	34
POLO (86C, 80)	1.3	08/98→07/98	GT	Petrol	1272	4	35
POLO (86C, 80)	1.3	08/98→07/98	HJ	Petrol	1272	4	36
POLO (86C, 80)	1.3	08/98→07/98	HK	Petrol	1272	4	37
POLO (86C, 80)	1.3	08/98→09/99	MH	Petrol	1272	4	38
POLO (86C, 80)	1.3	08/98→07/99	MN	Diesel	1272	4	39
POLO (86C, 80)	1.3	07/98→09/99	NZ	Petrol	1272	4	40
POLO (86C, 80)	1.4	10/99→09/99	1W	Diesel	1398	4	42
POLO Box (6NF)	1.4	05/99→12/99	AEX	Petrol	1390	4	44
POLO Box (6NF)	1.4	05/99→12/99	APQ	Petrol	1390	4	57
POLO Box (6NF)	1.7	08/99→12/99	AKU	Diesel	1716	4	171
POLO Box (6NF)	1.9	10/99→12/99	AEF	Diesel	1896	4	249
POLO Box (6NF)	1.9	07/99→12/99	AGD	Diesel	1896	4	252
POLO Box (86CF)	1.0	08/99→07/99	AAU	Petrol	1043	4	2
POLO Box (86CF)	1.3	08/99→07/99	AAV	Petrol	1272	4	32
POLO Box (86CF)	1.4	08/99→07/99	1W	Diesel	1398	4	42
POLO CLASSIC (6KV2)	1.4	12/99→09/00	AEX	Petrol	1390	4	44
POLO CLASSIC (6KV2)	1.4	05/99→07/00	AGY	Petrol	1390	4	47
POLO CLASSIC (6KV2)	1.4	12/99→09/00	AKK	Petrol	1390	4	49
POLO CLASSIC (6KV2)	1.4	12/99→09/00	AKV	Petrol	1390	4	52
POLO CLASSIC (6KV2)	1.4	12/99→09/00	ANW	Petrol	1390	4	54
POLO CLASSIC (6KV2)	1.4	01/99→08/99	ANX	Petrol	1390	4	55

	Ltr				CC		9
POLO CLASSIC (6KV2)	1.4	10/99 → 09/00	APE	Petrol	1390	4	56
POLO CLASSIC (6KV2)	1.4	12/99 → 09/00	APQ	Petrol	1390	4	57
POLO CLASSIC (6KV2)	1.4	10/99 → 09/00	AUA	Petrol	1390	4	61
POLO CLASSIC (6KV2)	1.4	12/99 → 09/00	AUD	Petrol	1390	4	63
POLO CLASSIC (6KV2)	1.6	11/99 → 09/99	1F	Petrol	1595	4	97
POLO CLASSIC (6KV2)	1.6	11/99 → 09/00	AEE	Petrol	1598	4	103
POLO CLASSIC (6KV2)	1.6	12/99 → 09/00	AEH	Petrol	1595	4	104
POLO CLASSIC (6KV2)	1.6	12/99 → 09/00	AFT	Petrol	1595	4	107
POLO CLASSIC (6KV2)	1.6	12/99 → 09/00	AKL	Petrol	1595	4	111
POLO CLASSIC (6KV2)	1.6	11/99 → 09/00	ALM	Petrol	1598	4	113
POLO CLASSIC (6KV2)	1.6	12/99 → 09/00	APF	Petrol	1595	4	116
POLO CLASSIC (6KV2)	1.6	12/99 → 09/00	AUR	Petrol	1595	4	120
POLO CLASSIC (6KV2)	1.7	07/99 → 09/00	AKW	Diesel	1716	4	172
POLO CLASSIC (6KV2)	1.8	01/99 → 09/00	ADD	Petrol	1781	4	183
POLO CLASSIC (6KV2)	1.8	01/99 → 09/00	ADZ	Petrol	1781	4	185
POLO CLASSIC (6KV2)	1.9	12/99 → 09/00	AEY	Diesel	1896	4	250
POLO CLASSIC (6KV2)	1.9	06/99 → 01/00	AFN	Diesel	1896	4	251
POLO CLASSIC (6KV2)	1.9	08/99 → 01/00	AGP	Diesel	1896	4	253
POLO CLASSIC (6KV2)	1.9	09/99 → 09/00	AGR	Diesel	1896	4	254
POLO CLASSIC (6KV2)	1.9	09/99 → 09/00	AHU	Diesel	1896	4	257
POLO CLASSIC (6KV2)	1.9	09/99 → 09/00	ALE	Diesel	1896	4	259
POLO CLASSIC (6KV2)	1.9	09/99 → 09/00	ALH	Diesel	1896	4	260
POLO CLASSIC (6KV2)	1.9	08/99 → 01/00	AQM	Diesel	1896	4	262
POLO CLASSIC (6KV2)	1.9	06/99 → 01/00	ASV	Diesel	1896	4	264
POLO CLASSIC (86C, 80)	1.0	01/98 → 09/99	AAK	Petrol	1043	4	1
POLO CLASSIC (86C, 80)	1.0	01/98 → 09/99	AAU	Petrol	1043	4	2
POLO CLASSIC (86C, 80)	1.0	01/98 → 09/99	HZ	Petrol	1043	4	13
POLO CLASSIC (86C, 80)	1.3	07/98 → 09/99	MH	Petrol	1272	4	38
POLO CLASSIC (86C, 80)	1.3	08/98 → 12/98	MN	Diesel	1272	4	39
POLO CLASSIC (86C, 80)	1.3	07/98 → 09/99	NZ	Petrol	1272	4	40
POLO CLASSIC (86C, 80)	1.4	10/99 → 09/99	1W	Diesel	1398	4	42
POLO Coupe (86C, 80)	1.0	08/98 → 09/99	AAK	Petrol	1043	4	1
POLO Coupe (86C, 80)	1.0	08/98 → 09/99	AAU	Petrol	1043	4	2
POLO Coupe (86C, 80)	1.0	08/98 → 09/99	ACM	Petrol	1043	4	3
POLO Coupe (86C, 80)	1.0	08/98 → 01/99	HZ	Petrol	1043	4	13
POLO Coupe (86C, 80)	1.3	07/98 → 08/99	2G	Petrol	1272	4	30
POLO Coupe (86C, 80)	1.3	10/98 → 09/99	3F	Petrol	1272	4	31
POLO Coupe (86C, 80)	1.3	07/98 → 08/99	AAV	Petrol	1272	4	32
POLO Coupe (86C, 80)	1.3	09/98 → 09/98	GK	Petrol	1272	4	34
POLO Coupe (86C, 80)	1.3	08/98 → 07/98	GT	Petrol	1272	4	35
POLO Coupe (86C, 80)	1.3	07/98 → 08/99	MH	Petrol	1272	4	38
POLO Coupe (86C, 80)	1.3	08/98 → 08/99	MN	Diesel	1272	4	39
POLO Coupe (86C, 80)	1.3	07/98 → 08/99	NZ	Petrol	1272	4	40
POLO Coupe (86C, 80)	1.3	01/98 → 09/99	PY	Petrol	1272	4	41
POLO Coupe (86C, 80)	1.4	08/99 → 09/99	1W	Diesel	1398	4	42
POLO Saloon (9A4)	1.4	07/00 →	BAY	Diesel	1422	3	66
POLO Saloon (9A4)	1.4	07/00 →	BBY	Petrol	1390	4	67
POLO Saloon (9A4)	1.4	11/00 →	BBZ	Petrol	1390	4	68
POLO Saloon (9A4)	1.4	07/00 →	BKY	Petrol	1390	4	72
POLO Saloon (9A4)	1.6	09/00 →	BAH	Petrol	1598	4	129
POLO Saloon (9A4)	1.9	09/00 →	ASY	Diesel	1896	4	266
POLO Saloon (9A4)	1.9	09/00 →	ATD	Diesel	1896	4	268
POLO Saloon	1.6	11/01 →	CFNB	Petrol	1598	4	149
POLO Saloon	1.6	05/01 →	CLSA	Petrol	1598	4	151
POLO Variant (6KV5)	1.4	05/99 → 09/00	AEX	Petrol	1390	4	44
POLO Variant (6KV5)	1.4	05/99 → 09/00	AKK	Petrol	1390	4	49
POLO Variant (6KV5)	1.4	12/99 → 09/00	AKP	Petrol	1390	4	50
POLO Variant (6KV5)	1.4	05/99 → 09/00	AKV	Petrol	1390	4	52
POLO Variant (6KV5)	1.4	05/99 → 09/00	ANW	Petrol	1390	4	54
POLO Variant (6KV5)	1.4	10/99 → 09/00	APE	Petrol	1390	4	56
POLO Variant (6KV5)	1.4	05/99 → 09/00	APQ	Petrol	1390	4	57
POLO Variant (6KV5)	1.4	10/99 → 09/00	AUA	Petrol	1390	4	61
POLO Variant (6KV5)	1.4	05/99 → 09/00	AUD	Petrol	1390	4	63
POLO Variant (6KV5)	1.6	05/99 → 09/00	AEE	Petrol	1598	4	103
POLO Variant (6KV5)	1.6	05/99 → 09/00	AEH	Petrol	1595	4	104
POLO Variant (6KV5)	1.6	05/99 → 09/00	AFT	Petrol	1595	4	107
POLO Variant (6KV5)	1.6	05/99 → 09/00	AKL	Petrol	1595	4	111
POLO Variant (6KV5)	1.6	05/99 → 09/00	ALM	Petrol	1598	4	113
POLO Variant (6KV5)	1.6	05/99 → 09/00	APF	Petrol	1595	4	116
POLO Variant (6KV5)	1.6	05/99 → 09/00	AUR	Petrol	1595	4	120

	Ltr				CC		9
POLO Variant (6KV5)	1.7	08/99→09/00	AKW	Diesel	1716	4	172
POLO Variant (6KV5)	1.8	05/99→09/00	ADZ	Petrol	1781	4	185
POLO Variant (6KV5)	1.9	06/99→09/00	AEY	Diesel	1896	4	250
POLO Variant (6KV5)	1.9	06/99→09/00	AFN	Diesel	1896	4	251
POLO Variant (6KV5)	1.9	08/99→09/00	AGP	Diesel	1896	4	253
POLO Variant (6KV5)	1.9	05/99→09/00	AGR	Diesel	1896	4	254
POLO Variant (6KV5)	1.9	05/99→09/00	AHU	Diesel	1896	4	257
POLO Variant (6KV5)	1.9	05/99→09/00	ALE	Diesel	1896	4	259
POLO Variant (6KV5)	1.9	05/99→09/00	ALH	Diesel	1896	4	260
POLO Variant (6KV5)	1.9	08/99→09/00	AQM	Diesel	1896	4	262
POLO Variant (6KV5)	1.9	06/99→09/00	ASV	Diesel	1896	4	264
SCIROCCO (53B)	1.6	01/98→12/98	EW	Petrol	1595	4	154
SCIROCCO (53B)	1.6	04/98→07/99	RE	Petrol	1595	4	163
SCIROCCO (53B)	1.8	08/98→12/98	DX	Petrol	1781	4	222
SCIROCCO (53B)	1.8	08/98→12/98	EV	Petrol	1781	4	224
SCIROCCO (53B)	1.8	08/98→07/99	EX	Petrol	1781	4	225
SCIROCCO (53B)	1.8	11/98→07/99	JH	Petrol	1781	4	230
SCIROCCO (53B)	1.8	08/98→12/98	JJ	Petrol	1781	4	231
SCIROCCO (53B)	1.8	10/98→07/98	KR	Petrol	1781	4	234
SCIROCCO (53B)	1.8	08/98→12/98	PB	Petrol	1781	4	235
SCIROCCO (53B)	1.8	03/98→07/99	PL	Petrol	1781	4	239
SCIROCCO (137)	1.4	05/00→	CAVD	Petrol	1390	4	85
SCIROCCO (137)	1.4	08/00→	CAXA	Petrol	1390	4	87
SCIROCCO (137)	1.4	05/00→	CNWA	Petrol	1390	4	95
SCIROCCO (137)	2.0	05/00→11/00	CAWB	Petrol	1984	4	367
SCIROCCO (137)	2.0	05/00→	CBBB	Diesel	1968	4	372
SCIROCCO (137)	2.0	08/00→	CBDB	Diesel	1968	4	374
SCIROCCO (137)	2.0	11/00→05/01	CCZB	Petrol	1984	4	383
SCIROCCO (137)	2.0	11/00→	CDLA	Petrol	1984	4	387
SCIROCCO (137)	2.0	11/00→	CDLC	Petrol	1984	4	388
SCIROCCO (137)	2.0	05/00→	CFGB	Diesel	1968	4	394
SCIROCCO (137)	2.0	11/01→	CFHB	Diesel	1968	4	395
SCIROCCO (137)	2.0	08/00→	CFHC	Diesel	1968	4	396
SHARAN (7M8, 7M9, 7M6)	1.8	09/99→03/01	AJH	Petrol	1781	4	190
SHARAN (7M8, 7M9, 7M6)	1.8	09/99→03/01	AWC	Petrol	1781	4	204
SHARAN (7M8, 7M9, 7M6)	1.9	09/99→03/01	IZ	Diesel	1896	4	246
SHARAN (7M8, 7M9, 7M6)	1.9	09/99→04/00	AFN	Diesel	1896	4	251
SHARAN (7M8, 7M9, 7M6)	1.9	09/99→03/01	AHU	Diesel	1896	4	257
SHARAN (7M8, 7M9, 7M6)	1.9	09/99→03/01	ANU	Diesel	1896	4	261
SHARAN (7M8, 7M9, 7M6)	1.9	11/00→03/01	ASZ	Diesel	1896	4	267
SHARAN (7M8, 7M9, 7M6)	1.9	04/00→03/01	AUY	Diesel	1896	4	270
SHARAN (7M8, 7M9, 7M6)	1.9	09/99→04/00	AVG	Diesel	1896	4	273
SHARAN (7M8, 7M9, 7M6)	1.9	06/00→03/01	BTB	Diesel	1896	4	292
SHARAN (7M8, 7M9, 7M6)	1.9	04/00→03/01	BVK	Diesel	1896	4	293
SHARAN (7M8, 7M9, 7M6)	2.0	09/99→02/00	ABF	Petrol	1984	4	304
SHARAN (7M8, 7M9, 7M6)	2.0	09/99→03/01	ADY	Petrol	1984	4	305
SHARAN (7M8, 7M9, 7M6)	2.0	09/99→03/01	ATM	Petrol/Petroleum Gas (LPG)	1984	4	313
SHARAN (7M8, 7M9, 7M6)	2.0	09/99→03/01	ATM	Petrol	1984	4	313
SHARAN (7M8, 7M9, 7M6)	2.0	11/00→03/01	BRT	Diesel	1968	4	349
SHARAN (7M8, 7M9, 7M6)	2.0	11/00→03/01	BVH	Diesel	1968	4	354
SHARAN (7M8, 7M9, 7M6)	2.8	09/99→04/00	AAA	Petrol	2792	6	483
SHARAN (7M8, 7M9, 7M6)	2.8	09/99→04/00	AMY	Petrol	2792	6	491
SHARAN (7M8, 7M9, 7M6)	2.8	04/00→03/01	AYL	Petrol	2792	6	499
SHARAN (7N)	1.4	05/01→	CAVA	Petrol	1390	4	82
SHARAN (7N)	1.8	05/01→	CDAA	Petrol	1798	4	218
SHARAN (7N)	2.0	12/01→	CCZA	Petrol	1984	4	382
SHARAN (7N)	2.0	05/01→	CFFA	Diesel	1968	4	390
SHARAN (7N)	2.0	05/01→	CFFB	Diesel	1968	4	391
SHARAN (7N)	2.0	05/01→	CFFE	Diesel	1968	4	393
SHARAN (7N)	2.0	08/01→	CFGB	Diesel	1968	4	394
TARO	1.8	04/98→09/99	2Y	Petrol	1812	4	179
TARO	2.2	06/98→07/99	4Y	Petrol	2237	4	417
TIGUAN (5N_)	1.4	09/00→	BWK	Petrol	1390	4	81
TIGUAN (5N_)	1.4	09/00→	CAVA	Petrol	1390	4	82
TIGUAN (5N_)	1.4	05/01→	CAVD	Petrol	1390	4	85
TIGUAN (5N_)	1.4	08/01→	CAXA	Petrol	1390	4	87
TIGUAN (5N_)	2.0	09/00→	CAWA	Petrol	1984	4	366
TIGUAN (5N_)	2.0	09/00→	CAWB	Petrol	1984	4	367
TIGUAN (5N_)	2.0	11/00→	CBAA	Diesel	1968	4	368
TIGUAN (5N_)	2.0	09/00→	CBAB	Diesel	1968	4	369

	Ltr				CC		9
TIGUAN (5N_)	2.0	02/00 → 08/00	CBBA	Diesel	1968	4	371
TIGUAN (5N_)	2.0	09/00 →	CBBB	Diesel	1968	4	372
TIGUAN (5N_)	2.0	09/00 →	CCTA	Petrol	1984	4	380
TIGUAN (5N_)	2.0	09/00 →	CCZA	Petrol	1984	4	382
TIGUAN (5N_)	2.0	05/01 →	CCZB	Petrol	1984	4	383
TIGUAN (5N_)	2.0	09/00 →	CCZC	Petrol	1984	4	384
TIGUAN (5N_)	2.0	11/00 →	CFFA	Diesel	1968	4	390
TIGUAN (5N_)	2.0	09/00 →	CFFB	Diesel	1968	4	391
TIGUAN (5N_)	2.0	05/01 →	CFFD	Diesel	1968	4	392
TIGUAN (5N_)	2.0	09/00 →	CFGB	Diesel	1968	4	394
TOUAREG (7LA, 7L6, 7L7)	2.5	01/00 → 05/01	BAC	Diesel	2461	5	461
TOUAREG (7LA, 7L6, 7L7)	2.5	08/00 → 05/01	BLK	Diesel	2461	5	472
TOUAREG (7LA, 7L6, 7L7)	2.5	08/00 → 05/01	BPD	Diesel	2461	5	475
TOUAREG (7LA, 7L6, 7L7)	2.5	01/00 → 05/01	BPE	Diesel	2461	5	476
TOUAREG (7LA, 7L6, 7L7)	3.0	11/00 → 05/01	BKS	Diesel	2967	6	504
TOUAREG (7LA, 7L6, 7L7)	3.0	04/00 → 05/01	BUN	Diesel	2967	6	506
TOUAREG (7LA, 7L6, 7L7)	3.0	11/00 → 05/01	CASA	Diesel	2967	6	508
TOUAREG (7LA, 7L6, 7L7)	3.0	04/00 → 05/01	CASB	Diesel	2967	6	509
TOUAREG (7LA, 7L6, 7L7)	3.0	11/00 → 05/01	CASC	Diesel	2967	6	510
TOUAREG (7LA, 7L6, 7L7)	3.0	11/00 → 05/01	CATA	Diesel	2967	6	512
TOUAREG (7LA, 7L6, 7L7)	3.2	10/00 → 11/00	AZZ	Petrol	3189	6	516
TOUAREG (7LA, 7L6, 7L7)	3.2	10/00 → 11/00	BAA	Petrol	3189	6	517
TOUAREG (7LA, 7L6, 7L7)	3.2	10/00 → 11/00	BKJ	Petrol	3189	6	521
TOUAREG (7LA, 7L6, 7L7)	3.2	10/00 → 11/00	BMV	Petrol	3189	6	525
TOUAREG (7LA, 7L6, 7L7)	3.2	10/00 → 11/00	BMX	Petrol	3189	6	526
TOUAREG (7LA, 7L6, 7L7)	3.2	10/00 → 11/00	BRJ	Petrol	3189	6	527
TOUAREG (7LA, 7L6, 7L7)	3.6	10/00 → 05/01	BHK	Petrol	3597	6	532
TOUAREG (7P5)	3.0	01/01 →	CASA	Diesel	2967	6	508
TOUAREG (7P5)	3.0	01/01 →	CASD	Diesel	2967	6	511
TOUAREG (7P5)	3.0	06/01 →	CATA	Diesel	2967	6	512
TOUAREG (7P5)	3.0	01/01 →	CJMA	Diesel	2967	6	514
TOURAN (1T1, 1T2)	1.4	11/00 → 05/01	BLG	Petrol	1390	4	73
TOURAN (1T1, 1T2)	1.4	02/00 → 05/01	BMV	Petrol	1390	4	76
TOURAN (1T1, 1T2)	1.4	11/00 → 05/01	CAVB	Petrol	1390	4	83
TOURAN (1T1, 1T2)	1.4	02/00 → 05/01	CAVC	Petrol	1390	4	84
TOURAN (1T1, 1T2)	1.4	05/00 → 05/01	CDGA	Petrol/Natural Gas (CNG)	1390	4	89
TOURAN (1T1, 1T2)	1.4	05/00 → 05/01	CDGA	Natural Gas	1390	4	89
TOURAN (1T1, 1T2)	1.4	05/00 → 05/01	CDGA	Bi-Fuel	1390	4	89
TOURAN (1T1, 1T2)	1.6	02/00 → 01/00	BAG	Petrol	1598	4	128
TOURAN (1T1, 1T2)	1.6	07/00 → 05/01	BGU	Petrol	1595	4	133
TOURAN (1T1, 1T2)	1.6	02/00 → 01/00	BLF	Petrol	1598	4	135
TOURAN (1T1, 1T2)	1.6	02/00 → 01/00	BLP	Petrol	1598	4	136
TOURAN (1T1, 1T2)	1.6	07/00 → 05/01	BSE	Petrol	1595	4	138
TOURAN (1T1, 1T2)	1.6	07/00 → 05/01	BSF	Petrol	1595	4	139
TOURAN (1T1, 1T2)	1.9	02/00 → 05/00	AVQ	Diesel	1896	4	274
TOURAN (1T1, 1T2)	1.9	08/00 → 05/01	BKC	Diesel	1896	4	283
TOURAN (1T1, 1T2)	1.9	08/00 → 05/01	BLS	Diesel	1896	4	284
TOURAN (1T1, 1T2)	1.9	11/00 → 05/01	BRU	Diesel	1896	4	289
TOURAN (1T1, 1T2)	1.9	08/00 → 05/01	BXE	Diesel	1896	4	294
TOURAN (1T1, 1T2)	1.9	11/00 → 05/01	BXF	Diesel	1896	4	295
TOURAN (1T1, 1T2)	1.9	11/00 → 05/01	BXJ	Diesel	1896	4	296
TOURAN (1T1, 1T2)	2.0	10/00 → 11/00	AXW	Petrol	1984	4	319
TOURAN (1T1, 1T2)	2.0	02/00 → 05/01	AZV	Diesel	1968	4	325
TOURAN (1T1, 1T2)	2.0	08/00 → 05/01	BKD	Diesel	1968	4	338
TOURAN (1T1, 1T2)	2.0	10/00 → 11/00	BLR	Petrol	1984	4	340
TOURAN (1T1, 1T2)	2.0	10/00 → 11/00	BLX	Petrol	1984	4	341
TOURAN (1T1, 1T2)	2.0	10/00 → 11/00	BLY	Petrol	1984	4	342
TOURAN (1T1, 1T2)	2.0	12/00 → 05/01	BMM	Diesel	1968	4	344
TOURAN (1T1, 1T2)	2.0	12/00 → 05/01	BMN	Diesel	1968	4	345
TOURAN (1T1, 1T2)	2.0	02/00 → 05/00	BSX	Natural Gas	1984	4	351
TOURAN (1T1, 1T2)	2.0	10/00 → 11/00	BVY	Petrol	1984	4	356
TOURAN (1T1, 1T2)	2.0	10/00 → 11/00	BVZ	Petrol	1984	4	357
TOURAN (1T1, 1T2)	2.0	12/00 → 05/01	CFJA	Diesel	1968	4	399
TOURAN (1T3)	1.2	05/01 →	CBZB	Petrol	1197	4	23
TOURAN (1T3)	1.4	05/01 →	CAVB	Petrol	1390	4	83
TOURAN (1T3)	1.4	05/01 →	CAVC	Petrol	1390	4	84
TOURAN (1T3)	1.4	05/01 →	CDGA	Petrol/Natural Gas (CNG)	1390	4	89
TOURAN (1T3)	1.4	05/01 →	CDGA	Natural Gas	1390	4	89
TOURAN (1T3)	1.4	05/01 →	CDGA	Bi-Fuel	1390	4	89
TOURAN (1T3)	1.6	05/01 →	CAYB	Diesel	1598	4	143



Ltr







CC



9

TOURAN (1T3)	1.6	05/01→	CAYC	Diesel	1598	4	144
TOURAN (1T3)	2.0	05/01→	CFHC	Diesel	1968	4	396
TOURAN (1T3)	2.0	05/01→01/01	CFJA	Diesel	1968	4	399
TOURAN (1T3)	2.0	11/01→	CLCA	Diesel	1968	4	406
TRANSPORTER III Box	1.6	10/98→07/99	JX	Diesel	1589	4	158
TRANSPORTER III Box	1.7	07/98→07/99	KY	Diesel	1716	4	173
TRANSPORTER III Box	1.9	10/98→07/99	DF	Petrol	1913	4	297
TRANSPORTER III Box	1.9	10/98→07/99	DG	Petrol	1913	4	298
TRANSPORTER III Box	1.9	10/98→02/98	DH	Petrol	1913	4	299
TRANSPORTER III Box	1.9	08/98→02/98	GW	Petrol	1913	4	300
TRANSPORTER III Box	2.1	03/98→07/99	DJ	Petrol	2110	4	413
TRANSPORTER III Box	2.1	08/98→07/99	MV	Petrol	2110	4	414
TRANSPORTER III Box	2.1	07/98→07/99	SS	Petrol	2110	4	416
TRANSPORTER III Bus	1.6	08/98→07/99	JX	Diesel	1589	4	158
TRANSPORTER III Bus	1.7	10/98→07/99	KY	Diesel	1716	4	173
TRANSPORTER III Bus	1.9	08/98→07/99	DF	Petrol	1913	4	297
TRANSPORTER III Bus	1.9	08/98→07/99	DG	Petrol	1913	4	298
TRANSPORTER III Bus	2.1	08/98→07/99	DJ	Petrol	2110	4	413
TRANSPORTER III Bus	2.1	08/98→07/99	MV	Petrol	2110	4	414
TRANSPORTER III Bus	2.1	10/98→07/99	SR	Petrol	2109	4	415
TRANSPORTER III Bus	2.1	07/98→07/99	SS	Petrol	2110	4	416
TRANSPORTER III Platform/Chassis	1.6	10/98→07/99	JX	Diesel	1589	4	158
TRANSPORTER III Platform/Chassis	1.7	07/98→07/99	KY	Diesel	1716	4	173
TRANSPORTER III Platform/Chassis	1.9	09/98→07/99	DF	Petrol	1913	4	297
TRANSPORTER III Platform/Chassis	1.9	08/98→07/99	DG	Petrol	1913	4	298
TRANSPORTER III Platform/Chassis	1.9	10/98→02/98	DH	Petrol	1913	4	299
TRANSPORTER III Platform/Chassis	2.1	03/98→07/99	DJ	Petrol	2110	4	413
TRANSPORTER III Platform/Chassis	2.1	08/98→07/99	MV	Petrol	2110	4	414
TRANSPORTER III Platform/Chassis	2.1	07/98→07/99	SS	Petrol	2110	4	416
TRANSPORTER IV Box (70XA)	1.9	07/99→12/99	1X	Diesel	1896	4	244
TRANSPORTER IV Box (70XA)	1.9	10/99→04/00	ABL	Diesel	1896	4	248
TRANSPORTER IV Box (70XA)	2.0	07/99→04/00	AAC	Petrol	1968	4	303
TRANSPORTER IV Box (70XA)	2.4	07/99→09/99	AAB	Diesel	2370	5	429
TRANSPORTER IV Box (70XA)	2.4	08/99→04/00	AJA	Diesel	2370	5	432
TRANSPORTER IV Box (70XA)	2.5	11/99→04/00	AAF	Petrol	2461	5	437
TRANSPORTER IV Box (70XA)	2.5	11/99→04/00	ACU	Petrol	2461	5	438
TRANSPORTER IV Box (70XA)	2.5	09/99→04/00	ACV	Diesel	2461	5	439
TRANSPORTER IV Box (70XA)	2.5	11/99→04/00	AEN	Petrol	2461	5	440
TRANSPORTER IV Box (70XA)	2.5	08/99→04/00	AET	Petrol	2461	5	441
TRANSPORTER IV Box (70XA)	2.5	11/99→04/00	AEU	Petrol	2461	5	442
TRANSPORTER IV Box (70XA)	2.5	12/99→04/00	AJT	Diesel	2461	5	447
TRANSPORTER IV Box (70XA)	2.5	08/99→04/00	APL	Petrol	2461	5	451
TRANSPORTER IV Box (70XA)	2.5	09/99→04/00	AUF	Diesel	2461	5	452
TRANSPORTER IV Box (70XA)	2.5	08/99→04/00	AVT	Petrol	2461	5	454
TRANSPORTER IV Box (70XA)	2.5	09/00→04/00	AXG	Diesel	2461	5	457
TRANSPORTER IV Box (70XA)	2.5	09/99→04/00	AXL	Diesel	2461	5	458
TRANSPORTER IV Box (70XA)	2.5	09/99→04/00	AYC	Diesel	2461	5	459
TRANSPORTER IV Box (70XA)	2.5	12/99→04/00	AYY	Diesel	2461	5	460
TRANSPORTER IV Box (70XA)	2.8	05/99→05/00	AES	Petrol	2792	6	485
TRANSPORTER IV Box (70XA)	2.8	06/00→04/00	AMV	Petrol	2792	6	489
TRANSPORTER IV Bus (70XB, 70XC, 7DB, 7DW)	1.8	12/99→07/99	PD	Petrol	1781	4	236
TRANSPORTER IV Bus (70XB, 70XC, 7DB, 7DW)	1.9	09/99→12/99	1X	Diesel	1896	4	244
TRANSPORTER IV Bus (70XB, 70XC, 7DB, 7DW)	1.9	10/99→04/00	ABL	Diesel	1896	4	248
TRANSPORTER IV Bus (70XB, 70XC, 7DB, 7DW)	2.0	09/99→04/00	AAC	Petrol	1968	4	303
TRANSPORTER IV Bus (70XB, 70XC, 7DB, 7DW)	2.4	09/99→09/99	AAB	Diesel	2370	5	429
TRANSPORTER IV Bus (70XB, 70XC, 7DB, 7DW)	2.4	08/99→04/00	AJA	Diesel	2370	5	432
TRANSPORTER IV Bus (70XB, 70XC, 7DB, 7DW)	2.5	11/99→04/00	AAF	Petrol	2461	5	437
TRANSPORTER IV Bus (70XB, 70XC, 7DB, 7DW)	2.5	11/99→04/00	ACU	Petrol	2461	5	438
TRANSPORTER IV Bus (70XB, 70XC, 7DB, 7DW)	2.5	09/99→04/00	ACV	Diesel	2461	5	439
TRANSPORTER IV Bus (70XB, 70XC, 7DB, 7DW)	2.5	11/99→04/00	AEN	Petrol	2461	5	440
TRANSPORTER IV Bus (70XB, 70XC, 7DB, 7DW)	2.5	07/99→04/00	AET	Petrol	2461	5	441
TRANSPORTER IV Bus (70XB, 70XC, 7DB, 7DW)	2.5	11/99→04/00	AEU	Petrol	2461	5	442
TRANSPORTER IV Bus (70XB, 70XC, 7DB, 7DW)	2.5	05/99→04/00	AHY	Diesel	2461	5	446
TRANSPORTER IV Bus (70XB, 70XC, 7DB, 7DW)	2.5	05/99→04/00	AJT	Diesel	2461	5	447
TRANSPORTER IV Bus (70XB, 70XC, 7DB, 7DW)	2.5	07/99→04/00	APL	Petrol	2461	5	451
TRANSPORTER IV Bus (70XB, 70XC, 7DB, 7DW)	2.5	09/99→04/00	AUF	Diesel	2461	5	452
TRANSPORTER IV Bus (70XB, 70XC, 7DB, 7DW)	2.5	07/99→04/00	AVT	Petrol	2461	5	454
TRANSPORTER IV Bus (70XB, 70XC, 7DB, 7DW)	2.5	05/99→04/00	AXG	Diesel	2461	5	457
TRANSPORTER IV Bus (70XB, 70XC, 7DB, 7DW)	2.5	01/99→04/00	AXL	Diesel	2461	5	458
TRANSPORTER IV Bus (70XB, 70XC, 7DB, 7DW)	2.5	09/99→04/00	AYC	Diesel	2461	5	459

	Ltr				CC		9
TRANSPORTER IV Bus (70XB, 70XC, 7DB, 7DW)	2.5	05/99 → 04/00	AYY	Diesel	2461	5	460
TRANSPORTER IV Bus (70XB, 70XC, 7DB, 7DW)	2.8	11/99 → 04/00	AES	Petrol	2792	6	485
TRANSPORTER IV Bus (70XB, 70XC, 7DB, 7DW)	2.8	04/00 → 04/00	AMV	Petrol	2792	6	489
TRANSPORTER IV Platform/Chassis (70XD)	1.8	12/99 → 07/99	PD	Petrol	1781	4	236
TRANSPORTER IV Platform/Chassis (70XD)	1.9	07/99 → 12/99	IX	Diesel	1896	4	244
TRANSPORTER IV Platform/Chassis (70XD)	1.9	10/99 → 04/00	ABL	Diesel	1896	4	248
TRANSPORTER IV Platform/Chassis (70XD)	2.0	07/99 → 04/00	AAC	Petrol	1968	4	303
TRANSPORTER IV Platform/Chassis (70XD)	2.4	09/99 → 09/99	AAB	Diesel	2370	5	429
TRANSPORTER IV Platform/Chassis (70XD)	2.4	08/99 → 04/00	AJA	Diesel	2370	5	432
TRANSPORTER IV Platform/Chassis (70XD)	2.5	11/99 → 04/00	AAF	Petrol	2461	5	437
TRANSPORTER IV Platform/Chassis (70XD)	2.5	11/99 → 04/00	ACU	Petrol	2461	5	438
TRANSPORTER IV Platform/Chassis (70XD)	2.5	09/99 → 04/00	ACV	Diesel	2461	5	439
TRANSPORTER IV Platform/Chassis (70XD)	2.5	11/99 → 04/00	AEN	Petrol	2461	5	440
TRANSPORTER IV Platform/Chassis (70XD)	2.5	08/99 → 04/00	AET	Petrol	2461	5	441
TRANSPORTER IV Platform/Chassis (70XD)	2.5	11/99 → 04/00	AEU	Petrol	2461	5	442
TRANSPORTER IV Platform/Chassis (70XD)	2.5	05/99 → 04/00	AJT	Diesel	2461	5	447
TRANSPORTER IV Platform/Chassis (70XD)	2.5	08/99 → 04/00	APL	Petrol	2461	5	451
TRANSPORTER IV Platform/Chassis (70XD)	2.5	09/99 → 04/00	AUF	Diesel	2461	5	452
TRANSPORTER IV Platform/Chassis (70XD)	2.5	08/99 → 04/00	AVT	Petrol	2461	5	454
TRANSPORTER IV Platform/Chassis (70XD)	2.5	05/99 → 04/00	AXL	Diesel	2461	5	458
TRANSPORTER IV Platform/Chassis (70XD)	2.5	09/99 → 04/00	AYC	Diesel	2461	5	459
TRANSPORTER IV Platform/Chassis (70XD)	2.5	05/99 → 04/00	AYY	Diesel	2461	5	460
TRANSPORTER IV Platform/Chassis (70XD)	2.8	05/99 → 05/00	AES	Petrol	2792	6	485
TRANSPORTER IV Platform/Chassis (70XD)	2.8	06/00 → 04/00	AMV	Petrol	2792	6	489
TRANSPORTER V Box (7HA, 7HH, 7EA, 7EH)	1.9	04/00 → 11/00	AXB	Diesel	1896	4	276
TRANSPORTER V Box (7HA, 7HH, 7EA, 7EH)	1.9	04/00 → 11/00	AXC	Diesel	1896	4	277
TRANSPORTER V Box (7HA, 7HH, 7EA, 7EH)	1.9	01/00 → 11/00	BRR	Diesel	1896	4	287
TRANSPORTER V Box (7HA, 7HH, 7EA, 7EH)	1.9	06/00 → 11/00	BRS	Diesel	1896	4	288
TRANSPORTER V Box (7HA, 7HH, 7EA, 7EH)	2.0	11/00 →	AXA	Petrol	1984	4	318
TRANSPORTER V Box (7HA, 7HH, 7EA, 7EH)	2.0	09/00 →	CAAA	Diesel	1968	4	361
TRANSPORTER V Box (7HA, 7HH, 7EA, 7EH)	2.0	09/00 →	CAAB	Diesel	1968	4	362
TRANSPORTER V Box (7HA, 7HH, 7EA, 7EH)	2.0	09/00 →	CAAC	Diesel	1968	4	363
TRANSPORTER V Box (7HA, 7HH, 7EA, 7EH)	2.0	05/01 →	CAAD	Diesel	1968	4	364
TRANSPORTER V Box (7HA, 7HH, 7EA, 7EH)	2.0	05/01 →	CAAE	Diesel	1968	4	365
TRANSPORTER V Box (7HA, 7HH, 7EA, 7EH)	2.0	09/00 →	CCHA	Diesel	1968	4	378
TRANSPORTER V Box (7HA, 7HH, 7EA, 7EH)	2.0	05/01 →	CCHB	Diesel	1968	4	379
TRANSPORTER V Box (7HA, 7HH, 7EA, 7EH)	2.5	04/00 → 11/00	AXD	Diesel	2461	5	455
TRANSPORTER V Box (7HA, 7HH, 7EA, 7EH)	2.5	04/00 → 11/00	AXE	Diesel	2461	5	456
TRANSPORTER V Box (7HA, 7HH, 7EA, 7EH)	2.5	04/00 → 11/00	BNZ	Diesel	2461	5	473
TRANSPORTER V Box (7HA, 7HH, 7EA, 7EH)	2.5	04/00 → 11/00	BPC	Diesel	2461	5	474
TRANSPORTER V Box (7HA, 7HH, 7EA, 7EH)	3.2	04/00 → 06/00	BDL	Petrol	3189	6	518
TRANSPORTER V Box (7HA, 7HH, 7EA, 7EH)	3.2	11/00 → 11/00	BKK	Petrol	3189	6	522
TRANSPORTER V Box (7HA, 7HH, 7EA, 7EH)	3.2	11/00 → 11/00	CFLA	Petrol	3189	6	531
TRANSPORTER V Bus (7HB, 7HJ, 7EB, 7EJ, 7EF)	1.9	04/00 → 11/00	AXB	Diesel	1896	4	276
TRANSPORTER V Bus (7HB, 7HJ, 7EB, 7EJ, 7EF)	1.9	04/00 → 11/00	AXC	Diesel	1896	4	277
TRANSPORTER V Bus (7HB, 7HJ, 7EB, 7EJ, 7EF)	1.9	01/00 → 11/00	BRR	Diesel	1896	4	287
TRANSPORTER V Bus (7HB, 7HJ, 7EB, 7EJ, 7EF)	1.9	06/00 → 11/00	BRS	Diesel	1896	4	288
TRANSPORTER V Bus (7HB, 7HJ, 7EB, 7EJ, 7EF)	2.0	11/00 →	AXA	Petrol	1984	4	318
TRANSPORTER V Bus (7HB, 7HJ, 7EB, 7EJ, 7EF)	2.0	09/00 →	CAAA	Diesel	1968	4	361
TRANSPORTER V Bus (7HB, 7HJ, 7EB, 7EJ, 7EF)	2.0	09/00 →	CAAB	Diesel	1968	4	362
TRANSPORTER V Bus (7HB, 7HJ, 7EB, 7EJ, 7EF)	2.0	09/00 →	CAAC	Diesel	1968	4	363
TRANSPORTER V Bus (7HB, 7HJ, 7EB, 7EJ, 7EF)	2.0	05/01 →	CAAD	Diesel	1968	4	364
TRANSPORTER V Bus (7HB, 7HJ, 7EB, 7EJ, 7EF)	2.0	05/01 →	CAAE	Diesel	1968	4	365
TRANSPORTER V Bus (7HB, 7HJ, 7EB, 7EJ, 7EF)	2.0	09/00 →	CCHA	Diesel	1968	4	378
TRANSPORTER V Bus (7HB, 7HJ, 7EB, 7EJ, 7EF)	2.0	05/01 →	CCHB	Diesel	1968	4	379
TRANSPORTER V Bus (7HB, 7HJ, 7EB, 7EJ, 7EF)	2.5	04/00 → 11/00	AXD	Diesel	2461	5	455
TRANSPORTER V Bus (7HB, 7HJ, 7EB, 7EJ, 7EF)	2.5	04/00 → 11/00	AXE	Diesel	2461	5	456
TRANSPORTER V Bus (7HB, 7HJ, 7EB, 7EJ, 7EF)	2.5	11/00 → 11/00	BLJ	Diesel	2461	5	471
TRANSPORTER V Bus (7HB, 7HJ, 7EB, 7EJ, 7EF)	2.5	04/00 → 11/00	BNZ	Diesel	2461	5	473
TRANSPORTER V Bus (7HB, 7HJ, 7EB, 7EJ, 7EF)	2.5	04/00 → 11/00	BPC	Diesel	2461	5	474
TRANSPORTER V Bus (7HB, 7HJ, 7EB, 7EJ, 7EF)	3.2	02/00 → 06/00	BDL	Petrol	3189	6	518
TRANSPORTER V Bus (7HB, 7HJ, 7EB, 7EJ, 7EF)	3.2	11/00 → 11/00	BKK	Petrol	3189	6	522
TRANSPORTER V Bus (7HB, 7HJ, 7EB, 7EJ, 7EF)	3.2	11/00 → 11/00	CFLA	Petrol	3189	6	531
TRANSPORTER V Platform/Chassis (7JD, 7JE, 7JL, 7JY, 7JZ, 7FD)	1.9	04/00 → 11/00	AXB	Diesel	1896	4	276
TRANSPORTER V Platform/Chassis (7JD, 7JE, 7JL, 7JY, 7JZ, 7FD)	1.9	04/00 → 11/00	AXC	Diesel	1896	4	277
TRANSPORTER V Platform/Chassis (7JD, 7JE, 7JL, 7JY, 7JZ, 7FD)	1.9	01/00 → 11/00	BRR	Diesel	1896	4	287
TRANSPORTER V Platform/Chassis (7JD, 7JE, 7JL, 7JY, 7JZ, 7FD)	1.9	06/00 → 11/00	BRS	Diesel	1896	4	288
TRANSPORTER V Platform/Chassis (7JD, 7JE, 7JL, 7JY, 7JZ, 7FD)	2.0	11/00 →	AXA	Petrol	1984	4	318
TRANSPORTER V Platform/Chassis (7JD, 7JE, 7JL, 7JY, 7JZ, 7FD)	2.0	09/00 →	CAAA	Diesel	1968	4	361
TRANSPORTER V Platform/Chassis (7JD, 7JE, 7JL, 7JY, 7JZ, 7FD)	2.0	09/00 →	CAAB	Diesel	1968	4	362



Ltr



















CC

















9

TRANSPORTER V Platform/Chassis (7JD, 7JE, 7JL, 7JY, 7JZ, 7FD)	2.0	09/00→	CAAC	Diesel	1968	4	363
TRANSPORTER V Platform/Chassis (7JD, 7JE, 7JL, 7JY, 7JZ, 7FD)	2.0	05/01→	CAAD	Diesel	1968	4	364
TRANSPORTER V Platform/Chassis (7JD, 7JE, 7JL, 7JY, 7JZ, 7FD)	2.0	05/01→	CAAE	Diesel	1968	4	365
TRANSPORTER V Platform/Chassis (7JD, 7JE, 7JL, 7JY, 7JZ, 7FD)	2.0	05/01→	CCHB	Diesel	1968	4	379
TRANSPORTER V Platform/Chassis (7JD, 7JE, 7JL, 7JY, 7JZ, 7FD)	2.5	04/00→11/00	AXD	Diesel	2461	5	455
TRANSPORTER V Platform/Chassis (7JD, 7JE, 7JL, 7JY, 7JZ, 7FD)	2.5	04/00→11/00	AXE	Diesel	2461	5	456
TRANSPORTER V Platform/Chassis (7JD, 7JE, 7JL, 7JY, 7JZ, 7FD)	2.5	04/00→11/00	BNZ	Diesel	2461	5	473
TRANSPORTER V Platform/Chassis (7JD, 7JE, 7JL, 7JY, 7JZ, 7FD)	2.5	04/00→11/00	BPC	Diesel	2461	5	474
TRANSPORTER V Platform/Chassis (7JD, 7JE, 7JL, 7JY, 7JZ, 7FD)	3.2	02/00→11/00	BDL	Petrol	3189	6	518
TRANSPORTER V Platform/Chassis (7JD, 7JE, 7JL, 7JY, 7JZ, 7FD)	3.2	08/00→05/00	BKK	Petrol	3189	6	522
VENTO (1H2)	1.4	11/99→09/99	ABD	Petrol	1390	4	43
VENTO (1H2)	1.4	11/99→09/99	AEX	Petrol	1390	4	44
VENTO (1H2)	1.6	09/99→09/99	ABU	Petrol	1598	4	100
VENTO (1H2)	1.6	09/99→09/99	AEA	Petrol	1598	4	102
VENTO (1H2)	1.6	09/99→09/99	AEE	Petrol	1598	4	103
VENTO (1H2)	1.6	10/99→09/99	AEK	Petrol	1595	4	105
VENTO (1H2)	1.6	10/99→09/99	AFT	Petrol	1595	4	107
VENTO (1H2)	1.8	11/99→09/99	AAM	Petrol	1781	4	180
VENTO (1H2)	1.8	11/99→09/99	ABS	Petrol	1781	4	181
VENTO (1H2)	1.8	11/99→09/99	ADZ	Petrol	1781	4	185
VENTO (1H2)	1.9	11/99→09/99	1Y	Diesel	1896	4	245
VENTO (1H2)	1.9	09/99→09/99	1Z	Diesel	1896	4	246
VENTO (1H2)	1.9	11/99→09/99	AAZ	Diesel	1896	4	247
VENTO (1H2)	1.9	04/99→09/99	AEY	Diesel	1896	4	250
VENTO (1H2)	1.9	04/99→09/99	AFN	Diesel	1896	4	251
VENTO (1H2)	1.9	09/99→09/99	AHU	Diesel	1896	4	257
VENTO (1H2)	1.9	09/99→09/99	ALE	Diesel	1896	4	259
VENTO (1H2)	2.0	11/99→09/99	2E	Petrol	1984	4	301
VENTO (1H2)	2.0	11/99→07/99	AAC	Petrol	1968	4	303
VENTO (1H2)	2.0	11/99→09/99	ADY	Petrol	1984	4	305
VENTO (1H2)	2.0	05/99→12/99	AEP	Petrol	1984	4	307
VENTO (1H2)	2.0	11/99→09/99	AGG	Petrol	1984	4	308
VENTO (1H2)	2.0	11/99→09/99	AKR	Petrol	1984	4	309
VENTO (1H2)	2.8	01/99→09/99	AAA	Petrol	2792	6	483
VOYAGE	1.0	07/00→	CCNA	Flexfuel	999	4	12
VOYAGE	1.4	05/99→07/00	AGY	Petrol	1390	4	47
VOYAGE	1.9	06/99→09/00	1Y	Diesel	1896	4	245
VOYAGE	1.9	09/99→09/00	1Z	Diesel	1896	4	246

		CC			9			CC			9
1C	Diesel	1588	4	76.50	96	AFY	Petrol	1781	4	81.00	187
1E	Petrol	2383	6	76.50	426	AGD	Diesel	1896	4	79.50	252
1F	Petrol	1595	4	81.00	97	AGE	Petrol	2771	6	82.50	486
1G	Diesel	2383	6	76.50	427	AGG	Petrol	1984	4	82.50	308
1H	Petrol	1781	4	81.00	176	AGK	Diesel	2799	4	93.00	487
1P	Petrol	1781	4	81.00	177	AGL	Petrol	2295	4	90.90	422
1S	Diesel	2383	6	76.50	428	AGN	Petrol	1781	4	81.00	188
1V	Diesel	1589	4	76.50	98	AGP	Diesel	1896	4	79.50	253
1W	Diesel	1398	4	75.00	42	AGR	Diesel	1896	4	79.50	254
1X	Diesel	1896	4	79.50	244	AGU	Petrol	1781	4	81.00	189
1Y	Diesel	1896	4	79.50	245	AGX	Diesel	2461	5	81.00	444
1Z	Diesel	1896	4	79.50	246	AGY	Petrol	1390	4	76.50	47
2E	Petrol	1984	4	82.50	301	AGZ	Petrol	2324	5	81.00	423
2G	Petrol	1272	4	75.00	30	AHB	Diesel	1716	4	79.50	169
2H	Petrol	1781	4	81.00	178	AHD	Diesel	2461	5	81.00	445
2Y	Petrol	1812	4	86.00	179	AHF	Diesel	1896	4	79.50	255
3F	Petrol	1272	4	75.00	31	AHG	Diesel	1716	4	79.50	170
4Y	Petrol	2237	4	91.00	417	AHH	Diesel	1896	4	79.50	256
9A	Petrol	1984	4	82.50	302	AHL	Petrol	1595	4	81.00	108
AAA	Petrol	2792	6	81.00	483	AHS	Petrol	1598	4	76.50	109
AAB	Diesel	2370	5	79.50	429	AHT	Petrol	997	4	72.00	6
AAC	Petrol	1968	4	81.00	303	AHU	Diesel	1896	4	79.50	257
AAF	Petrol	2461	5	81.00	437	AHW	Petrol	1390	4	76.50	48
AAK	Petrol	1043	4	75.00	1	AHY	Diesel	2461	5	81.00	446
AAM	Petrol	1781	4	81.00	180	AJA	Diesel	2370	5	79.50	432
AAU	Petrol	1043	4	75.00	2	AJH	Petrol	1781	4	81.00	190
AAV	Petrol	1272	4	75.00	32	AJM	Diesel	1896	4	79.50	258
AAZ	Diesel	1896	4	79.50	247	AJT	Diesel	2461	5	81.00	447
ABD	Petrol	1390	4	75.00	43	AJV	Petrol	1598	4	76.50	110
ABF	Petrol	1984	4	82.50	304	AKK	Petrol	1390	4	76.50	49
ABL	Diesel	1896	4	79.50	248	AKL	Petrol	1595	4	81.00	111
ABN	Petrol	1595	4	81.00	99	AKN	Diesel	2496	6	78.30	448
ABS	Petrol	1781	4	81.00	181	AKP	Petrol	1390	4	76.50	50
ABU	Petrol	1598	4	76.50	100	AKQ	Petrol	1390	4	76.50	51
ABV	Petrol	2861	6	82.00	503	AKR	Petrol	1984	4	82.50	309
ACC	Petrol	1781	4	81.00	182	AKS	Petrol	1595	4	81.00	112
ACK	Petrol	2771	6	82.50	484	AKU	Diesel	1716	4	79.50	171
ACL	Diesel	2383	6	76.50	430	AKV	Petrol	1390	4	76.50	52
ACM	Petrol	1043	4	75.00	3	AKW	Diesel	1716	4	79.50	172
ACT	Diesel	2383	6	76.50	431	ALD	Petrol	999	4	67.10	7
ACU	Petrol	2461	5	81.00	438	ALE	Diesel	1896	4	79.50	259
ACV	Diesel	2461	5	81.00	439	ALG	Petrol	2771	6	82.50	488
ADD	Petrol	1781	4	81.00	183	ALH	Diesel	1896	4	79.50	260
ADP	Petrol	1595	4	81.00	101	ALL	Petrol	999	4	67.10	8
ADR	Petrol	1781	4	81.00	184	ALM	Petrol	1598	4	76.50	113
ADX	Petrol	1296	4	76.50	33	ALT	Petrol	1984	4	82.50	310
ADY	Petrol	1984	4	82.50	305	ALZ	Petrol	1595	4	81.00	114
ADZ	Petrol	1781	4	81.00	185	AMF	Diesel	1422	3	79.50	53
AEA	Petrol	1598	4	76.50	102	AMV	Petrol	2792	6	81.00	489
AEB	Petrol	1781	4	81.00	186	AMX	Petrol	2771	6	82.50	490
AEE	Petrol	1598	4	76.50	103	AMY	Petrol	2792	6	81.00	491
AEF	Diesel	1896	4	79.50	249	ANA	Petrol	1595	4	81.00	115
AEG	Petrol	1984	4	82.50	306	ANB	Petrol	1781	4	81.00	191
AEH	Petrol	1595	4	81.00	104	ANJ	Diesel	2461	5	81.00	449
AEK	Petrol	1595	4	81.00	105	ANN	Petrol	1781	4	81.00	192
AEN	Petrol	2461	5	81.00	440	ANP	Petrol	1781	4	81.00	193
AEP	Petrol	1984	4	82.50	307	ANU	Diesel	1896	4	79.50	261
AER	Petrol	999	4	67.10	4	ANV	Petrol	999	4	67.10	9
AES	Petrol	2792	6	81.00	485	ANW	Petrol	1390	4	76.50	54
AET	Petrol	2461	5	81.00	441	ANX	Petrol	1390	4	76.50	55
AEU	Petrol	2461	5	81.00	442	ANY	Diesel	1191	3	76.50	14
AEV	Petrol	1043	4	75.00	5	APA	Diesel	2461	5	81.00	450
AEX	Petrol	1390	4	75.00	44	APE	Petrol	1390	4	76.50	56
AEY	Diesel	1896	4	79.50	250	APF	Petrol	1595	4	81.00	116
AF	Petrol	1584	4	85.50	106	APH	Petrol	1781	4	81.00	194
AFB	Diesel	2496	6	78.30	443	APK	Petrol	1984	4	82.50	311
AFH	Petrol	1390	4	76.50	45	APL	Petrol	2461	5	81.00	451
AFK	Petrol	1390	4	76.50	46	APQ	Petrol	1390	4	76.50	57
AFN	Diesel	1896	4	79.50	251	APR	Petrol	2771	6	82.50	492
AFT	Petrol	1595	4	81.00	107	APT	Petrol	1781	4	81.00	195

		CC			9			CC			9
APU	Petrol	1781	4	81.00	196	AXL	Diesel	2461	5	81.00	458
AQA	Petrol	1781	4	81.00	197	AXP	Petrol	1390	4	76.50	64
AQD	Petrol	2771	6	82.50	493	AXR	Diesel	1896	4	79.50	278
AQM	Diesel	1896	4	79.50	262	AXU	Petrol	1390	4	76.50	65
AQN	Petrol	2324	5	81.00	424	AXW	Petrol	1984	4	82.50	319
AQP	Petrol	2792	6	81.00	494	AXX	Petrol	1984	4	82.50	320
AQQ	Petrol	1390	4	76.50	58	AYC	Diesel	2461	5	81.00	459
AQY	Petrol	1984	4	82.50	312	AYD	Petrol	1595	4	81.00	125
ARC	Petrol	1598	4	76.50	117	AYL	Petrol	2792	6	81.00	499
ARG	Petrol	1781	4	81.00	198	AYQ	Diesel	1896	4	79.50	279
ARL	Diesel	1896	4	79.50	263	AYT	Petrol	3189	6	84.00	515
ARM	Petrol	1595	4	81.00	118	AYY	Diesel	2461	5	81.00	460
ARR	Petrol	1390	4	76.50	59	AYZ	Diesel	1191	3	76.50	16
ARX	Petrol	1781	4	81.00	199	AZD	Petrol	1598	4	76.50	126
ARZ	Petrol	1781	4	81.00	200	AZG	Petrol	1984	4	82.50	321
ASV	Diesel	1896	4	79.50	264	AZH	Petrol	1984	4	82.50	322
ASX	Diesel	1896	4	79.50	265	AZJ	Petrol	1984	4	82.50	323
ASY	Diesel	1896	4	79.50	266	AZM	Petrol	1984	4	82.50	324
ASZ	Diesel	1896	4	79.50	267	AZQ	Petrol	1198	3	76.50	17
ATA	Diesel	2799	4	93.00	495	AZV	Diesel	1968	4	81.00	325
ATD	Diesel	1896	4	79.50	268	AZX	Petrol	2324	5	81.00	425
ATJ	Diesel	1896	4	79.50	269	AZZ	Petrol	3189	6	84.00	516
ATL	Diesel	1422	3	79.50	60	BAA	Petrol	3189	6	84.00	517
ATM	Petrol/ Petroleum Gas (LPG)	1984	4	82.50	313	BAC	Diesel	2461	5	81.00	461
ATM	Petrol	1984	4	82.50	313	BAD	Petrol	1598	4	76.50	127
ATN	Petrol	1598	4	76.50	119	BAF	Petrol	1781	4	81.00	211
ATU	Petrol	1984	4	82.50	314	BAG	Petrol	1598	4	76.50	128
ATX	Petrol	2771	6	82.50	496	BAH	Petrol	1598	4	76.50	129
AUA	Petrol	1390	4	76.50	61	BAU	Diesel	2496	6	78.30	462
AUB	Petrol	1390	4	76.50	62	BAY	Diesel	1422	3	79.50	66
AUC	Petrol	999	4	67.10	10	BBE	Diesel	2461	5	81.00	463
AUD	Petrol	1390	4	76.50	63	BBF	Diesel	2461	5	81.00	464
AUE	Petrol	2792	6	81.00	497	BBG	Petrol	2771	6	82.50	500
AUF	Diesel	2461	5	81.00	452	BBM	Petrol	1198	3	76.50	18
AUH	Diesel	2799	4	93.00	498	BBU	Petrol	1781	4	81.00	212
AUM	Petrol	1781	4	81.00	201	BBY	Petrol	1390	4	76.50	67
AUQ	Petrol	1781	4	81.00	202	BBZ	Petrol	1390	4	76.50	68
AUR	Petrol	1595	4	81.00	120	BCA	Petrol	1390	4	76.50	69
AUS	Petrol	1598	4	76.50	121	BCB	Petrol	1598	4	76.50	130
AUY	Diesel	1896	4	79.50	270	BCQ	Diesel	2798	4	93.00	501
AVB	Diesel	1896	4	79.50	271	BDC	Petrol	1984	4	82.50	326
AVC	Petrol	1781	4	81.00	203	BDE	Petrol	2792	6	81.00	502
AVF	Diesel	1896	4	79.50	272	BDG	Diesel	2496	6	78.30	465
AVG	Diesel	1896	4	79.50	273	BDH	Diesel	2496	6	78.30	466
AVH	Petrol	1984	4	82.50	315	BDJ	Diesel	1968	4	81.00	327
AVQ	Diesel	1896	4	79.50	274	BDK	Diesel	1968	4	81.00	328
AVR	Diesel	2461	5	81.00	453	BDL	Petrol	3189	6	84.00	518
AVT	Petrol	2461	5	81.00	454	BEH	Bi-Fuel	1984	4	82.50	329
AVU	Petrol	1595	4	81.00	122	BEJ	Petrol	1984	4	82.50	330
AVY	Petrol	1598	4	76.50	123	BER	Petrol	1984	4	82.50	331
AWC	Petrol	1781	4	81.00	204	BEV	Petrol	1984	4	82.50	332
AWF	Petrol	1984	4	82.50	316	BEW	Diesel	1896	4	79.50	280
AWG	Petrol	1984	4	82.50	317	BFF	Petrol	1984	4	82.50	333
AWH	Petrol	1595	4	81.00	124	BFH	Petrol	3189	6	84.00	519
AWL	Petrol	1781	4	81.00	205	BFQ	Petrol	1595	4	81.00	131
AWM	Petrol	1781	4	81.00	206	BFS	Petrol	1595	4	81.00	132
AWP	Petrol	1781	4	81.00	207	BGD	Petrol	1984	4	82.50	334
AWT	Petrol	1781	4	81.00	208	BGG	Diesel	1896	4	79.50	281
AWU	Petrol	1781	4	81.00	209	BGU	Petrol	1595	4	81.00	133
AWV	Petrol	1781	4	81.00	210	BGW	Diesel	1968	4	81.00	335
AWX	Diesel	1896	4	79.50	275	BHK	Petrol	3597	6	89.00	532
AWY	Petrol	1198	3	76.50	15	BHP	Petrol	1984	4	82.50	336
AXA	Petrol	1984	4	82.50	318	BHW	Diesel	1968	4	81.00	337
AXB	Diesel	1896	4	79.50	276	BJB	Diesel	1896	4	79.50	282
AXC	Diesel	1896	4	79.50	277	BJH	Petrol	1595	4	81.00	134
AXD	Diesel	2461	5	81.00	455	BJJ	Diesel	2461	5	81.00	467
AXE	Diesel	2461	5	81.00	456	BJK	Diesel	2461	5	81.00	468
AXG	Diesel	2461	5	81.00	457	BJL	Diesel	2461	5	81.00	469
						BJM	Diesel	2461	5	81.00	470
						BJS	Petrol	3189	6	84.00	520

		CC			9			CC			9
BJX	Petrol	1781	4	81.00	213	BVX	Petrol	1984	4	82.50	355
BKC	Diesel	1896	4	79.50	283	BVY	Petrol	1984	4	82.50	356
BKD	Diesel	1968	4	81.00	338	BVZ	Petrol	1984	4	82.50	357
BKF	Petrol	1781	4	81.00	214	BWA	Petrol	1984	4	82.50	358
BKG	Petrol	1390	4	76.50	70	BWB	Diesel	1422	3	79.50	80
BKJ	Petrol	3189	6	84.00	521	BWK	Petrol	1390	4	76.50	81
BKK	Petrol	3189	6	84.00	522	BWS	Petrol	3597	6	89.00	534
BKL	Petrol	3189	6	84.00	523	BWV	Diesel	1968	4	81.00	359
BKP	Diesel	1968	4	81.00	339	BWX	Petrol	1596	4	81.00	141
BKR	Petrol	1390	4	76.50	71	BXE	Diesel	1896	4	79.50	294
BKS	Diesel	2967	6	83.00	504	BXF	Diesel	1896	4	79.50	295
BKY	Petrol	1390	4	76.50	72	BXJ	Diesel	1896	4	79.50	296
BLF	Petrol	1598	4	76.50	135	BYD	Petrol	1984	4	82.50	360
BLG	Petrol	1390	4	76.50	73	BZB	Petrol	1798	4	81.00	217
BLJ	Diesel	2461	5	81.00	471	BZG	Petrol	1198	3	76.50	21
BLK	Diesel	2461	5	81.00	472	CAAA	Diesel	1968	4	81.00	361
BLN	Petrol	1390	4	76.50	74	CAAB	Diesel	1968	4	81.00	362
BLP	Petrol	1598	4	76.50	136	CAAC	Diesel	1968	4	81.00	363
BLR	Petrol	1984	4	82.50	340	CAAD	Diesel	1968	4	81.00	364
BLS	Diesel	1896	4	79.50	284	CAAE	Diesel	1968	4	81.00	365
BLT	Diesel	1896	4	79.50	285	CARA	Diesel	2967	6	83.00	507
BLV	Petrol	3597	6	89.00	533	CASA	Diesel	2967	6	83.00	508
BLX	Petrol	1984	4	82.50	341	CASB	Diesel	2967	6	83.00	509
BLY	Petrol	1984	4	82.50	342	CASC	Diesel	2967	6	83.00	510
BMA	Diesel	1968	4	81.00	343	CASD	Diesel	2967	6	83.00	511
BMD	Petrol	1198	3	76.50	19	CATA	Diesel	2967	6	83.00	512
BME	Petrol	1198	3	76.50	20	CAVA	Petrol	1390	4	76.50	82
BMK	Diesel	2967	6	83.00	505	CAVB	Petrol	1390	4	76.50	83
BML	Petrol	3189	6	84.00	524	CAVC	Petrol	1390	4	76.50	84
BMM	Diesel	1968	4	81.00	344	CAVD	Petrol	1390	4	76.50	85
BMN	Diesel	1968	4	81.00	345	CAVE	Petrol	1390	4	76.50	86
BMP	Diesel	1968	4	81.00	346	CAWA	Petrol	1984	4	82.50	366
BMR	Diesel	1968	4	81.00	347	CAWB	Petrol	1984	4	82.50	367
BMS	Diesel	1422	3	79.50	75	CAXA	Petrol	1390	4	76.50	87
BMT	Diesel	1896	4	79.50	286	CAYA	Diesel	1598	4	79.50	142
BMV	Petrol	3189	6	84.00	525	CAYB	Diesel	1598	4	79.50	143
BMX	Petrol	3189	6	84.00	526	CAYC	Diesel	1598	4	79.50	144
BMY	Petrol	1390	4	76.50	76	CAYD	Diesel	1598	4	79.50	145
BNM	Diesel	1422	3	79.50	77	CAYE	Diesel	1598	4	79.50	146
BNU	Petrol	1781	4	81.00	215	CBAA	Diesel	1968	4	81.00	368
BNV	Diesel	1422	3	79.50	78	CBAB	Diesel	1968	4	81.00	369
BNY	Petrol	1781	4	81.00	216	CBAC	Diesel	1968	4	81.00	370
BNZ	Diesel	2461	5	81.00	473	CBBA	Diesel	1968	4	81.00	371
BPC	Diesel	2461	5	81.00	474	CBBB	Diesel	1968	4	81.00	372
BPD	Diesel	2461	5	81.00	475	CBDA	Diesel	1968	4	81.00	373
BPE	Diesel	2461	5	81.00	476	CBDB	Diesel	1968	4	81.00	374
BPY	Petrol	1984	4	82.50	348	CBDC	Diesel	1968	4	81.00	375
BRJ	Petrol	3189	6	84.00	527	CBFA	Petrol	1984	4	82.50	376
BRK	Petrol	3189	6	84.00	528	CBPA	Petrol	1984	4	82.50	377
BRR	Diesel	1896	4	79.50	287	CBRA	Petrol	3189	6	84.00	530
BRS	Diesel	1896	4	79.50	288	CBUA	Petrol	2480	5	82.50	477
BRT	Diesel	1968	4	81.00	349	CBZA	Petrol	1197	4	71.00	22
BRU	Diesel	1896	4	79.50	289	CBZB	Petrol	1197	4	71.00	23
BRY	Petrol	1595	4	81.00	137	CBZC	Petrol	1197	4	71.00	24
BSE	Petrol	1595	4	81.00	138	CCCA	Petrol	2480	5	82.50	478
BSF	Petrol	1595	4	81.00	139	CCHA	Diesel	1968	4	81.00	378
BST	Diesel	1968	4	81.00	350	CCHB	Diesel	1968	4	81.00	379
BSU	Diesel	1896	4	79.50	290	CCNA	Flexfuel	999	4	67.10	12
BSW	Diesel	1896	4	79.50	291	CCRA	Petrol/Ethanol	1598	4	76.50	147
BSX	Natural Gas	1984	4	82.50	351	CCRA	Petrol	1598	4	76.50	147
BTB	Diesel	1896	4	79.50	292	CCRA	Flexfuel	1598	4	76.50	147
BTS	Petrol	1598	4	76.50	140	CCSA	Petrol/Ethanol	1595	4	81.00	148
BTY	Petrol	999	4	67.10	11	CCSA	Petrol	1595	4	81.00	148
BUB	Petrol	3189	6	84.00	529	CCTA	Petrol	1984	4	82.50	380
BUD	Petrol	1390	4	76.50	79	CCTB	Petrol	1984	4	82.50	381
BUN	Diesel	2967	6	83.00	506	CCZA	Petrol	1984	4	82.50	382
BUZ	Diesel	1968	4	81.00	352	CCZB	Petrol	1984	4	82.50	383
BVE	Diesel	1968	4	81.00	353	CCZC	Petrol	1984	4	82.50	384
BVH	Diesel	1968	4	81.00	354	CDA A	Petrol	1798	4	82.50	218
BVK	Diesel	1896	4	79.50	293	CDAB	Petrol	1798	4	82.50	219

		CC			9			CC			9
CDBA	Diesel	1968	4	81.00	385	DW	Diesel	2383	6	76.50	436
CDCA	Diesel	1968	4	81.00	386	DX	Petrol	1781	4	81.00	222
CDDA	Petrol	1390	4	76.50	88	DZ	Petrol	1781	4	81.00	223
CDGA	Petrol/ Natural Gas (CNG)	1390	4	76.50	89	EV	Petrol	1781	4	81.00	224
CDGA	Natural Gas	1390	4	76.50	89	EW	Petrol	1595	4	81.00	154
CDGA	Bi-Fuel	1390	4	76.50	89	EX	Petrol	1781	4	81.00	225
CDLA	Petrol	1984	4	82.50	387	EZ	Petrol	1595	4	81.00	155
CDLC	Petrol	1984	4	82.50	388	GK	Petrol	1272	4	75.00	34
CDLF	Petrol	1984	4	82.50	389	GT	Petrol	1272	4	75.00	35
CEBA	Diesel	2461	5		479	GU	Petrol	1781	4	81.00	226
CEBB	Diesel	2461	5		480	GW	Petrol	1913	4	94.00	300
CECA	Diesel	2461	5		481	GX	Petrol	1781	4	81.00	227
CECB	Diesel	2461	5		482	GZ	Petrol	1781	4	81.00	228
CEXA	Diesel	2967	6	83.00	513	HJ	Petrol	1272	4	75.00	36
CFFA	Diesel	1968	4	81.00	390	HK	Petrol	1272	4	75.00	37
CFFB	Diesel	1968	4	81.00	391	HM	Petrol	1595	4	81.00	156
CFFD	Diesel	1968	4	81.00	392	HN	Petrol	1595	4	81.00	157
CFFE	Diesel	1968	4	81.00	393	HP	Petrol	1994	5	81.00	411
CFGB	Diesel	1968	4	81.00	394	HV	Petrol	1781	4	81.00	229
CFHB	Diesel	1968	4	81.00	395	HY	Petrol	2226	5	81.00	418
CFHC	Diesel	1968	4	81.00	396	HZ	Petrol	1043	4	75.00	13
CFHE	Diesel	1968	4	81.00	397	JH	Petrol	1781	4	81.00	230
CFHF	Diesel	1968	4	81.00	398	JJ	Petrol	1781	4	81.00	231
CFJA	Diesel	1968	4	81.00	399	JN	Petrol	1781	4	81.00	232
CFLA	Petrol	3189	6	84.00	531	JS	Petrol	1994	5	81.00	412
CFNB	Petrol	1598	4	76.50	149	JT	Petrol	2226	5	81.00	419
CFWA	Diesel	1199	3	79.50	25	JV	Petrol	1781	4	81.00	233
CGGA	Petrol	1390	4	76.50	90	JX	Diesel	1589	4	76.50	158
CGGB	Petrol	1390	4	76.50	91	KR	Petrol	1781	4	81.00	234
CGPA	Petrol	1198	3	76.50	26	KV	Petrol	2226	5	81.00	420
CGPB	Petrol	1198	3	76.50	27	KX	Petrol	2226	5	81.00	421
CGYA	Petrol	1798	4	82.50	220	KY	Diesel	1716	4	79.50	173
CHFA	Petrol	1198	3	76.50	28	MF	Diesel	1588	4	76.50	159
CHFB	Petrol	1198	3	76.50	29	MH	Petrol	1272	4	75.00	38
CHGA	Petrol/ Petroleum Gas (LPG)	1595	4	81.00	150	MN	Diesel	1272	4	75.00	39
CJAA	Diesel	1968	4	81.00	400	MV	Petrol	2110	4	94.00	414
CJMA	Diesel	2967	6	83.00	514	NZ	Petrol	1272	4	75.00	40
CKJA	Petrol	1984	4	82.50	401	PB	Petrol	1781	4	81.00	235
CKMA	Petrol/Ethanol	1390	4	76.50	92	PD	Petrol	1781	4	81.00	236
CKMA	Petrol	1390	4	76.50	92	PF	Petrol	1781	4	81.00	237
CKTB	Diesel	1968	4	81.00	402	PG	Petrol	1781	4	81.00	238
CKTC	Diesel	1968	4	81.00	403	PL	Petrol	1781	4	81.00	239
CKUB	Diesel	1968	4	81.00	404	PN	Petrol	1595	4	81.00	160
CKUC	Diesel	1968	4	81.00	405	PP	Petrol	1595	4	81.00	161
CLCA	Diesel	1968	4	81.00	406	PY	Petrol	1272	4	75.00	41
CLCB	Diesel	1968	4	81.00	407	RA	Diesel	1588	4	76.50	162
CLLA	Diesel	1968	4	81.00	408	RE	Petrol	1595	4	81.00	163
CLPA	Petrol	1390	4	76.50	93	RF	Petrol	1595	4	81.00	164
CLSA	Petrol	1598	4	76.50	151	RH	Petrol	1781	4	81.00	240
CMAA	Petrol/ Petroleum Gas (LPG)	1390	4	76.50	94	RL	Petrol	1595	4	81.00	165
CMXA	Petrol/Ethanol	1595	4	81.00	152	RM	Petrol	1781	4	81.00	241
CMXA	Petrol	1595	4	81.00	152	RP	Petrol	1781	4	81.00	242
CNEA	Diesel	1968	4	81.00	409	SB	Diesel	1588	4	76.50	166
CNWA	Petrol	1390	4	76.50	95	SR	Petrol	2109	4	94.00	415
CP	Diesel	2383	6	76.50	433	SS	Petrol	2110	4	94.00	416
CSHA	Diesel	1968	4	81.00	410	UDH	Petrol	1781	4	81.00	243
DF	Petrol	1913	4	94.00	297	WL	Petrol	1714	4	79.50	174
DG	Petrol	1913	4	94.00	298	WV	Petrol	1588	4	79.50	167
DH	Petrol	1913	4	94.00	299	YN	Petrol	1588	4	79.50	168
DJ	Petrol	2110	4	94.00	413	YX	Petrol	1714	4	79.50	175
DL	Petrol	2383	6	76.50	434						
DS	Petrol	1781	4	81.00	221						
DT	Petrol	1595	4	81.00	153						
DV	Diesel	2383	6	76.50	435						



cc



kW/PS



1.0										
AAK							1	BL570 (Fibre), 1.730mm	DL572 →Ch.80-PW-000000 DL574 Ch.80-PW-000 001→	EV460
Polo 1.3	08/89→09/94	1043	4	75.00	SOHC/OHC	33/45				
Polo Coupe 1.3	08/89→09/94									
Polo Cl 1.0	01/85→09/94									
AAU							2	BL570 (Fibre), 1.730mm	DL572 →Ch.80-PW-000000 DL574 Ch.80-PW-000 001→	EV460
Polo 1.3	08/89→09/94	1043	4	75.00	SOHC/OHC	33/45				
Polo Coupe 1.3	08/89→09/94									
Polo Van 1.0	08/92→07/94									
Polo Cl 1.0	01/85→09/94									
ACM							3	BL570 (Fibre), 1.730mm	DL572 →Ch.80-PW-000000 DL574 Ch.80-PW-000 001→	EV460
Polo 1.3	08/89→09/94	1043	4	75.00	SOHC/OHC	33/45				
Polo Coupe 1.3	08/89→09/94									
AER							4	AA5410 (MLS), 0.600mm	CA5410 [3]	EB961 [18]
Lupo 1.0	09/98→07/05	999	4	67.10	SOHC/OHC	37/50				
Polo 1.0 50	09/96→10/99									
AEV							5	BL570 (Fibre), 1.730mm	DL573	EB961 [18]
Polo 1.0 45	10/94→09/96	1043	4	75.00	SOHC/OHC	33/45				
AHT							6		DT581	
Lupo 1.0	10/98→05/00	997	4	72.00	OHV	37/50				
ALD							7	AD5630 (MLS), 0.500mm	CD5630	
Lupo 1.0	09/98→07/05	999	4	67.10	SOHC/OHC	37/50				
Polo 1.0	10/99→09/01									
ALL							8	AA5410 (MLS), 0.600mm	CA5410 [3]	EB961 [18]
Lupo 1.0	09/98→07/05	999	4	67.10	SOHC/OHC	37/50				
Polo 1.0 50	09/96→10/99									



AA5410



AD5630



BL570



JC259



JD246



JD488



JD5318



JD597



JD601

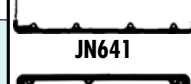

JN641



JP074

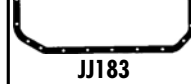

JJ183



cc



kW/PS



1.0 ANY							9	AD5630 (MLS), 0.500mm	CD5630	
Lupo 1.0	09/98→07/05	999	4	67.10	SOHC/OHC	37/50				
1.0 AUC							10	AD5630 (MLS), 0.500mm	CD5630	
Lupo 1.0	09/98→07/05	999	4	67.10	SOHC/OHC	37/50				
Polo 1.0	10/99→09/01									
1.0 BTY							11			
GOL 1.0	10/05→05/08	999	4	67.10	SOHC/OHC	48-53/ 65-72				
1.0 CCNA							12			
VOYAGE 1.0 Flex	07/08→	999	4	67.10	SOHC/OHC	53-56/ 71-76				
1.0 HZ							13	BL570 (Fibre), 1.730mm	DL572 →Ch.80-PW-000000 DL574 Ch.80-PW-000 001→	EV460
Golf II 1.0	08/85→10/91	1043	4	75.00	SOHC/OHC	33-37/ 45-50				
Polo 1.0	08/85→01/92									
Polo Coupe 1.0	08/85→01/92									
Polo Cl 1.0	01/85→09/94									
1.2 ANY Diesel							14	AC5190 (MLS), 1.450mm, 1 Hole AC5200 (MLS), 1.530mm, 2 Holes AC5210 (MLS), 1.610mm, 3 Holes	CC5190 ▲☒ [3]	ED5650 [18]
Lupo 1.2 TDI 3L	07/99→07/05	1191	3	76.50	SOHC/OHC	45/61				
1.2 AWY							15	AG8840 (MLS)	CG8840	EF5990
Polo 1.2	04/01→05/07	1198	3	76.50	SOHC/OHC	40/54				
1.2 AYZ Diesel							16	AC5190 (MLS), 1.450mm, 1 Hole AC5200 (MLS), 1.530mm, 2 Holes AC5210 (MLS), 1.610mm, 3 Holes	CC5190 ▲☒ [3]	ED5650 [18]
Lupo 1.2 TDI 3L	07/99→07/05	1191	3	76.50	SOHC/OHC	45/61				
1.2 AZQ							17	AF5990 (MLS)	CF5990	EF5990
Polo 1.2	10/01→07/07	1198	3	76.50	DOHC	47/64				
1.2 BBM							18	AG8840 (MLS)	CG8840	EF5990
Polo 1.2	05/07→11/09	1198	3	76.50	SOHC/OHC	44/60				
1.2 BMD							19	AG8840 (MLS)	CG8840	EF5990
FOX 1.2	04/05→	1198	3	76.50	SOHC/OHC	40/54				
Polo 1.2	01/02→05/07									

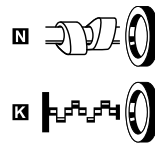
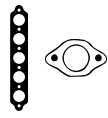

AC5190, AC5200,
AC5210



AD5630



BL570



JC259



JD246

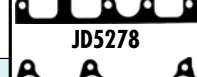

JD5278



JD5279



JD5318



JE5036

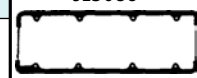

JN641



JJ183



cc



kW/PS



1.2	BME						20	AF5990 (MLS)	CF5990	EF5990
Polo 1.2	10/01→07/07	1198	3	76.50	SOHC/OHC	47/64				
1.2	BZG						21	AF5990 (MLS)	CF5990	EF5990
Polo 1.2 12V	05/07→11/09	1198	3	76.50	DOHC	51/69				
1.2	CBZA						22			
Caddy 3 1.2 TSI	09/10→	1197	4	71.00	SOHC/OHC	63/86				
Golf 6 1.2	05/10→11/12									
Golf 6V 1.2 TSI	07/10→									
Golf PL 1.2 TSI	05/10→									
1.2	CBZB						23			
Beetle 1.2 TSI	07/11→	1197	4	71.00	SOHC/OHC	77/105				
Caddy 3 1.2 TSI	09/10→									
Golf 6 1.2 TSI	05/09→11/12									
Golf 6 Conv 1.2	03/11→11/13									
Golf 6V 1.2 TSI	08/09→									
Golf PL 1.2 TSI	11/09→									
Jetta 4 1.2 TSI	02/11→									
Polo 1.2 TSI	11/09→									
Touran 1.2 TSI	05/10→									
1.2	CBZC						24			
Polo 1.2 TSI	05/11→	1197	4	71.00	SOHC/OHC	66/90				
1.2	CFWA Diesel						25			
Polo 1.2 TDI	10/09→	1199	3	79.50	DOHC	55/75				
1.2	CGPA						26	AF5990 (MLS)	CF5990	EF5990
Polo 1.2	06/09→	1198	3	76.50	DOHC	51/70				
1.2	CGPB						27	AF5990 (MLS)	CF5990	EF5990
Polo 1.2	06/09→	1198	3	76.50	DOHC	44/60				
1.2	CHFA						28	AG8840 (MLS)	CG8840	EF5990
FOX 1.2	09/10→	1198	3	76.50	DOHC	44/60				
1.2	CHFB						29	AG8840 (MLS)	CG8840	EF5990
FOX 1.2	04/05→	1198	3	76.50	DOHC	40/54				
1.3	2G						30	BL570 (Fibra), 1.730mm	DL572 →Ch.6K-2R-000 100 DL574 Ch.80-PW-000 001→	EV460 Ch.80-PW-000 001→
Golf 3 1.3	08/91→07/92	1272	4	75.00	SOHC/OHC	40/54				
Golf II 1.3	06/86→12/92									
Jetta II 1.3	06/87→12/91									
Polo 1.3	07/87→09/94									
Polo Coupe 1.3	07/87→08/94									

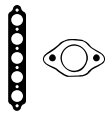

BL570



JC259



JD246

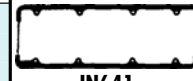

JN641



JJ183

HBS471 [5] M9x1.25x138.00mm (x8)	JD5811 [x3] JD5816	HR397	HR397	PA5041 (x12) 6.00/12.20x10.00 (FPM) HR280	NA5106 [2] 35.00x48.00x10.00mm, PTFE	
HBS471 [5] M9x1.25x138.00mm (x8)	JD5811 [x3] JD5816	HR397	HR397	PA5041 (x12) 6.00/12.20x10.00 (FPM) HR280	NA5106 [2] 35.00x48.00x10.00mm, PTFE	
		HR397	HR397	PA5041 (x8) 6.00/12.20x10.00 (FPM)	NA5124 [2] 32.00x47.00x10.00mm, PTFE/ACM NA5124 [2] 32.00x47.00x10.00mm, PTFE/ACM	
		HR397	HR397	PA5041 (x8) 6.00/12.20x10.00 (FPM)	NA5124 [2] 32.00x47.00x10.00mm, PTFE/ACM NA5124 [2] 32.00x47.00x10.00mm, PTFE/ACM	
					NA5124 [2] 32.00x47.00x10.00mm, PTFE/ACM NA5124 [2] 32.00x47.00x10.00mm, PTFE/ACM	
					NA5106 [2] 35.00x48.00x10.00mm, PTFE/ACM NA5106 [2] 35.00x48.00x10.00mm, PTFE	
HBS471 [5] M9x1.25x138.00mm (x8)	JD5811 [x3] JD5816	HR397	HR397	PA5041 (x12) 6.00/12.20x10.00 (FPM) HR280	NA5106 [2] 35.00x48.00x10.00mm, PTFE	
HBS471 [5] M9x1.25x138.00mm (x8)	JD5811 [x3] JD5816	HR397	HR397	PA5041 (x12) 6.00/12.20x10.00 (FPM) HR280	NA5106 [2] 35.00x48.00x10.00mm, PTFE	
HBS479 [5] M9x1.25x162.00mm (x8)	JD5808 [x3] JD5819	HR397	HR397	PA5041 (x6) 6.00/12.20x10.00 (FPM) HL5002	NA5106 [2] 35.00x48.00x10.00mm, PTFE	
HBS479 [5] M9x1.25x162.00mm (x8)	JD5808 [x3] JD5819	HR397	HR397	PA5041 (x6) 6.00/12.20x10.00 (FPM) HL5002	NA5106 [2] 35.00x48.00x10.00mm, PTFE	
HBS043 [22] M11x1.50x95.00mm (x10)	JD246 JC259 (x2)	JN641 [4]	JJ183	HR569 →Ch.80-HW-500 000 HR816 Ch.80-PW-000 001 →	NA5001 [1][2] 32.00x47.00x10.00mm, FPM NA5001 [1][2] 32.00x47.00x10.00mm, FPM NA5133 [1] 85.00x105.00x11.00mm, FPM	



cc



kW/PS



1.3	3F					31	BL570 (Fibra), 1.730mm	DL572 →Ch.80-PW-000000 DL574 Ch.80-PW-000001→	EV460
Polo 1.3	10/89→08/94	1272	4	75.00	SOHC/OHC	55/57/ 75-78			
Polo Coupe 1.3	10/89→09/94								
1.3	AAV					32	BL570 (Fibra), 1.730mm	DL572 →Ch.6K-2R-000100 →Ch.80-PW-000000 DL574 Ch.6K-2R-000101→ Ch.80-PW-000001→	EV460 Ch.80-PW-000 001→
Polo 1.3	07/87→09/94	1272	4	75.00	SOHC/OHC	40/55			
Polo Coupe 1.3	07/87→08/94								
Polo Van 1.3	08/92→07/94								
1.3	ADX					33	BZ180 (MLS), 0.500mm	DZ180 [3]	EB961 [18]
Polo 1.3 55	10/94→07/95	1296	4	76.50	SOHC/OHC	40/55			
1.3	GK					34	BL570 (Fibra), 1.730mm	DL570	EA900
Polo 1.3	09/82→09/89	1272	4	75.00	SOHC/OHC	55/75			
Polo Coupe 1.3	09/82→09/89								
1.3	GT					35	BL570 (Fibra), 1.730mm	DL570	EA900
Polo 1.3	08/82→07/88	1272	4	75.00	SOHC/OHC	43/58			
Polo Coupe 1.3	08/82→07/88								
1.3	HJ					36	BL570 (Fibra), 1.730mm	DL571	EA900
Polo 1.3	08/82→07/88	1272	4	75.00	SOHC/OHC	43/58			
1.3	HK					37	BL570 (Fibra), 1.730mm	DL570	EA900
Polo 1.3	08/83→07/88	1272	4	75.00	SOHC/OHC	40/55			
1.3	MH					38	BL570 (Fibra), 1.730mm	DL572 →Ch.80-PN-000 000	EV460
Golf II 1.3	06/86→12/92	1272	4	75.00	SOHC/OHC	40/55			
Jetta II 1.3	06/87→12/91								
Polo 1.3	08/83→09/94								
Polo Coupe 1.3	07/87→08/94								
Polo Cl 1.3	07/87→09/94								
1.3	MN Diesel					39	BV460 (Fibra), 1.530mm, 1 Notch BV471 (Fibra), 1.570mm, 2 Notches BV481 (Fibra), 1.610mm, 3 Notches	DV460 ▲	EV460
Polo 1.3 D	08/86→07/90	1272	4	75.00	SOHC/OHC	33/44			
Polo Coupe 1.3D	08/86→08/90								
Polo Cl 1.3 D	08/86→12/88								

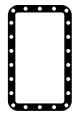
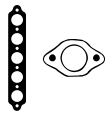

BL570



BV460



BZ180



JC259



JD246



JD487

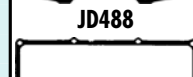

JD488

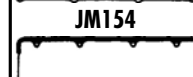

JM154

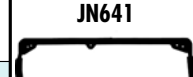

JN641

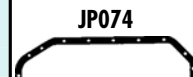

JP074

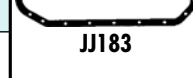

JJ183



cc



kw/PS



1.3		NZ					40	BL570 (Fibre), 1.730mm	DL572 →Ch.80-PN-000 000 DL574 Ch.80-PW-000 001→	EV460
Golf II 1.3	06/86→12/92	1272	4	75.00	SOHC/OHC	40/55				
Jetta II 1.3	06/87→12/91									
Polo 1.3	07/87→09/94									
Polo Coupe 1.3	07/87→08/94									
Polo Cl 1.3	07/87→09/94									
1.3		PY					41	AY930 (Fibre)	CY930 [3]	EV460
Polo Coupe 1.3	01/87→09/94	1272	4	75.00	SOHC/OHC	83-85/ 113-115				
1.4		1W Diesel					42	BV460 (Fibre), 1.530mm, 1 Notch BV471 (Fibre), 1.570mm, 2 Notches BV481 (Fibre), 1.610mm, 3 Notches	DV460 ▲	EV460
Polo 1.4 D	10/90→09/94	1398	4	75.00	SOHC/OHC	35/48				
Polo Coupe 1.4D	08/90→09/94									
Polo Van 1.4 D	08/92→07/94									
Polo Cl 1.4 D	10/90→09/94									
1.4		ABD					43	BL570 (Fibre), 1.730mm	DL574 →Eng.ABD558154 DL573 Eng.ABD558155→	EV460
Golf 3 1.4	10/91→04/99	1390	4	75.00	SOHC/OHC	40-44/ 55-60				
Vento 1.4	11/91→09/98									
1.4		AEX					44	BZ180 (MLS), 0.500mm	DZ181	EB961 [18]
Caddy II 1.4	11/95→01/04	1390	4	75.00	SOHC/OHC	40-44/ 55-60				
Caddy II 60 1.4	11/95→01/04									
Golf 3 1.4	10/91→04/99									
Polo 1.4	05/97→09/01									
Polo 1.4 55	08/95→10/99									
Polo 60 1.4	07/95→10/99									
Polo Cl 1.4 60	12/95→09/01									
Vento 1.4	11/91→09/98									
1.4		AFH					45	AA5500 (MLS)	CA5500 [3]	EB961 [18]
Polo 1.4 16V	04/96→10/99	1390	4	76.50	DOHC	74/100				
1.4		AFK					46	AB5701 (MLS)	CB5700 ☒	EB5700 [3][18]
Lupo 1.4 16V	08/99→07/05	1390	4	76.50	DOHC	74/101				
Polo 1.4 16V	10/99→09/01									
1.4		AGY					47			
Polo Cl 1.4	05/96→07/02	1390	4	76.50	SOHC/OHC	62/84				
VOYAGE 1.4	05/96→07/02									

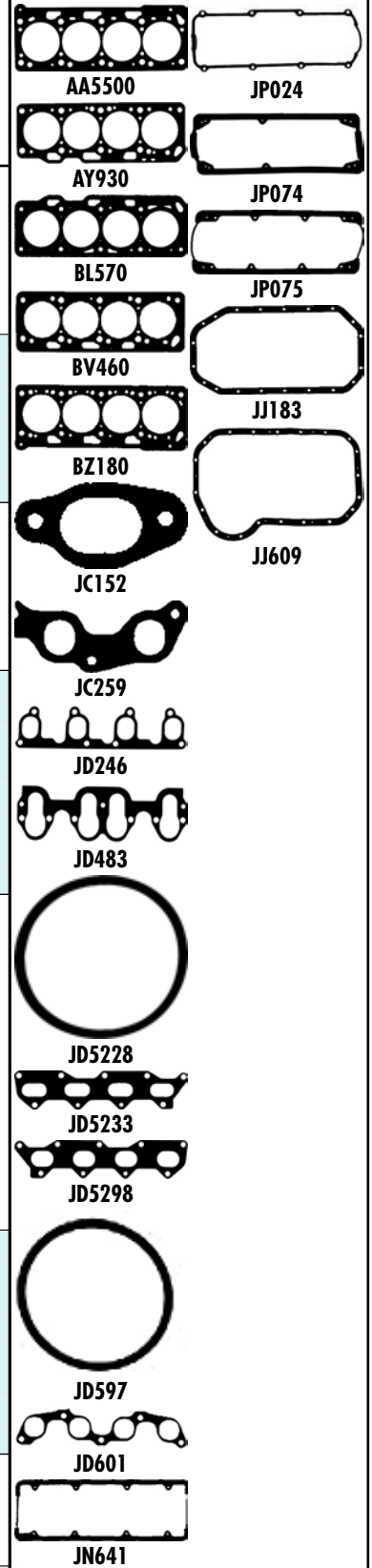
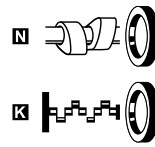
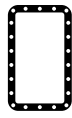



cc



kW/PS



1.4		AHW		48		AB5701 (MLS)		CB5700 ☒		EB5700 [3][18]	
Bora 1.4 16V	03/00→05/05	1390	4	76.50		55/75					
Golf 4 1.4 16V	08/97→06/06										
Lupo 1.4 16V	09/98→07/05										
Polo 3 S	10/99→09/01										
1.4		AKK		49		AD5640 (MLS), 0.640mm		CD5640 ☒ [3]			
Polo 1.4	05/97→09/01	1390	4	76.50	SOHC/OHC	44/60					
Polo Cl 1.4 60	12/95→09/01										
1.4		AKP		50		AD5640 (MLS), 0.640mm		CD5640 ☒ [3]			
Polo 1.4	12/98→09/01	1390	4	76.50	SOHC/OHC	40/54					
1.4		AKQ		51		AB5701 (MLS)		CB5700 ☒		EB5700 [3][18]	
Bora 1.4 16V	03/00→05/05	1390	4	76.50		55/75					
Golf 4 1.4 16V	08/97→06/06										
Lupo 1.4 16V	09/98→07/05										
1.4		AKV		52		BZ180 (MLS), 0.500mm		DZ181		EB961 [18]	
Caddy II 1.4	11/95→01/04	1390	4	76.50	SOHC/OHC	44/60					
Polo 1.4	05/97→09/01										
Polo 60 1.4	07/95→10/99										
Polo Cl 1.4 60	12/95→09/01										
1.4		AMF Diesel		53		AD5650 (MLS), 1.450mm, 1 Hole AD5660 (MLS), 1.530mm, 2 Holes AD5670 (MLS), 1.610mm, 3 Holes		CD5650 ▲		ED5650 [18]	
Lupo 1.4 TDI	01/99→07/05	1422	3	79.50	SOHC/OHC	55/75					
Polo 1.4 TDI	10/99→06/05										
1.4		ANW		54		AD5640 (MLS), 0.640mm		CD5640 ☒ [3]			
Polo 1.4	05/97→09/01	1390	4	76.50	SOHC/OHC	44/60					
Polo Cl 1.4 60	12/95→09/01										

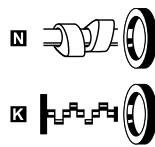
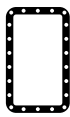
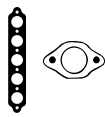

AD5640



AD5650, AD5660, AD5670



BZ180

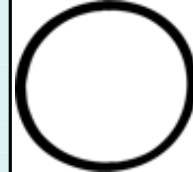

JD5228



JD5278



JD5279



JD5298



JD5318



JD597



JD601

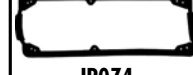

JP074



kW/PS

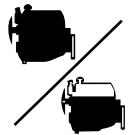

1.4										
ANX							55	BZ180 (MLS), 0.500mm	DZ181	EB961 [18]
Polo 1.4	10/99→09/01	1390	4	76.50	SOHC/OHC	40/54				
Polo Cl 54 1.4	01/98→08/99									
APE							56	AB5701 (MLS)	CB5700 ☒	EB5700 [3][18]
Bora 1.4 16V	03/00→05/05	1390	4	76.50	DOHC	55/75				
Golf 4 1.4 16V	08/97→06/06									
Lupo 1.4 16V	09/98→07/05									
Polo 1.4 16V	10/99→09/01									
Polo 3 S	10/99→09/01									
Polo Cl 1.4 16V	10/99→09/01									
APQ							57	BZ180 (MLS), 0.500mm	DZ181	EB961 [18]
Caddy II 1.4	11/95→01/04	1390	4	76.50	SOHC/OHC	44/60				
Caddy II 60 1.4	11/95→01/04									
Golf 3 1.4	07/93→04/99									
Polo 1.4	05/97→09/01									
Polo 60 1.4	07/95→10/99									
Polo Cl 1.4 60	12/95→09/01									
AQQ							58	AB5701 (MLS)	CB5700 ☒	EB5700 [3][18]
Lupo 1.4 16V	08/99→07/05	1390	4	76.50	DOHC	74/101				
Polo 1.4 16V	10/99→09/01									
ARR							59	AB5701 (MLS)	CB5700 ☒	EB5700 [3][18]
Lupo 1.4 FSI	02/01→07/05	1390	4	76.50	DOHC	77/105				
ATL Diesel							60	AD5650 (MLS), 1.450mm, 1 Hole AD5660 (MLS), 1.530mm, 2 Holes AD5670 (MLS), 1.610mm, 3 Holes	CD5650 ▲	ED5650 [18]
Polo 1.4 TDi	01/00→10/00	1422	3	79.50	SOHC/OHC	66/90				
AUA							61	AB5701 (MLS)	CB5700 ☒	EB5700 [3][18]
Caddy II 1.4	08/00→01/04	1390	4	76.50	DOHC	55/75				
Lupo 1.4 16V	09/98→07/05									
Polo 1.4 16V	10/99→05/08									
Polo 3 S	10/99→09/01									
Polo Cl 1.4 16V	10/99→09/01									
AUB							62	AB5701 (MLS)	CB5700 ☒	EB5700 [3][18]
Lupo 1.4 16V	08/99→07/05	1390	4	76.50	DOHC	74/101				
Polo 1.4 16V	10/99→05/08									

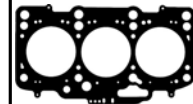

AD5650, AD5660,
AD5670



BZ180

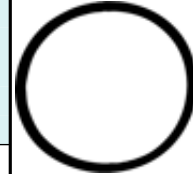

JD5228



JD5278



JD5279



JD5298

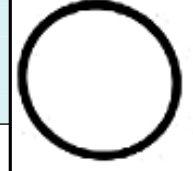

JD597



JD601



JP074



JJ183



cc



kW/PS



1.4		AUD				63	AD5640 (MLS), 0.640mm	CD5640 ☒ [3]	
Caddy II 1.4	11/95→01/04	1390	4	76.50	SOHC/OHC	44/60			
Caddy II 60 1.4	11/95→01/04								
Lupo 1.4	10/00→07/05								
Polo 1.4	05/97→09/01								
Polo Cl 1.4 60	12/95→09/01								
1.4		AXP				64	AB5701 (MLS)	CB5700 ☒	EB5700 [3][18]
Bora 1.4 16V	03/00→05/05	1390	4	76.50	DOHC	55/75			
Golf 4 1.4 16V	08/97→06/06								
1.4		AXU				65	AG8850 (MLS)	CG8850	
Polo 1.4 FSI	02/02→07/06	1390	4	76.50		63/86			
1.4		BAY Diesel				66	AD5650 (MLS), 1.450mm, 1 Hole AD5660 (MLS), 1.530mm, 2 Holes AD5670 (MLS), 1.610mm, 3 Holes	CD5650 ▲	ED5650 [18]
Polo 1.4 TDI	10/01→06/05	1422	3	79.50		55/75			
Polo Sal 1.4TDI	07/03→								
1.4		BBY				67	AB5701 (MLS)	CB5700 ☒	EB5700 [3][18]
Lupo 1.4 16V	09/98→07/05	1390	4	76.50	DOHC	55/75			
Polo 1.4 16V	10/01→05/08								
Polo Saloon 1.4	07/03→								
1.4		BBZ				68	AB5701 (MLS)	CB5700 ☒	EB5700 [3][18]
Polo 1.4 16V	10/01→05/08	1390	4	76.50	DOHC	74/101			
Polo Saloon 1.4	11/03→								
1.4		BCA				69	AB5701 (MLS)	CB5700 ☒	EB5700 [3][18]
Bora 1.4 16V	03/00→05/05	1390	4	76.50	DOHC	55/75			
Caddy 3 1.4	03/04→05/06								
Golf 4 1.4 16V	08/97→06/06								
Golf PL 1.4 16V	01/05→								
Golf V 1.4 16V	10/03→05/06								
New Beetle 1.4	11/01→								
Nw Beetle C 1.4	01/03→09/10								
1.4		BKG				70	AG8850 (MLS)	CG8850	
Golf V 1.4 FSI	10/03→07/06	1390	4	76.50	DOHC	66/90			
1.4		BKR				71			
FOX 1.4	04/05→	1390	4	76.50	DOHC	55/75			
1.4		BKY				72	AB5701 (MLS)	CB5700 ☒	EB5700 [3][18]
Polo 1.4 16V	10/01→05/08	1390	4	76.50	DOHC	55/75			
Polo Saloon 1.4	07/03→								



AD5640

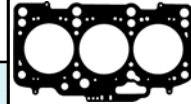

AD5650, AD5660, AD5670

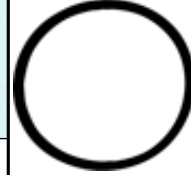

JD5228



JD5278



JD5279



JD5298



JD5318



JD597

HBS362 [5] M9x1.25x162.00mm (x10)	JD597 [1] [5] (x4) JD5318 [5]	HR397 [5]	HR397	PA5041 (x16) 6.00/12.20x10.00 (FPM) HR817 [5]	NA5185 [2] 32.00x42.00x7.00mm, FPM NA5185 [2] 32.00x42.00x6.00mm, FPM LK5011 [7] [26] 85.00x131.00x15.94mm, PTFE LK5006 [7] 85.00x131.00x16.000mm, PTFE	KA5025 [15]
HBS249 [5] M9x1.25x138.00mm (x10)	JD5228 [1] JD5298 [5]	HR397 [5]	HR397	PA5041 (x16) 6.00/12.20x10.00 (FPM) HR791 [5]	NA5180 [2] 27.00x42.00x8.00mm, FPM NA5185 [2] 32.00x42.00x6.00mm, FPM LK5011 [7] [26] 85.00x131.00x15.94mm, PTFE	KA5025 [15] KK5551 [20]
HBS249 [5] M9x1.25x138.00mm (x10)	JD5809 [1] JD5814 [5]	HR397 [5]		PA5041 (x16) 6.00/12.20x10.00 (FPM) HR791 [5]	NA5106 [2] 35.00x48.00x10.00mm, PTFE	
HBS264 [19] M12x1.75x172.00mm (x8)	JD5278 [1] JD5279 [5]	JM7032 (NBR)	HR397	HR5068 [5]	NA5124 [2] 32.00x47.00x10.00mm, PTFE/ACM NA5106 [2] 35.00x48.00x10.00mm, PTFE LK5003 [1] [7] 85.00x131.00x15.700mm, PTFE	
HBS249 [5] M9x1.25x138.00mm (x10)	JD5228 [1] [5] (x4) JD5298 [5]	HR397 [5]	HR397	PA5041 (x16) 6.00/12.20x10.00 (FPM) HR791 [5]	NA5180 [2] 27.00x42.00x8.00mm, FPM NA5185 [2] 32.00x42.00x6.00mm, FPM LK5011 [7] [26] 85.00x131.00x15.94mm, PTFE	KA5025 [15] KK5551 [20]
HBS249 [5] M9x1.25x138.00mm (x10)	JD5228 [1] [5] (x4) JD5298 [5]	HR397 [5]	HR397	PA5041 (x16) 6.00/12.20x10.00 (FPM) HR791 [5]	NA5180 [2] 27.00x42.00x8.00mm, FPM NA5185 [2] 32.00x42.00x6.00mm, FPM LK5011 [7] [26] 85.00x131.00x15.94mm, PTFE	KA5025 [15] KK5551 [20]
HBS249 [5] M9x1.25x138.00mm (x10)	JD5809 [1] JD5814 [5]			PA5041 (x16) 6.00/12.20x10.00 (FPM) HR791 [5]	NA5106 [2] 35.00x48.00x10.00mm, PTFE LK5013 [1] [7] [25] 85.00x111.00x15.50mm, PTFE	JR5048 [6]
HBS249 [5] M9x1.25x138.00mm (x10)	JD5807 [1] JD5318 [5]	HR397 [5]		PA5041 (x16) 6.00/12.20x10.00 (FPM) HR791 [5]	NA5185 [2] 32.00x42.00x7.00mm, FPM NA5185 [2] 32.00x42.00x6.00mm, FPM	
HBS249 [5] M9x1.25x138.00mm (x10)	JD5228 [1] JD5298 [5]	HR397 [5]		PA5041 (x16) 6.00/12.20x10.00 (FPM) HR791 [5]	NA5180 [2] 27.00x42.00x8.00mm, FPM NA5185 [2] 32.00x42.00x6.00mm, FPM	KA5025 [15] KK5551 [20]



cc



kW/PS



1.4	BLG					73	AH5960 (MLS), 0.800mm	CH5960	
Golf PL 1.4 TSI	05/06→06/08	1390	4	76.50	DOHC	125/170			
Golf V 1.4 TSI	11/05→11/08								
Jetta 3 1.4 TSI	07/06→10/10								
Touran 1.4 FSI	11/06→05/10								
1.4	BLN					74	AG8850 (MLS)	CG8850	
Golf PL 1.4 FSI	07/05→	1390	4	76.50	DOHC	66/90			
Golf V 1.4 FSI	10/03→07/06								
1.4	BMS Diesel					75	AD5650 (MLS), 1.450mm, 1 Hole AD5660 (MLS), 1.530mm, 2 Holes AD5670 (MLS), 1.610mm, 3 Holes	CD5650 ▲	ED5650 [18]
Polo 1.4 TDI	04/05→11/09	1422	3	79.50	SOHC/OHC	59/80			
1.4	BMV					76	AH5960 (MLS), 0.800mm	CH5960	
Golf PL 1.4 TSI	05/06→06/08	1390	4	76.50	DOHC	103/140			
Golf V 1.4 TSI	05/06→11/08								
Jetta 3 1.4 TSI	07/06→10/10								
Touran 1.4 TSI	02/06→05/10								
1.4	BNM Diesel					77	AD5650 (MLS), 1.450mm, 1 Hole AD5660 (MLS), 1.530mm, 2 Holes AD5670 (MLS), 1.610mm, 3 Holes	CD5650 ▲	ED5650 [18]
FOX 1.4 TDI	04/05→	1422	3	79.50	SOHC/OHC	51/70			
Polo 1.4 TDI	04/05→11/09								
1.4	BNV Diesel					78	AD5650 (MLS), 1.450mm, 1 Hole AD5660 (MLS), 1.530mm, 2 Holes AD5670 (MLS), 1.610mm, 3 Holes	CD5650 ▲	ED5650 [18]
Polo 1.4 TDI	04/05→11/09	1422	3	79.50	SOHC/OHC	59/80			
1.4	BUD					79	AB5701 (MLS)	CB5700 ☒	EB5700 [3][18]
Caddy 3 1.4 16V	05/06→08/10	1390	4	76.50	DOHC	59/80			
Golf 6 Var 1.4	07/09→								
Golf PL 1.4 16V	05/06→								
Golf V 1.4	06/07→								
Golf V 1.4 16V	05/06→11/08								
Polo 1.4 16V	05/06→11/09								
1.4	BWB Diesel					80	AD5650 (MLS), 1.450mm, 1 Hole AD5660 (MLS), 1.530mm, 2 Holes AD5670 (MLS), 1.610mm, 3 Holes	CD5650 ▲	ED5650 [18]
Polo 1.4 TDI	04/05→11/09	1422	3	79.50	SOHC/OHC	51/70			
1.4	BWK					81	AH5960 (MLS), 0.800mm	CH5960	
Tiguan 1.4 TSI	09/07→	1390	4	76.50	DOHC	110/150			
1.4	CAVA					82	AH5960 (MLS), 0.800mm	CH5960	
Jetta 4 1.4 TSI	04/11→	1390	4	76.50	DOHC	110/150			
Sharan 1.4 TSI	05/10→								
Tiguan 1.4 TSI	09/07→								
1.4	CAVB					83	AH5960 (MLS), 0.800mm	CH5960	
Touran 1.4 FSI	11/06→05/10	1390	4	76.50	DOHC	125/170			
Touran 1.4 TSI	05/10→								

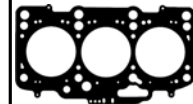
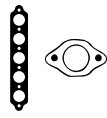

AD5650, AD5660,
AD5670

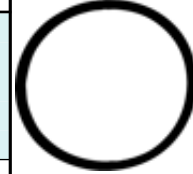

JD5228



JD5278



JD5279



JD5298

HBS518 [5][21]	JD5809 [1] JD5814 [3]	HR397 [3]		PA5041 (x16) 6.00/12.20x10.00 (FPM) HR791 [3]	NA5106 [2] 35.00x48.00x10.00mm, PTFE	JR5048 [6]
HBS249 [5] M9x1.25x138.00mm (x10)	JD5809 [1] JD5814 [3]	HR397 [3]		PA5041 (x16) 6.00/12.20x10.00 (FPM) HR791 [3]	NA5106 [2] 35.00x48.00x10.00mm, PTFE LK5013 [1][7][25] 85.00x111.00x15.50mm, PTFE	JR5048 [6]
HBS264 [19] M12x1.75x172.00mm (x8)	JD5278 [1]			HR5068 [3]	NA5124 [2] 32.00x47.00x10.00mm, PTFE/ACM NA5106 [2] 35.00x48.00x10.00mm, PTFE	
HBS518 [5][21]	JD5809 [1] JD5814 [3]	HR397 [3]		PA5041 (x16) 6.00/12.20x10.00 (FPM) HR791 [3]	NA5106 [2] 35.00x48.00x10.00mm, PTFE	JR5048 [6]
HBS264 [19] M12x1.75x172.00mm (x8)	JD5278 [1] JD5279 [3]	JM7032 (NBR)	HR397	HR5068 [3]	NA5124 [2] 32.00x47.00x10.00mm, PTFE/ACM NA5106 [2] 35.00x48.00x10.00mm, PTFE LK5003 [1][7] 85.00x131.00x15.700mm, PTFE	
HBS264 [19] M12x1.75x172.00mm (x8)	JD5278 [1] JD5279 [3]	JM7032 (NBR)	HR397	HR5068 [3]	NA5124 [2] 32.00x47.00x10.00mm, PTFE/ACM NA5106 [2] 35.00x48.00x10.00mm, PTFE LK5003 [1][7] 85.00x131.00x15.700mm, PTFE	
HBS249 [5] M9x1.25x138.00mm (x10)	JD5228 [1] (x4) JD5298 [3]	HR397 [3]		PA5041 (x16) 6.00/12.20x10.00 (FPM) HR791 [3]	NA5180 (x2)[2] 27.00x42.00x8.00mm, FPM NA5185 [2] 32.00x42.00x6.00mm, FPM LK5013 [1][7][25] 85.00x111.00x15.50mm, PTFE →10/06 LK5011 [7][26] 85.00x131.00x15.94mm, PTFE 11/06→	KA5025 [15] KK5551 [20]
HBS264 [19] M12x1.75x172.00mm (x8)	JD5278 [1] JD5279 [3]	JM7032 (NBR)	HR397	HR5068 [3]	NA5124 [2] 32.00x47.00x10.00mm, PTFE/ACM NA5106 [2] 35.00x48.00x10.00mm, PTFE	
HBS518 [5][21]	JD5809 [1] JD5814 [3]	HR397 [3]		PA5041 (x16) 6.00/12.20x10.00 (FPM) HR791 [3]	NA5106 [2] 35.00x48.00x10.00mm, PTFE	JR5048 [6]
HBS518 [5][21]	JD5809 [1] JD5814 [3]	HR397 [3]		PA5041 (x16) 6.00/12.20x10.00 (FPM) HR791 [3]	NA5106 [2] 35.00x48.00x10.00mm, PTFE	JR5048 [6]
HBS518 [5][21]	JD5809 [1]			PA5041 (x16) 6.00/12.20x10.00 (FPM) HR791 [3]	NA5106 [2] 35.00x48.00x10.00mm, PTFE	JR5048 [6]



cc



kW/PS



1.4 CAVC							84	AH5960 (MLS), 0.800mm	CH5960							
Touran 1.4 TSI	02/06→05/10	1390	4	76.50	DOHC	103/140										
1.4 CAVD							85	AH5960 (MLS), 0.800mm	CH5960							
Beetle 1.4 TSI	04/11→	1390	4	76.50	DOHC	118/160										
EOS 1.4 TSI	05/08→															
Golf 6 1.4 TSI	10/08→11/12															
Golf 6 Conv 1.4	03/11→															
Golf 6V 1.4 TSI	07/09→															
Golf PL 1.4 TSI	06/08→															
Golf V 1.4 TSI	07/08→															
Jetta 3 1.4 TSI	07/08→10/10															
Jetta 4 1.4 TSI	04/11→															
Scirocco 1.4 TSI	05/08→															
Tiguan 1.4 TSI	05/11→															
1.4 CAVE							86	AH5960 (MLS), 0.800mm	CH5960							
Polo 1.4 GTI	05/10→	1390	4	76.50	DOHC	132/180										
1.4 CAXA							87	AH5960 (MLS), 0.800mm	CH5960							
EOS 1.4 TSI	11/07→	1390	4	76.50	DOHC	90/122										
Golf 6 1.4 TSI	10/08→11/12															
Golf 6 Conv 1.4	11/11→															
Golf 6V 1.4 TSI	07/09→															
Golf PL 1.4 TSI	06/07→															
Golf V 1.4 TSI	05/07→11/08															
Jetta 3 1.4 TSI	05/07→10/10															
Jetta 4 1.4 TSI	05/11→															
Passat 1.4 TSI	05/07→11/10															
Scirocco 1.4 TSI	08/08→															
Tiguan 1.4 TSI	08/10→															
1.4 CDDA									88	AB5701 (MLS)	CB5700 ☒					
Polo 1.4	06/09→								1390	4	76.50	DOHC	63/86			
1.4 CDGA							89	AH5960 (MLS), 0.800mm	CH5960							
Passat 1.4 Eco	01/09→11/10	1390	4	76.50	DOHC	110/150										
Passat 1.4 TSI	01/09→07/10															
Touran 1.4 TSI	05/09→05/10															
1.4 CGGA							90	AB5701 (MLS)	CB5700 ☒							
Golf 6 1.4	10/08→11/12	1390	4	76.50	DOHC	59/80										
Golf 6 Var 1.4	07/09→															
Golf PL 1.4 16V	05/06→															
1.4 CGGB							91	AB5701 (MLS)	CB5700 ☒							
Polo 1.4	06/09→	1390	4	76.50	DOHC	63/85										
1.4 CKMA							92									
CC 1.4 TSI	11/11→	1390	4	76.50	DOHC	118/160										
Passat 1.4 TSI	11/10→															

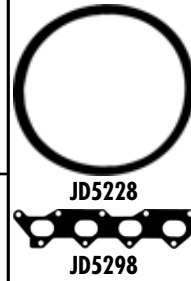

HBS518 ☉ [5][21]	JD5809 ■ JD5814 ■	HR397 ■		PA5041 (x16) 6.00/12.20x10.00 (FPM) HR791 ■	NA5106 ■ [2] 35.00x48.00x10.00mm, PTFE	JR5048 [6]
HBS518 ☉ [5][21]	JD5809 ■			PA5041 (x16) 6.00/12.20x10.00 (FPM) HR791 ■	NA5106 ■ [2] 35.00x48.00x10.00mm, PTFE	JR5048 [6]
HBS518 ☉ [5][21]	JD5809 ■ JD5814 ■	HR397 ■	HR397	PA5041 (x16) 6.00/12.20x10.00 (FPM) HR791 ■	NA5106 ■ [2] 35.00x48.00x10.00mm, PTFE	JR5048 [6]
HBS518 ☉ [5][21]	JD5809 ■ JD5814 ■			PA5041 (x16) 6.00/12.20x10.00 (FPM) HR791 ■	NA5106 ■ [2] 35.00x48.00x10.00mm, PTFE	
HBS249 ☉ [5] M9x1.25x138.00mm (x10)	JD5228 ■ (x4) JD5298 ■	HR397 ■	HR397	PA5041 (x16) 6.00/12.20x10.00 (FPM) HR791 ■	NA5180 (x2)[2] 27.00x42.00x8.00mm, FPM NA5106 [2] 35.00x48.00x10.00mm, PTFE/ACM NA5106 ■ [2] 35.00x48.00x10.00mm, PTFE	
HBS518 ☉ [5][21]	JD5809 ■	HR397 ■		PA5041 (x16) 6.00/12.20x10.00 (FPM)	NA5106 ■ [2] 35.00x48.00x10.00mm, PTFE	JR5048 [6]
HBS249 ☉ [5] M9x1.25x138.00mm (x10)	JD5228 ■ (x4) JD5298 ■	HR397 ■	HR397	PA5041 (x16) 6.00/12.20x10.00 (FPM) HR791 ■	NA5180 (x2)[2] 27.00x42.00x8.00mm, FPM NA5185 ■ [2] 32.00x42.00x6.00mm, FPM	
HBS249 ☉ [5] M9x1.25x138.00mm (x10)	JD5228 ■ (x4) JD5298 ■	HR397 ■	HR397	PA5041 (x16) 6.00/12.20x10.00 (FPM) HR791 ■	NA5180 (x2)[2] 27.00x42.00x8.00mm, FPM NA5185 ■ [2] 32.00x42.00x6.00mm, FPM	
					NA5106 [2] 35.00x48.00x10.00mm, PTFE/ACM NA5106 ■ [2] 35.00x48.00x10.00mm, PTFE	JR5048 [6]



cc



kW/PS



1.4		CLPA					93	AH5960 (MLS), 0.800mm	CH5960	
Polo 1.4	06/09→	1390	4	76.50	DOHC	63/85				
1.4		CMAA					94			
Polo 1.4 BiFuel	03/10→01/11	1390	4	76.50	DOHC	60/82				
1.4		CNWA					95			
Beetle 1.4 TSI	04/11→	1390	4	76.50	DOHC	118/160				
Golf 6 1.4 TSI	10/08→11/12									
Golf 6 Conv 1.4	03/11→									
Golf 6V 1.4 TSI	07/09→									
Golf PL 1.4 TSI	06/08→									
Scirocco 1.4 TSI	05/08→									
1.6		1C Diesel					96	BN940 (Fibre), 1.530mm, 1 Hole BN950 (Fibre), 1.570mm, 2 Holes BN960 (Fibre), 1.610mm, 3 Holes	DD502 ▲	
Iltis 1.6 TD	08/87→12/88	1588	4	76.50	SOHC/OHC	51/69				
1.6		1F					97	BM360 (Fibre)	DM368 [3]	EG872
Caddy II 1.6	11/95→05/97	1595	4	81.00	SOHC/OHC	53-55/ 72-75				
Caddy II 75 1.6	11/95→05/97									
Passat 1.6	02/88→09/91									
Polo Cl 1.6 75	11/95→09/97									
1.6		1V Diesel					98	BN940 (Fibre), 1.530mm, 1 Hole BN950 (Fibre), 1.570mm, 2 Holes BN960 (Fibre), 1.610mm, 3 Holes	DD502 ▲	EG872
Golf II 1.6 TD	08/89→10/91	1589	4	76.50	SOHC/OHC	44/60				
Jefta II 1.6 TD	01/90→10/91									
1.6		ABN					99	BM360 (Fibre)	DM368 [3]	EG872
Golf II 1.6	08/83→07/92	1595	4	81.00	SOHC/OHC	54-55/ 73-75				
Jefta II 1.6	01/84→07/92									
Passat 1.6	02/88→12/88									
1.6		ABU					100	BY620 (Fibre)	DY620 [3]	EV460
Golf 3 1.6	09/92→08/97	1598	4	76.50	SOHC/OHC	55/75				
Vento 1.6	09/92→09/98									
1.6		ADP					101	AY940 (MLS)	CY942	EC5220 [3] [18] EY940
Passat 1.6	10/96→11/00	1595	4	81.00	SOHC/OHC	74/101				

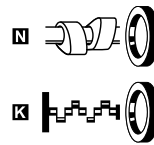
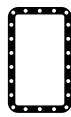
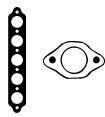

HBS518 [5][21]		HR397		PA5041 (x16) 6.00/12.20x10.00 (FPM) HR791	NA5106 [2] 35.00x48.00x10.00mm, PTFE	JR5048 [6]
					NA5185 [2] 32.00x42.00x7.00mm, FPM NA5185 [2] 32.00x42.00x6.00mm, FPM	
					NA5106 [2] 35.00x48.00x10.00mm, PTFE/ACM NA5106 [2] 35.00x48.00x10.00mm, PTFE	JR5048 [6]
HBS018 [19] M12x1.75x115.00mm (x10)	JC243 JC152 (x4)	HL457 [23] (Cork) HM5053 [24] (ACM)		HR569	NA5001 [1][2] 32.00x47.00x10.00mm, FPM	KA5020 [15]
HBS043 [22] M11x1.50x95.00mm (x10)	JC478 PA459 (NBR) JC152 (x4) JE160	HL457 [23] (Cork) HM5053 [24] (ACM) HM5062	JJ140 (SMG)	HR569	NA5001 [1][2] 32.00x47.00x10.00mm, FPM NA5001 [1][2] 32.00x47.00x10.00mm, FPM NA5133 [1] 85.00x105.00x11.00mm, FPM LK5006 [7] 85.00x131.00x16.00mm, PTFE	KA5020 [15]
HBS018 [19] M12x1.75x115.00mm (x10)	JC243 JC152 (x4)	HL457 [23] (Cork) HM5053 [24] (ACM)	JJ140 (SMG)	HR569	NA5001 [1][2] 32.00x47.00x10.00mm, FPM NA5001 [1][2] 32.00x47.00x10.00mm, FPM NA5133 [1] 85.00x105.00x11.00mm, FPM	KA5020 [15]
HBS043 [22] M11x1.50x95.00mm (x10)	JC478 PA459 (NBR) JC152 (x4) JE160	HL457 [23] (Cork) HM5053 [24] (ACM)		HR569	NA5001 [1][2] 32.00x47.00x10.00mm, FPM NA5001 [1][2] 32.00x47.00x10.00mm, FPM NA5133 [1] 85.00x105.00x11.00mm, FPM	KA5020 [15]
HBS075 [22] M11x1.50x110.00mm (x10)	JD487 JD488	JN641 [4] HM5062	JJ183		NA5001 [1][2] 32.00x47.00x10.00mm, FPM NA5001 [1][2] 32.00x47.00x10.00mm, FPM NA5133 [1] 85.00x105.00x11.00mm, FPM LK5006 [7] 85.00x131.00x16.00mm, PTFE	
HBS043 [22] M11x1.50x95.00mm (x10)	JD5341 JC152 (x4)	JPO24 [4]	JH5117 JJ609 (ACM)	HR816	NA5001 [1][2] 32.00x47.00x10.00mm, FPM NA5001 [1][2] 32.00x47.00x10.00mm, FPM NA5133 [1] 85.00x105.00x11.00mm, FPM LK5008 [1][7] 85.00x131.00x15.700mm, PTFE LK5006 [7] 85.00x131.00x16.000mm, PTFE	

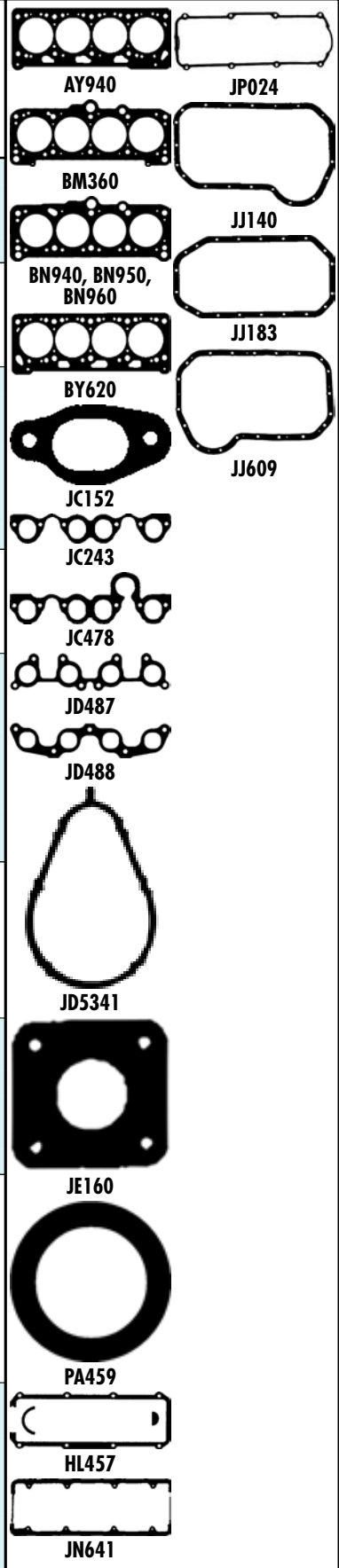



cc



kW/PS



1.6		AEA		102		BZ180 (MLS), 0.500mm	DZ180 [3]	EV460
Golf 3 1.6	09/92→08/97	1598	4	76.50	SOHC/OHC	55/75		
Polo 1.6 75	10/94→10/99							
Vento 1.6	09/92→09/98							
1.6		AEE		103		BZ180 (MLS), 0.500mm	DZ181	EB961 [18]
Caddy II 1.6	06/96→12/00	1598	4	76.50	SOHC/OHC	55/75		
Caddy II 75 1.6	11/95→09/00							
Golf 3 1.6	09/92→08/97							
Polo 1.6	05/97→09/01							
Polo 1.6 75	10/94→10/99							
Polo Cl 1.6 75	11/95→09/01							
Vento 1.6	09/92→09/98							
1.6		AEH		104		AC5220 (MLS)	CY980	EC080 [18] EC5220 [3][18]
Bora 1.6	10/98→05/05	1595	4	81.00	SOHC/OHC	74/100		
Golf 4 1.6	08/97→05/04							
Polo 1.6	05/97→09/01							
Polo Cl 1.6 100	12/95→09/01							
1.6		AEK		105		AY940 (MLS)	CY940 [3]	EB970
Golf 3 1.6	07/94→04/99	1595	4	81.00	SOHC/OHC	74/101		
Golf 3 Cabr 1.6	10/94→05/98							
Passat 1.6	07/94→08/96							
Vento 1.6	10/94→09/98							
1.6		AF		106			CV480 ▲○ [13]	FV500 ▲○ [13]
Kaefer 1600 Mex	05/73→09/92	1584	4	85.50		34/46		
1.6		AFT		107		AY940 (MLS)	CY941 [3]	EC5220 [3][18]
Golf 3 1.6	07/94→04/99	1595	4	81.00	SOHC/OHC	74/101		
Golf 3 Cabr 1.6	10/94→05/98							
Golf 4 Cabr 1.6	06/98→06/02							
Passat 1.6	07/94→08/96							
Polo 1.6	05/97→09/01							
Polo Cl 1.6 100	12/95→09/01							
Vento 1.6	10/94→09/98							
1.6		AHL		108		AC5220 (MLS)	CC5220 [3]	EC080 [18] EC5220 [3][18] EY940
Passat 1.6	10/96→11/00	1595	4	81.00	SOHC/OHC	74/101		

HBS075 [22] M11x1.50x110.00mm (x10)	JD487 [1] JD488 [1]	JP074 [4] HM5062 [1]	JJ183	HR816 [1]	NA5001 [1][2] 32.00x47.00x10.00mm, FPM NA5001 [1][2] 32.00x47.00x10.00mm, FPM NA5133 [1] 85.00x105.00x11.00mm, FPM LK5006 [7] 85.00x131.00x16.000mm, PTFE	AC5220 AY940 BZ180 JF211 JC152 JM986 JC478 JP024 JD487 JP074 JD488 JD5293 JJ183 JJ609	
HBS075 [22] M11x1.50x110.00mm (x10)	JC478 [1] JD597 [1][1] JD601 [1]	JP074 [4] HM5062 [1]	HR397	HR816 [1]	NA5001 [1][2] 32.00x47.00x10.00mm, FPM NA5001 [1][2] 32.00x47.00x10.00mm, FPM NA5133 [1] 85.00x105.00x11.00mm, FPM LK5006 [7] 85.00x131.00x16.000mm, PTFE NA5185 [2] 32.00x42.00x6.00mm, FPM Eng.562.758 →	JC152 JM986 JP024 JD487 JP074 JD488 JD5293 JJ183 JJ609	
HBS246 [22] M10x1.50x120.00mm (x10)	JD607 [1] (x4) JD5293 [1] JD600 [1] JF211	JP024 [4]	HR397 JH5117	HR816 [1]	NA5106 [2] 35.00x48.00x10.00mm, PTFE/ACM NA5124 [2] 32.00x47.00x10.00mm, PTFE/ACM NA5106 [2] 35.00x48.00x10.00mm, PTFE NA5124 [2] 32.00x47.00x10.00mm, PTFE/ACM NB716 [2] 35.00x48.00x10.00mm, FPM LK5008 [1][7] 85.00x131.00x15.700mm, PTFE	JD5341 JJ183 JJ609	
HBS043 [22] M11x1.50x95.00mm (x10)	JD599 [1][1] JD600 [1] JF205	JP024 [4]	JJ609 (ACM)	HR569 [1]	NA5001 [1][2] 32.00x47.00x10.00mm, FPM NA5001 [1][2] 32.00x47.00x10.00mm, FPM NA5133 [1] 85.00x105.00x11.00mm, FPM	JD597 JD599 JD600 JD601 JD607 JE689	
		JM986 [4]			NA784 [1] 70.00x90.00x10.00mm, ACM	JD597 JD599 JD600 JD601 JD607 JE689	
HBS043 [22] M11x1.50x95.00mm (x10)	JD599 [1][1] JD600 [1] JF205	JP024 [4]	JH5117 JJ609 (ACM)	HR816 [1]	NA5001 [1][2] 32.00x47.00x10.00mm, FPM NA5001 [1][2] 32.00x47.00x10.00mm, FPM NA5133 [1] 85.00x105.00x11.00mm, FPM LK5008 [1][7] 85.00x131.00x15.700mm, PTFE	JD597 JD599 JD600 JD601 JD607 JE689	
HBS246 [22] M10x1.50x120.00mm (x10)	JD5341 [1] JC152 [1] (x4) JE689	JP024 [4]	HR397	HR816 [1]	NA5124 [2] 32.00x47.00x10.00mm, PTFE/ACM NA5106 [2] 35.00x48.00x10.00mm, PTFE LK5008 [1][7] 85.00x131.00x15.700mm, PTFE LK5006 [7] 85.00x131.00x16.000mm, PTFE	JD5341 JC152 JE689	



cc



kW/PS

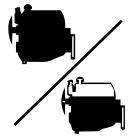

1.6	Model	Year Range	CC	Cyls	Power (kW/PS)	Configuration	Code	Part	Quantity
1.6 AHS 109									
Polo 1.6 75	10/94→10/99	1598	4	76.50	SOHC/OHC	55/75	BZ180 (MLS), 0.500mm	DZ181	EB961 [18]
1.6 AJV 110									
Polo 1.6 16VGTI	09/98→10/99	1598	4	76.50	DOHC	88/120	AC5280 (MLS)	CC5280 ☒ [59]	EB5700 [3][18]
1.6 AKL 111									
Bora 1.6	10/98→05/05	1595	4	81.00	SOHC/OHC	74/100	AC5220 (MLS)	CY980	EC080 [18] EC5220 [3][18]
Golf 4 1.6	08/97→05/04								
Polo 1.6	05/97→09/01								
Polo Cl 1.6 100	12/95→09/01								
1.6 AKS 112									
Golf 3 1.6	07/94→04/99	1595	4	81.00	SOHC/OHC	74/101	AY940 (MLS)	CY941 [3]	
Golf 3 Cabr 1.6	10/94→05/98								
Golf 4 Cabr 1.6	06/98→06/02								
1.6 ALM 113									
Polo 1.6	05/97→09/01	1598	4	76.50	SOHC/OHC	55/75	BZ180 (MLS), 0.500mm	DZ181	EB961 [18]
Polo Cl 1.6 75	11/95→09/01								
1.6 ALZ 114									
Passat 1.6	11/00→05/05	1595	4	81.00	SOHC/OHC	75/102	AC5220 (MLS)	CC5223	EC5220 [3][18]
1.6 ANA 115									
Passat 1.6	10/96→11/00	1595	4	81.00	SOHC/OHC	74/101	AC5220 (MLS)	CC5220 [3]	EC5220 [3][18] EY940

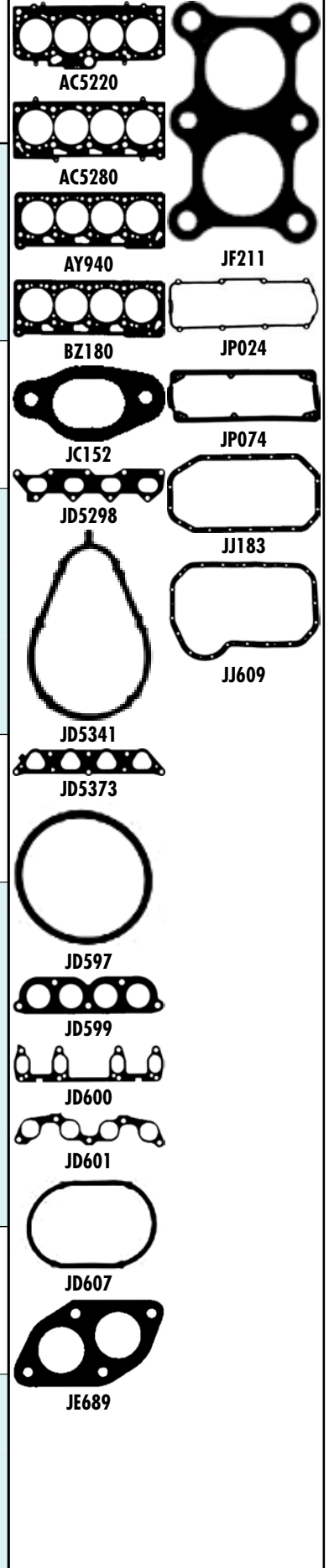

HBS075 [22]
M11x1.50x110.00mm (x10)

JD601 [E]

JP074 [4]
HM5062 [E]

HR816 [E]

NA5001 (x2) [1][2]
32.00x47.00x10.00mm, FPM
NA5001 [E] [1][2]
32.00x47.00x10.00mm, FPM
NA5133 [E] [1]
85.00x105.00x11.00mm, FPM
LK5006 [E] [7]
85.00x131.00x16.000mm, PTFE

HBS316 [5]
M9x1.25x97.00mm (x10)

JD5373 [E]
JD5298 [E]
JE5076

HR397 [E]

PA5041 (x16)
6.00/12.20x10.00
(FPM)
HR791 [E]

NA5180 (x2) [2]
27.00x42.00x8.00mm, FPM
NA5185 [E] [2]
32.00x42.00x6.00mm, FPM
LK5011 [E] [7][26]
85.00x131.00x15.94mm, PTFE

KA5025 [15]
KK5551 [20]

HBS246 [22]
M10x1.50x120.00mm (x10)

JD607 [E] (x4)
JD600 [E]
JF211

JP024 [4]

HR397
JH5117

HR816 [E]

NA5124 [2]
32.00x47.00x10.00mm, PTFE/ACM
NA5106 [E] [2]
35.00x48.00x10.00mm, PTFE
NA5124 [E] [2]
32.00x47.00x10.00mm, PTFE/ACM
NB716 [E] [2]
35.00x48.00x10.00mm, FPM
LK5008 [E] [1][7]
85.00x131.00x15.700mm, PTFE

HBS043 [22]
M11x1.50x95.00mm (x10)

JD599 [E] [E]
JD600 [E]
JF205

JP024 [4]

JJ609
(ACM)

HR816 [E]

NA5001 [1][2]
32.00x47.00x10.00mm, FPM
NA5001 [E] [1][2]
32.00x47.00x10.00mm, FPM
NA5133 [E] [1]
85.00x105.00x11.00mm, FPM

HBS075 [22]
M11x1.50x110.00mm (x10)

JD597 [E] [E]
JD601 [E]

JP074 [4]
HM5062 [E]

JJ183

HR816 [E]

NA5001 [1][2]
32.00x47.00x10.00mm, FPM
→ Eng. ALM 000 706
NA5185 [2]
32.00x42.00x7.00mm, FPM
Eng.000 707 →
NA5001 [E] [1][2]
32.00x47.00x10.00mm, FPM
→ Eng. ALM 000 706
LK5006 [E] [7]
85.00x131.00x16.000mm, PTFE
NA5185 [E] [2]
32.00x42.00x6.00mm, FPM
Eng.000 707 →

HBS246 [22]
M10x1.50x120.00mm (x10)

JD5341 [E] (x4)
JC152 [E] (x4)

JM5205
(Elastomer)

HR397

PA5041 (x8)
6.00/12.20x10.00
(FPM)
HR817 [E]

NA5124 [2]
32.00x47.00x10.00mm, PTFE/ACM
NA5106 [E] [2]
35.00x48.00x10.00mm, PTFE
LK5008 [E] [1][7]
85.00x131.00x15.700mm, PTFE

HBS246 [22]
M10x1.50x120.00mm (x10)

JD5341 [E] (x4)
JC152 [E] (x4)
JE689

JP024 [4]

JH5117

HR816 [E]

NA5124 [2]
32.00x47.00x10.00mm, PTFE/ACM
NA5106 [E] [2]
35.00x48.00x10.00mm, PTFE
LK5008 [E] [1][7]
85.00x131.00x15.700mm, PTFE
LK5006 [E] [7]
85.00x131.00x16.000mm, PTFE



cc



kW/PS



1.6		APF					116	AC5220 (MLS)	CC5221 [3]	EC5220 [3][18]
Bora 1.6	10/98→05/05	1595	4	81.00	SOHC/OHC	74/101				
Golf 4 1.6	08/97→05/04									
Polo 1.6	05/97→09/01									
Polo Cl 1.6 100	12/95→09/01									
1.6		ARC					117	AC5280 (MLS)	CC5280 ☒ [59]	
Polo 1.6 16VGTI	10/99→09/01	1598	4	76.50	DOHC	92/125				
1.6		ARM					118	AC5220 (MLS)	CC5220 [3]	EC5220 [3][18] EY940
Passat 1.6	10/96→11/00	1595	4	81.00	SOHC/OHC	74/101				
1.6		ATN					119	AC5280 (MLS)	CC5280 ☒ [59]	
Bora 1.6 16V	02/00→05/05	1598	4	76.50	DOHC	77/105				
Golf 4 1.6 16V	02/00→06/06									
1.6		AUR					120	AC5220 (MLS)	CC5221 [3]	EC5220 [3][18]
Polo 1.6	05/97→09/01	1595	4	81.00	SOHC/OHC	74/101				
Polo Cl 1.6 100	12/95→09/01									
1.6		AUS					121	AC5280 (MLS)	CC5280 ☒ [59]	EC5700
Bora 1.6 16V	02/00→05/05	1598	4	76.50	DOHC	77/105				
Golf 4 1.6 16V	02/00→06/06									
1.6		AVU					122	AC5220 (MLS)	CC5222 [3]	EC5220 [3][18]
Bora 1.6	08/00→05/05	1595	4	81.00	SOHC/OHC	75/102				
Golf 4 1.6	08/00→06/06									
1.6		AVY					123	AC5280 (MLS)	CC5280 ☒ [59]	EB5700 [3][18]
Lupo 1.6 GTI	09/00→07/05	1598	4	76.50	DOHC	92/125				
Polo 1.6 16VGTI	10/99→09/01									
1.6		AWH					124	AC5220 (MLS)	CC5221 [3]	EC5220 [3][18]
New Beetle 1.6	10/99→09/00	1595	4	81.00	SOHC/OHC	74/101				



AC5220



AC5280



JC152

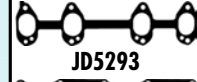

JD5293



JD5298



JD5341



JD5373



JE689

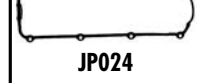

JP024

HBS246 [22]
M10x1.50x120.00mm (x10)

JD5340 (x4)
JD5293

JPO24 [4]

HR397

HR816

NA5124 [2]
32.00x47.00x10.00mm, PTFE/ACM
NA5106 [2]
35.00x48.00x10.00mm, PTFE
LK5008 [1][7]
85.00x131.00x15.700mm, PTFE

HBS316 [5]
M9x1.25x97.00mm (x10)

JD5373
JD5298
JE5076

HR397

HR397

PA5041 (x16)
6.00/12.20x10.00
(FPM)
HR791

NA5185 [2]
32.00x42.00x7.00mm, FPM
NA5180 [2]
27.00x42.00x8.00mm, FPM
NA5185 [2]
32.00x42.00x6.00mm, FPM
LK5011 [7][26]
85.00x131.00x15.94mm, PTFE

HBS246 [22]
M10x1.50x120.00mm (x10)

JD5341 (x4)
JC152 (x4)
JE689

JPO24 [4]

JH5117

HR816

NA5124 [2]
32.00x47.00x10.00mm, PTFE/ACM
NA5106 [2]
35.00x48.00x10.00mm, PTFE
LK5008 [1][7]
85.00x131.00x15.700mm, PTFE
LK5006 [7]
85.00x131.00x16.000mm, PTFE

HBS316 [5]
M9x1.25x97.00mm (x10)

JD5373
JD5298
JE5076

HR397

HR397

PA5041 (x16)
6.00/12.20x10.00
(FPM)
HR791

NA5180 [2]
27.00x42.00x8.00mm, FPM
NA5185 [2]
32.00x42.00x6.00mm, FPM
LK5011 [7][26]
85.00x131.00x15.94mm, PTFE

KK5551 [20]

HBS246 [22]
M10x1.50x120.00mm (x10)

JD5340 (x4)
JD5293

JPO24 [4]

HR397
JH5117

HR816

NA5124 [2]
32.00x47.00x10.00mm, PTFE/ACM
NA5106 [2]
35.00x48.00x10.00mm, PTFE
LK5008 [1][7]
85.00x131.00x15.700mm, PTFE

HBS316 [5]
M9x1.25x97.00mm (x10)

JD5373
JD5298
JE5076

HR397

HR397

PA5041 (x16)
6.00/12.20x10.00
(FPM)
HR791

NA5180 [2]
27.00x42.00x8.00mm, FPM
NA5185 [2]
32.00x42.00x6.00mm, FPM
LK5011 [7][26]
85.00x131.00x15.94mm, PTFE

KK5551 [20]

HBS246 [22]
M10x1.50x120.00mm (x10)

JD5340 (x4)
JD5293

JM5205
(Elastomer)

HR397

PA5041 (x8)
6.00/12.20x10.00
(FPM)
HR817

NA5124 [2]
32.00x47.00x10.00mm, PTFE/ACM
NA5106 [2]
35.00x48.00x10.00mm, PTFE
LK5008 [1][7]
85.00x131.00x15.700mm, PTFE

HBS316 [5]
M9x1.25x97.00mm (x10)

JD5373
JD5298
JE5076

HR397

PA5041 (x16)
6.00/12.20x10.00
(FPM)
HR791

NA5180 [2]
27.00x42.00x8.00mm, FPM
NA5185 [2]
32.00x42.00x6.00mm, FPM
LK5011 [7][26]
85.00x131.00x15.94mm, PTFE

KA5025 [15]
KK5470 [20]
KK5551 [20]

HBS246 [22]
M10x1.50x120.00mm (x10)

JD5340 (x4)
JD5293

JPO24 [4]

HR816

NA5124 [2]
32.00x47.00x10.00mm, PTFE/ACM
NA5106 [2]
35.00x48.00x10.00mm, PTFE
LK5008 [1][7]
85.00x131.00x15.700mm, PTFE



cc



kW/PS



1.6	AYD	125	AC5220 (MLS)	CC5222 [3]	EC5220 [3] [18]
New Beetle 1.6	06/00→	1595 4 81.00 SOHC/OHC 75/102			
1.6	AZD	126	AC5280 (MLS)	CC5281 [3]	EB5700 [3] [18]
Bora 1.6 16V	02/00→05/05	1598 4 76.50 DOHC 77/105			
Golf 4 1.6 16V	02/00→06/06				
1.6	BAD	127	AC5280 (MLS)	CC5282	
Bora 1.6 FSI	01/02→05/05	1598 4 76.50 DOHC 81/110			
Golf 4 1.6 FSI	01/02→06/06				
1.6	BAG	128	AG8850 (MLS)	CG8850	
Golf V 1.6 FSI	10/03→07/08	1598 4 76.50 DOHC 85/115			
Touran 1.6 FSI	02/03→01/07				
1.6	BAH	129			
FOX 1.6	10/03→	1598 4 76.50 SOHC/OHC 74/101			
Golf 4 1.6	02/01→06/01				
Polo 1.6	08/02→05/05				
Polo Saloon 1.6	09/02→				
1.6	BCB	130	AC5280 (MLS)	CC5281 [3]	EB5700 [3] [18]
Bora 1.6 16V	02/00→05/05	1598 4 76.50 DOHC 77/105			
Golf 4 1.6 16V	02/00→06/06				
1.6	BFQ	131	AC5220 (MLS)	CC5222 [3]	EC5220 [3] [18]
Bora 1.6	08/00→05/05	1595 4 81.00 SOHC/OHC 75/102			
Golf 4 1.6	08/00→06/06				
1.6	BFS	132	AC5220 (MLS)	CC5222 [3]	
New Beetle 1.6	06/00→	1595 4 81.00 SOHC/OHC 75/102			
Nw Beetle C 1.6	01/03→09/10				
1.6	BGU	133	AC5220 (MLS)	CC5222 [3]	EC5220 [3] [18]
Caddy 3 1.6	04/04→	1595 4 81.00 SOHC/OHC 75/102			
Golf V 1.6	01/04→11/08				
Jetta 3 1.6	10/05→10/10				
Touran 1.6	07/03→05/10				

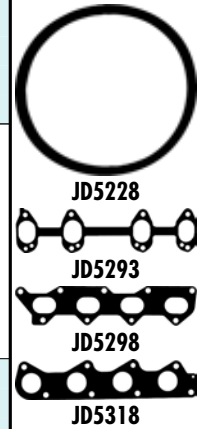
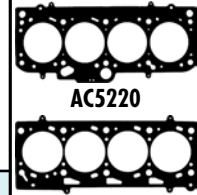



cc



kW/PS



1.6		BJH					134	AC5220 (MLS)	CC5222 [3]
Bora 1.6	08/00→05/05	1595	4	81.00	SOHC/OHC	75/102			
Golf 4 1.6	08/00→06/05								
1.6		BLF					135	AG8850 (MLS)	CG8850
EOS 1.6 FSI	06/06→05/08	1598	4	76.50	DOHC	85/115			
Golf PL 1.6 FSI	01/05→05/08								
Golf V 1.6 FSI	10/03→07/08								
Jetta 3 1.6 FSI	09/05→10/10								
Passat 1.6 FSI	03/05→06/08								
Touran 1.6 FSI	02/03→01/07								
1.6		BLP					136	AG8850 (MLS)	CG8850
Golf V 1.6 FSI	10/03→07/08	1598	4	76.50	DOHC	85/115			
Touran 1.6 FSI	02/03→01/07								
1.6		BRY					137		
Caddy 3 1.6	03/05→	1595	4	81.00	SOHC/OHC	74/101			
1.6		BSE					138	AC5220 (MLS)	CC5222 [3]
Caddy 3 1.6	04/04→	1595	4	81.00	SOHC/OHC	75/102			
Golf 6 1.6	10/08→11/12								
Golf 6 Var 1.6	07/09→								
Golf PL 1.6	05/05→								
Golf V 1.6	01/04→11/08								
Jetta 3 1.6	10/05→10/10								
Passat 1.6	05/05→11/10								
Touran 1.6	07/03→05/10								
1.6		BSF					139	AC5220 (MLS)	CC5222 [3]
Caddy 3 1.6	04/04→	1595	4	81.00	SOHC/OHC	75/102			
Golf 6 1.6	10/08→11/12								
Golf 6 Var 1.6	07/09→								
Golf PL 1.6	05/05→								
Golf V 1.6	01/04→11/08								
Jetta 3 1.6	10/05→10/10								
Passat 1.6	05/05→11/10								
Touran 1.6	07/03→05/10								
1.6		BTS					140	AG8850 (MLS)	
Polo 1.6 16V	05/06→11/09	1598	4	76.50	DOHC	77/105			
1.6		BWX					141	BZ910 (MLS)	
GOL 1.6	12/98→05/08	1596	4	81.00	SOHC/OHC	71-73/ 97-99			
1.6		CAYA Diesel					142		
Polo 1.6 TDI	06/09→	1598	4	79.50	DOHC	55/75			

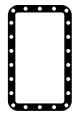

AC5220



BZ910

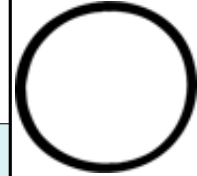

JD5228

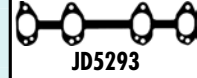

JD5293



JD600

HBS246 [22] M10x1.50x120.00mm (x10)	JD5340 (x4) JD5293	JM5205 (Elastomer)		PA5041 (x8) 6.00/12.20x10.00 (FPM) HR817	NAS124 [2] 32.00x47.00x10.00mm, PTFE/ACM NAS106 [2] 35.00x48.00x10.00mm, PTFE LK5008 [1][7] 85.00x131.00x15.700mm, PTFE	
HBS249 [5] M9x1.25x138.00mm (x10)	JD5809 JD5814	HR397		PA5041 (x16) 6.00/12.20x10.00 (FPM) HR791	NAS106 [2] 35.00x48.00x10.00mm, PTFE LK5013 [1][7][25] 85.00x111.00x15.50mm, PTFE LK5011 [7][26] 85.00x131.00x15.94mm, PTFE	JR5048 [6]
HBS249 [5] M9x1.25x138.00mm (x10)	JD5809 JD5814	HR397		PA5041 (x16) 6.00/12.20x10.00 (FPM) HR791	NAS106 [2] 35.00x48.00x10.00mm, PTFE LK5013 [1][7][25] 85.00x111.00x15.50mm, PTFE LK5011 [7][26] 85.00x131.00x15.94mm, PTFE	JR5048 [6]
HBS246 [22] M10x1.50x120.00mm (x10)	JD5340 (x4) JD600	JM5205 (Elastomer)		PA5041 (x8) 6.00/12.20x10.00 (FPM) HR817	NAS124 [2] 32.00x47.00x10.00mm, PTFE/ACM NAS106 [2] 35.00x48.00x10.00mm, PTFE LK5008 [1][7] 85.00x131.00x15.700mm, PTFE	
HBS246 [22] M10x1.50x120.00mm (x10)	JD5340 (x4) JD5293	JM5205 (Elastomer)	HR397	PA5041 (x8) 6.00/12.20x10.00 (FPM) HR817	NAS124 [2] 32.00x47.00x10.00mm, PTFE/ACM NAS106 [2] 35.00x48.00x10.00mm, PTFE	
HBS246 [22] M10x1.50x120.00mm (x10)	JD5340 (x4) JD5293	JM5205 (Elastomer)	HR397	PA5041 (x8) 6.00/12.20x10.00 (FPM) HR817	NAS124 [2] 32.00x47.00x10.00mm, PTFE/ACM NAS106 [2] 35.00x48.00x10.00mm, PTFE LK5008 [1][7] 85.00x131.00x15.700mm, PTFE	
HBS249 [5] M9x1.25x138.00mm (x10)	JD5228 JD5814	HR397	HR397	PA5041 (x16) 6.00/12.20x10.00 (FPM) HR646	NAS106 [2] 35.00x48.00x10.00mm, PTFE	JR5048 [6]
		HR397	HR397	PA5041 (x16) 6.00/12.20x10.00 (FPM)	NAS106 [2] 35.00x48.00x10.00mm, PTFE	



cc



kW/PS



1.6 CAYB Diesel 143									
Golf 6 1.6 TDI	02/09→11/12	1598	4	79.50	DOHC	66/90			
Golf 6V 1.6 TDI	12/09→								
Golf PL 1.6 TDI	02/09→								
Jetta 3 1.6 TDI	12/09→10/10								
Polo 1.6 TDI	06/09→								
Touran 1.6 TDI	05/10→								
1.6 CAYC Diesel 144									
Beetle 1.6 TDI	10/11→	1598	4	79.50	DOHC	77/105			
Golf 6 1.6 TDI	02/09→11/12								
Golf 6 Conv 1.6	03/11→								
Golf 6V 1.6 TDI	07/09→								
Golf PL 1.6 TDI	03/09→								
Jetta 3 1.6 TDI	06/09→10/10								
Jetta 4 1.6 TDI	02/11→								
Passat 1.6 TDI	08/09→11/10								
Polo 1.6 TDI	06/09→								
Touran 1.6 TDI	05/10→								
1.6 CAYD Diesel 145									
Caddy 3 1.6 TDI	08/10→	1598	4	79.50	DOHC	75/102			
1.6 CAYE Diesel 146									
Caddy 3 1.6 TDI	08/10→	1598	4	79.50	DOHC	55/75			
1.6 CCRA 147									
FOX 1.6	10/03→	1598	4	76.50	SOHC/OHC	74-77/ 101-105			
FOX 1.6 TotFlex	10/03→								
Polo 1.6 Flex	06/08→04/09								
1.6 CCSA 148							AC5220 (MLS)	CC5222 [3]	EC5220 [3][18]
Golf 6 1.6	10/08→11/12	1595	4	81.00	SOHC/OHC	75/102			
Golf 6 1.6 M F	10/08→11/12								
Golf 6 Var 1.6	07/09→								
Golf PL 1.6	05/05→								
Golf PL 1.6 MF	11/07→								
Golf V 1.6	06/07→								
Golf V 1.6 MF	10/07→11/08								
Jetta 3 1.6	10/05→10/10								
Jetta 3 1.6 M F	01/08→10/10								
1.6 CFNB 149									
Polo Saloon 1.6	11/10→	1598	4	76.50	DOHC	63/86			
1.6 CHGA 150							AC5220 (MLS)	CC5222 [3]	EC5220 [3][18]
Caddy 3 1.6	05/11→	1595	4	81.00	SOHC/OHC	75/102			
Golf 6 1.6 Bi F	03/09→11/12								
Golf PL 1.6 BiF	05/09→								
1.6 CLSA 151							AH5960 (MLS), 0.800mm		
Polo Saloon 1.6	05/10→	1598	4	76.50	DOHC	77/105			

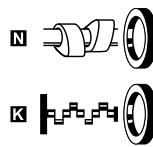
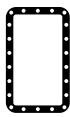
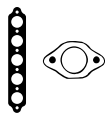

AC5220

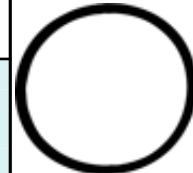

JD5228



JD5293



JD5318

		HR397	HR397	PA5041 (x16) 6.00/12.20x10.00 (FPM)	[2] 35.00x48.00x10.00mm, PTFE	
HBS364 [19] M12x1.75x149.00mm (x10)		HR397	HR397	PA5041 (x16) 6.00/12.20x10.00 (FPM)	[2] 35.00x48.00x10.00mm, PTFE	
				PA5041 (x16) 6.00/12.20x10.00 (FPM)	[2] 35.00x48.00x10.00mm, PTFE	
				PA5041 (x16) 6.00/12.20x10.00 (FPM)	[2] 35.00x48.00x10.00mm, PTFE	
	JD5318			PA5041 (x8) 6.00/12.20x10.00 (FPM)	[2] 32.00x42.00x7.00mm, FPM [2] 32.00x42.00x6.00mm, FPM	
HBS246 [22] M10x1.50x120.00mm (x10)	JD5340 (x4) JD5293	JM5205 (Elastomer)	HR397	PA5041 (x8) 6.00/12.20x10.00 (FPM) HR817	[2] 32.00x47.00x10.00mm, PTFE/ACM [2] 35.00x48.00x10.00mm, PTFE [1][7] 85.00x131.00x15.700mm, PTFE	
					[2] 35.00x48.00x10.00mm, PTFE/ACM [2] 35.00x48.00x10.00mm, PTFE	JR5048 [6]
HBS246 [22] M10x1.50x120.00mm (x10)	JD5340 (x4) JD5293	JM5205 (Elastomer)	HR397	PA5041 (x8) 6.00/12.20x10.00 (FPM) HR817	[2] 32.00x47.00x10.00mm, PTFE/ACM [2] 35.00x48.00x10.00mm, PTFE [1][7] 85.00x131.00x15.700mm, PTFE	
	JD5228 (x4)	HR397		PA5041 (x16) 6.00/12.20x10.00 (FPM)	[2] 35.00x48.00x10.00mm, PTFE	JR5048 [6]













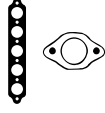

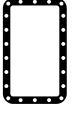

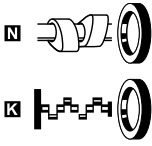































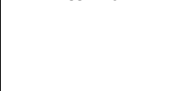
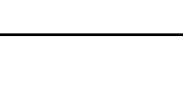













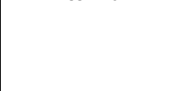
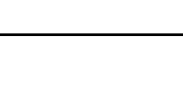













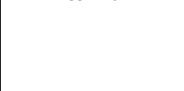
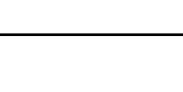













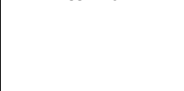
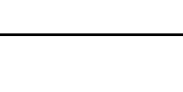













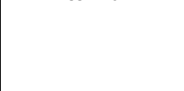
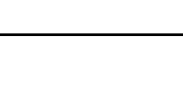







cc



kW/PS

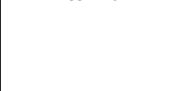
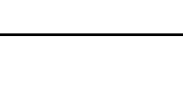

1.6		CMXA					152	AC5220 (MLS)	CC5222 [3]	EC5220 [3] [18]
Golf 6 1.6	10/08→11/12	1595	4	81.00	SOHC/OHC	75/102				
Golf 6 1.6 M F	10/08→11/12									
Golf 6 Var 1.6	07/09→									
Golf PL 1.6	05/05→									
Golf PL 1.6 MF	11/07→									
1.6		DT					153	BM360 (Fibre)	DM360	EG873
Passat 1.6	08/80→03/88	1595	4	81.00	SOHC/OHC	55/75				
1.6		EW					154	BM360 (Fibre)	DM368 [3]	EG872
Caddy I 1.6	01/83→07/92	1595	4	81.00	SOHC/OHC	55/75				
Golf I Cabr 1.6	08/83→04/92									
Scirocco 1.6	01/83→12/89									
1.6		EZ					155	BM360 (Fibre)	DM368 [3]	EG872
Golf II 1.6	08/83→07/92	1595	4	81.00	SOHC/OHC	53-55/ 72-75				
Jetta II 1.6	01/84→07/92									
Passat 1.6	02/88→09/91									
1.6		HM					156	BM360 (Fibre)	DM368 [3]	EG872
Golf II 1.6	08/83→07/92	1595	4	81.00	SOHC/OHC	55-60/ 75-82				
Jetta II 1.6	01/84→07/92									
1.6		HN					157	BM360 (Fibre)	DM368 [3]	EG872
Golf I Cabr 1.6	08/83→04/92	1595	4	81.00	SOHC/OHC	53-55/ 72-75				
1.6		JX Diesel					158	BT020 (Fibre), 1.530mm, 1 Notch	DD502 ▲	EG872
Trans 3 1.6 TD	08/84→07/92	1589	4	76.50	SOHC/OHC	51/69				
1.6		MF Diesel					159	BN940 (Fibre), 1.530mm, 1 Hole BN950 (Fibre), 1.570mm, 2 Holes BN960 (Fibre), 1.610mm, 3 Holes	DD502 ▲	EG872
Golf II 1.6 TD	08/83→10/91	1588	4	76.50	SOHC/OHC	51/70				
Jetta II 1.6 TD	01/84→10/91									
1.6		PN					160	BM360 (Fibre)	DM360 DM368 [3]	EG872
Golf II 1.6	10/86→12/92	1595	4	81.00	SOHC/OHC	51/70				
Jetta II 1.6	10/86→10/91									

      							
HBS246 [22] M10x1.50x120.00mm (x10)	JD5340 [x4] JD5293	JM5205 (Elastomer)	HR397	PA5041 (x8) 6.00/12.20x10.00 (FPM) HR817	NA5106 [2] 35.00x48.00x10.00mm, PTFE/ACM NA5124 [2] 32.00x47.00x10.00mm, PTFE/ACM NA5106 [2] 35.00x48.00x10.00mm, PTFE LK5008 [1][7] 85.00x131.00x15.700mm, PTFE		 AC5220  BM360  BN940, BN950, BN960  BT020  JC152  JC243  JC478  JD5293  JE138  JE160  JC243  JC478  JD5293  JE138  JE160  JC243  JC478  JD5293  JE138  JE160
HBS043 [22] M11x1.50x95.00mm (x10)	JC478 [x4] PA459 [x4] (NBR) JC152 [x4] JE138 [27]	HL457 [23] (Cork) HM5053 [24] (ACM)	JJ140 (SMG)	HR569	NA5001 [1][2] 32.00x47.00x10.00mm, FPM NA5001 [1][2] 32.00x47.00x10.00mm, FPM NA5133 [1] 85.00x105.00x11.00mm, FPM	KA5020 [15]	 BT020  JC152  JC243  JC478  JD5293  JE138  JE160  JC243  JC478  JD5293  JE138  JE160  JC243  JC478  JD5293  JE138 JE160
HBS043 [22] M11x1.50x95.00mm (x10)	JC478 [x4] PA459 [x4] (NBR) JC152 [x4] JE160	HL457 [23] (Cork) HM5053 [24] (ACM)	JJ140 (SMG)	HR569	NA5001 [1][2] 32.00x47.00x10.00mm, FPM NA5001 [1][2] 32.00x47.00x10.00mm, FPM NA5133 [1] 85.00x105.00x11.00mm, FPM	KA5020 [15]	 BT020  JC152  JC243  JC478  JD5293  JE138  JE160  JC243  JC478  JD5293  JE138  JE160  JC243  JC478  JD5293  JE138 JE160
HBS043 [22] M11x1.50x95.00mm (x10)	JC478 [x4] PA459 [x4] (NBR) JC152 [x4] JE160	HL457 [23] (Cork) HM5053 [24] (ACM)	JJ140 (SMG)	HR569	NA5001 [1][2] 32.00x47.00x10.00mm, FPM NA5001 [1][2] 32.00x47.00x10.00mm, FPM NA5133 [1] 85.00x105.00x11.00mm, FPM	KA5020 [15]	 BT020  JC152  JC243  JC478  JD5293  JE138  JE160  JC243  JC478  JD5293  JE138  JE160  JC243  JC478  JD5293  JE138 JE160
HBS018 [19] M12x1.75x115.00mm (x10)	JC243 [x4] JC152 [x4]	HL457 [23] (Cork) HM5053 [24] (ACM)	JJ140 (SMG)	HR569	NA5001 [1][2] 32.00x47.00x10.00mm, FPM NA5001 [1][2] 32.00x47.00x10.00mm, FPM NA5133 [1] 85.00x105.00x11.00mm, FPM	KA5020 [15]	 BT020  JC152  JC243  JC478  JD5293  JE138  JE160  JC243  JC478  JD5293  JE138  JE160  JC243  JC478  JD5293  JE138 JE160
HBS018 [19] M12x1.75x115.00mm (x10)	JC243 [x4] JC152 [x4]	HL457 [23] (Cork) HM5053 [24] (ACM)	JJ140 (SMG)	HR569	NA5001 [1][2] 32.00x47.00x10.00mm, FPM NA5001 [1][2] 32.00x47.00x10.00mm, FPM NA5133 [1] 85.00x105.00x11.00mm, FPM	KA5020 [15]	 BT020  JC152  JC243  JC478  JD5293  JE138  JE160  JC243  JC478  JD5293  JE138  JE160  JC243  JC478  JD5293  JE138 JE160
HBS043 [22] M11x1.50x95.00mm (x10)	JC478 [x4] PA459 [x4] (NBR) JC152 [x4] JE160	HL457 [23] (Cork) HM5053 [24] (ACM)	JJ140 (SMG)	HR569	NA5001 [1][2] 32.00x47.00x10.00mm, FPM NA5001 [1][2] 32.00x47.00x10.00mm, FPM NA5133 [1] 85.00x105.00x11.00mm, FPM	KA5020 [15]	 BT020  JC152  JC243  JC478  JD5293  JE138  JE160  JC243  JC478  JD5293  JE138  JE160  JC243  JC478  JD5293  JE138 JE160



cc



kW/PS



1.6	PP	161	BM360 (Fibre)	DM360	EG873
Passat 1.6	08/87→03/88	1595 4 81.00 SOHC/OHC 51/70			
1.6	RA Diesel	162	BN940 (Fibre), 1.530mm, 1 Hole BN950 (Fibre), 1.570mm, 2 Holes BN960 (Fibre), 1.610mm, 3 Holes	DD502 ▲	EG873
Golf II 1.6 TD	04/89→10/91	1588 4 76.50 SOHC/OHC 59/80			
Jetta II 1.6 TD	04/89→10/91				
Passat 1.6 TD	05/86→09/93				
1.6	RE	163	BM360 (Fibre)	DM360 DM368 [3]	EG872
Golf I Cabr 1.6	04/86→02/90	1595 4 81.00 SOHC/OHC 53/72			
Scirocco 1.6	04/86→07/90				
1.6	RF	164	BM360 (Fibre)	DM360 DM368 [3]	EG872
Golf II 1.6	02/86→10/91	1595 4 81.00 SOHC/OHC 53/72			
Jetta II 1.6	03/86→10/91				
1.6	RL	165	BM360 (Fibre)	DM360	EG872
Passat 1.6	01/85→03/88	1595 4 81.00 53/72			
1.6	SB Diesel	166	BN940 (Fibre), 1.530mm, 1 Hole BN950 (Fibre), 1.570mm, 2 Holes BN960 (Fibre), 1.610mm, 3 Holes	DD502 ▲	EG873
Golf II 1.6 TD	04/89→10/91	1588 4 76.50 SOHC/OHC 59/80			
Jetta II 1.6 TD	04/89→10/91				
Passat 1.6 TD	08/88→09/93				
1.6	WV	167	BG870 (Fibre)	DG871	EG873
Passat 1.6	08/80→03/88	1588 4 79.50 SOHC/OHC 55/75			
1.6	YN	168	BG870 (Fibre)	DG871	EG873
Passat 1.6	08/80→03/88	1588 4 79.50 SOHC/OHC 55/75			
1.7	AHB Diesel	169	BX800 (MLS), 1.450mm, 1 Hole BX810 (MLS), 1.530mm, 2 Holes BX820 (MLS), 1.610mm, 3 Holes	DX801 ▲	EC030 [18]
Caddy II 1.7SDI	07/96→09/00	1716 4 79.50 SOHC/OHC 42/57			

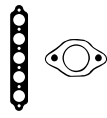

HBS043 [22] M11x1.50x95.00mm (x10)	JC478 [1] PA459 [1] (NBR) JC152 [x4] ☉ JE138 [27]	HL457 [23] (Cork) HM5053 [24] (ACM)	JJ140 (SMG)	HR569 [5]	NA5001 [1][2] 32.00x47.00x10.00mm, FPM NA5001 [1][2] 32.00x47.00x10.00mm, FPM NA5133 [1] 85.00x105.00x11.00mm, FPM	KA5020 [15]
HBS018 [19] M12x1.75x115.00mm (x10)	JC243 [1] JC152 [x4]	HL457 [23] (Cork) HM5053 [24] (ACM)	JJ140 (SMG)	HR569 [5]	NA5001 [1][2] 32.00x47.00x10.00mm, FPM NA5001 [1][2] 32.00x47.00x10.00mm, FPM NA5133 [1] 85.00x105.00x11.00mm, FPM	KA5020 [15]
HBS043 [22] M11x1.50x95.00mm (x10)	JC478 [1] PA459 [1] (NBR) JC152 [x4] ☉ JE160	HL457 [23] (Cork) HM5053 [24] (ACM)	JJ140 (SMG)	HR569 [5]	NA5001 [1][2] 32.00x47.00x10.00mm, FPM NA5001 [1][2] 32.00x47.00x10.00mm, FPM NA5133 [1] 85.00x105.00x11.00mm, FPM	KA5020 [15]
HBS043 [22] M11x1.50x95.00mm (x10)	JC478 [1] PA459 [1] (NBR) JC152 [x4] ☉ JE160	HL457 [23] (Cork) HM5053 [24] (ACM)	JJ140 (SMG)	HR569 [5]	NA5001 [1][2] 32.00x47.00x10.00mm, FPM NA5001 [1][2] 32.00x47.00x10.00mm, FPM NA5133 [1] 85.00x105.00x11.00mm, FPM	KA5020 [15]
HBS043 [22] M11x1.50x95.00mm (x10)	JC478 [1] PA459 [1] (NBR) JC152 [x4] ☉ JE138 [27]	HL457 [23] (Cork) HM5053 [24] (ACM)	JJ140 (SMG)	HR569 [5]	NA5001 [1][2] 32.00x47.00x10.00mm, FPM NA5001 [1][2] 32.00x47.00x10.00mm, FPM NA5133 [1] 85.00x105.00x11.00mm, FPM	KA5020 [15]
HBS018 [19] M12x1.75x115.00mm (x10)	JC243 [1] JC152 [x4]	HL457 [23] (Cork) HM5053 [24] (ACM)	JJ140 (SMG)	HR569 [5]	NA5001 [1][2] 32.00x47.00x10.00mm, FPM NA5001 [1][2] 32.00x47.00x10.00mm, FPM NA5133 [1] 85.00x105.00x11.00mm, FPM	KA5020 [15]
HBS043 [22] M11x1.50x95.00mm (x10)	JC478 [1] JC152 [x4] ☉ JE904	HL456 [5] (Cork) HL457 [23] (Cork) HM5053 [24] (ACM)	JJ140 (SMG)	HR569 [5]	NA5001 (x2)[1][2] 32.00x47.00x10.00mm, FPM NA5001 [1][2] 32.00x47.00x10.00mm, FPM NA5133 [1] 85.00x105.00x11.00mm, FPM	KA5020 [15]
HBS043 [22] M11x1.50x95.00mm (x10)	JC478 [1] JC152 [x4] ☉ JE904	HL456 [5] (Cork) HL457 [23] (Cork) HM5053 [24] (ACM)	JJ140 (SMG)	HR569 [5]	NA5001 [1][2] 32.00x47.00x10.00mm, FPM NA5001 [1][2] 32.00x47.00x10.00mm, FPM NA5133 [1] 85.00x105.00x11.00mm, FPM	KA5020 [15]
HBS018 [19] M12x1.75x115.00mm (x10)	JD170 [1] JC152 [x4] ☉ JE5076	JP003 [4] HM5367 [5]	JJ609 (ACM)	HR816 [5]	NA5001 [1][2] 32.00x47.00x10.00mm, FPM NA5001 [1][2] 32.00x47.00x10.00mm, FPM LK5006 [7] 85.00x131.00x16.00mm, PTFE	

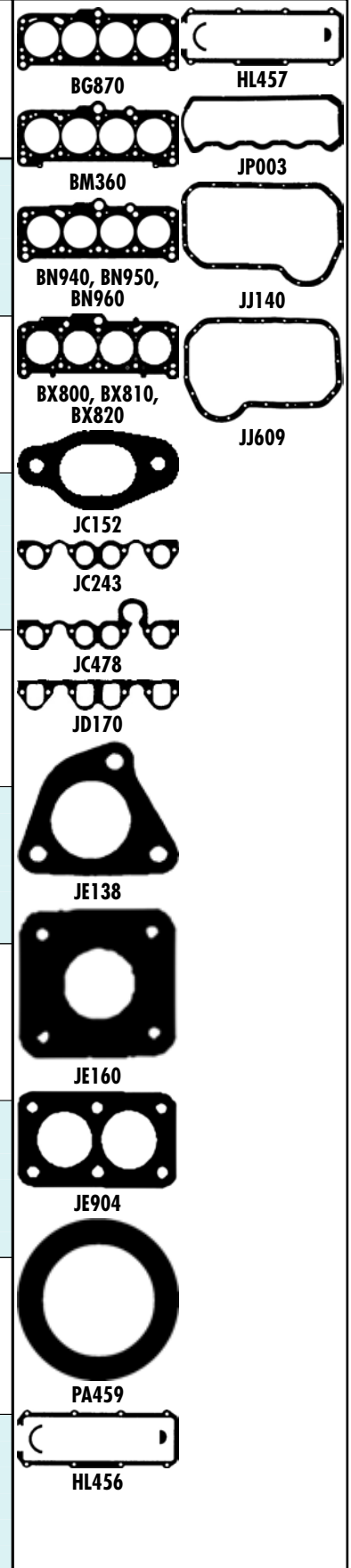



cc



kW/PS

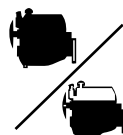

1.7	Model	Year Range	CC	Cyls	Power (kW/PS)	Configuration	Accessories	Part Number	Notes
1.7 AHG Diesel 170									
Polo 1.7 SDI	04/97→10/99	1716	4	79.50	SOHC/OHC	42-44/57-60	BX800 (MLS), 1.450mm, 1 Hole BX810 (MLS), 1.530mm, 2 Holes BX820 (MLS), 1.610mm, 3 Holes	DX801 ▲	ECO30 [18]
1.7 AKU Diesel 171									
Lupo 1.7 SDI	09/98→07/05	1716	4	79.50	SOHC/OHC	44/60	BX800 (MLS), 1.450mm, 1 Hole BX810 (MLS), 1.530mm, 2 Holes BX820 (MLS), 1.610mm, 3 Holes	DX801 ▲	ECO30 [18] →Eng.013 000
Polo 1.7 SDI	10/99→09/01								
Polo 1.7 SDI 60	08/97→10/99								
Polo Van 1.7SDI	08/97→12/99								
1.7 AKW Diesel 172									
Polo 1.7 SDI	08/97→09/01	1716	4	79.50	SOHC/OHC	42/57	BX800 (MLS), 1.450mm, 1 Hole BX810 (MLS), 1.530mm, 2 Holes BX820 (MLS), 1.610mm, 3 Holes	DX801 ▲	
Polo Cl 1.7 SDI	07/97→09/01								
1.7 KY Diesel 173									
Trans 3 1.7 D	10/86→07/92	1716	4	79.50	SOHC/OHC	42/57		DT590 ▲	EG872
1.7 WL 174									
Ilfis 120 E 23	03/79→12/88	1714	4	79.50	SOHC/OHC	55/75	BG870 (Fibre)	DG871	
1.7 YX 175									
Ilfis 120 E 23	03/79→12/88	1714	4	79.50	SOHC/OHC	55/75	BG870 (Fibre)	DG871	
1.8 1H 176									
Golf II 1.8 GTI	08/88→07/91	1781	4	81.00	SOHC/OHC	118/160	BY630 (MLS)	DT819	
1.8 1P 177									
Golf II 1.8 Syn	08/88→07/91	1781	4	81.00	SOHC/OHC	72/98	BM360 (Fibre)	DM368 [3]	EG872
Jetta 2 1.8 Syn	08/88→07/91								
1.8 2H 178									
Golf I Cabr 1.8	08/89→03/93	1781	4	81.00	SOHC/OHC	72/98	BM360 (Fibre)	DM368 [3]	EG872
1.8 2Y 179									
Taro 1.8	04/89→09/94	1812	4	86.00	OHV	61/83	BN640 (Graphite)	DN640 [3]	

HBS018 [19] M12x1.75x115.00mm (x10)	JD170 ■ JC152 ■ (x4) JE5076	JP003 [4] HM5367 ■	JJ609 (ACM)	HR816 ■	NA5001 [1][2] 32.00x47.00x10.00mm, FPM NA5001 ■ [1][2] 32.00x47.00x10.00mm, FPM LK5006 ■ [7] 85.00x131.00x16.000mm, PTFE		
HBS018 [19] M12x1.75x115.00mm (x10)	JD170 ■ JC152 ■ (x4)	JP003 [4] HM5367 ■	JJ609 (ACM)	HR816 ■	NA5001 [1][2] 32.00x47.00x10.00mm, FPM NA5001 ■ [1][2] 32.00x47.00x10.00mm, FPM NA5133 ■ [1] 85.00x105.00x11.00mm, FPM →Eng.013 000 LK5006 ■ [7] 85.00x131.00x16.000mm, PTFE		
HBS018 [19] M12x1.75x115.00mm (x10)	JD170 ■ JC152 ■ (x4)	JP003 [4] HM5367 ■	JJ609 (ACM)	HR816 ■	NA5001 [1][2] 32.00x47.00x10.00mm, FPM NA5001 ■ [1][2] 32.00x47.00x10.00mm, FPM LK5006 ■ [7] 85.00x131.00x16.000mm, PTFE		
HBS018 [19] M12x1.75x115.00mm (x10)	JD278 ■ JC152 ■ (x4)	HL457 ■ [23] (Cork) HM5053 ■ [24] (ACM)	JJ140 (SMG)	HR569 ■	NA5001 [1][2] 32.00x47.00x10.00mm, FPM NA5001 ■ [1][2] 32.00x47.00x10.00mm, FPM NA5133 ■ [1] 85.00x105.00x11.00mm, FPM	KA5020 [15]	
HBS043 [22] M11x1.50x95.00mm (x10)	JC478 ■ JC152 ■ (x4) JE904	HL456 ■ (Cork) HL457 ■ [23] (Cork) HM5053 ■ [24] (ACM)	JJ140 (SMG)	HR569 ■	NA5001 (x2)[1][2] 32.00x47.00x10.00mm, FPM NA5001 ■ [1][2] 32.00x47.00x10.00mm, FPM NA5133 ■ [1] 85.00x105.00x11.00mm, FPM		
HBS043 [22] M11x1.50x95.00mm (x10)	JC478 ■ JC152 ■ (x4) JE904	HL456 ■ (Cork) HL457 ■ [23] (Cork) HM5053 ■ [24] (ACM)	JJ140 (SMG)	HR569 ■	NA5001 (x2)[1][2] 32.00x47.00x10.00mm, FPM NA5001 ■ [1][2] 32.00x47.00x10.00mm, FPM NA5133 ■ [1] 85.00x105.00x11.00mm, FPM		
HBS043 [22] M11x1.50x95.00mm (x10)	JC478 ■ JC152 ■ (x4)	JN964 [4]	JJ140 (SMG)	HR569 ■	NA5001 [1][2] 32.00x47.00x10.00mm, FPM NA5001 ■ [1][2] 32.00x47.00x10.00mm, FPM NA5133 ■ [1] 85.00x105.00x11.00mm, FPM		
HBS043 [22] M11x1.50x95.00mm (x10)	JC478 ■ PA459 ■ (NBR) JC152 ■ (x4) JE160	HL457 ■ [23] (Cork) HM5053 ■ [24] (ACM)	JJ140 (SMG)	HR569 ■	NA5001 [1][2] 32.00x47.00x10.00mm, FPM NA5001 ■ [1][2] 32.00x47.00x10.00mm, FPM NA5133 ■ [1] 85.00x105.00x11.00mm, FPM	KA5020 [15]	
HBS043 [22] M11x1.50x95.00mm (x10)	JC478 ■ PA459 ■ (NBR) JC152 ■ (x4) JE160	HL457 ■ [23] (Cork) HM5053 ■ [24] (ACM)	JJ140 (SMG)	HR569 ■	NA5001 [1][2] 32.00x47.00x10.00mm, FPM NA5001 ■ [1][2] 32.00x47.00x10.00mm, FPM NA5133 ■ [1] 85.00x105.00x11.00mm, FPM		



cc



kW/PS



1.8		AAM					180	BM360 (Fibre)	DM367	EM362
Golf 3 1.8	11/91→04/99	1781	4	81.00	SOHC/OHC	55/75	→Eng.AAM 408 197	→Eng.AAM 408 197		
Golf 3 Cabr 1.8	07/93→05/98						BZ910 (MLS)	DZ910		
Golf 4 Cabr 1.8	06/98→06/02						Eng.AAM 408 198 →	Eng.AAM 408 198 →		
Passat 1.8	08/90→05/97									
Vento 1.8	11/91→09/98									
1.8		ABS					181	BM360 (Fibre)	DM367	EM362
Golf 3 1.8	11/91→04/99	1781	4	81.00	SOHC/OHC	66/90	→Eng.935 645	→Eng.935 645		
Golf 3 1.8 Syn	01/93→08/97						BZ910 (MLS)	DZ910		
Golf 3 Cabr 1.8	07/93→05/98						Eng.935 646 →	Eng.935 646 →		
Passat 1.8	02/88→05/97									
Vento 1.8	11/91→09/98									
1.8		ACC					182	BZ910 (MLS)	DZ910	
Golf 3 1.8	11/91→08/97	1781	4	81.00	SOHC/OHC	66/90				
Golf 4 1.8	10/97→09/99									
1.8		ADD					183	BZ910 (MLS)	DZ910	EB970
Polo Cl 1.8 90	01/97→09/01	1781	4	81.00	SOHC/OHC	66-75/ 90-102				
1.8		ADR					184	AY970 (MLS)	CY970	EY840
Passat 1.8	10/96→11/00	1781	4	81.00	DOHC	92/125				
Passat 1.8 Syn	10/96→11/00									
1.8		ADZ					185	BM360 (Fibre)	DM367	EB970
Golf 3 1.8	11/91→04/99	1781	4	81.00	SOHC/OHC	66/90	→Eng.011 565	→Eng.011 565		
Golf 3 1.8 Syn	01/93→04/99						BZ910 (MLS)	DZ910		
Golf 3 Cabr 1.8	07/93→05/98						Eng.011 566 →	Eng.011 566 →		
Golf 4 Cabr 1.8	06/98→06/02									
Passat 1.8	02/88→05/97									
Polo 1.8 Var	05/97→09/01									
Polo Cl 1.8 90	01/97→09/01									
Vento 1.8	11/91→09/98									

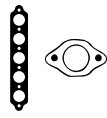

HBS043 [22]
M11x1.50x95.00mm (x10)

JC478 [1]
→Eng.AAM 408 197
PA459 [1]
(NBR)
→Eng.AAM 408 197
JD5235 [1]
Eng.AAM 408 198 →
JC152 [x4]
JE5076

JPO24 [4]
Eng.AAM 408 198 →
HL457 [23]
(Cork)
→Eng.AAM 408 197
HM5053 [24]
(ACM)
→Eng.AAM 408 197

JJ140
(SMG)
JJ609
(ACM)

HR363 [5]
→Eng.AAM 408 197
HR816 [5]
Eng.AAM 408 198 →

NA5001 [1][2]
32.00x47.00x10.00mm, FPM
NA5001 [1][2]
32.00x47.00x10.00mm, FPM
NA5133 [1]
85.00x105.00x11.00mm, FPM
LK5006 [7]
85.00x131.00x16.00mm, PTFE

HBS043 [22]
M11x1.50x95.00mm (x10)

JC478 [1]
→Eng.935 645
PA459 [1]
(NBR)
→Eng.935 645
JD5232 [1]
Eng.935 646 →
JC152 [x4]
JE5076

JPO24 [4]
Eng.935 646 →
HL457 [23]
(Cork)
→Eng.935 645
HM5053 [24]
(ACM)
→Eng.935 645

JJ140
(SMG)
JJ609
(ACM)

HR569 [5]
→Eng.935 645
HR816 [5]
Eng.935 646 →

NA5001 [1][2]
32.00x47.00x10.00mm, FPM
NA5001 [1][2]
32.00x47.00x10.00mm, FPM
NA5133 [1]
85.00x105.00x11.00mm, FPM
LK5006 [7]
85.00x131.00x16.00mm, PTFE

HBS043 [22]
M11x1.50x95.00mm (x10)

JD5235 [1]
JD600 [1]
JE5076

JPO24 [4]

JJ609
(ACM)

HR816 [5]

NA5001 [1][2]
32.00x47.00x10.00mm, FPM
NA5001 [1][2]
32.00x47.00x10.00mm, FPM
NA5133 [1]
85.00x105.00x11.00mm, FPM

HBS043 [22]
M11x1.50x95.00mm (x10)

JD5235 [1]
JC152 [x4]
JF205

JPO24 [4]

JJ609
(ACM)

HR599 [5]
HR816 [5]

NA5001 [1][2]
32.00x47.00x10.00mm, FPM
LK5006 [7]
85.00x131.00x16.00mm, PTFE

HBS171 [22]
M11x1.50x101.00mm (x10)
HBS268 [22]
M10x1.50x120.00mm (x10)

JD604 [1]
JD605 [1]
JE689

HL732 [5]

JJ610

PA5041 (x20)
6.00/12.20x10.00
(FPM)
HR822 [5]

NA5001 (x2)[1][2]
32.00x47.00x10.00mm, FPM
NA5124 (x2)[2]
32.00x47.00x10.00mm, PTFE/ACM
NA5001 [1][2]
32.00x47.00x10.00mm, FPM
NA5124 [x2][2]
32.00x47.00x10.00mm, PTFE/ACM
NA5133 [1]
85.00x105.00x11.00mm, FPM
LK5006 [7]
85.00x131.00x16.00mm, PTFE

HBS043 [22]
M11x1.50x95.00mm (x10)

JC478 [1]
→Eng.011 565
PA459 [1]
(NBR)
→Eng.011 565
JD5235 [1]
Eng.011 566 →
JD606 [1]

HL457 [23]
(Cork)
HM5053 [24]
(ACM)

JJ609
(ACM)

HR569 [5]
→Eng.011 565
HR816 [5]
Eng.011 566 →

NA5001 [1][2]
32.00x47.00x10.00mm, FPM
NA5001 [1][2]
32.00x47.00x10.00mm, FPM
NA5133 [1]
85.00x105.00x11.00mm, FPM

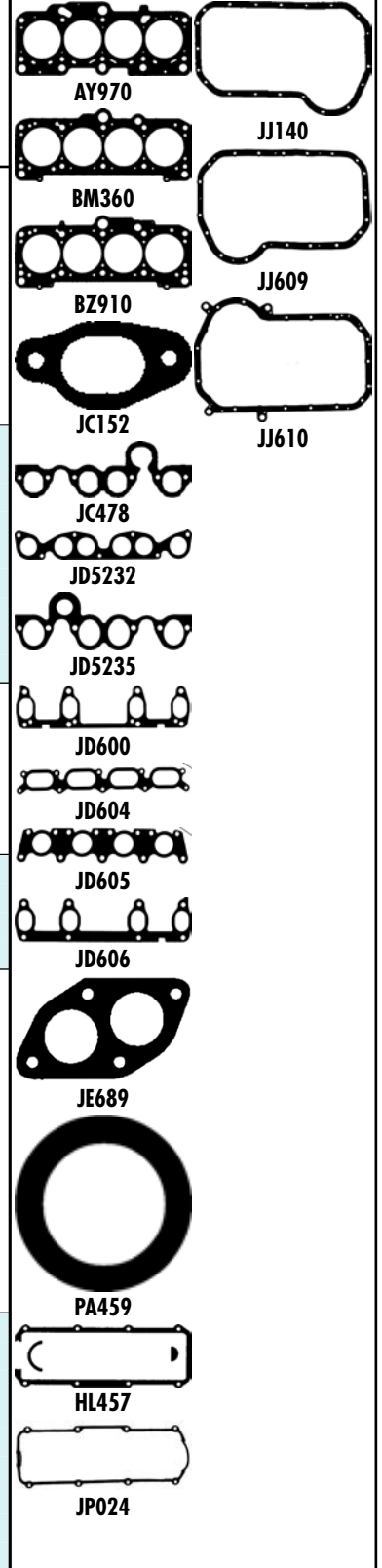



cc



kW/PS



1.8		AEB		186		AY970 (MLS)	CY970	EY840
Passat 1.8 T	10/96→11/00	1781	4	81.00	DOHC	110/150		
Passat 1.8T Syn	11/96→08/00							
1.8		AFY		187		AY970 (MLS)	CY970	EY840
Passat 1.8	01/97→11/00	1781	4	81.00	DOHC	85/115		
1.8		AGN		188		AY970 (MLS)	CY971	EY841 [3]
Bora 1.8	10/98→05/05	1781	4	81.00	DOHC	92/125		
Golf 4 1.8	08/97→06/05							
Golf 4 1.8 4mot	05/98→06/06							
1.8		AGU		189		AY970 (MLS)	CY971	EY841 [3]
Bora 1.8 T	05/00→05/05	1781	4	81.00	DOHC	110/150		
Golf 4 1.8 T	08/97→06/06							
New Beetle 1.8T	10/99→							
1.8		AJH		190		AY970 (MLS)	CY971	EY841 [3]
Sharan 1.8T 20V	09/97→03/10	1781	4	81.00	DOHC	110/150		
1.8		ANB		191		AY970 (MLS)	CY970	EY840
Passat 1.8 T	10/96→11/00	1781	4	81.00	DOHC	110/150		

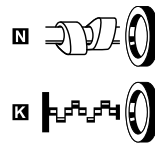
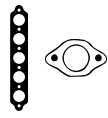

AY970



JD604



JD605



JD607



JE689



JJ610

HBS171 [22]
M11x1.50x101.00mm (x10)
HBS268 [22]
M10x1.50x120.00mm (x10)

JD604 [1]
JD605 [1]
JE689

HL732 [1]

JJ610

PA5041 (x20)
6.00/12.20x10.00
(FPM)
HR822 [1]

NA5001 (x2)[1][2]
32.00x47.00x10.00mm, FPM
NA5124 (x2)[2]
32.00x47.00x10.00mm, PTFE/ACM
NA5001 [1][2]
32.00x47.00x10.00mm, FPM
NA5133 [1]
85.00x105.00x11.00mm, FPM
LK5006 [7]
85.00x131.00x16.00mm, PTFE

HBS171 [22]
M11x1.50x101.00mm (x10)
HBS268 [22]
M10x1.50x120.00mm (x10)

JD604 [1]
JD605 [1]
JE689

HL732 [1]

JJ610

PA5041 (x20)
6.00/12.20x10.00
(FPM)
HR822 [1]

NA5001 [1][2]
32.00x47.00x10.00mm, FPM
NA5124 (x2)[2]
32.00x47.00x10.00mm, PTFE/ACM
NA5001 [1][2]
32.00x47.00x10.00mm, FPM
NA5124 (x2)[2]
32.00x47.00x10.00mm, PTFE/ACM
NA5133 [1]
85.00x105.00x11.00mm, FPM
LK5006 [7]
85.00x131.00x16.00mm, PTFE

HBS268 [22]
M10x1.50x120.00mm (x10)

JD607 [1]
JD605 [1]
JF205

HL732 [1]

HR397

PA5041 (x20)
6.00/12.20x10.00
(FPM)
HR822 [1]

NA5124 (x2)[2]
32.00x47.00x10.00mm, PTFE/ACM
NA5106 [2]
35.00x48.00x10.00mm, PTFE
NB716 [2]
35.00x48.00x10.00mm, FPM
LK5003 [1][7]
85.00x131.00x15.700mm, PTFE

HBS171 [22]
M11x1.50x101.00mm (x10)
HBS268 [22]
M10x1.50x120.00mm (x10)

JD604 [1]
JD605 [1]
JF205

HL732 [1]

HR397

PA5041 (x20)
6.00/12.20x10.00
(FPM)
HR822 [1]

NA5001 [1][2]
32.00x47.00x10.00mm, FPM
NA5124 (x2)[2]
32.00x47.00x10.00mm, PTFE/ACM
NA5106 [2]
35.00x48.00x10.00mm, PTFE
NB716 [2]
35.00x48.00x10.00mm, FPM
LK5003 [1][7]
85.00x131.00x15.700mm, PTFE

HBS268 [22]
M10x1.50x120.00mm (x10)

JD604 [1]
JD605 [1]
JF205

HL732 [1]

HR397
JH5117

PA5041 (x20)
6.00/12.20x10.00
(FPM)
HR822 [1]

NA5001 [1][2]
32.00x47.00x10.00mm, FPM
NA5124 [2]
32.00x47.00x10.00mm, PTFE/ACM
NA5106 [2]
35.00x48.00x10.00mm, PTFE
LK5003 [1][7]
85.00x131.00x15.700mm, PTFE

HBS171 [22]
M11x1.50x101.00mm (x10)
HBS268 [22]
M10x1.50x120.00mm (x10)

JD604 [1]
JD605 [1]
JE689

HL732 [1]

JJ610

PA5041 (x20)
6.00/12.20x10.00
(FPM)
HR822 [1]

NA5124 (x2)[2]
32.00x47.00x10.00mm, PTFE/ACM
NA5124 (x2)[2]
32.00x47.00x10.00mm, PTFE/ACM
LK5006 [7]
85.00x131.00x16.00mm, PTFE



cc



kW/PS

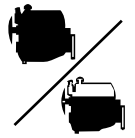

1.8							192	BZ910 (MLS)	DZ910	EM362
Golf 3 1.8	07/93→04/99	1781	4	81.00	SOHC/OHC	55/75				
Golf 4 Cabr 1.8	06/98→06/02									
1.8							193	BZ910 (MLS)	DZ910	
Golf 3 1.8	07/93→04/99	1781	4	81.00	SOHC/OHC	66/90				
Golf 4 Cabr 1.8	06/98→06/02									
1.8							194	AY970 (MLS)	CY971	EY841 [3]
New Beetle 1.8T	10/99→	1781	4	81.00	DOHC	110/150				
1.8							195	AY970 (MLS)	CY970	EY840
Passat 1.8	10/96→03/05	1781	4	81.00	DOHC	92/125				
Passat 1.8 Syn	10/96→11/00									
1.8							196	AY970 (MLS)	CY970	EY840
Passat 1.8 T	10/96→11/00	1781	4	81.00	DOHC	110/150				
1.8							197	AY970 (MLS)	CY971	
Golf 4 1.8 T	08/97→06/06	1781	4	81.00	DOHC	110/150				
1.8							198	AY970 (MLS)	CY970	EY841 [3]
Passat 1.8	10/96→11/00	1781	4	81.00	DOHC	92/125				
Passat 1.8 Syn	10/96→11/00									

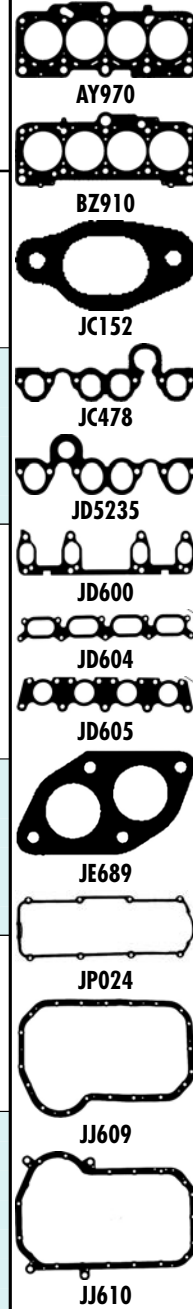
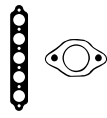

AY970

BZ910

JC152

JC478

JD5235

JD600

JD604

JD605

JE689

JP024

JJ609

JJ610



cc



kW/PS

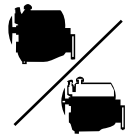

1.8		ARX		199		AY970 (MLS)		CY971	EY841 [3]
Bora 1.8 T	05/00→05/05	1781	4	81.00	DOHC	110/150			
1.8		ARZ		200		AY970 (MLS)		CY971	EY841 [3]
Golf 4 1.8 T	08/97→06/06	1781	4	81.00	DOHC	110/150			
1.8		AUM		201		AY970 (MLS)		CY971	EY841 [3]
Bora 1.8 T	05/00→05/05	1781	4	81.00	DOHC	110/150			
Golf 4 1.8 T	08/97→06/06								
1.8		AUQ		202		AY970 (MLS)		CY971	EY841 [3]
Bora 1.8 T	03/02→05/05	1781	4	81.00	DOHC	132/180			
Golf 4 1.8 TGI	08/01→06/05								
1.8		AVC		203		AY970 (MLS)		CY971	EY841 [3]
New Beetle 1.8T	10/99→	1781	4	81.00	DOHC	110/150			

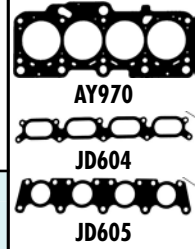

HBS268 [22]
M10x1.50x120.00mm (x10)

JD604
JD605
JF205

HL732

JH5117

PA5041 (x20)
6.00/12.20x10.00
(FPM)
HR822

NA5001 [1][2]
32.00x47.00x10.00mm, FPM
NA5124 (x2)[2]
32.00x47.00x10.00mm, PTFE/ACM
NA5001 [1][2]
32.00x47.00x10.00mm, FPM
NA5106 [2]
35.00x48.00x10.00mm, PTFE
NB716 [2]
35.00x48.00x10.00mm, FPM
LK5003 [1][7]
85.00x131.00x15.700mm, PTFE

HBS268 [22]
M10x1.50x120.00mm (x10)

JD604
JD6005
(Steel)
1.00mm
JD605
JF205

HL732

JH5117

PA5041 (x20)
6.00/12.20x10.00
(FPM)
HR822

NA5001 [1][2]
32.00x47.00x10.00mm, FPM
NA5124 (x2)[2]
32.00x47.00x10.00mm, PTFE/ACM
NA5001 [1][2]
32.00x47.00x10.00mm, FPM
NA5106 [2]
35.00x48.00x10.00mm, PTFE
NB716 [2]
35.00x48.00x10.00mm, FPM
LK5003 [1][7]
85.00x131.00x15.700mm, PTFE

HBS268 [22]
M10x1.50x120.00mm (x10)

JD604
JD605
JF205

HL732

JH5117

PA5041 (x20)
6.00/12.20x10.00
(FPM)
HR822

NA5001 [1][2]
32.00x47.00x10.00mm, FPM
NA5124 [2]
32.00x47.00x10.00mm, PTFE/ACM
NA5001 [1][2]
32.00x47.00x10.00mm, FPM
NA5106 [2]
35.00x48.00x10.00mm, PTFE
NB716 [2]
35.00x48.00x10.00mm, FPM
LK5003 [1][7]
85.00x131.00x15.700mm, PTFE

HBS268 [22]
M10x1.50x120.00mm (x10)

JD604
JD605

HL732

HR397
JH5117

PA5041 (x20)
6.00/12.20x10.00
(FPM)
HR822

NA5001 [1][2]
32.00x47.00x10.00mm, FPM
NA5124 (x2)[2]
32.00x47.00x10.00mm, PTFE/ACM
NA5001 [1][2]
32.00x47.00x10.00mm, FPM
NA5106 [2]
35.00x48.00x10.00mm, PTFE
NB716 [2]
35.00x48.00x10.00mm, FPM
LK5003 [1][7]
85.00x131.00x15.700mm, PTFE

HBS268 [22]
M10x1.50x120.00mm (x10)

JD604
JD605

HL732

JH5117

PA5041 (x20)
6.00/12.20x10.00
(FPM)
HR822

NA5001 [1][2]
32.00x47.00x10.00mm, FPM
NA5124 (x2)[2]
32.00x47.00x10.00mm, PTFE/ACM
NA5106 [2]
35.00x48.00x10.00mm, PTFE
LK5003 [1][7]
85.00x131.00x15.700mm, PTFE



cc



kW/PS



1.8	AWC	204	AY970 (MLS)	CY971	EY841 [3]
Sharan 1.8T 20V	09/97→03/10	1781 4 81.00 DOHC 110/150			
1.8	AWL	205	AY970 (MLS)	CY971	EY841 [3]
Passat 1.8 T20V	11/00→05/05	1781 4 81.00 DOHC 110/150			
1.8	AWM	206	AY970 (MLS)	CY971	EY841 [3]
Passat 1.8 4mot Passat 1.8 T	03/01→05/05 02/01→08/05	1781 4 81.00 DOHC 125/170			
1.8	AWP	207	AY970 (MLS)	CY971	EY841 [3]
New Beetle 1.8T	11/01→06/05	1781 4 81.00 DOHC 132/180			
1.8	AWT	208	AY970 (MLS)	CY971	EY841 [3]
Passat 1.8 T20V Passat 1.8T 20V	11/00→05/05 11/00→05/05	1781 4 81.00 DOHC 110/150			
1.8	AWU	209	AY970 (MLS)	CY971	EY841 [3]
New Beetle 1.8T New Beetle C 1.8	10/99→ 01/03→09/10	1781 4 81.00 DOHC 110/150			
1.8	AWV	210	AY970 (MLS)	CY971	EY841 [3]
New Beetle 1.8T New Beetle C 1.8	10/99→ 01/03→09/10	1781 4 81.00 DOHC 110/150			

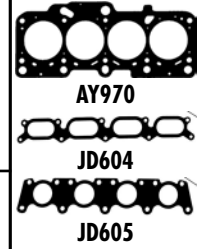

HBS268 [22] M10x1.50x120.00mm (x10)	JD604 JD605 ☉JF205	HL732	HR397 JH5117	PA5041 (x20) 6.00/12.20x10.00 (FPM) HR822	NA5001 [1][2] 32.00x47.00x10.00mm, FPM NA5124 (x2)[2] 32.00x47.00x10.00mm, PTFE/ACM NA5106 [2] 35.00x48.00x10.00mm, PTFE LK5003 [1][7] 85.00x131.00x15.700mm, PTFE	
HBS268 [22] M10x1.50x120.00mm (x10)	JD604 JD605 ☉JF205	HL732	JH5117	PA5041 (x20) 6.00/12.20x10.00 (FPM) HR822	NA5001 [1][2] 32.00x47.00x10.00mm, FPM NA5106 [2] 35.00x48.00x10.00mm, PTFE/ACM NA5124 (x2)[2] 32.00x47.00x10.00mm, PTFE/ACM NA5106 [2] 35.00x48.00x10.00mm, PTFE	
HBS268 [22] M10x1.50x120.00mm (x10)	JD604 JD605	HL732		PA5041 (x20) 6.00/12.20x10.00 (FPM) HR822	NA5124 (x2)[2] 32.00x47.00x10.00mm, PTFE/ACM NA5106 [2] 35.00x48.00x10.00mm, PTFE LK5003 [1][7] 85.00x131.00x15.700mm, PTFE	
HBS268 [22] M10x1.50x120.00mm (x10)	JD604 JD605	HL732	JH5117	PA5041 (x20) 6.00/12.20x10.00 (FPM) HR822	NA5001 [1][2] 32.00x47.00x10.00mm, FPM NA5124 (x2)[2] 32.00x47.00x10.00mm, PTFE/ACM NA5106 [2] 35.00x48.00x10.00mm, PTFE LK5003 [1][7] 85.00x131.00x15.700mm, PTFE	
HBS268 [22] M10x1.50x120.00mm (x10)	JD604 JD605 ☉JE5075	HL732	HR397 JH5117	PA5041 (x20) 6.00/12.20x10.00 (FPM) HR822	NA5001 [1][2] 32.00x47.00x10.00mm, FPM NA5124 (x2)[2] 32.00x47.00x10.00mm, PTFE/ACM NA5001 [1][2] 32.00x47.00x10.00mm, FPM NA5106 [2] 35.00x48.00x10.00mm, PTFE NB716 [2] 35.00x48.00x10.00mm, FPM LK5003 [1][7] 85.00x131.00x15.700mm, PTFE LK5006 [7] 85.00x131.00x16.000mm, PTFE	
HBS268 [22] M10x1.50x120.00mm (x10)	JD604 JD605	HL732	JH5117	PA5041 (x20) 6.00/12.20x10.00 (FPM) HR822	NA5001 [1][2] 32.00x47.00x10.00mm, FPM NA5124 (x2)[2] 32.00x47.00x10.00mm, PTFE/ACM NA5106 [2] 35.00x48.00x10.00mm, PTFE LK5003 [1][7] 85.00x131.00x15.700mm, PTFE	
HBS268 [22] M10x1.50x120.00mm (x10)	JD604 JD605	HL732	HR397 JH5117	PA5041 (x20) 6.00/12.20x10.00 (FPM) HR822	NA5001 [1][2] 32.00x47.00x10.00mm, FPM NA5124 (x2)[2] 32.00x47.00x10.00mm, PTFE/ACM NA5106 [2] 35.00x48.00x10.00mm, PTFE LK5003 [1][7] 85.00x131.00x15.700mm, PTFE	



cc



kW/PS



1.8	Code	Year Range	CC	Cyls	Power (kW/PS)	Configuration	Code	Code	Code
Bora 1.8 Golf 4 1.8	BAF	10/98→05/05 08/97→06/05	1781	4	81.00		211	AY970 (MLS)	EY841 [3]
Polo 1.8 GTi	BBU	05/06→11/09	1781	4	81.00	DOHC	212	AY970 (MLS)	CY971 EY841 [3]
Polo 1.8 GTI	BJX	09/05→11/09	1781	4	81.00	DOHC	213	AY970 (MLS)	CY971 EY841 [3]
New Beetle 1.8T Nw Beetle C 1.8	BKF	10/99→ 01/03→09/10	1781	4	81.00	DOHC	214	AY970 (MLS)	CY971 EY841 [3]
New Beetle 1.8T	BNU	11/01→06/05	1781	4	81.00	DOHC	215	AY970 (MLS)	CY971 EY841 [3]
Parati 1.8 Hybr	BNY	01/05→05/08	1781	4	81.00	SOHC/OHC	216	BZ910 (MLS)	
Passat 1.8 TSI	BZB	05/07→10/11	1798	4	81.00	DOHC	217	AH5380 (MLS)	
CC 1.8 TSI Golf 6 1.8 TSI Passat 1.8 TSI Sharan 1.8 TSI	CDAA	11/11→ 06/09→01/11 05/07→10/11 05/12→	1798	4	82.50	DOHC	218	AH5380 (MLS)	
CC 1.8 TSI Passat 1.8 TSI	CDAB	11/11→ 11/08→11/10	1798	4	82.50	DOHC	219		
Passat 1.8 TSI	CGYA	11/08→11/10	1798	4	82.50	DOHC	220		
Passat 1.8 Passat 1.8 Syn	DS	01/83→03/88 01/86→03/88	1781	4	81.00	SOHC/OHC	221	BM360 (Fibre)	DM360 EG873

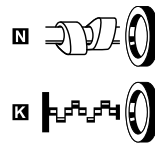

AY970



BM360



BZ910



JC152



JC478



JD604



JD605



JD607



JE138



JE904

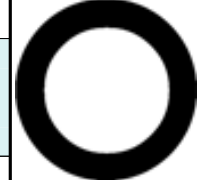

PA459

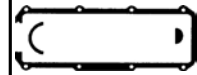

HL457



JJ140

HBS268 [22]
M10x1.50x120.00mm (x10)

JD607 [x4]
JD605 []
[]-JF205

HL732 []

JH5117

PA5041 (x20)
6.00/12.20x10.00
(FPM)
HR822 []

NA5124 (x2)[2]
32.00x47.00x10.00mm, PTFE/ACM
NA5106 [] [2]
35.00x48.00x10.00mm, PTFE
LK5003 [] [1][7]
85.00x131.00x15.700mm, PTFE

HBS268 [22]
M10x1.50x120.00mm (x10)

JD604 []
JD605 []

HL732 []

HR397

PA5041 (x20)
6.00/12.20x10.00
(FPM)
HR822 []

NA5124 (x2)[2]
32.00x47.00x10.00mm, PTFE/ACM
NA5106 [] [2]
35.00x48.00x10.00mm, PTFE
LK5003 [] [1][7]
85.00x131.00x15.700mm, PTFE

HBS268 [22]
M10x1.50x120.00mm (x10)

JD604 []
JD605 []

HL732 []

HR397

PA5041 (x20)
6.00/12.20x10.00
(FPM)
HR822 []

NA5124 (x2)[2]
32.00x47.00x10.00mm, PTFE/ACM
NA5106 [] [2]
35.00x48.00x10.00mm, PTFE
LK5003 [] [1][7]
85.00x131.00x15.700mm, PTFE

HBS268 [22]
M10x1.50x120.00mm (x10)

JD604 []
JD605 []

HL732 []

JH5117

PA5041 (x20)
6.00/12.20x10.00
(FPM)
HR822 []

NA5001 [1][2]
32.00x47.00x10.00mm, FPM
NA5124 (x2)[2]
32.00x47.00x10.00mm, PTFE/ACM
NA5106 [] [2]
35.00x48.00x10.00mm, PTFE
LK5003 [] [1][7]
85.00x131.00x15.700mm, PTFE

HBS268 [22]
M10x1.50x120.00mm (x10)

JD604 []
JD605 []

HL732 []

PA5041 (x20)
6.00/12.20x10.00
(FPM)
HR822 []

NA5124 (x2)[2]
32.00x47.00x10.00mm, PTFE/ACM
NA5106 [] [2]
35.00x48.00x10.00mm, PTFE
LK5003 [] [1][7]
85.00x131.00x15.700mm, PTFE

HR646 []

HBS476 [22]
M10x1.50x117.00mm (x10)

HR397 []

HR397

PA5041 (x16)
6.00/12.20x10.00
(FPM)
HR791 []

HBS476 [22]
M10x1.50x117.00mm (x10)

HR397 []

HR397

PA5041 (x16)
6.00/12.20x10.00
(FPM)
HR791 []

NA5124 [2]
32.00x47.00x10.00mm, PTFE/ACM

HBS476 [22]
M10x1.50x117.00mm (x10)

PA5041 (x16)
6.00/12.20x10.00
(FPM)
HR791 []

HBS476 [22]
M10x1.50x117.00mm (x10)

PA5041 (x16)
6.00/12.20x10.00
(FPM)
HR791 []

HBS043 [22]
M11x1.50x95.00mm (x10)

JC478 []
PA459 [] (x4)
(NBR)
JC152 [] (x4)
JE138 [] [27]
JE904

HL457 [] [23]
(Cork)
HM5053 [] [24]
(ACM)

JJ140
(SMG)

HR569 []

NA5001 [1][2]
32.00x47.00x10.00mm, FPM
NA5001 [] [1][2]
32.00x47.00x10.00mm, FPM
NA5133 [] [1]
85.00x105.00x11.00mm, FPM

KA5020 [15]



kW/PS

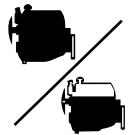

1.8	DX						222	BM360 (Fibre)	DM368 [3]	EG872
Golf I Cabr 1.8	08/82→12/92	1781	4	81.00	SOHC/OHC	82/112				
Golf II 1.8 GTI	08/83→10/91									
Scirocco 1.8	08/82→12/89									
1.8	DZ						223	BM360 (Fibre)	DM360	EG873
Passat 1.8	12/83→03/88	1781	4	81.00	SOHC/OHC	82/112				
1.8	EV						224	BM360 (Fibre)	DM368 [3]	EG872
Golf I Cabr 1.8	08/82→12/89	1781	4	81.00	SOHC/OHC	82/112				
Golf II 1.8 GTI	08/83→10/91									
Jetta II 1.8	01/84→10/91									
Scirocco 1.8	08/82→12/89									
1.8	EX						225	BM360 (Fibre)	DM368 [3]	EG872
Golf I Cabr 1.8	08/83→09/92	1781	4	81.00	SOHC/OHC	66/90				
Scirocco 1.8	08/83→07/92									
1.8	GU						226	BM360 (Fibre)	DM368 [3]	EG872
Golf II 1.8	08/84→10/91	1781	4	81.00	SOHC/OHC	66/90				
Golf II 1.8 Syn	02/86→07/91									
Jetta 2 1.8 Syn	08/87→12/88									
Jetta II 1.8	08/84→10/91									
1.8	GX						227	BM360 (Fibre)	DM368 [3]	EG872
Golf II 1.8	08/84→10/91	1781	4	81.00	SOHC/OHC	66/90				
Golf II 1.8 i	08/87→10/91									
Golf II 1.8 Syn	02/86→07/91									
Jetta II 1.8	08/84→10/91									
1.8	GZ						228	BM360 (Fibre)	DM368 [3]	EG872
Golf II 1.8 GTI	08/83→10/91	1781	4	81.00	SOHC/OHC	82/112				
Jetta II 1.8	01/84→10/91									
1.8	HV						229	BM360 (Fibre)	DM368 [3]	EG872
Golf II 1.8	08/84→10/91	1781	4	81.00	SOHC/OHC	66/90				
Jetta II 1.8	08/84→10/91									
1.8	JH						230	BM360 (Fibre)	DM368 [3]	EG872
Caddy I 1.8	08/85→07/92	1781	4	81.00	SOHC/OHC	70/95				
Golf I Cabr 1.8	08/83→04/93									
Scirocco 1.8	11/85→07/92									

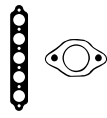

BM360



JC152

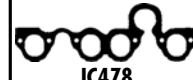

JC478



JE117



JE160



JE689

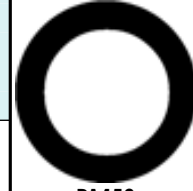

PA459



HL457



JJ140



cc



kW/PS



1.8		JJ		231		BM360 (Fibre)	DM368 [3] 08/83→	EG872
Scirocco 1.8	08/82→12/89	1781	4	81.00	SOHC/OHC	82/112		
1.8		JN		232		BM360 (Fibre)	DM361	EG873
Passat 1.8	01/83→03/88	1781	4	81.00	SOHC/OHC	66-68/ 90-93		
Passat 1.8 Syn	01/86→03/88							
1.8		JV		233		BM360 (Fibre)	DM360	EG873
Passat 1.8	01/83→03/88	1781	4	81.00	SOHC/OHC	66/90		
1.8		KR		234		BM360 (Fibre)	DM365 [3]	EG875 ET811
Corrado 1.8 16V	04/89→07/92	1781	4	81.00	DOHC	100-102/ 136-140		
Golf II 1.8 GTI	02/86→06/90							
Jetta 2 1.8 16V	06/87→12/89							
Passat 1.8 16V	04/88→12/89							
Passat 1.8 GL	08/91→09/93							
Passat 1.8 Var	08/91→09/93							
Scirocco 1.8	10/85→07/89							
1.8		PB		235		BM360 (Fibre)	DM368 [3] 08/83→	EG872
Golf I Cabr 1.8	08/82→12/89	1781	4	81.00	SOHC/OHC	82/112		
Golf II 1.8 GTI	08/83→10/91							
Jetta II 1.8	01/84→10/91							
Passat 1.8	04/88→07/92							
Scirocco 1.8	08/82→12/89							
1.8		PD		236		BW790 (Fibre)	DW790	
Trans 4 1.8	12/90→07/92	1781	4	81.00	SOHC/OHC	49/67		
1.8		PF		237		BM360 (Fibre)	DM368 [3]	EG872
Golf II 1.8 GTI	01/87→10/91	1781	4	81.00	SOHC/OHC	79/107		
Jetta II 1.8	01/87→10/91							
Passat 1.8	04/88→07/93							
1.8		PG		238		BY630 (MLS)	DT819	
Corrado 1.8 G60	09/88→09/93	1781	4	81.00	SOHC/OHC	110-118/ 150-160		
Golf II 1.8 GTI	08/88→07/91							
Passat 1.8 Syn	08/88→05/97							

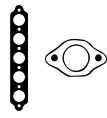

HBS043 [22] M11x1.50x95.00mm (x10)	JC478 [1] PA459 [1] (NBR) JC152 [x4] ☉ JE117 →07/83 ☉ JE160 08/83→	HL457 [23] (Cork) HM5053 [24] (ACM)	JJ140 (SMG)	HR569 [5]	NA5001 [1][2] 32.00x47.00x10.00mm, FPM NA5001 [1][2] 32.00x47.00x10.00mm, FPM NA5133 [1] 85.00x105.00x11.00mm, FPM	KA5020 [15]
HBS043 [22] M11x1.50x95.00mm (x10)	JC478 [1] PA459 [1] (NBR) JC152 [x4] ☉ JE138 [27]	HL457 [23] (Cork) HM5053 [24] (ACM)	JJ140 (SMG)	HR569 [5]	NA5001 [1][2] 32.00x47.00x10.00mm, FPM NA5001 [1][2] 32.00x47.00x10.00mm, FPM NA5133 [1] 85.00x105.00x11.00mm, FPM	KA5020 [15]
HBS043 [22] M11x1.50x95.00mm (x10)	JC478 [1] PA459 [1] (NBR) JC152 [x4] ☉ JE904	HL457 [23] (Cork) HM5053 [24] (ACM)	JJ140 (SMG)	HR569 [5]	NA5001 (x2)[1][2] 32.00x47.00x10.00mm, FPM NA5001 [1][2] 32.00x47.00x10.00mm, FPM NA5133 [1] 85.00x105.00x11.00mm, FPM	KA5020 [15]
HBS028 [22] M11x1.50x147.00mm (x10)	JD281 [1] JD282 [x4] ☉ JF205	HL606 [5]	JJ140 (SMG) JJ183	HR599 (x2) HR816 (x2)	NA5001 [1][2] 32.00x47.00x10.00mm, FPM NA5001 [1][2] 32.00x47.00x10.00mm, FPM NA5133 [1] 85.00x105.00x11.00mm, FPM	
HBS043 [22] M11x1.50x95.00mm (x10)	JC478 [1] PA459 [1] (NBR) JC152 [x4] ☉ JE117 →07/83 ☉ JE160 08/83→	HL457 [23] (Cork) HM5053 [24] (ACM)	JJ140 (SMG)	HR569 [5]	NA5001 [1][2] 32.00x47.00x10.00mm, FPM NA5001 [1][2] 32.00x47.00x10.00mm, FPM NA5133 [1] 85.00x105.00x11.00mm, FPM	KA5020 [15]
HBS043 [22] M11x1.50x95.00mm (x10)	JC478 [1] PA459 [1] (NBR) JC152 [x4] ☉ JE160	HL457 [23] (Cork) HM5053 [24] (ACM)	JJ140 (SMG)	HR569 [5]	NA5001 [1][2] 32.00x47.00x10.00mm, FPM NA5001 [1][2] 32.00x47.00x10.00mm, FPM NA5133 [1] 85.00x105.00x11.00mm, FPM	KA5020 [15]
HBS043 [22] M11x1.50x95.00mm (x10)	JC478 [1] PA459 [1] (NBR) JC152 [x4] ☉ JE160	HL457 [23] (Cork) HM5053 [24] (ACM)	JJ140 (SMG)	HR569 [5]	NA5001 [1][2] 32.00x47.00x10.00mm, FPM NA5001 [1][2] 32.00x47.00x10.00mm, FPM NA5133 [1] 85.00x105.00x11.00mm, FPM	KA5020 [15]
HBS043 [22] M11x1.50x95.00mm (x10)	JC478 [1] JC152 [x4] ☉ JF205	JN964 [4]	JJ140 (SMG) JJ609 (ACM)	HR569 [5]	NA5001 [1][2] 32.00x47.00x10.00mm, FPM NA5001 [1][2] 32.00x47.00x10.00mm, FPM NA5133 [1] 85.00x105.00x11.00mm, FPM	

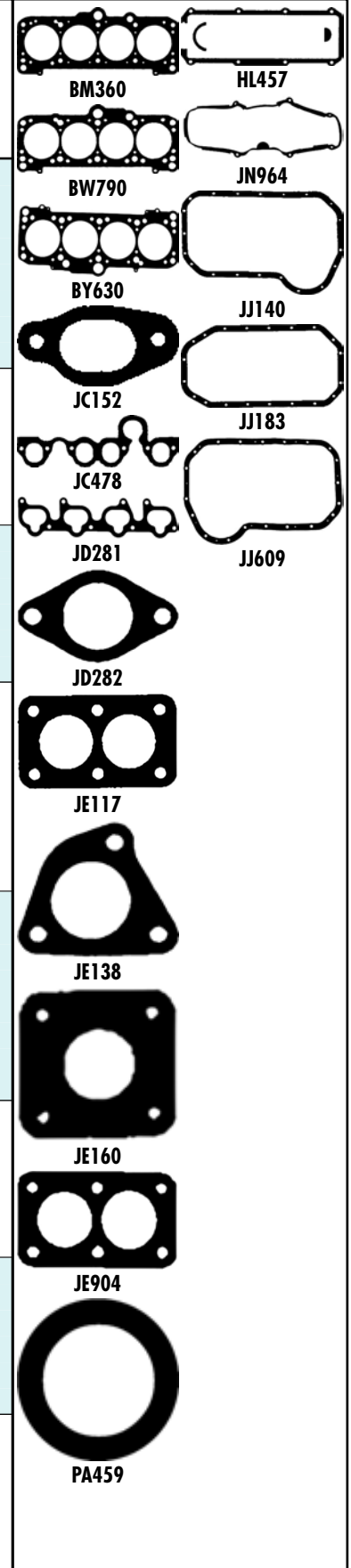



cc



kW/PS



1.8	PL						239	BM360 (Fibre)	DM365 [3]	EG875 ET811
Golf II 1.8 GTI	02/86→10/91	1781	4	81.00	DOHC	95/129				
Jetta 2 1.8 16V	08/86→10/91									
Scirocco 1.8	03/86→07/92									
1.8	RH						240	BM360 (Fibre)	DM368 [3]	EG872
Golf II 1.8	08/86→01/90	1781	4	81.00	SOHC/OHC	62/84				
Golf II 1.8 Syn	08/87→07/88									
Jetta 2 1.8 Syn	08/87→07/88									
Jetta II 1.8	08/86→01/90									
1.8	RM						241	BM360 (Fibre)	DM360	EG872
GOL 1.8	05/84→09/94	1781	4	81.00	SOHC/OHC	64/87				
Passat 1.8	05/86→03/88									
1.8	RP						242	BM360 (Fibre)	DM368 [3]	EG872 EM362
Golf II 1.8 i	08/87→10/91	1781	4	81.00	SOHC/OHC	66/90				
Golf II 1.8 i S	08/87→10/91									
Jetta 2 1.8 Syn	08/87→12/88									
Jetta II 1.8	08/87→10/91									
Passat 1.8	02/88→05/97									
1.8	UDH						243	BZ910 (MLS)		
Parati 1.8	08/02→	1781	4	81.00	SOHC/OHC	72-73/ 98-99				
1.9	1X Diesel						244	BV850 (MLS), 1.530mm, 1 Hole BV860 (MLS), 1.570mm, 2 Holes BV870 (MLS), 1.610mm, 3 Holes	DV850 ▲	EA800
Trans 4 1.9 D	07/90→12/95	1896	4	79.50	SOHC/OHC	44-45/ 60-61				
1.9	1Y Diesel						245	BV850 (MLS), 1.530mm, 1 Hole BV860 (MLS), 1.570mm, 2 Holes BV870 (MLS), 1.610mm, 3 Holes	DV850 ▲ →Eng.580 000 DV851 ▲ Eng.580 001→	EC030 [18] →Eng.800000
Caddy II 1.9 D	11/95→01/04	1896	4	79.50	SOHC/OHC	47-50/ 64-68				
Golf 3 1.9 D	11/91→04/99									
Passat 1.9 D	05/89→10/93									
Vento 1.9 D	11/91→09/98									
VOYAGE 1.9 D	06/96→09/01									
1.9	1Z Diesel						246	BX800 (MLS), 1.450mm, 1 Hole BX810 (MLS), 1.530mm, 2 Holes BX820 (MLS), 1.610mm, 3 Holes	DX800 ▲ →Eng.1Z-720 000 DX801 ▲ Eng.1Z-720 001→	EC030 [18]
Caddy II 1.9TDI	09/96→01/04	1896	4	79.50	SOHC/OHC	66/90				
Golf 3 1.9 TDI	09/93→04/99									
Golf 3 Cabr 1.9	08/95→05/98									
Passat 1.9 TDI	10/93→05/97									
Sharan 1.9 TDI	09/95→03/10									
Vento 1.9 TDI	09/93→09/98									
VOYAGE 1.9 TDi	09/99→09/01									

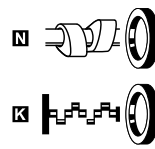
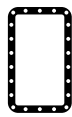
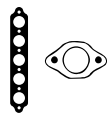

HBS028 [22] M11x1.50x147.00mm (x10)	JD281 [1] JD282 [4] ☉ JF205	HL606 [4]	JJ140 (SMG)	HR599 [4] (x2) HR816 [4] (x2)	NA5001 [1] [2] 32.00x47.00x10.00mm, FPM NA5001 [1] [2] 32.00x47.00x10.00mm, FPM NA5133 [1] 85.00x105.00x11.00mm, FPM	
HBS043 [22] M11x1.50x95.00mm (x10)	JC478 [1] PA459 [1] (NBR) JC152 [4] (x4) ☉ JE160	HL457 [23] (Cork) HM5053 [24] (ACM)	JJ140 (SMG)	HR569 [4]	NA5001 [1] [2] 32.00x47.00x10.00mm, FPM NA5001 [1] [2] 32.00x47.00x10.00mm, FPM NA5133 [1] 85.00x105.00x11.00mm, FPM	KA5020 [15]
HBS043 [22] M11x1.50x95.00mm (x10)	JC478 [1] PA459 [1] (NBR) JC152 [4] (x4) ☉ JE689	HL457 [23] (Cork) HM5053 [24] (ACM)	JJ140 (SMG)	HR569 [4]	NA5001 [1] [2] 32.00x47.00x10.00mm, FPM NA5001 [1] [2] 32.00x47.00x10.00mm, FPM NA5133 [1] 85.00x105.00x11.00mm, FPM	KA5020 [15]
HBS043 [22] M11x1.50x95.00mm (x10)	JC478 [1] PA459 [1] (NBR) JC152 [4] (x4) ☉ JE160	HL457 [23] (Cork) HM5053 [24] (ACM)	JJ140 (SMG)	HR569 [4]	NA5001 (x2) [1] [2] 32.00x47.00x10.00mm, FPM NA5001 [1] [2] 32.00x47.00x10.00mm, FPM NA5133 [1] 85.00x105.00x11.00mm, FPM	KA5020 [15]
				HR646 [4]		
HBS018 [19] M12x1.75x115.00mm (x10)	JD170 [1] JC152 [4] (x4) ☉ JE160	JN914 [4] HM5058 [4]	JH5023	HR569 [4]	NA5001 [1] [2] 32.00x47.00x10.00mm, FPM NA5001 [1] [2] 32.00x47.00x10.00mm, FPM NA5133 [1] 85.00x105.00x11.00mm, FPM LK5006 [7] 85.00x131.00x16.00mm, PTFE	
HBS018 [19] M12x1.75x115.00mm (x10)	JD170 [1] JC152 [4] (x4) ☉ JE138 [27] ☉ JE5076	JN914 [4] HM5058 [4]	JH5023	HR569 [4] → Eng. 580 000 HR816 [4] Eng. 580 001 →	NA5001 [1] [2] 32.00x47.00x10.00mm, FPM NA5001 [1] [2] 32.00x47.00x10.00mm, FPM NA5133 [1] 85.00x105.00x11.00mm, FPM LK5006 [7] 85.00x131.00x16.00mm, PTFE	
HBS018 [19] M12x1.75x115.00mm (x10)	JD170 [1] JC152 [4] (x4)	JP003 [4] HM5367 [4]	JJ609 (ACM)	HR569 [4] → Eng. 1Z-720 000 HR816 [4] Eng. 1Z-720 001 →	NA5001 [1] [2] 32.00x47.00x10.00mm, FPM NA5001 [1] [2] 32.00x47.00x10.00mm, FPM NA5133 [1] 85.00x105.00x11.00mm, FPM	

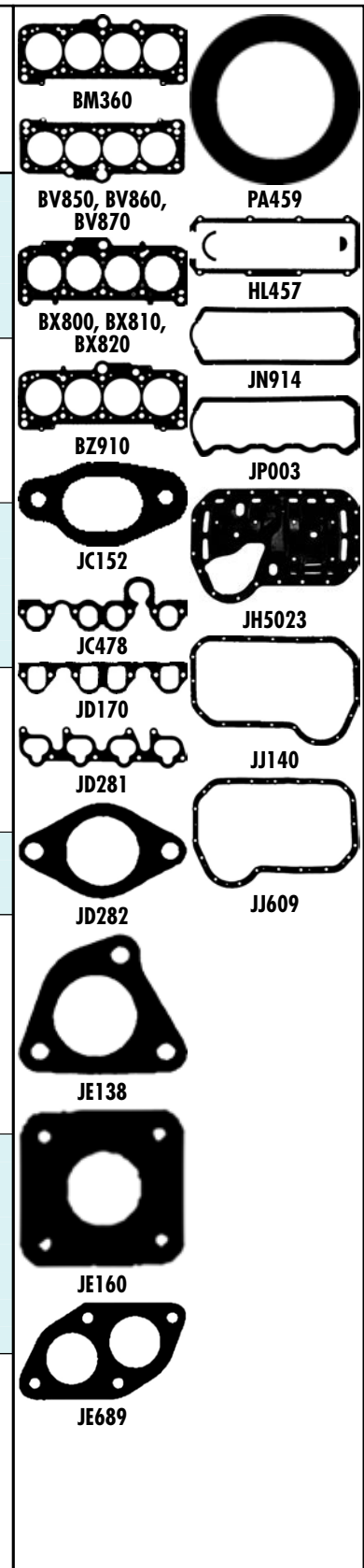



cc



kW/PS



1.9 AAZ Diesel 247							BV850 (MLS), 1.530mm, 1 Hole BV860 (MLS), 1.570mm, 2 Holes BV870 (MLS), 1.610mm, 3 Holes	DV850 ▲	ECO30 [18]
Golf 3 1.9 TD	11/91→04/99	1896	4	79.50	SOHC/OHC	55/75			
Golf 4 1.9 TD	10/97→09/99								
Passat 1.9 TD	03/91→05/97								
Vento 1.9 TD	11/91→09/98								
1.9 ABL Diesel 248							BV850 (MLS), 1.530mm, 1 Hole BV860 (MLS), 1.570mm, 2 Holes BV870 (MLS), 1.610mm, 3 Holes	DV851 ▲ →Eng.076 000 DV850 ▲ Eng.076 001→	EA800
Trans 4 1.9 TD	10/92→04/03	1896	4	79.50	SOHC/OHC	50/68			
1.9 AEF Diesel 249							BV850 (MLS), 1.530mm, 1 Hole BV860 (MLS), 1.570mm, 2 Holes BV870 (MLS), 1.610mm, 3 Holes	DV850 ▲ →Eng.007 000 DV851 ▲ Eng.007 001→	ECO30 [18] →Eng.265000
Caddy II 1.9 D	06/96→12/00	1896	4	79.50	SOHC/OHC	47/64			
Polo 1.9 D	10/99→09/01								
Polo 1.9 D 64	10/94→10/99								
Polo Van 1.9 D	10/94→12/99								
1.9 AEY Diesel 250							BX800 (MLS), 1.450mm, 1 Hole BX810 (MLS), 1.530mm, 2 Holes BX820 (MLS), 1.610mm, 3 Holes	DX801 ▲	ECO30 [18] →Eng.050000
Caddy II 1.9SDI	11/95→01/04	1896	4	79.50	SOHC/OHC	47-48/ 64-65			
Golf 3 1.9 SDI	07/95→04/99								
Golf 3 1.9SDI	07/95→08/97								
Polo 1.9 SDI	06/97→09/01								
Polo Cl 1.9 SDI	12/95→09/01								
Vento 1.9 SDI	04/97→09/98								
1.9 AFN Diesel 251							BX800 (MLS), 1.450mm, 1 Hole BX810 (MLS), 1.530mm, 2 Holes BX820 (MLS), 1.610mm, 3 Holes	DX800 ▲ →Eng.002 000 DX801 ▲ Eng.002 001→	ECO30 [18] →Eng.576000
Golf 3 1.9 TDI	04/96→04/99	1896	4	79.50	SOHC/OHC	81/110			
Golf 3 Cabr 1.9	07/96→05/98								
Golf 4 Cabr 1.9	06/98→06/02								
Passat 1.9 Syn	06/97→11/00								
Passat 1.9 TDI	03/96→11/00								
Polo 1.9 TDI	06/98→09/01								
Polo Cl 1.9 TDI	06/98→01/02								
Sharan 1.9 TDI	09/96→04/00								
Vento 1.9 TDI	04/96→09/98								
1.9 AGD Diesel 252							BX800 (MLS), 1.450mm, 1 Hole BX810 (MLS), 1.530mm, 2 Holes BX820 (MLS), 1.610mm, 3 Holes	DX801 ▲	ECO30 [18] →Eng.015000
Polo 1.9 SDI	10/99→09/01	1896	4	79.50	SOHC/OHC	47/64			
Polo 1.9 SDI 64	07/96→10/99								
Polo Van 1.9SDI	07/96→12/99								

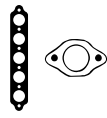

BV850, BV860,
BV870



BX800, BX810,
BX820



JC152



JD170

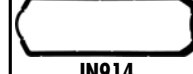

JN914



JP003



JH5023



JJ140



JJ609



cc



kW/PS



1.9		AGP Diesel				253			
Bora 1.9 SDI	10/98→05/05	1896	4	79.50	SOHC/OHC	50/68	BZ010 (MLS), 1.450mm, 1 Hole →Eng.028 000	DZ010 ▲☒	EC060 [18]
Golf 4 1.9 SDI	08/97→06/06						BZ020 (MLS), 1.530mm, 2 Holes →Eng.028 000		
Polo 1.9 SDI	08/99→09/01						BZ030 (MLS), 1.610mm, 3 Holes →Eng.028 000		
Polo Cl 1.9 SDI	08/99→01/02						BZ040 (MLS), 1.470mm, 1 Hole Eng.028 001→		
							BZ050 (MLS), 1.570mm, 2 Holes Eng.028 001→		
							BZ060 (MLS), 1.670mm, 3 Holes Eng.028 001→		
1.9		AGR Diesel				254			
Bora 1.9 TDI	10/98→05/05	1896	4	79.50	SOHC/OHC	66/90	BZ010 (MLS), 1.450mm, 1 Hole →Eng.151 000	DZ010 ▲☒	EC060 [18]
Golf 4 1.9 TDI	10/97→05/06						BZ020 (MLS), 1.530mm, 2 Holes →Eng.151 000		
Polo 1.9 TDI	05/97→09/01						BZ030 (MLS), 1.610mm, 3 Holes →Eng.151 000		
Polo Cl 1.9 TDI	09/96→09/01						BZ040 (MLS), 1.470mm, 1 Hole Eng.151 001→		
							BZ050 (MLS), 1.570mm, 2 Holes Eng.151 001→		
							BZ060 (MLS), 1.670mm, 3 Holes Eng.151 001→		
1.9		AHF Diesel				255			
Bora 1.9 TDI	10/98→06/01	1896	4	79.50	SOHC/OHC	81/110	BZ010 (MLS), 1.450mm, 1 Hole →Eng.140 000	DZ010 ▲☒	EC060 [18]
Golf 4 1.9 TDI	08/97→05/04						BZ020 (MLS), 1.530mm, 2 Holes →Eng.140 000		
							BZ030 (MLS), 1.610mm, 3 Holes →Eng.140 000		
							BZ040 (MLS), 1.470mm, 1 Hole Eng.140 001→		
							BZ050 (MLS), 1.570mm, 2 Holes Eng.140 001→		
							BZ060 (MLS), 1.670mm, 3 Holes Eng.140 001→		
1.9		AHH Diesel				256			
Passat 1.9 TDI	10/96→11/00	1896	4	79.50	SOHC/OHC	66/90	BX800 (MLS), 1.450mm, 1 Hole	DX801 ▲	EC030 [18]
							BX810 (MLS), 1.530mm, 2 Holes		
							BX820 (MLS), 1.610mm, 3 Holes		
1.9		AHU Diesel				257			
Caddy II 1.9TDI	09/96→01/04	1896	4	79.50	SOHC/OHC	66-67/ 90-91	BX800 (MLS), 1.450mm, 1 Hole	DX800 ▲ →Eng.720 000	EC030 [18] →Eng.390000
Golf 3 1.9 TDI	09/93→04/99						BX810 (MLS), 1.530mm, 2 Holes	DX801 ▲ Eng.720 001→	
Golf 3 Cabr 1.9	08/95→05/98						BX820 (MLS), 1.610mm, 3 Holes		
Golf 4 Cabr 1.9	06/98→06/02								
Passat 1.9 TDI	10/93→11/00								
Polo 1.9 TDI	05/97→09/01								
Polo Cl 1.9 TDI	09/96→09/01								
Sharan 1.9 TDI	09/95→03/10								
Vento 1.9 TDI	09/93→09/98								

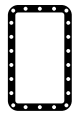
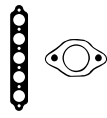

BX800, BX810,
BX820



BZ010, BZ020,
BZ030



BZ040, BZ050,
BZ060



JC152



JD170



JP003



JJ609

HBS018 [19]
M12x1.75x115.00mm (x10)

JD170
JC152 (x4)
JE5076

HR397

HR397

HR816

NA5001 [1][2]
32.00x47.00x10.00mm, FPM
NB716 [2]
35.00x48.00x10.00mm, FPM
LK5003 [1][7]
85.00x131.00x15.700mm, PTFE

HBS018 [19]
M12x1.75x115.00mm (x10)

JD170
JC152 (x4)

HR397

HR397

HR816

NA5001 [1][2]
32.00x47.00x10.00mm, FPM
NB716 [2]
35.00x48.00x10.00mm, FPM
LK5003 [1][7]
85.00x131.00x15.700mm, PTFE
LK5006 [7]
85.00x131.00x16.000mm, PTFE

HBS018 [19]
M12x1.75x115.00mm (x10)

JD170
JC152 (x4)

HR397

HR397

HR816

NA5001 [1][2]
32.00x47.00x10.00mm, FPM
NB716 [2]
35.00x48.00x10.00mm, FPM
LK5003 [1][7]
85.00x131.00x15.700mm, PTFE

HBS018 [19]
M12x1.75x115.00mm (x10)

JD170
JC152 (x4)

JP003 [4]
HM5367

HR397
JJ609
(ACM)

HR816

NA5001 [1][2]
32.00x47.00x10.00mm, FPM
NA5001 [1][2]
32.00x47.00x10.00mm, FPM
LK5006 [7]
85.00x131.00x16.000mm, PTFE

HBS018 [19]
M12x1.75x115.00mm (x10)

JD170
JC152 (x4)

JP003 [4]
HM5367

JJ609
(ACM)

HR569
→Eng.720 000
HR816
Eng.720 001→

NA5001 [1][2]
32.00x47.00x10.00mm, FPM
NA5001 [1][2]
32.00x47.00x10.00mm, FPM
NA5133 [1]
85.00x105.00x11.00mm, FPM
LK5006 [7]
85.00x131.00x16.000mm, PTFE



cc



kW/PS



1.9		AJM Diesel				258	AF5381 (MLS), 1.490mm, 1 Hole AF5391 (MLS), 1.530mm, 2 Holes AF5401 (MLS), 1.650mm, 3 Holes		CC5231 ▲	EC060 [18]
Bora 1.9 TDI	12/98→01/02	1896	4	79.50	SOHC/OHC	85/115				
Golf 4 1.9 TDI	12/98→06/01									
Passat 1.9 TDI	08/98→11/00									
1.9		ALE Diesel				259	BX800 (MLS), 1.450mm, 1 Hole BX810 (MLS), 1.530mm, 2 Holes BX820 (MLS), 1.610mm, 3 Holes		DX801 ▲	EC030 [18]
Caddy II 1.9 TDI	10/96→01/04	1896	4	79.50	SOHC/OHC	66/90				
Golf 3 1.9 TDI	09/93→04/99									
Golf 3 Cabr 1.9	08/95→05/98									
Golf 4 Cabr 1.9	06/98→06/02									
Polo 1.9 TDI	05/97→09/01									
Polo Cl 1.9 TDI	09/96→09/01									
Vento 1.9 TDI	09/93→09/98									
1.9		ALH Diesel				260	BZ010 (MLS), 1.450mm, 1 Hole →Eng,085 000 BZ020 (MLS), 1.530mm, 2 Holes →Eng,085 000 BZ030 (MLS), 1.610mm, 3 Holes →Eng,085 000 BZ040 (MLS), 1.470mm, 1 Hole Eng,085 001→ BZ050 (MLS), 1.570mm, 2 Holes Eng,085 001→ BZ060 (MLS), 1.670mm, 3 Holes Eng,085 001→		DZ010 ▲☒	EC060 [18]
Bora 1.9 TDI	10/98→06/01	1896	4	79.50	SOHC/OHC	66/90				
Caddy II 1.9 TDI	09/96→01/04									
Golf 4 1.9 TDI	10/97→05/06									
New Beetle 1.9	01/98→06/04									
Polo 1.9 TDI	05/97→09/01									
Polo Cl 1.9 TDI	09/96→09/01									
1.9		ANU Diesel				261	AF5381 (MLS), 1.490mm, 1 Hole AF5391 (MLS), 1.530mm, 2 Holes AF5401 (MLS), 1.650mm, 3 Holes		CC5230 ▲	EB5370 [3][18]
Sharan 1.9 TDI	09/95→03/10	1896	4	79.50	SOHC/OHC	66/90				
1.9		AQM Diesel				262	BZ040 (MLS), 1.470mm, 1 Hole BZ050 (MLS), 1.570mm, 2 Holes BZ060 (MLS), 1.670mm, 3 Holes		DZ010 ▲☒	EC060 [18]
Bora 1.9 SDI	10/98→05/05	1896	4	79.50	SOHC/OHC	50/68				
Golf 4 1.9 SDI	08/97→06/06									
Polo 1.9 SDI	08/99→09/01									
Polo Cl 1.9 SDI	08/99→01/02									
1.9		ARL Diesel				263	AF5381 (MLS), 1.490mm, 1 Hole AF5391 (MLS), 1.530mm, 2 Holes AF5401 (MLS), 1.650mm, 3 Holes		CC5231 ▲	EC060 [18]
Bora 1.9 TDI	05/00→05/05	1896	4	79.50	SOHC/OHC	110/150				
Golf 4 1.9 TDI	02/00→06/05									

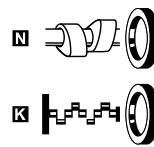
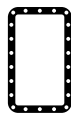
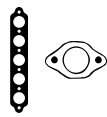

BX800, BX810,
BX820



BZ010, BZ020,
BZ030



BZ040, BZ050,
BZ060



JC152



JD170



JD600



JD606



JP003



JJ609



cc



kW/PS



1.9 ASV Diesel						264				
Bora 1.9 TDI	10/98→06/01	1896	4	79.50	SOHC/OHC	81/110	BZ040 (MLS), 1.470mm, 1 Hole	DZ010 ▲☒	ECO60 [18]	
Golf 4 1.9 TDI	08/97→05/04						BZ050 (MLS), 1.570mm, 2 Holes			
Polo 1.9 TDI	06/98→09/01						BZ060 (MLS), 1.670mm, 3 Holes			
Polo Cl 1.9 TDI	06/98→01/02									
1.9 ASX Diesel						265				
Polo 1.9 SDI	10/99→09/01	1896	4	79.50	SOHC/OHC	47/64	BX800 (MLS), 1.450mm, 1 Hole	DX801 ▲		
							BX810 (MLS), 1.530mm, 2 Holes			
							BX820 (MLS), 1.610mm, 3 Holes			
1.9 ASY Diesel						266				
Polo 1.9 SDI	10/01→11/09	1896	4	79.50	SOHC/OHC	47/64	BZ040 (MLS), 1.470mm, 1 Hole	CC5231 ▲	ECO60 [18]	
Polo Sal 1.9SDI	09/02→						BZ050 (MLS), 1.570mm, 2 Holes			
							BZ060 (MLS), 1.670mm, 3 Holes			
1.9 ASZ Diesel						267				
Bora 1.9 TDI	11/00→05/05	1896	4	79.50	SOHC/OHC	96/130	AF5381 (MLS), 1.490mm, 1 Hole	CC5230 ▲	ECO60 [18]	
Golf 4 1.9 TDI	11/00→06/06						AF5391 (MLS), 1.530mm, 2 Holes			
Polo 1.9 TDI	11/03→11/09						AF5401 (MLS), 1.650mm, 3 Holes			
Sharan 1.9 TDI	11/02→03/10									
1.9 ATD Diesel						268				
Bora 1.9 TDI	09/00→05/05	1896	4	79.50	SOHC/OHC	74/101	AF5381 (MLS), 1.490mm, 1 Hole	CC5230 ▲	ECO60 [18]	
Golf 4 1.9 TDI	09/00→06/06						AF5391 (MLS), 1.530mm, 2 Holes			
New Beetle 1.9	02/01→						AF5401 (MLS), 1.650mm, 3 Holes			
Polo 1.9 TDI	10/01→11/09									
Polo Sal 1.9TDi	09/02→									
1.9 ATJ Diesel						269				
Passat 1.9 TDI	08/98→11/00	1896	4	79.50	SOHC/OHC	85/115	AF5381 (MLS), 1.490mm, 1 Hole	CC5231 ▲	ECO60 [18]	
							AF5391 (MLS), 1.530mm, 2 Holes			
							AF5401 (MLS), 1.650mm, 3 Holes			
1.9 AUY Diesel						270				
Bora 1.9 TDI	12/98→01/02	1896	4	79.50	SOHC/OHC	85/115	AF5381 (MLS), 1.490mm, 1 Hole	CC5231 ▲	ECO60 [18]	
Golf 4 1.9 TDI	12/98→06/01						AF5391 (MLS), 1.530mm, 2 Holes			
Sharan 1.9 TDI	04/00→03/10						AF5401 (MLS), 1.650mm, 3 Holes			

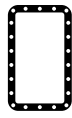
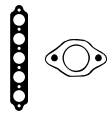

BX800, BX810, BX820



BZ040, BZ050, BZ060



JC152



JD170



JD600

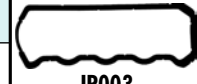

JP003



JJ609

HBS018 [19] M12x1.75x115.00mm (x10)	JD170 [1] JC152 [x4]		HR397	HR816 [5]	NA5001 [1][2] 32.00x47.00x10.00mm, FPM NA5106 [2] 35.00x48.00x10.00mm, PTFE NB716 [2] 35.00x48.00x10.00mm, FPM LK5003 [1][7] 85.00x131.00x15.700mm, PTFE	
HBS018 [19] M12x1.75x115.00mm (x10)	JD170 [1] JC152 [x4]	JP003 [4] HM5367 [5]	JJ609 (ACM)	HR816 [5]	NA5001 [1][2] 32.00x47.00x10.00mm, FPM NA5001 [1][2] 32.00x47.00x10.00mm, FPM LK5006 [7] 85.00x131.00x16.000mm, PTFE	
HBS018 [19] M12x1.75x115.00mm (x10)	JD170 [1] JC152 [x4]	JM5203 (Elastomer)	HR397	HR816 [5]	NA5001 [1][2] 32.00x47.00x10.00mm, FPM NA5106 [2] 35.00x48.00x10.00mm, PTFE/ACM NA5124 [2] 32.00x47.00x10.00mm, PTFE/ACM NA5106 [2] 35.00x48.00x10.00mm, PTFE NA5124 [2] 32.00x47.00x10.00mm, PTFE/ACM NB716 [2] 35.00x48.00x10.00mm, FPM LK5003 [1][7] 85.00x131.00x15.700mm, PTFE	
HBS300 [19] M12x1.75x166.00mm (x10)	JD170 [1] JC152 [x4]	JM5203 (Elastomer)	HR397	HR816 [5]	NA5124 [2] 32.00x47.00x10.00mm, PTFE/ACM NA5106 [2] 35.00x48.00x10.00mm, PTFE LK5003 [1][7] 85.00x131.00x15.700mm, PTFE	
HBS300 [19] M12x1.75x166.00mm (x10)	JD170 [1] JD600 [5]	JM5203 (Elastomer)	HR397	HR816 [5]	NA5124 [2] 32.00x47.00x10.00mm, PTFE/ACM NA5106 [2] 35.00x48.00x10.00mm, PTFE LK5003 [1][7] 85.00x131.00x15.700mm, PTFE	
HBS300 [19] M12x1.75x166.00mm (x10)	JD170 [1] JC152 [x4]	JM5120 (Elastomer)	HR397	HR816 [5]	NA5124 [2] 32.00x47.00x10.00mm, PTFE/ACM NA5106 [2] 35.00x48.00x10.00mm, PTFE NA5124 [2] 32.00x47.00x10.00mm, PTFE/ACM LK5003 [1][7] 85.00x131.00x15.700mm, PTFE	
HBS300 [19] M12x1.75x166.00mm (x10)	JD170 [1] JC152 [x4]	JM5203 (Elastomer)	HR397	HR816 [5]	NA5124 [2] 32.00x47.00x10.00mm, PTFE/ACM NA5106 [2] 35.00x48.00x10.00mm, PTFE LK5003 [1][7] 85.00x131.00x15.700mm, PTFE	



cc









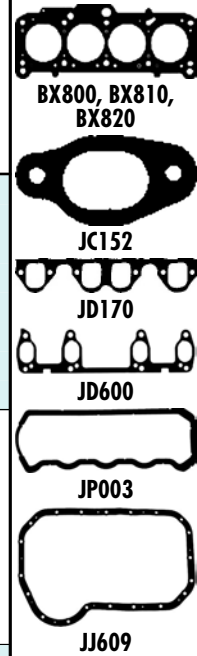









































































kW/PS



1.9	AVB Diesel	271					AF5381 (MLS), 1.490mm, 1 Hole	CC5230 ▲	EB5370 [3][18] EC060 [18]
Passat 1.9 TDI	02/00→05/05	1896	4	79.50	SOHC/OHC	74/101	AF5391 (MLS), 1.530mm, 2 Holes AF5401 (MLS), 1.650mm, 3 Holes		
1.9	AVF Diesel	272					AF5381 (MLS), 1.490mm, 1 Hole	CC5230 ▲	EC060 [18]
Passat 1.9 TDI	11/00→05/05	1896	4	79.50	SOHC/OHC	96/130	AF5391 (MLS), 1.530mm, 2 Holes AF5401 (MLS), 1.650mm, 3 Holes		
1.9	AVG Diesel	273					BX800 (MLS), 1.450mm, 1 Hole	DX801 ▲	EC030 [18]
Golf 4 Cabr 1.9	06/98→06/02	1896	4	79.50	SOHC/OHC	81/110	BX810 (MLS), 1.530mm, 2 Holes BX820 (MLS), 1.610mm, 3 Holes		
Passat 1.9 Syn	06/97→11/00								
Passat 1.9 TDI	10/96→11/00								
Sharan 1.9 TDI	09/96→04/00								
1.9	AVQ Diesel	274					AF5381 (MLS), 1.490mm, 1 Hole	CC5230 ▲	EF5380
Touran 1.9 TDI	02/03→05/04	1896	4	79.50	SOHC/OHC	74/100	AF5391 (MLS), 1.530mm, 2 Holes AF5401 (MLS), 1.650mm, 3 Holes		
1.9	AWX Diesel	275					AF5381 (MLS), 1.490mm, 1 Hole	CC5230 ▲	EC060 [18]
Passat 1.9 TDI	11/00→05/05	1896	4	79.50	SOHC/OHC	96/130	AF5391 (MLS), 1.530mm, 2 Holes AF5401 (MLS), 1.650mm, 3 Holes		
1.9	AXB Diesel	276					AF5381 (MLS), 1.490mm, 1 Hole	CC5230 ▲	EB5370 [3][18]
Multi V 1.9 TDI	04/03→11/09	1896	4	79.50	SOHC/OHC	77/105	AF5391 (MLS), 1.530mm, 2 Holes AF5401 (MLS), 1.650mm, 3 Holes		
Trans 5 1.9 TDI	04/03→11/09								
1.9	AXC Diesel	277					AF5381 (MLS), 1.490mm, 1 Hole	CC5230 ▲	EB5370 [3][18]
Multi V 1.9 TDI	04/03→11/09	1896	4	79.50	SOHC/OHC	63/85	AF5391 (MLS), 1.530mm, 2 Holes AF5401 (MLS), 1.650mm, 3 Holes		
Trans 5 1.9 TDI	04/03→11/09								
1.9	AXR Diesel	278					AF5381 (MLS), 1.490mm, 1 Hole	CC5230 ▲	EC060 [18]
Bora 1.9 TDI	09/00→05/05	1896	4	79.50	SOHC/OHC	74/100	AF5391 (MLS), 1.530mm, 2 Holes AF5401 (MLS), 1.650mm, 3 Holes		
Golf 4 1.9 TDI	09/00→06/06								
Nw Beetle C 1.9	06/03→09/10								
Polo 1.9 TDI	10/01→11/09								



HBS300  [19] M12x1.75x166.00mm (x10)	JD170  JD600 	JM5203 (Elastomer)	HR397	HR816 	 NA5124 [2] 32.00x47.00x10.00mm, PTFE/ACM  NA5106  [2] 35.00x48.00x10.00mm, PTFE  NA5124  [2] 32.00x47.00x10.00mm, PTFE/ACM  LK5003  [1][7] 85.00x131.00x15.700mm, PTFE
HBS300  [19] M12x1.75x166.00mm (x10)	JD170  JD600 	JM5203 (Elastomer)	HR397	HR816 	 NA5124 [2] 32.00x47.00x10.00mm, PTFE/ACM  NA5106  [2] 35.00x48.00x10.00mm, PTFE  NA5124  [2] 32.00x47.00x10.00mm, PTFE/ACM  LK5003  [1][7] 85.00x131.00x15.700mm, PTFE
HBS018  [19] M12x1.75x115.00mm (x10)	JD170  JC152  (x4) 	JP003 [4] HM5367 	HR397 JJ609 (ACM)	HR816 	 NA5001 [1][2] 32.00x47.00x10.00mm, FPM  NA5001  [1][2] 32.00x47.00x10.00mm, FPM  LK5006  [7] 85.00x131.00x16.000mm, PTFE
HBS300  [19] M12x1.75x166.00mm (x10)	JD170  JD600 	JM5203 (Elastomer)	HR397	HR816 	 NA5124 [2] 32.00x47.00x10.00mm, PTFE/ACM  NA5106  [2] 35.00x48.00x10.00mm, PTFE  LK5012  [1][7][28] 85.00x132.00x15.70mm, ACM
HBS300  [19] M12x1.75x166.00mm (x10)	JD170  JD600 	JM5203 (Elastomer)	HR397	HR816 	 NA5124 [2] 32.00x47.00x10.00mm, PTFE/ACM  NA5106  [2] 35.00x48.00x10.00mm, PTFE  NA5124  [2] 32.00x47.00x10.00mm, PTFE/ACM  LK5003  [1][7] 85.00x131.00x15.700mm, PTFE
HBS300  [19] M12x1.75x166.00mm (x10)	JD170  JD600 	JM5203 (Elastomer)	HR397	HR816 	 NA5124 [2] 32.00x47.00x10.00mm, PTFE/ACM  NA5106  [2] 35.00x48.00x10.00mm, PTFE  LK5003  [1][7] 85.00x131.00x15.700mm, PTFE
HBS300  [19] M12x1.75x166.00mm (x10)	JD170  JD600 	JM5203 (Elastomer)	HR397	HR816 	 NA5124 [2] 32.00x47.00x10.00mm, PTFE/ACM  NA5106  [2] 35.00x48.00x10.00mm, PTFE  LK5003  [1][7] 85.00x131.00x15.700mm, PTFE
HBS300  [19] M12x1.75x166.00mm (x10)	JD170  JD600 	JM5203 (Elastomer)	HR397	HR816 	 NA5124 [2] 32.00x47.00x10.00mm, PTFE/ACM  NA5106  [2] 35.00x48.00x10.00mm, PTFE  LK5003  [1][7] 85.00x131.00x15.700mm, PTFE



cc



kW/PS



1.9	AYQ Diesel	1896	4	79.50	SOHC/OHC	279	BZ040 (MLS), 1.470mm, 1 Hole BZ050 (MLS), 1.570mm, 2 Holes BZ060 (MLS), 1.670mm, 3 Holes	ECO60 [18]
Caddy II 1.9SDI	11/95→01/04					47/64		
1.9	BEW Diesel	1896	4	79.50	SOHC/OHC	280	AF5381 (MLS), 1.490mm, 1 Hole AF5391 (MLS), 1.530mm, 2 Holes Ch.F1C-6-406 663→ AF5401 (MLS), 1.650mm, 3 Holes Ch.F1C-6-406 663→	CC5230 ▲ EB5370 [3][18]
New Beetle 1.9	02/01→					74/101		
1.9	BGG Diesel	1896	4	79.50	SOHC/OHC	281	BV850 (MLS), 1.530mm, 1 Hole BV860 (MLS), 1.570mm, 2 Holes BV870 (MLS), 1.610mm, 3 Holes	DV851 ▲
Parati 1.9 SDI	08/02→					47/64		
1.9	BJB Diesel	1896	4	79.50	SOHC/OHC	282	AF5381 (MLS), 1.490mm, 1 Hole AF5391 (MLS), 1.530mm, 2 Holes AF5401 (MLS), 1.650mm, 3 Holes	CC5230 ▲ EF5380
Caddy 3 1.9 TDI	04/04→08/10					77/105		
1.9	BKC Diesel	1896	4	79.50	SOHC/OHC	283	AF5381 (MLS), 1.490mm, 1 Hole AF5391 (MLS), 1.530mm, 2 Holes AF5401 (MLS), 1.650mm, 3 Holes	CC5230 ▲ EF5380
Golf PL 1.9 TDI	01/05→01/09					77/105		
Golf V 1.9 TDI	10/03→11/08							
Jetta 3 1.9 TDI	08/05→10/10							
Passat 1.9 TDI	03/05→11/08							
Touran 1.9 TDI	08/03→05/10							
1.9	BLS Diesel	1896	4	79.50	SOHC/OHC	284	AF5381 (MLS), 1.490mm, 1 Hole AF5391 (MLS), 1.530mm, 2 Holes AF5401 (MLS), 1.650mm, 3 Holes	CC5230 ▲ EF5380
Caddy 3 1.9 TDI	04/04→08/10					77/105		
Golf PL 1.9 TDI	01/05→01/09							
Golf V 1.9 TDI	10/03→11/08							
Jetta 3 1.9 TDI	08/05→10/10							
Passat 1.9 TDI	03/05→11/08							
Touran 1.9 TDI	08/03→05/10							
1.9	BLT Diesel	1896	4	79.50	SOHC/OHC	285	AF5381 (MLS), 1.490mm, 1 Hole AF5391 (MLS), 1.530mm, 2 Holes AF5401 (MLS), 1.650mm, 3 Holes	CC5230 ▲ EB5370 [3][18]
Polo 1.9 TDI	11/03→11/09					96/130		
1.9	BMT Diesel	1896	4	79.50	SOHC/OHC	286	AF5381 (MLS), 1.490mm, 1 Hole AF5391 (MLS), 1.530mm, 2 Holes AF5401 (MLS), 1.650mm, 3 Holes	EF5380
Polo 1.9 TDI	10/01→11/09					74/101		
1.9	BRR Diesel	1896	4	79.50	SOHC/OHC	287	AF5381 (MLS), 1.490mm, 1 Hole AF5391 (MLS), 1.530mm, 2 Holes AF5401 (MLS), 1.650mm, 3 Holes	EF5380
Multi V 1.9 TDI	01/06→11/09					62/84		
Trans 5 1.9 TDI	01/06→11/09							



BV850, BV860, BV870



BZ040, BZ050, BZ060



JD170



JD600



JD606



JH5023



cc



kW/PS



1.9	BRS Diesel						288	AF5381 (MLS), 1.490mm, 1 Hole AF5391 (MLS), 1.530mm, 2 Holes AF5401 (MLS), 1.650mm, 3 Holes		EF5380
Multi V 1.9 TDI Trans 5 1.9 TDI	06/06→11/09 06/06→11/09	1896	4	79.50	SOHC/OHC	75/102				
1.9	BRU Diesel						289	AF5381 (MLS), 1.490mm, 1 Hole AF5391 (MLS), 1.530mm, 2 Holes AF5401 (MLS), 1.650mm, 3 Holes	CC5230 ▲	EF5380
Golf PL 1.9 TDI Golf V 1.9 TDI Touran 1.9 TDI	05/05→12/08 05/04→11/08 11/04→05/10	1896	4	79.50	SOHC/OHC	66/90				
1.9	BSU Diesel						290	AF5381 (MLS), 1.490mm, 1 Hole AF5391 (MLS), 1.530mm, 2 Holes AF5401 (MLS), 1.650mm, 3 Holes		EF5380
Caddy 3 1.9 TDI	09/05→08/10	1896	4	79.50	SOHC/OHC	55/75				
1.9	BSW Diesel						291	AF5381 (MLS), 1.490mm, 1 Hole AF5391 (MLS), 1.530mm, 2 Holes AF5401 (MLS), 1.650mm, 3 Holes	CC5230 ▲	EF5380
New Beetle 1.9 Nw Beetle C 1.9	07/05→ 07/05→09/10	1896	4	79.50	SOHC/OHC	77/105				
1.9	BTB Diesel						292	AF5381 (MLS), 1.490mm, 1 Hole AF5391 (MLS), 1.530mm, 2 Holes AF5401 (MLS), 1.650mm, 3 Holes	CC5230 ▲	EF5380
Sharan 1.9 TDI	06/05→03/10	1896	4	79.50	SOHC/OHC	110/150				
1.9	BVK Diesel						293	AF5381 (MLS), 1.490mm, 1 Hole AF5391 (MLS), 1.530mm, 2 Holes AF5401 (MLS), 1.650mm, 3 Holes	CC5231 ▲	EB5370 [3][18]
Sharan 1.9 TDI	04/00→03/10	1896	4	79.50	SOHC/OHC	85/115				
1.9	BXE Diesel						294	AF5381 (MLS), 1.490mm, 1 Hole AF5391 (MLS), 1.530mm, 2 Holes AF5401 (MLS), 1.650mm, 3 Holes	CC5230 ▲	EF5380
Golf PL 1.9 TDI Golf V 1.9 TDI Jetta 3 1.9 TDI Passat 1.9 TDI Touran 1.9 TDI	01/05→01/09 10/03→11/08 08/05→10/10 03/05→11/08 08/03→05/10	1896	4	79.50	SOHC/OHC	77/105				
1.9	BXF Diesel						295	AF5381 (MLS), 1.490mm, 1 Hole AF5391 (MLS), 1.530mm, 2 Holes AF5401 (MLS), 1.650mm, 3 Holes	CC5230 ▲	EF5380
Golf PL 1.9 TDI Golf V 1.9 TDI Touran 1.9 TDI	05/05→12/08 05/04→11/08 11/04→05/10	1896	4	79.50	SOHC/OHC	66/90				
1.9	BXJ Diesel						296	AF5381 (MLS), 1.490mm, 1 Hole AF5391 (MLS), 1.530mm, 2 Holes AF5401 (MLS), 1.650mm, 3 Holes		EF5380
Golf PL 1.9 TDI Golf V 1.9 TDI Touran 1.9 TDI	05/05→12/08 05/04→11/08 11/04→05/10	1896	4	79.50	SOHC/OHC	66/90				

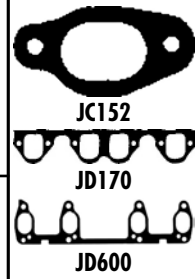

HBS300 [19] M12x1.75x166.00mm (x10)	JD170 [1] JD600 [2]	JM7113 (Elastomer)	HR397	HR816 [2]	NA5124 [2] 32.00x47.00x10.00mm, PTFE/ACM NA5106 [2] 35.00x48.00x10.00mm, PTFE LK5012 [1] [7] [28] 85.00x132.00x15.70mm, ACM	
HBS300 [19] M12x1.75x166.00mm (x10)	JD170 [1] JD600 [2]	JM5203 (Elastomer)	HR397	HR816 [2]	NA5124 [2] 32.00x47.00x10.00mm, PTFE/ACM NA5106 [2] 35.00x48.00x10.00mm, PTFE LK5012 [1] [7] [28] 85.00x132.00x15.70mm, ACM	
HBS300 [19] M12x1.75x166.00mm (x10)	JD170 [1] JD5992 [29] (Steel)	JM7107 (ACM)	HR397	HR816 [2]	NA5124 [2] 32.00x47.00x10.00mm, PTFE/ACM NA5106 [2] 35.00x48.00x10.00mm, PTFE LK5012 [1] [7] [28] 85.00x132.00x15.70mm, ACM	
HBS300 [19] M12x1.75x166.00mm (x10)	JD170 [1] JD600 [2]	JM5203 (Elastomer)	HR397	HR816 [2]	NA5124 [2] 32.00x47.00x10.00mm, PTFE/ACM NA5106 [2] 35.00x48.00x10.00mm, PTFE LK5003 [1] [7] 85.00x131.00x15.70mm, PTFE	
HBS300 [19] M12x1.75x166.00mm (x10)	JD170 [1] JD600 [2]	JM5203 (Elastomer)	HR397	HR816 [2]	NA5124 [2] 32.00x47.00x10.00mm, PTFE/ACM NA5106 [2] 35.00x48.00x10.00mm, PTFE LK5003 [1] [7] 85.00x131.00x15.70mm, PTFE	
HBS300 [19] M12x1.75x166.00mm (x10)	JD170 [1] JC152 [x4]	JM5203 (Elastomer)	HR397	HR816 [2]	NA5124 [2] 32.00x47.00x10.00mm, PTFE/ACM NA5106 [2] 35.00x48.00x10.00mm, PTFE LK5003 [1] [7] 85.00x131.00x15.70mm, PTFE	
HBS300 [19] M12x1.75x166.00mm (x10)	JD170 [1] JD600 [2]	JM5203 (Elastomer)	HR397	HR816 [2]	NA5124 [2] 32.00x47.00x10.00mm, PTFE/ACM NA5106 [2] 35.00x48.00x10.00mm, PTFE NA5124 [2] 32.00x47.00x10.00mm, PTFE/ACM LK5012 [1] [7] [28] 85.00x132.00x15.70mm, ACM	
HBS300 [19] M12x1.75x166.00mm (x10)	JD170 [1] JD600 [2]	JM5203 (Elastomer)	HR397	HR816 [2]	NA5124 [2] 32.00x47.00x10.00mm, PTFE/ACM NA5106 [2] 35.00x48.00x10.00mm, PTFE LK5012 [1] [7] [28] 85.00x132.00x15.70mm, ACM	
HBS300 [19] M12x1.75x166.00mm (x10)	JD170 [1] JD5992 [29] (Steel)	JM7107 (ACM)	HR397	HR816 [2]	NA5124 [2] 32.00x47.00x10.00mm, PTFE/ACM NA5106 [2] 35.00x48.00x10.00mm, PTFE LK5012 [1] [7] [28] 85.00x132.00x15.70mm, ACM	



cc



kw/PS



1.9	DF						297		DM690 ○	GM690 ○
Trans 3 1.9	08/82→07/92	1913	4	94.00	BOXER	44/60				
1.9	DG						298		DM690 ○	GM690 ○
Trans 3 1.9	08/82→07/92	1913	4	94.00	OHV, BOXER	57/78				
Trans 3 1.9 Syn	11/84→07/92									
1.9	DH						299		DM690 ○	GM690 ○
Trans 3 1.9	10/84→02/89	1913	4	94.00	OHV, BOXER	61/83				
1.9	GW						300		DM690 ○	GM690 ○
Trans 3 1.9	08/83→02/89	1913	4	94.00	BOXER	66/90				
2.0	2E						301	BT810 (Fibre)	DT811	ES471
Corrado 2.0 i	04/93→12/95	1984	4	82.50	SOHC/OHC	85/115		→Eng.2E 565 664	→Ch.1H-PB-130 001	
Golf 3 2.0	11/91→04/99							DT816	EB970	
Golf 3 Cabr 2.0	07/93→05/98							Eng.2E 565 665→	Ch.1H-PB-130 001→	
Passat 2.0	02/90→05/97									
Passat 2.0 Syn	10/90→05/97									
Vento 2.0	11/91→09/98									
2.0	9A						302	BT810 (Fibre)	DT812	EG875
Corrado 2.0 16V	08/91→12/95	1984	4	82.50	DOHC	100/136			ET811	
Passat 2.0 16V	08/88→09/93									
2.0	AAC						303	BW790 (Fibre)	DW790	EA800
Trans 4 2.0	07/90→04/03	1968	4	81.00	SOHC/OHC	62/84				
Vento 2.0 GL	11/91→07/98									
2.0	ABF						304	BT810 (Fibre)	DT81B ☒ [3]	EB970
Golf 3 2.0 GTI	08/92→08/97	1984	4	82.50	DOHC	110/150	→Ch.4A-S-110 000	Eng.031 252→		
Passat 2.0 16V	01/94→05/97						BY750 (MLS)			
Sharan 2.0 16V	09/95→02/00									
2.0	ADY						305	BY750 (MLS)	DY753 [3]	EB970
Corrado 2.0 i	04/93→12/95	1984	4	82.50	SOHC/OHC	85/115				
Golf 3 2.0	11/91→04/99									
Golf 3 Cabr 2.0	07/93→05/98									
Passat 2.0	02/90→05/97									
Passat 2.0 Syn	10/90→05/97									
Sharan 2.0	09/95→03/10									
Vento 2.0	11/91→09/98									
2.0	AEG						306	AB5370 (MLS)	CB5370 [13]	EB5370 [3][18]
New Beetle 2.0	01/98→	1984	4	82.50	SOHC/OHC	85/115				

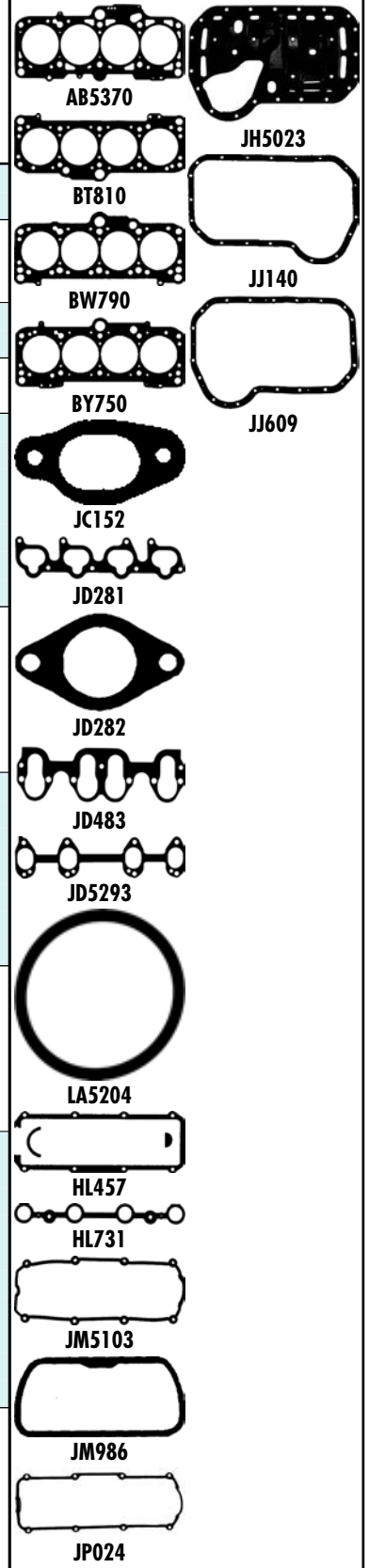

	JD237 ■ (x2) JD236 ■ (x4)	JM986 (x2)[4]			▣ NB953 ■ [1] 75.00x95.00x12.00mm, FPM	
	JD237 ■ (x2) JD236 ■ (x4)	JM986 (x2)[4]			▣ NB953 ■ [1] 75.00x95.00x12.00mm, FPM	
	JD237 ■ (x2) JD236 ■ (x4)	JM986 (x2)[4]			▣ NB953 ■ [1] 75.00x95.00x12.00mm, FPM	
	JD237 ■ (x2) JD236 ■ (x4)	JM986 (x2)[4]			▣ NB953 ■ [1] 75.00x95.00x12.00mm, FPM	
HBS043 ⊕ [22] M11x1.50x95.00mm (x10)	JD483 ■ JC152 ■ (x4) ⊕ JF205	JP024 [4]	JJ140 (SMG) JJ609 (ACM)	HR569 ■ →Eng.2E 565 664 HR816 ■ Eng.2E 565 665→	▣ NA5001 [1][2] 32.00x47.00x10.00mm, FPM ▣ NA5001 ■ [1][2] 32.00x47.00x10.00mm, FPM ▣ NA5133 ■ [1] 85.00x105.00x11.00mm, FPM	
HBS028 ⊕ [22] M11x1.50x147.00mm (x10)	JD281 ■ JD282 ■ (x4) ⊕ JF205	HL606 ■		HR599 ■ HR816 ■ (x2)	▣ NA5001 [1][2] 32.00x47.00x10.00mm, FPM ▣ NA5001 ■ [1][2] 32.00x47.00x10.00mm, FPM ▣ NA5133 ■ [1] 85.00x105.00x11.00mm, FPM	
HBS018 ⊕ [19] M12x1.75x115.00mm (x10)	JD483 ■ JC152 ■ (x4)	JP024 [4] Eng.049 001→ HL457 ■ [23] (Cork) →Eng.049 000 HM5053 ■ [24] (ACM)	JH5023	HR569 ■	▣ NA5001 [1][2] 32.00x47.00x10.00mm, FPM ▣ NA5001 ■ [1][2] 32.00x47.00x10.00mm, FPM ▣ NA5133 ■ [1] 85.00x105.00x11.00mm, FPM	
HBS028 ⊕ [22] M11x1.50x147.00mm (x10)	JD281 ■ JD282 ■ (x4) ⊕ JF205	HL606 ■ HL731 ■	JJ609 (ACM)	HR599 ■ HR816 ■ (x2)	▣ NA5001 [1][2] 32.00x47.00x10.00mm, FPM ▣ NA5001 ■ [1][2] 32.00x47.00x10.00mm, FPM ▣ NA5133 ■ [1] 85.00x105.00x11.00mm, FPM	
HBS043 ⊕ [22] M11x1.50x95.00mm (x10)	JD483 ■ JD5293 ■ ⊕ JF205	JP024 [4]	JJ609 (ACM)	HR569 ■ →Eng.000 778 HR816 ■ Eng.000 779→	▣ NA5001 [1][2] 32.00x47.00x10.00mm, FPM ▣ NA5124 [2] 32.00x47.00x10.00mm, PTFE/ACM ▣ NA5001 ■ [1][2] 32.00x47.00x10.00mm, FPM ▣ NA5133 ■ [1] 85.00x105.00x11.00mm, FPM ▣ LK5006 ■ [7] 85.00x131.00x16.000mm, PTFE	
HBS246 ⊕ [22] M10x1.50x120.00mm (x10)	LA5204 ■ JD5293 ■	JM5103 (Elastomer)	JH5117	HR816 ■	▣ NA5124 [2] 32.00x47.00x10.00mm, PTFE/ACM ▣ NA5106 ■ [2] 35.00x48.00x10.00mm, PTFE ▣ LK5003 ■ [1][7] 85.00x131.00x15.700mm, PTFE	



cc



kW/PS



2.0		AEP					307	BY750 (MLS)	DY753 [3]	EB970
Golf 3 2.0	08/95→04/96	1984	4	82.50	SOHC/OHC	79/107				
Golf 3 2.0 GL	08/95→09/97									
Passat 2.0	03/95→08/96									
Vento 2.0 GL	05/96→12/97									
2.0		AGG					308	BY750 (MLS)	DY753 [3]	EB970
Golf 3 2.0	11/91→04/99	1984	4	82.50	SOHC/OHC	85/115				
Golf 3 2.0 Syn	08/95→04/99									
Golf 3 Cabr 2.0	07/93→05/98									
Golf 4 Cabr 2.0	06/98→06/02									
Passat 2.0	02/90→05/97									
Passat 2.0 Syn	10/90→05/97									
Vento 2.0	11/91→09/98									
2.0		AKR					309	BY750 (MLS)	DY753 [3]	EB970
Golf 3 2.0	11/91→04/99	1984	4	82.50	SOHC/OHC	85/115				
Golf 3 Cabr 2.0	07/93→05/98									
Golf 4 Cabr 2.0	06/98→06/02									
Vento 2.0	11/91→09/98									
2.0		ALT					310	AG8810 (MLS)	CG8420	EG9600
Passat 2.0	11/01→05/05	1984	4	82.50	DOHC	96/130				
2.0		APK					311	AB5370 (MLS)	CB5370 [13]	EB5370 [3][18] EY841 [3]
Bora 2.0	10/98→05/05	1984	4	82.50	SOHC/OHC	85/116				
Golf 4 2.0	07/98→06/06									
New Beetle 2.0	01/98→									
2.0		AQY					312	AB5370 (MLS)	CB5370 [13]	EB5370 [3][18] EY841 [3]
Bora 2.0	10/98→05/05	1984	4	82.50	SOHC/OHC	85/115				
Golf 4 2.0	07/98→06/06									
New Beetle 2.0	01/98→									
2.0		ATM					313	AB5370 (MLS)		EB5370 [3][18]
Sharan 2.0	09/95→03/10	1984	4	82.50	SOHC/OHC	85/115				
Sharan 2.0 LPG	04/06→03/10									
2.0		ATU					314			
Golf 4 Cabr 2.0	06/98→06/02	1984	4	82.50	SOHC/OHC	85/116				

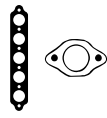

AB5370



BY750



JC152



JD483



JD5292



JD5293

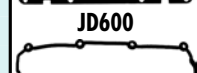

JD600



JM5103



JP024



JJ609



cc



kW/PS



2.0	AVH	315	AB5370 (MLS)						
New Beetle 2.0	01/98→	1984	4	82.50	SOHC/OHC	85/115			
2.0	AWF	316							
Golf 4 Cabr 2.0	06/98→06/02	1984	4	82.50	SOHC/OHC	85/115			
2.0	AWG	317							
Golf 4 Cabr 2.0	06/98→06/02	1984	4	82.50	SOHC/OHC	85/116			
2.0	AXA	318	AB5370 (MLS)						EB5370 [3][18]
Multi V 2.0	11/03→	1984	4	82.50	SOHC/OHC	85/115			
Trans 5 2.0	11/03→								
2.0	AXW	319	AG9600 (MLS)	CG9600					EG9600
Golf V 2.0 FSI	01/04→11/08	1984	4	82.50	DOHC	110/150			
Touran 2.0 FSI	10/03→11/05								
2.0	AXX	320	AH6930 (MLS)						
Golf V 2.0 GTI	10/04→02/09	1984	4	82.50	DOHC	147/200			
Jetta 3 2.0TFSI	10/05→10/10								
Passat 2.0 FSI	07/05→11/10								
2.0	AZG	321	AB5370 (MLS)	CB5370 [13]					EB5370 [3][18]
Bora 2.0	10/98→05/05	1984	4	82.50	SOHC/OHC	85/115			
Golf 4 2.0	07/98→05/04								
New Beetle 2.0	01/98→								
2.0	AZH	322	AB5370 (MLS)	CB5370 [13]					EB5370 [3][18] EY841 [3]
Bora 2.0	10/98→05/05	1984	4	82.50	SOHC/OHC	85/115			
Golf 4 2.0 4mot	10/00→06/06								
2.0	AZJ	323	AB5370 (MLS)	CB5370 [13]					EB5370 [3][18]
Bora 2.0	10/98→05/05	1984	4	82.50	SOHC/OHC	85/115			
Golf 4 2.0	07/98→06/06								
Golf 4 2.0 4mot	10/00→06/06								
New Beetle 2.0	01/98→10/10								
2.0	AZM	324	AB5370 (MLS)	CB5371					EB5370 [3][18]
Passat 2.0	11/00→05/05	1984	4	82.50	SOHC/OHC	85/116			
Passat 2.0 4mot	11/00→05/05								



AB5370



JD5292



JD5293



JD5341



JD600

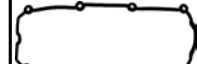

JM5103



JP024



JJ609

	JD5293 [E]	JM5103 (Elastomer)	JH5117		NA5106 [2] 35.00x48.00x10.00mm, PTFE LK5003 [1][7] 85.00x131.00x15.700mm, PTFE			
	JD600 [E]	JP024 [4]	JJ609 (ACM)		NA5124 [2] 32.00x47.00x10.00mm, PTFE/ACM LK5006 [7] 85.00x131.00x16.000mm, PTFE			
	JD600 [E]	JP024 [4]	JJ609 (ACM)		NA5124 [2] 32.00x47.00x10.00mm, PTFE/ACM LK5006 [7] 85.00x131.00x16.000mm, PTFE			
HBS246 [22] M10x1.50x120.00mm (x10)	JD5292 [E] JD5293 [E]	JM5103 (Elastomer)	HR397	HR646 [E]	NA5124 [2] 32.00x47.00x10.00mm, PTFE/ACM NA5106 [2] 35.00x48.00x10.00mm, PTFE LK5003 [1][7] 85.00x131.00x15.700mm, PTFE			
HBS363 [22] M10x1.50x122.00mm (x10)	JD5873 [E] (FPM) JD5813 [E]	JM7048 (SE)		PA5041 (x16) 6.00/12.20x10.00 (FPM) HR791 [E]	NA5124 [2] 32.00x47.00x10.00mm, PTFE/ACM NA5106 [2] 35.00x48.00x10.00mm, PTFE LK5008 [1][7] 85.00x131.00x15.700mm, PTFE			
HBS363 [22] M10x1.50x122.00mm (x10) HBS476 [22] M10x1.50x117.00mm (x10)				PA5041 (x16) 6.00/12.20x10.00 (FPM) HR791 [E]	NA5124 [2] 32.00x47.00x10.00mm, PTFE/ACM NA5106 [2] 35.00x48.00x10.00mm, PTFE LK5003 [1][7] 85.00x131.00x15.700mm, PTFE			
HBS246 [22] M10x1.50x120.00mm (x10)	JD5293 [E]	JM5103 (Elastomer)	JH5117	HR646 [E]	NA5124 [2] 32.00x47.00x10.00mm, PTFE/ACM NA5106 [2] 35.00x48.00x10.00mm, PTFE LK5003 [1][7] 85.00x131.00x15.700mm, PTFE			
HBS246 [22] M10x1.50x120.00mm (x10)	JD5340 [E] (x4) JD5293 [E]	JM5103 (Elastomer) JP024 [4]		HR816 [E]	NA5124 [2] 32.00x47.00x10.00mm, PTFE/ACM NA5106 [2] 35.00x48.00x10.00mm, PTFE NA5124 [2] 32.00x47.00x10.00mm, PTFE/ACM LK5003 [1][7] 85.00x131.00x15.700mm, PTFE			
HBS246 [22] M10x1.50x120.00mm (x10)	JD5340 [E] (x4) JD5293 [E]	JM5103 (Elastomer)	JH5117	HR599 [E] HR646 [E] HR816 [E]	NA5124 [2] 32.00x47.00x10.00mm, PTFE/ACM NA5106 [2] 35.00x48.00x10.00mm, PTFE LK5003 [1][7] 85.00x131.00x15.700mm, PTFE			
HBS246 [22] M10x1.50x120.00mm (x10)	JD5341 [E] JD600 [E]	JP024 [4]		HR599 [E] HR646 [E] HR816 [E]	NA5124 [2] 32.00x47.00x10.00mm, PTFE/ACM NA5106 [2] 35.00x48.00x10.00mm, PTFE NA5124 [2] 32.00x47.00x10.00mm, PTFE/ACM LK5003 [1][7] 85.00x131.00x15.700mm, PTFE			



cc



kW/PS



2.0	AZV Diesel						325	AG8970 (MLS), 1.550mm, 1 Hole AG8800 (MLS), 1.630mm, 2 Holes AG8960 (MLS), 1.710mm, 3 Holes	CG8410 ▲	EF5380
Golf PL 2.0 TDI	05/05→	1968	4	81.00	DOHC	100/136				
Golf V 2.0 TDI	10/03→11/08									
Jetta 3 2.0 TDI	09/05→10/10									
Touran 2.0 TDI	02/03→05/10									
2.0	BDC						326	AB5370 (MLS)	CB5370 [13]	EB5370 [3][18]
New Beetle 2.0	09/02→10/10	1984	4	82.50	SOHC/OHC	85/115				
2.0	BDJ Diesel						327	AG8940 (MLS), 1.410mm, 1 Hole AG8830 (MLS), 1.510mm, 2 Holes AG8950 (MLS), 1.610mm, 3 Holes	CC5231 ▲	EF5380
Caddy 3 2.0 SDI	03/04→08/10	1968	4	81.00	SOHC/OHC	51/70				
2.0	BDK Diesel						328	AG8940 (MLS), 1.410mm, 1 Hole AG8830 (MLS), 1.510mm, 2 Holes AG8950 (MLS), 1.610mm, 3 Holes	CC5231 ▲	EF5380
Golf V 2.0 SDI	01/04→11/08	1968	4	81.00	SOHC/OHC	55/75				
2.0	BEH						329	AB5370 (MLS)	CB5370 [13]	
Golf 4 2.0 Bi-F	02/02→06/06	1984	4	82.50	SOHC/OHC	85/116				
2.0	BEJ						330	AB5370 (MLS)		
New Beetle 2.0	01/98→	1984	4	82.50	SOHC/OHC	85/115				
2.0	BER						331	AB5370 (MLS)		EB5370 [3][18]
New Beetle 2.0	01/98→	1984	4	82.50	SOHC/OHC	85/116				
2.0	BEV						332	AB5370 (MLS)		EB5370 [3][18]
New Beetle 2.0	01/98→10/10	1984	4	82.50	SOHC/OHC	85/116				
2.0	BFF						333	AB5370 (MLS)		EB5370 [3][18]
Passat 2.0	11/00→05/05	1984	4	82.50	SOHC/OHC	85/115				
2.0	BGD						334	AB5370 (MLS)	CB5370 [13]	
New Beetle 2.0	09/02→10/10	1984	4	82.50	SOHC/OHC	85/115				
2.0	BGW Diesel						335	AG9630 (MLS), 1.450mm, 1 Hole AG9640 (MLS), 1.530mm, 2 Holes AG9650 (MLS), 1.610mm, 3 Holes	CC5231 ▲	
Passat 2.0 TDI	12/03→05/05	1968	4	81.00	SOHC/OHC	100/136				
2.0	BHP						336	AB5370 (MLS)		
New Beetle 2.0	01/98→	1984	4	82.50	SOHC/OHC	85/115				

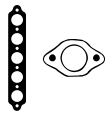

AB5370



JD170



JD5293



JD600

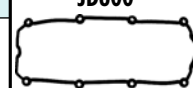

JM5103



JP024

HBS364 [19] M12x1.75x149.00mm (x10)	JD5805 [1] JD5806 [1] JD5815 [1]	JM7031 (Elastomer)		PA5041 (x16) 6.00/12.20x10.00 (FPM) HR791 [1]	NA5124 [2] 32.00x47.00x10.00mm, PTFE/ACM NA5106 [2] 35.00x48.00x10.00mm, PTFE LK5012 [1] [7] [28] 85.00x132.00x15.70mm, ACM	KK5522 [31]
HBS246 [22] M10x1.50x120.00mm (x10)	JD5340 [1] (x4) JD5293 [1]	JM5103 (Elastomer)		HR599 [1] HR646 [1]	NA5124 [2] 32.00x47.00x10.00mm, PTFE/ACM NA5106 [2] 35.00x48.00x10.00mm, PTFE LK5003 [1] [7] 85.00x131.00x15.70mm, PTFE	
HBS300 [19] M12x1.75x166.00mm (x10)	JD170 [1] JD600 [1]	JM5203 (Elastomer)		HR599 [1] HR646 [1] HR816 [1]	NA5124 [2] 32.00x47.00x10.00mm, PTFE/ACM NA5106 [2] 35.00x48.00x10.00mm, PTFE LK5012 [1] [7] [28] 85.00x132.00x15.70mm, ACM	
HBS300 [19] M12x1.75x166.00mm (x10)	JD170 [1] JD600 [1]	JM5203 (Elastomer)		HR599 [1] HR646 [1] HR816 [1]	NA5106 [2] 35.00x48.00x10.00mm, PTFE LK5012 [1] [7] [28] 85.00x132.00x15.70mm, ACM	
HBS246 [22] M10x1.50x120.00mm (x10)	JD5340 [1] (x4) JD5293 [1]	JM5103 (Elastomer)		HR599 [1] HR646 [1]	NA5124 [2] 32.00x47.00x10.00mm, PTFE/ACM NA5106 [2] 35.00x48.00x10.00mm, PTFE LK5003 [1] [7] 85.00x131.00x15.70mm, PTFE	
	JD5293 [1]	JM5103 (Elastomer)	JH5117		NA5106 [2] 35.00x48.00x10.00mm, PTFE LK5003 [1] [7] 85.00x131.00x15.70mm, PTFE	
	JD5293 [1]	JM5103 (Elastomer)	JH5117		NA5106 [2] 35.00x48.00x10.00mm, PTFE LK5003 [1] [7] 85.00x131.00x15.70mm, PTFE	
	JD5293 [1]	JM5103 (Elastomer)	JH5117		NA5106 [2] 35.00x48.00x10.00mm, PTFE LK5003 [1] [7] 85.00x131.00x15.70mm, PTFE	
	JD600 [1]	JP024 [4]			NA5106 [2] 35.00x48.00x10.00mm, PTFE LK5003 [1] [7] 85.00x131.00x15.70mm, PTFE	
HBS246 [22] M10x1.50x120.00mm (x10)	JD5340 [1] (x4) JD5293 [1]	JM5103 (Elastomer)		HR599 [1] HR646 [1]	NA5124 [2] 32.00x47.00x10.00mm, PTFE/ACM NA5106 [2] 35.00x48.00x10.00mm, PTFE LK5003 [1] [7] 85.00x131.00x15.70mm, PTFE	
HBS300 [19] M12x1.75x166.00mm (x10)	JD170 [1] JD600 [1]	JM5203 (Elastomer)		HR599 [1] HR646 [1] HR816 [1]	NA5124 [2] 32.00x47.00x10.00mm, PTFE/ACM NA5106 [2] 35.00x48.00x10.00mm, PTFE LK5003 [1] [7] 85.00x131.00x15.70mm, PTFE	
	JD5293 [1]	JM5103 (Elastomer)	JH5117		NA5106 [2] 35.00x48.00x10.00mm, PTFE LK5003 [1] [7] 85.00x131.00x15.70mm, PTFE	



cc



kW/PS



2.0		BHW Diesel		337		AG9630 (MLS), 1.450mm, 1 Hole AG9640 (MLS), 1.530mm, 2 Holes AG9650 (MLS), 1.610mm, 3 Holes		CC5231 ▲	
Passat 2.0 TDI	12/03→05/05	1968	4	81.00		100/136			
2.0		BKD Diesel		338		AG8970 (MLS), 1.550mm, 1 Hole AG8800 (MLS), 1.630mm, 2 Holes AG8960 (MLS), 1.710mm, 3 Holes		CG8410 ▲	EF5380
Golf PL 2.0 TDI	01/05→	1968	4	81.00	DOHC	103/140			
Golf V 2.0 TDI	10/03→11/08								
Jetta 3 2.0 TDI	08/05→10/10								
Touran 2.0 TDI	08/03→05/10								
2.0		BKP Diesel		339		AG8970 (MLS), 1.550mm, 1 Hole AG8800 (MLS), 1.630mm, 2 Holes AG8960 (MLS), 1.710mm, 3 Holes		CG8410 ▲	EF5380
Passat 2.0 TDI	03/05→	1968	4	81.00	DOHC	103/140			
2.0		BLR		340		AG9600 (MLS)		CG9600	EG9600
Golf PL 2.0 FSI	05/05→06/08	1984	4	82.50	DOHC	110/150			
Golf V 2.0 FSI	01/04→11/08								
Jetta 3 2.0 FSI	08/05→10/10								
Passat 2.0 FSI	03/05→11/10								
Touran 2.0 FSI	10/03→11/05								
2.0		BLX		341		AG9600 (MLS)		CG9600	EG9600
Golf V 2.0 FSI	01/04→11/08	1984	4	82.50	DOHC	110/150			
Jetta 3 2.0 FSI	08/05→10/10								
Passat 2.0 FSI	09/05→11/10								
Touran 2.0 FSI	10/03→11/05								
2.0		BLY		342		AG9600 (MLS)		CG9600	EG9600
Golf PL 2.0 FSI	05/05→06/08	1984	4	82.50	DOHC	110/150			
Golf V 2.0 FSI	01/04→11/08								
Jetta 3 2.0 FSI	08/05→10/10								
Passat 2.0 FSI	03/05→11/10								
Touran 2.0 FSI	10/03→11/05								
2.0		BMA Diesel		343		AG8970 (MLS), 1.550mm, 1 Hole AG8800 (MLS), 1.630mm, 2 Holes AG8960 (MLS), 1.710mm, 3 Holes		CG8410 ▲	EF5380
Passat 2.0 TDI	03/05→11/10	1968	4	81.00	DOHC	100/136			
2.0		BMM Diesel		344		AG9630 (MLS), 1.450mm, 1 Hole AG9640 (MLS), 1.530mm, 2 Holes AG9650 (MLS), 1.610mm, 3 Holes		CG8410 ▲	EF5380
Caddy 3 2.0 TDI	09/07→08/10	1968	4	81.00	SOHC/OHC	103/140			
EOS 2.0 TDI	06/06→05/08								
Golf 6V 2.0 TDI	07/09→								
Golf PL 2.0 TDI	12/05→05/09								
Golf V 2.0 TDI	08/04→11/08								
Jetta 3 2.0 TDI	10/05→10/10								
Touran 2.0 TDI	12/05→05/10								

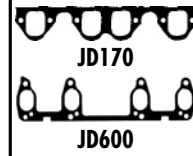
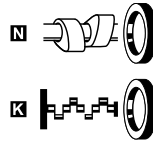
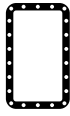
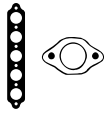

HBS300 [19] M12x1.75x166.00mm (x10)	JD170 [1] JD600 [1]	JM5203 (Elastomer)		HR599 [1] HR646 [1] HR816 [1]	NA5124 [2] 32.00x47.00x10.00mm, PTFE/ACM NA5106 [2] 35.00x48.00x10.00mm, PTFE LK5003 [1][7] 85.00x131.00x15.700mm, PTFE	
HBS364 [19] M12x1.75x149.00mm (x10)	JD5806 [1] →11/06 JD5805 [1] 12/06→ JD5815 [1] JD600 [1]	JM7031 (Elastomer)	HR397	PA5041 (x16) 6.00/12.20x10.00 (FPM) HR791 [1]	NA5124 (x2)[2] 32.00x47.00x10.00mm, PTFE/ACM NA5106 [2] 35.00x48.00x10.00mm, PTFE NA5124 [2] 32.00x47.00x10.00mm, PTFE/ACM LK5012 [1][7][28] 85.00x132.00x15.70mm, ACM	KK5522 [31]
HBS364 [19] M12x1.75x149.00mm (x10)	JD5806 [1] (Metal) →11/06 JD5805 [1] (Elastomer) 12/06→ JD5815 [1]	JM7031 (Elastomer)		PA5041 (x16) 6.00/12.20x10.00 (FPM) HR791 [1]	NA5106 [2] 35.00x48.00x10.00mm, PTFE NA5124 [2] 32.00x47.00x10.00mm, PTFE/ACM LK5012 [1][7][28] 85.00x132.00x15.70mm, ACM	KK5522 [31]
HBS363 [22] M10x1.50x122.00mm (x10)	JD5873 [1] (FPM) JD5813 [1]	JM7078 (Elastomer)	HR397	PA5041 (x16) 6.00/12.20x10.00 (FPM) HR791 [1]	NA5124 [2] 32.00x47.00x10.00mm, PTFE/ACM NA5106 [2] 35.00x48.00x10.00mm, PTFE LK5008 [1][7] 85.00x131.00x15.700mm, PTFE	
HBS363 [22] M10x1.50x122.00mm (x10)	JD5873 [1] (FPM) JD5813 [1]	JM7078 (Elastomer)	HR397	PA5041 (x16) 6.00/12.20x10.00 (FPM) HR791 [1]	NA5124 [2] 32.00x47.00x10.00mm, PTFE/ACM NA5106 [2] 35.00x48.00x10.00mm, PTFE LK5008 [1][7] 85.00x131.00x15.700mm, PTFE	
HBS363 [22] M10x1.50x122.00mm (x10)	JD5873 [1] (FPM) JD5813 [1]	JM7078 (Elastomer)	HR397	PA5041 (x16) 6.00/12.20x10.00 (FPM) HR791 [1]	NA5124 [2] 32.00x47.00x10.00mm, PTFE/ACM NA5106 [2] 35.00x48.00x10.00mm, PTFE LK5008 [1][7] 85.00x131.00x15.700mm, PTFE	
HBS364 [19] M12x1.75x149.00mm (x10)	JD5805 [1] JD5806 [1] JD5815 [1]	JM7031 (Elastomer)		PA5041 (x16) 6.00/12.20x10.00 (FPM) HR791 [1]	NA5124 [2] 32.00x47.00x10.00mm, PTFE/ACM NA5106 [2] 35.00x48.00x10.00mm, PTFE LK5012 [1][7][28] 85.00x132.00x15.70mm, ACM	KK5522 [31]
HBS300 [19] M12x1.75x166.00mm (x10)	JD170 [1] JD5992 [29] (Steel)	JM7031 (Elastomer) JM7107 (ACM)	HR397	HR599 [1] HR816 [1]	NA5106 [2] 35.00x48.00x10.00mm, PTFE NA5124 [2] 32.00x47.00x10.00mm, PTFE/ACM LK5012 [1][7][28] 85.00x132.00x15.70mm, ACM	



cc



kW/PS



2.0	BMN Diesel					345	AG8970 (MLS), 1.550mm, 1 Hole AG8800 (MLS), 1.630mm, 2 Holes AG8960 (MLS), 1.710mm, 3 Holes	CG8410 ▲	EF5380
Golf V 2.0 TDI	11/05→11/08	1968	4	81.00	DOHC	125/170			
Jetta 3 2.0 TDI	10/06→10/10								
Touran 2.0 TDI	12/05→05/10								
2.0	BMP Diesel					346	AG9630 (MLS), 1.450mm, 1 Hole AG9640 (MLS), 1.530mm, 2 Holes AG9650 (MLS), 1.610mm, 3 Holes		EF5380
Passat 2.0 TDI	03/05→	1968	4	81.00	SOHC/OHC	103/140			
2.0	BMR Diesel					347	AG8970 (MLS), 1.550mm, 1 Hole AG8800 (MLS), 1.630mm, 2 Holes AG8960 (MLS), 1.710mm, 3 Holes	CG8410 ▲	EF5380
Passat 2.0 TDI	08/05→	1968	4	81.00	DOHC	125/170			
2.0	BPY					348	AH6930 (MLS)		
EOS 2.0 TFSI	03/06→	1984	4	82.50	DOHC	147/200			
Golf V 2.0 GTI	10/04→02/09								
Jetta 3 2.0 TFSI	10/05→10/10								
Passat 2.0 FSI	07/05→11/10								
2.0	BRT Diesel					349	AG9630 (MLS), 1.450mm, 1 Hole AG9640 (MLS), 1.530mm, 2 Holes AG9650 (MLS), 1.610mm, 3 Holes		
Sharan 2.0 TDI	11/05→03/10	1968	4	81.00	SOHC/OHC	103/140			
2.0	BST Diesel					350	AG8940 (MLS), 1.410mm, 1 Hole AG8830 (MLS), 1.510mm, 2 Holes AG8950 (MLS), 1.610mm, 3 Holes	CC5231 ▲	
Caddy 3 2.0 SDI	03/04→08/10	1968	4	81.00	SOHC/OHC	51/70			
2.0	BSX					351			
Caddy 3 2.0 Eco	04/06→	1984	4	82.50	DOHC	80/109			
Touran 2.0 Eco	02/06→05/09								
2.0	BUZ Diesel					352	AG8970 (MLS), 1.550mm, 1 Hole AG8800 (MLS), 1.630mm, 2 Holes AG8960 (MLS), 1.710mm, 3 Holes		
Passat 2.0 TDI	08/05→	1968	4	81.00	DOHC	120/163			
2.0	BVE Diesel					353	AG8970 (MLS), 1.550mm, 1 Hole AG8800 (MLS), 1.630mm, 2 Holes AG8960 (MLS), 1.710mm, 3 Holes	CG8410 ▲	EF5380
Passat 2.0 TDI	08/05→07/06	1968	4	81.00	DOHC	90/122			

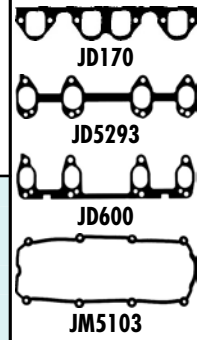
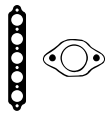

HBS364 [19] M12x1.75x149.00mm (x10)	JD5806 [1] (Metal) →11/06 JD5805 [1] (Elastomer) 12/06→ JD5815 [1]	JM7031 (Elastomer)	HR397	PA5041 (x16) 6.00/12.20x10.00 (FPM) HR791 [1]	NAS124 (x2) [2] 32.00x47.00x10.00mm, PTFE/ACM NAS106 [2] 35.00x48.00x10.00mm, PTFE LK5012 [1] [7] [28] 85.00x132.00x15.70mm, ACM	KK5522 [31]
HBS300 [19] M12x1.75x166.00mm (x10)	JD170 [1] JD5992 [29] (Steel)	JM7107 (ACM)		HR599 [1] HR816 [1]	NAS124 [2] 32.00x47.00x10.00mm, PTFE/ACM NAS106 [2] 35.00x48.00x10.00mm, PTFE LK5012 [1] [7] [28] 85.00x132.00x15.70mm, ACM	
HBS364 [19] M12x1.75x149.00mm (x10)	JD5806 [1] (Metal) →11/06 JD5805 [1] (Elastomer) 12/06→ JD5815 [1]	JM7031 (Elastomer)		PA5041 (x16) 6.00/12.20x10.00 (FPM) HR791 [1]	NAS124 (x2) [2] 32.00x47.00x10.00mm, PTFE/ACM NAS106 [2] 35.00x48.00x10.00mm, PTFE LK5012 [1] [7] [28] 85.00x132.00x15.70mm, ACM	
HBS476 [22] M10x1.50x117.00mm (x10)				PA5041 (x16) 6.00/12.20x10.00 (FPM) HR791 [1]	NAS124 [2] 32.00x47.00x10.00mm, PTFE/ACM NAS106 [2] 35.00x48.00x10.00mm, PTFE LK5003 [1] [7] 85.00x131.00x15.70mm, PTFE	
HBS300 [19] M12x1.75x166.00mm (x10)	JD170 [1] JD600 [1]	JM7113 (Elastomer)	HR397	HR599 [1] HR816 [1]	NAS124 [2] 32.00x47.00x10.00mm, PTFE/ACM NAS106 [2] 35.00x48.00x10.00mm, PTFE LK5012 [1] [7] [28] 85.00x132.00x15.70mm, ACM	
HBS300 [19] M12x1.75x166.00mm (x10)	JD170 [1] JD600 [1]	JM5203 (Elastomer)		HR599 [1] HR646 [1] HR816 [1]	NAS124 [2] 32.00x47.00x10.00mm, PTFE/ACM NAS106 [2] 35.00x48.00x10.00mm, PTFE LK5012 [1] [7] [28] 85.00x132.00x15.70mm, ACM	
	JD5293 [1]	JM5103 (Elastomer)			NAS106 [2] 35.00x48.00x10.00mm, PTFE LK5003 [1] [7] 85.00x131.00x15.70mm, PTFE	
	JD5806 [1] →11/06 Ch.3C-7-120 000→ JD5805 [1] 12/06→ →Ch.3C-7-120 001			PA5041 (x16) 6.00/12.20x10.00 (FPM) HR791 [1]	NAS124 [2] 32.00x47.00x10.00mm, PTFE/ACM NAS106 [2] 35.00x48.00x10.00mm, PTFE LK5012 [1] [7] [28] 85.00x132.00x15.70mm, ACM	
HBS364 [19] M12x1.75x149.00mm (x10)	JD5806 [1] (Metal) JD5815 [1]	JM7031 (Elastomer)		PA5041 (x16) 6.00/12.20x10.00 (FPM) HR791 [1]	NAS124 (x2) [2] 32.00x47.00x10.00mm, PTFE/ACM NAS106 [2] 35.00x48.00x10.00mm, PTFE LK5012 [1] [7] [28] 85.00x132.00x15.70mm, ACM	KK5522 [31]



cc



kW/PS



2.0							354			
BVH Diesel							AG9630 (MLS), 1.450mm, 1 Hole			
Sharan 2.0 TDI	11/05→03/10	1968	4	81.00	SOHC/OHC	100/136	AG9640 (MLS), 1.530mm, 2 Holes			
							AG9650 (MLS), 1.610mm, 3 Holes			
2.0							355			
BVX							AG9600 (MLS)	CG9600		EG9600
Golf V 2.0 FSI	01/04→11/08	1984	4	82.50	DOHC	110/150				
Passat 2.0 FSI	09/05→11/10									
2.0							356			
BVY							AG9600 (MLS)	CG9600		EG9600
EOS 2.0 FSI	03/06→05/08	1984	4	82.50	DOHC	110/150				
Golf PL 2.0 FSI	05/05→06/08									
Golf V 2.0 FSI	01/04→11/08									
Jetta 3 2.0 FSI	08/05→10/10									
Passat 2.0 FSI	03/05→11/10									
Touran 2.0 FSI	10/03→11/05									
2.0							357			
BVZ							AG9600 (MLS)	CG9600		EG9600
EOS 2.0 FSI	03/06→05/08	1984	4	82.50	DOHC	110/150				
Golf PL 2.0 FSI	05/05→06/08									
Golf V 2.0 FSI	01/04→11/08									
Jetta 3 2.0 FSI	08/05→10/10									
Passat 2.0 FSI	03/05→11/10									
Touran 2.0 FSI	10/03→11/05									
2.0							358			
BWA							AH6930 (MLS)			
EOS 2.0 TFSI	03/06→	1984	4	82.50	DOHC	147/200				
Golf V 2.0	06/07→									
Golf V 2.0 GTI	10/04→02/09									
Jetta 3 2.0 TFSI	10/05→10/10									
Passat 2.0 FSI	07/05→11/10									
2.0							359			
BWV Diesel							AG8970 (MLS), 1.550mm, 1 Hole			
Passat 2.0 TDI	11/05→05/07	1968	4	81.00	DOHC	88/120	AG8800 (MLS), 1.630mm, 2 Holes			
							AG8960 (MLS), 1.710mm, 3 Holes			
2.0							360			
BYD							AH6930 (MLS)			
Golf V 2.0 GTI	09/06→12/08	1984	4	82.50	DOHC	169/230				
2.0							361			
CAAA Diesel										
Multi V 2.0 TDI	09/09→	1968	4	81.00	DOHC	62/84				
Trans 5 2.0 TDI	09/09→									
2.0							362			
CAAB Diesel										
Multi V 2.0 TDI	09/09→	1968	4	81.00	DOHC	75/102				
Trans 5 2.0 TDI	09/09→									
2.0							363			
CAAC Diesel										
Multi V 2.0 TDI	09/09→	1968	4	81.00	DOHC	103/140				
Trans 5 2.0 TDI	09/09→									

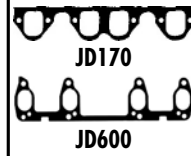

HBS300 [19] M12x1.75x166.00mm (x10)	JD170 JD600	JM7113 (Elastomer)		HR599 HR816	NA5124 [2] 32.00x47.00x10.00mm, PTFE/ACM NA5106 [2] 35.00x48.00x10.00mm, PTFE LK5012 [1][7][28] 85.00x132.00x15.70mm, ACM	
HBS363 [22] M10x1.50x122.00mm (x10)	JD5873 (FPM) JD5813	JM7078 (Elastomer)	HR397	PA5041 (x16) 6.00/12.20x10.00 (FPM) HR791	NA5124 [2] 32.00x47.00x10.00mm, PTFE/ACM NA5106 [2] 35.00x48.00x10.00mm, PTFE LK5008 [1][7] 85.00x131.00x15.700mm, PTFE	
HBS363 [22] M10x1.50x122.00mm (x10)	JD5873 (FPM) JD5813	JM7078 (Elastomer)	HR397	PA5041 (x16) 6.00/12.20x10.00 (FPM) HR791	NA5124 [2] 32.00x47.00x10.00mm, PTFE/ACM NA5106 [2] 35.00x48.00x10.00mm, PTFE LK5008 [1][7] 85.00x131.00x15.700mm, PTFE	
HBS363 [22] M10x1.50x122.00mm (x10)	JD5873 (FPM) JD5813	JM7078 (Elastomer)	HR397	PA5041 (x16) 6.00/12.20x10.00 (FPM) HR791	NA5124 [2] 32.00x47.00x10.00mm, PTFE/ACM NA5106 [2] 35.00x48.00x10.00mm, PTFE LK5008 [1][7] 85.00x131.00x15.700mm, PTFE	
HBS476 [22] M10x1.50x117.00mm (x10)			HR397	PA5041 (x16) 6.00/12.20x10.00 (FPM) HR791	NA5106 [2] 35.00x48.00x10.00mm, PTFE LK5003 [1][7] 85.00x131.00x15.700mm, PTFE	
	JD5806 →11/06 JD5805 12/06→	JM7031 (Elastomer)		PA5041 (x16) 6.00/12.20x10.00 (FPM) HR791	NA5124 (x2)[2] 32.00x47.00x10.00mm, PTFE/ACM NA5106 [2] 35.00x48.00x10.00mm, PTFE LK5012 [1][7][28] 85.00x132.00x15.70mm, ACM	
HBS476 [22] M10x1.50x117.00mm (x10)				PA5041 (x16) 6.00/12.20x10.00 (FPM) HR791	NA5124 [2] 32.00x47.00x10.00mm, PTFE/ACM NA5106 [2] 35.00x48.00x10.00mm, PTFE LK5003 [1][7] 85.00x131.00x15.700mm, PTFE	
				PA5041 (x16) 6.00/12.20x10.00 (FPM)	NA5106 [2] 35.00x48.00x10.00mm, PTFE	
				PA5041 (x16) 6.00/12.20x10.00 (FPM) HR791	NA5124 [2] 32.00x47.00x10.00mm, PTFE/ACM NA5106 [2] 35.00x48.00x10.00mm, PTFE	
				PA5041 (x16) 6.00/12.20x10.00 (FPM) HR791	NA5124 [2] 32.00x47.00x10.00mm, PTFE/ACM NA5106 [2] 35.00x48.00x10.00mm, PTFE	



cc



kW/PS



2.0	CAAD Diesel						364			
Multi V 2.0 TDI	05/11→	1968	4	81.00	DOHC	84/114				
Trans 5 2.0 TDI	05/11→									
2.0	CAAE Diesel						365			
Multi V 2.0 TDI	05/10→	1968	4	81.00	DOHC	100/136				
Trans 5 2.0 TDI	05/10→									
2.0	CAWA						366	AH5380 (MLS)		
Jetta 3 2.0TFSI	07/08→10/10	1984	4	82.50	DOHC	125/170				
Tiguan 2.0 TFSI	09/07→									
2.0	CAWB						367	AH5380 (MLS)		
EOS 2.0 TFSI	03/06→	1984	4	82.50	DOHC	147/200				
Golf V 2.0	06/07→									
Golf V 2.0 GTI	10/04→02/09									
Jetta 3 2.0TFSI	10/05→10/10									
Passat 2.0 FSI	07/05→11/10									
Passat 2.0 TSI	06/08→									
Scirocco 2.0TSI	05/08→11/09									
Tiguan 2.0 TFSI	09/07→									
2.0	CBAA Diesel						368	AG8970 (MLS), 1.550mm, 1 Hole AG8800 (MLS), 1.630mm, 2 Holes AG8960 (MLS), 1.710mm, 3 Holes	CG8410 ▲	EF5380
Golf 6 2.0 TDI	10/08→11/12	1968	4	81.00	DOHC	100/136				
Passat 2.0 TDI	03/05→05/11									
Tiguan 2.0 TDI	11/07→									
2.0	CBAB Diesel						369			EF5380
EOS 2.0 TDI 16V	05/08→	1968	4	81.00	DOHC	103/140				
Golf 6 2.0 TDI	10/08→05/13									
Passat 2.0 TDI	03/05→									
Tiguan 2.0 TDI	09/07→									
2.0	CBAC Diesel						370			
Passat 2.0 Blue	01/09→11/10	1968	4	81.00	DOHC	105/143				
Passat 2.0 TDI	01/09→									
2.0	CBBA Diesel						371			
Passat 2.0 TDI	05/08→11/08	1968	4	81.00	DOHC	120/163				
Tiguan 2.0 TDI	02/08→08/09									
2.0	CBBB Diesel						372			
Golf 6 2.0 TDI	04/09→11/12	1968	4	81.00	DOHC	125/170				
Passat 2.0 TDI	08/05→									
Scirocco 2.0TDI	05/09→									
Tiguan 2.0 TDI	09/07→									
2.0	CBDA Diesel						373			EF5380
Golf 6V 2.0 TDI	07/09→	1968	4	81.00	DOHC	100/136				
Golf PL 2.0 TDI	05/05→									
Golf V 2.0 TDI	10/03→11/08									
Jetta 3 2.0 TDI	09/05→10/10									
2.0	CBDB Diesel						374			EF5380
Golf 6V 2.0 TDI	07/09→	1968	4	81.00	DOHC	103/140				
Golf PL 2.0 TDI	01/05→									
Golf V 2.0 TDI	06/07→									
Jetta 3 2.0 TDI	08/05→10/10									
Scirocco 2.0TDI	08/08→									

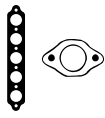

					NA5106 [2] 35.00x48.00x10.00mm, PTFE/ACM NA5106 [2] 35.00x48.00x10.00mm, PTFE	
				PA5041 (x16) 6.00/12.20x10.00 (FPM) HR791	NA5124 [2] 32.00x47.00x10.00mm, PTFE/ACM NA5106 [2] 35.00x48.00x10.00mm, PTFE	
HBS476 [22] M10x1.50x117.00mm (x10)				PA5041 (x16) 6.00/12.20x10.00 (FPM) HR791		
HBS476 [22] M10x1.50x117.00mm (x10)				PA5041 (x16) 6.00/12.20x10.00 (FPM) HR791		
HBS364 [19] M12x1.75x149.00mm (x10)	JD5805 [Elastomer] JD5806 [Metal] JD5815	JM7031 (Elastomer)		PA5041 (x16) 6.00/12.20x10.00 (FPM) HR791	NA5106 [2] 35.00x48.00x10.00mm, PTFE NA5124 [2] 32.00x47.00x10.00mm, PTFE/ACM	KK5522 [31]
	JD5805 JD5815			PA5041 (x16) 6.00/12.20x10.00 (FPM) HR791	NA5124 [2] 32.00x47.00x10.00mm, PTFE/ACM NA5106 [2] 35.00x48.00x10.00mm, PTFE	KK5522 [31]
				PA5041 (x16) 6.00/12.20x10.00 (FPM)	NA5106 [2] 35.00x48.00x10.00mm, PTFE	
				PA5041 (x16) 6.00/12.20x10.00 (FPM) HR791	NA5124 [2] 32.00x47.00x10.00mm, PTFE/ACM NA5106 [2] 35.00x48.00x10.00mm, PTFE	
				PA5041 (x16) 6.00/12.20x10.00 (FPM) HR791	NA5124 [2] 32.00x47.00x10.00mm, PTFE/ACM NA5106 [2] 35.00x48.00x10.00mm, PTFE	
HBS364 [19] M12x1.75x149.00mm (x10)	JD5815			PA5041 (x16) 6.00/12.20x10.00 (FPM) HR791	NA5124 [2] 32.00x47.00x10.00mm, PTFE/ACM NA5106 [2] 35.00x48.00x10.00mm, PTFE	KK5522 [31]
		HR397	HR397	PA5041 (x16) 6.00/12.20x10.00 (FPM)	NA5106 [2] 35.00x48.00x10.00mm, PTFE	KK5522 [31]



cc



kW/PS



2.0		CBDC Diesel				375				
Golf 6 2.0 TDI	10/08→11/12	1968	4	81.00	DOHC	81/110				
Golf PL 2.0 TDI	01/09→									
Passat 2.0 TDI	11/08→11/10									
2.0		CBFA				376		AH5380 (MLS)		
Beetle 2.0 TSI	04/11→	1984	4	82.50	DOHC	147/200				
CC 2.0 TSI	11/11→									
EOS 2.0 TFSI	03/06→									
Golf 6 2.0 GTi	06/09→11/13									
Golf V 2.0 GTI	10/04→02/09									
Jetta 3 2.0TFSI	10/05→10/10									
Jetta 4 2.0 TSI	12/10→									
Passat 2.0 FSI	07/05→11/10									
Passat 2.0 TSI	06/08→									
2.0		CBPA				377				
Jetta 4 2.0	06/10→	1984	4	82.50	SOHC/OHC	85/115				
New Beetle 2.0	01/98→									
2.0		CCHA Diesel				378				
Multi V 2.0 TDI	09/09→	1968	4	81.00	DOHC	103/140				
Trans 5 2.0 TDI	09/09→									
2.0		CCHB Diesel				379				
Multi V 2.0 TDI	05/10→	1968	4	81.00	DOHC	100/136				
Trans 5 2.0 TDI	05/10→									
2.0		CCTA				380		AH5380 (MLS)		
Beetle 2.0 TSI	04/11→	1984	4	82.50	DOHC	147/200				
CC 2.0 TSI	11/11→									
EOS 2.0 TFSI	03/06→									
Golf 6 2.0 GTi	06/09→11/13									
Golf V 2.0	06/07→									
Golf V 2.0 GTI	10/04→02/09									
Jetta 3 2.0TFSI	10/05→10/10									
Jetta 4 2.0 TSI	12/10→									
Passat 2.0 FSI	07/05→11/10									
Passat 2.0 TSI	06/08→									
Tiguan 2.0 TFSI	09/07→									
2.0		CCTB				381		AH5380 (MLS)		
Passat 2.0 FSI	08/07→11/10	1984	4	82.50	DOHC	125/170				
2.0		CCZA				382		AH5380 (MLS)		
Beetle 2.0 TSI	04/11→	1984	4	82.50	DOHC	147/200				
EOS 2.0 TFSI	03/06→									
Golf 6 2.0 GTi	06/09→11/13									
Golf 6V 2.0 TSI	07/09→									
Jetta 3 2.0TFSI	10/05→10/10									
Jetta 4 2.0 TSI	12/10→									
Passat 2.0 FSI	07/05→11/10									
Passat 2.0 TSI	06/08→									
Sharan 2.0 TSI	12/10→									
Tiguan 2.0 TFSI	09/07→									

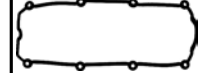
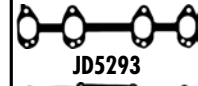
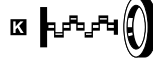
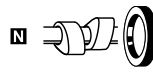
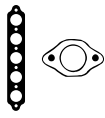

JD5293

JM5103

				PA5041 (x16) 6.00/12.20x10.00 (FPM) HR791	NAS124 [2] 32.00x47.00x10.00mm, PTFE/ACM NAS106 [2] 35.00x48.00x10.00mm, PTFE	
HBS476 [22] M10x1.50x117.00mm (x10)				PA5041 (x16) 6.00/12.20x10.00 (FPM) HR791		
	JD5293	JM5103 (Elastomer)	JH5117		NAS106 [2] 35.00x48.00x10.00mm, PTFE LK5003 [1][7] 85.00x131.00x15.700mm, PTFE	
				PA5041 (x16) 6.00/12.20x10.00 (FPM) HR791	NAS124 [2] 32.00x47.00x10.00mm, PTFE/ACM NAS106 [2] 35.00x48.00x10.00mm, PTFE	
				PA5041 (x16) 6.00/12.20x10.00 (FPM) HR791	NAS124 [2] 32.00x47.00x10.00mm, PTFE/ACM NAS106 [2] 35.00x48.00x10.00mm, PTFE	
HBS476 [22] M10x1.50x117.00mm (x10)				PA5041 (x16) 6.00/12.20x10.00 (FPM) HR791		
HBS476 [22] M10x1.50x117.00mm (x10)				PA5041 (x16) 6.00/12.20x10.00 (FPM) HR791		
HBS476 [22] M10x1.50x117.00mm (x10)		HR397		PA5041 (x16) 6.00/12.20x10.00 (FPM) HR791	NAS124 [2] 32.00x47.00x10.00mm, PTFE/ACM	



cc



kW/PS



2.0		CCZB				383	AH5380 (MLS)		
CC 2.0 TSI	11/11→	1984	4	82.50	DOHC	155/211			
EOS 2.0 TSI	11/09→								
Golf 6 2.0 TSI	04/09→11/12								
Golf 6 Conv 2.0	11/11→								
Passat 2.0 TSI	11/10→								
Scirocco 2.0 TSI	11/09→05/11								
Tiguan 2.0 TSI	05/11→								
2.0		CCZC				384			
Tiguan 2.0 TFSI	09/07→	1984	4	82.50	DOHC	125/170			
2.0		CDBA Diesel				385			
Amorak 2.0 TDI	09/10→	1968	4	81.00	DOHC	90/122			
2.0		CDCA Diesel				386			
Amorak 2.0	09/10→	1968	4	81.00	DOHC	120/163			
2.0		CDLA				387	AH6930 (MLS)		
Golf 6 2.0 R 4m	11/09→05/11	1984	4	82.50	DOHC	195/265			
Golf 6 Conv 2.0	01/13→								
Scirocco 2.0 R	11/09→								
2.0		CDLC				388	AH6930 (MLS)		
Golf 6 2.0 R 4m	11/09→11/13	1984	4	82.50	DOHC	188/256			
Scirocco 2.0 R	11/09→								
2.0		CDLF				389	AH6930 (MLS)		
Golf 6 2.0 R 4m	11/09→11/12	1984	4	82.50	DOHC	199/270			
2.0		CFFA Diesel				390			EF5380
CC 2.0 TDI	11/11→	1968	4	81.00	DOHC	100/136			
EOS 2.0 TDI	11/10→								
Golf 6 2.0 TDI	10/08→11/12								
Passat 2.0 TDI	06/08→05/11								
Sharan 2.0 TDI	05/10→05/12								
Tiguan 2.0 TDI	11/07→								
2.0		CFFB Diesel				391			
Beetle 2.0 TDI	04/11→	1968	4	81.00	DOHC	103/140			
CC 2.0 TDI	11/11→								
CC 2.0 TDI 4mot	11/11→								
EOS 2.0 TDI 16V	05/08→								
Golf 6 2.0 TDI	10/08→05/13								
Jetta 4 2.0 TDI	02/11→								
Passat 2.0 TDI	06/08→								
Sharan 2.0 TDI	05/10→								
Tiguan 2.0 TDI	09/07→								
2.0		CFFD Diesel				392			
Tiguan 2.0 TDI	05/10→	1968	4	81.00	DOHC	81/110			

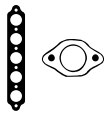

HBS476 [22] M10x1.50x117.00mm (x10)			HR397	PA5041 (x16) 6.00/12.20x10.00 (FPM) HR791		
				PA5041 (x16) 6.00/12.20x10.00 (FPM)		
				PA5041 (x16) 6.00/12.20x10.00 (FPM)	NA5106 [2] 35.00x48.00x10.00mm, PTFE	
				PA5041 (x16) 6.00/12.20x10.00 (FPM)	NA5106 [2] 35.00x48.00x10.00mm, PTFE	
HBS476 [22] M10x1.50x117.00mm (x10)			HR397	PA5041 (x16) 6.00/12.20x10.00 (FPM) HR791	NA5124 [2] 32.00x47.00x10.00mm, PTFE/ACM NA5106 [2] 35.00x48.00x10.00mm, PTFE LK5003 [1][7] 85.00x131.00x15.700mm, PTFE	
HBS476 [22] M10x1.50x117.00mm (x10)				PA5041 (x16) 6.00/12.20x10.00 (FPM) HR791	NA5124 [2] 32.00x47.00x10.00mm, PTFE/ACM NA5106 [2] 35.00x48.00x10.00mm, PTFE LK5003 [1][7] 85.00x131.00x15.700mm, PTFE	
HBS476 [22] M10x1.50x117.00mm (x10)				PA5041 (x16) 6.00/12.20x10.00 (FPM) HR791	NA5124 [2] 32.00x47.00x10.00mm, PTFE/ACM NA5106 [2] 35.00x48.00x10.00mm, PTFE LK5003 [1][7] 85.00x131.00x15.700mm, PTFE	
HBS364 [19] M12x1.75x149.00mm (x10)		HR397	HR397	PA5041 (x16) 6.00/12.20x10.00 (FPM)	NA5106 [2] 35.00x48.00x10.00mm, PTFE	KK5522 [31]
		HR397	HR397	PA5041 (x16) 6.00/12.20x10.00 (FPM)	NA5106 [2] 35.00x48.00x10.00mm, PTFE	
				PA5041 (x16) 6.00/12.20x10.00 (FPM)	NA5106 [2] 35.00x48.00x10.00mm, PTFE	



cc



kW/PS



2.0	CFFE Diesel						393			
Sharan 2.0 TDI	05/11→	1968	4	81.00	DOHC	85/116				
2.0	CFGB Diesel						394			
CC 2.0 TDI	11/11→	1968	4	81.00	DOHC	125/170				
CC 2.0 TDI 4mot	11/11→									
Golf 6 2.0 TDI	04/09→11/12									
Passat 2.0 TDI	06/08→									
Scirocco 2.0TDI	05/09→									
Sharan 2.0 TDI	08/10→									
Tiguan 2.0 TDI	09/07→									
2.0	CFHB Diesel						395			EF5380
Golf 6V 2.0 TDI	07/09→	1968	4	81.00	DOHC	100/136				
Golf PL 2.0 TDI	05/05→									
Scirocco 2.0TDI	11/10→									
2.0	CFHC Diesel						396			EF5380
Caddy 3 2.0 16V	11/10→	1968	4	81.00	DOHC	103/140				
Caddy 3 2.0 TDI	11/10→									
Golf 6 Conv 2.0	11/11→									
Golf 6V 2.0 TDI	07/09→									
Golf PL 2.0 TDI	01/05→									
Jetta 4 2.0 TDI	02/11→									
Scirocco 2.0TDI	08/08→									
Touran 2.0 TDI	05/10→									
2.0	CFHE Diesel						397			
Caddy 3 2.0 TDI	11/10→	1968	4	81.00	DOHC	62/85				
2.0	CFHF Diesel						398			
Caddy 3 2.0 TDI	08/10→	1968	4	81.00	DOHC	81/110				
2.0	CFJA Diesel						399			
Caddy 3 2.0 TDI	05/12→	1968	4	81.00	DOHC	125/170				
Touran 2.0 TDI	12/05→05/10									
2.0	CJAA Diesel						400			EF5380
Beetle 2.0 TDI	04/11→	1968	4	81.00	DOHC	103/140				
Golf 6 2.0 TDI	10/08→05/13									
Golf 6V 2.0 TDI	07/09→									
Jetta 3 2.0 TDI	08/05→10/10									
Jetta 4 2.0 TDI	02/11→									
2.0	CKJA						401			
Jetta 4 2.0	06/10→	1984	4	82.50	SOHC/OHC	85-88/ 115-120				
2.0	CKTB Diesel						402			
Crafter 2.0 TDI	05/11→	1968	4	81.00	DOHC	80/109				
2.0	CKTC Diesel						403			
Crafter 2.0 TDI	05/11→	1968	4	81.00	DOHC	100/136				
2.0	CKUB Diesel						404			
Crafter 2.0 TDI	07/11→	1968	4	81.00	DOHC	120/163				



					NA5106 [2] 35.00x48.00x10.00mm, PTFE/ACM NA5106 [2] 35.00x48.00x10.00mm, PTFE	
		HR397 [3]	HR397	PA5041 (x16) 6.00/12.20x10.00 (FPM)	NA5106 [2] 35.00x48.00x10.00mm, PTFE	
HBS364 [19] M12x1.75x149.00mm (x10)				PA5041 (x16) 6.00/12.20x10.00 (FPM)	NA5106 [2] 35.00x48.00x10.00mm, PTFE	KK5522 [31]
		HR397 [3]	HR397	PA5041 (x16) 6.00/12.20x10.00 (FPM)	NA5106 [2] 35.00x48.00x10.00mm, PTFE	KK5522 [31]
				PA5041 (x16) 6.00/12.20x10.00 (FPM)	NA5106 [2] 35.00x48.00x10.00mm, PTFE	
				PA5041 (x16) 6.00/12.20x10.00 (FPM) HR791 [3]	NA5124 [2] 32.00x47.00x10.00mm, PTFE/ACM NA5106 [2] 35.00x48.00x10.00mm, PTFE	
		HR397 [3]	HR397	PA5041 (x16) 6.00/12.20x10.00 (FPM)	NA5106 [2] 35.00x48.00x10.00mm, PTFE	
	JD5815 [3]			PA5041 (x16) 6.00/12.20x10.00 (FPM) HR791 [3]	NA5124 [2] 32.00x47.00x10.00mm, PTFE/ACM NA5106 [2] 35.00x48.00x10.00mm, PTFE	KK5522 [31]
				HR642 [3] HR646 [3]		
					NA5106 [2] 35.00x48.00x10.00mm, PTFE/ACM NA5106 [2] 35.00x48.00x10.00mm, PTFE	
					NA5106 [2] 35.00x48.00x10.00mm, PTFE/ACM NA5106 [2] 35.00x48.00x10.00mm, PTFE	
					NA5106 [2] 35.00x48.00x10.00mm, PTFE/ACM NA5106 [2] 35.00x48.00x10.00mm, PTFE	



cc



kW/PS



2.0		CKUC Diesel				405				
Crafter 2.0 TDI	10/11→	1968	4	81.00	DOHC	105/142				
2.0		CLCA Diesel				406				
Caddy 3 2.0 TDI	08/10→	1968	4	81.00	DOHC	81/110				
Golf 6 2.0 TDI	10/08→11/12									
Golf 6V 2.0 TDI	01/10→									
Golf PL 2.0 TDI	01/09→									
Jetta 4 2.0 TDI	10/10→									
Touran 2.0 TDI	11/10→									
2.0		CLCB Diesel				407				
Caddy 3 2.0 16V	11/10→	1968	4	81.00	DOHC	103/140				
Golf 6V 2.0 TDI	07/09→									
Jetta 4 2.0 TDI	02/11→									
2.0		CLLA Diesel				408				
CC 2.0 TDI	11/11→	1968	4	81.00	DOHC	125/170				
Passat 2.0 TDI	06/08→									
2.0		CNEA Diesel				409				
Amarok 2.0	11/11→	1968	4	81.00	DOHC	132/180				
2.0		CSHA Diesel				410				
Amarok 2.0	11/11→	1968	4	81.00	DOHC	132/180				
2.0		HP				411		BM840 (Fibre)	DM840	EX995
Passat 2.0	08/83→03/88	1994	5	81.00	SOHC/OHC	85/115				
2.0		JS				412		BM840 (Fibre)	DM840	EX995
Passat 2.0	08/83→03/88	1994	5	81.00	SOHC/OHC	85/115				
Passat 2.0 Syn	05/84→03/88									
2.1		DJ				413			DM690 ○	GM690 ○
Trans 3 2.1	08/85→07/92	2110	4	94.00	BOXER	82/112				
Trans 3 2.1 Syn	01/86→07/92									
2.1		MV				414			DM690 ○	GM690 ○
Trans 3 2.1	08/85→07/92	2110	4	94.00	BOXER	70/95				
Trans 3 2.1 Syn	08/85→07/92									
2.1		SR				415			DM690 ○	GM690 ○
Trans 3 2.1	10/86→07/92	2109	4	94.00	OHV, BOXER	64/87				
Trans 3 2.1 Syn	10/86→07/92									
2.1		SS				416			DM690 ○	GM690 ○
Trans 3 2.1 i	07/89→07/92	2110	4	94.00	OHV, BOXER	68-70/ 92-95				

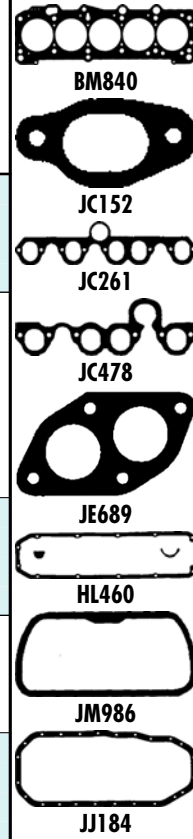
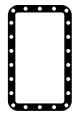
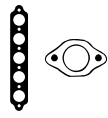

					NA5106 [2] 35.00x48.00x10.00mm, PTFE/ACM NA5106 [2] 35.00x48.00x10.00mm, PTFE	
				PA5041 (x16) 6.00/12.20x10.00 (FPM)	NA5106 [2] 35.00x48.00x10.00mm, PTFE	
		HR397 [S]	HR397	PA5041 (x16) 6.00/12.20x10.00 (FPM)	NA5106 [2] 35.00x48.00x10.00mm, PTFE	
					NA5106 [2] 35.00x48.00x10.00mm, PTFE/ACM NA5106 [2] 35.00x48.00x10.00mm, PTFE	
					NA5106 [2] 35.00x48.00x10.00mm, PTFE/ACM NA5106 [2] 35.00x48.00x10.00mm, PTFE	
					NA5106 [2] 35.00x48.00x10.00mm, PTFE/ACM NA5106 [2] 35.00x48.00x10.00mm, PTFE	
HBS024 [22] M11x1.50x95.00mm (x12)	JC261 [I] JC152 [S] (x5) JE689	JN438 (Elastomer) HL460 [S] (Cork) HM5277 [S] (Elastomer)	JJ184	HR615 [S]	NA5001 (x2) [1] [2] 32.00x47.00x10.00mm, FPM NB716 [S] [2] 35.00x48.00x10.00mm, FPM NA5133 [S] [1] 85.00x105.00x11.00mm, FPM	
HBS024 [22] M11x1.50x95.00mm (x12)	JC261 [I] JC152 [S] (x5) JE689	JN438 (Elastomer) HL460 [S] (Cork) HM5277 [S] (Elastomer)	JJ184	HR615 [S]	NA5001 (x2) [1] [2] 32.00x47.00x10.00mm, FPM NB716 [S] [2] 35.00x48.00x10.00mm, FPM NA5133 [S] [1] 85.00x105.00x11.00mm, FPM LK5006 [S] [7] 85.00x131.00x16.00mm, PTFE	
	JC478 [I] JD237 [I] (x2) JC152 [S] (x4) JD236 [S] (x4)	JM986 (x2) [4]			NB953 [S] [1] 75.00x95.00x12.00mm, FPM	
	JC478 [I] JD237 [I] (x2) JC152 [S] (x4) JD236 [S] (x4)	JM986 (x2) [4]			NB953 [S] [1] 75.00x95.00x12.00mm, FPM	
	JC478 [I] JD237 [I] (x2) JC152 [S] (x4) JD236 [S] (x4)	JM986 (x2) [4]			NB953 [S] [1] 75.00x95.00x12.00mm, FPM	
	JC478 [I] JD237 [I] (x2) JC152 [S] (x4) JD236 [S] (x4)	JM986 (x2) [4]			NB953 [S] [1] 75.00x95.00x12.00mm, FPM	

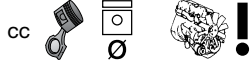

kW/PS

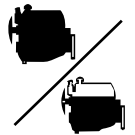

2.2	4Y						417	BP650 (Graphite)		GP650 [3]
Taro 2.2	06/89→07/94	2237	4	91.00	OHV	69/94				
Taro 2.2 4x4	06/89→07/94									
2.2	HY						418	BM840 (Fibre)	DM840	EX995
Passat 2.2 Syn	08/84→07/88	2226	5	81.00	SOHC/OHC	100/136			→Ch.8A-L-200 000	
2.2	JT						419	BM840 (Fibre)	DM840	EX995
Passat 2.2 Syn	08/85→03/88	2226	5	81.00	SOHC/OHC	88/120			→Ch.8A-L-200 000	
2.2	KV						420	BM840 (Fibre)	DM840	EX995
Passat 2.2	01/85→03/88	2226	5	81.00	SOHC/OHC	100/136			→Ch.8A-L-200 000	
Passat 2.2 Var	01/85→03/88									
2.2	KX						421	BM840 (Fibre)	DM840	EX995
Passat 2.2	01/85→03/88	2226	5	81.00	SOHC/OHC	85/115				
2.3	AGL						422	BZ900 (Fibre)	DZ160 ○	
LT28-35 II 2.3	05/96→07/06	2295	4	90.90	DOHC	105/143				
LT28-46 II 2.3	05/96→07/06									
2.3	AGZ						423	AG7800 (MLS)	CG7800	EG7800
Bora 2.3 V5	10/98→10/00	2324	5	81.00	DOHC, VR	110/150				
Golf 4 2.3 V5	08/97→06/06									
Passat 2.3 VR5	10/96→11/00									
2.3	AQN						424		CG9620 (MLS)	
Bora 2.3 V5	10/00→05/05	2324	5	81.00	DOHC, V	125/170				
Golf 4 2.3 V5	10/00→06/06									
New Beetle V5	10/00→									
2.3	AZX						425		CG9621	
Passat 2.3 V5	11/00→05/05	2324	5	81.00	DOHC, VR	125/170				
Passat 2.3 VR5	11/00→05/05									
2.4	1E						426			
LT28-35 I 2.4 i	08/89→06/96	2383	6	76.50	SOHC/OHC	69-70/ 94-95				
LT28-35 I 2.4 S	08/92→07/94									
LT40-55 I 2.4	08/88→07/89									
LT40-55 I 2.4 i	01/93→06/96									

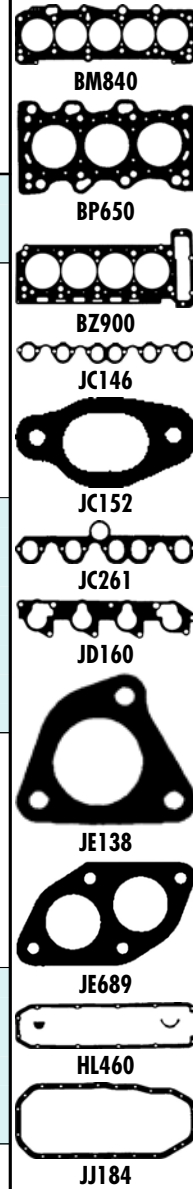

HBS024 [22]
M11x1.50x95.00mm (x12)

JC261 [1]
JC152 [5] (x5)
JE689

JN438
(Elastomer)
HL460 [5]
(Cork)
→Ch.8A-L-200 000
HM5277 [5]
(Elastomer)
→Ch.8A-L-200 000

JJ184

HR615 [5]

NA5001 (x2) [1][2]
32.00x47.00x10.00mm, FPM
NA5001 [1][2]
32.00x47.00x10.00mm, FPM
NB716 [2]
35.00x48.00x10.00mm, FPM
NA5133 [1]
85.00x105.00x11.00mm, FPM

HBS024 [22]
M11x1.50x95.00mm (x12)

JC261 [1]
JC152 [5] (x5)
JE689

JN438
(Elastomer)
HL460 [5]
(Cork)
→Ch.8A-L-200 000
HM5277 [5]
(Elastomer)
→Ch.8A-L-200 000

JJ184

HR615 [5]

NA5001 [1][2]
32.00x47.00x10.00mm, FPM
NA5001 [1][2]
32.00x47.00x10.00mm, FPM
NB716 [2]
35.00x48.00x10.00mm, FPM
NA5133 [1]
85.00x105.00x11.00mm, FPM

HBS024 [22]
M11x1.50x95.00mm (x12)

JC261 [1]
JC152 [5] (x5)
JE689

JN438
(Elastomer)
HL460 [5]
(Cork)
→Ch.8A-L-200 000
HM5277 [5]
(Elastomer)
→Ch.8A-L-200 000

JJ184

HR615 [5]

NA5001 [1][2]
32.00x47.00x10.00mm, FPM
NA5001 [1][2]
32.00x47.00x10.00mm, FPM
NB716 [2]
35.00x48.00x10.00mm, FPM
NA5133 [1]
85.00x105.00x11.00mm, FPM

HBS024 [22]
M11x1.50x95.00mm (x12)

JC261 [1]
JC152 [5] (x5)
JE689

JN438
(Elastomer)
HL460 [5]
(Cork)
HM5277 [5]
(Elastomer)

JJ184

HR615 [5]

NA5001 (x2) [1][2]
32.00x47.00x10.00mm, FPM
NB716 [2]
35.00x48.00x10.00mm, FPM
NA5133 [1]
85.00x105.00x11.00mm, FPM

HBS150 [19]
M12x1.75x102.00mm (x10)

JD160 [1]

NB973 [2]
45.00x67.00x8.00mm, FPM

HBS461 [22]

HR397 [5]

HR397

NA5106 [2]
35.00x48.00x10.00mm, PTFE/ACM
NA5106 [2]
35.00x48.00x10.00mm, PTFE
NA5305 [1][36]
01/01 →

HBS513 [22]

JM5234
(MLS)

PA5041 (x20)
6.00/12.20x10.00
(FPM)
HR822 [5]

NA5001 [1][2]
32.00x47.00x10.00mm, FPM
NA5106 [2]
35.00x48.00x10.00mm, PTFE
NA5305 [1][36]
01/01 →

HBS513 [22]
(FPM)

JD5927 [1]
(FPM)

JM5234
(MLS)

PA5041 (x20)
6.00/12.20x10.00
(FPM)
HR822 [5]

NA5106 [2]
35.00x48.00x10.00mm, PTFE
NA5305 [1][36]
01/01 →

HBS022 [19]
M12x1.75x115.00mm (x14)

JC146 [1]
JC152 [5] (x6)
JE138 [27]

JN849 [4]

HR805 [5]

NA5001 (x2) [1][2]
32.00x47.00x10.00mm, FPM
NB716 [2]
35.00x48.00x10.00mm, FPM
NA5133 [1]
85.00x105.00x11.00mm, FPM



cc



kW/PS

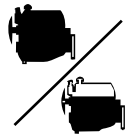

2.4		1G Diesel				427		BW680 (Fibre), 1.530mm, 1 Notch BW690 (Fibre), 1.570mm, 2 Notches BW700 (Fibre), 1.610mm, 3 Notches		DM660 ▲ [3]
LT28-35 2.4 S	08/91→07/92	2383	6	76.50	SOHC/OHC	68/93				
LT28-35 2.4TD	08/88→08/92									
LT40-55 2.4 S	08/91→07/92									
LT40-55 2.4TD	08/88→08/92									
2.4		1S Diesel				428		BW680 (Fibre), 1.530mm, 1 Notch BW690 (Fibre), 1.570mm, 2 Notches BW700 (Fibre), 1.610mm, 3 Notches		DM660 ▲ [3]
LT28-35 2.4 D	08/89→06/96	2383	6	76.50	SOHC/OHC	51/70				
LT28-35 2.4DS	08/91→07/92									
LT40-55 2.4 D	07/90→06/96									
2.4		AAB Diesel				429		AF5340 (MLS), 1.530mm, 1 Hole AF5350 (MLS), 1.570mm, 2 Holes AF5360 (MLS), 1.610mm, 3 Holes		DW830 ▲ →Ch.70-R-160000 CA5470 ▲ [3] Ch.70-R-160001→
Trans 4 2.4 D	07/90→09/98	2370	5	79.50	SOHC/OHC	57/78			EA5470 [3]	
2.4		ACL Diesel				430		BW680 (Fibre), 1.530mm, 1 Notch →Eng.ACL041031 BW690 (Fibre), 1.570mm, 2 Notches →Eng.ACL041031 BW700 (Fibre), 1.610mm, 3 Notches →Eng.ACL041031 BZ930 (MLS), 1.570mm, 2 Holes Eng.ACL041032→		
LT28-35 2.4 S	08/92→04/96	2383	6	76.50	SOHC/OHC	70/95				
LT28-35 2.4TD	06/92→06/96									
LT40-55 2.4 S	08/92→04/96									
LT40-55 2.4TD	06/92→06/96									
2.4		ACT Diesel				431		BW680 (Fibre), 1.530mm, 1 Notch →Eng.ACT011319 BW690 (Fibre), 1.570mm, 2 Notches →Eng.ACT011319 BW700 (Fibre), 1.610mm, 3 Notches →Eng.ACT011319 BZ930 (MLS), 1.570mm, 2 Holes Eng.ACT011320→		
LT28-35 2.4 D	08/89→06/96	2383	6	76.50	SOHC/OHC	51/70				
LT40-55 2.4 D	07/90→06/96									
2.4		AJA Diesel				432		AF5340 (MLS), 1.530mm, 1 Hole AF5350 (MLS), 1.570mm, 2 Holes AF5360 (MLS), 1.610mm, 3 Holes		EA5470 [3]
Trans 4 2.4 D	08/97→04/03	2370	5	79.50		55/75				
2.4		CP Diesel				433		BW680 (Fibre), 1.530mm, 1 Notch BW690 (Fibre), 1.570mm, 2 Notches BG940 (Fibre), 1.600mm, 3 Notches BW700 (Fibre), 1.610mm, 3 Notches		DM660 ▲ [3]
LT28-35 2.4 D	12/78→07/92	2383	6	76.50	SOHC/OHC	55/75				
LT28-35 2.4D	01/79→07/92									
LT40-55 2.4 D	12/78→07/92									
2.4		DL				434				
LT28-35 2.4	12/82→07/92	2383	6	76.50	SOHC/OHC	66/90				
LT28-35 2.4	12/82→07/92									
LT28-35 2.4 S	08/91→07/92									
LT40-55 2.4	12/82→07/92									
LT40-55 2.4 S	12/82→07/89									

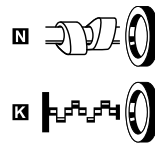
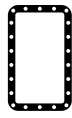
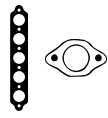

AF5340



AF5350



AF5360



BG940



BW680, BW690,
BW700



BZ930

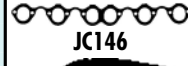

JC146



JC152

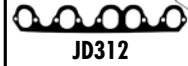

JD312



JE138



JE160



HL469

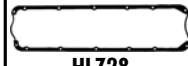

HL728

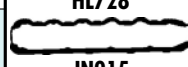

JN915

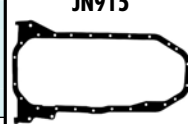

JJ501

HBS022 [19] M12x1.75x115.00mm (x14)	JC146 [1] JC152 [x6]	HL728 [5]			NA5001 (x2)[1][2] 32.00x47.00x10.00mm, FPM NB716 [2] 35.00x48.00x10.00mm, FPM NA5133 [1] 85.00x105.00x11.00mm, FPM	
HBS022 [19] M12x1.75x115.00mm (x14)	JC146 [1] JC152 [x6] JE138 [27]	HL728 [5]		HR805 [5]	NA5001 (x2)[1][2] 32.00x47.00x10.00mm, FPM NB716 [2] 35.00x48.00x10.00mm, FPM NA5133 [1] 85.00x105.00x11.00mm, FPM	
HBS021 [19] M12x1.75x115.00mm (x12)	JD312 [1] JC152 [x5] JE160	JN915 [4]	JJ501	HR615 [5]	NA5001 [1][2] 32.00x47.00x10.00mm, FPM NB716 [2] 35.00x48.00x10.00mm, FPM NA5133 [1] 85.00x105.00x11.00mm, FPM	KK5470 [20]
HBS022 [19] M12x1.75x115.00mm (x14)	JC146 [1] JC152 [x6]	HL728 [5]		HR805 [5]	NA5001 [1][2] 32.00x47.00x10.00mm, FPM NB716 [2] 35.00x48.00x10.00mm, FPM NA5133 [1] 85.00x105.00x11.00mm, FPM	
HBS022 [19] M12x1.75x115.00mm (x14)	JC146 [1] JC152 [x6]	HL728 [5]		HR805 [5]	NA5001 (x2)[1][2] 32.00x47.00x10.00mm, FPM NB716 [2] 35.00x48.00x10.00mm, FPM NA5133 [1] 85.00x105.00x11.00mm, FPM	
HBS021 [19] M12x1.75x115.00mm (x12)	JD312 [1] JC152 [x5]		JJ501	HR615 [5]	NA5001 [1][2] 32.00x47.00x10.00mm, FPM NB716 [2] 35.00x48.00x10.00mm, FPM NA5133 [1] 85.00x105.00x11.00mm, FPM LK5006 [7] 85.00x131.00x16.000mm, PTFE	KK5470 [20]
HBS022 [19] M12x1.75x115.00mm (x14)	JC146 [1] JC152 [x6] JE138 [27]	HL469 [5] HL728 [5]			NA5001 (x2)[1][2] 32.00x47.00x10.00mm, FPM NB716 [2] 35.00x48.00x10.00mm, FPM NA5133 [1] 85.00x105.00x11.00mm, FPM	
HBS022 [19] M12x1.75x115.00mm (x14)	JC146 [1] JC152 [x6] JE138 [27]	JN849 [4]		HR805 [5]	NA5001 (x2)[1][2] 32.00x47.00x10.00mm, FPM NB716 [2] 35.00x48.00x10.00mm, FPM NA5133 [1] 85.00x105.00x11.00mm, FPM	



cc



kW/PS



2.4		DV Diesel				435	BW680 (Fibre), 1.530mm, 1 Notch BW690 (Fibre), 1.570mm, 2 Notches BW700 (Fibre), 1.610mm, 3 Notches		DM660 ▲ [3]
LT28-35 2.4 S	08/91→07/92	2383	6	76.50	SOHC/OHC	75-80/ 102-109			
LT28-35 2.4TD	12/82→09/93								
LT40-55 2.4 S	08/91→07/92								
LT40-55 2.4TD	08/78→09/93								
2.4		DW Diesel				436	BW680 (Fibre), 1.530mm, 1 Notch BW690 (Fibre), 1.570mm, 2 Notches BG940 (Fibre), 1.600mm, 3 Notches BW700 (Fibre), 1.610mm, 3 Notches		DM660 ▲ [3]
LT28-35 2.4 D	12/78→07/92	2383	6	76.50	SOHC/OHC	55-57/ 75-78			
LT28-35 2.4D	01/79→07/92								
LT28-35 2.4DS	08/91→07/92								
LT40-55 2.4 D	12/78→07/92								
2.5		AAF				437	BV880 (Fibre)		DV880 EA5470 [3]
Trans 4 2.5	11/90→04/03	2461	5	81.00	SOHC/OHC	80-81/ 108-110			
Trans 4 2.5 Syn	10/92→04/03								
2.5		ACU				438	BV880 (Fibre)		DV880 EA5470 [3]
Trans 4 2.5	11/90→04/03	2461	5	81.00	SOHC/OHC	81/110			
Trans 4 2.5 Syn	10/92→04/03								
2.5		ACV Diesel				439	AF5310 (MLS), 1.510mm, 1 Hole AF5320 (MLS), 1.570mm, 2 Holes AF5330 (MLS), 1.610mm, 3 Holes		CA5470 ▲ [3] Ch.70-R-160001→ EA5470 [3]
Trans 4 2.5 TDI	09/95→04/03	2461	5	81.00	SOHC/OHC	75/102			
2.5		AEN				440	BV880 (Fibre)		DV880 EA5470 [3]
Trans 4 2.5	11/90→04/03	2461	5	81.00	SOHC/OHC	81/110			
Trans 4 2.5 Syn	10/92→04/03								
2.5		AET				441	BV880 (Fibre)		DV880 EA5470 [3]
Trans 4 2.5	08/96→04/03	2461	5	81.00	SOHC/OHC	81-85/ 110-115			
Trans 4 2.5 Syn	07/96→04/03								



AF5310



AF5320



AF5330



BG940



BV880



BW680, BW690,
BW700

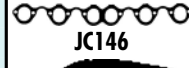

JC146



JC152



JD171



JD312



JE138



HL728

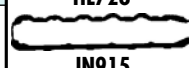

JN915



JJ183

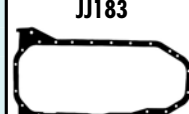

JJ501

HBS022 [19] M12x1.75x115.00mm (x14)	JC146 [1] JC152 [x6]	HL728 [5]	JJ183	HR805 [5]	NA5001 (x2) [1][2] 32.00x47.00x10.00mm, FPM NB716 [2] 35.00x48.00x10.00mm, FPM NA5133 [1] 85.00x105.00x11.00mm, FPM	
HBS022 [19] M12x1.75x115.00mm (x14)	JC146 [1] JC152 [x6] JE138 [27]	HL728 [5]		HR805 [5]	NA5001 (x2) [1][2] 32.00x47.00x10.00mm, FPM NB716 [2] 35.00x48.00x10.00mm, FPM NA5133 [1] 85.00x105.00x11.00mm, FPM	
HBS021 [19] M12x1.75x115.00mm (x12)	JD171 [1] JC152 [x5]	JN915 [4]	JJ501	HR615 [5]	NA5001 (x2) [1][2] 32.00x47.00x10.00mm, FPM NB716 [2] 35.00x48.00x10.00mm, FPM NA5133 [1] 85.00x105.00x11.00mm, FPM	KK5470 [20]
HBS021 [19] M12x1.75x115.00mm (x12)	JD171 [1] JC152 [x5]	JN915 [4]	JJ501	HR615 [5]	NA5001 (x2) [1][2] 32.00x47.00x10.00mm, FPM NB716 [2] 35.00x48.00x10.00mm, FPM NA5133 [1] 85.00x105.00x11.00mm, FPM	KK5470 [20]
HBS021 [19] M12x1.75x115.00mm (x12)	JD312 [1] JC152 [x5]	JM7077 (NBR)	JJ501	HR615 [5]	NA5001 (x2) [1][2] 32.00x47.00x10.00mm, FPM NA5124 [2] 32.00x47.00x10.00mm, PTFE/ACM NB716 [2] 35.00x48.00x10.00mm, FPM NA5133 [1] 85.00x105.00x11.00mm, FPM LK5006 [7] 85.00x131.00x16.000mm, PTFE	KK5470 [20]
HBS021 [19] M12x1.75x115.00mm (x12)	JD171 [1] JC152 [x5]	JN915 [4]	JJ501	HR615 [5]	NA5001 (x2) [1][2] 32.00x47.00x10.00mm, FPM NB716 [2] 35.00x48.00x10.00mm, FPM NA5133 [1] 85.00x105.00x11.00mm, FPM	KK5470 [20]
HBS021 [19] M12x1.75x115.00mm (x12)	JD171 [1] JC152 [x5]	JN915 [4]	JJ501	HR615 [5]	NA5001 [1][2] 32.00x47.00x10.00mm, FPM NA5001 [1][2] 32.00x47.00x10.00mm, FPM NB716 [2] 35.00x48.00x10.00mm, FPM NA5133 [1] 85.00x105.00x11.00mm, FPM LK5006 [7] 85.00x131.00x16.000mm, PTFE	KK5470 [20]



cc



kW/PS



2.5	AEU						442	BV880 (Fibre)	DV880	EA5470 [3]
Trans 4 2.5	11/90→04/03	2461	5	81.00	SOHC/OHC	81/110				
Trans 4 2.5 Syn	10/92→04/03									
2.5	AFB Diesel						443	AC5960 (MLS), 1.100mm, 1 Hole (x2) AC5970 (MLS), 1.150mm, 2 Holes (x2) AC5980 (MLS), 1.200mm, 3 Holes (x2)	CC5960 ▲ [33]	EC5960
Passat 2.5 Syn	12/98→11/00	2496	6	78.30	DOHC, V	110/150				
Passat 2.5 TDI	07/98→05/05									
2.5	AGX Diesel						444	AF5310 (MLS), 1.510mm, 1 Hole AF5320 (MLS), 1.570mm, 2 Holes AF5330 (MLS), 1.610mm, 3 Holes	CA5470 ▲ [3] Ch.70-R-160001→	EA5470 [3]
LT28-35 II 2.5S	07/96→07/06	2461	5	81.00		55/75				
LT28-46 II 2.5S	09/96→07/06									
2.5	AHD Diesel						445	AF5310 (MLS), 1.510mm, 1 Hole AF5320 (MLS), 1.570mm, 2 Holes AF5330 (MLS), 1.610mm, 3 Holes	CA5470 ▲ [3] Ch.70-R-160001→	EA5470 [3]
LT28-35 II 2.5	05/96→08/99	2461	5	81.00	SOHC/OHC	75/102				
LT28-46 II 2.5	05/96→08/99									
2.5	AHY Diesel						446	AF5310 (MLS), 1.510mm, 1 Hole AF5320 (MLS), 1.570mm, 2 Holes AF5330 (MLS), 1.610mm, 3 Holes	CA5470 ▲ [3] Ch.70-R-160001→	EF5310
Trans 4 2.5 TDI	05/98→04/03	2461	5	81.00		111/151				
2.5	AJT Diesel						447	AF5310 (MLS), 1.510mm, 1 Hole AF5320 (MLS), 1.570mm, 2 Holes AF5330 (MLS), 1.610mm, 3 Holes	CA5470 ▲ [3] Ch.70-R-160001→	EA5470 [3]
Trans 4 2.5 TDI	05/98→04/03	2461	5	81.00		65/88				
2.5	AKN Diesel						448	AC5960 (MLS), 1.100mm, 1 Hole (x2) AC5970 (MLS), 1.150mm, 2 Holes (x2) AC5980 (MLS), 1.200mm, 3 Holes (x2)	CC5960 ▲ [33]	EC5960
Passat 2.5 Syn	12/98→11/00	2496	6	78.30	DOHC, V	110/150				
Passat 2.5 TDI	07/98→05/05									

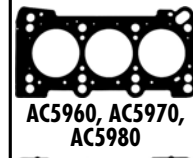

AC5960, AC5970,
AC5980



AF5310



AF5320



AF5330



BV880



JC152



JD171



JD312

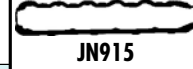

JN915



JJ501



cc



kW/PS



2.5		ANJ Diesel			449		AF5310 (MLS), 1.510mm, 1 Hole AF5320 (MLS), 1.570mm, 2 Holes AF5330 (MLS), 1.610mm, 3 Holes		CA5470 ▲ [3] Ch.70-R-160001 →	EF5310
LT28-35 II 2.5	05/99→07/06	2461	5	81.00		80/109				
LT28-46 II 2.5	05/99→07/06									
2.5		APA Diesel			450		AF5310 (MLS), 1.510mm, 1 Hole AF5320 (MLS), 1.570mm, 2 Holes AF5330 (MLS), 1.610mm, 3 Holes		CA5470 ▲ [3] Ch.70-R-160001 →	EF5310
LT28-35 II 2.5	05/99→07/06	2461	5	81.00	SOHC/OHC	66/90				
LT28-46 II 2.5	05/99→07/06									
2.5		APL			451		BV880 (Fibre)		DV880	EA5470 [3]
Trans 4 2.5	08/96→04/03	2461	5	81.00	SOHC/OHC	85/115				
Trans 4 2.5 Syn	07/96→04/03									
2.5		AUF Diesel			452		AF5310 (MLS), 1.510mm, 1 Hole AF5320 (MLS), 1.570mm, 2 Holes AF5330 (MLS), 1.610mm, 3 Holes		CA5470 ▲ [3] Ch.70-R-160001 →	EA5470 [3]
Trans 4 2.5 TDI	09/95→04/03	2461	5	81.00		75/102				
2.5		AVR Diesel			453		AF5310 (MLS), 1.510mm, 1 Hole AF5320 (MLS), 1.570mm, 2 Holes AF5330 (MLS), 1.610mm, 3 Holes			EF5310
LT28-35 II 2.5	05/99→07/06	2461	5	81.00	SOHC/OHC	80/109				
LT28-46 II 2.5	05/99→07/06									
2.5		AVT			454		BV880 (Fibre)		DV880	EF5310
Trans 4 2.5	08/96→04/03	2461	5	81.00	SOHC/OHC	85/115				
Trans 4 2.5 Syn	07/96→04/03									
2.5		AXD Diesel			455		AG8920 (MLS), 1.270mm, 1 Hole AG8820 (MLS), 1.350mm, 2 Holes AG8930 (MLS), 1.430mm, 3 Holes			EG8920
Multi V 2.5 TDI	04/03→11/09	2461	5	81.00	SOHC/OHC	96/130				
Trans 5 2.5 TDI	04/03→11/09									



AF5310



AF5320



AF5330



BV880



JC152



JD171



JD312

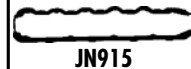

JN915

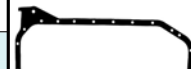

JJ501



cc



kW/PS

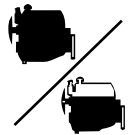

2.5 AXE Diesel						456	AG8920 (MLS), 1.270mm, 1 Hole AG8820 (MLS), 1.350mm, 2 Holes AG8930 (MLS), 1.430mm, 3 Holes		EG8920
Multi V 2.5 TDI	04/03→11/09	2461	5	81.00	SOHC/OHC	128/174			
Trans 5 2.5 TDI	04/03→11/09								
2.5 AXG Diesel						457	AF5310 (MLS), 1.510mm, 1 Hole AF5320 (MLS), 1.570mm, 2 Holes AF5330 (MLS), 1.610mm, 3 Holes	CA5470 ▲ [3] Ch.70-R-160001 →	
Trans 4 2.5 TDI	05/98→04/03	2461	5	81.00	SOHC/OHC	111/151			
2.5 AXL Diesel						458	AF5310 (MLS), 1.510mm, 1 Hole AF5320 (MLS), 1.570mm, 2 Holes AF5330 (MLS), 1.610mm, 3 Holes	CC5231 ▲ CA5470 ▲ [3] Ch.70-R-160001 →	EF5310
Trans 4 2.5 TDI	09/95→04/03	2461	5	81.00	SOHC/OHC	75/102			
2.5 AYC Diesel						459	AF5310 (MLS), 1.510mm, 1 Hole AF5320 (MLS), 1.570mm, 2 Holes AF5330 (MLS), 1.610mm, 3 Holes	CA5470 ▲ [3] Ch.70-R-160001 →	EA5470 [3]
Trans 4 2.5 TDI	09/95→04/03	2461	5	81.00	SOHC/OHC	75/102			
2.5 AYY Diesel						460	AF5310 (MLS), 1.510mm, 1 Hole AF5320 (MLS), 1.570mm, 2 Holes AF5330 (MLS), 1.610mm, 3 Holes	CA5470 ▲ [3] Ch.70-R-160001 →	EF5310
Trans 4 2.5 TDI	05/98→04/03	2461	5	81.00	SOHC/OHC	65/88			
2.5 BAC Diesel						461	AG8920 (MLS), 1.270mm, 1 Hole AG8820 (MLS), 1.350mm, 2 Holes AG8930 (MLS), 1.430mm, 3 Holes		EG8920
Touareg 2.5 R5	01/03→05/10	2461	5	81.00	SOHC/OHC	128/174			
2.5 BAU Diesel						462	AC5960 (MLS), 1.100mm, 1 Hole (x2) AC5970 (MLS), 1.150mm, 2 Holes (x2) AC5980 (MLS), 1.200mm, 3 Holes (x2)	CC5960 ▲ [33]	EC5960
Passat 2.5 TDI	01/03→05/05	2496	6	78.30	DOHC, V	132/180			
2.5 BBE Diesel						463	AF5310 (MLS), 1.510mm, 1 Hole AF5320 (MLS), 1.570mm, 2 Holes AF5330 (MLS), 1.610mm, 3 Holes	CA5470 ▲ [3] Ch.70-R-160001 →	EF5310
LT28-35 II 2.5	05/01→07/06	2461	5	81.00	SOHC/OHC	61/83			
LT28-46 II 2.5	05/01→07/06								

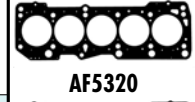
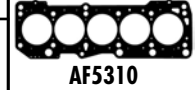
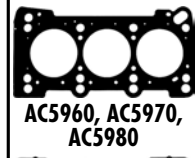



cc



kW/PS



2.5		BBF Diesel					464	AF5310 (MLS), 1.510mm, 1 Hole AF5320 (MLS), 1.570mm, 2 Holes AF5330 (MLS), 1.610mm, 3 Holes	CA5470 ▲ [3] Ch.70-R-160001→	EF5310
LT28-35 II 2.5	05/01→07/06	2461	5	81.00	SOHC/OHC	70/95				
LT28-46 II 2.5	05/01→07/06									
2.5		BDG Diesel					465	AC5960 (MLS), 1.100mm, 1 Hole (x2) AC5970 (MLS), 1.150mm, 2 Holes (x2) AC5980 (MLS), 1.200mm, 3 Holes (x2)	CC5960 ▲ [33]	EC5960
Passat 2.5 TDI	05/03→05/05	2496	6	78.30	DOHC, V	120/163				
2.5		BDH Diesel					466	AC5960 (MLS), 1.100mm, 1 Hole (x2) AC5970 (MLS), 1.150mm, 2 Holes (x2) AC5980 (MLS), 1.200mm, 3 Holes (x2)	CC5960 ▲ [33]	EC5960
Passat 2.5 TDI	01/03→05/05	2496	6	78.30	DOHC, V	132/180				
2.5		BJJ Diesel					467	AH5970 (MLS), 1.530mm, 1 Hole AH5980 (MLS), 1.570mm, 2 Holes AH5990 (MLS), 1.610mm, 3 Holes		
Crafter 2.5 TDI	04/06→07/11	2461	5	81.00	SOHC/OHC	65/88				
2.5		BJK Diesel					468	AH5970 (MLS), 1.530mm, 1 Hole AH5980 (MLS), 1.570mm, 2 Holes AH5990 (MLS), 1.610mm, 3 Holes		
Crafter 2.5 TDI	04/06→	2461	5	81.00	SOHC/OHC	80/109				
2.5		BJL Diesel					469	AH5970 (MLS), 1.530mm, 1 Hole AH5980 (MLS), 1.570mm, 2 Holes AH5990 (MLS), 1.610mm, 3 Holes		
Crafter 2.5 TDI	04/06→	2461	5	81.00	SOHC/OHC	100/136				
2.5		BJM Diesel					470	AH5970 (MLS), 1.530mm, 1 Hole AH5980 (MLS), 1.570mm, 2 Holes AH5990 (MLS), 1.610mm, 3 Holes		
Crafter 2.5 TDI	04/06→07/11	2461	5	81.00	SOHC/OHC	120/163				
2.5		BLJ Diesel					471	AG8930 (MLS), 1.430mm, 3 Holes		EG8920
Multi V 2.5 TDI	11/03→11/09	2461	5	81.00	SOHC/OHC	120/163				
Trans 5 2.5 TDi	11/03→11/09									
2.5		BLK Diesel					472	AG8930 (MLS), 1.430mm, 3 Holes		EG8920
Touareg 2.5 R5	08/03→05/10	2461	5	81.00	SOHC/OHC	120/163				
2.5		BNZ Diesel					473	AG8930 (MLS), 1.430mm, 3 Holes		EG8920
Multi V 2.5 TDI	04/03→11/09	2461	5	81.00	SOHC/OHC	96/130				
Trans 5 2.5 TDI	04/03→11/09									
2.5		BPC Diesel					474	AG8930 (MLS), 1.430mm, 3 Holes		EG8920
Multi V 2.5 TDI	04/03→11/09	2461	5	81.00	SOHC/OHC	128/174				
Trans 5 2.5 TDI	04/03→11/09									
2.5		BPD Diesel					475	AG8930 (MLS), 1.430mm, 3 Holes		EG8920
Touareg 2.5 R5	08/03→05/10	2461	5	81.00	SOHC/OHC	120/163				
2.5		BPE Diesel					476	AG8920 (MLS), 1.270mm, 1 Hole AG8820 (MLS), 1.350mm, 2 Holes AG8930 (MLS), 1.430mm, 3 Holes		EG8920
Touareg 2.5 R5	01/03→05/10	2461	5	81.00	SOHC/OHC	128/174				

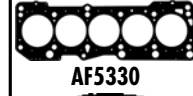
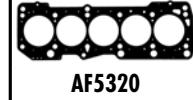
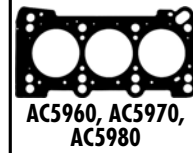



cc



kW/PS



2.5		CBUA					477			
Beetle 2.5	04/11→	2480	5	82.50	DOHC	125/170				
Jetta 3 2.5 FSI	07/08→10/10									
Jetta 4 2.5 FSI	04/10→									
2.5		CCCA					478			
Beetle 2.5	04/11→	2480	5	82.50	DOHC	125/170				
Jetta 3 2.5 FSI	07/08→10/10									
Jetta 4 2.5 FSI	04/10→									
2.5		CEBA Diesel					479	AH5970 (MLS), 1.530mm, 1 Hole AH5980 (MLS), 1.570mm, 2 Holes AH5990 (MLS), 1.610mm, 3 Holes		
Crafter 2.5 TDI	04/06→07/11	2461	5		SOHC/OHC	65/88				
2.5		CEBB Diesel					480	AH5970 (MLS), 1.530mm, 1 Hole AH5980 (MLS), 1.570mm, 2 Holes AH5990 (MLS), 1.610mm, 3 Holes		
Crafter 2.5 TDI	04/06→	2461	5		SOHC/OHC	80/109				
2.5		CECA Diesel					481	AH5970 (MLS), 1.530mm, 1 Hole AH5980 (MLS), 1.570mm, 2 Holes AH5990 (MLS), 1.610mm, 3 Holes		
Crafter 2.5 TDI	04/06→	2461	5		SOHC/OHC	100/136				
2.5		CECB Diesel					482	AH5970 (MLS), 1.530mm, 1 Hole AH5980 (MLS), 1.570mm, 2 Holes AH5990 (MLS), 1.610mm, 3 Holes		
Crafter 2.5 TDI	04/06→07/11	2461	5		SOHC/OHC	120/163				
2.8		AAA					483	AA5430 (Fibre)	CA5430 [13]	EC340 [3]
Golf 3 2.8 VR6	08/95→09/97	2792	6	81.00	DOHC, VR	120-128/ 163-174				
Golf 3 2.8VR6	01/92→08/97									
Passat 2.8 VR6	06/91→05/97									
Sharan 2.8 Syn	11/96→04/00									
Sharan 2.8 VR6	09/95→04/00									
Vento 2.8 VR6	01/92→09/98									
2.8		ACK					484			EY850
Passat 2.8 V6	08/96→11/00	2771	6	82.50	DOHC, V	142/193				
2.8		AES					485	AA5430 (Fibre)	CA5430 [13]	EC340 [3]
Trans 4 2.8	05/96→05/00	2792	6	81.00	SOHC/OHC, VR	103/140				
Trans 4 2.8 VR6	11/95→05/00									
2.8		AGE					486			
Passat 2.8 Syn	05/97→09/99	2771	6	82.50	DOHC, V	132/180				
Passat 2.8 V6	05/97→09/99									
2.8		AGK Diesel					487	AE5310 (Fibre), 1.400mm		
LT28-35 II 2.8	02/97→12/98	2799	4	93.00	SOHC/OHC	92/125				
LT28-46 II 2.8	06/97→12/98									
2.8		ALG					488			
Passat 2.8 V6	10/96→11/00	2771	6	82.50	DOHC, V	142/193				
2.8		AMV					489	AG5000 (MLS)	CG5000	EG5000 EG7800
Trans 4 2.8 V6	04/00→04/03	2792	6	81.00	DOHC, VR	150/204				
Trans 4 2.8 VR6	06/00→04/03									



AA5430



AE5310

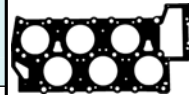

AG5000



JA5068



JA5069



JD312



JD5109



JD5232

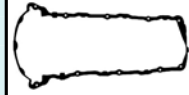

JM5030

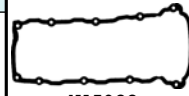

JM5099



JH5013

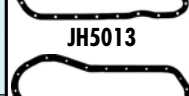

JH5059

HBS517 [22]

PA5041 (x20)
6.00/12.20x10.00
(FPM)

HBS517 [22]

PA5041 (x20)
6.00/12.20x10.00
(FPM)

HBS021 [19]
M12x1.75x115.00mm (x12)

JD312 [11]
JD5948 [13]
(Steel)

HR397

HR615 [13]
HR805 [13]

NA5124 [2]
32.00x47.00x10.00mm, PTFE/ACM
NA5106 [2]
35.00x48.00x10.00mm, PTFE

HBS021 [19]
M12x1.75x115.00mm (x12)

JD312 [11]
JD5948 [13]
(Steel)

HR397

HR615 [13]
HR805 [13]

NA5124 [2]
32.00x47.00x10.00mm, PTFE/ACM
NA5106 [2]
35.00x48.00x10.00mm, PTFE

HBS021 [19]
M12x1.75x115.00mm (x12)

JD312 [11]
JD5948 [13]
(Steel)

HR397

HR615 [13]
HR805 [13]

NA5124 [2]
32.00x47.00x10.00mm, PTFE/ACM
NA5106 [2]
35.00x48.00x10.00mm, PTFE

HBS021 [19]
M12x1.75x115.00mm (x12)

JD5948 [13]
(Steel)

JM7077
(NBR)

NA5106 [2]
35.00x48.00x10.00mm, PTFE

HBS077 [22]
M11x1.50x144.00mm (x3)

JD5232 [11]
JA5068 [11] [12]
JA5069 [13] [32]
JD5109 [13] [27]

JM5030
(Elastomer)
JM5099
(Elastomer)

JH5013
→ Ch.1H-PW-400 000
JH5059

HR662 [13]

NB716 [2]
35.00x48.00x10.00mm, FPM
NA5133 [1]
85.00x105.00x11.00mm, FPM

HBS270 [22]
M11x1.50x133.00mm (x16)

HM5224 [13]

JH5118 [13]

PA5041 (x30)
6.00/12.20x10.00
(FPM)

NA5001 (x4)[1][2]
32.00x47.00x10.00mm, FPM
NB716 [2]
35.00x48.00x10.00mm, FPM
NA5133 [1]
85.00x105.00x11.00mm, FPM

HBS077 [22]
M11x1.50x144.00mm (x3)

JA5068 [11]
JA5069 [13] [32]
JD5109 [13] [27]

JM5030
(Elastomer)

JH5059

HR662 [13]

NB716 [2]
35.00x48.00x10.00mm, FPM
NA5133 [1]
85.00x105.00x11.00mm, FPM

HBS270 [22]
M11x1.50x133.00mm (x16)

HM5224 [13]

PA5041 (x30)
6.00/12.20x10.00
(FPM)

NA5001 [1][2]
32.00x47.00x10.00mm, FPM
NA5106 [2]
35.00x48.00x10.00mm, PTFE
NB716 [2]
35.00x48.00x10.00mm, FPM

HBS499 [12]

HBS270 [22]
M11x1.50x133.00mm (x16)

HM5224 [13]

PA5041 (x30)
6.00/12.20x10.00
(FPM)

NA5001 (x4)[1][2]
32.00x47.00x10.00mm, FPM
NA5106 [2]
35.00x48.00x10.00mm, PTFE

HBS526 [21][94]

JD5928 [11]
(SE)
JE5077 (x2)
(SE)

JM7045
(Elastomer)

PA5041 (x24)
6.00/12.20x10.00
(FPM)

NA5106 [2]
35.00x48.00x10.00mm, PTFE
NA5305 [1][36]
01/01 →



cc



kW/PS



2.8	AMX	490							
Passat 2.8 4mot	11/00→05/05	2771	6	82.50	DOHC, V	142/193			
2.8	AMY	491							
Sharan 2.8 Syn	11/96→04/00	2792	6	81.00	DOHC, VR	128/174			
Sharan 2.8 VR6	09/95→04/00								
2.8	APR	492							
Passat 2.8 V6	08/96→11/00	2771	6	82.50	DOHC, V	142/193			
2.8	AQD	493							
Passat 2.8 V6	08/96→11/00	2771	6	82.50	DOHC, V	142/193			
2.8	AQP	494					AG5000 (MLS)	CG5010	EG5010 EG7800
Bora 2.8 V6	03/99→05/05	2792	6	81.00	DOHC, VR	150/204			
Golf 4 2.8 V6	03/99→06/06								
2.8	ATA Diesel	495					AE5310 (Fibre), 1.400mm		
LT28-35 II 2.8	01/99→01/02	2799	4	93.00	SOHC/OHC	96/130			
LT28-46 II 2.8	01/99→07/06								
2.8	ATX	496							
Passat 2.8 V6	09/99→11/00	2771	6	82.50	DOHC, V	140/190			
2.8	AUE	497					AG5000 (MLS)	CG5010	EG7800
Bora 2.8 V6	03/99→05/05	2792	6	81.00	DOHC, VR	150/204			
Bora 2.8 VR6	03/00→05/00								
Golf 4 2.8 V6	03/99→06/06								
2.8	AUH Diesel	498					AE5310 (Fibre), 1.400mm		
LT28-46 II 2.8	04/02→07/06	2799	4	93.00		116/158			
2.8	AYL	499					AG5000 (MLS)	CG5030	EG7800
Sharan 2.8 V6	04/00→03/10	2792	6	81.00	DOHC, V	150/204			
2.8	BBG	500							
Passat 2.8 V6	09/99→11/00	2771	6	82.50	DOHC, V	140/190			
2.8	BCQ Diesel	501					AE5310 (Fibre), 1.400mm		
LT28-35 II 2.8	05/01→06/06	2798	4	93.00	SOHC/OHC	116/158			
LT28-46 II 2.8	04/02→07/06								
2.8	BDE	502					AG5000 (MLS)		EG7800
Bora 2.8 V6	03/99→05/05	2792	6	81.00	DOHC, V	150/204			
Golf 4 2.8 V6	03/99→06/06								
2.9	ABV	503					AA5430 (Fibre)	CA5430 [13]	EC340 [3]
Corrado 2.9 VR6	08/91→12/95	2861	6	82.00	DOHC, VR	135-140/ 184-190			
Golf 3 2.9 VR6	10/94→04/99								
Passat 2.9 Syn	01/94→05/97								
3.0	BKS Diesel	504					AG8880 (MLS), 1.100mm, 1 Hole [32] AG8900 (MLS), 1.100mm, 1 Hole [27] AG8860 (MLS), 1.150mm, 2 Holes [32] AG8870 (MLS), 1.150mm, 2 Holes [27] AG8890 (MLS), 1.200mm, 3 Holes [32] AG8910 (MLS), 1.200mm, 3 Holes [27]	CG8880 ▲ [34][35]	
Touareg 3.0 V6	11/04→05/10	2967	6	83.00	DOHC, V	165/224			



AA5430



AE5310

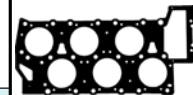

AG5000



JA5068

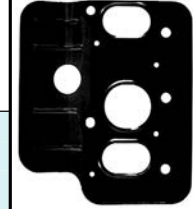

JA5069



JD5109



JD5232

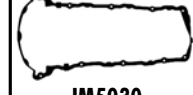

JM5030



JM5099



JH5013



JH5059



cc



kW/PS



3.0	BMK Diesel						505	AG8880 (MLS), 1.100mm, 1 Hole [32] AG8890 (MLS), 1.100mm, 1 Hole [27] AG8860 (MLS), 1.150mm, 2 Holes [32] AG8870 (MLS), 1.150mm, 2 Holes [27] AG8890 (MLS), 1.200mm, 3 Holes [32] AG8910 (MLS), 1.200mm, 3 Holes [27]	CG8880 ▲ [34][35]	
Phaeton 3.0 V6	09/04→	2967	6	83.00	DOHC, V	165/224				
3.0	BUN Diesel						506	AG8880 (MLS), 1.100mm, 1 Hole [32] AG8890 (MLS), 1.100mm, 1 Hole [27] AG8860 (MLS), 1.150mm, 2 Holes [32] AG8870 (MLS), 1.150mm, 2 Holes [27] AG8890 (MLS), 1.200mm, 3 Holes [32] AG8910 (MLS), 1.200mm, 3 Holes [27]	CG8880 ▲ [34][35]	
Touareg 3.0 TDI	04/06→05/10	2967	6	83.00	DOHC, V	155/211				
3.0	CARA Diesel						507			
Phaeton 3.0 V6	06/07→	2967	6	83.00	DOHC, V	171/233				
3.0	CASA Diesel						508			
Touareg 3.0 V6	11/07→05/10	2967	6	83.00	DOHC, V	176/240				
3.0	CASB Diesel						509			
Touareg 3.0 TDI	04/06→05/10	2967	6	83.00	DOHC, V	155/211				
3.0	CASC Diesel						510			
Touareg 3.0 V6	11/07→05/10	2967	6	83.00	DOHC, V	176/240				
3.0	CASD Diesel						511			
Touareg 3.0 V6	01/10→	2967	6	83.00	DOHC, V	150/204				
3.0	CATA Diesel						512			
Touareg 3.0 V6	11/04→05/10	2967	6	83.00	DOHC, V	165/224				
3.0	CEXA Diesel						513			
Phaeton 3.0 V6	11/08→	2967	6	83.00	DOHC, V	176/240				
3.0	CJMA Diesel						514			
Touareg 3.0 V6	01/10→	2967	6	83.00	DOHC, V	150/204				
3.2	AYT						515	AG9610 (MLS)	CG9610	
Phaeton 3.2 V6	04/02→	3189	6	84.00	DOHC, VR	177/241				
3.2	AZZ						516	AG9610 (MLS)	CG9610	
Touareg 3.2 V6	10/02→11/06	3189	6	84.00	DOHC, V	162/220				
3.2	BAA						517	AG9610 (MLS)	CG9610	
Touareg 3.2 V6	10/02→11/06	3189	6	84.00	DOHC, VR	162/220				
3.2	BDL						518	AG9610 (MLS)	CG9610	
Multi V 3.2 V6	02/04→06/04	3189	6	84.00	DOHC, VR	170/231				
Trans 5 3.2 V6	04/03→11/09									
3.2	BFH						519	AG9610 (MLS)	CG9610	
Golf 4 3.2 R32	09/02→06/05	3189	6	84.00	DOHC, VR	177/241				



HBS361 [22] M12x1.50x159.00mm (x16)	JD5872 [1] (ACM)	JM7046 [32] (ACM) JM7047 [27] (ACM)		PA5041 (x24) 6.00/12.20x10.00 (FPM)	NA5001 [1][2] 32.00x47.00x10.00mm, FPM	
HBS361 [22] M12x1.50x159.00mm (x16)	JD5872 [1] (ACM)	JM7046 [32] (ACM) JM7047 [27] (ACM)		PA5041 (x24) 6.00/12.20x10.00 (FPM)	NA5001 [1][2] 32.00x47.00x10.00mm, FPM	
	JD5872 [1] (ACM)	JM7046 [32] (ACM) JM7047 [27] (ACM)		PA5041 (x24) 6.00/12.20x10.00 (FPM)	NA5001 [1][2] 32.00x47.00x10.00mm, FPM	
	JD5872 [1] (ACM)	JM7046 [32] (ACM) JM7047 [27] (ACM)		PA5041 (x24) 6.00/12.20x10.00 (FPM)	NA5001 [1][2] 32.00x47.00x10.00mm, FPM	
	JD5872 [1] (ACM)	JM7046 [32] (ACM) JM7047 [27] (ACM)		PA5041 (x24) 6.00/12.20x10.00 (FPM)	NA5001 [1][2] 32.00x47.00x10.00mm, FPM	
	JD5872 [1] (ACM)	JM7046 [32] (ACM) JM7047 [27] (ACM)		PA5041 (x24) 6.00/12.20x10.00 (FPM)	NA5001 [1][2] 32.00x47.00x10.00mm, FPM	
	JD5872 [1] (ACM)	JM7046 [32] (ACM) JM7047 [27] (ACM)		PA5041 (x24) 6.00/12.20x10.00 (FPM)	NA5001 [1][2] 32.00x47.00x10.00mm, FPM	
	JD5872 [1] (ACM)	JM7046 [32] (ACM) JM7047 [27] (ACM)		PA5041 (x24) 6.00/12.20x10.00 (FPM)	NA5001 [1][2] 32.00x47.00x10.00mm, FPM	
	JD5872 [1] (ACM)	JM7046 [32] (ACM) JM7047 [27] (ACM)		PA5041 (x24) 6.00/12.20x10.00 (FPM)	NA5001 [1][2] 32.00x47.00x10.00mm, FPM	
				PA5041 (x24) 6.00/12.20x10.00 (FPM)		
	JD5874 [1] (FPM)	JM7045 (Elastomer)		PA5041 (x24) 6.00/12.20x10.00 (FPM)	NA5106 [2] 35.00x48.00x10.00mm, PTFE NA5305 [1][36]	
	JD5874 [1] (FPM)	JM7045 (Elastomer)		PA5041 (x24) 6.00/12.20x10.00 (FPM)	NA5106 [2] 35.00x48.00x10.00mm, PTFE/ACM NA5106 [2] 35.00x48.00x10.00mm, PTFE NA5305 [1][36]	
	JD5874 [1] (FPM)	JM7045 (Elastomer)		PA5041 (x24) 6.00/12.20x10.00 (FPM)	NA5305 [1][36]	
	JD5874 [1] (FPM)	JM7045 (Elastomer)		PA5041 (x24) 6.00/12.20x10.00 (FPM)	NA5106 [2] 35.00x48.00x10.00mm, PTFE NA5305 [1][36]	
	JD5874 [1] (FPM)	JM7045 (Elastomer)		PA5041 (x24) 6.00/12.20x10.00 (FPM)	NA5106 [2] 35.00x48.00x10.00mm, PTFE NA5305 [1][36]	



cc



kW/PS



3.2	BJS	520	AG9610 (MLS)	CG9610
Golf V 3.2 R32	01/04→11/08	3189 6 84.00 DOHC, VR	177/241	
3.2	BKJ	521	AG9610 (MLS)	CG9610
Touareg 3.2 V6	10/02→11/06	3189 6 84.00 DOHC, V	162/220	
3.2	BKK	522	AG9610 (MLS)	CG9610
Multi V 3.2 V6	02/04→11/09	3189 6 84.00 DOHC, V	173/235	
Trans 5 3.2	11/03→11/09			
Trans 5 3.2 V6	08/03→11/09			
3.2	BKL	523	AG9610 (MLS)	CG9610
Phaeton 3.2 V6	04/02→	3189 6 84.00 DOHC, V	177/241	
3.2	BML	524	AG9610 (MLS)	CG9610
Golf 4 3.2 R32	09/02→06/05	3189 6 84.00 DOHC, VR	177/241	
3.2	BMV	525	AG9610 (MLS)	CG9610
Touareg 3.2 V6	10/02→11/06	3189 6 84.00 DOHC, VR	162-177 / 220-241	
3.2	BMX	526	AG9610 (MLS)	CG9610
Touareg 3.2 V6	10/02→11/06	3189 6 84.00 DOHC, VR	162/220	
3.2	BRJ	527	AG9610 (MLS)	CG9610
Touareg 3.2 V6	10/02→11/06	3189 6 84.00 DOHC, VR	162/220	
3.2	BRK	528	AG9610 (MLS)	CG9610
Phaeton 3.2 V6	02/04→	3189 6 84.00 DOHC, V	177/241	
3.2	BUB	529	AG9610 (MLS)	CG9610
EOS 3.2 V6	06/06→05/09	3189 6 84.00 DOHC, VR	184/250	
Golf V 3.2	09/05→11/08			
Golf V 3.2 R32	11/05→11/08			
3.2	CBRA	530	AG9610 (MLS)	CG9610
EOS 3.2 V6	06/06→05/09	3189 6 84.00 DOHC, VR	184/250	
Golf V 3.2 R32	11/05→11/08			
3.2	CFLA	531	AG9610 (MLS)	CG9610
Multi V 3.2 V6	02/04→11/09	3189 6 84.00 DOHC, V	173/235	
Trans 5 3.2	11/03→11/09			
Trans 5 3.2 V6	11/03→11/09			
3.6	BHK	532		
Touareg 3.6 V6	10/05→05/10	3597 6 89.00 DOHC, V	206/280	
3.6	BLV	533		
Passat 3.6 FSI	06/08→	3597 6 89.00 DOHC, VR	206/280	
3.6	BWS	534		
CC 3.6 FSI 4mot	11/11→	3597 6 89.00 DOHC, VR	220/300	
Passat 3.6 FSI	06/08→05/10			
Passat 3.6 R36	04/07→11/10			











				PA5041 (x24) 6.00/12.20x10.00 (FPM)	☒ NAS106 [2] 35.00x48.00x10.00mm, PTFE	
	JD5874 [1] (FPM)	JM7045 (Elastomer)		PA5041 (x24) 6.00/12.20x10.00 (FPM)	☒ NAS106 [2] 35.00x48.00x10.00mm, PTFE/ACM ☒ NAS106 [2] 35.00x48.00x10.00mm, PTFE	
	JD5874 [1] (FPM)	JM7045 (Elastomer)		PA5041 (x24) 6.00/12.20x10.00 (FPM)	☒ NAS106 [2] 35.00x48.00x10.00mm, PTFE	
	JD5874 [1] (FPM)	JM7045 (Elastomer)		PA5041 (x24) 6.00/12.20x10.00 (FPM)	☒ NAS106 [2] 35.00x48.00x10.00mm, PTFE	
	JD5874 [1] (FPM)	JM7045 (Elastomer)		PA5041 (x24) 6.00/12.20x10.00 (FPM)	☒ NAS106 [2] 35.00x48.00x10.00mm, PTFE	
	JD5874 [1] (FPM)	JM7045 (Elastomer)		PA5041 (x24) 6.00/12.20x10.00 (FPM)	☒ NAS106 [2] 35.00x48.00x10.00mm, PTFE/ACM ☒ NAS106 [2] 35.00x48.00x10.00mm, PTFE	
	JD5874 [1] (FPM)	JM7045 (Elastomer)		PA5041 (x24) 6.00/12.20x10.00 (FPM)	☒ NAS106 [2] 35.00x48.00x10.00mm, PTFE/ACM ☒ NAS106 [2] 35.00x48.00x10.00mm, PTFE	
	JD5874 [1] (FPM)	JM7045 (Elastomer)		PA5041 (x24) 6.00/12.20x10.00 (FPM)	☒ NAS106 [2] 35.00x48.00x10.00mm, PTFE/ACM ☒ NAS106 [2] 35.00x48.00x10.00mm, PTFE	
	JD5874 [1] (FPM)	JM7045 (Elastomer)		PA5041 (x24) 6.00/12.20x10.00 (FPM)	☒ NAS106 [2] 35.00x48.00x10.00mm, PTFE	
	JD5874 [1] (FPM)	JM7045 (Elastomer)		PA5041 (x24) 6.00/12.20x10.00 (FPM)		
	JD5874 [1] (FPM)	JM7045 (Elastomer)		PA5041 (x24) 6.00/12.20x10.00 (FPM)	☒ NAS106 [2] 35.00x48.00x10.00mm, PTFE	
				PA5041 (x24) 6.00/12.20x10.00 (FPM)		
				PA5041 (x24) 6.00/12.20x10.00 (FPM)		
				PA5041 (x24) 6.00/12.20x10.00 (FPM)		

NUMERICAL PARTS LIST









Numerische Teilenummernliste • Liste des références produits
Elenco numerico articoli • Lista de referencias









Part	Make	Page	Part	Make	Page	Part	Make	Page	Part	Make	Page
AA3130	SEAT	1322	AA5840	CITROËN	282	AB5110	ALFA ROMEO	32	AB5680	CHEVROLET	212
AA3140	SEAT	1332, 1340		FIAT	398		FIAT	410		OPEL	932, 934, 936, 946
AA5020	MITSUBISHI	834, 836		PEUGEOT	1014		IVECO	610, 612, 614		SAAB	1306
AA5130	FORD	538		TOYOTA	1462	AB5120	FORD	438, 440		VAUXHALL	1530, 1532, 1534, 1536, 1542
	MAZDA	712	AA5850	CITROËN	282		MAZDA	692			
AA5410	SEAT	1320, 1322		FIAT	398	AB5130	FORD	450, 452, 454	AB5690	NISSAN	860
	VW	1624		PEUGEOT	1014		MAZDA	694		AUDI	56
AA5420	ALFA ROMEO	18, 20, 30	AA5860	CITROËN	282	AB5140	OPEL	896		SEAT	1326, 1328, 1330, 1332
	FIAT	382		FIAT	398		VAUXHALL	1498		SKODA	1378, 1380, 1382
	LANCIA	654, 656		PEUGEOT	1014	AB5150	FIAT	376		VW	1632, 1634, 1636, 1638, 1640, 1642
AA5430	FORD	538		TOYOTA	1462		LANCIA	654			
	MERCEDES-BENZ	768	AA5870	CITROËN	282	AB5200	TOYOTA	1478	AB5720	FIAT	408, 410
	VW	1734, 1736		FIAT	398	AB5230	CHEVROLET	208		IVECO	610
AA5500	SEAT	1326		PEUGEOT	1014		DAEWOO	318	AB5730	FIAT	408, 410
	VW	1632		TOYOTA	1462	AB5240	OPEL	898		IVECO	610
AA5520	ALFA ROMEO	28	AA5880	CITROËN	282		VAUXHALL	1500	AB5740	FIAT	408, 410
AA5550	ALFA ROMEO	20, 22		FIAT	398	AB5300	FORD	468, 470, 474, 476, 478, 496, 498		IVECO	610
AA5560	ALFA ROMEO	24, 26		PEUGEOT	1014				AB5750	TOYOTA	1454, 1456
	FIAT	388, 390, 392, 394, 396	AA5920	LAND ROVER	672	AB5310	FORD	468, 470, 474, 476, 478, 496, 498	AB5760	TOYOTA	1454, 1458, 1460
	LANCIA	656, 658		MG	802	AB5320	FORD	468, 470, 474, 476, 478, 496, 498	AB5780	ISUZU	604
	SAAB	1298	AA5940	FORD	526, 528					OPEL	946
	VAUXHALL	1526		LAND ROVER	670	AB5330	FORD	468, 470, 474, 476, 478, 496, 498		VAUXHALL	1542
AA5570	ALFA ROMEO	24, 26	AA5950	FORD	526, 528				AB5781	ISUZU	604
	FIAT	388, 390, 392, 394, 396		LAND ROVER	670	AB5340	FORD	468, 470, 474, 476, 478, 496, 498		OPEL	946
	LANCIA	656, 658	AA5960	FORD	526, 528					VAUXHALL	1542
	SAAB	1298		LAND ROVER	670	AB5350	FORD	468, 470, 474, 476, 478, 496, 498	AB5800	FORD	480, 482, 484, 486, 490, 492, 494, 496, 498
	VAUXHALL	1526	AA5970	FORD	500, 504, 508, 510, 512, 520, 522, 524	AB5360	OPEL	902		MAZDA	704
AA5580	ALFA ROMEO	24, 26		JAGUAR	622		VAUXHALL	1504	AB5810	FORD	480, 482, 484, 486, 490, 492, 494, 496, 498
	FIAT	388, 390, 392, 394, 396	AA5980	FORD	500, 504, 508, 510, 512, 520, 522, 524	AB5370	SEAT	1358, 1360		MAZDA	704
	LANCIA	656, 658		JAGUAR	622		SKODA	1396			
	SAAB	1298	AA5990	FORD	500, 504, 508, 510, 512, 520, 522, 524		VW	1696, 1698, 1700, 1702	AB5820	FORD	480, 482, 484, 486, 490, 492, 494, 496, 498
	VAUXHALL	1526		JAGUAR	622	AB5400	ROVER	1288, 1290			
AA5590	FIAT	402, 408	AB5000	TOYOTA	1458	AB5420	VOLVO	1562, 1564		MAZDA	704
	LANCIA	658	AB5010	ISUZU	600	AB5431	VOLVO	1554, 1560, 1562	AB5900	LAND ROVER	670
AA5620	VOLVO	1554, 1562		MAZDA	698	AB5440	VOLVO	1572, 1578, 1580	AB5910	LAND ROVER	670
AA5630	VOLVO	1590		OPEL	914, 916	AB5450	VOLVO	1578, 1580	AB5920	LAND ROVER	670
AA5720	FIAT	408		VAUXHALL	1516, 1518	AB5490	LAND ROVER	672	AB5980	BMW	176
	LANCIA	662	AB5020	ISUZU	600	AB5540	OPEL	912, 914	AB5990	BMW	174
AA5730	FIAT	408		MAZDA	698		VAUXHALL	1514, 1516	AC5011	CITROËN	288, 290, 292
	LANCIA	662		OPEL	914, 916	AB5550	MERCEDES-BENZ	730		FIAT	406
AA5740	FIAT	408		VAUXHALL	1516, 1518	AB5560	MERCEDES-BENZ	730		LANCIA	660
	LANCIA	662	AB5030	ISUZU	600	AB5570	MERCEDES-BENZ	734, 742		PEUGEOT	1020, 1022, 1024
AA5780	ALFA ROMEO	32		MAZDA	698	AB5630	NISSAN	858		SUZUKI	1430, 1432
	LANCIA	664		OPEL	914, 916	AB5660	BMW	156	AC5020	CITROËN	288, 290, 292
AA5790	ALFA ROMEO	32		VAUXHALL	1516, 1518	AB5670	CHEVROLET	212		FIAT	406
	LANCIA	664	AB5080	KIA	636		OPEL	932, 934, 936, 946		LANCIA	660
AA5800	ALFA ROMEO	32		ROVER	1290		SAAB	1306		PEUGEOT	1020, 1022, 1024
	LANCIA	664	AB5100	FIAT	410		VAUXHALL	1530, 1532, 1534, 1536, 1542		SUZUKI	1430, 1432
AA5830	CITROËN	282		IVECO	610, 612, 614						
	FIAT	398									
	PEUGEOT	1014									
	TOYOTA	1462									

 AC5031 CITROËN 288, 290, 292 FIAT 406 LANCIA 660 PEUGEOT 1020, 1022, 1024 SUZUKI 1430, 1432		 AC5160 ALFA ROMEO 26 FIAT 380, 384, 386, 394		 AC5590 CHRYSLER 218		 AD5050 DACIA 310 MITSUBISHI 826 RENAULT 1192	
AC5040 CITROËN 288, 290, 292 FIAT 406 LANCIA 660 PEUGEOT 1020, 1022, 1024 SUZUKI 1430, 1432		AC5180 ALFA ROMEO 26 FIAT 380, 384, 386, 394		AC5630 SAAB 1302, 1304, 1306		AD5100 CITROËN 276 PEUGEOT 1006	
AC5051 CITROËN 288, 290, 292 FIAT 406 LANCIA 660 PEUGEOT 1020, 1022, 1024 SUZUKI 1430, 1432		AC5190 AUDI 56 VW 1626		AC5640 BMW 192, 194		AD5130 CITROËN 258, 266, 268, 270 FIAT 372 FORD 458, 460, 468 MAZDA 698 MINI 806 PEUGEOT 998, 1000 SUZUKI 1428 VOLVO 1556	
AC5061 MITSUBISHI 826 NISSAN 860 OPEL 924 RENAULT 1198, 1200, 1202, 1204, 1206, 1208, 1210 SUZUKI 1428 VAUXHALL 1524 VOLVO 1566		AC5200 AUDI 56 VW 1626		AC5660 SMART 1404		AD5140 CITROËN 258, 266, 268, 270 FIAT 372 FORD 458, 460, 468 MAZDA 698 MINI 806 PEUGEOT 998, 1000 SUZUKI 1428 VOLVO 1556	
AC5062 NISSAN 860 RENAULT 1198, 1200, 1202, 1204, 1206, 1208, 1210 SUZUKI 1428 VOLVO 1566		AC5220 AUDI 58, 60, 62 SEAT 1334, 1336, 1338, 1340 SKODA 1382, 1384, 1386 VW 1646, 1648, 1650, 1652, 1654, 1656, 1658		AC5670 SMART 1404		AD5150 CITROËN 258, 266, 268, 270 FIAT 372 FORD 458, 460, 468 MAZDA 698 MINI 806 PEUGEOT 998, 1000 SUZUKI 1428 VOLVO 1556	
AC5070 OPEL 924, 926 RENAULT 1200, 1202, 1204, 1206 SMART 1404 VAUXHALL 1524 VOLVO 1566		AC5260 JAGUAR 622		AC5680 FORD 524, 526		AD5160 CITROËN 258, 266, 268, 270 FIAT 372 FORD 458, 460, 468 MAZDA 698 MINI 806 PEUGEOT 998, 1000 SUZUKI 1428 VOLVO 1556	
AC5080 OPEL 924, 926 RENAULT 1200, 1202, 1204, 1206 VAUXHALL 1524 VOLVO 1566		AC5270 JAGUAR 622		AC5690 SAAB 1306		AD5170 CITROËN 258, 266, 268, 270 FIAT 372 FORD 458, 460, 468 MAZDA 698 MINI 806 PEUGEOT 998, 1000 SUZUKI 1428 VOLVO 1556	
AC5090 OPEL 924, 926 RENAULT 1200, 1202, 1204, 1206 VAUXHALL 1524 VOLVO 1566		AC5280 AUDI 60 SEAT 1336, 1338 VW 1648, 1650, 1652		AC5700 CITROËN 256 PEUGEOT 990		AD5180 CITROËN 270, 272 PEUGEOT 1002, 1004	
AC5100 DACIA 308 NISSAN 858 RENAULT 1130, 1132, 1146, 1148, 1150, 1152, 1154, 1156, 1158, 1160		AC5290 FORD 468		AC5710 CITROËN 256 PEUGEOT 990		AD5190 LANCIA 664 RENAULT 1252	
AC5140 ALFA ROMEO 26 FIAT 380, 384, 386, 394		AC5300 BMW 156		AC5720 CHRYSLER 216		AD5220 FORD 502, 504, 512, 520, 522, 526 MAZDA 704, 706, 708, 712 VOLVO 1568	
AC5150 ALFA ROMEO 26 FIAT 380, 384, 386, 394		AC5310 BMW 158, 160, 168		AC5750 FORD 538 NISSAN 870		AD5230 HONDA 554, 556, 560	
		AC5320 BMW 174 OPEL 942 VAUXHALL 1540		AC5760 FORD 538 NISSAN 870		AD5250 NISSAN 854	
		AC5330 BMW 174 OPEL 942 VAUXHALL 1540		AC5770 FORD 538 NISSAN 870		AD5260 NISSAN 866	
		AC5340 BMW 174 OPEL 942 VAUXHALL 1540		AC5780 FORD 534, 536			
		AC5350 BMW 194, 196		AC5790 FORD 534, 536			
		AC5360 BMW 194, 196		AC5800 FORD 470, 472, 474, 486, 488			
		AC5370 BMW 194, 196		AC5860 FORD 456, 460, 464, 468 MAZDA 698			
		AC5380 BMW 194, 196		AC5870 FORD 534, 536 MAZDA 712			
		AC5390 JAGUAR 622		AC5880 FORD 534, 536 MAZDA 712			
		AC5400 JAGUAR 622		AC5890 FORD 456			
		AC5410 BMW 156, 158		AC5900 BMW 172, 176, 178			
		AC5420 BMW 156, 158		AC5910 FORD 518			
		AC5430 BMW 156, 158		AC5920 CHRYSLER 216 MINI 808			
		AC5440 BMW 152, 154, 160, 162		AC5940 FORD 470, 476, 478 MAZDA 704 VOLVO 1560, 1562			
		AC5460 CHEVROLET 210 OPEL 922, 924 SAAB 1298 VAUXHALL 1522, 1524		AC5960 AUDI 116, 118 SKODA 1400 VW 1726, 1730, 1732			
		AC5470 BMW 152, 154, 160, 162		AC5970 AUDI 116, 118 SKODA 1400 VW 1726, 1730, 1732			
		AC5500 JAGUAR 622		AC5980 AUDI 116, 118 SKODA 1400 VW 1726, 1730, 1732			
		AC5510 JAGUAR 622		AD5020 FORD 442			
		AC5520 MERCEDES-BENZ 776		AD5030 DACIA 310 MITSUBISHI 826 RENAULT 1192			
		AC5550 CHRYSLER 216		AD5040 DACIA 310 MITSUBISHI 826 RENAULT 1192			
		AC5560 CHRYSLER 216					
		AC5570 CHRYSLER 216					
		AC5580 CHRYSLER 218					

NUMERICAL PARTS LIST









Numerische Teilenummernliste • Liste des références produits
Elenco numerico articoli • Lista de referencias









 AD5280 NISSAN 860		 AD5660 AUDI 56		 AD5860 ALFA ROMEO 24, 26		 AE5310 VW 1734, 1736	
AD5281 NISSAN 860		SEAT 1326, 1330		FIAT 390, 394, 396		AE5320 FORD 500, 504, 506, 508, 510, 516, 518, 522	
AD5300 CITROËN 284, 292		SKODA 1378, 1380		OPEL 926		AE5330 DAEWOO 320	
FIAT 404		VW 1634, 1636, 1638, 1640		SAAB 1298		MERCEDES-BENZ 768, 770, 776, 786, 788, 794	
LANCIA 660		AD5670 AUDI 56		VAUXHALL 1526		SSANGYONG 1408, 1410	
PEUGEOT 1016, 1024		SEAT 1326, 1330		AD5870 ALFA ROMEO 28			
AD5310 CITROËN 272		SKODA 1378, 1380		AD5910 ALFA ROMEO 32			
PEUGEOT 1004		VW 1634, 1636, 1638, 1640		LANCIA 664		AE5340 BMW 194	
AD5330 TOYOTA 1466		AD5690 CHEVROLET 206		AD5920 ALFA ROMEO 32		AE5350 BMW 194	
AD5340 TOYOTA 1466, 1470		DAEWOO 316		LANCIA 664		AE5360 BMW 194	
AD5370 TOYOTA 1464		AD5700 CITROËN 256, 258, 260, 262		AD5930 ALFA ROMEO 32		AE5370 BMW 194	
AD5380 TOYOTA 1452		PEUGEOT 988, 990, 992, 994, 996		LANCIA 664		AE5470 KIA 636	
AD5400 OPEL 944, 946		AD5710 CITROËN 256, 258, 260, 262		AD5950 ALFA ROMEO 30		AE5520 CHEVROLET 208	
VAUXHALL 1542		PEUGEOT 988, 990, 992, 994, 996		LANCIA 660, 664		HONDA 558	
AD5490 CITROËN 288, 294		AD5720 JEEP 626		AD5970 FIAT 376		OPEL 916	
FIAT 404, 406		MERCEDES-BENZ 766, 768, 782		LANCIA 654		VAUXHALL 1518	
FORD 502, 504, 508, 510, 520, 522		AD5800 ALFA ROMEO 12		AD5980 NISSAN 850		AE5530 CHEVROLET 208	
LANCIA 660, 662		CHEVROLET 206		RENAULT 1104, 1106		HONDA 558	
PEUGEOT 1020, 1026		FIAT 356, 360, 362		AD5990 NISSAN 862		OPEL 916	
VOLVO 1572		FORD 440		OPEL 932		VAUXHALL 1518	
AD5500 CITROËN 288, 294		LANCIA 650		RENAULT 1186, 1188, 1218, 1220, 1222, 1224, 1226, 1228		AE5540 CHEVROLET 208	
FIAT 404, 406		OPEL 896, 898, 900		VAUXHALL 1530		HONDA 558	
FORD 502, 504, 508, 510, 520, 522		SUZUKI 1424		AE5010 CITROËN 272		OPEL 916	
LANCIA 660, 662		VAUXHALL 1498, 1500		PEUGEOT 1004		VAUXHALL 1518	
PEUGEOT 1020, 1026		AD5810 ALFA ROMEO 12		AE5020 CITROËN 272		AE5550 FIAT 356, 358, 362	
VOLVO 1572		CHEVROLET 206		PEUGEOT 1004		LANCIA 650	
AD5510 CITROËN 288, 294		FIAT 356, 360, 362		AE5030 CITROËN 272		AE5560 VOLVO 1588	
FIAT 404, 406		FORD 440		PEUGEOT 1004		AE5610 MITSUBISHI 824	
FORD 502, 504, 508, 510, 520, 522		LANCIA 650		AE5050 CITROËN 296		VOLVO 1562	
LANCIA 660, 662		OPEL 896, 898, 900		PEUGEOT 1028		AE5730 MERCEDES-BENZ 756	
PEUGEOT 1020, 1026		SUZUKI 1424		AE5060 SAAB 1304, 1308		AE5740 MERCEDES-BENZ 756	
VOLVO 1572		VAUXHALL 1498, 1500		AE5110 RENAULT 1222, 1224, 1226, 1228, 1230		AE5750 CHRYSLER 218	
AD5520 CITROËN 288, 294		AD5820 ALFA ROMEO 12		AE5140 VOLVO 1588		MERCEDES-BENZ 766, 770, 788, 790	
FIAT 404, 406		CHEVROLET 206		AE5150 VOLVO 1590		AE5760 CHRYSLER 218	
FORD 502, 504, 508, 510, 520, 522		FIAT 356, 360, 362		AE5160 VOLVO 1590		MERCEDES-BENZ 756, 766, 770, 788, 790	
LANCIA 660, 662		FORD 440		AE5170 VOLVO 1590		AE5880 NISSAN 876	
PEUGEOT 1020, 1026		LANCIA 650		AE5200 NISSAN 852, 854		AE5890 NISSAN 876	
VOLVO 1572		OPEL 896, 898, 900		RENAULT 1134		AE5910 INFINITI 596	
AD5600 LAND ROVER 672		SUZUKI 1424		SUZUKI 1426		NISSAN 876	
AD5610 LAND ROVER 672		VAUXHALL 1498, 1500		AE5210 NISSAN 864		RENAULT 1274	
AD5630 SEAT 1320, 1322		AD5830 FIAT 356, 358		OPEL 936		AE5920 CHEVROLET 208	
VW 1624, 1626		LANCIA 648, 650		RENAULT 1252, 1254, 1256		OPEL 912	
AD5640 SEAT 1326, 1328, 1330		AD5840 ALFA ROMEO 24, 26		VAUXHALL 1534		VAUXHALL 1514	
VW 1634, 1638		FIAT 390, 394, 396		AE5220 NISSAN 868		AE5930 OPEL 912, 914	
AD5650 AUDI 56		OPEL 926		OPEL 940		VAUXHALL 1516	
SEAT 1326, 1330		SAAB 1298		RENAULT 1264, 1266		AE5950 OPEL 896	
SKODA 1378, 1380		VAUXHALL 1526		VAUXHALL 1538		SUZUKI 1424	
VW 1634, 1636, 1638, 1640		AD5850 ALFA ROMEO 24, 26		AE5240 FIAT 356, 358, 360, 362		VAUXHALL 1498	
		FIAT 390, 394, 396		LANCIA 650		AF070 AUSTIN 134	
		OPEL 926		AE5260 VOLVO 1584, 1586, 1588		AF470 ROVER 1280	
		SAAB 1298		AE5270 VOLVO 1584, 1586, 1588		AF5030 LEXUS 680	
		VAUXHALL 1526		AE5280 VOLVO 1584, 1586, 1588		TOYOTA 1480	
				AE5290 VOLVO 1584, 1586, 1588		AF5031 LEXUS 680	
				AE5300 VOLVO 1584, 1586, 1588		TOYOTA 1480	
						AF5060 HYUNDAI 590	

							
AF5070 HYUNDAI	588, 590	AF5750 NISSAN	874	AG5720 SUZUKI	1430	AG7490 TOYOTA	1464
AF5190 BMW	172, 176, 178	AF5760 SUBARU	1418	AG5730 SUZUKI	1432	AG7500 TOYOTA	1464
AF5310 AUDI	116	AF5780 TOYOTA	1464	AG5740 SUZUKI	1432	AG7510 TOYOTA	1464
VOLVO	1590	AF5790 TOYOTA	1480	AG5760 HONDA	570	AG7520 TOYOTA	1476
VW	1724, 1726, 1728, 1730, 1732	AF5800 TOYOTA	1480	AG5780 HONDA	570	AG7530 TOYOTA	1476
AF5320 AUDI	116	AF5810 TOYOTA	1480	AG5810 HONDA	566, 572	AG7540 TOYOTA	1476
VOLVO	1590	AF5820 TOYOTA	1480	AG5920 DAIHATSU	328	AG7550 TOYOTA	1476
VW	1724, 1726, 1728, 1730, 1732	AF5840 DAIHATSU	332	TOYOTA	1452	AG7560 TOYOTA	1476
AF5330 AUDI	116	TOYOTA	1472	AG6040 HYUNDAI	582	AG7570 TOYOTA	1454
VOLVO	1590	AF5850 TOYOTA	1480	AG6050 FIAT	412	AG7580 TOYOTA	1454
VW	1724, 1726, 1728, 1730, 1732	AF5860 TOYOTA	1480	IVECO	618	AG7590 TOYOTA	1454
AF5340 AUDI	112	AF5870 TOYOTA	1480	AG6060 FIAT	378, 412	AG7600 MINI	806
VW	1722	AF5880 TOYOTA	1474	IVECO	618	SUBARU	1414
AF5350 AUDI	112	AF5890 TOYOTA	1474	AG6130 INFINITI	596	TOYOTA	1454
VW	1722	AF5981 TOYOTA	1474	NISSAN	876	AG7610 MINI	806
AF5360 AUDI	90, 112	AF5982 TOYOTA	1474	RENAULT	1274	SUBARU	1414
VW	1722	AF5983 TOYOTA	1474	AG6150 SUBARU	1418	TOYOTA	1454
AF5381 AUDI	82, 84, 86	AF5984 TOYOTA	1474	AG6220 FIAT	366, 370	AG7620 MINI	806
FORD	500	AF5990 SEAT	1322, 1324	LANCIA	652	SUBARU	1414
SEAT	1352, 1354, 1356, 1358	SKODA	1374, 1376	AG7300 FIAT	378, 412	TOYOTA	1454
SKODA	1392, 1394, 1396	VW	1626, 1628	IVECO	618	AG7630 LEXUS	680
VW	1686, 1688, 1690, 1692, 1694	AG5000 FORD	538	AG7310 ALFA ROMEO	12, 14	TOYOTA	1480
AF5391 AUDI	82, 84, 86	SEAT	1364	FIAT	358, 366, 368, 370	AG7640 LEXUS	680
FORD	500	AG5010 BMW	162, 164, 166, 168	LANCIA	650, 652, 656	TOYOTA	1464, 1480
SEAT	1352, 1354, 1356, 1358	AG5020 BMW	162, 164, 166, 168	OPEL	902	AG7650 TOYOTA	1464
SKODA	1392, 1394, 1396	AG5030 BMW	162, 164, 166, 168	VAUXHALL	1502	AG7660 TOYOTA	1464
VW	1686, 1688, 1690, 1692, 1694	AG5070 HYUNDAI	584, 588	AG7380 ALFA ROMEO	12	AG7670 TOYOTA	1466, 1470
AF5401 AUDI	82, 84, 86	AG5090 ISUZU	604	CHRYSLER	216	AG7690 MITSUBISHI	818
FORD	500	OPEL	944	FIAT	356, 360, 368, 370	AG7700 MITSUBISHI	828
SEAT	1352, 1354, 1356, 1358	VAUXHALL	1542	FORD	440	AG7710 MITSUBISHI	828
SKODA	1392, 1394, 1396	AG5100 LEXUS	680	LANCIA	648, 652	AG7720 OPEL	944, 946
VW	1686, 1688, 1690, 1692, 1694	AG5120 MAZDA	696	AG7390 ALFA ROMEO	24, 26	VAUXHALL	1542
AF5401 AUDI	82, 84, 86	AG5130 KIA	636	FIAT	388, 390, 392, 394, 396	AG7730 OPEL	944, 946
FORD	500	MAZDA	708	OPEL	926	VAUXHALL	1542
SEAT	1352, 1354, 1356, 1358	SUZUKI	1430	AG7400 ALFA ROMEO	24, 26	AG7740 MITSUBISHI	838
SKODA	1392, 1394, 1396	AG5160 MITSUBISHI	834, 836	FIAT	388, 390, 392, 394, 396	AG7750 MITSUBISHI	838
VW	1686, 1688, 1690, 1692, 1694	AG5170 NISSAN	866	VAUXHALL	1526	AG7760 MITSUBISHI	838
AF5430 HYUNDAI	586, 588	AG5180 NISSAN	866	AG7420 ALFA ROMEO	32	AG7770 TOYOTA	1456
KIA	634	AG5210 SUBARU	1416	FIAT	408	AG7800 SEAT	1364
AF5470 MITSUBISHI	818, 820	AG5230 TOYOTA	1476	OPEL	926	VW	1720
AF5480 MITSUBISHI	820	AG5240 TOYOTA	1466, 1470	VAUXHALL	1526	AG7810 FORD	542
AF5490 MITSUBISHI	838	AG5250 NISSAN	866	AG7410 ALFA ROMEO	32	AG7820 FORD	542
AF5500 MITSUBISHI	830	AG5260 SUZUKI	1428	FIAT	408	AG7840 KIA	632
AF5540 NISSAN	862	AG5270 RENAULT	1270	LANCIA	664	AG7850 MAZDA	694
AF5600 NISSAN	876	AG5280 SUBARU	1414	AG7420 ALFA ROMEO	32	AG7860 ACURA	2
AF5690 INFINITI	596	AG5290 SUBARU	1416	FIAT	408	HONDA	572
NISSAN	874	AG5300 MITSUBISHI	826	LANCIA	664	AG7870 ACURA	2
AF5710 INFINITI	596	AG5301 MITSUBISHI	826	AG7430 ALFA ROMEO	32	HONDA	574
NISSAN	874	AG5302 MITSUBISHI	826	FIAT	408	AG7880 NISSAN	850
AF5720 NISSAN	874	AG5420 RENAULT	1230, 1232	LANCIA	664	AG7890 HONDA	550
AF5730 NISSAN	874	AG5580 SUBARU	1416	AG7440 ALFA ROMEO	24, 26	AG7900 HONDA	558
AF5740 NISSAN	874	AG5590 SUBARU	1414	FIAT	388, 390, 392, 394, 396	AG7910 HYUNDAI	580
		AG5600 SUBARU	1418	OPEL	926	AG7920 HYUNDAI	586
		AG5610 SUBARU	1418	VAUXHALL	1526	KIA	634
		AG5690 HYUNDAI	590	AG7480 TOYOTA	1464	AG7930 HYUNDAI	586
		AG5710 SUZUKI	1430			KIA	634

NUMERICAL PARTS LIST









Numerische Teilenummernliste • Liste des références produits
Elenco numerico articoli • Lista de referencias









 AG7940 HYUNDAI 586		 AG8820 VW 1728, 1730, 1732		 AG9140 DAIHATSU 332		 AG9660 CHRYSLER 218	
KIA 634		AG8830 VW 1702, 1706		TOYOTA 1470		AG9670 CHRYSLER 218	
AG7950 NISSAN 850		AG8840 SEAT 1322		AG9150 MITSUBISHI 834		AG9680 CHRYSLER 218	
AG7960 HONDA 550		SKODA 1374, 1376		AG9170 ACURA 2		AG9690 JEEP 626	
AG7970 DAIHATSU 326		VW 1626, 1628		HONDA 572		AG9710 CITROËN 300	
AG7980 SUBARU 1414		AG8850 AUDI 60, 62		AG9180 HONDA 550		PEUGEOT 1032	
AG7990 CHEVROLET 206		SEAT 1338		AG9270 LEXUS 680		RENAULT 1270, 1272	
DAEWOO 316		SKODA 1384		TOYOTA 1478		AG9720 CITROËN 300	
AG8000 CHEVROLET 206, 208		VW 1638, 1640, 1652, 1654		AG9280 LEXUS 680		PEUGEOT 1032	
DAEWOO 316, 318		AG8860 AUDI 120, 122, 126, 128		TOYOTA 1478		RENAULT 1270, 1272	
AG8010 HONDA 566		VW 1736, 1738		AG9290 BMW 182, 184		AG9730 CITROËN 300	
AG8020 SUZUKI 1428, 1430		AG8870 AUDI 120, 122, 126, 128		CITROËN 254		PEUGEOT 1032	
AG8030 HYUNDAI 584, 586, 588		VW 1736, 1738		DAIHATSU 326		RENAULT 1270, 1272	
KIA 634		AG8880 AUDI 120, 122, 126, 128		PEUGEOT 988		AG9740 CITROËN 300	
AG8040 HYUNDAI 584		VW 1736, 1738		SUBARU 1414		PEUGEOT 1032	
AG8050 HYUNDAI 580		AG8890 AUDI 120, 122, 126, 128		TOYOTA 1452		RENAULT 1270, 1272	
AG8060 HYUNDAI 580		VW 1736, 1738		AG9490 DACIA 306		AG9750 CITROËN 294	
AG8080 MITSUBISHI 832		AG8900 AUDI 120, 122, 126, 128		NISSAN 852, 854		PEUGEOT 1024	
AG8100 SUZUKI 1426, 1432		VW 1736, 1738		RENAULT 1134, 1136, 1138, 1140, 1142, 1144		AG9760 OPEL 932	
AG8110 SUZUKI 1432		AG8910 AUDI 120, 122, 126, 128		SUZUKI 1428		RENAULT 1244	
AG8130 HONDA 566		VW 1736, 1738		AG9540 BMW 174		VAUXHALL 1530	
AG8150 MAZDA 712		AG8920 VW 1728, 1730, 1732		AG9550 BMW 174		AG9770 OPEL 944	
AG8160 MAZDA 712		AG8930 VW 1728, 1730, 1732		AG9560 FORD 456, 460, 468		RENAULT 1274	
AG8170 MAZDA 696, 698		AG8940 VW 1702, 1706		VOLVO 1554		SAAB 1308	
AG8180 SUZUKI 1426, 1428		AG8950 VW 1702, 1706		AG9570 OPEL 934		VAUXHALL 1542	
AG8190 MAZDA 708		AG8960 AUDI 90, 92, 94, 96, 100		VAUXHALL 1534		AG9780 OPEL 944	
AG8200 KIA 632, 634		MITSUBISHI 830		AG9580 ALFA ROMEO 32		RENAULT 1274	
AG8210 NISSAN 864		SEAT 1360		CHEVROLET 212		SAAB 1308	
AG8220 NISSAN 864		SKODA 1398		FIAT 408		VAUXHALL 1542	
AG8230 NISSAN 864		VW 1702, 1704, 1706, 1708, 1710		OPEL 934, 936		AG9790 OPEL 944	
AG8240 NISSAN 864		AG8970 AUDI 90, 92, 94, 96, 100		VAUXHALL 1534, 1536		RENAULT 1274	
AG8260 KIA 632		JEEP 626		AG9590 CHEVROLET 212		SAAB 1308	
AG8290 HYUNDAI 584		MITSUBISHI 830		OPEL 938		VAUXHALL 1542	
AG8310 FORD 440, 442		SEAT 1360		VAUXHALL 1536		AG9800 OPEL 944	
MAZDA 692		SKODA 1398		AG9600 AUDI 90, 92, 96		RENAULT 1274	
AG8320 FORD 534		VW 1702, 1704, 1706, 1708, 1710		SEAT 1360, 1362		SAAB 1308	
VOLVO 1588, 1590		AG8990 SMART 1404		SKODA 1398, 1400		VAUXHALL 1542	
AG8340 VOLVO 1578		AG9000 BMW 174, 178, 180, 188, 190		VW 1700, 1704, 1708		AG9810 OPEL 944	
AG8390 MERCEDES-BENZ 776, 778		AG9010 BMW 174, 178, 180, 188, 190		AG9610 AUDI 130		RENAULT 1274	
AG8400 MERCEDES-BENZ 776, 778		AG9020 BMW 174, 178, 180, 188, 190		VW 1738, 1740		SAAB 1308	
AG8430 MERCEDES-BENZ 794, 796		AG9030 CITROËN 262		AG9630 AUDI 92, 94		VAUXHALL 1542	
AG8440 MERCEDES-BENZ 794, 796		PEUGEOT 994		SEAT 1360, 1362		AG9820 OPEL 944	
AG8490 MERCEDES-BENZ 790		AG9080 MAZDA 692		SKODA 1398		RENAULT 1274	
AG8500 MERCEDES-BENZ 730		AG9090 LEXUS 680		VW 1702, 1704, 1706, 1708		SAAB 1308	
AG8501 MERCEDES-BENZ 742		TOYOTA 1478		AG9640 AUDI 92, 94		VAUXHALL 1542	
AG8790 MERCEDES-BENZ 732, 734		AG9100 LEXUS 680		SEAT 1360, 1362		AG9830 DAIHATSU 330	
AG8800 AUDI 90, 92, 94, 96, 100		TOYOTA 1478		SKODA 1398		TOYOTA 1454	
JEEP 626		AG9110 TOYOTA 1462		VW 1702, 1704, 1706, 1708		AG9870 KIA 636	
MITSUBISHI 830		AG9120 MITSUBISHI 830		AG9650 AUDI 92, 94		AG9880 KIA 636	
SEAT 1360		AG9130 MITSUBISHI 830, 832		SEAT 1360, 1362		AG9890 KIA 636	
SKODA 1398				SKODA 1398		AG9900 HYUNDAI 580	
VW 1702, 1704, 1706, 1708, 1710				VW 1702, 1704, 1706, 1708		KIA 632	
AG8810 AUDI 90				AG9920 MITSUBISHI 818, 820		AG9930 NISSAN 866	
JEEP 626				SMART 1404		AG9940 NISSAN 866	
VW 1698							

 AG9950 NISSAN 866		 AH5380 AUDI 76, 90, 98, 100, 102		 AH6330 NISSAN 858, 862		 AH6590 CITROËN 258	
AG9960 NISSAN 866		SEAT 1346, 1362		RENAULT 1242, 1244		FORD 450, 454	
AG9970 NISSAN 866		SKODA 1388, 1400		AH6340 HYUNDAI 582		MAZDA 694	
AG9980 NISSAN 866		VW 1674, 1710, 1712, 1714		AH6350 MAZDA 712		PEUGEOT 992	
AG9990 LEXUS 680		AH5630 KIA 636		AH6380 OPEL 930, 932, 934		SUZUKI 1426	
TOYOTA 1464		AH5660 HONDA 570		SAAB 1298, 1300, 1304		AH6600 CITROËN 258	
AH850 FORD 464		AH5661 HONDA 570		VAUXHALL 1528		FORD 450, 454	
AH860 FORD 512, 514, 516, 518		AH5662 HONDA 570		AH6390 CITROËN 294		MAZDA 694	
AH5000 MERCEDES-BENZ 740		AH5663 HONDA 570		FIAT 406		PEUGEOT 992	
AH5010 MERCEDES-BENZ 782, 784		AH5664 HONDA 570		FORD 522, 524		SUZUKI 1426	
AH5020 MERCEDES-BENZ 782, 784		AH5680 FORD 460, 468		PEUGEOT 1026		AH6620 NISSAN 850	
AH5030 OPEL 898, 902, 904		AH5690 CHEVROLET 210, 212		AH6400 CITROËN 294		OPEL 896	
SUZUKI 1424		OPEL 934		FIAT 406		SUZUKI 1424	
VAUXHALL 1500, 1504, 1506		VAUXHALL 1532		FORD 522, 524		VAUXHALL 1498	
AH5040 CITROËN 300		AH5700 CHEVROLET 212		PEUGEOT 1026		AH6630 CITROËN 284	
FIAT 412		OPEL 934		AH6410 CITROËN 294		FIAT 404	
PEUGEOT 1030, 1032		VAUXHALL 1532		FIAT 406		PEUGEOT 1016	
RENAULT 1272, 1274		AH5710 CHEVROLET 212		FORD 522, 524		AH6680 MAZDA 704, 706, 708	
AH5050 CITROËN 300		OPEL 934		PEUGEOT 1026		AH6700 LEXUS 680	
FIAT 412		VAUXHALL 1532		AH6420 BMW 188		TOYOTA 1476	
PEUGEOT 1030, 1032		AH5730 CITROËN 298		AH6430 FORD 460, 468		AH6710 LEXUS 680	
RENAULT 1272, 1274		PEUGEOT 1030		AH6440 CITROËN 256, 264		TOYOTA 1476	
AH5060 CITROËN 300		AH5731 CITROËN 298		MINI 806		AH6730 CITROËN 264	
FIAT 412		PEUGEOT 1030		PEUGEOT 990, 992, 998, 1002		MINI 806, 808	
PEUGEOT 1030, 1032		AH5732 CITROËN 298		AH6450 MERCEDES-BENZ 742, 744, 746		PEUGEOT 998, 1002	
RENAULT 1272, 1274		PEUGEOT 1030		AH6460 MERCEDES-BENZ 742, 744, 746		AH6760 NISSAN 876	
AH5070 CITROËN 300		AH5733 CITROËN 298		AH6470 MERCEDES-BENZ 742, 744, 746		RENAULT 1274	
FIAT 412		PEUGEOT 1030		AH6480 MITSUBISHI 834		AH6770 NISSAN 876	
PEUGEOT 1030, 1032		AH5760 HONDA 560, 568		AH6490 MITSUBISHI 834		RENAULT 1274	
RENAULT 1272, 1274		AH5920 BMW 178, 180, 190		AH6500 MITSUBISHI 834		AH6780 RENAULT 1106	
AH5080 CITROËN 296		AH5930 BMW 178, 180, 190		AH6510 ALFA ROMEO 12, 14		AH6880 ALFA ROMEO 18	
PEUGEOT 1026		AH5940 BMW 178, 180, 190		CHRYSLER 216		CHRYSLER 216	
AH5090 CITROËN 296		AH5950 BMW 178, 180, 190		FIAT 368, 370		FIAT 376, 378	
PEUGEOT 1026		AH5960 AUDI 56		LANCIA 652		LANCIA 654	
AH5100 CITROËN 296		FORD 442		OPEL 900		OPEL 908	
PEUGEOT 1026		SEAT 1332		VAUXHALL 1502		VAUXHALL 1508	
AH5110 CITROËN 296		SKODA 1382		AH6530 CITROËN 272		AH6890 ALFA ROMEO 18	
PEUGEOT 1026		VW 1640, 1642, 1644, 1656		PEUGEOT 1004		CHRYSLER 216	
AH5120 BMW 186		AH5970 VW 1732, 1734		AH6540 HYUNDAI 590		FIAT 376, 378	
AH5170 DACIA 306, 308		AH5980 VW 1732, 1734		KIA 636		LANCIA 654	
RENAULT 1132, 1162, 1164		AH5990 VW 1732, 1734		AH6560 CITROËN 258		OPEL 908	
AH5180 TOYOTA 1476		AH6000 SMART 1404		FORD 450, 454		VAUXHALL 1508	
AH5230 TOYOTA 1476		AH6210 BMW 182, 184		MAZDA 694		AH6900 ALFA ROMEO 18	
AH5240 ALFA ROMEO 22		AH6220 BMW 152, 160, 162		PEUGEOT 992		FIAT 376, 378	
CHEVROLET 206, 208, 210		AH6240 HYUNDAI 580		SUZUKI 1426		OPEL 908	
FIAT 382		KIA 632		AH6570 CITROËN 258		VAUXHALL 1508	
OPEL 908, 912, 914, 918, 924		AH6250 TOYOTA 1472, 1474		FORD 450, 454		AH6930 AUDI 94, 96, 98, 102	
SAAB 1298		AH6260 TOYOTA 1472, 1474		MAZDA 694		SEAT 1362	
VAUXHALL 1510, 1514, 1516, 1520, 1524		AH6280 NISSAN 856		PEUGEOT 992		SKODA 1400	
AH5260 LADA 640		AH6290 SUZUKI 1424		SUZUKI 1426		VW 1700, 1706, 1708, 1714	
AH5270 LADA 640		AH6300 NISSAN 850		AH6580 CITROËN 258		AH6940 TOYOTA 1460, 1462, 1468	
AH5340 NISSAN 870		AH6310 HYUNDAI 588		FORD 450, 454		AH7000 FORD 442	
AH5350 NISSAN 870		KIA 634		MAZDA 694		AH7010 FORD 524, 526	
AH5360 NISSAN 870		AH6320 HYUNDAI 588		PEUGEOT 992		AH7080 NISSAN 868	
		KIA 634		SUZUKI 1426		AH7090 TOYOTA 1480	

NUMERICAL PARTS LIST









Numerische Teilenummernliste • Liste des références produits
Elenco numerico articoli • Lista de referencias









 AH7120 FORD 454		 AY300 ALFA ROMEO 34		 AY560 ALFA ROMEO 32		 AY940 AUDI 58	
AH7130 MITSUBISHI 818		FIAT 410		FIAT 408		SEAT 1334	
SMART 1404		IVECO 614		LANCIA 662, 664		VW 1644, 1646, 1648	
AH7150 FORD 456		LANCIA 664		AY570 ALFA ROMEO 32		AY960 AUDI 106, 108, 110	
VOLVO 1554		OPEL 940, 942		FIAT 408		AY970 AUDI 64, 66, 68, 70, 72, 74,	
AH7170 OPEL 928, 930		RENAULT 1262, 1264, 1266,		LANCIA 662, 664		76	
VAUXHALL 1528		1268		AY580 FIAT 410		SEAT 1342, 1344, 1346	
AH7180 OPEL 928, 930		VAUXHALL 1540		IVECO 610, 612, 614		SKODA 1386, 1388	
VAUXHALL 1528		AY310 ALFA ROMEO 34		AY590 FIAT 410		VW 1664, 1666, 1668,	
AH7190 OPEL 928, 930		FIAT 410		IVECO 610, 612, 614		1670, 1672, 1674	
VAUXHALL 1528		LANCIA 664		RENAULT 1264, 1268		BC240 FORD 438, 446, 448	
AJ270 MAZDA 696		OPEL 940, 942		AY610 ALFA ROMEO 30		BC270 NISSAN 852	
TOYOTA 1452		VAUXHALL 1540		AY620 ALFA ROMEO 34		BC380 NISSAN 870	
AN300 ALFA ROMEO 28		AY320 FIAT 400		AY630 ALFA ROMEO 34		BC650 SAAB 1300	
AN350 ALFA ROMEO 12, 14, 16		LANCIA 658		AY640 ALFA ROMEO 34, 36		BC790 MERCEDES-BENZ 756, 758	
AX220 SKODA 1374		AY400 ALFA ROMEO 30, 34		LANCIA 666		BC800 MERCEDES-BENZ 782	
AY061 AUDI 112, 118, 120, 122, 124		CHRYSLER 218		AY680 FIAT 412		BC910 BMW 152	
FORD 502		FORD 536, 538		IVECO 616		BD040 MITSUBISHI 820	
AY070 CITROËN 284, 286		OPEL 940		AY690 FIAT 412		BD070 VOLVO 1566, 1568	
FIAT 404		ROVER 1290, 1292		IVECO 616		BD620 AUDI 108	
PEUGEOT 1016, 1018		AY410 ALFA ROMEO 30, 34		AY700 FIAT 412		BD630 BMW 156	
AY090 CITROËN 284, 286		CHRYSLER 218		IVECO 616		BD790 FIAT 350	
PEUGEOT 1018		FORD 536, 538		AY710 OPEL 924		BE060 MITSUBISHI 818	
AY100 CITROËN 284, 286		OPEL 940		RENAULT 1190, 1196, 1198		BE440 FIAT 386	
PEUGEOT 1018		ROVER 1290, 1292		VAUXHALL 1524		BE450 FIAT 386	
AY110 CITROËN 260, 262		AY420 ALFA ROMEO 30, 34		VOLVO 1564, 1566		BE460 FIAT 386	
PEUGEOT 994, 996		CHRYSLER 218		AY720 OPEL 924		BE540 FORD 454	
AY120 CITROËN 270, 272		FORD 536, 538		RENAULT 1190, 1196, 1198		BE580 FIAT 410	
PEUGEOT 1002, 1004		OPEL 940		VAUXHALL 1524		IVECO 612	
AY160 OPEL 916		ROVER 1290, 1292		VOLVO 1564, 1566		RENAULT 1262, 1264, 1266,	
VAUXHALL 1518		AY430 FIAT 350		AY730 OPEL 924		1268	
AY170 OPEL 916		AY460 CITROËN 268		RENAULT 1190, 1196, 1198		BE620 ALFA ROMEO 16, 18	
VAUXHALL 1518		FIAT 372, 374, 378		VAUXHALL 1524		BF040 CITROËN 284	
AY180 OPEL 916		LANCIA 654		VOLVO 1564, 1566		BF100 PEUGEOT 988, 990	
VAUXHALL 1518		PEUGEOT 1000		AY800 TOYOTA 1478		BF170 CITROËN 256	
AY200 LAND ROVER 672		AY470 FIAT 374, 376		AY840 ISUZU 600		PEUGEOT 990, 996	
AY210 OPEL 902		LANCIA 654		OPEL 904, 906		BF350 RENAULT 1100	
VAUXHALL 1504		AY480 FIAT 366		VAUXHALL 1506, 1508		BF570 PEUGEOT 990, 996	
AY220 CHEVROLET 208		LANCIA 652		AY850 ISUZU 600		BF730 RENAULT 1114	
OPEL 910, 912		AY500 ALFA ROMEO 18, 20, 22		OPEL 904, 906		BG120 RENAULT 1268	
VAUXHALL 1512		FIAT 382		VAUXHALL 1506, 1508		BG130 RENAULT 1268	
AY260 VOLVO 1590, 1592		LANCIA 654, 656		AY860 ISUZU 600		BG170 PEUGEOT 1016, 1026, 1028	
AY270 BMW 154		AY510 ALFA ROMEO 16		OPEL 904, 906		RENAULT 1212, 1232, 1234,	
AY280 BMW 154		AY520 ALFA ROMEO 26		VAUXHALL 1506, 1508		1236, 1238, 1240,	
AY290 ALFA ROMEO 34		FIAT 386		AY900 ISUZU 600		1242, 1256, 1258,	
FIAT 410		LANCIA 656		OPEL 904, 906		1260	
LANCIA 664		AY530 ALFA ROMEO 26		VAUXHALL 1506, 1508		BG450 CITROËN 296, 298	
OPEL 940, 942		FIAT 386		AY910 ISUZU 600		PEUGEOT 1028	
VAUXHALL 1540		LANCIA 656		OPEL 904, 906		TALBOT 1436	
		AY540 ALFA ROMEO 26		VAUXHALL 1506, 1508		BG480 PEUGEOT 988, 990	
		FIAT 386		AY920 ISUZU 600		BG490 CITROËN 256	
		LANCIA 656		OPEL 904, 906		PEUGEOT 990, 996	
		AY550 ALFA ROMEO 32		VAUXHALL 1506, 1508		BG540 CITROËN 296	
		FIAT 408		AY930 VW 1632		BG720 NISSAN 864	
		LANCIA 662, 664				BG740 SUBARU 1414	
						BG830 SEAT 1340	

							
BG870 VW 1660, 1662	BK580 ALFA ROMEO 22, 24, 30, 34	BL950 TOYOTA 1472, 1474	BN360 RENAULT 1114, 1116	BG900 JEEP 626	BL960 RENAULT 1144, 1146	BN390 TOYOTA 1458	
RENAULT 1244, 1246, 1248, 1250	CHRYSLER 216, 218	VOLVO 1556	BN450 HONDA 562		BL970 RENAULT 1144, 1146	BN470 FORD 464	
BG940 VW 1722, 1724	OPEL 940	BL980 RENAULT 1144, 1146	BN480 SUBARU 1414		ROVER 1290, 1292	SUZUKI 1426	
BH060 MITSUBISHI 828, 830	BK610 SAAB 1300, 1304	VOLVO 1556	BN530 TOYOTA 1452		BK640 VOLVO 1572, 1574, 1576	BN550 SUBARU 1414	
BH080 JEEP 626	BK670 TOYOTA 1460	BM330 BEDFORD 138	BN580 CITROËN 254, 258		RENAULT 1244, 1246, 1248, 1250	PEUGEOT 988, 992	
RENAULT 1244, 1246, 1248, 1250	BK680 TOYOTA 1464	ISUZU 600	BN620 KIA 636		BH090 JEEP 626	BN640 TOYOTA 1468	
RENAULT 1244, 1246, 1248, 1250	BK700 TOYOTA 1468	BM360 AUDI 58, 62, 64, 78, 80	MAZDA 710		RENAULT 1244, 1246, 1248, 1250	VW 1662	
BH680 RENAULT 1100, 1102, 1104	BK840 NISSAN 858	FORD 484, 486	BN670 AUSTIN 134		RENAULT 1110, 1114, 1116, 1118, 1120, 1122	BN720 MERCEDES-BENZ 760, 762	
BH690 RENAULT 1110, 1114, 1116, 1118, 1120, 1122	BL010 BEDFORD 138	SEAT 1334, 1340, 1342, 1348	BN740 MERCEDES-BENZ 774, 776		VOLVO 1554	BN780 CITROËN 282	
BH700 LADA 640	OPEL 906	VW 1644, 1658, 1660, 1662, 1664, 1674, 1676, 1678, 1680	PEUGEOT 1014, 1024		BH700 LADA 640	BN940 AUDI 64	
BH850 ALFA ROMEO 22	VAUXHALL 1508	BM370 ISUZU 602	BN950 AUDI 64		BH850 ALFA ROMEO 22	VW 1644, 1658, 1660	
BH870 MERCEDES-BENZ 730, 736	BL030 BEDFORD 138	OPEL 934	BN960 AUDI 64		BH870 MERCEDES-BENZ 730, 736	BP030 FIAT 350	
BH880 MERCEDES-BENZ 748, 750, 752	OPEL 906	SSANGYONG 1408	VW 1644, 1658, 1660		BH880 MERCEDES-BENZ 748, 750, 752	SEAT 1320	
BH930 CITROËN 284, 296	VAUXHALL 1508	VAUXHALL 1534	BP050 FIAT 350		BH930 CITROËN 284, 296	BP060 FIAT 352	
BH950 CITROËN 254, 258	BL280 SUBARU 1414	BM380 OPEL 918	BP110 FIAT 370		BH950 CITROËN 254, 258	LANCIA 650	
PEUGEOT 988	BL310 NISSAN 862	VAUXHALL 1520	BP190 FIAT 402		PEUGEOT 988	BP260 ALFA ROMEO 22, 24, 30, 34	
BJ170 OPEL 926, 938	BL320 KIA 634	BM530 CITROËN 282	BP280 FIAT 352, 354		VAUXHALL 1538	CHRYSLER 216, 218	
VAUXHALL 1538	BL350 TOYOTA 1466	FIAT 400, 406	LANCIA 648		BJ420 MAZDA 692	FORD 536, 538	
BJ420 MAZDA 692	BL380 AUSTIN 134	PEUGEOT 1014, 1024	648, 650		BJ430 MAZDA 694	OPEL 940	
BJ430 MAZDA 694	ROVER 1284	BM570 INFINITI 596	BP290 FIAT 352, 354, 362		BJ440 FORD 464, 466, 468	ROVER 1290, 1292	
BJ440 FORD 464, 466, 468	BL390 BEDFORD 138	NISSAN 872, 874	BP300 FIAT 362		BJ600 MITSUBISHI 832	BP520 FIAT 350	
BJ600 MITSUBISHI 832	SUZUKI 1424	BM590 NISSAN 858	BP530 TOYOTA 1458		BJ610 HONDA 550	BP540 MAZDA 696	
BJ610 HONDA 550	BL400 FORD 538	BM740 SUZUKI 1424	BP550 NISSAN 872		BJ630 DAIHATSU 326	BP570 MAZDA 698	
BJ630 DAIHATSU 326	BL410 FORD 538	BM760 NISSAN 860	BP580 NISSAN 858		BJ690 NISSAN 850	BP600 MAZDA 694, 696, 698	
BJ690 NISSAN 850	BL450 HYUNDAI 584	BM790 RENAULT 1100, 1102, 1104	BP640 HONDA 572		FIAT 352	ROVER 1292	
BJ850 FIAT 352	BL550 OPEL 896	BM800 VOLVO 1554	BP650 TOYOTA 1470		FIAT 352	VW 1720	
BJ860 FIAT 362, 364	VAUXHALL 1498	BM830 MITSUBISHI 822, 824	BP660 FIAT 350		FIAT 352		
BJ870 FIAT 362, 364	BL570 SEAT 1320, 1324	BM840 AUDI 106, 108, 110			FIAT 352		
BJ880 FIAT 362, 364	VW 1624, 1626, 1628, 1630, 1632	VW 1718, 1720			FIAT 352		
BK080 NISSAN 872	BL610 PEUGEOT 1026	BM850 CARBODIES 200			FIAT 352		
BK410 MITSUBISHI 822	BL620 CITROËN 258	BM880 TOYOTA 1474			FIAT 352		
BK420 MITSUBISHI 818	PEUGEOT 988	BM900 DAIHATSU 332			FIAT 352		
BK440 NISSAN 850, 852, 854	BL650 CITROËN 268, 270, 272, 274, 276, 278, 280, 282, 290	BM910 SUZUKI 1424			FIAT 352		
BK450 AUSTIN 134	PEUGEOT 1000, 1002, 1006, 1008, 1010, 1012	BM950 FORD 466			FIAT 352		
ROVER 1280		BM960 FORD 466			FIAT 352		
BK470 BEDFORD 138		BM980 FORD 466			FIAT 352		
OPEL 900		BM990 ACURA 2			FIAT 352		
VAUXHALL 1502		HONDA 554			FIAT 352		
BK480 NISSAN 858	BL680 BMW 170, 176	ROVER 1280			FIAT 352		
OPEL 906	BL690 BMW 192	BN010 OPEL 896			FIAT 352		
VAUXHALL 1508	BL760 NISSAN 850	BN040 OPEL 896, 898			FIAT 352		
BK570 ALFA ROMEO 22, 24, 30, 34	BL820 TOYOTA 1460	VAUXHALL 1498, 1500			FIAT 352		
CHRYSLER 216, 218	BL822 TOYOTA 1460	BN140 FORD 466			FIAT 352		
FORD 536, 538	BL830 CITROËN 296, 298	BN150 FORD 478, 480			FIAT 352		
OPEL 940	PEUGEOT 1030	BN200 TOYOTA 1452			FIAT 352		
ROVER 1290, 1292	BL910 RENAULT 1164, 1166, 1168, 1170, 1172, 1174, 1176, 1178	BN220 MITSUBISHI 822			FIAT 352		
	VOLVO 1556, 1558, 1560	BN230 HYUNDAI 582			FIAT 352		
		MITSUBISHI 820			FIAT 352		
		BN330 HYUNDAI 580			FIAT 352		
		MITSUBISHI 818			FIAT 352		

NUMERICAL PARTS LIST





Numerische Teilenummernliste • Liste des références produits
Elenco numerico articoli • Lista de referencias









 BP720 CITROËN 258		 BR430 BMW 170		 BR990 ISUZU 602, 604		 BS730 CITROËN 260	
PEUGEOT 988, 992		BR440 BMW 170		OPEL 938, 942		PEUGEOT 994	
BP730 SUBARU 1414		BR490 CITROËN 254, 256		VAUXHALL 1538, 1540		BS760 NISSAN 866, 870	
BP760 PEUGEOT 990, 996		PEUGEOT 988, 990		BS010 RENAULT 1144, 1146		BS770 FORD 528	
BP800 BEDFORD 138		BR510 CITROËN 268, 270, 272, 274, 276, 278, 280, 282		VOLVO 1556		NISSAN 866	
CHEVROLET 208		PEUGEOT 1000, 1002, 1006, 1008, 1010, 1012		BS020 RENAULT 1144, 1146		BS790 ROVER 1286, 1288, 1290	
DAEWOO 316, 318		BR540 HONDA 550, 552		VOLVO 1556		BS810 CITROËN 254, 256	
OPEL 906, 908, 910		BR560 SUBARU 1414		BS030 RENAULT 1144, 1146		PEUGEOT 988, 990	
VAUXHALL 1508, 1510, 1512		BR580 TOYOTA 1464, 1466		VOLVO 1556		BS820 CITROËN 284, 292	
BP810 DAEWOO 318		BR600 CHRYSLER 218		BS050 NISSAN 858		PEUGEOT 1016	
OPEL 918, 920		HYUNDAI 592		BS060 TOYOTA 1466, 1468		BS830 INFINITI 596	
VAUXHALL 1520, 1522		LANCIA 654		BS070 MAZDA 700		BS840 INFINITI 596	
BP820 CHEVROLET 210		PEUGEOT 1000		BS090 DAIHATSU 326		BS860 ROVER 1288, 1290	
DAEWOO 318		BR620 FIAT 364, 366, 370		BS110 HONDA 562		BS870 TOYOTA 1474	
OPEL 926, 928, 930, 932		LANCIA 650, 652, 656		BS120 HYUNDAI 586		BS880 HONDA 556, 558	
VAUXHALL 1526, 1528, 1530, 1532		BR630 CITROËN 268		KIA 634		ROVER 1284	
BP860 FIAT 362, 364, 372		FIAT 372, 374, 378		NISSAN 872		BS910 NISSAN 872	
LANCIA 652		LANCIA 654		BS130 HYUNDAI 590		BS940 MAZDA 696, 698	
BP880 ROVER 1290		PEUGEOT 1000		KIA 636		BS950 MAZDA 700, 702	
BP890 PEUGEOT 1028		BR650 ACURA 2		NISSAN 834		BS953 MAZDA 702	
BP900 PEUGEOT 1028		HONDA 572		BS230 ISUZU 600		BS970 TOYOTA 1470	
BP910 PEUGEOT 1028		ROVER 1292		BS240 HYUNDAI 584		BT020 VW 1658	
BP920 ISUZU 602		BR660 NISSAN 866, 868		NISSAN 822, 824		BT070 JAGUAR 622	
OPEL 938		BR670 DAIHATSU 328		BS260 BEDFORD 138		BT080 DACIA 306	
BP950 NISSAN 852		BR680 ALFA ROMEO 26		CHEVROLET 206, 208		VOLVO 1554	
BP970 NISSAN 856		FIAT 378, 380, 384, 394		DAEWOO 316		BT110 FORD 438	
BP990 ALFA ROMEO 20		LANCIA 656		OPEL 900, 902		BT140 FORD 442, 444, 446	
BR010 OPEL 938		BR690 FIAT 394		VAUXHALL 1502, 1504		MAZDA 694	
VAUXHALL 1536, 1538		LANCIA 656		BS290 LEXUS 680		BT190 FORD 480, 482, 484, 488, 490, 492, 494, 496	
BR020 OPEL 938		BR700 FIAT 394		TOYOTA 1474, 1478		BT200 FORD 480, 482, 484, 488, 490, 492, 494, 496	
VAUXHALL 1536, 1538		LANCIA 656		BS300 LEXUS 680		BT210 FORD 480, 482, 484, 488, 490, 492, 494, 496	
BR030 OPEL 938		BR730 MAZDA 702, 710		TOYOTA 1474, 1478		BT220 FIAT 378, 380, 384, 386	
VAUXHALL 1536, 1538		BR750 TOYOTA 1458		BS320 BMW 176		BT230 FIAT 378, 380, 384, 386	
BR070 ALFA ROMEO 32		BR780 CITROËN 274		BS360 TOYOTA 1478		BT240 FIAT 378, 380, 384, 386	
FIAT 410		HONDA 560		BS370 TOYOTA 1478		LANCIA 660	
RENAULT 1264, 1268		PEUGEOT 1006		BS430 DAIHATSU 326, 328		BT260 FIAT 350	
BR090 FIAT 410		ROVER 1286		BS460 KIA 636		BT320 FIAT 384	
LANCIA 664		BR790 CITROËN 274		MAZDA 710		BT340 ALFA ROMEO 20, 22	
BR120 FIAT 364		HONDA 560		BS520 RENAULT 1190, 1192, 1194, 1196, 1198		BT350 ALFA ROMEO 28	
BR140 DAIHATSU 326		PEUGEOT 1006		1184, 1186, 1190, 1192, 1194, 1196, 1198, 1212, 1214, 1216, 1218		BT360 ALFA ROMEO 22	
BR160 NISSAN 850		ROVER 1286		BS530 RENAULT 1178, 1180, 1182, 1184, 1186, 1190, 1192, 1194, 1196, 1198, 1212, 1214, 1216, 1218		BT380 ALFA ROMEO 34, 36	
BR190 ISUZU 602		BR830 BMW 152, 154		BS540 RENAULT 1190, 1192, 1194, 1196, 1198		LANCIA 666	
BR200 ISUZU 602		BR841 BMW 156		1196, 1198		BT390 ALFA ROMEO 34	
OPEL 934		BR850 KIA 634		BS600 SUZUKI 1428		BT400 FIAT 364, 366	
VAUXHALL 1534		MAZDA 704, 706		BS610 NISSAN 856		BT410 FIAT 400, 402	
BR240 NISSAN 854		BR880 DAIHATSU 328, 330, 332		BS620 LADA 640		LANCIA 652, 656	
BR250 TOYOTA 1466		BR890 TOYOTA 1480		BS630 LADA 640		BT420 ALFA ROMEO 28	
BR260 NISSAN 874		BR900 TOYOTA 1458		BS700 HONDA 560, 564, 566, 568		FIAT 372, 398, 400, 402	
BR270 TOYOTA 1456		BR940 ISUZU 602		ROVER 1286, 1290		LANCIA 656, 658	
BR280 CITROËN 296, 298		BR960 KIA 632		BS720 LADA 642		BT430 MITSUBISHI 818, 820	
BR290 LAND ROVER 672		MAZDA 692		OPEL 928, 932		PROTON 1036	
BR300 TOYOTA 1478		BR970 MAZDA 712		VAUXHALL 1528, 1530			
BR330 TOYOTA 1468		BR980 MAZDA 712					
BR360 NISSAN 862							
BR420 BMW 170							

 BT440 ALFA ROMEO 28, 30 FIAT 382, 400, 402, 404 LANCIA 656, 658, 660		 BV350 ACURA 2 HONDA 550, 556, 558 ROVER 1284		 BW010 FORD 480, 482, 484, 486, 490, 492, 494, 496, 498 MAZDA 704		 BW980 ALFA ROMEO 26 FIAT 378, 380, 384, 386, 394 SEAT 1340	
BT470 AUDI 106		BV360 HONDA 564, 568		BW020 FORD 480, 482, 484, 486, 490, 492, 494, 496, 498 MAZDA 704		BW5750 LOTUS 684 MG 802 ROVER 1280, 1282, 1284, 1286	
BT481 FORD 512, 514		BV370 TOYOTA 1462		BW030 FORD 480, 482, 484, 486, 490, 492, 494, 496, 498 MAZDA 704		BX030 FIAT 374, 376 LANCIA 654	
BT510 FIAT 398, 400 FORD 538, 540, 542		BV380 MAZDA 698, 702, 706		BW170 OPEL 896, 898 VAUXHALL 1498, 1500		BX040 FIAT 366 LANCIA 652	
BT520 FIAT 398, 400 FORD 538, 540, 542		BV410 MAZDA 712		BW280 ALFA ROMEO 28, 30		BX060 TOYOTA 1474	
BT530 OPEL 938, 942 VAUXHALL 1540		BV420 MAZDA 712		BW290 ALFA ROMEO 28, 30		BX080 VOLVO 1558	
BT540 MERCEDES-BENZ 740		BV430 KIA 632 MAZDA 692		BW321 FIAT 400, 402 LANCIA 658, 660		BX090 VOLVO 1568	
BT550 MERCEDES-BENZ 778, 780		BV440 NISSAN 856		BW330 LANCIA 662		BX190 TOYOTA 1478	
BT560 SAAB 1300, 1302, 1306		BV450 SUBARU 1416		BW340 FIAT 408 LANCIA 662		BX270 BMW 194	
BT580 SKODA 1376, 1378, 1380		BV460 SEAT 1324 VW 1630, 1632		BW350 FIAT 408 LANCIA 662		BX281 BMW 194	
BT680 BMW 158, 160		BV471 SEAT 1324 VW 1630, 1632		BW360 FIAT 408 LANCIA 662		BX290 BMW 194	
BT691 BMW 170, 172, 176		BV510 MAZDA 698		BW370 MERCEDES-BENZ 754, 756 SSANGYONG 1408		BX300 BMW 194	
BT800 FORD 528, 530, 532 LDV 676		BV540 NISSAN 864		BW380 DAEWOO 320 MERCEDES-BENZ 772 SSANGYONG 1410		BX390 CITROËN 298 FIAT 412 IVECO 616 PEUGEOT 1030 RENAULT 1268	
BT810 AUDI 80, 88 SEAT 1358 VW 1696		BV670 FIAT 356, 358, 362 LANCIA 650		BW410 ALFA ROMEO 22, 30		BX400 CITROËN 298, 300 FIAT 412 IVECO 614, 616 OPEL 944 PEUGEOT 1030 RENAULT 1268 VAUXHALL 1542	
BT820 AUDI 110, 112		BV680 ALFA ROMEO 24, 26 FIAT 378, 380, 384, 386, 394 SEAT 1340		BW420 NISSAN 860		BX410 CITROËN 298, 300 FIAT 412 IVECO 614, 616 OPEL 944 PEUGEOT 1030 RENAULT 1268 VAUXHALL 1542	
BT860 FIAT 350		BV690 ALFA ROMEO 24, 26 FIAT 378, 380, 384, 386, 394 SEAT 1340		BW540 NISSAN 870		BX420 CITROËN 298, 300 FIAT 412 IVECO 614, 616 OPEL 944 PEUGEOT 1030 RENAULT 1268 VAUXHALL 1542	
BT880 HYUNDAI 588 MITSUBISHI 832		BV700 ALFA ROMEO 24, 26 FIAT 378, 380, 384, 386, 394 SEAT 1340		BW560 TOYOTA 1464		BX480 FORD 478	
BT890 MITSUBISHI 822, 824 PROTON 1036		BV830 HONDA 560, 564, 568		BW620 NISSAN 872		BX550 FORD 514, 518	
BT900 SUZUKI 1424		BV850 AUDI 80 SEAT 1348 SKODA 1388		BW630 FORD 460, 462		BX570 RENAULT 1238, 1258	
BV010 MITSUBISHI 836		BV860 AUDI 80 SEAT 1348 SKODA 1388 VW 1680, 1682, 1692		BW640 FORD 480, 486, 488		BX580 RENAULT 1238, 1240, 1242	
BV020 HONDA 550, 552, 554, 556, 558 ROVER 1284		BV870 AUDI 80 SEAT 1348 SKODA 1388 VW 1680, 1682, 1692		BW650 FORD 516, 518		BX590 RENAULT 1242	
BV030 HONDA 570 ROVER 1290		BV880 VW 1724, 1726, 1728		BW680 VOLVO 1582 VW 1722, 1724		BX600 RENAULT 1178, 1180, 1182, 1184, 1186, 1212, 1214, 1216, 1218	
BV040 HONDA 554, 560		BV890 VW 1724, 1726, 1728		BW690 VOLVO 1582 VW 1722, 1724		BX610 RENAULT 1190	
BV050 HONDA 562		BV940 FIAT 352, 354 LANCIA 648		BW700 VOLVO 1582 VW 1722, 1724			
BV090 ACURA 2, 4 HONDA 574		BV950 OPEL 944 VAUXHALL 1542		BW710 ALFA ROMEO 28, 30			
BV100 ACURA 2, 4 HONDA 574		BV990 NISSAN 852		BW720 ALFA ROMEO 18, 20, 22 FIAT 382 LANCIA 654, 656			
BV110 KIA 632 MAZDA 696, 698				BW730 BMW 170, 172			
BV140 CITROËN 284, 286, 292 FIAT 404 LANCIA 660 PEUGEOT 1016, 1018				BW740 BMW 170, 172			
BV150 CITROËN 292 PEUGEOT 1024				BW750 LOTUS 684 MG 802 ROVER 1280, 1282, 1284, 1286			
BV160 CITROËN 292 PEUGEOT 1024				BW790 VW 1678, 1696			
BV190 RENAULT 1110, 1112				BW800 TOYOTA 1472			
BV250 NISSAN 872							
BV330 TOYOTA 1454, 1456							
BV340 HONDA 568							

NUMERICAL PARTS LIST









Numerische Teilenummernliste • Liste des références produits
Elenco numerico articoli • Lista de referencias









 BX620 RENAULT 1232	 BX890 CITROËN 276, 278, 280, 282	 BY030 DACIA 308	 BY430 FIAT 386
BX630 NISSAN 850	FIAT 398	RENAULT 1132, 1162, 1164	BY460 TOYOTA 1480
RENAULT 1106, 1108, 1110	HYUNDAI 586	BY070 RENAULT 1252	BY470 LAND ROVER 670, 672
BX651 RENAULT 1210, 1212	LADA 642	BY080 RENAULT 1252	BY480 LAND ROVER 670, 672
VOLVO 1560, 1562, 1564	PEUGEOT 1006, 1008, 1010, 1012	BY120 CITROËN 260	BY490 LAND ROVER 670, 672
BX720 RENAULT 1112, 1114, 1122, 1124, 1126, 1128	SUZUKI 1430	PEUGEOT 994	BY500 LAND ROVER 670, 672
BX730 RENAULT 1112, 1114, 1122, 1124, 1126, 1128	TALBOT 1436	ROVER 1282	BY560 BMW 154
BX740 RENAULT 1110, 1112	BX900 CITROËN 276, 278, 280, 282	BY130 CITROËN 258, 260, 262	BY580 MERCEDES-BENZ 780, 782
BX780 MAZDA 706	FIAT 398	PEUGEOT 996	BY590 MERCEDES-BENZ 762
BX790 MAZDA 706	HYUNDAI 586	BY140 CITROËN 296	BY620 SEAT 1334
BX800 AUDI 80, 82, 84	LADA 642	PEUGEOT 1028	VW 1644
FORD 500	PEUGEOT 1006, 1008, 1010, 1012	BY150 CITROËN 264	BY630 VW 1662, 1678
SEAT 1340, 1348, 1350, 1354	SUZUKI 1430	NISSAN 854	BY640 FORD 512
VW 1660, 1662, 1680, 1682, 1684, 1686, 1688, 1690	TALBOT 1436	PEUGEOT 996	BY650 FORD 438, 440
BX810 AUDI 80, 82, 84	BX910 CITROËN 276, 278, 280, 282	ROVER 1284	MAZDA 692
FORD 500	FIAT 398	BY170 CITROËN 258, 260, 262	BY660 FORD 450, 452
SEAT 1340, 1348, 1350, 1354	HYUNDAI 586	BY180 CITROËN 270, 272	BY730 HYUNDAI 580, 582
VW 1660, 1662, 1680, 1682, 1684, 1686, 1688, 1690	LADA 642	PEUGEOT 1002, 1004	BY740 FORD 448, 450, 452
BX820 AUDI 80, 82, 84	PEUGEOT 1006, 1008, 1010, 1012	BY240 CHEVROLET 210	BY750 AUDI 88
FORD 500	SUZUKI 1430	DAEWOO 318	SEAT 1358
SEAT 1340, 1348, 1350, 1354	TALBOT 1436	OPEL 920	VW 1696, 1698
VW 1660, 1662, 1680, 1682, 1684, 1686, 1688, 1690	BX920 CITROËN 276, 278, 280, 282	VAUXHALL 1520, 1522	BY900 NISSAN 850
BX830 CITROËN 274	FIAT 398	BY250 CHEVROLET 210	RENAULT 1100
PEUGEOT 1004, 1006	HYUNDAI 586	DAEWOO 318, 320	BY930 CITROËN 292, 294
BX840 CITROËN 274	LADA 642	OPEL 930, 932, 936, 938	PEUGEOT 1024
PEUGEOT 1004, 1006	PEUGEOT 1006, 1008, 1010, 1012	VAUXHALL 1532, 1534, 1536	BY941 CITROËN 292, 294
BX850 CITROËN 274	SUZUKI 1430	BY260 OPEL 930	FIAT 406
PEUGEOT 1004, 1006	TALBOT 1436	VAUXHALL 1528	LANCIA 662
BX860 CITROËN 274	BX930 CITROËN 278, 280	BY270 OPEL 940, 942	PEUGEOT 1024
PEUGEOT 1004, 1006	FIAT 396	SAAB 1308	BY950 CITROËN 292, 294
BX870 CITROËN 274	PEUGEOT 1008, 1010, 1012	VAUXHALL 1538, 1540	FIAT 406
PEUGEOT 1004, 1006	SUZUKI 1430	BY300 OPEL 944	LANCIA 662
BX880 CITROËN 276, 278, 280, 282	TALBOT 1436	SAAB 1308	PEUGEOT 1024
FIAT 398	BX940 CITROËN 278, 280	VAUXHALL 1542	BY961 CITROËN 292, 294
HYUNDAI 586	FIAT 396	BY310 CITROËN 286	FIAT 406
LADA 642	PEUGEOT 1008, 1010, 1012	FIAT 404	LANCIA 662
PEUGEOT 1006, 1008, 1010, 1012	SUZUKI 1430	PEUGEOT 1018	PEUGEOT 1024
BX970 CITROËN 278, 280	BX950 CITROËN 278, 280	BY320 CITROËN 286, 292	BY970 CITROËN 292, 294
FIAT 396	FIAT 396	FIAT 404	FIAT 406
PEUGEOT 1008, 1010, 1012	PEUGEOT 1008, 1010, 1012	PEUGEOT 1016, 1018	LANCIA 662
SUZUKI 1430	SUZUKI 1430	BY330 OPEL 914	PEUGEOT 1024
TALBOT 1436	FIAT 396	VAUXHALL 1516	BY981 CITROËN 292, 294
BX960 CITROËN 278, 280	PEUGEOT 1008, 1010, 1012	BY340 BEDFORD 138	FIAT 406
FIAT 396	SUZUKI 1430	OPEL 914	LANCIA 662
PEUGEOT 1008, 1010, 1012	BX970 CITROËN 278, 280	VAUXHALL 1516	PEUGEOT 1024
SUZUKI 1430	FIAT 396	BY350 BEDFORD 138	BZ010 AUDI 82, 84
BX980 CITROËN 278, 280	PEUGEOT 1008, 1010, 1012	OPEL 914	SEAT 1350, 1352
FIAT 396	SUZUKI 1430	VAUXHALL 1516	SKODA 1390
PEUGEOT 1008, 1010, 1012	BX990 CITROËN 278, 280	BY361 RENAULT 1262	VW 1684, 1686
SUZUKI 1430	FIAT 396	VOLVO 1582, 1588	BZ020 AUDI 82, 84
BX990 CITROËN 278, 280	PEUGEOT 1008, 1010, 1012	BY371 VOLVO 1570, 1576, 1578	SEAT 1350, 1352
FIAT 396	SUZUKI 1430	BY380 FIAT 356, 358	SKODA 1390
PEUGEOT 1008, 1010, 1012	BX990 CITROËN 278, 280	LANCIA 648, 650	VW 1684, 1686
SUZUKI 1430	FIAT 396	BY390 ALFA ROMEO 16	
BX990 CITROËN 278, 280	PEUGEOT 1008, 1010, 1012	BY410 FIAT 386	
FIAT 396	SUZUKI 1430	BY420 FIAT 386	
PEUGEOT 1008, 1010, 1012			
SUZUKI 1430			

							
BZ030	AUDI 82, 84 SEAT 1350, 1352 SKODA 1390 VW 1684, 1686	BZ670	BMW 176	CA5620	VOLVO 1554, 1562	CB5670	CHEVROLET 212 OPEL 932, 934, 936 SAAB 1306 VAUXHALL 1530, 1532, 1534, 1536
BZ040	AUDI 82, 84 SEAT 1350, 1352, 1354 SKODA 1390, 1392 VW 1684, 1686, 1688, 1692	BZ680	BMW 176	CA5780	ALFA ROMEO 32 LANCIA 664	CB5671	OPEL 936, 946 SAAB 1306 VAUXHALL 1534, 1536, 1542
BZ050	AUDI 82, 84 SEAT 1350, 1352, 1354 SKODA 1390, 1392 VW 1684, 1686, 1688, 1692	BZ690	MG 802 ROVER 1290	CA5830	CITROËN 282 FIAT 398 PEUGEOT 1014 TOYOTA 1462	CB5700	AUDI 56 SEAT 1326, 1328, 1330, 1332 SKODA 1378, 1380, 1382 VW 1632, 1634, 1636, 1638, 1640, 1642
BZ060	AUDI 82, 84 SEAT 1350, 1352, 1354 SKODA 1390, 1392 VW 1684, 1686, 1688, 1692	BZ700	MG 802 ROVER 1290	CA5920	LAND ROVER 672 MG 802 ROVER 1288, 1292	CB5720	FIAT 408, 410 IVECO 610
BZ111	BMW 170, 172 LAND ROVER 672 OPEL 938, 942 VAUXHALL 1538, 1540	BZ710	MG 802 ROVER 1290	CA5941	FORD 526, 528	CB5750	TOYOTA 1454, 1456
BZ120	BMW 170, 172 OPEL 938, 942 VAUXHALL 1538, 1540	BZ790	FIAT 388, 392	CA5970	FORD 500, 504, 508, 510, 512, 520	CB5760	TOYOTA 1454, 1458, 1460
BZ130	BMW 156	BZ800	FIAT 388, 392	CB5000	TOYOTA 1458	CC5010	CITROËN 288, 290, 292 FIAT 404, 406 LANCIA 660 PEUGEOT 1020, 1022, 1024 SUZUKI 1430, 1432
BZ170	TOYOTA 1474, 1476	BZ810	FIAT 388, 392	CB5080	KIA 636	CC5011	CITROËN 288, 290, 292 PEUGEOT 1020, 1022, 1024 SUZUKI 1432
BZ180	SEAT 1326, 1328, 1334, 1336 SKODA 1382, 1386 VW 1630, 1632, 1634, 1636, 1646, 1648	BZ850	MERCEDES-BENZ 732	CB5120	FORD 440, 442 MAZDA 692	CC5060	MITSUBISHI 826 NISSAN 860 OPEL 924, 926 RENAULT 1198, 1200, 1202, 1204, 1206, 1208, 1210 SUZUKI 1428 VAUXHALL 1524 VOLVO 1566
BZ280	HYUNDAI 590 KIA 636	BZ860	MERCEDES-BENZ 748	CB5130	FORD 450, 452, 454	CC5100	DACIA 308 NISSAN 858 RENAULT 1130, 1132, 1148, 1150, 1152, 1154
BZ290	HYUNDAI 590 KIA 636	BZ870	MERCEDES-BENZ 762, 764	CB5133	FORD 448, 454 MAZDA 694	CC5110	DACIA 308 RENAULT 1146, 1152, 1154, 1156, 1158, 1160
BZ300	CHEVROLET 208 DAEWOO 316	BZ880	MERCEDES-BENZ 738, 740, 746, 748 SSANGYONG 1408	CB5140	OPEL 896 VAUXHALL 1498	CC5190	AUDI 56 VW 1626
BZ340	LEXUS 680 TOYOTA 1478, 1480	BZ890	MERCEDES-BENZ 754	CB5150	FIAT 376 LANCIA 654	CC5220	AUDI 58, 60 VW 1646, 1648, 1650
BZ350	LEXUS 680 TOYOTA 1478, 1480	BZ900	DAEWOO 320 MERCEDES-BENZ 752, 754 SSANGYONG 1408 VW 1720	CB5200	TOYOTA 1478	CC5221	AUDI 60 SEAT 1336 VW 1650
BZ440	HONDA 562 ROVER 1288	BZ910	SEAT 1342 VW 1654, 1664, 1668, 1674, 1680	CB5230	CHEVROLET 208 DAEWOO 318	CC5222	AUDI 60, 62 SEAT 1338, 1340 SKODA 1382, 1384, 1386 VW 1650, 1652, 1654, 1656, 1658
BZ450	HONDA 562 ROVER 1288	BZ930	VOLVO 1582 VW 1722	CB5240	OPEL 898 VAUXHALL 1500		
BZ460	HONDA 562 ROVER 1288	BZ960	AUDI 112, 114, 120	CB5241	OPEL 898 VAUXHALL 1500		
BZ490	FORD 504, 506, 508, 516, 518	CA3140	SEAT 1332, 1340	CB5360	OPEL 902 VAUXHALL 1504		
BZ500	BMW 156	CA5021	NISSAN 834, 836	CB5370	SEAT 1360 SKODA 1396 VW 1696, 1698, 1700, 1702		
BZ510	BMW 156	CA5130	FORD 538 MAZDA 712	CB5371	SKODA 1396 VW 1700		
BZ520	BMW 156	CA5410	SEAT 1320, 1322 VW 1624	CB5420	VOLVO 1560, 1562, 1564		
BZ530	AUDI 66, 68, 70	CA5420	ALFA ROMEO 18, 20, 30	CB5421	VOLVO 1562, 1564		
BZ660	BMW 176	CA5421	FIAT 382 LANCIA 654	CB5440	VOLVO 1570, 1572, 1578		
		CA5430	MERCEDES-BENZ 768 VW 1734, 1736	CB5452	VOLVO 1578, 1580		
		CA5431	FORD 538	CB5540	OPEL 912, 914 VAUXHALL 1514, 1516		
		CA5470	VW 1722, 1724, 1726, 1728, 1730, 1732	CB5550	MERCEDES-BENZ 730		
		CA5500	SEAT 1326 VW 1632	CB5556	MERCEDES-BENZ 730		
		CA5560	ALFA ROMEO 24, 26 FIAT 388, 390, 392, 394, 396	CB5570	MERCEDES-BENZ 734, 736, 742		
		CA5561	ALFA ROMEO 24, 26 FIAT 388, 390, 392, 394, 396	CB5630	NISSAN 858		
			LANCIA 656, 658	CB5660	BMW 156		
			LANCIA 656 OPEL 926 SAAB 1298 VAUXHALL 1526				
		CA5590	FIAT 402, 408 LANCIA 658				

NUMERICAL PARTS LIST









Numerische Teilenummernliste • Liste des références produits
Elenco numerico articoli • Lista de referencias









 CC5223 AUDI 60 SEAT 1336 VW 1648		 CC5920 CHRYSLER 216 MINI 808		 CD5640 SEAT 1326, 1328, 1330 VW 1634, 1638		 CE5180 FIAT 356, 358 LANCIA 648	
CC5230 AUDI 84, 86 FORD 500 SEAT 1352, 1354, 1356, 1358 SKODA 1392, 1394, 1396 VW 1686, 1688, 1690, 1692, 1694		CC5921 MINI 808 CC5960 AUDI 116, 118 SKODA 1400 VW 1726, 1730, 1732		CD5650 AUDI 56 SEAT 1326, 1330 SKODA 1378, 1380 VW 1634, 1636, 1638, 1640		CE5181 FIAT 358 LANCIA 650 CE5200 DACIA 306 NISSAN 852, 854 RENAULT 1134, 1136, 1138, 1140, 1142 SUZUKI 1426, 1428	
CC5231 AUDI 82, 84, 94 FORD 500 SEAT 1352, 1354, 1356 SKODA 1392, 1394, 1398 VW 1686, 1688, 1694, 1702, 1704, 1706, 1730		CD5100 CITROËN 276 PEUGEOT 1006 CD5130 CITROËN 258 FORD 450, 454 MAZDA 694 PEUGEOT 992 SUZUKI 1426		CD5690 DAEWOO 316 CD5691 CHEVROLET 206 CD5720 JEEP 626 MERCEDES-BENZ 766, 768, 782		CE5210 NISSAN 864, 868 OPEL 936, 940 RENAULT 1252, 1254, 1256, 1264, 1266 VAUXHALL 1534, 1538	
CC5280 SEAT 1336 VW 1648, 1650		CD5140 CITROËN 258, 266, 268 FIAT 372 FORD 458, 460, 468 MAZDA 698 MINI 806 PEUGEOT 998, 1000 SUZUKI 1428		CD5810 ALFA ROMEO 12 CHEVROLET 206 FIAT 356, 360 FORD 440 LANCIA 650 OPEL 896, 898, 900 SUZUKI 1424 VAUXHALL 1498, 1500		CE5241 FIAT 358, 362 LANCIA 650 CE5242 FIAT 358, 360 LANCIA 650 CE5320 FORD 504, 506, 508, 522	
CC5281 SEAT 1338 VW 1652		CD5180 CITROËN 270, 272 PEUGEOT 1004		CD5820 ALFA ROMEO 12 FIAT 360, 362 LANCIA 650 OPEL 898 VAUXHALL 1500		CE5330 DAEWOO 320 MERCEDES-BENZ 768, 770, 786, 788, 794 SSANGYONG 1408, 1410	
CC5282 AUDI 60 VW 1652		CD5190 RENAULT 1252		CD5840 ALFA ROMEO 24 FIAT 390, 394, 396 OPEL 926 SAAB 1298 VAUXHALL 1526		CE5331 MERCEDES-BENZ 786 CE5470 KIA 636	
CC5290 FORD 468		CD5220 FORD 504, 512, 526 MAZDA 712 VOLVO 1568		CD5910 ALFA ROMEO 32 LANCIA 664 CD5960 LANCIA 660 CD5970 FIAT 376 LANCIA 654		CE5521 CHEVROLET 208 OPEL 916 VAUXHALL 1518 CE5522 OPEL 916 VAUXHALL 1518 CE5523 OPEL 916 VAUXHALL 1518 CE5612 MITSUBISHI 824 VOLVO 1562	
CC5310 BMW 168, 172, 178		CD5221 FORD 502, 504, 512, 520, 522, 526		CD5980 NISSAN 850 RENAULT 1104, 1106		CE5760 CHRYSLER 218 MERCEDES-BENZ 766, 770, 788, 790	
CC5350 BMW 192, 194, 196, 198		CD5230 HONDA 554, 556		CD5981 NISSAN 850 RENAULT 1104, 1106		CE5920 CHEVROLET 208 OPEL 912 VAUXHALL 1514	
CC5410 BMW 156, 158		CD5250 NISSAN 854		CD5991 NISSAN 862 OPEL 1186, 1188, 1218, 1220, 1222, 1224, 1226, 1228		CE5930 OPEL 912, 914 VAUXHALL 1514, 1516 CE5950 OPEL 896 SUZUKI 1424 VAUXHALL 1498	
CC5440 BMW 154, 160, 162		CD5260 NISSAN 866		CD9270 LEXUS 680 TOYOTA 1478		CF073 AUSTIN 134 CF474 ROVER 1280 CF5030 LEXUS 680 TOYOTA 1480	
CC5441 BMW 152		CD5280 NISSAN 860		CE5010 CITROËN 272 PEUGEOT 1004		CF5070 HYUNDAI 588, 590 CF5430 HYUNDAI 586, 588 KIA 634	
CC5460 CHEVROLET 210 OPEL 922, 924 SAAB 1298 VAUXHALL 1522, 1524		CD5300 CITROËN 284, 292 FIAT 404 PEUGEOT 1016, 1024		CE5050 CITROËN 296 PEUGEOT 1028		CF5470 MITSUBISHI 818 CF5481 MITSUBISHI 820 CF5500 MITSUBISHI 830 CF5541 NISSAN 862 CF5600 NISSAN 876	
CC5520 MERCEDES-BENZ 776		CD5310 CITROËN 272 PEUGEOT 1004		CE5060 SAAB 1304, 1308			
CC5550 CHRYSLER 216		CD5340 TOYOTA 1466, 1470		CE5111 RENAULT 1224			
CC5562 CHRYSLER 216		CD5380 TOYOTA 1452		CE5130 VOLVO 1554, 1560, 1562			
CC5580 CHRYSLER 218		CD5381 TOYOTA 1452		CE5131 VOLVO 1554, 1560, 1562			
CC5620 MERCEDES-BENZ 742, 744, 748, 766		CD5400 ISUZU 604 OPEL 942, 944, 946 VAUXHALL 1540, 1542					
CC5630 SAAB 1302, 1304, 1306		CD5490 CITROËN 294 FIAT 404, 406 LANCIA 662 PEUGEOT 1026					
CC5661 SMART 1404		CD5500 CITROËN 288 FIAT 404					
CC5670 SMART 1404		FORD 502, 504, 508, 510, 520, 522					
CC5680 FORD 524, 526		PEUGEOT 1020					
CC5690 SAAB 1306		VOLVO 1572					
CC5700 CITROËN 256 PEUGEOT 990		CD6300 SEAT 1320, 1322 VW 1624, 1626					
CC5720 CHRYSLER 216							
CC5750 FORD 538 NISSAN 870							
CC5800 FORD 470, 472							
CC5801 FORD 470, 472, 474							
CC5860 FORD 456, 460, 464, 468							
CC5870 FORD 536							
CC5890 FORD 456							
CC5900 BMW 172, 176							
CC5901 BMW 168, 172, 178							

 CF5690 INFINITI 596		 CG5781 ISUZU 604		 CG7970 DAIHATSU 326		 CG9180 HONDA 550	
NISSAN 874		OPEL 946		CG7980 SUBARU 1414		CG9310 CITROËN 254	
CF5740 NISSAN 874		VAUXHALL 1542		CG7990 CHEVROLET 206		DAIHATSU 326	
CF5760 SUBARU 1418		CG5790 HONDA 560		DAEWOO 316		PEUGEOT 988	
CF5780 TOYOTA 1464		CG5792 HONDA 560		CG8000 CHEVROLET 206		SUBARU 1414	
CF5781 TOYOTA 1464		CG5810 HONDA 566, 572		DAEWOO 316		TOYOTA 1452	
CF5792 TOYOTA 1480		CG5811 HONDA 566		CG8010 HONDA 566		CG9540 BMW 174, 182, 184	
CF5800 TOYOTA 1480		CG5882 INFINITI 596		CG8020 SUZUKI 1428, 1430		CG9560 FORD 456, 460, 468	
CF5860 TOYOTA 1480		NISSAN 876		CG8030 HYUNDAI 584, 586, 588		CG9570 OPEL 934	
CF5980 TOYOTA 1474		CG5920 DAIHATSU 328		KIA 634		VAUXHALL 1534	
CF5990 SEAT 1322, 1324		CG5950 HYUNDAI 584, 588		CG8040 HYUNDAI 584		CG9580 CHEVROLET 212	
SKODA 1374, 1376		CG6040 HYUNDAI 582		CG8060 HYUNDAI 580		OPEL 936	
VW 1626, 1628		CG6150 SUBARU 1418		CG8080 MITSUBISHI 832		VAUXHALL 1536	
CG01A FIAT 350		CG6220 FIAT 366, 370		CG8090 HYUNDAI 592		CG9581 OPEL 934	
CG5000 VW 1734		LANCIA 652		CG8100 SUZUKI 1432		SAAB 1304	
CG5010 SEAT 1364		CG7300 FIAT 412		CG8130 HONDA 566		VAUXHALL 1534	
VW 1736		IVECO 616, 618		CG8150 MAZDA 712		CG9590 CHEVROLET 212	
CG5011 BMW 162, 166		CG7310 FIAT 358, 366, 370		CG8170 MAZDA 698		OPEL 938	
CG5030 FORD 538		LANCIA 650, 652		CG8180 SUZUKI 1426		VAUXHALL 1536	
SEAT 1364		OPEL 902		CG8190 MAZDA 708		CG9600 AUDI 90, 92, 96	
VW 1736		VAUXHALL 1502		CG8191 MAZDA 708		SEAT 1360, 1362	
CG5090 ISUZU 604		CG7380 ALFA ROMEO 12		CG8200 KIA 632, 634		SKODA 1398, 1400	
OPEL 944		CHRYSLER 216		CG8261 KIA 632		VW 1700, 1704, 1708	
VAUXHALL 1542		FIAT 356, 368, 370		CG8291 HYUNDAI 584		CG9610 AUDI 130	
CG5270 RENAULT 1270		FORD 440		CG8410 AUDI 90, 92, 94, 96, 100		VW 1738, 1740	
CG5290 DAIHATSU 328		LANCIA 648, 652		MITSUBISHI 830		CG9620 SEAT 1364	
TOYOTA 1452		CG7381 FIAT 362		SEAT 1360		VW 1720	
CG5350 HONDA 564, 568		LANCIA 650		SKODA 1398		CG9621 VW 1720	
CG5360 HYUNDAI 580		CG7390 ALFA ROMEO 24, 26		VW 1702, 1704, 1706, 1710		CG9660 CHRYSLER 218	
CG5370 MAZDA 702		FIAT 390, 392, 396		CG8420 AUDI 90		CG9710 CITROËN 300	
CG5380 MAZDA 696		OPEL 926		VW 1698		PEUGEOT 1032	
CG5390 MAZDA 702		VAUXHALL 1526		CG8500 MERCEDES-BENZ 730		RENAULT 1270, 1272	
CG5420 RENAULT 1230, 1232		CG7410 ALFA ROMEO 26, 32		CG8501 MERCEDES-BENZ 742		CG9720 CITROËN 300	
CG5440 SUBARU 1416		FIAT 408		CG8790 MERCEDES-BENZ 732, 734		PEUGEOT 1032	
CG5450 SUBARU 1416		CG7480 TOYOTA 1464		CG8840 SEAT 1322		RENAULT 1270, 1272	
CG5460 KIA 636		CG7491 TOYOTA 1464		SKODA 1374, 1376		CG9740 CITROËN 300	
MAZDA 708		CG7520 TOYOTA 1476		VW 1626, 1628		PEUGEOT 1032	
SUZUKI 1430		CG7570 TOYOTA 1454		CG8850 AUDI 60, 62		RENAULT 1270, 1272	
CG5480 SUBARU 1414		CG7600 MINI 806		SKODA 1384		CG9750 CITROËN 294	
SUZUKI 1426		SUBARU 1414		VW 1638, 1640, 1652, 1654		PEUGEOT 1024	
CG5500 OPEL 946		TOYOTA 1454		CG8880 AUDI 120, 122, 126, 128		CG9760 RENAULT 1244	
VAUXHALL 1542		CG7691 MITSUBISHI 818		VW 1736, 1738		CG9770 OPEL 944	
CG5511 HONDA 566		CG7770 TOYOTA 1456		CG9000 BMW 174, 178, 180, 188, 190		RENAULT 1274	
CG5520 MITSUBISHI 826		CG7800 SEAT 1364		VW 1736, 1738		SAAB 1308	
CG5530 NISSAN 866		VW 1720		CG9030 CITROËN 262		VAUXHALL 1542	
CG5540 TOYOTA 1476		CG7810 FORD 542		PEUGEOT 994		CG9830 DAIHATSU 330	
CG5580 SUBARU 1416		CG7840 KIA 632		CG9110 TOYOTA 1462		CG9870 KIA 636	
CG5581 SUBARU 1416		CG7850 MAZDA 694, 712		CG9120 MITSUBISHI 830		CG9900 HYUNDAI 580	
CG5582 SUBARU 1416		CG7880 NISSAN 850		CG9130 MITSUBISHI 830, 832		KIA 632	
CG5590 SUBARU 1414		RENAULT 1100		CG9140 DAIHATSU 332		CH854 FORD 464	
CG5600 SUBARU 1418		CG7890 HONDA 550		TOYOTA 1470		CH864 FORD 512, 514, 516	
CG5690 HYUNDAI 590		CG7900 HONDA 558		CG9150 MITSUBISHI 834		CH865 FORD 512, 514, 516, 518	
CG5710 SUZUKI 1430		ROVER 1284		CG9170 ACURA 2		CH5010 MERCEDES-BENZ 782, 784	
CG5730 SUZUKI 1432		CG7910 HYUNDAI 580		HONDA 572		CH5030 OPEL 898, 902, 904	
CG5780 HONDA 570		CG7920 HYUNDAI 586				VAUXHALL 1500, 1504, 1506	
		KIA 634					

NUMERICAL PARTS LIST





Numerische Teilenummernliste • Liste des références produits
Elenco numerico articoli • Lista de referencias









 CH5031 OPEL 898		 CJ271 TOYOTA 1452		 CY942 AUDI 58		 DG452 CITROËN 298	
SUZUKI 1424		CN306 ALFA ROMEO 28		VW 1644		TALBOT 1436	
VAUXHALL 1500		CN353 ALFA ROMEO 12, 14, 16		CY960 AUDI 106, 108, 110		DG542 CITROËN 296	
CH5040 CITROËN 300		CV480 VW 1646		CY970 AUDI 64, 66, 68, 70, 74		DG724 NISSAN 864	
FIAT 412		CY070 CITROËN 284, 286		VW 1664, 1666, 1668		DG740 SUBARU 1414	
PEUGEOT 1030, 1032		CY080 CITROËN 286		CY971 AUDI 66, 68, 70, 72, 74, 76		DG811 SEAT 1340	
RENAULT 1272, 1274		PEUGEOT 1016, 1018		SEAT 1342, 1344, 1346		DG871 VW 1660, 1662	
CH5060 CITROËN 300		CY081 CITROËN 286, 292		SKODA 1386, 1388		DH061 MITSUBISHI 828, 830	
FIAT 412		FIAT 404		VW 1666, 1668, 1670, 1672, 1674		DH064 MITSUBISHI 828	
PEUGEOT 1030, 1032		CY082 CITROËN 286		CY980 AUDI 58		DH080 JEEP 626	
RENAULT 1272, 1274		FIAT 404		SEAT 1334, 1336		RENAULT 1244, 1246, 1248, 1250	
CH5240 ALFA ROMEO 22		PEUGEOT 1016, 1018		SKODA 1382		DH681 RENAULT 1100	
FIAT 382		CY082 CITROËN 286		VW 1646, 1648		DH683 RENAULT 1100, 1102, 1104	
OPEL 918, 924		FIAT 404		DC240 FORD 438, 446, 448		DH687 RENAULT 1100, 1102, 1104, 1110, 1114, 1116, 1118, 1120, 1122	
VAUXHALL 1520, 1524		PEUGEOT 1018		DC270 NISSAN 852		DH690 RENAULT 1110, 1114, 1116, 1118, 1120, 1122	
CH5241 OPEL 908, 912, 914		CY130 CITROËN 270, 276		DC380 NISSAN 870		DH692 RENAULT 1114, 1116, 1118, 1120, 1122	
SAAB 1298		PEUGEOT 1002, 1006		DC790 MERCEDES-BENZ 756, 758		DH693 RENAULT 1110, 1114, 1116, 1118, 1120, 1122	
VAUXHALL 1510, 1514		CY131 CITROËN 276		DC800 MERCEDES-BENZ 782		DH696 VOLVO 1554	
CH5242 CHEVROLET 206, 208, 210		PEUGEOT 1006		DD040 MITSUBISHI 820		DH700 LADA 640	
OPEL 908, 914		CY140 CITROËN 264		DD072 VOLVO 1568		DH854 ALFA ROMEO 22	
VAUXHALL 1510, 1516		CY200 LAND ROVER 672		DD073 VOLVO 1566, 1568		DH873 MERCEDES-BENZ 730, 736	
CH5630 KIA 636		CY210 OPEL 902		DD502 AUDI 64		DH876 MERCEDES-BENZ 730, 736	
CH5660 HONDA 570		VAUXHALL 1504		VW 1644, 1658, 1660		DH882 MERCEDES-BENZ 748, 750, 752	
CH5680 FORD 460, 468		CY211 OPEL 902		DD622 AUDI 108		DH890 PEUGEOT 1028	
CH5690 CHEVROLET 210, 212		VAUXHALL 1504		DD631 BMW 156		DJ420 MAZDA 692	
OPEL 934		CY220 CHEVROLET 208		DD790 FIAT 350		DJ430 MAZDA 694	
VAUXHALL 1532		OPEL 910, 912		DE545 FORD 454		DJ432 MAZDA 694	
CH5730 CITROËN 298		VAUXHALL 1512		DE588 ALFA ROMEO 34		DJ442 FORD 466, 468	
JAGUAR 622		CY260 VOLVO 1590, 1592		FIAT 410		DJ444 FORD 464	
LAND ROVER 672		CY270 BMW 154		OPEL 940, 942		DJ445 FORD 464	
PEUGEOT 1030		CY320 FIAT 400		RENAULT 1262, 1264		DJ600 MITSUBISHI 832	
CH5760 HONDA 560, 568		LANCIA 658		VAUXHALL 1540		DJ610 HONDA 550	
CH5960 AUDI 56		CY470 FIAT 374, 376		DE622 ALFA ROMEO 16		DJ690 NISSAN 850	
FORD 442		LANCIA 654		DE623 ALFA ROMEO 16, 18		DJ720 CITROËN 274, 276, 278, 280, 282	
SEAT 1332		CY520 ALFA ROMEO 32		DF044 CITROËN 284		FIAT 396, 398	
SKODA 1382		FIAT 408		DF050 CITROËN 254		HONDA 560	
VW 1640, 1642, 1644		LANCIA 662, 664		DF106 CITROËN 256		HYUNDAI 586	
CH6240 HYUNDAI 580		CY550 FIAT 386		PEUGEOT 988, 990, 996		LADA 642	
KIA 632		LANCIA 656		DF107 CITROËN 254, 256		PEUGEOT 1004, 1006, 1008, 1010, 1012	
CH6300 NISSAN 850		CY610 ALFA ROMEO 30		PEUGEOT 988, 990, 996		ROVER 1286	
CH6350 MAZDA 712		CY611 ALFA ROMEO 30		DF180 CITROËN 278, 280		SUZUKI 1430	
CH6390 CITROËN 294		CY620 ALFA ROMEO 34		PEUGEOT 1008, 1010		FIAT 352, 362, 364, 372	
FIAT 406		CY640 ALFA ROMEO 34, 36		DF490 CITROËN 254		LANCIA 652	
FORD 522, 524		LANCIA 666		DF572 PEUGEOT 990, 996		FIAT 352	
PEUGEOT 1026		CY680 FIAT 412		DF731 RENAULT 1114		FIAT 362, 364	
CH6430 FORD 460, 468		IVECO 616		DG050 PEUGEOT 1014, 1028		DK412 MITSUBISHI 822	
CH6440 CITROËN 256, 264		CY811 ISUZU 600		DG052 PEUGEOT 1028, 1030		DK420 MITSUBISHI 818	
MINI 806		MAZDA 698		DG170 RENAULT 1234, 1236, 1238, 1256, 1258			
PEUGEOT 990, 992, 998, 1002		OPEL 904, 906, 914, 916		DG171 PEUGEOT 1016, 1026, 1028			
CH6530 CITROËN 272		VAUXHALL 1506, 1508, 1516, 1518		DG173 RENAULT 1212, 1232, 1234, 1236, 1238, 1240, 1242, 1256, 1258, 1260			
PEUGEOT 1004		CY930 VW 1632					
CH6540 HYUNDAI 590		CY940 VW 1646					
KIA 636		CY941 SEAT 1334					
CH6730 CITROËN 264		VW 1646, 1648					
MINI 806							
PEUGEOT 998, 1002							

							
DK440 NISSAN	852	DL572 SEAT	1320, 1324	DM530 CITROËN	282	DN582 CITROËN	254, 258
DK446 NISSAN	854	VW	1624, 1626, 1628, 1630, 1632	FIAT	406	PEUGEOT	992
DK450 AUSTIN	134	DL573 SEAT	1324	PEUGEOT	1014, 1024	DN590 CITROËN	268, 270, 272, 276, 278, 280, 282
DK451 AUSTIN	1280	VW	1624, 1632	DM533 CITROËN	274, 282	PEUGEOT	1000, 1002, 1008, 1010, 1012
DK470 BEDFORD	138	DL574 SEAT	1320, 1324	FIAT	400, 406		
OPEL	900	VW	1624, 1626, 1628, 1630, 1632	PEUGEOT	1004, 1014, 1024	DN621 KIA	636
VAUXHALL	1502	DL650 CITROËN	268, 270, 276, 278, 280	DM574 NISSAN	872, 874	MAZDA	710
DK471 BEDFORD	138	PEUGEOT	1000, 1002, 1008, 1010	DM593 NISSAN	858	DN640 TOYOTA	1468
OPEL	900	DL651 CITROËN	274	DM596 NISSAN	854	VW	1662
VAUXHALL	1502	PEUGEOT	1006	DM660 VOLVO	1582	DN671 AUSTIN	134
DK480 OPEL	906	DL681 BMW	170, 176	VW	1722, 1724	DP011 FIAT	350
VAUXHALL	1508	DL690 BMW	192	DM690 VW	1696, 1718	SEAT	1320
DK570 ALFA ROMEO	30, 34	DL691 BMW	192	DM710 TALBOT	1436	DP051 FIAT	350
CHRYSLER	216, 218	DL761 NISSAN	850	DM740 SUZUKI	1424	DP110 FIAT	370
FORD	536, 538	DL831 CITROËN	296, 298	DM766 NISSAN	860	DP190 FIAT	402
OPEL	940	PEUGEOT	1030	DM830 MITSUBISHI	822	DP273 FIAT	410
ROVER	1290, 1292	DL910 RENAULT	1164, 1166, 1168, 1170, 1172, 1174, 1176, 1178	DM831 MITSUBISHI	824	LANCIA	664
DK573 CHRYSLER	218	VOLVO	1556, 1558, 1560	DM840 AUDI	106, 108, 110	DP286 FIAT	354
DK611 SAAB	1300, 1304	DL916 VOLVO	1558	VW	1718, 1720	DP289 FIAT	354
DK640 VOLVO	1574	DL950 TOYOTA	1472	DM850 CARBODIES	200	DP292 LANCIA	650
DK641 VOLVO	1572	DL951 TOYOTA	1474	DM883 TOYOTA	1474	DP293 FIAT	354, 362
DK643 VOLVO	1574, 1576	DL961 DACIA	310	DM910 SUZUKI	1424	DP294 LANCIA	648
DK644 VOLVO	1576	OPEL	924	DM940 FORD	466	DP530 TOYOTA	1458
DK670 TOYOTA	1460	RENAULT	1144, 1146, 1190, 1192, 1194, 1196, 1198	DM995 ACURA	2	DP540 MAZDA	696
DK680 TOYOTA	1464	VAUXHALL	1524	HONDA	554	DP564 DAIHATSU	332
DK831 NISSAN	854	VOLVO	1556	ROVER	1280	DP570 MAZDA	698
DL010 BEDFORD	138	DM330 BEDFORD	138	DN010 OPEL	896	DP580 NISSAN	858
OPEL	906	ISUZU	600	OPEL	896, 898	DP601 MAZDA	698
VAUXHALL	1508	DM360 AUDI	62, 64, 78, 80	VAUXHALL	1498, 1500	DP602 MAZDA	694, 696
DL011 BEDFORD	138	VW	1658, 1660, 1674, 1676, 1678, 1680	DN042 OPEL	896	DP650 TOYOTA	1470
OPEL	906, 914	DM361 AUDI	58, 78	VAUXHALL	1498	DP651 TOYOTA	1470
VAUXHALL	1508, 1516	VW	64	DN140 FORD	466	DP660 FIAT	350
DL012 OPEL	916	DM363 AUDI	64	DN150 FORD	478, 480	DP688 FIAT	398
VAUXHALL	1518	DM365 SEAT	1342, 1348	DN200 TOYOTA	1452	DP689 FIAT	374
DL280 SUBARU	1414	VW	1678, 1680	DN220 MITSUBISHI	822	DP730 SUBARU	1414
DL310 NISSAN	862	DM367 AUDI	58	DN221 MITSUBISHI	822	DP790 FORD	452
DL321 KIA	634	SEAT	1342	DN231 HYUNDAI	582	DP800 BEDFORD	138
DL350 TOYOTA	1466	VW	1664	MITSUBISHI	820	DAEWOO	318
DL381 AUSTIN	134	DM368 SEAT	1334, 1340, 1348	DN233 MITSUBISHI	820	OPEL	906
ROVER	1284	VW	1644, 1658, 1660, 1662, 1676, 1678, 1680	DN250 DAIHATSU	326	VAUXHALL	1508
DL390 SUZUKI	1424	DM370 ISUZU	602	DN330 HYUNDAI	580	DP802 OPEL	908, 910
DL391 BEDFORD	138	OPEL	934	MITSUBISHI	818	VAUXHALL	1510, 1512
SUZUKI	1424	SSANGYONG	1408	DN332 HYUNDAI	580	DP803 OPEL	908, 910
DL401 FORD	538	VAUXHALL	1534	MITSUBISHI	818	VAUXHALL	1510, 1512
DL402 FORD	538	DM381 OPEL	918	DN360 RENAULT	1114, 1116	DP806 OPEL	910
DL450 HYUNDAI	584	VAUXHALL	1520	DN361 RENAULT	1114, 1116	VAUXHALL	1512
DL491 AUDI	106	DM381 OPEL	918	DN390 TOYOTA	1458	DP810 DAEWOO	318
DL550 OPEL	896	VAUXHALL	1520	DN450 HONDA	562	OPEL	918, 920
VAUXHALL	1498	DM381 OPEL	918	DN451 HONDA	562	VAUXHALL	1520, 1522
DL551 OPEL	896	VAUXHALL	1520	DN471 FORD	464	DP811 OPEL	918
VAUXHALL	1498	DM381 OPEL	918	DN472 FORD	464	VAUXHALL	1520
DL570 VW	1630	VAUXHALL	1520	DN480 SUZUKI	1426	DP820 CHEVROLET	210
DL571 VW	1630	DM381 OPEL	918	DN484 SUZUKI	1426	DAEWOO	318
		VAUXHALL	1520	DN530 TOYOTA	1452	OPEL	926, 928, 930
		DM381 OPEL	918	DN551 SUBARU	1414	VAUXHALL	1526, 1528, 1530
		VAUXHALL	1520	DN571 PEUGEOT	988		

NUMERICAL PARTS LIST









Numerische Teilenummernliste • Liste des références produits
Elenco numerico articoli • Lista de referencias









 DP823 OPEL 932	 DR670 DAIHATSU 328	 DS600 SUZUKI 1428	 DT350 ALFA ROMEO 28
VAUXHALL 1532	DR730 MAZDA 710	DS610 NISSAN 856	DT400 FIAT 364
DP860 FIAT 372	DR732 MAZDA 710	DS620 LADA 640	DT401 FIAT 366
LANCIA 652	DR734 MAZDA 710	DS630 LADA 640	DT410 FIAT 402
DP861 FIAT 372	DR736 MAZDA 702	DS700 HONDA 560, 564, 568	LANCIA 656
LANCIA 652	DR750 TOYOTA 1458	ROVER 1286, 1290	DT411 FIAT 400
DP871 FIAT 362, 364	DR830 BMW 152, 154	DS705 HONDA 566	LANCIA 652
LANCIA 652	DR831 BMW 152, 154	DS720 LADA 642	DT413 FIAT 400, 402
DP920 ISUZU 602	DR850 KIA 634	OPEL 928, 932	DT420 ALFA ROMEO 28
OPEL 938	MAZDA 704, 706	VAUXHALL 1528, 1530	FIAT 398, 400, 402
DP951 NISSAN 852	DR880 DAIHATSU 328, 330, 332	DS731 CITROËN 260	DT423 FIAT 372
DR010 OPEL 938	DR881 DAIHATSU 330	PEUGEOT 994	LANCIA 652, 658, 660
VAUXHALL 1536, 1538	DR882 DAIHATSU 328	ROVER 1282	DT430 MITSUBISHI 818
DR013 OPEL 938	DR883 DAIHATSU 330	DS760 NISSAN 866	PROTON 1036
VAUXHALL 1538	DR890 TOYOTA 1480	DS771 FORD 528	DT440 FIAT 382, 400
DR040 ALFA ROMEO 22, 24	DR901 TOYOTA 1458	NISSAN 866	LANCIA 658, 660
DR073 FIAT 410	DR940 ISUZU 602	DS791 ROVER 1286	DT441 FIAT 382, 400
DR100 FIAT 364	DR961 MAZDA 692	DS810 CITROËN 254	LANCIA 658
DR140 DAIHATSU 326	DR990 ISUZU 602	PEUGEOT 988	DT442 LANCIA 658
DR190 ISUZU 602	OPEL 938	DS820 CITROËN 284, 292	DT443 FIAT 402
DR200 ISUZU 602	VAUXHALL 1538	FIAT 404	LANCIA 658, 660
OPEL 934	DS050 NISSAN 858	PEUGEOT 1016, 1018	DT446 FIAT 374, 382, 400
VAUXHALL 1534	DS051 NISSAN 858	DS863 ROVER 1288, 1290	LANCIA 658
DR240 NISSAN 854	DS060 TOYOTA 1468	DS870 TOYOTA 1474	DT447 ALFA ROMEO 30
DR250 TOYOTA 1466	DS070 MAZDA 700	DS881 HONDA 556, 558	FIAT 400
DR260 NISSAN 874	DS111 HONDA 562	ROVER 1284	LANCIA 658, 660
DR270 TOYOTA 1456	DS120 HYUNDAI 586	DS910 NISSAN 872	DT448 FIAT 402
DR290 LAND ROVER 672	KIA 634	DS940 MAZDA 696, 698	LANCIA 658, 660
DR301 TOYOTA 1478	mitsubishi 828	DS950 MAZDA 700, 702	DT449 FIAT 400
DR330 TOYOTA 1468	DS130 HYUNDAI 590	DT010 CITROËN 256, 258, 260, 262	LANCIA 656
DR332 TOYOTA 1468	KIA 636	PEUGEOT 988, 990, 992, 994, 996	DT482 FORD 512, 514
DR360 NISSAN 862	mitsubishi 834	DT012 CITROËN 254, 256, 258, 260, 262	DT510 FORD 538, 540, 542
DR480 FIAT 350	DS240 HYUNDAI 584	PEUGEOT 988, 990, 992, 994, 996	DT540 MERCEDES-BENZ 740
DR510 CITROËN 278, 280	mitsubishi 822, 824	DT013 CITROËN 256	DT541 MERCEDES-BENZ 740
PEUGEOT 1008, 1010	DS241 HYUNDAI 584	PEUGEOT 990	DT561 SAAB 1300, 1302
DR540 HONDA 550, 552	DS260 BEDFORD 138	DT050 NISSAN 864	DT562 SAAB 1306
DR541 HONDA 554	CHEVROLET 206	DT070 JAGUAR 622	DT580 SKODA 1376, 1378
DR560 SUBARU 1414	OPEL 900, 902	DT071 JAGUAR 622	DT581 SEAT 1320
DR581 TOYOTA 1464	VAUXHALL 1502, 1504	DT072 JAGUAR 622	SKODA 1374, 1378, 1380
DR600 CHRYSLER 218	DS261 CHEVROLET 208	DT81B SEAT 1358	VW 1624
DR601 MITSUBISHI 836	DAEWOO 316	VW 1696	DT590 VW 1662
DR610 FIAT 350	OPEL 900, 902	DT81C AUDI 88	DT660 AUDI 112, 120
SEAT 1320	VAUXHALL 1504	DT110 FORD 438, 444	DT680 BMW 158
DR611 FIAT 350	DS290 TOYOTA 1474	DT140 FORD 442, 444, 446	DT681 BMW 158
DR620 FIAT 364, 366, 370	DS292 LEXUS 680	DT193 FORD 480, 482, 484, 486, 488, 490, 492, 494, 496, 498	DT691 BMW 170
DR630 CITROËN 268	TOYOTA 1478	DT260 FIAT 350	DT692 BMW 172, 176
FIAT 372, 374, 378	DS360 TOYOTA 1478	DT270 FIAT 350	DT693 BMW 172, 176
LANCIA 654	DS381 ALFA ROMEO 32	DT290 FIAT 384, 394	DT752 LANCIA 664
PEUGEOT 1000	FIAT 410	LANCIA 656	DT800 FORD 528
DR631 FIAT 374	IVECO 610, 612, 614	DT300 FIAT 384	DT801 FORD 530, 532
DR632 FIAT 378	RENAULT 1264, 1268	DT340 ALFA ROMEO 20, 22	DT802 FORD 528, 530, 532
LANCIA 654	DS431 DAIHATSU 326		LDV 676
DR650 ACURA 2	DS432 DAIHATSU 326		DT803 FORD 528
HONDA 572	DS435 DAIHATSU 326, 328		DT805 FORD 530, 532
ROVER 1292	FIAT 386		DT806 FORD 528, 530, 532
DR660 NISSAN 866, 868	DS570 FIAT 350		LDV 676

											
DT811	SEAT	1358	DV680	ALFA ROMEO	24, 26	DW711	ALFA ROMEO	28	DX600	RENAULT	1178, 1180, 1182, 1184, 1186, 1212, 1214, 1216, 1218
	VW	1696		FIAT	378, 380, 384, 386, 394	DW712	ALFA ROMEO	28, 30			
DT812	VW	1696		LANCIA	656	DW720	FIAT	382			
DT813	AUDI	80, 88		LAND ROVER	670	DW721	ALFA ROMEO	18, 20	DX610	RENAULT	1190
DT814	AUDI	88	DV720	MERCEDES-BENZ	738, 746, 748	DW722	ALFA ROMEO	18, 20, 22	DX620	RENAULT	1232
DT815	AUDI	88	DV810	MERCEDES-BENZ	732	DW723	FIAT	382	DX630	NISSAN	850
DT816	SEAT	1358	DV820	AUDI	80		LANCIA	654, 656		RENAULT	1106, 1108, 1110
	VW	1696		SEAT	1348	DW730	BMW	170, 172	DX651	RENAULT	1110, 1112
DT819	VW	1662, 1678		SKODA	1388	DW731	BMW	170, 172	DX652	RENAULT	1210, 1212
DT820	AUDI	110, 112		VW	1680, 1682		OPEL	938, 942		VOLVO	1560, 1562, 1564
DT880	MITSUBISHI	832	DV851	AUDI	80	DW750	ROVER	1280	DX720	RENAULT	1112, 1114, 1122, 1124, 1126, 1128
DT890	MITSUBISHI	822, 824		SEAT	1348	DW754	LOTUS	684	DX721	RENAULT	1128
	PROTON	1036		SKODA	1388		MG	802	DX722	RENAULT	1122, 1128
DT900	SUZUKI	1424	DV880	VW	1680, 1682, 1692		ROVER	1286	DX800	AUDI	80, 82
DV010	MITSUBISHI	836		VW	1724, 1726, 1728	DW755	ROVER	1280		FORD	500
DV020	HONDA	554, 556, 558	DV951	OPEL	944	DW756	ROVER	1282		SEAT	1348, 1350
DV021	HONDA	550		VAUXHALL	1542	DW757	MG	802		VW	1680, 1682, 1684
DV022	HONDA	558	DV990	NISSAN	852	DW759	ROVER	1282, 1284, 1286	DX801	AUDI	80, 82, 84
DV030	HONDA	570		OPEL	896, 898	DW790	VW	1678, 1696		SEAT	1354
	ROVER	1290	DW170	VAUXHALL	1498, 1500	DW801	TOYOTA	1472		VW	1660, 1662, 1680, 1682, 1684, 1686, 1688, 1690
DV041	HONDA	554, 560		ALFA ROMEO	30	DW830	AUDI	112			
DV050	HONDA	562	DW280	ALFA ROMEO	28		VW	1722	DY030	DACIA	308
DV090	ACURA	2, 4	DW281	ALFA ROMEO	28	DW860	AUDI	116		RENAULT	1162, 1164
	HONDA	574	DW282	ALFA ROMEO	28	DW861	AUDI	116	DY040	MITSUBISHI	826
DV110	KIA	632	DW320	FIAT	400		VOLVO	1590		RENAULT	1196
	MAZDA	696		LANCIA	660	DW5757	LOTUS	684		VOLVO	1564, 1566
DV150	CITROËN	292, 294	DW322	FIAT	402		MG	802	DY070	RENAULT	1252
	FIAT	406		LANCIA	658, 660	DW5759	ROVER	1282, 1284, 1286	DY130	CITROËN	258, 260, 262, 270, 272
	LANCIA	662	DW340	FIAT	408		ROVER	1282, 1284, 1286		PEUGEOT	990, 996, 1002, 1004
	PEUGEOT	1024		LANCIA	662	DX030	FIAT	374, 376	DY140	CITROËN	296
DV190	RENAULT	1110, 1112	DW370	MERCEDES-BENZ	754, 756		LANCIA	654		PEUGEOT	1028
DV250	NISSAN	872		SSANGYONG	1408	DX040	FIAT	366	DY150	CITROËN	264
DV330	TOYOTA	1456	DW372	MERCEDES-BENZ	754, 756		LANCIA	652		NISSAN	854
DV331	TOYOTA	1454		SSANGYONG	1408	DX060	TOYOTA	1474		PEUGEOT	996
DV340	HONDA	568	DW373	MERCEDES-BENZ	754, 756	DX090	VOLVO	1568	DY231	OPEL	910
DV351	ACURA	2		SSANGYONG	1408	DX390	IVECO	614, 616		VAUXHALL	1512
	HONDA	550, 556, 558	DW380	DAEWOO	320	DX391	FIAT	412		VAUXHALL	1512
	ROVER	1284		MERCEDES-BENZ	772		IVECO	614, 616	DY232	OPEL	912
DV360	HONDA	568		SSANGYONG	1410		OPEL	944		VAUXHALL	1512
	TOYOTA	1462	DW381	DAEWOO	320	DX392	CITROËN	298	DY240	DAEWOO	318
DV370	TOYOTA	1458		MERCEDES-BENZ	772		FIAT	412	DY241	OPEL	920
DV371	TOYOTA	1458		SSANGYONG	1410		IVECO	616		VAUXHALL	1520, 1522
DV380	MAZDA	698, 706	DW410	ALFA ROMEO	22, 30		PEUGEOT	1030	DY250	CHEVROLET	210
DV410	MAZDA	712		NISSAN	860	DX400	IVECO	616		DAEWOO	318, 320
DV431	KIA	632	DW420	NISSAN	870	DX480	FORD	478		OPEL	930, 932
	MAZDA	692		NISSAN	870	DX550	FORD	514	DY251	OPEL	936
DV440	NISSAN	856	DW560	TOYOTA	1464	DX560	RENAULT	1238, 1258		VAUXHALL	1536
DV450	SUBARU	1416		TOYOTA	872	DX570	RENAULT	1238, 1258	DY253	OPEL	936, 938
DV460	SEAT	1324	DW630	FORD	460, 462		PEUGEOT	1030		VAUXHALL	1536
	VW	1630, 1632	DW631	FORD	462						
DV540	NISSAN	864	DW635	FORD	460, 462						
DV541	NISSAN	864	DW640	FORD	480						
DV672	FIAT	358, 362	DW641	FORD	486, 488						
	LANCIA	650	DW642	FORD	470						
DV675	FIAT	352, 354, 356, 358	DW643	FORD	470, 476, 478						
	LANCIA	648	DW650	FORD	516, 518						
			DW655	FORD	462, 516, 518						

NUMERICAL PARTS LIST









Numerische Teilenummernliste • Liste des références produits
Elenco numerico articoli • Lista de referencias









							
DY254	DAEWOO 320	DY750	AUDI 88, 90	EA441	FORD 448, 450, 452, 464, 466, 468	EB5370	AUDI 84, 94
	OPEL 936	DY751	AUDI 88				SEAT 1356, 1360
	VAUXHALL 1534	DY752	AUDI 88	EA800	VW 1680, 1682, 1696		SKODA 1392, 1394, 1396
DY255	DAEWOO 320	DY753	SEAT 1358	EA900	VW 1630		VW 1686, 1690, 1692, 1694, 1696, 1698,
	OPEL 936		VW 1696, 1698	EA3130	SEAT 1322, 1332, 1340		1700, 1702
	VAUXHALL 1536	DY850	AUDI 124	EA5020	MITSUBISHI 834, 836		
DY260	OPEL 930	DY863	HONDA 554	EA5420	ALFA ROMEO 18, 20, 30	EB5400	ROVER 1288, 1290
	VAUXHALL 1528	DY900	NISSAN 850		FIAT 382	EB5541	CHEVROLET 208
DY270	OPEL 940		RENAULT 1100		LANCIA 654		OPEL 902, 912
	SAAB 1308	DZ010	AUDI 82, 84	EA5470	VW 1722, 1724, 1726, 1728, 1730		VAUXHALL 1504, 1514
	VAUXHALL 1538		SEAT 1350, 1352	EA5620	RENAULT 1210, 1212	EB5550	MERCEDES-BENZ 730, 734
DY271	OPEL 942		SKODA 1390, 1392		VOLVO 1554, 1560, 1562, 1564	EB5660	BMW 152, 156
	VAUXHALL 1540	DZ121	BMW 170, 172	EA5780	ALFA ROMEO 32	EB5670	CHEVROLET 212
DY272	OPEL 942	DZ130	BMW 156		LANCIA 664		OPEL 932, 934, 936
	VAUXHALL 1540	DZ160	MERCEDES-BENZ 754	EA5830	CITROËN 282, 286, 288, 290, 292		SAAB 1306
DY300	OPEL 944		VW 1720		FIAT 398, 406		VAUXHALL 1530, 1532, 1534, 1536
	SAAB 1308	DZ180	VW 1630, 1646	EA5920	LAND ROVER 672	EB5671	OPEL 936, 946
	VAUXHALL 1542	DZ181	SEAT 1326, 1328, 1334, 1336		MG 802		VAUXHALL 1534, 1536, 1542
DY301	SAAB 1308		SKODA 1382, 1386		ROVER 1288, 1290, 1292	EB5700	AUDI 56
DY310	CITROËN 286		VW 1632, 1634, 1636, 1646, 1648	EA5940	FORD 526, 528		SEAT 1326, 1328, 1330, 1336, 1338
	FIAT 404	DZ280	HYUNDAI 590		CITROËN 294		SKODA 1378, 1380
	PEUGEOT 1018		KIA 636	EA5970	FORD 500, 504, 508, 510, 512, 520, 522, 524		VW 1632, 1634, 1636, 1638, 1640, 1648, 1650, 1652
DY360	VOLVO 1582	DZ350	LEXUS 680		JAGUAR 622	EC010	AUDI 106, 108, 110
DY362	VOLVO 1582		TOYOTA 1478	EA5990	PEUGEOT 1026	EC030	AUDI 80, 82, 84
DY370	VOLVO 1570, 1576, 1578	DZ440	HONDA 562		OPEL 944		FORD 500
DY371	VOLVO 1570		ROVER 1288	EB950	VAUXHALL 1542		SEAT 1340, 1348, 1350, 1354
DY382	FIAT 356, 358	DZ490	FORD 504, 506, 508		VAUXHALL 1542		SKODA 1388
	LANCIA 648	DZ491	FORD 516, 518	EB961	SEAT 1320, 1322, 1326, 1328, 1334, 1336		VW 1660, 1662, 1680, 1682, 1684, 1686, 1690
DY383	FIAT 358	DZ660	BMW 174, 176		SKODA 1382	EC040	OPEL 910
	LANCIA 650		OPEL 942	EB970	VW 1624, 1630, 1632, 1634, 1636, 1646, 1648		VAUXHALL 1512
DY390	ALFA ROMEO 16		VAUXHALL 1540		AUDI 58, 88, 90	EC060	AUDI 82, 84, 86
DY391	ALFA ROMEO 16	DZ720	FORD 468, 470, 474, 476, 478, 496, 498		SEAT 1342, 1358		FORD 500
DY410	FIAT 386	DZ790	FIAT 388, 392	EB990	VW 1646, 1664, 1696, 1698		SEAT 1350, 1352, 1354, 1356
DY470	LAND ROVER 670, 672	DZ860	MERCEDES-BENZ 748		FORD 440, 442, 454, 456, 460, 468	EC080	AUDI 58
DY520	BMW 154	DZ870	MERCEDES-BENZ 764	EB5120	MAZDA 692, 694, 698		SEAT 1334, 1336
DY541	BMW 154	DZ881	MERCEDES-BENZ 734, 738, 740		VOLVO 1554		SKODA 1382
DY542	BMW 154		SSANGYONG 1408	EB5140	OPEL 896	EC100	VW 1646, 1648
DY570	BMW 158, 160	DZ891	MERCEDES-BENZ 754		VAUXHALL 1498		DAEWOO 318, 320
DY571	BMW 158, 160	DZ900	DAEWOO 320	EB5150	FIAT 374, 376		OPEL 936
DY580	MERCEDES-BENZ 780, 782		MERCEDES-BENZ 752, 754		LANCIA 654	EC101	OPEL 936, 938
DY590	MERCEDES-BENZ 762	DZ910	SEAT 1342	EB5240	OPEL 898		VAUXHALL 1536
DY601	MERCEDES-BENZ 790		VW 1664, 1668		VAUXHALL 1500		VAUXHALL 1536
DY620	SEAT 1334	DZ960	AUDI 112, 114	EB5360	OPEL 902		
	VW 1644	EA140	NISSAN 850		VAUXHALL 1504		
DY640	FORD 512		RENAULT 1106, 1108, 1110				
DY641	FORD 512	EA150	RENAULT 1122, 1124, 1128, 1132				
DY650	FORD 438, 440	EA220	DACIA 308				
	MAZDA 692		RENAULT 1162				
DY651	FORD 438, 440						
	MAZDA 692						
DY660	FORD 450, 452						
DY671	FORD 442, 444, 446						
	MAZDA 694						
DY730	HYUNDAI 580, 582						
DY740	FORD 448, 450, 452						
DY741	FORD 448, 452						

								
EC102	CHEVROLET 210	EC5960	AUDI 116, 118	ED5991	NISSAN 862	EF5380	AUDI 86, 90, 92, 94, 96, 100, 102, 104	
	DAEWOO 320		SKODA 1400		OPEL 932		MITSUBISHI 830	
	OPEL 936		VW 1726, 1730, 1732		RENAULT 1186, 1188, 1218, 1220, 1222, 1224, 1226, 1228, 1230, 1232		SEAT 1354, 1356, 1358, 1360, 1362	
	VAUXHALL 1534, 1536	ED5130	CITROËN 258		VAUXHALL 1530		SKODA 1394, 1396, 1398, 1400	
EC130	CHEVROLET 210		FIAT 450, 454, 458, 460, 468	EE5110	RENAULT 1222, 1224, 1226, 1228, 1230		VW 1690, 1692, 1694, 1702, 1704, 1706, 1710, 1714, 1716	
	OPEL 920, 932		MAZDA 694	EE5150	VOLVO 1590		EF5990	SEAT 1322, 1324
	VAUXHALL 1520, 1522, 1532		PEUGEOT 992	EE5180	ALFA ROMEO 12		SKODA 1374, 1376	
EC230	OPEL 940, 942, 944		SUZUKI 1426		FIAT 356, 358, 368, 370		VW 1626, 1628	
	VAUXHALL 1538, 1540, 1542	ED5180	VOLVO 1556	EE5181	ALFA ROMEO 24, 26		EG176	JEEP 626
EC340	VW 1734, 1736		CITROËN 270, 272		FIAT 388, 390, 392, 394, 396		RENAULT 1212, 1232, 1234, 1236, 1238, 1240, 1242, 1244, 1246, 1248, 1250, 1256, 1258, 1260	
EC350	SAAB 1308		PEUGEOT 1004	EE5200	DACIA 306		EG340	FORD 438, 444, 446, 448
EC651	SAAB 1300, 1304	ED5220	FORD 470, 476, 478, 502, 504, 520, 522, 526		NISSAN 852, 854		EG872	AUDI 58, 88
EC790	MERCEDES-BENZ 756, 758		CITROËN 272, 284, 292		RENAULT 1134, 1136, 1138, 1140, 1144		SEAT 1334, 1340, 1348	
EC791	MERCEDES-BENZ 782		PEUGEOT 1004, 1016, 1024		SUZUKI 1428		VW 1644, 1658, 1660, 1662, 1676, 1678, 1680	
EC797	MERCEDES-BENZ 758	ED5300	CITROËN 294		NISSAN 864, 868		EG873	AUDI 58, 62, 64, 78, 80
EC5060	DACIA 310		FIAT 406	EE5220	NISSAN 864, 868		VW 1658, 1660, 1674, 1676, 1678	
	NISSAN 860		LANCIA 662		OPEL 936, 940		EG875	SEAT 1348
	OPEL 924, 926	ED5490	CITROËN 294		RENAULT 1252, 1254, 1256, 1264, 1266		VW 1678, 1680, 1696	
	RENAULT 1190, 1192, 1194, 1198, 1200, 1202, 1204, 1206, 1208, 1210, 1212, 1216, 1218, 1232		FIAT 404, 406	EE5242	ALFA ROMEO 12, 14		EG914	LAND ROVER 672
	VAUXHALL 1524		FORD 502, 504, 508, 510, 520, 522		FIAT 354, 356, 358, 360, 362, 366, 370		EG920	VOLVO 1582
	VOLVO 1566		PEUGEOT 1020		LANCIA 648, 650, 652, 656		EG5000	VW 1734
EC5061	RENAULT 1208, 1210		VOLVO 1572		VOLVO 1570, 1572, 1576, 1588		EG5010	VW 1736
EC5063	NISSAN 860	ED5650	AUDI 56	EE5250	VOLVO 1570, 1572, 1576, 1588		EG5130	MAZDA 708
	OPEL 924, 926		SEAT 1326, 1330		CHEVROLET 208		EG5220	SUZUKI 1426
	RENAULT 1198, 1200, 1202, 1204, 1206, 1208, 1210, 1212, 1216, 1218, 1232		SKODA 1378		OPEL 916		EG5260	LDV 676
	VAUXHALL 1524	ED5690	VW 1626, 1634, 1636, 1638, 1640		VAUXHALL 1518		SUZUKI 1428	
EC5220	AUDI 58, 60, 66, 68, 70		CHEVROLET 206	EE5520	CHEVROLET 208		EG5280	SUBARU 1414, 1416
	SEAT 1334, 1336, 1338, 1340		DAEWOO 316		OPEL 916		EG5770	ACURA 2
	SKODA 1382, 1384, 1386	ED5720	MERCEDES-BENZ 766, 768, 782		VAUXHALL 1518		HONDA 566, 572	
	VW 1644, 1646, 1648, 1650, 1652, 1656, 1658	ED5800	FIAT 360	EF07C	AUSTIN 134		EG6210	HONDA 564, 570
EC5410	BMW 156, 158		FORD 440		CITROËN 256		ISUZU 604	
EC5440	BMW 152, 154, 160, 162		LANCIA 650	EF102	PEUGEOT 988, 990, 996		OPEL 946	
EC5620	CHRYSLER 216		OPEL 896, 898, 900		VAUXHALL 1500		VAUXHALL 1542	
	MERCEDES-BENZ 742, 744, 748	ED5810	SUZUKI 1424	EF380	DACIA 306		EG6250	DAIHATSU 332
EC5660	SMART 1404		VAUXHALL 1498, 1500		AUSTIN 134		TOYOTA 1470	
EC5670	SMART 1404	ED5820	ALFA ROMEO 12	EF464	ROVER 1280		EG6290	TOYOTA 1462
EC5700	CITROËN 256		CHEVROLET 206	EF580	PEUGEOT 1014		EG6310	TOYOTA 1464
	PEUGEOT 990		FIAT 356, 360	EF731	RENAULT 1114		EG7390	ALFA ROMEO 24, 26
	VW 1650		ALFA ROMEO 12	EF5310	VW 1726, 1728, 1730, 1732		FIAT 390, 392, 396	
EC5800	FORD 470, 472, 474, 486, 488, 504, 506, 508, 516, 518		FIAT 360, 362				EG7410	ALFA ROMEO 32
	EC5890		LANCIA 650				FIAT 408	
	FORD 442, 456		OPEL 898				EG7450	ALFA ROMEO 24, 26
EC5921	CHRYSLER 216		VAUXHALL 1500				FIAT 396	
	MINI 808	ED5910	ALFA ROMEO 32					
			LANCIA 664					
		ED5960	FIAT 402, 408					
			LANCIA 658, 660, 662					

NUMERICAL PARTS LIST









Numerische Teilenummernliste • Liste des références produits
Elenco numerico articoli • Lista de referencias









 EG7800 FORD 538 SEAT 1364 VW 1720, 1734, 1736		 EH950 CITROËN 254, 258 PEUGEOT 988, 992		 EL650 CITROËN 268, 270, 272, 274, 276, 278, 280, 282 PEUGEOT 1000, 1002, 1006, 1008, 1010, 1012		 ES260 BEDFORD 138 CHEVROLET 208 DAEWOO 316 OPEL 898, 900, 902, 908 VAUXHALL 1498, 1500, 1504, 1510	
EG7950 NISSAN 850 RENAULT 1104, 1106, 1108, 1110		EH951 CITROËN 254, 256, 258, 260, 262 PEUGEOT 988, 990, 992, 994, 996		EL890 CITROËN 274, 276, 278, 280, 282 FIAT 396, 398 HONDA 560 LADA 642 PEUGEOT 1004, 1006, 1008, 1010, 1012, 1014 ROVER 1286 SUZUKI 1430 TALBOT 1436		ES381 IVECO 610, 614 ES471 AUDI 88 SEAT 1342, 1358 VW 1696 ES580 RENAULT 1112, 1114, 1122, 1124, 1126, 1128 ES720 LADA 642 OPEL 928, 930, 932 VAUXHALL 1528, 1530	
EG8020 SUZUKI 1428, 1430, 1432		EH952 CITROËN 254, 256, 258, 260, 262 PEUGEOT 988, 990, 992, 994, 996		EL960 MITSUBISHI 826 OPEL 924 RENAULT 1164, 1166, 1168, 1170, 1172, 1174, 1176, 1178, 1180, 1182, 1184, 1186, 1190, 1192, 1194, 1196, 1198, 1212, 1214, 1216, 1218, 1232 VAUXHALL 1524 VOLVO 1554, 1556, 1558, 1560, 1564, 1566		ES820 CITROËN 284, 286, 292 FIAT 404 PEUGEOT 1016, 1018 ET190 FORD 480, 482, 484, 486, 488, 490, 492, 494, 496 ET191 FORD 480, 482, 484, 486, 488, 490, 492, 494, 496 ET192 FORD 484, 486, 494, 496, 498 MAZDA 704	
EG8230 INFINITI 596 NISSAN 864 RENAULT 1274		EH5030 OPEL 898, 902, 904 SUZUKI 1424 VAUXHALL 1500, 1504, 1506		EM362 SEAT 1342, 1348 VW 1664, 1668, 1680		ET400 CITROËN 268 FIAT 366, 372, 374, 378 ET490 FORD 538, 540, 542 ET560 SAAB 1300, 1302, 1306 ET681 BMW 158, 170 ET800 FORD 528, 530, 532 LDV 676 ET811 AUDI 88 SEAT 1342, 1348 VW 1678, 1680, 1696	
EG8500 MERCEDES-BENZ 730, 740		EH5240 ALFA ROMEO 22 CHEVROLET 206, 208, 210 FIAT 382 OPEL 908, 912, 914, 918, 924 SAAB 1298 VAUXHALL 1510, 1514, 1520, 1524		EM531 CITROËN 274, 282 FIAT 406 PEUGEOT 1004, 1014		ET820 OPEL 896, 898 ET820 VAUXHALL 1498, 1502, 1504 EV020 HONDA 550, 552, 554, 556, 558 ROVER 1284 EV050 HONDA 554, 560, 562 EV150 CITROËN 292, 294 FIAT 406 LANCIA 662 PEUGEOT 1024	
EG8790 MERCEDES-BENZ 732, 734		EH5660 HONDA 570		EM682 ROVER 1286, 1288		EV190 RENAULT 1110, 1112 EV460 SEAT 1320, 1324, 1334 VW 1624, 1626, 1628, 1630, 1632, 1644, 1646 EV540 NISSAN 864 EV670 FIAT 356, 358	
EG8920 VW 1728, 1730, 1732		EH5760 HONDA 560, 568		EM685 ROVER 1290			
EG9030 CITROËN 262 PEUGEOT 994		EH6350 MAZDA 712		EM720 MERCEDES-BENZ 740, 754, 756 SSANGYONG 1408			
EG9270 LEXUS 680 TOYOTA 1478		EH6430 FORD 460, 468		EM850 CARBODIES 200			
EG9310 CITROËN 254 DAIHATSU 326 PEUGEOT 988 SUBARU 1414 TOYOTA 1452		EH6520 AUDI 100 CITROËN 294 FORD 522 PEUGEOT 1026		EM940 FORD 466			
EG9540 BMW 174, 182, 184		EJ160 OPEL 906, 926 VAUXHALL 1508		EM992 ROVER 1280			
EG9570 OPEL 934 VAUXHALL 1534		EJ161 OPEL 938 VAUXHALL 1536, 1538		EN260 FORD 528			
EG9600 AUDI 90, 92, 96 SEAT 1360, 1362 SKODA 1398, 1400 VW 1698, 1700, 1704, 1708		EK451 AUSTIN 134		EN720 DAEWOO 320 MERCEDES-BENZ 760, 762, 772 SSANGYONG 1410			
EG9660 CHRYSLER 218		EK470 BEDFORD 138 CHEVROLET 206 OPEL 896, 900, 902 VAUXHALL 1498, 1502, 1504		EP280 FIAT 350, 352, 354			
EG9690 JEEP 626		EK481 BEDFORD 138 OPEL 906		ER241 NISSAN 854			
EG9710 CITROËN 300 PEUGEOT 1032 RENAULT 1270, 1272, 1274		EK482 DAEWOO 318 OPEL 918, 920, 926, 928, 930 VAUXHALL 1520, 1522, 1526, 1528, 1530		ER320 ROVER 1280, 1282			
EG9750 CITROËN 294 FIAT 404 LANCIA 660 PEUGEOT 1024		EK484 BEDFORD 138 DAEWOO 316, 318 OPEL 906, 908, 910 VAUXHALL 1508, 1510, 1512		ER321 MG 802 ROVER 1280, 1282			
EG9760 RENAULT 1244, 1260, 1262		EK485 BEDFORD 138 OPEL 906, 914 VAUXHALL 1508, 1516		ER322 LOTUS 684 MG 802 ROVER 1284, 1286			
EG9770 OPEL 944 RENAULT 1274 SAAB 1308 VAUXHALL 1542		EK486 OPEL 916 VAUXHALL 1518		ER830 BMW 152, 154 ER993 ISUZU 604 OPEL 942, 944, 946 VAUXHALL 1540, 1542			
EG9870 KIA 636							
EH445 VOLVO 1566, 1568, 1572, 1574, 1576							
EH680 RENAULT 1100, 1102, 1104, 1114, 1116, 1118, 1120, 1122							
EH682 RENAULT 1114							
EH694 RENAULT 1114							
EH752 FORD 438, 442, 444							
EH850 FORD 464, 466, 478, 480, 512, 514, 516, 518							
EH872 MERCEDES-BENZ 730, 736, 750, 752							

 	 	 	 
EV684 ALFA ROMEO 26 FIAT 378, 380, 384, 386, 394	EY841 AUDI 66, 68, 70, 72, 74, 76 SEAT 1342, 1344, 1346 SKODA 1386, 1388, 1396 VW 1666, 1668, 1670, 1672, 1674, 1698, 1700	FF5070 HYUNDAI 588, 590 FF5470 MITSUBISHI 818 FF5481 MITSUBISHI 820 FF5490 MITSUBISHI 838 FF5541 NISSAN 862 FF5600 NISSAN 876 FF5690 INFINITI 596 NISSAN 874 FF5740 NISSAN 874 FF5760 SUBARU 1418 FF5781 TOYOTA 1464 FF5800 TOYOTA 1480 FF5980 TOYOTA 1474 FG5100 LEXUS 680 FG5130 MAZDA 708 FG5290 DAIHATSU 328 TOYOTA 1452 FG5581 SUBARU 1416 FG5590 SUBARU 1414 FG5600 SUBARU 1418 FG5690 HYUNDAI 590 FG5760 HONDA 570 FG5761 HONDA 570 FG5920 DAIHATSU 328 FG6040 HYUNDAI 582 FG7480 TOYOTA 1464 FG7600 MINI 806 SUBARU 1414 TOYOTA 1454 FG7650 TOYOTA 1464, 1466 FG7690 MITSUBISHI 818 FG7840 KIA 632 FG7860 HONDA 572 FG7880 NISSAN 850 FG7910 HYUNDAI 580 FG7960 HONDA 550 FG7980 SUBARU 1414 FG7990 CHEVROLET 206 DAEWOO 316 FG8000 CHEVROLET 206 DAEWOO 316 FG8010 HONDA 566 FG8040 HYUNDAI 584, 588 KIA 634 FG8050 HYUNDAI 580 FG8060 HYUNDAI 580 KIA 632 FG8090 HYUNDAI 592 FG8100 SUZUKI 1432 FG8130 HONDA 566 FG8131 HONDA 566 FG8150 MAZDA 712 FG8170 MAZDA 698 FG8190 MAZDA 708 FG8200 KIA 632, 634 FG8260 KIA 632	FG8291 HYUNDAI 584 FG9660 CHRYSLER 218 FG9770 OPEL 944 SAAB 1308 VAUXHALL 1542 FG9830 DAIHATSU 330 TOYOTA 1454 FH6240 HYUNDAI 580 KIA 632 FJ270 TOYOTA 1452 FJ271 TOYOTA 1452 FV500 VW 1646 FY291 ALFA ROMEO 34 CITROËN 296 FIAT 410 IVECO 612 OPEL 940, 942 VAUXHALL 1540 FY320 FIAT 400 LANCIA 658 FY520 ALFA ROMEO 32 FIAT 408 LANCIA 662, 664 FY550 FIAT 386 LANCIA 656 FY610 ALFA ROMEO 30 FY611 ALFA ROMEO 30 FY620 ALFA ROMEO 34 FY640 ALFA ROMEO 34, 36 LANCIA 666 FY691 FIAT 412 FY811 ISUZU 600 MAZDA 698 OPEL 904, 906, 914, 916 VAUXHALL 1506, 1508, 1516, 1518 GC275 NISSAN 852 GC383 NISSAN 870 GC790 MERCEDES-BENZ 756, 758 GD040 MITSUBISHI 820 GD671 FIAT 350 GD790 FIAT 350 GF044 CITROËN 284 GF051 CITROËN 254 GF054 CITROËN 254 GF492 CITROËN 254 GF570 PEUGEOT 990, 996 GG050 PEUGEOT 1028 GG052 PEUGEOT 1028, 1030 GG452 CITROËN 298 GG541 CITROËN 296 GG724 NISSAN 864 GG740 SUBARU 1414 GH061 MITSUBISHI 828 GH064 MITSUBISHI 828
EV720 LAND ROVER 670, 672	EY850 AUDI 118, 120, 122, 124 VW 1734 EY940 AUDI 58, 60 VW 1644, 1646, 1648, 1650	EZ142 VOLVO 1554 EZ440 HONDA 562 EZ660 BMW 174, 176 EZ690 MG 802 ROVER 1290 EZ720 FORD 468, 470, 474, 476, 478, 496, 498 EZ800 BMW 156 FA5130 MAZDA 712 FA5560 ALFA ROMEO 24, 26 FIAT 388, 390, 394, 396 LANCIA 656, 658 FB5000 TOYOTA 1458 FB5100 ALFA ROMEO 32 FIAT 410 IVECO 610 FB5101 FIAT 410 IVECO 612, 614 FB5102 FIAT 410 FB5610 NISSAN 860 FB5721 FIAT 408, 410 IVECO 610 FB5722 FIAT 408 LANCIA 664 FB5750 TOYOTA 1454, 1456 FB5760 TOYOTA 1454, 1458, 1460 FD5230 HONDA 556 FD5330 TOYOTA 1466 FD5380 TOYOTA 1452 FD5690 CHEVROLET 206 DAEWOO 316 FD5810 FIAT 356, 360 LANCIA 650 OPEL 896, 900 SUZUKI 1424 VAUXHALL 1498, 1500 FD5820 ALFA ROMEO 12 FIAT 360, 362 LANCIA 650 OPEL 898 VAUXHALL 1500 FD5970 FIAT 376 FE5240 FIAT 356, 358, 362 FE5470 KIA 636 FF5030 LEXUS 680 TOYOTA 1480	EW091 IVECO 614 EW320 FIAT 402 LANCIA 660 EW630 FORD 460, 462, 480, 486, 488, 516, 518 EW730 BMW 170, 172 EW801 TOYOTA 1472 EW802 BMW 158, 160, 168, 172, 176, 178 EW860 AUDI 106, 116 VOLVO 1590 EW870 OPEL 944 VAUXHALL 1542 EX550 FORD 512, 514 EX932 BMW 156, 170, 176 EX934 BMW 170 EX995 AUDI 106, 108, 110, 112 VW 1718, 1720 EY070 RENAULT 1252 EY130 CITROËN 258, 260, 262, 270, 272 PEUGEOT 1002, 1004 EY140 CITROËN 296 PEUGEOT 1028 EY200 LAND ROVER 672 EY230 CHEVROLET 208 OPEL 902, 910, 912 VAUXHALL 1504, 1512 EY270 BMW 154 EY280 BMW 170, 172 OPEL 938, 942 VAUXHALL 1538, 1540 EY370 VOLVO 1570, 1572, 1582, 1590, 1592 EY470 LAND ROVER 670, 672 EY580 MERCEDES-BENZ 780, 782 EY590 MERCEDES-BENZ 762, 764 EY650 FORD 438, 440, 450, 452, 454, 456, 464 MAZDA 692 EY671 FORD 442, 444, 446 MAZDA 694 EY840 AUDI 64, 66 VW 1664, 1666, 1668

NUMERICAL PARTS LIST









Numerische Teilenummernliste • Liste des références produits
Elenco numerico articoli • Lista de referencias









							
GH080 JEEP	626	GL951 TOYOTA	1474	GP921 OPEL	938	GS241 HYUNDAI	584
RENAULT	1244, 1246, 1248, 1250	GM310 PEUGEOT	1028	GP960 NISSAN	866	GS435 DAIHATSU	326, 328
GH681 RENAULT	1100	GM370 ISUZU	602	GP970 NISSAN	856	GS438 DAIHATSU	326
GH683 RENAULT	1100	OPEL	934	GR100 FIAT	364	GS600 SUZUKI	1428
GH690 RENAULT	1114	VAUXHALL	1534	GR140 DAIHATSU	326	GS610 NISSAN	856
GH691 RENAULT	1114	GM372 ISUZU	602	GR190 ISUZU	602	GS700 HONDA	568
GH700 LADA	640	OPEL	934	GR240 NISSAN	854	GS760 NISSAN	866
GH858 ALFA ROMEO	22	SSANGYONG	1408	GR250 TOYOTA	1466	GS770 FORD	528
GH930 CITROËN	284, 296	VAUXHALL	1534	GR270 TOYOTA	1456	GS870 TOYOTA	1474
GJ430 MAZDA	694	GM533 FIAT	406	GR301 TOYOTA	1478	GS881 HONDA	556
GJ431 MAZDA	694	PEUGEOT	1014, 1024	GR330 TOYOTA	1468	ROVER	1284
GJ432 MAZDA	694	GM596 NISSAN	854	GR332 TOYOTA	1468	GS910 NISSAN	872
GJ600 MITSUBISHI	832	GM690 VW	1696, 1718	GR360 NISSAN	862	GS941 MAZDA	696
GJ610 HONDA	550	GM765 NISSAN	860	GR480 FIAT	350	GS950 MAZDA	700, 702
GJ611 HONDA	550	GM766 NISSAN	860	GR540 HONDA	550	GS953 MAZDA	700
GJ690 NISSAN	850	GM830 MITSUBISHI	822	GR561 SUBARU	1414	GT050 NISSAN	864
GJ720 CITROËN	274, 276, 278, 280, 282	GM881 TOYOTA	1474	GR600 CHRYSLER	218	GT190 FORD	480, 482, 484, 486, 488, 490, 492, 494, 496
FIAT	396, 398	GM990 ROVER	1280	HYUNDAI	592		
HONDA	560	GN200 TOYOTA	1452	MITSUBISHI	836		
LADA	642	GN220 MITSUBISHI	822	GR611 FIAT	350	GT260 FIAT	350
PEUGEOT	1004, 1006, 1008, 1010, 1012	GN221 MITSUBISHI	822	GR620 FIAT	364, 366, 370	GT270 FIAT	350
ROVER	1286	GN390 TOYOTA	1458	GR630 CITROËN	268	GT300 FIAT	384
SUZUKI	1430	GN450 HONDA	562	FIAT	372, 374, 378	GT340 ALFA ROMEO	20, 22
GJ852 FIAT	352	GN451 HONDA	562	PEUGEOT	1000	GT350 ALFA ROMEO	28
GJ872 FIAT	362, 364	GN480 SUZUKI	1426	GR661 NISSAN	866, 868	GT400 FIAT	364
GK081 NISSAN	872	GN484 SUZUKI	1426	GR670 DAIHATSU	328	GT401 FIAT	366
GK420 MITSUBISHI	818	GN530 TOYOTA	1452	GR730 MAZDA	710	GT410 FIAT	402
GK444 NISSAN	850	GN551 SUBARU	1414	GR732 MAZDA	710	LANCIA	656
GK447 NISSAN	854	GN620 MAZDA	710	GR734 MAZDA	710	GT423 LANCIA	658, 660
GK470 OPEL	900	GN621 KIA	636	GR750 TOYOTA	1458	GT430 MITSUBISHI	818, 820
VAUXHALL	1502	MAZDA	710	GR850 KIA	634	GT440 FIAT	382, 398, 402
GK570 ALFA ROMEO	30, 34	GN622 KIA	636	MAZDA	704, 706	LANCIA	658
GK572 ALFA ROMEO	34	GN640 TOYOTA	1468	GR880 DAIHATSU	328, 330, 332	GT441 LANCIA	658
CHRYSLER	216, 218	GP011 FIAT	350	GR881 DAIHATSU	330	GT442 LANCIA	658
FORD	536, 538	SEAT	1320	GR882 DAIHATSU	328	GT446 FIAT	372, 374, 382
OPEL	940	GP051 FIAT	350	GR883 DAIHATSU	330	LANCIA	658
ROVER	1290, 1292	GP282 FIAT	352, 354	GR890 TOYOTA	1480	GT447 ALFA ROMEO	30
GK573 ALFA ROMEO	34	LANCIA	648	GR901 TOYOTA	1458	FIAT	400
CHRYSLER	218	GP285 LANCIA	648	GR940 ISUZU	602	LANCIA	658, 660
GK590 FIAT	352, 354, 362	GP286 FIAT	354	GR951 TOYOTA	1478	GT880 MITSUBISHI	832
GK671 TOYOTA	1460	GP530 TOYOTA	1458	GR961 MAZDA	692	GT890 MITSUBISHI	822, 824
GL321 KIA	634	GP570 MAZDA	698	ISUZU	602	PROTON	1036
GL390 SUZUKI	1424	GP580 NISSAN	858	OPEL	938	GT900 SUZUKI	1424
GL391 BEDFORD	138	GP601 MAZDA	698	VAUXHALL	1538	GV020 HONDA	554, 558
SUZUKI	1424	GP602 MAZDA	694, 696	GS050 NISSAN	858	GV021 HONDA	550
GL650 CITROËN	268, 270, 272, 276, 278, 280, 282	GP650 TOYOTA	1470	GS060 TOYOTA	1468	GV030 HONDA	570
PEUGEOT	1000, 1002, 1008, 1010, 1012	VW	1720	GS070 MAZDA	700	ROVER	1290
GL761 NISSAN	850	GP660 FIAT	350	GS111 HONDA	562	GV110 KIA	632
GL830 CITROËN	296, 298	GP730 SUBARU	1414	GS120 MITSUBISHI	828	GV250 NISSAN	872
PEUGEOT	1030	GP731 SUBARU	1414	HYUNDAI	590	GV330 TOYOTA	1456
GL950 TOYOTA	1472	GP861 FIAT	370, 372	KIA	636	GV331 TOYOTA	1454
		LANCIA	652	MITSUBISHI	834	GV360 TOYOTA	1462
		GP871 FIAT	362, 364	GS200 FORD	538	GV380 MAZDA	702
		GP920 ISUZU	602	NISSAN	874	GV431 KIA	632
		OPEL	938	GS240 HYUNDAI	584	MAZDA	692
				MITSUBISHI	822	GV440 NISSAN	856

							
GV670 FIAT	356	HA510 CITROËN	287	HBS002 BEDFORD	139	HBS031 FORD	461, 463, 471, 473, 475, 481, 487, 489, 501, 505, 507, 509, 511, 517, 519, 523
GV671 FIAT	356, 358	PEUGEOT	1019	CHEVROLET	207, 209		
GV680 ALFA ROMEO	26	HA512 CITROËN	287	DAEWOO	317, 319		
FIAT	378, 380, 384, 386, 394	PEUGEOT	1019	OPEL	897, 899, 901, 903, 907, 909, 911, 913	HBS032 FORD	513, 515, 519, 525, 527
LANCIA	656	HA5005 FIAT	375, 377	VAUXHALL	1499, 1501, 1503, 1505, 1509, 1511, 1513, 1515	HBS033 FORD	481, 483, 485, 487, 491, 493, 495, 497, 499
GV830 HONDA	564, 568	HA5006 MG	803			MAZDA	705
GV990 NISSAN	852	ROVER	1291	HBS005 LOTUS	685	HBS035 LADA	643
GW280 ALFA ROMEO	30	HA5008 CITROËN	283	MG	803	OPEL	929, 931, 933
GW281 ALFA ROMEO	28	FIAT	399	ROVER	1281, 1283, 1285, 1287, 1289	VAUXHALL	1529, 1531
GW282 ALFA ROMEO	28	PEUGEOT	1015			HBS036 CHEVROLET	209, 213
GW321 FIAT	400	HA5010 JAGUAR	623	HBS006 FORD	479	HONDA	559
GW341 FIAT	408	HA5011 JAGUAR	623	HBS007 FORD	467, 481, 483, 485, 489, 491, 493, 495, 497, 499	ISUZU	601
LANCIA	662	HA5020 CITROËN	295			MAZDA	699
GW410 ALFA ROMEO	22, 30	FORD	501, 505, 509, 511, 513, 521, 523, 525, 527, 529	HBS008 FORD	529, 531, 533	OPEL	905, 907, 915, 917
GW420 NISSAN	860	PEUGEOT	1027	LDV	677	VAUXHALL	1507, 1509, 1517, 1519
GW421 NISSAN	860	HA5023 BMW	159, 161, 169, 173, 177, 179	HBS010 JEEP	627	HBS038 CITROËN	269, 271, 275, 277, 279, 281, 283
GW560 TOYOTA	1464	HA5024 BMW	153, 155, 161, 163	RENAULT	1245, 1247, 1249, 1251	FIAT	401, 407
GW620 NISSAN	872	HA5028 CITROËN	257, 261, 263	HBS011 ALFA ROMEO	33, 35	PEUGEOT	1001, 1003, 1005, 1009, 1011, 1013, 1015, 1025
GW711 ALFA ROMEO	28	PEUGEOT	991, 993, 995, 997	CITROËN	259, 261		
GW712 ALFA ROMEO	28, 30	HA5029 CITROËN	259	FIAT	373, 411	HBS039 CITROËN	255, 257, 259, 261, 263, 271, 273
GW721 ALFA ROMEO	20, 22	FORD	451, 455	IVECO	611, 613, 615, 617	PEUGEOT	989, 991, 993, 995, 997, 1003, 1005
GW722 ALFA ROMEO	18, 20, 22	MAZDA	695	LANCIA	665		
GW723 FIAT	382	PEUGEOT	993	OPEL	941, 943, 945	HBS041 BMW	157, 171, 177
LANCIA	654, 656	SUZUKI	1427	PEUGEOT	993	HBS042 TOYOTA	1459, 1465, 1467, 1471
GW724 FIAT	382	HA5030 CITROËN	259, 267, 269	RENAULT	1263, 1265, 1267, 1269	HBS043 AUDI	59, 63, 65, 79, 81, 89, 91
LANCIA	654	FORD	459, 461, 469	VAUXHALL	1541, 1543	SEAT	1321, 1325, 1335, 1341, 1343, 1349, 1359
GW801 TOYOTA	1472	MAZDA	699	HBS015 PEUGEOT	1029	VW	1625, 1627, 1629, 1631, 1633, 1645, 1647, 1649, 1659, 1661, 1663, 1665, 1669, 1675, 1677, 1679, 1681, 1697, 1699
GX030 FIAT	374, 376	PEUGEOT	999, 1001	HBS017 CITROËN	297, 299		
GX041 FIAT	366	HA5031 CITROËN	259, 267, 269	PEUGEOT	1029, 1031	HBS044 SEAT	1323, 1333, 1341
LANCIA	652	FORD	459, 461, 469	HBS018 AUDI	65, 81, 83, 85	HBS045 MERCEDES-BENZ	757, 759
GX060 TOYOTA	1474	MAZDA	699	FORD	501	HBS046 MERCEDES-BENZ	775, 783
GX390 IVECO	616	MINI	807	SEAT	1325, 1341, 1349, 1351, 1353, 1355	HBS047 MERCEDES-BENZ	731, 737, 749, 751, 753
GX392 CITROËN	298	PEUGEOT	999, 1001	SKODA	1389, 1391, 1393	HBS050 FORD	439, 443, 445, 447, 449
FIAT	412	HA5032 CITROËN	271, 273	VW	1631, 1633, 1645, 1659, 1661, 1663, 1681, 1683, 1685, 1687, 1689, 1691, 1693, 1697	MAZDA	695
IVECO	616	PEUGEOT	1005			HBS051 CITROËN	269
PEUGEOT	1030	HA5034 SMART	1405	HBS021 AUDI	107, 113, 117	FIAT	353, 363, 365, 367, 371, 373, 375, 379
GX410 FIAT	412	HA5040 VOLVO	1571, 1589	VOLVO	1591	LANCIA	653, 655
OPEL	944	HA5041 VOLVO	1571, 1577, 1579, 1589	VW	1723, 1725, 1727, 1729, 1731, 1733, 1735	PEUGEOT	1001
RENAULT	1268	HA5042 VOLVO	1591, 1593	HBS022 VOLVO	1583		
VAUXHALL	1542	HA5053 ALFA ROMEO	13	VW	1721, 1723, 1725		
GY383 FIAT	356, 358	CHRYSLER	217	HBS024 AUDI	107, 109, 111, 113		
LANCIA	648, 650	FIAT	357, 361, 369, 371	VW	1719, 1721		
GY390 ALFA ROMEO	16	LANCIA	649, 651, 653	HBS028 AUDI	89		
GY391 ALFA ROMEO	16	HBS001 FORD	449, 451, 453, 465, 467, 469	SEAT	1343, 1349, 1359		
GY411 FIAT	386			VW	1679, 1681, 1697		
GY735 HYUNDAI	580						
GY861 HONDA	556						
GZ790 FIAT	388, 392						
HA371 NISSAN	851						
HA397 TOYOTA	1453						
HA399 KIA	635						
HA414 HYUNDAI	583						
HA497 FORD	439, 443, 445, 447						
MAZDA	695						

NUMERICAL PARTS LIST









Numerische Teilenummernliste • Liste des références produits
Elenco numerico articoli • Lista de referencias







 HBS052 ALFA ROMEO 13		 HBS074 BEDFORD 139		 HBS104 RENAULT 1101, 1103, 1105, 1111, 1113, 1115, 1117, 1119, 1121, 1123		 HBS146 MERCEDES-BENZ 765, 767, 775, 777	
CHRYSLER 217		OPEL 907, 915, 917		VOLVO 1555		HBS149 MERCEDES-BENZ 753	
FIAT 351, 353, 355, 357, 359, 361, 363, 369, 371		VAUXHALL 1509, 1517, 1519		HBS105 ALFA ROMEO 31, 35		HBS150 DAEWOO 321	
FORD 441		HBS075 SEAT 1327, 1329, 1335, 1337		HBS107 ALFA ROMEO 23, 25		MERCEDES-BENZ 733, 739, 741, 747, 749, 753, 755, 759	
LANCIA 649, 651, 653		SKODA 1383, 1387		HBS108 ALFA ROMEO 35		SSANGYONG 1409	
HBS053 CHEVROLET 211		VW 1631, 1633, 1635, 1637, 1645, 1647, 1649		CHRYSLER 217, 219		VW 1721	
DAEWOO 319		HBS077 FORD 539		FORD 537, 539		HBS152 DAEWOO 321	
OPEL 907, 919, 921, 927, 929, 931, 933		MERCEDES-BENZ 769		OPEL 941		MERCEDES-BENZ 769, 771, 777, 787, 789, 795	
VAUXHALL 1509, 1521, 1523, 1527, 1529, 1531, 1533		VW 1735, 1737		ROVER 1291, 1293		SSANGYONG 1409, 1411	
HBS054 CHEVROLET 211		HBS078 FORD 439, 441, 443, 449, 451, 453, 455, 457, 461, 465, 469		HBS110 NISSAN 851		HBS160 OPEL 939	
DAEWOO 319, 321		MAZDA 693, 695, 699		RENAULT 1101		VAUXHALL 1537	
LADA 643		VOLVO 1555		HBS112 OPEL 897, 899		HBS161 OPEL 927, 939	
OPEL 921, 929, 931, 933, 935, 937, 939		HBS082 CITROËN 261		VAUXHALL 1499, 1501		VAUXHALL 1539	
VAUXHALL 1521, 1523, 1529, 1531, 1533, 1535, 1537		PEUGEOT 995		HBS113 CITROËN 265		HBS163 OPEL 939	
HBS055 ALFA ROMEO 23		ROVER 1283		NISSAN 855		VAUXHALL 1537, 1539	
CHEVROLET 207, 209, 211		HBS083 CITROËN 269, 271, 273, 277, 279, 281, 283		PEUGEOT 997		HBS164 OPEL 941, 943, 945, 947	
FIAT 383		PEUGEOT 1001, 1009, 1011, 1013		ROVER 1285		SAAB 1309	
OPEL 903, 909, 911, 913, 915, 919, 923, 925		HBS084 CITROËN 275, 277, 279, 281, 283, 285, 287, 293		HBS114 CITROËN 297		VAUXHALL 1539, 1541, 1543	
SAAB 1299		FIAT 399, 405		PEUGEOT 1029		HBS171 AUDI 65, 67, 69, 71	
VAUXHALL 1505, 1511, 1513, 1515, 1517, 1521, 1523, 1525		HONDA 561		HBS115 CITROËN 293, 295		SKODA 1387	
HBS056 FORD 455, 465, 467, 479, 481, 513, 515, 517, 519		HYUNDAI 587		PEUGEOT 1025		VW 1665, 1667, 1669	
HBS057 FORD 539, 541, 543		LADA 643		HBS116 PEUGEOT 1017		HBS173 SKODA 1377, 1379	
HBS058 MERCEDES-BENZ 741, 757		PEUGEOT 1005, 1007, 1009, 1011, 1013, 1015, 1017, 1019		RENAULT 1213, 1233, 1235, 1237, 1239, 1241, 1243, 1257, 1259, 1261		HBS174 VOLVO 1567, 1569, 1573, 1575, 1577	
SSANGYONG 1409		ROVER 1287		HBS119 RENAULT 1253		HBS175 VOLVO 1569, 1577	
HBS059 DAEWOO 321		SUZUKI 1431		HBS120 DACIA 311		HBS177 RENAULT 1233	
MERCEDES-BENZ 761, 763, 773		HBS087 CITROËN 285, 287		MITSUBISHI 827		HBS178 RENAULT 1211, 1213	
SSANGYONG 1411		FIAT 405		RENAULT 1191, 1193, 1197, 1199, 1201, 1203, 1205, 1207		VOLVO 1555, 1561, 1563, 1565	
HBS060 MERCEDES-BENZ 779, 781, 791		LANCIA 661		VOLVO 1565, 1567		HBS179 SAAB 1301, 1305	
HBS061 MERCEDES-BENZ 741, 743, 749		PEUGEOT 1017, 1019		HBS121 BMW 155, 157, 159		SAAB 1301, 1303, 1305, 1307, 1309	
HBS062 MERCEDES-BENZ 763, 765		HBS089 CITROËN 277		MG 803		HBS185 FORD 535	
HBS063 MERCEDES-BENZ 781, 783		PEUGEOT 1007		ROVER 1291		VOLVO 1571, 1573, 1577, 1579, 1581, 1583, 1589, 1591	
HBS064 AUDI 113, 119, 121, 123, 125		HBS092 ALFA ROMEO 29		HBS125 CITROËN 293, 295		HBS187 NISSAN 853, 857	
HBS065 BMW 171		FIAT 373, 383, 399, 401, 403		FIAT 407		HBS188 NISSAN 865	
HBS066 BMW 171, 173, 175, 177, 179, 181, 189		LANCIA 653, 655, 657, 659, 661		LANCIA 663		HBS189 NISSAN 871	
OPEL 939, 943		661		PEUGEOT 1025		HBS190 NISSAN 873	
VAUXHALL 1539, 1541		HBS093 ALFA ROMEO 31		HBS127 CITROËN 301, 303		HBS194 FORD 539	
HBS067 BMW 159, 173		FIAT 383, 401, 403		PEUGEOT 1031, 1033		NISSAN 867, 871, 875	
HBS068 BMW 159, 161, 169, 171, 173, 177		LANCIA 659, 661		RENAULT 1269, 1271, 1275		HBS195 NISSAN 867	
HBS069 BMW 153, 155, 157		HBS095 ALFA ROMEO 25, 27		VOLVO 1591		HBS197 TOYOTA 1453	
HBS070 BMW 153		FIAT 365, 379, 381, 385, 387, 395		HBS130 FIAT 367		HBS198 TOYOTA 1467, 1469	
HBS071 BMW 177, 193		LANCIA 657		LANCIA 653		HBS200 DAIHATSU 333	
		HBS097 FIAT 385		HBS131 FIAT 375, 377		TOYOTA 1467, 1471	
		HBS098 FIAT 353, 355		LANCIA 655		HBS203 TOYOTA 1457, 1459, 1463	
		HBS102 DACIA 307, 309		HBS132 ALFA ROMEO 19, 21, 23, 29, 31		HBS209 TOYOTA 1477	
		RENAULT 1113, 1115, 1123, 1125, 1127, 1129, 1133, 1163, 1165		FIAT 383		HBS211 KIA 637	
				LANCIA 655, 657		MAZDA 701, 709, 711	
				HBS133 FIAT 401, 403, 409		SUZUKI 1431	
				LANCIA 659, 661, 663, 665			
				HBS136 MAZDA 699, 701, 703, 707			
				HBS140 FORD 541			

 HBS215 MITSUBISHI 823, 825, 829 PROTON 1037 VOLVO 1563		 HBS252 OPEL 899, 903, 905 SUZUKI 1425 VAUXHALL 1501, 1505, 1507		 HBS277 CITROËN 279, 281 FIAT 397 PEUGEOT 1009, 1013		 HBS300 AUDI 83, 85, 87, 93, 95 FORD 501 HONDA 555	
HBS216 MITSUBISHI 835, 837		HBS253 OPEL 897		HBS279 CHRYSLER 217		SEAT 1353, 1355, 1357, 1359, 1361, 1363	
HBS218 SUBARU 1415, 1417		SUZUKI 1425		FIAT 1321		SKODA 1393, 1395, 1397, 1399	
HBS223 LAND ROVER 671, 673		VAUXHALL 1499		SEAT 1321		VW 1687, 1689, 1691, 1693, 1695, 1703, 1705, 1707, 1709	
HBS224 LAND ROVER 671, 673		HBS254 CITROËN 271, 273		HBS281 HONDA 561, 565, 571			
HBS227 ALFA ROMEO 25, 27		PEUGEOT 1003, 1005		HBS282 HONDA 563			
FIAT 387, 389, 391, 393, 395, 397		HBS255 CITROËN 299, 301		ROVER 1289			
LANCIA 657, 659		FIAT 413		HBS283 NISSAN 851		HBS301 DACIA 309	
OPEL 927		PEUGEOT 1031		RENAULT 1105, 1107		NISSAN 859	
SAAB 1299		HBS257 ALFA ROMEO 33		HBS284 HONDA 561, 565, 567, 569, 571		RENAULT 1131, 1133, 1147, 1149, 1151, 1153, 1155, 1157, 1159, 1161	
VAUXHALL 1527		FIAT 409		ROVER 1287, 1291			
HBS241 NISSAN 851		LANCIA 663, 665		HBS285 CHEVROLET 207, 209		HBS302 PEUGEOT 1027, 1029	
RENAULT 1107, 1109, 1111		HBS259 CITROËN 273, 285, 293		DAEWOO 317, 319		HBS303 VOLVO 1571, 1573, 1577, 1579, 1581, 1583, 1589	
HBS243 FORD 469, 471, 475, 477, 479, 497, 499		FIAT 405		HBS286 ISUZU 603		HBS305 ROVER 1287, 1289, 1291	
HBS244 OPEL 925		LANCIA 661		OPEL 935		HBS306 TOYOTA 1455, 1457	
RENAULT 1145, 1147, 1165, 1167, 1169, 1171, 1173, 1175, 1177, 1179, 1181, 1183, 1185, 1187, 1191, 1193, 1195, 1197, 1199, 1213, 1215, 1217, 1219		PEUGEOT 1005, 1017, 1025		VAUXHALL 1535		HBS307 HYUNDAI 587	
VAUXHALL 1525		HBS260 CITROËN 271, 275, 277		HBS287 ISUZU 603, 605		KIA 635	
VOLVO 1555, 1557, 1559, 1561, 1567		PEUGEOT 1003, 1007		OPEL 943, 945, 947		MITSUBISHI 823, 831, 833	
HBS245 CITROËN 275, 283, 287, 293		HBS261 CITROËN 289, 291, 293, 295, 297		VAUXHALL 1541, 1543		HBS308 HYUNDAI 585, 587, 589	
FIAT 399, 405		FIAT 405, 407		HBS288 FORD 539		KIA 635	
PEUGEOT 1005, 1007, 1015		FORD 523		MAZDA 713		MITSUBISHI 823	
TOYOTA 1463		LANCIA 661, 663		HBS289 MAZDA 709		HBS309 CITROËN 295	
HBS246 AUDI 59, 61, 63		PEUGEOT 1021, 1023, 1025, 1027		HBS291 MERCEDES-BENZ 731		PEUGEOT 1025	
SEAT 1335, 1337, 1339, 1341, 1359, 1361		SUZUKI 1431, 1433		HBS292 CHRYSLER 217		HBS310 NISSAN 863	
SKODA 1383, 1385, 1387, 1397		VOLVO 1573		MERCEDES-BENZ 743, 745, 747, 749		OPEL 933	
VW 1647, 1649, 1651, 1653, 1655, 1657, 1659, 1697, 1699, 1701, 1703		HBS262 ALFA ROMEO 17, 19, 21		HBS293 JEEP 627		RENAULT 1187, 1189, 1219, 1221, 1223, 1225, 1227, 1229, 1231	
HBS247 ALFA ROMEO 13, 15		HBS264 AUDI 57		MERCEDES-BENZ 767, 769, 783		VAUXHALL 1531	
FIAT 357, 359, 367, 369, 371		SEAT 1327, 1331		HBS294 MERCEDES-BENZ 791		HBS311 AUDI 57	
LANCIA 649, 651, 653		SKODA 1379, 1381		HBS295 HYUNDAI 591		VW 1627	
OPEL 903		VW 1635, 1637, 1639, 1641		KIA 637		HBS312 DAIHATSU 331	
VAUXHALL 1503		HBS265 AUDI 117, 119		MITSUBISHI 833, 835		TOYOTA 1453, 1455	
HBS249 AUDI 57, 61, 63		SKODA 1401		HBS296 FORD 501, 505, 509, 511, 513, 521, 523, 525, 527, 529		HBS313 TOYOTA 1455, 1457	
SEAT 1321, 1323, 1327, 1329, 1331, 1333, 1339		VW 1727, 1731		JAGUAR 623		HBS314 TOYOTA 1465	
SKODA 1379, 1381, 1383, 1385		HBS268 AUDI 65, 67, 69, 71, 73, 75, 77		HBS297 FIAT 351		HBS315 TOYOTA 1473, 1475, 1479	
VW 1625, 1633, 1635, 1637, 1639, 1641, 1643, 1653, 1655		SEAT 1343, 1345, 1347, 1349		SEAT 1321		HBS316 AUDI 61	
HBS251 FIAT 409, 411		SKODA 1387, 1389		OPEL 933, 935, 937		SEAT 1337, 1339	
IVECO 611		VW 1665, 1667, 1669, 1671, 1673, 1675		SAAB 1307		VW 1649, 1651, 1653	
		HBS269 AUDI 107, 109, 111		VAUXHALL 1531, 1533, 1535, 1537		HBS349 JEEP 627	
		HBS270 AUDI 113, 115, 121, 125, 127		HBS299 DACIA 307		SMART 1405	
		VW 1735, 1737		NISSAN 853, 855		HBS353 ALFA ROMEO 13	
		HBS272 CITROËN 301		RENAULT 1135, 1137, 1139, 1141, 1143, 1145		CHEVROLET 207	
		FIAT 413		SUZUKI 1429		FIAT 357, 361, 363	
		LANCIA 667				FORD 441	
		PEUGEOT 1031, 1033				LANCIA 651	
		RENAULT 1271, 1273, 1275				OPEL 897, 899, 901	
		HBS273 CITROËN 297				SUZUKI 1425	
		PEUGEOT 1029				VAUXHALL 1499, 1501	
						HBS354 HYUNDAI 589	
						MITSUBISHI 829	
						HBS358 FORD 443, 457	

NUMERICAL PARTS LIST









Numerische Teilenummernliste • Liste des références produits
Elenco numerico articoli • Lista de referencias









 	 	 	 
HBS359 CITROËN 259, 267, 269, 271 FIAT 373 FORD 451, 455, 459, 461, 469 MAZDA 695, 699 MINI 807 PEUGEOT 993, 999, 1001 SUZUKI 1427, 1429 VOLVO 1557	HBS374 NISSAN 867, 871 HBS377 CHEVROLET 207 DAEWOO 317, 319 HBS378 HYUNDAI 581 KIA 633 HBS379 HYUNDAI 591 KIA 637 HBS382 HYUNDAI 587 KIA 635 HBS385 TOYOTA 1455, 1459, 1461, 1463 HBS386 TOYOTA 1475 HBS387 HYUNDAI 581, 583 HBS391 CHRYSLER 217 HBS392 FORD 535, 537, 543 MAZDA 713 HBS394 LEXUS 681 TOYOTA 1475, 1479, 1481 HBS397 TOYOTA 1479 HBS402 CHRYSLER 219 HYUNDAI 593 MITSUBISHI 837 HBS404 INFINITI 597 NISSAN 865, 875, 877 HBS405 SUBARU 1415, 1417, 1419 HBS407 SUZUKI 1425 HBS409 NISSAN 851, 853, 855 HBS413 BMW 159, 161, 169, 173, 177, 179 HBS415 FORD 469 HBS416 CHEVROLET 213 FIAT 409 OPEL 931, 935, 937, 939 SAAB 1305 VAUXHALL 1529, 1535, 1537 HBS417 OPEL 945 VAUXHALL 1543 HBS419 OPEL 945 VAUXHALL 1543 HBS420 MAZDA 697 HBS421 MITSUBISHI 827 HBS422 NISSAN 855, 859, 861 HBS423 KIA 637 LAND ROVER 673 MG 803 ROVER 1289, 1291, 1293 HBS425 TOYOTA 1465, 1475, 1477 HBS426 VOLVO 1591, 1593 HBS431 RENAULT 1231, 1233 HBS432 FORD 529 NISSAN 867 HBS433 NISSAN 877 HBS434 KIA 637 HBS440 HYUNDAI 581, 583, 589 MITSUBISHI 819, 821, 823, 825 PROTON 1037	HBS441 DAIHATSU 333 TOYOTA 1465, 1473 HBS443 INFINITI 597 NISSAN 875 HBS446 HYUNDAI 591 KIA 637 HBS447 SUZUKI 1431 HBS450 LEXUS 681 HBS452 TOYOTA 1481 HBS454 HYUNDAI 581, 583, 585 KIA 633 HBS455 KIA 635 HBS457 MERCEDES-BENZ 731, 735, 741, 743 HBS458 MERCEDES-BENZ 743 HBS459 MERCEDES-BENZ 733, 735 HBS460 SMART 1405 HBS461 SEAT 1365 VW 1721 HBS463 MERCEDES-BENZ 757, 767, 789, 791, 795 HBS464 IVECO 619 HBS465 ALFA ROMEO 27 FIAT 397 HBS467 BMW 153, 155, 161, 163 HBS468 BMW 175, 183, 185 HBS470 AUDI 131 HBS471 SEAT 1323, 1325 SKODA 1375, 1377 VW 1627, 1629 HBS474 MERCEDES-BENZ 783, 785 HBS476 AUDI 77, 91, 95, 97, 99, 101, 103, 105 SEAT 1347, 1363 SKODA 1389, 1401 VW 1675, 1701, 1707, 1709, 1711, 1713, 1715 HBS477 MITSUBISHI 819, 821 PROTON 1037 HBS479 SEAT 1323 SKODA 1375, 1377 VW 1627, 1629 HBS483 HYUNDAI 581 HBS489 CITROËN 263 PEUGEOT 995 HBS490 MINI 807 SUBARU 1415 TOYOTA 1455 HBS491 MITSUBISHI 839 HBS492 NISSAN 875 HBS494 MAZDA 709 HBS495 NISSAN 855, 859 HBS496 CHRYSLER 217 MINI 809 HBS497 SUZUKI 1429 HBS499 VW 1735, 1737 HBS500 TOYOTA 1481	HBS501 TOYOTA 1475, 1477 HBS502 OPEL 945 RENAULT 1275 SAAB 1309 VAUXHALL 1543 HBS503 CHRYSLER 219 HBS504 NISSAN 863, 869 HBS505 NISSAN 861 HBS506 NISSAN 851 HBS508 CITROËN 255 DAIHATSU 327 PEUGEOT 989 SUBARU 1415 TOYOTA 1453 HBS509 VW 1729, 1731, 1733 HBS510 AUDI 91 VW 1699 HBS511 MERCEDES-BENZ 777, 779, 791, 793, 795, 797 HBS512 AUDI 117, 127 HBS513 SEAT 1365 VW 1721 HBS516 NISSAN 857 HBS517 VW 1735 HBS518 AUDI 57 SEAT 1333 SKODA 1383 VW 1641, 1643, 1645 HBS519 BMW 183, 193, 195, 197, 199 HBS520 HONDA 551 HBS522 CITROËN 257, 265 MINI 807, 809 PEUGEOT 991, 993, 999, 1003 HBS523 MAZDA 695 HBS524 RENAULT 1243 HBS525 HYUNDAI 583 KIA 633 HBS526 FORD 539 SEAT 1365 VW 1735, 1737 HBS527 HONDA 561, 569 HBS528 HONDA 567, 573 HBS530 LAND ROVER 671 HBS531 LEXUS 681 TOYOTA 1463, 1469 HBS532 HONDA 571 HBS533 VOLVO 1585, 1587, 1589 HBS534 MERCEDES-BENZ 735, 747 HBS535 CITROËN 273, 285 PEUGEOT 1005, 1017 HBS536 AUDI 127, 129 HBS537 MITSUBISHI 819, 821 SMART 1405 HC027 FIAT 351, 353 SEAT 1321

 HC031 AUSTIN 135 ROVER 1281		 HJ283 FIAT 383, 385, 387, 401, 409 LANCIA 659, 661 ALFA ROMEO 17 FIAT 351		 HL5010 LADA 643 HM5053 AUDI 59, 63, 65, 79, 81, 89 SEAT 1335, 1341, 1343, 1349 VW 1645, 1659, 1661, 1663, 1665, 1675, 1677, 1679, 1681, 1697		 HM5247 ACURA 3 HONDA 573 ACURA 3, 5 HONDA 575 HONDA 551 HYUNDAI 581 HYUNDAI 587 KIA 635 SUBARU 1419 SUBARU 1419 SUBARU 1417 SUBARU 1417 SUBARU 1417 SUBARU 1415 HONDA 567 HYUNDAI 583 HYUNDAI 585 HYUNDAI 593 HYUNDAI 591 HONDA 569, 571 HONDA 567, 573 NISSAN 867 MITSUBISHI 825, 829 HYUNDAI 587, 589, 591 KIA 635 MERCEDES-BENZ 755, 767, 769, 783 HONDA 551 DAIHATSU 333 TOYOTA 1467, 1471 AUDI 107, 109, 111, 113 VW 1719, 1721 BMW 175, 185 MERCEDES-BENZ 743 BMW 175, 183 CITROËN 289 FIAT 405 FORD 503, 505, 509, 511, 521, 523 PEUGEOT 1021 VOLVO 1573 NISSAN 863, 865, 869 OPEL 937 RENAULT 1253, 1255, 1257, 1265, 1267 VAUXHALL 1535 RENAULT 1245 OPEL 945 RENAULT 1275 SAAB 1309 VAUXHALL 1543 VOLVO 1569, 1577 OPEL 941, 943, 945 VAUXHALL 1539, 1541, 1543 BMW 197, 199 BMW 197, 199
HC063 AUSTIN 135						
HC259 NISSAN 853						
HC285 FORD 465, 467, 479, 481, 513, 515, 517, 519						
HC288 OPEL 897, 899 VAUXHALL 1499, 1501						
HC295 OPEL 939, 943, 945 VAUXHALL 1541, 1543						
HC341 CITROËN 257 PEUGEOT 989, 991, 997						
HC346 PEUGEOT 1029						
HC354 RENAULT 1101, 1103, 1105, 1115, 1117, 1121, 1123 VOLVO 1555						
HC355 FORD 439						
HC417 OPEL 907, 927, 939 VAUXHALL 1509, 1537, 1539						
HC442 NISSAN 851, 853						
HC443 NISSAN 851						
HC451 FORD 529						
HC452 FORD 439, 443, 445, 447, 449						
HC459 NISSAN 855, 861						
HC460 NISSAN 873						
HC486 RENAULT 1115, 1117, 1119, 1121, 1123						
HC5004 CITROËN 295 FORD 501, 505, 509, 511, 513, 521, 523, 525, 527, 529 PEUGEOT 1027						
HC5005 MERCEDES-BENZ 748						
HC5006 CHEVROLET 208 DAEWOO 318						
HC5007 CHEVROLET 210 DAEWOO 318, 320 OPEL 922, 926, 930, 932 VAUXHALL 1522, 1526, 1532						
HC5009 KIA 633 MAZDA 693, 697, 699, 701, 703						
HC5010 NISSAN 851						
HG088 PEUGEOT 991, 997						
HG093 CITROËN 259						
HG108 CITROËN 259						
HJ013 AUSTIN 135 ROVER 1281						
HJ271 FIAT 411 IVECO 611, 613, 615						
HJ274 FIAT 363, 365						
HJ279 FIAT 355, 363, 365, 373						
HJ280 FIAT 355						
HJ282 FIAT 365, 367, 375, 377						
		HL442 CITROËN 259		HM5057 MERCEDES-BENZ 733, 739, 747, 749, 755 SSANGYONG 1409		
		HL456 VW 1661, 1663		HM5058 AUDI 81 SEAT 1349 SKODA 1389 VW 1681, 1683, 1693		
		HL457 AUDI 59, 63, 65, 79, 81, 89 SEAT 1335, 1341, 1343, 1349 VW 1645, 1659, 1661, 1663, 1665, 1675, 1677, 1679, 1681, 1697		HM5062 SEAT 1321, 1325, 1327, 1329, 1335, 1337 SKODA 1383, 1387 VW 1625, 1631, 1633, 1635, 1637, 1645, 1647, 1649		
		HL460 AUDI 107, 109, 111, 113 MAZDA 707 VW 1719, 1721		HM5066 BMW 193, 195, 197, 199 HM5067 BMW 193, 195, 197, 199 HM5069 BMW 169, 173, 179 HM5070 SAAB 1301, 1303, 1305, 1307, 1309		
		HL463 AUDI 107		HM5150 BMW 153		
		HL469 VW 1723		HM5160 BMW 155, 161, 163		
		HL472 CITROËN 275 PEUGEOT 1005, 1015, 1025		HM5170 MERCEDES-BENZ 743, 745, 749		
		HL474 FORD 467		HM5223 AUDI 117, 119 SKODA 1401 VW 1727, 1731, 1733		
		HL478 SUBARU 1415		HM5224 AUDI 113, 115, 117, 121, 125, 127 VW 1735, 1737		
		HL508 MAZDA 693, 695		HM5225 CHRYSLER 217		
		HL510 TOYOTA 1475		HM5226 DAEWOO 317		
		HL532 BEDFORD 139 ISUZU 601, 603 OPEL 939		HM5227 AUDI 107		
		HL606 AUDI 89 SEAT 1343, 1349, 1359 VW 1679, 1681, 1697		HM5228 HONDA 555, 561 HM5230 MITSUBISHI 835, 837 HM5231 SUBARU 1417 HM5232 SUBARU 1417 HM5233 SUBARU 1417 HM5234 SUBARU 1417 HM5235 TOYOTA 1463 HM5236 FORD 541, 543 HM5238 FORD 525, 527 HM5239 MITSUBISHI 833 HM5240 TOYOTA 1481 HM5241 TOYOTA 1481 HM5242 LEXUS 681 TOYOTA 1479 HM5243 LEXUS 681 TOYOTA 1481 HM5244 MITSUBISHI 819 HM5245 MITSUBISHI 831 HM5246 HONDA 563		HM5228 HONDA 503, 505, 509, 511, 521, 523 PEUGEOT 1021 VOLVO 1573 NISSAN 863, 865, 869 OPEL 937 RENAULT 1253, 1255, 1257, 1265, 1267 VAUXHALL 1535 RENAULT 1245 OPEL 945 RENAULT 1275 SAAB 1309 VAUXHALL 1543 VOLVO 1569, 1577 OPEL 941, 943, 945 VAUXHALL 1539, 1541, 1543 BMW 197, 199 BMW 197, 199
		HL657 MERCEDES-BENZ 774, 776				
		HL659 MERCEDES-BENZ 767				
		HL700 ALFA ROMEO 17, 19, 21, 23, 29, 31				
		HL701 FIAT 383 LANCIA 655, 657				
		HL702 JAGUAR 623				
		HL728 VW 1723, 1725				
		HL730 AUDI 107, 109, 111				
		HL731 AUDI 89 SEAT 1359 VW 1697				
		HL732 AUDI 65, 67, 69, 71, 73, 75, 77 SEAT 1343, 1345, 1347 SKODA 1387, 1389 VW 1665, 1667, 1669, 1671, 1673, 1675				
		HL733 BMW 155, 157				
		HL734 BMW 159, 171				
		HL735 BMW 159, 161, 171, 173, 177				
		HL736 BMW 159, 161, 173, 177				
		HL5002 SEAT 1323 SKODA 1375, 1377 SMART 1405 VW 1627, 1629				

NUMERICAL PARTS LIST









Numerische Teilenummernliste • Liste des références produits
Elenco numerico articoli • Lista de referencias





							
HM5300 CHEVROLET	213	HR343 BEDFORD	139	HR397 ALFA ROMEO	13, 23, 25, 27		1387, 1389, 1391,
OPEL	937	OPEL	907, 915, 917, 919	AUDI	57, 59, 61, 63, 67, 69,		1393, 1395, 1397,
VAUXHALL	1537	VAUXHALL	1509, 1517, 1519, 1521		71, 73, 75, 77, 83, 85,		1399, 1401
HM5367 AUDI	81, 83, 85	HR350 RENAULT	1101, 1105		87, 91, 93, 97, 99, 101,	SMART	1405
FORD	501	HR351 RENAULT	1245, 1247, 1249, 1251		103, 105	SUBARU	1415, 1419
SEAT	1341, 1349, 1351, 1355	HR354 ALFA ROMEO	17, 19, 21, 23, 29, 31	BMW	157, 193	SUZUKI	1425, 1427, 1429,
VW	1661, 1663, 1681,	FIAT	353, 355, 357, 359,	CHEVROLET	207, 209, 211, 213		1431, 1433
	1683, 1685, 1687,		363, 367, 387, 401,	DACIA	309	TOYOTA	1453, 1455, 1457,
	1689, 1691		403, 409	DAEWOO	317, 319		1459, 1461, 1463,
HM5368 BMW	163	LANCIA	649, 651, 653, 659	DAIHATSU	327, 329, 331, 333		1465, 1467, 1469,
HM5369 CITROËN	295	HR363 ALFA ROMEO	17, 19, 21, 23, 25, 27,	FIAT	367, 369, 371, 373,		1471, 1473, 1475,
FORD	523		29, 31, 33		377, 383, 391, 393,		1477, 1479, 1481
PEUGEOT	1027	AUDI	81, 91		395, 397, 405, 407,	VAUXHALL	1499, 1501, 1503,
HM5370 OPEL	935	CITROËN	269		413		1527, 1531, 1535,
SAAB	1305	FIAT	363, 365, 367, 371,	FORD	441, 443, 461, 469,		1537, 1543
VAUXHALL	1535		373, 375, 379, 383,		503	VOLVO	1557, 1579, 1581, 1583
HM5371 CITROËN	265		387, 389, 391, 393,	HONDA	551, 559, 561, 567, 569	VW	1625, 1627, 1629,
PEUGEOT	999, 1003		395, 397, 401, 403,	HYUNDAI	581, 583, 585, 587,		1631, 1633, 1635,
HM5374 HYUNDAI	581		409		589, 591, 593		1637, 1639, 1641,
KIA	633	FORD	501	KIA	633, 635, 637		1643, 1645, 1647,
HR280 BMW	159, 161, 169, 171,	LANCIA	657, 659, 663, 665	LAND ROVER	671, 673		1649, 1651, 1653,
	173, 177	OPEL	927	LEXUS	681		1655, 1657, 1659,
MERCEDES-BENZ	791, 793	PEUGEOT	1001	MAZDA	693, 695, 697, 699,		1667, 1671, 1673,
OPEL	915, 939, 943, 947	TOYOTA	1463		703, 705, 707, 709,		1675, 1685, 1687,
SEAT	1323, 1325	VAUXHALL	1527		713		1689, 1691, 1693,
SKODA	1375, 1377	VW	1665	MERCEDES-BENZ	731, 777,		1695, 1699, 1701,
VAUXHALL	1517, 1539, 1541, 1543				779, 783, 785, 789,		1705, 1707, 1709,
VW	1627, 1629				791, 793, 795, 797		1711, 1713, 1715,
HR291 OPEL	897, 899			MINI	819, 821, 823, 825,		1717, 1719, 1721,
VAUXHALL	1499, 1501				827, 829, 831, 833,		1729, 1731, 1735,
HR299 JAGUAR	623				835, 837	HR564 CITROËN	255, 257, 259, 261,
HR300 CITROËN	259			NISSAN	851, 853, 855, 857,		263
PEUGEOT	989, 991, 993, 997				859, 861, 863, 865,	PEUGEOT	989, 991, 993, 995,
TALBOT	1437				867, 869, 871, 873,		997
VOLVO	1591				875, 877	RENAULT	1115, 1119, 1121
HR336 OPEL	927, 939, 943, 945			OPEL	897, 899, 901, 927,	ROVER	1283
VAUXHALL	1539, 1541, 1543				933, 935, 939, 947	HR566 CITROËN	269, 271, 273, 277,
HR339 AUSTIN	135			PROTON	1037		279, 281, 283
ROVER	1281, 1289			RENAULT	1131, 1133, 1147, 1149,	PEUGEOT	1001, 1003, 1007,
HR340 CITROËN	297, 299				1151, 1153, 1155, 1157,		1009, 1011, 1013
PEUGEOT	1031				1159, 1161, 1187, 1189,		
HR342 BEDFORD	139				1219, 1221, 1223,		
CHEVROLET	207, 209, 211				1225, 1227, 1229,		
DAEWOO	317, 319, 321				1231, 1233, 1271,		
LADA	643				1273, 1275		
OPEL	897, 899, 901, 903,			SAAB	1299, 1305		
	907, 909, 911, 913,			SEAT	1321, 1323, 1325,		
	919, 921, 927, 929,				1327, 1329, 1331,		
	931, 933, 945				1333, 1335, 1337,		
VAUXHALL	1499, 1501, 1503,				1339, 1341, 1343,		
	1505, 1509, 1511,				1345, 1347, 1349,		
	1513, 1515, 1521,				1351, 1353, 1355,		
	1523, 1527, 1529,				1357, 1359, 1361,		
	1531, 1533, 1543				1363, 1365		
				SKODA	1375, 1377, 1379,		
					1381, 1383, 1385,		

											
HR569	AUDI	59, 63, 65, 79, 81, 83, 89, 121	HR599	ALFA ROMEO	17, 19, 21, 23, 29, 31	HR642	CITROËN	255, 257, 259, 261, 263, 265, 271, 273, 285, 287, 297	HR662	ALFA ROMEO	35, 37
	BMW	177		AUDI	89, 93, 95		PEUGEOT	989, 991, 993, 995, 997, 1003, 1005, 1019, 1029		AUDI	113, 119, 125
	CITROËN	255, 257, 269, 271, 273, 275, 277, 279, 281, 283, 285, 287, 293, 297		BMW	153, 169		ROVER	1283, 1285		BMW	157, 159, 171, 177, 199
	DACIA	311		CITROËN	255, 257, 259, 261, 263, 265, 273, 279, 281		SEAT	1361		CITROËN	297
	FIAT	367, 375, 379, 385, 397, 399, 401, 407		FIAT	351, 353, 355, 357, 359, 363, 367, 375, 377, 383, 401		VW	1633, 1717		FORD	539
	HONDA	561		LANCIA	649, 651, 655, 657, 659, 661	HR643	RENAULT	1101, 1105, 1111, 1113, 1115		LANCIA	667
	JEEP	627		PEUGEOT	989, 991, 993, 995, 997, 1005, 1009, 1011, 1019		AUDI	95		MERCEDES-BENZ	769
	LADA	641, 643		RENAULT	1111, 1113, 1115, 1123, 1125, 1127, 1129, 1211, 1213, 1233, 1253	HR646	BMW	153, 155, 157		PEUGEOT	1029
	OPEL	925		SEAT	1321, 1323, 1329, 1333, 1341, 1349, 1359, 1361, 1363		DACIA	307, 309, 311		RENAULT	1239, 1241, 1243, 1259
	PEUGEOT	991, 997, 1001, 1003, 1005, 1007, 1009, 1011, 1013, 1015, 1017, 1019, 1025, 1027, 1029, 1031		SKODA	1379, 1381, 1397, 1399		FORD	501		VW	1735, 1737
	RENAULT	1165, 1167, 1169, 1171, 1173, 1175, 1177, 1179, 1181, 1183, 1185, 1187, 1191, 1193, 1195, 1197, 1199, 1213, 1215, 1217, 1219, 1233, 1235, 1237, 1239, 1241, 1243, 1245, 1247, 1249, 1251, 1257, 1259, 1261, 1269, 1271		SUZUKI	1429		NISSAN	861		LOTUS	685
	ROVER	1287		VOLVO	1555, 1569, 1577, 1579, 1581, 1589, 1591		OPEL	925, 927		MG	803
	SEAT	1321, 1325, 1335, 1341, 1343, 1349, 1351, 1359		VW	1637, 1665, 1679, 1681, 1697, 1699, 1701, 1703, 1705, 1707, 1709, 1729, 1731, 1733		PEUGEOT	997		ROVER	1283, 1285, 1287
	SKODA	1377, 1379, 1389	HR602	ALFA ROMEO	15, 17, 33, 35		RENAULT	1101, 1103, 1105, 1111, 1113, 1115, 1117, 1119, 1121, 1123, 1125, 1127, 1129, 1133, 1163, 1165, 1191, 1199, 1201, 1203, 1205, 1207, 1209, 1211		MERCEDES-BENZ	731, 737, 749, 751, 753
	SUZUKI	1431		AUDI	125		SAAB	1301, 1303, 1305, 1307		MERCEDES-BENZ	741, 755, 757
	VAUXHALL	1525		CITROËN	299, 301		SEAT	1321, 1361		SSANGYONG	1409
	VOLVO	1555, 1557, 1559, 1561, 1565, 1567		FIAT	411, 413		SKODA	1375, 1397		MERCEDES-BENZ	761, 763, 773
	VW	1625, 1627, 1629, 1631, 1633, 1645, 1647, 1659, 1661, 1663, 1665, 1675, 1677, 1679, 1681, 1683, 1685, 1697, 1699		IVECO	611, 613, 615, 617		VAUXHALL	1525		SSANGYONG	1411
				LANCIA	665	HR655	VOLVO	1567		MERCEDES-BENZ	765, 767, 775, 777
HR573	PEUGEOT	991, 997		OPEL	945		VW	1625, 1633, 1655, 1675, 1681, 1701, 1703, 1705, 1707, 1717		MERCEDES-BENZ	779, 781, 791
HR574	PEUGEOT	1015, 1025		PEUGEOT	1031		MAZDA	695		NISSAN	865
HR596	ALFA ROMEO	27		RENAULT	1269	HR656	ROVER	1281, 1283		NISSAN	865
	FIAT	351, 353, 355, 363, 365, 371, 373, 379, 381, 385, 387, 395, 399, 403	HR615	AUDI	107, 109, 111, 113, 117, 1719, 1721, 1723, 1725, 1727, 1729, 1731, 1735	HR658	RENAULT	1113, 1115, 1123, 1125, 1127, 1129		CITROËN	297
	LANCIA	657		VW	1719, 1721, 1723, 1725, 1727, 1729, 1731, 1735		FORD	467, 481, 483, 485, 489, 491, 493, 495, 497		PEUGEOT	1029
	VW	1729, 1731, 1733	HR625	ROVER	1291	HR659	FORD	467, 481, 483, 485, 489, 491, 493, 495, 497		RENAULT	1253
			HR630	FORD	539	HR660	FORD	539, 541, 543			
			HR631	FORD	479, 481, 515, 517, 519	HR661	FORD	449, 451, 453, 465, 479, 515			
			HR633	FORD	539						
			HR635	CARBODIES	201						
			HR641	VOLVO	1567, 1569, 1573, 1575, 1577						

NUMERICAL PARTS LIST









Numerische Teilenummernliste • Liste des références produits
Elenco numerico articoli • Lista de referencias









							
HR791	ALFA ROMEO 13	HR805	CITROËN 293, 295	HR822	AUDI 65, 67, 69, 71, 73, 75, 77	HR5062	AUDI 117, 119, 121, 123
	AUDI 57, 61, 63, 77, 91, 93, 95, 97, 99, 101, 103, 107, 131		FIAT 407		SEAT 1343, 1345, 1347, 1349, 1365		BMW 169, 173, 179
	BMW 183, 193, 195, 197, 199		PEUGEOT 1025, 1031		SKODA 1387, 1389		CITROËN 301
	CHEVROLET 209, 211, 213		TALBOT 1437		VOLVO 1573, 1585, 1587, 1589		FIAT 413
	DAEWOO 319, 321		VOLVO 1559, 1561, 1567, 1583, 1591		VW 1665, 1667, 1669, 1671, 1673, 1675, 1721		FORD 539
	FIAT 361		VW 1721, 1723, 1725, 1733, 1735				MERCEDES-BENZ 793, 795
	FORD 441	HR808	FORD 439, 441, 443, 451, 453, 455, 457, 465	HR5030	SAAB 1307		OPEL 941, 943, 945
	MERCEDES-BENZ 795, 797		MAZDA 695		VOLVO 1571, 1573, 1577, 1579, 1581, 1583, 1593		PEUGEOT 1031, 1033
	MINI 831	HR809	FORD 439, 441, 443, 451, 453, 455, 457, 465	HR5031	LAND ROVER 673		RENAULT 1271, 1273, 1275
	NISSAN 865, 869		MAZDA 695		MG 803		SAAB 1309
	OPEL 903, 911, 913, 917, 921, 931, 933, 935, 937, 939	HR814	ALFA ROMEO 13, 15		ROVER 1289, 1291, 1293		SEAT 1365
	RENAULT 1253, 1255, 1257, 1265, 1267		FIAT 357, 359, 369, 371	HR5033	FORD 461, 463, 471, 473, 475, 481, 487, 489, 505, 507, 509, 511, 517, 519, 523		SKODA 1401
	SAAB 1307		LANCIA 649, 651				VAUXHALL 1539, 1541, 1543
	SEAT 1327, 1329, 1331, 1333, 1337, 1339, 1347, 1361, 1363	HR815	ALFA ROMEO 29, 31	HR5045	BMW 157, 159, 195		VW 1727, 1731, 1733, 1737
	SKODA 1379, 1381, 1383, 1385, 1389, 1399, 1401	HR816	AUDI 59, 61, 81, 83, 85, 87, 89, 93, 95, 109		MG 803		HR5063
	VAUXHALL 1505, 1513, 1515, 1519, 1521, 1523, 1531, 1533, 1535, 1537		FORD 501		ROVER 1291		FORD 471, 477, 479, 501, 503, 505, 513, 521, 523, 527
	VW 1633, 1635, 1637, 1639, 1641, 1643, 1645, 1649, 1651, 1653, 1655, 1675, 1701, 1703, 1705, 1707, 1709, 1711, 1713, 1715, 1717		SEAT 1321, 1323, 1325, 1327, 1335, 1337, 1341, 1343, 1349, 1351, 1353, 1355, 1357, 1359, 1361, 1363	HR5046	CITROËN 289, 291, 293, 295, 405, 407		MAZDA 705
HR794	OPEL 939		SKODA 1383, 1387, 1389, 1391, 1393, 1395, 1397, 1399		FORD 509, 511, 521, 523		VOLVO 1561, 1563, 1569
	VAUXHALL 1537, 1539		VW 1625, 1627, 1629, 1631, 1633, 1645, 1647, 1649, 1651, 1661, 1663, 1665, 1669, 1679, 1681, 1683, 1685, 1687, 1689, 1691, 1693, 1695, 1697, 1699, 1701, 1703, 1705, 1707, 1709		PEUGEOT 1021, 1023, 1025, 1027		FIAT 405, 407
HR800	ALFA ROMEO 21, 23, 35			HR5048	CHEVROLET 211		FORD 529, 531, 533
	AUDI 117	HR817	AUDI 61, 63, 91		MINI 803		LDV 677
	FIAT 359, 367, 375, 377, 383, 401, 403, 409		BMW 155, 157	HR5046	CITROËN 289, 291, 293, 295, 405, 407		HR5068
	LANCIA 653, 655, 659, 661, 663		DACIA 307, 309		FORD 509, 511, 521, 523		AUDI 57, 119, 123
HR801	FIAT 411		NISSAN 853, 855		PEUGEOT 1021, 1023, 1025, 1027		SEAT 1327, 1331
	FORD 469, 471, 475, 477, 479, 481, 483, 485, 487, 489, 491, 493, 495, 497, 499		RENAULT 1107, 1135, 1137, 1139, 1141, 1143, 1145		SUZUKI 1431, 1433		SKODA 1379, 1381
	LAND ROVER 671		SEAT 1321, 1323, 1327, 1329, 1331, 1337, 1339, 1341		VOLVO 1573		VW 1627, 1635, 1637, 1639, 1641
	MAZDA 705		SKODA 1383, 1385, 1387	HR5050	JAGUAR 623		HR5072
HR802	ROVER 1289		SUZUKI 1429		MINI 803		SAAB 1305, 1309
HR804	MERCEDES-BENZ 765		VW 1625, 1627, 1635, 1637, 1639, 1649, 1651, 1653, 1655, 1657, 1659, 1699	HR5051	HONDA 563		HR5075
					ROVER 1289		CHEVROLET 207
				HR5054	LAND ROVER 673		DAEWOO 317
				HR5055	DAEWOO 321		SUBARU 1415
					MERCEDES-BENZ 733, 735, 739, 743, 745, 747, 749, 753, 755, 769, 771, 777, 787, 789, 791, 795		SUZUKI 1427
					SSANGYONG 1409, 1411		HR5076
				HR5056	MERCEDES-BENZ 731		VOLVO 1555, 1561, 1563, 1565, 1569, 1581, 1583, 1589, 1591, 1593
				HR5057	MERCEDES-BENZ 781, 783		HR5080
				HR5060	VOLVO 1555, 1561, 1563, 1565		CITROËN 273, 277, 285, 287
				HR5061	CHRYSLER 217		PEUGEOT 1005, 1007, 1017, 1019
					MINI 809		HR5081
							CITROËN 277, 285, 287
							PEUGEOT 1007, 1017, 1019
							HR5082
							CITROËN 295
							FIAT 407
							FORD 501, 505, 509, 511, 513, 521, 523, 525, 527, 529
							LAND ROVER 671
							PEUGEOT 1027
							HR5085
							AUDI 107
							MERCEDES-BENZ 743, 745, 747, 749
							VW 1729, 1731
							HR5087
							OPEL 913, 915
							SAAB 1299
							VAUXHALL 1515, 1517

 HR5088 CHEVROLET 207	 JA5007 FIAT 383	 JB841 CITROËN 275, 283	 JC146 VOLVO 1583
FIAT 357, 361	LANCIA 655, 657	FIAT 401, 407	VW 1721, 1723, 1725
HONDA 565	JA5008 FIAT 389	PEUGEOT 1005, 1015, 1025	JC152 AUDI 59, 61, 63, 65, 79, 81,
LANCIA 651	JA5010 FIAT 355, 359, 363	TALBOT 1437	83, 85, 89, 91, 107,
OPEL 897, 899, 901	LANCIA 651	JB842 PEUGEOT 1015, 1029	109, 111, 113, 117
SUZUKI 1425	JA5011 FIAT 389, 393	JB851 DACIA 307	FORD 501
VAUXHALL 1499, 1501	JA5014 MITSUBISHI 835, 837	FIAT 401	SEAT 1335, 1337, 1341,
HR5092 CHEVROLET 207, 209	JA5035 ALFA ROMEO 25, 27	RENAULT 1101, 1115	1343, 1349, 1351,
DAEWOO 317, 319, 321	FIAT 387, 389, 391, 393,	VOLVO 1555	1353, 1355, 1357, 1359
HR5094 OPEL 945	395, 397	JB862 FORD 439, 447, 449	SKODA 1389, 1391, 1393
RENAULT 1275	LANCIA 657, 659	JB864 CITROËN 255	VOLVO 1583, 1591
SAAB 1309	OPEL 927	JB868 CITROËN 297, 299	VW 1633, 1645, 1647,
VAUXHALL 1543	SAAB 1299	PEUGEOT 1031	1649, 1651, 1659,
HR5095 ALFA ROMEO 25, 27	VAUXHALL 1527	JB869 CITROËN 285, 297, 299	1661, 1663, 1665,
FIAT 391, 395, 397	JA5036 ALFA ROMEO 33	PEUGEOT 1029, 1031	1669, 1675, 1677,
OPEL 927	FIAT 409	TALBOT 1437	1679, 1681, 1683,
SAAB 1299	LANCIA 663, 665	JB875 PEUGEOT 991, 997	1685, 1687, 1689,
VAUXHALL 1527	JA5037 VOLVO 1571, 1583, 1589	JB894 LAND ROVER 673	1691, 1695, 1697,
HR5096 OPEL 897	JA5038 VOLVO 1571, 1577, 1579,	JB910 TOYOTA 1453, 1457	1699, 1719, 1721,
VAUXHALL 1499	1581, 1583	JB917 VOLVO 1567, 1569, 1573,	1723, 1725, 1727,
HR5097 MERCEDES-BENZ 731, 735, 741, 743	JA5039 RENAULT 1211, 1213	1575, 1577	1729, 1731, 1733
HR5107 BMW 191	VOLVO 1555, 1561, 1563,	JB926 VOLVO 1567, 1569, 1573, 1575	JC155 OPEL 927
HR5110 BMW 163, 165, 167, 169	1565	JB954 CITROËN 285, 297	JC163 MAZDA 693, 695
HR5111 CITROËN 299, 301	JA5040 RENAULT 1211, 1213	PEUGEOT 1017, 1027, 1029	JC183 MAZDA 693
JAGUAR 623	VOLVO 1555, 1561, 1563,	RENAULT 1213, 1233, 1235,	JC214 NISSAN 853
LAND ROVER 673	1565, 1571, 1573,	1237, 1239, 1241,	JC215 TOYOTA 1475
PEUGEOT 1031, 1033	1577, 1579, 1581,	1243, 1257, 1259, 1261	JC222 SUZUKI 1425
HR5112 NISSAN 851, 855, 859, 861	1583, 1589, 1591, 1593	JB997 RENAULT 1115	JC224 HYUNDAI 591
HR5113 FORD 535	JA5042 VOLVO 1571, 1583	JC023 HYUNDAI 583	KIA 637
VOLVO 1579, 1589	JA5043 VOLVO 1571, 1577, 1579, 1583	JC054 ALFA ROMEO 33, 35	MITSUBISHI 833, 835
HT025 RENAULT 1113	JA5044 VOLVO 1591, 1593	CITROËN 299, 301	JC238 RENAULT 1235, 1237, 1239,
JA086 FORD 455	JA5058 TOYOTA 1481	FIAT 411, 413	1241, 1243, 1257,
JA415 OPEL 897, 899	JA5068 FORD 539	IVECO 611, 613, 615, 617	1259, 1261
VAUXHALL 1499, 1501	VW 1735, 1737	LANCIA 665	JC240 ROVER 1285
JA439 AUSTIN 135	JA5069 FORD 539	OPEL 941, 943, 945	JC241 JAGUAR 623
ROVER 1281	VW 1735, 1737	PEUGEOT 1031	JC242 SUZUKI 1425
JA752 FIAT 351	JA5078 LAND ROVER 673	RENAULT 1263, 1265, 1267, 1269	JC243 AUDI 65
JA757 FIAT 373, 375, 383, 399,	MG 803	VAUXHALL 1541, 1543	VW 1645, 1659, 1661
401, 403	ROVER 1289, 1291, 1293	JC055 ALFA ROMEO 35	JC250 MAZDA 695
LANCIA 657, 659	JA5079 LAND ROVER 673	CITROËN 299, 301	JC259 SEAT 1321, 1325
JA768 FORD 465, 467, 479, 481,	MG 803	FIAT 411, 413	SKODA 1377
513, 515, 517, 519	ROVER 1289, 1291, 1293	IVECO 611, 613, 615, 617	VW 1625, 1627, 1629,
JA769 FORD 465, 467, 479, 481,	JA5085 FORD 497, 501, 505, 509,	LANCIA 665	1631, 1633
513, 515, 517, 519	511, 513, 521	OPEL 941, 943, 945	JC261 AUDI 107, 109, 111, 113
JA770 FORD 465, 467, 479, 481,	MAZDA 705	PEUGEOT 1031	VW 1719, 1721
513, 515, 517, 519	JB162 MERCEDES-BENZ 743, 757, 759	RENAULT 1263, 1265, 1267, 1269	JC276 TOYOTA 1477, 1479
JA829 ALFA ROMEO 23, 29	JB776 NISSAN 871	VAUXHALL 1541, 1543	JC277 TOYOTA 1477
JA899 ALFA ROMEO 13, 15, 17, 19, 21	JB792 LAND ROVER 673	JC060 ISUZU 601	JC280 BEDFORD 139
JA5000 LAND ROVER 673	JB799 FORD 439, 445, 447, 449	JC091 PEUGEOT 1029, 1031	OPEL 897, 901
JA5001 LAND ROVER 673	JB830 CITROËN 255	JC116 TOYOTA 1459	VAUXHALL 1499, 1503
JA5005 FIAT 359	JB833 CITROËN 255	JC122 MITSUBISHI 819, 821	
LANCIA 651	JB836 CITROËN 257	JC123 MITSUBISHI 819, 821	
JA5006 FIAT 359, 367, 371	PEUGEOT 989, 991, 997	JC124 MITSUBISHI 819	
LANCIA 651	JB837 CITROËN 257	JC132 SUBARU 1415	
VAUXHALL 1503	PEUGEOT 989, 991, 997	JC133 NISSAN 867, 869	
		JC140 SUBARU 1415, 1417	

NUMERICAL PARTS LIST









Numerische Teilenummernliste • Liste des références produits
Elenco numerico articoli • Lista de referencias









							
JC281	BEDFORD 139	JC460	NISSAN 851	JC683	BEDFORD 139	JC791	ACURA 3
	CHEVROLET 207, 209	JC472	NISSAN 873, 875		ISUZU 601, 603		HONDA 573
	DAEWOO 317, 319	JC475	NISSAN 855, 861		OPEL 939		ROVER 1293
	OPEL 897, 899, 901, 903, 907, 909, 911	JC477	KIA 637	JC684	ISUZU 603	JC794	HYUNDAI 585
	VAUXHALL 1499, 1501, 1503, 1505, 1509, 1511, 1513	JC478	AUDI 59, 63, 65, 79, 81, 121		OPEL 939		NISSAN 825
JC282	BEDFORD 139		SEAT 1335, 1341, 1343, 1349	JC687	ACURA 3	JC795	HYUNDAI 585, 587
	CHEVROLET 211		SKODA 1383		HONDA 573		KIA 635
	DAEWOO 319		VW 1645, 1647, 1659, 1661, 1663, 1665, 1669, 1675, 1677, 1679, 1681, 1719	JC688	HONDA 563	JC805	FORD 539
	OPEL 907, 919, 921, 927, 929, 931, 933	JC493	NISSAN 829	JC694	FIAT 365	JC806	FORD 539
	VAUXHALL 1509, 1521, 1523, 1527, 1529, 1531, 1533	JC532	SUZUKI 1425	JC700	SUBARU 1415		NISSAN 871
JC283	OPEL 907, 919	JC554	NISSAN 823	JC702	CITROËN 255, 257, 259, 261, 263, 271, 273	JC823	CHEVROLET 209
	VAUXHALL 1509, 1521	JC558	TOYOTA 1453		PEUGEOT 989, 991, 993, 995, 997, 1003, 1005		DAEWOO 317, 319
JC284	ISUZU 603	JC559	TOYOTA 1453	JC710	NISSAN 875		OPEL 901, 903, 909, 911
JC305	SAAB 1301, 1305	JC565	FORD 467	JC712	PEUGEOT 1027	JC824	BEDFORD 139
JC317	NISSAN 855	JC576	TOYOTA 1459, 1465, 1467, 1471	JC719	NISSAN 819, 821		CHEVROLET 207
JC364	FORD 539	JC579	TOYOTA 1459	JC723	FIAT 351		OPEL 897, 899, 901, 903, 907, 909, 911
JC365	FORD 539	JC580	NISSAN 867, 869	JC724	FORD 465		VAUXHALL 1499, 1501, 1503, 1505, 1509, 1511, 1513
JC399	TOYOTA 1459	JC581	NISSAN 873, 875	JC738	ALFA ROMEO 27	JC829	FORD 449, 453, 465
JC400	KIA 635	JC584	TOYOTA 1475		FIAT 379, 381, 385, 387, 395	JC838	TOYOTA 1479
	MAZDA 711	JC598	KIA 637	JC739	TOYOTA 1479	JC841	TOYOTA 1469
JC401	KIA 635		MAZDA 711	JC745	HONDA 559	JC842	TOYOTA 1469
JC402	TOYOTA 1461, 1467	JC605	NISSAN 861	JC750	CITROËN 269, 271, 273, 277, 279, 281, 283	JC852	MG 803
JC404	HONDA 563	JC611	NISSAN 829, 833		PEUGEOT 1001, 1003, 1009, 1011, 1013	JC861	SUZUKI 1427
JC405	HONDA 563	JC612	HYUNDAI 589	JC751	NISSAN 837	JC863	HONDA 551
JC415	CITROËN 269, 271, 273, 277, 279, 281, 283, 285, 287, 293	JC615	TOYOTA 1471	JC756	CHEVROLET 211	JC867	SUZUKI 1429
	PEUGEOT 1001, 1003, 1009, 1011, 1013, 1017, 1019	JC627	NISSAN 823, 825		DAEWOO 319	JC868	SUZUKI 1429
JC420	BEDFORD 139	JC632	NISSAN 823, 827		OPEL 919, 927, 929, 931, 933	JC869	NISSAN 853, 857
	SUZUKI 1425	JC641	SUZUKI 1427		VAUXHALL 1521, 1527, 1529, 1531, 1533	JC870	NISSAN 853, 857
JC423	CITROËN 275, 277, 279, 281, 283	JC643	ISUZU 603	JC757	DAEWOO 319	JC872	LADA 641
	FIAT 397, 399		OPEL 935		OPEL 919, 921	JC875	NISSAN 851
	LADA 643	JC652	HONDA 563	JC759	VAUXHALL 1521, 1523		RENAULT 1101
	PEUGEOT 1005, 1007, 1009, 1011, 1013, 1015	JC658	TOYOTA 1471		CITROËN 277, 279, 281, 283	JC876	NISSAN 851
	SUZUKI 1431	JC660	FIAT 351		FIAT 397		RENAULT 1101, 1269
	TALBOT 1437		ALFA ROMEO 29		LADA 643	JC877	ROVER 1283
JC429	ISUZU 603		FIAT 383, 399, 401, 403		PEUGEOT 1007, 1009, 1011, 1013	JC879	TOYOTA 1459
JC435	AUSTIN 135	JC662	LANCIA 657, 659, 661		SUZUKI 1431	JC880	TOYOTA 1459
JC436	BEDFORD 139	JC664	MAZDA 697	JC760	NISSAN 865	JC881	TOYOTA 1459
	OPEL 907, 915	JC665	KIA 633	JC761	NISSAN 853	JC882	CARBODIES 201
	VAUXHALL 1509, 1517	JC666	KIA 633	JC777	MAZDA 703, 711	JC883	HONDA 569, 571
JC437	BEDFORD 139		MAZDA 699	JC778	MAZDA 711		ROVER 1291
	OPEL 907, 915, 917	JC669	RENAULT 1101, 1103, 1105, 1111, 1115, 1117, 1119, 1121, 1123	JC779	MAZDA 711	JC884	HONDA 571
	VAUXHALL 1509, 1517, 1519			JC781	MAZDA 699		ROVER 1291
JC440	VOLVO 1567, 1569, 1575, 1577	JC670	BEDFORD 139	JC784	MAZDA 699	JC885	HONDA 569
JC441	NISSAN 829, 831		ISUZU 601	JC788	NISSAN 855, 859	JC886	LAND ROVER 671
JC444	TOYOTA 1465, 1471	JC674	HONDA 551, 557	JC789	TOYOTA 1469	JC900	FORD 529
JC445	TOYOTA 1475		ROVER 1285	JC790	FORD 449, 451, 453, 467, 469, 479		NISSAN 867
JC459	NISSAN 851					JC901	FORD 529
							NISSAN 867
						JC907	ROVER 1283

 JC908 ROVER 1287, 1289		 JD091 NISSAN 855, 857, 861		 JD170 AUDI 81, 83, 85, 87, 93, 95		 JD266 FORD 463, 487, 489, 517, 519	
JC909 ROVER 1287, 1289, 1291		JD093 NISSAN 853, 857		FORD 501		JD271 ALFA ROMEO 19, 21, 23, 29, 31	
JC928 ALFA ROMEO 23, 25, 31, 35		JD097 BEDFORD 139		SEAT 1341, 1349, 1351,		FIAT 383	
FORD 537, 539		JD109 KIA 633		1353, 1355, 1357,		LANCIA 655	
OPEL 941		JD112 TOYOTA 1467		1359, 1361, 1363,		JD273 ALFA ROMEO 17, 19, 21, 23, 27, 29,	
ROVER 1291, 1293		JD121 MERCEDES-BENZ 765, 767, 775, 777		SKODA 1389, 1391, 1393,		31	
JC929 BMW 177, 193		JD134 NISSAN 865		1395, 1397, 1399		FIAT 383, 397	
JC931 MAZDA 713		JD135 NISSAN 865		VW 1661, 1663, 1681,		LANCIA 655, 657	
JC955 NISSAN 865		JD143 LANCIA 649, 651		1683, 1685, 1687,		JD274 BMW 171, 173	
RENAULT 1113, 1115, 1123,		JD146 CITROËN 269		1689, 1691, 1693,		OPEL 939, 943	
1125, 1127, 1129		FIAT 353, 355, 363, 365,		1695, 1703, 1705,		VAUXHALL 1539, 1541	
JC956 RENAULT 1113, 1115, 1123,		367, 371, 373, 375,		1707, 1709		JD275 BMW 155, 171, 173	
1125, 1127, 1129		379		JD171 AUDI 107, 111, 113		LAND ROVER 673	
JC967 SUBARU 1415		PEUGEOT 1001		VW 1725, 1727, 1729		JD276 BMW 171, 173	
JC968 MITSUBISHI 823, 825		JD148 FIAT 351, 353, 355, 357		JD175 HONDA 569		OPEL 939, 943	
JC973 FIAT 351, 353		LANCIA 649		TOYOTA 1457, 1463		VAUXHALL 1539, 1541	
SEAT 1321		JD150 FIAT 357, 359		JD176 HONDA 569		JD278 VW 1663	
JC974 MAZDA 695, 697		JD151 ALFA ROMEO 31		TOYOTA 1457, 1459, 1463		JD281 AUDI 89	
JC991 CITROËN 279, 281, 283		FIAT 383, 401, 403, 405		JD182 MERCEDES-BENZ 731, 737, 751, 753		SEAT 1343, 1349, 1359	
PEUGEOT 1009, 1011, 1013		LANCIA 659, 661		JD187 OPEL 939		VW 1679, 1681, 1697	
ROVER 1287		JD152 FIAT 401		VAUXHALL 1539		JD282 AUDI 89, 107, 109, 111	
SUZUKI 1431		LANCIA 661		JD188 FORD 449, 453, 465		SEAT 1343, 1349, 1359	
JD007 MITSUBISHI 823, 825		JD153 FIAT 383, 401, 403, 405		JD189 BMW 153, 155		VW 1679, 1681, 1697	
PROTON 1037		LANCIA 659, 661		JD194 TOYOTA 1467		JD283 BMW 153, 155	
JD009 FORD 439, 443, 445, 447		SUZUKI 1425		JD198 FIAT 351		JD291 MERCEDES-BENZ 737	
JD013 FIAT 385		JD158 MERCEDES-BENZ 741, 755, 757		JD221 ALFA ROMEO 17, 19, 21		JD292 MERCEDES-BENZ 731, 737, 749, 751,	
JD014 ALFA ROMEO 21, 23		SSANGYONG 1409		JD222 ALFA ROMEO 29, 31		753	
JD015 ALFA ROMEO 23, 29, 31		JD159 MERCEDES-BENZ 741, 755, 757		JD224 ALFA ROMEO 29, 31		JD293 MERCEDES-BENZ 731, 737, 751, 753	
JD018 ALFA ROMEO 23, 29		SSANGYONG 1409		JD225 FIAT 401, 403, 409		JD297 MERCEDES-BENZ 783	
JD019 ALFA ROMEO 29		JD160 MERCEDES-BENZ 733, 739, 747, 749,		LANCIA 659, 661		JD298 DAEWOO 321	
FIAT 383, 401		755		JD226 FIAT 401, 403, 409		MERCEDES-BENZ 761, 763, 773	
LANCIA 657, 661		SSANGYONG 1409		LANCIA 659, 661, 663		SSANGYONG 1411	
JD021 FIAT 363		VW 1721		JD228 ALFA ROMEO 33		JD299 DAEWOO 321	
JD022 FIAT 365, 367		JD161 DAEWOO 321		FIAT 409		MERCEDES-BENZ 761, 763, 773	
JD023 MITSUBISHI 819		MERCEDES-BENZ 733, 739, 747, 749,		LANCIA 663, 665		SSANGYONG 1411	
PROTON 1037		753, 755		JD230 CITROËN 293, 295		JD301 MERCEDES-BENZ 779, 781, 791	
JD025 ALFA ROMEO 23, 25, 31, 35		SSANGYONG 1409		FIAT 407		JD303 ISUZU 601	
FORD 537, 539		JD167 DAEWOO 321		LANCIA 663		MAZDA 699	
OPEL 941		MERCEDES-BENZ 769, 771, 787, 789,		PEUGEOT 1025		ISUZU 601	
ROVER 1291, 1293		795		JD231 RENAULT 1111, 1113		MAZDA 699	
JD028 FORD 479		SSANGYONG 1409, 1411		JD235 ALFA ROMEO 23, 31		OPEL 905, 907, 915, 917	
JD051 HONDA 555		JD169 DAEWOO 321		JD236 VW 1697, 1719		VAUXHALL 1507, 1509, 1517, 1519	
JD052 ACURA 3		MERCEDES-BENZ 769, 771, 777, 787,		JD237 VW 1697, 1719		JD309 FORD 469, 471, 475, 477,	
HONDA 555, 557, 559		789, 795		JD239 BMW 157, 171		479, 483, 485, 487,	
ROVER 1285		NISSAN 853		JD240 FORD 481, 483, 485, 489,		497, 499	
JD064 FORD 529, 531, 533		SSANGYONG 1409, 1411		491, 493, 495, 497		JD310 FORD 469, 471, 475, 477,	
LDV 677				705		479, 481, 483, 485,	
JD065 FORD 531, 533				JD243 BMW 153, 155, 157		487, 489, 491, 493,	
LDV 677				JD245 JEEP 627		495, 497, 499	
JD066 FORD 529, 531, 533				RENAULT 1245, 1247, 1249, 1251		MAZDA 705	
LDV 677				JD246 SEAT 1321, 1325		JD311 MG 803	
JD067 FIAT 351				SKODA 1377		ROVER 1283, 1285, 1287	
JD075 ACURA 3				VW 1625, 1627, 1629,		JD312 AUDI 113, 117	
HONDA 553, 555, 557				1631, 1633		VOLVO 1591	
ROVER 1285				JD264 FORD 461, 463, 481, 487		VW 1723, 1725, 1727,	
JD085 TOYOTA 1455, 1457				JD265 FORD 461, 463, 481, 487		1729, 1731, 1733, 1735	

NUMERICAL PARTS LIST





Numerische Teilenummernliste • Liste des références produits
Elenco numerico articoli • Lista de referencias





 JD315 BMW 193		 JD455 LADA 643		 JD519 CITROËN 271, 277, 287, 293		 JD600 AUDI 59, 85, 87, 93, 95	
JD327 AUDI 107, 111, 113		OPEL 929, 931, 933		PEUGEOT 1003, 1007, 1017, 1019		FORD 501	
JD331 MAZDA 703, 707		VAUXHALL 1529, 1531		JD520 CITROËN 271, 275, 277, 287		MITSUBISHI 831	
JD340 FIAT 377		JD456 OPEL 931		PEUGEOT 1003, 1007, 1019		SEAT 1335, 1337, 1343,	
JD342 FIAT 367		VAUXHALL 1529		JD529 CITROËN 293, 295		1353, 1355, 1357,	
LANCIA 653		JD457 OPEL 941		LANCIA 663		1359, 1361, 1363	
JD343 FIAT 367		SAAB 1309		PEUGEOT 1025		SKODA 1383, 1393, 1395,	
LANCIA 653		VAUXHALL 1539		JD530 CITROËN 271, 273		1397, 1399	
JD345 VOLVO 1569, 1577		JD458 OPEL 941		PEUGEOT 1003, 1005		VW 1647, 1649, 1655,	
JD346 VOLVO 1569, 1577		VAUXHALL 1539		JD531 CITROËN 297		1665, 1669, 1687,	
JD348 SAAB 1301, 1303, 1307		JD459 OPEL 941, 943, 945		PEUGEOT 1029		1689, 1691, 1693,	
JD409 DACIA 311		SAAB 1309		JD532 CITROËN 297		1695, 1699, 1701,	
OPEL 925		VAUXHALL 1539, 1541, 1543		PEUGEOT 1029		1703, 1705, 1707, 1709	
RENAULT 1145, 1147, 1165,		JD463 MITSUBISHI 827		JD535 CITROËN 285, 287		JD601 SEAT 1321, 1323, 1327,	
1167, 1169, 1171, 1173,		RENAULT 1191, 1197, 1199		PEUGEOT 1019		1329, 1335, 1337	
1175, 1177, 1179, 1181,		VOLVO 1565, 1567		JD536 CITROËN 285, 287		SKODA 1383, 1387	
1183, 1187, 1191,		JD464 FIAT 357, 359		FIAT 405		VW 1625, 1633, 1635,	
1193, 1195, 1197, 1199		LANCIA 649		PEUGEOT 1017, 1019		1637, 1647, 1649	
VAUXHALL 1525		JD465 FIAT 357, 359		JD538 CITROËN 263		JD602 AUDI 107, 109, 111	
VOLVO 1555, 1557, 1559, 1561		LANCIA 649		PEUGEOT 995, 997		JD603 AUDI 109, 111	
JD410 RENAULT 1191, 1233		JD466 ALFA ROMEO 17, 19		JD539 CITROËN 285, 287		JD604 AUDI 65, 67, 69, 71, 73, 75,	
JD411 RENAULT 1191, 1233		JD467 FIAT 387		FIAT 405		77	
JD413 RENAULT 1239, 1241, 1243		JD468 ALFA ROMEO 25, 27		PEUGEOT 1017, 1019		SEAT 1343, 1345, 1347	
JD414 RENAULT 1239, 1241, 1243		FIAT 387, 389, 391, 393,		JD542 FORD 513, 515, 519		SKODA 1387, 1389	
JD416 RENAULT 1239, 1259		395, 397		JD543 FORD 513, 515, 519		VW 1665, 1667, 1669,	
JD418 DACIA 307, 309		LANCIA 657, 659		JD545 FORD 439, 443, 445, 447		1671, 1673, 1675	
RENAULT 1123, 1125, 1129,		OPEL 927		MAZDA 695		JD605 AUDI 65, 67, 69, 71, 73, 75,	
1133, 1163, 1165		SAAB 1299		JD551 CITROËN 255, 257, 259, 261,		77	
JD419 RENAULT 1179, 1181, 1183,		VAUXHALL 1527		263		SEAT 1343, 1345, 1347,	
1185, 1187, 1213,		JD470 ISUZU 603, 605		PEUGEOT 989, 991, 993, 995,		1349	
1215, 1217, 1219		OPEL 943		997		SKODA 1387, 1389	
VOLVO 1561, 1567		VAUXHALL 1541		JD554 FORD 449, 453		VW 1665, 1667, 1669,	
JD420 NISSAN 851		JD471 LAND ROVER 671, 673		JD561 BMW 155, 159, 171		1671, 1673, 1675	
RENAULT 1107, 1109, 1111		JD474 OPEL 915, 917		JD563 LOTUS 685		JD606 AUDI 85	
JD421 NISSAN 851		VAUXHALL 1517, 1519		MG 803		SEAT 1343, 1353	
RENAULT 1107, 1109, 1111		JD475 MERCEDES-BENZ 741, 743, 749, 763,		ROVER 1287		SKODA 1391	
JD434 DACIA 309		765		JD564 LOTUS 685		VW 1665, 1687, 1693	
RENAULT 1163, 1165		JD476 MERCEDES-BENZ 763, 765		MG 803		JD607 AUDI 59, 67, 69	
JD435 RENAULT 1253		JD478 MERCEDES-BENZ 781		ROVER 1287		SEAT 1335, 1337, 1343,	
JD436 RENAULT 1253		JD482 AUDI 89		JD565 ALFA ROMEO 21, 23		1345	
JD441 ROVER 1291		JD483 AUDI 89		JD580 ALFA ROMEO 25, 27		SKODA 1383, 1387	
JD444 CHEVROLET 209		SEAT 1359		FIAT 387, 389, 391, 393,		VW 1647, 1649, 1667, 1675	
OPEL 903, 911, 913		VW 1633, 1697, 1699		395, 397		JD608 BMW 153, 155	
VAUXHALL 1505, 1513		JD487 SEAT 1335		LANCIA 659		JD611 BMW 153, 155, 157	
JD445 OPEL 903		VW 1631, 1645, 1647		JD586 ALFA ROMEO 35, 37		JD612 BMW 155, 171, 173	
VAUXHALL 1505		JD488 SEAT 1335		JD587 ALFA ROMEO 35, 37		JD654 ROVER 1281, 1283	
JD448 CHEVROLET 209		VW 1625, 1631, 1645,		JD597 SEAT 1321, 1323, 1327,		JD655 ROVER 1283	
OPEL 911		1647		1329, 1331, 1335, 1337		JD656 ROVER 1281, 1283	
VAUXHALL 1513		JD490 BMW 155		SKODA 1383, 1387		JD657 ROVER 1289	
JD451 CHEVROLET 211		JD492 BMW 159, 161, 173, 177		VW 1625, 1633, 1635,		JD5107 BMW 157, 175, 177, 179,	
DAEWOO 319, 321		JD493 BMW 171		1637, 1639, 1647, 1649		181, 189, 191	
OPEL 921, 931, 933, 935,		JD497 BMW 159, 161, 173, 177		JD599 SEAT 1335		OPEL 943	
937		JD498 CITROËN 265		VW 1647, 1649		VAUXHALL 1541	
SUBARU 1417		FORD 449, 451, 453, 465,					
VAUXHALL 1521, 1523, 1533,		467, 469					
1535, 1537		PEUGEOT 997					

							
JD5108 BMW	157, 159, 175, 177, 179, 181, 189, 191	JD5189 MITSUBISHI	827	JD5228 AUDI	57	JD5290 FORD	451, 453, 455, 457, 465
	OPEL	NISSAN	861	SEAT	1323, 1327, 1329, 1331, 1333, 1339	JD5291 FIAT	407
	ROVER	OPEL	925, 927	SKODA	1379, 1381, 1383, 1385	SEAT	1361
	VAUXHALL	RENAULT	1199, 1201, 1203, 1205, 1207, 1209, 1211	VW	1633, 1635, 1637, 1639, 1641, 1643, 1653, 1655, 1657	SKODA	1397
JD5109 FORD	539	VAUXHALL	1525			JD5292 SEAT	1359
	VW	VOLVO	1567			VW	1699, 1701
JD5117 OPEL	897, 899	JD5190 CITROËN	289, 291, 293	JD5230 FORD	439, 441, 451, 453	JD5293 AUDI	59, 61, 63
	VAUXHALL	FIAT	405, 407	MAZDA	693	SEAT	1337, 1339, 1341, 1359, 1361
JD5131 MAZDA	713	LANCIA	661	JD5232 FORD	539	SKODA	1383, 1385, 1387, 1397
JD5132 MAZDA	713	PEUGEOT	1021, 1023, 1025	SEAT	1343		
JD5134 BMW	171, 173	SUZUKI	1431, 1433	VW	1665, 1735, 1737	VW	1647, 1651, 1653, 1655, 1657, 1659, 1697, 1699, 1701, 1703, 1707, 1713
	OPEL	JD5191 CITROËN	289, 291, 293	JD5233 SEAT	1327		
	VAUXHALL	FIAT	407	VW	1633		
JD5135 MERCEDES-BENZ	731, 735, 743	LANCIA	661	JD5235 SEAT	1343		
JD5136 MERCEDES-BENZ	731	PEUGEOT	1021, 1023, 1025	VW	1665, 1669		
JD5143 FIAT	375, 377	SUZUKI	1431, 1433	JD5240 HONDA	555, 559, 561	JD5297 VOLVO	1591
	LANCIA	JD5192 CITROËN	283	JD5243 TOYOTA	1455, 1459, 1461, 1463	AUDI	57, 61
JD5144 ALFA ROMEO	23, 25, 31, 35	FIAT	399			SEAT	1327, 1329, 1331, 1333, 1337, 1339
	CHRYSLER	PEUGEOT	1015	JD5245 OPEL	899	SKODA	1379, 1381, 1383
	ROVER	TOYOTA	1463	VAUXHALL	1501	VOLVO	1591
JD5146 BMW	183, 193, 195, 197, 199	JD5196 CHEVROLET	211	JD5254 CITROËN	275		
JD5147 OPEL	903, 911, 913, 915	OPEL	923, 925	PEUGEOT	1007	VW	1633, 1635, 1637, 1639, 1641, 1643, 1649, 1651, 1653
	VAUXHALL	SAAB	1299	JD5255 CHEVROLET	213		
JD5148 OPEL	903, 913, 915	VAUXHALL	1523, 1525	OPEL	933, 935, 937	JD5299 FORD	471, 477, 479, 503, 505, 513, 521, 523, 527
	VAUXHALL	JD5197 CHEVROLET	211	VAUXHALL	1531, 1533, 1535, 1537	MAZDA	705
JD5149 OPEL	903	OPEL	923, 925	JD5256 CHEVROLET	213	VOLVO	1563, 1569
	VAUXHALL	SAAB	1299	OPEL	933, 935, 937	JD5300 CHEVROLET	211
JD5151 FORD	443, 445, 447	VAUXHALL	1523, 1525	SAAB	1307	DAEWOO	319, 321
	MAZDA	JD5201 OPEL	941	VAUXHALL	1531, 1533, 1535, 1537	OPEL	921, 931, 933, 937, 939
JD5155 FIAT	355, 363, 365	VAUXHALL	1539	JD5268 FORD	539, 541, 543	SUBARU	1415
	LANCIA	JD5202 OPEL	943, 945	OPEL	903, 911, 913	VAUXHALL	1521, 1523, 1533, 1535, 1537
JD5156 BMW	153	SAAB	1309	JD5269 OPEL	903, 911, 913		
JD5159 TOYOTA	1455, 1457	VAUXHALL	1541, 1543	VAUXHALL	1505, 1513, 1515		
JD5160 TOYOTA	1455, 1459, 1461, 1463	JD5203 OPEL	943, 945	JD5277 OPEL	937		
JD5164 FORD	439, 441, 451, 453, 455, 457, 465	SAAB	1309	VAUXHALL	1535, 1537	JD5311 FORD	463, 471, 473, 487, 489, 501, 505, 507, 509, 517, 519
	MAZDA	JD5204 OPEL	943	JD5278 AUDI	57		
JD5170 DAIHATSU	333	SAAB	1309	SEAT	1327, 1331	JD5312 FORD	463, 471, 473, 475, 487, 489, 505, 507, 509, 511, 517, 519, 523
	TOYOTA	VAUXHALL	1541	SKODA	1379, 1381		
JD5171 DAIHATSU	333	JD5205 SMART	1405	VW	1627, 1635, 1637, 1639, 1641	JD5313 FORD	471, 473, 475, 501, 507, 509, 511, 523
	TOYOTA	JD5206 SMART	1405	JD5279 AUDI	57	JD5315 DACIA	307, 309
JD5179 HYUNDAI	581	JD5210 SAAB	1303, 1305, 1307	SEAT	1327, 1331	RENAULT	1123, 1125, 1133, 1163, 1165
	KIA	JD5219 FORD	443, 445, 457	SKODA	1379, 1381	JD5318 SEAT	1321, 1323, 1327, 1329, 1331, 1339
JD5183 BMW	157, 159, 175, 177, 179, 181, 189, 191	JD5220 FORD	443	VW	1627, 1635, 1637, 1639, 1641	VW	1625, 1627, 1635, 1639, 1653, 1657
	OPEL	JD5223 OPEL	897	JD5280 CITROËN	283		
	ROVER	VAUXHALL	1499	PEUGEOT	1015	JD5327 KIA	637
	VAUXHALL	JD5225 MERCEDES-BENZ	749	SAAB	1303, 1305, 1307, 1309	JD5328 KIA	637
		JD5226 DAEWOO	321	JD5281 SAAB	1305, 1309		
		MERCEDES-BENZ	733, 739, 753, 755	JD5282 SAAB	1305, 1309		
		SSANGYONG	1409	JD5288 VOLVO	1573, 1577, 1579, 1581, 1583, 1589		
		JD5227 FORD	443, 457	JD5289 VOLVO	1555, 1561, 1563, 1565		

NUMERICAL PARTS LIST









Numerische Teilenummernliste • Liste des références produits
Elenco numerico articoli • Lista de referencias









 JD5329 CHEVROLET 209	 JD5379 MERCEDES-BENZ 743, 749	 JD5737 OPEL 937	 JD5802 MERCEDES-BENZ 731, 741
OPEL 917	JD5380 CHRYSLER 217	VAUXHALL 1537	JD5803 MERCEDES-BENZ 743
VAUXHALL 1519	MERCEDES-BENZ 743, 745, 747, 749	JD5738 TOYOTA 1455, 1457	JD5804 MERCEDES-BENZ 731
JD5330 DAEWOO 321	JD5384 HONDA 567, 573	JD5739 CHEVROLET 207, 209	JD5805 AUDI 91, 93, 95, 97, 101
OPEL 917	MERCEDES-BENZ 757, 767, 771, 789,	DAEWOO 317, 319	SEAT 1361
VAUXHALL 1519	791, 795	JD5740 CHEVROLET 207	SKODA 1399
JD5331 HONDA 559	JD5386 MERCEDES-BENZ 757, 767, 771, 789,	DAEWOO 317	VW 1703, 1705, 1707,
OPEL 917	791, 795	JD5748 HONDA 551, 553, 555, 557,	1709, 1711
VAUXHALL 1519	JD5393 DACIA 309	559	JD5806 AUDI 91, 93, 95, 97, 101
JD5332 CHEVROLET 209	NISSAN 859	JD5749 HONDA 565, 569, 571	MITSUBISHI 831
OPEL 917	RENAULT 1131, 1133, 1147, 1149,	JD5750 HONDA 567	SEAT 1361
VAUXHALL 1519	1151, 1153, 1155, 1157,	JD5751 HYUNDAI 581, 583	SKODA 1399
JD5333 CHEVROLET 209	1159, 1161	JD5753 KIA 633	VW 1703, 1705, 1707,
OPEL 917	JD5394 DACIA 309	MAZDA 693, 695, 697, 699	1709, 1711
VAUXHALL 1519	NISSAN 859	JD5755 MAZDA 707, 713	JD5807 SKODA 1375
JD5334 HONDA 559	RENAULT 1131, 1133, 1147, 1149,	JD5756 MAZDA 707, 713	VW 1627, 1639
OPEL 917	1151, 1153, 1155, 1157,	JD5757 MITSUBISHI 819, 821	JD5808 SEAT 1323
VAUXHALL 1519	1159, 1161	PROTON 1037	SKODA 1375, 1377
JD5336 CHEVROLET 209	JD5398 CHEVROLET 209	JD5759 MITSUBISHI 837, 839	VW 1627, 1629
OPEL 917	OPEL 913	JD5763 CITROËN 279, 281	JD5809 AUDI 57, 61, 63
VAUXHALL 1519	VAUXHALL 1515	PEUGEOT 1009, 1011	SEAT 1333
JD5337 FIAT 409, 411	JD5399 CHEVROLET 209	JD5764 CITROËN 279, 281	SKODA 1383, 1385
IVECO 611	OPEL 913	PEUGEOT 1009, 1011	VW 1637, 1639, 1641,
JD5338 FIAT 409, 411	VAUXHALL 1515	JD5765 OPEL 939	1643, 1653, 1655
IVECO 611	JD5400 OPEL 913, 915	VAUXHALL 1537, 1539	JD5810 ALFA ROMEO 33
JD5340 AUDI 61, 63	VAUXHALL 1515, 1517	JD5766 SKODA 1377, 1379	AUDI 117, 119
SEAT 1337, 1339, 1341	JD5401 OPEL 913, 915	JD5769 SUBARU 1415	SKODA 1401
SKODA 1383, 1385, 1387,	VAUXHALL 1515, 1517	SUZUKI 1427, 1429	VW 1727, 1731, 1733
1397	JD5402 DACIA 307, 309	JD5770 SUBARU 1415	JD5811 SEAT 1323, 1325
VW 1651, 1653, 1655,	MERCEDES-BENZ 739	SUZUKI 1427	SKODA 1375, 1377
1657, 1659, 1701, 1703	NISSAN 853, 855	JD5774 CHEVROLET 209	VW 1627, 1629
JD5341 AUDI 59, 61	RENAULT 1135, 1137, 1139, 1141,	DAEWOO 317, 319	JD5812 SKODA 1379, 1381
SEAT 1337	1143, 1145	JD5775 HONDA 559	JD5813 AUDI 67, 91, 93, 97
SKODA 1397	SUZUKI 1427, 1429	ROVER 1285	SEAT 1361, 1363
VW 1645, 1647, 1649,	JD5411 CHEVROLET 207	JD5776 HYUNDAI 583	SKODA 1399, 1401
1651, 1701	FIAT 357, 361	JD5777 HYUNDAI 585, 587, 589	VW 1699, 1701, 1705, 1709
JD5347 CHEVROLET 213	FORD 441	KIA 635	JD5814 AUDI 57, 61, 63
OPEL 933, 935, 937	LANCIA 651	MITSUBISHI 823	SEAT 1333, 1339
VAUXHALL 1531, 1533, 1535,	OPEL 897, 899, 901	JD5778 HYUNDAI 585, 587, 589	SKODA 1383, 1385
1537	SUZUKI 1425	KIA 635	VW 1639, 1641, 1643,
JD5372 MITSUBISHI 823, 825, 829	VAUXHALL 1499, 1501	MITSUBISHI 823	1653, 1655
VOLVO 1563	JD5412 FIAT 357	JD5781 MITSUBISHI 825	JD5815 AUDI 91, 93, 95, 97, 101
JD5373 SEAT 1337	LANCIA 651	PROTON 1037	MITSUBISHI 831
VW 1649, 1651	OPEL 897, 899	JD5782 RENAULT 1253	SEAT 1361
JD5375 ALFA ROMEO 13	SUZUKI 1425	JD5783 SUBARU 1417	SKODA 1399, 1401
CHRYSLER 217	VAUXHALL 1499, 1501	JD5794 CHEVROLET 207, 209	VW 1703, 1705, 1707,
FIAT 353, 355, 357, 359,	JD5413 ALFA ROMEO 13	DAEWOO 317, 319	1711, 1717
361, 363, 371	CHEVROLET 207	JD5795 HYUNDAI 591	JD5816 SEAT 1323, 1325
LANCIA 649, 651, 653	FIAT 357, 361	KIA 637	SKODA 1375, 1377
JD5376 ALFA ROMEO 25, 27	FORD 441	JD5797 JEEP 627	VW 1627, 1629
FIAT 391, 395, 397	LANCIA 651	MERCEDES-BENZ 767, 769, 783	JD5817 MITSUBISHI 831
OPEL 927	OPEL 897, 899, 901	JD5798 JEEP 627	SEAT 1321
SAAB 1299	SUZUKI 1425	MERCEDES-BENZ 767, 769, 783	SKODA 1375, 1379, 1381
VAUXHALL 1527	VAUXHALL 1499, 1501	JD5799 MERCEDES-BENZ 731, 741	VW 1625
JD5377 MERCEDES-BENZ 749	JD5428 BMW 153, 163	JD5800 MERCEDES-BENZ 743	
JD5378 MERCEDES-BENZ 743, 767, 769, 783		JD5801 MERCEDES-BENZ 733, 735	

 JD5818 SEAT 1321 SKODA 1375, 1379, 1381 VW 1625	 JD5851 AUDI 117, 119, 131 SKODA 1401 VW 1727, 1731, 1733	 JD5881 CITROËN 289 FIAT 405, 407 FORD 503, 505, 509, 511, 521, 523 PEUGEOT 1021 VOLVO 1573	 JD5906 CITROËN 301 FIAT 413 PEUGEOT 1031, 1033 RENAULT 1273, 1275
JD5819 SEAT 1323 SKODA 1375, 1377 VW 1627, 1629	JD5857 SEAT 1365 VW 1737	JD5882 CITROËN 263 PEUGEOT 995	JD5907 CITROËN 301 FIAT 413 PEUGEOT 1031, 1033 RENAULT 1273, 1275
JD5820 AUDI 91 VW 1699	JD5863 CITROËN 255 DAIHATSU 327 PEUGEOT 989 SUBARU 1415 TOYOTA 1453	JD5883 CITROËN 295 PEUGEOT 1025	JD5908 NISSAN 863 RENAULT 1187, 1189, 1219, 1221, 1223, 1225, 1227, 1229, 1243
JD5823 SMART 1405	JD5864 BMW 161, 175, 183, 185, 187, 189	JD5884 NISSAN 851 RENAULT 1105, 1107	JD5909 BMW 153, 161, 175, 183, 185
JD5826 CHRYSLER 217 MINI 809	JD5865 FORD 449, 455, 457, 461, 469	JD5885 NISSAN 851 RENAULT 1105, 1107	JD5910 NISSAN 863 RENAULT 1187, 1189, 1219, 1221, 1223, 1225, 1227, 1229, 1231, 1233, 1243
JD5827 CHRYSLER 217 MINI 809	JD5866 FORD 441, 443, 449, 455, 457, 461, 469	JD5886 RENAULT 1229	JD5911 RENAULT 1223, 1225, 1227, 1229, 1231
JD5829 CITROËN 259, 267, 269 FIAT 373 FORD 451, 455, 459, 461, 469	JD5867 FORD 441, 443, 449, 455, 457, 461, 469	JD5887 RENAULT 1229	JD5912 NISSAN 865 RENAULT 1253, 1255, 1257
MAZDA 695, 699	JD5868 ALFA ROMEO 33 CHEVROLET 213 FIAT 409 OPEL 937, 939 VAUXHALL 1537	JD5888 RENAULT 1229	JD5913 RENAULT 1223, 1225, 1227, 1229, 1231, 1233, 1243
MINI 807	JD5869 CHEVROLET 213	JD5889 RENAULT 1231, 1233	JD5914 OPEL 905, 907, 915, 917
PEUGEOT 993, 999, 1001	JD5870 CHEVROLET 213	JD5890 RENAULT 1209, 1211	JD5915 VAUXHALL 1507, 1509, 1517, 1519
SUZUKI 1427, 1429	JD5871 MITSUBISHI 819	JD5891 NISSAN 863, 865, 869 OPEL 937 RENAULT 1253, 1255, 1257, 1265, 1267 VAUXHALL 1535	JD5916 BMW 159, 161, 169, 173, 177, 179
VOLVO 1557	JD5872 AUDI 95, 121, 123, 127, 129, 131 VW 1737, 1739	JD5892 NISSAN 863, 865, 869 OPEL 937 RENAULT 1253, 1255, 1257, 1265, 1267 VAUXHALL 1535	JD5917 FORD 535, 537, 543 MAZDA 713
JD5830 CITROËN 259, 267, 269 FORD 459, 461 MAZDA 699 MINI 807 PEUGEOT 999, 1001 SUZUKI 1429	JD5873 AUDI 91, 93, 97 SEAT 1361, 1363 SKODA 1399, 1401 VW 1701, 1705, 1709	JD5893 RENAULT 1131, 1133	JD5918 VW 1721
JD5834 MERCEDES-BENZ 731	JD5874 AUDI 131 VW 1739, 1741	JD5894 RENAULT 1149, 1151, 1153, 1155, 1157	JD5919 VW 1735
JD5835 MERCEDES-BENZ 733, 735 SEAT 1339 VW 1653	JD5875 CHRYSLER 219	JD5895 RENAULT 1245	JD5920 SUZUKI 1431, 1433
JD5836 DAHATSU 331 TOYOTA 1453, 1455	JD5876 JEEP 627	JD5896 OPEL 945 RENAULT 1275 SAAB 1309 VAUXHALL 1543	JD5921 FORD 543
JD5837 DAHATSU 331 TOYOTA 1453, 1455	JD5877 JEEP 627	JD5897 OPEL 945 RENAULT 1275 SAAB 1309 VAUXHALL 1543	JD5922 VW 1721
JD5838 HONDA 551	JD5878 CITROËN 301 PEUGEOT 1033 RENAULT 1271, 1273, 1275	JD5898 VOLVO 1591	JD5923 VW 1735
JD5839 HONDA 551	JD5879 CITROËN 301 PEUGEOT 1033 RENAULT 1271, 1273	JD5899 HYUNDAI 581	JD5924 VW 1735
JD5840 HONDA 551	JD5880 CITROËN 301 PEUGEOT 1033 RENAULT 1271, 1273	JD5900 HYUNDAI 581 KIA 633	JD5925 SUZUKI 1431, 1433
JD5841 NISSAN 851 RENAULT 1101		JD5901 TOYOTA 1465	JD5926 FORD 535, 537, 543 MAZDA 713
JD5842 MITSUBISHI 829		JD5902 MERCEDES-BENZ 783, 785	JD5927 VW 1721
JD5845 CITROËN 255 DAIHATSU 327 PEUGEOT 989 SUBARU 1415 TOYOTA 1453		JD5903 OPEL 935 VAUXHALL 1535	JD5928 VW 1735
JD5846 CITROËN 255 DAIHATSU 327 PEUGEOT 989 SUBARU 1415 TOYOTA 1453		JD5904 OPEL 897, 899, 903, 905 SUZUKI 1425 VAUXHALL 1499, 1501, 1505, 1507	JD5929 SUZUKI 1431, 1433
JD5849 SEAT 1321 SKODA 1375, 1379, 1381 VW 1625		JD5905 MITSUBISHI 819, 821 SMART 1405	JD5930 FORD 543
			JD5931 FORD 543
			JD5932 SUZUKI 1431, 1433
			JD5933 SUZUKI 1431, 1433
			JD5934 OPEL 933 RENAULT 1245 VAUXHALL 1531
			JD5935 MITSUBISHI 829
			JD5936 VW 1733, 1735
			JD5937 HYUNDAI 581, 583
			JD5938 LADA 641
			JD5939 VW 1729, 1731, 1733
			JD5940 VW 1729, 1731, 1733
			JD5941 MINI 807 SUBARU 1415 TOYOTA 1455
			JD5942 KIA 637
			JD5943 TOYOTA 1465
			JD5944 HYUNDAI 581
			JD5945 SUZUKI 1427, 1429
			JD5946 MITSUBISHI 819, 821 TOYOTA 1477
			JD5947 TOYOTA 1475, 1477
			JD5948 CITROËN 285 PEUGEOT 1017

NUMERICAL PARTS LIST









Numerische Teilenummernliste • Liste des références produits
Elenco numerico articoli • Lista de referencias





							
JD5972 CITROËN 275, 277, 279, 283		JD6005 AUDI 67, 71, 73, 75		JE120 CHEVROLET 207, 211		JE904 AUDI 65, 79, 81	
FIAT 399		SEAT 1345, 1347, 1349		DAEWOO 319		VW 1661, 1663, 1675, 1679	
LADA 643		SKODA 1387		OPEL 901, 903, 907, 909, 911, 919, 921, 923, 925, 927, 929, 931, 933		JE5012 BMW 169, 173, 179	
PEUGEOT 1005, 1007, 1009, 1013, 1015		JD6023 CITROËN 283		VAUXHALL 1503, 1505, 1509, 1511, 1513, 1521, 1523, 1525, 1527, 1529, 1531, 1533		JE5017 OPEL 897	
SUZUKI 1431		FIAT 399				SUZUKI 1425	
TALBOT 1437		PEUGEOT 1015				VAUXHALL 1499	
JD5973 TOYOTA 1465, 1473		TOYOTA 1463				JE5018 MERCEDES-BENZ 777	
JD5977 NISSAN 855, 859, 861		JD6024 BMW 153, 155, 161, 163				JE5019 BMW 153, 155, 157	
JD5978 TOYOTA 1459		JD6025 HYUNDAI 587				JE5020 FORD 539, 541, 543	
JD5979 OPEL 897, 899		KIA 635		JE124 TOYOTA 1471		JE5021 FORD 461, 463, 481, 487, 489, 505, 507, 517, 519	
VAUXHALL 1499, 1501		JD6026 MAZDA 709		JE138 AUDI 63, 79, 81, 113		JE5022 FORD 467	
JD5980 LADA 643		JD6027 MAZDA 709		SEAT 1349		JE5024 OPEL 899, 903, 905	
OPEL 929, 933		JD6028 NISSAN 867, 871		VW 1659, 1661, 1675, 1679, 1681, 1721, 1723, 1725		VAUXHALL 1501, 1505, 1507	
VAUXHALL 1529, 1531		JD6029 NISSAN 867, 871				JE5025 FORD 439, 441, 451, 453, 455, 457, 465	
JD5981 FIAT 413		JD6030 MAZDA 699		JE145 PEUGEOT 997		MAZDA 693	
IVECO 617, 619		JD6031 MITSUBISHI 819, 821		JE146 DAIHATSU 327, 329, 331, 333		JE5026 MERCEDES-BENZ 737	
JD5982 ALFA ROMEO 23		SMART 1405		JE160 SEAT 1335, 1341, 1349		JE5028 MERCEDES-BENZ 787	
FIAT 383		JD6032 HYUNDAI 583		VW 1645, 1659, 1661, 1663, 1677, 1679, 1681, 1723		JE5029 OPEL 905, 907, 915, 917	
OPEL 919, 925		KIA 633				VAUXHALL 1507, 1509, 1517, 1519	
VAUXHALL 1521, 1525		JD6033 RENAULT 1107				JE5032 MERCEDES-BENZ 769, 791	
JD5983 HYUNDAI 581		JD6034 CITROËN 257, 265		JE189 CITROËN 255, 257, 259, 261, 263, 271, 273		JE5034 CHEVROLET 207	
KIA 633		MINI 807		PEUGEOT 989, 991, 993, 995, 997, 1003, 1005		DAEWOO 317	
JD5984 HONDA 561, 569		PEUGEOT 991, 993, 999, 1003		JE199 MITSUBISHI 825, 829		JE5036 AUDI 57	
JD5985 HONDA 561, 569		JD6035 HONDA 555, 557, 561		JE231 JAGUAR 623		VW 1627	
JD5986 BMW 197, 199		JD6036 MAZDA 695, 697, 699		JE248 VOLVO 1567, 1569, 1573, 1575, 1577		JE5037 FORD 471, 477, 479, 503, 505, 513, 521, 523, 527	
JD5987 FORD 461, 469		JD6037 CHEVROLET 207		JE390 FIAT 363, 365, 371, 373, 403		MAZDA 705, 713	
JD5988 LEXUS 681		DAEWOO 317		JE480 FIAT 351		VOLVO 1561, 1563, 1569	
TOYOTA 1463, 1469		JD6038 RENAULT 1107		JE555 BMW 157		JE5044 CITROËN 273	
JD5989 HONDA 571		JD6039 MITSUBISHI 825, 829		JE625 ACURA 3		PEUGEOT 1005	
JD5990 HONDA 571		VOLVO 1563		HONDA 555, 557, 563, 573		JE5050 BMW 153, 163	
JD5991 BMW 163, 165, 167, 169		JD6040 MAZDA 697		ROVER 1285, 1293		JE5058 BMW 175	
JD5992 AUDI 87, 93		JD6044 MAZDA 697		JE647 FIAT 407		JE5059 FORD 509, 513	
SEAT 1357, 1359, 1361		JD6045 HONDA 567, 573		PEUGEOT 989, 991, 1015		JE5060 RENAULT 1227	
SKODA 1395, 1399		JD6046 HYUNDAI 587		JE648 VOLVO 1555		JE5061 RENAULT 1209, 1211	
VW 1693, 1695, 1705, 1707		KIA 635		JE651 CITROËN 297, 299		JE5062 RENAULT 1209, 1211	
JD5993 ALFA ROMEO 13		JD6047 VW 1733		JE689 AUDI 59, 61, 65, 67, 69, 71, 73, 75, 79, 81, 89, 91, 107, 109, 111		JE5064 OPEL 945	
FIAT 361		JE011 MITSUBISHI 819				RENAULT 1275	
OPEL 899		JE012 TOYOTA 1465, 1467, 1471, 1475		VW 1647, 1649, 1651, 1665, 1667, 1669, 1677, 1681, 1719, 1721		SAAB 1309	
VAUXHALL 1501		JE015 TOYOTA 1453, 1459, 1479		JE696 ALFA ROMEO 13, 23, 29		VAUXHALL 1543	
JD5994 SUZUKI 1427, 1429		JE017 TOYOTA 1473		JE719 FORD 447, 449, 451, 453, 467, 469, 479, 481, 513, 515, 517, 519		JE5065 SAAB 1299	
JD5997 FIAT 383, 403		JE019 OPEL 935				JE5066 SAAB 1299	
LANCIA 659, 661		SSANGYONG 1409				JE5067 MERCEDES-BENZ 783, 785	
JD5998 CITROËN 295		VAUXHALL 1535				JE5068 MERCEDES-BENZ 783, 785	
FORD 527, 529		JE101 KIA 633				JE5069 RENAULT 1273, 1275	
PEUGEOT 1027		MAZDA 693				JE5070 RENAULT 1273, 1275	
JD5999 CITROËN 299, 301		JE102 KIA 633, 637				JE5071 RENAULT 1273, 1275	
JAGUAR 623		MAZDA 693				JE5072 CITROËN 263, 271, 273	
LAND ROVER 671, 673		JE106 TOYOTA 1461				PEUGEOT 995, 997, 1003, 1005	
PEUGEOT 1031, 1033		JE117 VW 1677, 1679				JE5074 BMW 157, 171, 177, 193	
JD6003 HYUNDAI 581		JE119 BEDFORD 139					
KIA 633		OPEL 901, 907, 915					
JD6004 LEXUS 681		VAUXHALL 1503, 1509, 1517					
TOYOTA 1463, 1469							

							
JE5075	AUDI 71, 75, 85, 95, 97	JH005	NISSAN 867, 869	JH5041	DACIA 311	JH5107	CITROËN 271, 273
	SEAT 1355	JH016	ISUZU 603		MITSUBISHI 827		PEUGEOT 1005
	SKODA 1389, 1399	JH024	TOYOTA 1477, 1479		NISSAN 861, 863	JH5108	NISSAN 859
	VW 1673, 1691	JH031	NISSAN 873		OPEL 925, 927, 933		RENAULT 1131, 1133, 1149, 1151,
JE5076	AUDI 81	JH040	FORD 455		RENAULT 1187, 1189, 1191, 1193,		1153, 1155
	SEAT 1321, 1323, 1337,	JH111	FIAT 403		1195, 1199, 1201,	JH5109	DACIA 307, 309
	1339, 1341, 1343,		LANCIA 659, 661		1203, 1205, 1207,		NISSAN 853, 855
	1349, 1351, 1353, 1355	JH310	FIAT 351		1209, 1211, 1213,		RENAULT 1135, 1137, 1139, 1141,
	SKODA 1389, 1391	JH409	CARBODIES 201		1217, 1219, 1221,		1143, 1145, 1155, 1157
	VW 1625, 1627, 1649,	JH434	LAND ROVER 673		1223, 1225, 1227,		SUZUKI 1429
	1651, 1653, 1661,	JH494	FIAT 353, 355, 371, 373		1229, 1231, 1233	JH5110	BMW 175, 177, 179, 181, 189
	1663, 1665, 1669,	JH565	ALFA ROMEO 13, 15, 17, 21, 23		SUZUKI 1429	JH5111	BMW 199
	1681, 1683, 1685,	JH683	MERCEDES-BENZ 755, 757, 759, 783		VAUXHALL 1525, 1531	JH5115	BMW 183, 193, 195, 197
	1687, 1693	JH881	LADA 641		VOLVO 1567	JH5116	BMW 183, 193, 195, 197
JE5077	VW 1735	JH5005	BEDFORD 139	JH5046	FORD 443, 457	JH5117	AUDI 59, 61, 67, 69, 71, 73,
JF017	MAZDA 711		CHEVROLET 207, 209	JH5050	BMW 153, 155, 157		75
JF021	HONDA 563		DAEWOO 317, 319	JH5051	CHRYSLER 217		SEAT 1335, 1337, 1343,
	ROVER 1293		OPEL 897, 899, 901, 903,		MINI 809		1345
JF024	ACURA 3		907, 909, 911	JH5052	OPEL 941, 943		SKODA 1383, 1387, 1389, 1397
	HONDA 555, 557, 559, 563,		VAUXHALL 1499, 1501, 1503,		SAAB 1309		VW 1645, 1647, 1649,
	569, 571		1505, 1509, 1511, 1513		VAUXHALL 1539, 1541		1651, 1667, 1669,
	ROVER 1285, 1291	JH5008	FORD 469, 471, 475, 477,	JH5056	BMW 199		1671, 1673, 1675,
JF046	SUZUKI 1429		479, 497, 499	JH5057	CHEVROLET 213		1697, 1701, 1703, 1713
JF067	CITROËN 261, 265	JH5011	VOLVO 1565, 1567		OPEL 933, 935, 937	JH5118	AUDI 119, 121, 123, 125
	PEUGEOT 995, 997	JH5012	ROVER 1289		SAAB 1307		FORD 509, 511, 521, 523
	ROVER 1285	JH5013	FORD 539		VAUXHALL 1531, 1533, 1537		VW 1735
JF087	TOYOTA 1453, 1477		VW 1735, 1737	JH5058	ISUZU 601	JH5119	OPEL 937, 939
JF119	HONDA 551, 555	JH5015	FORD 443, 445, 447		OPEL 905, 907, 915, 917		VAUXHALL 1537
JF123	ALFA ROMEO 23, 25, 31, 35		MAZDA 695		VAUXHALL 1507, 1509, 1517, 1519	JH5166	AUDI 117
	CITROËN 299	JH5016	MG 803	JH5059	VW 1735, 1737		VW 1727
	FIAT 411, 413		ROVER 1281, 1283	JH5060	CHRYSLER 217	JH5173	HONDA 553, 555, 559
	FORD 537, 539	JH5019	OPEL 939	JH5061	FORD 471, 473, 475, 487,	JH5178	CITROËN 299, 301
	IVECO 611, 615, 617		VAUXHALL 1537, 1539		489, 501, 505, 507,		FIAT 411, 413
	OPEL 941	JH5023	AUDI 81		509, 511, 517, 519, 523		IVECO 611, 613, 615
	PEUGEOT 1031		SEAT 1349	JH5065	FORD 535, 537, 543		OPEL 945
	ROVER 1291, 1293		SKODA 1389		MAZDA 713		PEUGEOT 1031
JF145	FIAT 353, 355, 357, 359		VW 1681, 1683, 1693,	JH5067	SAAB 1309		RENAULT 1269
	LANCIA 649		1697	JH5070	BMW 157, 159, 161, 163	JH5183	LADA 641
JF150	FIAT 365, 367, 371, 375,	JH5032	MG 803	JH5077	FIAT 409, 411	JH5184	SKODA 1375, 1377, 1379
	379		ROVER 1291		IVECO 611	JJ057	PEUGEOT 991, 997
	PEUGEOT 1001	JH5033	MG 803	JH5078	OPEL 933	JJ065	VOLVO 1567, 1569, 1573,
JF184	FIAT 357, 359		ROVER 1291		VAUXHALL 1533		1575, 1577
JF191	BMW 161, 171, 173, 177	JH5036	OPEL 899, 903, 905	JH5079	OPEL 937	JJ072	HYUNDAI 591
JF205	AUDI 67, 69, 71, 73, 75		VAUXHALL 1501, 1505, 1507		VAUXHALL 1535, 1537		KIA 637
	SEAT 1335, 1343, 1345,	JH5037	OPEL 897	JH5080	OPEL 937		MITSUBISHI 833, 835
	1349, 1359		SUZUKI 1425		VAUXHALL 1535, 1537	JJ075	MITSUBISHI 819, 821, 823, 825
	SKODA 1387, 1389		VAUXHALL 1499	JH5082	MERCEDES-BENZ 743, 745, 749, 755,	JJ078	FIAT 355, 363, 365
	VW 1647, 1649, 1665,				757		LANCIA 649, 651
	1667, 1669, 1671,				SSANGYONG 1409	JJ080	SAAB 1301, 1303, 1305,
	1673, 1675, 1679,			JH5096	OPEL 937		1307
	1681, 1697, 1699				VAUXHALL 1535, 1537	JJ089	BMW 153, 169
JF206	AUDI 89, 107, 117			JH5099	TOYOTA 1459	JJ093	TOYOTA 1453
JF211	AUDI 59			JH5101	SUBARU 1415, 1417	JJ098	HYUNDAI 581, 583
	SEAT 1335, 1337			JH5103	BMW 175, 183, 185, 187, 189		MITSUBISHI 819, 821
	SKODA 1383			JH5106	JEEP 627		
	VW 1647, 1649						

NUMERICAL PARTS LIST









Numerische Teilenummernliste • Liste des références produits
Elenco numerico articoli • Lista de referencias





							
JJ100	ALFA ROMEO 33, 35 FIAT 411 IVECO 613 OPEL 941, 943 VAUXHALL 1541	JJ283	CITROËN 269, 271, 273, 275, 277, 279, 281, 283, 285, 287, 293, 295 FIAT 397, 399, 405, 407 HONDA 561 LADA 643 PEUGEOT 1001, 1003, 1005, 1007, 1009, 1011, 1013, 1015, 1017, 1019, 1025 ROVER 1287 SUZUKI 1431 TALBOT 1437 TOYOTA 1463	JJ440	FIAT 363	JJ519	ALFA ROMEO 33, 35 FIAT 411 IVECO 611, 613, 615, 617 OPEL 941, 943 RENAULT 1263, 1265, 1267, 1269 VAUXHALL 1541
JJ104	BMW 157, 171, 177	JJ298	ALFA ROMEO 27 FIAT 365, 375, 379, 381, 383, 385, 387, 395, 399, 401, 403 LANCIA 657	JJ449	FIAT 351	JJ531	FORD 461, 463, 481, 487, 489, 517, 519
JJ120	BEDFORD 139 CHEVROLET 207 OPEL 897, 899, 901, 903, 907, 909, 911 VAUXHALL 1499, 1501, 1503, 1505, 1509, 1511, 1513	JJ299	NISSAN 873, 875	JJ450	ALFA ROMEO 17, 19	JJ536	BMW 171, 173 OPEL 939, 943 VAUXHALL 1539, 1541
JJ126	DAIHATSU 327, 329	JJ309	HONDA 551, 555, 557, 559	JJ451	ALFA ROMEO 29	JJ537	BMW 153, 155
JJ134	SUBARU 1415	JJ315	AUSTIN 135	JJ452	ALFA ROMEO 23, 29	JJ538	BMW 177
JJ136	SEAT 1341	JJ315	ROVER 1281, 1285	JJ453	CITROËN 269 FIAT 353, 363, 365, 367, 371, 373, 375, 377, 379 PEUGEOT 1001	JJ543	DAEWOO 321 MERCEDES-BENZ 761, 763, 765, 767, 769, 773, 783 SSANGYONG 1411
JJ140	AUDI 59, 63, 65, 79, 81, 89 SEAT 1335, 1341, 1343, 1349, 1359 VW 1645, 1659, 1661, 1663, 1665, 1675, 1677, 1679, 1681, 1683, 1697	JJ334	FORD 467	JJ456	FORD 481, 483, 485, 487, 489, 491, 493, 495, 497	JJ549	FIAT 411 LANCIA 665 RENAULT 1267
JJ149	MAZDA 693, 695	JJ341	SUZUKI 1427, 1429	JJ457	FORD 513, 515, 519	JJ551	VOLVO 1583
JJ150	TOYOTA 1475	JJ343	TOYOTA 1457	JJ458	FORD 539, 541, 543	JJ555	OPEL 945, 947 VAUXHALL 1543
JJ151	NISSAN 875	JJ348	FORD 449, 451, 453, 465, 467, 469	JJ459	CHEVROLET 211 DAEWOO 319, 321 LADA 643 OPEL 929, 931, 933, 937 VAUXHALL 1529, 1531, 1537	JJ557	MINISUBISHI 827 OPEL 925 RENAULT 1167, 1169, 1171, 1173, 1175, 1177, 1179, 1181, 1183, 1185, 1187, 1191, 1193, 1195, 1197, 1199, 1213, 1215, 1217, 1219, 1233 VAUXHALL 1525 VOLVO 1555, 1557, 1559, 1561
JJ183	SEAT 1321, 1325, 1329, 1335, 1337, 1349 VW 1625, 1627, 1629, 1631, 1633, 1637, 1645, 1647, 1649, 1679, 1725	JJ354	KIA 633 MAZDA 693, 695, 697, 699	JJ463	FORD 481, 483, 485, 487, 489, 491, 493, 495, 497, 499 MAZDA 705	JJ558	JEEP 627 PEUGEOT 1017, 1027, 1029 RENAULT 1213, 1233, 1235, 1237, 1239, 1241, 1243, 1245, 1247, 1249, 1251, 1257, 1259, 1261
JJ184	AUDI 107, 109, 111, 113, 117 VOLVO 1591 VW 1719, 1721	JJ358	BEDFORD 139 ISUZU 601 OPEL 939	JJ470	OPEL 939 VAUXHALL 1539	JJ559	RENAULT 1237, 1239, 1241, 1243, 1247, 1249, 1251, 1257, 1259, 1261
JJ187	SUZUKI 1425	JJ360	SUBARU 1415	JJ471	FIAT 351	JJ562	RENAULT 1239, 1241, 1243
JJ192	ISUZU 603 SSANGYONG 1409	JJ364	ACURA 3 HONDA 573 ROVER 1293	JJ484	FORD 529, 531, 533 LDV 677	JJ565	RENAULT 1107, 1109, 1111
JJ200	BEDFORD 139 OPEL 907, 915, 919 VAUXHALL 1509, 1517, 1521	JJ385	DAEWOO 319 OPEL 919, 921, 927, 929, 931 VAUXHALL 1521, 1523, 1527, 1529, 1531	JJ488	MERCEDES-BENZ 731, 737, 749, 751, 753, 759	JJ568	NISSAN 865, 869 OPEL 937, 941 RENAULT 1253, 1255, 1257, 1265, 1267 VAUXHALL 1535, 1539
JJ204	ISUZU 603	JJ389	SUBARU 1415	JJ491	MERCEDES-BENZ 765, 767, 775, 777	JJ572	OPEL 943, 945 VAUXHALL 1541, 1543
JJ265	NISSAN 855, 859, 861	JJ390	HONDA 563	JJ498	MERCEDES-BENZ 741, 749, 755, 757 SSANGYONG 1409	JJ573	OPEL 943, 945 VAUXHALL 1541, 1543
JJ268	KIA 635, 637 MAZDA 703, 705, 707, 711	JJ398	FIAT 365, 379, 381, 385, 387, 395	JJ499	DAEWOO 321 MERCEDES-BENZ 733, 739, 747, 749, 753, 755 SSANGYONG 1409	JJ574	OPEL 917 VAUXHALL 1519
JJ271	HONDA 563	JJ404	ROVER 1281, 1283	JJ501	AUDI 107, 109, 111 VW 1723, 1725, 1727, 1729		
JJ273	BEDFORD 139 SUZUKI 1425	JJ407	RENAULT 1113, 1115, 1123, 1125, 1127, 1129	JJ508	OPEL 945 VAUXHALL 1543		
JJ274	HYUNDAI 585 MITSUBISHI 823, 825, 829, 831, 833	JJ412	LADA 641				
		JJ413	ALFA ROMEO 29, 31 FIAT 375, 383, 399, 401, 403 LANCIA 659, 661				
		JJ417	HONDA 567, 569				
		JJ435	DAIHATSU 331				

 JJ575 CHEVROLET 209	 JM333 FIAT 351, 353	 JM5048 OPEL 899	 JM5103 SEAT 1359, 1361
OPEL 903, 911, 913	SEAT 1321	SUZUKI 1425	SKODA 1397
VAUXHALL 1505, 1513, 1515	JM350 CARBODIES 201	VAUXHALL 1501	VW 1697, 1699, 1701, 1703, 1707, 1713
JJ586 CITROËN 255, 257, 259, 261, 263	JM483 LAND ROVER 673	JM5059 OPEL 903, 911, 913, 915	JM5104 FORD 443, 457
PEUGEOT 989, 991, 993, 995, 997	JM663 FIAT 363, 371	VAUXHALL 1505, 1513, 1515, 1517	JM5106 BMW 175, 177, 179, 181, 189, 191
JJ587 CITROËN 261, 263, 265, 271, 273	JM674 FIAT 351	JM5063 BMW 171, 173	OPEL 943
PEUGEOT 997, 1003, 1005	JM848 MERCEDES-BENZ 743, 757, 759	JM5064 NISSAN 855	VAUXHALL 1541
ROVER 1285	JM850 MERCEDES-BENZ 755	JM5071 OPEL 899, 903, 905, 947	JM5107 BMW 183, 193, 195, 197
JJ588 CITROËN 297	JM875 FORD 539	SUZUKI 1425	JM5108 BMW 183, 193, 195, 197
PEUGEOT 1029	HYUNDAI 585	VAUXHALL 1501, 1505, 1507, 1543	JM5109 BMW 183, 193, 195, 197
JJ605 FIAT 351	LANCIA 823	JM5072 TOYOTA 1455, 1457	JM5111 MERCEDES-BENZ 733, 739, 747, 749, 753, 755
JJ609 AUDI 59, 81, 83, 85, 89	JM950 LADA 643	JM5073 TOYOTA 1455, 1459, 1461, 1463	JM5113 MERCEDES-BENZ 777, 787
FORD 501	OPEL 929, 931, 933	JM5074 LAND ROVER 671	JM5114 DAEWOOD 321
SEAT 1335, 1341, 1343, 1349, 1351, 1355, 1359	VAUXHALL 1529, 1531	JM5076 MG 803	MERCEDES-BENZ 769, 771, 787, 789, 795
VW 1633, 1645, 1647, 1649, 1661, 1663, 1665, 1669, 1679, 1681, 1683, 1685, 1687, 1689, 1691, 1697, 1699, 1701	JM956 OPEL 939	ROVER 1291	SSANGYONG 1409, 1411
JJ610 AUDI 65, 67, 69, 71	JM986 VW 1647, 1697, 1719	JM5078 ISUZU 605	JM5115 MERCEDES-BENZ 777, 787
VW 1665, 1667, 1669	JM2052 SEAT 1323, 1333, 1341	OPEL 947	JM5118 BMW 157, 161
JJ611 BMW 159, 161, 169, 171, 173, 177, 179	JM5002 ALFA ROMEO 19, 21, 29, 31	VAUXHALL 1543	JM5119 CHRYSLER 217
JJ612 BMW 153, 155	JM5003 FIAT 389, 393	JM5085 OPEL 897	MINI 809
JJ613 CITROËN 299, 301	JM5016 FORD 469, 471, 475, 477, 479, 497, 499	VAUXHALL 1499	JM5120 AUDI 83, 85
FIAT 413	JM5018 FIAT 403, 409	JM5086 MITSUBISHI 827	VW 1687, 1689
IVECO 617	LANCIA 659, 661	NISSAN 861	JM5121 OPEL 897
OPEL 945	JM5019 FIAT 355, 357, 359, 363	OPEL 925, 927	SUZUKI 1425
PEUGEOT 1031	LANCIA 651	RENAULT 1199, 1201, 1203, 1205, 1207, 1209, 1211	VAUXHALL 1499
VAUXHALL 1543	JM5022 MITSUBISHI 819, 821	SUZUKI 1429	JM5131 NISSAN 851
JJ614 BMW 155	JM5023 ALFA ROMEO 29, 31	VAUXHALL 1525	RENAULT 1107, 1109, 1111
JJ615 CHEVROLET 211	JM5024 ALFA ROMEO 29, 31	VOLVO 1567	JM5134 HONDA 555
OPEL 921, 933	JM5027 FORD 529, 531, 533	JM5087 CITROËN 289, 291, 293	JM5135 HONDA 553, 557
VAUXHALL 1521, 1523, 1533	LDV 677	FIAT 405, 407	JM5137 NISSAN 867
JJ616 CHEVROLET 211	JM5028 ALFA ROMEO 25, 27	PEUGEOT 1021, 1023, 1025	JM5138 NISSAN 861
DAEWOO 319, 321	FIAT 389, 391, 393, 395, 397	SUZUKI 1431, 1433	JM5139 CITROËN 273, 285, 295
OPEL 927, 931, 933, 935	LANCIA 657, 659	JM5088 CITROËN 283	FIAT 405
VAUXHALL 1527, 1533, 1535	OPEL 927	FIAT 399	PEUGEOT 1005, 1017, 1025
JJ617 CHEVROLET 211	SAAB 1299	PEUGEOT 1015	JM5141 CITROËN 289, 291, 295
DAEWOO 319, 321	VAUXHALL 1527	TOYOTA 1463	FIAT 407
OPEL 927, 931, 933, 935	JM5029 ALFA ROMEO 33	JM5089 CITROËN 283	LANCIA 661, 663
VAUXHALL 1527, 1533, 1535	LANCIA 665	FIAT 399	PEUGEOT 1021, 1023, 1027
JM008 NISSAN 853	JM5030 FORD 539	TOYOTA 1463	SUZUKI 1433
JM025 TOYOTA 1453, 1457	VW 1735, 1737	JM5092 CHEVROLET 211	JM5146 TOYOTA 1471
JM053 FORD 455	JM5034 FORD 461, 469	OPEL 923, 925	JM5149 DAIHATSU 329, 331
JM077 LADA 641	LAND ROVER 671	SAAB 1299	TOYOTA 1453, 1455
JM086 NISSAN 865, 867, 869	JM5035 LAND ROVER 673	VAUXHALL 1523, 1525	JM5153 FORD 471, 477, 479, 503, 505, 513, 521, 523, 527
JM154 VW 1631	MG 803	JM5094 OPEL 941, 943, 945, 947	MAZDA 705, 707, 709, 713
JM302 AUSTIN 135	ROVER 1289, 1291, 1293	SAAB 1309	VOLVO 1561, 1563, 1569
ROVER 1281	JM5037 CITROËN 295	VAUXHALL 1539, 1541, 1543	JM5154 FORD 463, 471, 473, 487, 489, 505, 507, 509, 517, 519
	FORD 501, 505, 509, 511, 513, 521, 523, 525, 527, 529	JM5095 OPEL 941, 943, 945, 947	
	LAND ROVER 671	SAAB 1309	
	PEUGEOT 1027	VAUXHALL 1539, 1541, 1543	
	JM5045 ROVER 1289, 1291	JM5096 BMW 193, 195, 197, 199	
	JM5046 HONDA 561, 567	JM5097 BMW 193, 195, 197	
	ROVER 1287, 1291	JM5098 BMW 193, 195, 197	
		JM5099 FORD 539	
		VW 1735, 1737	

NUMERICAL PARTS LIST





Numerische Teilenummernliste • Liste des références produits
Elenco numerico articoli • Lista de referencias





							
JM5155 FORD	439, 441, 443, 449, 451, 453, 455, 457, 461, 465, 469	JM5205 AUDI	61, 63	JM5302 CHEVROLET	207	JM7038 KIA	633, 635
	MAZDA	SEAT	1337, 1339, 1341	DAEWOO	317	JM7039 FORD	461
JM5157 MERCEDES-BENZ	763, 765, 781, 783	SKODA	1383, 1385, 1387	JM5303 CHEVROLET	207, 209	MITSUBISHI	835
		VW	1649, 1651, 1653, 1655, 1657, 1659	DAEWOO	317, 319	JM7041 MITSUBISHI	831
JM5158 FORD	471, 505, 513	JM5232 MITSUBISHI	825	JM5305 HYUNDAI	581	JM7042 CITROËN	255
MAZDA	705, 707, 709, 713	VOLVO	1563	JM5306 HYUNDAI	581	DAIHATSU	327
VOLVO	1561, 1563	JM5234 SEAT	1365	KIA	633	PEUGEOT	989
JM5159 CHEVROLET	213	VW	1721	JM5307 SUZUKI	1431, 1433	SUBARU	1415
OPEL	933, 935, 937	JM5235 OPEL	913, 915	JM5308 SUZUKI	1431, 1433	TOYOTA	1453
SAAB	1307	VAUXHALL	1515, 1517	JM5310 HYUNDAI	591	JM7045 AUDI	131
VAUXHALL	1531, 1533, 1535, 1537	JM5236 MERCEDES-BENZ	757, 767, 771, 789, 791, 795	KIA	637	FORD	539
JM5162 SMART	1405	JM5237 MERCEDES-BENZ	757, 767, 771, 789, 791, 795	JM5311 MAZDA	699	SEAT	1365
JM5163 MERCEDES-BENZ	731, 735, 743	JM5245 NISSAN	859, 861	JM5312 SUZUKI	1427	VW	1735, 1737, 1739, 1741
JM5164 MERCEDES-BENZ	731	JM5259 ALFA ROMEO	13	JM5314 MAZDA	709	JM7046 AUDI	95, 121, 123, 127, 129, 131
JM5165 MERCEDES-BENZ	731	CHEVROLET	207	JM5315 MAZDA	709	VW	1737, 1739
JM5166 AUDI	113, 119, 121, 123, 125	FIAT	357, 361, 363	JM5316 INFINITI	597	JM7047 AUDI	95, 121, 123, 127, 129, 131
JM5167 BMW	157, 159, 163	FORD	441	NISSAN	877	VW	1737, 1739
JM5176 ALFA ROMEO	13	LANCIA	651	JM5317 INFINITI	597	JM7048 AUDI	91, 93
FIAT	357, 359, 367, 369, 371	OPEL	897, 899, 901	NISSAN	877	VW	1701
LANCIA	649, 651, 653	SUZUKI	1425	RENAULT	1275	JM7049 CHRYSLER	219
OPEL	903	VAUXHALL	1499, 1501	JM5318 NISSAN	875	JM7050 JEEP	627
VAUXHALL	1503	JM5263 CHEVROLET	207	JM5320 KIA	633	JM7051 CITROËN	263
JM5184 FORD	463, 471, 473, 475, 487, 489, 505, 507, 509, 511, 517, 519, 523	DAEWOO	317	JM7022 TOYOTA	1465, 1473	PEUGEOT	995
JM5185 NISSAN	851	JM5267 NISSAN	863, 869	JM7023 TOYOTA	1475, 1477	JM7052 CITROËN	263
RENAULT	1105, 1107	JM5277 HYUNDAI	581, 583	JM7026 MERCEDES-BENZ	733, 735	PEUGEOT	995
JM5196 KIA	637	JM5281 NISSAN	851	JM7027 MERCEDES-BENZ	743	JM7053 RENAULT	1107
JM5197 CHEVROLET	209	RENAULT	1101	MERCEDES-BENZ	767, 769, 783	JM7054 DACIA	307
OPEL	917	JM5282 NISSAN	867	JM7029 AUDI	93, 95, 97	NISSAN	853, 855
VAUXHALL	1519	JM5283 CITROËN	273, 285, 295	VW	1699	RENAULT	1135, 1137, 1139, 1141, 1143, 1145
JM5198 OPEL	917	FIAT	405	JM7031 AUDI	91, 93, 97, 101	SUZUKI	1427, 1429
VAUXHALL	1519	PEUGEOT	1005, 1017, 1025	MITSUBISHI	831	JM7055 ALFA ROMEO	25, 27
JM5201 FIAT	409, 411	JM5285 SEAT	1321	SEAT	1361	FIAT	391, 395, 397
IVECO	611	SKODA	1375, 1377, 1379, 1381	SKODA	1399	OPEL	927
JM5202 FIAT	409	VW	1625	VW	1703, 1705, 1707, 1709, 1711	SAAB	1299
IVECO	611	JM5287 MAZDA	697	JM7032 AUDI	57	VAUXHALL	1527
JM5203 AUDI	85, 87, 95	JM5288 MINI	807	SEAT	1327, 1331	JM7060 FORD	439, 441, 443, 449, 451, 453, 455, 457, 461, 465, 469
FORD	501	SUBARU	1415	SKODA	1379, 1381	MAZDA	693, 695, 699
SEAT	1353, 1355, 1357, 1359	TOYOTA	1455	VW	1627, 1635, 1637, 1639, 1641	JM7077 VW	1725, 1727, 1729, 1731, 1733, 1735
SKODA	1393, 1395, 1397, 1399	JM5290 MITSUBISHI	825	JM7034 CITROËN	259, 267, 269	JM7078 AUDI	93, 97
VW	1687, 1689, 1691, 1693, 1695, 1703, 1705, 1707	VOLVO	1563	FIAT	373	SEAT	1361, 1363
JM5204 ALFA ROMEO	25, 27	JM5291 VOLVO	1563	FORD	459, 461, 469	SKODA	1399, 1401
FIAT	389, 391, 393, 395, 397	JM5293 FORD	543	MAZDA	699	VW	1705, 1709
LANCIA	657, 659	JM5294 FORD	543	MINI	807	JM7083 HONDA	561, 569
OPEL	927	JM5296 KIA	633	PEUGEOT	999, 1001	JM7092 FORD	461, 469
SAAB	1299	JM5298 NISSAN	851	SUZUKI	1427	JM7094 CITROËN	299
VAUXHALL	1527	JM5299 CITROËN	259	VOLVO	1557	PEUGEOT	1031
		FORD	451, 455	JM7035 CITROËN	271, 273	JM7098 BMW	187
		LANCIA	651	PEUGEOT	1005		
		MAZDA	695	JM7036 DAIHATSU	333		
		PEUGEOT	993	TOYOTA	1465, 1473		
		JM5300 HONDA	551	JM7037 INFINITI	597		
		JM5301 DAIHATSU	329	NISSAN	865, 875		
		TOYOTA	1453				

 JM7099 ALFA ROMEO 13	 JN276 MITSUBISHI 821	 JN459 ALFA ROMEO 27	 JN594 ALFA ROMEO 33, 35
CHRYSLER 217	JN279 VOLVO 1573, 1575	FIAT 365, 379, 381, 385, 387, 395	FIAT 411
FIAT 357, 359, 361, 369, 371	JN283 FIAT 353, 355, 363	LANCIA 657	IVECO 611, 613, 615
LANCIA 649, 651, 653	JN285 SAAB 1301	JN460 FORD 529	RENAULT 1263, 1265, 1267, 1269
JM7102 CHEVROLET 213	JN292 CITROËN 285, 297	JN462 ALFA ROMEO 35	JN596 CITROËN 255, 259
FIAT 409	PEUGEOT 1017, 1027, 1029	FIAT 411	FIAT 411
OPEL 937, 939	RENAULT 1213, 1233, 1235, 1237, 1239, 1241, 1243, 1257, 1259, 1261	JN469 TOYOTA 1461, 1467	IVECO 615
VAUXHALL 1537	JN297 BMW 157, 171, 177	JN494 NISSAN 851	PEUGEOT 989, 993
JM7103 ALFA ROMEO 23	JN299 BMW 153	JN513 SAAB 1301, 1305	JN597 NISSAN 875
FIAT 383	JN300 BMW 193	JN521 OPEL 939	JN598 TOYOTA 1453
OPEL 909, 913, 915, 919, 925	JN302 RENAULT 1269, 1271	VAUXHALL 1537, 1539	JN599 MITSUBISHI 823, 827
SAAB 1299	VOLVO 1591	JN523 OPEL 939	JN600 DACIA 307
VAUXHALL 1511, 1515, 1517, 1521, 1525	JN303 RENAULT 1269, 1271	VAUXHALL 1537, 1539	RENAULT 1101, 1103, 1105, 1111, 1115, 1117, 1119, 1121, 1123
JM7106 LEXUS 681	VOLVO 1591	JN528 NISSAN 859	VOLVO 1555
TOYOTA 1463, 1469	JN317 HYUNDAI 581, 583	JN532 TOYOTA 1459, 1467	JN603 TOYOTA 1459
JM7107 AUDI 87, 93	MITSUBISHI 819, 821	JN533 KIA 635	JN605 HONDA 563
SEAT 1357, 1359, 1361	JN332 FORD 449, 451, 453, 465, 467, 469	JN539 JAGUAR 623	JN606 SUZUKI 1427, 1429
SKODA 1395, 1399	JN344 BEDFORD 139	JN542 BMW 177, 193	JN607 MERCEDES-BENZ 731, 737, 749, 751, 753
VW 1693, 1695, 1705, 1707	OPEL 897, 901	JN544 CITROËN 275, 277, 279, 281, 283	JN611 SUBARU 1415
JM7113 SEAT 1363	VAUXHALL 1499, 1503	FIAT 397, 399	JN616 FORD 539
VW 1693, 1695, 1707, 1709	JN356 TOYOTA 1459	HONDA 561	JN619 MERCEDES-BENZ 741, 755, 757
JM7115 CHEVROLET 211, 213	JN365 MITSUBISHI 819, 823, 825	HYUNDAI 587	SSANGYONG 1409
OPEL 935	JN368 SUBARU 1415	LADA 643	JN620 FORD 465, 467, 479, 481, 513, 515, 517, 519
VAUXHALL 1533	JN369 RENAULT 1115	PEUGEOT 1005, 1007, 1009, 1011, 1013	JN621 DAEWOO 321
JM7117 ALFA ROMEO 33	JN396 MAZDA 693, 695	ROVER 1287	MERCEDES-BENZ 761, 763, 773
FIAT 409	JN403 HYUNDAI 591	SUZUKI 1431	SSANGYONG 1411
LANCIA 665	KIA 637	TALBOT 1437	JN622 MERCEDES-BENZ 761, 763, 773
JM7121 CITROËN 277, 287	MITSUBISHI 833, 835	JN547 CITROËN 269, 271, 273, 277, 279, 281, 283, 285, 287, 293	SSANGYONG 1411
FIAT 405	JN404 HONDA 551	FIAT 405	JN623 MERCEDES-BENZ 765, 767, 775, 777
LANCIA 661	JN408 ISUZU 603	PEUGEOT 1001, 1003, 1009, 1011, 1013, 1017, 1019	JN624 NISSAN 855, 859, 861
PEUGEOT 1007, 1019	OPEL 935	JN551 TOYOTA 1471	JN626 BEDFORD 139
JM7124 MITSUBISHI 819, 821	SSANGYONG 1409	JN562 ROVER 1281	CHEVROLET 207
SMART 1405	VAUXHALL 1535	JN568 FIAT 395	DAEWOO 319
JM7125 RENAULT 1107	JN414 BEDFORD 139	LANCIA 657	OPEL 897, 899, 901, 903, 907, 909, 911
JN041 OPEL 927	SUZUKI 1425	JN570 INFINITI 597	VAUXHALL 1499, 1501, 1503, 1505, 1509, 1511, 1513
JN068 OPEL 897, 899	JN415 DAIHATSU 327, 329	NISSAN 873, 875	JN628 MAZDA 693, 695, 697, 699
VAUXHALL 1499, 1501	JN426 CITROËN 297, 299	JN572 MERCEDES-BENZ 741, 755, 757	JN631 TOYOTA 1479
JN105 FORD 439, 443, 445, 447, 449	PEUGEOT 1029, 1031	SSANGYONG 1409	JN633 ACURA 3
MAZDA 695	TALBOT 1437	JN576 KIA 637	HONDA 573
JN185 TOYOTA 1469, 1475	JN438 AUDI 107, 109, 111, 113	MAZDA 709, 711	ROVER 1293
JN232 CITROËN 255	MAZDA 707	SUZUKI 1431	JN634 BEDFORD 139
JN234 CITROËN 285, 297, 299	VW 1719, 1721	JN578 BMW 171	ISUZU 601, 603
JN238 CITROËN 257	JN440 SUZUKI 1425	JN579 SUZUKI 1425	OPEL 939
PEUGEOT 989, 991, 997	JN449 TOYOTA 1477	JN585 FIAT 411	JN635 VOLVO 1567, 1569, 1575, 1577
JN244 CITROËN 275, 283	JN453 BEDFORD 139	LANCIA 665	JN636 DAIHATSU 333
FIAT 401, 407	OPEL 907, 919	JN587 LANCIA 649	JN641 SEAT 1321, 1325, 1335
PEUGEOT 1005, 1015, 1025	VAUXHALL 1509, 1521	JN588 ALFA ROMEO 13, 15, 17, 19	VW 1625, 1627, 1629, 1631, 1633, 1645
TALBOT 1437	JN454 MERCEDES-BENZ 731, 737, 749, 751, 753		
JN245 PEUGEOT 1029	JN456 ISUZU 603		
JN248 VOLVO 1555			
JN253 CITROËN 297			
JN273 MERCEDES-BENZ 783			

NUMERICAL PARTS LIST









Nummerische Teilenummernliste • Liste des références produits
Elenco numerico articoli • Lista de referencias









 JN643 ALFA ROMEO 29	 JN732 DACIA 311	 JN810 ALFA ROMEO 21, 23	 JN928 ALFA ROMEO 31
FIAT 375, 383, 399, 401, 403	MITSUBISHI 827	JN811 ALFA ROMEO 21, 23	FIAT 383, 401, 403
LANCIA 657, 661	OPEL 925	JN812 ALFA ROMEO 29	LANCIA 659, 661
JN649 HONDA 563	RENAULT 1145, 1147, 1165, 1167, 1169, 1171, 1173,	JN813 ALFA ROMEO 35	JN929 CHEVROLET 209
JN653 NISSAN 859	1175, 1177, 1179, 1181,	JN814 ALFA ROMEO 35	DAEWOO 317
JN654 NISSAN 859	1183, 1185, 1187, 1191,	JN815 FORD 479	OPEL 901, 903, 909, 911,
JN655 DAIHATSU 333	1193, 1195, 1197, 1199,	JN816 FORD 481, 483, 485, 487, 489, 491, 493, 495, 497, 499	VAUXHALL 1505, 1511, 1513, 1515
TOYOTA 1467, 1471	1213, 1215, 1217, 1219	MAZDA 705	JN933 FIAT 401
JN658 CITROËN 255, 257, 259, 261, 263, 271, 273	VAUXHALL 1525	JN817 FORD 513, 515, 519	LANCIA 659, 663
PEUGEOT 989, 991, 993, 995, 997, 1003, 1005	VOLVO 1555, 1557, 1559, 1561, 1565, 1567	JN819 FIAT 383	JN934 FIAT 409
JN662 FORD 539, 541, 543	JN736 ROVER 1281	JN821 FORD 529, 531, 533	LANCIA 663
JN663 DAIHATSU 327	JN743 FORD 529	LDV 677	JN936 LEXUS 681
JN665 NISSAN 853, 855	JN744 ACURA 3	JN829 NISSAN 857	RENAULT 1111, 1113
JN666 FIAT 351	HONDA 551, 555, 557	JN830 NISSAN 865	TOYOTA 1479
JN667 FIAT 351, 353, 355, 357, 359	ROVER 1285	JN831 LEXUS 681	JN937 RENAULT 1247, 1249, 1251
LANCIA 649, 651	JN752 MAZDA 697, 699	JN836 ROVER 1287, 1289	JN940 ALFA ROMEO 23, 31
JN669 FIAT 363, 365	JN755 HONDA 569	JN837 NISSAN 873	JN948 FIAT 383, 403
JN679 HONDA 551, 555	JN758 CITROËN 261	JN838 NISSAN 853, 857	LANCIA 657
JN681 SUBARU 1415	PEUGEOT 995	JN840 NISSAN 851	JN950 FORD 461, 463, 481, 487, 489, 517, 519
JN691 MAZDA 699	ROVER 1283	JN849 VW 1721, 1723	JN954 TOYOTA 1477
JN692 MAZDA 703, 711	JN774 KIA 633	JN851 MERCEDES-BENZ 779, 781, 791	JN955 BMW 171, 173
JN693 BEDFORD 139	MAZDA 693, 697, 699	JN852 MERCEDES-BENZ 779, 781	LAND ROVER 673
CHEVROLET 211	JN775 MAZDA 701, 703, 707	JN857 HONDA 557, 559	OPEL 939, 943
DAEWOO 319, 321	JN776 ISUZU 601	JN860 HONDA 569, 571	VAUXHALL 1539, 1541
OPEL 907, 915, 919, 921, 927, 929, 931	OPEL 905, 907	JN865 TOYOTA 1457	JN956 FIAT 411, 413
VAUXHALL 1509, 1517, 1521, 1523, 1527, 1529, 1531	VAUXHALL 1507, 1509	JN872 LAND ROVER 671, 673	IVECO 617
JN697 JEEP 627	JN777 ISUZU 601	JN877 MAZDA 707	OPEL 941, 943, 945
RENAULT 1245, 1247, 1249, 1251	MAZDA 699	JN886 SUBARU 1415	RENAULT 1267, 1269
JN698 BMW 153, 155	OPEL 905, 915, 917	SUZUKI 1427, 1429	VAUXHALL 1541, 1543
JN700 DAIHATSU 329, 331, 333	VAUXHALL 1507, 1517, 1519	JN889 MITSUBISHI 837	JN963 LOTUS 685
JN705 TOYOTA 1481	JN788 HYUNDAI 585, 587, 589	JN897 MITSUBISHI 819, 821	MG 803
JN706 TOYOTA 1459	KIA 635	PROTON 1037	ROVER 1283, 1285, 1287
JN707 ISUZU 603, 605	MITSUBISHI 829, 831, 833	JN904 HONDA 569	JN964 VW 1663, 1679
OPEL 939, 943	JN789 DACIA 307, 309, 311	TOYOTA 1457, 1459, 1463	JN965 TOYOTA 1473, 1475, 1479
VAUXHALL 1539, 1541	RENAULT 1113, 1115, 1123, 1125, 1127, 1129, 1133, 1163, 1165	JN911 DAEWOO 321	JN967 AUDI 117
JN710 MAZDA 701	JN792 LEXUS 681	MERCEDES-BENZ 733, 739, 747, 749, 753, 755	VOLVO 1591
JN712 TOYOTA 1479	TOYOTA 1479, 1481	SSANGYONG 1409	JN969 LANCIA 665
JN713 MITSUBISHI 837	JN798 NISSAN 865	JN914 AUDI 81	OPEL 943
JN714 MAZDA 713	JN800 MITSUBISHI 823, 825	SEAT 1349	RENAULT 1267
JN715 HYUNDAI 585	PROTON 1037	SKODA 1389	VAUXHALL 1541
MITSUBISHI 829	JN803 FIAT 351	VW 1681, 1683	JN972 FIAT 367
JN717 KIA 635	JN804 FIAT 351	JN915 AUDI 113	LANCIA 653
MAZDA 705, 707	JN805 CITROËN 269	VW 1723, 1725, 1727, 1729, 1731	JN973 FIAT 375, 377
JN722 NISSAN 863	FIAT 353, 355, 363, 365, 367, 371, 373, 375, 379	JN917 TOYOTA 1469	LANCIA 655
JN724 FORD 539	LANCIA 651, 653, 655	JN918 HONDA 561, 565, 569, 571	JN994 RENAULT 1243
NISSAN 867, 871, 875	PEUGEOT 1001	JN923 OPEL 939	JN995 RENAULT 1239, 1241, 1243, 1259
JN729 SUBARU 1415	JN806 ALFA ROMEO 23, 29	VAUXHALL 1539	JN996 RENAULT 1191, 1233
	JN807 ALFA ROMEO 29, 31	JN924 OPEL 939	JN997 RENAULT 1107, 1109, 1111
	JN808 ALFA ROMEO 29, 31	VAUXHALL 1539	JP003 AUDI 81, 83, 85
	JN809 FIAT 385	JN925 HONDA 557	FORD 501
		ROVER 1285	SEAT 1341, 1349, 1351, 1355
		JN927 JAGUAR 623	VW 1661, 1663, 1681, 1683, 1685, 1687, 1689, 1691

 JP006 RENAULT 1253	 JP069 CITROËN 299, 301	 KA546 FIAT 411	 KD929 CITROËN 299
JP008 OPEL 911, 913	FIAT 413	KA606 PEUGEOT 1029	FIAT 411, 413
VAUXHALL 1513	PEUGEOT 1031	KA611 CITROËN 269, 271, 273, 275, 277, 279, 281, 283, 285, 287, 293	IVECO 611, 613, 615, 617
JP009 OPEL 911, 913	JP070 ALFA ROMEO 35, 37	FIAT 397, 399, 405, 407	PEUGEOT 1031
VAUXHALL 1513	INFINITI 597	HONDA 561	RENAULT 1269
JP016 CHEVROLET 211	LANCIA 667	LADA 643	KD931 CITROËN 299
DAEWOO 319, 321	JP071 ALFA ROMEO 35, 37	PEUGEOT 1001, 1003, 1005, 1007, 1009, 1011, 1013, 1015, 1017, 1019, 1025	FIAT 409, 413
OPEL 921, 931, 933, 935, 937, 939	LANCIA 667	ROVER 1287	IVECO 613, 617
VAUXHALL 1521, 1523, 1533, 1535, 1537	JP074 SEAT 1321, 1323, 1325, 1327, 1329, 1335, 1337	SUZUKI 1431	PEUGEOT 1031
JP018 OPEL 917, 933	SKODA 1383, 1387	TALBOT 1437	RENAULT 1269
VAUXHALL 1519, 1533	VW 1625, 1631, 1633, 1635, 1637, 1647, 1649	KA625 RENAULT 1165, 1167, 1169, 1171, 1173, 1175, 1177, 1179, 1181, 1183, 1185, 1187, 1191, 1195, 1197, 1199, 1213, 1215, 1217, 1219, 1233	KG393 FIAT 351
JP019 FIAT 387	JP075 VW 1633	KA675 NISSAN 873, 875	KG664 FORD 439, 443, 445, 447, 449, 451, 453, 461, 463, 465, 467, 469, 479, 481, 487, 489, 513, 515, 517, 519, 525, 527, 539, 541, 543
JP020 LAND ROVER 671, 673	JP077 BMW 155, 157	KA835 CITROËN 297	KG5012 OPEL 925, 927
JP022 MERCEDES-BENZ 763, 765	JP078 BMW 155	PEUGEOT 1029	RENAULT 1189, 1191, 1193, 1199, 1201, 1203, 1205, 1207, 1209, 1211, 1213, 1219, 1221, 1223, 1225, 1227, 1229, 1231, 1233
JP024 AUDI 59, 61, 89, 91	JP079 BMW 153, 155, 157	KA845 ALFA ROMEO 33	VAUXHALL 1525, 1531
FIAT 375	JP097 ROVER 1289	FIAT 367, 383, 389, 393, 401, 409	VOLVO 1565, 1567
SEAT 1335, 1337, 1343, 1359, 1361	JR087 FIAT 351	LANCIA 657, 659, 663, 665	KG5157 CITROËN 259, 267, 283, 291, 293
SKODA 1383, 1397	JR264 AUSTIN 135	KA5020 AUDI 59, 63, 65, 79, 81	FIAT 399
VW 1633, 1645, 1647, 1649, 1651, 1665, 1669, 1697, 1699, 1701, 1703	ROVER 1281	SEAT 1335, 1349	PEUGEOT 993, 999, 1001, 1015, 1021, 1023, 1025
JP027 BMW 155, 157	JR349 ALFA ROMEO 13, 17, 19	VW 1645, 1659, 1661, 1663, 1675, 1677, 1679, 1681	KG5290 PEUGEOT 989, 991
JP032 BMW 155, 157	JR556 FIAT 351, 353, 355, 363	KA5021 FORD 443	KG5337 ALFA ROMEO 33
JP041 CITROËN 265	JR580 FIAT 411, 413	KA5025 AUDI 57	CHEVROLET 213
NISSAN 855	JR635 RENAULT 1101, 1105, 1113, 1115, 1119, 1121	SEAT 1321, 1323, 1327, 1329, 1331	FIAT 409
PEUGEOT 997	JR673 FIAT 351, 353, 355, 357, 359, 363	SKODA 1379, 1381	OPEL 937
JP043 CITROËN 271, 275, 277, 287	LANCIA 649	VW 1625, 1627, 1633, 1635, 1637, 1639, 1641, 1649, 1651	VAUXHALL 1537
PEUGEOT 1003, 1007, 1019	JR5022 BMW 157, 159, 163	KA5032 FIAT 351, 353, 355, 357, 359, 363	KH007 FIAT 351
JP044 CITROËN 279, 281, 285, 287	JR5029 OPEL 933, 935, 937	LANCIA 649, 651	KJ211 HYUNDAI 591
PEUGEOT 1009, 1011, 1019	VAUXHALL 1531, 1533, 1535, 1537	KA5035 MERCEDES-BENZ 743, 749	KIA 637
JP045 CITROËN 293, 295	JR5030 OPEL 897, 899, 903, 905	KA5036 CHRYSLER 217	NISSAN 875
FIAT 407	SUZUKI 1425	MERCEDES-BENZ 743, 745, 747, 749, 767, 769, 783	SUBARU 1415
PEUGEOT 1025	VAUXHALL 1499, 1501, 1505, 1507	KB5050 MERCEDES-BENZ 749	TOYOTA 1457, 1461, 1467
JP049 CITROËN 269	JR5031 BMW 153, 155, 157	KD226 FIAT 353	HYUNDAI 585, 587
FIAT 353, 355, 363, 365, 367, 371, 373, 375, 379	JR5040 MERCEDES-BENZ 769, 771, 777, 787, 789, 795	KD383 ALFA ROMEO 23, 29	KIA 635
LANCIA 651, 653, 655	JR5044 BMW 159, 161, 171, 173, 177	KD717 FIAT 353, 363, 365, 373	NISSAN 875
PEUGEOT 1001	JR5046 BMW 155, 157	KD726 FIAT 351	MITSUBISHI 819, 823
JP063 FIAT 387	JR5048 AUDI 57, 61, 63	KJ452 NISSAN 875	MITSUBISHI 829, 833
LANCIA 657	SEAT 1333, 1339	KJ462 SUBARU 1415	RENAULT 1101, 1115, 1211, 1213
JP064 ALFA ROMEO 33	SKODA 1383, 1385	KJ466 TOYOTA 1457, 1461, 1467	FORD 455
FIAT 409	VW 1639, 1641, 1643, 1645, 1653, 1655, 1657	KJ570 HYUNDAI 585, 587	MAZDA 693, 713
JP065 ROVER 1281, 1283	KA289 FORD 465, 467, 481, 519	KIA 635	DAEWOO 321
JP067 FORD 537, 539	KA293 FIAT 353	MITSUBISHI 819, 823	SSANGYONG 1411
OPEL 941	KA294 FIAT 355, 363, 365, 371, 373, 375, 379	KJ577 MITSUBISHI 829, 833	
JP068 ALFA ROMEO 31, 35	KA295 FIAT 351	KJ647 RENAULT 1101, 1115, 1211, 1213	
CHRYSLER 217, 219	KA525 PEUGEOT 991, 997	KJ710 FORD 455	
FORD 537, 539	KA533 RENAULT 1115	MAZDA 693, 713	
OPEL 941		DAEWOO 321	
		SSANGYONG 1411	

NUMERICAL PARTS LIST









Numerische Teilenummernliste • Liste des références produits
Elenco numerico articoli • Lista de referencias









 KK5001 FIAT 353, 355, 357, 359, 363 LANCIA 649		 KM5021 MG 802 ROVER 1280, 1282, 1284, 1286		 LK5003 AUDI 57, 67, 69, 71, 73, 75, 77, 83, 85, 87, 91, 95, 97, 99, 103 FORD 501 SEAT 1327, 1331, 1343, 1345, 1347, 1349, 1351, 1353, 1355, 1357, 1359, 1361, 1363 SKODA 1379, 1381, 1387, 1389, 1391, 1393, 1395, 1397, 1399, 1401 VW 1627, 1635, 1637, 1639, 1641, 1667, 1669, 1671, 1673, 1675, 1685, 1687, 1689, 1691, 1693, 1695, 1697, 1699, 1701, 1703, 1705, 1707, 1709, 1713, 1715		 LK5008 AUDI 59, 61, 63, 67, 69, 71, 91, 93, 97 SEAT 1335, 1337, 1339, 1341, 1361, 1363 SKODA 1383, 1385, 1387, 1399, 1401 VW 1645, 1647, 1649, 1651, 1653, 1655, 1657, 1659, 1699, 1701, 1705, 1709	
KK5470 AUDI 107, 117 VOLVO 1591 VW 1651, 1723, 1725, 1727, 1729, 1731, 1733		KT446 FIAT 353, 355, 363 KT639 FIAT 381, 383, 385, 387, 395, 399, 403 KT738 FORD 465, 467, 481, 519			LK5011 AUDI 61, 63 SEAT 1321, 1323, 1327, 1329, 1331, 1337, 1339 SKODA 1379, 1381, 1385 VW 1625, 1627, 1633, 1635, 1637, 1639, 1641, 1649, 1651, 1653, 1655		
KK5484 BMW 159, 161, 173, 177		KV086 ALFA ROMEO 29, 35 KV102 ALFA ROMEO 29 KV122 FIAT 365, 367 KV124 ALFA ROMEO 13, 17, 19, 21 KV927 FIAT 411 IVECO 611, 613, 615, 617 RENAULT 1269		LK5004 FORD 439, 441, 443, 449, 451, 453, 455, 457, 465 MAZDA 693, 695, 699	LK5012 AUDI 87, 91, 93, 95, 97 JEEP 627 MITSUBISHI 831 SEAT 1355, 1357, 1359, 1361, 1363 SKODA 1395, 1397, 1399 VW 1691, 1693, 1695, 1703, 1705, 1707, 1709		
KK5520 BMW 159, 161, 173, 177		LA378 PEUGEOT 1001 LA564 ROVER 1281 LA5204 SEAT 1361 SKODA 1397 VW 1697		LK5005 FORD 471, 477, 479, 503, 505, 513, 521, 523, 527 MAZDA 705, 707, 709, 713 VOLVO 1561, 1563, 1569	LK5013 AUDI 61, 63 SKODA 1381, 1385 VW 1639, 1641, 1653, 1655		
KK5522 AUDI 91, 93, 95, 97, 101, 103, 105 MITSUBISHI 831 SEAT 1361, 1363 SKODA 1399, 1401 VW 1703, 1705, 1707, 1711, 1715, 1717		LB161 ROVER 1289, 1291 LB414 FIAT 399, 401, 403 LB536 ROVER 1289, 1291 LC281 CITROËN 299 FIAT 413 PEUGEOT 1031		LK5006 AUDI 59, 61, 65, 67, 69, 71, 75, 81, 83, 85, 107 SEAT 1321, 1323, 1325, 1327, 1329, 1331, 1335, 1337, 1341, 1343, 1349, 1351, 1353, 1355, 1359 SKODA 1383, 1389, 1391 VW 1625, 1627, 1633, 1635, 1637, 1639, 1645, 1647, 1649, 1651, 1661, 1663, 1665, 1667, 1669, 1673, 1681, 1683, 1685, 1687, 1689, 1691, 1693, 1697, 1699, 1701, 1719, 1723, 1725, 1727, 1729, 1731, 1733	LR922 FIAT 351 LS856 FIAT 411 LS859 FIAT 411, 413 LT023 FIAT 385, 395 LT439 FIAT 363, 365 LT498 FIAT 379, 381, 385, 387, 395 LT634 CITROËN 269, 271, 273, 275, 277, 279, 281, 283 LADA 643 PEUGEOT 991, 997, 1001, 1005, 1007, 1009, 1011, 1013		
KK5551 AUDI 57 SEAT 1327, 1329, 1331, 1337, 1339 SKODA 1379, 1381 VW 1633, 1635, 1637, 1639, 1641, 1649, 1651, 1653		LC282 FIAT 413 LC292 CITROËN 269, 273, 277, 279, 281, 283 PEUGEOT 1001, 1003, 1009, 1011, 1013		LK5007 BMW 157, 159, 175, 179, 181, 189, 191	LT808 TOYOTA 1459 LT839 RENAULT 1105, 1113, 1119, 1121 LV501 NISSAN 875 LV583 FIAT 379, 381, 385, 387, 395 LANCIA 657 LV589 FIAT 365, 381, 385, 395 LV647 MITSUBISHI 825 LV847 CITROËN 259 NA473 AUSTIN 135 ROVER 1281 NA576 FORD 439, 443, 445, 447, 449 MAZDA 695		
KK5598 FIAT 409		LK5000 KIA 637 LAND ROVER 673 MG 803 ROVER 1289, 1291, 1293					
KK5599 ALFA ROMEO 33 FIAT 411, 413 IVECO 611, 613, 615, 617 RENAULT 1269		LK5001 ALFA ROMEO 13, 15 FIAT 359, 367, 369, 371 LANCIA 651, 653 OPEL 901, 903 RENAULT 1107 VAUXHALL 1503					
KK5643 DACIA 307 NISSAN 853, 855, 859 RENAULT 1135, 1137, 1139, 1141, 1145		LK5002 HONDA 563 ROVER 1289					
KK5646 FIAT 361 HONDA 565 LANCIA 651 OPEL 899 SUZUKI 1425 VAUXHALL 1501							
KK5682 BMW 159							
KK5683 MERCEDES-BENZ 741, 755, 757, 765, 767, 769, 771, 775, 777, 787, 789, 795 SSANGYONG 1409, 1411							
KK5684 BMW 155							
KL221 FIAT 411							
KL476 ALFA ROMEO 31 FIAT 383, 389, 393 LANCIA 657, 659							
KL477 ALFA ROMEO 33 FIAT 409 LANCIA 659, 663, 665							
KM5002 LAND ROVER 672 MG 802 ROVER 1288, 1290, 1292							

 NA581 VOLVO 1567, 1569, 1573, 1575, 1577		 NA5017 FORD 535 RENAULT 1211, 1213 VOLVO 1555, 1561, 1563, 1565, 1571, 1573, 1577, 1579, 1581, 1583, 1585, 1587, 1589, 1591, 1593		 NA5037 DACIA 311 MITSUBISHI 827 NISSAN 861, 863 OPEL 925, 927, 933 RENAULT 1179, 1181, 1185, 1187, 1189, 1193, 1195, 1197, 1199, 1201, 1203, 1205, 1207, 1209, 1211, 1213, 1215, 1217, 1219, 1221, 1223, 1225, 1227, 1229, 1231, 1233 VAUXHALL 1525, 1531 VOLVO 1567		 NA5058 ALFA ROMEO 13 FIAT 357, 359, 367, 369, 371 FORD 441 HONDA 551 LANCIA 649, 651, 653 MAZDA 695, 697 VAUXHALL 1503	
NA584 AUSTIN 135 ROVER 1281		NA5018 FORD 535 RENAULT 1211, 1213, 1263 VOLVO 1555, 1563, 1565, 1571, 1573, 1577, 1579, 1581, 1583, 1585, 1587, 1589, 1591, 1593		NA5045 FIAT 351		NA5061 ALFA ROMEO 13 FIAT 355, 357, 359, 361, 363, 369, 371 FORD 441 LANCIA 649, 651, 653	
NA784 SEAT 1323 VW 1647		NA5028 FORD 501, 505, 509, 511, 513, 521, 523, 525		NA5049 FIAT 351, 353, 355, 363, 365, 371, 373, 375, 379		NA5062 ALFA ROMEO 29, 31 FIAT 379, 381, 383, 385, 387, 395, 399, 401, 403 LANCIA 661	
NA869 VOLVO 1567, 1569, 1573, 1575, 1577		NA5030 CITROËN 295 FIAT 407 FORD 501, 505, 509, 511, 513, 521, 523, 525, 527, 529 JAGUAR 623 PEUGEOT 1027		NA5050 FIAT 365		NA5063 ALFA ROMEO 13, 15, 17, 19, 21, 23	
NA5001 ALFA ROMEO 35, 37 AUDI 59, 63, 65, 67, 69, 71, 73, 75, 77, 79, 81, 83, 85, 89, 91, 107, 109, 111, 113, 115, 117, 119, 121, 123, 125, 127, 129, 131 FORD 501 SEAT 1321, 1323, 1325, 1327, 1329, 1335, 1337, 1341, 1343, 1345, 1347, 1349, 1351, 1353, 1355, 1359, 1365 SKODA 1383, 1387, 1389, 1391, 1393, 1401 TOYOTA 1453 VW 1625, 1627, 1629, 1631, 1633, 1635, 1637, 1645, 1647, 1649, 1659, 1661, 1663, 1665, 1667, 1669, 1671, 1673, 1675, 1677, 1679, 1681, 1683, 1685, 1687, 1689, 1691, 1693, 1697, 1699, 1719, 1721, 1723, 1725, 1727, 1729, 1731, 1733, 1735, 1737, 1739		NA5031 CITROËN 295 FIAT 407 FORD 501, 505, 509, 511, 513, 521, 523, 525, 527, 529 JAGUAR 623 PEUGEOT 1027		NA5051 FIAT 363, 365, 367, 371, 373, 375, 377, 379 ISUZU 603, 605 OPEL 939, 945, 947 VAUXHALL 1539, 1543		NA5064 ALFA ROMEO 13, 15, 17, 19, 21 NA5065 ALFA ROMEO 13, 15, 17, 19, 21, 23, 31 NA5066 ALFA ROMEO 23, 29, 31 FORD 505, 507, 509	
NA5013 FORD 469, 471, 475, 477, 479, 497, 499		NA5035 CITROËN 287, 289, 291, 293, 295, 297 FIAT 405, 407 FORD 503, 505, 509, 511, 521, 523 LANCIA 661, 663 LAND ROVER 671 PEUGEOT 1019, 1021, 1023, 1025, 1027 SUZUKI 1431, 1433 VOLVO 1573		NA5052 FIAT 363, 365		NA5069 ALFA ROMEO 19, 21, 23 CHEVROLET 213 FIAT 383, 401, 403, 409 LANCIA 659, 661 OPEL 933, 935, 937 SAAB 1307 VAUXHALL 1531, 1533, 1535, 1537	
NA5016 DACIA 307, 309, 311 JEEP 627 NISSAN 859 PEUGEOT 1017, 1027, 1029 RENAULT 1113, 1115, 1123, 1125, 1127, 1129, 1131, 1133, 1147, 1149, 1151, 1153, 1155, 1157, 1159, 1161, 1163, 1165, 1213, 1233, 1235, 1237, 1239, 1241, 1243, 1245, 1247, 1249, 1251, 1257, 1259, 1261 VOLVO 1577		NA5036 DACIA 311 MITSUBISHI 827 NISSAN 861, 863 OPEL 925, 927, 933 RENAULT 1179, 1181, 1185, 1187, 1189, 1191, 1193, 1195, 1199, 1201, 1203, 1205, 1207, 1209, 1211, 1213, 1215, 1217, 1219, 1221, 1223, 1225, 1227, 1229, 1231, 1233 VAUXHALL 1525, 1531 VOLVO 1567		NA5053 ALFA ROMEO 17, 19, 21, 23, 25, 27, 29, 31, 33 DACIA 307, 309, 311 FIAT 351, 353, 355, 357, 359, 361, 363, 367, 383, 385, 387, 389, 391, 393, 395, 397, 401, 403, 409 LANCIA 649, 651, 653, 655, 657, 659, 661, 663, 665 MITSUBISHI 837 NISSAN 851, 865, 869 OPEL 927, 937, 941 RENAULT 1107, 1109, 1111, 1113, 1115, 1123, 1125, 1127, 1129, 1133, 1163, 1165, 1253, 1255, 1257, 1265, 1267 VAUXHALL 1527, 1535, 1539		NA5070 ALFA ROMEO 17, 19, 21, 23, 25, 27, 29, 31, 33 FIAT 367, 377, 379, 383, 387, 389, 391, 393, 395, 397, 401, 403, 409 LANCIA 653, 655, 657, 659, 661, 663, 665 OPEL 909, 927, 929, 931 SAAB 1299 VAUXHALL 1509, 1527, 1529	
				NA5057 ALFA ROMEO 13, 15 CHRYSLER 217 FIAT 355, 357, 359, 361, 367, 369, 371 FORD 441 LANCIA 649, 651, 653 OPEL 901, 903 VAUXHALL 1503		NA5074 CHRYSLER 217 DAEWOO 321 JEEP 627 MERCEDES-BENZ 731, 737, 741, 743, 745, 747, 749, 751, 753, 755, 757, 759, 761, 763, 765, 767, 769, 771, 773, 775, 777, 779, 781, 783, 787, 789, 791 SSANGYONG 1409, 1411	

NUMERICAL PARTS LIST









Numerische Teilenummernliste • Liste des références produits
Elenco numerico articoli • Lista de referencias









							
NA5083 KIA	637	NA5106 AUDI	57, 59, 61, 63, 67, 71, 73, 75, 83, 85, 87, 91, 93, 95, 97, 99, 101, 103, 105, 107, 113, 125, 127, 129, 131	NA5118 DACIA	307, 309	NA5133 AUDI	59, 63, 65, 67, 79, 81, 83, 89, 91, 107, 109, 111, 113, 117, 119, 121, 123, 125
LAND ROVER	673	FORD	443, 501, 539	NISSAN	853, 855	FORD	501, 539
MG	803	JEEP	627	RENAULT	1135, 1137, 1139, 1141, 1143, 1145	MERCEDES-BENZ	769
ROVER	1289, 1291, 1293	MITSUBISHI	831	SMART	1405	SEAT	1321, 1325, 1327, 1335, 1341, 1343, 1349, 1351, 1359
NA5088 MINI	807	SEAT	1323, 1325, 1327, 1331, 1333, 1335, 1337, 1339, 1341, 1343, 1345, 1347, 1349, 1351, 1353, 1355, 1357, 1359, 1361, 1363, 1365	SUZUKI	1427, 1429	SKODA	1375, 1377, 1379, 1381, 1383, 1387, 1389
TOYOTA	1455, 1457	SKODA	1375, 1377, 1379, 1381, 1383, 1385, 1387, 1389, 1391, 1393, 1395, 1397, 1399, 1401	NA5124 AUDI	57, 59, 61, 63, 65, 67, 69, 71, 73, 75, 77, 83, 85, 87, 91, 93, 95, 97, 99, 101, 103, 107	TOYOTA	1453
NA5089 CITROËN	271, 273	VW	1627, 1629, 1635, 1637, 1639, 1641, 1643, 1645, 1647, 1649, 1651, 1653, 1655, 1657, 1659, 1667, 1669, 1671, 1673, 1675, 1687, 1689, 1691, 1693, 1695, 1697, 1699, 1701, 1703, 1705, 1707, 1709, 1711, 1713, 1715, 1717, 1719, 1721, 1729, 1731, 1733, 1735,	FORD	501	VOLVO	1583, 1591
PEUGEOT	1003	NA5107 MERCEDES-BENZ	731, 735, 743	JEEP	627	VW	1625, 1627, 1629, 1631, 1633, 1645, 1647, 1649, 1659, 1661, 1663, 1665, 1667, 1675, 1677, 1679, 1681, 1683, 1685, 1697, 1699, 1719, 1721, 1723, 1725, 1727, 1729, 1735, 1737
TOYOTA	1455, 1459, 1461, 1463	NA5108 ACURA	3	SKODA	1375, 1379, 1381, 1383, 1385, 1387, 1389, 1393, 1395, 1397, 1399, 1401	NA5136 RENAULT	1211, 1213, 1263
NA5090 TOYOTA	1455, 1459, 1461, 1463	ALFA ROMEO	33	SEAT	1325, 1327, 1331, 1335, 1337, 1339, 1341, 1343, 1345, 1347, 1349, 1353, 1355, 1357, 1359, 1361, 1363	VOLVO	1555, 1561, 1563, 1565, 1571, 1573, 1577, 1579, 1581, 1583, 1589, 1591, 1593
NA5099 BMW	153, 155, 157	CHEVROLET	213	SEAT	1325, 1327, 1331, 1335, 1337, 1339, 1341, 1343, 1345, 1347, 1349, 1353, 1355, 1357, 1359, 1361, 1363	NA5137 FORD	439, 441, 443, 449, 451, 453, 455, 457, 465
NA5103 BMW	157, 159, 161, 173, 175, 177, 179, 181, 189, 191, 195, 197	CITROËN	283	SEAT	1325, 1327, 1331, 1335, 1337, 1339, 1341, 1343, 1345, 1347, 1349, 1353, 1355, 1357, 1359, 1361, 1363	MAZDA	693, 695, 699
MG	803	FIAT	409	SEAT	1325, 1327, 1331, 1335, 1337, 1339, 1341, 1343, 1345, 1347, 1349, 1353, 1355, 1357, 1359, 1361, 1363	NA5138 RENAULT	1211, 1213, 1263
ROVER	1291	HYUNDAI	589, 591	SEAT	1325, 1327, 1331, 1335, 1337, 1339, 1341, 1343, 1345, 1347, 1349, 1353, 1355, 1357, 1359, 1361, 1363	VOLVO	1563, 1565, 1571, 1579, 1583, 1589, 1593
NA5104 ALFA ROMEO	31	ISUZU	605	SEAT	1325, 1327, 1331, 1335, 1337, 1339, 1341, 1343, 1345, 1347, 1349, 1353, 1355, 1357, 1359, 1361, 1363	NA5139 CHRYSLER	217
BMW	153, 155, 157, 159, 161, 169, 171, 173, 175, 177, 179, 193	KIA	635	SEAT	1325, 1327, 1331, 1335, 1337, 1339, 1341, 1343, 1345, 1347, 1349, 1353, 1355, 1357, 1359, 1361, 1363	MINI	809
LAND ROVER	673	OPEL	897, 899, 903, 905, 931, 933, 935, 937, 939, 947	SEAT	1325, 1327, 1331, 1335, 1337, 1339, 1341, 1343, 1345, 1347, 1349, 1353, 1355, 1357, 1359, 1361, 1363	NA5140 CHRYSLER	217
MG	803	PEUGEOT	1015	SEAT	1325, 1327, 1331, 1335, 1337, 1339, 1341, 1343, 1345, 1347, 1349, 1353, 1355, 1357, 1359, 1361, 1363	MINI	809
OPEL	939, 943	SAAB	1305	SEAT	1325, 1327, 1331, 1335, 1337, 1339, 1341, 1343, 1345, 1347, 1349, 1353, 1355, 1357, 1359, 1361, 1363	NA5147 FORD	443, 457
ROVER	1291	SUZUKI	1425	SEAT	1325, 1327, 1331, 1335, 1337, 1339, 1341, 1343, 1345, 1347, 1349, 1353, 1355, 1357, 1359, 1361, 1363	NA5149 VOLVO	1571, 1583
VAUXHALL	1539, 1541	VAUXHALL	1499, 1501, 1505, 1507, 1529, 1535, 1537, 1543	SEAT	1325, 1327, 1331, 1335, 1337, 1339, 1341, 1343, 1345, 1347, 1349, 1353, 1355, 1357, 1359, 1361, 1363	NA5157 FORD	471, 477, 479, 503, 505, 513, 521, 523, 527
NA5105 BMW	155, 157, 159, 161, 169, 171, 173, 177, 179, 183, 193, 195, 197	NA5109 MERCEDES-BENZ	731, 735, 743	SEAT	1325, 1327, 1331, 1335, 1337, 1339, 1341, 1343, 1345, 1347, 1349, 1353, 1355, 1357, 1359, 1361, 1363	MAZDA	705, 707, 709, 713
		SMART	1405	SEAT	1325, 1327, 1331, 1335, 1337, 1339, 1341, 1343, 1345, 1347, 1349, 1353, 1355, 1357, 1359, 1361, 1363	VOLVO	1561, 1563, 1569
				SSANGYONG	1409, 1411	NA5164 CHEVROLET	209
				NA5132 BMW	183, 193, 195, 197, 199	DAEWOO	319
						NA5168 CHRYSLER	219
						MERCEDES-BENZ	735, 757, 767, 771, 789, 791, 795, 797, 799

							
NA5174 ALFA ROMEO	23	NA5191 CITROËN	269, 271, 273, 275, 277, 279, 281, 283, 285, 287, 289, 291, 293, 295, 297, 301, 303	NA5209 CHEVROLET	213	NA5257 NISSAN	863
CHEVROLET	207, 209, 211	FIAT	397, 399, 401, 405, 407	OPEL	933, 935, 937	OPEL	933
FIAT	383	FORD	503, 505, 509, 511, 521, 523	SAAB	1307	RENAULT	1187, 1189, 1219, 1221, 1223, 1225, 1227, 1229, 1231, 1233, 1243
OPEL	909, 913, 915, 919, 923, 925	HONDA	561	VAUXHALL	1531, 1533, 1535, 1537	VAUXHALL	1531
SAAB	1299	HYUNDAI	587	NA5215 DACIA	307, 309	NA5258 CITROËN	257, 259, 267, 269, 271
VAUXHALL	1511, 1515, 1517, 1521, 1523, 1525	LANCIA	661, 663	NISSAN	853, 855, 859	FIAT	373
NA5175 FORD	535, 537, 543	LAND ROVER	671	RENAULT	1131, 1133, 1135, 1137, 1139, 1141, 1143, 1145, 1147, 1149, 1151, 1153, 1155, 1157	FORD	451, 455, 459, 461, 469
NA5177 CHEVROLET	207, 209	PEUGEOT	1001, 1003, 1005, 1007, 1009, 1011, 1013, 1015, 1017, 1019, 1021, 1023, 1025, 1027, 1033	FIAT	357, 361, 363	MAZDA	695, 699
CITROËN	301	RENAULT	1275	FORD	441	MINI	807
DAEWOO	317, 319, 321	ROVER	1287	HONDA	565	PEUGEOT	993, 999, 1001
FIAT	351, 413	SUZUKI	1431, 1433	LANCIA	651	SUZUKI	1427, 1429
FORD	453, 525, 527	TALBOT	1437	NISSAN	857	VOLVO	1557
PEUGEOT	1033	TOYOTA	1463	OPEL	897, 899, 901	NA5259 CITROËN	259, 267, 269, 271
RENAULT	1271, 1273, 1275	VOLVO	1573	SUZUKI	1425	FORD	451, 455, 459, 461, 469
SEAT	1321	NA5192 CITROËN	269, 271, 273, 275, 277, 279, 281, 283, 285, 287, 289, 291, 293, 295	VAUXHALL	1499, 1501	MAZDA	695, 699
NA5178 FORD	535	FIAT	397, 399, 405, 407	NA5226 SUBARU	1415, 1417, 1419	MINI	807
VOLVO	1555, 1561, 1563, 1565, 1573, 1579, 1581, 1589, 1591	FORD	503, 505, 509, 511, 521, 523	NA5230 ALFA ROMEO	13	PEUGEOT	989, 1005, 1031, 1033
NA5179 VOLVO	1555, 1561, 1563, 1565, 1573, 1579, 1581, 1589, 1591	HONDA	561	CHEVROLET	207	RENAULT	1271, 1273, 1275
NA5180 AUDI	57, 61	LANCIA	651	CITROËN	257	SUBARU	1415
SEAT	1327, 1329, 1331, 1333, 1337, 1339	PEUGEOT	1001, 1003, 1005, 1007, 1009, 1011, 1013, 1015, 1017, 1019, 1021, 1023, 1025, 1027	FORD	441	TOYOTA	1453, 1455, 1461, 1463, 1469
SKODA	1379, 1381, 1383	ROVER	1287	LANCIA	651	NA5260 CITROËN	255, 271, 273, 301
VW	1633, 1635, 1637, 1639, 1641, 1643, 1649, 1651, 1653	SUZUKI	1431, 1433	OPEL	897, 899, 901	DAIHATSU	327
NA5185 AUDI	57, 61	VOLVO	1573	PEUGEOT	991	FIAT	413
SEAT	1321, 1323, 1327, 1329, 1331, 1333, 1335, 1337, 1339	NA5196 FORD	539	NA5242 HONDA	561, 565, 567, 569, 571	LOTUS	685
SKODA	1379, 1381, 1383	KIA	637	ROVER	1287, 1291	MINI	807
VW	1625, 1627, 1633, 1635, 1637, 1639, 1641, 1643, 1645, 1647, 1649, 1651, 1653, 1657	MAZDA	713	NA5243 MITSUBISHI	835, 837, 839	PEUGEOT	989, 1005, 1031, 1033
NA5187 ALFA ROMEO	27, 29	NA5197 FORD	539	NA5244 MITSUBISHI	835, 837	RENAULT	1271, 1273, 1275
FIAT	353, 355, 363, 365, 367, 371, 373, 375, 377, 379, 381, 383, 385, 387, 395, 399, 401, 403	KIA	637	NA5245 HONDA	569, 571	SUBARU	1415
LANCIA	655, 657, 659, 661	MAZDA	713	NA5246 MAZDA	695, 697, 699, 703, 707, 713	TOYOTA	1453, 1455, 1461, 1463, 1469
NA5190 FORD	449, 451, 453, 465, 467, 469, 479, 481, 513, 515, 517, 519, 539, 541, 543	NA5201 FIAT	409	NA5255 DACIA	307, 309	NA5261 NISSAN	851
		IVECO	611	NISSAN	853, 855	RENAULT	1105, 1107
		NA5202 FIAT	409	RENAULT	1135, 1137, 1139, 1141, 1143, 1145	NA5264 MERCEDES-BENZ	767
		NA5204 PEUGEOT	1017, 1021	SUZUKI	1429	NA5265 VOLVO	1557
		NA5205 PEUGEOT	1017, 1021	NA5256 CITROËN	273, 285, 293, 295	NA5266 MERCEDES-BENZ	731, 737, 741, 749, 751, 753, 757, 759, 761, 763, 765, 767, 769, 771, 775, 777, 779, 781, 787, 789, 791
				FIAT	405	SSANGYONG	1409, 1411
				LANCIA	661	NA5267 BMW	199
				PEUGEOT	1005, 1017, 1025	NA5271 OPEL	915
						VAUXHALL	1517
						NA5272 RENAULT	1269, 1271
						VOLVO	1591
						NA5282 TOYOTA	1465
						NA5299 BMW	163, 165, 167, 169, 191

NUMERICAL PARTS LIST









Numerische Teilenummernliste • Liste des références produits
Elenco numerico articoli • Lista de referencias









 NA5305 AUDI 131		 NB586 ROVER 1285		 NB716 AUDI 59, 67, 69, 71, 73, 75, 83, 85, 107, 109, 111, 113, 115, 117, 119, 121, 123, 125		 NB799 BMW 153, 155, 157, 171, 177	
FORD 539		NB619 AUDI 113, 115		FORD 539		TOYOTA 1463, 1465	
SEAT 1323, 1365		NB628 OPEL 897, 927, 939, 943, 945		MERCEDES-BENZ 769		NB806 ALFA ROMEO 33	
SKODA 1375		VAUXHALL 1499, 1537, 1539, 1541, 1543		SEAT 1335, 1337, 1343, 1345, 1347, 1351, 1353, 1355		BEDFORD 139	
VW 1627, 1721, 1735, 1737, 1739		NA5306 SEAT 1321		SKODA 1383, 1387, 1389, 1391, 1393, 1401		CHEVROLET 211, 213	
		SKODA 1375, 1377, 1379, 1381		VOLVO 1583, 1591		DAEWOO 319, 321	
		VW 1625		VW 1647, 1649, 1667, 1669, 1671, 1673, 1685, 1687, 1689, 1719, 1721, 1723, 1725, 1727, 1729, 1731, 1733, 1735, 1737		FIAT 409	
NA5310 FORD 461, 469		NB644 FIAT 381, 395		NB720 JAGUAR 623		LADA 643	
NA5317 VOLVO 1573, 1585, 1587, 1589		NB645 CITROËN 297		NB728 FIAT 351		LOTUS 685	
		FORD 449, 451, 453, 465, 467, 469, 479, 513, 515, 517		NB730 FIAT 355, 363		OPEL 907, 915, 917, 919, 921, 927, 929, 931, 933, 935, 937, 939, 941, 943, 945, 947	
		PEUGEOT 1029		NB732 ALFA ROMEO 27, 29, 31		SAAB 1305, 1309	
NA5318 CITROËN 299, 301		NB690 OPEL 939, 945		FIAT 379, 381, 383, 385, 387, 399, 401, 403		SEAT 1329	
JAGUAR 623		VAUXHALL 1537, 1539, 1543		LANCIA 657, 659, 661		VAUXHALL 1509, 1517, 1519, 1521, 1523, 1527, 1529, 1531, 1533, 1535, 1537, 1539, 1541, 1543	
LAND ROVER 673		NB691 OPEL 897, 899		NB734 OPEL 907, 915, 917		VW 1637	
PEUGEOT 1031, 1033		VAUXHALL 1499, 1501		VAUXHALL 1509, 1517, 1519		NB807 DAEWOO 319	
NA5319 LEXUS 681		NB697 CHEVROLET 207, 209		NB742 ALFA ROMEO 27, 29		OPEL 919, 921, 927, 929, 931	
TOYOTA 1463, 1469		DAEWOO 317, 319		FIAT 365, 379, 381, 383, 385, 387, 395, 399, 401, 403		VAUXHALL 1521, 1523, 1527, 1529, 1531	
NA5320 HONDA 561, 567, 571, 573		OPEL 897, 899, 901, 903, 907, 909, 911, 913, 915		LANCIA 657, 659, 661		NB808 FIAT 351, 353, 365, 367, 371, 379	
NA5321 ALFA ROMEO 13, 15		VAUXHALL 1499, 1501, 1503, 1505, 1509, 1511, 1513, 1515, 1517		NB772 AUSTIN 135		SEAT 1321	
FIAT 371		NB698 ACURA 3, 5		ROVER 1285, 1287, 1289, 1291		NB814 FIAT 351, 353, 355	
NA5322 ISUZU 601		BEDFORD 139		NB773 ROVER 1287, 1291		LANCIA 649	
RENAULT 1107, 1109		CHEVROLET 207, 209, 211		NB774 HONDA 563		NB815 FIAT 351, 353, 355, 357, 359, 363	
		DAEWOO 317, 319, 321		ROVER 1287, 1289, 1291		LANCIA 649, 651	
NA5323 CITROËN 299, 301		HONDA 551, 561, 567, 573, 575		NB775 HONDA 563		NB818 FIAT 353, 355, 363, 365, 367, 371, 373, 375, 377, 379	
FORD 463, 473, 475, 505, 507, 511, 523		OPEL 897, 899, 901, 903, 905, 907, 909, 911, 913, 915, 923, 925		LAND ROVER 671		LANCIA 655	
LAND ROVER 673		SAAB 1299		ROVER 1285, 1287, 1289, 1291		NB825 ALFA ROMEO 31	
PEUGEOT 1031, 1033		SUZUKI 1425		NB785 FORD 467, 469, 471, 475, 477, 479, 481, 483, 485, 487, 489, 491, 493, 495, 497, 499		FIAT 381, 385, 401	
NA5324 AUSTIN 135		VAUXHALL 1499, 1501, 1503, 1505, 1507, 1509, 1511, 1513, 1515, 1517, 1523, 1525		MAZDA 705		ROVER 1281, 1283, 1285, 1287	
CITROËN 255		NB700 CHEVROLET 211		NB786 FORD 467		NB829 MG 803	
DAIHATSU 327, 331		DAEWOO 319, 321		NB788 FORD 439, 443, 445, 447, 449, 465, 467, 481, 483, 485, 487, 489, 491, 493, 495, 497, 499, 513, 515, 517, 519, 529		ROVER 1281, 1283, 1285, 1287	
PEUGEOT 989		LOTUS 685		MAZDA 695, 705		NB843 HONDA 563	
TOYOTA 1453, 1455		OPEL 907, 919, 921, 927, 929, 931, 933, 935, 937, 939		NB792 BMW 177, 193		ROVER 1289, 1291	
		VAUXHALL 1509, 1521, 1523, 1527, 1529, 1531, 1533, 1535, 1537				NB847 FORD 449, 451, 453, 461, 463, 465, 467, 469, 471, 473, 475, 479, 481, 487, 489, 501, 505, 507, 509, 513, 515, 517, 519	
NA5327 OPEL 913, 915, 923		NB701 OPEL 907, 919				SAAB 1301, 1303, 1305, 1307, 1309	
SAAB 1299		VAUXHALL 1509, 1521					
VAUXHALL 1515, 1517, 1523		NB714 SAAB 1301, 1303, 1305, 1307, 1309					
NA5328 RENAULT 1137, 1139, 1141, 1143, 1147, 1153, 1155, 1157, 1159, 1161							
NA5330 KIA 637							
NB291 AUSTIN 135							
NB384 FORD 455							
MAZDA 693, 695							
NB431 BMW 153, 155, 157, 159, 161, 169, 171, 173, 177, 193							
OPEL 939, 943							
VAUXHALL 1539, 1541							
NB432 BMW 153							
NB469 CHEVROLET 213							
MERCEDES-BENZ 759							
OPEL 927, 933, 935, 939, 943, 945							
VAUXHALL 1531, 1533, 1539, 1541, 1543							
NB564 FORD 439, 539, 541, 543							

							
NB848	CARBODIES 201 FORD 453, 513, 525, 527 LAND ROVER 671 SAAB 1301, 1303, 1305, 1307, 1309	NB973	DAEWOO 321 MERCEDES-BENZ 733, 737, 739, 741, 747, 749, 751, 753, 755, 757, 759, 761, 763, 765, 773, 777, 779, 781, 783, 787, 791, 795	NC006	ALFA ROMEO 23 BEDFORD 139 CHEVROLET 207, 209, 211, 213 CHRYSLER 217 DAEWOO 317, 319, 321 FIAT 383 HYUNDAI 581, 583, 585 KIA 633 LADA 643 LOTUS 685 OPEL 897, 899, 901, 903, 907, 909, 911, 913, 915, 917, 919, 921, 923, 925, 927, 929, 931, 933, 935, 937, 939, 941, 943, 945, 947 SAAB 1299, 1309 VAUXHALL 1499, 1501, 1503, 1505, 1509, 1511, 1513, 1515, 1517, 1519, 1521, 1523, 1525, 1527, 1529, 1531, 1533, 1535, 1537, 1539, 1541, 1543	NF634	CITROËN 301, 303 DACIA 307 PEUGEOT 1031, 1033 RENAULT 1115, 1119, 1121, 1269, 1271 SKODA 1375, 1377 VOLVO 1555, 1591
NB849	CARBODIES 201 LAND ROVER 671	NB974	DAEWOO 321 MERCEDES-BENZ 731, 733, 737, 739, 741, 747, 749, 751, 753, 755, 757, 759, 761, 763, 765, 767, 769, 771, 773, 775, 777, 779, 781, 783, 787, 789, 791	NC015	BMW 153, 155, 157, 169	NF637	BMW 155, 157, 159, 161, 171, 173, 177, 183, 193, 195, 197 OPEL 939, 943 VAUXHALL 1539, 1541
NB854	FORD 529, 531, 533 LDV 677	NB975	MERCEDES-BENZ 731, 737, 741, 749, 751, 753, 755, 757, 759, 761, 763, 765, 767, 769, 771, 775, 777, 779, 781, 783, 787, 789, 791	NC044	FORD 481, 483, 485, 487, 489, 491, 493, 495, 497, 499	NF640	PEUGEOT 991, 997
NB855	FORD 529, 531, 533 LDV 677	NB978	MERCEDES-BENZ 755, 757, 759	NC048	DAIHATSU 327, 329 FORD 439, 441, 443, 449, 451, 453, 455, 457, 461, 465, 469 HYUNDAI 591 KIA 637 MAZDA 693, 695, 699 TOYOTA 1453 VOLVO 1555	NF641	CITROËN 255, 259 PEUGEOT 989, 993
NB856	FORD 529, 531, 533 LDV 677	NB979	MERCEDES-BENZ 731, 737, 741, 749, 751, 753, 755, 757, 759, 761, 763, 765, 767, 769, 771, 775, 777, 779, 781, 783, 787, 789, 791	NC052	BMW 159, 161	NF648	CITROËN 285, 297 JEEP 627 PEUGEOT 1017, 1027, 1029 RENAULT 1145, 1147, 1165, 1167, 1169, 1171, 1173, 1175, 1177, 1179, 1191, 1193, 1195, 1197, 1199, 1213, 1233, 1235, 1237, 1239, 1241, 1243, 1245, 1247, 1249, 1251, 1257, 1259, 1261
NB866	RENAULT 1239, 1241, 1243, 1259 SEAT 1323, 1333, 1341	NB980	BMW 153, 155	NC065	KIA 637 LAND ROVER 673 MERCEDES-BENZ 765, 767, 775, 777, 781, 783, 787, 789, 791 MG 803 ROVER 1281, 1283, 1285, 1287, 1289, 1291, 1293	NF677	CITROËN 255
NB884	CHEVROLET 209 DAIHATSU 329, 331, 333 HONDA 555, 559, 561 LADA 643 OPEL 917, 929, 931, 933, 941, 943, 945, 947 SAAB 1309 VAUXHALL 1519, 1529, 1531, 1539, 1541, 1543	NB984	FORD 481, 483, 485, 487, 489, 491, 493, 495, 497, 499	NC086	FORD 469, 471, 475, 477, 479, 481, 483, 485, 487, 489, 491, 493, 495, 497, 499	NF678	ACURA 3 CITROËN 255, 259 HYUNDAI 581, 583, 585, 587, 589, 591, 593 KIA 633, 635, 637 MITSUBISHI 819, 821, 823, 825, 827, 829, 831, 833, 835, 837 PEUGEOT 989, 993 PROTON 1037, 1039 VOLVO 1563
NB928	AUDI 119 SKODA 1401 VW 1733	NB988	MAZDA 705	NF036	CITROËN 255	NF692	CITROËN 257 PEUGEOT 989, 991, 997
NB953	VW 1697, 1719	NB998	KIA 637	NF387	PEUGEOT 1015, 1025, 1029	NF694	CITROËN 257 PEUGEOT 989, 991, 997
NB958	FORD 461, 463, 471, 473, 475, 481, 487, 489, 501, 505, 507, 509, 511, 517, 519, 523	NB999	LAND ROVER 673 MG 803 ROVER 1281, 1283, 1285, 1287, 1289, 1291, 1293	NF505	CITROËN 255	NF719	CITROËN 297
NB959	CITROËN 279, 281, 283, 297 FORD 461, 463, 471, 473, 475, 481, 487, 489, 501, 505, 507, 509, 517, 519, 523 PEUGEOT 1009, 1011, 1013, 1015, 1029 SUZUKI 1431			NF535	RENAULT 1101, 1103, 1105, 1115	NF722	ALFA ROMEO 23 DACIA 307 RENAULT 1101, 1103, 1105, 1111, 1113, 1115, 1117, 1119, 1121, 1123 VOLVO 1555
NB971	MERCEDES-BENZ 731, 737, 741, 751, 753, 761, 763, 765, 767, 769, 771, 775, 777, 779, 781, 787, 789 SSANGYONG 1409, 1411			NF577	CITROËN 255	NF741	CITROËN 297, 299 PEUGEOT 1031
NB972	MERCEDES-BENZ 731, 737, 751, 753, 765, 767, 769, 771, 775, 777, 787, 789 SSANGYONG 1409, 1411						

NUMERICAL PARTS LIST









Numerische Teilenummernliste • Liste des références produits
Elenco numerico articoli • Lista de referencias









													
NF746	ROVER	1287	NF841	CITROËN	275, 277, 279, 281, 283, 293, 295	NF846	DACIA	311	NF850	CITROËN	255, 257, 259, 261, 263, 265, 271, 273		
NF752	CITROËN	297, 299		FIAT	397, 399, 407		DAACIA	311		DAACIA	311		
	PEUGEOT	1029, 1031		HONDA	561		MITSUBISHI	827		MITSUBISHI	827		
	TALBOT	1437		LADA	643		NISSAN	861		NISSAN	855		
NF761	PEUGEOT	1031		LANCIA	663, 665		OPEL	925, 927		OPEL	925		
	RENAULT	1269		LDV	677		RENAULT	1145, 1147, 1165, 1167, 1169, 1171, 1173, 1175, 1177, 1179, 1181, 1183, 1185, 1187, 1191, 1193, 1195, 1197, 1199, 1201, 1203, 1205, 1207, 1209, 1211, 1213, 1215, 1217, 1219, 1233		PEUGEOT	989, 991, 993, 995, 997, 1003, 1005		
NF763	CITROËN	255		PEUGEOT	1005, 1007, 1009, 1011, 1013, 1015, 1025		SUZUKI	1429		RENAULT	1145, 1147, 1165, 1167, 1169, 1171, 1173, 1175, 1177, 1179, 1181, 1183, 1185, 1187, 1189, 1191, 1193, 1195, 1197, 1199, 1201, 1203, 1205, 1207, 1209, 1211, 1213, 1215, 1217, 1219, 1233		
NF775	RENAULT	1101		ROVER	1287		VAUXHALL	1525		ROVER	1285		
NF776	CITROËN	297, 299		SUZUKI	1431	NF847	RENAULT	1165, 1167, 1169, 1171, 1173, 1175, 1177, 1179, 1181, 1183, 1185, 1187, 1213, 1215, 1217, 1219		VAUXHALL	1525		
	PEUGEOT	1029, 1031		TALBOT	1437		VOLVO	1555, 1557, 1559, 1561, 1565, 1567, 1575		VOLVO	1555, 1557, 1559, 1561, 1565, 1567		
	TALBOT	1437		TOYOTA	1463								
NF780	LDV	677	NF843	CITROËN	285, 297					NF851	RENAULT	1191	
	PEUGEOT	1029, 1031		ISUZU	601, 603, 605					NF853	FIAT	411	
NF781	RENAULT	1237, 1239, 1241, 1247, 1251, 1261		JEEP	627						IVECO	611, 613, 615	
NF791	RENAULT	1101, 1109, 1111, 1113, 1115, 1123, 1163, 1179, 1181, 1183, 1185, 1187, 1191, 1195, 1197		MITSUBISHI	827						LANCIA	665	
				OPEL	947						NISSAN	851	
NF809	CITROËN	255		PEUGEOT	1017, 1027, 1029						RENAULT	1107, 1109, 1111	
NF810	CITROËN	255		RENAULT	1145, 1147, 1165, 1167, 1169, 1171, 1173, 1175, 1177, 1179, 1181, 1183, 1185, 1187, 1191, 1193, 1195, 1197, 1199, 1205, 1207, 1213, 1215, 1217, 1219, 1233, 1235, 1237, 1239, 1241, 1243, 1245, 1247, 1249, 1251, 1257, 1259, 1261					NF856	NISSAN	851	
NF812	CHEVROLET	209		TOYOTA	1477						RENAULT	1107, 1109, 1111	
	CITROËN	255		VAUXHALL	1543						NF857	CITROËN	255, 257, 259, 261, 263, 265, 271, 273
	DAEWOO	317, 319, 321		VOLVO	1555, 1557, 1559, 1561, 1565, 1567						PEUGEOT	989, 991, 993, 995, 997, 1003, 1005	
NF826	CITROËN	255, 261, 263, 265									ROVER	1283, 1285	
	PEUGEOT	993, 995, 997									RENAULT	1253	
NF833	ALFA ROMEO	35		NF844	CITROËN	285, 297					NF858	RENAULT	1253
	FIAT	411		JEEP	627						NF860	NISSAN	865, 869
	IVECO	611, 613		PEUGEOT	1017, 1027, 1029						OPEL	937, 941	
	RENAULT	1263, 1265, 1267, 1269		RENAULT	1213, 1233, 1235, 1237, 1239, 1241, 1243, 1245, 1247, 1249, 1251, 1257, 1259, 1261						RENAULT	1253, 1255, 1257, 1265, 1267, 1535, 1539	
NF834	RENAULT	1101, 1103, 1105, 1113, 1115, 1119, 1121									VAUXHALL	1535, 1539	
NF835	CITROËN	301, 303									NF861	RENAULT	1253
	DACIA	307, 309, 311									NF866	CITROËN	297
	NISSAN	859									PEUGEOT	1029	
	PEUGEOT	1033									NF867	CITROËN	297, 301
	RENAULT	1101, 1103, 1105, 1111, 1113, 1115, 1117, 1119, 1121, 1123, 1125, 1127, 1129, 1131, 1133, 1147, 1149, 1151, 1153, 1155, 1157, 1159, 1161, 1163, 1165, 1269, 1275									FIAT	413	
	VOLVO	1555									PEUGEOT	1029, 1031, 1033	
NF836	CITROËN	255, 261, 263, 265									RENAULT	1271, 1273, 1275	
	PEUGEOT	993, 995, 997									NF869	CITROËN	279, 281, 301, 303
											PEUGEOT	1009, 1011, 1033	
											NF870	CITROËN	255, 257, 259, 261, 263, 265, 271, 273
											NISSAN	855	
											PEUGEOT	989, 991, 993, 995, 997, 1003, 1005, 1015	
											ROVER	1283, 1285	

											
NF883	CITROËN	299, 301	NJ200	TOYOTA	1475, 1477	NJ312	ACURA	3	NJ376	SUBARU	1415
	FIAT	413	NJ207	NISSAN	857		HONDA	551, 553, 555, 557, 559, 561, 563, 565, 567, 569, 571	NJ377	CHEVROLET	207
	IVECO	611, 613, 615, 617	NJ215	DAIHATSU	333		ROVER	1281, 1285		DAEWOO	317, 319
	OPEL	941, 943, 945		LOTUS	685	NJ313	ACURA	3		SUZUKI	1425, 1427, 1429, 1431
	PEUGEOT	1031		TOYOTA	1461, 1463, 1467, 1469, 1471, 1473, 1475, 1479		HONDA	551, 553, 555, 557, 559, 561, 563	NJ378	SUZUKI	1425, 1429
	RENAULT	1265, 1267, 1269	NJ239	TOYOTA	1481		ROVER	1281, 1285	NJ381	HONDA	551, 553, 555, 557, 559
	VAUXHALL	1541, 1543	NJ240	TOYOTA	1481	NJ321	ISUZU	603, 605		ROVER	1281, 1285
NF885	CITROËN	299, 301	NJ242	ACURA	3		OPEL	945	NJ407	TOYOTA	1453
	FIAT	413		HYUNDAI	585, 587		VAUXHALL	1543	NJ446	ISUZU	601
	IVECO	611, 613, 615, 617		KIA	635	NJ322	BEDFORD	139	NJ448	KIA	633, 637
	OPEL	941, 943, 945		MAZDA	819, 821, 823, 825, 829, 833, 835, 839		ISUZU	601, 603, 605		MAZDA	693, 695, 697, 699, 701, 703, 707, 709, 711, 713
	PEUGEOT	1031		PROTON	1037		OPEL	939, 943	NJ449	CHEVROLET	209
	RENAULT	1263, 1265, 1267, 1269	NJ243	TOYOTA	1475	NJ323	VAUXHALL	1539, 1541		ISUZU	601
	VAUXHALL	1541, 1543	NJ251	HYUNDAI	585		BEDFORD	139		MAZDA	699
NF886	IVECO	611, 613, 615	NJ252	PROTON	1037	NJ324	DAIHATSU	327, 329, 331		OPEL	905, 907, 915, 917
NF887	FIAT	367, 375, 377, 379	NJ254	ACURA	3		KIA	633, 635, 637		VAUXHALL	1507, 1509, 1517, 1519
	LANCIA	653, 655		HONDA	551, 555, 557, 559, 563		MAZDA	697, 699, 701, 703, 705, 707, 709, 711	NJ450	ISUZU	601
NF888	ALFA ROMEO	17, 19, 21, 23, 25, 27, 29, 31, 33	NJ255	MAZDA	699		SUZUKI	1431		OPEL	915, 917
	FIAT	367, 377, 379, 383, 387, 389, 391, 393, 395, 397, 401, 403, 409	NJ258	ISUZU	603	NJ325	KIA	635, 637	NJ454	BEDFORD	139
	LANCIA	653, 655, 657, 659, 661, 663, 665	NJ265	OPEL	935		MAZDA	703, 705, 707, 711		ISUZU	601, 603
	OPEL	927, 929, 931	NJ266	SSANGYONG	1409	NJ336	BEDFORD	139		OPEL	939
	SAAB	1299	NJ267	VAUXHALL	1535		CHEVROLET	207	NJ610	MAZDA	823, 829, 833, 835
	VAUXHALL	1527, 1529	NJ268	ISUZU	603, 605		DAEWOO	317	NJ645	TOYOTA	1479
NJ001	HONDA	569	NJ269	SSANGYONG	1409		SUZUKI	1425	NJ650	KIA	633
	TOYOTA	1457, 1459, 1463	NJ270	VAUXHALL	1535		SUBARU	1415		MAZDA	693, 695, 697, 701, 703
NJ005	HYUNDAI	585	NJ276	ISUZU	603	NJ337	SUZUKI	1425, 1429, 1431, 1433	NJ654	TOYOTA	1453
	MAZDA	819, 821, 823, 829, 833, 835	NJ277	OPEL	935		BEDFORD	139	NJ655	MITSUBISHI	823, 829, 833
	PROTON	1037	NJ278	VAUXHALL	1535, 1541		CHEVROLET	207	NJ675	HONDA	573, 575
NJ006	HYUNDAI	581, 583, 585	NJ284	NISSAN	853, 855, 857, 859, 861, 865, 873		DAEWOO	317, 319		ROVER	1293
	KIA	633	NJ285	INFINITI	597	NJ341	SUZUKI	1425	NJ706	TOYOTA	1465
	MAZDA	819, 821, 823, 825	NJ286	MAZDA	697	NJ343	SUBARU	1415	NJ719	TOYOTA	1457
	PROTON	1037	NJ287	NISSAN	855, 859, 861, 873, 875	NJ344	TOYOTA	1461, 1467, 1471, 1477, 1479	NJ765	INFINITI	597
NJ007	MITSUBISHI	819	NJ288	NISSAN	851, 853, 855, 863, 867, 869, 873	NJ347	DAIHATSU	331, 333		NISSAN	851, 853, 855, 857, 859, 861, 863, 869, 871, 873, 875
NJ008	MITSUBISHI	819	NJ289	INFINITI	597		LEXUS	681		RENAULT	1101
NJ014	ISUZU	603, 605	NJ290	MAZDA	697		LOTUS	685	NJ829	FORD	539
	OPEL	943	NJ291	NISSAN	855, 859, 861, 873, 875	NJ349	TOYOTA	1455, 1459, 1461, 1465, 1467, 1471, 1473, 1475, 1479, 1481		NISSAN	871
	SSANGYONG	1409	NJ292	MAZDA	697	NJ353	DAIHATSU	331	NJ831	FORD	539
	VAUXHALL	1541	NJ293	NISSAN	855, 859, 861, 873, 875		HONDA	569		NISSAN	871
NJ021	NISSAN	853	NJ294	NISSAN	855, 859, 861, 873, 875	NJ349	TOYOTA	1459, 1463, 1479	NJ873	MITSUBISHI	839
NJ022	NISSAN	853	NJ295	INFINITI	597	NJ354	TOYOTA	1461	NJ874	CHRYSLER	219
NJ030	TOYOTA	1477, 1479	NJ296	MAZDA	697	NJ360	DAIHATSU	329, 331, 333		MITSUBISHI	825, 829, 837, 839
NJ042	TOYOTA	1477	NJ297	NISSAN	855, 859, 861, 873, 875		TOYOTA	1453, 1455, 1457, 1459, 1463, 1465, 1467, 1469, 1475, 1479			
NJ045	NISSAN	863, 867, 869, 873	NJ298	NISSAN	851, 853, 855, 863, 867, 869, 873		TOYOTA	1461			
NJ056	NISSAN	867, 869	NJ299	NISSAN	851, 853, 855						
NJ099	MAZDA	693, 695	NJ300	NISSAN	851, 853, 855, 863, 867, 869, 873						
NJ102	TOYOTA	1477	NJ301	NISSAN	851, 853, 855						
NJ106	NISSAN	865	NJ302	NISSAN	851, 853, 855						
NJ134	HONDA	561, 565, 567, 569, 571	NJ303	NISSAN	851, 853, 855						
	ISUZU	603	NJ304	NISSAN	851, 853, 855						
	ROVER	1287, 1291	NJ305	NISSAN	851, 853, 855						

NUMERICAL PARTS LIST

Numerische Teilenummernliste • Liste des références produits
Elenco numerico articoli • Lista de referencias

							
NJ933	ACURA 3, 5 CHRYSLER 219 HONDA 573, 575 HYUNDAI 581, 583, 585, 587, 589, 591, 593 INFINITI 597 KIA 633, 635, 637 MITSUBISHI 819, 821, 823, 825, 827, 829, 831, 833, 835, 837 NISSAN 851, 863, 871, 875 PROTON 1037, 1039 ROVER 1293 TOYOTA 1465 VOLVO 1563	NP067	CITROËN 299, 301 IVECO 611, 613, 615, 617 LANCIA 659 OPEL 941 PEUGEOT 1031 RENAULT 1265, 1267, 1269 VAUXHALL 1541	PA349	CITROËN 255, 257, 259, 261, 263, 269, 271, 273, 275, 277, 279, 281, 283, 285, 287, 293, 297, 301 DACIA 309 FIAT 405, 407 LADA 643 MINI 809 PEUGEOT 989, 991, 993, 995, 997, 1001, 1003, 1005, 1007, 1009, 1011, 1013, 1015, 1017, 1019, 1025, 1027, 1029, 1031, 1033 RENAULT 1101, 1105, 1109, 1111, 1113, 1115, 1119, 1121, 1123, 1125, 1127, 1129, 1133, 1149, 1151, 1153, 1155, 1157, 1163, 1165, 1167, 1169, 1171, 1173, 1175, 1177, 1179, 1181, 1183, 1185, 1187, 1191, 1195, 1197, 1199, 1213, 1215, 1217, 1219, 1233, 1235, 1237, ROVER 1287 SUZUKI 1431 VOLVO 1557, 1559	PA565	CHEVROLET 207, 209 DAEWOO 317, 319, 321 LADA 643 OPEL 897, 899, 901, 903, 907, 909, 911, 919, 921, 927, 929, 931, 933, 945 VAUXHALL 1499, 1501, 1503, 1505, 1509, 1511, 1513, 1521, 1523, 1527, 1529, 1531, 1533, 1543
NJ951	ALFA ROMEO 31	OK627	FIAT 383, 401 LANCIA 659	PA378	FORD 539 NISSAN 867, 871, 875, 877	PA567	TOYOTA 1453
NJ963	TOYOTA 1461	PA079	FORD 529 INFINITI 597 NISSAN 851, 855, 859, 861, 865, 867, 873, 875	PA378	NISSAN 867, 871, 875, 877	PA569	OPEL 897, 907, 927, 939, 943, 945 VAUXHALL 1499, 1509, 1539, 1541, 1543
NJ978	MAZDA 713	PA096	HONDA 571	PA387	DAIHATSU 327, 329	PA565	SUBARU 1415
NJ982	HONDA 563	PA136	TOYOTA 1465, 1475, 1477, 1481	PA387	DAIHATSU 327, 329	PA566	SUBARU 1415
NJ985	MAZDA 713	PA217	CITROËN 255, 285, 297, 299 PEUGEOT 1031	PA418	ISUZU 603, 605 OPEL 939, 943 VAUXHALL 1539, 1541	PA568	ISUZU 601 MAZDA 699 OPEL 905, 907, 915, 917 VAUXHALL 1507, 1509, 1517, 1519
NK023	ACURA 3 HONDA 573, 575 ROVER 1293	PA229	PEUGEOT 1029	PA425	HONDA 569 MITSUBISHI 821 TOYOTA 1453, 1463, 1469, 1477, 1479	PA568	ISUZU 601 MAZDA 699 OPEL 905, 907, 915, 917 VAUXHALL 1507, 1509, 1517, 1519
NK035	MAZDA 713	PA305	ACURA 3 BEDFORD 139 DAIHATSU 331, 333 SUZUKI 1425, 1429	PA459	AUDI 59, 63, 65, 79, 81, 89 SEAT 1335, 1341, 1343, 1349 VW 1645, 1659, 1661, 1663, 1665, 1675, 1677, 1679, 1681	PA569	KIA 637 MAZDA 711
NK055	TOYOTA 1475, 1477	PA310	TOYOTA 1481	PA528	HONDA 563, 573 ROVER 1281, 1293	PA815	MERCEDES-BENZ 743, 755, 757, 759, 767, 783
NK092	MAZDA 699	PA313	HONDA 563	PA529	HONDA 563	PA850	CITROËN 263 PEUGEOT 995
NK102	HONDA 551			PA531	HONDA 563 ROVER 1281	PA858	CITROËN 255, 257, 261 PEUGEOT 989, 991, 995
NK103	CHEVROLET 209 ISUZU 601 OPEL 905, 907, 917 VAUXHALL 1507, 1509, 1519			PA543	OPEL 939 VAUXHALL 1537, 1539	PA874	NISSAN 853, 855, 857, 859, 861, 871, 873, 877
NK106	NISSAN 865, 867					PA883	KIA 633, 635 MAZDA 693, 695, 697, 699, 701, 703, 705, 707, 711, 713
NK125	HONDA 551					PA889	DAIHATSU 327
NK143	HYUNDAI 587, 589, 591 KIA 635, 637 MITSUBISHI 823, 825, 827, 829, 831, 833, 835 PROTON 1037, 1039 VOLVO 1563					PA928	DAEWOO 317 SUZUKI 1425, 1427
NK157	MAZDA 693, 695, 697, 699					PA933	BEDFORD 139 FORD 529 ISUZU 601, 603 NISSAN 867, 869 OPEL 939
NK158	KIA 633, 635 MAZDA 693, 695, 697, 699, 703					PA952	DAIHATSU 329, 331, 333
NK159	ROVER 1285					PA956	KIA 633, 635 MAZDA 693, 701, 703, 705, 707, 711, 713
NK205	MAZDA 703, 707						SUZUKI 1431, 1433 TOYOTA 1459
NK209	DAIHATSU 329, 331, 333					PA969	HONDA 551, 553, 555, 557, 559, 569, 573
NK214	TOYOTA 1467, 1471, 1475						
NK216	TOYOTA 1481						
NK243	SUBARU 1415						
NK251	ISUZU 601 TOYOTA 1475, 1477, 1481						

															
PA5013	DACIA		309	PA5041	AUDI	57, 61, 63, 65, 67, 69, 71, 73, 75, 77, 91, 93, 95, 97, 99, 101, 103, 105, 107, 113, 115, 117, 119, 121, 123, 125, 127, 129, 131		PB180	FORD	439, 447, 449, 465, 467, 469, 471, 475, 477, 479, 481, 483, 485, 487, 491, 493, 495, 497, 499, 513, 515, 517, 519, 539, 541, 543					
	NISSAN		859, 863		BMW	155, 157, 159, 161, 169, 171, 173, 175, 177, 179, 183, 193, 195, 197			MAZDA	705					
	OPEL		933		CHEVROLET	209, 211, 213		PB256	MERCEDES-BENZ	767					
	RENAULT	1131, 1133, 1147, 1149, 1151, 1153, 1155, 1157, 1159, 1161, 1187, 1189, 1219, 1221, 1223, 1225, 1227, 1229, 1231, 1233			DAEWOO	321		PB259	CITROËN	261, 265					
	VAUXHALL		1531		FORD	441, 539			PEUGEOT	995, 997					
PA5016	BMW	157, 175, 177, 179, 181, 189, 191, 195			HONDA	559		PB281	LEXUS	681					
	OPEL		943		MERCEDES-BENZ	731, 735, 741, 743, 749, 763, 765, 781, 783			TOYOTA	1475, 1479					
	ROVER		1291		MITSUBISHI	831		PB313	TOYOTA	1459					
	VAUXHALL		1541		OPEL	903, 911, 913, 921, 931, 933, 935, 937, 939, 941, 943, 945		PB340	TOYOTA	1453					
PA5019	TOYOTA		1455, 1461		SEAT	1321, 1323, 1325, 1327, 1329, 1331, 1333, 1337, 1339, 1341, 1343, 1345, 1347, 1349, 1361, 1363, 1365		PB341	TOYOTA	1457					
PA5020	DAIHATSU		333		SKODA	1375, 1377, 1379, 1381, 1383, 1385, 1387, 1389, 1399, 1401		PB353	HONDA	571					
	NISSAN		867		VAUXHALL	1505, 1513, 1515, 1521, 1523, 1531, 1533, 1535, 1537, 1539, 1541, 1543			MAZDA	697					
	TOYOTA		1455, 1461, 1473		VOLVO	1587		PB354	ROVER	1291					
PA5025	ALFA ROMEO		13		VW	1625, 1627, 1629, 1633, 1635, 1637, 1639, 1641, 1643, 1645, 1649, 1651, 1653, 1655, 1657, 1659, 1665, 1667, 1669, 1671, 1673, 1675, 1699, 1701, 1703, 1705, 1707, 1709, 1711, 1713, 1715, 1717, 1719, 1721, 1727, 1731, 1733, 1735, 1737, 1739, 1741		PB355	HONDA	3, 5 551, 555, 557, 561, 565, 567, 569, 571, 573, 575 1285					
	CHEVROLET		211					PB356	ACURA	3, 5					
	FIAT		369, 371						HONDA	551, 553, 555, 557, 561, 565, 567, 569, 571, 573, 575 1285					
	FORD		441					PB681	NISSAN	851, 853, 855, 857, 859, 861, 863 1101					
	OPEL		897, 899, 923, 925						RENAULT	1101					
	SAAB		1299					PB852	CITROËN	255, 257, 259, 261, 263, 271, 273, 301					
	SUZUKI		1425						PEUGEOT	989, 991, 993, 995, 997, 1003, 1005, 1031, 1033					
	VAUXHALL	1499, 1501, 1505, 1523, 1525							RENAULT	1191, 1213, 1233, 1235, 1237, 1239, 1241, 1243, 1245, 1247, 1249, 1251, 1257, 1259, 1261					
PA5033	FORD		443, 445, 457					PB907	CITROËN	269, 271, 273, 277, 279, 281, 283, 285, 287, 291, 293, 295					
									FIAT	399, 405, 407					
									PEUGEOT	997, 1001, 1003, 1005, 1007, 1009, 1011, 1013, 1015, 1017, 1019, 1021, 1023, 1025, 1027 1285					
									ROVER	1285					
					PA6055	LEXUS	681								
						TOYOTA	1463, 1469								
					PB071	NISSAN	853, 857								
					PB156	HONDA	557								
						ROVER	1285								

INTERCHANGE OE → PAYEN

Vergleichsliste OE → Payen • Références croisées 1ère Monte → Payen
Intercambio OE → Payen • Intercambio entre equipo original y Payen

OE reference	▲ Payen	OE reference	▲ Payen	OE reference	▲ Payen	OE reference	▲ Payen	OE reference	▲ Payen
000 053 45 58	PA5041	0059973846	NB975	0139259	JH5070	0197G4	CY131	019853	G6050
000 053 46 58	PA5041	0059979047	NB975	0139976847	NB971	0197G6	CY080	019854	DG050
000 053 47 58	PA5041	0060507576	JD015	0149971647	NB978	0197G7	CY090	019864	GM533
0000023614	NF841	006504017100	NJ255	0149974647	NB928	0197H0	DV150	019865	GF570
0000530022	HR599	0069971247	NB971	016402	PA349	0197H1	DV150	019872	DM530
0000534558	PA5041	0069975347	NC065	016430	PA349	0197H3	DS820	019883	DF572
0000534658	PA5041	0069978046	NB975	0165T0	GF492	0197H3	DY310	019884	GF570
0000534758	PA5041	007603014106	KG664	0179977447	NB974	0197H4	DJ720	019888	GM533
0000689	JH5032	007603016303	PA349	018710507	NB384	0197H5	GJ720	019894	G6050
0001421V003	JM5162	0089971547	NB975	018710507A	NB384	0197H6	DN590	019896	DG050
000160320	AA5430	0089971647	NB975	018710507B	NB384	0197H8	DS810	019897	CG9710
0002998600	JB837	0089972346	NB975	0189975247	NB973	0197H8	DT010	0198C3	GM533
0003019700000032449	HC341	0089972547	NB972	0189977947	NC065	0197H8	DT012	019901	DG171
0003086V003	AC5660	0089972647	NB972	019713	GM533	0197H8	DT013	019905	DG052
0003093V001000000	HA5034	0089974047	NA5264	019722	DG171	0197H9	EH951	019906	G6052
0003831400	BF100	0089975247	NB971	019725	G6050	0197J0	DY130	019910	GF570
0003833300	BF170	0099973547	NB971	019726	G6050	0197J1	EY130	0199971947	NB973
0003900453+E6525	CA3140	0099973647	NB972	019728	G6052	0197J2	DR510	0199976647	NB928
00039621840	HR805	0099974547	NB975	019731	DH890	0197J4	DM533	020012306A	HR599
0004489200	JB836	0099978547	NB975	019736	GJ720	0197J6	DF106	020012326A	HR800
0004551V000	HBS460	0099978947	NB973	019737	DJ720	0197J9	DM533	02029X0	AA5430
0004553	CC5350	00A103085A	NB973	019742	EL650	0197K1	DG452	020301	B6450
0004886400	BF170	00A198012	DZ160	019750	DG052	0197K3	DS731	020302	BG170
0007189V001000000	JD5823	010 997 34 47	NB972	019751	NB972	0197K4	EH950	020304	BP890
0009660V001000000	NA5118	0109970947	NB973	019752	GM533	0197K7	DN571	020308	BH950
001 997 74 47	PA815	0109973347	NB973	019755	GL650	0197K7	DN582	02030800	BH950
00128534 00	HC341	0109973447	NB971	019756	GG452	0197N5	DG052	020323	BL620
0012853400	HC341	0109976147	NC065	019772	DF106	0197N7	DG050	020349	BX900
0012857000	NF694	0109978247	NB972	019773	DF106	0197N8	G6050	020366	BG120
0013166700	BF100	0109978947	NB971	019774	DN571	0197N9	DH890	020367	BG130
0013195100	NF692	0109979047	NA5266	019775	DN571	0197P2	GM310	020383	BF570
0013236800	JB836	0109979047	NB975	019775	DN582	0197R9	DL831	0204.A3	HBS535
0013627500	BL610	01117811	NB775	019776	EH950	0197S1	DG542	0204.A4	HBS359
0014875400	BF170	01118693	KG664	019784	DM533	0197S2	G6541	0204.C1 (x10)	HBS522
0016877200	BF170	011257	HR574	019791	GF570	0197T3	CY082	0204.C5 (x10)	HBS359
0017507000	BG490	011258	HR574	019792	DF572	0197T4	CY081	020457	HBS038
0017596900	BG480	011259	HR574	019798	GM533	0197T6	DY140	020467	HBS115
0017751800	BF100	011276	HR564	019799	DM530	0197T8	CY082	020468	HBS125
0017796791	BF170	011278	HR566	019799	DM533	0197V1	CY140	020472	HBS087
0019970847	NB975	011280	HL472	0197A2	DF106	0197V1	DY150	020474	HBS114
0019971241	PA815	01143554	PA349	0197A6	EH951	0197V3	DR630	020475	HBS114
0024472608	NB775	01157880	PA349	0197A7	DT010	0197W3	CE5050	020480	HBS089
0029571	HR5061	01160496	NJ255	0197AC	CD5500	0197X3	CC5010	020481	HBS254
0029903722	HBS349	01170213	NB775	0197AG	CG9310	0197X5	CA5830	020484	HBS082
0029970847	NB975	011913	NF867	0197C4	GM533	0197X8	CY070	020485	HBS112
003760040101	NB775	011914	NF867	0197C6	DM530	0197Y2	GX410	020485	HBS113
0039403920	NB866	0119970647	NA5266	0197C7	DF106	0197Y6	ED5490	020486	HBS272
0039902522	HBS474	0119972247	NB978	0197C9	DS820	0197Y7	CD5490	020487	HBS273
0039970347	NA5264	0119978846	NB775	0197E5	DV150	0197Y8	CG9750	020488	HBS273
004219U	AY170	0124191000	GW420	0197E7	DV150	0197Y9	GX392	020490	HBS261
0043181200	LT634	0126902103	JH683	0197F9	GJ720	0197Z4	GX392	020493	HBS259
004634596	BY380	0127.47	NA5191	0197G0	DJ720	019806	DM530	020495	HBS309
0049976647	NA5264	0127.47	NA5192	0197G2	DS720	019811	DM710	020497	HBS084
0049976846	NB975	012728	NF844	0197G2	DS731	019830	DM710	020497	HBS245
0055116500	JB837	012728	NF869	0197G3	CY130	019837	DM530	020498	HBS277
0055116900	JN238	012742	NA5259	0197G4	CY130	019851	GM533	0204A5	HBS489

OE reference	▲ Payen	OE reference	▲ Payen	OE reference	▲ Payen	OE reference	▲ Payen	OE reference	▲ Payen
0205.57 (x10)	HBS359	020972	BR510	0209G8	BH950	0209W3	AE5020	022103384C (x13)	HBS526
0209.04	BM530	020975	BG450	0209H8	BG490	0209W6	DT010	022103384D (x6)	HBS513
0209.0S	AD5490	020976	BM530	0209H9	BF100	0209W7	AD5710	022103384D (x7)	HBS526
0209.0T	AD5500	020979	BR510	0209J0	BF170	0209X0	AA5830	022103483E	JM7045
0209.0V	AD5510	020981	BR780	0209J3	BG120	0209X1	AA5840	022110602	NJ042
0209.1C	AA5880	020982	BR790	0209J4	BG130	0209X2	AA5850	022110602B	NJ042
0209.89	DS810	020983	BS820	0209J8	BV140	0209X3	AA5860	022133227A	JD5928
0209.CH	AG9030	020989	BS810	0209K1	BX920	0209X4	AA5870	022133227B	JE5077
0209.CW	AH5730	020990	BR490	0209K3	BF040	0209X5	AC5011	022133237A	JD5857
0209.CY	AH5732	020993	AG5270	0209K9	BH930	0209X6	AC5020	022133237C	JD5874
0209.CZ	AH5733	020999	BV150	0209L3	BR510	0209X7	AC5031	022531503	DM690
0209.EA, 0209.FS	AH6630	0209A0	BV160	0209L5	BG450	0209X8	AC5040	023103383	BV880
0209.ER	AH6730	0209A6	BN580	0209L6	BL830	0209X9	AC5051	023103383B	BV880
0209.EV, 0209.FR	AH6530	0209A7	BP720	0209L7	BL650	0209Y0	AC5700	023198009A	GM690
0209.Y1	AC5710	0209A8	BL650	0209L8	BR510	0209Y1	AC5710	023198009B	GM690
020904	BM530	0209A9	BY130	0209L9	BY310	0209Y5	BX930	023198012	DV880
020906	BL650	0209AC	AH6560	0209N0	AY090	0209Y6	BX940	023280P	JM5088
02090H	AG9750	0209AE	AH6570	0209N1	BS820	0209Y7	BX950	023717P	JH5041
02090N	AG9710	0209AF	AH6580	0209N3	BG540	0209Y7	BX970	0239978447	NA5131
02090P	AG9730	0209AG	AH6590	0209N4	BS730	0209Y8	BX960	024099	HBS125
02090Q	AG9720	0209AH	AH6600	0209N6	AY070	0209Y9	BX970	0242110	KT738
02090R	AG9740	0209AJ	AD5130	0209N9	BY320	0209Z0	AE5010	0249.A6	JM5141
02090W	AD5520	0209AK	AD5140	0209P0	AY100	0209Z1	AE5030	0249.A9	JM7035
02090X	AH5040	0209AL	AD5150	0209P1	AY120	0209Z3	AE5300	0249.C2	JM7034
02090Y	AH5060	0209AN	AD5160	0209P4	BY961	021 103 051 C	NA5305	0249.E4+0249.E5(x2)	HM5369
02090Z	AH5050	0209AP	AD5170	0209Q0	BR780	021 103 609	JH5013	024903	JP041
020912	BH950	0209AQ	AH5080	0209Q1	BR790	021 133 227 H	JA5068	024914	JN244
02091200	BH950	0209AR	AH5090	0209Q3	AD5100	021 253 050	JD5109	024919	JN245
020917	BX870	0209AS	AH5100	0209Q8	BX930	021103383L	AA5430	024925	JN245
02091A	AH5070	0209AT	AH5110	0209Q9	BX940	021103384D	HBS077	024937	JN302
02091E	AD5180	0209CO	BS820	0209QG	AD5310	021103384DEF	HBS077	024943	JN292
020920	BR510	0209C1	BY170	0209R0	BX950	021103384DS	HBS077	024945	JN426
020921	BL650	0209C3	BP890	0209R1	BX950	021103384E	HBS077	024946	JN544
020923	BM530	0209C5	BP900	0209R1	BX960	021103384F	HBS077	024948	JN547
020927	BF100	0209C7	BP910	0209R2	BX970	021103483B	JM5030	024953	JN238
020928	BG480	0209C8	BP890	0209R3	BY140	021103483D	JM5099	024954	JN658
020929	BF170	0209C9	BP900	0209R4	BY941	021103609	JH5013	024955	JN245
020930	BG490	0209CH	AG9030	0209R5	BY950	021103609B	JH5059	024970	JP045
020931	BP890	0209CJ	AD5700	0209R6	BY961	021105245B	NB953	024971	JP043
020932	BP900	0209CR	AH5060	0209R7	BY970	021105247A	NA5272	024974	JP044
020934	BP900	0209CS	AH5040	0209R8	BY981	021105247B	NA5272	024976	JM758
020935	BR510	0209D1	BP910	0209S0	BX830	0221133227C	JD5232	024978	JN426
020941	AG5270	0209D6	AY110	0209S1	BX840	0221133227J	JD5232	024981	JP041
020943	BS810	0209D7	BS820	0209S2	BX850	0221198011A	EC340	024983	JP049
020947	BN580	0209E1	BL650	0209S3	BX860	0221198012A	CA5430	024991	JN544
020949	BN780	0209E9	BY120	0209S4	BX870	0221198012A	CA5431	024993	JP041
020950	BP900	0209EC	AG9310	0209S5	BX880	0221253039C	JA5069	024995	JM5088
020951	BP910	0209EH	AH6390	0209S6	BX890	0221253039E	JA5069	024999	JM5087
020953	BP720	0209ES	AH6400	0209S7	BX900	0221253050	JD5109	0249A3	JM7121
020955	BP890	0209ET	AH6410	0209S8	BX910	0221253050B	JD5109	0249A4	JM5139
020956	BX900	0209EW	AH6440	0209S9	BX920	0219971847	NA5131	0249A5	JM5283
020957	BX920	0209F4	BM530	0209T1	BY150	0219977647	NA5131	0249A6	JM5141
020959	BP890	0209F6	BY180	0209T5	AE5050	022103383F	AG5000	0249A9	JM7035
020961	BP910	0209G0	BX870	0209T6	BY930	022103383K	AG9610	0249C1	JM5299
020969	AG5270	0209G1	BP760	0209T7	BX980	022103383M	AG9610	0249C2	JM7034
020970	BR490	0209G7	BF570	0209T8	BY150	022103384C (x12)	HBS513	0249C5	JM7051

INTERCHANGE OE → PAYEN

Vergleichsliste OE → Payen • Références croisées 1ère Monte → Payen
Intercambio OE → Payen • Intercambio entre equipo original y Payen

OE reference	▲ Payen	OE reference	▲ Payen	OE reference	▲ Payen	OE reference	▲ Payen	OE reference	▲ Payen
0249C9	JM7042	028 103 609 D	JJ140	030198011	EV460	034103383AD	AY960	0348R2	HA5029
0249E2	JM7052	028 103 717 D	JD170	030198011A	EB961	034103383G	BM840	0348R4	HA5030
0249E6+0249E7(x2)	HM5371	028103171B	LK5006	030198012	DL572	034103383R	BM840	0348R5	HA5031
025 129 717 C	JD237	028103383AH	BV850	030198012A	DL572	034103385C	HBS269	0348R7	JD5883
025001P	JD5189	028103383AJ	BV860	030198012B	DL574	034115147	NB716	0348R8	JD5971
025198009A	GM690	028103383AK	BV870	030198012C	CY930	034115147A	NB716	0348S1	JD5882
025198009B	GM690	028103383AL	BV850	030198012D	DL573	034129589A	JD603	0348S3	HM5289
025198012	DM690	028103383AS	BX800	030198012E	CA5500	034129717E	JD327	0348S4	JD5845
025198012A	DM690	028103383AT	BX810	030198012F	CA5410	034129717F	JD171	0348T4	JD6034
025198012B	DM690	028103383BA	BX820	030198025	JN641	034129717K	JD602	0349.J8	JD5829
025550	JN279	028103383BH	BV850	030253039A	JC259	034129717M	JC261	0349.L0	JD5999
026 103 085 A	NA5001	028103383BJ	BV860	030253039H	JD5318	034198011	EX995	0349.N0	JD5829
026 106 675	HR805	028103383BK	BV870	030405	JJ057	034198011A	EC010	034903	JB841
026 109 675	HR569	028103383BP	BX800	030409	JJ057	034198011B	EC010	034906	JB842
026103085A	NA5001	028103383BQ	BX810	030426	JJ283	034198011C	EX995	034923	JB875
026103085F	NA5001	028103383BR	BX820	030433	HC341	034198012B	DT820	034932	JB954
026103383	BM360	028103383F	JN914	030434	JJ283	034198012E	DT820	034946	JB869
026103383K	BM360	028103483F	JN914	030455	JH5107	034198012L	DT820	034947	JC423
026103383M	BM360	028103483G	HM5367	031103383C	BV460	034198012M	CY960	034949	JC415
026103383P	BM360	028103483G	JP003	031103383M	BV460	034198025	HL460	034959	JC415
026103383Q	BM360	028103483H	JN914	031103383Q	BV460	034198025A	HL460	034960	JB837
026107675	HR805	028103609A	JJ140	031103383QM	BV460	034198025D	HL460	034963	JC702
026109675	HR569	028129589A	JC152	031103383R	BV471	034198025D	HM5277	034970	JC415
026109675	HR615	028129589B	JC152	031103383S	BV481	034198025F	HL730	034976	JD230
026121041P	KA5020	028129717D	JD170	031198012A	DV460	0342.E0	HA5028	034978	JC423
026129589A	JC152	028198011D	EC030	031198012B	DV460	0342E0F520	JD538	034992	HA512
026129717	JC478	028198012B	DV850	031307	HC346	0345L5	JD5880	034994	JB841
026129717D	JC478	028198012C	DX800	031326	PA349	0348.Q5	HA5032	034998	JD535
026198011	EG872	028198012D	DV850	032 103 609 D	JJ183	0348.R2	HA5029	0349A6	JC702
026198012F	DM360	028198012E	DV851	03210316100K	KK5551	0348.R4	HA5030	0349E2	JB837
026198012K	DM363	028198012F	DX801	032103383G	BY620	0348.R5	HA5031	0349E6	JD531
026198012K	DM370	028198025	HM5058	032103384	HBS075	0348.S5	JD5830	0349E8	JD5764
026198012S	DM361	029105245B	NB953	032103609B	JJ183	034863	JB868	0349F0	JB869
026198012T	DM363	02JDE3880	JM7094	032129717C	JD487	034880	JB836	0349G0	JD5878
026198025A	HL457	030 103 384D	HBS362	032148	HG093	034889	JC759	0349H4	JD5190
026198025C	HM5053	030103085A	NA5001	032163	NF694	034891	JC750	0349H7	JD5192
027 109 675	HR816	030103171K	LK5011	032198012	DY620	034896	JD529	035 121 171 C	PA459
027103385A	HBS028	030103171S	LK5013	032198012A	DZ180	034898	JD5972	035 121 717 C	PA459
027103385C	HBS028	030103383AH	BZ180	032198012B	DZ181	0348C0	JC991	035103383G	BD620
027103483D	HL606	030103383AK	AA5410	032253039B	JD488	0348C8	JD536	035103383J	BD620
027109675	HR599	030103383AK	CA5410	032253039E	JD601	0348E5	JD530	035103383K	BD620
027109675	HR816	030103383AT	AD5640	032410235	JM053	0348F6	JD519	035103483C	HL460
027129589A	JD282	030103383BE	AD5630	032410235A	JM053	0348F9	JD532	035129717F	JC261
027129589B	JD282	030103383J	BL570	03241035	JM053	0348G4	JD5763	035129717G	JC261
027129717C	JD281	030103383K	BL570	032410431	JH040	0348H0	JB868	035129717H	JC261
027129717E	JD281	030103383M	BL570	032413111	JA086	0348H9	JC759	035129717J	JC261
027198011	EG872	030103383MI	BL570	0326.27	NA5256	0348.J0	JC991	035129717M	JC261
027198011A	EG872	030103383R	AY930	0326.28	NA5323	0348K7	JD5879	035198011A	EX995
027198011B	EG872	030103483D	JP074	032625	NF866	0348L7	JD5254	035198012C	DD622
027198012E	DM361	030103483K	JP074	033129717B	JD278	0348N1	HA5008	035198012F	DM840
027198012H	DM365	030103609	JJ183	033198012	DT590	0348N1	JD6023	035198012K	DD622
027198012K	DM365	030121043D	KA5025	033198012A	DT590	0348N2	HA5008	035198012N	DM840
027198012L	DM360	030129589	JC259	034 103 383 D	AY960	0348N4	JD5191	035198025E	HL460
027198012L	DM368	030129717	JD246	034103383	BM840	0348P9	JD5907	035198011C	EX995
027198025	HL606	030129717D	JD246	034103383A	BM840	0348Q0	JD5906	036 103 383 AL	AB5701
028 103 609 B	JJ140	030129717F	JD597	034103383AA	BM840	0348Q5	HA5032	036 109 675	PA5041

OE reference	▲ Payen	OE reference	▲ Payen	OE reference	▲ Payen	OE reference	▲ Payen	OE reference	▲ Payen
036103085A	NA5180	038103383CQ	AG9640	0411112012	FJ271	0411173042	GP650	0411216190	DR901
036103085H	NA5185	038103383CR	AG9650	0411112013	FJ271	0411174030	GR332	0411216191	DN390
036103383A	BL570	038103383DE	AF5381	0411112014	FJ271	0411174031	GR332	04112-16220	CG7770
036103383AB	AC5280	038103383DF	AF5391	0411112016	FJ271	0411174032	GR332	0411216230	DV370
036103383AJ	AB5701	038103383DG	AF5401	0411112017	FJ271	0411174033	GR332	0411216250	DV371
036103383AL	AB5701	038103383E	BZ030	0411112018	FJ271	0411174040	GR330	0411216260	DV370
036103383AN	AC5280	038103383F	BZ020	0411112020	FJ270	0411174041	GR330	0411216270	DV360
036103383C	BL570	038103383G	BZ010	0411112030	FJ271	0411174042	GR330	0411216280	DV360
036103383F	BL570	038103383H	BZ040	0411112031	FJ271	0411174050	GR250	04112-20040	DZ350
036103383G	BL570	038103383J	BZ050	0411113040	GR270	0411174051	GR250	04112-20050	CD9270
036103383K	AA5500	038103383K	BZ060	0411113041	GR270	0411174060	GS060	0411221040	CB5750
036103383M	BL570	038103384	HBS264	0411113042	GR270	0411174061	GS060	0411222060	CB5760
036103383N	BL570	038103384	HBS300	0411116022	GN390	0411174062	GS060	04112-22070	CG9110
036103383Q	AB5701	038103384A	HBS311	0411116023	GN390	0411174592	FD5330	0411222182	CB5760
036103384	HBS360	038103483D	JM5203	0411116070	GN390	0411175010	GW560	0411223040	CD5380
036103384B	HBS249	038103483E	JM5120	0411116071	GN390	0411175011	GW560	0411227090	CG7491
036103384B	HBS471	038198011	EC060	0411116072	GN390	0411175030	GX060	0411228070	CF5781
036103384E	HBS316	038198012	DZ010	0411116073	GN390	0411176070	GS870	0411230070	CF5980
036109675	PA5041	039198012C	DL491	0411116074	GN390	0411187108	GR880	0411233021	CG7600
036129717E	JD5228	03C 103 383 D	AG8850	0411116090	GP530	0411187109	GR880	0411235420	DM883
036129717G	JD5373	03C 109 287 F	JR5048	0411116130	GR750	0411187111	GR880	0411242030	DR301
036198011	EB5700	03C 109 287 G	JR5048	0411116131	GR750	0411187112	GR880	0411250112	CF5030
036253039C	JD5233	03C 129 717 C	JD5809	0411116190	GR901	0411187112	GR882	04112-50121	CF5860
036253039F	JD5298	03C 253 039 A	JD5814	0411212040	FB5750	0411187116	GR880	0411254030	DL951
037011399	NJ099	03C103383R	AH5960	0411122182	FB5760	0411187116	GR881	0411254031	DL951
037103383L	BY630	03D 103 383 G	AG8840	041123040	FD5380	0411187123	GR880	0411254032	DL951
037103483AC	JN969	03D 129 717 A	JD5807	0411128070	FF5781	0411187123	GR883	0411254033	DL951
037103483C	JN964	03D 129 717 B	JD5808	0411130540	FF5980	0411187208	GR140	041125403N	DL951
037108483C	JN964	03D 253 039 B	JD5819	0411135050	GM881	0411187212	GR140	0411254040	DL950
037115220B	JH5023	03E 129 717 B	JD5811	0411135060	GM881	04111-87742	GS435	0411254041	DL950
037129717D	JD599	03E 253 039	JD5816	0411135070	GM881	0411187757	GR670	0411254042	DL950
037129717F	JD281	03E103383F	AF5990	0411142030	GR301	0411196150	GP650	0411254071	DW801
037198011C	EG872	03G 103 383 AA	AG8970	04111-46044	FG5100	04111-97206-000	FG5290	0411254072	DW801
037198011C	EG873	03G 103 383 AC	AG8960	0411150112	FF5030	04111-97401-000	FG9830	0411254101	BW800
037198011E	ES471	03G 103 483 B	JM7029	0411154042	GL951	04111-97403-000	FG9830	0411255030	CG7570
037198011G	EB970	03G 103 483 F	JM7113	0411154044	GL951	041120B010	CG7480	0411256060	CB5200
037198012B	DT811	03G 129 717 B	JD5806	0411154045	GL951	0411210020	DN530	0411262020	DS290
037198012E	DT819	03G 129 717 C	JD5805	0411154050	GL950	0411211010	DN200	0411262040	DS292
037198012G	DT811	03G103383A	AG8800	0411154051	GL950	0411211020	DN200	0411263010	DK670
037198012G	DT816	03G103383AB	AG8800	0411154052	GL950	0411211100	DV330	0411263020	DK670
037198012J	DT81B	03G103383J	AG9630	0411154053	GL950	04112-11121	DV331	0411264050	DL951
037198012K	CY940	03G103384	HBS364	0411154054	GL950	0411212011	CJ271	0411264051	DR581
037198012L	DY753	03G103483	JM7031	0411154080	GW801	0411212012	CJ271	0411264052	DR581
037198012M	CY941	03G103483D	JM7107	0411154081	GW801	0411212013	CJ271	0411264070	DR581
037253039D	JD600	03G253039	JD5815	0411154082	GW801	0411212014	CJ271	0411264071	DR581
037253039F	JD606	03G253039A	JD5992	0411154083	GW801	0411212020	CJ271	04112-64272	CD5340
038103085C	NA5124	041110B010	FG7480	0411156050	GR951	0411213020	DR270	041126452	DR581
038103085E	NA5106	041110N010	FG7600	0411163021	GK671	0411216022	DN390	0411265010	DS360
038103171S	LK5012	0411110030	GN530	0411164293	FG7650	0411216023	DN390	04112-67024	CG5540
038103383AL	BZ040	0411110031	GN530	0411168030	GR890	0411216024	DN390	0411268030	DR890
038103383AM	BZ050	0411111020	GN200	0411173011	GN640	0411216070	DN390	0411268031	DR890
038103383AN	BZ060	0411111021	GN200	0411173012	GN640	0411216071	DN390	0411270010	DK680
038103383CH	AG8940	0411111130	GV330	0411173020	GN640	0411216072	DN390	0411270011	DK680
038103383CJ	AG8830	0411111141	GV331	0411173021	GN640	0411216090	DP530	0411273011	DN640
038103383CK	AG8950	0411112010	FJ270	0411173040	GP650	0411216130	DR750	0411273020	DN640
038103383CP	AG9630	0411112011	FJ271	0411173041	GP650	0411216131	DR750	0411273021	DN640

INTERCHANGE OE → PAYEN

Vergleichsliste OE → Payen • Références croisées 1ère Monte → Payen
Intercambio OE → Payen • Intercambio entre equipo original y Payen

OE reference	▲ Payen	OE reference	▲ Payen	OE reference	▲ Payen	OE reference	▲ Payen	OE reference	▲ Payen
0411273030	DP651	04556666	JH5060	05093904AA	JD5875	0555497400	JN248	0605359490	HR660
0411273031	DP651	046103483A	JN967	051103483A	JP024	056103489A	HL457	0605359490	HR801
0411273040	DP650	046198011	EW860	051103483E	JP024	056103609A	JJ140	0605359490	PB180
0411273041	DP650	046198012A	DW860	051198011	EG875	056103609B	JJ140	0605484480	BT340
0411274010	DL350	046198012A	DW861	051198011A	EG875	056129589	JC152	0605487510	BT380
0411274030	DR332	04621939AB	NA5140	051198011A	ET811	056129589A	JC152	0605525770	BW410
0411274031	DR332	046671398	NA5139	051198011B	EM362	056129717	JC478	0605663950	BW280
0411274032	DR332	047 103 085	NA5306	051198011B	ES471	056198025	HL456	0605818460	AN350
0411274040	DR330	047 129 717 E	JD5812	051198012A	DT812	056198025A	HL457	0605918100	BE620
0411274041	DR330	047103383E	BT580	051198012C	DM367	056198025B	HL456	060596952	JD271
0411274050	DR250	047103383F	BT580	051198012D	DZ910	057103384A	HBS361	0607328120	JD025
0411274060	DS060	047103383J	BT580	051198025	HL731	058 129 717 C	JD5820	0607550160	BE620
0411274061	DS060	047103483	JM5285	0514.32	NF776	058 129 717 D	JD6005	060755017	AN350
04112-74581	CG9140	047253039H	JD5849	051414	NF641	058103383K	AY970	0611006111679010	GJ610
0411275010	DW560	047253039J	JD5818	051415	NF678	058103383M	AY970	06110679010	DJ610
0411275011	DW560	047253050	JD5817	051417	NF641	058103383Q	AY970	06110P08000	DV020
0411275030	DX060	048 198 383 D	BY750	051418	NF678	058103385A	HBS171	06110-POD-010	CG5350
0411276070	DS870	048103383B	BT810	051420	NF634	058103609	JJ610	06110-POD-010	GV830
0411287106	DR880	048103383D	BY750	051427	NF780	058103609E	JJ610	06110-POD-030	CG5350
0411287107	DR880	048129717A	JD483	051429	NF692	058129717B	JD604	06110P13000	DV340
0411287110	DR882	048129717D	JD5235	051435	NF780	058198011	EY840	06110P14000	DV030
0411287114	DR881	048198012	DT814	051438	NF870	058198012	CY970	06110P27010	DV351
0411287120	DR883	048198012A	DT815	051465	NF752	058198025A	HL732	06110-P2A-010	GY861
0411287204	DR140	048198012B	DT81C	051474	NF857	058253039G	JD605	06110P3RD01	DV021
0411287324	DP564	048198012C	DY750	05166481AA	AG9660	059 103 383 CM	AG8880	06110P3RD01	GV021
0411287720	DS431	048198012D	DY750	05166482AA	AG9670	059 103 383 CN	AG8860	06110P5M000 + 06111P5P	FG5760
0411287725	DN250	0482401005	HR805	05166483AA	AG9680	059 103 383 CP	AG8890	06110-PAA-L00	CG5780
04112-87728	DS435	0490172008	NA5001	052103483A	JM154	059 103 383 CQ	AG8900	06110PDEE00 + 06111PCB	FG5761
0411287735	DS432	0490525	HR630	052103483C	JM154	059 103 383 CR	AG8870	06110-PDT-E00	DV022
0411287740	DR670	0490525	HR631	052103483E	JM154	059 103 383 CS	AG8910	06110PHM000 + 06111PHM	FG7960
0411287745	DS432	0490525	PB180	052103609A	JJ183	059 129 717 G	JD5810	06110PLC010	CG5790
0411287750	DS432	049103051C	NF857	052129589	JC259	059103085A	NF637	06110PLD010	CG5792
04112-97206-000	CG5290	049103383	BG870	052198011A	EA900	059103085B	NF637	06110-PNB-000	CG5811
0411297401000	CG9830	049103383A	BG870	052198012AB	DL570	059103085E	NF637	06110PNB000 + 06114PNA	FG8131
0415 3728	HR631	049103383D	BG870	052198012AB	DL571	059103383AA	AC5970	06110P08000	DV020
0415 3728	PB180	049103383E	BG870	052198012D	DL570	059103383AB	AC5980	06110PR7010 + 06111PR7	FG7860
04153728	HR660	049103383K	BG870	052198012G	DL571	059103383T	AC5960	06110PRBA00 + 06114PRB	FG8130
04153728	HR801	049103384B	HBS024	052198012P	DL570	059103384	HBS265	06110-PSH-E00	FD5230
04153728	PB180	049103384B	HBS043	052198012R	DL570	059103483M	JM7047	06110PSME00	CD5230
04221154	HR801	049103385A	HBS043	053 198 012 E	DT813	059103483N	JM7046	06110-PSM-E00	CD5230
0428255000	JR635	049129717A	JC478	053103383	BT810	059103610B	JH5166	06110-PT5-020	DS705
044103383D	BW790	049198011A	EG872	053103383A	BT810	059129717J	JD5872	06110-PWA-010	CG9180
044103609D	JJ609	049198012C	DG871	053103383B	BT810	059198001A	CC5960	06110PY3000	DV090
044198011	EA800	049198012H	DG871	053198012A	DT813	059198025	HM5223	06110RMAE11	CH5660
044198012	DW790	050103383	AY940	053198012B	DT813	059253039B	JD5851	06110-RNA-000	CH5760
045 103 483 C	JM7032	050103383A	BZ910	053198012C	DY751	0605041100	HR805	06111P08000	EV020
045103383C	AC5190	050103383B	BZ910	053198012D	DY752	0605071070	NA5066	06111-P8A-A01	EG5770
045103383D	AC5200	0501321	NJ255	054103383	BT820	0605075570	HR646	06111-PDA-E00	EG6210
045103383E	AC5210	05017826AC	CC5562	054103383G	BT820	0605075760	JD015	06111P08000	EV020
045103383F	AD5650	050198011	EY940	054103609	JJ184	0605129480	JN808	06111RBDE01	EH5660
045103383G	AD5660	050198012A	DM360	054115147B	NB716	0605129490	JN807	06114PND010	EG5810
045103383H	AD5670	050198012B	CY942	0543491	JM875	0605133160	JN812	06114RBA000	EG5810
045115441	KK5522	05019801B	CY942	0551110000012853300	HC341	0605149100+E4450	BP990	06114-RNA-010	CH5760
045128717	JD5278	05066786AA	JM7049	055253115A	JE117	0605155010	KD383	06120-P8A-A11	CG9170
045129717	JD5278	05080084AA	JM7028	055253115A	JE5029	0605155020	JR349	061A1679010	GJ611
045253039	JD5279	05083152AA	CC5720	0555348700	BF350	0605212930	NB814	061A1PE0670	GM990

OE reference	▲ Payen	OE reference	▲ Payen	OE reference	▲ Payen	OE reference	▲ Payen	OE reference	▲ Payen
061A1PE3000	DM995	068129717A	JC478	06F103383G	AH6930	078103483C	JM5166	095648	HR5046
061A1PE3010	DM995	068129717E	JC243	06J103383G	AH5380	078103483L	JM5166	0990664400	DH681
061A1PE3020	DM995	068198012E	DD502	070 103 383 J	AG8920	078103609F	JH5118	0998600030	JD6036
061A1PH4000	DN450	068198012F	DD502	070 103 383 K	AG8820	078198011A	EY850	0B3C7-10-602B	NK158
061A1PH4000	GN450	068198012H	DD502	070 103 383 L	AG8930	078198012	DT660	0B6S710235C	JM5296
061A1PH4600	DN450	068198171	NA5133	070129717	JD5955	078198012A	DY850	0K05410270	CG5460
061A1PJ0000	DN450	069103383CE	BT470	070129717A	JD5956	078198012D	DZ960	0K054-10-270	CG5460
061A1PJA00	DN451	069103383CP	BT470	070129717B	JD5957	078198025	HM5224	0K05410271	AG5130
061A1PJA00	GN451	069115147	NB716	070129717E	JD6047	08 24 008 900	NF775	0K55110235	JM5310
061A1PK2660	DS111	069115147C	NB716	0706305500	HBS104	08 52 165 200	NF775	0K65A10236C	JM5196
061A1PK2660	GS111	069198012B	DL491	071103383	AG7800	0801191	KA289	0K65A10270A	FE5470
061A1PL2000	DR650	069198012C	DL491	07131487226 (x10)	HBS496	080724	NA5260	0K65A10271B	AE5470
061A1PL2660	DR650	069198015C	DL491	072103383CT	BW680	080728	NA5035	0K65A13461B	JD5327
061A1PL2661	DR650	069198015D	DL491	072103383DA	BW690	080729	NP067	0K90011312	NA5196
061A1PM3000	DR540	069198025C	HL463	072103383DB	BW700	080730	NA5258	0K95510135	HBS455
061A1PM3000	GR540	06A 103 338 F	AY970	072103383DJ	BG940	080736	NA5318	0K9BV10135	HBS423
061A1PM4000	DR541	06A103171A	LK5003	072103383E	BG940	08966202	JM956	0VS0110602	NA5197
061A1PM5A03	DR540	06A103383AH	AY970	072103609B	JJ551	09 48 350 532	NF775	1 004 928	NA5001
061A1PM6000	DR541	06A103383AN	AB5370	072198012	DM660	090570008	AB5140	1 005 254	BX800
061A1PM7G00	DS881	06A103383F	AY970	072198012A	DM660	09119338	BY270	1 005 261	BX820
061A1PT3000	DS700	06A103383L	AB5370	072198025	HL469	09129038	BY250	1 005 262	JP003
061A1PT3000	GS700	06A103384C	HBS246	072198025A	HL728	09129105	BY270	1 005 891	JC152
061B1PE0000	EM992	06A103385A	HBS268	072198025B	HL469	09194750	KG5337	1 033 121	JJ609
061B1PE0010	EM992	06A103483C	JM5103	072198031	JC152	09240105	AY170	1 064 459	JE5025
062103383A	AE5310	06A103609C	JH5117	074103383AG	AF5330	09275497	JN068	1 119 182	NA5157
062103383B	AE5310	06A129717	JD5291	074103383AH	AF5320	0928332003	NJ336	1 148 115	JD5829
0638196	NA5069	06A129717D	LA5204	074103383AJ	AF5310	0928332016	NJ336	1 254 375	HA5030
06561900706	KG664	06A129717F	JD5292	074103383M	AF5340	0928332022	NJ336	1 254 376	HA5031
066103483F	JM5234	06A133398D	JD607	074103383N	AF5350	0928332025	NJ336	1 308 383	AC5800
066133237A	JD5927	06A133398F	JD5340	074103383P	AF5360	0928332026	NJ377	1 535 493	NA5057
068 103 085 E	NA5001	06A198011	EC080	074103383R	AF5310	0928332036	NJ377	1 535 494	NA5057
068103085A	NA5001	06A198011A	EY841	074103383S	AF5320	0928360003	NJ337	1.0512013	AN300
068103085E	NA5001	06A198012	CY980	074103383T	AF5330	0928360005	NJ337	1.1633011	AN300
068103171F	LK5006	06A198012A	CY971	074103469F	JM7077	0928368001	NJ378	1000389	BT140
068103383CE	BT020	06A253039L	JD5293	074103483	JN915	0928905012	HR5075	1000438	JN105
068103383CP	BN940	06B 103 383 AF	AG8810	074103483B	JN915	0928905013000	HR5075	1000439	JN105
068103383CP	BT470	06B 253 039 E	JD5813	074103609B	JJ501	0928905013000	PA928	1002814	JH5015
068103383CQ	BN950	06B103171B	LK5008	074103609F	JJ501	0928907002	PA096	1004302	NC048
068103383CR	BN960	06B103383AE	AC5220	074115189B	KK5470	0928907005	PA305	1004421	HBS078
068103383DB	BN940	06B103383B	BZ530	074129717	JD312	0928970005	PA305	1004457	NA5137
068103383DC	BN960	06B103383H	AC5220	074198011B	EA5470	0956.24	HR800	1004459	JE5025
068103383DD	BN950	06B103383T	AC5220	074198012	DW830	0956.28	HR800	1004476	JD5230
068103383DE	BN940	06B103385 (x8)	HBS536	074198012A	CA5470	0956.53	HR5111	1004928	NA5001
068103383DF	BN950	06B103385 (x10)	HBS510	074253039	JD5948	095601	PA229	1005062	JA5068
068103383DG	BN960	06B103483H	JM7030	075103383E	BZ930	095605	HR300	1005063	JD5232
068103383EF	BT020	06B103483L	JM5205	075103483A	HL728	095618	HR569	1005258	BX810
068103383EH	BN940	06B129717A	JD5341	075103483F	HL728	095619	HR599	1005293	EC340
068103383EJ	BN950	06D103383L	AG9600	075198012A	DM660	095619	HR642	1005303	NA5133
068103383EK	BN960	06D103383M	AG9600	076103383C	AH5970	095619	HR646	1005304	JH5013
068103383FE	BT020	06D103385	HBS363	076103383C	AH5980	095622	HR569	1005441	HR808
068103383FM	BT020	06D103385D	HBS476	076103383E	AH5990	095622	HR805	1005442	HR809
068103384A	HBS018	06D103385D (x12)	HBS517	078103383E	AY061	095628	HR599	1005899	JA5069
068103384A	HBS021	06D103483D	JM7048	078103383K	BZ960	095628	HR642	1005900	JD5109
068103384A	HBS022	06D103483E	JM7078	078103385A	HBS064	095628	HR816	1008718	DP790
068103384A	HBS140	06D129717D	JD5873	078103385F	HBS064	095634	HR5080	1008718	DY740
068129589A	JC152	06E103385 (x16)	HBS512	078103385K	HBS270	095642	HR5081	1008739	DJ444

INTERCHANGE OE → PAYEN

Vergleichsliste OE → Payen • Références croisées 1ère Monte → Payen
Intercambio OE → Payen • Intercambio entre equipo original y Payen

OE reference	▲ Payen	OE reference	▲ Payen	OE reference	▲ Payen	OE reference	▲ Payen	OE reference	▲ Payen
1008739	DN472	10101G5525	GR360	1020160520	BH870	1041410580	JE5018	1096227	AA5940
1010101A27	GK444	10101H8925	GC275	1020160521	JN607	1041410980	JE5028	1096228	AA5950
1010101A28	GK444	10101H9826	GC275	1020160620	BH870	1041411080	JD167	1096230	AA5960
1010101Y25	GS050	10101Q1125	GC383	1020161121	JN454	1041420380	JD169	1096253	HR5082
1010101Y85	GS050	10101T7025	GG724	1020161221	JN607	1041420780	JD169	1097083	AC5860
1010105E75	GR360	10101T8026	GG724	1020162220	BH870	1044867	JE5021	1099084	AC5890
1010105E76	GR360	10101V0725	GK081	1020162320	BH870	1047533851	BW680	1099778	JM5037
10101-0W026	FF5690	10101V0726	GK081	1020162420	BH880	1048093	JD5311	11 12 1 740 065 (14x)	HBS413
1010110B25	GL761	10101V0727	GK081	1020162520	BH880	105000117600	NA5066	11 12 7 560 274 (x10)	HBS522
1010117A26	GP580	10101-VC125	FF5740	1020163220	BH880	105000117602	NA5066	11 12 7 805 927	JM7034
1010117C27	GR661	10101W2525	GK081	1020500058	HR757	105000170400	JA829	11 34 1 736 916	PA5041
1010117C28	GR661	10101W4125	GG724	1020500067	HR756	1050369	AY400	11 34 2 245 151	PA5041
1010122J25	GV250	10101W4126	GG724	1020500158	HR756	1050370	AY410	11 61 1 247 478	JD611
1010122J26	GV250	101041	JH565	102078	JA899	1050371	AY420	11 61 1 717 259	JD493
1010123E87	GM596	10105AA021HS	DV450	1021413480	JD291	105120150800	AN300	11 61 1 721 763	JD490
1010124C25	GR661	10105AA060	FF5760	1021421480	JD292	10512015080001	AN300	11 61 1 726 012	JD239
1010124E87	GM765	10105AA060K	CF5760	1021421580	JD293	105120150801	AN300	11 61 1 726 016	JD315
10101-37J27	FF5600	10105AA070K	CG5290	1022220	AC5680	105120150805	AN300	11 61 1 734 684	JD490
1010140F25	GS770	10105AA280K	CG5590	1022869	CC5680	1053830	AC5800	11 61 1 739 545	JD608
1010140L25	GW620	10105AA290K	CG5580	1024198503	BW420	1053902	JD5313	11 61 1 740 069	JD492
1010140P27	GS910	10105AA351K	CG5581	1024198503	GW420	105480150800	BH850	11 62 1 744 252	JD497
1010141M25	GJ690	10105AA530	FG5600	1029900810	HBS146	10548015080001	BH850	11 62 7 806 008	JD5829
1010141M85	GJ690	10105AA530K	CG5600	1029900810	HBS150	1056737	HR5033	11 65 7 791 076	JD5959
1010141M86	GJ690	10105KA110	FG7980	103 142 14 80	JD121	105E6362A	NA576	110 016 03 21	PB256
1010143G25	GS200	101060411000	KD383	1030100180	HL657	105E6362D	NA576	1100100830	HL659
1010143G25	GS760	101096	JR349	1030100280	HL657	105E6K600P	NA576	11001260662	EX932
1010143G28	GS200	1011782	DY641	1030105420	HL657	1060162720	BH870	11001287579	EX934
1010143G85	GS760	101267300	AC5500	1030140422	JJ491	1061468	JM5154	1100310181	NB975
101014M7256	FB5610	101267300	AC5550	1030160221	JN623	1068119	AB5800	1100328	AB5120
10101-52H26	FF5600	1012728	BT110	1030160421	HL657	1068120	AB5810	11004-JA21A	AH6770
1010154A25	GP580	1012744	BY660	1030160421	JN623	1068121	AB5820	11011030	DR630
1010154A85	GP580	1012744	DY660	1030161920	BN740	1068123	BW020	1101405	BX550
1010155M25	GR240	1015368	EY650	1030162120	BN740	1068124	BW030	110196	JN588
1010157Y25	GP960	10153680R	EY650	1030500058	HR760	107028	JH565	1102415	NA5323
1010161W25	GG724	10153680R96MX6013AA	EY650	1030500158	HL657	1071744	BZ490	1102674	HBS296
1010165A25	GK447	1015369	DY650	1030500158	HR759	1072018	AB5130	1102676	HBS296
1010166A25	GK447	1015369	DY660	1031000	AC5290	1072063	JD5290	1104201Y25	DS050
1010170J25	DV541	1016149	EY671	1032209	NB788	1072066	JD5164	1104205E25	DR360
1010170J28	GT050	1016155	DY671	103331	AN350	1072160	JM7060	110420W025	CF5690
1010171J25	GV440	101670	KV124	1035729	BY650	107234	AN350	1104210B25	DL761
10101-74N26	GW421	101827	AN350	1035729	DY650	1077686	NC048	1104211A25	DK440
1010174N28	GW420	1019030 / 96XM6051A3B	AH7010	103725407	AX220	1078498	JH5008	1104211A26	DK440
1010174Y25	GP970	102 141 27 80	JD182	1040100630	JM5113	1078524	JM5016	1104211A27	DK440
1010178E26	GT050	1020101180	EH872	1040101920	CE5331	1078528	NC086	1104211A28	DK440
1010178E27	GT050	1020103305	EH872	1040102020	CC5520	1078707	JH5061	1104211E25	DK831
1010184M25	GK447	1020103405	EH872	1040103220	CE5330	1079925	HBS243	1104211M25	DK440
1010187A25	GV990	1020106141	DH873	1040103620	CE5331	1079926	HBS243	1104211M26	DK440
1010187A26	GV990	1020106141	DH876	1040103720	CE5330	1085617	BY640	1104211M27	DK440
1010188A25	GS610	1020106241	DH882	104012020	CC5520	1086431	HR5033	1104211M85	DK440
10101-8H726	FF5541	1020107741	DH873	1040150220	JR5040	1086437	JD5151	1104211M86	DK440
10101AX527	FG7880	1020107741	DH876	1040160021	JM5115	108811	BE620	1104211M87	DK440
10101D3527	GM766	1020107841	DH882	1040160321	JM5113	1089765	HBS358	1104211M88	DK440
10101D3529	GM766	1020140722	JJ488	1040160821	JM5114	1089772	JD5220	1104215B25	DL761
10101D9727	GR360	1020160321	JN454	1040161620	AC5520	1089837	NA5147	1104215B26	DL761
10101D9728	GR360	1020160421	JN454	1040162820	AE5330	1089844	JM5104	1104215B85	DL761
10101D9785	GR360	1020160421	JN607	1040500258	HR5055	1090949	JD5312	1104215B86	DL761

OE reference	▲ Payen	OE reference	▲ Payen	OE reference	▲ Payen	OE reference	▲ Payen	OE reference	▲ Payen
1104217A26	DP580	11042N4225	DC380	1104440126	BW620	11044-9N01B	AH6760	11044V0700	BK080
1104219P85	DM574	11042T7025	DG724	1104440F00	BS770	11044AA001	BN550	11044V0710	BK080
1104220H25	DR660	11042T7026	DG724	1104440F10	BS770	11044AA003	BN550	11044V0711	BK080
1104221E85	DM593	11042V1326	DC380	1104440L26	BW620	11044AA011	BN550	11044V4212	BM570
1104221E87	DM593	11042V1327	DC380	1104440P00	BS910	11044AA012	BN550	11044V5200	BM570
1104221P26	DM574	11042-VC125	CF5740	1104441B00	BY900	11044AA013	BN550	11044V5201	BM570
1104222J25	DV250	11042W1725	DL310	1104441M01	BJ690	11044AA030	BN550	11044V5202	BM570
1104223E85	DM596	11042W1726	DL310	1104441M02	BJ690	11044-AA100	AG5280	11044V5212	BM570
1104223E87	DM596	11042W1727	DL310	1104441M10	BJ690	11044AA110	BV450	11044V7200	BW620
1104230R25	DS771	11042W1728	DL310	1104441M11	BJ690	11044AA111	BV450	11044VK501	AH5340
1104232F26	DM574	11042W4125	DG724	1104441M01	BJ690	11044AA112	BV450	11044VK504	AH5350
1104237J27	CF5600	11042W4126	DG724	1104441M02	BJ690	11044AA113	BV450	11044VK505	AH5360
1104240P25	DS910	11042Y8525	DC380	1104444G01	BS760	11044AA114	BV450	11044W0402	BG720
1104241M25	DJ690	1104400QAD	AE5210	1104444G02	BS760	11044AA355	AG5210	11044W1700	BL310
1104241M85	DJ690	1104401M00	BK440	1104444G03	BS760	11044-AA360	AG5290	11044W1701	BL310
1104241M86	DJ690	1104401M01	BK440	1104445V00	BS910	11044-AA521	AG6150	11044W1702	BL310
1104242E25	DM574	1104401M02	BK440	1104445V11	BS910	11044BC20A	AH6280	11044W2500	BK080
1104243G25	DS760	1104401Y00	BS050	1104448L01	BM590	11044BC20B	AH6280	11044W2501	BK080
11042-4M526	CD5250	1104402N01	BS760	11044453Y00	BP950	11044BX000	AG7880	11044W2502	BK080
1104254A25	DP580	1104402N01	DS760	11044453Y10	BP950	11044BX005	AH6300	11044W4000	BG720
1104261W25	DG724	1104402N02	BS760	11044454T06	AC5760	11044-BX005	AH6300	11044W4001	BG720
1104263A25	DK446	1104402N03	BS760	11044454T07	AC5770	11044C8700	BR260	1105601M03	HBS409
1104265A25	DK446	1104405B00	BR160	11044455M01	BR240	11044C8701	BR260	11056-1C310 (10x)	HBS505
1104265M25	DR240	1104405E00	BR360	11044457Y00	BV440	11044D0200	BK840	11056-31U01 (8x)	HBS404
1104266A25	DK446	1104405E20	BR360	11044-5M313	AD5260	11044D0201	BK840	1105641B00	HBS110
11042-6N226	CF5541	1104406P00	BM570	11044-5M320	AD5250	11044D0202	BK840	1105653Y00	HBS187
1104270J25	DV541	1104408B00	BR160	1104460U10	BS830	11044D0203	BK840	1105689J00	HBS188
1104270J26	DV540	1104408B01	BR160	1104460U15	BS840	11044D0204	BM590	11056-AR000 (10x)	HBS504
1104270L25	DW620	1104408B02	BR160	1104467S02	BP550	11044D0205	BM590	11056-AX000 (x10)	HBS506
1104271J25	DV440	110440C402	BW420	110446N201	AH7080	11044D0210	BM590	11056-D4200 (10x)	HBS495
11042-73Y85	DP951	110440C410	BW420	110446N202	AH7080	11044D1704	BM760	11056-ED000 (x10)	HBS516
11042-74N25	CD5280	110440C412	BW420	1104470J01	BV540	11044D1705	BM760	11056G2401	HBS194
1104274N28	DW420	1104410B00	BL760	1104470J02	BV540	11044D1706	BM760	11056G2401	HBS433
1104278E26	DT050	1104410B01	BL760	1104474Y00	BP970	11044D1707	BM760	11056V7200	HBS190
1104287A00	DV990	1104410B02	BL760	1104477A00	BV990	11044D1710	BM760	11057052	NB792
1104287A25	DV990	1104410W02	BR660	110447J500	AB5690	11044D2800	BP580	1105771	AC5800
1104287A26	DV990	1104413C00	BR360	1104484A00	BS610	11044D2801	BP580	11057H11500	HBS432
1104287G25	DW540	1104413C01	BR360	1104485M00	BR240	11044D2802	BP580	1105914	AB5300
1104288A25	DS610	1104413C02	BR360	1104486J00	BV440	11044EA200	AG6130	1105916	AB5310
110428M025	CB5630	1104416A06	BP580	1104487A00	BP990	11044-EN200	AH6330	1105919	AB5320
1104299B25	DY900	110441P010	BW620	1104487G01	BW540	11044ET80A	AH7080	1105920	AB5330
11042-9C625	CG5530	110441P012	BW620	1104487G02	BW540	11044G5500	BR360	1105922	AB5350
11042-AD225	CD5260	110441P060	BW620	1104487G03	BW540	11044G5501	BR360	11082802	HBS002
11042AX03J	CH6300	110441P063	BW620	1104488A00	BS610	11044G5502	BR360	11082802	HBS050
11042C8725	DR260	1104422J10	BV250	110448H800	AG9930	11044H7200	BC270	11095AA041 (12x)	HBS405
11042C8726	DR260	1104422J11	BV250	110448H801	AG9940	11044H7201	BC270	1110060811	DS600
11042C8727	DR260	1104422J12	BV250	110448H802	AG9950	11044H9820	BC270	1110060821	DS600
11042D3527	DM766	1104422J15	BV250	110448H803	AG9960	11044H9821	BC270	1110061810	DT900
11042D9727	DR360	1104422J16	BV250	110448H804	AG9970	11044-JA11A	AH6770	1110061840	DN484
11042D9728	DR360	1104422J17	BV250	110448H805	AG9980	11044-JA11B	AH6760	11100-71811	CG5511
11042D9790	CC5750	11044-2J615	AD5280	110448J022	AH7080	11044-JA21B	AH6760	1110077850	CG5710
11042G5525	DR360	110442J616	AD5280	11044-8M020	AB5630	11044KA010	BR560	1110078830	DM910
11042H7225	DC270	110442J617	AD5281	11044-9C601	AG5170	11044N4210	BC380	1110080810	DL390
11042H7227	DC270	1104431U10	AG8220	11044-9C602	AG5180	11044N4220	BC380	1110080811	DL390
11042M9528	DC270	1104431U15	AG8210	11044-9C603	AG5250	11044P8600	BC380	1110080812	DL390
11042M9529	DC270	11044-38U05	AF5710	11044-9N01A	AH6770	11044P8601	BC380	1110080818	DL390

INTERCHANGE OE → PAYEN

Vergleichsliste OE → Payen • Références croisées 1ère Monte → Payen
Intercambio OE → Payen • Intercambio entre equipo original y Payen

OE reference	▲ Payen	OE reference	▲ Payen	OE reference	▲ Payen	OE reference	▲ Payen	OE reference	▲ Payen
1110082810	DM740	11112247511	EZ800	1111533021C0	AG7600	1111574090	BS060	11120621144	HBS070
1110082812	DM740	11112248975	EZ660	1111533021E0	AG7620	1111574100	BL350	11120621144	HBS071
1110082813	DM740	11112248976	EZ690	1111535020	BM880	1111574101	BL350	11121059238	DL691
1110082814	DM740	1111410480	JD160	1111535030	BM880	1111574110	AD5330	1112121000	JH005
1110082821	DN480	1111410680	JD160	1111535040	BM880	11115-74120	AG9140	11121262571	HR397
1110082822	DN480	1111410780	JD160	1111535060	BM880	1111575010	BW560	11121265108	JN297
1110082823	DN480	1111410880	JD5226	1111537010	BK700	1111575020	BX060	11121265404	BC910
1110082824	DN480	1111411280	JD5226	1111537020	BK700	1111576030	BS870	11121266208	BD630
1110082825	DN480	1111420380	JD161	1111537021	BK700	1111587105	BR880	11121267136	JN299
11100-83816	CG5480	1111420580	JD161	11115-37030	AH6940	1111587106	BR880	11121267138	JN300
1110085820	DL391	1111510010	BN530	1111540060	AG9310	1111587208	BR140	11121268816	BC910
1110100430	HM5057	1111510020	BN530	1111542020	BR300	1111587307	BM900	11121269235	BR841
1110100430	JN911	1111510040	BN530	11115-46045	AG5100	1111587308	BM900	11121277779	DL690
1110102820	DV810	1111511010	BN200	1111554020	BL950	1111587309	BM900	11121278305	BL680
1110102920	DV820	1111511020	BN200	1111554021	BL950	1111587312	BM900	11121278306	BL690
1110103108	EV810	1111511030	BN200	1111554080	BW800	1111587701	BJ630	11121285609	NB799
1110103920	DZ160	1111511060	BN200	1111554081	BW800	1111587703	BJ630	11121285620	NB799
1110104120	DZ900	1111511070	BV330	1111554082	BW800	1111587717	BR670	11121285973	JN578
1110105020	DZ881	1111511071	BV330	1111554083	BW800	1111587723	BS090	11121286335	DD631
1110105120	DZ891	1111511080	BV330	1111554083B0	AH6250	1111587727	BR670	11121287450	BR420
1110106220	DZ881	1111512010	AJ270	1111554084	BW800	1111587728	BR670	11121287451	BR430
1110106220	DZ891	1111512011	AJ270	1111554084B0	AH6250	1111587729	BS430	11121287452	BR440
1110106420	DZ891	1111512012	AJ270	11115-54084-DO	AH6260	1111587732	BS090	11121287686	BL690
1110140022	JJ499	1111512013	AJ270	1111556110	BX190	1111588360	BR330	11121287834	BD630
1110140122	JJ499	1111513040	BR270	1111562030	BS290	1111588361	BR330	11121287934	BC910
1110140222	JJ499	11115-15090	AG7770	1111562030B	BS290	1111588362	BR330	11121427825	DY571
1110160221	JN911	1111515120	BV360	1111562060	BS290	1111588380	BS060	11121427826	DT692
1110160420	BZ900	1111516030	BN390	1111563010	BK670	1111588381	BS060	11121432885	JP079
1110160620	BZ900	1111516050	BP530	1111563011	BK670	1111588382	BS060	11121433463	AC5640
1110160720	BZ850	1111516070	BR900	1111564050	AB5000	1111597201000	AG5920	11121433467	AC5650
1110160721	JM5111	1111516080	BR750	1111564060	BR580	11116-20010	BZ350	11121433473	AC5350
1110160921	JN911	1111516081	BR750	1111564080	BR580	11116-20031	AG9100	11121433477	AC5360
1110161220	BZ900	1111516082	BR750	1111564100	BR580	11116-31031	AH6710	11121433950	BZ130
1110161221	JN911	1111516090	BR750	1111564110	BR580	1111662030	BS300	11121435586	AC5310
1110161320	BZ850	1111516100	BR750	1111564121	BR580	1111662030B	BS300	11121436760	JM5096
1110161420	BZ880	1111516130	BV370	1111564122	BR580	1111662071	BY460	11121436761	JM5097
1110161520	BZ900	1111516150	BV370	11115-64200-01	AD5340	1111665020	BS370	11121436822	CC5900
1110161620	BZ890	111151701001	AH7090	11115-64200-03	AG5240	11117511529	EC5440	11121437343	JM5098
1110161720	BZ890	111151704001	AH7090	1111565020	BS360	11117548101	EG9540	11121485838	JM5119
1110162420	BZ850	11115-20010	BZ340	11115-67040-01	AH5180	11117802665	NA5299	1112161500	JJ151
1110162620	BZ880	11115-20031	AG9090	11115-67040-03	AH5230	11119059257	ER830	1112161501	JJ151
1110162720	BZ880	1111521030	AB5750	11115-67050-05	AG5230	11119063134	EX932	1112161502	JJ151
1110162820	BZ900	1111521040	AB5750	1111568030	BR890	11119064460	ET681	11121708891	BL680
1110162920	BZ890	1111521050	AB5750	1111568050	BR890	11119066462	EW730	11121712309	CB5660
1110163020	BZ890	1111522031	AB5760	1111570010	BK680	111198007	FV500	11121715181	JN698
111092850	AX220	1111522040	AB5760	1111570020	BK680	11120004553	CC5350	11121715452	BR830
111092851	AX220	1111522050	AB5760	1111571010	BL820	11120030496	HM5069	11121716223	BL690
11110394505	EC5410	11115-22060	AG9110	1111571011	BN640	11120031987	HM5150	11121716226	BS320
11111432478	EW802	1111523030	AD5380	1111573010	BP650	11120032224	HM5160	11121716228	DL691
11111485171	NA5139	1111523041	AG9830	1111573040	BL820	11120035738	HM5368	11121718931	HBS041
11111492244	NA5140	1111523042	AG9830	1111574010	BL350	11120141055	CC5901	11121721335	ER830
11111712981	EB5660	11115-27010-A0	AD5370	1111574010N	BL350	11120143667	CC5441	11121721336	DR830
11112243888	EX934	11115-28012	AF5840	1111574020	BL350	11120147561	CC5921	11121721476	JP077
11112244327	EW730	1111528020	AF5780	1111574030	BR250	11120147641	CC5921	11121721495	BR830
11112245749	EY280	1111530040A0	AF5980	1111574070	BS970	11120150670	CG9000	11121721546	BY560
11112246703	EY270	11115-31051	AH6700	1111574080	BS970	11120427690	CH6730	11121721547	BY560

OE reference	▲ Payen	OE reference	▲ Payen	OE reference	▲ Payen	OE reference	▲ Payen	OE reference	▲ Payen
11121721875	JP077	11121739849	BZ130	11122247447	JM5106	11127788072	CC5410	111308N700	NA5118
11121721938	HBS068	11121740982	DY570	11122247498	BZ500	11127788587	AG9000	11131280901	JJ104
11121721939	HBS069	11121740984	DT693	11122247499	BZ510	11127788588	AG9010	11131315154	JJ538
11121722021	HBS041	11121741468	AC5370	11122247500	BZ520	11127788589	AG9020	111313739592	JJ537
11121722388	JN297	11121741469	AC5370	11122247501	DZ661	11127788636	AC5300	11131432109	JH5050
11121722389	JN542	11121741470	AC5380	11122247591	JM5076	11127788640	AB5990	11131436324	JH5116
11121722390	JN297	11121741471	AC5380	11122247673	BZ690	11127788642	AB5980	11131437237	JJ611
11121722725	BD630	11121743114	BR830	11122247674	BZ700	11127788651	AE5340	11131487221	JH5051
11121722727	BD630	11121743375	DZ130	11122247675	BZ710	11127788652	AE5350	11131702047	JH5111
11121722728	BD630	11121743704	AB5660	11122247677	BZ660	11127788656	AE5360	11131722695	JJ538
11121722734	BL680	11121747021	JM5109	11122247678	BZ670	11127788657	AE5370	11131727974	JJ089
11121726	HBS041	11121747022	JM5108	11122247679	BZ680	11127790052	AC5410	11131730234	JJ104
11121726478	HBS041	11121747023	JM5107	11122248982	BZ660	11127790053	AC5420	11131739592	JJ537
11121726617	BT691	11121A3500	JH005	11122248983	BZ670	11127790054	AC5430	11131742109	JH5115
11121726618	BT691	11121A3501	JH005	11122248984	BZ680	11127790944	HBS490	1113201B25	HC443
11121726623	BT680	11121AA000	JJ360	11122248985	DZ660	11127790954	AG7600	1113201B26	HC443
11121726624	BT680	11121C7800	JJ151	11122248987	BZ690	11127790955	AG7610	1113201B27	HC443
11121727726	JN698	11121D0100	JJ265	11122248988	BZ700	11127790956	AG7620	1113201M25	HC442
11121729246	HBS067	11121D0101	JJ265	11122248989	BZ710	11127794495	JM5167	11132-01M25	HC5010
11121729246	HBS519	11121E3000	JH031	11122248990	DZ690	11127794857	AH5950	1113211	LK5004
11121729247 (x10)	HBS519	11121E3001	JH031	11122354013	AC5320	11127796378	JM5106	11132245174	JJ536
11121730217	BS320	11121V5000	JJ299	11122354014	AC5330	11127801698	AH5920	11132247949	JH5033
11121730220	BS320	11121W4400	JJ265	11122354015	AC5340	11127801699	AH5930	11132H5025	HC259
11121730223	BL690	11122241051	BR420	11127501304	AC5900	11127801700	AH5940	11137548031	JH5103
11121730226	BL690	11122241052	BR430	11127501305	AF5190	11127807293	CG5011	11139063331	JJ536
11121730229	JN297	11122241053	BR440	11127504631	BR830	11128506128	AG5010	11139066503	JJ536
11121730231	JN542	11122242959	BR420	11127506983	AC5310	11128506129	AG5020	11139067655	JJ614
11121730252	DR831	11122242960	BR430	11127507597	CC5310	11128506130	AG5030	1114121111000	AG8020
11121730252	DT680	11122242961	BR440	11127508543	AC5920	11129058467	DL681	11141255010	NB792
11121730253	DT691	11122243143	HBS065	11127508545	CC5920	11129059238	DL691	11141255012	NB431
11121730780	DL690	11122243203	JN955	11127508936	HBS359	11129059240	DL681	11141255014	NB432
11121730876	DD631	11122244327	EW730	11127509710	AC5440	11129063330	DY542	11141255015	NF634
11121730934	JN300	11122244328	DW730	11127509711	AC5470	11129063333	DY542	11141265431	NF637
11121730935	JN300	11122244398	JN955	11127511534	HBS467	11129064466	DT681	11141271081	NF637
11121730936	JN300	11122244727	BR420	11127511535	CC5440	11129064467	DT691	11141274346	NF637
11121733966	JM5107	11122244728	BR430	11127513194	HM5296	11129064467	DT693	11141275293	NB431
11121733967	JM5109	11122244729	BR440	11127513195	HM5297	11129065439	DY541	11141275466	NF637
11121733968	JM5108	11122244920	BW730	11127536785	HM5288	11129065653	BC910	11141278108	NB432
11121734030	JN299	11122244921	BW740	11127548799	HBS468	11129066434	DY520	11141308342	NC015
11121734215	JN299	11122245355	BZ111	11127548921	CG9540	11129066452	DR831	11141439570	NA5099
11121734267	DR830	11122245356	BZ120	11127553209	AH6210	11129067790	HBS066	1114160A00	BS600
11121734276	JN299	11122245426	BZ111	11127555755	AG9540	11129067792	HBS121	1114160B00	BT900
11121734624	JP079	11122245427	BZ120	11127555756	AG9550	11129070058	DW731	1114160B01	BT900
11121736113	JM5109	11122245483	BW730	11127555757	AG9290	11129070530	HL734	11141706785	NB431
11121736114	JM5108	11122245484	BW740	11127557265	AH5120	11129070531	HL735	11141706999	NB431
11121736115	JM5107	11122245547	AY270	11127559311	HM5278	11129070532	HL736	11141709593	JR5031
11121736315	BX270	11122245548	AY280	11127560271	AH6440	11129070615	DZ130	11141709632	NB432
11121736316	BX281	11122245599	JP078	11127560276	CH6730	11129070622	DZ121	11141710247	NA5132
11121736317	BX270	11122245686	JM5063	11127565286	JM7098	11129071589	HMS066	11141713722	NA5267
11121736318	BX281	11122246092	AY280	11127570859	AH6440	11129071590	HMS067	11141713730	NA5132
11121736319	BX290	11122246093	AY270	11127578093	AH6220	111294206	CG5920	11141714617	NB980
11121736340	BX300	11122246704	CY270	11127591482	AH6420	1112953	HC5004	11141715100	NB792
11121736341	BX290	11122246996	JM5118	11127595138	AH6730	11130000689	JH5032	11141715101	NB792
11121736342	BX300	11122247029	BZ500	11127595139	AH6440	11130139259	JH5070	11141-71C00	AG5260
11121739331	BR830	11122247030	BZ510	11127599212	AH6420	11130149329	JH5110	11141721560	NC015
11121739334	BR830	11122247031	BZ520	11127787074	JM5167	11130607100	JJ089	11141725994	NA5267

INTERCHANGE OE → PAYEN

Vergleichsliste OE → Payen • Références croisées 1ère Monte → Payen
Intercambio OE → Payen • Intercambio entre equipo original y Payen

OE reference	▲ Payen	OE reference	▲ Payen	OE reference	▲ Payen	OE reference	▲ Payen	OE reference	▲ Payen
11141741532	JR5044	1120391	AA5990	11251PE2010	JJ309	1140060811	GS600	1150160180	JM850
11141743033	JR5046	1121231	AD5020	11251PE2020	JJ309	1140061822	GT900	115094	BE620
1114175101	BL390	1121300010	JM7042	11251PH7000	JJ364	1140061823	GT900	1151082600	JJ341
1114175102	BL390	1121310010	JN598	11251PK1010	JJ390	1140061824	GT900	1151934	DW642
11141-75F30-000	AH6290	1121311040	JN865	11251PT0000	JJ417	1140061825	GT900	1152018	JD5998
1114178400	BM910	1121315010	JN356	1126120	JM5184	1140061850	GN484	115276	JN588
1114178401	BM910	1121315020	JN356	1127417	JD5219	1140065862000	CG8020	1152979100	JJ187
1114178402	BM910	1121315021	JN356	1129970046	NA5168	1140065870HS	CG5730	1152979110	JJ187
1114182000	BM740	1121315050	JN706	1129970146	NA5168	1140065871HS	CG5730	1152980000	JJ273
1114182001	BM740	1121315070	JN904	1129970246	NA5168	1140065872HS	CG5730	115309	JAB99
1114182011	BM740	1121316010	JN603	1129970346	NA5168	1140065873HS	CG5730	11531432874	KK5484
1114182600	BN480	1121317010	HM5241	1129970446	NA5168	1140069833	CG8180	11531721172	KK5684
1114182601	BN480	1121321011	JM5072	113028540	HR805	1140078850	DM910	11531748047	KK5682
1114182602	BN480	1121322010	JM025	113090920	JH5184	1140080810	GL390	11537509357	KK5484
1114182611	BN480	1121322050	JM5073	113101481A	JM986	1140080811	GL390	11543491	JM875
1114186501	BN480	1121323020	JM5149	113101481F	JM986	1140080812	GL390	11599609	JM875
1114186FA0	AG5730	1121324010	JM025	113105245F	NA784	1140080813	GL390	116000120500	JJ452
11142245364	NB431	1121326010	JM7106	113105245G	NA784	1140080814	GL390	116003016501	JE696
11142247091	JR5022	11213-28021	JM7036	11312185916	NB775	1140080815	GL390	1160030165010	JE696
11142249532	NA5105	1121335010	JN185	1131305	LK5005	1140082821	GN480	116010172000	JE696
11142249533	NA5104	1121338010	JN185	1131831	AB5300	1140082822	GN480	116080150804	BH850
11142249534	NA5103	1121342020	JN631	1131832	AB5310	1140082823	GN480	11608015080401	BH850
1114286FA0	AG5740	1121343020	JN449	1131833	AB5320	1140082824	GN480	11608701300	BH850
1114286FA1	AG5740	1121354050	JN965	1131834	AB5330	1140082825	GN480	11611436631	HA5023
11147787262	LK5007	1121362020	JN792	1131835	AB5340	1140085820	GL391	11611437383	JD5156
11147790960	NA5088	1121363010	JN469	1131836	AB5350	1140177850HS	CG5710	11611437384	JD5858
1114A78B01000	AD5690	1121363011	JN469	113198101	CV480	1140177851HS	CG5710	11611720740	NC052
1116663	JE5059	1121364020	JN532	113198101A	CV480	1140177852HS	CG5710	11611721344	JD283
1117453	NA5030	1121364040	JN532	11340029571	HR5061	1140177853HS	CG5710	11611721346	JD189
1117582245	HM5278	11213-64061	JM5146	11341273501	HR569	1140177854HS	CG5710	11611730788	JC929
11176-85FA0	JM5307	1121365010	JN712	11341273501	HR596	1140178852	FG5130	11611734401	JD283
1118008 (x13)	HBS526	1121368020	JN705	11341285249	HR569	11405062	NB564	11612244384	JD274
1118011 (x7)	HBS526	1121371020	JN551	11341288544	HR599	11405468	JM875	11612244391	JD274
1118342	NA5147	1121374020	JN655	11341288544	HR646	11405576	NB564	11612245438	JD612
11186-85FA0	JM5308	1121375030	JN954	11341289948	PA815	11406307	JC365	11612246944	JD5108
1118971C00	JN886	1121387103	JN700	11341461679	PA5041	114-092801	JM5285	11612246945	JD5107
11189-71C00	JN886	1121387203	JN663	11341706580	HR599	114092852	BT580	11612777	HR397
1118973000	JN414	1121387305	JN636	11341706707	HR599	114-095840	JD5766	11617503215	HA5024
1118973001	JN414	1121387705	JN415	11341736916	PA5041	1141575	JM5155	11617513044	JD5826
1118978100	JN440	1121412080	JD5385	11342245151	PA5041	11422249532	NA5105	11617521181	JD5986
111898200	JN579	1121420180	JD5386	11342247171	PA5016	1142359	NA5259	11617528173	JD6034
1118982600	JN606	1121426010	JM7106	11347807347	HR5110	1142502	JD5866	11617528584	JD6024
11189A78B0000	JM5263	1121446010	JN831	11347812926	HR5107	1143317	LK5004	11617530703	HA5024
1119162	NA5157	1121488381	JN917	11349059169	HR363	11448543	NB564	11617547242	JD5864
1119194	AC5940	1122617	AC5940	11349059169	HR569	1145953	NA5258	11617790198	JD5108
1119284	JD5299	112330	JN758	11349059171	HR646	1146049	AH6560	11617801438	JD5991
111941003020	AH5260	1124372	AD5220	11349059172	HR602	1146050	AH6570	11621174968	JD5827
1119878	JM5158	11251P2A004	JH5173	11349059172	HR662	1146051	AH6580	11621728981	JD561
1120160120	AE5730	11251PC6000	JJ271	11349063193	HR791	1146052	AH6590	11621728983	JD561
1120160220	AE5740	11251PC6010	JJ271	11349065438	HR817	1146053	AH6600	11621732969	JD5916
1120160221	JM5236	11251PE0003	JJ309	11349070982	HR5045	114812	JN635	11621743620	JD243
1120160320	AE5750	11251PE0004	JJ309	1136695	KA5021	11490525	HR630	11621743719	JD243
1120160321	JM5237	11251PE0010	JJ309	1137860	JA5085	11490525	HR631	11622243781	JD275
1120160420	AE5760	11251PE0020	JJ309	1138392	HA5020	11490525	PB180	11622243782	JD275
1120389	AA5970	11251PE2003	JJ309	1139357	NA5028	1149707	JD5227	11622244568	JD276
1120390	AA5980	11251PE2004	JJ309	1140052820	FG8100	1150140122	JH683	11622244569	JD276

OE reference	▲ Payen	OE reference	▲ Payen	OE reference	▲ Payen	OE reference	▲ Payen	OE reference	▲ Payen
11622246174	JD5134	1215112010	JJ093	12251PL2003	BR650	12328679010	JN404	1273501	PA815
11622248287	JD5183	1215113011	JJ343	12251-PLC-003	AD5230	12328679020	JN404	1275055	JA5043
11627505789	JD5146	1215141010	JH024	12251PLZD00	AE5520	12341P08000	JN857	1276191	BK640
11627787630	JD5183	1215154010	JJ150	12251PLZD10	AE5530	12341PC6000	JN605	12761910	BK640
116330150800	AN300	1215154011	JJ150	12251PLZD20	AE5540	12341PE0000	JN562	1276424	NA581
1163679013	CN306	1215154020	JJ150	12251PM3003	BR540	12341PH3000	JN649	12764247	NA581
116550117601	NA5066	1215187103	JJ435	12251PM5000	BR540	12341PH4000	JN605	1276425	NA581
116760150800	DK570	1215187702	JJ126	12251PM5S01	BV350	12341PH7000	JN633	12764254	NA581
116760150802	BK570	1218027	NF634	12251PM5S02	BV350	12341PK2000	JN649	12857000	NF694
11676015080200	BK570	12180279	NF634	12251PM7003	BS880	12341PK2010	JN649	1288544	HR646
116760150803	BK580	1219287	NA5147	12251-POA-004	BV830	12341PM3000	JN679	12A14	JM302
11676015080300	BK580	1219337	NA5147	12251PR7A010M1	AG7860	12341PM6000	JN744	12A190	AF070
116760150804	BK570	1220025	JM5153	12251PT0004	BS700	12341PM7000	JN925	12G2230	AF470
11676015080400	BK570	122060150801	BP260	12251-PWA-J01	AG9180	12341P08000	JN857	12G2625	JR264
116760150805	BP260	12210PD2003	PA528	12251PY3003	BV090	12341-POA-000	JN918	12G293	AF070
11676015080500	BP260	12210PD2004	PA528	12251RBDE01	AH5660	12341-PR3-000	HM5228	1302345	AC5940
116760150806	BK580	12210PJ7004	PA969	12251RBDE010	AH5660	12341PT0000	JN755	1304201M00	NJ288
116760150806	JC928	12210PM7004	PB156	12251RNAA02	AH5760	12341PT2000	JN860	1304216A05	NJ285
11676015080600	BK580	12210PT2004	PB353	12252RBDE004	AH5661	12341-PWA-000	HM5275	1304216V00	NJ765
116760160100	JC928	12210PZ1004	PB355	12253RBDE004	AH5662	12341-RNA-A01	JM7083	1304218000	NJ022
1167601704	JD025	12211689003	PA313	12254RBDE004	AH5663	1234920380	JE5026	1304242L00	NJ765
1167601704003	JD025	12211689013	PA313	12255RBDE004	AH5664	1235994	JM7034	1304273000	NJ045
116760179903	JF123	12211PD2004	PA529	12261PY3003	BV100	1238067	NA5031	13042A3500	NJ045
116767901000	GK570	12211PE0003	PA531	1227901M00	NJ287	1239900412	HBS149	13042A3510	NJ045
116797901300	DK570	12211PE0004	PA531	1227918000	NJ021	1247478	JD611	13042A8600	NJ045
116850160100	JD018	12211PT2004	PB354	1227918001	NJ021	125065	JH565	13042D0100	NJ285
117017901300	CN306	12211PZ1004	PB356	1227918010	NJ021	1250941	AA5980	13042D0101	NJ285
117137901300	CN306	12251679004	BJ610	1227921000	NJ056	1253984	AB5133	130455	BP990
117177901300	DH854	12251679014	BJ610	1227921010	NJ056	12551P5TG00	BZ440	1305949	AG9560
11761711717	JE5074	12251679024	BJ610	1227942L00	NJ287	12551P5TG10	BZ450	1306333	NA5016
11896985004	NF036	12251P08004	BV020	1227943G00	NJ829	12551P5TG20	BZ460	13063334	NA5016
119000117600	NF637	12251P13004	BV340	1227953J10	NJ284	1256130	AA5950	13063417	HBS174
119000150701	JN807	12251P14A02	BV030	1227976200	LV501	1256146	AA5940	1306630	HR641
119000150901	JN808	12251P1K000	AG7900	12279A4600	NJ056	1256149	AA5960	1306630	HR801
119001727703	NB792	12251P1K003	AG7900	12279C8600	LV501	1257113	NB716	1306630	PB180
119468	NJ255	12251P1KE01	AG7900	12279D0100	NJ284	12571139	NB716	13066303	HR641
1198045	NA5013	12251P2J004	BV020	12279D0100	NJ284	1257174	JC152	1308385	AE5320
119972247	NB978	12251-P8A-A01	AG9170	12279H1000	NJ021	12571741	JC152	1311285	HR5111
1200310181	NB975	12251-PAA-A02	AG5780	12279R4600	NJ056	1257221	NA5001	1311318	NA5318
12014726	NP068	12251PBYJ01	AG7870	12279R4601	NJ056	12572210	NA5001	1311913000	JC420
12015120	NP068	12251PE0003	BM990	12279R4610	NJ056	1257257	BG940	1311913001	JC420
12032063	DK570	12251PE0004	BM990	12279R4611	NJ056	12572574	BG940	1311960A00	JC868
120607	KA606	12251PE0010	BM990	12279T7200	NJ287	1257264	JD310	1311969G00	JD5994
12060700	KA606	12251PE0013	BM990	12279T7201	NJ287	12589346	AH6380	1311973000	JC420
120613	KA525	12251PE0023	BM990	12279T7202	NJ287	12589366	JD5867	1311973001	JC420
12061300	KA525	12251PE3003	BM990	12279V1700	NJ287	12667135	JE248	1311977E00	JD5929
120623	KA606	12251PE3004	BM990	1228836	HC5004	1266796	JC440	1311982000	JC532
12062300	KA606	12251PE3014	BM990	1229267	HBS369	12667960	JC440	13119-85C10	JD5770
120646	KA611	12251PE0004	BM990	1229474	AG8310	12667961	JC440	131510403	KV086
1206655	HR5063	12251PE0010	BM990	1229872	AD5220	126907123	JM848	131512408	KV102
1206A4	KA611	12251PH4003	BN450	1229877	AD5130	1271483	JN302	1315154	JJ538
1207615	NC086	12251PH7003	BP640	1229880	AD5160	12714838	JN302	1316639	NA5190
1207619	NB785	12251PH7004	BP640	123 050 00 67	HL196	12714978	AG5270	1316801M00	NJ951
1209970346	NB973	12251PK1660	BS110	1231144	NA5130	1271699	JA5044	13177613	HBS175
1211161	LK5004	12251PK1661	BS110	12328679000	JN404	12716999	JA5044	1317772	HR646
1211759	LK5005	12251PK1662	BS110	12328679003	JN404	1273501	HR596	13177720	HR599

INTERCHANGE OE → PAYEN

Vergleichsliste OE → Payen • Références croisées 1ère Monte → Payen
Intercambio OE → Payen • Intercambio entre equipo original y Payen

OE reference	▲ Payen	OE reference	▲ Payen	OE reference	▲ Payen	OE reference	▲ Payen	OE reference	▲ Payen
13177720	HR646	132708H300	JM5267	13510H1000	NJ022	1403540F00	JC901	1432109	JH5050
1319177	JM7092	13270-99B00	JM5281	13510H1001	NJ022	140354M500	JD5977	1432478	EW802
1319178	NA5310	13270-9C601	JM5282	13510H1010	NJ022	1403553J00	JD134	1432874	KK5484
131951	NF692	13270AA000	JN611	13510R2000	NJ267	1403570J16	JD135	1433463	AC5640
1319733	AH5680	13270-AD200	JM5137	13510V7200	NJ765	1403570J20	JD134	1433467	AC5650
1320160120	AH6000	13270C6800	JN597	1351410080	JD6031	1403574Y00	JD093	1433473	AC5350
1320742L00	PA933	13270C8600	JN597	1351420280	JD5905	1403584A00	JC869	1433477	AC5360
1320753Y00	PB681	13270C8610	JN597	1352017	NA5030	1403599B002	JC875	1436760	JM5096
1320753Y10	PB681	13270D4200	JN653	1360589	JD5998	140359F600	JD5977	1436761	JM5097
1320770J05	HR767	13270D4210	JN654	1366786	JA5040	140359F610	JD5977	1436822	CC5900
1320770J15	HR768	13270G2500	JM086	1366787	JA5039	14035-AD200	JD6028	1437237	JJ611
1320776200	KJ452	13270H1000	JM008	1367767	JM7094	14035C8701	JC710	1437343	JM5098
1320776201	KJ452	13270H1010	JM008	1369851 (x20)	HR5113	14035D0100	JC317	1437384	JD5858
1320776203	KJ452	13270M0100	JN494	1370373	AG8320	14035D2000	JC605	1438209	AH850
1320777A10	PB071	13270V5000	JN570	1378217	JB917	14035H8901	JC214	1438210	AH860
1320781W00	PA933	13270V7210	JN837	13782172	JB917	14035KA000	JC967	1439570	NA5099
13207D0100	HR5112	1327653Y00	NJ207	1378218	JE248	14035KA040	JC967	1451231	JA769
13207D0100	PA079	1327653Y10	NJ207	13782180	JE248	14035M000	JC140	1469973000	JE735
13207D0101	HR5112	1327653Y11	NJ207	1378475	BX090	14035N3200	JB776	1469973001	JE735
13207D0101	PA079	1328017	BW680	13784756	BX090	14035V5202	JC581	1470910	HR630
13207D0111	HR5112	13280177	BW680	1378645	BD070	1403601B25	JC459	1470910	HR631
13207D0111	PA079	1328018	BW690	13786454	BD070	1403601B26	JC459	1470910	PB180
13207D4200	PA874	13280185	BW690	1378646	BK640	1403601M03	JC745	1471525	AH7150
13207KA000	PA655	1328019	BW700	13786462	BK640	1403602	JC475	1471557	AH6430
13207KA001	PA655	13280193	BW700	13788526	JD346	1403640F00	JC900	1472928	JA770
13207V1700	PA378	13294KA060	JN681	1378854	JD345	1403643G00	JC806	1472929	JA768
1321041	DF106	13294KA061	JN681	13788542	JD345	1403653Y00	JD091	1474550	HR630
13211KA000	PA656	1332644	BK640	1378864	JJ065	1403670J01	JC760	1474550	HR631
13211KA001	PA656	13326442	BK640	13788641	JJ065	1403671J00	JC761	1474550	PB180
132176	BE620	13367537	JN635	1378870	JN635	1403671J05	JC761	1477466	AB5300
132241	BE620	1338179	JD5987	13788708	JN635	1403677A00	JC870	1477467	AB5310
13238800	BF170	1338204	KT738	1378879	JC440	1403699B00	JC876	1477470	AB5320
13262399	HBS175	133910	LC292	13788799	JB926	14036-AD200	JD6029	1477472	AB5330
1326381	JD5865	133924	PB259	13788799	JC440	14036-AD210	JD6029	1477473	AB5340
13266408	JN279	1340160120	AH7130	1378909	JN279	14036D4200	JC788	1477474	AB5350
1327001B02	JN840	1341420280	JD5871	13789094	JN279	14036W0401	JC133	1481472	NA576
1327001E00	JN624	134697	JD565	13971330	HBS052	14036W7060	JC133	1481478	NA576
1327001M00	JN494	1348683	AH5731	1397727	AA5630	14037V5000	JC472	1483200	HC285
1327001M01	JN665	1348686	AH5732	13977272	AA5630	14038KA050	JC700	1485838	JM5119
1327005E02	JN722	1348688	AH5733	1397728	AY260	14140-52G00	JD5769	1486852	HR630
1327016A00	JN528	135 053 00 58	HR5048	13977285	AY260	1414060A10	JC867	1486852	HR631
1327016A01	JN528	1350160021	JM7124	13H150	NA584	1414060A20	JC867	1486852	PB180
1327018001	JM008	1350607	NA5192	13H2934	NA584	1414067D03	JD5933	1486853	HR630
1327030R00	JN743	1350608	NA5191	13H4061	NA473	14140-69G00	JD5965	1486853	HR631
13270-31V10	JM7037	1351001M00	NJ286	13H6516	NA473	1414073000	JC222	1486853	PB180
1327043601	JN724	1351016A00	NJ280	13H6517	NA473	1414073001	JC222	1487220	HR5061
1327051J10	JN838	1351016V10	NJ280	14009V5201	JD152	1414078100	JC242	1487221	JH5051
1327053J01	JN798	1351018000	NJ022	1403071J05	JC761	1414079100	JC242	1487226 (x10)	HBS496
1327053J02	JN798	1351018V10	NJ280	14032-AX600	JD5841	1414079200	JC222	1490506	HR630
1327053J05	JN798	1351019V00	NJ765	1403501	JC317	1414079200	JD097	1490506	HR631
1327053J13	JN830	1351040F00	NK106	1403501B25	JC460	1414083000	JC641	1490506	PB180
1327056E00	JN653	1351043G00	NJ831	1403501B26	JC460	1414083010	JC641	1490525	HR630
1327056E10	JN654	1351053J10	NK106	1403502	JC605	1414164B00	JC861	1490525	HR631
13270-57J01	JM5138	1351077A05	NJ765	1403510W00	JC580	1418382601	JF046	1490525	PB180
1327057Y10	JN829	1351077A10	NJ765	1403510W01	JC580	1427825	DY571	1492228	HC285
1327057Y20	JN829	13510D0100	NJ280	1403511M25	HA371	143204202	HBS160	1492244	NA5140

OE reference	▲ Payen	OE reference	▲ Payen	OE reference	▲ Payen	OE reference	▲ Payen	OE reference	▲ Payen
1516570010	NJ963	1606239	CG9590	1606653	EB950	1612203	BP890	1660180080	JM5163
1521100	JA769	1606247	CH5030	1606663	EK482	1612205	BP900	1661400134	JD5135
1521106	JA769	1606248	EH5030	1606664	DP820	1612206	BP900	1661400234	JD5135
1524546	HC285	1606250	CG9581	1606665	EW870	1612236	NF387	1661410080	JD5804
1525251	HR630	1606254	CD5840	1606668	ET820	161253115	JE160	1662772	ET191
1525251	HR631	1606278	CH5031	1606669	DM381	161253115A	JE160	1662936	BT190
1525251	PB180	1606295	DY300	1606670	DK480	1620378	HR630	1662937	BT200
1528222	HR633	1606318	DN010	1606672	DP802	1620378	HR631	1662938	BT210
1538348	AH7120	1606322	DN041	1606673	DP800	1620378	PB180	1663389	JD264
1538349; 8A666051BB	AH7000	1606328	DN041	1606674	DL550	162060150800	BK570	1663390	HBS031
1540074	JM875	1606353	DY271	1606674	DL551	162060150801	BP260	1663394	JN950
154020970400	JD015	1606365	CB5241	1606675	DN041	162060150802	BK580	1663814	NB959
155253115	JE5076	1606380	DY232	1606676	DK470	1620861	HR659	1663822	NB958
1565558	JE719	1606381	CY211	1606679	EK470	1626168	JN620	1665138	JJ463
1568734	JB799	1606382	CC5460	1606681	DK471	1626328	BN470	1665145	GT190
1568834	HR630	1606399	EB5670	1606683	EK485	1634647	NB564	1665146	ET190
1568834	HR631	1606455	CD5820	1606686	EK484	1635583	DT193	1665147	DT193
1568834	PB180	1606460	HC417	1606687	DS720	1635583	HR659	1669254	NA5177
1576410	PA229	1606463	CB5140	1606688	ES720	1635942	JJ334	1669785	HR5030
1576414	JN245	1606464	EB5140	1606689	DP802	1639237	BN150	1669785	HR599
1576433	KJ647	1606501	EK481	1606697	DS260	1639420	BN470	1669794	AA5430
1576433	PA349	1606511	DK470	1606701	DW170	1640200	PA349	1669798	JM5030
1576433#	KJ647	1606511	GK470	1606719	EK481	164046	JB841	1669970246	NA5109
1576449	JB842	1606512	DK470	1606720	EJ161	16406015080001	DK570	16744200	NF694
1576837	JC364	1606528	ET820	1606728	EC040	1641037	JN815	1684287	NA5030
1579537	HR633	1606529	EK470	1606728	EK484	1641890	NF780	17055PLD004	JD6035
1583656	JC365	1606530	EJ161	1606728	ES260	1641893	NB788	17055PNA004	JD5384
1596529	HR630	1606532	EJ160	1606729	DP803	1644642	DT193	17065804	HR599
1596529	HR631	1606535	CH5241	1606730	DS261	1644647	HR660	17067073	HR599
1596529	PB180	1606537	CH5240	1606750	DY260	1644647	HR801	170912	JE5044
16 06 823	DP823	1606559	DK480	1606762	DY231	1644647	PB180	170915	JE189
1600160120	AC5660	1606560	EK470	1606767	EY280	1644898	JD5268	170920	JE5069
1600160320	AG8990	1606570	DM381	1606769	DY241	1646401	BP900	170921	JE5071
1601420280	JD5205	1606575	EK486	1606770	DY250	1646402	BP890	170923	JE5070
1606034	CY210	1606576	EK470	1606774	DY250	1646403	HBS015	170933	JE5072
1606057	EB5671	1606584	DK480	1606787	EC102	1646404	HBS015	1709593	JR5031
1606076	DY253	1606585	DM381	1606790	EY230	1646405	HBS015	171009	JE647
1606077	EC101	1606586	DL550	1606819	DL012	1649205	BJ440	17100900	JE647
1606078	CG9580	1606586	DL551	1606820	CY220	1649205	BX480	171032	JE145
1606093	CB5141	1606587	DK470	1606834	EC130	1651474	JN662	17103200	JE145
1606094	CB5240	1606595	ET820	1606835	EC230	1651532	HR631	171045	JE189
1606095	CE5920	1606596	EB5240	1606880	DY270	1651532	PB180	17104500	JE189
1606096	EB5360	1606602	DN042	1606881	DY271	1651564	JD028	171058	JE189
1606097	CB5360	1606604	DK470	1606912	DP806	1651565	JD028	17105P00T01	JD051
1606126	EC102	1606615	DK471	1606914	DY240	1651775	JN332	17105P08004	JD075
1606127	DY255	1606617	EK482	1606915	EC040	1651865	JJ456	17105PH3000	JC652
1606130	CB5540	1606618	EK484	1606919	DY251	1653964	JJ455	17105PL2000	JC791
1606167	CB5141	1606619	DP820	1606923	EY230	1653965	HBS001	17105PL2003	JC791
1606169	CB5240	1606626	EK470	1606924	HC5007	1653965	HBS006	17105PM3003	JC863
1606170	EB5541	1606630	CY811	1606953	DY254	1657016	BT110	17105P08004	JD075
1606171	CG9570	1606639	ES720	1606953	DY255	1657620	JN620	17105PT2004	JC883
1606172	EG9570	1606640	EK470	1606993	DY251	166 050 00 58	HR5097	17105-PWA-007	JD5838
1606184	HC295	1606640	ES260	1606999	DY251	166 140 02 34	JD5135	17105RBDE01	JD5989
1606221	CE5930	1606641	DS260	1609970146	NA5118	1660100014	NA5107	17105RNAA01	JD5985
1606228	HC288	1606646	EK485	1609970246	NA5118	1660160120	AB5550	171099	LT634
1606230	HC417	1606651	EK484	1611351	JE719	1660160220	AB5570	1712309	CB5660

INTERCHANGE OE → PAYEN

Vergleichsliste OE → Payen • Références croisées 1ère Monte → Payen
Intercambio OE → Payen • Intercambio entre equipo original y Payen

OE reference	▲ Payen	OE reference	▲ Payen	OE reference	▲ Payen	OE reference	▲ Payen	OE reference	▲ Payen
171253115	JE160	17177-23020	JD5836	18115-P5S-601	JD5749	1972800	GG052	2000574	HBS002
171253117	JE160	1717727010	JD5901	18115PC6000	JC404	1973100	DH890	2000574	HBS050
1712981	EB5660	17177-28010	JD5170	18115PC6010	JC404	1973600	GJ720	2024152	HBS161
17146-PWA-004	JD5839	17177-28020	JD5973	18115PH3000	JC688	1973700	DJ720	2024153	HBS161
17171-OR010	JD6004	1717735010	JC215	18115PH7003	JC687	1974100	DL650	2030100	BG450
1717115020	JC880	1717735011	JC215	18115PK2000	JC688	19749	GM310	2030200	BG170
1717115030	JD175	1717735020	JC215	18115-PLC-J01	JD5240	1974900	GM310	20459855	HR801
1717116030	JC879	1717735021	JC215	18115PM3003	JC674	1975000	DG052	20459855	PB180
1717116040	JC879	1717735021N	JC215	18115PNB003	JD6045	1975100	DM530	20489	HBS260
1717122030	JD5243	1717735030	JC215	18115PNB0031	JD6045	1975400	DL650	20496	HBS272
1717213020	JB910	1717735050	JC215	18115P00004	JD052	19790	DL650	20711W7100	JE747
1717213021	JB910	1717742010	JC739	18115PRBA01	JD6045	1980600	DM530	209.CX	AH5731
1717213030	JB910	1717743010	JC277	18115PT0004	JC884	1983000	DM710	2090400	BM530
1717214011	JC116	1717764010	JC576	18115PT3A21	JC885	1983700	DM530	2090600	BL650
1717215010	JC116	1717774010	JC841	18115-PWA-004	JD5840	19850	DM530	2091002F00	FG8060
1717224010	JB910	1717774070	JD194	18115RBDE01	JD5990	1985000	DM530	2091016	PA349
1717224011	JB910	1717788360	JC841	18115RNA004	JD5984	1985300	GG050	2091022ACO	GY735
1717263010	JC402	1717788380	JC841	18116PC6000	JC405	1985400	DG050	2091023A10	FG8040
1717263020	JC402	1717916021	JD5978	18116PC6010	JC405	1990500	DG052	2091026E00	FG8291
1717273010	JC615	172101	LT634	18153PM3003	JF119	1990600	GG052	2091026L00	FH6240
1717300010	JD5846	17210100	LT634	18212671003	JE625	1H0253115	JE5075	2091027C00	FG7910
171730R010	JD5988	17211	LT634	18212SA0003	JE625	1N2G6051A2D	AD5020	2091035	KJ647
1717310020	JC558	1721547	BY560	18212SA7003	JF021	1S4G6K321AA	LK5004	2091037D00	FG5690
1717315010	JC881	17215604	NC015	18212SB2960	JF024	1S4Q6051GA	AB5300	20910-38C01	FF5070
1717315040	JD176	17218103	NC015	18212SB2961	JF024	1S4Q6051GB	AB5300	20920-02B00	CG5360
1717316010	JC579	1722734	BL680	18301711968	JE5019	1S4Q6051HA	AB5310	2092002F00	CG8060
17173-21020	JD5738	172363	JD520	18301728208	JE5019	1S4Q6051HB	AB5310	20920-22A00	DY730
1717322010	JD5160	1723843	JE555	18301728410	JE5019	1S4Q6051JA	AB5320	2092026E00	CG8291
1717323010	JD5837	1726016	JD315	18307540797	JD5428	1S4Q6051JB	AB5320	20920-26L00	CH6240
17173-23010	JD5837	1726617	BT691	18307540798	JE5050	1S4Q6051KA	AB5330	2092027C00	CG7910
1717327010	JD5961	1726623	BT680	18407530606	JD5909	1S4Q6051KB	AB5330	2092037D00	CG5690
1717328010	JD5171	1730217	BS320	18801000	NF692	1S4Q6051LA	AB5340	20920-38C00	CF5070
17173-28010	JD5171	1730226	BL690	1900812	CG01A	1S4Q6051LB	AB5340	2092100	BL650
17173-30020	JD5967	1736317	BX270	1904382	NC048	1S4Q6051MA	AB5350	2092300	BM530
1717335060	JC584	1736318	BX281	1904915	JC055	1S4Q6051MB	AB5350	2092700	BF100
1717342010	JC276	1736319	BX290	1905933	DR073	1S6G6K260AA	JM5155	2092900	BF170
1717343010	JC276	1736340	BX300	1907799	DR073	1S7E6051DC	AC5780	2093000	BG490
1717343020	JC276	1736916	PA5041	1907799	DS381	1S7E6083DC	AC5790	2094700	BN580
1717343030	JC276	1739545	JD608	1907801	DS381	1S7G6013AA	DW642	2095000	BP900
1717343040	JC276	1739849	BZ130	1907802	DS381	1S7G6051AF	AD5220	2095100	BP910
1717354020	JC445	1740982	DY570	1908009	DE588	1S7G6051AG	AC5940	2095300	BP720
1717364020	JC399	1741468	AC5370	1908015	DR073	1S7G6051AG	AD5220	2095500	BP890
1717364030	JC444	1741470	AC5380	191253115F	JE160	1S7G6051BE	AC5940	20958	BL650
1717364050	JC444	1743719	JD243	195100120500	JJ451	1S7G6051BF	AC5940	2095800	BL650
1717365020	JC838	1745187705	JE146	195240351100	JN806	1S7G6051BG	AC5940	20978	BL830
1717374040	JD112	17596900	BG490	195260860100	JD018	1S7G6584AE	JM5158	21011003270	JM077
1717388360	JC842	17779904	BW340	195360351101	JN812	1S7G6700AC	NA5157	21011005155	KT639
1717388380	JC789	17796891	BF100	195510150800	BT350	1S7G6A321AA	LK5005	21011007026	HR363
1717662040	JA5058	179010	JE189	195590970400	JD025	1S7G6A517BG	HR5063	21011007026	HR596
1717673011	JC658	18107502346	JE5012	195610151300	BW280	1S7G6K260AA	JM5153	21011009070	JH881
1717700010	JD5845	18107549447	JE5058	1959975	AC5750	1S7G9441AE	JD5299	210111003020	BH700
1717710010	JC559	18110PG6003	JC674	1959976	AC5760	1W936051AA	AC5510	21011106170	KT446
1717711010	JC559	18111101192	JE555	1959977	AC5770	1W936051AC	AC5510	21011203020	JE390
1717711020	JD085	18111723843	JE555	1962292	HBS432	1W936083AC	AC5500	210119070	JH881
17177-21020	JD5159	18115-P2A-003	JD5748	1972500	GG050	2000021	HBS002	21014V5000	KA675
1717723020	JD5836	18115-P5L-004	JD5750	1972600	GG050	2000021	HBS050	21014V5001	KA675

OE reference	▲ Payen	OE reference	▲ Payen	OE reference	▲ Payen	OE reference	▲ Payen	OE reference	▲ Payen
2103120302001	JE390	2231102760	AG9900	2246996	JM5118	247606	JM350	2757441	HL469
21051009070	JH5183	2231102800	AG8060	2247030	BZ510	2491400	JN244	2757458	DL491
210801003020	BS620	22311-22130	BY730	2247091	JR5022	2491900	JN245	283554A001	JD5960
210801009070	JJ412	22311-23000	AG5070	22472090	PA349	2492500	JN245	2841102500	JD5900
2108100302010	BS620	2231123100	AG8290	2247447	JM5106	2494300	JN292	2841121000	JC122
21081007026	HR805	22311-25012	AH6310	2247498	BZ500	2494500	JN426	2841122020	JD5949
210831003020	BS630	22311-25013	AH6320	2247499	BZ510	2494600	JN544	2841126011	JD5179
210831008081	JC872	2231125211	AH6340	2247500	BZ520	2494800	JN547	2841127000	JD6025
210846602447	DS620	2231126051	AG6040	2247501	DZ661	2495300	JN238	28411-27500	JD5964
210906	NF640	22311-26603	AH6240	2247511	EZ800	2495400	JN658	2841137100	JD5795
210910	HG108	2231127000	AG7920	2247591	JM5076	26109675	HR805	2841137200	JD5795
21091000	HG108	2231127010	AG7930	22478009	PA217	26126699	NF752	2841221000	JC123
210911	LV847	2231127020	AG7940	2247949	JH5033	26126729	NF809	2852102503	JD5899
21091100	LV847	2231137210	BZ280	2248975	EZ660	26126779	NF810	28521-02700	JD6003
210915	NF640	22311-37220	BZ290	2248976	EZ690	266 016 06 20	AG8500	2852121000	JC023
210922	NF640	2231138400	AH5630	2248982	BZ660	266 141 00 80	JD5799	28521-22020	JD5751
21124100809001	JD5950	223114A000	AG9880	2248983	BZ670	266 142 00 80	JD5802	2852126600	JD5983
211261003020	AH5270	223114A010	AG9870	2248984	BZ680	2660160720	AH5000	2852127000	JD6046
2116910	NA784	223114A020	AG9890	2248985	DZ660	270679	EH445	28521-27500	JD5963
2129717	JD281	223114X910	AH6540	2248987	BZ690	2706794	EH445	28521-2A100	JD6032
2129717E	JD281	22321-22000	HBS387	2248988	BZ700	270686	DD072	2865971	JA415
2132047280	NA5330	2232123000	HBS308	2248989	BZ710	2706869	DD072	2866918	BN010
2132142041	NJ251	2232123010	HBS308	2248990	DZ690	270688	DD073	2877490	BN010
2142133114	NJ005	2232127000	HBS382	2249350	DP823	270689	DK643	2888120	JD5979
2142135001	NJ874	22321-2A100 (x10)	HBS525	2249532	NA5105	2706893	DK643	29004708	DS630
2144321000	NJ008	2232137120 (16x)	HBS446	2249533	NA5104	271 016 05 20	AG8790	29105245	NB953
2144321010	NJ006	223214A000	HBS434	2249534	NA5103	2710160320	AG8790	29740682	NB775
2144333004	NJ251	2243781	JD275	231938	NB619	2710160921	JM7026	2992531	FB5721
2145121010	JJ098	2244102400	JM5306	2319382	NB619	27103385	HBS028	2995573	CG7300
21501189	HR801	2244121000	JN317	2337430129	JM7094	2711410880	JD5835	2995608	FB5721
21501189	PB180	22441-22012	JM5277	23540139	AC5320	2711420380	JD5801	2995609	CB5720
217782	NB984	22441-22013	JM5277	23540159	AC5340	271393	HMS293	29986L	JB837
22022072F	AY400	2244126001	HMS261	23614	NF841	2717049	JB917	2A24	JM302
22022073F	AY410	22441-26020	HMS374	2361400	NF841	271734	HA5042	2A689	AF070
22022074F	AY420	2244132010	HMS272	236210	NA5205	2717353	HA5041	2A805	JM302
22022078F	JD5144	2244135000	JN713	24401453	AE5920	271736	HA5040	2A935	AF070
22022080F	AY400	22442-23500 (2x)	HMS374	24401490	JD5399	2720160269 (x16)	HBS511	2A939	NA473
22022081F	AY410	2244328	DW730	24401511	JD5398	2720160720	AG8390	2A971	AF070
22022082F	AY420	2244384	JD274	24403772	JM5121	2720160820	AG8400	2C109448AA	JD5998
22032114F	JD025	2244398	JN955	24403788	JM5071	272395	JD5898	2C109448AB	JD5998
22032145H	JP067	2244568	JD276	24405819	HR5087	2730160820	AG8430	2F3121	NB628
22032152	BK570	22454009R	PA349	24405959	JD5401	2730160920	AG8440	2F3122	NB628
22032152F	BK570	2245426	BZ111	24407477	JD5147	2730E6K600C	NA576	2M5Q6L270AA	NB785
22032153	BP260	2245427	BZ120	24417040	JC824	2743173JA0	NA5204	2N1324	JN234
22032153F	BP260	2245438	JD612	2443291	JD5300	275254	DY362	2R8E6710AA	JH5065
22032154	BK580	2245483	BW730	24440093	JM5235	275580	EH445	2S6G6A321AA	NA5130
22032154F	BK580	2245484	BW740	24454151	HBS253	2755809	EH445	2S6G6A321AA	NA5147
22032185F	BK570	2245599	JP078	24458336	JD5400	275581	EH445	2S6G6D316AA	NA5147
22032186F	BP260	2245686	JM5063	24465791	NA5174	2755817	EH445	2S6G6D321AA	NA5147
22032187F	BK580	2245749	EY280	245291	BG130	27559311	HMS278	2S6Q6051AA	AH6560
22032245G	JP068	2246093	AY270	2452910	BG130	275721	HL469	2S6Q6051BA	AH6570
2206154	NA784	2246174	JD5134	245585	BG120	2757219	HL469	2S6Q6051CA	AH6580
2214421010	NJ242	2246703	EY270	2455855	BG120	275727	EG920	2S6Q6051DA	AH6590
221443B000	NF678	2246704	CY270	247088	JH409	2757276	EG920	2S6Q6051EA	AH6600
2222411000	KJ211	2246944	JD5108	247576	NF763	275743	HL463	2S6Q6700AA	NA5259
2222421010	KJ570	2246945	JD5107	2475762	NF761	2757433	HL463	2S6Q6L270AA	NA5258

INTERCHANGE OE → PAYEN

Vergleichsliste OE → Payen • Références croisées 1ère Monte → Payen
Intercambio OE → Payen • Intercambio entre equipo original y Payen

OE reference	▲ Payen	OE reference	▲ Payen	OE reference	▲ Payen	OE reference	▲ Payen	OE reference	▲ Payen
256U9441AA	JD5227	3210112	BR070	33437930	JN732	3517947	HBS303	40004270	NB818
257Q9448BA	JA5085	321103	HR800	33438611	BS020	3531015	AA5620	40004290	NA784
30003780	HR800	32134611	BH690	3343862	BS010	3531016	BX651	40004300	NB644
3002100	JN238	3214136	BR070	33438623	BS010	3531017	BY361	40004300	NB732
30021L	JN238	3214139	BE580	3343863	BS020	35310176	BY361	40004340	NA5051
30197J	HC341	3214800	HG093	33438631	BL970	3531018	BY371	40004370	NA5052
302087	JH434	322115100	JC140	33438631	BS020	3531207	NA5138	40004400	NA5053
3034022013	HJ013	32449U	HC341	3343864	BS030	3531326	JE248	40004450	NB730
3042600	JJ283	32638	BG120	33438649	BS030	35313261	JE248	40004750	NA5177
30430K	JB836	3267244	NF634	3344044	DL916	3547615	JC152	40004930	NA5187
30637066	AE5560	32672446	NF634	33440447	DL916	35476159	JC152	40005010	NB825
30637067	AG8320	32674939	DH696	33440504	DL916	3547852	JC261	40100070	NP067
30637336	AE5140	3267783	HC354	33442617	HR569	3656963	JD5926	40100080	NP068
30711613	AG9560	32677832	HC354	33443037	BL910	366303	NB619	40100311	NF833
30731261	AE5260	32705139	DH693	33443136	JD409	372412	NB775	40100314	NF833
30731262	AE5270	3277158	NF722	3383442	BL910	38314S	BF100	40100320	NP067
30731263	AE5280	32771583	NF722	34022013	HJ013	38333V	BF170	40100320	NP068
30731264	AE5290	3277432	BT080	34062353	AF070	3901836	AG7810	40100321	NP068
30731265	AE5300	32774325	BT080	34129277	JD602	3901840	AG7820	40100324	NP068
30757227	NA5191	3277433	BH690	3448125	NB691	39066353	AF470	40100330	NP067
30757227	NA5192	32844375	JB997	3448943	JN521	39066363	AF470	40100330	NP068
30873424	JM5232	3285200	NF692	3449977446	NB978	3922601	AC5880	40100331	NP067
30874279	JD6039	328520	NF692	3452604	BX080	3940202	JC365	40100331	NP068
30874307	NF678	3287347	BH690	34526046	HR080	39403920	NB866	40100334	NP067
30874405	AE5610	32873473	BH690	3456314	NB469	3C106051AA	AA5940	40100340	NP068
30875138	JD5372	3287542	NF851	34659680	JD409	3C106051BA	AA5950	40101524	NF886
30875194	JD6039	32875429	NF850	34666172	JD419	3M5Q 6L004AA	HA5030	4010395	KH007
30875617	JM5290	3287555	BL970	34676056	BX600	3M5Q 6L004BA	HA5031	4028565	AC5870
30875618	JM5291	32875551	BL970	3490300	JB841	3M5Q6700BC	NA5191	406307	JC365
3101036	JN248	32875551	BS020	3490600	JB842	3M5Q6700BC	NA5192	4097111	JD5931
31010366	JN248	3287710	EL960	34908	JB842	3N1123	BF040	4100576	KD226
31010366	JN600	32877102	EL960	3490800	JB842	3N266700A4A	NA5147	4109133	KV122
3101048	JB851	3287961	BL960	3492300	JB875	3S4G6051BA	AG8310	411197206	FG5920
31010481	JB851	32879611	BL960	3493200	JB954	3S706051BA	AA5980	411605500	JJ389
3102768	KJ647	32879611	BS010	34934	JC091	3S706700AA	NA5031	411605600	JJ389
3104301	JE648	3287962	BL980	3493400	JC091	3S706710AA	HC5004	411607000	JJ134
31043011	JE648	32879629	BL980	3494600	JB869	40000040	NA784	4117850	JM333
310620315	HR800	32879629	BS030	3494700	JC423	40000160	NA5045	412305400	BL280
310620353	HR800	32978850	JB851	3494900	JC415	40003300	NA5045	412305500	BL280
31064346	JM302	3310075	AF070	3495900	JC415	40003300	NB728	412305600	BL280
31164	HR599	3310671	BL390	3501775	HR805	40003460	HR730	412305700	BL280
3121.26	NF826	3310742	BR510	35017755	HR805	40003630	NP068	412306102	BP730
3121.27	NA5205	3310865	BY340	3507025	JJ551	40003634	NP068	412306112	BP730
3121.27	NF836	33111C6200	NJ450	35070259	JJ551	40003637	NP068	412306202	BP730
31211106220	NF036	3314488	BP290	3507033	JC146	40003640	NP068	412307202	BG740
31212634108	NF036	33420621	DL910	35070333	JC146	40003650	NP067	412307212	BG740
312127	NF836	3342088	BL910	3507074	JA5042	40003657	NP067	412307222	BG740
312146	NA5204	33420886	BL910	3507309	NA5149	40003760	NA5062	412605500	JN729
312147	NA5204	33424029	JD409	3509977746	NB775	40003850	NF833	412607000	JN368
31216200	AH7150	3342917	JH5011	35103609	JJ184	40003990	NA5049	412777000	KJ462
31302	KJ647	33429176	JH5011	3514521	BK640	40004000	NA5050	4127971	JC973
3131106100	NJ042	33430547	BX080	3517860	HR599	40004000	NA784	4129204	AC5780
3131106101	NJ042	33434309	BL960	35178607	HR646	40004190	NB814	4129205	AC5790
3150300080	NB984	33434317	BL970	3517893	HR5060	40004200	NB815	4129763	KT639
31964346	JM302	33434325	BL980	3517893	HR599	40004250	NB742	4139726	JH5065
3210061	BE580	3343793	JN732	35178938	HR800	40004260	NB825	4142114	NA784

OE reference	▲ Payen	OE reference	▲ Payen	OE reference	▲ Payen	OE reference	▲ Payen	OE reference	▲ Payen
4145587	JM333	4369825	JD019	4501060	HBS164	46432087	JP063	46475574	HBS297
4147260	JE390	4370933	HR596	4502167	JH5052	46432735	JD150	46477509	JF184
4151277	JA757	4379220	BP190	4502789	GX392	46434102	BV670	46480910	JA752
4151468	KV122	4379970	BD790	4503102	JD5926	46434591	NA5058	46513955	JM5176
4153728	PB180	4387346	BP060	4503983	NC006	46434596	BY380	46514710	HA5005
4163738	JM077	4387623	BP190	4506016	NF860	46434691	KV122	46514722	HA5005
4174016	JH5065	4394109	JN459	4552600	AC5780	46435513	NF888	46525557	JD226
4177112	JA757	4403519	NF860	4585202	AD5610	46436047	HR599	46526271	JA5006
4179038	JH494	4403536	CE5210	458600	EW630	46437256	JP064	46527523	JD225
4179085	JN805	4403864	EE5220	4607627	KV927	46437440	JD580	46529117	BZ790
4179112	JA757	4403866	EE5220	463224	JB926	46440885	HR800	46529118	BZ800
4179138	LR922	4403867	AE5210	4632246	JB926	46442435	AY550	46529119	BZ810
4179155	KA293	4404240	HBS373	463412	BD070	46442436	AY560	46539824	LK5001
4179809	JD5930	4404512	BP060	4634127	BD070	46442437	AY570	46541379	BP290
4180964	KT639	4404985	NA5187	4634127	JN635	46444964	BD790	46546120	AE5240
4181043	KT446	4405405	LT498	463587	JJ065	46444964	BT860	46548441	JM5003
4181046	KV122	4407095	BD790	4635876	JJ065	46447765	AY520	46548450	JA5008
4192740	KA295	4408006	JM5086	463846	JB917	46449944	AY530	46548459	JA5011
4192860	JH881	441054073726	AX220	4638466	JB917	46449945	AY540	46549807	AA5590
4193959	KA294	441054074216	BT580	463999	JN279	46451593	AC5140	46552427	KK5001
4194300	BP030	441054074406	BT580	4639993	JN279	46451593	BV680	46552748	JM5028
4195130	JM663	441054151716	HR599	46402972	AY430	46451594	AC5150	46554619	JD5155
4197026	HR641	4411018 (16x)	HBS392	46402972J	AY430	46451594	BV690	46556651	HR5088
4216787	BP030	4415053	HBS492	46404034	NA5057	46451595	AC5180	46641908	HR800
422215400	JC967	4424154	JN669	46404094	NA5057	46451595	BV700	4667156	NF886
422215500	JC967	4428157	KD717	46410505	JD340	46451596	AC5160	46737936	JC738
4227446	LR922	4428391	LT023	46410880	JD342	46451596	BW980	46739135	AA5780
4249510	JJ078	4431654	BP110	46410890	JD342	46452670	BT320	46739136	AA5790
4249510	JJ440	4432544	KD726	46410891	JD342	46454063	BY410	46739137	AA5800
4249516	JR556	4434864	BP110	46410891	JD343	46454064	BE450	46739261	JM5029
42531636	NP067	4434865	BP110	46410960	BX030	46454065	BY430	46743167	HR5095
42531636	NP068	4434903	BP050	46412116	JD5143	46457491	KL476	46744434	KL476
4258405	JM663	4436580	JC738	46414221	BT320	46460125	NF888	46749904	AA5560
4265701	HR599	444409	BP110	46414437	JD228	46461755	JD467	46749905	AA5570
4271052	JE480	4444408	BP110	46414438	JD343	46461883	BW340	46749906	AA5580
4279427	KL221	4444409	BP110	46414567	AY460	46461884	BW350	46752127	AB5150
4279436	JC054	4444450	BP110	46414567	BR630	46461885	BW360	46754320	JD148
4279438	JC055	4446715	JJ136	46416034	BT320	46462481	BT260	46757318	JD150
4279457	KL221	4446952	NB730	46416876	NF887	46462772	JC738	46757321	JD464
4279599	KA546	4448165	LT439	46420638	HBS130	46464114	JM5018	46757609	JD465
428449300	BH680	4448401	BP110	46425904	JD464	46465291	JF145	46759989	JM5019
4291098	BP190	4448677	JM663	46425908	JD465	46467203	JN973	46764762	HBS371
430118	NA869	4460810	BG830	46426046	JD148	46467746	JD228	46767211	AD5970
4301180	NA869	4464012	KG393	46426755	AY320	46467747	JD468	46771926	AD5840
430132	NA581	4464457	LT439	46427653	JD343	46468413	AA5720	46771927	AD5850
4306719	JM674	4467264	AC5780	46430687	HBS051	46468413	BW340	46771928	AD5860
4309031	JD146	4467939	BP050	46430688	HBS051	46468414	AA5730	46772389	JA5035
431253115A	JE689	4467996	BJ860	46431639	BV680	46468415	AA5740	46772390	JA5036
432 253 115 A	JE689	4467997	BJ870	46431640	BR690	46470334	HR814	46774976	AD5960
4323221000	NJ106	4467998	BJ880	46431640	BT230	46473174	BE440	46811291	JA5035
4323710	JN283	4468200	BP050	46431640	BV690	46473175	BE450	46814120	JM5176
4330005	BP190	4469751	HBS051	46431641	BV700	46473175	BY420	46814174	JM7055
4331606	JH111	4469752	HBS051	46431642	BR700	46473176	BE460	46814175	JM7117
433253115	JE138	4469883	BP110	46431642	BT240	46473176	BY430	46817515	AD5800
4357028	HR599	44892M	JB836	46431642	BV700	46473336	AY460	46817516	AD5810
4358946	NB732	4501060	HBS054	46431642	BW980	46475573	HBS297	46817517	AD5820

INTERCHANGE OE → PAYEN

Vergleichsliste OE → Payen • Références croisées 1ère Monte → Payen
Intercambio OE → Payen • Intercambio entre equipo original y Payen

OE reference	▲ Payen	OE reference	▲ Payen	OE reference	▲ Payen	OE reference	▲ Payen	OE reference	▲ Payen
46820225	JD5143	497123013	GR561	500383472	AB5730	5012980	JM077	5020123	DX480
469336	NB854	497123051HS	DL280	500383473	AB5740	5012994	JN283	5020274	DT510
4694216	AC5580	497123057	GP730	500387067	AB5720	5012995	JN297	5020402	DN471
4694216B	AC5580	497123057HS	DP730	500387068	AB5730	5012999	JM333	5020844	DT110
4694217	AC5590	497123058	GP731	500387069	AB5740	5013001	JN244	5020866	DT482
4694217B	AC5590	497123059HS	DR560	500391047	AY700	5013002	JN248	5023360	DJ444
4696011	JN911	4F126065AB (16x)	HBS392	5004856	DC240	5013007	JN238	5023478	DG050
4697094	AN350	4H236051AC	AD5600	5004857	DC240	5013009	JM663	5026563	DC240
4706862	LS859	4H236083AC	AD5610	5006393	HC452	5013010	JM986	5026592	JB799
4708883	AH6620	4M5G6K292CB	NA5310	5010033	GG050	5013012	JN232	5026593	BC240
47097	BX740	4S7Q6K292AB	NA5318	5010035	HC346	5013013	JM848	5027040	CH865
4710881	JR580	5000296030	DS381	5010036	DG050	5013014	JM850	5027041	CH864
4716458	NP067	5000560823	NB928	5010037	DH890	5013019	JN273	5027042	HC285
4716750	NP068	5000815434	NP067	5010173	DL401	5013020	JM302	5028398	EG340
4720740	EG9690	5000815434	NP068	5010956	DC240	5013021	JM025	5028399	DT110
4722674	LS856	5000815452	BR070	5010958	DC240	5013022	JM008	5028400	DC240
4731124	BE580	5001000786	NA784	5011844	DM940	5013025	JN068	5028414	DW630
4732165	LS856	5001000816	NA784	5012613	CH854	5013028	JN317	5028414	DW635
4738019	JN462	5001000816	NP068	5012614	CH864	5013030	JN365	5028414	DW640
4741124	BE580	5001001151	NF833	5012615	DN140	5013031	JN292	5028415	DW631
4741822	BE580	5001001215	HBS011	5012797	DC270	5013032	JN285	5028415	DW641
4770290	BY270	5001001216	HBS011	5012819	DH681	5013033	JN454	5028415	DW650
4770293	BY270	5001001231	BE580	5012820	DM530	5013034	JN356	5028415	DW655
4770764	JD5204	5001001234	JN462	5012830	DL570	5013037	JN299	5028416	EW630
4773487	BY270	5001001254	NP067	5012839	DM710	5013044	JN459	5028466	EH850
4777071	AC5550	5001001283	JC054	5012847	DP190	5013047	JN368	5028468	CH864
4798966AC	CC5550	5001001288	KA546	5012850	DC790	5013058	JN513	5028468	DN150
4804888	AH5690	5001823706	BR070	5012851	DC800	5013062	JN462	5028469	CH865
4804889	AH5700	5001829815	AY590	5012853	DG871	5013064	JN344	5028484	EA441
4804890	AH5710	5001829882	JN594	5012865	CJ271	5013068	JN533	5028484	EM940
4804896	AH6380	5001836510	GX410	5012871	DP011	5013070	JN562	5028485	DP790
4804952	JD5867	5001836511	DX391	5012877	DP110	5013071	JN576	502855	DX550
4805331	JM7115	5001836513	DX390	5012878	DJ420	5013076	JM053	5028550	EX550
4828150	HBS011	5001853924	NP067	5012879	DJ430	5013077	JN396	5028552	DX550
4830224	HR602	5002397	DC240	5012882	DD631	5013081	HL474	5028553	DX550
4832015	BR090	5002398	HC355	5012890	DN010	5013179	BG830	5028555	DY640
4834948	JF123	500306170	AY680	5012900	DH693	5013180	BL010	5028583	ET490
48364N	BF170	500306171	AY690	5012901	DH683	5013181	BL020	5028596	JC364
4837051	AB5100	500306172	AY700	5012904	DK640	5013182	BL030	5028781	BW010
4837141	JC055	500314225	NF883	5012922	DJ690	5013293	DN150	5028782	BW020
4837300	KV927	500315684	NF885	5012923	DK440	5013294	CH864	5028783	BW030
4837347	DS381	500316112	JJ613	5012924	DD502	5013627AA	AC5570	5031032	EW630
4837349	DS381	500317403	JN956	5012925	DK480	5013820	EH752	504014155	NA5202
4844484	KA546	500327440	JH5178	5012927	DM530	5013820	HC452	504017372	JJ613
4846584	JR580	500350049	NA5201	5012929	DK470	5013872AA	CC5580	504018307	JH5077
4848254	BR090	500354411	CY680	5012930	DL010	5014127AC	AC5550	504019494	JM5201
4851923	KV927	500366171	GX390	5012931	DM381	5014173AC	AC5560	504022754	JD5981
4854648	HBS011	500366181	DX400	5012933	DK611	5014257	DL402	504031409	NF885
4854648	HBS255	500366511	GX390	5012936	DM840	5016204	DP790	504034832	NF885
4862154	NF886	500366528	DX391	5012942	DJ852	5016204	DY740	504037859	JD5338
4897383AA	JD5876	500369188	KK5599	5012947	DG811	5016206	DJ442	504049360	FB5722
490525	PB180	500369482	FV691	5012952	CF073	5016720	DT510	504049362	CB5720
494262	EM850	500369483	CY680	5012954	CF474	5016759	BP890	504052452	JM5202
4971230001HS	DG740	500376626	JD5337	5012968	CH865	5016760	BP900	504059361	NF883
497123001	GG740	500378462	KK5598	5012969	DC240	5016761	BP890	504093499	AG6060
497123005	GP731	500383471	AB5720	5012977	JN279	5016762	BP900	504093500	AG6050

OE reference	▲ Payen	OE reference	▲ Payen	OE reference	▲ Payen	OE reference	▲ Payen	OE reference	▲ Payen
504093501	AG7300	546841	JH409	55195892	AD5840	5607437	AY920	5850616	JC437
504123772	NA5202	5469955	HR340	55195910	AD5850	5607438	AB5010	5850623	JD5256
50471	AY061	5477994N	GF044	55195911	AD5860	5607439	AB5020	5850624	JD5149
5094005027	HBS285	5478690	BF040	55197283	AD5830	5607440	AB5030	5850637	JC824
5096250220	NJ267	5487062	GF492	55197598	JM5204	5607442	JM5159	5850638	JD5347
5096250280	NJ266	5491223	JB833	55197682	JD5375	5607443	AY160	5850644	JD5300
5096250360	NJ265	5491225	JB864	55198843	AD5800	5607444	AY170	5850653 part A	JD5869
5096250531	NJ321	5493998	BG450	55198844	AD5810	5607445	AY180	5850653 Part B	JD5870
5096250532	NJ321	5494183	BG540	55198845	AD5820	5607448	AB5240	5850667	JD5400
5096250790	NJ014	549772	BF040	55199355	JD5375	5607459	AG5090	5850671	JD5336
5096250830	NJ266	55 565 954	AH7170	55200890	AD5840	5607463	AE5920	5850672	JD5333
51015100145	NB928	55 565 955	AH7180	55200891	AG7390	5607467	JM5071	5850673	JD5412
51015100150	NB928	55 565 956	AH7190	55201694	AD5850	5607474	AG9580	5850674	JD5411
51015100197	NB928	5500387068	AB5730	55201695	AD5860	5607512	JM7102	5850796	JD5904
51015100199	NB928	5500387069	AB5740	55202010	AG7400	5607593	JM5235	5850858	JD5223
51015106002	NB928	5500449	JN234	55202011	AG7440	5607815	JM5198	5850862	JD5196
51015106004	NB928	550421303	JJ126	55202800	AG7310	5607816	AE5520	5854981	JE5065
5111410040	BX040	550621303	JN415	55206232	AH6510	5607817	AE5530	5854987	JE5066
5111410300	BX040	550621305	JN415	552142160	HBS465	5607818	AE5540	5858607	JD457
5111410570	BX040	551169	JN238	55221093	AH6880	5607820	AG9810	5878101702	GM370
5111410671	BM370	5513006	BG450	55221094	AH6890	5607821	AG9820	5878102042	DM330
5111410821	BM370	5514849	DT013	55351605	JD5256	5607822	AG9770	5878102580	DM330
5111410830	BX040	55180937	NA5230	55353885	AC5460	5607823	AG9780	5878102581	DM330
5111730170	JN408	55183371	AG7380	55354237	JM7103	5607837	AH5030	5878102582	DM330
5113670040	JH016	55184024	AG6220	55355235	NA5327	5607838	AE5950	5878103192	GP920
5113670460	JJ192	55184740	AG7410	5542219	BG540	5607839	AD5800	5878103200	GP921
5120058	JM5028	55184741	AG7420	5546438	GG541	5607840	AD5810	5878103201	GP921
5125690060	PA418	55184742	AG7430	55560688	JM7102	5607841	AD5820	5878103202	GP921
5141460180	JC643	55185775	AD5830	55561181	JR5030	5607842	JM5259	5878103203	GP921
5142000	NF634	55186663	KK5646	55568529	EH5240	5607843	AG7390	5878103204	GP921
5142900	NF692	55187650	AD5970	5569124	GG541	5607845	AG7400	5878103211	DP920
51435	NF780	55187704	AD5870	558132	BM850	5607847	AG7440	5878103212	DP920
517615	JM154	55187705	AD5960	56 07 430	AY410	5607863	AE5930	5878103213	DP920
52177600	CC5630	55187899	AD5800	56 07 431	AY420	5607864	AE5920	5878103214	DP920
53006695	JM7050	55187900	AD5810	56 07 451	HBS419	5607872	AE5520	5878103215	DP920
53020490	AG9690	55187901	AD5820	56 07 819	AG9800	5607875	AD5840	5878103240	DR200
533253115C	JF205	55189864	AE5240	56 07 824	AG9790	5607876	AD5850	5878103241	DR200
535554	BM850	55189950	AE5240	5606427	BY250	5607877	AD5860	5878103242	DR200
5403212	HR340	55189962	AA5420	5606449	BY250	5607895	AH5240	5878103423	GP921
54041	DY070	55189997	NA5321	5607058	AB5140	5607937	HBS252	5878103433	GP920
5412007	HR340	55190350	AD5840	5607180	HM5300	5607937	HBS253	5878103442	DP920
5412579F	JN234	55190351	AD5850	5607405	JN955	5607942	HM5370	5878103590	GS435
5414228	JB868	55190352	AD5860	5607406	BZ111	5607948	HBS502	5878104560	GR990
5414228E	JB868	55190353	AD5910	5607407	BZ120	5607949	HBS502	5878105792	GR990
5414415	BF040	55190354	AD5920	5607408	BP800	5607980	JM7103	5878106481	GR990
5414415C	BF040	55190355	AD5930	5607409	BY250	5614844	NA5327	5-87810-979-0	CG5500
5414415M	BF040	55190356	AG7390	5607410	AY210	562645	HR659	58800958	DD790
5440081R	GF492	55190357	AG7400	5607422	AB5670	563145	BL650	5880416	GP011
5449772C	BF040	55190358	AG7440	5607423	AB5680	5850075	JD5737	5880417	DP011
5449772M01	BF040	55190359	AA5780	5607425	BS260	5850345	JD5982	5880639	CG01A
5450155R	JN253	55190360	AA5790	5607432	AY160	5850607	JD457	5880858	GD671
5451440H	GF044	55190361	AA5800	5607432	BY330	5850609	JD5269	5880858	GD790
5452930	JB869	55192265	HBS353	5607433	AY170	5850612	JD445	5880860	DD790
5452930D	JB869	55192551	AY320	5607434	AY180	5850613	JD444	5880948	BD790
5463048	GF051	55193766	KA5032	5607435	AY900	5850614	JD276	5880957	GD790
5463048G	GF051	55194045	JM5176	5607436	AY910	5850615	JD445	5880958	DD790

INTERCHANGE OE → PAYEN

Vergleichsliste OE → Payen • Références croisées 1ère Monte → Payen
Intercambio OE → Payen • Intercambio entre equipo original y Payen

OE reference	▲ Payen	OE reference	▲ Payen	OE reference	▲ Payen	OE reference	▲ Payen	OE reference	▲ Payen
5881122	DP110	5888941	HJ283	5890655	DP689	5891308	BT410	5891915	DP293
5881172	DP051	5888989	DT410	5890657	DT446	5891321	JE480	5891916	GT446
5881189	DG811	5888992	GT410	5890658	GT446	5891342	GR611	5891921	DP190
5881251	HJ274	5889087	GT400	5890664	DT446	5891343	DR611	5891924	DP292
5881252	HJ279	5889095	DT443	5890665	GT446	5891633	DR480	5891927	DD790
5881256	HJ271	5889117	GT423	5890670	DT446	5891634	GR480	5891928	DP190
5881360	DJ872	5889118	DT423	5890671	GT446	5891657	GT260	5891929	DD790
5881650	DP110	5889160	DT420	5890672	GT423	5891658	DT260	5891930	DP293
5881652	DJ851	5889162	DT413	5890673	DT423	5891780	BP520	5891933	DG811
5881692	GK590	5889163	DP688	5890674	DT446	5891781	BP030	5891934	DJ872
5881821	HJ274	5889165	DT411	5890676	DT413	5891791	BD790	5891935	DP293
5881923	DR073	5889175	DP689	5890678	DT420	5891795	GP011	5891936	DP051
5881945	DG811	5889180	DT420	5890681	GT446	5891796	DP011	5891937	DJ851
5881970	GJ852	5889186	DP273	5890683	DT441	5891798	GR480	5891937	DP293
5881971	DJ852	5889190	GR611	5890683	DT442	5891801	GK590	5891940	DT420
5882026	GK590	5889191	DR611	5890684	DT441	5891804	GD790	5891943	DG811
5882038	GP051	5889193	DS570	5890685	GT441	5891806	G0671	5891945	DV680
5882039	DP051	5889194	GR611	5890690	DT410	5891806	GD790	5891949	DP051
5882040	GP051	5889195	DR611	5890691	GT410	5891818	GK590	5891950	DP051
5882041	DP051	5890228	DT441	5890692	DT440	5891819	DR480	5891953	DT413
5882049	DV680	5890229	GT441	5890693	GT446	5891825	GT270	5891955	DP292
5882086	HJ280	5890312	DT440	5890694	GV680	5891827	DE588	5891957	DT420
5882265	DR610	5890323	GT410	5890695	DV680	5891828	GJ852	5891972	DE588
5882305	HJ279	5890455	DT446	5890696	GV680	5891829	DJ852	5891973	DT411
5882328	DT413	5890456	GT446	5890699	DT290	5891831	GK590	5891980	GT410
5882343	HC027	5890457	DT446	5890703	GV680	5891839	DP292	5891981	DP689
5882358	GV680	5890458	GT446	5890704	DV680	5891840	GP051	5891983	DP689
5882461	DP688	5890459	GT440	5890739	DS381	5891841	GP051	5891987	DT413
5882567	DP660	5890461	GT446	5890764	GP282	5891850	DT290	5891989	DT410
5882568	GP660	5890467	DT446	5890825	DP292	5891854	DR610	5891990	GT410
5882634	DR100	5890468	GT446	5890851	DT446	5891857	DP688	5891992	GT400
5882669	GP861	5890469	DT446	5890981	DT270	5891859	DP660	5892007	DT440
5882674	DP860	5890470	GT446	5890982	GT270	5891860	GP660	5892007	DT446
5882781	GP871	5890471	DT446	5891200	LB414	5891862	DR100	5892008	GT446
5882782	DP871	5890473	DT446	5891203	JN568	5891864	DP860	5892009	DT440
5882900	GK590	5890474	GT446	5891205	JA752	5891866	GV680	5892009	DT446
5888178	DR480	5890475	DT446	5891206	JE480	5891871	GP871	5892010	GT446
5888179	GR480	5890476	GT446	5891207	JE390	5891872	DP871	5892011	DT440
5888217	GP282	5890480	DT446	5891213	JD146	5891879	DP292	5892011	DT446
5888241	DR610	5890481	GT446	5891220	JD021	5891881	GT300	5892012	GT446
5888261	GR620	5890483	GT446	5891227	KL221	5891882	DT300	5892013	DT440
5888262	DR620	5890524	DP293	5891273	BP190	5891891	DT443	5892014	GT446
5888318	GR630	5890584	DT440	5891276	BP110	5891893	DT420	5892015	DT446
5888319	DR630	5890584	DT446	5891277	BP050	5891895	DP688	5892016	GT446
5888447	DP292	5890585	GT446	5891279	BP110	5891902	GR611	5892341	DT440
5888526	DP689	5890586	DT446	5891282	BE580	5891903	DR611	5892341	DT446
5888534	GT300	5890587	GT446	5891284	BR090	5891905	DS570	5892342	GT446
5888535	DT300	5890640	GP282	5891287	BD790	5891906	GR611	5892343	GT423
5888591	DT441	5890642	GP282	5891289	BP290	5891907	DR611	5892344	DT423
5888632	DV680	5890643	GT400	5891292	BP060	5891909	GT440	5892345	DT446
5888634	DT290	5890645	GR620	5891293	BP060	5891909	GT446	5892347	DT420
5888652	BP520	5890646	DR620	5891298	BG830	5891910	DT440	5892349	DT446
5888654	BP060	5890649	GR630	5891300	BR070	5891910	DT446	5892350	GT446
5888657	BP110	5890650	DR630	5891302	BR090	5891911	GT446	5892351	GT441
5888664	BP190	5890651	GP861	5891303	BP520	5891912	DT446	5892352	DT441
5888940	HJ282	5890653	DP689	5891307	BT420	5891913	GT446	5892353	DT441

OE reference	▲ Payen	OE reference	▲ Payen	OE reference	▲ Payen	OE reference	▲ Payen	OE reference	▲ Payen
5892353	DT449	5893004	DT446	5949822	OK627	6 763 409	JA769	602512	JM483
5892354	GT441	5893005	GT446	5950597	HR5094	600-001130	DT580	602828510	BW410
5892367	GJ852	5893177	DP292	5950662	AG9770	6000057304	JN369	6030107320	DY601
5892368	DJ852	5893282	DR632	5950670	AG9780	6000057315	JN369	6030140822	JJ500
5892369	DP660	5893329	DT440	5950704	AG9810	6001000550	JN369	6030160221	JN851
5892370	GP660	5893329	DT449	5950712	AG9820	6001040367	BX620	6030160321	JN852
5892371	DP860	5893330	GT440	5950720 (x8)	HBS502	6010100180	EM720	6030163220	BT550
5892374	DP871	5893400	DT441	5950738 (x8)	HBS502	6010100280	DT540	6031064346	JM302
5892376	GP282	5893400	DT448	5951664	BP290	6010103320	DT541	6031164303	NA473
5892377	DT400	5893560	GT442	5951683	BJ850	6010103620	DW370	6031420080	JD301
5892378	GR630	5893658	GP285	5951859	BP060	6010104805	EM720	6033901	BC240
5892379	DR630	5893660	GV670	5953970	BJ850	6010104820	DW370	6034062353	AF070
5892380	GP861	5893662	GV671	5955570	HR5072	6010104820	DW373	6034305	NB564
5892381	DP861	5893692	GT401	5956115	FG9770	6010140222	JJ498	6035115	JN105
5892382	GP282	5893693	DT401	5959226	JJ298	6010160320	BT540	6035121	JB862
5892385	GP011	5893767	DT441	5960083	AE5060	6010160420	BT540	6036603	JC364
5892386	DP011	5893767	DT447	5960967	BP060	6010160421	JN572	6039066353	AF470
5892389	GD790	5893768	GT447	5960968	BP060	6010160521	JN619	6039100	HR633
5892391	GD790	5893773	DT441	5960970	LS859	6010160621	JN572	6039900110	HBS058
5892397	GP051	5893774	GT441	5962711	AC5140	6010160721	JN619	6039900110	HBS059
5892398	GP051	5893776	GT442	5962711	BT220	6010161920	BT540	6039900110	HBS060
5892400	DR610	5893811	JC723	5962712	BT230	6010162320	BW370	6039900210	HBS058
5892404	DS570	5893816	JN426	5962713	BT240	6010162520	BW370	6039900210	HBS059
5892405	GR611	5893819	KD726	5962714	AC5140	6010162920	BT540	6039900210	HBS060
5892406	DR611	5893843	HJ291	5962714	BT220	6010163320	BW370	6039900210	HBS061
5892407	GT260	5894257	DR630	5962715	BT230	6011410280	JD158	6039900210	HBS062
5892408	DT260	5894257	DR631	5962716	BT240	6011410580	JD158	6039900210	HBS063
5892409	GT400	5894379	DM533	596842	BM530	6011420280	JD159	6039900310	HBS058
5892410	GR620	5894503	DP294	5970285	BP280	6011840580	KK5683	6039900310	HBS059
5892411	DR620	5894575	BR090	5980056	JN568	6020100080	EN720	6039900310	HBS060
5892412	GP871	5894789	DS381	5984010	BT410	6020104220	DW380	6039900310	HBS061
5892413	GR611	5894834	KA845	5984039	BP280	6020105505	EN720	6039900310	HBS062
5892414	DR611	5894837	DW320	5984080	JR673	6020106720	DW380	6039900310	HBS063
5892415	GT270	5894838	GW321	5984092	BG830	6020107520	DW381	6040100620	DZ860
5892416	DT270	5894974	BV940	5994226	JN667	6020140322	JJ543	6040100805	HC5005
5892419	DT290	5895002	GW341	599609	JM875	6020160121	JN621	6040140022	JJ498
5892420	GT300	5895003	DW340	5997192	LV589	6020160221	JN622	6040160420	BZ860
5892421	DT300	5895156	GW711	5997543	BP300	6020160321	JN621	6040500058	HR791
5892422	GV680	5895243	DW720	59979047	NB975	6020160420	BN720	6040500158	HR5056
5892423	DV680	5895244	GW724	599891	JN279	6020162220	BW380	6040689	BC240
5892424	GV680	5895398	DW281	5999103	BP290	6020162320	BW380	6041410160	JD475
5892427	DT290	5895398	DW282	5C1Q6051AA	AA5940	6020162420	BW380	6041420280	JD5225
5892431	DP273	5895399	GW281	5C1Q6051BA	AA5950	6020162620	BN720	6050100605	EY590
5892434	DE588	5895399	GW282	5C1Q6051CA	AA5960	6020163020	BN720	6050101220	DY590
5892436	DP273	5895540	DT448	5H2E6700AA	NA5190	6020163120	BN720	6050102420	DZ870
5892438	DP273	5895644	DX040	5S439448AB	JE5037	6020163520	BW380	6050140022	JJ543
5892439	GR100	5895645	GX041	5S7Q6051AA	AA5970	6020163920	BW380	6050140122	JJ543
5892440	DR100	5895663	DX030	5S7Q6051CA	AA5990	6020500058	HR758	6050160221	JP022
5892441	GJ872	5895664	GX030	6 07 859	AH7170	602087	JH434	6050160420	BY590
5892454	KD717	59 50 688	AG9790	6 07 860	AH7180	6021410080	JD299	6050160520	BZ870
5892672	DT441	59 50 696	AG9800	6 07 861	AH7190	6021410280	JD298	6050160720	BZ870
5892673	GT441	5921087	BP290	6 165 502	NB848	6021410680	JD298	60502831	NA5063
5892678	DT752	5928264	BP060	6 42 533	PA5041	6021410780	JD298	60502891	NA5063
5893002	DT440	5930415	HR596	6 52 600	JJ536	6021410880	JD298	60502913	NA5064
5893002	DT449	5932825	LV583	6 535 949	HR631	6021420080	JD299	60502984	JA899
5893003	GT440	5945253	JN426	6 535 949	PB180	602216	JB894	60503075	JH565

INTERCHANGE OE → PAYEN

Vergleichsliste OE → Payen • Références croisées 1ère Monte → Payen
Intercambio OE → Payen • Intercambio entre equipo original y Payen

OE reference	▲ Payen	OE reference	▲ Payen	OE reference	▲ Payen	OE reference	▲ Payen	OE reference	▲ Payen
60503075	JJ450	60535949	PB180	60596115	BW710	607208	HBS416	607472	BY340
60503078	KV124	605359490	PB180	60596116	BW720	607234	HBS112	607473	BY260
605030780	KV124	60542965	JN810	6060101305	EY580	607237	HBS160	607491	AY220
60503099	AN350	60544360	KV102	6060101320	DY580	607238	HBS160	607492	JM5197
6050313	NA5065	60546397	JD565	6060140022	JJ500	607242	HBS002	607494	HM5300
60503131	NA5065	60548448	BT340	6060160120	BY580	607242	HBS050	607499	JM5121
60503303	JN588	60548495	HR800	6060160221	JM5157	607248	HBS035	60750004	DT420
60503304	JA899	60548751	BT380	6060160320	BY580	60724921	BH850	60750006	DT420
60503916	JR349	60549557	BP990	60602071	AY640	607256	HBS054	60750597	DE622
60504851	JD221	60552577	BW410	60603436	NA5069	607256	HBS164	60750651	DE622
6050500058	HR816	60558500	JD018	6060500058	HR5062	60725751	DH854	60750652	CN353
6050500058	HR822	60558505	JD235	6060500158	HR5057	60727820	CN306	60755016	BE620
6050500158	HR804	60560701	NA5066	60605898	BK580	60728351	DH854	60755077	GT340
60505485	BE620	60560702	NA5066	60605899	BP260	607296	HBS252	607626	BK470
60505488	BE620	60560916	BT350	60605900	BK570	607296	HBS253	607630	JM950
60507000	JE696	60563670	JD224	60607218	HL700	6073070	KT738	607631	JN777
60507020	JE696	60563671	JD222	60607219	HL700	60732778	DK570	607642	HM5294
60507102	NA5066	60565962	BT350	60607745	AY610	60732780	DK570	607643	JM950
60507107	NA5066	60565962	BW410	60608122	AY620	60732780	GK570	607645	HM5294
605071070	NA5066	60566395	BW280	60608894	AY500	60733096	GK570	607646	JP016
60507155	BK570	60566396	BW290	60608894	BW720	60733352	JD018	607647	JP016
60507156	BP260	60567019	AN300	60608895	BW710	60734690	CN306	607653	JD5204
60507157	BK580	605670190	AN300	60609156	BW410	60735201	DH854	607655	JN245
605071720	JC928	60567020	BH850	60609159	JN940	60735218	BH850	607664	JN041
60507557	HR800	60568808	JN814	60609978	JP070	607400	BR101	607666	JM956
60507652	JD025	60568809	JN813	60609979	JP071	607401	BK470	607668	JN521
60507653	JF123	60570141	JD221	60611531	JD273	607402	BR030	607670	JN068
60509396	HR280	60570141	JH565	60611545	JD466	607407	AB5540	607672	JN523
60512669	NA5066	60570141	JJ450	6061410080	JD478	607410	AB5360	607685	HBS053
60512948	JN808	60570142	JJ450	60616864	BY390	607410	BM380	607686	HBS074
60512949	JN807	60570351	BT390	60616867	HBS262	607411	BL550	607749	JM5085
60513181	JD222	60570352	BT380	60619673	BY390	607413	BM380	60777054	DT350
60513311	JN812	60570617	NJ951	60621381	JD466	607414	BL550	60777058	GT350
60513316	JN812	60572819	HBS108	60630269	JD224	60741414	DT350	60777062	DH854
60513350	KV086	60572819	HBS160	60654310	NF888	607415	BK470	60777068	GH858
60513358	KV086	60572819	HBS163	60655592	JM5002	607416	BP800	60777105	GT340
60513428	BT350	60572821	HBS108	60655830	NF888	607417	BR010	60777118	DE623
60513869	JD586	60572821	HBS160	60659190	AA5420	607418	BR020	60777155	GW280
6051420080	JD476	60572821	HBS163	6065962	JE719	607419	BR030	60777156	DW280
60514910	BP990	60572823	HBS108	60659746	JD466	607420	BR020	60777313	GH858
60514910	BT360	60572823	HBS160	60659747	JD271	607423	BN010	60777319	DH854
60515501	KD383	60572823	HBS163	60659758	AA5420	607430	BN040	60777321	DT350
60515502	JR349	60573536	JD587	6066331	NB645	607431	BP810	60777615	DW410
60515780	NA5066	60581645	AN350	6066335	NB847	607432	BP820	60777616	GW410
60515781	NA5066	60581846	AN350	60664260	JA5007	607443	BR030	60777692	KV124
60515793	JA829	6058294	AH850	60664642	AA5420	607444	BR010	60777695	JD221
60518068	BT360	60583721	JP067	60665425	HBS262	607445	BN010	60777697	JE696
60523	JN811	60583742	JC928	60667293	JM5024	607446	BR020	60777724	DT443
60523241	BH850	60584488	AY630	60667294	JM5023	607449	BS260	60777747	JN588
60525029	JD014	60586217	HL701	60667495	AA5420	607451	BN040	60777771	CN306
60525316	JN811	60589234	BK570	60671874	AD5870	607458	BL010	60777775	CN306
60525822	BT340	60591809	BP990	60677983	AD5950	607459	BL020	60777776	CN306
60534406	HR815	60591810	BE620	607 493	AY400	607460	BL030	60777780	CN306
60534664	JN806	60591811	BE620	607034	AY850	607464	BY330	60777781	CN306
60534705	JD018	60591812	BP990	607098	EG914	607466	BY350	60777790	DT420
60535949	HR801	60593329	BT360	60711523	AN300	607471	BJ170	60777792	DT420

OE reference	▲ Payen	OE reference	▲ Payen	OE reference	▲ Payen	OE reference	▲ Payen	OE reference	▲ Payen
60777795	GT340	607974	AY840	60813258	JP071	6088343	BJ440	6131420380	JE5032
60777797	GT350	607975	AY860	60813259	JP070	6088344	HBS001	6131420480	JE5032
60777939	DK570	607980	AB5030	60813744	JD468	6090129	AH860	6132755	JN332
60777939	GK570	607981	JN521	60813760	BT380	6092063	AH850	6132943	BJ440
60777953	DH854	607983	BS720	60814219	AC5140	6093964	HBS008	6132957	JN620
60777955	CN306	607985	BN040	60814219	BV680	6094666	JN460	6134416	JJ458
60777957	DH854	607986	BP810	60814220	AC5150	6104534	JM875	6134416	JN594
60777959	DH854	607987	BP820	60814221	AC5180	610704	NB469	6134622	JE719
60777967	CN353	607988	BP800	60814222	AC5160	610705	NB469	6134623	JE719
60777968	DE622	607988	DP800	60814374	NF888	610706	NB469	6135090	NB785
60777970	DE622	607989	BL550	60814599	AY520	6107901	BJ440	6135093	NB786
60777971	CN353	607990	BK470	60814600	AY530	611 010 01 74	NA5074	6136076	BJ440
60777982	DE623	607991	BM380	60814601	AY540	6110100114	NA5074	6136909	BJ440
60777984	GW280	607992	BK480	60814602	JP063	6110100605	EC5620	6137531	JE719
60777991	GH858	607994	BT530	60814607	JD580	6110104520	CC5620	6139049	NA576
60777997	DH854	607995	BL010	6081461	JN332	6110140222	JH5082	6140090	JJ348
60777999	DT350	607996	BL020	60814724	CY550	6110160121	HM5170	6140310	BN140
60778001	DW280	607997	BL030	60814725	FY550	6110160520	AC5620	6140740	BL400
60778051	DR040	607998	BW170	60814952	JP064	6110160620	AC5620	6140741	BL410
60778115	GW281	60805104	JC662	60814966	AY550	6110161020	AC5620	6141655	JC364
60778116	DW280	60805718	NA5053	60814967	AY560	6110940080	JD5378	6141810	JJ334
60778116	DW281	60805835	HR800	60814968	AY570	6110980380	JD5379	6141835	BM950
60778154	DH854	60806695	BT440	60814969	CY520	6111410180	JD5377	6141836	BM950
60778156	DH854	60807143	JD153	60814970	FY520	6111420780	JD5380	6141837	BM960
60778158	DH854	60807357	HBS092	60815726	JC738	6112010180	KA5035	6141838	BM980
60778161	CN353	60807621	HBS093	60815877	KL476	6112010280	KA5036	6141839	BM980
60778162	DE622	60808412	JN808	60816179	JA5035	6112201	NB788	6143745	JC790
60778164	DE622	60808430	JN807	60816183	JA5036	611409	NB291	6144784	JJ334
60778165	CN353	60808640	BR680	60816184	FY550	61164304	NA473	6145436	JE5020
60778175	DE623	60808640	BV680	60816185	CY550	6119900322	HBS292	6147047	HR660
60778177	GH858	60808641	BV690	60816186	FY520	6119900322	HBS293	6147047	PB180
60778181	DH854	60808642	BW980	60816187	CY520	6119900322	HBS294	6147502	BN150
60778234	GK572	60808659	JN459	60816190	AA5420	6120101405	ED5720	6147503	AH860
60778235	DK570	60809643	BV680	60816233	AA5560	6120101820	CD5720	614805	NB690
60778236	GK570	60809644	BV690	60816234	AA5570	6120160020	AD5720	614808	NB691
60778236	GK572	60809645	BW980	60816235	AA5580	6120160021	JM7028	614809	NB469
60778459	GK572	60809849	NA5053	60816385	JM5028	6120160320	AD5720	614810	NB469
60778648	DT443	60810586	BT390	60816423	AA5420	6120500058	HR5055	614811	NB698
60778648	DT448	60810669	HR800	60816451	FA5560	6120500058	HR5085	614812	NB469
60778765	DT340	60811349	JD271	60816452	FA5560	6121410180	JD5797	614813	NB701
60778967	DK573	60811572	HR800	60816453	CA5560	6121420380	JD5798	614814	NB691
60778968	GK573	60811872	HR800	60816562	AA5780	6121888	JC565	614815	NB469
60778969	GK573	60811964	NA5187	60816563	AA5790	6121889	JE5022	614816	EB950
6078809	NB645	60812121	AC5140	60816564	AA5800	6123003	BM950	614816	NB690
6078810	NB847	60812121	BV680	60816595	CA5780	6123004	BM950	614817	NB701
6078814	JC829	60812122	AC5150	608632	BY270	6123005	BM950	614818	NB691
607923	HBS298	60812122	BV690	6087166	BJ440	6123006	BM950	614819	NB806
607939	HBS036	60812123	AC5180	6087639	KA606	6123007	BM960	614820	NB698
607952	HBS074	60812123	BV700	608804	AB5030	6123008	BM960	614821	NB698
607960	HBS055	60812124	AC5160	608805	AB5010	6123009	BM980	614822	NJ450
607966	BL020	60812124	BW980	608806	AB5020	6123010	BM980	614825	NK103
6079676	JC365	60812490	BW720	608807	BY270	6123011	BM980	614826	NB690
6079678	JC364	60812729	JD273	608809	BY240	6123012	BM980	614827	EC230
607971	BJ170	60812985	KL476	608810	AY220	6130580	EN260	614827	NB700
607972	JN923	60813045	JC738	608814	BY300	6131024	BC240	614827	NB806
607973	BV950	60813241	AY640	608815	BY260	6131025	BC240	6148286	AH860

INTERCHANGE OE → PAYEN

Vergleichsliste OE → Payen • Références croisées 1ère Monte → Payen
Intercambio OE → Payen • Intercambio entre equipo original y Payen

OE reference	▲ Payen	OE reference	▲ Payen	OE reference	▲ Payen	OE reference	▲ Payen	OE reference	▲ Payen
614829	NB806	6170160820	BC800	638177	JM5092	642529	PA619	652590	JJ200
614830	NB698	6171420780	JD297	6381786	JR5029	642530	HR336	652593	JJ459
614838	NB431	6172130	JD542	638181	NB628	642530	PA619	652594	JH5019
614855	NA5209	6173218	DT800	638182	BT530	642531	PA658	652596	JH5058
614860	NA5230	6173339	JD009	638186	NB628	642533	DY241	652598	JJ508
6150160080	JM848	6173340	HA497	638187	NB628	642533	PA5041	652599	JJ459
6151420580	JB162	6174264	AH860	638192	JN693	642540	HR280	652601	JH5019
6153084	JN616	6175355	BT190	638194	NB807	642542	HR5096	652602	JJ574
6154456	JN620	6175356	BT200	638196	NA5069	6460160520	AD5720	652604	JH5119
6155561	BT520	6175860390	DC800	638198	JR5030	6460161920	AH6450	652605	JH5057
6155565	BT510	6175915	NB984	638199	NA5108	6460162020	AH6470	652610	JH5037
6155577	JN662	6176006	BP910	638225	JR5030	6460162120	AH6460	652611	JH5005
6155579	NA5177	6176471	NB645	638252	JN924	6461420080	KB5050	652613	JH5036
6156076	DM940	6176471	NB959	638260	JN929	6461884	BW350	652614	JH5078
6157016	DT110	6176472	NB847	638265	JP009	646260	NC065	652634	JJ572
6159538	BP890	6176727	BT140	638266	JP008	646262	NB697	6526341	AB5800
6159539	BP900	6176775	BT140	638269	NF637	646263	NB700	6526342	AB5810
6159540	BP890	6178334	JD188	638287	JR5030	646265	NB700	6526343	AB5820
6159541	BP900	6179100	BT210	638644	JN344	646266	NB734	652635	JJ616
6159900112	HBS045	6179489	NC044	638646	JN453	646266	NF834	652636	JJ617
6159900212	HBS045	6179653	JD543	638646	JN693	646267	NB697	652665	JH5052
6159900212	HBS047	6180424	JD309	638648	JN626	646268	NA5271	652669	JJ575
6159900312	HBS045	6180425	JD310	638649	JN693	646269	NB884	652672	JH5096
6159900312	HBS046	6180638	JN817	638720	JN626	646270	NB697	6531620	BT481
6159984	BN150	6182957	NB856	638721	JN693	646271	NB884	6535949	HR660
6160100380	EC790	6182959	NB855	638725	JN693	646289	NB700	6535949	HR801
6160105221	GC790	6182960	NB854	638727	JN626	646299	NA5174	6535949	PB180
6160105506	EC790	6184406	HBS050	638733	JP018	646904	KK5646	6558046	HBS032
6160105606	EC797	6185177	BT520	638736	JP009	646910	NA5223	6561911213	KJ647
6160140122	JH683	6185178	BT520	638737	JP008	6470140022	JJ543	6581669	BY640
6160160920	BC790	6185181	BT510	638741	JM5048	6470160121	HMS274	6591016	JC790
6160161220	BC790	6185182	BT510	638742	JM5059	6470160620	AD5720	6591017	JC829
6160161420	BC790	6185881	JN816	640 016 03 21	JM7027	6474024	BT190	6600100030	JM5162
6160161520	BC790	6188592	JC724	640 016 07 20	AG8501	6474025	BT200	6600160020	AC5670
6160162020	BC790	6189298	BT110	640 098 06 80	JD5800	6474026	BT210	6601420080	JD5206
6163883	HR661	6190943	GT190	640 142 05 80	JD5803	6480160320	AG8490	6606019	CH5242
6165498	NA5177	6190948	NC044	6400160321	HM5286	6491460	JN620	6608692	JA769
6165499	NB645	6191988	JJ457	642 533	PA5041	6498578	JJ457	6614762	NA576
6165499	NB959	6192141	BT481	6420162120	AH5020	6503561 (4x)	HBS391	6656422	HBS006
6165500	NB645	6193087	JJ484	6420162220	AH5010	6504060 (x16)	HBS503	6663814	NB645
6165500	NB959	6193676	JD066	6421420080	JD5902	6505239AA (10x)	HBS496	6663814	NB959
6165502	NB847	6195424	JJ458	6421421280	JE5067	651 016 04 69	HBS534	6669767	JD265
6165860390	GC790	6198560	AH860	6421421380	JE5068	6518302	BT800	6674302	HR661
6165860490	DC790	620 280	DX800	642500	HR5048	652 666	JJ573	6678475	BT481
6165860990	DC790	6201251	JM5027	642500	PA5025	652261	JJ615	6678476	BT481
6165861290	DC790	6201251	JN821	642504	HR5088	652274	JJ615	6680160120	AB5560
6166108	JJ348	62103384 (x10)	HBS499	642518	HR336	6523435	HR661	6680160221	JM5165
6166499	HBS032	628188	NB628	642519	HR291	652575	JH5080	6680160421	JM5164
6166533	HR655	6306910	DF106	642520	HR336	652576	JH5079	6680980065	JD5834
6167440	BC240	636836	NC006	642524	HR343	652577	JH5005	6681420380	JD5136
6169448	JD240	636838	DY241	642525	HR343	652577	JJ120	6689713	ET800
6170100380	EC791	636838	NC006	642526	HR343	652582	JJ120	6689714	ET800
6170101105	EC791	636839	NB807	642527	HR342	652585	JJ200	6689715	DT800
6170160180	JN273	636840	NJ449	642527	PA565	652586	JJ200	6689715	DT802
6170160680	BC800	636841	DY240	642528	PA543	652587	JJ385	6689715	DT806
6170160720	BC800	636841	NC006	642529	HR291	652590	JJ120	6689716	DT801

OE reference	▲ Payen	OE reference	▲ Payen	OE reference	▲ Payen	OE reference	▲ Payen	OE reference	▲ Payen
6689716	DT805	701H6700A1A	NA576	71712891	AA5520	71718365	NF888	71744285	CD5810
6689900122	HBS291	701M6700A1A	NA576	71713031	DX030	71718389	GP286	71744285	FD5810
6707924	HC355	701M6700AA	NA576	71713032	GX030	71718390	DP286	71744286	ED5810
6707927	HC452	702219	BL650	71713041	NF888	71718658	CA5560	71744286	FD5810
6718225	JE248	702246877	JN248	71713629	DY391	71718659	FA5560	71744287	ED5820
67332295	HBS033	702246877	JN600	71713630	GY391	71718738	LK5001	71744287	FD5820
6740296	JD310	7024740	HM5238	71713631	DW722	71718831	HA5005	71744288	CD5820
6751295	JD065	702607235	JE648	71713632	GW722	71718852	CD5970	71744288	FD5820
6755720	BW630	702672445	NF634	71713633	DW712	71718853	FD5970	71744395	AH5240
6765358	JN816	702673237	BH680	71713634	GW712	71719654	CE5181	71744413	JD5982
6772502	BJ440	702677832	HC354	71713675	DW322	71719751	CE5180	71747638	CG7310
6772502	DM940	703328000	KJ647	71713695	DX391	71719779	EA5420	71753175	BT230
6780895	JD264	7048712	NB984	71713696	GX410	71728337	GX410	7181761	JE5021
6780895	JD266	7058058000	HC346	71713723	CY640	71728339	GX392	71HM6013AA	HC285
6782777	BW650	7079275	HBS031	71713724	FY640	71728825	EV684	71HM6013BA	HC285
68004099AA	FG9660	7087348	BX550	71713861	AY470	71728826	EB5150	71HM9441AB	JA769
68010	EG5130	7087349	BY640	71713924	AY500	71728827	EV670	71HM9448AA	JA768
6812072	BP890	70HM6051A1A	AH850	71713956	AY480	71728831	EA5780	71HM9448BA	JA770
6812073	BP900	70HM6051C1A	AH850	71713987	CY680	71728839	EE5180	72TM6571A1A	HR633
6812074	BP910	70HM6051F1A	AH850	71714093	AY510	71728880	EE5242	73001262	NP068
6816643	AH860	70HM6051G1A	AH860	71714142	CY610	71729223	JA5005	7300877	JC055
6822.X0	NA5324	70HM6051GA	AH860	71714142	CY611	71729498	ED5800	7301198	NP067
6838365	KA289	70HM6571A3B	HR655	71714143	FY610	71730147	EA5420	7301262	NP068
6842093	NA869	70HM8507AA	KA289	71714143	FY611	71730148	EA5420	7301481	JN462
68420934	NA869	70HM8507AB	KA289	71714940	DW723	71730149	ED5960	7301683	JJ100
6842160	NA869	710003	PA229	71714941	GW723	71730213	EE5181	7302293	JN594
68421601	NA869	7104290	NA5175	71715110	BV940	71730214	CD5840	7302473	BR070
6842272	NA5138	7114447	BW650	71715130	AE5550	71730404	EE5181	7302624	JN585
68422724	NA5138	7116165	AC5910	71715448	AY460	71732900	CE5181	7303161	DR073
6842273	NA5018	7116166	BX550	71715698	DZ790	71734258	ED5910	7303596	BR090
68422732	NA5016	71198011	EG7800	71715698	GZ790	71734259	CD5910	7334619 / 959M 6584 AA	HM5236
6842274	NA5017	712000740	HBS189	71715699	DZ790	71736222	CD5970	73500063	JM5259
68422740	NA5017	7126483	JD545	71716050	FA5560	71736243	CE5181	73TM6584AA	JM875
6842347	HBS178	71711023	DW721	71716051	CA5560	71736315	CG7381	7402415	CA5431
6842347	HBS185	71711024	GW721	71716583	JA5005	71736913	ED5800	7433517893	HR800
6847748	BW640	71711143	GY411	71716584	JA5005	71737120	GR620	7438610009	DX652
6847749	BW630	71711144	DY410	71716585	JA5005	71737128	DR620	7438610010	EA5620
6850672	JD5333	71711279	DW711	71716684	JA5010	71737153	CD5960	7438610010	EY370
6851355	JD498	71711280	GW711	71716868	DV672	71737163	CY320	744022000	JC132
6909665	JA770	71711493	DW322	71716869	GP286	71737164	FY320	744022010	JC132
69185	DY740	71711517	CY320	71716870	DY383	71739214	JD5868	7484405	BT560
6918548	BY740	71711518	FY320	71716871	GY383	71739933	CE5180	7500713	HR599
6918549	BJ440	71711735	DY390	71717683	CA5420	71739945	CG6220	7500713	HR646
6930966	JD554	71711736	GY390	71717685	CA5420	71739971	CA5561	7500716	HR816
694223	BL410	71711936	DY382	71717833	FY550	71740083	EG7390	7501304	AC5900
6C1Q6051AB	AH6390	71711967	CY640	71717834	CY550	71740084	EG7450	7502346	JE5012
6C1Q6051BB	AH6400	71711968	FY640	71717836	CY520	71740296	CE5241	750521	BK610
6C1Q6051CB	AH6410	71712360	CY520	71717900	CA5421	71740362	DP289	7505217	BK610
6E0253115	JE5036	71712361	FY520	71717901	CA5421	71740655	CG7380	75061982	JM302
6M5G6051AA	AG8320	71712434	CY620	71718011	GX392	71740678	JM7099	7506983	AC5310
7 560 274 (x10)	HBS522	71712435	FY620	71718012	DX392	71740681	NA5057	7508543	AC5920
7008824	JJ531	71712630	AA5550	71718045	CA5590	71740961	CG7410	7508545	CC5920
70103384 (x12)	HBS509	71712830	FY550	71718129	FA5560	71740962	EG7410	7509710	AC5440
701349529	HR300	71712831	CY550	71718130	CA5560	71740964	CG7390	7510241	JJ080
701815	BN200	71712889	CY610	71718142	CB5150	71741374	CE5242	7511535	CC5440
701815	BN530	71712890	FY610	71718333	CA5780	71741916 (x10)	HBS497	75134	DE622

INTERCHANGE OE → PAYEN

Vergleichsliste OE → Payen • Références croisées 1ère Monte → Payen
Intercambio OE → Payen • Intercambio entre equipo original y Payen

OE reference	▲ Payen	OE reference	▲ Payen	OE reference	▲ Payen	OE reference	▲ Payen	OE reference	▲ Payen
7514946	JJ080	7564650	BT220	7625272	JD021	7677631	JC738	7700500971	JB851
7516529	BT560	7564650	BV680	7625273	JD021	7678282	JF150	7700501503	JB851
7518343	HBS179	7564651	BR690	7625500	BT410	7684064	JN948	7700502706	JE648
7518996	JD348	7564651	BT230	7625504	JC662	7688249	BP520	7700509372	NF640
7521859	BK610	7564651	BV690	7628414	JD013	7688450	JN667	7700512723	BF350
752673	BN200	7564652	BT240	7628850	NA5070	7694363	BT260	7700514879	BF350
7533476	BP520	7564652	BV700	7630180	BR680	7694624	BT260	7700517057	NF634
7533479	BP520	7571344	HR5030	7630181	BR690	7696197	HBS052	7700518676	BH680
7533622	NB825	7574959	BT860	7630181	BV690	7698712	JD019	7700519829	BH680
7537664	JC660	7574967	JN643	7630182	BR700	76VB1175BA	NB792	7700522314	NF678
7537684	BP660	7575382	JN928	7630182	BV700	77 01 052 721	AG9790	7700522345	KA533
7539929	BP030	7575386	JD153	7631023	BP520	77 01 052 722	AG9800	7700540568	JB851
7540289	BT420	7575665	BP860	7631024	BP030	77 01 065 098 (x10)	HBS524	7700567327	BH690
7540290	BT410	7579741	BP280	763181	BR690	77 03 087 032	NF775	7700575468	HR658
7540379	BT440	7579742	BP280	7636480	JD022	7700101348	NA5053	7700575994	HR564
7541092	JN587	7580221	BP860	7637103	BP860	7700103245	NA5036	7700579	JD5997
7541250	BT860	7581344	HR599	7638954	JC662	7700103687	JH5108	7700581	JD153
7541251	JN666	7581344	HR646	7640074	BP300	7700103938	PA5013	7700586044	HR564
7541252	JC723	7581344	HR800	7640074	BT400	7700104839	HR599	7700611182	BF350
7541776	BJ860	7581743	HBS052	7640783	BP660	7700105392	AC5070	7700613230	JN248
7541777	BJ870	7582158	HR599	7640784	BP280	7700105393	AC5090	7700614729	JN292
7541778	BJ880	7582245	HMS278	7641616	BJ860	7700105843	JD5910	7700616154	BH680
75452930	JB869	7585003	BK610	7641616	BJ880	7700105852	JD5393	7700619237	NF687
7545293080	JB869	7585037	BK610	7644534	BR620	7700106172	JN997	7700619239	NF648
7545293080A	JB869	7585045	BT560	7645030	BJ850	7700106783	AY720	7700622018	BH680
7545293080B	JB869	7588905	JC694	7646223	JD148	7700107181	JD5394	7700622122	BH950
7545947	BP280	7588940	JC305	7646248	JJ413	770010744	HBS241	7700622286	JB954
75491221	JB868	7589788	BP110	7647596	JJ398	7700107818	BS530	7700638093	NF634
75491223	JB833	7591482	AH6420	7648057	BV670	7700108023	AY710	7700638094	NF634
75491225	JB864	7596552	BT400	7648248	BP520	7700108024	AY730	7700638592	BG170
75491352	JB830	7596614	JN667	7648249	BP520	7700108167	AD5030	7700640439	BG170
75491735	BG450	7596714	JC738	7648250	HBS279	7700108170	AD5050	7700640441	JN248
75501082	JB864	7596968	BP660	7648251	HBS279	7700108254	AD5990	7700641718	JB997
75505394	JB830	7597077	JD019	7649849	JJ449	7700109421	JD5893	7700642547	BH690
75513006	BG450	7597077	JE744	7650355	HR599	7700109906	JD5908	7700648719	HBS116
75513624	DG452	7597555	BT320	7650612	HBS097	7700112365	JD5889	7700650089	BF730
75516398	JN232	7597832	JN809	7651738	LB414	7700112675	AG5420	7700650152	HR564
75518008	GF492	7604263	BT410	7653650	HBS095	7700112739	AC5100	7700656001	BH950
7552453	LA378	7604264	BT420	7657305	JN804	7700113234	BX630	7700658325	HR599
7552551	BT410	7604403	BR620	7659102	BV680	7700113265	AC5061	7700658325	HR643
7552552	BT420	7604404	BR630	7659103	BV690	7700114234	JD5886	7700660406	BH930
7553022	BR120	7604488	KA5032	7659104	BV700	7700114424023717P	JH5041	7700661444	NF641
75530731	JN426	7609752	JC738	7659618	JD151	7700114745	HBS372	7700662756	HR564
7553073180	JN426	7610498	JD013	7660565	JN643	7700115822	AC5061	7700665229	JN697
7553561	NB814	7613726	HR5064	7660759	JN803	7700267279	AG5270	7700668576	NF687
7553561	NB815	7616679	BT860	7660966	BT440	7700274003	JN789	7700670732	JR635
7553616	HR599	7621070	JD022	7662197	BT410	7700316230	JN248	7700670738	JR635
7553616	HR800	7621071	JD022	7663366	JJ453	7700465265	DH683	7700671577	BG900
7553636	HR596	7624874	BR680	7665093	JD067	7700468385	EY070	7700671626	BH950
7553637	HR805	7624874	BV680	7666858	BR620	7700471213	JN997	7700671834	NF648
7554279	NB815	7624875	BR690	7667675	BR630	7700490	BR680	7700672860E	AD5190
7554363	JJ453	7624875	BV700	7668195	JD151	7700490	BV680	7700680688	BH680
7554851	JP049	7624876	BR700	7669581	JF145	7700491	BR690	7700680689	BH690
7554963	JJ471	7624876	BV690	7669585	JJ440	7700491	BV690	7700681417	LT839
7555140	BR620	7624876	BV700	7672168	BT410	7700492	BR700	7700683866	JB851
7564332	BR630	7624876	BW980	7676324	JN948	7700492	BV700	7700693430	HR564

OE reference	▲ Payen	OE reference	▲ Payen	OE reference	▲ Payen	OE reference	▲ Payen	OE reference	▲ Payen
7700694142	KA625	7700745724	BS520	7700859803	BV190	7701039396	BS010	7701404452	HR397
7700695943	JJ558	7700745725	BS540	7700859863	JD231	7701039397	BS030	7701418097	BH680
7700696483	BH690	7700746591	JC956	7700859886	JD435	7701039398	BS520	7701427228	CC5060
7700696484	BH680	7700747291	NA5053	7700860898	JJ562	7701039399	BS540	7701457561	HC354
7700698219	LT839	7700748648	JC955	7700864736	JC955	7701040009	AY290	7701458694	DH692
7700702604	KA625	7700749395	NA5053	7700864736F	BX630	7701040010	AY300	7701459392	GH681
7700706149	JC669	770083008	HBS120	7700865764	JD434	7701040011	AY310	7701459392	GH683
7700711666	BG900	7700850292	JN996	7700866465	JJ565	7701040198	AG5270	7701460132	DG170
7700713860	BL910	7700851083	BL910	7700866683	BY030	7701040490	AB5110	7701460151	DG170
7700716521	BL970	7700851213	KA625	7700866689	JD420	7701040547	JJ558	7701460626	GH690
7700716923	NA5016	7700851896	BX080	7700866876	NF844	7701041926	NF883	7701460626	GH691
7700716924	NA5265	7700852506	BX570	7700866876	NF846	7701042340	NP067	7701460628	DH690
7700718521	JN292	7700853324	HBS011	7700866877	NF843	7701043299	NP068	7701461245	EF380
7700719273	NA5265	7700853324	HBS177	7700867360	JD418	7701044092	NF883	7701461333	DH080
7700719274	NF843	7700853373	NF844	7700867870	BS530	7701044093	NF885	7701461333	GH080
7700719666	JN732	7700853496	JD245	7700867871	BS020	7701044224	BX390	7701461334	GH080
7700719683	NF843	7700853753	JD416	7700868132	JN997	7701044225	BX400	7701461765	DH080
7700720788	BG170	7700853859	JN937	7700872030	BX720	7701044226	BX410	7701461930	NP067
7700723967	JN248	7700853879	JN994	7700872383	BY080	7701049734	JM5131	7701461930	NP068
7700723967	JN600	7700854041	JC955	7700872534	NF856	7701049888	JM5185	7701462215	DH683
7700724333	BF350	7700854252	JD463	7700872848	HBS119	7701052719	AG9770	7701462216	DH693
7700732419	BL910	7700854492	JC238	7700872849	HBS119	7701052720	AG9780	7701462357	EF731
7700733041	BN360	7700854493	JB954	7700872850	HBS119	7701052723	AG9810	7701462358	DF731
7700733464	HR300	7700854507	BG900	7700872860	AD5190	7701052724	AG9820	7701462492	DH696
7700734646	BH680	7700854539	JD419	7700873534	NA5322	7701052840-7701052837+	HM5292	7701462816	DL961
7700735948	JJ559	7700854640	JN789	7700874592	JD5189	7701052863	JD5896	7701462817	EL960
7700736277	JD411	7700854641	JC955	7700875717	AD5040	7701052864	JE5064	7701463110	DL910
7700736465	HR599	7700854644	LT839	7701020094	JN369	7701059314	JM7053	7701463203	EH680
7700736465	HR615	7700854652	JB997	7701024762	BH090	7701061753	JD5897	7701463203	EH682
7700736465	HR646	7700854710	BG170	7701024924	BH080	7701108679	NA5257	7701463925	DN360
7700736465	HR800	7700854867	JD409	7701026263	BE580	7701203212	DS381	7701464133	EG176
7700736567	JD410	7700855382	JN697	7701028289	BH080	7701204563	DE588	7701464134	DG170
7700737124	HR569	7700855384	HBS244	7701028290	BH090	7701204926	DE588	7701464134	DG173
7700737124	HR805	7700855663	JD231	7701029773	BM790	7701204945	JD421	7701465194	DX610
7700738282	BX610	7700855717	BV190	7701029774	BM800	77013348717	JB997	7701465195	DL961
7700738987	HBS102	7700855962	JC669	7701030298	BL960	7701348002	BH680	7701465227	DL910
7700739165	JN789	7700856350	HBS302	7701030299	BL980	7701348031	BF350	7701465261	EH680
7700739302	BX730	7700857118	NF861	7701031953	JN594	7701348088	BF350	7701465261	EH682
7700739392	JJ407	7700857119	NF858	7701033527	BH080	7701348097	BH680	7701465262	DH692
7700739970	BS020	7700857225	JJ568	7701033528	BH090	7701348118	BH690	7701465262	DH693
7700740075	JC956	7700858334	BY070	7701034967	JC054	7701348119	BT080	7701465265	DH683
7700741186	BL970	7700858384	JD410	7701035019	NF833	7701348178	HR564	7701465268	DN360
7700741490	JD413	7700858385	JD411	7701035217	BH080	7701348227	JB851	7701465503	DX590
7700741501	JC955	7700858386	BX610	7701035218	BH090	7701348574	JN248	7701465765	DH080
7700741998	BG900	7700858735	JD435	7701035740	NP067	7701348717	JB997	7701466406	DL910
7700743161	NF634	7700858736	JD436	7701035740	NP068	7701348923	JD245	7701466407	DL961
7700743369	BS530	7700858806	LT839	7701035770	JN969	7701348943	NF641	7701466408	EL960
7700743903	JN732	7700858850	JP006	7701036311	JN936	7701349138	NF687	7701466416	EH694
7700743953	JN697	7700858879	BX580	7701036381	BL970	7701349270	LT839	7701466416	EV190
7700744797	NB866	7700859059	ACS080	7701036382	BL960	7701349276	JC669	7701466417	DH690
7700744798	JD414	7700859200	BX600	7701036383	BL980	7701349330	BH680	7701466417	DH692
7700745109	JN995	7700859266	NF860	7701036387	BF350	7701349331	BH690	7701466417	DH693
7700745716	BL960	7700859273	BX600	7701038393	AY300	7701349469	JR635	7701466446	DX610
7700745717	BL980	7700859691	NF834	7701038871	BE580	7701349561	JN292	7701466819	DX570
7700745722	BS010	7700859692	NF835	7701038965	BM790	7701349687	BH690	7701466820	DX560
7700745723	BS030	7700859751	JJ557	7701039145	BF730	7701349715	NF791	7701467058	DX600

INTERCHANGE OE → PAYEN

Vergleichsliste OE → Payen • Références croisées 1ère Monte → Payen
Intercambio OE → Payen • Intercambio entre equipo original y Payen

OE reference	▲ Payen	OE reference	▲ Payen	OE reference	▲ Payen	OE reference	▲ Payen	OE reference	▲ Payen
7701467144	EG176	7701474194	HBS502	7710582	HBS133	7770025	LA378	77BM9448EA	JB799
7701467154	DV190	7701474372	CC5110	7711030	JD198	7770028	KA294	77BM9448EB	JB799
7701467154	DX651	7701475009	NA5255	7715139	JD151	7772358	JD226	7810024000	LT634
7701467230	DX610	7701475375	CE5111	7715492	HL701	7772495	JD146	7812103000	HR300
7701467609	DG170	7701475822	CD5980	7715789	JN819	7773831	JN973	7812103200	HR300
7701467609	DG173	7701476555	HM5291	7716337	HCO27	7774233	KL477	7812103200	HR363
7701467610	DH080	7701477450	CG9760	7716337	JJ449	7775920	HBS227	7812103800	HR300
7701467610	GH080	7701477452	EG9760	7719720	BT320	7775920	HBS257	7832119200	NF640
7701467611	DX580	7701716521	BL970	7724059	BR630	7777153	BP280	7842706000	NB775
7701467612	EG176	7701853	JN643	7724244	JD148	7777226	JJ605	78EM6571BA	PA229
7701467618	DX620	7702768	LT498	7724665	NA5061	7779904	BW340	78EM6584AA	JN245
7701467896	DN360	7702769	LV589	7735415	JA5036	7779905	BW350	78EM6710BA	HC346
7701467918	DH683	7702772	LV583	7736289	BW340	7779906	BW360	78EM6734AA	KJ647
7701467946	DF731	7702774	JN459	7736290	BW350	7782288	BJ860	78EM6734AA	PA349
7701468142	DX720	7702873	BP290	7736291	BW360	7784728	JN805	78EM9448AA	JB842
7701468155	DY070	7702981	KV122	77363787	HA5053	7785234	JC694	78GB8507BA	KA606
7701468189	DY040	7703032062	PA349	7737607	JP019	7785805	BR680	78TM9A454AA	JC364
7701468385	EY070	7703053075	HBS104	7738383	JN805	7785805	BV680	78TM9A454HB	JC364
7701468506	DX590	7703062003	PA349	7738687	JN643	7785806	BR690	78TM9A454HC	JC364
7701468669	DY070	7703062062	PA349	7741845	JN669	7785806	BV690	7900652756	HR564
7701468709	DX721	7703062063	PA349	7742042	JC973	7785807	BT240	7903062003	PA349
7701468709	DX722	7703065212	PA858	7742045	KD226	7785807	BV700	7903065016	PA858
7701468710	DY030	7703087035	NF634	7742046	KT446	7785807	BW980	7903065023	LC292
7701469326	DX630	7703087075	NF678	7742760	BT320	7787262	LK5007	7903087086	NF812
7701469762	CD5190	7703087080	NF634	7744000	BX040	7787630	JD5183	7905108000	NF857
7701470176	EC5060	7703087087	NF775	7745836	BP520	7788072	CC5410	7910003502	LV847
7701470176	EC5063	7703087097	NF722	7745837	BP520	7788636	AC5300	7910003805	HG108
7701470288	CC5060	7703087104	NF535	7749148	BT240	7788640	AB5990	7910003805+G21905	HG108
7701470855	CG9740	7703087114	NF791	7749709	JC660	7788641	BJ870	7910004826	NF641
7701470856	CG9720	7703087146	NF791	7750404	NF888	7788642	AB5980	7910006487	NF678
7701470977	EG9710	7703087189	NF849	7750406	BX040	7788651	AE5340	7910008483	NF641
7701471360	ED5991	7703087190	NF850	7751688	BT860	7788652	AE5350	7910009720	JB841
7701471366	HBS310	7703087191	NF847	7752460	BT260	7788656	AE5360	7910009723	JN244
7701471372	NA5257	7703087192	NF846	7755741	KT446	7788657	AE5370	7910011371	JN544
7701471373	HBS301	7703087224	NA5037	7755742	JD067	7789503	BJ880	7910018525	BM530
7701471376	NA5215	7704000289	KA533	7755744	JJ471	7789977	AC5410	7910019491	NF640
7701471777	CG5420	7706068	HR800	7758731	HBS131	7789978	AC5420	7910033356	JE145
7701471779	HBS431	7706480	JF145	7759146	BR680	7789979	AC5430	7910245291	BG130
7701471886	CC5100	770658325	HR643	7759146	BT220	7790052	AC5410	7910245585	BG120
7701472449	JD5891	770733041	BN360	7759147	BT230	7790053	AC5420	7910246393	BG120
7701472450	HM5290	770738986	HBS102	7759148	BT240	7790054	AC5430	7910246394	BG130
7701472821	CE5210	7707675	JD019	7759873	JC152	7792170	BT320	7910248324	HBS127
7701473003	CD5981	7708317	JN934	7759873	JD152	7794462	JN568	7932567498	JB842
7701473007	JD5885	7708513	BT400	7761598	JD225	7794495	JM5167	795192	DE622
7701473135	CE5110	7708514	JD022	7764415	KA295	7795992	HBS247	795193	CN353
7701473137	EE5110	7708720755	BH690	7765224	JD013	7797034	JP049	795365	DR040
7701473178	HBS299	7709257	BT410	7765227	JD225	77BM6051A1A	BC240	79TM9448DA	JC365
7701473371	CE5200	7709257	BT440	7765454	JC738	77BM6051A2A	BC240	757G6051CB	AH7150
7701473495	NA5261	7709259	JA757	7766037	JD150	77BM6051A3A	BC240	8012426	BJ850
7701473543	HBS283	7709435	BT400	7766203	BW330	77BM6561CA	JN105	8035260	BP820
7701473544	NA5118	7709658	JP049	7766236	JN933	77BM6571AB	PB180	8054130	BL390
7701473545	NA5255	7709714	HR800	7766268	BW321	77BM6584BA	JN105	806730021	NJ252
7701473571	HBS373	7709978	LT439	7766412	JN928	77BM6584CA	JN105	806730110	NJ313
7701474059	CG9770	7710013	JN805	7766959	JR673	77BM6700AB	NB564	806733010	NA5226
7701474060	EG9770	7710162	HBS092	7768026	JN972	77BM9148EA	JB799	806733030	NA5226
7701474149	NA5328	7710582	HBS132	7770023	KA293	77BM9441DA	JB862	806738040	NJ022

OE reference	▲ Payen	OE reference	▲ Payen	OE reference	▲ Payen	OE reference	▲ Payen	OE reference	▲ Payen
806738070	NJ341	8200062273	AD5980	83EM6051BA	BP890	84FM6700A1B	NB786	850719	JC283
806757013	NJ376	8200067710	JD5911	83EM6051CA	BP900	84FM6710AD	JJ334	8528623	JB851
806768060	NK243	8200068744	NF791	83EM6051CB	BP900	84FM6710AE	JJ334	854929	JE119
806776010	NJ343	8200071111	AE5200	83EM6051DA	BP900	84FM6710AF	JJ334	854933	JE120
806776011	NJ343	8200073003	KK5643	83HM6584AB	JN620	84FM6L270A1A	NB785	855483900	BH680
8096541	AY690	8200117388	JM7054	83HM6584BB	JN620	84FM6L270AA	NB785	856910271	BE540
8096619	JR580	8200121998	AE5210	83SM6051A3B	BJ440	84FM9441AB	JC565	856910271A	BE540
8096682	JC055	8200128551	JD5402	83SM6710AA	HC452	84FM9448AB	JE5022	859093	BY270
8096748	BR070	8200149425	JE5062	83TM6051EA	BL400	84FM9E583A1B	NB788	859171	PB180
8096764	BE580	8200188390	AD5030	83TM6051EB	BL400	84HM6051AC	BN140	85EM6051AA	BP890
8096780	AY300	8200215051	AE5210	83TM6083EA	BL410	850500	JC756	85EM6051AB	BP890
8096910	BX410	8200264952	AE5110	83TM6083EB	BL400	850510	JD5148	85EM6051BA	BP900
8096911	AY590	8200275057	JD5940	83TM6083EB	BL410	850521	JD5398	85EM6051BB	BP900
8096930	DX391	8200296969	AH5170	841253115B	JE904	850522	JC824	85HM6051A1D+E3859	BN150
8097064	AY290	8200310867	JD5884	84142413	NF843	850536	JC280	85HM6051A2C	BN150
8097066	AY310	8200313217	JD5892	84142413	NF844	850537	JC281	85HM6051A2D	BN150
8097075	BX420	8200342238	AH6780	843253115	JE904	850537	JC282	85HM6051B2C	AH860
8097421	CY680	8200351353	AG9490	844F6013AAA	EN260	850540	JC283	85HM6051B2E	AH860
80TM6584AA	JM875	8200363223	JD5895	844F6065AA	HBS008	850541	JC282	85HM6051B3C	AH860
80TM6584BA	JM875	8200364849	JD5937	844F6584AA	JN460	850542	JC436	85HM6065BA	HBS056
81026800	HBS313	8200365915	JD5894	844F6710DA	HC451	850543	JC437	85HM6584AC	JN620
81034900	HBS502	8200399103	AG9760	849193	JD5255	850544	JC283	85HM6584BA	JN620
8112180	BP660	8200403823	JD5890	849196	JD5147	850600	JC757	85TM6584CA	JN616
811253115B	JE904	8200406740	AE5210	849213	JD5256	850601	JC756	860996480339	NB775
812607000	JN368	8200428141	AE5220	849216	JD5334	850602	JE5029	8642629	AG8340
812774110	KJ462	8200490282	JD5888	849218	JD5330	850603	JD5914	8653739	NA5191
812777000	KJ462	8200490285	JD5887	849219	JD5413	850606	JD455	8653739	NA5192
817310155	KJ710	8200549617	JM7125	849504	JD458	850607	JC823	8658620	AF5320
817310155A	KJ710	8200589692	JD6038	849509	JD5203	850608	JC437	8675251	AE5150
81AB9451AA	JE719	8200706057	JD6033	849510	JD5202	850610	JA415	86AB9451BA	JE719
81AB9451CA	JE719	822118600	JC140	849511	JD474	850611	JD187	86BM6051B1A	BC240
81AB9451CB	JE719	82293355	HR599	849515	JD5117	850613	JC282	86BM6051B2A	BC240
81AB9451DA	JE719	82347860	JE744	849518	JD5399	850615	JC281	86BM6051B2B	BC240
81AB9451DB	JE719	82380384	JC662	849520	JD459	850616	JC436	86BX6014AA	DC240
81SM6051R1C	BJ440	82473209	JE744	849521	JD5277	850618	JD5979	86EM6700AA	NF780
81SM6051R2D	BJ440	8306938	NB714	849522	JD5903	850619	JC155	86EX6051BA	BP890
81SM6051R3	BJ440	8312037854	NB975	849530	JD5331	850632	JD5980	86EX6051CA	BP900
81SM6051R3C	BJ440	831450	JJ080	849934	JD5300	850633	JC823	86EX6051DA	BP890
81SM6051R3D	BJ440	8314502	JJ080	849999	JD5245	850634	JC824	86EX6051EA	BP900
81SM6051R3E	BJ440	833347	HR660	849F6700AA	NB855	850645	JC282	86HM6700A6A	NA5177
81SM6065HA	HBS001	833347	HR801	84BM6051A1A	BC240	850646	JD456	86HM6700AA	NA5177
81SM6571A2F	HR661	833347	PB180	84BM6051A2A	BC240	850648	JD459	86HM6701A1A	NB788
81SM6571AF	HR661	8338782	JJ080	84FF6051AAA	BM980	850655	JD451	86SM6051A3A	BJ440
81SM6584DA	JN332	8348161	BC650	84FF6051BAA	BM980	850663	JD5201	86SM6051A3C	BJ440
81SM6584FA	JN332	835878	BC650	84FM6051F1A	BM950	850665	JD275	86SM6700A1A	NB959
81SM6584FB	JN332	8358780	BC650	84FM6051F2A	BM950	850666	JD274	86SM6700AA	NB645
81SM6700AA	NB645	836184	JC305	84FM6051F2B	BM950	850668	JD448	86SM6701A6A	NB847
81SM6700AA	NB959	8361842	JC305	84FM6051G1A	BM960	850672	JE5017	86SM6701A6A	NB848
81SM6701AA	NB847	836583	JN285	84FM6051G2A	BM960	850673	JE5024	86SM6701AA	NB847
8200028727	AE5210	8365835	JN285	84FM6051G2B	BM960	850675	JD5332	86SX6014AA	DP790
8200030251	JE5060	8383183160	NB775	84FM6051H2B	BM980	850677	JD5329	86SX6014BA	DJ442
8200034315	BX630	83BM6700A4A	NA576	84FM6051J1A	BM980	850696	JA415	86TM6051A4D	BT520
8200045668	JE5061	83BM6700AA	NA576	84FM6051J2A	BM980	850696	JD5979	86TM6051AD	BT520
8200049012	AG7950	83BM6701AA	NB564	84FM6051J2B	BM980	850699	JD5979	86TM6065EA	HBS057
8200057611	AE5220	83EM6051AA	BP890	84FM6571BA	HR659	850709	JD5765	86TM6083A4D	BT510
8200060882	JM5086	83EM6051AB	BP890	84FM6571CA	HR659	850716	JC280	86TM6083AD	BT510

INTERCHANGE OE → PAYEN

Vergleichsliste OE → Payen • Références croisées 1ère Monte → Payen
Intercambio OE → Payen • Intercambio entre equipo original y Payen

OE reference	▲ Payen	OE reference	▲ Payen	OE reference	▲ Payen	OE reference	▲ Payen	OE reference	▲ Payen
86TM6571AA	HR660	8941105590	PA658	8942488300	DR200	8981425	BN040	8AG610271	GR850
86TM6571AA	PB180	8941116490	JC670	8942511710	NJ449	8981931	JN041	8AG610271A	GR850
86TM6571AB	HR660	8941140630	JJ204	8942568300	DM370	8983127	HC417	8AG610271B	GR850
86TM6571AB	HR801	8941140690	JJ204	8943125870	GR940	89BM6051B1D	BT110	8AG610271HS	DR850
86TM6571AB	PB180	8941152430	DM370	8943125880	DR940	89BM6051B2C	BT110	8AG710271A	GN622
86TM6584AA	JN662	8941152431	DM370	8943138030	JN777	89BM6051B2D	BT110	8AG810271CHS	DR736
86TM6584BA	JN662	8941152432	DM370	8-94317375-4	CD5400	89BM6051C1C	BT140	8AGC10271	GR850
86TM6701AA	NB564	8941248800	BR190	8943193700	GR990	89BM6051C2B	BT140	8AGC10271A	GR850
86TM6710AA	JJ458	8941298840	NA5322	8943193760	DR990	89BM9441AB	JD009	8AGC10271B	GR850
86TM9441AD	JD5268	8941298840	NJ446	8943193760	GR990	89BM9448BA	HA497	8AK3-10-271	FG8150
86TM9448AA	JE5020	8941451480	JC643	8943240530	BP920	89EX6014AA	DG050	8AN110235	DS940
8787111	AC5690	8941462440	BP920	8943270631	NK103	89FF6008AA	GT190	8AN2-10-235	CG5370
878777	NB714	8941462441	BP920	8943323270	BR990	89FF6013AB	ET190	8AN4-10-271	GS941
87EM6051AA	BP890	8941462442	BP920	8943358371	GP921	89FF6014AB	DT193	8ASX10271B	FA5130
87EM6051BA	BP900	8941462490	JC684	8943358372	GP921	89FF6051AAA	BT190	8AU110271	GL321
87EM6051CA	BP910	8941524510	JJ454	8943399970	NJ323	89FF6051ABA	BT200	8AU110271A	GL321
880146	JC365	8941524521	JJ454	8943626640	JD303	89FF6051ACA	BT210	8AU110271B	GL321
8801466	JC365	8941524522	JJ454	8943626652	JD304	89FF6065AA	HBS007	8AU110271C	GL321
8811101	NB564	8941560780	BR200	8943864410	AY840	89FF6441AA	JD240	8AU310271	GN621
881202	JM333	8941653240	BM330	8943864420	AY850	89FF6700A2A	NB984	8AU310271A	GN621
8812067	HR633	8941723410	JN776	8944097260	JC683	89FF6710BA	JJ456	8AU310271AHS	DN621
881452	LR922	8941723411	JN776	8944097261	JC683	89FF6A735AA	NC044	8AU310271B	GN621
8818254	HM5070	8941723412	JN776	8944097262	JC683	89FF6B653AC	NC044	8AU810271	GR734
8819112	JC305	8941742790	BR940	8944127471	JD303	89FF6K260AD	JN816	8AU810271HS	DR734
8819831	DT561	894179391	JJ470	8944296260	BS230	89FF6K260AE	JN816	8AZ610271A	GN621
8822041	HM5070	8942104020	JC060	8944296261	BS230	89FF9441AA	JD240	8CB110271	GV110
88BX6014BA	DT140	8942149120	NJ323	8944337320	BR990	89FF9441BA	JD309	8CB210271N	GS953
88G561	NA473	8942149130	NJ322	8944337440	JN707	89FF9448CA	JD310	8CB310271	GS950
88SM6584AA	JN332	8942149850	JN634	8944383150	GR190	89SF9H486AB	JD188	8CB610235	DV431
88SM6710AA	JJ348	8942152200	NJ454	8944383180	DR190	89SM9441AB	JC724	8CB610271	GV431
88SX6014AA	DN471	8942210220	JC429	8944475700	JN408	89SX6014BA	DJ444	8CBR10235	DE545
88TM6051A2A	BT520	8942210250	JC284	8944509540	BS230	8A6G6051DA	AH7120	8CBR10271	DE545
88TM6051A4A	BT520	8942265641	JJ204	8944509541	BS230	8AB110271	GJ432	8CBZ-10-235	CG5380
88TM6051AA	BT520	8942320520	JC670	8944686540	NJ449	8AB110271HS	DJ432	8CG6-10-271	CG5390
88TM6083A2A	BT510	8942352800	BM330	8944716191	NK092	8AB210235	DP601	8CGB10271	CG8191
88TM6083A4A	BT510	8942352880	JJ358	8944821570	NJ449	8AB310271HS	DP540	8DSX10271	FA5130
88TM6083AA	BT510	8942353690	NJ322	894F6013AA	ET800	8AB410235	DV110	8E89736	AC5720
88TX6014BA	DT510	8942363450	JE751	894F6014AA	DT800	8AB510271	GJ432	8FG6-10-271	GV380
88WM6051A2J	BT481	8942363451	JE751	894F6700A1A	NB855	8AB610235	DS950	8FGB10271	CG8191
88WM6051A2K	BT481	8942391400	JN456	894F6701AB	NB854	8ABA10271	GJ432	8G2548	AF470
88WM6065CA	HBS032	8942391401	JN456	894F6710CA	JJ484	8ABD10271	GP570	8G756	HC063
88WM6065CB	HBS032	8942391402	JN456	894F6L270AA	NB856	8ABD10271HS	DP570	8LB910271	FG8170
88WM6571BB	HR655	8942415160	GM370	894F9461AB	JD064	8ABF10271	GR961	8LG310271	FG8190
88WM6584AE	JN817	8942415161	GM370	8960714	BN040	8ABF10271HS	DR961	90002406	JN041
88WM6710AF	JJ457	8942415162	GM370	8970193611	AB5781	8ABN10271	GS070	90002418	JN068
88WM9441BB	JD542	8942415163	GM370	8970491450	NK251	8ABN10271HS	DS070	90002472	JM956
88WM9448AC	JD543	8942415164	GM370	8970747281	JJ555	8ABS10271	GP602	9000269	GF051
88YX6014AA	DX480	8942415180	DM370	8971092160	JD470	8ABS10271HS	DP602	9000269U	GF051
8930216	JC155	8942415181	DM370	8-97136259-2	AB5781	8ABT10271A	GP601	9000340U	GF492
8940281870	JN408	8942461090	JC683	8971362593	AB5781	8AG310235	DR732	90003P5TG00	HBS282
8941059730	NJ449	8942461091	JC683	8971421100	AY900	8AG310235A	DR732	90005299	HC295
8941059731	NJ449	8942479031	JN707	8971421110	AY910	8AG310271	GR732	90005374	DN041
8941060600	NK092	8942488290	GM372	8971421120	AY920	8AG510235B	DV410	90005-PNA-003 (10)	HBS528
8941060683	JD304	8942488291	GM372	8-97148520-2	AB5780	8AG510271	GR730	90005PT0003	HBS284
8941095531	BR990	8942488292	GM372	8971485203	AB5780	8AG510271HS	DR730	90005RBDE01	HBS532
8941095532	BR990	8942488293	GM372	8981424	BN040	8AG610235	DV380	90005-RNA-A01 (10)	HBS527

OE reference	▲ Payen	OE reference	▲ Payen	OE reference	▲ Payen	OE reference	▲ Payen	OE reference	▲ Payen
90006778	DL550	90122996	BL010	90220216	BP810	9031138025	NJ706	9031195003	NJ240
90006PT0003	HBS284	90122997	BL020	90220309	JN693	9031138036	NJ347	9031195005	NJ240
90007707	ET820	90122998	BL030	90220621	BJ170	9031138046	NJ347	9031195008	NK216
90008-PWA-003 (x10)	HBS520	90126607	NB701	90231452	JE120	9031138059	NA5089	9031195091	NJ240
90009378	DK470	90128293	JE120	90231580	BJ170	9031138111	NJ102	90311W0005	NA5319
90011301350	NJ255	90128529	BM380	90231792	BK470	9031138138	NJ102	90311W0009	NA5319
90019654	HR291	90136297	NB700	90231938	BN040	9031142003	NJ344	90322816	BS260
90019655	HR336	90136849	NB697	90231939	BN040	9031142007	NJ344	90322930	JN923
90020184	BN010	90141910	EK470	90233236	NB698	9031142008	NJ344	90323252	BY340
90027135	NB628	90156001	NB697	90233238	NB806	9031142012	NJ344	90323399	JC824
90027731	BJ170	90156002	NB700	90233244	NB697	9031142014	NJ344	90323445	BJ170
9002921007	NJ654	90156004	NB701	90233720	BP800	9031142015	NJ344	90323592	JN521
9002921020	NJ654	90156007	NC006	90264658	NB808	9031142026	NJ344	90323853	JN626
9003805	NB775	90156354	NB734	90264787	NB807	9031145002	NJ243	90324060	HBS035
9004310029	NJ454	90156855	NB700	90265553	JD5980	9031145006	NJ243	90324263	JN693
9004311095	NJ269	90156857	NB469	90271435	BL010	9031145011	NJ243	90324544	BV950
9004311109	NJ268	90167457	EK470	90271436	BL020	9031145017	NA5282	90325572	NB806
9004311141	NJ454	90180294	HR343	90271437	BL030	9031145026	NJ243	90325839	BP810
9004311144	NJ324	90180500	NB700	90272342	HR291	9031145047	NJ243	9032853	JN626
9004311149	NJ270	90180504	NB734	90280360	BS720	9031145069	NJ243	90349024	DS720
9004311222	NJ269	90180504	NF834	90280462	NB806	9031145094	NJ243	90349025	ES720
9004311230	NJ360	90180509	NB691	90280464	NB807	9031148002	NJ042	90349032	DS260
9004311231	NK209	90180515	NB698	90280542	HR291	9031148004	NJ042	90349032	EK470
9004311292	NA5324	90180517	NB701	90284185	HR336	9031148014	NJ200	90349032	ES260
9004812006	PA387	90180521	NB469	90284185	PA619	9031150002	NJ239	90349033	DS260
9004812009	PA889	90180525	NB690	90284652	BL550	9031150006	NJ239	90349873	BY330
9004812011	PA952	90183135	HBS163	90284657	BL550	9031150007	NJ239	90349947	BJ170
90067012	HR291	90188185	HR343	90284658	BK470	9031150049	NJ239	90350024	BS260
90067926	NB628	90188186	HR343	90285291	NC006	9031152003	NJ645	90351504	JC757
90076086	NB469	90190028	JJ200	90295205	EK482	9031155008	NJ258	90352112	NB698
90076919	JJ120	90190136	JC283	90295206	EK484	9031170001	NJ001	90353146	JN924
90076934	BK470	90190481	PA543	90295207	DP820	9031170003	NJ001	90353443	JC280
9008031067	NA5324	90194295	JJ385	90295209	DP800	9031170004	NJ001	90353443	JC282
90080-31094	NA5088	90194974	BR020	90298131	JJ120	9031170075	NJ001	90353579	JC756
90080727	NB697	90194975	BR030	90298131	JJ200	9031170105	NJ001	90354545	JN626
90091657	JC280	90200349	BM380	90298172	BR010	9031170120	NJ001	90363443	JC280
90091769	JE119	90200737	BL550	90298173	BR020	9031173001	NA5324	90371771	DY251
90091791	JC281	90200738	BL550	90298174	BR030	9031175004	NJ407	90391046	HBS002
90091791	JC282	90200739	BL550	90298195	NB628	90311-75016	NA5088	90391046	HBS050
90091903	NC006	90200740	BL550	90298205	NB884	9031176001	NA5090	90392502	BV950
90091926	NB698	90200742	BK470	90298949	JC823	9031180001	NJ030	90392518	EB950
90096047	NB628	90200743	BK470	9031132001	NJ349	9031180002	NJ030	90392639	BT530
90096964	JN344	90200744	BK470	9031132018	NJ349	9031180003	NJ360	90392709	BW170
90106350	NB701	90200745	BK470	9031132106	NJ268	9031180004	NJ030	90392751	DW170
90106425	JJ200	90200834	BR010	9031135003	NJ353	9031180005	NJ360	90397690	DP820
90106465	JC436	90200921	JC756	9031135008	NJ353	9031180068	NJ030	90397692	DP810
90106468	JC437	9020111034	HBS441	9031135013	NJ353	9031180139	NJ030	90397696	DP800
90106506	JN453	902071	HC027	9031135017	NJ353	9031185001	NF857	90397697	DL550
90106610	JC283	90215011	JC757	9031135018	NK214	9031185001	NJ354	90397697	DL551
90106615	JC282	90215026	BP800	9031135049	NJ353	9031185003	NJ354	90397699	DK480
90114587	ET820	90215296	DP800	9031138002	NJ102	9031185004	NJ354	90397806	DK470
90114589	EK470	90215296	DP811	9031138013	NJ102	9031185006	NJ215	90397812	EK470
90114653	EJ160	90215296	HR342	9031138017	NJ347	9031188001	NK055	90397813	DS720
90118383	BL550	90215296	PA565	9031138018	NJ347	9031188003	NK055	90397815	DP802
90122134	HR336	90215968	JN626	9031138022	NJ719	9031195001	NJ240	90397819	EK485
90122607	NB701	90220215	BP820	9031138024	NJ102	9031195002	NJ240	90398046	BK470

INTERCHANGE OE → PAYEN

Vergleichsliste OE → Payen • Références croisées 1ère Monte → Payen
Intercambio OE → Payen • Intercambio entre equipo original y Payen

OE reference	▲ Payen	OE reference	▲ Payen	OE reference	▲ Payen	OE reference	▲ Payen	OE reference	▲ Payen
90398047	BL550	90412303	JN693	90502291	JD5204	90571925	NA5108	9091302023	KJ466
90398048	BP800	90412459	JD451	90502462	JD448	90572108	JD5347	9091302024	KJ466
90398049	BP810	90412701	HBS055	90509135	JD274	90572656	JH5005	9091302040	KJ466
90398050	BP820	90412781	JP009	90509145	JD275	90572656	JJ120	9091302050	PA310
90398091	BM380	90412782	JP008	90509714	BP800	90572788	AY170	9091302053	PA136
90398092	BK480	90412846	JJ575	90509770	EY280	90572789	AY160	9091302056	KJ466
90398347	DS260	90421993	BN010	90509837	DY250	90572790	AY170	9091302057	KJ466
90398572	EK481	90423026	JD456	90509849	BY250	90572791	AY180	9091302058	KJ466
90398797	BL010	90423709	AG9570	90510631	JD276	90573447	JH5079	9091302062	PA425
90398798	BL020	90442252	EK484	90510684	AY210	90573498	JM5059	9091302067	PA567
90398799	BL030	90442252	ES260	90510807	AY210	9059169	HR363	9091302071	PA567
90399186	BR010	90442262	JC823	90511165	EY230	9059169	HR569	9091302072	PA136
90399187	BR020	90442263	DP803	90511490	AY220	90602512	JM483	9091302081	PB340
90399188	BR030	90442264	DS261	90511798	EC130	9060530358	HR660	9091302086	PB341
90409456	JD455	90443459	BY270	90511878	EC230	9060530358	HR801	9091302095	PB281
90409568	BM380	90443999	DY260	90512823	DY271	9060530358	PB180	9091302101	PA5020
90409569	BK480	90444066	BY240	90512825	DY270	9060530458	HR660	9091302111	PA5019
90409570	BP810	90444862	HBS074	90528632	JJ615	9063193	HR791	9091303018	PA310
90409572	JC436	90466480	HBS054	90529438	JH5037	9064457	HR280	90913W2001	PA6055
90409572	JC437	90466480	HBS164	90529485	JD5223	9064460	ET681	9091706001	JE012
90409594	JN929	90466638	JM950	90529537	HBS253	9065438	HR817	9091706004	JE015
90409640	JA415	90467661	JP018	90529586	JM5085	9065439	DY541	9091706020	JE106
90409642	JC281	90467759	JJ616	90529957	JH5036	9066452	DR831	9091706026	JE124
90409642	JC282	90467802	JC437	90530075	JM5048	9066462	EW730	9091706038	JE012
90409643	JC281	90469379	JJ572	90531025	JH5078	9066503	JJ536	9091706039	JF087
90409644	JC282	90470036	JD444	90531106	HR5096	9067655	JJ614	9099242960	NJ014
90409645	JC281	90470231	JD5269	90531106	PA5025	9070058	DW731	9099244480	NJ014
90409645	JC282	90470303	JD445	90531731	JD5149	9070530	HL734	90FF6051AAA	BT190
90409648	JD187	90486686	HR343	90531832	JR5030	9070531	HL735	90FF6051ABA	BT200
90409652	JC155	90486975	HM5294	90536009	AC5460	9070532	HL736	90FF6051ACA	BT210
90409678	BL550	90487290	BY300	90536057	JD5196	9070615	DZ130	90FF6051BBA	BT200
90409679	BK470	90487444	BY260	90536199	JD5197	9070622	DZ121	90FF6051BCA	BT210
90409682	BN040	90487795	JJ537	90536414	JM5092	9070982	HR5045	91000883	NB469
90409693	JJ120	90487796	NB431	90537319	HM5300	90750670661	KJ647	9106027	AY210
90409709	JC823	90487863	BZ111	90537687	HM5370	9091002075 (16x)	HBS397	9106235	BY240
90409710	BS720	90487864	BZ120	90540061	AB5680	9091002080	HBS315	9106305	AY220
90409877	BS260	90487874	JN955	90540351	DP806	9091002081	HBS315	91111863	BL390
90410036	JD5979	90487889	NF637	90540356	EY230	90910-02096 (x26)	HBS500	91111872	JN414
90410526	HBS054	90490239	JH5067	90540357	HC5007	9091002097	HBS042	91118404	GL391
90410697	JD459	904F6584CA	JM5027	90540460	AB5670	9091002099	HBS042	91120283	NJ336
90410741	NB884	904F6584CA	JN821	90541019	BS260	9091002100	HBS306	91120284	NJ336
90410741	PA5041	90500342	JD474	90542155	BY330	9091002101	HBS306	91120287	NJ337
90410753	BY300	90500532	JJ574	90542156	BY340	9091002120	HBS203	91125494	DL391
90410754	BY270	90500805	NA5069	90542157	BY350	9091002121	HBS203	9113671390	JH016
90411286	JJ459	90501195	JJ573	90543010	AB5140	9091002136	HBS314	91151559	DY251
90411386	JJ459	90501525	JP009	90543333	AY160	9091002137	HBS312	91151626	DY251
90411752	JM5095	90501526	JP008	90543334	AY170	9091002139	HBS314	91174357	HBS447
90411753	JM5094	90501641	JM5095	90543335	AY180	9091002141	HBS441	9117667	CB5241
90411814	JH5052	90501647	JH5019	90543375	CB5140	90910-02151 (x8)	HBS508	9117670	DY232
90411816	JJ572	90501652	JD5202	90543376	EB5140	9091002152 (10x)	HBS385	9117671	CY211
90411816	JJ573	90501653	JD5203	90543900	EB5670	9091002158 (x10)	HBS531	9117672	CC5460
90412126	JD457	90501720	NB700	90543909	AC5460	9091010132	HBS200	9117674	EB5240
90412126	JD458	90501944	JP016	90544049	AB5240	90910T2005 (x10)	HBS501	9118348	DY300
90412127	JD458	90502090	JJ617	90570009	AB5240	9091302	PA6055	9118351	CY210
90412127	JD5201	90502092	JH5119	90570322	NA5209	9091302018	KJ466	9118642	EK486
90412128	JD457	90502195	JH5057	90571075	JD5245	9091302019	KJ466	9119304	AB5360

OE reference	▲ Payen	OE reference	▲ Payen	OE reference	▲ Payen	OE reference	▲ Payen	OE reference	▲ Payen
91203611003	NJ254	9126277	JD5210	9158057	PA5025	924F6014BA	DT805	93177255	JM5259
91203611004	NJ254	9128894	JH5080	9162593	GX392	924F6051AA	BT800	93177284	NA5230
91203PA5004	NJ254	9129716	JD5148	9166497	JD5280	924F6051AA	DT802	93177310	HR5088
91203PG6003	NJ254	9129909	HBS180	9169079	BT560	924F6051AA	BT800	93177328	JD5411
9120660	EB5671	9135513	BY371	9175902	NB847	9275816	JN521	93177329	JD5412
91212679003	NK102	9135513	DY370	9177957	JH5067	9275816	JN523	93177335	JD5413
91212679004	NK102	91355131	BY371	9180611	JC152	92810460100	HR599	93177338	KK5646
91212679014	NK125	9135894	HL728	9185695	AC5630	92810460107	HR800	93177701	NA5223
91212P0A004	NA5242	91358945	HL728	9186404	JD5281	9281324	NB628	93177867	EH5030
91212-PAA-A01	NA5242	9141460630	JC643	9186412	JD5282	928905012	PA928	93177868	CE5950
91212PC6003	NJ311	9146007	BW680	9186609	JJ501	928F9441DB	JD264	93177869	CH5030
91212PD2004	NJ311	91460071	BW680	9194642	DY253	928M6051AG	BW630	93180240	AE5930
91212PE0000	NJ381	9146008	BW690	9194643	EC101	928M6051BH	BW640	93180282	AE5920
91212PE0003	NJ381	91460089	BW690	9196318	CB5141	928M6065BC	HBS031	93182932	CH5031
91212PE0662	NJ381	9146009	BW700	9196320	CE5920	928M6065BD	HBS031	93185729	JD5982
91212PE1721	NJ381	91460097	BW700	9196358	EB5360	928M6584C1B	JN950	93186122	AH5240
91212PH1003	NJ311	9146262	JA5037	9196359	CB5360	928M6584CB	JN950	93186907	CH5241
91212PH1004	NJ311	91462622	JA5037	91EM6051AA	BP890	928M6700B5A	NB959	93186911	CH5240
91212PH1013	NJ311	9146266	JA5038	91EM6051BA	BP900	928M6700BA	NB959	93190885	CH5242
91212PH1661	NJ311	91462663	JA5038	91EM6051CA	BP910	928M6K292B5A	NB958	93192070	JD5993
91212PH7003	NK023	9146603	HR800	91FF6013AA	ET191	928M6K292BA	NB958	93193714	AH6620
91212PH7013	NK023	914F9448AA	JD066	91FF6051ACA	AB5820	928M6K929B5A	NB958	9321464	HM5070
91212PJ5003	NJ982	914F9461AA	JD065	91FF6051BAA	BW010	928M9441GB	JD265	9321597	CC5690
91212PJ5013	NJ982	91503348	BH950	91FF6051BBA	BW020	928X6014BA	DW631	9321605	DT562
91212PT0003	NK159	915035000028	PA349	91FF6051BCA	BW030	9292234	NB690	933724	DK611
91212-PT0-004	NJ134	91503885	BH950	91FF6051CAA	BM950	9295029	JN523	9337247	DK611
91212PT0004	NJ312	9150388580	BH950	91FF6051CBA	BM960	92HM6013AA	HC285	93501128	NF841
91212-RBD-E01	NA5320	91505109	BL650	91FF6051CCA	BM980	92HM6014BA	CH865	93501444	JN544
91212-RBD-E02	NA5320	91505110	BL650	91FF6710AA	JJ463	92HM6014CA	CH864	9350144480	JN544
91212-RNA-A01	NA5320	91505500	JC415	91HM9441AA	JA769	92HM6051AA	AH860	93502226	JJ283
91212-RTA-A03	NA5320	91505787	BL650	91SM9448AA	JC790	92HM8507AA	KA289	9350228980	NF781
91213PC6000	NJ313	9150683280	HG093	91SM9448AB	JC790	92SM6051AB	BY740	9350281	BK610
91213PC6003	NJ313	91506974	BM530	91SM9448BA	JC790	92SM6051BA	BJ440	935599	JN513
91213PD2004	NJ313	91507124	HR566	91SM9448BB	JC829	92SM6051BB	BJ440	9355991	JN513
91213PE1721	NJ313	91508054	JN547	91XM6051A4D	BY640	92SM6441AA	JD498	93740012	F68000
91213PH1003	NJ313	91508290	NF746	9202219	JR5029	92SM9441AA	JD498	93740053	FD5690
91213PH1004	NJ313	91509974	BM530	92030773	JC282	93010242	JJ283	93740055	FG7990
91213PH7003	NJ933	91511138	KA611	92030808	JC757	9301024280	JJ283	938M6051AA	BW630
91213PH7004	NF678	91511857	HBS083	92060518	BP810	93010402	JC423	938M6051AG	BW640
91213PH7013	NJ933	91515138	NF746	92061971	EC100	9301040280	JC423	938M6051CE	BW650
91213PL2003	NJ933	91517355	JN596	92061971	EC102	930597	JN285	938M6710AC	JJ531
91213PT0003	NJ134	91520521	BM530	92063977	DY254	9305970	JN285	938M9441DC	JD266
91214PC6003	NJ312	9152052180	BM530	92065111	EC102	9306911	JN513	938X6013AA	EW630
91214PC6013	NJ312	9153738980	BF570	92065112	DY255	9307281	BK610	938X6013AB	EW630
91214PD2004	NJ312	91538218	JD5764	92065529	JD5737	930781	HR800	938X6014AA	DW630
91214PE1721	NJ312	91538297	BM530	9221160210	JE019	9309204	NB714	938X6014AA	DW640
91214PH1003	NJ312	915386	BR510	9225834	JE5017	9311077	JC365	938X6014BA	DW641
91214PH1004	NJ312	91538611	BL650	9225835	JE5024	93160143	CD5991	938X6014BA	DW650
91214PH1661	NJ312	9153861180	BL650	9226543	JD5277	93171267	CB5540	938X6014AA	DT110
91214PH3751	NJ312	91538612	BR510	9230949	JD5868	93172423	EB5541	93FF6700AA	NB984
91214PH7003	NJ675	91538925	NF678	924F6013AA	ET800	93174527	AG9590	93FF9448AA	JD310
91214PH7013	NJ675	91539050	JD5763	924F6013BA	ET800	93176980	CE5930	93HX6013AA	EH850
91214PL2003	NJ675	9153974080	BL650	924F6014AA	DT802	93177186	AE5950	93HX6014AB	CH864
91214PL2004	NJ675	91539812	BL650	924F6014AA	DT803	93177249	AD5800	93HX6014AB	DN150
91214PR4A01	NJ312	9157510	JD5117	924F6014AA	DT806	93177250	AD5810	93HX6014AC	CH865
91214PR4A01	NJ313	9157567	JR5030	924F6014BA	DT801	93177251	AD5820	93SX6013BA	EA441

INTERCHANGE OE → PAYEN

Vergleichsliste OE → Payen • Références croisées 1ère Monte → Payen
Intercambio OE → Payen • Intercambio entre equipo original y Payen

OE reference	▲ Payen	OE reference	▲ Payen	OE reference	▲ Payen	OE reference	▲ Payen	OE reference	▲ Payen
93SX6014AB	DP790	94324053	BP920	95493998	BG450	9567224080	JC991	96105057	JC991
93SX6014AB	DY740	94327063	NK103	95494022	BH930	9567526480	DV190	9610505780	JC759
93SX6014BB	DJ444	94334845	NJ454	95494183	BG540	9569757780	JD6023	9612547U	NF677
93SX6014EB	DN472	94339997	NJ323	95495497	BL830	9582001100	JN936	9612552U	NF637
93TX6013AA	ET490	94367979	JHS058	95496271	NF776	958M9448AA	JE5021	96129692	BS810
93TX9A454AA	JC364	94386441	AY840	95496879	NF809	959085112	NB619	96132009	BS730
93WX6013AA	EX550	94386442	AY850	95496879	NF810	95BM9448AC	JD545	96133146	BL650
93WX6014AA	DX550	94386443	AY860	95510438300	AG9610	95VW6051AA	AA5430	96133360	BS820
93WX6014BA	DX550	9440651	NA5178	95542218	BG450	95VW6571BA	HR5030	96136745	HBS125
9400127459	NA5192	94429626	BS230	95542219	BG540	95VW6571BA	HR599	9613674580	HBS115
9400197139	GM533	9443310	NA5136	95543282	GH930	95VW9448AA	JA5069	96144620	HMS226
9400197149	DM530	9443787	HR5076	95552708	GF054	95VW9448BA	JD5109	961494980	NA5191
9400197169	DM533	9443787 (x20)	HR5113	95567410	DG452	95WM 6584 AC	HMS238	9614972480	BM530
9400197369	GJ720	9443896	AB5440	95567411	GG452	95WM6051C4A	AC5910	9616067680	BY140
9400197379	DJ720	9443897	AE5170	95569119	DG452	95WM6051D2A	BX550	96160677	BY140
9400197849	DM533	94450954	BS230	95569120	GG452	95WM6051D2B	BX550	96177786	JB830
9400209239	BM530	94468654	NB734	95569123	DG542	95WM6051D4A	BX550	96177787	JB864
9400807289	NA5035	94482157	NJ449	95569124	GG541	95XM6051B2A	BY640	96181218	BZ300
9400956480	HR5081	94501031	HBS285	95586979	DN582	96000436	JE189	96181823	BS730
9400956489	HR5046	9456000224	BP720	95590761	NF776	96003915	HBS082	9618182380	BS730
94020262	NJ014	9456001368	BP720	9559076180	NF776	96005977	HBS038	9618603280	BG540
94021915	JE019	9456001370	BP720	95590822	GL650	96008902	BL650	9618603680	BG450
94026324	NJ265	9456001443	BR490	95590823	DL650	9600897480	BR510	96190676	BY310
94026351	JH016	9456002680	BR510	95591804	JC415	96010048	JC759	9619100480	BY310
94026399	JC643	9456033280	BM530	9559180480	JC415	9601004880	JC759	9619659980	BY310
94028187	JN408	9456033480	BR490	95593775	GL830	96016489	BG450	9619659980	BY320
94028764	JJ192	9456043880	JC423	95602513	DJ720	96020124	HR599	9620571080	JD5972
94029787	NJ267	9456043980	JD5972	95602514	GJ720	96020124	HR800	9621469980	JC759
94030188	BM370	9456062380	BN580	95605041	BH930	9602087	JH434	9621917180	BX930
94030585	NJ266	9456062480	BP720	95605462	DG452	96026579	JN758	9621917280	BX940
94033612	DM330	94580081	HBS377	95605462	GG452	96026976	BR780	9621917380	BX950
9404725	AB5420	94580655	HR342	95605463	GG452	9602697680	BR780	9621917480	BX960
9404726	AB5450	94581178	NA5017	95614597	GL650	96026977	BR790	9623068080	BX880
9404727	AE5160	9458309	NA5179	9561800	HR569	9602697780	BR790	9623068180	BX890
94070854807402	AE5310	9458503	JD5289	95619476	DT012	96028464	JC415	9623068280	BX900
94110559	PA658	9458534	JD5288	95619477	DS810	96033224	HBS115	9623068380	BX910
94115243	DM370	9458535	JD5297	95619477	DT010	96034899	JD230	9623068480	BX920
94129884	NJ446	9463330180	JM7121	95619477	DT012	96035354	JC750	9624116780	HBS089
94145839	BX040	9463377480	JM5139	95619749	GL830	96041703	BS730	9624851880	AA5830
94210402	JC060	9463377580	JM5283	95625019	DF180	96042653	JJ283	9624851980	AA5840
94214912	NJ323	9463380380	JM5141	95634287	BH930	96051581	JN579	9624852080	AA5850
94214985	JN634	948103384B	HBS024	95636678	BL830	9605348380	HR667	9624852180	AA5860
94221022	JC429	94840023	NJ001	95638362	JF067	96055143	BM740	9624852280	AA5870
94221025	JC284	94840104	JC116	95644580	DJ720	96059994	HBS087	9628139180	BX980
94226564	JJ204	94840602	JE015	95644580	GJ720	96061328	BV150	9630117480	AH5040
94235280	BM330	94843886	JN356	95644581	DJ720	96061330	BV160	9630117580	AH5060
94235369	NJ322	9497825	HBS533	95647731	DS731	96061591	HBS407	9630142380	JM5087
94236345	JE751	94SM9441AB	JD554	95650948	DS820	96062536	BS810	9631366780	AD5490
94239140	JN456	95 512 889	NA5057	95650949	DS820	96073848	HBS084	9631366980	AD5500
94239332	NA5271	95100257	HR599	95654054	DV150	96075122	BL650	9631367180	AD5510
94241516	GM370	953080413	NF634	95655248	DV150	96080067	NA5205	9631367380	AD5520
94241518	DM370	9543455	NA5069	95655249	DV150	96080067	NF836	9631424480	JD5881
94248829HS	DM370	9549050	ET560	9566937980	DS820	9608064880	JP045	96351213	HMS227
94251171	NJ449	9549070	EC350	9567221180	DJ720	96080792	NF826	96352281	JD5740
94313803	JN777	95493120	BG450	9567223980	EL890	96093134	BS820	96352947	JD5774
94320618	HBS036	95493121	BG540	9567223980	GJ720	96103003	AB5230	96352947	JD5794

OE reference	▲ Payen	OE reference	▲ Payen	OE reference	▲ Payen	OE reference	▲ Payen	OE reference	▲ Payen
96353035	NA5164	96MM6710AD	JE5025	97599116	PA850	988803	JE480	A83SX6014CA	DC240
96353036	JE5034	96MM6K292A2A	NC048	978M6051CF	BZ490	988M6051BC	AC5800	A83SX6014DA	DM940
96353096	JE5034	96MM6K292A2B	NC048	9790015700	DF106	988M6584AE	JM5154	A84SX6008HA	EH850
9635967180	AC5011	96MM9441AD	JD5230	9790018200	DM530	988M6700A5B	NA5323	A84SX6014BA	CH854
9635967280	AC5020	96MX6013AA	EY650	9790018300	DM530	988M6710AG	JH5061	A84SX6014CA	CH864
9635967380	AC5031	96MX6014AA	DY650	9790464500	NA5204	988M9461AA	JD5311	A84SX6014DA	DN140
9635967480	AC5040	96MX6014AA	DY660	9790464580	NA5204	98JV6051BC	AC5260	A84SX6014FA	DN150
9635967580	AC5051	96XM6051B3B	AC5680	97MF6051AA	AC5290	98JV6083BC	AC5270	A84SX6014GA	CH864
9636017380	AD5300	97002474	HBS039	97MM6050BC	BY660	98MM6051AB	AB5130	A850X6013A2A	HC452
9636179280	AH5050	97044731	AB5010	97MM6051BC	BY660	98MM9441AA	JD5290	A850X6013AA	EH752
9636180080	AH5070	97044732	AB5020	97MX6014AA	CC5290	98MM9448AB	JD5164	A850X6014ATA	DH681
96378805	JD5739	97044733	AB5030	98410475	AB5100	99310411101	HR805	A850X6014AUA	DM530
96391435	BZ300	97066198	AD5400	98410476	AY590	99425767	JC054	A850X6014BKA	DL570
96411866	JN808	97142110	AY900	98414010	JJ549	9942588	JP069	A850X6014CBA	DM710
96411875	JN812	97142111	AY910	98421263	JR580	99430005	BX390	A850X6014CKA	DP190
96411878	JJ451	97142112	AY920	98421269	KV927	99432353	BX400	A850X6014CLA	DL571
96411879	JJ452	97183007	JM5197	98421275	LS859	99432354	BX390	A850X6014CNA	DC790
9641780680	AH5080	97218651	JD5332	98421304	KA546	99432807	LC281	A850X6014CRA	DC800
9642252180	AH5090	97219444	JD5329	98424150	JN585	99432808	LC282	A850X6014CTA	DG871
9642252280	AH5100	97229307	HBS502	98424150	JN969	99433965	NP067	A850X6014DLA	CJ271
9642252380	AH5110	97229308	HBS502	98425767	JC054	99442951	HBS255	A850X6014DUA	DP011
9643596780	AD5150	97232207	JD5336	98427998	NP067	99443512	KV927	A850X6014EFA	DP110
9643597080	AD5130	97232208	JD5333	98428409	NP068	9944352	DS381	A850X6014EGA	DJ420
9643597180	AD5140	97240455	JD5334	98430478	KD929	99447458	NF883	A850X6014EHA	DJ430
9643597380	AD5160	97252689	JM5198	98432857	LS856	99453418	NF883	A850X6014ELA	DD631
9643597480	AD5170	97253294	AG9810	98434020	JC055	99453418	NF885	A850X6014FBA	DN010
96440163	AH5690	97253297	AG9780	98436545	NF853	99458402	BX420	A850X6014FMA	DH693
96440164	AH5700	97263015	JD5331	98445099	AB5110	99460983	BX410	A850X6014FNA	DH683
96440165	AH5710	972965PM	JD245	98448817	AB5110	99461498	AY580	A850X6014FTA	DK640
96440309	JM7115	97313266	JD5330	98451055	NP068	99461499	AY590	A850X6014GUA	DJ690
9645863080	NA5191	97315052	AE5520	98454039	NP067	99462206	JJ549	A850X6014HAA	DK440
9645863280	NA5192	97315053	AE5530	98454041	NP067	99462588	JP069	A850X6014HBA	DD502
9651363780	AH6580	97315054	AE5540	98454045	NP067	99468744	NF883	A850X6014HCA	DK480
9651363880	AH6560	97370797	AE5520	98454045	NP068	99477116	GX410	A850X6014HEA	DM530
9651363980	AH6570	97370798	AE5530	98454057	NF853	99477119	DX391	A850X6014HGA	DK470
9651364080	AH6590	97370799	AE5540	98461673	NF885	99477120	DX390	A850X6014HHA	DL010
9651364180	AH6600	974068	NB775	98471766	BR070	99487487	GX410	A850X6014HJA	DM381
9651513280	AH5040	97506647	HR805	98472291	JN956	99488483	JJ519	A850X6014HLA	DK611
9652803180	AD5700	9750664780	HR805	98480250	BE580	9S51 6659 EA	NA5057	A850X6014HRA	DM840
96571108	JD6037	9751080000	NF857	98482291	AY310	9S9V360005	NJ337	A850X6014JCA	DJ852
9660534980	AH6400	9751080080	NF857	98482940	NF853	A010140L2F	GW620	A850X6014JHA	DG811
9660535080	AH6410	97510801	NF870	98484659	KD931	A010182A2EHS	DS051	A850X6014JKA	DK641
968M71L720AA	NB788	97510802	NF746	98492142	EW091	A104215B8F	DL761	A850X6014JNA	CF073
968M9448AA	JD5313	97511321	JB837	98492149	EW091	A72SX6013AA	HC285	A850X6014JSA	CF474
96BM6051A2A	BT140	97520610	BS810	98492150	DS381	A76SX6013A1A	HC355	A850X6014KMA	CH865
96BM6584A4A	JN105	97523053	JN658	98492152	DR073	A76SX6013AA	HC355	A850X6014KNA	DC240
96BM6710A2A	JH5015	97530738	JC702	98492580	AY290	A76SX6014AA	DC240	A850X6014KTA	DL402
96BX6013AA	EY671	97531278	HR599	98492581	AY300	A78SX6014CA	DC240	A850X6014LA	DC270
96BX6013CA	HC452	97531278	HR642	98498291	AY310	A78SX6014DA	DC240	A850X6051AAA	BL030
96BX6014AA	DY671	97531278	HR646	9851103U	GF492	A80SX6013AA	HC452	A850X6051SA	BG830
96HM6065AB	HBS078	9753127800	HR599	9855561	DX652	A82SX6008AA	GG050	A850X6051TA	BL010
96MM6051BC	BY650	9753127880	HR646	986955	JH310	A82SX6013AA	HC346	A850X6051UA	BL020
96MM6065AB	HBS078	97531974	BN580	986965	JR087	A82SX6014AA	DG050	A850X6584AEA	JN283
96MM6571AE	HR808	9753197480	BN580	986984	JA752	A82SX6014BA	DH890	A850X6584AFA	JN297
96MM6571BE	HR809	97531988	HR646	987057	KG393	A82SX6014DA	DL401	A850X6584AKA	JM333
96MM6710A2A	NA5137	9753198880	HR646	987112	KH007	A83SX6014AA	DC240	A850X6584AMA	JN244

INTERCHANGE OE → PAYEN

Vergleichsliste OE → Payen • Références croisées 1ère Monte → Payen
Intercambio OE → Payen • Intercambio entre equipo original y Payen

OE reference	▲ Payen	OE reference	▲ Payen	OE reference	▲ Payen	OE reference	▲ Payen	OE reference	▲ Payen
A850X6584ANA	JN248	AJ0310272	AG7820	B66010235A	JN691	D40799101	DE545	E58099100D	GJ430
A850X6584BAA	JN238	AJ0310SF0	CG7810	B66010271	BP570	D4226584A	JM875	E58099101	DJ430
A850X6584BCA	JM663	AJ0313111A	JD5930	B66010271A	BP570	D4Z26584A	JM875	E5A199100A	GJ431
A850X6584BDA	JM986	AJ0313135	JD5931	B66010271B	BP570	D50699101	DE545	E5A199100AHS	DJ431
A850X6584BFA	JN232	AJ83743	AC5510	B66010271C	BP570	D9726571B	KJ710	E5D710271	BP540
A850X6584BGA	JM848	AJM1238	CF474	B66013460	JC781	DA04112871067	DR880	E7EE6051C7B	BJ440
A850X6584BHA	JM850	AJM1250	CF073	B69513460	JC781	DBP4100	JJ309	E7EE6051C7B	BX480
A850X6584BNA	JN273	AJM1251	CF073	B6B113460A	JC784	DBP4105	BM990	E7EE6584C8B	JN815
A850X6584BRA	JM302	AJM293	EF07C	B6F410271A	BS940	DBP4106	BM990	E7EE9439A6C	JD028
A850X6584BSA	JM025	AJM302	AF070	BAU5092	BK580	DBP4141	EM992	E7EE9439A8C	JD028
A850X6584BTA	JM008	AJM401	JM302	BAU5093	BP260	DBP9265	JN562	E7G26051A	BP600
A850X6584CBA	JN068	AJM436	JM483	BAU5094	BK570	DBP9278	BM990	E7G26051B	BP600
A850X6584CEA	JN317	AJM4501	JN562	BDU1772	JJ315	DBP9347	JJ309	E7G26584A	JN628
A850X6584CGA	JN365	AJM502	HC031	BDU2140	JJ315	DBP9737	EM992	E834078S	KT738
A850X6584CHA	JN292	AJM528	HC063	BDU2388	BP880	E10110271	BJ420	E853100S	KT738
A850X6584CJA	JN285	AJM539	JH434	BHM1391	DK450	E10199101	DJ420	E8B26051A	BR960
A850X6584CKA	JN454	AJM692	JB792	BHM1393	DK451	E1726571A	KJ710	E8B26051B	BR960
A850X6584CLA	JN356	AJM693	JB894	BHM1393B	DK451	E1F26584A	JN332	E8EE6710A8A	JJ455
A850X6584CRA	JN299	AM1323A	JN232	BHM1429	EF07C	E23497	NF694	E9226584A	JN692
A850X6584DDA	JN459	AM1412D	JB864	BHM1586	DN671	E30110235	HL508	E9RE6051A7A	BX480
A850X6584DGA	JN368	AM1412E	JB830	BHM1587	DN671	E30110235	JN396	EAC2912	JN539
A850X6584EA	JN279	B30110271	BR960	BHM1609	EM685	E30110235A	HL508	EAC4691	JC241
A850X6584EAA	JN513	B30113460	JD109	BHM1617	DS791	E30110235A	JN396	EAC5032	BR299
A850X6584EBA	JN494	B30210271	BR960	BHM1619	DS791	E30110235B	HL508	EAC7504	BT070
A850X6584EEA	JN462	B30210271A	BR960	BHM1624	EM682	E30110271	BJ430	EAC7954	NB720
A850X6584EGA	JN344	B31R-10-271	AG9080	BHM1625	EM682	E30110271A	BJ430	EAC8994	HA5010
A850X6584EJA	JM154	B36610235	JN774	BHM1627	DL381	E30110271B	BJ430	EBC11081	JC241
A850X6584ELA	JN533	B36610235A	JN774	BNP3418	NJ254	E30110431	JJ149	EBC11330	HA5011
A850X6584ENA	JN562	B36610271	BV430	BNP4653	NJ254	E30113510	JC250	EBC1551	BT070
A850X6584ERA	JN576	B37610271	BR960	BP0510235	JN775	E30113510A	JC250	EBC3956	HR5050
A850X6584FBA	JM053	B3C710602A	NK158	BP0510235A	JN775	E30123099	JJ149	ECP7248	BM990
A850X6584FCA	JN396	B3D210271	BV430	BP0510271	BS950	E30140305	JE102	ERC3605	JB792
A850X6584FGA	HL474	B541-13-460	JD5753	BP0511312	NK157	E30199100	GJ430	ERC3606	JB792
A850X6584HA	JM077	B61610271A	BP600	BP2610271	BS950	E30199100A	GJ430	ERC3990	JB894
A850X6013AA	HC452	B61613460A	JC974	BWC0322770	DN233	E30199100B	GJ430	ERC7865	HR5054
ADU8891	NB774	B61L10271	BV110	C184051	JE231	E30199101	DJ430	ERR1208	JC886
ADU9143	NB772	B61P10235	JN752	C3NE6701A	NB564	E30199101A	DJ430	ERR1632	NB849
ADU9144	NB773	B61P10235A	JN752	C8981	JE231	E30199101B	DJ430	ERR1636	BY470
ADU9145	NB775	B63010155	PA883	CAM7557	JC435	E30210271	BJ430	ERR1637	BY480
ADU9154	NB774	B63010155	PA956	CAM7774	BN670	E30340395	JE101	ERR1638	BY490
AEU2078L	HBS105	B63010235	JN628	CAM7777	JJ315	E30340395A	JE101	ERR1782	HR5054
AEU2078L	HBS107	B63010237A	PA858	CAM8298	JC240	E30540305	JE102	ERR2393	JN872
AEU2083	HBS105	B63010271	BP600	CAM9780	BL380	E43E6700D	NJ324	ERR2409	JP020
AEU2083L	HBS105	B63010271A	BP600	CAM9991	NB772	E43Z6584B	JN576	ERR2532	NB848
AEU2083L	HBS107	B63010431A	JJ354	CBC4834	JE231	E43Z9448A	JC477	ERR3785	JD471
AEU2085L	HBS105	B63010602	NJ448	CDU1890	JJ404	E50110271	BJ430	ERR382	BY470
AEU2085L	HBS107	B63011312	NJ650	CDU3860	HR656	E50110271A	BJ430	ERR383	BY480
AHT188	AF470	B63013111	JC666	D176 404.A2	HR397	E50413502	JC163	ERR384	BY490
AHU2157	NB772	B63013111A	JC666	D1F26700B	NA576	E50813111	JC183	ERR4537	BY470
AHU2198	NB774	B63013135	JC665	D1F28255A	KT738	E58010271	BJ430	ERR4538	BY480
AHU2242	NB772	B63013460	JC664	D1F29448A	JA768	E58010271A	BJ430	ERR4539	BY490
AHU2243	NB775	B63013460A	JC664	D1F29448B	JA770	E58010271B	BJ430	ERR5261	BY470
AHU2283	NB775	B64D10271	BV110	D2721190A	NJ042	E58099100	GJ430	ERR5262	BY480
AHU2310	BP880	B64D10271	BV510	D2726700A	NJ042	E58099100A	GJ430	ERR5263	BY490
AHU2804	NB829	B66010155	PA956	D2RY6701A	NB564	E58099100B	GJ430	ERR5384	HBS530
AJ0310271	AG7810	B66010235	JN691	D40199101	DE545	E58099100C	GJ430	ERR5437	AY200

OE reference	▲ Payen	OE reference	▲ Payen	OE reference	▲ Payen	OE reference	▲ Payen	OE reference	▲ Payen
ERR6130	NB843	F80199101B	DL321	GUG701209HS	DW755	GX0316801A	JB833	LGP100310L	HR5045
ERR6824	AB5900	F80199101C	DL321	GUG701583CS	ER320	GX0410301A	JB833	LJQ100560B	HR656
ERR7029	JH5012	F80210271	BL320	GUG701584CS	EB5400	GY0113-60A	JD5926	LKG10002	JC909
ERR7094	JM5034	F80211399	NJ325	GUG701585CS	ER321	H40591-00	AH6780	LKG10011	JC852
ERR7154	BY500	FE0110602	NJ324	GUG701590	ER322	H75AB9451AC	JE719	LKG100290L	JA5078
ERR7217	AY200	FE0210602	NJ324	GUG701590CS	ER322	HE1910155	KJ710	LKG100590L	JD5183
ETC5301	BM850	FE1013460	JC400	GUG701591CS	EZ440	HG132204A	JN245	LKJ10029	JC877
ETC6438	JM350	FE1H10271	BR730	GUG701627CS	ER321	HG1812	JB842	LKJ100680	JD441
ETC7401	BM850	FE1H10271A	BR730	GUG701628CS	ER322	HG23187	KA606	LKJ100992L	JA5079
ETC7750	JC882	FE1H10271B	BR730	GUG701629CS	EZ690	H0061A1PE3000010	DM995	LQX10002	NB828
ETC7788	BM850	FE3010271	BL320	GUG701630CS	EZ440	H0061B1PE0000010	EM992	LQX100040	NB828
ETC7819	BR290	FE3010271A	BL320	GUG702523HG	BS790	IS8942488290123	GM372	LQX100070	NA5083
ETC8808	HBS224	FE3010271B	BL320	GUG702534HG	BS860	IS8944383180	DR190	LR004418	AA5940
ETC8809	HBS224	FE3N10235	JN717	GUG702568HG	BZ440	JD411273043	GP650	LR004419	AA5950
ETC8810	HBS224	FE3N10235A	JN717	GUG702569HG	BZ450	J9010512092 (10x)	HBS386	LR004420	AA5960
FORE6710AA	JJ455	FE3N10271	BR850	GUG702570HG	BZ460	JE0110270	BR980	LUB10009	HR802
F1B26854A	JN628	FE5H11399	NJ325	GUG702576HG	BW750	JE0110270A	BR980	LUB10026	HR752
F20110235	JN692	FE5H11399A	NJ325	GUG702580HG	AB5400	JE01102H0	BR970	LUB100350	HR752
F20110235A	JN692	FE8513460	JC400	GUG702607HG	AB5080	JE01102H0A	BR970	LUC100220	NB998
F20110235B	JN692	FE8513460A	JC400	GUG702608HG	AA5920	JF0110235	JN714	LUC100290	NC065
F20110235C	JN692	FE8513460B	JC400	GUG702610HG	BZ710	JF0110235A	JN714	LUC100290L	NB586
F20110235D	JN692	FP3910271	BV380	GUG702611HG	BZ690	JF0110602	NJ978	LUF000020	NA5132
F20110235D9A	JN692	FS0110271	BV380	GUG702612HG	BZ700	JF0110602A	NJ978	LUF10001	NB829
F20113111	JC779	FS0111399	NK205	GUG703004SG	JJ404	JF0111312	NK035	LUF10002	NR772
F20113460	JC777	FS01-13-460	JD331	GUG703044SG	JH5016	JF0111312A	NK035	LUF10007	NB843
F20113460A	JC777	FS0210602	NA5246	GUG703058SG	JH5032	JF0112602	NJ985	LUF10008	NB828
F20113460B	JC777	FS0510271A	BV380	GUG703059SG	JH5033	JF0112602A	NJ985	LUF10019	NB829
F20113464	JC778	GEG1257	DK570	GUG703060SG	JH5012	JF0113460	JC931	LUF100300	LK5000
F20210271	BR730	GEG1269	EG914	GUG704002MG	JD656	JLM11088	DT070	LUF100420	LK5002
F20210271A	BR730	GEG242	EG914	GUG704004MG	JC877	JLM113	DT070	LUF100530	NA5103
F22010271A	BR730	GEG269	EG914	GUG704052	JD311	JLM11383	DT071	LUF100530L	NA5103
F3226051A	BV380	GEG286	EG914	GUG704056MG	JD657	JLM11649	DT072	LUF100540	NA5104
F3226584C	JN877	GEG298	EG914	GUG704064	JD563	JLM12305	DT072	LUF100540L	NA5104
F3AE6701AA	NA5175	GEG404	JM302	GUG704064MG	JD563	K0AH1-10270A	CG9870	LJ10002	JN736
F43X6014	CC5870	GEG502	HC031	GUG704066MG	JD441	K4111400	NJ007	LUL10007	NB843
F60140395	JF017	GEG692	JB792	GUG704091MG	JA5079	K4111403	NJ007	LVB000100L	BZ710
F60140395A	JF017	GUG1004	DW750	GUG704094MG	JD311	K418AF02	NB774	LVB000190	AB5900
F80110235	JN533	GUG1004HS	DW750	GUG704403MG	JD654	K418FF01	NB772	LVB000210	AB5920
F80110235A	JN533	GUG1006HS	DW750	GUG704412MG	JC909	K418FF02	NB773	LVB000230	BW750
F80110235B	JN533	GUG1007	DW755	GUG704430MG	JC852	K418FF05	NB775	LVB000240	AB5900
F80110235C	JN533	GUG1007HS	DW755	GUG704435MG	JA5078	KF0110271A	BX780	LVB000250	AB5910
F80110235D	JN533	GUG1012HS	DW5757	GUG704446MG	JD5183	KF0110272A	BX790	LVB000260	AB5920
F80110235D9A	JN533	GUG2523HG	BS790	GUG704806MG	LA564	KL0110155	PB313	LVB000290	BZ660
F80110271	BL320	GUG2534HG	BS860	GUG704816MG	JD564	KL0110271B	BV410	LVB000300	BZ670
F80110271A	BL320	GUG4052	JD311	GUG704817MG	JC907	KL0110272B	BV420	LVB000310	BZ680
F80110271B	BL320	GUG4403MG	JD654	GUG704821MG	JD655	KL31-13-111	JD5756	LVB000340	AC5350
F80110271C	BL320	GUG701115HS	DW755	GUG705006VC	JN963	KL68-13-460	JD5755	LVB000360	AC5360
F80110271D	BL320	GUG701126HS	DZ440	GUG705040VC	LB536	KN1629A	GF492	LVB000390	AB5980
F80110431	JJ268	GUG701138HS	DW756	GUG705045VC	JP097	KS271-10-270	CH6540	LVB10001	BN670
F80110602	NJ324	GUG701154	DW754	GUG705047	JN963	L309-10-271	AD5220	LVB10003	BN670
F80111399	NJ325	GUG701154HS	DW754	GUG705053VC	JM5045	L3G210271A	AH6680	LVB1000760	BW750
F80113111	JC401	GUG701200HS	CB5080	GUG705054VC	JP065	L50410271	AH6350	LVB10010	BW750
F80113111A	JC401	GUG701201HS	DZ690	GUG705062VC	JM5046	L681EF06	BP880	LVB10045	BS790
F80113111B	JC401	GUG701207HS	DW754	GUG705069VC	JM5035	L681KF06	JJ315	LVB10048	BS790
F80113460	JC400	GUG701208HS	DW756	GUG705073VC	JM5076	LDN10027	HBS423	LVB10048	BS860
F80113460A	JC400	GUG701209HS	DW750	GUG705074VC	JN963	LF01-10-271	AD5220	LVB100760	BW750

INTERCHANGE OE → PAYEN













Vergleichsliste OE → Payen • Références croisées 1ère Monte → Payen
Intercambio OE → Payen • Intercambio entre equipo original y Payen

OE reference	▲ Payen	OE reference	▲ Payen	OE reference	▲ Payen	OE reference	▲ Payen	OE reference	▲ Payen
LVB100910	BZ440	MD016163	BN230	MD093227	JC611	MD190393	BT880	MD997145	DT880
LVB100920	BZ450	MD016310	NJ242	MD095355	NJ655	MD191470	HBS354	MD997146	GT880
LVB100930	BZ460	MD016490	KJ570	MD096264	NJ655	MD192250	JC124	MD997160	GH061
LVB101000	AB5400	MD016549	NJ006	MD099568	BN220	MD193224	JD5842	MD997165	GH064
LVB101380	AB5080	MD020232	JJ072	MD101666	JC719	MD301578	AG5302	MD997168	GT880
LVB101630	AA5920	MD020435	NJ251	MD101915	NJ873	MD301579	AG5300	MD997170	GN221
LVB101820L	BZ690	MD030133	JJ098	MD104623	JC751	MD304511	BK420	MD997232	DJ600
LVB101830L	BZ700	MD030282	JN317	MD108180	JC611	MD305835	JD5781	MD997233	GJ600
LVB101840L	BZ710	MD030290	BE060	MD111805	BR600	MD309720	JD5759	MD997234	DN332
LVB500190	BW5750	MD030468	JC023	MD112095	JC968	MD322820	AG7710	MD997235	DN233
LVF000030	JH5115	MD030680	JC122	MD112531	BS130	MD323473	BT430	MD997248	DS130
LVF100290	JH5016	MD030681	JC123	MD113173	BS120	MD331145	AF5470	MD997249	GS130
LVF100420L	JH5032	MD030789	NJ252	MD113178	BS240	MD333227	AG9150	MD997311	DR600
LVF100430L	JH5033	MD031630	JC122	MD115000	JC751	MD333279	AE5610	MD997312	GR600
LVP000020	JM5074	MD031631	JC123	MD117643	NJ006	MD342397	AF5480	MD997433	DS130
LVP000050	HM5066	MD031837	NJ252	MD117728	JC795	MD346750	JM5232	MD997435	DR600
LVP000060	HM5067	MD034094	BK410	MD117729	JC795	MD347377	JD6039	MD997436	GR600
LVP100470L	JM5035	MD034095	BD040	MD120091	JN713	MD348283	JM7041	MD997455	DN233
LVP100620L	JM5076	MD034235	JC124	MD124763	JC794	MD360457	JD6039	MD997468	DS240
LVP100630	JN963	MD040342	JJ274	MD125939	JN715	MD361466	AG9130	MD997469	DS241
LQV10010	DW750	MD040514	HBS295	MD130494	JN788	MD377774	AH6480	MD997470	DS120
LQV10012	ER320	MD040514	HBS307	MD133317	NJ933	MD377775	AH6490	MD997471	DS120
LQV101240	EZ690	MD040532	BL450	MD133671	JN713	MD377776	AH6500	MD997472	GS240
LQV101240L	EZ690	MD040533	BH060	MD137976	BS130	MD970441	DT890	MD997473	GS241
LQV101250	DZ690	MD040974	JC493	MD138312	BR600	MD970444	GT890	MD997474	GS120
LQV101250L	DZ690	MD041012	NJ610	MD143540	BR600	MD971345	CF5500	MD997475	GS120
MA152415	JE011	MD041329	JC612	MD143995	JN897	MD971622	CG9120	MD997477	DM830
MB431544	JE199	MD050092	GJ600	MD145826	BV010	MD971653	CG5520	MD997479	GM830
MD000248	NJ008	MD050092HS	DJ600	MD147241	BR600	MD974547	CF5470	MD997488	DR601
MD000254	NJ007	MD050109	KJ211	MD149392	JJ072	MD975562	CG9150	MD997496	GR600
MD000508	KJ211	MD050312	JN403	MD150161	NK143	MD976462	CG9130	MD997496HS	DR600
MD006268	KJ577	MD050482	JC224	MD150525	JD023	MD976861	CG7691	MD997513	DM831
MD007015	BD040	MD050545	BJ600	MD151227	BK410	MD978013	FG7690	MD997640	DV010
MD007383	JN365	MD050604	NJ251	MD151232	BT430	MD978094	CE5612	MD997671	DT430
MD007515	BD040	MD050605	NJ255	MD153103	NJ242	MD978240	CF5481	MD997672	GT430
MD008762	NJ242	MD050606	NJ005	MD153104	NJ252	MD978241	FF5481	ME024156	NJ258
MD008766	BD040	MD050608	NJ610	MD154781	BJ600	MD997014	DT890	ME200403	HM5230
MD008769	HBS440	MD062144	BM830	MD157084	JD007	MD997015	DK420	ME200751	AA5020
MD008785	JN276	MD065959 (16x)	HBS402	MD160942	BS130	MD997030	GK420	ME200752	AG5160
MD008828	JC124	MD066163	BN330	MD163293	BN220	MD997044	GK420	ME200754	AA5020
MD008882	NJ005	MD066813	BN220	MD163597	BT430	MD997046	GH061	ME202145	JA5014
MD008885	NJ006	MD068905	JC612	MD165614	BR600	MD997060	DH061	ME202850	NA5243
MD008897	JJ075	MD069947	NJ251	MD166371	JD5757	MD997061	DL450	ME202851	NA5244
MD009038	NJ255	MD069948	NJ255	MD166720	BV010	MD997089	GK420	ME203051	HBS491
MD009366	KJ577	MD069949	NJ005	MD167815	JN800	MD997090	GK420	ME203052	HBS491
MD009447	GD040	MD069950	NJ610	MD168005	NJ874	MD997104	DM830	ME203250	NA5244
MD009448	GD040	MD070669	JC554	MD168061	NJ005	MD997105	GM830	ME995720	FF5490
MD009451	BD040	MD072804	JC023	MD173023	BT880	MD997106	DH064	ME996019H	CA5021
MD010313	BK410	MD076481	JC441	MD173371	JM7039	MD997107	GH064	MH034027	NJ258
MD012189	JC611	MD081533	JC224	MD174796	BS130	MD997108	DN330	MIMD9972487433	DS130
MD012886	BK410	MD084230	JC632	MD174940	NK143	MD997109	DN231	MIMD9972497434	GS130
MD012887	BK420	MD085548	BN220	MD177339	BT890	MD997115	DN220	MN149030	JD6031
MD012908	JN599	MD088384	KJ577	MD183808	BS120	MD997116	GN220	MN158130	HBS537
MD015051	JC627	MD088445	JC122	MD184399	BT890	MD997134	DN221	MN158200	JM7124
MD015521	JN317	MD088581	BJ600	MD186786	JN889	MD997135	GN221	MN163442	JD5871
MD015623	JN365	MD088855	NJ874	MD188435	HM5239	MD997136	DK412	MN195370	AG9920









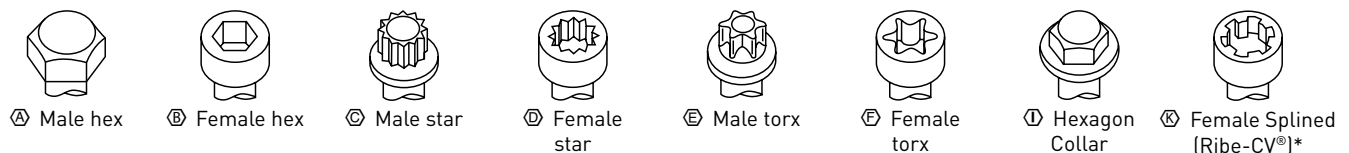



OE reference	▲ Payen	OE reference	▲ Payen	OE reference	▲ Payen	OE reference	▲ Payen	OE reference	▲ Payen
MN195371	AH7130	R95VW6051AA	BX810	SE021006142A	HBS044	X039442760	HR646	YS6G6051A2B	AC5890
MR323599	JD5372	RF0110135	HBS211	SE021006221A	JM2052	X03962184	HR805	YS6G6051BA	AB5120
MR420441	JD5966	RF0110155	PA659	SE039442760	HR646	XR843470	AC5390	YS6G6051C2A	AC5890
MR984262	HR5048	RF0110235	JN576	SE039442760A	HR599	XR843474	AC5400	YS6G6659EB	KA5021
MRFTA10271	AG5130	RF0110235A	JN576	SE700004221A	JJ136	XR85386	AC5390	YS6G9448EC	JD5219
N 901 316 02	JD236	RF0110271	BN620	SE700006121C	BG830	XR85388	AC5400	Z501-10-271	AG5120
N 901 316.02	JD236	RF0110271	BS460	SE021006221A	JM2052	XS4Q6051AD	AB5300	Z50113111	JD6040
N0138452	PA349	RF0112602	NJ448	STC1639	EG914	XS4Q6051BD	AB5310	Z50113460	JD6044
N1123	BF040	RF0113111	JC598	STC1641	DR290	XS4Q6051CD	AB5320	Z505-10-235A	JM5287
N600000990079	NB619	RF0113462	JC477	STC2031	BZ120	XS4Q6051DD	AB5330	Z6TM13111	JD6036
N7701465261	EH682	RF0199100	GN620	STC2801	EY470	XS4Q6051ED	AB5340	ZC9000271	DM530
N804732S	HBS001	RF0310271D	BN620	STC2802	DY470	XS4Q6051FD	AB5350	ZC9612552U	NF637
N804732S	HBS006	RF0310271E	BN620	STC2823	EY200	XS4Q6051NA	AB5800	ZC9612557U	NF677
N8066838S	HBS006	RF0310271F	BN620	STC362	DV720	XS4Q6051PA	AB5810	ZJ01-10-135 (x10)	HBS523
NBC2520AB	BT070	RF1L10271C	AG5130	STC363	EV720	XS4Q6051RA	AB5820	ZJ0110235	JM5311
NBC2520BB	BT070	RF1L1071B	AG5130	STC4082	CY200	XS4Q6051TA	BW020	ZJ0113111	JD6036
NBC2525AA	JN927	RF2A10235	JM5315	STC4082	JAS001	XS4Q6051UA	BW030	ZJ01-13-460A	JD6030
NBC2909AA	HA5011	RF2A13111A	JD6026	STC494	DR290	XS4Q6700AD	NA5013	ZY01-10-271A	AG8170
NCA2540AD	AC5260	RF2A13460	JD6027	SU001-00494	AH6570	XS4Q6710AE	JH5008		
NCA2541AD	AC5270	RF5C10135	HBS494	SU001-00495	AH6580	XS4Q6K260AB	JM5016		
NCC2540BC	AC5260	RF5C13460	JD6027	SU001-00496	AH6590	XS4Q6K301AE	NC086		
NCC2541BC	AC5270	RF7110271D	AG5130	SU001-00497	AH6600	XS4Q6K301AF	NC086		
NI1010105E7576	GR360	RF7110271F	AG5130	TAM1521	BK450	XS6E6065AB	HBS358		
NI1010157Y26	GP960	RFJ510271B	AG5130	TAM2121	AF070	XS6E6571AA	PA5033		
NI1010171J25	GV440	RFJ510271C	AG5130	TMG2696669704A	PA5041	XS6E6584AB	JM5104		
NI1104205E252728	DR360	RFJ510271D	AG5130	T004111540404142	GL951	XS6E6700A6C	NA5147		
NI1104270J25	DV541	RFJ5-10-271D	AG5130	T004112540303132	DL951	XS6E6700BA	NA5147		
NI1104271J25	DV440	RTC0811	EG914	UAM1636	NB775	XS6E6710A2B	JH5046		
No OE set	CB5670	RTC2104	EG914	UAM2287	BN670	XS6E6K301BF	NA5130		
No OE set	DK644	RTC3037	DM850	UAM2794	JJ315	XS6E9441BA	JD5220		
No OE set	DL011	RTC3038	EM850	UAM3543	NB775	XS6G9441AA	JD5151		
No OE set	DL012	RTC3306	EG914	UAM5445	JC908	XS7G 6051BC	AC5800		
No OE set	DW757	RTC3906	EM850	UAM7323	JN836	XS7G6051BB	AC5800		
No OE set	DX652	RTC5296	JJ315	V85SF6051AA	BN470	XS7G6584AC	JM5184		
OK24710235B	JM7038	RTC5307	NB772	V85SF6051AB	BN470	XS7G9461AA	JD5312		
PN1110235	JN710	RTC5309	NB773	V97DD6051AA	AY400	XS7Q6051AE	AA5970		
PN1110235A	JN710	RTC5310	NB775	V97DD6051BA	AY420	XS7Q6065A2D	HBS296		
PN1110271	BS070	RTC5312	BP880	V97DD6051CA	AY410	XS7Q6065C2C	HBS296		
PN1110271A	BS070	RTC5422	NB775	VAM2490	BS790	XS7Q6385AB	NA5030		
PN1110271B	BS070	RTC5428	NB773	VGH291	DH692	XS7Q6571AD	HR5082		
PN4110271	BS070	RTC5429	NB774	VX021133227JVX	JD5232	XS7Q8565AA	HA5020		
R20110271D	BN620	RTC5465	BN670	W703983S430	HBS243	XU3E6051AB	AC5870		
R20110271E	BN620	RTC5477	NB775	W703985S430	HBS243	XU3E6083AA	AC5880		
R20110271E	BS460	RTC5626	JJ315	W81SM6571A2C	HR631	XW4E6710BC	JH5065		
R20110271F	BN620	RTC811	EG914	W81SM6571A2C	PB180	Y401-10-271	AH6560		
R20110271F	BS460	S1141024	CB5230	WAM2293	HBS005	Y401-10-272	AH6570		
R20110271G	BN620	SE0110431	GV431	WAM2935	JC852	Y401-10-273	AH6580		
R20110271G	BS460	SE0199104	GV431	WHT000912 (x10)	HBS518	Y401-10-274	AH6590		
R20199100	GN620	SE0199104A	GV431	WL0113111A	JD5131	Y401-10-2H1	AH6600		
R20199100A	GN620	SE020000020A	GP011	WLY110271B	AA5130	Y401-13-460	JD5829		
R20199100B	GN620	SE020000032A	DP011	X039481870	AA3140	Y601-10235	JM7034		
R20199100C	GN620	SE020004000A	HC027	X1041AA001	GN551	YB0225	KA289		
R20199100D	GN620	SE021004000A	EA3130	X1041AA001HS	DN551	YC106051CE	AA5960		
R20199100E	GN620	SE021006000C	CA3140	X1041AA002	GN551	YF1010602A	NA5323		
R20210271	BN620	SE021006121A	AA3130	XF1E-6051-DC	AG7810	YM216065AA (x13)	HBS526		
R2B610271	BN620	SE021006121B	AA3140	XF1E-6083-BC	AG7820	YM216065BA (x7)	HBS526		

CYLINDER HEADBOLTS

Zylinderkopfschrauben • Vis de culasse
Tornillo • Viti testa Cilindro

				QTY							QTY		
HBS001	M10	1.50	135.00	10	Ⓐ		HBS047	M12	1.75	119.00	10	Ⓓ	✓
HBS002	M10	1.25	140.00	10	Ⓔ		HBS050	M11	1.50	120.00	10	Ⓐ	
HBS003	M11	1.25	140.00	10	Ⓐ		HBS051	M10	1.25	84.00	5	Ⓐ	
HBS005	M9	1.25	413.00	10	Ⓔ		HBS051	M10	1.25	98.00	5	Ⓐ	
HBS006	M10	1.50	133.00	10	Ⓐ		HBS052	M9	1.25	95.00	10	Ⓓ	
HBS007	7/16	14H	135.00	10	Ⓐ		HBS053	M11	1.25	140.00	10	Ⓔ	
HBS008	M12	1.75	92.00	18	Ⓓ		HBS054	M11	1.25	105.00	10	Ⓔ	
HBS010	M12	1.50	148.00	4	Ⓐ		HBS055	M10	1.25	153.00	10	Ⓔ	
HBS010	M12	1.50	247.00	2	Ⓐ		HBS056	M12	1.75	92.5.00	10	Ⓔ	
HBS010	M12	1.50	134.00	8	Ⓑ		HBS057	M12	1.75	87.00	16	Ⓔ	
HBS011	M12	1.25	163.00	10	Ⓓ		HBS058	M10	1.50	80.00	4	Ⓓ	
HBS011	M12	1.25	119.00	12	Ⓓ		HBS058	M10	1.50	102.00	9	Ⓓ	
HBS015	M11	1.50	97.50	8	Ⓐ		HBS058	M10	1.50	115.00	5	Ⓓ	
HBS015	M11	1.50	107.50	7	Ⓐ		HBS059	M10	1.50	80.00	5	Ⓓ	
HBS015	M11	1.50	120.00	7	Ⓐ		HBS059	M10	1.50	102.00	11	Ⓓ	
HBS016	M11	1.50	107.50	15	Ⓐ		HBS059	M10	1.50	115.00	6	Ⓓ	
HBS016	M11	1.50	120.00	7	Ⓐ		HBS060	M10	1.50	80.00	6	Ⓓ	
HBS017	M12	1.50	118.00	9	Ⓐ		HBS060	M10	1.50	102.00	13	Ⓓ	
HBS017	M12	1.50	146.00	8	Ⓐ		HBS060	M10	1.50	115.00	7	Ⓓ	
HBS018	M12	1.75	115.00	10	Ⓓ		HBS061	M10	1.50	102.00	14	Ⓓ	
HBS021	M12	1.75	115.00	12	Ⓓ		HBS061	M10	1.50	115.00	4	Ⓓ	
HBS022	M12	1.75	115.00	14	Ⓓ		HBS062	M10	1.50	102.00	17	Ⓓ	
HBS024	M11	1.50	95.00	12	Ⓓ		HBS062	M10	1.50	115.00	5	Ⓓ	
HBS028	M11	1.50	147.00	10	Ⓓ		HBS063	M10	1.50	102.00	20	Ⓓ	
HBS029	M11	1.50	98.00	10	Ⓓ	✓	HBS063	M10	1.50	115.00	6	Ⓓ	
HBS031	M10	1.50	102.00	10	Ⓔ		HBS064	M11	1.50	137.00	16	Ⓓ	
HBS032	M11	1.50	178.00	10	Ⓔ		HBS065	M11	1.50	140.00	14	Ⓔ	
HBS033	M12	1.75	136.00	10	Ⓔ		HBS066	M12	1.50	146.50	14	Ⓔ	
HBS035	M11	1.25	110.00	10	Ⓔ		HBS067	M10	1.50	110.00	14	Ⓔ	
HBS036	M12	1.50	102.00	10	Ⓑ		HBS068	M10	1.50	95.00	14	Ⓔ	
HBS038	M11	1.50	175.00	10	Ⓔ		HBS069	M10	1.50	95.00	10	Ⓔ	
HBS039	M10	1.50	175.00	10	Ⓔ		HBS070	M12	1.75	157.00	10	Ⓐ	
HBS041	M10	1.50	150.00	14	Ⓔ		HBS071	M12	1.75	157.00	14	Ⓐ	
HBS042	M11	1.25	123.00	8	Ⓒ		HBS074	M11	1.25	154.00	10	Ⓔ	
HBS042	M11	1.25	145.00	10	Ⓒ		HBS075	M11	1.50	110.00	10	Ⓓ	
HBS043	M11	1.50	95.00	10	Ⓓ		HBS077	M11	1.50	119.00	10	Ⓓ	
HBS044	M12	1.75	115.00	10	Ⓑ		HBS077	M11	1.50	85.00	7	Ⓓ	
HBS045	M12	1.75	119.00	8	Ⓓ		HBS077	M11	1.50	144.00	3	Ⓓ	
HBS045	M12	1.75	104.00	4	Ⓓ		HBS078	M10	1.50	143.00	10	Ⓔ	
HBS045	M12	1.75	144.00	6	Ⓓ		HBS082	M10	1.50	185.00	10	Ⓔ	
HBS046	M12	1.75	119.00	9	Ⓓ	✓	HBS083	M11	1.50	168.00	10	Ⓐ	
HBS046	M12	1.75	104.00	5	Ⓓ		HBS084	M12	1.50	120.00	10	Ⓔ	
HBS046	M12	1.75	144.00	8	Ⓓ		HBS087	M12	1.50	110.00	10	Ⓔ	



				QTY							QTY		
HBS088	M12	1.50	145.00	10	Ⓔ		HBS131	M10	1.25	100.00	10	Ⓔ	
HBS089	M11	1.50	159.00	10	Ⓔ		HBS132	M10	1.25	254.00	10	Ⓔ	
HBS092	M10	1.25	115.00	10	Ⓔ		HBS133	M10	1.25	254.00	12	Ⓔ	
HBS093	M10	1.25	172.00	10	Ⓔ		HBS136	M11	1.50	104.50	10	Ⓔ	
HBS095	M12	1.25	133.00	10	Ⓔ		HBS140	M12	1.75	115.00	16	Ⓔ	
HBS097	M12	1.25	120.00	10	Ⓔ		HBS146	M12	1.75	102.00	14	Ⓔ	
HBS098	M12	1.25	140.00	5	Ⓔ		HBS149	M12	1.75	110.00	10	Ⓔ	
HBS098	M10	1.25	116.00	5	Ⓔ		HBS150	M12	1.75	102.00	10	Ⓔ	
HBS102	M10	1.50	98.00	5	Ⓔ	✓	HBS152	M12	1.75	160.00	14	Ⓔ	
HBS102	M10	1.50	113.00	5	Ⓔ	✓	HBS160	M13	1.50	134.00	10	Ⓔ	
HBS104	M10	1.50	100.00	10	Ⓔ	✓	HBS161	M12	1.50	97.50	5	Ⓔ	
HBS105	M14	2.00	137.00	10	Ⓔ		HBS161	M12	1.50	64.00	5	Ⓔ	
HBS105	M12	1.75	116.00	4	Ⓔ		HBS163	M13	1.50	134.00	10	Ⓔ	
HBS105	M12	1.75	80.00	4	Ⓔ		HBS164	M11	1.25	105.00	16	Ⓔ	
HBS106	M14	2.00	137.00	12	Ⓔ		HBS171	M11	1.50	101.00	10	Ⓔ	
HBS106	M12	1.75	116.00	5	Ⓔ		HBS173	M11	1.50	168.00	7	Ⓔ	
HBS106	M12	1.75	80.00	5	Ⓔ		HBS173	M11	1.50	133.00	1	Ⓔ	
HBS107	M14	2.00	137.00	8	Ⓔ		HBS173	M11	1.50	182.00	2	Ⓔ	
HBS107	M12	1.75	116.00	3	Ⓔ		HBS174	M12	1.75	133.00	10	Ⓔ	
HBS107	M12	1.75	80.00	3	Ⓔ		HBS175	M12	1.75	77.00	3	Ⓔ	
HBS108	M14	2.00	137.00	10	Ⓔ		HBS175	M12	1.75	115.00	7	Ⓔ	
HBS108	M12	1.75	79.50	4	Ⓔ		HBS177	M12	1.50	108.00	10	Ⓔ	
HBS108	M12	1.75	115.00	4	Ⓔ		HBS178	M12	1.75	157.00	10	Ⓔ	
HBS109	M9	1.25	95.00	9	Ⓔ		HBS179	M12	1.75	121.50	10	Ⓔ	
HBS109	M9	1.25	60.00	1	Ⓔ		HBS180	M12	1.75	95.50	10	Ⓔ	
HBS110	M10	1.50	146.00	10	Ⓔ		HBS185	M12	1.75	157.00	12	Ⓔ	
HBS111	M11	1.50	119.00	10	Ⓔ		HBS187	M10	1.50	97.00	10	Ⓔ	
HBS112	M9	1.25	80.00	5	Ⓔ		HBS188	M11	1.50	157.00	10	Ⓔ	
HBS112	M9	1.25	100.00	5	Ⓔ		HBS189	M12	1.75	105.50	18	Ⓔ	
HBS113	M11	1.50	185.00	10	Ⓔ		HBS190	M12	1.75	112.00	14	Ⓔ	
HBS114	M12	1.50	138.00	14	Ⓔ		HBS194	M12	1.50	113.00	18	Ⓔ	
HBS114	M10	1.50	148.00	8	Ⓔ		HBS195	M12	1.75	165.00	4	Ⓔ	
HBS115	M12	1.50	145.00	10	Ⓔ		HBS195	M12	1.75	135.00	6	Ⓔ	
HBS116	M12	1.50	243.00	10	Ⓔ		HBS197	M9	1.25	98.00	10	Ⓔ	
HBS119	M11	1.50	185.00	5	Ⓔ		HBS198	M10	1.25	93.00	10	Ⓔ	
HBS119	M11	1.50	103.00	4	Ⓔ		HBS200	M10	1.25	94.50	10	Ⓔ	
HBS119	M11	1.50	183.00	5	Ⓔ		HBS203	M10	1.25	90.00	5	Ⓔ	
HBS119	M11	1.50	207.50	4	Ⓔ		HBS203	M10	1.25	108.00	5	Ⓔ	
HBS120	M12	1.50	118.00	10	Ⓔ	✓	HBS209	M12	1.25	127.00	18	Ⓔ	
HBS121	M12	1.50	146.50	10	Ⓔ		HBS211	M12	1.50	113.00	10	Ⓔ	
HBS125	M12	1.50	150.50	10	Ⓔ		HBS215	M10	1.25	95.00	10	Ⓔ	
HBS127	M12	1.50	178.00	16	Ⓔ		HBS216	M8	1.25	90.00	2	Ⓔ	
HBS130	M10	1.25	163.00	10	Ⓔ		HBS216	M12	1.25	124.00	4	Ⓔ	

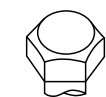

Ⓐ Male hex



Ⓑ Female hex



Ⓒ Male star



Ⓓ Female star



Ⓔ Male torx



Ⓕ Female torx















Ⓖ Hexagon Collar



Ⓗ Female Splined (Ribe-CV)*

CYLINDER HEADBOLTS

Zylinderkopfschrauben • Vis de culasse
Tornillo • Viti testa Cilindro

				QTY							QTY		
HBS216	M12	1.25	104.00	14	Ⓐ		HBS270	M11	1.50	133.00	16	Ⓐ	
HBS217	M10	1.25	95.00	16	Ⓐ		HBS272	M10	1.50	147.00	16	Ⓐ	
HBS218	M11	1.25	190.00	12	Ⓐ		HBS273	M12	1.50	163.00	14	Ⓐ	
HBS222	M11	1.75	65.00	14	Ⓐ		HBS273	M10	1.50	174.00	8	Ⓐ	
HBS222	M11	1.75	97.00	6	Ⓐ		HBS277	M12	1.50	148.00	10	Ⓐ	
HBS223	M10	1.50	117.00	4	Ⓐ		HBS279	M11	1.50	154.00	6	Ⓐ	
HBS223	M12	1.50	140.00	10	Ⓐ		HBS279	M11	1.50	109.00	4	Ⓐ	
HBS223	M12	1.50	100.00	4	Ⓐ		HBS280	M11	1.50	145.00	10	Ⓐ	
HBS224	M12	1.50	100.00	4	Ⓐ		HBS281	M12	1.50	162.00	9	Ⓐ	
HBS224	M12	1.50	125.00	10	Ⓐ		HBS281	M12	1.50	198.00	1	Ⓐ	
HBS224	M10	1.50	117.00	4	Ⓐ		HBS282	M11	1.50	230.00	10	Ⓐ	
HBS226	M15	2.00	168.00	2	Ⓐ		HBS283	M9	1.25	122.00	10	Ⓐ	
HBS226	M15	2.00	144.00	3	Ⓐ		HBS284	M12	1.50	163.00	9	Ⓐ	
HBS226	M15	2.00	109.00	1	Ⓐ		HBS284	M12	1.50	198.00	1	Ⓐ	
HBS227	M12	1.25	218.00	fhbs405	Ⓐ		HBS285	M10	1.25	166.00	10	Ⓐ	
HBS229	M11	1.50	97.50	7	Ⓐ		HBS286	M11	1.50	117.00	3	Ⓐ	
HBS229	M11	1.50	107.50	7	Ⓐ		HBS286	M11	1.50	116.00	16	Ⓐ	
HBS229	M11	1.50	120.00	7	Ⓐ		HBS287	M11	1.50	121.00	18	Ⓐ	
HBS229	M11	1.50	97.00	1	Ⓐ		HBS288	M12	1.50	113.00	10	Ⓐ	
HBS241	M9	1.25	103.00	10	Ⓐ		HBS288	M10	1.25	100.00	8	Ⓐ	
HBS243	M12	1.75	137.00	2	Ⓐ		HBS289	M12	1.50	113.00	10	Ⓐ	
HBS243	M12	1.75	177.00	8	Ⓐ		HBS291	M12	1.75	185.00	10	Ⓐ	
HBS244	M12	1.50	111.00	10	Ⓐ		HBS292	M12	1.75	102.00	10	Ⓐ	
HBS245	M12	1.50	125.00	10	Ⓐ		HBS293	M12	1.75	102.00	12	Ⓐ	
HBS246	M10	1.50	120.00	10	Ⓐ		HBS294	M12	1.75	102.00	14	Ⓐ	
HBS247	M9	1.25	87.00	10	Ⓐ		HBS295	M12	1.25	104.00	18	Ⓐ	✓
HBS249	M9	1.25	138.00	10	Ⓐ		HBS296	M10	1.50	159.00	10	Ⓐ	
HBS251	M14	1.50	193.00	6	Ⓐ		HBS296	M8	1.25	120.00	8	Ⓐ	
HBS251	M11	1.50	133.00	4	Ⓐ		HBS297	M9	1.25	56.00	1	Ⓐ	
HBS252	M8	1.25	119.00	12	Ⓐ		HBS297	M9	1.25	91.00	9	Ⓐ	
HBS253	M8	1.25	119.00	10	Ⓐ		HBS298	M12	1.50	235.00	10	Ⓐ	
HBS254	M10	1.50	122.00	10	Ⓐ		HBS299	M11	1.50	125.00	10	Ⓐ	
HBS255	M12	1.25	160.00	14	Ⓐ		HBS300	M12	1.75	166.00	10	Ⓐ	
HBS255	M12	1.25	90.00	8	Ⓐ		HBS301	M10	1.50	117.00	10	Ⓐ	
HBS257	M12	1.25	218.00	12	Ⓐ		HBS302	M12	1.50	204.00	10	Ⓐ	
HBS259	M11	1.50	144.50	10	Ⓐ		HBS303	M12	1.75	162.00	12	Ⓐ	
HBS260	M11	1.50	168.00	10	Ⓐ		HBS305	M11	1.50	162.00	10	Ⓐ	
HBS261	M12	1.50	126.00	10	Ⓐ		HBS306	M9	1.25	98.00	5	Ⓐ	
HBS262	M10	1.25	220.00	10	Ⓐ		HBS306	M9	1.25	84.00	5	Ⓐ	
HBS264	M12	1.75	172.00	8	Ⓐ		HBS307	M12	1.25	104.00	10	Ⓐ	
HBS265	M12	1.50	155.00	16	Ⓐ		HBS308	M12	1.25	151.00	2	Ⓐ	
HBS268	M10	1.50	120.00	10	Ⓐ		HBS308	M10	1.25	99.00	8	Ⓐ	
HBS269	M11	1.50	141.50	12	Ⓐ		HBS309	M11	1.50	127.00	10	Ⓐ	



Ⓐ Male hex

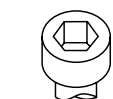

Ⓑ Female hex



Ⓒ Male star



Ⓓ Female star



Ⓔ Male torx















Ⓕ Female torx



Ⓖ Hexagon Collar



Ⓗ Female Splined (Ribe-CV)*

				QTY							QTY			
HBS310	M12	1.50	117.00	10	Ⓐ		HBS386	M12	1.25	163.00	10	Ⓐ		
HBS311	M12	1.75	115.00	8	Ⓓ		HBS387	M10	1.25	107.00	10	Ⓑ		
HBS312	M9	1.25	84.00	10	Ⓓ		HBS391	M11	1.50	160.00	4	Ⓐ		
HBS313	M9	1.50	143.00	10	Ⓓ		HBS391	M11	1.50	205.00	6	Ⓐ		
HBS314	M11	1.25	160.00	8	Ⓒ		HBS392	M10	1.50	150.00	16	Ⓓ		
HBS314	M12	1.25	104.00	10	Ⓒ		HBS394	M11	1.25	96.00	16	Ⓒ		
HBS315	M12	1.25	126.00	14	Ⓒ		HBS397	M11	1.25	115.00	16	Ⓐ		
HBS315	M12	1.25	106.00	4	Ⓒ		HBS402	M12	1.25	102.00	16	Ⓓ		
HBS316	M9	1.25	97.00	10	Ⓓ		HBS403	M12	1.25	120.00	10	Ⓓ		
HBS349	M9	1.25	145.00	8	Ⓐ		HBS404	M11	1.25	120.00	8	Ⓒ		
HBS350	M18	2.00	210.00	4	Ⓒ		HBS405	M11	1.25	173.00	12	Ⓒ		
HBS351	M16	2.00	149.00	10	Ⓒ		HBS406	M11	1.25	136.00	10	Ⓒ		
HBS352	M16	2.00	149.00	14	Ⓒ		HBS407	M10	1.50	91.00	8	Ⓓ		
HBS353	M10	1.25	119.00	10	Ⓚ		HBS408	M10	1.50	100.00	8	Ⓓ		
HBS354	M11	1.25	97.00	10	Ⓒ		HBS409	M10	1.50	100.00	1	Ⓓ		
HBS358	M11	1.50	158.00	10	Ⓔ		HBS409	M10	1.50	70.00	4	Ⓓ		
HBS358	M8	1.00	45.00	2	Ⓔ		HBS409	M10	1.50	85.00	5	Ⓓ		
HBS359	M11	1.50	147.00	10	Ⓐ		HBS413	M10	1.50	110.00	14	Ⓐ		
HBS360	M11	1.50	142.00	10	Ⓓ		HBS415	M10	1.50	140.00	10	Ⓔ		
HBS361	M12	1.50	159.00	16	Ⓓ		HBS416	M11	1.50	163.00	10	Ⓚ		
HBS362	M9	1.25	162.00	10	Ⓓ		HBS417	M12	1.50	88.00	14	Ⓔ		
HBS363	M10	1.50	122.00	10	Ⓔ		HBS419	M11	1.50	110.00	18	Ⓐ		
HBS364	M12	1.75	149.00	10	Ⓓ		HBS420	M11	1.50	100.00	10	Ⓑ		
HBS366	M15	2.00	198.00	3	Ⓐ		HBS421	M11	1.25	118.00	10	Ⓒ		
HBS366	M15	2.00	259.50	3	Ⓐ		HBS422	M10	1.50	92.00	10	Ⓑ		
HBS367	M16	2.00	287.30	3	Ⓐ		HBS423	M9	1.25	200.00	16	Ⓐ		
HBS367	M16	2.00	225.80	3	Ⓐ		HBS425	M11	1.25	105.00	10	Ⓒ		
HBS368	M12	1.50	131.50	10	Ⓐ		HBS426	M12	1.75	162.00	14	Ⓚ		
HBS369	M10	1.25	145.50	10	Ⓔ		HBS427	M11	1.50	140.00	20	Ⓐ		
HBS370	M12	1.25	225.00	10	Ⓚ		HBS431	M12	1.50	137.00	10	Ⓐ		
HBS371	M12	1.25	225.00	12	Ⓚ		HBS432	M10	1.50	110.00	10	Ⓐ		
HBS372	M12	1.50	121.00	10	Ⓐ		HBS433	M12	1.50	113.00	26	Ⓐ		
HBS373	M12	1.50	131.00	10	Ⓐ		HBS434	M12	1.25	152.00	18	Ⓒ		
HBS374	M11	1.25	118.00	18	Ⓑ		HBS435	M11	1.75	105.00	10	Ⓐ		
HBS377	M10	1.25	97.00	8	Ⓚ		HBS436	M11	1.50	115.00	8	Ⓒ		
HBS378	M10	1.25	106.50	10	Ⓑ		HBS436	M11	1.50	95.00	2	Ⓒ		
HBS379	M12	1.25	92.00	8	Ⓒ		HBS438	M12	2.00	113.00	7	Ⓒ		
HBS379	M12	1.25	131.00	10	Ⓒ		HBS438	M12	2.00	94.00	5	Ⓒ		
HBS380	M12	1.50	175.00	11	Ⓓ		HBS438	M12	2.00	94.00	2	Ⓚ + male pin without thread		
HBS380	M12	1.50	158.00	1	Ⓓ									
HBS381	M12	1.50	183.00	10	Ⓒ									
HBS382	M12	1.50	183.00	10	Ⓒ		HBS439	M11	1.50	170.00	10	Ⓐ		
HBS385	M10	1.50	147.00	10	Ⓓ		HBS439	M8	1.25	28.00	4	Ⓐ		



Ⓐ Male hex

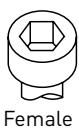

Ⓑ Female hex

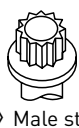

Ⓒ Male star



Ⓓ Female star



Ⓔ Male torx

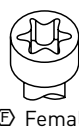

Ⓕ Female torx





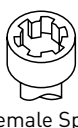









Ⓚ Hexagon Collar











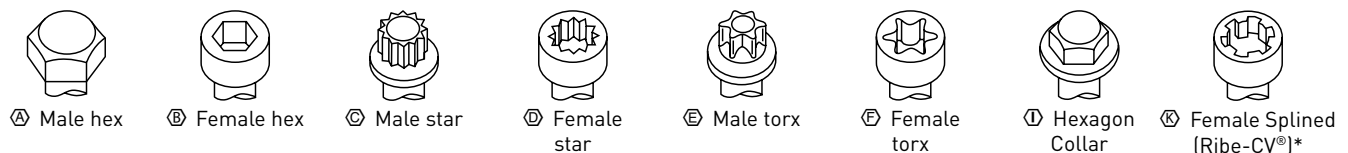

Ⓚ Female Splined (Ribe-CV)*

CYLINDER HEADBOLTS

Zylinderkopfschrauben • Vis de culasse
Tornillo • Viti testa Cilindro

				QTY							QTY		
HBS440	M10	1.25	100.00	10	Ⓐ		HBS479	M9	1.25	162.00	8	Ⓓ	
HBS441	M11	1.50	162.00	10	Ⓓ		HBS480	M16	2.00	210.00	8	Ⓐ	
HBS443	M10	1.50	127.00	4	Ⓒ		HBS481	M19	2.50	200.00	8	Ⓐ	
HBS443	M10	1.50	116.00	9	Ⓒ		HBS482	M14	2.00	189.00	8	Ⓐ	
HBS445	M10	1.50	110.00	10	Ⓐ		HBS483	M12	1.50	185.00	8	Ⓒ	
HBS446	M11	1.50	147.75	16	Ⓓ		HBS484	M11	1.50	293.00	6	Ⓔ	
HBS447	M11	1.50	116.00	10	Ⓓ		HBS485	M16	2.00	170.00	10	Ⓙ	
HBS447	M6	1.00	40.00	1	Ⓓ		HBS489	M10	1.50	117.00	10	Ⓔ	
HBS450	M11	1.25	91.00	14	Ⓓ		HBS490	M12	1.75	180.00	10	Ⓒ	
HBS452	M10	1.25	120.00	10	Ⓓ		HBS491	M12	1.25	118.00	14	Ⓒ	
HBS454	M10	1.25	95.00	10	Ⓑ		HBS491	M12	1.25	133.00	4	Ⓒ	
HBS455	M12	1.25	95.00	10	Ⓒ		HBS492	M12	1.50	132.00	18	Ⓒ	
HBS457	M10	1.50	180.00	10	Ⓔ		HBS494	M12	1.50	160.00	10	Ⓑ	
HBS458	M12	1.75	115.00	10	Ⓔ		HBS495	M11	1.50	103.00	10	Ⓑ	
HBS459	M10	1.50	165.00	10	Ⓔ		HBS496	M10	1.50	149.00	10	Ⓐ	
HBS460	M10	1.50	154.00	8	Ⓕ		HBS497	M10	1.50	149.00	10	Ⓒ	
HBS461	M11	1.50	119.00	9	Ⓓ		HBS499	M14	2.00	165.00	10	Ⓐ	
HBS461	M11	1.50	85.00	6	Ⓓ		HBS500	M11	1.25	133.00	26	Ⓒ	
HBS461	M11	1.50	144.00	3	Ⓓ		HBS501	M12	1.25	110.00	10	Ⓒ	
HBS463	M11	1.50	141.00	8	Ⓕ		HBS501	M12	1.25	167.00	8	Ⓒ	
HBS464	M15	1.50	193.00	6	Ⓔ	✓	HBS502	M12	1.50	145.00	8	Ⓒ	
HBS464	M8	1.25	117.00	4	Ⓔ	✓	HBS502	M12	1.50	175.00	8	Ⓒ	
HBS464	M12	1.50	165.00	4	Ⓔ	✓	HBS503	M11	1.50	121.00	16	Ⓐ	
HBS464	M8	1.25	58.00	1	Ⓔ	✓	HBS504	M12	1.75	125.00	10	Ⓑ	
HBS465	M12	1.50	220.00	10	Ⓚ		HBS505	M12	1.50	117.00	10	Ⓑ	
HBS466	M10	1.50	111.00	13	Ⓓ		HBS506	M10	1.50	116.00	10	Ⓑ	
HBS466	M10	1.50	150(141)	7	Ⓓ		HBS507	M11	1.50	103.00	14	Ⓔ	
HBS467	M10	1.50	170.00	6	Ⓔ		HBS508	M9	1.50	121.00	8	Ⓓ	
HBS467	M8	1.25	125.00	3	Ⓔ		HBS509	M12	1.50	149.50	12	Ⓓ	
HBS467	M8	1.25	95.00	3	Ⓔ		HBS510	M10	1.50	131.00	10	Ⓚ	
HBS468	M10	1.50	125.00	10	Ⓔ		HBS511	M11	1.50	260.00	16	Ⓔ	
HBS468	M9	1.25	95.00	1	Ⓔ		HBS512	M10	1.50	172.00	16	Ⓒ	
HBS468	M9	1.25	125.00	3	Ⓔ		HBS513	M11	1.50	100.00	12	Ⓓ	
HBS470	M12	1.50	159.00	20	Ⓓ		HBS513	M11	1.50	131.00	6	Ⓓ	
HBS471	M9	1.25	138.00	8	Ⓓ		HBS514	M11	1.50	158.00	20	Ⓓ	
HBS472	M14	2.00	152.00	8	Ⓔ		HBS515	M12	1.50	200.00	10	Ⓔ	
HBS473	M14	2.00	140.00	8	Ⓔ		HBS516	M10	1.50	121.00	10	Ⓑ	
HBS474	M12	1.75	205.00	16	Ⓔ		HBS517	M10	1.50	117.00	12	Ⓚ	
HBS475	M15	2.00	210.00	4	Ⓔ		HBS518	M9	1.25	105.00	10	Ⓓ	
HBS476	M10	1.50	117.00	10	Ⓚ		HBS519	M10	1.50	110.00	10	Ⓔ	
HBS477	M9	1.25	99.00	10	Ⓒ		HBS520	M9	1.25	155.00	10	Ⓐ	
HBS478	M10	1.25	99.00	8	Ⓑ		HBS521	M12	1.75	115.00	8	Ⓔ	
HBS478	M12	1.25	151.00	2	Ⓑ		HBS522	M10	1.50	151.00	10	Ⓔ	



					QTY							QTY	
HBS523	M10	1.25	129.00	10	⊙								
HBS524	M11	1.25	123.00	10	⊕								
HBS525	M12	1.50	178.00	10	⊙								
HBS526	M11	1.50	100.00	13	⊕								
HBS526	M11	1.50	131.00	7	⊕								
HBS527	M11	1.50	183.00	10	⊙								
HBS528	M11	1.50	156.00	10	⊙								
HBS529	M10	1.25	97.00	10	Ⓛ								
HBS530	M11	1.50	293.00	12	⊕								
HBS531	M12	1.50	179.00	10	⊙								
HBS532	M13	1.25	202.00	10	Ⓐ								
HBS533	M12	1.75	171.00	12	Ⓐ								
HBS534	M12	1.50	225.00	10	⊕								
HBS535	M11	1.50	128.00	10	⊕								
HBS536	M10	1.50	132.00	8	Ⓚ								
HBS537	M9	1.25	143.00	10	Ⓚ								
HBS538	M12	1.5	103	10	Ⓑ								
HBS539	M9	1.25	126.50	10	Ⓛ								
HBS540	M10	1.5	119	8	⊙								
HBS541	M10	1.5	119	10	⊙								
HBS542	M10	1.5	134	10	ⓕ								
HBS543	M12	1.5	217	14	⊕								
HBS544	M12	1.5	201.50	10	⊕								
HBS545	M10	1.5	147	10	Ⓛ								
HBS547	M11	1.5	148	20	Ⓐ								
HBS548	M16	2	169	6	Ⓐ								
HBS549	M16	2	169	16	Ⓐ								
HBS550	M16	2	189	6	Ⓐ								
HBS551	M18	2	245	13	⊕								
HBS552	M10	1.5	126	10	Ⓛ								
HBS553	M16	2	169	11	Ⓐ								
HBS554	M14	2.00	151.00	8	⊕								
HBS555	M14	2.00	151.00	6	⊕								



Ⓐ Male hex

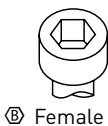

Ⓑ Female hex



Ⓒ Male star

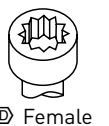

Ⓓ Female star



Ⓔ Male torx

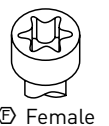

Ⓕ Female torx

























































































Ⓛ Hexagon Collar





Ⓚ Female Splined (Ribe-CV®)*

OIL SEALS



































































































Öldichtungen • Bagues d'étanchéité
Retenes de aceite • Alberos a camme



																	
17.00	x	28.00	x	7.00	NBR	827S RD		NJ255	30.00	x	44.00	x	7.00	NBR	827S RD		NJ448
18.00	x	30.00	x	7.00	ACM	827S RD		NJ963	30.00	x	45.00	x	8.00	NBR	827S DD		NJ454
18.00	x	32.00	x	6.00	ACM	827SRD		NA5271	30.00	x	46.00	x	7.00	NBR	827S RD		NJ252
20.00	x	30.00	x	7.00	NBR	827S RD		NJ655	30.00	x	47.00	x	7.00	FPM	827N DD		NA5136
20.00	x	32.00	x	5.00	ACM	827S RD		NJ654	30.00	x	50.00	x	7.50	PTFE	829S LD		NA5013
22.00	x	45.00	x	7.00	FPM / ACM	827S LD W		NF847	30.00	x	52.00	x	7.00	ACM	827S RD		NA5187
23.00	x	35.00	x	7.00	FPM	829S RD		NB815	30.00	x	54.00	x	15.00 / 19.30	FPM	827N LD		NA5149
25.00	x	35.00	x	6.00	NBR	827S RD		NJ610									
25.00	x	40.00	x	7.00	FPM / ACM	827S RD W		NF851	31.00	x	41.00	x	7.00	FPM	829S RD W		NA5070
25.00	x	42.00	x	7.00	FPM / ACM	827S RD W		NF846	31.00	x	42.00	x	8.00	NBR	827N DD		NF505
26.00	x	42.00	x	8.00	FPM	827S RD W		NB697	31.00	x	46.00	x	8.00	NBR	827S LD		NJ381
26.00	x	42.00	x	8.00 / 12.00	ACM	827S SP W		NF781	31.00	x	50.00	x	8.00	MVQ	827S RD		NB700
									31.50	x	42.00	x	7.00	FPM	829S RD W		NA5174
26.00	x	45.00	x	8.00	FPM	ASW		NA5318	32.00	x	42.00	x	6.00 / 7.00	FPM	829S RD W		NA5185
27.00	x	37.00	x	7.00	FPM	829S RD W		NA5057									
27.00	x	42.00	x	8.00	FPM	827S RD W		NA5180	32.00	x	44.00	x	6.00	FPM	827S RD W		NF856
27.00	x	43.00	x	9.00	NBR	827S LD		NJ254	32.00	x	45.00	x	6.00	FPM	829S RD		NA5139
27.00	x	47.00	x	7.00	FPM	827S RD W		NA5035	32.00	x	45.00	x	8.00	FPM	827N LD W		NF869
27.00	x	47.00	x	7.00	PTFE	827S RD W		NA5258	32.00	x	47.00	x	6.00	ACM	827S RD		NJ377
27.00	x	49.00	x	7.50	ACM	827N		NJ207	32.00	x	47.00	x	8.00	NBR	827S RD		NJ336
27.50	x	39.50	x	7.00	FPM	827S RD		NB828	32.00	x	47.00	x	10.00	FPM	827S DD W		NA5001
27.95	x	56.00	x	7.00	ACM	827S RD		NF791	32.00	x	47.00	x	10.00	PTFE / ACM	827S RD W		NA5124
28.00	x	38.00	x	7.00	FPM	827S RD		NB785	32.00	x	47.00	x	10.00	PTFE	827S LD W		NA5307
28.00	x	42.00	x	5.00	FPM	827S RD W		NA5215	32.00	x	48.00	x	7.00	NBR	827SS RD		NJ268
28.00	x	42.00	x	7.00	FPM	827S RD		NB866	32.00	x	50.00	x	8.00	FPM	829S RD W		NJ951
28.00	x	42.00	x	8.00	MVQ	827S		NJ134	32.50	x	45.00	x	7.70	FPM	827S RD		NA5083
28.00	x	47.00	x	5.50	FPM	827S RD W		NA5257	32.50	x	46.00	x	6.00	NBR	827S RD		NJ349
28.00	x	47.00	x	8.00	PTFE / ACM	827S RD W		NA5261	32.90	x	47.40	x	5.00	FPM	827S RD W		NA5137
28.00	x	47.00	x	8.00	NBR	827N RD W		NJ321	33.00	x	43.00	x	6.00	FPM	827S RD W		NF858
28.00	x	52.00	x	10.00	ACM	822N RD		NF677	33.00	x	47.00	x	8.00	NBR	827S RD		NJ280
29.00	x	45.00	x	8.00	ACM	827S LD		NJ313	34.00	x	48.00	x	7.00	ACM	827S RD		NJ324
29.00	x	46.00	x	10.00	ACM	827N LD		NF741	34.00	x	48.00	x	8.00	NBR	827S RD		NJ285
29.90	x	47.00	x	11.30	PTFE / ACM	827S RD W		NA5204	34.00	x	60.00	x	10.00	FPM	829S RD W		NA5201
29.90	x	47.00	x	11.30	ACM	827S RD W SP		NF826	35.00	x	45.00	x	7.00 / 8.00	FPM	827S RD		NB774
30.00	x	40.00	x	7.00	FPM	827NRDW		NA5265									
30.00	x	40.00	x	7.00	MVQ	827S RD		NB586	35.00	x	47.00	x	5.60	FPM	827S RD		NA5018
30.00	x	40.00	x	7.00	FPM	827S LD W		NB998	35.00	x	47.00	x	7.00	FPM / ACM	827N RD W		NA5016
30.00	x	40.00	x	7.00	FPM	827S RD W		NC065	35.00	x	47.00	x	7.00	PTFE / ACM	827S RD W		NA5255
30.00	x	40.00	x	7.00	MVQ	827S RD W		NF849	35.00	x	47.00	x	7.00	FPM	827N RD W		NF687
30.00	x	42.00	x	7.00	FPM	827S RD W		NA5053	35.00	x	48.00	x	7.00	MVQ	829S RD W		NC006
30.00	x	42.00	x	8.00	NBR	827N LD		NF535	35.00	x	48.00	x	10.00	PTFE	827S RD W		NA5106
30.00	x	42.00	x	8.00	ACM	827N LD		NF812	35.00	x	48.00	x	10.00	FPM	827S RD W		NB716
30.00	x	43.00	x	8.00	ACM	829S RD W		NB742	35.00	x	49.00	x	6.00	NBR	827S RD		NJ353
30.00	x	43.00	x	8.00	FPM	829S RD W		NB825	35.00	x	49.60	x	11.00	NBR	827S RD		NJ985

													
35.00 x 50.00 x 7.00	MVQ	827N RD W	↻	NB645	40.00 x 56.00 x 7.00	FPM	827N	↻	NA5051				
35.00 x 50.00 x 7.00	FPM	827S RD W	↻	NB959	40.00 x 56.00 x 7.00	ACM	822N RD	↻	NB818				
35.00 x 50.00 x 8.00	FPM	829S RD	↻	NB734	40.00 x 56.00 x 7.00	NBR	827SS RD	↻	NJ323				
35.00 x 50.00 x 8.00	ACM	827N RD	↻	NF678	40.00 x 56.00 x 10.00	ACM	822S RD	↻	NA5063				
35.00 x 50.00 x 8.00	FPM	827S RD	↻	NF834	40.00 x 58.00 x 8.00	ACM	827N RD	↻	NF694				
35.00 x 50.00 x 8.00	FPM	827N DD	↻	NF841	40.00 x 58.00 x 10.00	FPM / ACM	827S DD W	↻	NA5205				
35.00 x 50.00 x 8.00	NBR	827S RD	↻	NJ242	40.00 x 58.00 x 11.30	ACM	827S DD W SP	↻	NF836				
35.00 x 50.00 x 8.00	FPM	827S RD	↻	NJ933	40.00 x 62.00 x 7.40	PTFE	827S RD W	↻	NA5147				
35.00 x 50.00 x 10.00	ACM	827S RD W	↻	NA5066	40.00 x 62.00 x 8.00	PTFE	827S RD W	↻	NA5109				
35.00 x 50.00 x 10.00	MVQ	827S RD	↻	NF722	40.00 x 62.00 x 10.00	NBR	827S DD	↻	NJ106				
35.00 x 55.00 x 12.00	ACM	827S RD W	↻	NB432	40.00 x 138.00 x 11.60 / 22.20	FPM	840S RD	↻	NC044				
35.00 x 58.00 x 10.00	ACM	827S RD W	↻	NA5064									
35.00 x 63.00 x 10.00 / 16.50	ACM	822S SP	↻	NK214									
36.00 x 50.00 x 7.00	PTFE	827S LD W	↻	NA5028	42.00 x 53.00 x 7.00	FPM	827S RD W	↻	NB958				
36.00 x 50.00 x 7.00	ACM	827N RD	↻	NF746	42.00 x 54.00 x 6.00	FPM	827S RD W	↻	NA5036				
36.00 x 54.00 x 7.50	ACM	827S DD	↻	NF775	42.00 x 55.00 x 7.00	FPM / ACM	827S RD W	↻	NA5108				
36.50 x 52.30 x 8.00	MVQ	827S RD W	↻	NA576	42.00 x 55.00 x 9.00	NBR	827SS RD	↻	NJ267				
37.00 x 50.00 x 6.00	ACM	827S RD	↻	NJ874	42.00 x 56.00 x 7.00	FPM	829S RD W	↻	NA5177				
37.00 x 50.00 x 8.00	PTFE	827S RD W	↻	NA5157	42.00 x 56.00 x 7.00	FPM	827SS RD W	↻	NA5190				
37.00 x 50.50 x 7.00	ACM	827S RD	↻	NK158	42.00 x 58.00 x 8.00	ACM	827S RD W	↻	NA5306				
37.50 x 50.00 x 6.00	ACM	827S RD	↻	NJ706	42.00 x 58.00 x 11.00	FPM	827S RD	↻	NB786				
38.00 x 50.00 x 6.00	FPM	827S RD W	↻	NA5260	42.00 x 60.00 x 7.00	NBR	827S RD	↻	NJ344				
38.00 x 50.00 x 7.00	FPM	827S DD W	↻	NB799	42.00 x 60.00 x 10.00	NBR	827N	↻	NF387				
38.00 x 50.00 x 8.00	NBR	827S RD	↻	NA5089	42.00 x 62.00 x 7.00	PTFE	829S RD W	↻	NA5191				
38.00 x 50.00 x 8.00	FPM	829S RD W	↻	NB884	42.00 x 62.00 x 10.00	ACM	829S RD W	↻	NA5272				
38.00 x 50.00 x 8.00	NBR	827S RD	↻	NJ347	42.00 x 62.00 x 10.00	FPM / ACM	827S RD	↻	NF761				
38.00 x 52.00 x 6.00	FPM	827S RD W	↻	NC048	42.00 x 62.00 x 12.00	FPM	829S RD W	↻	NB792				
38.00 x 53.00 x 7.00	FPM	SP	↻	NJ982	42.00 x 66.00 x 6.00	FPM / ACM	827S RD W	↻	NF870				
38.00 x 59.00 x 9.00	NBR	827S RD	↻	NJ341	42.50 x 54.50 x 6.00	MVQ		↻	NA5246				
38.50 x 58.00 x 8.50	NBR	827S RD	↻	NJ719	44.00 x 60.00 x 7.00	NBR	827S RD	↻	NJ005				
38.50 x 58.00 x 11.00	NBR	827S RD	↻	NJ102	44.00 x 60.00 x 10.00	PTFE	829S RD W	↻	NA5099				
39.70 x 59.00 x 9.50	NBR	827S RD	↻	NA473	44.00 x 60.00 x 10.00	FPM	827S RD W	↻	NC015				
40.00 x 52.00 x 6.00	NBR	827S RD	↻	NJ449	44.50 x 57.20 x 6.75	ACM	827S RD	↻	NA5138				
40.00 x 52.00 x 7.00	FPM	829S RD W	↻	NA5223	45.00 x 60.00 x 7.00	ACM	827S RD W	↻	NF780				
40.00 x 52.00 x 7.00	FPM	827S LD	↻	NA5242	45.00 x 60.00 x 8.00 / 9.00	ACM	827S RD W	↻	NB628				
40.00 x 52.00 x 7.00	FPM	827N DD	↻	NB775									
40.00 x 52.00 x 7.00	NBR	827S RD	↻	NJ765	45.00 x 62.00 x 8.00	NBR	822S DD	↻	NF036				
40.00 x 52.00 x 7.00	FPM	SP	↻	NK159	45.00 x 63.00 x 7.00	FPM	827SDD	↻	NA5282				
40.00 x 55.00 x 6.40	PTFE	827S RD W	↻	NA5259	45.00 x 65.00 x 7.00	FPM / ACM	827S RD W	↻	NA5178				
40.00 x 55.00 x 6.50	FPM	827S RD W	↻	NA5256	45.00 x 67.00 x 8.00	PTFE	827S RD W	↻	NA5131				
40.00 x 55.00 x 7.00	FPM	827S RD	↻	NA5058	45.00 x 67.00 x 8.00	FPM	829S RD W	↻	NB973				
40.00 x 55.00 x 8.00	NBR	827S RD	↻	NB384	45.00 x 67.00 x 10.00	FPM	829S RD W	↻	NB971				
40.00 x 55.00 x 9.00	NBR	827SS LD	↻	NJ288	45.00 x 67.00 x 13.00	FPM	827 SSPRD	↻	NA5264				

OIL SEALS

Öldichtungen • Bagues d'étanchéité
Retenes de aceite • Alberos a camme

     							     										
45.00	x	68.00	x	12.00	NBR	827S		NJ243	62.00	x	80.00	x	12.00	ACM	822N LD		NA5065
45.00	x	68.00	x	12.00	NBR	827S DD		NJ450	64.00	x	80.00	x	8.00	ACM	822S LD		NA5049
45.00	x	74.50	x	12.00	FPM	827S RD W SP		NB975	64.00	x	80.00	x	8.00	FPM	829S LD W		NB808
46.00	x	56.40	x	7.00	FPM	827S RD W		NA5310	64.00	x	88.00	x	6.00	FPM / ACM	827S RD		NF866
46.00	x	58.00	x	7.00	ACM	827S RD		NK106	64.00	x	112.50	x	20.00	FPM	840		NF887
46.00	x	59.00	x	7.00	FPM	827S RD W		NF861	65.00	x	84.00	x	9.00	NBR	827S RD		NJ266
46.00	x	60.00	x	7.00	FPM	827N LD		NB773	65.00	x	90.00	x	13.00	FPM	829N RD W		NB978
46.00	x	60.00	x	7.00	MVQ	827N RD		NJ978	66.67	x	89.30	x	10.00	FPM	827S RD W		NB984
47.62	x	66.50	x	11.00	PTFE	827N RD W		NB856	67.00	x	86.00	x	9.50	PTFE	829S RD W		NB855
48.00	x	65.00	x	10.00	PTFE	829S RD W		NA5105	68.00	x	86.00	x	8.00	ACM	827S LD		NJ378
48.00	x	65.00	x	10.00	FPM	829S RD W		NF637	70.00	x	85.00	x	8.00	FPM	822N LD		NA5052
48.00	x	66.70	x	10.00	MVQ	827S RD W		NB714	70.00	x	85.00	x	8.00	ACM	822N LD		NB730
48.00	x	68.00	x	7.00	NBR	827SS RD		NJ200	70.00	x	88.00	x	8.00	FPM	829S LD W		NB814
48.00	x	70.00	x	9.00	NBR	827N RD		NJ045	70.00	x	88.00	x	12.00	MVQ	827S LD		NJ099
48.00	x	70.00	x	12.00	NBR	827SS RD		NJ042	70.00	x	90.00	x	10.00	ACM	827S		NA5050
48.70	x	63.50	x	8.00	FPM	827S RD		NB849	70.00	x	90.00	x	10.00	ACM	827N LD		NA784
50.00	x	68.00	x	9.00	NBR	827S RD		NJ014	70.00	x	92.00	x	8.50	MVQ	827S LD		NJ001
50.00	x	68.00	x	9.00	NBR	827S RD		NK251	70.00	x	159.00 / 179.00	x	16.00	FPM	840S RD		NF885
50.00	x	68.00	x	10.00	MVQ	827N RD		NF648									
50.00	x	68.00	x	10.00	FPM / ACM	827S RD W		NF843	71.00	x	88.00	x	8.00	MVQ	827N LD W		NF692
50.00	x	70.00	x	10.00	FPM	829S RD W		NP067	72.00	x	95.50	x	7.50	NBR	SP		NF577
50.00	x	72.00	x	12.00	NBR	827SS RD		NJ239	72.00	x	96.00	x	9.00	MVQ	827S LD		NJ006
50.00	x	74.00	x	11.00	FPM	827S RD		NA5243	72.00	x	96.00	x	9.00	NBR	827S LD		NJ008
50.00	x	86.50	x	13.70	PTFE	827S W		NA5031	74.00	x	88.00	x	8.00	FPM	829S LD W		NA5061
51.00	x	65.00	x	7.00	FPM	827S RD W		NA5179	74.00	x	90.00	x	10.00	ACM	829S LD W		NA5062
52.00	x	68.00	x	10.00	MVQ	827S RD W		NA581	74.00	x	90.00	x	10.00	FPM	829S LD W		NB732
52.00	x	70.00	x	8.50	ACM	827SS RD		NJ645	74.00	x	187.50	x	17.00	FPM	840		LK5001
53.00	x	68.00	x	10.00	ACM	827N		NB728	75.00	x	90.00	x	11.50	FPM / ACM	827SW RD W		NF776
53.00	x	69.85	x	11.00	MVQ	827S		NA5197	75.00	x	93.00	x	9.00	MVQ	827SS LD		NK035
54.00	x	82.00	x	9.00	ACM	827S LD		NB691	75.00	x	95.00	x	12.00	FPM	827 N		NB953
55.00	x	68.00	x	8.00	FPM	829S RD W		NA5069	75.00	x	100.00	x	8.50	MVQ	827S LD		NJ407
55.00	x	68.00	x	8.00	PTFE	829S RD W		NA5103	76.00	x	93.00	x	10.00	MVQ	827S LD		NJ343
55.00	x	70.00	x	8.00	FPM	827S RD W		NP068	76.00	x	94.00	x	8.50	FPM	827S LD		NA5090
55.00	x	70.00	x	10.00	MVQ	827N LD		NA584	77.00	x	100.00	x	11.50	FPM	829S LD		NB469
55.00	x	72.00	x	10.00	FPM	829S RD W		NA5267	78.00	x	94.00	x	8.00	Rope			PA815
56.00	x	69.00	x	10.00	FPM	827S LD W		NF809	78.00	x	100.00	x	9.00	PTFE	827S RD W		NA5230
57.00	x	71.00	x	9.50	FPM	827S RD		NC007	78.00	x	100.00	x	10.00	MVQ	827N LD		NF641
57.50	x	70.00	x	10.00	MVQ	827S LD W		NF810	79.00	x	99.00	x	9.50	PTFE	829S LD W		NB854
58.00	x	74.00	x	10.00	ACM	827S LD		NJ269	79.00	x	196.00	x	21.50	PTFE	841 LD		NA5130
58.00	x	80.00	x	10.00	NBR	827S RD		NJ831	79.40	x	95.30	x	11.10	PTFE	829S LD W		NB788
58.00	x	80.00	x	12.00	ACM	827SS RD		NJ369	79.80	x	184.00	x	18.80	PTFE	841S LD		NC086
60.00	x	80.00	x	8.00	NBR	827S LD		NJ337	79.95	x	116.00 / 126.00	x	11.50	FPM	829S LD W		NB829
60.45	x	76.18	x	10.00	FPM / FELT	827S LD W		NB564									
60.50	x	78.00	x	9.00	MVQ	827N RD		NF640	80.00	x	96.00	x	9.00	MVQ	827S LD		NJ251

																	
80.00	x	98.00	x	10.00	FPM	827S LD W	↻	NB698	90.00	x	110.00	x	9.00	ACM		↻	NA5196
80.00	x	98.00	x	10.00	NBR	827SS LD	↻	NJ675	90.00	x	110.00	x	9.00	MVQ	827S LD	↻	NJ325
80.00	x	100.00	x	8.00	FPM / ACM	827S LD W	↻	NF835	90.00	x	110.00	x	11.00	FPM / ACM	827S LD W	↻	NF844
80.00	x	100.00	x	8.50	MVQ	827SS LD	↻	NJ360	90.00	x	110.00	x	12.00	PTFE	829S LD W	↻	NA5104
80.00	x	100.00	x	9.00	PTFE	827S DD W	↻	NA5118	90.00	x	110.00	x	12.00	FPM	829S LD W	↻	NB431
80.00	x	100.00	x	10.00	MVQ	827S LD	↻	NJ287	90.00	x	115.00	x	13.00	FPM	829S LDW	↻	NF833
80.00	x	100.00	x	10.00	MVQ	827S RD	↻	NJ312	90.00	x	167.00	x	10.50	PTFE	841S LD SP	↻	NA5107
80.00	x	100.00	x	12.00	ACM	827S LD	↻	NJ030	90.00	x	173.00	x	24.00	PTFE	841S	↻	LK5007
80.00	x	100.00	x	13.00	MVQ	827N LD	↻	NF634	91.00	x	108.00	x	9.50	NBR	829N LD	↻	NA5175
80.00	x	100.00	x	13.00	MVQ	827S LD	↻	NJ056	91.00	x	111.00	x	9.00	FPM	827SS LD	↻	NJ873
80.00	x	182.00	x	19.40	PTFE	841N LS SP	↻	LK5004	91.00	x	111.00	x	10.00	FPM	823S LD	↻	NA5140
81.00	x	100.10	x	11.50	FPM	827S LD	↻	NB690	91.00	x	114.00	x	12.00	FPM	827S LD	↻	NA5244
82.00	x	105.00	x	13.00	MVQ	827SS LD	↻	NJ265	92.00	x	110.00	x	10.00	MVQ	827N LD	↻	NA869
82.60	x	98.70	x	12.70	MVQ	827N LD	↻	NB291	93.00	x	108.00	x	7.00	FPM / ACM	827S LD W	↻	NF860
83.00	x	100.00	x	9.00	ACM	827S LD	↻	NJ650	93.00	x	114.00	x	11.50	PTFE	827S LD W	↻	NA5168
84.00	x	100.00	x	10.00	FPM	827S DD	↻	NK157	93.00	x	114.00	x	13.00	FPM	827S LD W	↻	NB974
84.00	x	104.00	x	11.00	MVQ	827S LD W	↻	NJ284	93.00	x	114.00	x	14.00	FPM	829S LD W	↻	NA5266
85.00	x	103.00	x	8.00	FPM	827S LD	↻	NK143	93.00	x	117.00	x	12.00	FPM	823S LD	↻	NB972
85.00	x	105.00	x	8.00	FPM	827S LD W	↻	NF850	93.00	x	133.50	x	15.50	PTFE	841S LD SP	↻	NA5074
85.00	x	105.00	x	9.00	FPM / ACM	827S LD W	↻	NF857	93.00	x	139.70 / 172.00	x	12.00	FPM	840S LD	↻	NF888
85.00	x	105.00	x	10.00	FPM	823S LD	↻	NJ215									
85.00	x	105.00	x	10.00	MVQ	827S LD	↻	NJ354	95.00	x	112.00	x	12.50	FPM	827N LD W	↻	NF752
85.00	x	105.00	x	11.00	ACM	827S LDW	↻	NA5037	95.00	x	115.00	x	9.50	MVQ	827SS	↻	NK216
85.00	x	105.00	x	11.00	FPM	829S LD W	↻	NA5133	95.00	x	115.00	x	12.00	MVQ	827S LD	↻	NJ240
85.00	x	105.00	x	11.00	PTFE	829S LD W	↻	NA5305	95.00	x	118.00	x	10.00	NBR	827S LD	↻	NJ322
85.00	x	111.00	x	15.50	PTFE	841 LD	↻	LK5013	98.00	x	110.00	x	8.50	FPM	827S LD	↻	NA5017
85.00	x	131.00	x	15.70	PTFE	841S LD SP	↻	LK5003	98.00	x	120.00	x	7.00	FPM / ACM	827S LD	↻	NF867
85.00	x	131.00	x	15.70	PTFE	841S LD SP	↻	LK5008	100.00	x	118.00	x	10.00	FPM	829S LD W	↻	NF853
85.00	x	131.00	x	15.94	PTFE	841S		LK5011	100.00	x	120.00	x	11.00	PTFE	829N LD W	↻	NB848
85.00	x	131.00	x	16.00	PTFE	841S		LK5006	100.00	x	124.00	x	13.00	FPM	829S LD W	↻	NA5268
86.00	x	100.00	x	10.00	MVQ	827S	↻	NJ829	100.00	x	125.00	x	13.00	FPM	829S LD W	↻	NA5132
86.00	x	104.00	x	11.00	FPM	827S LD	↻	NB701	100.00	x	179.00	x	15.80	FPM	840S LD	↻	NF886
87.00	x	100.00	x	8.00	MVQ	827N LD	↻	NJ446	105.00	x	130.00	x	12.00	FPM	829S RD W	↻	NB928
87.00	x	100.00	x	8.50	FPM	827S LD	↻	NK103	106.00	x	190.00 / 196.00	x	15.20	FPM	841S LD	↻	NA5030
88.00	x	106.00	x	8.70	FPM	827S LD	↻	NK055									
88.00	x	108.00	x	11.00	FPM	827S LD W	↻	NB847	114.00	x	171.00 / 177.00	x	13.00	FPM	840S LD	↻	NF883
88.00	x	188.00	x	15.00	PTFE	841 SP	↻	LK5005									
88.90	x	104.80	x	9.52	MVQ	827S LD W	↻	NB772	132.00	x	153.00	x	15.70	PTFE	841S LD	↻	LK5012
88.90	x	145.00	x	12.00	FPM	840N LD SP	↻	NB843	136.00	x	153.00	x	21.00	PTFE	841S LD	↻	LK5002
89.00	x	109.00	x	9.00 / 10.30	MVQ	827S LD	↻	NK205									
89.00	x	116.00	x	10.20	FPM	840S LD SP	↻	LK5000									
90.00	x	104.00	x	11.00	FPM	829S LD	↻	NB806									
90.00	x	110.00	x	7.00	PTFE	829S LD W	↻	NA5192									

JOINTS CUIVRE - COPPER WASHERS

Jointes cuivre : Cuivre recuit pour une dureté maximale de 50 HB - Résistance thermique : 600°C environ

JO.	CUIVRE	ANC. RÉF.	RÉF. PAYEN	JO.	CUIVRE	ANC. RÉF.	RÉF. PAYEN	JO.	CUIVRE	ANC. RÉF.	RÉF. PAYEN
4	4 X 8 X 1	323505	KG5234		10,2 X 13,5 X 1,5	321777	KG5185		14 X 21 X 0,8	303808	KG5099
5	5 X 8,5 X 0,9	321184	KG5171		10,2 X 13,9 X 1	322335	KG5219		14,1 X 18 X 1	322360	KG5227
	5 X 10 X 1,5	320386	KG5159		10,2 X 15 X 1	305332	KG5105		14,1 X 18 X 1,5	322076	KG5218
	5,2 X 8 X 1	305231	KG5101		10,2 X 17 X 1	302465	KG5092		14,1 X 20,5 X 1,5	311823	KG5147
6	6 X 9,4 X 0,8	321924	KG5198		10,2 X 17 X 1,5	311462	KG5139		14,2 X 19,5 X 1	320849	KG5165
	6 X 10 X 0,5	323504	KG5233		10,2 X 17 X 2	323915	KG5239		14,2 X 20 X 1	305358	KG5110
	6 X 11 X 2,5	322347	KG5223		10,2 X 20 X 1	310308	KG5130		14,2 X 21,8 X 2	309012	KG5122
	6,2 X 10 X 1	306285	KG5117		10,3 X 15,8 X 1	305372	KG5112		14,2 X 22 X 1	322393	KG5232
	6,5 X 12 X 1	306225	KG5114		10,5 X 16 X 2,5	323773	KG5237		14,3 X 18 X 1,5	311725	KG5144
7	7,2 X 11 X 1	305317	KG5103		10,5 X 18 X 2	300004	KG5077		14,3 X 19 X 1	302291	KG5089
8	8 X 13 X 1,5	321180	KG5170		10,8 X 19,5 X 1	300002	KG5075		14,3 X 19 X 1,5	311694	PA335
	8 X 16 X 2	322026	KG5214	11	11 X 16 X 1,5	320528	KG5160		14,4 X 19 X 2	308783	KG5121
	8,1 X 11,2 X 1	323794	KG5238		11 X 20 X 1,5	300025	KG5083		14,5 X 20 X 1,5	311136	PA401
	8,1 X 11,5 X 1	311853	KG5149		11 X 20 X 2	300042	PA413		14,5 X 20 X 2	322355	KJ920
	8,2 X 12 X 1	302830	KG5094		11,2 X 16 X 1	310309	KG5131		14,5 X 21 X 1,5	304687	KG5100
	8,2 X 12 X 1,5	322337	KG5221		11,2 X 20 X 1	300001	KG5074		14,5 X 21 X 1,8	323758	KG5235
	8,2 X 14 X 1	305356	KG5108	12	12 X 15,5 X 1	321093	KG5168		14,5 X 21,3 X 1,5	322336	KG5220
	8,2 X 14 X 1,5	300003	KG5076		12 X 16 X 1	321968	KG5202		14,5 X 21,3 X 1,8	300035	KG5085
	8,2 X 15 X 2	321394	KG5177		12 X 20 X 1,5	322008	KG5209		14,5 X 21,4 X 2,3	312620	KG5151
	8,3 X 16 X 1	306235	KG5116		12 X 22 X 1	321825	KG5190		14,7 X 21,4 X 1,95	300037	KG5087
	8,5 X 17 X 1	305243	KG5102		12,1 X 15,7 X 1	309806	KG5124		14,8 X 22 X 1,5	311458	KG5138
9	9,2 X 14 X 1,2	321354	KG5173		12,2 X 15,9 X 1,5	320693	KG5162	15	15 X 20 X 1	321785	KG5187
	9,2 X 20 X 1	306234	KG5115		12,2 X 17 X 2	300012	KG5081		15 X 20 X 1,5	311483	KG5143
	9,5 X 16 X 2,5	323759	KG5236		12,2 X 18 X 1	302844	KG5095		15 X 24 X 1	306308	KG5118
	9,5 X 17,5 X 1,5	321473	KG5181		12,2 X 21,5 X 1	305357	KG5109		15,3 X 21 X 1,2	310289	PA348
	9,5 X 18 X 1	321961	KG5201		12,5 X 16,8 X 1	321989	KG5206		15,5 X 20 X 2	321915	KG5197
	9,5 X 18 X 2	321441	KG5179		12,5 X 18 X 1	322012	SUPP.		15,6 X 21,2 X 2,2	320694	PA345
	9,5 X 20 X 1	321472	KG5180		12,5 X 18 X 1,5	311581	PA400	16	16 X 20 X 1,5	320107	KG5155
	9,5 X 20 X 1,5	300005	KG5078		12,5 X 18 X 2	311756	KG5145		16 X 22,5 X 3	321983	KG5205
	9,7 X 14,2 X 1,8	311858	KG5150		12,5 X 19 X 1,5	302918	KG5097		16 X 23,6 X 1,5	321998	KG5207
	9,8 X 21 X 2	312768	KG5153		12,5 X 20 X 0,8	302466	KG5093		16 X 24 X 1	321914	KG5196
10	10 X 14 X 0,8	321973	KG5204		12,5 X 20 X 1	321574	KG5183		16,2 X 19 X 1,5	322023	KG5212
	10 X 15 X 3	300019	SUPP.		12,7 X 16 X 2	300014	PA347		16,2 X 20 X 0,5	321967	KJ749
	10 X 15 X 3,5	300020	KG5082		12,7 X 17 X 1,5	320092	KG5154		16,2 X 20 X 1	302317	KG5091
	10 X 15,7 X 2,5	321305	KG5172		12,8 X 17,1 X 1,5	321806	KG5189		16,2 X 21,5 X 1	305320	KG5104
	10 X 16 X 1,5	311794	KG5146	13	13 X 18 X 1	320848	KG5164		16,2 X 21,5 X 2	322348	KG5224
	10 X 19,5 X 2	321076	KG5167		13 X 19 X 1,5	321940	KG5199		16,2 X 22 X 1,5	320669	KG5161
	10,1 X 14,5 X 1	320847	KG5163		13 X 20,4 X 1,5	321972	KG5203		16,2 X 22,9 X 1,5	321828	KG5191
	10,1 X 18 X 1	302290	PA333		13,1 X 19,8 X 1	310340	KG5132		16,3 X 22 X 1	310141	PA217
	10,0 X 18,8 X 2	321365	KG5174		13,2 X 18 X 1,5	322363	KG5228		16,5 X 20,5 X 2	311138	KG5136
	10,0 X 20,8 X 2	320347	KG5157		13,7 X 18,5 X 1	310861	KG5134		16,5 X 21 X 2,5	322015	KG5211
	10,2 X 13 X 1	321390	KG5175	14	14 X 18 X 2	305638	KG5113		16,5 X 23 X 1	310066	KG5127

JOINTS CUIVRE - COPPER WASHERS

JO.	CUIVRE	ANC. RÉF.	RÉF. PAYEN	JO.	CUIVRE	ANC. RÉF.	RÉF. PAYEN
	16,5 X 24 X 1,5	306352	KG5119		24,4 X 32 X 1,5	311354	KG5137
	16,85 X 20 X 1,5	300048	KG5088		24,5 X 32 X 2	321953	KG5200
17	17 X 21 X 1	302910	KG5096	25	25,4 X 30 X 1,5	310067	KJ646
	17 X 22 X 1,5	321779	KG5186	26	26 X 30 X 1,5	321893	KG5193
18	18,2 X 22 X 1	322394	KJ645		26,1 X 32 X 1	305359	KG5111
	18,2 X 22 X 1,5	322375	KG5231		26,3 X 33 X 3	322028	KG5215
	18,2 X 23 X 1	300008	KG5080	27	27 X 34 X 2	300034	KG5084
	18,2 X 23 X 1,5	321573	KG5182		27,2 X 32 X 1,5	300043	PA416
	18,2 X 26 X 1,5	321391	KG5176	28	28,2 X 35 X 1,5	311479	KG5140
	18,3 X 24 X 1,5	320383	KG5158	30	30,4 X 38 X 1	310162	KG5129
	18,3 X 24 X 2	320871	PA336		30,5 X 36 X 2	306410	KG5120
	18,3 X 24,3 X 2	322001	KG5208	32	32 X 42 X 1	322357	KG5226
	18,5 X 23 X 1	302920	KG5098	36	36 X 42 X 2	310779	KG5133
	18,5 X 23 X 2	321070	KG5166		36,4 X 45 X 2	321805	KG5188
	18,5 X 24 X 1	310145	KG5128				
	18,5 X 26 X 2	310021	KG5126				
19	19,3 X 23,9 X 1,5	320117	KG5156				
20	20,1 X 26 X 1	302298	KG5090				
	20,2 X 25 X 1,5	321094	KG5169				
	20,5 X 25,5 X 1	305348	KG5107				
	20,5 X 26,2 X 1,5	321913	KG5195				
	20,5 X 28 X 2	310020	KG5125				
21	21 X 30 X 1,5	311482	KG5142				
	21,2 X 25,5 X 1	322344	KG5222				
	21,5 X 25 X 2	321912	KG5194				
22	22 X 26 X 1	322356	KG5225				
	22 X 28 X 1,5	321679	KG5184				
	22 X 29 X 1	321408	KG5178				
	22,1 X 26,9 X 1,5	311825	KG5148				
	22,2 X 30 X 1,5	305338	KG5106				
	22,4 X 30 X 1	322010	KG5210				
	22,5 X 27 X 1	310998	KG5135				
	22,5 X 27,7 X 1	311874	SUPP				
	22,5 X 29 X 1	322064	KG5217				
	22,5 X 30 X 2	309444	KG5123				
	22,7 X 26,8 X 2	322367	KG5229				
23	23 X 34,5 X 1,5	322031	KG5216				
	23,4 X 31 X 1	300036	KG5086				
24	24 X 29 X 1	300007	KG5079				
	24 X 29 X 1,5	311481	KG5141				
	24 X 30 X 1	321849	KG5192				
	24 X 32,5 X 2	322368	KG5230				

JOINTS MÉTALLOPLASTIQUES FERMÉS - COPPER/FIBRE WASHERS JOINTS REPLIÉS - COPPER SEALS

Joint métalloplastiques fermés se composent d'un garnissage plastique recouvert d'une enveloppe métallique ductile.
Résistance thermique : Jusqu'à environ 350°C

COFFRET KK5182 (P019 064100) JOINTS MÉTALLOPLASTIQUES FERMÉS

QTÉ	RÉF. PAYEN	DIM.
20	KG5039	6.2 X 10 X 2
20	KG5024	8.2 X 12 X 2
20	KG5019	9.2 X 14 X 2
20	N/A	10.2 X 14 X 2
20	KG5041	11.2 X 16 X 2
20	PA331	12.2 X 17 X 2
40	KG5009	14.1 X 19 X 2.5
40	PA349	16.3 X 22 X 2
20	KJ647	18.3 X 23 X 2
10	KG5042	20.4 X 26 X 2
10	KG5055	22.4 X 29 X 2

MÉTALLO FERMÉS PAR DIMENSIONS			MÉTALLO FERMÉS PAR DIMENSIONS		
DIM.	RÉF. PAYEN	RÉF. PAYEN	DIM.	RÉF. PAYEN	RÉF. PAYEN
6,2 X 10 X 2	212367	KG5039	21 X 26 X 2	211983	KG5035
7,2 X 11 X 2	212368	KG5040	22 X 28 X 3	205038	PB853
8,2 X 12 X 2	206634	KG5024	22 X 30 X 3	211987	KG5037
9,2 X 14 X 2	202838	KG5019	22,3 X 26,8 X 2	211985	KG5036
10,2 X 16 X 2	209875	KG5027	23 X 29,8 X 4	210507	KG5028
11,2 X 16 X 2	212369	KG5041	24,2 X 30 X 3	205039	KG5022
12 X 16 X 2	211964	KG5033	24,4 X 32 X 2	209556	KG5026
12,2 X 17 X 2	202947	PA331	25 X 32 X 2	206311	KG5023
13,4 X 18 X 2	212390	KG5048	26 X 32 X 2	212406	KG5050
14,1 X 19 X 2,5	205035	KG5009	26 X 36 X 3	212407	KG5051
14 X 21 X 2	224504	PB907"	26,4 X 30 X 2	211238	KG5031
14,3 X 19 X 2	211172	KG5030	27,4 X 35 X 2	212373	KG5043
16 X 23 X 3	211973	SUPP	28,5 X 38 X 1,5	211993	KG5038
16,3 X 22 X 2	212370	PA349	30,2 X 36 X 3	209511	KG5025
16,3 X 24 X 3	211974	KG5034	30,4 X 38 X 2	212374	KG5044
17 X 23 X 2	212396	KG5049	32 X 40 X 2	200001	KG5018
18,1 X 24 X 3	205037	KG5021	32,4 X 41 X 2	206310	PB258
18,3 X 24 X 2	208832	KJ647	33,4 X 41 X 2	212375	KG5045
20 X 25,4 X 2	210725	KG5029	36,4 X 44 X 2	212376	KG5046
20,4 X 26 X 2	212371	KG5042	42,4 X 50 X 2	212377	KG5047

JOINTS REPLIÉS (OUVERTS) JOINT EN CUIVRE RECUIT REPLIÉ PERMET UNE BONNE RÉSISTANCE À L'ÉCRASEMENT RÉSISTANCE THERMIQUE : JUSQU'À 350°C

DIM.	RÉF. PAYEN	RÉF. PAYEN
8,2 X 13 X 1,8	230001	KG5052
10,2 X 15 X 2	230002	KG5053
12,2 X 17X2	230003	KG5054
14,25 X 20X 2	230005	KG5056
16,3 X 24X 2	230006	KG5057
18,3 X 24 X 2	230007	KG5058
22,4 X 29 X2	230004	KG5055

JOINTS FIBRE - FIBRE SEALS

JO Fibre de la série 600 000 = Fibre vulcanisée

Ces joints acceptent moins de serrage que les joints métalliques

Résistance thermique : Jusqu'à 150°C

JOINTS FIBRE PAR DIMENSIONS			JOINTS FIBRE PAR DIMENSIONS		
DIM.		RÉF. PAYEN	DIM.		RÉF. PAYEN
4 X 8 X 1	611932	KG5297	13 X 18 X 2	611650	KG5293
5 X 9 X 1	611933	KG5298	14 X 18 X 2	611801	KG5296
5 X 9 X 1,5	621182	KG5303	14,1 X 20 X 1	605490	KG5281
6 X 10 X 1	603073	KG5276	14,1 X 23 X 1,5	622690	KG5309
7 X 11 X 1	620751	KG5302	14,2 X 19 X 1	606699	KG5283
8 X 12 X 1	605581	KG5282	14,2 X 20 X 1,5	611717	KG5294
8,2 X 14 X 1	605265	KG5278	14,3 X 19 X 1,5	610173	KG5288
10 X 14 X 1	605266	KG5279	14,4 X 20 X 2	610010	KG5286
10 X 16 X 1	611938	KG5299	14,5 X 22 X 2	611423	KG5292
10,2 X 16 X 1,5	622662	KG5308	16 X 22 X 2	611421	KG5291
11 X 16 X 1	611940	KG5300	16,2 X 21 X 2	622094	KG5305
12 X 17 X 1,5	609590	KG5284	17 X 23 X 2	611727	KG5295
12 X 18 X 1	603143	KG5277	18,5 X 26 X 2	622649	KG5307
12 X 18 X 2	621765	KG5304	20,4 X 27 X 3	611324	KG5290
12,5 X 18 X 1,5	611132	KG5289	20,5 X 26 X 1,5	620729	KG5301
12,5 X 20 X 2	610014	KG5287	22,5 X 28 X 1,5	622199	KG5306
13 X 18 X 1	605267	KG5280	30,5 X 38 X 2	610009	KG5285

JOINTS ALUMINIUM - ALUMINIUM WASHERS

Joint Aluminium : Dureté maxi 32 à 45 HB

Résistance thermique : Jusqu'à 300°C environ

JO.	DIM.	ANC. RÉF.	RÉF. PAYEN
6	6,2 X 10 X 1	331001	KG5240
8	8,2 X 12 X 1	331010	KG5241
12	12 X 16 X 1,6	331022	KG5242
	12,2 X 18 X 1,2	331023	KG5243
14	14,1 X 18 X 1	331027	KG5244
	14,3 X 19 X 1,5	331051	KG5248
	14,7 X 20 X 1,6	331037	KJ247
16	16 X 24 X 1	331028	KG5245
18	18,5 X 24 X 1,5	331049	KG5246
	22,5 X 29 X 1,5	331050	KG5247

JOINTS CUIVRE - COPPER WASHERS

ASSORTIMENTS DE JOINTS & RONDELLES POUR INJECTION DIESEL

JOINTS CUIVRE : CUIVRE RECUIT POUR UNE DURETÉ MAXIMALE DE 50 HB - RÉSISTANCE THERMIQUE : 600°C ENVIRON
 RÉF. KK5184 (EX.P019065300)
 CE COFFRET PERMET D'ÉQUIPER LES VÉHICULES FRANÇAIS EN JOINTS D'INJECTEURS ET JOINTS PARE-FEU
 402 JOINTS D'INJECTION ET DE RACCORDS POUR MOTEURS DIESEL

QTÉ	RÉF. PAYEN	DIM.	ANC. RÉF.	MAT.	DES.
30	KG5117	6.2 X 10 X 1	P030628500	JOINT CUIVRE	JOINT RACCORD 6MM RENAULT
20	KG5087	14.7 X 21.4 X 1.95	P030003700	JOINT CUIVRE	JOINT INJECTEUR RENAULT J8S, F8Q
40	PA335	14.3 X 19 X 1.5	P031169400	JOINT CUIVRE	JOINT RACCORD DIA. 14
50	PA346	7.2 X 13.5 X 1.3	P02008300	ACIER NERVURÉ	JOINT PARE-FEU BMW, CITROËN, FORD, PEUGEOT
20	KG5020	14.5 X 21.2 X 2	P02374700	JOINT CUIVRE	JOINT INJECTEUR INDÉNOR
20	KG5091	16.2 X 20 X 1	P030231700	JOINT CUIVRE	JOINT RACCORD 16MM INDÉNOR
20	KG5085	14.5 X 21.3 X 1.8	P030003500	JOINT CUIVRE	JOINT INJECTEUR PSA CRD
40	KG5094	8 X 12 X 1	P030283000	JOINT CUIVRE	JOINT RACCORD DIA. 8MM (STANDARD)
20	PA345	15.6 X 21.2 X 2.2	P032069400	JOINT CUIVRE	JOINT INJECTEUR FORD
12	-	5.3 X 20.3 X 3.5	P02527100	ACIER DÉCOLLETÉ	JOINT INJECTEUR AUDI, FIAT, SEAT, VW
40	KG5095	12.2 X 18 X 1	P030284400	JOINT CUIVRE	JOINT RACCORD DIA. 12
20	KJ920	14.5 X 20 X 2	P032235500	JOINT CUIVRE	JOINT INJECTEUR FIAT, SOFIM, VM
20	KG5081	12.2 X 17 X 2	P030001200	JOINT CUIVRE	JOINT INJECTEUR OPEL
50	-	5.1 X 13.5 X 1.3	P02511000	ACIER NERVURÉ	JOINT PARE-FEU PSA CRD

ASSORTIMENT DE RONDELLES INJECTEURS
 RÉF. KK5180 (EX.190660/19058600)
 144 JOINTS D'INJECTEUR

QTÉ	RÉF. PAYEN	DIM.	ANC. RÉF.
12	KG5117	6.2X10X1	306285
12	KG5094	8 X 12 X 1	30283
12	KG5219	10X13.9X1	322335
12	KG5095	12.2X18X 1	302844
12	PA335	14.3X19X1.5	311694
12	KG5220	14.5X21.3X1.5	322336
12	KG5197	15.5X20X2	321915
12	KG5196	16 X 24 X 1	321914
12	KG5182	18.2 X 23 X 1.5	321573
12	KG5195	20 X 26 X 1.5	321913
12	KG5222	21.2 X 25.5 X 1	322344
12	KG5225	22 X 26 X 1	322356

COFFRET SUPPRIME (ANC. RÉF. KK5183/ 190665)
 QTTE 450
 COMMANDER LES REF. À L'UNITÉ

QTÉ	RÉF. PAYEN	DIM.	ANC. RÉF.
50	KG5257	5 X 9 X 0,05	P0332015
50	KG5258	5 X 9 X 0,1	P0332016
50	KG5260	5,5 X 11,5X 0,05	P0332018
50	KG5261	5,5 X 11,5 X 0,1	P0332019
50	KG5266	6,5 X 11 X 0,05	P0332031
50	KG5267	6,5 X 11 X 0,1	P0332032
50	KG5269	7,5 X 13 X 0,05	P0332035
50	-	3,6 X 7,5 X 0,05	P0332119
50	-	3,6 X 7,5 X 0,1	P0332120

CALES DE TARAGE : PAR DIMENSIONS

QTÉ	DIM.	ANC. RÉF.	RÉF. PAYEN	QTÉ	DIM.	ANC. RÉF.	RÉF. PAYEN	QTÉ	DIM.	ANC. RÉF.	RÉF. PAYEN
3	3,6 X 7,5 X 0,05	332119			5 X 9 X 0,2	332017	KG5259		6,5 X 11 X 0,1	332032	KG5267
	3,6 X 7,5 X 0,1	332120			5,5 X 11,5 X 0,05	332018	KG5260		6,5 X 11 X 0,2	332033	KG5268
4	4 X 7 X 0,05	332001	KG5252		5,5 X 11,5 X 0,1	332019	KG5261		6,5 X 11 X 0,5	332034	
	4 X 7 X 0,1	332002	KG5253		5,5 X 11,5 X 0,2	332020	KG5262		6,5 X 13,4 X 0,05	332101	KG5274
	4,9 X 9,5 X 0,05	332010	KG5254		5,5 X 11,5 X 0,5	332021			6,5 X 13,4 X 0,1	332102	
	4,9 X 9,5 X 0,1	332011	KG5255	6	6 X 10 X 0,05	332026	KG5263		6,5 X 13,4 X 0,2	332103	
	4,9 X 9,5 X 0,2	332012	KG5256		6 X 10 X 0,1	332027	KG5264	8	8,2 X 14 X 0,1	332045	KG5272
	4,9 X 9,5 X 1	332014			6 X 10 X 0,2	332028	KG5265		8,2 X 14 X 0,2	332046	
5	5 X 9 X 0,05	332015	KG5257		6 X 10 X 0,5	332029		12	12,4 X 18 X 1	332098	KG5273
	5 X 9 X 0,1	332016	KG5258		6,5 X 11 X 0,05	332031	KG5266				

JOINTS CUIVRE - COPPER WASHERS

RONDELLES POUR INJECTEURS

ASSORTIMENT DE 138 RONDELLES INJECTEURS KK5179 (EX.PO19058300)

QTÉ	QTÉ	ANC. RÉF.	RÉF. PAYEN
12	14.5 X 23 X 2	903900	-
12	8 X 12 X 1	302830	KG5094
12	12.2 X 18 X 1	302844	KG5095
12	14.2 X 21.8 X 2	309012	KG5122
6	14.4 X 24.5 X 4	310684	-
12	14.3 X 19 X 1.5	311694	PA335
12	18.2 X 23 X 1.5	321573	KG5182
12	10.2 X 13.9 X 1	322335	KG5219
12	14.5 X 21.3 X 1.5	322336	KG5220
12	21.2 X 25.5 X 1	322344	KG5222
12	22 X 26 X 1	322356	KG5225
12	9.5 X 21 X 1.5	190438	-

GAMME EUROPÉENNE RÉF. KK5180 (EX.PO19058600) 144 JOINTS D'INJECTEUR

QTÉ	RÉF. PAYEN	DIM.	ANC. RÉF.
12	KG5094	8 X 12 X 1	PO30283000
12	KG5095	12.2 X 18 X 1	PO30284400
12	KG5117	6.2 X 10 X 1	PO30628500
12	PA335	14.3 X 19 X 1.5	PO31169400
12	KG5182	18.2 X 23 X 1.5	PO32157300
12	KG5195	20 X 26 1.5	PO32191300
12	KG5196	16 X 24 X 1	PO32191400
12	KG5197	15.5 X 20 X 2	PO32191500
12	KG5219	10.2 X 13.9 X 1	PO32233500
12	KG5220	14.5 X 21.3 X 1.5	PO32233600
12	KG5222	21.2 X 25.5 X 1	PO32234400
12	KG5225	22 X 26 X 1	PO32235600

JOINTS TORIQUES - O'RINGS

QTÉ	DIAM. INT.	ANC. RÉF	RÉF. PAYEN	MAT.	QTÉ	DIAM. INT.	ANC. RÉF	RÉF. PAYEN	MAT.	QTÉ	DIAM. INT.	ANC. RÉF	RÉF. PAYEN	MAT.
2	2,6 X 1,9	015001	LA5020	NBR		19,8 X 3,6	015016	LA5031	NBR	50	50 X 3	015992	LA5112	NBR
3	3,4 X 1,9	015002	LA5021	NBR	20	20 X 2	015589	LA5110	NBR		50,17 X 5,33	015032	LA5047	NBR
4	4,2 X 1,9	015003	LA5022	NBR		20,22 X 3,53	015116	LA5074	NBR		50,39 X 3,53	015539	LA5101	NBR
	4,9 X 1,9	015004	LA5023	NBR		20,3 X 2,6	015604	LA5116	NBR	52	52 X 2	015642	PA434	NBR
5	5,28 X 1,78	015104	LA5062	NBR	21	21,3 X 3,6	015017	LA5032	NBR		52 X 3	015629	PA625	NBR
	5,7 X 1,9	015005	LA5024	NBR		21,82 X 3,53	015117	LA5075	NBR	53	53,34 X 5,33	015033	LA5048	NBR
6	6,07 X 1,78	015105	LA5063	NBR	22	22 X 2	015717	LA5135	NBR		53,97 X 3,53	0155580	LA5105	NBR
	6,35 X 2,4	015596	LA5013	NBR		22 X 2,7	015668	LA5126	NBR	54	54,3 X 1,9	015750	PA370	NBR
	6,5 X 2,7	015907	LA5142	ACM		22,5 X 2,7	015303	LA5086	NBR		54,5 X 3	015540	LA5102	NBR
7	7,2 X 1,9	015106	LA5025	NBR	23	23 X 3	015523	LA5092	NBR	56	56,2 X 5,33	015034	LA5049	NBR
	7,5 X 3,25	015501	LA5087	NBR		23 X 3,6	015018	LA5033	NBR	58	58 X 3	015728	LA5138	NBR
	7,65 X 1,78	015106	LA5064	NBR		23,39 X 3,53	015118	LA5076	NBR		58,6 X 7	015729	LA5139	NBR
8	8 X 2	015586	LA5108	NBR		23,4 X 3,5	015585	LA5107	NBR	59	59,69 X 5,33	015035	LA5050	NBR
	8,5 X 1,5	015505	LA5088	NBR		23,5 X 1,75	015703	LA5132	NBR	60	60 X 3	015541	LA5103	NBR
	8,5 X 2,5	015908		ACM	24	24 X 2	015524	LA5093	NBR	62	62 X 3	015634	LA5119	NBR
	8,9 X 1,9	015007	LA5026	NBR		24,6 X 3,6	015019	LA5034	NBR		62,87 X 5,33	015036	LA5051	NBR
9	9,19 X 2,62	015108	LA5066	NBR		24,99 X 3,53	015119	LA5077	NBR	63	63,1 X 3,53	015723	LA5137	NBR
	9,25 X 1,78	015107	LA5065	NBR	25	25 X 2,50	015525	LA5094	NBR	65	65 X 3	015706	LA5133	NBR
	9,5 X 6	015684	LA5129	NBR		25,1 X 3,6	015695	LA5131	NBR	69	69,22 X 5,33	015038	LA5052	NBR
10	10 X 2	015672	LA5127	NBR	26	26,2 X 3	015527	LA5095	NBR	72	72 X 3	015688	LA5130	NBR
	10 X 3	015587	LA5109	NBR		26,2 X 3,6	01502	LA5035	NBR		72,39 X 5,33	015039	LA5053	NBR
	10,5 X 2,7	015009	PA172	NBR		26,57 X 3,53	015120	LA5078	NBR	75	75,57 X 5,33	015040	LA5054	NBR
	10,77X2,62	015109	LA5067	NBR	27	27 X 2	015638	LA5121	NBR	78	78,74 X 5,33	015041	LA5055	NBR
11	11,11 X 1,78	015509	LA5089	NBR		27,5 X 3	01528	LA5096	NBR	85	85 X 3,5	015590	LA5111	NBR
12	12 X 2	015735	LA5141	NBR		27,8 X 3,6	015021	LA5036	NBR		85,09 X 5,33	015043	LA5056	NBR
	12 X 3	015510	LA5090	ACM	28	28,17X3,53	015121	LA5079	NBR	88	88,27 X 5,33	015044	LA5057	NBR
	12,1 X 1,9	015751	PA371	NBR	29	29,3 X 3,6	015022	LA5037	NBR	90	90 X 3	015730	LA5140	NBR
	12,1 X 2,7	015010	LA5027	NBR		29,74X3,53	015122	LA5080	NBR	91	91 X 3	015720	LA5136	NBR
	12,37 X 2,62	015110	LA5068	NBR	30	30,2 X 3	015678	KJ651	NBR		91,44 X 5,33	015045	LA5058	NBR
13	13 X 2,5	015917	LA5143	ACM		30,3 X 2,4	015530	LA5097	NBR	94	94,62 X 5,33	015046	LA5059	NBR
	13 X 3		LA5238	NBR		30,8 X 3,6	015023	LA5038	NBR	99	99 X 3	015683	PA714	NBR
	13,3 X 2,4	015512	LA5091	NBR	31	31,34 X 3,53	015123	LA5081	NBR	100	100 X 2	015698		NBR
	13,6 X 2,7	015011	PA173	NBR	32	32,5 X 3,6	015024	LA5039	NBR		100,97 X 5,33	015048	LA5060	NBR
	13,94X2,62	015111	LA5069	NBR		32,92 X 3,53	015124	LA5082	NBR	104	104 X 3	015690	PA706	NBR
14	14 X 2	015630	LA5117	NBR	34	34 X 1,9	015749	PA369	NBR	110	110 X 3	015557	PA711	NBR
15	15,1 X 2,7	015012	LA5028	NBR		34,1 X 3,6	015025	LA5040	NBR	112	112 X 3	015611	PA713	NBR
	15,2 X 1,78	015655	LA5123	NBR		34,52 X 3,53	015125	LA5083	NBR	113	113,67 X 5,33	015052	LA5061	NBR
	15,54X2,62	015112	LA5070	NBR	35	35 X 2,5	015603	LA5115	NBR	116	116 X 3	015562	LA5104	NBR
	15,9 X 2,62	015652	LA5122	NBR		35 X 3	015631	LA5118	NBR	125	125 X 4,2	015566	PA705	NBR
16	16,7 X 2,5	015584	LA5016	NBR		35,6 X 3,6	015026	LA5041	NBR	126	126 X 3	015682	LA5128	NBR
	16,9 X 2,7	015013	LA5029	NBR	36	36,09 X 3,53	015126	LA5084	NBR		126 X 3	015922	PA709	ACM
17	17 X 2,5	015707	LA5134	NBR	37	37,3 X 3,6	015027	LA5042	NBR	129	129 X 2	015913	PA708	ACM
	17,12 X 2,62	015113	LA5071	NBR		37,47 X 5,33	015028	LA5043	NBR	142,47	142,47 X 3,53	015742	PA712	NBR
	17,17 X 1,78	15657	LA5125	NBR		37,69 X 3,53	015127	LA5085	NBR					
18	18 X 2	015637	LA5120	NBR	38	38,9 X 2,7	015601	LA5114	NBR					
	18,3 X 3,6	015015	LA5030	NBR	40	40,64 X 5,33	015029	LA5044	NBR					
	18,4 X 2,7	015014	PA326	NBR	43	43,82 X 5,33	015030	LA5045	NBR					
	18,64X3,53	015115	LA5073	NBR	44	44 X 3	015664	JB881	NBR					
	18,7 X 1,78	015656	LA5124	NBR		44,1 X 5	015535	LA5098	NBR					
	18,7 X 1,9	015722	PA177	NBR	46	46,6 X 5,3	015031	LA5046	NBR					
	18,72X2,62	015114	LA5072	NBR	48	48 X 3,6	015536	LA5099	NBR					
19	19,4 X 2,7	015665	PA175	NBR	49	49 X 3	015537	LA5100	NBR					

ASSORTIMENTS DE JOINTS TORIQUES - O'RINGS KITS

JOINTS TORIQUES 2,6 À 18 - COFFRET RÉF. LA5156 (EX.RÉF. 19060100)

RÉF. PAYEN	QTÉ	DIM.	ANC. RÉF.	RÉF. PAYEN	QTÉ	DIM.	ANC. RÉF.	RÉF. PAYEN	QTÉ	DIM.	ANC. RÉF.
LA5020	20	2,6 X 1,9	1500100	LA5088	20	8,5 X 1,5	1550500	LA5123	10	15,2 X 1,78	1565500
LA5021	20	3,4 X 1,9	1500200	LA5065	20	9,2 X 1,7	1510700	LA5122	10	15,9 X 2,62	1565200
LA5022	20	4,2 X 1,9	1500300	LA5109	20	10 X 3	1558700	LA5016	5	16,7 X 2,5	1558400
LA5023	20	4,9 X 1,9	1500400	PA172	20	10,5 X 2,7	1500900	LA5125	5	17,17 X 1,78	1565700
LA5024	20	5,7 X 1,9	1500500	LA5089	10	11,11 X 1,78	1550900	LA5120	5	18 X 2	1563700
LA5113	20	6,35 X 2,4	1559600	LA5027	10	12,1 X 2,7	1501000	PA326	5	18,4 X 2,7	1501400
LA5025	20	7,2 X 1,9	1500600	LA5091	10	13,3 X 2,4	1551200	LA5124	5	18,7 X 1,78	1565600
LA5108	20	8 X 2	1558600	LA5117	10	14 X 2	1563000	LA5110	5	20 X 2	1558900

JOINTS TORIQUES 19,8 À 50,17 - COFFRET RÉF. LA5157 (EX.RÉF. 19060200)

RÉF. PAYEN	QTÉ	DIM.	ANC. RÉF.	RÉF. PAYEN	QTÉ	DIM.	ANC. RÉF.	RÉF. PAYEN	QTÉ	DIM.	ANC. RÉF.
LA5116	10	20,3 X 2,6	1560400	LA5035	10	26,2 X 3,6	1502000	LA5039	5	32,5 X 3,6	1502400
LA5032	10	21,3 X 3,6	1501700	LA5121	10	27 X 2	1563800	LA5040	10	34,1 X 3,6	1502500
LA5092	10	23 X 3	1552300	LA5096	10	27,5 X 3	1552800	LA5083	5	34,52 X 3,53	1512500
LA5107	10	23,4 X 3,5	1558500	LA5036	10	27,8 X 3,6	1502100	LA5115	10	35 X 2,5	1560300
LA5093	10	24 X 2	1552400	LA5079	10	28,17 X 3,53	1512100	LA5118	5	35 X 3	1563100
LA5034	10	24,6 X 3,6	1501900	LA5037	10	29,3 X 3,6	1502200	LA5041	5	35,6 X 3,6	1502600
LA5094	10	25 X 2,5	1552500	LA5097	10	30,3 X 2,4	1553000	LA5042	10	37,3 X 3,6	1502700
LA5095	10	26,2 X 3	1552700	LA5038	10	30,8 X 3,6	1502300	LA5114	10	38,9 X 2,7	1560100

JOINTS TORIQUES 5,28 À 31,34 - COFFRET RÉF. LA5155 (EX.RÉF. 190600)

RÉF. PAYEN	QTÉ	DIM.	ANC. RÉF.	RÉF. PAYEN	QTÉ	DIM.	ANC. RÉF.	RÉF. PAYEN	QTÉ	DIM.	ANC. RÉF.
LA5062	10	5,2 X 1,7	1510500	LA5070	10	15,54 X 2,62	1511200	LA5078	10	26,57 X 3,53	1512000
LA5063	10	6,07 X 1,78	1510500	LA5071	10	17,12 X 2,62	1511300	LA5079	10	28,1 X 3,53	1512100
LA5064	10	7,65 X 1,78	1510600	LA5072	10	18,72 X 2,62	1511400	LA5080	10	29,74 X 3,53	1512200
LA5065	10	9,25 X 1,78	1510700	LA5073	10	18,64 X 3,53	1511500	LA5081	10	31,34 X 3,53	1512300
LA5066	10	9,19 X 2,62	1510800	LA5074	10	20,22 X 3,53	1511600	LA5082	10	32,92 X 3,53	1512400
LA5067	10	10,77 X 2,62	1510900	LA5075	10	21,82 X 5,33	1511700	LA5083	5	34,52 X 3,53	1512500
LA5068	10	12,37 X 2,62	1511000	LA5076	10	23,39 X 3,53	1511800	LA5084	5	36,09 X 3,53	1512600
LA5069	10	13,94 X 2,62	1511100	LA5077	10	24,99 X 3,53	1511900	LA5085	5	37,69 X 3,53	1512700

JOINTS TORIQUES 5,70 À 29,30 - COFFRET DE 300 JOINTS- RÉF. LA5159 (EX.RÉF.190643)

RÉF. PAYEN	QTÉ	DIM.	ANC. RÉF.	RÉF. PAYEN	QTÉ	DIM.	ANC. RÉF.	RÉF. PAYEN	QTÉ	DIM.	ANC. RÉF.
LA5024	20	5,7 X 1,9	1500500	PA173	20	13,6 X 2,7	1501100	LA5032	10	21,3 X 3,6	1510700
LA5025	20	7,2 X 1,9	1500600	LA5028	20	15,1 X 2,7	1501200	LA5033	10	23 X 3,6	1501800
LA5026	20	8,9 X 1,9	1500700	LA5029	20	16,9 X 2,7	1501300	LA5034	10	24,6 X 3,6	1501900
PA171	20	8,9 X 2,7	1500800	PA326	20	18,4 X 2,7	1501400	LA5035	10	26,2 X 3,6	1502000
PA172	20	10,5 X 2,7	1500900	LA5030	20	18,3 X 3,6	1501500	LA5036	10	27,8 X 3,6	1502100
LA5027	20	12,1 X 2,7	1501000	LA5031	20	19,8 X 3,6	1501600	LA5037	10	29,3 X 3,6	1502200

JOINTS TORIQUES 44,10 À 62,87 - COFFRET DE 60 JOINTS- RÉF. LA5158 (EX.RÉF. 190603)

RÉF. PAYEN	QTÉ	DIM.	ANC. RÉF.	RÉF. PAYEN	QTÉ	DIM.	ANC. RÉF.	RÉF. PAYEN	QTÉ	DIM.	ANC. RÉF.
LA5098	5	44,1 X 5	15535	LA5101	5	50,39 X 3,53	15539	LA5049	5	56,2 X 5,33	15034
LA5099	5	48 X 3,6	15536	PA625	5	52 X 3	15629	LA5103	5	60 X 3	15541
LA5100	5	49 X 3	15537	LA5105	5	53,97 X 3,53	15580	LA5119	5	62 X 3	15634
LA5112	5	50 X 3	15592	LA5102	5	54,5 X 3	15540	LA5051	5	62,87 X 5,33	15036

JOINTS DE BOUCHON DE VIDANGE - OIL DRAIN PLUG WASHERS

M = MÉTALLOPLASTIQUE FERMÉS

CU = CUIVRE

AL = ALUMINIUM

NYL = NYLON

FIB = FIBRE

TOR = TORIQUE

BS = BAGUES BS (AUTOCENTRÉES)

COMPOSÉES DE RONDELLES ACIER ET D'UN CORDON ÉLASTOMÈRE

CLASSEMENT PAR RÉFÉRENCE

RÉF. PAYEN	DIM.	MAT.
LA5120	18X2	TOR
PA217	16,3X22X1	CU
PA331	12,2X17X2	M
PA349	16,3X22X2	M
PA401	14,5X20X1,5	CU
PB852	16X24X1,5	BS
PB907	14X21X2	M
KG5011	14 X 21 X 1,5	BS
KG5012	16X23X1,5	BS
KG5030	14,3X19X2	M
KG5032	14,2 X 8,3 X 1,3	BS
KG5050	26 X 32 X 2	CU
KG5111	26,1X32X1	CU
KG5125	20,5X28X2	CU
KG5126	18,5X26X2	CU
KG5148	22,1X26,9X15	CU
KG5156	19,3X23,9X1,5	CU
KG5157	10,1X20,8X2	CU
KG5158	18,3X 24X1,5	CU
KG5162	12,2X15,9X1,5	CU
KG5195	20X26X1,5	CU
KG5207	16X23,6X1,5	CU
KG5215	26,3X33X3	CU
KG5232	14,2X22X1	CU
KG5242	12X16X1,6	AL
KG5247	22,5X29X1,5	AL
KG5248	14,3X19X1,5	AL
KG5249	14,9X22,2X2	NYL
KG5290	20,4X27X3	FIB
KG5292	14,5X22 X 2	FIB
KG5313	13X22,5X3	BS
KJ647	18,3X23X2	M
KJ920	14,5X20,2	CU

CLASSEMENT PAR DIMENSIONS

RÉF. PAYEN	DIM.	MAT.
KG5157	10,1 X 20,8 X 2	CU
KG5242	12 X 16 X 1,6	AL
KG5162	12,2 X 15,9 X 1,5	CU
PA331	12,2 X 17 X 2	M
KG5313	13 X 22,5 X 3	BS
PB907	14 X 21 X 2	M
KG5011	14 X 21 X 1,5	BS
KG5232	14,2 X 22 X 1	CU
KG5032	14,2 X 8,3 X 1,3	BS
KG5248	14,3 X 19 X 1,5	AL
KG5030	14,3 X 19 X 2	M
KJ920	14,5 X 20,2	CU
PA401	14,5 X 20 X 1,5	CU
KG5292	14,5X22 X 2	FIB
KG5249	14,9 X 22,2 X 2	NYL
KG5012	16 X 23 X 1,5	BS
KG5207	16 X 23,6 X 1,5	CU
PB852	16 X 24 X 1,5	BS
PA217	16,3 X 22 X 1	CU
PA349	16,3 X 22 X 2	
KG5158	18, X 24 X 1,5	CU
KG5013	18, X 27 X 2	BS
LA5120	18 X 2	TOR
KJ647	18,3 X 23 X 2	M
KG5126	18,5X26X2	CU
KG5156	19,3 X 23,9 X 1,5	CU
KG5290	20,4 X 27 X 3	FIB
KG5125	20,5 X 28 X 2	CU
KG5195	20 X 26 X 1,5	CU
KG5148	22,1 X 26,9 X 15	CU
KG5247	22,5 X 29 X 1,5	AL
KG5111	26,1 X 32 X 1	CU
KG5215	26,3 X 33 X 3	CU
KG5050	26 X 32 X 2	M

COFFRETS JOINTS DE BOUCHON DE VIDANGE - OIL DRAIN PLUG WASHERS KITS

COFFRET 290 JOINTS DE BOUCHONS DE VIDANGE PSA/RENAULT HR525 (EX. P019064700)

QTÉ	RÉF. PAYEN	DIM.	ANC. RÉF.	APPL.	MAT.
100	PA349	16,3X22X2	P021237000	CITROËN, PEUGEOT, RENAULT	MÉTALLOPLASTIQUE FERMÉ
40	KG5290	20,4X27X3	P061132400	TALBOT	FIBRE
50	KG5009	14,1X19X2,5	P020503500	SIMCA	MÉTALLOPLASTIQUE FERMÉ
100	KJ647	18,3X23X2	P020883200	RENAULT, MITSUBISHI	MÉTALLOPLASTIQUE FERMÉ

JOINTS MÉTALLOPLASTIQUES FERMÉS (M)

RÉF. PAYEN	DIM.	ANC. RÉF.
PA331	12,2 X 17 X 2	202947
PB907	14 X 21 X 2	224504
KG5030	14,3 X 19 X 2	211172
PA349	16,3 X 22 X 2	212370
KJ647	18,3 X 23 X 2	208832
PB853	22 X 28 X 3	205038
KG5026	24,4X32X 2	209556
KG5050	26 X 32 X 2	212406

JOINTS CUIVRE (CU)

RÉF. PAYEN	DIM.	ANC. RÉF.
KG5157	10,1 X 20,8 X 2	320347
KG5162	12,2 X 15,9 X 1,5	320693
KG5081	12,2 X 17 X 2	300012
KG5232	14,2 X 22 X 1	322393
PA401	14,5X20X1,5	311136
KJ920	14,5 X 20 X 2	322355
KG5207	16 X 23,6 X 1,5	321998
PA217	16,3 X 22 X 1	310141
KG5158	18,3 X 24 X 1,5	320383
KG5126	18,5 X 26 X 2	310021
SUPP	19,2 X 24,9 X 2	321852
KG5156	19,3 X 23,9 X 1,5	320117
KG5195	20 X 26 X 1,5	321913
KG5125	20,5 X 28 X 2	310020
KG5148	22,1X26,9X1,5	311825
KG5111	26,1 X 32 X 1	305359
KG5215	26,3 X 33 X 3	322028

JOINT FIBRE (FIB)

RÉF. PAYEN	DIM.	ANC. RÉF.
KG5290	20,4 X 27 X 3	611324

JOINT NYLON (NYL)

RÉF. PAYEN	DIM.	ANC. RÉF.
KG5249	14,9 X 22,2 X 2	331052

BAGUES "BS" (BS)

RÉF. PAYEN	DIM.	ANC. RÉF.
KG5011	14 X 21 X 1,5	P02526800
SUPP	14 X 24 X 1,5	25345
KG5032	14,2 X 8,3 X 1,3	P02118700
KG5012	16 X 23 X 1,5	P02526900
PB852	16 X 24 X 1,5	P02534000
SUPP	16,3 X 22 X 1	25346
KG5013	18 X 27 X 2	P02527000
SUPP	20 X 28 X 1,5	25342
SUPP	20,5 X 28 X 2	25339

COFFRET JOINT DE BOUCHONS DE VIDANGE VAG HL5192

QTÉ	RÉF. PAYEN	DIM
10	KG5011	14X21X1,5
10	KG5012	16X23X1,5
10	KG5030	14,3X19X2
25	KG5148	22,1X26,9X1,5
10	KG5157	10,1X20,8X2
25	KG5249	14,9X22,2X2
15	KJ647	18,3X23X2
10	LA5120	18X2
25	PA349	16,3X22X2
25	PA401	14,5X20X1,5
10	PB852	16X24X1,5
25	PB907	14X21X2
10	LA5238	13X22X3
2	KK5708	M14X1,5

ASSORTIMENTS - KITS

COFFRET 260 JOINTS MÉTALLOPLASTIQUES FERMÉS ET JOINTS REPLIÉS (CUIVRE) KK5182 (ANC. RÉF. 190641)

QTÉ	RÉF. PAYEN	DIM.	ANC. RÉF.	MAT.
20	KG5039	6,2 X 10 X 2	212367	MÉTALLO FERMÉ
20	KG5040	7,2 X 11 X 2	212368	MÉTALLO FERMÉ
20	KG5024	8,2 X 12 X 2	206634	MÉTALLO FERMÉ
20	KG5019	9,2 X 14 X 2	202838	MÉTALLO FERMÉ
20	KG5053	10,2 X 15 X 2	230002	JOINT REPLIÉ
20	KG5041	11,2 X 1 X 2	212369	MÉTALLO FERMÉ
20	PA331	12,2 X 17 X 2	202947	MÉTALLO FERMÉ
40	KG5009	14,1X19X 2,5	205035	MÉTALLO FERMÉ
40	PA349	16,3X22X 2	212370	MÉTALLO FERMÉ
20	KJ647	18,3X23X 2	208832	MÉTALLO FERMÉ
10	KG5042	20,4X26X 2	212371	MÉTALLO FERMÉ
10	KG5055	22,4X29X 2	230004	JOINT REPLIÉ

COFFRET 350 RONDELLES EN FIBRE HR524 (ANC. RÉF. 190642)

QTÉ	RÉF. PAYEN	DIM.	ANC. RÉF.
40	KG5298	5X9X1	611933
40	KG5276	6X10X1	603073
40	KG5302	7X11X1	620751
40	KG5278	8,2X14X1	605265
40	KG5308	10,2X16X1,5	622662
20	KG5300	11X16X1	611940
20	KG5289	12,5X18X1,5	611132
20	KG5280	13 X 18 X 1	605267
20	KG5283	14,2X19X1	606699
20	KG5286	14,4X20X2	610010
10	KG5305	16,2X21X2	622094
10	KG5295	17X23X2	611727
10	KG5307	18,5X26X2	622649
10	KG5301	22,5X28X1,5	620729
10	KG5306	22,5X28X1,5	622199

COFFRET 600 JOINTS CUIVRE ET FIBRE (SERVICE DIESEL) KK5181 (ANC. RÉF. 190610)

QTÉ	RÉF. PAYEN	DIM.	ANC. RÉF.	MAT.
20	KG5117	6,2 X 10 X 1	306285	CUIVRE
50	KG5094	8 X 12 X 1	302830	CUIVRE
20	KG5108	8,2 X 14 X 1	305356	CUIVRE
20	KG5150	9,7X 14,2X 1,8	311858	CUIVRE
20	KG5219	10,2 X13,9 X 1	322335	CUIVRE
20	KG5162	12,2X15,9X1,5	320693	CUIVRE
20	KG5206	12,5 X 16,8 X 1	321989	CUIVRE
50	PA335	14,3X19X1,5	311694	CUIVRE
20	KG5020	14,5 X21,2X 2	237470	CUIVRE
20	KG5220	14,5X21,3 X1,5	322336	CUIVRE
20	KG5197	15,5 X 20 X 2	321915	CUIVRE
20	PA345	15,6 X 21,2 X 2,2	320694	CUIVRE
20	KG5091	16,2 X 20 X 1	302317	CUIVRE
20	KG5231	18,2 X 22 X 1,5	322375	CUIVRE
20	KG5195	20 X 26 X 1,5	321913	CUIVRE
20	KG5225	22 X 26 X 1	322356	CUIVRE
20	KG5298	5X9X1	611933	FIBRE
50	KG5276	6X10X1	603073	FIBRE
20	KG5278	8,2X14X1	605265	FIBRE
20	KG5308	10,2X16X1,5	622662	FIBRE
20	KG5289	12,5X18X1,5	611132	FIBRE
20	KG5309	14,1X23X1,5	606690	FIBRE
50	KG5286	14,4X20X2	610010	FIBRE
20	KG5307	18,5X26X2	622649	FIBRE

"COFFRET 250 JOINTS CUIVRE" HR522 (ANC. RÉF. 190608)

QTÉ	RÉF. PAYEN	DIM.	ANC. RÉF.
20	KG5101	5,2 X 8 X 1	305231
20	KG5117	6,2 X 10 X 1	306285
20	KG5103	7,2 X 11 X 1	305317
20	KG5102	8,5 X 17 X 1	305243
20	KG5115	9,2 X 20 X 1	306234
20	PA333	10,1 X 18 X 1	302290
20	KG5074	11 X 20 X 1	300001
20	KG5093	12,5 X 20 X 0,8	302466
20	KG5134	13,7 X18,5X1	310861
20	KG5110	14,2 X 20 X1	305358
10	KG5118	15 X 24 X 1	306308
10	KG5091	16,2 X 20 X 1	302317
10	KG5096	17 X 21 X 1	302910
10	KG5098	18,5 X 23 X 1	302920
10	KG5090	20,1 X 26 X 1	302298

CALES DE TARAGE POUR INJECTEURS

KK5183 ANC. RÉF.19064900 = SUPPRIMÉ RÉF. VENDUES AU DÉTAIL

COFFRET "SERVICE" 700 JOINTS ASSORTIMENT SERVICE, ENTRETIEN ET RÉPARATION HR523 (ANC. RÉF. 190611)

RONDELLES CUIVRE

QTÉ	RÉF. PAYEN	DIM.	ANC. RÉF.
50	KG5094	8 X 12 X 1	302830
50	PA333	10,1 X 18 X 1	302290
20	KG5206	12,5X16,8 1	321989
50	PA401	14,5X20X1,5	311136
20	PA217	16,3X22X1	310141
20	KG5182	18,2X23X1,5	321573
20	KG5195	20X26X1,5	321913
20	KG5148	22, X26,9X1,5	311825

RONDELLES FIBRE

QTÉ	RÉF. PAYEN	DIM.	ANC. RÉF.
20			603329
20			605579
20			611717
50	KG5278	8,2X14X1	605265
50	KG5308	10,2X16X1,5	622662
20	KG5277	12X18X1	603143
50	KG5294	14,2X20X1,5	611717
20	KG5307	18,5X26X2	622649

JOINTS CIRCULAIRES FERMÉS

QTÉ	RÉF. PAYEN	DIM.	ANC. RÉF.
20	KG5024	8,2X12X2	206634
20	KG5053	10,2X15X2	230002
20	KG5033	12X16X2	211964
50	KG5030	14,3X19X2	211172
20	PA349	16,3X22X2	212370
30	KJ647	18,3X23X2	208832
20	KG5042	20,4X26X2	212371
20	PB853	22X28X3	205038

TECHNICAL NOTES

Technische Hinweise • Notes techniques
Note tecniche • Notas técnicas

	ENG	DE	FR	IT
1	Rotation Direction Anti-clockwise rotation	Drehrichtung: Gegen den Uhrzeigersinn	Sens de rotation: Rotation dans le sens antihoraire	Senso di rotazione: Rotazione in senso antiorario
2	Rotation Direction Clockwise rotation	Drehrichtung: Im Uhrzeigersinn	Sens de rotation: Rotation dans le sens horaire	Senso di rotazione: Rotazione in senso orario
3	Supplementary Article/Supplementary Info with gaskets/seals	Ergänzender Artikel/zusätzliche Info: mit Dichtungen/Wellendichtringen	Article supplémentaire / Infos supplémentaires: avec joints/bagues d'étanchéité	Articolo aggiuntivo/Informazioni aggiuntive: con guarnizioni/elementi di tenuta
4	Composite material	Verbundwerkstoff:	Matériau composite	Materiale Composito:
5	Thread Pitch 1 [mm]: 1.25	Gewindeteilung 1 [mm]: 1,25	Pas du filetage : 1 [mm]: 1,25	Passo filettatura 1 [mm]: 1,25
6	PART Gasket, timing case	Teil: Steuergehäusedichtungssatz	PIÈCE: Jeu de joints de carter de distribution	Guarnizione coperchio distribuzione: Guarnizione coperchio distribuzione
7	Specification Oil Seal in housing	Spezifikation: Wellendichtring im Gehäuse	Caractéristiques: Bague d'étanchéité d'huile dans son logement	Specifiche: Paraolio in sede
8	PART Gasket Set, manual transmission	Teil: Dichtungssatz, Schaltgetriebe	PIÈCE: Pochette de joints d'étanchéité, boîte de vitesses manuelle	COMPONENTE: Set guarnizioni, Cambio manuale
9	Type 103 HP Only	Typ: Nur 103 PS	Type 103 HP uniquement	Tipo: Solo 103 CV
10	PART Radial Oil Seal, oil pump	Teil: Radialwellendichtring, Ölpumpe	PIÈCE: Bague d'étanchéité radiale d'huile, pompe à huile	COMPONENTE: Paraolio, Pompa olio
11	PART Gasket, carburettor flange	Teil: Dichtung, Vergaserflansch	PIÈCE: Joint d'étanchéité, bride du carburateur	COMPONENTE: Guarnizione, Flangia carburatore
12	Thread Pitch 1 [mm]: 2.00	Gewindeteilung 1 [mm]: 2	Pas du filetage : 1 [mm]: 2,00	Passo filettatura 1 [mm]: 2,00
13	Supplementary Article/Supplementary Info without gaskets/seals	Ergänzender Artikel/zusätzliche Info: ohne Dichtungen/Wellendichtringe	Article supplémentaire / Infos supplémentaires: sans joints/bagues d'étanchéité	Articolo aggiuntivo/Informazioni aggiuntive: senza guarnizioni/elementi di tenuta
14	Supplementary Article/Supplementary Info 2 with cylinder sleeve ring	Ergänzender Artikel/zusätzliche Info 2: mit Zylinderbuchsenring	Article supplémentaire / Infos supplémentaires 2: avec joint de chemise de cylindre	Articolo aggiuntivo/Informazioni aggiuntive 2: con anello tenuta canna cilindro
15	PART Gasket, water pump	Teil: Dichtung, Wasserpumpe	PIÈCE: Joint d'étanchéité, pompe à eau	COMPONENTE: Guarnizione, pompa acqua
16	Supplementary Article/Supplementary Info without crankshaft seal	Ergänzender Artikel/zusätzliche Info: ohne Kurbelwellen-Dichtring	Article supplémentaire / Infos supplémentaires: sans bague d'étanchéité de vilebrequin	Articolo aggiuntivo/Informazioni aggiuntive: senza paraolio-albero a gomito
17	PART Gasket, timing case cover	Teil: Dichtung, Steuergehäusedeckel	PIÈCE: Joint d'étanchéité, couvercle de carter de distribution	COMPONENTE: Guarnizione copricatena distribuzione
18	Supplementary Article/Supplementary Info 2 without oil pan gasket	Ergänzender Artikel/zusätzliche Info 2: ohne Ölwanndichtung	Article supplémentaire / Infos supplémentaires 2: sans joint de carter d'huile	Articolo aggiuntivo/Informazioni aggiuntive 2: senza guarnizione coppa olio
19	Thread Pitch 1 [mm]: 1.75	Gewindeteilung 1 [mm]: 1,75	Pas du filetage : 1 [mm]: 1,75	Passo filettatura 1 [mm]: 1,75
20	PART Seal, oil pump	Teil: Dichtring, Ölpumpe	PIÈCE: Bague d'étanchéité, pompe à huile	COMPONENTE: Guarnizione, pompa olio
21	Bolt / Nut Version without plain washer	Schraube/Mutter, Version: ohne Unterlegscheibe	Version vis/écrou: sans rondelle plate	Modello bullone / dado: senza rondella d'appoggio
22	Thread Pitch 1 [mm]: 1.50	Gewindeteilung 1 [mm]: 1,5	Pas du filetage : 1 [mm]: 1,50	Passo filettatura 1 [mm]: 1,50
23	Centering Diameter [mm]: 8.5	Zentrierdurchmesser [mm]: 8,5	Diamètre de centrage [mm]: 8,5	Diametro centraggio [mm]: 8,5
24	Centering Diameter [mm]: 6.5	Zentrierdurchmesser [mm]: 6,5	Diamètre de centrage [mm]: 6,5	Diametro centraggio [mm]: 6,5
25	Outer Diameter 1 [mm]: 163.0	Außendurchmesser 1 [mm]: 163	Diamètre extérieur 1 [mm]: 163,0	Diametro esterno 1 [mm]: 163,0
26	Outer Diameter 1 [mm]: 152.0	Außendurchmesser 1 [mm]: 152	Diamètre extérieur 1 [mm]: 152,0	Diametro esterno 1 [mm]: 152,0
27	to engine cylinder 4-6	zum Zylinder: 4-6	vers cylindre moteur: 4-6	al cilindro motore: 4-6
28	Outer Diameter 1 [mm]: 153.0	Außendurchmesser 1 [mm]: 153	Diamètre extérieur 1 [mm]: 153,0	Diametro esterno 1 [mm]: 153,0
29	Supplementary Article/Supplementary Info 2 with heat shield	Ergänzender Artikel/zusätzliche Info 2: mit Hitzeschutzblech	Article supplémentaire / Infos supplémentaires 2: avec écran thermique	Articolo aggiuntivo/Informazioni aggiuntive 2: con paracolore
30	Vehicle Trim Level Audi 100	Fahrzeug-Ausstattungsstufe: Audi 100	Version du véhicule: Audi 100	Livello finitura veicolo: Audi 100
31	PART Seal, oil filter housing	Teil: Dichtring, Ölfiltergehäuse	PIÈCE: Bague d'étanchéité, boîtier de filtre à huile	COMPONENTE: Guarnizione, Carter filtro olio

	ES	PL	RU	AR
1	Posición del conductor: Giro a la izquierda	Kierunek obrotu: Obróty w kierunku przeciwnym do ruchu wskazówek zegara	Направление вращения: Вращение против часовой стрелки	اتجاه الدوران: دوران عكس اتجاه عقارب الساعة
2	Dirección de giro: Giro a la derecha	Kierunek obrotu :Obróty w kierunku zgodnym z ruchem wskazówek zegara	Направление вращения: Вращение по часовой стрелке	اتجاه الدوران: دوران في اتجاه عقارب الساعة
3	Artículo complementario / Información complementaria: con juntas/retenes	Element uzupełniający/Informacje uzupełniające :z uszczelkami/uszczelnieniami	Дополнительный элемент/Дополнительная информация: с прокладками/уплотнениями	مادة تكميلية/معلومات تكميلية مزود بحشيات/سدادات
4	Material compuesto:	Materiał kompozytowy	Композитный материал:	المواد المركبة
5	Paso de rosca 1 (mm): 1,25	Skok gwintu 1 [mm]: 1,25	Шаг резьбы 1 [мм]: 1,25	بُعد سن اللولب 1 [مم]: 1,25
6	PIEZA: Juego de juntas para cárter de distribución	CZĘŚĆ: Uszczelka pokrywy rozrządu	ДЕТАЛЬ: Прокладка, картер ГРМ	حشية طقم الكتاتينا
7	Especificaciones: Retén de aceite de la carcasa	Specyfikacja: Uszczelnienie olejowe w obudowie	Спецификации: Сальник в корпусе	المواصفات: سداة الزيت داخل التجويف
8	PIEZA: Juego de juntas, transmisión manual	CZĘŚĆ: Zestaw uszczeltek, manualna skrzynia biegów	ДЕТАЛЬ: Комплект прокладок, механическая коробка передач	قطعة: مجموعة حشية، ناقل حركة يدوي
9	Tipo: Únicamente 103 HP	Typ: Tylko 103 HP	Тип: Только для двиг. 103 л.с.	فقط HP النوع: 103
10	PIEZA: Retén de aceite radial, bomba de aceite	CZĘŚĆ: Promieniowe uszczelnienie olejowe, pompa olejowa	ДЕТАЛЬ: Радиальный сальник, масляный насос	قطعة: سداة زيت قطرية، مضخة زيت
11	PIEZA: Junta, brida del carburador	CZĘŚĆ: Uszczelka, kotniierz gaźnika	ДЕТАЛЬ: Прокладка, фланец карбюратора	قطعة: حشية، شفة المكربن
12	Paso de rosca 1 (mm): 2,00	Skok gwintu 1 [mm]:	Шаг резьбы 1 [мм]: 2,00	بُعد سن اللولب 1 [مم]: 2
13	Artículo complementario / Información complementaria: sin juntas/retenes	Element uzupełniający/Informacje uzupełniające: bez uszczeltek/uszczelnień	Дополнительный элемент/Дополнительная информация: без прокладок/уплотнений	مادة تكميلية/معلومات تكميلية: بدون حشيات/سدادات
14	Artículo complementario / Información complementaria 2: con segmento de la camisa de cilindro	Element uzupełniający/Informacje uzupełniające 2: z pierścieniem tulei cylindrowej	Дополнительный элемент/Дополнительная информация 2: с кольцом гильзы цилиндра	مادة تكميلية/معلومات تكميلية 2: مزود بحلقة كم الاسطوانة
15	PIEZA: Junta, bomba de agua	CZĘŚĆ	ДЕТАЛЬ: Прокладка, водяной насос	قطعة: حشية، مضخة ماء
16	Artículo complementario / Información complementaria: sin retén del cigüeñal	Element uzupełniający/Informacje uzupełniające: bez uszczelnienia wału korbowego	Дополнительный элемент/Дополнительная информация: без сальника коленчатого вала	مادة تكميلية/معلومات تكميلية 2: بدون سداة عمود المرفق
17	PIEZA: Junta, tapa de la caja de distribución	CZĘŚĆ: Uszczelka, pokrywa obudowy mechanizmu rozrządu	ДЕТАЛЬ: Прокладка, крышка картера ГРМ	قطعة: حشية، غطاء حاوية التوقيت
18	Artículo complementario / Información complementaria 2: sin junta del cárter de aceite	Element uzupełniający/Informacje uzupełniające 2: bez uszczelki miski olejowej	Дополнительный элемент/Дополнительная информация 2: без прокладки поддона картера	مادة تكميلية/معلومات تكميلية 2: بدون حشية وعاء الزيت
19	Paso de rosca 1 (mm): 1,75	Skok gwintu 1 [mm]: 1,75	Шаг резьбы 1 [мм]: 1,75	بُعد سن اللولب 1 [مم]: 1,75
20	PIEZA: Retén, bomba de aceite	CZĘŚĆ: Uszczelnienie, pompa olejowa	ДЕТАЛЬ: Уплотнение, масляный насос	قطعة: سداة، مضخة الزيت
21	Versión de perno/tuerca: sin arandela plana	Wersja śruby/nakrętki: bez podkładki płaskiej	Тип болта/гайки: без плоской шайбы	نسخة مسمار الربط/الصامولة: بدون وردة عادية
22	Paso de rosca 1 (mm): 1,50	Skok gwintu 1 [mm]: : 1,5	Шаг резьбы 1 [мм]: 1,50	بُعد سن اللولب 1 [مم]: 1,5
23	Diámetro central (mm): 8,5	Średnica centrująca [mm]: 8,5	Базовый диаметр [мм]: 8,5	قطر وضع التركيز [مم]: 8,5
24	Diámetro central (mm): 6,5	Średnica centrująca [mm]: 6,5	Базовый диаметр [мм]: 6,5	قطر وضع التركيز [مم]: 6,5
25	Diámetro exterior 1 (mm): 163,0	Średnica zewnętrzna 1 [mm]: 163	Наружный диаметр 1 [мм]: 163,0	قطر خارجي 1 [ملم]: 163
26	Diámetro exterior 1 (mm): 152,0	Średnica zewnętrzna 1 [mm]: 152	Наружный диаметр 1 [мм]: 152,0	قطر خارجي 1 [ملم]: 152
27	al cilindro del motor: 4-6	do cylindra silnika: 4-6	к цилиндрам : 4-6	إلى اسطوانة المحرك: 4-6
28	Diámetro exterior 1 (mm): 153,0	Średnica zewnętrzna 1 [mm]: 153	Наружный диаметр 1 [мм]: 153,0	قطر خارجي 1 [ملم]: 153
29	Artículo complementario / Información complementaria 2: con escudo térmico	Element uzupełniający/Informacje uzupełniające 2: z osłoną termiczną	Дополнительный элемент/Дополнительная информация 2: с теплозащитным экраном	مادة تكميلية/معلومات تكميلية 2: مزود بواقى الحرارة
30	Nivel de ajuste del vehículo: Audi 100	Poziom wyważenia samochodu Audi 100	Тип комплектации автомобиля: Audi 100	مستوى اقطاع المركبة: أودي 100
31	PIEZA: Retén, carcasa del filtro de aceite	CZĘŚĆ: Uszczelnienie, obudowa filtra oleju	ДЕТАЛЬ: Уплотнение, корпус масляного фильтра	قطعة: سداة، مبيت فلتر الزيت

TECHNICAL NOTES

Technische Hinweise • Notes techniques
Note tecniche • Notas técnicas

	ENG	DE	FR	IT
32	to engine cylinder 1-3	zum Zylinder: 1-3	vers cylindre moteur: 1-3	al cilindro motore: 1-3
33	Fitting Position Left and right	Einbauposition: Links und rechts	Côté d'assemblage: Gauche et droit	Posizione di montaggio: Sinistra e destra
34	Supplementary Article/Supplementary Info without exhaust pipe gasket	Ergänzender Artikel/zusätzliche Info: ohne Auspuffrohrdichtung	Article supplémentaire / Infos supplémentaires: sans bride d'échappement	Articolo aggiuntivo/Informazioni aggiuntive: senza guarnizione tubo di scappamento
35	Specification Complete	Spezifikation: Komplett	Caractéristiques: Complet	Specifiche: Completo
36	Outer Diameter 1 [mm]: 105.00	Außendurchmesser 1 [mm]: 105	Diamètre extérieur 1 [mm]: 105,00	Diametro esterno 1 [mm]: 105,00
37	Height [mm]: 7.50	Höhe [mm]: 7,5	Hauteur [mm]: 7,50	Altezza [mm]: 7,50
38	Inner Diameter 1 [mm]: 40.10	Innendurchmesser 1 [mm]: 40,1	Diamètre intérieur 1 [mm]: 40,10	Diametro interno 1 [mm]: 40,10
39	Outer Diameter [mm]: 43.50	Außendurchmesser [mm]: 43,5	Diamètre extérieur [mm]: 43,50	Diametro esterno [mm]: 43,50
40	to engine cylinder 1,3,4	zum Zylinder: 1,3,4	PIÈCE: 1,3,4	al cilindro motore: 1,3,4
41	PART Gasket, thermostat	Teil: Dichtung, Thermostat	PIÈCE: Joint d'étanchéité, thermostat	COMPONENTE: Guarnizione, termostato
42	Driver Position for left-hand drive vehicles	Fahrerposition: für Fahrzeuge mit Lenkslenkung	Côté du conducteur: pour véhicules avec conduite à gauche	Posizione guidatore: per veicoli con guida a sinistra
43	Engine Block Material Cast Steel	Motorblockmaterial: Gussstahl	Matériau du bloc moteur: Fonte	Materiale blocco motore: Acciaio fuso
44	Engine Block Material Aluminium	Motorblockmaterial: Aluminium	Matériau du bloc moteur: Aluminium	Materiale blocco motore: Alluminio
45	PART Gasket, thermostat housing	Teil: Dichtung, Thermostatgehäuse	PIÈCE: Joint d'étanchéité, logement du thermostat	COMPONENTE: Guarnizione, sede termostato
46	to engine cylinder 1,2,5-8	zum Zylinder: 1,2,5-8	vers cylindre moteur: 1,2,5-8	al cilindro motore: 1,2,5-8
47	to engine cylinder 5 - 8	zum Zylinder: 5 - 8	vers cylindre moteur: 5 - 8	al cilindro motore: 5 - 8
48	to engine cylinder 1 - 4	zum Zylinder: 1 - 4	vers cylindre moteur: 1 - 4	al cilindro motore: 1 - 4
49	to engine cylinder 5-8	zum Zylinder: 5-8	vers cylindre moteur: 5-8	al cilindro motore: 5-8
50	to engine cylinder 1-4	zum Zylinder: 1-4	vers cylindre moteur: 1-4	al cilindro motore: 1-4
51	Inner Diameter [mm]: 6.0	Innendurchmesser [mm]: 6	Diamètre intérieur [mm]: 6,0	Diametro interno [mm]: 6,0
52	PART Oil Seal, wheel hub	Teil: Öldichtring, Radnabe	PIÈCE: Bague d'étanchéité d'huile, moyeu de roue	COMPONENTE: Paraolio, mozzo ruota
53	PART Radial Oil Seal, differential	Teil: Radialwellendichtring, Differential	PIÈCE: Bague d'étanchéité radiale d'huile, différentiel	COMPONENTE: Anello tenuta, Differenziale
54	PART Shaft Oil Seal, steering gear	Teil: Radialwellendichtring, Lenkgetriebe	PIÈCE: Bague d'étanchéité d'arbre, boîtier de direction	COMPONENTE: Paraolio, Sterzo
55	PART O-Ring Set, cylinder sleeve	Teil: O-Ringsatz, Zylinderbuchse	PIÈCE: Pochette de joints toriques, chemise de cylindre	COMPONENTE: Set guarnizioni, Canna cilindro
56	PART Radial Oil Seal, intermediate shaft	Teil: Radialwellendichtring, Zwischenwelle	PIÈCE: Bague d'étanchéité radiale d'huile, arbre intermédiaire	COMPONENTE: Paraolio, Albero intermedio
57	Thread Pitch 1 [mm]: 1.51	Gewindeteilung 1 [mm]: 1,51	Pas du filetage : 1 [mm]: 1,51	Passo filettatura 1 [mm]: 1,51
58	Supplementary Article/Supplementary Info 2 without shaft seal	Ergänzender Artikel/zusätzliche Info 2: ohne Radialwellendichtring	Article supplémentaire / Infos supplémentaires 2: sans bague d'étanchéité d'arbre	Articolo aggiuntivo/Informazioni aggiuntive 2: senza paraolio
59	Supplementary Article/Supplementary Info 2 with shaft oil seal	Ergänzender Artikel/zusätzliche Info 2: mit Wellen-Öldichtring	Article supplémentaire / Infos supplémentaires 2: avec bague d'étanchéité d'arbre	Articolo aggiuntivo/Informazioni aggiuntive 2: con paraolio controlloalbero
60	PART Gasket Set, timing case	Teil: Dichtungssatz, Steuergehäuse	PIÈCE: Pochette de joints d'étanchéité, carter de distribution	COMPONENTE: Carterino della distribuzione, set di guarnizioni
61	Transmission Type Manual Transmission, 5-speed	Getriebetyp: Schaltgetriebe, 5-Gang	Type de boîte de vitesses: Boîte de vitesses manuelle, 5 vitesses	Tipo cambio: Cambio manuale, a 5 marce
62	Wet Sump Material Steel	Nassumpfmateriale: Stahl	Matériau du carter d'huile: Acier	Materiale carter umido: Acciaio
63	Type Evasion Only	Typ: Nur Evasion	Type: Evasion uniquement	Tipo: Solo Evasion
64	Type Jumper	Typ: Jumper	Type: Jumper	Tipo: Jumper
65	Type Xantia	Typ: Xantia	Type: Xantia	Tipo: Xantia

	ES	PL	RU	AR
32	al cilindro del motor: 1-3	do cylindra silnika: 1-3	к цилиндрам: 1-3	إلى اسطوانة المحرك: 1-3
33	Posición de montaje: Derecha e izquierda	Miejsce montażu: Lewa i prawa	Положение установки: Слева и справа	وضع التثبيت: يسار ويمين
34	Artículo complementario / Información complementaria: sin junta del tubo de escape	Element uzupełniający/Informacje uzupełniające: bez uszczelki rury wydechowej	Дополнительный элемент/Дополнительная информация: без прокладки выпускной трубы	مادة تكميلية/معلومات تكميلية: بدون حشية أنبوب العادم
35	Especificaciones: Completo	Specyfikacja: Kompletny	Спецификации: полный	المواصفات: كامل
36	Diámetro exterior 1 (mm): 105,00	Średnica zewnętrzna 1 [mm]: 105	Наружный диаметр 1 [мм]: 105,00	قطر خارجي 1 [ملم]: 105
37	Altura (mm): 7,50	Wysokość [mm]: 7,5	Высота [мм]: 7,50	الارتفاع [ملم]: 7,5
38	Diámetro interior 1 (mm): 40,10	Średnica wewnętrzna 1 [mm]: 40,1	Внутренний диаметр 1 [мм]: 40,10	القطر الداخلي 1 [ملم]: 40,1
39	Diámetro exterior (mm): 43,50	Średnica zewnętrzna [mm]: 43,5	Наружный диаметр [мм]: 43,50	قطر خارجي [ملم]: 43,5
40	al cilindro del motor: 1,3,4	do cylindra silnika: 1,3,4	к цилиндрам: 1,3,4	إلى اسطوانة المحرك: 1,3,4
41	PIEZA: Junta, termostato	CZĘŚĆ: Uszczelka, termostat	ДЕТАЛЬ: Прокладка, термостат	قطعة: حشية، ثرموستات
42	Posición del conductor: para vehículos con conducción a la izquierda	Pozycja kierowcy: do samochodów z kierownicą po lewej stronie	Положение водителя: для автомобилей с левосторонним управлением	وضع السائق: للمركبات ذات نظام القيادة الأيسر
43	Material del bloque motor: Acero fundido	Materiał bloku silnika: Staliwo	Материал блока цилиндров: литая сталь	مادة كتلة المحرك: صلب مصبوب
44	Material del bloque motor: Aluminio	Materiał bloku silnika: Aluminium	Материал блока цилиндров: Алюминий	مادة كتلة المحرك: ألومنيوم
45	PIEZA: Junta, carcasa del termostato	CZĘŚĆ: Uszczelka, obudowa termostatu	ДЕТАЛЬ: Прокладка, корпус термостата	قطعة: حشية، مبيت ثرموستات
46	al cilindro del motor: 1,2,5-8	do cylindra silnika: 1,2,5-8	к цилиндрам: 1,2,5-8	إلى اسطوانة المحرك: 1,2,5-8
47	al cilindro del motor: 5 - 8	do cylindra silnika: 5 - 8	к цилиндрам : 5 - 8	إلى اسطوانة المحرك: 8 - 5
48	al cilindro del motor: 1 - 4	do cylindra silnika: 1 - 4	к цилиндрам: 1 - 4	إلى اسطوانة المحرك: 4 - 1
49	al cilindro del motor: 5-8	do cylindra silnika: 5-8	к цилиндрам : 5-8	إلى اسطوانة المحرك: 5-8
50	al cilindro del motor: 1-4	do cylindra silnika: 1-4	к цилиндрам: 1-4	إلى اسطوانة المحرك: 1-4
51	Diámetro interior (mm): 6,0	Średnica wewnętrzna [mm]: 6	Внутренний диаметр [мм]: 6,0	القطر الداخلي [ملم]: 6
52	PIEZA: Retén de aceite, buje de rueda	CZĘŚĆ: Uszczelnienie olejowe, piasta kota	ДЕТАЛЬ: Сальник, ступица колеса	قطعة: سدادة الزيت، محور العجلة
53	PIEZA: Retén de aceite radial, diferencial	CZĘŚĆ: Promieniowe uszczelnienie olejowe, mechanizm różnicowy	ДЕТАЛЬ: Радиальный сальник, дифференциал	قطعة: سدادة زيت قطرية، تفاضلي
54	PIEZA: Retén de aceite del eje, sistema de dirección	CZĘŚĆ: Uszczelnienie olejowe wału, przekładnia kierownicza	ДЕТАЛЬ: Сальник вала, рулевой механизм	قطعة: سدادة زيت العمود، ترس التوجيه
55	PIEZA: Conjunto de juntas tóricas, camisa de cilindro	CZĘŚĆ: Zestaw oringów, tuleja cylindrowa	ДЕТАЛЬ: Комплект кольцевых уплотнений, гильза цилиндра	قطعة: مجموعة حلقة دائرية، كُم الاسطوانة
56	PIEZA: Retén de aceite radial, eje intermedio	CZĘŚĆ: Promieniowe uszczelnienie olejowe, wał pośredni	ДЕТАЛЬ: Радиальный сальник, промежуточный вал	قطعة: سدادة زيت قطرية، عمود وسط
57	Paso de rosca 1 (mm): 1,51	Skok gwintu 1 [mm]: 1,51	Шаг резьбы 1 [мм]: 1,51	بُعد سن اللولب 1 [مم]: 1,51
58	Artículo complementario / Información complementaria 2: sin retén del eje	Element uzupełniający/Informacje uzupełniające 2: bez uszczelnienia wału	Дополнительный элемент/Дополнительная информация 2: без сальника вала	مادة تكميلية/معلومات تكميلية 2: بدون سدادة العمود
59	Artículo complementario / Información complementaria 2: con retén de aceite del eje	Element uzupełniający/Informacje uzupełniające 2: z uszczelnieniem olejowym wału	Дополнительный элемент/Дополнительная информация 2: с сальником вала	مادة تكميلية/معلومات تكميلية 2: مزود بسدادة العمود
60	PIEZA: Conjunto de junta, caja de distribución	CZĘŚĆ: Zestaw uszczeltek, obudowa mechanizmu rozrządu	ДЕТАЛЬ: Комплект прокладок, картер ГРМ	قطعة: مجموعة حشية، حاوية التوقيت
61	Tipo de transmisión: Transmisión manual, cinco velocidades	Typ skrzyni biegów: Manualna 5-biegowa skrzynia biegów	Тип коробки передач: Механическая коробка передач, 5-ступенчатая	نوع ناقل الحركة: ناقل حركة يدوي، خماسي السرعات
62	Material del colector de aceite en el cárter: Acero	Materiał mokrej miski olejowej: Stal	Материал поддона "мокрого" типа: Сталь	مادة الحوض الرطبة: الصلب
63	Tipo: Únicamente Evasion	Typ: Tylko obejście	Тип: Только Evasion	النوع: إيفازيون فقط
64	Tipo: Jumper	Typ: Jumper	Тип: Jumper	النوع: Jumper
65	Tipo: Xantia	Typ: Xantia	Тип: Xantia	النوع: Xantia

TECHNICAL NOTES

Technische Hinweise • Notes techniques
Note tecnica • Notas técnicas

	ENG	DE	FR	IT
66	Type ZX	Typ: ZX	Type: ZX	Tipo: ZX
67	Diameter [mm]: 82.5	Durchmesser [mm]: 82,5	Diamètre [mm]: 82,5	Diametro [mm]: 82,5
68	PART Gasket, charger	Teil: Dichtung, Lader	PIÈCE: Joint d'étanchéité, turbo	COMPONENTE: Guarnizione sovralimentatore
69	Charge Type Turbo/Intercooler	Ladetyp: Turbo/Ladeluftkühler	Type de turbo: Turbo/Echangeur	Tipo alimentazione: Turbo/Intercooler
70	Diameter [mm]: 77.5	Durchmesser [mm]: 77,5	Diamètre [mm]: 77,5	Diametro [mm]: 77,5
71	Weight [kg] 0.277	Gewicht [kg]: 0,277	Poids [kg]: 0,277	Peso [kg]: 0,277
73	Type SIRION	Typ: SIRION	Type: SIRION	Tipo: SIRION
75	Specification Contains JJ449	Spezifikation: Enthält JJ449	Caractéristiques: Contient JJ449	Specifiche: Contiene JJ449
76	PART Gasket, fuel pump	Teil: Dichtung, Kraftstoffpumpe	PIÈCE: Joint d'étanchéité, pompe à carburant	COMPONENTE: Guarnizione, Pompa carburante
77	PART Distributor, ignition	Teil: Verteiler, Zündung	PIÈCE: Répartiteur, allumage	COMPONENTE: Distributore accensione
78	Cylinder Head Cover Material Plastic	Zylinderkopfdeckel-Material: Kunststoff	Matériau du cache-culbuteurs: Plastique	Materiale copertura testa cilindro: Plastica
79	Cylinder Head Cover Material Aluminium	Zylinderkopfdeckel-Material: Aluminium	Matériau du cache-culbuteurs: Aluminium	Materiale copertura testa cilindro: Alluminio
80	Wet Sump Material Sheet Steel	Nasssumpfmaterial: Stahlblech	Matériau du carter d'huile: Tôle d'acier	Materiale carter umido: Lamiera di acciaio
81	Vehicle Trim Level FIESTA, ESCORT	Fahrzeug-Ausstattungsstufe: FIESTA, ESCORT	Version du véhicule: FIESTA, ESCORT	Livello finitura veicolo: FIESTA, ESCORT
82	Wet Sump Material Aluminium	Nasssumpfmaterial: Aluminium	Matériau du carter d'huile: Aluminium	Materiale carter umido: Alluminio
83	Vehicle Trim Level FOCUS	Fahrzeug-Ausstattungsstufe: FOCUS	Version du véhicule: FOCUS	Livello finitura veicolo: MESSA A FUOCO
84	Vehicle Trim Level MONDEO	Fahrzeug-Ausstattungsstufe: MONDEO	Version du véhicule: MONDEO	Livello finitura veicolo: MONDEO
85	Fitting Position Upper Left	Einbauposition: Links oben	Côté d'assemblage: Supérieur gauche	Posizione di montaggio: Addominale superiore sinistro
86	Specification Contains BT480	Spezifikation: Mit BT480	Caractéristiques: Contient BT480	Specifiche: Contiene BT480
87	Bolt Ø [mm]: 6	Schraube Ø [mm]: 6	Ø vis [mm]: 6	Bullone Ø [mm]: 6
88	Specification Contains JM5027	Spezifikation: Mit JM5027	Caractéristiques: Contient JM5027	Specifiche: Contiene JM5027
89	Specification Contains JN821	Spezifikation: Mit JN821	Caractéristiques: Contient JN821	Specifiche: Contiene JN821
90	Inner Diameter [mm]: 6.00	Innendurchmesser [mm]: 6	Diamètre intérieur [mm]: 6,00	Diametro interno [mm]: 6,00
91	Outer Diameter [mm]: 19.80	Außendurchmesser [mm]: 19,8	Diamètre extérieur [mm]: 19,80	Diametro esterno [mm]: 19,80
92	Outer Diameter 1 [mm]: 13.20	Außendurchmesser 1 [mm]: 13,2	Diamètre extérieur 1 [mm]: 13,20	Diametro esterno [mm]: 13,20
93	Comment For engines with glow plugs fitted vertically	Kommentar: Für Motoren mit vertikal eingebauten Glühkerzen	Pour moteur avec bougies de préchauffage montées verticalement	Commento: Per motori con candele pre-riscaldamento montate verticalmente
94	Thread Pitch 1 [mm]: 1.5	Kraftstoffaufbereitung 1 [mm]: 1,5	Filetage 1 [mm]: 1,5	Passo filettatura 1 [mm]: 1,5
95	Fuel Mixture Formation Multipoint Injection	Kraftstoffaufbereitung: Multipoint-Injektion	Mélange air-carburant: Injection Multipoint	Preparazione carburante: Iniezione Multi-punto
96	Inner Diameter [mm]: 6.75	Innendurchmesser [mm]: 6,75	Diamètre Intérieur [mm]: 6,75	Diametro Interno [mm]: 6,75
97	Bolt / Nut Version with plain washer	Schraube/Mutter, Version: mit Unterlegscheibe	Version vis/écrou: avec rondelle plate	Modello bullone / dado: con rondella d'appoggio
98	Type XJ6	Typ: XJ6	Type: XJ6	Tipo: XJ6
99	Diameter [mm]: 81.5	Durchmesser [mm]: 81,5	Diamètre [mm]: 81,5	Diametro [mm]: 81,5
100	PART Radial Oil Seal Set	Teil: Radialwellendichtring-Satz	PIÈCE: Pochette de bagues d'étanchéité radiale d'huile	COMPONENTE: Set paraolio
101	Specification Black	Spezifikation: schwarz	Caractéristiques: Noir	Specifiche: Nero
102	Diameter [mm]: 84.5	Durchmesser [mm]: 84,5	Diamètre [mm]: 84,5	Diametro [mm]: 84,5
103	Type ES	Typ: ES	Type: ES	Tipo: ES

	ES	PL	RU	AR
66	Tipo: ZX	Typ: ZX	Тип: ZX	ZX: النوع
67	Diámetro (mm): 82,5	Średnica wewnętrzna (mm): 82,5	Диаметр (мм): 82,5	الفطر [ملم]: 82,5
68	PIEZA: Junta, cargador	CZĘŚĆ: Uszczelka, dotadowanie	ДЕТАЛЬ: Прокладка, нагнетатель	قطعة: حشية، شاحن
69	Tipo de carga: Turbo/intercooler	Typ dotadowania: Turbo/chłodzenie międzystopniowe (Intercooler)	Тип нагнетания: Турбированный с промежуточным охлаждением	نوع الشحنة: تيربو/مبرد داخلي
70	Diámetro (mm): 77,5	Średnica wewnętrzna (mm): 77,5	Диаметр (мм): 77,5	الفطر [ملم]: 77,5
71	Peso (kg): 0,277	Waga (kg): 0,277	Вес (кг): 0,277	الوزن [بالكجم]: 0,277
73	Tipo: SIRION	Typ: SIRION	Тип: SIRION	SIRION: النوع
75	Especificaciones: Contiene JJ449	Specyfikacja: Zawiera JJ449	Спецификации: Включает JJ449	JJ449 المواصفات: يتضمن
76	PIEZA: Junta, bomba de combustible	CZĘŚĆ: Uszczelka, pompa paliwa	ДЕТАЛЬ: Прокладка, топливный насос	قطعة: حشية، مضخة وقود
77	PIEZA: Distribuidor, encendido	CZĘŚĆ: Rozdzielacz, zapłon	ДЕТАЛЬ: Распределитель, зажигание	قطعة: الموزع، الإشعال
78	Material de la tapa de la culata: Plástico	Materiał pokrywy głowicy cylindrów: Tworzywo sztuczne	Материал крышки головки цилиндров: Пластик	مادة غطاء رأس الأسطوانة: البلاستيك
79	Material de la tapa de la culata: Aluminio	Materiał pokrywy głowicy cylindrów: Aluminium	Материал крышки головки цилиндров: Алюминий	مادة غطاء رأس الأسطوانة: ألومنيوم
80	Material del colector de aceite en el cárter: Hoja de acero	Materiał mokrej miski olejowej: Blacha stalowa	Материал поддона "мокрого" типа: Листовая сталь	مادة الحوض الرطبة: صفحة صلب
81	Nivel de ajuste del vehículo: FIESTA, ESCORT	Poziom wyważenia samochodu: FIESTA, ESCORT	Тип комплектации автомобиля: FIESTA, ESCORT	مستوى اقتطاع المركبة: فيستا، اسكورت
82	Material del colector de aceite en el cárter: Aluminio	Materiał mokrej miski olejowej: Aluminium	Материал поддона "мокрого" типа: Алюминий	مادة الحوض الرطبة: ألومنيوم
83	Nivel de ajuste del vehículo: FOCUS	Poziom wyważenia samochodu: FOCUS	Тип комплектации автомобиля: FOCUS	مستوى اقتطاع المركبة: فوكس
84	Nivel de ajuste del vehículo: MONDEO	Poziom wyważenia samochodu: MONDEO	Тип комплектации автомобиля: MONDEO	مستوى اقتطاع المركبة: مونديو
85	Posición de montaje: Parte superior izquierda	Miejsce montażu: U góry po lewej stronie	Положение установки: Вверху слева	وضع التثبيت: الأيسر العلوي
86	Specifiche: Especificaciones	Specyfikacja Zawiera BT480	Спецификации: содержит BT480	BT480 : يحتوي على
87	Bullone Ø (mm): Perno Ø (mm)	Średnica śruby (mm): 6	Диаметр болта Ø (мм): 6	ملم: Ø 6 الثقب
88	Specifiche: Especificaciones	Specyfikacja: Zawiera JM5027	Спецификации: содержит JM5027	JM5027 : يحتوي على
89	Specifiche: Especificaciones	Specyfikacja: Zawiera JN821	Спецификации: содержит JN821	JN821 : يحتوي على
90	Diametro interno (mm): 6,00	Średnica wewnętrzna (mm): 6	Внутренний диаметр (мм): 6,00	الفطر الداخلي 1: 6
91	Diametro externo (mm): 19,80	Średnica zewnętrzna (mm): 19,8	Наружный диаметр (мм): 19,80	الفطر الخارجي 1: 19,8
92	Diametro externo 1 (mm): 13,20	Średnica zewnętrzna 1 (mm): 13,2	Наружный диаметр 1 (мм): 13,20	الفطر الخارجي 1: 13,2
93	Comentario: Para motores con verificador de calentadores	komentarz: Do silników ze świecami żarówymi zamontowanymi pionowo	Комментарий: Для двигателей с вертикальным расположением свечей накаливания	التعليق: للمحركات مع شمعات التوهج تم تركيبها عمودياً
94	Gewindeteilung 1 (mm): 1,5	Шаг резьбы 1 (мм): 1,5	Шаг резьбы 1 (мм): 1,5	بُعد سن اللولب 1 [مم]: 1,5
95	Préparación de la mezcla carburante: Inyección Multipunto	Wtrysk wielopunktowy: Tworzenie mieszanki paliwa	Подготовка топливовоздушной смеси: Многоочечный распределенный впрыск	تشكيل مزيج الوقود: حقن متعدد النقاط
96	Diámetro interior (mm): 6,75	Średnica wewnętrzna (mm): 6,75	Внутренний диаметр (мм): 6,75	الفطر الداخلي: 6,75
97	Versión de perno/tuerca: con arandela plana	Modello bullone / dado: z podkładką płaską	Тип болта/гайки: с плоской шайбой	نسخة مسمار الربط/الصامولة: مزود بوردة عادية
98	Tipo: XJ6	Typo: XJ6	Тип: XJ6	النوع: النوع
99	Diámetro (mm): 81,5	Diametro (mm): 81,5	Диаметр (мм): 81,5	الفطر [ملم]: 81,5
100	PIEZA: Conjunto de retén de aceite radial	COMPONENTE: Zestaw poprzecznego uszczelnienia olejowego	ДЕТАЛЬ: Комплект радиальных сальников	قطعة: مجموعة سداة زيت قطرية
101	Especificaciones: Negro	Specifiche: Czarna/a	Спецификации: Черный	يحتوي على: أسود
102	Diámetro (mm): 84,5	Diametro (mm): 84,5	Диаметр (мм): 84,5	الفطر [ملم]: 84,5
103	Tipo: ES	Typo: ES	Тип: ES	ES: النوع

TECHNICAL NOTES

Technische Hinweise • Notes techniques
Note tecnica • Notas técnicas

	ENG	DE	FR	IT
104	Height 1 [mm]: 10.3	Höhe 1 [mm]: 10,3	Hauteur 1 [mm]: 10,3	Altezza 1 [mm]: 10,3
105	Diameter [mm]: 89.00	Durchmesser [mm]: 89	Diamètre [mm]: 89	Diametro [mm]: 89
106	Vehicle Equipment for vehicles without ride height control	Fahrzeugausstattung: für Fahrzeuge without Niveauregulierung	Équipement véhicule: Pour véhicules sans correcteur d'assiette	Equipaggiamento del veicolo: Per veicoli senza regolazione altezza pianale
107	Vehicle Equipment for vehicles with ride height control	Fahrzeugausstattung: für Fahrzeuge mit Niveauregulierung	Équipement véhicule: Pour véhicules avec correcteur d'assiette	Equipaggiamento del veicolo: Per veicoli con regolazione altezza pianale
108	PART Seal, spark plug stem	Teil: Dichtring, Zündkerzenschaft	PIÈCE: Bague d'étanchéité, tige de bougie	COMPONENTE: Guarnizione, Gambo candela
109	PART Seal, oil filter	Teil: Dichtring, Ölfilter	PIÈCE: Bague d'étanchéité, filtre à huile	COMPONENTE: Guarnizione, Filtro olio
110	Charge Type Exhaust Turbo Charger	Ladetyp: Abgas-Turbolader	Type de turbo: Turbocompresseur d'échappement	Tipo alimentazione: Alimentatore turbo di scarico
111	Diameter [mm]: 84.50	Durchmesser [mm]: 84,5	Diamètre [mm]: 84,50	Diametro [mm]: 84,50
112	Bolt Ø [mm]: 8	Schraube Ø [mm]: 8	Ø vis [mm]: 8	Bullone Ø [mm]: 8
113	Alternate description HeadSaver®	Alternative Beschreibung: HeadSaver®	Autre description: HeadSaver®	Descrizione alternativa: HeadSaver®
114	Diameter [mm]: 87.5	Durchmesser [mm]: 87,5	Diamètre [mm]: 87,5	Diametro [mm]: 87,5
115	Type L 400	Typ: L 400	Type: L 400	Tipo: L 400
116	Diameter [mm]: 10.70	Durchmesser [mm]: 10,7	Diamètre [mm]: 10,70	Diametro [mm]: 10,70
117	Type PRIMERA	Typ: PRIMERA	Type: PRIMERA	Tipo: PRIMERA
118	Diameter [mm]: 77	Durchmesser [mm]: 77	Diamètre [mm]: 77	Diametro [mm]: 77
119	Diameter [mm]: 96	Durchmesser [mm]: 96	Diamètre [mm]: 96	Diametro [mm]: 96
120	Vehicle Trim Level Corsa	Fahrzeug-Ausstattungsstufe: Corsa	Modèle du véhicule: Corsa	Livello finitura veicolo: Corsa
121	Type ASTRA F	Typ: ASTRA F	Type: ASTRA F	Tipo: ASTRA F
122	Type CORSA B	Typ: CORSA B	Type: CORSA B	Tipo: CORSA B
123	Type TIGRA	Typ: TIGRA	Type: TIGRA	Tipo: TIGRA
124	Type ASTRA G	Typ: ASTRA G	Type: ASTRA G	Tipo: ASTRA G
125	Transmission Type Fully Automatic	Getriebetyp: Vollautomatisch	Type de transmission: Complètement automatique	Tipo di trasmissione: Completamente Automatico
126	Vehicle Trim Level Kadett E	Fahrzeug-Ausstattungsstufe: Kadett E	Version du véhicule: Kadett E	Livello finitura veicolo: Kadett E
127	Vehicle Trim Level Kadett E, Vectra	Fahrzeug-Ausstattungsstufe: Kadett E, Vectra	Version du véhicule: Kadett E, Vectra	Livello finitura veicolo: Kadett E, Vectra
128	Vehicle Equipment for vehicles with air conditioning	Fahrzeugausstattung: für Fahrzeuge mit Klimaanlage	Équipement véhicule: pour véhicule avec système de climatisation	Equipaggiamento del veicolo: Per veicoli con aria condizionata
129	Vehicle Equipment for vehicles without air conditioning	Fahrzeugausstattung: für Fahrzeuge ohne Klimaanlage	Équipement véhicule: pour véhicule sans système de climatisation	Equipaggiamento del veicolo: Per veicoli senza aria condizionata
130	Type VECTRA	Typ: VECTRA	Type: VECTRA	Tipo: VECTRA
131	Type ZAFIRA	Typ: ZAFIRA	Type: ZAFIRA	Tipo: ZAFIRA
132	Diameter [mm]: 87.05	Durchmesser [mm]: 87,05	Diamètre [mm]: 87,05	Diametro [mm]: 87,05
133	Comment For engines with two piece oil pan	Kommentar: Für Motoren mit 2 Ölwanne	Commentaire: Moteurs avec carter d'huile en deux parties	Commento: Per motori con coppa olio in 2 pezzi
134	Type Sintra	Typ: Sintra	Type: Sintra	Tipo: Sintra
135	Type Frontera	Typ: Frontera	Type: Frontera	Tipo: Frontera
136	Type Omega	Typ: Omega	Type: Omega	Tipo: Omega
137	Drive Type: Rear Wheel Drive	Antriebstyp: Heckantrieb	Motricité: Propulsion	tipo di auto: Con guida a trazione posteriore
138	Drive Type: All-wheel Drive	Antriebstyp: Antriebsart	Motricité: Traction Intégrale	tipo di auto: Con guida a trazione completa
139	for cylinder 1 per cylinder bank	für Zylinder: 1 pro Zylinderreihe	pour cylindre: 1 par rangée de cylindres	per cilindro: 1 per bancata

	ES	PL	RU	AR
104	Altura 1 (mm): 10,3	Altezza 1 [mm]: 10,3	Высота 1 [мм]: 10,3	الارتفاع 1 [ملم]: 10,3
105	Diámetro (mm): 89	Średnica (mm): 89,00	диаметр [мм]: 89	الفطر [ملم]: 89.00
106	Equipamiento del vehículo: Para vehículos sin regulación de nivel	Wyposażenie samochodu: Do samochodów bez regulacji wysokości prześwitu pojazdu	Комплектация автомобиля: Для автомобилей без регулировки высоты подвески	تجهيزات السيارة فيما يتعلق بالمركبات مع جهاز التحكم في ارتفاع المركبة
107	Equipamiento del vehículo: Para vehículos con regulación de nivel	Wyposażenie samochodu: Do samochodów z regulacją prześwitu pojazdu	Комплектация автомобиля: Для автомобилей с регулировкой высоты подвески	عدة المركبة: فيما يتعلق بالمركبات مع جهاز التحكم في ارتفاع المركبة
108	PIEZA: Junta, vástago de la bujía	CZĘŚĆ: Uszczelnienie, trzpień świecy zapłonowej	ДЕТАЛЬ: Уплотнение, стержень свечи зажигания	قطعة: سداة، جذر سداة الشمعة
109	PIEZA: Retén, filtro de aceite	CZĘŚĆ: Uszczelnienie, filtr oleju	ДЕТАЛЬ: Уплотнение, масляный фильтр	قطعة: سداة، فلتز الزيت
110	Tipo de carga: Turbo accionado por gases de escape	Typ dotadowania: Turbodoładowanie	Тип нагнетания: Турбонагнетатель с приводом от выхлопной системы	نوع الشحنة: شاحن تيربو ماسورة العادم
111	Diámetro (mm): 84,50	Średnica (mm): 84,5	Диаметр [мм]: 84,50	الفطر [ملم]: 84,5
112	Perno Ø (mm): 8	Średnica śruby [mm]: 8	Диаметр болта Ø [мм]: 8	ملم: Ø 8: الثقب
113	Descripción alternativa: HeadSaver®	Opis alternatywny: HeadSaver®	Альтернативное описание: HeadSaver®	HeadSaver®: وصف بديل
114	Diámetro (mm): 87,5	Średnica (mm): 87,5	Диаметр [мм]: 87,5	الفطر [ملم]: 87,5
115	Tipo: L 400	Typ: L 400	Тип: L 400	L 400: النوع
116	Diámetro (mm): 10,70	Średnica (mm): 10,7	Диаметр [мм]: 10,70	الفطر [ملم]: 10,7
117	Tipo: PRIMERA	Typ: PRIMERA	Тип: PRIMERA	PRIMERA: النوع
118	Diámetro (mm): 77	Średnica (mm): 77	Диаметр [мм]: 77	الفطر [ملم]: 77
119	Diámetro (mm): 96	Średnica (mm): 96	Диаметр [мм]: 96	الفطر [ملم]: 96
120	Nivel de ajuste del vehículo: Corsa	Poziom wyważenia samochodu: Corsa	Тип комплектации автомобиля: Corsa	مستوى اقتطاع المركبة: كورسا
121	Tipo: ASTRA F	Typ: ASTRA F	Тип: ASTRA F	ASTRA F: النوع
122	Tipo: CORSA B	Typ: CORSA B	Тип: CORSA B	CORSA B: النوع
123	Tipo: TIGRA	Typ: TIGRA	Тип: TIGRA	TIGRA: النوع
124	Tipo: ASTRA G	Typ: ASTRA G	Тип: ASTRA G	ASTRA G: النوع
125	Tipo de transmisión: Automático	W pełni automatyczny: W pełni automatyczny	Тип коробки передач: полностью автоматическая	نوع الناقل: الأتوماتيكي
126	Nivel de ajuste del vehículo: Kadett E	Poziom wyważenia samochodu: Kadett E	Тип комплектации автомобиля: Kadett E	مستوى اقتطاع المركبة: كاديت إي
127	Nivel de ajuste del vehículo: Kadett E, Vectra	Poziom wyważenia samochodu: Kadett E, Vectra	Тип комплектации автомобиля: Kadett E, Vectra	تجهيزات السيارة فيما يتعلق بالمركبات مع تكييف الهواء
128	Equipamiento de vehículo: para vehículos con climatizador	Do samochodów bez klimatyzacji: Do samochodów wyposażonych w klimatyzację	Комплектация автомобиля: Для автомобилей с кондиционером	تجهيزات السيارة فيما يتعلق بالمركبات بدون تكييف الهواء
129	Equipamiento de vehículo: para vehículos sin climatizador	Do samochodów wyposażonych w klimatyzację	Комплектация автомобиля: Для автомобилей без кондиционера	عدة المركبة: فيما يتعلق بالمركبات بدون تكييف الهواء
130	Tipo: VECTRA	Typ: VECTRA	Тип: VECTRA	VECTRA: النوع
131	Tipo: ZAFIRA	Typ: ZAFIRA	Тип: ZAFIRA	ZAFIRA: النوع
132	Diámetro (mm): 87,05	Średnica (mm): 87,05	Диаметр [мм]: 87,05	الفطر [ملم]: 87,05
133	Comentario: Para motores con dos juntas de cárter	komentarz: Do silników z dwuczęściową miską olejową	Комментарий: Для двигателей с двухсекционным поддоном картера	التعليق: للمحركات مع شمعات التوهج تم تركيبها عموديا
134	Tipo: Sintra	Typ: Sintra	Тип: Sintra	Sintra: النوع
135	Tipo: Frontera	Typ: Frontera	Тип: Frontera	Frontera: النوع
136	Tipo: Omega	Typ: Omega	Тип: Omega	Omega: النوع
137	Tipo di auto: Tracción trasera	Napęd na koła tylne: Napęd na koła tylne	Тип привода: задний привод	نوع الدفع: جر خلفي
138	Tipo di auto: A las 4 ruedas	Napęd na wszystkie koła: Napęd na wszystkie koła	Тип привода: полный привод	نوع الدفع: نظام الدفع بكافة العجلات
139	para cilindros: 1 por bancada de cilindros	do cylindra: 1 na rząd cylindrów	для цилиндра: 1 на блок цилиндров	للاسطوانة: 1 لكل خزان أسطوانة

TECHNICAL NOTES

Technische Hinweise • Notes techniques
Note tecniche • Notas técnicas

	ENG	DE	FR	IT
140	Diameter [mm]: 0,85	Durchmesser [mm]: 0,85	Diamètre [mm]: 0,85	Diametro [mm]: 0,85
141	Type YARIS	Typ: YARIS	Type: YARIS	Tipo: YARIS
142	Type AVENSIS	Typ: AVENSIS	Type: AVENSIS	Tipo: AVENSIS
143	Height 1 [mm]: 16,5	Höhe 1 [mm]: 16,5	Hauteur 1 [mm]: 16,5	Altezza 1 [mm]: 16,5
144	Type AVALON	Typ: AVALON	Type: AVALON	Tipo: AVALON
145	Height 2 [mm]: 19,30	Höhe 2 [mm]: 19,3	Hauteur 2 [mm]: 19,30	Altezza 2 [mm]: 19,30
146	to engine cylinder 1	zum Motorzylinder: 1	vers cylindre moteur: 1	al cilindro motore: 1
147	to engine cylinder 2 + 3	zum Motorzylinder: 2 + 3	vers cylindre moteur: 2 + 3	al cilindro motore: 2 + 3
148	to engine cylinder 4 + 5	zum Motorzylinder: 4 + 5	vers cylindre moteur: 4 + 5	al cilindro motore: 4 + 5
149	Vehicle Trim Level Corrado	Fahrzeug-Ausstattungsstufe: Corrado	Version du véhicule: Corrado	Livello finitura veicolo: Corrado
150	Type MOVE / CUORE	Typ: MOVE / CUORE	Type: MOVE / CUORE	COMPONENTE: MOVE / CUORE
151	Type AGILA	Typ: AGILA	Type: AGILA	Tipo: AGILA
152	Type ASTRA	Typ: ASTRA	Type: ASTRA	Tipo: ASTRA
153	Type CORSA	Typ: CORSA	Type: CORSA	Tipo: CORSA

	ES	PL	RU	AR
140	Diámetro (mm): 0,85	Średnica [mm]: 0,85	Диаметр [мм]: 0,85	القطر [مم]: 0,85
141	Tipo: YARIS	Typ: YARIS	Тип: YARIS	النوع: YARIS
142	Tipo: AVENSIS	Typ: AVENSIS	Тип: AVENSIS	النوع: AVENSIS
143	Altura 1 (mm): 16,5	Wysokość 1 [mm]: 16,5	Высота 1 [мм]: 16,5	الارتفاع 1 [مم]: 16,5
144	Tipo: AVALON	Typ: AVALON	Тип: AVALON	النوع: AVALON
145	Altura 2 (mm): 19,30	Wysokość 2 [mm]: 19,3	Высота 2 [мм]: 19,30	الارتفاع 2 [مم]: 19,3
146	al cilindro del motor: 1	do cylindra silnika: 1	к цилиндру: 1	إلى اسطوانة المحرك: 1
147	al cilindro del motor: 2 + 3	do cylindra silnika: 2 + 3	к цилиндрам: 2 + 3	إلى اسطوانة المحرك: 3 + 2
148	al cilindro del motor: 4 + 5	do cylindra silnika 4 + 5	к цилиндрам: 4 + 5	إلى اسطوانة المحرك: 5 + 4
149	Nivel de ajuste del vehículo: Corrado	Poziom wyważenia samochodu: Corrado	Тип комплектации автомобиля: Corrado	مستوى اقتطاع المركبة: كورادو
150	Tipo: MOVE / CUORE	Typ: MOVE / CUORE	Тип: MOVE / CUORE	النوع: MOVE / CUORE
151	Tipo: AGILA	Typ: AGILA	Тип: AGILA	النوع: AGILA
152	Tipo: ASTRA	Typ: ASTRA	Тип: ASTRA	النوع: ASTRA
153	Tipo: CORSA	Typ: CORSA	Тип: CORSA	النوع: CORSA

CAMPUS

WWW.FMCAMPUS.EU

THE NEXT GENERATION
OF OUR ONLINE
F-M CAMPUS TRAINING PLATFORM



Free, fully interactive, technical education experience. The virtual departments cover technologies and product information related to all Steering & Suspension systems, Braking and Engine. Now F-M Campus is also available on mobile devices - learn on the move!



Federal-Mogul Global Aftermarket EMEA bvba

Prins Boudewijnlaan 5 • B-2550 Kontich • Belgium

Central Distribution Centre

Prins Boudewijnlaan 7 • B-2550 Kontich • Belgium

Phone +32 (0) 3450 83 10 • Fax +32 (0) 3450 83 38

Federal-Mogul Italy Srl**Aftermarket Division**

Via Enrico Fermi 8 • 37135 Verona • Italy

Phone +39 045 828 13 11 • Fax +39 045 828 14 00

Federal-Mogul Germany GmbH

Albert-Ruprecht-Strasse 2 • 71636 Ludwigsburg • Germany

Phone +49 (0) 7141-64865-8230 • Fax +49 (0) 7141-64865-8390

Federal-Mogul Aftermarket UK Limited

Greyhound Drive • Bradford • BD7 1NQ • England

Phone +49 (0) 7141-64865-8230 • Fax: +49 (0) 7141-64865-8390

Federal-Mogul Ibérica, S.L.**Federal-Mogul Aftermarket España, S.A.**

Calle Alcarria, nº 2 • 28823 Coslada • Madrid • Spain

Phone: + 34 91 746 1900 • Fax: + 34 91 746 18 90

Federal-Mogul Aftermarket France

60-62, rue Danjou • 92517 Boulogne-Billancourt Cedex • France

Phone +33 (0) 1 46 94 27 00 • Fax +33 (0) 1 46 94 27 01

Service Commande de stock :

Phone +33 (0) 810 000 029 • Fax +32 34 50 80 26

Service Commande express :

Phone +33 (0) 810 000 029 • Fax +32 34 50 80 26

Federal-Mogul Aftermarket**Southern Africa (PTY) Ltd**

33 Western Boulevard • City West • Johannesburg • South Africa

Phone +27 11 630 3000 • Fax +27 11 630 3040

Federal-Mogul Aftermarket Turkey

Meclis-i Mebusan Cad. No: 53 Dereli İş Merkezi 34427 • Fındıklı / İstanbul • Türkiye

Phone +90 212 292 6313 • Fax +90 212 292 6260

Federal-Mogul Aftermarket Russia Ltd

Smolnaya street 24D, 13th floor • 125445 Moscow • Russia

Phone +7 495 221 50 60 • Fax +7 495 221 50 64



BERU is a registered Trademark of BorgWarner Ludwigsburg GmbH. All other logos and trademarks are the property of Federal-Mogul Corporation and its affiliates.

